

J.D. 4/Stephenson
TJ/Seaver



NATIONAL AERONAUTICS AND SPACE ADMINISTRATION

MSC INTERNAL NOTE NO. 69-FM-248

September 25, 1969

SPACECRAFT OPERATIONAL TRAJECTORY
FOR APOLLO 12 (MISSION H-1)
VOLUME I
HYBRID MISSION PROFILE LAUNCHED
NOVEMBER 14, 1969

Lunar Mission Analysis Branch,
Landing Analysis Branch,
and
Orbital Mission Analysis Branch
MISSION PLANNING AND ANALYSIS BRANCH



MANNED SPACECRAFT CENTER
HOUSTON, TEXAS

APD-020932Q

BOX 679-22/23-A

480915

MSC INTERNAL NOTE NO. 69-FM-248

PROJECT APOLLO

SPACECRAFT OPERATIONAL TRAJECTORY
FOR APOLLO 12 (MISSION H-1)
VOLUME I - HYBRID MISSION PROFILE
LAUNCHED NOVEMBER 14, 1969

By Lunar Mission Analysis Branch, Landing Analysis Branch, and
Orbital Mission Analysis Branch

September 25, 1969

MISSION PLANNING AND ANALYSIS DIVISION
NATIONAL AERONAUTICS AND SPACE ADMINISTRATION
MANNED SPACECRAFT CENTER
HOUSTON, TEXAS

Approved: Ronald L. Berry
Ronald L. Berry, Chief
Lunar Mission Analysis Branch

Approved: Floyd V. Bennett
Floyd V. Bennett, Chief
Landing Analysis Branch

Approved: Edgar C. Lineberry
Edgar C. Lineberry, Chief
Orbital Mission Analysis Branch

Approved: John P. Mayer
John P. Mayer, Chief
Mission Planning and Analysis Division

FOREWORD

The landing site REFSMMAT is used for the MCC-4, LOI-1, LOI-2, DOI, PDI, and landing maneuvers. Because of an unwarrantable change in landing time by a few seconds, the REFSMMAT for LM/CSM separation, DOI, PDI, and landing is different from the landing site REFSMMAT. Because this document was to be published as soon as possible, no changes were to be made to have the REFSMMAT used in the descent maneuvers the same as the landing site REFSMMAT; consequently, both REFSMMAT's are presented. The REFSMMAT's will be corrected in the revised operational trajectory.

A number of changes have occurred since initiation of work on this document. These changes will appear in Revision 1, but it was not possible to incorporate them into this edition. These changes include the following.

- a. The nominal entry range is to be reduced from 1285 n. mi. to 1250 n. mi.
- b. The first lunar orbit plane change (LOPC-1) will occur in the nineteenth revolution instead of the seventeenth revolution.
- c. The low gate parameters for LM descent will be 16 fps vertical velocity and 80 fps horizontal velocity.
- d. LM and CSM attitudes will be changed for LM jettison.
- e. A LM yaw maneuver during ascent will be incorporated.
- f. The map coordinates of the landing site as well as the photography sites will be refined.
- g. The initiation of the MCC-2 maneuver will be delayed 4 hours, from TLI plus 24 hours to TLI plus 28 hours.
- h. The TEI maneuver will be initiated in lunar revolution 45 rather than revolution 46.
- i. Lalande will be added to Fra Mauro and Descartes as a photography site, and it will be photographed during revolution 39. Photography of Hipparchus will be deleted.

j. The southerly launch azimuth will be limited to 96° for mission planning purposes.

k. LM jettison will occur approximately 2.5 hours after docking.

CONTENTS

Section		Page
1.0	SUMMARY AND INTRODUCTION	1-5
	1.1 Summary	1-5
	1.2 Introduction	1-7
2.0	SYMBOLS AND NOMENCLATURE	2-3
3.0	PRIMARY GUIDELINES AND CONSTRAINTS	3-3
4.0	MISSION SUMMARY	4-3
	4.1 Earth Launch	4-7
	4.2 Earth Parking Orbit (EPO)	4-11
	4.3 Translunar Injection (TLI)	4-15
	4.4 Free-return Circumlunar Trajectory	4-19
	4.5 Post-Translunar Injection Events	4-23
	4.6 Translunar Coast	4-31
	4.7 Lunar Orbit Insertion (LOI-1)	4-41
	4.8 Lunar Orbit Circularization (LOI-2)	4-49
	4.9 CSM/LM Coast from LOI-1 to Undock	4-53
	4.10 CSM/LM Undock to Landing	4-57
	4.10-1 CSM/LM undock and separation	4-58
	4.10-2 Descent orbit insertion (DOI)	4-58
	4.10-3 Powered descent	4-58
	4.11 First CSM Lunar Orbit Plane Change (LOPC-1)	4-111
	4.12 LM Ascent	4-115

Section	Page
4.13 Rendezvous Sequence	4-155
4.13.1 Sequence summary	4-155
4.13.2 CSI	4-156
4.13.3 PC maneuver	4-156
4.13.4 CDH	4-157
4.13.5 TPI	4-158
4.13.6 Midcourse corrections and TPF	4-158
4.14 LM Jettison and Separation to Transearth Injection	4-175
4.15 Transearth Injection	4-181
4.16 Transearth Coast	4-189
4.17 Entry	4-197
5.0 INPUT DATA	5-3
6.0 REFERENCES	6-3

TABLES

Table		Page
1.1-I	SEQUENCE OF MAJOR EVENTS	1-8
1.1-II	LUNAR ORBIT ACTIVITIES	1-14
1.1-III	LAUNCH WINDOW SUMMARY	1-16
1.1-IV	TIMETABLE OF MISSION EVENTS	1-17
1.1-V	MISSION RADAR TIMELINE	
	(a) CSM acquisition and termination - 0° minimum elevation	1-18
	(b) LM acquisition and termination - 0° minimum elevation	1-53
	(c) CSM acquisition and termination - 5° minimum elevation	1-54
	(d) LM acquisition and termination - 5° minimum elevation	1-88
1.1-VI	MISSION SHADOW TIMELINE	
	(a) CSM	1-89
	(b) LM	1-108
4.5-I	SUMMARY OF EVENTS FROM TLI CUTOFF THROUGH LOX DUMP	4-24
4.6-I	TARGET LOAD FOR NON-FREE-RETURN MANEUVER	
	(a) Target	4-33
	(b) REFSMMAT	4-33
	(c) Gimbal angles at t_{IG}	4-33
4.7-I	TARGET LOAD FOR LOI-1 MANEUVER	
	(a) Target	4-42
	(b) REFSMMAT	4-42
	(c) Gimbal angles at t_{IG}	4-42

Table	Page	
4.8-I	TARGET LOAD FOR LOI-2 MANEUVER	
	(a) Target	4-50
	(b) REFSMMAT	4-50
	(c) Gimbal angles at t_{IG}	4-50
4.10-I	SUMMARY OF LM DESCENT EVENTS	4-61
4.10-II	LM DESCENT WEIGHT	4-62
4.10-III	LM DESCENT ENGINE PERFORMANCE SUMMARY	4-62
4.10-IV	MSFN TRACKING SUMMARY FOR LM DESCENT	4-63
4.10-V	TARGET LOAD FOR CSM SEPARATION MANEUVER	
	(a) Target	4-64
	(b) CSM REFSMMAT	4-64
	(c) CSM gimbal angles at t_{IG}	4-64
4.10-VI	TARGET LOADS FOR LM DOI MANEUVER	
	(a) Target	4-65
	(b) REFSMMAT	4-65
	(c) Gimbal angles at t_{IG}	4-65
4.10-VII	TARGET LOADS FOR LM POWERED DESCENT MANEUVER	
	(a) Ignition algorithm parameters (P63)	4-66
	(b) Targets	4-66
	(c) REFSMMAT	4-67
	(d) Gimbal angles at t_{IG}	4-67
4.11-I	TARGET LOAD FOR FIRST LUNAR ORBIT PLANE CHANGE MANEUVER (LOPC-1)	
	(a) Target	4-112
	(b) REFSMMAT	4-112
	(c) Gimbal angles at t_{IG}	4-112
4.12-II	LM ASCENT EVENTS SUMMARY	4-117

Table	Page
4.12-III	TARGET LOAD FOR LM ASCENT
	(a) Target 4-118
	(b) REFSMMAT 4-118
	(c) Gimbal angles at t_{IG} 4-118
4.12-IV	LM ASCENT PROPULSION PERFORMANCE SUMMARY 4-118
4.13-I	RENDEZVOUS MANEUVER SUMMARY 4-159
4.13-II	MSFN TRACKING AND SHADOW TIMELINE 4-160
4.13-III	TARGET LOADS FOR CSI MANEUVER
	(a) Target 4-161
	(b) REFSMMAT 4-161
	(c) Gimbal angles at t_{IG} 4-161
4.13-IV	TARGET LOADS FOR CDH MANEUVER
	(a) Target 4-162
	(b) REFSMMAT 4-162
	(c) Gimbal angles at t_{IG} 4-162
4.13-V	TARGET LOADS FOR TPI MANEUVER
	(a) Target 4-163
	(b) REFSMMAT 4-163
	(c) Gimbal angles at t_{IG} 4-163
4.14-I	TARGET LOAD FOR CSM SEPARATION MANEUVER FOLLOWING LM JETTISON
	(a) Target 4-176
	(b) REFSMMAT 4-176
	(c) Gimbal angles at t_{IG} 4-176
4.14-II	TARGET LOAD FOR SECOND LUNAR ORBIT PLANE CHANGE MANEUVER (LOPC-2)
	(a) Target 4-177
	(b) REFSMMAT 4-177
	(c) Gimbal angles at t_{IG} 4-177

Table		Page
4.15-I	TARGET LOAD FOR TEI MANEUVER	
	(a) Target	4-182
	(b) REFSMMAT	4-182
	(c) Gimbal angles at t_{IG}	4-182
4.17-I	ENTRY EVENTS SEQUENCE	4-199
4.17-II	COMMAND MODULE MASS PROPERTIES	4-200
4.17-III	CONDITIONS AT ENTRY INTERFACE AND TARGET POINT	4-201
5-I	LAUNCH PAD REFSMMAT	
	(a) Applicable maneuvers	5-4
	(b) Definition of REFSMMAT	5-4
	(c) REFSMMAT components	5-4
5-II	PTC REFSMMAT	
	(a) Applicable maneuvers	5-5
	(b) Definition of REFSMMAT	5-5
	(c) REFSMMAT components	5-5
5-III	LANDING SITE REFSMMAT	
	(a) Applicable maneuvers	5-6
	(b) Definition of REFSMMAT	5-6
	(c) REFSMMAT components	5-6
5-IV	SPECIAL REFSMMAT	
	(a) Applicable maneuvers	5-7
	(b) Definition of REFSMMAT	5-7
	(c) REFSMMAT components	5-7
5-V	PREFERRED (LOPC-1) REFSMMAT	
	(a) Applicable maneuver	5-8
	(b) Definition of REFSMMAT	5-8
	(c) REFSMMAT components	5-8

Table		Page
5-VI	LM ASCENT REFSMMAT	
	(a) Applicable maneuvers	5-9
	(b) Definition of REFSMMAT	5-9
	(c) REFSMMAT components	5-9
5-VII	PREFERRED (LOPC-2) REFSMMAT	
	(a) Applicable maneuvers	5-10
	(b) Definition of REFSMMAT	5-10
	(c) REFSMMAT components	5-10
5-VIII	PREFERRED (TEI) REFSMMAT	
	(a) Applicable maneuvers	5-11
	(b) Definition of REFSMMAT	5-11
	(c) REFSMMAT components	5-11
5-IX	ENTRY REFSMMAT	
	(a) Applicable maneuvers	5-12
	(b) Definition of REFSMMAT	5-12
	(c) REFSMMAT components	5-12
5-X	SPACECRAFT WEIGHT SUMMARY	5-13
5-XI	ASSUMED MISSION-INDEPENDENT EXPENDABLES	5-14
5-XII	SERVICE MODULE PROPULSION PERFORMANCE SUMMARY	5-15
5-XIII	LUNAR MODULE PERFORMANCE TABULAR INPUTS	5-15
5-XIV	COMMAND MODULE AERODYNAMIC COEFFICIENTS	5-16
5-XV	LUNAR LANDING AND PHOTOGRAPHY SITE POSITIONS	5-17
5-XVI	IMU ALINEMENT CRITERIA AND REFSMMAT DEFINITIONS	5-18
5-XVII	LM BRAKING SCHEDULE	5-19
5-XVIII	MSFN STATION CHARACTERISTICS	5-20
5-XIX	MSFN STATION IDENTIFICATION	5-21

FIGURES

Figure		Page
1.1-1	H-1 hybrid mission profile	1-109
4.2-1	Earth parking orbit groundtrack	4-12
4.3-1	TLI geometry	4-16
4.5-1	Motion of the S-IVB relative to the spacecraft for the S-IVB evasive maneuver on Apollo Mission H-1	
	(a) Range versus time	4-25
	(b) Cross range versus horizontal displacement	4-26
	(c) Vertical displacement versus horizontal displacement	4-27
4.6-1	Translunar coast groundtrack	4-34
4.6-2	Time history of altitude for first 10 hours of translunar coast	4-35
4.6-3	Time history of true anomaly for first 10 hours of translunar coast	4-36
4.6-4	Altitude time history from translunar injection to lunar orbit insertion	4-37
4.6-5	Time history of altitude 10 hours prior to LOI ignition	4-38
4.7-1	LOI-1 geometry	4-43
4.7-2	Lunar orbit groundtracks from LOI-1 to LM landing	4-44
4.7-3	Time history of trajectory parameters for LOI-1	
	(a) Velocity, flight-path angle, and altitude versus time from LOI burn initiation	4-45
	(b) Local horizontal pitch and yaw versus time from LOI burn initiation	4-46

Figure		Page
4.10-1	LM events	
	(a) Lunar descent orbital events	4-68
	(b) Powered descent profile	4-69
	(c) Powered descent events summary	4-70
4.10-2	LM and CSM groundtrack during powered descent	
	(a) LM groundtrack	4-71
	(b) CSM groundtrack	4-71
	(c) LM groundtrack	4-72
	(d) CSM groundtrack	4-72
4.10-3	Time history of LM trajectory parameters from undocking to landing	4-73
4.10-4	Time histories of LM-CSM relative parameters from undocking to landing	
	(a) Phase angle and elevation angle	4-74
	(b) Range and range rate	4-75
4.10-5	Time histories of three body relationships as viewed from the LM from undocking to landing	
	(a) CSM-LM-sun angle	4-76
	(b) CSM-LM-earth angle	4-77
4.10-6	LM CSM range rate versus range	
	(a) Undocking to landing	4-78
	(b) DOI to PDI	4-79
4.10-7	LM-CSM relative motion from separation to DOI	4-80
4.10-8	LM-CSM relative motion (CSM-centered) from DOI to landing	4-81
4.10-9	Time histories of engine gimbal angles during DOI	4-82
4.10-10	Time history of platform gimbal angles during DOI	4-83

Figure		Page
4.10-11	Time histories of FDAI angles during DOI	4-84
4.10-12	Time history of LM trajectory parameters from PDI to landing	
	(a) Altitude, velocity, and flight-path angle	4-85
	(b) LPD angle	4-86
	(c) Thrust angle from local vertical	4-87
	(d) LM thrust magnitude	4-88
	(e) LM weight, oxidizer, and fuel remaining	4-89
	(f) Time-to-go	4-90
	(g) LM altitude rate	4-91
	(h) Altitude difference, ΔH	4-92
4.10-13	Time history of attitudes from PDI to landing	
	(a) Engine gimbal angles	4-93
	(b) Platform gimbal angles	4-94
	(c) FDAI angles	4-95
	(d) S-band antenna elevation angle	4-96
	(e) S-band antenna azimuth angle	4-97
	(f) S-band gimbal angle profile	4-98
	(g) Rendezvous radar elevation angle	4-99
	(h) Rendezvous radar azimuth angle	4-100
4.10-14	LM altitude above landing site versus landing site surface range from PDI to landing	
	(a) LM altitude above landing site	4-101
	(b) Terrain altitude	4-102
4.10-15	LM altitude above landing site radius versus altitude rate from PDI to landing	4-103
4.10-16	LM-CSM relative parameters from PDI to landing	
	(a) Phase angle and elevation angle	4-104
	(b) Range and range rate	4-105
4.10-17	LM altitude above landing site surface during approach and landing	4-106

Figure		Page
4.10-18	Landing phase summary	4-107
4.12-1	LM ascent	4-120
4.12-2	Vertical rise phase	4-121
4.12-3	Orbit insertion phase	4-122
4.12-4	LM and CSM groundtracks during powered descent	
	(a) LM groundtrack	4-123
	(b) CSM groundtrack	4-123
4.12-5	Time histories of LM trajectory parameters during powered ascent	
	(a) LM altitude above launch site	4-124
	(b) LM altitude rate	4-125
	(c) LM horizontal velocity	4-126
	(d) LM selenographic velocity	4-127
	(e) LM selenographic flight-path angle	4-128
	(f) LM thrust angle from local vertical	4-129
	(g) LM inner gimbal angle	4-130
	(h) Velocity-to-be-gained along X-body axis	4-131
	(i) Velocity-to-be-gained along Z-body axis	4-132
	(j) FDAI pitch angle	4-133
4.12-6	LM altitude above launch site versus LM altitude rate	4-134
4.12-7	Time histories for LM propulsion performance parameters during powered ascent	
	(a) LM thrust	4-135
	(b) Mass flow rate	4-136
	(c) Specific impulse	4-137
	(d) Thrust acceleration	4-138
4.12-8	LM weight versus time from lift-off	4-139
4.12-9	Time histories of LM-CSM relative parameters during powered ascent	
	(a) LM-CSM line-of-sight angle	4-140
	(b) LM-CSM phase angle	4-141
	(c) LM-CSM range	4-142

Figure	Page
(d) LM-CSM range rate	4-143
(e) LM rendezvous radar elevation angle	4-144
4.12-10 LM-CSM relative range (CSM referenced)	4-145
4.12-11 LM-CSM range versus LM-CSM range rate during powered ascent	4-146
4.12-12 Time histories of LM-CSM earth or sun relative parameters during powered ascent	
(a) LM S-band elevation angle	4-147
(b) LM S-band azimuth angle	4-148
(c) LM S-band antenna angle profile	4-149
(d) CSM-LM-earth angle	4-150
(e) CSM-LM-sun angle	4-151
4.13-1 Orbital schematic of ascent through docking	4-164
4.13-2 Parameters from LM orbit insertion through terminal rendezvous	
(a) LM-CSM elevation angle versus time from LM orbit insertion	4-165
(b) CSM-LM-sun angle versus time from LM orbit insertion	4-166
(c) CSM phase angle versus time from LM orbit insertion	4-167
(d) LM-CSM range versus time from LM orbit insertion	4-168
(e) LM-CSM range rate versus time from LM orbit insertion	4-169
(f) Vertical relative range versus horizontal relative range	4-170
4.13-3 Mission events and tracking summaries for LM-active rendezvous	4-171
4.14-1 Lunar orbit groundtracks from CSM plane change after LM jettison to transearth injection	4-178
4.15-1 Time history of trajectory parameters for transearth injection	
(a) Velocity, flight-path angle, and altitude versus time from TEI burn initiation	4-183
(b) Local horizontal pitch and yaw versus time from TEI burn initiation	4-184

Figure		Page
4.15-2	TEI geometry	4-184
4.16-1	Transearch coast groundtrack	4-190
4.16-2	Altitude time history during the first 10 hours of transearch coast	4-191
4.16-3	Altitude time history from transearch injection to entry interface	4-192
4.16-4	Altitude time history 10 hours prior to entry interface	4-193
4.17-1	Entry corridor	4-202
4.17-2	Maneuver footprint and nominal groundtrack	4-203
4.17-3	Geodetic altitude versus range-to-go	4-204
4.17-4	CMC commanded bank angle, altitude, and altitude rate time histories	4-205
4.17-5	Total aerodynamic heating rate and heat load time histories	4-206
4.17-6	Time histories of velocity and flight-path angle for entry	
	(a) Relative and inertial velocity	4-207
	(b) Relative and inertial flight-path angle	4-207
4.17-7	Total propellant consumed from separation	4-208
4.17-8	Communications blackout	4-209
4.17-9	Primary DSKY display VERB 06 NOUN 74	4-210
4.17-10	DSKY displays (final phase) VERB 06 NOUN 66	4-211
4.17-11	Relative velocity and relative flight-path angle time histories from drogue parachute deployment	4-212
4.17-12	Geodetic altitude and load factor time histories from drogue parachute deployment	4-213

Figure

Page

4.17-13 EMS parameters

- (a) Load factor versus inertial velocity 4-214
- (b) CMC commanded bank angle and EMS
range-to-go versus inertial velocity 4-214

1.0 SUMMARY AND INTRODUCTION

2.0 SYMBOLS AND NOMENCLATURE

3.0 PRIMARY GUIDELINES AND CONSTR

4.0 MISSION SUMMARY

4.1 EARTH LAUNCH

4.2 EARTH PARKING ORBIT

4.3 TRANSLUNAR INJECTION

4.4 FREE-RETURN CIRCUMLUNAR

4.5 POST-TRANSLUNAR INJECTION EVE

4.6 TRANSLUNAR COAST

4.7 LUNAR ORBIT INSERTION

4.8 LUNAR ORBIT CIRCULARIZATION

4.9 CSM/LM COAST FROM LOI-1 TO UN

4.10 CSM/LM UNDOCK TO LANDING

4.11 1ST CSM LUNAR ORBIT PLANE CH

4.12 LM ASCENT

4.13 RENDEZVOUS SEQUENCE

4.14 LM JETTISON AND SEPARATION T

4.15 TRANSEARTH INJECTION

4.16 TRANSEARTH COAST

4.17 ENTRY

5.0 INPUT DATA

6.0 REFERENCES

SPACECRAFT OPERATIONAL TRAJECTORY FOR APOLLO 12 (MISSION H-1)

VOLUME I - HYBRID MISSION PROFILE

LAUNCHED NOVEMBER 14, 1969

By Lunar Mission Analysis Branch, Landing Analysis Branch,
and Orbital Mission Analysis Branch

1.0 SUMMARY AND INTRODUCTION

1.1 Summary

In volumes I and II of the Spacecraft Operational Trajectory, a detailed description of the hybrid mission profile is presented. The launch date for the operational trajectory is November 14, 1969. The basic lunar trajectory profile is a hybrid type as compared to the standard free-return profile used on the Apollo 11 mission.

Translunar injection places the spacecraft on a free-return trajectory with a high perilune altitude. Unlike Apollo 11, the evasive maneuver is performed by the S-IVB prior to the blowdown rather than by the spacecraft SPS. Twenty-four hours after TLI, an SPS transfer maneuver is performed to lower perilune to 60 n. mi.^a After the maneuver, the spacecraft is on a non-free-return trajectory which is restricted such that an earth return would be within the DPS docked ΔV capability if an SPS failure should occur at LOI ignition.

The lunar orbit timeline is similar to the Apollo 11 timeline except that after rendezvous, docking, and LM jettison, a plane change is made to gain photographic coverage of selected prime sites for future landing missions. This type of photography is commonly referred to as bootstrap photography.

For the nominal mission, the launch time is 10^h22^m c.s.t., and the launch azimuth is $\approx 72^\circ$. Translunar injection occurs during the second revolution over the Pacific Ocean.

^aBecause of the crew rest/work cycle, the transfer maneuver time has recently been changed to TLI plus 28 hours.

The mission duration is approximately 10 days 4 hours and 41 minutes. The translunar flight time is 80.6 hours. The time spent in lunar orbit is 90.8 hours, and the transearth flight time is 70 hours. An inertial plot of the basic profile is shown in figure 1.1-1.

The nominal mission is summarized in the following tables.

- a. Table 1.1-I.- Sequence of major events
- b. Table 1.1-II.- Lunar orbit activities
- c. Table 1.1-III.- Launch window summary
- d. Table 1.1-IV.- Timetable of mission events
- e. Table 1.1-V.- Radar timeline
- f. Table 1.1-VI.- Shadow timeline

1.2 Introduction

The operational trajectory document is divided into numbered sections with index tabs. The symbols and nomenclature are presented in section 2.0, and a list of the primary mission guidelines and constraints are presented in section 3.0.

The main body of the document is section 4.0. This section is divided into subsections according to mission phases, and each subsection contains the text, tables, and figures related to the particular mission phase. In general, the information in each subsection includes a tracking timeline summary, a shadow timeline summary, target parameters, and a sequence of events table with a standard set of parameters. The propellant consumption predictions in section 4.0 are approximate and are included for completeness. The official predictions will be published in the operational consumables document.

The input data that were used to generate the operational trajectory are presented in section 5.0, which also contains the REFSMMATS. Almost all of the input data are tabulated; however, for some data, only the source is identified. The references are listed in section 6.0.

The mission tracking timeline, shadow timeline, and more detailed trajectory data are contained in volume II of the operational trajectory document.

TABLE 1.1-I.- SEQUENCE OF MAJOR EVENTS

Event	Time, hr:min:sec, g.e.t.	Time, hr:min:sec, c.s.t.	Data summary
Launch	00:00:00	November 14, 1969 10:22:00	Azimuth, deg ~72 Launch complex 39A
EPO insertion	00:11:53.2	10:33:53.2	Geodetic latitude, deg 32.7 Longitude, deg -52.5 Geodetic altitude, n. mi. 103.4 Velocity, fps 25 567.7
Translunar injection Burn initiation	00:47:21.7	13:09:21.7	Geodetic latitude, deg 2.3 Longitude, deg -176.6 Velocity, fps 25 587.5 Apogee altitude, n. mi. 107.8 Geographic altitude, n. mi. 98.8
Burn cutoff	02:52:43.7	13:14:43.7	Geodetic latitude, deg 15.6 Longitude, deg -155.2 Burn duration, sec 322. Plane change, deg 2.7 Apogee altitude, n. mi. 236 999.8 Geographic altitude, n. mi. 183.6
Evasive maneuver (performed by S-IVB)	04:25:0.0	14:47:0.0	ΔV , fps 10 S-IVB gimbal angles Pitch, deg (IGA) 2.1 Yaw, deg (MGA) 28.2 Roll, deg (OGA) 176.0
Translunar coast, midcourse correction maneuvers			
MCC-1	TLI plus 9 hr	22:14:43.7	Geodetic altitude, n. mi. 56 200
MCC-2 ^a (hybrid transfer)	26:52:43.7	November 15, 1969 13:14:43.7	Geodetic altitude, n. mi. 106 897. ΔV , fps 63.8 Burn duration, sec 9.3 SPS propellant used, lb 607.2 Plane change, deg 0.9
MCC-3	LOI-1 minus 22 hr	November 16, 1969 23:50:47.5	Geodetic altitude, n. mi. 174 400
MCC-4	LOI-1 minus 5 hr	November 17, 1969 16:50:47.5	Altitude above mean lunar radius, n. mi. 12 300

^aBecause of the crew rest/work cycle, the transfer maneuver time has been changed to TLI plus 28 hr.

TABLE 1.1-I.- SEQUENCE OF MAJOR EVENTS - Continued

Event	Time, hr:min:sec, g.e.t.	Time, hr:min:sec, c.s.t.	Data summary
Lunar orbit insertion (LOI-1) Burn initiation	83:28:47.5	November 17, 1969 21:50:47.5	Mass, lb 94 595. Altitude above LLS, n. mi. 85.3 Selenographic latitude, deg 6.5 Selenographic longitude, deg 177.4 Perilune altitude above LLS, n. mi. 59.9 Selenographic inclination, deg 158.0 Velocity, fps 8162.5
Burn cutoff	83:34:47.7	21:56:47.7	Altitude above LLS, n. mi. 59.8 Selenographic latitude, deg -1.1 Selenographic longitude, deg 155.3 Selenographic inclination, deg 164.7 Burn duration, sec 360.2 Inertial burn arc, deg 23.3 Plane change, deg 6.7 ΔV, fps 2890.4 SPS propellant used, lb 23 511. Velocity, fps 5484.3 Orbital period, hr:min:sec 2:08:39.5 Perilune altitude above LLS, n. mi. 59.7 Apolune altitude above LLS, n. mi. 170.1
Circularization maneuver (LOI-2) Burn initiation	87:47:36.7	November 18, 1969 02:09:36.7	Mass, lb 71 050 Altitude above LLS, n. mi. 61.3 Selenographic latitude, deg 2.4 Selenographic longitude, deg 166.0 Perilune altitude above LLS, n. mi. 59.6 Apolune altitude above LLS, n. mi. 170.2 Velocity, fps 5476.3
Burn cutoff	87:47:54.8	02:09:54.8	Altitude above LLS, n. mi. 61.2 Selenographic latitude, deg 2.1 Selenographic longitude, deg 165.1 Selenographic inclination, deg 164.7 Burn duration, sec 18.1 Inertial burn arc, deg 0.9 Plane change, deg 0.0 ΔV, fps 169.3 Velocity, fps 5338.7 SPS propellant used, lb 1178.9 Orbital period, hr:min:sec. 1:58:43.3 Perilune altitude above LLS, n. mi. 54.1 Apolune altitude above LLS, n. mi. 65.9

TABLE 1.1-I.- SEQUENCE OF MAJOR EVENTS - Continued

Event	Time, hr:min:sec, g.e.t.	Time, hr:min:sec, c.s.t.	Data summary
Descent			
CSM/LM undock	107:58:00	22:20:00	
CSM SEP	108:27:49	22:49:49	ΔV, fps 2.5
DOI (DPS ignition time)	109:26:27	23:48:27	ΔV, fps 72
PDI (DPS ignition time)	110:23:26	November 19, 1969	Burn duration, sec 28
High gate (P63 to P64)	110:31:54	0:45:26	Altitude above LLS, ft 49 250
Low gate (500 ft)	110:33:48	0:53:54	Velocity, fps 5577
Vertical descent (P64 to P65)	110:34:38	0:55:48	Altitude above LLS, ft 7511
Landing	110:35:23	0:56:38	Velocity, fps 519
		0:57:23	Altitude above LLS, ft 497
			Velocity, fps 49
			Altitude above LLS, ft 148
			Velocity, fps 6.4
			ΔV, fps 6779
			Burn duration, min:sec 11:56
			DPS propellant consumed, lb 16 735
CSM plane change (LOPC-1)	115:53:24.7	06:15:24.7	Mass, lb 36 038.4
			ΔV, fps 372.67
			Burn duration, sec 19.972
			Selenographic latitude, deg -14.1
			Selenographic longitude, deg 76.4
			Altitude above LLS, n. mi. 63.0
			Perilune altitude above LLS, n. mi. 56.3
			Apolune altitude above LLS, n. mi. 62.9
			Plane change, deg 4.0
			Selenographic inclination, deg 165.7
			Velocity, fps 5328.5
			Revolution number 17
Ascent			
LM lift-off	142:04:37.125	November 20, 1969	Mass, lb 10 663.4
		08:26:37.125	Selenographic latitude, deg -2.94
			Selenographic longitude, deg -23.45
LM insertion	142:11:47.720	08:33:47.720	Weight, lb 5802.45
			ΔV, fps 6049.05
			Burn duration, sec 430.59
			Latitude, deg -0.475
			Longitude, deg -33.232
			Altitude above LLS, ft 59 983
			Perilune altitude above LLS, ft 54 960
			Apolune altitude above LLS, ft 282 470

1-10

TABLE 1.1-I.- SEQUENCE OF MAJOR EVENTS - Continued

Event	Time, hr:min:sec, g.e.t.	Time, hr:min:sec, c.s.t.	Data summary
Rendezvous CSI	143:01:25.3	9:23:25.3	Burn duration, sec 44.7 ΔV, fps 49.9 Propellant used, lb 31.9 Resultant h_a/h_p , n. mi. 46.7/44.5 Range at cutoff, n. mi. 140.1 Range rate at cutoff, fps -107.7 Propulsion system LM RCS
CDH	143:59:49.9	10:21:49.9	Burn duration, sec 2.0 ΔV, fps 4.4 Propellant used, lb 2.8 Resultant h_a/h_p , n. mi. 45.3/44.4 Range at cutoff, n. mi. 77.5 Range rate at cutoff, fps -119.7 Propulsion system LM RCS
TPI	144:38:56.1	11:00:56.1	Burn duration, sec 22.2 ΔV, fps 24.8 Propellant used, lb 15.8 Resultant h_a/h_p , n. mi. 61.9/43.8 Range at cutoff, n. mi. 32.2 Range rate at cutoff, fps -133.0 Propulsion system LM RCS
Braking	145:20:15.0	11:42:15.0	Burn duration, sec 27.8 ΔV, fps 31.3 Propellant used, lb 19.9 Range at final braking, n. mi. 0.01 Range rate at final braking, fps -0.2 h_a/h_p at final braking, n. mi. 60.0/59.2 Propulsion system LM RCS
Docking	145:40:00.0	12:02:00.0	
LM jettison ^a	147:21:26.8	13:43:26.8	Mass, lb 34 807.6 ΔV, fps 1.5 Burn duration, sec 4.6 Selenographic latitude, deg -11.5 Selenographic longitude, deg 90.0 Altitude above LLS, n. mi. 59.4 Perilune altitude above LLS, n. mi. 59.0 Apolune altitude above LLS, n. mi. 59.4 Plane change, deg 0.0 Selenographic inclination, deg 165.6 Velocity, fps 5346.4 Revolution number 33

^aThe LM jettison maneuver time has been changed to 148^h00^m g.e.t.

TABLE 1.1-I.- SEQUENCE OF MAJOR EVENTS - Continued

Event	Time, hr:min:sec, g.e.t.	Time, hr:min:sec, c.s.t.	Data summary
LOPC-2	159:13:53.1	November 21, 1969 1:35:53.1	Mass, lb 34 800.5 ΔV, fps 297.3 Burn duration, sec 15.4 Selenographic latitude, deg -12.1 Selenographic longitude, deg 80.1 Altitude above LLS, n. mi. 58.2 Perilune altitude above LLS, n. mi. 58.2 Apolune altitude above LLS, n. mi. 60.6 Plane change, deg 3.2 Selenographic inclination, deg 167.0 Velocity, fps 5353.2 Revolution number 39
Transearth injection Burn initiation	174:24:47.8	16:46:47.8	Mass, lb 33 754. Altitude above LLS, n. mi. 60.6 Selenographic latitude, deg 9.2 Selenographic longitude, deg -175.0 Perilune altitude above LLS, n. mi. 57.1 Selenographic inclination, deg 167.0 Velocity, fps 5341.3
Burn cutoff	174:27:04.8	16:49:04.8	Altitude above LLS, n. mi. 64.6 Selenographic latitude, deg 7.8 Selenographic longitude, deg 176.2 Perilune altitude above LLS, n. mi. 60.1 Selenographic inclination, deg 168.4 Burn duration, sec 137 Inertial burn arc, deg 8.8 Plane change, deg 2.0 ΔV, fps 3113. SPS propellant used, lb 8942. Velocity, fps 8427.0
Transearth coast, midcourse correction maneuvers			
MCC-5	TEI plus 15 hr	November 22, 1969 7:46:47.8	Geodetic altitude, n. mi. ~180 000
MCC-6	EI minus 22 hr	November 23, 1969 16:48:36.0	Geodetic altitude, n. mi. ~101 000
MCC-7	EI minus 3 hr	November 24, 1969 11:48:36.0	Geodetic altitude, n. mi. ~24 900

TABLE 1.1-I.- SEQUENCE OF MAJOR EVENTS - Concluded

Event	Time, hr:min:sec, g.e.t.	Time, hr:min:sec, c.s.t.	Data summary
Entry interface	244:26:36.0	November 24, 1969 14:48:36.0	Transearth coast time, hr 70. Inertial velocity, fps 36 128.8 Geodetic altitude, n. mi. (ft) 65.8(400 095) Inertial flight-path angle, deg -6.5 Geodetic latitude, deg -18.7 Longitude, deg 172.8 Equatorial inclination (ascending), deg 18.8
Landing	244:40:26.8	14:62:26.8	Geodetic latitude, deg -16.04 Longitude, deg -165.0

Table 1.1-II - LUNAR ORBIT ACTIVITIES

Activity	Revolution number	Time, ^a hr:min, g.e.t.
LOI-1	Beginning of 1	83:29
LOI-2	Beginning of 3	87:48
IVT to LM for housekeeping activities	3	89:30
Landmark track	4	90:20
Inertial attitude	4	90:40
IVT to CSM	4	91:10
Begin 9-hr rest period	5	92:30
End rest period	9	101:30
IVT to LM for LM checkout	11	103:55
Landing site landmark track	12	106:30
Undock	13	108:01
CSM separation	13	108:28
DOI	Beginning of 14	109:26
Touchdown	14	110:35
Begin EVA	16	114:35
First CSM lunar orbit plane change (LOPC-1)	17	115:53
End EVA	18	118:00
Begin 9.5 hr rest period	19	121:00
End rest period	24	130:30

^aTimes are approximate.

Table 1.1-II - LUNAR ORBIT ACTIVITIES - Concluded

Activity	Revolution number	Time, ^a hr:min, g.e.t.
Begin EVA	26	133:35
End EVA	27	136:50
LM ascent	30	142:05
Docking	32	145:40
LM jettison	33	147:21
Begin 8.5-hr rest period	34	149:30
End rest period	38	158:00
Second CSM lunar orbit plane change (LOPC-2)	39	159:14
Begin photography	40	161:00
TEI	End of 46	174:25

^aTimes are approximate.

^bThis maneuver has been moved to the end of the forty-fifth revolution.

TABLE 1.1-III.- LAUNCH WINDOW SUMMARY

Parameter	Launch date	
	November 14	November 16
Site	7	5
Launch time (c.s.t.)	10 ^h 22 ^m to 15 ^h 02 ^m	13 ^h 09 ^m to 17 ^h 46 ^m
Free-return h _p	1850 n. mi.	1000 n. mi.
Hybrid transfer ΔV	62 to 69 fps	105 fps
Translunar flight time	~81 hr	79 hr
Lunar orbit inclination	15.3°	10°
Approach azimuth at landing	-75°	-80°
Sun elevation at landing	5.1° to 8.3°	11° to 14°
Goldstone landing coverage	First 2.5 hr	Entire window
Lunar surface stay time	32 hr	~32 hr
Photo sites	Fra Mauro, Descartes, Lalande	Fra Mauro, Descartes, Lalande
Total lunar orbit stay	88.9 hr, 46 revs	~89.0 hr, 46 revs
Transearth flight time	72 to 65 hr	72 to 66 hr
Total mission time	245 to 240 hr	244 to 239 hr
3σ low nominal reserves	820 to 600 fps	697 to 582 hr
3σ low contingency reserves	630 to 560 fps	410 to 350 fps

	Launch	EOI	TLI	Hybrid transfer	LOI-1	LOI-2
Launch						
EOI	0:11:53					
TLI	2:47:22	2:35:29				
Hybrid transfer	26:52:44	26:40:51	24: 5:22			
LOI-1	83:28:48	83:16:55	80:41:26	56:36:04		
LOI-2	87:47:37	87:35:44	85: 0:15	60:54:53	4:18:49	
Undocking	108:02:14	107:50:21	105:14:52	81:09:30	24:33:26	20:14:37
LM separation	108:27:50	108:15:57	105:40:28	81:35:06	24:59:02	20:40:13
DOI	109:26:28	109:14:35	106:39: 6	82:33:44	25:57:40	21:38:51
PDI	110:23:27	110:11:34	107:36: 5	83:30:43	26:54:39	22:35:50
CSM first pass over LLS	110:31:09	110:19:16	107:43:47	83:38:25	27:02:21	22:43:32
LM landing	110:35:18	110:23:25	107:47:56	83:42:34	27:06:30	22:47:41
CSM plane change 1	115:53:25	115:41:32	113: 6: 3	89:00:41	32:24:37	28:05:48
LM ascent	142:04:37	141:52:44	139:17:15	115:11:53	58:35:49	54:17:00
CSI	143:01:25	142:49:32	140:14: 3	116:08:41	59:32:37	55:13:48
CDH	143:59:50	143:47:57	141:12:28	117:07:06	60:31:02	56:12:13
TPI	144:38:56	144:27:03	141:51:34	117:46:12	61:10:08	56:51:19
TPF	145:21:35	145:09:42	142:34:13	118:28:51	61:52:47	57:33:58
CSM separation	147:21:27	147:09:34	144:34: 5	120:28:43	63:52:39	59:33:50
CSM plane change 2	159:13:53	159:02:00	156:26:31	132:21:09	75:45:05	71:26:16
Pass over photo site 1	163:30:54	163:19:01	160:43:32	136:38:10	80:02:06	75:43:17
Pass over photo site 2	163:42:00	163:30:07	160:54:38	136:49:16	80:13:12	75:54:23
TEI	174:24:48	174:12:55	171:37:26	147:32:04	90:56:00	86:37:11
Entry	244:26:36	244:14:43	241:39:14	217:33:52	160:57:48	156:38:59
Landing	244:40:36	244:28:43	241:53:14	217:47:52	161:11:48	156:52:59

TABLE 1.1-IV.- TIMETABLE OF MISSION EVENTS

	LOI-1	LOI-2	Undocking	LM separation	DOI	PDI	CSM first pass over LLS	LM landing	CSM plane change 1	LM ascent	CSI	CDH
4												
3	4:18:49											
0	24:33:26	20:14:37										
6	24:59:02	20:40:13	0:25:36									
4	25:57:40	21:38:51	1:24:14	0:58:38								
3	26:54:39	22:35:50	2:21:13	1:55:37	0:56:59							
5	27:02:21	22:43:32	2:28:55	2:03:19	1:04:41	0:07:42						
4	27:06:30	22:47:41	2:33:04	2:07:28	1:08:50	0:11:51	0:04:09					
1	32:24:37	28:05:48	7:51:11	7:25:35	6:26:57	5:29:58	5:22:16	5:18:07				
3	58:35:49	54:17:00	34:02:23	33:36:47	32:38:09	31:41:10	31:33:28	31:29:19	26:11:12			
1	59:32:37	55:13:48	34:59:11	34:33:35	33:34:57	32:37:58	32:30:16	32:26:07	27:08:00	0:56:48		
6	60:31:02	56:12:13	35:57:36	35:32:00	34:33:22	33:36:23	33:28:41	33:24:32	28:06:25	1:55:13	0:58:25	
2	61:10:08	56:51:19	36:36:42	36:11:06	35:12:28	34:15:29	34:07:47	34:03:38	28:45:31	2:34:19	1:37:31	0:39
1	61:52:47	57:33:58	37:19:21	36:53:45	35:55:07	34:58:08	34:50:26	34:46:17	29:28:10	3:16:58	2:20:10	1:21
3	63:52:39	59:33:50	39:19:13	38:53:37	37:54:59	36:58:00	36:50:18	36:46:09	31:28:02	5:16:50	4:20:02	3:21
9	75:45:05	71:26:16	51:11:39	50:46:03	49:47:25	48:50:26	48:42:44	48:38:35	43:20:28	17:09:16	16:12:28	15:14
0	80:02:06	75:43:17	55:28:40	55:03:04	54:04:26	53:07:27	52:59:45	52:55:36	47:37:29	21:26:17	20:29:29	19:31
6	80:13:12	75:54:23	55:39:46	55:14:10	54:15:32	53:18:33	53:10:51	53:06:42	47:48:35	21:37:23	20:40:35	19:42
4	90:56:00	86:37:11	66:22:34	65:56:58	64:58:20	64:01:21	63:53:39	63:49:30	58:31:23	32:20:11	31:23:23	30:21
2	160:57:48	156:38:59	136:24:22	135:58:46	135:00:08	134:03:09	133:55:27	133:51:18	128:33:11	102:21:59	101:25:11	100:26
2	161:11:48	156:52:59	136:38:22	136:12:46	135:14:08	134:17:09	134:09:27	134:05:18	128:47:11	102:35:59	101:39:11	100:40

EVENTS

LM ascent	CSI	CDH	TPI	TPF	CSM separation	CSM plane change 2	Pass over photo site 1 (Descartes)	Pass over photo site 2 (Fra Mauro)	TEI	Entry
0:56:48										
1:55:13	0:58:25									
2:34:19	1:37:31	0:39:06								
3:16:58	2:20:10	1:21:45	0:42:39							
5:16:50	4:20:02	3:21:37	2:42:31	1:59:52						
17:09:16	16:12:28	15:14:03	14:34:57	13:52:18	11:52:26					
21:26:17	20:29:29	19:31:04	18:51:58	18:09:19	16:09:27	4:17:01				
21:37:23	20:40:35	19:42:10	19:03:04	18:20:25	16:20:33	4:28:07	0:11:06			
32:20:11	31:23:23	30:24:58	29:45:52	29:03:13	27:03:21	15:10:55	10:53:54	10:42:48		
102:21:59	101:25:11	100:26:46	99:47:40	99:05:01	97:05:09	85:12:43	80:55:42	80:44:36	70:01:48	
102:35:59	101:39:11	100:40:46	100:01:40	99:19:01	97:19:09	85:26:43	81:09:42	80:58:36	70:15:48	0:14:00

TABLE 1.1-V.- MISSION RADAR TIMELINE^a

(a) CSM acquisition and termination - 0° minimum elevation

VEHICLE	RADAR TABLE	TRACKING TIME			STATION ACQUISITION DATA										STATION TERMINATION DATA											
		HRS	MIN	SEC	DAY	HRS	MIN	SEC	RA	DEC	AZ	ELV	X	Y	RANGE	DAY	HRS	MIN	SEC	RA	DEC	AZ	ELV	X	Y	RANGE
BCA-02 X-Y USR-30		C	0	57	0	0	11	53	-33	7	85	4	86	5	632	0	0	12	50	-29	5	84	0	90	6	850
BCA-C2 AZ-EL FPQ6		C	0	57	0	0	11	53	-33	7	85	4	86	5	631	0	0	12	50	-29	5	84	0	90	6	850
INSERT S-IPI		0	4	10	0	0	11	53	145	57	-32	14	-65	55	356	0	0	16	4	-7	16	72	0	90	18	849
CYI-04 X-Y USR-30		0	7	7	0	0	14	37	-171	15	-72	0	-90	17	848	0	0	23	44	8	-20	113	0	90	-23	841
CRC-CR AZ-EL FPQ6		C	5	50	0	0	52	20	-38	-28	-121	0	-90	-31	834	0	0	58	10	175	-32	126	0	90	-36	833
CRC-CR X-Y USR-30		0	5	50	0	0	52	20	-38	-28	-121	0	-90	-31	834	0	0	58	11	175	-32	126	0	90	-36	833
HSK-2E X-Y USR-85		C	6	2	0	0	59	28	20	10	-78	0	-90	-78	822	0	1	5	41	162	27	42	0	-90	42	827
GYM-14 X-Y USR-30		0	7	4	0	1	28	22	135	-25	-119	0	-90	-28	840	0	1	35	26	-51	13	75	0	90	15	848
GDS-2R X-Y USR-85		0	4	29	0	1	29	4	177	-51	-163	0	90	-17	838	0	1	33	44	-79	-19	114	0	90	66	845
MIL-71 X-Y USR-30		0	6	53	0	1	35	9	147	10	-75	0	-90	11	847	0	1	42	2	-16	18	70	0	90	20	849
MLA-71 AZ-EL TQ19		0	6	52	0	1	35	9	147	10	-78	0	-90	12	847	0	1	42	2	-16	18	69	0	90	21	849
CNV-21 AZ-EL FPS16		C	6	52	0	1	35	10	147	10	-75	0	-90	11	848	0	1	42	3	-16	18	70	0	90	20	849
BDA-02 X-Y USR-30		C	7	10	0	1	36	25	147	4	-85	0	-90	5	850	0	1	45	44	-12	-4	95	0	90	-5	848

81-1

^a See Tables 5-XVIII, MSFN Station Characteristics and 5-XIX, MSFN Station Identification.

VEHICLE 1 RADAR TABLE

	TRACKING TIME			STATION ACQUISITION DATA										STATION TERMINATION DATA													
	HRS	MIN	SEC	DAY	HRS	MIN	SEC	RA	DEC	AZ	ELV	X	Y	RANGE	DAY	HRS	MIN	SEC	RA	DEC	AZ	ELV	X	Y	RANGE		
RDA-02 AZ-EL FPQ6	0	7	10	0	1	38	35	167	4	-85	0	-90	5	850	0	1	45	44	-12	-4	95	0	90	-5	848		
INSERT SHIP1	0	7	5	0	1	42	15	175	19	-68	0	-90	22	850	0	1	49	20	5	-6	96	0	90	-6	844		
CYI-C4 X-Y USB-30	0	5	18	0	1	50	10	-134	-10	-101	0	-90	-11	842	0	1	55	29	-12	-57	161	0	90	-71	833		
CRD-CR X-Y USB-30	0	6	17	0	2	25	28	-18	-33	-127	0	-90	-37	835	0	2	31	44	-172	-14	106	0	90	-16	833		
CRC-CR AZ-EL FPQ6	0	6	17	0	2	25	28	-18	-33	-127	0	-90	-37	835	0	2	31	44	-172	-14	106	0	90	-16	833		
TLI CUTOFF TO NEW MANEUVER																											
HAW-12 X-Y USB-30	0	10	17	0	2	52	44	-134	-30	146	17	61	-53	512	0	3	3	1	-77	18	70	0	90	20	3305		
GDS-28 X-Y USP-8F	13	4	47	0	2	55	31	152	-21	-115	0	90	-65	1663	0	16	0	18	-28	1	-89	0	-90	-89	76025		
GYM-14 X-Y USB-30	12	38	0	0	2	55	56	145	-5	-95	0	-90	-5	1751	0	15	33	57	-28	1	-88	0	-90	2	74394		
MIL-71 X-Y USP-30	10	28	32	0	2	59	52	169	8	-81	0	-90	9	2609	0	13	28	24	-30	2	-88	0	-90	2	66250		
MLA-71 AZ-EL TPC19	2	37	12	0	2	59	52	169	8	-81	0	-90	9	2609	0	5	37	5	-41	10	139	66	16	-18	23400		
RDA-02 X-Y USP-30	9	19	17	0	3	2	13	-175	8	-81	0	-90	9	3132	0	12	21	31	-31	2	-87	0	-90	3	61622		
RDA-02 AZ-EL FPQ6	2	34	58	0	3	2	13	-175	8	-81	0	-90	9	3132	0	5	37	11	-43	9	-174	67	-3	-23	23400		
ANG-C1 X-Y USP-30	5	1	30	0	3	3	40	-174	24	-65	0	-90	25	3449	0	12	5	10	-32	3	-87	0	-90	3	60456		

1-19

VEHICLE 1 RACAR TABLE

	TRACKING TIME			STATION ACQUISITION DATA							STATION TERMINATION DATA														
	HRS	MIN	SEC	DAY	HRS	MIN	SEC	RA	DEC	AZ	ELV	X	Y	RANGE	DAY	HRS	MIN	SEC	RA	DEC	AZ	ELV	X	Y	RANGE
INSERT SHIP1	2	31	18	0	3	5	18	-151	14	-74	0	-90	16	3808	0	5	36	36	-46	10	-130	64	-21	-17	23400
CYI-04 X-Y USR-30	5	31	20	0	3	14	29	-127	17	-71	0	-90	19	5775	0	8	45	59	-37	5	-85	0	-90	5	44874
MAD-23 X-Y USR-85	4	42	49	0	3	17	35	-115	11	-75	0	-90	-75	6363	0	8	0	23	-39	5	-84	0	-90	-84	40847
ACN-75 X-Y USR-30	4	55	11	0	3	24	46	-100	34	-56	0	-90	34	7741	0	8	19	57	-29	8	-82	0	-90	8	42600
HAW-12 X-Y USR-30	12	45	38	0	6	10	21	-34	8	81	0	90	8	30042	0	18	55	59	-26	1	-89	0	-90	1	86312
QWN-24 X-Y USR-30	12	13	18	0	10	30	49	-27	4	85	0	90	5	53425	0	22	44	7	-24	0	-90	0	-90	0	98400
USN-25 X-Y USR-85	11	45	35	0	10	37	17	-27	7	81	0	-90	81	53922	0	22	22	52	-24	2	-88	0	-90	-88	97326
CRO-08 X-Y USR-30	11	54	47	0	12	55	29	-25	5	84	0	90	6	63998	1	0	50	16	-29	1	-89	0	-90	1	104581
BRKS AUSTRALIA	5	42	39	0	13	10	32	-26	5	60	30	56	26	63333	0	19	53	11	-25	-2	-64	30	-57	22	87757
MAD-23 X-Y USR-85	5	59	55	0	20	52	49	-21	0	91	0	90	18	92661	1	2	52	44	-21	-2	-180	48	-42	0	107753
ACN-75 X-Y USR-30	5	17	23	0	21	35	21	-21	1	89	0	90	1	94888	1	2	52	44	-21	0	59	77	11	8	106982
CYI-04 X-Y USR-30	5	13	7	0	21	39	42	-21	0	90	0	90	0	95113	1	2	52	44	-21	-1	157	59	13	-28	107375
ANG-51 X-Y USR-30	2	4	21	1	0	45	22	-20	-1	91	0	90	-1	104491	1	2	52	44	-19	-1	101	29	60	-10	108619

VEHICLE 1 RADAR TABLE

TRACKING TIME			STATION ACQUISITION DATA										STATION TERMINATION DATA													
HRS	MIN	SEC	DAY	HRS	MIN	SEC	RA	DEC	AZ	ELV	X	Y	RANGE	DAY	HRS	MIN	SEC	RA	DEC	AZ	ELV	X	Y	RANGE		
BDA-07 X-Y USB-30	1	51	27	1	1	1	17	-20	-1	91	0	90	-1	105105	1	2	52	44	-20	-1	107	23	66	-16	108960	
MIL-71 X-Y USB-30	0	46	11	1	2	6	32	-19	-1	91	0	90	-1	108167	1	2	52	44	-19	-1	97	10	80	-7	109694	
TRANSLUNAR COAST TO LCII																										
MAD-23 X-Y USB-85	5	52	26	1	2	52	53	-21	-2	-190	48	42	0	107760	1	8	45	19	-20	-2	-93	0	90	-87	125136	
ACN-75 X-Y USB-30	6	40	38	1	2	52	53	-21	0	53	77	10	8	106989	1	9	33	31	-21	-1	-91	0	-90	-1	127026	
CYI-04 X-Y USB-30	6	41	34	1	2	52	53	-21	-1	157	59	13	-28	107382	1	9	34	27	-20	-2	-92	0	-90	-2	127062	
ANG-91 X-Y USB-30	9	49	47	1	2	52	53	-19	-1	101	29	60	-10	108624	1	12	42	40	-20	-2	-92	0	-90	-2	134150	
BDA-02 X-Y USB-30	9	58	24	1	2	52	53	-20	-1	107	23	66	-16	108966	1	12	51	17	-20	-3	-93	0	-90	-3	134464	
MIL-71 X-Y USB-30	11	3	58	1	2	52	53	-19	-1	97	10	80	-7	109699	1	13	56	51	-19	-3	-93	0	-90	-3	136826	
GYM-14 X-Y USB-30	11	48	57	1	4	9	4	-19	-1	92	0	90	-2	113667	1	15	58	1	-19	-3	-93	0	-90	-3	141062	
EOS-28 X-Y USB-85	11	45	29	1	4	25	15	-19	-2	92	0	90	88	114805	1	16	20	44	-19	-3	-94	0	90	-86	141838	
HAW-12 X-Y USB-30	11	40	9	1	7	27	27	-18	-2	92	0	90	-2	122018	1	19	16	36	-18	-3	-93	0	-90	-3	147668	
MSK-25 X-Y USB-95	12	5	12	1	10	49	55	-18	-1	91	0	90	89	129958	1	22	55	7	-18	-2	-92	0	90	-88	154491	
GWM-24 X-Y USB-30	11	50	58	1	11	11	38	-17	-2	92	0	90	-2	130777	1	23	2	36	-18	-3	-93	0	-90	-3	154715	

VEHICLE 1 RADAR TABLE

	TRACKING TIME			STATION ACQUISITION DATA								STATION TERMINATION DATA													
	HRS	MIN	SEC	DAY	HRS	MIN	SEC	RA	DEC	AZ	ELV	X	Y	RANGE	DAY	HRS	MIN	SEC	RA	DEC	AZ	ELV	X	Y	RANGE
CRO-0A X-Y, USP-30	12	3	2	1	13	12	28	-17	-1	91	0	90	-1	135233	2	1	15	30	-17	-2	-93	0	-90	-3	158645
PARKS AUSTRALIA	7	12	47	1	13	16	21	-17	-1	69	30	58	18	133733	1	20	31	8	-19	-2	-71	30	-59	17	148332
MAD-23 X-Y, USP-85	11	30	12	1	21	21	9	-16	-3	95	0	90	85	151610	2	8	51	21	-16	-4	-96	0	90	-84	171026
ACN-75 X-Y, USP-30	11	58	9	1	21	49	56	-16	-2	93	0	90	-3	152502	2	9	48	4	-16	-4	-94	0	-90	-4	172459
CVI-C4 X-Y, USP-30	11	39	55	1	22	3	2	-16	-3	94	0	90	-4	152904	2	9	42	57	-16	-4	-95	0	-90	-5	172329
ANG-91 X-Y, USP-30	11	45	35	2	1	6	9	-15	-3	92	0	90	-3	158373	2	12	51	46	-16	-4	-94	0	-90	-4	176939
ECA-02 X-Y, USP-30	11	38	9	2	1	27	30	-15	-4	94	0	90	-4	158847	2	12	57	40	-16	-5	-95	0	-90	-5	177076
PIL-71 X-Y, USP-30	11	27	41	2	2	25	52	-15	-4	94	0	90	-4	160664	2	14	3	35	-16	-5	-95	0	-90	-5	178629
GYP-14 X-Y, USP-30	11	37	21	2	4	26	49	-15	-4	94	0	90	-4	164039	2	16	4	10	-15	-5	-95	0	-90	-5	181392
GES-28 X-Y, USP-85	11	30	59	2	4	54	27	-15	-4	95	0	90	85	164754	2	16	25	25	-15	-5	-96	0	90	-84	181869
FAW-12 X-Y, USP-30	11	40	13	2	7	42	6	-14	-4	94	0	90	-4	169248	2	19	22	39	-15	-5	-95	0	-90	-5	185747
FSW-25 X-Y, USP-85	12	16	30	2	10	52	34	-14	-3	94	0	90	85	174059	2	23	9	4	-15	-4	-95	0	90	-85	190521
GMW-24 X-Y, USP-30	11	46	13	2	11	23	7	-14	-4	94	0	90	-4	174805	2	23	9	19	-15	-5	-95	0	-90	-5	190523

VEHICLE 1 RADAR TABLE

	TRACKING TIME			STATION ACQUISITION DATA								STATION TERMINATION DATA														
	HRS	MIN	SEC	DAY	HRS	MIN	SEC	RA	DEC	AZ	ELV	X	Y	RANGE	DAY	HRS	MIN	SEC	RA	DEC	AZ	ELV	X	Y	RANGE	
CRO-CR X-Y USR-30	12	9	35	2	13	17	1	-14	-3	94	0	90	-4	177538	3	1	26	36	-15	-4	-95	0	-90	-5	193222	
PARKS AUSTRALIA	7	25	27	2	13	20	20	-14	-3	73	30	59	15	175901	2	20	45	47	-15	-4	-74	30	-59	14	185832	
MAD-23 X-Y USP-35	11	15	18	2	21	33	53	-13	-5	97	0	90	83	189526	3	8	49	10	-14	-6	-98	0	90	-82	201467	
ACN-75 X-Y USP-30	11	57	16	2	21	55	40	-13	-4	94	0	90	-4	189023	3	9	52	56	-14	-6	-96	0	-90	-6	202640	
CYI-04 X-Y USR-30	11	29	4	2	22	13	28	-13	-5	96	0	90	-6	189369	3	9	42	31	-14	-6	-97	0	-90	-7	202446	
ANG-51 X-Y USR-30	10	1	30	3	1	14	10	-13	-5	95	0	90	-5	192966	3	11	15	40	-15	-6	-105	22	-67	-14	202693	
BDA-02 X-Y USR-30	9	43	12	3	1	32	31	-13	-5	96	0	90	-6	193307	3	11	15	43	-14	-7	-112	20	-69	-21	202823	
MIL-71 X-Y USR-30	8	40	42	3	2	34	55	-13	-5	96	0	90	-6	194501	3	11	15	41	-14	-7	-122	34	-51	-26	202073	
GVM-14 X-Y USR-30	6	40	21	3	4	35	16	-13	-6	96	0	90	-6	196778	3	11	15	37	-14	-7	-156	53	-17	-34	201279	
GDS-28 X-Y USR-85	6	11	34	3	5	4	3	-13	-6	97	0	90	83	197320	3	11	15	37	-14	-7	-168	47	42	-8	201485	
FAW-12 X-Y USR-30	3	26	48	3	7	48	40	-12	-6	96	0	90	-6	200761	3	11	15	28	-13	-7	126	45	39	-24	201567	
FSK-25 X-Y USR-85	0	27	36	3	10	47	36	-13	-5	97	0	90	83	203632	3	11	15	12	-13	-6	93	6	25	94	203651	
COAST IN EC X 170 TO LC12																										
HSK-25 X-Y USR-85	1	24	26	3	11	47	37	-13	-6	88	13	-9	77	202578	3	13	12	3	-12	-5	75	28	-26	58	201877	

VEHICLE 1 RADAR TABLE

TRACKING TIME

STATION ACQUISITION DATA

STATION TERMINATION DATA

	TRACKING TIME			STATION ACQUISITION DATA										STATION TERMINATION DATA											
	HRS	MIN	SEC	DAY	HRS	MIN	SEC	RA	DEC	AZ	ELV	X	Y	RANGE	DAY	HRS	MIN	SEC	RA	DEC	AZ	ELV	X	Y	RANGE
GMM-24 X-Y USB-30	1	24	30	3	11	47	42	-13	-7	98	5	85	-8	203009	3	13	12	12	-12	-6	103	25	65	-12	202079
HAW-12 X-Y USB-30	1	24	33	3	11	47	53	-13	-7	135	51	30	-26	200657	3	13	12	26	-13	-6	167	61	7	-28	200536
GDS-28 X-Y USB-85	1	24	32	3	11	48	4	-14	-7	-156	45	43	-17	200899	3	13	12	36	-13	-6	-133	36	43	-37	201531
GYM-14 X-Y USB-30	1	24	32	3	11	48	5	-14	-7	-144	49	-27	-32	200733	3	13	12	37	-13	-6	-122	36	-45	-26	201517
MIL-71 X-Y USB-30	1	24	29	3	11	48	9	-14	-7	-116	28	-60	-23	201710	3	13	12	38	-13	-6	-102	11	-78	-13	202861
ANG-91 X-Y USB-30	1	6	16	3	11	48	11	-15	-7	-102	15	-75	-11	202427	3	12	54	28	-14	-6	-96	C	-90	-6	202640
PCA-02 X-Y USB-30	1	10	0	3	11	48	12	-15	-7	-107	13	-76	-17	202509	3	12	58	14	-14	-6	-97	C	-90	-7	202824
CRO-08 X-Y USB-30	1	24	24	3	13	55	49	-12	-5	92	9	81	-2	202950	3	15	20	13	-11	-5	82	27	63	7	202123
PARKS AUSTRALIA	1	24	24	3	13	55	52	-12	-5	69	37	51	17	201382	3	15	20	16	-11	-5	48	52	31	24	200982
PSK-25 X-Y USB-85	1	24	26	3	13	55	52	-12	-5	66	37	-28	47	201402	3	15	20	18	-11	-5	45	50	-30	27	201034
GMM-24 X-Y USB-30	1	24	27	3	13	55	57	-12	-6	107	35	54	-14	201489	3	15	20	24	-11	-5	119	54	33	-17	200912
HAW-12 X-Y USB-30	1	24	28	3	13	56	11	-13	-6	-170	61	-5	-28	200452	3	15	20	38	-12	-5	-135	53	-28	-25	200943
GYM-14 X-Y USB-30	1	24	26	3	13	56	15	-13	-6	-114	27	-60	-22	201865	3	15	20	45	-12	-6	-102	11	-79	-12	203031

VEHICLE 1 RADAR TABLE

TRACKING TIME				STATION ACQUISITION DATA								STATION TERMINATION DATA															
HRS	MIN	SEC		DAY	HRS	MIN	SEC	RA	DEC	AZ	ELV	X	Y	RANGE	DAY	HRS	MIN	SEC	RA	DEC	AZ	ELV	X	Y	RANGE		
GDS-28 X-Y USR-85	1	24	76		3	13	56	20	-13	-6	-123	28	45	-48	201805	3	15	20	46	-12	-6	-108	14	50	-68	202845	
MIL-71 X-Y USP-30	0	8	19		3	13	56	20	-14	-6	-98	2	-88	-8	203337	3	14	4	39	-14	-6	-97	C	-90	-7	203021	
LPC COAST TO LM SEPARATION																											
CPC-08 X-Y USR-30	1	11	35		3	16	4	47	-11	-5	77	37	52	11	201544	3	17	16	22	-10	-4	63	51	36	16	200958	
MSK-25 X-Y USR-85	1	11	37		3	16	4	54	-11	-5	29	56	-31	16	200759	3	17	16	30	-11	-4	-3	58	-32	-1	200710	
PARKS AUSTRALIA	1	11	37		3	16	4	55	-11	-5	32	58	18	27	200654	3	17	16	32	-11	-4	-2	61	-1	29	200633	
GWM-24 X-Y USP-30	1	11	38		3	16	5	0	-11	-5	122	63	21	-18	200548	3	17	16	35	-11	-5	171	72	3	-18	200390	
PAW-12 X-Y USB-30	1	11	38		3	16	5	16	-12	-6	-123	45	-40	-23	201160	3	17	16	55	-11	-5	-111	31	-57	-18	201880	
GVM-14 X-Y USP-30	0	4	52		3	16	5	19	-12	-6	-97	1	-89	-7	203506	3	16	10	12	-12	-6	-56	C	-90	-6	203324	
GDS-28 X-Y USR-85	0	27	6		3	16	5	21	-12	-6	-101	5	64	-78	203261	3	16	32	27	-12	-6	-97	C	90	-83	202391	
CPC-08 X-Y USP-30	1	11	58		3	18	2	54	-10	-4	50	60	24	19	200767	3	19	14	52	-10	-4	14	68	6	21	200594	
MSK-25 X-Y USP-85	1	11	55		3	18	2	2	-11	-4	-24	55	-31	-13	200886	3	19	14	57	-10	-3	-48	47	-32	-30	201254	
PARKS AUSTRALIA	1	11	55		3	18	3	2	-11	-4	-25	59	-14	28	200803	3	19	14	57	-10	-4	-50	49	-33	25	201169	
GWM-24 X-Y USP-30	1	11	54		3	18	3	13	-11	-5	-153	70	-10	-18	200518	3	19	15	6	-10	-4	-122	58	-27	-16	200863	

1-25

VEHICLE 1 RADAR TABLE

	TRACKING TIME			STATION ACQUISITION DATA								STATION TERMINATION DATA													
	HRS	MIN	SEC	DAY	HRS	MIN	SEC	RA	DEC	AZ	ELV	X	Y	RANGE	DAY	HRS	MIN	SEC	RA	DEC	AZ	ELV	X	Y	RANGE
HAW-12 X-Y USR-30	1	11	44	3	19	3	29	-11	-5	-105	21	-69	-14	202503	3	19	15	14	-10	-4	-97	5	-85	-7	203465
CRO-CR X-Y USR-30	1	11	41	3	20	1	30	-10	-4	-18	69	-7	21	200685	3	21	13	11	-9	-3	-50	58	-25	20	200990
PARKS AUSTRALIA	0	59	20	3	20	1	36	-10	-4	-62	41	-45	21	201588	3	21	0	56	-9	-3	-72	30	-59	15	201536
HSK-25 X-Y USR-85	1	11	39	3	20	1	36	-10	-4	-61	39	-21	-42	201668	3	21	13	15	-9	-3	-74	26	-30	-59	202386
GWM-24 X-Y USR-30	1	11	47	3	20	1	42	-10	-4	-112	48	-40	-15	201294	3	21	13	30	-9	-4	-103	32	-57	-11	202077
MAD-23 X-Y USR-85	1	11	47	3	21	56	36	-8	-4	97	2	73	82	203858	3	23	11	23	-7	-4	105	15	49	66	203126
CRO-CR X-Y USR-30	1	11	46	3	21	56	46	-9	-3	-64	49	-28	17	201390	3	23	11	34	-8	-3	-75	34	-55	12	202106
HSK-25 X-Y USR-85	1	11	43	3	21	56	51	-9	-3	-81	17	-26	-71	202981	3	23	11	34	-8	-2	-91	3	18	-87	203875
GWM-24 X-Y USR-30	1	11	39	3	22	0	4	-10	-4	-95	21	-69	-9	202734	3	23	11	42	-9	-3	-94	5	-85	-4	203756
ACN-75 X-Y USR-30	0	57	56	3	22	13	16	-8	-3	93	0	90	-3	203310	3	23	11	12	-7	-3	91	13	77	-1	203228
CYI-04 X-Y USR-30	0	42	7	3	22	20	12	-7	-4	94	0	90	-4	202758	3	23	11	19	-7	-3	95	9	81	-9	203495
ACN-75 X-Y USR-30	1	11	40	3	23	57	45	-7	-3	90	25	55	0	202673	4	1	9	30	-6	-2	86	42	48	3	201870
CYI-04 X-Y USR-30	1	11	44	3	23	57	57	-7	-4	105	19	70	-14	202997	4	1	9	43	-6	-3	115	34	54	-20	202267

1-26

VEHICLE 1 RADAR TABLE

	TRACKING TIME			STATION ACQUISITION DATA										STATION TERMINATION DATA											
	HRS	MIN	SEC	DAY	HRS	MIN	SEC	RA	DEC	AZ	ELV	X	Y	RANGE	DAY	HRS	MIN	SEC	RA	DEC	AZ	ELV	X	Y	RANGE
MAD-23 X-Y USR-95	1	11	50	3	23	57	60	-7	-4	118	23	47	54	202751	4	1	9	49	-6	-3	132	35	44	37	202223
CRO-09 X-Y USR-30	1	11	49	3	23	58	11	-8	-3	-81	24	-66	8	202719	4	1	10	0	-8	-2	-88	8	-82	2	203689
ACN-75 X-Y USR-30	1	11	49	4	1	56	4	-6	-2	83	54	36	4	201512	4	3	7	52	-5	-2	73	70	19	6	201086
ANG-91 X-Y USR-30	1	11	43	4	1	56	6	-6	-3	94	5	85	-4	203963	4	3	7	49	-5	-2	59	21	68	-9	203047
BDA-C2 X-Y USR-30	1	11	46	4	1	54	9	-6	-3	94	1	89	-4	204190	4	3	7	54	-5	-2	103	16	74	-13	203371
CYT-04 X-Y USR-30	1	11	47	4	1	56	13	-6	-3	125	43	42	-25	201934	4	3	8	1	-5	-2	144	54	23	-28	201533
MAD-23 X-Y USR-85	1	11	43	4	1	56	15	-6	-3	145	40	44	26	202027	4	3	9	2	-6	-3	168	46	43	8	201831
MIL-71 X-Y USR-30	1	11	56	4	2	55	52	-5	-2	93	0	90	-3	203669	4	3	7	51	-5	-2	94	3	87	-4	204145
ANG-91 X-Y USR-30	1	11	51	4	3	54	24	-5	-2	104	32	57	-12	202556	4	5	6	17	-4	-2	113	48	39	-15	201887
MIL-71 X-Y USR-30	1	11	51	4	3	54	24	-5	-2	100	13	77	-10	203633	4	5	6	17	-4	-2	105	28	61	-17	202849
PCA-02 X-Y USR-30	1	11	52	4	3	54	30	-5	-3	111	25	63	-19	202929	4	5	6	23	-4	-2	124	39	46	-26	202312
ACN-75 X-Y USR-30	1	11	56	4	3	54	33	-6	-2	45	81	7	6	201017	4	5	6	29	-5	-1	-58	78	-10	7	201115
CYT-04 X-Y USR-30	1	11	54	4	3	54	37	-6	-2	154	59	9	-30	201461	4	5	6	31	-5	-2	-162	59	-10	-29	201516

1-27

VEHICLE 1 PARAR TABLE

	TRACKING TIME			STATION ACQUISITION DATA										STATION TERMINATION DATA											
	HRS	MIN	SEC	DAY	HRS	MIN	SEC	RA	DEC	AZ	ELV	X	Y	RANGE	DAY	HRS	MIN	SEC	RA	DEC	AZ	ELV	X	Y	RANGE
MAD-23 X-Y USB-E5	1	10	5	4	3	54	42	-6	-3	-175	47	43	-3	201883	4	5	4	47	-5	-2	-151	44	43	-20	201998
GYM-14 X-Y USB-30	0	7	46	4	4	58	25	-4	-2	92	0	90	-2	204025	4	5	6	12	-4	-2	93	2	88	-3	204336
GYM-14 X-Y USB-30	1	11	42	4	5	52	42	-4	-2	99	12	78	-8	203818	4	7	4	25	-3	-1	107	27	62	-15	203020
GDS-28 X-Y USB-P5	1	11	39	4	5	52	46	-4	-2	97	6	49	91	204163	4	7	4	25	-3	-1	107	20	39	-64	203415
MIL-71 X-Y USB-30	1	11	42	4	5	52	47	-4	-2	117	37	50	-21	202457	4	7	4	31	-3	-1	133	50	31	-26	201959
ANG-91 X-Y USB-30	1	11	42	4	5	52	50	-4	-2	124	58	27	-17	201617	4	7	4	32	-4	-1	154	76	9	-18	201371
PCA-02 X-Y USB-30	1	11	40	4	5	52	54	-4	-2	136	46	34	-30	202052	4	7	4	33	-4	-1	160	55	14	-33	201794
ACR-75 X-Y USB-30	1	11	38	4	5	52	56	-5	-1	-75	57	-22	6	201376	4	7	4	37	-4	-1	-82	50	-40	5	201961
CPZ-84 X-Y USB-30	1	11	39	4	5	52	4	-5	-2	-142	54	-24	-28	201739	4	7	4	44	-4	-1	-122	43	-42	-23	202240
MAD-23 X-Y USB-R5	1	11	43	4	5	52	6	-5	-2	-137	39	43	-32	202392	4	7	4	48	-4	-1	-120	28	43	-50	202957
GYM-14 X-Y USB-30	1	12	3	4	7	50	59	-3	-1	115	37	51	-20	202670	4	9	3	11	-2	-1	131	50	33	-25	202414
GDS-28 X-Y USB-R5	1	12	1	4	7	50	59	-3	-1	115	29	38	53	203018	4	9	2	58	-2	-1	130	41	36	35	202482
MIL-71 X-Y USB-30	1	12	1	4	7	51	5	-4	-1	150	54	18	-29	201811	4	9	3	6	-3	-1	-178	61	-1	-29	201751

1-28

VEHICLE 1 RADAR TABLE

	TRACKING TIME			STATION ACQUISITION DATA							STATION TERMINATION DATA														
	HRS	MIN	SEC	DAY	HRS	MIN	SEC	RA	DEC	AZ	ELV	X	Y	RANGE	DAY	HRS	MIN	SEC	RA	DEC	AZ	ELV	X	Y	RANGE
GYM-14 X-Y USB-30	0	31	24	4	12	28	5	-1	0	-140	55	-24	-26	200864	4	12	59	29	-1	0	-130	51	-32	-24	202345
MIL-71 X-Y USP-30	0	31	27	4	12	28	5	-2	0	-111	33	-55	-17	201812	4	12	59	32	-1	0	-106	27	-62	-14	203452
RCA-02 X-Y USB-30	0	31	29	4	12	28	5	-2	0	-102	19	-71	-12	202586	4	12	59	34	-2	0	-98	12	-77	-8	204262
ANG-51 X-Y USB-30	0	31	31	4	12	28	5	-2	0	-96	18	-72	-5	202559	4	12	59	36	-2	0	-93	11	-79	-3	204335
MSK-25 X-Y USP-30	1	11	44	4	12	45	38	0	1	71	23	-38	61	203766	4	14	57	22	1	2	57	35	-38	44	203169
GMM-24 X-Y USP-30	1	11	48	4	12	45	43	0	0	96	24	66	-5	203675	4	14	57	31	1	1	100	41	45	-8	202888
FAW-12 X-Y USP-30	1	11	53	4	12	45	54	-1	0	157	67	10	-22	201933	4	14	57	47	0	1	-158	67	-9	-21	201985
EDS-28 X-Y USP-30	1	11	57	4	12	46	6	-1	0	-130	62	35	-35	202751	4	14	58	4	0	1	-114	31	34	-52	203392
GYM-14 X-Y USB-30	1	10	6	4	12	46	6	-1	0	-118	42	-44	-21	202761	4	14	56	13	0	1	-106	25	-60	-14	203407
MIL-71 X-Y USP-30	1	10	4	4	12	46	6	-2	0	-99	17	-72	-9	204071	4	14	56	13	-1	1	-90	2	-88	0	204911
RCA-C2 X-Y USP-30	0	12	27	4	12	46	6	-2	0	-91	3	-87	-1	204905	4	12	58	37	-1	0	-90	0	-90	0	204434
CRO-08 X-Y USP-30	0	42	32	4	14	14	46	0	1	89	0	90	1	203857	4	14	57	18	1	2	84	9	81	6	204582
PARKS AUSTRALIA	0	31	47	4	14	25	36	0	2	66	30	58	21	202097	4	14	57	23	1	2	59	35	50	24	203128

15-1-31

VEHICLE 1 RACAR TABLE

TRACKING TIME

STATION ACQUISITION DATA

STATION TERMINATION DATA

	HRS MIN SEC			DAY HRS MIN SEC RA DEC AZ ELV X Y RANGE								DAY HRS MIN SEC RA DEC AZ ELV X Y RANGE													
CRO-08 X-Y USB-30	1	11	40	4	15	43	54	1	2	75	19	70	11	204077	4	16	55	34	2	2	69	34	54	10	203336
MSK-25 X-Y USB-85	1	11	41	4	15	43	57	1	2	46	42	-38	32	202917	4	16	55	38	1	2	23	50	-38	15	202651
PARKS AUSTRALIA	1	11	41	4	15	43	59	1	2	48	44	38	29	202856	4	16	55	40	1	2	26	52	19	34	202572
GUM-24 X-Y USB-30	1	11	42	4	15	44	4	1	1	106	52	37	-10	202518	4	16	55	46	2	2	120	68	19	-11	202102
HAN-12 X-Y USB-30	1	11	38	4	15	44	27	0	1	-134	61	-22	-20	202207	4	16	56	1	1	1	-114	48	-39	-16	202726
GNS-28 X-Y USB-85	1	11	37	4	15	44	31	-1	1	-106	22	34	-63	203917	4	16	56	9	0	1	-95	9	28	-80	204776
GUM-14 X-Y USB-30	1	11	34	4	15	44	23	-1	1	-95	18	-72	-9	204117	4	16	56	7	0	1	-90	4	-86	0	205069
CRO-08 X-Y USB-30	1	11	52	4	17	42	13	2	2	60	44	42	21	202985	4	18	54	6	2	3	40	35	24	26	202589
MSK-25 X-Y USB-85	1	11	56	4	17	42	19	1	2	5	52	-38	3	202651	4	18	54	17	2	3	-22	49	-35	-14	202820
PARKS AUSTRALIA	1	11	60	4	17	42	19	1	2	6	55	4	35	202561	4	18	54	19	2	3	-22	52	-17	35	202722
GUM-24 X-Y USB-30	1	11	59	4	17	42	26	1	2	146	75	7	-12	202027	4	18	54	25	2	2	-137	75	-10	-11	202126
HAN-12 X-Y USB-30	1	11	59	4	17	42	37	0	1	-106	38	-51	-13	203235	4	18	54	36	1	2	-97	23	-67	-7	204110
CRO-08 X-Y USB-30	0	12	47	4	19	40	38	2	3	20	61	11	27	202501	4	19	53	25	2	3	14	62	7	27	201836

VEHICLE 1 RADAR TABLE

TRACKING TIME

STATION ACQUISITION DATA

STATION TERMINATION DATA

	HRS	MIN	SEC	DAY	HRS	MIN	SEC	RA	DEC	AZ	ELV	X	Y	RANGE	DAY	HRS	MIN	SEC	RA	DEC	AZ	ELV	X	Y	RANGE	
MSK-25 X-Y USE-85	0	12	39	4	19	40	45	2	3	-38	44	-39	-26	203084	4	19	53	25	2	3	-42	43	-39	-29	202519	
PARKS AUSTRALIA	0	12	39	4	19	40	46	2	3	-39	47	-31	32	202984	4	19	53	25	2	3	-43	45	-34	31	202420	
GWM-24 X-Y USE-30	0	12	31	4	19	40	54	2	2	-115	65	-22	-10	202367	4	19	53	25	2	2	-112	63	-26	-10	201809	
HAW-12 X-Y USE-30	C	12	21	4	19	41	4	1	2	-93	12	-78	-3	204774	4	19	53	25	1	2	-92	9	-81	-2	204317	
LCFC1 TC LM JETTISON																										
HAW-12 X-Y USE-30	0	41	38	4	19	53	45	1	2	-92	9	-81	-1	204305	4	20	35	22	2	2	-87	0	-90	3	204666	
CRO-OR X-Y USE-30	0	58	34	4	19	53	45	2	3	13	62	7	27	201819	4	20	52	19	3	3	-16	61	-9	28	202557	
PARKS AUSTRALIA	0	58	40	4	19	53	45	2	3	-43	45	-34	31	202405	4	20	52	25	3	3	-56	36	-49	27	203547	
MSK-25 X-Y USE-85	C	58	41	4	19	53	45	2	3	-42	43	-39	-29	202505	4	20	52	26	3	3	-55	34	-40	-43	203643	
GWM-24 X-Y USE-30	0	58	52	4	19	53	45	2	2	-112	63	-26	-10	201794	4	20	52	37	3	3	-102	50	-40	-8	202945	
CRO-OR X-Y USE-30	1	11	47	4	21	38	56	3	3	-37	56	-22	27	202792	4	22	50	46	4	4	-56	44	-41	23	203308	
MSK-25 X-Y USE-85	1	11	43	4	21	38	5	2	3	-65	25	-41	-55	204150	4	22	50	48	3	4	-76	12	-48	-72	204983	
GWM-24 X-Y USE-30	1	11	40	4	21	38	18	2	3	-97	38	-51	-6	203488	4	22	50	58	3	3	-92	22	-68	-2	204422	
HAW-23 X-Y USE-85	C	40	46	4	22	9	52	4	2	97	0	-90	87	204374	4	22	50	39	5	3	93	8	20	82	205235	

1-33

VEHICLE 1 RADAR TABLE

TRACKING TIME

STATION ACQUISITION DATA

STATION TERMINATION DATA

	HRS	MIN	SEC	DAY	HRS	MIN	SEC	RA	DEC	AZ	ELV	X	Y	RANGE	DAY	HRS	MIN	SEC	RA	DEC	AZ	ELV	X	Y	RANGE
ACN-75 X-Y USB-30	1	11	33	4	23	37	9	5	3	85	8	82	5	205272	5	0	48	42	6	4	82	25	65	7	204366
CYI-04 X-Y USB-30	1	11	33	4	23	27	19	5	3	91	8	82	-1	205275	5	0	48	52	6	3	99	23	66	-8	204457
MAD-23 X-Y USB-85	1	11	35	4	23	27	22	5	3	101	16	32	70	204790	5	0	48	56	6	3	113	29	35	53	204151
CRO-C8 R-Y USB-30	1	11	39	4	23	37	31	3	4	-56	35	-53	20	203800	5	0	49	10	4	4	-75	20	-70	14	204672
HSK-25 X-Y USB-85	0	12	57	4	23	27	32	3	4	-83	3	-69	-83	205600	4	23	50	29	3	4	-85	0	-90	-85	205102
GMM-24 X-Y USB-30	0	45	56	4	23	37	41	3	2	-84	10	-80	1	205125	5	0	23	37	4	3	-86	0	-90	4	204633
ACN-75 X-Y USB-30	1	11	51	5	1	35	16	6	4	75	37	53	9	203883	5	2	47	6	7	5	71	53	-36	11	203239
CYI-04 X-Y USB-30	1	11	46	5	1	35	25	6	3	106	34	55	-13	204016	5	2	47	11	7	4	118	48	38	-10	203422
MAD-23 X-Y USB-85	1	11	42	5	1	35	34	6	3	124	37	36	42	203838	5	2	47	16	6	4	142	47	36	25	203459
CRO-C8 X-Y USB-30	0	43	42	5	1	35	47	4	4	-81	9	-80	9	205332	5	2	19	29	5	5	-85	0	-90	5	204712
ANG-91 X-Y USB-30	0	35	12	5	2	11	54	7	4	86	0	90	4	204620	5	2	47	5	7	4	88	8	82	2	205484
BDA-02 X-Y USB-30	0	28	9	5	2	19	1	7	4	86	0	90	4	204704	5	2	47	10	7	4	89	6	84	1	205622
ANG-91 X-Y USB-30	1	11	36	5	3	37	47	7	4	92	19	71	-2	204914	5	4	45	22	8	5	97	36	54	-5	204101

VEHICLE 1 RADAR TABLE

	TRACKING TIME			STATION ACQUISITION DATA									STATION TERMINATION DATA												
	HRS	MIN	SEC	DAY	HRS	MIN	SEC	RA	DEC	AZ	ELV	X	Y	RANGE	DAY	HRS	MIN	SEC	RA	DEC	AZ	ELV	X	Y	RANGE
MIL-71 X-Y USP-30	1	11	35	5	3	32	48	7	4	87	2	88	3	205935	5	4	45	24	8	5	94	17	73	-4	205096
ACN-75 X-Y USP-30	1	11	41	5	3	33	49	6	5	62	64	24	17	202980	5	4	45	30	7	5	24	76	6	13	202801
BCA-C2 X-Y USP-30	1	11	39	5	3	33	49	7	4	95	16	74	-5	205118	5	4	45	28	8	4	105	30	59	-13	204384
CYI-C4 X-Y USP-30	1	11	47	5	3	33	54	6	4	131	57	26	-21	203182	5	4	45	41	7	5	162	66	8	-23	203001
MAD-23 X-Y USP-85	1	11	41	5	3	34	1	6	4	155	52	37	13	203355	5	4	45	42	7	4	-172	54	36	-4	203361
GYM-14 X-Y USP-30	1	11	38	5	5	32	2	8	4	85	1	89	5	206140	5	6	43	40	9	5	93	16	74	-3	205293
ANG-91 X-Y USP-30	1	11	40	5	5	32	4	8	5	102	47	42	-8	203650	5	6	43	44	8	5	113	63	25	-10	203209
MIL-71 X-Y USP-30	1	11	40	5	5	32	5	8	4	100	27	62	-9	204614	5	6	43	45	9	5	111	42	46	-15	203955
BCA-C2 X-Y USP-30	1	11	36	5	5	32	11	9	4	114	40	48	-18	204002	5	6	43	47	8	5	131	52	30	-23	203547
ACN-75 X-Y USP-30	1	11	35	5	5	32	12	7	5	-25	75	-5	13	202974	5	6	43	51	8	6	-60	63	-24	13	203210
CYI-04 X-Y USP-30	1	11	37	5	5	32	15	7	4	-168	65	-5	-23	203045	5	6	43	56	8	5	-133	59	-23	-21	203325
MAD-23 X-Y USP-85	1	11	36	5	5	32	24	7	4	-153	51	36	-16	203515	5	6	43	60	8	5	-131	43	35	-33	203909
GCS-28 X-Y USP-85	0	03	52	5	5	45	52	8	4	85	0	-90	85	205315	5	6	43	44	9	5	91	11	8	79	205619

1-35

VEHICLE 1 PACAR TABLE

	TRACKING TIME			STATION ACQUISITION DATA							STATION TERMINATION DATA														
	HRS	MIN	SEC	DAY	HRS	MIN	SEC	RA	DEC	AZ	ELV	X	Y	RANGE	DAY	HRS	MIN	SEC	RA	DEC	AZ	ELV	X	Y	RANGE
GYN-14 X-Y USB-30	1	11	45	5	7	30	21	9	5	99	27	63	-8	204798	5	8	42	6	10	6	109	42	47	-14	204126
EDS-28 X-Y USB-R5	1	11	47	5	7	30	21	9	5	95	20	22	68	205146	5	8	42	9	10	5	110	34	27	51	204478
MIL-71 X-Y USB-30	1	11	53	5	7	30	24	8	5	122	51	34	-19	203650	5	8	42	16	9	6	145	63	16	-22	203356
ANG-51 X-Y USB-30	1	11	53	5	7	30	26	8	5	131	73	13	-11	203065	5	8	42	19	9	6	-159	78	-4	-11	203066
PGA-02 X-Y USB-30	1	11	53	5	7	30	28	8	5	148	55	18	-26	203369	5	8	42	20	9	6	-177	63	-1	-27	203357
ACN-75 X-Y USB-30	1	11	54	5	7	30	32	7	6	-70	52	-36	12	203611	5	8	42	27	8	6	-76	36	-53	11	204406
CYL-04 X-Y USB-30	1	11	57	5	7	30	37	7	5	-119	-51	-36	-18	203672	5	8	42	34	8	6	-105	37	-52	-12	204371
PAS-23 X-Y USB-R5	1	11	58	5	7	30	39	7	5	-119	36	34	-45	204303	5	8	42	33	8	5	-104	24	29	-62	205013
HAM-12 X-Y USB-30	1	11	34	5	9	28	37	10	6	-87	9	81	2	205959	5	10	40	11	11	6	93	25	65	-3	205105
GYN-14 X-Y USB-30	1	11	34	5	9	28	45	9	6	119	51	35	-18	203804	5	10	40	19	10	6	142	63	17	-21	203487
EDS-28 X-Y USB-R5	1	11	34	5	9	28	45	9	5	120	43	28	40	204140	5	10	40	19	10	6	135	54	29	22	203768
MIL-71 X-Y USB-30	1	11	34	5	9	28	52	9	6	172	67	3	-23	203318	5	10	40	27	10	6	-147	64	-15	-22	203473
ANG-51 X-Y USB-30	1	11	33	5	9	28	55	9	6	-124	71	-16	-11	203237	5	10	40	28	9	6	-104	56	-33	-8	203721

VEHICLE 1 RADAR TABLE

	TRACKING TIME			STATION ACQUISITION DATA									STATION TERMINATION DATA												
	HRS	MIN	SEC	DAY	HRS	MIN	SEC	RA	DEC	AZ	ELV	X	Y	RANGE	DAY	HRS	MIN	SEC	RA	DEC	AZ	ELV	X	Y	RANGE
BDA-02 X-Y USB-30	1	11	33	5	9	28	57	9	5	-153	60	-15	-26	203483	5	10	40	30	10	6	-126	51	-33	-22	203873
ACN-75 X-Y USB-30	1	11	29	5	9	29	3	8	6	-90	24	-65	9	205033	5	10	40	32	9	7	-82	8	-82	8	206087
MAC-23 X-Y USB-P5	1	11	33	5	9	29	6	8	5	-96	15	22	-73	205538	5	10	40	39	9	6	-85	3	-61	-84	206383
CYI-04 X-Y USB-30	1	11	31	5	9	29	7	8	5	-98	27	-63	-7	204918	5	10	40	38	9	6	-89	12	-78	1	205852
HAW-12 X-Y USB-30	1	11	58	5	11	26	50	11	6	99	35	54	-7	204628	5	12	38	47	12	7	108	51	37	-11	204026
GYM-14 X-Y USB-30	1	11	55	5	11	27	0	10	6	168	68	5	-22	203446	5	12	38	56	11	7	-148	65	-14	-21	203589
EDS-28 X-Y USB-P5	1	11	55	5	11	27	1	10	6	159	59	29	11	203675	5	12	38	56	11	7	-167	61	29	-6	203720
MIL-71 X-Y USB-30	1	11	55	5	11	27	6	10	6	-127	57	-28	-20	203745	5	12	39	2	10	7	-110	44	-45	-14	204338
ANG-91 X-Y USB-30	1	11	55	5	11	27	10	9	6	-98	44	-45	-6	204201	5	12	39	4	10	7	-91	28	-62	-1	205080
ECA-02 X-Y USB-30	1	11	55	5	11	27	11	9	6	-115	43	-45	-18	204279	5	12	39	6	10	7	-102	29	-60	-10	205034
CYI-C4 X-Y USB-30	0	6	17	5	11	27	15	9	6	-84	1	-89	6	206516	5	11	33	32	9	6	-83	0	-90	7	206280
MSK-25 X-Y USB-P5	1	11	32	5	13	25	3	12	7	76	6	-66	75	206390	5	14	36	35	13	8	65	19	-51	59	205699
GMM-24 X-Y USB-30	1	11	31	5	13	25	10	12	7	85	10	80	5	206159	5	14	36	40	13	7	98	27	63	1	205275

1-37

VEHICLE 1 RADAR TABLE

	TRACKING TIME			STATION ACQUISITION DATA										STATION TERMINATION DATA											
	HRS	MIN	SEC	DAY	HRS	MIN	SEC	RA	DEC	AZ	ELV	X	Y	RANGE	DAY	HRS	MIN	SEC	RA	DEC	AZ	ELV	X	Y	RANGE
HAW-12 X-Y USP-30	1	11	36	5	13	25	16	11	7	110	61	26	-13	203751	5	14	36	54	12	7	152	73	0	-15	203552
GDS-28 X-Y USP-85	1	11	36	5	13	25	32	11	6	-145	56	29	-18	203985	5	14	37	8	11	7	-122	47	27	-35	204339
GYM-14 X-Y USB-30	1	11	34	5	13	25	33	11	7	-120	58	-26	-19	203820	5	14	37	7	11	7	-110	45	-43	-14	204401
MIL-71 X-Y USB-30	1	11	36	5	13	25	37	10	7	-102	34	-56	-10	204836	5	14	37	13	11	7	-92	19	-71	-2	205720
ANG-51 X-Y USP-30	1	11	32	5	13	25	40	10	7	-80	17	-73	2	205720	5	14	37	12	11	7	-83	1	-89	7	206701
BDA-07 X-Y USP-30	1	11	32	5	13	25	40	10	6	-95	19	-71	-4	205599	5	14	37	12	11	7	-85	5	-85	5	206525
CRB-08 X-Y USB-30	1	11	53	5	15	23	11	13	8	80	3	87	10	206750	5	16	35	4	14	8	72	17	72	17	205949
MSK-25 X-Y USP-85	1	11	56	5	15	23	15	12	8	56	27	-47	47	205933	5	16	35	11	13	9	39	37	-46	30	204901
GWM-24 X-Y USB-30	1	11	54	5	15	23	20	13	7	51	30	52	-1	204764	5	16	35	14	13	8	95	55	35	-3	204173
HAW-12 X-Y USB-30	1	11	55	5	15	23	22	12	7	-165	75	-4	-15	203600	5	16	35	27	13	8	-122	65	-22	-13	203887
GDS-28 X-Y USP-85	1	11	55	5	15	23	39	11	7	-112	39	25	-47	204770	5	16	35	35	12	8	-95	25	18	-64	205538
GYM-14 X-Y USB-30	1	11	54	5	15	23	40	11	7	-102	35	-54	-10	204910	5	16	35	34	12	8	-92	21	-69	-2	205788
MIL-71 X-Y USB-30	0	43	7	5	16	23	44	11	7	-87	9	-81	3	206365	5	16	6	45	12	7	-82	0	-90	8	205697

VEHICLE 1 RADAR TABLE

TRACKING TIME			STATION ACQUISITION DATA										STATION TERMINATION DATA												
HRS	MIN	SEC	DAY	HRS	MIN	SEC	RA	DEC	AZ	ELV	X	Y	RANGE	DAY	HRS	MIN	SEC	RA	DEC	AZ	ELV	X	Y	RANGE	
PARKS AUSTRALIA	1	1	6	5	15	34	3	13	8	55	30	55	29	204644	5	16	35	9	13	9	42	35	40	36	204926
CRO-08 X-Y USP-30	1	11	31	5	17	21	42	14	8	65	27	60	22	205477	5	18	23	12	14	9	52	40	43	28	204892
HSK-25 X-Y USP-25	1	11	33	5	17	21	45	13	9	26	42	-45	19	204727	5	18	23	18	14	9	3	45	-45	2	204670
PARKS AUSTRALIA	1	11	33	5	17	21	46	13	9	28	44	35	39	204638	5	18	23	20	14	9	4	48	3	42	204566
GWM-24 X-Y USP-30	1	11	34	5	17	21	53	13	8	101	66	23	-4	203901	5	18	23	27	14	8	129	82	6	-5	203728
HAW-12 X-Y USP-30	1	11	34	5	17	22	9	12	8	-109	55	-24	-11	204222	5	18	23	42	13	8	-98	40	-50	-6	204936
GDS-28 X-Y USP-25	1	11	34	5	17	22	14	12	7	-92	15	7	-74	206105	5	18	23	48	13	8	-82	2	-77	-81	207015
GYP-14 X-Y USP-30	0	49	25	5	17	22	15	12	7	-97	10	-30	3	206417	5	18	11	50	13	8	-81	0	-90	9	206040
CRO-08 X-Y USP-30	1	11	57	5	18	19	48	14	9	40	48	30	31	204650	5	20	31	45	15	10	15	55	10	34	204469
PARKS AUSTRALIA	1	11	54	5	18	19	55	14	9	-14	47	-12	41	204678	5	20	31	51	15	10	-35	40	-24	38	205040
HSK-25 X-Y USP-25	1	11	54	5	19	19	56	14	9	-14	44	-45	-10	204788	5	20	31	50	15	10	-35	38	-46	-27	205153
GWM-24 X-Y USP-30	1	11	57	5	19	20	1	14	8	-131	82	-6	-5	203800	5	20	31	58	15	9	-99	67	-23	-3	204127
HAW-12 X-Y USP-30	1	11	48	5	19	20	19	13	8	-97	29	-61	-2	205521	5	20	32	7	14	9	-86	13	-77	4	206496

VEHICLE 1 RACAR TABLE

	TRACKING TIME			STATION ACQUISITION DATA										STATION TERMINATION DATA											
	HRS	MIN	SEC	DAY	HRS	MIN	SEC	RA	DEC	AZ	ELV	X	Y	RANGE	DAY	HRS	MIN	SEC	RA	DEC	AZ	ELV	X	Y	RANGE
CRO-08 X-Y USP-30	1	11	34	5	21	18	26	15	0	-6	55	-4	34	204499	5	22	29	60	16	10	-32	50	-24	33	204788
PARKS AUSTRALIA	0	24	21	5	21	19	31	14	10	-48	34	-48	34	205402	5	21	42	52	15	10	-53	30	-54	32	204493
MSK-25 X-Y USP-85	1	11	33	5	21	18	31	14	10	-47	32	-48	-39	205512	5	22	30	5	15	10	-61	20	-53	-55	206224
GWM-24 X-Y USP-30	1	11	41	5	21	18	37	14	0	-94	55	-35	-2	204498	5	22	30	17	15	9	-89	39	-51	1	205269
HAW-12 X-Y USB-30	0	10	14	5	21	18	48	14	0	-82	2	-88	8	207167	5	21	29	2	14	0	-81	0	-90	9	206784
MAD-23 X-Y USP-85	1	11	48	5	23	16	30	17	0	85	8	-29	91	206984	6	0	28	18	18	9	96	22	15	68	206287
CRO-C8 X-Y USP-30	1	11	46	5	23	16	41	15	10	-48	43	-38	30	205134	6	0	28	27	16	10	-60	30	-56	26	205837
MSK-25 X-Y USP-85	1	0	43	5	23	16	44	15	10	-49	11	-61	-66	206781	6	0	17	27	16	10	-77	0	-90	-77	206969
GWM-24 X-Y USP-30	1	11	39	5	23	16	60	15	0	-86	27	-63	3	205982	6	0	28	38	16	10	-82	11	-79	7	206917
CYI-04 X-Y USP-30	0	57	43	5	23	20	31	17	9	80	0	90	10	206772	6	0	28	14	18	10	85	12	78	4	206824
ACN-75 X-Y USP-30	0	36	16	5	23	51	52	17	10	80	0	90	10	206191	6	0	28	8	18	10	76	8	82	11	207045
ACN-75 X-Y USP-30	1	11	36	6	1	14	47	18	10	76	20	70	13	206460	6	2	26	23	19	11	71	36	53	16	205678
CYI-04 X-Y USP-30	1	11	39	6	1	14	51	18	10	91	23	67	-1	206299	6	2	26	31	18	10	99	38	52	-7	205587

VEHICLE 1 RADAR TABLE

	TRACKING TIME			STATION ACQUISITION DATA										STATION TERMINATION DATA													
	HRS	MIN	SEC	DAY	HRS	MIN	SEC	RA	DEC	AZ	ELV	X	Y	RANGE	DAY	HRS	MIN	SEC	RA	DEC	AZ	ELV	X	Y	RANGE		
MAD-23 X-Y USP-85	1	11	30	6	1	14	58	17	9	105	30	23	57	205874	6	2	26	37	18	10	119	43	27	40	205363		
CRD-08 X-Y USB-30	1	11	43	6	1	15	9	16	10	-67	20	-58	21	206400	6	2	26	52	17	11	-75	6	-84	15	207372		
ACN-75 X-Y USB-30	0	8	28	6	3	12	59	18	11	65	47	41	17	205278	6	3	21	27	18	11	64	49	38	17	204771		
ANG-51 X-Y USP-30	0	8	26	6	3	13	0	19	10	81	6	84	9	207425	6	3	21	27	19	10	82	8	82	8	206878		
BFA-02 X-Y USP-30	0	8	23	6	3	13	3	19	10	82	5	85	8	207443	6	3	21	27	19	10	83	7	83	7	206912		
CYI-04 X-Y USP-30	0	8	19	6	3	13	6	18	10	107	48	41	-11	205217	6	3	21	27	18	10	108	50	39	-12	204724		
MAD-23 X-Y USB-85	0	8	12	6	3	13	15	18	10	132	50	29	28	205126	6	3	21	27	18	10	135	51	29	26	204665		
LPC COAST TO LPC?																											
ANG-51 X-Y USB-30	1	3	7	6	3	21	31	19	10	82	3	82	8	206873	6	4	24	38	20	11	85	22	68	5	206542		
ACN-75 X-Y USB-30	1	3	10	6	3	21	31	19	11	64	49	38	17	204767	6	4	24	42	19	11	49	61	23	19	204845		
BFA-02 X-Y USP-30	1	3	16	6	3	21	31	19	10	83	7	83	7	206907	6	4	24	48	20	10	90	20	70	0	206661		
CYI-04 X-Y USB-30	1	3	20	6	3	21	31	18	10	108	50	39	-12	204720	6	4	24	52	19	11	123	62	24	-15	204815		
MAD-23 X-Y USB-85	1	3	27	6	3	21	31	19	10	135	51	29	26	204661	6	4	24	58	19	10	158	58	30	11	204934		
MIL-71 X-Y USB-30	0	28	2	6	3	56	44	19	10	78	0	90	12	206576	6	4	24	46	20	10	81	6	84	9	207483		

VEHICLE 1 RADAR TABLE

	TRACKING TIME			STATION ACQUISITION DATA								STATION TERMINATION DATA													
	HRS	MIN	SEC	DAY	HRS	MIN	SEC	RA	DEC	AZ	ELV	X	Y	RANGE	DAY	HRS	MIN	SEC	RA	DEC	AZ	ELV	X	Y	RANGE
ANG-01 X-Y USP-30	1	11	31	6	5	11	21	20	11	88	33	57	1	206024	6	6	22	52	20	11	93	50	40	-2	205366
MIL-71 X-Y USP-30	1	11	31	6	5	11	22	20	10	87	16	74	3	206951	6	6	22	53	21	11	94	31	59	-4	206197
BDA-02 X-Y USP-30	1	11	30	6	5	11	23	19	10	97	30	60	-6	206193	6	6	22	53	20	11	108	44	44	-12	205587
ACN-75 X-Y USP-30	1	11	34	6	5	11	25	19	11	78	68	11	19	204725	6	6	22	59	20	12	-20	69	-7	20	204785
CYI-04 X-Y USB-30	1	11	31	6	5	11	32	19	11	146	70	12	-17	204690	6	6	23	4	20	11	-161	72	-6	-16	204727
MAC-23 X-Y USB-R5	1	11	31	6	5	11	37	19	10	-180	60	30	0	204931	6	6	23	8	20	11	-148	57	29	-17	205128
GYM-14 X-Y USP-30	0	22	42	6	6	0	10	20	11	78	0	90	12	206872	6	6	22	53	21	11	80	5	85	-10	207692
ECS-28 X-Y USP-R5	0	5	21	6	6	17	21	21	11	77	0	-90	77	207686	6	6	22	53	21	11	77	1	-85	77	207916
GYM-14 X-Y USP-30	1	11	42	6	7	9	30	21	11	85	15	75	4	207158	6	8	21	13	22	12	93	30	60	-2	206395
GRS-28 X-Y USP-R5	1	11	46	6	7	9	32	21	11	84	11	-29	78	207423	6	8	21	19	22	11	93	25	7	65	206699
ANG-01 X-Y USB-30	1	11	51	6	7	9	34	20	11	98	61	79	-4	205056	6	8	21	25	21	12	113	77	12	-5	204806
MIL-71 X-Y USP-30	1	11	47	6	7	9	34	20	11	101	42	48	-8	205774	6	8	21	21	21	12	114	56	31	-13	205288
BDA-02 X-Y USP-30	1	11	51	6	7	9	38	20	11	119	54	33	-17	205293	6	8	21	28	21	12	-143	65	16	-20	205040

VEHICLE 1 RADAR TABLE

TRACKING TIME

STATION ACQUISITION DATA

STATION TERMINATION DATA

	HRS MIN SEC			STATION ACQUISITION DATA										STATION TERMINATION DATA											
	DAY	HRS	MIN	SEC	RA	DEC	AZ	ELV	X	Y	RANGE	DAY	HRS	MIN	SEC	RA	DEC	AZ	ELV	X	Y	RANGE			
ACN-75 X-Y USP-30	1	11	54	6	7	9	39	19	12	-44	63	-20	19	205002	6	8	21	33	20	12	-61	49	-37	19	205574
CYI-04 X-Y USP-30	1	11	51	6	7	9	45	19	11	-132	66	-18	-15	204904	6	8	21	37	20	12	-109	54	-35	-11	205397
MAD-23 X-Y USP-85	1	11	52	6	7	9	49	19	11	-131	51	28	-29	205385	6	8	21	40	20	11	-112	40	24	-45	205951
GYP-14 X-Y USP-30	1	11	29	6	9	7	50	21	11	79	41	49	-7	205958	6	10	19	19	22	12	111	56	33	-12	205450
GDS-28 X-Y USP-85	1	11	27	6	9	7	52	21	11	101	34	16	54	206263	6	10	19	20	22	12	114	48	20	38	205735
MIL-71 X-Y USP-30	1	11	32	6	9	7	56	21	12	129	65	20	-15	205085	6	10	19	27	22	12	172	73	2	-16	205002
ANG-91 X-Y USP-30	1	11	29	6	9	7	60	21	12	179	95	0	-5	204764	6	10	19	28	22	12	-104	73	-17	-4	205014
BCA-02 X-Y USP-30	1	11	29	6	9	8	2	21	11	172	69	3	-21	204993	6	10	19	31	22	12	-144	66	-15	-19	205160
ACN-75 X-Y USP-30	1	11	28	6	9	8	9	20	12	-58	38	-50	17	206058	6	10	19	37	21	13	-73	22	-67	16	206991
CYI-04 X-Y USP-30	1	11	28	6	9	8	13	20	12	-101	43	-46	-8	205920	6	10	19	41	21	12	-91	29	-61	-1	206643
MAD-23 X-Y USP-85	1	11	25	6	9	8	14	20	11	-103	31	20	-56	206388	6	10	19	39	21	12	-90	19	1	-71	207176
HAW-12 X-Y USP-30	0	53	59	6	9	25	15	22	12	78	0	90	12	207336	6	10	19	14	23	12	82	12	78	8	207570
HAW-12 X-Y USP-30	1	11	49	6	11	5	54	23	12	96	23	67	4	207026	6	12	17	43	23	13	91	39	51	-1	206288

VEHICLE 1 RACAR TABLE

	TRACKING TIME			STATION ACQUISITION DATA									STATION TERMINATION DATA												
	HRS	MIN	SEC	DAY	HRS	MIN	SEC	RA	DEC	AZ	ELV	X	Y	RANGE	DAY	HRS	MIN	SEC	RA	DEC	AZ	ELV	X	Y	RANGE
GYM-14 X-Y USR-30	1	11	54	6	11	5	59	22	12	125	65	21	-14	205244	6	12	17	53	23	13	167	74	4	-15	205150
GDS-28 X-Y USR-95	1	11	54	6	11	6	2	22	12	127	56	22	26	205465	6	12	17	55	23	12	156	65	23	10	205329
MIL-71 X-Y USB-30	1	11	52	6	11	6	7	22	12	-149	71	-10	-16	205098	6	12	17	59	22	13	-117	60	-27	-13	205473
ANG-51 X-Y USR-30	1	11	53	6	11	6	10	21	12	-96	62	-28	-3	205325	6	12	18	3	22	13	-89	45	-45	1	206014
PCA-02 X-Y USE-30	1	11	51	6	11	6	10	21	12	-125	59	-27	-17	205411	6	12	18	1	22	12	-107	46	-43	-11	205989
ACN-75 X-Y USR-30	C	47	55	6	11	6	15	21	12	-76	11	-79	14	207676	6	11	54	11	22	13	-77	0	-90	13	207284
NAC-23 X-Y USE-85	C	58	19	6	11	6	18	21	12	-83	10	-35	-78	207735	6	12	4	37	22	12	-74	0	-90	-74	207738
CYI-64 X-Y USR-30	1	11	50	6	11	6	16	21	12	-86	18	-72	4	207252	6	12	18	8	22	12	-78	4	-86	12	208237
HAW-12 X-Y USB-30	1	11	31	6	13	4	17	23	13	97	50	40	-4	205880	6	14	15	48	24	13	107	65	24	-7	205464
GDS-28 X-Y USB-85	1	11	32	6	13	4	27	23	12	-175	67	23	-2	205327	6	14	15	59	24	13	-137	62	22	-19	205567
GYM-14 X-Y USR-30	1	11	30	6	13	4	28	23	13	-152	73	-8	-15	205211	6	14	15	58	23	13	-117	62	-25	-12	205559
MIL-71 X-Y USR-30	1	11	30	6	13	4	25	22	12	-106	50	-38	-10	205828	6	14	16	5	23	13	-95	36	-54	-4	206569
ANG-51 X-Y USR-30	1	11	32	6	13	4	28	22	13	-86	34	-56	3	206553	6	14	16	10	23	13	-81	18	-72	8	207532

1111

VEHICLE 1 RADAR TABLE

	TRACKING TIME			STATION ACQUISITION DATA										STATION TERMINATION DATA													
	HRS	MIN	SEC	DAY	HRS	MIN	SEC	RA	DEC	AZ	ELV	X	Y	RANGE	DAY	HRS	MIN	SEC	RA	DEC	AZ	ELV	X	Y	RANGE		
BDA-02 X-Y USB-30	1	11	29	6	13	4	40	22	12	-88	36	-54	-7	206450	6	14	16	9	23	13	-88	22	-68	2	207303		
GWM-24 X-Y USB-30	0	53	35	6	13	22	2	24	13	77	0	30	13	207616	6	14	15	38	25	13	79	12	78	11	207841		
HSK-25 X-Y USB-85	C	15	50	6	13	55	43	24	14	73	0	-90	73	207731	6	14	15	33	25	14	71	3	-81	70	208378		
PSK-25 X-Y USB-85	C	11	41	6	15	2	12	24	14	63	12	-65	61	207936	6	15	13	53	24	14	61	14	-63	58	207226		
GWM-24 X-Y USB-30	C	11	39	6	15	2	14	25	13	81	23	66	8	207277	6	15	13	53	25	13	82	26	64	7	206539		
HAW-12 X-Y USB-30	C	11	28	6	15	2	25	24	13	126	75	12	-9	205328	6	15	13	53	24	13	133	77	9	-9	204718		
GDS-28 X-Y USB-85	C	11	20	6	15	2	33	23	13	-121	54	20	-30	205854	6	15	13	53	23	13	-118	52	20	-33	205351		
GVM-14 X-Y USB-30	0	11	19	6	15	2	34	23	13	-106	52	-37	-10	205924	6	15	13	53	23	13	-104	50	-35	-9	205439		
MIL-71 X-Y USB-30	0	11	13	6	15	2	40	23	13	-89	26	-54	1	207140	6	15	13	53	23	13	-88	23	-67	2	206702		
BDA-02 X-Y USB-30	0	11	12	6	15	2	41	23	13	-82	12	-78	7	207906	6	15	13	53	23	13	-81	10	-80	9	207472		
ANG-91 X-Y USB-30	C	11	11	6	15	2	42	23	13	-78	7	-33	11	208212	6	15	13	53	23	13	-78	4	-86	12	207797		
LOPC? TO TEI																											
ANG-91 X-Y USB-30	0	19	28	6	15	14	9	23	13	-78	4	-86	12	207788	6	15	33	36	23	13	-76	0	-90	14	207380		
BDA-02 X-Y USB-30	C	51	32	6	15	14	9	23	13	-81	10	-30	9	207462	6	16	5	41	24	13	-74	0	-90	16	208272		

1-45

VEHICLE 1 RADAR TABLE

	TRACKING TIME			STATION ACQUISITION DATA										STATION TERMINATION DATA											
	HRS	MIN	SEC	DAY	HRS	MIN	SEC	RA	DEC	AZ	ELV	X	Y	RANGE	DAY	HRS	MIN	SEC	RA	DEC	AZ	ELV	X	Y	RANGE
HSK-25 X-Y USR-85	0	59	48	6	15	14	9	24	14	61	14	-63	58	207211	6	16	13	56	25	14	51	23	-56	45	207364
GMM-24 X-Y USR-30	0	59	54	6	15	14	9	25	13	82	26	64	7	206523	6	16	14	2	25	14	83	40	50	5	206515
HAW-12 X-Y USR-30	1	0	9	6	15	14	9	24	13	134	77	9	-9	204705	6	16	14	18	25	14	-151	80	-5	-8	205364
GYM-14 X-Y USR-30	1	0	18	6	15	14	9	23	13	-103	50	-40	-9	205429	6	16	14	26	24	13	-94	37	-52	-3	206656
GDS-28 X-Y USR-85	1	0	20	6	15	14	9	23	13	-118	52	20	-33	205340	6	16	14	29	24	13	-104	41	16	-47	206473
MIL-71 X-Y USR-30	1	0	22	6	15	14	9	23	13	-87	23	-67	2	206652	6	16	14	31	24	13	-81	11	-75	9	208093
CRO-C8 X-Y USR-30	0	2	4	6	16	11	48	24	14	74	0	90	16	208599	6	16	13	52	26	14	74	0	90	16	208676
CRO-C8 X-Y USR-30	1	11	24	6	17	0	36	26	14	65	11	79	21	209148	6	18	12	1	26	15	59	24	62	28	207446
HSK-25 X-Y USR-85	1	11	23	6	17	0	42	25	14	40	30	-53	34	207063	6	18	12	5	26	15	22	37	-51	18	206805
PARKS AUSTRALIA	1	11	24	6	17	0	43	25	14	42	31	48	39	206983	6	18	12	7	26	15	24	35	27	45	206705
GMM-24 X-Y USR-30	1	11	23	6	17	0	47	25	14	85	51	38	3	206059	6	18	12	11	26	14	85	66	22	2	205691
HAW-12 X-Y USR-30	1	11	27	6	17	1	2	24	14	-115	72	-17	-8	205516	6	18	12	29	25	14	-98	57	-33	-4	206013
GDS-28 X-Y USR-85	1	11	26	6	17	1	11	24	13	-96	32	10	-58	206944	6	18	12	38	25	14	-86	18	-12	-71	207802

VEHICLE 1 RADAR TABLE

	TRACKING TIME			STATION ACQUISITION DATA								STATION TERMINATION DATA													
	HPS	MIN	SEC	DAY	HRS	MIN	SEC	RA	DEC	AZ	ELV	X	Y	RANGE	DAY	HRS	MIN	SEC	RA	DEC	AZ	ELV	X	Y	RANGE
GYM-14 X-Y USB-30	1	11	23	6	17	1	13	24	13	-89	27	-63	1	207207	6	18	12	37	25	14	-81	12	-78	9	208153
MIL-71 X-Y USB-30	0	3	28	6	17	1	14	24	13	-75	1	-89	15	208710	6	17	4	42	24	13	-75	C	-90	15	208579
CRO-08 X-Y USB-30	1	11	48	6	18	58	43	26	15	51	33	50	32	207063	6	20	10	32	27	15	34	43	31	37	206675
PARKS AUSTRALIA	1	11	49	6	18	58	45	26	15	9	42	10	47	206645	6	20	10	37	27	15	-13	41	-15	48	206783
HSK-25 X-Y USB-85	1	11	47	6	18	58	50	26	15	8	39	-51	6	206756	6	20	10	37	27	15	-13	38	-51	-10	206904
GWM-24 X-Y USB-30	1	11	49	6	18	59	52	26	14	84	80	10	1	205567	6	20	10	41	27	15	-77	83	-6	1	205631
HAW-17 X-Y USB-30	1	11	48	6	18	59	6	25	14	-83	46	-44	-2	206461	6	20	10	53	26	14	-86	30	-60	4	207312
GYM-14 X-Y USB-30	0	9	57	6	18	59	10	25	14	-76	2	-88	14	208793	6	19	9	7	25	14	-74	C	-90	16	208407
GDS-28 X-Y USB-95	0	48	27	6	18	59	12	25	14	-80	9	-50	-76	208350	6	19	47	39	26	14	-73	C	-90	-73	207893
CRO-C9 X-Y USB-30	1	11	25	6	20	57	12	27	15	19	48	15	39	206524	6	22	8	37	28	16	-6	45	-5	41	206560
HSK-25 X-Y USB-85	1	11	25	6	20	57	19	26	15	-27	35	-52	-22	207105	6	22	8	44	27	16	-43	26	-56	-38	207635
PARKS AUSTRALIA	1	1	30	6	20	57	20	26	15	-27	37	-31	45	206980	6	21	58	50	27	16	-42	30	-45	40	206911
GWM-24 X-Y USB-30	1	11	28	6	20	57	24	26	15	-84	72	-18	2	205812	6	22	8	52	27	15	-83	55	-34	4	206351

VEHICLE 1 RADAR TABLE

	TRACKING TIME			STATION ACQUISITION DATA								STATION TERMINATION DATA													
	HRS	MIN	SEC	DAY	HRS	MIN	SEC	RA	DEC	AZ	ELV	X	Y	RANGE	DAY	HRS	MIN	SEC	RA	DEC	AZ	ELV	X	Y	RANGE
HAW-12 X-Y USB-30	1	11	27	6	20	57	37	26	14	-82	19	-71	8	207921	6	22	9	4	27	15	-76	4	-86	14	208937
CRD-08 X-Y USB-30	1	11	49	6	22	55	20	27	16	-23	47	-20	39	206730	7	0	7	0	28	16	-42	38	-41	36	207219
GMM-24 X-Y USB-30	1	11	48	6	22	55	22	27	15	-82	44	-46	6	206837	7	0	7	20	28	15	-79	28	-62	9	207741
MAD-23 X-Y USB-85	1	10	56	6	22	56	5	28	14	71	0	-90	71	209191	7	0	7	1	30	15	81	13	-35	75	208563
FSK-25 X-Y USB-85	1	9	55	6	22	57	16	27	16	-53	19	-60	-49	208010	7	0	7	11	28	16	-64	7	-74	-63	208899
CYI-04 X-Y USB-30	0	2	31	7	0	4	29	30	15	73	0	90	17	209184	7	0	6	60	20	15	73	1	89	17	209285
ACN-75 X-Y USB-30	1	11	20	7	0	53	22	30	16	74	3	87	16	209189	7	2	4	52	31	16	70	19	70	19	208336
CYI-04 X-Y USB-30	1	11	25	7	0	53	27	30	15	78	11	79	11	208737	7	2	5	1	31	16	85	26	64	4	207969
MAD-23 X-Y USB-85	1	11	22	7	0	53	43	29	15	89	22	-4	68	208100	7	2	5	6	30	15	99	35	13	54	207500
CRD-08 X-Y USB-30	1	11	26	7	0	53	52	28	16	-52	30	-54	32	207438	7	2	5	18	29	16	-62	17	-71	26	208472
GMM-24 X-Y USB-30	1	11	26	7	0	54	4	28	15	-78	16	-73	12	208381	7	2	5	31	29	16	-74	0	-90	16	209447
ACN-75 X-Y USB-30	1	11	49	7	2	51	31	31	16	66	30	58	20	207829	7	4	3	19	31	17	57	44	41	23	207208
CYI-04 X-Y USB-30	1	11	47	7	2	51	37	30	16	90	36	54	0	207507	7	4	3	24	31	16	99	51	38	-6	206939

148

VEHICLE 1 RADAR TABLE

	TRACKING TIME			STATION ACQUISITION DATA										STATION TERMINATION DATA													
	HRS	MIN	SEC	DAY	HRS	MIN	SEC	RA	DEC	AZ	ELV	X	Y	RANGE	DAY	HRS	MIN	SEC	RA	DEC	AZ	ELV	X	Y	RANGE		
MAD-23 X-Y USB-R5	1	11	47	7	2	51	42	30	15	109	43	19	43	207168	7	4	3	29	31	16	127	55	22	27	206798		
CRO-09 X-Y USB-30	0	34	23	7	2	52	1	29	16	-68	7	-82	22	209063	7	3	26	23	29	17	-72	0	-90	18	208238		
BDA-02 X-Y USB-30	0	46	12	7	3	17	12	31	15	72	0	90	18	208376	7	4	3	24	32	16	77	9	81	13	209073		
ANG-91 X-Y USB-30	0	35	54	7	3	27	27	31	15	73	0	90	17	208242	7	4	3	21	32	16	75	8	82	14	209137		
ANG-91 X-Y USB-30	1	11	25	7	4	50	3	32	16	78	19	71	11	208553	7	6	1	27	33	17	81	35	55	7	207786		
MIL-71 X-Y USB-30	1	11	23	7	4	50	5	32	16	74	4	85	16	209396	7	6	1	28	33	16	81	19	71	8	208623		
BCA-02 X-Y USB-30	1	11	25	7	4	50	6	32	16	83	19	71	7	208556	7	6	1	30	33	16	91	33	57	-1	207868		
ACN-75 X-Y USB-30	1	11	26	7	4	50	7	31	17	47	54	28	24	206896	7	6	1	33	32	17	21	63	10	25	206702		
CYI-C4 X-Y USB-30	1	11	27	7	4	50	12	31	16	108	62	27	-9	206648	7	6	1	35	32	17	135	75	11	-11	206457		
MAD-23 X-Y USB-R5	1	11	29	7	4	50	15	31	16	145	62	24	16	206642	7	6	1	44	32	16	-178	66	24	-1	206637		
TEI TO FI																											
ANG-91 X-Y USB-30	9	26	29	7	6	37	7	32	17	83	44	46	5	207922	7	16	3	37	31	16	-73	0	-90	17	193478		
GYM-14 X-Y USB-30	12	57	22	7	6	37	8	33	16	72	1	89	18	210225	7	19	34	29	31	15	-72	0	-90	18	187233		
MIL-71 X-Y USB-30	10	57	46	7	6	37	8	32	16	85	27	63	4	208721	7	17	34	54	31	16	-72	0	-90	18	190800		

VEHICLE 1 RADAR TABLE

	TRACKING TIME			STATION ACQUISITION DATA										STATION TERMINATION DATA											
	HRS	MIN	SEC	DAY	HRS	MIN	SEC	RA	DEC	AZ	ELV	X	Y	RANGE	DAY	HRS	MIN	SEC	RA	DEC	AZ	ELV	X	Y	RANGE
BDA-02 X-Y USP-30	9	59	21	7	6	37	9	32	16	96	41	49	-5	208035	7	16	36	30	31	16	-72	0	-90	18	192524
ACN-75 X-Y USP-30	5	47	16	7	6	27	13	32	17	1	65	0	25	207183	7	12	24	29	31	16	-73	0	-90	17	199818
CYI-04 X-Y USP-30	6	36	30	7	6	37	15	32	17	171	79	2	-11	206930	7	13	13	45	31	16	-72	0	-90	18	198404
MAD-23 X-Y USB-85	6	11	29	7	6	37	17	32	16	-158	64	24	-9	207155	7	12	48	46	31	16	-69	0	-90	-69	199128
GDS-28 X-Y USB-85	13	25	57	7	6	44	29	32	16	70	0	-90	70	210073	7	20	10	37	31	15	-71	0	-90	-71	186158
HAW-12 X-Y USP-30	12	46	51	7	9	56	2	32	16	73	0	90	17	204132	7	22	42	53	32	15	-73	0	-90	17	181493
GWN-24 X-Y USB-30	12	25	20	7	13	49	58	33	16	74	0	90	15	197365	8	2	15	18	32	16	-74	0	-90	16	174766
MSK-25 X-Y USB-85	10	17	6	7	14	37	43	33	17	69	0	-90	69	195981	8	0	54	49	32	16	-70	0	-90	-70	177343
CRC-08 X-Y USB-30	10	51	54	7	16	42	5	33	17	72	0	90	18	192336	8	3	33	58	32	16	-72	0	-90	18	172200
PARKS AUSTRALIA	4	37	29	7	17	30	30	33	17	39	30	49	42	189199	7	22	7	59	32	17	-40	30	-48	42	180851
MAD-29 X-Y USP-85	12	43	9	7	23	9	20	33	15	70	0	-90	70	180672	8	12	52	25	34	15	-71	0	-90	-71	152719
CYI-04 X-Y USB-30	13	2	7	8	0	16	29	34	15	73	0	90	17	178563	8	13	18	36	34	15	-72	0	-90	17	151742
ACN-75 X-Y USB-30	11	37	11	8	0	54	19	34	16	74	0	90	16	177360	8	12	31	31	33	16	-74	0	-90	16	153490

VEHICLE 1 RADAP TABLE

	TRACKING TIME			STATION ACQUISITION DATA										STATION TERMINATION DATA											
	HRS	MIN	SFC	DAY	HRS	MIN	SEC	RA	DEC	AZ	ELV	X	Y	RANGE	DAY	HRS	MIN	SEC	RA	DEC	AZ	ELV	X	Y	RANGE
BDA-02 X-Y USR-30	13	15	11	8	3	27	26	34	15	72	0	90	18	172420	8	16	42	37	34	15	-73	0	-90	17	143916
ANG-01 X-Y USP-30	12	34	27	8	3	36	29	34	15	74	0	90	16	172122	8	16	10	56	34	15	-74	0	-90	16	145157
MIL-71 X-Y USB-30	13	3	57	8	4	37	50	34	15	73	0	90	17	170095	8	17	41	47	34	15	-73	0	-90	17	141569
GYN-14 X-Y USP-30	13	2	18	8	6	30	52	35	15	73	0	90	17	165983	8	19	42	9	35	14	-74	0	-90	16	136680
GDS-28 X-Y USB-85	13	24	0	8	6	53	36	35	15	72	0	-90	72	165513	8	20	17	37	35	14	-72	0	-90	-72	135209
HAW-12 X-Y USP-30	12	46	53	8	10	5	28	35	15	74	0	90	16	158807	8	22	52	21	35	14	-74	0	-90	16	128614
GMM-24 X-Y USP-30	12	26	10	8	14	1	2	36	15	75	0	90	15	150146	9	2	27	22	36	14	-75	0	-90	15	118937
FSK-25 X-Y USP-85	10	23	44	8	14	46	2	35	16	70	0	-90	70	148431	9	1	9	46	36	16	-70	0	-90	-70	122499
CRG-08 X-Y USR-30	10	58	18	8	16	51	35	37	16	72	0	90	18	143558	9	3	49	53	37	15	-73	0	-90	17	115042
PARKS AUSTRALIA	4	45	56	8	17	37	41	36	16	41	30	48	41	140014	8	22	23	37	36	16	-41	30	-49	41	128144
MAD-23 X-Y USR-85	13	38	34	8	23	28	55	38	14	72	0	-90	72	127015	9	13	7	29	40	12	-74	0	-90	-74	85434
CYI-04 X-Y USR-30	13	2	14	9	0	35	5	39	14	74	0	90	16	124072	9	13	37	15	40	13	-76	0	-90	14	83643
ACN-75 X-Y USR-30	11	44	13	9	1	10	19	39	15	75	0	90	15	122477	9	12	54	32	40	14	-76	0	-90	14	86198

VEHICLE 1 RADAR TABLE

	TRACKING TIME			STATION ACQUISITION DATA								STATION TERMINATION DATA													
	HRS	MIN	SEC	DAY	HRS	MIN	SEC	RA	DEC	AZ	ELV	X	Y	RANGE	DAY	HRS	MIN	SEC	RA	DEC	AZ	ELV	X	Y	RANGE
BDA-02 X-Y USB-30	13	15	7	9	3	49	32	40	14	74	0	90	16	115064	9	17	4	39	43	12	-76	0	-90	14	70410
ANG-01 X-Y USB-30	12	39	7	9	3	56	49	40	14	75	0	90	15	114714	9	16	35	57	42	12	-77	0	-90	13	72333
MIL-71 X-Y USB-30	13	6	6	9	5	0	37	40	14	74	0	90	16	111626	9	18	6	43	43	12	-77	0	-90	13	66129
GYM-14 X-Y USB-30	13	6	52	9	7	4	56	41	14	75	0	90	15	105404	9	20	11	48	45	11	-78	0	-90	12	56932
GDS-28 X-Y USB-85	13	25	24	9	7	20	13	41	13	74	0	-90	74	104619	9	20	45	37	46	10	-78	0	-90	-78	54291
HAW-12 X-Y USB-30	13	2	42	9	10	34	40	43	13	76	0	90	14	94222	9	23	37	22	50	9	-80	0	-90	10	35497
CWM-24 X-Y USB-30	13	43	43	9	14	36	57	46	13	77	0	90	13	79985	10	4	20	40	138	-76	-175	0	-90	-85	2061
MSK-25 X-Y USB-85	13	7	15	9	15	17	3	46	15	71	0	-90	71	77458	10	4	24	18	-148	43	33	0	-90	33	1196
CRO-C8 X-Y USB-30	10	51	13	9	17	30	1	48	14	74	0	90	16	68675	10	4	21	13	-145	7	82	0	90	8	1936
PARKS AUSTRALIA	5	22	11	9	18	12	4	49	15	43	30	50	39	64046	9	23	34	14	52	14	-45	30	-51	28	38102
CRO-C8 AZ-EL FP06	2	31	17	10	1	49	56	60	13	-42	42	-36	34	23400	10	4	21	13	-145	7	82	0	90	8	1936

TABLE 1.1-V.- MISSION RADAR TIMELINE - Continued

(b) LM acquisition and termination - 0° minimum elevation

	Signal acquisition, g.e.t., day:hr:min:sec	Signal loss, g.e.t., day:hr:min:sec	Coverage duration, g.e.t., hr:min:sec	Maximum elevation, deg	Minimum range, n. mi.	Acquisition range, n. mi.
Insertion	5:22:11:47.7					
RDR 23 CRO-08 X-Y USB-30	5:22:11:47.7	5:22:30:56.8	0:19:09.1	51.8	203 625.76	203 625.76
RDR 29 HSK-25 X-Y USB-85	5:22:11:47.7	5:22:31:04.0	0:19:16.2	23.2	204 960.83	204 960.83
RDR 31 Parks Australia	5:22:11:47.7	5:22:31:05.2	0:19:17.5	25.0	204 863.16	204 863.16
RDR 24 GWM-24 X-Y USB-30	5:22:11:47.7	5:22:31:12.4	0:19:24.7	43.1	203 978.19	203 978.19
CSI	5:23:01:25.3					
RDR 28 MAD-23 X-Y USB-85	5:23:19:34.2	6:00:28:21.2	1:08:47.0	21.6	205 295.72	206 911.59
RDR 23 CRO-08 X-Y USB-30	5:23:19:41.2	6:00:28:34.0	1:08:52.9	42.4	204 162.98	205 121.28
RDR 31 Parks Australia	5:23:19:46.6	6:00:23:02.2	1:03:15.7	12.3	205 840.71	206 695.21
RDR 29 HSK-25 X-Y USB-85	5:23:19:46.7	6:00:17:26.7	0:57:40.0	10.9	205 915.98	206 777.68
RDR 24 GWM-24 X-Y USB-30	5:23:20:00.7	6:00:28:42.6	1:08:41.9	26.5	205 074.39	205 883.93
RDR 21 CYI-04 X-Y USB-30	5:23:30:29.1	6:00:28:18.3	0:57:49.1	12.2	205 896.37	206 880.70
Plane change	5:23:30:37.6					
RDR 22 ACN-75 X-Y USB-30	5:23:51:54.8	6:00:28:10.0	0:36:15.2	8.3	206 151.51	206 213.89
CDH	5:23:59:49.9					
TPI	6:00:38:56.1					
MC-1	6:00:53:56.1					
MC-2	6:01:08:56.1					
RDR 22 ACN-75 X-Y USB-30	6:01:14:37.6	6:02:25:18.3	1:10:44.7	27.7	204 743.4	206 465.5
RDR 21 CYI-04 X-Y USB-30	6:01:14:44.8	6:02:25:25.6	1:10:40.8	30.0	204 619.6	206 302.3
RDR 28 MAD-23 X-Y USB-85	6:01:14:49.4	6:02:25:30.4	1:10:41.1	36.6	204 294.5	205 881.8
RDR 23 CRO-08 X-Y USB-30	6:01:15:02.5	6:02:25:41.5	1:10:39.0	13.2	205 550.8	206 404.2
First braking gate	6:01:17:44.5					
Second braking gate	6:01:20:15.0					
Third braking gate	6:01:21:28.3					
Fourth braking gate	6:01:23:06.7					
Fifth braking gate	6:01:24:26.3					
Docking	6:01:40:00.0					

TABLE 1.1-V.- MISSION RADAR TIMELINE - Continued
(c) CSM acquisition and termination - 5° minimum elevation

VEHICLE	1	RADAR TABLE			STATION ACQUISITION DATA									STATION TERMINATION DATA												
		TRACKING TIME			DAY	HRS	MIN	SEC	RA	DEC	AZ	ELV	X	Y	RANGE	DAY	HRS	MIN	SEC	RA	DEC	AZ	ELV	X	Y	RANGE
		HRS	MIN	SEC																						
INSERT SHIP1		0	2	60	0	0	11	53	145	57	-32	14	-65	55	356	0	0	14	53	-7	27	63	5	84	27	600
CYI-04 X-Y USB-30		0	4	58	0	0	17	42	-165	17	-74	5	-85	16	597	0	0	22	40	3	-18	114	5	85	-23	594
CRO-08 X-Y USB-30		0	2	54	0	0	53	48	-45	-47	-141	5	-82	-51	588	0	0	56	42	-177	-52	146	5	81	-56	587
CRO-08 AZ-EL FPQ6		0	2	54	0	0	53	48	-45	-48	-141	5	-82	-51	588	0	0	56	42	-177	-52	146	5	81	-56	587
WSK-25 X-Y USB-85		0	3	22	0	1	0	59	35	19	-62	5	-79	-61	583	0	1	4	21	141	43	26	5	-84	26	582
GVM-14 X-Y USB-30		0	4	55	0	1	29	27	141	-24	-121	5	-84	-31	594	0	1	34	21	-57	13	78	5	85	12	599
MIL-71 X-Y USB-30		0	4	36	0	1	36	17	148	19	-71	5	-85	19	600	0	1	40	53	-17	27	62	5	84	28	601
MLA-71 AZ-EL TPQ18		0	4	35	0	1	36	18	148	19	-71	5	-85	19	600	0	1	40	53	-17	27	62	5	84	28	601
CRV-31 AZ-EL FPS16		0	4	36	0	1	36	19	148	19	-71	5	-85	19	600	0	1	40	55	-17	27	62	5	84	28	601
BDA-02 X-Y USB-30		0	5	1	0	1	39	39	171	7	-85	5	-85	5	601	0	1	44	40	-16	-2	95	5	85	-5	600
BDA-02 AZ-EL FPQ6		0	5	1	0	1	39	39	171	7	-85	5	-85	5	601	0	1	44	40	-16	-2	95	5	85	-5	600
INSERT SHIP1		0	4	54	0	1	43	21	178	25	-64	5	-84	26	601	0	1	48	15	2	0	92	5	85	-2	597
CYI-04 X-Y USB-30		0	1	37	0	1	52	1	-112	-32	-130	5	-83	-40	593	0	1	53	38	-68	-55	-169	5	-66	-78	590

VEHICLE 1 RADAR TABLE

TRACKING TIME			STATION ACQUISITION DATA										STATION TERMINATION DATA													
HRS	MIN	SEC	DAY	HRS	MIN	SEC	RA	DEC	AZ	ELV	X	Y	RANGE	DAY	HRS	MIN	SEC	RA	DEC	AZ	ELV	X	Y	RANGE		
CRC-08 X-Y USB-30	0	3	43	0	2	26	45	-22	-48	-141	5	-82	-51	586	0	2	30	28	-171	-29	120	5	84	-30	585	
CRC-08 AZ-EL FPQ6	0	3	42	0	2	26	45	-22	-48	-141	5	-82	-51	586	0	2	30	27	-171	-29	120	5	84	-30	585	
TLI CUTOFF TO NFR MANEUVER																										
HAW-12 X-Y USB-30	0	6	7	0	2	52	44	-134	-39	146	17	61	-53	512	0	2	58	50	-85	15	75	5	85	15	2098	
GCS-28 X-Y USB-85	12	36	49	0	2	56	9	157	-19	-117	5	79	-62	1520	0	15	34	58	-28	1	-92	5	24	-85	74158	
GYM-14 X-Y USB-30	12	13	51	0	2	56	34	149	-2	-95	5	-85	-5	1609	0	15	10	25	-29	1	-91	5	-85	-1	72616	
MIL-71 X-Y USB-30	10	3	46	0	3	0	41	174	10	-21	5	-85	9	2503	0	13	4	27	-30	2	-90	5	-85	0	64318	
MLA-71 AZ-EL TPQ18	2	36	23	0	3	0	41	174	10	-21	5	-85	9	2505	0	5	37	5	-41	10	139	66	16	-18	23400	
BDA-02 X-Y USB-30	9	53	14	0	3	3	11	-170	10	-92	5	-85	8	3059	0	11	56	25	-32	3	-90	5	-85	0	59527	
BDA-02 AZ-EL FPQ5	2	33	60	0	3	3	12	-170	10	-82	5	-85	8	3059	0	5	37	11	-43	9	-174	67	-3	-23	23400	
ANG-91 X-Y USB-30	8	37	54	0	3	4	45	-169	26	-64	5	-84	26	3399	0	11	42	39	-32	4	-88	5	-85	2	58527	
INSERT SHIPI	2	30	5	0	3	6	31	-156	16	-74	5	-85	16	3783	0	5	36	36	-46	10	-130	64	-21	-17	23400	
CYI-04 X-Y USB-30	5	2	51	0	3	17	8	-121	18	-72	5	-85	18	5979	0	8	19	58	-38	5	-87	5	-85	3	42304	
MAD-23 X-Y USB-85	4	8	37	0	3	21	3	-108	12	-78	5	-67	-77	6747	0	7	29	40	-40	5	-88	5	-26	-84	37703	

VEHICLE 1 RADAR TABLE

VEHICLE	TRACKING TIME			STATION ACQUISITION DATA										STATION TERMINATION DATA													
	HRS	MIN	SEC	DAY	HRS	MIN	SEC	RA	DEC	AZ	ELV	X	Y	RANGE	DAY	HRS	MIN	SEC	RA	DEC	AZ	ELV	X	Y	RANGE		
ACN-75 X-Y USB-30	4	25	35	0	3	28	56	-102	33	-56	5	-84	34	8216	0	7	54	31	-40	9	-81	5	-85	9	40011		
HAW-12 X-Y USB-30	11	55	48	0	6	37	59	-33	8	84	5	85	6	32631	0	18	33	46	-26	1	-91	5	-85	-1	84764		
GWM-24 X-Y USB-30	11	30	8	0	10	52	58	-27	4	87	5	85	3	54626	0	22	23	7	-24	0	-91	5	-85	-1	97039		
HSK-25 X-Y USB-85	10	54	28	0	11	2	45	-27	7	78	5	-68	77	55565	0	21	57	13	-24	2	-84	5	-50	-82	95716		
PARKS AUSTRALIA	6	42	39	0	13	10	32	-26	5	60	30	56	26	63333	0	19	53	11	-25	2	-64	30	-57	22	87757		
CRO-08 X-Y USB-30	11	9	19	0	13	18	13	-25	5	82	5	85	8	65289	1	0	27	33	-23	1	-87	5	-85	3	103191		
MAD-23 X-Y USB-85	5	32	43	0	21	20	0	-21	-1	95	5	45	83	93790	1	2	52	44	-21	-2	-180	48	42	0	107753		
ACN-75 X-Y USB-30	4	56	51	0	21	55	53	-21	1	98	5	85	2	95648	1	2	52	44	-21	0	53	77	11	8	106982		
CYI-04 X-Y USB-30	4	49	49	0	22	2	54	-21	0	93	5	85	-3	96009	1	2	52	44	-21	-1	157	59	13	-28	107375		
ANG-91 X-Y USB-30	1	43	2	1	1	9	42	-20	-1	92	5	85	-2	105205	1	2	52	44	-19	-1	101	29	60	-10	108619		
BCA-02 X-Y USB-30	1	27	12	1	1	25	32	-20	-1	94	5	85	-4	105552	1	2	52	44	-20	-1	107	23	66	-16	108960		
MIL-71 X-Y USB-30	0	22	56	1	2	29	47	-19	-1	94	5	85	-4	108939	1	2	52	44	-19	-1	97	10	80	-7	109694		
TRANSLUNAR COAST TO LOII																											
MAD-23 X-Y USB-95	5	25	52	1	2	52	53	-21	-2	-180	48	42	0	107760	1	8	18	45	-21	-2	-97	5	55	-81	123781		

VEHICLE 1 RADAR TABLE

	TPACKING TIME			STATION ACQUISITION DATA										STATION TERMINATION DATA											
	HRS	MIN	SEC	DAY	HRS	MIN	SEC	RA	DEC	AZ	ELV	X	Y	RANGE	DAY	HRS	MIN	SEC	RA	DEC	AZ	ELV	X	Y	RANGE
CYI-04 X-Y USB-30	6	18	43	1	2	52	53	-21	-1	157	59	13	-28	107382	1	9	11	36	-21	-2	-95	5	-85	-5	125870
ACN-75 X-Y USB-30	6	20	8	1	2	52	53	-21	0	53	77	10	8	106989	1	9	13	1	-21	-1	-90	5	-85	0	125927
ANG-91 X-Y USB-30	9	28	39	1	2	52	53	-19	-1	101	29	60	-10	108624	1	12	21	32	-20	-2	-94	5	-85	-4	133076
BDA-02 X-Y USB-30	9	34	30	1	2	52	53	-20	-1	107	23	66	-16	108966	1	12	27	23	-20	-2	-96	5	-85	-6	133290
MIL-71 X-Y USB-30	10	41	0	1	2	52	53	-19	-1	87	10	80	-7	109699	1	13	23	53	-20	-3	-96	5	-85	-6	135704
GYM-14 X-Y USB-30	11	3	2	1	4	32	8	-19	-1	94	5	85	-4	114370	1	15	35	10	-19	-3	-96	5	-85	-6	139975
GDS-28 X-Y USB-85	10	55	42	1	5	0	18	-19	-2	96	5	48	82	115582	1	15	55	59	-19	-3	-97	5	55	-81	140692
HAW-12 X-Y USB-30	11	5	27	1	7	49	23	-18	-2	94	5	85	-4	122604	1	18	54	49	-19	-3	-95	5	-85	-5	146663
HSK-25 X-Y USB-85	11	15	39	1	11	14	24	-18	-1	87	5	-29	84	130588	1	22	30	13	-18	-2	-89	5	-13	-85	153435
GWM-24 X-Y USB-30	11	9	27	1	11	32	25	-17	-2	93	5	85	-3	131257	1	22	41	53	-18	-3	-94	5	-85	-4	153789
PARKS AUSTRALIA	7	12	47	1	13	18	21	-17	-1	69	30	58	18	133733	1	20	21	9	-18	-2	-71	30	-59	17	148332
CRO-09 X-Y USB-30	11	18	37	1	13	34	37	-17	-1	89	5	85	1	135721	2	0	53	14	-17	-2	-90	5	-85	0	157698
MAD-23 X-Y USB-85	10	36	53	1	21	47	54	-15	-4	59	5	61	80	152138	2	8	24	48	-16	-4	-100	5	63	-79	170048

VEHICLE 1 RADAR TABLE

	TRACKING TIME			STATION ACQUISITION DATA								STATION TERMINATION DATA													
	HRS	MIN	SEC	DAY	HRS	MIN	SEC	RA	DEC	AZ	ELV	X	Y	RANGE	DAY	HRS	MIN	SEC	RA	DEC	AZ	ELV	X	Y	RANGE
ACN-75 X-Y USB-30	11	17	29	1	22	10	15	-15	-3	92	5	85	-2	152825	2	9	27	44	-16	-3	-93	5	-85	-3	171648
CYT-04 X-Y USB-30	10	54	14	1	22	25	55	-16	-3	96	5	85	-6	153204	2	9	20	10	-16	-4	-97	5	-85	-7	171456
ANG-91 X-Y USB-30	11	3	26	2	1	27	16	-15	-3	95	5	85	-5	158685	2	12	30	42	-16	-4	-96	5	-85	-6	176137
BCA-02 X-Y USB-30	10	47	18	2	1	46	30	-15	-4	98	5	85	-8	159229	2	12	23	48	-16	-4	-99	5	-85	-8	175210
MIL-71 X-Y USB-30	10	51	43	2	2	49	56	-15	-4	97	5	85	-7	161016	2	13	40	39	-16	-4	-98	5	-85	-8	177792
GYM-14 X-Y USB-30	10	51	36	2	4	49	44	-15	-4	97	5	85	-7	164266	2	15	41	21	-16	-5	-98	5	-85	-8	180576
GDS-29 X-Y USB-85	10	41	21	2	5	19	20	-15	-4	99	5	59	80	165168	2	16	0	41	-15	-5	-99	5	62	-79	181013
HAW-12 X-Y USB-30	10	57	0	2	8	3	55	-14	-4	96	5	85	-6	169512	2	19	0	55	-15	-5	-97	5	-85	-7	184981
MSK-25 X-Y USB-85	11	26	47	2	11	17	10	-14	-3	90	5	3	85	174261	2	22	43	58	-15	-4	-91	5	15	-85	189684
GMM-24 X-Y USB-30	11	4	16	2	11	43	49	-14	-4	95	5	85	-5	175008	2	22	48	5	-15	-5	-96	5	-85	-6	189743
PARKS AUSTRALIA	7	25	27	2	13	20	20	-14	-3	73	30	59	15	175901	2	20	45	47	-15	-4	-74	30	-59	14	185832
CRO-08 X-Y USB-30	11	24	59	2	13	39	7	-14	-4	92	5	85	-2	177758	3	1	4	6	-15	-4	-92	5	-85	-2	192444
MAD-23 X-Y USB-85	10	22	6	2	22	0	39	-13	-5	101	5	66	78	198796	3	8	22	45	-14	-6	-102	5	68	-77	200674

VEHICLE 1 RADAR TABLE

	TRACKING TIME			STATION ACQUISITION DATA										STATION TERMINATION DATA												
	HRS	MIN	SEC	DAY	HRS	MIN	SEC	RA	DEC	AZ	ELV	X	Y	RANGE	DAY	HRS	MIN	SEC	RA	DEC	AZ	ELV	X	Y	RANGE	
ACN-75 X-Y USB-30	11	17	2	2	22	15	44	-13	-4	94	5	85	-4	189103	3	9	32	46	-14	-6	-95	5	-85	-5	201970	
CYI-04 X-Y USB-30	10	43	52	2	22	36	5	-13	-5	98	5	85	-8	189485	3	9	19	57	-14	-6	-100	5	-85	-10	201729	
ANG-91 X-Y USB-30	9	40	41	3	1	34	59	-13	-5	97	5	85	-7	193044	3	11	15	40	-15	-6	-105	22	-67	-14	202693	
BCA-02 X-Y USB-30	9	18	55	3	1	56	48	-13	-5	100	5	85	-10	193503	3	11	15	43	-14	-7	-112	20	-69	-21	202823	
MIL-71 X-Y USB-30	8	17	25	3	2	58	16	-13	-5	99	5	85	-9	194674	3	11	15	41	-14	-7	-122	34	-51	-26	202073	
GYM-14 X-Y USB-30	6	17	11	3	4	58	26	-13	-6	99	5	85	-9	196935	3	11	15	37	-14	-7	-156	53	-17	-34	201279	
GCS-28 X-Y USB-85	5	46	40	3	5	29	57	-13	-6	101	5	65	78	197503	3	11	15	37	-14	-7	-168	47	42	-8	201485	
HAW-12 X-Y USB-30	3	4	42	3	8	10	46	-12	-6	98	5	85	-8	200486	3	11	15	28	-13	-7	126	45	39	-24	201567	
MSK-25 X-Y USB-85	0	3	51	3	11	11	22	-13	-6	93	5	33	84	203669	3	11	15	12	-13	-6	93	6	25	84	203651	
COAST IN 60 x 170 TO LC12																										
MSK-25 X-Y USB-85	1	24	26	3	11	47	37	-13	-6	88	13	-9	77	202578	3	13	12	3	-12	-5	75	28	-26	58	201877	
GWM-24 X-Y USB-30	1	24	30	3	11	47	42	-13	-7	98	5	85	-8	203008	3	13	12	12	-12	-6	103	25	65	-12	202079	
HAW-12 X-Y USB-30	1	24	33	3	11	47	53	-13	-7	135	51	30	-26	200657	3	13	12	26	-13	-6	167	61	7	-28	200536	
GDS-28 X-Y USB-85	1	24	32	3	11	48	4	-14	-7	-156	45	43	-17	200889	3	13	12	36	-13	-6	-133	36	43	-37	201531	

VEHICLE 1 RACAR TABLE

TRACKING TIME			STATION ACQUISITION DATA										STATION TERMINATION DATA													
HRS	MIN	SEC	DAY	HRS	MIN	SEC	RA	DEC	AZ	ELV	X	Y	RANGE	DAY	HRS	MIN	SEC	RA	DEC	AZ	ELV	X	Y	RANGE		
GVM-14 X-Y USB-30	1	24	32	3	11	48	5	-14	-7	-144	49	-27	-32	200733	3	13	12	37	-13	-6	-122	36	-49	-26	201517	
MIL-71 X-Y USB-30	1	24	29	3	11	48	9	-14	-7	-116	28	-60	-23	201710	3	13	12	38	-13	-6	-103	11	-78	-13	202861	
ANG-91 X-Y USB-30	0	43	27	3	11	48	11	-15	-7	-102	15	-75	-11	202437	3	12	31	38	-14	-6	-98	5	-85	-8	201629	
BDA-02 X-Y USB-30	0	43	45	3	11	48	13	-15	-7	-107	13	-76	-17	202509	3	12	31	59	-14	-6	-101	5	-85	-11	201632	
CRD-08 X-Y USB-30	1	24	24	3	13	55	49	-12	-5	92	9	81	-2	202950	3	15	20	13	-11	-5	82	27	63	7	202123	
PARKS AUSTRALIA	1	24	24	3	13	55	52	-12	-5	69	37	51	17	201382	3	15	20	16	-11	-5	48	52	31	24	200982	
MSK-25 X-Y USB-85	1	24	26	3	13	55	52	-12	-5	66	37	-28	47	201402	3	15	20	18	-11	-5	45	50	-30	27	201034	
GVM-24 X-Y USB-30	1	24	27	3	13	55	57	-12	-6	107	35	54	-14	201489	3	15	20	24	-11	-5	119	54	33	-17	200912	
HAW-12 X-Y USB-30	1	24	28	3	13	56	11	-13	-6	-170	61	-5	-28	200452	3	15	20	38	-12	-5	-135	53	-28	-25	200943	
GVM-14 X-Y USB-30	1	24	26	3	13	56	19	-13	-6	-114	27	-60	-22	201865	3	15	20	45	-12	-6	-102	11	-79	-12	203031	
GDS-28 X-Y USB-85	1	24	26	3	13	56	20	-13	-6	-123	28	45	-48	201805	3	15	20	46	-12	-6	-108	14	50	-68	202845	
LPO COAST TO LM SEPARATION																										
CRD-08 X-Y USB-30	1	11	35	3	16	4	47	-11	-5	77	37	52	11	201544	3	17	16	22	-10	-4	63	51	36	16	200958	
MSK-25 X-Y USB-85	1	11	37	3	16	4	54	-11	-5	29	56	-31	16	200758	3	17	16	30	-11	-4	-3	58	-32	-1	200710	

VEHICLE 1 RACAR TABLE

	TRACKING TIME			STATION ACQUISITION DATA								STATION TERMINATION DATA													
	HRS	MIN	SEC	DAY	HRS	MIN	SEC	RA	DEC	AZ	ELV	X	Y	RANGE	DAY	HRS	MIN	SEC	RA	DEC	AZ	ELV	X	Y	RANGE
PARKS AUSTRALIA	1	11	37	3	16	4	55	-11	-5	32	58	18	27	200694	3	17	16	32	-11	-4	-2	61	-1	29	200633
GWM-24 X-Y USB-30	1	11	38	3	16	5	0	-11	-5	132	63	21	-18	200548	3	17	16	39	-11	-5	171	72	3	-18	200390
HAW-12 X-Y USB-30	1	11	38	3	16	5	16	-12	-6	-123	45	-40	-23	201160	3	17	16	55	-11	-5	-111	31	-57	-18	201880
GCS-28 X-Y USB-85	0	0	29	3	16	5	21	-12	-6	-101	5	64	-78	203261	3	16	5	49	-12	-6	-101	5	65	-78	203243
CRO-08 X-Y USB-30	1	11	58	3	18	2	54	-10	-4	50	60	24	19	200767	3	19	14	52	-10	-4	14	68	6	21	200594
MSK-25 X-Y USB-85	1	11	55	3	18	3	2	-11	-4	-24	56	-31	-13	200886	3	19	14	57	-10	-3	-48	47	-32	-30	201254
PARKS AUSTRALIA	1	11	55	3	18	3	2	-11	-4	-25	59	-14	28	200803	3	19	14	57	-10	-4	-50	49	-33	25	201169
GWM-24 X-Y USB-30	1	11	54	3	18	3	13	-11	-5	-153	70	-10	-18	200518	3	19	15	6	-10	-4	-122	58	-27	-16	200863
HAW-12 X-Y USB-30	1	11	44	3	18	3	29	-11	-5	-105	21	-69	-14	202503	3	19	15	14	-10	-4	-97	5	-85	-7	203465
CRO-08 X-Y USB-30	1	11	41	3	20	1	30	-10	-4	-18	68	-7	21	200685	3	21	13	11	-9	-3	-50	58	-25	20	200990
PARKS AUSTRALIA	0	59	20	3	20	1	36	-10	-4	-62	41	-45	21	201588	3	21	0	56	-9	-3	-72	30	-59	15	201536
MSK-25 X-Y USB-85	1	11	39	3	20	1	36	-10	-4	-61	39	-31	-42	201668	3	21	13	15	-9	-3	-74	26	-30	-59	202386
GWM-24 X-Y USB-30	1	11	47	3	20	1	42	-10	-4	-112	48	-40	-15	201294	3	21	13	30	-9	-4	-103	32	-57	-11	202077

19-1

VEHICLE 1 RADAR TABLE

	TRACKING TIME			STATION ACQUISITION DATA										STATION TERMINATION DATA											
	HRS	MIN	SEC	DAY	HRS	MIN	SEC	RA	DEC	AZ	ELV	X	Y	RANGE	DAY	HRS	MIN	SEC	RA	DEC	AZ	ELV	X	Y	RANGE
CRO-08 X-Y USB-30	1	11	46	3	21	59	48	-9	-3	-64	49	-38	17	201390	3	23	11	34	-8	-3	-75	34	-55	12	202106
HSK-25 X-Y USB-85	1	0	45	3	21	59	51	-9	-3	-81	17	-26	-71	202981	3	23	0	37	-8	-2	-89	5	-6	-85	203160
ENH-24 X-Y USB-30	1	11	6	3	22	0	4	-10	-4	-99	21	-69	-9	202734	3	23	11	10	-9	-3	-94	5	-85	-4	203721
MAD-23 X-Y USB-85	0	56	56	3	22	14	27	-8	-4	100	5	63	79	202955	3	23	11	23	-7	-4	109	15	49	66	203126
ACM-75 X-Y USB-30	0	36	3	3	22	35	9	-7	-3	93	5	85	-3	202395	3	23	11	12	-7	-3	91	13	77	-1	203228
CYI-04 X-Y USB-30	0	18	19	3	22	53	0	-7	-4	97	5	85	-7	202755	3	23	11	19	-7	-3	99	9	81	-9	203495
ACM-75 X-Y USB-30	1	11	40	3	23	57	49	-7	-3	90	25	65	0	202673	4	1	9	30	-6	-2	86	42	48	3	201870
CYI-04 X-Y USB-30	1	11	46	3	23	57	57	-7	-4	105	19	70	-14	202997	4	1	9	43	-6	-3	115	34	54	-20	202267
MAD-23 X-Y USB-85	1	11	50	3	23	57	50	-7	-4	118	23	47	54	202751	4	1	9	49	-6	-3	132	35	44	37	202223
CRO-08 X-Y USB-30	1	11	49	3	23	58	11	-8	-3	-81	24	-66	8	202718	4	1	10	0	-8	-2	-88	8	-82	2	203689
ACM-75 X-Y USB-30	1	11	48	4	1	56	4	-6	-2	83	54	36	4	201512	4	3	7	52	-5	-2	73	70	19	6	201086
ANG-91 X-Y USB-30	1	11	43	4	1	56	6	-6	-3	94	5	85	-4	203963	4	3	7	49	-5	-2	99	21	68	-9	203047
CYI-04 X-Y USB-30	1	11	47	4	1	56	13	-6	-3	125	43	42	-25	201934	4	3	8	1	-5	-2	144	54	23	-28	201533

VEHICLE 1 RADAR TABLE

	TRACKING TIME			STATION ACQUISITION DATA									STATION TERMINATION DATA												
	HRS	MIN	SEC	DAY	HRS	MIN	SEC	RA	DEC	AZ	ELV	X	Y	RANGE	DAY	HRS	MIN	SEC	RA	DEC	AZ	ELV	X	Y	RANGE
MAD-23 X-Y USB-85	1	11	43	4	1	56	19	-6	-3	145	40	44	26	202027	4	3	8	2	-6	-3	168	46	43	8	201831
BCA-02 X-Y USB-30	0	53	10	4	2	14	44	-6	-3	97	5	85	-7	203060	4	3	7	54	-5	-2	103	16	74	-13	203371
ANG-91 X-Y USB-30	1	11	51	4	3	54	26	-5	-2	104	32	57	-12	202556	4	5	6	17	-4	-2	113	48	39	-15	201887
MIL-71 X-Y USB-30	1	11	51	4	3	54	26	-5	-2	100	13	77	-10	203633	4	5	6	17	-4	-2	109	28	61	-17	202849
BCA-02 X-Y USB-30	1	11	53	4	3	54	30	-5	-3	111	25	63	-19	202929	4	5	6	23	-4	-2	124	39	46	-26	202312
ACN-75 X-Y USB-30	1	11	56	4	3	54	33	-6	-2	49	81	7	6	201017	4	5	6	29	-5	-1	-58	78	-10	7	201115
CYI-04 X-Y USB-30	1	11	54	4	3	54	37	-6	-2	164	59	9	-20	201461	4	5	6	31	-5	-2	-162	59	-10	-29	201516
MAD-23 X-Y USB-85	1	10	5	4	3	54	42	-6	-3	-175	47	43	-3	201883	4	5	4	47	-5	-2	-151	44	43	-20	201998
GYM-14 X-Y USB-30	1	11	42	4	5	52	43	-4	-2	99	12	78	-8	203818	4	7	4	25	-3	-1	107	27	62	-15	203020
GCS-24 X-Y USB-85	1	11	39	4	5	52	46	-4	-2	97	5	49	81	204183	4	7	4	25	-3	-1	107	20	39	64	203415
MIL-71 X-Y USB-30	1	11	43	4	5	52	47	-4	-2	117	37	50	-21	202457	4	7	4	31	-3	-1	133	50	31	-26	201959
ANG-91 X-Y USB-30	1	11	42	4	5	52	50	-4	-2	124	58	27	-17	201617	4	7	4	32	-4	-1	154	70	9	-18	201371
BDA-02 X-Y USB-30	1	11	40	4	5	52	54	-4	-2	136	46	34	-30	202052	4	7	4	33	-4	-1	160	55	14	-33	201794

/1-63

VEHICLE 1 RADAR TABLE

	TRACKING TIME			STATION ACQUISITION DATA										STATION TERMINATION DATA											
	HRS	MIN	SEC	DAY	HRS	MIN	SEC	RA	DEC	AZ	ELV	X	Y	RANGE	DAY	HRS	MIN	SEC	RA	DEC	AZ	ELV	X	Y	RANGE
ACN-75 X-Y USB-30	1	11	38	4	5	52	59	-5	-1	-75	67	-22	6	201376	4	7	4	37	-4	-1	-82	50	-40	5	201961
CVI-04 X-Y USB-30	1	11	39	4	5	53	4	-5	-2	-142	54	-24	-28	201739	4	7	4	44	-4	-1	-122	43	-42	-23	202240
MAD-23 X-Y USB-85	1	11	43	4	5	53	6	-5	-2	-137	38	43	-32	202392	4	7	4	48	-4	-1	-120	28	43	-50	202957
GYM-14 X-Y USB-30	1	12	3	4	7	50	59	-3	-1	115	37	51	-20	202620	4	9	3	1	-2	-1	131	50	33	-25	202114
GDS-28 X-Y USB-85	1	12	1	4	7	50	59	-3	-1	115	29	38	53	203018	4	9	2	59	-2	-1	130	41	36	35	202482
MIL-71 X-Y USB-30	1	12	1	4	7	51	5	-4	-1	150	56	18	-29	201811	4	9	3	6	-3	-1	-178	61	-1	-29	201751
ANG-91 X-Y USB-30	1	12	1	4	7	51	7	-4	-1	-170	71	-3	-18	201418	4	9	3	8	-3	-1	-129	63	-21	-16	201684
BDA-02 X-Y USB-30	1	12	3	4	7	51	7	-4	-1	-180	56	0	-34	201814	4	9	3	10	-3	-1	-150	53	-21	-31	202006
ACN-75 X-Y USB-30	1	11	59	4	7	51	11	-4	-1	-85	38	-51	4	202528	4	9	3	11	-4	0	-87	21	-69	3	203488
CVI-04 X-Y USB-30	1	12	1	4	7	51	16	-4	-1	-113	34	-54	-19	202737	4	9	3	16	-3	-1	-102	20	-70	-11	203579
MAD-23 X-Y USB-85	1	11	57	4	7	51	19	-4	-2	-111	20	44	-61	203457	4	9	3	16	-3	-1	-98	8	45	-78	204254
HAN-12 X-Y USB-30	0	22	60	4	8	39	52	-2	-1	93	5	85	-3	203302	4	9	2	52	-2	-1	95	10	80	-5	204109
HAN-12 X-Y USB-30	1	11	37	4	9	49	18	-2	-1	100	21	69	-9	203573	4	11	0	56	-1	0	108	37	52	-14	202805

1-64

VEHICLE 1 RADAR TABLE

TRACKING TIME

STATION ACQUISITION DATA

STATION TERMINATION DATA

			STATION ACQUISITION DATA											STATION TERMINATION DATA											
			DAY	HPS	MIN	SEC	RA	DEC	AZ	ELV	X	Y	RANGE	DAY	HRS	MIN	SEC	RA	DEC	AZ	ELV	X	Y	RANGE	
HPS	MIN	SEC																							
GDS-28 X-Y USB-85	1	11	38	4	9	49	28	-2	-1	144	48	36	24	202266	4	11	1	6	-2	0	169	54	36	6	202092
GYM-14 X-Y USB-30	1	11	39	4	9	49	28	-2	-1	147	57	20	-27	201933	4	11	1	7	-2	0	180	62	0	-28	201842
MIL-71 X-Y USB-30	1	11	41	4	9	49	34	-3	-1	-155	58	-15	-29	201883	4	11	1	16	-2	0	-130	49	-34	-25	202272
ANG-91 X-Y USB-30	1	11	37	4	9	40	40	-3	-1	-116	54	-34	-15	202031	4	11	1	15	-2	0	-104	38	-51	-11	202737
BDA-02 X-Y USB-30	1	11	39	4	9	49	41	-3	-1	-124	47	-34	-29	202289	4	11	1	20	-2	0	-117	35	-51	-22	202882
ACN-75 X-Y USB-30	0	19	44	4	9	49	43	-4	0	-89	10	-80	1	204200	4	10	9	27	-3	0	-89	5	-85	1	203535
CVI-04 X-Y USB-30	0	21	20	4	9	49	46	-4	-1	-96	9	-90	-6	204212	4	10	11	6	-3	-1	-93	5	-85	-3	203475
HAW-12 X-Y USB-30	0	40	22	4	11	47	28	-1	0	116	47	40	-17	202448	4	12	27	49	-1	0	125	55	30	-19	200887
GYM-14 X-Y USB-30	0	40	11	4	11	47	39	-2	0	-156	60	-13	-28	201981	4	12	27	49	-1	0	-140	55	-24	-26	200860
GDS-28 X-Y USB-85	0	40	11	4	11	47	39	-2	0	-171	54	36	-5	202166	4	12	27	49	-1	0	-155	52	35	-15	200982
MIL-71 X-Y USB-30	0	40	4	4	11	47	45	-2	0	-118	40	-46	-21	202702	4	12	27	49	-2	0	-111	33	-55	-17	201806
BDA-02 X-Y USB-30	0	40	4	4	11	47	45	-2	0	-109	26	-63	-17	203414	4	12	27	49	-2	0	-102	19	-71	-12	202580
ANG-91 X-Y USB-30	0	40	2	4	11	47	48	-3	0	-99	27	-62	-8	203352	4	12	27	49	-2	0	-96	18	-72	-5	202593

1-65

VEHICLE 1 RADAR TABLE

VEHICLE	TRACKING TIME			STATION ACQUISITION DATA								STATION TERMINATION DATA													
	HRS	MIN	SEC	DAY	HRS	MIN	SEC	RA	DEC	AZ	ELV	X	Y	RANGE	DAY	HRS	MIN	SEC	RA	DEC	AZ	ELV	X	Y	RANGE
MSK-25 X-Y USB-85	0	13	27	4	12	14	22	-1	1	85	5	-43	83	203467	4	12	27	49	0	1	83	7	-41	80	203232
GWN-24 X-Y USB-30	0	1	37	4	12	26	13	0	0	91	5	85	-1	203363	4	12	27	49	0	0	91	5	85	-1	203355
LPO COAST TC LOPCI																									
MSK-25 X-Y USB-85	0	30	56	4	12	28	5	0	1	83	7	-41	80	203233	4	12	59	2	0	1	79	13	-40	73	204193
GWN-24 X-Y USB-30	0	30	59	4	12	28	5	0	0	91	5	85	-1	203355	4	12	59	4	0	1	92	13	77	-2	204227
NAN-12 X-Y USB-30	0	31	12	4	12	28	5	-1	0	125	55	30	-19	200888	4	12	59	17	0	0	134	60	22	-20	202022
GCS-28 X-Y USB-85	0	31	23	4	12	28	5	-1	0	-155	52	35	-15	200986	4	12	59	29	-1	0	-144	49	35	-23	202414
GWN-14 X-Y USB-30	0	31	24	4	12	28	5	-1	0	-140	55	-24	-26	200864	4	12	59	29	-1	0	-130	51	-32	-24	202345
MIL-71 X-Y USB-30	0	31	27	4	12	28	5	-2	0	-111	33	-55	-17	201812	4	12	59	32	-1	0	-106	27	-62	-14	203452
BGA-02 X-Y USB-30	0	31	29	4	12	28	5	-2	0	-102	19	-71	-12	202586	4	12	59	34	-2	0	-98	12	-77	-8	204262
ANG-91 X-Y USB-30	0	31	31	4	12	28	5	-2	0	-96	18	-72	-5	202599	4	12	59	36	-2	0	-93	11	-79	-3	204335
MSK-25 X-Y USB-85	1	11	44	4	13	45	30	0	1	71	23	-38	61	203766	4	14	57	22	1	2	57	35	-38	44	203169
GWN-24 X-Y USB-30	1	11	48	4	13	45	43	0	0	96	24	66	-5	203675	4	14	57	31	1	1	100	41	49	-8	202888
NAN-12 X-Y USB-30	1	11	53	4	13	45	54	-1	0	157	67	10	-22	201933	4	14	57	47	0	1	-158	67	-9	-21	201985
X-A 00000																									
CAH-10																									
X-A 00000																									
CAH-08																									

99-1

VEHICLE 1 RADAR TABLE

	TRACKING TIME			STATION ACQUISITION DATA										STATION TERMINATION DATA											
	HRS	MIN	SEC	DAY	HRS	MIN	SEC	RA	DEC	AZ	ELV	X	Y	RANGE	DAY	HRS	MIN	SEC	RA	DEC	AZ	ELV	X	Y	RANGE
GDS-28 X-Y USB-85	1	11	57	4	13	46	6	-1	0	-130	42	35	-35	202751	4	14	58	4	0	1	-114	31	34	-52	203392
GYM-14 X-Y USB-30	1	10	6	4	13	46	6	-1	0	-118	42	-44	-21	202761	4	14	56	13	0	1	-106	29	-60	-14	203407
MIL-71 X-Y USB-30	0	57	58	4	13	46	9	-2	0	-99	17	-73	-9	204071	4	14	44	7	-1	1	-92	5	-85	-2	204122
PARKS AUSTRALIA	0	31	47	4	14	25	36	0	2	66	30	58	21	202657	4	14	57	23	1	2	59	35	50	24	203128
CRO-09 X-Y USB-30	0	18	7	4	14	39	11	1	2	86	5	85	4	203890	4	14	57	18	1	2	84	9	81	6	204582
CRO-08 X-Y USB-30	1	11	40	4	15	43	54	1	2	79	19	70	11	204677	4	16	55	34	2	2	69	34	54	18	203336
MSK-25 X-Y USB-85	1	11	41	4	15	43	57	1	2	46	42	-38	32	202917	4	16	55	38	1	2	23	50	-38	15	202651
PARKS AUSTRALIA	1	11	41	4	15	43	59	1	2	48	44	38	29	202856	4	16	55	40	1	2	26	52	19	34	202572
GWM-24 X-Y USB-30	1	11	42	4	15	44	4	1	1	106	52	37	-10	202518	4	16	55	46	2	2	120	68	19	-11	202102
HAW-12 X-Y USB-30	1	11	38	4	15	44	23	0	1	-134	61	-22	-20	202207	4	16	56	1	1	1	-114	48	-39	-16	202726
GDS-28 X-Y USB-85	1	11	37	4	15	44	31	-1	1	-106	22	34	-63	203917	4	16	56	9	0	1	-95	9	28	-80	204776
GYM-14 X-Y USB-30	1	4	50	4	15	44	33	-1	1	-99	19	-72	-9	204117	4	16	49	23	0	1	-91	5	-85	-1	204626
CRO-08 X-Y USB-30	1	11	53	4	17	42	13	2	2	60	44	42	21	202585	4	18	54	6	2	3	40	55	24	26	202589

1-67

VEHICLE 1 RADAR TABLE

	TRACKING TIME			STATION ACQUISITION DATA							STATION TERMINATION DATA																
	HRS	MIN	SEC	DAY	HRS	MIN	SEC	RA	DEC	AZ	ELV	X	Y	RANGE	DAY	HRS	MIN	SEC	RA	DEC	AZ	ELV	X	Y	RANGE		
HSK-25 X-Y USB-85	1	11	58	4	17	42	19	1	2	5	52	-38	3	202651	4	18	54	17	2	3	-22	49	-39	-14	202820		
PARKS AUSTRALIA	1	11	50	4	17	42	19	1	2	6	55	4	35	202561	4	18	54	19	2	3	-22	52	-17	35	202722		
GWM-24 X-Y USB-30	1	11	59	4	17	42	25	1	2	148	75	7	-12	202C27	4	18	54	25	2	2	-137	75	-10	-11	202126		
HAW-12 X-Y USB-30	1	11	59	4	17	42	37	0	1	-106	39	-51	-13	203235	4	18	54	36	1	2	-97	23	-67	-7	204116		
CRD-08 X-Y USB-30	0	12	47	4	19	40	38	2	3	20	61	11	27	202501	4	19	53	25	2	3	14	62	7	27	201836		
HSK-25 X-Y USB-85	0	12	39	4	19	40	45	2	3	-28	44	-39	-26	203CE4	4	19	53	25	2	3	-42	43	-39	-29	202519		
PARKS AUSTRALIA	0	12	39	4	19	40	46	2	3	-39	47	-31	32	202584	4	19	53	25	2	3	-43	45	-34	31	202420		
GWM-24 X-Y USB-30	0	12	31	4	19	40	54	2	2	-115	65	-22	-10	202367	4	19	53	25	2	2	-112	63	-26	-10	201809		
HAW-12 X-Y USB-30	0	12	21	4	19	41	4	1	2	-93	12	-78	-3	204774	4	19	53	25	1	2	-92	9	-81	-2	204317		
LOPCI TO LM JETTISON																											
HAW-12 X-Y USB-30	0	17	51	4	19	53	45	1	2	-92	9	-81	-1	204305	4	20	11	36	2	2	-90	5	-85	0	203931		
CRD-08 X-Y USB-30	0	58	34	4	19	53	45	2	3	13	62	7	27	201819	4	20	52	19	3	3	-16	61	-9	28	202557		
PARKS AUSTRALIA	0	58	40	4	19	53	45	2	3	-43	45	-34	31	202405	4	20	52	25	3	3	-56	36	-49	27	203547		
HSK-25 X-Y USB-85	0	58	41	4	19	53	45	2	3	-42	43	-39	-29	202505	4	20	52	26	3	3	-55	34	-40	-43	203643		

1-68

VEHICLE 1 RADAR TABLE

	TRACKING TIME			STATION ACQUISITION DATA								STATION TERMINATION DATA													
	HRS	MIN	SEC	DAY	HRS	MIN	SEC	RA	DEC	AZ	ELV	X	Y	RANGE	DAY	HRS	MIN	SEC	RA	DEC	AZ	ELV	X	Y	RANGE
GWM-24 X-Y USB-30	0	58	52	4	19	53	45	2	2	-112	63	-26	-10	201794	4	20	52	37	3	3	-102	50	-40	-8	202945
CRO-08 X-Y USB-30	1	11	47	4	21	38	59	3	3	-37	56	-22	27	202792	4	22	50	46	4	4	-56	44	-41	23	203308
MSK-25 X-Y USB-85	1	11	43	4	21	39	5	2	3	-65	25	-41	-55	204150	4	22	50	48	3	4	-76	12	-48	-72	204983
GWM-24 X-Y USB-30	1	11	40	4	21	39	18	2	3	-97	38	-51	-6	203488	4	22	50	58	3	3	-92	22	-68	-2	204422
MAD-23 X-Y USB-85	0	13	43	4	22	36	56	5	3	91	5	8	85	204663	4	22	50	39	5	3	93	8	20	82	205235
ACN-75 X-Y USB-30	1	11	33	4	23	37	9	5	3	85	8	82	5	205272	5	0	48	42	6	4	82	25	65	7	204366
CYI-04 X-Y USB-30	1	11	33	4	23	37	19	5	3	91	8	82	-1	205275	5	0	48	52	6	3	99	23	66	-8	204457
MAD-23 X-Y USB-85	1	11	35	4	23	37	22	5	3	101	16	32	70	204790	5	0	48	56	6	3	113	29	35	53	204151
CRO-08 X-Y USB-30	1	11	39	4	23	37	31	3	4	-66	35	-53	20	203800	5	0	49	10	4	4	-75	20	-70	14	204672
GWM-24 X-Y USB-30	0	23	23	4	23	37	41	3	3	-39	10	-80	1	205125	5	0	1	5	3	3	-88	5	-85	2	204370
ACN-75 X-Y USB-30	1	11	51	5	1	35	16	6	4	79	37	53	9	203883	5	2	47	6	7	5	71	53	36	11	203239
CYI-04 X-Y USB-30	1	11	46	5	1	35	25	6	3	106	34	55	-13	204016	5	2	47	11	7	4	118	48	38	-18	203422
MAD-23 X-Y USB-85	1	11	42	5	1	35	34	6	3	124	37	36	42	203838	5	2	47	16	6	4	142	47	36	25	203459

169

VEHICLE 1 RACAP TABLE

	TRACKING TIME			STATION ACQUISITION DATA								STATION TERMINATION DATA													
	HRS	MIN	SEC	DAY	HRS	MIN	SEC	RA	DEC	AZ	ELV	X	Y	RANGE	DAY	HRS	MIN	SEC	RA	DEC	AZ	ELV	X	Y	RANGE
CRO-08 X-Y USB-30	0	20	18	5	1	35	47	4	4	-81	9	-80	9	205332	5	1	56	5	4	4	-83	5	-85	7	204622
ANG-91 X-Y USB-30	0	13	6	5	2	33	59	7	4	87	5	85	3	204969	5	2	47	5	7	4	88	8	82	2	205484
BDA-02 X-Y USB-30	0	3	49	5	2	43	21	7	4	89	5	85	1	205469	5	2	47	10	7	4	89	6	84	1	205622
ANG-91 X-Y USB-30	1	11	36	5	3	33	47	7	4	92	19	71	-2	204914	5	4	45	22	8	5	97	36	54	-5	204101
ACN-75 X-Y USB-30	1	11	41	5	3	33	49	6	5	82	64	24	12	202980	5	4	45	30	7	5	24	76	6	13	202801
BDA-02 X-Y USB-30	1	11	39	5	3	33	49	7	4	95	16	74	-5	205118	5	4	45	28	8	4	105	30	59	-13	204384
CYI-04 X-Y USB-30	1	11	47	5	3	33	54	6	4	131	57	26	-21	203182	5	4	45	41	7	5	162	66	8	-23	203001
MAD-23 X-Y USB-85	1	11	41	5	3	34	1	6	4	159	52	37	13	203355	5	4	45	42	7	4	-172	54	36	-4	203361
MIL-71 X-Y USB-30	0	57	6	5	3	48	17	7	4	88	5	85	2	205024	5	4	45	24	8	5	94	17	73	-4	205096
ANG-91 X-Y USB-30	1	11	40	5	5	32	4	8	5	102	47	42	-8	203690	5	6	43	44	8	5	113	63	25	-10	203209
MIL-71 X-Y USB-30	1	11	40	5	5	32	5	8	4	100	27	62	-9	204614	5	6	43	45	9	5	111	42	46	-15	203955
BDA-02 X-Y USB-30	1	11	36	5	5	32	11	8	4	114	40	48	-18	204002	5	6	43	47	8	5	131	52	30	-23	203547
ACN-75 X-Y USB-30	1	11	36	5	5	32	12	7	5	-25	76	-6	13	202874	5	6	43	51	8	6	-60	63	-24	13	203210

VEHICLE 1 RACAR TABLE

	TRACKING TIME			STATION ACQUISITION DATA										STATION TERMINATION DATA											
	HRS	MIN	SEC	DAY	HRS	MIN	SEC	RA	DEC	AZ	ELV	X	Y	RANGE	DAY	HRS	MIN	SEC	RA	DEC	AZ	ELV	X	Y	RANGE
CYI-04 X-Y USB-30	1	11	37	5	5	32	19	7	4	-168	65	-5	-23	203049	5	6	43	56	8	5	-133	59	-23	-21	203325
MAD-23 X-Y USB-85	1	11	36	5	5	32	24	7	4	-153	51	36	-16	203515	5	6	43	60	8	5	-131	43	35	-33	203909
GYM-14 X-Y USB-30	0	52	31	5	5	51	9	8	4	88	5	85	2	204565	5	6	43	40	9	5	93	16	74	-3	205293
GCS-28 X-Y USB-85	0	28	13	5	6	15	31	8	5	88	5	-24	85	204885	5	6	43	44	9	5	91	11	8	79	205619
GYM-14 X-Y USB-30	1	11	45	5	7	30	21	9	5	99	27	63	-8	204798	5	8	42	6	10	6	109	42	47	-14	204126
GCS-28 X-Y USB-85	1	11	47	5	7	30	21	9	5	99	20	22	68	205146	5	8	42	9	10	5	110	34	27	51	204478
WIL-71 X-Y USB-30	1	11	53	5	7	30	24	8	5	122	51	34	-19	203650	5	8	42	16	9	6	145	63	16	-22	203356
ANG-91 X-Y USB-30	1	11	53	5	7	30	26	8	5	131	73	13	-11	203065	5	8	42	19	9	6	-159	78	-4	-11	203066
BCA-02 X-Y USB-30	1	11	53	5	7	30	28	8	5	148	59	18	-26	203398	5	8	42	20	9	6	-177	63	-1	-27	203357
ACN-75 X-Y USB-30	1	11	54	5	7	30	32	7	6	-70	52	-36	12	203611	5	8	42	27	8	6	-76	36	-53	11	204406
CYI-04 X-Y USB-30	1	11	57	5	7	30	37	7	5	-119	51	-36	-18	203672	5	8	42	34	8	6	-105	37	-52	-12	204371
MAD-23 X-Y USB-85	1	11	54	5	7	30	39	7	5	-119	36	34	-45	204303	5	8	42	33	8	5	-104	24	29	-62	205013
HAW-12 X-Y USB-30	1	11	34	5	9	28	37	10	6	87	9	81	2	205959	5	10	40	11	11	6	93	25	65	-3	205105

VEHICLE 1 RADAR TABLE

	TRACKING TIME			STATION ACQUISITION DATA										STATION TERMINATION DATA											
	HRS	MIN	SEC	DAY	HRS	MIN	SEC	RA	DEC	AZ	ELV	X	Y	RANGE	DAY	HRS	MIN	SEC	PA	DEC	AZ	ELV	X	Y	RANGE
GYM-14 X-Y USB-30	1	11	34	5	9	28	45	9	6	119	51	35	-18	203804	5	10	40	19	10	6	142	63	17	-21	203487
GDS-28 X-Y USB-85	1	11	34	5	9	28	45	9	5	120	43	28	40	204140	5	10	40	19	10	6	139	54	29	22	203768
MIL-71 X-Y USB-30	1	11	34	5	9	28	52	9	6	172	67	3	-23	203318	5	10	40	27	10	6	-147	64	-15	-22	203473
ANG-91 X-Y USB-30	1	11	33	5	9	28	55	9	6	-124	71	-16	-11	203237	5	10	40	28	9	6	-104	56	-33	-8	203721
BDA-02 X-Y USB-30	1	11	33	5	9	28	57	9	5	-153	60	-15	-26	203483	5	10	40	30	10	6	-126	51	-33	-22	203873
ACN-75 X-Y USB-30	1	11	29	5	9	29	3	8	6	-80	24	-65	9	205033	5	10	40	32	9	7	-82	8	-82	8	206087
MAD-23 X-Y USB-85	0	50	47	5	9	29	6	8	5	-96	15	22	-73	205538	5	10	28	53	9	6	-87	5	-34	-84	205631
CYI-04 X-Y USB-30	1	11	31	5	9	29	7	8	5	-98	27	-63	-7	204918	5	10	40	38	9	6	-89	12	-78	1	205852
HAW-12 X-Y USB-30	1	11	58	5	11	26	50	11	6	99	35	54	-7	204628	5	12	28	47	12	7	108	51	37	-11	204026
GYM-14 X-Y USB-30	1	11	55	5	11	27	0	10	6	168	68	5	-22	203446	5	12	38	56	11	7	-148	65	-14	-21	203589
GDS-28 X-Y USB-85	1	11	55	5	11	27	1	10	6	159	59	29	11	203675	5	12	38	56	11	7	-167	61	29	-6	203720
MIL-71 X-Y USB-30	1	11	55	5	11	27	6	10	6	-127	57	-28	-20	203745	5	12	39	2	10	7	-110	44	-45	-14	204338
ANG-91 X-Y USB-30	1	11	55	5	11	27	10	9	6	-98	44	-45	-6	204201	5	12	39	4	10	7	-91	28	-62	-1	205080

VEHICLE 1 RADAR TABLE

	TRACKING TIME			STATION ACQUISITION DATA										STATION TERMINATION DATA											
	HRS	MIN	SEC	DAY	HRS	MIN	SEC	RA	DEC	AZ	ELV	X	Y	RANGE	DAY	HRS	MIN	SEC	RA	DEC	AZ	ELV	X	Y	RANGE
BDA-02 X-Y USB-30	1	11	55	5	11	27	11	9	6	-115	43	-45	-18	204279	5	12	39	6	10	7	-102	29	-60	-10	205034
HSK-25 X-Y USB-85	1	11	32	5	13	25	3	12	7	76	6	-66	75	206390	5	14	36	35	13	8	65	19	-51	59	205699
GWM-24 X-Y USB-30	1	11	31	5	13	25	10	12	7	85	10	80	5	206159	5	14	36	40	13	7	88	27	63	1	205275
HAW-12 X-Y USB-30	1	11	36	5	13	25	18	11	7	110	61	26	-13	203751	5	14	36	54	12	7	152	73	8	-15	203552
GDS-28 X-Y USB-85	1	11	36	5	13	25	32	11	6	-145	56	29	-18	203885	5	14	37	8	11	7	-122	47	27	-35	204339
GYM-14 X-Y USB-30	1	11	34	5	13	25	33	11	7	-128	58	-26	-19	203828	5	14	37	7	11	7	-110	45	-43	-14	204401
MIL-71 X-Y USB-30	1	11	36	5	13	25	37	10	7	-102	34	-56	-10	204836	5	14	37	13	11	7	-92	19	-71	-2	205720
ARG-91 X-Y USB-30	0	53	55	5	13	25	40	10	7	-88	17	-73	2	205729	5	14	19	35	11	7	-84	5	-85	6	205629
BDA-02 X-Y USB-30	1	11	32	5	13	25	40	10	6	-95	19	-71	-4	205858	5	14	37	12	11	7	-85	5	-85	5	206525
HSK-25 X-Y USB-85	1	11	56	5	15	23	15	12	8	56	27	-47	47	205333	5	16	35	11	13	9	39	37	-46	30	204901
GWM-24 X-Y USB-30	1	11	54	5	15	23	20	13	7	91	38	52	-1	204784	5	16	35	14	13	8	95	55	35	-3	204173
HAW-12 X-Y USB-30	1	11	59	5	15	23	32	12	7	-165	75	-4	-15	203600	5	16	35	27	13	8	-122	65	-22	-13	203887
GDS-28 X-Y USB-85	1	11	55	5	15	23	39	11	7	-112	38	25	-47	204770	5	16	35	35	12	8	-99	25	18	-64	205538

VEHICLE 1 RACAR TABLE

	TRACKING TIME			STATION ACQUISITION DATA										STATION TERMINATION DATA											
	HRS	MIN	SEC	DAY	HRS	MIN	SEC	RA	DEC	AZ	ELV	X	Y	RANGE	DAY	HRS	MIN	SEC	RA	DEC	AZ	ELV	X	Y	RANGE
GYM-14 X-Y USB-30	1	11	54	5	15	23	40	11	7	-102	35	-54	-10	204910	5	15	25	34	12	8	-92	21	-69	-2	205788
MIL-71 X-Y USB-30	0	17	36	5	15	23	44	11	7	-87	9	-81	3	206365	5	15	41	19	11	7	-85	5	-85	5	205722
PARKS AUSTRALIA	1	1	6	5	15	34	3	13	8	55	30	55	29	204644	5	15	35	9	13	9	42	39	40	36	204826
CRO-08 X-Y USB-30	1	0	18	5	15	34	46	13	8	79	5	85	11	206023	5	16	25	4	14	8	72	17	72	17	205949
CRO-08 X-Y USB-30	1	11	31	5	17	21	42	14	8	65	27	60	22	205472	5	18	33	12	14	9	52	40	43	28	204892
MSK-25 X-Y USB-85	1	11	33	5	17	21	45	13	9	26	42	-45	19	204727	5	18	33	18	14	9	3	45	-45	2	204670
PARKS AUSTRALIA	1	11	33	5	17	21	46	13	9	28	44	25	39	204638	5	18	33	20	14	9	4	48	3	42	204566
GMM-24 X-Y USB-30	1	11	34	5	17	21	53	13	8	101	46	23	-4	203901	5	18	33	27	14	8	129	82	6	-5	203728
HAW-12 X-Y USB-30	1	11	34	5	17	22	9	12	8	-109	55	-34	-11	204222	5	18	33	42	13	8	-98	40	-50	-6	204936
GOS-28 X-Y USB-85	0	55	39	5	17	22	14	12	7	-92	15	7	-74	206105	5	18	17	53	13	8	-84	5	-50	-82	206000
GYM-14 X-Y USB-30	0	24	11	5	17	22	15	12	7	-87	10	-80	3	205417	5	17	46	26	12	8	-84	5	-85	6	205621
CRO-08 X-Y USB-30	1	11	57	5	19	19	48	14	9	40	48	30	31	204650	5	20	31	45	15	10	15	55	10	34	204469
PARKS AUSTRALIA	1	11	56	5	19	19	55	14	9	-14	47	-12	41	204678	5	20	31	51	15	10	-35	40	-34	38	205040

1-74

VEHICLE 1 RADAR TABLE

TRACKING TIME				STATION ACQUISITION DATA										STATION TERMINATION DATA												
HRS	MIN	SEC		DAY	HRS	MIN	SEC	RA	DEC	AZ	ELV	X	Y	RANGE	DAY	HRS	MIN	SEC	RA	DEC	AZ	ELV	X	Y	RANGE	
HSK-25	1	11	54		5	19	19	56	14	9	-14	44	-45	-10	204788	5	20	31	50	15	10	-35	38	-46	-27	205153
X-Y USB-85																										
GWM-24	1	11	57		5	19	20	1	14	9	-131	82	-6	-5	203800	5	20	31	58	15	9	-99	67	-23	-3	204127
X-Y USB-30																										
HAW-12	1	11	49		5	19	20	19	13	8	-93	29	-61	-2	205521	5	20	32	7	14	9	-86	13	-77	4	205496
X-Y USB-30																										
CRC-08	1	11	34		5	21	18	26	15	9	-6	55	-4	34	204459	5	22	29	60	16	10	-32	50	-24	33	204788
X-Y USB-30																										
PARKS AUSTRALIA	0	24	21		5	21	18	31	14	10	-48	34	-48	34	203402	5	21	42	52	15	10	-53	30	-54	32	204493
HSK-25	1	11	33		5	21	18	31	14	10	-47	32	-48	-30	205512	5	22	30	5	15	10	-61	20	-53	-55	206224
X-Y USB-85																										
GWM-24	1	11	41		5	21	18	37	14	9	-54	55	-35	-2	204498	5	22	30	17	15	9	-89	39	-51	1	205269
X-Y USB-30																										
MAD-23	1	11	48		5	23	15	30	17	9	85	8	-29	81	205564	5	0	28	18	18	9	96	22	15	68	206287
X-Y USB-85																										
CRC-08	1	11	46		5	23	15	41	15	10	-46	43	-38	30	205134	5	0	28	27	16	10	-60	30	-56	26	205837
X-Y USB-30																										
HSK-25	0	34	24		5	23	15	44	15	10	-69	11	-61	-65	205781	5	23	51	9	16	10	-74	5	-73	-73	205890
X-Y USB-85																										
GWM-24	1	11	39		5	23	16	60	15	9	-85	27	-63	3	205882	5	0	28	38	16	10	-82	11	-79	7	206917
X-Y USB-30																										
CYI-04	0	33	35		5	23	54	39	17	9	82	5	85	8	205904	5	0	28	14	18	10	95	12	78	4	206824
X-Y USB-30																										
ACN-75	0	14	4		5	0	14	4	18	10	70	5	85	11	206500	5	0	28	8	18	10	78	8	82	11	207045
X-Y USB-30																										

1-75

VEHICLE 1 RADAR TABLE

	TRACKING TIME			STATION ACQUISITION DATA									STATION TERMINATION DATA														
	HRS	MIN	SEC	DAY	HRS	MIN	SEC	RA	DEC	AZ	ELV	X	Y	RANGE	DAY	HRS	MIN	SEC	RA	DEC	AZ	ELV	X	Y	RANGE		
ACN-75 X-Y USB-30	1	11	36	6	1	14	47	18	10	76	20	70	13	206460	6	2	26	23	19	11	71	36	53	16	205678		
CYI-04 X-Y USB-30	1	11	39	6	1	14	51	18	10	91	23	67	-1	206259	6	2	26	31	18	10	99	38	52	-7	205587		
MAD-23 X-Y USB-85	1	11	39	6	1	14	59	17	9	105	30	23	57	205674	6	2	26	37	18	10	119	43	27	40	205363		
CRO-08 X-Y USB-30	1	11	43	6	1	15	9	16	10	-57	20	-68	21	205400	6	2	26	52	17	11	-75	6	-84	15	207372		
ACN-75 X-Y USB-30	0	8	28	6	3	12	59	18	11	65	47	41	17	205278	6	3	21	27	18	11	64	49	38	17	204771		
ANG-91 X-Y USB-30	0	8	26	6	3	13	0	19	10	91	6	84	9	207425	6	3	21	27	19	10	82	8	82	8	205878		
BCA-02 X-Y USB-30	0	8	23	6	3	13	3	19	10	82	5	85	8	207443	6	3	21	27	19	10	83	7	83	7	206912		
CYI-04 X-Y USB-30	0	8	19	6	3	13	8	18	10	107	49	41	-11	205217	6	3	21	27	18	10	108	50	39	-12	204724		
MAD-23 X-Y USB-85	0	8	12	6	3	13	15	18	10	132	50	29	28	205126	6	3	21	27	18	10	135	51	29	26	204665		
LPO COAST TO LOPC2																											
ANG-91 X-Y USB-30	1	3	7	6	3	21	31	19	10	82	8	82	8	206673	6	4	24	38	20	11	85	22	58	5	206542		
ACN-75 X-Y USB-30	1	3	10	6	3	21	31	18	11	64	49	38	17	204767	6	4	24	42	19	11	49	61	23	19	204845		
BDA-02 X-Y USB-30	1	3	16	6	3	21	31	19	10	83	7	83	7	206507	6	4	24	49	20	10	90	20	70	0	206661		
CYI-04 X-Y USB-30	1	3	20	6	3	21	31	18	10	109	50	29	-12	204720	6	4	24	52	19	11	123	62	24	-15	204815		

VEHICLE 1 RACAP TABLE

	TRACKING TIME			STATION ACQUISITION DATA										STATION TERMINATION DATA											
	HRS	MIN	SEC	DAY	HRS	MIN	SEC	RA	DEC	AZ	ELV	X	Y	RANGE	DAY	HRS	MIN	SFC	RA	DEC	AZ	ELV	X	Y	RANGE
MAD-23 X-Y USB-85	1	3	27	6	3	21	31	18	10	135	51	29	26	204661	6	4	24	58	19	10	158	58	30	11	204934
MIL-71 X-Y USB-30	0	4	9	6	4	20	37	20	10	81	5	85	9	207219	6	4	24	46	20	10	81	6	84	9	207483
ANG-91 X-Y USB-30	1	11	31	6	5	11	21	20	11	88	33	57	1	206024	6	6	22	52	20	11	93	50	40	-2	205366
MIL-71 X-Y USB-30	1	11	31	6	5	11	22	20	10	87	16	74	3	206951	6	6	22	53	21	11	94	31	59	-4	206197
BDA-02 X-Y USB-30	1	11	30	6	5	11	23	19	10	87	30	60	-6	206193	6	6	22	53	20	11	108	44	44	-12	205587
ACM-75 X-Y USB-30	1	11	34	6	5	11	25	19	11	28	68	11	19	204725	6	6	22	59	20	12	-20	69	-7	20	204789
CYI-04 X-Y USB-30	1	11	31	6	5	11	32	19	11	146	70	12	-17	204690	6	6	23	4	20	11	-161	73	-6	-16	204727
MAD-23 X-Y USB-85	1	11	31	6	5	11	37	19	10	-130	60	30	0	204921	6	6	23	8	20	11	-148	57	29	-17	205128
CYM-14 X-Y USB-30	1	11	43	6	7	9	30	21	11	85	15	75	4	207159	6	8	21	13	22	12	93	30	60	-2	206395
GDS-28 X-Y USB-95	1	11	46	6	7	9	33	21	11	84	11	-29	78	207423	6	8	21	19	22	11	93	25	7	65	205699
ANG-91 X-Y USB-30	1	11	51	6	7	9	34	20	11	88	61	29	-4	205056	6	8	21	25	21	12	113	77	12	-5	204806
MIL-71 X-Y USB-30	1	11	47	6	7	9	34	20	11	101	42	48	-8	205774	6	8	21	21	21	12	114	56	31	-13	205288
BDA-02 X-Y USB-30	1	11	51	6	7	9	38	20	11	119	54	33	-17	205293	6	8	21	28	21	12	143	65	16	-20	205040

VEHICLE 1 RADAR TABLE

	TRACKING TIME			STATION ACQUISITION DATA											STATION TERMINATION DATA										
	HRS	MIN	SEC	DAY	HRS	MIN	SEC	PA	DEC	AZ	ELV	X	Y	PANCE	DAY	HRS	MIN	SEC	RA	DEC	AZ	ELV	X	Y	RANGE
ACN-75 X-Y USB-30	1	11	54	6	7	9	39	19	12	-44	63	-20	19	205002	6	8	21	33	20	12	-61	49	-37	19	205574
CYI-04 X-Y USB-30	1	11	51	6	7	9	45	19	11	-132	65	-18	-15	204904	6	8	21	37	20	12	-109	54	-35	-11	205397
MAD-23 X-Y USB-85	1	11	52	6	7	9	49	19	11	-131	51	28	-29	205365	6	8	21	40	20	11	-112	40	24	-45	205951
GYM-14 X-Y USB-30	1	11	29	6	9	7	50	21	11	99	41	49	-7	205959	6	10	19	19	22	12	111	56	33	-12	205450
GDS-28 X-Y USB-85	1	11	27	6	9	7	52	21	11	101	34	16	54	206263	6	10	19	20	22	12	114	48	20	38	205735
MIL-71 X-Y USB-30	1	11	32	6	9	7	55	21	12	129	65	20	-15	205085	6	10	19	27	22	12	172	73	2	-16	205002
ANG-91 X-Y USB-30	1	11	29	6	9	7	60	21	12	179	85	0	-5	204784	6	10	19	28	22	12	-104	73	-17	-4	205014
BDA-02 X-Y USB-30	1	11	29	6	9	8	2	21	11	172	69	3	-21	204653	6	10	19	31	22	12	-144	66	-15	-19	205160
ACN-75 X-Y USB-30	1	11	28	6	9	8	9	20	12	-68	38	-50	17	206058	6	10	19	37	21	13	-73	22	-67	16	206991
CYI-04 X-Y USB-30	1	11	28	6	9	8	13	20	12	-101	43	-46	-8	205820	6	10	19	41	21	12	-91	29	-61	-1	206643
MAD-23 X-Y USB-85	1	11	25	6	9	8	14	20	11	-103	31	20	-56	206388	6	10	19	39	21	12	-90	19	1	-71	207176
HAW-12 X-Y USB-30	0	30	32	6	9	48	42	22	12	79	5	95	11	206665	6	10	19	14	23	12	82	12	78	8	207570
HAW-12 X-Y USB-30	1	11	49	6	11	5	54	23	12	86	23	67	4	207026	6	12	17	43	23	13	91	39	51	-1	206288

VEHICLE 1 RADAR TABLE

	TRACKING TIME			STATION ACQUISITION DATA										STATION TERMINATION DATA											
	HRS	MIN	SEC	DAY	HRS	MIN	SEC	RA	DEC	AZ	ELV	X	Y	RANGE	DAY	HRS	MIN	SEC	RA	DEC	AZ	ELV	X	Y	RANGE
GYM-14 X-Y USB-30	1	11	54	6	11	5	59	22	12	125	65	21	-14	205244	6	12	17	53	23	13	167	74	4	-15	205150
GDS-28 X-Y USB-85	1	11	54	6	11	6	2	22	12	127	56	22	26	205495	6	12	17	55	23	12	156	65	23	10	205329
MIL-71 X-Y USB-30	1	11	52	6	11	6	7	22	12	-140	71	-10	-16	205098	6	12	17	59	22	13	-117	60	-27	-13	205473
ANG-91 X-Y USB-30	1	11	53	6	11	6	10	21	12	-96	62	-28	-3	205325	6	12	18	3	22	13	-89	45	-45	1	206014
BDA-02 X-Y USB-30	1	11	51	6	11	6	10	21	12	-125	59	-27	-17	205411	6	12	18	1	22	12	-107	46	-43	-11	205989
ACN-75 X-Y USB-30	0	25	34	6	11	6	15	21	12	-76	11	-70	14	207676	6	11	31	50	21	13	-77	5	-85	13	206889
MAD-23 X-Y USB-85	0	27	56	6	11	6	18	21	12	-83	10	-35	-78	207735	6	11	34	14	21	12	-79	5	-66	-78	206838
CYI-04 X-Y USB-30	1	5	1	6	11	6	18	21	12	-86	18	-72	4	207252	6	12	11	19	22	12	-79	5	-85	11	207791
HAW-12 X-Y USB-30	1	11	31	6	13	4	17	23	13	97	50	40	-4	205880	6	14	15	48	24	13	107	65	24	-7	205464
GDS-28 X-Y USB-85	1	11	32	6	13	4	27	23	12	-175	67	23	-2	205327	6	14	15	59	24	13	-137	62	22	-19	205567
GYM-14 X-Y USB-30	1	11	30	6	13	4	28	23	13	-152	73	-8	-15	205211	6	14	15	58	23	13	-117	62	-25	-12	205559
MIL-71 X-Y USB-30	1	11	30	6	13	4	35	22	12	-106	50	-38	-10	205828	6	14	15	5	23	13	-95	36	-54	-4	206569
ANG-91 X-Y USB-30	1	11	32	6	13	4	38	22	13	-86	34	-56	3	206553	6	14	16	10	23	13	-81	18	-72	8	207532

VEHICLE 1 RADAR TABLE

	TRACKING TIME			STATION ACQUISITION DATA										STATION TERMINATION DATA													
	HRS	MIN	SEC	DAY	HRS	MIN	SEC	RA	DEC	AZ	ELV	X	Y	RANGE	DAY	HRS	MIN	SEC	PA	DEC	AZ	ELV	X	Y	RANGE		
BDA-02 X-Y USB-30	1	11	29	6	13	4	40	22	12	-98	36	-54	-7	206450	6	14	15	9	23	13	-88	22	-68	2	207303		
GWM-24 X-Y USB-30	0	30	60	6	13	44	38	24	13	78	5	85	12	206951	6	14	15	38	25	13	79	12	78	11	207841		
HSK-25 X-Y USB-85	0	11	41	6	15	2	12	24	14	53	12	-65	61	207536	6	15	13	53	24	14	61	14	-63	58	207226		
GWM-24 X-Y USB-30	0	11	39	6	15	2	14	25	13	81	23	66	8	207277	6	15	13	53	25	13	82	26	64	7	206539		
HAW-12 X-Y USB-30	0	11	28	6	15	2	25	24	13	126	75	12	-9	205328	6	15	13	53	24	13	133	77	9	-9	204718		
GDS-28 X-Y USB-85	0	11	20	6	15	2	33	23	13	-121	54	20	-30	205654	6	15	13	53	23	13	-118	52	20	-33	205351		
GVM-14 X-Y USB-30	0	11	19	6	15	2	34	23	13	-106	52	-37	-10	205924	6	15	13	53	23	13	-104	50	-39	-9	205439		
MIL-71 X-Y USB-30	0	11	13	6	15	2	40	23	13	-89	26	-64	1	207140	6	15	13	53	23	13	-88	23	-67	2	206702		
BDA-02 X-Y USB-30	0	11	12	6	15	2	41	23	13	-82	12	-78	7	207506	6	15	13	53	23	13	-81	10	-80	9	207472		
ANC-01 X-Y USB-30	0	7	47	6	15	2	42	23	13	-78	7	-83	11	208212	6	15	10	29	23	13	-78	5	-85	12	207926		
LOPC2 TC TEI																											
BDA-02 X-Y USB-30	0	24	45	6	15	14	9	23	13	-81	10	-80	9	207462	6	15	39	53	23	13	-78	5	-85	12	207056		
HSK-25 X-Y USB-85	0	59	48	6	15	14	9	24	14	61	14	-63	58	207211	6	16	13	56	25	14	51	23	-56	45	207364		
GWM-24 X-Y USB-30	0	59	54	6	15	14	9	25	13	82	26	64	7	206523	6	16	14	2	25	14	83	40	50	5	206515		

VEHICLE 1 RADAR TABLE

	TRACKING TIME			STATION ACQUISITION DATA								STATION TERMINATION DATA													
	HRS	MIN	SEC	DAY	HRS	MIN	SEC	RA	DEC	AZ	ELV	X	Y	RANGE	DAY	HRS	MIN	SEC	RA	DEC	AZ	ELV	X	Y	RANGE
HAW-12 X-Y USB-30	1	0	9	6	15	14	9	24	13	134	77	9	-9	204705	6	16	14	18	25	14	-151	80	-5	-8	205364
GYM-14 X-Y USB-30	1	0	18	6	15	14	9	23	13	-103	50	-40	-9	205429	6	16	14	26	24	13	-94	37	-52	-3	206656
GCS-28 X-Y USB-85	1	0	20	6	15	14	9	23	13	-118	52	20	-33	205340	6	16	14	29	24	13	-104	41	16	-47	206473
MIL-71 X-Y USR-30	1	0	22	6	15	14	9	23	13	-87	23	-67	2	206692	6	16	14	31	24	13	-81	11	-79	9	208093
CRO-08 X-Y USR-30	1	11	24	6	17	0	36	26	14	69	11	79	21	208148	6	18	12	1	26	15	59	24	62	28	207446
HSK-25 X-Y USB-85	1	11	23	6	17	0	42	25	14	40	30	-53	34	207063	6	18	12	5	26	15	22	37	-51	18	206805
PARKS AUSTRALIA	1	11	24	6	17	0	43	25	14	42	31	48	39	206983	6	18	12	7	26	15	24	39	27	45	206705
GWM-24 X-Y USB-30	1	11	23	6	17	0	47	25	14	35	51	38	3	206009	6	18	12	11	26	14	85	68	22	2	205691
HAW-12 X-Y USB-30	1	11	27	6	17	1	2	24	14	-115	72	-17	-8	205516	6	18	12	29	25	14	-98	57	-33	-4	206013
GCS-28 X-Y USB-85	1	11	26	6	17	1	11	24	13	-96	32	10	-59	206544	6	18	12	38	25	14	-86	18	-12	-71	207802
GYM-14 X-Y USB-30	1	11	23	6	17	1	13	24	13	-99	27	-63	1	207202	6	18	12	37	25	14	-81	12	-78	9	209153
CRO-08 X-Y USR-30	1	11	48	6	18	58	43	26	15	51	33	50	32	207063	6	20	10	32	27	15	34	43	31	37	206675
PARKS AUSTRALIA	1	11	49	6	18	58	49	26	15	9	42	10	47	206643	6	20	10	37	27	15	-13	41	-15	48	206783

1-91

VEHICLE 1 RADAR TABLE

TRACKING TIME

STATION ACQUISITION DATA

STATION TERMINATION DATA

	HRS MIN SEC			DAY	STATION ACQUISITION DATA							DAY	STATION TERMINATION DATA												
	HRS	MIN	SEC		HRS	MIN	SEC	RA	DEC	AZ	ELV		X	Y	RANGE	HRS	MIN	SEC	PA	DEC	AZ	ELV	X	Y	RANGE
HSK-25 X-Y USB-85	1	11	47	6	18	58	50	26	15	8	39	-51	6	205756	6	20	10	37	27	15	-13	38	-51	-10	205904
GWM-24 X-Y USB-30	1	11	49	6	18	58	52	26	14	34	80	10	1	205567	6	20	10	41	27	15	-77	83	-6	1	205631
HAW-12 X-Y USB-30	1	11	48	6	18	58	6	25	14	-93	45	-44	-2	206461	6	20	10	53	25	14	-96	30	-60	4	207312
GDS-28 X-Y USB-85	0	18	56	6	16	59	12	25	14	-80	9	-50	-76	208290	6	19	19	8	25	14	-77	5	-69	-76	207654
CRO-08 X-Y USB-30	1	11	25	6	20	57	12	27	15	19	48	16	39	206524	6	22	8	37	28	16	-6	49	-5	41	206560
HSK-25 X-Y USB-85	1	11	25	6	20	57	19	25	15	-27	35	-52	-22	207105	6	22	8	44	27	16	-43	26	-56	-38	207635
PARKS AUSTRALIA	1	1	30	6	20	57	20	26	15	-27	37	-31	45	206580	6	21	58	50	27	15	-42	30	-49	40	205911
GWM-24 X-Y USB-30	1	11	28	6	20	57	24	26	15	-84	72	-18	2	205812	6	22	8	52	27	15	-83	55	-34	4	206351
HAW-12 X-Y USB-30	1	7	0	6	20	57	37	26	14	-82	19	-71	8	207521	6	22	4	37	27	15	-76	5	-85	14	208646
CRO-08 X-Y USB-30	1	11	45	6	22	55	20	27	16	-23	47	-20	39	206730	7	0	7	9	28	16	-42	38	-41	36	207219
GWM-24 X-Y USB-30	1	11	48	6	22	55	32	27	15	-82	44	-46	6	206837	7	0	7	20	28	15	-79	28	-62	9	207741
HSK-25 X-Y USB-85	1	9	55	6	22	57	16	27	16	-53	19	-60	-49	208010	7	0	7	11	28	16	-64	7	-74	-63	208899
AD-23 X-Y USB-85	0	42	30	6	23	24	31	29	15	75	5	-71	74	207699	7	0	7	1	30	15	81	13	-35	75	208563

VEHICLE 1 RACAP TABLE

TRACKING TIME				STATION ACQUISITION DATA										STATION TERMINATION DATA												
HRS	MIN	SEC		DAY	HRS	MIN	SEC	RA	DEC	AZ	ELV	X	Y	RANGE	DAY	HRS	MIN	SEC	RA	DEC	AZ	ELV	X	Y	RANGE	
CYI-04 X-Y USB-30	1	11	25		7	0	53	37	30	15	78	11	79	11	208737	7	2	5	1	31	16	85	26	64	4	207969
MAD-23 X-Y USB-85	1	11	22		7	0	53	43	29	15	88	22	-4	68	208100	7	2	5	6	30	15	99	35	13	54	207500
CRO-08 X-Y USB-30	1	11	26		7	0	53	52	28	16	-52	30	-54	32	207638	7	2	5	18	29	16	-62	17	-71	26	208472
GMM-24 X-Y USB-30	0	51	7		7	0	54	4	28	15	-78	15	-73	12	208381	7	1	45	12	29	16	-75	5	-85	15	208147
ACN-75 X-Y USB-30	1	2	44		7	1	2	8	30	16	73	5	85	17	208620	7	2	4	52	31	16	70	19	70	19	208336
ACN-75 X-Y USB-30	1	11	48		7	2	51	31	31	16	66	30	58	20	207828	7	4	3	19	31	17	57	44	41	23	207208
CYI-04 X-Y USB-30	1	11	47		7	2	51	37	30	15	90	35	54	0	207507	7	4	3	24	31	16	99	51	38	-6	206939
MAD-23 X-Y USB-85	1	11	47		7	2	51	42	30	15	109	43	19	43	207168	7	4	3	28	31	16	127	55	22	27	206798
CRC-08 X-Y USB-30	0	0	43		7	2	52	1	29	16	-58	7	-82	22	209083	7	3	1	44	29	16	-69	5	-85	21	203706
BDA-02 X-Y USB-30	0	20	5		7	3	43	19	31	16	74	5	85	15	208293	7	4	3	24	32	16	77	9	81	13	209073
ANG-91 X-Y USB-30	0	12	48		7	3	50	33	32	15	75	5	85	15	208627	7	4	3	21	32	16	75	8	82	14	209137
ANG-01 X-Y USB-30	1	11	25		7	4	50	3	32	15	78	19	71	11	208553	7	6	1	27	33	17	81	35	55	7	207786
BDA-02 X-Y USB-30	1	11	25		7	4	50	6	32	15	83	17	71	7	208556	7	6	1	30	33	16	91	33	57	-1	207868

VEHICLE 1 RACAP TABLE

	TRACKING TIME			STATION ACQUISITION DATA										STATION TERMINATION DATA													
	HRS	MIN	SEC	DAY	HRS	MIN	SEC	RA	DEC	AZ	ELV	X	Y	RANGE	DAY	HRS	MIN	SEC	PA	DEC	AZ	ELV	X	Y	RANGE		
ACN-75 X-Y USB-30	1	11	26	7	4	50	7	31	17	47	54	29	24	206696	7	6	1	33	32	17	21	63	10	25	206702		
CYI-04 X-Y USB-30	1	11	27	7	4	50	12	31	16	108	62	27	-9	206648	7	6	1	39	32	17	135	75	11	-11	206457		
MAD-23 X-Y USB-85	1	11	29	7	4	50	15	31	16	145	62	24	16	206642	7	6	1	44	32	16	-178	66	24	-1	206637		
MIL-71 X-Y USB-30	1	8	46	7	4	52	43	32	16	75	5	85	15	209234	7	6	1	28	33	16	81	19	71	8	208623		
TEI TO EI																											
ANG-91 X-Y USB-30	9	5	13	7	6	37	7	32	17	83	44	46	5	207922	7	15	42	20	31	16	-75	5	-85	15	193791		
MIL-71 X-Y USB-30	10	34	35	7	6	37	8	32	16	85	27	63	4	208721	7	17	11	43	31	16	-75	5	-85	15	191169		
BCA-02 X-Y USB-30	9	35	9	7	6	37	9	32	16	96	41	49	-5	208025	7	16	12	18	31	16	-75	5	-85	15	192916		
ACN-75 X-Y USB-30	5	25	40	7	6	37	13	32	17	1	65	0	25	207183	7	12	2	52	31	16	-73	5	-85	17	200146		
CYI-04 X-Y USB-30	6	12	29	7	6	37	15	32	17	171	79	2	-11	206930	7	12	49	44	31	16	-75	5	-85	15	198800		
MAD-23 X-Y USB-85	5	43	50	7	6	37	17	32	16	-158	64	24	-9	207195	7	12	21	7	31	16	-74	5	-73	-73	199628		
GXM-14 X-Y USB-30	12	15	52	7	6	55	35	32	16	74	5	85	16	209421	7	19	11	27	31	16	-75	5	-85	15	187606		
GCS-28 X-Y USB-85	12	35	11	7	7	10	10	32	16	74	5	-73	73	208936	7	19	45	20	31	15	-75	5	-72	-74	186598		
HAN-12 X-Y USB-30	12	2	10	7	10	18	11	32	16	75	5	85	15	203187	7	22	20	22	31	16	-75	5	-85	15	181890		

VEHICLE 1 RADAR TABLE

VEHICLE	TRACKING TIME			STATION ACQUISITION DATA								STATION TERMINATION DATA													
	HRS	MIN	SEC	DAY	HRS	MIN	SEC	RA	DEC	AZ	ELV	X	Y	RANGE	DAY	HRS	MIN	SEC	RA	DEC	AZ	ELV	X	Y	RANGE
GWM-24 X-Y USB-30	11	42	5	7	14	11	47	33	16	75	5	85	15	196421	8	1	53	53	32	16	-75	5	-85	15	175157
HSK-25 X-Y USB-85	9	23	38	7	15	4	24	23	17	65	5	-78	65	194903	8	0	28	2	32	17	-86	5	-78	-65	177892
CRO-08 X-Y USB-30	10	5	29	7	17	4	60	33	17	69	5	85	21	191380	8	3	10	29	32	16	-69	5	-85	20	172669
PARKS AUSTRALIA	4	37	29	7	17	30	30	33	17	39	30	48	42	189199	7	22	7	59	32	17	-40	30	-48	42	180851
MAD-23 X-Y USB-85	12	47	38	7	23	37	10	34	15	74	5	-72	74	179501	8	12	24	48	34	15	-75	5	-71	-74	153442
CYI-04 X-Y USB-30	12	14	51	8	0	40	9	34	15	75	5	85	15	177514	8	12	54	60	33	15	-76	5	-85	14	152322
ACN-75 X-Y USB-30	10	54	49	8	1	15	31	34	16	73	5	85	17	176385	8	12	10	20	33	16	-73	5	-85	17	153972
BCA-02 X-Y USB-30	12	25	30	8	3	52	21	34	15	75	5	85	15	171301	8	16	17	51	34	15	-76	5	-85	14	144588
ANG-91 X-Y USB-30	11	50	46	8	3	59	21	34	15	75	5	85	15	171102	9	15	49	7	34	15	-76	5	-85	14	145706
MIL-71 X-Y USB-30	12	16	17	9	5	1	43	34	15	75	5	85	14	168999	8	17	18	0	34	15	-76	5	-85	14	142216
GYM-14 X-Y USB-30	12	14	53	8	7	3	37	35	15	76	5	85	14	164870	8	19	18	30	35	14	-76	5	-85	14	137353
GDS-28 X-Y USB-85	12	32	32	8	7	19	24	35	15	75	5	-71	74	164228	8	19	51	56	35	14	-76	5	-70	-75	135976
HAW-12 X-Y USB-30	12	1	47	8	10	28	5	35	15	76	5	85	14	157691	8	22	29	52	35	14	-76	5	-85	14	129291

VEHICLE 1 RADAR TABLE

	TRACKING TIME			STATION ACQUISITION DATA										STATION TERMINATION DATA											
	HRS	MIN	SEC	DAY	HRS	MIN	SEC	RA	DEC	AZ	ELV	X	Y	RANGE	DAY	HRS	MIN	SEC	RA	DEC	AZ	ELV	X	Y	RANGE
GWM-24 X-Y USB-30	11	43	21	9	14	22	34	36	15	76	5	85	14	149030	9	2	5	55	36	14	-76	5	-85	14	119632
MSK-25 X-Y USB-85	9	30	7	8	15	12	48	36	16	65	5	-78	66	147104	9	0	42	55	36	16	-66	5	-78	-66	123413
CRO-08 X-Y USB-30	10	11	7	8	17	15	9	37	15	70	5	85	20	142325	9	3	26	16	37	15	-70	5	-85	20	115867
PARKS AUSTRALIA	4	45	56	8	17	37	41	36	16	41	30	48	41	140014	8	22	23	37	36	16	-41	30	-49	41	128144
MAD-23 X-Y USB-85	12	43	0	9	23	56	52	38	14	76	5	-70	75	125478	9	12	39	52	40	12	-78	5	-67	-77	86767
CYI-04 X-Y USB-30	12	14	38	9	0	58	56	39	14	77	5	85	13	122696	9	13	13	34	40	13	-78	5	-85	12	84770
ACN-75 X-Y USB-30	11	1	23	9	1	31	39	39	15	74	5	85	16	121205	9	12	33	3	40	14	-75	5	-85	15	87164
BCA-02 X-Y USB-30	12	25	4	9	4	14	35	40	14	77	5	85	13	113562	9	16	39	40	42	12	-79	5	-85	11	71787
ANG-91 X-Y USB-30	11	54	53	9	4	18	53	40	14	77	5	85	13	113354	9	16	13	46	42	13	-78	5	-85	12	73499
MIL-71 X-Y USB-30	12	17	51	9	5	24	45	40	14	77	5	85	13	110139	9	17	42	36	43	12	-79	5	-85	11	67513
GYM-14 X-Y USB-30	12	18	34	9	7	28	60	41	14	77	5	85	13	103865	9	19	47	34	45	11	-80	5	-85	10	58481
GDS-28 X-Y USB-85	12	33	8	9	7	46	20	41	13	77	5	-68	76	102968	9	20	19	28	46	10	-81	5	-61	-60	55040
HAW-12 X-Y USB-30	12	15	28	9	10	57	44	43	13	78	5	85	12	92633	9	23	13	11	49	9	-82	5	-85	8	41450

VEHICLE 1 RACAP TABLE

	TRACKING TIME			STATION ACQUISITION DATA										STATION TERMINATION DATA											
	HRS	MIN	SEC	DAY	HRS	MIN	SEC	RA	DEC	AZ	ELV	X	Y	RANGE	DAY	HRS	MIN	SEC	RA	DEC	AZ	ELV	X	Y	RANGE
GMM-24 X-Y USB-30	13	19	35	9	14	59	11	46	13	78	5	85	12	78293	10	4	18	46	111	-63	-160	5	-75	-70	2231
HSK-25 X-Y USB-85	10	45	13	9	15	44	36	46	15	67	5	-77	67	75393	10	2	29	49	61	12	-71	5	-75	-70	20384
CRO-08 X-Y USB-30	10	25	57	9	17	54	35	48	14	72	5	85	18	56675	10	4	20	32	-151	7	80	5	85	10	1821
PARKS AUSTRALIA	5	22	11	9	18	12	4	48	15	43	30	50	30	64046	9	23	34	14	52	14	-45	30	-51	38	38102
CRO-08 AZ-EL FPQ6	2	30	35	10	1	49	56	60	13	-42	42	-36	34	23400	10	4	20	32	-151	7	80	5	85	10	1821
HSK-25 X-Y USB-85	0	26	56	10	3	56	31	82	11	-72	5	-74	-72	5584	10	4	23	27	-167	45	20	5	-85	20	1131

TABLE 1.1-V.- MISSION RADAR TIMELINE - Concluded

(d) LM acquisition and termination - 5° minimum elevation

	Signal acquisition g.e.t., day:hr:min:sec	Signal loss, g.e.t., day:hr:min:sec	Coverage duration, g.e.t., hr:min:sec	Maximum elevation, deg	Minimum range, n. mi.	Acquisition range, n. mi.
Insertion	5:22:11:47.7					
RDR 23 CRO-08 X-Y USB-30	5:22:11:47.7	5:22:30:58.0	0:19:10.3	51.8	203 625.18	203 625.18
RDR 29 HSK-25 X-Y USB-85	5:22:11:47.7	5:22:31:04.0	0:19:16.2	23.2	204 960.25	204 960.25
RDR 31 Parks Australia	5:22:11:47.7	5:22:31:04.7	0:19:17.0	25.0	204 862.58	204 862.58
RDR 24 GWM-24 X-Y USB-30	5:22:11:47.7	5:22:31:12.8	0:19:25.1	43.1	203 977.61	203 977.61
CSI	5:23:01:25.3					
RDR 28 MAD-23 X-Y USB-85	5:23:19:30.6	6:00:28:22.4	1:08:51.8	21.6	205 295.13	206 914.69
RDR 23 CRO-08 X-Y USB-30	5:23:19:41.1	6:00:28:32.9	1:08:51.8	42.4	204 162.40	205 120.79
RDR 29 HSK-25 X-Y USB-85	5:23:19:46.4	5:23:51:05.9	0:31:19.5	10.9	205 912.78	206 777.31
RDR 31 Parks Australia	5:23:19:48.2	5:23:57:36.3	0:37:48.2	12.3	205 840.12	206 693.58
RDR 24 GWM-24 X-Y USB-30	5:23:19:58.1	6:00:28:43.3	1:08:45.2	26.6	205 073.81	205 885.01
Plane change	5:23:30:29.1					
RDR 21 CYI-04 X-Y USB-30	5:23:54:35.6	6:00:28:19.4	0:33:43.8	12.2	205 895.79	205 909.07
CDH	5:23:59:49.9					
RDR 22 ACN-75 X-Y USB-30	6:00:14:1.7	6:00:28:10.0	0:14:08.3	08.3	206 450.29	206 450.29
TPI	6:00:38:56.1					
MC-1	6:00:53:56.1					
MC-2	6:01:08:56.1					
Coast to first braking gate	6:01:14:38.5					
RDR 22 ACN-75 X-Y USB-30	6:01:14:38.5	6:01:26:23.0	0:11:44.5	22.4	205 718.8	206 463.8
RDR 21 CYI-04 X-Y USB-30	6:01:14:44.1	6:01:26:23.0	0:11:38.9	25.1	205 577.2	206 302.6
RDR 28 MAD-23 X-Y USB-85	6:01:14:47.5	6:01:26:23.0	0:11:35.5	32.5	205 189.5	205 880.9
RDR 23 CRO-08 X-Y USB-30	6:01:15:0.7	6:01:26:23.0	0:11:22.3	20.5	205 960.1	206 402.4
First braking gate	6:01:17:44.5					
Second braking gate	6:01:20:15.0					
Third braking gate	6:01:21:28.3					
Fourth braking gate	6:01:23:06.7					
Fifth braking gate	6:01:24:26.3					
Docking	6:01:40:00.0					

TABLE 1.1-VI.- MISSION SHADOW TIMELINE

(a) CSM

LIGHTING CONDITION FOR VEH 1

EPOI TO TLII

VEH IN SUNLIGHT

AT PHASE INITIATION

	DAYS HRS MINS SECS				TIME SPENT IN REGION			
	DAYS	HRS	MINS	SECS	DAYS	HRS	MINS	SECS
VEH ENTERING EARTH PENUMBRA	0	0	31	30.9	0	0	0	11.9
VEH ENTERING EARTH UMBRA	0	0	31	42.7	0	0	33	51.3
VEH ENTERING EARTH PENUMBRA	0	1	5	34.0	0	0	0	12.6
VEH ENTERING SUNLIGHT	0	1	5	46.6	0	0	53	56.1
VEH ENTERING EARTH PENUMBRA	0	1	59	42.8	0	0	0	11.5
VEH ENTERING EARTH UMBRA	0	1	59	54.3	0	0	33	49.7
VEH ENTERING EARTH PENUMBRA	0	2	33	43.9	0	0	0	12.6
VEH ENTERING SUNLIGHT	0	2	33	56.5				

TLI CUTOFF TO NFR MANEUVER

VEH IN SUNLIGHT

AT PHASE INITIATION

	DAYS HRS MINS SECS				TIME SPENT IN REGION			
	DAYS	HRS	MINS	SECS	DAYS	HRS	MINS	SECS

LIGHTING CONDITION FOR VEH 1

TRANSLUNAR COAST TO LO11

VEH IN SUNLIGHT

AT PHASE INITIATION

	DAYS HRS MINS SECS				TIME SPENT IN REGION			
	DAYS	HRS	MINS	SECS	DAYS	HRS	MINS	SECS
VEH ENTERING LUNAR PENUMBRA	3	10	47	47.0	0	0	1	19.9
VEH ENTERING LUNAR UMBRA	3	10	49	6.9	0	0	31	37.2
VEH ENTERING LUNAR PENUMBRA	3	11	20	44.2	0	0	0	41.0
VEH ENTERING SUNLIGHT	3	11	21	25.2				

COAST IN 60 X 170 TO LO12

VEH IN SUNLIGHT

AT PHASE INITIATION

	DAYS HRS MINS SECS				TIME SPENT IN REGION			
	DAYS	HRS	MINS	SECS	DAYS	HRS	MINS	SECS
VEH ENTERING LUNAR PENUMBRA	3	12	47	46.7	0	0	0	12.9
VEH ENTERING LUNAR UMBRA	3	12	47	59.6	0	0	44	59.5
VEH ENTERING LUNAR PENUMBRA	3	13	32	59.1	0	0	0	12.1
VEH ENTERING SUNLIGHT	3	13	33	11.2	0	1	23	7.1
VEH ENTERING LUNAR PENUMBRA	3	14	56	18.4	0	0	0	12.9
VEH ENTERING LUNAR UMBRA	3	14	56	31.2	0	0	45	.6
VEH ENTERING LUNAR PENUMBRA	3	15	41	31.8	0	0	0	17.0
VEH ENTERING SUNLIGHT	3	15	41	48.9				

LIGHTING CONDITION FOR VEH 1

	DAYS HRS MINS SECS				TIME SPENT IN REGION			
	DAYS	HRS	MINS	SECS	DAYS	HRS	MINS	SECS
					0	0	45	33.6
VEH ENTERING LUNAR PENUMBRA	4	3	33	27.0				
					0	0	0	10.9
VEH ENTERING SUNLIGHT	4	3	33	37.9				
					0	1	12	41.3
VEH ENTERING LUNAR PENUMBRA	4	4	46	19.2				
					0	0	0	11.3
VEH ENTERING LUNAR UMBRA	4	4	46	30.5				
					0	0	45	36.1
VEH ENTERING LUNAR PENUMBRA	4	5	32	6.6				
					0	0	0	10.7
VEH ENTERING SUNLIGHT	4	5	32	17.3				
					0	1	12	36.2
VEH ENTERING LUNAR PENUMBRA	4	6	44	53.5				
					0	0	0	10.8
VEH ENTERING LUNAR UMBRA	4	6	45	4.3				
					0	0	45	36.9
VEH ENTERING LUNAR PENUMBRA	4	7	30	41.2				
					0	0	0	11.3
VEH ENTERING SUNLIGHT	4	7	30	52.5				
					0	1	12	40.4
VEH ENTERING LUNAR PENUMBRA	4	8	43	32.9				

LIGHTING CONDITION FOR VEH 1

	TIME SPENT IN REGION			
	DAYS	HRS	MINS	SECS
	0	0	0	10.8
VEH ENTERING LUNAR UMBRA	4	8	43	43.7
	0	0	45	37.2
VEH ENTERING LUNAR PENUMBRA	4	9	29	20.9
	0	0	0	14.0
VEH ENTERING SUNLIGHT	4	9	29	35.0
	0	1	12	31.1
VEH ENTERING LUNAR PENUMBRA	4	10	42	6.0
	0	0	0	11.2
VEH ENTERING LUNAR UMBRA	4	10	42	17.2
	0	0	45	38.3
VEH ENTERING LUNAR PENUMBRA	4	11	27	55.5
	0	0	0	11.0
VEH ENTERING SUNLIGHT	4	11	28	6.5

LIGHTING CONDITION FOR VEH 1

LPO COAST TO LOPCI

VEH IN SUNLIGHT

AT PHASE INITIATION

	DAYS HRS MINS SECS				TIME SPENT IN REGION			
	DAYS	HRS	MINS	SECS	DAYS	HRS	MINS	SECS
VEH ENTERING LUNAR PENUMBRA	4	12	40	40.3	0	0	0	11.0
VEH ENTERING LUNAR UMBRA	4	12	40	51.4	0	0	45	38.0
VEH ENTERING LUNAR PENUMBRA	4	13	26	29.4	0	0	0	11.1
VEH ENTERING SUNLIGHT	4	13	26	40.5	0	1	12	35.9
VEH ENTERING LUNAR PENUMBRA	4	14	39	16.4	0	0	0	10.3
VEH ENTERING LUNAR UMBRA	4	14	39	26.7	0	0	45	36.4
VEH ENTERING LUNAR PENUMBRA	4	15	25	3.0	0	0	0	11.1
VEH ENTERING SUNLIGHT	4	15	25	14.2	0	1	12	40.0
VEH ENTERING LUNAR PENUMBRA	4	16	37	54.2	0	0	0	11.3
VEH ENTERING LUNAR UMBRA	4	16	38	5.6	0	0	45	37.0
VEH ENTERING LUNAR PENUMBRA	4	17	23	42.6				

LIGHTING CONDITION FOR VEH 1

	DAYS HRS MINS SECS				TIME SPENT IN REGION			
	DAYS	HRS	MINS	SECS	DAYS	HRS	MINS	SECS
					0	0	0	15.1
VEH ENTERING SUNLIGHT	4	17	23	57.7				
					0	1	12	30.6
VEH ENTERING LUNAR PENUMBRA	4	18	36	28.3				
					0	0	0	10.9
VEH ENTERING LUNAR UMBRA	4	18	36	39.2				
					0	0	45	38.7
VEH ENTERING LUNAR PENUMBRA	4	19	22	17.8				
					0	0	0	11.3
VEH ENTERING SUNLIGHT	4	19	22	29.1				

LIGHTING CONDITION FOR VEH 1

LOPCI TO LM JETTISON

VEH IN SUNLIGHT

AT PHASE INITIATION

	DAYS HRS MINS SECS				TIME SPENT IN REGION			
	DAYS	HRS	MINS	SECS	DAYS	HRS	MINS	SECS
VEH ENTERING LUNAR PENUMBRA	4	20	35	17.1	0	0	0	8.8
VEH ENTERING LUNAR UMBRA	4	20	35	26.0	0	0	45	46.9
VEH ENTERING LUNAR PENUMBRA	4	21	21	12.9	0	0	0	11.3
VEH ENTERING SUNLIGHT	4	21	21	24.2	0	1	12	35.0
VEH ENTERING LUNAR PENUMBRA	4	22	33	59.2	0	0	0	11.2
VEH ENTERING LUNAR UMBRA	4	22	34	10.4	0	0	45	42.0
VEH ENTERING LUNAR PENUMBRA	4	23	19	52.4	0	0	0	9.7
VEH ENTERING SUNLIGHT	4	23	20	2.1	0	1	12	30.3
VEH ENTERING LUNAR PENUMBRA	5	0	32	32.4	0	0	0	11.0
VEH ENTERING LUNAR UMBRA	5	0	32	43.4	0	0	45	44.4
VEH ENTERING LUNAR PENUMBRA	5	1	18	27.8				

LIGHTING CONDITION FOR VEH 1

	DAYS HRS MINS SECS				TIME SPENT IN REGION			
	DAYS	HRS	MINS	SECS	DAYS	HRS	MINS	SECS
					0	0	0	11.1
VEH ENTERING SUNLIGHT	5	1	18	38.9				
					0	1	12	28.8
VEH ENTERING LUNAR PENUMBRA	5	2	31	7.7				
					0	0	0	11.5
VEH ENTERING LUNAR UMBRA	5	2	31	19.3				
					0	0	45	42.2
VEH ENTERING LUNAR PENUMBRA	5	3	17	1.5				
					0	0	0	11.2
VEH ENTERING SUNLIGHT	5	3	17	12.6				
					0	1	12	33.7
VEH ENTERING LUNAR PENUMBRA	5	4	29	46.3				
					0	0	0	11.3
VEH ENTERING LUNAR UMBRA	5	4	29	57.6				
					0	0	45	48.8
VEH ENTERING LUNAR PENUMBRA	5	5	15	46.5				
					0	0	0	9.0
VEH ENTERING SUNLIGHT	5	5	15	55.4				
					0	1	12	25.1
VEH ENTERING LUNAR PENUMBRA	5	6	28	20.5				
					0	0	0	10.8
VEH ENTERING LUNAR UMBRA	5	6	28	31.4				

LIGHTING CONDITION FOR VEH 1

	DAYS HRS MINS SECS				TIME SPENT IN REGION			
	DAYS	HRS	MINS	SECS	DAYS	HRS	MINS	SECS
					0	0	45	45.2
VEH ENTERING LUNAR PENUMBRA	5	7	14	16.5				
					0	0	0	11.3
VEH ENTERING SUNLIGHT	5	7	14	27.8				
					0	1	12	32.3
VEH ENTERING LUNAR PENUMBRA	5	8	27	.1				
	2				0	0	0	1.9
VEH ENTERING LUNAR UMBRA	5	8	27	2.0				
					0	0	45	49.0
VEH ENTERING LUNAR PENUMBRA	5	9	12	51.0				
					0	0	0	10.7
VEH ENTERING SUNLIGHT	5	9	13	1.7				
					0	1	42	31.9
VEH ENTERING LUNAR PENUMBRA	5	10	25	33.6				
					0	0	0	11.3
VEH ENTERING LUNAR UMBRA	5	10	25	44.9				
					0	0	45	45.8
VEH ENTERING LUNAR PENUMBRA	5	11	11	30.7				
					0	0	0	10.9
VEH ENTERING SUNLIGHT	5	11	11	41.6				
					0	1	12	23.6
VEH ENTERING LUNAR PENUMBRA	5	12	24	5.2				

LIGHTING CONDITION FOR VEH 1

	DAYS HRS MINS SECS				TIME SPENT IN REGION			
	DAYS	HRS	MINS	SECS	DAYS	HRS	MINS	SECS
					0	0	0	9.0
VEH ENTERING LUNAR UMBRA	5	12	24	14.2				
					0	0	45	50.9
VEH ENTERING LUNAR PENUMBRA	5	13	10	5.1				
					0	0	0	11.4
VEH ENTERING SUNLIGHT	5	13	10	16.4				
					0	1	12	31.7
VEH ENTERING LUNAR PENUMBRA	5	14	22	48.1				
					0	0	0	11.2
VEH ENTERING LUNAR UMBRA	5	14	22	59.3				
					0	0	45	43.7
VEH ENTERING LUNAR PENUMBRA	5	15	8	43.0				
					0	0	0	13.5
VEH ENTERING SUNLIGHT	5	15	8	56.5				
					0	1	12	24.9
VEH ENTERING LUNAR PENUMBRA	5	16	21	21.4				
					0	0	0	11.1
VEH ENTERING LUNAR UMBRA	5	16	21	32.5				
					0	0	45	47.5
VEH ENTERING LUNAR PENUMBRA	5	17	7	20.0				
					0	0	0	11.1
VEH ENTERING SUNLIGHT	5	17	7	31.1				

LIGHTING CONDITION FOR VEH 1

	DAYS HRS MINS SECS				TIME SPENT IN REGION			
	DAYS	HRS	MINS	SECS	DAYS	HRS	MINS	SECS
					0	1	12	27.1
VEH ENTERING LUNAR PENUMBRA	5	18	19	58.2				
					0	0	0	9.3
VEH ENTERING LUNAR UMBRA	5	18	20	7.5				
					0	0	45	46.2
VEH ENTERING LUNAR PENUMBRA	5	19	5	53.7				
					0	0	0	11.3
VEH ENTERING SUNLIGHT	5	19	6	5.0				
					0	1	12	30.6
VEH ENTERING LUNAR PENUMBRA	5	20	18	35.6				
					0	0	0	11.4
VEH ENTERING LUNAR UMBRA	5	20	18	47.0				
					0	0	45	50.5
VEH ENTERING LUNAR PENUMBRA	5	21	4	37.5				
					0	0	0	8.9
VEH ENTERING SUNLIGHT	5	21	4	46.4				
					0	1	12	23.4
VEH ENTERING LUNAR PENUMBRA	5	22	17	9.7				
					0	0	0	10.9
VEH ENTERING LUNAR UMBRA	5	22	17	20.7				
					0	0	45	48.3
VEH ENTERING LUNAR PENUMBRA	5	23	3	9.0				

LIGHTING CONDITION FOR VEH 1

	DAYS HRS MINS SECS				TIME SPENT IN REGION			
	DAYS	HRS	MINS	SECS	DAYS	HRS	MINS	SECS
					0	0	0	11.3
VEH ENTERING SUNLIGHT	5	23	3	20.3				
					0	1	12	29.0
VEH ENTERING LUNAR PENUMBRA	6	0	15	49.2				
					0	0	0	3.4
VEH ENTERING LUNAR UMBRA	6	0	15	52.7				
					0	0	45	50.5
VEH ENTERING LUNAR PENUMBRA	6	1	1	43.1				
					0	0	0	10.9
VEH ENTERING SUNLIGHT	6	1	1	54.1				
					0	1	12	29.1
VEH ENTERING LUNAR PENUMBRA	6	2	14	23.2				
					0	0	0	11.4
VEH ENTERING LUNAR UMBRA	6	2	14	34.5				
					0	0	45	48.6
VEH ENTERING LUNAR PENUMBRA	6	3	0	23.1				
					0	0	0	10.8
VEH ENTERING SUNLIGHT	6	3	0	33.9				

LIGHTING CONDITION FOR VEH 1

LPO COAST TO LOPC2

VEH IN SUNLIGHT

AT PHASE INITIATION

	DAYS HRS MINS SECS				TIME SPENT IN REGION			
	DAYS	HRS	MINS	SECS	DAYS	HRS	MINS	SECS
VEH ENTERING LUNAR PENUMBRA	6	4	12	56.1	0	0	0	11.3
VEH ENTERING LUNAR UMBRA	6	4	13	7.4	0	0	45	48.1
VEH ENTERING LUNAR PENUMBRA	6	4	58	55.5	0	0	0	10.8
VEH ENTERING SUNLIGHT	6	4	59	6.3	0	1	12	19.0
VEH ENTERING LUNAR PENUMBRA	6	6	11	25.4	0	0	0	11.1
VEH ENTERING LUNAR UMBRA	6	6	11	36.4	0	0	45	50.7
VEH ENTERING LUNAR PENUMBRA	6	6	57	27.2	0	0	0	11.2
VEH ENTERING SUNLIGHT	6	6	57	38.3	0	1	12	14.5
VEH ENTERING LUNAR PENUMBRA	6	8	9	52.8	0	0	0	14.3
VEH ENTERING LUNAR UMBRA	6	8	10	7.1	0	0	45	49.4
VEH ENTERING LUNAR PENUMBRA	6	8	55	56.5				

LIGHTING CONDITION FOR VEH 1

	DAYS HRS MINS SECS				TIME SPENT IN REGION			
	DAYS	HRS	MINS	SECS	DAYS	HRS	MINS	SECS
					0	0	0	11.2
VEH ENTERING SUNLIGHT	6	8	56	7.7				
					0	1	12	22.9
VEH ENTERING LUNAR PENUMBRA	6	10	8	30.6				
					0	0	0	11.4
VEH ENTERING LUNAR UMBRA	6	10	8	42.0				
					0	0	45	50.3
VEH ENTERING LUNAR PENUMBRA	6	10	54	32.3				
					0	0	0	16.2
VEH ENTERING SUNLIGHT	6	10	54	48.5				
					0	1	12	8.2
VEH ENTERING LUNAR PENUMBRA	6	12	6	56.8				
					0	0	0	15.7
VEH ENTERING LUNAR UMBRA	6	12	7	12.5				
					0	0	45	50.5
VEH ENTERING LUNAR PENUMBRA	6	12	53	2.9				
					0	0	0	11.4
VEH ENTERING SUNLIGHT	6	12	53	14.3				
					0	1	12	22.2
VEH ENTERING LUNAR PENUMBRA	6	14	5	36.6				
					0	0	0	11.2
VEH ENTERING LUNAR UMBRA	6	14	5	47.8				
					0	0	45	49.7
VEH ENTERING LUNAR PENUMBRA	6	14	51	37.5				
					0	0	0	14.5
VEH ENTERING SUNLIGHT	6	14	51	52.0				

LIGHTING CONDITION FOR VEH 1

LOPC2 TO TE1

VEH IN SUNLIGHT

AT PHASE INITIATION

	DAYS HRS MINS SECS				TIME SPENT IN REGION			
	DAYS	HRS	MINS	SECS	DAYS	HRS	MINS	SECS
VEH ENTERING LUNAR PENUMBRA	6	16	4	12.7	0	0	0	11.1
VEH ENTERING LUNAR UMBRA	6	16	4	23.7	0	0	45.	59.0
VEH ENTERING LUNAR PENUMBRA	6	16	50	22.8	0	0	0	11.0
VEH ENTERING SUNLIGHT	6	16	50	33.7	0	1	12	10.1
VEH ENTERING LUNAR PENUMBRA	6	18	2	43.8	0	0	0	12.7
VEH ENTERING LUNAR UMBRA	6	18	2	56.5	0	0	45	56.2
VEH ENTERING LUNAR PENUMBRA	6	18	48	52.7	0	0	0	11.3
VEH ENTERING SUNLIGHT	6	18	49	4.1	0	1	12	15.4
VEH ENTERING LUNAR PENUMBRA	6	20	1	19.4	0	0	0	11.4
VEH ENTERING LUNAR UMBRA	6	20	1	30.8	0	0	46	1.9
VEH ENTERING LUNAR PENUMBRA	6	20	47	32.7				

LIGHTING CONDITION FOR VEH 1

	DAYS HRS MINS SECS				TIME SPENT IN REGION			
	DAYS	HRS	MINS	SECS	DAYS	HRS	MINS	SECS
					0	0	0	8.8
VEH ENTERING SUNLIGHT	6	20	47	41.5				
					0	1	12	9.0
VEH ENTERING LUNAR PENUMBRA	6	21	59	50.5				
					0	0	0	10.8
VEH ENTERING LUNAR UMBRA	6	22	0	1.3				
					0	0	45	69.5
VEH ENTERING LUNAR PENUMBRA	6	22	46	.8				
					0	0	0	11.3
VEH ENTERING SUNLIGHT	6	22	46	12.0				
					0	1	12	14.4
VEH ENTERING LUNAR PENUMBRA	6	23	58	26.5				
					0	0	0	11.0
VEH ENTERING LUNAR UMBRA	6	23	58	37.4				
					0	0	45	93.9
VEH ENTERING LUNAR PENUMBRA	7	0	44	31.4				
					0	0	0	10.8
VEH ENTERING SUNLIGHT	7	0	44	42.1				
					0	1	12	14.1
VEH ENTERING LUNAR PENUMBRA	7	1	56	56.2				
					0	0	0	11.2
VEH ENTERING LUNAR UMBRA	7	1	57	7.4				

LIGHTING CONDITION FOR VEH 1

	DAYS HRS MINS SECS				TIME SPENT IN REGION			
	DAYS	HRS	MINS	SECS	DAYS	HRS	MINS	SECS
					0	0	46	5.4
VEH ENTERING LUNAR PENUMBRA	7	2	43	7.8				
					0	0	0	10.9
VEH ENTERING SUNLIGHT	7	2	43	18.7				
					0	1	12	9.8
VEH ENTERING LUNAR PENUMBRA	7	3	55	28.5				
					0	0	0	8.8
VEH ENTERING LUNAR UMBRA	7	3	55	37.3				
					0	0	46	1.0
VEH ENTERING LUNAR PENUMBRA	7	4	41	38.3				
					0	0	0	11.4
VEH ENTERING SUNLIGHT	7	4	41	49.7				
					0	1	12	13.7
VEH ENTERING LUNAR PENUMBRA	7	5	54	3.3				
					0	0	0	11.4
VEH ENTERING LUNAR UMBRA	7	5	54	14.7				

TE1 TO E1

VEH IN LUNAR UMBRA AT PHASE INITIATION

	DAYS HRS MINS SECS				TIME SPENT IN REGION			
	DAYS	HRS	MINS	SECS	DAYS	HRS	MINS	SECS
VEH ENTERING LUNAR PENUMBRA	7	6	32	52.4				
					0	0	0	5.3
VEH ENTERING SUNLIGHT	7	6	32	57.6				

TABLE 1.1-VI.- MISSION SHADOW TIMELINE - Concluded

(b) LM

UMBRA/PENUMBRA CROSSINGS FOR VEH. 2		UMBRA				PENUMBRA			
REVOLUTIONS	DAY	HRS	MIN	SEC	DAY	HRS	MIN	SEC	
1.059					5	22	18	5.7	
1.069	5	22	19	21.5					
1.256	5	23	6	35.4					
1.456					5	23	6	46.7	
1.125					6	0	15	56.3	
1.105	6	0	16	6.9					
1.483	6	1	2	14.6					
1.493					6	1	2	25.0	

1-108

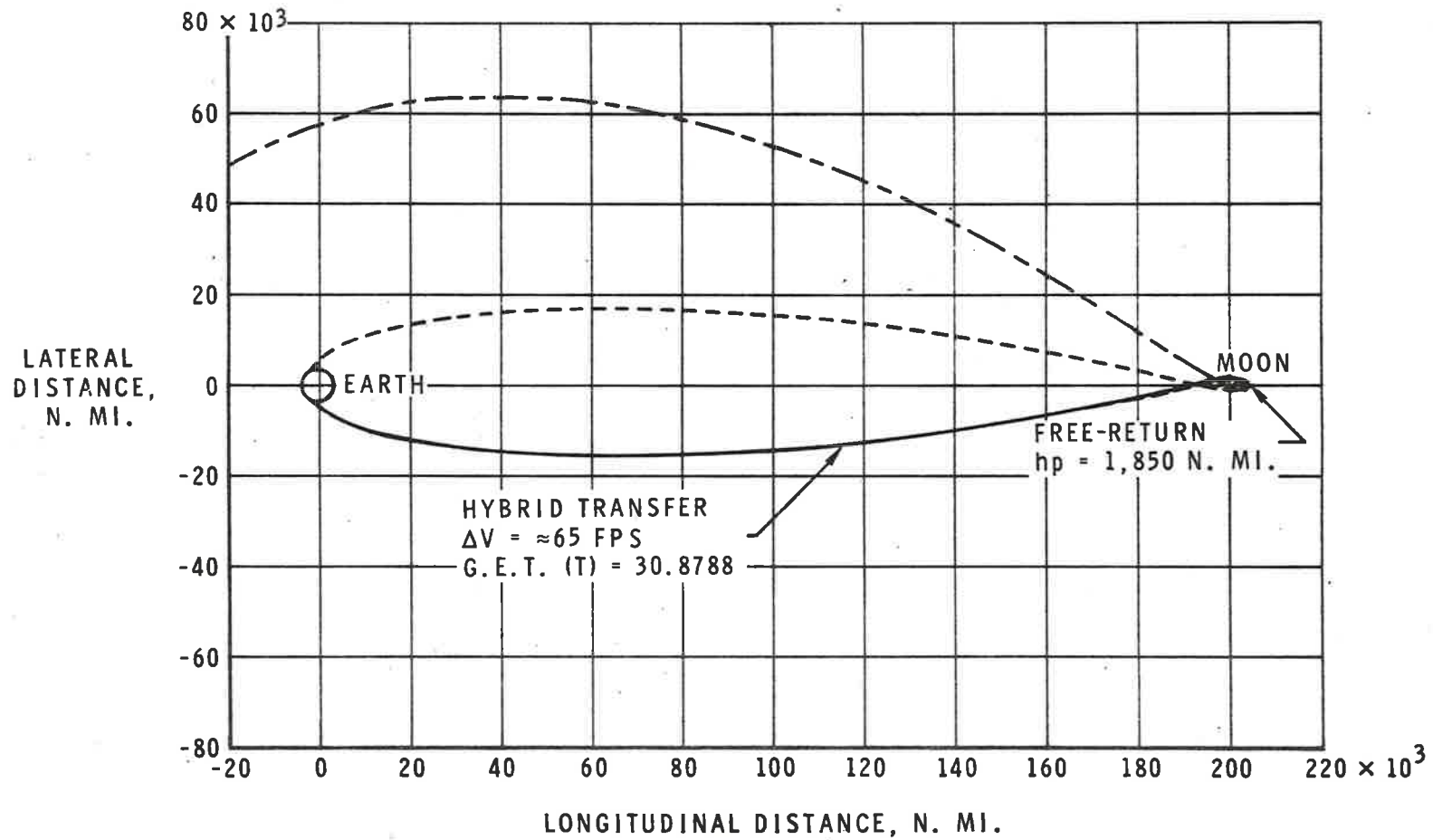

1-109

Figure 1.1-1.- H-1 hybrid mission profile.

2.0 SYMBOLS AND NOMENCLATURE

AGS	abort guidance system
AOS	acquisition of signal
APS	ascent propulsion system
C	cross-product steering gain constant
CDH	constant delta height
CDR	commander
CM	command module
CMC	command module computer
CMP	command module pilot
CSI	coelliptic sequence initiation
CSM	command and service modules
c.g.	center of gravity
DOI	descent orbit insertion
DPS	descent propulsion system
DSKY	display keyboard
ECI	earth centered inertial
EI	entry interface
EMS	entry monitor system
EPO	earth parking orbit
FTP	fixed throttle point
g.e.t.	ground elapsed time
h_a	apogee altitude
h_p	perigee altitude

IGA inner gimbal angle
IMU inertial measurement unit
IVT intravehicular transfer
Jerk time derivative of acceleration
L/D lift-to-drag ratio
LGC LM guidance computer
LLM lunar landing mission
LLS lunar landing site
LM lunar module
LMP lunar module pilot
LOI lunar orbit insertion
LOS loss of signal
LPO lunar parking orbit
LOX liquid oxygen
LV launch vehicle
MC LM midcourse correction
MCC midcourse correction
MCI moon centered inertial
MGA middle gimbal angle
MNBY mean nearest Besselian year
MSFC Marshall Space Flight Center
MSFN Manned Space Flight Network
OGA outer gimbal angle
OPS oxygen purge system
PC plane change

PDI powered descent initiation

PGNCS primary guidance and navigation control subsystem

PTC passive thermal control

RDG position target for LM powered descent

RCS reaction control system

REFSMMAT transformation matrix from the basic reference coordinate system to the stable member (IMU) coordinate system

RR rendezvous radar

RT target vector for Lambert guidance scheme

SC spacecraft

SPS service propulsion system

TB7 time elapsed since TLI engine cutoff

T&D transposition and docking

TD&E transposition and docking and extraction

TEI transearth injection

t_{IG} time at ignition

TLI translunar injection

T_f Δt from ignition time (t_{IG}) to Lambert target vector (RT)

TPF terminal phase finalization

TPI terminal phase initiation

VHF very high frequency

ΔV change in velocity caused by thrusting

Δt change in time

ΔV_X	}	components of velocity to be gained in the local vertical coordinate system
ΔV_Y		
ΔV_Z		
X_I	}	components of unit vector in inertial coordinate system
Y_I		
Z_I		
X_{SM}	}	components of unit vector in vehicle stable member system
Y_{SM}		
Z_{SM}		

3.0 PRIMARY GUIDELINES AND CONSTRAINTS

3.0 PRIMARY GUIDELINES AND CONSTRAINTS

The design of the mission and the monthly and daily launch windows were based on the guidelines and constraints listed below. Since the generation of the operational trajectory, there have been some changes in the profile and in mission guidelines. The guidelines are presented below, and the changes are included in brackets.

- a. The primary lunar landing site is site 7, and either site 5 or site 6 will be used for recycle.
- b. Only one backup launch month will be targeted.
- c. Daylight launch is highly desirable.
- d. The launch windows and profiles will be designed to achieve favorable lunar lighting at the lunar landing sites. The sun elevation range of 5° to 14° is highly desirable; a range of 18° to 20° is acceptable.
- e. A launch azimuth range of 72° to 108° will be targeted. Launch may be delayed, if necessary, to provide 210-foot dish coverage of lunar landing; in this case, the opening launch azimuth would be greater than 72° . [To minimize MSFN and ARIA support requirements, the actual operational launch azimuth range for planning will be limited to 72° to 96° .]
- f. The mission will be designed for a Pacific translunar injection.
- g. Two TLI opportunities will be targeted: the first on the second revolution and the second on the third revolution.
- h. TLI will be targeted to provide a free-return circumlunar trajectory.
- i. The S-IVB will perform an evasive maneuver prior to the blowdown. The blowdown will be targeted to place the S-IVB on a slingshot trajectory.
- j. A hybrid profile will be used where necessary to provide a Pacific injection, optimum lunar lighting, 210-foot dish coverage of lunar landing, or a preferred lunar groundtrack.
- k. The hybrid transfer maneuver will be planned for TLI plus 24 hours. After the maneuver, the SC will be on a non-free-return trajectory which will be restricted such that, in the case of an SPS failure at LOI ignition, an earth return is within the DPS docked ΔV

capability. [Because of the crew work/rest cycle, the hybrid transfer maneuver time has been changed to TLI plus 28 hours rather than TLI plus 24 hours. This change is not reflected in the operational trajectory.]

l. An even integer number of days of flight time to the moon is highly desirable because of the crew work/rest cycle. [This guide line was not satisfied.]

m. The LOI maneuver will be performed in two stages; the first burn, LOI-1, will result in a 60- by 170-n. mi. elliptical orbit. The targeting for LOI-2 will be biased to account for the perturbations caused by the lunar potential. The biased targeting results in a noncircular orbit after LOI-2, and the perturbations circularize this orbit at the time of the planned CDH maneuver.

n. For missions launched in November, the spacecraft will pass over the lunar landing site on the fourteenth revolution after LOI-1. The time from LOI-1 to DOI will be approximately 26 hours. The current profile for the December window includes 24 hours rather than 26 hours from LOI-1 to DOI.

o. The lunar surface staytime will be approximately 32 hours. The lunar orbit orientation will be restricted to permit an any-orbit lift-off.

p. A CSM plane change will be made 2.75 revolutions after LM landing to place the landing site in the orbital plane at time of LM lift-off.

q. After LM jettison, a plane change may be made to gain photographic coverage of selected prime sites for future landing missions. The additional time spent in lunar orbit for photographic objectives will be restricted by SPS performance, the maximum mission duration of 10.7 days, and by the capability to return from any revolution after a cryogenics tank failure.

r. The lunar orbit will be designed within the SPS capability to return to earth from any orbit including the cryogenic tank failure situation.

s. The TEI maneuver will be targeted to return as soon as possible to the prime recovery area within the available ΔV capability and without exceeding a return inclination of 40° .

t. The earth relative entry range target will be 1285 n. mi. [The range has recently been reduced to 1250 n. mi.]

4.0 MISSION SUMMARY

4.0 MISSION SUMMARY

In this section, a mission profile is summarized for a mission launched November 14, 1969. The burn times, predictions of propellents used, and most mission phase times that are presented are typical of the lunar landing missions planned for the November and December launch windows. Major events, spacecraft performance characteristics, and significant trajectory parameters are described in detail for each phase.

In the design of the spacecraft operational mission, the LV mission phases were simulated independently of the exact LV operational trajectory. The trajectory data presented here for the LV mission phases were simulated with data received from the MSFC for the Apollo 11 mission. No attempt was made to duplicate exactly the LV operational mission, and the information for the LV phases will differ from information that will be presented in the official MSFC trajectory document.

4.1 EARTH LAUNCH

4.1 Earth Launch^a

The launch time for this mission was determined to provide an optimized injected payload to support two injection opportunities. The launch is summarized as follows.

Date, month, day, year	November 14, 1969
Time, hr:min, c.s.t.	10:22
Azimuth, deg	~72
Location (Cape Kennedy, complex 39A)	
Geodetic latitude, deg:min:sec	28°:36':30.32"
Longitude, deg:min:sec	279°:23':45.12"

The launch pad REFSMMAT is presented in table 5-I.

^aThe parameters for this phase are approximate and are presented for information only. The official source for this phase is the MSFC LV operational trajectory (ref. 1).

4.2 EARTH PARKING ORBIT

4.2 Earth Parking Orbit^a (EPO)

The EPO insertion conditions are as follows.

Time, hr:min:sec, g.e.t.	00:11:53.2
Geodetic latitude, deg	32.7
Longitude, deg	-52.5
Altitude, n. mi.	103.4
Inclination, deg.	32.6

The insertion ship positioned at 28°N latitude and 49°W longitude tracks the vehicle for approximately 3 minutes after insertion for a minimum elevation angle of 5°.

The LV maintains local horizontal attitude throughout the EPO phase except for an inertial hold of approximately 10 seconds immediately after EPO insertion. The total time spent in EPO is 2^h35^m28^s. The EPO groundtrack from insertion through translunar injection is shown in figure 4.2-1.

^aThe parameters for this phase are approximate and are presented for information only. The official source for this phase is the MSFC ΔV operational trajectory (ref. 1).

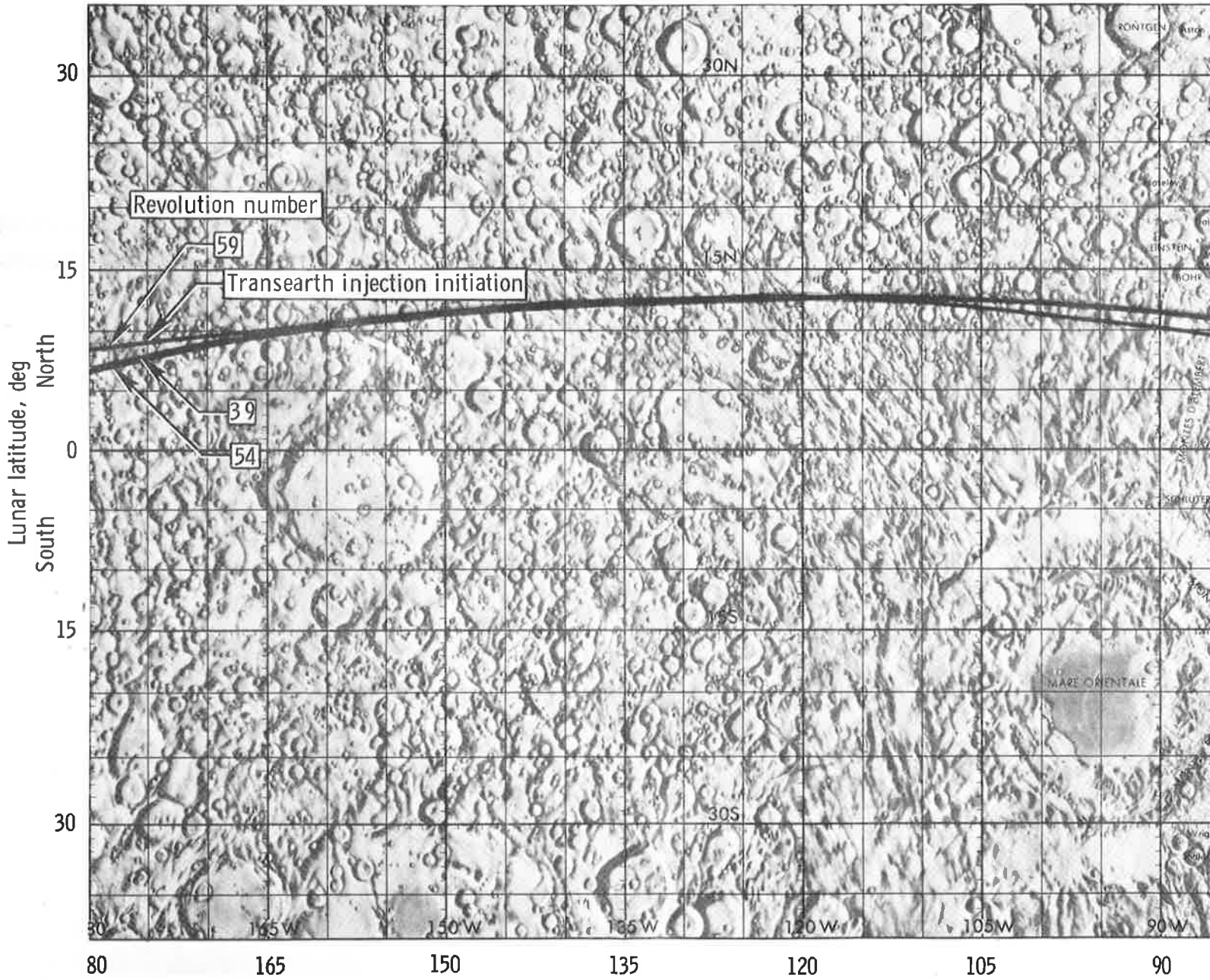

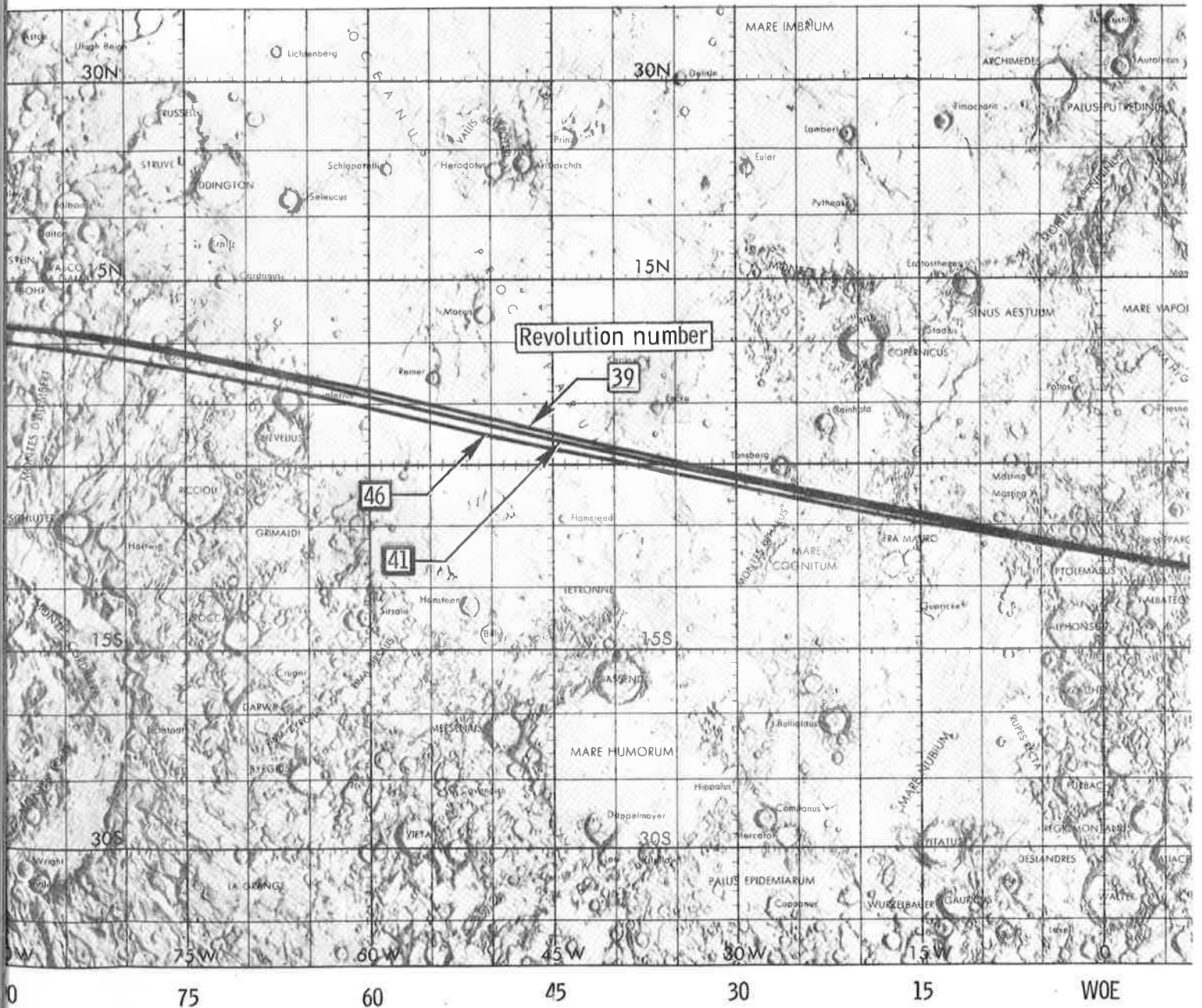

4.3 TRANSLUNAR INJECTION

4.3 Translunar Injection^a (TLI)

The TLI burn is initiated near the equator on the second revolution in earth orbit, and the burn is totally in sunlight. Three ARIA support the burn, and one additional aircraft is used for backup. The TLI ships are not used for this mission; thus, except for ARIA, there is no MSFN coverage during the preignition sequence or the majority of the burn. Hawaii acquires just prior to burn cutoff. The TLI burn geometry is shown in figure 4.3-1.

The TLI burn places the spacecraft on a free-return trajectory with a high perilune altitude (~1850 n. mi.). The evasive maneuver after CSM/LM ejection is made with the S-IVB APS rather than with the SM SPS; therefore the TLI burn cutoff is not biased to compensate for an SPS evasive maneuver as it was for the Apollo 11 mission. The characteristics of the TLI burn are as follows.

Burn initiation

Time, hr:min:sec, g.e.t.	2:47:21.7
Geodetic latitude, deg	2.3
Longitude, deg	-176.6
Velocity, fps	25 587
Apogee altitude above mean radius, n. mi.	107.8
Perigee altitude, n. mi.	98.6

Burn cutoff

Time, hr:min:sec, g.e.t.	2:52:43.7
Geodetic latitude, deg	15.6
Longitude, deg	-155.2
Velocity, fps	35 476
Burn duration, sec	322.
S-IVB propellant used, lb	156 129.
Plane change, deg	2.7
Inclination to earth-moon plane, deg	57.7
Apogee altitude above mean radius, n. mi.	237 000
Perigee altitude above mean radius, n. mi.	109.7

^aThe parameters for this phase are approximate and are presented for information only. The official source for this phase is the MSFC ΔV operational trajectory (ref. 1).

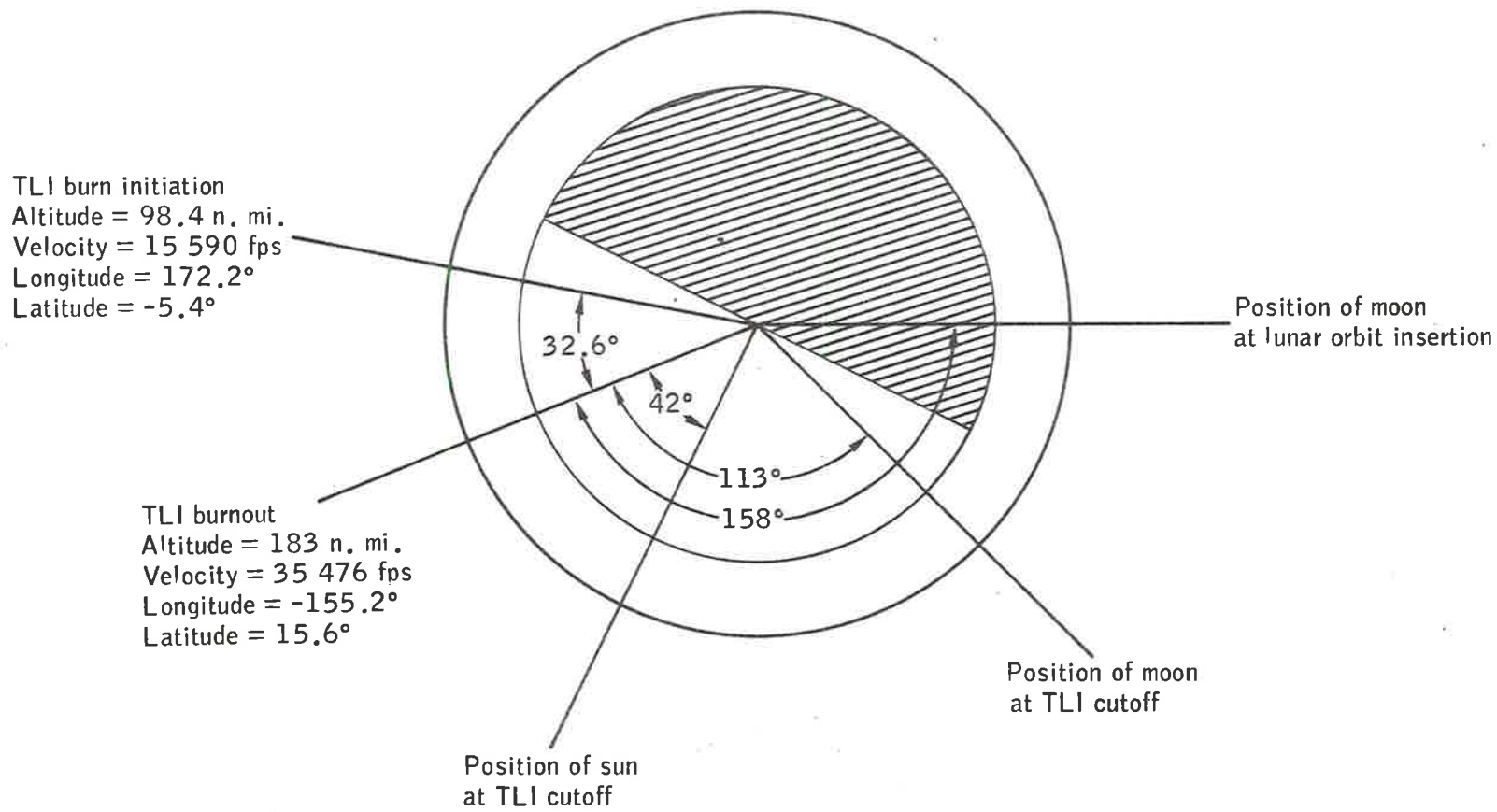

9T-4

Figure 4.3-1.- TLI geometry.

4.4 FREE-RETURN CIRCUMLUNAR

4.4 Free-return Circumlunar Trajectory

The free-return trajectory of the hybrid profile, shown in figure 1.1-1, is plotted in an inertial reference frame anchored at the time of perilune. The characteristics of the trajectory are the following.

Perilune

Time, hr:min:sec, g.e.t.	83:25:50.8
Altitude above LLS, n. mi.	1851.7
Selenographic latitude, deg	-2.6
Selenographic longitude, deg	-177.1

Return vacuum perigee altitude, n. mi.	20
--	----

Transit time from TLI

Burnout to entry interface, hr:min:sec	160:38:14.2
--	-------------

Earth entry interface

Time, hr:min:sec, g.e.t.	163:30:57.9
Altitude, n. mi.	65.8
Geodetic latitude, deg	2.4
Longitude, deg	-91.9
Inclination, deg	16.5

Touchdown

Time, hr:min:sec, g.e.t.	163:45:00
Geodetic latitude, deg	8.4
Longitude, deg	-71.2
Time prior to sunset, hr:min	10:34

4.5 POST-TRANSLUNAR INJECTION EVENTS

4.5 Post-Translunar Injection Events

The summary of the major events from TLI cutoff through S-IVB LOX blowdown is given in table 4.5-I. To determine the separation attitude maneuver (TB7 plus 900 sec), the sun was constrained to between 32° and 90° of the LV +X-axis. This constraint provides over-the-shoulder lighting and avoids any CSM shadow on the S-IVB for the docking phase.

Upon ground command, the S-IVB performs an APS evasive maneuver approximately 12 minutes after CSM/LM separation. The S-IVB attitude for this maneuver will be the same as the separation attitude except that the sign of the middle gimbal angle (yaw gimbal) will be reversed. The APS burn will be 10 fps.

The S-IVB performs a LOX dump 21 minutes 20 seconds after the APS evasive maneuver. The local horizontal attitude for this dump is pitch 191° , yaw 0° , roll 180° .

The LOX dump maneuver is designed to reduce the probability of SC recontact with the S-IVB and also to prevent S-IVB impact with the earth or moon. Nominally, the LOX dump maneuver results in a slingshot trajectory; the S-IVB will pass behind the trailing edge of the moon and will be accelerated by the lunar gravitational field. The result is a heliocentric orbit which avoids both earth and lunar impact.

The relative motion between the S-IVB and SC for this post-T, D, and E phase is shown in figure 4.5-1.

TABLE 4.5-1.- SUMMARY OF EVENTS FROM TLI
CUTOFF THROUGH LOX DUMP

Time from TB7 hr:min:sec	Event	ΔV , fps	Comments
0:00:00	Hold cutoff attitude		
0:00:20	Command and hold local horizontal		
0:15:00	Initiate maneuver to separation attitude		
0:20:00	Freeze separation attitude inertially		Latest time for maneuver to be completed
0:25:00	Begin SC separation/SLA jettison	0.8	
0:25:35	Null 0.3 fps separation rate	.3	-X RCS
0:25:40	Pitch 180° (SC)		1.5/deg/sec
0:27:40	Null pitch Start roll 60°		.5 deg/sec
0:29:40	Null 0.5 fps separation rate and initiate 1 fps closing rate	1.5	+X RCS
0:32:10	Null 1 fps closing rate	1	-X RCS
0:32:15	Begin dock		
1:20:00	LM/CSM undock from S-IVB	1.2	Spring ejection and 3 sec -X RCS
1:32:00	S-IVB APS	10	Start TB8
1:53:20	S-IVB LOX		Local horizontal attitude pitch = 191° yaw = 0° roll = 180°

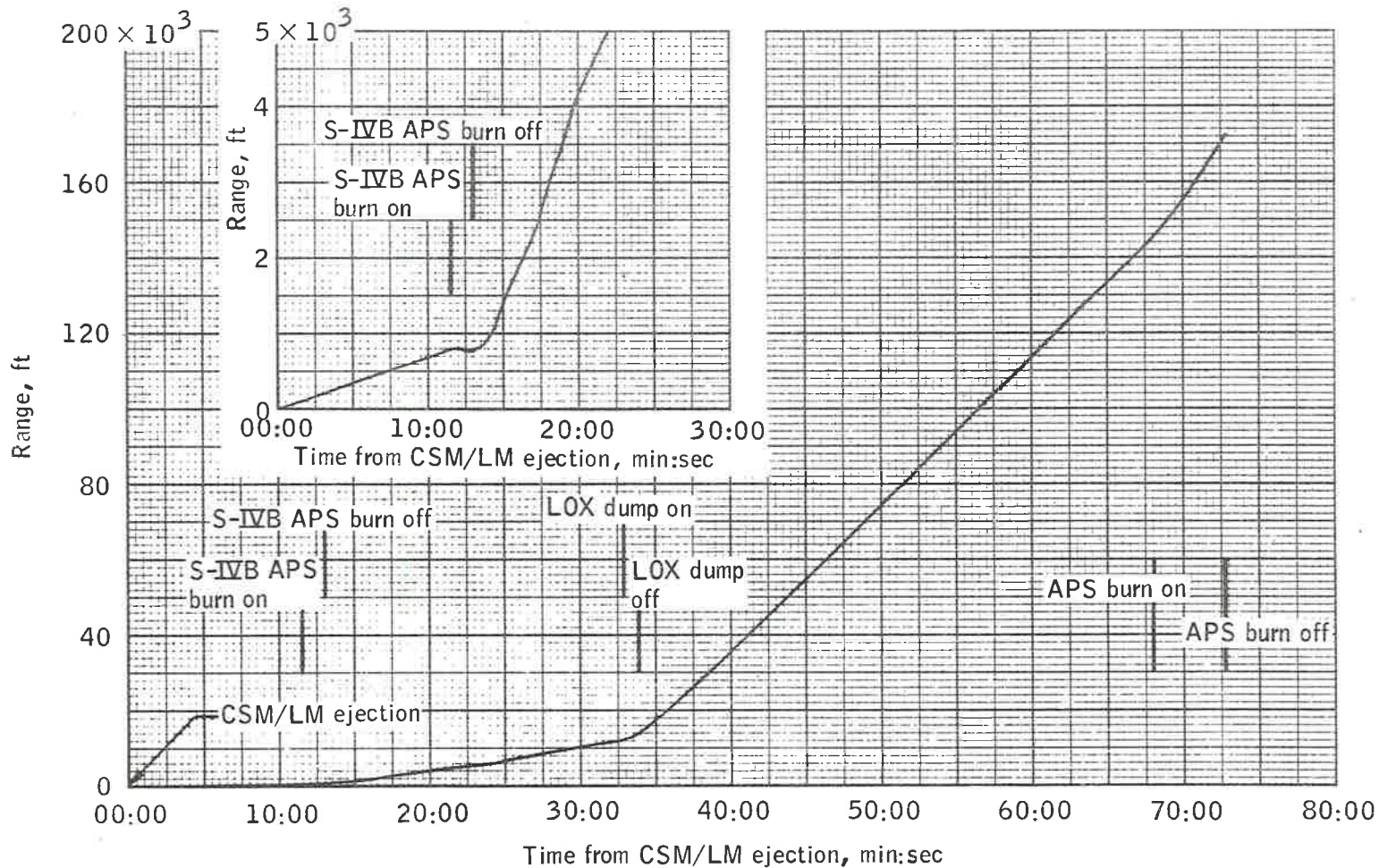

(a) Range versus time.

Figure 4.5-1. -Motion of the S-IVB relative to the spacecraft for the S-IVB evasive maneuver on Apollo Mission H-1.

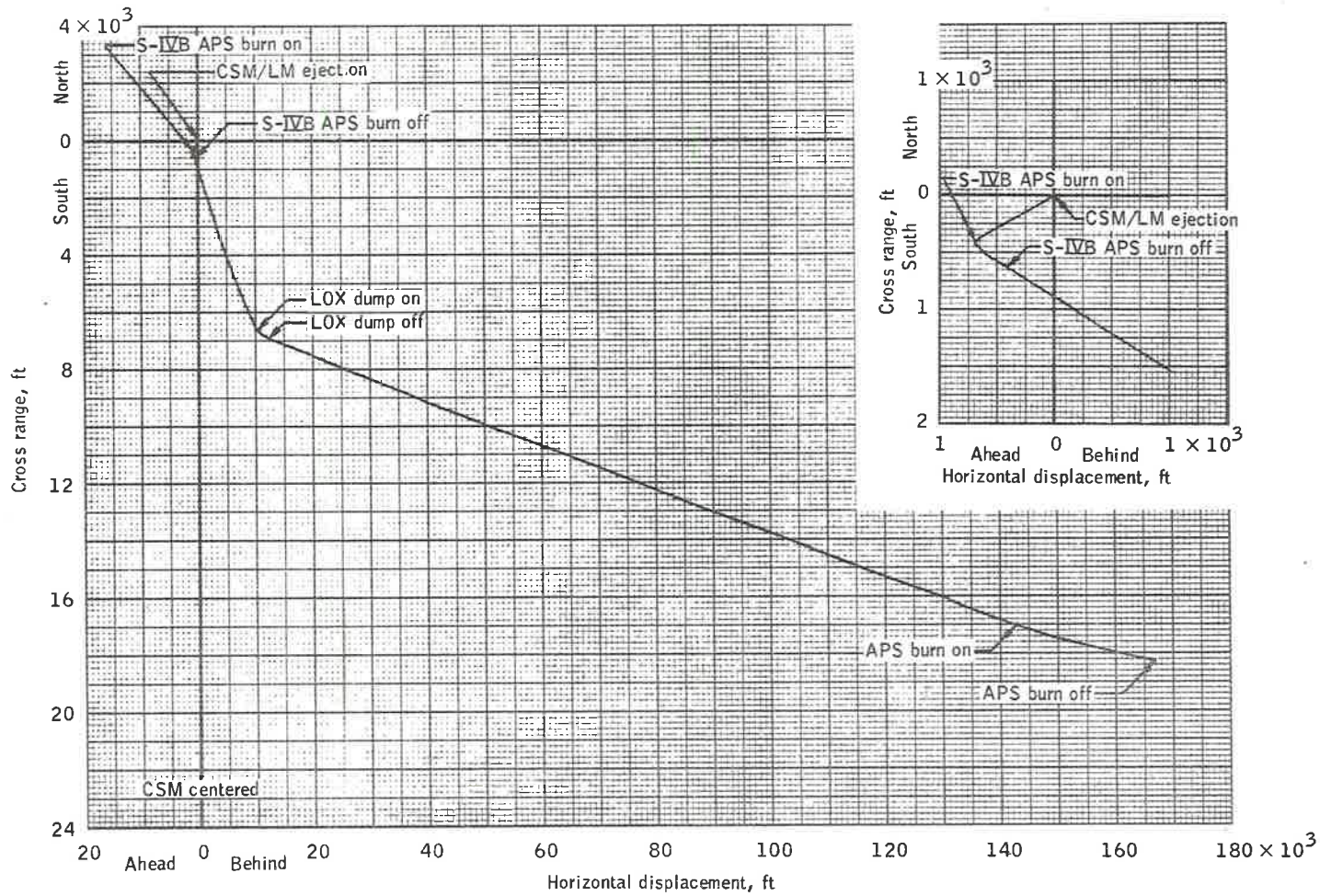

(b) Cross range versus horizontal displacement.

Figure 4.5-1.- Continued.

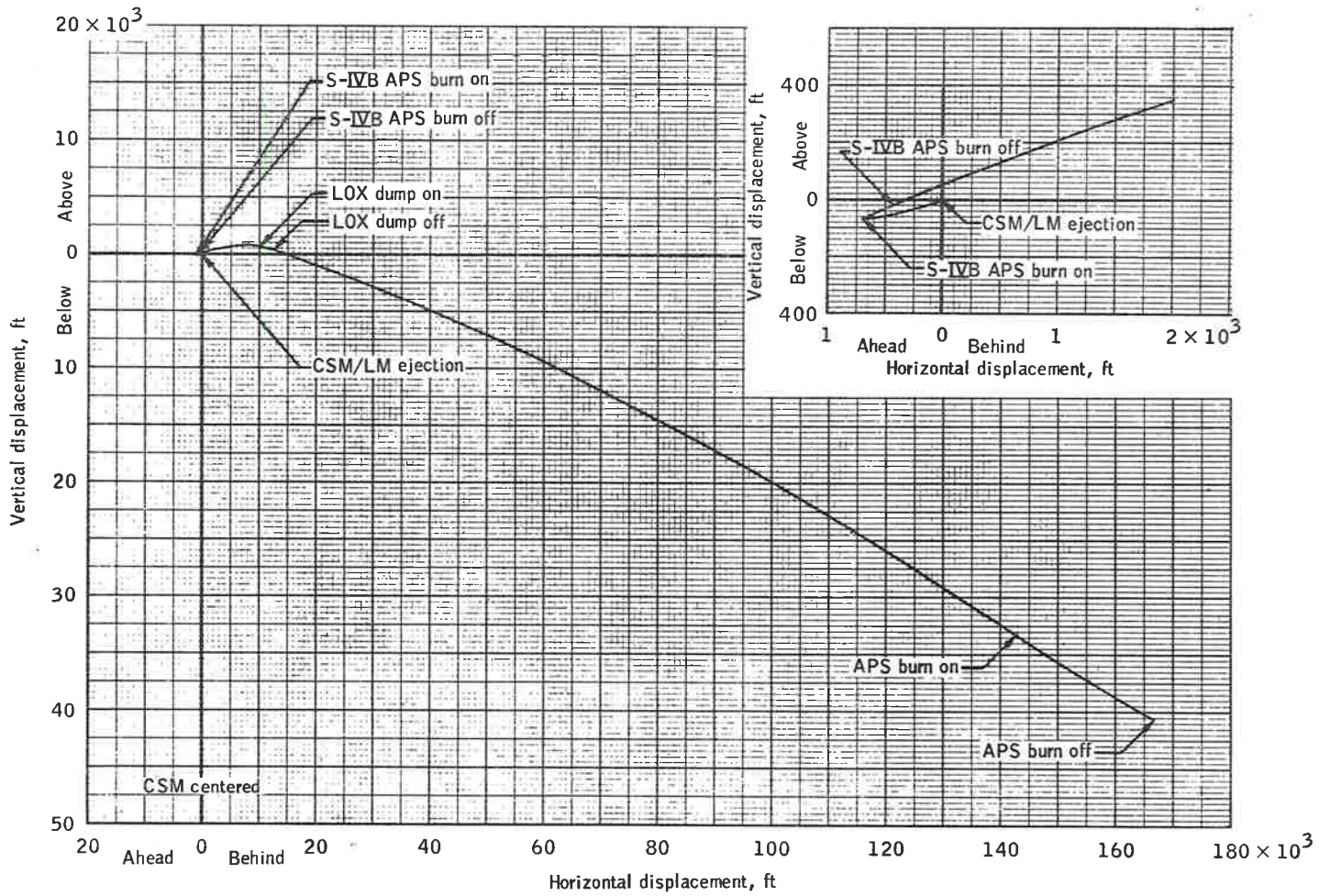

(c) Vertical displacement versus horizontal displacement.

Figure 4.5-1.- Concluded.

4-27

4.6 TRANSLUNAR COAST

4.6 Translunar Coast

A groundtrack of the translunar coast phase is shown in figure 4.6-1. Time histories of altitude and true anomaly for the first 10 hours of translunar coast are provided in figures 4.6-2 and 4.6-3.

After TLI, the spacecraft is on a free-return circumlunar trajectory with a perilune altitude of 1851.7 n. mi. At TLI plus 24 hours^a, a transfer maneuver is performed which results in a non-free-return translunar trajectory with a 60-n. mi. perilune altitude. The transfer trajectory is restricted such that, in the event that an SPS maneuver could not be made, an earth return would be possible within the DPS docked ΔV capability. It is assumed that the LM maneuver could be made at a minimum of 2 hours after perilune. The target load for this maneuver is presented in table 4.6-I.

The transfer maneuver is GNCS controlled, and external ΔV guidance and the PTC REFSMMAT are used. The characteristics of the burn are the following.

Time ^a , hr:min:sec, g.e.t.	26:52:43.7
Geodetic altitude, n. mi.	106 897.0
ΔV , fps	63.8
Burn time, sec	9.3
SPS propellant used, lb	607.2
Plane change, deg	0.9

Passive thermal control attitude will be maintained during most of the translunar coast phase. The PTC REFSMMAT is given in table 5-II.

Four midcourse correction maneuver points have been defined at the following times.

- a. TLI plus 9 hours (MCC-1)
- b. TLI plus 24 hours^a (MCC-2) (the transfer maneuver)
- c. LOI minus 22 hours (MCC-3)
- d. LOI minus 5 hours (MCC-4)

^aBecause of the crew rest/work recycle, the transfer maneuver time has been changed to TLI plus 28 hours.

The midcourse correction strategy has been defined and documented through the Apollo Data Priority Coordination Office (ref. 2). The maneuvers are GNCS controlled, and external ΔV guidance is used. Unless gimbal lock problems occur, the pad IMU alinement (REFSMMAT) will be used for the MCC-1, the PTC REFSMMAT (table 5-II) will be used for MCC-2 and MCC-3, and the descent REFSMMAT will be used for MCC-4. The alinement criteria are presented in section 5.0.

The SC enters the lunar umbra approximately 40 minutes prior to LOI-1 ignition and stays in shadow for 32 minutes. There is continual MSFN coverage from TLI cutoff until lunar occultation.

The duration of the translunar coast phase is 80 hours 36 minutes. Note that this duration violates the highly desirable ground rule of an even integer number of days for translunar flight to provide a more favorable crew work/rest cycle. However, a thorough review of mission design scans indicated that no even-integer day was possible without violation of other mandatory ground rules.

Geodetic altitude from translunar injection to LOI-1 is shown in figure 4.6-4. Altitude above the lunar surface during the last 10 hours of translunar coast is shown in figure 4.6-5.

TABLE 4.6-I.- TARGET LOAD FOR NON-FREE-RETURN MANEUVER

[Propulsion system: SPS; guidance: external ΔV]

(a) Target

t_{IG} , hr:min:sec, g.e.t.	26:52:43.7
ΔV_X , fps	-23.5
ΔV_Y , fps	-18.0
ΔV_Z , fps	56.5
Weight, lb	96 597.6

(b) REFSMMAT

Refer to table 5-II

(c) Gimbal angles at t_{IG}

IMA, deg	21.2
MGA, deg	-28.2
OGA, deg	-169.4

APOLLO TRACKING NETWORK

All stations operational May 1968

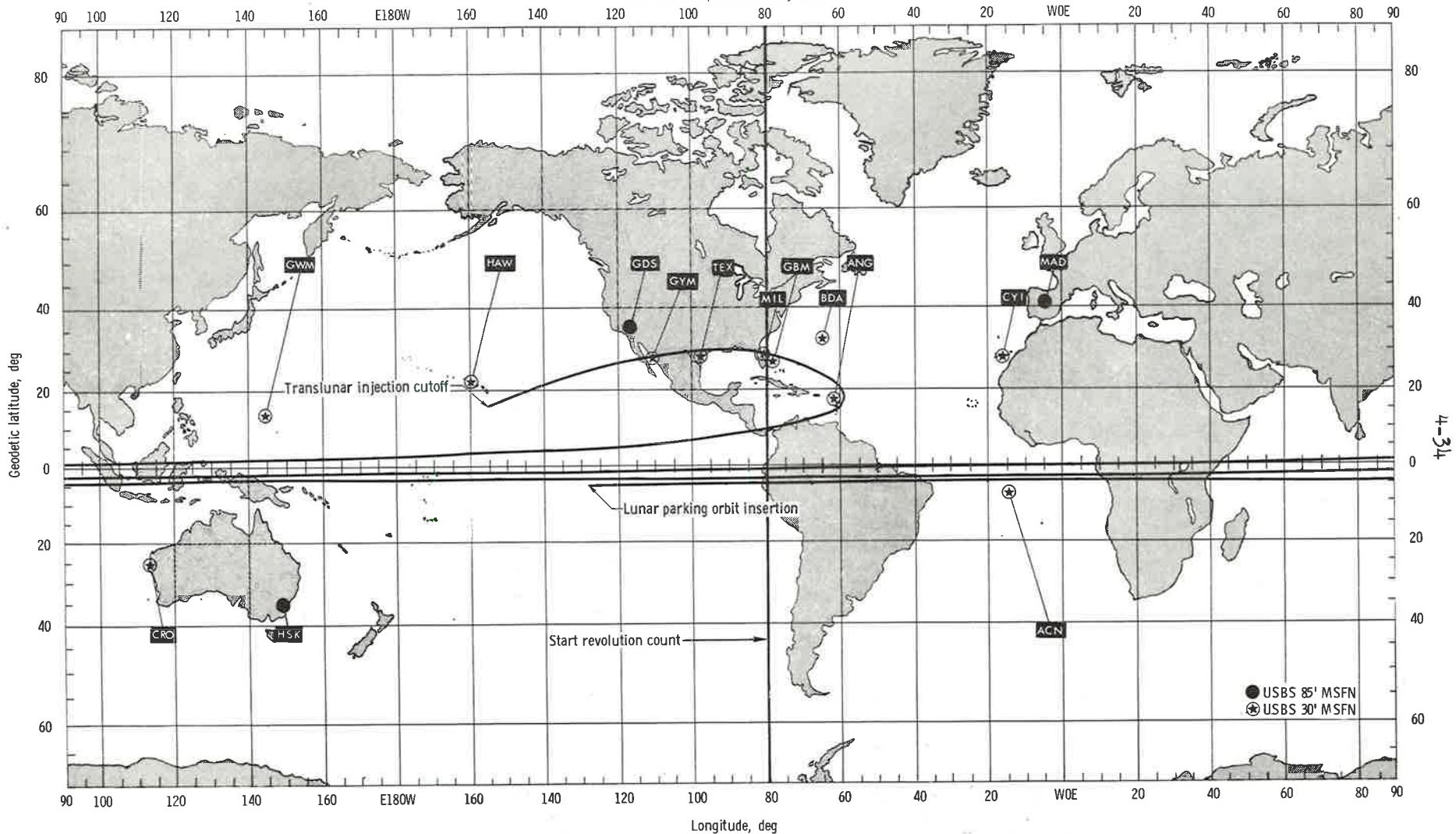

Figure 4.6-1. - Translunar coast groundtrack.

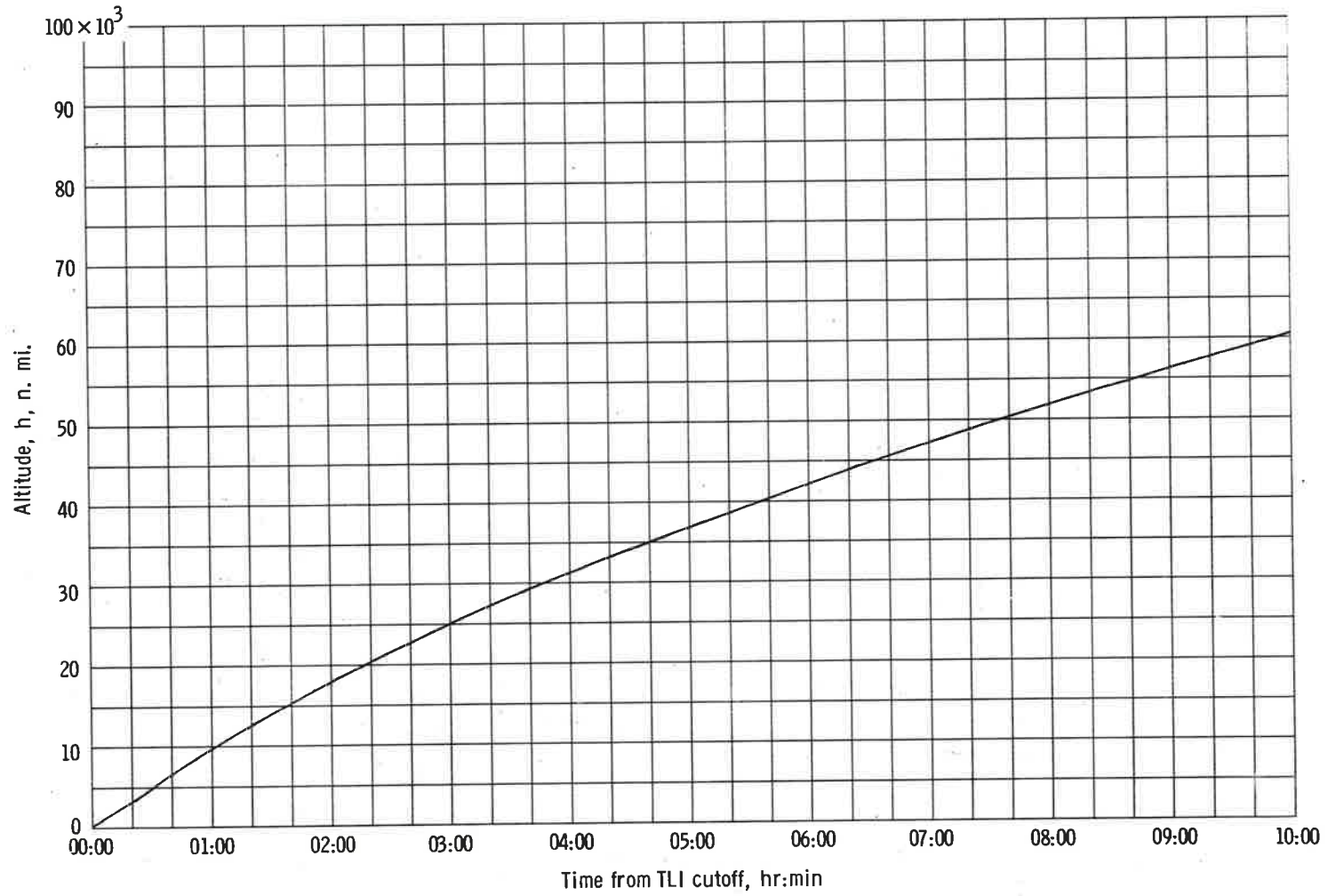

Figure 4.6-2. - Time history of altitude for first 10 hours of translunar coast.

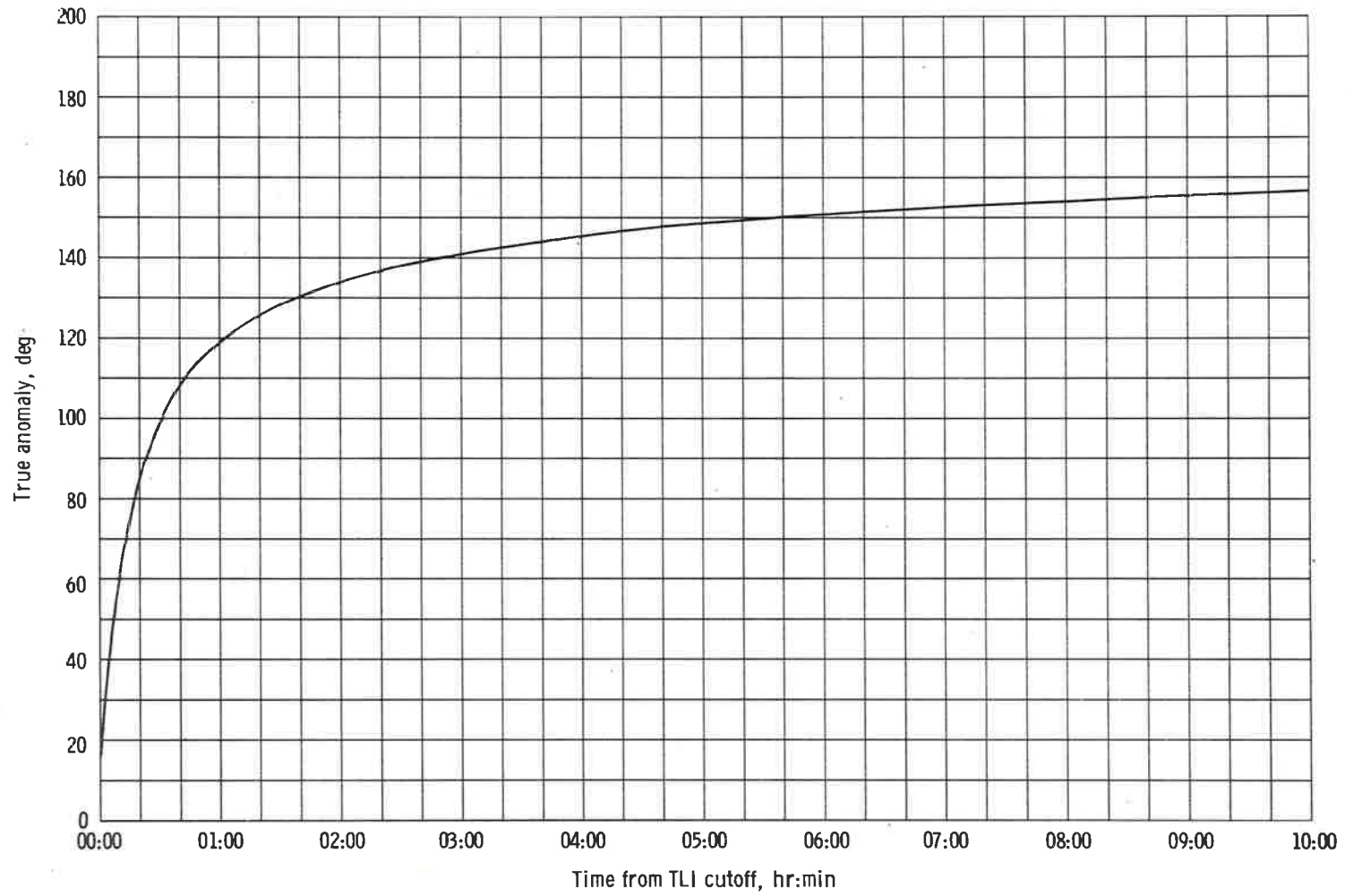

Figure 4.6-3. - Time history of true anomaly for first 10 hours of translunar coast.

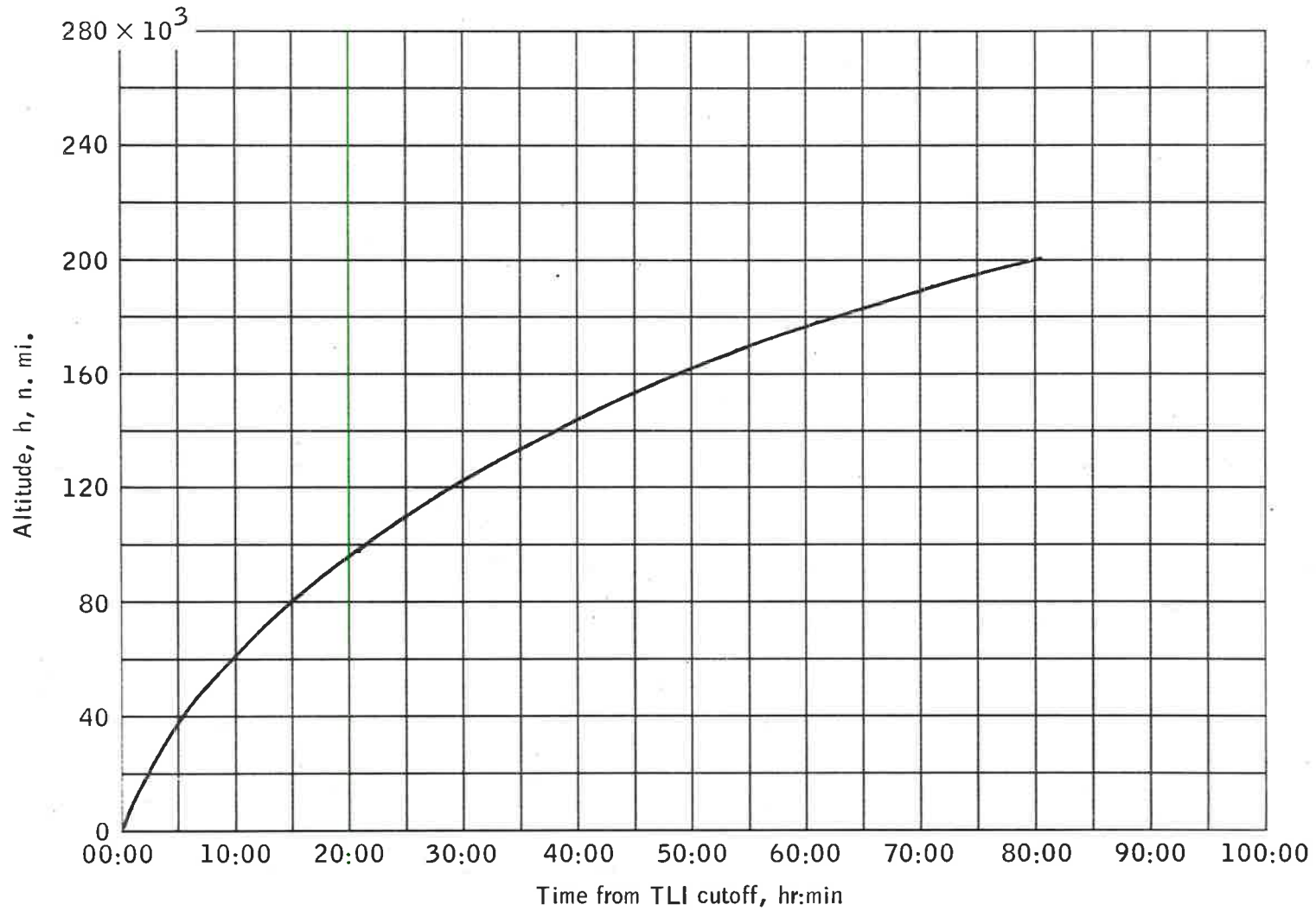

Figure 4.6-4.- Altitude time history from translunar injection to lunar orbit insertion.

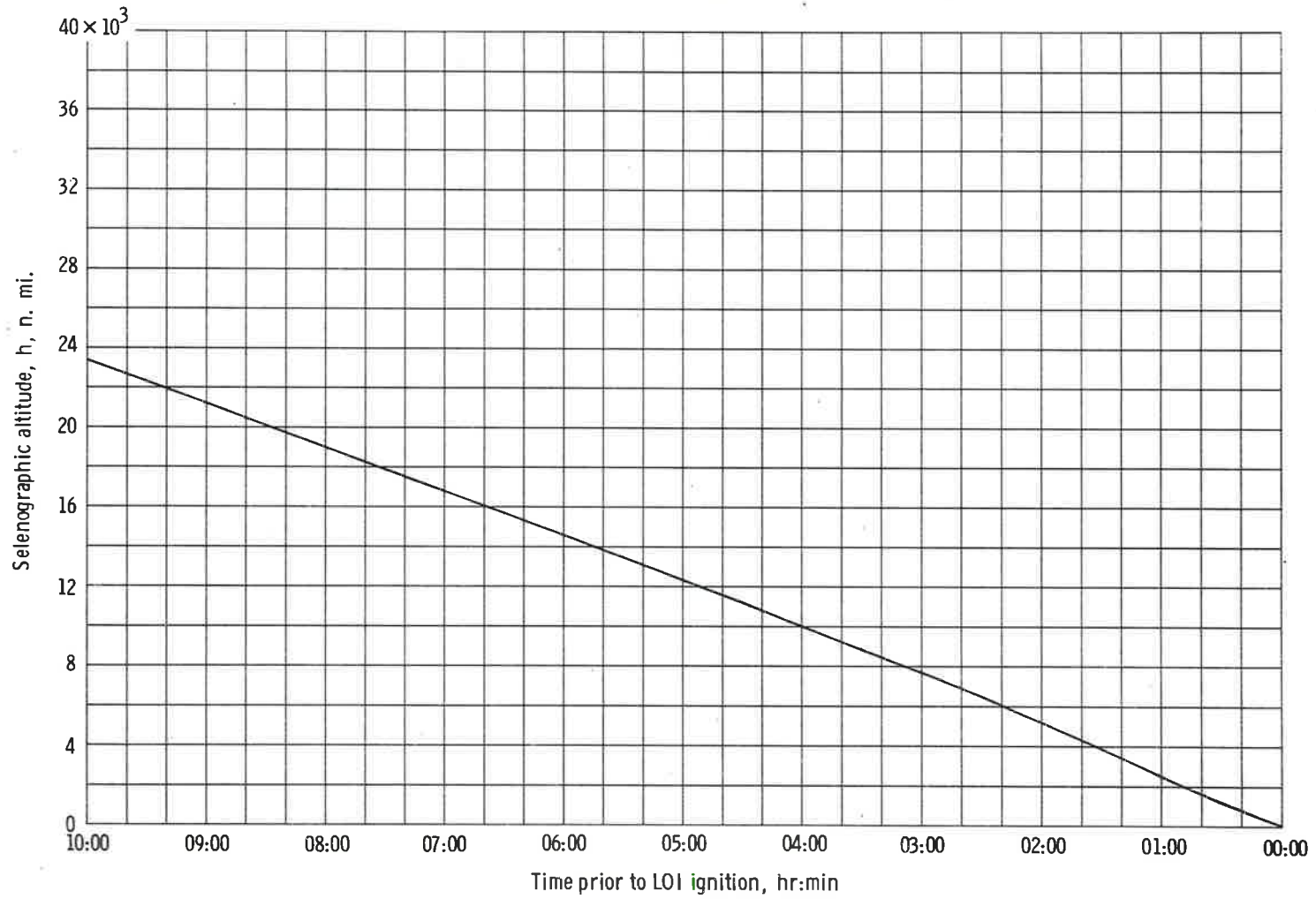

Figure 4.6-5. - Time history of altitude 10 hours prior to LOI ignition.

4.7 LUNAR ORBIT INSERTION

4.7 Lunar Orbit Insertion (LOI-1)

The LOI-1 maneuver is designed to insert the CSM into approximately a 60- by 170-n. mi. lunar parking orbit (LPO). The lunar orbit insertion geometry is shown in figure 4.7-1, and the lunar orbit groundtrack from LOI-1 to LM landing is shown in figure 4.7-2. A time history of trajectory parameters during the burn is presented in figure 4.7-3. The burn was simulated with external ΔV guidance. A description of the burn is as follows.

LOI-1 burn initiation

Time, hr:min:sec, g.e.t.	83:28:47.5
Mass, lb	94.595
Altitude above LLS, n. mi.	85.3
Selenographic latitude, deg	6.5
Selenographic longitude, deg	177.4
Velocity, fps	8162.5
Perilune altitude above LLS, n. mi.	59.9
Selenographic inclination, deg	158.0

LOI-1 burnout - start LPO

Time, hr:min:sec, g.e.t.	83:34:47.7
Altitude above LLS, n. mi.	59.7
Selenographic latitude, deg	-1.1
Selenographic longitude, deg	155.3
Velocity, fps	5484.3
Selenographic inclination, deg	164.7
Burn duration, sec	360:2
Inertial burn arc, deg	23.3
Plane change, deg	6.7
ΔV , fps	2890.4
SPS propellant used, lb	23 511.
Orbit period, hr:min:sec	2:08:39.5
Perilune altitude above LLS, n. mi.	59.7
Apolune altitude above LLS, n. mi.	170.1

The LOI-1 burn parameters were computed without simulation of the SPS thrust buildup and tailoff. However, the effect of these is reflected in the burn parameters presented in the simulation data package (ref. 3).

The REFSMMAT used for the LOI-1 burn as well as for the LOI-2 burn is the lunar landing site alinement at the nominal lunar landing time.

The target load for the LOI-1 burn is given in table 4.7-I. More detailed information about the burn, including reset points, navigation updates, and ignition gimbal angles, is given in reference 3.

TABLE 4.7-I.- TARGET LOAD FOR LOI-1 MANEUVER
 [Propulsion system, SPS; guidance: external ΔV]

(a) Target

t_{IG} , hr:min:sec, g.e.t.	83:28:47.5
ΔV_X , fps	-2815.7
ΔV_Y , fps	644.2
ΔV_Z , fps	-106.7
Weight, lb	94 595.4

(b) REFSMMAT

Refer to table 5-III

(c) Gimbal angles at t_{IG}

IGA, deg	-99.5
MGA, deg	18.9
OGA, deg	3.7

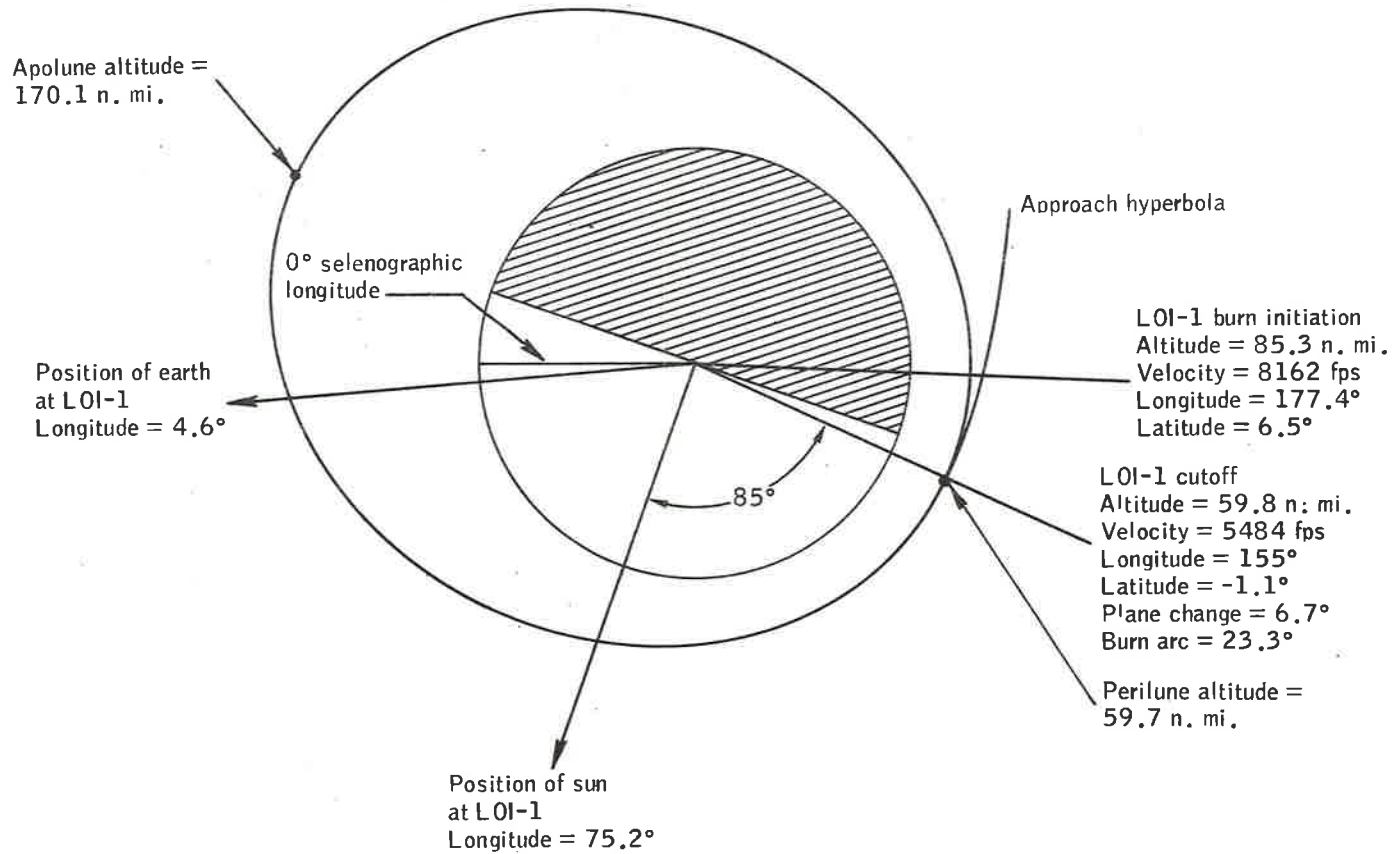

4-43

Figure 4.7-1.- LOI-1 geometry.

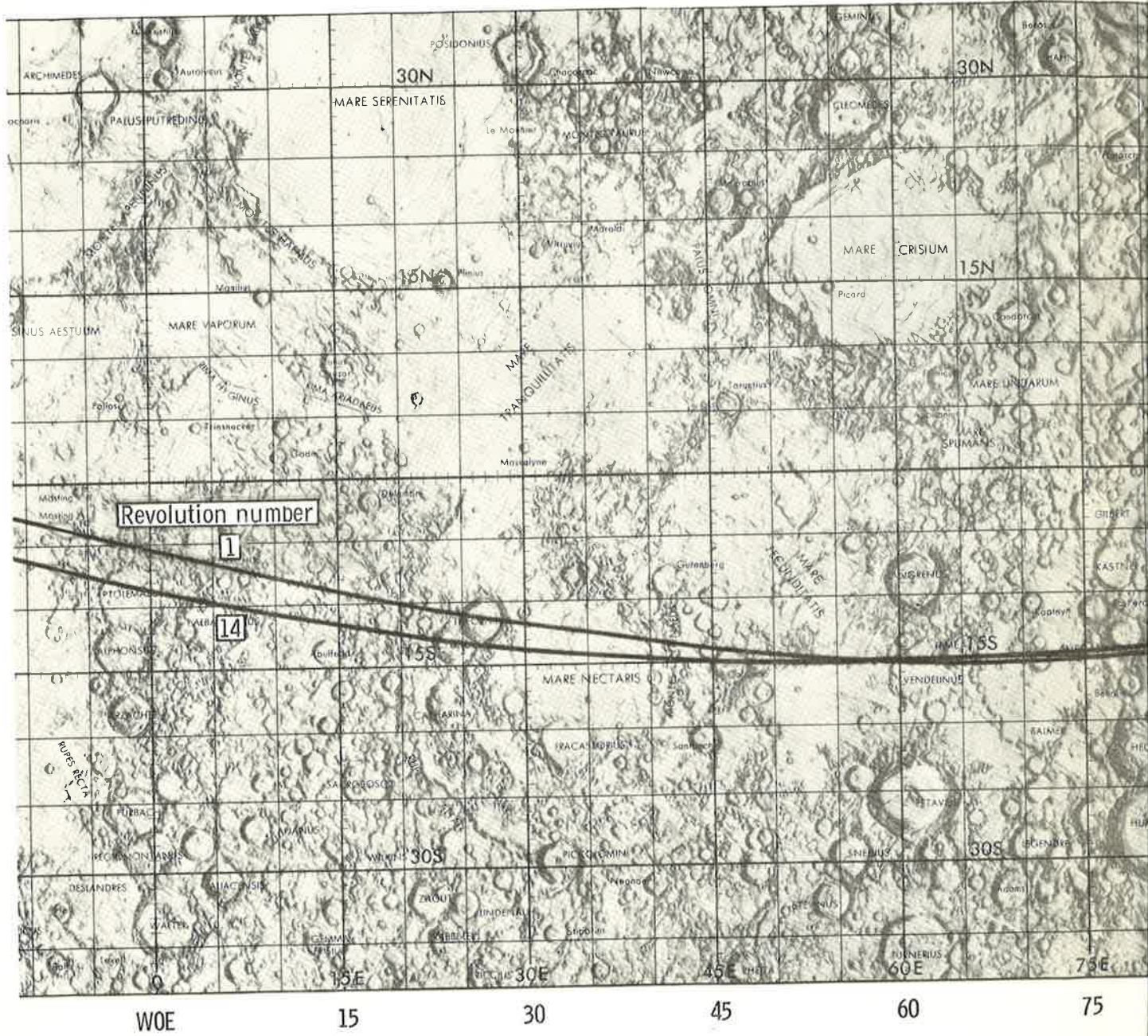

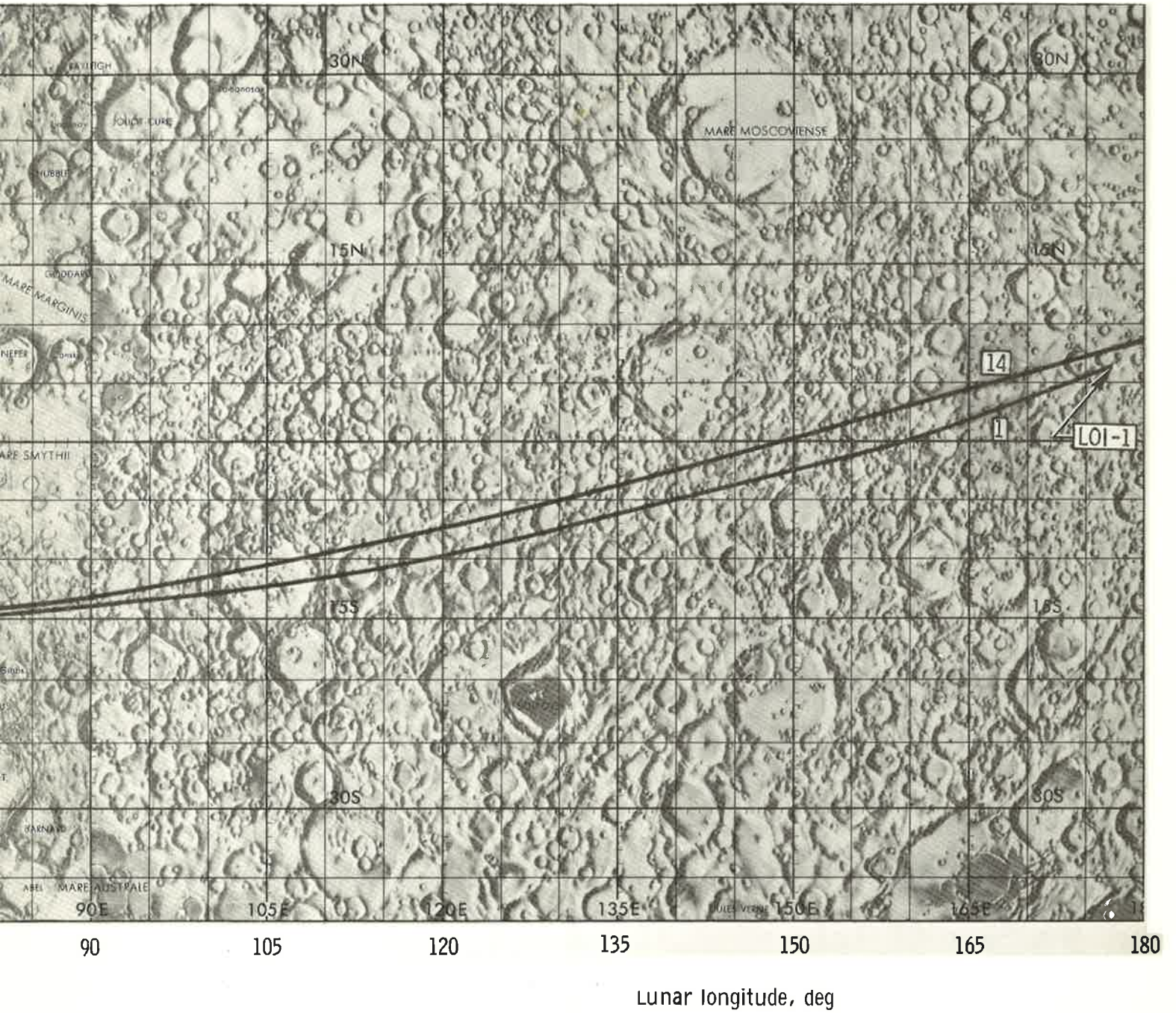
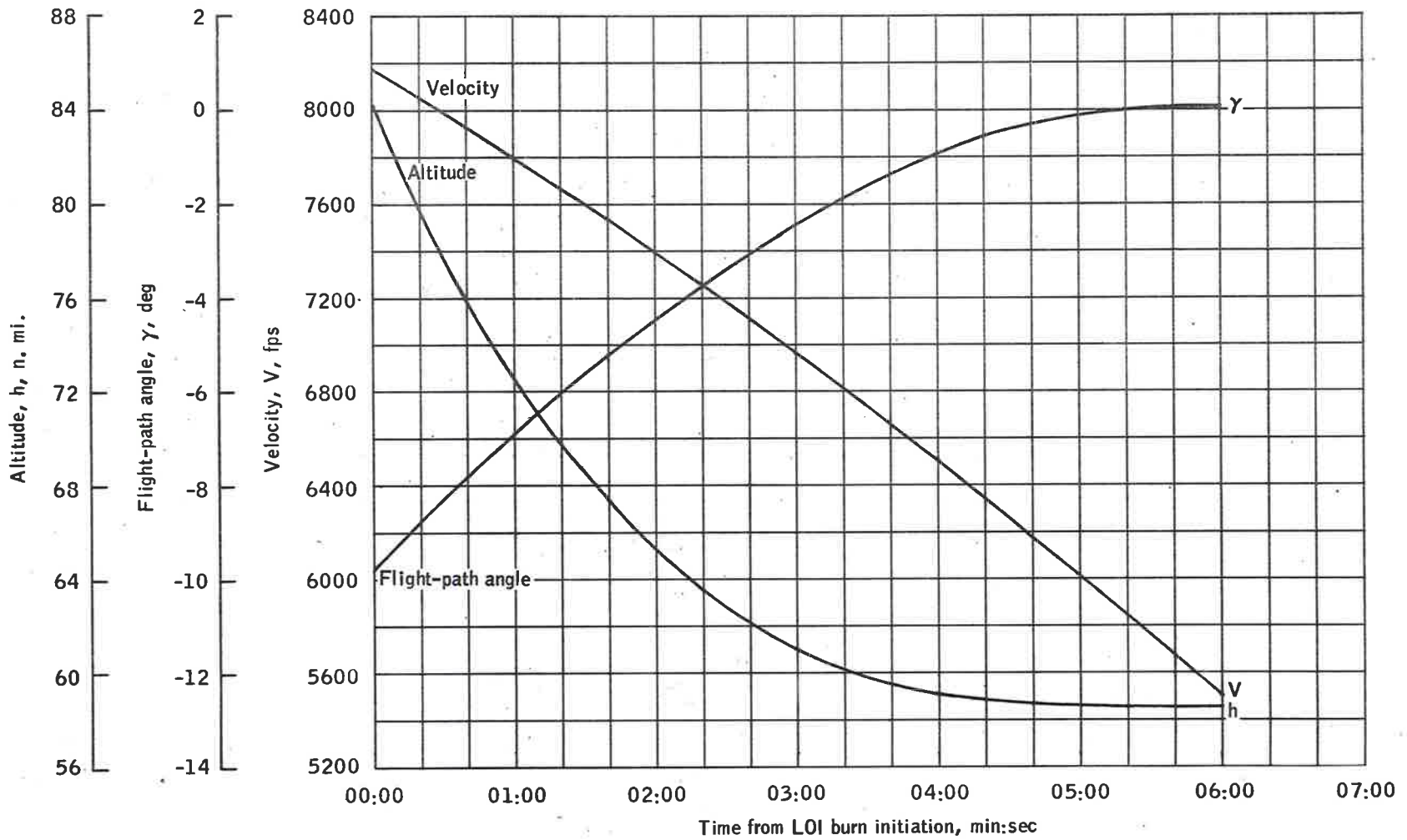

Figure 4.7-2. - Lunar orbit groundtracks from LOI-1 to LM landing.



54-7

(a) Velocity, flight-path angle, and altitude versus time from LOI burn initiation.

Figure 4.7-3.- Time history of trajectory parameters for LOI-1.

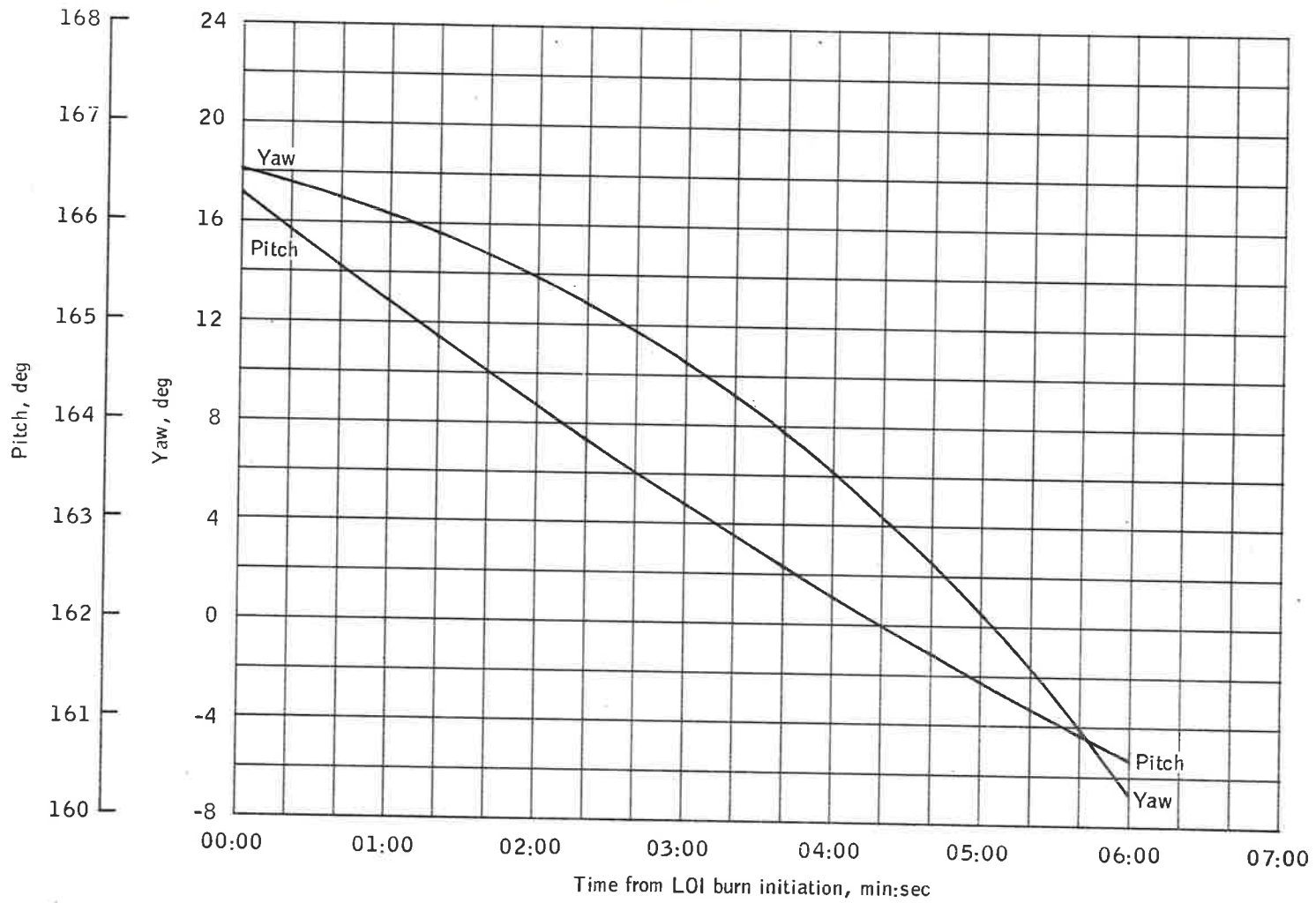

94-4

(b) Local horizontal pitch and yaw versus time from LOI burn initiation.

Figure 4.7-3.- Concluded.

4.8 LUNAR ORBIT CIRCULARIZATION

4.8 Lunar Orbit Circularization (LOI-2)

The LOI-2 maneuver occurs after two revolutions in the 60- by 170-n. mi. orbit. The targeting is biased to place the spacecraft in a noncircular orbit. The orbit is designed such that the predicted perturbations caused by the lunar potential will gradually circularize the orbit at ~60 n. mi. by the time of the CDH maneuver (approximately 60.5 hr after LOI-1). The initial orbit is 54.1 by 65.9 n. mi. with perilune located at a selenographic longitude of 72°E. These altitudes are relative to the landing site radius.

For the LOI-2 burn, the landing REFSMMAT (table 5-III) is used, and the CSM is oriented heads down. The burn is initiated near perilune of the second revolution in the 60- by 170-n. mi. orbit. The target load for the LOI-1 maneuver is presented in table 4.8-I. The characteristics of the burn are the following.

LOI-2 burn initiation

Time, hr:min:sec, g.e.t.	87:47:36.7
Mass, lb.	71 050.
Altitude above LLS, n. mi.	61.3
Selenographic latitude, deg	2.4
Selenographic longitude, deg	166.0
Velocity, fps	5476.3
Perilune altitude above LLS, n. mi.	59.6
Apolune altitude above LLS, n. mi.	170.2

LOI-2 burnout

Time, hr:min:sec, g.e.t.	87:47:54.8
Altitude above LLS, n. mi.	61.2
Selenographic latitude, deg	2.1
Selenographic longitude, deg	165.1
Velocity, fps	5338.7
Selenographic inclination, deg	164.7
Burn duration, sec	18.1
Inertial burn arc, deg	0.9
Plane change, deg	0.0
ΔV , fps	169.3
SPS propellant used, lb	1178.9
Orbit period, hr:min:sec	1:58:43.3
Perilune altitude above LLS, n. mi.	54.1
Apolune altitude above LLS, n. mi.	65.9

TABLE 4.8-I.- TARGET LOAD FOR LOI-2 MANEUVER

[Propulsion system: SPS; guidance: external ΔV]

(a) Target

t_{IG} , hr:min:sec, g.e.t.	87:47:36.7
ΔV_X , fps	-137.6
ΔV_Y , fps	0
ΔV_Z , fps	-98.6
Weight, lb	71 050.3

(b) REFSMMAT

Refer to table 5-III

(c) Gimbal angles at t_{IG}

IGA, deg	-128.6
MGA, deg	-0.3
OGA, deg	-0.3

4.9 CSM/LM COAST FROM LOI-1 TO UNDOCK

4.9 CSM/LM Coast from LOI-1 to Undock

The activities in lunar orbit prior to undock include a lunar landmark sighting during rev 4, a LM housekeeping period, a 9-hour rest period, the LM checkout, and a landmark sighting on the landing site landmark. The following is a summary of the major activities in lunar orbit prior to undock.

Activity	Revolution number	Time, hr:min, g.e.t.
LOI-1	Beginning of 1	83:29
LOI-2	Beginning of 3	87:48
IVT to LM for housekeeping activities	3	89:30
Landmark track	4	90:20
Inertial attitude	4	90:40
IVT to CSM	4	91:10
Begin 9-hr rest period	5	92:30
End rest period	9	101:30
IVT to LM for LM checkout	11	103:55
Landing site landmark track	12	106:30
Undock	13	108:01

4.10 CSM/LM UNDOCK TO LANDING

4.10 CSM/LM Undock to Landing

The period from undock to landing (touchdown) includes the following maneuvers: CSM/LM undock, CSM separation, descent orbit insertion (DOI), and the powered descent [fig. 4.10-1(a)]. The undocking occurs during the thirteenth orbit. Approximately 30 minutes later, the CSM performs a separation maneuver. One-half orbit after separation, the DOI maneuver is performed to place the LM on a Hohmann transfer orbit to carry it from the near 60-n. mi. circular parking orbit to a low altitude of 50 000 feet. The powered descent maneuver is initiated near the 50 000-foot perilune of the descent transfer orbit. The powered descent maneuver [fig. 4.10-1(b)] consists of three operational phases: braking, for efficiency; approach, for crew visibility; and landing, for takeover of manual control to landing on the lunar surface. The transition from braking to approach phase is termed high gate, and the transition from approach to landing phase is termed low gate.

The lunar groundtracks for the spacecraft are included in figure 4.10-2. The track of the LM from undocking to landing with the location of the major events are shown in figure 4.10-2(a); the same track is shown in figure 4.10-2(b) for the CSM. The LM track during the powered descent is shown in figure 4.10-2(c); the locations of powered descent initiation (PDI), high gate, and landing are indicated. The CSM track during powered descent is shown in figure 4.10-2(d). A summary of the LM descent events including related data during the descent is shown in table 4.10-I. Lunar module weight data used are provided in table 4.10-II; engine performance data are given in table 4.10-III. Data for both of these tables were taken from references 4 and 5, respectively. The MSFN tracking summary is given in table 4.10-IV.

Time histories of LM altitude, velocity, and flight-path angle from undocking to landing are shown in figure 4.10-3; major events are also indicated. Time histories of the LM-CSM relative parameters to show vehicle-to-vehicle relationships during the LM descent are shown in figure 4.10-4. The parameters shown are LM-CSM elevation angle, phase angle, range, and range rate with the major events indicated. Time histories of the three body relationships (i.e., CSM-LM-sun and CSM-LM-earth) are shown in figure 4.10-5. The angular relationship between the CSM and the sun as viewed from the LM is shown in figure 4.10-5(a), and the relationship between the CSM and the earth is shown in figure 4.10-5(b). The LM-CSM range rate versus range from undocking to landing with time ticks every 20 minutes is shown in figure 4.10-6(a). An enlargement of these data from DOI to PDI is shown in figure 4.10-6(b). The LM-CSM relative motion is shown in two figures. Separation through DOI is shown in figure 4.10-7, and DOI through powered descent to landing is shown in figure 4.10-8.

More details of each maneuver from undocking to landing are given in the following subsections.

4.10.1 CSM/LM undock and separation.- During the thirteenth orbit and 2.5 hours prior to landing, the LM and CSM undock in preparation for descent. One-half hour after undocking (one revolution prior to PDI), the CSM performs a manual maneuver of 2.5 fps directed radially downward toward the center of the moon. This maneuver provides an increase in LM-CSM separation distance from the 40-foot stationkeeping position to 10 571 feet (1.7 n. mi.) at DOI, as shown previously in figure 4.10-7. The target load for the separation maneuver is given in table 4.10-V.

4.10-2 Descent orbit insertion (DOI).- The DOI maneuver occurs one-half revolution after separation and one-half revolution prior to PDI. This maneuver places the LM in a 60-n. mi. by 50 000-foot altitude orbit with perilune located to the east of the landing site longitude by a central angle of approximately 15° . The DOI includes a two-jet, 7.5-second ullage followed by a 28.2-second retrograde burn. During the first 15 seconds of the burn, the DPS manual throttle is set to the minimum position. After this 15-second trim period, the throttle is increased manually to 40 percent for the remainder of the burn. The target load for the maneuver is shown in table 4.10-VI. Time histories of the engine gimbals angles, platform gimbals angles, and FDAI angles during the DOI burn are shown in figures 4.10-9 through 4.10-11.

4.10-3 Powered descent.- The powered descent maneuver (PDI) which consists of braking phase, approach phase, and landing phase [fig. 4.10-1(b)] is initiated at perilune of the descent transfer orbit (50 000 ft). The ullage maneuver and DPS engine gimbals angle trim periods are performed at the constant inertial attitude required by PGNCs guidance at DPS ignition. The braking phase is designed for efficient reduction of orbital velocity and, therefore, uses maximum thrust from the DPS for most of the phase; however, the DPS is throttled during the final 2 minutes of this phase for guidance control. The spacecraft is in a windows-up attitude so that the landing radar can be used. The braking phase guidance is based on quadratic acceleration equations. The targets for this phase are listed in table 4.10-VII. However, these targets are not actually achieved because the guidance automatically switches when time to go (to achieve targets) becomes less than 62 seconds from braking phase targets to approach phase targets.

The approach phase, which begins at approximately a 7000-foot altitude (high gate), provides for pilot visual monitoring of the approach to the lunar surface. That is, the guidance is targeted to provide spacecraft attitudes which permit crew visibility of the landing area through the forward window throughout this phase. The same quadratic acceleration guidance law used in the braking phase is also used here. The targets for

the approach phase are listed in table 4.10-VII. Note that the altitude target is approximately 110 feet. However, the approach phase is operationally considered to be terminated at an altitude of 500 feet (low gate) where the landing phase begins. The landing phase is designed to provide continued visual assessment of the landing site and to provide compatibility for pilot takeover from the automatic control. There is no change in guidance law or targets at this point because the approach phase targets have been selected to satisfy these additional constraints. Under automatic guidance, a vertical descent is initiated when time to go becomes less than 12 seconds. The vertical descent portion of the landing phase starts at an altitude of 150 feet and terminates at landing on the lunar surface. The guidance is a velocity error nulling routine. Normally, a 3-fps rate of descent is used throughout the vertical descent. The target conditions for the vertical descent portion of the landing phase are included in table 4.10-VII.

Time histories of the LM trajectory parameters along with related data are shown in figure 4.10-12. Each of the plots show major events; DPS throttle recovery, high gate, low gate, start of vertical descent, and landing are indicated. Altitude, velocity, and flight-path angle are provided in figure 4.10-12(a). The angle to the landing site as measured along a vertical grid on the commander's window [termed landing point designator (LPD)] is shown in figure 4.10-12(b). The boundary of the lower window limit is also shown. The LM thrust vector pitch profile is shown in figure 4.10-12(c). The guidance commanded thrust and the actual thrust delivered by the DPS are shown in figure 4.10-12(d). The instantaneous weight of the LM as well as the DPS oxidizer and fuel used during the descent are provided in figure 4.10-12(e), while the guidance computed time-to-go during the descent is indicated in figure 4.10-12(f). The figure also shows the target switch at high gate. Altitude rate is shown in figure 4.10-12(g). The difference between the landing radar measured and PGNCs-navigated altitudes is provided in figure 4.10-12(h). This difference is indicative of the terrain profile being sensed by the landing radar.

Time histories of engine gimbal angles, platform gimbal angles, FDAI angles, S-band antenna elevation and azimuth angles, and rendezvous radar elevation and azimuth angles, are shown in figure 4.10-13. Also included is an S-band antenna gimbal angle profile that shows areas of vehicle blockage.

The LM altitude/range profile is shown in figure 4.10-14(a). LM altitude is referenced to the landing site radius with the mean lunar radius designated as well as DPS throttle recovery, high gate, and low gate. The terrain altitude referenced to the landing site radius with a 1-power to 40-power magnification of the terrain elevation is found in figure 4.10-14(b). The altitude/altitude rate profile for the descent is given in figure 4.10-15.

The time histories of LM/CSM relative parameters, phase angle, elevation angle, range and range rate from PDI to landing are shown in figure 4.10-16.

The LM altitude/range profile and a tabulation of pertinent trajectory parameters during the approach phase are shown in figure 4.10-17. The altitude/range and altitude/altitude rate profiles for the landing are shown in figure 4.10-18. A tabulation of pertinent trajectory parameters is also provided in this figure.

TABLE 4.10-I.- SUMMARY OF LM DESCENT EVENTS

LM lighting	MSFN track	Event	Time, : hr:min:sec, g.e.t.:	Propulsion system	Ullage time, sec	Burn time, sec	ΔV , fps	Total ΔV , fps	Initial weight, lb	Propellant used, lb
		CSM/LM undock	107:58:00	--	--	--	--	--	--	--
		CSM SEP	108:27:49	SM RCS	--	15.8	2.5	2.5	^a 36 100.8	12.3
		Enter lunar penumbra	108:40:41	--	--	--	--	--	--	--
		Enter lunar umbra	108:40:52	--	--	--	--	--	--	--
		MSFN LOS	108:59:38	--	--	--	--	--	--	--
		DOI								
		Ullage	109:26:20	LM RCS	7.5	7.5	1.3	1.3	33 617.7	4.8
		DPS 12%	109:26:27	LM DPS	--	15.0	17.9	19.2	33 612.9	65.4
		Enter lunar penumbra	109:26:31	--	--	--	--	--	--	--
		Enter sunlight	109:26:42	--	--	--	--	--	--	--
		DPS 40%	109:26:42	LM DPS	--	13.2	54.1	73.3	33 547.5	187.2
		DPS shutdown	109:26:56	--	--	--	--	--	--	--
		MSFN AOS	109:46:24	--	--	--	--	--	--	--
		Powered descent								
		Ullage	110:23:19	LM RCS	7.5	7.5	1.3	74.6	33 360.9	4.8
		PDI trim	110:23:26	LM DPS	--	26.0	31.8	106.4	33 356.1	115.1
		FTP	110:23:52	LM DPS	--	352.0	4138.3	4244.7	33 239.0	11 496.5
		Begin LR altitude update	110:27:52	LM DPS	--	--	--	--	--	--
		DPS throttle recovery	110:29:44	LM DPS	--	130.0	1216.9	5461.6	21 725.1	2 545.3
		Begin LR velocity update	110:30:12	LM DPS	--	--	--	--	--	--
		High gate	110:31:54	LM DPS	--	114.0	873.4	6335.0	19 169.6	1 568.0
		Acquire landing site visibility	110:31:56	LM DPS	--	--	--	--	--	--
		Low gate	110:33:48	LM DPS	--	50	280.5	6615.5	17 502.8	508.4
		Lose landing site visibility	110:34:30	LM DPS	--	--	--	--	--	--
		Vertical descent	110:34:38	LM DPS	--	44.2	236.3	6852.8	16 990.5	419.9
		Touchdown	110:35:22	LM DPS	--	--	--	6852.8	16 567.1	--

^aCSM weight at separation.

461

TABLE 4.10-II.- LM DESCENT WEIGHT

Total weight of ascent stage, lb	10 493.6
Inert weights, consumables, and unusable DPS propellant, lb	4 770.1
Tanked DPS propellant, lb	17 964.0
Total weight of descent stage, lb	22 734.1
Weight of crew and equipment, lb	436.0
Total LM weight at undock, lb	33 663.7

TABLE 4.10-III.- LM DESCENT ENGINE PERFORMANCE SUMMARY

Propulsion system	I_{sp} , sec	Thrust per engine, lbf	Percent relative throttle	Flow-rate per engine, lb/sec
DPS ^a	286.3 to 303.7	1267 to 6615	12 to 63	4.4 to 21.8
DPS ^b	304.6	9824	93.5	32.2
RCS	281.0	89.6		0.357

^aThrottle region.

^bFixed throttle setting.

TABLE 4.10-IV.- MSFN TRACKING SUMMARY FOR LM DESCENT

Station	Acquisition			Termination		
	Time, hr:min:sec, g.e.t.	Azimuth, deg	Range, n. mi.	Time, hr:min:sec, g.e.t.	Azimuth, deg	Range, n. mi.
Parks	a	--	--	108:59:00	79.7	204 199
Honeysuckle	a	--	--	108:59:04	78.6	204 194
Hawaii	a	--	--	108:59:19	134.1	202 022
Goldstone	a	--	--	108:59:31	-144.1	202 415
Guaymas	a	--	--	108:59:32	-130.0	202 346
Corpus	a	--	--	108:59:34	-116.6	202 755
Bermuda	a	--	--	108:59:36	-97.7	204 263
Merritt Island	a	--	--	108:59:36	-105.5	203 452
Antigua Island	a	--	--	108:59:37	-93.0	204 336
Grand Bahama	a	--	--	108:59:38	-103.2	203 546
Guam	108:04:19	90.0	204 113	108:59:08	92.5	204 228
Parks	109:46:24	72.3	203 707	b	--	--
Honeysuckle	109:46:24	70.9	203 717	b	--	--
Guaymas	109:46:26	-118.2	202 745	b	--	--
Guam	109:46:29	95.6	203 625	b	--	--
Hawaii	109:46:42	157.5	201 889	b	--	--
Goldstone	109:46:57	-129.7	202 712	b	--	--
Corpus	109:46:57	-108.1	203 242	b	--	--
Merritt Island	109:47:00	-99.0	204 036	b	--	--
Grand Bahama	109:47:01	-97.2	204 145	b	--	--
Bermuda	109:47:04	-91.3	204 868	109:58:40	-89.8	204 420

^aStations tracking at undocking.

^bStations tracking at touchdown.

TABLE 4.10-V.- "TARGET" LOAD FOR CSM SEPARATION MANEUVER

[Propulsion system: CM L-30]

(a) Target

t_{1G} , hr:min:sec, g.e.t.	108:27:49.4
ΔV_x , fps	0.0
ΔV_y , fps	0.0
ΔV_z , fps	2.5
CSM weight, lb	36 100.8

(b) CSM REFSMMAT

Refer to table 5-IV

(c) CSM gimbal angles at t_{1G}

IGA, deg	-75.6
MGA, deg	0.0
OCA, deg	180.0

TABLE 4.10-VI.- TARGET LOADS FOR LM DOI MANEUVER

[Propulsion system: DPS guidance: external ΔV (P30, P40)]

(a) Target

t_{IG} , hr:min:sec, g.e.t.	109:26:27.4
ΔV_X , fps	-71.047
ΔV_Y , fps	0.0
ΔV_Z , fps	18.704
Weight at t_{IG} , lb	33 612.9

(b) REFSMMAT

Refer to table 5-IV

(c) Gimbal angles at t_{IG}

IGA, deg	-60.8
MGA, deg	0.0
OGA, deg	0.0

TABLE 4.10-VII.-- TARGET LOADS FOR LM POWERED DESCENT MANEUVER

[Propulsion system: DPS; guidance: powered descent (P63, P64, P65)]

(a) Ignition algorithm parameters (P63)

TIG, hr:min:sec, g.e.t.	110:23:26
RIGXG, ft	-130 519.86
RIGZG, ft	-1 432 597.3
VIGG, fps	5 545.5
K_X617631
K_Y , ft ⁻¹0000007551944
K_V , ft/fps	410.

(b) Targets

Braking phase (P63)	Approach phase (P64)	Vertical descent (P65)
Position, ft	Position, ft	Velocity, fps
$R_x = 171.83468$	$R_x = 111.0852$	$V_x = -3.0$
$R_y = 0.0$	$R_y = 0.0$	$V_y = 0.0$
$R_z = -10 678.596$	$R_z = -26.793499$	$V_z = 00.0$
Velocity, fps	Velocity, fps	
$V_x = -105.87606$	$V_x = -4.993$	
$V_y = 0.0$	$V_y = 0.0$	
$V_z = -1.0403022$	$V_z = .24785119$	
Acceleration, fps ²	Acceleration, fps ²	
$A_x = .62412594$	$A_x = -.26237170$	
$A_y = 0.0$	$A_y = 0.0$	
$A_z = -9.1043852$	$A_z = -.5120091$	
Jerk, fps ³	Jerk, fps ³	
$J_z = -.018826723$	$J_z = .001807716$	
TENDBRAK = 62.	TENDAPP = 12.	

TABLE 4.10-VII.- TARGET LOADS FOR LM POWERED

DESCENT MANEUVER - Concluded

[Propulsion system: DPS; guidance:
powered descent (P63, P64, P65)]

(c) REFSMMAT

Refer to table 5-IV

(d) Gimbal angles at t_{IG}

IGA, deg	106.5
MGA, deg	0.0
OGA, deg	0.0

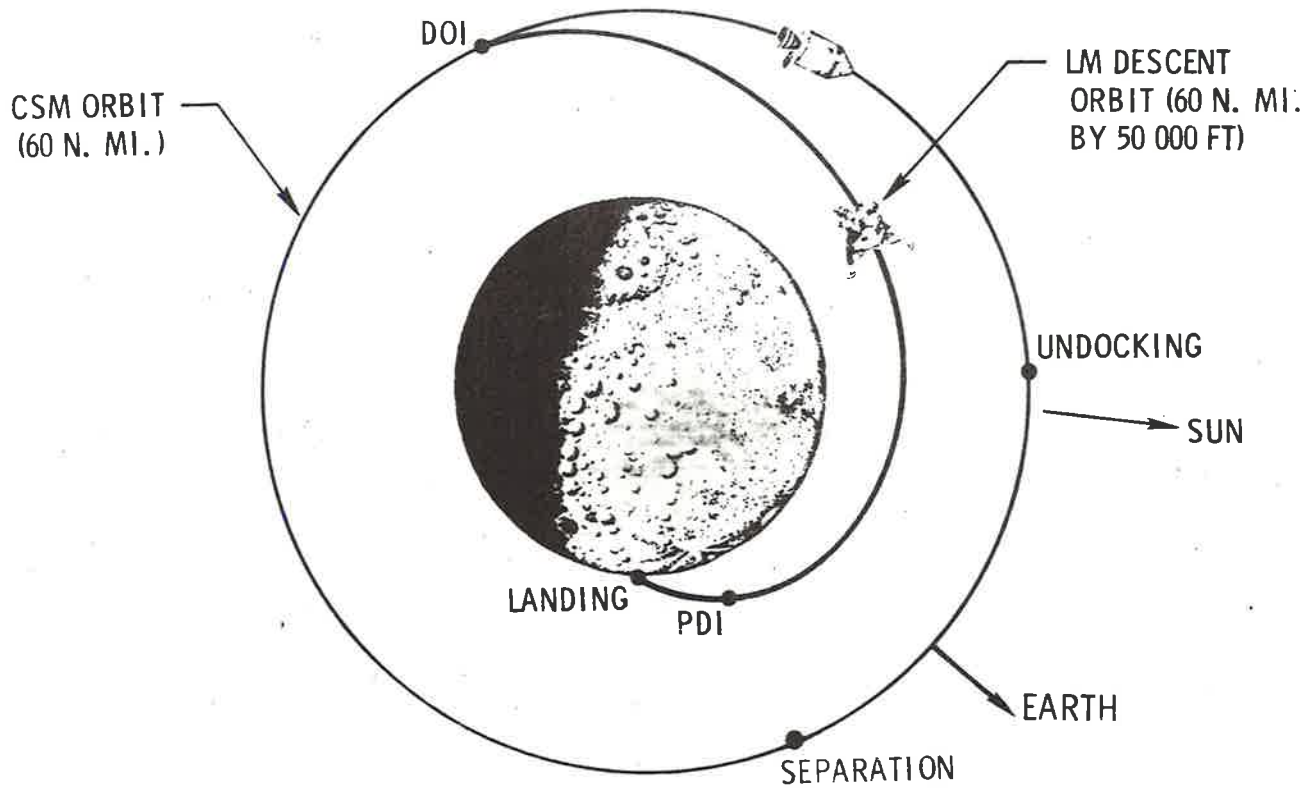

(a) Lunar descent orbital events.

Figure 4.10-1 - LM events.

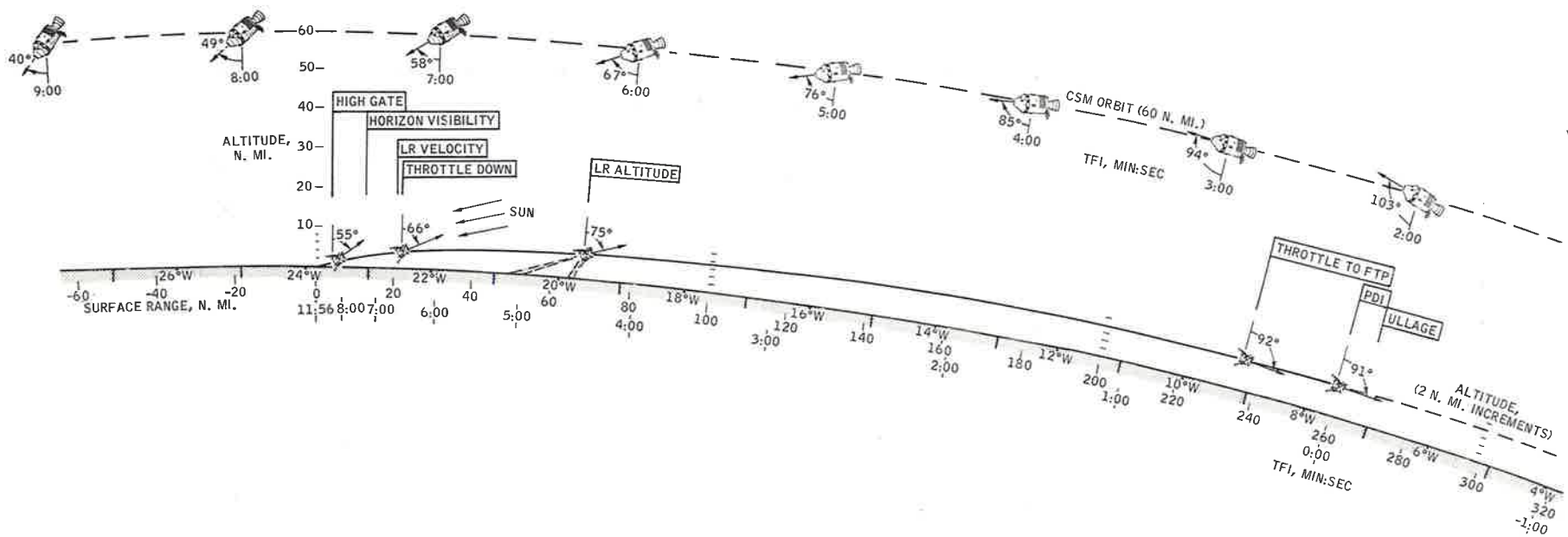

(b) Powered descent profile.

Figure 4.10-1. - Continued.

SUMMARY					
EVENT	TFI, MIN:SEC	V_i , FPS	\dot{H} , FPS	H, FPS	ΔV , FPS
POWERED DESCENT INITIATION	0:00	5560	-4	48 814	0
THROTTLE TO MAXIMUM THRUST	0:26	5529	-3	48 725	32
LANDING RADAR ALTITUDE UPDATE	4:26	2959	-94	39 146	2647
THROTTLE RECOVERY	6:18	1522	-106	25 744	4170
LANDING RADAR VELOCITY UPDATE	6:46	1301	-136	22 715	4420
HORIZON VISIBILITY	7:04	1162	-148	20 130	4582
HIGH GATE	8:28	505	-137	7 273	5387
LOW GATE	10:22	35 (47)*	-14	524	6260
TOUCHDOWN (PROBE CONTACT)	11:56	-15 (0)*	-3	12	6778
*(HORIZONTAL VELOCITY RELATIVE TO SURFACE)					

4-70

(c) Powered descent events summary.

Figure 4.10-1.- Concluded.

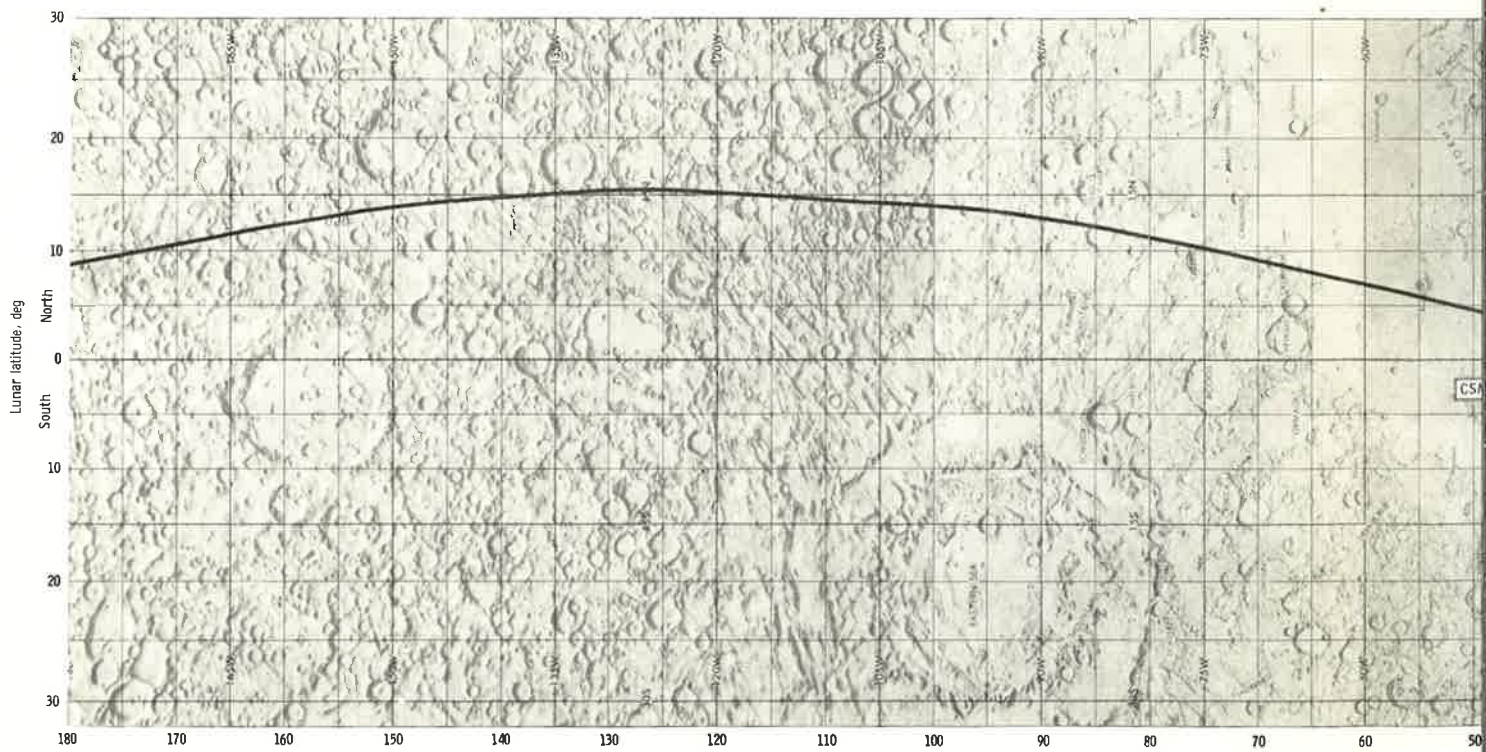
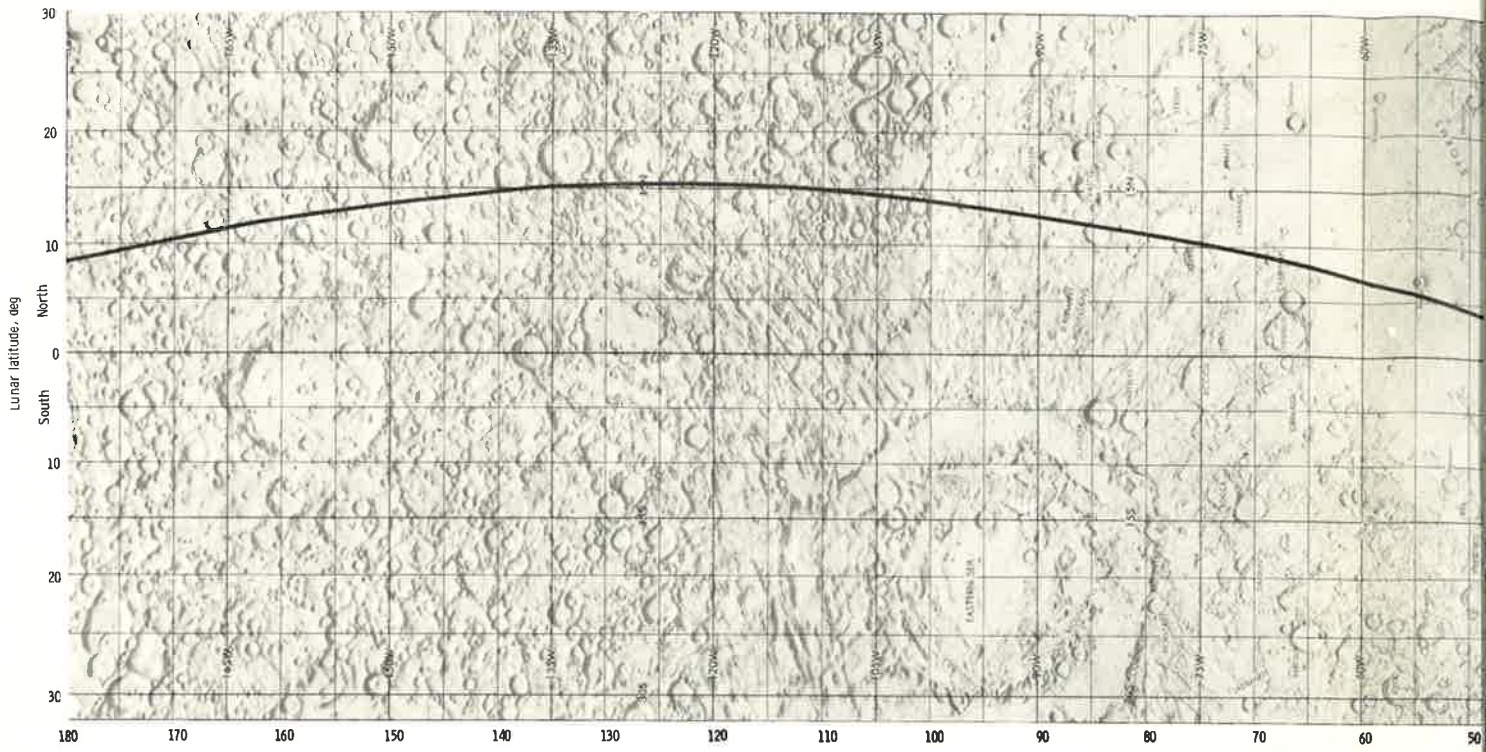

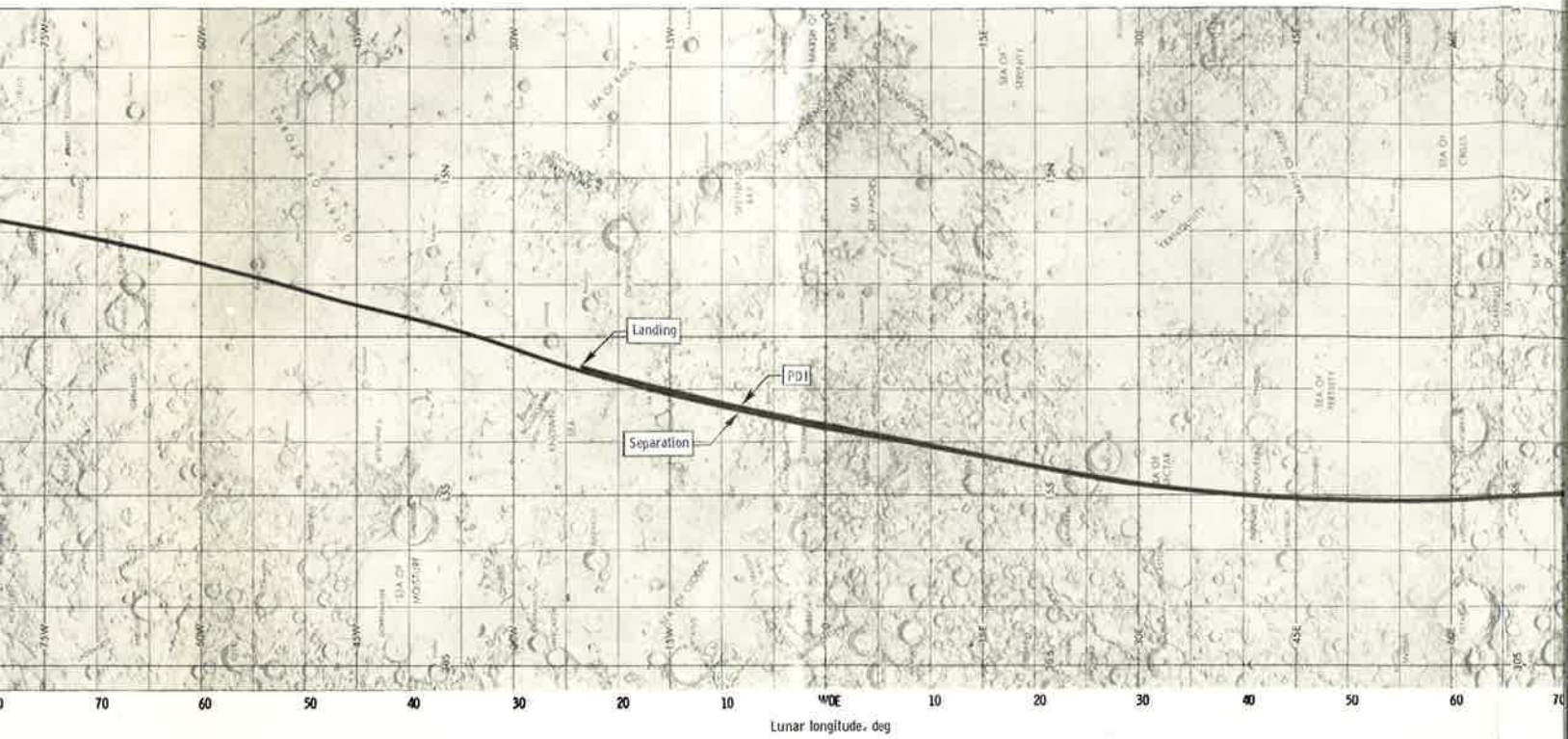

(a) LM groundtrack.

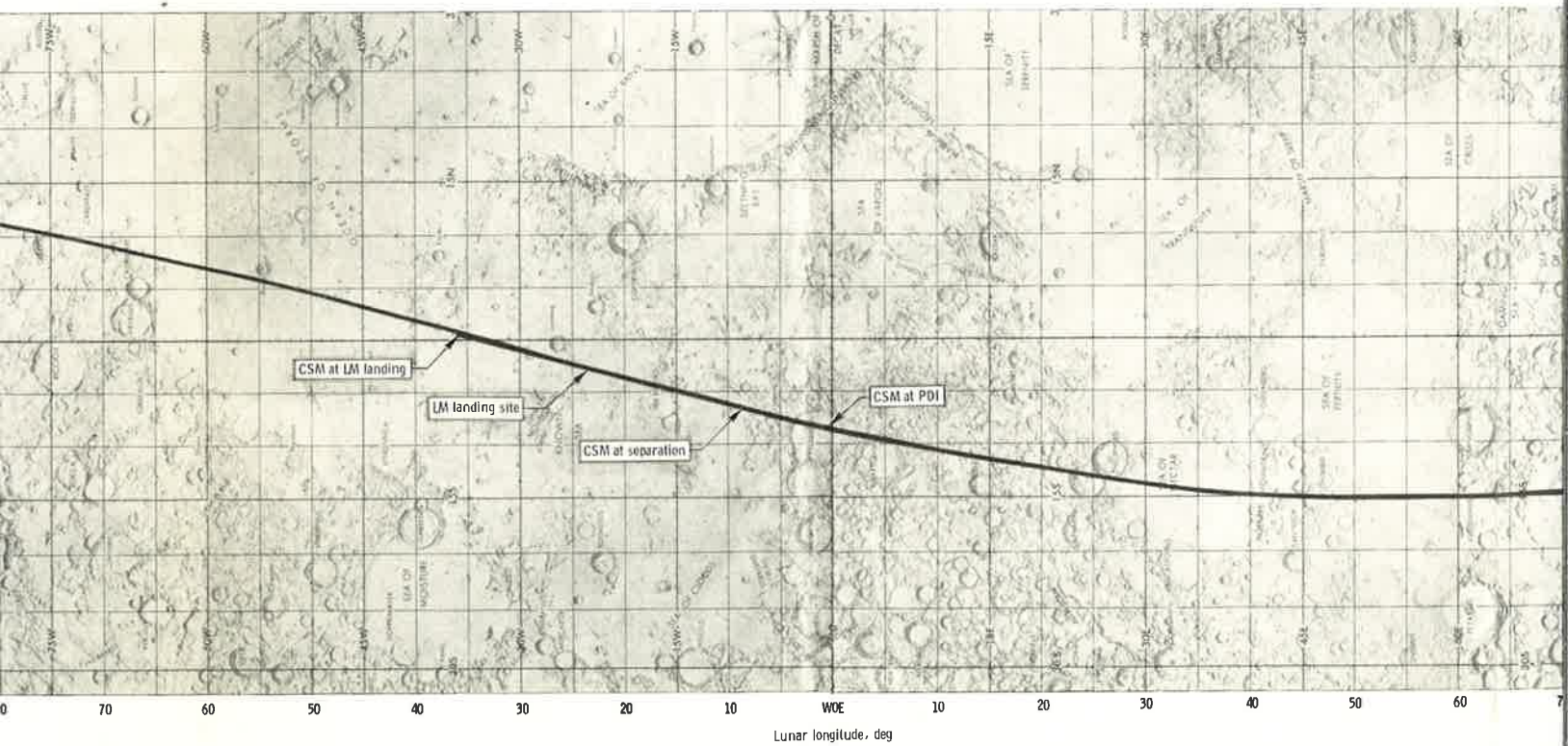

(b) CSM groundtrack.

Figure 4.10-2. - LM and CSM groundtrack during powered descent.

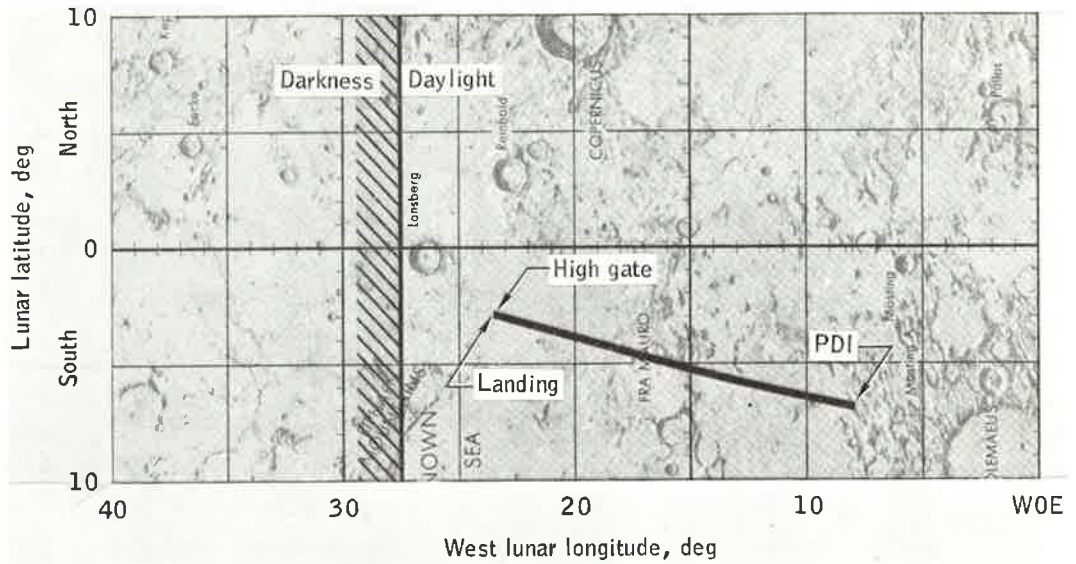

(c) LM groundtrack.

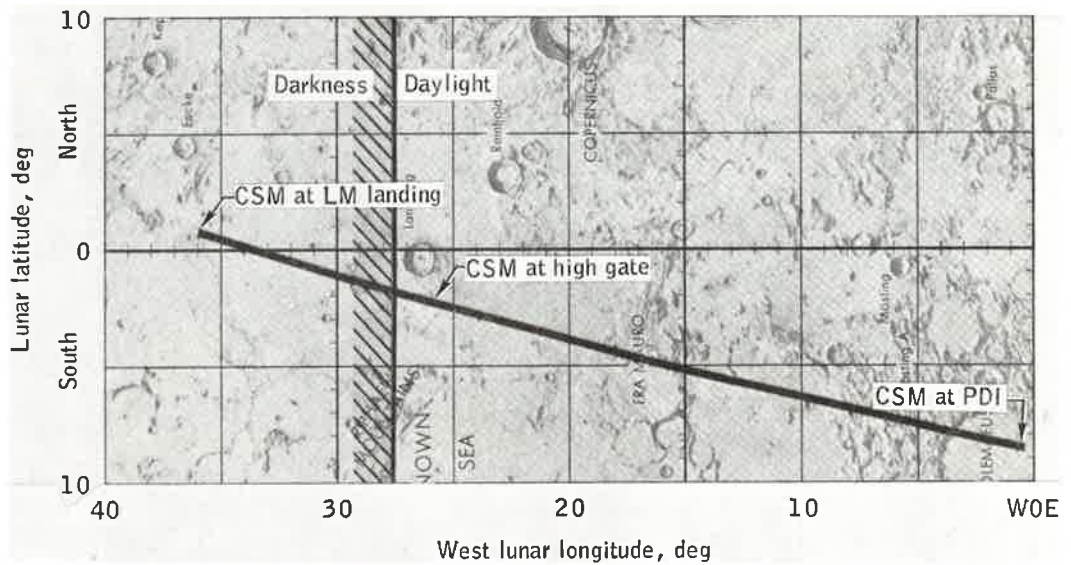

(d) CSM groundtrack.

Figure 4.10-2.- Concluded.

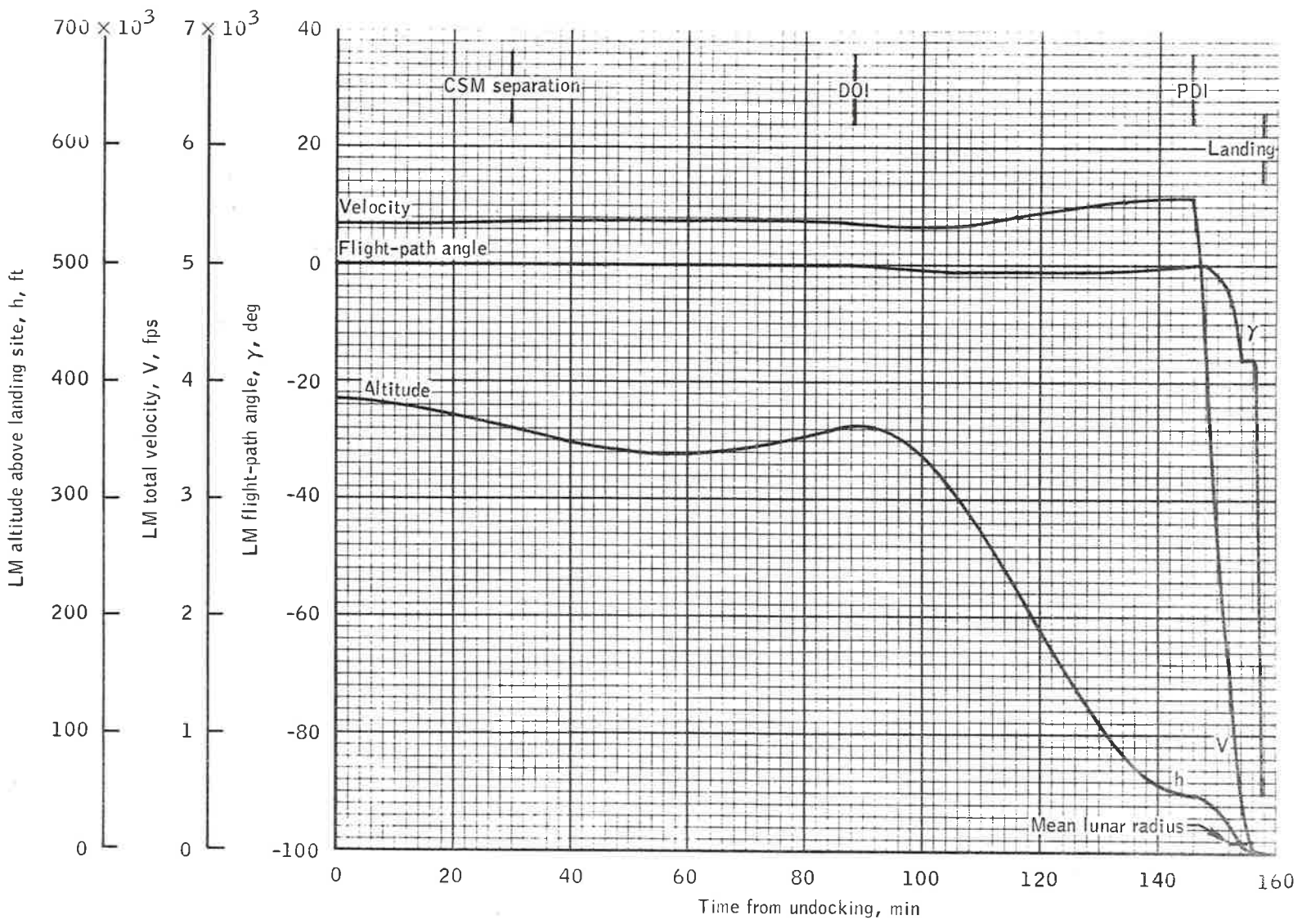
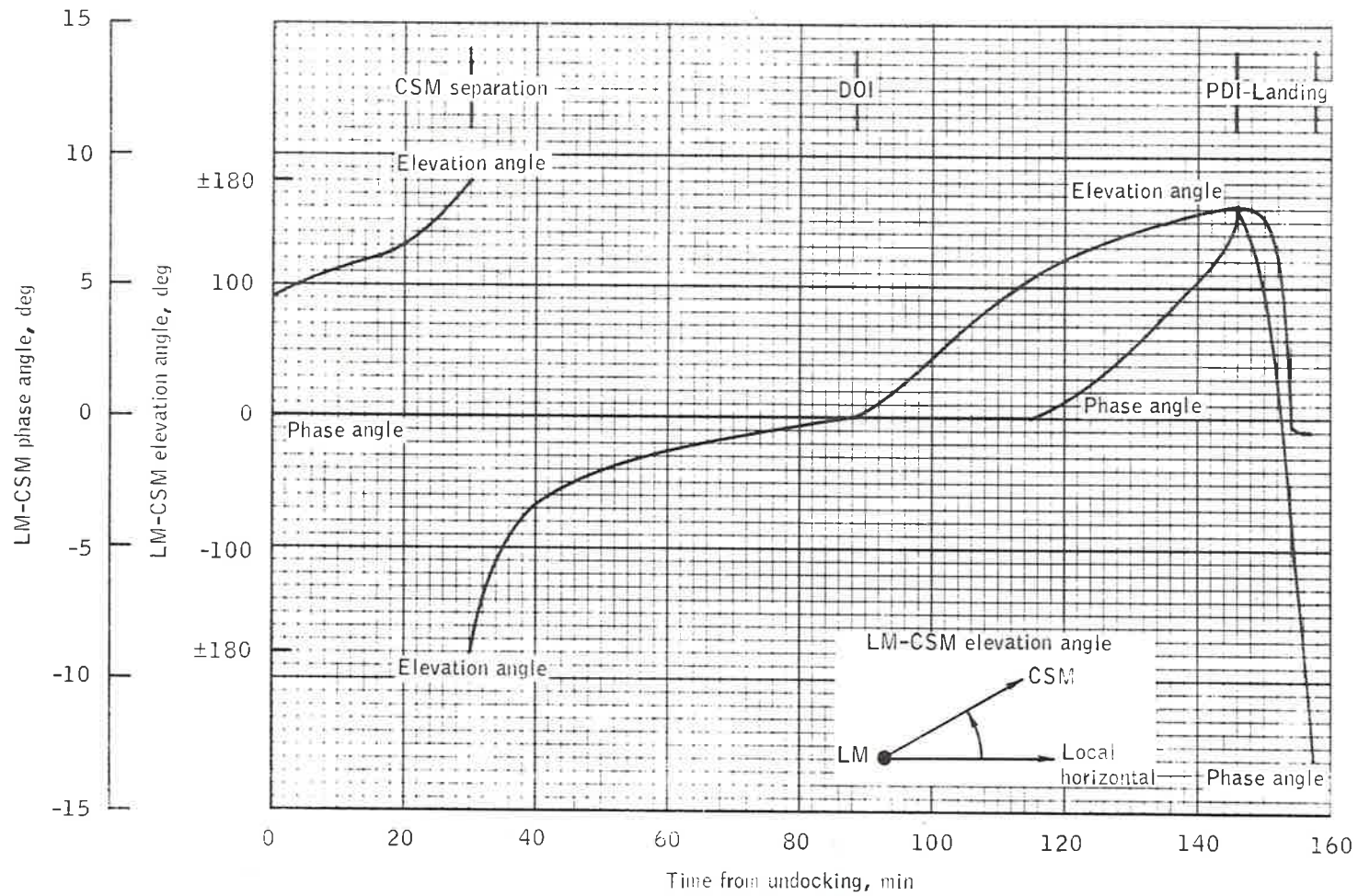

Figure 4.10-3.- Time history of LM trajectory parameters from undocking to landing.



4-74

(a) Phase angle and elevation angle.

Figure 4.10-4. Time histories of LM-CSM relative parameters from undocking to landing.

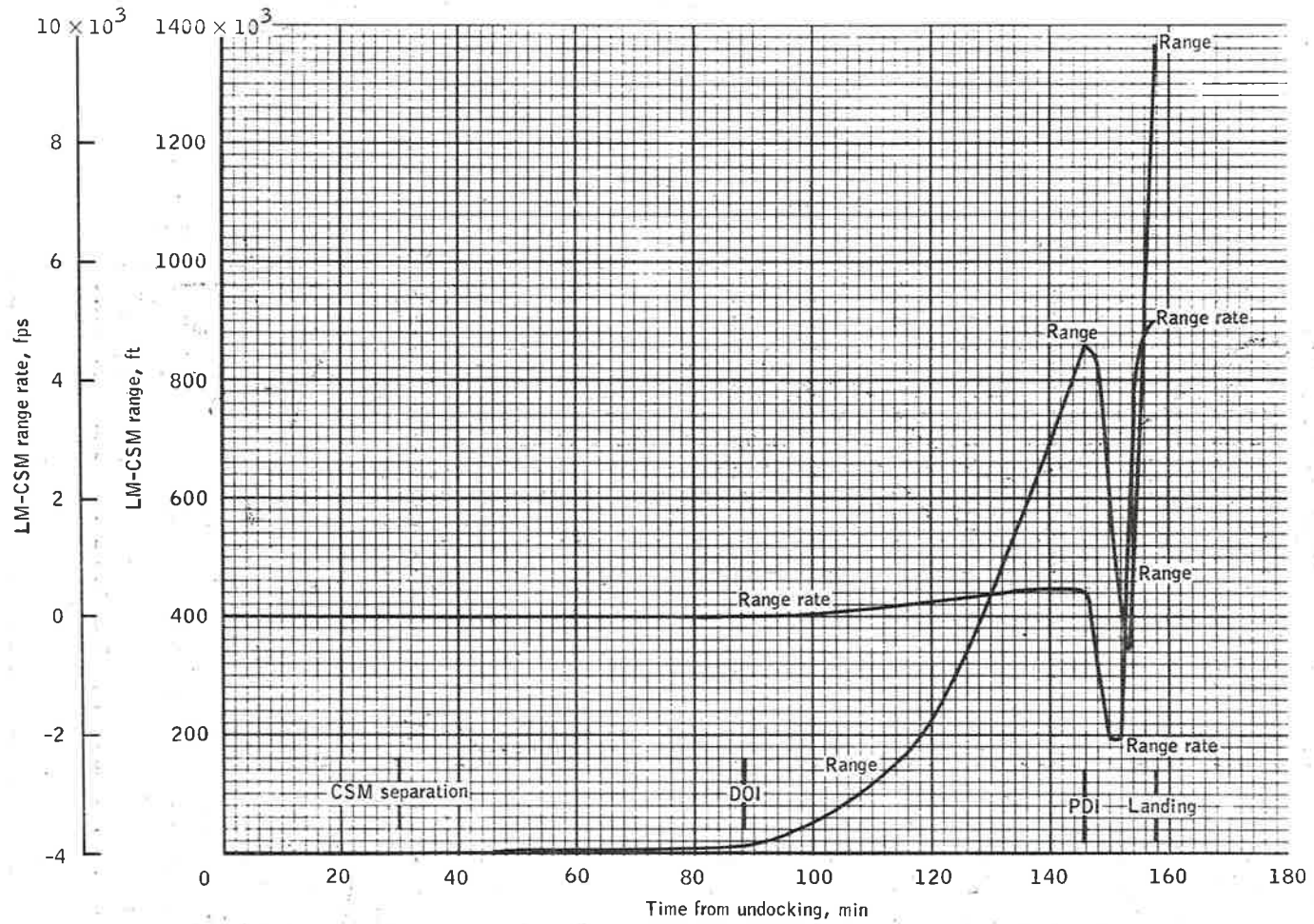

(b) Range and range rate.

Figure 4.10-4.- Concluded.

56-7

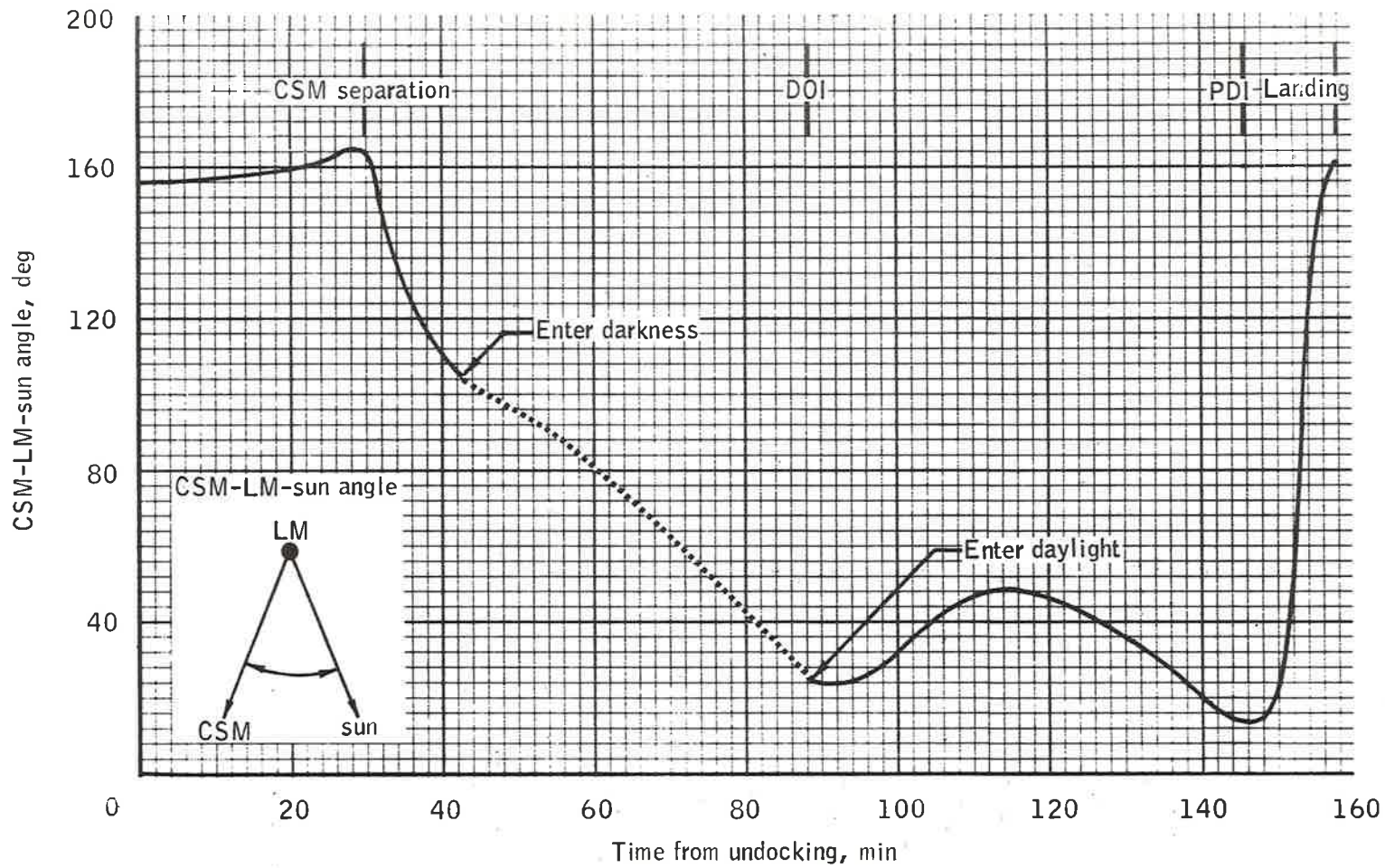

4-76

(a) CSM-LM-sun angle.

Figure 4.10-5.- Time histories of three body relationships as viewed from the LM from undocking to landing.

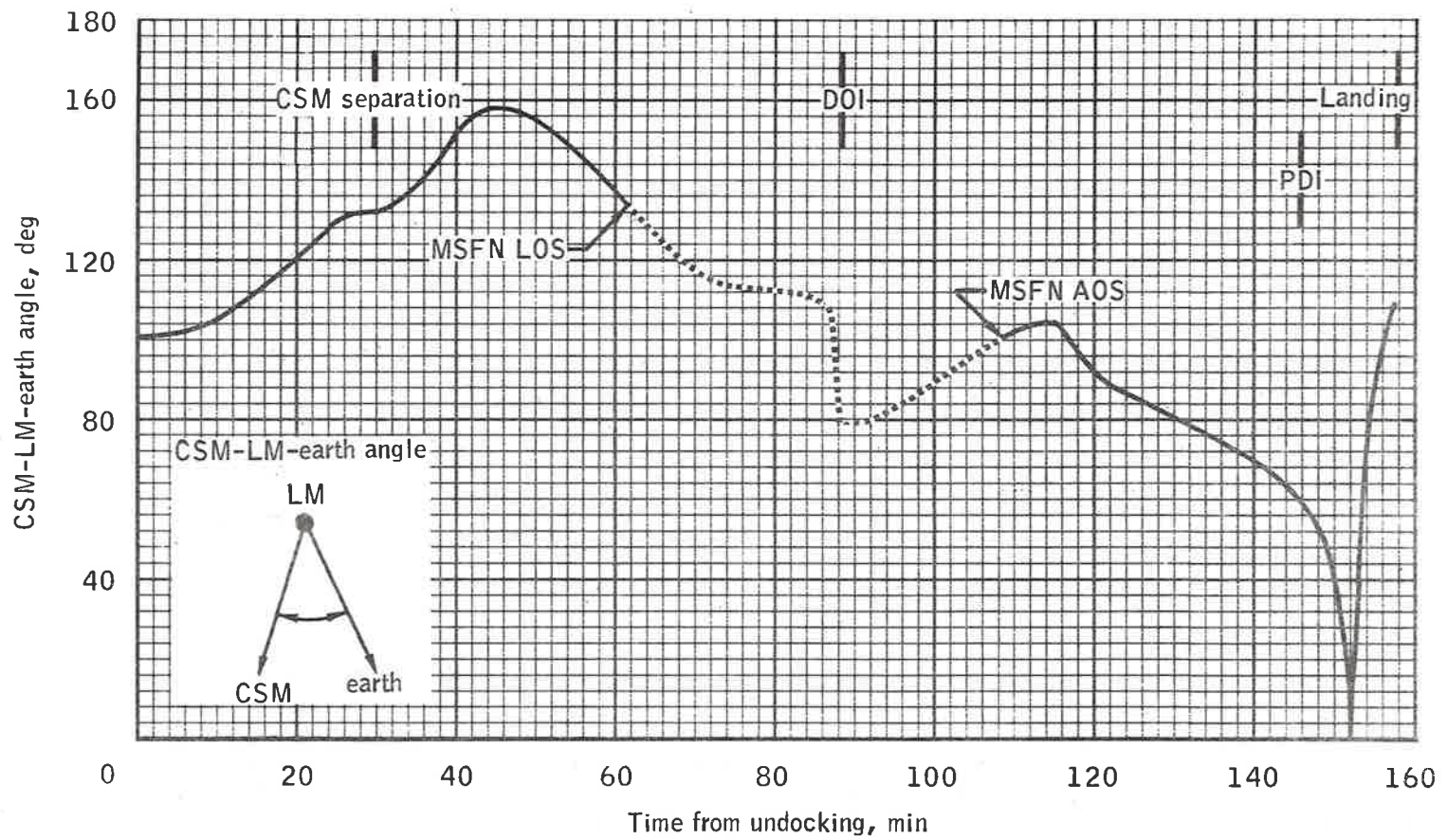

(b) CSM-LM-earth angle.

Figure 4.10-5.- Concluded.

4-77

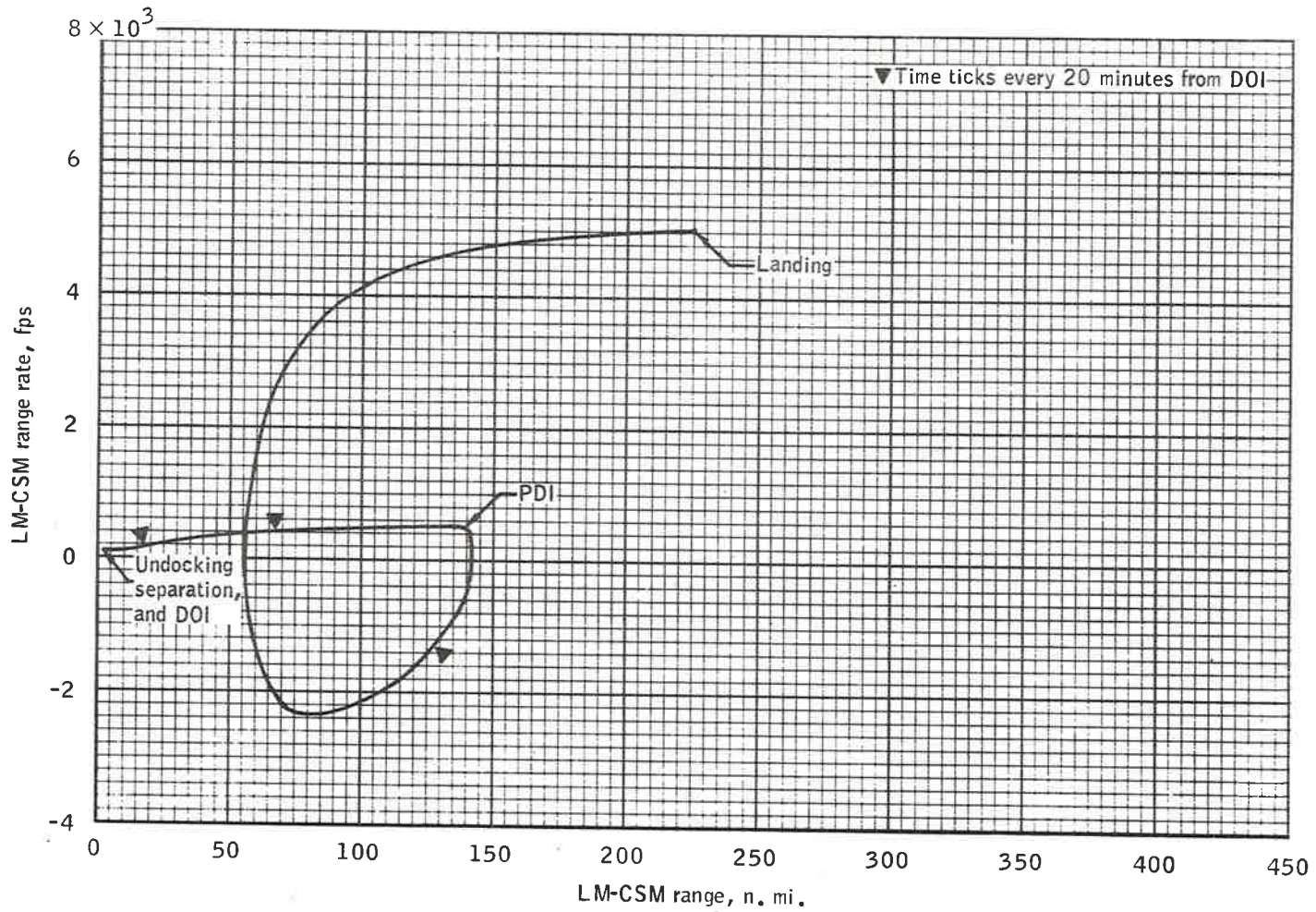

(a) Undocking to landing.

Figure 4.10-6.- LM CSM range rate versus range.

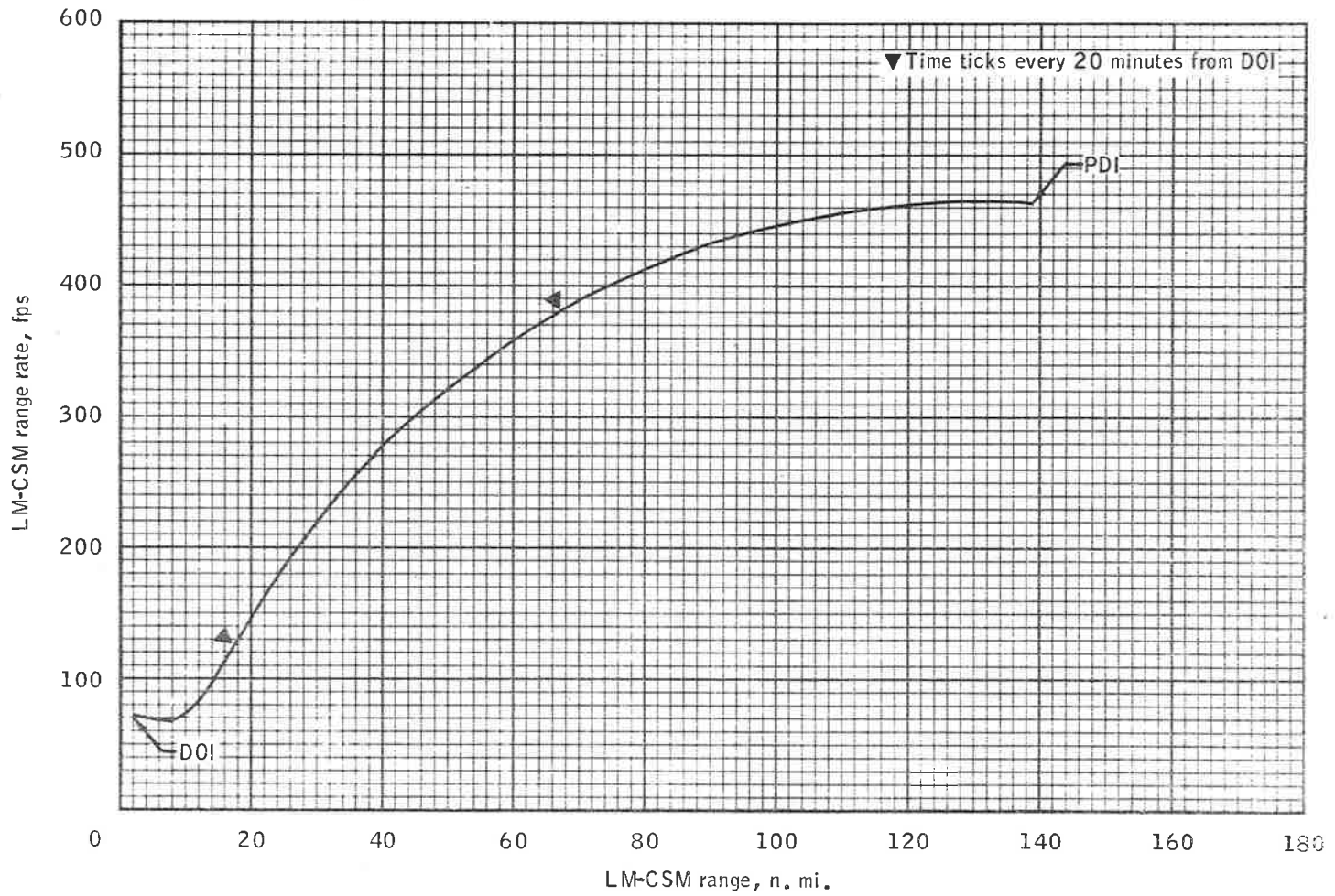

4-79

(b) DOI to PDI.

Figure 4.10-6.- Concluded.

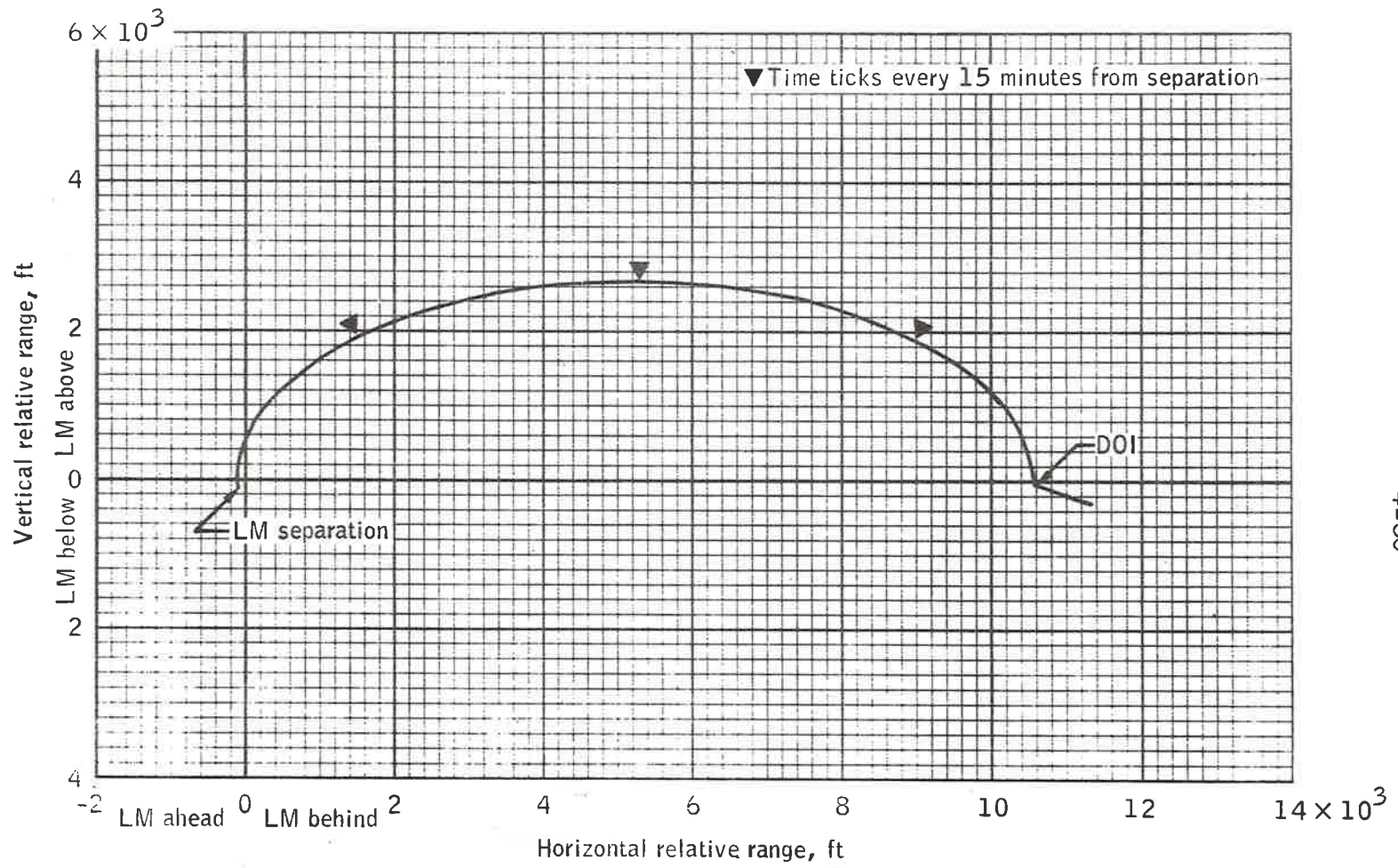

08-7

Figure 4.10-7.- LM-CSM relative motion from separation to DOI.

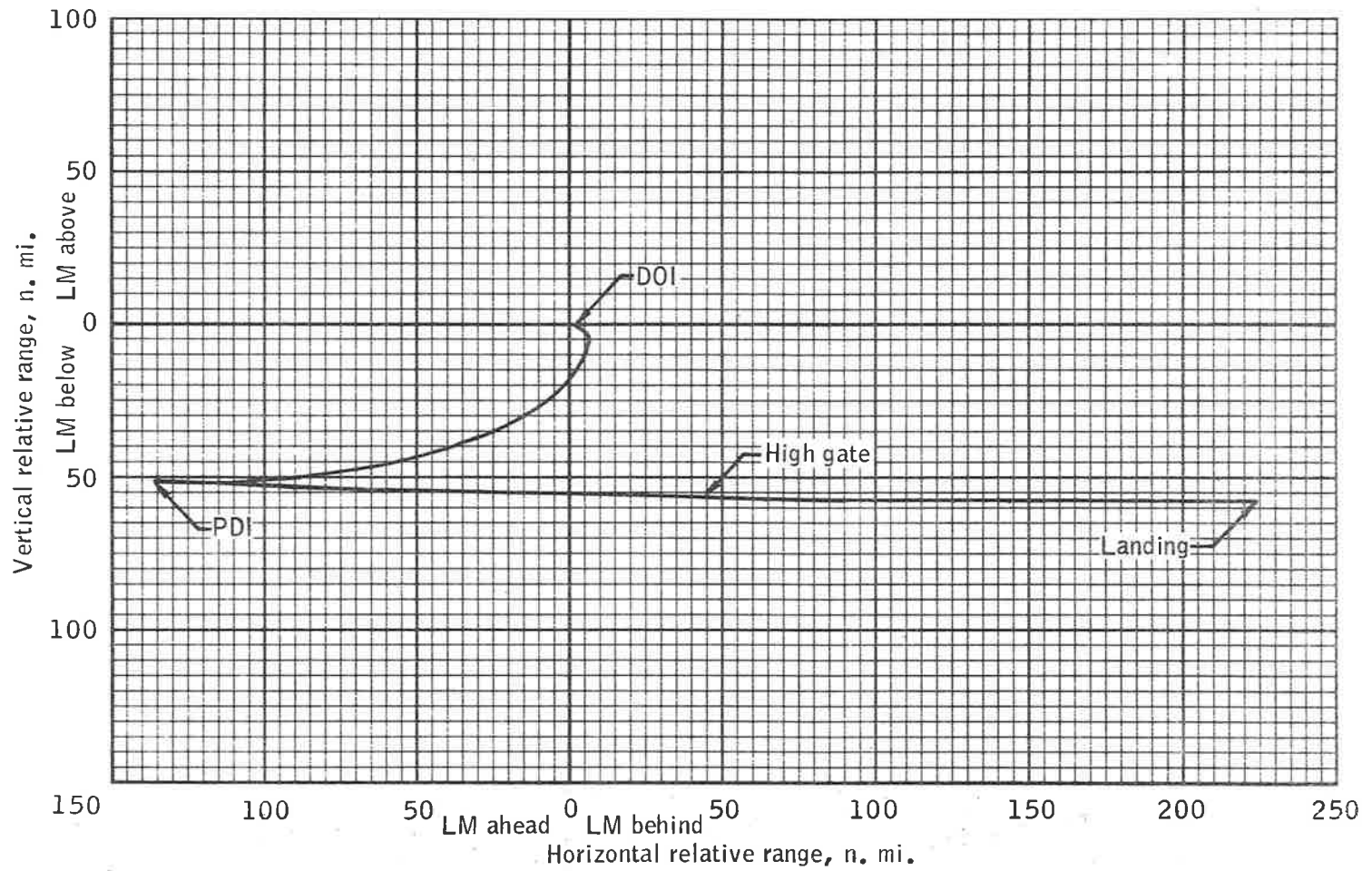

Figure 4.10-8.- LM-CSM relative motion (CSM-centered) from DOI to landing.

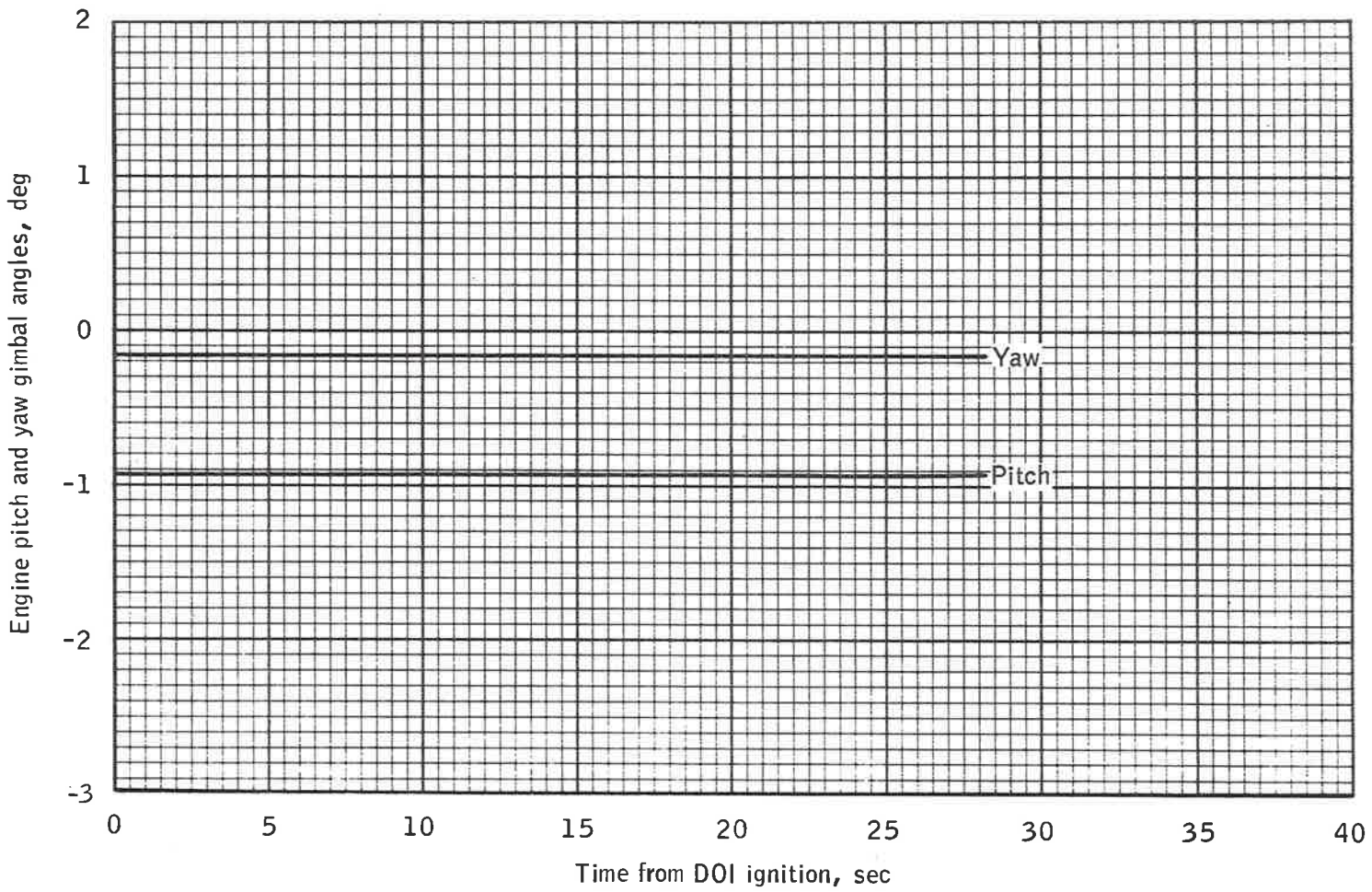

Figure 4.10-9.- Time histories of engine gimbal angles during DOI.

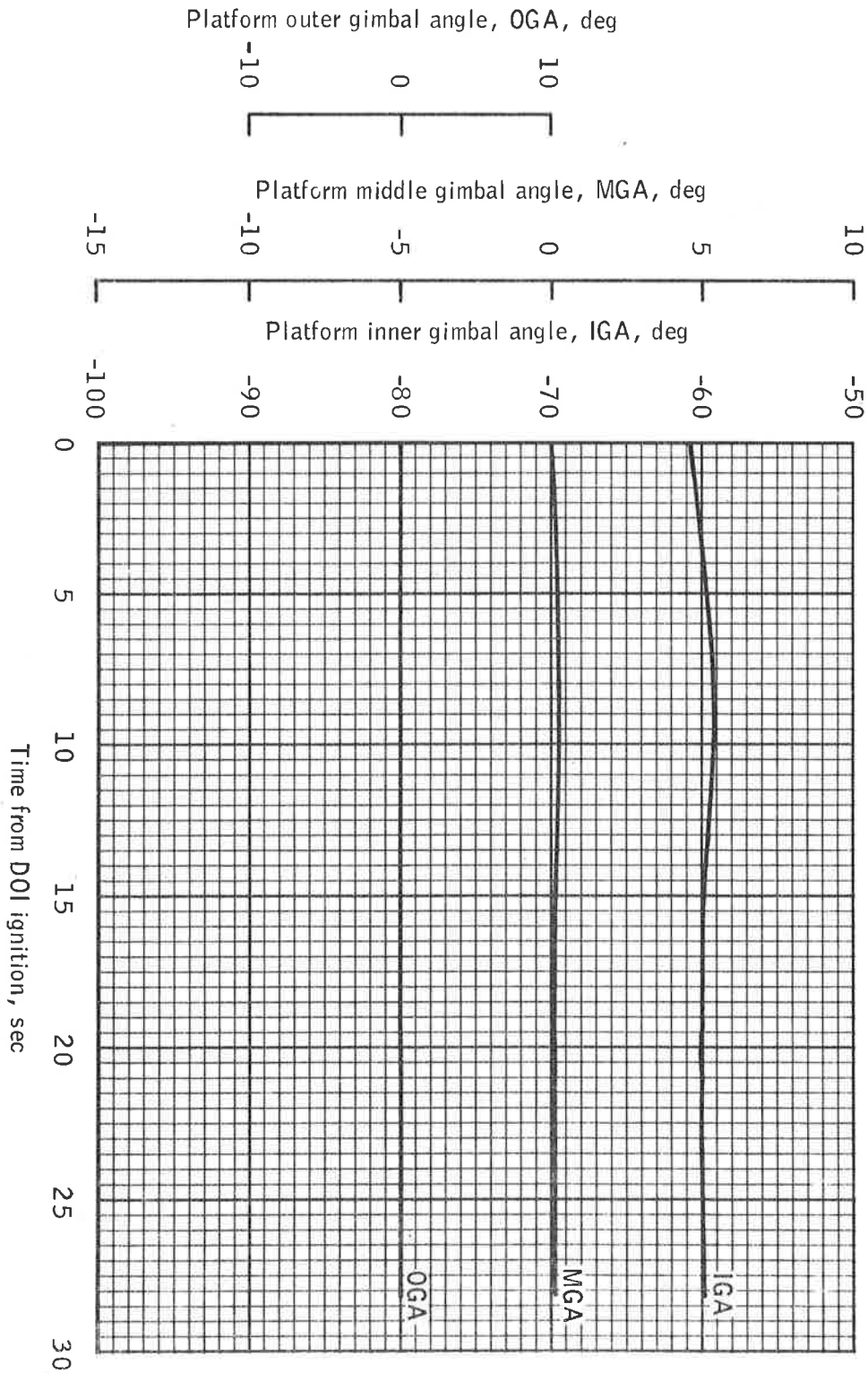
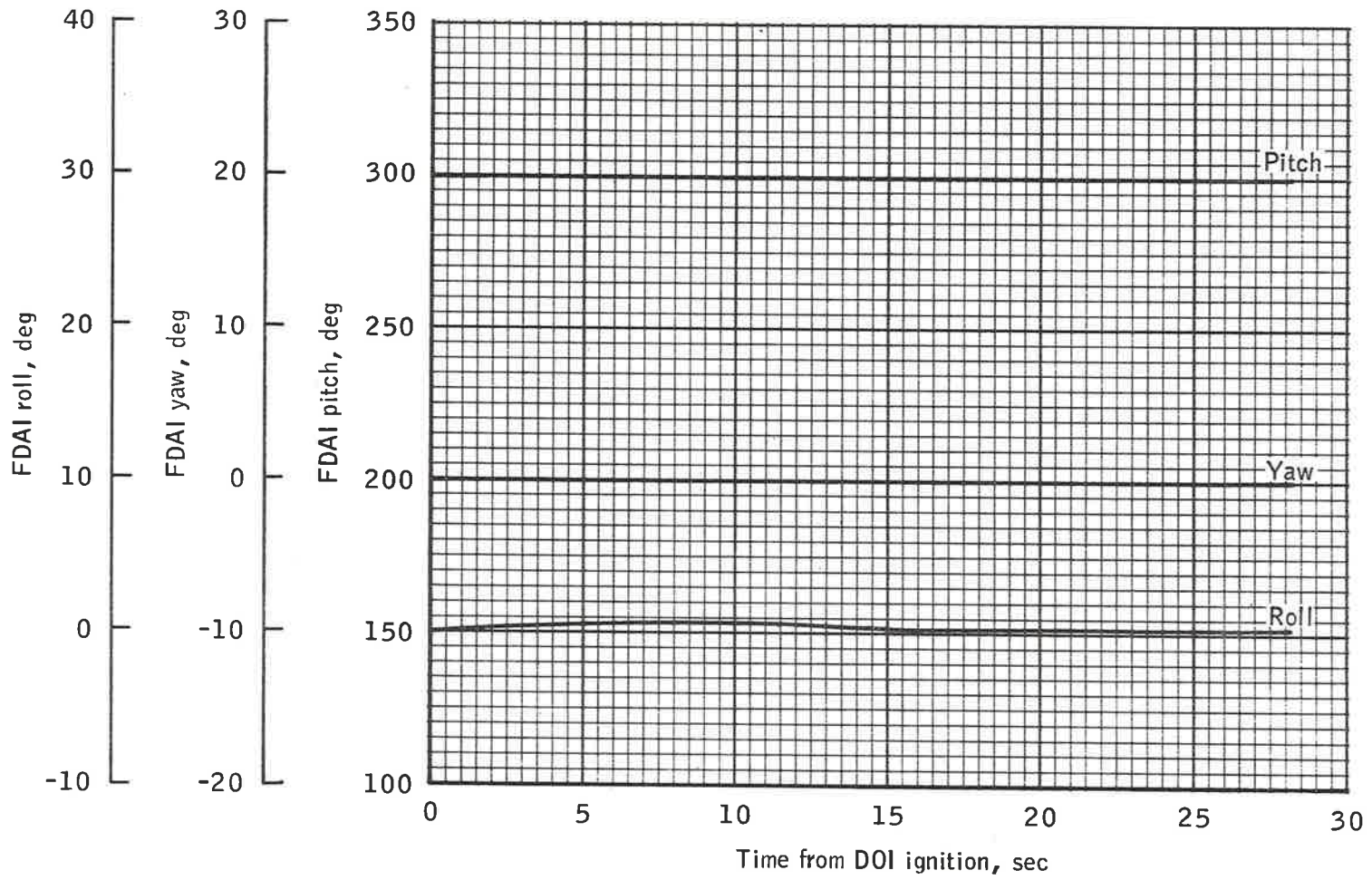
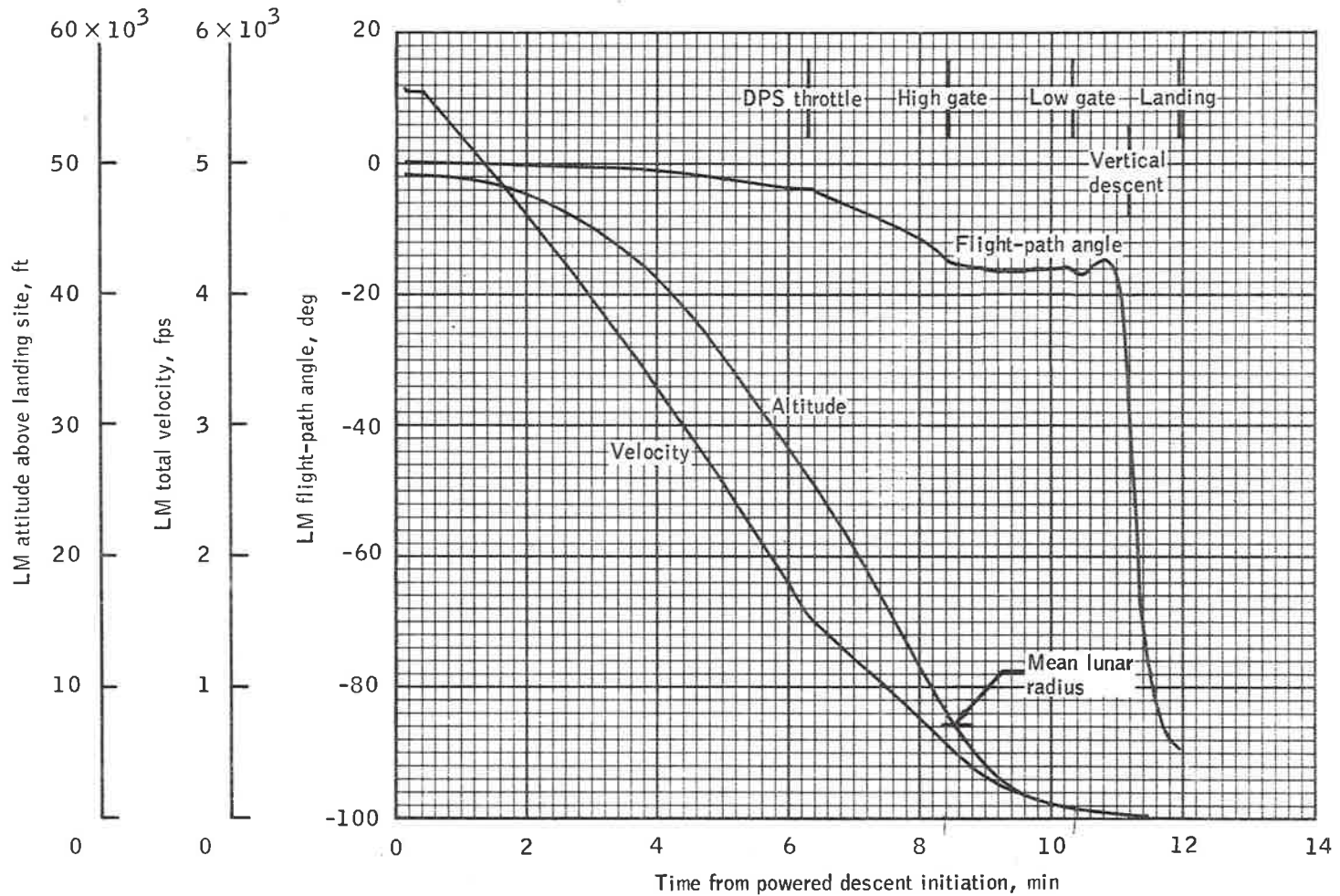

Figure 4.10-10. - Time history of platform gimbal angles during DOI.



48-4

Figure 4.10-11.- Time histories of FDAI angles during DOI.



(a) Altitude, velocity, and flight-path angle.

Figure 4.10-12.- Time history of LM trajectory parameters from PDI to landing.

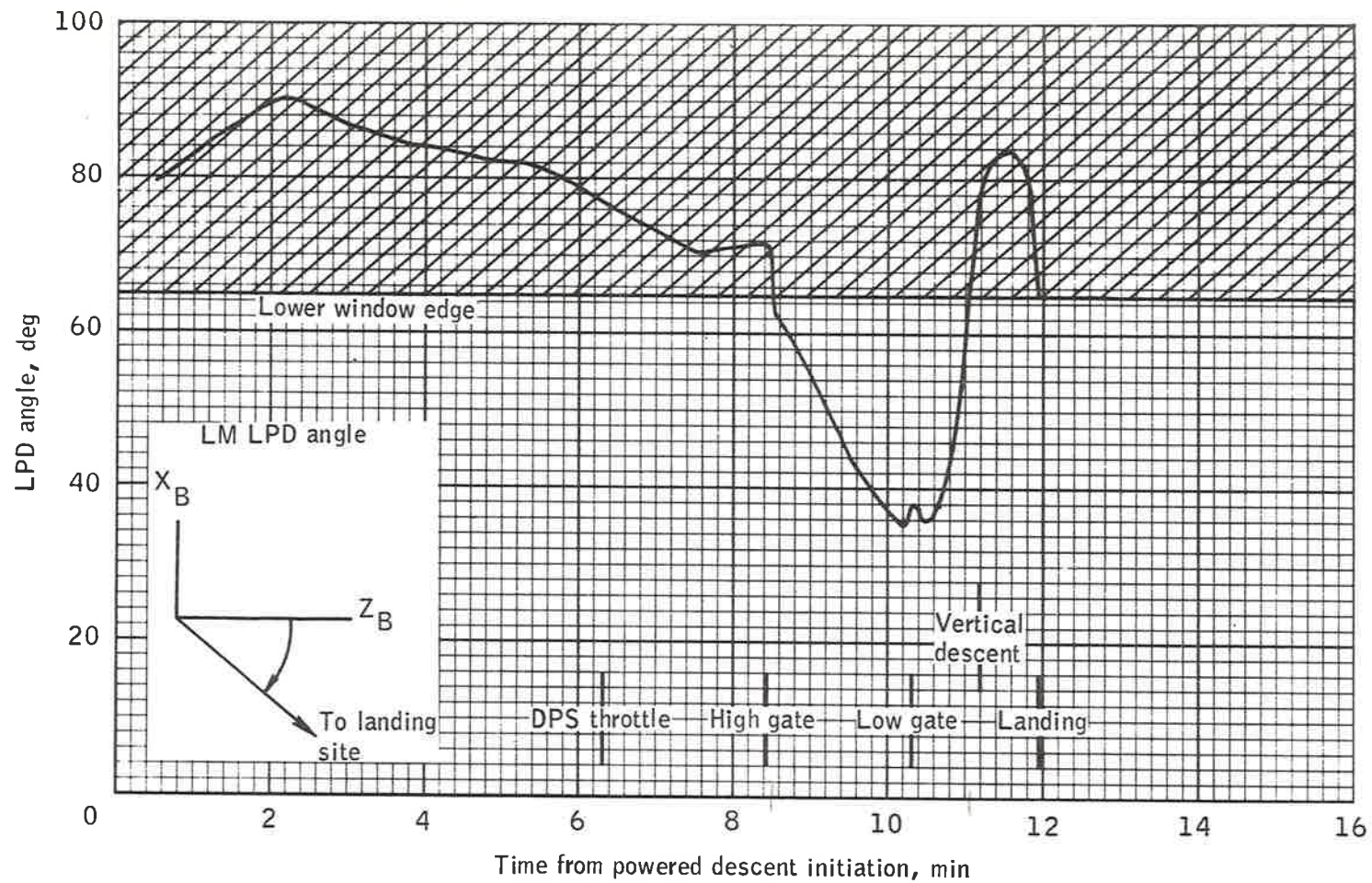

(b) LPD angle.

Figure 4.10-12.- Continued.

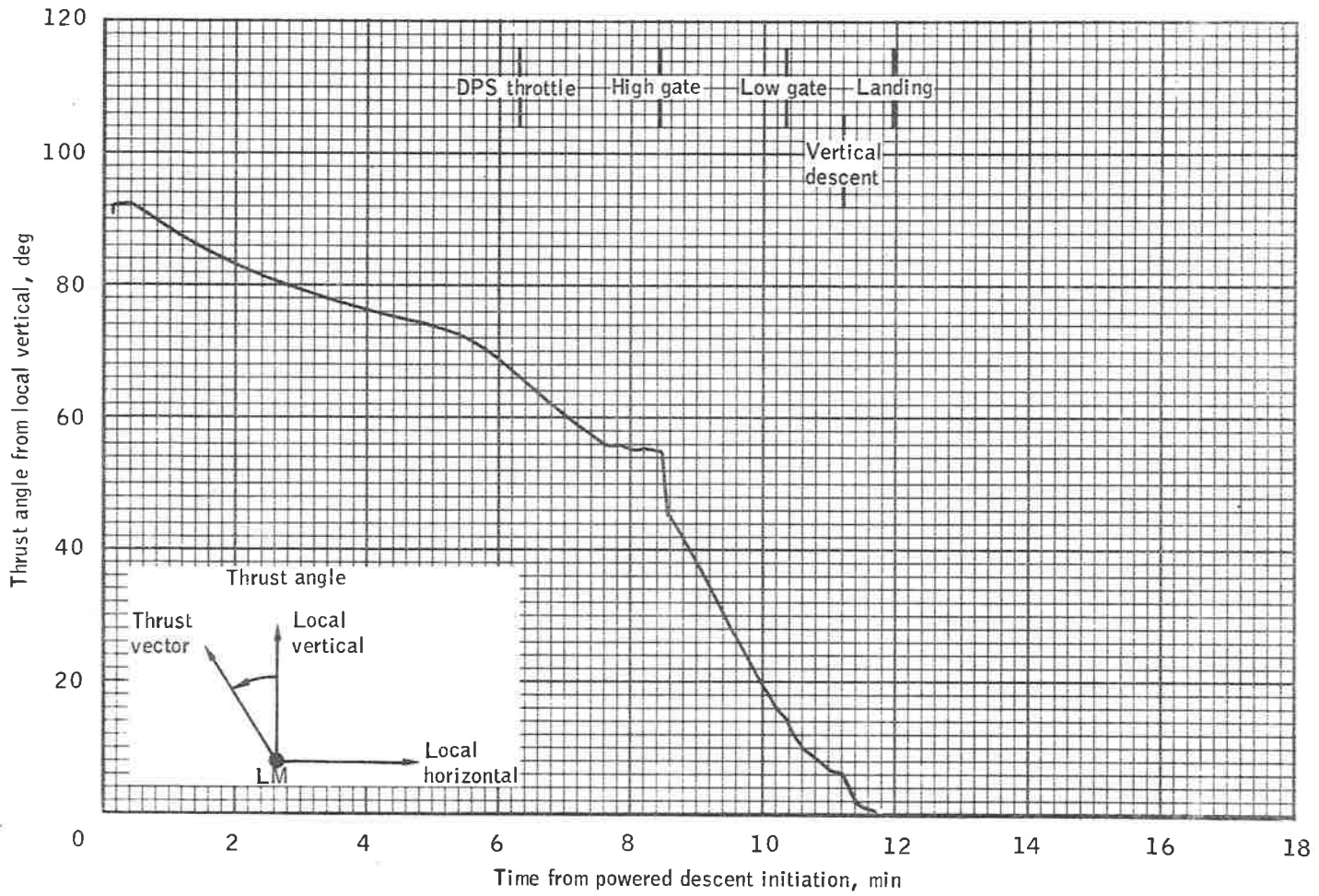

(c) Thrust angle from local vertical.

Figure 4.10-12.- Continued.

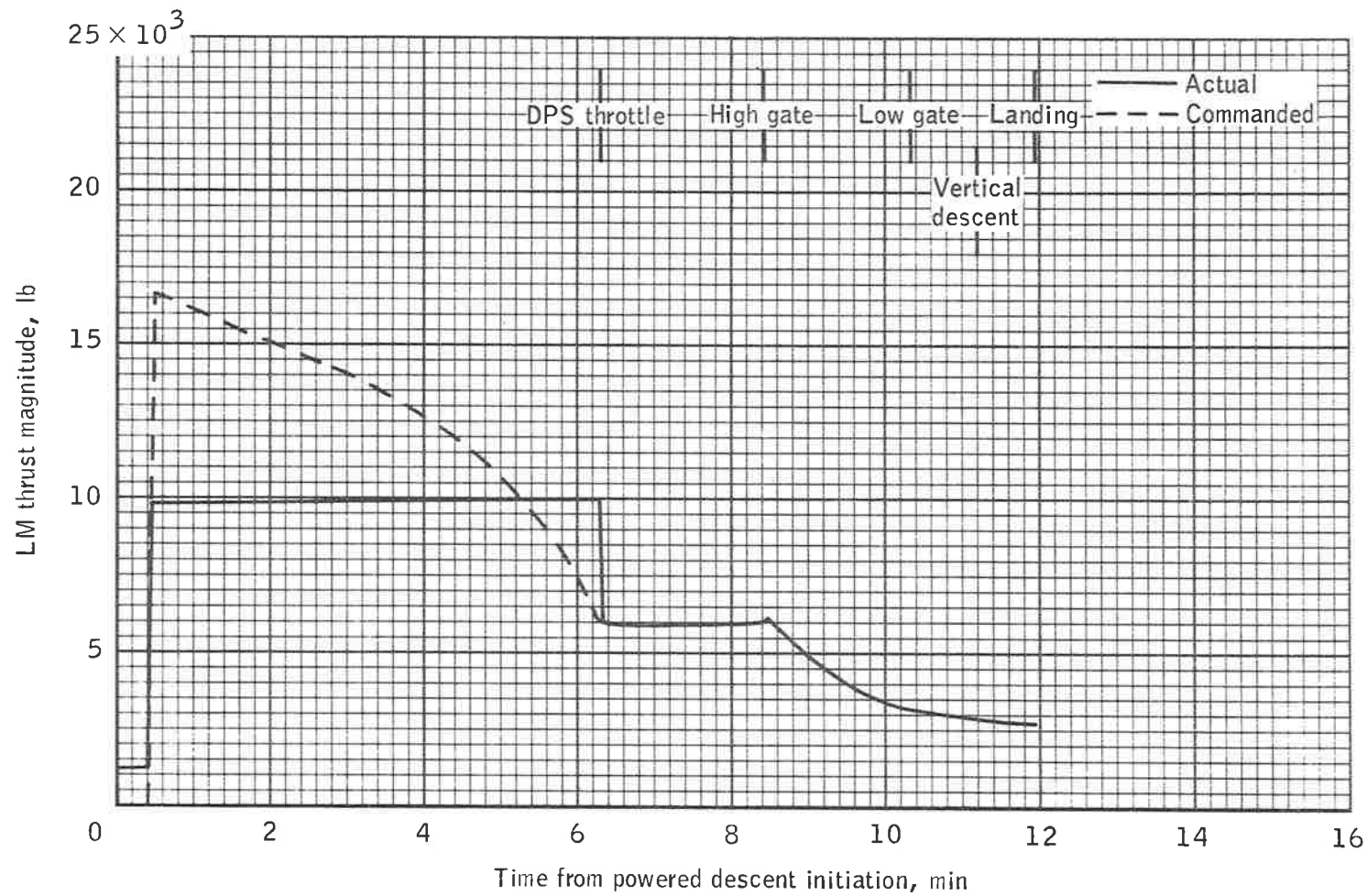

88-17

(d) LM thrust magnitude.

Figure 4.10-12.- Continued.

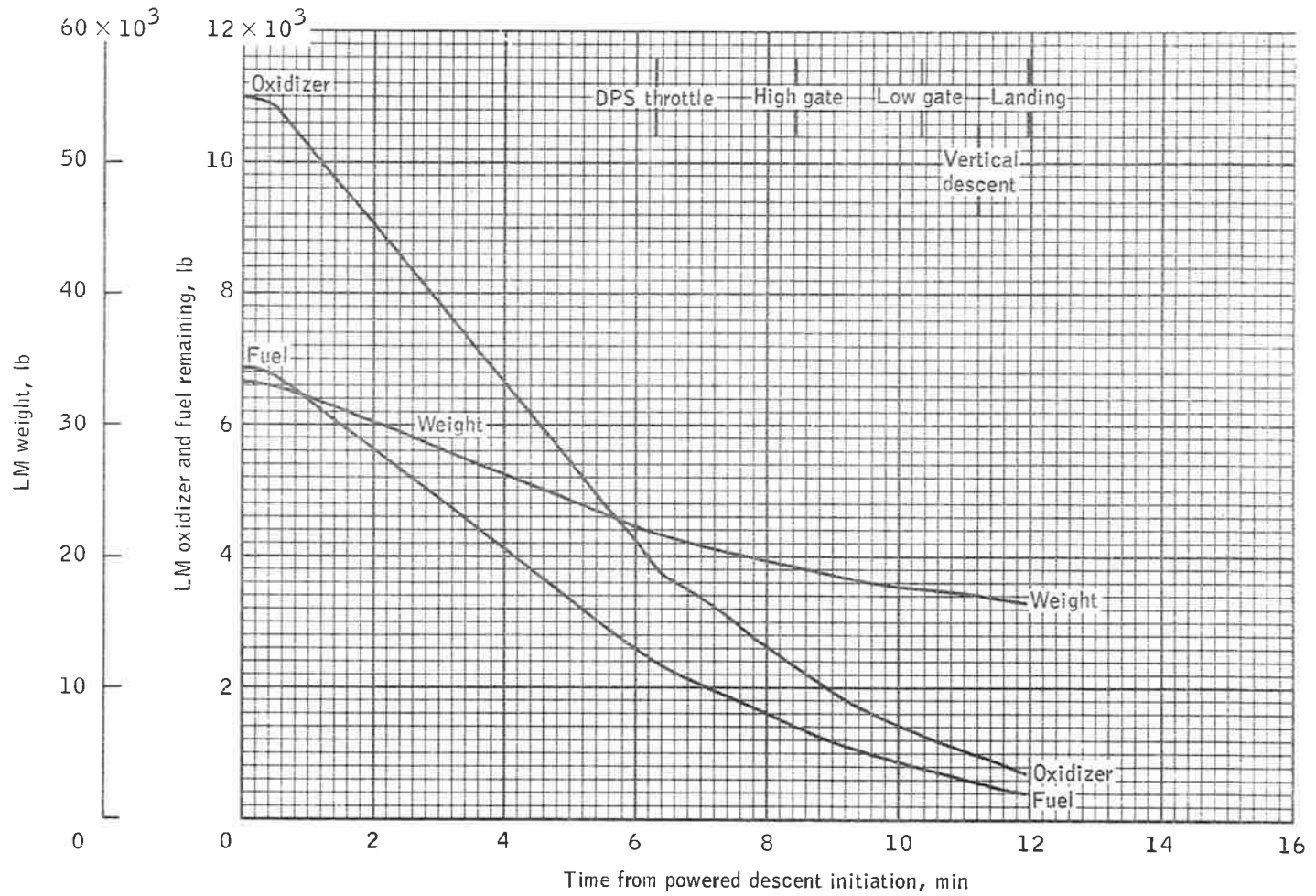

(e) LM weight, oxidizer, and fuel remaining.

Figure 4.10-12.- Continued.

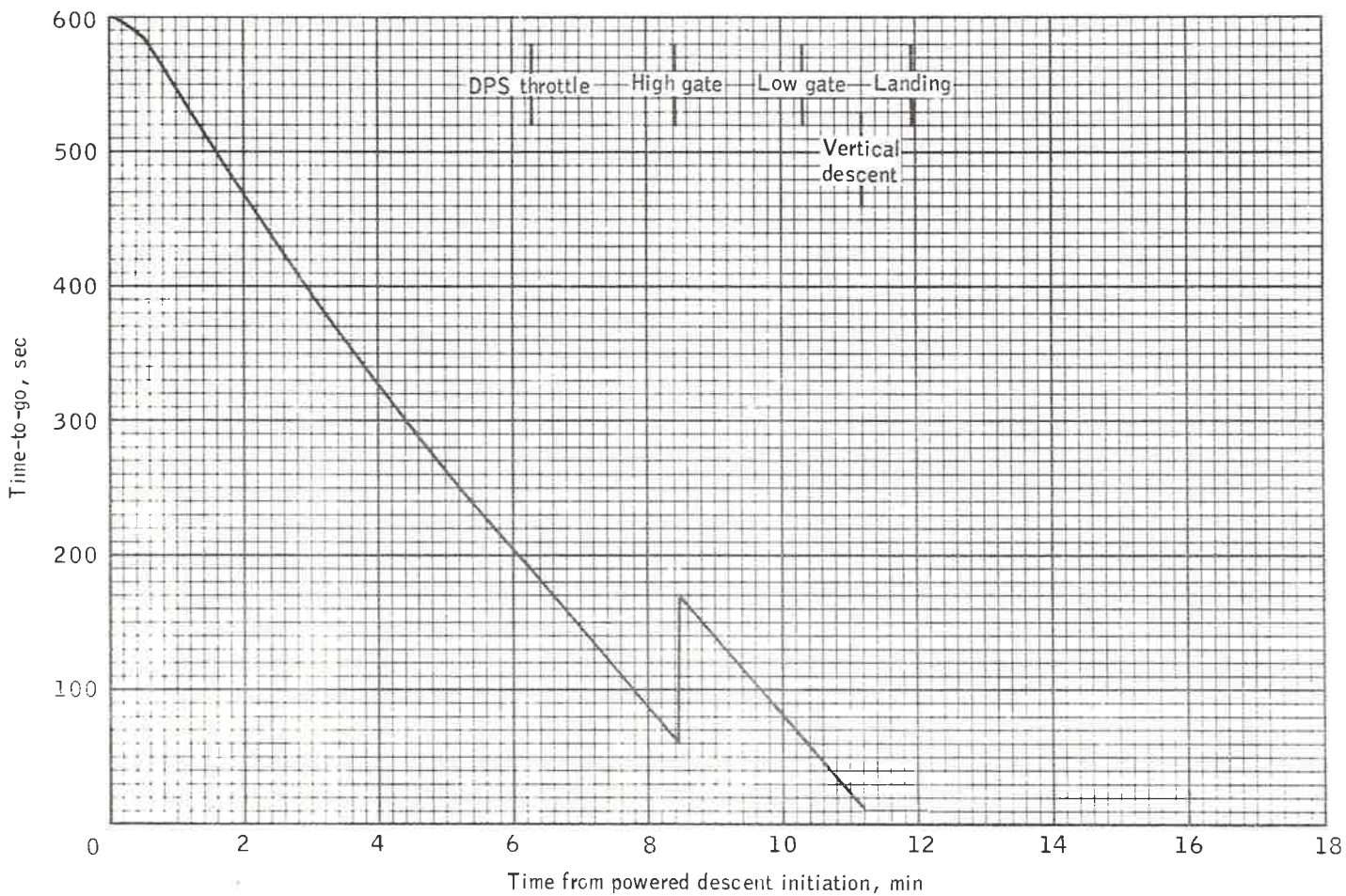

(f) Time-to-go.

Figure 4.10-12.- Continued.

06-7

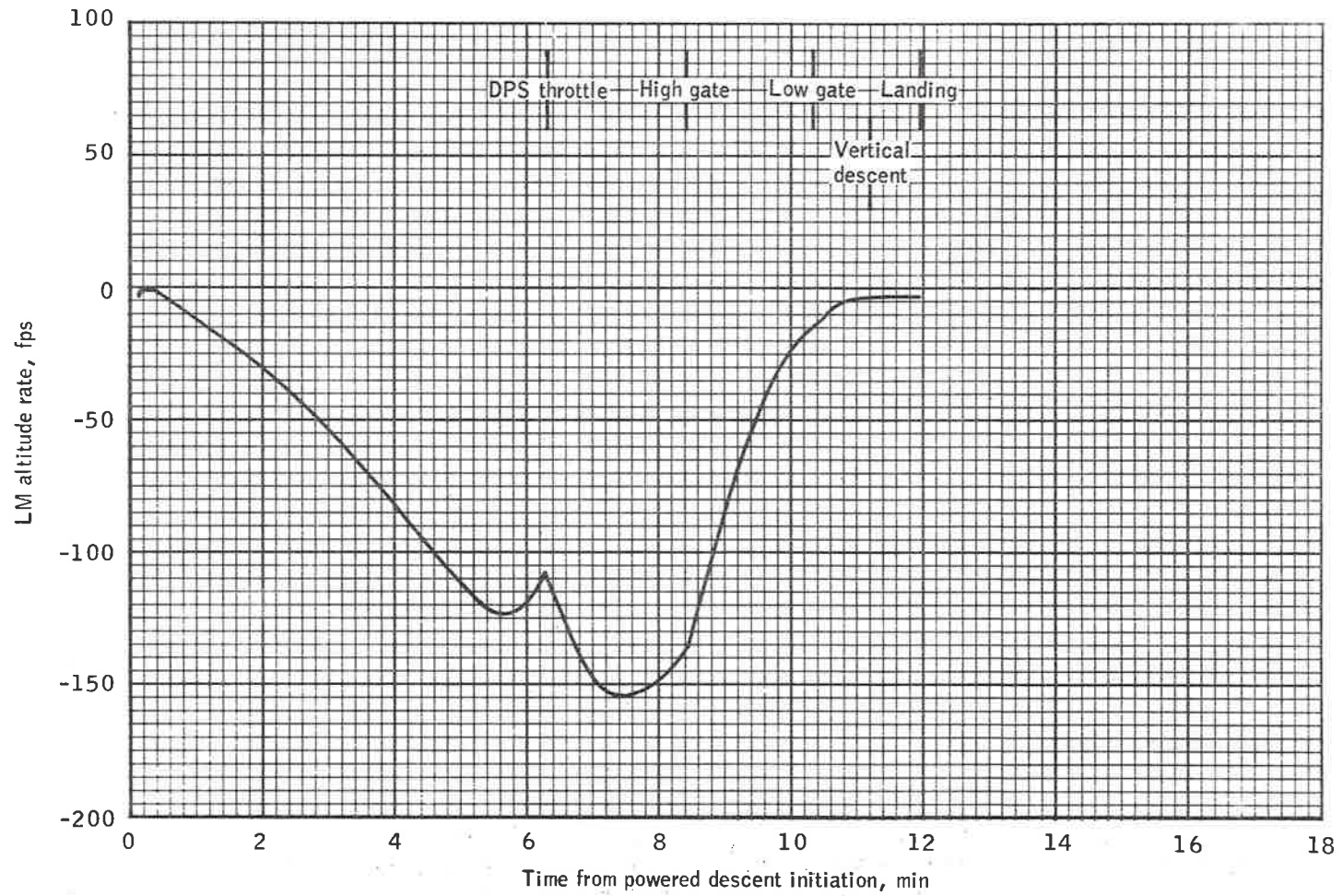

(g) LM altitude rate.

Figure 4.10-12.- Continued.

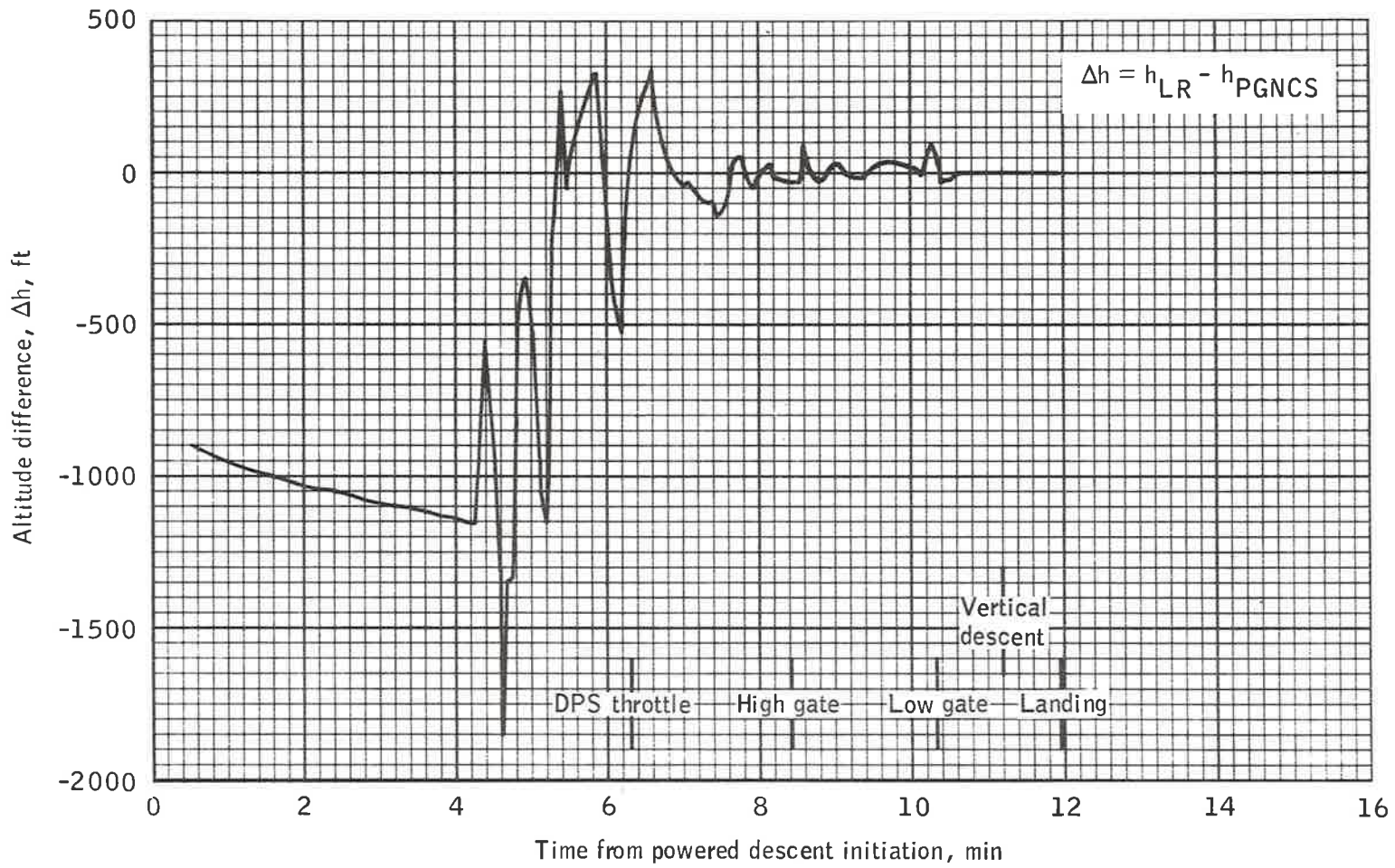

4-92

(h) Altitude difference.

Figure 4.10-12.- Concluded.

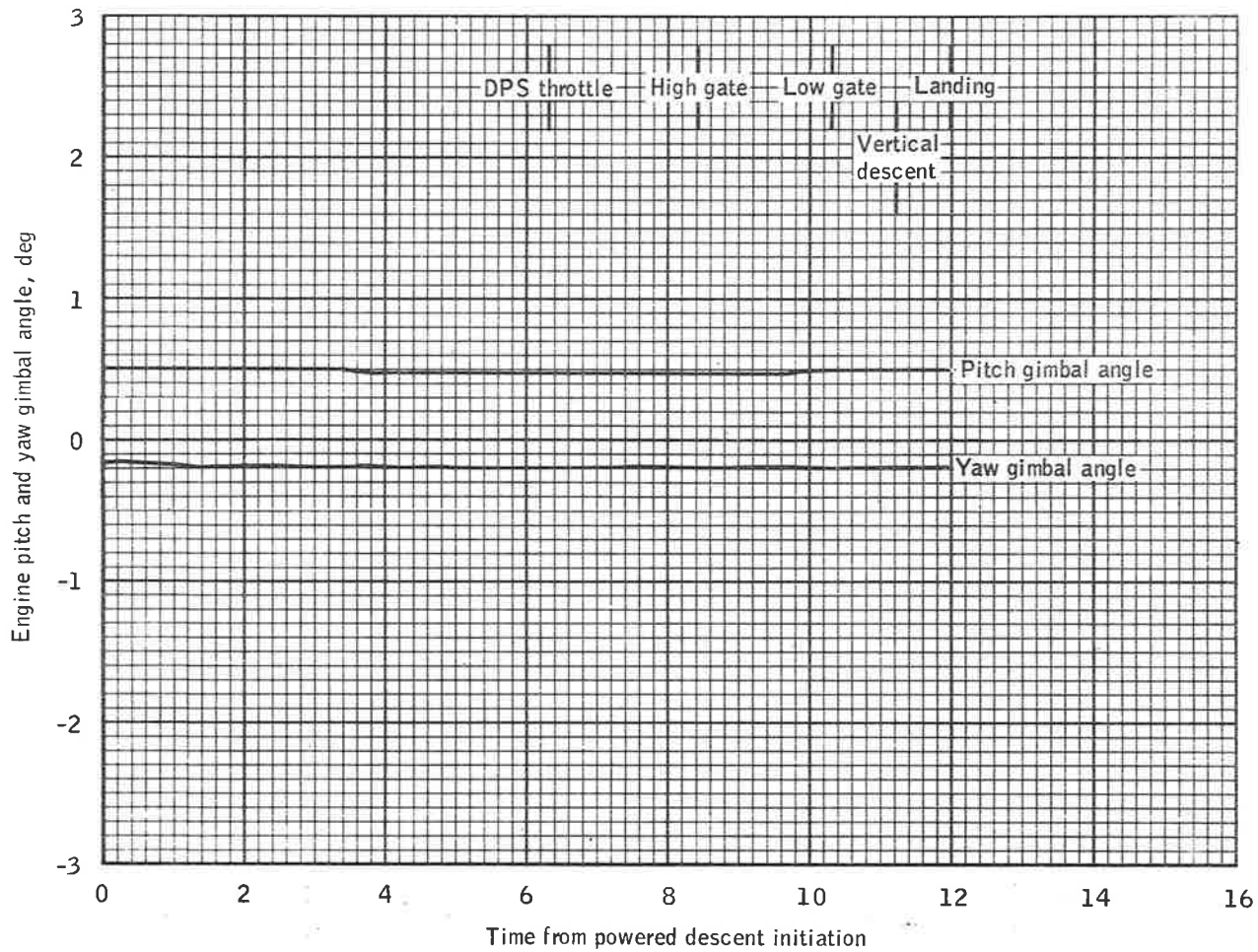

(a) Engine gimbal angles.

Figure 4.10-13.- Time history of attitudes from PDI to landing.

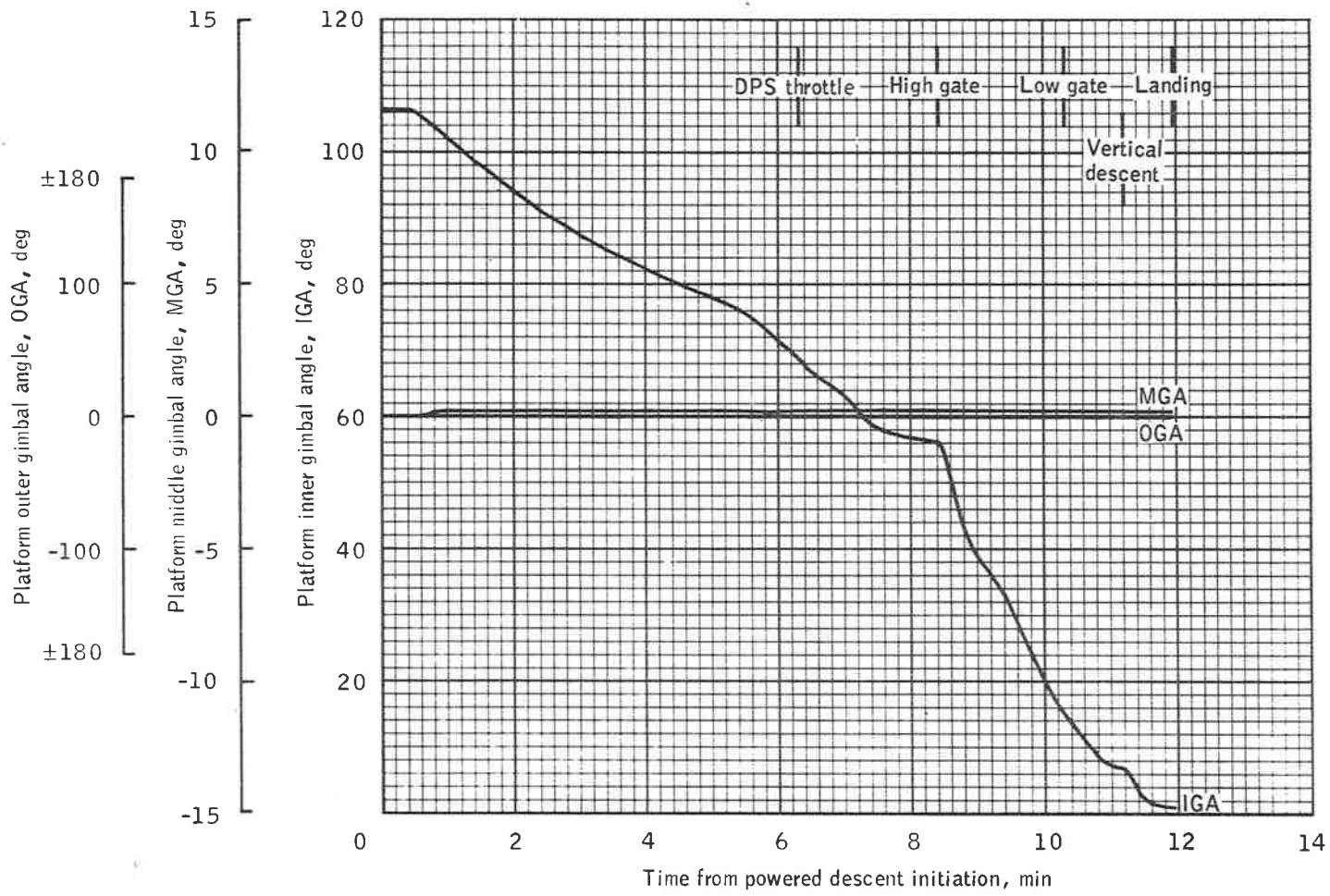

(b) Platform gimbal angles.

Figure 4.10-13. - Continued.

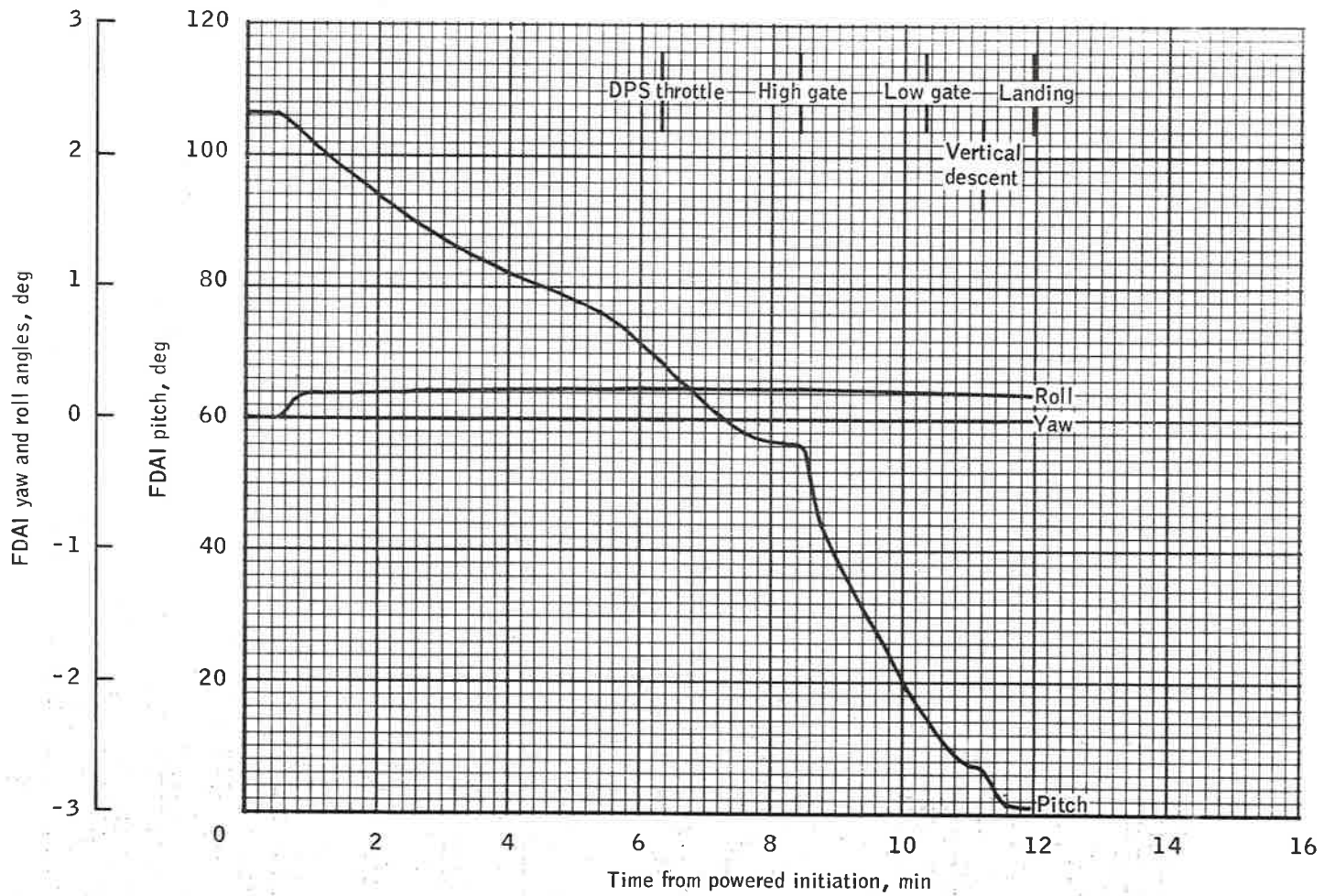

(c) FDAI angles.

Figure 4.10-13.- Continued.

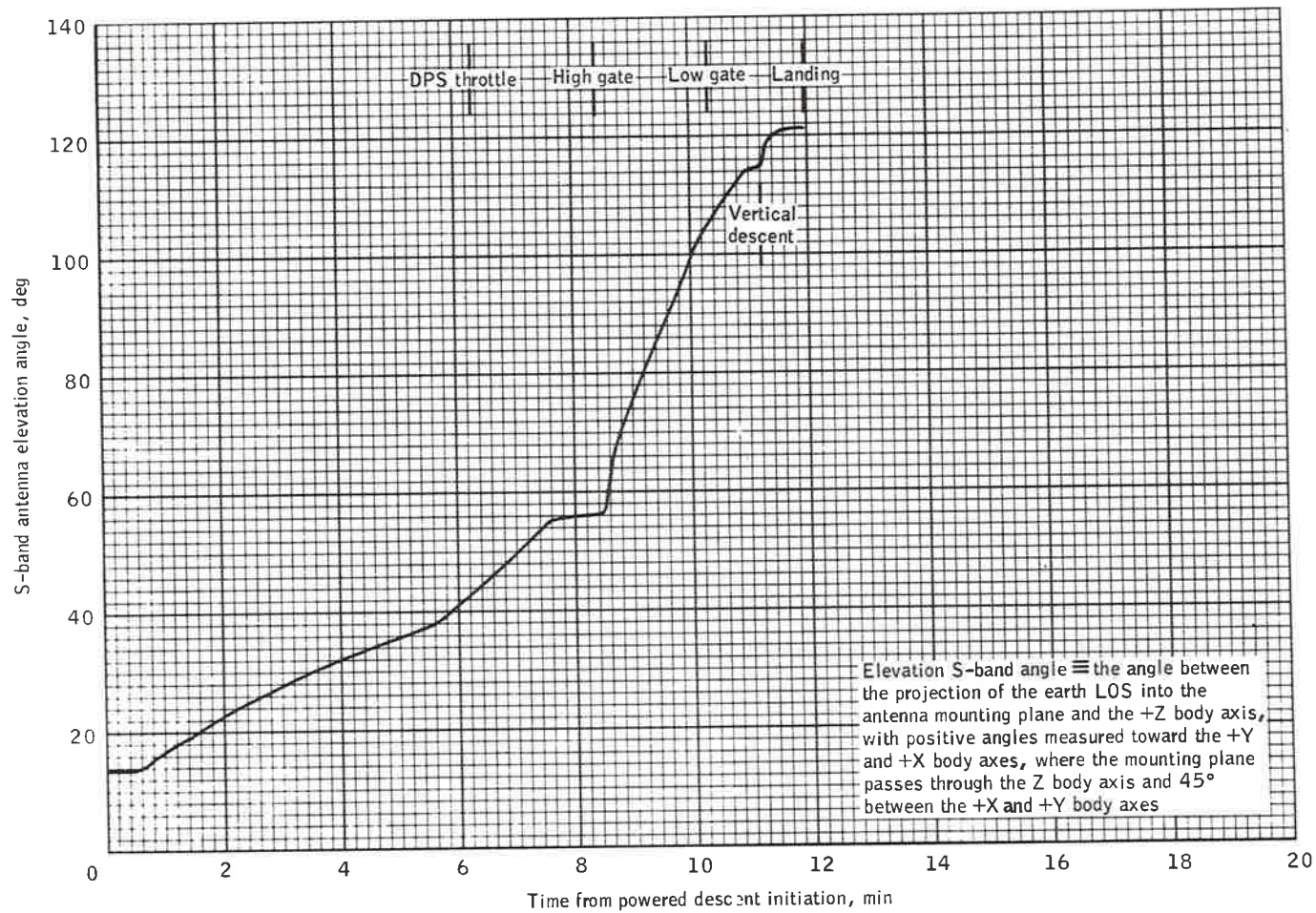

(d) S-band antenna elevation angle.

Figure 4.10-13.- Continued.

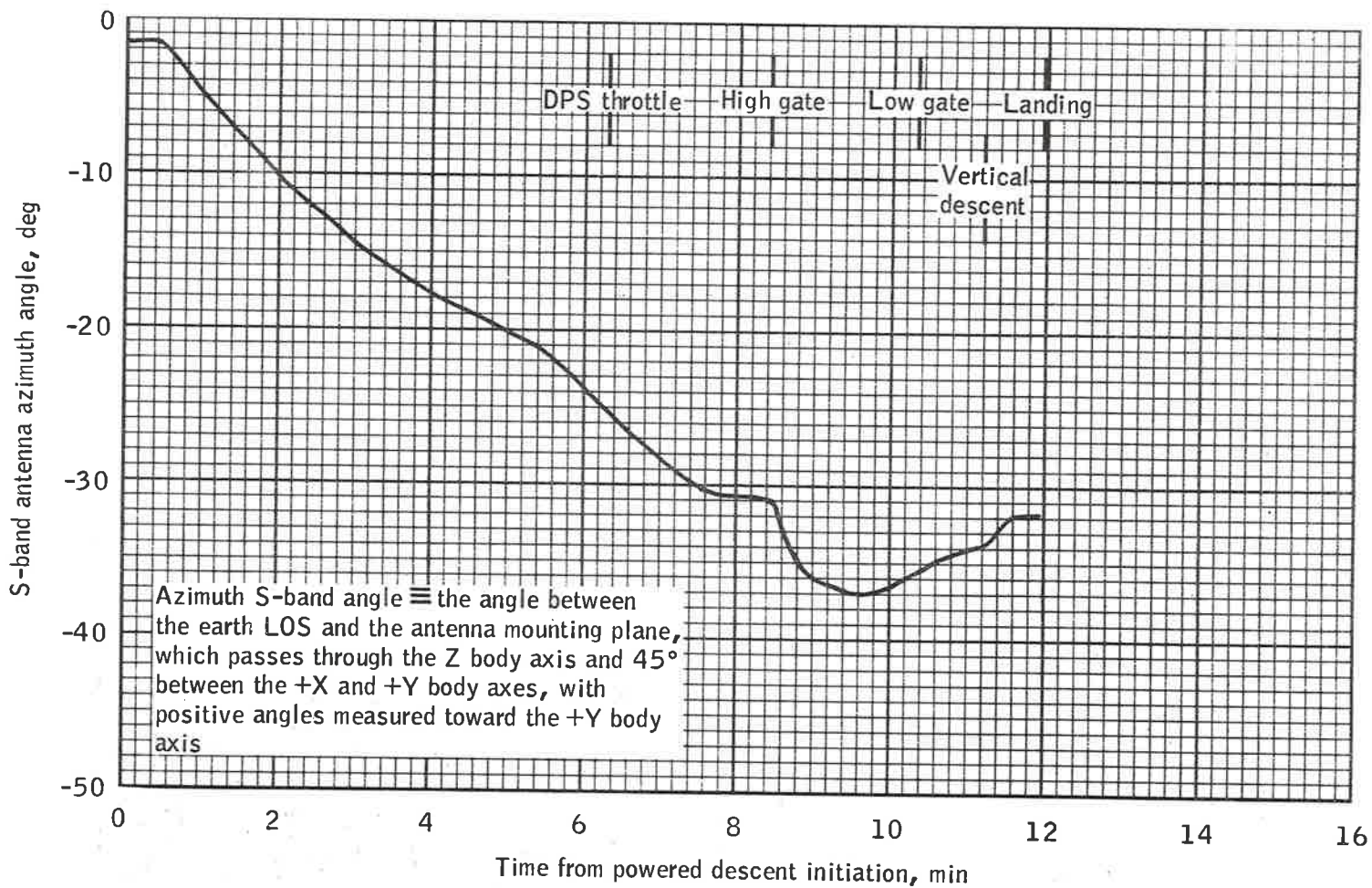

(e) S-band antenna azimuth angle.

Figure 4.10-13.- Continued.

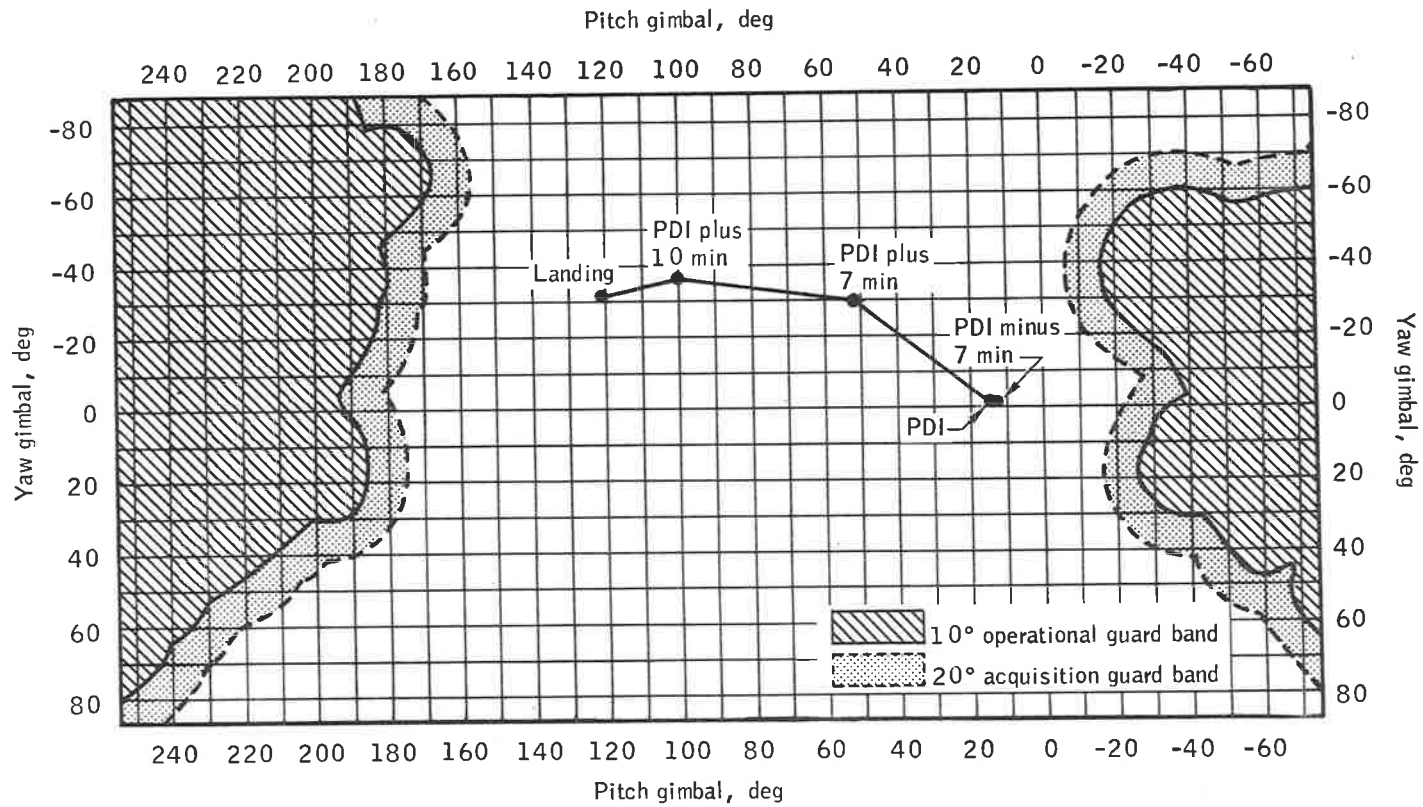

(f) S-band gimbal angle profile.

Figure 4.10-13.- Continued.

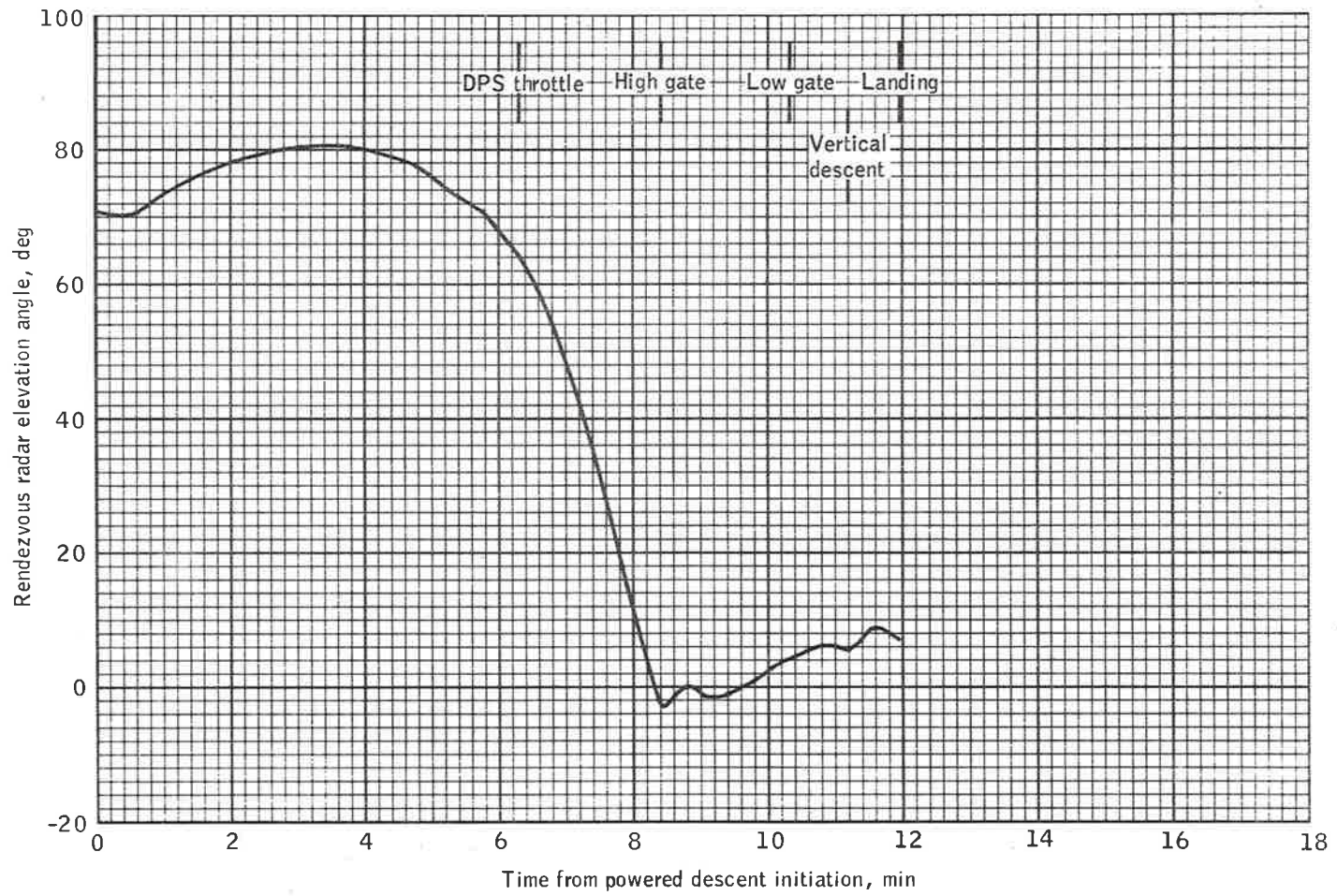

(g) Rendezvous radar elevation angle.

Figure 4.10-13.- Continued.

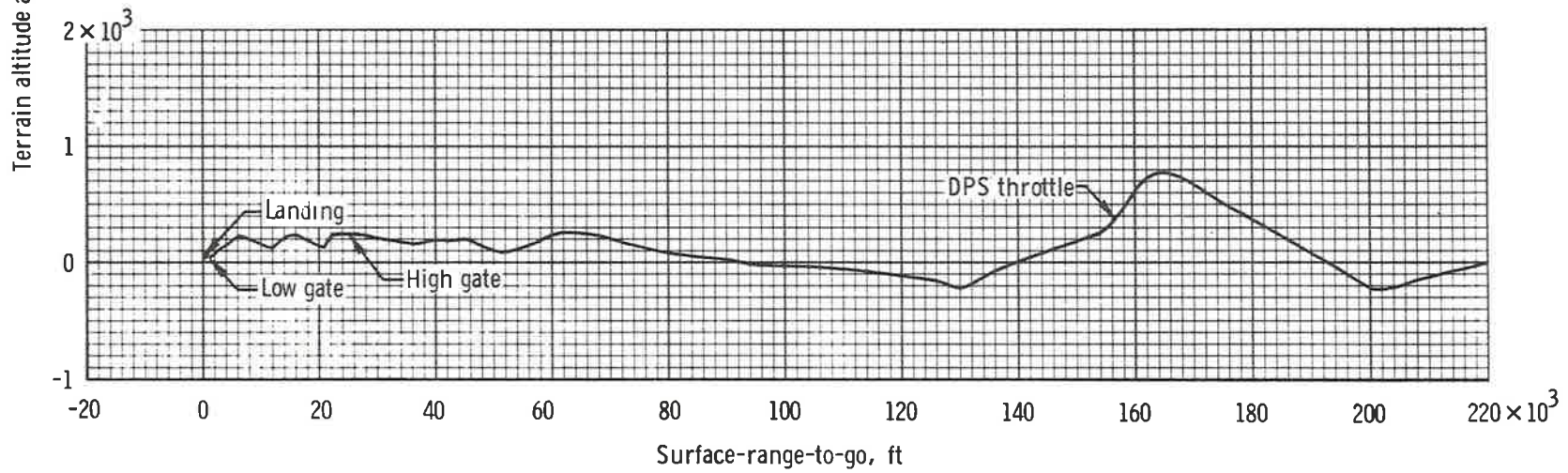
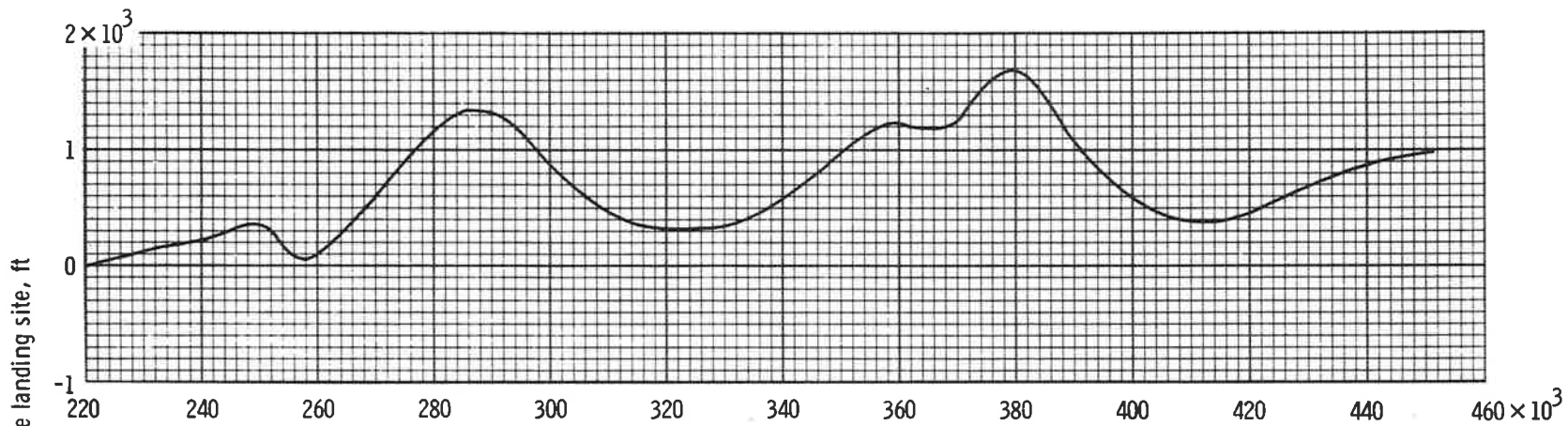

(b) Terrain altitude.

Figure 4.10-14. - Concluded.

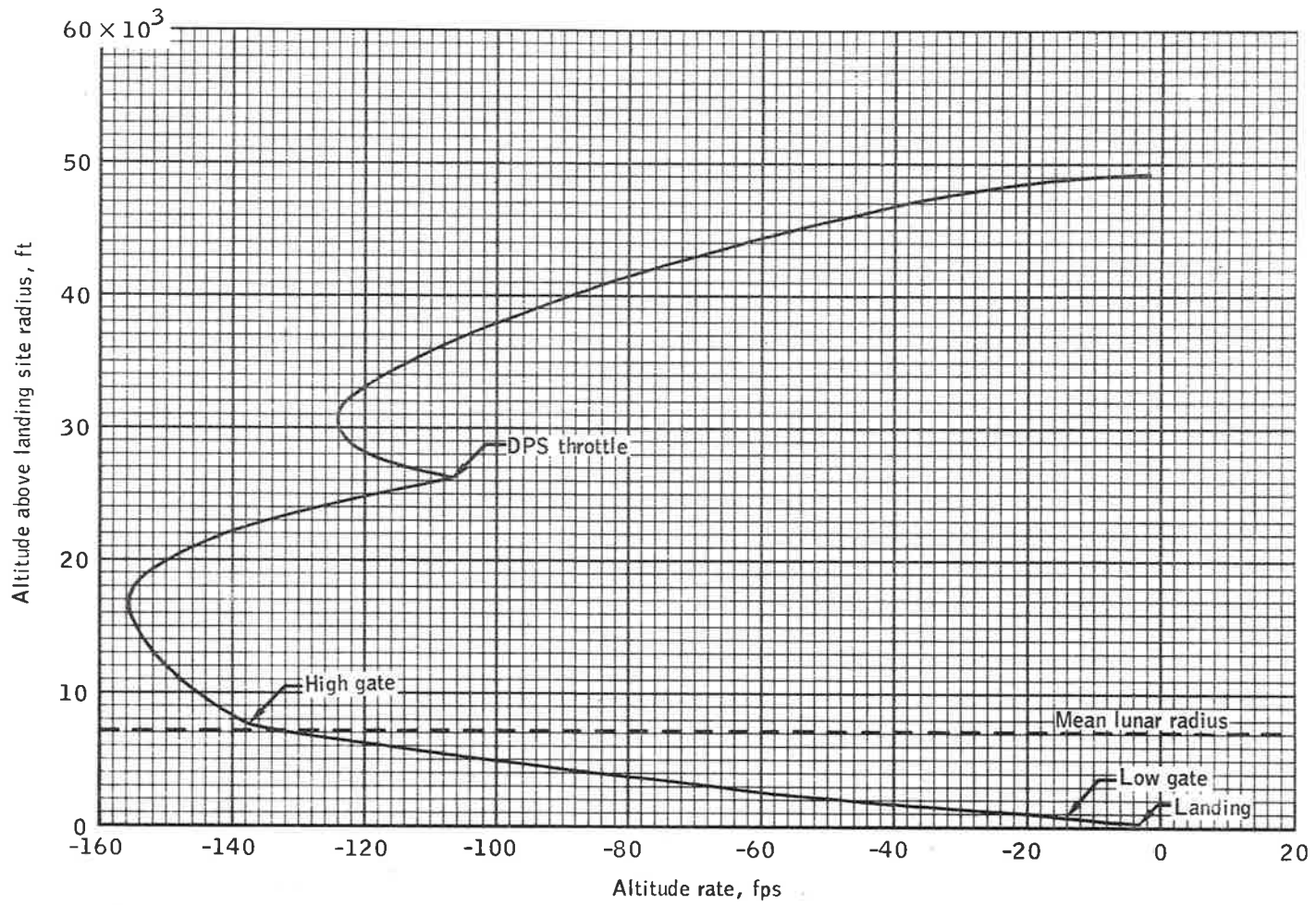
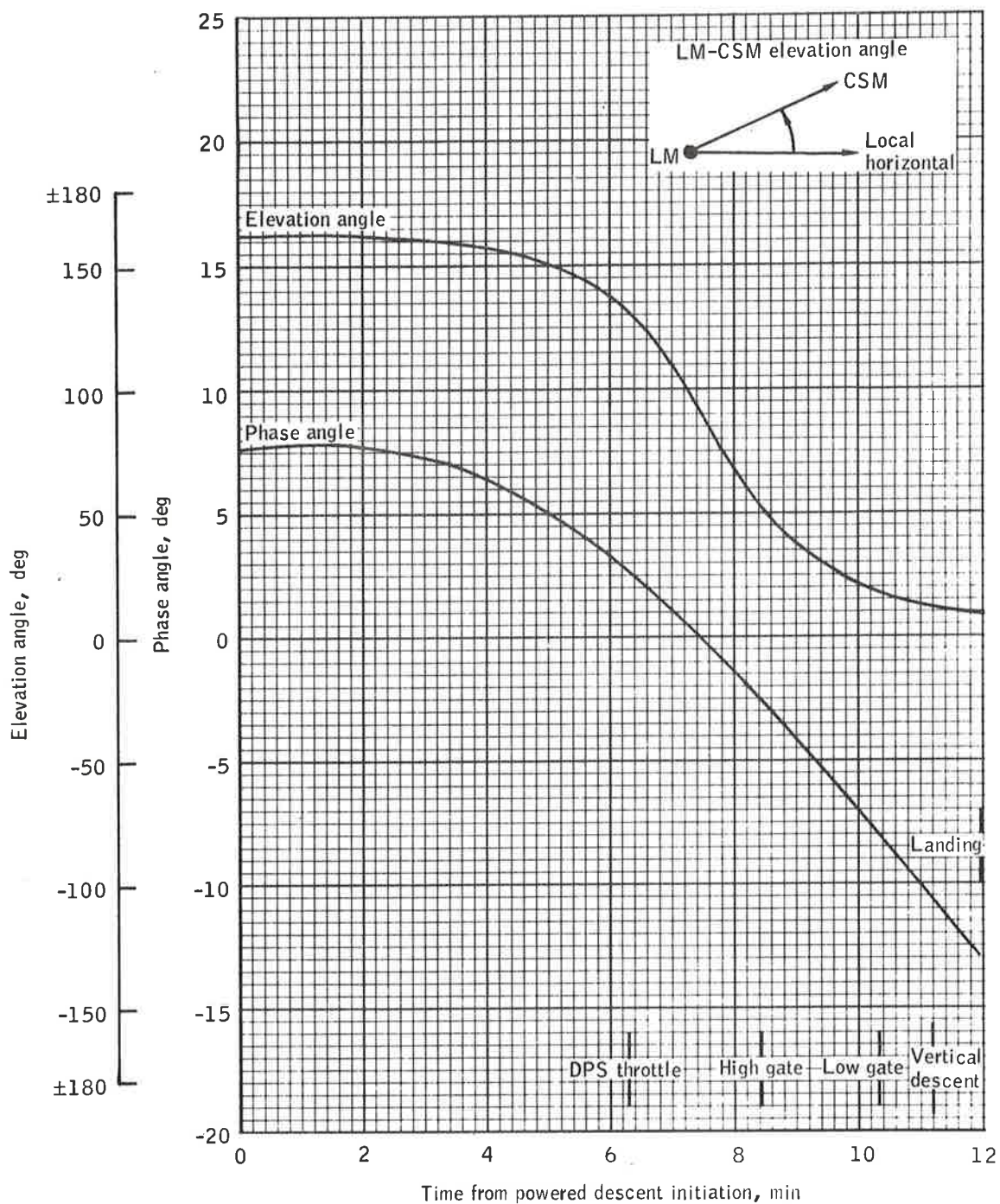
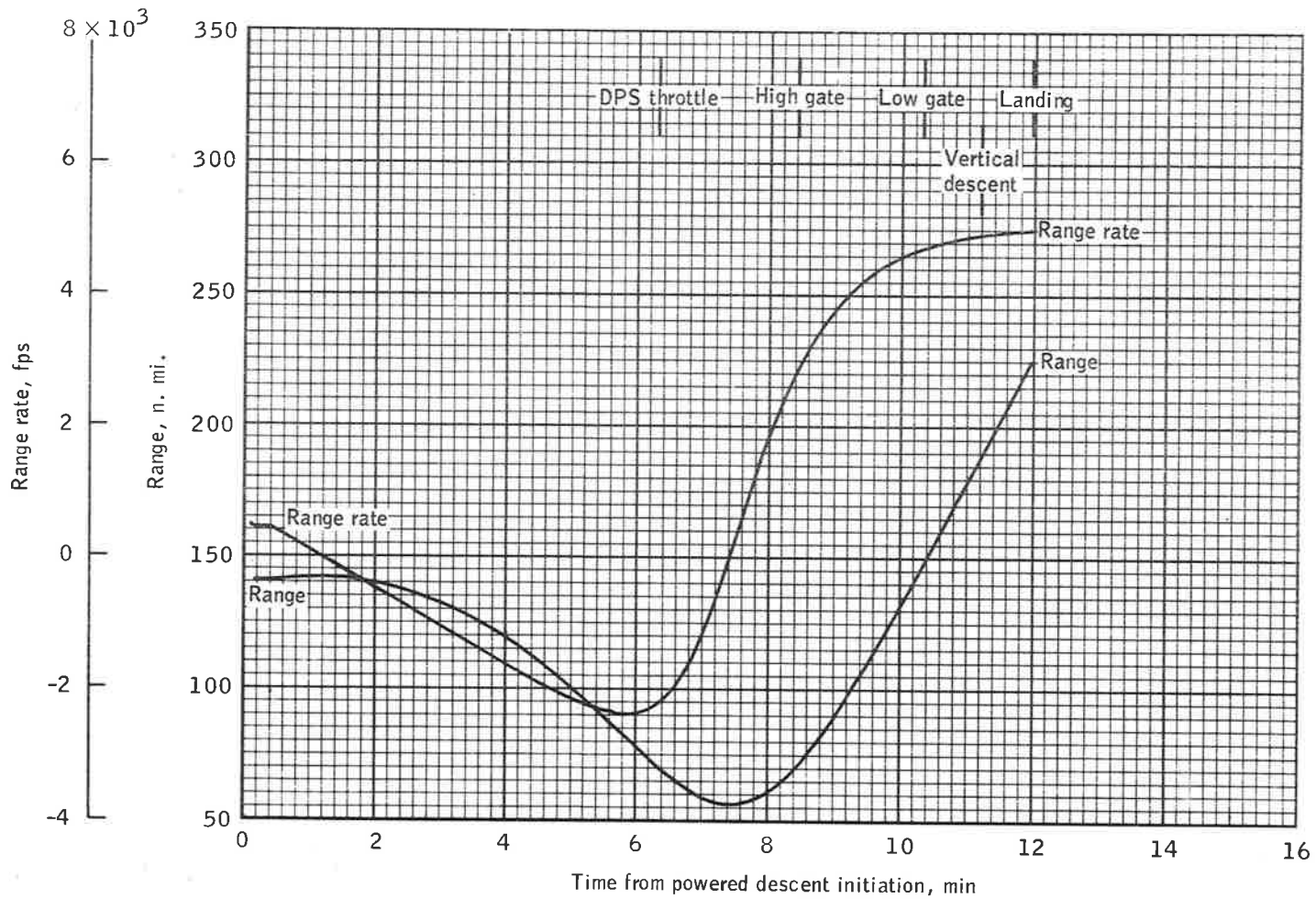

Figure 4.10-15. - LM altitude above landing site radius versus altitude rate from PDI to landing.



(a) Phase angle and elevation angle.

Figure 4.10-16.- LM-CSM relative parameters from PDI to landing.



(b) Range and range rate.

Figure 4.10-16.- Concluded.

4-105

POSITION NUMBER	TIME FROM HIGH GATE, SEC	RANGE, FT	ALTITUDE ABOVE LANDING SITE, FT	NAVIGATED ALTITUDE, FT	ALTITUDE ABOVE TERRAIN, FT	ALTITUDE RATE, FPS	HORIZONTAL VELOCITY, FPS	PITCH ANGLE, DEG
1	0	24 619	7494	7273	7523	-136.9	500	54.5
2	20	16 050	5084	4882	4859	-103.7	362	41.6
3	40	9 905	3307	3139	3137	-74.8	254	35.5
4	60	6 567	2056	1838	1841	-50.8	172	28.8
5	80	3 767	1236	1111	1130	-32.2	111	22.7
6	100	1 993	726	664	659	-19.6	68	16.8
7	114	1 191	496	524	516	-14.1	47	13.5

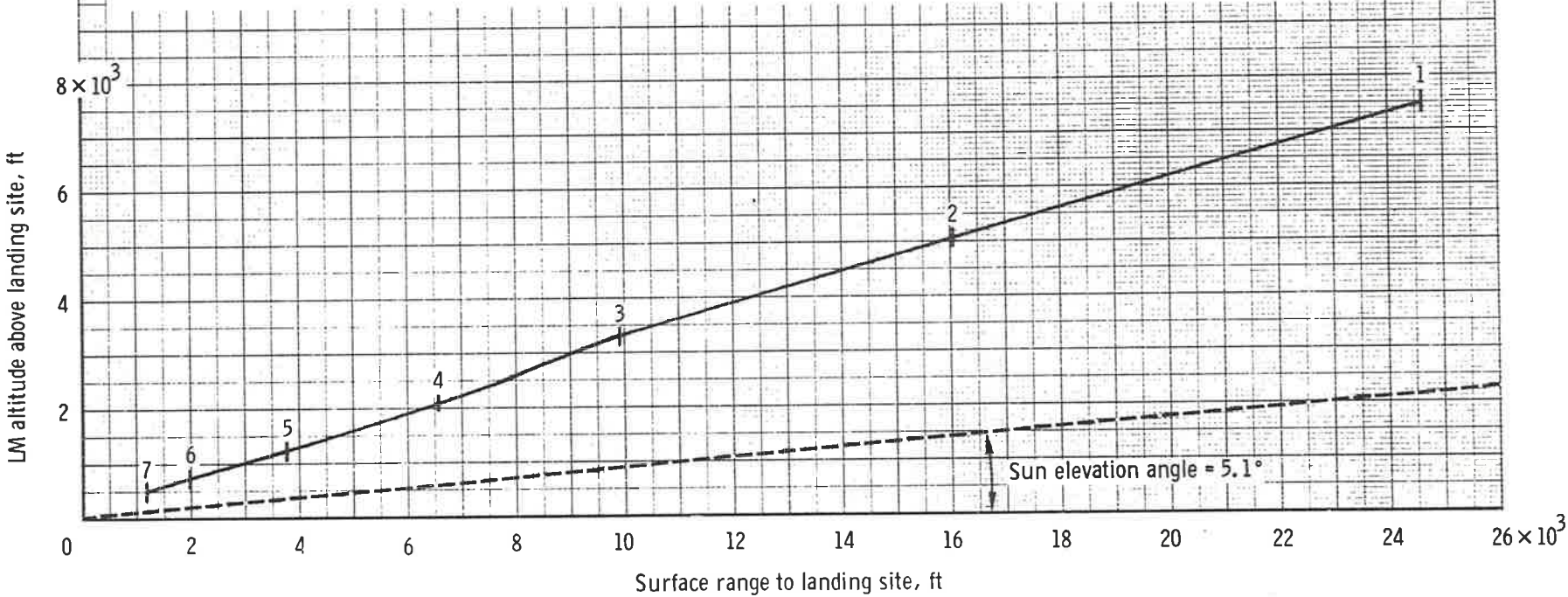

Figure 4.10-17. -LM altitude above landing site surface during approach and landing.

POSITION NUMBER	TIME FROM LOW GATE, SEC	RANGE, FT	ALTITUDE ABOVE LANDING SITE, FT	NAVIGATED ALTITUDE, FT	ALTITUDE ABOVE TERRAIN, FT	ALTITUDE RATE, FPS	HORIZONTAL VELOCITY, FPS	PITCH ANGLE, DEG
1	0	1191	496	524	516	-14.1	47.0	13.5
2	10	783	370	357	356	-10.5	34.9	10.5
3	20	483	284	275	277	-6.9	25.3	8.8
4	30	271	227	223	225	-4.6	17.3	7.4
5	40	131	186	186	188	-3.7	10.8	6.4
6*	50	52	148	151	152	-3.9	5.0	5.8
7	94	6	7	12	12	-3.0	0.0	0.0

* Begin vertical descent

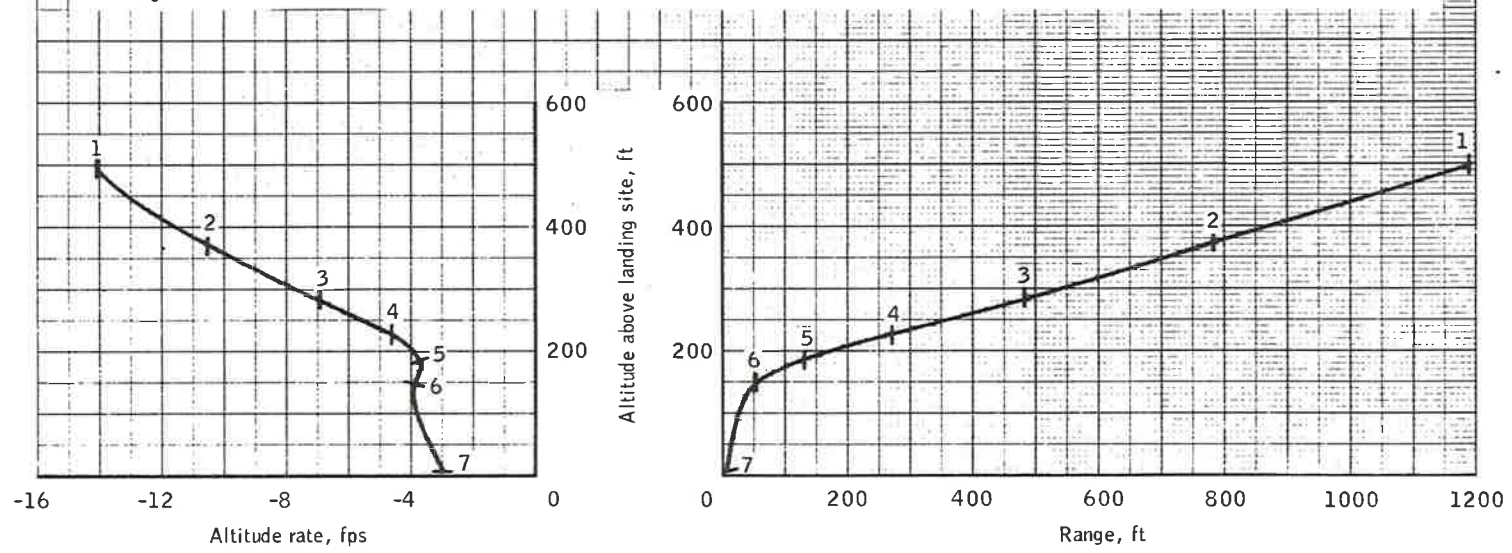

Figure 4.10-18. - Landing phase summary.

4-107

4.11 1ST CSM LUNAR ORBIT PLANE CHANGE

4.11 First CSM Lunar Orbit Plane Change (LOPC-1)

Approximately 32 hours 24 minutes after LOI-1, the CSM performs a plane change to place the LM in the CSM orbital plane at the time of LM lift-off. The maneuver is performed approximately 2.75^a revolutions after LM landing. The target load for the maneuver is presented in table 4.11-I.

The burn characteristics are the following.

Burn initiation

Time, hr:min:sec, g.e.t.	115:53:24.7
Mass, lb	36 038.4
Altitude above LLS, n. mi.	63.0
Selenographic latitude, deg	-14.1
Selenographic longitude, deg	76.4
Velocity, fps	5328.5
Perilune altitude above LLS, n. mi.	56.4
Apolune altitude above LLS, n. mi.	63.0

Burn cutoff

Time, hr:min:sec, g.e.t.	115:53:44.7
Altitude above LLS, n. mi.	63.0
Selenographic latitude, deg	-14.2
Selenographic longitude, deg	75.3
Velocity, fps	5328.5
Burn duration, sec	20.0
Inertial burn arc, deg	1.0
Plane change, deg	4.0
ΔV , fps	372.7
SPS propellant used	1303.6
Orbit period, hr:min:sec	1:58:40
Perilune altitude above LLS, n. mi.	56.4
Apolune altitude above LLS, n. mi.	63.0

^aThe time for the maneuver has recently been changed to 4.75 revolutions after LM landing.

TABLE 4.11-I.- TARGET LOAD FOR FIRST LUNAR ORBIT

PLANE CHANGE MANEUVER (LOPC-1)

[Propulsion system: SPS; guidance: external ΔV]

(a) Target

t_{IG} , hr:min:sec, g.e.t.	115:53:24.7
ΔV_X , fps	-13.0
ΔV_Y , fps	372.4
ΔV_Z , fps	0.0
Weight, lb	36 038.4

(b) REFSMMAT

Refer to table 5-V

(c) Gimbal angles at t_{IG}

IGA, deg	3.0
MGA, deg	-1.4
OGA, deg	0.1

4.12 LM ASCENT

4.12 LM Ascent

LM ascent begins after a lunar stay time of approximately 32 hours. Time of LM lift-off is determined primarily by the LM-CSM phase requirements for rendezvous. A sketch of the powered ascent phase is shown in figure 4.12-1. The powered ascent is divided into two phases. The first phase is the vertical rise phase which is required for the ascent stage to achieve terrain clearance. A description of trajectory parameters and vehicle attitudes during the vertical rise phase and the transition to the orbital insertion phase is shown in figure 4.12-2. Guidance switches to the orbital insertion phase for radial rates greater than 40 fps, but because of DAP steering lag the pitchover does not begin until a radial rate of approximately 50 fps is achieved. This means the vertical rise phase is actually terminated at 10 seconds after lift-off. During the vertical rise, the LM Z-body axis is rotated to the desired azimuth which is normally in the CSM orbital plane.

A description of the orbital insertion phase is shown in figure 4.12-3. Included is a description of total ascent phase performance, insertion orbital parameters, and onboard displays at insertion. The onboard display values reflect LGC estimated values. Yaw steering is used during the orbital insertion phase, if required, to maneuver the LM into the CSM orbital plane or into a plane that is coplanar with the CSM orbit. In the nominal case, no yaw steering is required. A ground-track for the LM and CSM during LM ascent is shown in figure 4.12-4. LM ascent weight and events summaries are shown in tables 4.12-I and 4.12-II, respectively. The target load is shown in table 4.12-III.

Time histories of important LM trajectory and attitude parameters are shown in figure 4.12-5. An altitude/altitude rate profile is shown in figure 4.12-6.

Because +X-axis RCS thrusting is used for attitude control during LM ascent, the effective thrust, flow rate, and specific impulse must include effects of both APS and RCS thrusting. Time histories of these effective combined APS and RCS parameters during LM ascent are shown in figure 4.12-7. In the LM ascent propulsion performance summary (table 4.12-IV), the effect of combined APS and RCS performance is illustrated as a function of time. (APS interconnect is open during LM ascent; all propellant is assumed to come from the APS tank.) A LM weight history is presented in figure 4.12-8. Note that the data do not include the effects of nonpropulsive consumables loss during ascent.

Time histories of LM-CSM relative parameters are shown in figure 4.12-9. LM-CSM relative range data are shown in figure 4.12-10, and the LM-CSM range/range rate history is shown in figure 4.12-11. LM S-band elevation and azimuth angles, LM S-band antenna angle profile, the CSM-LM-earth, and CSM-LM-sun angles are shown in figure 4.12-12.

TABLE 4.12-1.- LM ASCENT WEIGHT SUMMARY

Weight of LM crew, inert weights, consumables, and unusable APS propellant, lb	5 568.0
Tanked APS propellant, lb	5 222.6
Total weight of ascent stage, lb	10 790.6
Net off-loaded weight on lunar surface, lb	-127.2
Total ascent stage lift-off weight, lb	10 663.4

TABLE 4.12-II.- LM ASCENT EVENTS SUMMARY

Event	Time, hr:min:sec, g.e.t.	Propulsion system	Burn time, sec	ΔV , fps	Weight lb	Propellant, lb
LM lift-off	142:04:37.125	APS ^a	0.0	0.0	10 663.40	0.0
End vertical rise	142:04:47.125	APS ^a	10.0	108.03	10 548.05	115.35
LM insertion	142:11:47.720	APS ^a	430.59	6049.05	5 802.45	4860.95

^aCombines APS and +X-axis RCS.

TABLE 4.12-III.- TARGET LOAD FOR LM ASCENT

[Propulsion systems: APS, RCS; guidance:
orbit insertion (P12)]

(a) Target

t_{IG} (lift-off), hr:min:sec, g.e.t.	142:04:37.125
R_D (desired injection radius), ft	5 755 208.2
Y_D (desired injection cross-range distance), ft	0.0
R_D (desired injection radial velocity), fps	32.0
Y_D (desired injection cross-range velocity), fps	0.0
Z_D (down-range velocity for desired injection), fps	5535.62
Weight at t_{IG} , lb	10 663.4

(b) REFSMMAT

Refer to table 5-VI

(c) Gimbal angles at t_{IG}

IGA, deg	0.349
MGA, deg	0.047
OGA, deg	-0.868

TABLE 4.12-IV.-- LM ASCENT PROPULSION PERFORMANCE SUMMARY

[Combined APS and RCS]

Event	Time from lift-off sec	APS thrust, lb	APS \dot{W} , lb/sec	RCS effective thrust, lb	RCS effective \dot{W} , lb/sec	Total thrust, lb	Total \dot{W} , lb/sec	I_{sp} , sec
LM lift-off	0	3486.91	11.18	78.62	0.37	3565.53	11.55	308.70
	100	3448.56	11.08	62.32	.29	3510.88	11.37	308.78
	200	3441.68	11.07	44.46	.21	3486.14	11.28	309.05
	300	3436.20	11.08	22.65	.11	3458.85	11.19	309.10
LM insertion	430.59	3442.68	11.11	19.70	.09	3462.38	11.20	309.14

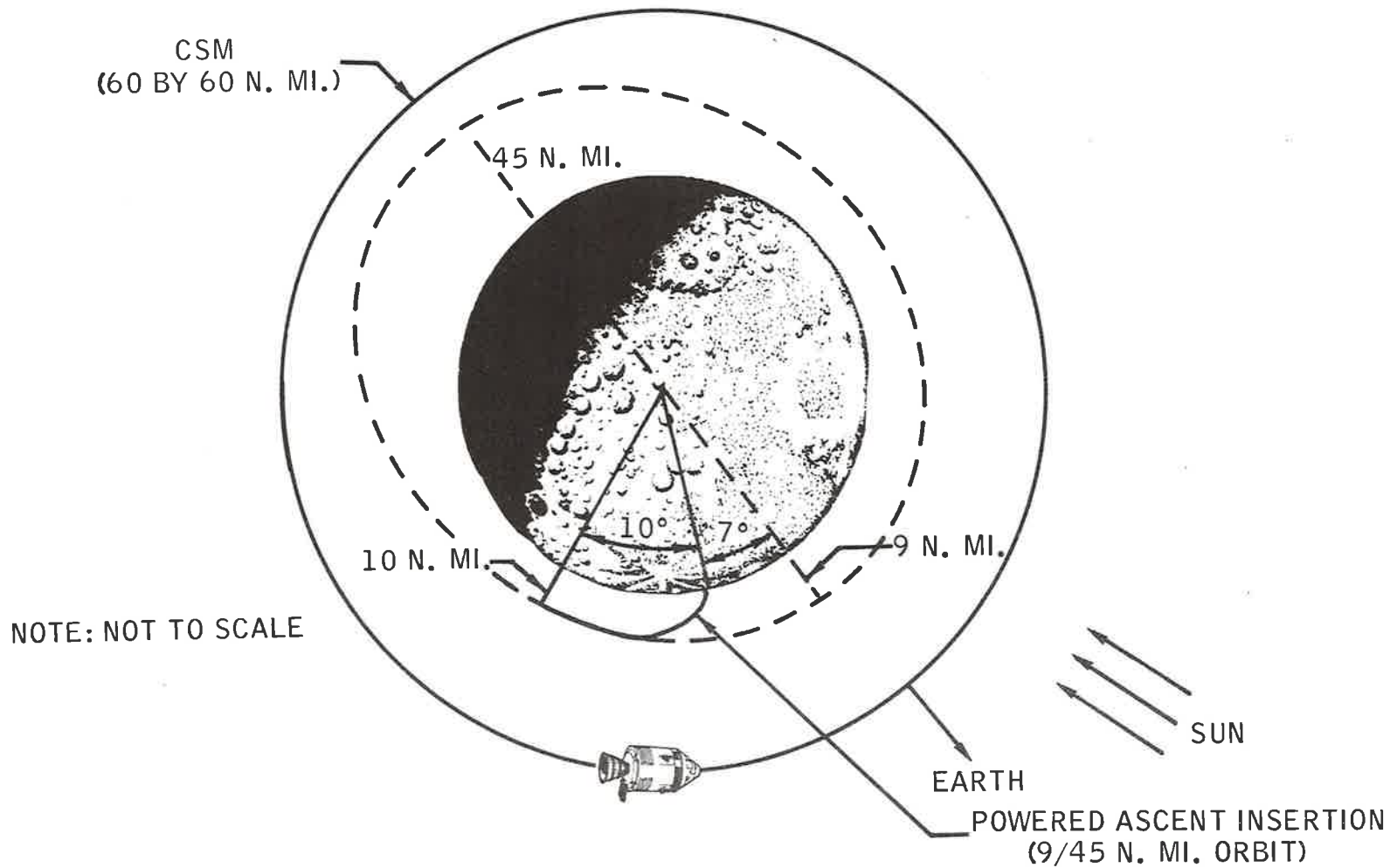

4-120

Figure 4.12-1.- LM ascent.

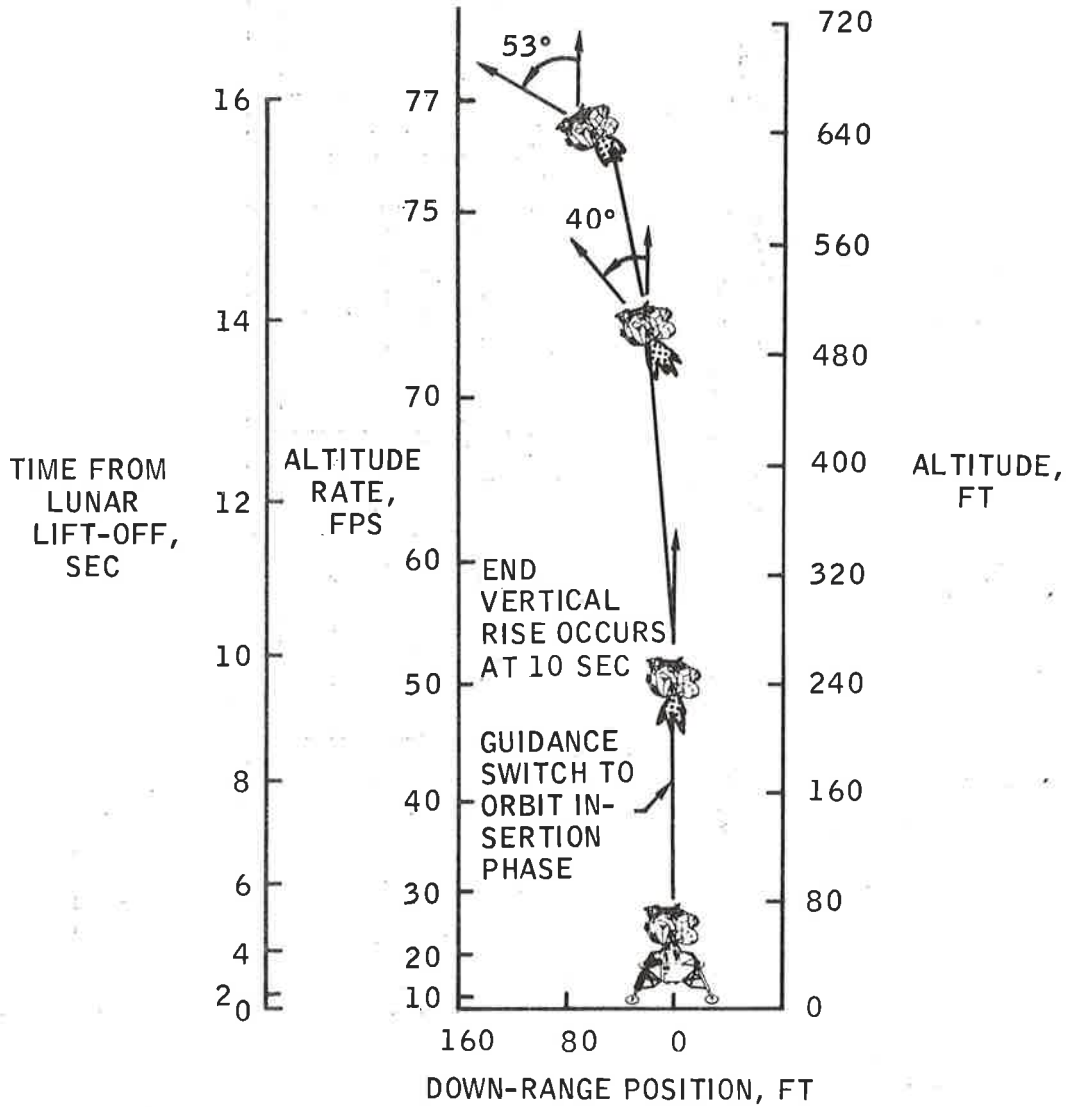
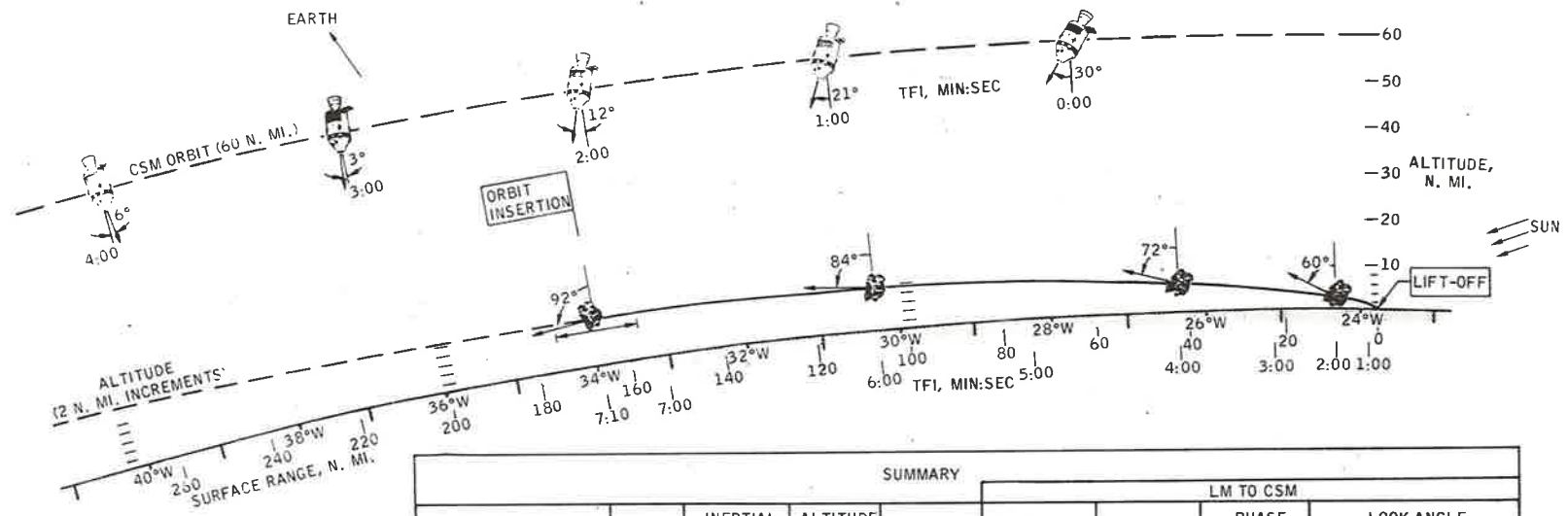

Figure 4.12-2. - Vertical rise phase.



SUMMARY					LM TO CSM			
EVENT	TFI, MIN:SEC	INERTIAL VELOCITY, FPS	ALTITUDE RATE, FPS	ALTITUDE, FT	RANGE, N. MI.	RANGE RATE, FPS	PHASE ANGLE, DEG	LOOK ANGLE, (LOCAL VERTICAL) DEG
LIFT-OFF	0:00	15	0	0	82	3571	3.3	45.1
END OF VERTICAL RISE	0:10	56	55	272	88	3793	3.8	49.4
	2:00	1036	172	14 316	160	3807	8.9	73.6
	4:00	2474	185	36 764	224	2549	12.9	82.8
	6:00	4273	106	55 024	258	797	14.97	86.3
ORBIT INSERTION	7:10.6	5535.5	32.2	59 983.2	260.2	-454.9	15.1	86.7

$h_{\mu} = 54\,959.7$ FT
 $h_a = 45.3$ N. MI.
 $\eta = 17.4^\circ$
 $\gamma = .33^\circ$
 $\Delta V = 6049$ FPS

Figure 4.12-3.- Orbit insertion phase.

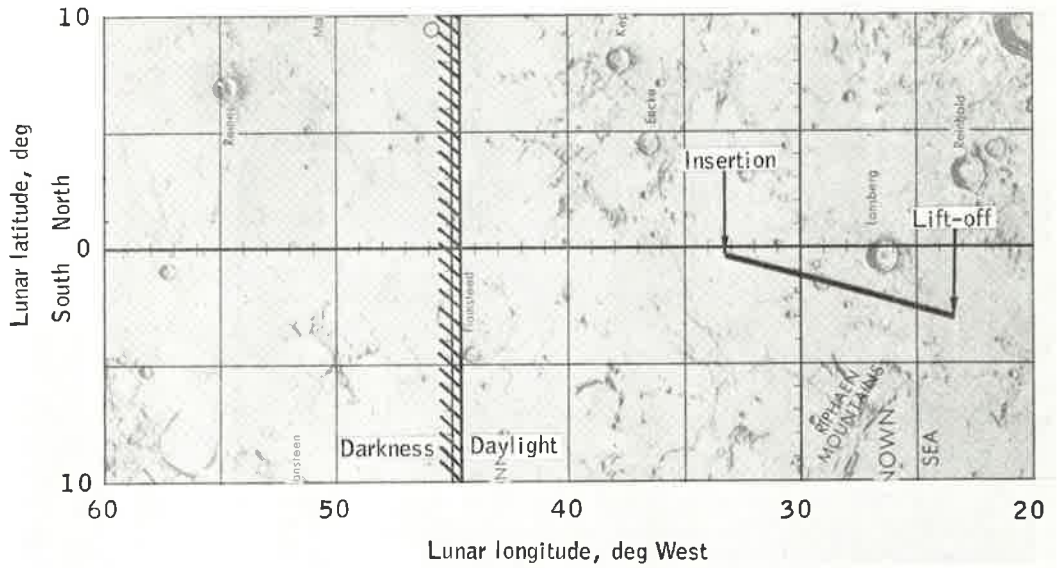

(a) LM groundtrack.

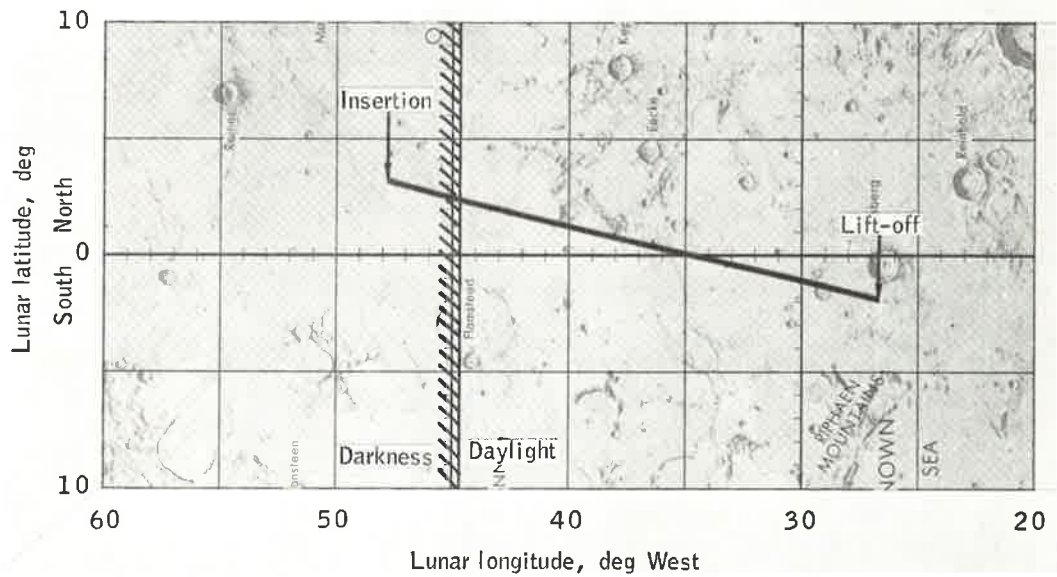

(b) CSM groundtrack.

Figure 4.12-4.- LM and CSM groundtracks during powered ascent.

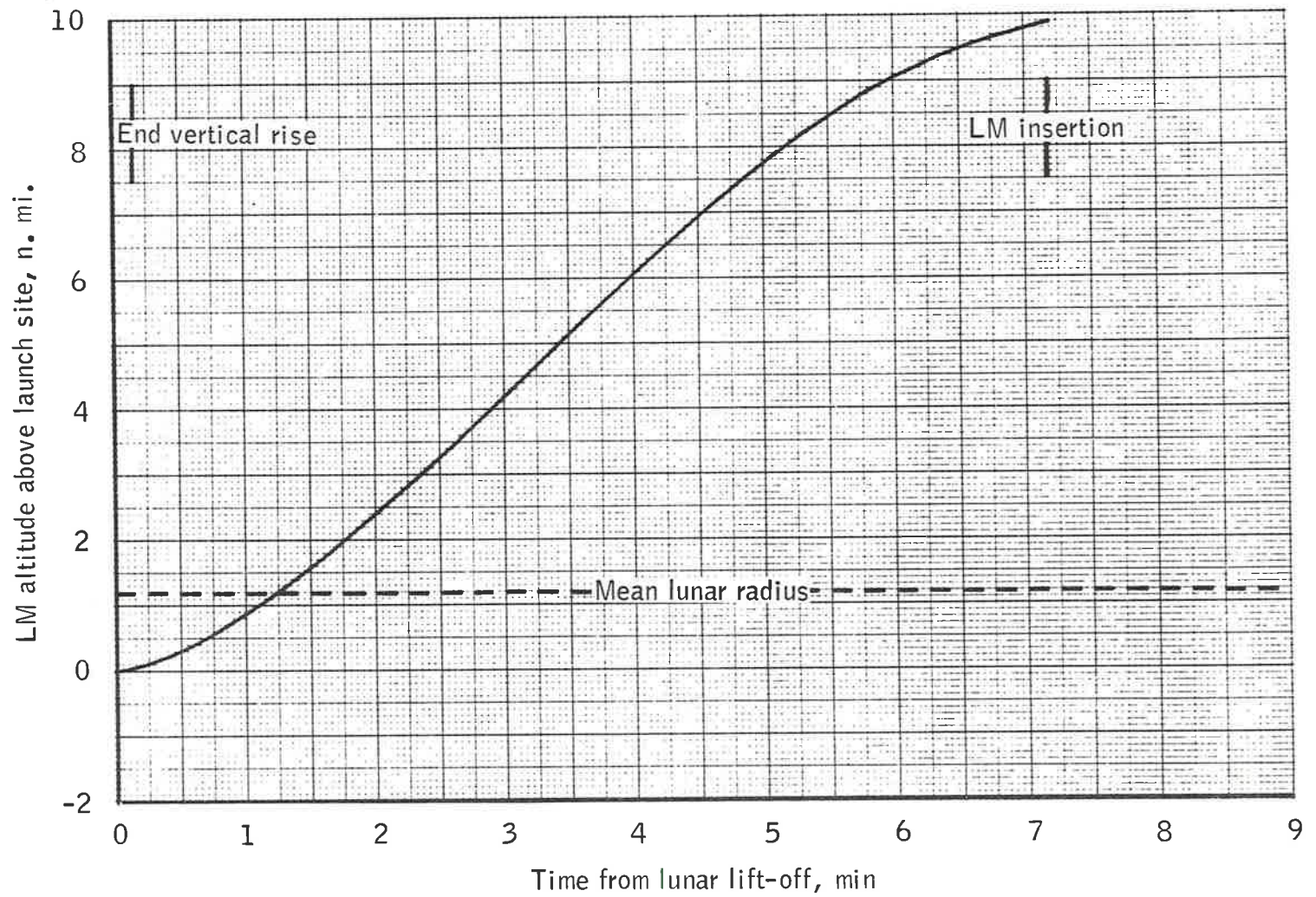

4-124

(a) LM altitude above launch site.

Figure 4.12-5.- Time histories of LM trajectory parameters during powered ascent.



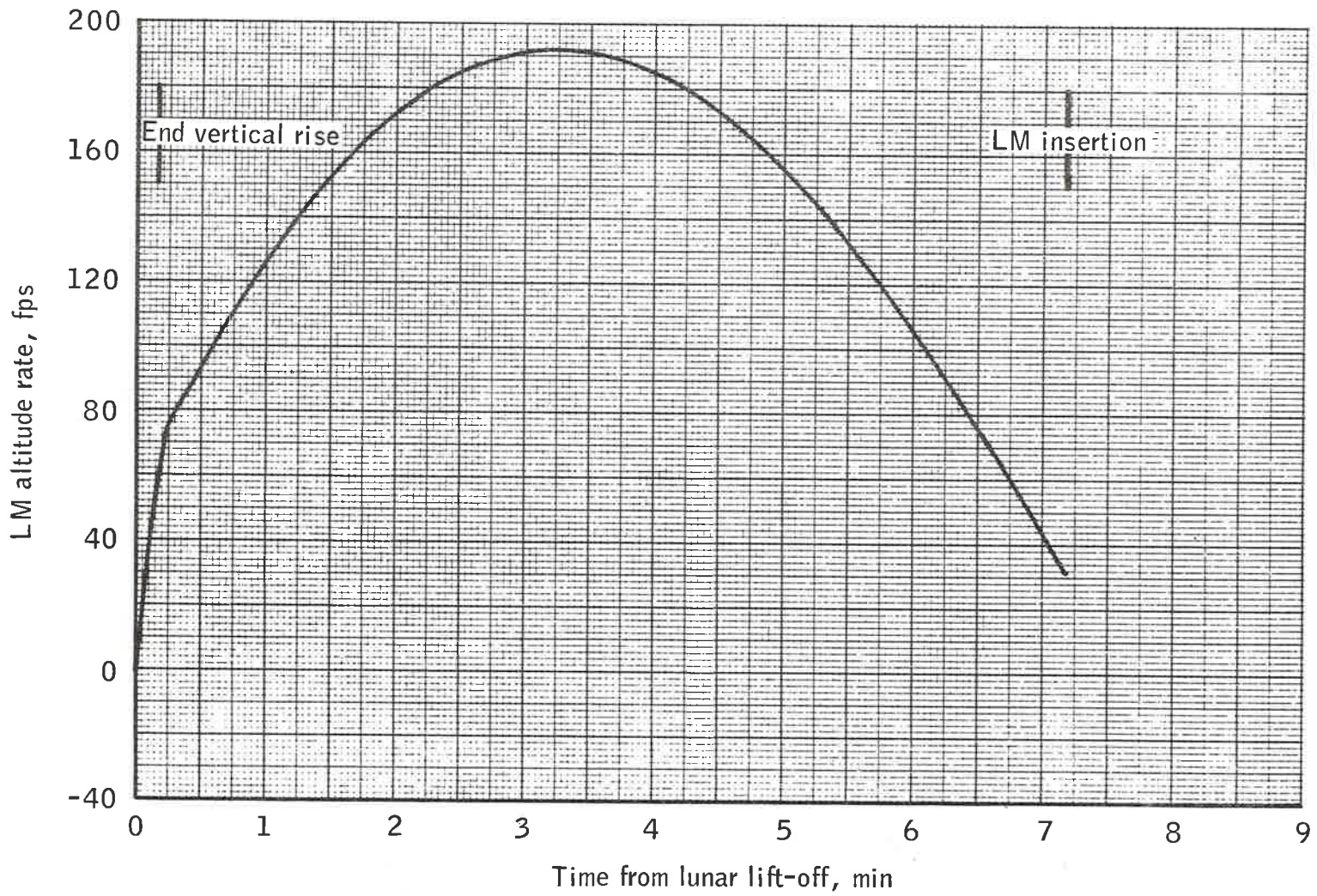

(b) LM altitude rate .

Figure 4.12-5.- Continued.

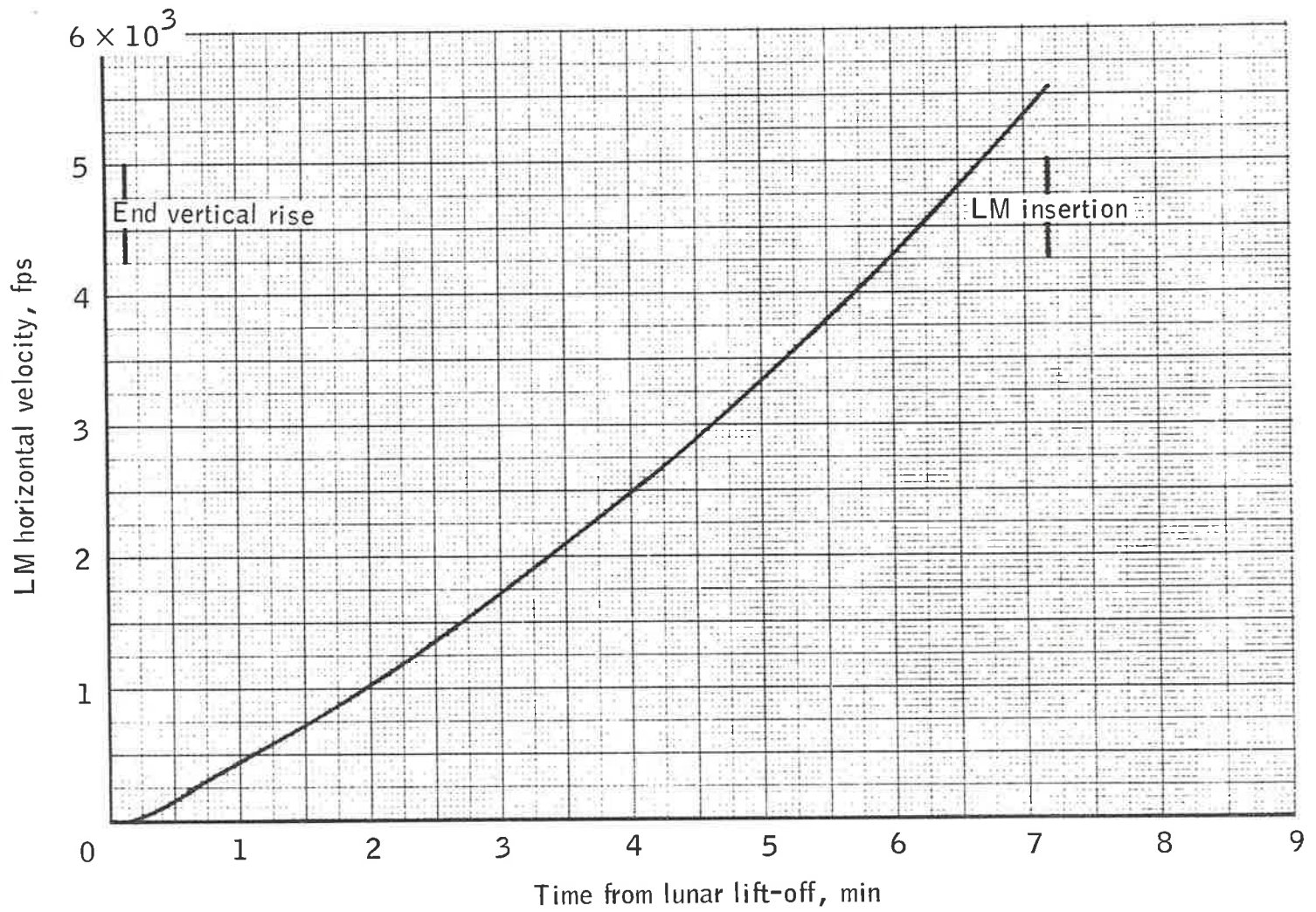

(c) LM horizontal velocity.

Figure 4.12-5.- Continued.

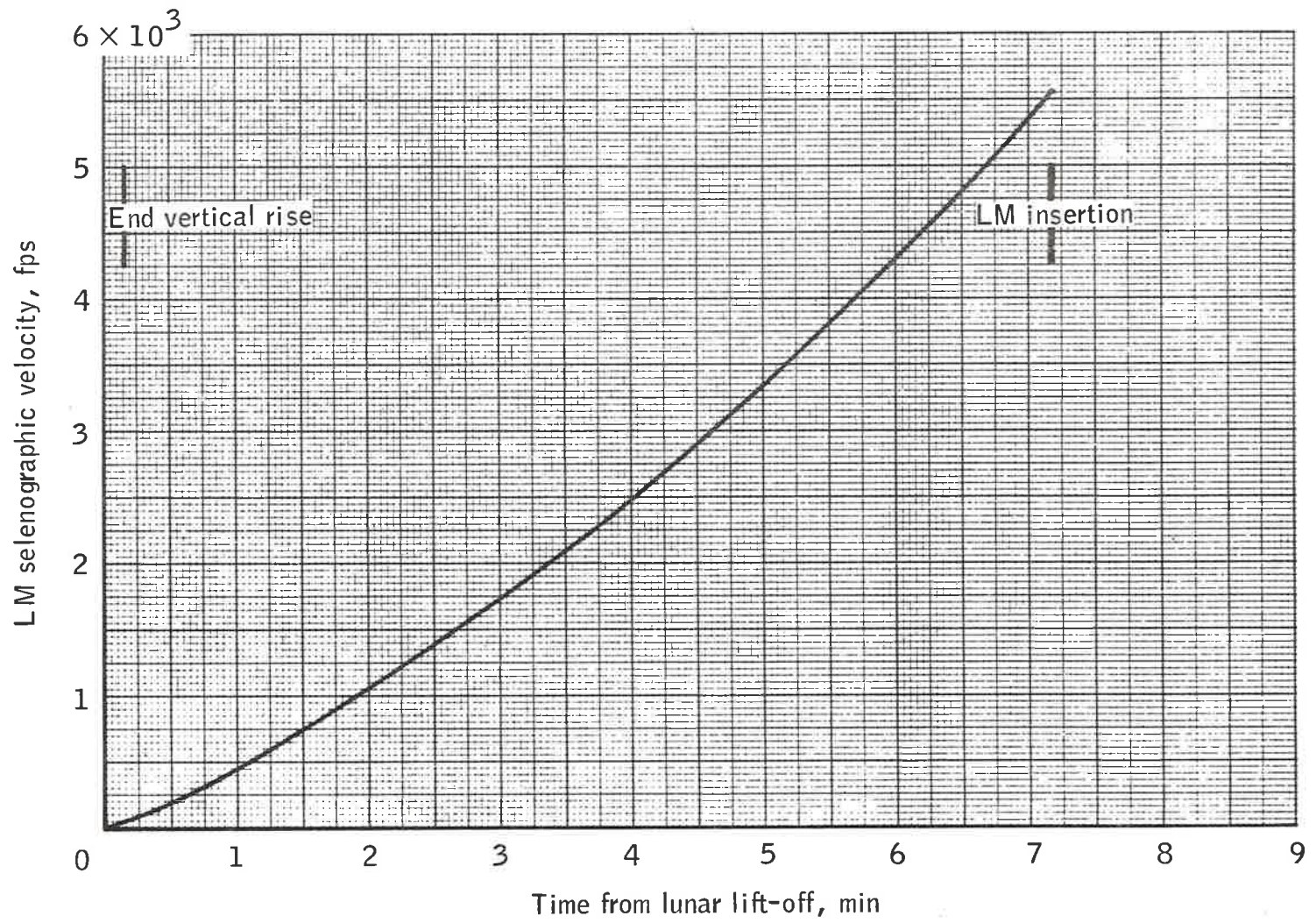

(d) LM selenographic velocity.

Figure 4.12-5.- Continued.

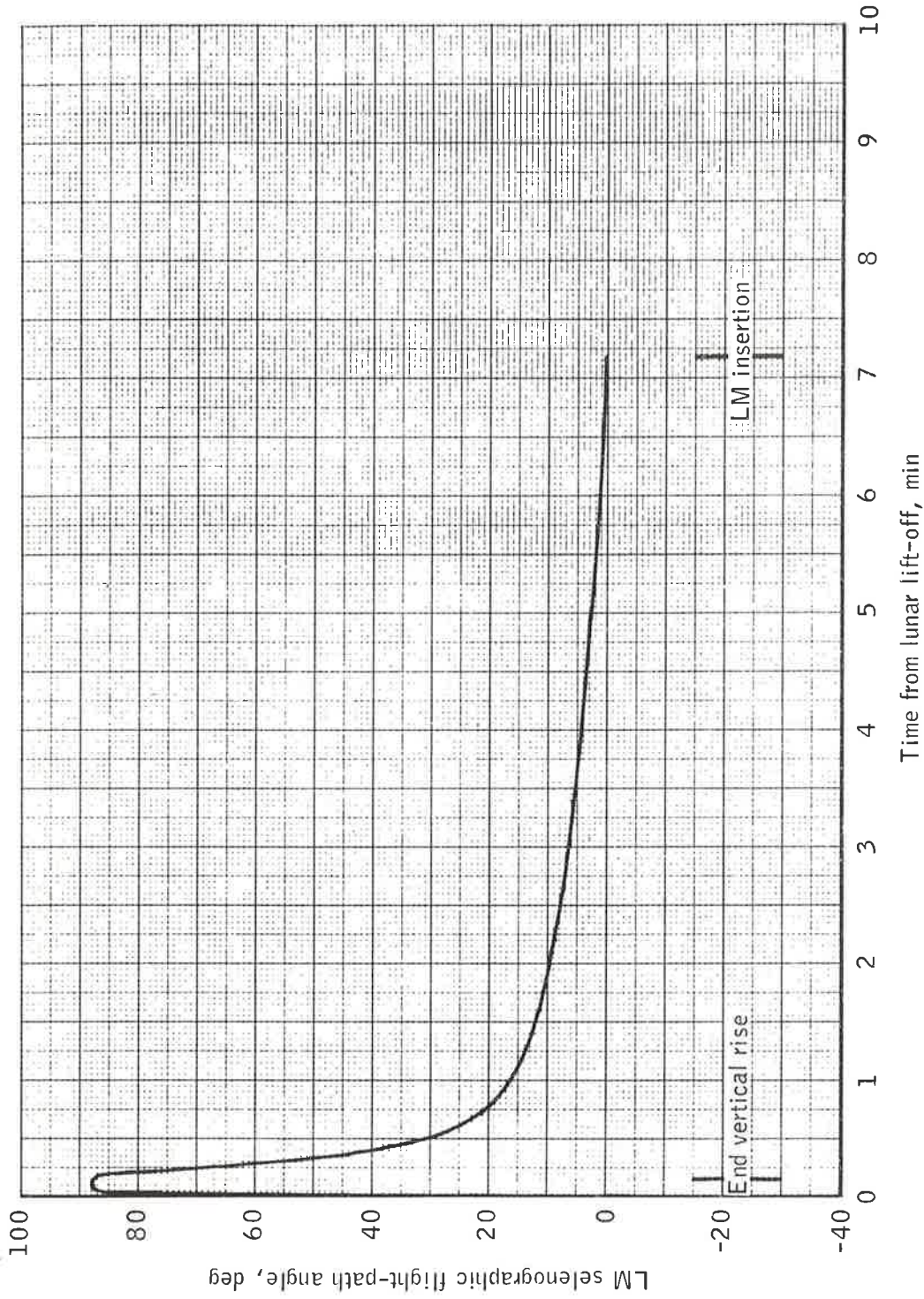

(e) LM selenographic flight-path angle.

Figure 4.12-5.- Continued.

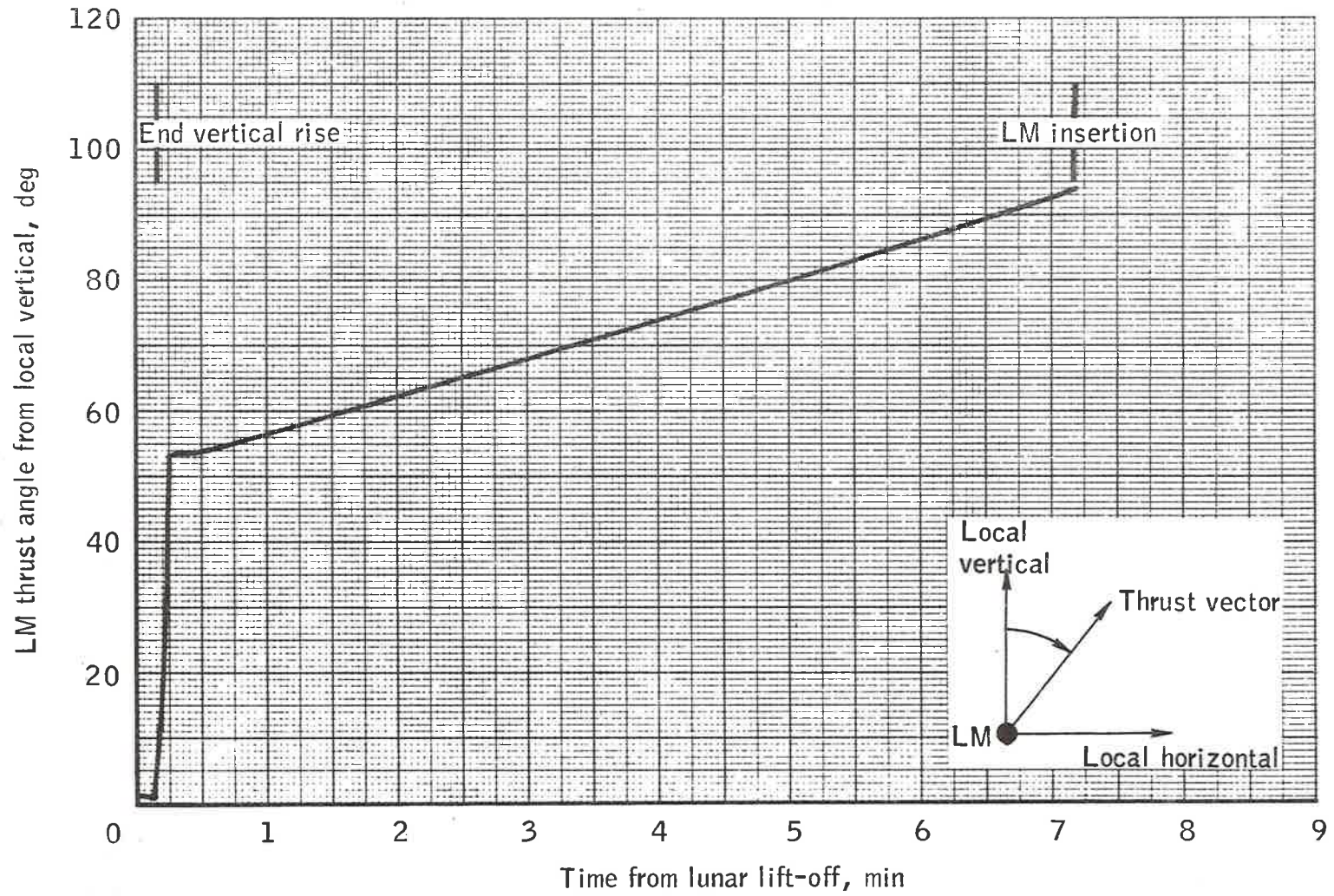

4-129

(f) LM thrust angle from local vertical.

Figure 4.12-5.- Continued.

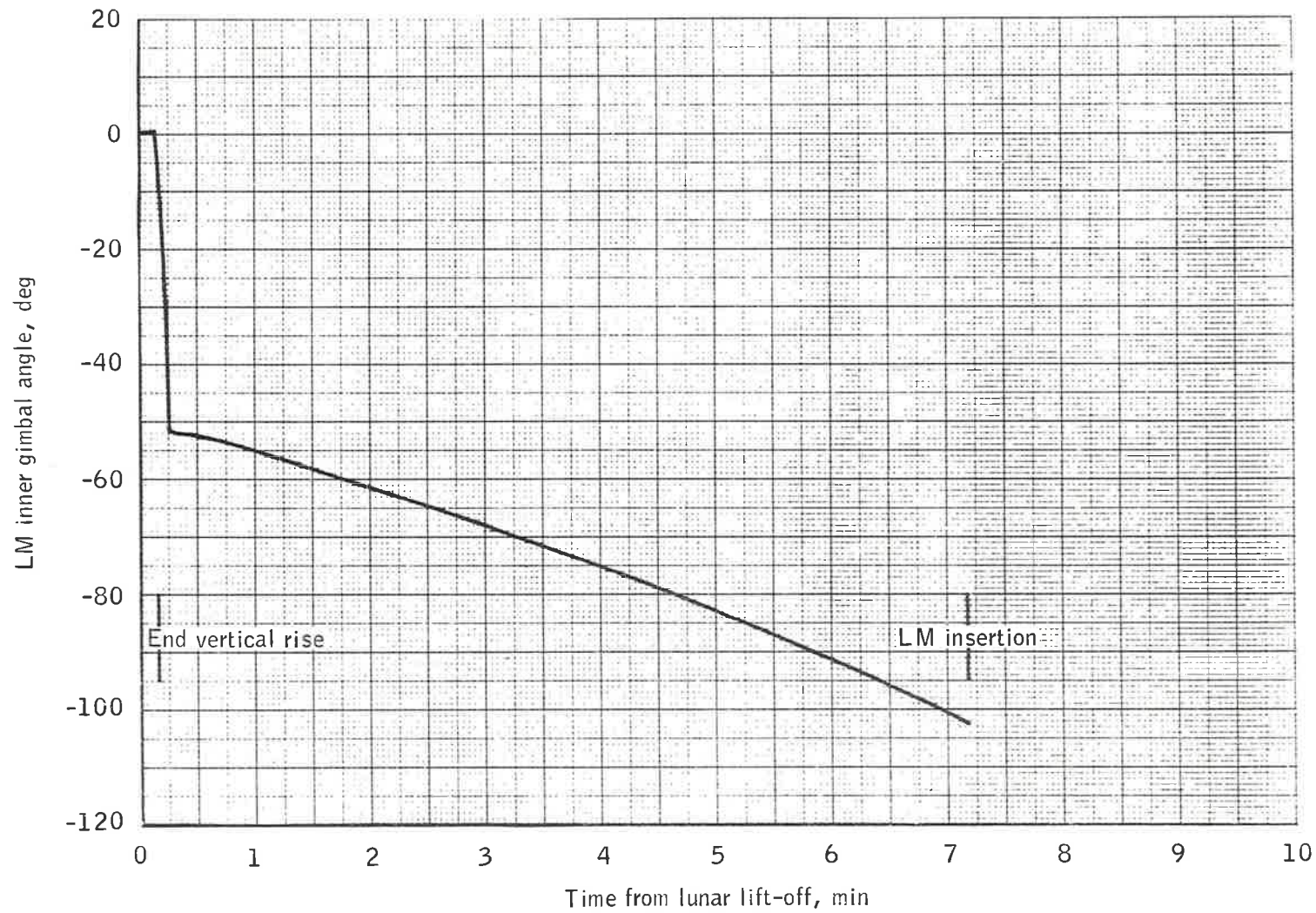

(g) LM inner gimbal angle.

Figure 4.12-5.- Continued.

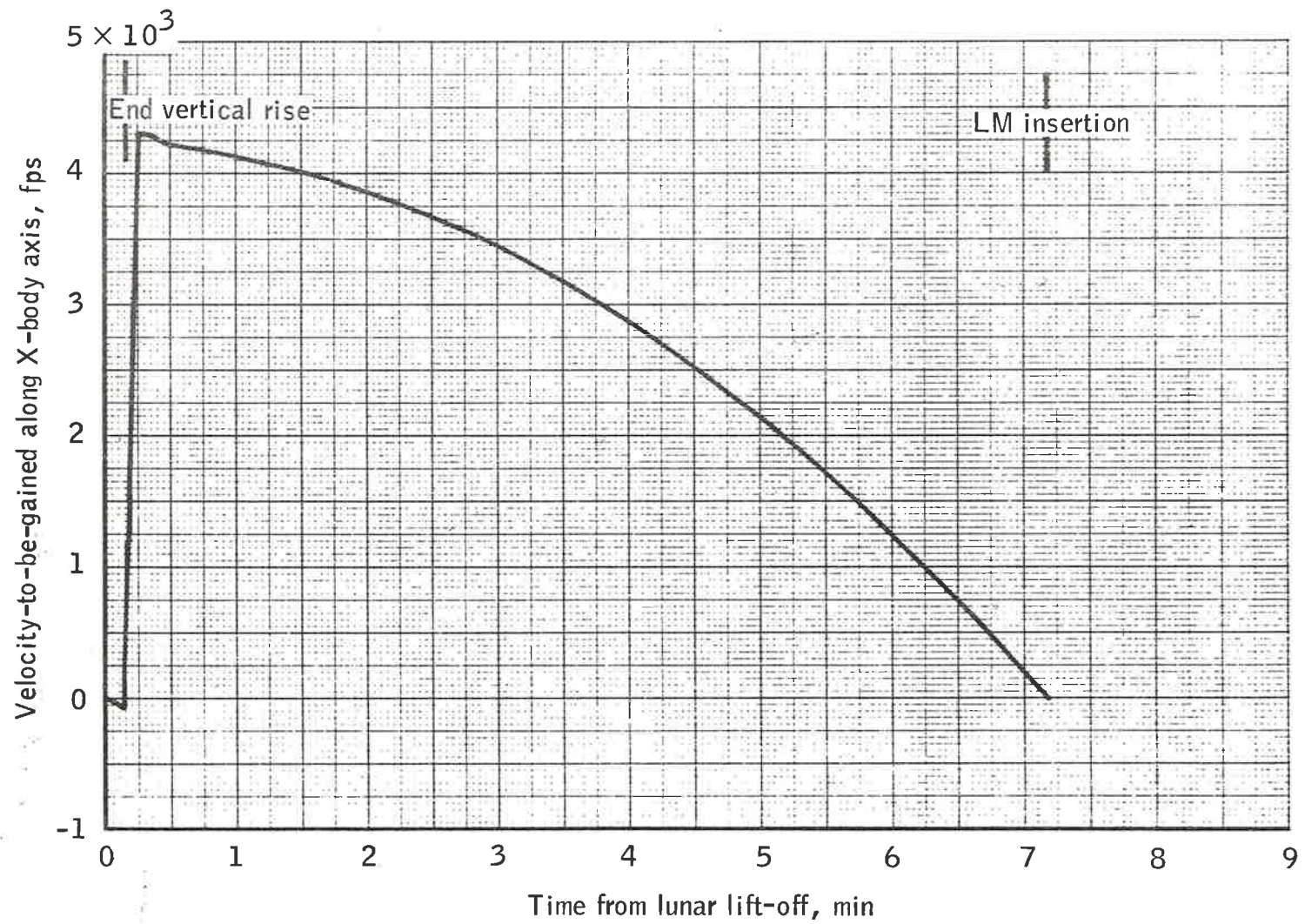

(h) Velocity-to-be-gained along X-body axis.

Figure 4.12-5. - Continued.

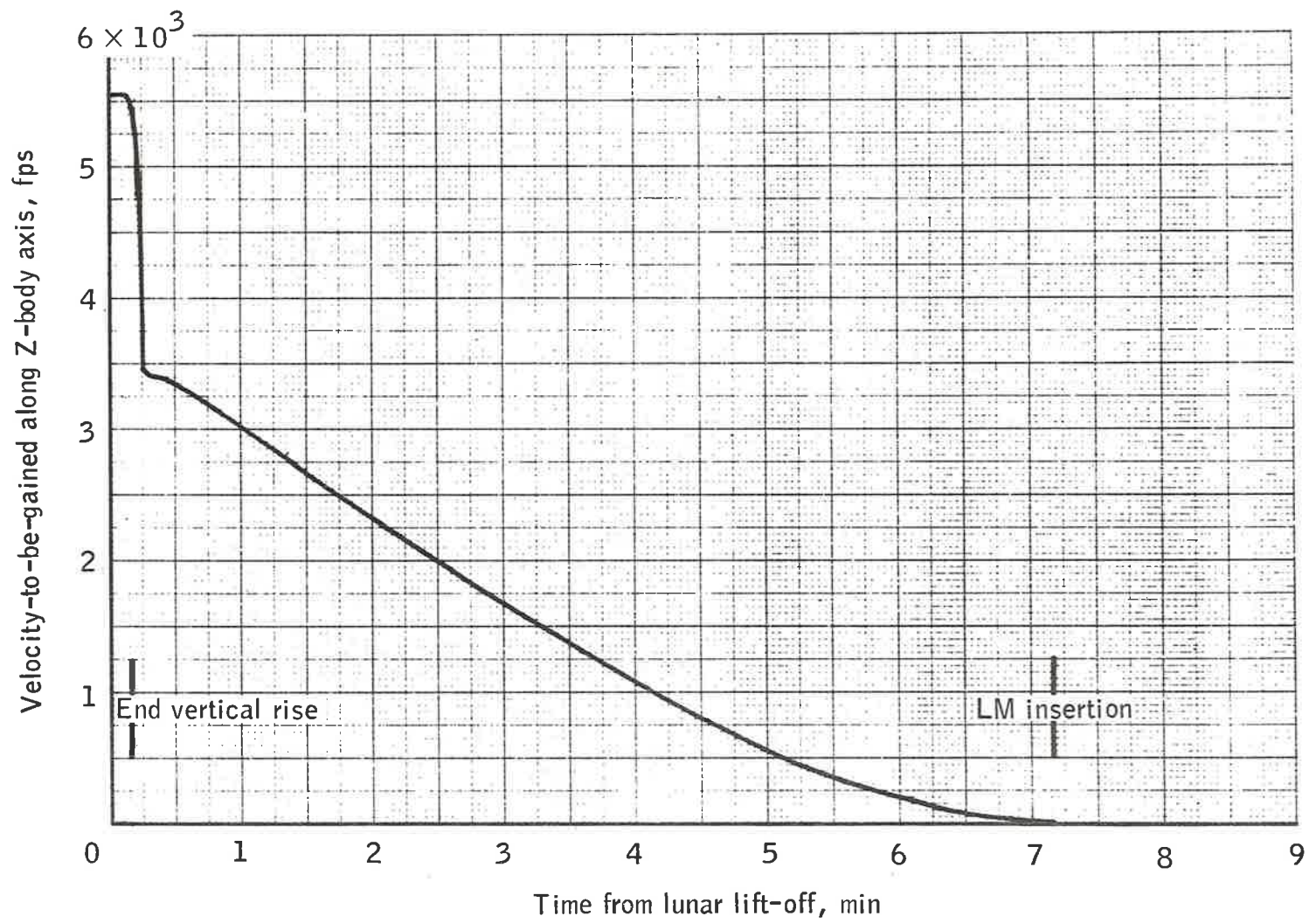

4-132

(i) Velocity-to-be-gained along Z-body axis.

Figure 4.12-5.- Continued.

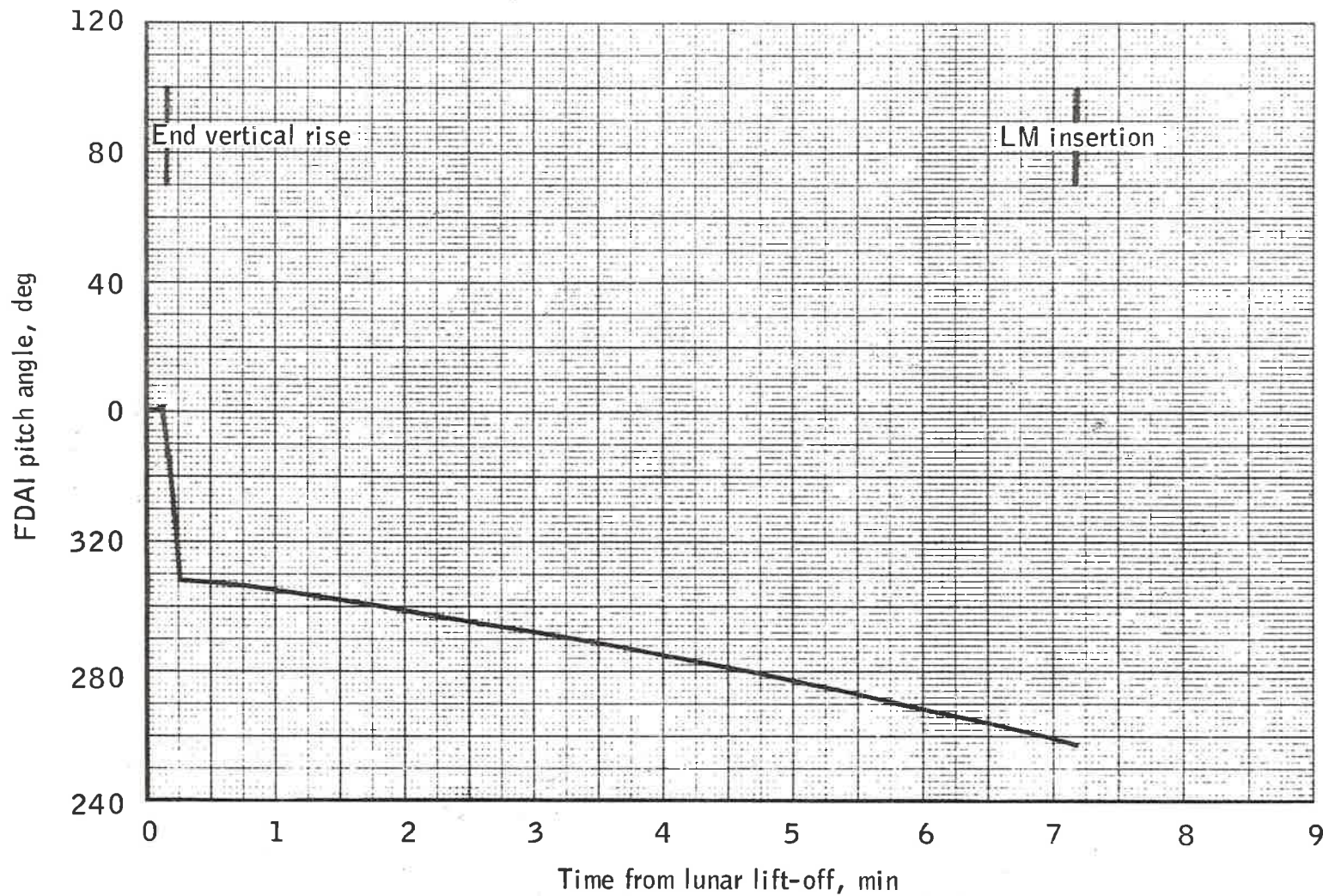

4-133

(j) FDAI pitch angle.

Figure 4.12-5.- Concluded.

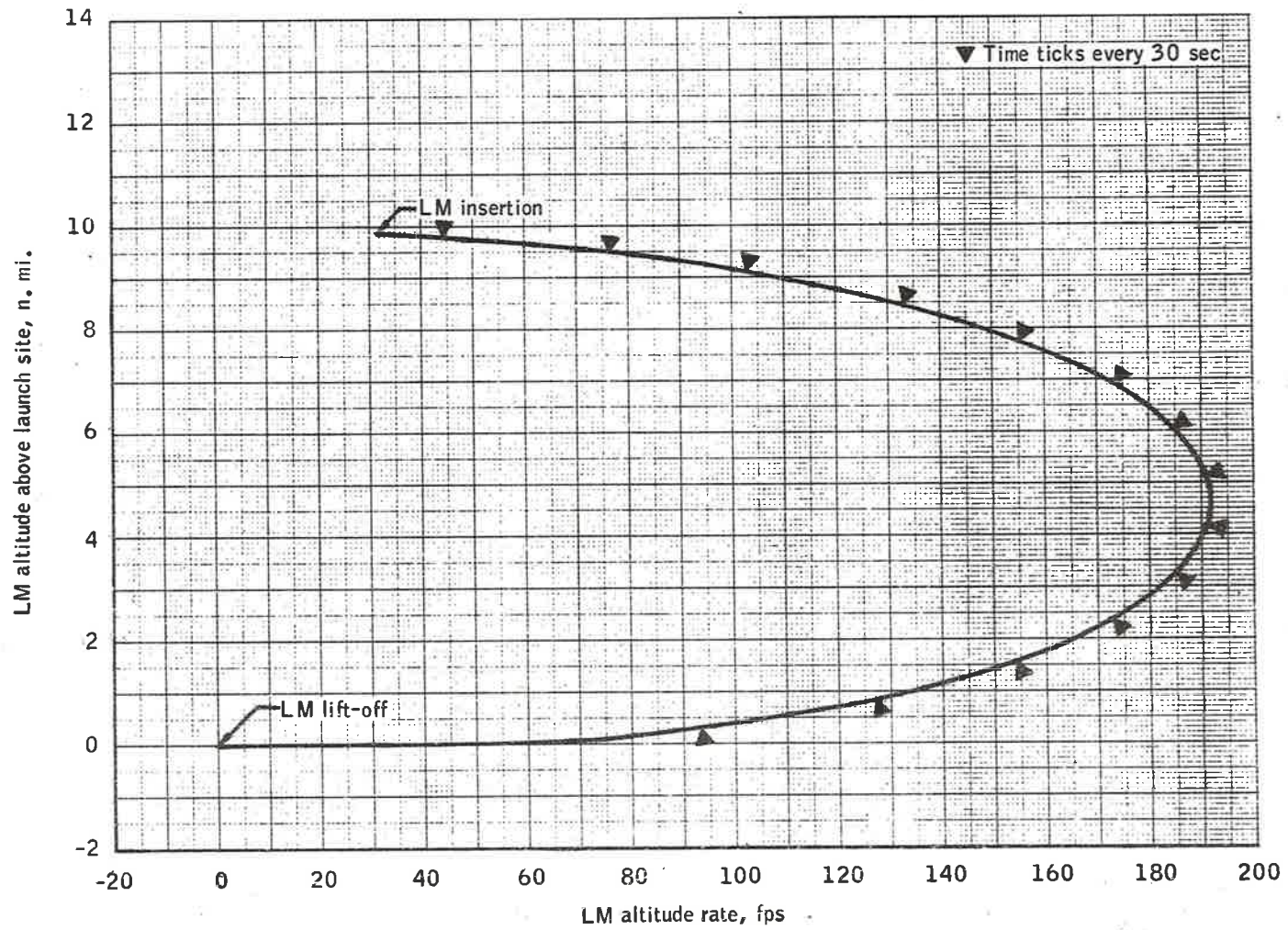
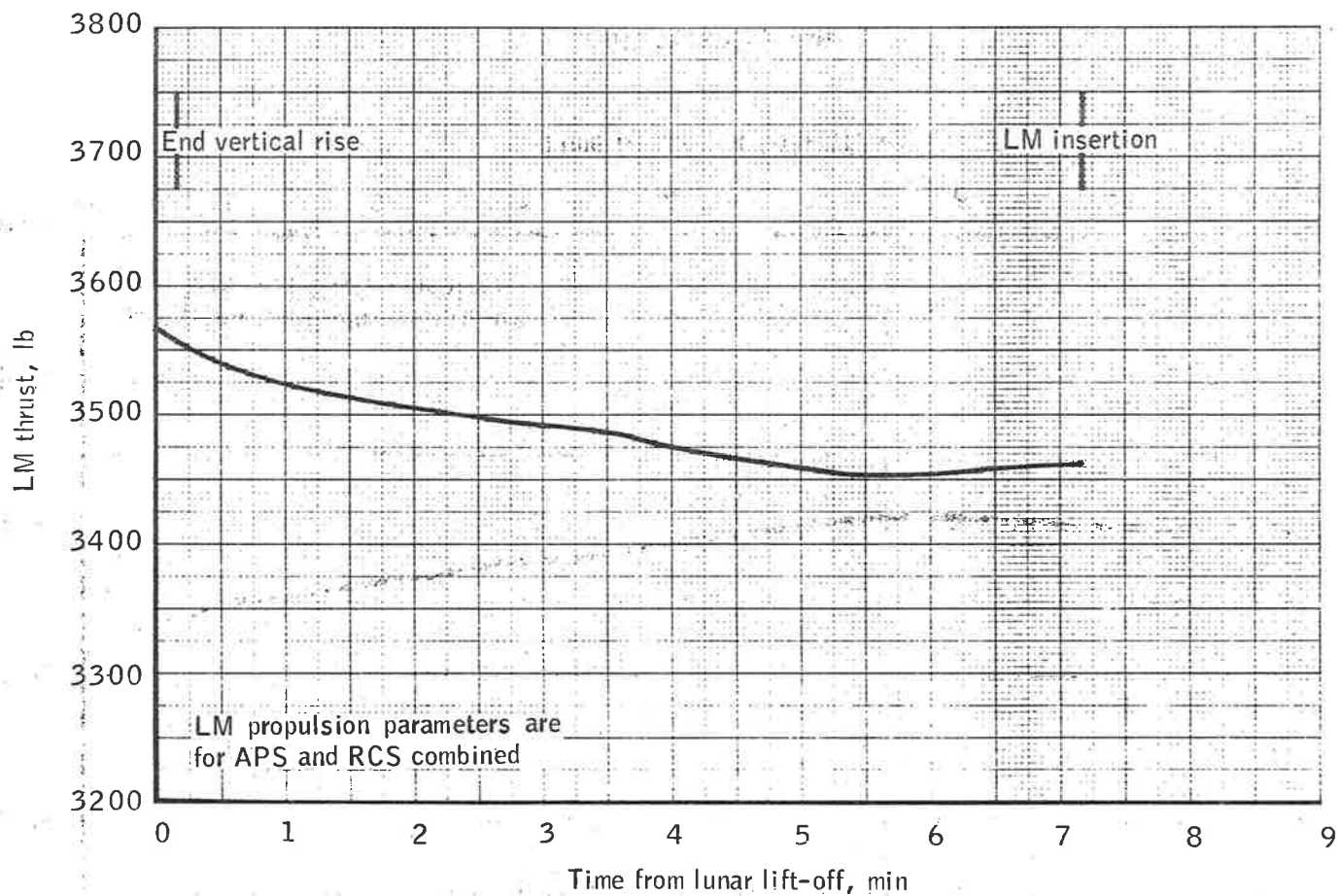

Figure 4.12-6.- LM altitude above launch site versus LM altitude rate.



4-135

(a) LM thrust.

Figure 4.12-7.- Time histories for LM propulsion performance parameters during powered ascent.

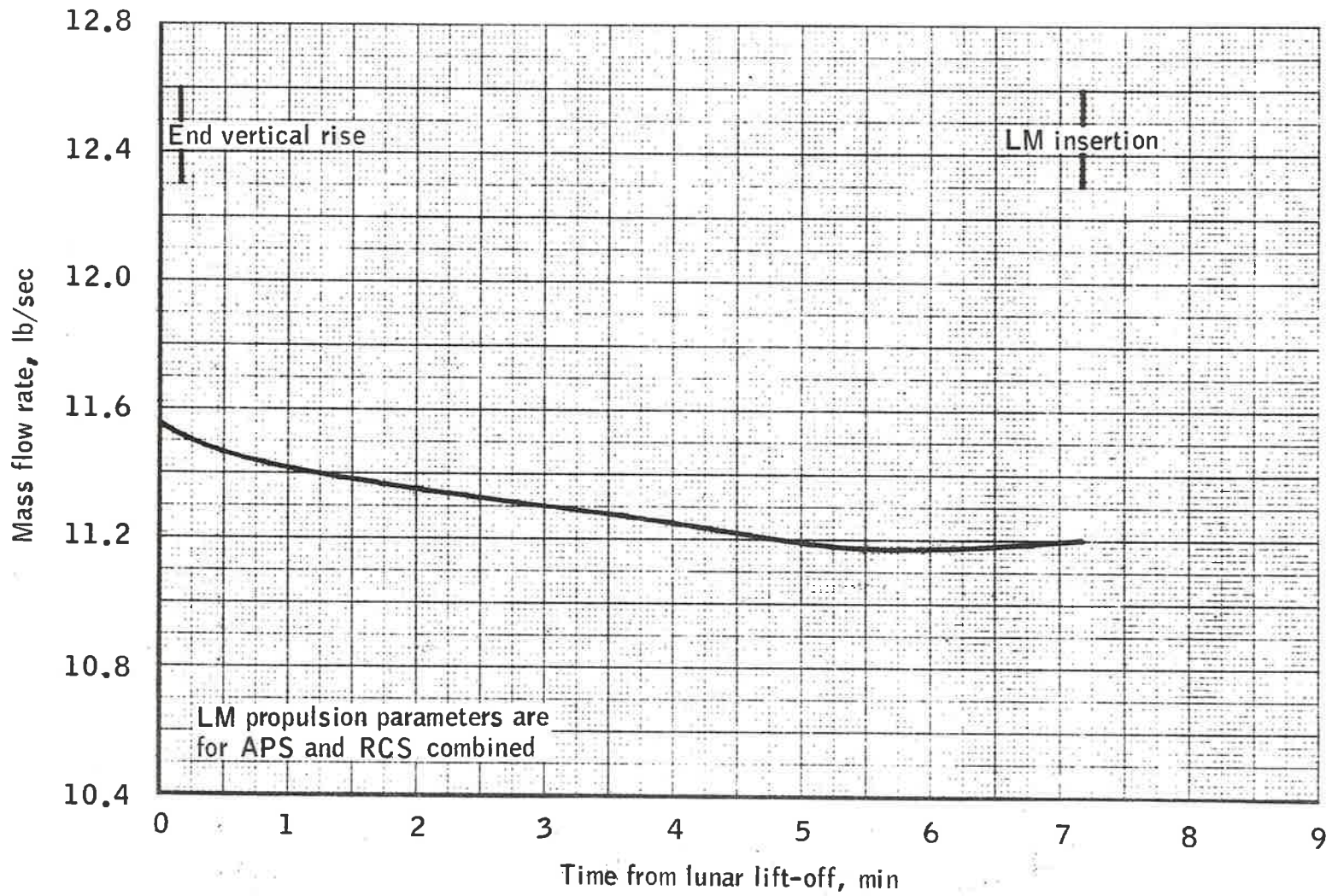

4-136

(b) Mass flow rate.

Figure 4.12-7.- Continued.

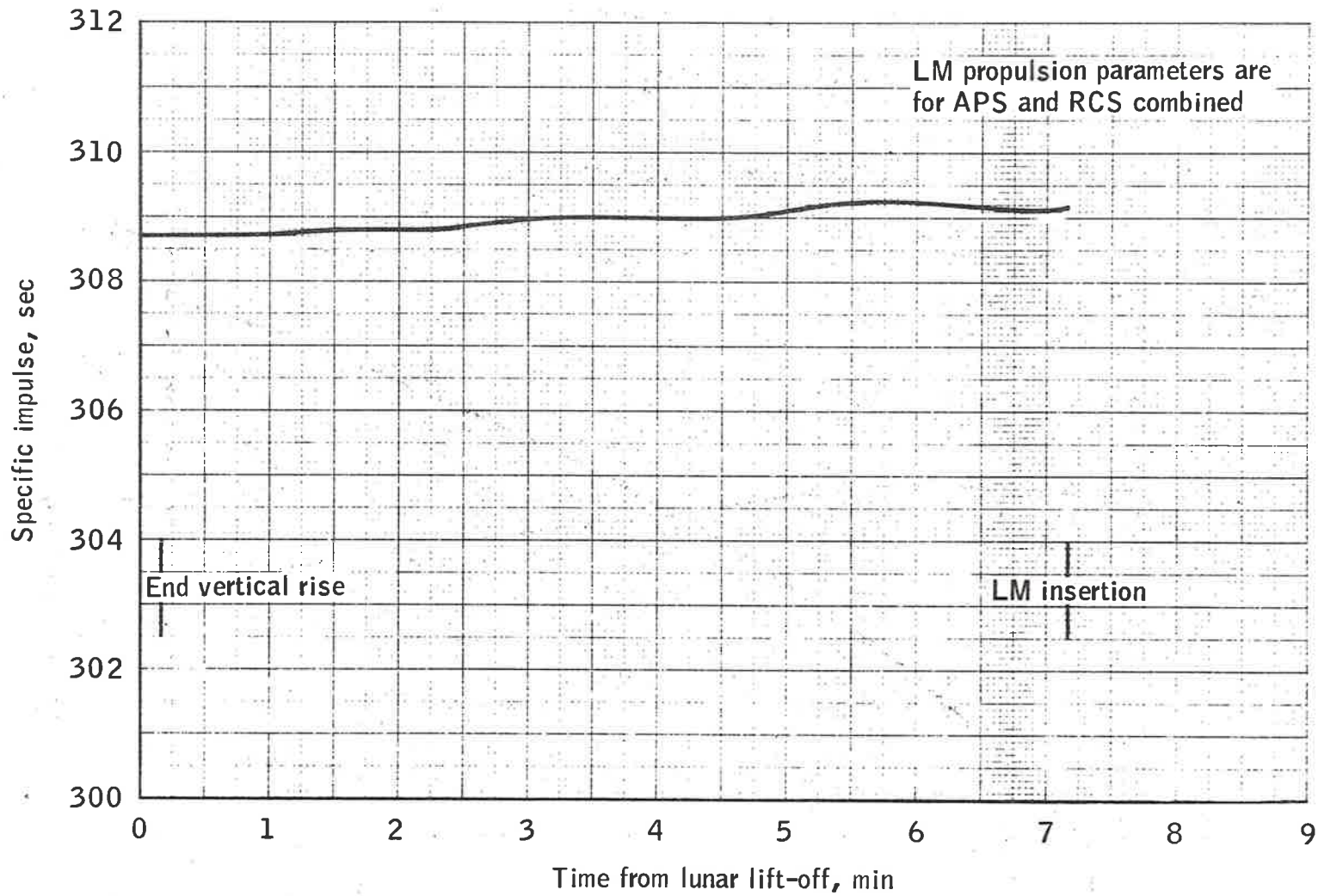

4-137

(c) Specific impulse.

Figure 4.12-7.- Continued.

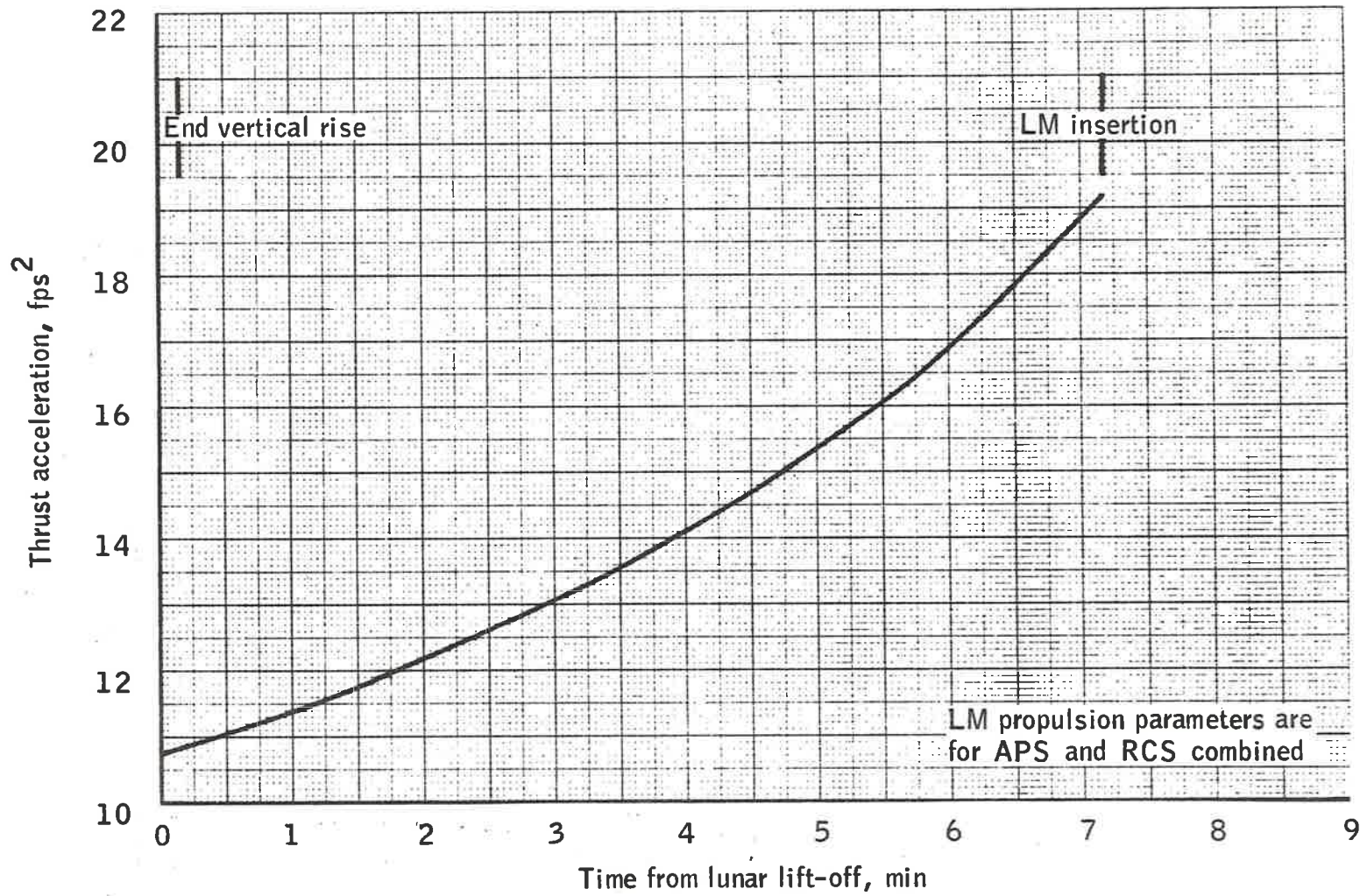

(d) Thrust acceleration.

Figure 4.12-7.- Concluded.

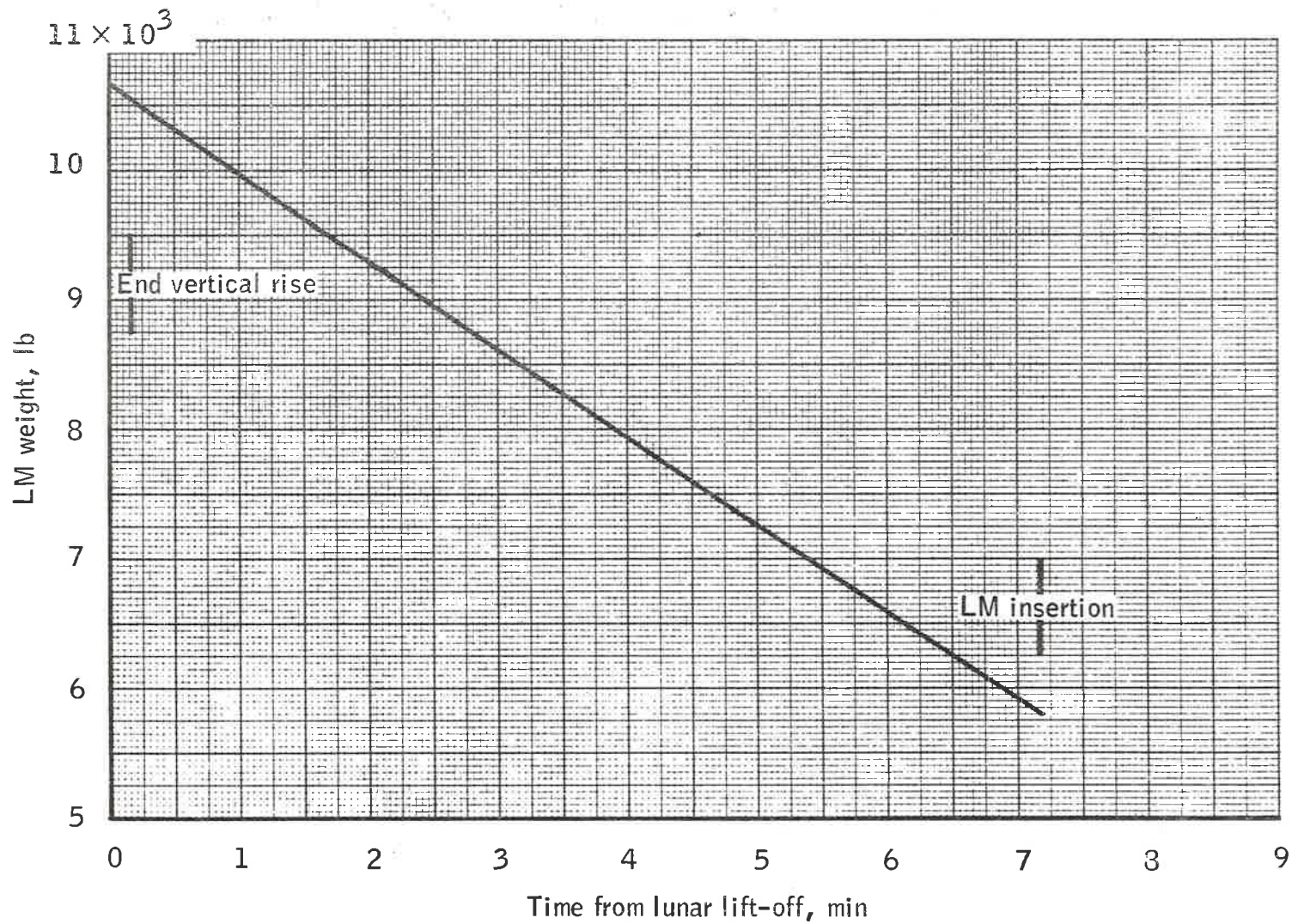
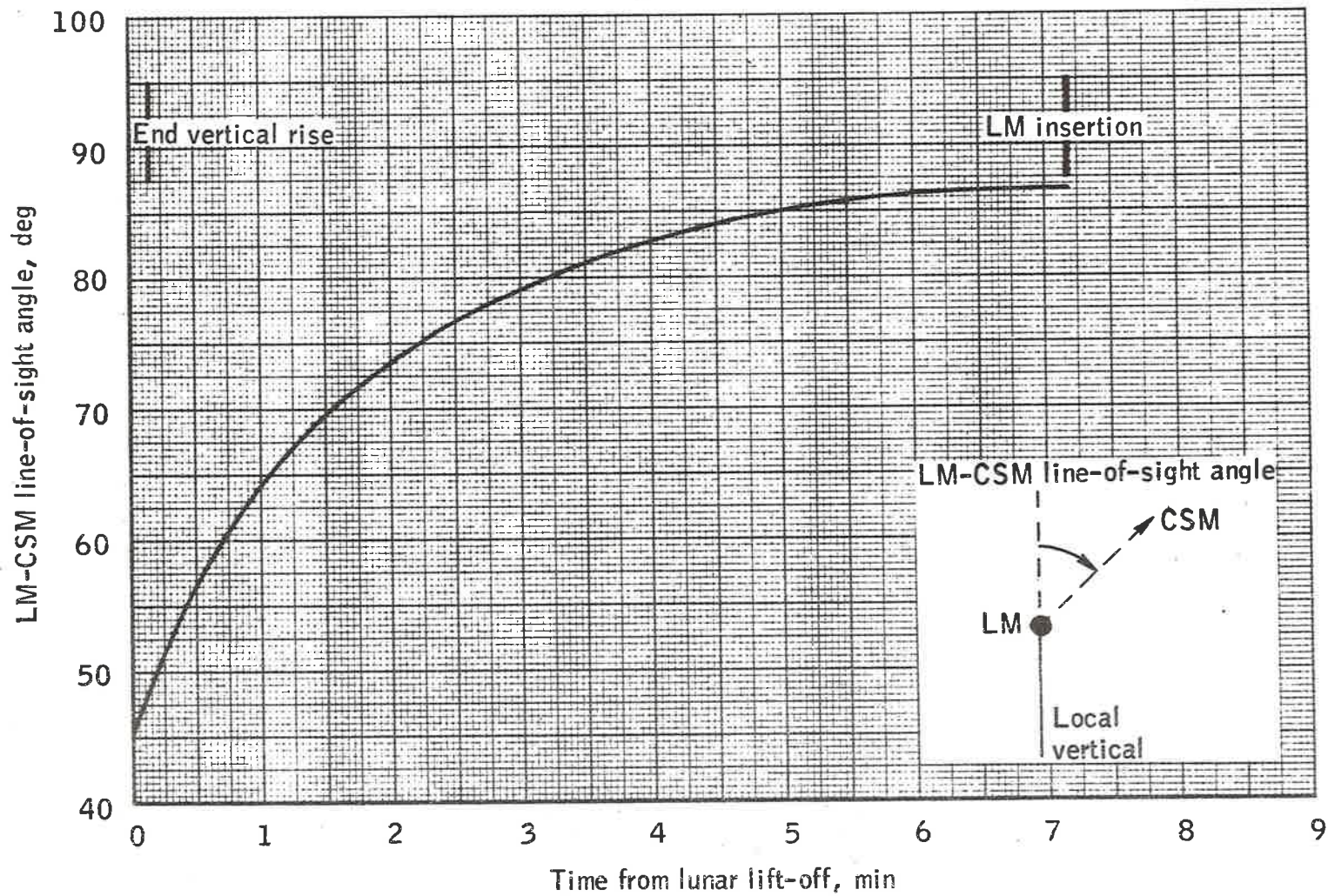

Figure 4.12-8.- LM weight versus time from lift-off.



4-11-7

(a) LM-CSM line-of-sight angle.

Figure 4.12-9.- Time histories of LM-CSM relative parameters during powered ascent.

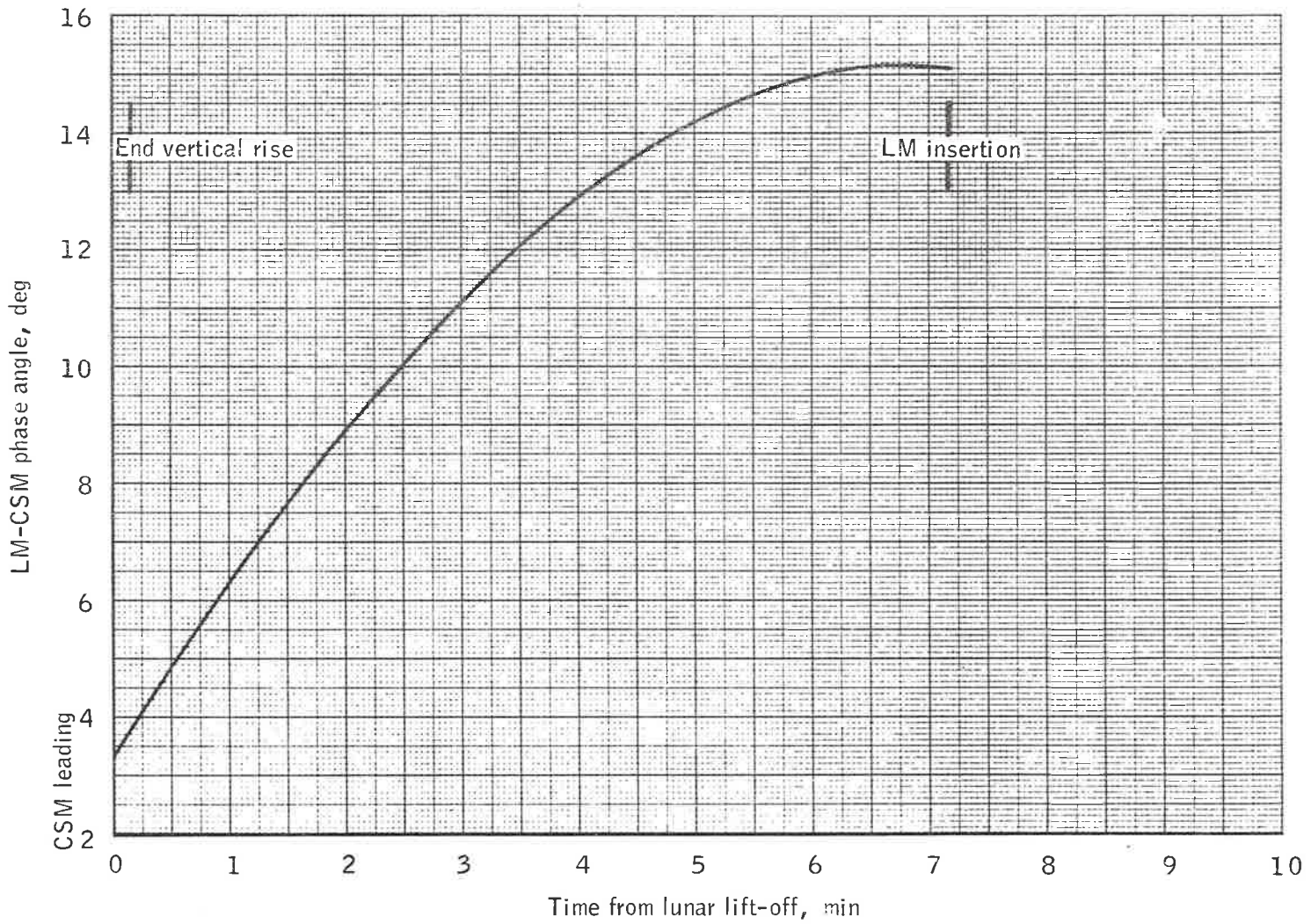

(b) LM-CSM phase angle.

Figure 4.12-9.- Continued.

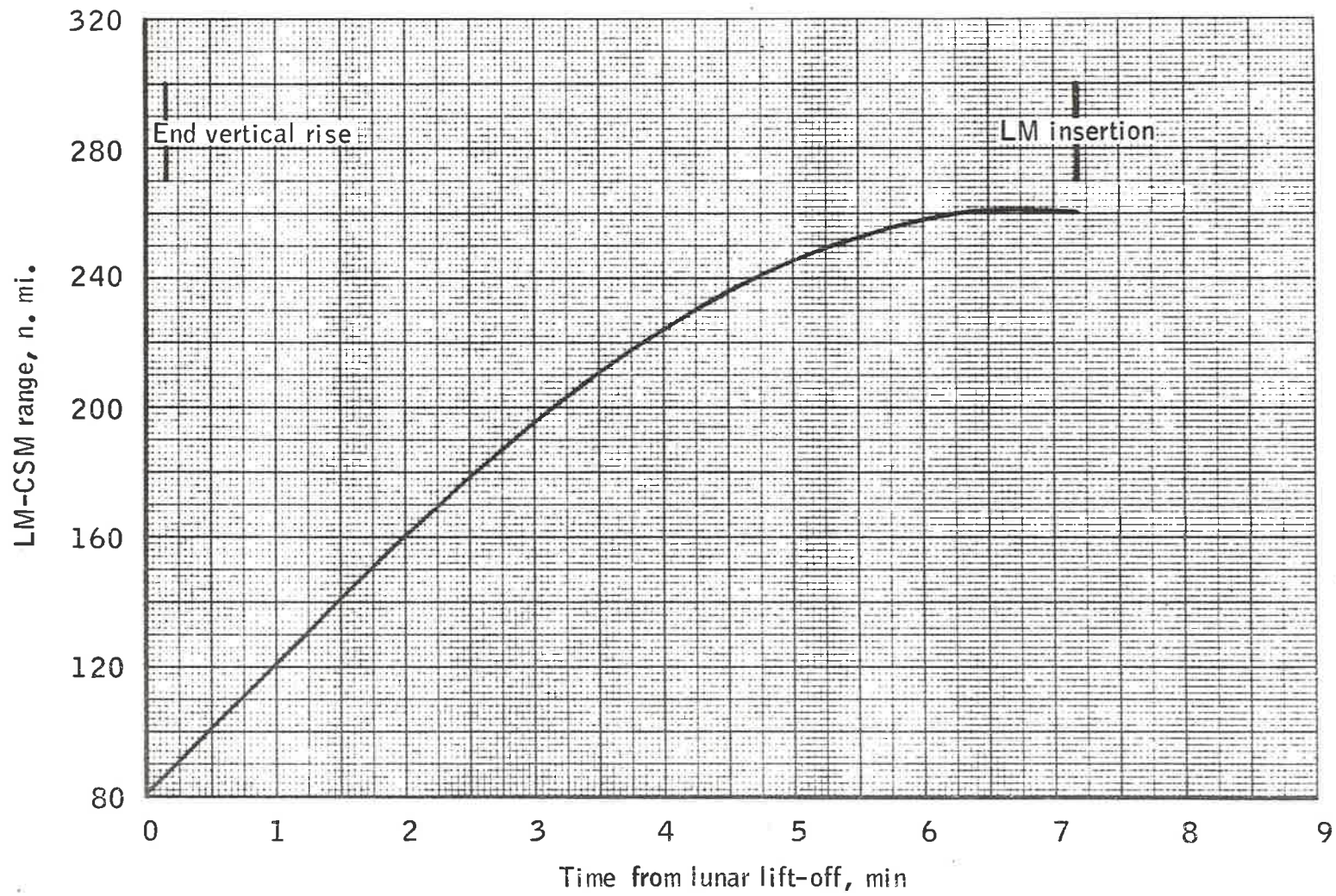

4-142

(c) LM-CSM range.

Figure 4.12-9.- Continued.

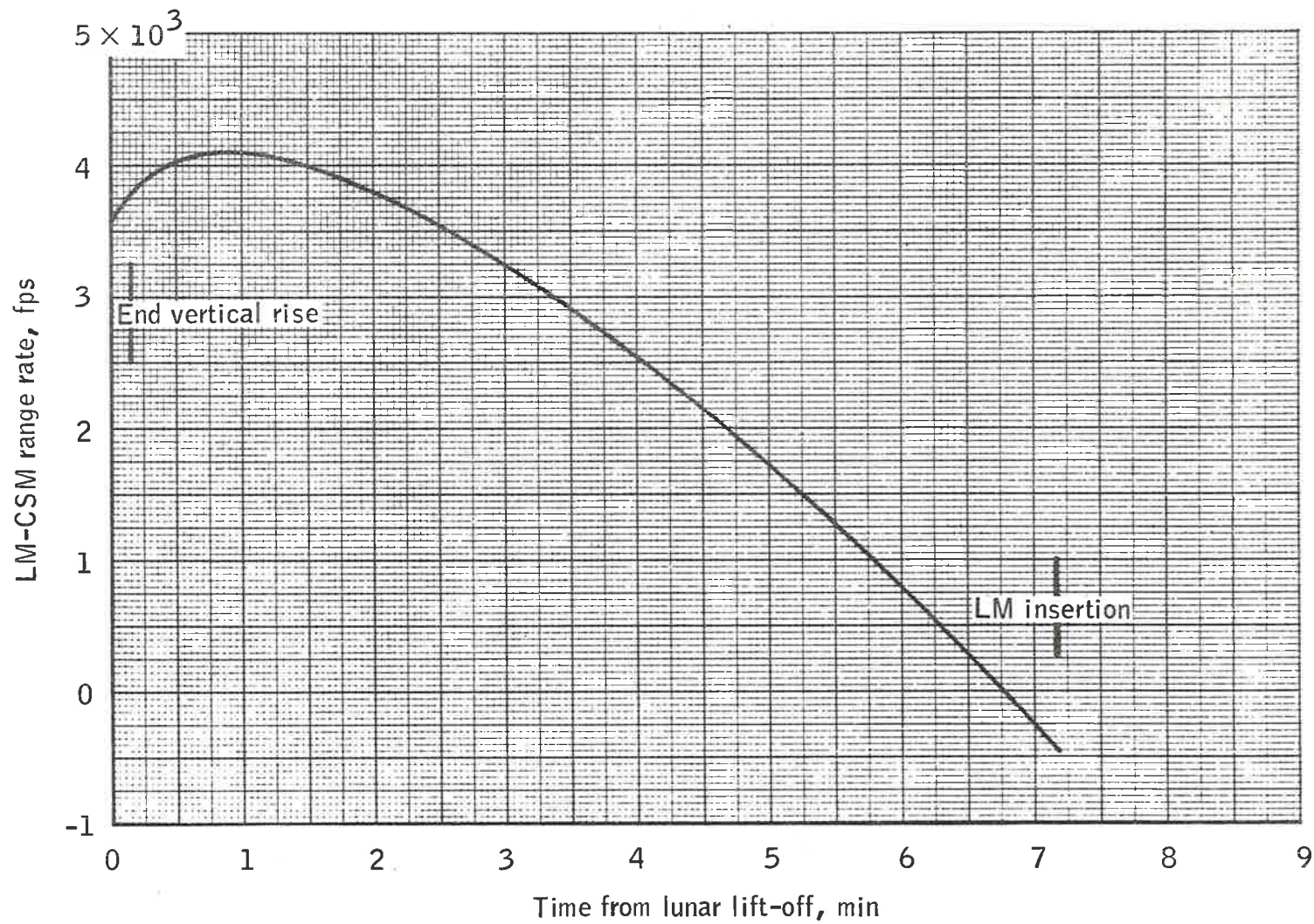

4-143

(d) LM-CSM range rate.

Figure 4.12-9.- Continued.

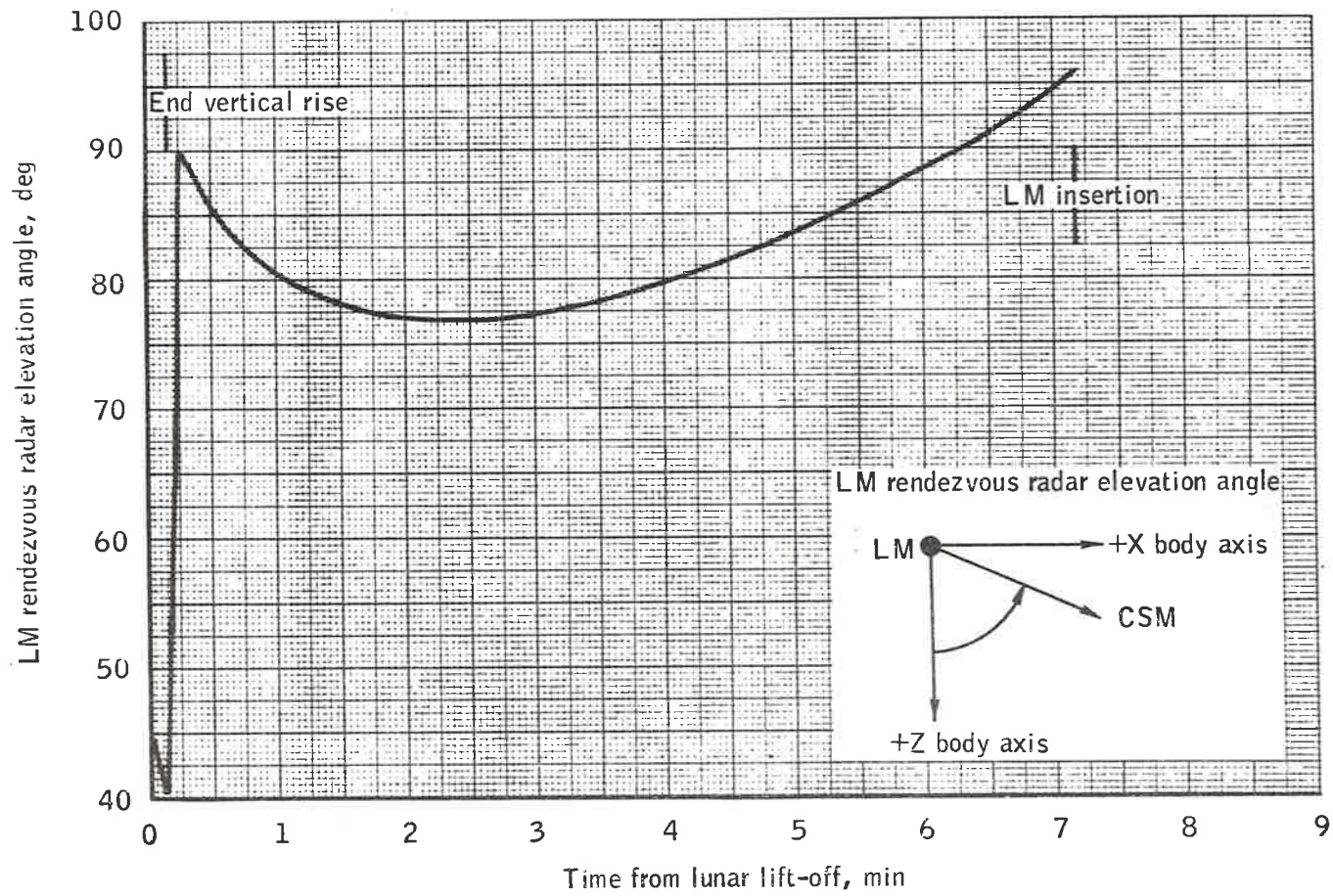

(e) LM rendezvous radar elevation angle.

Figure 4.12-9.- Concluded.

4444

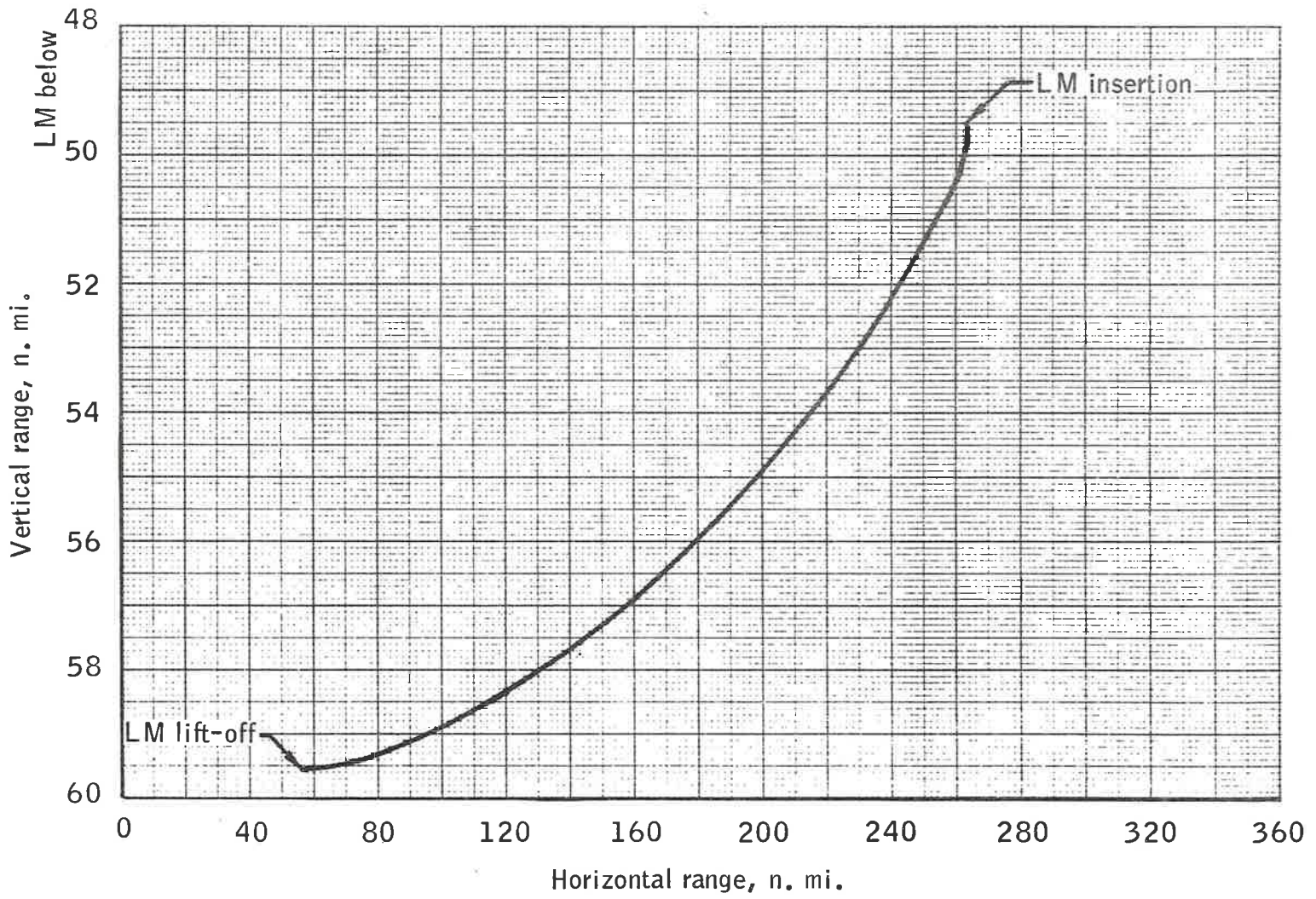

4-11-7

Figure 4.12-10.- LM-CSM relative range (CSM referenced).

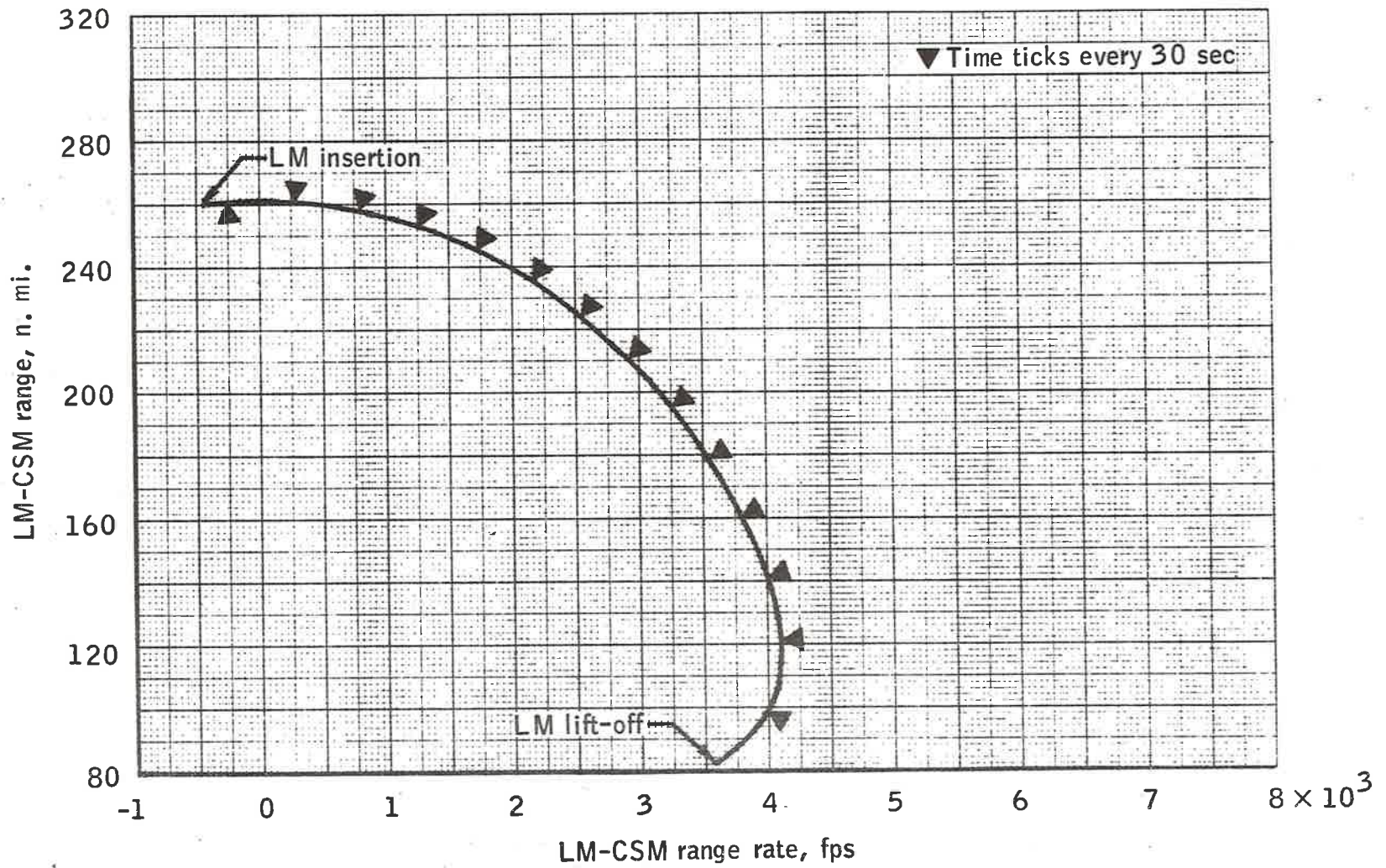
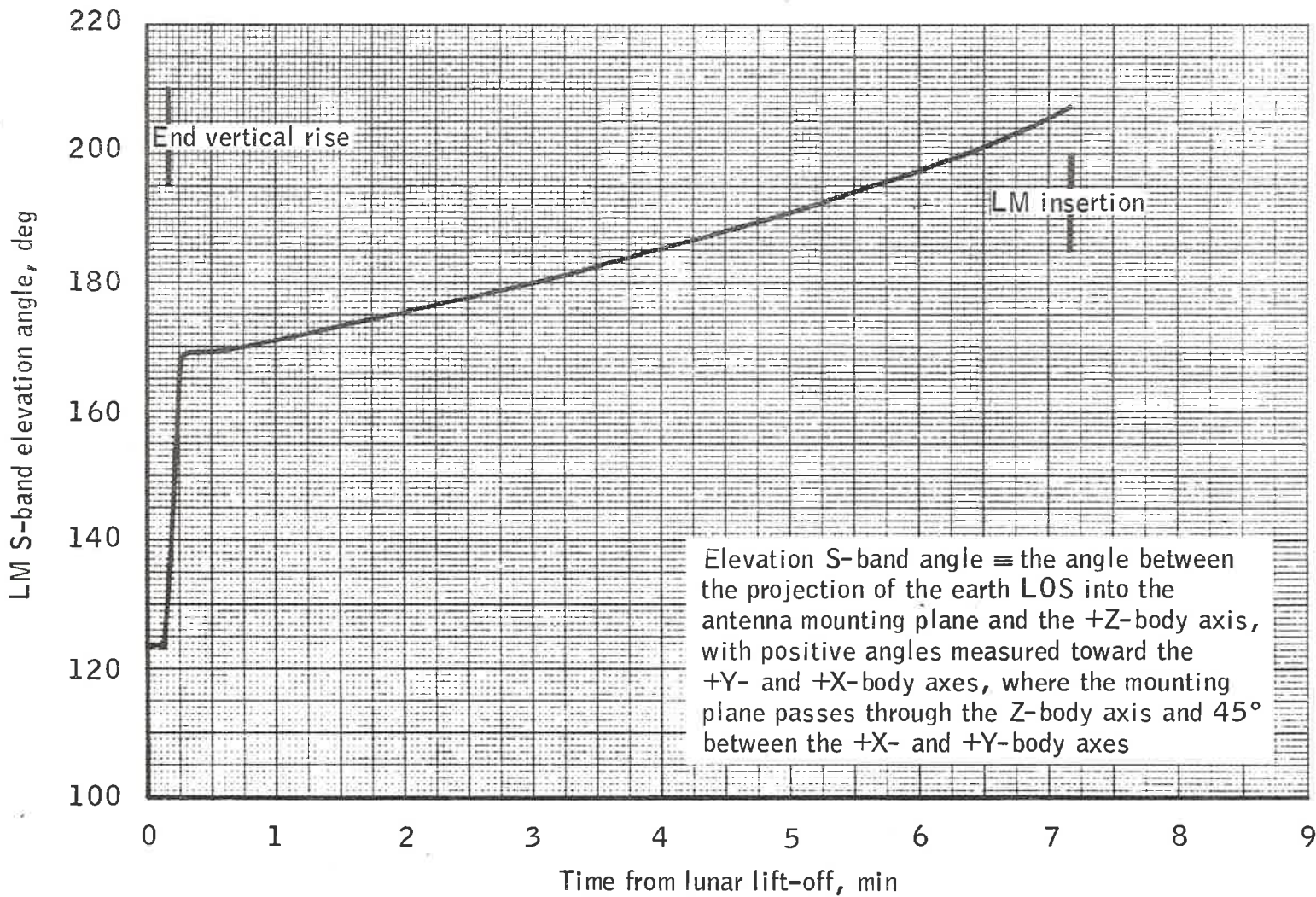

Figure 4.12-11.- LM-CSM range versus LM-CSM range rate during powered ascent.



4-147

(a) LM S-band elevation angle.

Figure 4.12-12.- Time histories of LM-CSM earth or sun relative parameters during powered ascent.

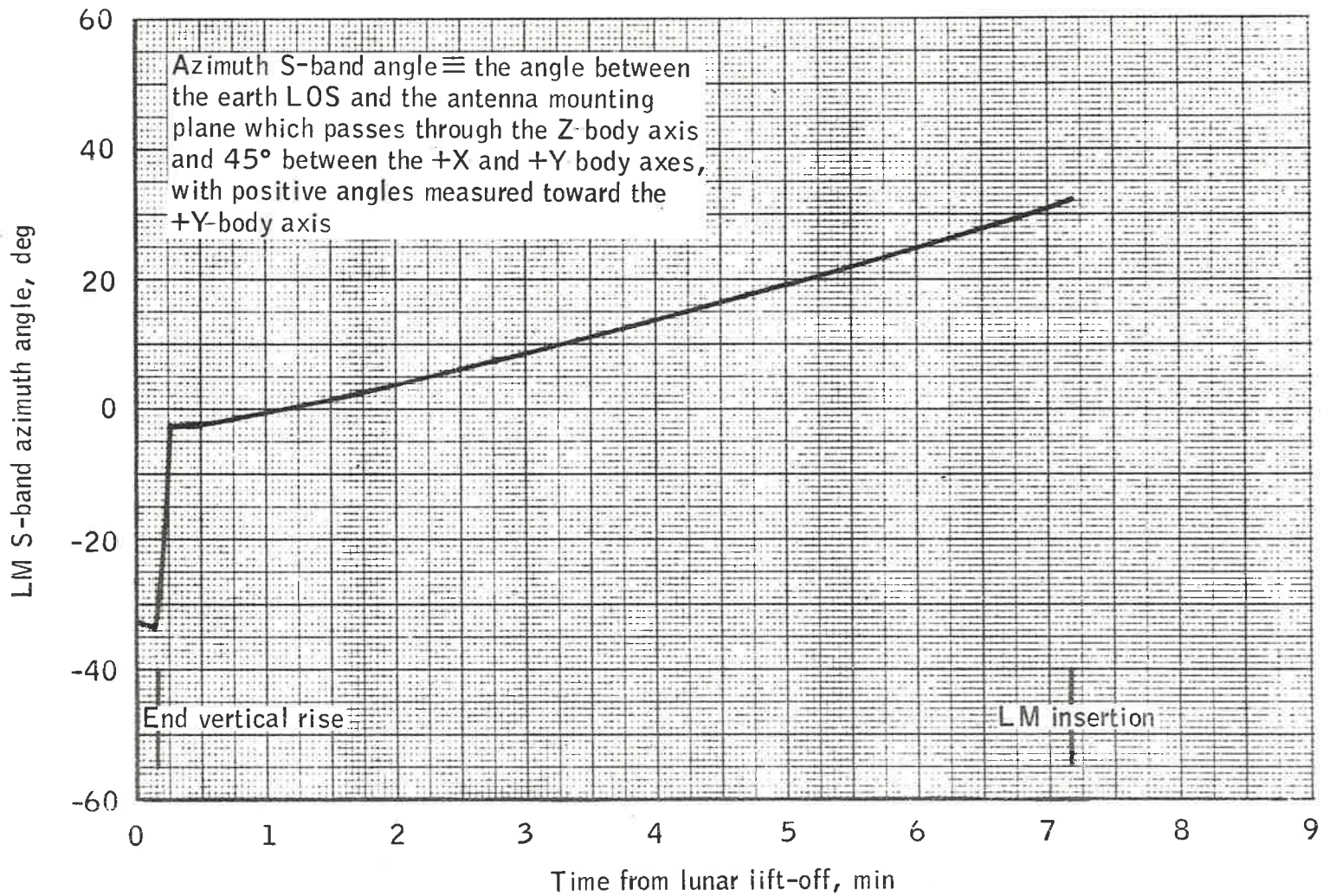

841-4

(b) LM S-band azimuth angle.

Figure 4.12-12.- Continued.

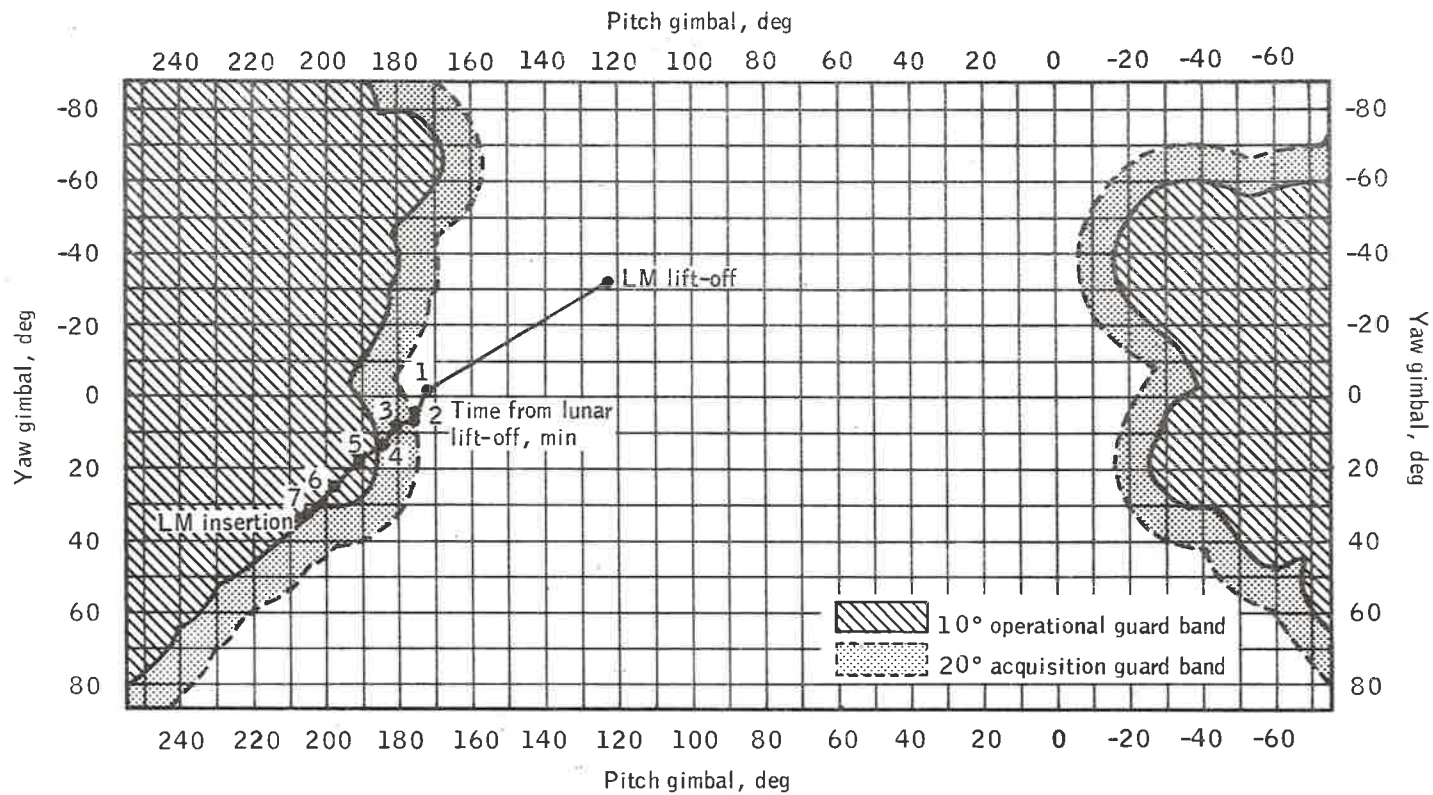

(c) S-band gimbal angle profile.

Figure 4.12-12.- Continued.

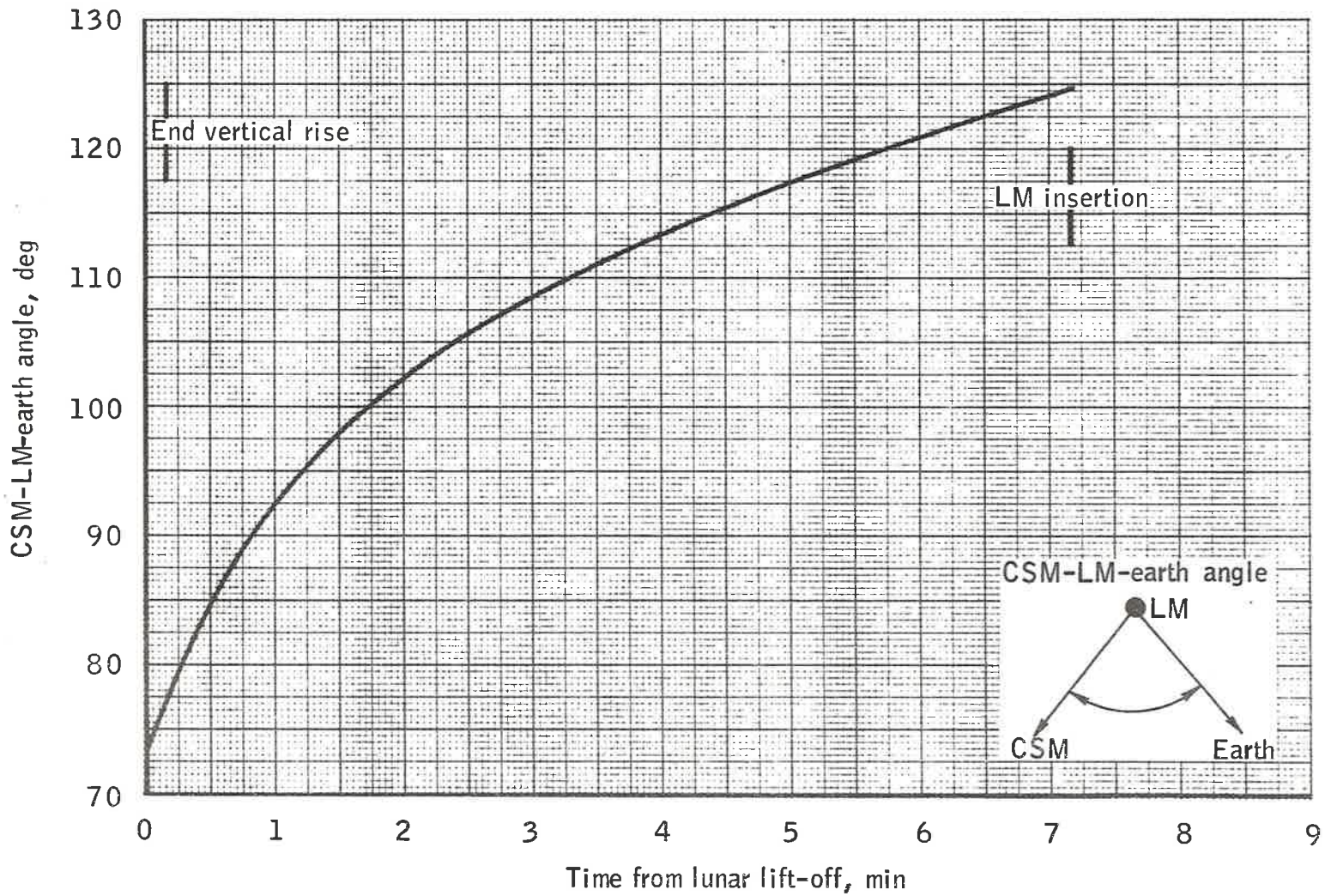

4-150

(d) CSM-LM-earth angle.

Figure 4.12-12.- Continued.

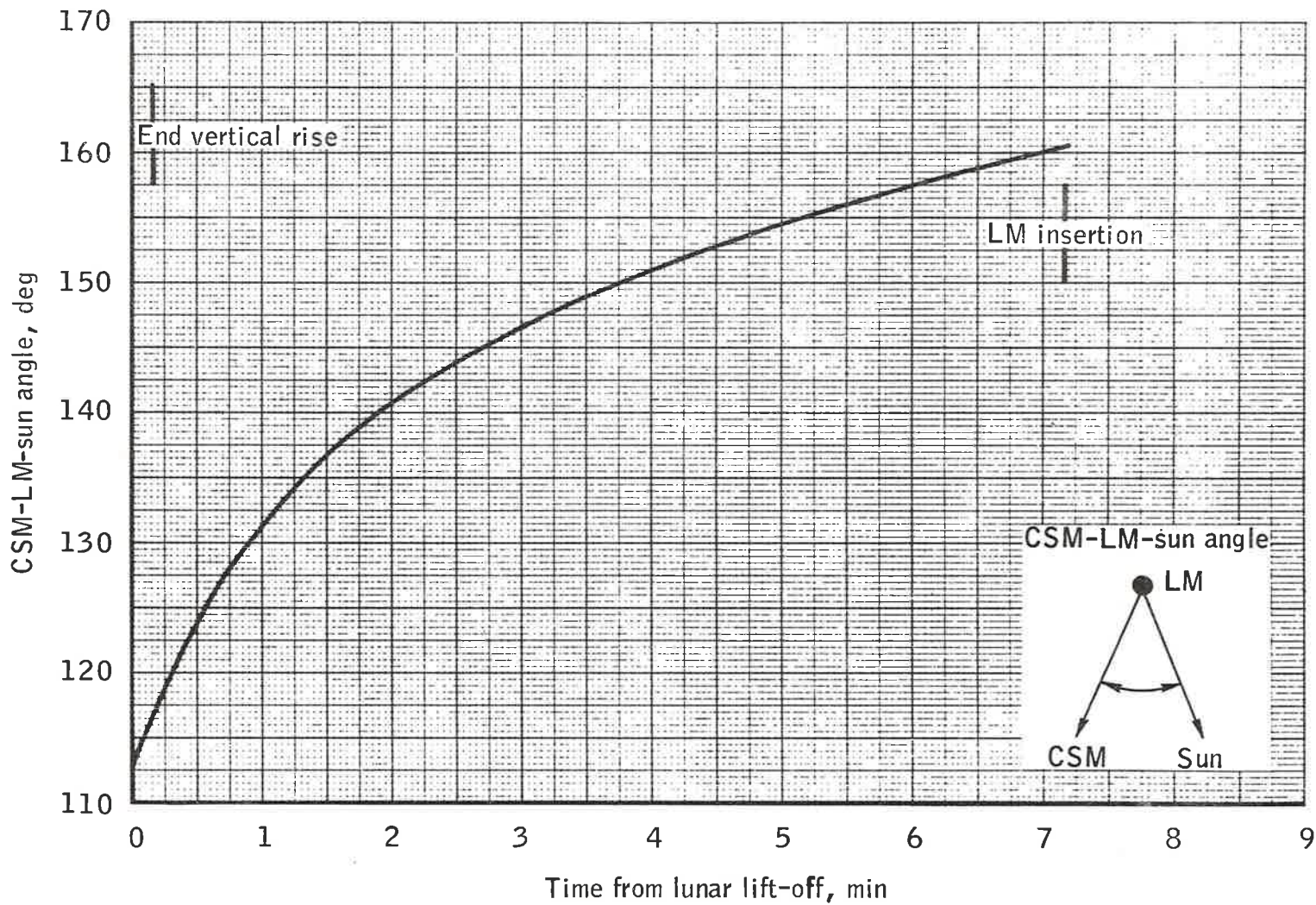

4-151

(e) CSM-LM-sun angle.

Figure 4.12-12.- Concluded.

4.13 RENDEZVOUS SEQUENCE

4.13 Rendezvous Sequence

4.13.1 Sequence summary.— After insertion of the LM into orbit, the LM will compute and execute the coelliptic rendezvous sequence which nominally consists of four major maneuvers: CSI, CDH, TPI, and TPF. A nominally-zero plane change maneuver will be scheduled between CSI and CDH, and two nominally-zero midcourse correction maneuvers will be scheduled between TPI and TPF; the TPF maneuver is actually divided into several braking maneuvers. The complete maneuver sequence is presented in table 4.13-I. All maneuvers will be performed with the LM RCS system with either two jets or four jets of a prescribed quad for thrust vector control. The entire maneuver sequence from lift-off through docking requires approximately 3.5 hours.

Before detailed information is presented about each maneuver, some general mission and trajectory design requirements for the rendezvous plan are noted.

1. CSI will occur impulsively approximately 50 minutes after insertion.
2. CDH will occur one-half period after CSI.
3. LM coelliptic Δh will be 15 n. mi. below CSM.
4. Time between CDH and TPI will be approximately 39 minutes.
5. TPI will occur at the midpoint of darkness and on a LM-to-CSM elevation angle of 26.6° .
6. Braking should occur in daylight; stationkeeping should begin approximately 25 minutes after the vehicles enter sunlight.

The orbital schematic for the rendezvous sequence is presented in figure 4.13-1. The time histories of range, range rate, phase angle, CSM-LM elevation angles, and the CSM-LM-sun angles are presented in figures 4.13-2(a) to 4.13-2(e). The relative motion of the LM with respect to the CSM is shown in figure 4.13-2(f). The onboard tracking, lighting, and mission events summary are presented in figure 4.13-3 and in table 4.13-II.

4.13.2 CSI.- The purpose of the CSI maneuver is to establish the proper phasing conditions at CDH so that after the CDH maneuver is performed, TPI will occur at the desired time and elevation angle. The 50-minute interval between insertion and CSI is required for LM RR and CSM sextant/VHF ranging navigation, MSFN state vector update, and LM platform realignment. The CSI maneuver will be scheduled approximately 50 minutes after insertion, 5.0 minutes prior to sunrise, and nominally will place the LM in an orbit 15.0 n. mi. below the CSM orbit at the time of CDH, one-half an orbital period after CSI. Should the CSM tracking of the LM prior to CSI indicate that an out-of-plane situation exists, an out-of-plane component designed to force a common node 90° after CSI would be incorporated in the CSI maneuver. The characteristics of the horizontal posigrade CSI maneuver which is performed with the +Z (two-jet) RCS thrusters are as follows.

Initiation

Time, hr:min:sec, g.e.t.	143:01:25.3
Latitude, deg N	5.8
Longitude, deg E	168.0
Altitude above landing site, n. mi.	45.8
Phase angle, deg	8.1

Burnout

Time, hr:min:sec, g.e.t.	143:02:10.0
Latitude, deg N	5.3
Longitude, deg E	165.7
Altitude above landing site, n. mi.	45.9
Burn duration, sec	44.7
ΔV , fps	49.9
Propellant used, lb	31.9
Resultant h_a/h_p , n. mi.	46.7/44.5
Catchup rate, deg/min	0.070

The CSI target load is shown in table 4.13-III.

4.13.3 PC maneuver.- A plane change, nominally not required, would be executed approximately 29 minutes after CSI at the common node of the CSM and LM orbital planes; this common node is forced by the CSI maneuver. At the time of the PC maneuver, the out-of-plane velocity component would be nulled to zero with a coplanar situation being established by the Y-axis RCS thrusters. If a required plane change is not begun at CSI,

the PC maneuver would force a common node at CDH, and the plane change would be completed at CDH. The onboard LM and CSM tracking schedule and navigation plan is resumed immediately after the CSI and PC maneuvers.

4.13.4 CDH.- Nominally, CDH will be a small burn performed with the +X RCS (four-jet) thrusters and is designed to coellipticize the LM orbit with the orbit of the CSM. If the CSM orbit were perfectly circular, the CDH maneuver nominally would be zero; however, because of the simulated 6°- by 59-n. mi. CSM orbit, a small CDH maneuver is required. This maneuver is performed with the +X thrusters so that radar lock-on at an elevation angle of approximately 9° above the local horizontal will not be disturbed. The burn occurs approximately 16.0 minutes before darkness and places the LM in a coelliptic orbit 15.0 n. mi. below the CSM. The characteristics of the CDH maneuver are as follows.

Initiation

Time, hr:min:sec, g.e.t.	143:59:49.8
Latitude, deg S	5.6
Longitude, deg W	13.4
Altitude above landing site, n. mi.	44.6
Phase angle, deg	4.4

Termination

Time, hr:min:sec, g.e.t.	143:59:51.8
Latitude, deg N	5.6
Longitude, deg E	13.5
Altitude above landing site, n. mi.	44.6
Burn duration, sec	2.0
ΔV , fps	4.4
Propellant used, lb	2.9
Resultant h_a/h_p , n. mi.	45.3/44.4
Catchup rate, deg/min	0.073

After the CDH maneuver, the LM maintains the RR track attitude and continues to track the CSM. Meanwhile, the CSM is also following the navigation plan with SXT/VHF tracking of the LM. The CDH external ΔV target load is presented in table 4.13-IV.

4.13.5 TPI.- The TPI maneuver, executed with the +Z RCS (two-jet) thrusters, is initiated on a 26.6° line-of-sight elevation angle to the CSM. The ΔV vector is approximately along the line of sight to the CSM. The maneuver occurs approximately 39 minutes after CDH and approximately 23 minutes before daylight. The Lambert targeting for this maneuver is based on a 130° CSM central travel angle between TPI and TPF. The target load for the TPI maneuver is presented in table 4.13-V. The characteristics of the TPI maneuver are as follows.

Initiation

Time, hr:min:sec, g.e.t.	144:38:56.1
Latitude, deg N	14.2
Longitude, deg W	134.8
Altitude above landing site, n. mi.	44.1
Phase angle, deg	1.7

Termination

Time, hr:min:sec, g.e.t.	144:39:18.2
Latitude, deg N	14.2
Longitude, deg W	136.0
Altitude above landing site, n. mi.	44.1
Burn duration, sec	22.2
ΔV , fps	24.8
Propellant used, lb	15.8
Resultant h_a/h_p , n. mi.	61.9/43.8
Catchup rate, deg/min	0.033

4.13.6 Midcourse corrections and TPF.- The LM RR tracking and CSM sextant and VHF ranging will resume approximately 4 minutes after TPI and will cease approximately 4 minutes prior to MC-1. MC-1 is scheduled 15 minutes after TPI and is nominally zero. LM RR tracking and CM sextant and VHF ranging begin again approximately 4 minutes after MC-1 and end approximately 3 minutes prior to MC-2 which occurs 30 minutes after TPI and is also nominally a zero maneuver. The terminal phase braking schedule performed with the two-jet -Z RCS thrusters is presented in table 5-XVII. Line-of-sight corrections will be made as required. Final approach and stationkeeping should occur at approximately

$6^d 01^h 24^m 30.5^s$ g.e.t., approximately 25 minutes after the vehicles enter sunlight on the backside of the moon. Docking should begin at approximately $6^d 01^h 40^m 00^s$ g.e.t. to complete 3.5 hours of rendezvous activities.

TABLE 4.13-I- RENDEZVOUS MANEUVER SUMMARY

Event	Time, day:hr:min:sec, g.e.t.	Propulsion system	Burn time, sec	Total ΔV , fps	Weight at ignition, lb	Propellant used ^a , lb	Resultant orbit ^b h_a/h_p , n. mi.	Range at cutoff, n. mi.	Range rate at cutoff, fps
CSI	5:23:01:25.3	RCS +Z (two-jet)	44.7	49.9	5802.4	31.9	46.7/44.5	140.1	-107.7
PC ^c	5:23:30:37.6	RCS ±Y (two-jet)	0.0	0.0	5770.5	0.0	46.7/44.5	122.1	-104.5
CDH	5:23:59:49.9	RCS +X (four-jet)	2.0	4.4	5770.5	2.9	45.3/44.4	77.5	-119.7
TPI	6:00:38:56.1	RCS +Z (two-jet)	22.2	24.8	5767.6	15.8	61.9/43.8	32.2	-133.0
MC-1 ^c	6:00:53:56.1	RCS ±Z (two-jet)	0.0	0.0	5751.8	0.0	61.9/43.8	14.7	-96.2
MC-2 ^c	6:01:08:56.1	RCS ±Z (two-jet)	0.0	0.0	5751.8	0.0	61.9/43.8	4.4	-45.3
First braking maneuver	6:01:20:15.1	RCS -Z (two-jet)	10.7	12.0	5751.8	7.6	60.9/49.1	0.4	-19.7
Second braking maneuver	6:01:21:28.3	RCS -Z (two-jet)	8.7	9.8	5744.2	6.3	60.3/53.9	0.2	-9.8
Third braking maneuver	6:01:23:06.7	RCS -Z (two-jet)	4.3	4.8	5737.9	3.0	60.1/56.5	0.08	-4.9
Fourth braking maneuver	6:01:24:26.3	RCS -Z (two-jet)	4.1	4.7	5734.9	3.0	60.0/59.2	0.01	-0.2
Docking	6:01:40:00.0	--	--	--	5731.9	--	59.9/59.1	0.0	0.0

^a Estimates for completing consumables document will present official propellant usage. Slight changes caused by rigor of analysis are expected.

^b Altitudes measured above landing site.

^c Nominally a zero ΔV maneuver.

651-7

TABLE 4.13-II.- MSFN TRACKING
AND SHADOW TIMELINE

Event	Time, day:hr:min:sec, g.e.t.
Insertion	5:22:11:47.7
Sunset	5:22:15:26.5
MSFN LOS	5:22:31:41.2
CSI	5:23:01:25.3
Sunrise	5:23:12:12.0
MSFN AOS	5:23:19:29.9
PC	5:23:30:37.6
CDH	5:23:59:49.9
Sunset	6:00:10:31.7
MSFN LOS	6:00:28:32.1
TPI	6:00:38:56.1
MC-1	6:00:53:56.1
Sunrise	6:01:08:25.7
MC-2	6:01:08:56.1
MSFN AOS	6:01:14:37.6
First braking maneuver	6:01:17:44.5
Second braking maneuver	6:01:20:15.0
Third braking maneuver	6:01:21:28.3
Fourth braking maneuver	6:01:24:26.7
Docking	6:01:40:00.0

TABLE 4.13-III.- TARGET LOADS FOR CSI MANEUVER

[Propulsion system: RCS; guidance: external ΔV]

(a) Target

t_{IG} , hr:min:sec, g.e.t.	143:1:25.3
ΔV_X , fps	49.9
ΔV_Y , fps	0.0
ΔV_Z , fps	0.0
Weight at t_{IG} , lb	5802.4

(b) REFSMMAT

Refer to table 5-VI

(c) Gimbal angles at t_{IG}

IGA, deg	191.2
MGA, deg	0.0
OGA, deg	0.0

TABLE 4.13-IV.- TARGET LOADS FOR CDH MANEUVER

[Propulsion system: RCS; guidance: external ΔV]

(a) Target

t_{IG} , hr:min:sec, g.e.t.	143:59:49.8
ΔV_X , fps	-2.0
ΔV_Y , fps	0.0
ΔV_Z , fps	-4.0
Weight at t_{IG} , lb	5770.5

(b) REFSMMAT

Refer to table 5-VI

(c) Gimbal angles at t_{IG}

IGA, deg	38.4
MGA, deg	0.0
OGA, deg	0.0

TABLE 4.13-V.- TARGET LOADS FOR TPI MANEUVER

[Propulsion system: RCS; guidance: external ΔV]

(a) Target

t_{IG} , hr:min:sec, g.e.t.	144:38:56.1
ΔV_X , fps	22.0
ΔV_Y , fps	0.1
ΔV_Z , fps	-11.1
Weight at t_{IG} , lb	5767.6

(b) REFSMMAT

Refer to table 5-VI

(c) Gimbal angles at t_{IG}

IGA, deg	276.5
MGA, deg	-0.1
OGA, deg	-0.2

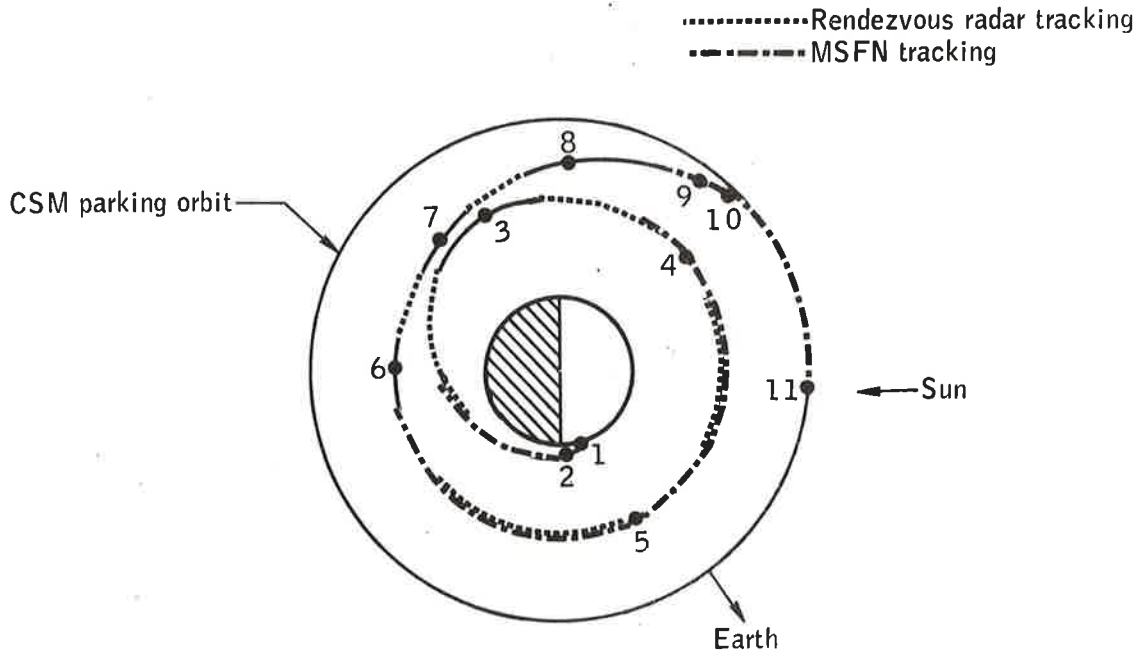

Event	Time, hr:min:sec g.e.t.	Event	Time, hr:min:sec g.e.t.
1. Lift-off	147:04:37.1	7. MC-1	144:53:56.1
2. LM insertion	142:11:47.7	8. MC-2	145:08:56.1
3. CSI	143:01:25.3	9. Begin braking	145:17:44.5
4. PC	143:30:37.6	10. Begin stationkeeping	145:24:26.7
5. CDH	143:59:49.9	11. Docking	145:40:00.0
6. TPI	144:38:56.1		

Figure 4.13-1. - Orbital schematic of ascent through docking.

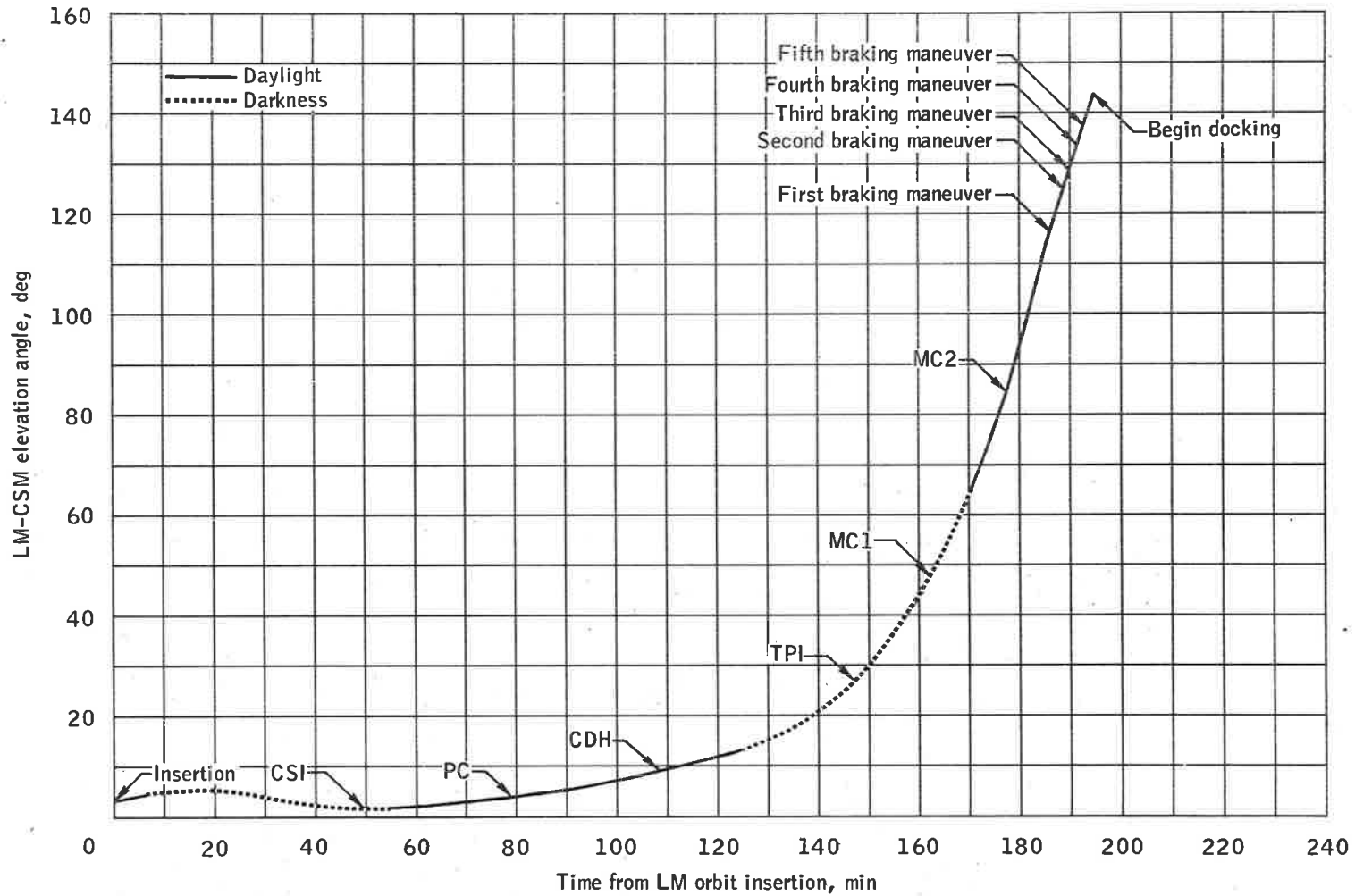

4-165

(a) LM-CSM elevation angle versus time from LM orbit insertion.

Figure 4.13-2.- Parameters from LM orbit insertion through terminal rendezvous.

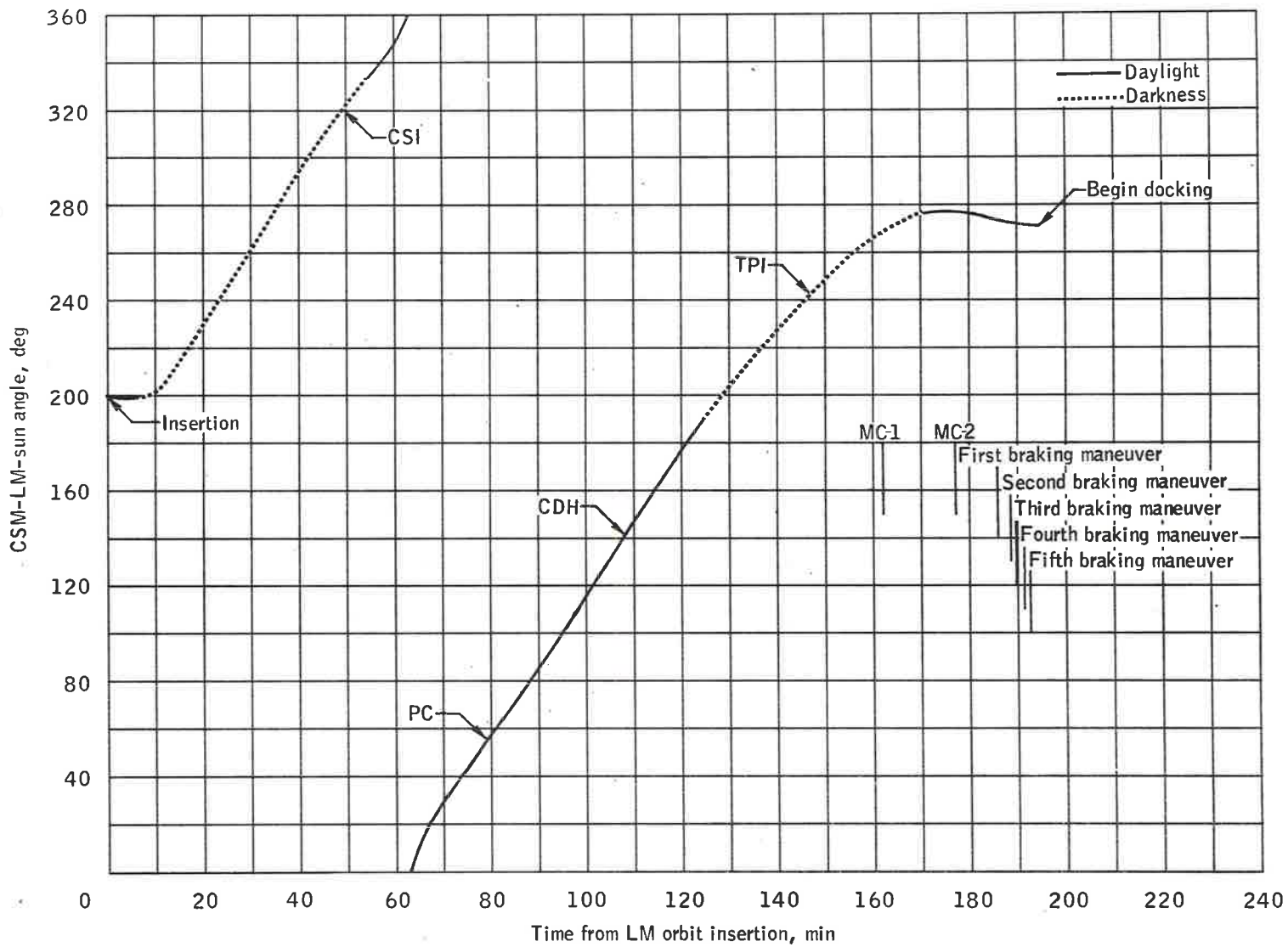

4-166

(b) CSM-LM-sun angle versus time from LM orbit insertion.

Figure 4.13-2.- Continued.

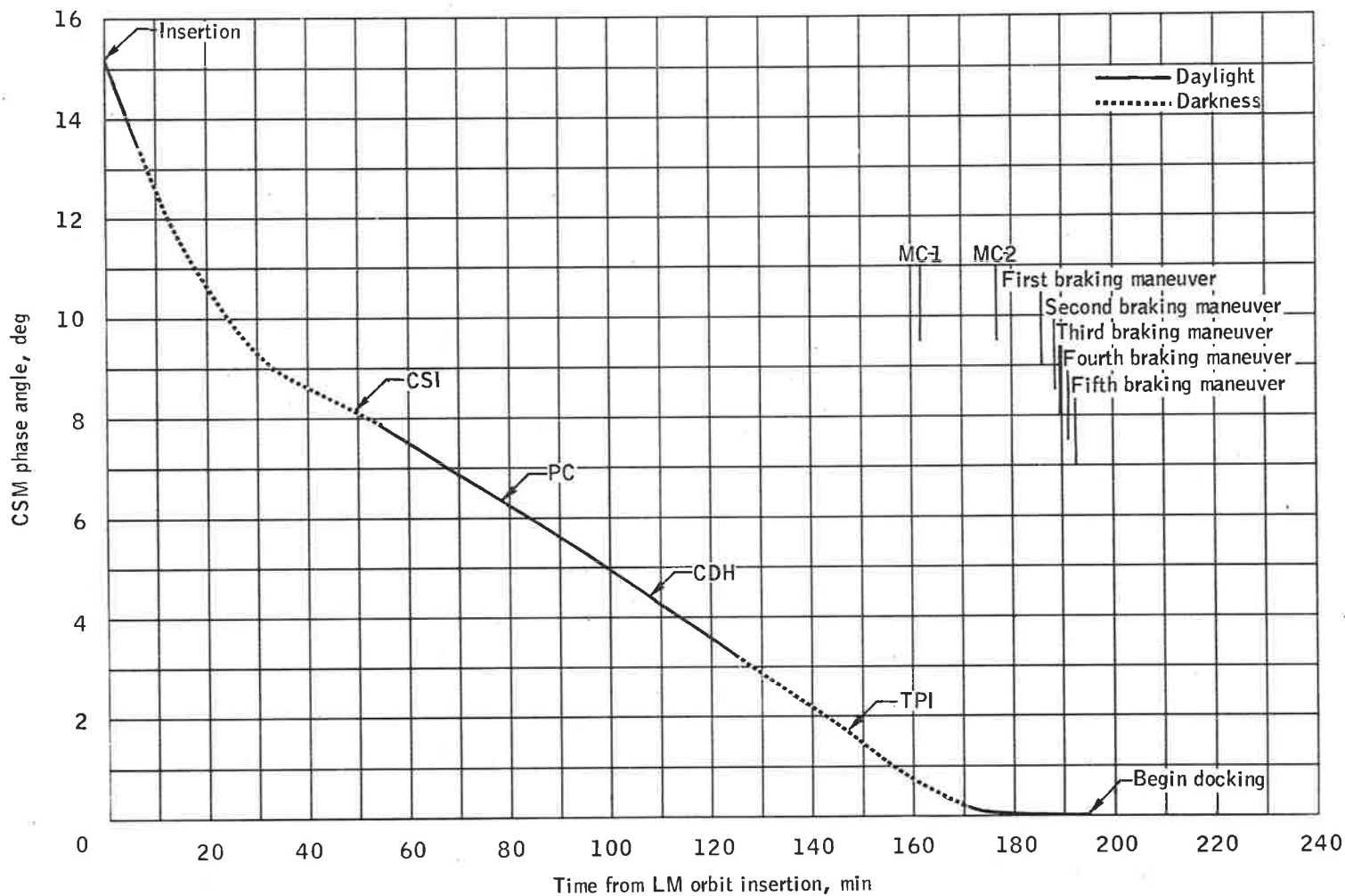

(c) CSM phase angle versus time from LM orbit insertion.

Figure 4.13-2.- Continued.

4-167

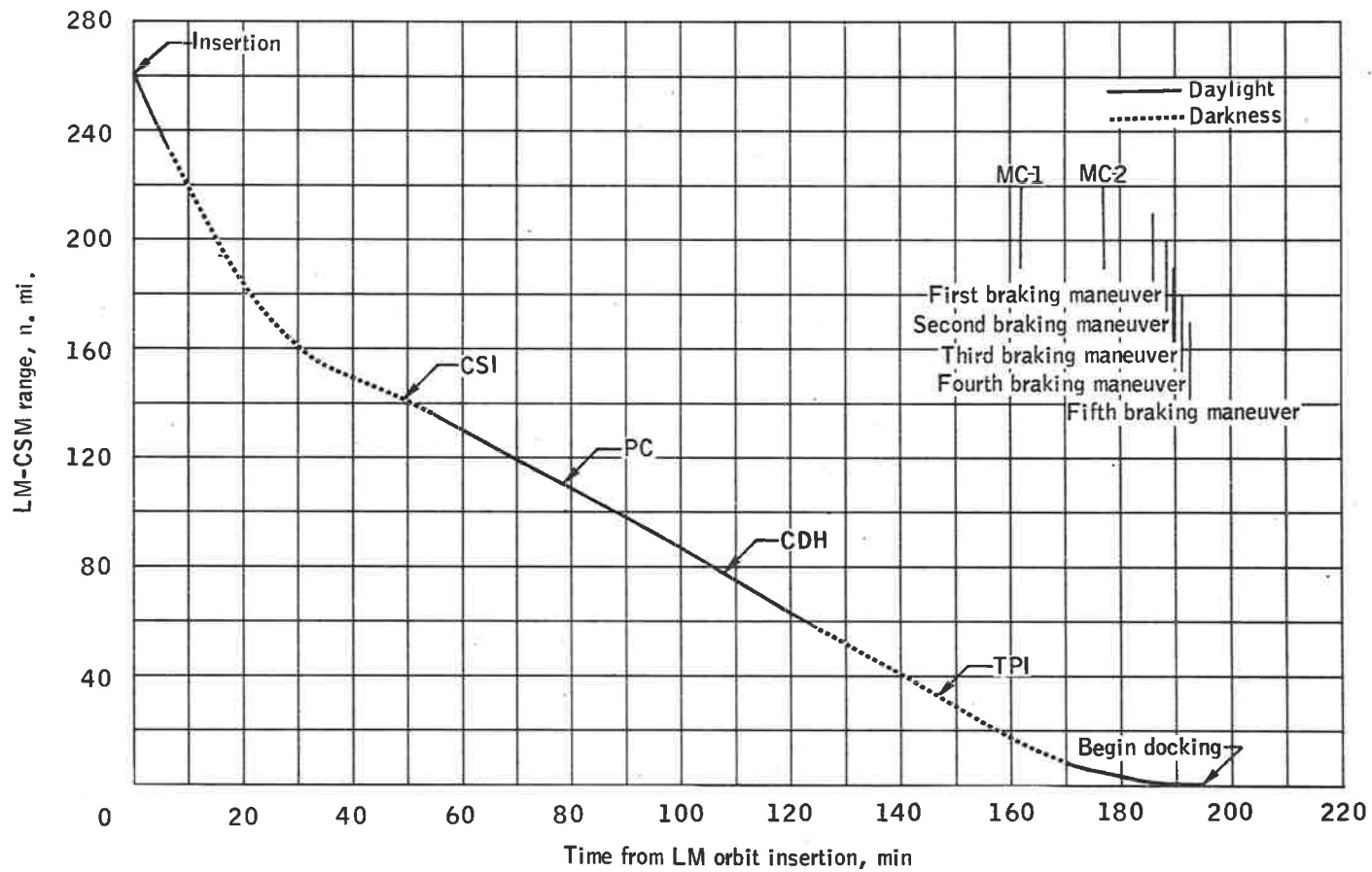

(d) LM-CSM range versus time from LM orbit insertion.

Figure 4.13-2.- Continued.

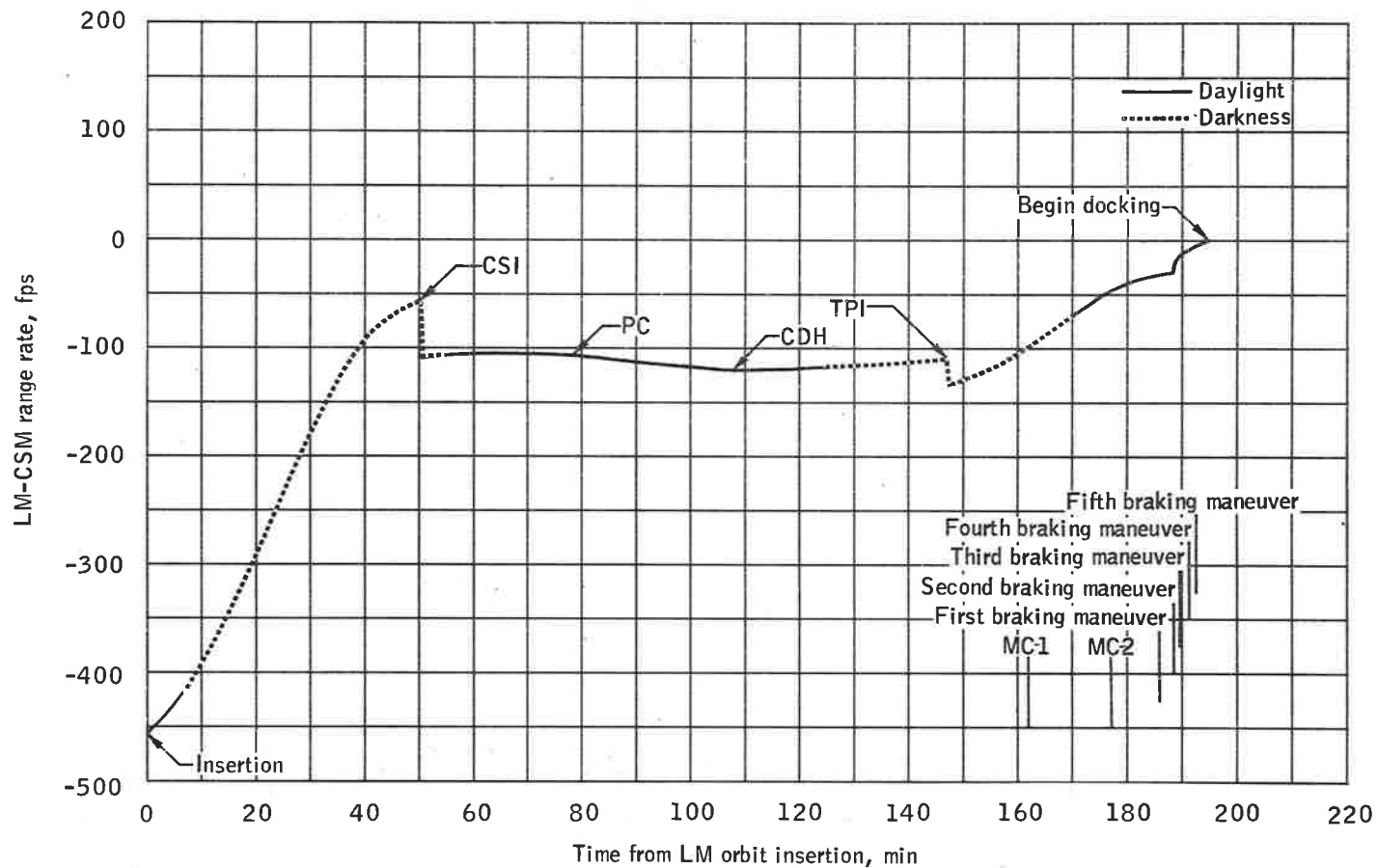

69T-7

(e) LM-CSM range rate versus time from LM orbit insertion.

Figure 4.13.2.- Continued.

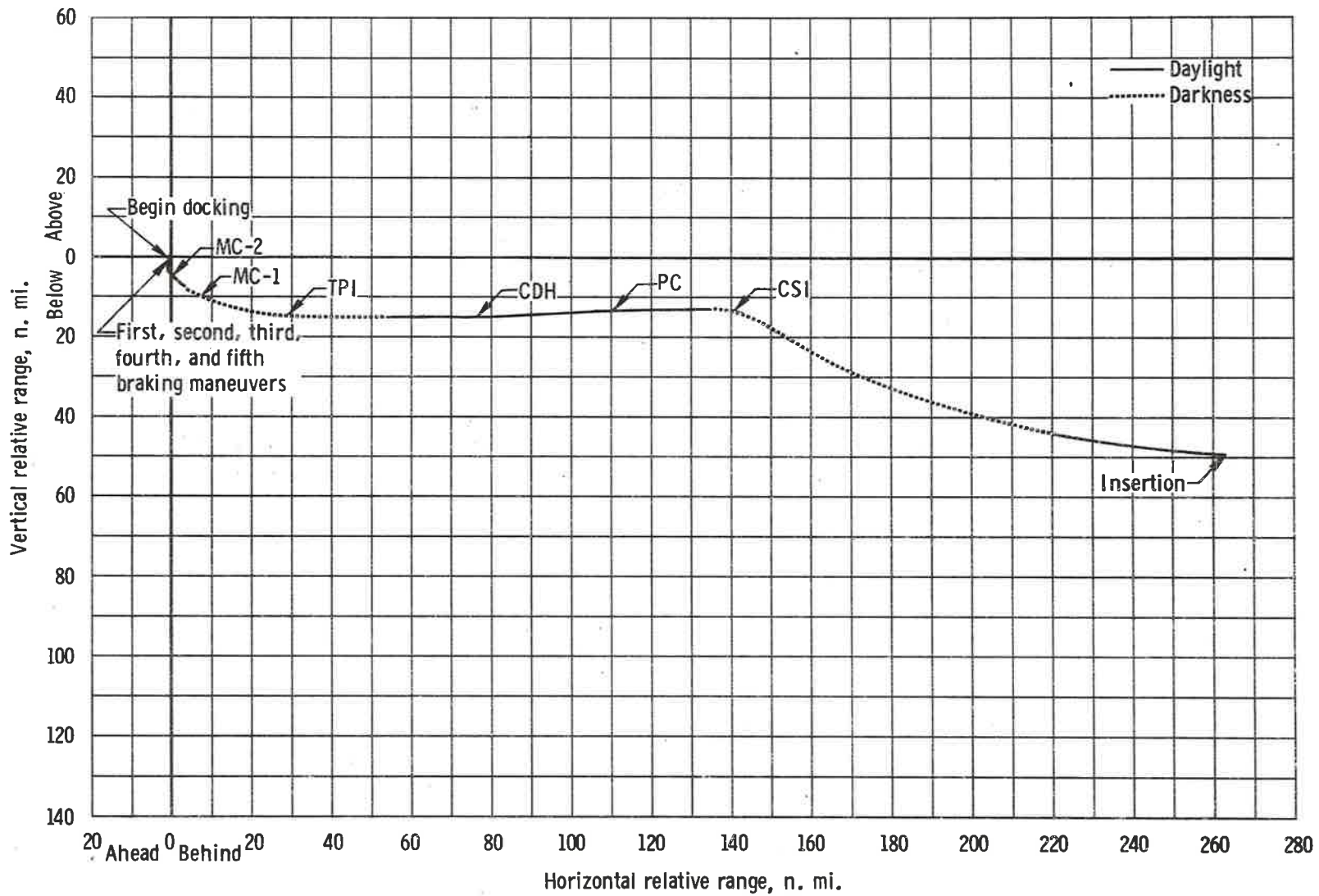

4-170

(f) Vertical relative range versus horizontal relative range.

Figure 4.13-2.- Concluded.

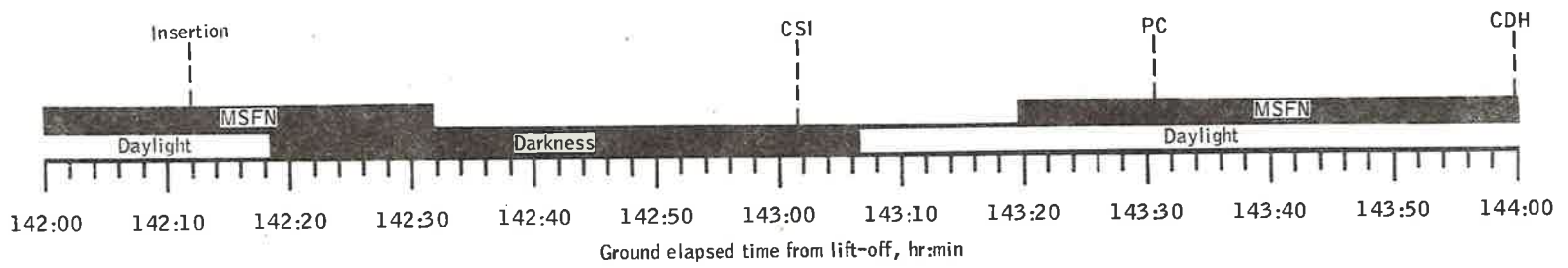

4-1771

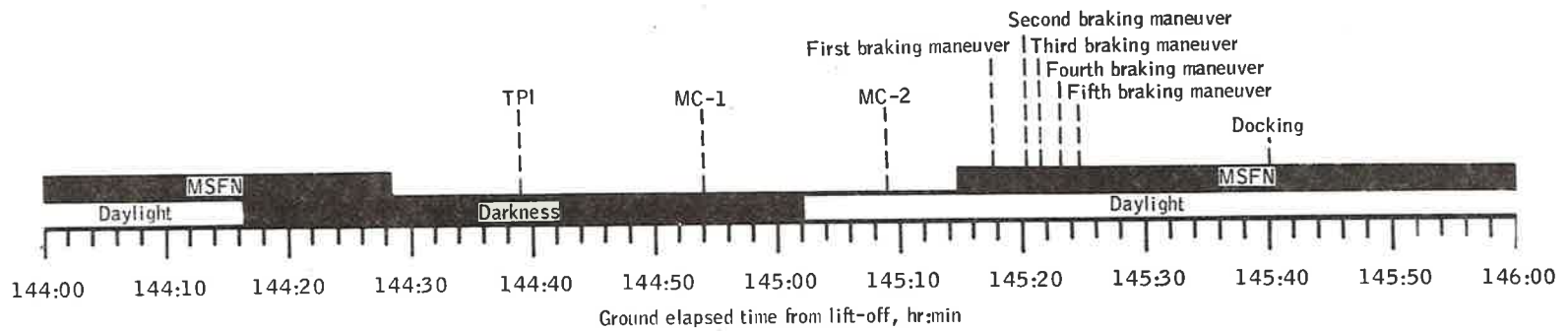

Figure 4. 13-3.- Mission events and tracking summaries for LM-active rendezvous.

4.14 LM Jettison and Separation to Transearth Injection

Docking occurs at approximately $145^{\text{h}}40^{\text{m}}$ g.e.t. After equipment transfer and decontamination procedures, the LM is jettisoned at $147^{\text{h}}21^{\text{m}}$ g.e.t. The CSM is pitched up 45° with respect to the local horizontal for the LM jettison. The CSM separates from the LM by performing a -X RCS translation of 1.5 fps in the inertial jettison attitude.^a The target load for this separation maneuver is shown in table 4.14-I.

An 8.5-hour crew rest period is begun at $149^{\text{h}}30^{\text{m}}$ g.e.t. The rest period is ended in revolution 38 at approximately $158^{\text{h}}00^{\text{m}}$ g.e.t. A plane change is performed in revolution 39 at $159^{\text{h}}13^{\text{m}}53.1^{\text{s}}$ g.e.t. The plane change, which is an SPS burn of 360.1 fps, results in an orbit that passes directly over Descartes and Fra Mauro two revolutions later. The target load for the LOPC-2 maneuver is presented in table 4.14-II.

Photography and landmark tracking are performed during revolutions 40, 41, 42, 43, and 44. The TEI maneuver is performed in revolution 46 at $174^{\text{h}}24^{\text{m}}47.8^{\text{s}}$ g.e.t. The lunar orbit groundtrack from the CSM plane change after LM jettison to TEI is shown in figure 4.14-1.

^aThe LM jettison has now been moved to $148^{\text{h}}00^{\text{m}}$ g.e.t. or 39 minutes later. The LM will be jettisoned in an inertial attitude and a retrograde burn can be made during the following revolution at 63.7°E longitude so that the ascent stage could be made to impact the moon near the landing site if headquarters approves such a procedure.

TABLE 4.14-I.- TARGET LOAD FOR CSM SEPARATION

MANEUVER FOLLOWING LM JETTISON^a

[Propulsion system: CSM RCS]

(a) Target

t_{IG} , hr:min:sec, g.e.t.	147:21:26.8
ΔV_X , fps	-1.0607
ΔV_Y , fps	0.0
ΔV_Z , fps	1.0607
Weight, lb	34 807.6

(b) REFSMMAT

Refer to table 5-VI

(c) Gimbal angles at t_{IG}

IGA, deg	70.0
MGA, deg	0.0
OGA, deg	-0.1

^aThe LM jettison has now been moved to 148^h00^m g.e.t. or 39 minutes later. The LM will be jettisoned in an inertial attitude and a retro-grade burn can be made during the following revolution at 63.7°E longitude so that the ascent stage could be made to impact the moon near the landing site if headquarters approves such a procedure.

TABLE 4.14-II.- TARGET LOAD FOR SECOND LUNAR
ORBIT PLANE CHANGE MANEUVER (LOPC-2)

[Propulsion system: SPS; guidance: external ΔV]

(a) Target

t_{IG} , hr:min:sec, g.e.t.	159:13:53.1
ΔV_X , fps	-8.1
ΔV_Y , fps	297.1
ΔV_Z , fps	0.0
Weight, lb	34 800.5

(b) REFSMMAT

Refer to table 5-VII

(c) Gimbal angles at t_{IG}

IGA, deg	2.9
MGA, deg	-1.2
OGA, deg	0.1

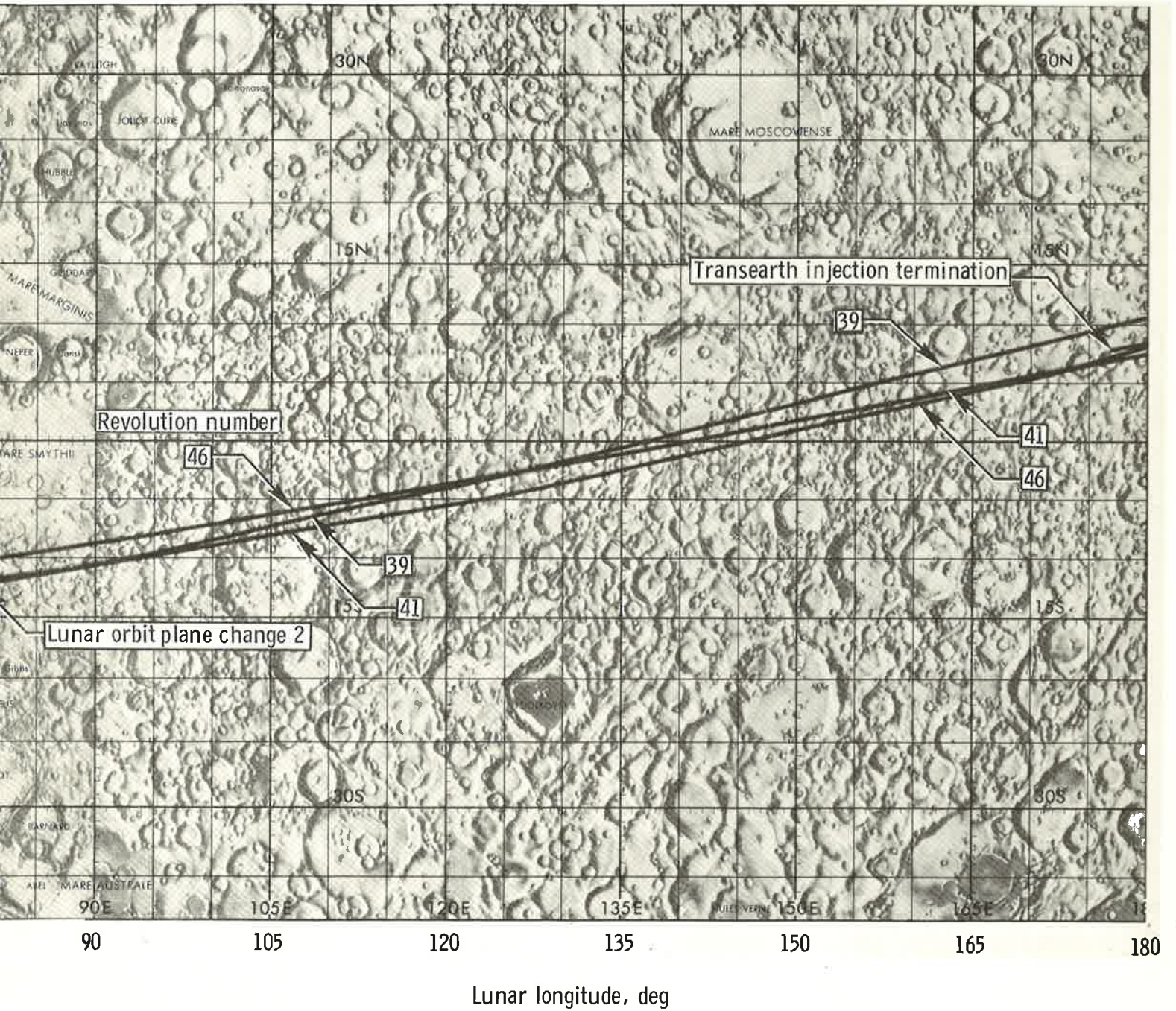

Figure 4.14-1. - Lunar orbit groundtracks from CSM plane change after LM jettison to transearth injection.

4.15 TRANSEARTH INJECTION

4.15 Transearth Injection

The TEI maneuver occurs 3^d18^h50^m after LOI-1. The burn was targeted for a 70-hour transearth flight time. A time history of the trajectory parameters during the burn is presented in figure 4.15-1. The transearth injection geometry is shown in figure 4.15-2.

For the TEI burn, the IMU is alined to the preferred REFSMMAT. The target load is presented in table 4.15-I.

The characteristics of the burn are the following.

TEI burn initiation

Time, hr:min:sec, g.e.t.	174:24:47.8
Mass, lb	33 754
Altitude above LLS, n. mi.	60.6
Selenographic latitude, deg	9.2
Selenographic longitude, deg	<u>-175.0</u>
Velocity, fps	5341.3
Selenographic inclination, deg	167.0
Perilune altitude above LLS, n. mi.	57.1
Apolune altitude above LLS, n. mi.	62.2

TEI burnout

Time, hr:min:sec, g.e.t.	174:27:4.8
Altitude above LLS, n. mi.	64.6
Selenographic latitude, deg	7.8
Selenographic longitude, deg	<u>176.2</u>
Velocity, fps	8427.0
Selenographic inclination, deg	168.4
Burn duration, min:sec	2:17
Inertial burn arc, deg	8.8
Plane change, deg	2.0
ΔV , fps	3113
SPS propellant used, lb	8942
Perilune altitude above LLS, n. mi.	60.1

TABLE 4.15-I.- TARGET LOAD FOR TEI MANEUVER

[Propulsion system: SPS; guidance: external ΔV]

(a) Target

t_{IG} , hr:min:sec, g.e.t.	174:24:47.8
ΔV_X , fps	3092.9
ΔV_Y , fps	296.6
ΔV_Z , fps	-195.6
Weight, lb	33 754.3

(b) REFSMMAT

Refer to table 5-VIII

(c) Gimbal angles at t_{IG}

IGA, deg	3.0
MGA, deg	-1.1
OGA, deg	0.1

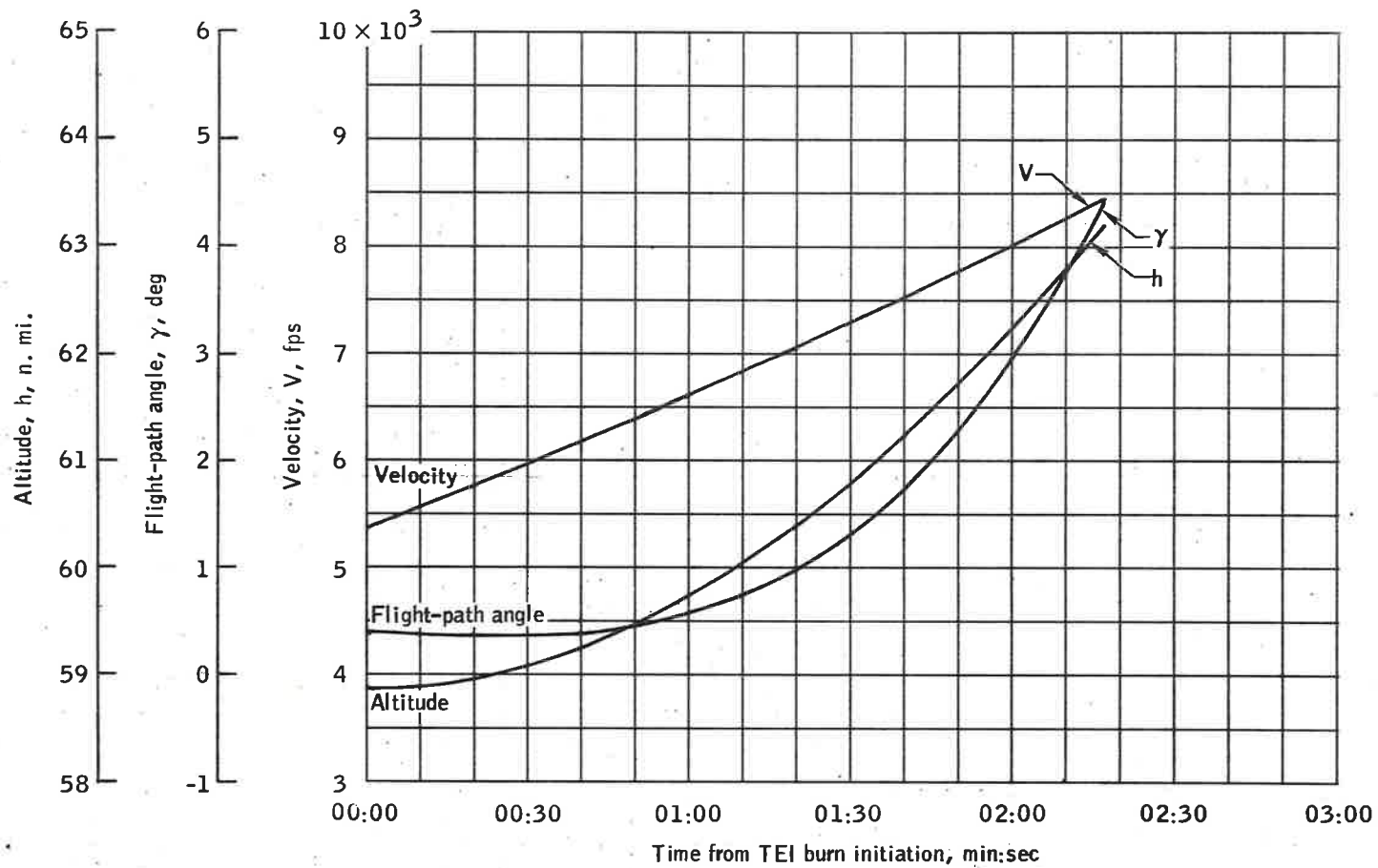

(a) Velocity, flight-path angle, and altitude versus time from TEI burn initiation.

Figure 4.15-1.- Time history of trajectory parameters for transearth injection.

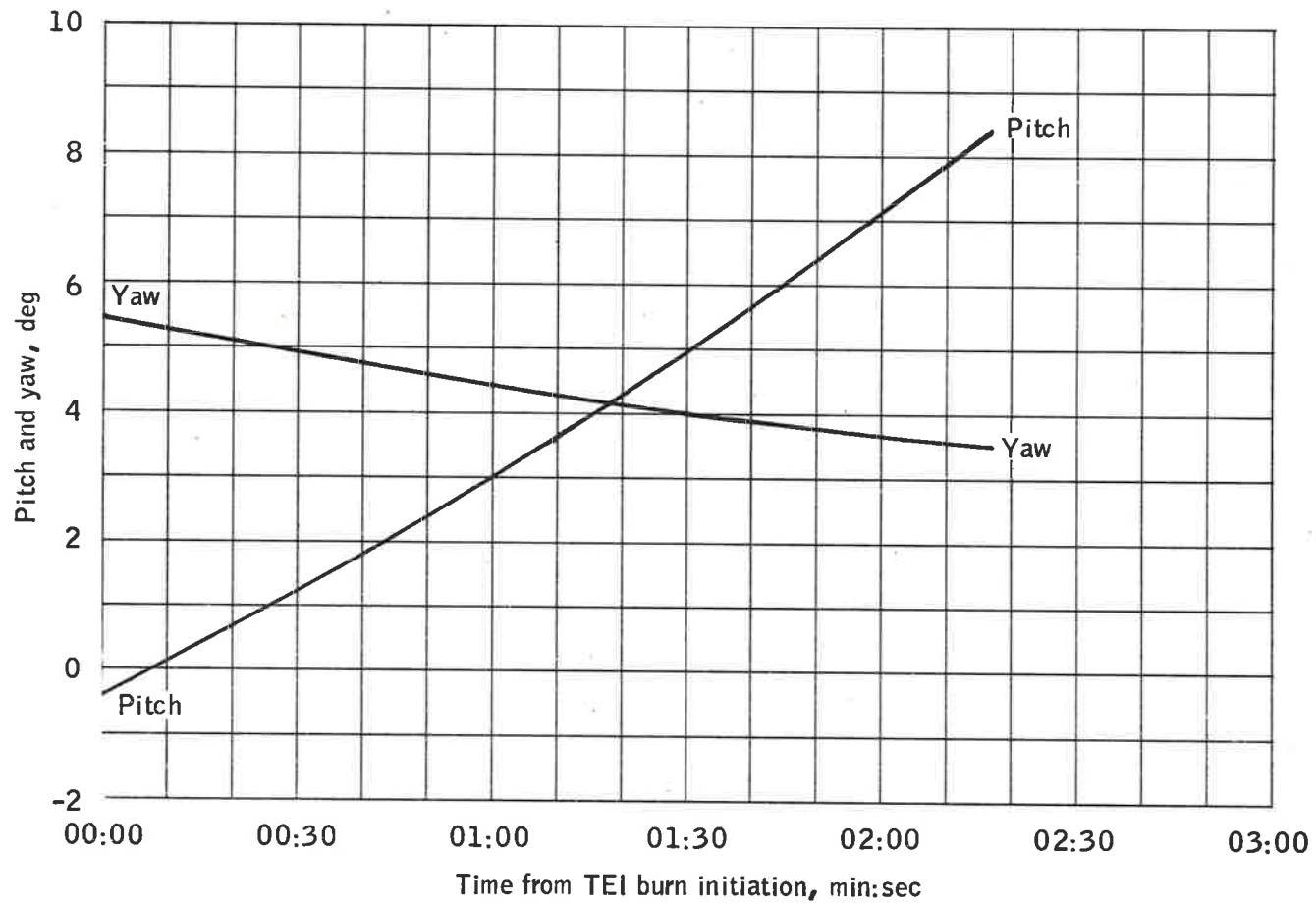

481-4

(b) Local horizontal pitch and yaw versus time from TEI burn initiation.

Figure 4.15-1.- Concluded.

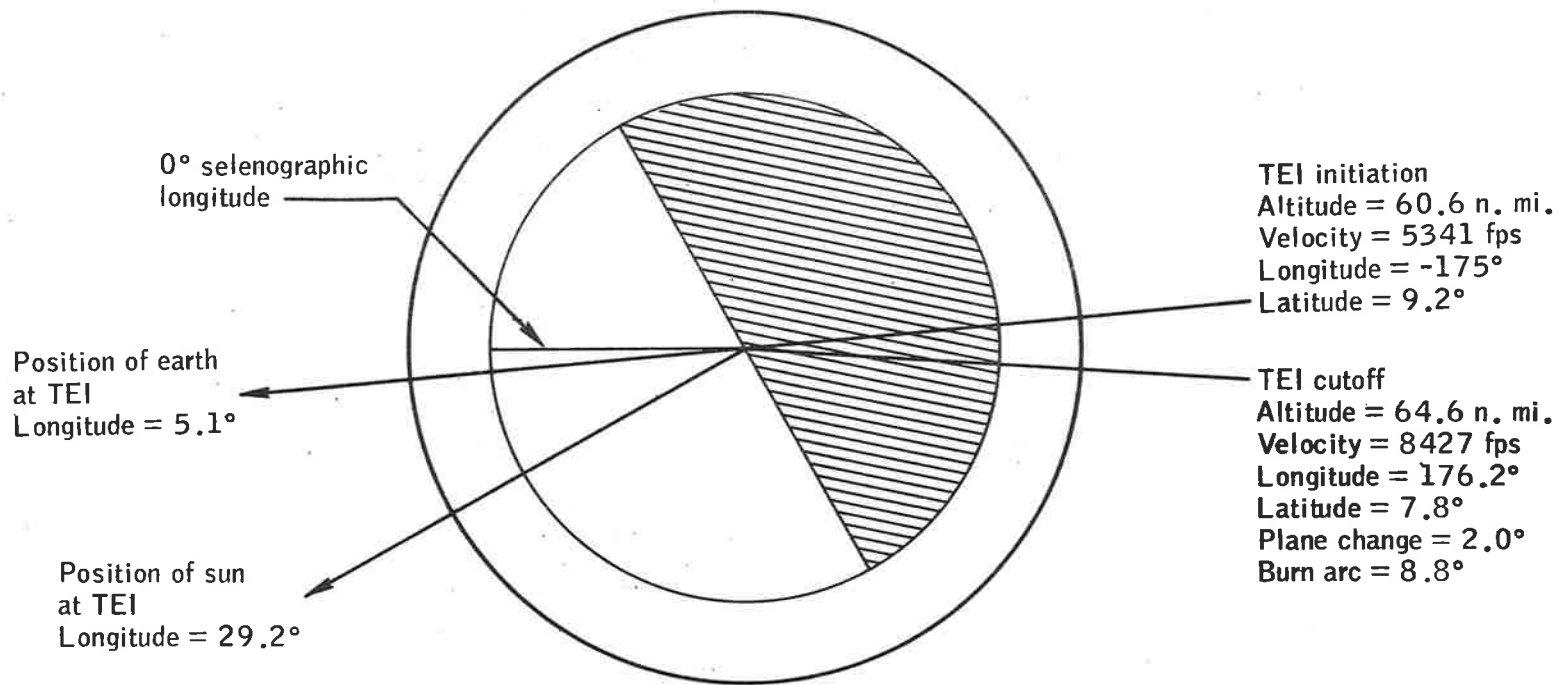

Figure 4.15-2.- TEI geometry.

4.16 Transearth Coast

A groundtrack of the transearth coast phase is provided in figure 4.16-1. Altitude above the moon is shown for the first 10 hours of coast in figure 4.16-2. The altitude time history for TEI to entry is shown in figure 4.16-3. Three midcourse decision points have been defined for the transearth phase.

- a. MCC-5, TEI plus 15 hours
- b. MCC-6, EI minus 22 hours
- c. MCC-7, EI minus 3 hours

The maneuvers will be targeted for corridor control only. The midcourse strategy, which includes the threshold values for each maneuver, is contained in reference 2. Altitude is plotted against time for the last 10 hours of transearth coast in figure 4.16-4.

The SC remains in the lunar umbra during the entire TEI burn, enters sunlight approximately 6 minutes after cutoff, and remains in sunlight until entry.

Passive thermal control will be maintained during most of the transearth coast phase. The PTC REFSMMAT (table 5-II) will be used for MCC-5 and MCC-6; the entry REFSMMAT (table 5-IX) will be used for MCC-7. The CM/SM separation occurs approximately 15 minutes prior to entry.

The SC is acquired by MSFN approximately 10 minutes after TEI cutoff, and the last station to lose signal is Honeysuckle (5° minimum elevation) which loses signal at 244^h23^m27^s g.e.t. or approximately 3 minutes prior to entry.

The primary trajectory parameters at entry interface are the following.

Time, hr:min:sec, g.e.t.	244:26:36.0
Transearth coast time, hr	70
Inertial velocity, fps	36 128.8
Altitude, n. mi.	65.8
Inertial flight-path angle, deg	-6.5
Latitude, deg	-18.7
Longitude, deg	172.8
Equatorial inclination (ascending), deg	18.8

APOLLO TRACKING NETWORK

All stations operational May 1968

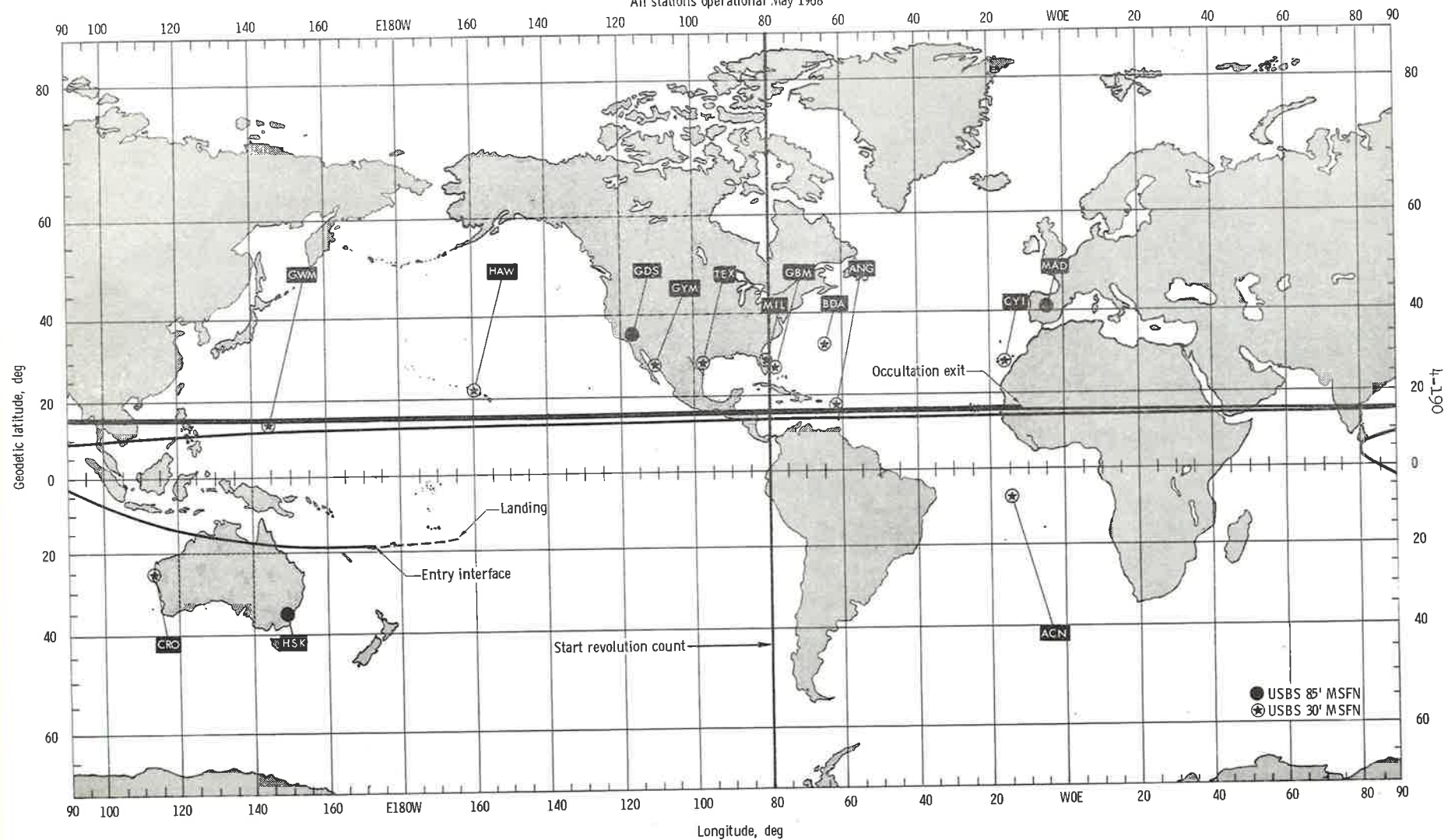

Figure 4.16-1. - Transearth coast groundtrack.

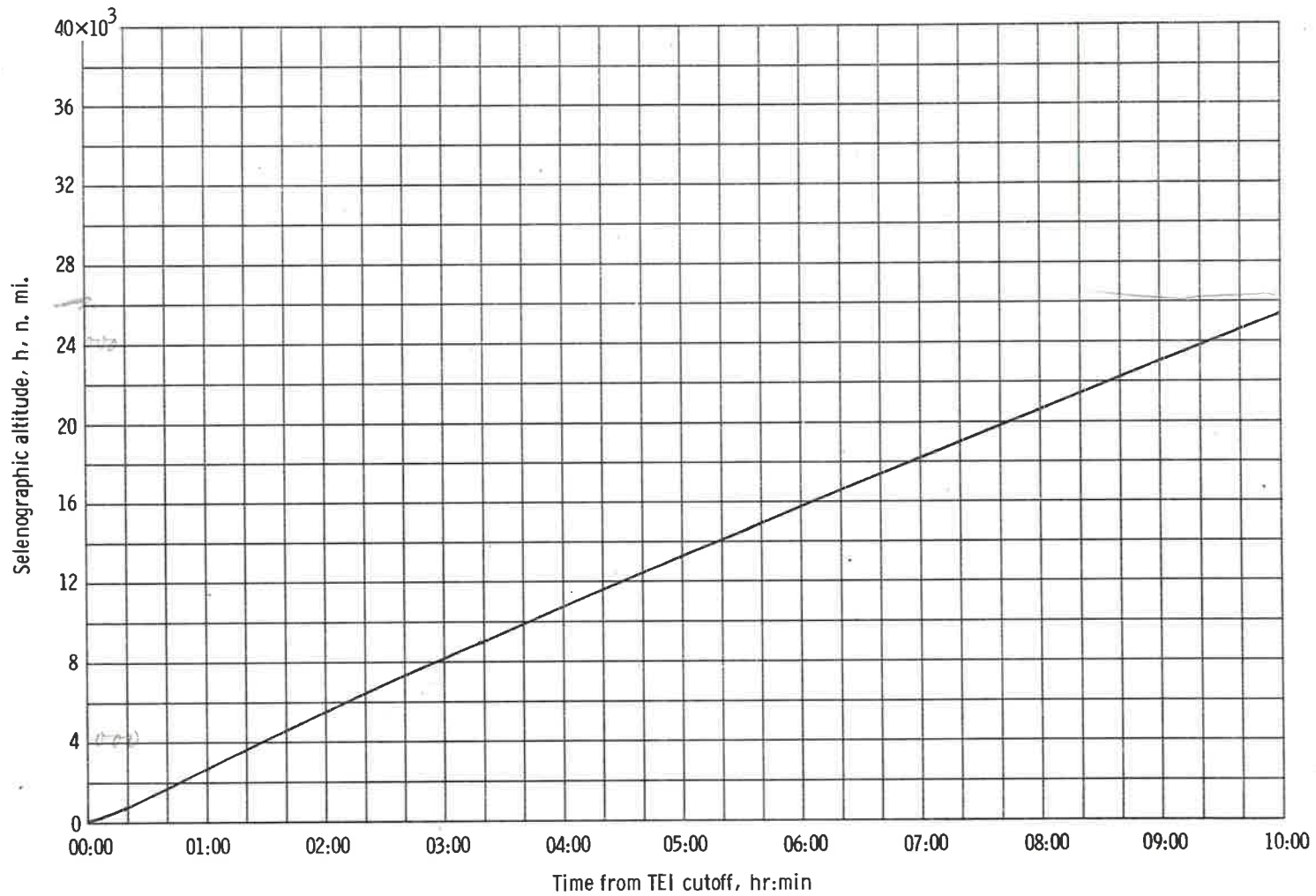
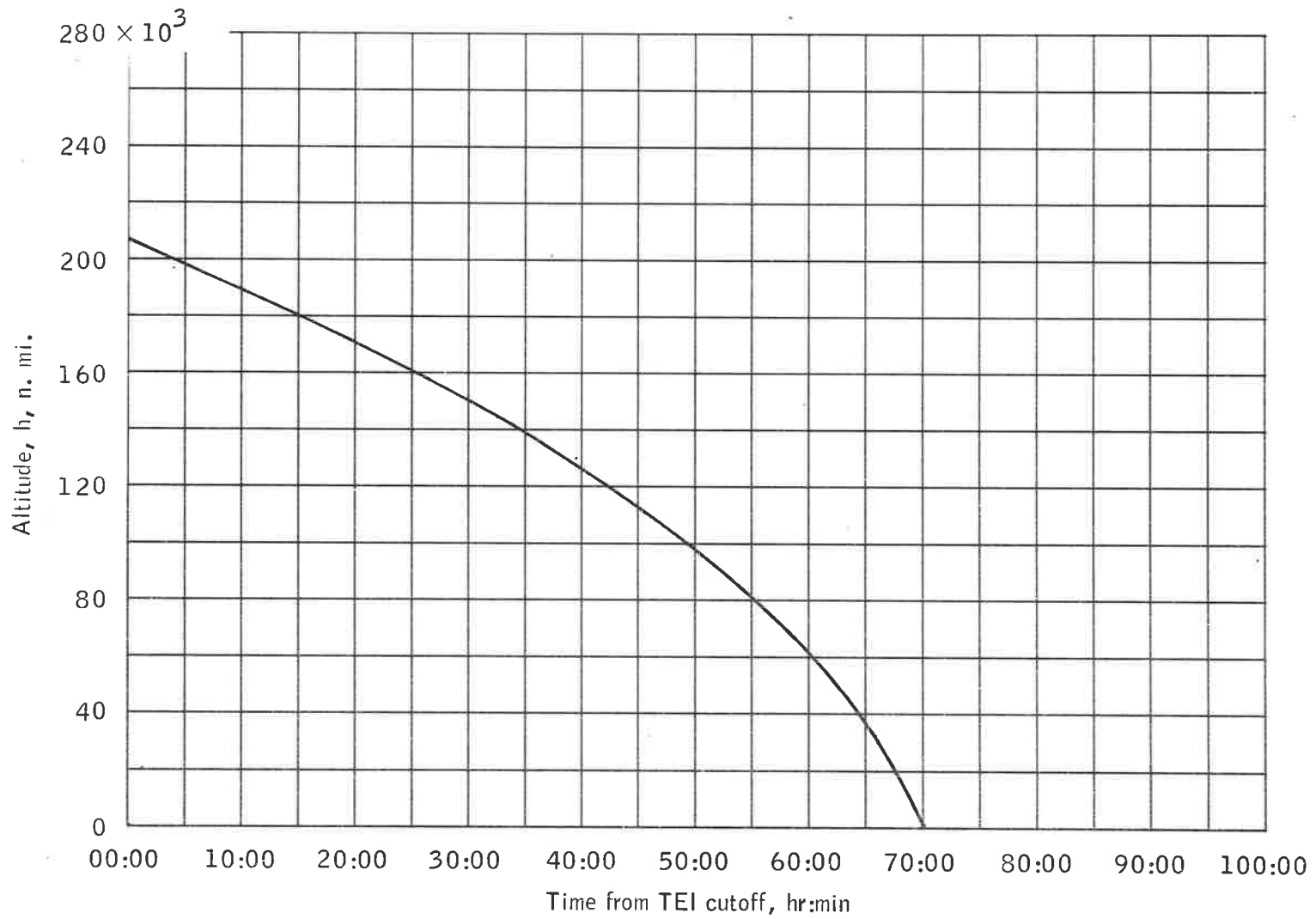

Figure 4.16-2. - Altitude time history during the first 10 hours of transearth coast.



4-192

Figure 4.16-3.- Altitude time history from transearth injection to entry interface .

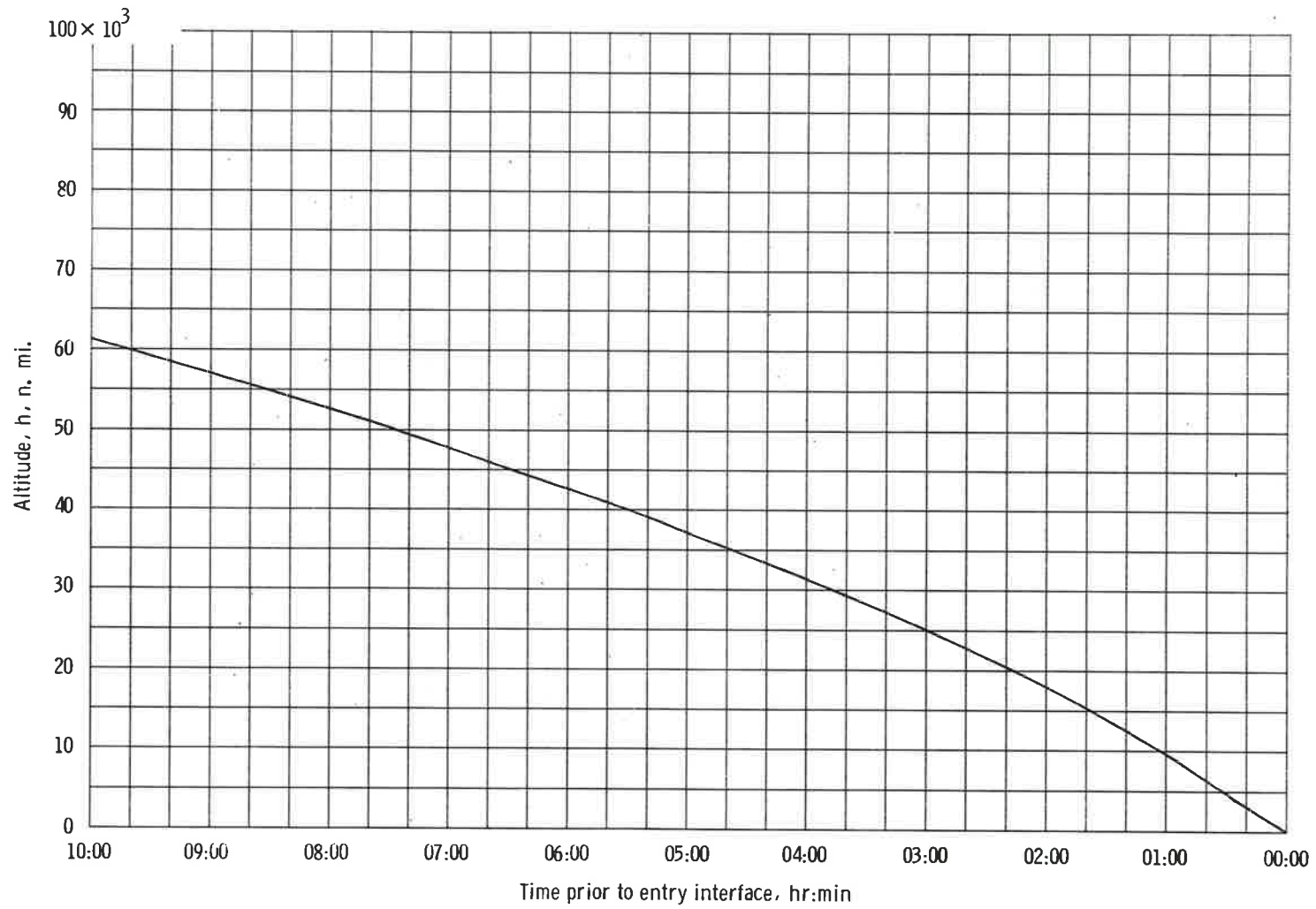

Figure 4. 16-4. - Altitude time history 10 hours prior to entry interface.

4.17 ENTRY

4.17 Entry

The entry phase of the operational trajectory was simulated with the Apollo Reentry Simulation program with six degrees of freedom. Three-degree-of-freedom trajectories were used to determine the CM maneuver footprint. The entry corridor is presented in figure 4.17-1.

At the nominal EI, $244^{\text{h}}26^{\text{m}}36^{\text{s}}$ after lift-off, the CM is at an altitude of 400 095 feet, and the coordinates are 18.659°S geodetic latitude and 172.75°E longitude. Inertial velocity, flight-path angle, and azimuth at this point are 36 128 fps, 6.50° below the local horizontal, and 86.70° , respectively. The gimbal angles are as follows: yaw = 0° , pitch = 153° , roll = 0° .

A plot of the CM maneuver footprint and the nominal ground trace on a map of the entry area are presented in figure 4.17-2. The footprint is extended to a 3500-n. mi. entry range. The nominal touchdown target location is 1285-n. mi. down range from the EI position, and the coordinates of the target are 165°W longitude and 16.04°N geodetic latitude. A sequence of pertinent events is given in table 4.17-I and includes the periods of communications blackout which occur along the trajectory. The guidance phases are shown in figure 4.17-3, which shows altitude as a function of range to the target. Time histories of the bank angle commanded by the guidance system, of the altitude rate, and of the altitude are presented in figure 4.17-4. Time histories of the total heating rate and the total heat load are presented in figure 4.17-5. The maximum total heating rate is $286.7\text{ Btu/ft}^2/\text{sec}$, and the total heat load is $26\ 344\text{ Btu/ft}^2$. Time histories for inertial and relative velocity and flight-path angles are presented in figure 4.17-6.

The CM RCS used 11.55 pounds of propellant for the separation and attitude hold maneuvers before the spacecraft reaches 400 000 feet. The RCS used 30.7 pounds of propellant to perform the guidance commands during the remainder of the entry. A time history of the total RCS propellant consumed from separation is presented in figure 4.17-7. In figure 4.17-8, the altitude is plotted in relation to relative velocity, and the boundary for S-band communication blackout is shown (ref. 6). Time histories for the primary DSKY displays, commanded bank angle, inertial velocity, and load factor are shown in figure 4.17-9. The load factor at the c.g. reaches a first maximum of $6.26g$ and a second maximum of $5.55g$. Time histories for the final phase DSKY displays, commanded bank angle, cross-range error, and down-range error are shown in figure 4.17-10.

The drogue parachute deployment sequence begins at an altitude of 23 300 feet, which is 8 minutes 8 seconds after EI. The two drogue parachutes are deployed 2 seconds later. At an altitude of 10 500 feet, the low altitude baroswitch closes, and the drogue parachutes are disconnected. The three main parachutes are deployed 1 second after the

baroswitch closes. The CM, suspended on the main parachutes, reaches splashdown 13 minutes 50 seconds after EI. The relative velocity and relative flight-path angle are plotted against time from drogue chute deployment in figure 4.17-11. Load factor and altitude are plotted against time from drogue chute deployment in figure 4.17-12.

An EMS scroll (non-exit pattern) is presented in figure 4.17-13(a) with the reference trajectory from 0.05g superimposed upon it. This pattern has limit lines which allow the crew to monitor the entry trajectory to prevent an exit by the spacecraft from the atmosphere ($g < 0.2$). The commanded bank angle and EMS range-to-go are plotted against the inertial velocity in figure 4.17-13(b).

The CM mass properties are shown in table 4.17-II. The conditions at EI are presented in table 4.7-III, and the entry REFSMMAT is presented in table 5-IX.

TABLE 4.17-I.- ENTRY EVENTS SEQUENCE

Event	Time from lift-off hr:min:sec	Time from 400 000 ft min:sec
Entry	244:26:36	0:00
Enter S-band communication blackout	244:26:54	:18
Enter C-band communication blackout Load factor = 0.05g	244:27:05	:29
Maximum heating rate	244:27:46	1:10
Guidance initiate at R-DOT = -700 fps	244:27:54	1:18
Maximum load factor (FIRST)	244:27:58	1:22
Exit C-band communication blackout	244:29:28	2:52
Exit S-band communication blackout	244:29:51	3:15
Maximum load factor (SECOND)	244:32:12	5:36
Termination of CMC guidance	244:33:46	7:10
Drogues parachute deployment	244:34:44	8:08
Main parachutes deployment	244:35:31	8:55
Splashdown	244:40:26	13:50

TABLE 4.17-II.- COMMAND MODULE MASS PROPERTIES

CM weight, lb

Entry	12 229.0
Main chute deploy	11 767.0
Splashdown	11 006.3

Centers of gravity in Apollo
coordinate system, in.

X_A	1 039.8
Y_A	-0.4
Z_A	6.2

Moments of inertia, slug-ft²

I_{XX}	6 287.0
I_{YY}	5 412.0
I_{ZZ}	4 828.0

Products of inertia, slug-ft²

I_{XY}	54.0
I_{XZ}	-417.0
I_{YZ}	-54.0

TABLE 4.17-III.- CONDITIONS AT ENTRY INTERFACE AND TARGET POINT

Elapsed time from launch, hr:min:sec	244:26:36
Inertial velocity, fps	36 128
Inertial flight-path angle, deg	-6.50
Inertial azimuth, deg	86.700
Spacecraft geodetic latitude, deg S	18.659
Spacecraft longitude, deg E	172.757
Altitude, ft	400 095
Target geodetic latitude, deg S	16.04
Target longitude, deg W	165.0

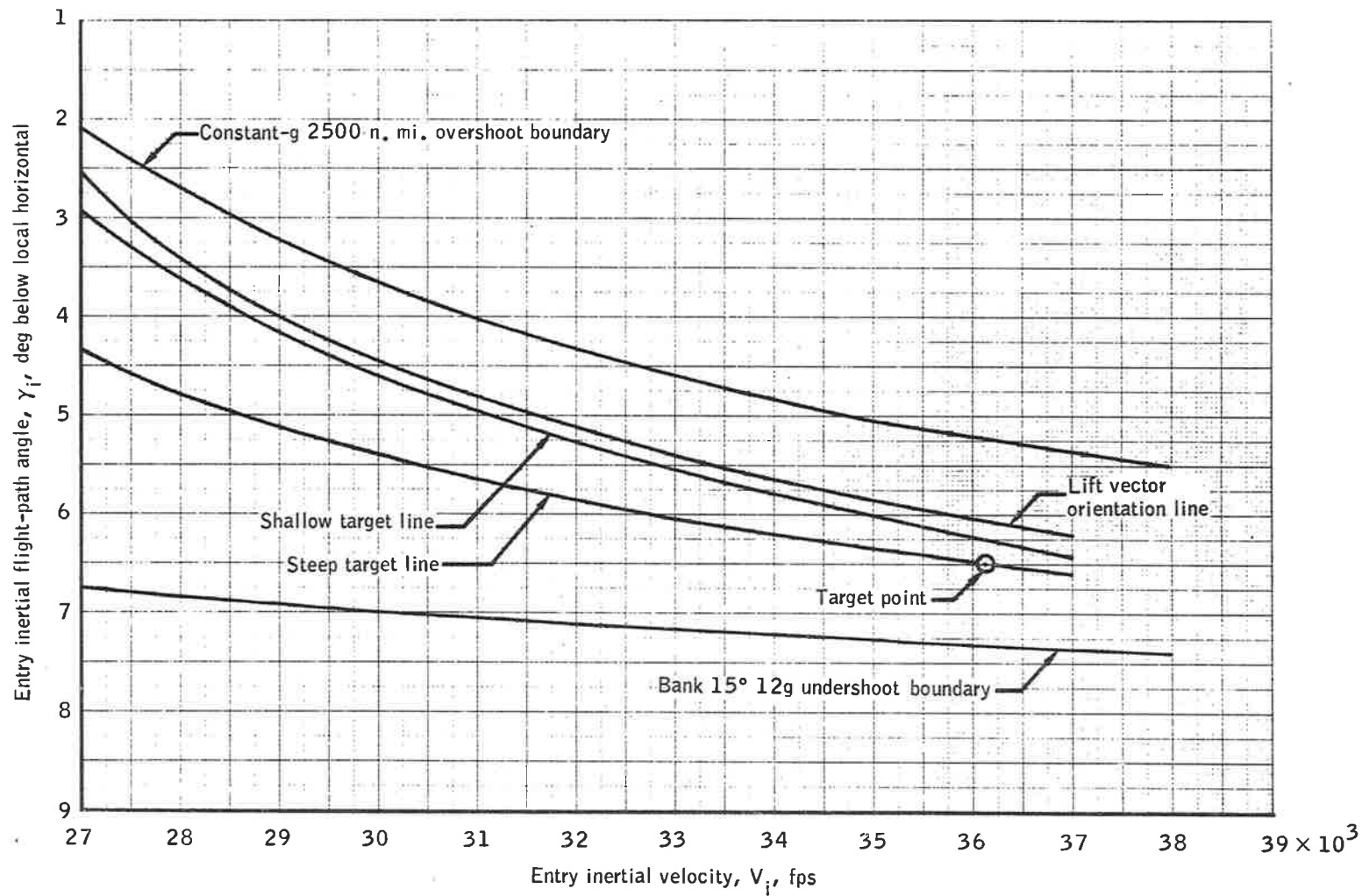

4-202

Figure 4.17-1.- Entry corridor.

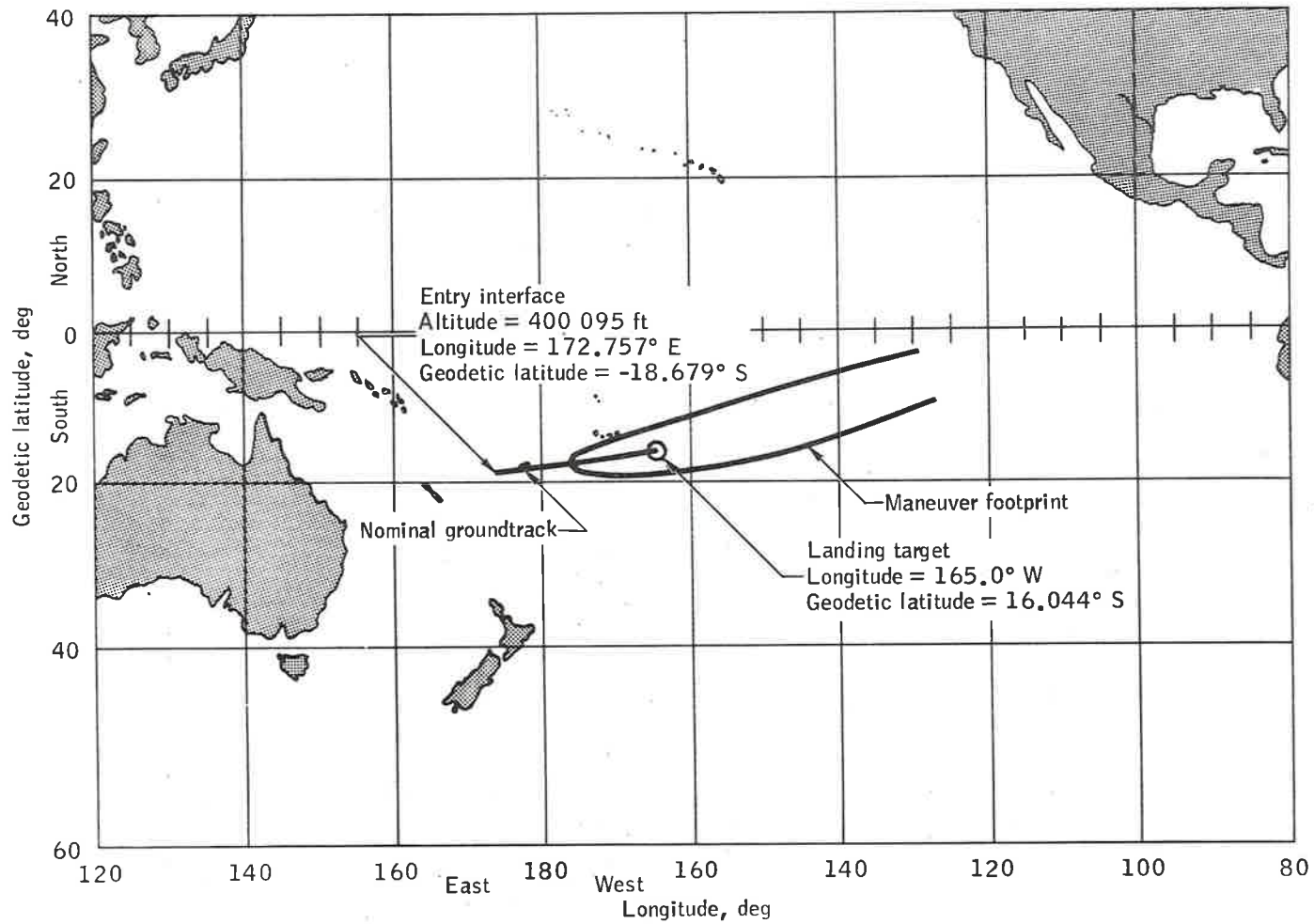

4-203

Figure 4.17-2.- Maneuver footprint and nominal groundtrack.

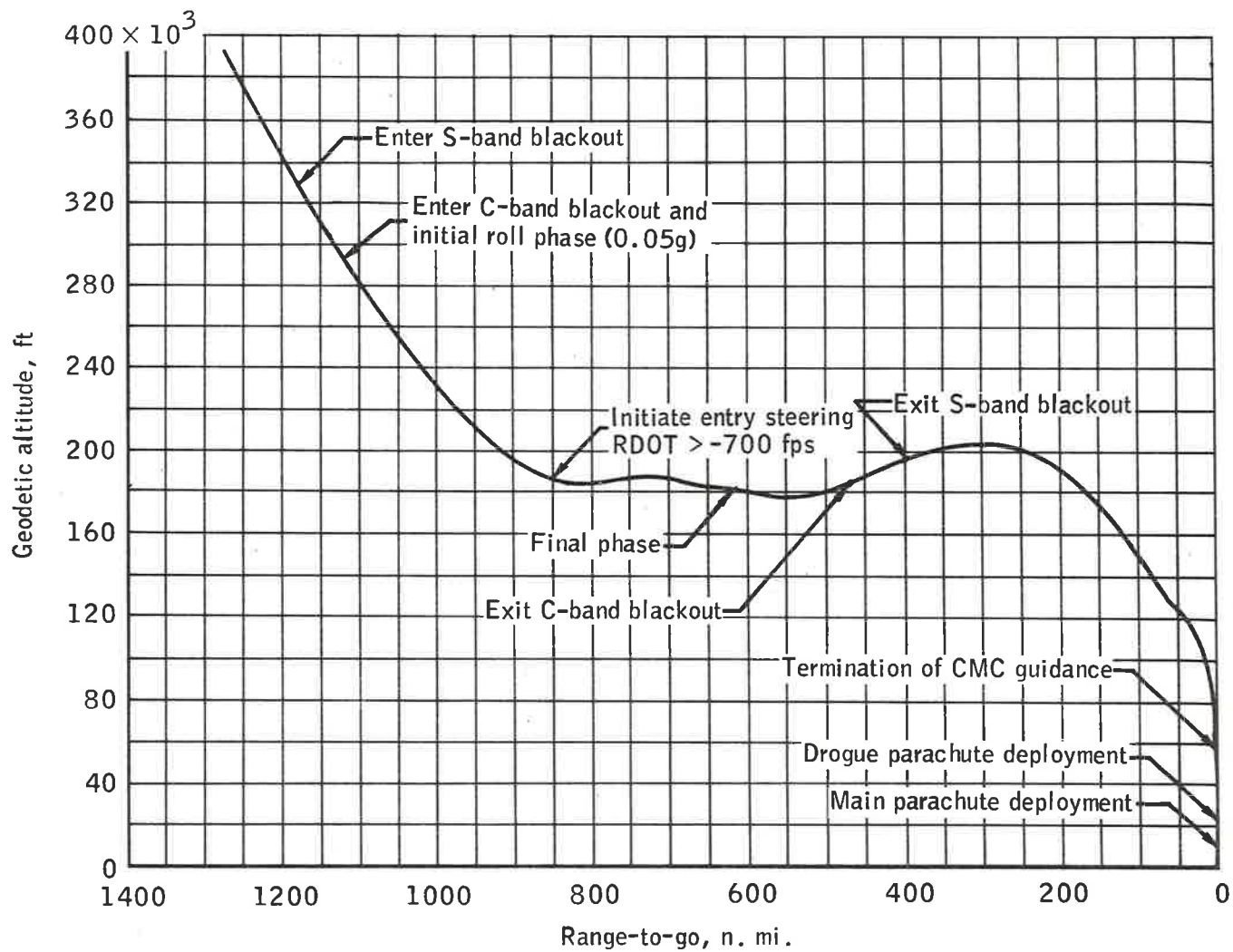

4-204

Figure 4.17-3.- Geodetic altitude versus range-to-go.

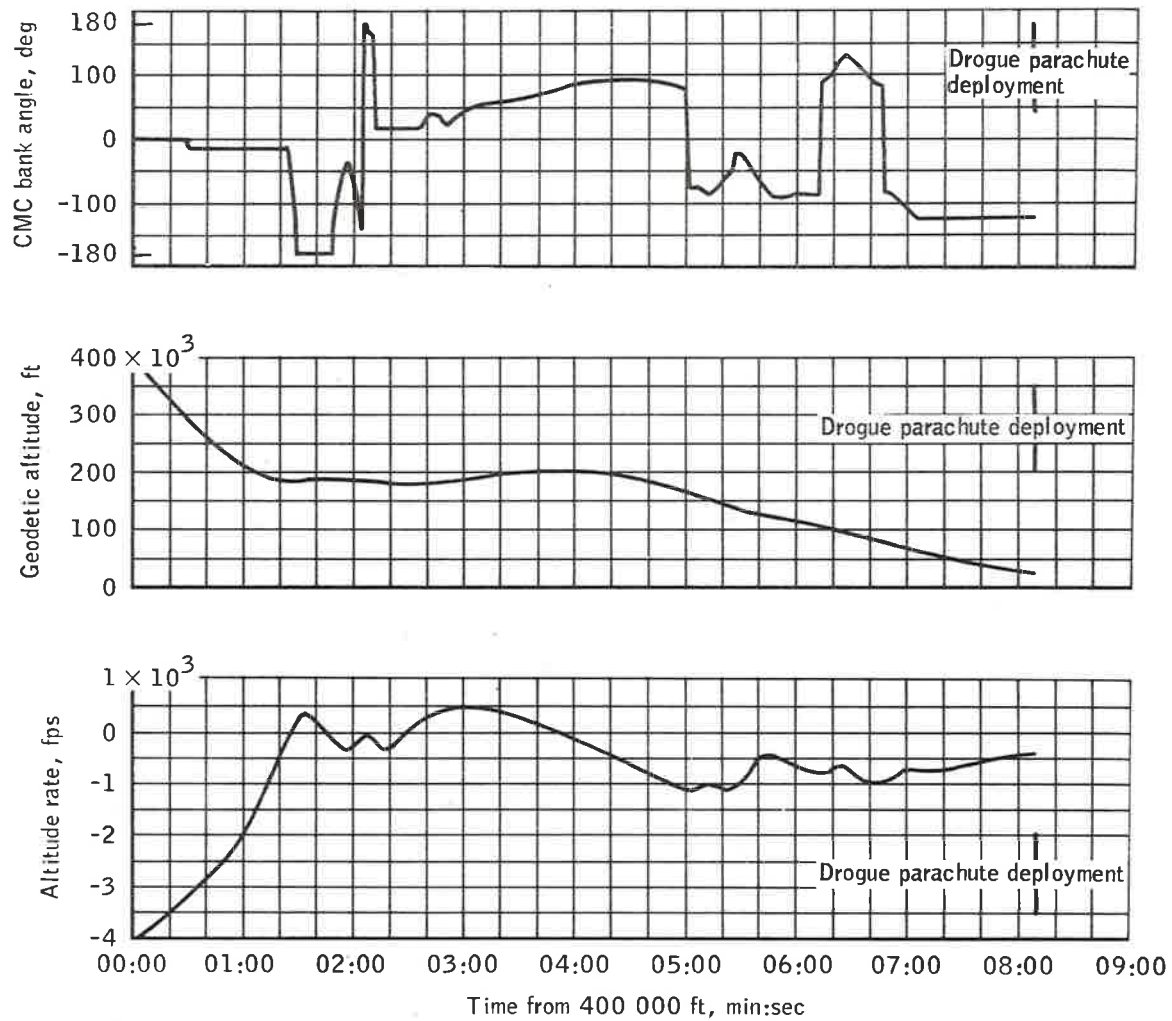

4-205

Figure 4.17-4.- CMC commanded bank angle, altitude, and altitude rate time histories.

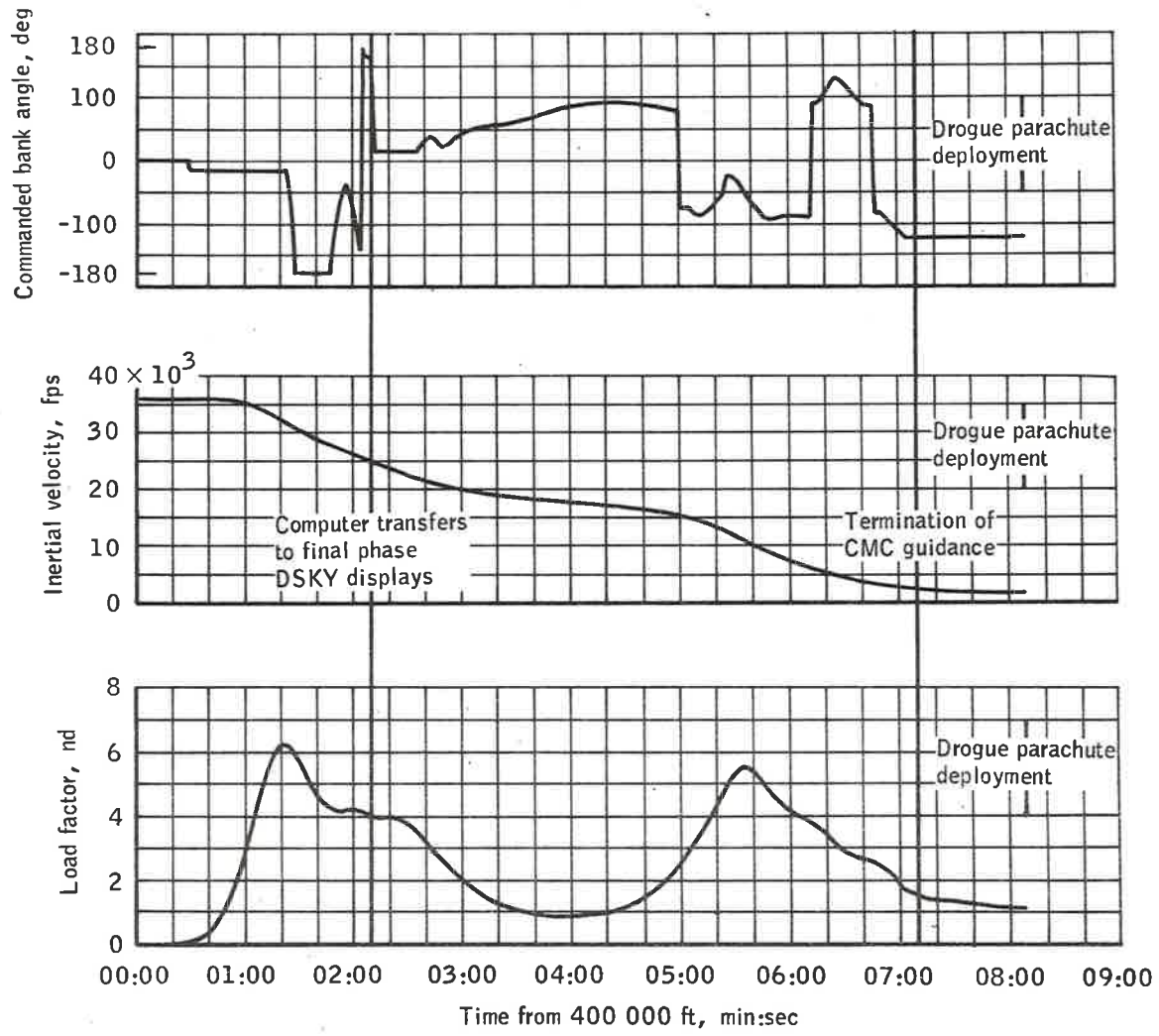
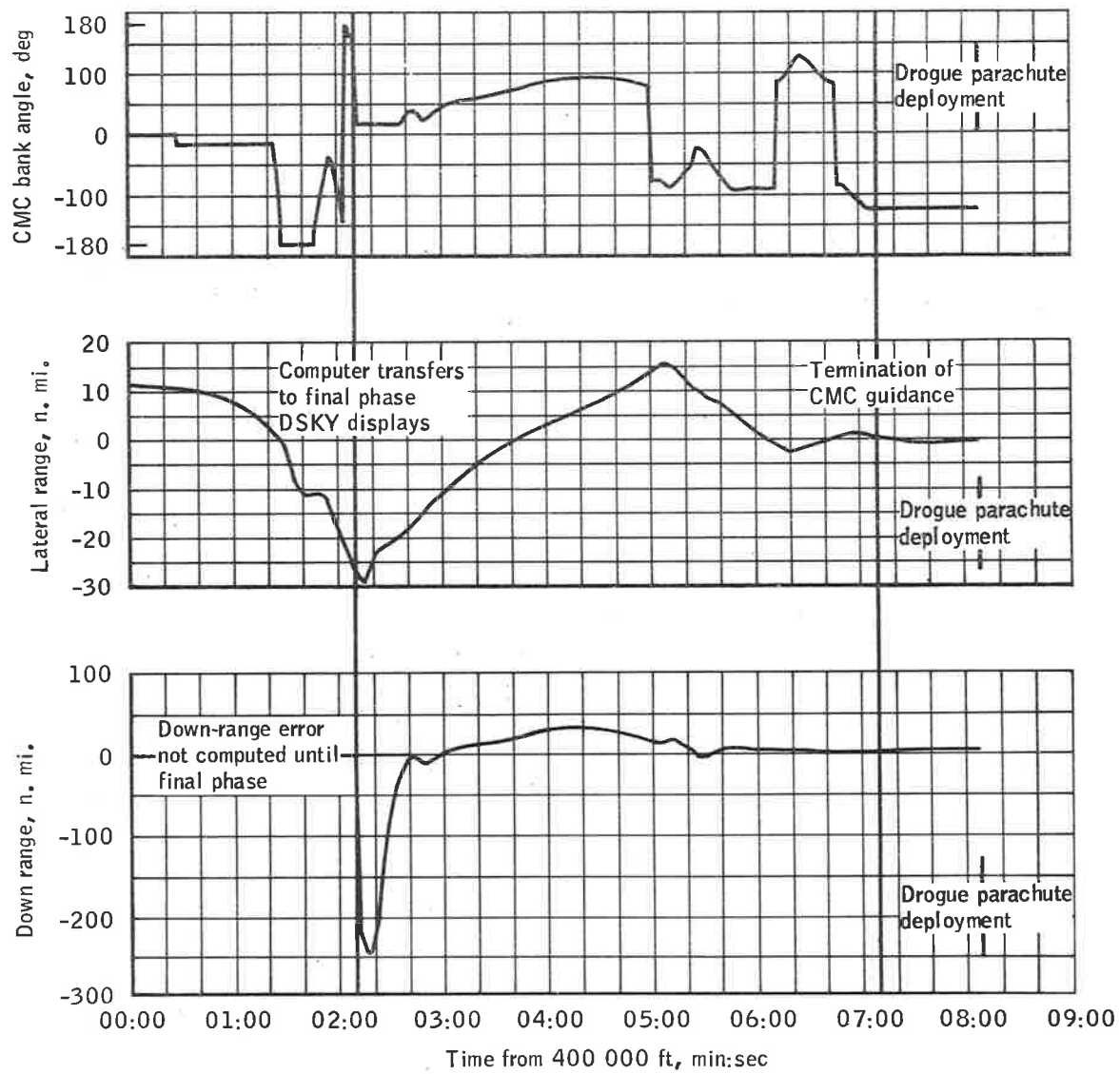

Figure 4.17-9.- Primary DSKY display VERB 06 NOUN 74.



4-211

Figure 4.17-10.- DSKY displays (final phase) VERB 06 NOUN 66.

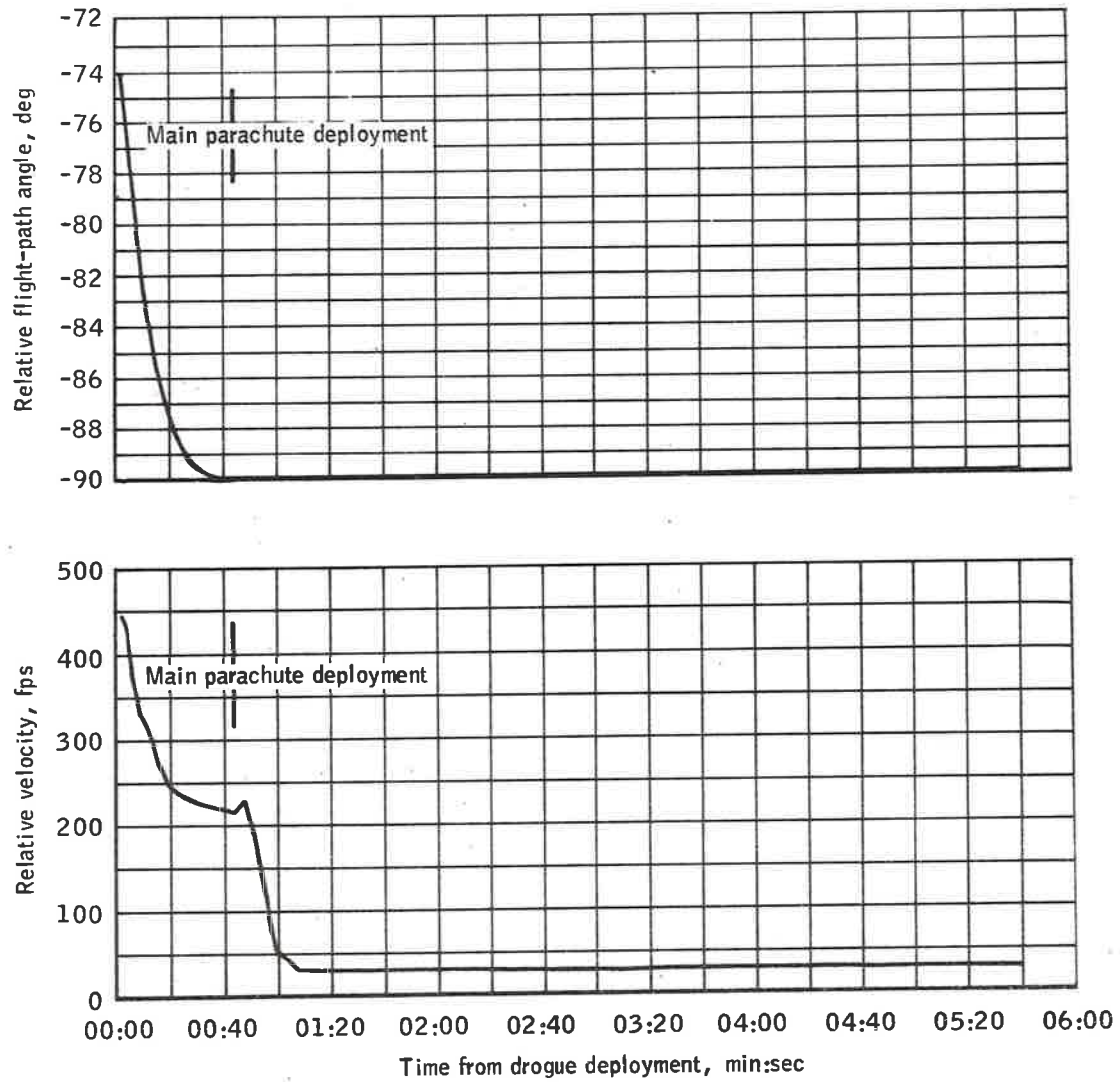
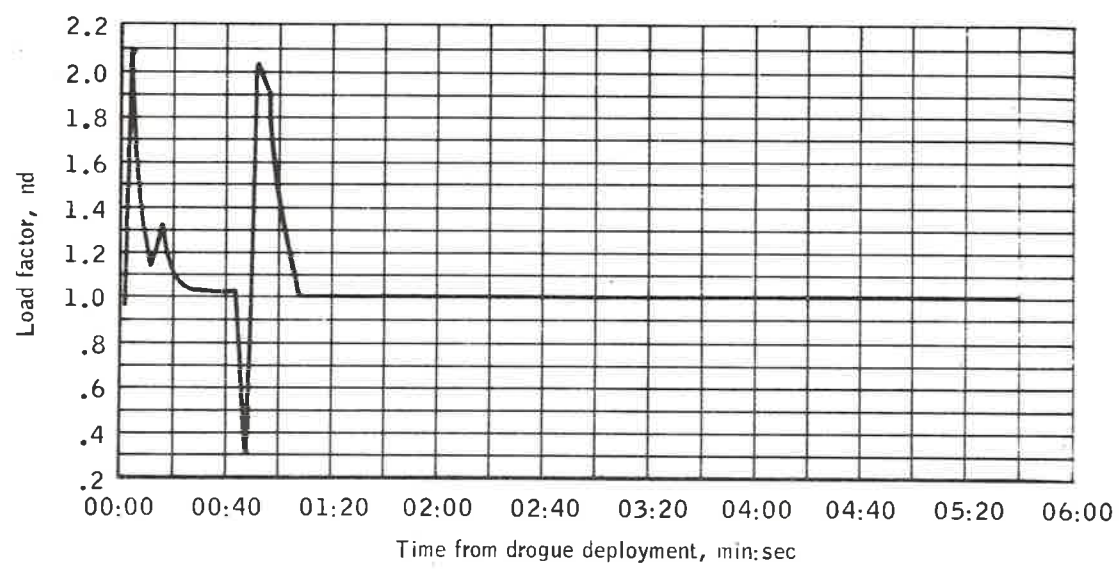
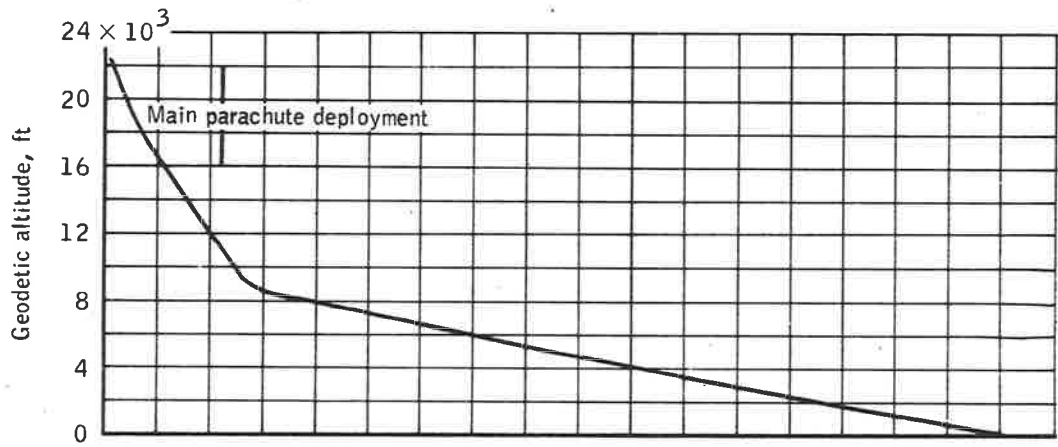
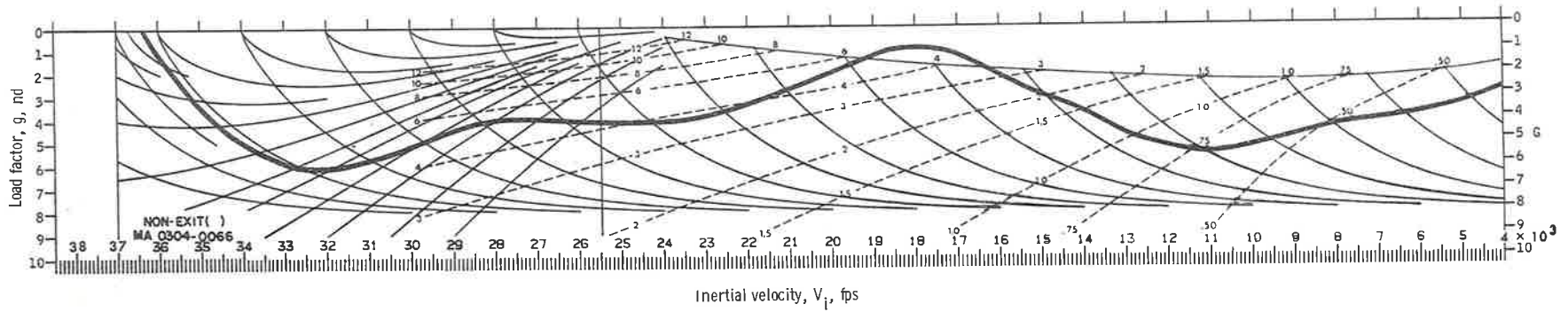

Figure 4.17-11.- Relative velocity and relative flight-path angle time histories from drogue parachute deployment.



4-213

Figure 4.17-12.- Geodetic altitude and load factor time histories from drogue parachute deployment.



(a) Load factor versus inertial velocity.

4-214

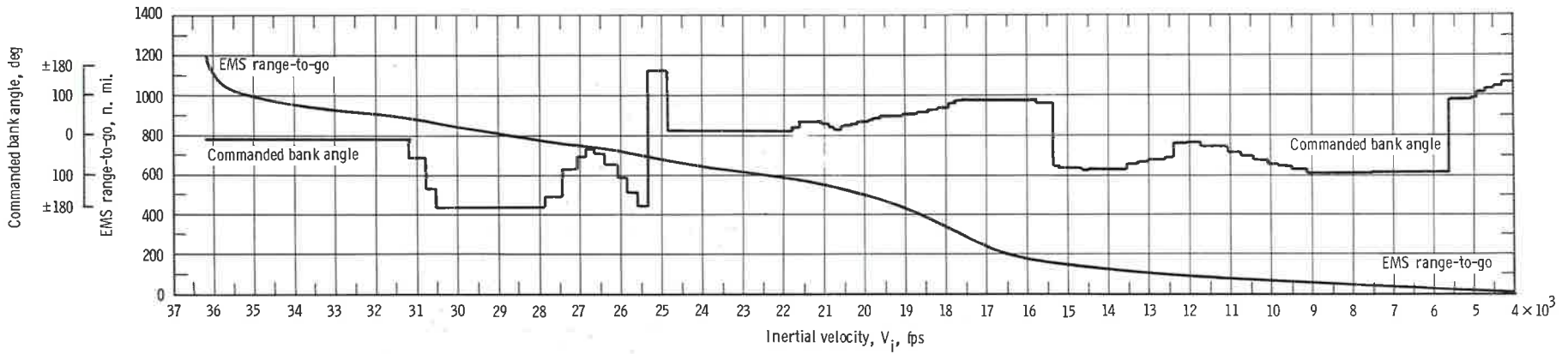

(b) CMC commanded bank angle and EMS range-to-go versus inertial velocity.

Figure 4.17-13, - EMS parameters.

5.0 INPUT DATA

The following input data or reference sources were used to compute the Apollo 12 (H-1) mission operational trajectory.

Launch pad REFSMMAT	Table 5-I
PTC REFSMMAT	Table 5-II
Landing site REFSMMAT	Table 5-III
Special REFSMMAT ^a	Table 5-IV
Preferred (LOPC-1) REFSMMAT	Table 5-V
LM ascent REFSMMAT	Table 5-VI
Preferred (LOPC-2) REFSMMAT	Table 5-VII
Preferred (TEI) REFSMMAT	Table 5-VIII
Entry REFSMMAT	Table 5-IX
Spacecraft weight summary	Table 5-X
Sequential mass properties	Reference 3
Consumables weight change summary.	Reference 3
Assumed mission-independent expendables	Table 5-XI
Service module propulsion per- formance	Table 5-XII
Command module RCS performance	Reference 7
Lunar module propulsion per- formance	Table 5-XIII
Command module aerodynamic parameters	Table 5-XIV
Lunar landing site positions	Table 5-XV
IMU alinement criteria	Table 5-XVI
Terminal rendezvous braking schedule	Table 5-XVII
MSFN station characteristics	Tables 5-XVIII and 5-XIX
Launch trajectory	Reference 1
Mission requirements	Reference 8
Aerodynamic heating data	References 9 and 10
Atmosphere model	Reference 11
Standards and constants	Reference 12
Guidance equations and logic	References 13 and 14

^aThis REFSMMAT represents a change from the landing site REFSMMAT (table 5-III). This change resulted from a small change in LM landing time which was made subsequent to publication of the H-1 Simulator Data Package (ref. 3). It is planned to use only one REFSMMAT for MCC-4, LOI-1, LOI-2, DOI, PDI, and landing; and future documents will reflect only one.

TABLE 5-1.- LAUNCH PAD REFSMMAT

(a) Applicable maneuvers

1. Launch

(b) Definition of REFSMMAT

$$\begin{bmatrix} X \\ Y \\ Z \end{bmatrix} = \begin{bmatrix} XIX & XIY & XIZ \\ YIX & YIY & YIZ \\ ZIX & ZIY & ZIZ \end{bmatrix} \begin{bmatrix} X \\ Y \\ Z \end{bmatrix}$$

SPACECRAFT
PLATFORM
STABLE
MEMBERS

ECI (MNBY)

(c) REFSMMAT components

XIX	=	0.70768873	XIY	=	-0.65236373	XIZ	=	0.27128992
YIX	=	-0.16414623	YIY	=	-0.52528436	YIZ	=	-0.83494452
ZIX	=	0.68719187	ZIY	=	0.54634961	ZIZ	=	-0.47882088

TABLE 5-II.- PTC REFSMMAT

(a) Applicable maneuvers

1. Non-free-return maneuver (MCC-2)
2. Passive thermal control

(b) Definition of REFSMMAT

$$\begin{bmatrix} X \\ Y \\ Z \end{bmatrix} = \begin{bmatrix} XIX & XIY & XIZ \\ YIX & YIY & YIZ \\ ZIX & ZIY & ZIZ \end{bmatrix} \begin{bmatrix} X \\ Y \\ Z \end{bmatrix}$$

SPACECRAFT PLATFORM STABLE MEMBERS ECI(MNBY)

(c) REFSMMAT components

XIX = -0.64278761	XIY = 0.70281115	XIZ = 0.30476315
YIX = 0.76604445	YIY = 0.58972856	YIZ = 0.25572665
ZIX = 0.0	ZIY = 0.39784004	ZIZ = -0.91745479

TABLE 5-III.- LANDING SITE REFSMMAT

(a) Applicable maneuvers

1. LOI-1
2. LOI-2
3. MCC-4

(b) Definition of REFSMMAT

$$\begin{bmatrix} X \\ Y \\ Z \end{bmatrix} \text{ SPACECRAFT PLATFORM STABLE MEMBERS} = \begin{bmatrix} XIX & XIY & XIZ \\ YIX & YIY & YIZ \\ ZIX & ZIY & ZIZ \end{bmatrix} \begin{bmatrix} X \\ Y \\ Z \end{bmatrix} \text{ ECI (MNBY) or MCI (MNB\dot{Y})}$$

(c) REFSMMAT components

XIX	=	-0.88016880	XIY	=	0.45530411	XIZ	=	0.13416806
YIX	=	-0.16028699	YIY	=	-0.55115812	YIZ	=	0.81886068
ZIX	=	0.44677844	ZIY	=	0.69923022	ZIZ	=	0.55809150

TABLE 5-IV.- SPECIAL REFSMMAT^a

(a) Applicable maneuvers

1. CSM separation
2. LM DOI
3. LM powered descent

(b) Definition of REFSMMAT

$$\begin{bmatrix} X \\ Y \\ Z \end{bmatrix} = \begin{bmatrix} XIX & XIY & XIZ \\ YIX & YIY & YIZ \\ ZIX & ZIY & ZIZ \end{bmatrix} \begin{bmatrix} X \\ Y \\ Z \end{bmatrix}$$

SPACECRAFT
PLATFORM
STABLE
MEMBERS
ECI(MNBY) or
MCI(MNBY)

(c) REFSMMAT components

XIX	=	-0.87988016	XIY	=	0.45580302	XIZ	=	0.13436711
YIX	=	-0.16042743	YIY	=	-0.55108787	YIZ	=	0.81888047
ZIX	=	0.44729628	ZIY	=	0.69896051	ZIZ	=	0.55801459

^aThis REFSMMAT represents a change from the landing site REFSMMAT (table 5-III). This change resulted from a small change in LM landing time which was made subsequent to publication of the H-1 Simulator Data Package (ref. 3). It is planned to use only one REFSMMAT for MCC-4, LOI-1, LOI-2, DOI, PDI, and landing; and future documents will reflect only one.

TABLE 5-V.- PREFERRED (LOPC-1) REFSMMAT

(a) Applicable maneuver

1. LOPC-1

(b) Definition of REFSMMAT

$$\begin{bmatrix} X \\ Y \\ Z \end{bmatrix} = \begin{bmatrix} XIX & XIY & XIZ \\ YIX & YIY & YIZ \\ ZIX & ZIY & ZIZ \end{bmatrix} \begin{bmatrix} X \\ Y \\ Z \end{bmatrix}$$

SPACECRAFT
PLATFORM
STABLE
MEMBERS

ECI(MNBY) or
MCI(MNBY)

(c) REFSMMAT components

XIX	=	-0.12663911	XIY	=	-0.56259131	XIZ	=	0.81697831
YIX	=	-0.95686775	YIY	=	0.28638127	YIZ	=	0.048885917
ZIX	=	-0.26147008	ZIY	=	-0.77554934	ZIZ	=	-0.57459255

TABLE 5-VI.- LM ASCENT REFSMMAT

(a) Applicable maneuvers

1. LM ascent
2. CSI
3. CDH
4. TPI
5. CSM separation following LM jettison

(b) Definition of REFSMMAT

$$\begin{bmatrix} X \\ Y \\ Z \end{bmatrix} = \begin{bmatrix} XIX & XIY & XIZ \\ YIX & YIY & YIZ \\ ZIX & ZIY & ZIZ \end{bmatrix} \begin{bmatrix} X \\ Y \\ Z \end{bmatrix}$$

SPACECRAFT
 PLATFORM
 STABLE
 MEMBERS

ECI(MNBY) or
 MCI(MNBY)

(c) REFSMMAT components

XIX = -0.98067976	XIY = 0.19339904	XIZ = 0.029394829
YIX = -0.089024482	YIY = -0.57503148	YIZ = 0.81327330
ZIX = 0.17418922	ZIY = 0.79494378	ZIZ = 0.58113898

TABLE 5-VII.- PREFERRED (LOPC-2) REFSMMAT

(a) Applicable maneuvers

1. LOPC-2

(b) Definition of REFSMMAT

$$\begin{bmatrix} X \\ Y \\ Z \end{bmatrix} = \begin{bmatrix} XIX & XIY & XIZ \\ YIX & YIY & YIZ \\ ZIX & ZIY & ZIZ \end{bmatrix} \begin{bmatrix} X \\ Y \\ Z \end{bmatrix}$$

SPACECRAFT PLATFORM STABLE MEMBERS
 ECI(MNBY) or MCI(MNBY)

(c) REFSMMAT components

XIX	=	-0.059483849	XIY	=	-0.57365426	XIZ	=	0.81693479
YIX	=	-0.97755460	YIY	=	-0.13222167	YIZ	=	-0.16402562
ZIX	=	0.20211048	ZIY	=	-0.80835525	ZIZ	=	-0.55291332

TABLE 5-VIII.- PREFERRED (TEI) REFSMMAT

(a) Applicable maneuvers

1. TEI

(b) Definition of REFSMMAT

$$\begin{bmatrix} X \\ Y \\ Z \end{bmatrix} = \begin{bmatrix} XIX & XIY & XIZ \\ YIX & YIY & YIZ \\ ZIX & ZIY & ZIZ \end{bmatrix} \begin{bmatrix} X \\ Y \\ Z \end{bmatrix}$$

SPACECRAFT
PLATFORM
STABLE
MEMBERS

ECI(MNBY) or
MCI(MNBY)

(c) REFSMMAT components

XIX	=	0.57785334	ZIY	=	-0.72768623	XIZ	=	-0.36953793
YIX	=	0.084969430	YIY	=	0.50396717	YIZ	=	-0.85953318
ZIX	=	0.81170545	ZIZ	=	0.46528469	ZIZ	=	0.35305020

TABLE 5-IX.- ENTRY REFSMMAT

(a) Applicable maneuvers

1. Entry

(b) Definition of REFSMMAT

$$\begin{bmatrix} X \\ Y \\ Z \end{bmatrix} = \begin{bmatrix} XIX & XIY & XIZ \\ YIX & YIY & YIZ \\ ZIX & ZIY & ZIZ \end{bmatrix} \begin{bmatrix} X \\ Y \\ Z \end{bmatrix}$$

SPACECRAFT PLATFORM STABLE MEMBERS ECI(MNBY)

(c) REFSMMAT components

XIX = .13015041	XIY = -.98999549	XIZ = .05449596
YIX = .32253844	YIY = -.0096993153	YIZ = -.94650666
ZIX = .93756590	ZIY = .14076527	ZIZ = .31804923

TABLE 5-X.- SPACECRAFT WEIGHT SUMMARY

Total CSM inert, lb	22 968.8
CM inert, lb	12 363.0
SM inert, lb	10 507.8
SLA ring, lb	98.0
 Total SPS propellant tanked, lb	 40 593.4
SPS deliverable, lb	40 354.1
SPS trapped, lb	239.3
 Total LM at earth launch, lb	 33 231.5
LM DPS inert, lb	4 646.5
LM DPS tanked, lb	18 091.4
LM APS inert, lb	5 271.0
LM APS tanked, lb	5 222.6
 Spacecraft at earth launch (including LES), lb	 109 653.4
 Spacecraft before T & D	 100 743.0

TABLE 5-XI.- ASSUMED MISSION-INDEPENDENT EXPENDABLES

Mission-independent SPS budget	
Translunar MCC (100 fps), lb	1130
Transearth MCC (0 fps), lb	0
SPS propellant allowances	
Unbalance meter, lb	100
Mean outage, lb	59
Dispersions, lb	426

TABLE 5-XII.- SERVICE MODULE PROPULSION PERFORMANCE SUMMARY

Propulsion system	I_{sp} , sec	Thrust, lb	Flow rate, lb/sec
SPS	314.4	20 520.0	65.267
RCS (four quad)	228.5	354.15	1.550

TABLE XIII.- LUNAR MODULE PERFORMANCE TABULAR INPUTS

Descent				Ascent		
DPS		RCS		APS + RCS		
Thrust, lb	I_{sp} , sec	Thrust per engine, lb	I_{sp} , sec	Burn time, sec	Effective thrust, lb	Effective I_{sp} , sec
1050	293.6	100.3	281.0	0	3565.5	308.7
2807	296.6			40	3534.3	308.7
3216	298.0			80	3516.9	308.8
4315	300.0			120	3505.7	308.9
5851	303.7			160	3496.2	308.8
9819	303.5			200	3486.1	309.05
9903	302.4			240	3475.3	308.9
				280	3464.2	309.03
				320	3453.8	309.2
				360	3454.5	309.3
				400	3459.0	309.1
				430.6	3462.4	309.1

TABLE 5-XIV.- COMMAND MODULE AERODYNAMIC COEFFICIENTS

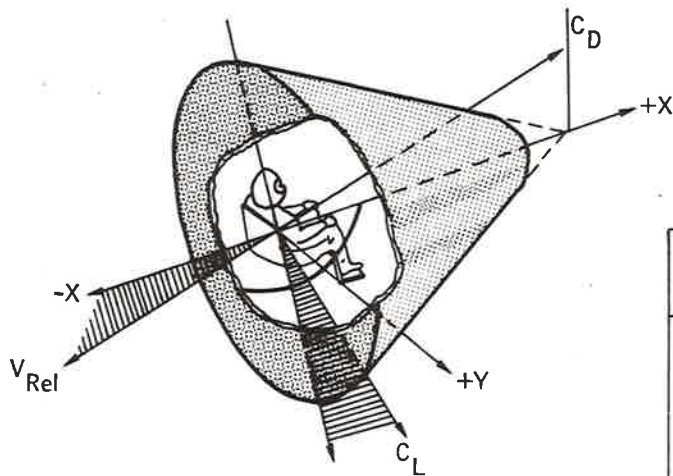

AERODYNAMIC COEFFICIENTS AT TRIM ANGLE OF ATTACK
AS A FUNCTION OF MACH NUMBER

M	α , deg	C_L	C_D	L/D
0.4	166.65	0.25540	0.85104	0.30011
0.7	163.78	0.27015	0.98128	0.27530
0.9	161.08	0.32941	1.0600	0.31076
1.1	154.04	0.50613	1.1596	0.43646
1.2	154.41	0.49002	1.1474	0.42707
1.35	153.29	0.57558	1.2694	0.45342
1.65	152.54	0.55850	1.2570	0.44432
2.0	152.43	0.53830	1.2581	0.42786
2.4	152.88	0.51366	1.2267	0.41874
3.0	153.46	0.48482	1.2018	0.40342
4.0	155.51	0.44803	1.2032	0.37235
10.0	156.21	0.43489	1.2127	0.35862
29.5	159.48	0.39557	1.2778	0.30956

Center of gravity location in body coordinates

$X_{cg} = 1039.8$ in.

$Y_{cg} = -.4$ in

$Z_{cg} = 6.2$ in.

TABLE 5-XV.- LUNAR LANDING AND PHOTOGRAPHY SITE POSITIONS

Launch date	Lunar site name	Latitude, deg	Longitude, deg	Altitude, ^a n. mi.
Nov. 14	Site 7	-2.9425	-23.44333	-1.19
	Descartes ^b	-10.0	16.0	
	Descartes ^c	-8.85	15.5667	
	Fra Mauro	-3.7333	-17.50	
Nov. 16	Site 5	1.67806	-41.8992	-1.25
	Hipparchus	-4.6667	-3.85	
	Fra Mauro	-3.7333	-17.50	

^aReference radius = 938.5 n. mi.

^bVolume II photography site.

^cCurrent photography site.

TABLE 5-XVI.- IMU ALINEMENT CRITERIA AND REFSMMAT DEFINITIONS

Applicable maneuvers	REFSMMAT	Alinement criteria (IMU axis)	Remarks
Launch TLI T&D MCC-1	Launch Pad (CSM only)	X-axis along launch azimuth at pad Z-axis along negative radius vector Y-axis completes right-hand system	At earth launch, the FDAI will display roll = 180° pitch = 90° yaw = 0°
MCC-2 (Hybrid transfer) MCC-3	PTC (passive thermal control) (CSM only)	X-axis in the ecliptic plane and perpendicular to the earth-moon line projection in the ecliptic plane at the average time of transearth injection for the monthly launch window and azimuth range. Z-axis perpendicular to the ecliptic and directed south. Y-axis completes the right-hand system.	At the beginning of the Barbeque mode, the spacecraft will maneuver to an FDAI display of roll = 0° pitch = 90° yaw = 0°
MCC-4 LOI-1 LOI-2	Landing site (CSM and LM)	X-axis along positive lunar radius vector at landing site at predicted landing time. Z-axis in direction of flight parallel to the CSM orbital plane and perpendicular to X. Y-axis completes the right-hand system.	At nominal touchdown, the LM FDAI will display roll = 0° pitch = 0° yaw = 0° (Actual touchdown yaw and slope tilt will be reflected by the FDAI.)
DOI PDI Landing	Special	Same as above landing site alignment	See footnote at bottom of table 5-IV.
CSM plane changes	Preferred (CSM only)	X-axis aligned with the spacecraft X-body axis at the vehicle attitude for ignition with the thrust directed through the center of gravity. Z-axis in the plane formed by the X-axis and position vector and directed down towards the moon. Y-axis completes the right-hand system.	At burn ignition, the FDAI will display roll = 0° pitch = 0° yaw = 0°
LM lift-off rendezvous	Lift-off (CSM and LM)	X-axis along positive lunar radius vector at landing site at predicted lift-off time. Z-axis down range parallel to the CSM orbital plane and perpendicular to X. Y-axis completes the right-hand system.	At nominal lift-off time, the LM FDAI will display roll = 0° pitch = 0° yaw = 0° (Actual touchdown yaw and slope tilt angles will be reflected.)
TEI	Preferred (CSM only)	Same as above Preferred alignment.	Same as above Preferred remarks.
MCC-5 MCC-6 MCC-7	PTC (CSM only)	Same as above PTC alignment.	Same as above PTC remarks.
Entry	Entry (CSM only)	X-axis is in local horizontal plane in the direction of flight at entry interface (400 000 ft). Z-axis is down along negative radius at entry interface. Y-axis completes right-hand system.	At entry interface with wings level local horizontal, heat shield forward, in place, lift up, heads down, the FDAI will display roll = 0° pitch = 180° yaw = 0°

TABLE 5-XVII.- LM BRAKING SCHEDULE
DURING TERMINAL RENDEZVOUS PHASE

Gate	Range, ft	Desired range rate, fps
First	6000	35
Second	3000	20
Third	1500	10
Fourth	500	5
Fifth	100	0.25

TABLE 5-XVIII. - MSFN STATION CHARACTERISTICS

Geodetic latitude, LATR, deg
 Longitude, LONR, deg
 Altitude, ALTR, ft
 Range capability, SRANGE, n. mi.

Keyhole, FTINDC: 0 = none
 1 = north-south
 2 = east-west

RADAR	■MLA-71 AZ-EL TPQ18,	LATR	■ 28.424862,	LONR	■ -80.4644n4
ALTR	■ 39.372,	SRANGE	■ 23400.0,	FTINDC	■ 0.0
RADAR	■CNV-31 AZ-EL FPS16,	LATR	■ 28.481767,	LONR	■ -80.576514
ALTR	■ 45.934,	SRANGE	■ 1000.0,	FTINDC	■ 0.0
RADAR	■BDA-02 AZ-EL FPQ6,	LATR	■ 32.347964,	LONR	■ -64.453742
ALTR	■ 62.339,	SRANGE	■ 23400.0,	FTINDC	■ 0.0
RADAR	■CRO-08 AZ-EL FPQ6,	LATR	■ -24.896389,	LONR	■ 113.717289
ALTR	■ 78.744,	SRANGE	■ 23400.0,	FTINDC	■ 0.0
RADAR	■MIL-71 X-Y USB-30,	LATR	■ 28.508272,	LONR	■ -80.493417
ALTR	■ 32.810,	SRANGE	■ 30000.0,	FTINDC	■ 1.0
RADAR	■BDA-02 X-Y USB-30,	LATR	■ 32.351286,	LONR	■ -64.458181
ALTR	■ 68.901,	SRANGE	■ 30000.0,	FTINDC	■ 1.0
RADAR	■ANG-91 X-Y USB-30,	LATR	■ 17.016917,	LONR	■ -61.752849
ALTR	■ 141.083,	SRANGE	■ 30000.0,	FTINDC	■ 1.0
RADAR	■CYI-04 X-Y USB-30,	LATR	■ 27.764536,	LONR	■ -15.434814
ALTR	■ 567.613,	SRANGE	■ 30000.0,	FTINDC	■ 1.0
RADAR	■ACN-75 X-Y USB-30,	LATR	■ -7.954794,	LONR	■ -14.327128
ALTR	■ 1784.864,	SRANGE	■ 30000.0,	FTINDC	■ 1.0
RADAR	■CRO-08 X-Y USB-30,	LATR	■ -24.906578,	LONR	■ 113.725458
ALTR	■ 65.620,	SRANGE	■ 30000.0,	FTINDC	■ 1.0
RADAR	■GWM-24 X-Y USB-30,	LATR	■ 13.310575,	LONR	■ 144.736917
ALTR	■ 301.852,	SRANGE	■ 30000.0,	FTINDC	■ 1.0
RADAR	■HAW-12 X-Y USB-30,	LATR	■ 22.124307,	LONR	■ -159.665669
ALTR	■ 3776.431,	SRANGE	■ 30000.0,	FTINDC	■ 1.0
RADAR	■GYM-14 X-Y USB-30,	LATR	■ 27.963206,	LONR	■ -110.720850
ALTR	■ 62.339,	SRANGE	■ 30000.0,	FTINDC	■ 1.0
RADAR	■MAD-23 X-Y USB-85,	LATR	■ 40.454992,	LONR	■ -4.167994
ALTR	■ 2553.930,	SRANGE	■ 50000.0,	FTINDC	■ 2.0
RADAR	■MSK-25 X-Y USB-85,	LATR	■ -35.583494,	LONR	■ 148.978286
ALTR	■ 3755.433,	SRANGE	■ 50000.0,	FTINDC	■ 2.0
RADAR	■GDS-28 X-Y USB-85,	LATR	■ 35.341594,	LONR	■ -116.873200
ALTR	■ 2976.195,	SRANGE	■ 50000.0,	FTINDC	■ 2.0
RADAR	■ PARKS AUSTRALIA,	LATR	■ -33.000111,	LONR	■ 148.26167
ALTR	■ 1230.375,	SRANGE	■ 30000.0,	FTINDC	■ 0.0
RADAR	■ INSERT SHIP1,	LATR	■ 28.000,	LONR	■ -49.00n
ALTR	■ 0.0,	SRANGE	■ 23400.0,	FTINDC	■ 0.0

TABLE 5-XIX.- MSFN STATION IDENTIFICATION

MLA CB	Merritt Island C-band
CNV CB	Cape Kennedy C-band
BDA CB	Bermuda C-band
CRO CB	Carnarvon C-band
SHIP 1 CB	Insertion Ship
MIL SB	Merritt Island S-band
BDA SB	Bermuda S-band
ANG SB	Antigua S-band
CYI SB	Grand Canary S-band
ACN SB	Ascension S-band
CRO SB	Carnarvon S-band
GWM SB	Guam S-band
HAW SB	Hawaii S-band
GYM SB	Guaymas S-band
MAD DS	Madrid deep space
HSK DS	Canberra deep space
GDS DS	Goldstone deep space

6.0 REFERENCES

1. AS-507 November Launch Operation Trajectory. MSFC memo S&E-AERO-MFT-188-69, August 25, 1969, and Boeing document D5-15551(F)-7, August 12, 1969.
2. Apollo Mission Techniques, Missions F and G, Transearth Injection, Midcourse Corrections, and Entry. MSC IN SPA-9T-040, February 24, 1969, revised June 6, 1969.
3. Apollo 12 (H-1) Mission Operational Trajectory Simulator Data Package. MSC memo 69-FM13-448, August 28, 1969.
4. CSM/LM Spacecraft Operational Data Book, Volume III - Mass Properties. SNA-8-D-027, through amendment 65, Rev 1, November 1968.
5. CSM/LM Spacecraft Operational Data Book, Volume II - LM Data Book. SNA-8-D-027 (II), Rev 1, through amendments 1-132 and 2-188, March 15, 1969.
6. RTCC Requirements: Revised S-band Communication Blackout Data for Apollo F and Subsequent Missions. MSC memo 69-FM23-43, February 26, 1969.
7. CSM/LM Spacecraft Operational Data Book, Volume I - CSM Data Book. SNA-8-D-027 (I) Rev 1, through amendments 1-138 and 2-154, November 1, 1968.
8. Mission Requirements, SA-507/CSM-108/LM-6, H-1 Type Mission. SPD9-R-051, July 18, 1969.
9. Ried, Robert C., Jr.: Apollo Command Module Entry Air Radiation Heating Rate. MSC memo ES5/1-2/67, January 9, 1968.
10. Heating Rate Factors for Reentry Studies. MSC memo ES5/9-11/173M, September 14, 1967.
11. United States Weather Bureau: U. S. Standard Atmosphere, 1962. December 1962.
12. Apollo Navigation Working Group: Apollo Missions and Navigation Systems Characteristics. Technical report no. AN-1.3, December 15, 1967.

13. MIT: Guidance Systems Operations Plan for Manned CM Earth
Orbital and Lunar Missions Using Program COLOSSUS, Section 5,
Guidance Equations, Revision 2. R577, December 1968.
14. Tolin, J. W., Jr.: RTCC Requirements for Missions F and G Reentry
Phase. MSC IN 69-FM-28, February 6, 1969.