

C65-8261
~~CONFIDENTIAL~~
DOWNGRADED AT 7 YEAR INTERVALS:
DECLASSIFIED AFTER 12 YEARS
DOI DAR 5200.10

CLASSIFICATION CHANGE

UNCLASSIFIED

To: _____
By authority of GDW - Eo 11652 Date 12/11/62
Changed by L. Shirley
Classified Document Master Control Station, NASA
Scientific and Technical Information Facility

MASSACHUSETTS INSTITUTE OF TECHNOLOGY

APOLLO

GUIDANCE AND NAVIGATION

Approved: Milton B. Trageser Date: 1/19/65
MILTON B. TRAGESER, DIRECTOR
APOLLO GUIDANCE AND NAVIGATION PROGRAM

Approved: Roger B. Woodbury Date: 7/2/65
ROGER B. WOODBURY, DEPUTY DIRECTOR
INSTRUMENTATION LABORATORY

TYPE I DOCUMENT
APPROVED BY NASA

R-477 (Rev. 1)
(Unclassified Title)

GUIDANCE AND NAVIGATION
SYSTEM OPERATIONS PLAN
APOLLO MISSION 202

July 1965

John M. Dahlen
Albrecht Kosmala
Daniel J. Lickly
Raymond H. Morth
John T. Shillingford
Balraj Sökkappa



INSTRUMENTATION LABORATORY

CAMBRIDGE 39, MASSACHUSETTS

COPY # 327 OF 360 COPIES
THIS DOCUMENT CONTAINS 208 PAGES

~~CONFIDENTIAL~~

ACKNOWLEDGEMENT

This report was prepared under DSR Project 55-238, sponsored by the Manned Spacecraft Center of the National Aeronautics and Space Administration through Contract NAS 9-4065.

~~This document contains information affecting the national defense of the United States within the meaning of the Espionage Laws, Title 18, U.S.C., Sections 793 and 794, the transmission or the revelation of which in any manner to an unauthorized person is prohibited by law.~~

TABLE OF CONTENTS

Section	
1	INTRODUCTION
2	G&N FLIGHT OPERATIONS SUMMARY
3	LOGIC AND TIMELINE FOR SPACE - CRAFT AND MISSION CONTROL
4	GUIDANCE EQUATIONS
5	CONTROL DATA
6	G&N ERROR ANALYSIS
7	G&N CONFIGURATION
8	INSTRUMENTATION
9	G&N PERFORMANCE ANALYSIS
10	DISTRIBUTION

Alteration of technical content since R-477 January 1965
is indicated by "(Rev. 1 - 7/65)" at bottom of page.

1. INTRODUCTION

1.1 Purpose

This plan governs the operation of the Guidance and Navigation System and defines its functional interface with the spacecraft and ground support systems on Mission 202.

1.2 Authority

This plan constitutes a control document to govern the implementation of:

- (1) Detailed G&N flight test objectives
- (2) G&N interfaces with the spacecraft and launch vehicle
- (3) Digital UPLINK to the Apollo Guidance Computer (AGC)
- (4) AGC logic and timeline for spacecraft control*
- (5) Guidance and navigation equations*
- (6) Digital DOWNLINK from the AGC
- (7) G&N System configuration

Revisions to this plan which reflect changes in control items (1) through (7) require approval of the NASA Configuration Control Board.

This plan also constitutes an information document to define:

- (1) Trajectory uncertainties due to G&N component errors (Error Analysis)
- (2) Trajectory deviations due to spacecraft performance variations and launch vehicle cut-off dispersions (Performance Analysis)
- (3) G&N instrumentation (PCM telemetry and on-board recording) exclusive of AGC DOWNLINK
- (4) External tracking data

Revisions to this plan which reflect changes in information items (1) through (4) will not require approval of the NASA CCB.

*To support these functions this document contains a Control Data section which defines the reference trajectory, AGC memory data and applicable mission data (mass, propulsion, aerodynamic and SCS data)

2. G&N FLIGHT OPERATIONS SUMMARY

This section defines the mission plan as originated by NASA and summarizes the manner in which the G&N system will operate to implement this plan as developed by MIT in cooperation with NASA and NAA/S&ID. This section is divided into three parts:

- Par 2.1 Test Objectives
- Par 2.2 Spacecraft and Mission Control
- Par 2.3 Mission Description

2.1 Test Objectives

2.1.1 Spacecraft Test Objectives which require proper operation of G&N System:

- 1) Evaluate the thermal performance of the CM heat shield ablator during a high heat load, long duration entry.
- 2) Demonstrate CM adequacy for manned entry from low earth orbit.
- 3) Determine nominal mode separation characteristics of the CSM from the SIVB and the CM from the SM.
- 4) Demonstrate multiple SPS restart (after the second major burn, two 3 second burns with 10 second intervals between burns are required).
- 5) Determine performance of CSM systems: G&N, SCS, ECS (pressure and temperature control), EPS, RCS and Telecommunications.

2.1.2 Detailed G&N Test Objectives

- 1) Evaluate performance of the following integrated G&N/Spacecraft modes of operation:
 - a. Boost Monitor
 - b. Thrust Vector Control
 - c. Orbit Attitude Control
 - d. Lift Vector Control
 - e. Unmanned Spacecraft Control
- 2) Determine accuracy of G&N system in computation of spacecraft position and velocity during all mission phases.

2.2 Spacecraft & Mission Control

2.2.1 Spacecraft Control

Spacecraft Control is implemented by the Apollo Guidance Computer (AGC) provided by MIT and the Mission Control Programmer (MCP) provided by NAA/S&ID. Basically, the MCP performs those non-guidance functions that would otherwise be performed by the crew, while the AGC initiates major modes which are dependent upon trajectory or guidance functions.

The function interface between the AGC and the MCP is complex and its description is deferred until Section 3. The electrical interface is simple,

being relay contacts in the AGC DSKY wired to the MCP, and is described in ICD MH01-01200-216. The following AGC output discrete signals are provided:

- 1) G&N ATT. CONTR. MODE SELECT
- 2) G&N ENTRY MODE SELECT
- 3) G&N ΔV MODE SELECT
- 4) + X TRANSLATION ON/OFF
- 5) CM/SM SEPARATION COMMAND
- 6) FDAI ALIGN
- 7) T/C ANTENNA SWITCH
- 8) G&N FAIL INDICATION
- 9) 0.05 g INDICATION
- 10) GIMBAL MOTOR POWER ON/OFF
- 11) BACKUP ABORT COMMAND

2.2.2 Mission Control

Mission Control is provided by the Houston Mission Control Center (MCC-H) via the Digital Command System (DCS), which has many discrete inputs to the spacecraft and an UPLINK to the AGC. The discrete commands to the spacecraft and the AGC UPLINK are described in Section 3.

The AGC UPLINK provides MCC-H with the capability to enter the AGC with any instruction or data which can be entered by the crew via the DSKY keyboard. It is specifically planned to use this link to backup the LIFTOFF and SIVB/CSM SEPARATION inputs, signal boost abort and update the orbit parameters in erasable memory during coast with more accurate data if it is available from ground tracking.

2.2.3 Guidance Errors

The performance of the G&N system for mission 202 has been estimated assuming that no navigation data is inserted via the AGC UPLINK.

The most significant G&N error is that error in the critical path angle at entry which is estimated to be 0.165 degree on a one sigma basis. The next most significant error is manifested in the CEP at splash which is estimated to be 15.6 n. m.

A complete breakdown of G&N errors is given in Section 6.

2.3 Mission Description

The purpose of this section is to describe G&N functions during each mission phase. Note that these functions are described in greater detail, sufficient to specify the AGC program, in Section 3.

The reference trajectory is defined in Section 5 in sufficient detail to satisfy MIT's requirements for development of guidance equations, spacecraft control logic and determination of flight environment.

Section 9 presents those path and attitude characteristics resulting from guidance control which are believed to have significant effects on other spacecraft equipment and ground support systems.

The overall mission profile is illustrated in Fig. 5-1 and Table 5-1 and might well be examined at this point.

2.3.1 Pre-Launch

During this phase the IMU stable member is held at a fixed orientation with respect to the earth. The X PIPA input axis is held to the local vertical (up) by torquing the stable member about Y and Z in response to Y and Z PIPA outputs. Azimuth orientation about the X axis is held by a gyro-compassing loop such that the Z PIPA axis points downrange at an azimuth of 104,9901 degrees East of True North. Initial azimuth is determined by tracking a ground target with the G&N Sextant at $T_0 - 13.5$ hours. Upon receipt of the GUIDANCE RELEASE signal from the Saturn I. U. the stable member is released to maintain a fixed orientation in inertial space for the remainder of the mission. In this manner the Saturn and Apollo IMU stable members retain a fixed relative orientation. Also, at the time of GUIDANCE RELEASE, the G&N system starts its computation of position and velocity, which continues until first SPS burn cut-off.

2.3.2 SI Boost

The boost trajectory is described in Fig. 5-2. Upon receipt of the LIFT OFF signal from the Saturn I. U., 5 seconds after GUIDANCE RELEASE, the AGC will command the CDUs to the time history of gimbal angles associated with the nominal SI attitude polynomials. The GUIDANCE RELEASE signal is backed up by the LIFTOFF signal. The CDU outputs after resolution will then represent vehicle attitude errors in spacecraft axes and will be displayed on the FDAI and telemetered to the ground. This SI attitude monitor is a required element of the launch vehicle malfunction detection scheme, and, in association with computed position and velocity, constitute the Boost Monitor data provided by the G&N system during this period.

2.3.3 Staging, Coast and SIVB Boost

The G&N system will not have the capability to control the SIVB. The CDUs will be held until LET jetison at which time they will be switched to the Fine Align Mode. After LET jetison the G&N system will monitor IMU gimbal angles to detect tumbling and will compute the free-fall time to entry interface altitude (400,000 ft.) from present position and velocity. These quantities are used in the Abort Logic and, in association with computed position and velocity, constitute the Boost Monitor data provided by the G&N system during this period.

2.3.4 Aborts from SIVB Boost

Aborts from the boost phase are mechanized in the same way as manned flight aborts whenever possible. G&N control of CSM aborts from SIVB boost is enabled by the MCP 2.5 seconds after start of the MCP SIVB/CSM Separation sequence. Upon receipt of the SIVB/CSM SEPARATION signal from the Mission Event Sequence Controller (MESCC) the AGC determines a sequence of events using the control logic given in Section 3. Briefly, the sequence of events is derived from three tests:

- A. Has the AGC received the ABORT signal from the ground via the UPLINK?
- B. Do the spacecraft body rates exceed the tumbling threshold?
- C. Does the free-fall time to entry interface altitude fall below the abort T_{ff} criterion of 160 seconds?

For NO ABORT and NO TUMBLING, the AGC commands a normal sequence and SPS burn to the nominal First Burn aim point as described more fully below.

If the ABORT signal is received and there is NO TUMBLING, the AGC commands an abort separation sequence followed by an SPS abort burn to the downrange Atlantic Recovery Point. Landing area control capability is illustrated on Fig. 5-1 which shows a continuous recovery area and the selected downrange Atlantic Recovery Point. The G&N system will control the thrust and lift vectors to achieve this splash point with the constraint that the spacecraft X axis be directed 35 degrees above the visible horizon during thrusting. A 10 g limit is incorporated in the entry program to minimize excessive g loads.

If the abort occurs too early in the boost phase or at an "unsafe" flight path angle, the selected downrange Atlantic Recovery Point cannot be reached because either (1) there is insufficient fuel in the SM tanks, or (2) the booster cut-off conditions are such that the spacecraft would dip into the atmosphere while thrusting. These two conditions are avoided by test C which is mechanized as an interrupt. If the free-fall time falls below 160 seconds so that test C results in a YES answer, the AGC will command engine shutdown and a CSM attitude maneuver to the CM/SM separation attitude. When the free-fall time to entry interface altitude falls below 85 seconds the AGC will command CM/SM SEPARATION and CM orientation to the aerodynamic trim attitude. The lift vector will be up during the entry phase. Note that "early" aborts result in splash points within the continuous recovery area.

If TUMBLING is detected the AGC will start the SPS 3.0 seconds after receipt of the SIVB/CSM SEPARATION signal. This will result in stabilization by the SCS rate loops, and SPS cutoff by the AGC when it senses that spacecraft body rates have dropped below the tumbling threshold. Following SPS shutdown the AGC will estimate the maneuver

time, T_M , required to orient to the abort SPS burn attitude (X axis 35 degrees above the visible horizon). If the free-fall time to entry interface altitude is greater than $T_M + 160$, the AGC will command the CSM to the abort SPS burn attitude, command engine on at T_M and guide to the downrange Atlantic Recovery area. Again as in the non-tumbling abort case the engine will be shutdown if free-fall time drops below 160 seconds. If, after tumbling-arrest burn shutdown, the free-fall time is less than $T_M + 160$, the AGC will command the CSM to the CM/SM SEPARATION attitude. Abort area control is illustrated in Fig. 9-4.

2.3.5 CSM/SIVB Separation

There are two CSM/SIVB separation sequences, a normal sequence and an abort sequence used if tumbling or the abort signal is present. In the normal sequence the SPS is ignited by the AGC a fixed time delay of 12.7 seconds after it receives the CSM/SIVB SEPARATION signal. This time delay permits the RCS ullage thrust to build up enough separation distance to prevent the SPS from damaging the SIVB or upsetting its attitude. On the other hand the time delay is not so long as to cause an unjustified ΔV penalty. After separation the AGC computes the initial SPS thrust attitude and commands the required attitude maneuver. If the spacecraft is not completely oriented at the end of the fixed time delay, the SPS is started anyway and orientation is completed during the first few seconds of the burn. Only when large rates and/or large negative pitch attitude dispersions exist at SIVB cut-off will the fixed time delay be too short to permit completion of spacecraft orientation before SPS ignition.

In the abort separation sequence, the SPS is ignited by the AGC a time delay of 3.0 seconds after it receives the CSM/SIVB SEPARATION signal. This time delay is made as short as possible to minimize the probability of CSM-SIVB re-contact or loss of IMU reference in the tumbling case and to get the CSM away from the SIVB as quickly as possible in any abort case.

2.3.6 SPS First Burn

First burn thrust will be controlled by the G&N system to achieve the reference trajectory major axis and eccentricity at cut-off. The trajectory plane at cut-off will include the Pacific Recovery Point at nominal splash time. The steer law used in this maneuver is given in Section 4, where are found all the CSM guidance equations for Mission 202. It will be noted that the universal cross product steering law for Apollo is used whenever possible, specifically, for this mission, in all cases except tumbling arrest and the short third and fourth burns.

2.3.7 Coast Phase, First Burn Cut-off to Second Burn Ignition

Following first burn cut-off the AGC will compute and command a spacecraft attitude maneuver to align the X-axis with the local vertical, nose down, and the Y-axis with the angular momentum vector $R * V$.

When the commanded inner gimbale angle reaches -259.55 ± 0.25 degrees the AGC will command FDAI ALIGN for 10 seconds thereby resetting the backup attitude reference to correct for its accumulated drift error. At this time, nominally 300.0 seconds after 1st SPS burn cutoff, the outer gimbale angle will be $180.0^\circ \pm 1.0^\circ$ and the middle gimbale angle will be $0.0^\circ \pm 1.0^\circ$.

After a time interval of 2037.2 secs. from first burn cut-off the vehicle attitude in tracking the local vertical will come closest, in the nominal case, to the second burn ignition attitude. At this time the local vertical mode will be terminated. The AGC will then establish the second burn ignition point by a process of precision numerical integration and will compute the second burn ignition attitude. The AGC will then command the vehicle to this attitude, which it will hold inertially until ignition.

2.3.8 Second, Third and Fourth SPS Burns

Second burn ignition occurs after a fixed time delay of 3163.7 seconds from first burn cut-off. The AGC will command + X TRANSLATION 30 seconds before ignition to provide ullage. Thrust is controlled by the G&N system to achieve the reference trajectory major axis and eccentricity at cut-off, and a trajectory plane which includes the Pacific Recovery Point at nominal splash time.

Second burn is terminated by the AGC six seconds before the required velocity is attained. The spacecraft attitude at this time will be held until fourth burn cutoff. During second burn the G&N attitude error signal will develop a bias proportional to the c.g. shift from the engine gimbale trim position set in prior to second burn ignition. After second burn cutoff the CDUs will be moved off from their position at cutoff by a stored estimate of this bias in order to minimize the attitude transient after engine shutdown.

The AGC will start and shutdown the SPS on a time basis so that the last two burns are each of 3 seconds duration and so that the two short coast periods are each of 10 seconds duration. The AGC will control the + X TRANSLATION signal so that the RCS will provide ullage thrust as well as attitude control during the 10-second coast periods. Note that the SCS disables + X translation during SPS firing.

2.3.9 Pre-Entry Sequence

The fourth burn cutoff attitude is held until the free-fall time to entry interface altitude drops below the normal T_f criterion of 160 seconds, when the G&N system will start pitching the spacecraft up to the CM/SM separation attitude (+ X axis up in the trajectory plane and tipped forward in the direction of motion 60 degrees above the velocity vector). When the free-fall time drops below 85 seconds the AGC will command CM/SM SEPARATION. After a 7-second time delay to allow for separation and stabilization, the G&N system will start orienting the CM to the entry attitude. The CM will then be at the aerodynamic trim angle of attack with roll angle for down lift.

2.3.10 Entry

The velocity and critical flight path angle at entry are directly controlled by the G&N system during the second, third and fourth burns. The entry guidance equations, which are given in Section 4, are designed to provide a trajectory which will satisfy heat shield test objectives while controlling the roll angle so as to splash at the designated Pacific Recovery Point.

2.3.11 Navigation Update

The ground will compare radar tracking data with the AGC state vector transmitted via DOWNLINK after first SPS burn cutoff, and, if necessary, update the AGC during the coast phase. The update is initiated by a Digital Command System message to "accept a navigation update". Upon verification via DOWNLINK that the AGC is ready to receive the data, the DCS loads position, velocity, and time for use in second SPS burn guidance. After verification via DOWNLINK that the data are correctly loaded the DCS will signal the AGC to use the new data. (see Section 3.1.2)

3. LOGIC AND TIMELINE FOR SPACECRAFT AND MISSION CONTROL

3.1 Interfaces, Ground Commands and Constraints

3.1.1 G&N Interface with Spacecraft

The following interfaces will be effective on Mission 202/AF 011/ AGC 017:

3.1.1.1 AGC Outputs to MCP

This interface is documented in ICD No. MH01-01200-216 and provides the following signals:

- (1) G&N ATTITUDE CONTROL MODE SELECT
- (2) G&N ENTRY MODE SELECT
- (3) G&N Δ V MODE SELECT
- (4) + X TRANSLATION ON/OFF

There is a requirement for this command (over and above the translation requirement) to provide for termination of Direct Ullage mode.

At SIVB/CSM Separation the AGC must command "+X TRANSLATION ON" to key the MCP to terminate the "SIVB/CSM Separate" command to the MESC, which in turn deactivates the MESC-controlled "DIRECT ULLAGE" command. The MESC will not terminate direct ullage earlier than 2.5 sec after receipt of "SIVB/CSM Separate" nor continue it longer than 12 sec regardless of whether the SIVB/CSM Separate command is terminated or not.

- (5) CM/SM SEPARATION COMMAND
- (6) FDAI ALIGN

This signal brings the backup attitude reference system (BMAG's caged to AGCU) to a zero reference determined by the current vehicle attitude. It is initiated first during the prelaunch countdown.

It is again initiated after the first SPS burn when the CSM has been commanded to the local vertical and the commanded inner gimbal angle reaches $-259.55^{\circ} \pm 0.25^{\circ}$. This will result in FDAI ALIGN when the spacecraft is within 1 degree of a prescribed inertial orientation.

When initiated, the signal must be continued for 10 sec.

- (7) T/C ANTENNA SWITCH

The AGC has the capability to switch the T/C Antennas although the requirements for this function have not yet been defined and thus not incorporated in AGC programming.

(8) G&N FAIL INDICATION

This signal is generated by the G&N Failure Detection Module. This module is mounted at the rear of the main DSKY and is electrically interposed between the NAA harness to the DSKY and the DSKY itself.

The module is composed of two sections:

(1) ELECTRONICS SECTION - Monitors bit 4 of register OUT 1. This bit is under the control of the AGC UPLINK and DOWNLINK programs and is used to control the TELEMETRY ALARM light in the NAV DSKY. Superimposed on the AGC UPLINK and DOWNLINK program's control of bit 4 is control by the NIGHT WATCHMAN program. This program briefly complements the existing state of bit 4 and then restores its initial condition.

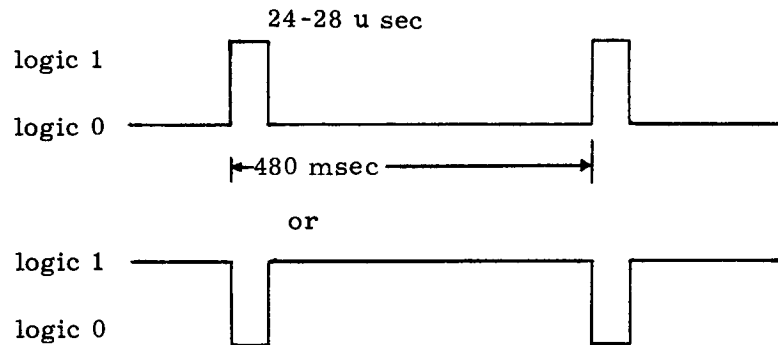

The ELECTRONICS SECTION of the G&N Failure Detection Module monitors only the brief complement (or lack of complement) of bit 4. If the complement pulse is lacking for more than 1.6 sec ($\begin{matrix} -0.6 \\ +1.6 \end{matrix}$) the ELECTRONICS SECTION generates the G&N FAIL INDICATION which is a contact closure to the MCP and G&N ERROR LIGHT, and a 5 VDC level to the S/C TELEMETRY SYSTEM (A TM discrete as distinguished from AGC Digital Downlink). Should the complement pulse be restored the G&N FAIL INDICATION is removed.

(2) WIRING JUNCTION BOX

(a) Routes the G&N FAIL INDICATION to the NAA harness for the MCP, S/C TELEMETRY SYSTEM and the G&N ERROR LIGHT in the CAUTION and WARNING PANEL.

- (b) Routes all remaining wires of the DSKY interface directly through the module.

The logic of the generation of the G&N FAIL INDICATION is thus under the control of the "Night Watchman's Alarm" program. This program monitors G&N activity in two phases completing a monitor cycle in 480 ms.

The first phase involves the examination of an error register (OLDERR). Should this register indicate an error present, the complement pulse would not be generated and a G&N FAIL INDICATION would result. The error register will include the following error indications;

- (1) The failure of an AGC RESTART sequence. This sequence is automatically done when the AGC's normal sequences have been momentarily interrupted by failures such as TC TRAP, PARITY FAIL or a momentary loss of PRIMARY POWER. The RESTART sequence will normally perform a limited recycle of the interrupted sequences restoring the initial conditions within milliseconds.
- (2) The receipt by the AGC of an indication from the Inertial Subsystem error detection circuitry of an IMU FAIL or ACCEL FAIL. Each of these fail indications is a summation of several relevant analog parameters, any one of which will cause a fail indication if exceeding the following criteria.

- (a) IMU FAIL

- IG Servo Error - greater than 2.9 mr for 2 sec
- MG Servo Error - greater than 2.9 mr for 2 sec
- OG Servo Error - greater than 2.9 mr for 2 sec
- 3200 cps loss - decrease to 50% of normal level
- wheel supply loss - decrease to 50% of normal level

The receipt of this fail indication is ignored by the AGC program if the G&N system is in the Coarse Align Mode. In this mode (used only during pre-launch alignment for Mission 202) the servo errors normally exceed the criteria above.

- (b) ACCEL FAIL

- X PIPA Error - greater than 27 mr for 5 sec
- Y PIPA Error - greater than 27 mr for 5 sec
- Z PIPA Error - greater than 27 mr for 5 sec

The receipt of this fail indication is ignored by the AGC program during the COAST Phase (start of CSM orientation to local vertical until termination of local vertical phase).

The second phase exercises the AGC executive programs by a request for a new job (NEWJOB) via a periodic programmed interrupt (T4RUPT) with a high job priority (36 - the highest available with the exception of an alarm priority). This new job examines bit 4 of register OUT 1 and complements it as described above. Should the executive routines or the interrupt processes be disabled (as, for instance, if an AGC program had become trapped in a loop) the NEWJOB request would not be honored, the complement pulse would not be generated, and a G&N FAIL INDICATION would result.

The G&N FAIL INDICATION can also be sent to the MCP via the Up Data Link (UDL) based upon ground assessment of tracking or telemetry data. Upon receipt of G&N FAIL INDICATION the MCP immediately disables all mode commands from the AGC and commands the SCS system to SCS ΔV MODE. The attitude reference becomes the BMAG's. The SCS system is now no longer responsive to any G&N-originated attitude signals, attitude error signals, engine on-off commands (disabled by removal of ΔV mode), or AGC commands via the MCP.

The MCP can be reset to retransfer S/C control to G&N; however, this command must come from the ground.

(9) .05 G INDICATION

G&N will sense .05G with the PIPA's, give this indication to the SCS (via the MCP) and the SCS system will inhibit pitch and yaw attitude control on the assumption that these axes will be stabilized by aerodynamic forces. Should the G&N .05G indication not be received by the MCP/SCS this attitude control would not be inhibited, and if sufficient pitch and yaw attitude errors are generated, RCS fuel would be wasted throughout entry. The G&N entry program will attempt to null the pitch and yaw error signals during entry based on its estimation of the pitch and yaw trim angles of attack. MIT estimates that the resulting pitch and yaw attitude errors will not exceed the deadbands in the SCS. Should this be incorrect RCS fuel loss will occur. The G&N 0.05G indication is used within the re-entry program, however, so should this function be backed up by a redundant CM sensor or by the UDL signal, no AGC confusion should result.

(10) GIMBAL MOTOR POWER ON/OFF

The AGC must terminate SPS GIMBAL MOTOR POWER in order to key the MCP to select the appropriate SPS motor gimbal trim inputs. The MCP does this sequentially and therefore the AGC must terminate this command only once after 1st SPS burn, (to select trim position for 2nd burn) and once after 2nd SPS burn (to select trim position for 3rd burning). The trim position for the 1st burn is selected by MCP upon keying from the SIVB/CSM Separate Command. The 3rd burn trim position is also satisfactory for the 4th burn.

(11) BACKUP ABORT COMMAND

This is a relay identical to those used in (1) through (10) and is identically wired to the MIT/NAA interface to provide a backup or alternate abort signal to the MCP.

3.1.1.1.1 Detailed Interface Operation

Certain additional facts are pertinent to the use and comprehension of the AGC/MCP interface:

- (1) The AGC must not command more than one SCS mode simultaneously. This requires termination of each mode before commanding the next; 250 ms has been established as sufficient time interval between termination and selection.
- (2) The response of the SCS system to the commands and/or indication signals of the AGC via the MCP are subject to the arming of these command/indications by the MCP. Presently the arming logic for the G&N/MCP interface is as shown in Fig. 3-1.
- (3) In all cases the MCP initiates the SIVB/CSM Separation Sequence. For normal cases its action is keyed upon notification from the Saturn I. U. For boost aborts the ground or the AGC BACKUP ABORT SIGNAL must command the MCP to start the sequence.

3.1.1.2 Additional Interfaces

Pertinent G&N electrical signal interfaces with other S/C subsystems are described in detail in the ICD's below.

ICD NO.	TITLE	SIGNALS INCLUDED
MH01 01224-216	Attitude Error Signals	Pitch Error (Body & Body Offset) Yaw Error (Body) Yaw Error (Body Offset) Roll Error (Body) Roll Error (Body Offset) Error Signal Reference (all signals go from G&N to SCS)

ICD NO.	TITLE	SIGNALS INCLUDED
MH01 01225-216	Total Attitude Signals	SIN AIG COS AIG SIN AMG COS AMG SIN AOG COS AOG Attitude Signal Reference (all signals go from G&N to SCS)
MH01 01238-216	Engine On Signal to SCS	Engine ON/OFF (AGC command to SCS system - not via MCP)
MH01 01226-216	Central Timing Equipment Synch. Pulse	AGC synch. pulse to PCM telemetry system
MH01 01228-216	G&N DATA Transmission to Operational PCM Telemetry Equipment	G&N analog data and AGC serial digital data (AGC Downlink) to PCM (Includes flight recorder data).
MH01 01236-200	ACE Uplink/Spacecraft Digital Up-Data Link to AGC	Coded data input to AGC from ground
MH01 01278-216	Launch Vehicle to G&N Inter- faces (Block I Series 100)	1. Liftoff 2. Guidance Reference Release
MH01 01280-216	Vehicle Separation Signals to AGC (Block I Series 100)	1. CSM/SIVB Separate

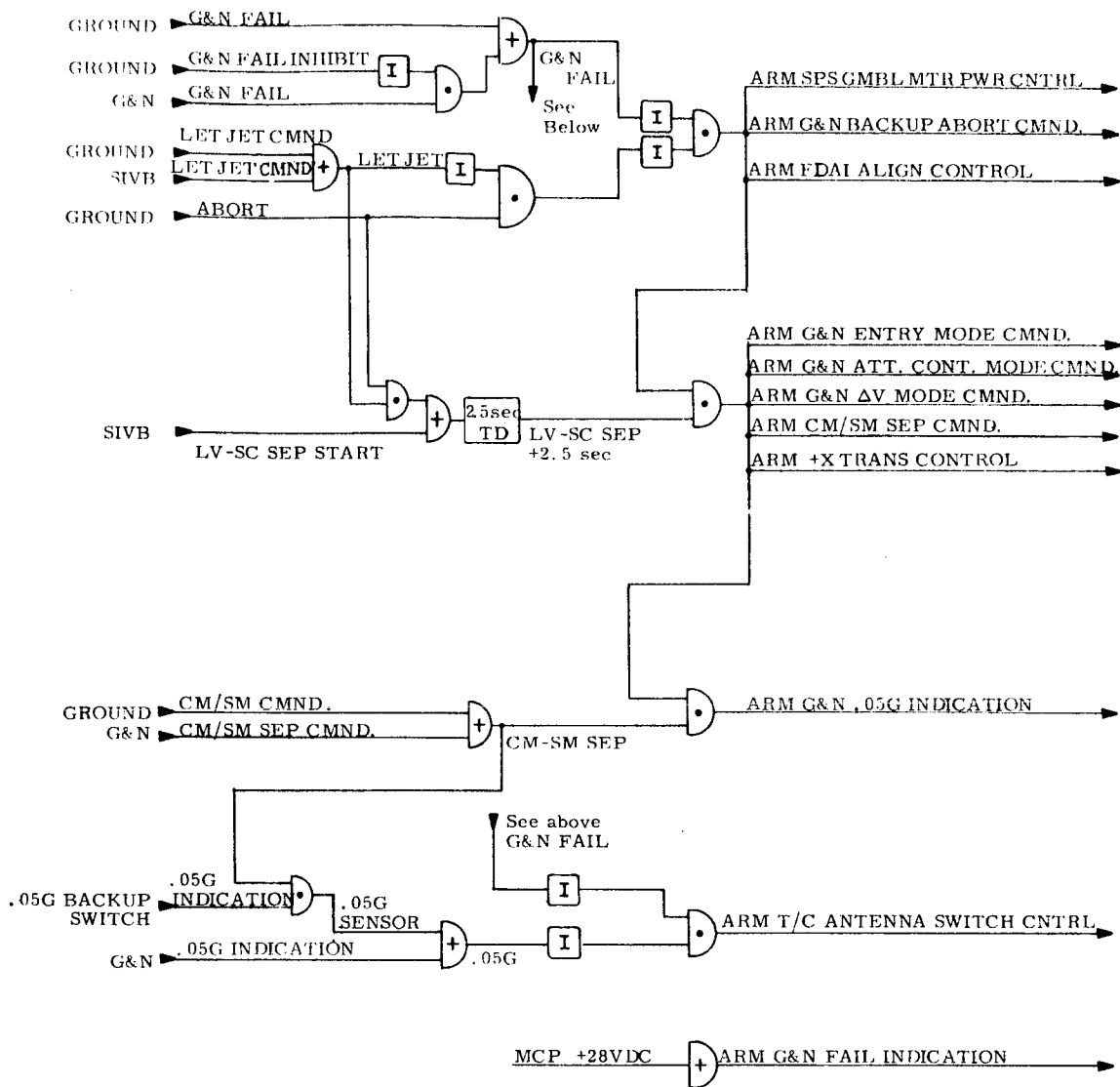

Fig. 3-1 Arming Logic for G&N/MCP Interface.

3.1.2 Ground Commands

3.1.2.1 Digital UPLINK to AGC

By means of the AGC UPLINK, the ground can insert data or instruct the AGC in the same manner normally performed by the crew using the DSKY Keyboard. The AGC will be programmed to accept the following UPLINK inputs:

- (1) ABORT INDICATION (required for abort logic as described earlier)
- (2) LIFTOFF (backup to discrete input)
- (3) SIVB/CSM SEPARATION (backup to discrete input)
- (4) POSITION and VELOCITY data (provides ground capability to update navigation data in the AGC).
- (5) AGC CLOCK ALIGNMENT
- (6) SPS GIMBAL MOTOR POWER ON/OFF (for only pre-launch control of gimbal motors).
- (7) FDAI ALIGN (primarily for prelaunch use).

Operational procedures governing the use of these Uplink inputs must be developed to ensure proper operation within program constraints.

All information received by the AGC from the Uplink is in the form of keyboard characters. Each character transmitted to the AGC is triply redundant. Thus, if C is the 5-bit character code, then the 16-bit message has the form:

$$1\bar{C}\bar{C}\bar{C}$$

where \bar{C} denotes the bit-by-bit complement of C. To these 16 bits of information the ground adds a 3-bit code specifying which system aboard the spacecraft is to be the final recipient of the data and a 3-bit code indicating which spacecraft should receive the information. The 22 total bits are sub-bit encoded (replacing each bit with a 5-bit code for transmission.) If the message is received and successfully decoded, the receiver onboard will send back an 8-bit "message accepted pulse" to the ground and shift the original 16 bits to the AGC ($1\bar{C}\bar{C}\bar{C}$).

All uplink words given in this section are in the form transmitted from the uplink receiver to the AGC. Therefore they do not contain the vehicle or sub-system addresses added on by the ground facilities. For the purpose of this section, the following definitions hold:

1. 1 uplinkword = 1 character
2. 5 characters or uplink words = contents of one AGC register
3. 1 downlink word = verification of 1 character or a display change.

3.1.2.1.1 ABORT INDICATION - to send an abort message to the AGC, the following special word should be sent via the uplink.

Binary Uplink Word (1 C \bar{C} C)	Equivalent Keyboard Character (C)
1 10011 01100 10011	ABORT

3.1.2.1.2 LIFTOFF - to send the backup liftoff discrete to the AGC, the following 6 words should be sent via the uplink.

1 10001 01110 10001	VERB
1 00111 11000 00111	7
1 00101 11010 00101	5
1 11100 00011 11100	ENTER
1 00011 11100 00011	3
1 11100 00011 11100	ENTER

3.1.2.1.3 SIVB/CSM SEPARATION - to send this backup separation discrete to the AGC, the following 6 words should be sent via the uplink.

1 10001 01110 10001	VERB
1 00111 11000 00111	7
1 00101 11010 00101	5
1 11100 00011 11100	ENTER
1 00100 11011 00100	4
1 11100 00011 11100	ENTER

3.1.2.1.4 NAVIGATION UPDATE - to begin a navigation update on flight 202 prior to SPS2 burn the following 4 words should be sent via uplink.

1 10001 01110 10001	VERB
1 00111 11000 00111	7
1 00110 11001 00110	6
1 11100 00011 11100	ENTER

The ground station should then await confirmation via Downlink that the AGC is in Major Mode 27.

In Major Mode 27 the AGC will accept a complete ground navigation update in the format to be described below.

The data itself will take the form of three (3) double precision components of position, three (3) double precision components of velocity, and double precision time. The position and velocity components should be given in stable member co-ordinates (see Sec. 2.3.1) and the time should be in the time of the "fix" referenced to AGC CLOCK ZERO. The data must be sent in the following sequence:

XXXXXX	(most sig. part of X position)....	ENTER
XXXXXX	(least sig. part of X position)....	ENTER
XXXXXX	(most sig. part of Y position)....	ENTER
XXXXXX	(least sig. part of Y position)....	ENTER
XXXXXX	(most sig. part of Z position)....	ENTER
XXXXXX	(least sig. part of Z position)....	ENTER
XXXXXX	(most sig. part of X velocity)....	ENTER
XXXXXX	(least sig. part of X velocity)....	ENTER
XXXXXX	(most sig. part of Y velocity)....	ENTER
XXXXXX	(least sig. part of Y velocity)....	ENTER
XXXXXX	(most sig. part of Z velocity)....	ENTER
XXXXXX	(least sig. part of Z velocity)....	ENTER
XXXXXX	(most sig. part of time from AGC clock zero)	ENTER
XXXXXX	(least sig. part of time from AGC clock zero).....	ENTER

where each "X" and "ENTER" above represents an uplink word. If, for some reason, the ground wishes to resend any 5 uplink word group before the ENTER associated with that group has been transmitted, the following "CLEAR" word should be sent

1 11110 00001 11110

and the 5 word group retransmitted.

If the ground station wishes to terminate the load before the ENTER associated with the least sig. part of time has been sent, the following 4 uplink words must be sent

Binary UPLINK WORD (1 C \bar{C} C)	Equivalent Keyboard Character (C)
1 10001 01110 10001	VERB
1 00011 11100 00011	3
1 00100 11011 00100	4
1 11100 00011 11100	ENTER

which will return the AGC to the mode it was in before the update was initiated.

After the ENTER associated with the least sig. part of time, the ground station must verify via Downlink that the AGC has correctly received the navigational update before sending another ENTER to signal the AGC that it can use the data in guidance computations.

This entire load must be completed at least 50 sec* before SPS 2 ignition.

If, during the final verification period after the ENTER associated with the least sig. part of time, it is found that the data in the AGC are not correct, the ground station may change the load in either of the following ways.

- 1) If only a few parts must be changed the ground station should send

Binary Uplink Work (1 C \bar{C} C)	Equivalent Keyboard Character (C)
1 10001 01110 10001	VERB
1 00011 11100 00011	3
1 00100 11011 00100	4
1 11100 00011 11100	ENTER

followed by the relative address of the part to be changed, these addresses run in order from 1 to 16₈ for the 14 parts of the load shown above; i. e. if the least sig. part of the Y velocity were to be changed VERB 34 ENTER should be followed by

1 00001 11110 00001	1
1 00010 11101 00010	2
1 11100 00011 11100	ENTER

then the 5 uplink words corresponding to the part to be changed are sent followed by an ENTER. This procedure, VERB 34 ENTER etc., must be repeated for each part to be changed. When all changes are made and verified via Downlink an additional ENTER must be sent to signal the AGC that it can use the data.

- 2) If many parts must be reloaded, the ground station may choose to start the load from the beginning. To do

*"Fix" time must be within 200 sec. of SPS 2 + X translation time.

this during the final verification period after the ENTER associated with the least sig. part of time the ground station must send VERB 34 ENTER followed by another VERB 34 ENTER which will terminate the load and allow the AGC to return to its pre-update condition.

If the AGC receives an improperly coded word from the uplink receiver during the load (not $C \bar{C} C$) it will turn on bit 4 of OUT 1 which is transmitted via Downlink (see Sec. 8.1.1). When this occurs the ground station should send the following 3 uplink words:

1 00000 00000 00000	(to clear uplink buffer)
1 10010 01101 10010	ERROR RESET
1 11110 00001 11110	CLEAR

The ground station should then begin loading with the first word of the 5 word group it was sending when the alarm condition occurred.

If insufficient time remains to SPS 2 + X translation, the AGC will change its major mode and proceed with the internally computed data.

The scale factors for AGC navigational updating are:

position	meters/ 2^{24}
velocity	(meters/C.S.)/ 2^7
"fix" time	C.S. / 2^{28}
(1 C.S. = .01 sec)	

The AGC is a fixed pt. machine with the pt. just to the left of the most significant bit.

The scaling indicated above will be sufficient to force the 3 components of position and the 3 components of velocity and time to numbers less than one.

To form the double precision quantities ready for coding and transmission the scaled magnitudes of time and each component of position and velocity should be expressed as two binary words as follows:

1 st word	O	X	X	X	X	X	X	X	X	X	X	X	X	X	X	X	X
		2^{-1}	2^{-2}	2^{-3}	2^{-4}	2^{-5}	2^{-6}	2^{-7}	2^{-8}	2^{-9}	2^{-10}	2^{-11}	2^{-12}	2^{-13}	2^{-14}		
2 nd word	O	X	X	X	X	X	X	X	X	X	X	X	X	X	X	X	X
		2^{-15}	2^{-16}	2^{-17}	2^{-18}	2^{-19}	2^{-20}	2^{-21}	2^{-22}	2^{-23}	2^{-24}	2^{-25}	2^{-26}	2^{-27}	2^{-28}		

Each X above represents a binary bit of the appropriate magnitude, the place value of which is indicated below the corresponding X. Once the magnitude of the component is accounted for in the above 28 X's, the sign must be considered.

If the component is positive, the words remain as formed; if the component is negative, the "1's complement" of the 2 words is used (all 1's are replaced by 0's and all 0's by 1's).

The first word is then transformed into a 5 character octal word. The first character is the octal equivalent of the first three bits, the second character is the octal equivalent of the next three bits, etc. This word is referred to as the "most significant part" of data in the text above. Similarly the second word is transformed into a 5 character octal word which is the "least significant part" of data.

Each character must now be coded into a 16 bit uplink word for transmission. A table of the characters and their uplink word follows.

3.1.2.1.5 AGC CLOCK ALIGN-to align the AGC clock two procedures are required. To set the AGC clock to a specific value, the following uplink words must be sent.

Binary Uplink Word (1 C \bar{C} C)	Equivalent Keyboard Character (C)
1 10001 01110 10001	VERB
1 00010 11101 00010	2
1 00001 11110 00001	1
1 11111 00000 11111	NOUN
1 00001 11110 00001	1
1 00110 11001 00110	6
1 11100 00011 11100	ENTER

This must be followed by ± XXXXX ENTER where each X represents one decimal digit, properly coded (see Table 1) and the total number represents the time in C. S. that will be set into the AGC clock. If it is required to zero the clock, all the X's should be zeros.

TABLE 1

<u>Character</u>	<u>Uplink Word</u>
0	1 10000 01111 10000
1	1 00001 11110 00001
2	1 00010 11101 00010
3	1 00011 11100 00011
4	1 00100 11011 00100
5	1 00101 11010 00101
6	1 00110 11001 00110
7	1 00111 11000 00111
8	1 01000 10111 01000
9	1 01001 10110 01001
VERB	1 10001 01110 10001
NOUN	1 11111 00000 11111
ENTER	1 11100 00011 11100
ERROR RESET	1 10010 01101 10010
CLEAR	1 11110 00001 11110
KEY RELEASE	1 11001 00110 11001
+	1 11010 00101 11010
-	1 11011 00100 11011
ABORT	1 10011 01100 10011

NOTE: It is good operation procedure to end every uplink message with a KEY RELEASE.

Since there are uncertainties in time of transmission, etc., it is anticipated that a time increment may be needed. To increment the AGC clock, the following uplink words must be sent.

Binary Uplink Word (1 C C C)	Equivalent Keyboard Character (C)
1 10001 01110 10001	VERB
1 00101 11010 00101	5
1 00101 11010 00101	5
1 11100 00011 11100	ENTER

This must be followed by ± XXXXX ENTER where the total number represents the time increment in C.S.

The AGC must already have the inertial co-ordinates of the launch pad at some reference time, TEPOCH, wired in fixed memory. Also the difference between TEPOCH and the clock zero time, ΔT , must have been loaded in erasable memory. The diagram below shows the relationship of the different times.

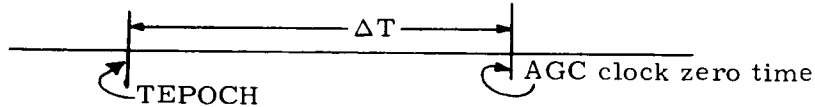

The following restraints must be observed on the magnitudes of the times shown above.

- 1) $|\Delta T + \text{AGC clock}|$ at guidance reference release must be less than 2^{28} C.S. since the AGC must use this time to determine the inertial platform co-ordinates at guidance reference release.
- 2) $|\text{AGC clock}|$ during the flight must be less than 2^{28} C.S. to prevent overflow.

3.1.2.1.6 SPS GIMBAL MOTOR POWER ON/OFF - To turn the SPS Gimbal Motors on or off the following message must be sent

V75E { Refer to TABLE I }
 XE { for Codes }

where the X above is a 1 if the motors are to be turned on or a 2 if they are to be turned off.

3.1.2.1.7 FDAI ALIGN - To start an FDAI ALIGN sequence (terminated by program after 10 sec) the following message must be sent

V75E (Refer to TABLE I)
5E (for codes)

3.1.2.2 Discrete Real-Time Commands to MCP

The following list details the real-time commands (RTC's) planned for support of the Apollo 202 Mission. This list is restricted to commands to the Mission Control Programmer and is exclusive of commands to the SIVB and AGC Uplink commands:

RTC #	02 ...04	Fuel Cell Purge (cell #1 - cell #3)
etc.	05	Reset RTC 02-04
	10	Lifting Entry - Necessary for no-roll entry in the SCS entry mode.
	11	Direct Thrust On - Turns on SPS engine; backup to onboard command in case of malfunction.
	12	Direct Thrust off - Turn off SPS engine; backup to onboard command in case of malfunction
	13	Reset RTC 10 -12
	14	Direct rotation + pitch.
	15	Direct rotation - pitch.
	16	Direct rotation + yaw.
	17	Direct rotation - yaw.
	20	Direct rotation + roll.
	21	Direct rotation - roll.
	22	Direct Ullage.
	23	Reset RTC 14 -22
	24/32	SM Quad A Propellant Off/On.
	25/33	SM Quad B Propellant Off/On.
	26/34	SM Quad C Propellant Off/On.
	27/35	SM Quad D Propellant Off/On.
	30/36	CM System A Propellant Off/On.
	31/37	CM System B Propellant Off/On.
	40	Let Jettison Start-Backup to onboard command from S-IVB.
	41	G&N Failure - Backup to G&N function.
	42	G&N Failure Inhibit - Reset G&N failure.
	43	Reset RTC 41-42
	44	Roll Rate Gyro Backup-Switches roll BMAG to rate mode and uses this gyro for roll rate data.
	45	Pitch Rate Gyro Backup - Switches pitch BMAG to rate mode and uses this gyro for pitch rate data.

- 46 Yaw Rate Gyro Backup - Switches yaw BMAG to rate mode and uses this gyro for yaw data.
- 47 FDAI align.
- 50 Reset RTC 44-47.
- 51 -Z Antenna ON.
- 52 +Z Antenna ON.
- 53 G&N Antenna Switching - Enable of G&N command capability for Antenna switching.
- 54 Roll A and C Channel Disable - Disables the automatic A and C RCS channels.
- 55 Roll B and D Channel Disable - Disables the automatic B and D RCS roll channels.
- 56 Pitch Channel Disable - Disables the automatic pitch RCS channels.
- 57 Yaw Channel Disable - Disables the automatic yaw RCS channels.
- 60 Reset RTC 54-57.
- 61 CM/SM Separation - Backup to onboard command from the G&N
- 62 UDL/S Band RCVR ON.
- 63 UDL UHF RCVR ON.
- 64 .. 67 Cryogenic Heater Fan Switch (O₂#1, O₂#2, H₂#1, H₂#2).
- 70 Reset RTC 64-67.
- 71 Abort (Also Backup for SIVB/CSM Separation Start).
- 72 Reset RTC 73-77.

Commands 14-17, 20-21, and 54-57 will be used to control S/C attitude in cases where the G&N is not operable. Commands 62-67 are operable on Mission 202 but are not intended to be used (designed for 500 series mission use only).

Of these commands only six are intimately concerned with G&N operation; RTC 11, 12, 22, 41, 42 and 71.

RTC 11-Direct Thrust On:	AGC Engine On logic presently includes a monitor of ΔV to ensure engine ignition. This monitor continues for 10 sec after sensing no thrust during which time the ground might start the SPS engine. If suitable ΔV has not been sensed after 10 seconds the AGC would exit from thrust vector control and hold attitude until the free-fall interrupt occurs. Should the ground successfully start the engine within 10 sec the AGC will guide the burn normally. It must be assumed however
--------------------------	---

that as the AGC Engine On command did not work correctly, AGC Engine Off will not either. The ground must therefore command a timely "Thrust Off" compatible with the AGC TVC calculation.

RTC 12-Direct
Thrust
Off:

The ground may thus inhibit starting of or may stop the SPS thrust. Should AGC-controlled firing be inhibited or shutdown the ΔV monitor logic would after 10 seconds exit from thrust vector control and hold attitude until the free-fall interrupt occurs.

RTC 22-Direct
Ullage:

A backup command for ground use during a ground controlled burn in the SCS ΔV mode. Its use during G&N controlled flight would inhibit G&N attitude control with the possibility of the G&N being unaware of the control loss.

RTC 41-G&N
Failure:

This command is a ground backup for the G&N originated command. All control of the vehicle by G&N is thereby inhibited.

RTC 42-G&N
Failure
Inhibit:

This command overrides the G&N FAIL signal. Use of this command does not guarantee that the AGC will correctly resume control of the S/C.

RTC 71-Abort:

This command normally initiates SIVB/CSM Separation in a boost abort. For appropriate AGC action, it must be accompanied by an abort command to the AGC via AGC Uplink which itself generates the G&N BACKUP ABORT command to the MCP. The G&N BACKUP ABORT command initiates identical action in the MCP as RTC 71. Thus there are two methods of initiating boost aborts.

- (a) RTC 71 and "Abort" to AGC via UPLINK.
- (b) "Abort" to AGC via uplink alone

3.1.3 Backup Control Systems Constraints on G&N Operation

3.1.3.1 Backup Attitude Reference System

The backup attitude reference system is the SCS BMAGs in conjunction with AGCU. G&N control of the CSM orientation is always done with consideration for the maintenance and accuracy of this system. As the SCS system is presently designed, the BMAG's operate as free gyros in the G&N ΔV MODE; in other modes they are caged through the AGCU.

As the mechanical stops of the BMAG's are at $\pm 17^\circ$ it is apparent that during boost (MONITOR MODE) and attitude maneuvers (G&N ATTITUDE CONTROL OR ENTRY MODES) both involving angular changes of over 17° the BMAG's must be caged. In the G&N ΔV mode however, should attitude changes over 17° occur, integrity of the backup attitude system will be lost. Such changes are not anticipated in the nominal mission.

The rate limits of the backup attitude reference system in the caged mode are $5^\circ/\text{sec}$ in Pitch and Yaw and $20^\circ/\text{sec}$ in Roll. To preclude controlling the S/C at rates beyond which the backup attitude reference system can maintain its reference, the G&N will limit its command rate to the CSM and CM.

3.1.3.2 Backup Entry Control

During the pre-entry coast the G&N system must orient the CM for aerodynamic trim and lift vector down. Then, in the event of G&N FAIL INDICATION, the MCP/SCS will hold this attitude until it senses a prescribed "g" level at which time it will command a continuous roll angular velocity.

3.2 Normal and Abort Mission Logic

The following pages describe the timeline and logic for AGC control of the spacecraft.

3.2.1 Normal Sequence of Events

3.2.2 AGC Program Logic

SECTION 3.2.1
 NORMAL SEQUENCE OF EVENTS - MISSION 202
 S/C 011 MISSION CONTROL PROGRAMMER/G&N

TIME	SIB/SIVB	MESC	CSM	MCP	AGC	GROUND
$T_0 - 16$ hrs.					AGC CLOCK ALIGNMENT	GROUND SYN-CHRONIZATION OF AGC TIME THRU ACE
$T_0 - 16$ hrs.					UPDATE LAUNCH POINT AND TARGETS TO CLOCK ZERO TIME	
$T_0 - 14.5$ hrs.					G&N STARTS GYROCOMPASSING MODE FOR IMU ALIGNMENT TO LAUNCH AZIMUTH. SET FINE ALIGN MODE IN G&N	
$T_0 - 13.5$ hrs.					OPTICS SIGHTING TO VERIFY GYROCOMPASSING	CLOSE OPTICS HATCH
$T_0 - 13$ hrs.						GROUND RESET OF MCP
$T_0 - 5$ hrs.				PROGRAM RESET ARM GM. MOT. PWR. ON/OFF. G&N BACKUP. ABORT CMND, G&N FAIL I/C SWITCH. ARM G&N FAIL CIRCUITRY FOR INDICATION ONLY TO MCP. MCP WILL NOT REVERT TO BACKUP MODE UNTIL SIVB/CSM SEPARATION		
$T_0 - 1$ hr.				FINAL MCP CHECK	FINAL G&N SYSTEMS CHECK	GROUND CONTROL PRELAUNCH SEQUENCE

SCS MODE

G&N MONITOR MODE

FINE ALIGN MODE

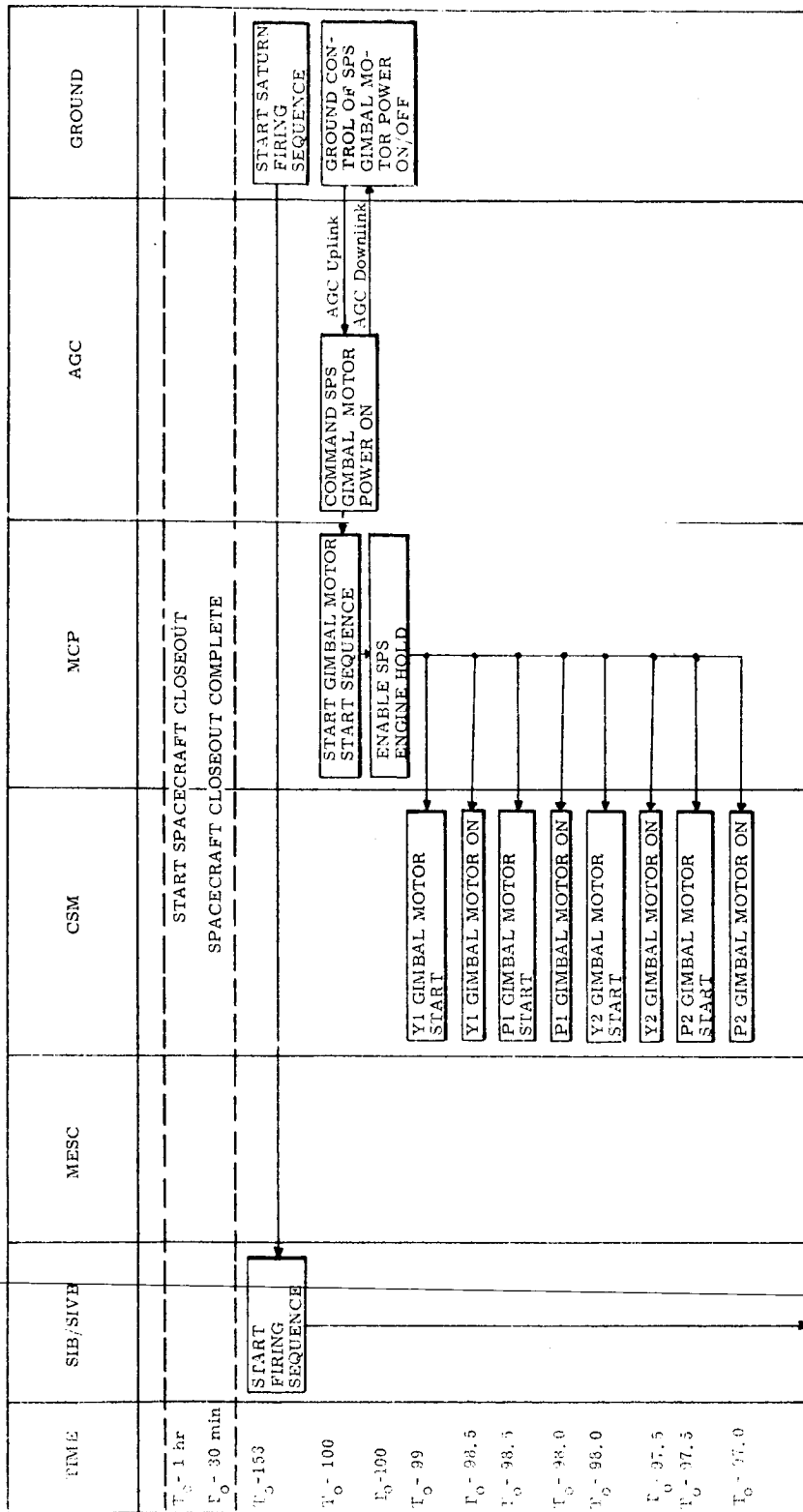

← GSN MONITOR MODE
← GSN MODE

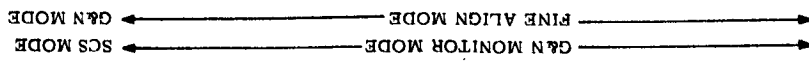
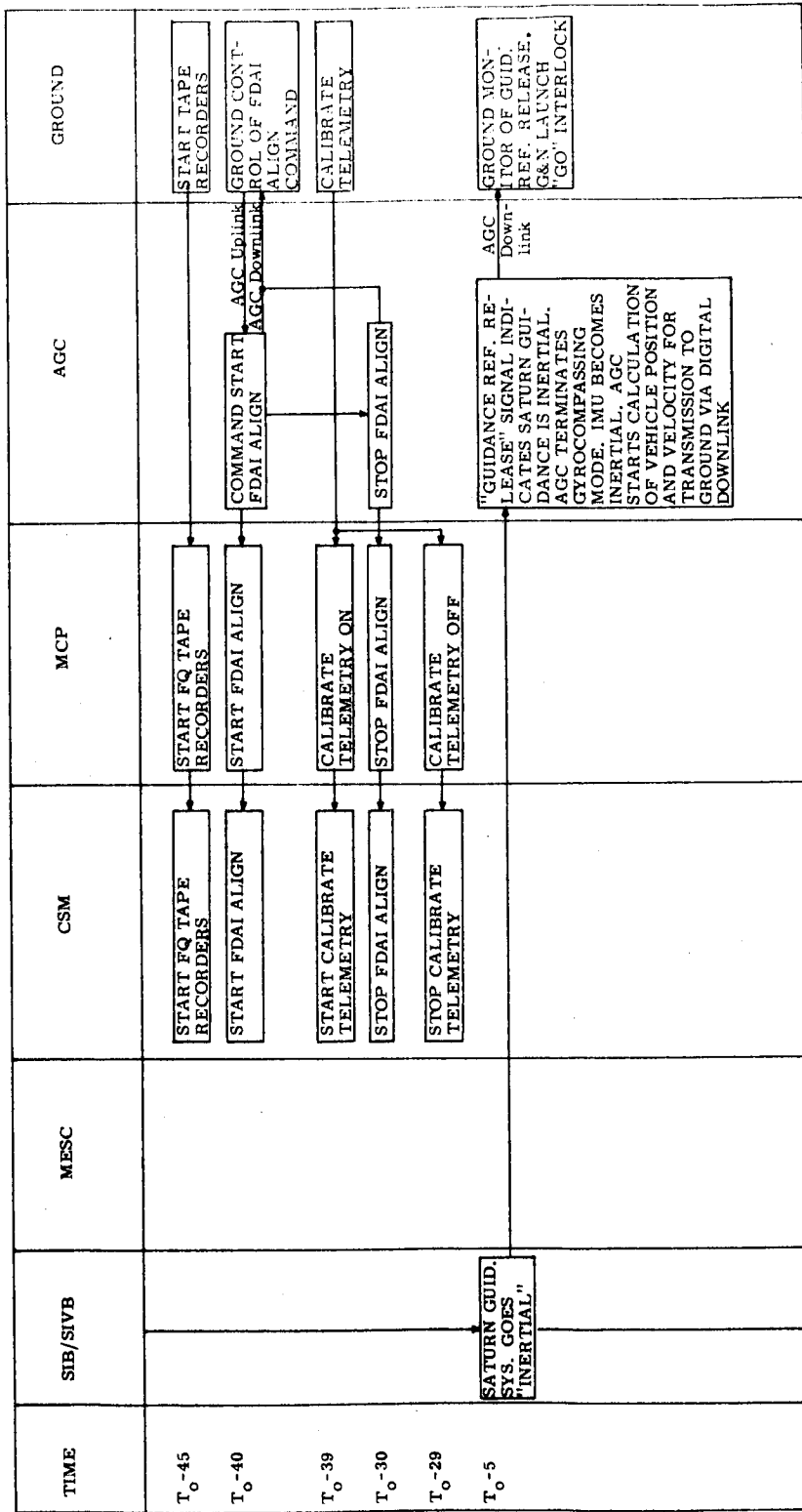

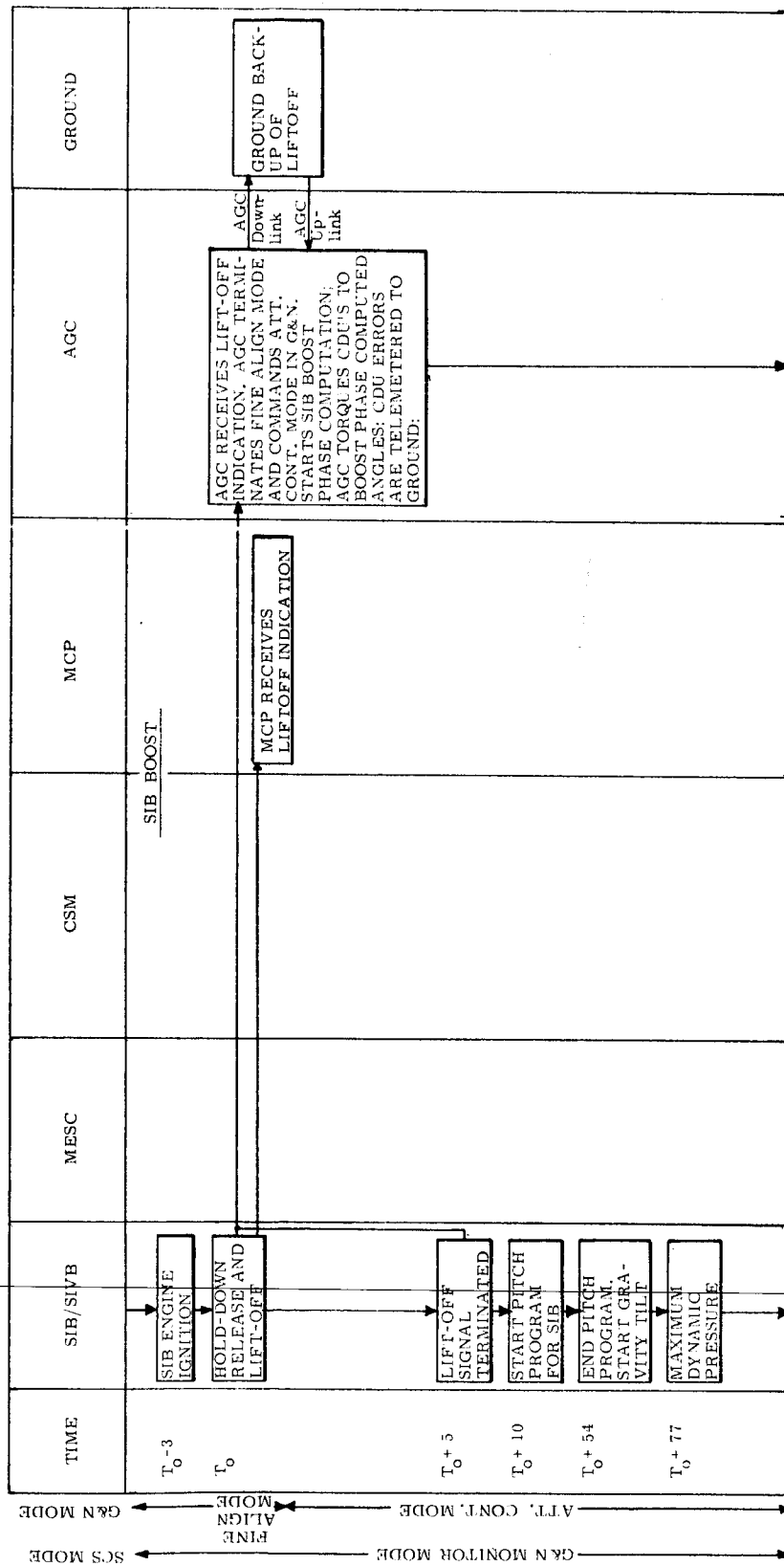

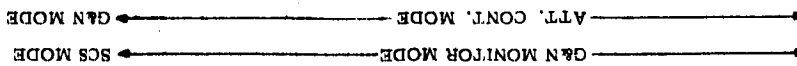
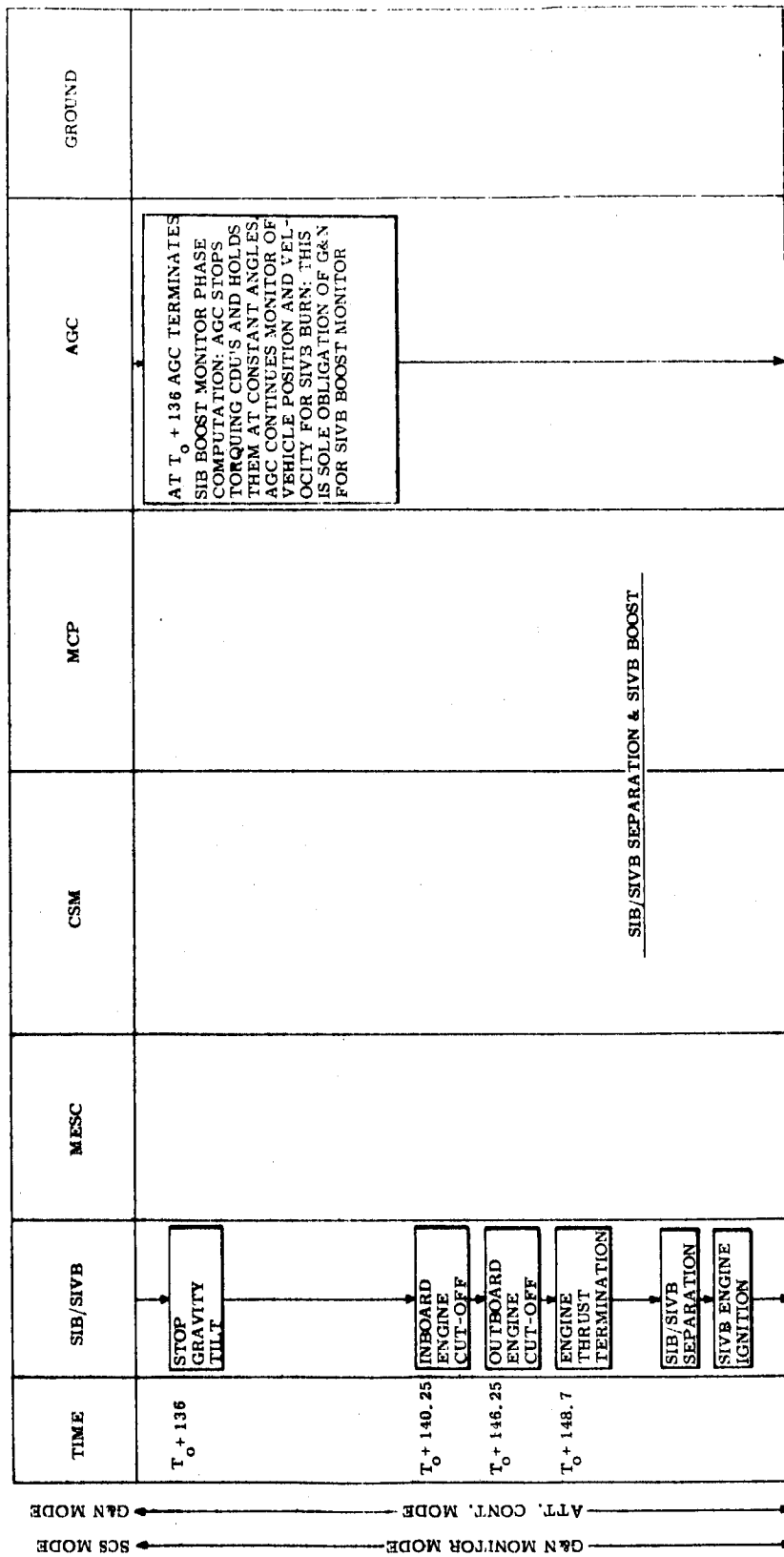

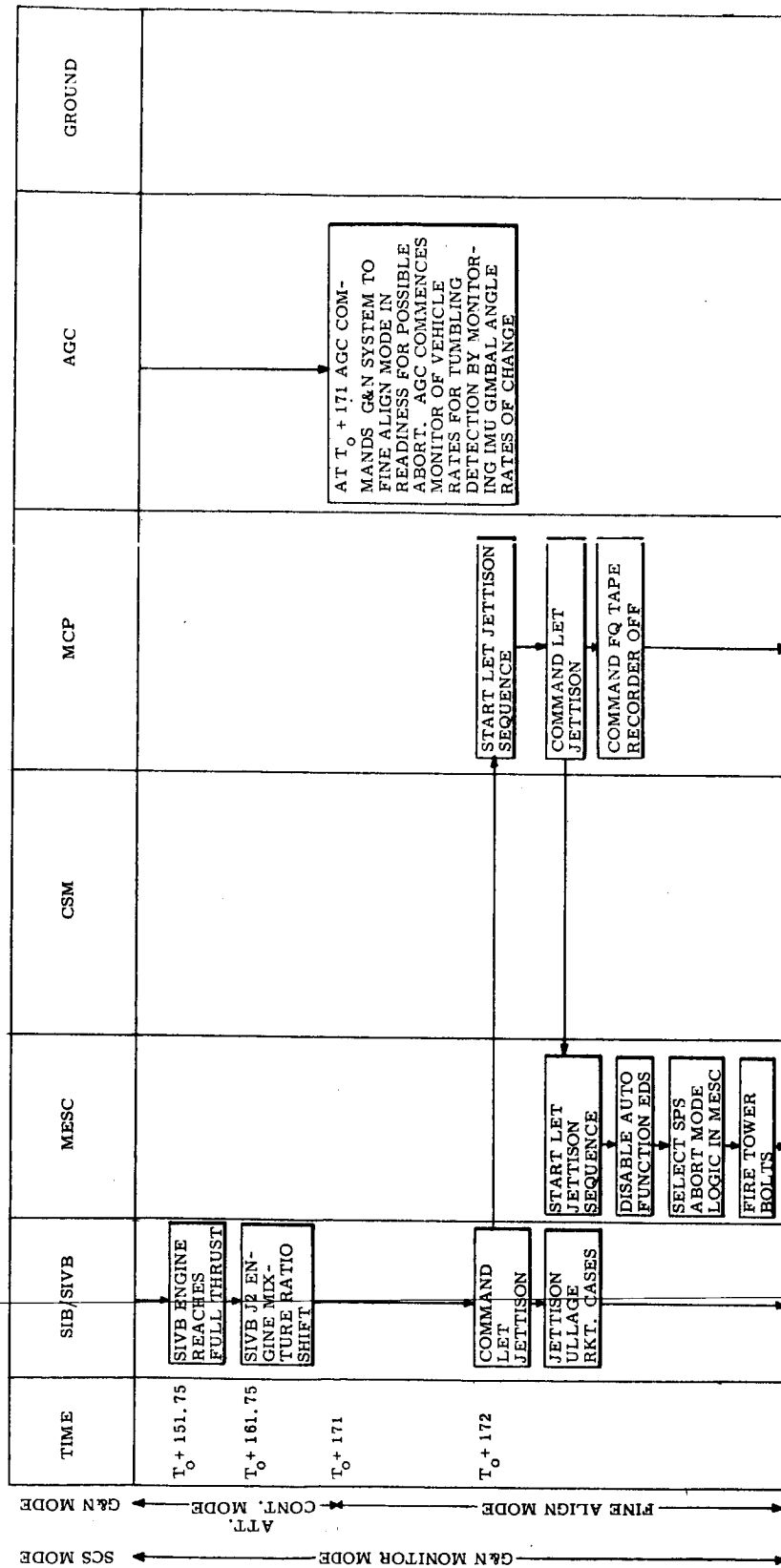

TIME	SIB/SIVB	MESC	CSM	MCP	AGC	GROUND
$T_0 + 172.5$		FIRE JETTISON MOTOR				
$T_0 + 451.7$	SIVB J2 ENGINE MIXTURE RATIO SHIFT			BACKUP IGNITION OF LAUNCH ESCAPE MOTOR SHOULD JETTISON MOTOR NOT HAVE FIRED (ASSUMES BOLTS HAVE SEPARATED)		
$T_0 + 551$						
$T_0 + 610$ (T_{co-s})	GUIDANCE SHUTDOWN OF SIVB					
T_{co-s}	SIVB GOES TO RATE STABILIZATION MODE WITH ZERO RATE COMMAND					
$T_{co-s} + 1.5$	SIVB THRUST TAIL OFF COMPLETE					

TRACKING ACQUIRED BY ANTIGA
LAT 17° 08' 36" N
LONG 61° 47' 33" W

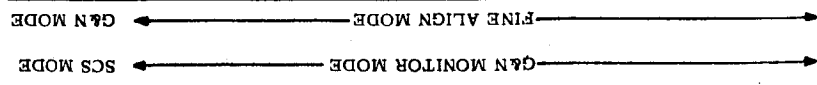

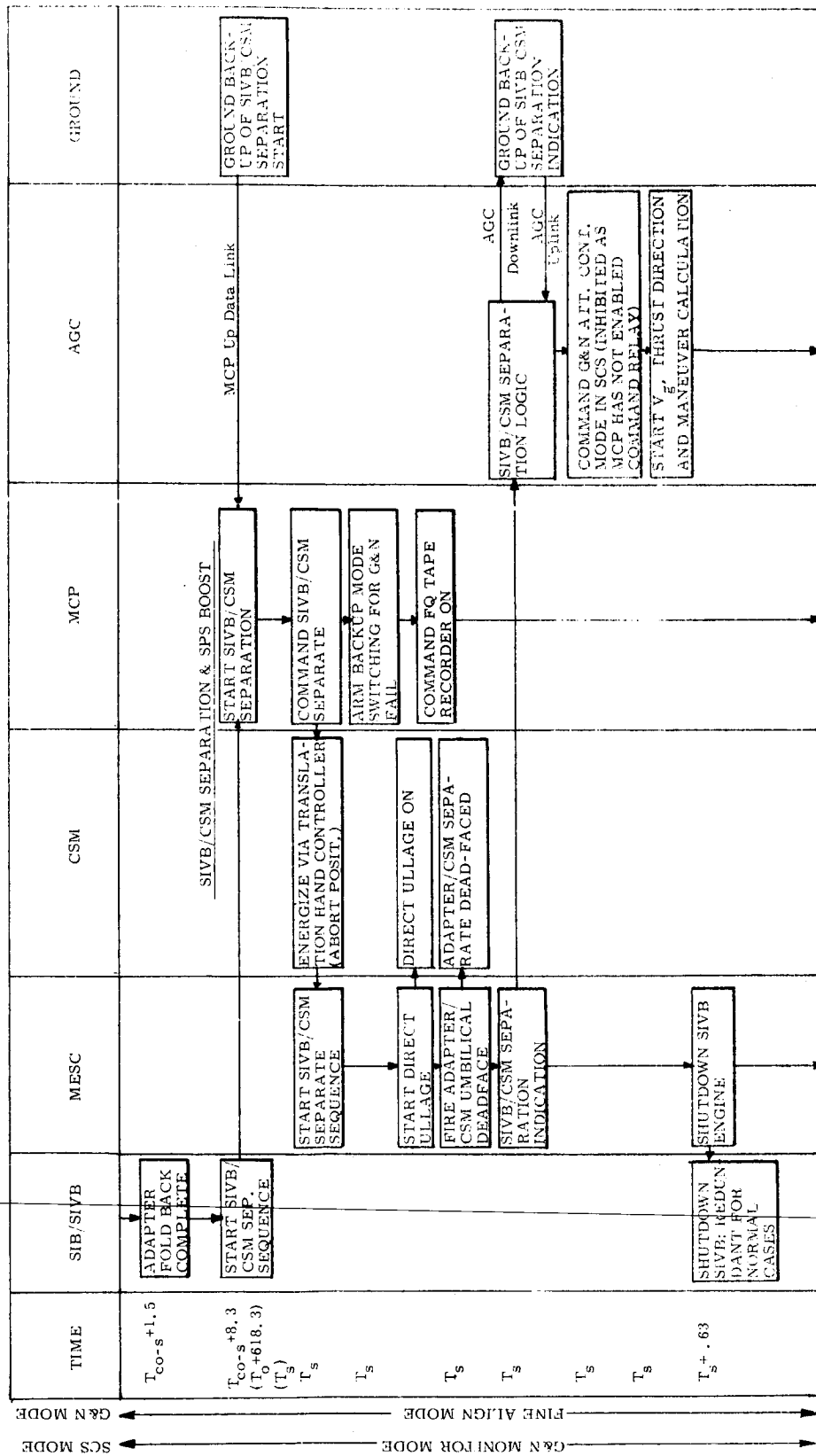

TIME	SIB/SIVB	MESC	CSM	MCP	AGC	GROUND
T ₈ +1.7		FIRE ADAPTER/ CSM SEPARATION SQUIBS	ADAPTER/CSM SEPARATION			
T ₈ +2.5		SCS RCS ENABLE ON	SCS RCS ENABLE ON			
T ₈ +2.5			ROLL CHANNEL UNDER CONTROL OF ROLL RATE GYRO: ATTITUDE ERROR SIGNAL AT OR NEAR NULL DUE TO FINE ALIGN MODE IN G&N. PITCH AND YAW CHANNEL INHIBITED BY DIRECT ULLAGE			
T ₈ +2.5				ARM G&N CONTROL RELAYS: (1) G&N ATT. CONT. MODE CMND. (2) G&N AV MODE CMND. (3) G&N ENTRY MODE CMND. (4) +X TRANS ON/OFF CMND. (5) CM/SM SEP. CMND.		
T ₈ +2.5			SET G&N ATT. CONT. MODE	COMMAND G&N ATT. CONT. MODE (COM- MANDED BY AGC AT T ₈ ; ENABLED BY MCP ARMING)		
T ₈ +2.5		SIVB/CSM SEPARA- TION COMMAND TERMINATED	DE-ENERGIZE VIA TRANSLATION HAND CONTROLLER (ABORT POSIT.)	AT RECEIPT OF +X TRANS ON (COMMANDED BY AGC AT T ₈ AND AR- MED BY MCP AT T ₈ -2.5) (1) TERMINATE SIVB/ CSM SEPARATION COMMAND		

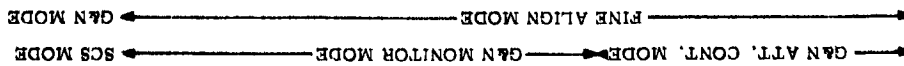

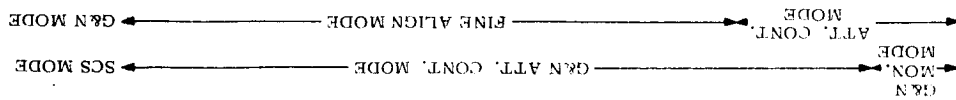
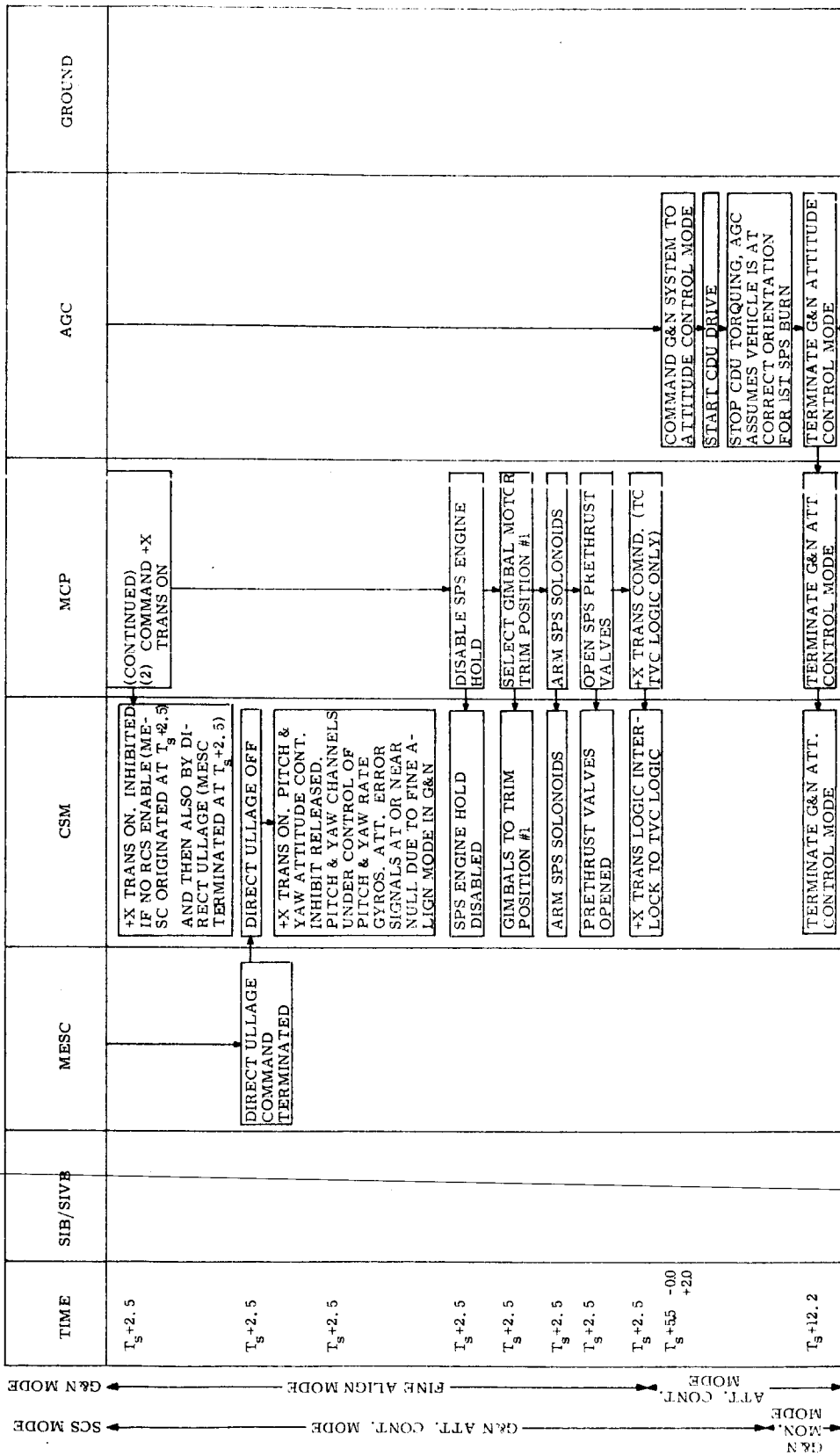

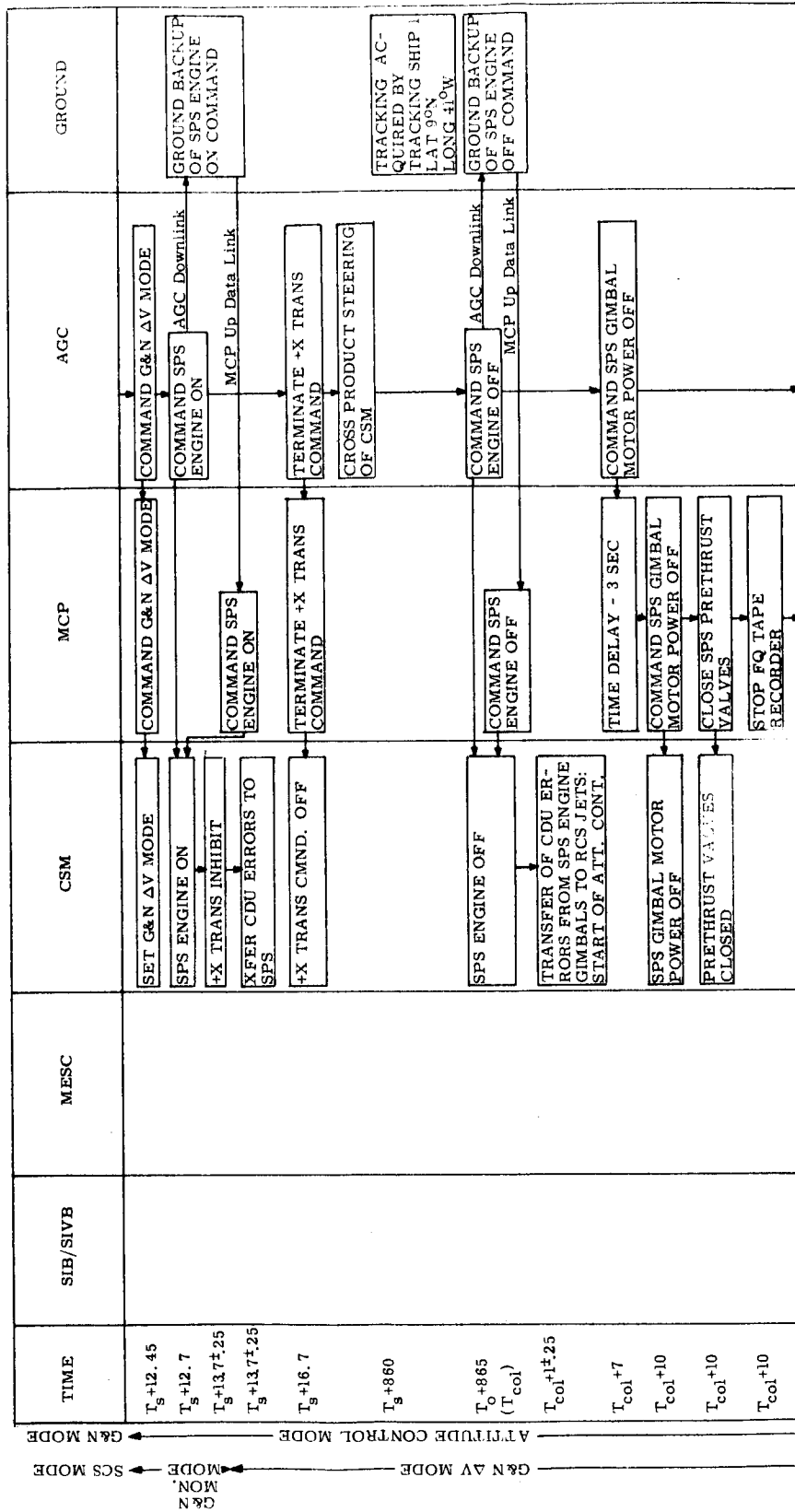

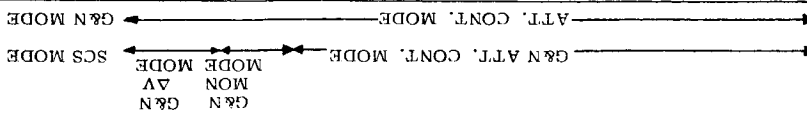
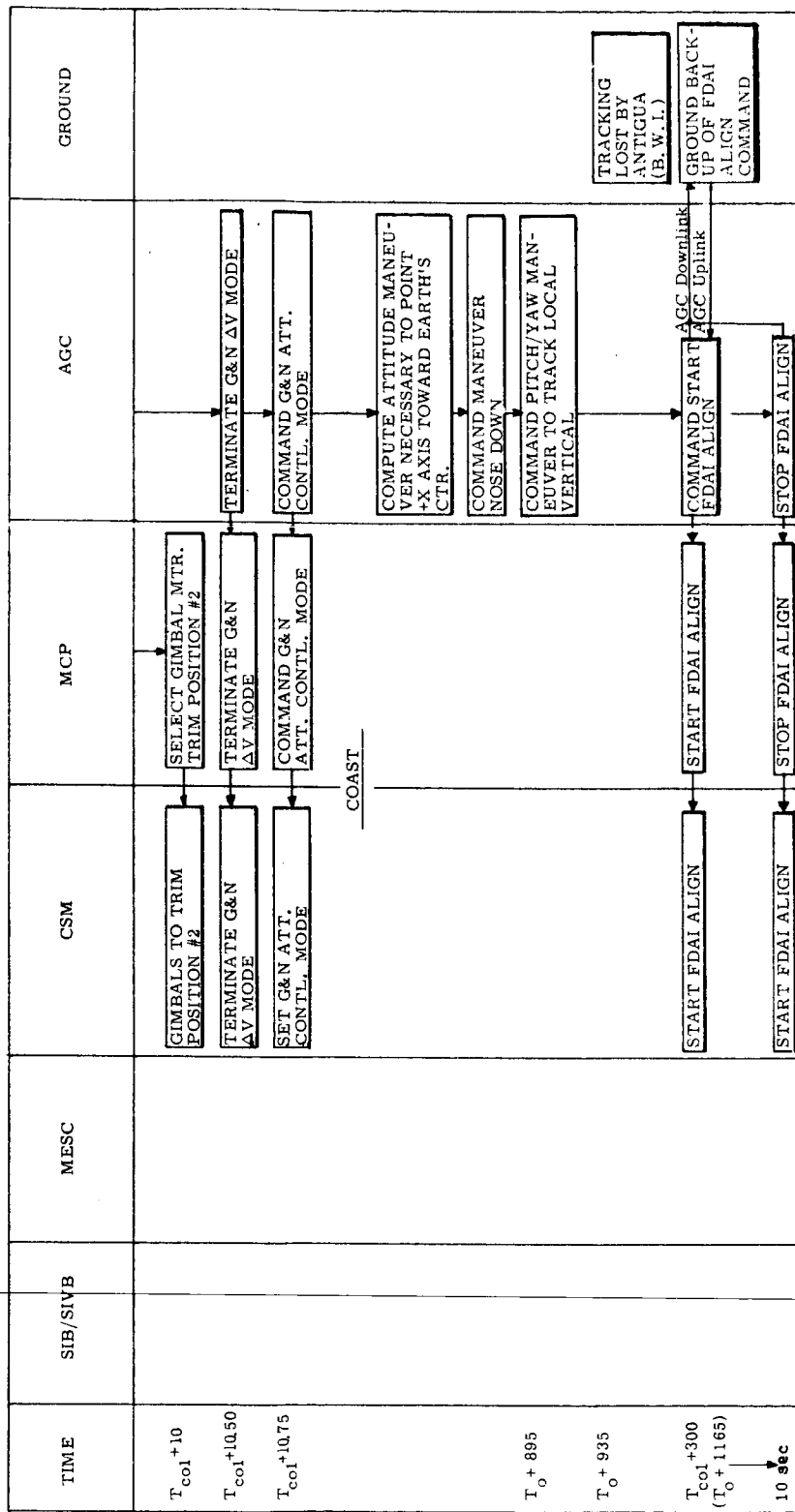

TIME	SIB/SIVB	MESC	CSM	MCP	AGC	GROUND
T ₀ + 1280						TRACKING AC- QUIRED BY ASCENSION IS. LAT. 07° 37' 05" S LONG. 14° 24' 45" W
T ₀ + 1460						TRACKING LOST BY TRACKING SHIP 1
T ₀ + 2200						TRACKING LOST BY ASCENSION IS. 120 sec without ground coverage
T ₀ + 2320						TRACKING ACQUIRED BY PRETORIA S. A. LAT. 25° 56' 14" S LONG. 23° 22' 64" W
T ₀ + 2800						TRACKING LOST BY PRETORIA 240 sec without ground coverage

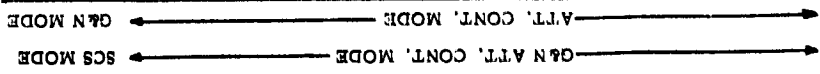

TIME	SIB/SIVB	MESC	CSM	MCP	AGC	GROUND
$T_{col}+2037$ (T_0+2902)			<u>2ND SPS BURN</u>		STOP LOCAL VERTICAL MODE AT $T_{col}+2037.2$ sec.	
T_0+2902					AGC CALCULATES (A) VEHICLE POSITION AND VELOCITY FOR 2ND BURN IGNITION (B) VEHICLE ATTITUDE REQUIRED FOR 2ND BURN IGNITION (C) COMMAND S/C MANEUVER TO THIS ATTITUDE.	
T_0+3640					R. V. T. UPDATE AGC UpLink AGC Downlink	TRACKING ACQ. BY CARNARYON AUST. LAT. $24^{\circ}52'00''$ S LONG. $113^{\circ}38'00''$ E
$T_{col}+3134$			+X TRANS. ON	COMMAND +X TRANS.	BASED ON ELAPSED TIME FROM 1ST SPS BURN CUT-OFF AGC STARTS 2ND SPS BURN SEQUENCE COMMAND +X TRANS.	TRANSMIT R. V. T AGC UPDATE

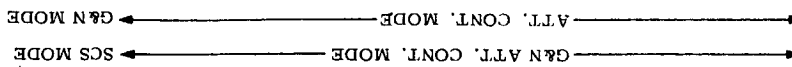

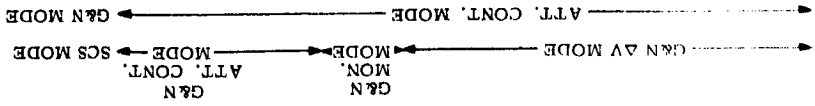
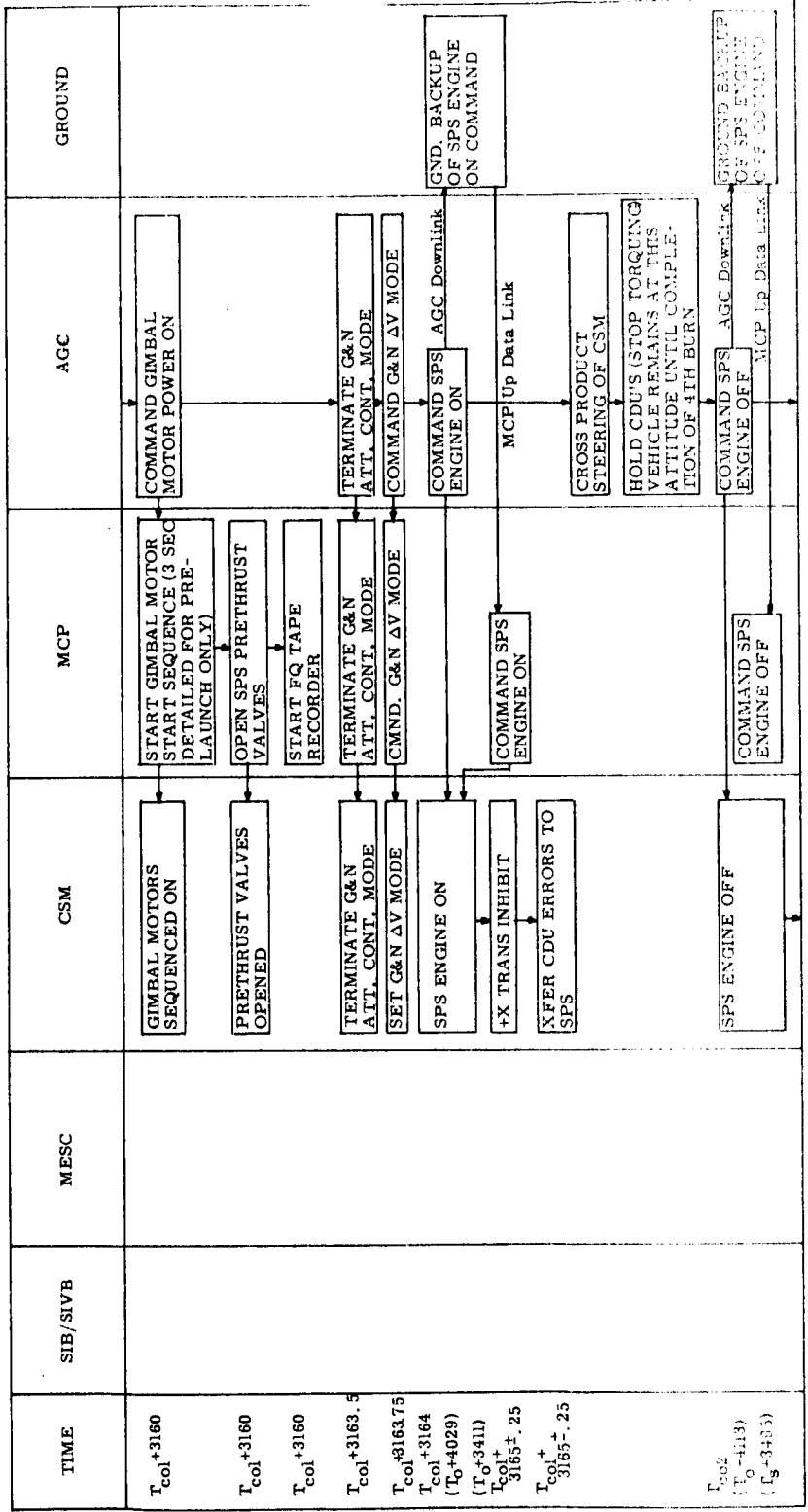

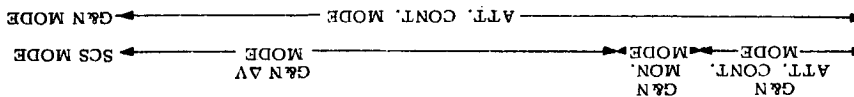
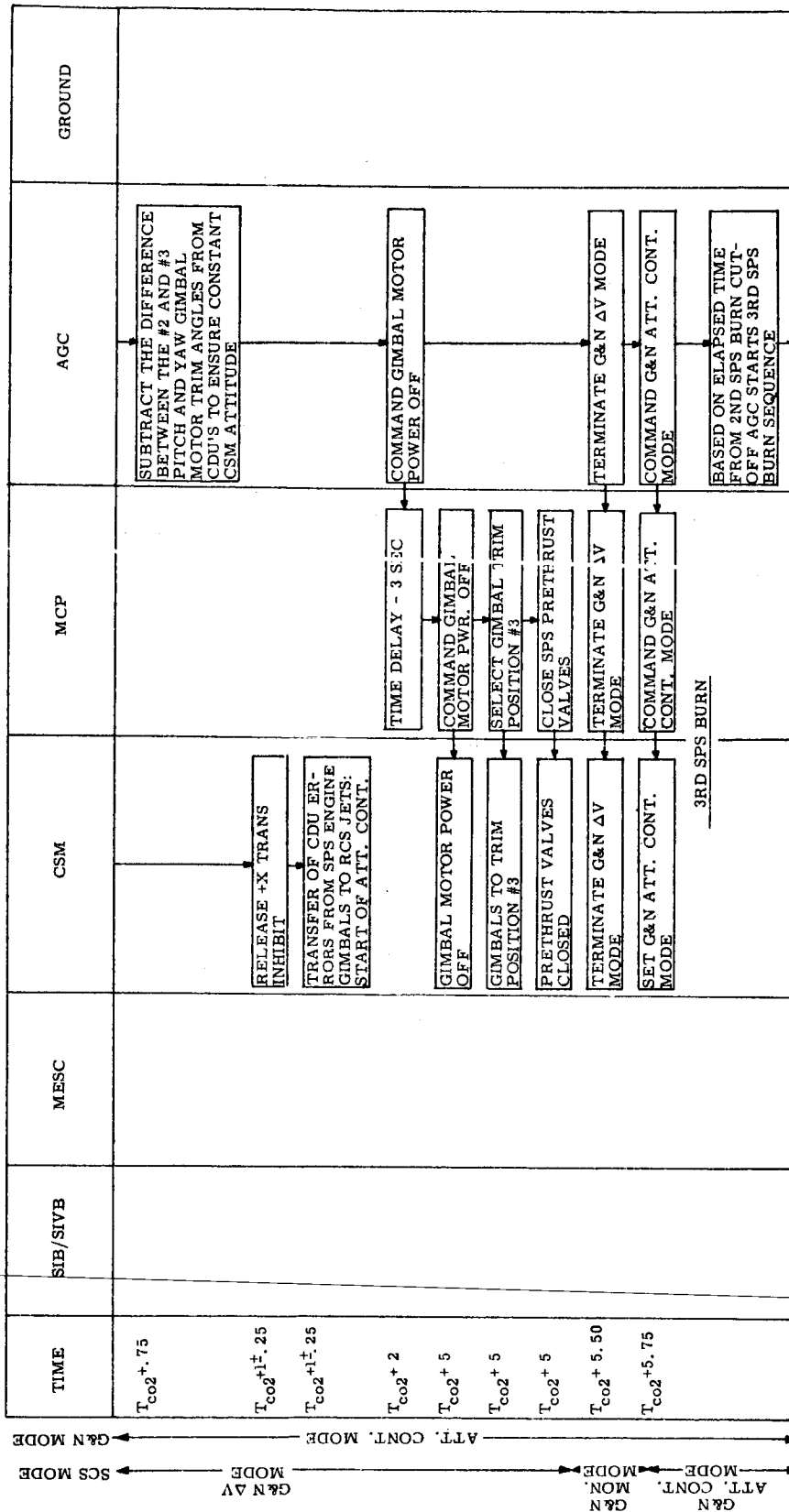

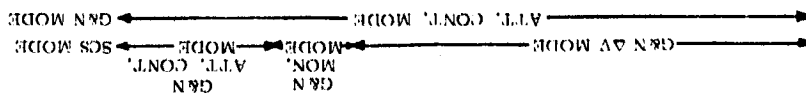
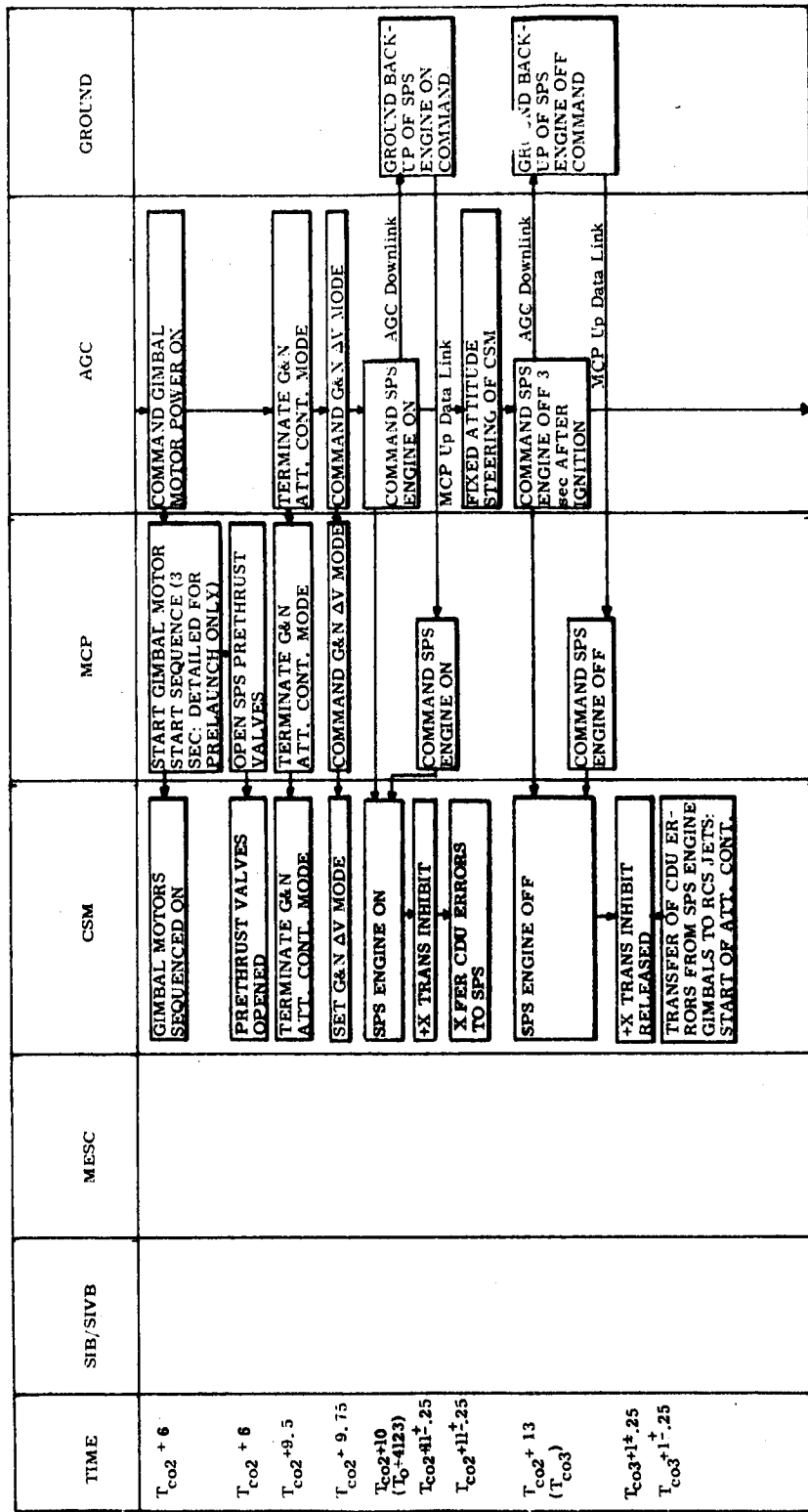

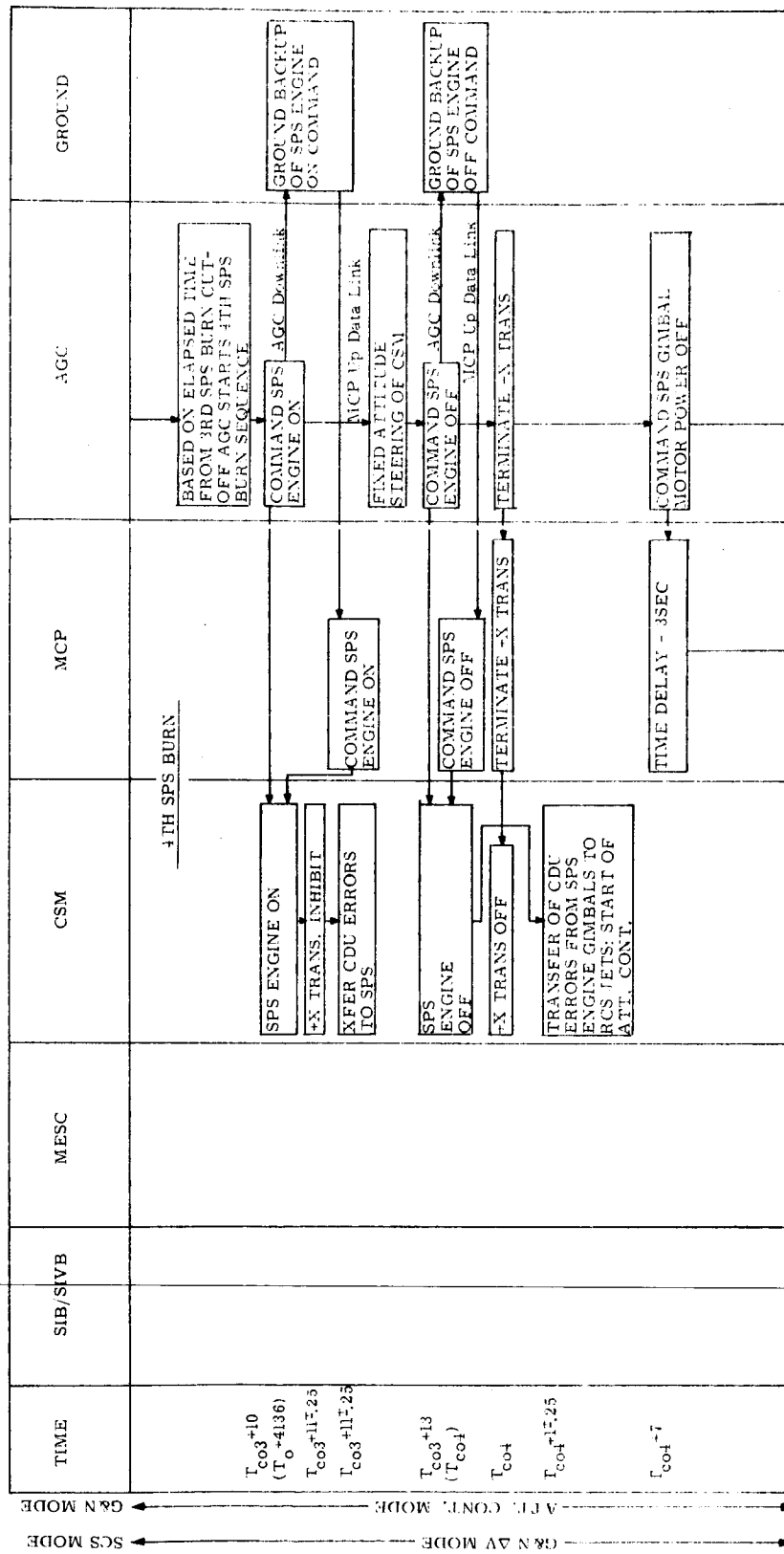

G&N MODE ←
 G&N ΔV MODE ←
 A.F.T. CONT. MODE ←

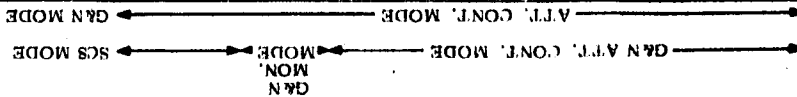
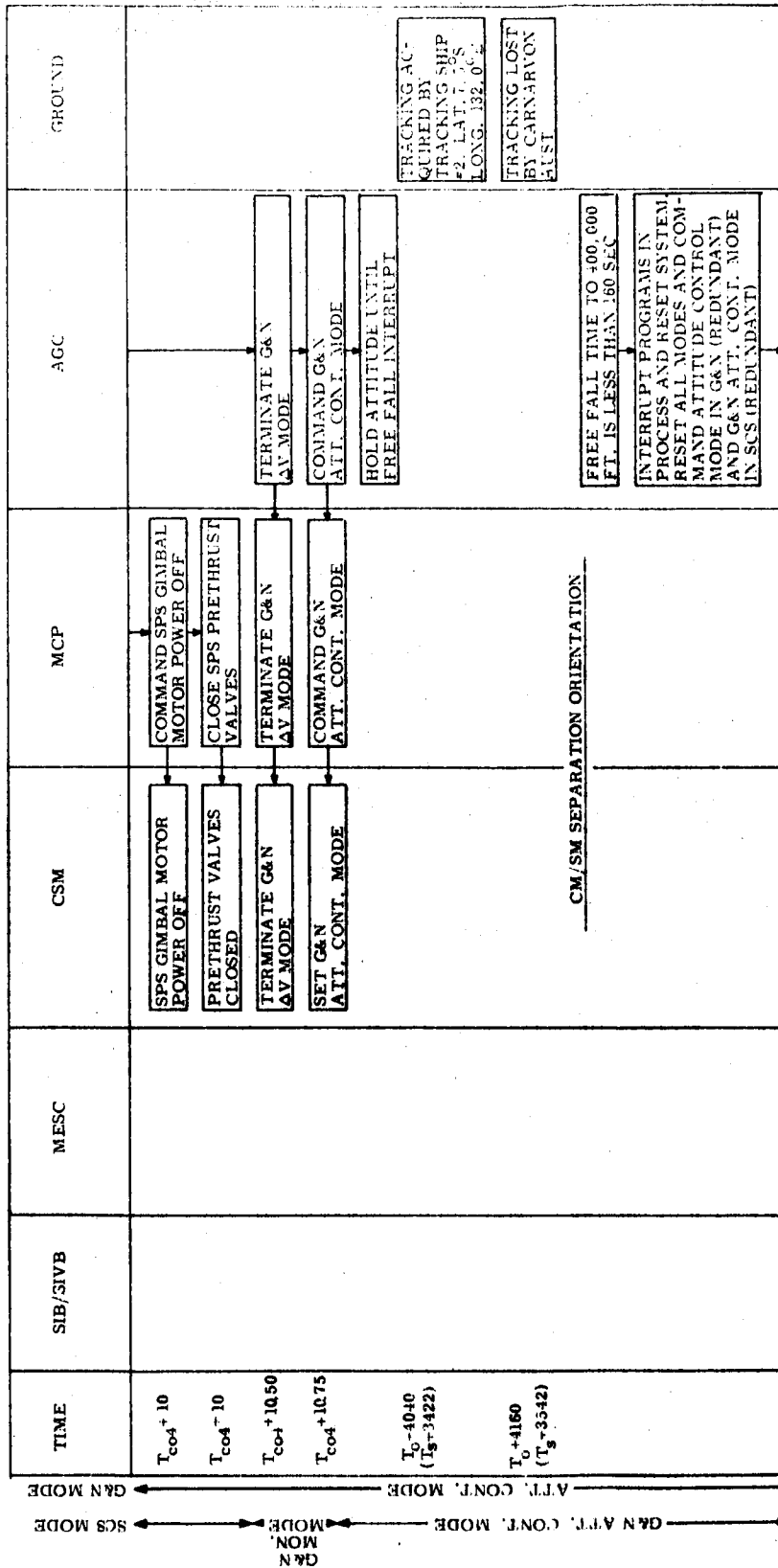

TIME	MESC	CSM	SM	MCP	AGC	GROUND
(T ₀ +4139)					AGC ASSUMES COMMANDED ATTITUDE TO BE HELD & CALCULATES ATTITUDE MANEUVER START VEHICLE REORIENTATION: COMMAND ROLL IF NECESSARY (FROM GIMBAL LOCK CALCULATION) TIME DELAY FOR CSM RESPONSE 3 SEC COMMAND PITCH/YAW MANEUVER TIME DELAY FOR CSM RESPONSE 3 SEC COMMAND ROLL TIME DELAY FOR CSM RESPONSE 5 SEC STANDBY FOR CM/SM SEPARATION COMMAND TO BE KEYED ON FREE FALL TIME TO 400,000' CALCULATION FREE FALL TIME TO 400,000' LESS THAN 85 SEC	

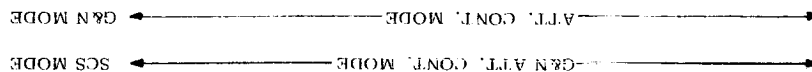

CM/SM SEPARATION

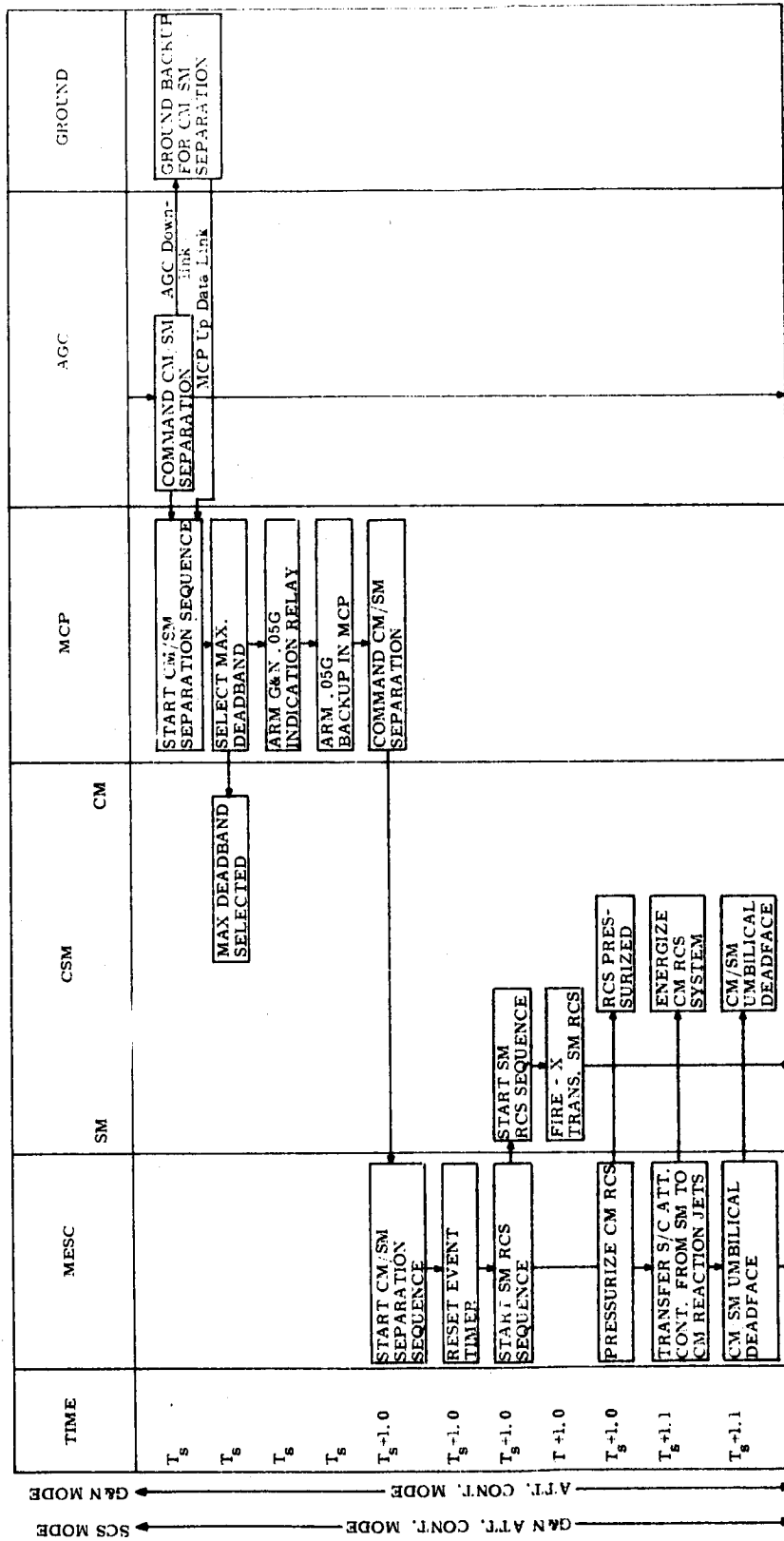

← G&N MODE
 ← G&N ATT. CONF. MODE
 ← SCS MODE

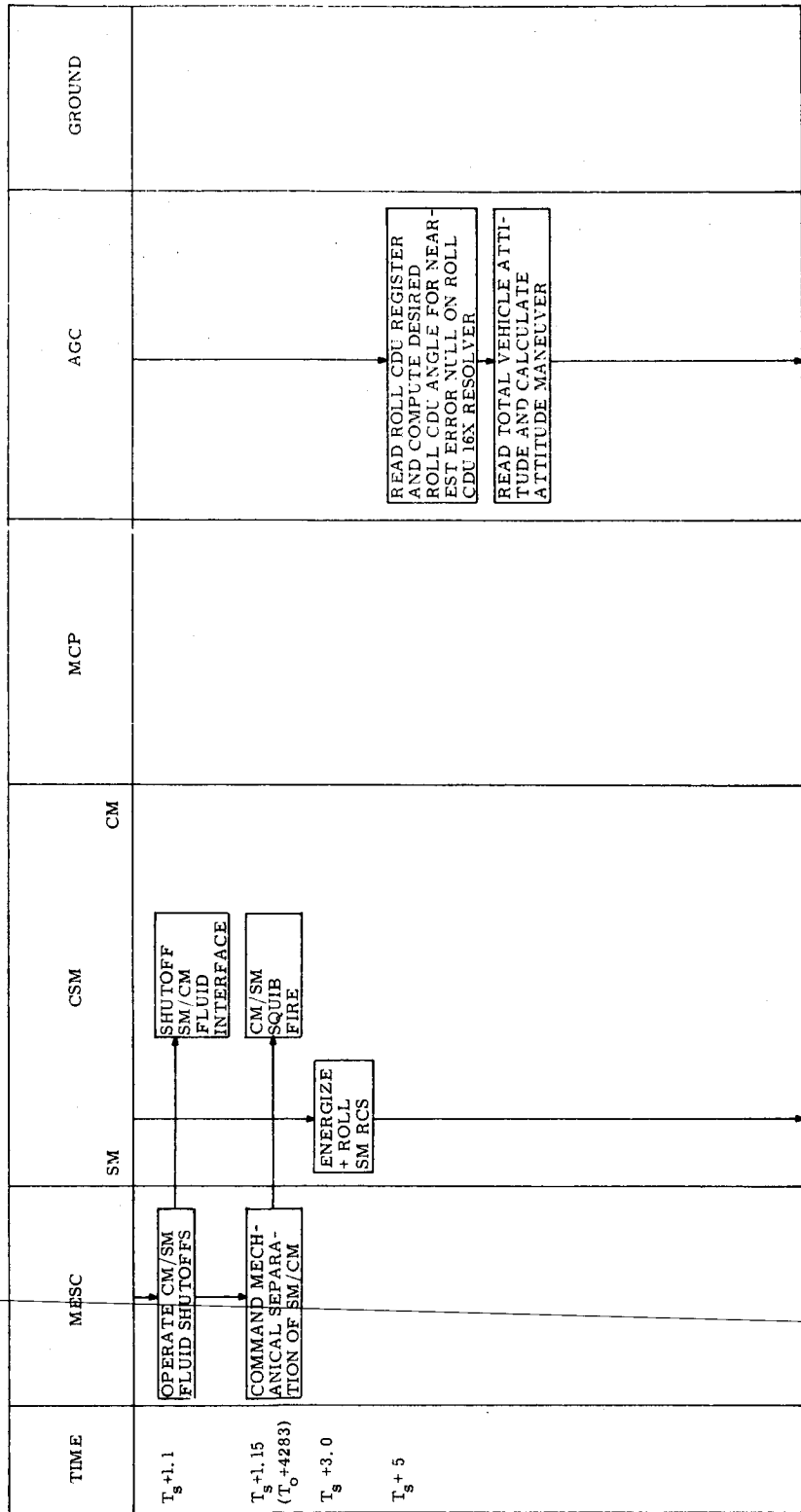

← G&N ATT. CONT. MODE
 ← G&N CONT. MODE
 ← SCS MODE

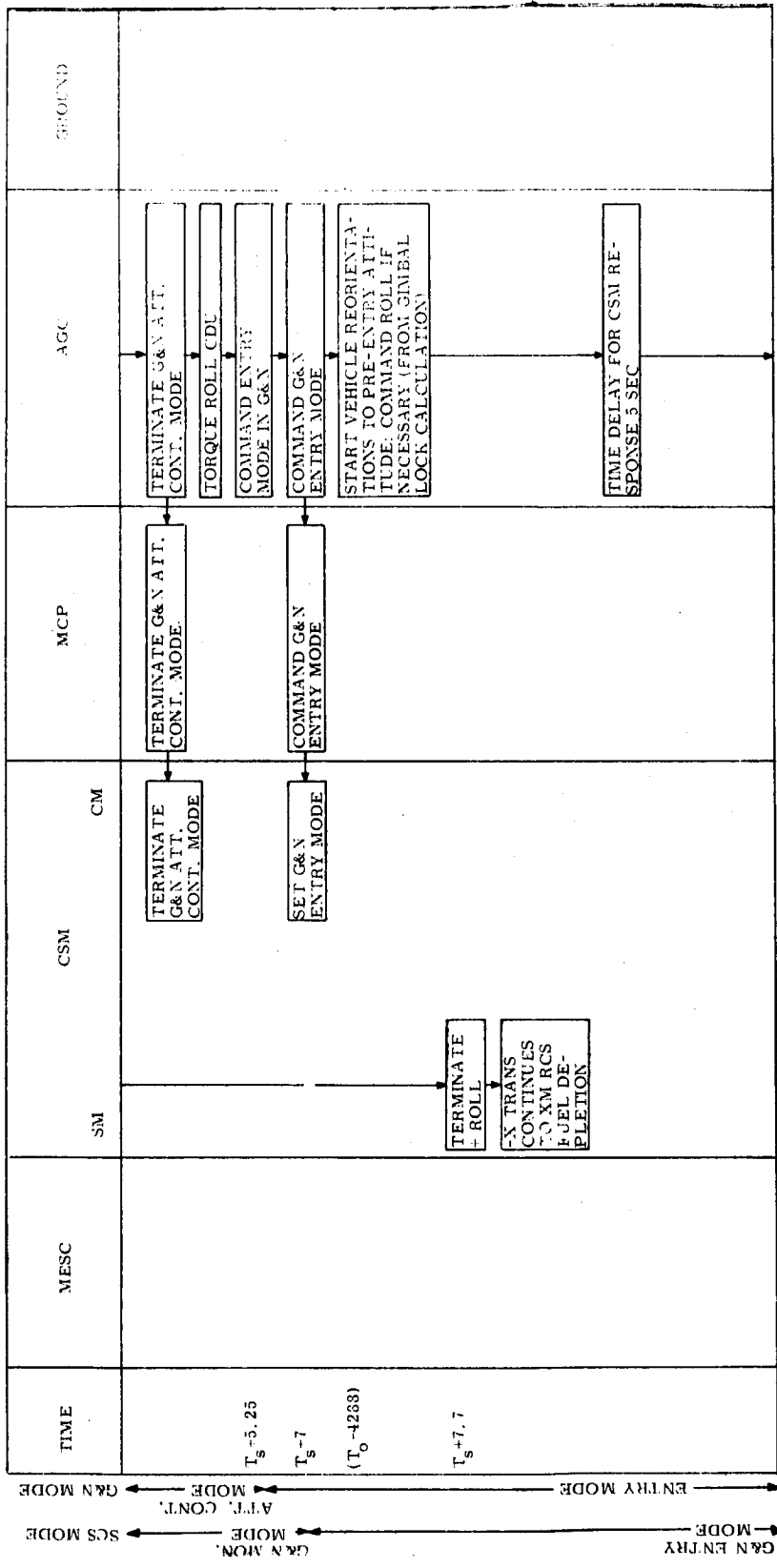

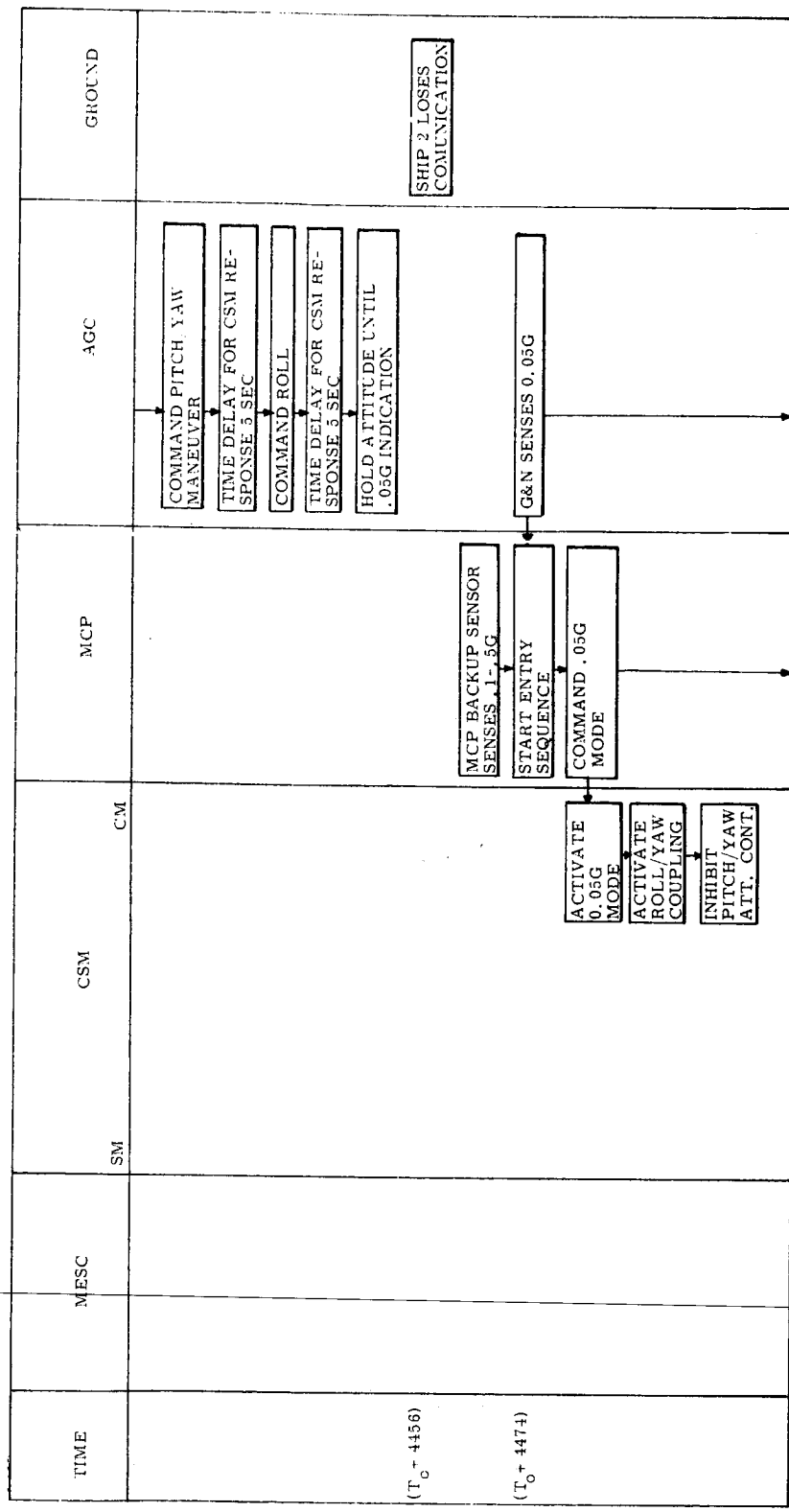

← G&N ENTRY MODE →
 ← G&N MODE →

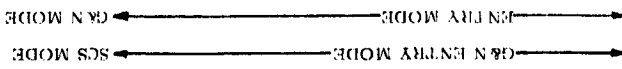
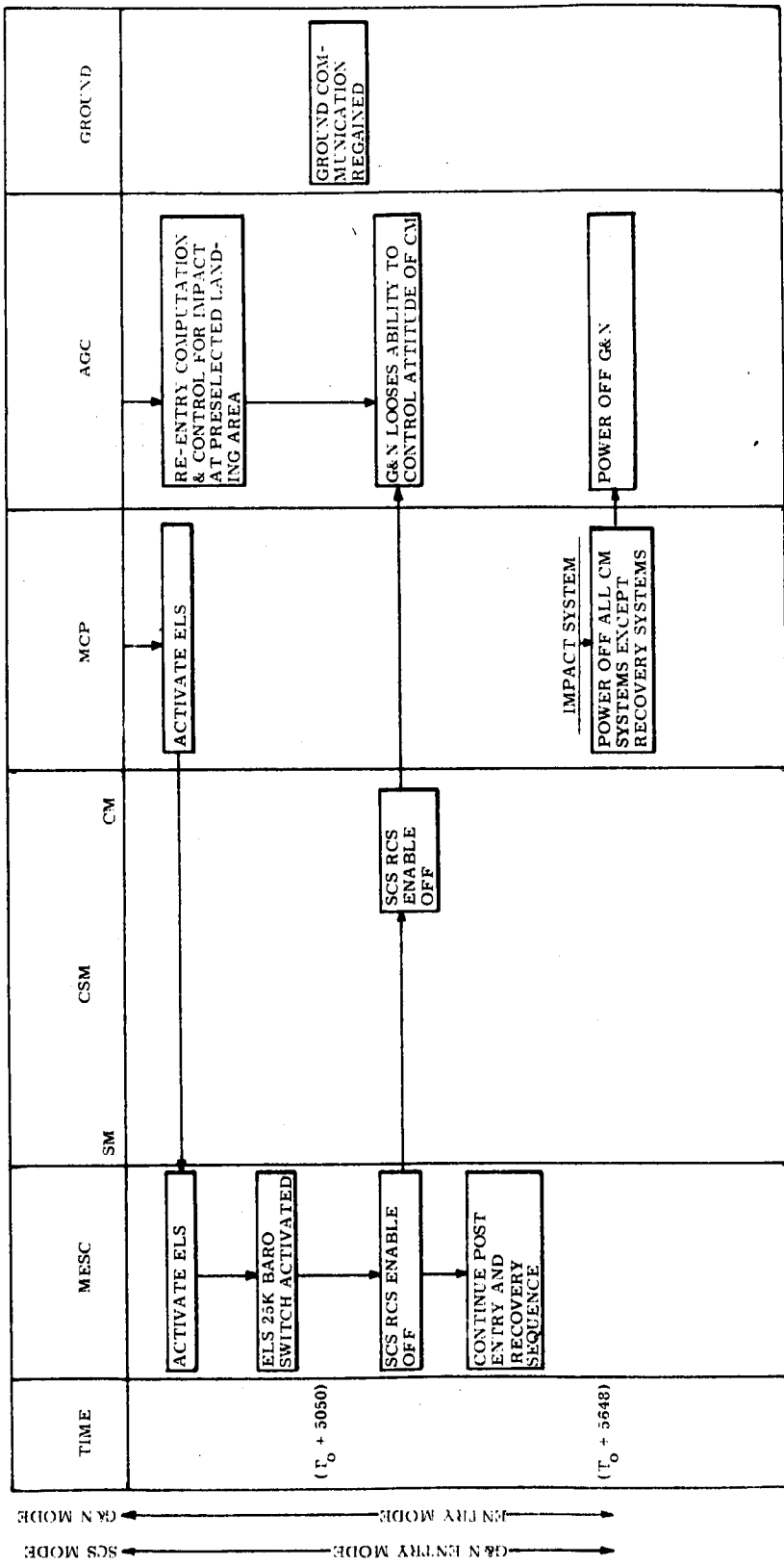

3.2.2 AGC Program Logic, Mission 202

The following diagrams illustrate the presently programmed AGC logic for Mission 202.

A program timeline shows the major program sections operating during each phase of the mission along with a functional description of each.

The block diagrams following the timeline expand in detail on each of these program sections and serve to explain fully the AGC logic involved in guidance, (navigation), and spacecraft control functions. Certain details are added to assist the reader in following through the actual program print out.

The terminology used is defined as follows:

- Establish - Cause a specified job to be performed under executive control.
- ENDOFJOB - Terminate a job.
- TOSLEEP - Suspend operation of a job.
- Call - Cause a specified task to be started at a specified time, under AGC waitlist control. A task may interrupt a job and, once called, continues to completion.
- TASKOVER - Terminate a task.
- Do - Branch to a routine with a return to the next operation in sequence.
- Set - Cause an "on" state of a specified bit in a register (flag).
- Remove - Cause an "off" state of a specified bit in a register (flag).
- Store - Store indicated quantity in erasable for future reference.
- T - Present time.
- TFF - Free fall time to 400,000 ft altitude.

The "on" state of flagwords used are defined as follows:

FLAGWRD1

- TUMB - Tumble state detected.
- ENTRY - Ready for entry.
- STEER - TVC steering mode on.
- DVMON - ΔV monitor on.
- INT1 - TFF < TFF criteria.
- INIT - Initial VR, thrust attitude computation.
- INTP - Free fall interrupt enabled.

CHDT - Change computation time step.
SHTDN - Preparation for free fall commenced.
COAST - In coast phase.
VERT - Local vertical control on.
MONIT - Saturn pitch monitor on.

FLAGWRD2

ARRST - Tumble arrest burn	}	Burn Switches
ABRT - Abort burn		
TABT - Burn after tumble arrest		
SPS1 - SPS 1 burn		
SPS2 - SPS 2 burn		
SPS3 - SPS 3 burn		
SPS4 - SPS 4 burn		
CALC -	}	Control flags for Calcmanu routine
ROLL -		
SPLIT -		
MANU -		
DOMAN - Enables manujob (attitude maneuvers)		
CMSM - Separation commanded		

MISSION 202 PROGRAM TIMELINE

<u>Time</u>	<u>Major Event</u>	<u>Operating Program Section</u>	<u>Functional Description</u>
To -11 hrs	Initiate Prelaunch	PRELAUNCH	Prelaunch Alignment (Gyro-Compassing and Vertical Erection):
To -1 hr	S/C Closeout		Final G&N systems check:
To -5 sec	Guidance Ref. Release		Saturn Guidance and IMU go Inertial. [READACCI] and [SERVICER] initiated. (Cycle independently during burns). [READACCI] reads PIPA's and establishes [SERVICER] which updates RN and VN via CALCRVG and computes TFF via CALCTFE.
To	Liftoff	[LIFTOFF]	[LIFTOFF] monitors vehicle attitude via MONJOB which drives CDU's to precom- puted boost angles. Ground monitors CDU errors.
To +138	Terminate Attitude Monitor		[LIFTOFF] terminated at this precomputed time.
To +150	SIB/SIVB SEP		
To +151	SIVB Ignition		
To +171	Initiate Tumble Monitor	[TUMBTSK1]	[TUMBTSK1] initiated at this precomputed time. (Monitors vehicle attitude rates via <u>TUMBJOB</u>).
To +172	Let Jettison		
To +618	SIVB/CSM SEP	[S4BSMSEP]	[S4BSMSEP] determines if tumble, abort, or SPS1 burn.

Footnotes:

1. Normal Sequence of events is shown in timeline.
2. Terms in Brackets [] refer to program section titles that have a separate page of description. Each page may describe more actions than is described by the mnemonic.
3. Terms underlined identify a location within the program.

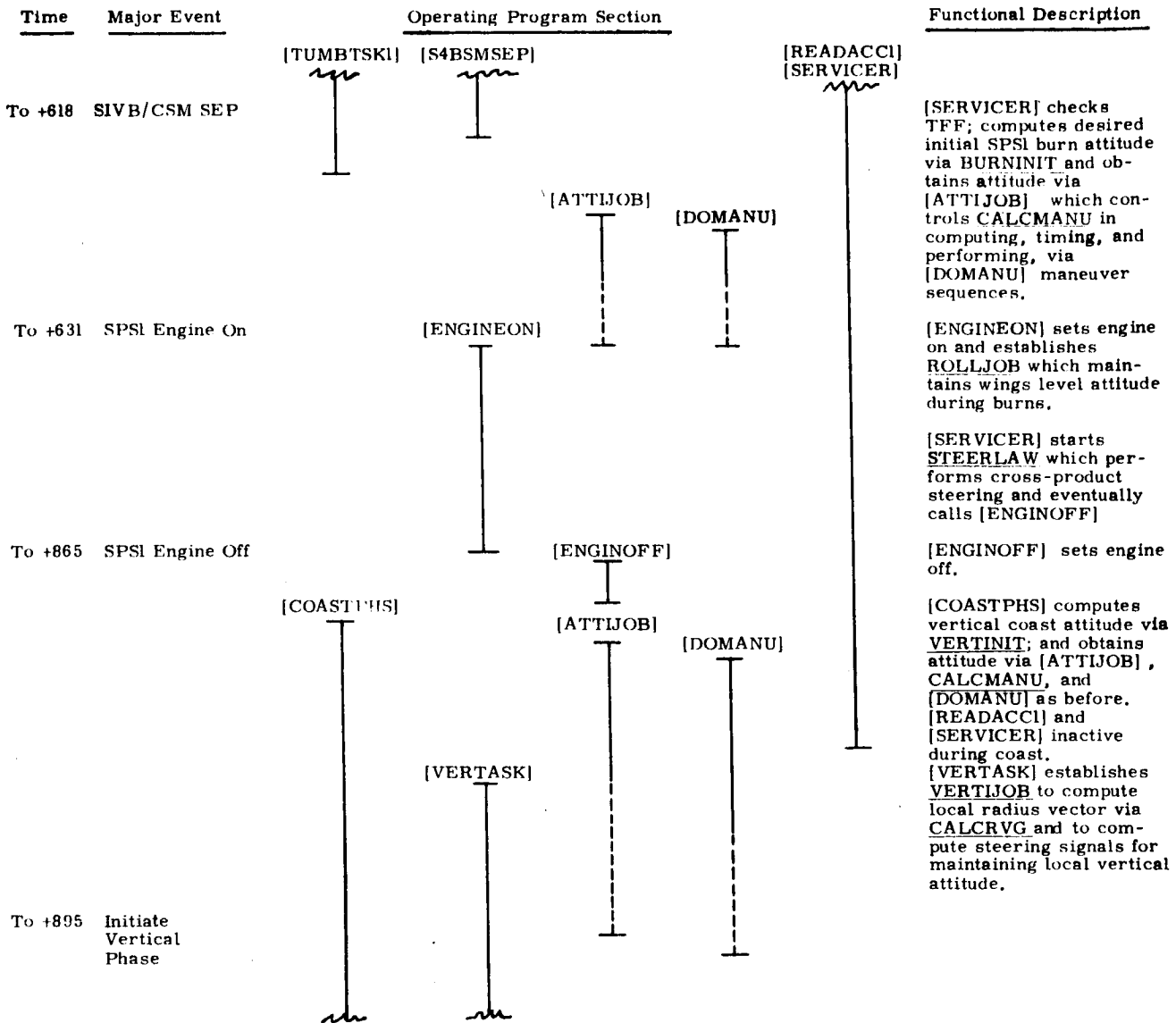

Time	Major Event	Operating Program Section				Functional Description
To +2902	Vertical phase over. Initiate maneuver to SPS2 attitude	[COASTPHS]	[VERTASK]	[ATTJOB]	[DOMANU]	At completion of vertical phase AVETOMID computes SPS2 initial burn point. [VERTASK] computes desired SPS2 initial attitude via CALCRAV, 202SPS2, and BURNINIT; and obtains attitude via [ATTJOB], CALCMANU and [DOMANU] as before.
To +3999	+X Trans On				[READACCU] [SERVICER]	[COASTPHS] reactivates [READACCU] and [SERVICER]; and calls [ENGINEON]
To +4020	SPS2 Engine On		[ENGINEON]			[ENGINEON] sets engine on.
To +4113	SPS2 Engine Off			[ENGINOFF]		[ENGINOFF] sets Engine Off.
To +4123	SPS3 Engine On		[ENGINEON]			[SERVICER] starts STEERLAW which performs cross-product steering and calls [ENGINOFF].
To +4126	SPS3 Engine Off			[ENGINOFF]		The 3 sec SPS3 and SPS4 burns proceed at 10 sec intervals, at SPS2 cut-off attitude.
To +4136	SPS4 Engine On		[ENGINEON]			[SERVICER], via F. F. interrupts, initiates pre-entry routines.
To +4139	SPS4 Engine Off			[ENGINOFF]		
To +4140	Pre-Entry				SEPMANU	SEPMANU computes and performs attitude maneuver for CM/SM separation.
To +4283	CM/SM Separation			ENTAJOB		ENTAJOB computes and performs attitude maneuver for entry.
To +4474	0.05g sensed	RE-ENTRY CONTROL				[SERVICER] updates target vector for entry routines.
To + 5648	Impact					RE-ENTRY CONTROL controls vehicle during atmospheric entry phase.

READACC1

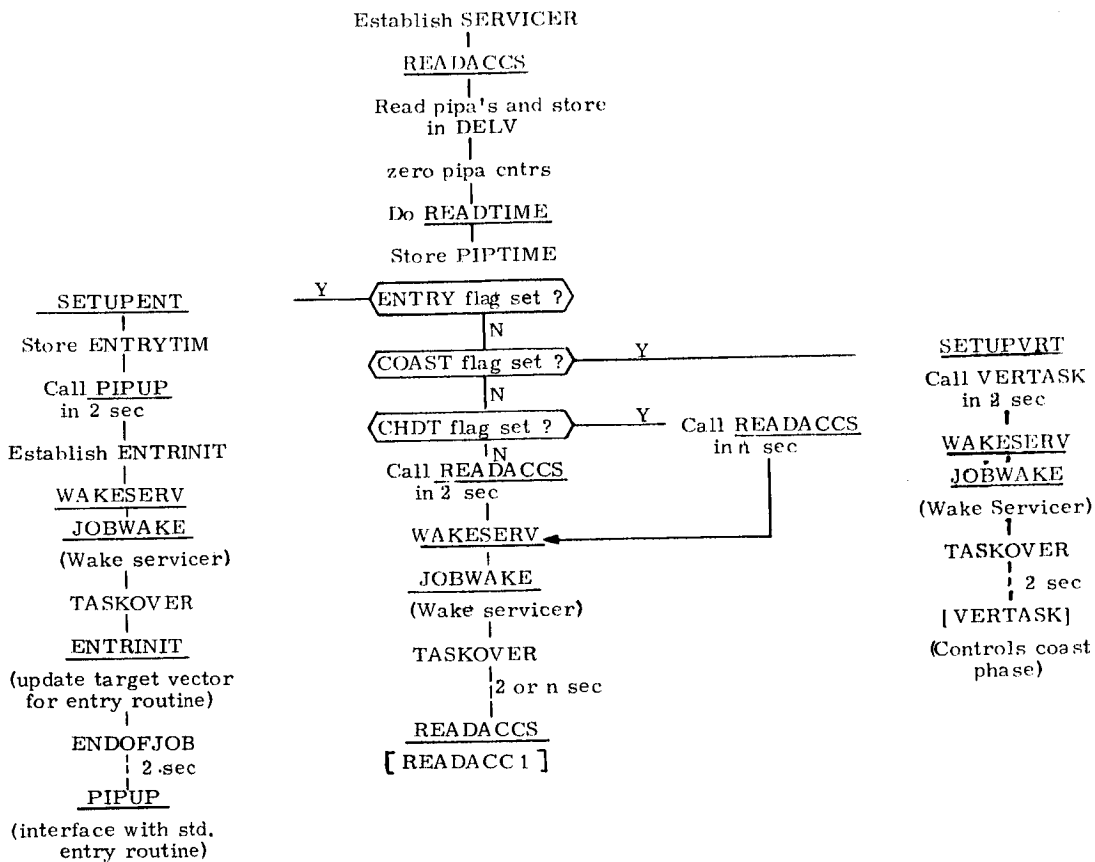

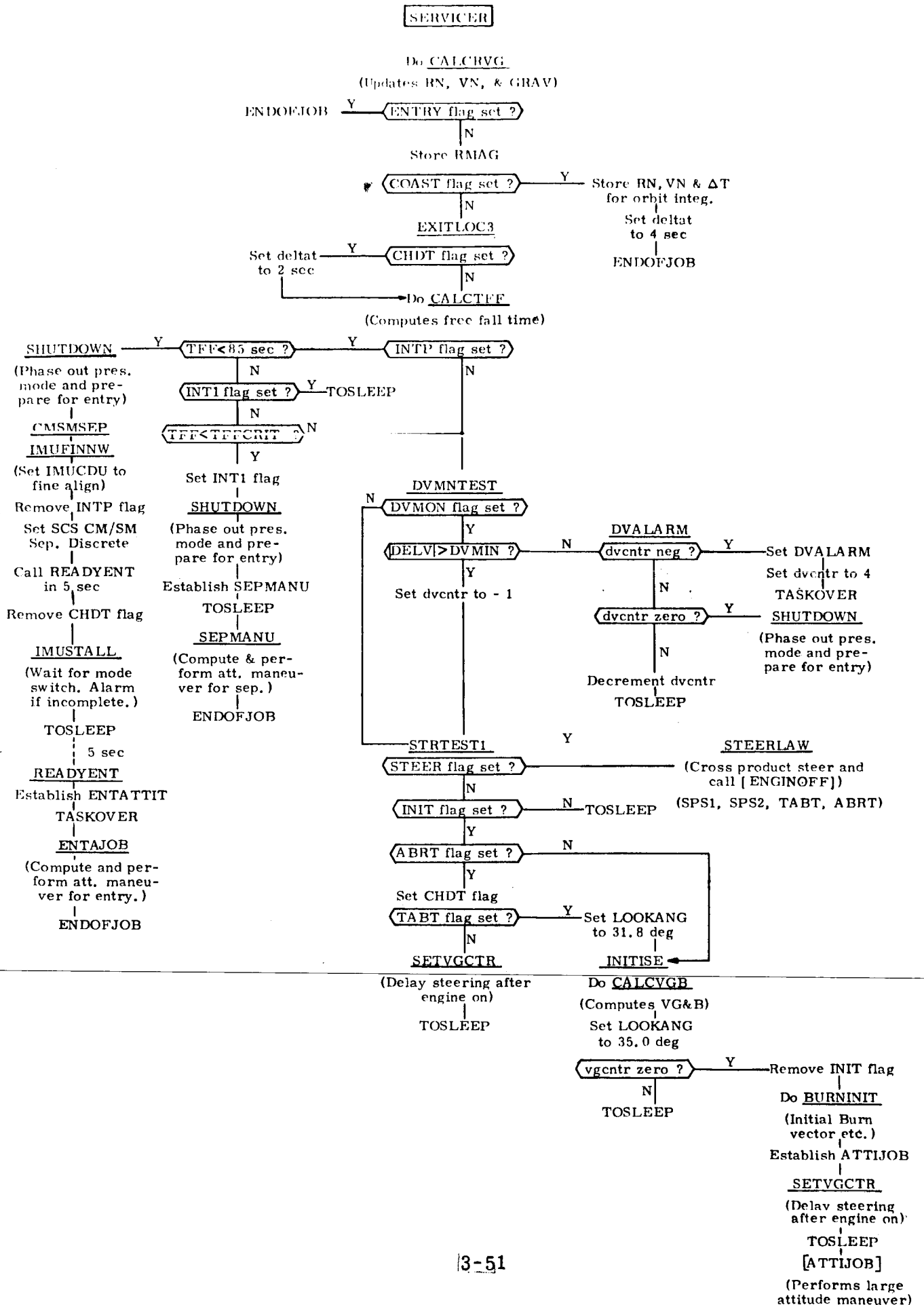

LIFTOFF

Call MONITSK1
in trise sec
Do READTIME
Store as TCUTOFF
IMUATTC

(Set IMUCDU to
att. cont. mode)
Store wc, thetaman
and dtheta

IMUSTALL
(Wait for mode switch.
Alarm if incomplete)

Set vgcnt to nroll
ENDOFJOB
trise sec

MONITSK1
Set DC MAN flag
MONITASK

vg cnt zero ? Y

N
Decrement vgcnt
Establish MONIJOB
Reset 3
Call MONITASK
in 1 sec
TASKOVER
MONIJOB

MONIT flag set ? N

Y
Increment POLYTIM
JUMP 6
POLYENT 1
(Evaluate poly)
ISTO25

(Change CDU scaling)
Update thetad + 1
ENDOFJOB
1 sec
MONITASK
[LIFTOFF]

JUMP 5

MONIT flag set ? Y

N
Set vgcnt to npitch
Set MONIT flag
Establish MONIJOB1
Reset 3
Call MONITASK
in 1 sec
TASKOVER
MONIJOB1
Set AOG = 180°
AMG = 0°
Set POLYTIM
to zero

SETUMON
Remove MONIT flag
Call TUMBTSK1 in
TTUM sec
TASKOVER
TTUM sec
[TUMBTSK1.]

MANUJOB + 1
1 sec
MONITASK
[LIFTOFF]

TUMBTASK1

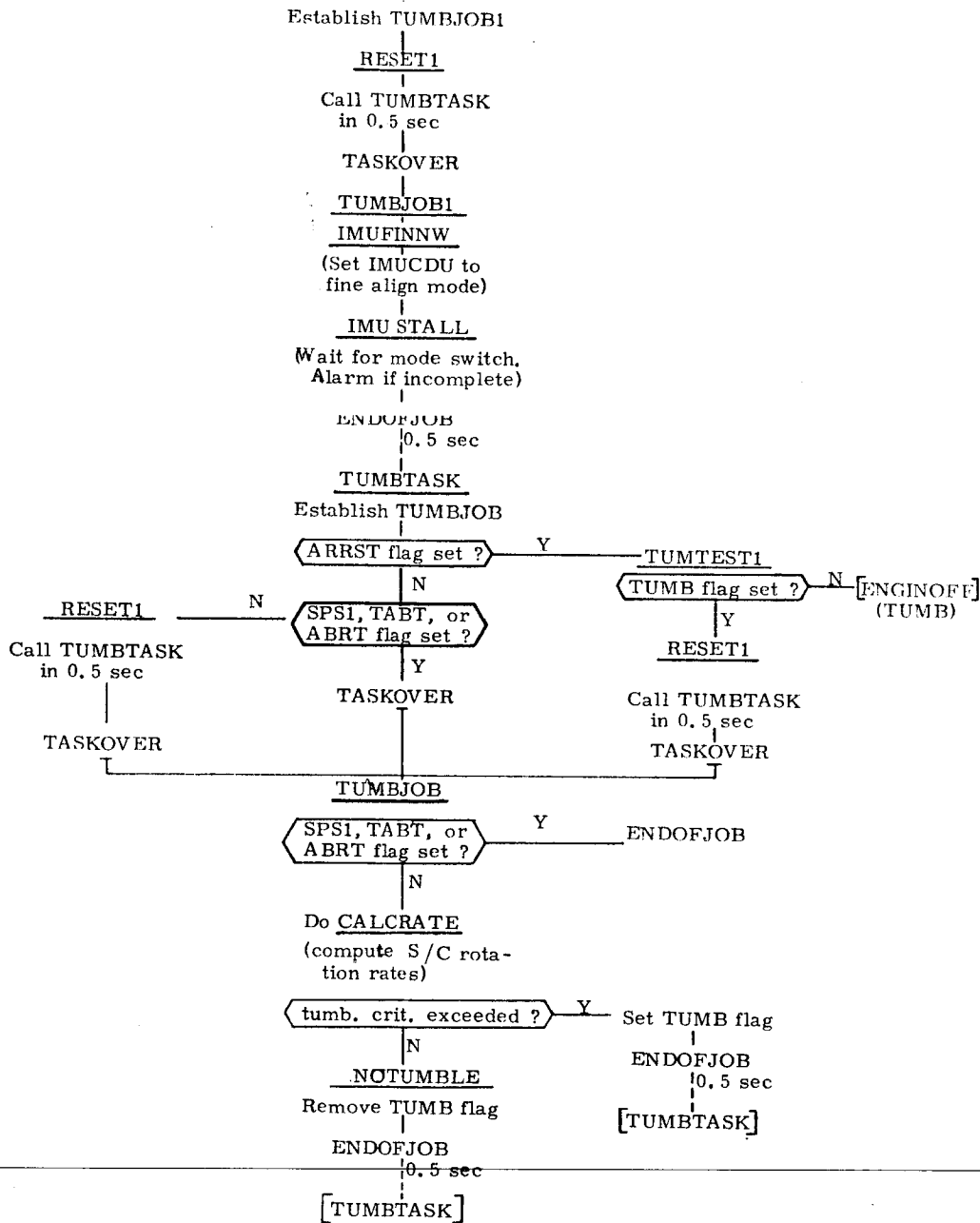

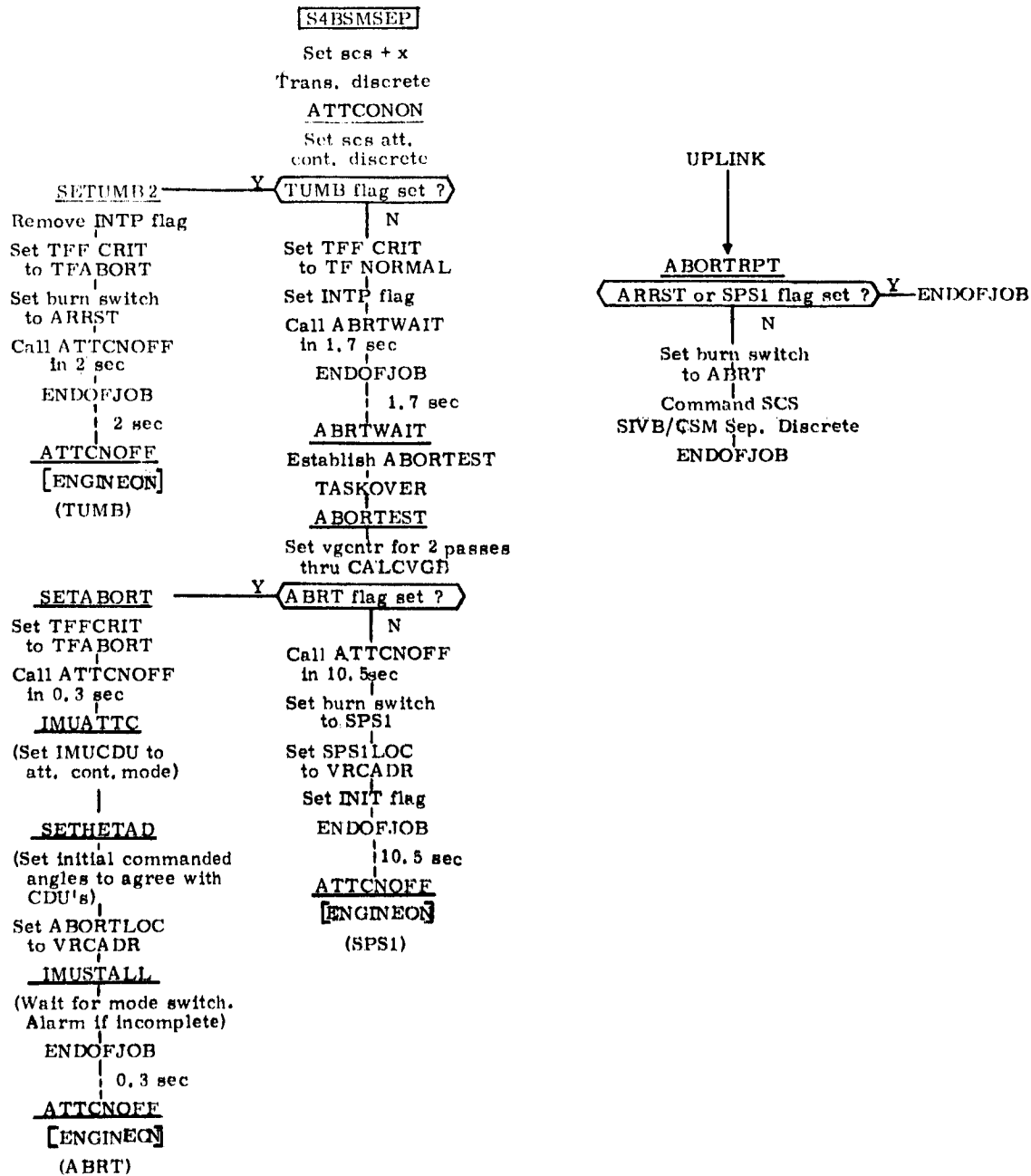

ATTIJOB

IMUATTC

(Set IMUCDU to att. cont. mode)

SETHETAD

(Set initial commanded angles to agree with CDU's)

initialise and store TMANU

Do CALCMANU

(Cycle through for maneuver time)

TABT flag set ?

N

CALC flag set ?

N

Compute and store TMANU

Y TFF < TMANU + TFFCRIT ?

IMUSTALL
(Wait for mode switch, Alarm if incomplete)

ENDOFJOB

(Wait for free fall interrupt)

NEXTMAN

NEXTLOC

(Pick up next maneuver in sequence)

TMANTEST

TMANU < 120 sec ?

N Set up LONGCALL with TMANU

Store ATTCLOC1 in CALLCADR

Call ATTCNOFF in TMANU + 0.5 sec

SHRTCALL

Call ATTCNOFF in TMANU + 1 sec

RELEASE1

Do CALCMANU

(Get first maneuver)

WAITHERE

IMUSTALL
(Wait for mode switch, Alarm if incomplete)

Store EXITLOC in EXITCADR

Call DOMANU in 0.01 sec

ENDOFJOB

0.01 sec

[DOMANU]

(commands S/C maneuvers)

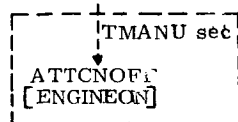

(called only for TABT)

ATTIJOB1

(Enter here if no mode change)

Do CALCMANU

(Defines maneuver sequence to desired attitude)

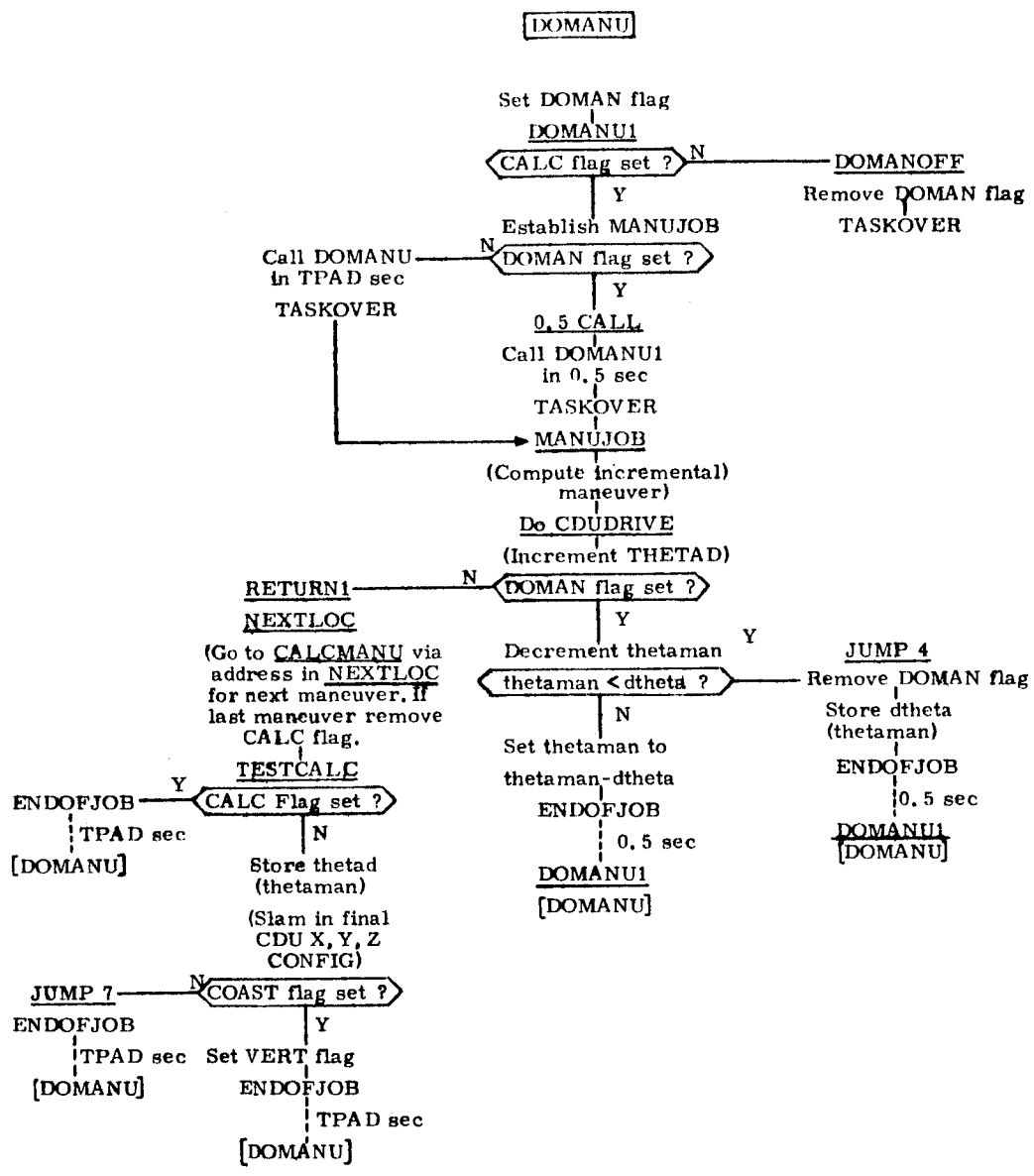

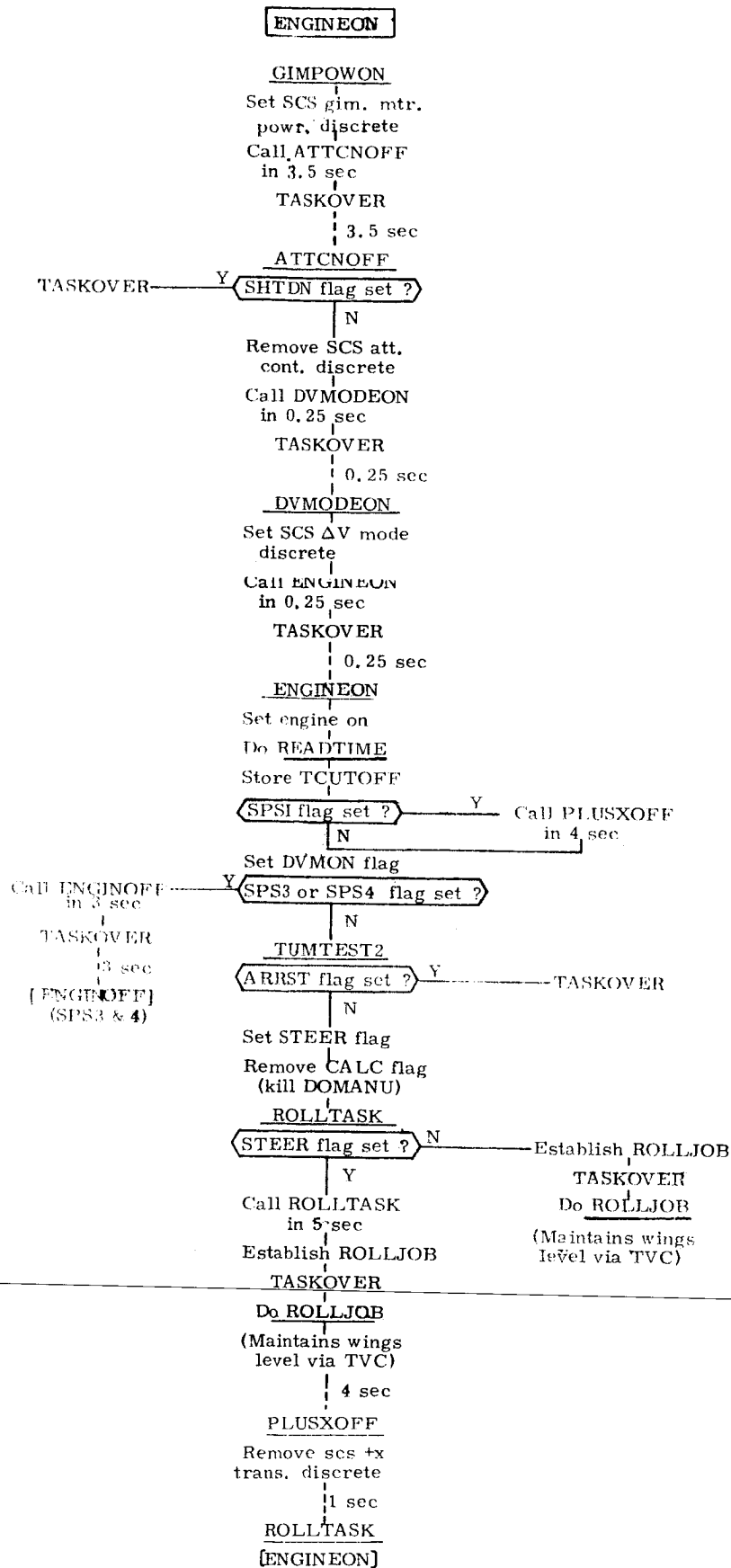

ENGINEOFF

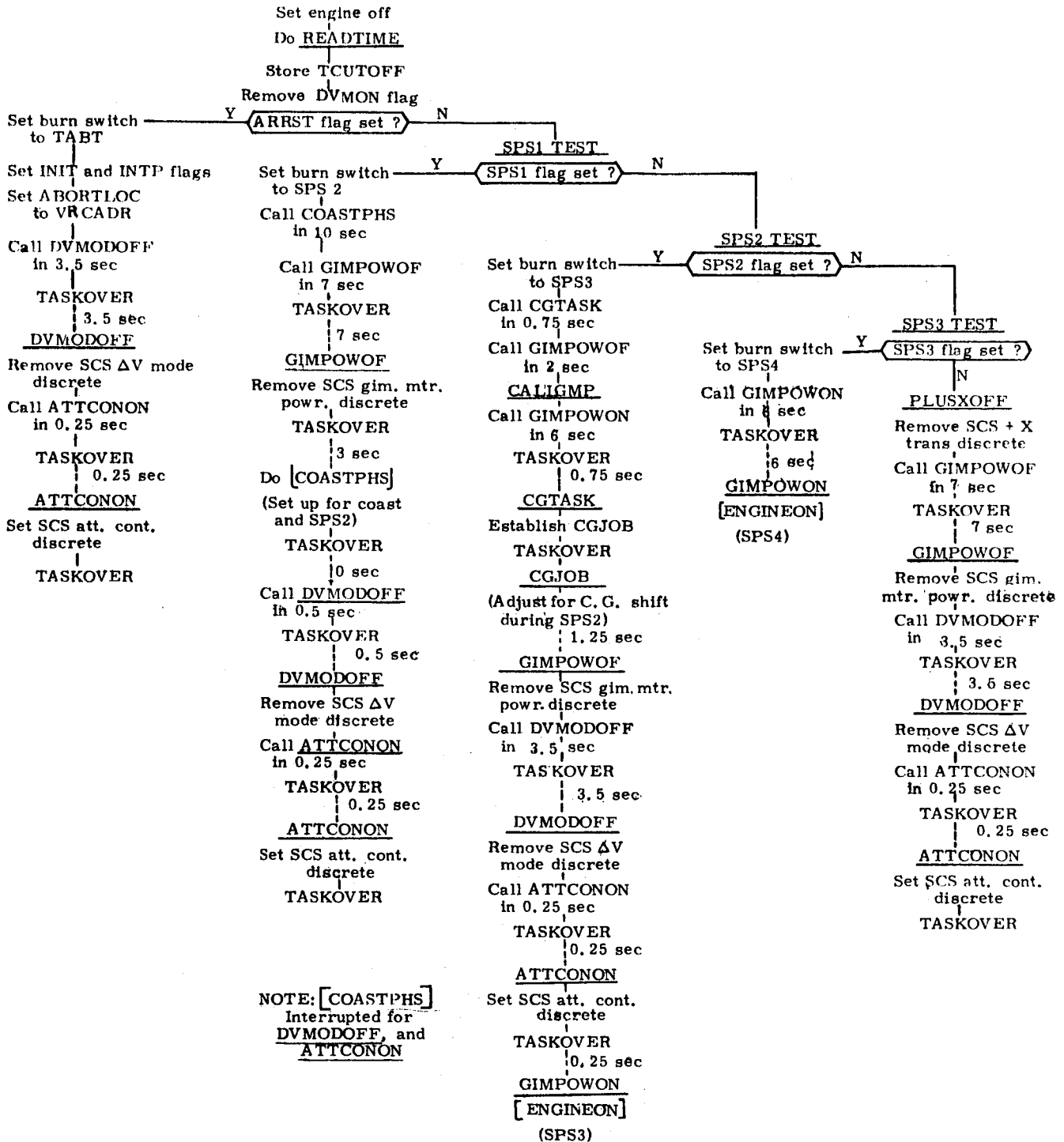

COASTPHS

Set COAST flag
|
Set up LONGCALL
with 298 sec
|
Store FDAILOC
in CALLCADR
|
Establish VERTINIT
TASKOVER
|
Do VERTINIT
(Compute and store
desired post SPS1
S/C attitude)
|
Do ATTIJOB1
(Maneuver to vert.
coast phase attitude)
| 298 sec
FDAONTSK
Call FDAOFTSK
in 10 sec
|
Set FDAI align
discrete
|
TASKOVER
| 10 sec
FDAOFTSK
Set up LONGCALL
with TCOAST
|
Store PLUSXLOC
in CALLCADR
|
Remove FDAI align
discrete
|
TASKOVER
| 2824 secs
PLUSX2
Set INTP flag
|
Clear PIPA Reg
|
Call GIMPOWON
in 26 sec
|
Set SCS + X trans.
discrete
|
Call READACCI
in 1 sec
|
TASKOVER
| 1 sec
[READACCI]
(Read PIPA's)
|
TASKOVER
| 25 sec
GIMPOWON
[ENGINEON]
(SPS2)

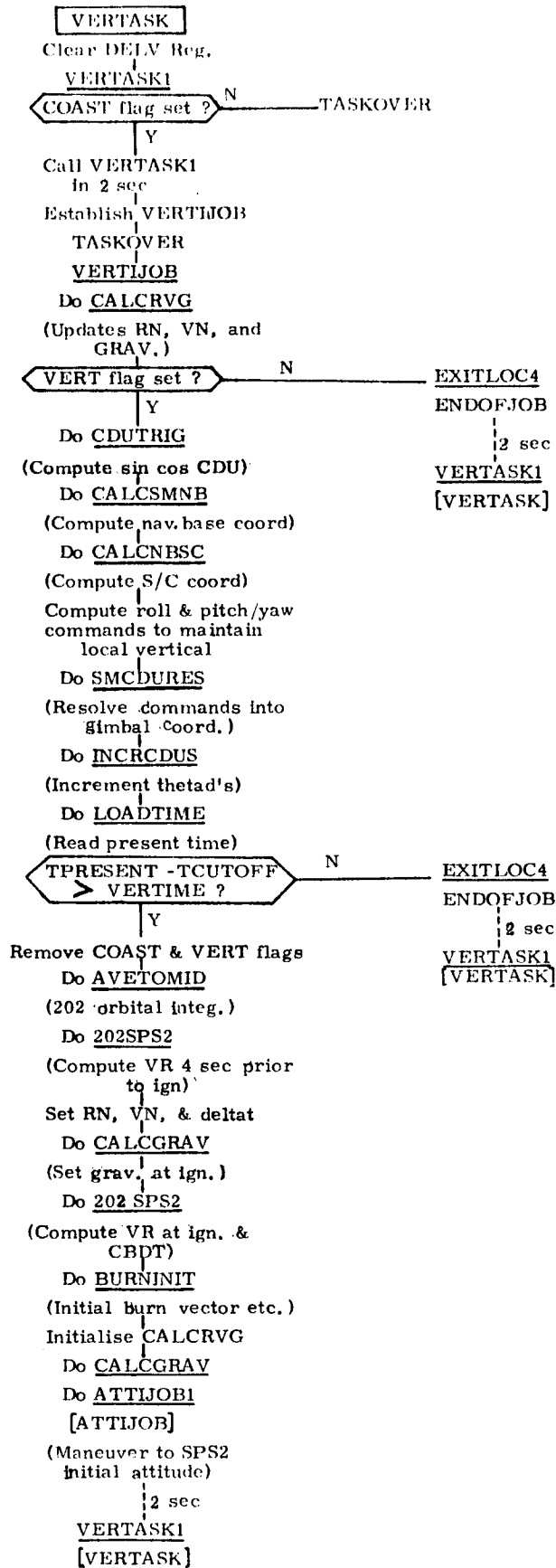

4. GUIDANCE EQUATIONS FOR CSM

4.1 Powered Flight Guidance Scheme

The guidance scheme for Mission 202 is the same as that planned for all Apollo CSM powered flights. It is based on the possibility of an analytical description of a required velocity (\underline{v}_r) which is defined as the velocity required at the present position \underline{r} , in order to achieve the stated objective of a particular powered flight maneuver.

If \underline{v} is the present velocity, then the velocity to be gained (\underline{v}_g) is given by

$$\underline{v}_g = \underline{v}_r - \underline{v} \quad (1)$$

Differentiation of both sides yields

$$\dot{\underline{v}}_g = \dot{\underline{v}}_r - \dot{\underline{v}} \quad (2)$$

$$= \dot{\underline{v}}_r - \underline{g} - \underline{a}_T \quad (3)$$

$$= \underline{b} - \underline{a}_T \quad (4)$$

where

$$\underline{b} = \dot{\underline{v}}_r - \underline{g} \quad (5)$$

and \underline{g} is the gravitational acceleration.

The steering command is developed by formulating a desired thrust acceleration (\underline{a}_{T_D}) as that which satisfies the equation

$$\underline{a}_{T_D} * \underline{v}_g = c \underline{b} * \underline{v}_g \quad (6)$$

where c is a constant scalar.

* Indicates vector cross product

Hence a measure of the error between \underline{a}_{T_D} and the actual acceleration \underline{a}_T is given by

$$\underline{\omega}_c = \frac{\underline{v}_g * \dot{\underline{m}}}{|\underline{v}_g| |\dot{\underline{m}}|} \quad (7)$$

where

$$\dot{\underline{m}} = c \underline{b} - \underline{a}_T \quad (8)$$

It can be verified that $\underline{\omega}_c$ is also the axis about which the thrust vector should be rotated to null the error. Hence $\underline{\omega}_c$ is used as the steering command.

Once a required velocity \underline{v}_r is defined satisfactorily, the procedure for the generation of the steering command $\underline{\omega}_c$ is the same for all phases of powered flight. The equations for the required velocity for the various phases are described in the succeeding pages. Descriptions of the initial alignment procedure, ignition and cutoff logic and implementation in AGC are also included.

4.2 Nominal Mission

4.2.1 Required Velocity

The required velocity for the first and second burns of the nominal mission is defined as that velocity which will put the vehicle in an elliptical trajectory of predefined parameters (semi major axis a , and eccentricity e). The values used are

	First Burn	Second Burn
a	2.2491076×10^7 feet	2.8286389×10^7 feet
e	0.10988556	0.25332143

These numbers correspond to the trajectory described in Section 5. The value of c in Eq. (6) is 1.

The required velocity can be written as

$$\underline{v}_r = \underline{i}_r v_{rad} + \underline{i}_H v_H \quad (9)$$

where

$$v_{\text{rad}} = \pm \left[\frac{\mu}{p} \left[e^2 - \left(\frac{p}{r} - 1 \right)^2 \right] \right]^{1/2} \quad (10)$$

$$v_H = + \left(\frac{\mu p}{r^2} \right)^{1/2} \quad (11)$$

$$p = a (1 - e^2) \quad (12)$$

$$\underline{i}_r = \frac{\underline{r}}{|\underline{r}|} \quad (13)$$

and

$$\underline{i}_H = \text{UNIT} (\underline{i}_N * \underline{i}_r) \quad (14)$$

The positive sign is used in Eq. (10) for the radial velocity during first burn and the negative sign is used during second burn.

4.2.2 Yaw Steering

Plane control during the nominal mission is achieved by specifying the normal (\underline{i}_N) to the required plane appearing in Eq. (14). The required trajectory plane is defined to be the plane containing the present position vector (\underline{r}) and the landing site vector taken as point of drogue chute deployment at 24,000 ft (\underline{r}_{LS} ; 17.15N, 170.00E) at the nominal time (5243.5 sec) of landing and is given by

$$\underline{i}_N = \text{UNIT} (\underline{r} * \underline{r}_{LS}) \text{ Sign} \left[(\underline{r} * \underline{r}_{LS}) \cdot \underline{i}_w \right] \quad (15)$$

where \underline{i}_w is the earth's polar unit vector. At cutoff the vehicle velocity will be equal to \underline{v}_r , thereby ensuring the trajectory plane to be \underline{i}_N according to Eqs. (9) and (14).

During the third and fourth burns, no computations are made for \underline{v}_r . The desired thrust direction is held fixed at the direction computed at the end of the second burn.

4.2.3 Engine Ignition

In the nominal mission the engine is always ignited after a fixed interval of time from a previous event. The first burn is

initiated 12.7 seconds after receipt of SIV-B/CSM separation signal, the second burn 3163.67 seconds after first burn cutoff, the third burn 10 seconds after second burn cutoff and the fourth burn 10 seconds after third burn cutoff.

4.2.4 Engine Cutoff

During all the burns a time to cutoff (T_g) is continuously being estimated from the equation

$$T_g = \left| \frac{v_g}{a_T} \right| \quad (16)$$

The accuracy of T_g increases as $T_g \rightarrow 0$, because as $|v_g| \rightarrow 0$, $|a_T| \rightarrow 0$.

For the first burn, when T_g falls, for the first time, below the critical value of 4.0 seconds, the clock is set to turn off the engine T_g seconds later. For the second burn, when T_g falls, for the first time, below 10 secs, the clock is set to turn off the engine ($T_g - 6$) secs later.

In the third and fourth burns the engine is turned off 3 seconds after ignition.

4.3 Aborts During Boost

The guidance equations for aborts during boost have been designed to meet the following constraints that have been imposed on the spacecraft attitude.

The visual horizon is to be kept on a hairline on the forward window during the entire powered flight and this line should be independent of the time at which abort is initiated.

The window geometry indicates that this requires the thrust direction to be between 4° and 36° to the line of sight to the visual horizon. Within this limitation, the larger the angle, the greater is the interval of time before nominal SIV-B cutoff during which the capability exists to reach a particular recovery area in the event of an abort. Hence a thrust angle of 35° to the line of sight to the horizon is used (See Fig. 4.1).

4.3.1 Required Velocity

The definition of a required velocity, in the usual sense, consistent with the direction of thrust pre-specified as above, is not possible. Hence, a pseudo required velocity is defined for aborts, which,

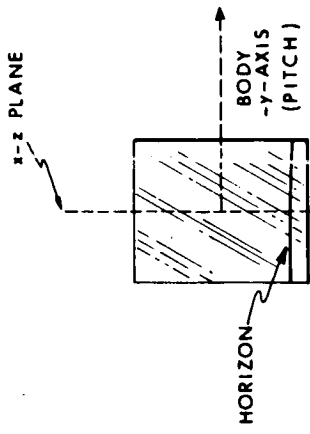
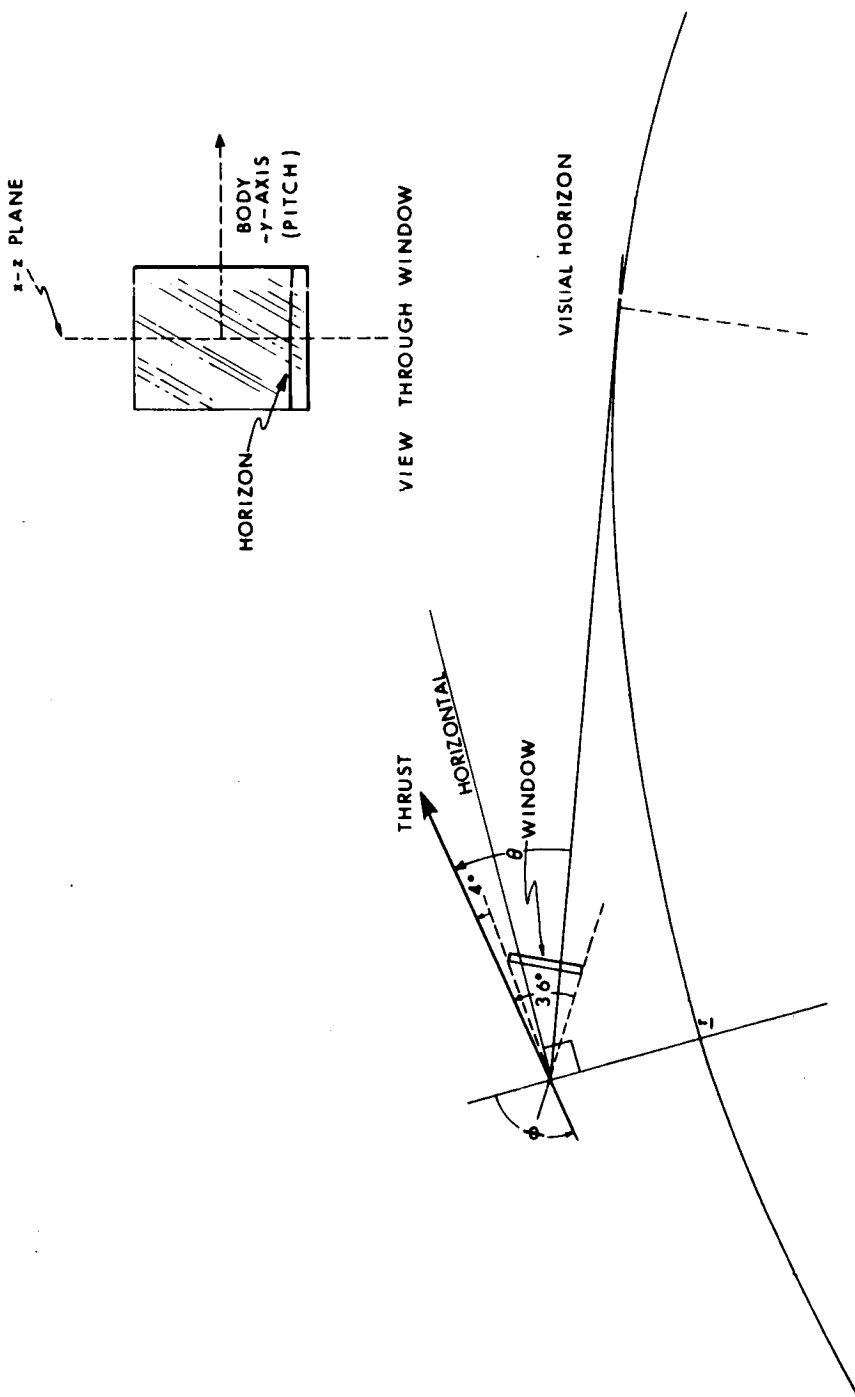

Fig. 4-1 Window Geometry

when incorporated into the general steering scheme, will satisfy not only the constraint on the thrust direction but also permit recovery from a specified landing area.

Let r_e be the entry position (400, 000 ft) corresponding to a free fall from the present position. Then we can write

$$x = \cot\left(\frac{\theta_f}{2}\right) \quad (17)$$

$$= \frac{r_e \cot \gamma + r \cot \gamma_e}{r_e - r} \quad (18)$$

and

$$\sin \theta_f = \frac{2x}{x^2 + 1} \quad (19)$$

$$\cos \theta_f = \frac{x^2 - 1}{x^2 + 1} \quad (20)$$

where

$$\cot \gamma = \frac{\underline{v} \cdot \underline{i}_r}{\underline{v} \cdot \underline{i}_H} \quad (21)$$

$$\cot \gamma_e = r/p \left[e^2 - \left(\frac{p}{r_e} - 1\right)^2 \right]^{1/2} \quad (22)$$

$$\underline{i}_H' = \underline{i}_p * \underline{i}_r \quad (23)$$

$$\underline{i}_p = \text{UNIT} (\underline{r} * \underline{v}) \quad (24)$$

θ_f is the free-fall central angle to the entry point,

r_e is the radius at 400, 000 ft altitude,

γ_e is the flight path angle w. r. t. the local vertical at entry

γ is the present flight path angle (w. r. t. vertical)

The entry-point is given by

$$\underline{r}_e = r_e (\underline{i}_r \cos \theta_f + \underline{i}_H' \sin \theta_f) \quad (25)$$

Now let \underline{r}_T be the desired landing site (target vector) at the nominal time. The target vector for aborts is the inertial position of 4.00°N and 329°E longitude at 1420 seconds from lift-off. This choice corresponds to minimum plane change for aborts at 609.95 seconds from the nominal boost trajectory. The normal ($\underline{1}_N$) to the desired plane is defined in section 4.3.2.

The desired entry point (\underline{r}_{ed}) is a function of the entry velocity and flight path angle. This vector is computed during each computational repetition as a function of the expected entry velocity and the inertial location of the nominal landing site.

If the engine were to be cut-off at the present time, the velocity at entry (v_e) will be (from the vis-viva integral)

$$v_e = (v^2 + 2 \mu (\frac{1}{r_e} - \frac{1}{r}))^{1/2} \quad (25a)$$

Based on this velocity v_e an anticipated entry range (ϕ_e) is computed from an empirical formula

$$\phi_e = \frac{6076.15}{R_e} (.1875 v_e - 3712.5) \quad (25b)^{\#}$$

if $v_e \geq 21400$ ft/sec, and

$$\phi_e = \frac{6076.15}{R_e} \quad (300) \quad (25c)$$

if $v_e < 21400$ ft/sec.

The desired entry vector (\underline{r}_{ed}) is computed as

$$\underline{r}_{ed} = r_e (\underline{1}_{r_{LS}} \cos \phi_e - \text{UNIT} (\underline{1}_N^* \underline{1}_{r_{LS}}) \sin \phi_e) \quad (25d)$$

At cut-off, $\underline{r}_{ed} = \underline{r}_e$ and the actual entry velocity is v_e , satisfying the entry range equation.

The error d can be written as

$$d = \left| \underline{r}_{ed} - \underline{r}_e \right| \quad (26)$$

[#]It should be noted that Eq. (25b) does not take into account the entry flight path angle. The co-efficients are pre-computed on the basis of the nominal trajectory and hence the flight path angle is implied in Eq. (25b).

The rate of change of this error is computed by differencing \underline{r}_e as

$$\dot{d} = \frac{\Delta d}{\Delta t} \quad (27)$$

$$\approx \left| \underline{r}_{e_n} - \underline{r}_{e_{n-1}} \right| / \Delta t \quad (28)$$

where the subscript n denotes the nth computational repetition

Observing that d/\dot{d} is a measure of the time to cutoff (T_g) and that T_g according to Eq. (16) is $|\underline{v}_g| / |\underline{a}_T|$ in the general scheme, the magnitude of \underline{v}_g is defined as

$$|\underline{v}_g| = \frac{d}{\dot{d}} |\underline{a}_T| \quad (29)$$

or

$$|\underline{v}_g| = \frac{d}{\Delta d} |\underline{\Delta v}| \quad (30)$$

where $\underline{\Delta v}$ is the velocity increment measured with the accelerometers in the interval Δt .

Now consider Eq. (6). Set $c = 0$; then

$$\underline{a}_{TD} * \underline{v}_g = 0 \quad (31)$$

If the direction of \underline{v}_g is chosen as the desired and known direction of \underline{a}_T , the specified constraint on the spacecraft attitude will be satisfied.

Figure 4-1 shows the geometry of the spacecraft window. The angle ϕ between the thrust and \underline{r} is given by

$$\phi = \theta + \sin^{-1} \left(\frac{R_{vh}}{|\underline{r}|} \right) \quad (32)$$

where θ is the specified angle (35°) to the horizon and R_{vh} is the radius to the visual horizon.

From Eq. (32) and Eq. (30) we can define \underline{v}_g as,

$$\underline{v}_g = \frac{d|\Delta v|}{\Delta d} (-\cos \phi \underline{i}_r + \sin \phi \underline{i}_{H'}) \quad (33)$$

4.3.2 Yaw and Roll Steering

The development of Eq. (33) is based on \underline{i}_r and $\underline{i}_{H'}$ which are both in the present trajectory plane according to Eq. (23). However, normally, a plane change will be required to reach the same landing site from different points of aborts on the boost trajectory.

Let the plane containing the present position \underline{r} and the target vector (See Section 4.3.1) \underline{r}_T be defined by

$$\underline{i}_N = \text{UNIT} (\underline{r} * \underline{r}_T) \text{Sign} [(\underline{r} * \underline{r}_T) \cdot \underline{i}_w] \quad (34)$$

The velocity increment along \underline{i}_p (normal to \underline{v}) to null the error between \underline{i}_p and \underline{i}_N is given by (See Fig. 4-2).

$$\Delta v_N = |v| (\underline{i}_p * \underline{i}_N) \cdot \underline{i}_r \quad (35)$$

The acceleration along \underline{i}_p required to accomplish the plane change is given by

$$\underline{a}_N = \underline{i}_p \frac{\Delta v_N}{T_g + \delta} \quad (36)$$

where δ is a small scalar (5 seconds). In order to prevent large yaw rate commands, a limit of 5 ft/sec^2 is imposed on $|\underline{a}_{N_n} - \underline{a}_{N_{n-1}}|$.

Equation (33) can be now modified to include yaw steering,
as

$$\underline{v}_g = \underline{i}_T \frac{d}{\Delta d} |\Delta V| \quad (37)$$

where

$$\underline{i}_T = \text{UNIT} \left[-\underline{i}_r \cos \phi + \text{UNIT} (i_H, a_T + \underline{a}_n) \sin \phi \right] \quad (38)$$

and a_T is the magnitude of the thrust acceleration.

The required velocity is given by

$$\underline{v}_r = \underline{v} + \underline{v}_g \quad (39)$$

where \underline{v}_g is given by Eq. (37). With the required velocity so computed and with $c = 0$, the same steering (Eq. 6) as for the nominal mission is used.

The rate command resulting from the required velocity \underline{v}_r has only pitch and yaw components. However, the vehicle must be rolled such that the pitch axis is in the horizontal plane (See Fig. 4-1). This is achieved by generating a roll command ($\underline{\omega}_R$) proportional to the cross product of the desired pitch-axis vector, unit ($\underline{r}^* \underline{i}_{\text{roll}}$), with the actual pitch axis unit vector, $\underline{i}_{\text{pitch}}$.

$$\underline{\omega}_R = K_{\text{roll}} \left[\underline{i}_{\text{roll}} \cdot \left(\underline{i}_{\text{pitch}} * \text{UNIT} [\underline{r}^* \underline{i}_{\text{roll}}] \right) \right] \underline{i}_{\text{roll}} \quad (39a)$$

The roll rate command is added to the rate command generated from Eq. (7).

4.3.3 Engine Ignition

In the case of a non-tumbling abort the engine is ignited 3.0 secs after receipt of the SIV-B/CSM separation signal.

If tumbling has been detected by the time the separation signal is received, the engine is ignited 3.0 secs later and is shut down when tumbling has been arrested. If the capability of landing area control

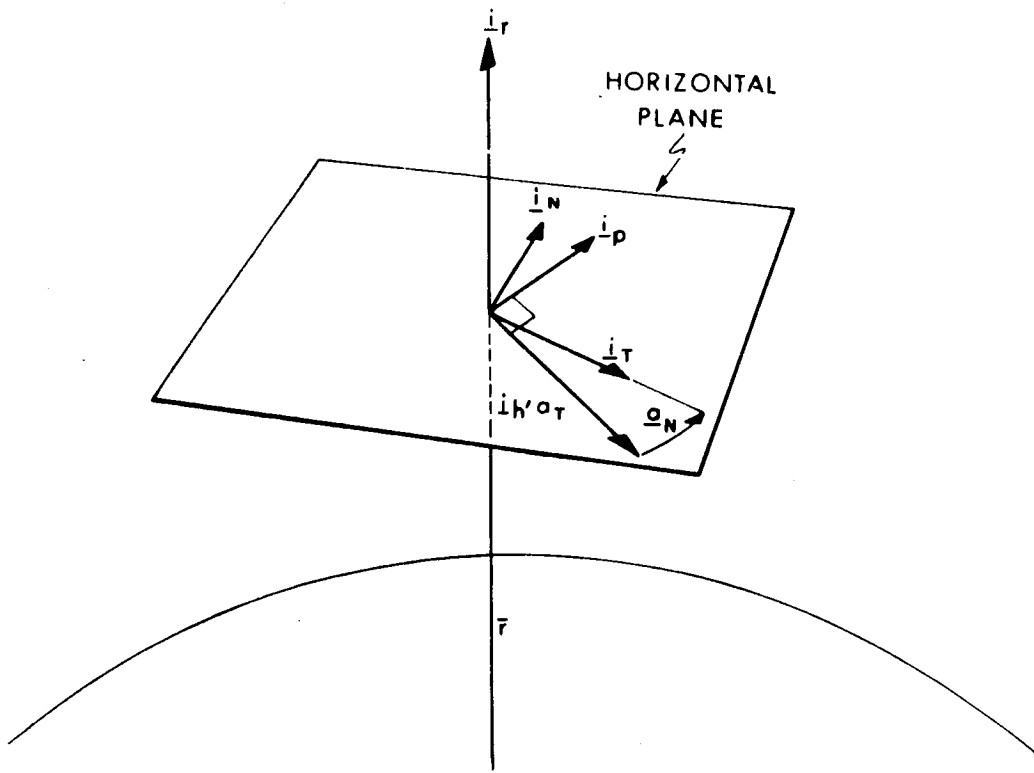

Fig. 4-2 Computation of a_n and i_t

exists, the engine is re-ignited after a time interval calculated to be sufficient to orient to the desired initial thrust direction.

4.3.4 Engine Cutoff

When T_g falls below 4.0 secs, the clock is set to turn off the engine T_g seconds later under normal area control. However, the engine will be turned off if any one of the following violations has occurred before $T_g < 4.0$ secs.

- a) Free-fall time to 400,000 ft is below 160 seconds
- b) \underline{r}_e is beyond \underline{r}_T . That is,

$$\underline{r} \cdot \underline{r}_e < \underline{r} \cdot \underline{r}_T \quad (40)$$

It should be pointed out that the estimate of T_g is very poor in the early part of the burn for long burns. Hence its value at ignition cannot be used in back-up systems.

4.4 AGC Computations

Since the information about the thrust acceleration comes from the accelerometers in the form of velocity increments (Δv), the computations in the AGC are in terms of increments of velocity rather than instantaneous acceleration. The repetitive guidance computations are shown in the form of a block diagram in Fig. 4-3. The computational blocks are common to all powered flight maneuvers except the computation of \underline{v}_r described in the preceding sections.

4.4.1 Average \underline{g} Equations

The vector position and velocity are updated in each computational cycle with a set of equations based on the average gravitational acceleration written as

$$\underline{r}_n = \underline{r}_{n-1} + \Delta t \left(\underline{v}_{n-1} + \underline{g}_{n-1} \frac{\Delta t}{2} + \frac{\Delta \underline{v}}{2} \right) \quad (46)$$

$$\underline{g}_n = \frac{-\mu}{r_n^2} \left[\left[1 + \left(\frac{r_e}{r_n} \right)^2 J(1 - 5 \sin^2 \phi) \right] \underline{i}_{r_n} + \left(\frac{r_e}{r_n} \right)^2 2J \sin \phi \underline{i}_w \right] \quad (47)$$

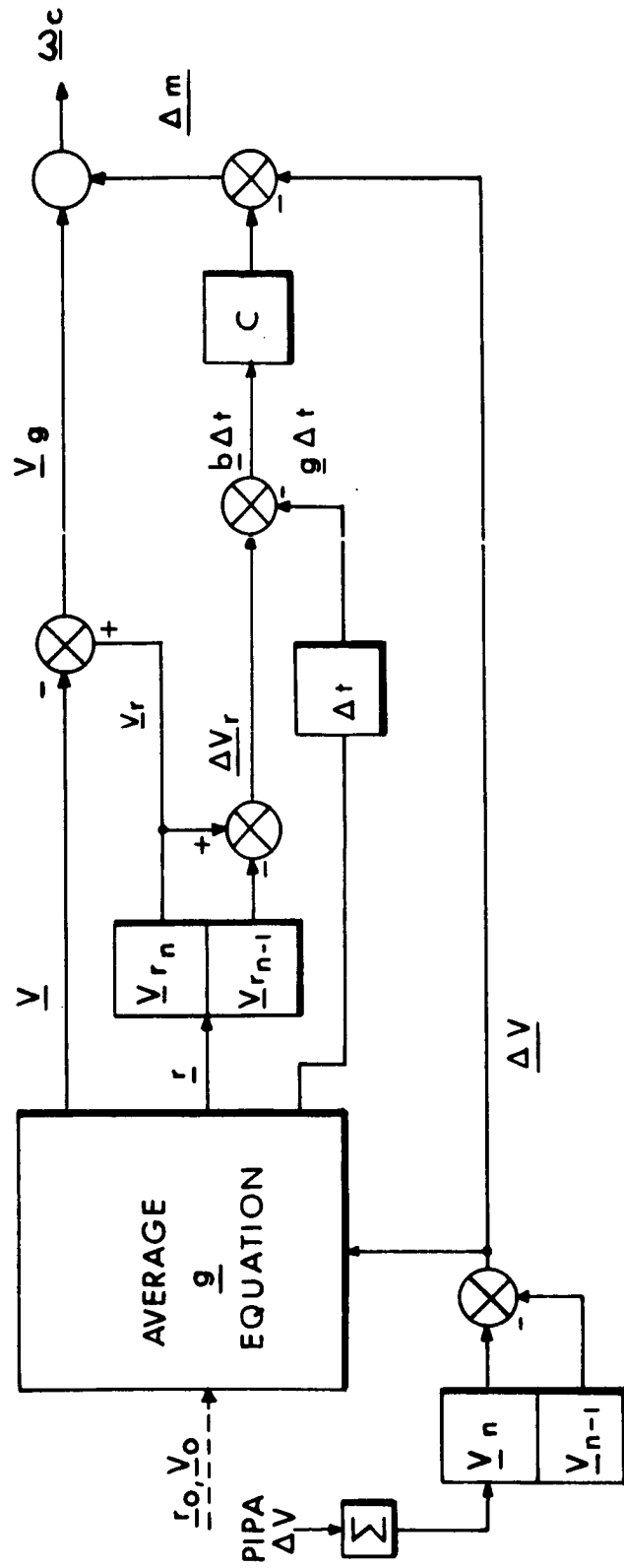

Fig. 4-3 Block Diagram of AGC Guidance Computations

and

$$\underline{v}_n = \underline{v}_{n-1} + \frac{(\underline{g}_{n-1} + \underline{g}_n)}{2} \Delta t + \Delta \underline{v} \quad (48)$$

where the subscript n denotes the nth computational repetition.

$J = 1.62346 \times 10^{-3}$, the first gravitation harmonic coefficient.

$\sin \phi = \sin (\text{Latitude})$

$$= \underline{i}_{r_n} \cdot \underline{i}_{w}$$

4.4.2 Steering Command

The vector \underline{b} was defined in Eq. (5) as

$$\underline{b} = \dot{\underline{v}}_r - \underline{g} \quad (5)$$

In the AGC (as shown in Fig. 4-3), the increment ($\underline{b} \Delta t$) is computed as

$$\underline{b} \Delta t \cong \underline{\Delta v}_r - \underline{g} \Delta t \quad (49)$$

Then the steering command in Eq. (7) can be written as

$$\underline{\Delta \theta}_c = \frac{\underline{v}_g * \underline{\Delta m}}{|\underline{v}_g| |\underline{\Delta m}|} \Delta t \quad (50)$$

where

$$\underline{\Delta \theta}_c = \underline{\omega}_c \Delta t \quad (51)$$

$$\underline{\Delta m} = c \underline{b} \Delta t - \underline{\Delta v} \quad (52)$$

4.4.3 Orbital Integration Equations

Position and velocity during the free-fall phases of the mission are calculated by a direct numerical integration of the equations of motion. Since the disturbing accelerations are small the technique of differential acceleration due to Encke is mechanized in the AGC, as described in MIT Report R-467, The Compleat Sunrise.

4.5 Initial Thrust Alignment

Before the engine is ignited for any particular maneuver, the vehicle should be oriented so that on ignition the thrust is in the desired direction at that point. Since the time of ignition is known beforehand, the position and velocity at ignition can be computed prior to the arrival of the vehicle at that

point. By integrating over Δt seconds from that point, the vectors \underline{v}_g and $\underline{b}\Delta t$ can be computed as shown in Fig. 4-3.

The desired thrust direction can be now calculated (prior to arrival at the ignition point) as

$$\underline{i}_T = \text{UNIT} \left[\underline{q} + (a_T^2 - |\underline{q}|^2)^{1/2} \underline{i}_g \right] \quad (53)$$

where

$$\underline{i}_g = \text{UNIT} (\underline{v}_g) \quad (54)$$

and

$$\underline{q} = \underline{cb} - (\underline{i}_g \cdot \underline{cb}) \underline{i}_g \quad (55)$$

and a_T is an estimate of the magnitude of the thrust acceleration.

Once \underline{i}_T is computed from Eq. (53), the vehicle is oriented prior to arrival at the ignition point such that the thrust axis is along \underline{i}_T , and the pitch axis is along the desired pitch axis vector, $\text{UNIT} (\underline{r} * \underline{i}_{\text{roll}})$ i. e. a wings-level, z(yaw) - axis up roll attitude.

4.6 Free-Fall Time

Since the free-fall time is not very large, the radial acceleration from cut-off to entry can be assumed constant. With this assumption the equation for the magnitude of the radius can be written as

$$r(T_f) = \ddot{r}(0) \frac{T_f^2}{2} + \dot{r}(0) T_f + r(0) \quad (56)$$

where T_f is the free-fall time to the radius $r(T_f)$ and $T_f = 0$ corresponds to present time.

Solving Eq. (56) for T_f yields

$$T_f = \frac{-\dot{r}(0) - \sqrt{\dot{r}(0)^2 - 2\ddot{r}(0)(r(0) - r(T_f))}}{\ddot{r}(0)} \quad (57)$$

Setting $r(T_f) = r_e$ in Eq. (57) the time of free-fall to entry is given as

$$T_f = \frac{-\dot{r} - \sqrt{\dot{r}^2 - 2\ddot{r}(r - r_e)}}{\ddot{r}} \quad (58)$$

If $r < r_e$, the radical in Eq. 58 will be negative. In this case T_f is set equal to zero. On the other hand, if \ddot{r} is so small, to cause an overflow, T_f is set to the maximum value of $2^{28}/100$ seconds.

4.7 Entry Mode

Included in this section is a set of flow charts that describe the logic and equations that control the entry vehicle. Figure 4.4 shows the overall picture of the sequence of operations during entry. Each block in Figure 4.4 is described in detail in subsequent charts. Table 4-1 defines symbols which represent computed variables stored in erasable memory. The value and definition of constants is given in Section 5.

Every pass through the entry equations (done once every 2 seconds) is begun with the section called navigation. (See Figure 4.5). This integrates to determine the vehicle's new position and velocity vector. This sub-routine is used by other phases than entry and is called the Average G routine.

Next, the targeting is done. This updates the desired landing site position vector and computes some quantities based on the vehicle's position and velocity and the position of the landing site. (See Figure 4.6).

The next sequence of calculations is dependent upon the phase of the entry trajectory that is currently being flown. First is the initial roll angle computation. (See Figure 4.7). This merely adjusts the Initial roll angle (180° for a nominal 202 entry; 0° for abort cases) and tests when to start the next phase.

The next phase maintains a constant drag trajectory while testing to see if it is time to go into the up-control phase. The testing is presented in Figures 4.8 and 4.9. The constant drag equations are given in Figure 4.10. The other phases (up-control, ballistic and final) are listed in Figure 4.11, 4.12 and 4.13. The final phase is accomplished by a stored reference trajectory. Its characteristics as well as the steering gains are stored as shown in Figure 4.14. The routine that prevents excessive acceleration build-up (G limiter) is given in Figure 4.15. And finally, the section that does the lateral logic calculations and computes the commanded roll angle is shown in Figure 4.16.

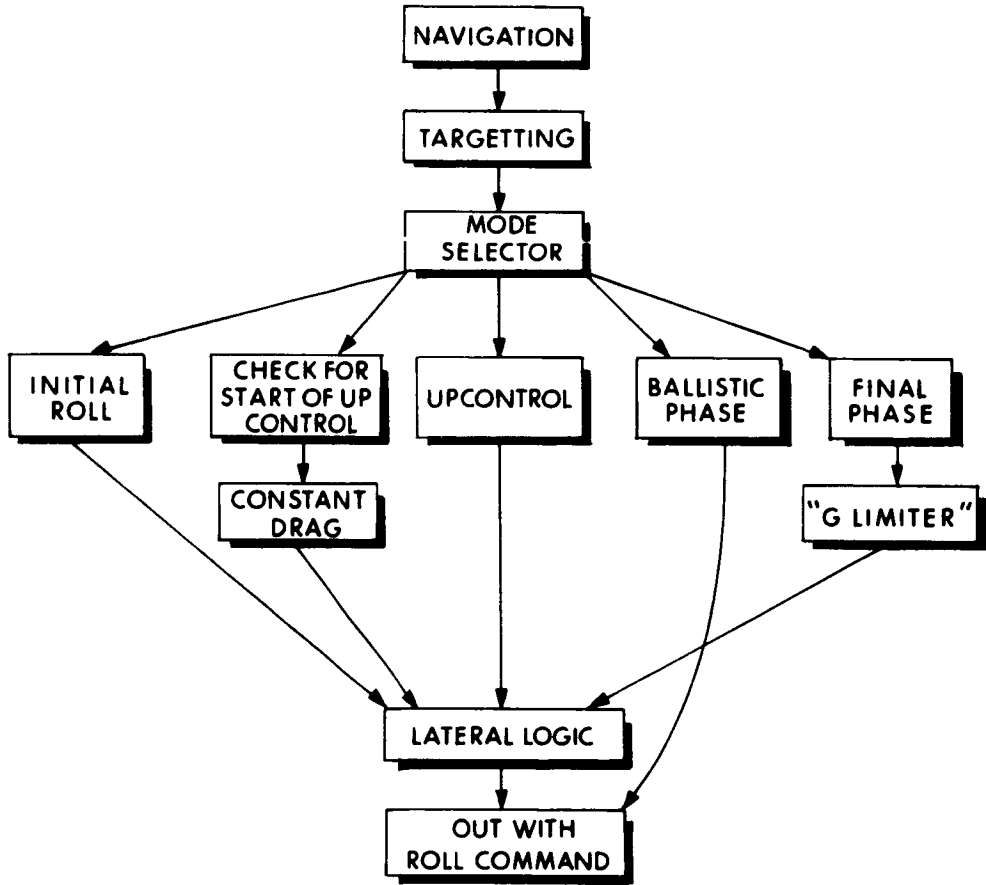

Fig. 4-4 Re-Entry Steering

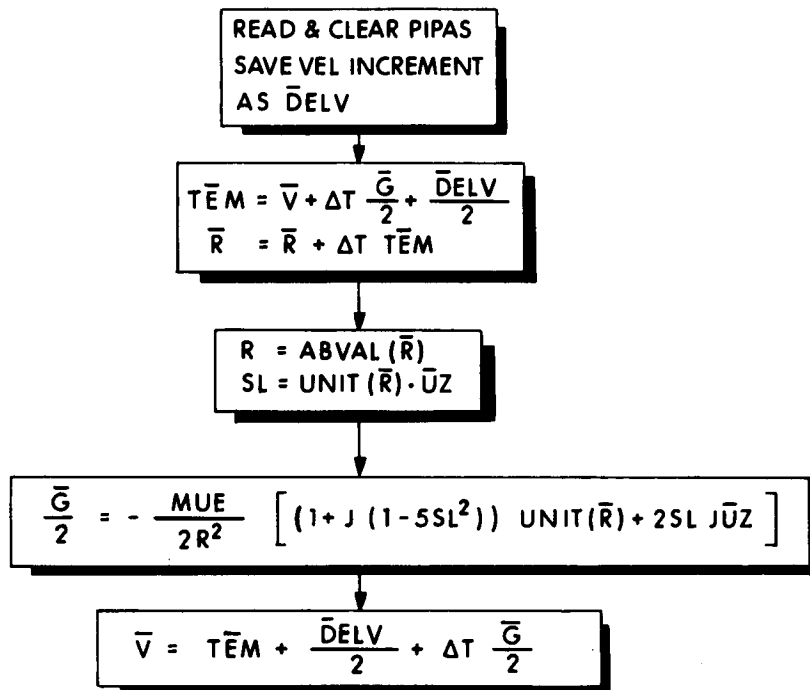

Fig 4-5 Re-Entry Steering - Navigation (AVG. G)

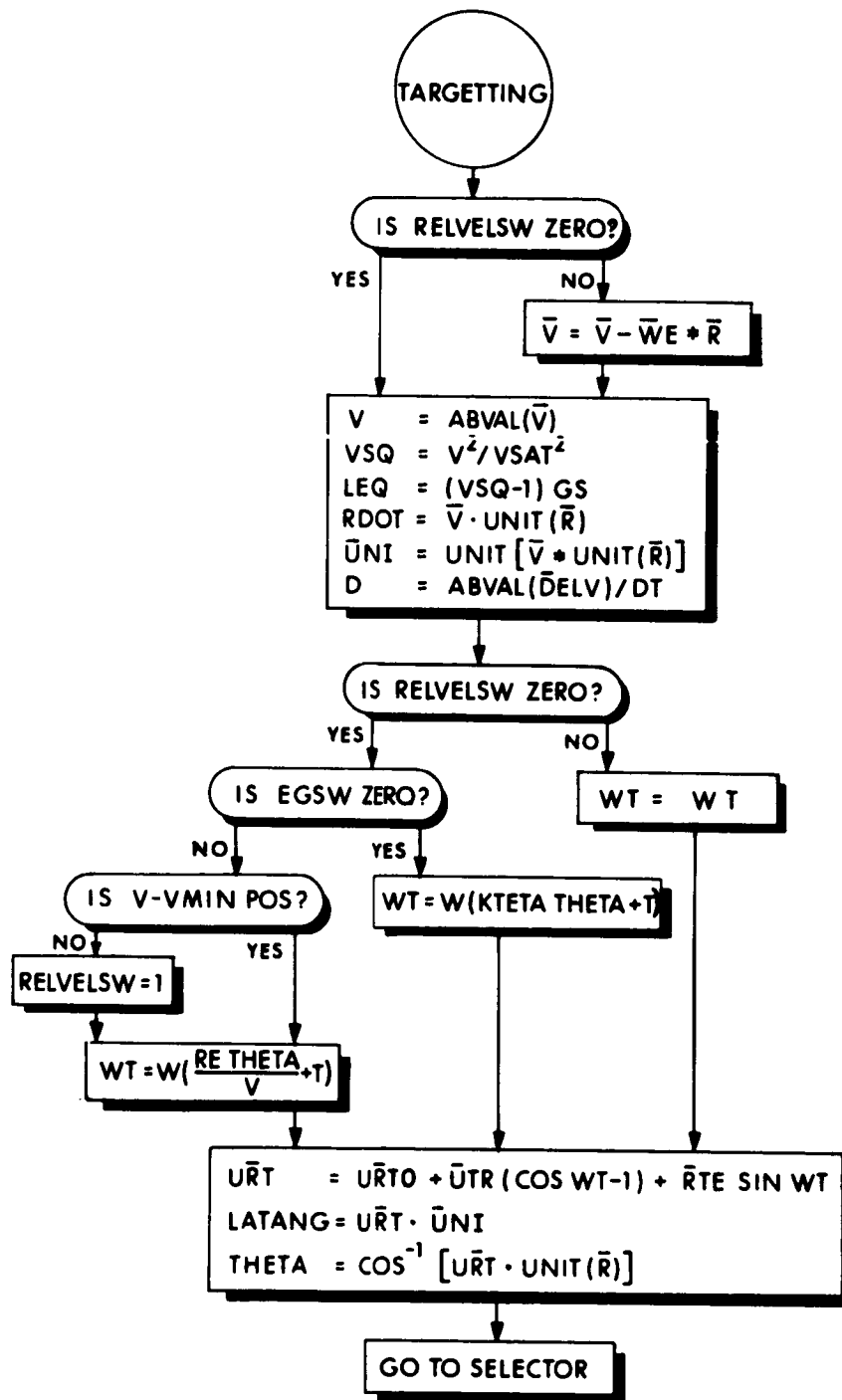

Fig. 4-6 Re-Entry Steering - Targetting

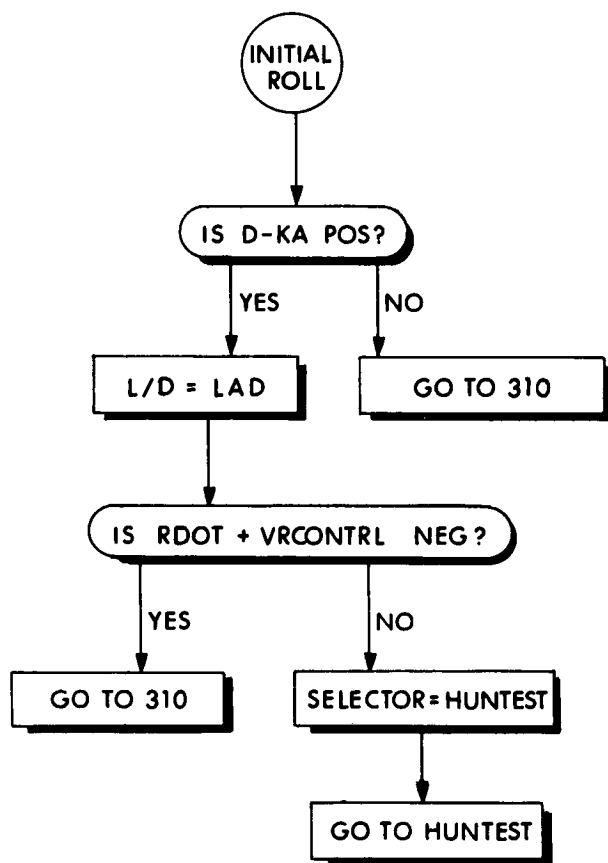

Fig 4-7 Re-Entry Steering - Initial Roll

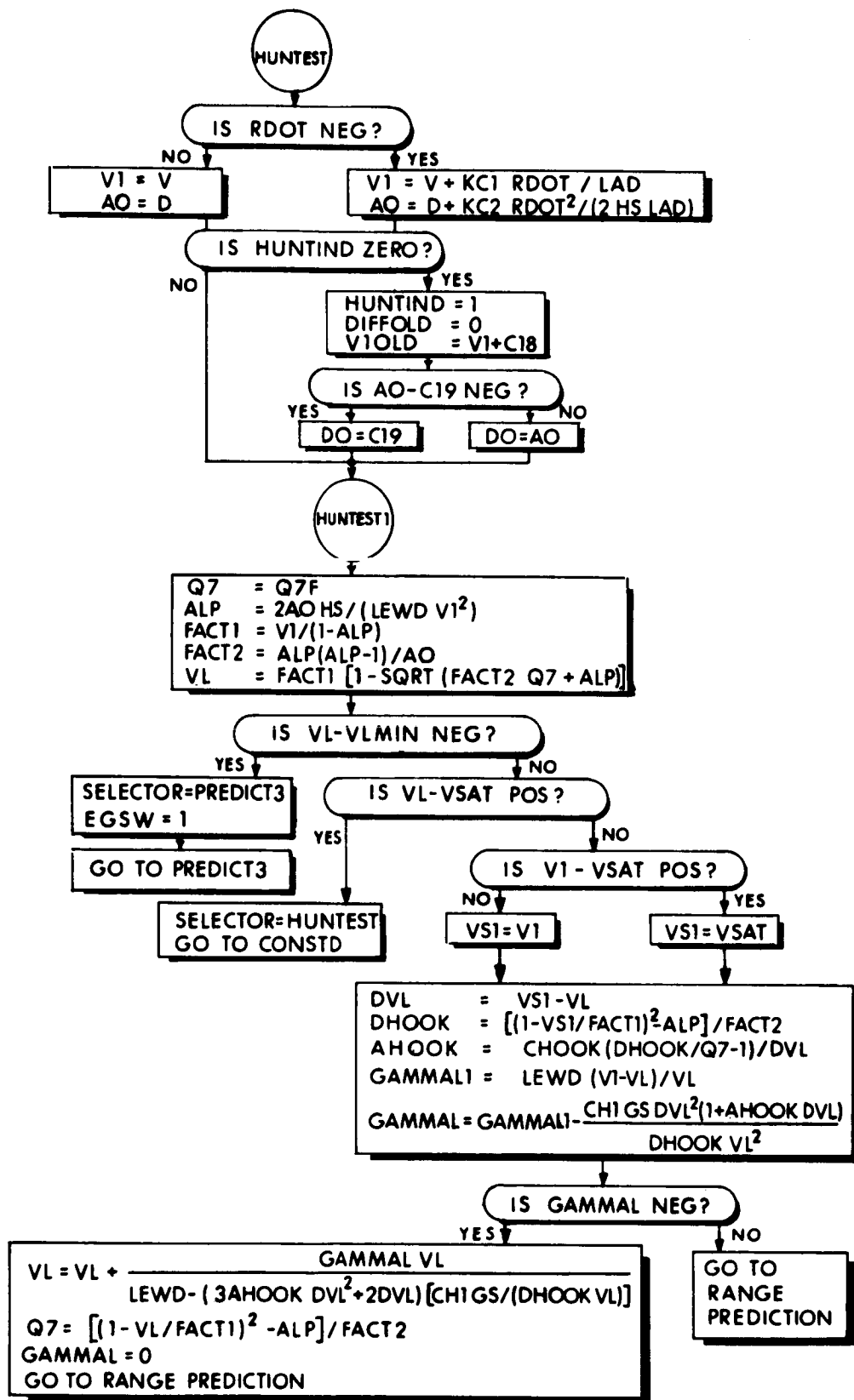

Fig. 4-8 Re-Entry Steering - Hunttest

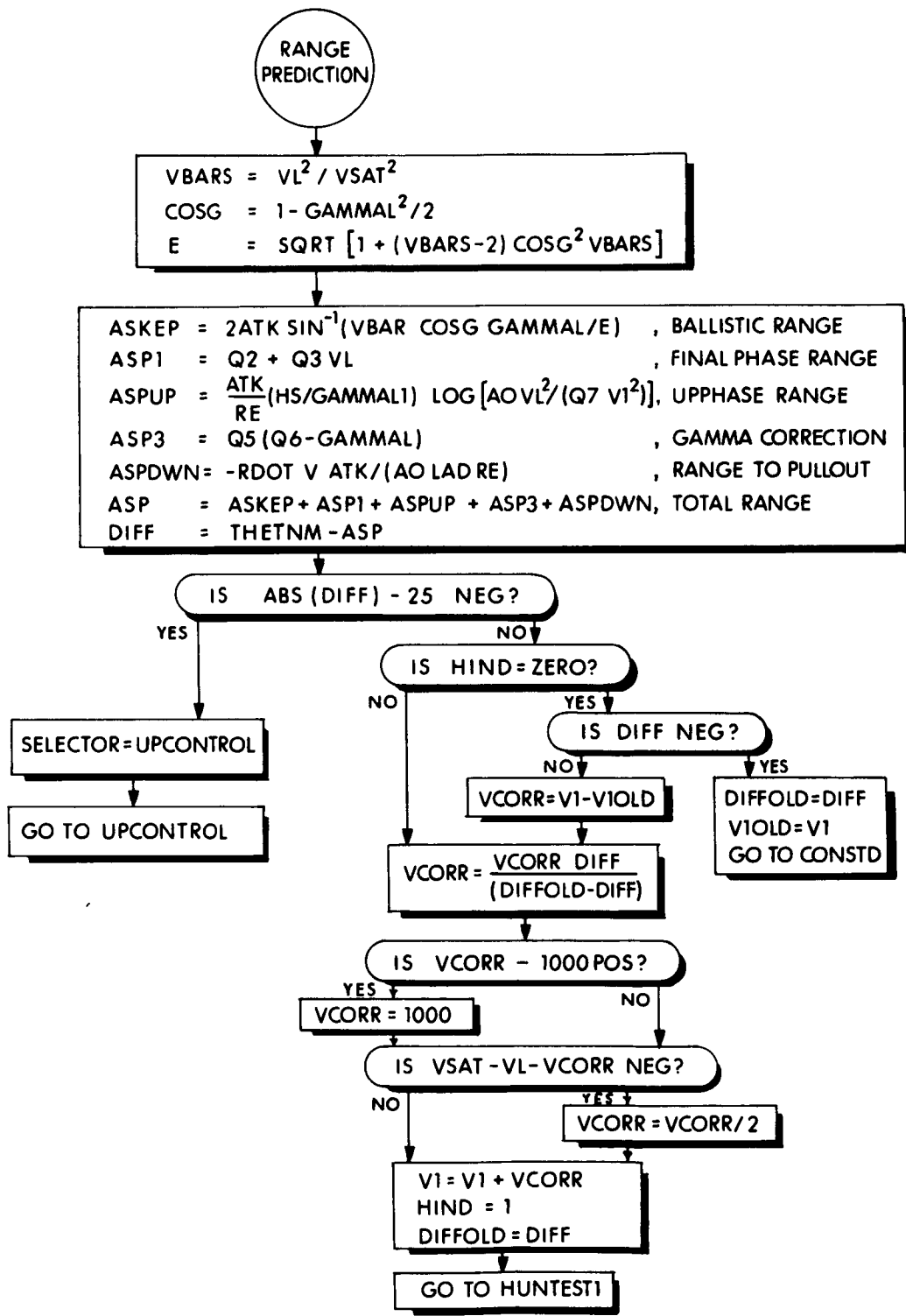

Fig 4-9 Re-Entry Steering - Range Prediction

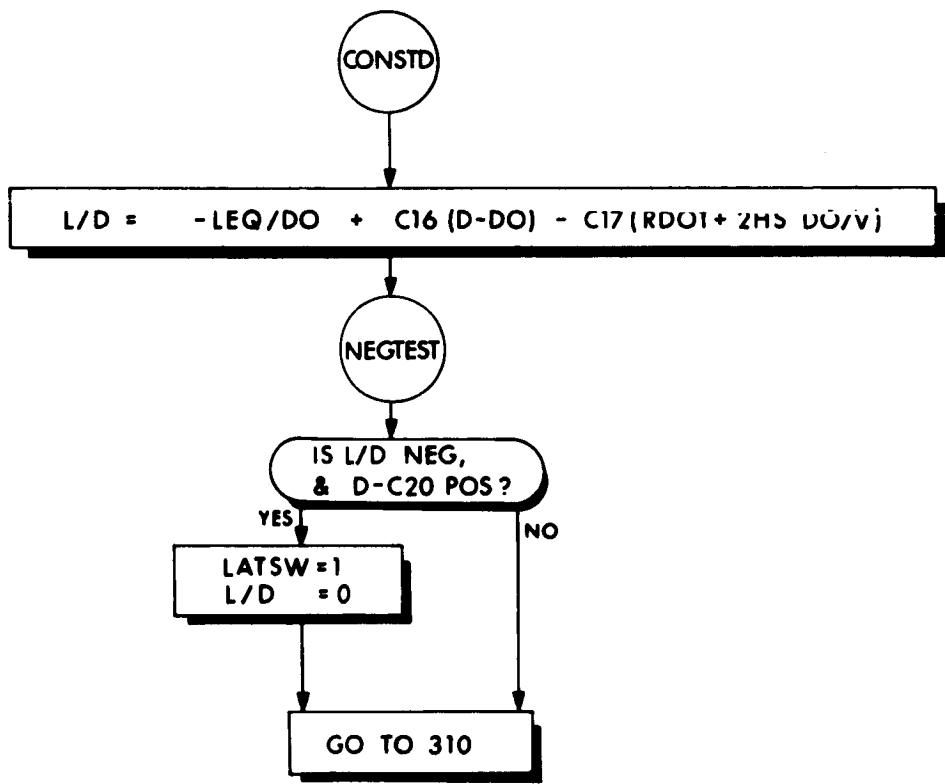

Fig 4-10 Re-Entry Steering - CONSTD

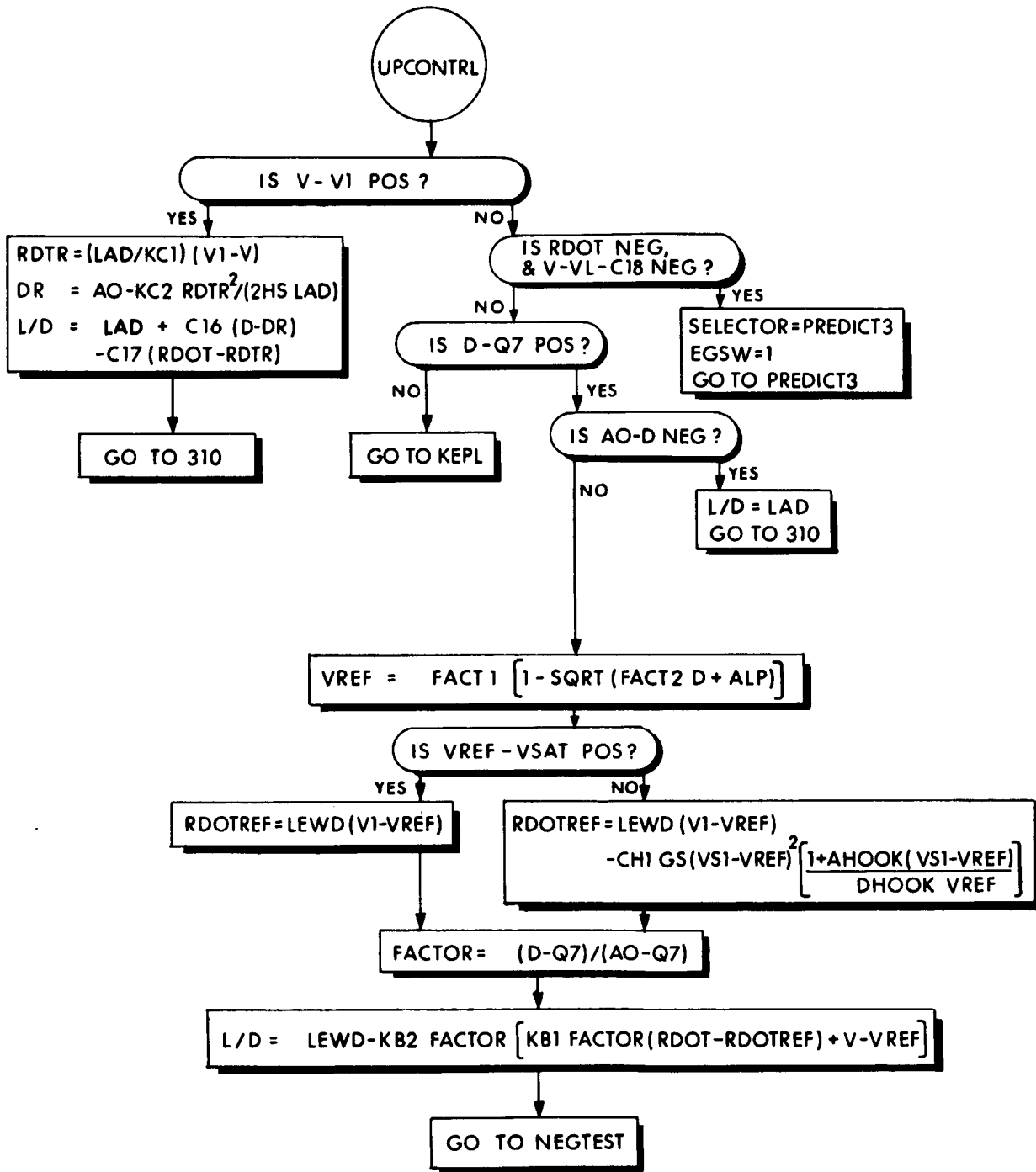

Fig. 4-11 Re-Entry Steering - UPCONTRL

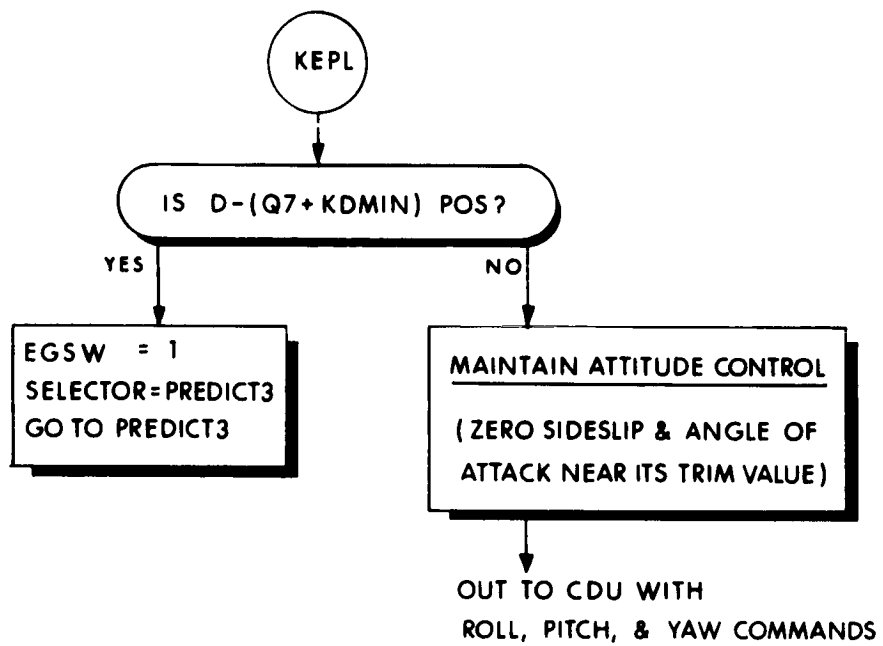

Fig. 4-12 Re-Entry Steering - Ballistic

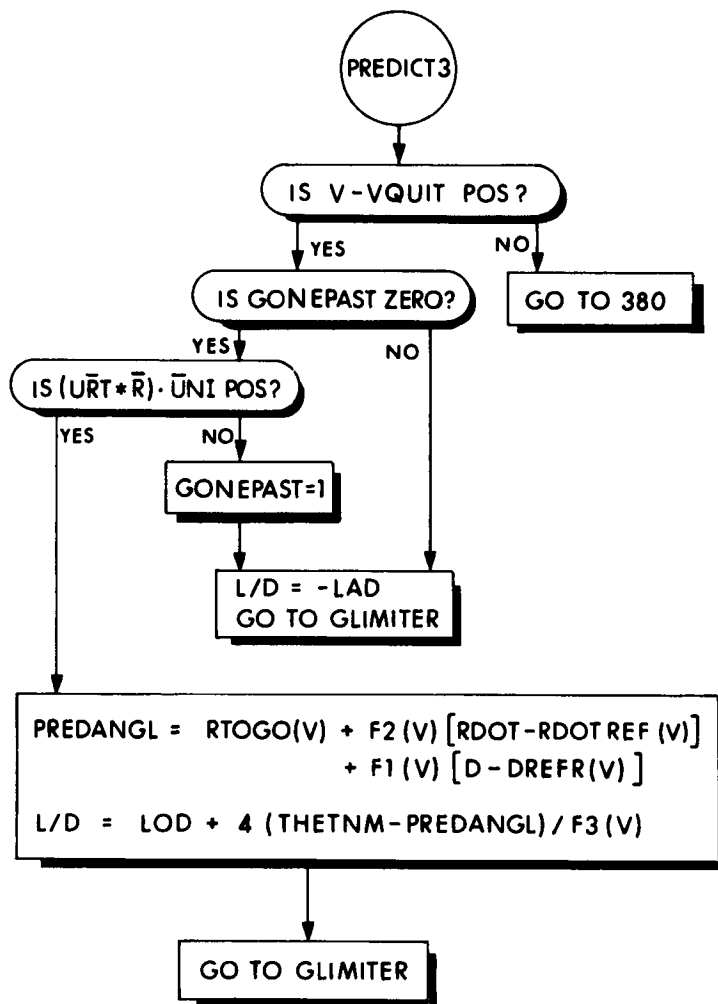

Fig. 4-13 Re-Entry Steering - Predict 3

VREF	RDOTREF	AREF	DR/DRDOT	DR/DA	RTOGO	DR/DL/D
FPS	FPS	FPSS	F2 NM/FPS	F1 NM/FPSS	NM	F3 NM
0	-331	34.1	0	-.02695	0	1
337	-331	34.1	0	-.02695	0	1
1080	-693	42.6	.002591	-.03629	3.7	6.44 x 2
2103	-719	60.	.003582	-.05551	9.9	10.91 x 2
3922	-694	81.5	.007039	-.09034	23.1	21.64 x 2
6295	-609	93.9	.01446	-.1410	46.3	48.35 x 2
8531	-493	98.5	.02479	-.1978	75.4	93.72 x 2
10101	-416	102.3	.03391	-.2372	99.9	141.1 x 2
14014	-352	118.7	.06139	-.3305	170.9	329.4
15951	-416	125.2	.07683	-.3605	210.3	465.5
18357	-566	120.4	.09982	-.4956	266.8	682.7
20829	-781	95.4	.1335	-.6483	344.3	980.5
23090	-927	28.1	.2175	-2.021	504.8	1385
23500	-820	6.4	.3046	-7.569	643.0	1508
35000	-820	6.4	.3046	-7.569	643.0	1508

Fig. 4-14 Final Phase Reference

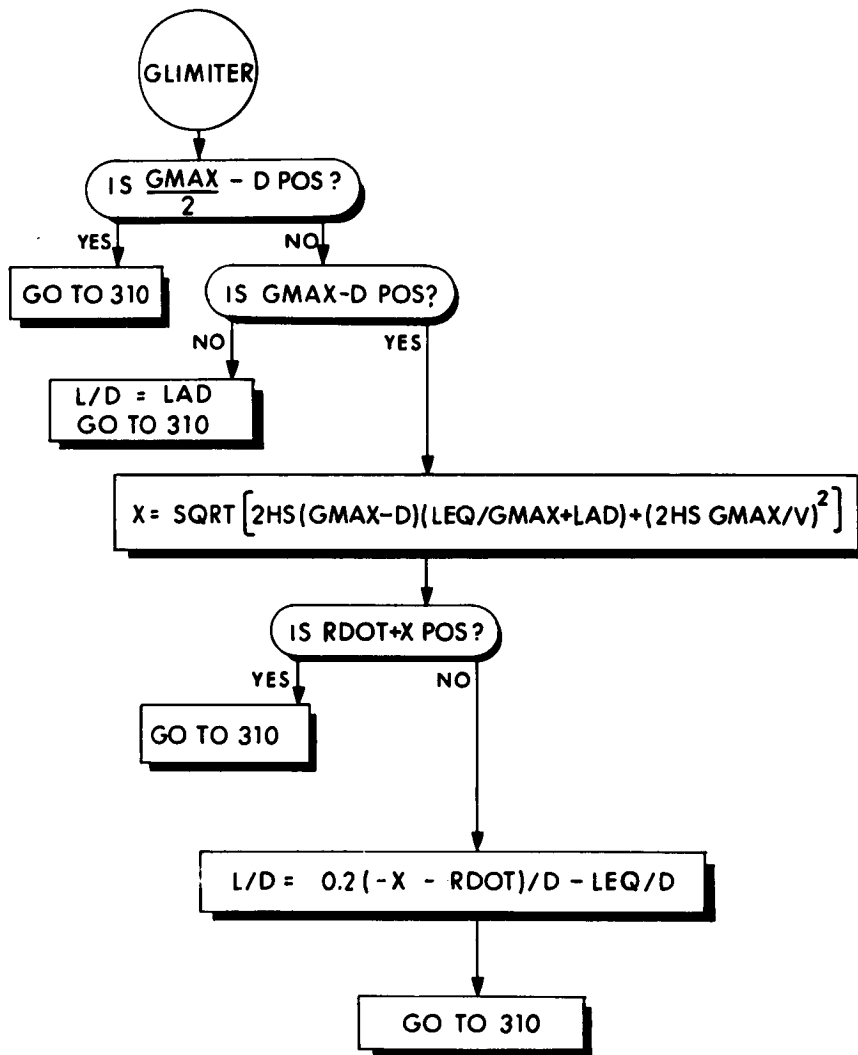

Fig. 4-15 Re-Entry Steering - GLIMITER

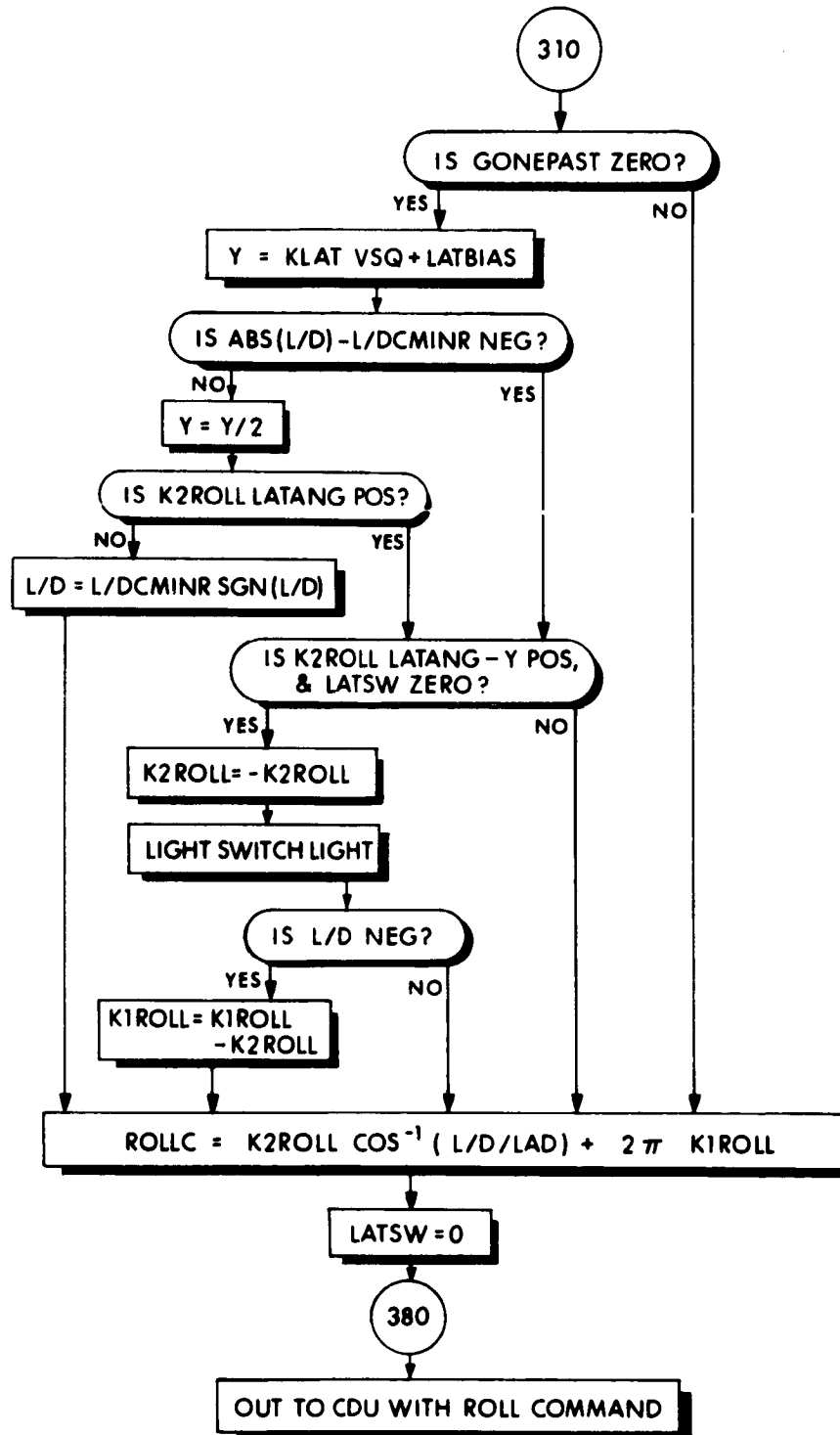

Fig. 4-16 Re-Entry Steering - Lateral Logic

TABLE 4-1

VARIABLES FOR RE-ENTRY CONTROL

$\bar{U}RTO$	INITIAL TARGET VECTOR
$\bar{U}Z$	UNIT VECTOR NORTH
\bar{V}	VELOCITY VECTOR
\bar{R}	POSITION VECTOR
$\bar{R}TE$	VECTOR EAST AT INITIAL TARGET
$\bar{U}TR$	NORMAL TO $\bar{R}TE$ AND $\bar{U}Z$
$\bar{W}E$	EARTH RATE VECTOR
$\bar{U}RT$	TARGET VECTOR
$\bar{U}NI$	UNIT NORMAL TO TRAJECTORY PLANE
$\bar{D}ELV$	INTEGRATED ACCELERATION VECTOR
\bar{G}	GRAVITY VECTOR
AO	INITIAL DRAG FOR UPCONTRL
AHOOK	TERM IN GAMMAL COMPUTATION
ALP	CONST FOR UPCONTRL
ASKEP	KEPLER RANGE
ASP1	FINAL PHASE RANGE
ASPUP	UPRANGE
ASP3	GAMMA CORRECTION
ASPDWN	RANGE DOWN TO PULL-UP
ASP	PREDICTED RANGE = ASKEP+ASP1+ASPUP+ASP3+ASPDWN
COSG	COSINE (GAMMAL)
D	TOTAL ACCELERATION
DO	CONTROLLED CONST DRAG
DHOOK	TERM IN GAMMAL COMPUTATION
DIFF	THETNM-ASP (RANGE DIFFERENCE)
DIFFOLD	PREVIOUS VALUE OF DIFF
DR	REFERENCE DRAG FOR DOWNCONTROL
DREF	REFERENCE DRAG
DVL	VS1 -VL

TABLE 4-1 (Cont'd)

E	ECCENTRICITY	
F1	DRANGE/D DRAG	(FINAL PHASE)
F2	DRANGE/DRDOT	(FINAL PHASE)
F3	DRANGE/D(L/D)	(FINAL PHASE)
FACT1	CONST FOR UPCONTRL	
FACT2	CONST FOR UPCONTRL	
FACTOR	USED IN UPCONTRL	
GAMMAL	FLIGHT PATH ANGLE AT VL	
GAMMAL1	SIMPLE FORM OF GAMMAL	
KA	ACCELERATION LEVEL TO ROLL LIFT UP	
K1ROLL	INDICATOR FOR ROLL SWITCH	
K2ROLL	INDICATOR FOR ROLL SWITCH	
LATANG	LATERAL RANGE	
LEQ	EXCESS C. F. OVER GRAV = $(VSQ-1)$ GS	
L/D	DESIRED LIFT TO DRAG RATIO (VERTICAL PLANE)	
PREDANGL	PREDICTED RANGE	(FINAL PHASE)
Q7	MINIMUM DRAG FOR UPCONTROL	
RDOT	ALTITUDE RATE	
RDOTREF	REFERENCE RDOT FOR UPCONTRL	
RDTR	REFERENCE RDOT FOR DOWNCONTRL	
ROLLC	ROLL COMMAND	
RTOGO	RANGE TO GO	(FINAL PHASE)
SL	SIN OF LATITUDE	
T	TIME	
THETA	DESIRED RANGE (RADIAN)	
THETNM	DESIRED RANGE (NM)	
V	VELOCITY MAGNITUDE	
V1	INITIAL VELOCITY FOR UPCONTRL	
V1OLD	PREVIOUS VALUE OF V1	

TABLE 4-1 Cont'd

VCORR	VELOCITY CORRECTION FOR UPCONTRL
VL	EXIT VELOCITY FOR UPCONTRL
VS1	VSAT OR V1, WHICHEVER IS SMALLER
VBARS	$VL^2/VSAT^2$
VSQ	NORMALIZED VELOCITY SQUARED = $V^2/VSAT^2$
WT	EARTH RATE X TIME
X	INTERMEDIATE VARIABLE USED IN G LIMITER
Y	LATERAL MISS LIMIT

SWITCHES

INITIAL STATE

RELVELSW	RELATIVE VELOCITY SWITCH	BRANCH (1)
EGSW	FINAL PHASE SWITCH	NON-BRANCH (0)
HUNTIND	INITIAL PASS THRU HUNTEST	NON-BRANCH (0)
HIND	INDICATES INTERATION IN HUNTEST	NON-BRANCH (0)
LATSW	NO LATERAL CONTROL WHEN ON	NON-BRANCH (0)
GONEPAST	INDICATES OVERSHOOT OF TARGET	NON-BRANCH (0)

5. MISSION AND VEHICLE DATA

5.1 Scope

Section 5 is a summary of all Flight 202 mission and vehicle data that have an impact on AGC programming. Data have been collected under the following headings:

Section 5.2 Mission Data. Establishes the outlines of the mission in terms of trajectories, profiles etc. Includes performance figures for Saturn boost phase inasmuch as they affect conditions pertaining at take-over of control by G&N system.

Section 5.3 Memory Data. Contains all mission- and vehicle-dependent data that are, in one form or another, written directly into the memory of the AGC. In a wired-memory computer such as the AGC, the very limited erasable section is intended primarily for storage of computational variables. An attempt has been made to consign those mission parameters that do not change during flight to the fixed section of the memory. Some exceptions have had to be made in the case of the Saturn boost polynomials and SPS aim-point criteria, since these will not be available until shortly before the flight.

Section 5.4 Vehicle Data. Contains information that will mainly affect simulations and rope verification and will not, with only one or two exceptions, appear directly in the AGC program.

Section 5.5 Physical Constants. These definitions will be used in AGC programs and verification work.

Numerical data are presented in the most convenient and widely accepted units. The AGC is, however, programmed in the metric set of kilogram, meter, and centisecond (10^{-2} sec). Conversion to other sets of units is done by use of the factors defined in Section 5.5.2.

Points on the surface of the earth are defined in terms of geodetic latitude and longitude referred to the Fischer ellipsoid of 1960, and geocentric radius.

It is pointed out that not all items of numerical data included in this section are to be found in the memory explicitly as defined. They are often rescaled, changed in units, or combined with other data for storage in the most convenient and/or economical fashion.

5.2 Mission Data

5.2.1 Mission Trajectories

Saturn Boost Trajectory ¹ (For data from Lift-off to SIVB thrust cut-off)	Apollo Trajectory Document No. 65-FMP-1, Apollo Mission 202, Joint Reference Tra- jectory, April 12, 1965. Published jointly by MSFC/MSC.
Spacecraft Trajectory (For data from SIVB thrust cut- off to touch down)	Project Apollo Spacecraft Reference Tra- jectory SA-202 April 9, 1965. Published as MSC Internal Note No. 65-FM-37.
Nominal mission profile	see Fig. 5.1
Major events during nominal mission	see Table 5.1
Nominal Saturn boost pro- file	see Fig. 5.2

Note 1. MIT is in receipt of a computer print-out of this portion of the referenced trajectory from MSC, which provides additional information at more frequent points during the boost than the document quoted.

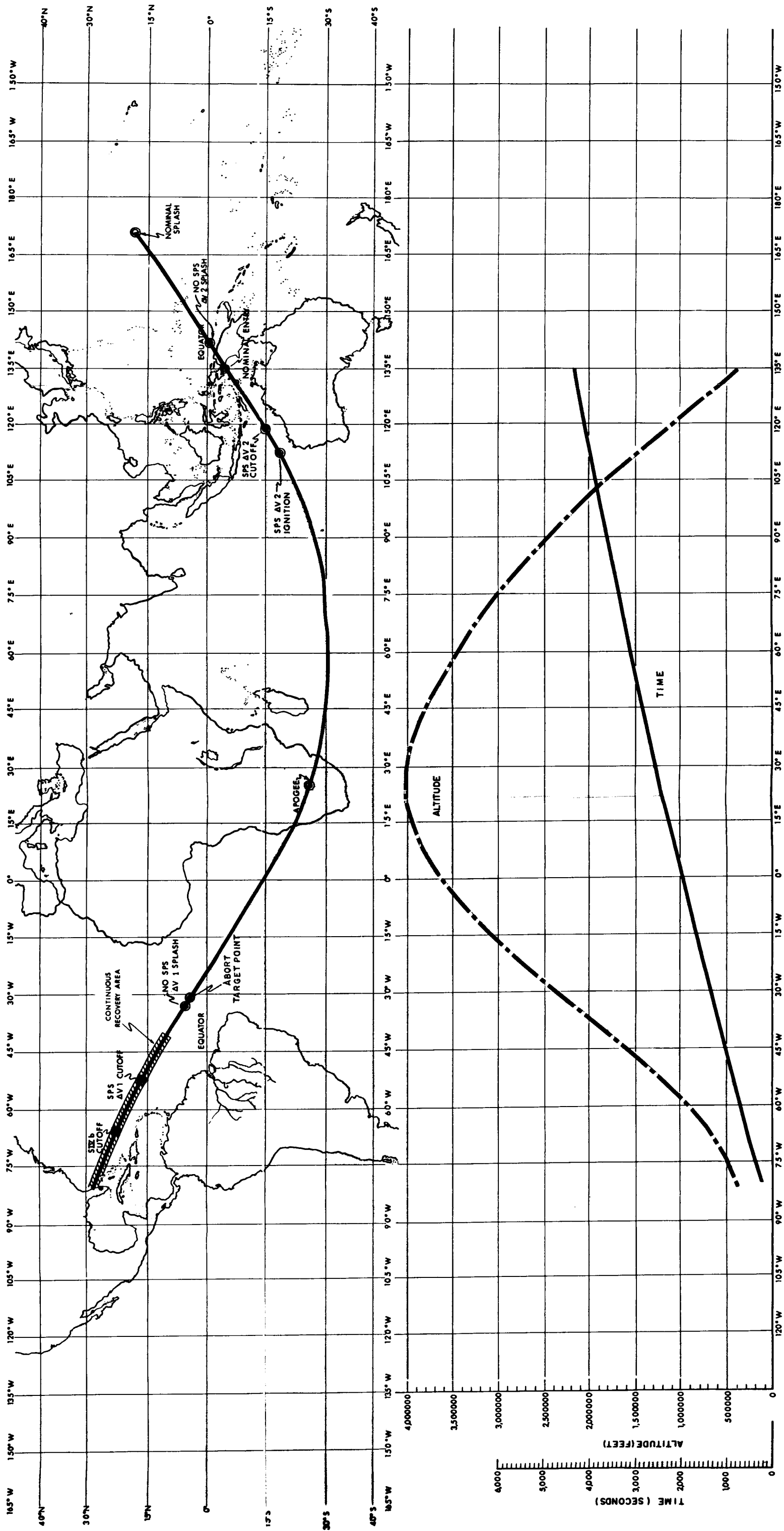

FIG. 5-1 MISSION 202 PROFILE

TP 13216

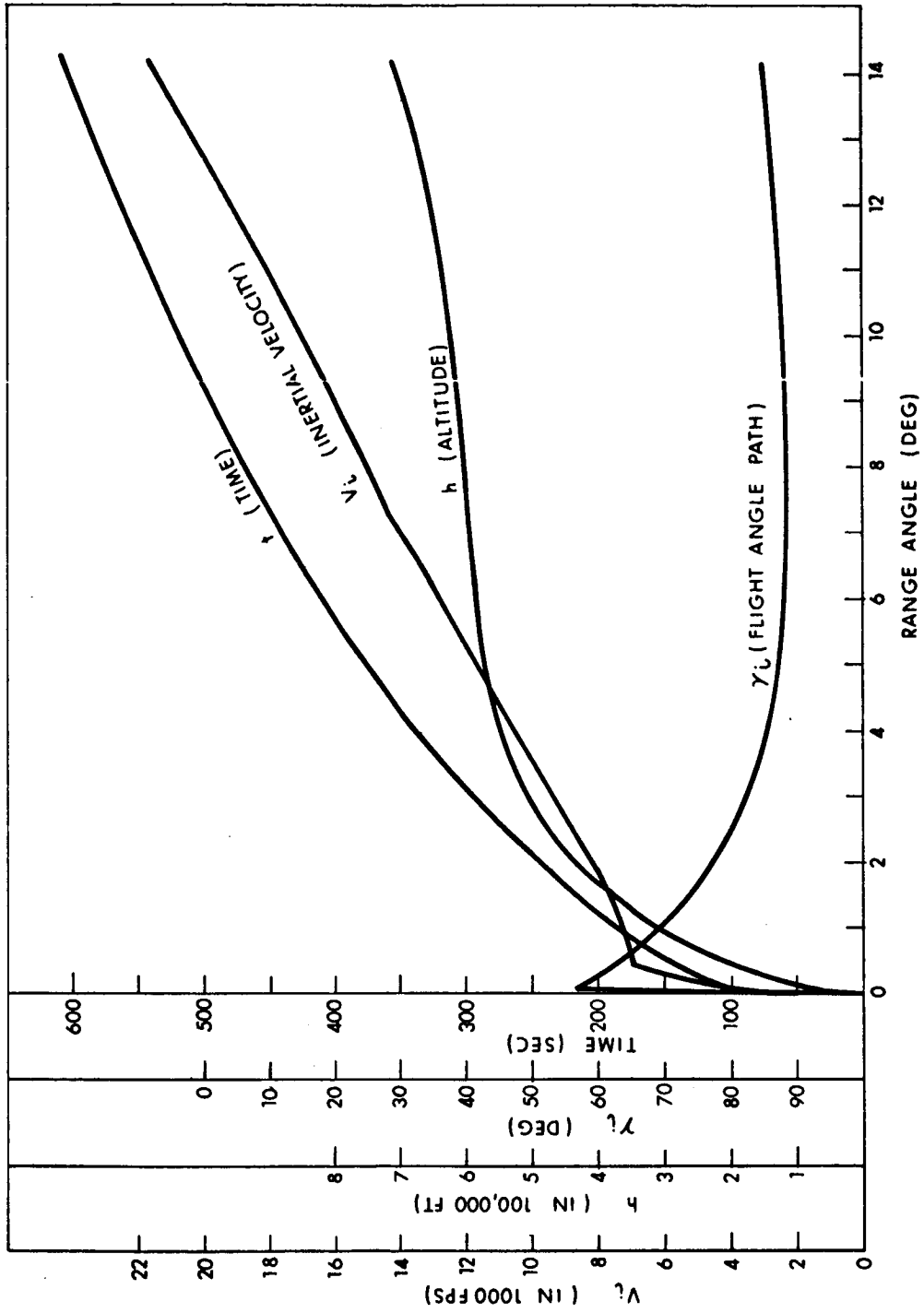

Fig. 5-2 Saturn Boost Trajectory Profile

Table 5-1

Event	t (sec)	V _i (fps)	γ _i (deg)	AZ _i (deg)	ALT (ft)	N. Geod. Lat. (deg)	W. Long. (deg)	Weight
liftoff	0	1341.61	90	90	0	28.53	80.56	
SIB c/o	148.65	6977.31	62.78	102.34	201,409	28.40	80.00	
SIVB Ign.	151.75	6932.95	63.45	102.37	211,136	28.38	79.96	
LES Jett.	171.75	7097.35	68.46	102.73	269,621	28.31	79.66	
SIVB c/o	609.95	21,802	85.07	111.92	715,530	23.71	65.72	
SPS Ign.	630.95*	21,751	85.52	112.26	752,673	23.24	64.60	43,685
SPS c/o	865.14	25,416	83.76	117.16	1,209,592	17.25	51.70	27,842
Apogee	2395.14	22,440	89.372	110.45	3,995,357	-24.17	-19.81	
Ullage	3998.82							
SPS Ign.	4028.82	25,116	96.28	63.69	1,475,984	-18.55	-112.11	27,801
SPS c/o	4114.82	27,678	97.52	62.17	1,199,135	-15.96	-117.17	21,983
SPS Ign.	4124.82	27,716	97.40	61.99	1,163,191	-15.63	-117.78	21,983
SPS c/o	4127.82	27,818	97.41	61.94	1,152,455	-15.53	-117.97	21,780
SPS Ign.	4137.82	27,855	97.29	61.77	1,116,843	-15.20	-118.58	21,780
SPS c/o	4140.82	27,959	97.30	61.72	1,106,214	-15.10	-118.77	21,577
Entry	4402.0	28,706	93.57	58.65	399,188	-5.11	-134.79	11,000
End of Entry	5262.0	1,483			24,793	17.24	-170.00	

*Data from this time on is from MIT 202 performance simulations

5. 2. 2 Nominal SIVB Separation Attitude Conditions

X-axis in plane of maneuver, forward of inertial vertical
defined at the launch point by 76.00°

(Y-axis along momentum vector $\underline{R*V}$

Z-axis above local horizontal)

Roll rate $0^\circ/\text{sec}$

Pitch rate $0^\circ/\text{sec}$

Yaw rate $0^\circ/\text{sec}$

5. 2. 3 3σ Dispersions from Nominal at SIVB Separation

X-axis attitude dispersion	2°
Y-axis attitude dispersion	2°
Z-axis attitude dispersion	2°
Roll rate residual	0. 2° /sec
Pitch rate residual	0. 2° /sec
Yaw rate residual	0. 2° /sec

5.2.4 SIVB Engine-off Transient

Decay time 100%-10%	not available
Decay time 10%-0%	not available
Tail-off impulse 100%-10%	not available
Tail-off impulse 10%-0%	not available

5.3 Memory Data

5.3.1 Prelaunch

	<u>Memory Type</u>	<u>Value</u>
Launch Pad #34: Latitude	F	28.521 9586°N
Longitude	F	279.438589°E
Geocentric Radius	F	6.3733354 x 10 ⁶ meters
Ellipsoid Radius	F	6.3733224 x 10 ⁶ meters
Inertial reference plane (IMU) azimuth	F	104.9901° E of N at Guidance Reference Release
Optical target 1		
Azimuth	F	Not available
Elevation	F	Not available
Optical target 2		
Azimuth	F	Not available
Elevation	F	Not available

5.3.2 Saturn Boost

	Memory Type	Value
(Interval: Lift-off-LET jettison assumed complete		171.0 sec)
Interval: Lift-off to start of roll maneuver	E	8.0 sec
Interval: Duration of roll maneuver	E	5.0 sec
(Interval: Lift-off to start of Pitch maneuver		10.0 sec)
Interval: Duration of Pitch maneuver	E	126.0 sec
Interval: End of pitch maneuver to LES jettison assumed complete (start of tumble monitor)	E	33.0 sec
Roll maneuver: Rotation about inertial vertical	E	5°
Roll maneuver rate (constant)	E	1°/sec
Pitch polynomial ¹ coefficient A ₀	E + 0.8993 0120	× 10 ⁺²
A ₁	E - 0.6240 1300	× 10 ⁻²
A ₂	E - 0.5634 4084	× 10 ⁻²
A ₃	E - 0.1461 5114	× 10 ⁻³
A ₄	E + 0.3090 4335	× 10 ⁻⁵
A ₅	E - 0.1992 7579	× 10 ⁻⁷
A ₆	E + 0.4465 2766	× 10 ⁻¹⁰

Note 1. Form of pitch polynomial is:

$$\theta = \sum_{n=0}^6 A_n t^n$$

where θ = angle between inertial horizontal at launch and vehicle X-axis, in degrees

t = Time in secs (t = 0 at 10 secs after Lift-off)

5.3.3 Attitude Maneuvers

	Memory Type	Value
Limit: commanded S/C angular rate:		
Roll (CSM)	F	7.2°/sec
Roll (CM only)	F	15°/sec
Pitch, Yaw (CSM, CM)	F	4°/sec
Interval between attitude updates	F	0.5 sec
Interval for stabilization after maneuver	F	5.0 sec
Interval: SPS1 cut-off to end of local vertical phase	F	2037.2 sec

5.3.4 TVC (Normal mission)

	Memory Type	Value
CSM c. g. displacement in X-Y plane: (SPS 1)	F	6.60 ^{0 1}
CSM c. g. displacement in X-Y plane: (SPS 2)	F	3.35 ^{0 1}
CSM c. g. displacement in X-Y plane: (SPS 3)	F	0.30 ^{0 1}
CSM c. g. displacement in X-Z plane: (SPS 1)	F	2.25 ^{0 1}
CSM c. g. displacement in X-Z plane: (SPS 2)	F	0.60 ^{0 1}
CSM c. g. displacement in X-Z plane: (SPS 3)	F	-0.70 ^{0 1}
(Mean Tail-off impulse/Mean thrust) of SPS engine	F	0.39 sec
Minimum ΔV criterion for thrust monitor	F	1 ft/s/s
Interval for thrust monitor	F	10 sec
Interval between steering updates	F	2 sec
Steer law gain	F	0.125
Steer law velocity bias	F	160 ft/sec
Steer law coefficient (C)	F	1.0
Maximum Interval: freeze CDUs to engine-off cmd.	F	4.0 sec
Interval: SIVB/CSM Sep. - SPS 1 ignition	F	12.7 sec
Interval: SPS 1 cut-off - SPS 2 ignition	E	3163.67 sec
Interval: SPS 2, 3, cut-off - SPS 3, 4 ignition	F	10 sec
Interval: SPS 3, 4 ignition - SPS 3, 4 cut-off	F	3 sec
Interval: + X translation - SPS 2 ignition	F	30 sec
Interval: between SCS mode change commands	F	0.25 sec
Interval: Gimbal mot. power ON - Engine start	F	4.0 sec

Note 1: Figures derived from data in Section 5.4.1 using weight data in Table 5-1.

Interval: Engine off - Gimbal mot. power OFF	F	3.0 sec
Minimum Interval: RVT update to SPS2 ignition	F	50 sec
Maximum Interval: Receipt of SIVB/CSM sep to receipt of VERB 77 abort	F	1.7 sec
Interval: SPS1 cut-off to FDAI align command	F	300 sec.
Six seconds of ΔV prior to SPS2 cut-off	F	172.0 ft/sec
Interval: mean effective SPS tail-off duration	F	0.39 sec
SPS1 aim-point criteria		
Semi-major axis	E	$2.249\ 107\ 6 \times 10^7$ feet
Eccentricity	E	0.109 885 56
SPS2 aim-point criteria		
Semi-major axis	E	$2.828\ 638\ 9 \times 10^7$ feet
Eccentricity	E	0.253 321 43
Interval: Lift-off - touch down (Nominal mission)	E	5243.5 sec

5.3.5 Entry (Normal mission)

	Symbol	Memory Type	Value
CSM attitude for SM/CM Separation:			
X-axis above velocity vector by (Y-axis along momentum vector ($\underline{R} * \underline{V}$), Z-axis above velocity vector)		F	60°
CM Pacific pre-entry attitude:			
X-axis below velocity vector by (Y-axis along momentum vector ($\underline{R} * \underline{V}$), Z-axis below velocity vectory. A lift- vector down attitude).		F	160°
Trim angle of attack		F	20°
Interval: SM/CM Sep. - start maneuver		F	5 sec
Pacific recovery point: Latitude		E	17.25°N
Longitude		E	170.00°E
Constant drag gain (on drag)	C16	F	0.1
Constant drag gain (on RDOT)	C17	F	0.00497
Lead velocity for up control start	C18	F	500 ft/s
Minimum constant drag	C19	F	40 ft/s/s
Minimum D for lift up	C20	F	175 ft/s/s
Factor in AHOOK computation	CHOOK	F	0.25
Factor in GAMMAL computation	CH1	F	0.75
G-limit	GMAX	F	10g
Minimum drag for lift up if down	KAFIX	F	0.2g
Up control gain, optimized	KB2	F	0.0034
Up control gain, optimized	KB2	F	3.4
Factor in V1 computation	KC1	F	0.8
Factor in A0 computation	KC2	F	0.7
Lateral switch gain	KLAT	F	0.0075
Increment to Q7 to end kepler	KDMIN	F	0.5 ft/s/s
Time of flight calculation gain	KTETA	F	1000
Max L/D	LAD	F	0.3
Lateral switch bias term	LATBIAS	F	0.00012
LAD cos (15°)	L/DCMINR	F	0.2895
Up control L/D	LEWD	F	0.2
Final Phase L/D	LOD	F	0.18
Acceptable tolerance to stop range iteration	25NM	F	25 n. m.
Final phase range (-23500 Q3)	Q2	F	-1002 n. m.
Final phase dR/dV	Q3	F	0.07 n. m. /ft/s
Interval between steering updates	DT	F	2 sec

	Symbol	Memory Type	Value
Final phase dR/dGAMMAL	Q5	F	7050 n. m.
Final phase initial GAMMAL	Q6	F	0.0349
Minimum drag for up control	Q7F	F	6 ft/s/s
Limit value of V CORR	VCORLIM	F	1000 ft/s
Minimum RDOT to close loop	VRCONTRL	F	700 ft/s
Velocity to switch to relative velocity	VMIN	F	12,883 ft/s
Minimum VL	VLMIN	F	18,000 ft/s
Velocity to stop steering	VQUIT	F	1,000 ft/s
Normalization factor, acceleration	GS	F	32.2 ft/s/s
Atmosphere Scale Height	HS	F	28,500 ft
Normalization factor, velocity	VSAT	F	25,766.197 ft/sec
Nominal earth's radius (entry only)	RE	F	21,202,909 ft
Range angle to nautical mile factor	ATK	F	3437.7468 n. m. /rad.

5.3.6 TVC (Abort)

	Symbol	Memory Type	Value
Criterion for tumbling detection		F	5°/sec
Interval: SIVB/CSM Sep. - SPS ignition (tumbling and abort)		F	3.0 sec
Interval: Time-to-go-bias		F	5 sec
Interval: between steering updates		F	not available
Thrust attitude:			
X-axis above visual horizon by (Y-axis normal to local vertical Z-axis above local horizontal)		F	35°
Limit: commanded change in yaw acceleration		F	5 ft/s/s
Abort target point: Latitude		E	4.00°N
Longitude		E	329.00°E
Interval: Lift-off - abort target point			
(Abort from nominal mission (See Section 4.0))		E	1420 sec
Mean geo-centric radius of visual	R_{vh}	F	6.378 165 x 10 ⁶ meters
Entry range angle constant		F	1,139 sec
Entry range angle coefficient		F	2,261,239 feet
Entry range angle critical entry velocity		F	21,400 ft/sec
Minimum entry range coefficient		F	300 rad

* See sec 4.3.1.

5.3.7 Entry (Abort)

	Memory Type	Value
CM Atlantic pre-entry attitude:		
X-axis above velocity vector by	F	160°
(Y-axis along neg. momentum vector (V*R))		
Z-axis above velocity vector		
A lift-vector up attitude)		
Atlantic recovery point: Latitude	E	not available
Longitude	E	not available

5.3.8 Free-fall time (T_f) monitor

	Memory Type	Value
Entry interface altitude	F	400,000 feet
Abort T_f criterion (A) to start orientation to CM/SM Separation Attitude	F	160 sec
Normal T_f criterion (N) to start orienta- to CM/SM Separation Attitude	F	160 sec
Interval: min T_f to start CM/SM Separation	F	85 sec
Interval: between T_f updates	F	2 sec

5.4 Vehicle Data

5.4.1 CSM Data

Weight empty	MS	21,200 lbs
Weight of initial fuel load	ML	22,500 lbs
Variation of principal inertia with mass	IXX	Defined in Fig. 5.4
Variation of principal inertia with mass	IYY	Defined in Fig. 5.5
Variation of principal inertia with mass	IZZ	Defined in Fig. 5.6
Variation of product ⁴ of inertia with mass	IXY	Defined in Fig. 5.7
Variation of product ⁴ of inertia with mass	IYZ	Defined in Fig. 5.8
Variation of product ⁴ of inertia with mass	IZX	Defined in Fig. 5.9
Variation of C. G. X-location ² with mass	CGX	Defined in Figs. 5.10, 5.11
Variation of C. G. Y-location ² with mass	CGY	Defined in Figs. 5.12, 5.13
Variation of C. G. Z-location ² with mass	CGZ	Defined in Figs. 5.14, 5.15
Fuel equivalent slosh mass	MF	14.3 slugs
Oxidizer equivalent slosh mass	MO	44.6 slugs
Fuel mass C. G. X-location ³	RF	970 ins to 840 ins (Apollo ref.)
Oxidizer mass C. G. X-location ³	RO	974 ins to 840 ins (Apollo ref.)
Fuel mass natural frequency	WF	4.07 ¹ rad/sec
Fuel mass damping ratio	ZF	.005
Oxidizer mass natural frequency	WO	3.82 ¹ rad/sec
Oxidizer mass damping ratio	ZO	.005
RCS thruster moment arm	LT	7.1 feet
Engine hinge point location	LE	833 ins. (Apollo ref.)
Spacecraft Launch Configuration		See Fig. 5-3

- NOTE: 1. Data corresponds to initial thrust acceleration of 15.7 ft/sec² and the relation $(W^2/a_T)_t = (W^2/a_T)_{initial}$ is assumed.
2. Angles given as positive rotations of (engine hinge-point to c. g.) line about positive CSM Y and Z axes.
3. Range is from vehicle half-full to empty. A linear interpolation is assumed.
4. The products of inertia are assumed to satisfy:

$$\begin{matrix} \text{Angular} \\ \text{momentum} \end{matrix} = \begin{bmatrix} h_x \\ h_y \\ h_z \end{bmatrix} = \begin{bmatrix} I_{XX} & -I_{XY} & -I_{XZ} \\ -I_{XY} & I_{YY} & -I_{YZ} \\ -I_{XZ} & -I_{YZ} & I_{ZZ} \end{bmatrix} \begin{bmatrix} \omega_x \\ \omega_y \\ \omega_z \end{bmatrix}$$

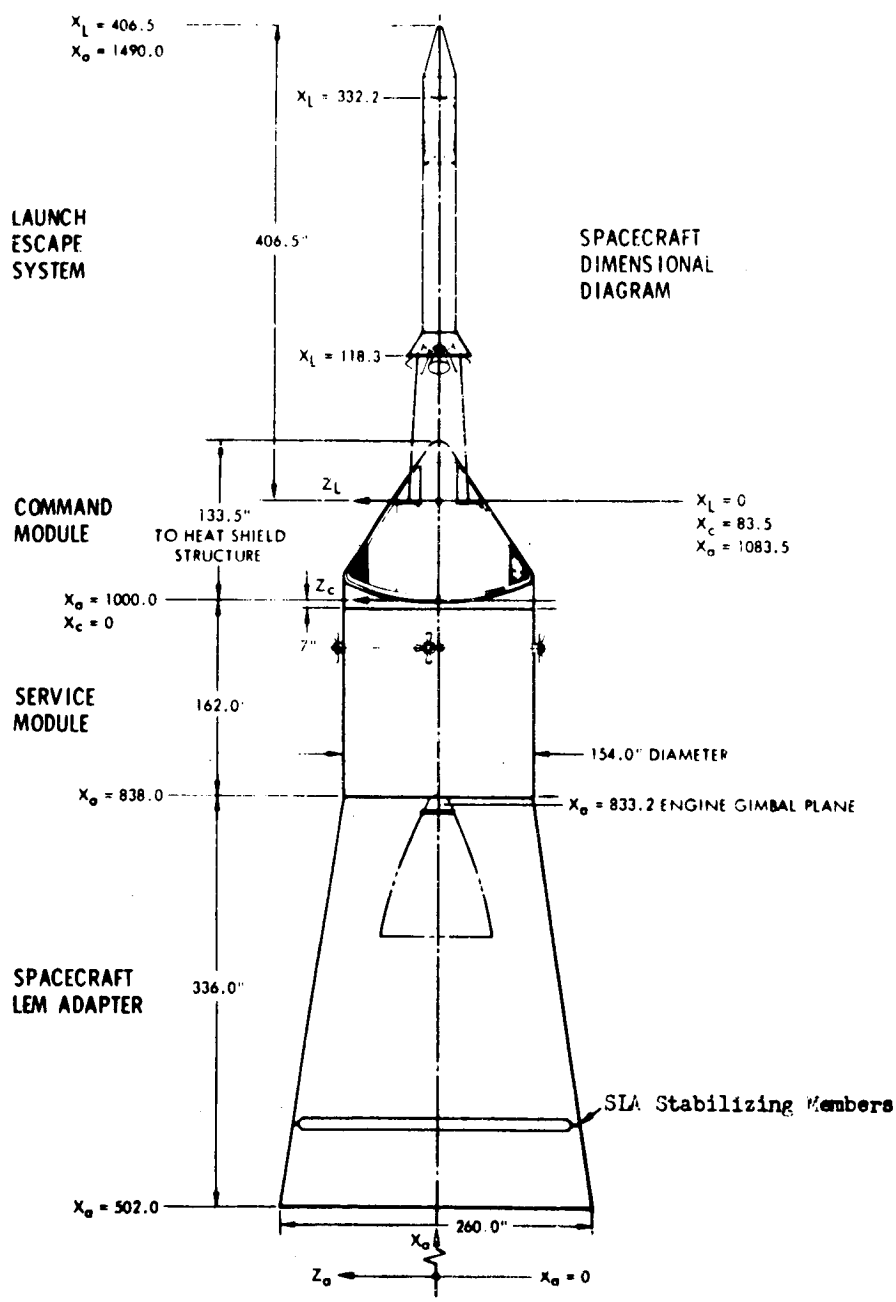

Fig. 5-3 CSM Launch Configuration

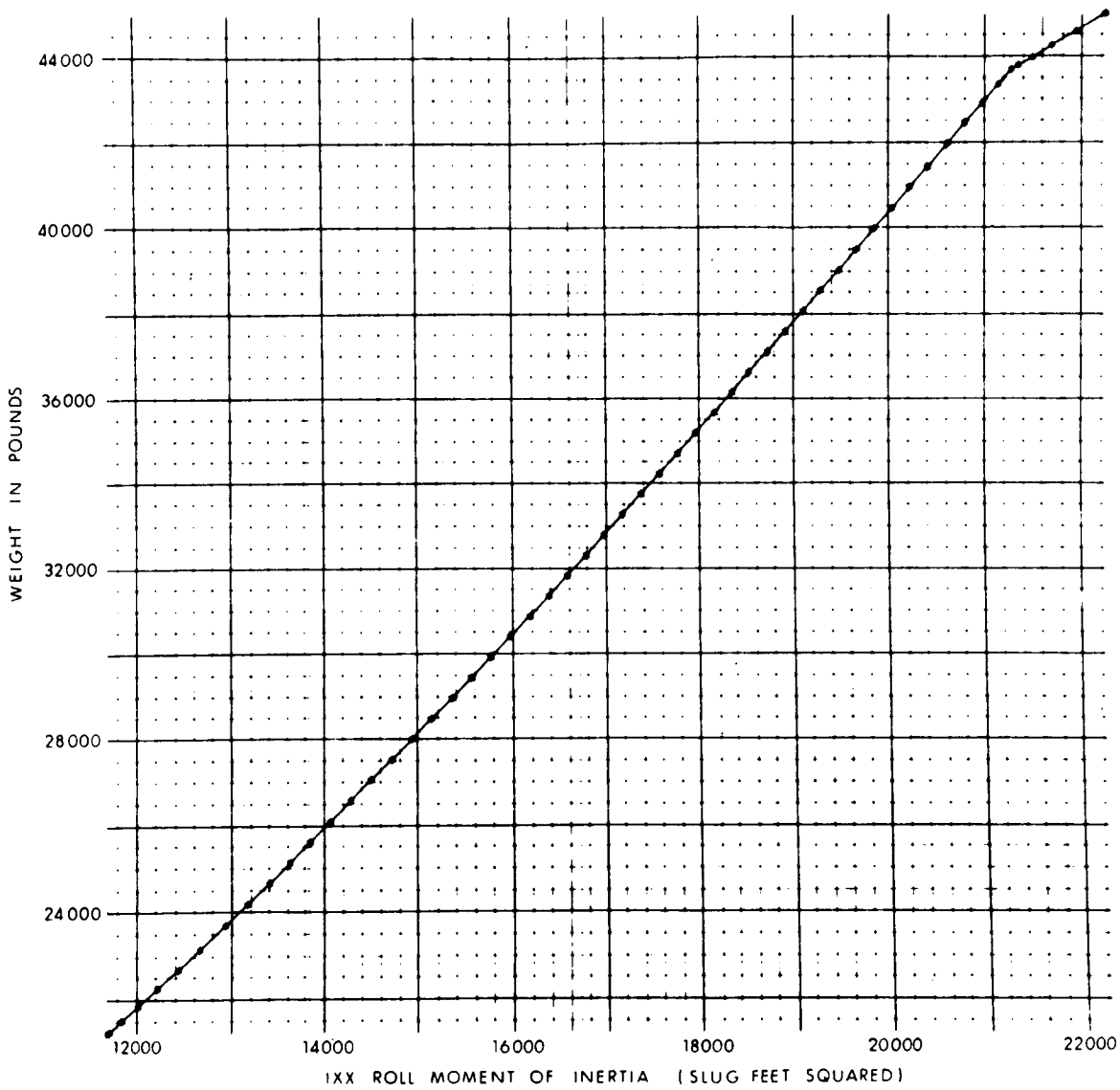

Fig. 5-4 IX X Moment of Inertia against CSM Weight

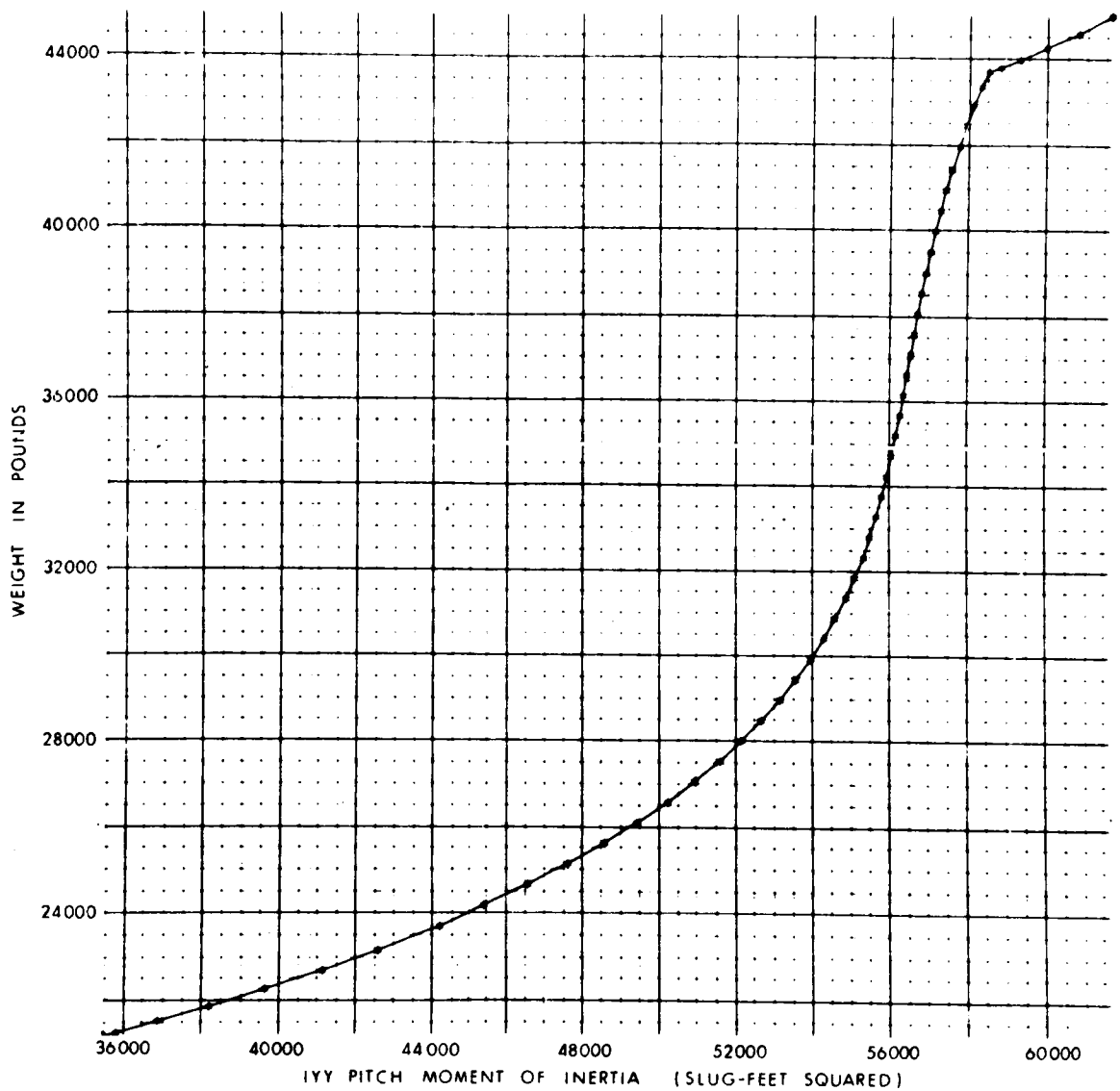

Fig. 5-5 IYY Moment of Inertia against CSM Weight

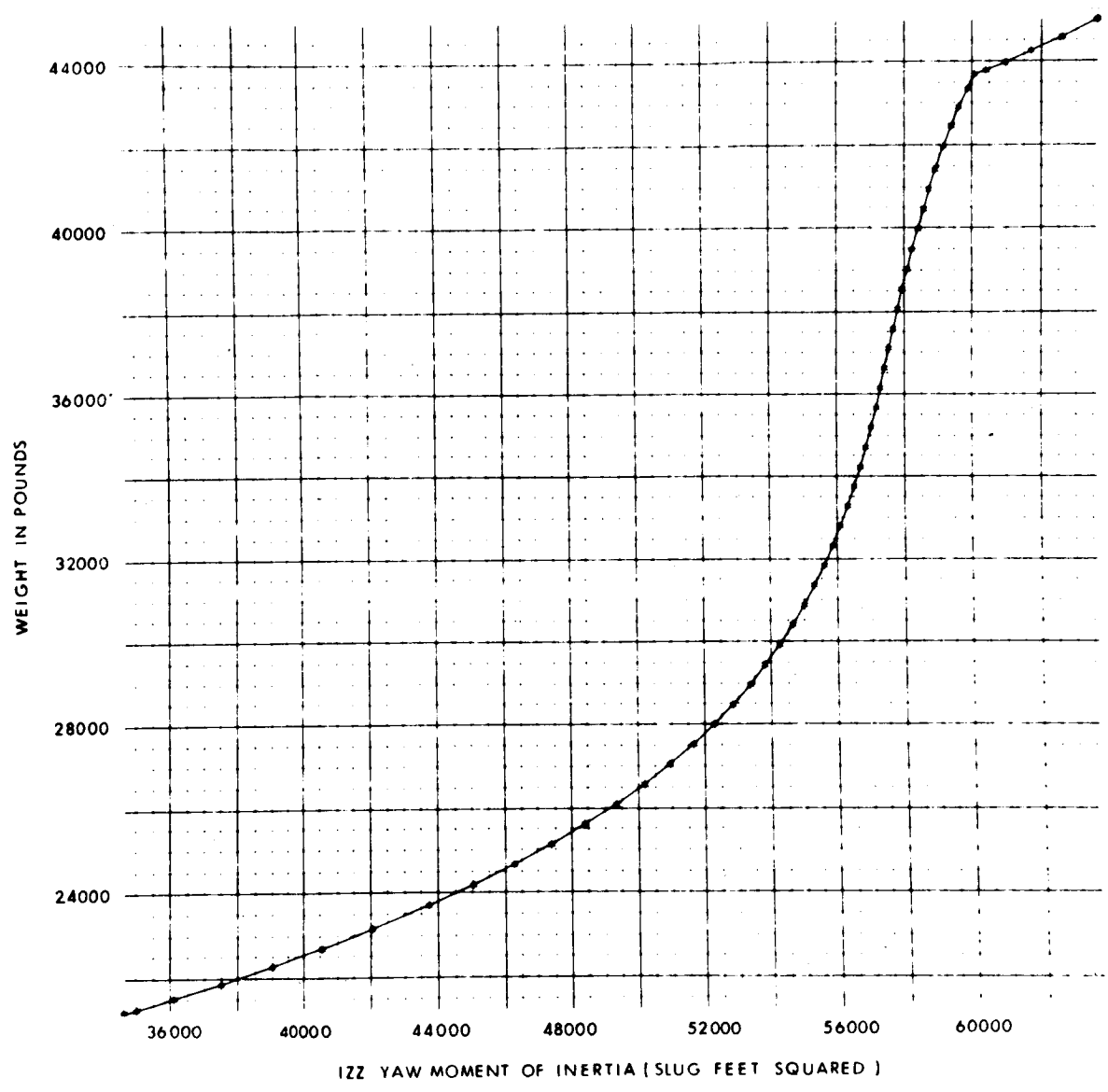

Fig. 5-6 IZZ Moment of Inertia against CSM Weight

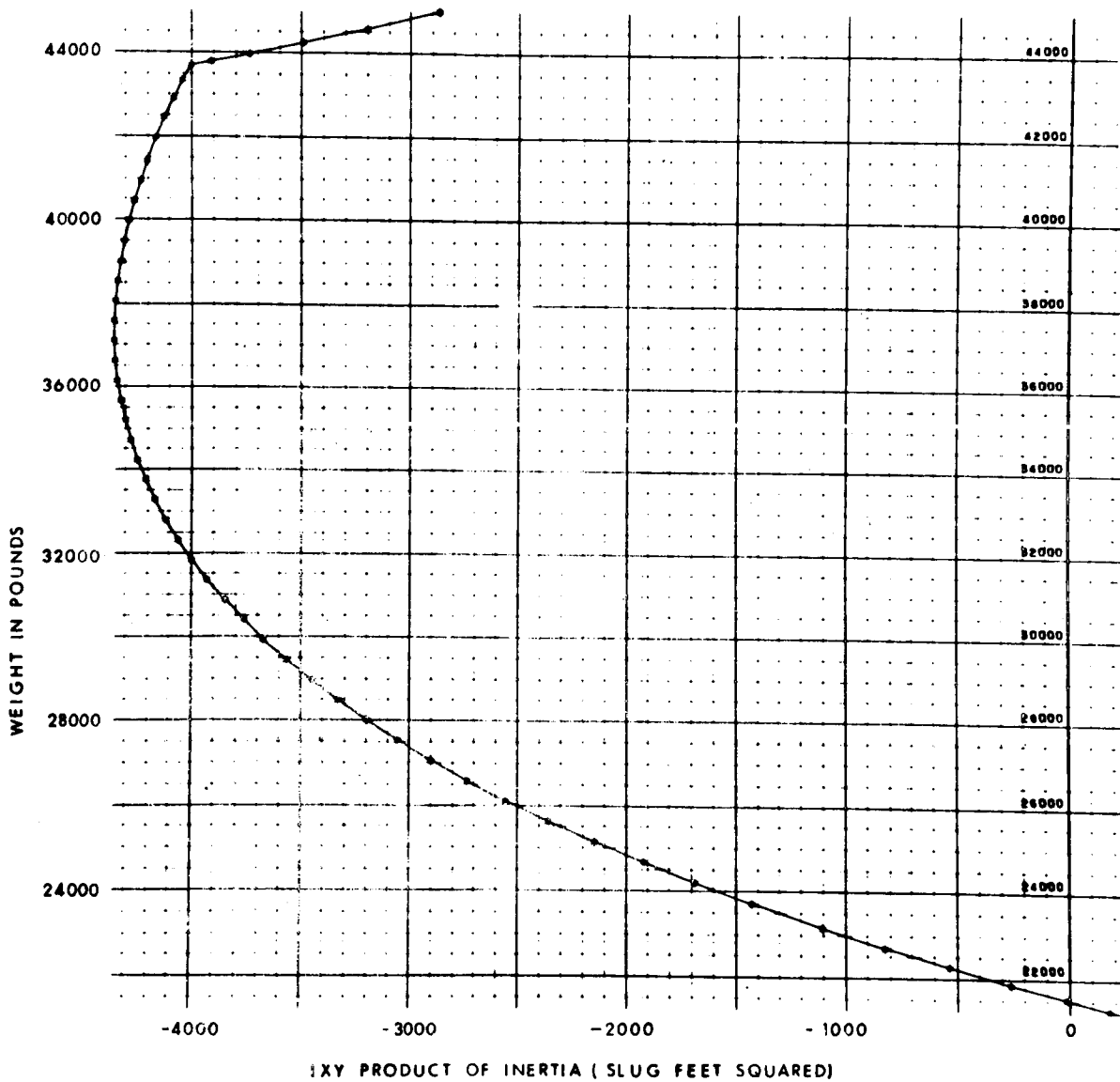

Fig. 5-7 IXY Product of Inertia against CSM Weight

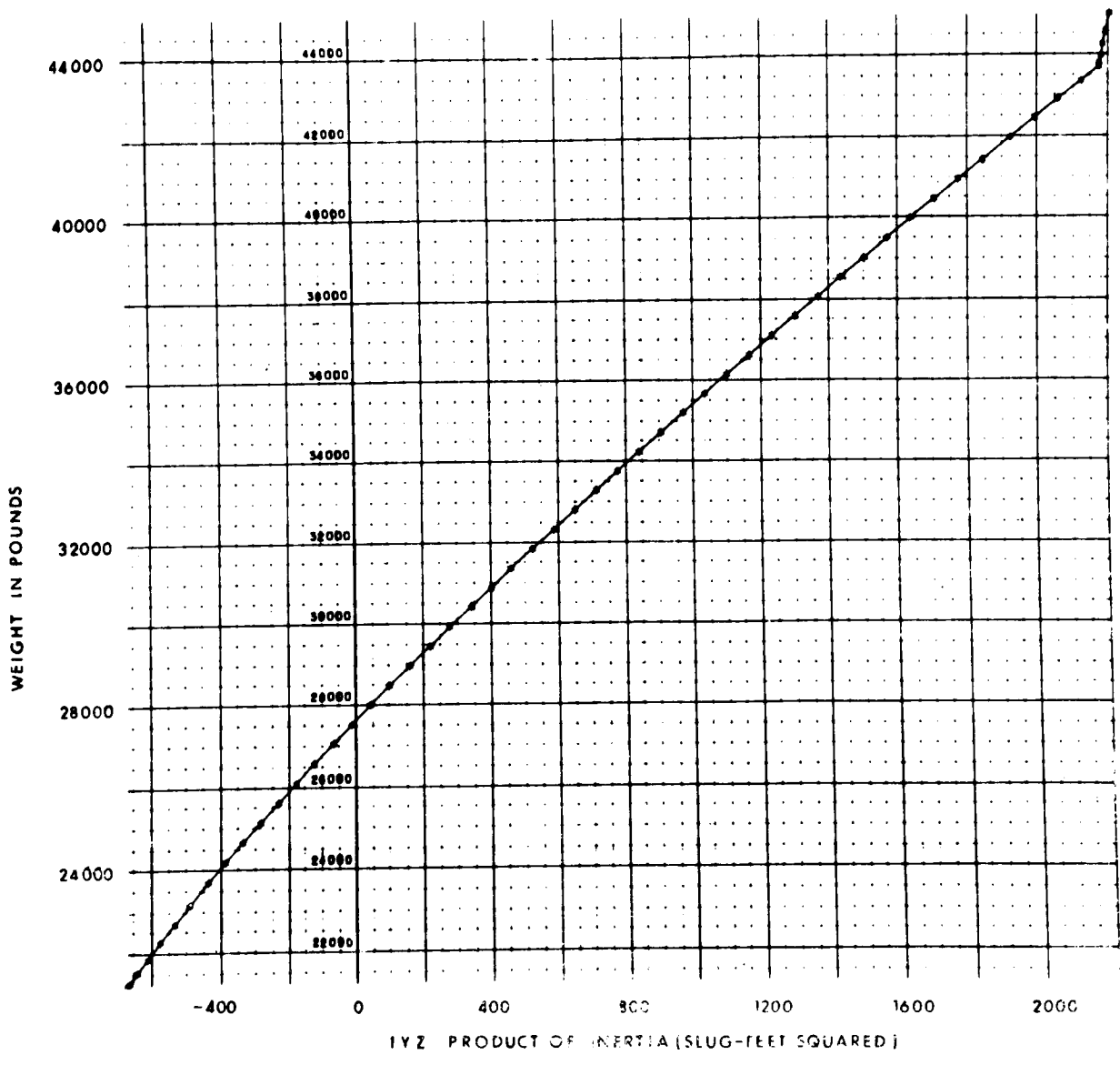

Fig. 5-8 IYZ Product of Inertia against CSM Weight

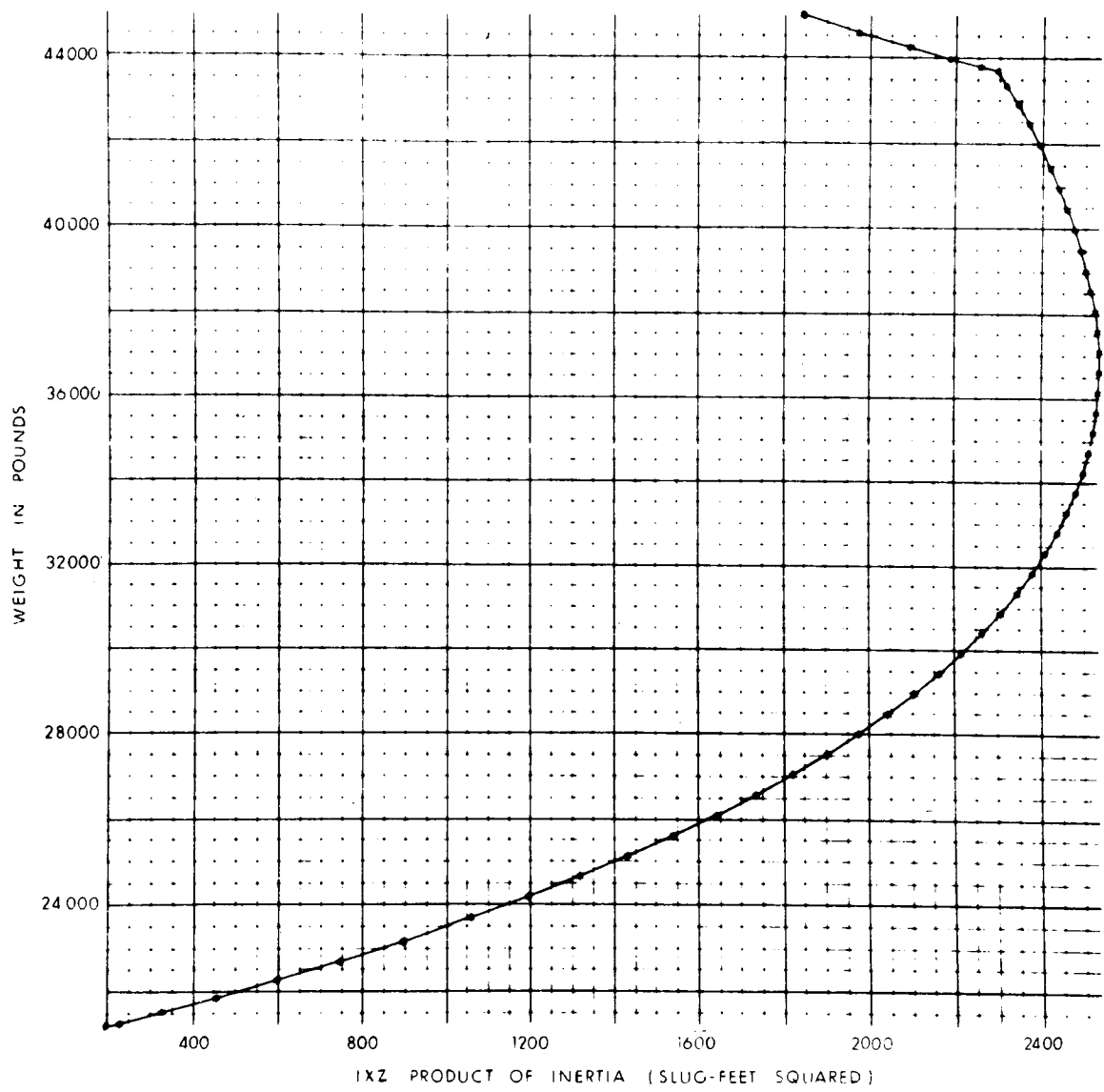

Fig. 5-9 IXZ Product of Inertia against CSM Weight

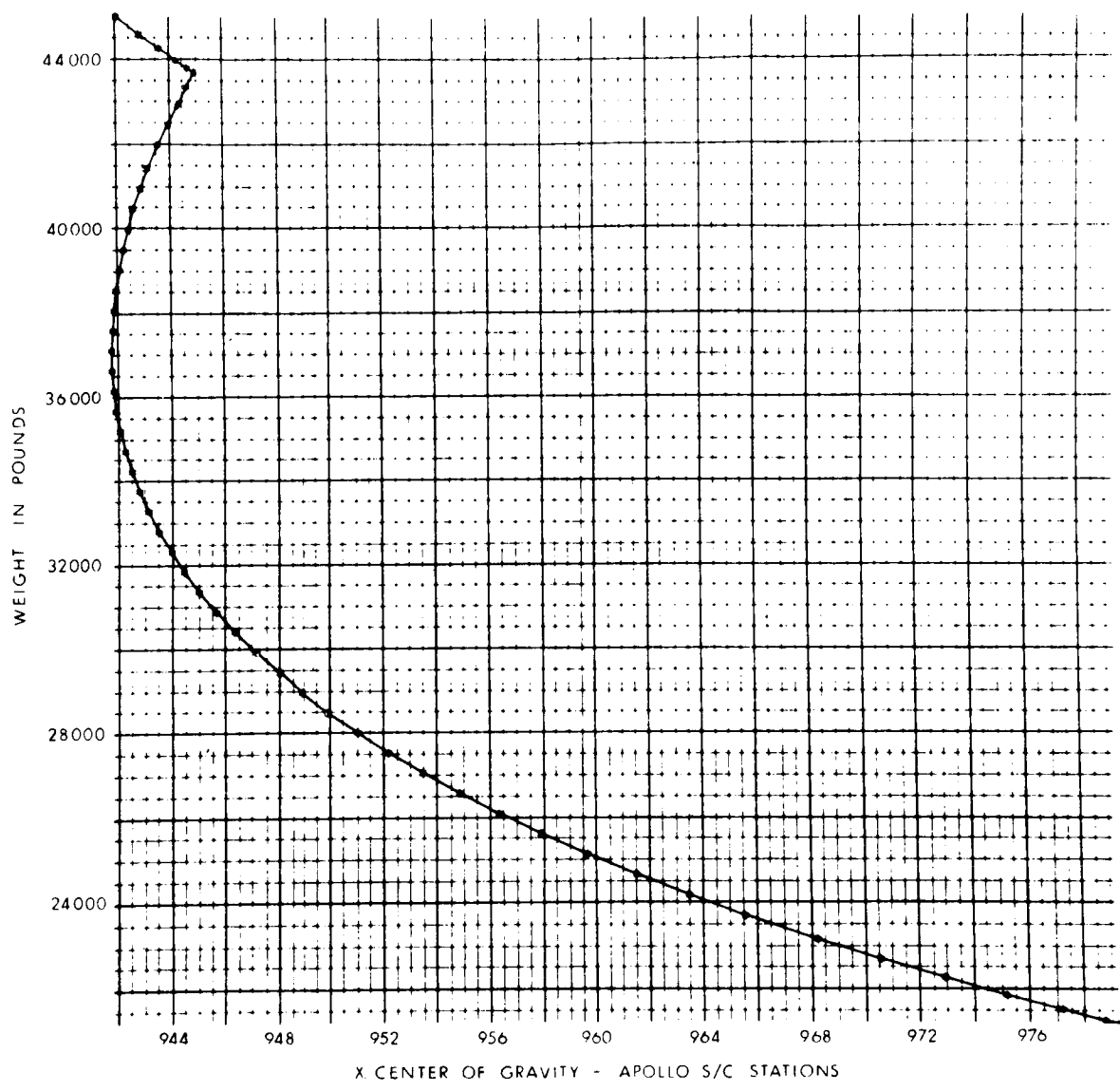

Fig. 5-10 C. g. X-Axis Coordinate against CSM Weight

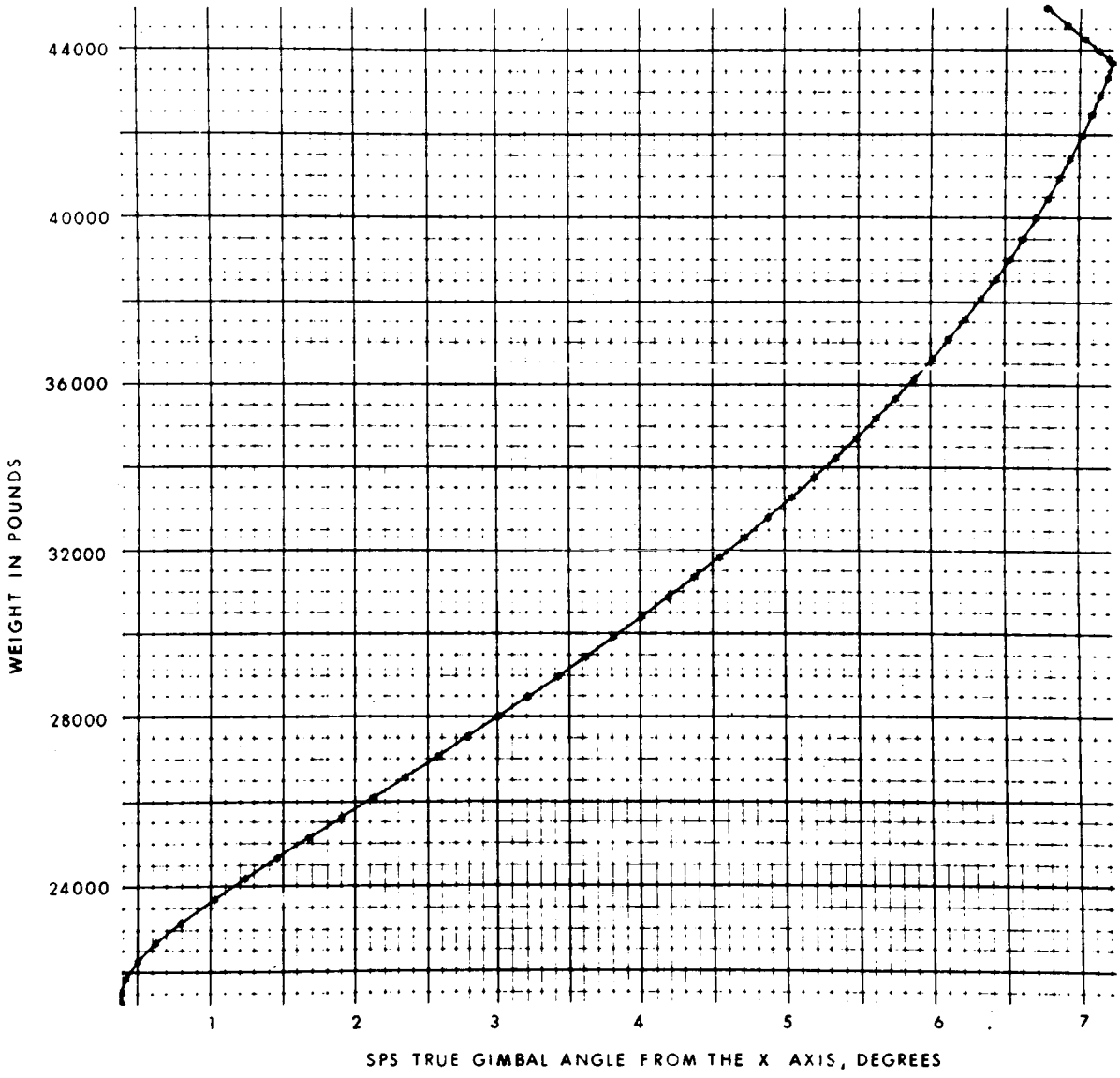

Fig. 5-11 SPS True Gimbal Angle from X-Axis against CSM Weight.

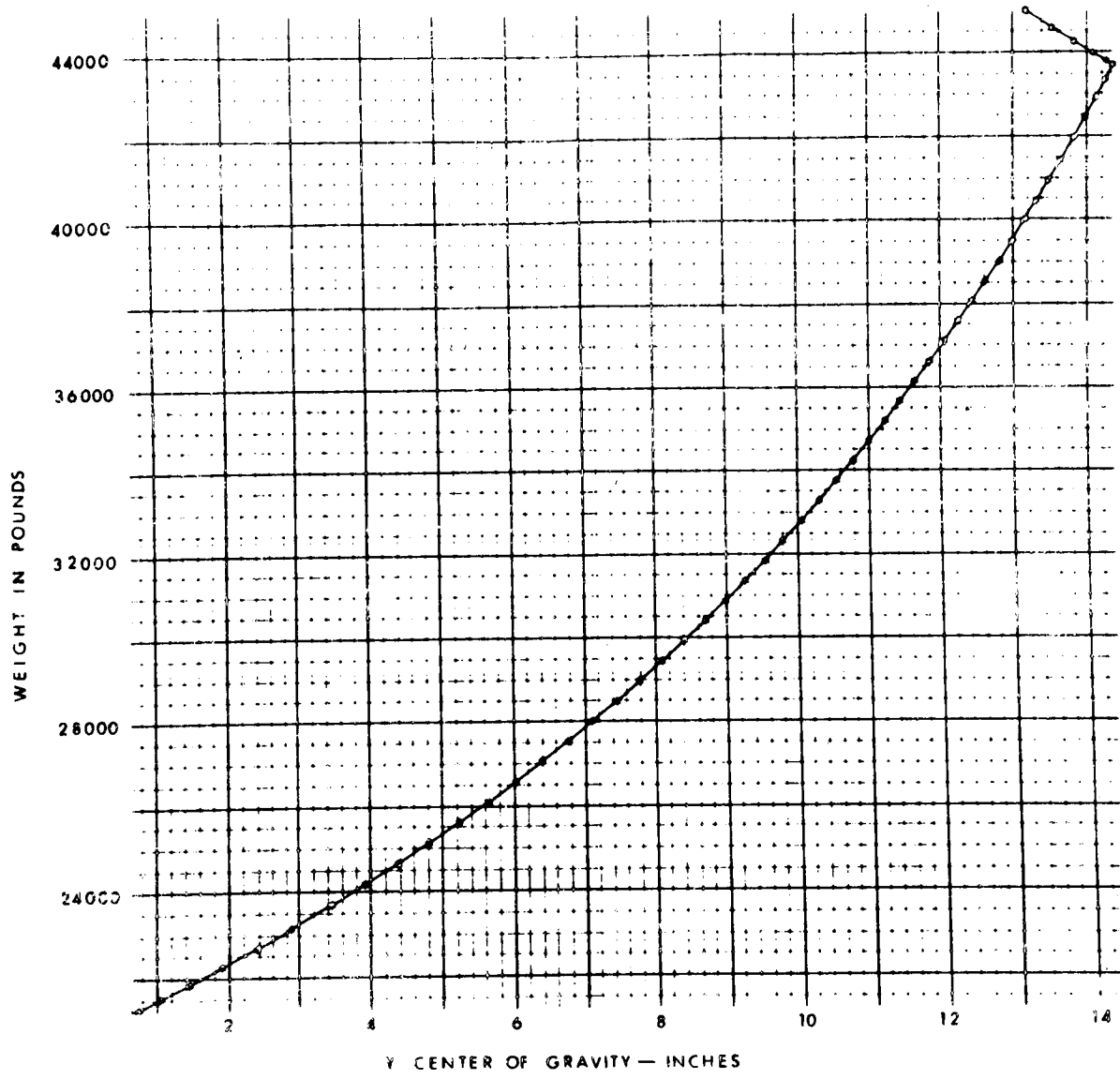

Fig. 5-12 C. g. Y-Axis Coordinate against CSM Weight

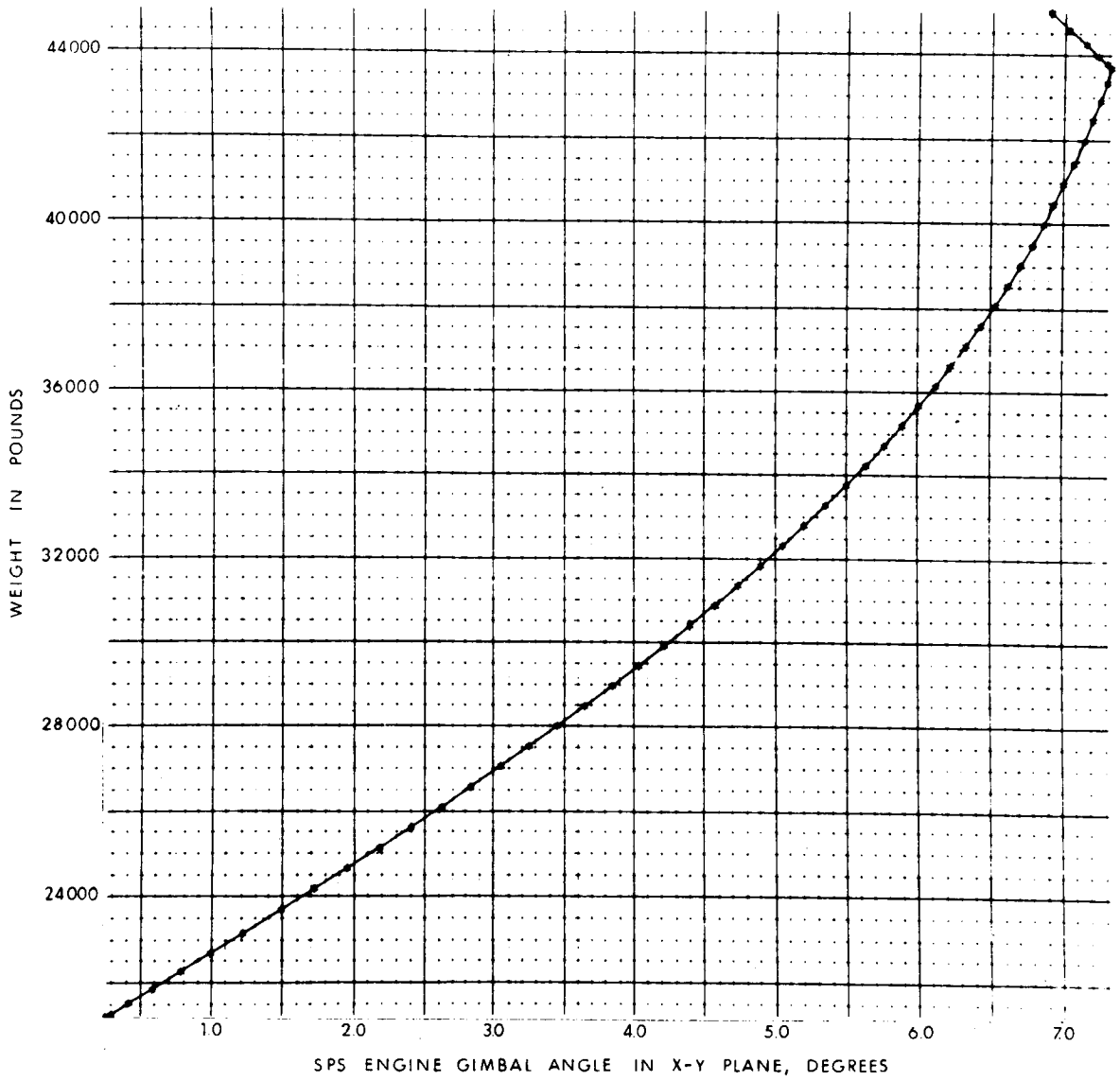

Fig. 5-13 SPS Gimbal Angle in X-Y Plane against CSM Weight.

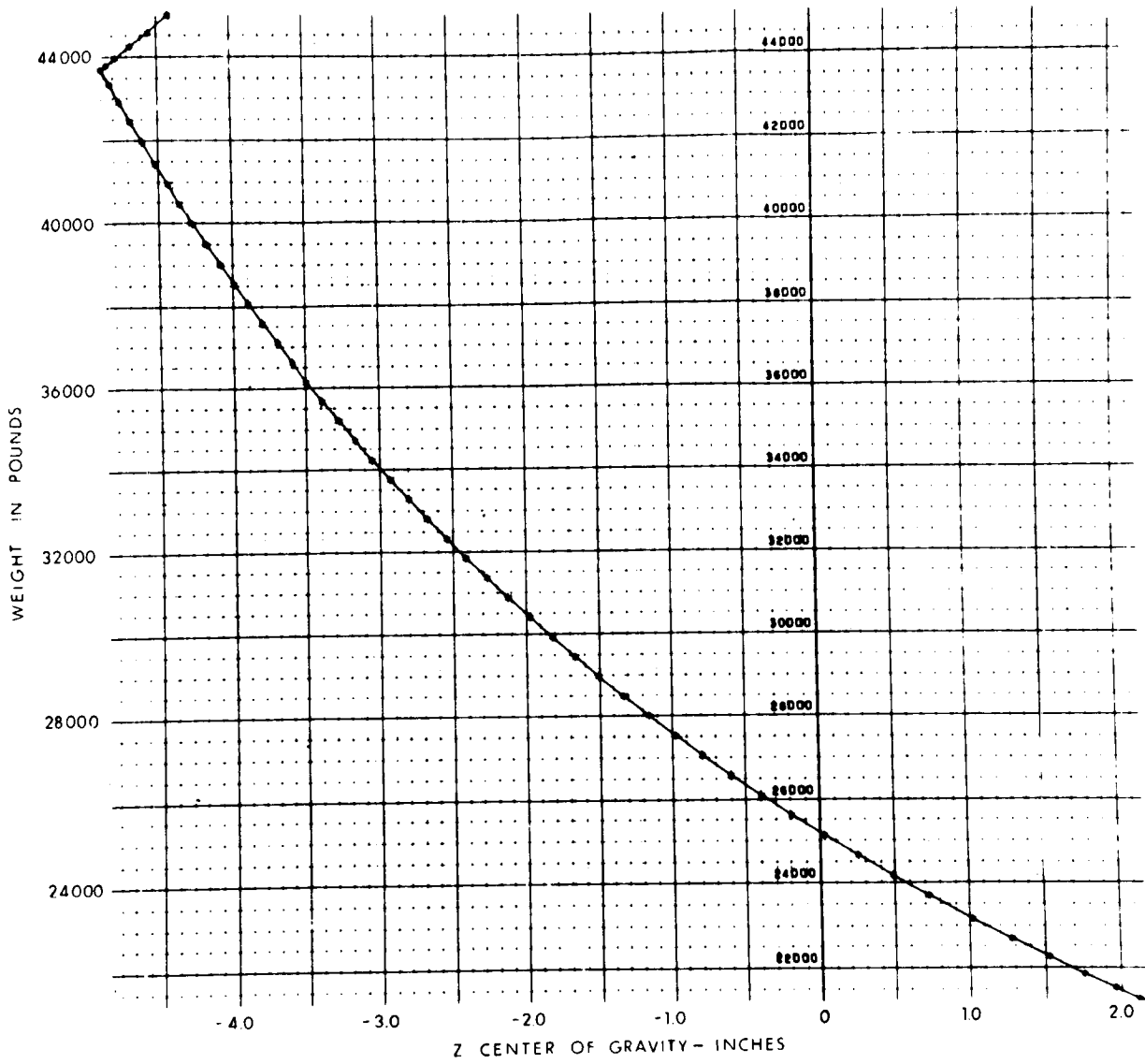

Fig. 5-14 C.g. Z-Axis Coordinate against CSM Weight

~~CONFIDENTIAL~~

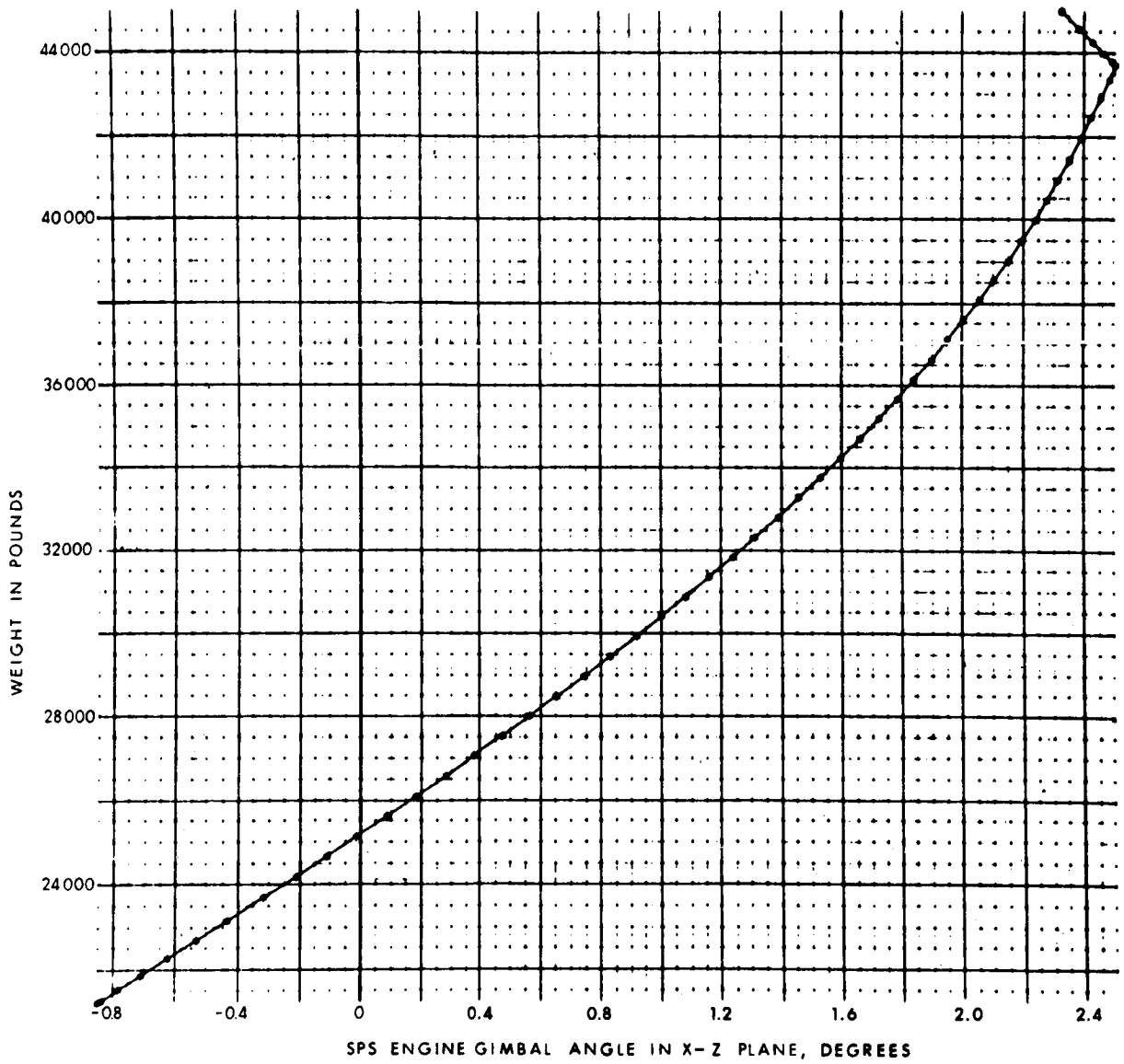

Fig. 5-15 SPS Gimbal Angle in X-Z Plane against CSM Weight.

~~CONFIDENTIAL~~

5.4.2 SPS Engine Data

Item	Symbol	Value
Mass	ME	20 slugs
Inertia (IY = IZ = IR)	IR	213 slug ft ²
Hinge to c. g. radius	LE	8.0 inches
Vacuum thrust	TF	21,500 lbs (± 1% after 30 sec) (+10% after 750 sec) (-1% after 750 sec)
Specific impulse	ISP	317.8 ± 4.8 secs (3σ variation)
Maximum start and shutdown transients		See Fig. 5.16
Mean thrust-off impulse		8,400 lb-sec
Displacement, thrust vector from engine gimbal axes intersection		<0.125 inches
Misalignment, thrust vector from engine mount plane normal		<0.5 deg.

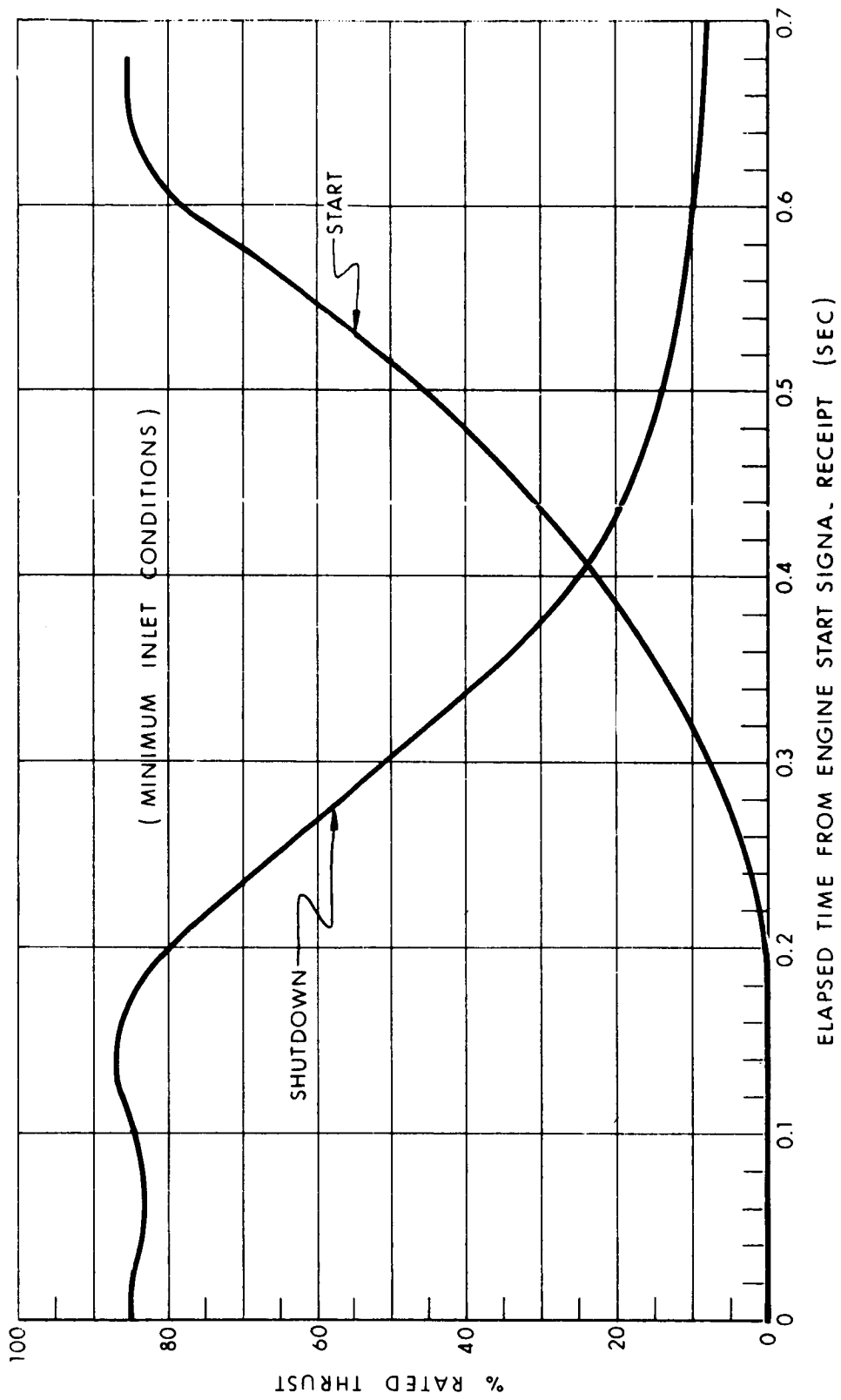

Fig. 5-16 SPS Engine Start and Shutdown Transients

5. 4. 3 TVC Autopilot Data

TVC Autopilot Data	Symbol	Pitch (Y)	Yaw (Z)	Units
Configuration		Defined in Fig. 5. 17		
Attitude error gain	KA	1. 00		rad/rad
Attitude rate gain	KR	0. 500		rad/rad/sec
Rate command limit	L	0. 140		rad (effectively 16°/sec)
Att. rate filter lead time constant	τ_1	0. 125		sec
Att. rate filter lag time constant	τ_2	0. 042		sec
Forward filter gain	KE	1. 50		
Commanded position breakpoint	LMP(1)	0. 105		rads(6°)
Commanded position limit	LMP(2)	0. 227		rads(13°)
Clutch servo amplifier gain	KS	20. 0		Amps/rad
Clutch servo amp. lead time const.	τ_3	0. 025		sec
Clutch servo amp. lag time const.	τ_4	0. 029		sec
Clutch servo current limit	LMI	0. 600		Amps
Clutch gain	KC	3, 530		lbs/amp
Actuator moment arm	RA	1. 00	1. 05	feet
Clutch lead time constant	τ_5	0. 022		sec
Clutch lag time constant	τ_6	0. 029		sec
Total actuator load inertia	JT	281	287	slug-ft ²
Actuator load time constant	WA	6. 652	6. 499	rad/sec
Actuator load natural frequency	WB	104	81. 7	rad/sec
Actuator load damping ratio	ξ	0. 104	0. 137	
Engine rate limit	LMR	0. 300		rad/sec
Engine position limit (pitch)	LMY	±0. 105		rad(±6°)
Engine position limit (yaw)	LMZ		+0. 192 -0. 052	rad($\begin{matrix} +11. 0^\circ \\ -3. 0^\circ \end{matrix}$)
Position feedback gain	KD	1. 00		rads/ft/sec
Position pickoff frequency	WD	63. 0	46. 2	
Rate feedback gain	KG	0. 090		rads/ft
Rate pickoff frequency	WC	48. 1	40. 0	rads/sec

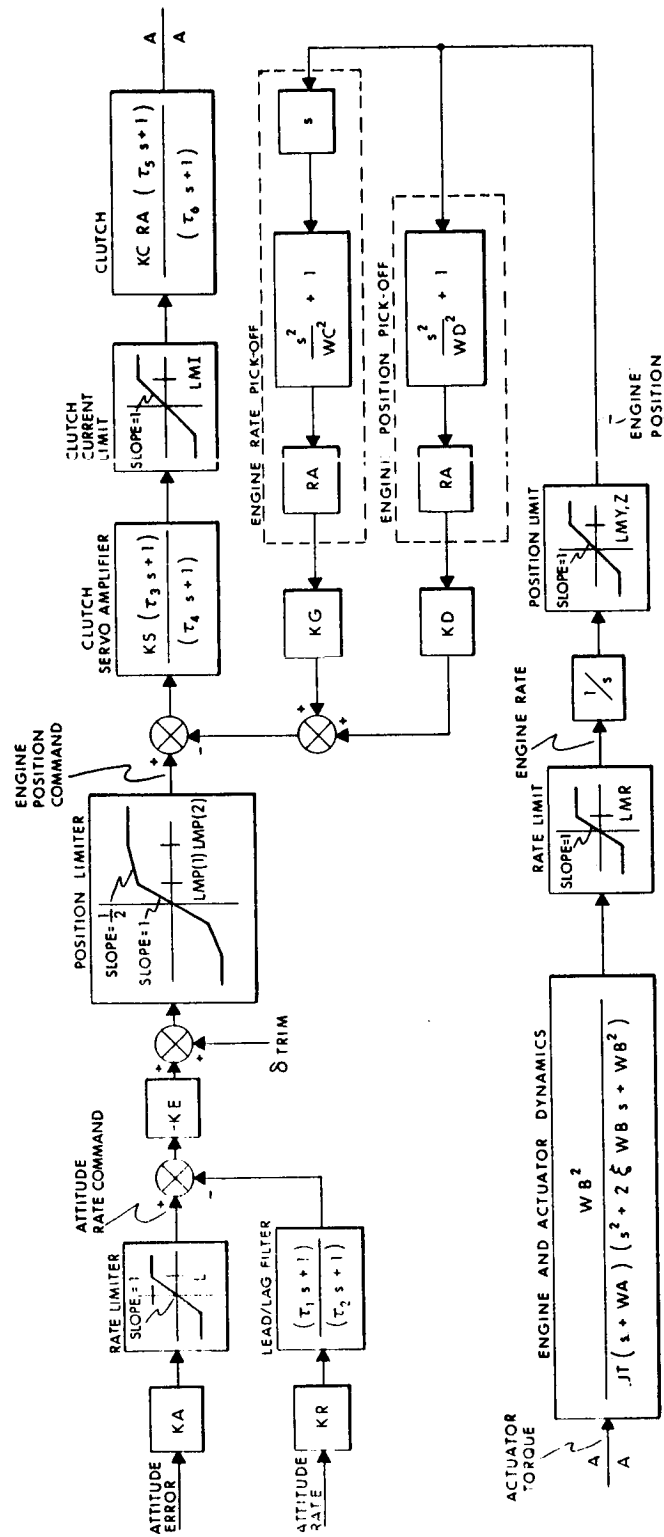

Fig. 5-17 TVC Autopilot Block Diagram

5. 4. 4 RCS Autopilot Data

Configuration: see Fig. 5-18	Att. Cont.		TVC		Pre-05g		Entry
	Roll, Pitch, Yaw	Roll	Roll	Pitch, Yaw	Roll	Pitch, Yaw	
Attitude error deadband	0	0	0	4.0	4.0	4.0	---(1)
Attitude error gain	1.0	1.0	1.0	0.2	0.2	0.2	---(1)
Rate command limiter	---(3)	---(3)	---(3)	1.9 ⁴	0.7 ⁵	1.9 ⁴	---(1)
Rate Gain	1.0	1.0	1.0	0.1	0.1	0.1	
Roll-to-yaw coupling angle	---	---	---	---	---	22	
Filter gain	1.0	1.0	1.0	--(2)	--(2)	--(2)	
Filter Time constant	1.0	1.0	1.0	--(2)	--(2)	--(2)	
Switch Deadband	0.2	0.2	0.2	0.2	0.2	0.2	
	A-0.007	A-0.007	A-0.007	A-0.007	A-0.007	A-0.007	A-0.007

NOTES

1. Pitch, yaw attitude error channels open-circuited during entry.
2. Filter feedback open-circuited during entry.
3. Effective attitude rate limit set by saturation of electronics at approximately 9.3°/sec. Commanded rates will be limited to 4°/sec (pitch, yaw) 7.2°/sec (CSM-roll) 15°/sec (CM only-roll)
4. Effective attitude rate limit (roll): 17°/sec
5. Effective attitude rate limit (pitch, yaw): 5°/sec

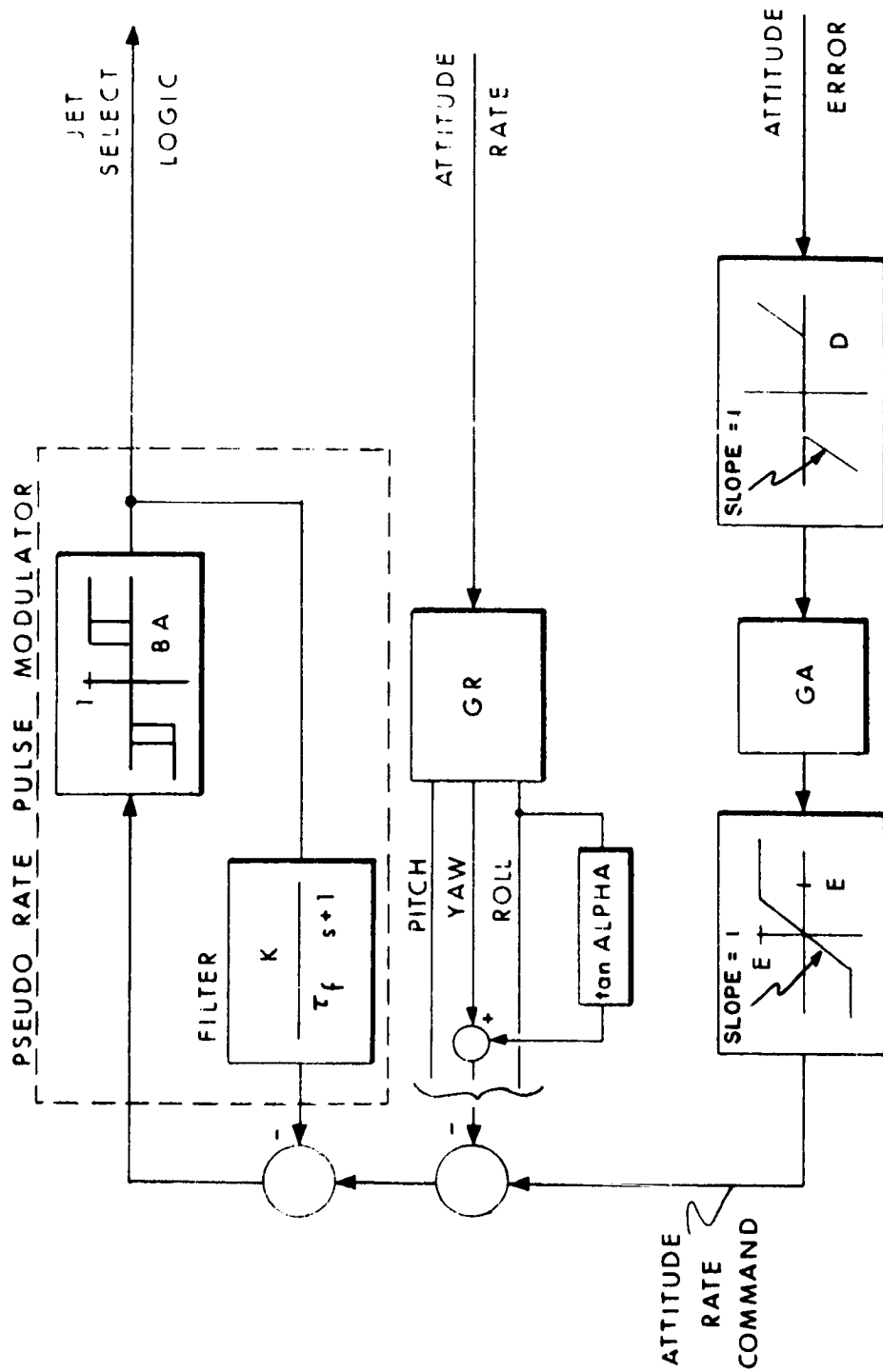

Fig. 5-18 RCS Autopilot Block Diagram

5.4.5 RCS Reaction Jet Data

<u>Item</u>	<u>Units</u>	<u>Value</u>	
		<u>SM</u>	<u>CM</u>
Configuration		(see Fig. 5.19)	(see Fig. 5.20)
Nominal vacuum thrust	lbs	100 ± 5	91 ± 3
Specific impulse (steady)	secs	283 ± 11 (3σ)	270 ± 4
Minimum impulse	lb-sec	0.75 ± 0.15	2.0 ± 0.3
Thrust rise lag	millisec	<12.5	<13.0
Thrust rise time constant	millisec	2.0 (exp)	2.0 (linear)
Duration, minimum impulse electrical signal	millisec	18.0 ± 4.0	18.0 ± 4.0

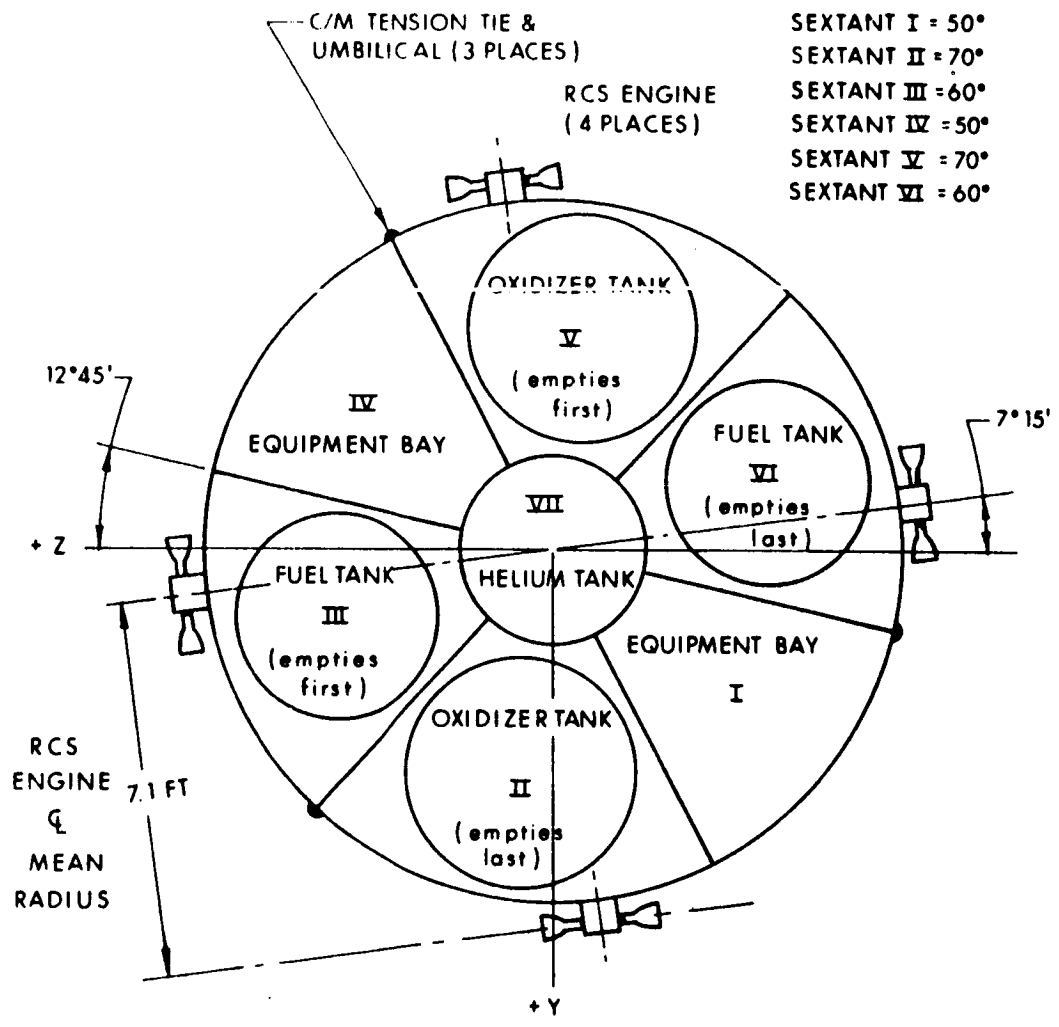

Fig. 5-19 (1) CSM Reaction Jet Positions

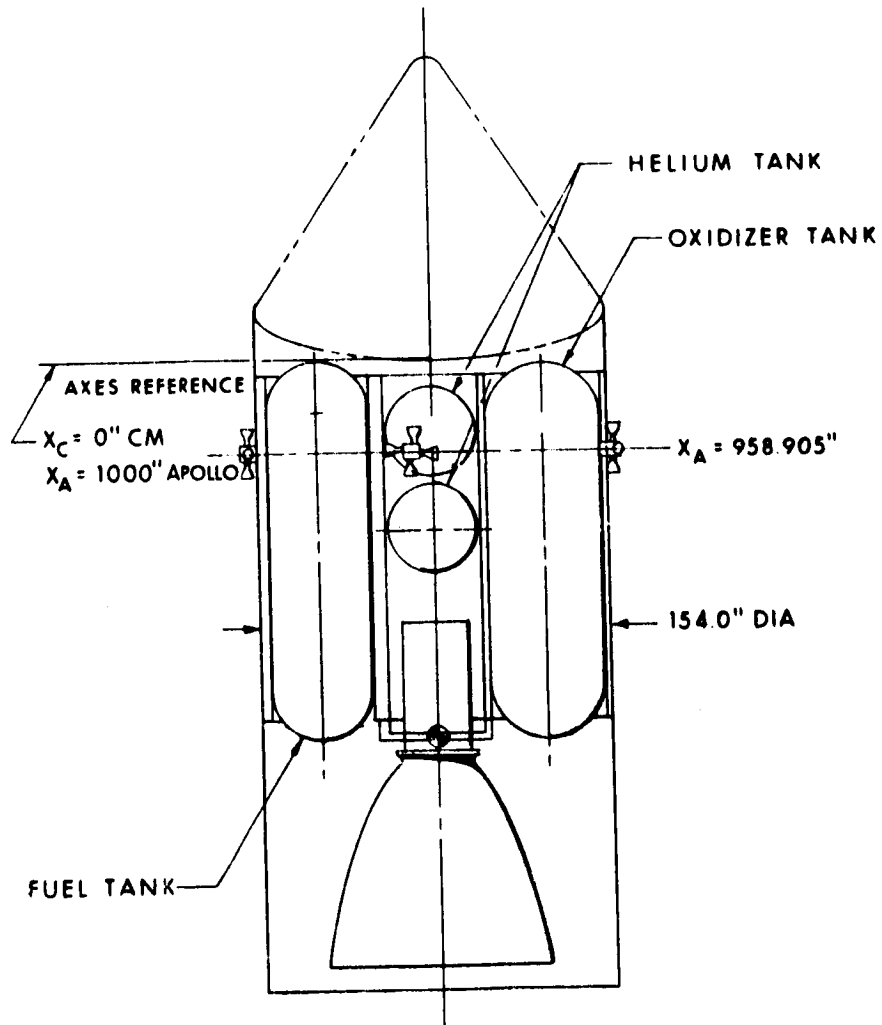
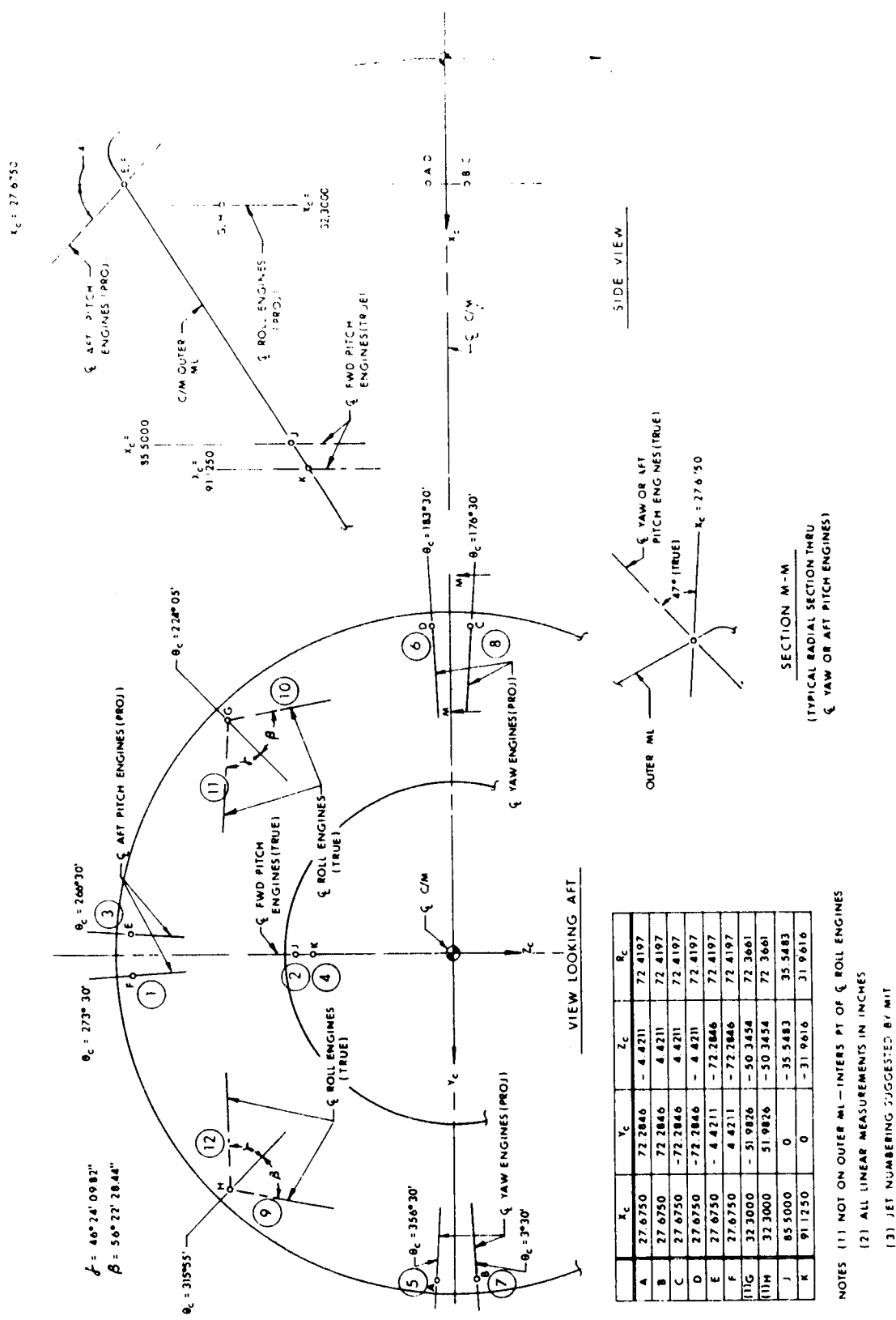

Fig. 5-19 (2) CSM Reaction Jet Positions



NOTES (1) NOT ON OUTER ML - INTERS PT OF ξ ROLL ENGINES
 (2) ALL LINEAR MEASUREMENTS IN INCHES
 (3) JET NUMBERING SUGGESTED BY MIT

Fig. 5-20 CM Reaction Jet Positions

5.4.6 CM Data

Control Weight	11,000 lbs	
Principal inertia (IXX)	5065.0 slug-ft ²	
Principal inertia (IYY)	4491.3 slug-ft ²	
Principal inertia (IZZ)	3973.5 slug-ft ²	
Product ¹ of inertias (IXY)	-1.7 slug-ft ²	
Product ¹ of inertias (IYZ)	-43.5 slug-ft ²	
Product ¹ of inertias (IXZ)	-291.8 slug-ft ²	
CG X-location	43.4 inches	} from CM origin = S/C sta. 1000
CG Y-location	0.5 inches	
CG Z-location	5.3 inches	
Aerodynamic reference area	129.4 square feet	
Aerodynamic reference diameter	154.0 inches	
Aerodynamic coefficients	see: Table (5.2), Fig. (5.21)	
Variation of coefficients with Mach number	see: Fig. (5.22)	

Note 1. See note at foot of 5.4.1

Table 5.2
Aerodynamic Coefficients Against Angle of Attack
for the Command Module with Protuberances

α , deg.	C_M	C_N	C_A	C_L	C_D	L/D
140.465	0.03282	0.13187	-0.99218	0.52987	0.84915	0.62400
145.465	0.02686	0.10490	-1.10571	0.54042	0.97033	0.55695
150.465	0.01851	0.07990	-1.20796	0.52595	1.09038	0.48236
155.465	0.00779	0.06223	-1.29105	0.47950	1.20032	0.39947
160.465	-0.00268	0.05562	-1.36511	0.40405	1.30513	0.30958
165.465	-0.01411	0.04354	-1.42967	0.31666	1.39484	0.22702
170.465	-0.02601	0.01772	-1.47186	0.22634	1.45446	0.15562
175.465	-0.03708	-0.00144	-1.50081	0.12010	1.49600	0.08082

- NOTES: 1. Above Table for Mach 10.0
2. Coefficients for Moment Center at

$$X_{c.g.} = 1043.1 \text{ inches}$$

$$Y_{c.g.} = 0.0 \text{ inches}$$

$$Z_{c.g.} = 5.4 \text{ inches}$$

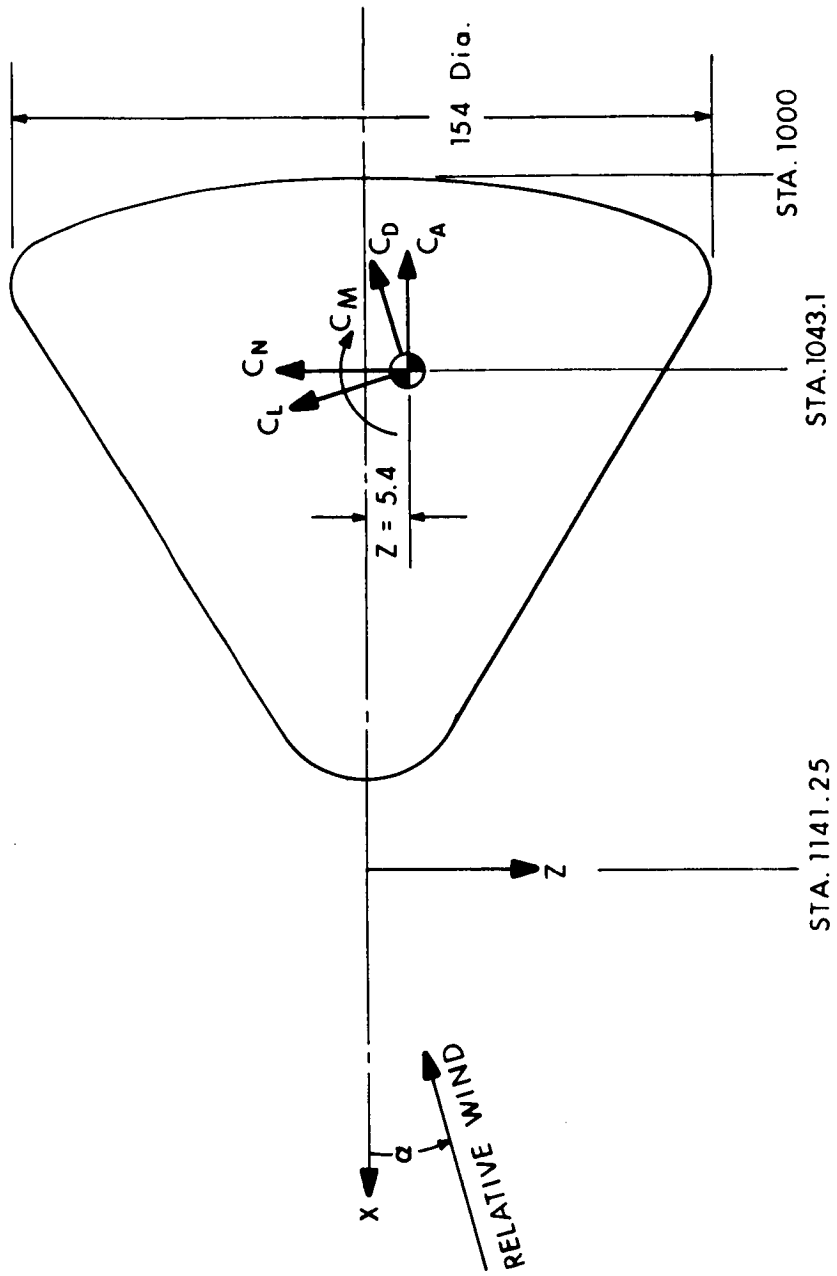
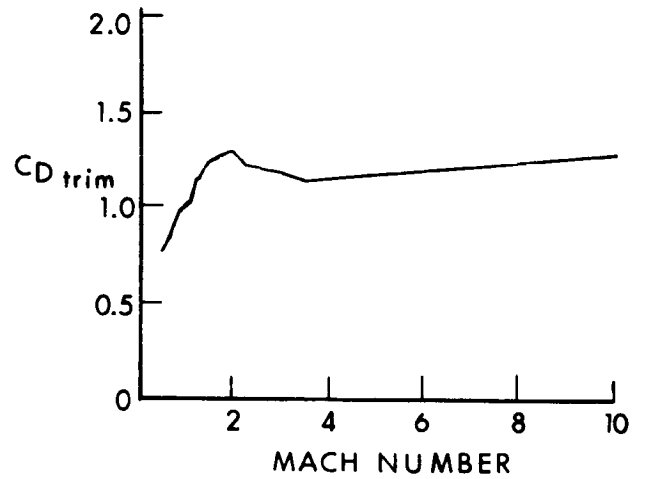
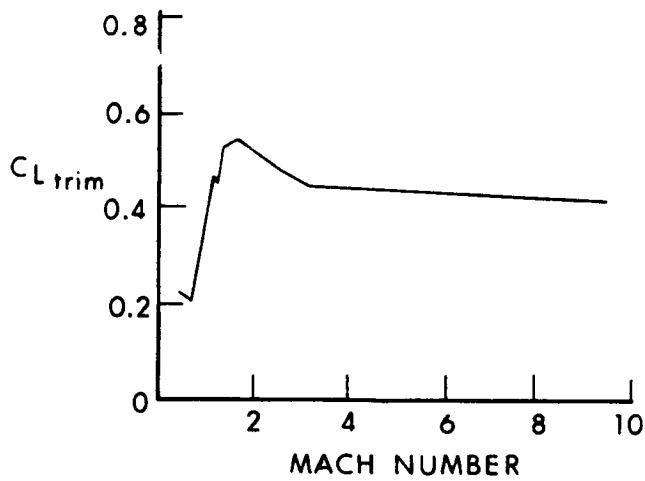
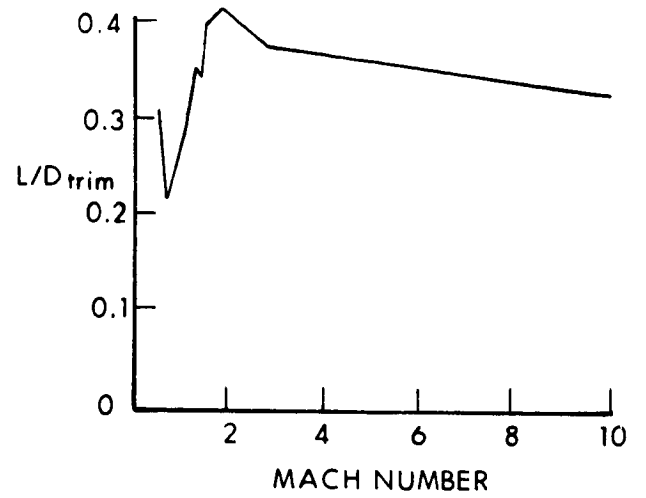
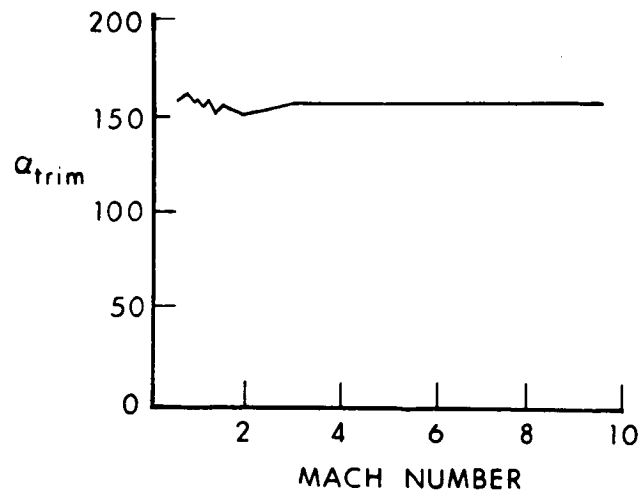

Fig. F-21 CM Axis System and Reference Center of Gravity



NOTE : COEFFICIENTS FOR MOMENT CENTER AT.
 $X_{c.g.} = 1043.1$ ins
 $Y_{c.g.} = 0.0$ ins
 $Z_{c.g.} = 5.4$ ins

Fig. 5-22 Experimental Trim Values for Block I CM with External Protruberances

5.5 Physical constants

5.5.1 Geophysical constants

	Symbol	Value
Earth's gravitation constant	MUE	$3.986\ 032\ 233 \times 10^{14}$ meters ³ /sec ²
Gravity potential harmonic coeff.	J	1.62345×10^{-3}
	H	-0.575×10^{-5}
	D	0.7875×10^{-5}
Earth's mean equatorial radius	RE	$6.378\ 165 \times 10^6$ meters
Earth's sidereal rate	WIE	$7.292\ 115\ 04 \times 10^{-5}$ radians/sec
Reference ellipsoid		Fischer, 1960

5.5.2 Conversion Factors

	Multiply by
International feet to meters	0.304 8
Pounds to newtons	4.448 221 530
Slugs to kilograms	14.593 902 680
Nautical miles to kilometers	1.852
Statute miles to kilometers	1.609 344 000
Slugs to pounds (g)	32.174 048 000 ft/s/s

6. G&N ERROR ANALYSIS

This section provides the results of G&N Error Analysis. Table 6-1 summarizes the one-sigma total error at each major event time and breaks these down into the contributions of IMU errors accumulated during each powered phase. Tables 6-2 through 6-16 break down each line of Table 6-1 into the contributions of each IMU sensor error term.

On the basis of these data the following key errors are estimated:

Entry γ_i (one sigma)	:	0.165 degree
Entry V_i (one sigma)	:	18.0 feet per second
CEP at Pacific Recovery Point.	:	15.0 nautical miles

The following comments explain the terminology, method of analysis and the basic assumptions used.

- 1) The IMU Stable Member axes are aligned prior to launch relative to local vertical axes as indicated in sketch. X_{SM} is up along local vertical at instant of launch, while Z_{SM} is along local horizontal pointed down-range at an azimuth of 105 degrees.
- 2) The data in the error tables are given relative to local vertical axes (altitude, track, range) at the particular event designated.
- 3) Only the significant error figures have been listed in the error tables.
- 4) No realignment of the Stable Member was assumed.
- 5) Accelerometer bias errors affect indication errors in two ways. First, they affect the initial pre-launch alignment of the Stable Member. Second, they affect the in-flight computation of position and velocity. The two effects are summed in the tables, since the accelerometer bias error prior to launch is assumed to be correlated with the bias error during flight.
- 6) Accelerometer inputs to the AGC are not used during the free-fall phases of the trajectory.
- 7) "Initial S. M. Alignment Errors" includes only the uncorrelated alignment errors. They do not include the alignment errors due to accelerometer bias errors. The azimuth alignment error (about X_{SM}) is affected principally by Z gyro drift effect on the gyro-compassing loop. Since there are other contributing factors to azimuth misalignment, this alignment error has been assumed to be statistically independent of Z gyro drift.

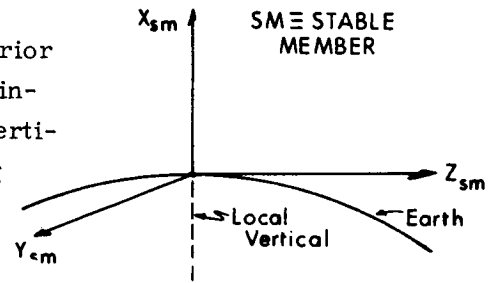

- 8) The position and velocity errors given in the tables for the various IMU sensor error terms are indication errors. No steering error was assumed. The indication errors in position and velocity were computed separately for each sensor error term using an array of error equations and the input position and acceleration trajectory data. These equations take into account the effect of the platform error on the gravity vector computation. For each trajectory run the position and velocity errors due to each platform error are computed simultaneously and printed in a summary table for all trajectory events of interest.

~~CONFIDENTIAL~~

TABLE 6-1

202 TRAJECTORY ERRORS

Event	Time from start (mins)	Type of Error	Position Error (n. miles)			Velocity Error (ft/sec)		
			Alt.	Track	Range	Alt.	Track	Range
SIVB Cutoff	10.3	1) Total Indication Error	0.34	3.07	0.17	9.2	72.1	4.2
SPS 1st Burn Cutoff	14.7	1) Total Indication Error	0.75	6.35	0.53	13.5	79.5	7.7
		2) Effect of IMU Errors during SPS 1st Burn	0.06	0.34	0.05	3.3	17.7	2.3
Coast Apogee	42.2	1) Total Indication Error	2.68	11.14	5.84	33.8	46.2	12.2
		2) Effect of IMU Errors during SPS 1st Burn	0.74	2.72	1.16	7.3	3.6	3.1
Coast End (SPS 2nd Burn Ignition)	65.4	1) Total Indication Error	3.84	5.35	11.36	70.3	73.5	16.1
		2) Effect of IMU Errors during SPS 1st Burn	1.46	0.08	2.99	20.0	17.1	6.2
SPS 2nd Burn Cutoff	67.0	1) Total Indication Error	3.78	6.51	11.80	73.2	74.1	17.7
		2) Effect of IMU Errors during SPS 1st & 2nd Burns	1.46	0.39	3.20	20.7	22.1	7.7
		3) Effect of IMU errors during SPS 2nd Burn	0.02	0.05	0.01	3.1	6.1	1.6
Entry Start	72.0	1) Total Indication Error	3.17	9.70	13.20	82.5	53.5	18.0
		2) Effect of IMU Errors during SPS 1st & 2nd Burns	1.24	1.43	3.93	24.3	19.8	7.5
		3) Effect of IMU Errors during SPS 2nd Burn	0.20	0.34	0.04	3.9	5.6	0.6
Entry End (at altitude of 50,000ft)		1) Total Indication Error	4.76	12.06	14.43	116.0	38.7	28.6
		2) Effect of IMU Errors during SPS 1st & 2nd Burns & Entry	2.25	3.60	4.92	56.1	50.3	11.9
		3) Effect of IMU Error during SPS 2nd Burn & Entry	1.07	1.64	0.62	36.8	49.0	9.7
		4) Effect of IMU Errors during Entry only	1.70	1.66	0.31	45.3	48.9	7.80

~~CONFIDENTIAL~~

Error			RMS Error	Final Position Error in Local Axes (in feet)			Final Velocity Error in Local Axes (in ft/sec)					
				Alt.	Track	Range	Alt.	Track	Range			
Init. Cond. Matrix Diag. Term. Errors	Position	(F)X _{I0}	0 ft	0	0	0	0	0	0			
		(F)Y _{I0}	0 ft									
		(F)Z _{I0}	0 ft									
	Velocity	(F)V _{XI0}	0 ft/sec									
		(F)V _{YI0}	0 ft/sec									
		(F)V _{ZI0}	0 ft/sec									
Stable Member	Initial S. M. Alignment Errors	A(SM)XI	3.6 mr						-71.61			
		A(SM)YI	0.04 mr	153		- 283	0.75			-0.73		
		A(SM)ZI	0.07 mr		403				0.89			
ACCELEROMETER	Accel. IA Nonorthog-onality	X to Y		0.1 mr								
		X to Z		0.1 mr	557		- 157	2.34			-0.61	
		Y to Z		0.1 mr								
	Bias Error	ACBX	Direct effect	0.2 cm/sec ²		-1,316		369	-4.65		1.18	
			Fff on Init Mlm									
			Combined Fff									
		ACBY	Direct effect	0.2 cm/sec ²		- 1,194					- 3.69	
			Fff on Init Mlm								2.60	
			Combined Fff								- 1.09	
		ACBZ	Direct effect	0.2 cm/sec ²		- 359		-1,142	-1.24			-3.52
			Fff on Init Mlm			- 779		1,441	-3.83			3.73
			Combined Fff			-1,138		299	-5.07			0.21
	Scale Factor Error	SFEX		87 PPM	- 573		159	-1.62			0.38	
		SFEY		87 PPM			0				0	
		SFFZ		87 PPM	- 134		- 430	-0.56			-1.65	
	Accel. Sq. Sensitive Indication Error	NCXX		10 μg/g ²	- 95		26	-0.24			0.05	
		NCYY		10 μg/g ²			0				0	
		NCZZ		10 μg/g ²	- 21		- 68	-0.09			-0.27	
GYRO	Bias Drift	BDX	Direct effect	3.6 meru		- 333				- 1.97		
		BDY	Direct effect	3.6 meru	281		- 302	1.86			-1.29	
		BDZ	Direct effect	3.6 meru			213				0.74	
	Acceleration Sensitive Drift	ADIA X		15 meru/g		- 1,594					-7.71	
		ADSRAY		10.5 meru /g	- 692		642	-4.95			3.19	
		ADIAZ		15 meru /g			608				2.47	
	Acceleration Squared Sensitive Drift	A ² D _{(IA)(IA)} X		1 meru/g ²		- 162					-0.71	
		A ² D _{(SRA)(SRA)} Y		1 meru/g ²	94		- 88	0.65			-0.42	
		A ² A _{(IA)(IA)} Z		1 meru/g ²			58				0.23	
Root Sum Square Error (in ft and ft/sec)					2,069	18,667	1,028	9.20	72.12	4.16		
Root Sum Square Error (in n. ml. and ft/sec)					0.34	3.07	0.17	9.2	72.1	4.2		

Table 6-2 Total Indication Errors at SIVB Cutoff

Error			RMS Error	Final Position Error in Local Axes (in feet)			Final Velocity Error in Local Axes (in ft/sec)			
				Alt.	Track	Range	Alt.	Track	Range	
Init. Cond. Matrix Diag. Term. Errors	Position	(F)X _{I0}	0 ft	0	0	0	0	0	0	
		(F)Y _{I0}	0 ft							
		(F)Z _{I0}	0 ft							
	Velocity	(F)V _{XI0}	0 ft/sec							
		(F)V _{YI0}	0 ft/sec							
		(F)V _{ZI0}	0 ft/sec							
Stable Member	Initial S. M. Alignment Errors	A(SM)XI	3.6 mr							
		A(SM)YI	0.04 mr	240		- 558	0.83		-0.92	
		A(SM)ZI	0.07 mr		622				0.75	
ACCELEROMETER	Accel. IA Nonorthogonality	X to Y	0.1 mr							
		X to Z	0.1 mr	1,160		- 671	3.12		-1.47	
		Y to Z	0.1 mr							
	Bias Error	ACBX	Direct effect	0.2 cm/sec ²	-2,598		1,491	-6.97		3.21
			Eff on Init Mlm							
			Combined Fff							
		ACBY	Direct effect	0.2 cm/sec ²		- 2,307				- 4.72
			Eff on Init Mlm			1,812			2.20	
			Combined Fff			- 495			- 2.52	
		ACBZ	Direct effect	0.2 cm/sec ²	-1,412		-1,893	-3.61		-3.79
			Eff on Init Mlm			-1,224		2,844	-4.22	4.67
			Combined Fff			-2,636		951	-7.83	0.88
	Scale Factor Error	SFEX	87 PPM	- 962		539	-2.07		0.82	
		SFEY	87 PPM		0			0		
		SFEZ	87 PPM							
	Accel. Sq. Sensitive Indication Error	NCXX	10 μg/g ²	- 152		84	-0.31		0.11	
		NCYY	10 μg/g ²		0			0		
		NCZZ	10 μg/g ²	- 89		- 120	-0.22		-0.22	
GYRO	Bias Drift	BDX	Direct effect	3.6 meru		- 938			-2.73	
		BDY	Direct effect	3.6 meru	685		- 894	2.55		-2.26
		BDZ	Direct effect	3.6 meru		411			0.77	
	Acceleration Sensitive Drift	ADIA X	15 meru/g		- 3,816				-9.27	
		ADSRAY	10.5 meru/g	-1,842		2,174	-6.92		5.96	
		ADIA Z	15 meru/g			1,294			2.71	
	Acceleration Squared Sensitive Drift	A ² D _{(IA)(IA)} X	1 meru/g ²		- 363				-0.82	
		A ² D _{(SRA)(SRA)} Y	1 meru/g ²	245		- 290	0.91		-0.78	
		A ² A _{(IA)(IA)} Z	1 meru/g ²			122			0.25	
Root Sum Square Error (in ft and ft/sec)				4,506	38,600	3,224	13.50	79.54	7.66	
Root Sum Square Error (in n. mi. and ft/sec)				0.75	6.35	0.53	13.5	79.5	7.7	

Table 6-3 Total Indication Errors at SPS 1st Burn Cutoff

Error			RMS Error	Final Position Error in Local Axes (in feet)			Final Velocity Error in Local Axes (in ft/sec)			
				Alt.	Track	Range	Alt.	Track	Range	
Init. Cond. Matrix Diag. Term. Errors	Position	(F)X _{I0}	0 ft	0	0	0	0	0	0	
		(F)Y _{I0}	0 ft							
		(F)Z _{I0}	0 ft							
	Velocity	(F)V _{XI0}	0 ft/sec							
		(F)V _{YI0}	0 ft/sec							
		(F)V _{ZI0}	0 ft/sec							
Stable Member	Initial S. M. Alignment Errors	A(SM)XI	3.6 mr		-2,041			-17.46		
		A(SM)YI	0.04 mr	17		-15	-0.15		-0.13	
		A(SM)ZI	0.07 mr		6			0.05		
ACCELEROMETER	Accel. IA Nonorthog-onality	X to Y		0.1 mr						
		X to Z		0.1 mr	49		-31	0.42		0.27
		Y to Z		0.1 mr						
	Bias Error	ACBX	Direct effect		0.2 cm/sec ²	-180	115	-1.44		0.90
			Eff on Init Mlm							
			Combined Eff							
		ACBY	Direct effect		0.2 cm/sec ²		-210			-1.64
			Eff on Init Mlm							
			Combined Eff							
	ACBZ	Direct effect		0.2 cm/sec ²	-116	-89	-176	-0.93		-1.37
		Eff on Init Mlm								
		Combined Eff								
	Scale Factor Error	SFEX		87 PPM	-7		4	-0.06		0.03
		SFEY		87 PPM		0			0	
		SFEZ		87 PPM	-27		-41	-0.24		-0.35
	Accel. Sq. Sensitive Indication Error	NCXX		10 μg/g ²	0		0	0		0
		NCYY		10 μg/g ²		0			0	
		NCZZ		10 μg/g ²	-2		-3	-0.02		-0.02
GYRO	Bias Drift	BDX	Direct effect	3.6 meru		-107			-0.98	
		BDY	Direct effect	3.6 meru	82		-73	0.77	-0.66	
		BDZ	Direct effect	3.6 meru		17			0.14	
	Acceleration Sensitive Drift	ADIA X		15 meru/g		-290			-2.51	
		ADSRAY		10.5 meru/g	-237		210	-2.16	1.84	
		ADIA Z		15 meru/g			71		0.58	
	Acceleration Squared Sensitive Drift	A ² _D (IA)(IA)X		1 meru/g ²		-23			-0.20	
		A ² _D (SRA)(SRA)Y		1 meru/g ²	31		-28	0.28	-0.24	
		A ² _A (IA)(IA)Z		1 meru/g ²			7		0.05	
Root Sum Square Error (in ft and ft/sec)					376	2,074	276	3.25	17.74	2.32
Root Sum Square Error (in n. mi. and ft/sec)					0.06	0.34	0.05	3.3	17.7	2.3

Table 6-4 Effect of IMU Errors during SPS 1st Burn at SPS 1st Burn Cutoff

Error			RMS Error	Final Position Error in Local Axes (in feet)			Final Velocity Error in Local Axes (in ft/sec)				
				Alt.	Track	Range	Alt.	Track	Range		
Int. Cond. Matrix Diag. Term. Errors	Position	(F)X _{I0}	0 ft	0	0	0	0	0	0		
		(F)Y _{I0}	0 ft								
		(F)Z _{I0}	0 ft								
	Velocity	(F)V _{XI0}	0 ft/sec								
		(F)V _{YI0}	0 ft/sec								
		(F)V _{ZI0}	0 ft/sec								
Stable Member	Initial S. M. Alignment Errors	A _{(SM)XI}	3.6 mr		32,300			72.86			
		A _{(SM)YI}	0.04 mr	- 2,715		3,804	- 4.62		2.01		
		A _{(SM)ZI}	0.07 mr		- 573			- 0.67			
ACCELEROMETER	Accel. IA Nonorthog- onality	X to Y	0.1 mr								
		X to Z	0.1 mr	- 58		-10,813	9.70		1.26		
		Y to Z	0.1 mr								
	Bias Error	ACBX	Direct effect	0.2 cm/sec ²	- 57		24,562	-22.12		- 2.70	
			Fff on Init Mlm								
			Combined Fff								
		ACBY	Direct effect	0.2 cm/sec ²		1,945			4.36		
			Fff on Init Mlm			- 1,669			- 1.95		
			Combined Fff			276			2.41		
		ACBZ	Direct effect	0.2 cm/sec ²	-25,226		71,298	-75.49		14.70	
			Fff on Init Mlm			13,843		-10,396	23.57		-10.27
			Combined Fff			-11,383		51,893	-51.92		4.43
	Scale Factor Error	SFEX	87 PPM	- 1,455		10,356	-16.18		0.07		
		SFEY	87 PPM		0		0				
		SFEZ	87 PPM	-10,167		28,673	-30.37		5.93		
	Accel. Sq. Sensitive Indication Error	NCXX	10 μg/g ²	288		1,683	- 1.69		0.05		
		NCYY	10 μg/g ²		0		0				
		NCZZ	10 μg/g ²	- 1,508		4,290	- 4.54		0.88		
	GYRO	Bias Drift	BDX Direct effect	3.6 meru		714			2.57		
			BDY Direct effect	3.6 meru	- 5,996		4,750	- 7.23		4.77	
			BDZ Direct effect	3.6 meru		- 354			- 0.71		
Acceler- ation Sensitive Drift		ADIAX	15 meru/g		3,080			8.64			
		ADSRAY	10.5 meru /g	15,515		-10,670	17.39		-12.47		
		ADIAZ	15 meru /g		- 1,085			- 2.51			
Acceler- ation Squared Sensitive Drift		A ² D _{(IA)(IA)X}	1 meru/g ²		300			0.76			
		A ² D _{(SRA)(SRA)Y}	1 meru/g ²	- 2,010		1,361	- 2.23		1.62		
		A ² A _{(IA)(IA)Z}	1 meru/g ²		- 102			- 0.23			
Root Sum Square Error (In ft and ft/sec)				23,320	32,485	69,050	70.32	73.51	16.06		
Root Sum Square Error (In n. mi. and ft/sec)				3.84	5.35	11.36	70.3	73.5	16.1		

Table 6-5 Total Indication Errors at Coast End
(SPS 2nd Burn Ignition)

Error			RMS Error	Final Position Error in Local Axes (in feet)			Final Velocity Error in Local Axes (in ft/sec)				
				Alt.	Track	Range	Alt.	Track	Range		
Init. Cond. Matrix Diag. Term. Errors	Position	(E)X _{I0}	0 ft	0	0	0	0	0	0		
		(E)Y _{I0}	0 ft								
		(E)Z _{I0}	0 ft								
	Velocity	(F)V _{XI0}	0 ft/sec								
		(E)V _{YI0}	0 ft/sec								
		(F)V _{ZI0}	0 ft/sec								
Stable Member	Initial S. M. Alignment Errors	A(SM)XI	3.6 mr		478			16.83			
		A(SM)YI	0.04 mr	- 432		377	- 0.58		0.33		
		A(SM)ZI	0.07 mr		- 2			- 0.05			
ACCELEROMETER	Accel. IA Nonorthog- onality	X to Y	0.1 mr								
		X to Z	0.1 mr	- 763		132	- 0.58		0.63		
		Y to Z	0.1 mr								
	Bias Error	ACBX	Direct effect	0.2 cm/sec ²		2,515		- 278	1.78		-2.09
			Eff on Init Mlm								
			Combined Eff								
		ACBY	Direct effect	0.2 cm/sec ²			64			1.58	
			Eff on Init Mlm			- 6			- 0.14		
			Combined Eff			58			1.44		
		ACBZ	Direct effect	0.2 cm/sec ²	-7,204		18,366	-19.86		4.43	
			Eff on Init Mlm		2,204		- 1,922	2.98		-1.68	
			Combined Eff		-5,000		16,444	-16.88		2.75	
	Scale Factor Error	SFEX	87 PPM	97		- 11	0.07		-0.08		
		SFEY	87 PPM		0			0			
		SFEZ	87 PPM	-1,841		4,679	- 5.06		1.13		
	Accel. Sq. Sensitive Indication Error	NCXX	10 μg/g ²	1		0	0		0		
		NCYY	10 μg/g ²		0			0			
		NCZZ	10 μg/g ²	- 129		328	- 0.36		0.08		
	GYRO	Bias Drift	BDX Direct effect	3.6 meru		20			0.94		
			BDY Direct effect	3.6 meru	-2,191		1,932	- 2.98		1.67	
			BDZ Direct effect	3.6 meru		- 4			- 0.14		
Acceler- ation Sensitive Drift		ADIAX	15 meru/g			66			2.42		
		ADSRAY	10.5 meru /g	6,142		- 5,393	8.34		-4.67		
		ADIAZ	15 meru /g		- 19			- 0.56			
Acceler- ation Squared Sensitive Drift		A ² D _{(LA)(LA)} X	1 meru/g ²			5			0.19		
		A ² D _{(SRA)(SRA)} Y	1 meru/g ²	- 789		690	- 1.07		0.60		
		A ² A _{(LA)(LA)} Z	1 meru/g ²		- 2			- 0.05			
Root Sum Square Error (in ft and ft/sec)				8,893	492	18,180	19.96	17.10	6.24		
Root Sum Square Error (in n. mi. and ft/sec)				1.46	0.08	2.99	20.0	17.1	6.2		

Table 6-6 Effect of IMU Errors during SPS 1st Burn at Coast End
(SPS 2nd Burn Ignition)

Error				RMS Error	Final Position Error in Local Axes (in feet)			Final Velocity Error in Local Axes (in ft/sec)				
					Alt.	Track	Range	Alt.	Track	Range		
Init. Cond. Matrix Diag. Term. Errors	Position	(F)X _{I0}		0 ft	0	0	0	0	0	0		
		(F)Y _{I0}		0 ft								
		(F)Z _{I0}		0 ft								
	Velocity	(F)V _{XI0}		0 ft/sec								
		(F)V _{YI0}		0 ft/sec								
		(F)V _{ZI0}		0 ft/sec								
Stable Member	Initial S. M. Alignment Errors	A(SM)XI		3.6 mr								
		A(SM)YI		0.04 mr	- 2,720		4,309	- 4.96		73.40	2.12	
		A(SM)ZI		0.07 mr		- 626				- 0.43		
ACCELEROMETER	Accel. IA Nonorthogonality	X to Y		0.1 mr								
		X to Z		0.1 mr	- 323		-10,663	9.92			1.40	
		Y to Z		0.1 mr								
	Bias Error	ACBX	Direct effect		0.2 cm/sec ²		574		24,235	-21.87		- 3.52
			Fff on Init Mlm									
			Combined Fff									
		ACBY	Direct effect		0.2 cm/sec ²			2,322				3.47
			Fff on Init Mlm					- 1,824				- 1.24
			Combined Fff						498			2.23
		ACBZ	Direct effect		0.2 cm/sec ²		-24,424		75,517	-79.58		15.03
			Fff on Init Mlm				13,866		-21,971	25.28		-10.79
			Combined Fff				-10,558		53,546	-54.30		4.24
	Scale Factor Error	SFEX		87 PPM		- 1,268		10,506	-10.34		- 0.15	
		SFEY		87 PPM			0			0		
		SFEZ		87 PPM		- 9,855		30,364	-32.23		5.75	
Accel. Sq. Sensitive Indication Error	NCXX		10 μg/g ²		- 260		1,723	- 1.74		0.03		
	NCYY		10 μg/g ²			0			0			
	NCZZ		10 μg/g ²		- 1,460		4,541	- 4.80		0.87		
GYRO	Bias Drift	BDX Direct effect		3.6 meru			1,022			3.88		
		BDY Direct effect		3.6 meru	- 6,019		5,964	- 5.58		6.31		
		BDZ Direct effect		3.6 meru		- 304				1.87		
	Acceleration Sensitive Drift	ADIAX		15 meru/g			3,926			8.98		
		ADSRAY		10.5 meru/g	15,864		-13,705	18.29		-13.86		
		ADIAZ		15 meru/g		- 1,222				- 0.27		
	Acceleration Squared Sensitive Drift	A ² D _{(IA)(IA)X}		1 meru/g ²			373			0.78		
		A ² D _{(SRA)(SRA)Y}		1 meru/g ²	- 2,055		1,755	- 2.35		1.86		
		A ² A _{(IA)(IA)Z}		1 meru/g ²		- 115				- 0.03		
Root Sum Square Error (in ft and ft/sec)					22,982	39,576	71,726	73.17	74.11	17.70		
Root Sum Square Error (in n. mi. and ft/sec)					3.78	6.51	11.30	73.2	74.1	17.7		

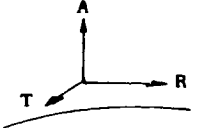
Table 6-7 Total Indication Errors at SPS 2nd Burn Cutoff

Error				RMS Error	Final Position Error in Local Axes (in feet)			Final Velocity Error in Local Axes (in ft/sec)			
					Alt.	Track	Range	Alt.	Track	Range	
Init. Cond. Matrix Diag. Term. Errors	Position	(F)X ₁₀		0 ft	0	0	0	0	0	0	
		(F)Y ₁₀		0 ft							
		(F)Z ₁₀		0 ft							
	Velocity	(F)V _{X10}		0 ft/sec							
		(F)V _{Y10}		0 ft/sec							
		(F)V _{Z10}		0 ft/sec							
Stable Member	Initial S. M. Alignment Errors	A(SM)XI		3.6 mr							
		A(SM)YI		0.04 mr	- 440		461	- 0.55		0.40	
		A(SM)ZI		0.07 mr		1			0.12		
ACCELEROMETER	Accel. IA Nonorthog-onality	X to Y		0.1 mr							
		X to Z		0.1 mr	- 796		279	- 0.59		0.60	
		Y to Z		0.1 mr							
	Bias Error	ACBX	Direct effect	0.2 cm/sec ²		2,670		- 794	2.69		-2.59
			Fff on Init Mlm								
			Combined Fff								
		ACBY	Direct effect	0.2 cm/sec ²			185			0.93	
			Fff on Init Mlm				3		0.35		
			Combined Fff				188		1.28		
		ACBZ	Direct effect	0.2 cm/sec ²		-7,022		19,619	-20.76		4.95
			Fff on Init Mlm			2,245		- 2,352	2.82		-2.03
			Combined Fff			-4,777		17,262	-17.94		2.92
	Scale Factor Error	SFEX		87 PPM	110		- 36	0.26		-0.20	
		SFEY		87 PPM			0		0		
		SFFZ		87 PPM	-1,802		4,988	- 5.45		1.03	
	Accel. Sq. Sensitive Indication Error	NCXX		10 μg/g ²	2		- 1	0.02		-0.01	
		NCYY		10 μg/g ²			0		0		
		NCZZ		10 μg/g ²	- 126		350	- 0.37		0.08	
GYRO	Bias Drift	BDX	Direct effect	3.6 meru		175			2.35		
		BDY	Direct effect	3.6 meru	-2,136		2,407	- 0.75		3.09	
		BDZ	Direct effect	3.6 meru		97			2.39		
	Acceleration Sensitive Drift	ADIAX		15 meru/g		332				3.17	
		ADSRAY		10.5 meru /g	6,249		- 6,592	7.81		-5.71	
		ADIAZ		15 meru /g		24				1.55	
	Acceleration Squared Sensitive Drift	A ² D _{(IA)(IA)X}		1 meru/g ²		26				0.25	
		A ² D _{(SRA)(SRA)Y}		1 meru/g ²	- 803		845	- 1.00		0.73	
		A ² A _{(IA)(IA)Z}		1 meru/g ²		2				0.14	
Root Sum Square Error (in ft and ft/sec)					8,870	2,359	19,472	20.66	22.14	7.73	
Root Sum Square Error (in n. mi. and ft/sec)					1.46	0.39	3.20	20.7	22.1	7.7	

Table 6-8 Effect of IMU Errors during SPS 1st and 2nd Burn at SPS 2nd Burn Cutoff

Effect of IMU Errors during SPS 2nd Burn at SPS 2nd Burn Cutoff

Error			RMS Error	Final Position Error in Local Axes (in feet)			Final Velocity Error in Local Axes (in ft/sec)				
				Alt.	Track	Range	Alt.	Track	Range		
Init. Cond. Matrix Diag. Term. Errors	Position	(F)X _{I0}	0 ft	0	0	0	0	0	0		
		(F)Y _{I0}	0 ft								
		(F)Z _{I0}	0 ft								
	Velocity	(F)V _{XI0}	0 ft/sec								
		(F)V _{YI0}	0 ft/sec								
		(F)V _{ZI0}	0 ft/sec								
Stable Member	Initial S. M. Alignment Errors	A(SM)XI	3.6 mr		227			4.88			
		A(SM)YI	0.04 mr	5		2	0.10		0.05		
		A(SM)ZI	0.07 mr		8			0.17			
ACCELEROMETER	Accel. IA Nonorthog-onality	X to Y	0.1 mr								
		X to Z	0.1 mr	5		- 3	0.11		-0.07		
		Y to Z	0.1 mr								
	Bias Error	ACBX	Direct effect	0.2 cm/sec ²	25		- 17	0.53		-0.35	
			Eff on Init Mlm								
			Combined Fff								
		ACBY	Direct effect	0.2 cm/sec ²			- 30			-0.63	
			Fff on Init Mlm								
			Combined Fff								
		ACBZ	Direct effect	0.2 cm/sec ²	17	23	- 12	25	0.35		0.53
			Fff on Init Mlm								
			Combined Fff								
	Scale Factor Error	SFEX	87 PPM	8		- 5		0.18		-0.12	
		SFEY	87 PPM		0				0		
		SFEZ	87 PPM								
Accel. Sq. Sensitive Indication Error	NCXX	10 μg/g ²	3		- 5		0.02		-0.10		
	NCYY	10 μg/g ²						0			
	NCZZ	10 μg/g ²	0			0			0		
GYRO	Bias Drift	BDX	Direct effect	3.6 meru		65			1.42		
		BDY	Direct effect	3.6 meru	118		60	2.58		1.33	
		BDZ	Direct effect	3.6 meru		115			2.52		
	Acceleration Sensitive Drift	ADIAX		15 meru/g		35			0.77		
		ADSRAY		10.5 meru /g	70		- 35	-1.51		-0.77	
		ADIAZ		15 meru /g		97			2.10		
	Acceleration Squared Sensitive Drift	A ² D _{(IA)(IA)X}		1 meru/g ²		3			0.06		
		A ² D _{(SRA)(SRA)Y}		1 meru/g ²	9		4	0.19		0.10	
		A ² A _{(IA)(IA)Z}		1 meru/g ²		9			0.19		
Root Sum Square Error (in ft and ft/sec)				140	282	73	3.06	6.11	1.61		
Root Sum Square Error (in n. ml. and ft/sec)				0.02	0.05	0.01	3.1	6.1	1.6		

Table 6-9 Effect of IMU Errors during SPS 2nd Burn at SPS 2nd Burn Cutoff

Error			RMS Error	Final Position Error in Local Axes (in feet)			Final Velocity Error in Local Axes (in ft/sec)			
				Alt.	Track	Range	Alt.	Track	Range	
Init. Cond. Matrix Diag. Term. Errors	Position	(F)X _{Io}	0 ft	0	0	0	0	0	0	
		(F)Y _{Io}	0 ft							
		(F)Z _{Io}	0 ft							
	Velocity	(F)V _{XIo}	0 ft/sec							
		(F)V _{YIo}	0 ft/sec							
		(F)V _{ZIo}	0 ft/sec							
Stable Member	Initial S. M. Alignment Errors	A _{(SM)XI}	3.6 mr		58,534			52.86		
		A _{(SM)YI}	0.04 mr	- 2,400		5,968	- 6.26		2.17	
		A _{(SM)ZI}	0.07 mr		- 714			- 0.15		
ACCELEROMETER	Accel. IA Nonorthogonality	X to Y	0.1 mr							
		X to Z	0.1 mr	- 1,351		- 9,853	9.84		1.80	
		Y to Z	0.1 mr							
	Bias Error	ACBX	Direct effect	0.2 cm/sec ²		3,063		22,286	-21.93	- 4.62
			Fff on Init Mlm							
			Combined Fff							
		ACBY	Direct effect	0.2 cm/sec ²		3,201			2.31	
			Fff on Init Mlm			- 2,079			- 0.43	
			Combined Fff			1,122			1.88	
		ACBZ	Direct effect	0.2 cm/sec ²	-18,174		88,387	-91.67		14.40
			Fff on Init Mlm		12,230		-30,427	31.94		-11.06
			Combined Fff		- 5,944		57,956	-59.73		3.34
	Scale Factor Error	SFEX	87 PPM	- 348		10,745	-11.12		- 0.37	
		SFEY	87 PPM			0			0	
		SFEZ	87 PPM	- 7,444		35,501	-37.25		5.63	
	Accel. Sq. Sensitive Indication Error	NCXX	10 μg/g ²	- 117		1,803	- 1.89		0.01	
		NCYY	10 μg/g ²			0			0	
		NCZZ	10 μg/g ²	- 1,092		5,304	- 5.53		0.84	
GYRO	Bias Drift	BDX Direct effect	3.6 meru		2,102			3.23		
		BDY Direct effect	3.6 meru	- 4,917		9,940	- 7.84	5.61		
		BDZ Direct effect	3.6 meru		262			1.87		
	Acceleration Sensitive Drift	ADIA X	15 meru/g		6,330			6.83		
		ADSRAY	10.5 meru/g	15,079		-24,114	25.69	- 14.57		
		ADIA Z	15 meru/g		- 1,227			0.25		
	Acceleration Squared Sensitive Drift	A ² _D (IA)(IA)X	1 meru/g ²		578			0.58		
		A ² _D (SRA)(SRA)Y	1 meru/g ²	- 1,955		3,104	- 3.31	1.89		
		A ² _A (IA)(IA)Z	1 meru/g ²		- 117			0.02		
Root Sum Square Error (in ft and ft/sec)				19,231	58,944	80,193	82.52	53.48	18.03	
Root Sum Square Error (in n. mi. and ft/sec)				3.17	9.70	13.20	82.5	53.5	18.0	

Table 6-10 Total Indication Errors at Entry Start

Error			RMS Error	Final Position Error in Local Axes (in feet)			Final Velocity Error in Local Axes (in ft/sec)			
				Alt.	Track	Range	Alt.	Track	Range	
Init. Cond. Matrix Diag. Term. Errors	Position	(F)X _{I0}	0 ft	0	0	0	0	0	0	
		(F)Y _{I0}	0 ft							
		(F)Z _{I0}	0 ft							
	Velocity	(F)V _{XI0}	0 ft/sec							
		(F)V _{YI0}	0 ft/sec							
		(F)V _{ZI0}	0 ft/sec							
Stable Member	Initial S. M. Alignment Errors	A(SM)XI	3.6 mr		8,514			19.27		
		A(SM)YI	0.04 mr	- 400		748	- 0.75		0.40	
		A(SM)ZI	0.07 mr		37			0.11		
ACCELEROMETER	Accel. IA Nonorthog-onality	X to Y	0.1 mr							
		X to Z	0.1 mr	- 827		793	- 1.01		0.69	
		Y to Z	0.1 mr							
	Bias Error	ACBX	Direct effect	0.2 cm/sec ²	2,971		- 2,778	3.94		-3.15
			Fff on Init Mlm							
			Combined Fff							
		ACBY	Direct effect	0.2 cm/sec ²		448				0.80
			Fff on Init Mlm			107			0.33	
			Combined Fff			555			1.13	
		ACBZ	Direct effect	0.2 cm/sec ²	-5,334		23,528	-24.05		4.73
			Fff on Init Mlm			2,037		- 3,816	3.82	-2.05
			Combined Fff			-3,297		19,712	-20.23	2.68
	Scale Factor Error	SFEX	87 PPM	154		- 160	0.28		-0.27	
		SFEY	87 PPM		0			0		
		SFFZ	87 PPM	-1,448		5,947	- 6.40		1.07	
	Accel. Sq. Sensitive Indication Error	NCXX	10 μg/g ²	5		- 6	0.01		-0.02	
		NCYY	10 μg/g ²		0			0		
		NCZZ	10 μg/g ²	- 98		420	- 0.44		0.06	
	GYRO	Bias Drift	BDX Direct effect	3.6 meru		855			2.13	
			BDY Direct effect	3.6 meru	-1,179		3,867	- 1.12	2.14	
			BDZ Direct effect	3.6 meru		793			2.20	
Acceleration Sensitive Drift		ADIA X	15 meru/g		1,243			2.83		
		ADSRAY	10.5 meru /g	5,633		-10,670	10.56	-5.70		
		ADIA Z	15 meru /g		477			1.44		
Acceleration Squared Sensitive Drift		A ² D _{(LA)(IA)X}	1 meru/g ²		97			0.22		
		A ² D _{(SRA)(SRA)Y}	1 meru/g ²	- 725		1,369	- 1.36	0.73		
		A ² A _{(LA)(IA)Z}	1 meru/g ²		42			0.13		
Root Sum Square Error (in ft and ft/sec)				7,513	8,715	23,880	24.25	19.81	7.53	
Root Sum Square Error (in n. mi. and ft/sec)				1.24	1.43	3.93	24.3	19.8	7.5	

Table 6-11 Effect of IMU Errors during SPS 1st and 2nd Burns at Entry Start

Error				RMS Error	Final Position Error in Local Axes (in feet)			Final Velocity Error in Local Axes (in ft/sec)		
					Alt.	Track	Range	Alt.	Track	Range
Init. Cond. Matrix Diag. Term. Errors	Position	(F)X _{I0}		0 ft	0	0	0	0	0	0
		(F)Y _{I0}		0 ft						
		(F)Z _{I0}		0 ft						
	Velocity	(F)V _{XI0}		0 ft/sec						
		(F)V _{YI0}		0 ft/sec						
		(F)V _{ZI0}		0 ft/sec						
Stable Member	Initial S. M. Alignment Errors	A(SM)XI		3.6 mr		1,648			4.49	
		A(SM)YI		0.04 mr	40		3	0.13		0.01
		A(SM)ZI		0.07 mr		57			0.16	
ACCELEROMETER	Accel. LA Nonorthog. onality	X to Y		0.1 mr						
		X to Z		0.1 mr	29		-39	0.05		-0.11
		Y to Z		0.1 mr						
	Bias Error	ACBX	Direct effect		0.2 cm/sec ²	134	-180	0.44		-0.50
			Eff on Init Mlm							
			Combined Eff							
		ACBY	Direct effect		0.2 cm/sec ²	-214	166	-0.58	0.45	
			Eff on Init Mlm							
			Combined Eff							
	ACBZ	Direct effect		0.2 cm/sec ²	189	118	0.59	0.31		
		Eff on Init Mlm								
		Combined Eff								
	Scale Factor Error	SFEX		87 PPM	44		-60	0.14		-0.17
		SFEY		87 PPM		0			0	
		SFEZ		87 PPM	-35		-22	-0.11		-0.06
	Accel. Sq. Sensitive Indication Error	NCXX		10 μg/g ²	4		-5	0.01		-0.02
		NCYY		10 μg/g ²		0			0	
		NCZZ		10 μg/g ²	2		1	0.01		0
	GYRO	Bias Drift	BDX Direct effect		3.6 meru		477			1.30
			BDY Direct effect		3.6 meru	1,048		67	3.35	0.13
			BDZ Direct effect		3.6 meru		850			2.32
Acceleration Sensitive Drift		ADIA X		15 meru/g		260			0.71	
		ADSRAY		10.5 meru/g	-612		-39	-1.95		-0.07
		ADIAZ		15 meru/g		708			1.93	
Acceleration Squared Sensitive Drift		A ² D _{(IA)(IA)X}		1 meru/g ²		20			0.05	
		A ² D _{(SRA)(SRA)Y}		1 meru/g ²	78		5	0.25	0.01	
		A ² A _{(IA)(IA)Z}		1 meru/g ²		63			0.17	
Root Sum Square Error (in ft and ft/sec)					1,226	2,060	234	3.92	5.61	0.63
Root Sum Square Error (in n. mi. and ft/sec)					0.20	0.34	0.04	3.9	5.6	0.6

Table 6-12 Effect of IMU Errors during SPS 2nd Burn at Re-entry Start

Error				RMS Error	Final Position Error in Local Axes (in feet)			Final Velocity Error in Local Axes (in ft/sec)			
					Alt.	Track	Range	Alt.	Track	Range	
Init. Cond. Matrix Diag. Term. Errors	Position	(F)X _{I0}	0 ft	0	0	0	0	0	0		
		(F)Y _{I0}	0 ft								
		(F)Z _{I0}	0 ft								
	Velocity	(F)V _{XI0}	0 ft/sec								
		(F)V _{YI0}	0 ft/sec								
		(F)V _{ZI0}	0 ft/sec								
Stable Member	Initial S. M. Alignment Errors	A _{(SM)XI}	3.6 mr		72,198			1.86			
		A _{(SM)YI}	0.04 mr	- 3,317		8,430	- 11.06		- 1.21		
		A _{(SM)ZI}	0.07 mr		- 953			- 1.13			
ACCELEROMETER	Accel. IA Nonorthogonality	X to Y	0.1 mr								
		X to Z	0.1 mr	- 903		- 6,514	7.39		3.77		
		Y to Z	0.1 mr								
	Bias Error	ACBX	Direct effect	0.2 cm/sec ²		1,757		12,345	- 17.64		-15.00
			Eff on Init Mlm								
			Combined Eff								
		ACBY	Direct effect	0.2 cm/sec ²			1,631			- 6.11	
			Eff on Init Mlm			- 2,778			- 3.30		
			Combined Eff			- 1,147			- 9.41		
		ACBZ	Direct effect	0.2 cm/sec ²	-23,933		100,229	-111.25			-25.28
			Eff on Init Mlm		16,909		-42,983	56.39		6.18	
			Combined Eff		- 7,023		57,246	- 54.86		-19.10	
	Scale Factor Error	SFEX	87 PPM	- 1,298		10,112	- 11.47			- 1.82	
		SFEY	87 PPM		0				0		
		SFEZ	87 PPM	-11,211		40,671	- 49.22			- 9.56	
	Accel. Sq. Sensitive Indication Error	NCXX	10 μg/g ²	- 320		1,570	- 2.18			- 1.25	
		NCYY	10 μg/g ²			0			0		
		NCZZ	10 μg/g ²	- 1,599		6,039	- 7.05			- 1.47	
	GYRO	Bias Drift	BDX	Direct effect	3.6 meru		4,307			10.09	
			BDY	Direct effect	3.6 meru	-12,100		14,663	- 52.03		- 7.86
			BDZ	Direct effect	3.6 meru		- 6,270			-31.00	
Acceleration Sensitive Drift		ADIA X		15 meru/g		8,174			- 2.86		
		ADSRAY		10.5 meru /g	22,045		-41,880	65.19		3.16	
		ADIAZ		15 meru /g		- 5,670			-15.14		
Acceleration Squared Sensitive Drift		A ² D _{(IA)(IA)X}		1 meru/g ²		843			1.08		
		A ² D _{(SRA)(SRA)Y}		1 meru/g ²	- 2,896		5,400	- 8.86		0.56	
		A ² A _{(IA)(IA)Z}		1 meru/g ²		- 558			- 1.99		
Root Sum Square Error (in ft and ft/sec)					28,923	73,302	87,695	116.03	38.73	28.61	
Root Sum Square Error (in n.m. and ft/sec)					4.76	12.06	14.43	116.0	38.7	28.6	

Table 6-13 Total Indication Errors at Entry End (at 50,000 ft Alt).

Error			RMS Error	Final Position Error in Local Axes (in feet)			Final Velocity Error in Local Axes (in ft/sec)			
				Alt.	Track	Range	Alt.	Track	Range	
Init. Conc. Matrix Diag. Term. Errors	Position	(I)X _{Io}	0 ft	0	0	0	0	0	0	
		(I)Y _{Io}	0 ft							
		(I)Z _{Io}	0 ft							
	Velocity	(I)V _{XIo}	0 ft/sec							
		(I)V _{YIo}	0 ft/sec							
		(I)V _{ZIo}	0 ft/sec							
Stable Member	Initial S. M. Alignment Errors	A(SM)XI	3.6 m		20,284			31.15		
		A(SM)YI	0.04 m	- 720		1,195	- 2.54		- 0.26	
		A(SM)ZI	0.07 m		- 336			- 1.72		
ACCELEROMETER	Accel. IA Nonorthog- onality	X to Y	0.1 m							
		X to Z	0.1 m	- 1,148		1,781	- 2.58		- 0.61	
		Y to Z	0.1 m							
	Bias Error	ACBX	Direct effect	0.2 cm/sec ²		3,777	- 8,881	8.05		- 5.38
			Fff on Init Mlm							
			Combined Fff							
		ACBY	Direct effect	0.2 cm/sec ²		- 1,003			- 4.30	
			Fff on Init Mlm			- 980			- 5.00	
			Combined Fff			- 1,983			3.30	
		ACBZ	Direct effect	0.2 cm/sec ²	- 4,766		27,117	24.54		- 7.11
			Fff on Init Mlm		3,673	- 6,092	12.95		1.31	
			Combined Fff		- 1,093	21,025	-11.59		- 5.80	
	Scale Factor Error	SFEX	87 PPM	262		74	0.76		2.03	
		SFEY	87 PPM		- 51			- 0.07		
		SFEZ	87 PPM	- 2,300		7,140	- 9.43		- 1.37	
	Accel. Sq. Sensitive Indication Error	NCXX	10 μg/g ²	- 12		- 154	- 0.08		- 0.67	
		NCYY	10 μg/g ²		4			- 0.02		
		NCZZ	10 μg/g ²	- 122		493	- 0.47		- 0.12	
	GYRO	Bias Drift	BDX	Direct effect	3.6 meru		2,844		10.67	
			BDY	Direct effect	3.6 meru	- 7,370		4,180	-39.52	- 7.59
			BDZ	Direct effect	3.6 meru		- 5,740			-31.32
Acceler- ation Sensitive Drift		ADIAX	15 meru/g			2,510			- 0.23	
		ADSRAY	10.5 meru/g	10,148		-16,954	35.33		32.58	
		ADIAZ	15 meru/g		- 3,870			-19.11		
Acceler- ation Squared Sensitive Drift		A ² D _{(IA)(IA)X}	1 meru/g ²			323			1.34	
		A ² D _{(SRA)(SRA)Y}	1 meru/g ²	- 1,352			2,169	- 4.94	- 0.57	
		A ² A _{(IA)(IA)Z}	1 meru/g ²		- 391				- 2.08	
Root Sum Square Error (in ft and ft/sec)				13,665	21,867	29,873	56.08	50.27	11.91	
Root Sum Square Error (in n. ml. and ft/sec)				2.25	3.60	4.92	56.1	50.3	11.9	

Table 6-14 Effect of IMU Errors during SPS 1st and 2nd Burns and Entry End (Alt. of 50,000 ft)

Error				RMS Error	Final Position Error in Local Axes (in feet)			Final Velocity Error in Local Axes (in ft/sec)			
					Alt.	Track	Range	Alt.	Track	Range	
Init. Cond. Matrix Diag. Term. Errors	Position	(F)X _{I0}		0 ft	0	0	0	0	0	0	
		(F)Y _{I0}		0 ft							
		(F)Z _{I0}		0 ft							
	Velocity	(F)V _{XI0}		0 ft/sec							
		(F)V _{YI0}		0 ft/sec							
		(F)V _{ZI0}		0 ft/sec							
Stable Member	Initial S. M. Alignment Errors	A(SM)XI		3.6 mr		6,435			29.17		
		A(SM)YI		0.04 mr	- 112		- 89	- 0.94		-0.24	
		A(SM)ZI		0.07 mr		- 296			- 1.71		
ACCELEROMETER	Accel. IA Nonorthogonality	X to Y		0.1 mr							
		X to Z		0.1 mr	19		- 205	- 0.03		-0.83	
		Y to Z		0.1 mr							
	Bias Error	ACBX	Direct effect		0.2 cm/sec ²	- 78		-2,431	- 0.25		-4.58
			Eff on Init Mlm								
			Combined Eff								
		ACBY	Direct effect		0.2 cm/sec ²				-2,306		- 4.46
			Eff on Init Mlm								
			Combined Eff								
		ACBZ	Direct effect		0.2 cm/sec ²	3,246	57	- 610	8.44	4.77	-1.12
			Eff on Init Mlm								
			Combined Eff								
	Scale Factor Error	SFEX		87 PPM	113		323	0.44		2.06	
		SFEY		87 PPM		- 51			- 0.07		
		SFEZ		87 PPM	- 256		62	- 1.02		0.15	
Accel. Sq. Sensitive Indication Error	NCXX		10 μg/g ²	- 14		- 151	- 0.08		-0.67		
	NCYY		10 μg/g ²		- 4			- 0.02			
	NCZZ		10 μg/g ²	23		- 4	0.12		-0.02		
GYRO	Bias Drift	BDX Direct effect		3.6 meru		2,070			10.55		
		BDY Direct effect		3.6 meru	-4,283		-2,344	-31.37		-7.49	
		BDZ Direct effect		3.6 meru		-5,626			-31.31		
	Acceleration Sensitive Drift	ADIA X		15 meru/g		523			- 0.52		
		ADSRAY		10.5 meru/g	1,500		1,315	12.51		3.00	
		ADIA Z		15 meru/g		3,408			19.05		
	Acceleration Squared Sensitive Drift	A ² D _{(IA)(IA)X}		1 meru/g ²		166			1.32		
		A ² D _{(SRA)(SRA)Y}		1 meru/g ²	- 241		- 177	- 2.01		-0.54	
		A ² A _{(IA)(IA)Z}		1 meru/g ²		- 349			- 2.07		
Root Sum Square Error (in ft and ft/sec)					6,492	9,977	3,783	36.77	49.03	9.69	
Root Sum Square Error (in n. mi. and ft/sec)					1.07	1.64	0.62	36.8	49.0	9.7	

Table 6-15 Effect of IMU Errors during SPS 2nd Burn and Entry at Entry End (50,000 ft alt)

Error				RMS Error	Final Position Error in Local Axes (in feet)			Final Velocity Error in Local Axes (in ft/sec)			
					Alt.	Track	Range	Alt.	Track	Range	
Init. Cond. Matrix Diag. Term. Errors	Position	(F)X _{Io}	0 ft	0	0	0	0	0	0		
		(F)Y _{Io}	0 ft								
		(F)Z _{Io}	0 ft								
	Velocity	(F)V _{XIo}	0 ft/sec								
		(F)V _{YIo}	0 ft/sec								
		(F)V _{ZIo}	0 ft/sec								
Stable Member	Initial S. M. Alignment Errors	A(SM)XI	3.6 mr								
		A(SM)YI	0.04 mr	- 284		11	- 1.25		-0.16		
		A(SM)ZI	0.07 mr		- 433			- 1.75			
ACCELEROMETER	Accel. IA Nonorthogonality	X to Y		0.1 mr							
		X to Z		0.1 mr	- 10		- 69	- 0.11		-0.78	
		Y to Z		0.1 mr							
	Bias Error	ACBX	Direct effect		0.2 cm/sec ²	- 212		- 1,795	- 0.63		-4.31
			Fff on Init Mlm								
			Combined Fff								
		ACBY	Direct effect		0.2 cm/sec ²			- 1,797		- 4.33	
			Fff on Init Mlm					- 1,281		- 5.09	
			Combined Fff					- 3,058		- 9.42	
		ACBZ	Direct effect		0.2 cm/sec ²	2,201		- 316	6.57		-0.77
			Fff on Init Mlm			1,446		- 55	6.39		0.83
			Combined Fff			3,647		- 371	12.96		0.06
	Scale Factor Error	SFEX		87 PPM	69		535	0.31		2.15	
		SFEY		87 PPM		- 51			- 0.07		
		SFFZ		87 PPM		- 55		7	- 0.67	0.09	
	Accel. Sq. Sensitive Indication Error	NCXX		10 μg/g ²	- 18		- 132	- 0.09		-0.66	
		NCYY		10 μg/g ²			4		- 0.02		
		NCZZ		10 μg/g ²	13		- 2	0.11		-0.01	
	GYRO	Bias Drift	BDX	Direct effect	3.6 meru		928		10.25		
			BDY	Direct effect	3.6 meru	- 8,757		254	-39.66		-5.50
			BDZ	Direct effect	3.6 meru		- 7,662			-31.84	
Acceleration Sensitive Drift		ADLAX		15 meru/g		- 100			- 0.68		
		ADSRAY		10.5 meru /g	4,107		- 201	17.34		1.84	
		ADIAZ		15 meru /g		- 5,103			-19.49		
Acceleration Squared Sensitive Drift		A ² D(LA)(IA)X		1 meru/g ²		120			1.30		
		A ² D(SRA)(SRA)Y		1 meru/g ²	- 572		16	- 2.63		-0.39	
		A ² A(LA)(LA)Z		1 meru/g ²		- 500			- 2.11		
Root Sum Square Error (in ft and ft/sec)					10,359	10,069	1,942	45.30	48.88	7.80	
Root Sum Square Error (in n. mi. and ft/sec)					1.70	1.66	0.31	45.3	48.9	7.80	

Table 6-16 Effect of IMU Errors during Entry only at Entry End (50,000 ft Alt)

7. G&N CONFIGURATION

System 017 will be the G&N system for Mission 202. It is a Block I series 50 system with one modification; the wiring of the 11 spare relays in the main DSKY to the MCP to provide the AGC/MCP signal interface (refer ICD #MH01-01200-216) described in Section 3.

Without giving a detailed analysis of each G&N Block configuration, a brief description of each and the reason for its evolution is useful in understanding G&N's capabilities for Mission 202.

Block I is the original G&N design. It is composed of IMU, AGC, PSA, CDU's (mechanical), Harnesses, and OPTICS (sextant and telescope). As the G&N flight requirements became more clearly defined it was apparent that Block I would need modification to qualify for flight.

Block I, series 100 therefore evolved. It is the Block I system modified generally as follows:

- (a) IMU - Vibration dampers added; moisture insulation added.
- (b) AGC - Colling interface modified; humidity proofing added.
- (c) PSA - Cooling interface modified; humidity proofing added.
- (d) CDU's - Minor electrical and mechanical changes.
- (e) Harnesses - All wiring changed to teflon; connectors humidity proofed.
- (f) OPTICS - Addition of automatic star tracker, photometer and minor servo modifications.

When the full design and production schedule impact of the series 100 modifications become clear the Block I series 50 configuration was originated, being a limited 100 series modification qualified for flight and available on an early schedule.

Block I series 50 is basically the Block I series 100 system less the automatic star tracker and the photometer.

8. INSTRUMENTATION

8.1 G&N Instrumentation

The inflight information from G&N is available in three distinct forms: PCM telemetry of the AGC DIGITAL DOWNLINK, (PCMD); PCM telemetry of low band-width G&N measurements, (PCM+, PCM, PCME); and on-board recording of high band-width G&N measurements (TR).

The PCM telemetry of the AGC DIGITAL DOWNLINK has been clearly defined at the MIT/NAA interface as 50 words of 40 bits each per second. The particular format of this DOWNLINK is AGC program variable and can remain under MIT's control without having interface repercussion (see 8.1.1).

The PCM telemetry of the low band-width measurement and the on-board recording of the high band-width measurements have been defined by NASA in (1) APOLLO CM/SM BLOCK I, OPERATIONAL BASELINE MASTER MEASUREMENT LIST No. 4 of 15 March 1965 and (2) APOLLO CM/SM BLOCK I R and D BASELINE MASTER MEASUREMENTS LIST No. 4 of 15 March 1965 as modified by (3) NASA TWX 032 02/2231Z of 2 June 1965 from MSC Houston to NAA Downey. (see 8.1.2)

8.1.1 AGC Digital Downlink

The AGC digital downlink consists of 50 words/sec on the high rate and 10 words/sec on the low rate. Each "word" contains 40 bits (a 16-bit register transmitted twice and an 8-bit "word order code"). Since the high rate will be used exclusively for flight 202 all further discussion will use the 50 words/sec rate.

The digital downlink format is controlled by an AGC program which loads the next word to be transmitted into register OUT4. This program is entered on an interrupt caused by an "endpulse" from the telemetry system.

The AGC downlink transmits a 100-word list. This list will take two seconds to be transmitted. The general format of the list is given in Fig. 8-1.

The ID word marks the beginning of the list and also identifies which list is being transmitted. The 14-word DSPTAB group is included in the list twice so that it will be transmitted at a once-per-second rate. The 14 DSPTAB words contain the states of the latching relays in the DSKY and, therefore, they indicate all displays and the mode status of the G&N and MCP/SCS. A list of the displays and other relay commands is given below. All keycodes, with the exception of KEY RELEASE and ERROR RESET, will initiate some display change; therefore, Uplink transmissions may also be monitored via DSPTAB.

<u>Word No.</u>	<u>Contents</u>
1	ID WORD
2 ... 15	DSPTAB
16 ... 27	COMMON GROUP
28 ... (48 + K)	PART A & K MARKERS
(49 + K) ... 51	DUMMY MARKERS OR ACTUAL MARKERS
52 ... 65	DSPTAB
66 ... (97 + J)	PART B & J MARKERS
(98 + J) ... 100	DUMMY MARKERS OR ACTUAL MARKERS

Figure 8.1
GENERAL AGC DOWNLINK FORMAT

The 12-word common group will contain the following data words:

<u>Data Word</u>	<u>Remarks</u>
Time 2	AGC clock Register
Time 1	AGC clock Register
IN0	Contains keyboard characters, mark, block uplink, inhibit upsinc
IN2	Four lowest order time bits, CDU, PIPA, and IMU Fail and Parity Alarm, Lift Off, Guid. Release, SIVB Separate
IN3	Zero CDU encoders, lock CDU, fine align, re-entry, OPT modes 2 & 3, star present, zero OPT, Coarse align, ATT SW and TRN SW, Sextant On, OR OF C1-C33
OUT1	Engine on; block end pulse; ID word; RUPT trap reset; T/M, program, and program check fail alarms, key release, and computer activity
FLAGWRD1, FLAGWRD2 and STATE	Give information on state of programs
CDU X	Register gives actual X CDU angle
CDU Y	Register gives actual Y CDU angle
CDU Z	Register gives actual Z CDU angle

Part A and B contain the following data words:

<u>Data Word</u>	<u>Remarks</u>
Position, Velocity	Output of average G routine
PIPTIME	Time that the PIP registers are read and therefore the time corresponding to position and velocity above during average G task and time for VRECT and RRECT after they are frozen
T _{FF}	Time of free-fall
RRECT, VRECT	The state vector which is frozen just after SPS1 tailoff and used in the orbital integration program
TAVEGON	Time that average G program will be activated for SPS2 burn
RAVEGON & VAVEGON	Position & velocity from orbital integration program to be used for SPS2 burn
Desired CDU's	3 AGC registers which give desired CDU angles
PIPA's	Sampled contents of the three PIP accumulation registers
Special event time	2 registers which contain the time of guidance ref. release, lift-off, or time of engine on or off, depending on which was last to occur

A new list will be used during a V 76 update (see sec. 3.1.2.1.4) in which Parts A and B will contain the update parameters.

There may also be changes to allow for transmission of certain entry program variables during the re-entry portion of the mission. The common section and DSPTAB will always remain in the positions shown in Fig. 8-1 on all data lists.

Since certain groups of data words are updated by programs which are not synchronized with the downlink program, three marker words are required to indicate when these groups were updated. As indicated in Fig. 8-1, these marker words may be interspersed in Part A or Part B. If they do not occur in a particular part, dummy markers are added so that DSPTAB will always retain the positions relative to the ID word shown in Fig. 8-1. These markers are not allowed to interrupt the DSPTAB or common groups of data words. Marker 1 is used for PIPA's and PIPTIME, marker 2 for Position and Velocity, and marker 3 for the desired CDU's and T_{FF} .

DSPTAB INFORMATION

A. Displays

<u>Item</u>	<u>Remark</u>
V _{gx}	Components of velocity-to-be gained during powered flight
V _{gy}	
V _{gz}	

B. Other Relay Commands

<u>Item</u>	<u>Remark</u>
1. G/N ATT CONTROL SELECT G/N ΔV MODE SELECT G/N ENTRY MODE SELECT CM/SM SEP COMMAND +X TRANSLATION ON/OFF G/N FAIL INDICATION .05 G INDICATION GIMBAL MOTOR POWER ON/OFF FDAI ALIGN T/C ANTENNA SWITCH	MCP/SCS Modes
2. ZERO ENCODE COARSE ALIGN LOCK CDU FINE ALIGN RE-ENTRY ATT CONTR ZERO OPT. CDU's	G&N Modes
3. CDU ZERO LIGHT CDU FAIL LIGHT PIPA FAIL LIGHT IMU FAIL LIGHT OR OF ALL ALARMS COND LAMP TEST	FAILURE & WARNING LIGHTS

8.1.2 G&N PCM Telemetry and On-Board Recording for Mission #202

OPERATIONAL

CG0001	V	Computer Digital Data	PCMD	50 S/S (See 8.1.1)
CG1040	V	+120 VDC Pipa Supply	PCM	1
CG1101	V	-28 VDC Supply	PCM+	1
CG1110	V	2.5 VDC TM Bias	PCM+	1
CG1320	V	IMU 2V 3200 CPS Supply	PCM	1
CG1503	X	IMU +28 VDC Operate	PCME	10
CG1513	X	IMU +28 VDC Standby	PCME	10
CG1523	X	AGC +28 VDC	PCME	10
CG1533	X	OPTX +28 VDC	PCME	10
CG2015	V	X Pipa SG Output, in phase	PCM	10
CG2035	V	Y Pipa SG Output, in phase	PCM	10
CG2055	V	Z Pipa SG Output, in phase	PCM	10
CG2110	V	IGA Torque Motor Input	PCM	10
CG2112	V	IGA 1X Res Output, sine, in phase	PCM	10
CG2113	V	IGA 1X Res Output, cos, in phase	PCM	10
CG2117	V	IGA Servo Error, in phase	PCM	100
CG2140	V	MGA Torque Motor Input	PCM	10
CG2142	V	MGA 1X Resolver Output, sine in phase	PCM	10
CG2143	V	MGA 1X Resolver Output, cos, in phase	PCM	10
CG2147	V	MGA Servo Error in phase	PCM	100
CG2170	V	OGA Torque Motor Input	PCM	10
CG2172	V	OGA 1X Resolver Output, sine in phase	PCM	10
CG2173	V	OGA 1X Resolver Output, cos, inphase	PCM	10
CG2177	V	OGA Servo Error, in phase	PCM	100
CG2206	V	IGA CDU 1X Res Error, in phase	PCM	10
CG2236	V	MGA CDU 1X Res Error, in phase	PCM	10

OPERATIONAL (Cont'd)

CG2264	V	OGA CDU 16X Res Error, in phase	PCM+	10
CG2266	V	OGA CDU 1X Res Error, in phase	PCM	10
CG2300	T	PIPA Temp.	PCM+	1
CG2301	T	IRIG Temp.	PCM+	1
CG2302	C	IMU Heater Current	PCM+	1
CG2303	C	IMU Blower Current	PCM+	1
CG4300	T	AGC Temp.	PCM	1
CG5000	X	PIPA FAIL	PCME	10
CG5001	X	IMU FAIL	PCME	10
CG5002	X	CDU FAIL	PCME	10
CG5003	X	Gimbal Lock Warning	PCME	10
CG5005	X	Error Detect	PCME	10
CG5006	X	IMU Temp. Light	PCME	10
CG5007	X	Zero Encoder Light	PCME	10
CG5008	X	IMU Delay Light	PCME	10
CG5020	X	AGC Alarm #1 (Program)	PCME	10
CG5021	X	AGC Alarm #2 (AGC Activity)	PCME	10
CG5022	X	AGC Alarm #3 (T/M)	PCME	10
CG5023	X	AGC Alarm #4 (PROG CHK FAIL)	PCME	10
CG5024	X	AGC Alarm #5 (Scalar FAIL)	PCME	10
CG5025	X	AGC Alarm #6 (Parity FAIL)	PCME	10
CG5026	X	AGC Alarm #7 (Counter FAIL)	PCME	10
CG5027	X	AGC Alarm #8 (Key Release)	PCME	10
CG5028	X	AGC Alarm #9 (RUPT Lock)	PCME	10
CG5029	X	AGC Alarm #10 (TC Trap)	PCME	10
CG5030	X	Computer Power Fail Light	PCME	10
CG6000	P	IMU Pressure	PCM	1
CG6020	T	PSA Temp. 1 Tray 3	PCM	1

FLIGHT QUALIFICATION

CG2010	V	X PIPA SG Output, in phase	TR	2000 cps
CG2030	V	Y PIPA SG Output, in phase	TR	2000 cps
CG2050	V	Z PIPA SG Output, in phase	TR	2000 cps
CG6001	D	NAV Base Roll Vibration	TR	2000 cps
CG6002	D	NAV Base Pitch Vibration	TR	2000 cps
CG6003	D	NAV Base Yaw Vibration	TR	2000 cps

The Flight Qualification Tape Recorder (TR) has a capacity for 30 minutes of operation. This operating time is controlled by the Mission Control Programmer (MCP). The MCP logic is designed to operate the recorder over the following time intervals.

(a) Normal Mission

ON	Liftoff -45 sec	(T _o -45)
OFF	Launch Escape Tower Jettison	(T _o +172)
ON	CSM/SIVB Separation	(T _o +618)
OFF	1st SPS burn Cutoff +3 sec	(T _o +868)
ON	2nd SPS burn Ignition -4 sec	(T _o +4025)
OFF	When Recorder runs out of tape	(≈ T _o +5358)

(b) Boost Abort Mission

ON	Liftoff -45 sec	(T _o -45)
OFF	Launch Escape Tower Jettison	(T _o +172)
ON	Abort Initiation (CSM/SIVB Separation)	(T _{ABORT})
OFF	When Recorder runs out of tape	(T _{ABORT} +1583)

8.2 External Data Requirements

G&N requirements for external data fall into three categories:

8.2.1 Navigation Data via the Uplink

No requirement for this data is made at this time.

8.2.2 Radar Tracking Data for Post Flight Analysis

Tracking data requirements to a degree of accuracy and completeness which would permit the most comprehensive determination of G&N flight performance, are given in Table 8-1. Subsequent revisions of this plan will reflect more realistic requirements.

8.2.3 Radar Tracking Data for Real-Time Monitor of G&N

This requirement is given by Table 8-2, which is derived from the total indication error expected in the position and velocity data telemetered to the ground via the AGC DOWNLINK.

TABLE 8-1

EXTERNAL TRACKING DATA REQUIREMENTS
TO SUPPORT POST FLIGHT ANALYSIS OF G&N

Three orthogonal components of position and velocity are required in IMU coordinates at one second intervals during each powered phase. The required accuracies are given in this table in local vertical coordinates.

Phase	one sigma Position Error (ft)			one sigma Velocity Error (fps)		
	Alt.	Track	Range	Alt.	Track	Range
S-IB Boost	200	1900	100	0.9	7.2	0.4
1st SPS Burn	40	210	30	0.3	1.8	0.2
2nd, 3rd, 4th SPS Burns	10	30	10	0.3	0.6	0.2
Entry	1100	1000	200	4.6	4.9	0.8

TABLE 8-2

EXTERNAL TRACKING DATA REQUIREMENTS
TO PROVIDE REAL-TIME MONITOR OF G&N

Three orthogonal components of position and velocity are required in IMU coordinates at one second intervals during each powered phase. The required accuracies are given in this table in local vertical coordinates.

	one sigma			one sigma		
	Position Error (ft)			Velocity Error (fps)		
	Alt.	Track	Range	Alt.	Track	Range
S-IB Boost	200	1900	100	0.9	7.2	0.4
1st SPS Burn	400	3900	300	1.4	8.0	0.8
2nd, 3rd, 4th SPS Burns	2300	4000	7200	7.3	7.4	1.8
Entry	2900	7300	8800	11.6	3.9	2.9

9. G&N Performance Data

This section presents brief summaries of the performance of those phases of the Flight 202 mission that are performed under G&N control.

The first part, (Figs. 9-1, 9-2, 9-3, 9-4, 9-5) illustrates performance data which were derived from point mass studies of the G&N guidance and navigation equations using the reference boost trajectory defined in Section 5.2.1.

The second part (Fig. 9-6, Tables 9-1 through 9-8) present performance data derived by perturbing the nominal mission defined by the boost trajectory in the previous issue of this report, with the dispersions listed. Perturbation studies for the current trajectory defined in Section 5.2.1 could not be made in time for the publication of this report, but will be included in a later revision.

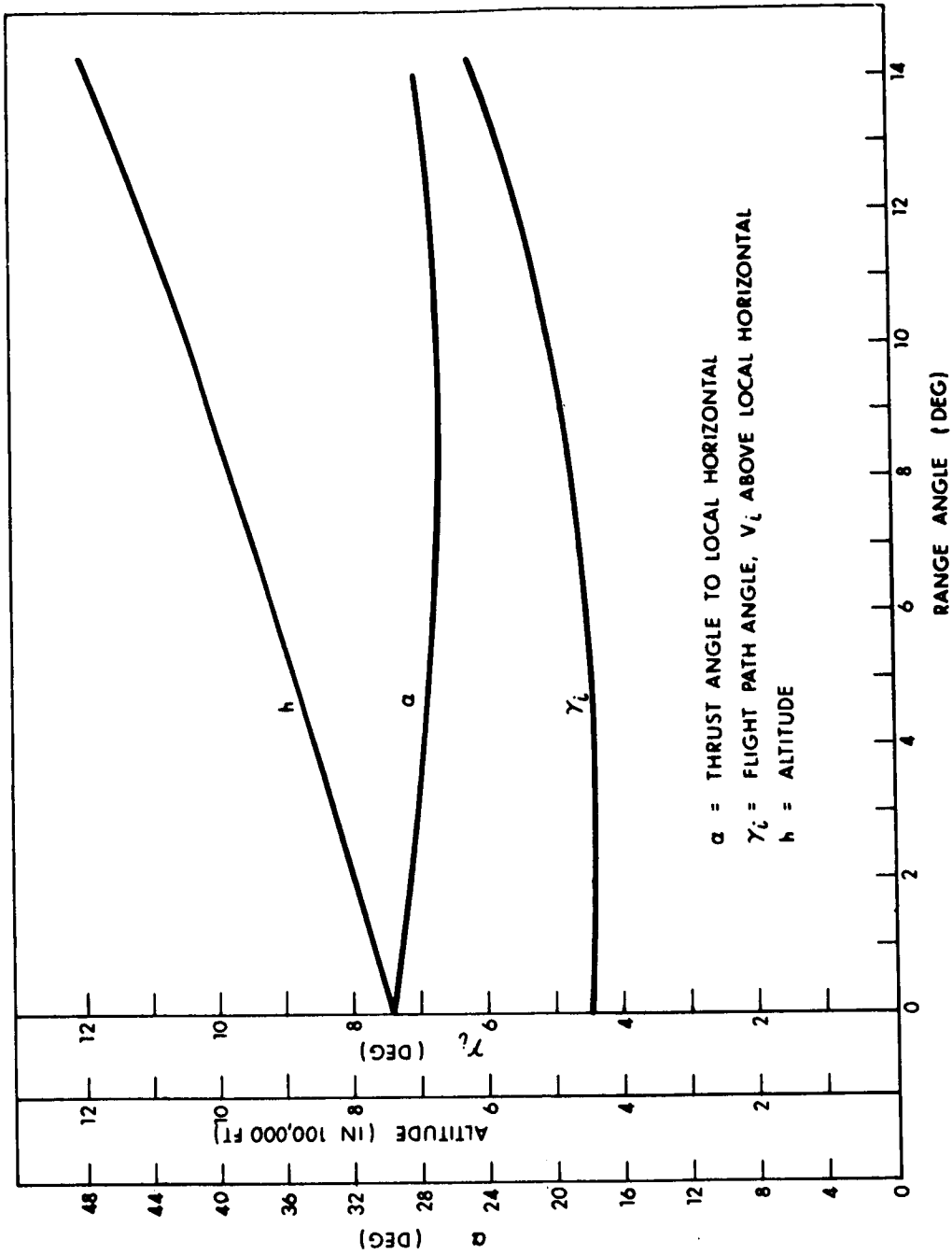

Fig. 9-1 Mission 202 First Burn Trajectory

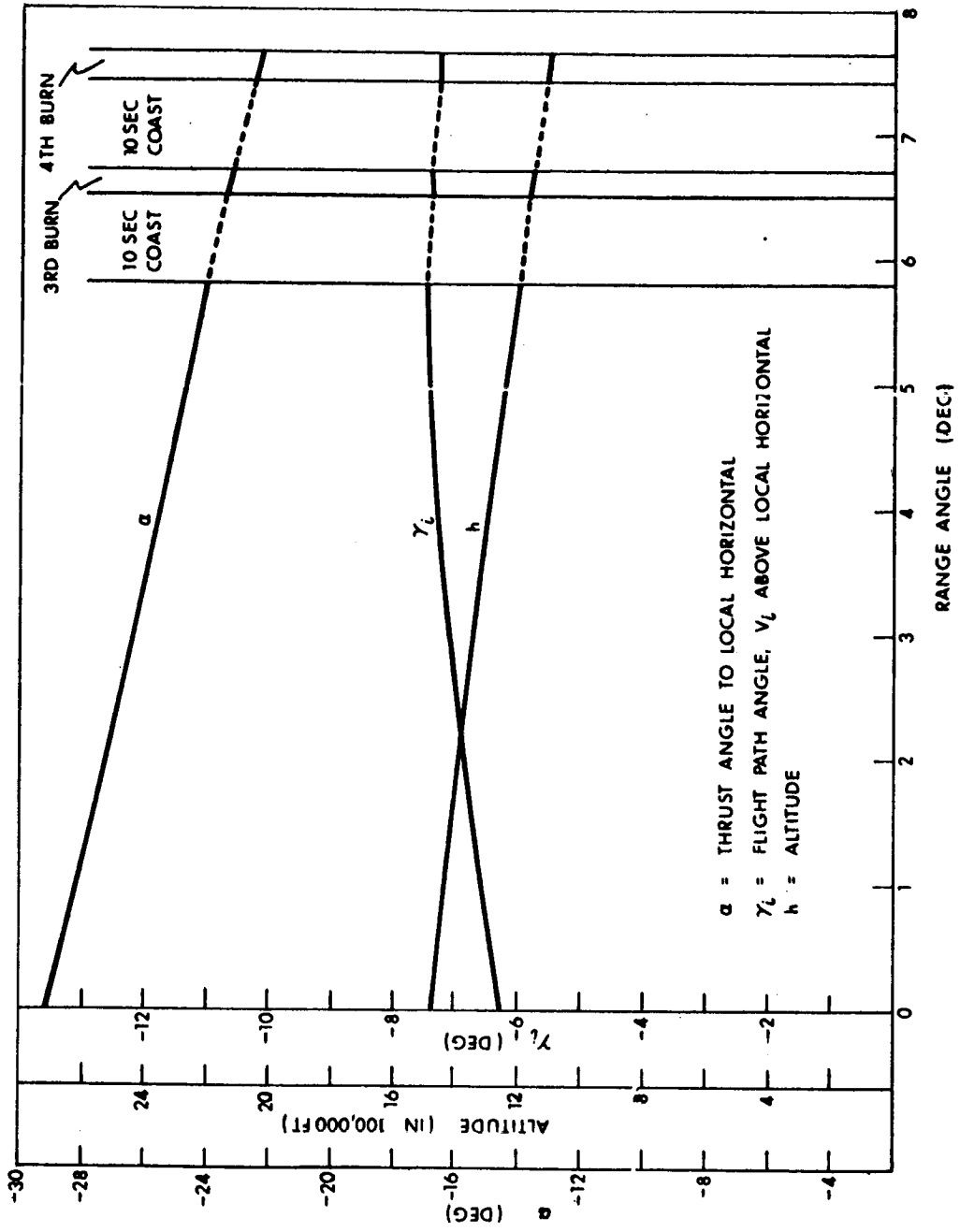

Fig. 9-2 Second, Third and Fourth Burn Trajectory

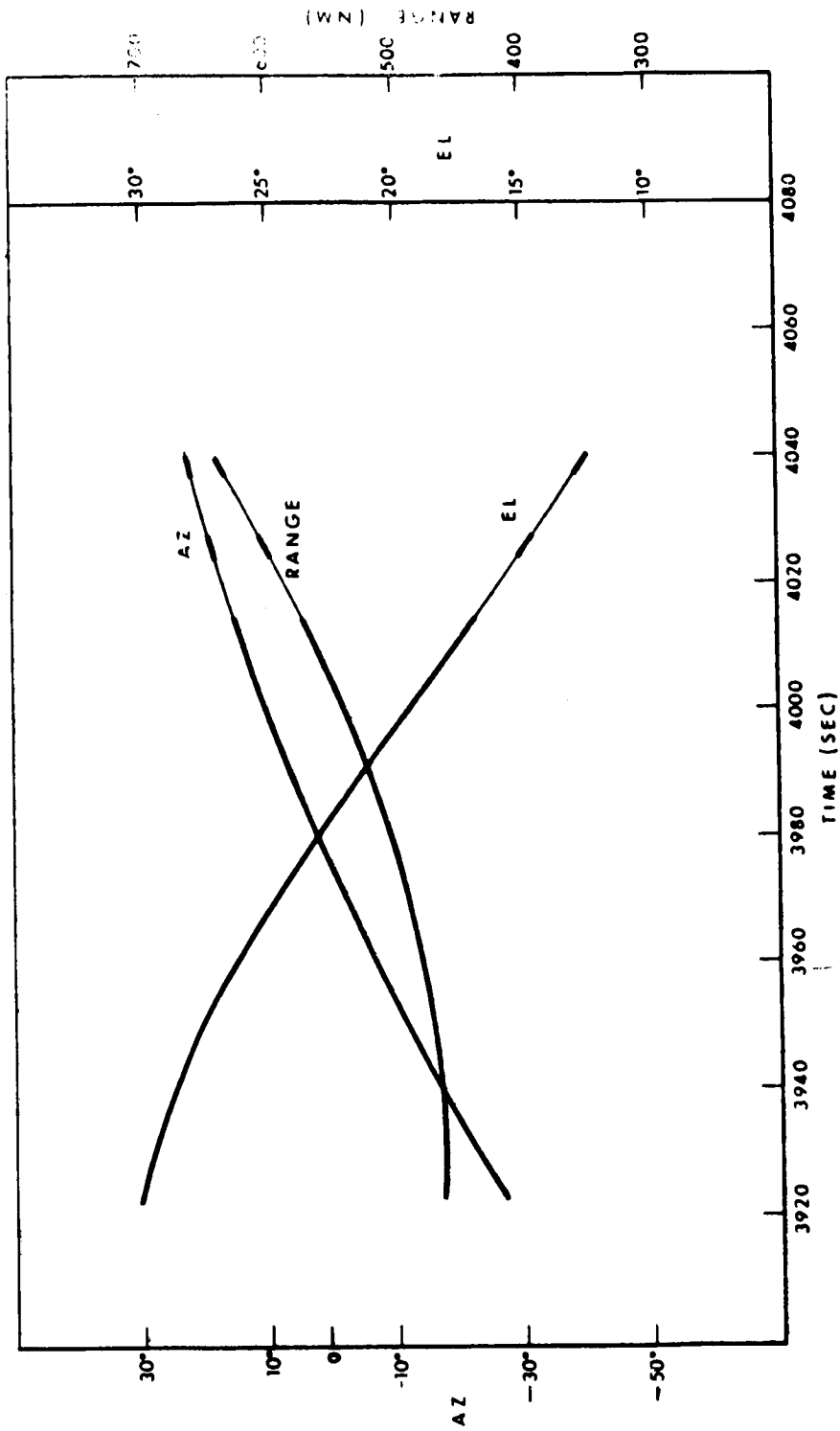

Fig. 9-3 Slant Range, Azimuth, and Elevation from Carnarvan during 2nd, 3rd, and 4th SPS Burns.

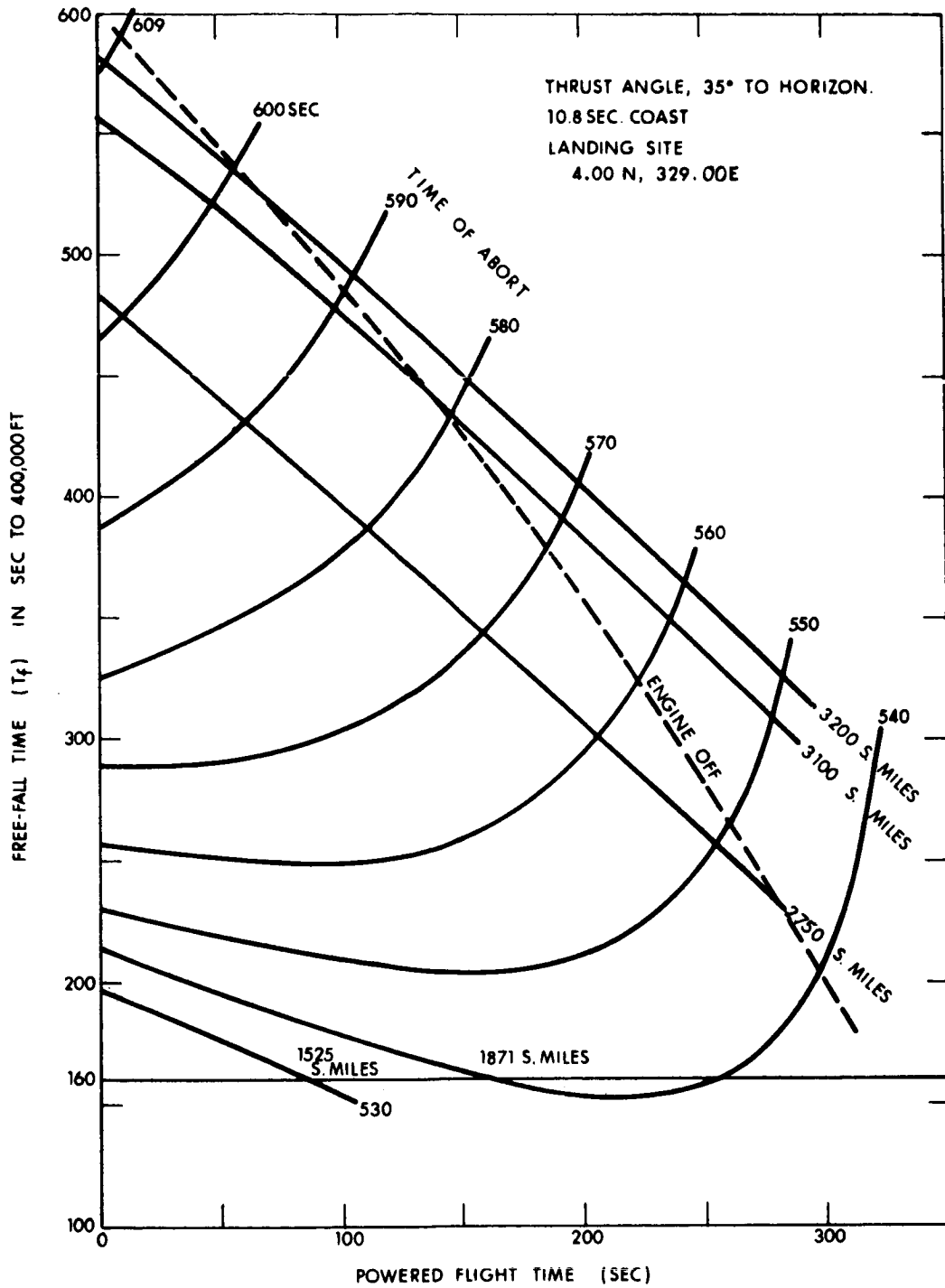

Fig. 9-4 Area Control Capability for Aborts
 During Saturn Boost

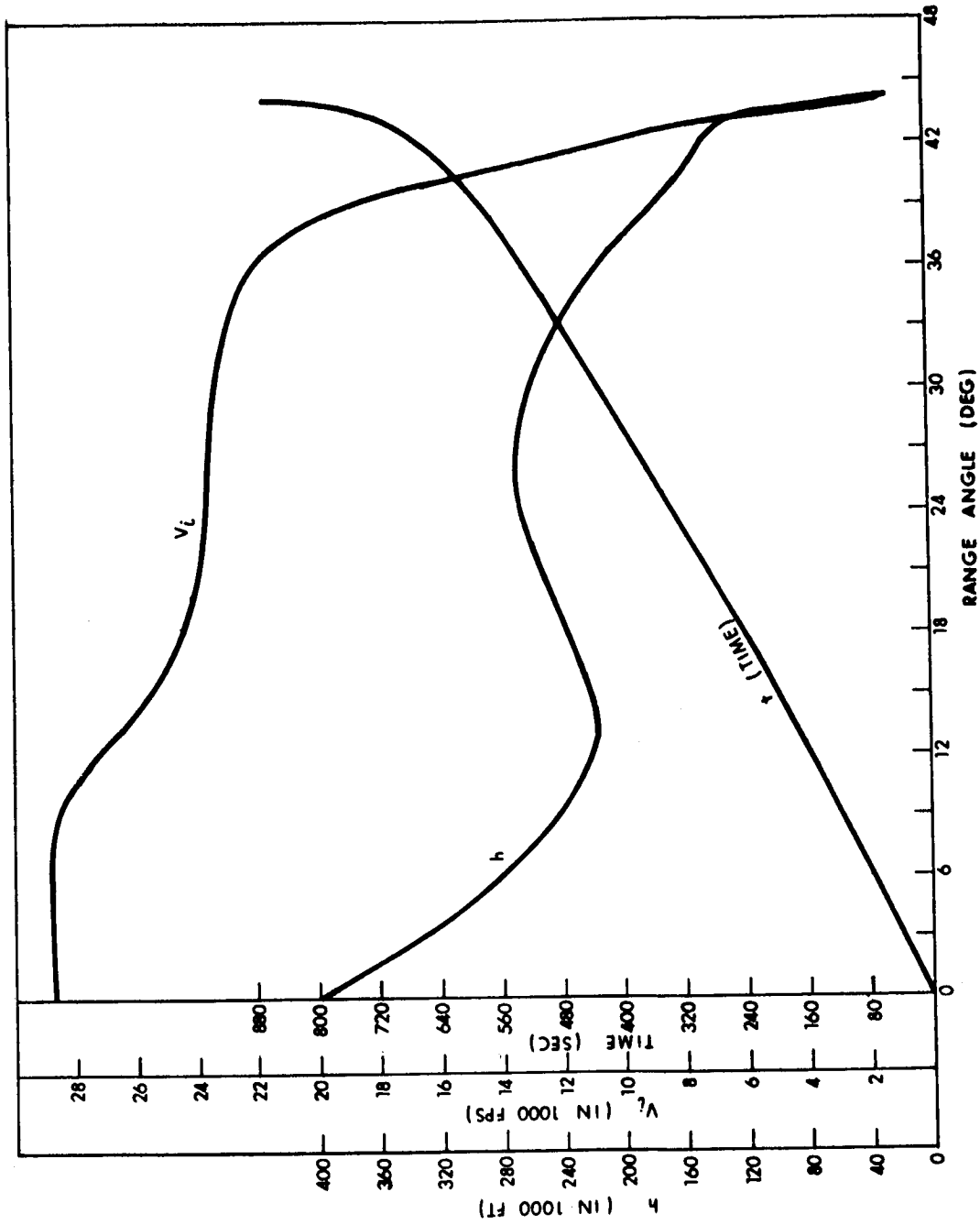

Fig. 9-5 Mission 202 Guided Entry Trajectory.

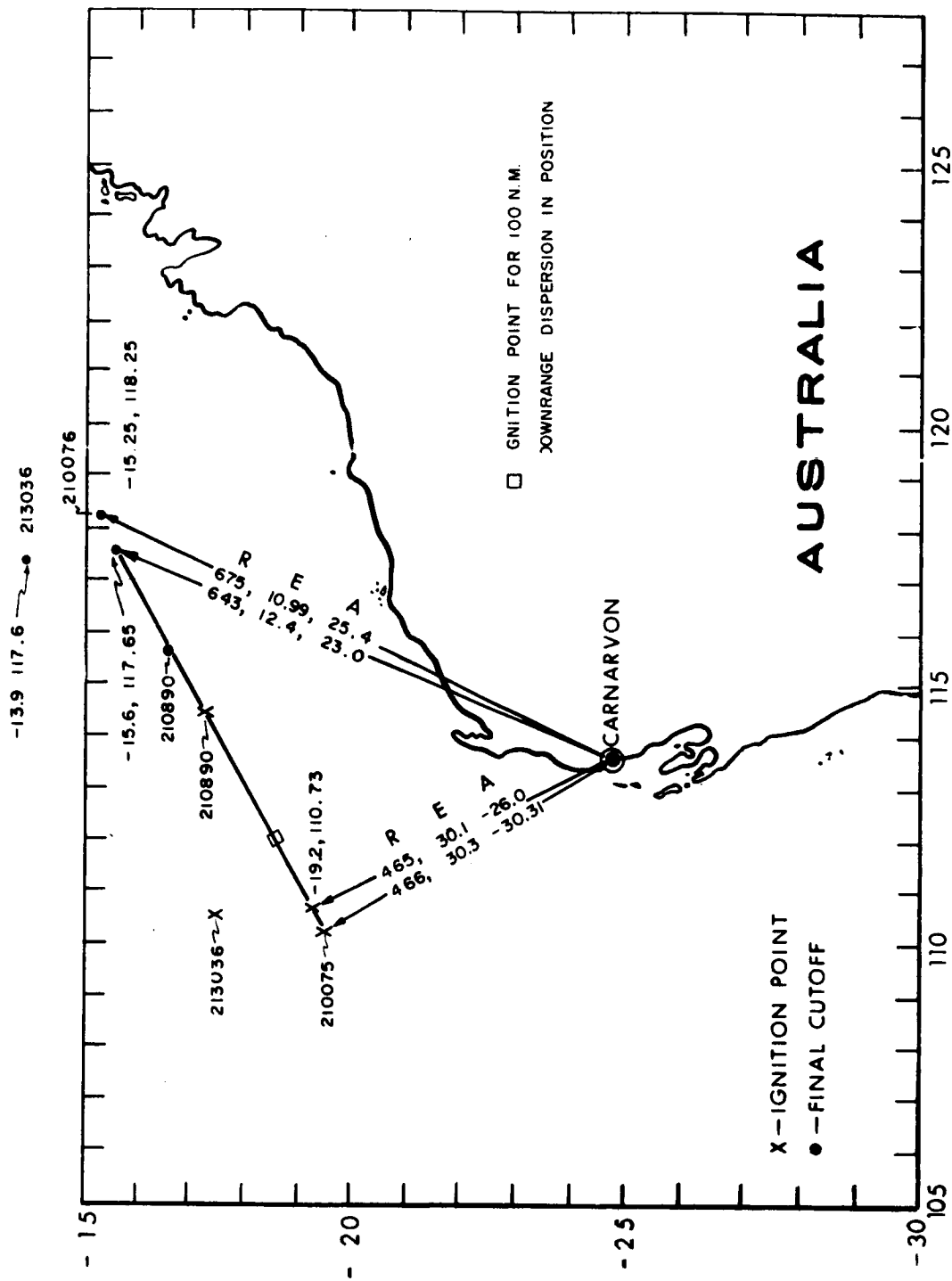

Fig. 9-6 SPS Second Burn Dispersions

The data in the Tables 9-1 through 9-8 present performance data derived by perturbing the nominal mission¹ with the dispersions listed on the following page.

The affects of these dispersions are demonstrated in the tables as follows:

- Table 9-1 Time, latitude, longitude, altitude, velocity, flight path angle and range (central angle from SIVB cut-off point) at the start of the first SPS burn.
- Table 9-2 Same as Table 9-1 at the end of the first SPS burn, plus fuel remaining and burn time.
- Table 9-3 Time latitude, longitude, altitude, velocity flight path angle, R, A, and E from Carnarvon at the start of the second SPS burn.
- Table 9-4 Same as Table 9-3 at the end of the second SPS burn.
- Table 9-5 Same as Table 9-3 at the final cut off.
- Table 9-6 Time latitude, longitude, altitude, velocity flight path angle at entry after fourth burn or fuel depletion.
- Table 9-7 Velocity and flight path angle at entry without the two short burns.
- Table 9-8 Same as Table 9-6 after the first burn only.

The radar at Carnarvon was taken to be at 24.867S latitude and 113.63E longitude at a radius of 20,913,669 feet.

The latitude and longitude at entry in Table 9-7 above will be practically the same as Table 9-6 above.

Fig. 9-6 shows the track during the nominal second SPS burn and the two short burns. The ignition point and final cut off points of extreme cases are also shown. It should be observed that

- a) The maximum westerly dispersion at ignition is about 0.5° longitude.
- b) The dispersion in track (213036) cannot be rectified by modification of the second ignition logic.

Any downrange dispersion at SIVB cut-off will move the entire trajectory downrange by the amount of dispersion.

Note 1. See remarks on first page of Section 9.0.

List of Dispersions

Mac Run	Dispersions
210066	617.4 sec, + 200'/sec inertial velocity
210067	617.4 sec, + 40'/sec inertial velocity
210068	617.4 sec, -40'/sec inertial velocity
210069	617.4 sec, + 3000 ft altitude
210070	617.4 sec, - 3000 ft altitude
210071	617.4 sec, + 0.5° flight path angle
210072	617.4 sec, - 0.5° flight path angle
210073	617.4 sec, + 3 sec I_{sp}
210074	617.4 sec, -3 sec I_{sp}
210075	617.4 sec, + 660 lbs thrust
210076	617.4 sec, -660 lbs thrust
210077	617.4 sec, + 500 lbs weight
210078	617.4 sec, - 500 lbs weight
210890	600 sec, + 30,000 ft. altitude -2° flight path angle -3 sec I_{sp} - 660 lbs thrust + 500 lbs weight
210891	600 sec, negative of above
211683	617.4 sec, nominal
213036	617.4 sec, +1° azimuth -1.63 southern latitude

NOTE:

1. Nominal I_{sp} was increased by 3 seconds over the November figure.
2. All cases have an 11 second coast between SIVB time indicated and SPS 1 ignition.
3. Altitude is in feet
Velocity is in ft/sec
All angles are in degrees
Time is in seconds; total time is measured from lift-off
Range from Carnarvon is slant range in n. m.
Radius of earth used in 20,925,738 feet.
The coast time used is 3041 seconds
Precision integration was used during coast

Table 9-1

SPS First Burn Ignition

Mac Run	Ignition Time	Lat.	Long.	Arc.	Alt.	V	γ
210066	628.4	23.20	295.19	0.646	555239	22034	2.41
210067	628.4	23.20	295.18	0.641	555138	21874	2.40
210068	628.4	23.20	295.18	0.639	555088	21794	2.39
210069	628.4	23.20	295.18	0.640	558114	21834	2.40
210070	628.4	23.20	295.18	0.640	552113	21834	2.39
210071	628.4	23.20	295.18	0.640	557207	21831	2.90
210072	628.4	23.20	295.18	0.640	553019	21837	1.90
210073	628.4	23.20	295.18	0.640	555113	21834	2.40
to	Same						
210078							
210890	611.0	23.58	294.22	0.607	559265	20715	-4.20
210891	611.0	23.58	294.22	0.607	515147	20692	3.58
211683	628.4	23.20	295.18	0.640	555113	21834	2.40
213036	628.4	21.56	295.17	0.640	555113	21834	2.40

Table 9-2

SPS First Burn Cut Off

Mac Run	Burn Time	Lat.	Long.	Arc	Alt.	V	γ	Fuel Left
210066	244.94	16.68	308.97	15.997	914031	25638	5.77	7525
210067	252.33	16.49	309.30	16.392	918982	25632	5.77	7012
210068	256.00	16.40	309.47	16.586	921243	25629	5.77	6758
210069	254.04	16.45	309.37	16.477	923082	25627	5.77	6894
210070	254.31	16.44	309.39	16.501	917178	25634	5.77	6876
210071	250.00	16.58	309.13	16.197	945703	25601	5.78	7174
210072	258.59	16.30	309.65	16.799	893486	25661	5.76	6578
210073	254.75	16.43	309.41	16.525	921086	25630	5.77	7011
210074	253.59	16.47	309.35	16.452	919192	25632	5.77	6757
210075	245.92	16.68	308.95	15.980	910290	25642	5.77	6943
210076	263.01	16.20	309.85	17.033	930580	25619	5.77	6822
210077	257.27	16.36	309.55	16.680	9238.9	25626	5.77	7169
210078	251.08	16.54	309.22	16.298	916432	25635	5.79	6599
210890	340.15	14.57	312.77	21.479	752820	25824	5.67	1418
210891	285.16	16.30	309.66	17.833	959525	25585	5.79	4333
211683	254.17	16.45	309.38	16.489	920130	25631	5.77	6884
213036	255.68	14.75	309.29	16.581	921928	25629	5.77	6780

Table 9-3

SFS Second Burn Ignition

Mac Run	Time	Lat.	Long.	Alt.	V	γ	Range (nm)	Elev.	Azimuth	From Carnarvon
210066	3914.3	-19.42	110.31	1545371	24920	-5.83	465.1	30.27	-30.20	
210067	3921.7	-19.25	110.65	1540221	24925	-5.83	464.6	30.18	-26.86	
210068	3925.4	-19.16	110.82	1537872	24928	-5.83	464.9	30.10	-25.22	
210069	3923.4	-19.21	110.72	1536144	24930	-5.83	464.4	30.09	-26.18	
210070	3923.7	-19.20	110.75	1541913	24923	-5.83	465.0	30.18	-25.89	
210071	3919.4	-19.35	110.44	1514190	24955	-5.84	462.1	29.75	-28.95	
210072	3928.0	-19.05	111.05	1564895	24898	-5.82	468.4	30.46	-22.94	
210073	3924.1	-19.19	110.77	1538141	24928	-5.83	464.7	30.12	-25.74	
210074	3923.0	-19.22	110.70	1539997	24926	-5.83	464.7	30.16	-26.35	
210075	3915.3	-19.42	110.30	1549110	24915	-5.83	465.5	30.32	-30.33	
210076	3932.4	-18.97	111.20	1528456	24938	-5.83	465.9	29.77	-21.48	
210077	3926.7	-19.12	110.90	1535303	24931	-5.83	464.9	30.03	-24.43	
210078	3920.5	-19.29	110.57	1542763	24922	-5.83	464.8	30.22	-27.65	
210890	3992.1	-17.28	114.54	1699460	24747	-5.77	551.8	26.82	6.61	
210891	3937.2	-19.08	110.97	1500239	24970	-5.84	462.2	29.39	-23.73	
211683	3923.6	-19.21	110.73	1539027	24927	-5.83	464.7	30.14	-26.04	
213036	3925.1	-17.40	110.67	1534096	24932	-5.83	533.6	23.34	-20.97	

Table 9-4

SPS Second Burn Cut Off

Mac Run	Burn Time	Time	Lat.	Long.	Alt.	V	γ	Range	From Carnarvon	
									Elev.	Azimuth
210066	94	4008.3	-16.59	115.81	1250376	27624	-7.64	563.5	17.33	14.38
210067	92	4013.7	-16.48	116.03	1251680	27615	-7.64	573.1	16.89	15.52
210068	91	4016.4	-16.42	116.13	1252555	27610	-7.64	577.8	16.68	16.06
210069	91	4014.4	-16.47	116.04	1251168	27599	-7.62	573.5	16.86	15.57
210070	91	4014.7	-16.46	116.06	1256700	27592	-7.64	575.0	16.89	15.70
210071	92	4011.4	-16.58	115.83	1226923	27640	-7.56	563.0	16.92	14.48
210072	91	4019.0	-16.31	116.35	1278291	27585	-7.72	589.1	16.62	17.16
210073	92	4016.4	-16.42	116.14	1249716	27615	-7.63	577.9	16.63	16.11
210074	91	4014.0	-16.48	116.02	1254557	27610	-7.65	572.9	16.95	15.48
210075	89	4004.3	-16.76	115.50	1269437	27586	-7.69	552.1	18.27	12.64
210076	94	4026.4	-16.12	116.68	1234429	27635	-7.58	601.7	15.28	18.79
210077	92	4018.7	-16.34	116.27	1247262	27607	-7.62	583.5	16.32	16.77
210078	91	4011.5	-16.55	115.89	1256943	27618	-7.66	567.5	17.26	14.79
210890	20.89	4013.0	-16.67	115.68	1643339	25352	-6.53	589.0	23.28	13.63
210891	61.27	3998.4	-17.27	114.52	1315852	26950	-7.35	518.81	21.05	6.47
211683	91	4014.6	-16.46	116.05	1253933	27595	-7.63	574.2	16.88	15.64
213036	91	4016.1	-14.76	115.98	1248948	27613	-7.63	668.8	12.85	12.85

Table 9-5

Final Cut Off Conditions

Mac Run	Burn Time	Time	Lat.	Long.	Alt.	V	γ	Range	From Carnarvon	
									Elev.	Azimuth
210066	100	4034.3	-15.74	117.42	1155966	27904	-7.45	631.2	12.78	22.05
210067	98	4039.7	-15.62	117.63	1157306	27898	-7.45	642.1	12.40	22.90
210068	97	4042.4	-15.56	117.73	1158195	27894	-7.46	647.5	12.22	23.31
210069	97	4040.4	-15.61	117.63	1157013	27882	-7.44	642.6	12.38	22.93
210070	97	4040.7	-15.60	117.66	1162358	27875	-7.46	644.2	12.41	23.03
210071	98	4037.4	-15.71	117.44	1133495	27921	-7.37	631.2	12.42	22.12
210072	94.92	4042.9	-15.51	117.81	1190537	27797	-7.52	653.6	12.50	23.63
210073	98	4042.1	-15.55	117.74	1155440	27897	-7.45	647.7	12.17	23.34
210074	96.57	4039.6	-15.63	117.59	1161644	27874	-7.46	640.7	12.52	22.76
210075	95	4030.3	-15.90	117.10	1174504	27875	-7.51	617.3	13.63	20.71
210076	100	4052.4	-15.25	118.28	1140699	27913	-7.39	675.1	10.99	25.39
210077	96.24	4042.9	-15.54	117.76	1159533	27828	-7.41	649.0	12.18	23.42
210078	97	4037.5	-15.69	117.49	1162261	27903	-7.48	635.6	12.72	22.35
211683	97	4040.6	-15.60	117.65	1159684	27878	-7.45	643.4	12.39	22.98

Table 9-6

Final Entry ConditionsAt 400,000 ft.
Altitude

Mac Run	Time	Lat.	Long.	Alt.	V	γ	V	γ
210066	4314	-5.26	134.7	394160	28711	-3.47	28702	-3.49
210067	4320	-5.13	134.9	394943	28706	-3.48	28698	-3.50
210068	4322	-5.07	135.0	395452	28703	-3.49	28695	-3.50
210069	4320	-5.13	134.9	395282	28690	-3.49	28682	-3.50
210070	4321	-5.12	134.9	397910	28686	-3.52	28680	-3.50
210071	4307	-5.63	134.1	400988	28699	-3.53	28697	-3.50
210072	4333	-4.67	135.6	395489	28642	-3.51	28634	-3.52
210073	4322	-5.06	134.0	394113	28705	-3.48	28695	-3.50
210074	4320	-5.16	134.9	397455	28690	-3.51	28684	-3.50
210075	4310	-5.46	134.4	403404	28693	-3.56	28693	-3.50
210076	4323	-5.10	134.9	403655	28695	-3.56	28696	-3.50
210077	4323	-5.07	135.0	398082	28637	-3.54	28632	-3.52
210078	4317	-5.21	134.8	396989	28715	-3.50	28708	-3.49
210890	4484	-5.26	141.8	403303	26749	-4.79	26748	-4.75
210891	4332	-5.35	134.5	403340	27941	-3.33	27940	-3.88
211683	4321	-5.13	135.0	396594	28688	-3.50	28681	-3.50
213036	4322	-3.84	135.0	393717	28704	-3.48	28695	-3.50

Table 9-7
Entry Conditions (400, 000 ft) After Second Burn
(no short burns)

Mac Run	V	γ
210066	28497	-3.57
210067	28518	-3.57
210068	28514	-3.57
210069	28502	-3.57
210070	28501	-3.57
210071	28518	-3.57
210072	28515	-3.56
210073	28516	-3.57
210074	28516	-3.57
210075	28508	-3.57
210076	28520	-3.57
210077	28506	-3.57
210078	28526	-3.56
211683	28501	-3.57
213036	28514	-3.57

Table 9-8
Entry Conditions After First Burn
(No Second Burn)

Mac Run	Time	Lat.	Long.	Alt.	V	γ
210066	4364	-4.76	135.3	399677	26241	-5.34
210067	4371	-4.58	135.6	397107	26244	-5.34
210068	4374	-4.48	135.7	394821	26246	-5.34
210069	4372	-4.54	135.6	393152	26248	-5.34
210070	4373	-4.53	135.7	398742	26242	-5.34
210071	4358	-5.04	134.9	396344	26245	-5.34
210072	4387	-4.02	136.4	396602	26244	-5.34
210073	4373	-4.51	135.7	395084	26246	-5.34
210074	4372	-4.55	135.6	396887	26244	-5.34
210075	4367	-4.70	135.4	398418	26242	-5.34
210076	4381	-4.24	136.1	385683	26257	-5.33
210077	4376	-4.43	135.8	392327	26249	-5.34
210078	4369	-4.64	135.5	399577	26241	-5.34
211683	4373	-4.53	134.7	395945	26245	-5.34
213036	4374	-3.24	135.7	390864	26251	-5.34

The entry conditions at 400,000 feet are 26237 ft/sec 5.34° for all cases.

R-477
DISTRIBUTION LIST

Internal

R. Alonso	A. Hopkins	E. Olsson
R. Arrufo	F. Houston	J. Rhode
R. Baker	L. B. Johnson	M. Richter
R. Battin (5)	M. Johnston	M. Sanders
P. Bowditch	A. Kosmala (3)	M. Sapuppo
D. Bowler	A. Koso	R. Scholten
R. Boyd	M. Kramer	E. Schwarm
E. Copps	A. Laats	J. Shillingford (3)
R. Crisp	L. Larson	W. Shotwell (MIT/ACSP)
J. Dahlen (5)	J. Lawrence (MIT/GAEC)	J. Sitomer
E. Duggan	T. J. Lawton (2)	B. Sokappa
K. Dunipace (MIT/AMR) (3)	T. M. Lawton (MIT/MSC)	M. Sullivan
J. B. Feldman	D. Lickly	J. Suomala
S. Felix (MIT/S&ID) (3)	H. Little	R. Therrien
J. Flanders	G. Mayo	W. Toth
J. Fleming (4)	J. McNeil	M. Trageser
G. Fujimoto	H. McOuat	R. Weatherbee
F. Grant	R. Morth	L. Wilk
Eldon Hall	James Miller (2)	R. Woodbury
Edward Hall	John Miller	W. Wrigley
E. Hickey	J. Nevins	Apollo Library (2)
D. Hoag	J. Nugent	MIT/IL Library (6)
J. Dunbar		

External

(ref. PP1-64; April 8, 1964)

P. Ebersole (NASA/MSC) (2)

W. Rhine (NASA/RASPO) (1)

L. Holdridge (NAA S&ID/MIT) (1)

T. Heueremann (GAEC/MIT) (1)

AC Spark Plug (10)

Kollsman (10)

Raytheon (10)

Major W. Delaney (AFSC/MIT) (1)

NAA RASPO: National Aeronautics and Space Administration (1)
Resident Apollo Spacecraft Program Office
North American Aviation, Inc.
Space and Information Systems Division
12214 Lakewood Boulevard
Downey, California

FO: National Aeronautics and Space Administration, MSC (3)
Florida Operations, Box MS
Cocoa Beach, Florida 32931
Attn: Mr. B. P. Brown

HDQ: NASA Headquarters (6)
600 Independence Ave., SW
Washington 25, D. C. 20546
Attn: MAP-2

AMES: National Aeronautics and Space Administration (2)
Ames Research Center
Moffett Field, California
Attn: Library

LEWIS: National Aeronautics and Space Administration (2)
Lewis Research Center
Cleveland, Ohio
Attn: Library

FRC: National Aeronautics and Space Administration (1)
Flight Research Center
Edwards AFB, California
Attn: Research Library

LRC: National Aeronautics and Space Administration (2)
Langley Research Center
Langley AFB, Virginia
Attn: Mr. A. T. Mattson

GSFC: National Aeronautics and Space Administration (2)
Goddard Space Flight Center
Greenbelt, Maryland
Attn: Manned Flight Support Office Code 512

MSFC: National Aeronautics and Space Administration (20)
George C. Marshall Space Flight Center
Huntsville, Alabama
Attn: R-SA (10)
L. Richards (10)

ERC: National Aeronautics and Space Administration (1)
 Electronics Research Center
 575 Technology Square
 Cambridge, Massachusetts
 Attn: R. Hayes/A. Colella

GAEC: Grumman Aircraft Engineering Corporation (10)
 Bethpage, Long Island, New York
 Attn: Mr. A. Whitaker

NAA: North American Aviation, Inc. (52)
 Space and Information Systems Division
 12214 Lakewood Boulevard
 Downey, California
 Attn: Mr. R. Berry (40)
 Mr. L. Hogan (10)
 Mr. R. Frimtzis (2)

GAEC RASPO: National Aeronautics and Space Administration (1)
 Resident Apollo Spacecraft Program Officer
 Grumman Aircraft Engineering Corporation
 Bethpage, L. I., New York

ACSP RASPO: National Aeronautics and Space Administration (1)
 Resident Apollo Spacecraft Program Officer
 Dept. 32-31
 AC Spark Plug Division of General Motors
 Milwaukee 1, Wisconsin
 Attn: Mr. W. Swingle

WSMR: National Aeronautics and Space Administration (2)
 Post Office Drawer MM
 Las Cruces, New Mexico
 Attn: BW44

MSC: National Aeronautics and Space Administration (100)
 Manned Spacecraft Center
 Apollo Document Control Group
 Houston 1, Texas 77058

Mr. H. Peterson (1)
 Bureau of Naval Weapons
 c/o Raytheon Company
 Foundry Avenue
 Waltham, Massachusetts

Queens Material Quality Section (1)
 c/o Kollsman Instrument Corp.
 Building A 80-08 45th Avenue
 Elmhurst, New York 11373
 Attn: Mr. S. Schwartz

Mr. H. Anschuetz (1)
 USAF Contract Management District
 AC Spark Plug Division of General Motors
 Milwaukee, Wisconsin 53201

BELLCOM (3)

Link Div. of GPI (3)
 Hillcrest
 Binghamton, New York
 Attn: Mr. Fred Martikan