

7-31-63

Preliminary Memo #1
LEM Prime Guidance System Study.

R. J. Phagan

Subject: IMU Error Compilation.

The IMU errors as gleaned from several MIT/IL documents are tabulated below with reference to the source of the data.

A. Accelerometer errors:

1. Bias = 0.2 cm/sec^2 E1306, p. 148, p. 172
= $0.2 \text{ cm/sec}^2 \text{ rms}$ E1164, p. 9
= 0.5 cm/sec^2 R373, p. 13
= 0.2 cm/sec^2 E1117, p. 56
= 0.2 cm/sec^2 each accel. E1117, p. 62

2. Scale factor error = 100 PPM E1306, p. 148, p. 172
= 100 PPM rms E1164, p. 9
= 100 PPM E1117, p. 56
= 100 PPM each accel. E1117, p. 62

3. Acceleration sensitive scale factor

error = 10 PPM/g E1306, p. 148, p. 172
= 10 PPM/g rms E1164, p. 9
= 1 PPM/g E1117, p. 56
= 10 PPM/g each accel. E1117, p. 62

7-31-63

Prelim. Memo #1

R. Phagan

B. Gyro errors:

1. Drift = 10 meter (bias drift) E1306, p. 148, p. 172

= 10 meter rms E1164, p. 9, p. 8

= 10 meter R373, p. 13

= 10 meter E1117, p. 56

= 10 meter each gyro E1117, p. 62

2. acceleration sensitive drift

= 10 meter/g E1306, p. 148, p. 172

= 10 meter/g rms E1164, p. 9

= 10 meter/g due to acceleration

along input axis E1117, p. 56

= 10 meter/g each gyro E1117, p. 62

3. acceleration squared sensitive drift

= 1 meter/g² E1306, p. 148, p. 172= 1 meter/g² rms E1164, p. 9= 1 meter/g² about gyro

input axis E1117, p. 56

= 1 meter/g² about gyro

spin reference axis E1117, p. 56

= 1 meter/g² cross term about gyro

input axis - spin reference

axis E1117, p. 56

7-31-63

Prelim. Memo #1

R. J. Shagan

B.3, continued

$$= 1 \text{ msec} / g^2 \text{ each gyro}$$

E1117, p. 62

4. XTASI No. MIT 3-A dated July 19, 1963 states on p. 6 that gyro drift due to residual magnetism present in the gyro torques is about an order of magnitude greater than drifts due to other causes. This drift can be braced out for torques applied in one direction. Correction more complex and possibly less effective with bi-directional torquing.

C. Accelerometer Input-axis Nonorthogonality.

$$\text{Misalignment} = 0.1 \text{ mrad.}$$

E1306, p. 148, p. 172

$$= 0.1 \text{ mrad.} \times \text{msec}$$

E1164, p. 9

Accelerometer misalignments

$$X \text{ about } Z_p \text{ and } Y_p = 0.1 \text{ mrad.}$$

E1117, p. 62

$$Z \text{ about } X_p = 0.1 \text{ mrad.}$$

E1117, p. 62

IMV case misalignment about $Y_{NB} = 9 \text{ secs.}, 0.044 \text{ mrad.}$

+msec. est.

E1288, p. 8.

Outer gimbal axis error, X_{NB} axis = 22 secs., 0.107 mrad.

+msec. est.

E1288, p. 8.

Middle to outer gimbal axis nonorthogonality, Y_{OG} axis

$$= 13 \text{ secs.}, 0.063 \text{ mrad.} \times \text{msec. est.} \quad E1288, p. 8$$

7-31-63

Berlin. Memo #1

R. Shagan

C. Continued.

Middle gimbal axis error, Z_{OG} axis = 20 secs, 0.097 m.r.
 rms. est. E 1288, p. 8

Inner to middle gimbal axis nonorthogonality, X_{MG} axis
 = 13 secs, 0.063 m.r. rms. est. E 1288, p. 8

Inner gimbal axis error, Y_{MG} axis = 20 secs, 0.097 m.r.
 rms. est. E 1288, p. 8

D. Platform Misalignments:

IMU alignment uncertainty

= 1 m.r. E 1306, p. 148

= 0.2 m.r. (initial to 0.7 in 15 min) E 1306, p. 172, p. 173.

= 0.206 m.r. rms E 1164, p. 9

= 0.1 m.r. each about

X_I, Y_I, Z_I E 1117, p. 62

= 0.5 m.r.

Meeting 1-11-63
 at MIT/IL, p. 5.

E. Resolver errors:

Resolution = $\frac{360^\circ}{(32)(1024)}$ E 1125, p. 1

Based on 2 speed system 32:1 with 1-speed
 & 32 speed resolver excited by 100 cps for cross-over control

7-31-63

Helim. Memo #1

R. Phagan

of 102.4 keps pulse source. Inaccuracy in frequency drift, count loss, etc. not included.

F. Definition of MERU:

MERU is an abbreviation for Milli Earth Rate Units. Earth rate is defined, on p. 2 of "Physical Data" published by G.E. as document PIBD-1 dated 11-59, as 72.9×10^{-6} rad./sec. From this

$$1 \text{ MERU} = 72.9 \times 10^{-6} \times 10^{-3} = 7.29 \times 10^{-8} \text{ rad./sec.}$$

MERU is defined in E-1164, p. 8 as follows:

$$10 \text{ MERU} = 2.62 \text{ m.r./hr.}$$

Reduced, this becomes

$$1 \text{ MERU} = (.262 \times 10^{-3}) \left(\frac{1}{3600} \right) = 7.28 \times 10^{-8} \text{ rad./sec.}$$

G. Reference Documents:

The documents referred to in the preceding paragraphs are

E-1117 Monthly Technical Progress Report Project Apollo
Guidance and Navigation Program, period 12-11-61 to 1-16-62. Conf.

E-1125 Preliminary Resolver Angle Measurement by Ramon
L. Alonso. Feb, 1962.

Reelin. Memo #1

R. L. Hagan

G. continued.

E-1164 The Relationships Between IMU Drift, Misalignments, and Target Errors by Frederic D. Frank. May, 1962. Conf.

E-1288 alignment Errors of the IMU Stable Member by Frederic D. Frank. Feb., 1963. Conf.

E-1306 Monthly Technical Progress Report Project Apollo Guidance and Navigation Program. Period 1-11-63 to 2-11-63. Conf.

R-373 Guidance and Navigation System for Lunar Excursion Module. August 1962. Conf.

Project Apollo. Abstract of Meeting of Guidance Analysis Panel on LEM Guidance. 1-11-63 at MIT/IL. Conf.

XTASI. Entry No. 3 MIT, section A (Hardware Information) dated 7-19-63. Technical description of Apollo IMU with block diagram and transfer functions for gimbals, servos and gyros.

7

7-31-63

Asclim. Memo #1

RJ Phagan

H. Comments:

I have requested Ted Heuserman, the GAEC representative at MIT/IL, to acquire all data possible on ~~744-444912~~ (in general terms), plus confirmation of currently "in house" data. Reply expected on or about 8-5-63.

7-18-63

Technical Note

R. P. Hagan

IMU Alignment:

1. Warm up & check out IMU prior to lunar orbit.
2. Lunar orbit assumed circular.
3. Use telescope and movable reticle to make several (number unknown) horizon sightings. Align X axis of IMU to $\frac{1}{2}$ mean angle. Turn CM/LEM about IMU X axis for refinement. Yields local vertical.
4. Use telescope and movable reticle to make several star sights (number unknown). Provides IMU (Z-axis) azimuth correction.
5. Refine alignment until separation.

On lunar surface:

6. Null outputs of Y & Z accelerometers for local vertical alignment.
7. Telescopic star sights as in 5. above for azimuth alignment.
8. Refine alignment until lift-off.

L- IMU

NON-GRAVITATIONAL ACCELERATION ON IMU DUE TO DISPLACEMENT BETWEEN IMU-CG AND LEM-CG

$$\begin{aligned}
 A_{x/B} &= \frac{F_{x/B}}{m_T} - \bar{\alpha}_{IMU}(\dot{g}_B^2 + \dot{z}_B^2) + \bar{\beta}_{IMU}(P_B \dot{g}_B - \dot{z}_B) + \bar{\gamma}_{IMU}(\dot{z}_B P_B + \dot{g}_B) \\
 A_{y/B} &= \frac{F_{y/B}}{m_T} - \bar{\beta}_{IMU}(\dot{z}_B^2 + P_B^2) + \bar{\delta}_{IMU}(\dot{g}_B P_B - \dot{P}_B) + \bar{\alpha}_{IMU}(P_B \dot{g}_B + \dot{z}_B) \\
 A_{z/B} &= \frac{F_{z/B}}{m_T} - \bar{\alpha}_{IMU}(P_B^2 + \dot{g}_B^2) + \bar{\alpha}_{IMU}(\dot{z}_B P_B - \dot{g}_B) + \bar{\beta}_{IMU}(\dot{g}_B P_B + \dot{P}_B)
 \end{aligned}$$

DISPLACEMENT BETWEEN IMU-CG AND LEM-CG

$$\begin{aligned}
 \bar{\alpha}_{IMU} &= \alpha_{IMU} - \alpha_{CG} \\
 \bar{\beta}_{IMU} &= \beta_{IMU} - \beta_{CG} \\
 \bar{\gamma}_{IMU} &= \gamma_{IMU} - \gamma_{CG}
 \end{aligned}$$

TRANSFORMATION MATRIX FROM BODY AXES TO ACTUAL IMU AXES

$$\begin{aligned}
 d'_{11} &= \cos \psi_{IMU} \cos \theta_{IMU} \\
 d'_{12} &= \sin \psi_{IMU} \\
 d'_{13} &= -\cos \psi_{IMU} \sin \theta_{IMU} \\
 d'_{21} &= -\cos \phi_{IMU} \sin \psi_{IMU} \cos \theta_{IMU} + \sin \phi_{IMU} \sin \theta_{IMU} \\
 d'_{22} &= \cos \phi_{IMU} \cos \psi_{IMU} \\
 d'_{23} &= \cos \phi_{IMU} \sin \psi_{IMU} \sin \theta_{IMU} + \sin \phi_{IMU} \cos \theta_{IMU} \\
 d'_{31} &= \sin \phi_{IMU} \sin \psi_{IMU} \cos \theta_{IMU} + \cos \phi_{IMU} \sin \theta_{IMU} \\
 d'_{32} &= -\sin \phi_{IMU} \cos \psi_{IMU} \\
 d'_{33} &= -\sin \phi_{IMU} \sin \psi_{IMU} \sin \theta_{IMU} + \cos \phi_{IMU} \cos \theta_{IMU}
 \end{aligned}$$

IMU ERROR ANGLES

$$\begin{aligned}
 \phi_x &= \phi_{IMU} - \phi \\
 \phi_y &= \theta_{IMU} - \theta \\
 \phi_z &= \psi_{IMU} - \psi
 \end{aligned}$$

NON-GRAVITATIONAL ACCELERATIONS ALONG ACTUAL IMU AXES

$$\begin{aligned}
 A_{x/IMU} &= d'_{11} A_{x/B} + d'_{21} A_{y/B} + d'_{31} A_{z/B} \\
 A_{y/IMU} &= d'_{12} A_{x/B} + d'_{22} A_{y/B} + d'_{32} A_{z/B} \\
 A_{z/IMU} &= d'_{13} A_{x/B} + d'_{23} A_{y/B} + d'_{33} A_{z/B}
 \end{aligned}$$

PLATFORM GYRO DRIFT RATES DUE TO UNBALANCE AND COMPLIANCE ERRORS

$$\begin{aligned}
 \dot{\phi}_d &= R_x + U_{Sx} A_{x/IMU} + U_x A_{y/IMU} - (S_{55} - S_{xx}) A_{x/IMU} A_{y/IMU} + S_{Sx} A_{x/IMU}^2 - S_{Sx} A_{y/IMU}^2 \\
 \dot{\theta}_d &= R_y + U_{Sy} A_{y/IMU} + U_y A_{z/IMU} - (S_{55} - S_{yy}) A_{y/IMU} A_{z/IMU} + S_{Sy} A_{y/IMU}^2 - S_{Sy} A_{z/IMU}^2 \\
 \dot{\psi}_d &= R_z + U_{Sz} A_{z/IMU} - U_z A_{y/IMU} + (S_{55} - S_{zz}) A_{y/IMU} A_{z/IMU} + S_{Sz} A_{z/IMU}^2 - S_{Sz} A_{y/IMU}^2
 \end{aligned}$$

PLATFORM GYRO DUE TO AOT MISALIGNMENT

$$\begin{aligned}
 \Delta \phi_c &= \Delta \phi_{AOT} + \Delta \phi_G + \int_{t_{AOT}}^{t_{ACT}} \dot{\phi}_d dt \\
 \Delta \theta_c &= \Delta \theta_{AOT} + \Delta \theta_G + \int_{t_{AOT}}^{t_{ACT}} \dot{\theta}_d dt \\
 \Delta \psi_c &= \Delta \psi_{AOT} + \Delta \psi_G + \int_{t_{AOT}}^{t_{ACT}} \dot{\psi}_d dt
 \end{aligned}$$

CONSTANTS AND INITIAL CONDITIONS

- $\alpha_{IMU}, \beta_{IMU}, \gamma_{IMU}$
- $R_i, U_{Si}, U_i, (S_{55} - S_{ii}), S_{Si}, S_{is}$
- $\Delta \phi_{AOT}, \Delta \theta_{AOT}, \Delta \psi_{AOT}, t_{AOT}$
- $\Delta \phi_G, \Delta \theta_G, \Delta \psi_G, \psi_{GL}$
- $\dot{\phi}_F, \dot{\theta}_F, \dot{\psi}_F$
- $C_i, C_{1i}, C_{2i}, C_{3i}, C_{4i}, C_{5i}, C_{6i}$
- $(V_i/acc)_0$

ACTUAL IMU GIMBAL ANGLES

$$\begin{aligned}
 \phi_{IMU} &= I_x \left[(\phi - \Delta \phi_c) \Big|_{t=t_0} + \int_{t_0}^{t_2} \dot{\phi}_F dt + K_x (\text{NOISE FUNCTION}) \right] \\
 \theta_{IMU} &= I_y \left[(\theta - \Delta \theta_c) \Big|_{t=t_0} + \int_{t_0}^{t_2} \dot{\theta}_F dt + K_y (\text{NOISE FUNCTION}) \right] \\
 \psi_{IMU} &= I_z \left[(\psi - \Delta \psi_c) \Big|_{t=t_0} + \int_{t_0}^{t_2} \dot{\psi}_F dt + K_z (\text{NOISE FUNCTION}) \right]
 \end{aligned}$$

GIMBAL LOCK WARNING	
IF	THEN
$-\psi_{GL} \leq \psi_{IMU} \leq \psi_{GL}$	ACTIVATE WARNING LIGHT

PLATFORM GYRO FAILURE LOGIC

IF FAILURE RESULTS IN:	THEN:
RANDOM NOISE	K_x AND/OR K_y AND/OR $K_z = 1$
PLATFORM FREEZE	$\phi - \Delta \phi_c$ REMAINS CONSTANT AT $t = t_\phi$; AND/OR $\theta - \Delta \theta_c$ REMAINS CONSTANT AT $t = t_\theta$; AND/OR $\psi - \Delta \psi_c$ REMAINS CONSTANT AT $t = t_\psi$.
PLATFORM RETURN TO BODY AXIS	I_x AND/OR I_y AND/OR $I_z = 0$
PLATFORM TUMBLING AT TIME t_{ϕ_1} AND/OR t_{θ_1} AND/OR t_{ψ_1}	J_x AND/OR J_y AND/OR $J_z = 1$ GIMBALS FREEZE IN ARBITRARY POSITION WHEN EITHER t_{ϕ_2} AND/OR t_{θ_2} AND/OR t_{ψ_2} ACTIVATED
EXCESSIVE DRIFT	ALTER APPROPRIATE CONSTANT IN EQS (L-14)

ACCELEROMETER MEASUREMENT ERRORS

$$\begin{aligned}
 \Delta A_{x/IMU} &= C_x + C_{1x} A_{x/IMU} + C_{2x} A_{x/IMU}^2 + C_{3x} A_{y/IMU} + C_{4x} A_{y/IMU} A_{x/IMU} + C_{5x} A_{z/IMU} + C_{6x} A_{z/IMU} A_{x/IMU} \\
 \Delta A_{y/IMU} &= C_y + C_{1y} A_{y/IMU} + C_{2y} A_{y/IMU}^2 + C_{3y} A_{x/IMU} + C_{4y} A_{x/IMU} A_{y/IMU} + C_{5y} A_{z/IMU} + C_{6y} A_{z/IMU} A_{y/IMU} \\
 \Delta A_{z/IMU} &= C_z + C_{1z} A_{z/IMU} + C_{2z} A_{z/IMU}^2 + C_{3z} A_{x/IMU} + C_{4z} A_{x/IMU} A_{z/IMU} + C_{5z} A_{y/IMU} + C_{6z} A_{y/IMU} A_{z/IMU}
 \end{aligned}$$

VEHICLE VELOCITIES (NON GRAVITY) DETERMINED FROM ACCELEROMETERS

$$\begin{aligned}
 V_{x/acc} &= \int_0^t A_{x/acc} dt + (V_{x/acc})_0 \\
 V_{y/acc} &= \int_0^t A_{y/acc} dt + (V_{y/acc})_0 \\
 V_{z/acc} &= \int_0^t A_{z/acc} dt + (V_{z/acc})_0
 \end{aligned}$$

VEHICLE ACCELERATIONS DETERMINED FROM ACCELEROMETERS

$$\begin{aligned}
 A_{x/acc} &= I_x' \left[A_{x/IMU} + \Delta A_{x/IMU} + K_x' (\text{NOISE FUNCTION}) \right] \\
 A_{y/acc} &= I_y' \left[A_{y/IMU} + \Delta A_{y/IMU} + K_y' (\text{NOISE FUNCTION}) \right] \\
 A_{z/acc} &= I_z' \left[A_{z/IMU} + \Delta A_{z/IMU} + K_z' (\text{NOISE FUNCTION}) \right]
 \end{aligned}$$

ACCELEROMETER FAILURE LOGIC

IF FAILURE RESULTS IN:	THEN:
RANDOM NOISE	K_x' AND/OR K_y' AND/OR $K_z' = 1$
LOSS OF SIGNAL	I_x' AND/OR I_y' AND/OR $I_z' = 0$
CONTINUAL SIGNAL	ALTER CONSTANTS C_{1x} AND/OR C_{1y} AND/OR C_{1z} (L-22)
EXCESSIVE DRIFT	ALTER CONSTANTS C_x AND/OR C_y AND/OR C_z (L-22)

RASPO

Rec'd	7/26/64	Sm
Exp'd		

NASA - MSC
Bldg. 4 Room 136 CF5
2101 Webster-Seabrook Road
Houston, Texas 77058
June 24, 1964

REC'D GAEC

JUN 30 1964

DATA MGMT

Mr. Steve Green
LEM Dynamics Section
Plant 25
Grumman Aircraft Corp.
Bethpage, Maryland

Dear Steve,

This document was written in answer to NAA and Link's comments on the first document which I presented to you some months ago. The information presented in this second document is directly applicable to the LEM, AMS, and IMCC integrated mode of operation as far as math model compatibility is concerned.

This document is presented for information only. MSC will have a "stripped-down" version of the JPL Ephemeris tape by July 31. If questions arise concerning any areas covered therein, please feel free to contact me at your convenience.

Sincerely,

Sam H. Nassiff
Sam H. Nassiff

w/enc
S. GREEN
E. GORCZYCKI

Massachusetts Institute of Technology
Instrumentation Laboratory
Cambridge, Massachusetts

Space Guidance Analysis Memo #57

TO: SGA Distribution
FROM: Larry D. Brock
DATE: September 16, 1963
SUBJECT: Coordinate System Used in the Moon Position Subroutine

The coordinate system that is used in the moon position subroutine is defined by the mean equator and the mean orbit of the earth (the ecliptic) at the nearest beginning of a Besselian year. For example, the coordinate system used for a mission that begins in the interval from July 1, 1963 through June 30, 1964 would use the mean equator and equinox at the beginning of the Besselian year 1964 (denoted by 1964.0) which occurs January 1.314. The x axis is defined along the ascending node of the ecliptic on the equator (the equinox), the z axis is defined along the mean pole, and the y axis is defined so as to complete a right handed set.

The coordinate system is defined by the mean equator and ecliptic as of a certain date because the true equator and ecliptic are in constant motion.¹ The motion of the equator is caused primarily by the gravitational attraction of the sun and moon of the earth's equatorial buldge and is divided into two components. One component, called luni-solar precession, defines the position of the mean pole and consists of a smooth long period rotation of the mean pole around the pole of the ecliptic with a period of about 26,000 years.

The other component, called nutaton, describes the true pole relative to the mean pole and consists of many oscillatory terms with periods ranging from 19 years to a few days. The primary term is ^{an} irregular circular motion of the true pole about the mean pole with a period of about 19 years and an amplitude of about 9". Nutation is described by two quantities; nutation in longitude ($\Delta\psi$) and nutation in obliquity ($\Delta\epsilon$). These quantities are shown in Fig. 1 and are defined by a series similar to the Brown series for the position

¹ Explanatory Supplement to the Astronomical Ephemeris and American Ephemeris and Nautical Almanac, Her Majesty's Stationery Office, 1961, pp 28.

2. Several of the terms in equation (1) can be neglected in transforming from earth fixed coordinates to the reference coordinates.
3. This is the coordinate system in which much of the data from the Nautical Almanac Office is given such as the position of the moon, sun, stars, etc. Thus possible errors are avoided in transforming these data.

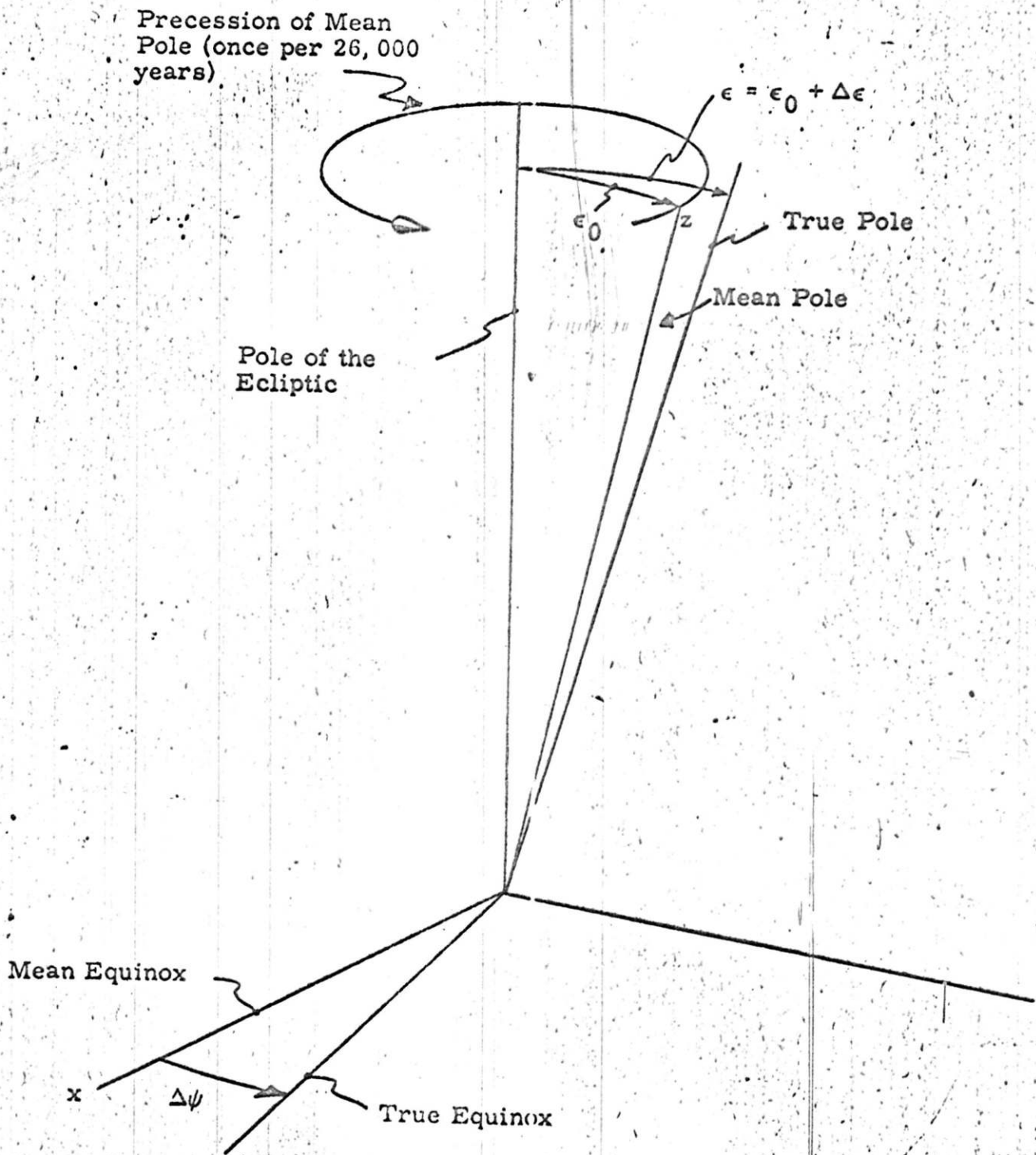

The Motion of the Earth's Pole

Figure 1

of the moon. The Nautical Almanac Office uses all terms of $0''.0002$ or greater. These series are given on pages 44 and 45 of the Explanatory Supplement to the Ephemeris. There are 69 terms for $\Delta\psi$ and 40 terms for $\Delta\epsilon$.

The motion of the ecliptic is called planetary precession and is caused by the gravitational force of the planets on the earth as a whole. It consists primarily of a slow rotation π ($0.47''$ per year) of the ecliptic about a diameter that is also slowly rotating (Π). This precession is shown in Fig. 2.

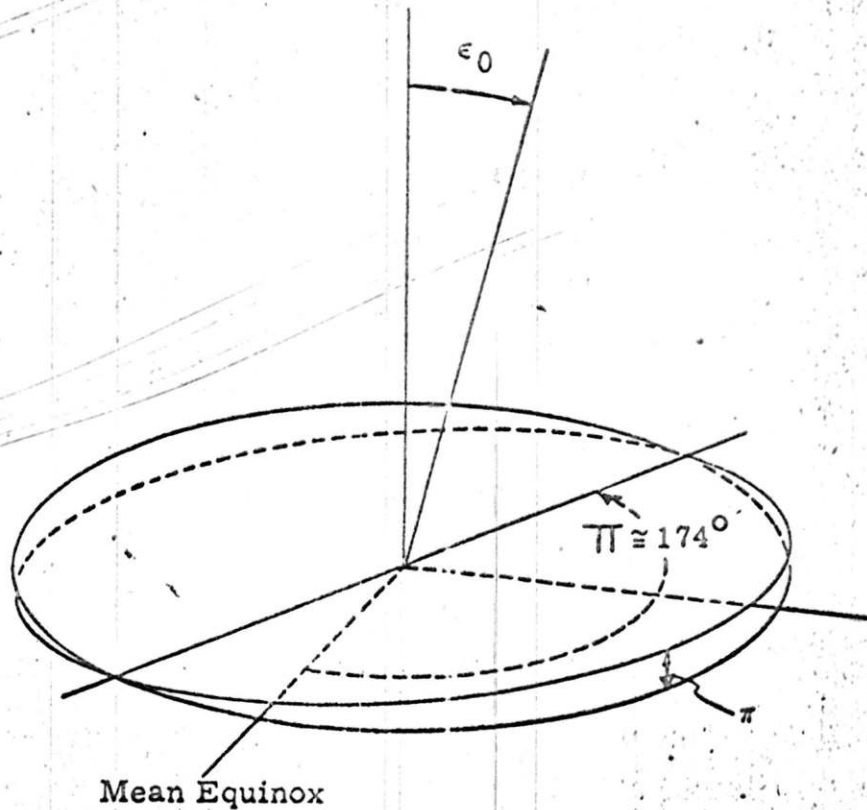

The Motion of the Ecliptic
Figure 2

The precession of the ecliptic is combined with the precessional component of the motion of the equator to form the total precession which defines the mean equator and ecliptic.² A vector in rectangular coordinates referred to the equinox of one epoch (1950.0 + T₀) can be transformed to the rectangular coordinates of the vector referred to another epoch (1950.0 + T₀ + T) by the equation

$$\begin{bmatrix} X \\ Y \\ Z \end{bmatrix} = \begin{bmatrix} X_x & Y_x & Z_x \\ X_y & Y_y & Z_y \\ X_z & Y_z & Z_z \end{bmatrix} \begin{bmatrix} X_0 \\ Y_0 \\ Z_0 \end{bmatrix} \quad (1)$$

where

$$X_x = 1 - (.00029696 + .00000026 T_0) T^2 - .00000013 T^3$$

$$Y_x = -X_y = -(.02234941 + .00001355 T_0) T - .00000676 T^2 + .00000221 T^3$$

$$Z_x = -X_z = -(.00971690 + .00000414 T_0) T + .00000207 T^2 + .00000096 T^3$$

$$Y_y = 1 - (.00024975 + .00000030 T_0) T^2 - .00000015 T^3$$

$$Y_z = Z_y = -(.00010858 + .00000002 T_0) T^2$$

$$Z_z = 1 - (.00004721 - .00000004 T_0) T^2$$

where T₀ and T are in tropical centuries.

Some of the advantages of using a coordinate system referred to the mean equinox at the nearest beginning of the year are the following:

1. The precession of the earth can usually be neglected in computing the earth oblateness acceleration. Since the reference equinox is always within six months of the mean equinox of date, the maximum error in the pole due to precession is about 10".

² Ibid pp. 34

APPENDIX B

STANDARD ASTRODYNAMIC CONSTANTS
AND CONVERSION FACTORS
FOR PROJECT APOLLO

January 8, 1964

Bellcomm, Inc.
Washington, D. C.

J. O. Cappellari, Jr.
Trajectory Department

STANDARD ASTRODYNAMIC CONSTANTS AND
CONVERSION FACTORS FOR PROJECT APOLLO

The attached Appendices list the current standard astrodynamic constants for Project Apollo along with a set of conversion factors in a form suitable for quick access. All values given are identical with those which will appear in the second issue of the OMSF Program Directive entitled "Natural Environment and Physical Standards for Project Apollo."

The present document is intended to serve two primary purposes: (1) to make the standard astrodynamic constants readily available to the user in a non-classified document, and (2) to reflect several minor modifications of the constants contained in the original OMSF document, i.e., the value of G has been slightly modified for the sake of internal consistency; the rotational rate and mean equatorial radius of the Moon have been added; and a set of conversion factors has been furnished.

STANDARD ASTRODYNAMIC CONSTANTS FOR PROJECT APOLLO1 General Constants

1.1 Velocity of light in a vacuum

$$c = 299792.5 \text{ km/sec}$$

1.2 Universal gravitational constant*

$$G = 6.671 \times 10^{-8} \text{ cm}^3 \text{ gm}^{-1} \text{ sec}^{-2}$$

1.3 Astronomical unit

$$\text{a.u.} = 1.49599000 \times 10^8 \text{ km}$$

1.4 Ephemeris Time - Universal Time reduction

The relationship between Ephemeris Time (ET) and Universal Time (UT) is given in the American Ephemeris and Nautical Almanac.

2 Earth Constants

2.1 Equatorial Earth radius (gravitational)

$$R_e = 6378.165 \text{ km}$$

2.2 Flattening

$$f = 1/298.30$$

2.3 Acceleration of gravity at equator

$$g_e = 9.78030 \text{ m/sec}^2$$

2.4 Rotational rate of the Earth

$$\omega_e = \frac{360}{87661.6409892 + 0.00164 T} \text{ deg/sec}$$

where T is the number of Julian centuries from 1900 January 0.5 U.T. (Julian Date = 241 5020.0)

*This slightly modified value of G, adopted for internal consistency, will appear in the second issue of the OMSF document "Natural Environment and Physical Standards for Project Apollo."

2.5 Gravitational potential function

$$\begin{aligned}
 V(r, \phi) = \frac{\mu_e}{r} & \left[1 + \frac{J}{3} \left(\frac{R_e}{r} \right)^2 (1 - 3 \sin^2 \phi) \right. \\
 & + \frac{H}{5} \left(\frac{R_e}{r} \right)^3 (3 - 5 \sin^2 \phi) \sin \phi \\
 & \left. + \frac{D}{35} \left(\frac{R_e}{r} \right)^4 (3 - 30 \sin^2 \phi + 35 \sin^4 \phi) \right]
 \end{aligned}$$

where $J = 1.62345 \times 10^{-3}$

$H = -5.75 \times 10^{-6}$

$D = 7.875 \times 10^{-6}$

r = magnitude of geocentric radius vector

ϕ = geocentric latitude

2.6 Gravitational parameter

$$\mu_e = GM_e = 3.986032 \times 10^5 \text{ km}^3/\text{sec}^2$$

2.7 Mass of the Earth

$$M_e = 5.975 \times 10^{24} \text{ kg}$$

3 Lunar Constants

3.1 Mean lunar radius

$$R = 1738.09 \text{ km}$$

3.2 Rotational rate of the Moon

$$\omega_m = \frac{360}{2360591.545 + 0.014T} \frac{\text{deg}}{\text{sec}}$$

where T is the number of Julian centuries from 1900

January 0.5 U.T. (Julian Date = 241 5020.0)

3.3 Principal axes

$$a = 1738.57 \text{ km}$$

$$b = 1738.21 \text{ km}$$

$$c = 1737.49 \text{ km}$$

where a is directed toward the mean center of the lunar disk, c is coincident with the Moon's rotational axis and b is perpendicular to a and c.

3.4 Principal moments of inertia

$$A = 8.8782 \times 10^{34} \text{ kg meters}^2$$

$$B = 8.8800 \times 10^{34} \text{ kg meters}^2$$

$$C = 8.8837 \times 10^{34} \text{ kg meters}^2$$

3.5 Earth-Moon mass ratio

$$M_e/M_m = 81.3015$$

3.6 Gravitational parameter

$$\mu_m = GM_m = 4.902778 \times 10^3 \text{ km}^3/\text{sec}^2$$

3.7 Gravitational potential function

$$V(r, \phi, \theta) = \frac{\mu_m}{r} \left[1 + \frac{J}{3} \left(\frac{R_m}{r} \right)^2 (1 - 3 \sin^2 \phi) + L \left(\frac{R_m}{r} \right)^2 (\cos^2 \phi \cos 2\theta) \right]$$

where: $J = 3109 \times 10^{-7}$

$$L = 608 \times 10^{-7}$$

r = magnitude of selenocentric radius vector

ϕ = selenocentric latitude

θ = selenocentric longitude

$$R_m = 1738.39 \text{ km} = \text{mean equatorial radius of the Moon}$$

4 Solar and Planetary Constants

Planet	Mass Ratio M_s/M_{Planet}	Gravitational Constant km^3/sec^2
Sun	1	$1.32715445 \times 10^{11}$
Venus	408645	3.247695×10^5
Earth	332951.3	3.986032×10^5
Mars	3,088,000	4.297780×10^4
Jupiter	1047.39	1.267106×10^8

5 Ephemerides

The ephemerides of celestial bodies (Sun, Moon and planets) to be used shall be the comprehensive set being prepared by the Jet Propulsion Laboratory (to be made available in late 1963). The JPL material consists of three magnetic tapes covering the years 1950 - 2000, an engineering document describing the data and tape format, plots of residuals, and symbolic and binary decks of user subroutines, suitable for use on the IBM 7094. Data not provided within this source shall be taken from the American Ephemeris and Nautical Almanac.

6 Atmospheric Models

The atmospheric models to be used in Apollo reference trajectory calculations are as follows:

- a. For launch phase calculations, the Patrick Reference Atmosphere is to be used up to 35 km, and the U. S. Standard Atmosphere, 1962, is to be used above 35 km.

- b. For reentry calculations, the U. S. Standard Atmosphere, 1962, is to be used.

October 25, 1963

CONVERSION FACTORS

In the following table of conversion factors all lengths are given in International units, e.g., International feet, nautical miles, statute miles, etc. Those conversion factors denoted by an asterisk are to be considered as exact.

In order to convert

<u>From</u>	<u>To</u>	<u>Multiply By</u>
feet	meters	0.3048 0000*
meters	feet	3.2808 3990
sq. feet	sq. meters	0.0929 0304*
sq. meters	sq. feet	10.7639 1042
nautical miles	kilometers	1.8520 0000*
statute miles	kilometers	1.6093 4400*
nautical miles	feet	6076.1154 8556
pounds	kilograms	0.4535 9237*
kilograms	pounds	2.2046 2262
pounds	slugs	0.0310 80950
slugs	pounds	32.1740 4856
kilograms	slugs	0.0685 21766
slugs	kilograms	14.5939 0294

<u>From</u>	<u>To</u>	<u>Multiply By</u>
pounds/sq. foot	kilograms/sq. meter	4.8824 2764
kilograms/sq. meter	pounds/sq. foot	0.2048 16144
degrees	radians	0.01745 32925
radians	degrees	57.29577 95131
π	=	3.14159 26536
g_0 (meters/sec/sec)	=	9.8066 5000*
g_0 (feet/sec/sec)	=	32.1740 4856

For reference purposes only, the relationship between the U. S. Survey Foot and the meter is included:

feet (U. S. Survey)	meters	0.3048 0061
meters	feet (U. S. Survey)	3.2808 3333

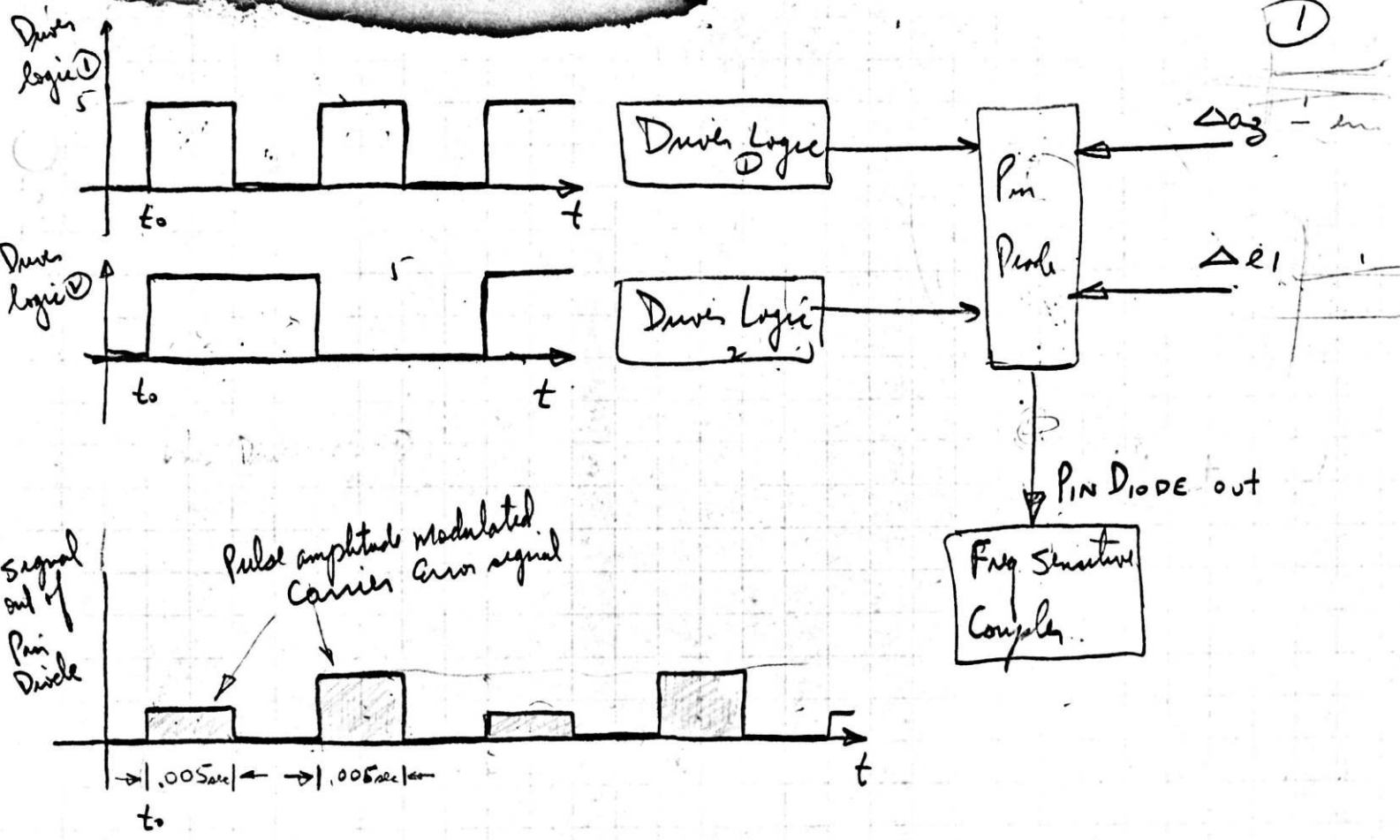

When Driver Logic ① is ON } $\Rightarrow \Delta a_2$ Error sees "off axis" signal reaches
 and " " " ② is ON } Freq sensitive coupler (shown in blue)

When Driver Logic ① is off } \Rightarrow No signal gets out of Pin diode
 and " " logic ② is ON

When Driver logic ① is ON } Δe_1 Error sees "off axis" signal reaches
 and " " " ② is OFF } Freq sensitive coupler (shown in purple)

When Driver logic ① is off } \Rightarrow No signal gets out of Pin diode
 and " " " ② is off

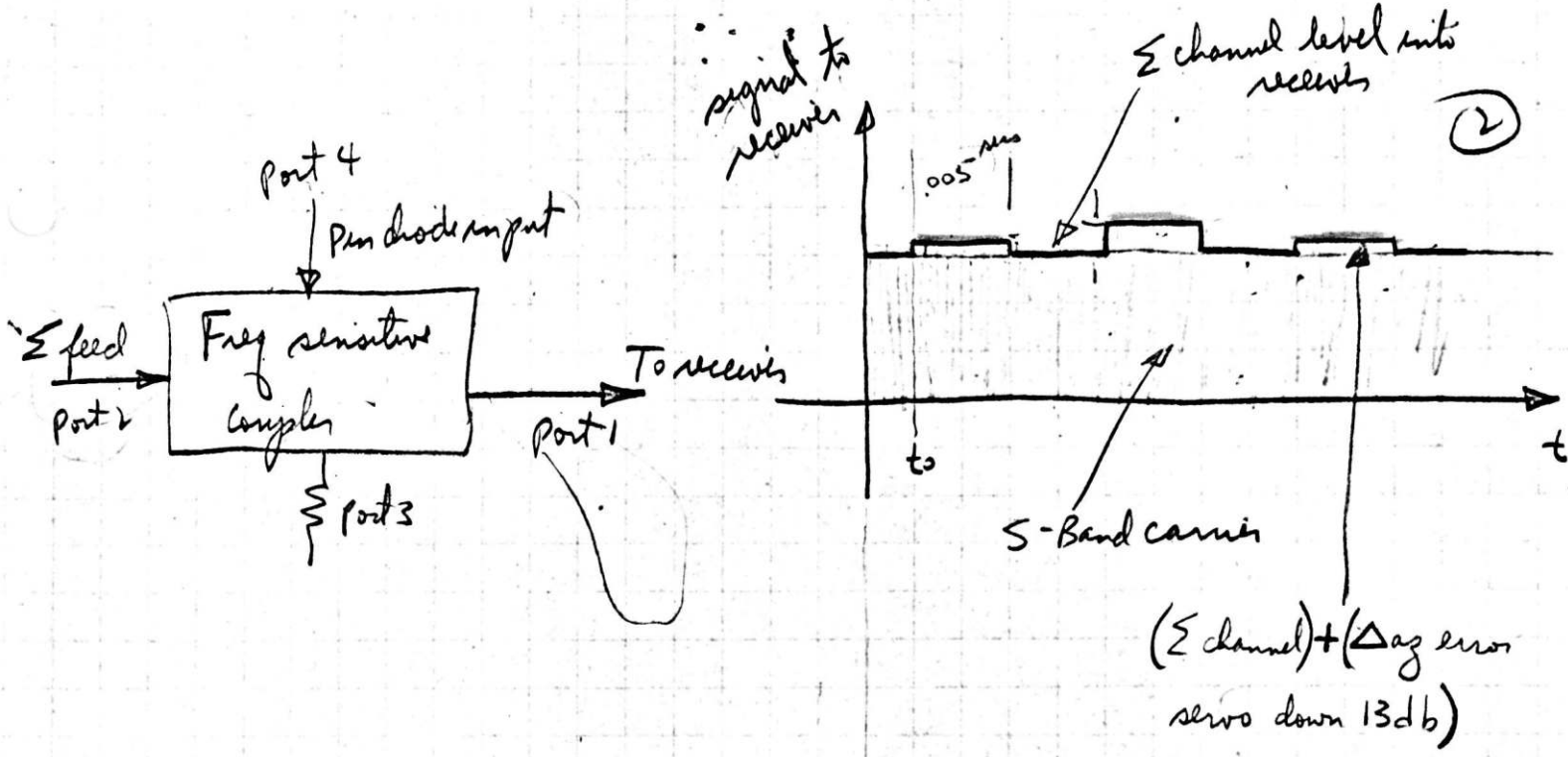

The fast AGC loop in the receiver will respond to the Pulse A.M. and generate a voltage proportional to the magnitude of signal sent into the receiver

This signal is now passed thru an RC circuit to remove its DC value

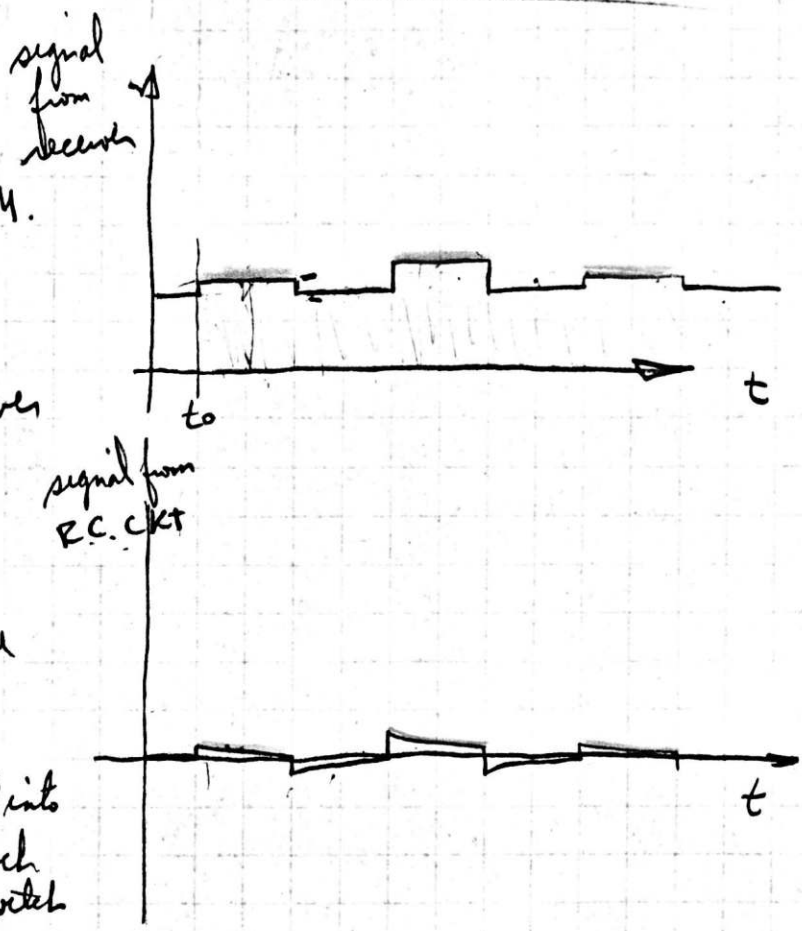
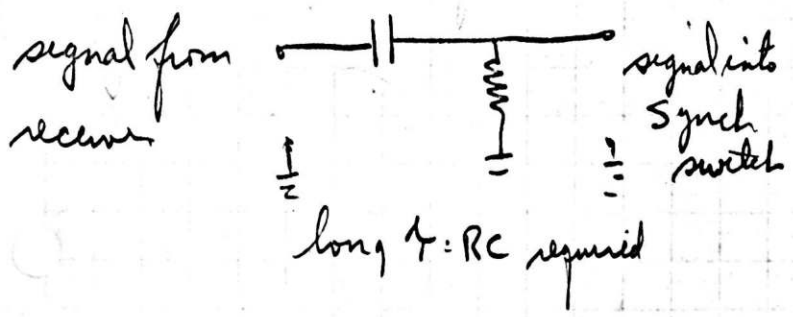

Now signal is sent to the Synchronous Switch

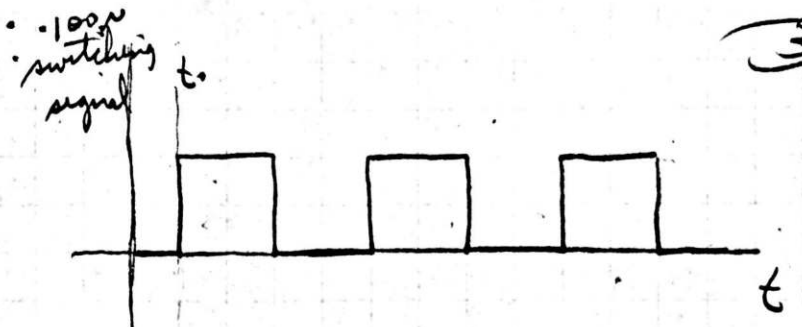
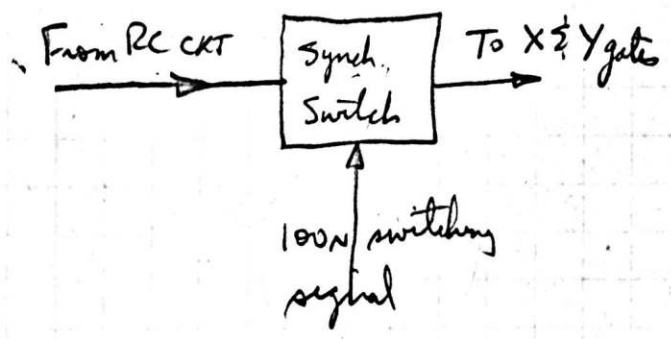

The output of Synch. Switch will be zero when the 100n switching signal into it is zero.

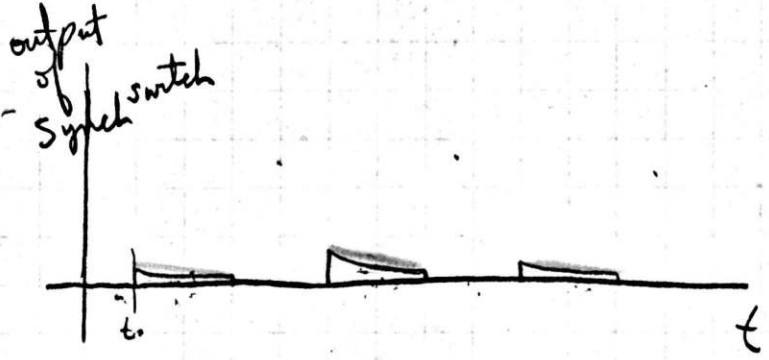
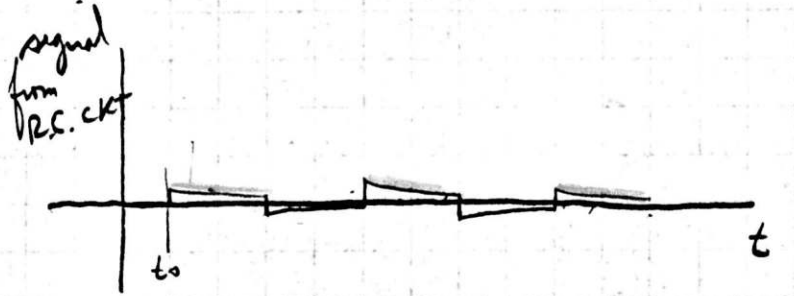

The input to both the Xg gate and Yg gate is the output of the Synch SW. However the Xg & Yg gates are opened and closed by a 50n drive. Since this is a synchronous drive the Xg signal & Yg signal will be sent to their respective channels.

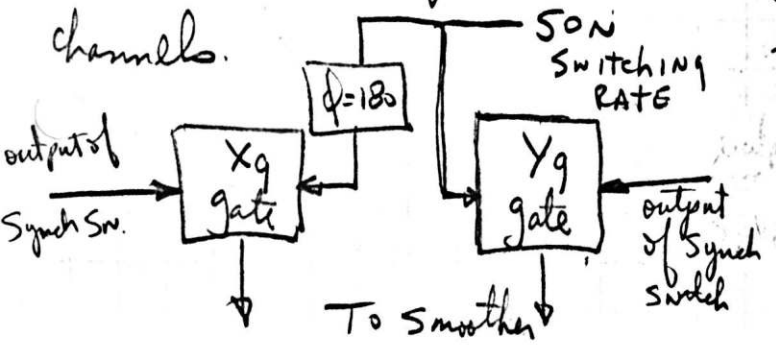
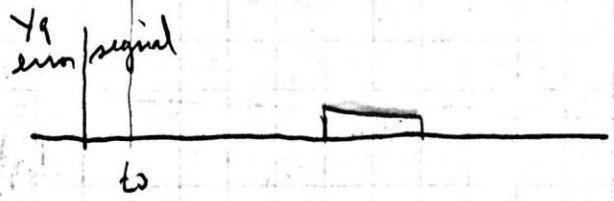
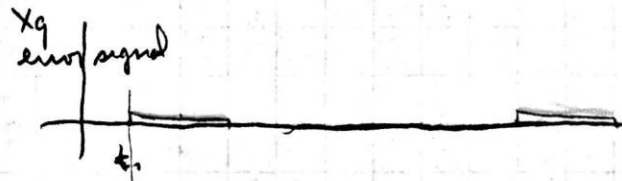
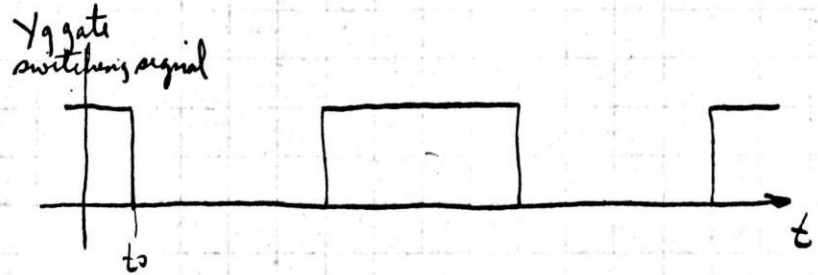
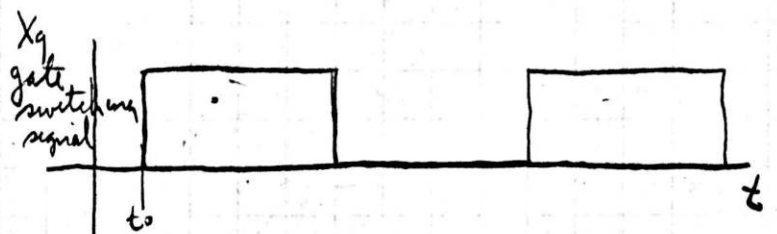

STEERABLE ANTENNA PACKAGE

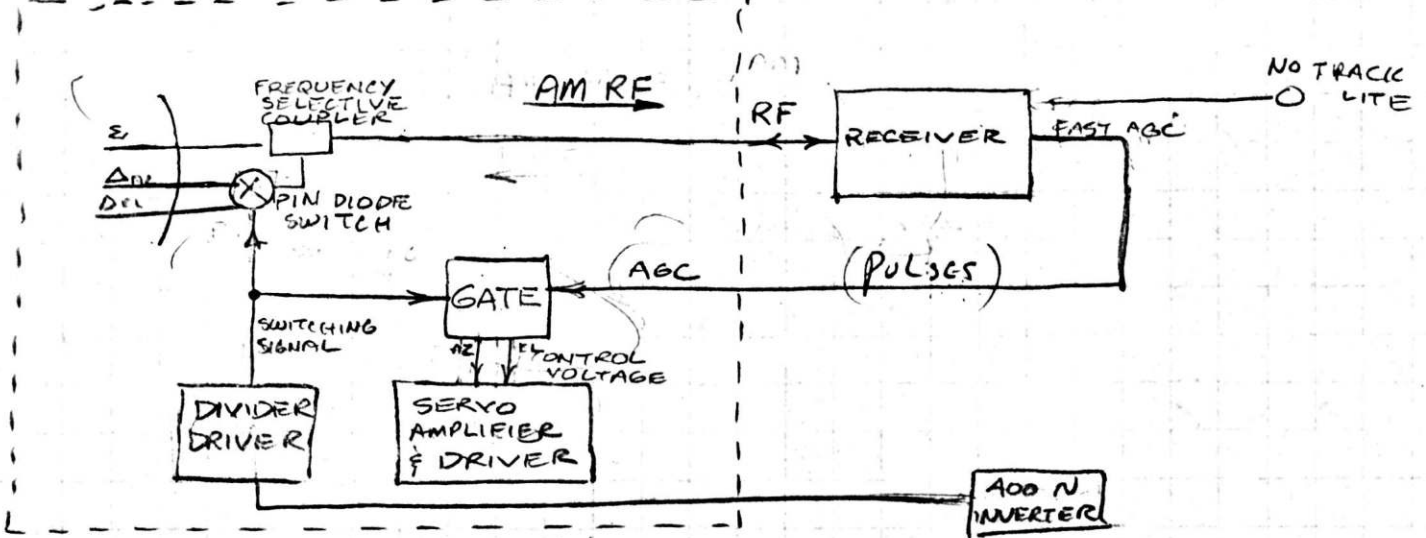

FREQ SELECTIVE COUPLER - HYBRID FILTER

2/1/2
2/5/2

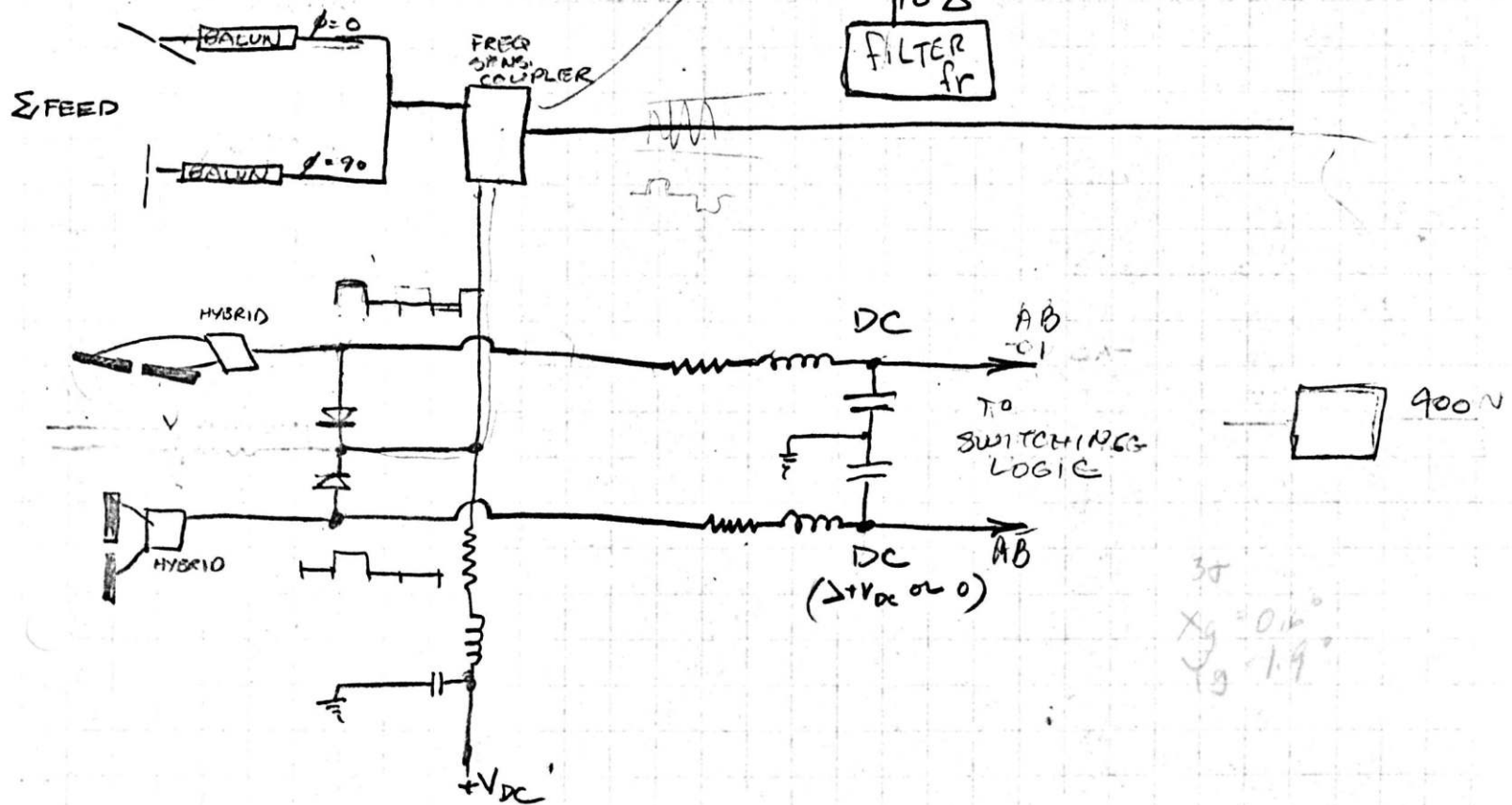
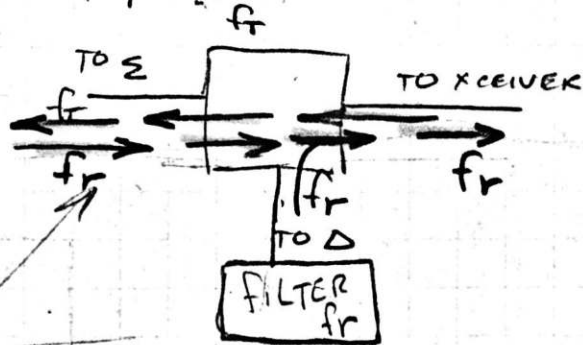

30
 $X_g = 0.1$
 $Y_g = 1.4$

UNITED STATES GOVERNMENT

Memorandum

RECD

JUN 30 1964

DATA MGMT

TO : CF/Flight Crew Support Division
Attention: Mr. S. H. Nassiff

FROM : OM/Chief, Mission Planning and
Analysis Division

SUBJECT: IMCC and AMS Mathematical Model; Comments and
Recommendations

In reply refer to:
OM (HDB:svm)

- References:
- (a) "IMCC and AMS Mathematical Model Compatibility Requirements" NASA Manned Spacecraft Center, OMA (HDB:svm), November 8, 1963
 - (b) Memorandum from North American, "Preliminary Comments on Reference (a)"
 - (c) Document by the Office of Manned Space Flight, M-D E 8020.008A, "Natural Environment and Physical Standards for Project Apollo"
 - (d) Document by Goddard Space Flight Center, dated May 1, 1963, "Interplanetary Trajectory Encke Method (ITEM) Program Manual"
 - (e) ARL Technical Report 60-281, dated August 1960

1. Introduction

a. At the request of the Flight Simulation Branch of the Flight Crew Support Division, the following has been prepared in an effort to better define compatibility requirements between the AMS and IMCC mathematical models, and to reply to the comments by North American and Link Division of General Precision (reference (b)).

b. The paragraphs in this memorandum are generally in the order of comments as they appear in reference (b).

2. Standardization

a. To effect compatibility between the AMS and IMCC, standardization of the mathematical models is required with respect to physical constants, coordinate systems, and ephemeris data.

b. Standardization in symbology and units of measurement is required at least for output quantities.

3. Basic Coordinate System

a. Either of two basic geocentric coordinate systems are being considered for the lunar trajectory programs in the IMCC. Both systems are essentially the usual geocentric equatorial inertial coordinate systems; in one system the basic reference is mean of date, and in the second system the reference is of a particular epoch such as the nearest beginning of the Besselian year.

b. Appendix A defines some of the advantages of using a coordinate system referenced to a particular epoch. This appendix is included for information only, and it may not be concluded that a fixed reference frame will necessarily be used in the IMCC.

c. Though the preparation of the special ephemeris tapes will be dictated by the choice of reference systems, the formulation of the trajectory programs may well be independent of the choice. This will be discussed further in the Ephemeris section of this memorandum (paragraph 7).

d. On the basis of the information available at this time, it is recommended that the coordinate system for the AMS be referenced to the mean earth equatorial plane and the mean equinox of the nearest beginning of the Besselian year. If in the future it is decided that the coordinate system of a fixed epoch will not be used in the IMCC earth-moon model, the only modification necessary to effect compatibility between the AMS and the IMCC will be in the ephemeris tape routine for the AMS.

4. Method of Trajectory Computation

a. There should be no requirement for the mathematical models in the AMS and IMCC to employ the same methods of trajectory computation or methods of integration. The only requirement should be on the accuracy of the computations within the AMS. When operating with the IMCC, the AMS should be capable of computing the trajectory parameters accurately within certain limits. When these accuracy limits are exceeded, AMS trajectory updating should be required. These limits are discussed in the section on AMS trajectory accuracy (paragraph 11).

b. For information, the advantages and disadvantages of special trajectory computation techniques as well as bases for comparison are considered in detail in reference (e).

5. Earth-Moon Plane Coordinate System

The moon's orbital plane is the fundamental plane of the rotating geocentric earth-moon plane coordinate system as described in reference (a). The XMP axis is directed outward from the geocenter along the earth-moon line, the YMP axis lies in the earth-moon plane, and the ZMP axis completes the right-handed orthogonal coordinate system.

6. Unit of Time

a. Reference (a) implied a requirement for time output to be in days, hours, minutes and seconds, exclusively. This is incorrect; though the mission will (probably) be referenced to GMT, thrust phases would also probably be referenced to elapsed time from phase initiation - in seconds.

b. The unit of time measurement in the computation of the trajectory is immaterial; only the AMS and IMCC output units must be compatible.

c. In the ephemeris, lunar positions and velocities are referred to the geocentric equatorial rectangular reference frame of the mean equator and equinox of 1950.0 = JD 243 3282.423. In the IMCC, the epoch for which data will be required will be in Universal Time. Because the ephemeris data is in Ephemeris Time, the Universal Time epoch must be converted to Ephemeris Time prior to entering the interpolation routine.

7. Standard Ephemeris

a. The JPL ephemeris package should be ready for distribution in the immediate future. It is understood that the package shall consist of at least the following:

(1) Three magnetic tapes containing ephemerides of the sun, moon, and planets for the years 1950 through 2000.

(2) Two documents, which in part describe in detail the data, tape format, and certain subroutines.

(3) Symbolic and binary decks of user subroutines suitable for the IBM 7094.

b. The details of the JPL ephemeris will influence the choice of the basic reference system for the IMCC lunar programs. If the data on the ephemeris tapes is referenced to a fixed epoch, it will perhaps be more convenient computationally to reference the basic frame to the nearest beginning of the Besselian year than continuously rotate to obtain a coordinate system referenced to the mean of date. Appendix A contains excerpts from an MIT memorandum in which the advantages of referencing to a particular epoch are discussed.

c. The recommended data interpolation routine suitable for use on the IBM 7094, is included in the JPL ephemeris package. Though it would not be necessary that any routine used be checked with the JPL routine as a standard.

Through Mission Planning and Analysis Division, a specialized routine is available which affords certain advantages in terms of computer storage requirements and computational speed. The routine is programmed in Fortran IV and is suitable for use on the IBM 7094.

d. The standard ephemeris package will be made available to North American and Link at the earliest possible time.

4

8. Necessary Complexity of the Mathematical Model for the AMS

a. The required frequency of AMS trajectory update, of course, depends upon the AMS trajectory accuracy requirements as stated in paragraph 11. If this frequency of required update is to be at all minimized, it is recommended that the AMS mathematical model include at least an oblate earth, a triaxial moon, and the sun.

b. Solar pressure and the planetary perturbations are not significant; and on the basis of the best known value for the earth equatorial ellipticity term, the ellipticity may be ignored without serious consequence.

c. For computational efficiency, it is felt that for orbit computation in the immediate vicinity of the oblate earth, lunar triaxiality and the sun perturbation may be ignored; when in the immediate vicinity of the triaxial moon, earth oblateness terms may be ignored.

9. Basic Features of the IMCC Trajectory Programs

a. Because it was felt that many of the features of the ITEM Program would be of interest and of some value in the formulation of the AMS trajectory model, the mathematical appendices from the ITEM Program Manual were included in reference (a).

b. Though many of the basic features of the ITEM Program and the IMCC trajectory program will be very similar, it must be emphasized that in general, the IMCC program will bear little resemblance to the ITEM Program; certainly, the two programs must not be considered synonymous.

10. Thrusting Logic

Except for the earth launch and the translunar injection phases, MIT guidance will be primarily employed during each of the thrust phases of the Apollo mission. In the IMCC, during thrusting, a Cowell technique will be used for integrating the equations of motion.

11. Recommended AMS Trajectory Computation Accuracy and Update Requirement

a. The complexity of the AMS mathematical model and the necessary frequency of AMS trajectory update depend primarily upon the allowable tolerances placed upon position and velocity computation within the AMS. It is impossible to state either position or velocity tolerances which would be applicable during the duration of an Apollo mission. Accuracy tolerances which would be meaningful during particular phases of a mission would be unreasonable during other phases. However, at least the following recommendations are feasible.

(1) During the translunar coast phase, it is recommended that the vectorial difference between the predicted AMS and IMCC pericyynthion vectors be less than five nautical miles.

During the transearth coast phase, it is recommended that the vectorial difference between the predicted AMS and IMCC return perigee vectors be less than ten nautical miles.

When these vectorial differences are exceeded, it is recommended that updating be required.

12. In reference (b) it was proposed that certain computations be deleted from the AMS program.

While it is advantageous to eliminate as many computations as possible, it is necessary to incorporate a certain degree of versatility in order that the AMS program may satisfy future display requirements. The ecliptic coordinates, for instance, may be quite useful in shadow simulation; and the osculating elements computation may be necessary for the guidance implementation. The other proposed deletions seem in order.

13. Appendix B is a copy of "Standard Astrodynamic Constants and Conversion Factors for Project Apollo" dated January 8, 1964. The unclassified memorandum was distributed by Bellcomm and is compatible with the information in reference (c) which is confidential. The unclassified document contains convenient conversion factors which are not included in reference (c). In particular, the nautical miles-to-feet conversion is of interest.

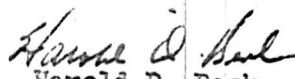
Harold D. Beck
Head, Lunar Trajectory Section

Enclosures 2

APPROVAL:



John P. Mayer
Chief, Mission Analysis Division

PROPRIETARY

E. Gorczycki

GRUMMAN AIRCRAFT ENGINEERING CORPORATION

LEM ENGINEERING MEMORANDUM

LMO-540-286

1 April 1964

Subject: Fundamental Navigation Matrices

From: *MJF J.E.K.*
M. J. Fish and J. E. Kmiecik,
Systems Analysis, Ext. 1341

To:

A. Alexandrovitch	W. Nufer
E. Bonan	P. Nolan
R. Carbee	M. Olstad
S. Chomak	H. Otten
R. Fleisig	R. Phagan
T. Haggerty	C. W Rathke/T. J. Kelly
G. Henderson	E. Stern
T. Heuermann	L. Tucker
R. Knoetgen	L. VanDercreek
R. Kress	A. B. Whitaker
J. McNamara	M. Yablon
A. Nathan	F. Yagi

Primary No. 663

Secondary No. 027/038

PROPRIETARY



TABLE OF CONTENTS

	<u>PAGE</u>
References	
Introduction	1
Fundamental Navigation Matrices	
1. General Solution of the Linearized Trajectory	2
2. The Vector Velocity Correction	14
3. Differential Equation Solutions	19
4. The State Transition Matrix	24



References

1. Battin, Richard H., A Statistical Optimizing Navigation Procedure for Space Flight, R-341, MIT Instrumentation Laboratory, Cambridge, Massachusetts, September 1961, Revised May 1962.
2. Baker, Robert M. L. Jr. and Makemson, Maud W., An Introduction to Astrodynamics, Academic Press, N.Y., 1960.
3. Coddington, Earl A. and Levinson, Norman, Theory of Ordinary Differential Equations, McGraw-Hill Book Company, Inc., N. Y., 1955.
4. Halmos, Paul R., Finite-Dimensional Vector Spaces, 2nd ed., D. Van Nostrand Company, Inc., Princeton, New Jersey, 1958.
5. McLean, John D., Schmidt, Stanley F., and McGee, Leonard A., Optimal Filtering and Linear Prediction Applied to a Midcourse Navigational System for the Circumlunar Mission, NASA, Technical Note D-1208.
6. Laning, J. Halcombe and Battin, Richard H., Random Processes in Automatic Control, McGraw-Hill Book Company, Inc., 1956.
7. Fish, Maurice J., Kopp, Richard E., Liban, Eric, The Adjoint Method for Obtaining the Mean Square Response in a Time Varying Linear System, Research Report RE-144, Grumman Aircraft Engineering Corporation, January 1961.
8. Stone, C. R., Johnson, Charles W., Smith, Fred B., Lee, E. Bruce, and Harvey, Charles A., Time-Optimal Control of Linear Systems, Aero. Document R-ED 6134, Minneapolis-Honeywell Regulator Company, September 1, 1959.



PROPRIETARY

IMO-540-286
M. J. Fish/J. E. Kmiecik

Page 1
1 April 1964

INTRODUCTION

The report R-341 entitled A Statistical Optimizing Navigation Procedure For Space Flight, revised edition, May 1962, by Richard H. Battin of the MIT Instrumentation Laboratory, Ref. 1, is written in an unusually concentrated fashion. For this reason, simply to read the report with some sort of understanding is a prodigious task. Indeed the writers of this present memorandum have found that their colleagues who have attempted to do this found the task too formidable and consequently they just did not read the report.

In this present memorandum, the writers have selected Chapter 3, R-341, Fundamental Navigation Matrices for clarification. They have supplied the steps which are missing in the original exposition, together with detailed explanations of the mathematics and the terminology. Although this paper is complete within itself, it is suggested that it be read in conjunction with R-341. Then the reader can decide how well the writers have succeeded in their purpose.

The nomenclature and symbols conform to those used by Battin. Definitions are provided for the symbols as they are introduced. When there is no ambiguity, arguments of functions are deleted for convenience; that is R is used instead of $R(t)$, \underline{x} instead of $\underline{x}(t)$.

No attempt has been made to pass judgement on the value of Battin's proposed navigation and guidance system. This would be presumptuous until all of R-341 is presented in such a manner that it can be better understood. Although Battin's N & G scheme is applied for translunar midcourse navigation and orbital navigation phases it is essentially the same for LEM rendezvous mission, as stated in the LEM N & G systems meeting No. 6, held at Houston on October 3, 1963. The mathematical procedures which are used in the R-341 report also constitute the fundamental building blocks for other navigation and guidance procedures, as well as their error analyses.

PROPRIETARY



FUNDAMENTAL NAVIGATION MATRICES

Basic to the solution of the navigation problem is a certain collection of matrices, which will be introduced here. The role which these matrices play in the navigation theory is indicated, and it is shown how they may be obtained as solutions of differential equations.

1. General Solution of the Linearized Trajectory Equations

Consider a vehicle which is launched into orbit at time t_L and travels under the influence of a gravity field to reach a target point at time t_A . The navigation procedure is based on the assumption that a standard reference trajectory has been precalculated. Let $\underline{r}_O(t)$ and $\underline{v}_O(t)$ be the position and velocity vectors at time t for a vehicle travelling on the reference path. Since there are initial errors which are due to the inability to put the vehicle into the exact reference orbit at injection or launch, the true position and velocity vectors $\underline{r}_S(t)$ and $\underline{v}_S(t)$ will not correspond with the associated reference values. The assumption is that these deviations from the reference trajectory are small throughout the complete path so that linearized equations can be considered valid.

To find the basic equations of motion, first let $\underline{r}_S(t)$ and $\underline{v}_S(t)$ denote the position and velocity at time t of the vehicle in an inertial coordinate system. Lower case letters with an underlying bar are used to represent column vectors. That is:

$$\underline{r}_S(t) = \begin{vmatrix} x_S(t) \\ y_S(t) \\ z_S(t) \end{vmatrix} \quad \text{and} \quad \underline{v}_S(t) = \begin{vmatrix} v_{x_S}(t) \\ v_{y_S}(t) \\ v_{z_S}(t) \end{vmatrix} \quad (1.1)$$



When the vehicle is in free fall, that is no propulsion is applied, the equations of motion for unit mass are:

$$\frac{d\underline{r}_s(t)}{dt} = \underline{v}_s(t), \quad \frac{d\underline{v}_s(t)}{dt} = -\mu \frac{\underline{r}_s(t)}{r_s^3} \equiv \underline{g}(\underline{r}_s, t). \quad (1.2)$$

In the above μ equals $G(m_1 + m_2)$, in the cgs system, for a two body problem. This can be replaced by Gm , where m is the mass of the more ponderous body. For a space ship in orbit around the Earth, m would be the mass of the Earth. G is the universal gravitational constant, Ref. 2, p. 16, and is not to be confused with the matrix $G(\underline{r}_0, t)$, Eq. (1.9).

Let the vectors $\underline{r}_0(t)$ and $\underline{v}_0(t)$ denote the position and velocity at time t , which the vehicle would have if it adhered exactly to the reference trajectory. The corresponding differential equations for the vehicle reference trajectory are:

$$\frac{d\underline{r}_0}{dt} = \underline{v}_0(t), \quad \frac{d\underline{v}_0}{dt} = \underline{g}(\underline{r}_0, t). \quad (1.3)$$

The deviations $\delta\underline{r}$ and $\delta\underline{v}$ at time t which represent the differences between the actual and the reference positions and velocities respectively are defined by:

$$\delta\underline{r}(t) = \underline{r}_s(t) - \underline{r}_0(t), \quad \delta\underline{v}(t) = \underline{v}_s(t) - \underline{v}_0(t). \quad (1.4)$$

Now

$$\frac{d}{dt}(\delta\underline{r}) = \frac{d}{dt}(\underline{r}_s) - \frac{d}{dt}(\underline{r}_0) = \underline{v}_s - \underline{v}_0 \equiv \delta\underline{v}, \quad (1.5)$$

and

$$\frac{d}{dt}(\delta\underline{v}) = \frac{d}{dt}(\underline{v}_s) - \frac{d}{dt}(\underline{v}_0) = \underline{g}(\underline{r}_s, t) - \underline{g}(\underline{r}_0, t). \quad (1.6)$$



The x , y , and z components of $\underline{g}(\underline{r}_s, t)$ and $\underline{g}(\underline{r}_o, t)$ are respectively:

$$\underline{g}(\underline{r}_s, t) = [g_x(x_s, y_s, z_s, t) : g_y(x_s, y_s, z_s, t) : g_z(x_s, y_s, z_s, t)]$$

and

(1.7)

$$\underline{g}(\underline{r}_o, t) = [g_x(x_o, y_o, z_o, t) : g_y(x_o, y_o, z_o, t) : g_z(x_o, y_o, z_o, t)].$$

Since it has been assumed that the deviation of the actual trajectory from the nominal is small, a Taylor's series representation in which the higher order terms are discarded of $\underline{g}(\underline{r}_s, t)$ about $\underline{r}_o(t)$ is valid. The Taylor's series is:

$$g_i(x_s, y_s, z_s, t) \cong g_i(x_o, y_o, z_o, t) + \frac{\partial(g_i)_o}{\partial x_s} (x_s - x_o) + \frac{\partial(g_i)_o}{\partial y_s} (y_s - y_o) + \frac{\partial(g_i)_o}{\partial z_s} (z_s - z_o) \quad (1.8)$$

In Eq. (1.8) $i=x_s, y_s, z_s$ components, and all derivatives are evaluated at x_o, y_o, z_o . This equation can be rewritten as:

$$\begin{aligned} \underline{g}(\underline{r}_s, t) - \underline{g}(\underline{r}_o, t) &\cong \left(\frac{\partial g_{x_s}}{\partial x_s} \right)_o (x_s - x_o) + \left(\frac{\partial g_{x_s}}{\partial y_s} \right)_o (y_s - y_o) + \left(\frac{\partial g_{x_s}}{\partial z_s} \right)_o (z_s - z_o) \\ &+ \left(\frac{\partial g_{y_s}}{\partial x_s} \right)_o (x_s - x_o) + \dots \\ &+ \left(\frac{\partial g_{z_s}}{\partial x_s} \right)_o (x_s - x_o) + \dots \end{aligned}$$



In matrix form this latter is:

$$\underline{g}(\underline{r}_s, t) - \underline{g}(\underline{r}_0, t) \cong \begin{bmatrix} \left(\frac{\partial g_{x_s}}{\partial x_s}\right)_0 & \left(\frac{\partial g_{x_s}}{\partial y_s}\right)_0 & \left(\frac{\partial g_{x_s}}{\partial z_s}\right)_0 \\ \left(\frac{\partial g_{y_s}}{\partial x_s}\right)_0 & \left(\frac{\partial g_{y_s}}{\partial y_s}\right)_0 & \left(\frac{\partial g_{y_s}}{\partial z_s}\right)_0 \\ \left(\frac{\partial g_{z_s}}{\partial x_s}\right)_0 & \left(\frac{\partial g_{z_s}}{\partial y_s}\right)_0 & \left(\frac{\partial g_{z_s}}{\partial z_s}\right)_0 \end{bmatrix} \cdot \begin{bmatrix} x_s - x_0 \\ y_s - y_0 \\ z_s - z_0 \end{bmatrix} \quad (1.9)$$

The matrix above consisting of first order partial derivatives is denoted by $G(\underline{r}_0, t)$. In what follows, upper case or capital letters will be used for matrix notation. From Eqs. (1.5) and (1.6), the equations of motion can be written as:

$$\frac{d}{dt}(\delta \underline{r}) = \delta \underline{v}, \quad \frac{d}{dt}(\delta \underline{v}) \cong G(\underline{r}_0, t) \delta \underline{r} \quad (1.10)$$

in which $\delta \underline{r}$ has the components $x_s - x_0$, $y_s - y_0$ and $z_s - z_0$.

To evaluate the elements of $G(\underline{r}_0, t)$, remember that $\underline{g}(\underline{r}_s, t) = -\mu \underline{r}_s / r_s^3$. The x, y, and z components of the right side of this identity are:

$$-\mu \frac{x_s}{r_s^3}, \quad -\mu \frac{y_s}{r_s^3}, \quad -\mu \frac{z_s}{r_s^3} \quad (1.11)$$

Then

$$\left(\frac{\partial g_{x_s}}{\partial x_s}\right)_0, \quad \left(\frac{\partial g_{x_s}}{\partial y_s}\right)_0, \quad \left(\frac{\partial g_{x_s}}{\partial z_s}\right)_0 \quad \text{are}$$

respectively:

$$-\left(\frac{\mu}{r_s^5} (r_s^2 - 3x_s^2)\right)_0, \quad \left(\frac{3\mu}{r_s^5} x_s y_s\right)_0, \quad \text{and} \quad \left(\frac{3\mu}{r_s^5} x_s z_s\right)_0.$$



For this differentiation, use is made of the fact that

$$\text{and } \underline{r}_0 = (x_0^2 + y_0^2 + z_0^2)^{\frac{1}{2}}$$

$$\underline{r}_s = (x_s^2 + y_s^2 + z_s^2)^{\frac{1}{2}}$$

The matrix $G(\underline{r}_0, t)$ can now be written as:

$$\begin{bmatrix} -\left(\frac{\mu}{r_s^3}(r_s^2 - 3x_s^2)\right)_0 & \left(\frac{\mu}{r_s^3} 3x_s y_s\right)_0 & \left(\frac{\mu}{r_s^3} 3x_s z_s\right)_0 \\ \left(\frac{\mu}{r_s^3} 3y_s x_s\right)_0 & -\left(\frac{\mu}{r_s^3}(r_s^2 - 3y_s^2)\right)_0 & \left(\frac{\mu}{r_s^3} 3y_s z_s\right)_0 \\ \left(\frac{\mu}{r_s^3} 3z_s x_s\right)_0 & \left(\frac{\mu}{r_s^3} 3z_s y_s\right)_0 & -\left(\frac{\mu}{r_s^3}(r_s^2 - 3z_s^2)\right)_0 \end{bmatrix} \quad (1.12)$$

In Ref. 1, p. 14, Battin states that the matrix $G(\underline{r}_0, t)$ is symmetrical. The development which has just been presented here proves this assertion. The elements of $G(\underline{r}_0, t)$ are functions of the characteristics of the reference trajectory and are independent of the components of \underline{r}_0 .

At the bottom of p. 11, Ref. 1, Battin develops a useful fundamental set of solutions of Eqs. (1.10) in an extremely cursory manner. Since the general solution of this system of six first order differential equations can be expressed as a superposition of six fundamental solutions, we shall digress at this point to explain what is meant by a fundamental set of solutions of a linear homogeneous system of ordinary differential equations. The term linear homogeneous system can be written as (LH).

On pps. 68-69 of Ref. 3, the definition of a fundamental matrix of solutions will be found, the highlights of which will be presented here. Let $A(t)$ be an $n \times n$ matrix with elements a_{ij} of continuous complex functions on a real time interval (T_1, T_2) . Then the linear system of differential equations

$$\frac{d\underline{x}}{dt} = A(t)\underline{x} \quad , \quad t \in (T_1, T_2) \quad (1.13)$$



is called a linear homogeneous system of the n th order. It has been shown in Ref. 3 that a unique solution of $\phi(t)$ exists such that $\phi(t=\tau)$ equals some value ξ . In the following theorem, the terms field, vector space, linear dependence, linear independence, and basis are explained in Ref. 5 pps. 1, 3, 7, and 10 respectively. The theorem is:

The set of all solutions of (LH) on (T_1, T_2) form an n -dimensional vector space over a complex field.

To show that the space is n -dimensional, a set of n linearly independent solutions $\phi_1(t), \dots, \phi_n(t)$ must be exhibited such that every other solution of (LH) is a linear combination with complex coefficients c_i of these ϕ_i $i=1, \dots, n$. If $\xi_i, i=1, \dots, n$, are n linear independent points in the vector \underline{x} space, the uniqueness provision, previously mentioned, shows the existence of n solutions ϕ_i of (LH) such that $\phi_i(\tau) = \xi_i$. The method of proof of the theorem is to assume the theorem not to be true, and then to find a contradiction. That is the assumption is made that the ϕ_i are not linearly independent, but rather are dependent. Then there must exist n complex numbers c_i , not all zero, such that

$$\sum_{i=1}^n c_i \phi_i(t) = 0. \quad (t \in (T_1, T_2)) \quad (1.14)$$

This implies that

$$\sum_{i=1}^n c_i \phi_i(\tau) = \sum_{i=1}^n c_i \xi_i = 0, \quad (1.15)$$

and this latter contradicts the assumption that the c_i are not linearly independent, and proves the theorem.

The consequence of this theorem is that every solution $\phi(t)$ is a unique linear combination of the ϕ_i such that

$$\phi = \sum_{i=1}^n c_i \phi_i. \quad (1.16)$$



Eq. (1.16) can be carried over to Battin's report in that if the set of fundamental solutions ϕ_i are known, a unique general solution ϕ can be obtained. If ϕ_1, \dots, ϕ_n are a set of linearly independent solutions of (L H), they are said to form a basis or a fundamental set of solutions of (L H).

For the application of the above digression to the solution of Eq. (1.10), use the initial and terminal conditions defined by the differential equations to obtain particular solutions. Denote the time of launch by t_L . If the launch point is the origin of coordinates, then the particular solution

$$\delta \underline{r}_1(t_L) = \begin{vmatrix} \delta x = 0 \\ \delta y = 0 \\ \delta z = 0 \end{vmatrix}, \quad \delta \underline{v}_1(t_L) = \begin{vmatrix} \delta v_x = 1 \\ \delta v_y = 0 \\ \delta v_z = 0 \end{vmatrix} \quad (1.17)$$

represents one fundamental solution. That is $\delta \underline{r}_1(t), \delta \underline{v}_1(t)$ satisfy the differential equations

$$\frac{d}{dt}(\delta \underline{r}_1(t)) = \delta \underline{v}_1(t), \quad \frac{d}{dt}(\delta \underline{v}_1(t)) = G(\underline{r}_0, t) \delta \underline{r}_1(t). \quad (1.18)$$

In particular the values of $\delta \underline{r}_1(t_L), \delta \underline{v}_1(t_L)$ satisfy (1.18) for $t=t_L$. Another fundamental solution is $\delta \underline{r}_2(t), \delta \underline{v}_2(t)$ satisfying the equations

$$\frac{d}{dt}(\delta \underline{r}_2(t)) = \delta \underline{v}_2(t), \quad \frac{d}{dt}(\delta \underline{v}_2(t)) = G(\underline{r}_0, t) \delta \underline{r}_2(t), \quad (1.19)$$

and

$$\delta \underline{r}_2(t_L) = \begin{vmatrix} \delta x = 0 \\ \delta y = 0 \\ \delta z = 0 \end{vmatrix}, \quad \delta \underline{v}_2(t_L) = \begin{vmatrix} \delta v_x = 0 \\ \delta v_y = 1 \\ \delta v_z = 0 \end{vmatrix} \quad (1.20)$$



A third fundamental solution is $\delta r_3(t)$, $\delta v_3(t)$ which satisfies the equations

$$\frac{d}{dt}(\delta r_3(t)) = \delta v_3(t), \quad \frac{d}{dt}(\delta v_3(t)) = G(r_0, t) \delta r_3(t), \quad (1.21)$$

with initial conditions

$$\delta r_3(t_L) = \begin{bmatrix} 0 \\ 0 \\ 0 \end{bmatrix}, \quad \delta v_3(t_L) = \begin{bmatrix} 0 \\ 0 \\ 1 \end{bmatrix}. \quad (1.22)$$

These three fundamental solutions can be summarized in matrix form as $R(t)$, $V(t)$ where

$$\frac{dR(t)}{dt} = V(t), \quad \frac{dV(t)}{dt} = G(r_0, t) R(t), \quad (1.23)$$

and

$$R(t_L) = \begin{bmatrix} 0 & 0 & 0 \\ 0 & 0 & 0 \\ 0 & 0 & 0 \end{bmatrix} \equiv 0, \quad V(t_L) = \begin{bmatrix} 1 & 0 & 0 \\ 0 & 1 & 0 \\ 0 & 0 & 1 \end{bmatrix} \equiv I. \quad (1.24)$$

In (1.24) a row or column represents a fundamental solution, each of which is the deviation in position and velocity at launch from a predetermined reference trajectory. The symbols 0 and I denote the null matrix and identity matrix respectively.



A second group of three fundamental solutions can be found by considering the terminal conditions at arrival time, $t=t_A$. Companion equations to (1.23) and (1.24) are

$$\frac{d}{dt} R^*(t) = V^*(t), \quad \frac{d}{dt} V^*(t) = G(\underline{r}_0, t) R^*(t), \quad (1.25)$$

and

$$R^*(t_A) = \begin{bmatrix} 0 & 0 & 0 \\ 0 & 0 & 0 \\ 0 & 0 & 0 \end{bmatrix} \equiv 0, \quad V^*(t_A) = \begin{bmatrix} 1 & 0 & 0 \\ 0 & 1 & 0 \\ 0 & 0 & 1 \end{bmatrix} \equiv I. \quad (1.26)$$

For the physical meaning of R^* and V^* , it is convenient to consider the roles of launch and arrival points as reversed. In the literature, Eq. (1.25) is called the adjoint equation of (1.23).

In a manner similar to the development of the matrix $G(\underline{r}_0, t)$, the elements of the matrices R and V will now be found. From Eq. (1.10)

$$\delta \underline{r}(t) = \underline{r}_s(t) - \underline{r}_0(t), \quad (1.27)$$

where

$$\underline{r}(s, t) = \left[r_x(v_{sx}, v_{sy}, v_{sz}, t) : r_y(v_{sx}, v_{sy}, v_{sz}, t) : r_z(v_{sx}, v_{sy}, v_{sz}, t) \right]$$

$$\underline{r}(0, t) = \left[r_x(v_{0x}, v_{0y}, v_{0z}, t) : r_y(v_{0x}, v_{0y}, v_{0z}, t) : r_z(v_{0x}, v_{0y}, v_{0z}, t) \right] \quad (1.28)$$

Then

$$\begin{aligned} \underline{r}_s(t) \cong \underline{r}_0(t) &+ \left(\frac{\partial r_{sx}}{\partial v_{sx}} \right)_0 (v_{sx} - v_{0x}) + \left(\frac{\partial r_{sx}}{\partial v_{sy}} \right)_0 (v_{sy} - v_{0y}) + \left(\frac{\partial r_{sx}}{\partial v_{sz}} \right)_0 (v_{sz} - v_{0z}) \\ &+ \left(\frac{\partial r_{sy}}{\partial v_{sx}} \right)_0 (v_{sx} - v_{0x}) + \dots \\ &+ \left(\frac{\partial r_{sz}}{\partial v_{sx}} \right)_0 (v_{sx} - v_{0x}) + \dots \end{aligned} \quad (1.29)$$

In matrix form this is

$$\underline{r}_s(t) - \underline{r}_0(t) = \begin{bmatrix} \left(\frac{\partial r_{sx}}{\partial v_{sx}} \right)_0 & \left(\frac{\partial r_{sx}}{\partial v_{sy}} \right)_0 & \left(\frac{\partial r_{sx}}{\partial v_{sz}} \right)_0 \\ \left(\frac{\partial r_{sy}}{\partial v_{sx}} \right)_0 & \left(\frac{\partial r_{sy}}{\partial v_{sy}} \right)_0 & \left(\frac{\partial r_{sy}}{\partial v_{sz}} \right)_0 \\ \left(\frac{\partial r_{sz}}{\partial v_{sx}} \right)_0 & \left(\frac{\partial r_{sz}}{\partial v_{sy}} \right)_0 & \left(\frac{\partial r_{sz}}{\partial v_{sz}} \right)_0 \end{bmatrix} \cdot \begin{bmatrix} v_{sx} - v_{0x} \\ v_{sy} - v_{0y} \\ v_{sz} - v_{0z} \end{bmatrix} \quad (1.30)$$

In the above the matrix of partial derivatives is denoted by $R(t)$. The derivatives are evaluated at x_0, y_0, z_0 .

Although the matrix for $V(t)$ can be found from the second of Eq. (1.10), on p. 15 of Ref. 1, Battin states that the elements of the R and V matrices represent deviations in position and velocity from the corresponding quantities on the reference trajectory as the result of certain deviations in the launch velocity from its reference value. In order to follow the work of Ref. 1,

we shall proceed as follows:

$$\underline{v}(t) = \underline{v}_s(t) - \underline{v}_0(t), \quad \text{where} \quad (1.31)$$

$$\underline{v}(s,t) = \left[v_x(v_{sx}, v_{sy}, v_{sz}, t) : v_y(v_{sx}, v_{sy}, v_{sz}, t) : v_z(v_{sx}, v_{sy}, v_{sz}, t) \right]$$

and

$$\underline{v}_0(t) = \left[v_x(v_{0x}, v_{0y}, v_{0z}, t) : v_y(v_{0x}, v_{0y}, v_{0z}, t) : v_z(v_{0x}, v_{0y}, v_{0z}, t) \right] \quad (1.32)$$

Then since the corresponding values on the actual and the reference trajectories are close enough to assume linearity, a Taylor's series expansion with higher order terms neglected furnishes a valid approximation. That is

$$\begin{aligned} v_s(t) \cong v_0(t) &+ \left(\frac{\partial v_{sx}}{\partial v_{sx}} \right)_0 (v_{sx} - v_{0x}) + \left(\frac{\partial v_{sx}}{\partial v_{sy}} \right)_0 (v_{sy} - v_{0y}) + \left(\frac{\partial v_{sx}}{\partial v_{sz}} \right)_0 (v_{sz} - v_{0z}) \\ &+ \left(\frac{\partial v_{sy}}{\partial v_{sx}} \right)_0 (v_{sx} - v_{0x}) + \dots \\ &+ \left(\frac{\partial v_{sz}}{\partial v_{sx}} \right)_0 (v_{sx} - v_{0x}) + \dots \end{aligned} \quad (1.33)$$

This is rewritten as

$$\underline{v}_s(t) - \underline{v}_0(t) = \begin{bmatrix} \left(\frac{\partial v_{sx}}{\partial v_{sx}} \right)_0 & \left(\frac{\partial v_{sx}}{\partial v_{sy}} \right)_0 & \left(\frac{\partial v_{sx}}{\partial v_{sz}} \right)_0 \\ \left(\frac{\partial v_{sy}}{\partial v_{sx}} \right)_0 & \left(\frac{\partial v_{sy}}{\partial v_{sy}} \right)_0 & \left(\frac{\partial v_{sy}}{\partial v_{sz}} \right)_0 \\ \left(\frac{\partial v_{sz}}{\partial v_{sx}} \right)_0 & \left(\frac{\partial v_{sz}}{\partial v_{sy}} \right)_0 & \left(\frac{\partial v_{sz}}{\partial v_{sz}} \right)_0 \end{bmatrix} \cdot \begin{array}{l} v_{sx} - v_{0x} \\ v_{sy} - v_{0y} \\ v_{sz} - v_{0z} \end{array} \quad (1.34)$$



The matrix above of partial derivatives evaluated at the launch point is denoted by $V(t)$. The R and V matrices are not independent. On p. 13, Ref. 1, it is shown that

$$V(t) = R(t) C(t) \quad (1.35)$$

The validity of this matrix equation follows from Eqs. (1.30), (1.34) and

$$C(t) = \begin{bmatrix} \left(\frac{\partial V_{sx}}{\partial r_{sx}} \right)_0 & \left(\frac{\partial V_{sy}}{\partial r_{sx}} \right)_0 & \left(\frac{\partial V_{sz}}{\partial r_{sx}} \right)_0 \\ \left(\frac{\partial V_{sx}}{\partial r_{sy}} \right)_0 & \left(\frac{\partial V_{sy}}{\partial r_{sy}} \right)_0 & \left(\frac{\partial V_{sz}}{\partial r_{sy}} \right)_0 \\ \left(\frac{\partial V_{sx}}{\partial r_{sz}} \right)_0 & \left(\frac{\partial V_{sy}}{\partial r_{sz}} \right)_0 & \left(\frac{\partial V_{sz}}{\partial r_{sz}} \right)_0 \end{bmatrix} \quad (1.36)$$

The elements of matrices $R^*(t)$, $V^*(t)$, and $C^*(t)$ can be found by analogy. The differentiation takes place at the arrival time $t=t_A$ for the adjoint case.

Now the general solution of Eq. (1.10)

$$\frac{d}{dt}(\delta \underline{r}) = \delta \underline{v} \quad , \quad \frac{d}{dt}(\delta \underline{v}) \cong G(\underline{r}_0, t) \delta \underline{r} \quad (1.10)$$

can be written as

$$\begin{aligned} \delta \underline{r}(t) &= R(t) \underline{c} + R^*(t) \underline{c}^* \\ \delta \underline{v}(t) &= V(t) \underline{c} + V^*(t) \underline{c}^* \end{aligned} \quad (1.37)$$



In these equations \underline{c} and \underline{c}^* are arbitrary constants. They represent the required six constants which arise from the solution of the differential equations. For the particular problem at hand, they must be manipulated to fulfill the requirements of the equations for all values of t , including the initial and final conditions.

2. The Vector Velocity Correction

When the vehicle is at the position \underline{r}_s at time t and is to continue in free fall to the target destination $\underline{r}_o(t_A)$ in the time $t_A - t$, there is an associated vector velocity required. This vector velocity can be obtained from Eq. (1.37). For the vehicle to pass through the target point, the requirement is that

$$\underline{\delta r}(t_A) = 0 = R(t_A)\underline{c} + R^*(t_A)\underline{c}^* \tag{2.1}$$

Since $R^*(t_A) = 0$, see Eq. (1.26), it follows that \underline{c} equals zero in (2.1). Hence Eq. (1.37) becomes

$$\underline{\delta r}(t) = R^*(t)\underline{c}^* \tag{2.2}$$

and

$$\underline{\delta v}(t) = V^*(t)\underline{c}^* \tag{2.3}$$

Premultiplication of the first of these latter two equations by the inverse matrix $[R^*(t)]^{-1}$ yields

$$\underline{c}^* = [R^*(t)]^{-1} \underline{\delta r}(t) \tag{2.4}$$

since

$$[R^*(t)]^{-1} R^*(t) = R^*(t) [R^*(t)]^{-1} = I$$



When this expression for \underline{c}^* is substituted in the second equation, the result is

$$\delta \underline{v}(t) = V^*(t) [R^*(t)]^{-1} \delta \underline{r}(t) \quad (2.5)$$

The expression for $\delta \underline{v}(t)$ Eq. (2.5) is the velocity deviation of the vehicle which must exist at position $\underline{r}_s(t)$ at time t in order for the position deviation at arrival $\delta \underline{r}(t_A)$ to be zero. It is to be noticed that in (2.5) $\delta \underline{v}(t)$ is expressed in terms of $\delta \underline{r}(t)$, where $\delta \underline{r}(t)$ is itself not known. We can state that in general, $\delta \underline{r}(t)$ would be determined by the initial conditions at launch, together with the time history of the thrust subsequent to launch.

If a correction $\delta \underline{v}(t)$ is made in the velocity of the spacecraft at time t , in keeping with Battin's notation, $(t-)$ and $(t+)$ will be used to distinguish the velocity just prior to the correction from the velocity immediately after the correction. To proceed with the analysis, assume that the actual deviation in velocity $\delta \underline{v}(t-)$ which exists at time t is known. Then the velocity correction which is needed to achieve a velocity $\underline{v}(t+)$ at time t to make the terminal position deviation zero, that is $\delta \underline{r}(t_A) = 0$, is

$$\Delta \underline{v}^*(t) = \delta \underline{v}(t+) - \delta \underline{v}(t-) \quad (2.6)$$

Substitution of (2.5) in the above gives

$$\Delta \underline{v}^*(t) = V^*(t) [R^*(t)]^{-1} \delta \underline{r}(t) - \delta \underline{v}(t-) \quad (2.7)$$

Denote the matrix $V^*(t) [R^*(t)]^{-1}$ by $C^*(t)$ (see Eq. (1.35)). Then Eq. (2.7) is rewritten as

$$\Delta \underline{v}^*(t) = C^*(t) \delta \underline{r}(t) - \delta \underline{v}(t-) \quad (2.8)$$

In the development of this latter equation, if the value $\delta \underline{r}(t_L)$, prescribed



by the launch conditions, is taken for $\delta \underline{r}(t)$, and $\delta \underline{v}(t)$ is considered arbitrary, it can be shown that Eq.(3.14), p. 13, Ref. 1, holds. The value of $\delta \underline{r}(t)$ at time t differs from zero as a result of an error in the injection velocity. The intermediate steps leading to the referenced equation are as follows:

In Eq. (1.37), the launch conditions are

$$\delta \underline{r}(t_L) = 0 = R(t_L) \underline{c} + R^*(t_L) \underline{c}^* \quad (2.9)$$

Since the matrix $R(t_L) = 0$, the zero matrix, and $R^*(t_L) \neq 0$ it follows that $\underline{c}^* = 0$. Then for the second of (1.37), one can write

$$\delta \underline{v}(t_L) = V(t) \underline{c} \quad (2.10)$$

But since $V(t_L) = I$, the unit matrix, then

$$\delta \underline{v}(t_L) = I \underline{c} = \underline{c} \quad (2.11)$$

Then (1.37) can be written as

$$\delta \underline{r}(t) = R(t) \delta \underline{v}(t_L)$$

and

$$\delta \underline{v}(t) = V(t) \delta \underline{v}(t_L) \quad (2.12)$$



Premultiplication of the first of the above by $[R(t)]^{-1}$ gives

$$[R(t)]^{-1} \delta \underline{r}(t) = \delta \underline{v}(t_L) \quad (2.13)$$

When this is substituted into the second of (2.12), the result is

$$\begin{aligned} \delta \underline{v}(t) &= V(t) [R(t)]^{-1} \delta \underline{r}(t) \\ &\equiv C(t) \delta \underline{r}(t), \end{aligned} \quad (2.14)$$

where C is defined by $V(t)[R(t)]^{-1}$, see Eq. (1.36). At the terminal point $t = t_A$, the equation

$$\delta \underline{r}(t_A) = R(t_A) \delta \underline{v}(t_L) \quad (2.15)$$

is obtained from (2.12). The value of $\delta \underline{r}(t_A)$ is not zero unless the injection velocity error $\delta \underline{v}(t_L)$ is equal to zero.

It should be noticed that in Eq. (2.5), $\delta \underline{v}(t)$ represents the velocity deviation which is required at time t for $\delta \underline{r}(t_A)$ to equal zero. However the $\delta \underline{v}(t)$ in Eq. (2.14) is the actual velocity deviation which exists at time t. In general, these two deviations will not be equal, in which case the difference between the required and the existing can be called the necessary velocity correction. This is

$$\Delta \underline{v}^*(t) = C^* \delta \underline{r}(t) - C(t) \delta \underline{r}(t). \quad (2.16)$$



Substitution of the first of (2.12) into the above gives

$$\begin{aligned}\Delta \underline{v}^*(t) &= V^*(t)[R^*(t)]^{-1}R(t)\delta \underline{v}(t_L) - V(t)[R(t)]^{-1}R(t)\delta \underline{v}(t_L) \\ &= \left\{ V^*(t)[R^*(t)]^{-1}R(t) - V(t)[R(t)]^{-1}R(t) \right\} \delta \underline{v}(t_L) \\ &\equiv -\Lambda(t)\delta \underline{v}(t_L),\end{aligned}\tag{2.17}$$

where

$$-\Lambda(t) \text{ is defined by } C^*(t)R(t) - V(t).\tag{2.18}$$

By analogy $-\Lambda^*(t)$ is defined by

$$-\Lambda^*(t) = C(t)R^*(t) - V^*(t).\tag{2.19}$$

For the interpretation of Eq. (2.17), it is assumed that the velocity deviation $\delta \underline{v}(t_L)$ at launch is known. The value of $\Delta \underline{v}^*(t)$ in Eq. (2.8) is the required velocity correction at time t . In this equation $\delta \underline{v}(t^-)$ is the velocity deviation immediately prior to the correction.

In Ref. 1, p. 3, a time convention based upon discrete observations is adopted. Let t_n represent the time of a measurement, and t_{n+1} the time of a later observation. Then (2.8) can be rewritten as

$$\Delta \underline{v}^*(t_n) = C^*(t_n)\delta \underline{r}(t_n) - \delta \underline{v}(t_n^-),\tag{2.20}$$

where $\delta \underline{v}(t_n^-)$ is the velocity deviation just before the correction is made. The matrix form of (2.20) is

$$\Delta \underline{v}_n^* = \left[C_n^*, -I \right] \cdot \begin{vmatrix} \delta \underline{r}_n \\ \delta \underline{v}_n \end{vmatrix}\tag{2.21}$$



In Ref. 1, p. 9, the above matrix is replaced by B_n ; that is,

$$B_n = \begin{bmatrix} C_n^* & -I \end{bmatrix}, \quad (2.22)$$

where I is the 3 x 3 unit diagonal matrix. The 6 x 1 deviation vector

$$\delta \underline{x}_n = \begin{bmatrix} \delta \underline{r}_n \\ \delta \underline{v}_n \end{bmatrix} \quad (2.23)$$

defines the "state" of the vehicle dynamics at time t_n . Finally, Eq. (2.21) is

$$\Delta \underline{v}_n^* = B_n \delta \underline{x}_n. \quad (2.24)$$

3. Differential Equation Solutions

The matrices C , C^* , Λ , Λ^* may also be obtained directly as the solutions of differential equations. The definition of C has been given in (1.35) as

$$C(t) = V(t)[R(t)]^{-1}. \quad (3.1)$$

The corresponding equation for C^* is

$$C^*(t) = V^*(t)[R^*(t)]^{-1}. \quad (3.2)$$



From the fact that the initial values of the R and R* matrices are zero, there are singularities in C and C*. That is in Eq. (3.1), $R(t_L) = 0$, which gives $C(t_L) \rightarrow \infty$, whereas in (3.2) $R^*(t_A) = 0$. The latter furnishes the singularity $C^*(t_A) \rightarrow \infty$. Hence Battin decided to work directly with the inverse matrices C^{-1} and $(C^*)^{-1}$ in order to avoid the singularities. The inverse of (3.1) is

$$C^{-1}(t) = \{V(t)[R(t)]^{-1}\} = R(t)V^{-1}(t). \quad (3.3)$$

At $t = t_L$ the above is

$$C^{-1}(t_L) = R(t_L)V^{-1}(t_L). \quad (3.4)$$

From Eq. (1.24) $R(t_L)$ equals the zero matrix, and $V(t_L)$ the identity matrix. Then the singularity is avoided since $C^{-1}(t_L)$ equals 0.

Postmultiplication of (3.3) by $V(t)$ gives

$$C^{-1}(t)V(t) = R(t), \quad (3.5)$$

which upon differentiation with respect to t is

$$\frac{dC^{-1}}{dt}V + C^{-1}\frac{dV}{dt} = \frac{dR}{dt}. \quad (3.6)$$

The Eq. (1.23) shows that $\frac{dR}{dt} = V$, and $\frac{dV}{dt} = GR$. (This $G = G(r_0, t)$ is the 3×3 matrix of Eq. (1.9) and is not to be confused with the universal gravitational constant.) When these are substituted in (3.6), the result is

$$\frac{dC^{-1}}{dt}V + C^{-1}GR = V. \quad (3.7)$$



Postmultiplication of (3.7) by $V^{-1}(t)$ gives

$$\frac{dC^{-1}}{dt} + C^{-1}GRV^{-1} = I. \quad (3.8)$$

The Eq. (3.3), $C^{-1} = RV^{-1}$, is substituted into the second term on the left of the above to yield

$$\frac{dC^{-1}}{dt} + C^{-1}GC^{-1} = I. \quad (3.9)$$

This latter equation is Eq. (3.18) of Battin's report, Ref. 1, p. 14. In a manner similar to the above the following can be developed from Eq. (3.2);

$$\frac{dC^{*-1}}{dt} + C^{*-1}GC^{*-1} = I. \quad (3.10)$$

In order to derive differential equations for $\Lambda(t)$ and $\Lambda^*(t)$, commence by rewriting Eqs. (2.18) and (2.19). Thus

$$\Lambda(t) = V(t) - C^*(t)R(t), \quad (2.18)$$

and

$$\Lambda^*(t) = V^*(t) - C(t)R^*(t). \quad (2.19)$$

In the following procedure, a differential equation will be developed for $\Lambda(t)$, the first of these two. First differentiate (2.18) with respect to t .

This gives

$$\frac{d\Lambda(t)}{dt} = \frac{dV}{dt} - \frac{dC^*}{dt}R - C^* \frac{dR}{dt}. \quad (3.11)$$



Rewrite Eqs. (1.23), (1.25), and (3.2). These are respectively

$$\frac{dR}{dt} = V, \quad \frac{dV}{dt} = GR; \quad \frac{dR^*}{dt} = V^*, \quad \frac{dV^*}{dt} = GR^*;$$

and

$$C^* = V^* R^{*-1},$$

(3.12)

Differentiation of the latter of these gives

$$\frac{dC^*}{dt} = \frac{dV^*}{dt} R^{*-1} + V^* \frac{dR^{*-1}}{dt}.$$

(3.13)

Substitution of (3.13) into (3.11) allows the latter to be written as

$$\begin{aligned} \frac{dA}{dt} &= GR - \left(\frac{dV^*}{dt} R^{*-1} + V^* \frac{dR^{*-1}}{dt} \right) R - C^* V \\ &= GR - GR^* R^{*-1} R - \frac{dR^*}{dt} \frac{dR^{*-1}}{dt} R - C^* V. \end{aligned}$$

(3.14)

The last step was obtained by the use of Eq. (3.12). Use is made of the fact that $R^* R^{*-1}$ equals the identity matrix I. Then differentiation with respect to t of $R^* R^{*-1} = I$ gives

$$\frac{dR^*}{dt} R^{*-1} + R^* \frac{dR^{*-1}}{dt} = 0.$$

(3.16)

Premultiplication of the above by R^{*-1} yields

$$\frac{dR^{*-1}}{dt} = -R^{*-1} \frac{dR^*}{dt} R^{*-1}.$$

(3.17)



When this is substituted into the term $-\frac{dR^*}{dt} \frac{dR^{*-1}}{dt} R$ of Eq. (3.15),

this term becomes

$$\frac{dR^*}{dt} (R^* \frac{dR^*}{dt} R^{*-1}) R \quad (3.18)$$

Substitution of $\frac{dR^*}{dt} = V^*$ and $V^* R^{*-1} = C^*$ from (3.12) into the above gives

$$V^* R^{*-1} V^* R^{*-1} R = C^* C^* R. \quad (3.19)$$

Eq. (3.15) can now be written as

$$\frac{d\Lambda}{dt} = GR - GIR + C^* C^* R - C^* V,$$

or

$$\frac{d\Lambda}{dt} + C^* V - C^* C^* R = 0 \quad (3.20)$$

But from Eq. (2.18), it is known that $\Lambda = V - C^* R$. When this is substituted into (3.20), the latter becomes

$$\frac{d\Lambda}{dt} + C^* (V - C^* R) = 0,$$

or

$$\frac{d\Lambda}{dt} + C^* \Lambda = 0 \quad (3.21)$$



This latter equation is Eq. (3.21), p. 14 of Battin's report. Since Λ equals $V - C^* R$, which in turn is $V - V^* R^{*-1} R$ from (3.2), the initial condition for Λ is

$$\Lambda(t_L) = V(t_L) - V^*(t_L) R^{*-1}(t_L) R(t_L)$$

Reference to Eq. (1.24) shows that the first term on the right of the above is the identity matrix, while the second term on the right is the zero matrix.

Therefore

$$\Lambda(t_L) = I \quad (3.22)$$

From conditions of similarity, the following differential equation can be obtained:

$$\frac{d\Lambda^*}{dt} + C\Lambda^* = 0, \quad \text{with} \quad \Lambda^*(t_A) = I. \quad (3.23)$$

4. The State Transition Matrix

On account of the dynamic coupling of position and velocity, it is convenient to introduce the concept of a six dimensional space in which the coordinates represent the components of both position and velocity deviations of the vehicle from the reference path as functions of time. Points in this space are defined by the six dimensional deviation vector

$$\delta \underline{x}_n = \begin{vmatrix} \delta \underline{r}_n \\ \delta \underline{v}_n \end{vmatrix} = \begin{vmatrix} \delta x_n \\ \delta y_n \\ \delta z_n \\ \delta v_{x_n} \\ \delta v_{y_n} \\ \delta v_{z_n} \end{vmatrix} \quad (4.1)$$



The vector $\delta \underline{x}_n$, which is the same as $\delta \underline{x}(t_n)$ defines the state of the vehicle at time t_n . Transition from one state at t_n to another at t_{n+1} is provided by the relation

$$\delta \underline{x}_{n+1} = \phi_{n+1, n} \delta \underline{x}_n \quad (4.2)$$

The term

$$\phi(t_{n+1}, t_n) \equiv \phi_{n+1, n} \quad (4.3)$$

is called the state transition matrix. In this section, we shall augment the write-up of it which is presented in Ref. 1. For this purpose, Eq. (1.37) will be rewritten for t_n . These equations are

$$\begin{aligned} \delta \underline{r}(t_n) &= R(t_n) \underline{c} + R^*(t_n) \underline{c}^* , \\ \delta \underline{v}(t_n) &= V(t_n) \underline{c} + V^*(t_n) \underline{c}^* . \end{aligned} \quad (4.4)$$

In the following, values of \underline{c} and \underline{c}^* which are found from the above will be used in similar representations of $\delta \underline{r}(t_{n+1})$ and $\delta \underline{v}(t_{n+1})$. First premultiply the first equation of (4.4) by $R(t_n)^{-1} = R_n^{-1}$ to obtain

$$R_n^{-1} \delta \underline{r}_n = R_n^{-1} R_n \underline{c} + R_n^{-1} R_n^* \underline{c}^* ,$$

from which

$$\underline{c} = R_n^{-1} \delta \underline{r}_n - R_n^{-1} R_n^* \underline{c}^* . \quad (4.5)$$



is obtained, since $R_n^{-1} R_n = I$. Substitution of (4.5) into the equation for $\delta \underline{v}_n$ of (4.4) gives

$$\begin{aligned} \delta \underline{v}_n &= V_n R_n^{-1} \delta \underline{r}_n - V_n R_n^{-1} R_n^* \underline{c}^* + V_n^* \underline{c}^* \\ &= V_n R_n^{-1} \delta \underline{r}_n + (-V_n R_n^{-1} R_n^* + V_n^*) \underline{c}^* . \end{aligned} \quad (4.6)$$

The following definitions (1.35), (3.1), and (2.19);

$$V_n R_n^{-1} = C_n \quad , \quad \Lambda_n^* = V_n^* - C_n R_n^* \quad ,$$

when substituted in (4.6) yield

$$\delta \underline{v}_n = C_n \delta \underline{r}_n + \Lambda_n^* \underline{c}^* . \quad (4.7)$$

This latter equation can be rearranged as

$$\Lambda_n^* \underline{c}^* = \delta \underline{v}_n - C_n \delta \underline{r}_n , \quad (4.8)$$

which when premultiplied by Λ_n^{*-1} gives

$$\underline{c}^* = \Lambda_n^{*-1} (\delta \underline{v}_n - C_n \delta \underline{r}_n) . \quad (4.9)$$

In a similar fashion \underline{c} may be obtained as

$$\underline{c} = \Lambda_n^{-1} (\delta \underline{v}_n - C_n^* \delta \underline{r}_n) . \quad (4.10)$$



Now it is desired to express $\delta \underline{r}(t_{n+1})$ and $\delta \underline{v}(t_{n+1})$ in terms of R_{n+1} and V_{n+1} . The forms of the constants \underline{c} and \underline{c}^* in these expressions are Eqs. (4.10) and (4.9) respectively. The Eqs. (1.37) for $t = t_{n+1}$ are

$$\delta \underline{r}_{n+1} = R_{n+1} \underline{c} + R_{n+1}^* \underline{c}^* \quad (4.11)$$

$$\delta \underline{v}_{n+1} = V_{n+1} \underline{c} + V_{n+1}^* \underline{c}^* .$$

Substitution for \underline{c} and \underline{c}^* into the above gives

$$\begin{aligned} \delta \underline{r}_{n+1} &= R_{n+1} \Lambda_n^{-1} (\delta \underline{v}_n - C_n^* \delta \underline{r}_n) + R_{n+1}^* \Lambda_n^{*-1} (\delta \underline{v}_n - C_n \delta \underline{r}_n) , \\ \delta \underline{v}_{n+1} &= V_{n+1} \Lambda_n^{-1} (\delta \underline{v}_n - C_n^* \delta \underline{r}_n) + V_{n+1}^* \Lambda_n^{*-1} (\delta \underline{v}_n - C_n \delta \underline{r}_n) . \end{aligned} \quad (4.12)$$

Rearrangement of terms in the above furnishes

$$\begin{aligned} \delta \underline{r}_{n+1} &= (R_{n+1} \Lambda_n^{-1} + R_{n+1}^* \Lambda_n^{*-1}) \delta \underline{v}_n - (R_{n+1} \Lambda_n^{-1} C_n^* + R_{n+1}^* \Lambda_n^{*-1} C_n) \delta \underline{r}_n \\ \delta \underline{v}_{n+1} &= (V_{n+1} \Lambda_n^{-1} + V_{n+1}^* \Lambda_n^{*-1}) \delta \underline{v}_n - (V_{n+1} \Lambda_n^{-1} C_n^* + V_{n+1}^* \Lambda_n^{*-1} C_n) \delta \underline{r}_n . \end{aligned} \quad (4.13)$$

These equations can be written in partitioned matrix form as

$$\begin{bmatrix} \delta \underline{r}_{n+1} \\ \delta \underline{v}_{n+1} \end{bmatrix} = \begin{bmatrix} -(R_{n+1} \Lambda_n^{-1} C_n^* + R_{n+1}^* \Lambda_n^{*-1} C_n) & R_{n+1} \Lambda_n^{-1} + R_{n+1}^* \Lambda_n^{*-1} \\ -(V_{n+1} \Lambda_n^{-1} C_n^* + V_{n+1}^* \Lambda_n^{*-1} C_n) & V_{n+1} \Lambda_n^{-1} + V_{n+1}^* \Lambda_n^{*-1} \end{bmatrix} \cdot \begin{bmatrix} \delta \underline{r}_n \\ \delta \underline{v}_n \end{bmatrix} . \quad (4.14)$$



This can be written as

$$\delta \underline{x}(t_{n+1}) = \phi(t_{n+1}, t_n) \delta \underline{x}(t_n), \quad (4.15)$$

where $\phi_{n+1, n}$ is the matrix of (4.14).

In order to determine the state transition matrix $\phi_{n+1, n}$ in the form of Eq. (3.31), p. 15, Ref. 1, proceed as follows. Rewrite (4.14) as

$$\begin{aligned} \begin{vmatrix} \delta \underline{r}_{n+1} \\ \delta \underline{v}_{n+1} \end{vmatrix} &= \begin{bmatrix} R_{n+1} & R_{n+1}^* \\ V_{n+1} & V_{n+1}^* \end{bmatrix} \cdot \begin{bmatrix} -\Lambda_n^{-1} C_n^* & \Lambda_n^{-1} \\ -\Lambda_n^{*-1} C_n & \Lambda_n^{*-1} \end{bmatrix} \cdot \begin{vmatrix} \delta \underline{r}_n \\ \delta \underline{v}_n \end{vmatrix} \\ &= \begin{bmatrix} R_{n+1} & R_{n+1}^* \\ V_{n+1} & V_{n+1}^* \end{bmatrix} \cdot \begin{bmatrix} (C_n^{*-1} \Lambda_n)^{-1} & 0 \\ 0 & (C_n^{-1} V_n^*)^{-1} \end{bmatrix} \cdot \begin{bmatrix} -I & C_n^{*-1} \\ -I & C_n^{-1} \end{bmatrix} \cdot \begin{vmatrix} \delta \underline{r}_n \\ \delta \underline{v}_n \end{vmatrix}. \end{aligned} \quad (4.16)$$

It should be noted that in (4.16)

$$(C_n^{*-1} \Lambda_n)^{-1} = \Lambda_n^{-1} C_n^*, \quad \text{and that} \quad C_n^* C_n^{*-1} = I,$$

where I is the identity matrix.

The state transition matrix shows the relationship between $\delta \underline{x}_{n+1}$ and $\delta \underline{x}_n$, which is

$$\delta \underline{x}(t_{n+1}) = \phi(t_{n+1}, t_n) \delta \underline{x}(t_n). \quad (4.17)$$



Knowledge of the matrix $\phi(t_{n+1}, t_n) = \phi_{n+1, n}$ allows the position and velocity vector $\delta \underline{x}_{n+1}$ at time t_{n+1} to be ascertained from the position and velocity vector $\delta \underline{x}_n$ at time t_n . Successive applications of (4.17) produce the following

$$\delta \underline{x}(t_1) = \phi(t_1, t_0) \delta \underline{x}(t_0), \quad (4.18)$$

where t_0 represents initial time. If the time intervals are close enough together in order not to violate the assumptions of linearity, then

$$\delta \underline{x}(t_2) = \phi(t_2, t_1) \delta \underline{x}(t_1). \quad (4.19)$$

Substitution of (4.18) into (4.19) gives

$$\delta \underline{x}(t_2) = \phi(t_2, t_1) \phi(t_1, t_0) \delta \underline{x}(t_0),$$

which can be rewritten as

$$\delta \underline{x}_2 = \phi(t_2, t_0) \delta \underline{x}_0. \quad (4.20)$$

Generalization of the above leads to the relation

$$\delta \underline{x}_n = \phi(t_n, t_0) \delta \underline{x}_0, \quad (4.21)$$

in which

$$\phi(t_n, t_0) = \prod_{i=0}^{i=n-1} \phi(t_{i+1}, t_i). \quad (4.22)$$



The relation between the inverse and the transpose of a non-singular state transition matrix can be found in the following manner. First write

$$\delta \underline{x}(t_n) = \phi(t_n, t_m) \delta \underline{x}(t_m) \quad (4.23)$$

If the matrix $\phi_{n,m} = \phi(t_n, t_m)$ is non-singular, Eq. (4.23) can be premultiplied by $\phi_{n,m}^{-1}$ to find $\delta \underline{x}(t_n)$. This is

$$\phi_{n,m}^{-1} \delta \underline{x}_n = \delta \underline{x}_m \quad (4.24)$$

Another representation for $\delta \underline{x}_m$ is

$$\delta \underline{x}_m = \phi(m, n) \delta \underline{x}_n \quad (4.25)$$

Comparison of Eqs. (4.24) and (4.25) shows that

$$\phi_{n,m}^{-1} = \phi_{m,n} \quad (4.26)$$

An alternate calculation to (4.16) for the transition matrix can be made directly from a consideration of the system of perturbation equations, as is done in Ref. 5. Define the perturbation of the state vector \underline{x} by

$$\begin{array}{lcl} \delta x = \delta x_1 & , & \delta v_x = \delta x_4 \\ \delta y = \delta x_2 & , & \delta v_y = \delta x_5 \\ \delta z = \delta x_3 & , & \delta v_z = \delta x_6 \end{array} \quad (4.27)$$



Then the system of Eqs. (1.10) can be written as

$$\frac{d}{dt} \delta \underline{x} = F(t) \delta \underline{x}, \quad (4.28)$$

or

$$\begin{bmatrix} \delta \dot{x}_1 \\ \delta \dot{x}_2 \\ \delta \dot{x}_3 \\ \delta \dot{x}_4 \\ \delta \dot{x}_5 \\ \delta \dot{x}_6 \end{bmatrix} = \begin{bmatrix} 0 & 0 & 0 & 1 & 0 & 0 \\ 0 & 0 & 0 & 0 & 1 & 0 \\ 0 & 0 & 0 & 0 & 0 & 1 \\ \left(\frac{\partial g_{x_5}}{\partial x_5}\right)_0 & \left(\frac{\partial g_{x_5}}{\partial y_5}\right)_0 & \left(\frac{\partial g_{x_5}}{\partial z_5}\right)_0 & 0 & 0 & 0 \\ \left(\frac{\partial g_{y_5}}{\partial x_5}\right)_0 & \left(\frac{\partial g_{y_5}}{\partial y_5}\right)_0 & \left(\frac{\partial g_{y_5}}{\partial z_5}\right)_0 & 0 & 0 & 0 \\ \left(\frac{\partial g_{z_5}}{\partial x_5}\right)_0 & \left(\frac{\partial g_{z_5}}{\partial y_5}\right)_0 & \left(\frac{\partial g_{z_5}}{\partial z_5}\right)_0 & 0 & 0 & 0 \end{bmatrix} \begin{bmatrix} \delta x_1 \\ \delta x_2 \\ \delta x_3 \\ \delta x_4 \\ \delta x_5 \\ \delta x_6 \end{bmatrix}. \quad (4.29)$$

In partitioned form, the matrix F is

$$F = \begin{bmatrix} 0 & I \\ G & 0 \end{bmatrix}, \quad (4.30)$$

For the solution of (4.28), let $\phi(t, t_0)$ be a nonsingular matrix having 6 columns of 6 linearly independent fundamental solutions (see the discussion on fundamental solutions, Section 1, General Solution of the Linearized Trajectory Equations.) Then ϕ is the solution of

$$\frac{d}{dt} \phi(t, t_n) = F(t) \phi(t, t_n). \quad (4.31)$$



In the approach which will be used the initial condition of $\phi(t, t_n)$ is a six dimensional matrix formed in the following manner. That is ϕ can be obtained one column at a time if Eq. (4.28) is solved 6 times, each with a different member of $\delta \underline{x}(t_0)$ set equal to unity, and all the other members equal to zero. That is by the use of

$$\delta \underline{x}^{(1)}(0) = \begin{vmatrix} 1 \\ 0 \\ 0 \\ 0 \\ 0 \\ 0 \end{vmatrix} \quad (4.32)$$

calculate the corresponding $\delta \underline{x}^{(1)}(t_n)$ by solving the trajectory Eqs. (4.28)
 Then

$$\delta \underline{x}^{(1)}(t_n) = \phi^{(1)}(t_n, 0) \delta \underline{x}^{(1)}(0) \quad (4.33)$$

is formed. The required state transition matrix $\phi_{n,0}^{(1)}$ for this equation represents deviations from the reference trajectory at time t_n in relation to initial deviations at time t_0 . Use this $\phi_{n,0}^{(1)}$ as the first column of $\phi_{n,0}$. For the second column, solve for the corresponding $\delta \underline{x}^{(2)}(0)$ from the trajectory equations where

$$\delta \underline{x}^{(2)}(0) = \begin{vmatrix} 0 \\ 1 \\ 0 \\ 0 \\ 0 \\ 0 \end{vmatrix} \quad (4.34)$$

is an initial condition. The relation corresponding to (4.33) is

$$\delta \underline{x}^{(2)}(t_n) = \phi^{(2)}(t_n, 0) \delta \underline{x}^{(2)}(0). \quad (4.35)$$



In this manner, the six columns of $\phi(n,0)$ can be found. The matrix is one with 6 fundamental solutions, and is known as a fundamental matrix.

We shall now introduce the concept of a system of differential equations which is adjoint to the system of Eqs. (4.28), see Ref. 3. In general, from the rule for the differentiation of two product matrices α , and β with respect to t

$$\frac{d}{dt}(\alpha\beta) = \frac{d\alpha}{dt}\beta + \alpha\frac{d\beta}{dt}, \quad (4.36)$$

where in general $\frac{d\alpha}{dt}\beta \neq \beta\frac{d\alpha}{dt}$. If α is replaced by ϕ , and β by its inverse matrix ϕ^{-1} , then the above is

$$\frac{d}{dt}(\phi\phi^{-1}) = \frac{d\phi}{dt}\phi^{-1} + \phi\frac{d\phi^{-1}}{dt}. \quad (4.37)$$

Since $\phi\phi^{-1}$ is the identity matrix I , its derivative is O the zero matrix. Thus (4.37) can be rewritten

$$O = \frac{d\phi}{dt}\phi^{-1} + \phi\frac{d\phi^{-1}}{dt}. \quad (4.38)$$

Premultiplication of the above by ϕ^{-1} gives

$$O = \phi^{-1}\frac{d\phi}{dt}\phi^{-1} + \frac{d\phi^{-1}}{dt}, \quad (4.39)$$

from which

$$\frac{d\phi^{-1}}{dt} = -\phi^{-1}\frac{d\phi}{dt}\phi^{-1}, \quad \det \phi \neq 0. \quad (4.40)$$



In order to apply (4.40) to the Eqs. (4.31), postmultiply the latter by ϕ^{-1} to yield

$$\frac{d\phi}{dt} \phi^{-1} = F \phi \phi^{-1}, \quad (4.41)$$

or

$$\frac{d\phi}{dt} \phi^{-1} = F. \quad (4.42)$$

Then in Eq. (4.40) if ϕ is a fundamental matrix for (L H); see Section 1, General Solution of the Linearized Trajectory Equations,

$$\frac{d\phi^{-1}}{dt} = -\phi^{-1} \left(\frac{d\phi}{dt} \phi^{-1} \right) = -\phi^{-1} F, \quad (4.43)$$

in which (4.42) has been used. In this equation the conjugate transpose of the reciprocal ϕ^{-1} can be substituted. That is if ϕ^{-1} is replaced by ϕ^{-1T} , the equation reads as

$$\frac{d}{dt} (\phi^{-1T}) = -F^T (\phi^T)^{-1}. \quad (4.44)$$

In this latter the rule is that when a matrix product $\phi^{-1}F$ is transposed then the order of the matrices which form the product is reversed. This system of equations can be rewritten as

$$\frac{d}{dt} \delta \underline{\lambda} = -F^T \delta \underline{\lambda}. \quad (4.45)$$



This in turn has a fundamental matrix θ which is the solution of

$$\frac{d\theta}{dt} = -F^T \theta. \quad (4.46)$$

The expansion of F^T is

$$F^T = \begin{bmatrix} 0 & 0 & 0 & \left(\frac{\partial g_{x_s}}{\partial x_s}\right)_0 & \left(\frac{\partial g_{y_s}}{\partial x_s}\right)_0 & \left(\frac{\partial g_{z_s}}{\partial x_s}\right)_0 \\ 0 & 0 & 0 & \left(\frac{\partial g_{x_s}}{\partial y_s}\right)_0 & \left(\frac{\partial g_{y_s}}{\partial y_s}\right)_0 & \left(\frac{\partial g_{z_s}}{\partial y_s}\right)_0 \\ 0 & 0 & 0 & \left(\frac{\partial g_{x_s}}{\partial z_s}\right)_0 & \left(\frac{\partial g_{y_s}}{\partial z_s}\right)_0 & \left(\frac{\partial g_{z_s}}{\partial z_s}\right)_0 \\ 1 & 0 & 0 & 0 & 0 & 0 \\ 0 & 1 & 0 & 0 & 0 & 0 \\ 0 & 0 & 1 & 0 & 0 & 0 \end{bmatrix} \quad (4.47)$$

or in partitioned matrix form

$$F^T = \begin{bmatrix} 0 & G^T \\ I & 0 \end{bmatrix}. \quad (4.48)$$

The linear system represented by (4.31) can be replaced by its associated adjoint system (4.44). In many solutions of physical problems this has certain advantages. The logic which allows this replacement comes under the notion of reciprocity. As an example of Maxwell's Theory of Reciprocity consider a tightly stretched string. Then a concentrated load applied at position 1 of the string produces the



same deflection at position 2 as would be produced at position 1 by the same load applied at position 2. In the replacement of a linear system by its adjoint certain pitfalls must be avoided. Suppose that in the system under discussion a function $f(t)$ represents an input at time t , and $r(t+\tau)$ represents the accompanying response at a time interval τ later than t . In order for the system to be a realizable one, the response must follow the input in time.

When these notions are transferred to the adjoint system, the time t must be run backwards to be both compatible with the original, and also to provide a realizable system. These ideas are developed completely in Refs. 6 and 7. In Ref. 8 it is proved, and from Appendix F, p. 398, Ref. 6, it can be deduced, that in our problem

$$\theta(t) = (\phi(t))^{-1T} \quad (4.49)$$

The transpose of both sides of the above furnishes

$$\phi^{-1} = \theta^T, \quad (4.50)$$

where it has been remembered the transpose of an already transposed matrix returns the original matrix.

Now Eq. (4.28) can be rewritten in partitioned form as

$$\begin{vmatrix} \delta \ddot{x}_a \\ \delta \dot{x}_b \end{vmatrix} = \begin{bmatrix} 0 & I \\ G & 0 \end{bmatrix} \begin{vmatrix} \delta x_a \\ \delta x_b \end{vmatrix}, \quad (4.51)$$



where the definitions of $\delta \underline{x}_a$, $\delta \underline{x}_b$, and G can be seen by comparison of (4.51) with (4.29). Expansion of (4.51) gives

$$\begin{aligned} \delta \dot{\underline{x}}_a &= \delta \dot{\underline{x}}_b \\ \delta \dot{\underline{x}}_b &= G \delta \underline{x}_a \end{aligned} \quad (4.52)$$

The derivative with respect to time of the first of these is

$$\delta \ddot{\underline{x}}_a = \delta \ddot{\underline{x}}_b$$

When the second of (4.52) is substituted for the right side of the latter, the result is

$$\delta \ddot{\underline{x}}_a = G \delta \dot{\underline{x}}_a \quad (4.53)$$

Now if this same procedure is followed for the adjoint system (4.45), the corresponding partitioned form is

$$\begin{vmatrix} \delta \dot{\lambda}_a \\ \delta \dot{\lambda}_b \end{vmatrix} = - \begin{bmatrix} 0 & G^T \\ I & 0 \end{bmatrix} \begin{vmatrix} \delta \lambda_a \\ \delta \lambda_b \end{vmatrix} \quad (4.54)$$

Expansion of this latter gives

$$\begin{aligned} \delta \dot{\lambda}_a &= -G^T \delta \lambda_b \\ \delta \dot{\lambda}_b &= -\delta \lambda_a \end{aligned} \quad (4.55)$$



from which Eq. (4.56) is obtained. That is

$$\delta \ddot{\lambda}_b = G^T \delta \lambda_b. \quad (4.56)$$

Reference to Eq. (1.12) shows that the matrix G is symmetrical, so that the above can also be written as

$$\delta \ddot{\lambda}_b = G \delta \lambda_b. \quad (4.57)$$

The reader will recognize that when a matrix is symmetrical it is identical with its transpose. What is of interest in these manipulations is that Eqs. (4.53) and (4.57) have the same form.

For the solution of Eq. (4.53) assume that $\delta x_1(t_0)$ is set equal to unity, and other initial conditions equal zero. Then the system is solved for $\delta x_1, \delta x_2, \delta x_3$ and their first derivatives, see (4.27) for the explanation of the numerical subscripts. If δx_4 is set equal to $\delta \dot{x}_1, \delta x_5 = \delta \dot{x}_2$ and $\delta x_6 = \delta \dot{x}_3$ then the first column of the θ matrix is obtained. However in having obtained the solution of (4.53) with a unit initial condition on δx_1 , a solution of Eq. (4.57) has also been obtained with a unit initial condition on $\delta \lambda_4$, other initial conditions are zero. Then by setting $\delta \lambda_1 = -\delta \lambda_4, \delta \lambda_2 = -\delta \lambda_5$, and $\delta \lambda_3 = -\delta \lambda_6$, the fourth column of the θ matrix has been obtained. In a similar manner a positive unit initial condition on $\delta \dot{x}_1, \delta \dot{x}_2, \delta \dot{x}_3$, that is on $\delta x_4, \delta x_5, \delta x_6$ is equivalent to putting a negative unit initial condition on $\delta \lambda_1, \delta \lambda_2, \delta \lambda_3$ respectively. Notice the interchange of the subscripts a, b between Eqs. (4.52) and (4.55).

If this analysis is carried through completely and both the θ and ϕ matrices are written in partitioned form as

$$\theta = \begin{bmatrix} \theta_1 & \theta_2 \\ \theta_3 & \theta_4 \end{bmatrix}, \quad \text{and} \quad \phi = \begin{bmatrix} \phi_1 & \phi_2 \\ \phi_3 & \phi_4 \end{bmatrix}, \quad (4.58)$$



then it follows that

$$\theta = \begin{bmatrix} \phi_4 & -\phi_3 \\ -\phi_2 & \phi_1 \end{bmatrix} \quad (4.59)$$

But from Eq. (4.50) $\phi^{-1} = \theta^T$. When this is used in (4.59), the reciprocal ϕ^{-1} is

$$\phi^{-1} = \begin{bmatrix} \theta_4^T & -\theta_2^T \\ -\theta_3^T & \theta_1^T \end{bmatrix} \quad (4.60)$$

which is the sought for result. Likewise

$$\theta^{-1} = \begin{bmatrix} \theta_4^T & -\theta_2^T \\ -\theta_3^T & \theta_1^T \end{bmatrix}$$

The above analysis applies to trajectories which are run forward in time, to trajectories which are run backward in time, and for any initial and final times. Due to the symmetrical properties of the perturbation equations, the transition matrix which relates any two points on the trajectory can be inverted in this manner.

Our Eq. (4.60) is Eq. (3.34) p. 15 of Ref. 1 and brings us to the end of Section 3 of Battin's report R-341.

MJF:JEK/amp



GRUMMAN AIRCRAFT ENGINEERING CORPORATION

LEM ENGINEERING MEMORANDUM

LMO-540-327
1 July 1964
663-027

From: *JSD* *SE* *E.S.*
F. DeVito, D. Lowen, Systems Analysis, x-1341

To: E. Stern H. Rothstein C. Witt
R. Knoetgen A. Nathan T. Kelly
M. Olstad P. Munter W. Rathke
T. Haggerty G. Sullivan E. Bonan
J. Roth F. Yagi R. Fleisig
J. Kmiecik M. Fish C. Kirchen
R. Catenaro F. Kractovil F. Lamazor
A. Whitaker N. Gutfield G. Patterson
T. Heuermann F. Zito, RASPO S. Chomak *SE*

Subject: MODIFICATIONS OF PROGRAM FOR ALLOCATING SYSTEM ERRORS.

Reference: (1) LEM Engineering Memorandum LMO-540-193, A Method for Allocating System Errors, by F. Lamazor, G. Patterson, S. Chomak, dated 16 December 1963.

Introduction:

This memorandum is a continuation of Reference (1) in which a method for allocating system errors among the error sources is described. The general closed-form solution which yields the ΔX_i from the simultaneous equations (9), (10), (11), (12) of Reference (1) is derived in Section A. Section B contains a description of how to expand the program to provide for error sources with fixed allocations and for error sources with sensitivities that are proportional to the source error. The solution derived in Section A requires no modification to include the results of Section B.

Section A -- Closed Form Solution of Equations Utilized in Maximizing the Payoff Function, P.

Consider the following set of equations in the variables $\Delta X_1, \Delta X_2, \dots, \Delta X_n, \alpha, \beta, \delta$.

$$(1) \quad \frac{\partial P}{\partial X_i} - 2 \times \Delta X_i + \rho \frac{\partial f_1}{\partial X_i} + \delta \frac{\partial f_2}{\partial X_i} = 0 \quad i = 1, 2, \dots, n$$

$$(2) \quad C - \sum_{i=1}^n (\Delta X_i)^2 = 0$$

$$(3) \quad \sum_{i=1}^n \frac{\partial f_1}{\partial X_i} \Delta X_i = 0$$

$$(4) \quad \sum_{i=1}^n \frac{\partial f_2}{\partial X_i} \Delta X_i = 0 \quad , \text{ where}$$

P is the payoff function to be maximized; f_1, f_2 are the two end point errors; X_1, X_2, \dots, X_n are the independent error sources; and α, β, γ are Lagrange multipliers.

The solution of equations (1) may be expedited by defining the new variable,

$$(5) \quad \Delta y_i \equiv \alpha \Delta X_i, \text{ which upon substitution into the above equations yields,}$$

$$(1') \quad \frac{\partial P}{\partial X_i} - 2 \Delta y_i + \beta \frac{\partial f_1}{\partial X_i} + \gamma \frac{\partial f_2}{\partial X_i} = 0 \quad i = 1, 2, \dots, n$$

$$(2') \quad C - \frac{1}{\alpha^2} \sum_{i=1}^n (\Delta y_i)^2 = 0$$

$$(3') \quad \sum_{i=1}^n \frac{\partial f_1}{\partial X_i} \Delta y_i = 0$$

$$(4') \quad \sum_{i=1}^n \frac{\partial f_2}{\partial X_i} \Delta y_i = 0$$

From equations (1'), it is clear that

$$(6) \quad \Delta y_i = \frac{1}{2} \left[\frac{\partial P}{\partial X_i} + \beta \frac{\partial f_1}{\partial X_i} + \gamma \frac{\partial f_2}{\partial X_i} \right] \quad i = 1, 2, \dots, n$$

and substituting (6) into equations (3') and (4'), one obtains:

$$(7) \quad \sum_{i=1}^n \frac{\partial f_1}{\partial X_i} \frac{\partial P}{\partial X_i} + \beta \sum_{i=1}^n \left(\frac{\partial f_1}{\partial X_i} \right)^2 + \delta \sum_{i=1}^n \frac{\partial f_2}{\partial X_i} \frac{\partial f_1}{\partial X_i} = 0$$

$$(8) \quad \sum_{i=1}^n \frac{\partial f_2}{\partial X_i} \frac{\partial P}{\partial X_i} + \beta \sum_{i=1}^n \frac{\partial f_1}{\partial X_i} \frac{\partial f_2}{\partial X_i} + \delta \sum_{i=1}^n \left(\frac{\partial f_2}{\partial X_i} \right)^2 = 0$$

One now has 2 equations and 2 unknowns in β and δ

Let

$$C_1 \equiv \sum_{i=1}^n \frac{\partial f_1}{\partial X_i} \frac{\partial P}{\partial X_i} \quad a_1 \equiv \sum_{i=1}^n \left(\frac{\partial f_1}{\partial X_i} \right)^2$$

$$C_2 \equiv \sum_{i=1}^n \frac{\partial f_2}{\partial X_i} \frac{\partial P}{\partial X_i} \quad b_1 \equiv \sum_{i=1}^n \frac{\partial f_2}{\partial X_i} \frac{\partial f_1}{\partial X_i}$$

$$d_1 \equiv \sum_{i=1}^n \left(\frac{\partial f_2}{\partial X_i} \right)^2$$

Substitution into equations (7) and (8) yields

$$(9) \quad \begin{aligned} C_1 + a_1 \beta + b_1 \delta &= 0 \\ C_2 + b_1 \beta + d_1 \delta &= 0. \end{aligned}$$

Simple solution yields, assuming a non-singular system,

$$\beta = \frac{C_2 b_1 - C_1 d_1}{a_1 d_1 - b_1^2} \quad \delta = \frac{C_1 b_1 - a_1 C_2}{a_1 d_1 - b_1^2}.$$

The solutions for β and δ may now be substituted into (6) to yield the n ΔY_i 's. From equation (2'), one obtains

$\alpha = \pm \left[\frac{1}{c} \sum_{i=1}^n (\Delta y_i)^2 \right]^{1/2}$, which upon substitution into equation (5) yields the desired outputs

$$(10) \quad \Delta X_i = \pm \Delta y_i / \left[\frac{1}{c} \sum_{i=1}^n (\Delta y_i)^2 \right]^{1/2}$$

Note that if the number of end point errors is k, then there are k linear equations (equivalent to (7) and (8)) with k unknowns. Cramer's rule may then be expeditiously applied to obtain the ΔX_i 's, for non-singular systems.

Section B -- Fixed Error Allocation and Linear Sensitivities.

Reference (1) was written for the case of error sources that have constant sensitivities and unknown allocations. In order to provide for error sources with fixed error allocations and for error sources with linear sensitivities, equation (1) (and (2)) of Reference (1) is changed to the following relation (derived in Appendix I): *

$$f_i = \left[\sum_{i=1}^{\ell} (A_i)^2 + \sum_{i=\ell+1}^m (A_i x_i)^2 + \sum_{i=m+1}^n (2A_i x_i^2)^2 \right]^{\frac{1}{2}}$$

where ℓ , m , n , and the A_i are inputs according to the following schedule:

$1 \leq i \leq \ell$	$A_i =$ sensitivity x fixed error allocation
$(\ell + 1) \leq i \leq m$	$A_i =$ constant sensitivity
$(m + 1) \leq i \leq n$	$A_i =$ coefficient of squared term in quadratic function

The calculation for the derivative $\frac{\partial f_i}{\partial x_i}$ similarly depends on the value of the subscript "i" so that the appropriate logic must be included in the program. This calculation (also shown in Appendix I) is as follows:

$1 \leq i \leq \ell$	$\frac{\partial f_i}{\partial x_i} = 0$
$(\ell + 1) \leq i \leq m$	$\frac{\partial f_i}{\partial x_i} = A_i^2 x_i / F_{i,max}$
$(m + 1) \leq i \leq n$	$\frac{\partial f_i}{\partial x_i} = 8A_i^2 x_i^3 / F_{i,max}$

* Valid only if the quadratic state variables are symmetric with respect to the nominal operating point (see page 5, Eq. 3).

Appendix I-- Modifications to the Mathematical Model of the Error Allocation Program

The error allocation program is modified herein to include those error sources whose allocations are fixed and whose end point error contributions are quadratic. Figure 1 depicts the state variable ϕ and the end point error f for an error source whose contribution to the total error is linear (see Reference 1). This is the type of error which is handled by the present computer program. The case of a quadratic error source is shown in Figure 2. For the purpose of this memorandum, it is assumed that the output of a quadratic error source is symmetric with respect to the nominal operating point X_n so that the slope (sensitivity) at the operating point is zero.

The end point error f_i or the deviation of the state variable (output) ϕ_i , for the case of independent error sources, is

$$f_i = \Delta \phi_i$$

and the root-sum-squared total error is

$$(1) \quad f_i = \left[\sum_{i=1}^n \left(\frac{\partial \phi_i}{\partial X_i} x_i \right)^2 \right]^{1/2}$$

$$\text{where } x_i = \Delta X_i$$

The end point error attributable to independent error sources which have fixed error allocations x_{if} relative to nominal values X_{in} is

$$(2) \quad f_{if} = \left[\sum_{i=1}^l \left(\frac{\partial \phi_i}{\partial X_i} \right)_{X_i = X_{in} + x_{if}}^2 (x_{if})^2 \right]^{1/2}$$

$$f_{if} = \left[\sum_{i=1}^l A_i^2 \right]^{1/2}$$

$$\text{where } A_i = \left(\frac{\partial \phi_i}{\partial X_i} \right)_{X_i = X_{in} + x_{if}} (x_{if}) \quad \text{for } l \geq i \geq 1$$

The case of an error source which can be described by a constant sensitivity (see Figure 1)

$$A_i = \frac{\partial \phi_i}{\partial X_i} \approx \text{constant for } m \geq i \geq (l+1)$$

is treated in Reference (1). The end point error attributable to independent linear error sources is

$$(3) \quad f_{1l} = \left[\sum_{i=l+1}^m (A_i x_i)^2 \right]^{\frac{1}{2}}$$

If the state variable ϕ_i is a quadratic function of the inputs X_i ($m \geq i \geq (m+1)$), then

$$\phi_i = \sum_{i=m+1}^m (A_i X_i^2 + A_i' X_i + A_i'')$$

The quadratic function may be expressed by a Taylor series written about the nominal point. Noting that all derivatives except the first and second are zero:

$$\phi_i(X) = \phi_i(X_n) + \phi_i'(X_n)(X - X_n) + \frac{\phi_i''(X_n)}{2!} (X - X_n)^2$$

where $\phi_i''(X_n)$ refers to the second partial derivatives $\left. \frac{\partial^2 \phi_i}{\partial X_i^2} \right|_{X=X_n}$ since there are no cross product $(X_i X_j)$ terms.

The end point error due to the quadratic error sources is

$$f_{1q} = \phi_i(X) - \phi_i(X_n)$$

$$(4) \quad f_{1q} = \phi_i'(X_n)(X - X_n) + \frac{\phi_i''(X_n)}{2} (X - X_n)^2$$

If the output ϕ_i is symmetric with respect to the nominal inputs X_{in} , $x_i = 0$ (see Figure 2), then

$$(5) \quad \phi_i'(X_n) = 0$$

The second partial derivative of the state variable with respect to an input X_i is

$$(6) \quad \frac{\partial^2 \phi_i}{\partial X_i^2} = 2A_i$$

The substitution of equations (5) and (6) into equation (4) and taking a root-sum-squared total yields the end point error attributable to quadratic error sources.

$$(7) \quad f_{1g} = \left[\sum_{i=m+1}^n (A_i x_i^2)^2 \right]^{1/2}$$

The independent errors (equations (2), (3), (7)) are combined into a root-sum-squared total as shown in equation (8).

$$f_1 = \left[f_{1f}^2 + f_{1e}^2 + f_{1g}^2 \right]^{1/2}$$

$$(8) \quad f_1 = \left[\sum_{i=1}^l (A_i^2) + \sum_{i=l+1}^m (A_i x_i)^2 + \sum_{i=m+1}^n (A_i x_i^2)^2 \right]^{1/2}$$

where $A_i = \left(\frac{\partial \Phi}{\partial X_i} \right)_{X_i = X_{in} + X_{if}} (X_{if})$ for $l \geq i \geq 1$

A_i = constant sensitivity for $m \geq i \geq (l+1)$

A_i = coefficient of squared term in quadratic function for $n \geq i \geq (m+1)$

The partial derivative $\frac{\partial f_1}{\partial X_i}$ for the quadratic case is calculated as follows:

$$\begin{aligned} \frac{\partial f_1}{\partial X_i} &= \frac{1}{2} \left[\sum_{i=1}^l (A_i^2) + \sum_{i=l+1}^m (A_i x_i)^2 + \sum_{i=m+1}^n (A_i x_i^2)^2 \right]^{-1/2} \cdot \frac{\partial A_i^2 x_i^4}{\partial X_i} \\ &= \frac{4 A_i^2 x_i^3}{2 f_1} \\ &= 2 A_i^2 x_i^3 / f_1 \end{aligned}$$

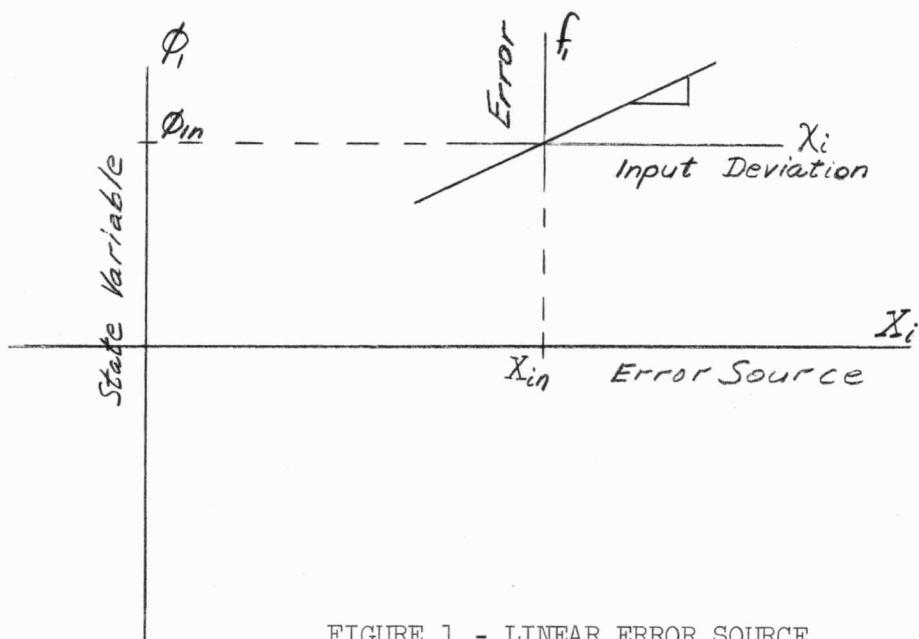

FIGURE 1 - LINEAR ERROR SOURCE

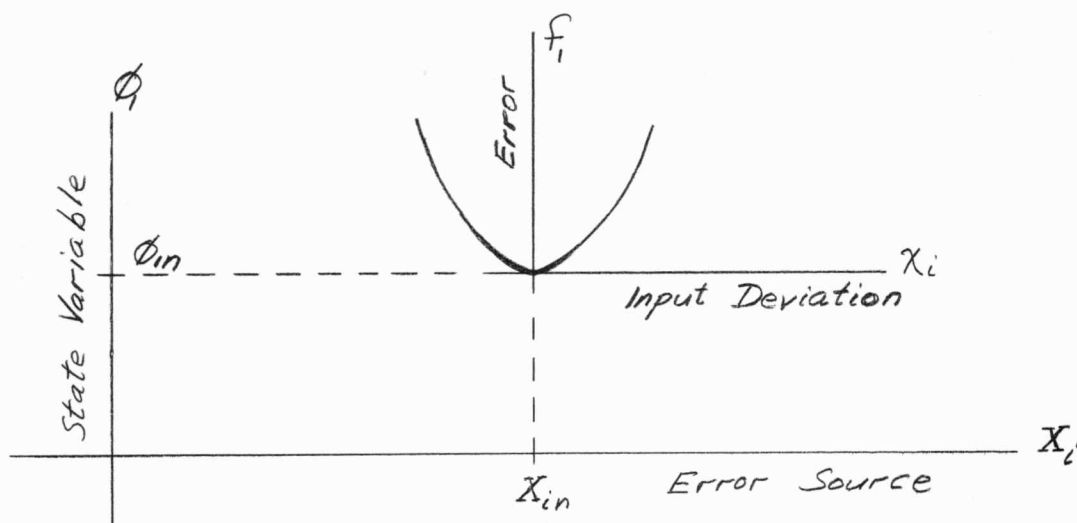
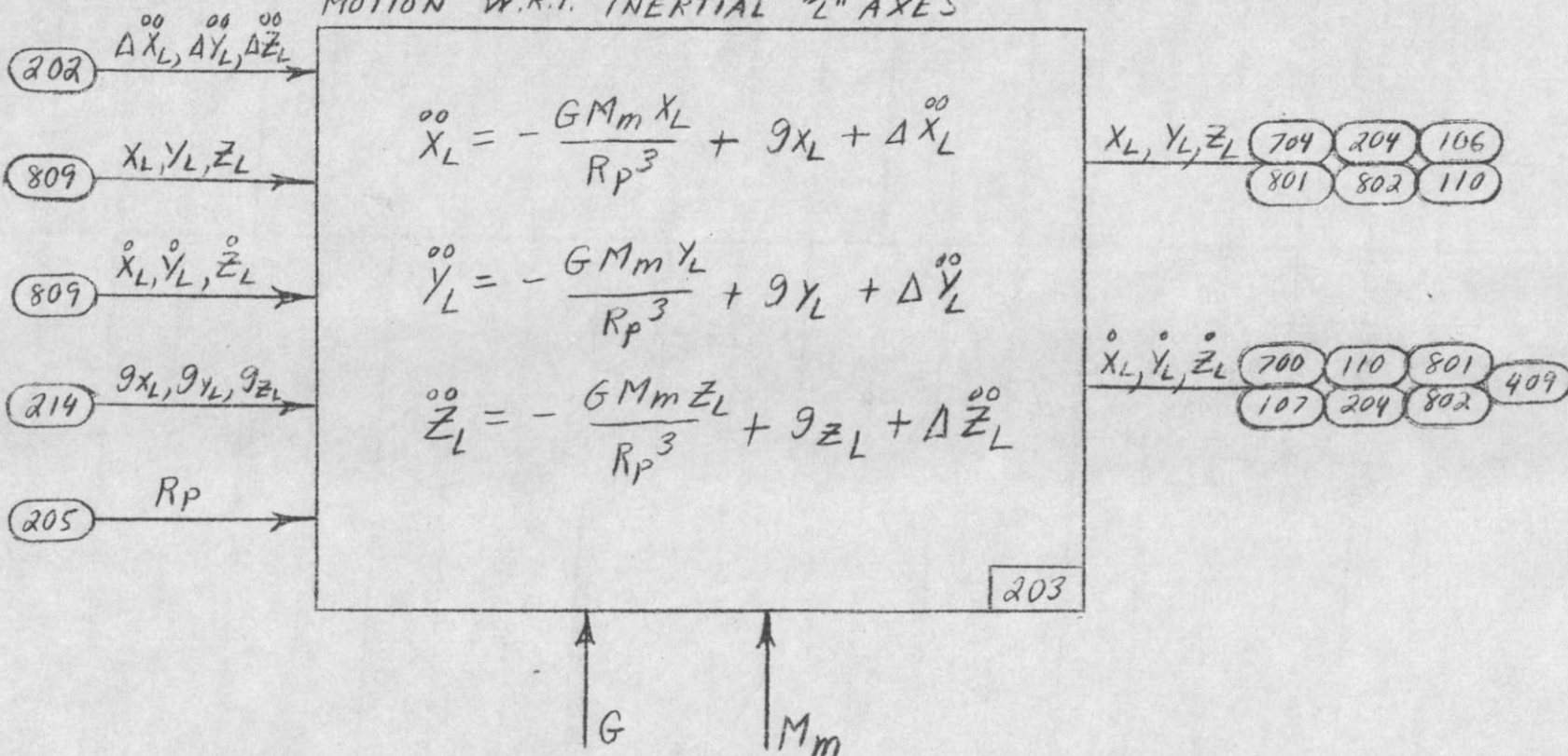
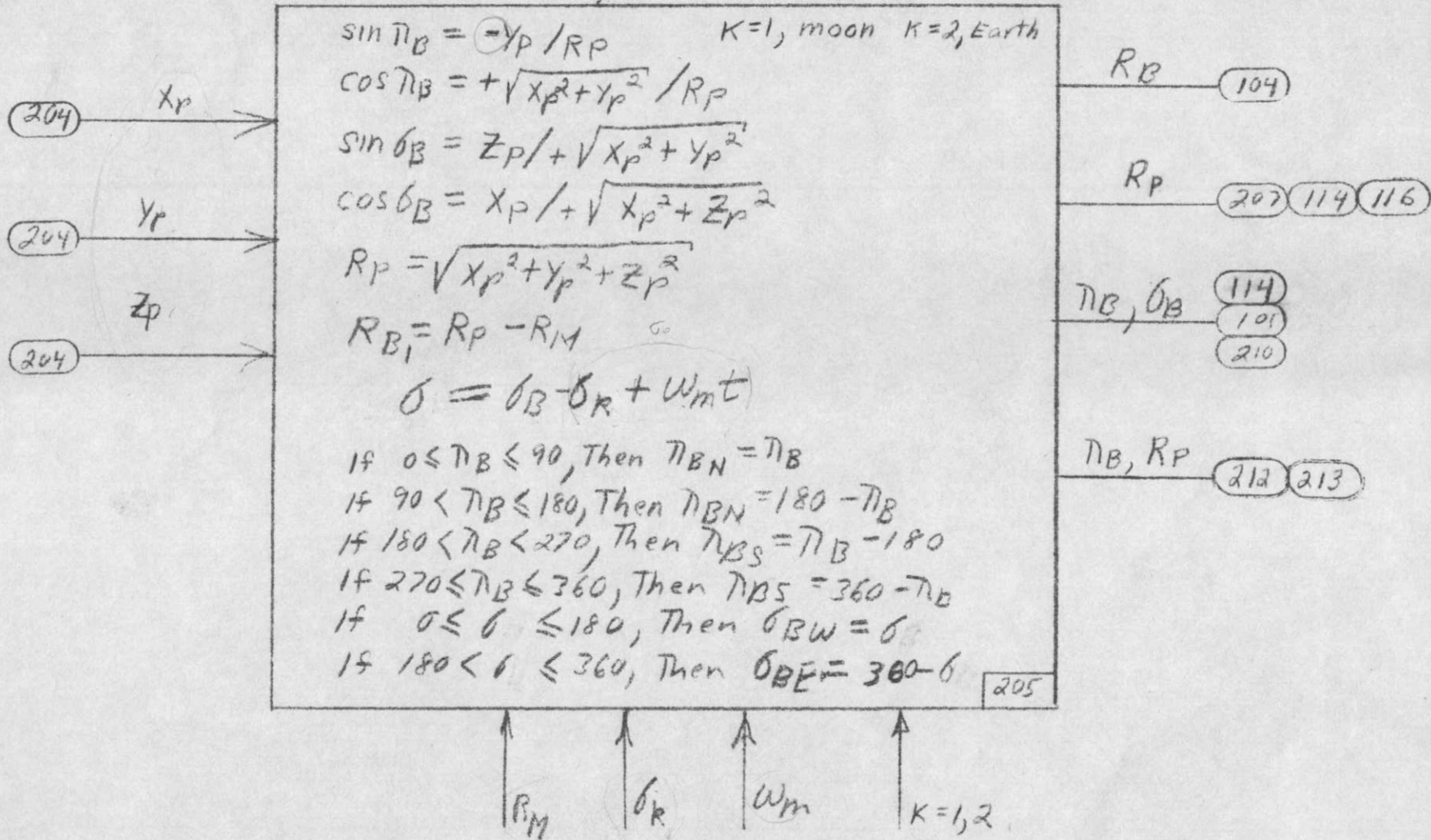

FIGURE 2 - QUADRATIC ERROR SOURCE

LEM TRANSLATIONAL EQUATIONS OF MOTION W.R.T. INERTIAL "L" AXES



LEM LATITUDE, LONGITUDE + ALTITUDE



GEODETTIC ALTITUDE AND LATITUDE

FOR EARTH ORBIT ONLY

$$R_{NL} = \frac{R_e R_{Pe}}{\sqrt{R_{Pe}^2 \cos^2 \pi_{B_2} + R_e^2 \sin^2 \pi_{B_2}}}$$

$$R_{B_2} \cong h' = R_{P_2} - R_{NL}$$

$$h^* = h' \times 10^{-6}$$

$$\pi_g = (K_0 + K_1 h^* + K_2 h^{*2} + K_3 h^{*3}) \sin \pi_{B_2} + \pi_{B_2}$$

212

↑
Re

↑
R_{Pe}

↑
K₀₋₃

(205) → π_B, R_P

COMPONENTS OF GRAVITY IN LEM LOCAL VERTICAL COORDINATES

FOR EARTH ORBIT ONLY

$$P_2 = 1 - 3 \sin^2 \tau_B$$

$$P_3 = 3 \sin \tau_B - 5 \sin^3 \tau_B$$

$$P_4 = 3 - 30 \sin^2 \tau_B + 35 \sin^4 \tau_B$$

$$P_5 = \sin \tau_B \cos \tau_B$$

$$P_6 = \cos \tau_B (1 - 5 \sin^2 \tau_B)$$

$$P_7 = \sin \tau_B \cos \tau_B (-3 + 7 \sin^2 \tau_B)$$

$$g_{n_B} = -\frac{GM_e}{R_p^2} \left[1 - \frac{J}{3} \left(\frac{R_e}{R_p} \right)^2 P_2 - \frac{2H}{5} \left(\frac{R_e}{R_p} \right)^3 P_3 - \frac{K}{10} \left(\frac{R_e}{R_p} \right)^4 P_4 \right]$$

$$g_{n_{2B}} = \frac{GM_e}{R_p^2} \left[-2J \left(\frac{R_e}{R_p} \right)^2 P_5 + \frac{3H}{5} \left(\frac{R_e}{R_p} \right)^3 P_6 + \frac{2K}{3} \left(\frac{R_e}{R_p} \right)^4 P_7 \right]$$

213

205 τ_B R_p →

→ $g_{n_B}, g_{n_{2B}}$ 214

↑ G ↑ M_e ↑ J ↑ H ↑ K ↑ R_e

GRAVITATIONAL ACCELERATION ALONG INERTIAL "L" AXES
FOR EARTH ORBIT ONLY

213 g_{r1B}, g_{r2B}

$$g_{XL} = g_{r1B} (c_1 a_1 + c_2 a_2 + c_3 a_3) + g_{r2B} (c_1 a_4 + c_2 a_5 + c_3 a_6)$$

210 $a_1 - a_8$

$$g_{YL} = g_{r1B} (c_4 a_2 + c_5 a_3) + g_{r2B} (c_4 a_5 + c_5 a_6)$$

211 $c_1 - c_8$

$$g_{ZL} = g_{r1B} (c_6 a_1 + c_7 a_2 + c_8 a_3) + g_{r2B} (c_6 a_4 + c_7 a_5 + c_8 a_6)$$

203

214

LEM-EARTH COMMUNICATION CAPABILITY

$$\delta_0 = \delta_R + \omega_m t$$

$$\delta' = \delta_B - \delta_0$$

if $\delta' < 180$, then $\delta_E = \delta'$

if $\delta' > 180$, then $\delta_W = 360 - \delta'$

$$R_G = R_E^2 + R_p^2 - 2R_E R_p \cos \delta_{E,W}$$

$$\sin \beta = R_p \frac{\sin \delta_{E,W}}{R_G}$$

$$R^* = R_E \sin \beta$$

if $R^* \geq R_M$ COMM. IS POSSIBLE

if $R^* < R_M$ Test δ^*

if $\delta_{E,W} \leq \delta^*$ COMM. IS POSSIBLE

if $\delta_{E,W} > \delta^*$ COMM. NOT POSSIBLE

(205) δ_B, R_p →

215



LEM-CSM COMMUNICATION CAPABILITY

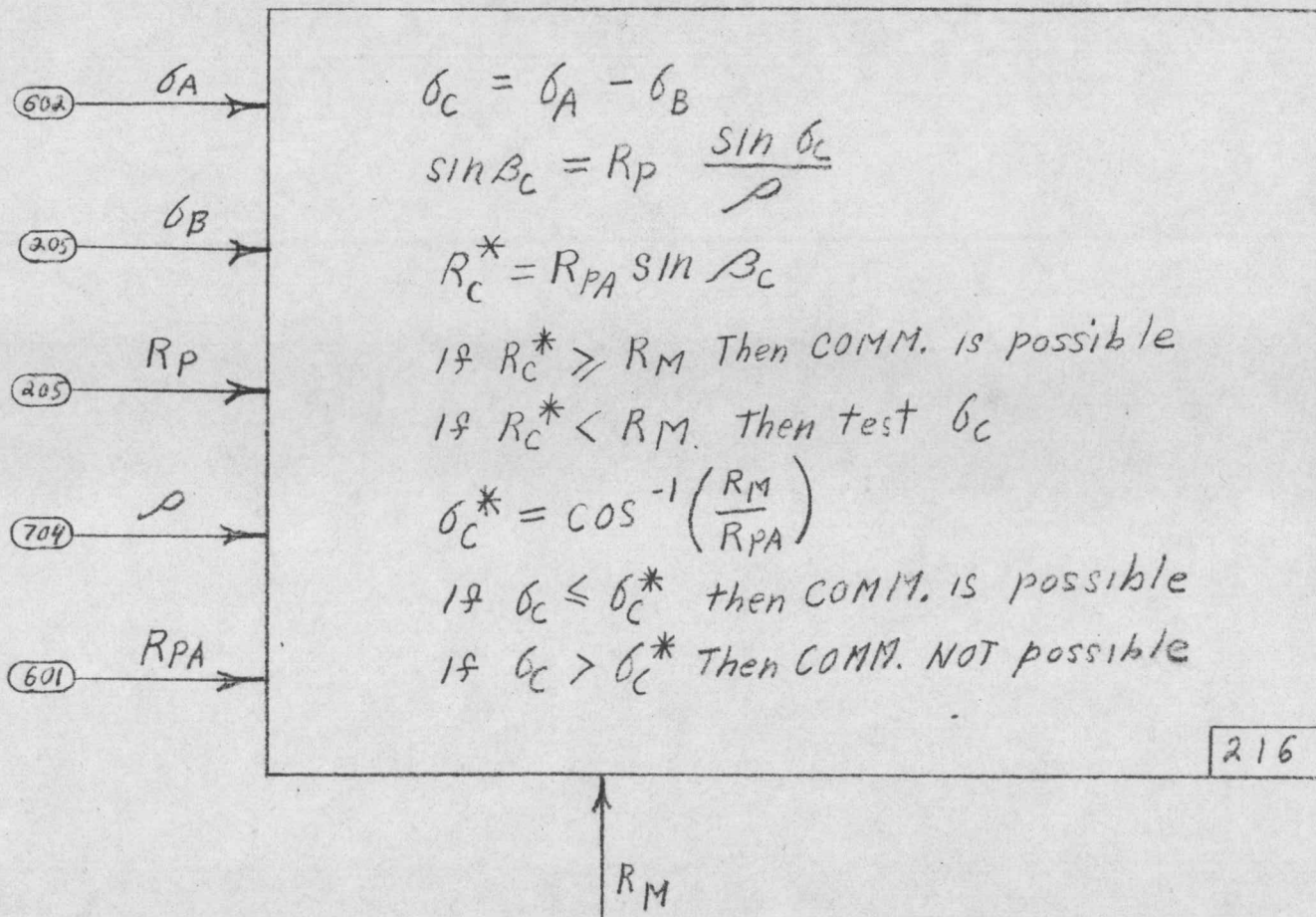

DIRECTION COSINES RELATING DOPPLER BEAM AXES TO BODY AXES

$$a_{j1} = -\cos \Lambda_1 \cos (\xi_j + \alpha_j)$$

$$a_{j2} = -\cos \Lambda_2 \cos (\xi_j + \alpha_j)$$

$$a_{j3} = -\cos \Lambda_3 \cos (\xi_j - \alpha_j)$$

$$a_{j4} = -\cos (\xi_j - \alpha_j)$$

$$b_{j1} = \sin \Lambda_1$$

$$b_{j2} = -\sin \Lambda_2$$

$$b_{j3} = -\sin \Lambda_3$$

$$c_{j1} = -\cos \Lambda_1 \sin (\xi_j + \alpha_j)$$

$$c_{j2} = -\cos \Lambda_2 \sin (\xi_j + \alpha_j)$$

$$c_{j3} = \cos \Lambda_3 \sin (\xi_j - \alpha_j)$$

$$c_{j4} = -\sin (\xi_j + \alpha_j)$$

$$k = 1, 2, 3, 4$$

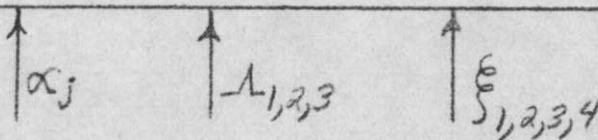

a_{jk} (116)
(117)

b_{jk} (116)
(117)

c_{jk} (116)
(117)

118

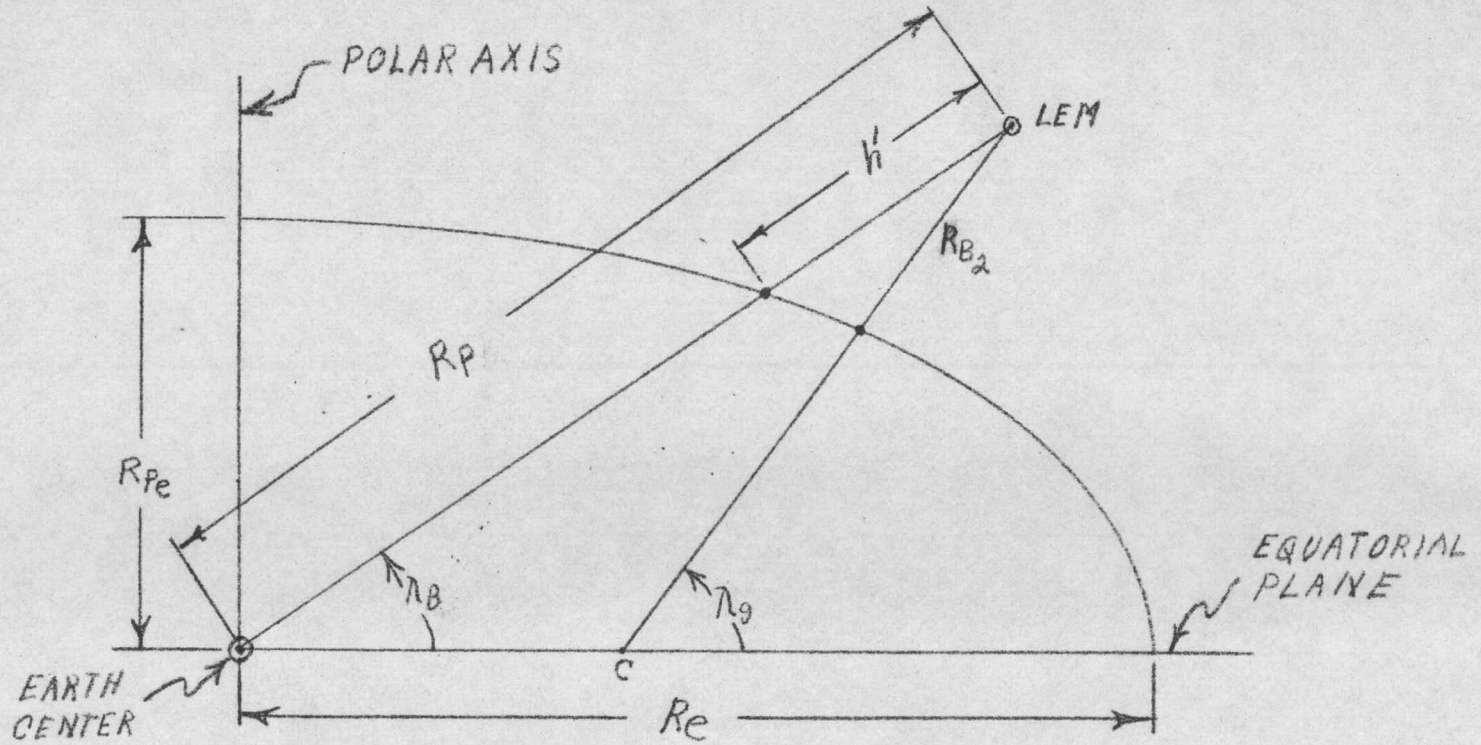

EARTH-OBLATENESS EFFECT ON LATITUDE AND ALTITUDE

DIAG. 13

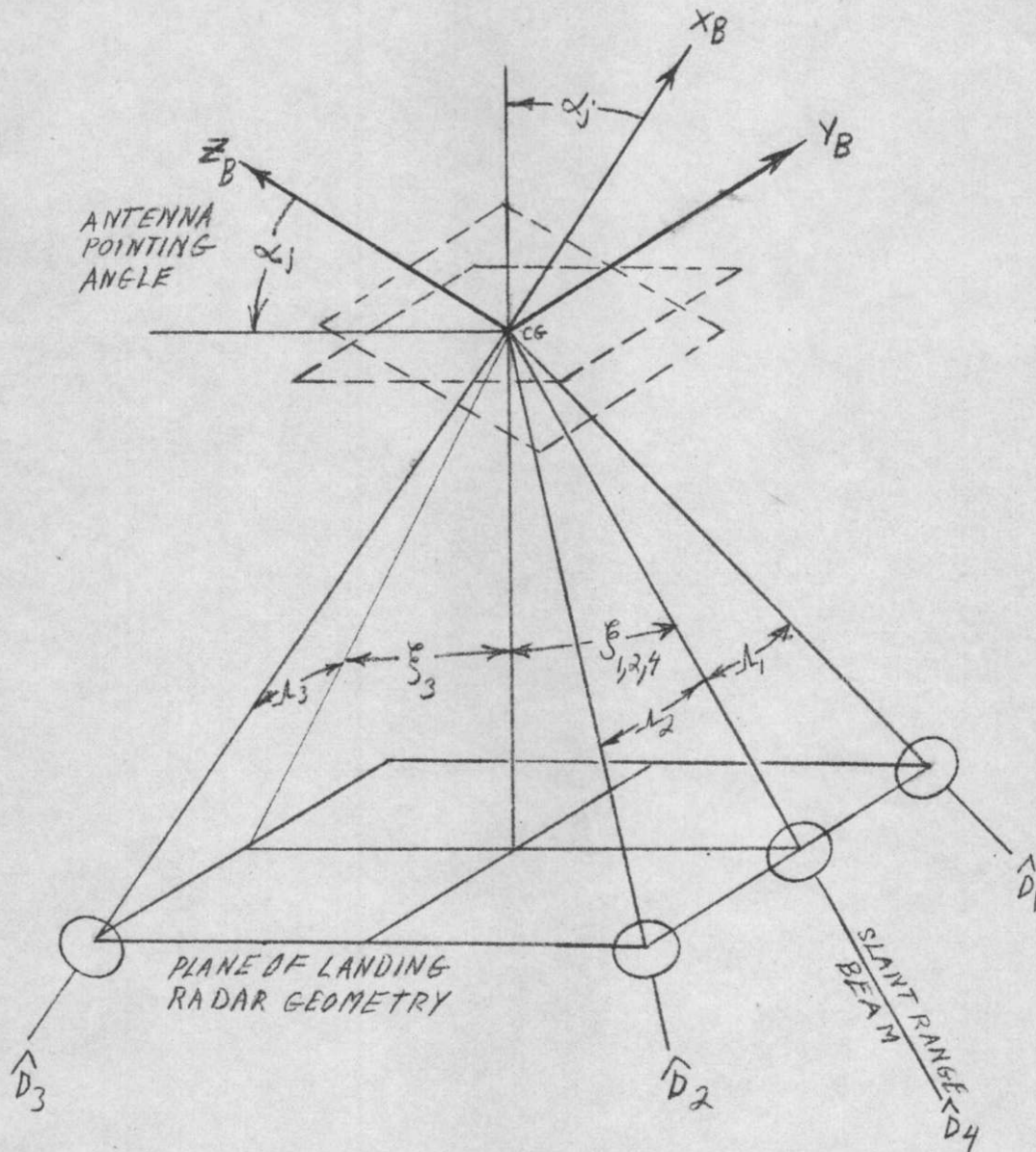

LANDING RADAR GEOMETRY

DIAG. 8

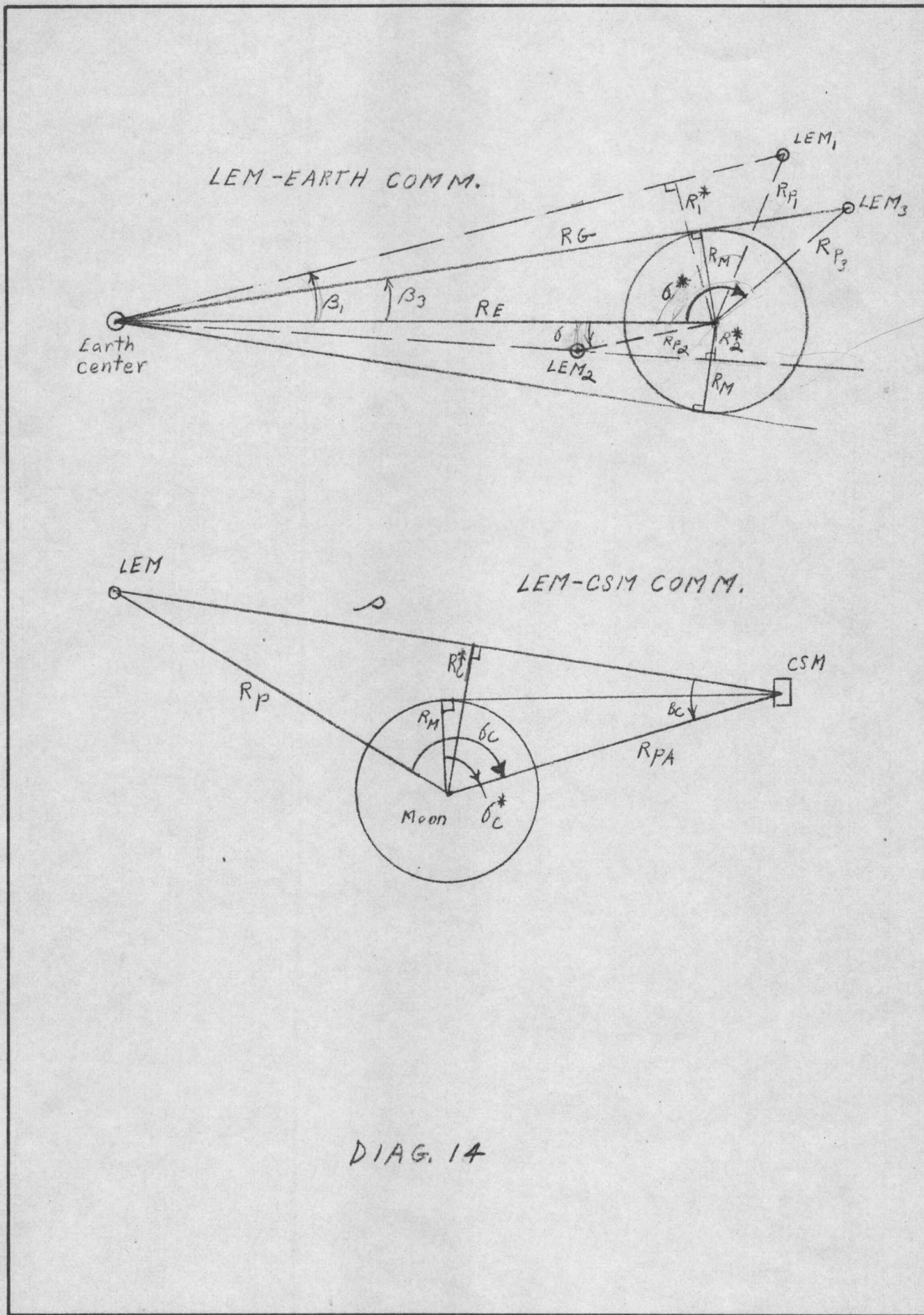

DIAG. 14

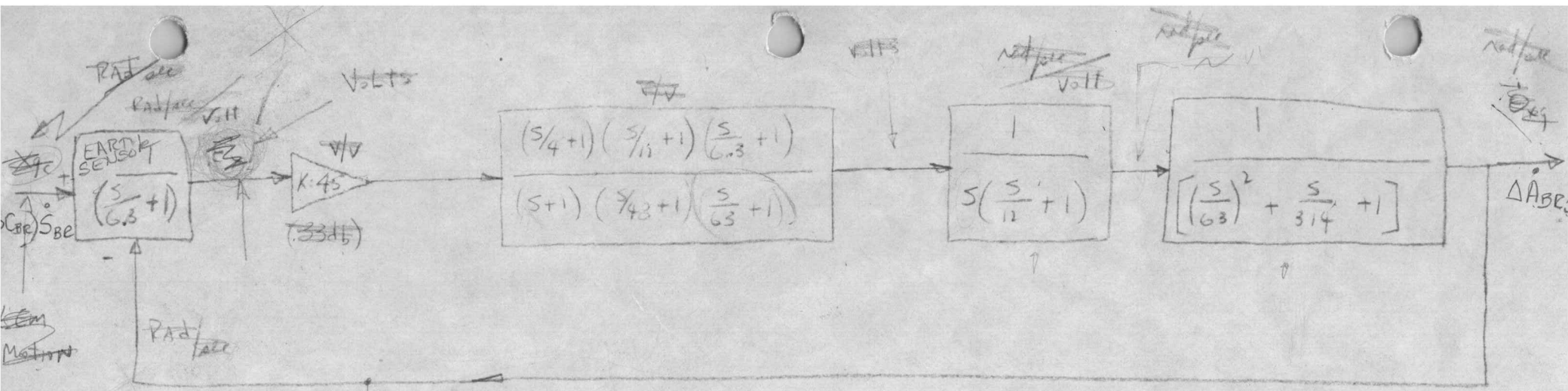

1st Revision of S-Band Steerable loop
 as of March 1, 1965

$G(s) =$

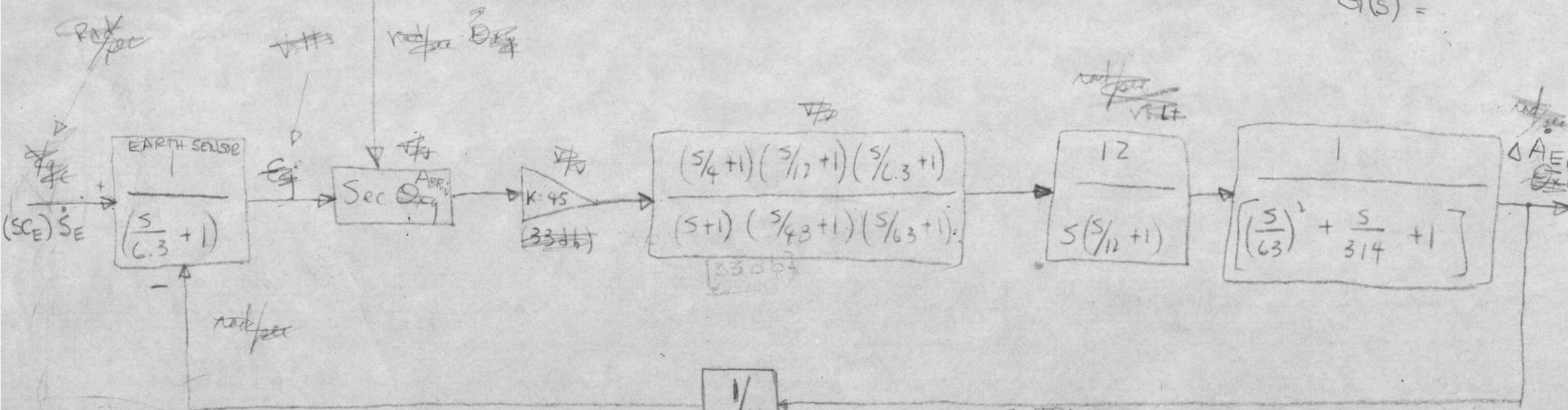

OPEN LOOP TRANSFER FUNCTION OF EACH LOOP

$$HG(s) = \frac{33dB (s/4 + 1)}{s(s + 1)(s/43 + 1)(s/63 + 1) \left[\left(\frac{s}{63}\right)^2 + 2(1)\frac{s}{63} + 1 \right]}$$

Sec A_{BE}

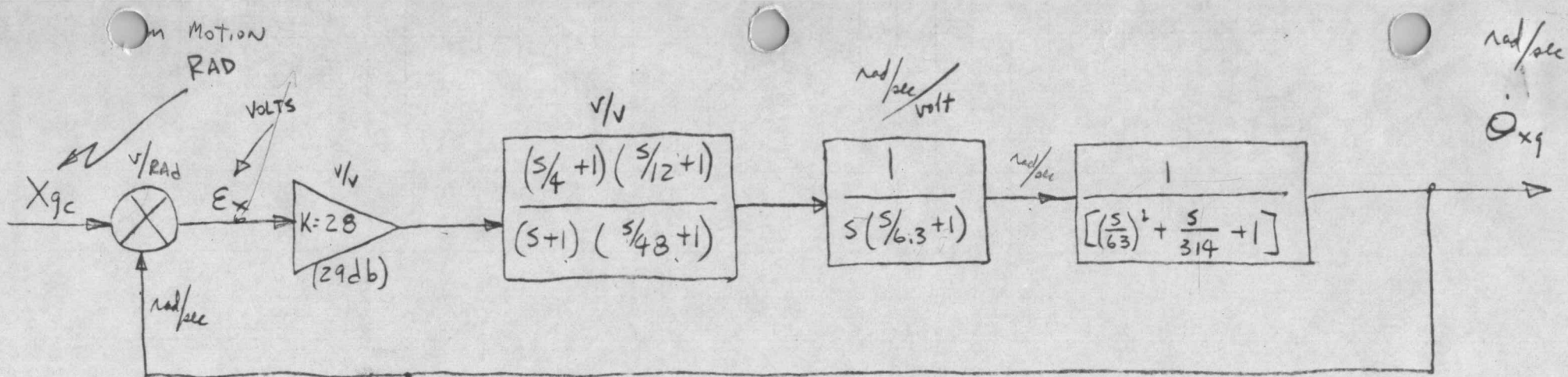

S-BAND STEERABLE LOOP
 D. J. Feb. 26, 1965

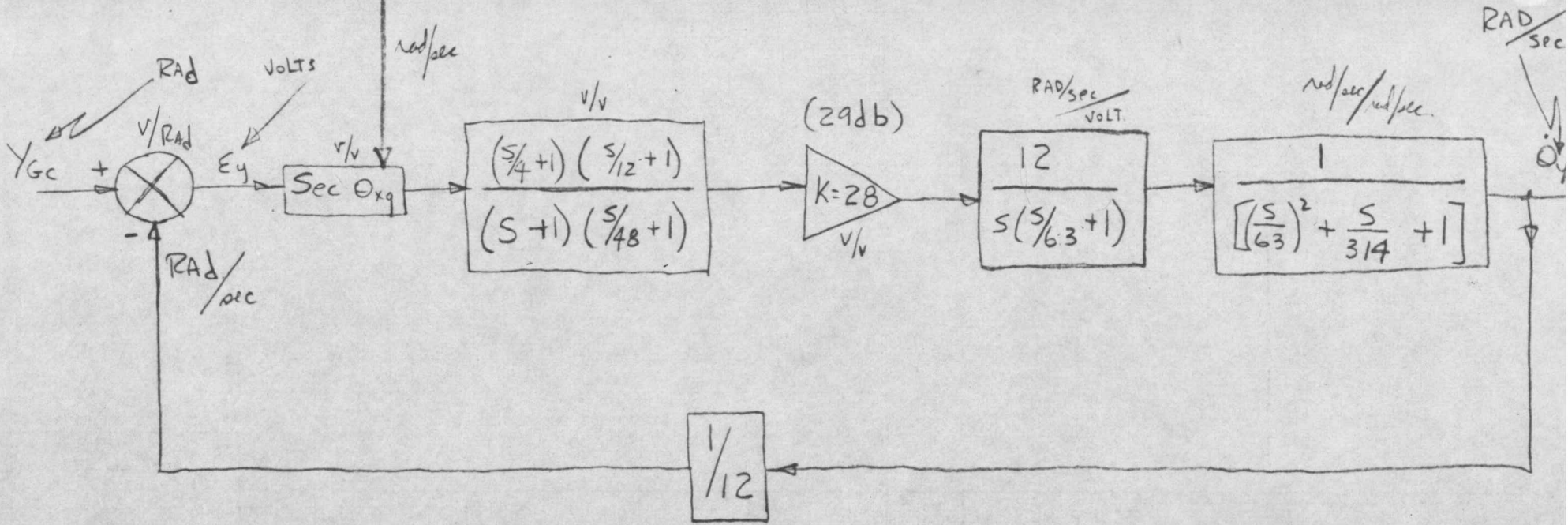

PROPRIETARY

A. Winkler

JUL 14 1964

GRUMMAN AIRCRAFT ENGINEERING CORPORATION

LEM ENGINEERING MEMORANDUM

Shim/gorczycki
ES
LMO-410-200
6 July 1964

From: L. J. Armani/H. K. Dunton

To: J. W. Coursen/C. R. Spinner

Subject: TRIP REPORT; XTASI HARDWARE MEETING NO. 4 AT MIT/IL JUNE 30 - JULY 1, 1964.

Enclosures: (1) List of Attendees at XTASI Hardware Meeting No. 4 MIT/IL
(2) Agenda of XTASI Meeting No. 4 at MIT/IL, June 30 - July 1, 1964.

SUMMARY:

XTASI Hardware Meeting No. 4 at MIT/IL was attended by personnel from GAEC, NAA, MIT, Raytheon and NASA (chairman). The attendees and agenda are listed in Enclosures 1 and 2 respectively.

The objectives of these meetings is to (a) exchange information and (b) resolve hardware problems related to NAA simulation instrumentation.

The purpose of GAEC personnel attendance at these meetings are threefold:

1. By observing NAA's and MIT's problems and resolution of these problems, GAEC will be able to avoid the same pitfalls in the FCS and FMES efforts.
2. To establish a rapport with the personnel involved so that when LEM problems arise, they may be solved as easily and rapidly as possible.
3. These meetings are a good advance source of information as to NASA's thinking and may prove valuable in formulating the test plans in the FCS and FMES.

The items discussed at this meeting which are of direct interest are summarized below:

PROPRIETARY



1/36 x 8
22 + 20/2

PROPRIETARY

GRUMMAN AIRCRAFT ENGINEERING CORPORATION
LEM ENGINEERING MEMORANDUM LMO-410-200

Page 2
6 July 1964

1. MIT presented a preliminary outline of a "Daily Checkout of Simulation Equipment" (GFE portions only). John Miller of MIT estimated that it would take approximately one hour to perform the checkout.
2. MIT (John Miller) stated that the G&N subsystem would not work, without a major redesign, if the IMU and PSA were not connected in a flight configuration. NAA (Paul Green) stated that it was not possible to fit the IMU and PSA on the FAT because of their size. RASPO MIT (T. Michaels) will check with MSC for resolution of this problem.
3. After much discussion concerning monitoring of the NAA required AGC signals, it was decided that if the signals were available elsewhere in the system, they would not be monitored at the computer interface.
4. As a result of an action item (X-H-16) from XTASI Meeting No. 3, MIT designed a recommended buffer circuit for monitoring AGC signals. At Meeting No. 3, Eldon Hall (MIT) insisted that MIT build the buffer circuits because, (1) MIT had the parts available and (2) MIT has a better feel for the circuits that had to be buffered. At this meeting, MIT (Don Bowler and Eldon Hall) tried to persuade NAA to build the circuits, but NAA simply restated MIT's arguments from the last meeting and refused to build them.
5. NAA requested that MIT prepare a list of signals which would be on "Downlink". MIT admitted being delinquent on this matter and intimated that they were "not sure" of what signals would be on "downlink".
6. NAA (P. Green and S. Robbins) stated that NAA had called Raytheon with regard to the CTS training for NAA and GAEC personnel (action item X-H-23, Meeting No. 3) and were informed that there will be no CTS or AGC available for training the class beginning July 13, 1964. NAA felt that all of the other information to be taught at the school is available in the CTS manuals and indicated they would not send personnel to the school.

Ted Michaels (RASPO/MIT) indicated that the training course may get a CTS and AGC in September 1964 and that the next class begins in December 1964.

C. Bobelis, GAEC N&G, stated that he would find out if GAEC was going to send anyone, in light of this information, and notify T. Michaels.

PROPRIETARY

PROPRIETARY

GRUMMAN AIRCRAFT ENGINEERING CORPORATION
LEM ENGINEERING MEMORANDUM LMO-410-200

Page 3
6 July 1964

7. In an informal discussion with Ted Michaels, the writer asked what was happening with Block II. He stated that he had just returned from MSC where he had attended the first of a series of four meetings to be held on Block II. He said that a block diagram of the Block II system was generated by NAA and MIT which makes the SCS completely back up. That means that the RCS will be controlled directly from the G&N unless in a back up mode.
8. T. Michaels also stated informally that Raytheon and Kollsman would become sub-contractors to AC Spark Plug before July 29, 1964, the reason being that NASA wants AC to be responsible for all schedules and deliveries.
9. NAA made a brief presentation to their proposed IMU and PIPA simulators.
10. The next XTASI meeting will be held on August 18 and 19 at NAA.

RH:sda

cc: R. Carbee
A. Whitaker
H. Kline/G. Emilio/J. Winsten
H. Wright/J. Cohen
H. Peck
410 Distribution
410 File
G. Henderson
R. Constable
C. Bobelis
C. Witt Jr.
F. Fitzgerald
R. Magner
LEM Project File
Data Management
R. Holmes

RH

PROPRIETARY



PROPRIETARY

GRUMMAN AIRCRAFT ENGINEERING CORPORATION
ENCLOSURE (1) to LMO-410-200

Page 1
6 July 1964

ATTENDEES: XTASI Hardware Meeting No. 4 MIT/IL

T. Michaels	RASPO/MIT
J. Miller	MIT
E. Hall	MIT
D. Bowler	MIT
G. Savage	NAA
P. Green	NAA
S. Robbins	NAA
A. Selagy	NAA
J. Freeman	RAY
J. Poundstone	RAY
C. Bobelis	GAEC
R. Holmes	GAEC

PROPRIETARY



PROPRIETARY

GRUMMAN AIRCRAFT ENGINEERING CORPORATION
ENCLOSURE (2) to LMO-410-200

Page 1
6 July 1964

AGENDA

XTASI Meeting No. 4 at MIT/IL

June 30 - July 1, 1964

1. Review old action items.
2. Review of Block 100 changes as listed in NASA TWX 105W 00008-ALOULO
3. Downlink information - The information on downlink is required to complete simulation data acquisition requirements.
4. IMU Simulator - Discuss method of IMU simulation to assure correct interface with G&N subsystem.
5. PIPA Simulation - discussion of correct PIPA interface to introduce acceleration into the simulator.
6. Remote DSKY's - discussion of providing remote indication of DSKY signals for remote display, control and data acquisition.
7. Discussion of S-1 optics CDU requirements.
8. Discussion of Spacecraft Optics - answers to questions on optics submitted to H. Koso.
9. Discussion of available information for simulation computer and core rope simulator.

PROPRIETARY



BRUNNEN AIRWAY MANAGEMENT CORPORATION
10000 W. 10th Ave. Suite 100
Denver, CO 80202

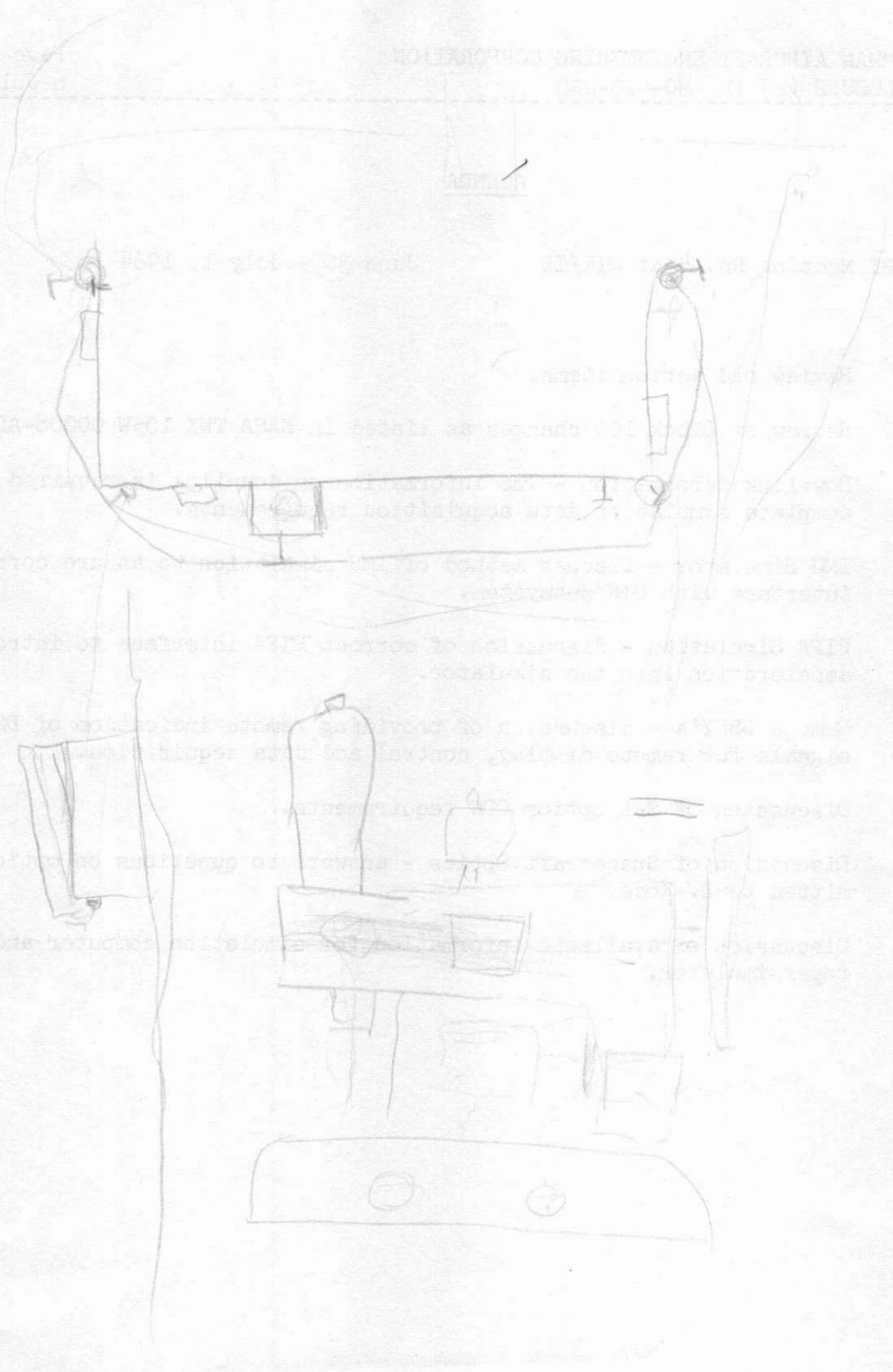

**GRUMMAN AIRCRAFT ENGINEERING CORPORATION
BETHPAGE, L. I., NEW YORK**

INTERFACE CONTROL DOCUMENT

THIS DOCUMENT SPECIFIES TECHNICAL REQUIREMENTS BETWEEN ALL PARTIES AFFECTED HEREIN. NOTHING CONTAINED IN THIS DOCUMENT SHALL BE DEEMED TO ALTER THE TERMS OF ANY CONTRACT OR PURCHASE ORDER BETWEEN GAEC AND THE ADDRESSEE.

ICD NO. LIS-300-10003

SEP 9 1964

APPROVALS

AUTHORIZED SIGNATURES	REPRESENTING	DATE
	GAEC	
	GAEC	7-8-64
	MIT	

PREPARED BY: F. W. Ellis *F W Ellis*

CHECKED: *J. Russell W. Smith*
J. Russell W. Smith

TITLE:
Attitude Steering Error Signal (Body Referenced) Electrical Interface with PGNS

CCA NO.

REV	MODEL NUMBER	REV	MODEL NUMBER	REV	MODEL NUMBER

EFFECTIVITY

CODE IDENT NO. 26512	SHEET 1 OF 10	ICD NO. LIS-300-10003	REV
-------------------------	---------------	-----------------------	-----

INTERFACE CONTROL DOCUMENT

**GRUMMAN AIRCRAFT ENGINEERING CORPORATION
BETHPAGE, L. I., NEW YORK**

REVISIONS

REV LTR	IRN NO.	SHEET	DESCRIPTION — INCLUDE CCA NUMBER	REV. BY	APPROVALS		DATE
					GAEC		

INTERFACE CONTROL DOCUMENT

**SHEET
2 OF 10**

**ICD NO.
LIS-300-10003**

REV

**GRUMMAN AIRCRAFT ENGINEERING CORPORATION
BETHPAGE, L. I., NEW YORK**

Key:

Responsibility is identified herein as follows:

- ① Grumman Aircraft Engineering Corporation
Bethpage, L. I., New York
- ② Massachusetts Institute of Technology
Cambridge, Massachusetts
- ③ National Aeronautics and Space Administration
Manned Spacecraft Center
Houston, Texas
- ④ Design data to be supplied by:

INTERFACE CONTROL DOCUMENT

SHEET
3 OF 10

ICD NO.
LIS-300-10003

REV

GRUMMAN AIRCRAFT ENGINEERING CORPORATION
BETHPAGE, L. I., NEW YORK

- Notes:
1. The steering error (body referenced) signal electrical interaction is defined for the Primary Guidance and Navigation Subsystem (PGNS) and the Flight Control Subsystem (FCS) of the Lunar Excursion Module (LEM).
 2. The signals are defined at the interface of the PGNS when operating in any vehicle control mode providing steering error and total attitude signals to the FCS. Loading on the steering errors also includes that caused by cockpit displays and telemetry requirements. The reference voltage required for CES (Control Electronics Section) power supply synchronization is also defined.

I. Specification of Signals

A. Reference Voltage

- (1) The CES Power Supply Synchronizing Voltage shall be supplied on two lines. This voltage shall be from the same source as the excitation voltage for the ladder networks of the steering error Coupling Data Units (CDU), and shall have the following characteristics:
- (2) Reference Voltage = $E_o \sin wt$ [Harmonic content consistent with definition of paragraph B(7)]
- (3) Amplitude: 28 ± 0.5 volts rms (for a 0.5 to 2.0 watt load)
- (4) Frequency: 800 ± 8 cps (or better) with computer synchronization (720 to 800 cps without synchronization)
- (5) Load: 2.0 watts maximum (including Abort Guidance and Displays requirements) at a minimum power factor of 0.8.

INTERFACE CONTROL DOCUMENT

SHEET
4 OF 10

ICD NO.
LIS-300-10003

REV

- (6) The Reference Voltage may have a turn-on overdrive not to exceed 45 volts rms and shall return exponentially to specified levels within 5 seconds.
- (7) The Reference Voltage will be isolated from ground in the CES.

B. Attitude Steering Error Signal Components

- (1) The steering error signal shall consist of 3 component steering error voltages each supplied on a pair of ground-isolated lines. Each steering error voltage shall be of the following form: $E_s = A_e KE_o \sin (wt + \theta)$

Where: E_s = steering error voltage (designated E_x , E_y or E_z for corresponding vehicle axes)
 KE_o = scale factor in volts per degree
 A_e = Attitude steering error component angle in degrees (designated A_x , A_y or A_z for corresponding vehicle axes). A_e varies incrementally and corresponds to the difference between the actual vehicle attitude and a commanded attitude.
 θ = carrier phase shift
 w = $2\pi (800)$

- (2) Steering Error Signal Carrier: The steering error signal carrier shall be an 800 cps sinusoidal voltage synchronous with the Reference Voltage and linearly proportional to steering error.
- (3) Source Impedance: $1 K \Omega / 0^\circ$ (Reference).

GRUMMAN AIRCRAFT ENGINEERING CORPORATION
BETHPAGE, L. I., NEW YORK

- (4) Load Impedance and Scale Factor: The load presented by the Flight Control System to each steering error signal shall be as follows:
- (a) $Z = 20K \pm 5\%$, angle of $Z = 0 \pm 5$ degrees
 - (1) $KE_o = 0.3 \pm 7\%$ rms volts per degree for $0.1^\circ \leq |A_e| \leq 6^\circ$
 - (2) $KE_o = 0.3 \pm 10\%$ rms volts per degree for $0 < |A_e| < 0.1^\circ$ or $6^\circ < |A_e| \leq 15^\circ$
 - (b) Load impedance range: $10K \leq Z \leq 80K$, angle of $Z = 0^\circ \pm 5^\circ$
 - (1) $KE_o = 0.3 \pm 13\%$ rms volts per degree for $0 < |A_e| \leq 15^\circ$.
 - (c) $Z = \infty$ when PGNS is not in use.
 - (d) The steering error voltage shall never exceed 10 volts rms for circuit protection considerations.
- (5) Phase Shift: The phase shift between each steering error voltage, E_s , and the reference voltage E_o shall be as follows:
- $|\theta| \leq 8^\circ$ for $E_s = 1.8$ volts (corresponding to an error $A_e = 6^\circ$)
- (6) Null Voltage: Total null (consisting of harmonics and quadrature) shall not exceed 56 millivolts rms (when $A_e = 0$).
 - (7) Harmonic Content: (4) (2)
 - (8) Resolution: The steering error signal resolution is $2\pi/2^{15}$ radians.

- (9) Response: The response of the steering error signal shall be as defined in LIS-290-10001.

II. Definition of Steering Error Component Angle:

- The attitude steering error component angle, A_e , shall be as follows as A_e approaches zero:

(1) For Yaw: $A_e = A_x \propto \sin (A_{oc}-A_{og}) + \sin (A_{ic}-A_{ig}) \sin A_{mg}$

(2) For Pitch: $A_e = A_y \propto +\sin (A_{ic}-A_{ig}) \cos A_{mg} \cos A_{og} + \sin (A_{mc}-A_{mg}) \sin A_{og}$

(3) For Roll: $A_e = A_z \propto -\sin (A_{ic}-A_{ig}) \cos A_{mg} \sin A_{og} + \sin (A_{mc}-A_{mg}) \cos A_{og}$

where: \propto Signifies "is proportional to".

A_{og} = IMU outer gimbal angle

A_{mg} = IMU middle gimbal angle

A_{ig} = IMU inner gimbal angle

A_{oc} = outer axis command angle

A_{mc} = middle axis command angle

A_{ic} = inner axis command angle

Figure 2 illustrates a mechanization of the Steering Error Signals.

- (4) Signal Phase: The steering error signal phasing is defined one body axis at a time using positive rotations measured from IMU gimbal zero position as shown.

A positive rotation is defined as a clockwise rotation of the vehicle about its axis viewed from the inside of the vehicle out along the positive direction of the axis (Figure 1).

GRUMMAN AIRCRAFT ENGINEERING CORPORATION
BETHPAGE, L. I., NEW YORK

A positive vehicle displacement of 0° to 180° from a commanded position shall give rise to a out of phase (180° from reference voltage) steering error signal. A negative vehicle displacement of 0° to 180° from a commanded position shall give rise to an in phase steering error signal.

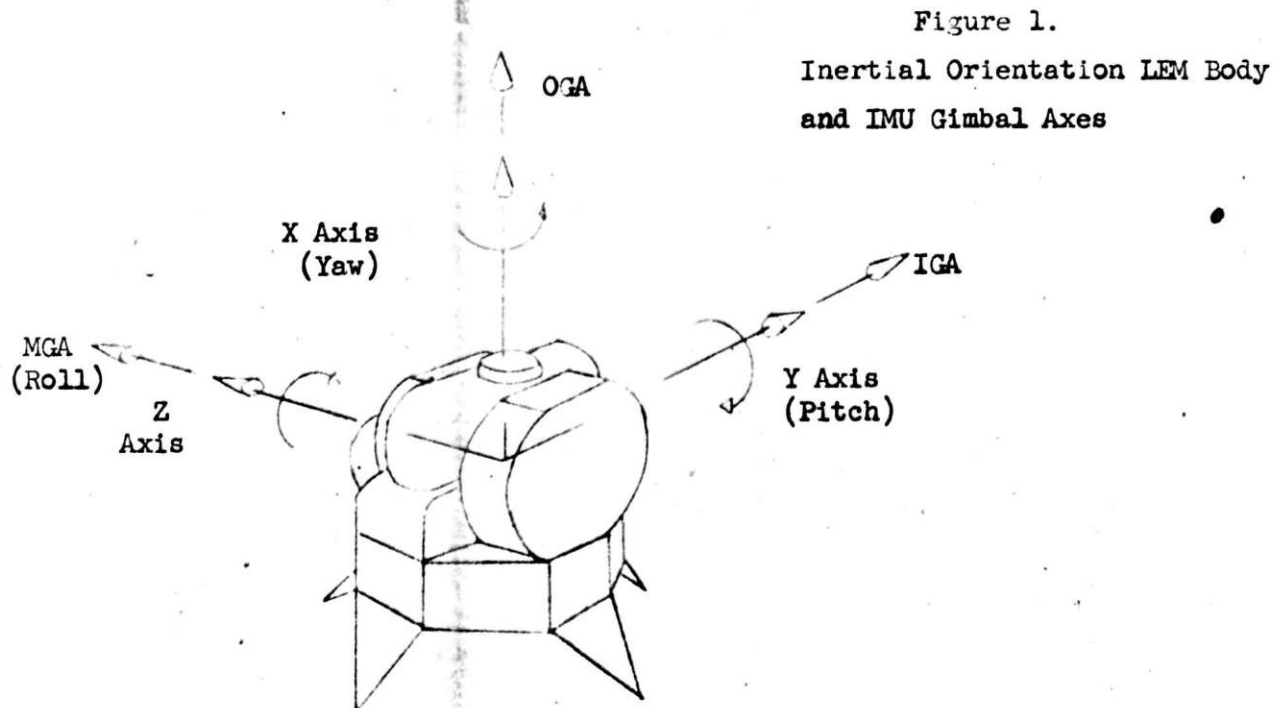

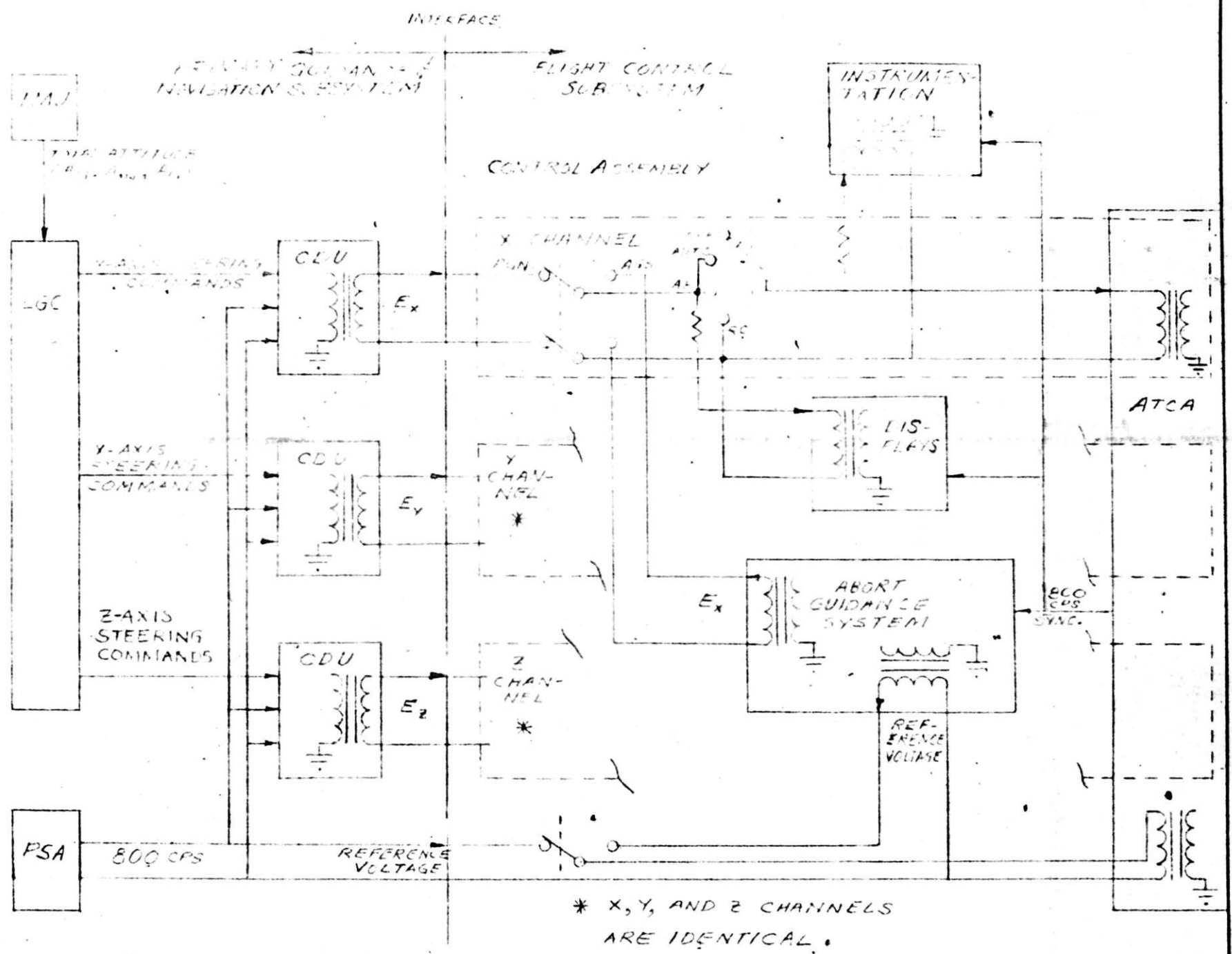
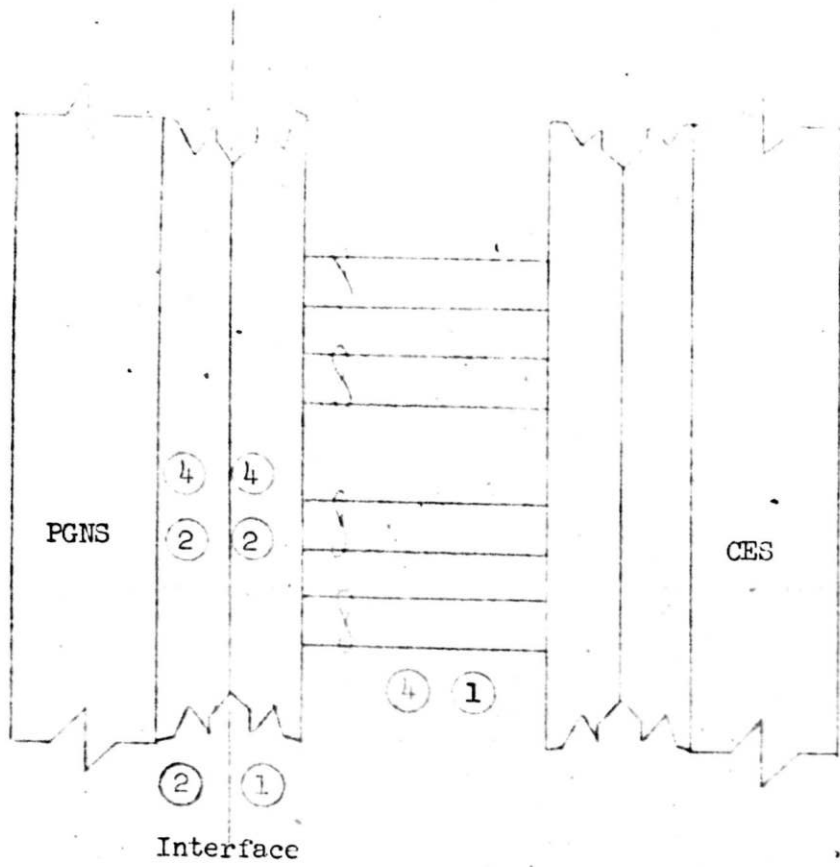

Figure 2 - PGNS Steering Error Voltage and Reference Voltage to Flight Control System (For Reference Only)



Interface

Connector Identification	Wire Gauge	Signal Identification
4 2	4 1	E_y - Pitch Error
4 2	4 1	E_y - Pitch Error - Low
4 2	4 1	E_z - Roll Error
4 2	4 1	E_z - Roll Error - Low
4 (2)	4 1	E_x - Yaw Error
4 2	4 1	E_x - Yaw Error - Low
4 2	4 1	800 cps Reference
4 2	4 1	800 cps Reference - Low

Note: Connector types are defined in LIS-390-10001 with pin numbers and wire gauges, also summarized for all PGNS wiring interfaces.

Figure 3 - Steering Error and Power Supply Reference Voltage Interface Connections

J. Gosczycki

GRUMMAN AIRCRAFT ENGINEERING CORPORATION

LEM ENGINEERING MEMORANDUM

LMO-540-433
15 December 1964

86. *E.S.* ^{cas}

From: S. Chomak, A. Schmur
Systems Analysis and Integration, X1986

To: J. Russell R. Carbee
F. Kratochvil A. Whitaker
E. Stern R. Fleisig
T. Kelly/W. Rathke F. Doennebrink
E. Bonan/T. Fessenden G. Henderson

Subject: PREFERRED GYRO ORIENTATION FOR THE ABORT SENSOR ASSEMBLY (ASA)

Reference: (1) Inertial Guidance Engineering, by M. Fernandez and G.R. Macomber - Prentice-Hall, Inc. - 1962

Summary:

The question of orienting the gyros in the ASA is considered with the intention of minimizing the drift rates incurred by operating the gyros with applied accelerations.

Discussion:

One major cause of drift rates appear as a consequence of the fact that the center of mass is not coincident with the center of buoyancy. Consider the following illustration:

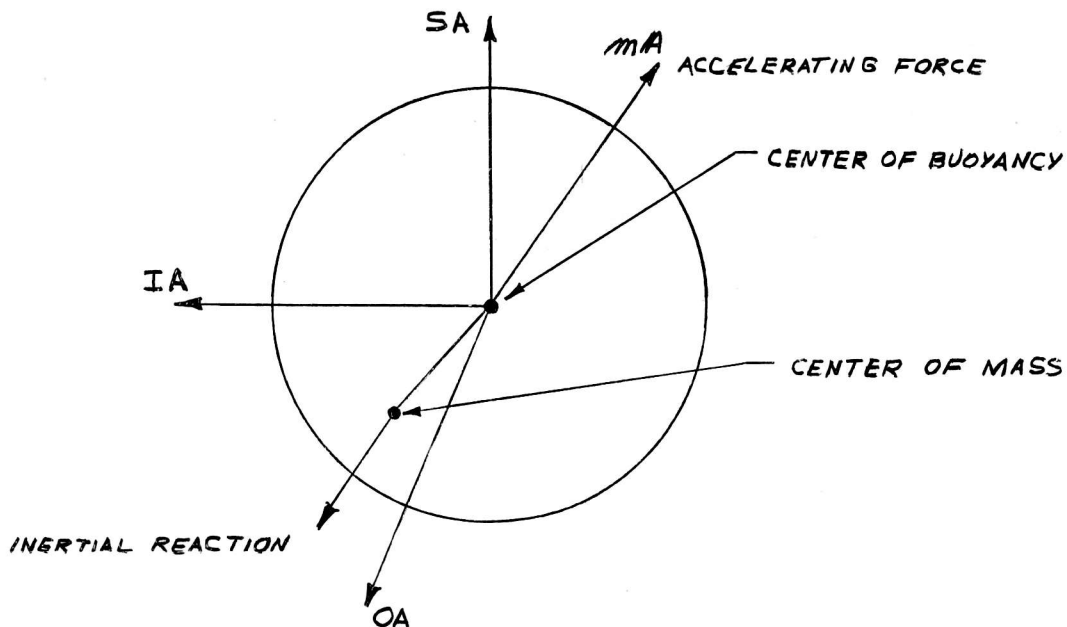

Torque is developed as a function of the direction and magnitude of the acceleration float mass (floated gyro) and the deflection of the center of mass. The effect of an unbalanced mass is to present a moment couple which results in an undesired drift rate. During powered flight the force field created by the thrust vector is directed along the body X-axis (gravity does not affect the gyros during flight). On the lunar surface the gravity field is in the X-axis direction also.

Minimization of this drift may be accomplished by orienting the unbalanced couple 90° from the sensitive axis. Consequently, a requirement is established for mounting the gyros. The preferred orientation is that the gyros be positioned so that the output axes (OA) are aligned in the direction of sensed accelerations whenever possible.

The preferred orientation based on this requirement is illustrated in the following sketch.

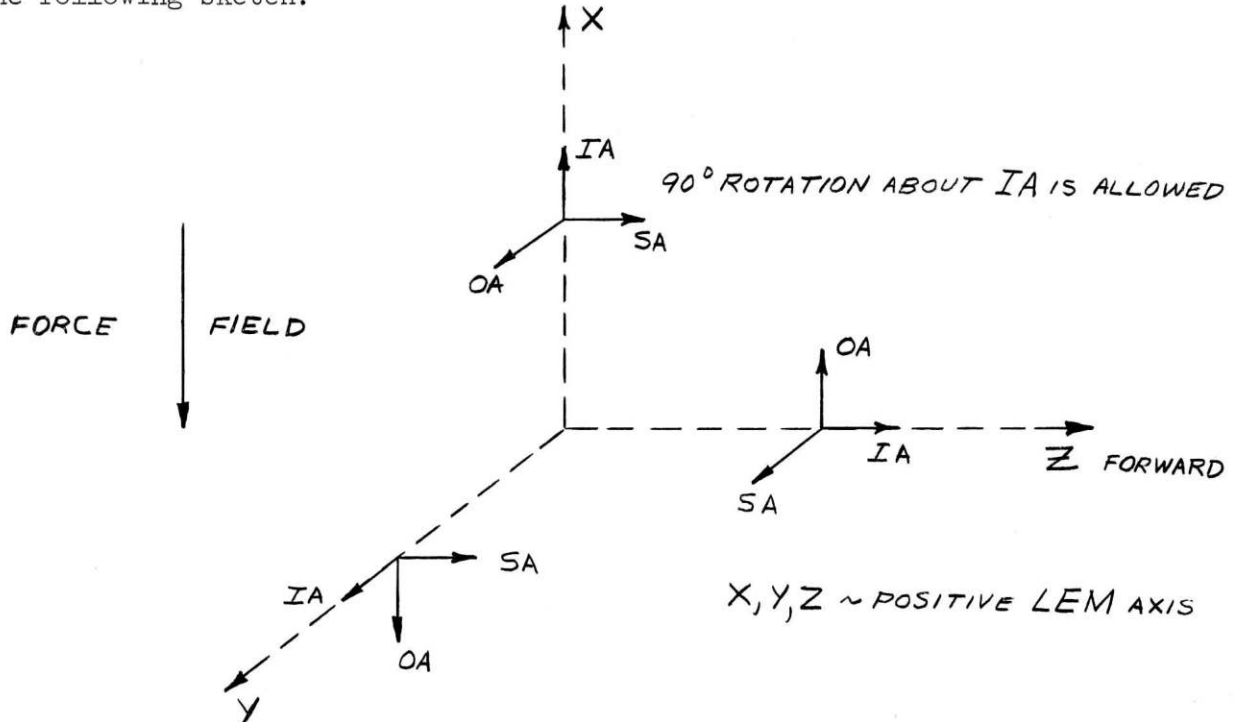

Note: No positive-negative direction of the gyro axis are implied by the above discussions.

SC/AS:dh

cc:

- | | | | |
|--------------|----------------|-------------|------------------|
| M. Olstad | H. Rothstein | D. McCabe | T. Heuermann |
| E. Gorczycki | P. Hoffman | A. Nathan | L. Koty |
| F. Saphra | R. Schindewolf | F. DeVito | F. Zito, RASPO |
| G. Sullivan | J. Asbedian | C. Witt | Data Management |
| K. Speiser | R. Adornato | B. Perini | LEM Project File |
| P. Kelly | L. Tucker | R. Witt | |
| D. Hawkins | L. Weber | A. Kreutzer | |

PRELIMINARY

FUNCTIONAL REQUIREMENTS OF
THE ABORT GUIDANCE
SYSTEM

Prepared by:

F. Lamazor
F. Lamazor

F. DeVito
F. DeVito

A. Schnur
A. Schnur

Checked by:

S. Chomak
S. Chomak

Approved by:

E. Stern
E. Stern

A. B. Whitaker
A. B. Whitaker

T. J. Kelly/W. Rathke
T. J. Kelly/W. Rathke

PRELIMINARY

TABLE OF CONTENTS

PRELIMINARY

SECTION

PAGE

PRELIMINARY

- I. INTRODUCTION
 - A. Ground Rules
 - B. Major Characteristics of the Computer
 - C. Tasks and Functional Objectives
 - D. Constraints

- II. COMPUTER ROUTINES (QUALITATIVE DISCUSSION)

- III. MISSION PHASE & TIME LINE UTILIZATION

- IV. COMPUTER INPUTS AND OUTPUTS
 - A. Computer Input - Output Functional Diagram
 - B. Glossary
 - 1. Computer Inputs via the Data Entry and Display Unit
 - 2. Computer Outputs via the Data Entry and Display Unit
 - 3. Other Computer Inputs
 - 4. Other Computer Outputs

- V. COMPUTER FLOW CHARTS
 - A. Timed Routines
 - 1. Mode Selection Flow Diagram
 - 2. Direction Cosine Updating and ΔV Accumulation
 - 3. Attitude Computations
 - 4. LEM Navigation Computations
 - 5. Guidance and Steering Computations
 - B. Untimed Routines
 - C. Overall Computer Functional Flow Chart

- VI. PRIMARY COMPUTATIONAL QUANTITIES

PRELIMINARY

TABLE OF CONTENTS (Cont'd)

<u>SECTION</u>	<u>PAGE</u>
VII. COORDINATE SYSTEMS	
A. LEM Body Axis System	
B. Inertial Guidance Coordinate System	
C. Rendezvous Radar Coordinate System	
VIII. SYNCHRONIZATION AND REAL TIME REQUIREMENTS	
IX. SPECIAL TOPICS	
A. Computer Checkout Procedures	
B. Guidance Monitoring Technique	
C. Initialization Procedures Prior to Launch	
D. Inertial Component Compensation	

I. INTRODUCTION

The purpose of this report is to set forth the systems requirements of the Abort Guidance System. Its primary concern is to define functional requirements of the system. It is anticipated that this information will form the basis of the major Abort Guidance System computer specification revision that is about to be undertaken. The requirements contained in this document are pertinent to the LEM 10 or lunar landing mission. Other missions for which there are distinct requirements will be covered in separate documents. Numerical requirements for both the LEM 10 Mission and other missions will be treated in separate documents.

The scope of this report encompassed defining the following aspects of Abort Guidance System Operation.

- a. Ground Rules
- b. Constraints
- c. Mission objectives
- d. Specific tasks
- e. Computational Requirements
- f. Vehicle characteristics and limitations
- g. Input-output requirements

It will be noticed that the requirements stated in this document are quite specific rather than general in nature. This has been done because specifics are more easily communicated. Furthermore, contradictions in requirements are more easily identified and eliminated. It is anticipated that this set of requirements will form a basis or foundation upon which the many detailed requirements can evolve.

In consideration of a set of requirements for the Abort Guidance System, the question of the terms in which to speak of the computational reqmt's arose. A natural dilemma had to be considered. It is important to state the desired end results and desired techniques that should be employed to obtain those results. It is not particularly desirable to constrain the specific equations used to bring the specific techniques to fruition. However the only satisfactory method of communicating computational requirement is in the language of computation namely, equations. With this in mind, a set of primary quantities (See Section VI) and a set of techniques are defined. These primary quantities and techniques represent the system requirements. The specific equations serve to define the systems

requirements as defined above, and to form a foundation for subsequent evolution. It is anticipated that the Abort Guidance System Computer Specification will follow in a similar vein.

PROPERTY

I. INTRODUCTION (Cont'd)

A. Ground Rules

The systems requirements for the Abort Guidance System are based upon the following NASA directives:

- (1) 4096 word computer
- (2) General serial data link between the PGNS and AGS
- (3) Data Entry and Display Unit for the Abort Computer
- (4) MSC monitoring to be implemented

B. Major Characteristics of the Computer

With regard to the above directives, the Computer Specification is to be based upon the following Abort Guidance System configurational constraints:

- (1) Full capability navigation system utilized for all mission phases.
- (2) Explicit Guidance Techniques are used
- (3) MSC monitoring concepts will be implemented

C. Functional Objectives

The basic Abort Guidance System Functional Objectives Implemented by the AEA Computer are as follows:

- (1) Abort from Powered Descent (beacon or non beacon)
- (2) Abort from lunar surface
- (3) Abort from Powered ascent
- (4) Abort from Coasting Descent
- (5) Engine Select Capability (descent-ascent engine combination or ascent engine only)
- (6) Self contained midcourse correction capability (with either main engine or RCS).
- (7) Performs Injection Maneuver from phasing orbit to intercept orbit
- (8) Trajectory Optimization Capability (inflight choice of rend. pt.)
- (10) Abort monitoring capability

D. Constraints

The basic abort guidance system requirement implemented by the computer are as follows:

- (1) 30,000 ft. minimum pericyynthion altitude maintained for all aborts
- (2) Total ΔV required to rendezvous does not exceed 98% of budget, e.g.,
 - V Budget for Ascent Stage = 6646 fps
 - V Budget for Descent Stage = 7385 fps
- (3) System can handle maximum out-of-plane condition of .5°

(4) Guidance System must bring CSM to within 5 n.mi. of CSM with a relative velocity deviation of less than 30 fps

(5) 10 hour maximum flight time from abort initiation to rendezvous.(contingency time)

Trajectory Constraints

The following trajectory constraints are to be implemented by the Abort Guidance System:

1. Launch Window - Constants appearing in the guidance equations (Section V) must be adjusted to insure the launch window objectives indicated by the accompanying sketch:

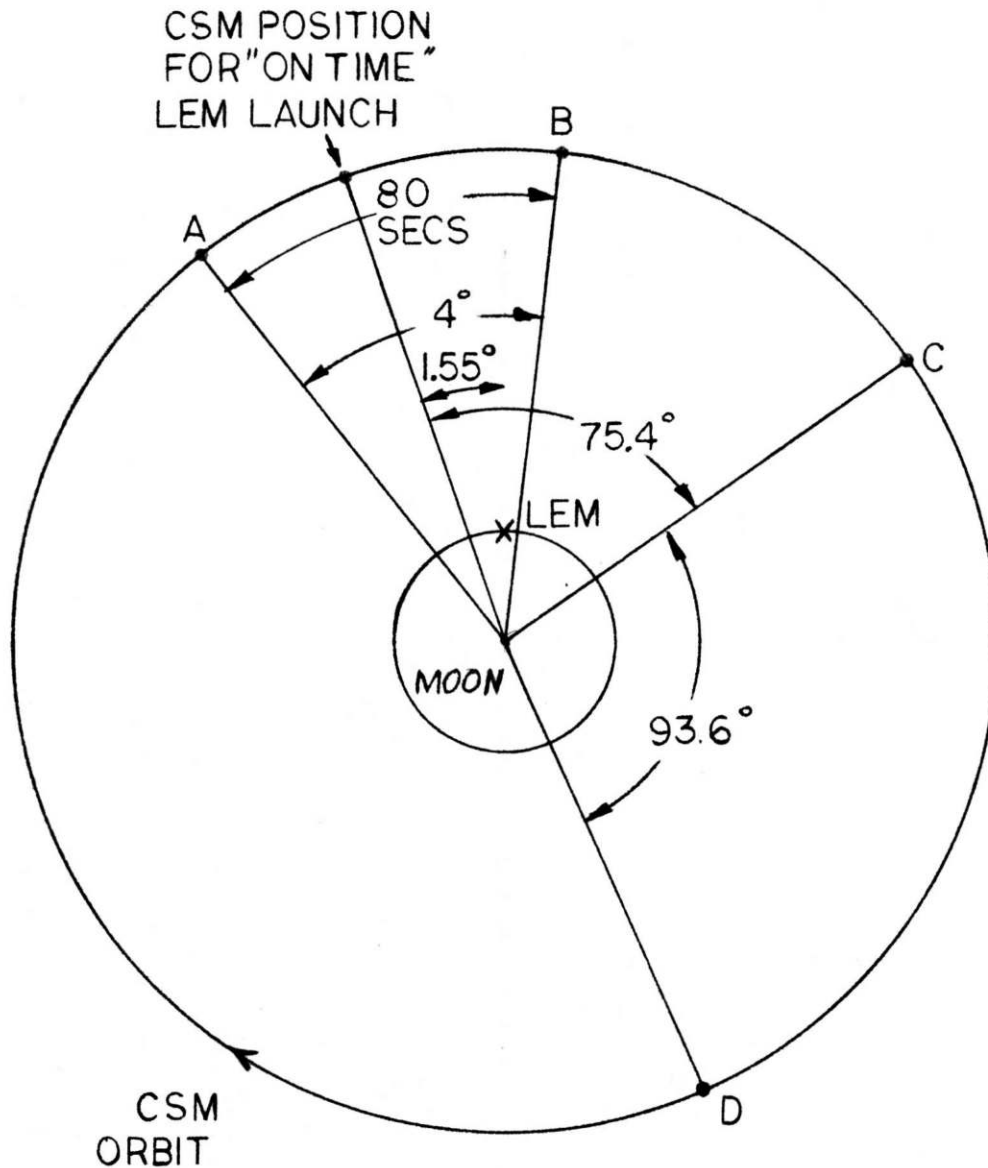

The CSM positions for which a direct intercept ascent trajectory can be attained, are indicated on the Figure - pt A to pt. B) Note that a direct intercept trajectory is defined as one whose transfer angle is less than 360° . The CSM positions, at launch time, for which it is possible to go into a parking orbit without exceeding the 10hour contingency time, are also shown on the figure - pt. D to pt. A. (A launch is not required for CSM positions "C to D"). For nominal conditions, an "on time" launch (as indicated on the figure) is defined as the launch (within the direct intercept launch window) for which a combination of total ΔV , and time to rendezvous, is minimized.

2. Parking Orbits - Constants appearing in the guidance equations (Section V) must be adjusted, in order to insure the capability of the Abort Guidance System to guide the vehicle on either one of the following two parking orbits.
 - a. Low eccentricity, low apocynthion orbit, In this type of orbit a low pericynthion of 30,000 ft. is maintained with an allowable excess velocity (over-speed) of up to 20 ft/sec.
 - b. High eccentricity, high apocynthion orbit. A clear pericynthion of 30,000 feet is specified and the apocynthion on the order of 90 nautical miles. Excess velocities (over-speeds) are on the order of 120 ft/sec.

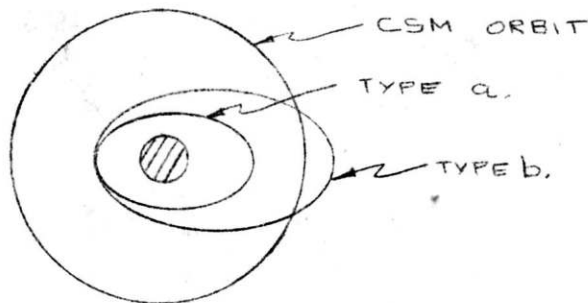

- c. The Launch Azimuth for going into a parking orbit is constrained to be parallel to the CSM Plane (velocity vector at burnout parallel to the CSM Plane).
3. Midcourse Correction Constraints
 - a) The minimum time before a midcourse correction maneuver can be executed is 20 minutes subsequent to burnout. This time includes the radar lock on procedures, radar data procurement, and manual insertion of the radar data into the computer.
 - b) The midcourse maneuver to correct for out-of-plane errors is to be made at the line of nodes. The vehicle launches in a plane parallel to the CSM orbit approximately 90 degrees prior to the line of nodes.

II. Computer Routines

This section outlines the various computer routines that implement the Abort Guidance System functional objectives. For these routines, a mission phase, and time utilization breakdown is presented in Section III.

- (1) Processing of ASA gyro and accelerometer information - accumulation of pulses over a fixed time interval.
- (2) Direction cosine updating - second order integration.
- (3) Attitude Computations - for guidance (θ, ψ, ϕ) and display (8Ball α, β, γ).
- (4) Rotation of body axis ΔV components to the inertial frame.
- (5) LEM inertial navigation routine - trajectory integration.
- (6) Calculation of LEM navigational quantities used for the monitoring technique
(Section IX)
- (7) Radar Data Filter for Navigation Updating (near optimum and time varying)
- (8) LEM orbit determination routine
- (9) Flight Planning and prediction - V_n calculation via Herrick P iteration method, constraint checks, and trajectory optimization.
- (10) Steering routine - function of the velocity to be gained vector, and includes powered flight prediction.
- (11) Vehicle pointing routine for facilitating a radar "lock on" condition.
- (12) Alignment routines (IMU, Lunar) - calculation of initial direction cosines directly from the Euler angles.
- (13) Computer checkout routines (Section IX)
- (14) Mode selection logic

III. Mission Phase and Time Line Utilization

Mission Phase

<u>COMPUTER ROUTINE</u>	<u>Prior to Separation</u>	<u>Coasting Descent</u>	<u>Powered Descent</u>	<u>Prior to Liftoff</u>	<u>Powered Ascent (or Abort)</u>	<u>Coasting Ascent (or abort)</u>
1. <u>Mode Selection</u>	X	X	X	X	X	X
2. <u>Checkout</u>	X	X	X	X	X	X
3. <u>Attitude Reference & ΔV Accumulation</u>						
a. Initialization	X	X		X		
b. Direction Cosine Updating	X	X	X	X	X	X
c. Euler angle & 8 ball calculations	X	X	X	X	X	X
d. ΔV accumulation			X		X	
4. <u>LEM Navigation Routine</u>						
a. Initialization	X			X		
b. Updating		X	X			
c. LEM Inertial state vector determination	X	X	X	X	X	X
d. Utilization of H, \dot{H} etc. for monitoring		X	X		X	
5. <u>Guidance and Steering</u>						
a. CSM state determination	X	X	X	X	X	X
b. Radar data utilization						X
c. LEM orbit determination	X	X	X	X	X	X
d. Herrick P, constrained checks & traj. opt.	X	X	X	X	X	X
e. Steering calculations	X	X	X	X	X	X
f. Utilization of steering calculations to guide the vehicle					X	X
g. Calculations of radar lock on steering	X	X	X	X	X	X
h. Utilization of radar lock on steering						X

IV-A COMPUTER INPUT OUTPUT FUNCTIONAL DIAGRAM

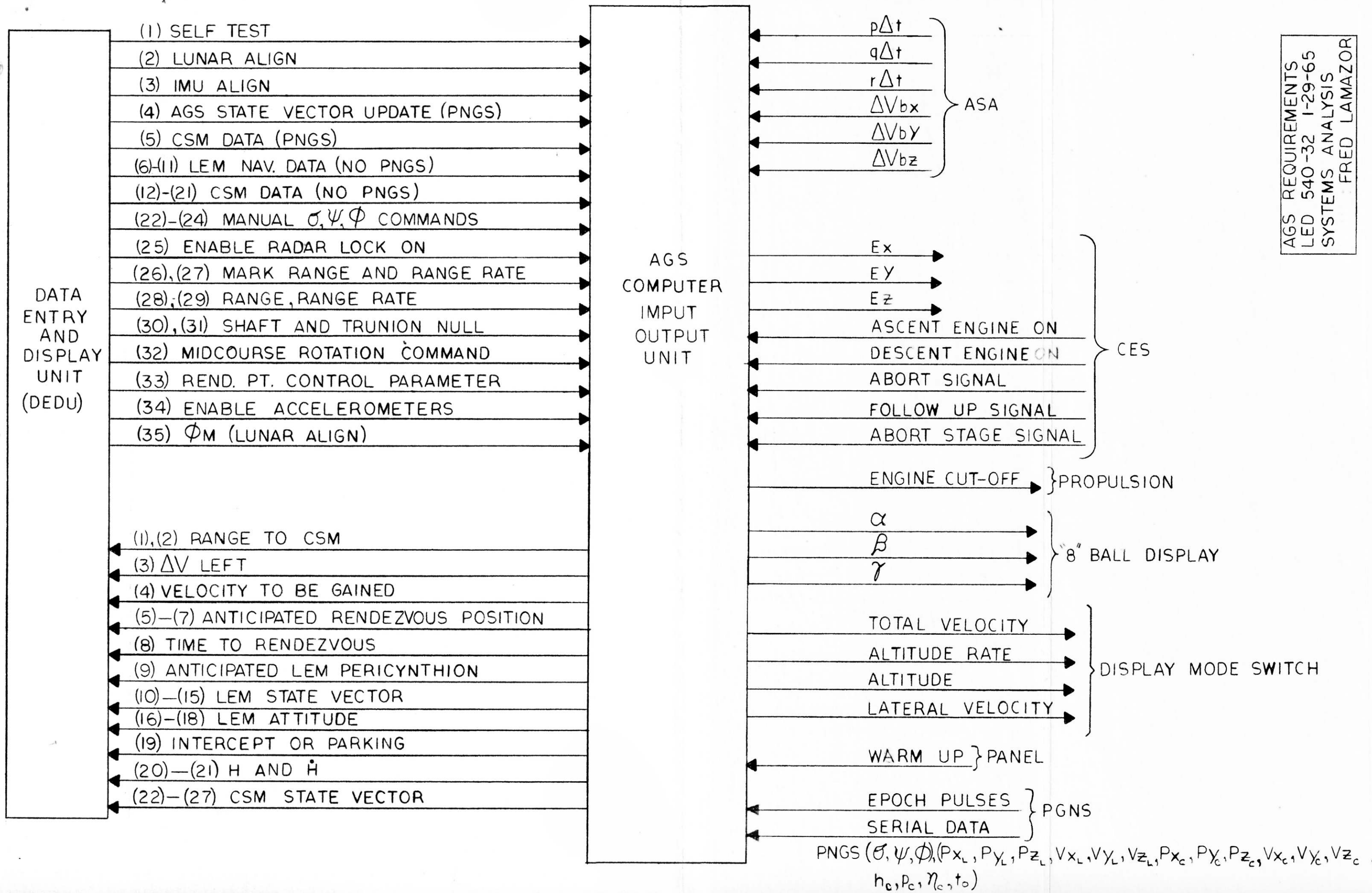

AGS REQUIREMENTS
 LED 540-32 1-29-65
 SYSTEMS ANALYSIS
 FRED LAMAZOR

IV. COMPUTER INPUTS AND OUTPUTS (Cont'd)

B. GLOSSARY

1. Computer Inputs via the Data Entry and Display Unit (DEDU)

Data entered into the AEA Computer via the DEDU is to be accomplished in the following manner, and with the following constraints.

- (1) Astronaut enters the address* (computer address of where the data or input is to be stored).
- (2) Astronaut verifies the address.
- (3) Astronaut enables use of the address.
- (4) Astronaut enters the data.
- (5) Astronaut verifies the data.
- (6) Astronaut enables use of the data.
- (7) Data is to be in decimal form.
- (8) Address may be coded in octal form.

* Astronaut utilizes a list of storage addresses for the variables involved.

- (1) Self Test - Upon Computer receipt of the self test discrete, a memory check is initiated. The sum of the contents of the fixed memory locations is compared with a pre-determined number.
- (2) Lunar Align - If an alignment is to be accomplished on the lunar surface, and the PGNS is inoperative, the astronaut enters the Lunar align code input via the DEDU. The computer, upon sensing the discrete accepts accelerometer information, ΔV_{BY} and ΔV_{BZ} , and thus enables the attitude reference to be aligned to the local vertical. Note that input (35) - ϕ_M (lunar align) must also be entered for lunar alignment.
- (3) IMU Align - If the PGNS is working properly, and the astronaut wants to align the AGS from the PGNS, he enters the IMU align code input to the computer via the DEDU. The three primary system Euler angles θ , ψ , and ϕ are received by the abort computer over the crosslink. The initial direction cosines, are then computed directly from these Euler angles.
- (4) AGS State Vector Update (PGNS) - If the Primary System is functioning properly, and it is desired to initialize, or update the AGS Navigation Routine, the astronaut inserts this code into the DEDU. The navigational quantities P_{XL} , P_{YL} , P_{ZL} , V_{XL} , V_{YL} , V_{ZL} from the crosslink, are utilized.
- (5) CSM Data (PGNS) - If the Primary System is functioning properly and CSM information from the voice-link is available, e.g., r_c , p_c , h_c , P_{XC} , P_{YC} , P_{ZC} , V_{XC} , the astronaut enters the data into the LGC via the Disky. Upon inserting the CSM Data (PGNS) Code into the DEDU, the information is sent to the Abort Guidance Computer, via the crosslink, and utilized by the guidance routines.
- (6)-(11) LEM Nav. Data (No PGNS) - If the Primary System has failed, the astronaut enters the LEM Navigation (P_{XL} , P_{YL} , P_{ZL} , V_{XL} , V_{YL} , V_{ZL}) directly into the computer, via the DEDU. This is used for initializing, or updating the navigation routine. (The information could be obtained from the CSM via the voice link).
- (12)-(21) CSM Data (No PGNS)

If the Primary System has failed, and CSM data (See Input 5) is available to the astronaut, e.g., via the voice link, this information is directly input to the computer, via the DEDU, and utilized by the guidance routines.

- (22-24) - Manual θ , ψ , ϕ Commands - These are LEM attitude commands entered into the computer by the astronaut via the DEDU. Upon sensing these inputs (see computer flow diagram) the computer generates, the commands, which are sent to the control system, and rotate the vehicle to the commanded attitude.
- (25) - Enable Radar Lock on - After any maneuver during coast, which causes a "loss of track", the astronaut commands this input in order to have the vehicle automatically rotated to point its Z axis along the LOS, (as calculated by prediction routines). The astronaut, by subsequently rotating the radar gimbal angles to zero, will be very close (within the accuracy of the prediction routines) to having a radar lock on condition.
- (26-27) - Mark Range & Range Rate - The procedure for inserting a radar data point into the computer includes separate marks for range, and range rate. (The mark for range rate is optional). The astronaut, upon observing a convenient value of range (or range rate) on the radar indicator, inputs the mark range (or mark range rate) code into the DEDU. These "time" marks are subsequently utilized in the radar filter calculations.
- (28-29) - Range and Range Rate - The values of range, and range rate, are input to the computer via the DEDU after the mark inputs have been received (as discussed above).
- (30-31) - Shaft and Trunnion Null - After inserting the radar data into the computer, (range and range rate) the vehicle is rotated in order to null out the radar gimbal angles. The two gimbal angles are nulled independently, and separate marks are utilized. These marks are used for storing the present values of vehicle direction cosines. After the second mark, the computer calculates the inertial LOS direction to the CSM.

- (32) - Midcourse Rotation Command - Before a desired midcourse correction impulse is applied, it is necessary to rotate the vehicle in order to line up the thrust vector (X_B) with the velocity - to be gained vector. Upon receipt of this input, (via the DEDU) the computer calculates the steering commands which enable this rotation.
- (33) - Rendezvous Point Control Parameter - The Abort Guidance System is provided with a trajectory optimization capability by having the computer calculate (during flight) the constraint (T) used for solving the rendezvous problem. The cost function, for each rendezvous is a linear combination of T (time to rendezvous) and ΔV_T (total ΔV for rendezvous) e.g., $C = \Delta V_T + K_T T$. The astronaut has direct control over the trajectory optimization technique by having the capability of inserting "K" (the rendezvous point control parameter) into the computer, via the DEDU.
- (34) - Enable Accelerometers - During coast phases, the accelerometer outputs are set equal to zero (within the computer). For any translational maneuver performed with the RCS, this signal enables the accelerometer outputs to be utilized. (for a midcourse performed with the ascent engine, the "ascent engine on" signal enables the use of accelerometer information).
- (35) - ϕ_M - This Euler angle is used for yaw alignment on the lunar surface. The value of ϕ is directly input to the computer via the DEDU. (ϕ is obtained either from star-sightings, or recorded by the astronaut prior to shutdown on lunar surface).

IV. B (Cont'd)

2. Computer Outputs via the Data Entry and Display Unit

The procedure for displaying data from the DEDU is as follows:

- (1) Astronaut enters the proper address
- (2) Astronaut verifies the address
- (3) Astronaut then presses a "display data" button.

Note: Most of the outputs called for will be time varying - e.g., Vg. The DEDU will display the continuous variation.

- (1) (2) - Range to CSM, Range Rate - These quantities are calculated every major guidance cycle and are available for display at any time. Range and range rate should be displayed during coasting maneuvers since they provide useful monitoring information if the PGNS has failed. e.g., Range, as calculated by the abort computer, can be compared to both range - as determined from the rendezvous radar, and Range - obtained from the CSM via the voice link.
- (3) - ΔV left - The ΔV left in the LEM is calculated every major guidance cycle, and can be displayed to the astronaut at any time in the mission. The calculation is based upon the ascent and descent stage ΔV budgets, and the ΔV accumulation from the X body axis accelerometer. (This quantity is useful for monitoring the low level indicator).
- (4) - Velocity to be Gained - At any point in the mission, it is possible to have the DEDU display the velocity to be gained. (Not including rendezvous ΔV). It is thus possible for the astronaut to anticipate when to expect engine cutoff.
- (5, 6, 7) - Anticipated Rendezvous Position - At each major guidance cycle, the anticipated rendezvous position (for an abort with the AGS) is updated. These position components are available for display via the DEDU at any point in the mission. The rendezvous position is indirectly controlled by the rendezvous pt. control parameter (input 33).
- (8) - Time to Rendezvous - At each major guidance cycle, the time (from now) to rendezvous is updated, and available for display via the DEDU.
- (9) - Anticipated LEM Pericyynthion - At each major guidance cycle, the LEM pericyynthion altitude is calculated by the LEM orbit determination routine, and can be displayed to the astronaut via the DEDU.
- (10-15) - LEM State Vector - The LEM position and velocity components are calculated each navigation cycle, by the AGS computer navigation routine and are available for display via the DEDU.
- (16-18) - LEM Attitude - The actual LEM attitude (θ, ϕ, ψ gimbal angles) which is

calculated every "Attitude Computation" cycle (see flow charts) is available for display via the DEDU. (attitude is also available for display via the 8 Ball). Prior to shutdown on the Lunar surface, ϕ should be displayed, and recorded by the astronaut (see input 35).

- (19) - Intercept or Parking - The computer calculates the steering commands to guide the vehicle either on a direct intercept, or parking orbit trajectory, depending upon whether certain constraints have been met. e.g., pericyynthion, ΔV , etc. The result of these constraint checks can be displayed to the astronaut via the DEDU.
- (20-21) - H & \dot{H} - These quantities are calculated by the AGS computer navigation routine every navigation cycle, and are used for the monitoring technique. (H & \dot{H} are sent to display, via mode switch) H and \dot{H} are also available for display via the DEDU.
- (22-27) - CSM State Vector - The six components of the CSM State Vector are computed every guidance cycle and are available for display via the DEDU.

IV. B (Cont'd)

3. Other Computer Inputs

(1) Inputs from Abort Sensor Assembly

- a) P_t, q_t, r_t are inputs to the computer from the gyros, representing body angle increments accumulated since the previous direction cosine update.
- b) V_{Bx}, V_{By}, V_{Bz} are inputs to the computer from the accelerometers representing body axis components of integrated specific thrust.

(2) Inputs from the Control Electronics Section (CES)

- a) Ascent engine on - If the ascent engine is on, there is an input signal present to the computer.
- b) Descent engine on - If the descent engine is on, there is an input signal present to the computer. The computer mode selection is dependent upon the presence of these inputs. (See section V A.1).
- c) Abort signal - If an abort is initiated, regardless of which system performs the abort, an input signal is sent to the computer. Depending upon the presence of the other signals, the computer will enter the proper mode (see mode selection logic flow diagram).
- d) Follow up signal - This input signal is sent to the computer when the toggle switch on the control panel is set to the PGNS position. The computer mode will depend upon the presence of this, and other input signals (see mode selection flow diagram)
- e) Abort stage signal - This signal is sent to the computer when the abort stage button is depressed on the control panel. This button is depressed when the astronaut receives a low level indication (if an abort were initiated with the descent engine), or if an abort is to be initiated with the ascent engine. This signal is also used in the major guidance cycle program in calculating the ΔV remaining in LEM.

(3) Input from the Panel

- a) Warmup signal - This signal must be present in order for the computer to be in the warmup mode (see mode selection logic).

(4) Inputs from PGNS

- a) The Epoch pulses and serial data comprise the non-mechanization portion of the general purpose serial data link from the PGNS to the AGS.

IV. B (Contd)

4. Other Computer Outputs

- (1) Outputs to CES - E_x , E_y , E_z are the instantaneous body axis attitude error signals computed every major guidance cycle.
- (2) Computer output to propulsion - engine cutoff signal - computer calculates when to issue the engine cut-off signal ($V_g \approx 0$).
- (3) Computer outputs to 8 Ball Display - The computer makes the necessary attitude ball transformations whenever the LEM attitude is computed. e.g., (α, β, γ) are the outer, middle, and inner gimbal angles of the attitude ball.
- (4) Computer outputs to display mode switch - total velocity, altitude rate, altitude, and lateral velocity - These quantities are calculated by the LEM Navigation Routine, and are utilized for the guidance monitoring technique.

V. COMPUTER FLOW CHARTS

INTRODUCTION

In order to simplify the understanding of the logical procedure of computer operation, the flow charts are broken down as follows:

- (1) Computation and Logic are separated, according to the different timing requirements. e.g., Equations which are updated every 1 sec. appear in a separate flow from those updated every 20 ms.
- (2) Detailed mode selection logic, which "test" for the presence of input signals at a "timed" rate, (see item (1) above) is presented.
- (3) The above routines are presented in the order of decreasing "time" of updating. e.g.,
 - a) Mode selection logic (fastest)
 - b) direction cosine updating and ΔV accumulation
 - c) attitude calculations
 - d) navigation computations
 - e) guidance and steering
- (4) Following each of the above 5 flow diagrams is a separate glossary, defining all of the "numbered" quantities appearing in the flow charts.
- (5) The numerical timing requirements for all of the above routines are given in a separate document.
- (6) A separate flow is presented for "un-timed" computations, e.g., alignment routines.
- (7) The flow charts contain detailed equations. (Some equations may be subject to change in accordance with the designation of Primary Computational Quantities appearing in Section VI.)
- (8) "Exits" are used to indicate the completion of the various "timed" routines. (Executive Program statements are omitted).
- (9) An overall functional flow chart is presented which "ties-together" (in road map fashion) all of the computer functions appearing in the detailed flow charts.

TIMED ROUTINES

I. MODE SELECTION FLOW DIAGRAM

(LOGIC DEPENDENT UPON COMPUTER SENSING OF INPUT DISCRETES)

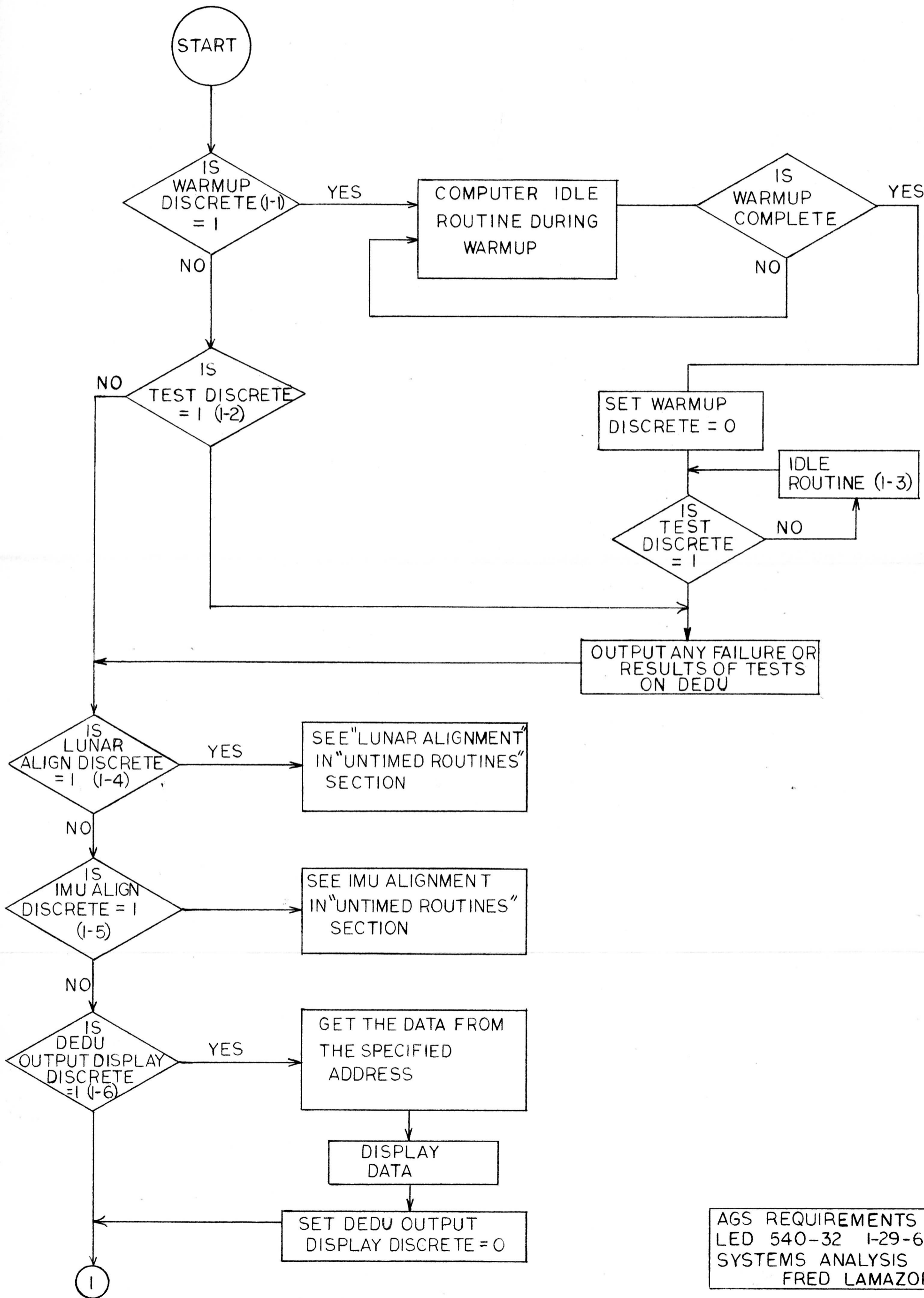

AGS REQUIREMENTS
LED 540-32 1-29-65
SYSTEMS ANALYSIS
FRED LAMAZOR

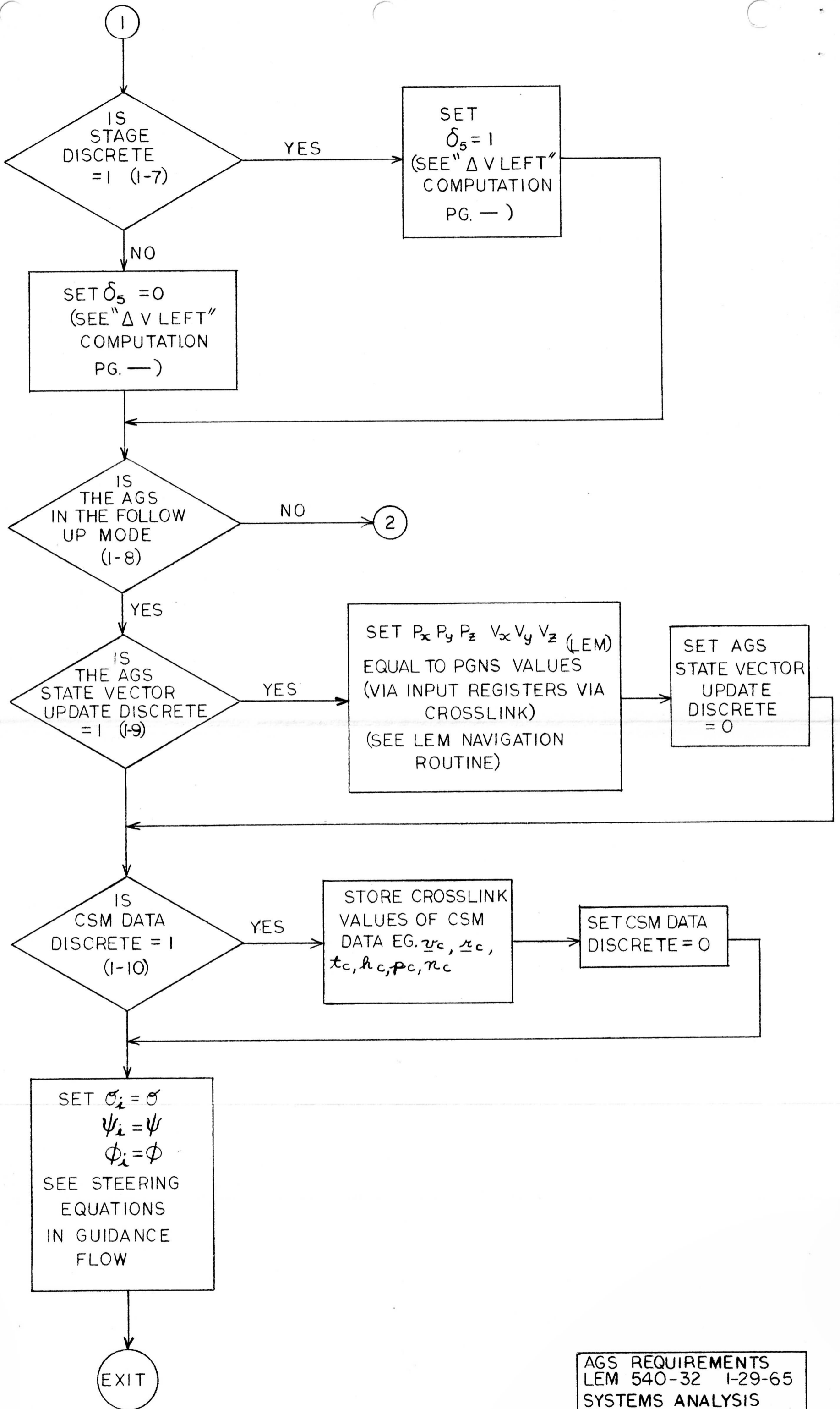

AGS REQUIREMENTS
 LEM 540-32 1-29-65
 SYSTEMS ANALYSIS
 FRED LAMAZOR

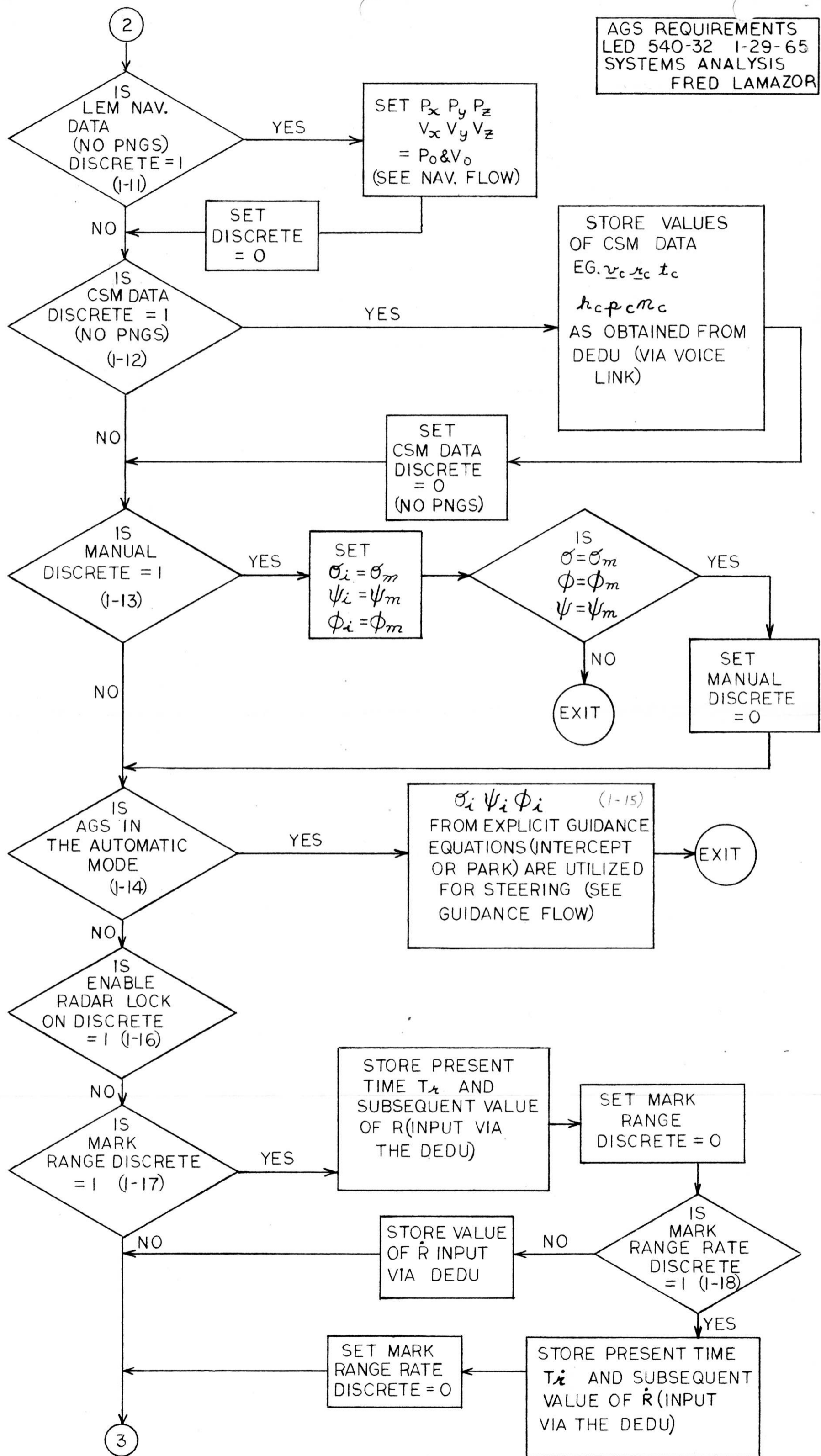

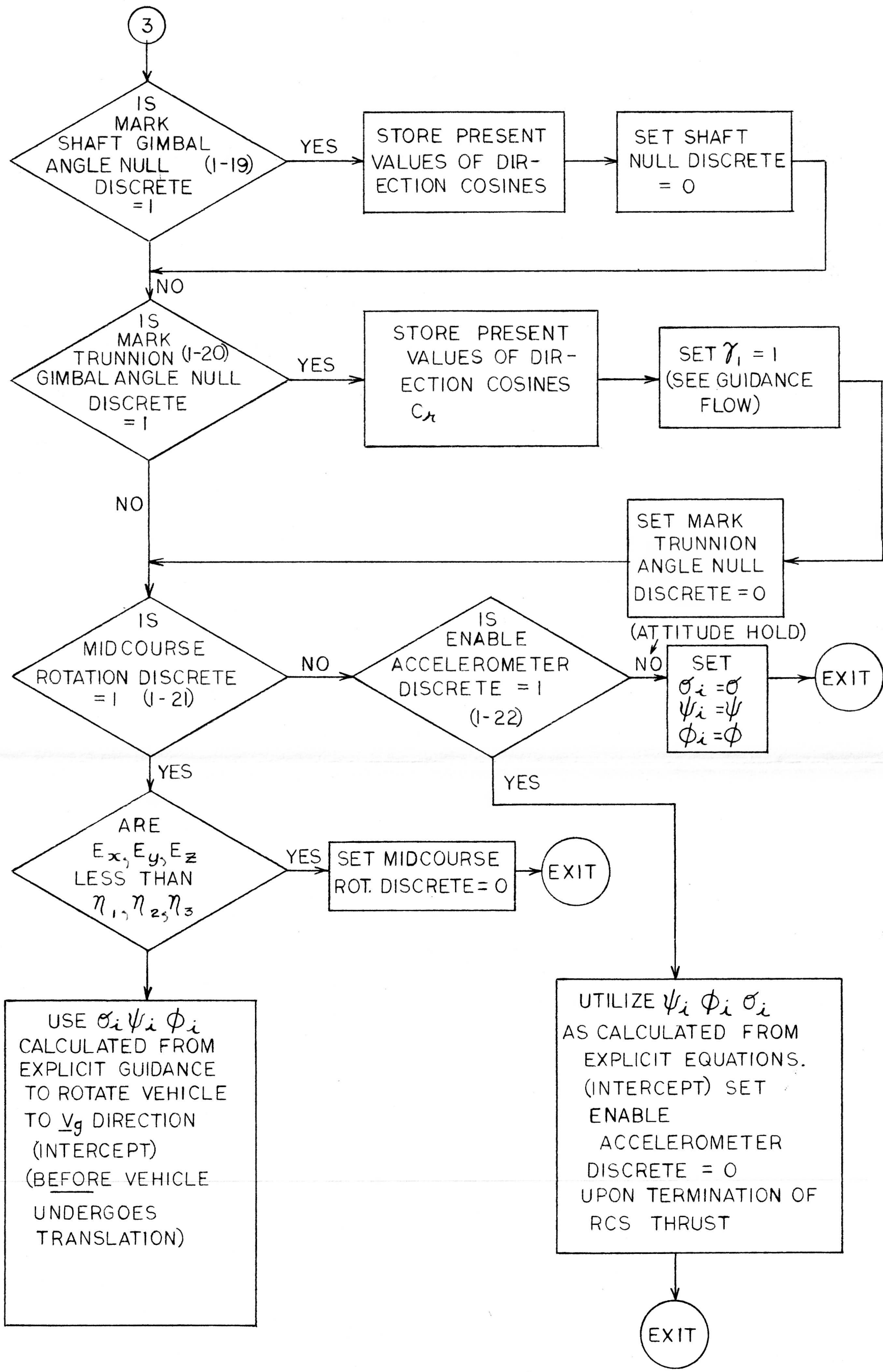

AGS REQUIREMENTS
 LED 540-32 1-29-65
 SYSTEMS ANALYSIS
 FRED LAMAZOR

NOTES FOR MODE SELECTION FLOW DIAGRAM

- 1-1 The warmup discrete is equal to 1 upon the computer receipt of a warmup signal from control panel.
- 1-2 The test discrete is equal to 1 upon computer receipt of self test signal (Input 1) from the DEDU.
- 1-3 Idle Routine represents the period between computer warmup and self test. The computer routines during this period, are, as of yet undefined.
- 1-4 The Lunar align discrete is equal to 1 upon the computer receipt of Lunar Align signal (Input 2) from the DEDU.
- 1-5 The IMU align discrete is equal to 1 upon the computer receipt of IMU align signal (Input 3) from the DEDU.
- 1-6 The DEDU Output Display discrete is equal to 1 upon the astronaut depressing the "display data" key on the DEDU.
- 1-7 The stage discrete is equal to 1 upon computer receipt of (abort) stage input from the CES. This is used for calculating the ΔV remaining in the LEM.
- 1-8 The AGC is in the follow-up mode for the duration of PGNS vehicle controlled phases (with the exception of the warmup and alignment periods). The attitude error signals calculated by the AGC are nulled. The AGC will be in the Follow-up Mode if the followup signal from CES is present (PGNS-AGS toggle switch on control panel set to PGNS position) and the warmup and alignment signals are not present.
- 1-9 The AGS State Vector Update discrete is equal to 1 upon receipt of input 4 (AGS State Vector Update PGNS) from the DEDU. Initialization for Navigation, and State Vector Updating require the presence of this discrete.
- 1-10 The CSM Data discrete is equal to 1 when input 5 (CSM Data - PGNS) is received by the computer. The PGNS transmits the CSM data to the computer via the cross-link. The data to be transmitted includes: $P_{XC}, P_{YC}, P_{ZC}, V_{XC}, V_{YC}, V_{ZC}$
 n_c, h_c, p_c
- 1-11 LEM Navigation Data discrete (No PGNS) is equal to 1 upon computer receipt of input 6 (LEM Nav. Data No PGNS) via the DEDU. This discrete remains 1 until signal (input 11) is sensed. The state vector ($P_{XL}, P_{YL}, P_{ZL}, V_{XL}, V_{YL}$)
 V_{ZL} is transmitted to the computer via the voice link and DEDU.
- 1-12 CSM Data discrete is equal to 1, upon computer receipt of input 12 (CSM Data No PGNS) via the DEDU. This discrete remains 1 until

- input 21 is sensed. The CSM state vector ($P_{X_C}, P_{Y_C}, P_{Z_C}, V_{X_C}, V_{Y_C}, V_{Z_C}$) orbital information (n_C, p_C, h_C) and epoch time, t_0 , are input to the computer via the voice link (CSM) and DEDU.
- 1-13 The Manual discrete is equal to 1 upon the computer receipt of input 22 (Manual θ, ψ, ϕ) commands via the DEDU. This discrete remains 1 until input 24 is sensed by the computer. The signals are the LEM attitude manual commands θ_M, ψ_M, ϕ_M .
- 1-14 The AGC will be in the automatic mode for an AGS takeover, and a main engine is being utilized. The guidance law steering computations are utilized for vehicle control. The PGNS-AGS toggle switch on the control panel is in the AGS position.
- 1-15 θ_i, ψ_i, ϕ_i represents the required inertial attitude of the vehicle, and is calculated every major guidance cycle.
- 1-16 Enable radar lock on discrete = 1 upon computer receipt of input 25 via the DEDU. (Enable radar lock on). The astronaut will utilize this discrete upon completion of any maneuver during coast, which causes the CSM track to be lost. It is also used for initially "locking" on to the CSM subsequent to burnout. (Note that the PGNS is inoperative.) Upon receipt of this input, the computer calculates the required steering commands in order to rotate the vehicle to an orientation with the Z body axis along the LOS direction.
- 1-17 Mark Range Discrete = 1 upon computer receipt of input 26 (Mark Range) via the DEDU. The computer stores the present value of time t_r .
- 1-18 Mark Range Rate Discrete = 1 upon computer receipt of input 27 (Mark Range Rate) via the DEDU. The computer stores the present value of time t_r . (Note that this input is optional.)
- 1-19 Mark shaft gimbal angle null discrete = 1 upon computer receipt of input 30 (shaft null) via the DEDU. Note that the shaft angle is nulled first.
- 1-20 Mark trunnion gimbal angle null discrete = 1 upon computer receipt of input 31 (trunnion null) via the DEDU. Note that the trunnion angle is nulled after the shaft angle has been nulled.
- 1-21 Midcourse rotation discrete = 1 upon computer receipt of input 32 (mid-course rotation command) via the DEDU. Astronaut utilizes this input if the vehicle is under AGS control, and a midcourse correction is required. (See input-output signal glossary).
- 1-22 Enable accelerometer discrete = 1 upon computer receipt of input 34 (enable accelerometers) via the DEDU.

TIMED ROUTINES (CONTINUED)

2. DIRECTION COSINE UPDATING AND ΔV ACCUMULATION

(LOGIC AND COMPUTATIONS PERFORMED UPON COMPUTER RECEIPT OF INCREMENTAL GYRO AND ACCELEROMETER INFORMATION FROM THE ASA)

START

$$\begin{aligned}
 \gamma_1 &= \bar{c}_{11}^2 + \bar{c}_{12}^2 + \bar{c}_{13}^2 & \gamma_2 &= \bar{c}_{21}^2 + \bar{c}_{22}^2 + \bar{c}_{23}^2 & \gamma_3 &= \bar{c}_{11}\bar{c}_{22} - \bar{c}_{12}\bar{c}_{21} & (2-1) \\
 C_{11} &= \bar{c}_{11} + \Delta\alpha_3\bar{c}_{21} - \Delta\alpha_2\bar{c}_{31} + \frac{\Delta\alpha_3\Delta\alpha_1}{2}\bar{c}_{31} - \frac{(\Delta\alpha_3)^2}{2}\bar{c}_{11} - \frac{(\Delta\alpha_2)^2}{2}\bar{c}_{11} + \frac{\Delta\alpha_1\Delta\alpha_2}{2}\bar{c}_{21} + K_1(1-\gamma_1)\bar{c}_{11} - K_2\gamma_3\bar{c}_{13} \\
 C_{12} &= \bar{c}_{12} + \Delta\alpha_3\bar{c}_{22} - \Delta\alpha_2\bar{c}_{32} + \frac{\Delta\alpha_3\Delta\alpha_1}{2}\bar{c}_{32} - \frac{(\Delta\alpha_3)^2}{2}\bar{c}_{12} - \frac{(\Delta\alpha_2)^2}{2}\bar{c}_{12} + \frac{\Delta\alpha_1\Delta\alpha_2}{2}\bar{c}_{22} + K_1(1-\gamma_1)\bar{c}_{12} - K_2\gamma_3\bar{c}_{11} \\
 C_{13} &= \bar{c}_{13} + \Delta\alpha_3\bar{c}_{23} - \Delta\alpha_2\bar{c}_{33} + \frac{\Delta\alpha_3\Delta\alpha_1}{2}\bar{c}_{33} - \frac{(\Delta\alpha_3)^2}{2}\bar{c}_{13} - \frac{(\Delta\alpha_2)^2}{2}\bar{c}_{13} + \frac{\Delta\alpha_1\Delta\alpha_2}{2}\bar{c}_{23} + K_1(1-\gamma_1)\bar{c}_{13} - K_2\gamma_3\bar{c}_{12} \\
 C_{21} &= \bar{c}_{21} + \Delta\alpha_1\bar{c}_{31} - \Delta\alpha_3\bar{c}_{11} + \frac{\Delta\alpha_1\Delta\alpha_2}{2}\bar{c}_{11} - \frac{(\Delta\alpha_1)^2}{2}\bar{c}_{21} - \frac{(\Delta\alpha_3)^2}{2}\bar{c}_{21} + \frac{\Delta\alpha_3\Delta\alpha_2}{2}\bar{c}_{31} + K_1(1-\gamma_2)\bar{c}_{21} - K_2\gamma_3\bar{c}_{23} \\
 C_{22} &= \bar{c}_{22} + \Delta\alpha_1\bar{c}_{32} - \Delta\alpha_3\bar{c}_{12} + \frac{\Delta\alpha_1\Delta\alpha_2}{2}\bar{c}_{12} - \frac{(\Delta\alpha_1)^2}{2}\bar{c}_{22} - \frac{(\Delta\alpha_3)^2}{2}\bar{c}_{22} + \frac{\Delta\alpha_3\Delta\alpha_2}{2}\bar{c}_{32} + K_1(1-\gamma_2)\bar{c}_{22} - K_2\gamma_3\bar{c}_{21} \\
 C_{23} &= \bar{c}_{23} + \Delta\alpha_1\bar{c}_{33} - \Delta\alpha_3\bar{c}_{13} + \frac{\Delta\alpha_1\Delta\alpha_2}{2}\bar{c}_{13} - \frac{(\Delta\alpha_1)^2}{2}\bar{c}_{23} - \frac{(\Delta\alpha_3)^2}{2}\bar{c}_{23} + \frac{\Delta\alpha_3\Delta\alpha_2}{2}\bar{c}_{33} + K_1(1-\gamma_2)\bar{c}_{23} - K_2\gamma_3\bar{c}_{22} \\
 C_{31} &= C_{12}C_{23} - C_{22}C_{13} & C_{32} &= C_{13}C_{21} - C_{11}C_{23} & C_{33} &= C_{11}C_{22} - C_{12}C_{21}
 \end{aligned}$$

IS AN ENGINE ON SIGNAL (EITHER ENGINE) PRESENT OR IS ENABLE ACCELEROMETER DISCRETE = 1?

(2-2)

$$\begin{aligned}
 \Delta V_x &= 0 \\
 \Delta V_y &= 0 \\
 \Delta V_z &= 0
 \end{aligned}$$

AGC. INPUT OUTPUT UNIT

(2-3)

$$\begin{aligned}
 \Delta V_x &= C_{11}\Delta V_{bx} + C_{21}\Delta V_{by} + C_{31}\Delta V_{bz} \\
 \Delta V_y &= C_{12}\Delta V_{bx} + C_{22}\Delta V_{by} + C_{32}\Delta V_{bz} \\
 \Delta V_z &= C_{13}\Delta V_{bx} + C_{23}\Delta V_{by} + C_{33}\Delta V_{bz}
 \end{aligned}$$

SET ACCELEROMETER INPUT REGISTERS TO ZERO

(2-4)

$$\begin{aligned}
 \Delta V_{sx} &= \Delta V_{sx} + \Delta V_x \\
 \Delta V_{sy} &= \Delta V_{sy} + \Delta V_y \\
 \Delta V_{sz} &= \Delta V_{sz} + \Delta V_z
 \end{aligned}$$

AGS REQUIREMENTS
LED 540-32 1-29-65
SYSTEMS ANALYSIS
FRANK DE VITO

EXIT

NOTES FOR DIRECTION COSINE UPDATING AND V ACCUMULATION

- 2-1 Direction Cosine Updating
- 2-1.a The barred quantities are the past direction cosines
- 2-1.b The unbarred quantities are the updated direction cosines
- 2-1.c p, q, r are the instantaneous rates about the $X_B, Y_B,$ and Z_B axes.
- 2-1.d $\Delta \alpha_1 = p \Delta t \quad \Delta \alpha_2 = q \Delta t \quad \Delta \alpha_3 = r \Delta t$
denote the body angle increments about X_B, Y_B, Z_B axes respectively turned through in the direction cosine computational interval.
- 2-1.e K_1 and K_2 are respectively the normality and orthogonality gain constraints.
- 2-2 $\Delta V_X, \Delta V_Y$ and ΔV_Z are set equal to zero if the vehicle is not translating.
- 2-3 These quantities represent the inertial velocity components in terms of the body velocity components.
- 2-4 These quantities are the sensed velocity components in inertial coordinates.

TIMED ROUTINES (CONTINUED)

3 ATTITUDE CALCULATIONS

(THESE COMPUTATIONS ARE TO BE PERFORMED AT A SLOWER RATE THAN THE DIRECTION COSINE UPDATING, IN ORDER TO CUT DOWN ON ANY POSSIBLE "REAL TIME" PROBLEMS, AND AT A FASTER RATE THAN THE GUIDANCE AND STEERING COMPUTATIONS, IN ORDER TO AVOID DISCRETE (JERKY) MOVEMENTS IN THE ATTITUDE BALL)

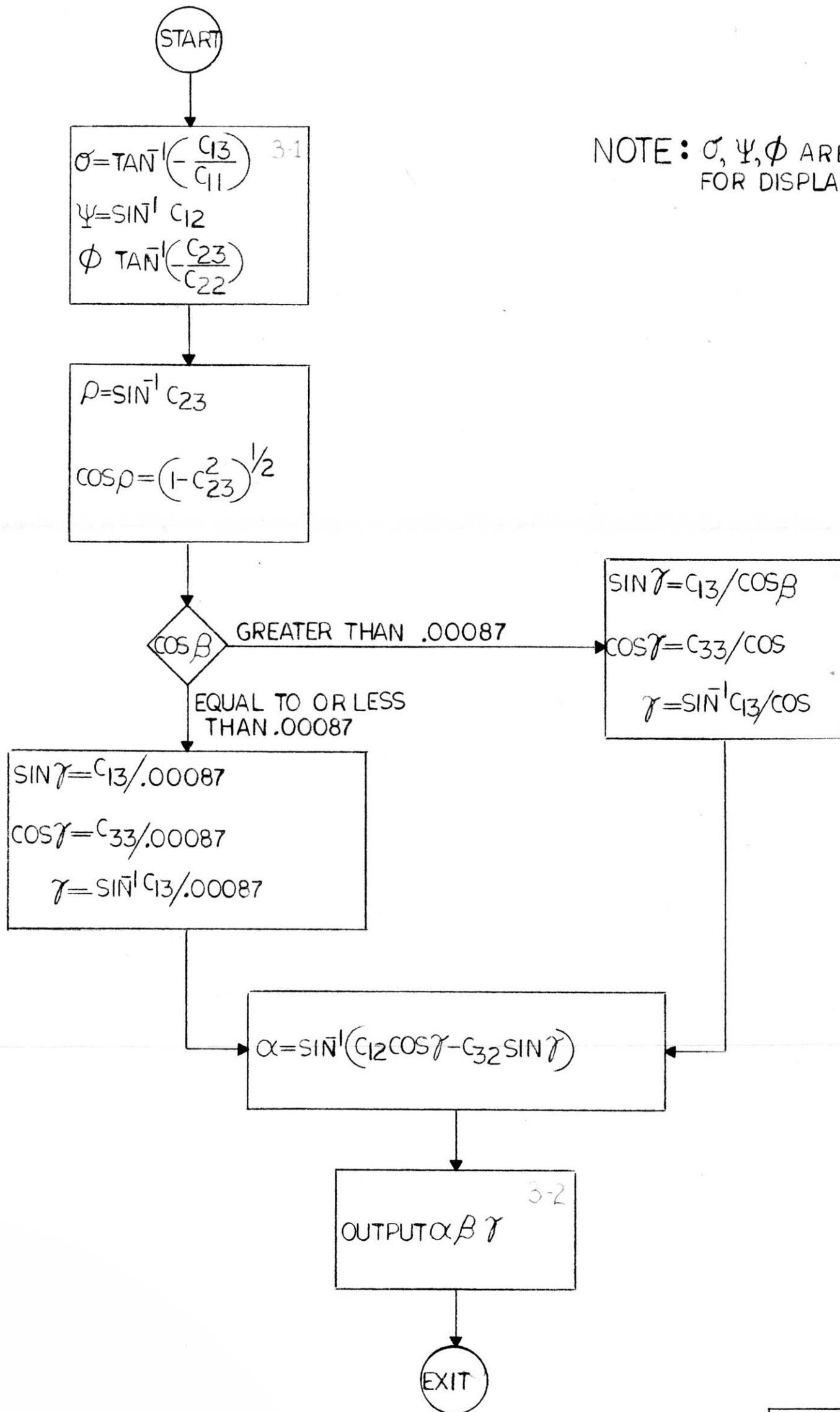

NOTE: σ, ψ, ϕ ARE AVAILABLE FOR DISPLAY VIA DEDU

NOTES FOR ATTITUDE CALCULATIONS

- 3-1 The Euler angles θ , ψ , and ϕ represent the actual LEM attitude angles as calculated by the AGS computer. (The Primary System sequence is pitch, roll and yaw θ , ψ , ϕ).
- 3-2 α , β , γ denote the outer, middle and inner gimbal angles of the attitude ball. (The signals, α , β , γ are sent from the input-output unit to the D/A converters and 8-ball).

TIMED ROUTINES (CONTINUED)

4 LEM NAVIGATION COMPUTATIONS

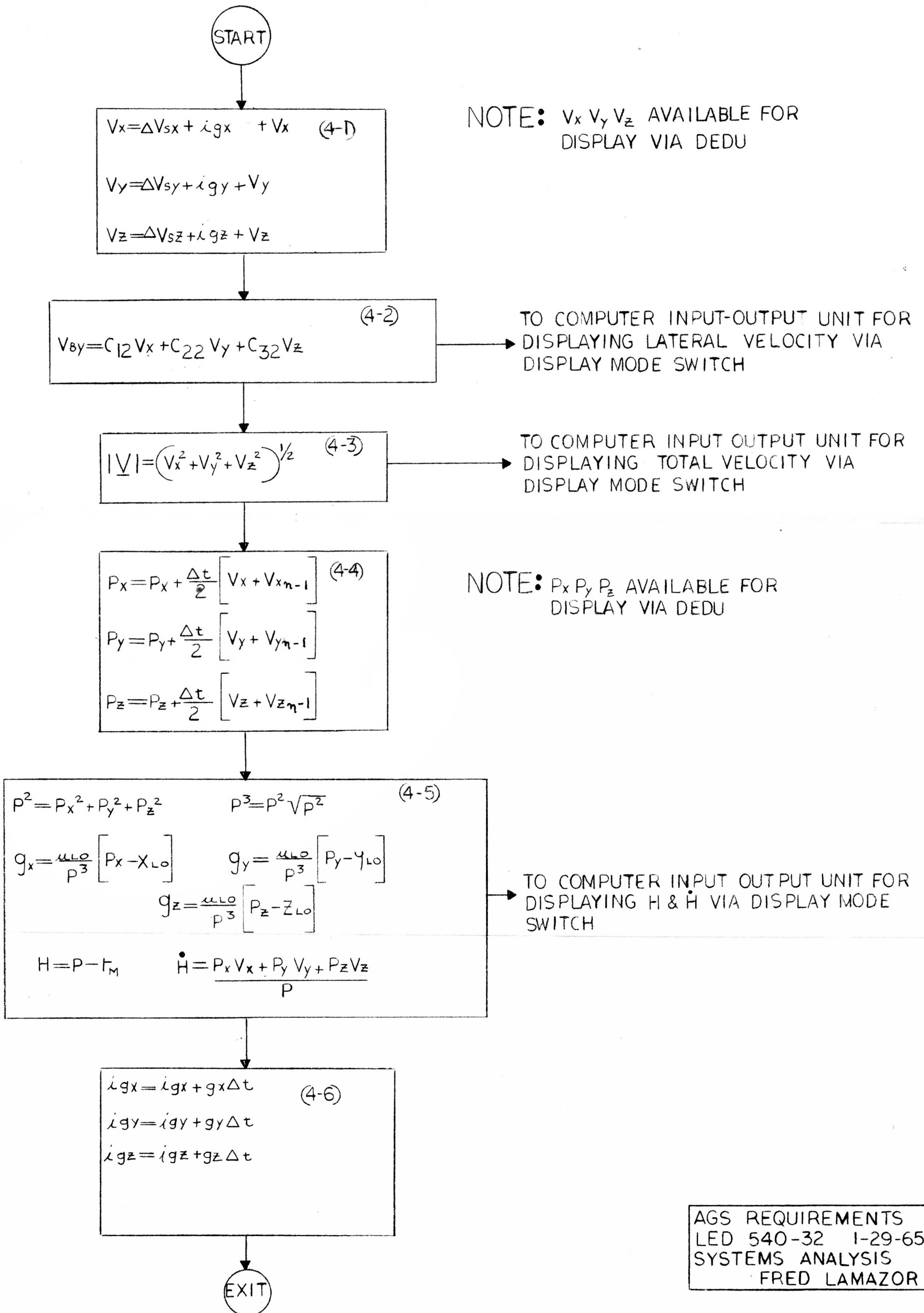

AGS REQUIREMENTS
 LED 540-32 1-29-65
 SYSTEMS ANALYSIS
 FRED LAMAZOR

NOTES FOR LEM NAVIGATION COMPUTATION

- 4-1 V_x, V_y, V_z are the inertial velocity components in guidance coordinates
- 4-2 V_{By} LEM Lateral Velocity in Body Coordinates
- 4-3 V Total Inertial Velocity
- 4-4 P_x, P_y, P_z Inertial Position Coordinates
- 4-5 P^2, P^3 Square and Cube of the Inertial Position Vector
- G_x Value of the Gravitational Acceleration at Current Time
- G_y
- G_z
- H LEM Altitude
- \dot{H} LEM Altitude Rate
- 4-6 i_{gx} Predicted current integrated gravities in inertial coordinates
- i_{gy}
- i_{gz}

TIMED ROUTINES (CONTINUED)

5. GUIDANCE AND STEERING COMPUTATIONS

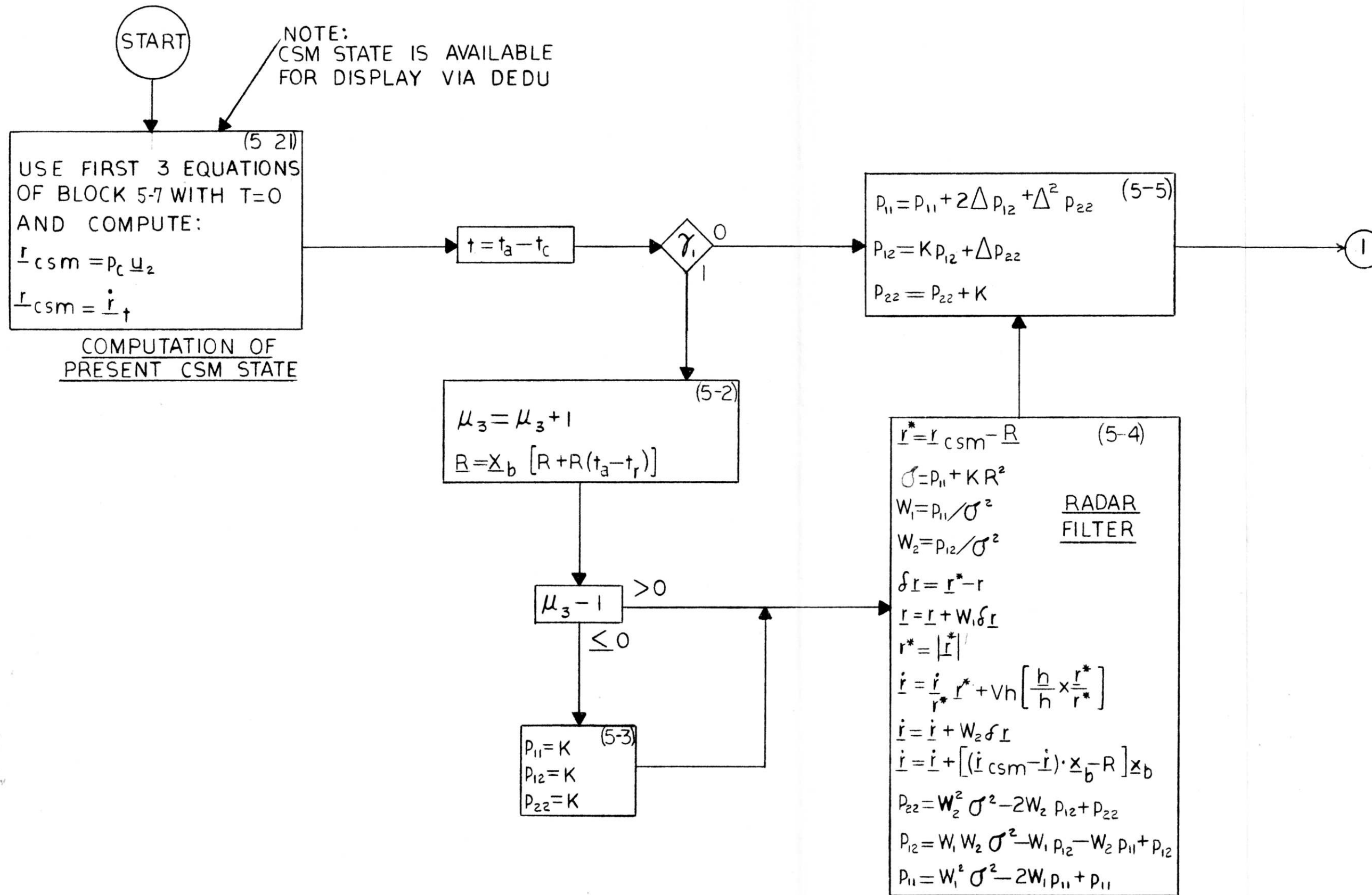

AGS REQUIREMENTS
LED 540-32 1-29-65
SYSTEMS ANALYSIS
FRANK DE VITO

1

COMPUTATION OF LEM ORBITAL PARAMETERS

$$r = |r|$$

$$\underline{u}_1 = r/r$$

$$\dot{r} = \dot{r} \cdot \underline{u}_1$$

$$\underline{h} = r \times \dot{r}$$

$$h = |\underline{h}|$$

$$p = h^2/\mu$$

$$e = \left(\frac{p_0}{r_0} - 1\right)^2 + \frac{r_0^2 p}{\mu}$$

$$d = p/(1-e^2)$$

$$e = \sqrt{e^2}$$

$$q = \alpha (1-e)$$

$$v_h = h/r$$

$$i = -1$$

$$C_0 = K$$

$$T = T_0 - \Delta - \Delta_6$$

$$\text{LIM: } J + \Delta_7 \leq T \leq J + K + \Delta_8$$

$$p = K$$

(5-6)

NOTE: q (LEM PERICENTHON) IS AVAILABLE FOR DISPLAY VIA DEDU

3

COMPUTATION OF CSM STATE T SECS FROM NOW

$$A_c = (t+T)h_c \text{ MOD } 2\pi$$

$$\underline{U}_2 = \cos A_c \underline{U}_c + \sin A_c \underline{V}_c$$

$$\dot{r}_T = (-\sin A_c \underline{U}_c + \cos A_c \underline{V}_c) \frac{h_c}{p_c}$$

$$c_1 = \underline{U}_1 \cdot \underline{U}_2$$

$$\underline{W}_{1a} = \underline{U}_1 \times \underline{U}_2$$

$$c_2 = (1-c_1^2)^{1/2} [\text{sgn } \underline{W}_{1a} \cdot \underline{W}_c]$$

$$\underline{W}_{1a} = \underline{W}_{1a}/c_2$$

$$\underline{V}_{1a} = (\underline{U}_2 - c_1 \underline{U}_1)/c_2$$

$$\underline{V}_2 = (c_1 \underline{U}_2 - \underline{U}_1)/c_2$$

$$\mu_2 = 0$$

(5-7)

P ITERATION

$$x_1 = (p/r_f) - 1$$

$$x_2 = (p/p_c) - 1$$

$$x_3 = (c_1 x_1 - x_2)/c_2$$

$$x_4 = (x_1 - c_1 x_2)/c_2$$

$$e^2 = x_1^2 + x_3^2 \text{ (IF } e^2 \geq .95, \text{ GO TO (M))}$$

$$x_7 = (r_f/p) \sqrt{1-e^2} x_3$$

$$x_8 = (p_c/p) \sqrt{1-e^2} x_4$$

$$S_{\Delta E} = \sqrt{1-e^2} (c_2 + x_4 - x_3)$$

$$C_{\Delta E} = c_1 + e^2 + x_1 + x_2 - x_3 x_4$$

$$\alpha = p/(1-e^2)$$

$$\frac{1}{n} = (\alpha^3/\mu)^{1/2}$$

$$P = 2\pi/n$$

$$\Delta E = \text{TAN}^{-1}(S_{\Delta E}/C_{\Delta E}); 0 \leq \Delta E < 2\pi$$

$$T_p = \frac{1}{n} (\Delta E + x_7 - x_8)$$

$$m = (T - T_p)/P, \text{ ROUNDED TO INTEGER}$$

$$T_p = mP + T_p$$

$$\mu_2 = \mu_2 + 1$$

(5-8)

$$p' = p$$

$$p = p' + k$$

$$T_p' = T_p$$

$$\mu_2 - 1$$

≤ 0
 > 0

$$\mu_2 - k$$

> 0
 ≤ 0

$$\mu_2 - 2$$

$$\partial_T = \frac{p - p'}{T_p - T_p'}$$

$$p = p + (T - T_p) \partial_T$$

2

$$\dot{r}_I = \left(\frac{\mu}{P}\right)^{1/2} X_3$$

$$\dot{r}_I = \dot{r}_I U_1 + \frac{\mu P}{r_f} V_{1a}$$

$$\dot{r}_F = \left(\frac{\mu}{P}\right)^{1/2} X_4 U_2 + \frac{\mu P}{P_c} V_{2}$$

$$V_G = \dot{r}_I - \dot{r}_F$$

$$V_F = \dot{r}_T - \dot{r}_F$$

$V_G = |V_G|$ REQUIRED VELOCITY AND COST
 $V_F = |V_F|$ COST
 $V_T = V_I + V_F$ FUNCTION CALCULATIONS
 $g_i = \alpha(1-e)$
 IF $g_i \leq K$
 $C = K - q_i$
 IF $q_i > K$
 $C = \Delta V_T + KT$

(5-9)

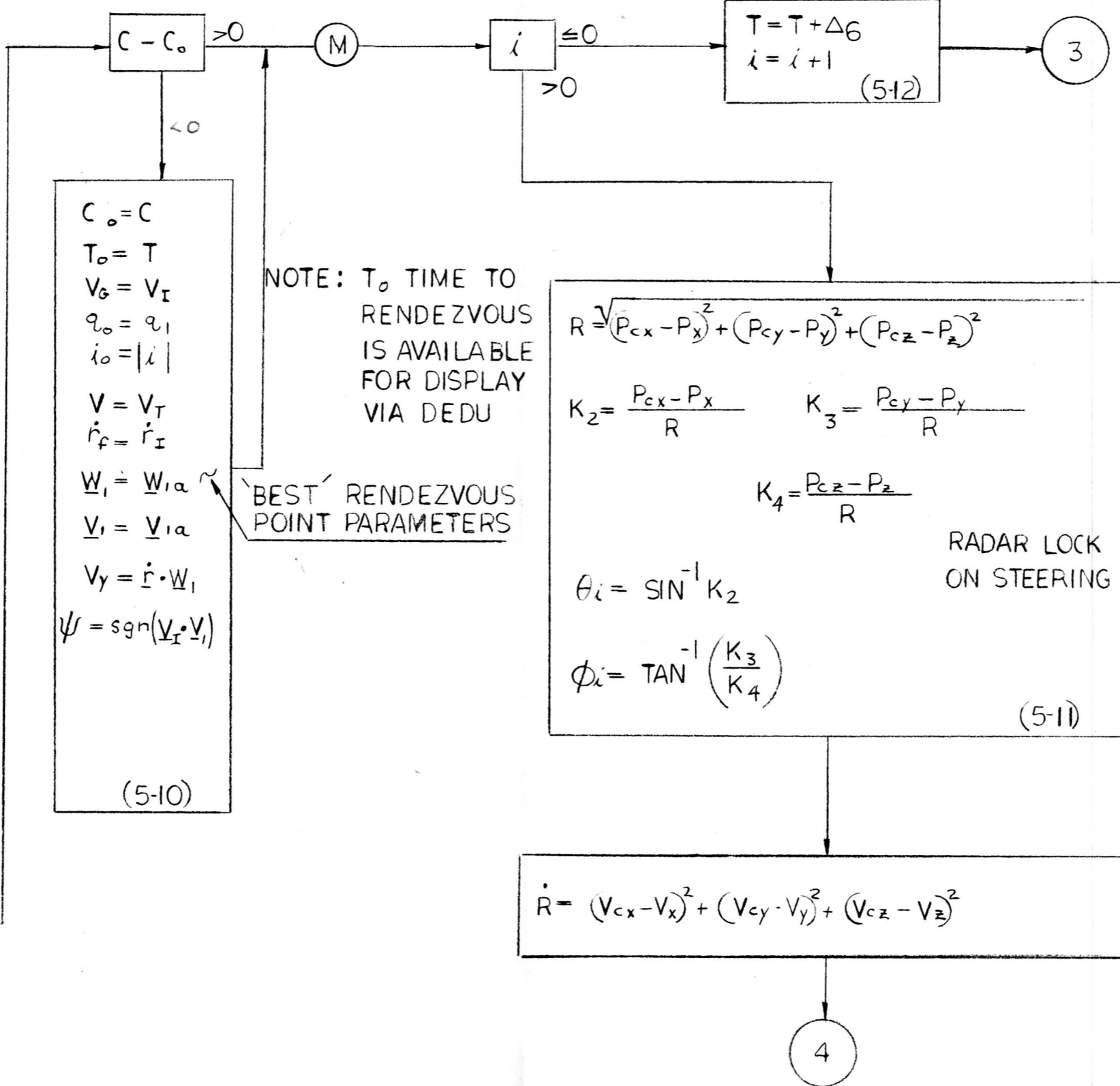

NOTE: R IS AVAILABLE FOR DISPLAY VIA DEDU

NOTE: R-dot IS AVAILABLE FOR DISPLAY VIA DEDU

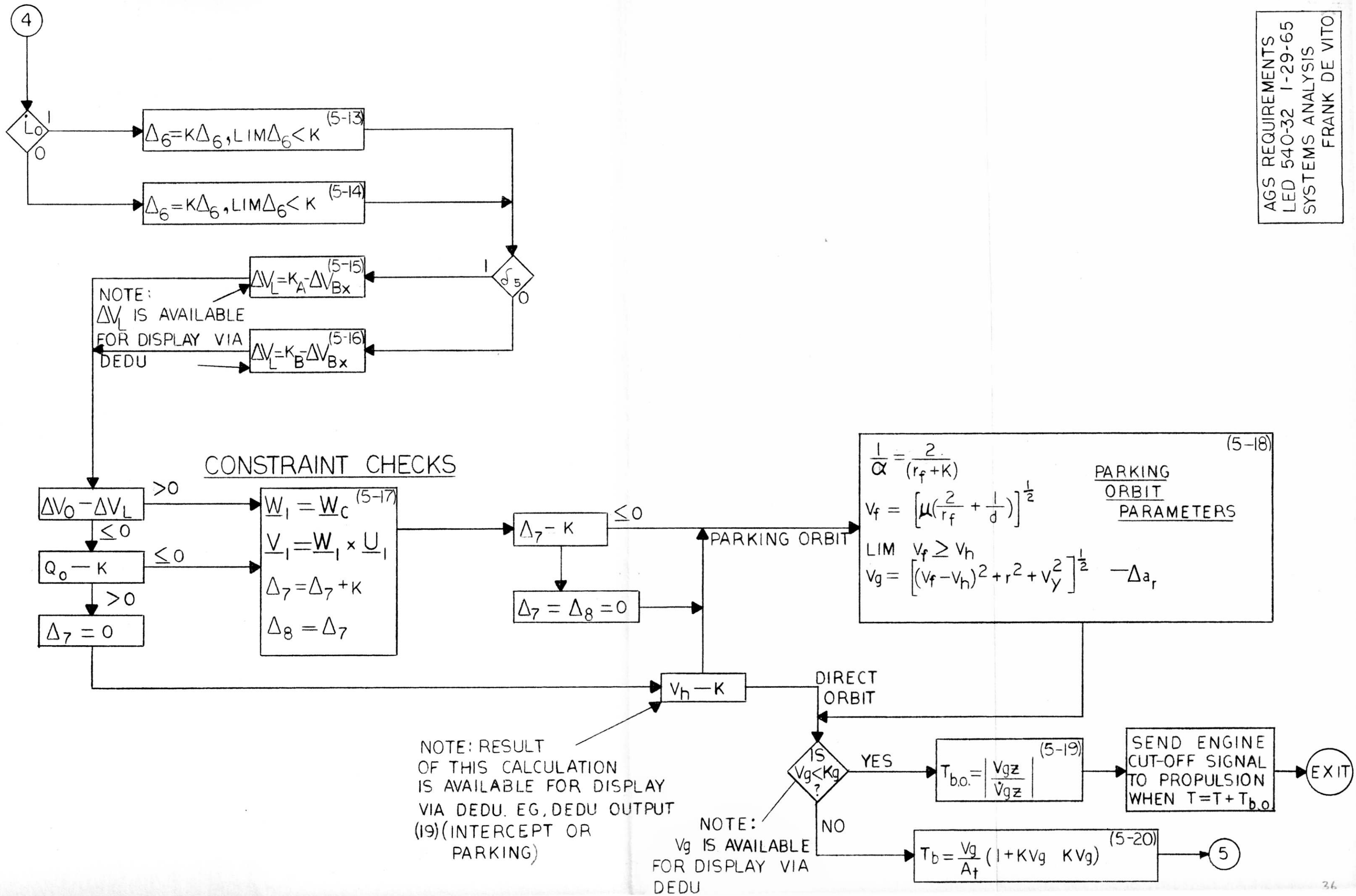

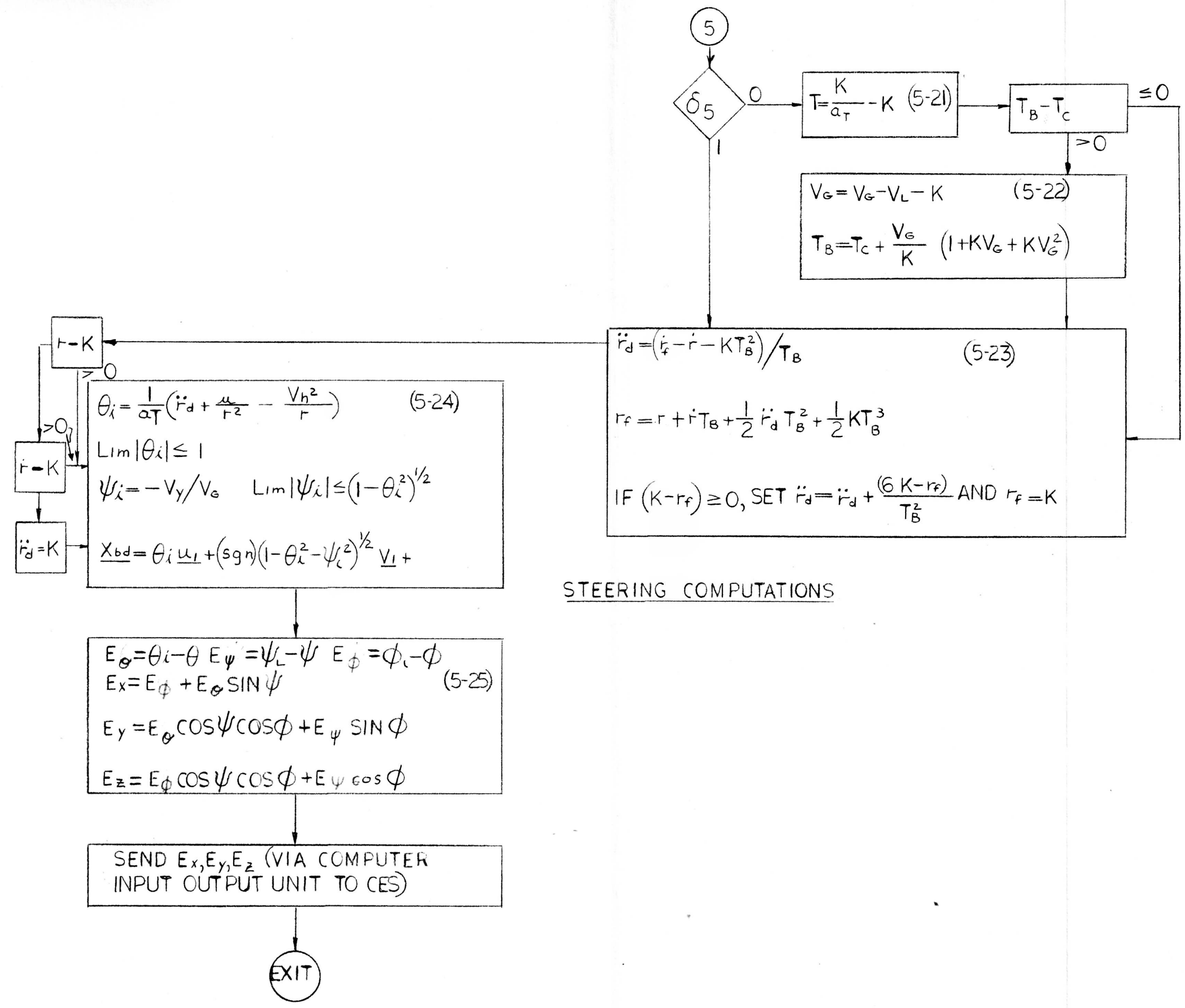

STEERING COMPUTATIONS

NOTES FOR GUIDANCE AND STEERING CALCULATIONS

- 1 This routine computes the present CSM position and velocity and is computed every major guidance cycle.
- 5-2 The present LEM-CSM range vector R is computed. Provision in the calculation is made for time difference between time of data acquisition and time of R computation.
- 5-3 The computations for the position and velocity covariance parameters are initialized.
- 5-4 These equations describe the digital radar filter, which is a simplified time-varying near optimum filter.
- 5-5 The position and velocity covariance parameters are updated for the next computation cycle.
- 5-6 The present LEM orbit parameters are computed.
- 5-7 This routine computes the CSM state vector T seconds from now. Local coordinate systems are computed for LEM position (now) and CSM (T seconds from now).
- 5-8 The Herrick-p iteration equations solve for transfer ellipse between LEM (now) and CSM (at T seconds from now).
- 9 The ΔV requirements (for injection and for rendezvous) are computed. The cost function for rendezvous at time T is also determined.
- 5-10 The best rendezvous parameters as computed in 5-9 are stored.
- 5-11 The range from LEM to CSM is computed. The required inertial attitudes to line up the Z_D^+ with the inertial LOS direction is also computed.
- 5-12 The rendezvous time T is updated, and trial index i is incremented so that computations 5-7 to 5-10 are repeated.
- 5-13, 14 The T iteration step size is adjusted in this calculation.
- 5-15, 16 The ΔV capability remaining in the LEM is computed.
- 5-17 The local coordinate system located at LEM for parking orbit insertion is computed in this routine.
- 5-18 The desired parking orbit parameters are computed.
- 5-19 A vernier time-to-burnout (t_{BO}) for a more accurate engine cutoff is computed by this routine.
- 5-20 The approximate time to burnout is computed for both parking or direct transfer orbits.
- 5-21 The time-to-go to descent engine staging is computed at this time.
- 22 These computations adjust T_B if staging will occur between now and desired thrust termination.

NOTES FOR GUIDANCE AND STEERING CALCULATIONS (Cont'd)

- 5-23 Constant yaw, linear pitch steering computations are done here. r_f is the predicted burnout altitude.
- 5-24 This routine computes required attitude angles so that the vehicle thrust vector and the V_G vector are colinear.
- 5-25 The attitude error commands in body coordinates are computed and transmitted to the Control Electronics Section.

LUNAR ALIGNMENT

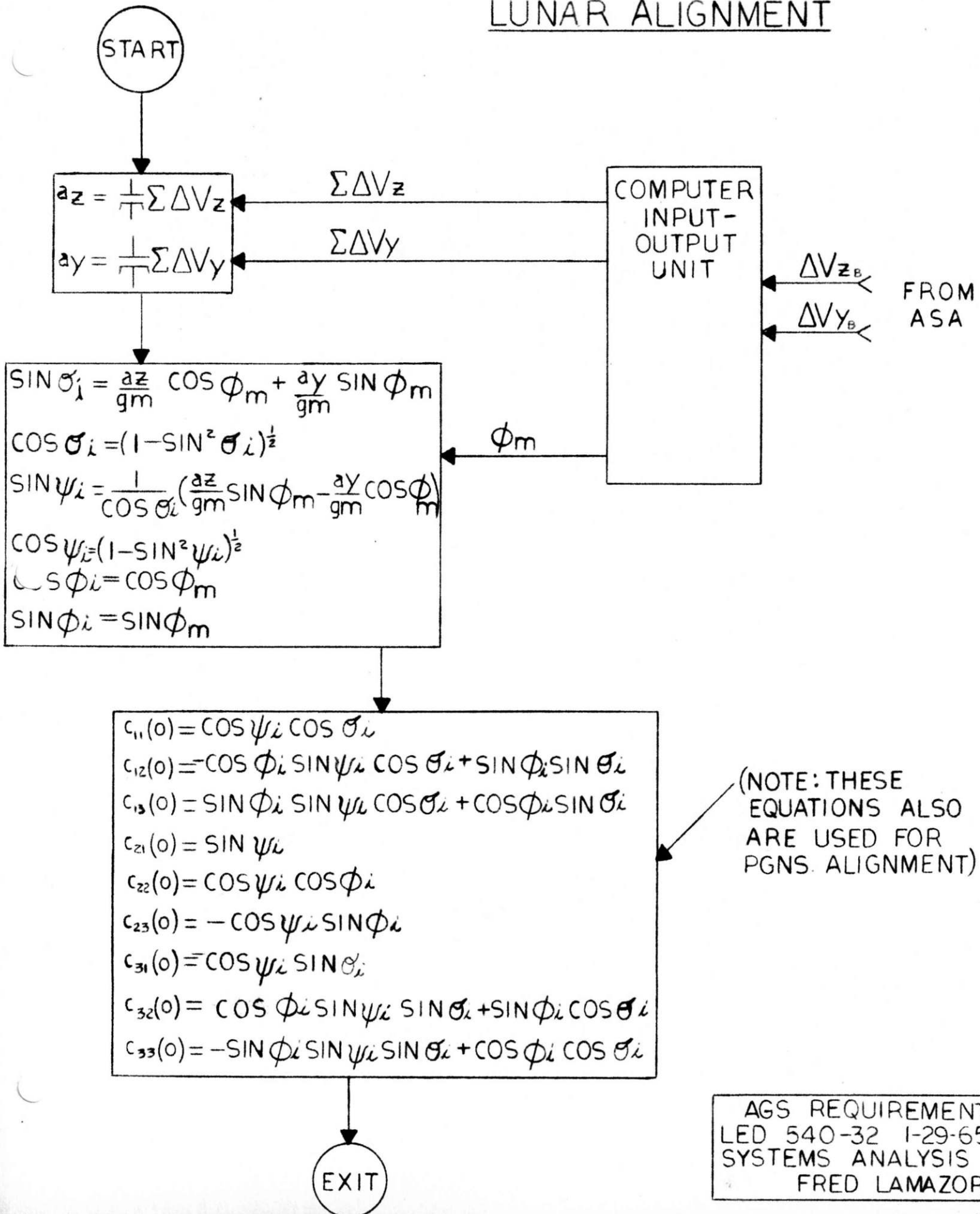

V C. COMPOSITE AGC FUNCTIONAL FLOW DIAGRAM

AGS REQUIREMENTS
LED 540-32 1-29-65
SYSTEMS ANALYSIS
FRED LAMAZOR

(1) MODE SELECTION

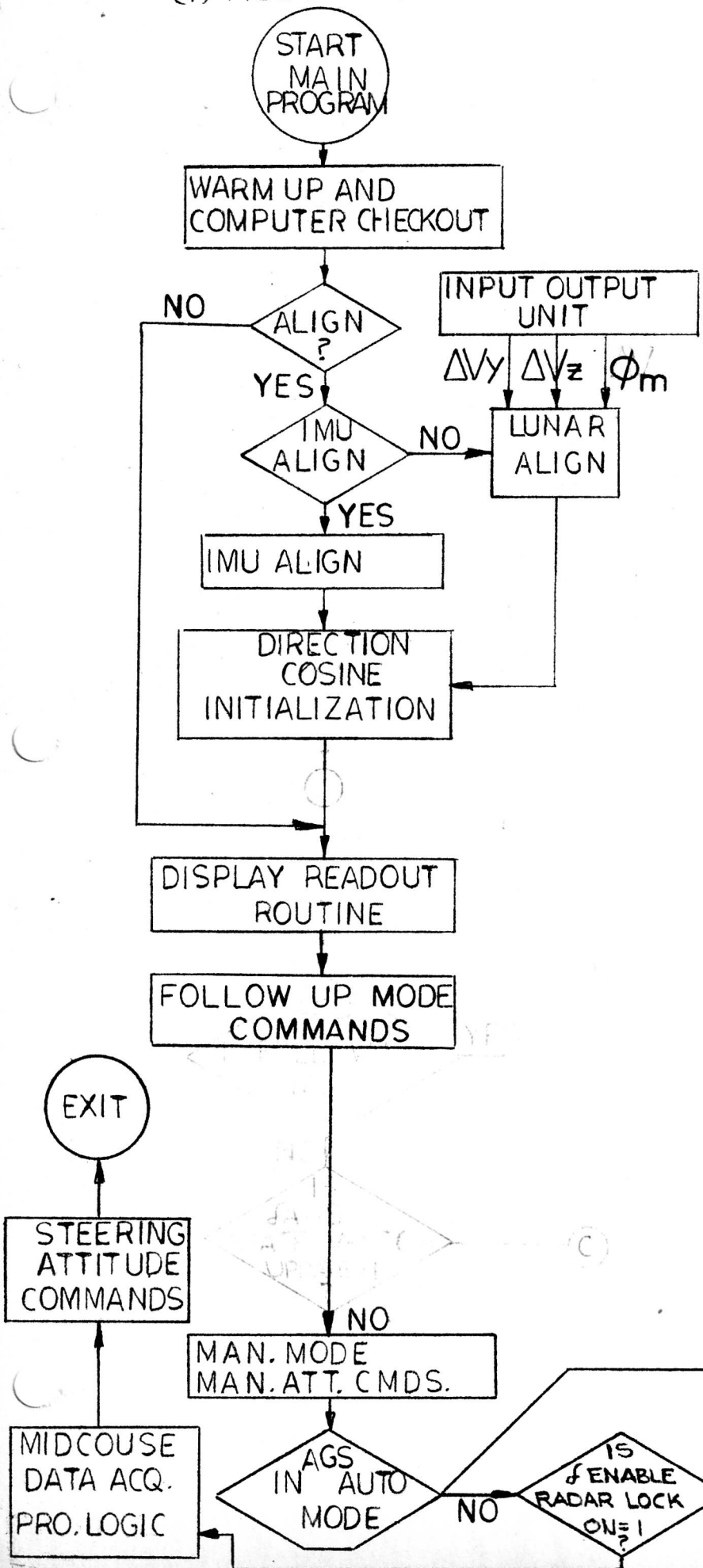

(2) DIRECTION COSINE UPDATING AND ΔV ACCUMULATION LOOP

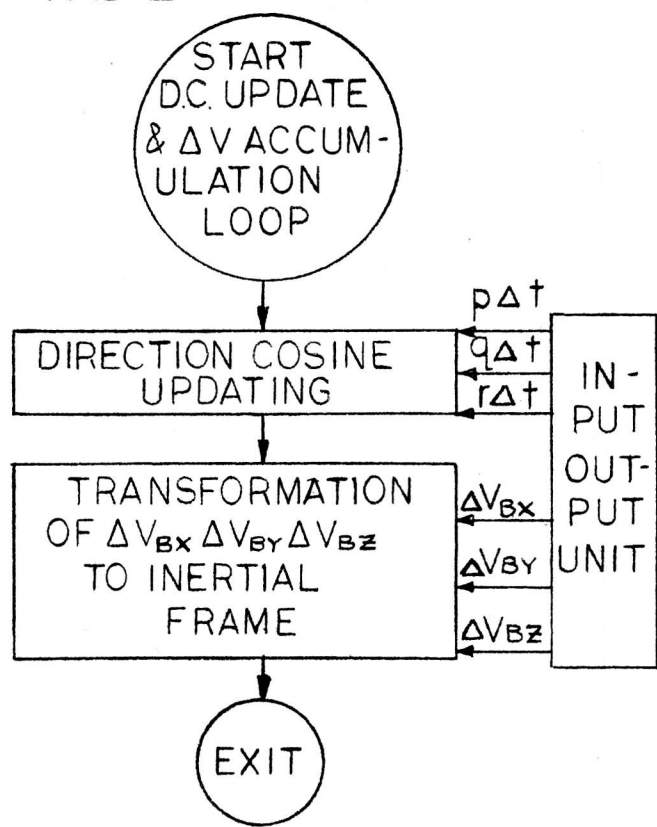

(3) ATTITUDE COMPUTATION LOOP

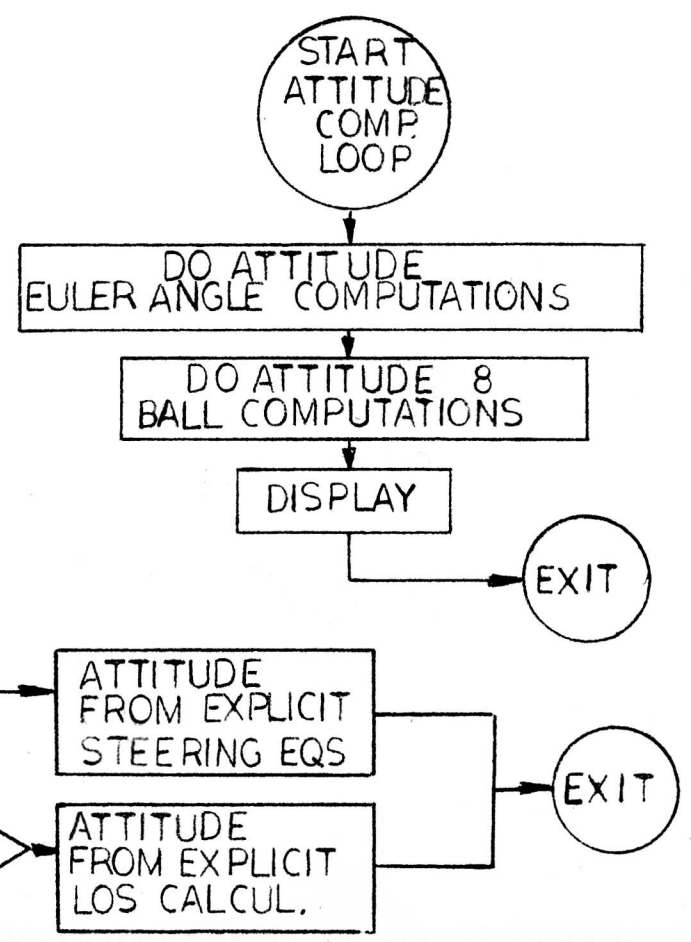

(4) NAVIGATION COMPUTATION LOOP

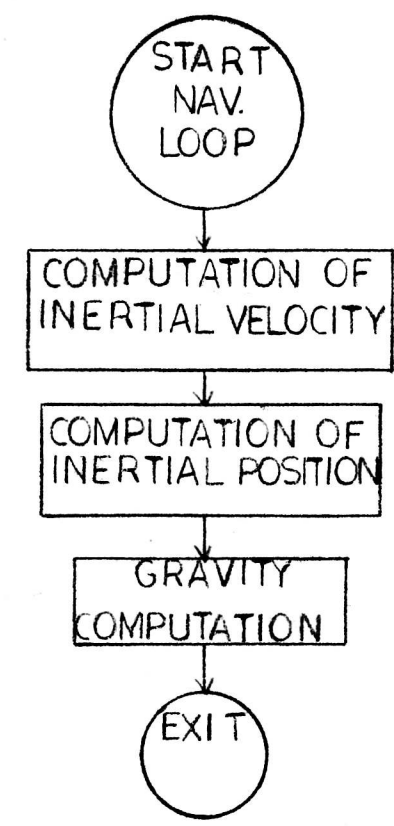

(5) GUIDANCE AND STEERING LOOP

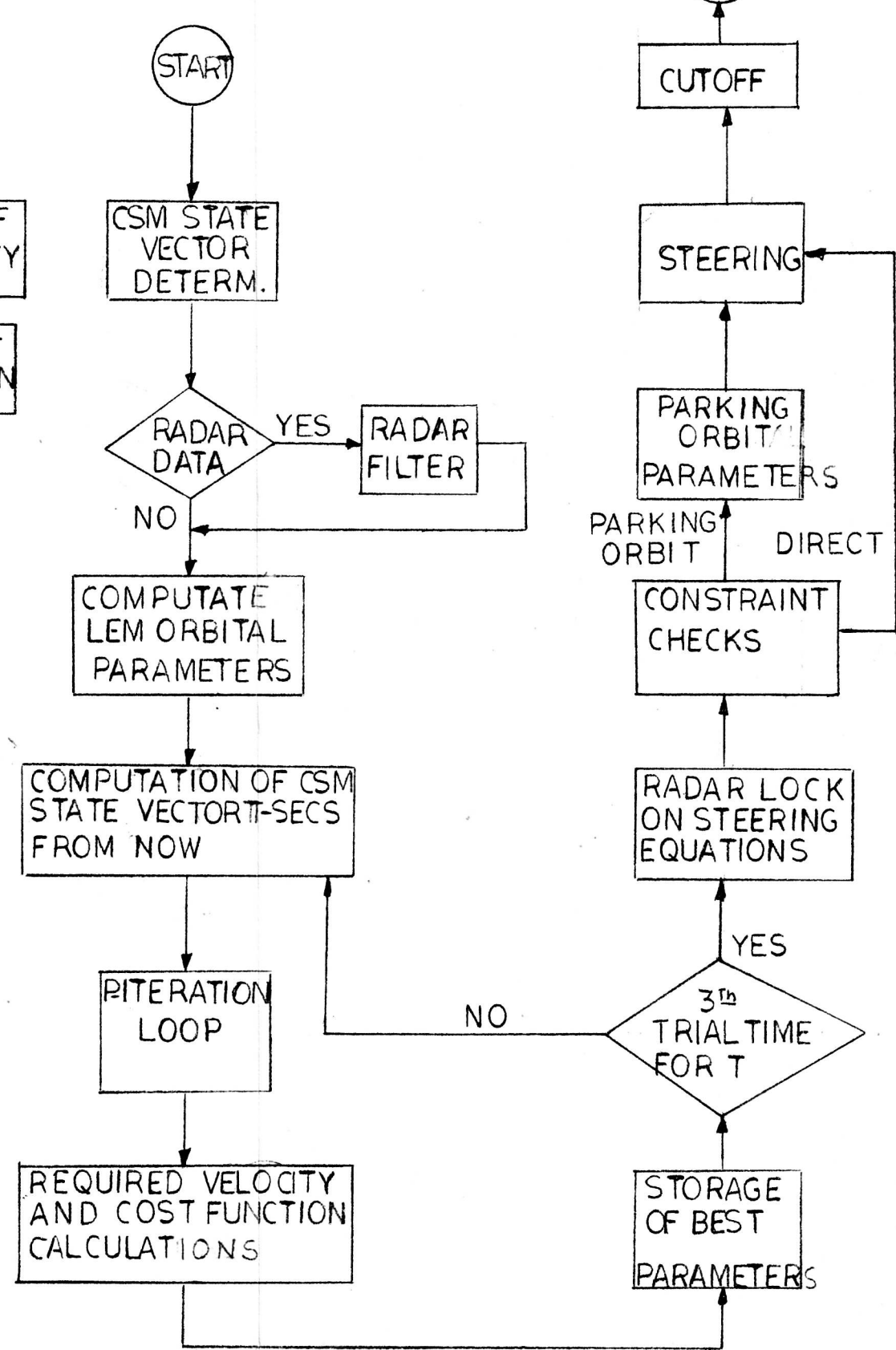

VI. PRIMARY COMPUTATIONAL QUANTITIES

PARAMETER	DESCRIPTION	SOURCE	DESTINATION
θ_i	Required attitude for parking orbit	V_g for parking orbit	Steering equations
ϕ_i	"	"	"
ψ_i	"	"	"
θ_i	Required attitude for direct orbit	V_g for direct orbit	Steering equations
ϕ_i	"	"	"
ψ_i	"	"	"
θ_i	Required instantaneous attitude from PGNS (IMU alignment)	cross link from PGNS to AGS	IMU alignment routine
ϕ_i	"	"	"
ψ_i	"	"	"
θ_i	Required attitude for radar lock on	From LOS calculations	Steering equations
ϕ_i	"	"	"
ψ_i	"	"	"
θ_i	Required attitude for rotating vehicle with RCS (prior to midcourse translation)	From V_g (intercept orbit)	Steering Equations
ϕ_i	"	"	"
ψ_i	"	"	"
θ	Actual LEM Pitch Attitude Angle	Direction cosines	Steering calc.
ψ	Actual LEM Roll Attitude Angle	computations	
ϕ	Actual LEM Yaw Attitude Angle		
ϕ	(Yaw) lunar alignment	Dedu (LEM attitude routine)	Attitude initialization
$c_{11}(0) \dots$ $c_{33}(0)$	Initial direction cosines (lunar alignment)	Accelerometers and T	Computation of initial direction cosines
$c_{11}(0) \dots$ $c_{33}(0)$	Initial direction cosines for IMU alignment	θ, ϕ, ψ PGNS	Direction cosine updating
$9c_{ij}, i, j=1, 2, 3$	Direction cosines of LEM body axes W/R inertial space	AGC (Attitude Ref.)	AGC (Nav) AGC (Radar Filter) attitude calculations

PRIMARY COMPUTATIONAL QUANTITIES (Continued)

PARAMETER	DESCRIPTION	SOURCE	DESTINATION
α	Outer gimbal angle of the attitude 8-ball	direction	"8" ball display
β	Middle gimbal angle of attitude 8-ball	cosines	"8" ball display
γ	Inner gimbal angle of attitude 8-ball		"8" ball display
ΔV_{EX}	Body X-axis accelerometer increment	ASA (accelerometer)	AGC (Nav. computation)
ΔV_{EY}	Body Y-axis accelerometer increment	ASA (accelerometer)	AGC (Nav. computation)
ΔV_{EZ}	Body Z-axis accelerometer increment	ASA (accelerometer)	AGC (Nav. computation)
$p \Delta t$	Body angular increments about <u>pitch</u> axis	ASA (Gyro assembly)	AEA (attitude computation)
$q \Delta t$	Body angular increments about <u>yaw</u> axis	ASA (Gyro assembly)	AEA (attitude computation)
$r \Delta t$	Body angular increments about <u>roll</u> axis	ASA (Gyro assembly)	AEA (attitude computation)
V_{xL} V_{yL} V_{zL} P_{xL} P_{yL} P_{zL}	LEM state vector from PGNS via crosslink (initialization and updating)	PGNS	LEM Navigation routine
V_{xL} V_{yL} V_{zL} P_{xL} P_{yL} P_{zL}	LEM state vector from CSM via voice link (inserted via Dedu)		

PRIMARY COMPUTATIONAL QUANTITIES (Continued)

PARAMETER	DESCRIPTION	SOURCE	DESTINATION
P_x	Calculated LEM -inertial coordinate	AGC (Nav.)	AGC (Guid)(Steering)
P_y	Calculated LEM -inertial coordinate	AGC (Nav.)	AGC (Guid)(Steering)
P_z	Calculated LEM -inertial coordinate	AGC (Nav.)	AGC (Guid)(Steering)
V_x	LEM -inertial velocity	AGC (Nav.)	AGC (Guid)(Steering)
V_y	LEM -inertial velocity	AGC (Nav.)	AGC (Guid)(Steering)
V_z	LEM -inertial velocity	AGC (Nav.)	AGC (Guid)(Steering)
e	Computed LEM orbital eccentric.	AGC (Nav.)	AGC (Guidance)
a	Computed LEM orbital semi-major diameter	AGC (Nav.)	AGC (Guidance)
q	Computed LEM pericynthion	AGC (Nav.)	AGC (Guidance)
V_{x_c}	CSM data from PGNS via crosslink	PGNS	CSM state vector determination
V_{y_c}	"	"	"
V_{z_c}	"	"	"
P_{x_c}	"	"	"
P_{y_c}	"	"	"
P_{z_c}	"	"	"
t_o	CSM epoch time	"	"
h_c	CSM angular momentum at t_o	"	"
p_c	CSM semi-latus rectum at t_o	"	"
η_c	Mean CSM angular rate	"	"
V_{x_c}	CSM data from CSM via voicelink (inserted via Dedu)	CSM	"
V_{y_c}	"	"	"
V_{z_c}	"	"	"
P_{x_c}	"	"	"
P_{y_c}	"	"	"
P_{z_c}	"	"	"
t_o	"	"	"
h_c	"	"	"
p_c	"	"	"
η_c	"	"	"

PRIMARY COMPUTATIONAL QUANTITIES (Continued)

PARAMETER	DESCRIPTION	SOURCE	DESTINATION
P_{xc}	Computed CSM x-inertial	CSM data	Target definition and LOS steering
P_{yc}	Computed CSM Y-inertial position	CSM data	Target definition and LOS steering
P_{zc}	Computed CSM Z-inertial position	CSM data	Target definition and LOS steering
V_{xc}	Computed coordinate CSM \dot{x} -inertial velocity comp.	CSM data	Target definition and LOS steering
V_{yc}	Computed CSM \dot{y} -inertial velocity comp.	CSM data	Target definition and LOS steering
V_{zc}	Computed CSM \dot{z} -inertial velocity comp.		
E_x	Body axis attitude error signals	Actual and required attitudes	Control system
E_y	"		
E_z	"		
V_{Rx}	LEM Required x-inertial velocity (intercept)	P iteration routine	V_g calculation
V_{Ry}	LEM required y-inertial velocity (intercept)	P iteration routine	V_g calculation
V_{Rz}	LEM required z-inertial velocity (intercept)	P iteration routine	V_g calculation
V_{gx}	LEM velocity to be gained for parking	Req'd velocity for parking orbit and actual LEM velocity	Steering equations
V_{gy}	LEM velocity to be gained for parking		
V_{gz}	LEM velocity to be gained for parking		
V_{gx}	$V_{Rx} - V_x$	Velocity to be gained to "first" burnout (intercept)	Required and actual velocities
V_{gy}	$V_{Ry} - V_y$		
V_{gz}	$V_{Rz} - V_z$		
gx	X-component of lunar gravity vector	AGC (Nav.)	AGC (Nav.)
gy	Y-component of lunar gravity vector	AGC (Nav.)	AGC (Nav.)
gz	Z-component of lunar gravity vector	AGC (Nav.)	AGC (Nav.)
H	LEM altitude from lunar surface	AGC (Nav.)	Monitor (Display Steering)
\dot{H}	LEM altitude rate W/R to lunar surface	AGC (Nav.)	Monitor (Display Steering)

PRIMARY COMPUTATIONAL QUANTITIES (Continued)

PARAMETER	DESCRIPTION	SOURCE	DESTINATION
R	Magnitudes of \underline{R} and $\dot{\underline{R}}$ input to the radar filter	Dedo via radar display	Radar filter
\dot{R}		Dedo via radar display	Radar filter
t_R, \dot{t}_R	Times of applicability of radar data	Mark	Radar filter
λ_{S_N}	Shaft and trunion angle null	Mark	Radar filter
λ_{T_N}			
$t_{B.O.}$	Calculated time for engine cutoff	V_g	Engine cutoff discrete
K_g	Value of V_g when $t_{B.O.}$ is calculated	Constant	---
K_A	ΔV Budget for ascent stage	Constant	ΔV_{left} calculation
K_B	Total LEM ΔV (budget)	Constant	ΔV_{left} calculation (before staging)
a_z	Thrust acceleration (for lunar alignment)	Accelerometers and T	Computation of initial direction cosines
a_y	"	Accelerometers and T	
T	Time interval for resolving Z and Y acceleration in lunar align procedure	Constant	a_z and a_y calc.
a_R	Transfer ellipse semi major diam.	P iteration routine	P.iteration routine
e_R	Transfer ellipse eccentricity	P iteration routine	P iteration routine
p_R	Transfer ellipse semi-latus rectum	P iteration routine	P iteration routine
q_R	Transfer ellipse pericyynthion	P iteration routine	P iteration routine
T	Time to rendezvous	P iteration routine	P iteration routine
K	# of Herrick-P iterations	AGC (Guid.)	AGC (Guid.)
ΔV_T	Total ΔV required for intercept and rend.	AGC (Guid.)	AGC (Guid) Rend. PT. Det.
K_1	Cost function coefficient	AGC (Guid.)	Rend. Pt. Det.

PRIMARY COMPUTATIONAL QUANTITIES (Continued)

PARAMETER	DESCRIPTION	SOURCE	DESTINATION
$C = \Delta V_T + K_1 T$	Cost function	AGC (Guid.)	AGC (Guid.) Rend. Pt. Det.
q_1	Pericynthion constraint	AGC (Guid)	AGC (Guid.)
K_1	# of T trial times per major guidance cycle	AGC (Guid)	AGC (Guid.)
ΔV_{LEFT}	Amount of ΔV left in LEM	ΔV Budget, accelerometer	Constraint checks

VII COORDINATE SYSTEMS

A. LEM BODY AXIS COORDINATE SYSTEM

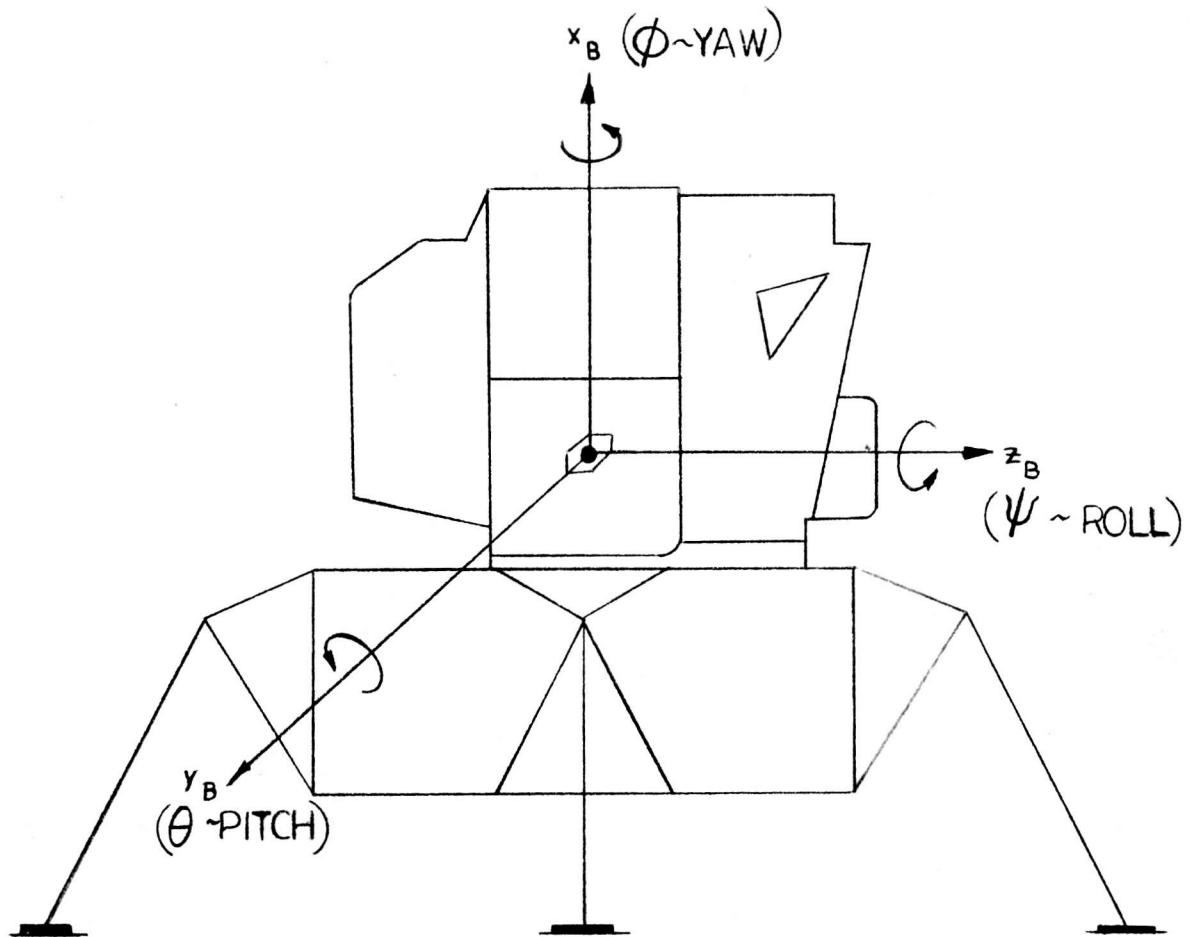

AGS REQUIREMENTS
LED 540-32 1-29-65
SYSTEMS ANALYSIS
AL SCHNUR

B. INERTIAL GUIDANCE COORDINATE SYSTEM

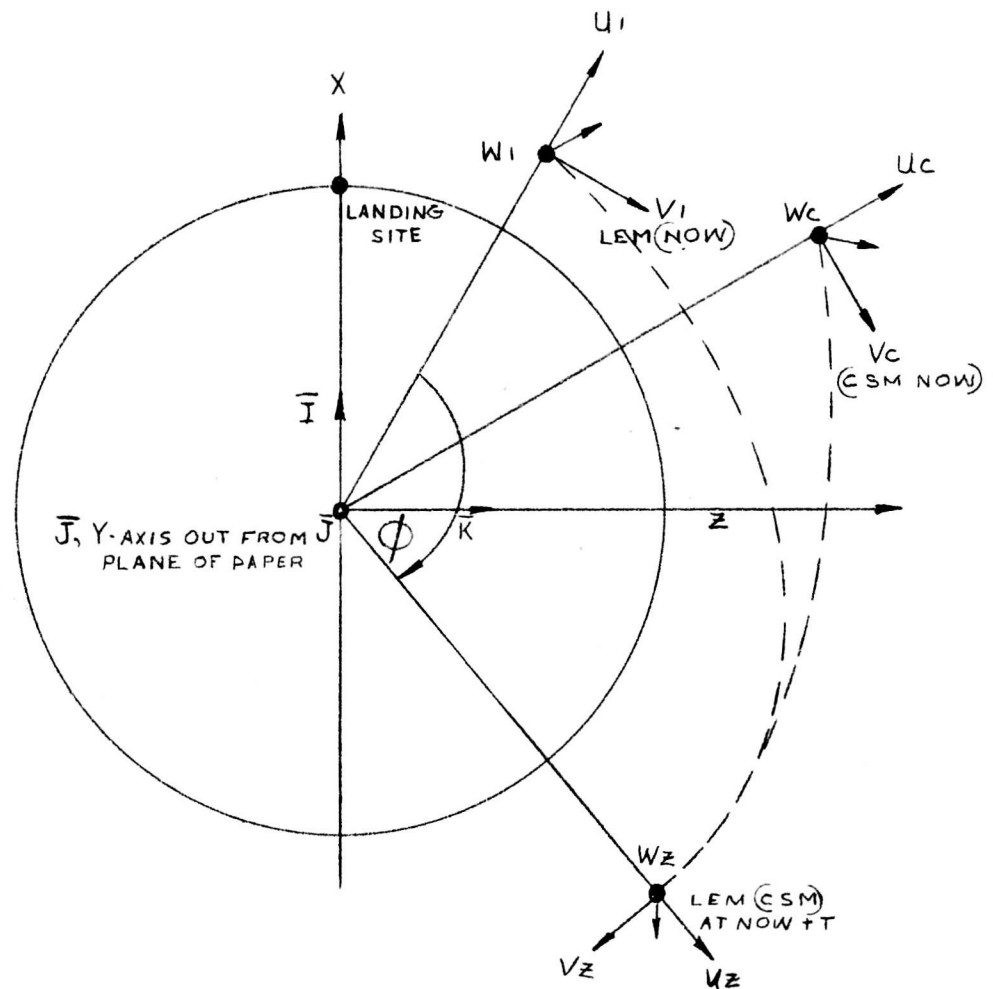

SYMBOLS

U_i, V_i, W_i ~ UNIT VECTORS AT VEHICLES POINTING RADIALLY, HORIZONTALLY IN PLANE, AND PERPENDICULAR TO ORBIT PLANE, FORMING ORTHOGONAL TRIHEDRAL. SUBSCRIPTS DENOTE USAGE: $i=1$, LEM NOW; $i=2$, LEM OR CSM NOW + T SECONDS; $i=c$, CSM AT EPOCH.

I, J, K ~ UNIT VECTOR INERTIAL COORDINATE

ϕ ~ RANGE ANGLE TO INTERCEPT

AGS REQUIREMENTS
LED 540-32 1-29-65
SYSTEMS ANALYSIS
AL SCHNUR

C. RENDEZVOUS RADAR COORDINATE SYSTEM

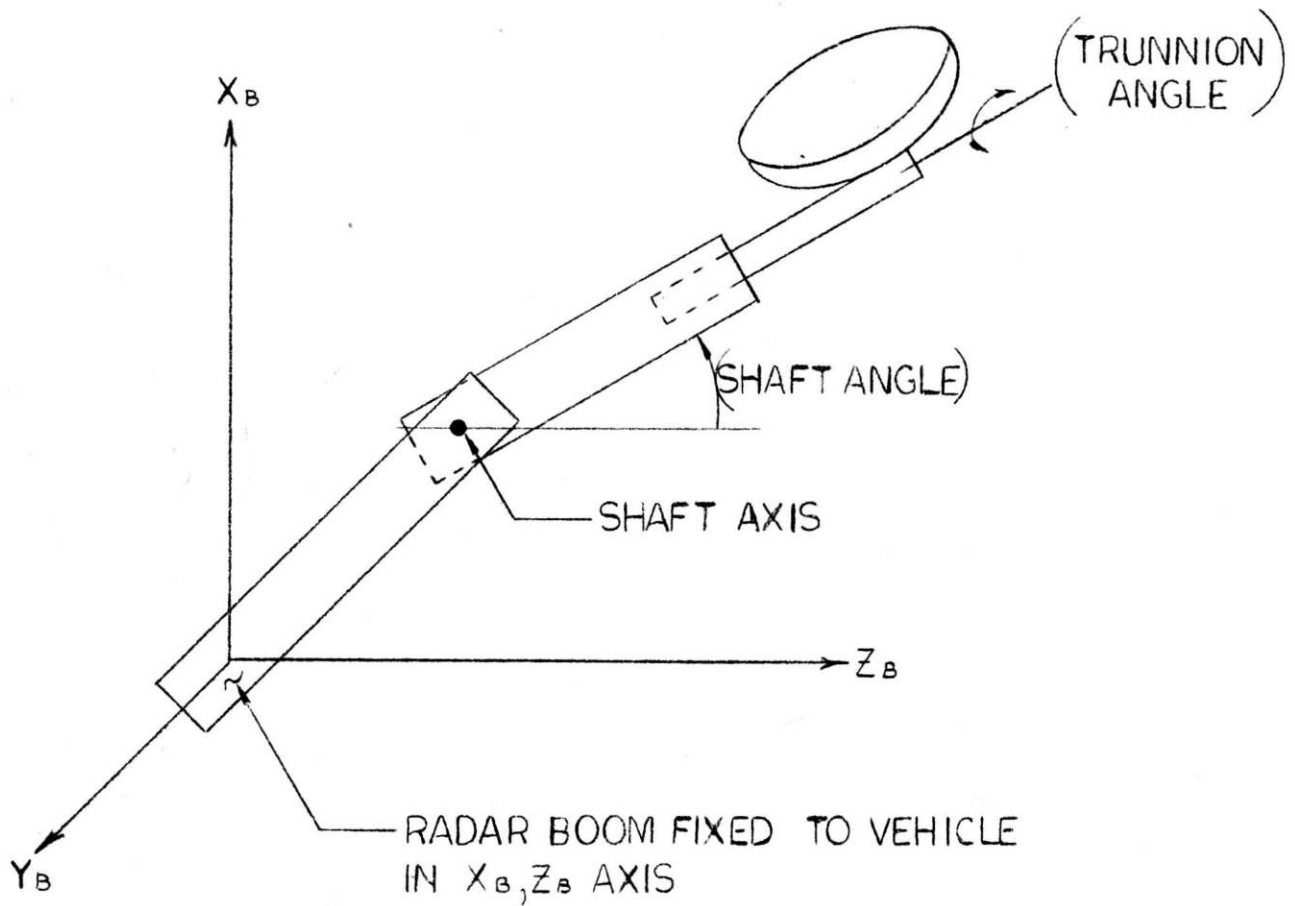

AGS REQUIREMENTS
LED 540-32 1-29-65
SYSTEMS ANALYSIS
AL SCHNUR

VIII Synchronization and Real Time Requirements

This section defines qualitatively data synchronization requirements of the AGS computer. This section is not concerned with synchronization for mechanization, such as strobing of digital data at the proper time to effect data transmission. The latter type of synchronization requirements are primarily due to the need for time identification of rapidly changing navigation variables. Data synchronization requirements can be either two (2) ways as follows:

- 1) By keeping real time at each source of information, as well as the AGS computer, and by forcing these time records to match.
- 2) By use of time marks or "epoch pulses" associated with each data, which identifies the instant of time to which the data, is associated.

Following is a table of the sources requiring synchronization and the data that is affected.

SYNCHRONIZATION TABLE

- I AGS - CSM Apollo Guidance Computer
 - a. CSM Position
 - b. CSM Velocity
- II AGS - PGNS LEM Guidance Computer
 - a. LEM Position
 - b. LEM Velocity
 - c. LEM Attitude Angle
- III AGS - Rendezvous Radar
 - a. Range
 - b. Range Rate
 - c. Shaft Angle
 - d. Trunnion Angle

Certain output data of the AGS must be in time synchronization with the corresponding data from the PGNS for monitoring purposes. This data is listed below:

Synchronized Outputs

- a. Altitude
- b. Altitude Rate
- c. Lateral Velocity
- d. Total Velocity

Internal real time requirements of the AGS refer to items which require accurate counting of time. Most of the routines and computations and processes do not require accurate real time. There are however, two (2) notable exceptions which are listed below:

- a) Inertial component sampling rate
- b) Navigation computation, namely integrations

IX. SPECIAL TOPICS

A. COMPUTER CHECKOUT

Provision must be made for verifying normal AGC operation by performing internal computer self checks. Some check procedures are carried out continuously, while others are performed at specific times during a mission.

1. Pre-Separation and Pre-Launch

Subsequent to warmup periods the following computer checks are to be made:

(a) Fixed Memory Check

This check is to be performed by summing the contents of all the fixed memory locations and comparing with a pre-determined number.

(b) Arithmetic Check

A programmed routine will check the fundamental arithmetic operations, namely, addition, subtraction, multiplication and division.

(c) Powered Phases and Coasting Phases

Whenever the LEM vehicle is in flight, the computer checkout procedures will include the arithmetic check as described above.

In addition, Parity Checks and Reasonableness Checks are required.

(a) Arithmetic Check, as described above

(b) Parity Check - The sum of all (but the last) bits of an instruction word is compared with the parity (odd or even) of the last bit.

(c) Reasonableness Check - Those computations carried out on a continuous basis provide a reasonableness check by keeping track of the " Δ - differences" of some computed parameters. If a pre-assigned " Δ - difference" threshold is exceeded then there is an indication that a failure may have taken place.

B. GUIDANCE MONITORING TECHNIQUE

The basic feature of the monitoring scheme as proposed by MSC is to determine with early sensing, catastrophic failures. In this scheme displays are utilized. It is assumed further that the crew will have the capability of verifying the display. The monitoring concept is implemented by comparing the following like quantities of different LEM systems:

1. Total Attitude
2. Total Velocity

3. Altitude and Altitude Rate
4. Out-of-Plane Velocity

The method of comparing these quantities and establishing a catastrophic failure will be specified in a future document.

Each of the above monitored quantities will have two or more inputs that are selected by the astronaut. The required quantities to be displayed are:

1. L.R. Forward Velocity
2. LGC Forward Velocity
3. RR LOS El. Rate (Shaft)
4. LR Lateral Velocity
5. LGC Lateral Velocity
- *6. AGS Lateral Velocity
7. RR LOS Azimuth Rate (Trunnion)
8. IMU Total Attitude
- *9. AGS Total Attitude
10. LR Range Along Altitude Beam
11. LGC Altitude
- *12. AGS Altitude
13. LR Velocity Along Altitude Beam
14. LGC Altitude Rate
- *15. AGS Altitude Rate
16. RR Range
17. RR Range Rate
- *18. AGS ΔV_x (Incremental)
- *19. AGS Total Velocity (Incremental)
20. LGC Total Velocity

* Supplied by AGS Computer

C. Initialization Procedures Prior to Launch

All the basic navigation and guidance computations are performed in Inertial Landing Site Coordinates. The CSM also computes and updates its orbital parameters relative to this coordinate system. This information is transmitted to LEM for the guidance computations. PGNS calculations as well as the AGS calculations must be carried out in this coordinate system. Hence, a transformation is required (accounting for vehicle misorientation, vehicle shift and lunar motion) to erect an inertial launch coordinate system which coincides with the inertial Landing Site Coordinate system.

The following procedure will define the required transformation matrix. This procedure will be presented in symbolic form, whose details will be given in forth coming documents. The following acronyms will define the various coordinate system orientations with respect to the Landing Site Coordinate System. These are utilized to produce the required inertial reference frame.

LSCS	Landing Site Coordinate System
LDSV	Inertially measured Landing Site Vertical (as measured with vehicle accelerometers)
BAF	Body Axis Frame at nominal touchdown
LV	Launch Vertical (as measured on lunar surface prior to liftoff)
BAFL	Body Axis Frame at Launch

The figure below symbolically shows how these coordinate systems may be oriented.

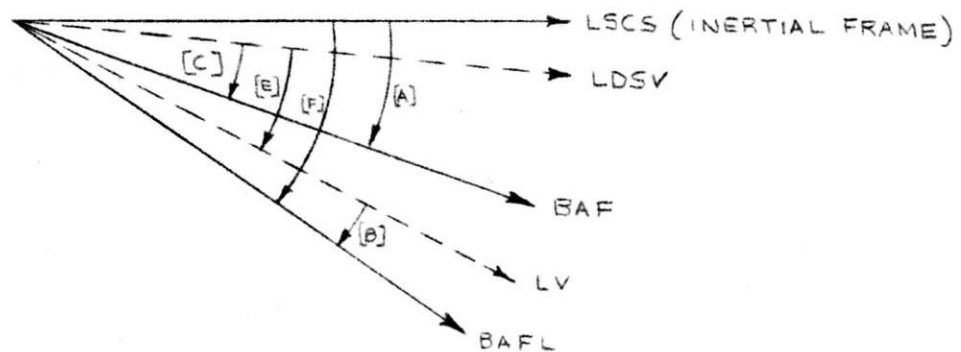

The transformations (Euler Angle Set) denoted by the bracketed quantities, are defined as follows:

- [A] That transformation from LSCS to BAF resulting from the LEM vehicle landing on lunar surface. (The surface terrain may tilt the vehicle axes from LSCS.
- [C] That transformation from LDSV coordinates to BAF, where LDSV will be in error from the LSCS.
- [E] That transformation of Lunar motion (which includes lunar rotations, librations etc.) of the local vertical relative to LSCS. This transformation is clearly a function of time.
- [B] That matrix accounting for the shift of the vehicle while on the lunar surface.
- [F] The overall transformation between LSCS at nominal touchdown to BAFL just prior to launch.

The overall transformation [F] may be written as

$$[F] = [B][E][C]^{-1}[A]$$

This composite matrix will erect an inertial frame at launch identical to LSCS. This provides the required utilization for the attitude reference computations. The required state vector for navigation initialization referred to LSCS may be computed from:

$$\left\{ P \right\}_{\substack{\text{BAFL} \\ \text{Desired}}} = [F]^{-1} \left\{ P \right\}_{\text{BAFL}} \quad \text{for position, and}$$

$$\left\{ V \right\}_{\substack{\text{BAFL} \\ \text{Desired}}} = [F]^{-1} \left\{ V \right\}_{\text{BAFL}} \quad \text{for velocity}$$

D. Inertial Component Compensation

Inertial components have inherent error drifts which produce errors in gyro and accelerometer outputs, thus affecting attitude and navigation. For strapped-down systems, the gyros are body mounted in a cluster arrangement. The accelerometers are also mounted in this manner. The following procedure describes a technique for compensating these unwanted error drifts. Consider a gyro whose error drift, D is the sum of the scale factor error, S and constant bias, B .

Assume there exists procedures for estimating B and S . Let the gyro output be expressed as

$$Y = Y_D + B + S + \eta$$

where Y_D is the uncontaminated output signal and η is a noise component which can't be compensated for. Let $K_S = 1 \pm \delta$, which is the scale factor compensation gain. δ is a small quantity (to be determined), whose sign is such as to remove the deterministic scale factor error. For example a gyro incremental rate output multiplies K_S , Δt being the interval of the rate increment. A gyro bias correction then removes the bias error. The remaining signal should be simply $Y_D + \eta$. The schematic below shows how this gyro compensation procedure is mechanized.

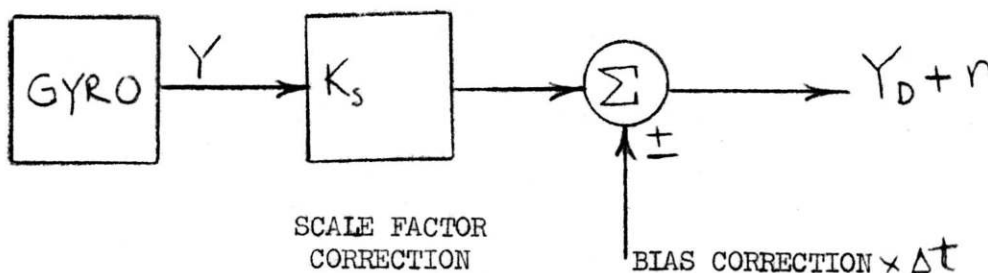

GYRO ERROR COMPENSATION

Compensation for similar errors in the accelerometers proceeds in exactly the same way.

ATTACHMENT

LEM Explicit Equation Flow Charts

List of Symbols of Principal Variables:

$\underline{r}, \dot{\underline{r}}$	estimated position and velocity of LEM
$\underline{r}_{\text{-CSM}}, \dot{\underline{r}}_{\text{-CSM}}$	estimated position and velocity of CSM
T	expected time from now of rendezvous
t_a	present time
t_c	CSM epoch time
t_r	time of validity of radar range, R , as determined manually
\underline{x}_b	LEM longitudinal axis (unit vector)
μ_3	count of radar points supplied
\underline{r}^*	raw radar estimate of LEM's position
w_1, w_2	filter weights
$\underline{h}, \underline{h}_c$	angular momentum vector of LEM, CSM respectively
V_h	horizontal velocity of LEM
σ^2	sum of variance of radar measurements and p_{11}
p_{11}, p_{12}, p_{22}	LEM position, velocity covariances
K	this symbol stands for any fixed value
S_1	$S_1 = 1$ when new CSM epoch is input to computer
S_2	$S_2 = 1$ when radar data is present
$\underline{r}_c, \dot{\underline{r}}_c$	CSM position, velocity vector at epoch
$\underline{U}_i, \underline{V}_i, \underline{W}_i$	unit vectors at vehicles pointing radially, horizontally in plane, and perpendicular to orbit plane, forming orthogonal trihedral. Subscripts denote usage: $i = 1$, LEM now; $i = 2$, LEM now + T seconds; $i = c$, CSM at epoch.
p, p_c	semi-latus rectums of LEM, CSM respectively

List of Symbols of Principal Variables (Continued)

α, α_c	semi-major axes of LEM, CSM orbits
e, e_c	eccentricity of LEM, CSM orbits
q	LEM perilune of present orbit
C_o	cost of optimum rendezvous
J	manual setting (by astronaut) of limits of rendezvous time search
Δ_T, Δ_B	limits on rendezvous time T
A_C	predicted central angle of CSM with respect to the epoch position
\dot{r}_T	predicted velocity vector of CSM at rendezvous
c_1	cosine of central angle between LEM (now) and CSM (at now + T seconds)
c_2	sine of aforesaid central angle
μ_2	p-iteration control index
P	period of trial transfer orbit
T_p	time to rendezvous associated with p iteration
∂_T	partial of p with respect to T_p
\underline{V}_I	initial velocity vector increment to cause rendezvous, associated with trial T
\underline{V}_F	final velocity vector increment for rendezvous, associated with trial T
V_T	total velocity magnitude required for rendezvous, associated with trial time T
q_1	perilune of transfer orbit associated with trial time T
C	cost of rendezvous associated with trial time T
V_G	present velocity-to-be-gained for best rendezvous
T_c	time-to-rendezvous for best rendezvous solution
q_o	perilune of best rendezvous orbit
i_o	index controlling Δ_C , trial T search interval

List of Symbols of Principal Variables (Continued)

V_o	total velocity magnitude required for best rendezvous
\dot{r}_f	predicted LEM burnout altitude rate
r_f	predicted LEM burnout altitude
I	index sequencing trial F logic
V_D	integral of thrust acceleration
V_L	ΔV capability remaining in LEM
V_f	velocity required for parking orbit insertion
a_T	thrust acceleration from accelerometers
T_E	time to engine cutoff
T_C	time to descent section staging
Δ	computation cycle time interval
ψ	+1 or -1 depending on whether increased or decreased inertial velocity is required
\ddot{r}_d	desired altitude acceleration
V_y	yaw velocity error
ψ_p, ψ_y	desired pitch and yaw attitudes
\underline{x}_{bd}	desired pointing direction of LEM thrust vector (unit vector)
δ_1	engine ON/OFF signal. $\delta_1 = 1$ when engine ON
δ_5	descent section staging signal. $\delta_5 = 1$ after staging
\underline{R}	relative position vector, $\underline{r}_{CSM} - \underline{r}$
R	magnitude of \underline{R} , as measured by the radar
\dot{R}	rate of change of R
μ	lunar gravitational constant
\dot{r}, \dot{r}_c	rate of change of LEM and CSM altitude
n_c	CSM central angular rate
m	integer number of orbits in transfer
\dot{r}_I	altitude rate after first impulse
$\dot{\underline{r}}_I$	velocity vector after first impulse
$\dot{\underline{r}}_F$	velocity vector at T

D. K. MIECIK

GRUMMAN AIRCRAFT ENGINEERING CORPORATION

LEM Engineering Memorandum

LMO-540-211
13 January 1964

E.S. *ES*

From: E. Gorczycki

To: R. Kress

Subject: A. FMES MATH MODEL: KINEMATIC RELATIONSHIP BETWEEN LEM ATTITUDE ANGLES (EULER ANGLES) AND IMU PICKOFF ANGLES.

Purpose:

This memorandum constitutes an initial input into the large-scale effort of generating math model implementation equations for the Full Mission Engineering Simulator (FMES). Whenever a math model is presented in any memo issued by the author, an honest effort will be made to search existing literature to avoid duplication of work and to give proper credits to authors of existing memoranda on pertinent subjects. Besides, references to existing literature will serve as an excellent bibliography to substantiate the math model validity and compatibility with system operation. As additional memoranda are generated on the subject of FMES MATH MODEL implementation equations, they will be issued as supplements or addenda to the memorandum bearing the present reference number. Consequently, all FMES math model implementation equations will be identified by a single memo reference number but will be differentiated from one another by successive letters.

References to all work not given here!!! There are several references where the definition of terms are defined for the primary IMU.

No analytical derivations of results will be presented in these memoranda at this time for reasons of expediency. These will be presented in their complete form in a final FMES engineering report.

What expediency (It is laziness when one leave out definition or derivation. This type of thing lead to confusion at a later date. And these feature long delays. (e.g. OAO dynamic testing)

The FMES MATH MODEL of the present memorandum is preceded by the letter "A". The subject covers the implementation equations of the kinematic relationship between LEM attitude angle, also referred to as Euler angles and IMU pickoff angles.

Physical Description of the IMU

This was obtain from ref. (3) and (8) of LMO-540-160

Figure 1 shows schematically the arrangement of the Inertial Measurement Unit (IMU) as it applies to the LEM. The IMU gimbal case is mounted on the Navigation Base together with the Scanning Telescope whose function is space-alignment of the IMU. Inertial space stabilization is derived from three 25 size Inertial Reference Integrating Gyroscopes (IRIG) depicted by the large X, Y, Z units on the stable member in figure 1. The small x, y, z units in the same figure represent three 16 size Pulsed Integrating Pendulum Accelerometers (PIPA) which measure the specific force. A desired inertial reference coordinate system is maintained by isolating the stable member from LEM motions by means of servo-controlled gimbals which support the stable member.

Furthermore, since they were develop it is no great effort to write down the development. There might be mistakes in the development which are hidden since the average reader can not waste time redeveloping the transformation

*What is particular will math model simulate or represent?
A memo that is a beginning of a series of memos should explain the organization of the future memos.
Not doing this leave one with the impression that the author is not sure and prepared to cover the subject matter.*

First derived in LMO-540-160

The IMU gimbaling configuration might be commonly referred to as "pitch-on-the-inside". The axis orientation of the IMU is such that with all gimbal angles zero (gimbal axes orthogonal), the inner axis (Y) will be aligned with the LEM pitch axis (astronaut pitch axis, also), the middle axis (Z) will be aligned with the LEM yaw axis (astronaut roll axis) and the outer gimbal axis (X) along the LEM roll axis (astronaut yaw axis). Subsequent referral to the LEM reference coordinate system shall be with respect to the astronaut in the manner which was just discussed. This is clearly shown in figure 1.

Pitch and yaw axes have unlimited angular freedom. In the "pitch-on-the-inside" configuration, the IMU would experience gimbal lock if the LEM middle gimbal reaches ninety degrees; actually, the middle gimbal angle is maintained to less than 70°.

Conventions and Definition of Terms

The conventions which are used in the generation of the math models for the FMES are consistent with those currently in use. The IMU gimbal angles, for instance, are reckoned from the condition where the gimbal axes are initially orthogonal and are defined as follows:

A_{IG} IMU Inner Gimbal Angle. The angle formed by the Z axis of the middle gimbal, Z_{MG} , and the Z axis of the stable member, Z_{SM} . The angle is measured in degrees from Z_{MG} to Z_{SM} as shown in figure 1.

and also X axis of a trend set.

A_{MG} IMU Middle Gimbal Angle. The angle formed by the X axis of the outer gimbal, X_{OG} , and the X axis of the middle gimbal, X_{MG} . The angle is measured in degrees from X_{MG} to X_{OG} as shown in figure 1.

A_{OG} IMU Outer Gimbal Angle. The angle formed by the Y axis of the gimbal case, Y_{GC} and the Y axis of the outer gimbal Y axis of the outer gimbal Y_{OG} . The angle is measured in degrees from Y_{GC} to Y_{OG} as shown in figure 1.

LEM attitude with respect to a set of inertial reference axes shall be specified in accordance with the sequence of rotations: pitch (θ), roll (ψ) and yaw (ϕ) when referred with respect to the astronaut. This sequence is pitch (θ), yaw (ψ), and roll (ϕ) when referred with respect to the LEM body. The orientation of LEM body axes based on the sequence of rotations, pitch, roll and yaw as related to the astronaut is shown in figure 2. By convention, LEM attitude angles are defined with respect to the astronaut as follows:

ϕ Euler yaw angle

θ Euler pitch angle

ψ Euler roll angle

LMO-540-160 defines these Euler angles as the platform gimbal angles

LMO-540-160 took pains to eliminate pitch, roll, yaw notation because of the NASA direction to speak of it in terms of the astronaut at all times.

The subscripts in figure 2 denote the orientation of the XYZ triad just following a rotation in the order:

- (1) pitch (θ)
- (2) roll (ψ)
- (3) yaw (ϕ)

This has already created confusion in that some people believe that the LEM can only be rotated in a particular sequence.

Different sequences of rotation would require a re-drawing of figure 2 with a renumbering of the rotational operations with number "1" corresponding to the first rotation and so on.

What was the initial orientation?

LMO-540-760 Define the primary IMU with a semi-mathematical model that defines the transformation order once in the beginning and does not require continually order sequence repetition

Table I presents a tabulation of transformation matrices of the LEM body axes in their final orientation (denoted by the "3" subscript) with respect to the stable member axes (denoted by the "0" subscript) for different sequences of rotation. Thus, in the transformation matrix of table I based on the sequence of rotations pitch, roll, yaw, the first row of the matrix represents the direction cosines of the X body axis with respect to the stable member axes. A similar discussion applies to the Y and Z axes.

A FMES or any other simulator will be very restrictive if only sequence of rotation can be used.

Table II shows the transformation equations from actual Euler angles to IMU kinematic pickoff angles for the IMU configuration shown in figure 1. Kinematic pickoff angles differ from indicated pickoff angles by the amount of error introduced by the sensing and display devices.

This presentation will be confusing to the average reader (Sequence - transformation)

Table III shows the inverse transformation equations from IMU kinematic pickoff angles to actual Euler angles for the IMU configuration shown in figure 1.

Tables II and III show clearly the justification for the choice of sequence of rotations: pitch, roll, yaw for the IMU configuration shown in figure 1.

For this choice of sequence of rotations, the Euler angles transform directly into IMU pickoff angles and vice versa. Note that for any other sequence of rotation, an interaction between gimbals takes place and the transformation is no longer direct. It is obvious that for the same orientation of the LEM body with respect to the stable member reference axes, the magnitude of corresponding Euler angles differs for the different sequences of rotation.

It should be stated that this is the IMU display information with astronaut correction factors

A much clearer presentation is to speak about the LEM body axis and LEM IMU axis orientation differences for different body slow sequences.

The math model of the actual Euler angle to kinematic IMU pickoff angle transformation is shown in figure 3. Note that the double-ended arrow denotes that the transformation is reversible.

- cc: E. Stern
- A. Walsh
- M. Olstad
- W. Kozak
- S. Greene
- F. Nichols
- Dist. Lists D & E (one copy)
- Sys. Anal. & Integ. Group Leaders
- Sys. Anal. Personnel

Error of the IMU gimbal were not covered in this memo; i.e. error due to missing resolver chain in platform servo loop.

The math model in the above just discusses the astronaut display information differences. It should be considered that the LEM will slow transition

Handwritten title or header at the top of the page.

$$\begin{bmatrix} 0 & 0 & -10 \\ 0 & 1 & 0 \\ -10 & 0 & 10 \end{bmatrix} \begin{bmatrix} x \\ y \\ z \end{bmatrix} = \begin{bmatrix} 0 \\ 0 \\ 0 \end{bmatrix}$$

Text describing the system of equations or matrix operation.

Text describing the system of equations or matrix operation.

Text describing the system of equations or matrix operation.

Text describing the system of equations or matrix operation.

Text describing the system of equations or matrix operation.

Text describing the system of equations or matrix operation.

Text describing the system of equations or matrix operation.

Text describing the system of equations or matrix operation.

Transformation define as a positive order
as going from stable number to body.

TABLE I

TRANSFORMATION MATRICES OF LEM BODY AXES WITH RESPECT TO SM AXES

SEQUENCE OF ROTATION	TRANSFORMATION MATRIX	SEQUENCE OF ROTATION	TRANSFORMATION MATRIX
PITCH	$\begin{bmatrix} \cos\psi \cos\theta & \sin\psi \cos\theta & -\cos\psi \sin\theta \\ +\sin\psi \sin\theta & \cos\psi \sin\theta & +\sin\psi \cos\theta \end{bmatrix}$	PITCH	<p>ok Same as LMO 540-160 page 31 (stable number to body)</p> $\begin{bmatrix} \cos\psi \cos\theta & \sin\psi \cos\theta & -\sin\psi \cos\theta \\ \sin\psi \sin\theta & \cos\psi \cos\theta & \sin\psi \cos\theta \\ -\cos\psi \sin\theta & \cos\psi \cos\theta & +\cos\psi \sin\theta \end{bmatrix}$
YAW	$\begin{bmatrix} -\sin\psi \cos\theta & \cos\psi \cos\theta & \sin\psi \sin\theta \\ +\cos\psi \sin\theta & \sin\psi \sin\theta & +\cos\psi \cos\theta \end{bmatrix}$	ROLL	$\begin{bmatrix} \sin\psi \sin\theta & \cos\psi \cos\theta & \sin\psi \cos\theta \\ -\cos\psi \sin\theta & \sin\psi \sin\theta & +\cos\psi \cos\theta \\ \cos\psi \sin\theta & -\sin\psi \cos\theta & \cos\psi \cos\theta \end{bmatrix}$
ROLL	$\begin{bmatrix} \cos\psi \sin\theta & -\sin\psi & \cos\psi \cos\theta \end{bmatrix}$	YAW	$\begin{bmatrix} \cos\psi \sin\theta & -\sin\psi \cos\theta & \cos\psi \cos\theta \\ +\sin\psi \sin\theta & \cos\psi \cos\theta & -\sin\psi \sin\theta \end{bmatrix}$
YAW	$\begin{bmatrix} \cos\psi \cos\theta & \cos\psi \sin\psi & \sin\psi \sin\psi \\ +\sin\psi \cos\psi \sin\theta & +\sin\psi \cos\psi \cos\theta & -\cos\psi \cos\psi \sin\theta \end{bmatrix}$	YAW	<p>ok stable number to body.</p> $\begin{bmatrix} \cos\psi \cos\theta & \sin\psi \sin\theta & -\cos\psi \sin\theta \\ +\cos\psi \sin\psi \cos\theta & +\cos\psi \sin\psi \cos\theta & +\sin\psi \sin\psi \cos\theta \\ -\sin\psi & \cos\psi \cos\theta & \sin\psi \cos\theta \end{bmatrix}$
PITCH	$\begin{bmatrix} -\sin\psi \cos\theta & \cos\psi \cos\psi & \sin\psi \cos\psi \\ -\sin\psi \sin\psi \sin\theta & -\sin\psi \sin\psi \sin\theta & +\cos\psi \sin\psi \sin\theta \end{bmatrix}$	ROLL	$\begin{bmatrix} -\sin\psi & \cos\psi \cos\theta & \sin\psi \cos\theta \\ \cos\psi \sin\theta & -\sin\psi \cos\theta & \cos\psi \cos\theta \\ +\cos\psi \sin\psi \sin\theta & +\cos\psi \sin\psi \sin\theta & +\sin\psi \sin\psi \sin\theta \end{bmatrix}$
ROLL	$\begin{bmatrix} \sin\theta & -\sin\psi \cos\theta & \cos\psi \cos\theta \end{bmatrix}$	PITCH	$\begin{bmatrix} \cos\psi \sin\theta & -\sin\psi \cos\theta & \cos\psi \cos\theta \\ +\cos\psi \sin\psi \sin\theta & +\cos\psi \sin\psi \sin\theta & +\sin\psi \sin\psi \sin\theta \end{bmatrix}$
ROLL	$\begin{bmatrix} \cos\psi \cos\theta & \sin\psi \cos\theta & -\sin\theta \\ -\cos\psi \sin\psi & \cos\psi \cos\psi & \sin\psi \cos\psi \\ +\sin\psi \cos\psi \sin\theta & +\sin\psi \cos\psi \sin\theta & \cos\psi \cos\psi \end{bmatrix}$	ROLL	$\begin{bmatrix} \cos\psi \cos\theta & \sin\psi \cos\theta & -\cos\psi \sin\theta \\ -\sin\psi \sin\psi \sin\theta & +\sin\psi \cos\psi \sin\theta & \sin\psi \cos\psi \sin\theta \\ -\cos\psi \sin\psi & \cos\psi \cos\psi & \sin\psi \end{bmatrix}$
PITCH	$\begin{bmatrix} \sin\psi \sin\psi & -\sin\psi \cos\psi & \cos\psi \cos\psi \\ +\cos\psi \cos\psi \sin\theta & +\cos\psi \cos\psi \sin\theta & \cos\psi \cos\psi \end{bmatrix}$	YAW	$\begin{bmatrix} -\cos\psi \sin\psi & \cos\psi \cos\psi & \sin\psi \\ \cos\psi \sin\theta & \sin\psi \sin\theta & \cos\psi \cos\theta \\ +\sin\psi \sin\psi \cos\theta & -\sin\psi \cos\psi \cos\theta & \cos\psi \cos\theta \end{bmatrix}$
YAW	$\begin{bmatrix} \sin\psi \sin\psi & -\sin\psi \cos\psi & \cos\psi \cos\psi \\ +\cos\psi \cos\psi \sin\theta & +\cos\psi \cos\psi \sin\theta & \cos\psi \cos\psi \end{bmatrix}$	PITCH	$\begin{bmatrix} \cos\psi \sin\theta & \sin\psi \sin\theta & \cos\psi \cos\theta \\ +\sin\psi \sin\psi \cos\theta & -\sin\psi \cos\psi \cos\theta & \cos\psi \cos\theta \end{bmatrix}$

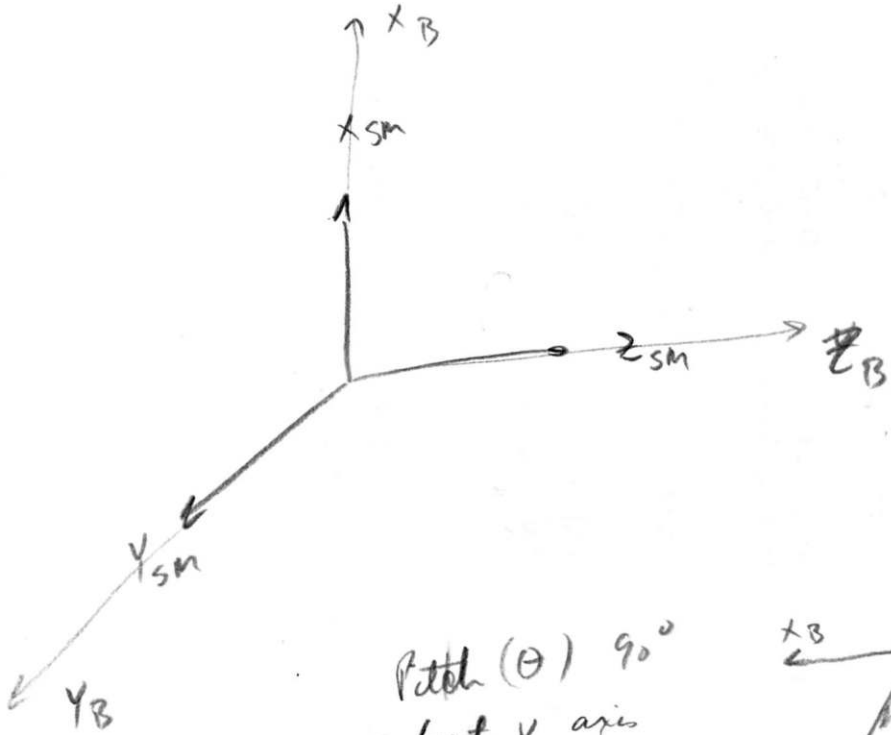

Pitch (θ) 90°
about Y_B axis

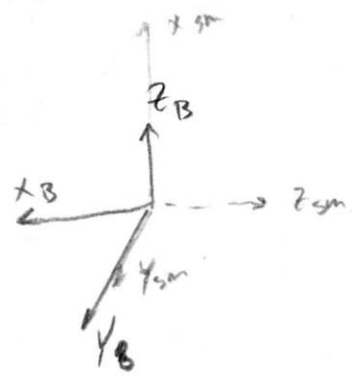

Yaw (ϕ) 90°
about X_B axis

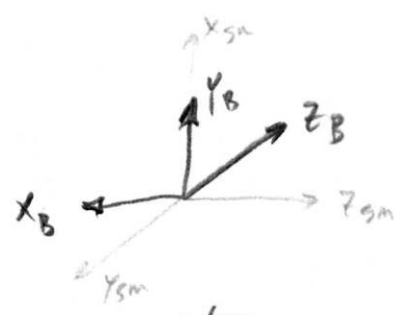

roll (ψ) 90°
about Z_B axis

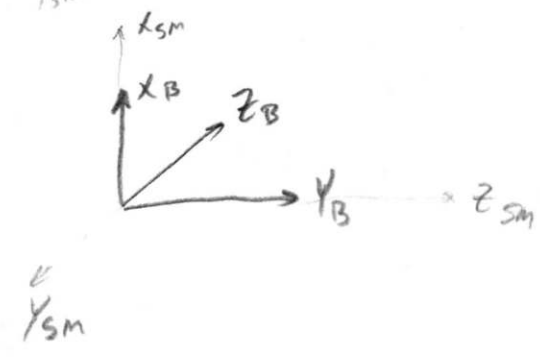

- there A_{IG} or inner gimbal signal is zero
- A_{OG} or outer gimbal signal is $+90^\circ$
- A_{MG} or middle gimbal signal is zero.

TABLE II

TRANSFORMATION FROM EULER ANGLES TO IMU PICKOFF ANGLES

SEQUENCE OF ROTATION of body axis	A_{IG} Y axis inner gimbal	A_{CG} X axis outer gimbal	A_{MG} Z axis middle gimbal
PITCH θ +90 YAW ϕ +90 ROLL ψ +90	$\theta - \tan^{-1} [\tan \psi \sin \phi]$	$\tan^{-1} [\tan \phi \sec \psi]$	$\sin^{-1} [\sin \psi \cos \phi]$
PITCH θ ROLL ψ YAW ϕ	θ	ϕ	ψ
YAW PITCH ROLL	$\tan^{-1} [\tan \theta \cos \phi - \tan \psi \sin \phi \sec \psi]$	$\tan^{-1} \left[\frac{\tan \phi \cos \theta}{\cos \psi - \sin \psi \sin \theta \tan \phi} \right]$	$\sin^{-1} [\sin \psi \cos \phi + \cos \psi \sin \theta \sin \phi]$
YAW ROLL PITCH	$\tan^{-1} [\tan \theta \cos \phi \sec \psi - \tan \psi \sin \phi]$	$\tan^{-1} [\tan \phi \cos \theta \sec \psi - \sin \theta \tan \psi]$	$\sin^{-1} [\sin \psi \cos \theta \cos \phi + \sin \theta \sin \psi \sin \phi]$
ROLL PITCH YAW	$\tan^{-1} [\tan \theta \sec \psi]$	$\phi - \tan^{-1} [\sin \theta \tan \psi]$	$\sin^{-1} [\sin \psi \cos \theta]$
YAW ROLL PITCH	$\tan^{-1} \left[\frac{\tan \theta \cos \phi}{\cos \psi - \tan \theta \sin \phi \sin \psi} \right]$	$\tan^{-1} [\tan \phi \cos \theta - \sin \theta \tan \psi \sec \psi]$	$\sin^{-1} [\sin \psi \cos \theta + \sin \theta \sin \phi \cos \psi]$

TABLE III

TRANSFORMATION FROM IMU PICKOFF ANGLES TO EULER ANGLES

SEQUENCE OF ROTATION	θ	ϕ	ψ
PITCH YAW ROLL	$A_{12} + \tan^{-1} [\tan A_{02} \sin A_{12}]$	$\sin^{-1} [\sin A_{02} \cos A_{12}]$	$\tan^{-1} [\tan A_{12} \sec A_{02}]$
PITCH ROLL YAW	A_{12}	A_{02}	A_{12}
YAW PITCH ROLL	$\sin^{-1} \left[\frac{\sin A_{12} \cos A_{02}}{+ \sin A_{02} \sin A_{12} \cos A_{12}} \right]$	$\tan^{-1} \left[\frac{\tan A_{02} \cos A_{12}}{(- \tan A_{02} \sin A_{12} \sin A_{12})} \right]$	$\tan^{-1} \left[\frac{\tan A_{12} \cos A_{02}}{- \sin A_{02} \tan A_{12} \sec A_{12}} \right]$
YAW ROLL PITCH	$\tan^{-1} \left[\frac{\tan A_{12} \cos A_{02} \sec A_{12}}{+ \sin A_{02} \tan A_{12}} \right]$	$\tan^{-1} \left[\frac{\tan A_{02} \cos A_{12} \sec A_{12}}{+ \tan A_{12} \sin A_{12}} \right]$	$\sin^{-1} \left[\frac{\sin A_{12} \cos A_{02} \cos A_{12}}{- \sin A_{02} \sin A_{12}} \right]$
ROLL PITCH YAW	$\sin^{-1} [\sin A_{12} \cos A_{12}]$	$A_{02} + \tan^{-1} [\sin A_{12} \tan A_{12}]$	$\tan^{-1} [\tan A_{12} \sec A_{12}]$
ROLL YAW PITCH	$\tan^{-1} \left[\frac{\tan A_{12} \cos A_{12}}{(- \sin A_{02} \sin A_{12} \tan A_{12})} \right]$	$\sin^{-1} \left[\frac{\sin A_{02} \cos A_{12}}{+ \cos A_{02} \sin A_{12} \sin A_{12}} \right]$	$\tan^{-1} \left[\frac{\tan A_{12} \cos A_{12}}{- \tan A_{02} \sin A_{12} \sec A_{12}} \right]$

RELATIVE ORIENTATION OF THE IMU WITH RESPECT TO LEM REFERENCE COORDINATES

(ASTRONAUT) X (BODY HEAD)
 HEAD X (BODY THRUST)

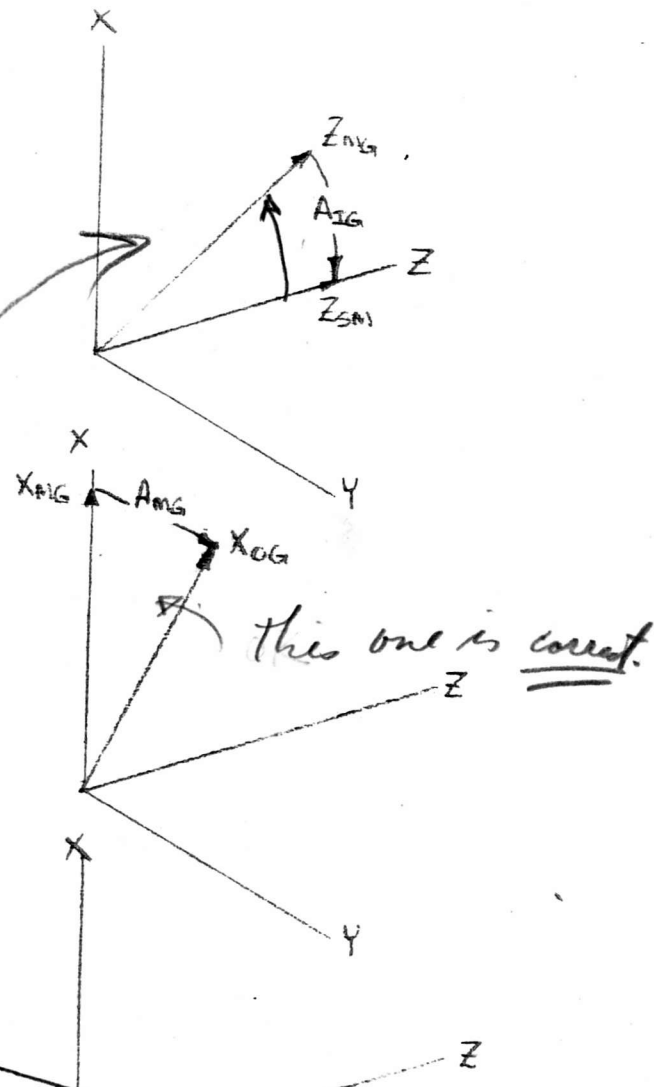
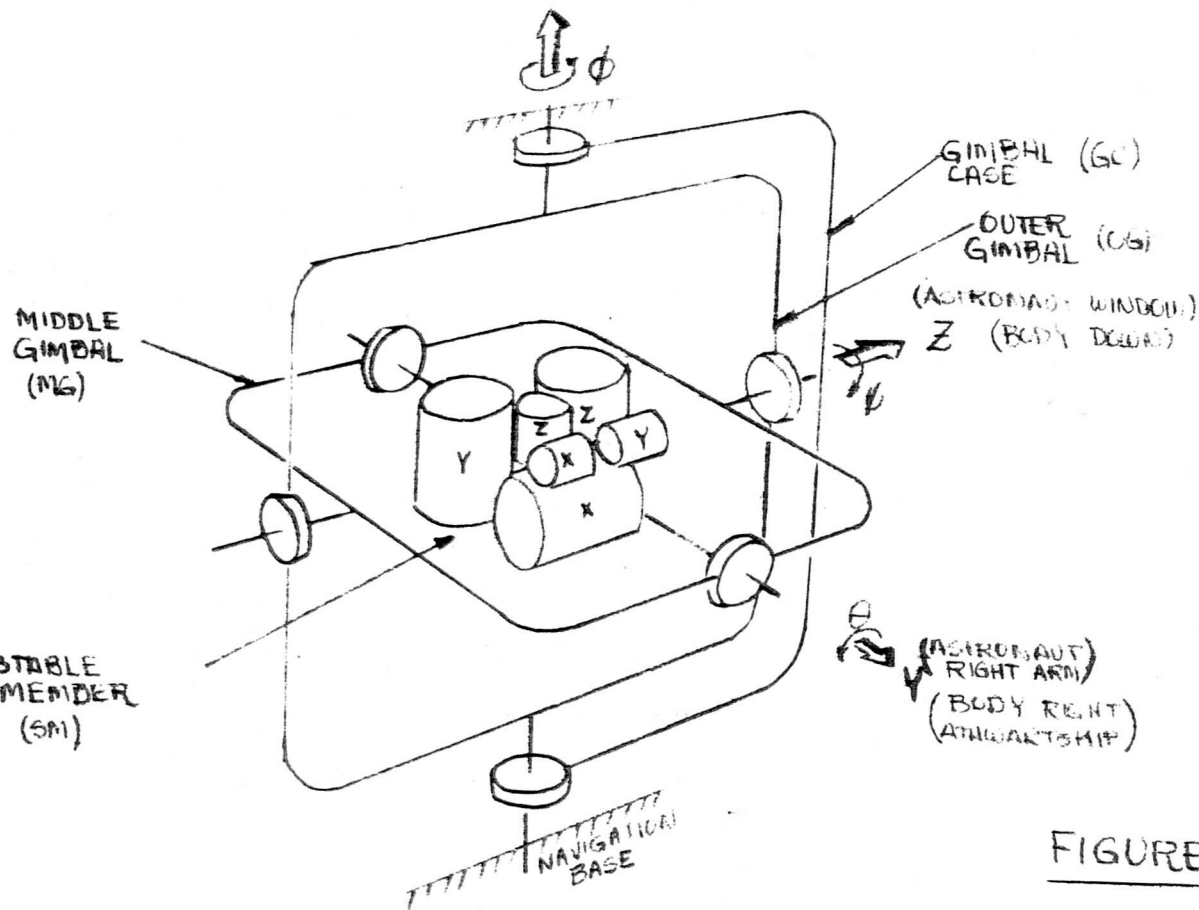
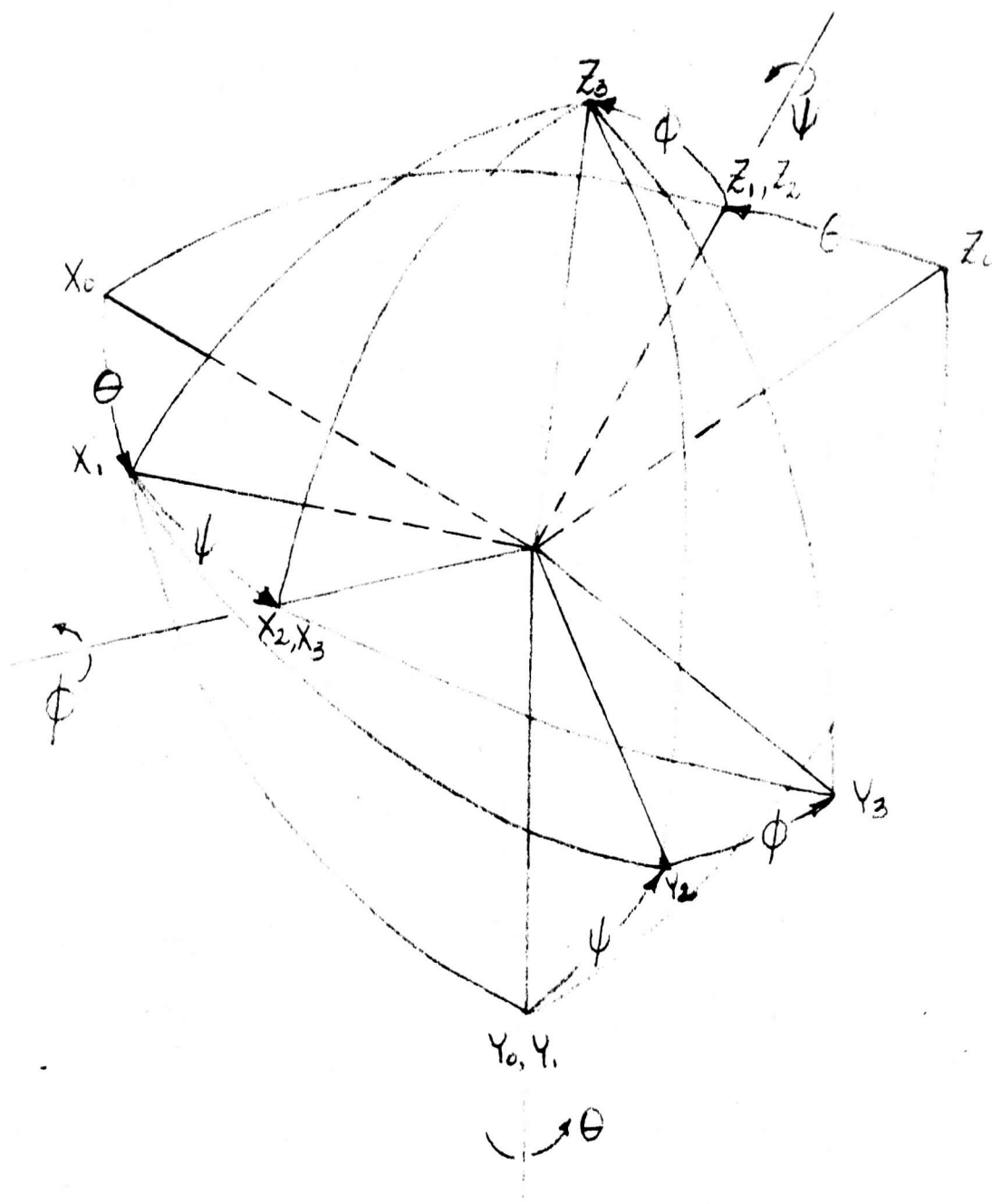

FIGURE 1

SEQUENCE OF ROTATION FOR ATTITUDE DETERMINATION

				BODY RATES
Astronaut	PITCH	(θ)		q
Astronaut	ROLL	(ψ)		r
Astronaut	YAW	(ϕ)		p

This is not what MIT/IL defines as positive!!
 (SEE LMO-540-160)
DEFINITION OF POSITIVE IMU ANGLES



- NOTES:
1. X_0, Y_0, Z_0 ARE INITIAL ORIENTATION OF BODY AXES
 2. SEQUENCE OF ROTATION RELATED TO THE BODY: PITCH (θ), YAW (ψ), ROLL (ϕ)
 3. SEQUENCE OF ROTATION RELATED TO ASTRONAUT: PITCH (θ), ROLL (ψ), YAW (ϕ)

FIGURE 2
ORIENTATION OF BODY AXES BASED ON SEQUENCE OF ROTATIONS PITCH, ROLL, YAW RELATED TO ASTRONAUT

SEQUENCE OF ROTATION WITH RESPECT TO ASTRONAUT	1) PITCH	2) ROLL	3) YAW
ACTUAL EULER ANGLE \updownarrow KINEMATIC IMU PICKOFF ANGLE	θ \updownarrow A_{IG}	ψ \updownarrow A_{MG}	ϕ \updownarrow A_{CG}

NOTE : THE TRANSFORMATION IS REVERSIBLE

FIGURE 3
 MATH MODEL OF EULER ANGLE TO IMU TRANSFORMATION

FILE COPY

RADIO CORPORATION OF AMERICA
DEFENSE ELECTRONIC PRODUCTS
BURLINGTON, MASSACHUSETTS

LTM-(B)-7029-1
19 June 1964
Page 1 of 14 Pages

LEM TECHNICAL MEMORANDUM

SUBJECT: MATH MODEL OF INERTIAL MEASURING UNIT(IMU) AND COUPLING DATA UNIT (CDU) OF LEM PRIMARY GUIDANCE AND NAVIGATION SYSTEM

AUTHOR: A. V. Lazuk

TO: R. Fleisig

FOREWORD: This report is submitted in partial fulfillment of Task 29.2 as described in LEM Project Engineering Memorandum L250-MO-35-5 dated 7 May 1964. The work was performed by RCA under contract to GAEC on their purchase order number 2-18826-C (NAS-9-1100).

ABSTRACT: This document describes the mathematical model which has been developed to simulate the operation of the LEM Inertial Measuring Unit and the Coupling Data Unit. The model described is based on the IMU and CDU designs as of 15 June 1964.

Initiated and
Classification
Assigned by:

A. V. Lazuk
A. V. Lazuk

Approved:

Distribution:

GAEC
R. Fleisig (4)
G. Sullivan
R. Phagan
J. Kmiecik
E. Gorczycki
S. Greene

RCA
L. Matson
A. Schneider
W. Johnson
J. Gwinn
A. Lazuk

MATH MODEL OF IMU AND CDU FOR IMS

INTRODUCTION

In order to generate a finished math model of the IMU and CDU suitable for IMS, which is to be performed in real time, it is necessary to have a specification of the time allotted for solving the equations defining the IMU and CDU in the computer, the computer storage allocated to this block of equations, the digital computer operating speed, and a knowledge of the executive routine which will be used in the implementation of the full simulation, and the characteristics of the analog equipment and the associated converters. The performance functions of devices such as the inertial reference integrating gyros and the pendulous integrating gyro accelerometers contain time constants of the order of 1 millisecond.

Before a decision is made to include the effects of these small time constants (high frequency dynamics), an investigation of the round-off errors resulting from the necessarily short integration interval should be investigated. The Math Model of the IMU and CDU presented here neglects the high frequency dynamics mentioned previously as well as the servo stabilization drive dynamics. The model assumes that the coefficients (mass unbalances, etc.) necessary to generate the IMU platform drift matrix will be available.

The model generated is preliminary in nature but will serve as a starting point for further additions or corrections. The various modes of the IMU will not be analyzed at this time. The purpose of this memorandum is to develop a simple, compact representation of the IMU that will be useful in the IMS. Standard GAEC LEM nomenclature and sign conventions

will be used when they are known.

FUNCTIONAL DESCRIPTION OF THE LEM INERTIAL MEASURING UNIT

The Inertial Measuring Unit (IMU) is a three-degree-of-freedom stabilized platform assembly consisting of a stable member, SM, (inner gimbal), three gimbals, gimbal mounted electronics, and six inter-gimbal assemblies which house torque motors and resolvers. The IMU is designed to provide a space reference for the stable member regardless of spacecraft motion.

The space reference for the stable member is established by the use of three single degree-of-freedom gyroscopes (IRIG) with their input axes mutually perpendicular mounted on the stable member, and aligned along the stable member axes. Each gyro and its associated servo drive is used to preserve angular fixity with respect to inertial space. In addition, to the three gyroscopes, three angular differentiating ~~stablernmembers~~ (ADA) which sense changes in the orientation of the stable member, are used to stabilize the torque drive loops by extending the bandwidth without presenting the severe noise and stability problems encountered when passive (lead - lag) networks are used. The dynamic effects of the stabilization loop discussed above are not considered. Three pendulous integrating gyro accelerometers (PIGA) with their input axes mutually perpendicular are also mounted on the stable member and along the stable member axes to sense the linear non-field acceleration of the stable member, i.e., the accelerometers measure the components of the vector specific force with respect to inertial space along stable member axes. The outputs of the PIPA's (after processing) are pulses and the number of positive or negative pulses counted in a time interval is proportional to the velocity increment increase or decrease accumulated

in that time interval.

Each inter-gimbal assembly contains a gimbal angle resolver (or resolvers for fine and coarse data outputs) to indicate the orientation of the stable member with respect to the LEM body. The resolvers provide gimbal angle information.

FUNCTIONAL DESCRIPTION OF THE LEM COUPLING DATA UNIT (CDU)

The purpose of the three Coupling Data Units (CDU's) is to connect the IMU to the LEM Guidance Computer (LGC) and to display IMU angular data to the astronaut. The various modes of the CDU's will not be considered. The CDU's are all interchangeable.

The CDU inputs are the IMU gimbal angle signals indicating the angles of the inner, middle, and outer gimbals, and the digital signals from the LGC which position the inner, middle, and outer CDU resolvers.

The CDU outputs are the digital signals to the LGC which indicate changes in the position of the CDU resolvers and the delta angle (IMU to CDU) signal representing the difference between the IMU gimbal angles and the CDU resolver angles. This signal is supplied to the resolver network for attitude control, to the IMU control panel for display, and to the coarse align amplifier.

INERTIAL MEASURING UNIT MATH MODEL

The initial stable member axes, X_{SM_0} , Y_{SM_0} , and Z_{SM_0} form a righthanded orthogonal coordinate system aligned with the LEM body axes at the instant the stable platform goes inertial.

The LEM body axes, X_B , Y_B , and Z_B form a righthanded orthogonal coordinate system fixed to the body. The positive X_B axis points in the direction of the astronaut's head measured from his feet (X_B axis is astronaut's yaw axis), the Y_B axis points in the direction of

the astronaut's extended right arm (Y_B axis is astronaut's pitch axis), and Z_B axis points in the direction of the astronaut's nose points (Z_B axis is astronaut's roll axis). Figure 1, taken from GAEC LEM Engineering Memorandum LMO-540-160- REv.A dated 29 November 1963 by J. E. Kmiecik, Systems Analysis, depicts the LEM body axis.

The IMU is actually attached to a navigation base which is a structural part of the guidance and navigation system. The navigation base is designed to provide a rigid supporting structure ^{the} for IMU and optical assembly so that a precision alignment of these units may be retained. It serves as a shock mount and as a seal of the spacecraft interior at the optical instrument opening in the LEM vehicle wall. The transformation matrix from navigation base axes to LEM body axes will be neglected, ie, the matrix will be assumed to be an identity matrix.

Most of the transformations of coordinates can be expressed as the product (composition) of simpler transformations called rotations. It is convenient to define the following elementary matrix rotations:

$$P_1(A) = \begin{pmatrix} 1 & 0 & 0 \\ 0 & \cos A & \sin A \\ 0 & -\sin A & \cos A \end{pmatrix}$$

$$P_2(A) = \begin{pmatrix} \cos A & 0 & -\sin A \\ 0 & 1 & 0 \\ \sin A & 0 & \cos A \end{pmatrix}$$

$$P_3(A) = \begin{pmatrix} \cos A & \sin A & 0 \\ -\sin A & \cos A & 0 \\ 0 & 0 & 1 \end{pmatrix}$$

These rotations represent geometrical rotations which are all positive according to the right-hand rule for rotations when the argument A is positive, and each rotation has the same magnitude as the magnitude of the argument A. The inverse of any of these transformations is obtained simply by changing the sign of the argument, i.e.,

$$[P_i(A)]^{-1} = P_i(-A)$$

Consider now an ideal stable member, i.e., the gimbal angles are equal to the Euler angles. The relationship between the ideal stable member axes and the body axes is a function of the Euler angles θ , ϕ , and ψ , defined below. A rotation of θ about Y_{SM_0} , a rotation of ψ about the carried position of Z_{SM_0} , and a rotation of ϕ about the final position of X_{SM_0} carries the stable member axes parallel to the body axes. Then by the definition of the matrix (Stable Member Axes to LFM Body Axes),

$$[SM \text{ to } B] = [P_1(\phi)][P_3(\psi)][P_2(\theta)] \quad (1)$$

and

$$[B \text{ to } SM] = [P_2(-\theta)][P_3(-\psi)][P_1(-\phi)] \quad (2)$$

Expanding equation (2) yields:

$$\begin{aligned}
 & \left[\begin{array}{l} \text{B to SM} \\ \text{for ideal} \\ \text{stable platform} \end{array} \right] = \begin{bmatrix} \cos \psi \cos \theta & -\sin \psi \cos \theta \cos \phi & \sin \psi \cos \theta \sin \phi \\ & + \sin \phi \sin \theta & + \sin \theta \cos \phi \\ \sin \psi & \cos \phi \cos \psi & -\sin \phi \cos \psi \\ -\sin \theta \cos \psi & \cos \phi \sin \psi \sin \theta & -\sin \theta \sin \psi \sin \phi \\ & + \sin \phi \cos \theta & + \cos \theta \cos \phi \end{bmatrix} \quad (3)
 \end{aligned}$$

For a non-ideal (drifting) stable platform the (B to SM) matrix is expressed in terms of the inner, middle, and outer gimbal angles - A_{IG} , A_{MG} , and A_{OG} respectively. The (B to SM) matrix for the non-ideal platform is obtained by replacing θ , ψ , and ϕ by A_{IG} , A_{MG} , A_{OG} respectively, in equation (3).

$$\begin{aligned}
 & \left[\begin{array}{l} \text{B to SM} \\ \text{non-ideal} \\ \text{stable platform} \end{array} \right] = \begin{bmatrix} \cos A_{MG} \cos A_{IG} & -\sin A_{MG} \cos A_{IG} \cos A_{OG} & \sin A_{MG} \cos A_{IG} \sin A_{OG} \\ & + \sin A_{OG} \sin A_{IG} & + \sin A_{IG} \cos A_{OG} \\ \sin A_{MG} & \cos A_{OG} \cos A_{MG} & -\sin A_{OG} \cos A_{MG} \\ -\sin A_{IG} \cos A_{MG} & \cos A_{OG} \sin A_{MG} \sin A_{IG} & -\sin A_{IG} \sin A_{MG} \sin A_{OG} \\ & + \sin A_{OG} \cos A_{IG} & + \cos A_{IG} \cos A_{OG} \end{bmatrix} \quad (4)
 \end{aligned}$$

In order to determine the gimbal angles, it is necessary to obtain an expression for the angular velocity of the LEM body (assumed to be rigid) with respect to the stable member in gimbal angle rates and in components along the orthogonal X_B , Y_B , and Z_B axes fixed in the body.

Let

Let

- $\bar{\omega}_{B-SM}$ = angular velocity of the LEM body with respect to the stable member
- $\bar{i}_{X_B}, \bar{i}_{Y_B}, \bar{i}_{Z_B}$ = unit vectors along $X_B, Y_B,$ and Z_B body axes, respectively
- $\bar{i}_{\dot{A}_{IG}}, \bar{i}_{\dot{A}_{MG}}, \bar{i}_{\dot{A}_{OG}}$ = unit vectors along the inner gimbal (stable member), middle gimbal, and outer gimbal axes, respectively.

The unit vectors are in the directions of the gimbal angle rates and are not orthogonal.

Expressing $\bar{\omega}_{B-SM}$ in terms of components along $\bar{i}_{X_B}, \bar{i}_{Y_B}, \bar{i}_{Z_B}$ and $\bar{i}_{\dot{A}_{IG}}, \bar{i}_{\dot{A}_{MG}}, \bar{i}_{\dot{A}_{OG}}$ coordinate systems:

$$\bar{\omega}_{B-SM} = \omega_{X_B} \bar{i}_{X_B} + \omega_{Y_B} \bar{i}_{Y_B} + \omega_{Z_B} \bar{i}_{Z_B} = \dot{A}_{IG} \bar{i}_{\dot{A}_{IG}} + \dot{A}_{MG} \bar{i}_{\dot{A}_{MG}} + \dot{A}_{OG} \bar{i}_{\dot{A}_{OG}} \quad (5)$$

Taking the dot products indicated below:

$$\begin{aligned} \bar{\omega}_{B-SM} \cdot \bar{i}_{\dot{A}_{IG}} &= \dot{A}_{IG} (\bar{i}_{\dot{A}_{IG}} \cdot \bar{i}_{\dot{A}_{IG}}) + \dot{A}_{MG} (\bar{i}_{\dot{A}_{MG}} \cdot \bar{i}_{\dot{A}_{IG}}) + \dot{A}_{OG} (\bar{i}_{\dot{A}_{OG}} \cdot \bar{i}_{\dot{A}_{IG}}) = \\ &\omega_{X_B} (\bar{i}_{X_B} \cdot \bar{i}_{\dot{A}_{IG}}) + \omega_{Y_B} (\bar{i}_{Y_B} \cdot \bar{i}_{\dot{A}_{IG}}) + \omega_{Z_B} (\bar{i}_{Z_B} \cdot \bar{i}_{\dot{A}_{IG}}) \end{aligned} \quad (6)$$

$$\bar{W}_{B-SM} \cdot \bar{I}_{\dot{A}_{MG}} = \dot{A}_{IG} (\bar{I}_{\dot{A}_{IG}} \cdot \bar{I}_{\dot{A}_{MG}}) + \dot{A}_{MG} (\bar{I}_{\dot{A}_{MG}} \cdot \bar{I}_{\dot{A}_{MG}}) + \dot{A}_{OG} (\bar{I}_{\dot{A}_{OG}} \cdot \bar{I}_{\dot{A}_{MG}}) =$$

$$W_{X_B} (\bar{I}_{X_B} \cdot \bar{I}_{\dot{A}_{MG}}) + W_{Y_B} (\bar{I}_{Y_B} \cdot \bar{I}_{\dot{A}_{MG}}) + W_{Z_B} (\bar{I}_{Z_B} \cdot \bar{I}_{\dot{A}_{MG}}) \quad (7)$$

$$\bar{W}_{B-SM} \cdot \bar{I}_{\dot{A}_{OG}} = \dot{A}_{IG} (\bar{I}_{\dot{A}_{IG}} \cdot \bar{I}_{\dot{A}_{OG}}) + \dot{A}_{MG} (\bar{I}_{\dot{A}_{MG}} \cdot \bar{I}_{\dot{A}_{OG}}) + \dot{A}_{OG} (\bar{I}_{\dot{A}_{OG}} \cdot \bar{I}_{\dot{A}_{OG}}) =$$

$$W_{X_B} (\bar{I}_{X_B} \cdot \bar{I}_{\dot{A}_{OG}}) + W_{Y_B} (\bar{I}_{Y_B} \cdot \bar{I}_{\dot{A}_{OG}}) + W_{Z_B} (\bar{I}_{Z_B} \cdot \bar{I}_{\dot{A}_{OG}}) \quad (8)$$

Substituting the values of the dot products into equations (6), (7), and (8) and solving equations (6), (7), and (8) simultaneously, yields:

$$\dot{A}_{IG} = W_{Y_B} \left(\frac{\cos A_{OG}}{\cos A_{MG}} \right) + W_{Z_B} \left(\frac{-\sin A_{OG}}{\cos A_{MG}} \right) \quad (9)$$

$$\dot{A}_{MG} = W_{Y_B} (\sin A_{OG}) + W_{Z_B} (\cos A_{OG}) \quad (10)$$

$$\dot{A}_{OG} = W_{X_B} + W_{Y_B} (-\cos A_{OG} \tan A_{MG}) + W_{Z_B} (\sin A_{OG} \tan A_{MG}) \quad (11)$$

The angular velocity of the LEM body with respect to the stable member resolved along body axes may now be transformed into gimbal angle rates by means of the LEM body to gimbal angle axes transformation given below:

$$\begin{bmatrix} \dot{A}_{IG} \\ \dot{A}_{MG} \\ \dot{A}_{OG} \end{bmatrix} = \begin{bmatrix} 0 & \left(\frac{\cos A_{OG}}{\cos A_{MG}} \right) & \left(\frac{-\sin A_{OG}}{\cos A_{MG}} \right) \\ 0 & \sin A_{OG} & \cos A_{OG} \\ 1 & -\cos A_{OG} \tan A_{MG} & \sin A_{OG} \tan A_{MG} \end{bmatrix} \begin{bmatrix} W_{X_B} \\ W_{Y_B} \\ W_{Z_B} \end{bmatrix} \quad (12)$$

The preliminary math model of the LEM (IMU) is shown in general form in Figure 2. The basic inputs to the math model are the vector specific force of the LEM vehicle with respect to inertial space resolved along LEM body axes, \bar{f}_{B-I}^B , and the angular velocity of the LEM vehicle with respect to inertial space resolved along LEM body axes, $\bar{\omega}_{B-I}^B$. The effects of the angular accelerations with respect to inertial space are not considered in the basic model; however, the linearized input and output axis equations for the IRIG and PIPA will be developed to show that the angular accelerations influence the outputs from the IRIG's and PIPA's (not included in this report).

The outputs from the math model of the LEM (IMU) are the inner, middle, and outer gimbal angles and the components of the velocity increment accumulated along the stable member axes during the time of one computation cycle $([t_i - t_{i-1}])$.

The vector specific force, \bar{f}_{B-I}^B , is transformed into stable member coordinates (\bar{f}_{B-I}^{SM}) by means of the LEM body to stable member axes coordinate transformation which is a function of the (IMU) gimbal angles. The drift computation determines the angular velocity of the stable member with respect to inertial space resolved along stable member axes, $\bar{\omega}_{SM-I}^{SM}$, (stabilization drive dynamics are assumed to be rapid with negligible error), This angular velocity may now be resolved along body axes $(\bar{\omega}_{SM-I}^B)$ and combined with the angular velocity of the LEM body with respect to inertial space

(not included
in this
report)

resolved along body axes, $\overline{\omega}_{B-I}^B$, to obtain the angular velocity of the body with respect to the stable member resolved along body axes, $\overline{\omega}_{B-SM}^B$. $\overline{\omega}_{B-SM}^B$ may then be transformed into components along the gimbal angle axes to obtain the inner, middle, and outer gimbal angle rates, \dot{A}_{IG} , \dot{A}_{MG} and \dot{A}_{OG} , respectively. The gimbal angles at any time may then be determined by combining the initial gimbal angles with the time integral of the gimbal angle rates.

The stable platform utilized for LEM has only three gimbals; and therefore, it does not possess an "all-attitude" capability, i.e., gimbal lock may occur when the gimbals are coplanar. The gimbal lock logic will provide an indication when gimbal lock occurs and the A_{IG} , A_{MG} , and A_{OG} gimbal angles cannot be used when this condition occurs. The actual IMU has a switch included on the middle gimbal axis to signal the astronauts when the middle gimbal angle exceeds plus or minus 60 degrees. If gimbal lock does not occur the gimbal angles A_{IG} , A_{MG} , and A_{OG} are merely passed through the gimbal lock logic block which will have a unity transfer function for this condition. The gimbal angle information is fed back to all coordinate transformations which are a function of the gimbal angles.

The vector specific force of the body with respect to inertial space resolved along stable member axes, which was discussed previously is the force which the three orthogonally mounted PIPA's sense. The output of the PIPA's is proportional to the velocity increment increase or decrease accumulated in the time interval under consideration. This increment is a function of the accelerometer scale factor, K_x , K_y or K_z , the component of vector specific force along the

particular stable member axis, $f_{x_{SM}}$, $f_{y_{SM}}$, or $f_{z_{SM}}$, the accelerometer bias, $b_{x_{SM}}$, $b_{y_{SM}}$, or $b_{z_{SM}}$ and the time interval under consideration ($t_i - t_{i-1}$). The outputs from the (IMU) math model are the three measured components of vector specific force along stable member axes and the stable platform gimbal angles.

DRIIFT RATE COMPUTATION

The drift rate of the stable member with respect to inertial space resolved along stable member axes may be determined by equations (13), (14), and (15) given below:

$$W_{OA_x} = R_x + MI_x [\bar{I}g_{sx} \cdot \bar{f}_{B-I}^{SM}] + MS_x [\bar{I}g_{Ix} \cdot \bar{f}_{B-I}^{SM}] \quad (13)$$

$$W_{OA_y} = R_y + MI_y [\bar{I}g_{sy} \cdot \bar{f}_{B-I}^{SM}] + MS_y [-\bar{I}g_{Iy} \cdot \bar{f}_{B-I}^{SM}] \quad (14)$$

$$W_{OA_z} = R_z + MI_z [\bar{I}g_{sz} \cdot \bar{f}_{B-I}^{SM}] + MS_z [-\bar{I}g_{Iz} \cdot \bar{f}_{B-I}^{SM}] \quad (15)$$

where

- $W_{OAx}, W_{OAY}, W_{OAZ}$ = angular rates with respect to inertial space about the output axes of the X, Y and Z IRIG's, respectively, due to random drifts and mass unbalances along the gyro input and spin axes.
- R_x, R_y, R_z = random drift with respect to inertial space about the output axes of the X, Y, and Z IRIG's, respectively.
- MI_x, MI_y, MI_z = drift coefficients due to mass unbalance along the input axes of the X, Y and Z IRIG's, respectively, in (rad/sec. per unit of vector specific force along the spin axes of the X, Y and Z IRIG's, respectively.)
- MS_x, MS_y, MS_z = drift coefficients due to mass unbalance along the spin axes of the X, Y, and Z IRIG's, respectively, in (rad/sec. per unit of vector specific force along the negative input axes of the X, Y and Z IRIG's, respectively).

$\bar{I}_{g_{SX}}, \bar{I}_{g_{SY}}, \bar{I}_{g_{SZ}}$ = unit vectors along the spin axes of the X, Y and Z IRIG's, respectively.

$\bar{I}_{g_{IX}}, \bar{I}_{g_{IY}}, \bar{I}_{g_{IZ}}$ = unit vectors along the input axes of the X, Y and Z IRIG's, respectively.

The input, output, and spin axes of the IRIG's are simply related to the stable member axes (neglecting stabilization drive dynamics). The exact orientation of the inertial elements with respect to the stable member axes has not been determined (by the writer) and therefore the coordinate transformation between these coordinates has not been specified. When the transformation is determined, $I_{g_{SX}}, I_{g_{SY}}, I_{g_{SZ}}, I_{g_{IX}}, I_{g_{IY}},$ and $I_{g_{IZ}}$ may be replaced by appropriate unit vectors and direction cosines along the stable member axes.

COUPLING DATA UNIT MATH MODEL

The present coupling data unit (three required to couple IMU and LGC) is electronic (non-mechanical). It consists principally of an analog-to-digital converter to convert the gimbal angle(s) into a sequence of pulses and a digital-to-analog converter to convert the approximated sine of the difference between the commanded Euler angle(s) and the digitized gimbal angle(s) after resolution into the sine differences about the LEM body axes. Since the difference angle(s) are small, the resolved sine of the difference angle is very nearly the difference angle necessary for attitude control. The resolution and interpolation problems associated with the CDU have not been considered in this preliminary document in order that the specified report date could be met.

The complete functional block diagram of the preliminary math model of the IMU and CDU of the LEM PGNS is shown in Figures 3 and 4.

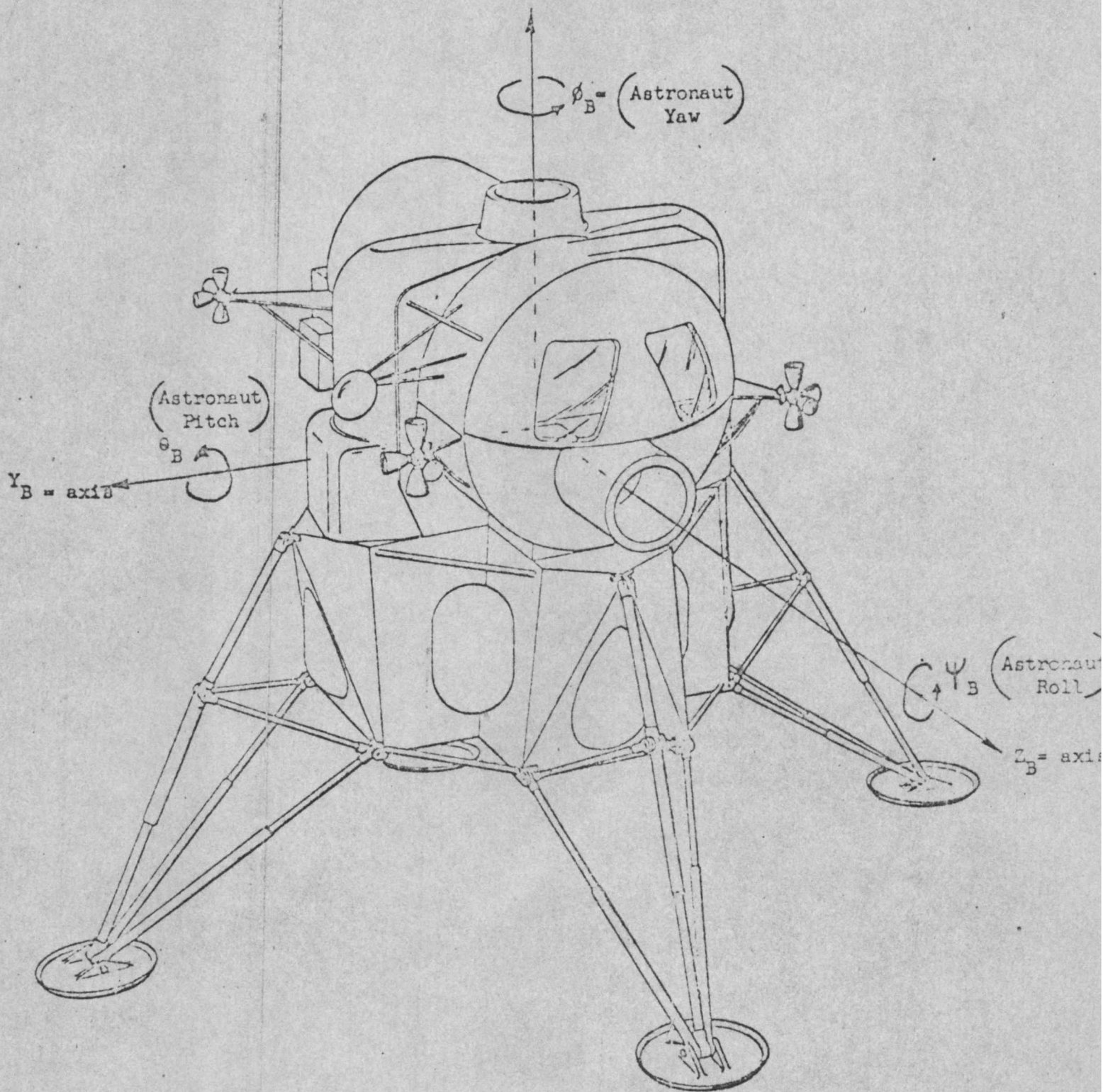

Note: The structural configuration is not the latest; however the coordinate axis representation is upto date.

Figure 1 - LEM COORDINATE AXIS DEFINITION

LEM

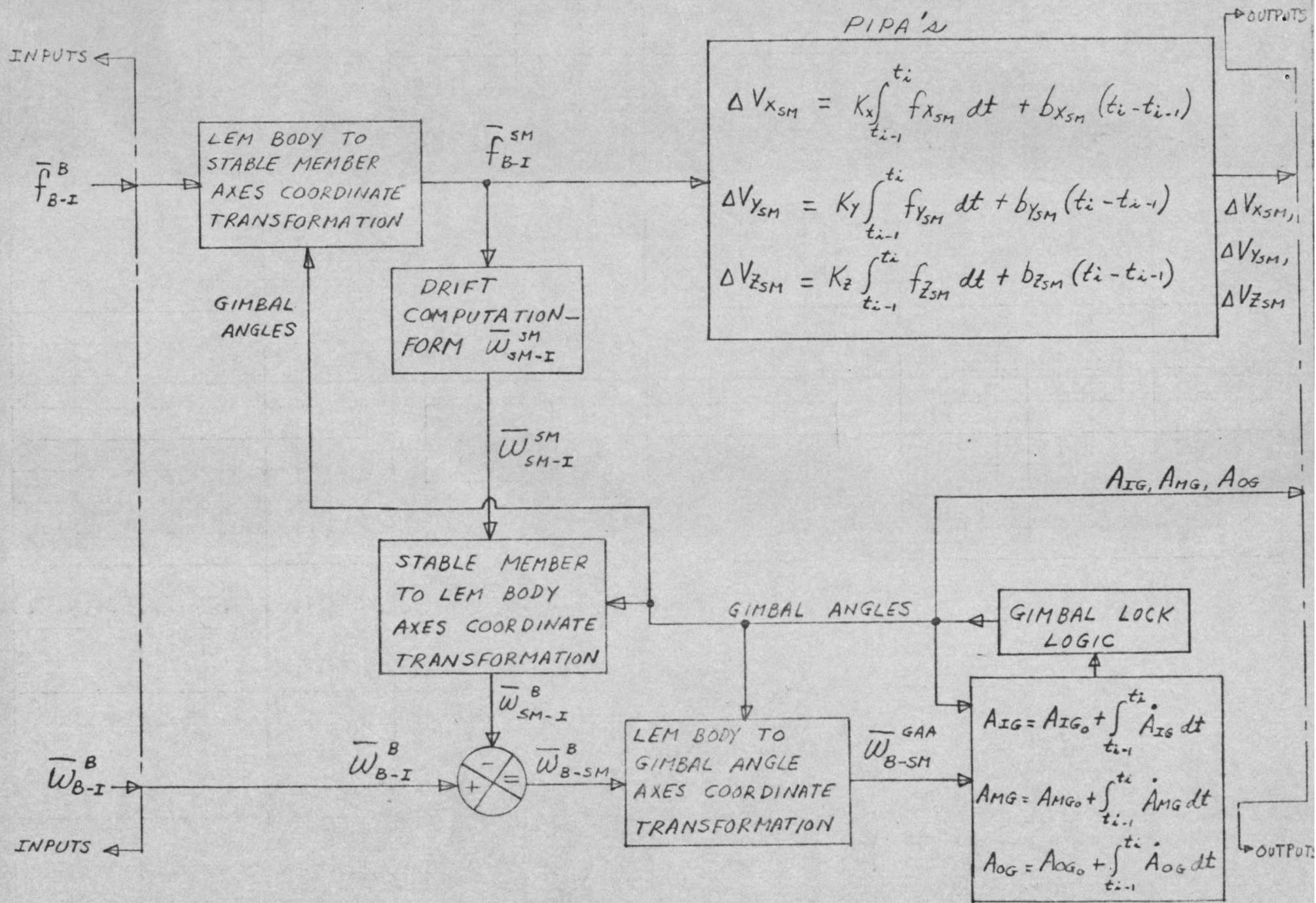

MATH MODEL OF LEM INERTIAL MEASUREMENT UNIT

FIGURE 2.

PRELIMINARY MATH MODEL OF IMU & CDU OF LEM PGNS

FILE COPY

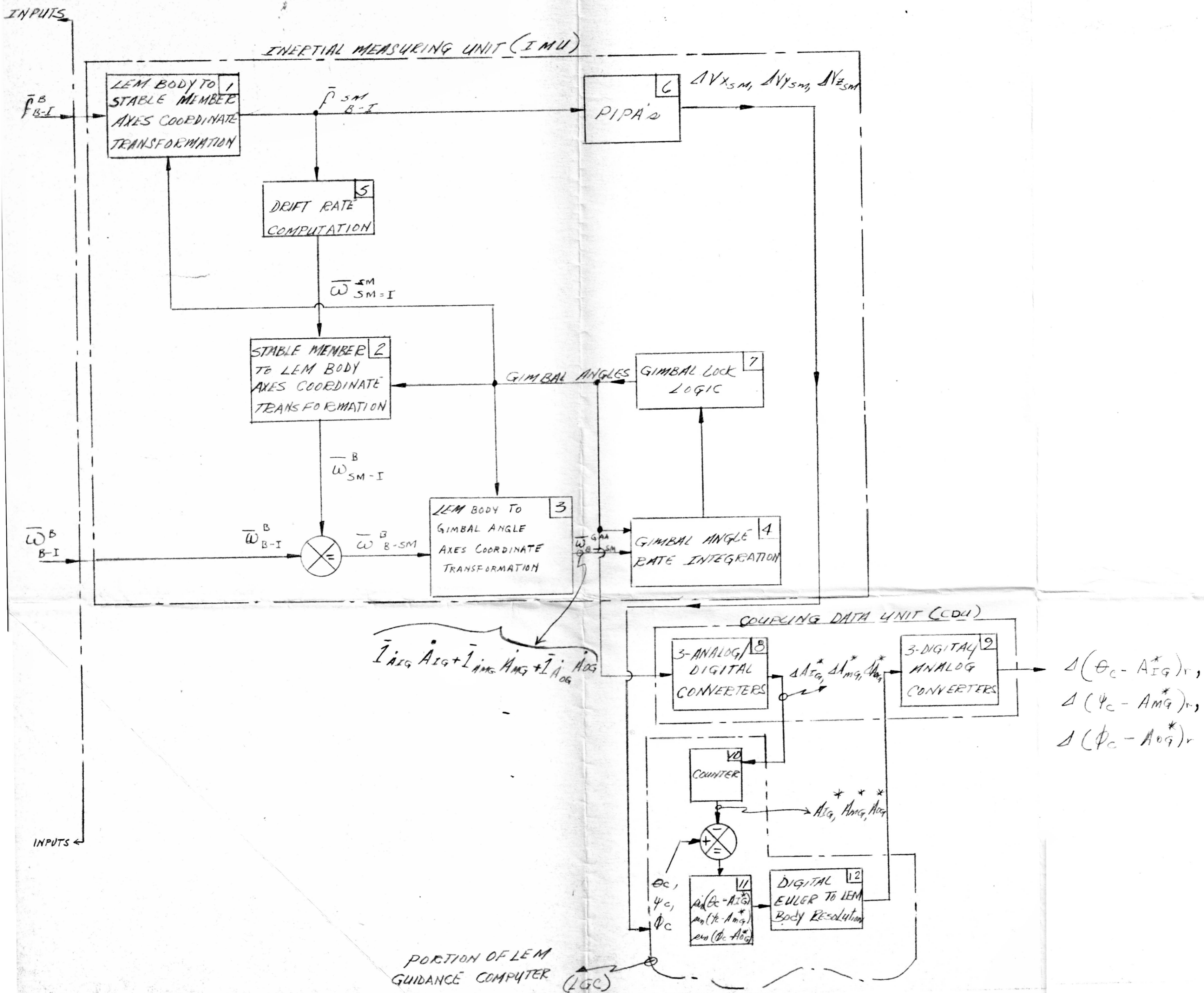

PRELIMINARY MATH MODEL OF IMU & CDU OF LEM PGNS

FILE COPY

$$\begin{bmatrix} \ddot{X}_{SM} \\ \ddot{Y}_{SM} \\ \ddot{Z}_{SM} \end{bmatrix} = \begin{bmatrix} \cos A_{MG} \cos A_{IG} - \sin A_{MG} \cos A_{IG} \cos A_{OG} & \sin A_{MG} \cos A_{IG} \sin A_{OG} & 1 \\ \sin A_{MG} \cos A_{IG} & \cos A_{MG} \cos A_{IG} & \sin A_{IG} \cos A_{OG} \\ -\sin A_{IG} \cos A_{MG} & \cos A_{OG} \sin A_{MG} \sin A_{IG} - \sin A_{IG} \sin A_{MG} \sin A_{OG} & \cos A_{IG} \cos A_{OG} \end{bmatrix} \begin{bmatrix} \ddot{X}_B \\ \ddot{Y}_B \\ \ddot{Z}_B \end{bmatrix} \quad [B \text{ to } SM]$$

$$\begin{bmatrix} \cos A_{MG} \cos A_{IG} & \sin A_{MG} & -\sin A_{IG} \cos A_{MG} \\ -\sin A_{MG} \cos A_{IG} \cos A_{OG} & \cos A_{MG} \cos A_{IG} & \cos A_{OG} \sin A_{MG} \sin A_{IG} \\ + \sin A_{OG} \sin A_{IG} & & + \sin A_{OG} \cos A_{IG} \\ \sin A_{MG} \cos A_{IG} \sin A_{OG} & -\sin A_{OG} \cos A_{MG} & -\sin A_{IG} \sin A_{MG} \sin A_{OG} \\ + \sin A_{IG} \cos A_{MG} & & + \cos A_{IG} \cos A_{OG} \end{bmatrix} \quad [SM \text{ to } B]$$

$$\begin{bmatrix} \dot{A}_{IG} \\ \dot{A}_{MG} \\ \dot{A}_{OG} \end{bmatrix} = \begin{bmatrix} 0 & \left(\frac{\cos A_{OG}}{\cos A_{MG}} \right) & \left(\frac{-\sin A_{OG}}{\cos A_{MG}} \right) \\ 0 & \sin A_{OG} & \cos A_{OG} \\ 1 & -\cos A_{OG} \tan A_{MG} & \sin A_{OG} \tan A_{MG} \end{bmatrix} \begin{bmatrix} \omega_{XB} \\ \omega_{YB} \\ \omega_{ZB} \end{bmatrix} \quad [B \text{ to } GAA]$$

GIMBAL ANGLE RATE INTEGRATION

$$\begin{aligned} A_{IG} &= A_{IG0} + \int_{t_{i-1}}^{t_i} \dot{A}_{IG} dt \\ A_{MG} &= A_{MG0} + \int_{t_{i-1}}^{t_i} \dot{A}_{MG} dt \\ A_{OG} &= A_{OG0} + \int_{t_{i-1}}^{t_i} \dot{A}_{OG} dt \end{aligned} \quad [4]$$

DRIFT RATE COMPUTATION

$$\begin{aligned} \omega_{OX} &= R_x + M_{LX} \left[\bar{I}_{g_{sx}} \cdot \bar{P}_{B-I}^{SM} \right] + M_{SX} \left[\bar{I}_{g_{sx}} \cdot \bar{P}_{B-I}^{SM} \right] \\ \omega_{OY} &= R_y + M_{LY} \left[\bar{I}_{g_{sy}} \cdot \bar{P}_{B-I}^{SM} \right] + M_{SY} \left[-\bar{I}_{g_{xy}} \cdot \bar{P}_{B-I}^{SM} \right] \\ \omega_{OZ} &= R_z + M_{LZ} \left[\bar{I}_{g_{sz}} \cdot \bar{P}_{B-I}^{SM} \right] + M_{SZ} \left[-\bar{I}_{g_{yz}} \cdot \bar{P}_{B-I}^{SM} \right] \end{aligned} \quad [5]$$

PIPA'S

$$\begin{aligned} \Delta V_{X_{SM}} &= K_x \int_{t_{i-1}}^{t_i} f_{X_{SM}} dt + b_{X_{SM}}(t_i - t_{i-1}) \\ \Delta V_{Y_{SM}} &= K_y \int_{t_{i-1}}^{t_i} f_{Y_{SM}} dt + b_{Y_{SM}}(t_i - t_{i-1}) \\ \Delta V_{Z_{SM}} &= K_z \int_{t_{i-1}}^{t_i} f_{Z_{SM}} dt + b_{Z_{SM}}(t_i - t_{i-1}) \end{aligned} \quad [6]$$

Blocks > 6 TO BE EXPANDED FURTHER AT FUTURE DATE.

