

MASSACHUSETTS INSTITUTE OF TECHNOLOGY

APOLLO

GUIDANCE, NAVIGATION
AND CONTROL

Approved: David G. Hoag Date: 10 Aug 66
DAVID G. HOAG, DIRECTOR
APOLLO GUIDANCE AND NAVIGATION PROGRAM

Approved: Ralph R. Ragan Date: 12 Aug 66
RALPH R. RAGAN, DEPUTY DIRECTOR
INSTRUMENTATION LABORATORY

E-1970

CASE HISTORY OF THE APOLLO GUIDANCE COMPUTER

This paper is to be presented in Europe by the author in June of 1966 under the sponsorship of NATO's Advisory Group for Aerospace Research and Development.

by
Eldon C. Hall

June 1966



CAMBRIDGE 39, MASSACHUSETTS

COPY # _____

ACKNOWLEDGEMENT

This report was prepared under DSR Project 55-238, sponsored by the Manned Spacecraft Center of the National Aeronautics and Space Administration through Contract NAS S-4065.

The publication of this report does not constitute approval by the National Aeronautics and Space Administration of the findings or the conclusions contained therein. It is published only for the exchange and stimulation of ideas.

© Copyrighted by the Massachusetts Institute of Technology
Published by the Instrumentation Laboratory of the
Massachusetts Institute of Technology.
Printed in Cambridge, Massachusetts, U.S. A., 1965.

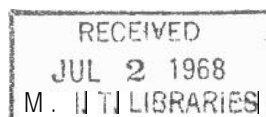

E-1970

CASE HISTORY OF THE APOLLO GUIDANCE COMPUTER

ABSTRACT

The characteristics of two complex digital computers that have been designed for a space application are presented. These computers make extensive use of microcircuits. The first computer has been in production for approximately eighteen months and has completed all qualification testing required to determine flight readiness. It will be used in the early Apollo spacecraft missions. The second computer, which has increased computational and control capabilities, is designed to meet the increased requirements of later Apollo missions. This computer has been in production for about six months. The construction techniques used in these computers will be described.

A large volume of data has been collected on the computers during the design, production, and qualification program in preparation for the flight usage. These data confirm the reliability claims for microelectronic systems; that is, with 221×10^6 part hours in system operation the microcircuit components are demonstrating a failure rate of $0.030/10^6$ part hours. Extensive engineering tests that have been run also demonstrate that microelectronic computers can survive the environments of space missions.

by Eldon C. Hall
June 1966

TABLE OF CONTENTS

Section	Page
I Introduction	7
II Computer Characteristics	12
III Construction Techniques	20
IV Computer Qualification Tests and Results	26
V Summary	35

LIST OF TABLES AND ILLUSTRATIONS

Fig. 1 Overall Apollo Mission	8
Fig. 2 Midcourse Navigation Sighting	9
Fig. 3 Automatically Guided Flight Vehicle	10
Fig. 4 Guidance Steering Control	11
Table I Environmental/ Reliability Requirements	13
Fig. 5 Guidance, Navigation & Control Interconnections In Command Module	14
Fig. 6 Guidance, Navigation & Control Interconnections in LEM	15
Fig. 7 Block I Computer and DSKYs	16
Fig. 8 Block II Computer and DSKYs	17
Fig. 9 Equivalent Circuits and Packages of Logic Gate	18
Table II Computer Characteristics	19
Fig. 10 Exploded View of Block II Computer	21
Fig. 11 Logic Module Assembly	22
Fig. 12 Tray A Wire-Wrap Side	23
Fig. 13 Standard Component Module Assembly	24
Table III Failure Summary	27
Table IV Microcircuit Failure Analysis	28
Fig. 14 Block I Screen and Burn-in Data Summary	29
Fig. 15 Photograph of Loose, Gold Filament	31
Fig. 16 Block II Screen and Burn-in Data Summary	32
Fig. 17 Subsystem Qualification	33
Fig. 18 Power Transient Test	34

CASE HISTORY OF THE APOLLO GUIDANCE COMPUTER

I. Introduction

The computer to be described in this paper is a subsystem of the Guidance and Navigation system designed for the Apollo program for manned lunar landing. In order to better understand the requirements of this computer, the overall Apollo mission and the function of the Guidance and Navigation system must be described briefly.

In Fig. 1, the Apollo mission trajectory is summarized. The heavy lines define the phases of the mission during which acceleration maneuvers are performed. The light lines define the phases of the mission when the spacecraft is in free-fall. During the phase when acceleration maneuvers are performed, the Guidance and Navigation system must measure the acceleration and must steer the vehicle, thus providing the function of guidance. During the free-fall phases of the mission, the system is concerned with navigational computations, i. e., determination of position and velocity, such that required trajectory changes can be determined and made. A typical example of measurements that are made using the G&N system for navigation is illustrated in Fig. 2 where the sextant is being used to measure the angle between a landmark and a star. Several sequential measurements of this type are recorded by the computer, then used to update the position and velocity. Likewise, ground-tracking data can be entered into the computer via a telemetry link and used to update position and velocity. During acceleration maneuvers, the computer accepts inputs from the inertial measurement unit which provides attitude data and measures the velocity change. This information will be processed by the computer and used to steer the vehicle as well as to compute position and velocity. A typical example of this mode is shown in Fig. 3, where the service module propulsion system is being controlled in order to put the spacecraft into lunar orbit.

The G&N system is made up of elements to provide sensing, display, manual controls, and spacecraft steering controls. These are illustrated in Fig. 4. The interconnection of these elements is shown for the steering control mode when a spacecraft velocity change is being made. In all of the modes, the computer provides the function of mode control, display of information, and computation.

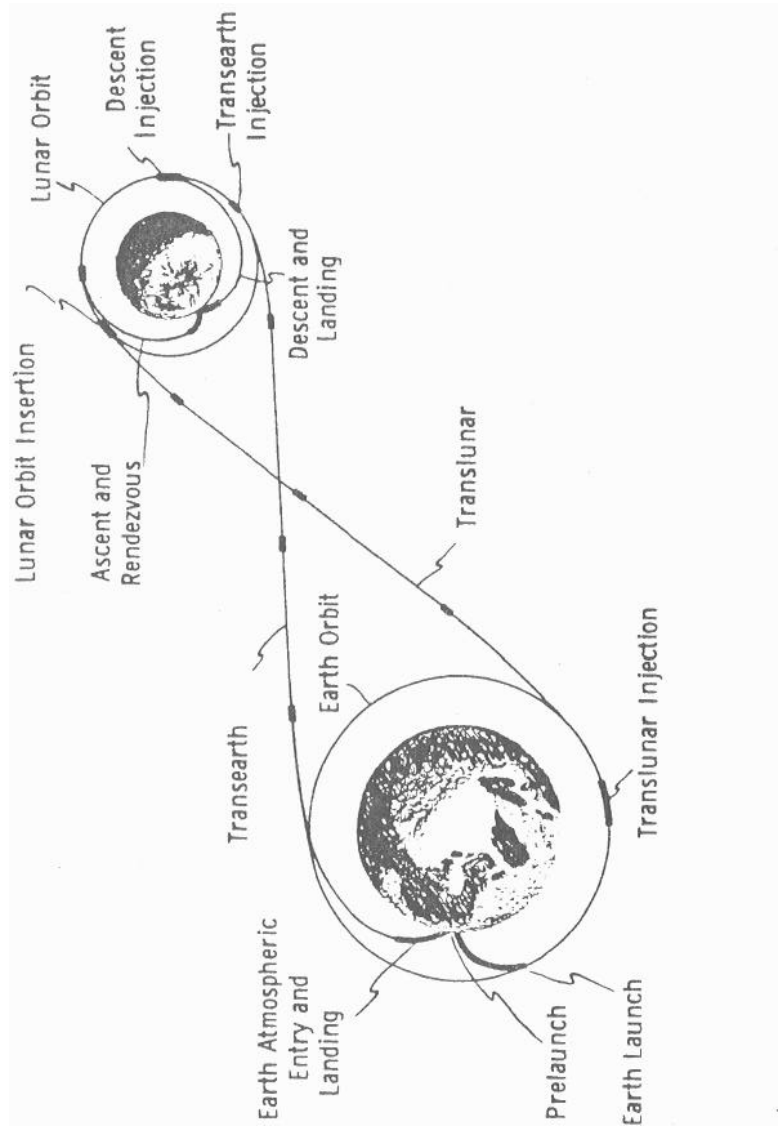

Fig. 1 Overall Apollo Mission

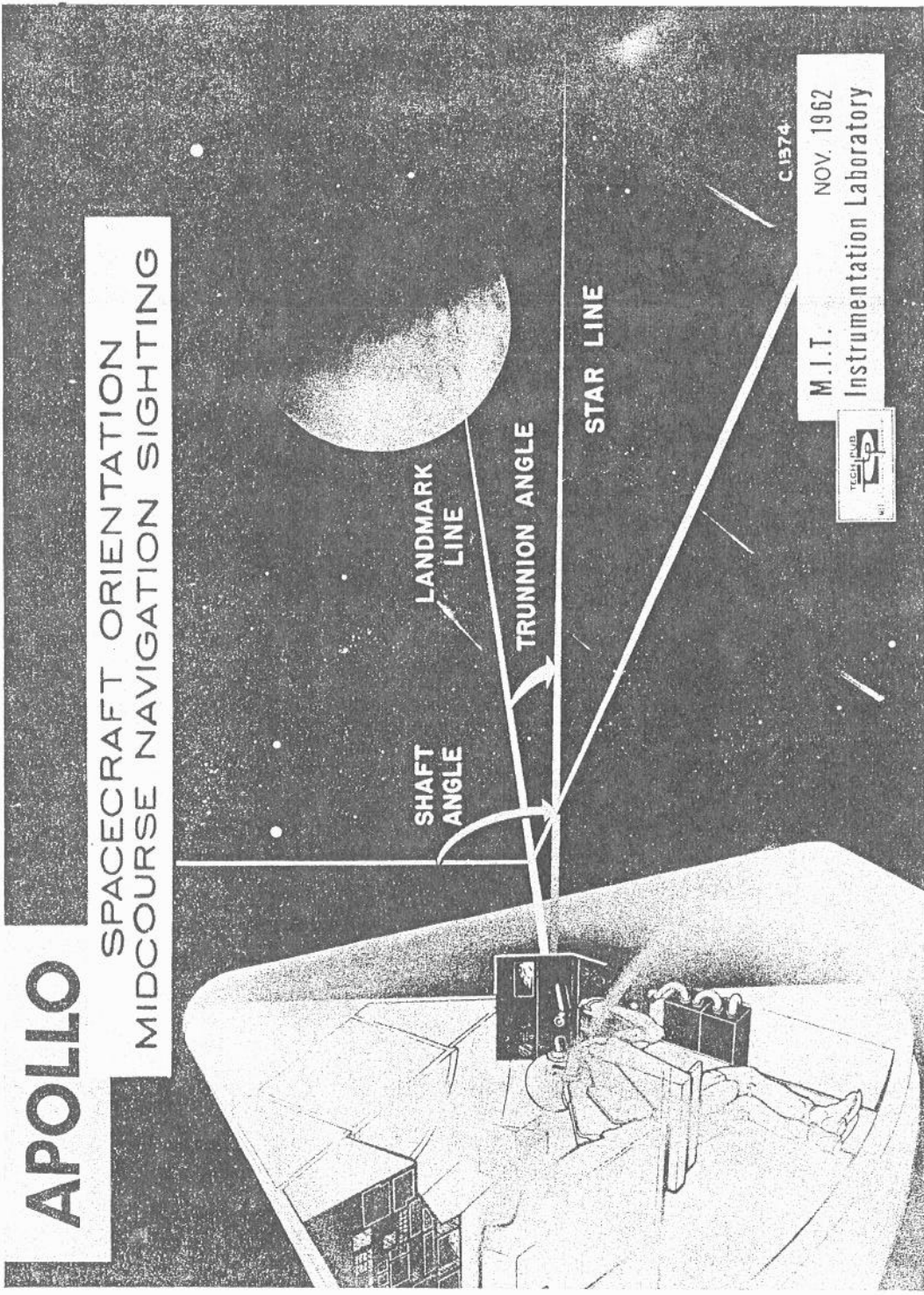

Fig. 2 Midcourse Navigation Sighting

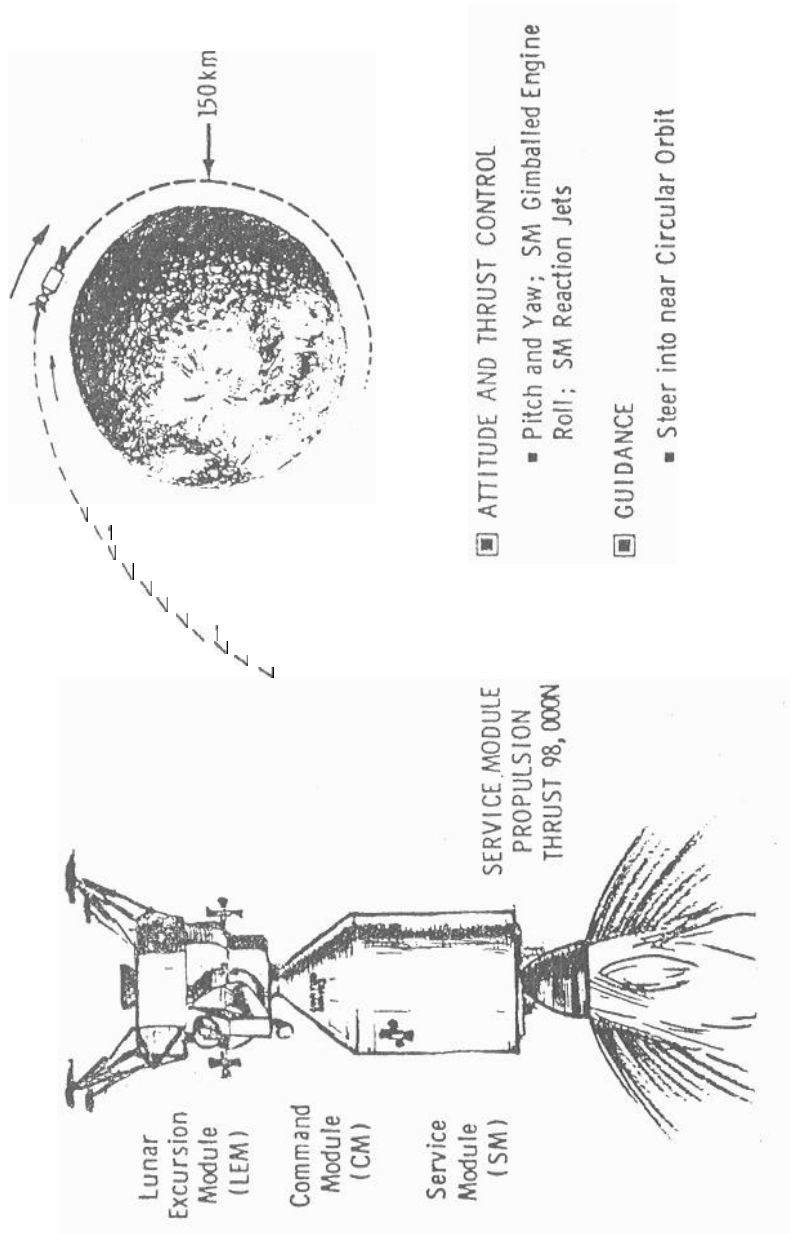

Fig. 3 Automatically Guided Flight Vehicle

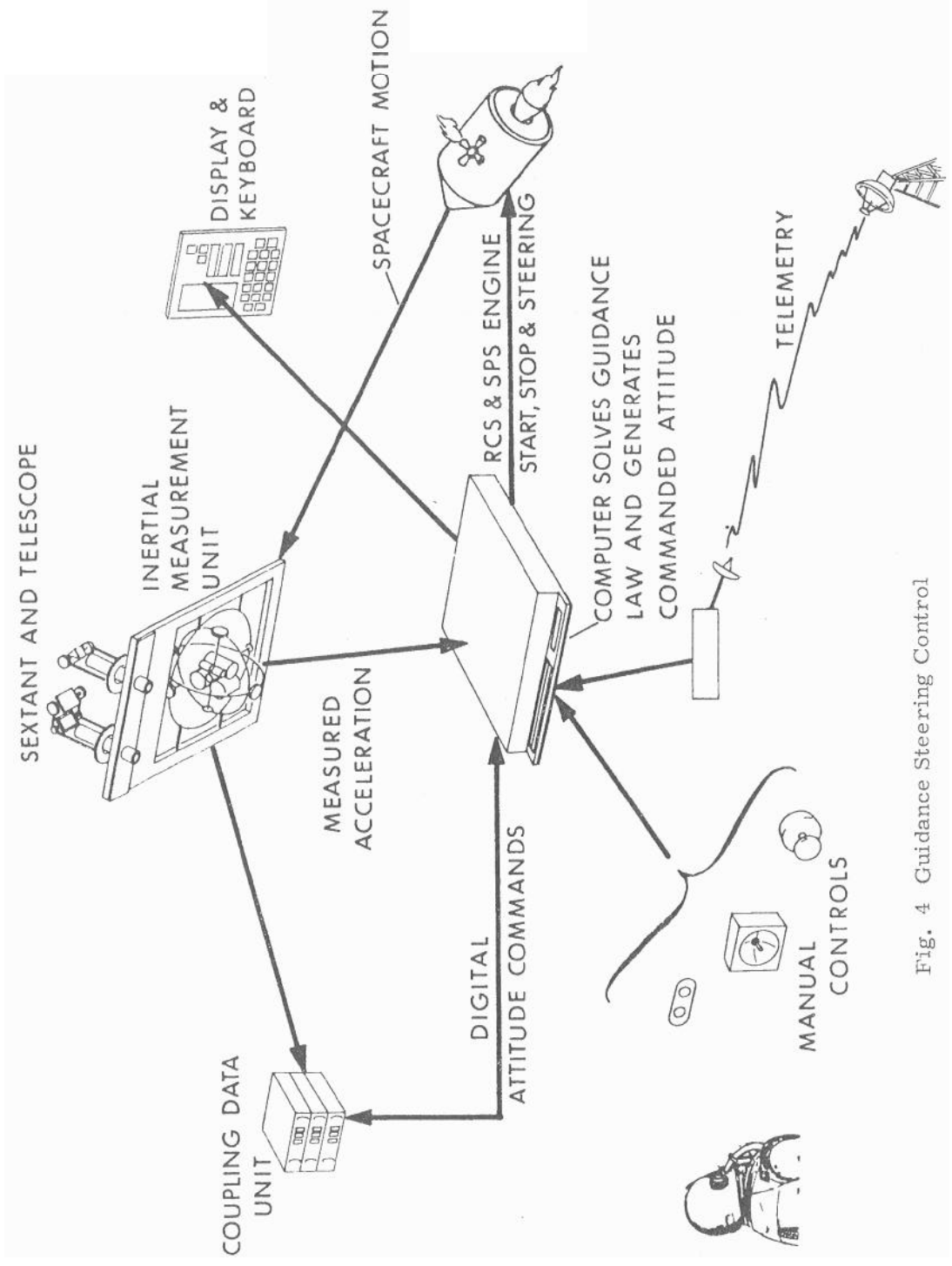

Fig. 4 Guidance Steering Control

Manual control inputs are provided via the keyboard, mark button, and manual engine control inputs.

Each spacecraft (LEM and CM) has a guidance system and each contains one of these computers. The guidance systems of the two vehicles are different because different types of sensors are used and different functions are performed in each vehicle, but the computers are identical. The interconnection between the equipment and the different programs stored in the computer provide for the different functions required via the two vehicles. The LEM lands on the moon, then returns to rendezvous with the CM in lunar orbit. The guidance system is used for all other mission phases, including earth re-entry. Figures 5 and 6, respectively, illustrate the interconnection between the computer and its associated sensing and control equipment in the CM and LEM vehicles.

The functional requirement of the computer then can be summarized as those necessary to provide the functions briefly described above. The other requirements, that is, environmental and reliability, are summarized briefly in Table I.

As these requirements, functional and environmental, were being formulated, the computer was being designed and prototype production initiated. The introduction of a change in the method of vehicle control and other requirements made it necessary to redesign the G&N system and its respective computers. The first computer of the two is referred to as the Block I and has been in low-volume production for approximately eighteen months. The Block II computer is smaller and lighter than the first even though it has increased capacity. Figure 7 is a picture of the Block I computer with the two different display and keyboard units required in the Block I CM application. This computer will be used in the early test flights of the Block I Apollo Command Module. Figure 8 is a picture of the Block II computer and one display and keyboard unit. The Block II CM requires two of these display and keyboard units, the LEM only one.

II. Computer Characteristics

Table II is a comparison of the Block II computer characteristics with those of Block I. As can be noted by the comparison, the Block II is similar in many respects but has larger storage capacity, more instructions, and greatly increased interface capacity. The computational speed has been increased by the addition of new instructions and a change to the way others were mechanized.

Probably the most interesting comparison for the purpose of this report is in the microcircuits used. Figure 9 illustrates this difference. As microcircuit techniques improved, it became possible to increase the complexity of the equivalent circuit in each microcircuit element and also to change from the TO-47

TABLE I
ENVIRONMENTAL/ RELIABILITY REQUIREMENTS

REQUIREMENTS	LEVEL	REMARKS
<u>Vibration</u>		
1. Launch	7.8 g rms	Shaped random.
2. Emergency	10.8 rms	Flat random. (.069 g ² /cps)
Acoustic Noise	133 db	Ref. . 002 Dynes/cm ²
<u>Shock</u>		
1. Lunar Landing	8 g 260 millisecc	
2. Earth Landing	78 g 11 millisecc	Non-operating
<u>Acceleration</u>		
1. Entry	10 g	
2. Emergency	20 g	
Climatic	95 ± 5% O ₂ 0-100% RH	Contaminants due to perspiration.
<u>Thermal</u>		
1. Surface & Structure	0-70°C	
2. Coldplate	0-40°C	
<u>Pressure</u>		
1. Pre -Launch	100 mm Hg	
2. Lunar Surface	3 × 10 ⁻⁹ mm Hg	
Electromagnetic Compatibility	MIL-I-26600 and EM1 10A	
Nuclear Radiation	Space Environment Attenuated by Spacecraft Structure.	
Reliability Failure Rate Less Than	235 Failures/Million Hours.	

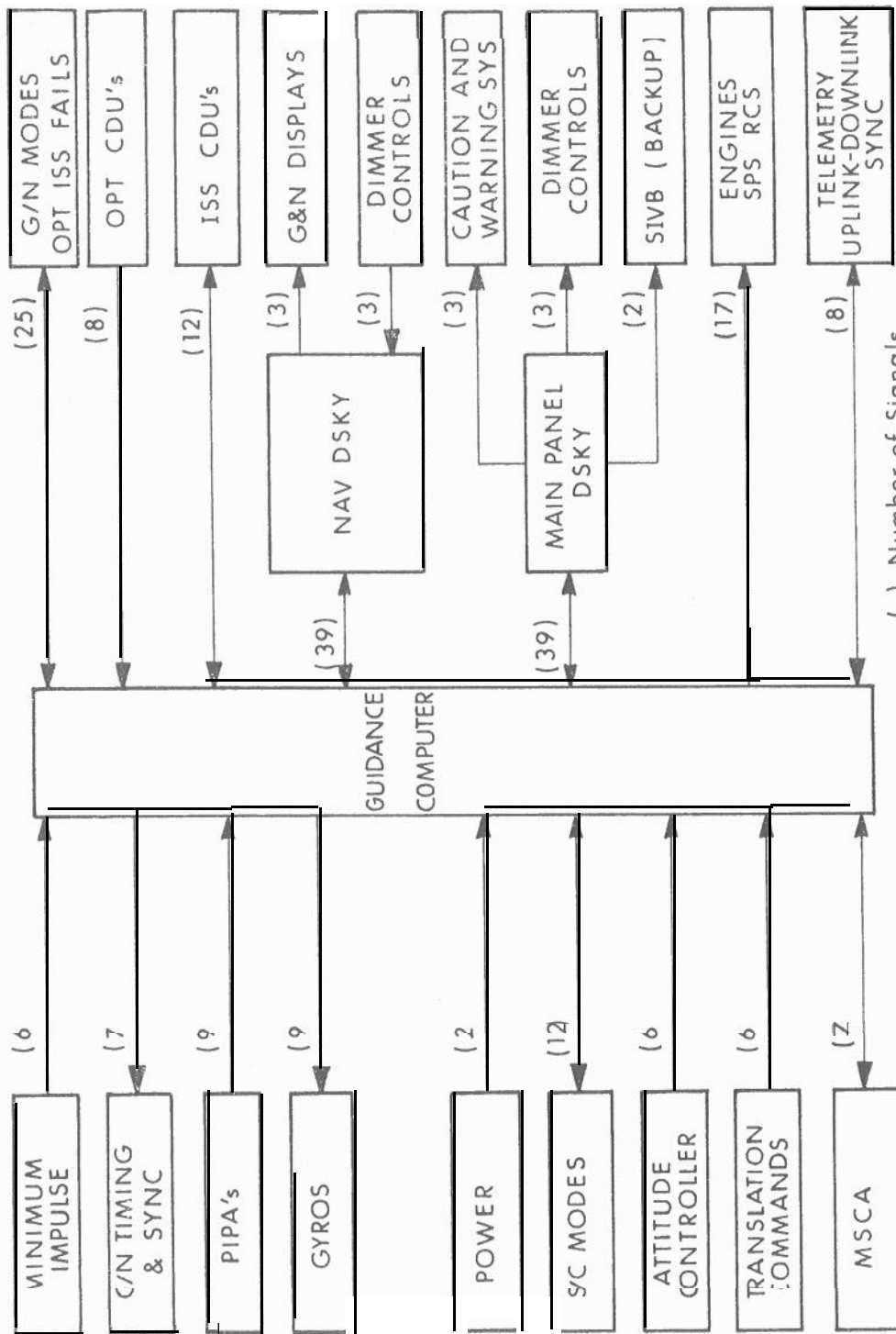

() Number of Signals
 Fig. 5 Guidance, Navigation & Control interconnections in Command Module

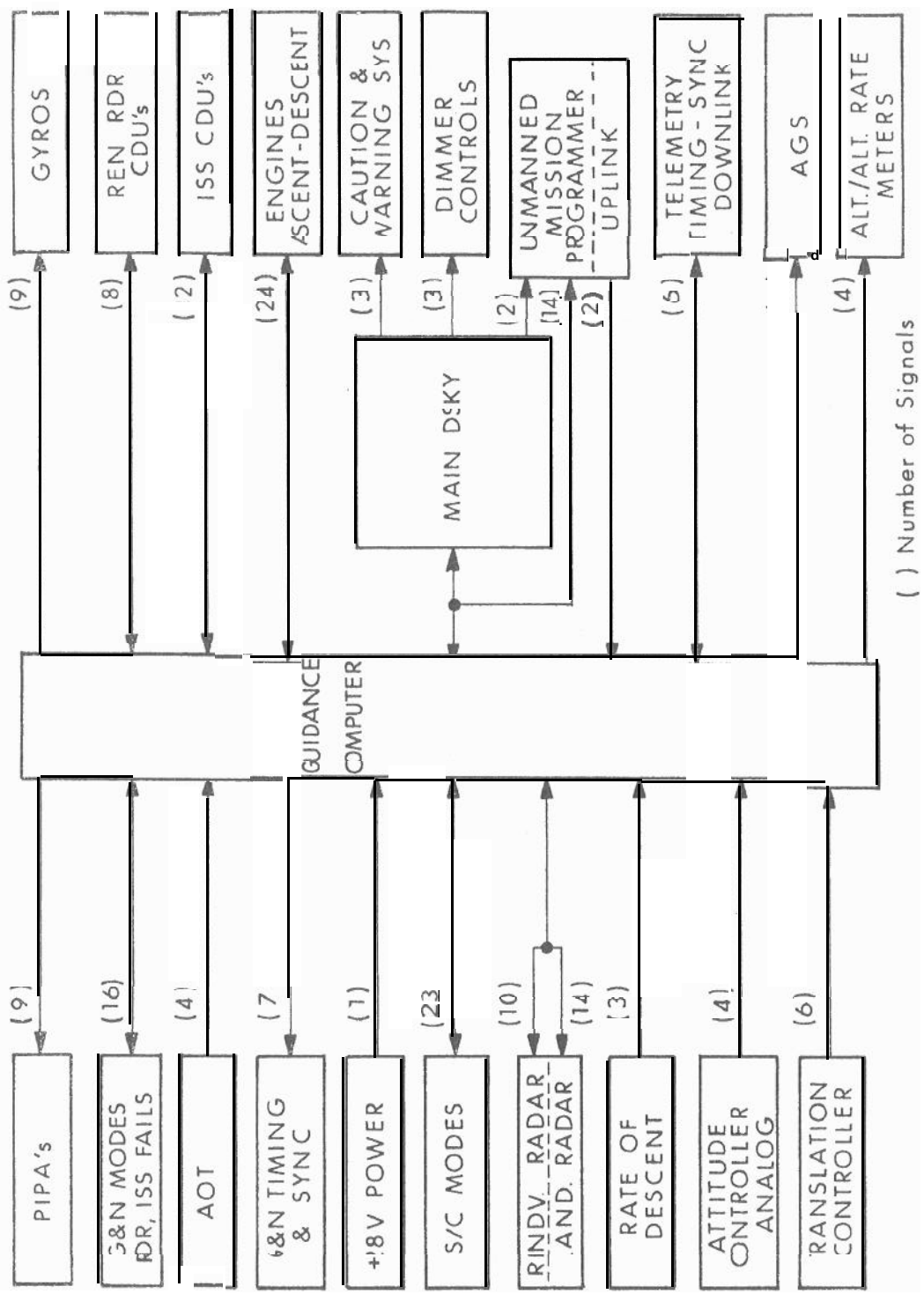

Fig. 6 Guidance, Navigation & Control Interconnections in LEM

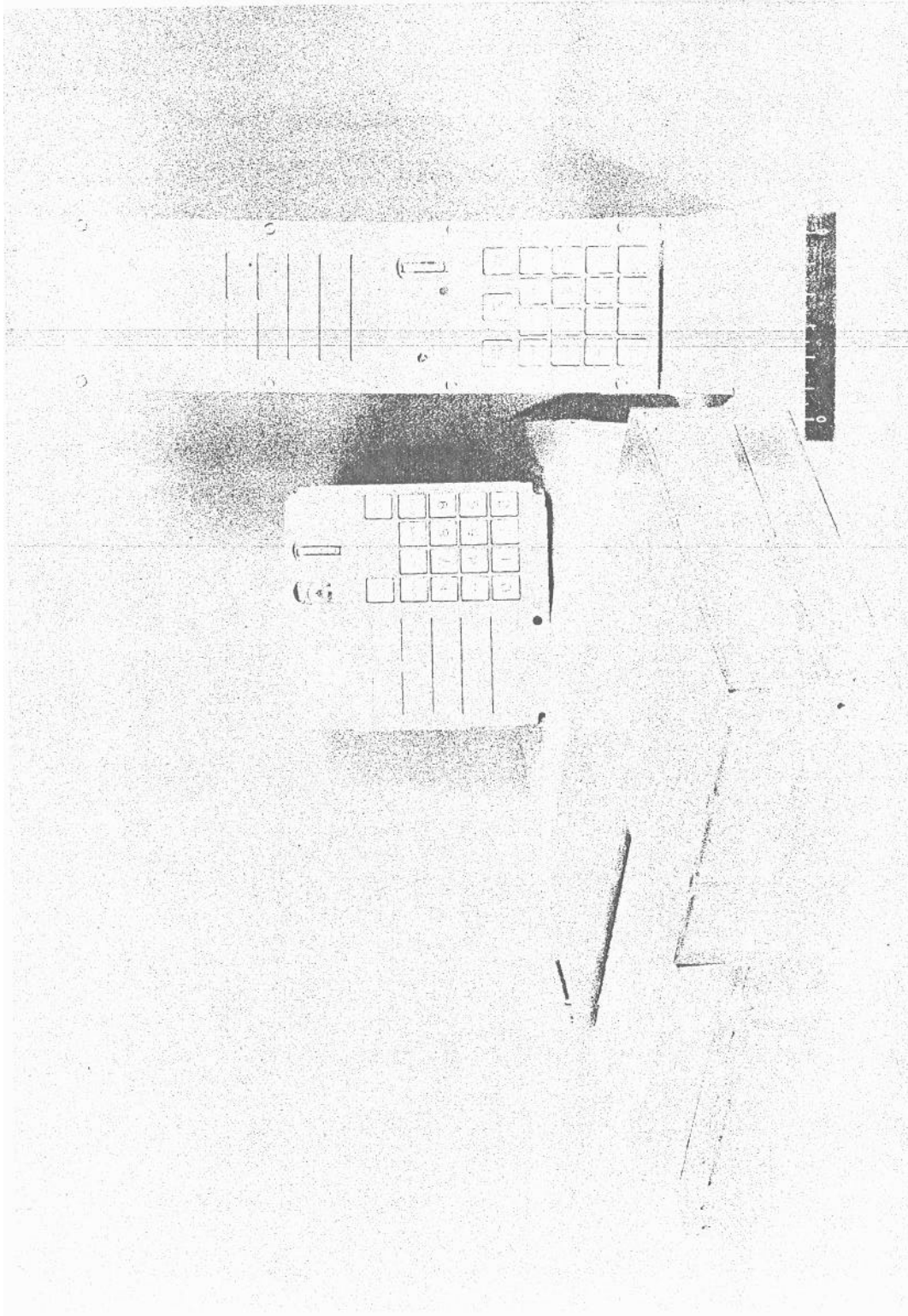

Fig. 7 Block I Computer and DSKYs

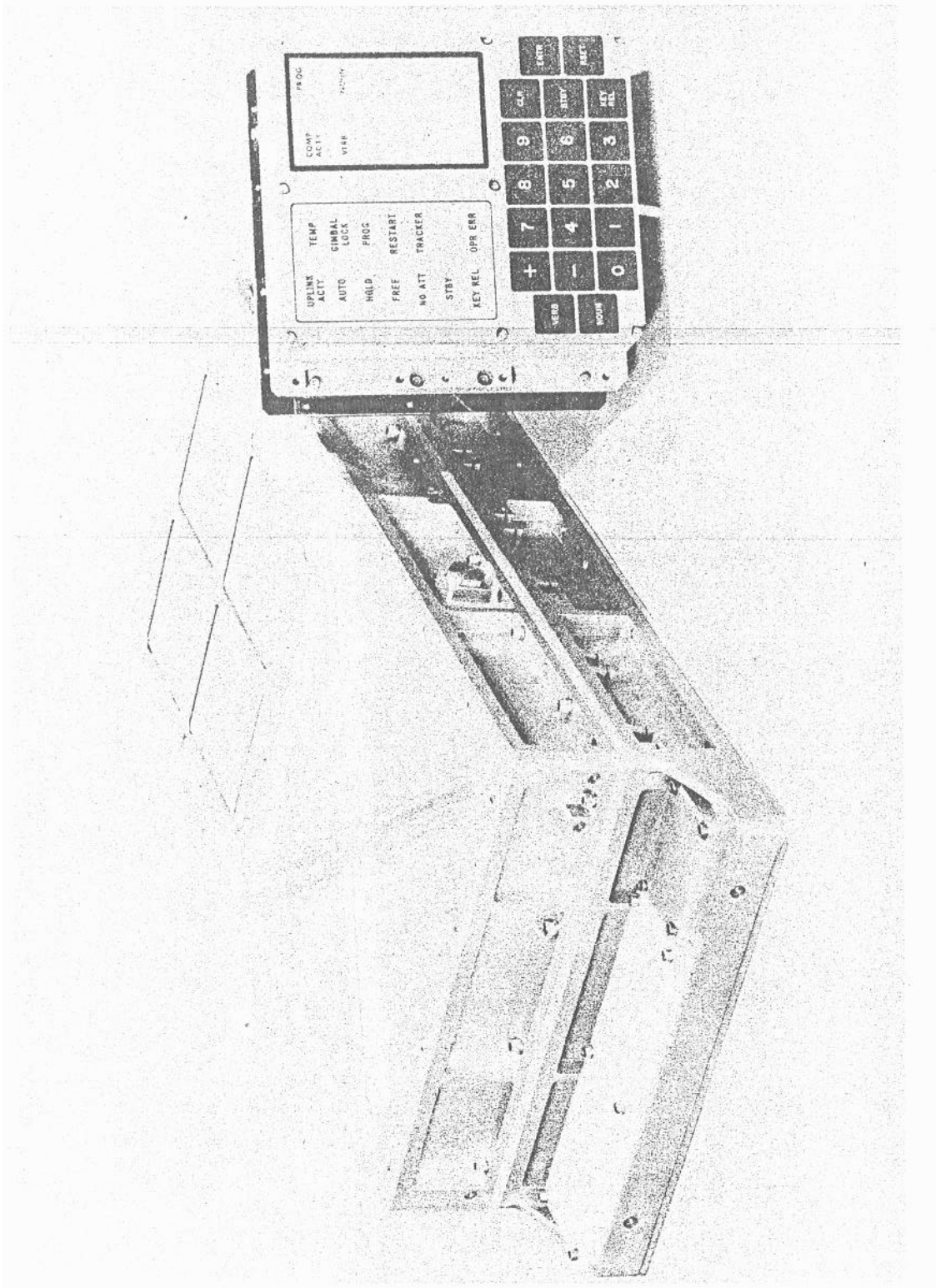
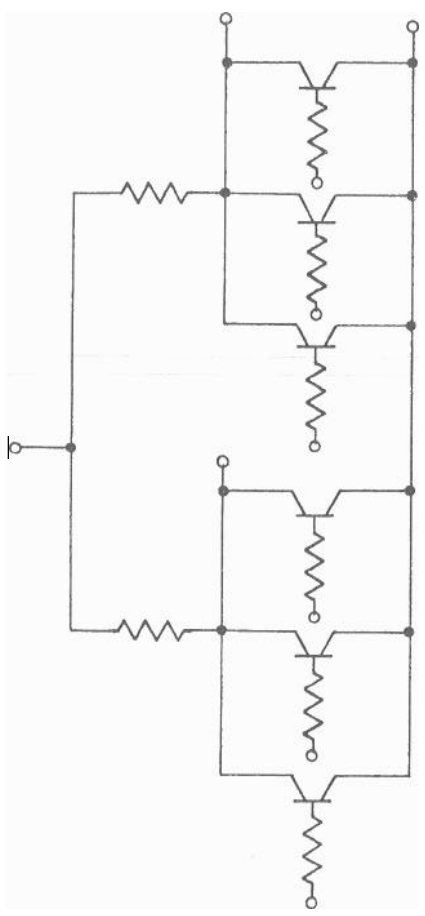
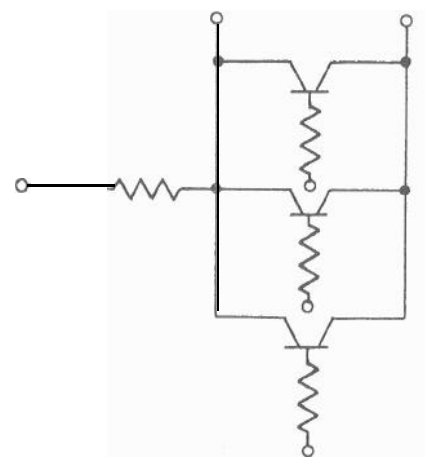

Fig. 8 Block II Computer and DSKYs



BLOCK II CIRCUIT



BLOCK I CIRCUIT



BLOCK I TO-47 PACKAGE

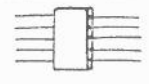

BLOCK II FLAT PACKAGE

Fig. 9 Equivalent Circuits and Packages of Logic Gate

TABLE II

Performance Characteristics	COMPUTER CHARACTERISTICS	
	Block I	Block II
Word Length	15 Bits + Parity	15 Bits + Parity
Number System	One's Complement	One's Complement
Fixed Memory Registers	24,576 Words	36,864 Words
Erasable Memory Registers	1,024 Words	2,048 Words
Number of Normal Instructions	11	34
Number of Involuntary Instructions (Interrupt, Increment, etc.)	8	10
Number of Interrupt Options	5	10
Number of Counters	20	29
Number of Interface Circuits	143	227
Memory Cycle Time	11.7 μ sec	11.7 μ sec
Counter Increment Time	11.7 μ sec	11.7 μ sec
Addition Time	23.4 μ sec	23.4 μ sec
Multiplication Time	117 μ sec	46.8 μ sec
Double Precision Addition Time	Subroutine (1.65 millisecc)	35.1 μ sec
Number of Logic Gates (Microcircuits)	4,100	5,600 (2,800 packages)
Volume	1.21 cubic ft. (34,300 cc)	0.97 cubic ft. (27,400 cc)
Weight	87 pounds (39.4 Kg)	65 pounds (29.5 Kg)
Power Consumption	100 Watts	70 Watts

package to the flat package. Therefore, during the development of the Block I computer, improvements in microcircuits and packaging made it possible to provide a Block II computer design that has greatly increased capacity with reduction in size and power. The reduction in size is attributed mostly to the decrease in the number and size of the logic-gate packages, that is, from 4, 100 TO-47 packages to 2,800 flat packages.

III. Construction Techniques

The construction techniques used in these two computers are very similar in that circuits are packaged in modular assemblies which plug into a tray containing the back-panel wiring. The back-panel wiring is accomplished by automatic machine wrapping. Each module subassembly is constructed using welding for interconnection of circuit elements. In the case for microcircuitry in the flat package, interconnections are made by welding to a multilayer printed circuit board. Figure 10 is an exploded view of the Block II computer assembly. This illustrates a module being unplugged from one of the two trays that contain the back panel wiring, and the trays are themselves plugged together. The complete computer is enclosed and hermetically sealed. The Block I computer was not hermetically sealed. The requirement for sealing developed during the design of the Block I system.

The series of pictures, Figures 11, 12, and 13, show in more detail the construction of modules and trays with the interconnection techniques used. Figure 11 is a logic module. The module contains 240 microcircuit logic gates contained in 120 flat packages. There are 60 flat packages mounted on each of two multilayer boards which are housed in each side of the module as shown. The multilayer boards provide the interconnection between the 60 logic gates on the board and interconnections to the connector pins. The tray wiring shown in Fig. 12 provides connections to the other side of the module and to the other modules. This wiring is accomplished by using a Gardner-Denver wire-wrap machine which makes all interconnections automatically under control of a punched card deck. The tray shown here has 8, 126 pins and requires about one km of wire to provide the interconnections between the modules in the tray. Figure 13 illustrates the assembly techniques used for modules containing standard components. The components are inserted into a drilled block, then interconnected with point-to-point welded wire. After wiring, the modules and trays are completed by encapsulation to provide protection and mechanical support for the wiring, thus preventing damage during the exposure to the environmental requirements for the computer. In the above photographs, the modules and trays are shown with no encapsulation for clarity in illustrating the construction techniques.

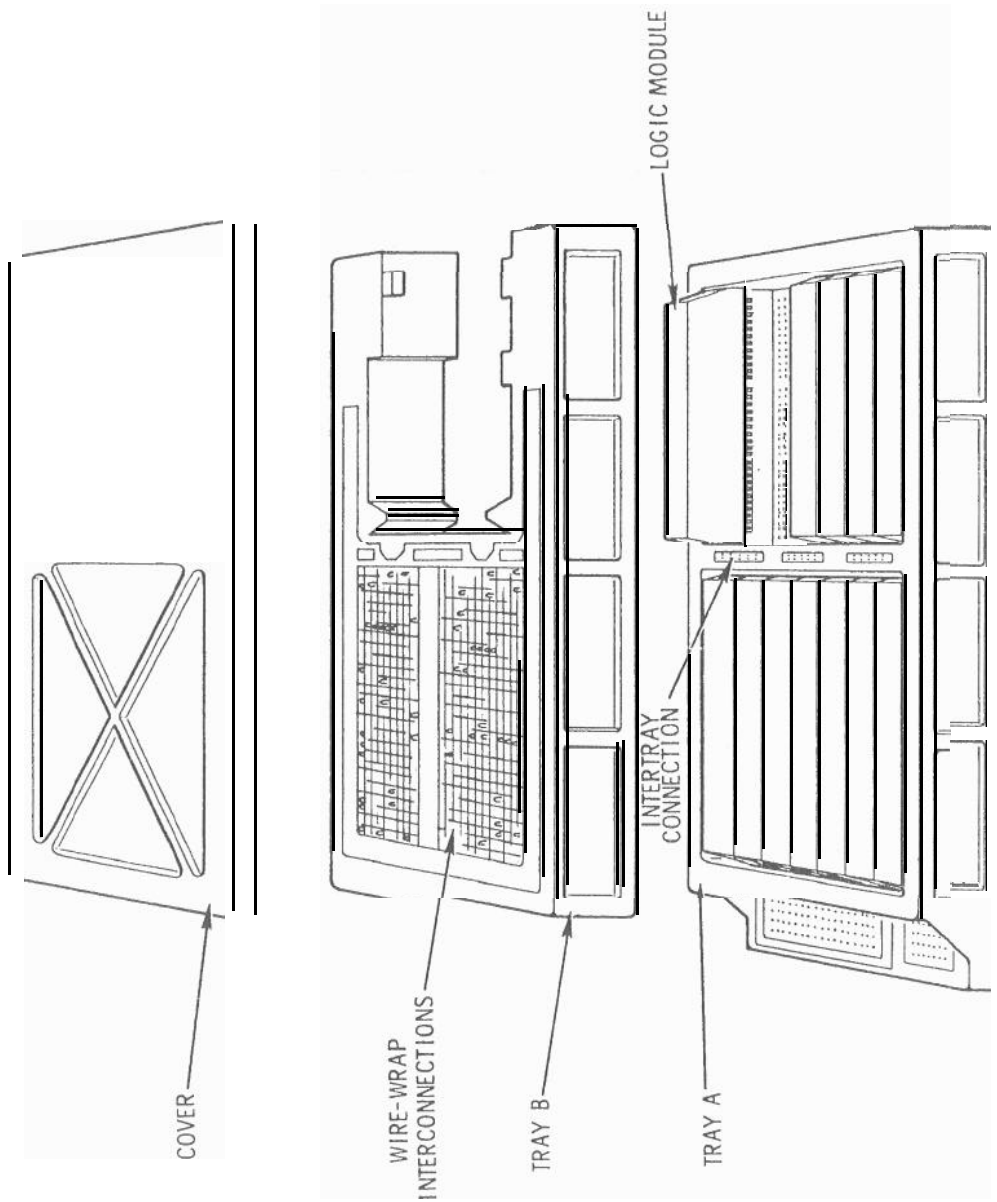
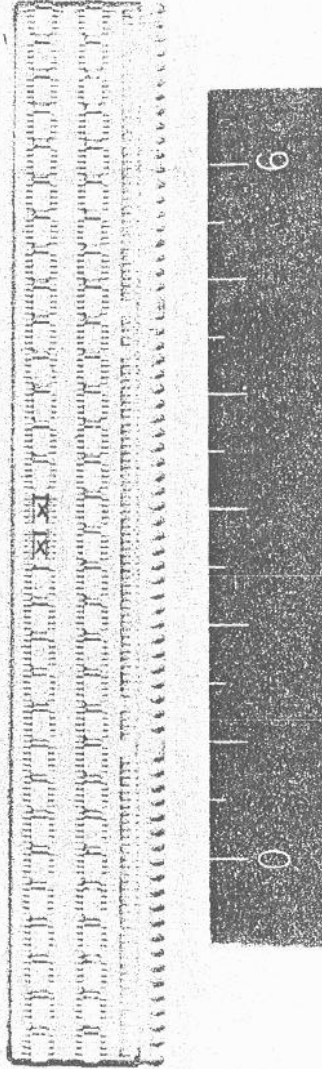

Fig. 10 Exploded View of Block II Computer

MODULE MOUNTING FRAME AND
MULTILAYER BOARD
WITH MICROLOGIC ASSEMBLED
(PRIOR TO FINAL WELDING)



— FINAL ASSEMBLY —
(PRIOR TO ENCAPSULATION)
TYPICAL DIGITAL MODULE BLOCK II CDU

Fig. 11 Logic Module

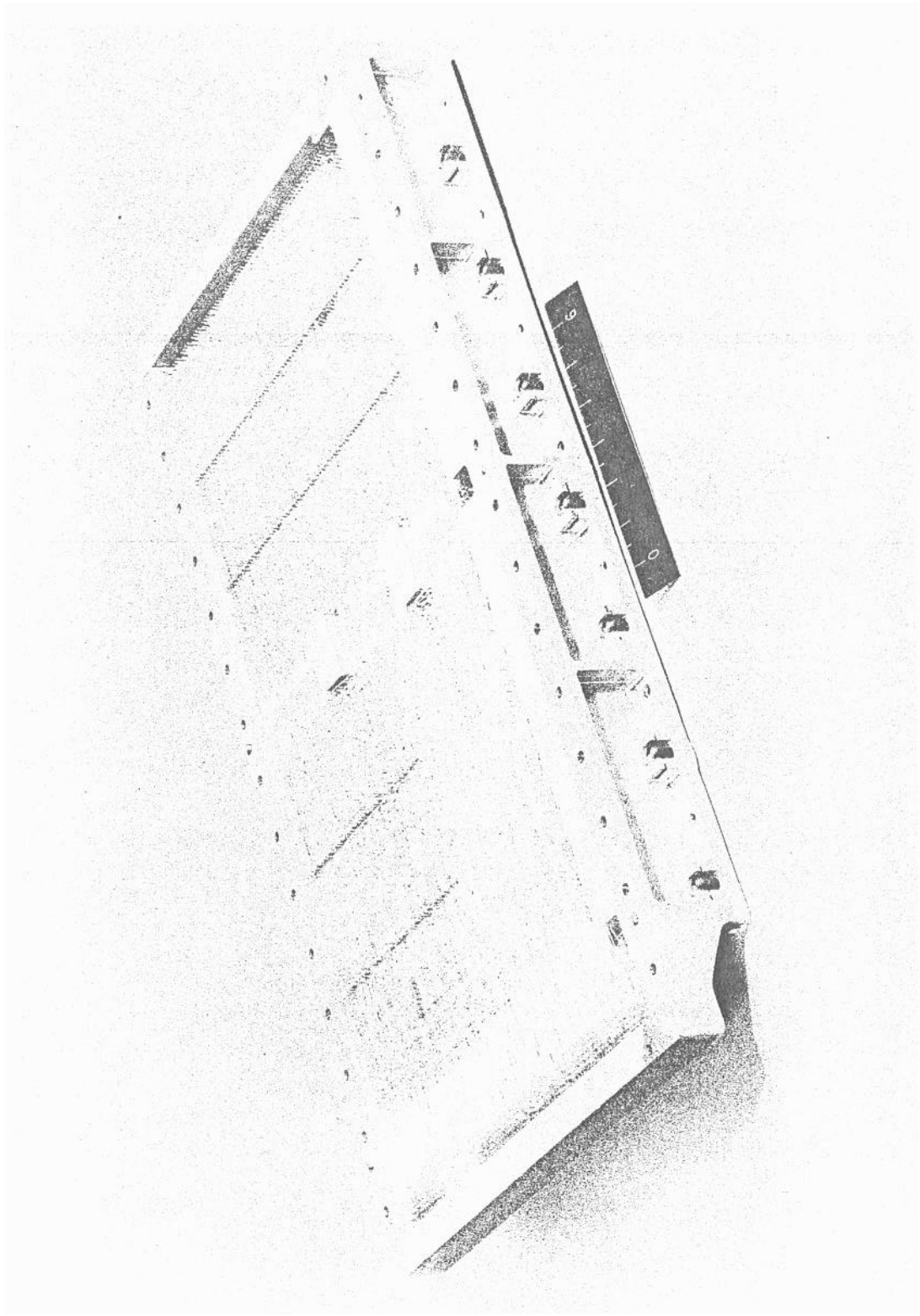

Fig. 12 Tray A Wire-Wrap Side

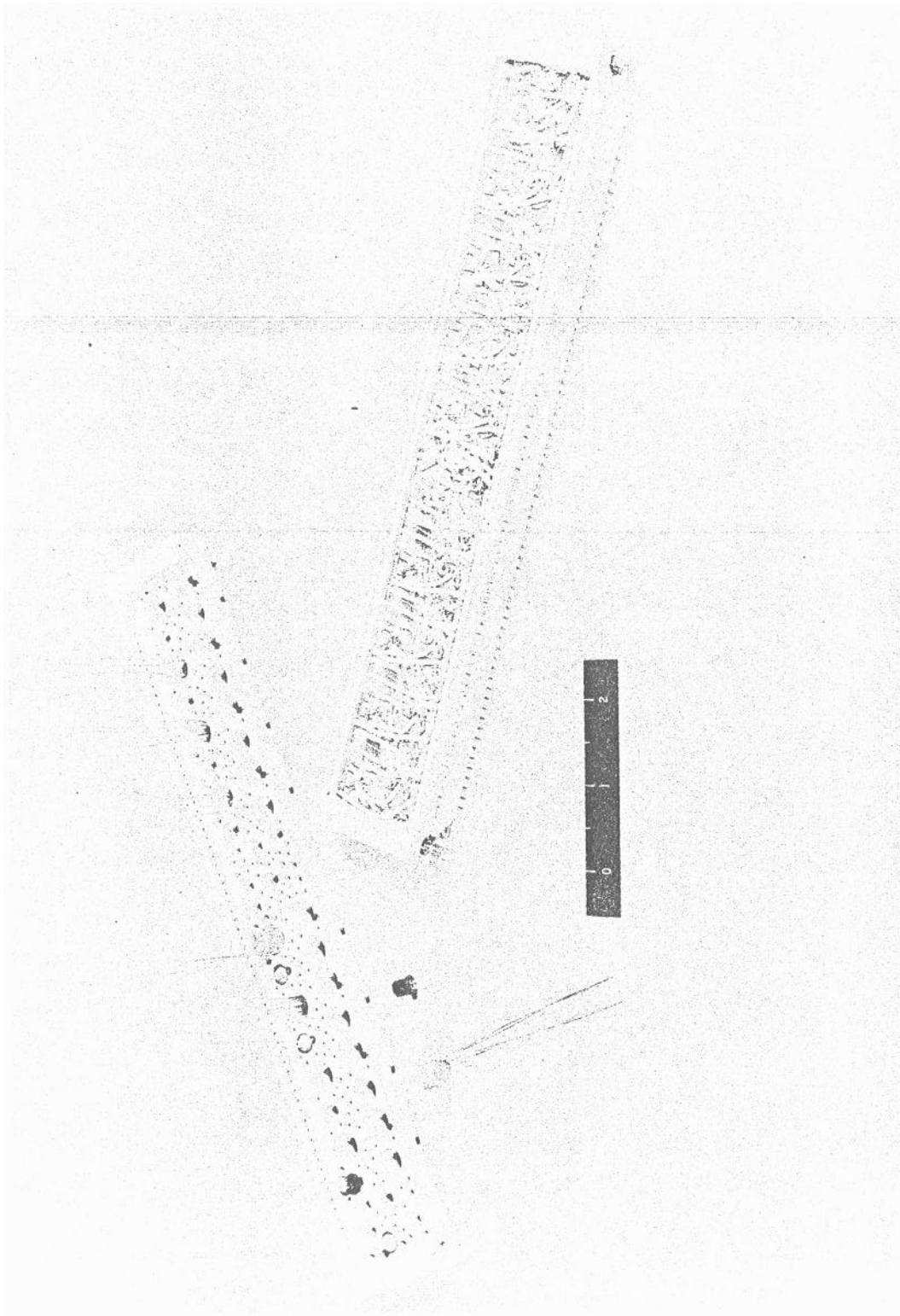

Fig. 13

Assembly

These basic construction techniques, using welding and wire-wrap interconnections, were developed for the airborne guidance computer of the Polaris Ballistic Missile system. They have been extended for use on the Apollo computer where even greater miniaturization and higher reliability were required. The production experience of about six years with these techniques has verified the reliability of this approach. For welded and wire-wrap interconnections, this extensive operating experience shows that the failure rate is negligibly small. Another point of interest for the use of these techniques is that of cost; in volume production it has been shown that a computer manufactured using these techniques is very competitive, cost-wise, to the same type computer manufactured using printed wiring boards and interconnections.

In order to achieve or exceed the reliability requirements for the computer, strict process controls are used throughout the assembly, from the individual components through final assembly of the computer. Parts are procured from vendors with very tight process-control specifications, requiring, among other controls, the traceability of all materials that go into the part during assembly. Following delivery of a component to the factory for computer assembly, the component must go through a screen and burn-in procedure designed to weed out maverick units. The screening procedure for microcircuit elements, as for other large volume components, is used not only to weed out but also to identify defective lots. For failure modes not easily screened, only a very few failures are permitted during the screen and burn-in procedure before the complete lot is rejected. The rejection level has been determined by the type of failure mode and the ease with which that failure can be screened. If the failure mode is not easily screened, then a very few failures are permitted in screen and burn-in before rejection of the complete lot. For example, a lot of 5,000 microcircuit elements which exhibits more than one failure due to corrosion of the metalization will be rejected, but the lot will pass if no more than 100 units fail to pass the leak test. These testing procedures and failure criteria have been more completely described.³⁴

The welding and wire-wrap procedures (as well as all other assembly procedures) are also under tight process controls. For example, the procedure for welding of components is specified and the methods of inspection identified. The lead materials used at every weld joint are tightly controlled and the weld setting of the welding machine is specified for any particular set of materials to be welded. Periodic quality control inspections are made on each welding machine to verify that the machine and the operator are producing weld joints that can pass destructive type tests on the weld joints. The lead materials, size, and shape for

*Superscripts refer to similarly numbered references in the Bibliography.

electronid components are standardized where possible without sacrificing the reliability of the component. The lead materials used are kovar, dumet, and nickel, The interconnection wiring is nickel, thus limiting the number of different kinds of weld joints that must be made during assembly.

IV. Computer Qualification Tests and Results

Since the Block I computer has had the longest history of testing, the major portion of the data and testing have been derived from tests on it. The Block II is just starting qualification testing, therefore only limited data are available. Because of the similarities in the components and design, however, it is assumed that similar results can be projected.

As of March 1966, the Block I computers have accumulated approximately 60, 000 computer hours and have established a mean-time between failures of about 3,000 hours at 90 percent confidence. This experience was developed on 17 computers, some of which are in excess of two years old and others only a few months old. These computers have been used for engineering tests, qualification tests, and system simulations; therefore, they have been subjected to severe environments and considerable handling. Table III provides a summary of the failure history for these computers,

Of the twelve failures, the four logic gates that failed provide some very interesting information on the effectiveness of the processing procedures (see reference) as well as on the reliability of microcircuit elements. Table IV lists these failures, the analysis of the failures, and the lot numbers from which the gates were obtained. All of the logic failures were detected during acceptance-type testing at the computer manufacturing facility where environmental testing is done on each unit. Two of the failures occurred when the computer was being sold off initially. The other two computers, after considerable field operation, were returned to the factory for some rework and retest. Figure 14 summarizes the quality history on the microcircuit elements as they have been processed through the screen and burn-in procedures. It is clear that the quality of the lots, as determined from these data, has fluctuated throughout the history of the program. In particular, there was a severe degradation in quality following the break-in production deliveries during the summer months of 1964. Also, the lots of the four units that failed are identified, thus relating their failure history at screen and burn-in with the failures experienced in the gates.

Lot 442 exhibited corrosion of the metalization as one of the prime failure modes during screen and burn-in. The lot was passed on waiver because of the pressures of schedule and because the numbers set for rejection were felt to be somewhat arbitrary and maybe too tight. The other failures have all been the

TABLE III
FAILURE SUMMARY

EQUIPMENT	MICROCIRCUIT FAILURES	DATE TESTING INITIATED	TOTAL FAILURES	TOTAL OPERATING HOURS
AGC -4	0	February 1963*	0	6900
AGC-104B	0	November 1963	0	12439
AGC -105	0	May 1964	2	12146
AGC-6	0	September 1964	0	3277
AGC-7M	0	January 19 64	0	369
AGC-120	0	March 1965	1	707
AGC-117	1	March 1965	2	1300
AGC-112	1	April 1965	1	1541
AGC -108	0	April 1965	0	1569
AGC -9M	0	April 1965	0	6957
AGC -107	0	May 1965	0	2600
AGC-110	0	July 1965	0	1390
AGC -121	1	August 1965		452
AGC-111	0	September 1965	2	1669
AGC-109	0	October 1965	0	678
AGC -122	1	March 1966	3	330
AGC -SP1	0	March 1966	0	366

*Testing terminated April 1964.

Total Computer Hours 55214

Total Flight Category Failures 12

Total Micrologic Failures 4

Micrologic Failure Rate, 90% Confidence

with 221×10^6 Part Hours .030/10⁶

Computer Failure Rate, 90% Confidence 299/10⁶

Computer Mean-Time Between Failures,
90% Confidence 3350

M		M	NE	M
AGC-121	7/27/65	442		Corrosion of metal zation
AGC-117	11/2/65	418 or 420*		Metallic particle inside package
AGC-122	11/13/65	446		Metallic particle in ide package
AGC-112	1/22/66	444		Metallic particle inside package

*No data from screen and burn-in but failures during assembly indicate the lot was bad.

Failure Rate @90% Confidence
with 221 x 10⁶ Part Hours. 0.003%/1000

Table IV Microcircuit Failure Analysis

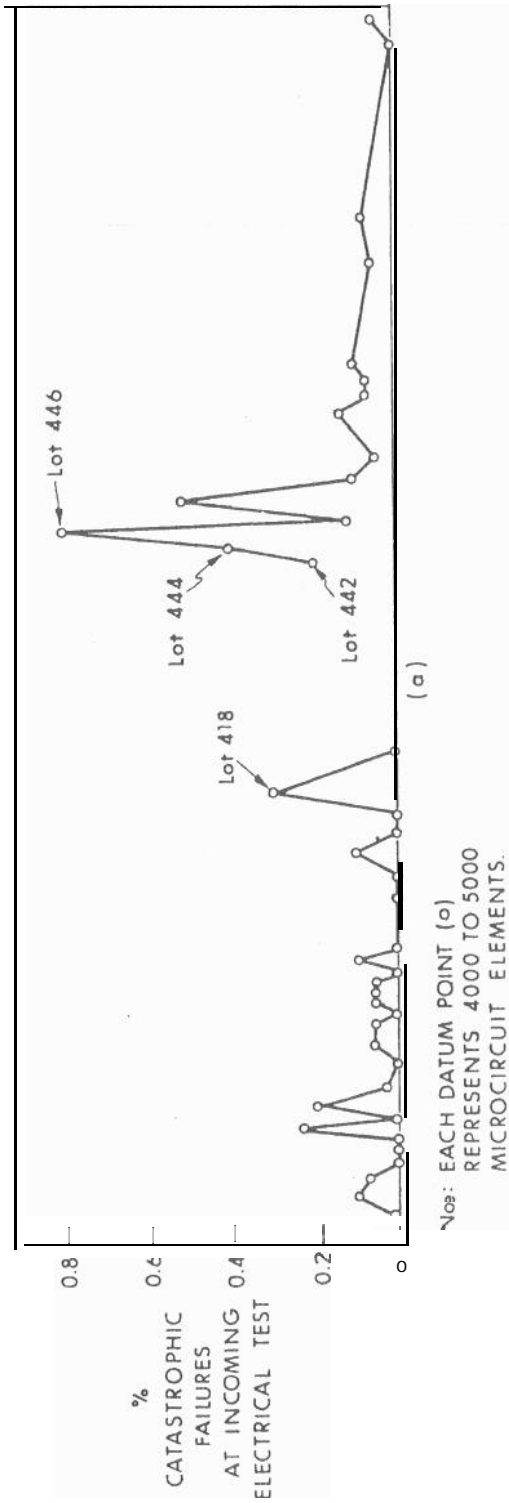
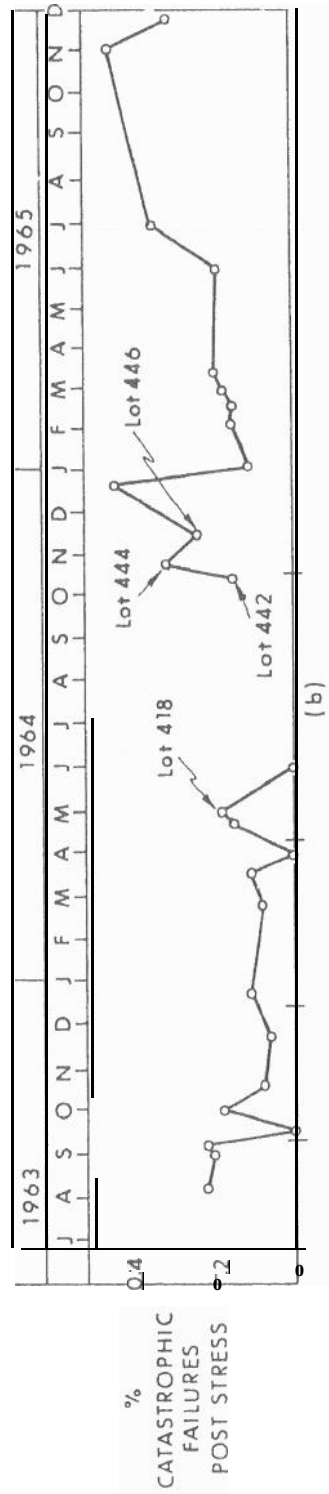

Fig. 14 Block I Screen and Burn-in Data Summary

result of metallic particles inside the can, This failure mode may be more serious than it appears even from this record. During the manufacturing process, there has been an excessive number (a few percent) of failures with metallic slivers external to the package that short between the header and the leads. See Fig. 15. These seemed to be caused by handling during assembly. The source was fairly well established to be the gold flaking from the surface of the package. The problem was solved external to the package by cleaning and insulating the header, thus fixing any gold flaking. Internal to the package, these flakes may be growing or becoming loosened with environmental exposure.

Figure 16 is the screen and burn-in data summary for the flat package configuration. Comparing the Block I with the Block II indicates the Block II device is exhibiting higher quality if the first four lots are discounted. If one can use this data comparison to predict the failure rate of the Block II logic package from the failure rate of the Block I logic package, then the prediction for the Block II failure rate should be less than $0.030/10^6$ experienced with Block I. This, in effect, provides at least a factor of two decrease in gate failure rate since the Block II package has two logic gates per package.

In addition to the running time history, the computer has gone through pre-flight checkout with complete spacecraft. In addition, Figure 17 illustrates the tests that have been used to qualify the computer for simulated spacecraft environment. These tests are designed to subject the computer to the worst-case conditions of the flight profile plus providing some overstress conditions to define the margin of safety. One computer has been subjected to and passed these tests for subsystem qualification. A second computer as part of a complete G&N system has been subjected to and passed the system qualification tests. The electromagnetic compatibility tests were of considerable interest on this computer because of the possible susceptibility of the microcircuit elements to electromagnetic interference. During engineering-type tests ~~previous~~ to qualification, the computer was subjected to a series of tests with the intent of inducing failures in order to determine the level of susceptibility. For this series of tests, two methods were used as measures of susceptibility (see Fig. 18), mainly the power line transient tests as instrumented and second electrostatic (spark) discharge between a generator and the computer case or cabling. For the power line transients, the computer can operate with a ~~10-microsecond~~ line transient in excess of 50 volts applied either between the power line inputs or between a single power line input and the case of the computer.

The spark discharges were used to simulate interference from radiation, since the normal methods for radiation susceptibility measurements would not introduce any failures. This test could not be very well calibrated, but

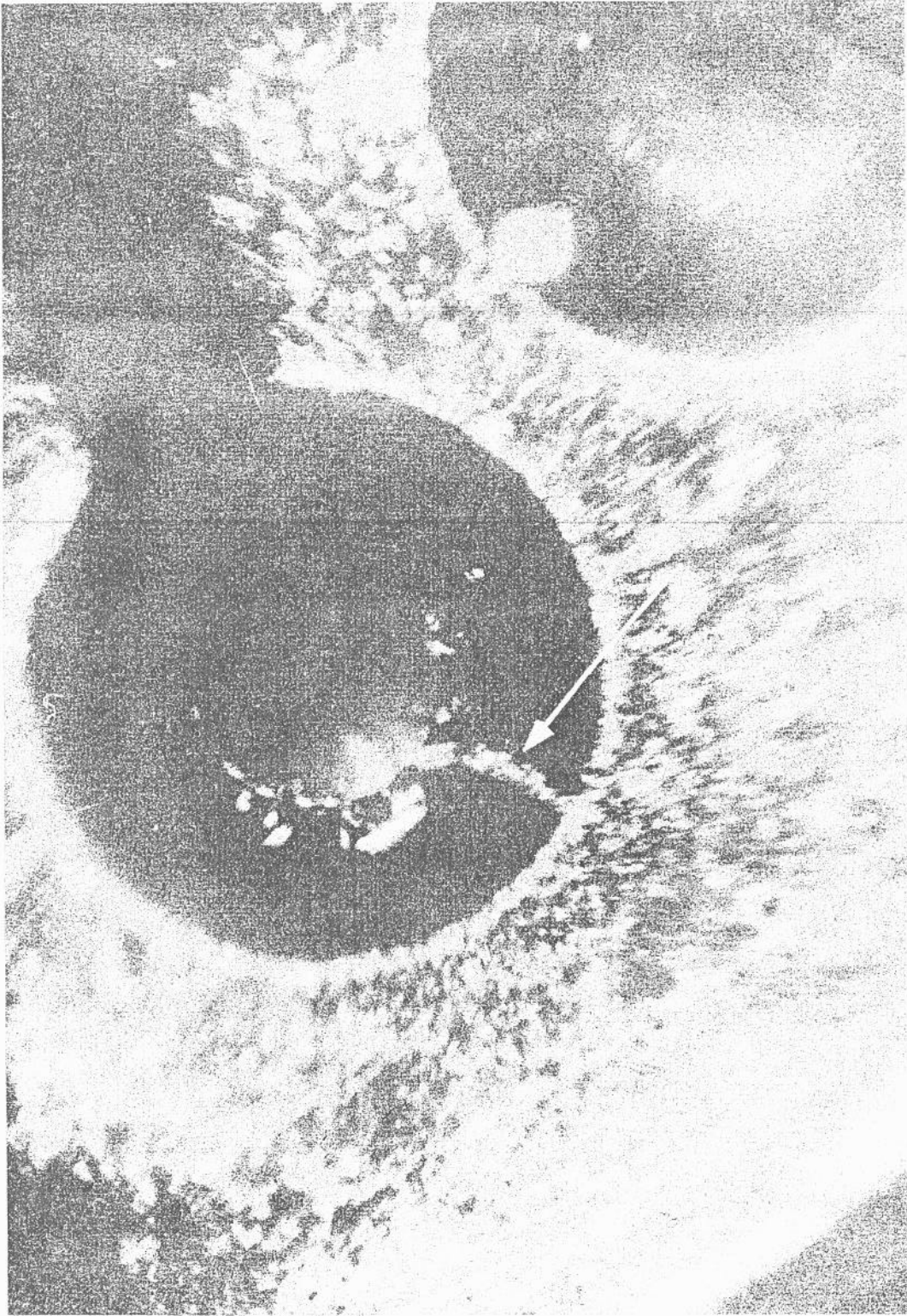
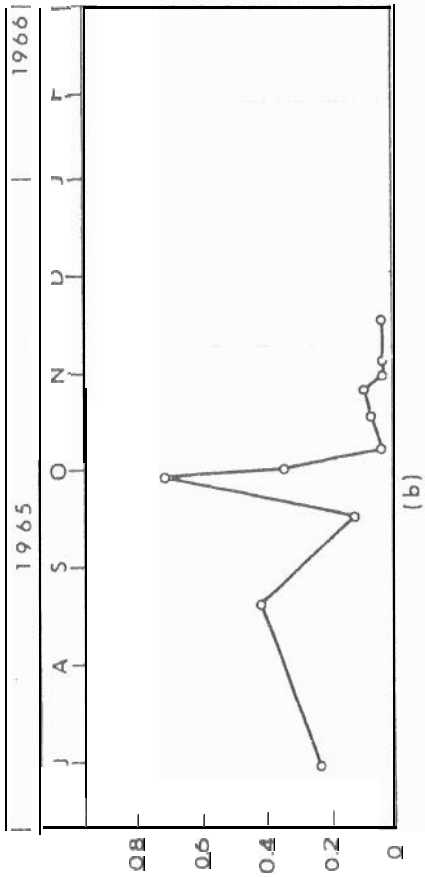
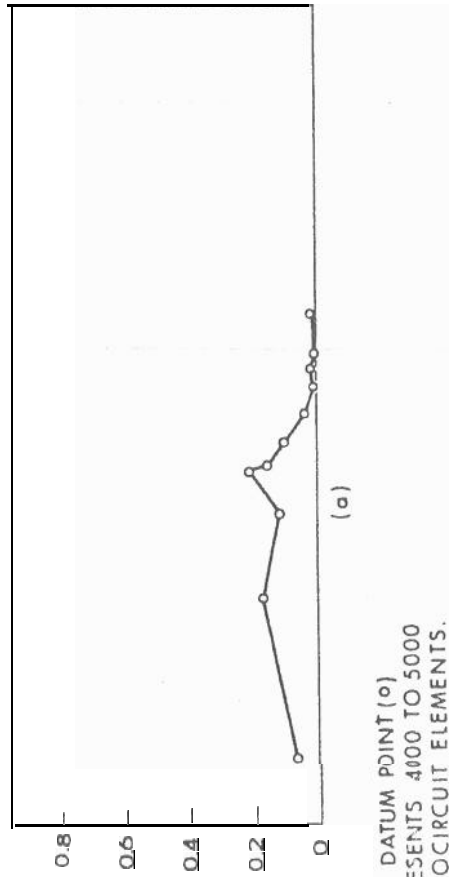

Fig. 15 Photograph of Loose, Gold Filament



%
CATASTROPHIC
FAILURES
POST STRESS



%
CATASTROPHIC
FAILURES
AT INCOMING
ELECTRICAL TEST

Note: EACH DATUM POINT (o)
REPRESENTS 4000 TO 5000
MICROCIRCUIT ELEMENTS.

Fig. 16 Block II Screen and Burn-in Data Summary

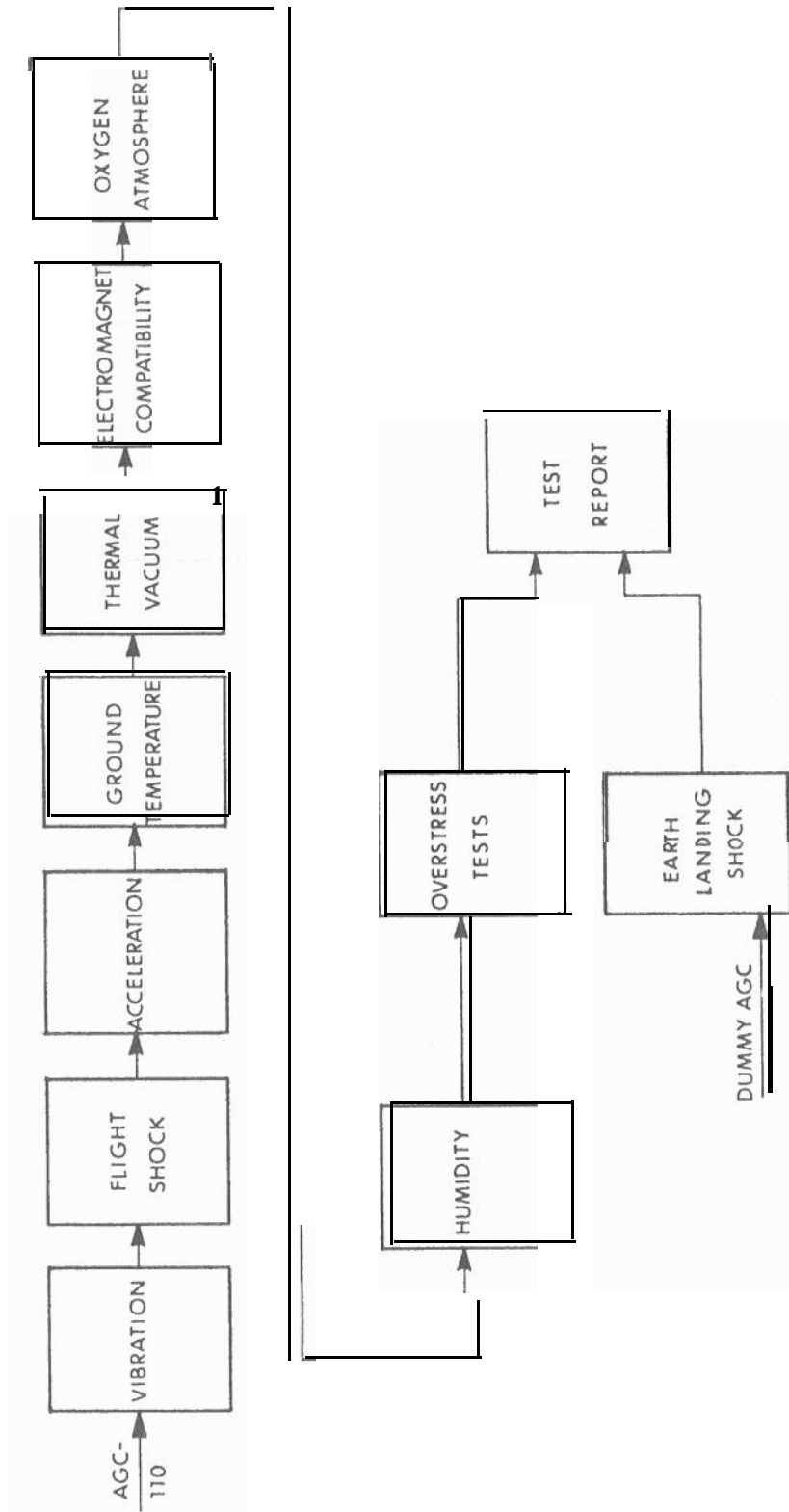

Fig. 17 Subsystem Qualification

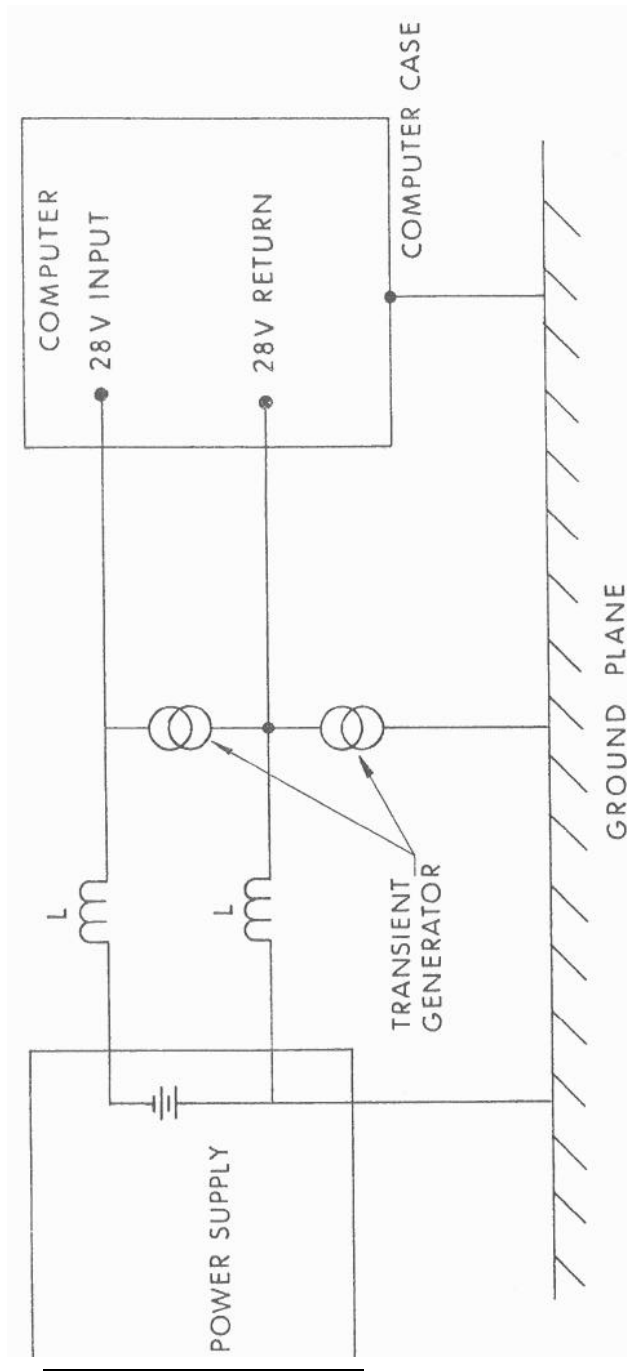

Fig. 18 Power Transient Test

considerable information could be determined about areas of susceptibility. In general, in order to withstand spark discharges, the computer must be completely enclosed in a conducting case and the cabling, going into the computer, must be shielded with shields connected to the case.

VI Summary

The history of the development of the guidance computer for the Apollo mission has provided a large volume of usage data on one type of microcircuit element. The data have been accumulated over a period of about three years of production. This history reveals quite conclusively that the use of microcircuit elements can improve the reliability of a system just by comparing the failure history of these elements with the standard component elements used in much lower volume in the same computer. A word of caution, however; the history also shows some problem areas and the value of tight process control and screening procedures on the components. The detrimental effect of relaxing these controls cannot be determined, but the failure history during usage does indicate that the reliability would degrade.

Circuit design type problems have been experienced with the microcircuit elements. These problems, however, were minor and were of the type designers would have with any new component and, therefore, were not discussed in the report. Again, if a comparison between standard components and the microcircuit elements is attempted, the results are not so clearly defined, but it seems the total number of design problem areas was greatly reduced by the introduction of the microcircuit element. This is in part true because the design was limited to the use of only one type of gate.

BIBLIOGRAPHY

1. Draper, C. S., W. Wrigley, D. Hoag, R. Battin, J. Miller, D. Koso, A. Hopkins, W. Vander Velde, "Space Navigation and Control", AGARD Presentation at Wiesbaden, Germany and Brussels, Belgium, June 1965; Technivision Ltd., Maidenhead, Berks., England.
2. Partridge, J., L. D. Hanley, and E. C. Hall, "Progress Report on Attainable Reliability of Integrated Circuits for Systems Application", Microelectronics and Large Systems, Edited by Mathis, Wiley and Spandorfer; Spartan Books Inc., MacMillan and Co., Ltd.
3. Hanley, L. D., J. Partridge, and E. C. Hall, "The Application of Failure Analysis in Procuring and Screening of Integrated Circuits", presented at the Physics of Failure in Electronics Symposium IITRI, Rome Air Development Center, Chicago, Ill., November 1965.
4. Partridge, J., "Impact of ND 1002238 on the Failure Rate of Single Nor Gates", MIT/IL Report No. E-1944, April 1966.

DISTRIBCTIOS LIST

Internal

M↓ Adams (MIT/GAEC)	J. Lawrence (MIT/GAEC)
J↓ Alexshun	T. J↓ Law-ton
R↓ Battin	T↓ M↓ Law-ton (MIT/MS)
P. Bowditch/ F↓ Siraco	D. Lickly
R↓ Byers	G. Mayo
G↓ Cherry	J. McNeil
E↓ Copps	James Miller
R↓ Crisp	John Miller
J. Dahlen	J. Nevins
J↓ DeLisle	J. Nugent
E. Duggan	E↓ Olsson
J. B. Feldman	R↓ Ragan
P↓ Felleman	J. Sciegienny
S. Felix	N. Sears
J↓ Flanders (MIT/KSC)	J. Shillingfor d
J↓ Fleming	W↓ Shotwell (MIT /AC)
Eldon Hall (10)	W↓ Stameris
T↓ Hemker (MIT/NAA)	J. Suomala
D↓ Hoag	R. Weatherbee
L. B↓ Johnson	L. Wilk
M. Johnston	M↓ Wolff
A. Koso	R. Woodbury
A. Laats	W. Wrigley
L. Larson	Apollo Library (2)
S↓ Laquidara (MIT/ FOD)	MIT/IL Library (6)

External:

W. Rhine (NASA/ MSC) (2)
NASA/RASPO (1)
T. Heuermann (GAEC/ MIT) (1)
AC Electronics (3)
Kollsman (2)
Raytheon (2)
Major H. J. Wheeler (AFSC/MIT) (1)

MSC: (25 + 1R)
National Aeronautics and Space Administration
Manned Spacecraft Center
Apollo Document Distribution Office (PA2)
Houston, Texas 77058

LRC: (2)
National Aeronautics and Space Administration
Langley Research Center
Hampton, Virginia
Attn: Mr. A. T. Mattson

GAEC: (3 + 1R)
Grumman Aircraft Engineering Corporation
Data Operations and Services, Plant 25
Bethpage, Long Island, New York
Attn: Mr. E. J. Stern

NAA: (18 + 1R)
North American Aviation, Inc.
Space and Information Systems Division
12214 Lakewood Boulevard
Downey, California
Attn: Apollo Data Requirements AE99
Dept. 41-096-704 (Bldg 6)

NAA RASPO: (1)
NASA Resident Apollo Spacecraft Program Office
North American Aviation, Inc.
Space and Information Systems Division
Downey, California 9 0241

ACSP RASPO: (1)
National Aeronautics and Space Administration
Resident Apollo Spacecraft Program Officer
Dept. 32-31
AC Electronics Division of General Motors
Milwaukee 1, Wisconsin
Attn: Mr. W. Swingle

Defense Contract Administration (1)
Service Office, R
Raytheon Company
Hartwell Road
Bedford, Massachusetts 01730

Mr. S. Schwartz
DOD, DCASD, Garden City
605 Stewart Avenue
Garden City, L. I. , New York
Attn: Quality Assurance

(1)

Mr. DJ FJ Kohls
AFPRO (CMRKKK)
AC Electronics Division of General Motors
Milwaukee 1, Wisconsin 53201

(1)

SEP 9 9 2003

RETROSPECTIVE
COLLECTION

MAR 9 1990

JAN 8 3 '95

JAN 0 2 '97

JUN 0 2 1999