

MASSACHUSETTS INSTITUTE OF TECHNOLOGY

APOLLO

GUIDANCE AND NAVIGATION

Approved: Milton B. Trageser Date: 5/1/64
MILTON B. TRAGESER, DIRECTOR
APOLLO GUIDANCE AND NAVIGATION PROGRAM

Approved: Roger B. Woodbury Date: 5/1/64
ROGER B. WOODBURY, DEPUTY DIRECTOR
INSTRUMENTATION LABORATORY

To be presented May 6, 1964 at the 4th Session
of the 10 th Annual Meeting of the American
Astronautical Society, New York, N. Y.

R-445
Technical Development Status of
Apollo Guidance and Navigation
by
Norman E. Sears
April 1964

MIT INSTRUMENTATION
LABORATORY

CAMBRIDGE 39, MASSACHUSETTS

COPY # 202

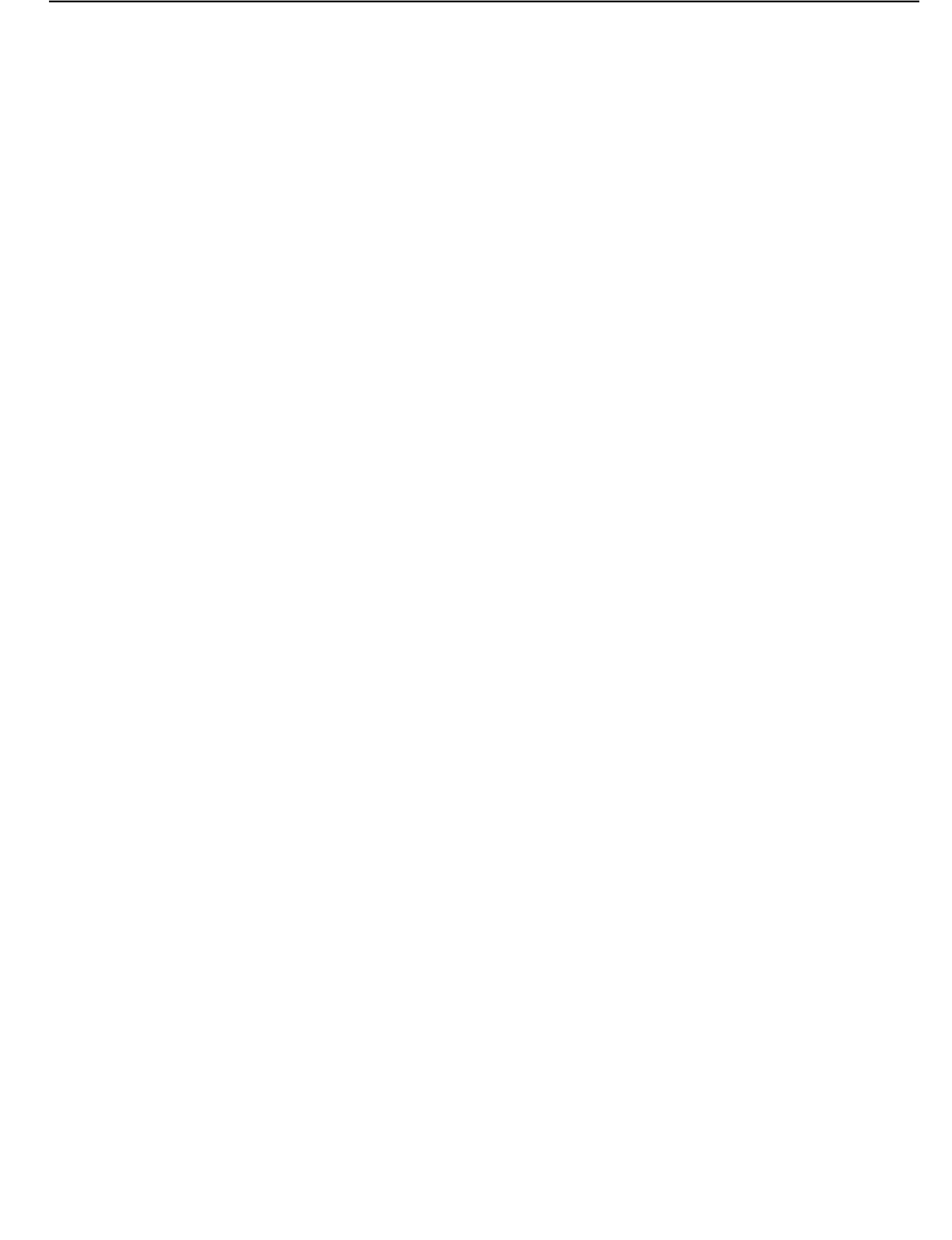

ACKNOWLEDGMENT

This report was prepared under DSR Project 55 -191, sponsored by the Manned Spacecraft Center of the National Aeronautics and Space Administration through Contract NAS 9-153.

The publication of this report does not constitute approval by the National Aeronautics and Space Administration of the findings or the conclusions contained therein. It is published only for the exchange and stimulation of ideas.



TECHNICAL DEVELOPMENT STATUS OF APOLLO GUIDANCE AND NAVIGATION

Norman E. Sears*

A general description and review of the primary guidance and navigation system is made for installations in the Apollo Command Service Modules and Lunar Excursion Module. The guidance and navigation system operating procedure is then described for the lunar orbit phases of the Apollo mission. These mission phases are primarily concerned with the Lunar Excursion Module operations from orbital descent, through landing, ascent and rendezvous. The lunar orbit navigation phase in the Command Module is included since it establishes the initial inputs for the Lunar Excursion Module guidance system. In the description of the lunar orbit phases of operation, the general guidance concepts are briefly described, and the manner in which the particular guidance and navigation system units are used by the astronauts to achieve the required objectives of the individual phases is then outlined.

INTRODUCTION

The objective of this paper is to describe and review the current status of the primary guidance and navigation (G&N) systems in the Command and Service Modules (CSM) and in the Lunar Excursion Module (LEM). The installation of the primary G&N system in these two vehicles is currently in the detailed design phase. A description of the G&N system in the CSM, and its operation in the various phases of the Apollo mission with the exception of LEM lunar phases has been previously presented in Ref. 1. A brief review of this system, and the LEM G&N installation is described in the following section. The primary G&N system operation during the lunar orbit phases of the Apollo lunar landing mission is then presented in order to complete the operations

* Assistant Director of the Apollo Program, Massachusetts Institute of Technology, Instrumentation Laboratory, Cambridge, Massachusetts.

outlined in Ref. 1. The lunar orbit phases considered are primarily concerned with the LEM primary G&N operation from orbital descent, through landing, ascent and rendezvous. CSM G&N operation for the lunar orbit navigation phase is included since it establishes the initial data inputs for the LEM G&N system. Knowledge of the CSM orbital ephemeris is also an important parameter used in the LEM launch and rendezvous mission phases. The CSM maintains this orbit navigation mode of operation along with a monitoring function throughout the LEM phases of the nominal landing mission. In the description of the lunar orbit phases of operation, the general guidance concepts are briefly described, and the manner in which the particular G&N system units are used by astronauts to achieve the required objectives of the individual phases is then outlined.

PRIMARY GUIDANCE AND NAVIGATION SYSTEM DESCRIPTION AND INSTALLATIONS

The primary G&N system consists of the following basic units in CSM and LEM installations:

<u>CSM Installation</u>		<u>LEM Installation</u>	
IMU	Inertial Measurement Unit	IMU	Inertial Measurement Unit
AGC	Apollo Guidance Computer	LGC	LEM Guidance Computer
PSA	Power Servo Assembly	PSA	Power Servo Assembly
CDU	Coupling Data Units	CDU	Coupling Data Units
SXT	Sextant	AOT	Alignment Optical Telescope
SCT	Scanning Telescope	D&C	Display and Controls
D&C	Display and Controls	RR	Rendezvous Radar
RR	Rendezvous Radar	LR	Landing Radar

Grumman Aircraft Engineering Corporation is the contractor for the rendezvous and landing radars for these installations. The other G&N units listed are being designed and developed by the MIT Instrumentation Laboratory with associate contractors: AC Spark Plug, Sperry Gyroscope Company, Raytheon Company and the Kollsman Instrument Corporation. A general description of the basic units of the primary G&N system is as follows:

IMU, Inertial Measurement Unit

The inertial measurement units are identical in the CSM and LEM installations and are the primary inertial sensing device on both vehicles. Three gyros and three accelerometers are mounted on the innermost gimbal of a three degree-of-freedom **gimbal** structure. This inner gimbal assembly is shown in Fig. 1 and the current **IMU** mock-up is shown in Fig. 2. External forces acting upon the vehicles are sensed by the accelerometers of this unit, which produce signals representing incremental changes in vehicle velocity. Signals proportional to changes in the attitude of the vehicles are generated by the three gimbal angle resolvers of the **IMU** and are transmitted to the computer through the coupling data units (CDU). Accelerometer outputs are transferred directly to the computer.

AGC , LGC Guidance Computers

The primary G&N guidance computers installed on the CSM (AGC) and LEM (LGC) are identical basic units differing only in fixed programming, installation, and external covers. A CSM installation mock-up of the AGC is illustrated in Fig. 3. This configuration incorporates removable trays made up of plugged modules. The four trays shown in Fig. 3 represent two complete computers since each AGC requires two trays. The computer is the data processing center of the guidance and navigation system. It is a general purpose, parallel, fixed point, one's complement digital computer having a large fixed core memory for guidance programs. It has an additional erasable ferrite core memory sufficient to meet the operational requirements of all mission phases. Basic word length of the computer in parallel operation is 15 bits plus an added bit for parity check with routines for double and triple precision as required. Angle inputs to the computer from the **IMU**, optics and radar units are through the **CDUs**. Direct inputs to counters in the computer are made from the **IMU** accelerometers, and the radar range and velocity tracking networks. Discrete input and output signals inform and allow the computer to control various G&N modes of operation. Astronaut inputs and commands are made through a data entry keyboard on the control panel. The major outputs of the computer are direct engine commands, and thrust angle commands

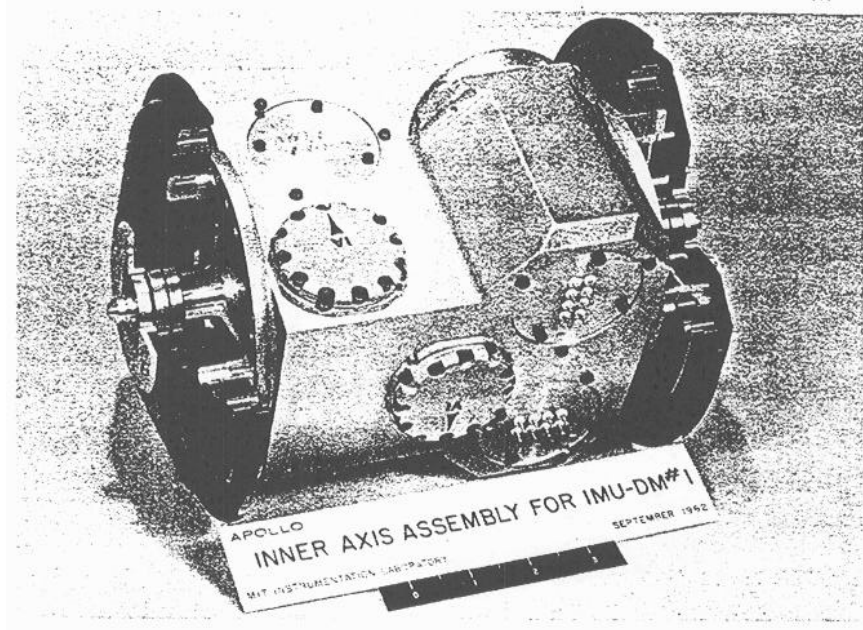

22938 Fig. 1 Inner Axis Assembly for IMU-DM #1

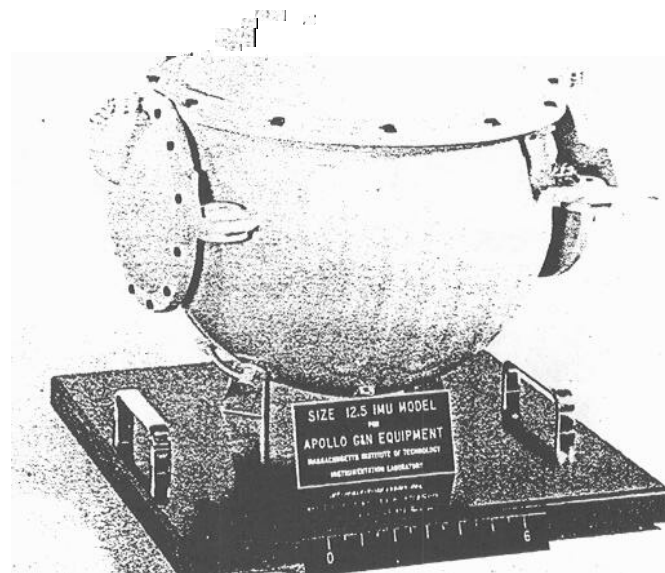

29642 Fig. 2 Size 12.5 IMU Model

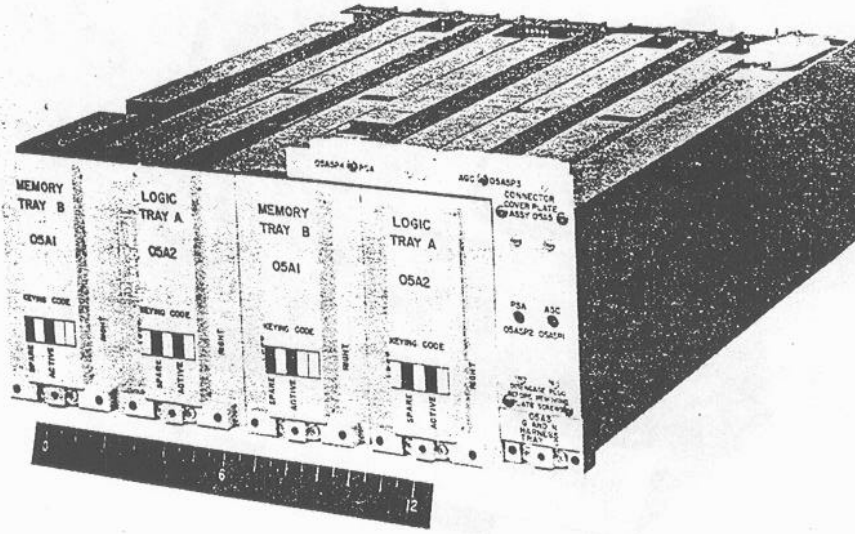

Fig. 3 Apollo Guidance Computer 5A1

27042

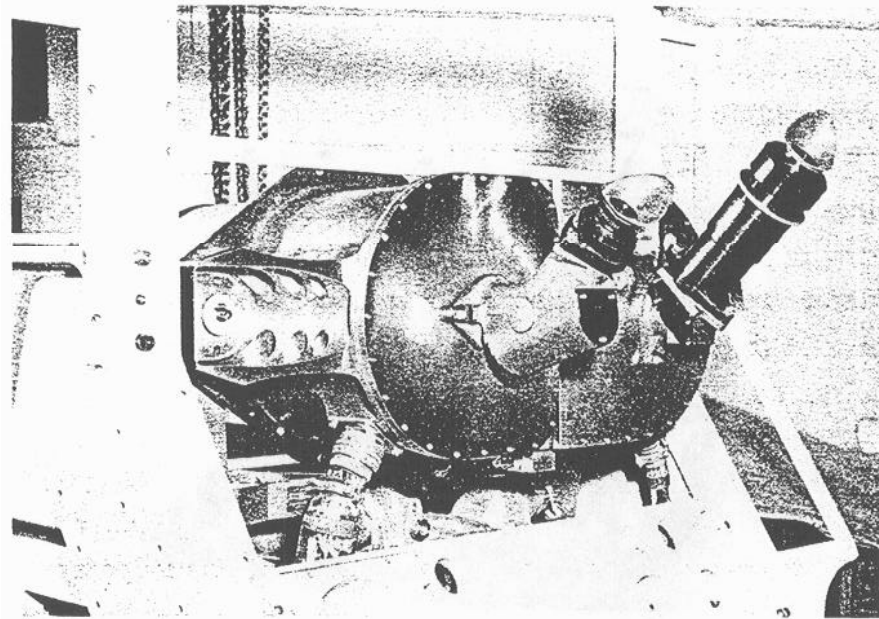

Fig. 4 Optics for Apollo G&N

29605

through the CDUs to the vehicle stabilization and control system (SCS). Radar pointing angles are also commanded through CDUs. The computer display panel is the major astronaut monitoring unit for the G&N system.

PSA Power Servo Assembly

The power servo assembly is a support item and is used in all operations involving the IMU and AGC. It provides various levels and types of d. c. and a. c. power to the rest of the G&N system. In addition, it serves as a location for various other support electronics such as the servo control amplifiers for the IMU and optics drives. The CSM installation of the PSA is directly above the AGC units (Fig. 6). LEM and CSM PSA units are essentially identical except for installation.

CDU Coupling Data Unit

The coupling data units are used to transfer angular information between the guidance computer and the IMU, optics, rendezvous radar and the vehicle stabilization and control system. The CDU is essentially an analog-digital conversion device. The three IMU CDUs in the CSM and LEM installations are identical units. The CSM installation involves two optics CDUs which are used to couple both the optical (SXT and SCT) angles and rendezvous radar angles to the AGC by appropriate mode switching. The LEM installation does not involve articulating optics (AOT), and, therefore, uses two radar CDUs to couple rendezvous radar command and tracking angles. These two LEM radar CDUs are identical to the IMU CDUs.

SXT Sextant, SCT Scanning Telescope

These two optical units are mounted with the IMU on a rigid framework, called the navigation base, in the CSM installation. The SXT is a two line-of-sight instrument used for translunar midcourse navigation angle sightings. It is a narrow field, high power instrument with two degree-of-freedom articulation. The SCT is a single line-of-sight, unity power instrument of wide field used for general viewing and earth and lunar landmark sightings during orbital navigation phases. The SCT can be made to look directly along its main optical axis, or to follow the same two degree-of-freedom line-of-sight of the SXT for

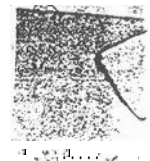

use as a recognition and acquisition aid. Both SXT and SCT are operated in the CSM by two optics CDUs, one for each degree of freedom. A picture of the SXT and SCT as seen from the navigation station is shown in Fig. 4. Installation of this unit in CSM with other G&N units is shown in Fig. 5.

D&C Display and Controls

A G&N display and control mock-up is shown in Fig. 6 for the CSM lower equipment bay installation. A map and data viewer is located in the top center of the figure. This unit is a projection system using film cartridges that can be motor driven. Star charts, maps, emergency procedures and general information are stored in film cartridges for use in this unit.

The center installation, second from the top in Fig. 6, is the SXT and SCT eyepieces, left and right respectively, with the optics display and control panel located directly below. Operation of these units is described in Ref. 1 along with the IMU control panel shown on the left in Fig. 6.

The computer display and control is shown on the right in Fig. 6. The communication between the astronaut and computer is accomplished with this unit. The computer display, top right, consists of three, two-digit displayed numbers labelled "program", "verb" and "noun" and three, five-digit general word, read-out displays. The two-digit displays are coded for various modes and instructions. The "program" display indicates the major operation mode of the computer such as "lunar landing maneuver". The "verb" and "noun" displays are used together and coded to give numerous possibilities of meaningful phrases or instructions. Examples of typical verb and noun combinations are:

Verb	Noun
Display Value	Velocity
Compute	Abort Velocity
Read In	Landmark Angle

When the computer wishes to communicate a request for data, or signal an alarm to the astronaut, the "verb" and "noun" numbers flash

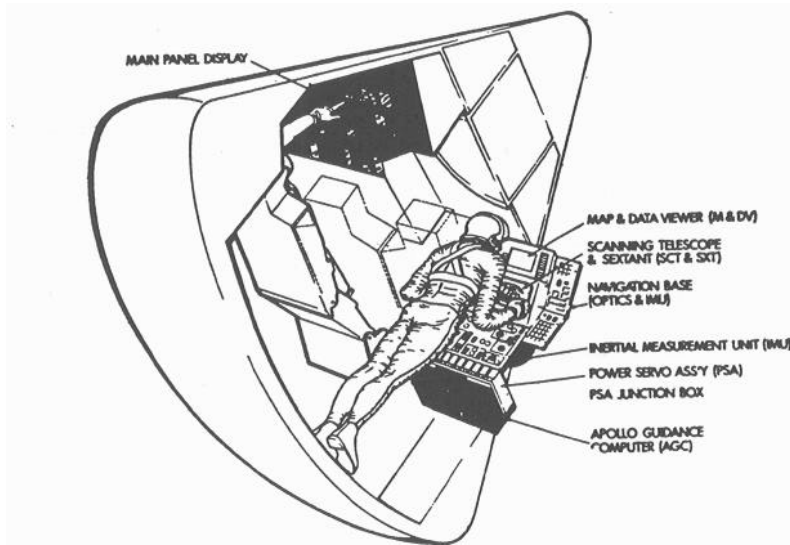

30495
25040

Fig. 5 CSM Spacecraft Installation

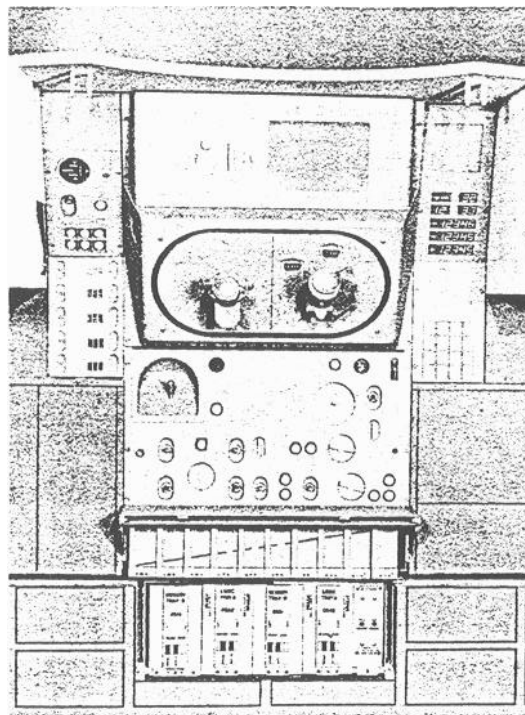

29790

Fig. 6 Navigation Station

until the astronaut takes action. The astronaut enters data to the computer through the 12 button keyboard control directly below the computer display in Fig. 6. A slightly abridged version of the computer control and display unit is mounted on the main display area of the CSM between the center and left astronauts, and operates in parallel with the unit in the lower equipment bay.

A possible primary G&N display configuration in the LEM is shown in Fig. 7. The main LGC display and control panel is the same as that described for the CSM, and is located between the two astronauts at hand level. The IMU control is located to left of the commander, and CDU control panel is incorporated in the main display area as shown.

AOT Alignment Optical Telescope

The optical subsystem in the LEM installation is different from that in the CSM in that a single, non-articulating telescope is used for IMU alignment. This is a unity power instrument with wide field of view, and can be positioned in three distinct viewing positions or a fourth position for storage during non-use. The AOT has a manually rotated reticle with visual read-out. This reticle is shown in Fig. 8, and consists of a radial orientation line with a superimposed spiral. The IMU alignment operation on the lunar surface using the AOT reticle is also illustrated in Figs. 8 and 9. The first measurement in the alignment requires the astronaut to position the orientation line on the reference star as shown in Fig. 8, and then read the orientation angle into the LGC through the computer keyboard. The second measurement continues the rotation of the AOT reticle until the alignment star is coincident with the spiral (Fig. 8) and the second angle then read into the LGC by the astronaut. This operation is repeated for at least two stars. The LGC then computes the proper IMU gimbal orientation and orients the IMU to the desired course alignment through the CDUs as shown in Fig. 9. The final fine alignment is then made by directly torquing the IMU gyros from the LGC until the desired alignment is achieved. A similar procedure is used to align the IMU while in orbit, except that only the orientation reticle line is used as the vehicle SCS limit cycle operation holds the motion of the alignment star in some pattern which intersects the reticle. The astronaut "marks" appropriate

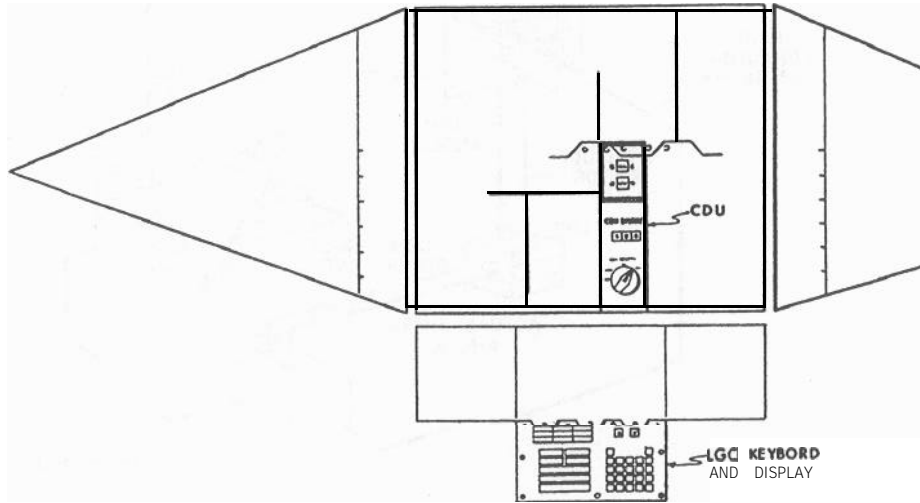

30496

Fig. 7 Preliminary LEM D&C Installation

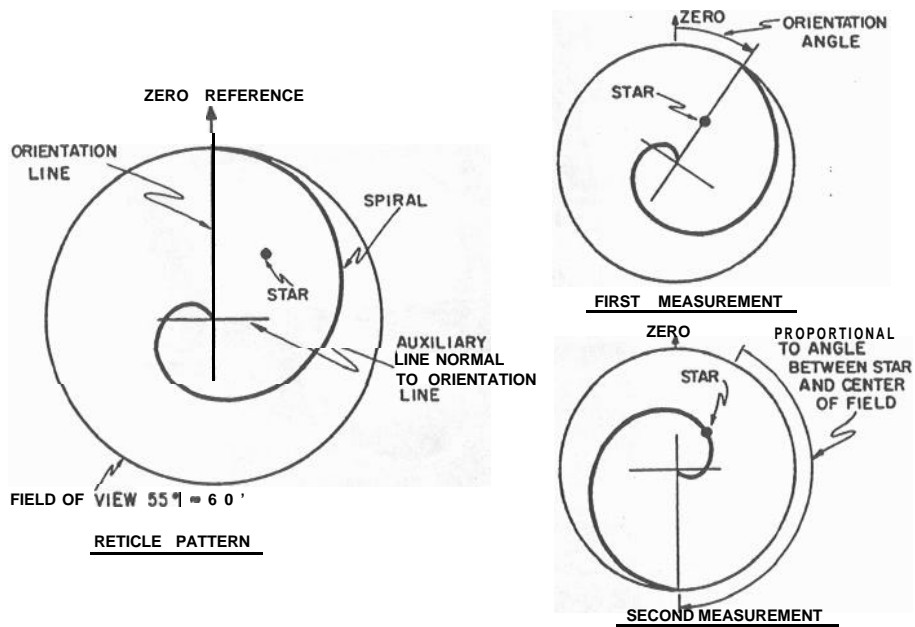

30477

Fig. 8 AOT Reticle Pattern Lunar Surface IMU Alignment

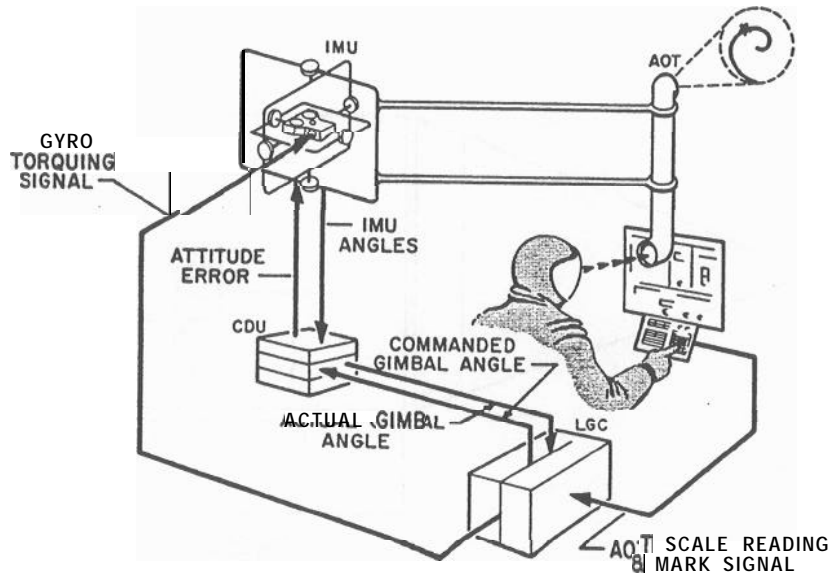

Fig. 9 LEM IMU Alignment

30974

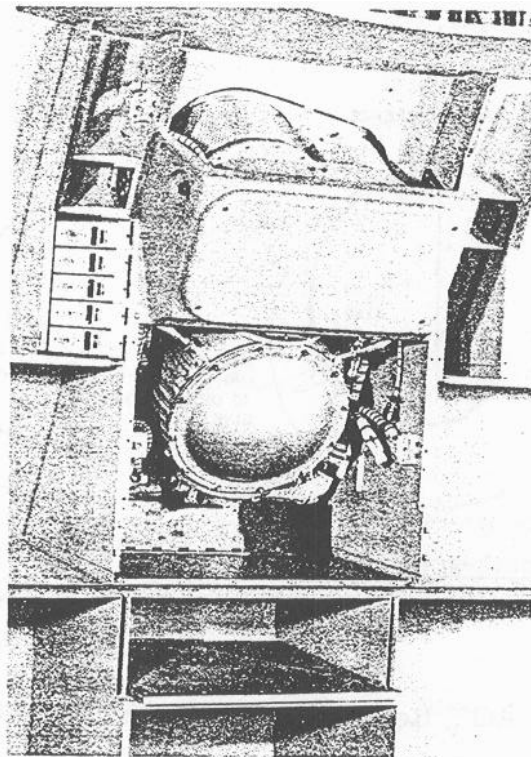

Fig. 10 Optics and IMU Installed in CSM Lower Equipment Bay

27037

star crossings on this line after course alignment is made, so that the LGC can compute appropriate torquing signals to the IMU gyro for the fine alignment.

RR Rendezvous Radar

The rendezvous radar is a tracking radar which normally operates against a transponder unit on the other vehicle. Virtually identical RR units will be installed on the LEM and CSM. Basic inputs to LGC from the RR will be tracking angles, range and range rate signals.

LR Landing Radar

The landing radar will be installed on the LEM and will provide the LGC altitude and velocity signals during the powered landing maneuver. The landing radar uses a four beam antenna array. Three beams are used for CW velocity sensing, and the fourth beam provides altitude in a FM-CW mode (Ref. 2).

Primary G&N Installations

A general diagram of the G&N installation in the CM was shown in Fig. 5. A photograph of the installation mock-up of the optics and IMU in the lower equipment bay is shown in Figs. 10 and 11. In Fig 10, the optics, without the eyepieces installed, appear above the spherical IMU. Both are mounted to the rigid navigation base as shown in Fig. 11. The bellows units for the optics penetration of the CM pressure hull are visible in both these figures. The display and control mock-up of Fig. 6 illustrates the detailed primary G&N installation as seen in the CM lower equipment bay.

A current possible G&N installation in the LEM ascent stage is shown in Fig. 12. The IMU and AOT are mounted above and between the two astronauts. These two units are mounted on the same structure supporting the back-up guidance attitude reference and rendezvous radar as shown. The astronaut position shown in this figure is between the normal two positions behind each window. This third position is used during IMU alignment with the AOT. The LGC display and control panel (Fig. 7) is within reach of all three positions. A window reticle is indicated in Fig. 12, and will be described in a latter section. The computer (LGC) and PSA units are shown in the aft equipment bay.

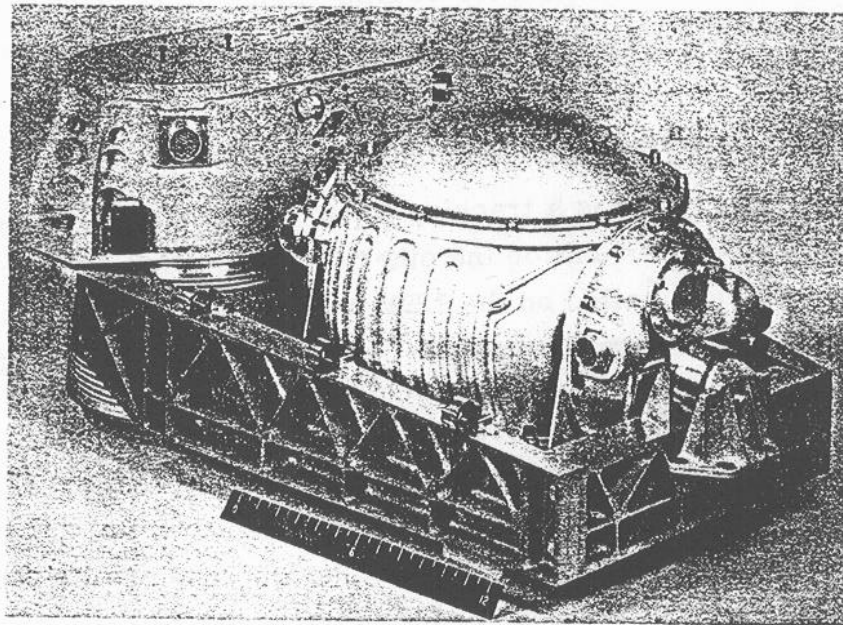

Fig. 11 Optics and IMU on Navbase

26901

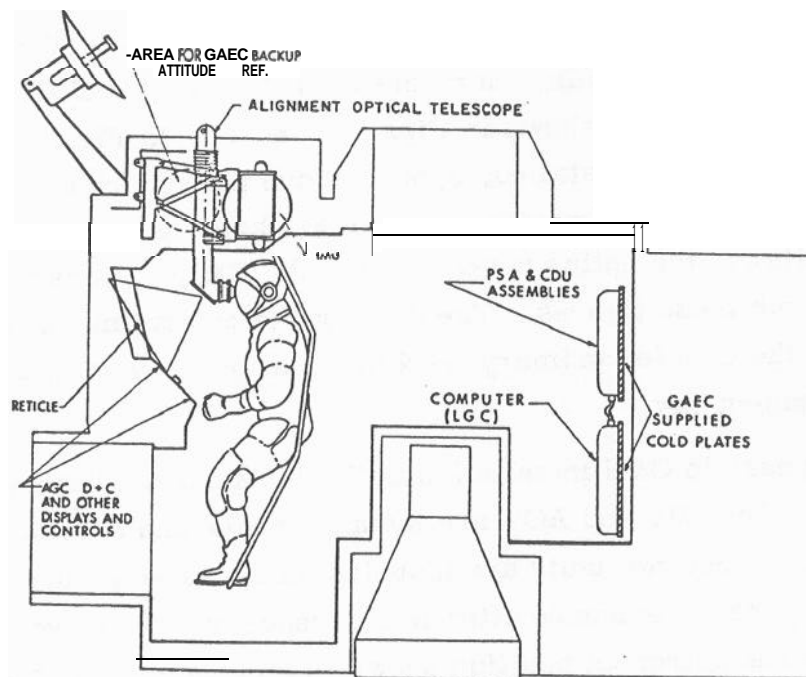

Fig. 12 LEM Primary G&N Installation

3049.3

PRIMARY G&N LUNAR ORBIT OPERATIONS

The primary G&N operation during the lunar orbit phase of the Apollo mission is described along with typical trajectories in the following sections.

Lunar Orbit Navigation Phase

The lunar orbit phase starts after the combined CSM and LEM vehicles have been injected into a near circular lunar orbit at an altitude of approximately 80 n m. The primary objectives of the G&N system is to determine this orbit with respect to a lunar coordinate system. During this process the desired landing site area is surveyed with the CSM optical units and referenced in the same coordinate system. The orbital parameters, or ephemeris, along with the landing site position are then used to determine the required timing and injection maneuver for the LEM descent orbit. The accuracy of orbit and landing site determination during this phase represents the position and velocity uncertainties from which the LEM landing phases of the mission must be initiated. As previously mentioned, the CSM continues the orbit navigation operation to keep orbit uncertainties to an acceptable level after the active LEM phases of the mission have started, since the CSM orbital ephemeris is an important parameter in general monitoring operations, LEM aborts from landing, and nominal ascent and rendezvous maneuvers. The CSM orbital navigation terminates just prior to trans - earth injection, and again the accuracy of this operation determines the initial uncertainties of this injection maneuver.

Orbit navigation is done with the CSM, G&N system. Three basic optical measurements are used in the operation as shown in Fig. 13. The SCT is used for sighting measurements of mapped lunar landmarks, horizon sightings, and orbital period measurements by timing, either the passage over an identifiable landmark or two successive occultations of a star by the lunar horizon. The general G&N system operation during lunar orbit navigation is shown in Fig. 14. The astronaut positions the SCT reticle in one of the three types of basic measurements by an optics hand controller driving the optic servo by the two CDUs as shown. These commands are monitored by the AGC starting from an initial optics zero or reference position such that SCT

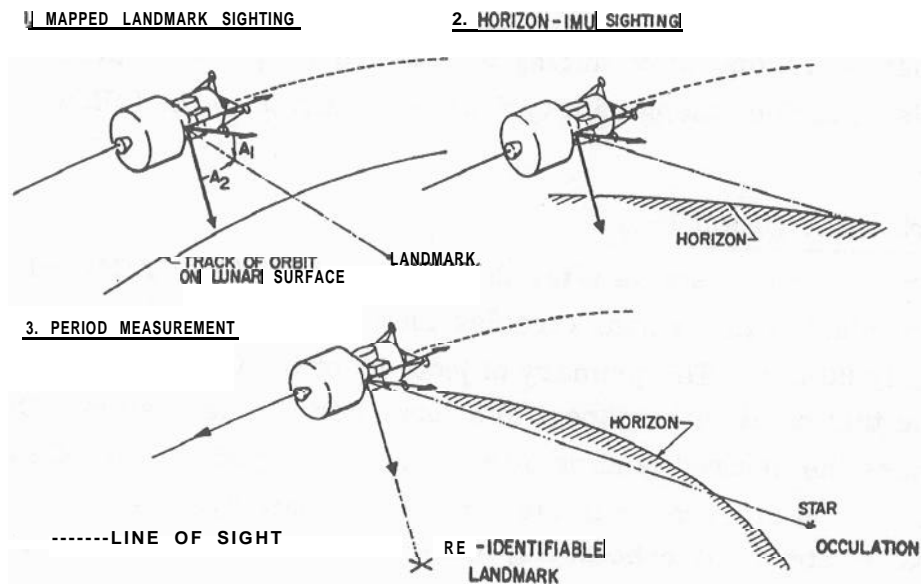

Fig. 13 Basic Optical Orbital Navigation Measurements

30479

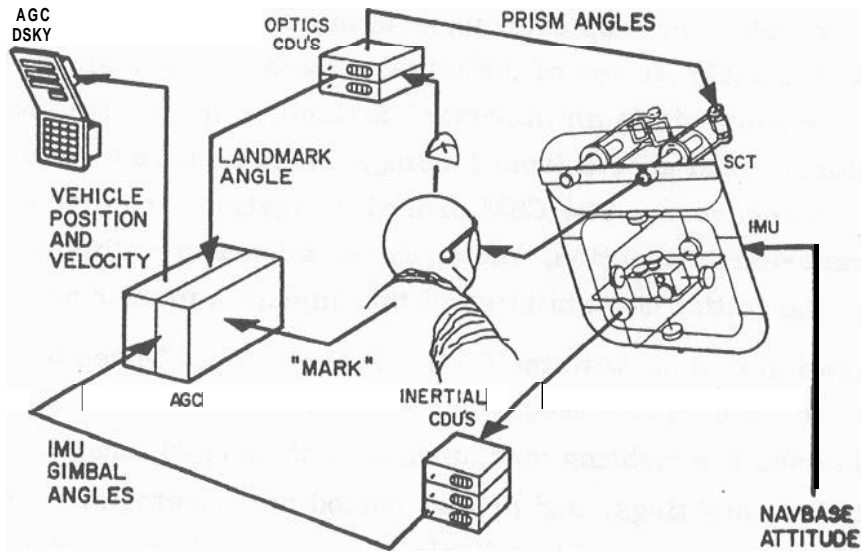

Fig. 14 Lo-w Orbit Navigation Landmark Tracking

30475

tracking angles can be continually determined from the reference position. When the astronaut has centered the SCT reticle, he "marks" this event by a discrete signal from the AGC keyboard. The AGC then determines the angle between the SCT tracking line and IMU. This angle is the basic input to the orbit navigation computation.

The orbit navigation computation is essentially identical to that of the translunar midcourse navigation technique described in Ref. 3. The adaptation of this navigation technique to the orbital navigation problem was presented in Ref. 4 and is shown in simplified form in Fig. 15. The current estimated vehicle position vector (\underline{r}) and velocity vector (\underline{v}) are determined by integration of the vehicle equations of motion. When a navigation measurement such as a landmark sighting is to be made, an estimate of the angle to be measured, \hat{A}_{SL} , is computed on the basis of current vehicle position and stored landmark coordinates. The actual angle measured, \tilde{A}_{SL} , is then compared with this estimate to establish the measurement deviation $\delta \tilde{A}_{SL}$. A statistical weighting vector, \underline{W} , is generated from a prior knowledge of nominal trajectory uncertainties, optical tracking performance, and a geometry vector \underline{b} based on the type of measurement being made. This weighting vector is defined such that a statistically optimum linear estimate of the deviation of the vehicle position $\delta \underline{r}$, and velocity $\delta \underline{v}$ from the estimated orbit or trajectory is obtained when the weighting vector is multiplied by the measurement deviation $\delta \tilde{A}_{SL}$. The deviation $\delta \underline{r}$ and $\delta \underline{v}$, are then added to the vehicle position and velocity estimates respectively to form a new orbit estimate. This procedure is repeated for each navigation measurement until orbital uncertainties are reduced to an acceptable level.

The general procedure shown in Fig. 15 is used in all unpowered portions of the CSM and LEM mission phases. Any type of valid tracking data or measurement can be used such as range, range rate, optical or radar tracking angles.

Descent and Landing Phase

A general descent trajectory profile for the LEM is illustrated in Fig. 16. This particular descent orbit is a Holmann type trajectory which is one of several possible trajectories that have been considered. With

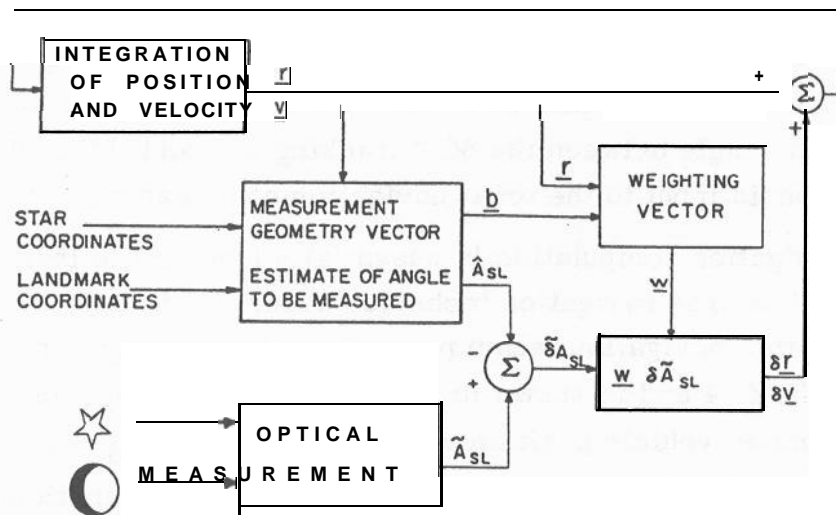

$\frac{\delta r}{\delta v}$ VARIATION IN MEASURED QUANTITY RESULTING FROM VARIATIONS IN COMPONENTS OF \underline{r} & \underline{v}

Fig. 15 Coast Phase Navigation

3 0492

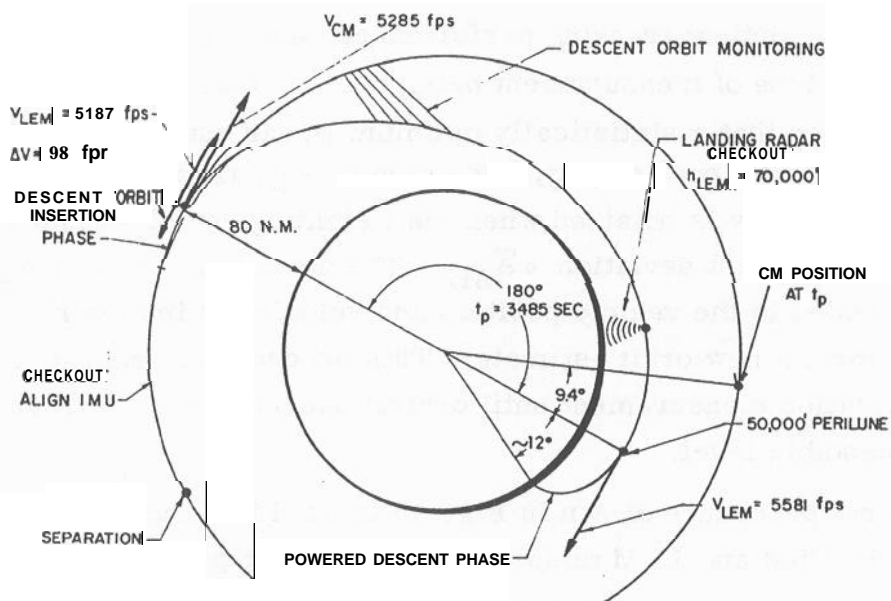

Fig. 16 LEM Hohmann Descent Orbit

30476

reference to Fig. 16, the general G&N operation during this phase of the landing mission includes final IMU alignment after LEM separation and prior to the descent injection maneuver which was determined in the preceding orbit navigation phase. After LEM injection into the descent orbit, the G&N system on both vehicles monitor, or check, the descent trajectory by a technique similar to that outlined in Fig. 15 except that rendezvous radar tracking data is used instead of optical angles. Prior to the final powered landing maneuver the LEM landing radar may be checked against the lunar terrain as shown in Fig. 16. For the type of descent trajectory shown in this figure, the CSM is positioned 9.. 4degrees behind the LEM when it initiates the powered landing maneuver at the perilune of the descent trajectory.

The LEM powered landing maneuver has been divided into three major phases illustrated in Fig. 17 as the inertial phase, constant attitude phase, and finally the terminal hover and touchdown. The inertial phase is the longest with respect to time and ground range, and is controlled by the inertial guidance system. The objective of this initial phase is to achieve a position and velocity condition at the start of the second phase which will allow a near constant vehicle attitude as the LEM approaches the landing site. The general characteristic of this constant attitude phase is shown in Fig. 18. The objective of the constant attitude phase is to allow the astronaut to visibly check the landing area for the first time through the main LEM windows. This phase is controlled at reduced descent engine throttle setting to lengthen the maneuver time to about two minutes for visual and landing radar updating of the inertial guidance units. The terminal objective of the second phase is to achieve hover or zero velocity conditions over the desired landing site at some designated altitude. The final let-down and landing is initiated from this hover condition.

The guidance concept used during the inertial and constant attitude phases of the landing maneuver is an explicit solution to a two point boundary-value problem. A commanded thrust vector is determined by solution of the appropriate equations of motion subject to the initial boundary condition of the vehicle's instantaneous computed position and velocity, and the desired terminal boundary conditions at end of the

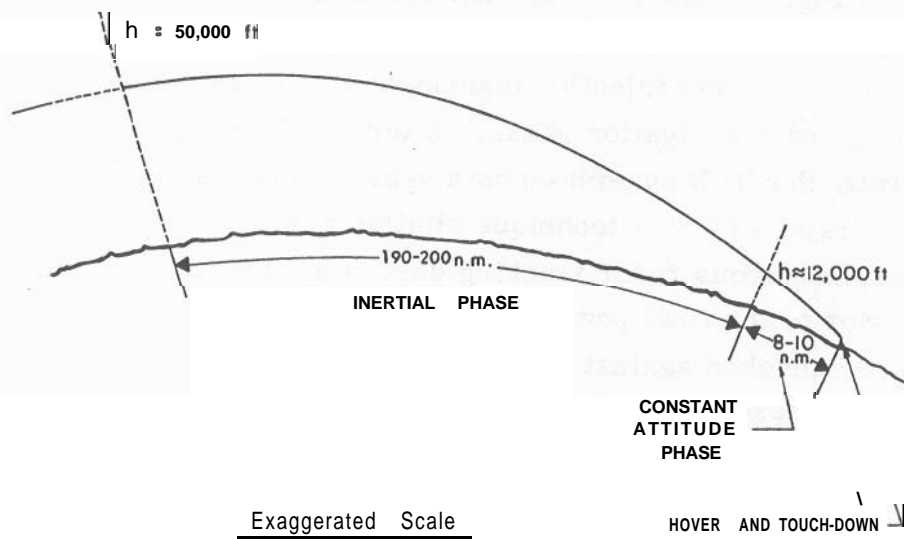

Fig. 17 Lunar Landing Maneuver Phases

30491

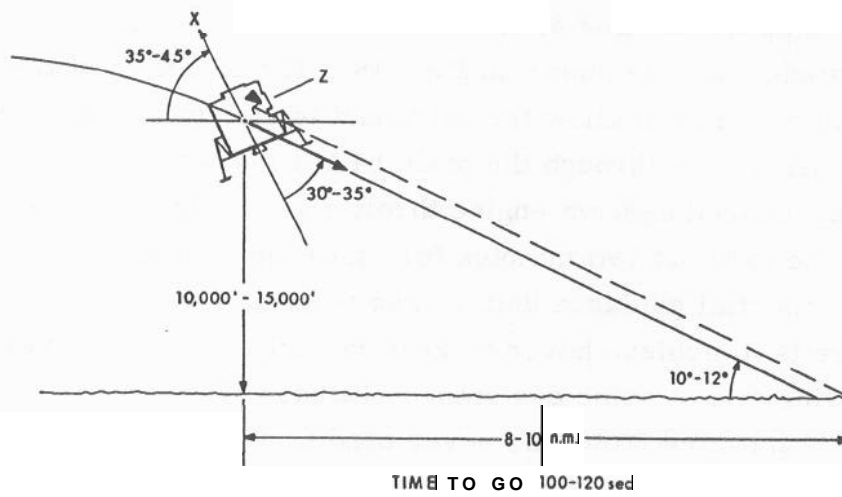

Fig. 18 Lunar Landing Maneuver - Constant Attitude Phase

30481

phase. During the inertial phase, the controlled terminal boundary conditions are a desired position and velocity vector at the start of the second phase that will allow a near constant flight angle to hover conditions. When the vehicle achieves these conditions by controlling the thrust magnitude and direction of descent engine, the desired boundary conditions are then changed to those at the hover condition (zero velocity at a desired position) for control during the second phase. This change in controlled boundary condition will immediately command a change in thrust level and direction which initiates the second phase of the maneuver.

A typical landing maneuver trajectory and thrust profile for the inertial and constant attitude phases commanded by the explicit landing equations are illustrated in Figs. 19 through 22. Figure 19 is an altitude vs range profile of the inertial phase with time indicated along the trajectory in seconds from initial engine ignition. Figure 20 is a similar plot for the second phase of the maneuver which was initiated at an altitude of 11,500 ft at a range of approximately 8 miles from the landing site. The trajectory time during the constant attitude phase lasted 115 seconds for this maneuver and maintained the near constant vehicle attitude as shown. The line-of-sight to the landing area subtended an angle with respect to the LEM-X axis (thrust axis) of 32 degrees which placed the landing site 7 degrees above the lower edge of the LEM windows.

The thrust magnitude profile commanded by the guidance system is shown in Fig. 21. The initial thrust magnitude was chosen to be near maximum by appropriate parameters in explicit equations, and was then throttled to a level of about 9,000 lbs during the inertial phase to achieve the desired terminal conditions or boundary values of the first phase. These conditions were achieved after 332 seconds at which time the desired boundary values were changed to hover position with zero velocity. The thrust magnitude was changed to slightly less than half full throttle and was essentially maintained at this level until the end of the second phase. The thrust angle profile for this landing maneuver is shown in Fig. 22. During the inertial phase the thrust direction is slowly changed from an initial negative angle (below the horizon) to a positive 17 degrees. The scale of the trajectory in Fig. 19 does not

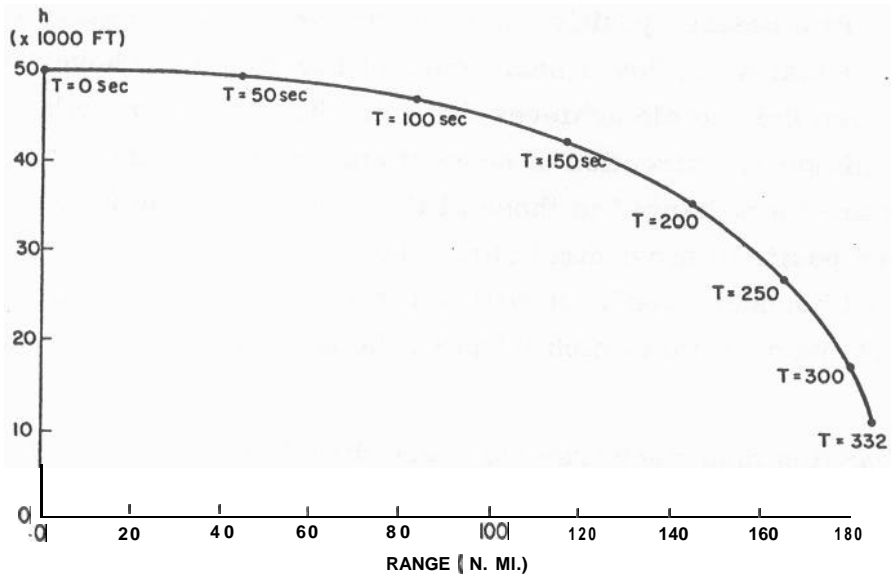

Fig. 19 Lunar Landing Trajectory Phase 1

30480

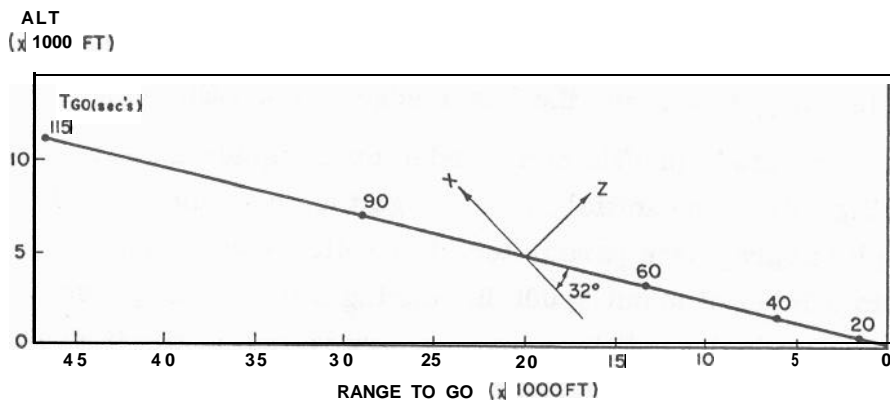
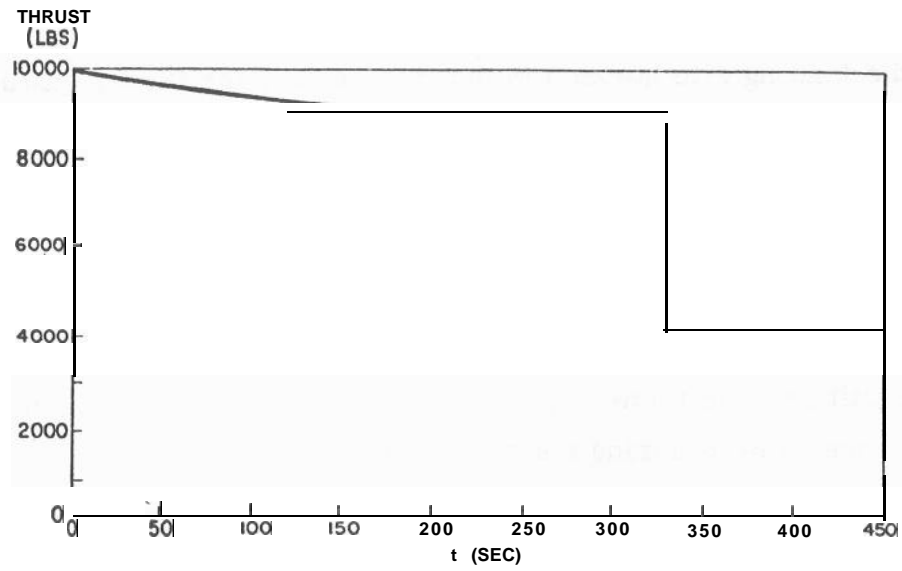
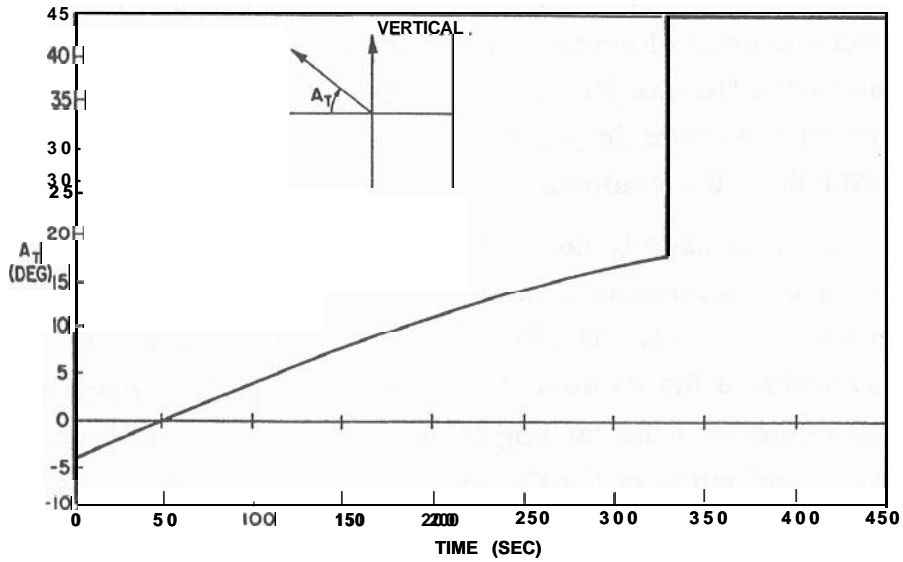

Fig. 20 Lunar Landing Trajectory Phase 2

30483



30498 Fig. 21 Thrust vs Time for Landing Trajectory



30482 Fig. 22 Thrust Angle vs Time

indicate that the ignition point of the landing maneuver is below the horizon relative to the desired landing site. Even when the LEM is above the landing site horizon in the first phase, the thrust attitude of the vehicle is such that the landing site is not visible through the current LEM window configuration. It is not until the sharp pitch-up maneuver, indicated at the start of phase 2 at 332 sec in Fig. 22, that the landing site is within visible limits as previously mentioned. The desired boundary conditions for the inertial phase are chosen relative to terminal hover position so that a near constant thrust magnitude and vehicle attitude within the window visibility limits are commanded by the guidance system during the second phase.

The primary G&N system is operated in a pure inertial configuration for control of the LEM during the initial descent orbit injection phase and the first or inertial phase of the landing maneuver. This G&N configuration is shown in Fig. 23. The guidance computer (LGC) directly monitors the IMU accelerometer outputs and commands thrust magnitude and direction to achieve the desired terminal conditions. The LGC commands the descent engine throttle servo through the LEM stabilization and control system (SCS) and the desired thrust direction through the IMU CDUs as shown. The LGC also displays maneuver parameters such as vehicle position, velocity and time to go, selected by the astronaut at the computer display panel.

The G&N system is used to control the second, or constant attitude phase of the landing maneuver in an aided inertial guidance configuration as shown in Fig. 24. The inertial portion (IMU, LGC, CDU) of this configuration is the same as that shown in Fig. 23. Altitude and velocity parameters of the landing trajectory are measured by the landing radar and compared with similar computed parameters. These four inertial or computed parameters are then up-dated on the basis of the landing radar data so that the desired terminal conditions can be achieved by the explicit guidance commands from the current improved vehicle position and velocity conditions.

The trajectory parameters not up-dated by the landing radar are horizontal position uncertainties relative to the landing site. The astronaut can monitor and change the predicted landing site by some form of

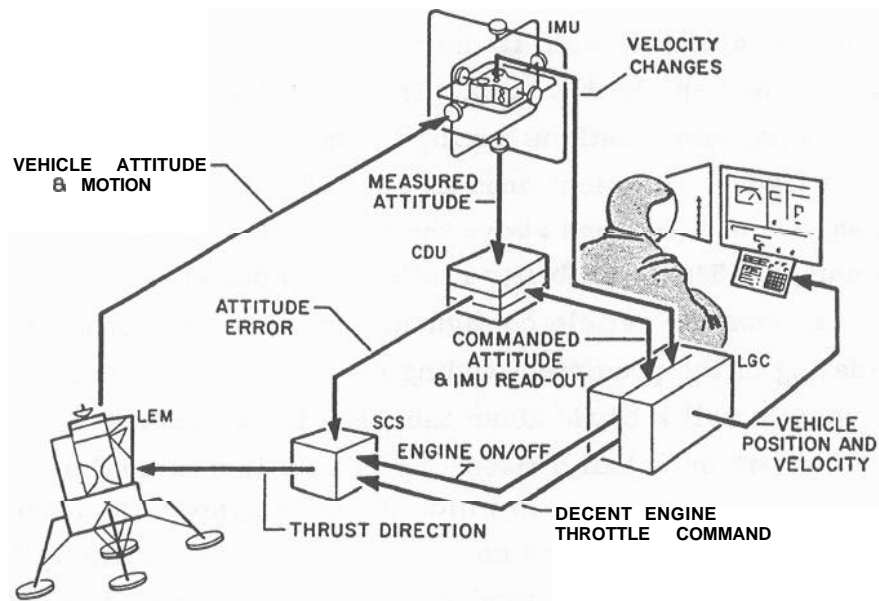

30473 Fig. 23 Descent and Initial Landing Phase (Inertial Control)

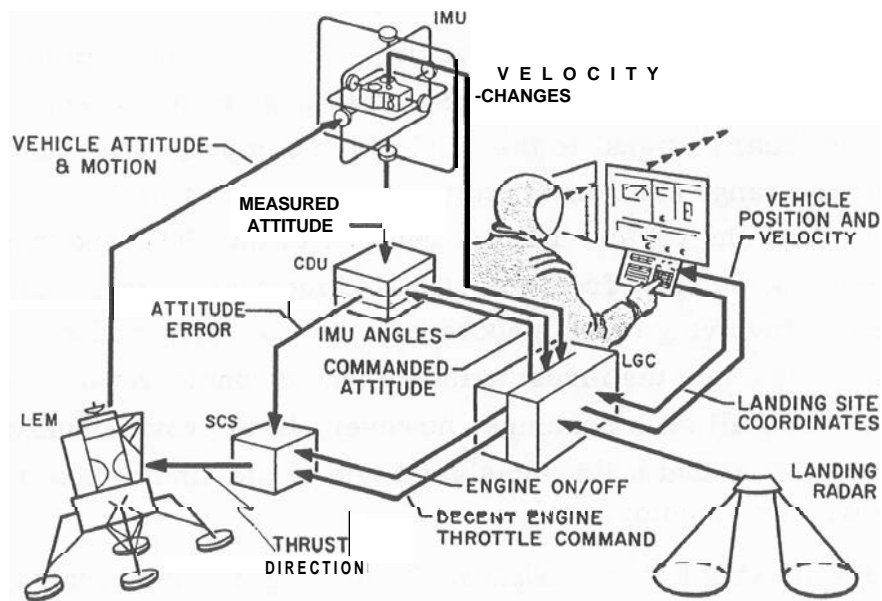

30497 Fig. 24 Final Landing Phase Maneuver Control

window reticle system and LGC display, as indicated in Fig. 24. The current LEM visibility limits are shown in Fig. 25 in which the center of the coordinate system is the nominal eye position of the astronaut parallel the vehicle + Z axis. The normal positions of the lunar horizon and landing site locations during the constant attitude phase are indicated in this figure. As mentioned in Fig. 22, landing site locations typically appear about 7 degrees above the lower edge of LEM window during this maneuver. These visibility limits are repeated in Fig. 26 with one of several possible reticle configurations for astronaut surveillance and up-dating of the predicted landing site. In this particular reticle scheme the vehicle roll attitude about the LEM thrust axis is controlled by the G&N system such that a fixed line reticle lies in the landing trajectory plane. The landing site to which the G&N system is controlling the trajectory therefore, lies on this line and LGC indicates this site to the astronaut by a two digit read-out which is referred to markings on the reticle line. This procedure assumes a normal astronaut eye position or eye register device. If the astronaut wishes to choose a landing site other than that indicated, he rolls the vehicle about the thrust axis until the vehicle line intersects the new landing site and slews the two digit read-out to correspond to a marking number on the reticle over the desired landing site. When these conditions are achieved, the astronaut sends a "mark" signal to the LGC which computes a new line-of-sight angle and range components to the landing site from the two digit read-out setting, the vehicle attitude relative to the IMU and knowledge of altitude and velocity from the up-dated inertial system. Other reticle schemes involving more elaborate reticle patterns and reduced roll maneuvers about the thrust axis are under consideration. The basic objective of all such schemes, however, is to provide sufficient data to the LGC so that a line-of-sight angle of the landing site relative to the IMU can be computed.

After achieving hover conditions and making the final landing radar up-dating of the inertial system, the final vertical descent is made, manually, automatically under IMU control, or some combination of both in a semi-automatic mode depending upon lunar surface conditions under the descent engine exhaust.

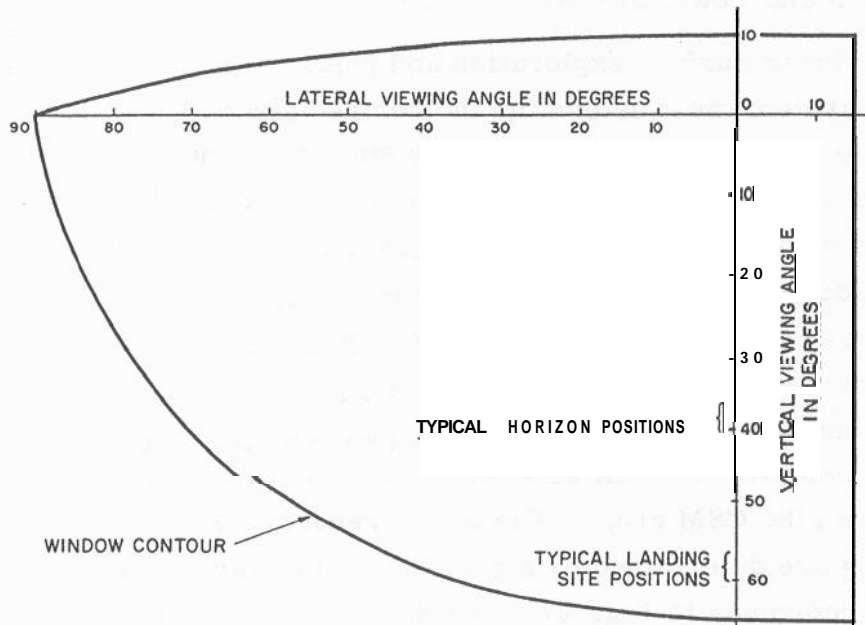

30485 Fig. 25 LEM Visibility Angle Limits

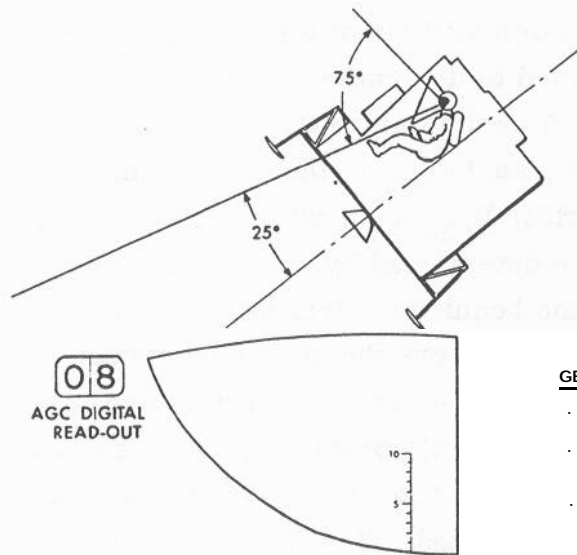

GENERAL REQUIREMENTS

- . FIXED RETICLE LINE ON WINDOW
- . EYE REGISTER DEVICE
- . AGC 2 DIGIT READ-OUT NEAR WINDOW
- . READ-OUT SLEWING SWITCH
- . X AXIS MANUAL ATTITUDE CONTROL MODE OF SCS

304818 Fig. 26 Fixed Reticle Concept for Terminal Lunar Landing Maneuver

Launch and Powered Ascent Phase

After lunar surface exploration and prior to LEM ascent, the primary G&N system must determine the **desired launch** time and ascent trajectory to terminal rendezvous. The guidance concept for ascent trajectories is a fixed aim point and time of arrival on the CSM orbit which would result in an intercept trajectory if achieved. If the lunar launch is made at the desired time, or within a designated launch window, a direct ascent is made to CSM orbit. If the launch is delayed beyond this direct ascent launch window, the LEM is injected into a parking orbit until the phasing between the two vehicles is reduced to an acceptable condition for initiation of a transfer orbit to a desired rendezvous point on the CSM orbit. The initial rendezvous aim point and launch timing are determined by a procedure summarized in Figs. 27 and 28. With reference to Fig. 27, the CSM orbit is determined by the operation previously described in the CSM and relayed to the LEM over the communication link, or by the LEM tracking the CSM with its rendezvous radar on at least one pass prior to the intended launch. The time, distance covered, and injection altitude of a typical powered ascent maneuver are known and used to determine an injection point, \underline{R}'_{LEM} and time from launch, t_1 . A particular phasing condition at injection between the LEM and CSM, angle θ_0 , is then assumed, and various aim points along the CSM orbit, $\underline{R}_{CSM}(t_A)$, with their respective times of arrival for intercept are determined by an iterative procedure. This procedure determines the required velocities at injection and rendezvous for the trajectory that covers the distance between the injection position vector, \underline{R}'_{LEM} and the aim point under investigation, $\underline{R}_{CSM}(t_A)$ in the prescribed time (Lambert's problem). Successive aim points and trajectories along the CSM orbit are computed until those that meet two requirements are determined. The first requirement is that the ascent trajectory have a minimum altitude, or perilune, of no lower than a pre-selected level such as 35,000 feet. The second requirement is that the sum of the required injection velocity, V_1 of Fig. 27, and rendezvous closing velocity, ΔV_2 , is not more than a set AV limit for direct ascents. Since nominal launch conditions will not be coplanar with the CSM orbit, there are two central angle sectors in which these requirements are met, one less than 180 degrees central angle, ϕ ,

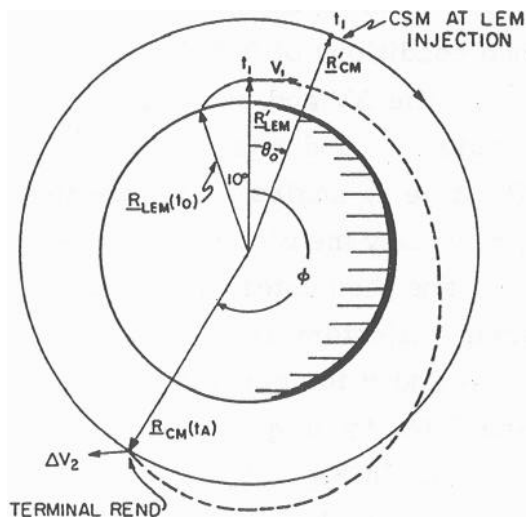

304781

Fig. 27 Launch Aim Point Determination

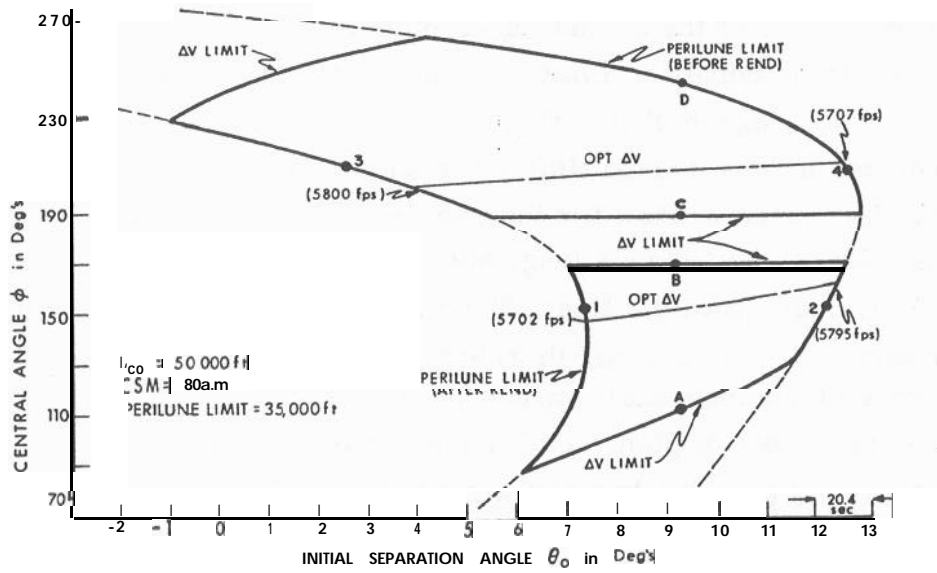

30486

Fig. 28 Lunar Launch Window $IO = 0.5^0$

from injection to aim point and the other greater than 180 degrees.

These aim point and ascent trajectory conditions are illustrated in Fig. 28 for launch conditions of 0.5 degrees (about 8 nm) out of the CSM orbital plane. The AV and perilune requirements are plotted against central angle, ϕ , and injection phase angle, θ_0 , coordinates in the figure. Positive θ_0 angles indicating the CSM ahead of the LEM. The procedure previously mentioned would assume a phase angle θ_0 , such as 9 degrees, and then determine acceptable aim points, ϕ , that meet the two ascent trajectory requirements. Acceptable aim points would lie between A and B for central angles less than 180 degrees, and between C and D for those greater than 180 degrees for the 9 degree phase angle condition. In Fig. 28 the total AV requirement is the limiting condition for the particular phase angle chosen (9 degrees). The iterative procedure is continued within the acceptable aim point zone until a minimum or optimum AV aim point is found. A simplified procedure for then determining the direct ascent launch window, involves holding the central angle ϕ constant at the optimum AV case, and then vary the phase angle θ until the limits of the launch window are determined by one of the ascent requirements. In the case shown in Fig. 28, the perilune condition limits the launch timing, points 1 to 2 and 3 to 4. Since each degree of initial phase angle between the two vehicles represents a 20.4 second time interval, or launch delay, it can be seen that the launch window for the 155 degree aim point (interval 1 to 2 of Fig. 28) is 100 seconds long, and that for the 210 degree aim point is 195 seconds, points 3 to 4. For the ascent trajectory AV and perilune criteria, it can be seen, therefore, that aim points greater than 180 degrees have essentially twice the direct ascent launch window for the 0.5 degree out of plane condition assumed in Fig. 28. A further difference between the two aim points is that the initial launch time condition of the 155 degree aim point, # 1 of Fig. 28, requires a total ideal AV of 5705 fps. As launch delay times advance from point 1 to 2, the total AV requirement increases to 5800 fps at point 2. For the 210 degree case, however, the AV requirement decreases from 5800 fps to 5710 fps at point 4. In either case, once the launch time has slipped beyond the point where the maximum phasing angles (points 2 and 4) can be achieved by a nominal powered ascent maneuver, a parking

orbit injection is required unless the launch time is rescheduled for the next CSM orbital pass.

The guidance concept used to control direct and parking orbit powered ascents is an explicit technique of the same form used in powered landing maneuver and controls the injection position and velocity conditions (final boundary values) to satisfy the aim point time of arrival conditions for direct ascents, or the altitude and injection velocity for parking orbit injection. The G&N configuration for the powered ascent is inertial as shown in Fig. 29. This configuration differs from that shown in Fig. 23 only in that the G&N system now controls the ignition and termination (engine ON, engine OFF) of a fixed thrust ascent engine. Thrust direction control is done by the RCS system commanded from the LGC through the CDUs and SCS.

A typical powered ascent maneuver profile is shown in Figs. 30 and 31. Figure 30 is an altitude-range trajectory profile with time and injection conditions indicated. Figure 31 is a thrust angle profile for this ascent maneuver. After a brief vertical rise interval of 10 seconds, the LEM is pitched at its maximum attitude rate until the commanded guidance thrust angle is achieved. This thrust angle command then slowly decreased to injection as shown.

Rendezvous Phase

The normal primary G&N rendezvous phase of the lunar landing mission starts at ascent injection and terminates at the manual docking operation. The rendezvous phase is commonly divided into midcourse and terminal maneuvers. Midcourse velocity corrections are made as soon as possible after ascent injection and continued until the terminal phase is nominally started at a range of approximately 5 nm. The G&N system objective in the midcourse phase is to establish an intercept trajectory with the CSM which is nominally at the ascent aim point at the designated time of arrival. The objective of the terminal thrust maneuvers is to control the acceleration of the LEM such that the relative velocity between the two vehicles is reduced to zero as the range closes to some desired terminal separation distance for the docking operation.

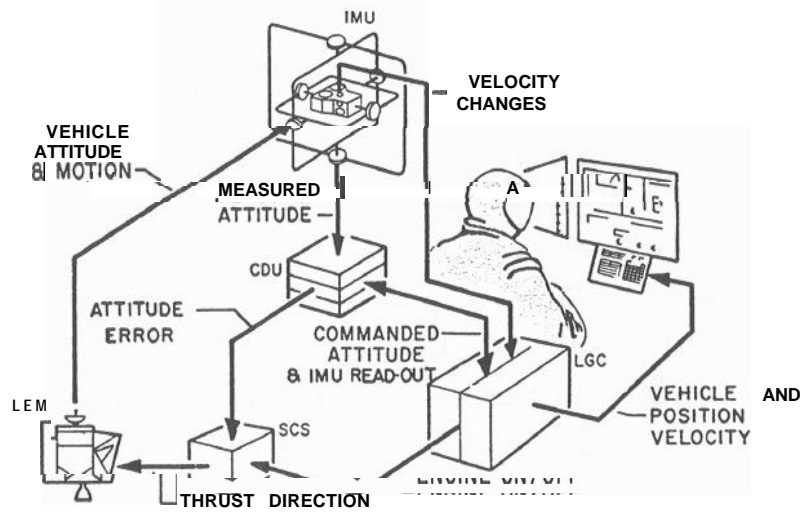

Fig. 29 Powered Ascent Maneuver

30489

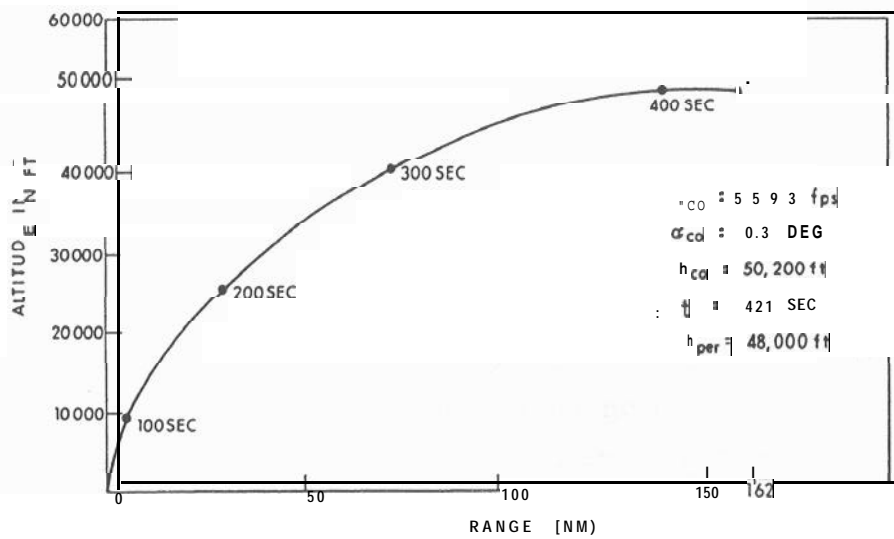
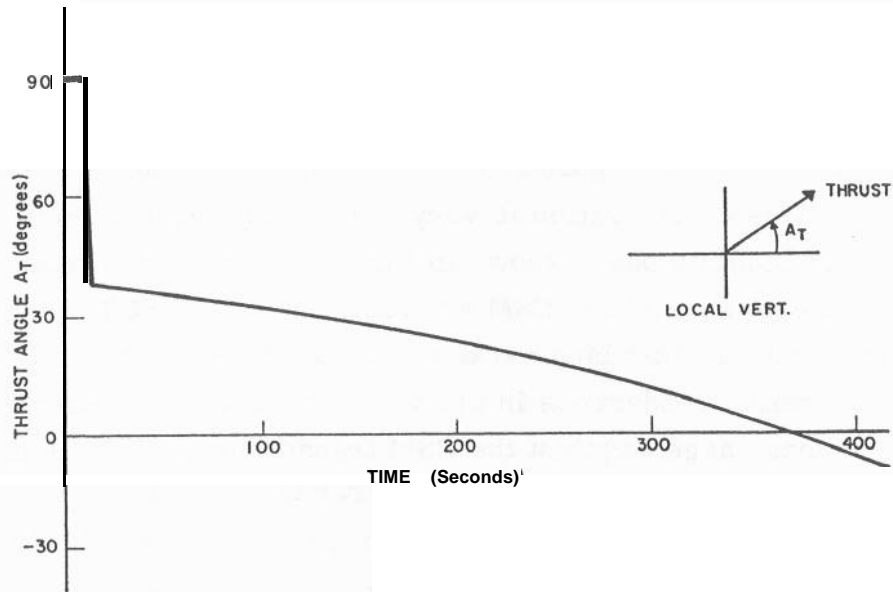

Fig. 30 Typical LEM Powered Ascent Trajectory

30490



30484

Fig. 3 1 Powered Ascent Thrust Angle History

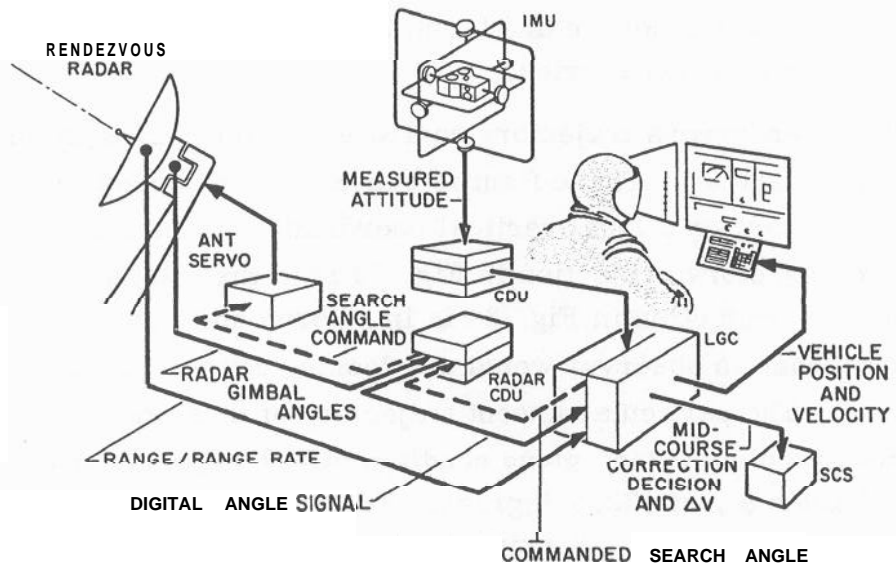

30472

Fig. 32 Rendezvous Computation Phase

The guidance concept used for the midcourse rendezvous phase is the same as that used for the midcourse translunar phase of the Apollo mission. The general navigation concept for this operation was described in the section on orbital determination.

The primary G&N configuration for the rendezvous phase is shown in Fig. 32. This configuration is very similar to that used in the CSM orbit determination phase shown in Fig. 14 except that tracking radar measurements against the CSM are made instead of SCT optical measurements against landmarks or stars. It should be noted that this is a cooperative rendezvous in the sense that radar tracking is established at long ranges against the CSM transponder. This guidance concept would use the estimated LEM trajectory parameters (Fig. 15), determined by CSM tracking data to compute the required midcourse velocity corrections to achieve an intercept trajectory. The G&N configuration for the application of these velocity corrections is the same as that shown in Figs. 23 and 29 except that the engine commands from the LGC are directed to the RCS jets through the SCS instead of the main propulsion system. Current design requires the LEM RCS jets to provide both midcourse and terminal rendezvous maneuvers for nominal mission trajectories.

A typical rendezvous trajectory controlled by the G&N system is shown in Figs. 33 and 34. These figures represent the projection of rendezvous trajectory on a local vertical coordinate system centered on CSM. The XY trajectory projection in Fig. 33 is in the CSM orbital plane, and the XZ projection in Fig. 34 is in a horizontal plane and is representative of what an observer would see looking down on the rendezvous problem. The particular ascent trajectory of these two figures was launched from an out-of-plane condition of 2.2 degrees, and covered a central angle ϕ , of 132.5 degrees. For an assumed ascent injection uncertainty condition, the LEM would miss the intended aim point, and have a point of closest approach relative to CSM of 8.5 nm as indicated by the dashed uncorrected trajectory in these two figures. The primary G&N system commanded three midcourse corrections as shown. The first midcourse correction was made nine minutes after injection at a range of 117 nm. The objective of early midcourse corrections is to

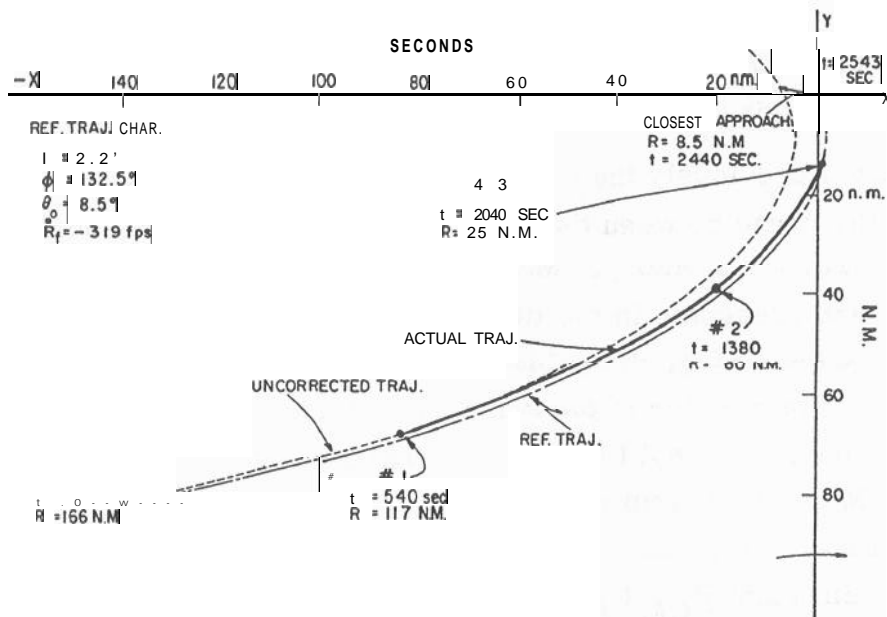

30470 Fig. 33 Rendezvous from Ascent - XY Plane Trajectory Projection

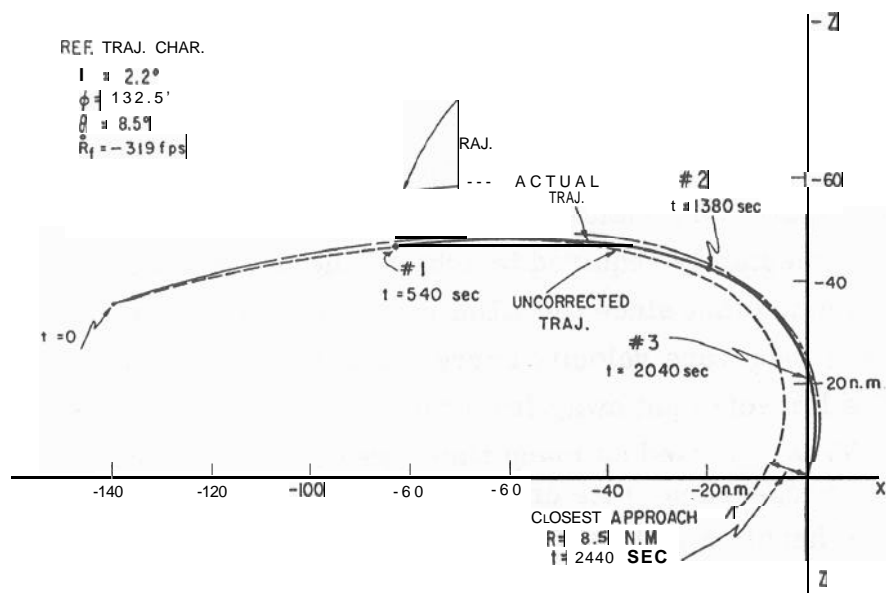

30471 Fig. 34 Rendezvous from Ascent - XZ Plane Trajectory Projection

reduce the total rendezvous AV requirement. The third and final mid-course correction was applied at a range of 25 nm after which the LEM was on an intercept trajectory which was very close, but not coincident with the original reference trajectory as shown in Figs. 33 and 34.

As stated previously the terminal rendezvous phase is normally started when the range between the two vehicles has closed to about 5 nm on the intercept trajectory. Many terminal rendezvous guidance schemes have been presented in the literature. In order to minimize additional LGC programming, the guidance concept currently planned for this phase of the mission is the same as that used in the long range or mid-course phase, except that the terminal aim point is shifted further down the CSM orbit as terminal velocity corrections are made. This concept is outlined in Fig. 35. The midcourse rendezvous phase was directed to the aim point $\underline{R}_{CM}(t_A)$ to establish the intercept trajectory. When the relative range has decreased to some selected value, a new time to go, T_{GO} , is defined as shown. The desired range rate, \dot{R}_d , at this range is chosen on the basis of range-range rate phase plane profiles that allow sufficient time for G&N tracking and computation, and astronaut monitoring. Terminal rendezvous maneuvers are normally controlled with the LEM +Z axis RCS jets allowing visible monitoring through the main windows. A new time of arrival, T_A' , is then computed as shown in Fig. 35, and a new aim point $\underline{R}_{CM}(t_A')$ defined by integrating the CSM position forward by T_{GO} . A velocity correction will be immediately required to achieve the new end condition. It might be noted that since the LEM is on an intercept trajectory, the terminal rendezvous velocity corrections will normally be directed along the line-of-sight away from the CSM. The process summarized in Fig. 35 is repeated as many times as required by the pre-selected terminal range-range rate criteria. The guidance concept is general enough to handle a wide variety of terminal $R-\dot{R}$ criteria.

The last terminal rendezvous maneuver will achieve the desired initial clocking conditions within the accuracy of the G&N system. As previously stated, final docking is manually controlled by the astronaut. After crew transfer the CSM orbital navigation mode of operation is continued until the trans-earth injection phase.

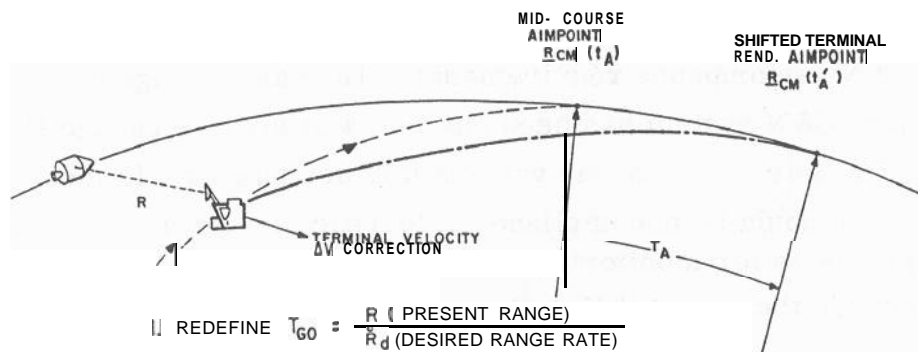

1. REDEFINE $T_{GO} = \frac{R \text{ (PRESENT RANGE)}}{\dot{R}_d \text{ (DESIRED RANGE RATE)}}$
2. TERMINAL $R-\dot{R}$ CRITERIA (FIXED SCHEDULE, PARABOLIC, ETC)
3. NEW TIME OF ARRIVAL $T_A' = \text{TIME} + T_{GO}$
4. INTEGRATE ORIGINAL AIMPOINT $R_{CM}(t_A)$ AHEAD BY T_{GO} FOR NEW AIMPOINT $R_{CM}(t'_A)$
5. PROCESS REPEATED UNTIL DESIRED TERMINAL CONDITIONS ARE ACHIEVED BY $R-\dot{R}$ CRITERIA

30487

Fig. 35 Terminal Rendezvous Phase

In **summary**, the primary G&N system operation and guidance concepts for the lunar orbit phases of the Apollo mission are very similar to those of the other mission phases. The basic primary G&N systems in the LEM and CSM are essentially identical except for the optical subsystem and landing radar installation. The guidance concept for all **unpowered** phases of operation, i. e. translunar, orbit determination and rendezvous, is based on the statistical navigation **concept** of Ref.' 3. Many of the powered maneuvers are controlled by guidance concepts that are similar to each other such as injection into the descent orbit, powered ascent, and midcourse corrections. The notable exception is the powered landing maneuver which involves special vehicle attitude and G&N performance requirements. The basic design approach to the primary G&N system has been one that will provide enough flexibility for all requirements of the various mission phases. In most cases this operation could be accomplished automatically as an aid to the navigator, but provision for monitoring and manual control modes have been included to enhance the probabilities of mission success and crew safety.

REFERENCES

1. D. G. Hoag, "Apollo Guidance and Navigation - A problem in Man and Machine Integration", Presented at the second AIAA - NASA Manned Spaceflight Meeting, April 22-23, 1963, Dallas, Texas.
2. J.A. Strasser, "Four - Beam Landing Radar Set for LEM" Electronics, Vol 36, No. 6, February 7, 1964.
3. R. H. Battin, "A Statistical Optimizing Navigation Procedure for Space Flight", ARS #2461-62, July 17, 1962.
4. G. M. Levine, "Application of Midcourse Guidance Technique to Orbit Determination", Presented at the Annual IAS Meeting and Wright Brothers Lecture, New York City, N. Y., January 21-23, 1963.

R-445
DISTRIBUTION LIST

Internal

R. Alonso	D. Hanley	C. Parker
J. Arnow (Lincoln)	W. Heintz	W. Patterson
R. Battin	E. Hickey	J. Potter
W. Bean	D. Hoag	K. Samuelian
E. Berk	A. Hopkins	P. Sarmanian
P. Bowditch	F. Houston	W. Schmidt
A. Boyce	L. B. Johnson	R. Scholten
R. Boyd	M. Johnston	E. Schwarm
P. Bryant,	B. Katz	J. Sciegienny
R. Byers,	A. Koso	N. Sears
G. Cherry	M. Kramer	D. Shansky
E. Copps	W. Kupfer	W. Shotwell (MIT/ACSP)
R. Crisp	A. Laats	T. Shuck
W. Crocker	D. Ladd	J. Sitomer
G. Cushman	A. LaPointe	E. Smith
J. Dahlen	J. Lawrence (MIT/ GAEC)	W. Stameris
E. Duggan	T. Law-ton	J. Suomala
J. Dunbar	D. Lickly	W. Tanner
K. Dunipace (MIT/AMR)	R. Magee	R. Therrien
R. Euvrard	G. Mayo	W. Toth
P. Felleman	J. McNeil	M. Trageser
S. Felix (MIT/S & ID)	R. McKern	R. Weatherbee
J. Flanders	R. Mudgett	R. White
J. Fleming	James Miller	L. Wilk
L. Gediman	John Miller	R. Woodbury
F. Grant	J. Nevins	W. Wrigley
D. Grief	G. Nielson	D. Yankovich
Eldon Hall	J. Nugent	Apollo Library (2)
I. Halzel	E. Olsson	MIT/IL Library (6)

External

(ref. PP1-64)

P. Ebersole (NASA/ MSC)	(2)
W. Rhine (NASA/ RASPO)	(1)
S. Gregorek (NAA/ S & ID/MIT)	(1)
T. Heuermann (GAEC/ MIT)	(1)
AC Spark Plug	(10)
Kollsman	(10)
Raytheon	(10)
WESCO	(2)
Capt. W. Delaney (AFSC/MIT)	(1)
NAA RASPO: National Aeronautics and Space Administration Resident Apollo Spacecraft Program Office North American Aviation, Inc. Space and Information Systems Division 122 14 Lakewood Boulevard Downey, California	(1)
FO: National Aeronautics and Space Administration, MSC Florida Operations, Box MS Cocoa Beach, Florida 32931 Attn: Mr. B. P. Brown	(3)
HDQ: NASA Headquarters 600 Independence Avenue, SW Washington, D. C. 20546 MAP, E. T. Sullivan	(6)
AMES: National Aeronautics and Space Administration Ames Research Center Moffett Field, California Attn: Library	(2)
LEWIS: National Aeronautics and Space Administration Lewis Research Center Cleveland, Ohio Attn: Library	(2)
FRC: National Aeronautics and Space Administration Flight Research Center Edwards AFB, California Attn: Research Library	(1)
LRC: National Aeronautics and Space Administration Langley Research Center Langley AFB, Virginia Attn: Mr. A. T. Mattson	(2)
GSFC: National Aeronautics and Space Administration Goddard Space Flight Center Greenbelt, Maryland Attn: Manned Flight Support Office Code 512	(2)

MSFC:	National Aeronautics and Space Administration George C. Marshall Space Flight Center Huntsville, Alabama Attn: R-SA	(2)
GAEC:	Grumman Aircraft Engineering Corporation Bethpage, Long Island, New York Attn: Mr. A. Whitaker	(1)
NAA:	North American Aviation, Inc. Space and Information Systems Division 12214 Lakewood Boulevard Downey, California Attn: Mr. R. Berry	(1)
GAEC RASPO:	National Aeronautics and Space Administration Resident Apollo Spacecraft Program Officer Grumman Aircraft Engineering Corporation Bethpage, L. I., New York	(1)
WSMR:	National Aeronautics and Space Administration Post Office Drawer D White Sands Missile Range White Sands, New Mexico Attn: AW1	(2)
MSC:	National Aeronautics and Space Administration Manned Spacecraft Center Apollo Document Control Group Houston 1, Texas 77058	(45)