



This is a digital copy of a book that was preserved for generations on library shelves before it was carefully scanned by Google as part of a project to make the world's books discoverable online.

It has survived long enough for the copyright to expire and the book to enter the public domain. A public domain book is one that was never subject to copyright or whose legal copyright term has expired. Whether a book is in the public domain may vary country to country. Public domain books are our gateways to the past, representing a wealth of history, culture and knowledge that's often difficult to discover.

Marks, notations and other marginalia present in the original volume will appear in this file - a reminder of this book's long journey from the publisher to a library and finally to you.

Usage guidelines

Google is proud to partner with libraries to digitize public domain materials and make them widely accessible. Public domain books belong to the public and we are merely their custodians. Nevertheless, this work is expensive, so in order to keep providing this resource, we have taken steps to prevent abuse by commercial parties, including placing technical restrictions on automated querying.

We also ask that you:

- + *Make non-commercial use of the files* We designed Google Book Search for use by individuals, and we request that you use these files for personal, non-commercial purposes.
- + *Refrain from automated querying* Do not send automated queries of any sort to Google's system: If you are conducting research on machine translation, optical character recognition or other areas where access to a large amount of text is helpful, please contact us. We encourage the use of public domain materials for these purposes and may be able to help.
- + *Maintain attribution* The Google "watermark" you see on each file is essential for informing people about this project and helping them find additional materials through Google Book Search. Please do not remove it.
- + *Keep it legal* Whatever your use, remember that you are responsible for ensuring that what you are doing is legal. Do not assume that just because we believe a book is in the public domain for users in the United States, that the work is also in the public domain for users in other countries. Whether a book is still in copyright varies from country to country, and we can't offer guidance on whether any specific use of any specific book is allowed. Please do not assume that a book's appearance in Google Book Search means it can be used in any manner anywhere in the world. Copyright infringement liability can be quite severe.

About Google Book Search

Google's mission is to organize the world's information and to make it universally accessible and useful. Google Book Search helps readers discover the world's books while helping authors and publishers reach new audiences. You can search through the full text of this book on the web at <http://books.google.com/>

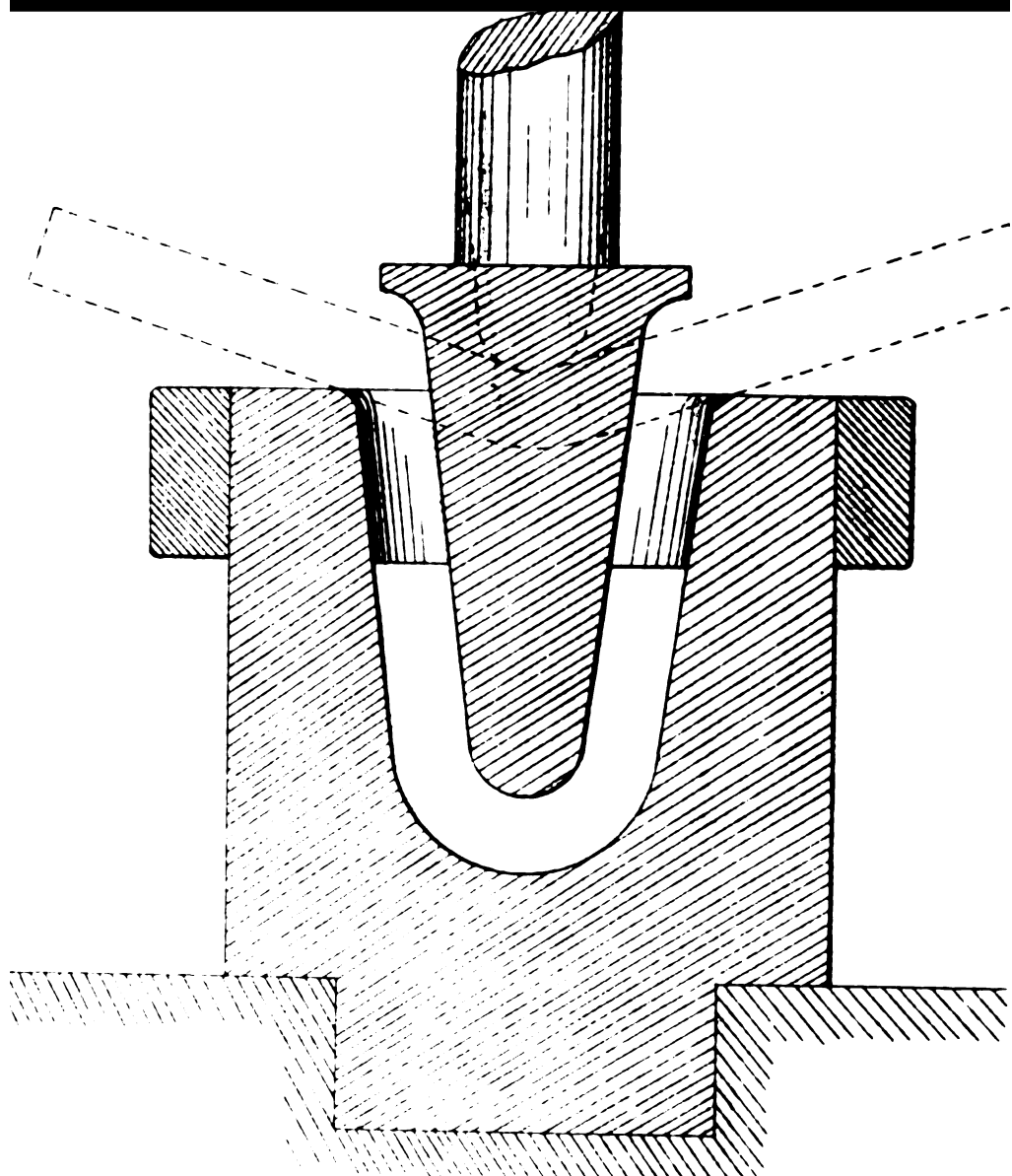

*Annual reports of
the Navy Department..*

United States. Navy Dept

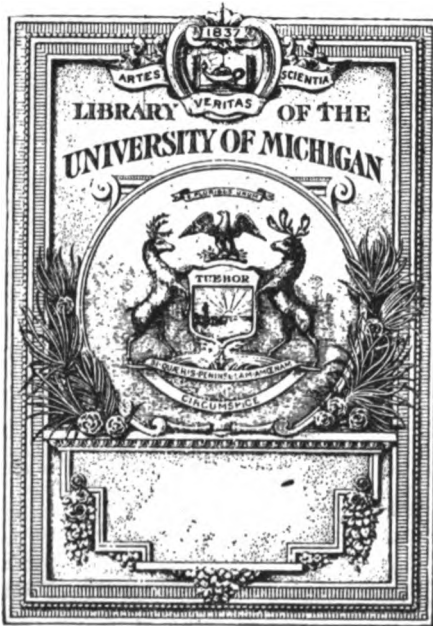

THE GIFT OF
U. S. Gov't.

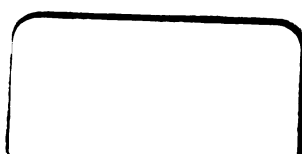

VA
52
A1



U.S. Navy Dept.
ANNUAL REPORT

*From the Navy Department
Dec. 17, 1892*

353.7
U58
S45m

OF THE

SECRETARY OF THE NAVY

FOR



THE YEAR 1885.

IN TWO VOLUMES.

VOLUME I.

WASHINGTON:
GOVERNMENT PRINTING OFFICE.
1885.

U.S. Navy Dept.

353.7

U58

S45m

ANNUAL REPORT

From the Navy Department

Dec. 17, 1885

OF THE

SECRETARY OF THE NAVY

FOR

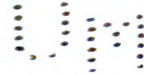

THE YEAR 1885.

IN TWO VOLUMES.

VOLUME I.

WASHINGTON:
GOVERNMENT PRINTING OFFICE.
1885.

24

ANNUAL REPORT

40845-

OF THE

SECRETARY OF THE NAVY

FOR

THE YEAR 1885.

IN TWO VOLUMES.

VOLUME I.

WASHINGTON:
GOVERNMENT PRINTING OFFICE.
1885.

en. gt.
U.S. govt.

REPORT
OF THE
SECRETARY OF THE NAVY.

WASHINGTON, D. C.,
NAVY DEPARTMENT,
November 30, 1885.

TO THE PRESIDENT:

SIR: I have the honor to lay before you the regular annual report of the Navy Department for the fiscal year ending June 30, 1885:

WAR VESSELS IN COMMISSION.

The North Atlantic squadron remains under the command of Acting Rear-Admiral James E. Jouett. The Brooklyn was put in commission on October 15, at the Brooklyn navy-yard, and now forms a part of this squadron. A serious revolution, threatening the transit of the Isthmus of Panama, having occurred on the isthmus early in the spring, a force of about 600 blue-jackets and marines, under the command of Commander B. H. McCalla, was sent thither in April, to act under the orders of Acting Rear-Admiral Jouett in keeping the transit open and in maintaining treaty obligations. This force was withdrawn in May, when the necessity for its presence no longer existed, one or more vessels remaining in Colombian waters until the month of July. The vessels of the North Atlantic squadron at present are the Tennessee (flag-ship), Brooklyn, Galena, Swatara, Alliance, and Yantic.

The South Atlantic squadron was re-enforced by the arrival of Rear-Admiral Earl English in his flagship, the Lancaster, at Rio de Janeiro on July 1. This officer assumed command immediately upon his arrival. The only other vessel on this station is the Nipsic. Because of several complaints recently forwarded by the Department of State from American citizens residing in the Comoro Islands and in Zanzibar, the Lancaster has been ordered to make an extended cruise in the neighborhood of these places, with a view to the satisfactory settlement of the differences which have occurred or may occur.

Acting Rear-Admiral John L. Davis is still in command of the Asiatic station. The Enterprise has been ordered to proceed home by way of Australia and Cape Horn, running a line of soundings across the Pa-

cific Ocean, and the Juniata to proceed home by way of the **Cape of Good Hope**, touching at Zanzibar and the Comoro Islands, in view of the difficulties at those places already referred to. Each of these vessels will have been slightly over three years away from the **United States** by the time her orders are executed. The Asiatic station has been re-enforced by the **Omaha** and **Marion**, so that it now consists of the **Trenton** (flagship), **Omaha**, **Marion**, **Ossipee**, **Alert**, **Monocacy**, and **Palos**.

The Pacific squadron was, until May 28, under the command of **Rear-Admiral John H. Upshur**. On this day **Rear-Admiral E. Y. McCauley** assumed command at **San Francisco**. Of this squadron the **Lackawanna** and **Wachusett** have gone out of commission during the year, it having been reinforced by the reporting of the **Mohican** and **Adams**. The **Shenandoah**, **Iroquois**, and **Wachusett**, of this squadron, assisted in maintaining treaty obligations in the insurrection on the **Isthmus of Panama** in the spring. The squadron now consists of the **Hartford** (flag-ship), **Shenandoah**, **Mohican**, **Iroquois**, **Adams**, and **Pinta**. The latter vessel is occupied exclusively in cruising in Alaskan waters.

The command of the European squadron was relinquished by **Rear-Admiral English** at the **Congo River** on May 2, 1885, and was assumed by **Rear-Admiral Samuel R. Franklin**, in his flag-ship **Pensacola**, at **Gibraltar**, on June 18. The squadron now consists of the **Pensacola**, **Quinnebaug**, and **Kearsarge**.

The vessels of the Navy on detached service are the **Powhatan** and **Despatch** on the Atlantic coast, the **Michigan** on the lakes, and the **Ranger** in surveying and sounding work on the coast of California.

BUREAU OF YARDS AND DOCKS.

The Chief of the Bureau of Yards and Docks, **Commodore D. B. Harmony**, reports on the condition of the navy-yards, docks, wharves, buildings, and other property in charge of the Bureau, with recommendations as to the most pressing improvements required.

It appears from his report that this property, aggregating in value some fifty millions of dollars, is falling rapidly into a condition of extreme decay. The reports from the yards make frequent complaint of buildings falling or about to fall; roofs leaking to such an extent as to involve the destruction of property stored underneath; wharves so rotten that persons cannot walk over them in safety; stone dry-docks which are required to be shored up with timber; bad roadways, defective water-pipes, and in general such an extent of decay and dilapidation as to imply a general destruction.

If it is the policy of Congress to maintain the navy-yards as ship-yards, workshops, or depots of supply, it is manifest that the work of putting the buildings, wharves, and other appurtenances in proper repair should be undertaken at once and should be kept up from year

to year, as the only alternative must be the abandonment of all the property to waste and ruin.

Attention is called to the special improvements recommended by the Bureau at the several yards, and the importance of beginning these improvements is commended to the consideration of Congress. It is especially desirable that such dry-docks should be constructed at the several yards as will give adequate facilities for docking the vessels of the Navy.

The League Island yard is now practically closed. In case Congress should decide to reopen the yard, an estimate of \$232,000 is presented for necessary improvements. To make the plant now in the yard available for the repairs of ships, a Simpson dry-dock will be a necessity. Such a dock will cost about \$700,000, and will require two years to complete.

BUREAU OF EQUIPMENT AND RECRUITING.

The report of the Chief of the Bureau of Equipment and Recruiting, Commodore Winfield S. Schley, describes in detail the operations of the Bureau in the purchase, manufacture, and supply of coal, sails, hemp, cordage, chains, anchors, galleys, and other articles of equipment under its charge. Tables are presented showing the superiority in strength of the rope manufactured at the rope-walk in the Boston navy yard over that furnished by private dealers.

The Bureau strongly recommends the acquisition of a modern plant for the rolling mill, chain shop, and forge and anchor shop at the Washington navy-yard. The plant has undergone no improvement for twenty-five years, and it is believed that the expenditure necessary to defray the cost of its renewal would in a short time be more than covered by the increased efficiency of the establishment. Legislation is also recommended looking to the compulsory inspection and test of anchors and chains intended for the Navy and mercantile marine, which could be conducted by naval officers with no additional expense to the Government or to private parties, and which would add greatly to the security of navigation.

The number of apprentices received in the Navy during the past year was 759. The cruising training ships have been kept at sea as much as possible, making two cruises, each of several months' duration, to the West Indies and to Europe. In view of the antiquated type of these vessels, and the fact that they will shortly become unseaworthy, it is recommended that two composite vessels be constructed of modern type, embodying the latest improvements in engines, guns, and torpedo apparatus, for use in the training service.

The average number of seamen and apprentices has not exceeded the legal quota. The cost of maintaining the 409 men allowed to the Coast Survey and the Fish Commission is about \$332,428. These men should be provided for independently of the quota for the Navy, as it cannot

certainly be the intention of Congress that such a heavy drain upon the naval appropriation should be made for the support of outside services. Certain other changes in the legislation in regard to enlisted men are urgently needed. A comparison of the statutes relating to enlisted men in the Army and Navy shows that the latter service is placed in many ways at a great disadvantage. Honorably discharged men should be allowed to elect a home on board receiving-ships during the three months allowed by law to re-enlist. The statute relating to the admission to citizenship of aliens enlisted in the Army should be extended to cover naval enlistments, and authority should be given to commissioned officers of the Navy to administer the oath of allegiance to the men. The recruit, upon enlistment, should receive his clothing outfit from the Government, instead of becoming, as at present, a debtor to the Government to the amount of three months' pay. Appropriation should be made for the purchase of reading matter for the crews. Provision should be made for the retirement of seamen after thirty years of service, as is now done in the Army and Marine Corps. Finally, the savings-bank system, introduced in the Army by statute in 1872, with excellent results, should be applied to the Navy.

BUREAU OF NAVIGATION.

The chief of the Bureau of Navigation, Commodore John G. Walker, reports the operations of the Bureau in reference to the manufacture and testing of compasses, the examination of compass reports from cruising vessels with a view to the preparation of a new variation chart, and the publication and distribution of information on the magnetism of iron and steel ships. The erection of the new compass-testing house has been begun, and a compass station for the accurate determination of deviation has been established in Narragausett Bay. The report dwells upon the urgent necessity of establishing compass stations at the principal seaports, for the benefit of the merchant marine, under the direction of naval officers.

In connection with the subject of ocean surveys, it is recommended that the *Thetis* be employed in examining the imperfectly-surveyed coasts in the Pacific frequented by merchant vessels.

The chief of Bureau also reports on the condition of the Nautical Almanac Office, the Department library, and the War Record Office; on the progress of work on the revision of the naval signal books; on the publication of the results of observations for the telegraphic determination of longitudes, and on the supply of the various materials and instruments under the charge of the Bureau, including illuminating oils, electric lights, chronometers, and books for the libraries of ships of war.

The steady decrease in the appropriation for the purchase of necessary supplies, together with the gradual exhaustion of the surplus materials on hand at the close of the war, leaves the Bureau in a crippled

condition, and an increase of the appropriation to the amount called for by the estimates is urgently needed.

The preparation of the Naval Records of the War for publication has been partly completed, but an additional force, for which estimates have been submitted, is needed to carry on the work. It is desirable that no time should be lost in securing the valuable papers, now in private hands, relating to naval affairs during the war, and that provision should be made for an agent for the collection of Confederate documents.

BUREAU OF ORDNANCE.

The report of the Chief of the Bureau of Ordnance, Commodore Montgomery Sicard, describes the operations of the Bureau in reference to the design, construction, and testing of guns and torpedoes, and to experiments and improvements in gunpowder, gun-cotton, gas-checks, gun-carriages, torpedoes and their fittings, ammunition for the Hotchkiss gun, and electrical apparatus for firing great guns:

Work of all kinds has been pushed forward rapidly at the ordnance department of the Washington navy-yard. It will require a considerable quantity of modern machinery to place this department on a suitable footing. The instruction of the seamen gunners continues at the yard as well as at the torpedo station, and a class of "continuous service" men is also receiving instruction at both places.

Satisfactory progress has been made in the ordnance of the new cruisers, five 6-inch and two 5-inch breech-loading high-power steel guns having been completed since the last report, at the Washington yard. They have been satisfactorily tested at the Naval Ordnance Proving Ground, and several will be mounted on the Atlanta when she is ready to receive them. Of the twenty sets of steel forgings for 6-inch guns ordered from the Midvale Steel Company nineteen have passed inspection and been delivered.

The work of machine-finishing and assembling forgings has made satisfactory progress at the South Boston Iron Works and the works of the West Point Foundry Association, and several 6-inch guns will shortly be finished. The forgings for 8-inch guns have just arrived from England, being more than a year overdue, a delay which shows the importance of having a heavy gun-forging plant in the United States.

Designs have been made for the batteries of the four ships projected in the act passed at the last session of Congress, and estimates have been prepared for a modern armament for six of the present third-rate ships of the Navy.

Estimates have also been submitted for the armament of the double-turreted monitors.

The naval ordnance proving ground has remained under the charge of Commander William M. Folger, and much important and active work has been done there during the year, including the testing of guns; ascertaining the best composition and temper of steel for armor-piercing

projectiles, and the resistance of steel and other armor plates; **the** measurement of chamber pressures in the different classes of guns; **the** employment of gun-cotton in armor-piercing projectiles, and **various** other very important operations. Successful experiments have **been** made with the new high-power musket with satisfactory results, **the** bullet perforating one inch of steel at short range with reserve of **force** sufficient to kill two men. The experiments with Clark's defective turret have been delayed by the want of funds and steel with which **to** complete the 10-inch gun to be used in the trial; but the material **and** money are now available, and the gun will be pushed to completion **as** soon as the tests of the steel are made.

The present site of the proving ground at Annapolis is very defective for a number of reasons, to which attention is called in the report of the Chief of Bureau, and it is highly desirable to obtain a new site as early as possible.

The trials of the Howell torpedo show that it possesses certain valuable qualities and a further examination is being made of the system.

The torpedo station, under the charge of Commander William T. Sampson, has continued its work in the manufacture of gun-cotton and in the elaboration of designs and the improvements of various details in reference to the action of torpedoes. The usual course of instruction, embodying some improvements, was given during the summer with excellent results, and an advanced course of instruction for a limited number of officers has been arranged to follow the general course, and has gone into operation.

BUREAU OF CONSTRUCTION AND REPAIR.

The report of Chief Constructor Theodore D. Wilson describes the work done by his Bureau, recommends the purchase of supplies by annual schedule, presents with some detail his views as to the requirements of the Navy in the matter of new steel vessels, and urges the completion of the monitors. The report expresses the opinion that it should be the policy of the Government to maintain one large navy-yard, combining in itself the advantages and facilities of all the others, and advocates League Island as the most advantageous site for this purpose. In the event of an appropriation being made for more steel ships, the Bureau hopes that at least one-half of the ships may be built in our navy-yards, in competition with outside establishments, and it dwells with emphasis upon the serious obstacle existing at the present time in the want of docking facilities. The report closes with the presentation of certain considerations in reference to the education of naval constructors.

BUREAU OF STEAM-ENGINEERING.

The report of the Chief of the Bureau of Steam-Engineering, Engineer-in-Chief Charles H. Loring, contains an account of expenditures

during the past year, and describes the present condition of the machinery of naval vessels, and the work required to be done to fit them for sea service or to keep them on such duty during the next fiscal year. The report dwells upon the necessity of building a new boiler-shop at the New York navy-yard.

BUREAU OF MEDICINE AND SURGERY.

Surgeon-General Francis M. Gunnell reports on the condition and operations of his Bureau during the past year. The report states that the Bureau has not been able to maintain the hospitals in a satisfactory condition for want of sufficient appropriation. A temporary hospital or quarantine station to which naval vessels containing yellow-fever patients might be sent has been established on Widow's Island, off the coast of Maine. Instructions have been issued to the surgeon in charge of the United States naval hospital at Yokohama to receive and care for sick seamen from American merchant vessels in the same manner as for enlisted men in the Navy.

The trials in the courts of the District of Columbia for frauds perpetrated on the Government through this Bureau have resulted in the conviction of the two indicted clerks and of several accomplices. Others are to be tried at the next term of the court.

The Museum of Hygiene continues to make satisfactory progress. During the past year it has made valuable additions to its collection and has conducted important experiments.

MARINE CORPS.

The report of Col. Charles G. McCawley, commandant of the Marine Corps, shows a satisfactory state of discipline and efficiency in the corps during the year, and especially in the difficult and arduous service in April on the Isthmus of Panama, and recommends an increase of 500 privates in the number of the force. It also calls attention to the fact that the Marine Corps should have a complete outfit of tents and camp equipage for 500 men. These supplies cannot be purchased with the present appropriation.

HYDROGRAPHIC OFFICE.

The Hydrographic Office has made numerous improvements during the past year in the construction, arrangement, and mode of issue of charts and sailing directions, which are described in detail in the report of the hydrographer, Commander John R. Bartlett. The collection of nautical information from a great variety of sources, and its dissemination for the benefit of the merchant marine and in the interests of safe navigation, especially through the monthly pilot chart and the notices to mariners, have been carried on with increased thoroughness, promptness, and efficiency. Invaluable assistance has been rendered in this direction by the branch hydrographic offices established in the principal

seaports, the work at these offices having been more than doubled during the past year.

The publication of charts from the important surveys of the west coast of Mexico and Central America, performed by the officers of the *Ranger*, awaits a special appropriation.

In view of the impossibility of carrying on the work of chart printing in the executive building, and the necessity that the valuable engraved plates of charts, representing the labor and expenditure of many years, should be removed from all danger of destruction by fire, it is recommended that a fire-proof building for storing the plates and printing charts should be erected.

NAVAL ACADEMY.

The Superintendent of the Naval Academy, Capt. Francis M. Ramsay, reports that the prescribed course of instruction has been carried out during the past year and the usual practice cruise has been made. The most important improvements in buildings and grounds have been the enlargement of the cadets' sick quarters and the partial renewal of the system of drainage of the Academy.

The Superintendent recommends that permits should be issued to candidates a year in advance of their admission, and that they should report for examination by the 15th of May. It is also recommended that changes be made in legislation, by which the selection of cadets to fill vacancies in the lower grades of different corps may take place at the completion of the four years' course instead of after the six years' course, as at present, and that certain legislative provisions prescribed for the Military Academy be applied to the Naval Academy.

NAVAL OBSERVATORY.

The report of the Superintendent of the Naval Observatory, Commodore George E. Belknap, presents a statement of the astronomical work performed during the year with the various instruments, of the observations of the eclipse of March 15, and of the transmission of correct time to the principal cities and seaports. A report is also made of the work done for the Transit of Venus Commission, relating to the observations made in 1874 and 1882.

The time service is now performed, with the gratuitous co-operation of the telegraph companies, at Boston, Newport, the New York navy-yard, Philadelphia, Hampton Roads, Savannah, New Orleans, and San Francisco. Requests received from other cities for an extension of the system can only be complied with upon an increase of the appropriation for the purpose.

It is strongly urged that appropriation should be made for the erection of the new observatory upon the site already purchased by the Government for that purpose. The plans for the structure are now prepared, and no time should be lost in effecting a removal from the dilapidated buildings and unhealthy site of the present Observatory.

NAVAL WAR COLLEGE.

The Naval War College began its first session September 3, under the direction of Rear-Admiral Stephen B. Luce, president of the college. The instruction consisted of lectures on military science, the art of naval warfare, and marine international law. The college, now fairly in operation, by giving officers an advanced course of instruction on subjects directly connected with the most important duties of the profession, fills what has hitherto been a serious want in our system of naval education.

SALE OF OLD VESSELS AND GOVERNMENT PROPERTY.

The only condemned vessels sold during the past year were the hulk *Niagara*, at Boston, and the tug *Rose*, at Pensacola, Fla.; the amount realized for the former, after paying auctioneer's commission, being \$12,117, and from the latter \$419.25. An account of the receipts and expenditures in connection with the sale of old vessels will be found in the appendix to the report.

The deposits from the sale of Government property under the control of the Navy Department, including sums realized from difference in exchange, interest paid by the foreign fiscal agents, and those from other sources, classed as "miscellaneous receipts," under section 3618 of the Revised Statutes, from November 1, 1834, to November 1, 1885, amounted to \$233,040.31, as shown by the statement of the Fourth Auditor of the Treasury, which will also be found in the appendix to the report. Of this sum, \$197,324.51 were covered into the Treasury as "miscellaneous receipts on account of proceeds of Government property," and \$35,715.80 were deposited to the credit of sundry appropriations, as directed by the statutes governing such cases.

DECORATION DAY.

A joint resolution of Congress, approved January 6, 1885, provides that all per diem employes of the Government on duty at Washington and elsewhere in the United States shall be allowed certain holidays, and shall receive the same pay as on other days. The days named in the resolution are the 1st day of January, the 22d day of February, the 4th day of July, the 25th day of December, and such days as may be designated by the President as days for national thanksgiving.

It is recommended that the resolution be amended so as to include the day which is generally observed throughout the United States as Decoration Day.

Under section 1545 of the Revised Statutes, per diem employes in the navy-yards can receive pay for the time only during which they may be actually employed, and as all such should have an opportunity of par-

participating in the commemoration of those who fell during the late war without being deprived of a portion of their livelihood, an amendment of the law as indicated would seem to be manifestly appropriate.

EXPENDITURES.

The amount of appropriations applicable to the current expenses of the first six months of the fiscal year was \$7,255,283.48, the amount for the last six months of said year ending June 30, 1885, \$6,230,253.85, making the total amount \$13,485,537.33, in which is included \$47,362 transferred from navy-yard Brooklyn, N. Y., 1884, to that appropriation 1885 per appropriation warrant No. 383, \$140,000 from machinery double-turreted monitors, indefinite, to steam engineering, 1885, per appropriation warrant No. 390, and \$2,191.87 pay miscellaneous 1885, appropriated to supply deficiencies for said fiscal year per appropriation warrant No. 391.

There was a balance on hand at the commencement of the fiscal year on account of pay of the Navy and pay of the Marine Corps of \$2,407,491.35. The total gross amount, therefore, which was available for the year was \$15,893,028.68. There should, however, be deducted from this amount the sum of \$59,813, appropriated for the Naval Asylum, as that sum was brought to the credit of the asylum February 25, 1885, by requisition in its favor, and is included in the exhibit of expenditures chargeable to Navy appropriations at that time as refunded and deducted from the amount drawn in that month, also \$1,407,272.87 due to general account of advances, which leaves a balance of \$14,425,942.81 available for the year, being \$1,504,828.93 less than the amount available for the fiscal year ending June 30, 1884.

The net amount drawn from the Treasury by warrant during the last fiscal year was \$13,337,867.72, as shown by the books of the Department, which leaves a balance undrawn of \$1,088,075.09; to this should be added the net amount unexpended in the hands of pay officers on said June 30, 1885, as shown by the office of the Fourth Auditor, \$1,265,570.64, leaves an aggregate balance unexpended of \$2,353,645.73, which stood to the credit of the Department at the beginning of the present fiscal year. That is, the total net expenditure for the fiscal year ending June 30, 1885, was that much less than the appropriations. The annexed table shows the amount of expenditures by warrant and the amount refunded, as well also as that expended from the close of the year to November 1, 1885.

The appropriations available for the present fiscal year, commencing July 1, 1885, are \$13,590,704.95. The amount drawn by warrant from the Treasury from July 1, 1885, to November 1, 1885, deducting that refunded, is \$4,285,761.39. The amount drawn by warrant during the same period of last year was \$4,383,244.93.

The amount of appropriations applicable to the current expenses

of the fiscal year ending June 30, 1885, was \$13,485,537.33, as shown by the following table:

Statement of appropriations and expenditures for the fiscal year ending June 30, 1885.

Appropriations.	Balances on hand June 30, 1884.	Appropriations for fiscal year ending June 30, 1885.	Amounts applicable to the service for the fiscal year ending June 30, 1885.	Amounts expended fiscal year ending June 30, 1885.	Balances June 30, 1885.
Pay of the Navy	\$2,182,550 75	\$6,917,605 00	\$9,100,155 75	\$6,832,983 50	\$2,267,172 25
Pay, miscellaneous		339,691 87	339,691 87	335,993 42	3,698 45
Contingent Navy		57,500 00	57,500 00	54,165 74	3,334 26
Pay of the Marine Corps	224,940 60	653,240 86	878,180 96	608,094 89	270,086 07
Quartermaster's department of the Marine Corps		217,436 50	217,436 50	206,455 20	10,981 30
Naval Academy		181,256 10	181,256 10	177,049 40	4,206 70
Navigation and navigation supplies		87,500 00	87,500 00	70,543 72	16,956 28
Ordnance and ordnance stores		125,000 00	125,000 00	117,736 88	7,263 12
Repairs, ordnance		15,000 00	15,000 00	9,514 52	5,485 48
Steel rifled breech-loading guns		41,632 50	41,632 50	40,902 99	729 51
Torpedo corps		50,000 00	50,000 00	43,837 13	6,162 87
Equipment of vessels		750,000 00	750,000 00	682,122 21	67,877 79
Transportation and recruiting		25,000 00	25,000 00	24,921 44	78 56
Naval training station		21,000 00	21,000 00	18,048 07	2,951 93
Maintenance (Yards and Docks)		200,000 00	200,000 00	192,980 70	7,019 30
Navy-yard, Brooklyn, N. Y.		77,362 00	77,362 00	32,183 03	45,228 97
Navy-yard, Mare Island, Cal.		250,000 00	250,000 00	186,141 18	63,858 82
Repairs and preservation at navy-yards		125,000 00	125,000 00	121,646 34	3,353 66
Naval Asylum, Philadelphia, Pa.		59,813 00	59,813 00	46,054 45	13,758 55
Surgeons' necessaries and appliances		40,000 00	40,000 00	19,349 58	20,650 42
Naval Hospital fund		30,000 00	30,000 00	29,974 21	25 79
Repairs (Medicine and Surgery)		10,000 00	10,000 00	8,726 98	1,273 02
Provisions, Navy		1,100,000 00	1,100,000 00	983,979 72	116,020 28
Construction and repair		1,000,000 00	1,000,000 00	972,847 86	27,152 14
Steam machinery		920,000 00	920,000 00	801,782 42	118,217 58
Contingent (Bureaus)		92,500 00	92,500 00	73,784 02	18,715 98
Civil establishment at yards and stations		99,000 00	99,000 00	95,191 34	3,808 66
Add this amount, difference in general account of advances (which is not an expenditure), being June 30, 1884, \$1,407,272.87, and June 30, 1885, \$2,022,992.65 difference				615,719 78	
	2,407,491 35	13,485,537 33	15,893,028 68	13,397,680 72	3,111,067 74
Deduct on account of Naval Asylum as heretofore explained. Also amounts due general account and Naval Asylum, June 30, 1884			1,467,085 87	59,813 00	
And amount due general account of advances, June 30, 1885					2,022,992 65
Net amounts			14,425,942 81	13,337,867 72	1,088,075 09

The above balance of \$3,111,067.74 does not include the amount unexpended in the hands of pay officers at that time, which, as furnished by the office of the Fourth Auditor, is \$1,265,570.64.

Net amounts drawn during the fiscal year ending June 30, 1885.

Appropriations, 1885	\$13,337,867 72
Appropriations, 1884	383,079 26
Appropriations, 1883	72,023 61
Appropriations, indefinite	2,221,501 51
	<hr/>
	16,014,472 10
Less amount refunded appropriation 1883-'84	78
Total drawn fiscal year ending June 30, 1885	16,014,471 32

Statement of appropriations for the fiscal year ending June 30, 1886.

Pay of the Navy	\$6,940,780 00
Pay, miscellaneous	375,000 00
Contingent, Navy	20,000 00
Pay of the Marine Corps	649,642 00
Quartermaster's department, Marine Corps	219,686 50
Naval Academy	181,229 45
Navigation and navigation supplies	87,500 00
Ocean surveys	10,000 00
Naval War College	8,000 00
Ordnance and ordnance stores	146,000 00
Repairs (Ordnance)	15,000 00
Torpedo corps	60,000 00
Equipment of vessels	800,000 00
Transportation and recruiting (Equipment and Recruiting)	30,000 00
Naval training station, Coasters' Harbor Island, R. I.	25,000 00
Maintenance (Yards and Docks)	200,000 00
Navy-yard, Brooklyn, N. Y.	30,000 00
Navy-yard, Mare Island, Cal.	276,000 00
Repairs and preservation at navy-yards	125,000 00
Naval Asylum, Philadelphia, Pa.	59,867 00
Medical Department (Medicine and Surgery)	60,000 00
Naval Hospital fund	30,000 00
Repairs (Medicine and Surgery)	10,000 00
Provisions, Navy	1,085,000 00
Construction and Repair	1,000,000 00
Steam-Engineering	950,000 00
Contingent, Bureaus	118,000 00
Civil establishment at yards and stations	79,000 00
	<hr/>
	13,590,704 95

ESTIMATES.

The estimates for the Navy for the fiscal year ending June 30, 1887, amount to \$35,104,695.15, as shown by the following summary:

Summary of the estimates for the Navy for the fiscal year ending June 30, 1887.

General maintenance yards and stations (Yard and Docks)	\$300,000 00
Support of the Naval Asylum (Yards and Docks)	96,661 00
Equipment of vessels, coal, hemp, &c. (Equipment and Recruiting)	860,000 00
Transportation and recruiting (Equipment and Recruiting)	30,000 00
Equipment plant, Washington yard (Equipment and Recruiting)	38,894 00
Preservation and repair of vessels (Construction and Repair)	2,000,000 00
Steam machinery, boilers, &c. (Steam-Engineering)	840,000 00
Provisions (Provisions and Clothing)	1,221,825 00
Navigation supplies (Navigation)	\$130,000 00
Ocean surveys and publications thereof (Navigation)	37,000 00
Repairs, improvements, and Naval War College (Navigation)	14,000 00
Observation of transit of Venus (Navigation)	3,000 00
Completing compass-testing house (Navigation)	2,000 00
Publication of professional papers (Navigation)	12,000 00
	<hr/>
	198,000 00
Procuring and preserving ordnance material, &c. (Ordnance)	177,500 00
Batteries of the new types for six ships (Ordnance)	670,000 00
Thirty machine cannon, modern caliber (Ordnance)	93,000 00
Twenty musket caliber machine-guns (Ordnance)	55,000 00
Magazine and cadet rifles, equipments, &c. (Ordnance)	44,250 00
Proof of naval guns and appendages (Ordnance)	6,000 00
Modern armament for two training vessels (Ordnance)	10,000 00
Land and buildings for proving ground (Ordnance)	57,000 00
Repairs to ordnance building (Ordnance)	15,000 00
	<hr/>
	1,127,750 00
Torpedo corps and station, labor, material, freight, &c. (Ordnance)	75,500 00
Purchase of auto-mobile torpedoes, fast torpedo-boat, &c.	175,000 00
	<hr/>
	250,500 00
Steel rifled breech-loading gun (Ordnance)	60,000 00
Machinery for ordnance (Ordnance)	50,000 00
Surgeons' necessaries and appliances (Medicine and Surgery)	60,000 00
Naval Hospital fund (Medicine and Surgery)	30,000 00
Repairs to hospitals (Medicine)	40,000 00
	<hr/>
	130,000 00
For increase of the Navy:	
Bureau of Construction and Repair	5,150,000 00
Bureau of Steam Engineering	3,750,000 00
Bureau of Ordnance	878,770 00
Bureau of Equipment and Recruiting	725,600 00

Double-turreted monitors:		
Bureau of Construction and Repair.....	2,923,656 00	
Bureau of Steam-Engineering.....	206,000 00	
Bureau of Ordnance.....	1,073,000 00	
		4,202,656 00
Civil establishment at yards and stations.....		248,458 12
Contingent expenses under Bureaus and contingent, Navy.....		165,500 00
Support of the Naval Academy.....		190,894 45
Support of the Marine Corps.....		918,841 67
Public work and improvements:		
Quarters for cadets at the Academy.....	120,000 00	
New Naval Observatory.....	250,000 00	
Improvements Coasters' Harbor Island.....	30,000 00	
Improvement and preservation yards and stations.....	3,868,337 41	
		4,268,337 41
Pay of the Navy (officers and enlisted men).....		7,129,087 50
Pay, miscellaneous.....		273,530 00
Total.....		35,104,696 15

DISTURBANCES AT PANAMA.

On the 16th day of March last an insurgent demonstration against the Colombian Government, under the lead of Aizpuru, resulted in the occupation of the town of Panama by the insurgents and in such obstruction to the operations of the Panama Railroad as virtually to close the transit. Upon the arrival of a detachment of national troops from Aspinwall, however, Aizpuru was forced to retire.

During the absence of the national forces from Aspinwall, another insurrectionary movement was successfully made at that place under the leadership of Prestan. On the 1st of April an encounter took place between Prestan and the forces of the Government outside of Aspinwall, in which Prestan was defeated. During the conflict the city of Aspinwall was set on fire by the insurgents and in great part destroyed. Meantime Aizpuru succeeded in reoccupying Panama and the greater portion of the Isthmus included along the line of the railroad, thereby effectually blocking the transit of trains.

Under these circumstances it became evident that the occasion had arisen for the enforcement of the rights secured to the United States by the following clause of our treaty of 1846 with New Granada (United States of Colombia):

"And, in order to secure to themselves the tranquil and constant enjoyment of these advantages, and as an especial compensation for the said advantages, and for the favors they had acquired by the fourth, fifth, and sixth articles of this treaty, the United States guarantee, positively and efficaciously, to New Granada, by the present stipulation, the perfect neutrality of the before-mentioned Isthmus, with the view that the free transit from the one to the other sea may not be interrupted or embarrassed in any future time while this treaty exists; and in consequence, the United States also guarantee, in the same manner, the rights of sovereignty and property which New Granada has and possesses over the said territory."

In order the more effectually to maintain the rights of the United States as defined by the treaty, the vessels of the North Atlantic squadron under Rear-Admiral Jouett, with the exception of the Yantic, were ordered to Aspinwall, where they arrived on April 10. Previously to their arrival, the U. S. S. "Galena," which had been lying off the port, had sent ashore a landing party of seamen for the purpose of protecting American property at that point, while a landing party from the U. S. S. "Shenandoah" was performing a like service at Pauama.

In addition to the ships already sent to Aspinwall, the Department promptly dispatched an expeditionary force from New York for the special purpose of operating on shore. This force, consisting of about 750 seamen and marines, under the command of Commander B. H. McCalla, and including three Gatling guns and three 3-inch rifled guns, sailed from New York; the first detachment, comprising the first battalion of marines, in the steamship *City of Para*, on April 3, and the second, comprising the remainder of the force, in the steamship *Acapulco*, on April 7. The steamships arrived at Aspinwall on the 11th and 15th of April, respectively.

Immediately upon his arrival at Aspinwall, on the 10th of April, Rear-Admiral Jouett issued orders for the landing of a force to open the transit across the Isthmus. In accordance with these orders, garrisons were placed at Aspinwall and at Matachin, and the first detachment of the expeditionary force from New York, immediately upon its arrival out, was ordered to Panama.

Two armored cars also were fitted up and equipped with howitzers, Gatlings, and Hotchkiss guns for patrol duty along the line of the railroad. All these arrangements were completed on the 11th of April, and on the 12th regular schedule trains were run over the road, and have continued to run without further interruption.

Upon the arrival of the *Acapulco*, on the 15th of April, the expeditionary force relieved the detachment which had been landed from the squadron, and Commander McCalla, in accordance with the instructions of the Department and the orders of Rear Admiral Jouett, assumed command of all the United States forces on shore. On the 21st of April the headquarters of the expeditionary force, together with two companies of marines, were transferred from Aspinwall to Panama, at that time occupied by Aizpuru, who was erecting barricades to resist the expected attack of the national troops, then on their way to the city. As many of the persons composing Aizpuru's force had taken part in the burning of Aspinwall, it was feared that a conflict at Panama might there result in a similar disaster. Commander McCalla therefore, on the 24th, ordered up the garrison from Aspinwall, together with the reserve battalion of marines from the squadron, occupied the city; arrested Aizpuru and other revolutionary leaders, and detained them until a stipulation was signed that fighting should not take place nor barricades be erected within the limits of the town.

On the evening of the day on which this agreement was executed (the 25th) our naval force was withdrawn to a position at the railroad depot outside of the city, from which all the avenues of approach to Panama could readily be occupied. On the 27th a landing party from the *Iroquois*, which had arrived off Panama the day previous, came ashore and was quartered for the night at the railroad wharf.

On the 28th the national forces, under Colonels Montoya and Reyes, arrived from Buenaventura, and the day after a conference took place

between these officers, Aizpurn, and Rear-Admiral Jouett, which resulted in the capitulation of the insurgent troops.

The re-establishment of the national authority having rendered the presence of our expeditionary force no longer necessary, the greater part of it returned to New York, where it arrived on the 16th of May, and by the 25th of May all the United States forces had withdrawn from the Isthmus.

The officers and men charged with restoration of the freedom of transit on the Isthmus, in accordance with the provisions of the treaty of 1846, discharged their duty in a highly satisfactory manner. The action of the Department was carefully confined to measures only as were necessary to enforce treaty stipulations, every precaution being taken to respect the autonomy of Colombia; and our interference ceased the moment the object had been accomplished and the freedom of transit had been securely re-established. Among the results of these naval operations upon the Isthmus, by no means the least gratifying, has been the establishment of still closer and more friendly relations with a sister republic, while our commercial and other interests in Central America have been strengthened, and an additional guarantee of security has been given to the mercantile enterprise of Americans in this quarter. It is largely for the purpose of protecting the mercantile marine and for assisting its healthy development that the Navy exists; and there are reasons for believing that its services on the Isthmus during the months of April and May last will have important and far-reaching consequences in this direction.

THE ADDITIONAL NEW CRUISERS.

At its last session Congress authorized the construction of two additional cruisers and two gunboats, at an aggregate cost of not exceeding \$2,995,000. No appropriation for the armament of these ships was made, the preparation of which requires at present a longer period than would be probably employed in the construction of the ships.

Early in May last (anticipating the date when the appropriation would become available, viz, July 1) it was decided to proceed, in accordance with the law, with the work incident to the construction of the ships. The terms of the act provided:

And authority is hereby given for the construction of said four vessels at not exceeding the total cost for each above specified, in accordance with such final plan as may be determined upon after a revision and reconsideration of all designs which have been heretofore made, and in the manner and in conformity to the conditions and limitations provided for the construction of the new cruisers in the acts of August 5, 1852, and of March 3, 1883, except so far as said acts provide for and define the duties of the Naval Advisory Board.

One of the provisions of the act of 1882 directed the Secretary of the Navy to invite, by public advertisement, the submission of plans by engineers and mechanics of established reputation, naval constructors, and others, within a period, not less than sixty days, to be named. Some

doubt was entertained by the Department as to whether this obligation attached to the construction of these new vessels, but it was deemed wise to solve it in favor of the public advertisement, and accordingly such advertisement was made, the time for the submission of plans thereunder expiring upon the 15th day of July last.

A large number of models and plans were received at the Department, and as the law contemplated the thorough examination of such matter, the same were, upon the 29th day of July, referred to a Board for examination and report thereon.

In addition thereto the Board were required to report to the Department their recommendations as to the characteristics to be attained in the proposed new ships, with preliminary plans, for the consideration of the Department. Upon the 18th day of September last, after most painstaking and elaborate investigation, the Board submitted their report, embodying their views of the characteristics which the Department ought to secure in the construction of the ships.

The same was thereupon, with the preliminary plans, referred to the Bureaus of Construction and Engineering, with directions to proceed with the preparation of detailed plans and specifications. That work is still in progress.

It is the desire of the Department to avoid the long delays which have occurred in the construction of the ships now in process, arising from the making of changes in the plans after the letting of the work. It is believed that careful preparation of details at the outset will avoid this harassing difficulty.

Meanwhile a great effort has been made to gather, for the information and use of the Department, plans of the latest work of eminent naval constructors of other countries.

In this work the Department has received important aid from Commander Chadwick, the naval attaché at London, as well as from Lieutenant Jaques, while acting under the detail of the Department as the secretary of the Senate Committee on Ordnance.

Within the next thirty days it is believed that the plans will be sufficiently advanced as to justify the commencement of the advertisements, and it is perhaps well that attention should be called to the fact that the ships are likely to be finished at a period long prior to the probable completion of their armament.

There is a growing interest in the matter of this Government work, and the field of the bidders will, I think, be larger than ever before. Several large builders of engines and machinery have expressed a desire to be permitted to compete for the construction of the machinery of the new ships, and it may be decided to separate the hull and her fittings from the machinery in the advertisement, as is sometime done in other countries. In that event the field of the bidders would probably be greatly increased.

THE DOLPHIN, BOSTON, ATLANTA, AND CHICAGO.

Upon my accession to office the Department had in process of construction, under contract with Mr. John Roach, three modern steel cruisers and one dispatch boat. They constituted the first attempt of the Navy Department for many years to construct a war vessel up to the modern requirements. They should be looked upon and judged as such. As such they will, I trust, be found in the main creditable to those who have been engaged in their creation. They will certainly, if they have been well built, be an improvement upon the previous work of the Department, but it is not profitable to consider them as standards of excellence for future work, nor was it to be expected that they would be.

It is to be regretted (I think all will now accede to this suggestion) that greater deliberation was not had over the preparation of the plans. It seems that the plans had not been prepared when the publication of the advertisement for proposals for bids was first made. In fact, they were not passed upon and approved by the Advisory Board and finally settled until about the day when the bids were to be submitted. From the complaints of the contractor (largely, I am inclined to think, just) long delays took place in settling details after the contracts were entered into.

In the case of the Chicago more than six months of delay in the work was admitted by the Advisory Board as attributable to these causes, and to the delays arising from changes in plans, and a much longer time is claimed by the contractor. Greater deliberation over the plans would likewise, doubtless, have resulted in the avoidance of some serious mistakes.

The Dolphin, as she now is, should be regarded as a pleasure boat rather than as a dispatch boat. The absence of the most ordinary and approved devices for protection against hostile fire in her design take her out of the category of war vessels. The use for instance of vertical engines, exposing her machinery above the water-line in a vessel without armor protection, is far from being good practice at this time. In fact, she does not bear favorable comparison with similar vessels built at about the same time by other countries.

The Surprise, built by the English Government contemporaneously with the construction by us of the Dolphin, has horizontal engines placed below the water-line, with a horizontal steel protective deck and with coal protection in addition. She has 40 water-tight compartments as against the Dolphin's 6. Her machinery weighed 10 per cent. less than the Dolphin's and produced 20 per cent. more power, and her speed is from two to three knots better than that of the Dolphin. The vital parts of the Dolphin are so exposed that under fire she would be quite useless; yet her design is chargeable to the Government. At the present time it is quite profitless to discuss her characteristics. She

doubtless would not be thought worthy of duplication at the present time by any one.

Upon the 18th of March last a paper was presented to me for examination and signature, constituting an acceptance of the Dolphin on behalf of the Government. Having been then less than two weeks in office, I took the papers for examination. From these papers it appeared that she had not upon her trial fulfilled one of the conditions requisite under the contract for her acceptance; namely, she had not developed and maintained twenty-three hundred indicated horse-power during the trial required by the contract. In that event the contract placed upon me a serious responsibility. It said :

Provided, That in case of the failure of the development of this power, the vessel shall be accepted if it can be shown to the satisfaction of the Naval Advisory Board and the Secretary of the Navy that this failure was due neither to defective workmanship nor material.

The Advisory Board, in referring to this failure on her part, said :

The Board is of opinion that the deficiency of 188 power from mean of 2,300, required by the contract, for six consecutive hours, was not due to defective workmanship nor material, *but that with better coal and a well-trained engineer force this result will be exceeded.*

From this it appeared that they passed her somewhat conditionally ; at all events, upon a supposition the correctness of which it was quite easy to test.

Upon the 20th of March, therefore, a communication was sent by the Department to the contractor suggesting another trial, with a view of reaching an easy and quick settlement of the matter. An immediate reply was expected, and it was supposed that the trial might be had and the whole matter disposed of within a few days. More than two weeks having passed without any reply to this suggestion, I decided to have an examination made of the vessel. For that purpose there was selected Commodore Belknap, unknown to me, whose reputation is second to none of his rank in the service; Commander Evans, who for some time had been engaged in the inspection of steel at the city of Pittsburgh, and who possessed a high reputation for knowledge and experience in that regard; and Mr. Herman Winter, a marine engineer known to me to be of the highest standing, character, and reputation. No other expectation was entertained but that their examination would justify an immediate acceptance of the vessel; and upon April 7 the president of the Advisory Board was notified of my action by the following letter :

SIR: After examining the contract and laws relating to the construction of the Dolphin, I am of opinion that the act performed by me in passing upon the final payment and plans is not a formal act, but one with reference to which I seem to have responsibility.

I have neither the time nor the expert knowledge with which to possess myself of the necessary information upon which to base a judgment, and while if I had been present in the Department during the construction of the vessel I should doubtless

be possessed of a matured opinion and judgment upon the subject, under the present circumstances that is quite impossible.

In view of the fact that my formal act is required in addition to the act of the Advisory Board, it is quite evident it was not intended that I should rely solely upon the action of the Advisory Board in this matter; otherwise, the action of the Secretary would not be required. I have, consequently, decided to designate three persons, who have not been connected with the construction, for the purpose of assisting me in the discharge of the duty which, without such aid, it is quite impossible for me to perform.

I desire to notify your Board of my action, that it may not be construed to arise from any intention to reflect upon the correctness of the conclusion to which the Advisory Board has come.

On the 7th of April, contemporaneously with the appointment of the Examining Board, I addressed the contractor calling his attention to the fact that he had made no reply to that portion of my letter of March 20, suggesting another trial for the Dolphin. It is proper for me to say in justice to the contractor that he afterwards stated to me that my first letter of March 20, containing a suggestion of another trial, he considered to be merely suggestive and not requiring an answer, and that he had no recollection of having received the second letter of April 7 calling his attention to the fact that he had not answered my former letter.

Upon the 5th of May, after about six weeks silence, he assented that a trial should be had; and in accordance with his request Long Island Sound was assigned as the place of trial, and his request that the Advisory Board should be present was also acquiesced in. Two unsuccessful attempts at a trial subsequently ensued, after each of which the contractor desired a further opportunity, to which I acceded. At one of these interviews, referred to by me in a letter of May 22 to the contractor, he stated that the boat had not the speed nor the horsepower contemplated by the contract, but denied responsibility therefor.

The third attempt resulted in a six hours' run, but she did not reach the limit of power required by the contract, and upon the 15th of July the Examining Board reported the results of her examination. This report was replied to by the Advisory Board upon the 13th of July, which in turn was reviewed by the Board of Examination on the 31st of July. From a comparison of the statements of these reports certain things must be conceded as having been established. Of course a completed ship can only be judged as to her character by what can be seen. It is too late to pass any very satisfactory judgment upon her merits, and this fact has been commented upon in the report of the Examining Board. Only surface indications are available as indicating

the character of her work. From these reports it appears that the contractor, immediately upon the selection of the Board, proceeded to remedy defects which were apparent in her construction.

The first report says:

Since the Board began its detailed examination, the results of which are embodied in this report and its addenda, the contractor has been at work upon the vessel from time to time in remedying defects discovered by the Board, and the Dolphin is now in

much better condition and appearance than when the Board first saw her, and in some important regards she is substantially improved.

For instance, she has been stiffened forward in the forepeak abreast the hawse-pipes by a vertical plate-brace, a point where special weakness was observed; in the after-transom, where the reverse-frames were cut off, the cut frames have been connected by a floor-plate; the spar-deck and berth-deck have been calked fore and aft; the step of the mizzenmast, which was weak and insecure by reason of defective support, has been strengthened to a degree promising perfect security; the skin of the vessel has been repainted at various points where the skin was accessible; the hold store-rooms, fore and aft, have been freshly painted and fitted with proper shelving, and other things have been done in the direction of making the Dolphin a much better ship than the Board found her on its first inspection.

In their supplemental report, reviewing the answer of the Advisory Board, they explain that "the Board had no authority to ask or authorize any changes that were made," and they state that no mention was made of their discoveries to the contractor, but that what he did was upon his own opinion as to the necessities of the case, or that of his advisers. Thus the action of the Department in causing an investigation to be made had been fully justified by the admissions made by all the parties of defects then existing in the ship. This left the question of whether the loose inspection which these defects indicated had existed throughout the construction; and with regard to this it was, of course, quite difficult to satisfactorily ascertain, except inferentially.

The decision of the Department was that under the circumstances no point could properly be made with regard to her general workmanship, the contractor having remedied and being willing further to remedy apparent defects, and there were left but two points in the case for consideration; the one was her speed, and the other her strength. The results of the trials had shown that she had not the speed contemplated by Congress in making the appropriation, nor that which similar boats built contemporaneously elsewhere were given, and a question was raised, although no positive statement was made, with regard to her strength. The Board state in full the circumstances considered by them with reference to her strength, and state that "nothing short of a trial at sea for some time and in rough water can satisfactorily determine her actual strength and weakness," and expressed regret that it was a mere matter of opinion without such a test.

Under the circumstances the Department decided to submit the question to the Attorney-General, whether, under the contract and law, the contractor was responsible for the speed and strength of the vessel. The opinion is annexed with other papers, the decision being that he was responsible both for the speed and the strength of the ship, and that by reason of a certain clause in the contract, referred to in the opinion, the paper which purported to be a contract for the construction of the Dolphin was null and void as such.

Prior to this time I had become aware of the circumstance that the officers of the Department had surrendered to the contractor the reser-

ervations upon all of his pending contracts, with the exception of a small sum of about \$25,000, which reservations had been provided for as the security of the Government for the faithful performance of the work. At this time there were five contracts pending and incomplete, namely, the contracts upon the three cruisers and the dispatch boat and for the machinery in the Puritan.

In the case of the Puritan the contract had specifically provided that the reservations should not be paid until the contract was completed in all its parts and the machinery should have been in use for three months. It also provided for a sea trial of twenty-four hours before the tenth or last payment upon the contract should be made. In December, 1884, many months prior to the completion of the contract, in view of the fact that a sea trial was not possible, a dock trial was had, not satisfactory to the engineer-in-chief; and thereupon, in January, 1885, when a considerable amount of work, estimated at a probable cost of \$26,327, remained to be done in order to complete the requirements of the contract, the sum of \$76,225.46, constituting the reservations upon the contract, was paid to the contractor in violation of the specific provisions of the contract.

The circumstances under which the reservations had been surrendered upon the other four contracts were as follows: The contracts had provided that the vessels should be provided with steel shafts. The first of these placed in the Dolphin broke upon her trial trip. It had previously been condemned by the Advisory Board upon the tests made under their direction, and had been put in nevertheless upon the responsibility of the contractor. At his suggestion a modification of the contracts and specifications was made by which iron was substituted for steel in the shafts of the four boats.

Upon the supposition, then, that this change of plan had caused delay in the construction, an opinion was obtained from the Attorney-General that the contracts could be modified so as to surrender the reservations to the contractor. With reference to the Boston, Atlanta, and Chicago, in point of fact, no serious delay in the final completion of the ships could properly have been attributed to this cause. Nevertheless, the reservations were, with the exception of about \$25,000, surrendered to the contractor.

By these processes something over the sum of \$200,000 of Government moneys had been advanced to the contractor, and all of the five contracts were substantially stripped of the security which by the terms of the contracts was provided.

These acts produced an unfavorable impression upon me, inasmuch as I was unable to see that the grounds upon which these moneys were surrendered were substantial. At the same time, it is proper for me to say that I believe the participation of the officers of the Department therein had been in good faith, and with no expectation that the interests of the Government would be imperiled thereby.

It had for some time been no secret in the Department, as I subsequently learned, that the contractor was in financial difficulty, and the departures from the law had been made under the pressure of these circumstances. The assignment of the contractor developed the fact that he had been carrying an indebtedness of over \$2,200,000, largely upon unavailable assets.

The assignment rendered entirely clear the duty of the Government. There was no other course but to take the vessels and complete them. This was the wish of the contractor and the duty of the Government at the same time.

Upon the 25th of July I stated the position of the Department in a letter to the assignees, as follows :

As I view the matter, the rule which governs individuals in these business transactions should govern the action of the Department. At all events, if there is a different rule proper to be applied I am not aware of it. My duty heretofore has seemed to be very simple and plain. It has been to insist upon the strict enforcement of contract obligations, as interpreted to me, without regard to consequences. That is the ordinary plain business method, a departure from which in a public officer can have no justification; and in like manner I know of no reason why the ordinary principle which actuates merchants in dealing with each other, and, in accordance with which generous consideration is extended ordinarily to an unfortunate business associate, should not govern the action of the Department under similar circumstances.

Early in August I stated to them fully the manner in which the four ships should be dealt with, with which they were entirely satisfied.

On October 1st I embodied (having meanwhile disposed of the more important matters of the other boats in process of construction, the Boston, Atlanta and Chicago) my views with regard to the Dolphin in a proposition, the substance of which was that the Government should take her and should pay the contract price for her when made equal in all respects to the contract requirements. If the contractor should be able to show that this had been done, he should recover the balance of the money; if not, there should be reserved from the judgment a sufficient sum to make her equal to the contract requirements. By so doing I have taken the responsibility of placing the Government in the position which it ought to assume. If the ship is the Government's design, the contractor should be held to correct construction, but not for the performance of the ship. If the design is the contractor's, as in England is often the case, then the contractor may properly be held for both. The contracts should be clearly expressed to this effect.

The Dolphin case remains, therefore, to be disposed of upon proof to be supplied to the court upon these points.

I have, in addition, taken measures to ascertain and settle the question as to her strength. If she proves well built in that regard the other matters of dispute can be, I think, settled by agreement or arbitration out of court.

As to the Boston, Atlanta, and Chicago, the eleventh clause of the con

tract provided for the contingency of work being stopped upon them, and the provisions of the contract have been pursued; the ships have been taken possession of by the Government; an inventory of the amount of work performed has been made; the valuation also had, and the Government is proceeding to complete them where they stand in the yard, employing the foremen and force of the contractor.

It is of no use to discuss the character of the boats, their merits or demerits. Under the present circumstances all that the Government can do from a business point of view is to complete them. Whatever they turn out to be they will demonstrate in practice.

PROMOTIONS IN THE SERVICE.

The rewards which the service affords at the present time for the more meritorious officers are inadequate. I commend to your attention the considerations advanced upon the subject of promotion in the service by my predecessor in office in his annual reports of 1882 and 1884. Some remedy should be found for the long delay in promotions and the inequality therein which will result from the working out of the present laws. I shall hereafter make it the subject of special attention, in the hope that some method may be found by which, without additional burdens to the Treasury, the rewards for superior attainments in the service may, in time of peace as in war, be distributed by some just system, and the tone and spirit of the service be kept up.

FUTURE APPROPRIATIONS FOR NEW SHIPS.

A most intelligent effort has been made by Congress within the last three years to gather information upon the subjects of heavy ordnance and war ships, and as to the best method of developing in the United States the industries connected therewith. The elaborate and most valuable investigations of the Gun Foundry Board, and the more recent ones of the committees of the two houses and of the Fortifications Board in the present year, will place the country in the possession of the latest information, and, I doubt not, mark an era in the history of legislation upon these subjects.

I refrain, therefore, from any discussion at the present time of the subject of future appropriations for material of war. Indeed, so many and most formidable implements of war have become now so well established and approved that at the present time any movement on the part of our Government in any direction would, if intelligently executed, prove of incalculable importance to our naval strength and power.

Cruising ships, however, we must have, unless the policy of continuing repairs upon worthless ships is to continue, or unless we are to abandon the national duty of affording the security and protection of our presence and power throughout the world wherever our people sojourn.

I commend to your consideration the recommendations of the Bureau officers of the Department upon these subjects.

In order to illustrate the importance attached elsewhere to the torpedo-boat as a branch of naval warfare, I insert a list of those possessed and in process of construction by other countries. The United States has none:

Nation.	In service 1884.	Ordered for 1885.	Remarks.
England	129	55	Does not include those in colonies.
Germany	11	61	Fleet to be increased to 150 of first class.
France	82	77	Fleet to number 283 in all.
Russia	131	14	Fleet to number 180 in all.
Austria	14	2	Fleet to number 70 in all.
Denmark	12		To build 21 more.
Greece	37		To build 100 more.
Italy	53	18	One of these is to be 164 feet long.
China	5	10	The largest boat under construction, 166 feet long, is now building for Japan by Yarrow & Co. Others are building in Germany.
Japan			

THE FLEET AT THE NEW ORLEANS EXHIBITION.

Upon the occasion of the recent exhibition at New Orleans the North Atlantic Squadron was directed by my predecessor in office to visit the harbor of New Orleans; and the admiral in command was authorized to expend a very limited sum, which amounted to about \$400, in receiving and extending the hospitality of the ships to visitors entitled to official recognition. This sum was subsequently checked against the admiral in the Treasury Department; but at my request the payment of his salary has not been stopped, awaiting an application to Congress for authority to pay the amount. Without intending to question the correctness of the action of the Treasury Department, it seems quite clear that the amount should be allowed and appropriated for.

In connection with this subject it is proper to call attention to the fact that in a time of peace the Navy is the agency through which largely national courtesies and hospitalities are exchanged throughout the world. It is somewhat the custom of other nations to avail of their navy as a means of creating and extending national good-will, and fleet officers are frequently supplied by their Governments with reasonable means for reciprocating official courtesies. Without some such provision these burdens would fall sometimes with undue severity upon officers of small means.

It has been the custom of the Department to reimburse them certain expenditures in those lines, but under recent rulings of the Treasury Department it may be necessary to discontinue this custom.

It may well be considered by Congress whether a small sum may not judiciously be allowed annually for this purpose, to be accounted for under direction of the Secretary. From three to five thousand dollars would probably be in excess of the annual amount to be required. It is a small sum, but the burden falls upon fleet commanders largely, of which there are but five, who are thus pecuniarily punished for their high rank and station of duty.

THE ORGANIZATION OF THE DEPARTMENT.

Thus closes the résumé of the proceedings of the Department for the fiscal year, most of which occurred under my predecessor in office. Before formally closing this annual report I feel called upon to express for such discussion and consideration as they may seem to warrant my first impressions of the difficulties and drawbacks under which the Department labors.

It must be evident that there is something radically wrong with the Department. The universal dissatisfaction is the conclusive proof of this. It is expressed to me by influential members of both political parties, and quite universally by the naval officers, coupled with the hope and expectation that some remedy may be found and speedily applied. Placed temporarily in charge of the interests of the service, it forces itself daily upon me for consideration.

It is desirable to discriminate at the outset between the naval service and the Navy Department.

Our naval service, numbering altogether, including line officers, engineers, chaplains, pay officers, naval constructors, &c., on the active list, 1,500, consists of a body of accomplished men representing a high standard of personal character, who are deservedly respected and honored throughout the world.

This, unfortunately, cannot be said with equal justice of the Navy Department, and whatever dissatisfaction the country has ever experienced with the naval arm of our Government will be found to have had its origin, not in the naval service, but in the naval administration, and even there dissatisfaction should be limited to certain branches only of the business of the Department.

Historically it is a fact that up to the time that the present Bureau system was created, in 1842, and for some time thereafter, the American Navy, though inferior in numbers to the navies of some other countries, was as formidable as any for its tonnage, and seems to have contributed to, and appropriated improvements in, the art of naval warfare as largely and as rapidly as any other naval power.

During the thirty years between the close of the war of 1812 and the commencement of the Mexican war, our naval force increased fifty-fold and the navies of no other power were superior to it except in the number of their vessels. "As respects the navies of this hemisphere, it was supreme, the united marines of all the rest of this continent being unable to contend against it for an hour."*

Prior to 1842 the business of the Department had been managed by a Board of Naval Commissioners, and the result of my reading leads me to the conclusion that while the affairs of the Department were intelligently administered so far as the general scope of the conduct of its affairs was concerned, yet the system failed in executive force.

* Cooper's Naval History: Preface.

In 1839 Congress called upon the Secretary of the Navy, by resolution, to propose a plan of reorganization, embracing "a division of the duties performed by the Board of Naval Commissioners and their assignment to separate Bureaus." In compliance with this resolution the Secretary reported in December, 1839, a system, and in 1842 Bureaus with independent heads were first established. It was quite evident that with the application of steam to naval vessels a new problem, and one which has been greatly multiplied since by the constant progress of the arts, had been brought to the Department for solution. The Secretary says:

Should the introduction of steam as an auxiliary to naval warfare be sanctioned by the results of experience, it must be obvious that new and very important duties will devolve on the Secretary of the Navy, rendering the aid of professional science and experience still more indispensable in the administration of the Department.

Up to that time a Naval Commission, composed of naval officers, without responsible executive heads subordinate to them, had resulted for a long time satisfactorily, but finally had failed with the accumulation of labor and with the problems which science had thrown upon the Department.

If one should take up the subject in this form and consider, in the first place, what business does the Department transact? what should be the organization for its proper disposition? and compare it with the organization as it exists here and elsewhere, perhaps some light may be thrown upon the difficulties encountered under the present form of administration.

The natural division of the work of the Department is into three branches:

First. The Department having to do with the personnel and the fleet. This covers the enrollment, service, detail, uniform, organization, and discipline of the personnel; of the movements and command of fleets and vessels when commissioned; and this is properly the military branch of the Department.

Second. The Department of Material and Construction. This covers the construction, repair, and care of vessels before commissioned; their armament and equipment, including military stores (but not provisions and clothing), as well as the management and maintenance of dock-yards, their buildings, machinery, and their civil establishment.

Third. The Department of Finance and Accounts, this covering contracts and purchases of all naval stores, flags, coal, stationery, and care of storehouses, &c.

This division of functions is not the one existing. It properly separates, however, the business of the Department for purposes of analysis and consideration. The functions of these last two departments are largely civil.

It is in these last two branches of the service that the difficulties arise. The first or military branch may be placed out of consideration, for the

duties of that have been satisfactorily performed. With reference to the last two branches note that it is the consideration of any ordinary business, and the first requisite to successful transaction of any business is a proper system by which responsibility is lodged in its appropriate place. This division, according to the functions, is one that is, in general, common to the systems of England, France, and Germany. There will be found variations peculiar to each, but there is a substantial agreement in the distribution of functions such as I have indicated.

In the first place, there is the financial department. The last of those above named where the ordinary purchasing, the payment of bills, the auditing, the general system of accounting, &c., are brought under one head. It is sometimes placed in civil hands and the naval service relieved from any responsibility with reference to it. If a certain class of goods, or a certain article, is required by a branch of the service a requisition is made upon the financial department; there the accounts are kept, the distribution and disposition of the property accounted for; purchases are made largely by contract, and for this class of business a person is selected having business capacity. The inspection of goods and material is by the department for which they are intended. This seems to be a proper distribution or location of these functions.

Here this business is scattered through all the Bureaus.

I have very scant means of investigating, but have conducted a few inquiries into the workings of the system in vogue with us for the purpose of informing myself as to its merits, with results such as one might anticipate.

For the security of the public it is provided by law that the purchases of the Navy Department shall be by contract, after advertisement, and shall go to the lowest bidder; that only "regular dealers" shall be dealt with by the Department, which has been interpreted to mean persons whose occupation it is to deal in such articles with the general public. The contract system can be dispensed with only when there is an emergency certified to by the Bureau officer for the immediate purchase, doubtless largely intended for a time of war. Without an efficient head to establish a system and attend to its proper enforcement in the matter of purchases, one would expect to find that order of things which has heretofore brought grave scandals upon the Department, namely, large private purchases where contracts were intended by law, and the business falling into the hands of naval contract brokers to the exclusion of regular dealers in the articles. These abuses (quite inevitable in the absence of a proper system) were investigated and exposed by Congressional committee years ago; but by recent investigations I find the same order of things largely existing down to a recent date, and the same men named in the Congressional report holding substantially the same relation to the Department as before, and with the same scandalous results.

The open purchases of the Navy Department for the year ending June 30, 1885, amounted to \$841,285.84 while the purchases by contract amounted to only a little over a million. A large proportion of the open purchases consisted of articles of either comparatively small value, or more or less difficult of classification; but \$138,000 of the amount was spent by the seven Bureaus, each acting independently of the other for coal bought, not in one lot, but at 166 several open purchases (this does not include coal bought by ships on foreign stations); 299 different open purchases of stationery were made by eight different Bureaus; \$121,315.66 was spent for lumber and hardware by six Bureaus in 499 separate open purchases. Seven Bureaus spent \$46,000 for oils and paints in 269 separate purchases; 117 different open purchases of iron and steel were made at an expense of \$41,524.48; \$68,881.59 was spent for hemp and cordage in 45 different open purchases. Eight Bureaus supply stationery to ships; three Bureaus supply ships with lamps and lanterns. To the same ship one Bureau supplies electric lights and the light for general illuminating purposes; another supplies electric search lights, and a third oil and light for the engine and fire rooms.

These facts are taken from the records of the year ending June 30, 1885, and its showing is more favorable than that for the previous year. I do not question the good faith of the Bureau officers through whom these purchases were made, nor that the purchases were for the most part honestly made. The abuses inevitable under a system of such divided responsibility for the discharge of duties which are only incidental to the general business of the Bureau does not necessarily imply fraud or even indifference to the interests of the service.

But under a system in which these purchases are a mere incident to their general business, it is inevitable that they should be neglected, and the suggestion I make is that they are not properly classified and placed under the proper management and control; for, if the list of persons is examined from whom these purchases are made, there is an astonishing repetition of the names of naval contract brokers, not engaged in a regular business, and whose dealings with the Department caused grave scandals many years since. These purchases have to be made in this form under a certificate made by the Bureau officers, that there is a necessity for the immediate purchase of the articles, which, when used to such an extent as is exhibited under these investigations with reference to standard articles like coal, stationery, lumber, oil, and paints, and articles of that character, simply indicate that the most convenient and not the most economical method of making purchases is resorted to. In some cases private (in distinction from public and open) competition is resorted to, and in some cases short advertising.

Illustrations of a rather extraordinary character of the resort to this certificate of necessity for immediate purchases as a convenience appear among these records.

In the summer of 1883 an order was given for \$61,000 worth of can-

was to a person who was not a dealer in the article and at a time when there was the usual supply of canvas on hand.

Under an order made by Secretary Thompson in 1877 it was understood that the limit of any single purchase under a "certificate of necessity" was \$500. For purchases involving a larger amount resort must be had to the ordinary contract system. Several months were consumed in the delivery of this \$61,000 worth of canvas and the bills were made out in sums of less than \$500 each. The "certificate of necessity" accompanied each one, and in that form the bills passed the Treasury Department.

Two or three of these bills, with the Bureau officer's certificate of necessity upon them, would sometimes be dated and presented on the same day.

During the same year coal was purchased by different paymasters from the same person on or about the same days, deliverable at the very same place, of like quality and character, but at prices differing from 50 to 65 cents a ton.

It is idle to suppose that abuses of the character I have glanced at can be prevented merely by a change in the personnel of the Department. It is the system that is vicious.

The business of the Bureau of Equipment and Recruiting at the time the abuses here referred to occurred was under the charge of a distinguished naval officer of unquestioned integrity and conspicuous executive capacity. It is due to each of the chiefs at present discharging the duties of the various Bureaus that I should express my conviction that they have all labored conscientiously to do what in them lay to protect the service from the unsatisfactory results of a system which they can neither reform nor control.

Each Bureau in the matter of purchases being practically independent of every other, and charged with duties to which these are generally subordinate; with no immediate responsibility to any common head, it is not only not surprising, but it is inevitable that their purchases should be made without the precautions and the judgment and the sagacity which might be expected if that class of duties were confided to an individual selected for the purpose, and upon whom its entire responsibility could be concentrated. With such a concentration of responsibility, the financial operations of the Department would all center at a single point; a system of books would be kept that would show at a glance all the financial transactions of the Department, and at the same time would establish what is sadly lacking at present, an exhibit of all the property of the Department for which some one would always be accountable.

I have taken measures to obtain a complete inventory of the stock on hand in our various navy-yards and stations. It is the first that has been made in seven years. In view of the defective system under which

the Navy Department has been allowed to drift during the last twenty years, I was not greatly surprised to discover that the stock on hand fails to agree with the amounts shown by the books of the Department. In some cases it is largely in excess, in others there is a deficiency.

The discrepancy can only be explained by the absence of a proper system of accountability. Taking for an illustration the article of canvas, of which the Navy is a large consumer. When it is taken from the storehouse upon requisition the amount is checked off on the books. Here accountability practically ceases. What of it, if any, is not used, remains in the sail-loft. What finally becomes of it, sooner or later, it becomes difficult, if not impossible, to ascertain. Charges of its being pilfered and redelivered to the Department by contractors, in collusion with the clerks, have been made from time to time. The remnants, if returned, have not always been entered on the books. This necessarily left in store a surplus beyond what the books called for, constituting a temptation which it is not wise for any Government to offer. Were this business placed under a single and competent head, with entire responsibility, discrepancies like these, which, if known, would be fatal to the credit of any commercial house, could only occur in rare cases, nor then without blasting the character of the responsible officer.

It is probable that a person equipped with the business training and experience requisite for the effective discharge of such a trust might more readily be selected from civil life than from the naval service. Such has been the experience and the practice of the great naval powers of the world. In England the class of duties to which I have referred is devolved upon the financial secretary, who is selected by the first lord of the admiralty, and who is required to be a civilian and a member of Parliament. He sits with the Admiralty board, and is expected to present and defend the estimates of the Admiralty in the House of Commons, and upon him the Government depends mainly for the direction and control of this branch of the Department's business.

From the consideration of this branch of the service two or three things would seem to appear. In the first place, that the present system has worked badly, even down to the present time; in the second place, that any proper system would throw this work together under one head; and, in the third place, that that is in general the system adopted by other countries.

Returning now to what I have called the second branch of the functions of the Department, that of material and construction, we encounter difficulties of a yet more serious character. It is here that the Department has most lamentably failed. The rapid advance of the art of naval warfare and the singular fertility of human genius in devising new and ever more formidable implements of destruction are rendering the problems of this branch of the public service daily more complicated and difficult. At the present moment it must be conceded that we have

nothing which deserves to be called a navy. The highest official authority in our service said in 1876:

There is no navy in the world that is not in advance of us with regard to ships and guns, and I, in common with the older officers of the service, feel an anxiety on the subject which can only be appreciated by those who have to command fleets and take them into battle.

And so recently as 1883 the same distinguished authority stated that it was universally admitted "that we have no navy either for offense or defense."

The country has expended since July 1, 1868—more than three years subsequent to the close of the late civil war—over seventy-five millions of money on the construction, repair, equipment, and ordnance of vessels, which sum, with a very slight exception, has been substantially thrown away; the exception being a few ships now in process of construction. I do not overlook the sloops constructed in 1874 and costing three or four millions of dollars, and to avoid discussion they may be excepted also. The fact still remains that for about seventy of the seventy-five millions of dollars which have been expended by the Department for the creation of a navy we have practically nothing to show.

It is questionable whether we have a single naval vessel finished and afloat at the present time that could be trusted to encounter the ships of any important power—a single vessel that has either the necessary armor for protection, speed for escape, or weapons for defense. This is no secret; the fact has been repeatedly commented upon in Congress by the leading members of both parties, confessed by our highest naval authorities, and deprecated by all. Such is not the kind of navy which this country, with its extensive coast line, its enormous territorial area, and incalculable commercial resources, requires, nor such as it is entitled to have. This country can afford to have, and it cannot afford to lack, a naval force at least so formidable that its dealings with foreign powers will not be influenced at any time, nor even be suspected of being influenced, by a consciousness of weakness on the sea. While still striving to build up its merchant marine and to multiply its relations with foreign markets, it cannot be expected much longer to tolerate such expenditures for a navy which could not for a moment defend even its diminutive commerce against any considerable power.

A naval vessel at the present moment is a product of science. Taking the world over, it will be found that each part of her—her armor, her armament, her power, her form, and the distribution of her parts or characteristics—each of these features of the completed vessel is absorbing from year to year the exclusive study of a class of scientific men. And as men of science throughout the world are continually stimulated to new discoveries and inventions, no vessel that can be built can be considered a finality in any particular.

The problem of keeping pace with the march of improvement in these lines of industry is one of incalculable difficulty; and yet unless the

Government is prepared to avail itself promptly of all the improvements that are made in the construction and equipment of its ships its expenditures are largely useless.

It is of little service to a nation to have any navy at all unless it is a fair expression of the highest scientific resources of its day. The destructive power of the modern implements has become so great as to dominate in actual warfare. The bravest and best commander is helpless without them.*

For the construction and maintenance of such a navy we have made but little provision. To have and maintain such a navy is, I believe, the wish of the country and the duty of the Government.

In order to encounter and deal with this problem other countries have made certain important changes in their policy of late years, to which it may be proper to call attention for whatever consideration seems proper.

First, in the matter of the education of their men they have differentiated them and spent money to create in each branch men with the necessary scientific training. In England and France the education of the naval constructor and the designing engineer is, from beginning to end, entirely different from that of a line officer, and highly scientific. Follow the education of a constructing engineer in England. By a competitive examination students are selected for entrance at the naval dock-yards. They become apprentices, and for six years work as such, and become familiar by actual work with machinery and mechanics, attending the dock-yard schools meanwhile. At the end of six years they are eligible for entrance to the Royal Naval College at Greenwich, where they pursue a scientific engineering course for one year, when they are commissioned as assistant engineers and sent to sea; but from this class, at the end of the one-year's course, two are chosen annually by competition, and reserved for higher education at the college. These pursue a further scientific course in marine engineering for two additional years. At the end of this course one year is supposed to be passed at sea, when they become foremen at the Admiralty dock-yards, and are eligible for the positions of draughtsmen and assistant constructors attached to the Admiralty force. Upon graduation they become permanent civil servants, entitled to a pension, with a fixed tenure, and these men, with the naval constructors similarly educated, are to be found not only in the Admiralty, but throughout the private dock-yards

* The destructive power of the modern implements of war is well illustrated by the battle between the French and Chinese fleets at Pagoda Anchorage, Min River, in August, 1884. There was not sufficient difference in the number and tonnage of the vessels engaged to justify any decided opinion as to the result of the contest. There were nearly a dozen vessels in line or in reserve on each side. Most of the Chinese fleet, too, were of modern construction, but it was not equipped with torpedoes nor machine-guns, besides being in other respects inferior to the French in the destructive power of its armament. Within fifteen minutes after the signal for the attack was given the entire Chinese fleet was disabled, and in less than half an hour all that could be seen of it were hulks in flames or sunken vessels.

and ship-building establishments everywhere in England; and in several notable instances these men have risen to great distinction, with very high social and professional rank, and have contributed greatly to the advancement of the ship-building interests of their country.

In France there is but one corps of construction, called the engineer corps. The education is here entirely separate from that of the line officer, and they are given high rank in the service. The head of the corps ranks with a rear-admiral; he is called the inspector-general. The director of naval construction ranks above a captain and after rear-admiral. Engineers of the first class rank with captains; engineers of the second class with commanders; this is the designing-engineer class, with high scientific training. It is a separate corps from what is called the engineering mechanics, who have the supervision of engines and machinery on board ships.

In broad contrast with the policy of both the great naval powers here indicated, the only step we have taken for many years to meet the constantly changing exigencies of the service has been to discontinue the special education of engineers. The separate engineer class at the Naval Academy was abolished in 1882, and the man who now graduates from the Naval Academy into the engineer corps will have had no experience in the dock-yard, no familiarity with construction; except such elementary knowledge as he may have acquired in common with a line officer at the Academy. Even his sea service has been in a sailing vessel, where he has been taught the seamanship of a past generation, and he may have never seen a modern engine in his life. Upon graduation, instead of being sent where practical experience in his branch of work can be acquired—to a marine-engine establishment or a ship-yard—he is sent to sea, and it is from this class that designers, who are expected not only to utilize all the latest improvements of other naval powers, but to add to and perfect them, are supposed to be selected. One exception should be noted to this: By the courtesy of the Governments of England and France we are permitted to maintain two students at the Royal Naval College at Greenwich, and two at the French Naval College at Cherbourg. This privilege will doubtless prove an important advantage to us in process of time, though somewhat slowly; and our students are still without the dock-yard experience which theirs enjoy.

In other words, we have traveled in one direction in this regard and other people in another. They imagine that to keep up with one branch of scientific human industry at the present time is sufficient for one man, and that it is necessary to educate to it and to furnish adequate rewards within the line in which talent and science are desired.

The result of this is seen in the fact that while they have been steadily advancing in the arts of naval construction and equipment until there is scarcely a feature of the vessels they are now constructing or a weapon which figures at all conspicuously among the destructive powers of their

armament which is not comparatively a novelty, we stand but little in advance of our position as it was twenty years ago.

We are also called upon to take note of the fact that all the great naval powers appear to have found it to be to their advantage to avail themselves largely of private enterprise in the creation of implements of war. No designing engineer of the English Admiralty has designed an engine for many years. In their stead the private marine-engine builders of the nation, who can produce evidence of adequate responsibility, are invited to compete with each other to produce, for example, an engine that shall be able to accomplish certain defined results, such as a certain amount of power with the greatest economy of weight and space consistent with strength and durability.

The Admiralty designer acts as a critic of the plans, and as general adviser. He is relieved, in a great degree, from executive labor, that he may have time for study and for keeping up with the progress of his art. Having prescribed the general conditions of the proposed engine, his subordinates supervise the construction. To stimulate and encourage the competitors to spare no effort or expense in executing any order that may be awarded them it is usual to offer a liberal premium for every increase of the required power of the machine, and to attach a pecuniary penalty proportioned to the amount it falls short of such required power.

By this process the Admiralty secures for the Government the best results of all the ingenuity and capital that is engaged in this branch of industry throughout the empire, in addition to whatever aid its own trained agents can contribute. In this way, too, every improvement in marine engineering, wherever and by whomsoever made, is pretty certain to be first offered to the Government. For successful competition under such conditions it becomes absolutely indispensable for competing establishments to avail themselves of all the tributary resources of science, while the Government, by turning over such work to private enterprise, secures a maximum of economy and executive force.

It is the tendency of all governmental service to fall into ruts and grooves, for which in the preparation of implements of war there is perhaps no antidote so effective as an appeal, where practicable, to private enterprise.

Indeed, it is to private enterprise that the art of naval warfare is indebted for most of its improvements. It is difficult to name a single component part of a first-class vessel of war to which private enterprise has not made quite the most important contributions. The iron or steel used for her hull and for her armor; her power and the engines by which it is controlled and directed; her revolving turrets; her guns; her projectiles; her explosives; her torpedoes; her search-lights; her steering gear; her wire cordage, are almost exclusively the invention of

private individuals, and are manufactured and supplied by industrial agencies operated mainly by private capital.

By the system I have described the designer is not only relieved from all the financial business with which he is burdened with us, but, what is of incalculable importance, he is assisted in his work by all the great marine-engine designers of the country. They become as effectually his aids and subordinates as if they held their commissions from their Government.

With us, on the contrary, the head of the Bureau of Steam Engineering, upon whom we depend for designs, is selected from a corps which is at present given by the Government only an elementary training in the science of engineering. He is at once loaded down with the distracting executive work of construction. Having the charge of a multitude of shops in the various navy-yards, he must look after a great variety of contracts, purchases, and so on. In addition to all this, for which of itself few men are equal, he is expected to design the most complicated machinery and give his country the benefit of the daily improvements in his art. It is needless to say that to such a task no man is equal.

The policy of enlisting private enterprise in the work tends to the creation and development of important branches of industry within the country. The resources of our country, its ingenuity and enterprise in any line of human endeavor, when called out, are unexcelled by any nation or people on earth.

If the \$75,000,000 spent since 1868 by our Government had been used to stimulate competition among our people in the production of modern ships of war, it is quite fair to assume that the activities and agencies at the disposal of the Government would have been by this time entirely adequate to its needs. It has been wasted by Government agencies upon worthless things. The invention of the country has been discouraged. The Hotchkiss gun now commanding the widest attention, the manufacture of which is becoming an important industry in France, was the product of American invention, which, when ignored and rejected by Government agencies here, found elsewhere its field of development. Ericsson, whose name will always be one of the great ones of our time in history, works now at the age of 83 without encouragement or notice at the great problems of naval warfare, and is receiving more attention and greater encouragement from other Governments than from our own. Examples might easily be multiplied.

Suffice it to say our Government has placed itself in no relation to the inventive genius of the country, and is without the rich fruits which such a course would bring to it.

Another distinction to which attention may properly be called between our system and that in general use elsewhere is as to the manner in which the general policy of the Department is shaped and directed. At the top of the system there should be wise general direction. After

you have freed your technical, scientific men from unnecessary burdens, put the finances where they will be well handled in a business way, freed your designers largely from the executive work, so that they are enabled to put the Department in the way of producing advanced products (appropriating, adapting, and inventing new and improved methods in their various lines), it is of the first importance that the system should center in a wise and judicious and capable directing power, for there is necessarily the daily decision to be made of what shall be done in any particular line.

With reference to a naval vessel, the first step is the consideration of the direction in which the nation shall move amid the conflicting opinions of disputants. All the difficult problems in the construction of a vessel of war present themselves and must be settled before the construction is commenced. Her size, her speed, her armament, her protections; the proportion of displacement which shall be given to each, and her probable cost, are all of them problems of incalculable difficulty, and about which the most competent authorities are usually most diffident in expressing opinions.

For the determination of these questions boards consisting partly of naval officers and partly of civilians are usually constituted. The naval powers of the Old World provide a permanent council or board, whose duty it is to consult with and advise the minister of marine. They are largely freed of executive duties and functions, so that they may have time for investigation and study, and to be thus enabled to take a large view generally of the questions which are involved in directing the course and general policy of the Department.

It occurs to me that the superiority of our system as it existed up to 1842 was in this regard; for it seems that what was done was wisely done. The ships that were built were up to the state of the art at the time. There was the necessary intelligence directing the movements of the Department; but they failed in executive business capacity, and the Bureau system was devised to remedy this. It was supposed at the time, as the record shows, that the Bureau chiefs would be able to sit in consultation with the Secretary and that the Department would not lack intelligent guidance. But the inevitable result of throwing large executive duties upon any man is to disqualify him for council. At the present time this function is not performed at all. The Secretary may at once be eliminated from the problem. A civilian ordinarily, not skilled in the art of war, nor having the technical knowledge with reference to its implements; having no personal staff, his separate office force consisting, as estimated for and appropriated by Congress, of but one stenographer, one clerk, and three messengers—all the other force having general clerical work. Thus it happens, as it has happened for the last twenty years, that the Department drifts along doing without consideration whatever is done and with no intelligent guidance in any direction.

If illustration should be thought desirable of the fact that the De-

partment lacks wise directing power, the unwisdom of its expenditures, the fact that it has steadily gone behind in the race, while its Bureau officers are known to be able and experienced men, may properly be cited.

My experience of the manner in which important decisions are necessarily made by the Secretary, without opportunity for proper deliberation and intelligent advice, leads me to say without hesitation that the follies of the Department are largely attributable to this. Take the "Omaha" for an example. She has been rebuilt within the last four years, at an expense of \$572,000. It was an act of the greatest folly. She is a repaired wooden vessel, with boilers, machinery, and guns, all of which would at the time have been sold for what they would have brought by any other nation on earth. In the event of a war she can neither fight nor run away from any cruiser built contemporaneously by any other nation. Her rebuilding cost the full price of a modern steel ship of her size and all modern characteristics.

Now, if one should seek to ascertain who is responsible for the decision that the "Omaha" should be rebuilt, it would be found that no one so decided, after discussion and an intelligent knowledge of facts. The chief constructor will deny responsibility except for the survey; the engineer-in-chief the same; and the Secretary of the Navy, if he should be able to recall the circumstances, would doubtless remember that he was advised that she needed general repairs and rebuilding, and gave the orders in ignorance of the probable result of his decision.

It may be said that the Secretary should call the chief constructor and designing engineer and the other Bureau chiefs and ask them to sit down and discuss with him the problems of the Department. They would be very competent to assist him in that capacity, but, in the first place, they are too fully occupied with executive work to leave them any time for such investigations as could be of any service to the Secretary, and, in the second place, the responsibility is not placed upon them.

The most that can be said is that the Secretary might enforce the necessary aid in an individual case, but it would not be possible to extend it much further.

I find myself forced, therefore, to the conviction that everything connected with the construction and equipment of our Navy is done with too little deliberation, and that under the present organization of the Department this cannot be otherwise. I have occasion to know that the amounts found to have been expended upon the "Omaha" and upon the "Mohican" surprised no persons more than the Bureau officers who had been engaged upon the work. Seeing the ill-advised and inconsiderate manner in which important steps are necessarily taken by me under the present system, I feel certain that a similar record of mismanagement, or wasteful expenditure, of injudicious and ill-advised disposition of public moneys might be made by any Secretary under the present system. Nor can I undertake, with the hope of any substantial success, to prevent

entirely the mismanagement which has so long been the reproach of this Department. As in the English service, and notably in the French and German, the Secretary should be provided with a board or boards for consultation, consisting of naval officers and experts, most of them comparatively free from executive duties, whose duty it should be to assist him in solving the technical problems of the Department.

The creation of the Naval Advisory Board was an attempt to supply this want to the Secretary in the matter of the consideration of the four ships authorized in 1883. It was, I have no doubt, a benefit in many respects and a substantial aid to the Secretary. I think it unfortunate that the intention of the law, as it is now understood by both the Advisory Board and the Bureau officers after a general consultation with me, was not carried out. If they had remained with an advisory function merely, preparing plans, consulting over and advising the Secretary with regard to what the ships should be, examining and inspecting the work as critics and independent advisers, leaving the responsibility for the work with the Bureaus, instead of taking into their own hands the executive function and practically superintending and doing the work, it would, I think, have worked in a more satisfactory manner to the Department and the service.

My brief experience in this Department has satisfied me that whatever changes in its organization may be desired, it is of first necessity to separate, as much as practicable, the work of direction and deliberation from the details of execution; in other words, that there should be in the construction of a navy, as in every other kind of business, a proper distribution of labor.

It is proper to say that many improvements in the present organization may be made by the Secretary without additional legislation; and to the extent to which, after full consideration and discussion, changes will seem to be judicious, they will be undertaken. In the matter of obtaining designs for ships and determining the form in which proposals shall be made to private ship and engine builders, he is allowed a reasonable latitude. Indeed, prior to the war the engines of a large proportion of the naval vessels were designed in various establishments, in answer to proposals calling for general requisites of machinery. I have deemed it wise to avail myself of these discretionary powers to accumulate for the instruction and use of the Department in preparing the plans of the ships about to be advertised the latest designs, so far as possible, of eminent naval constructors of other countries; but no power is lodged with the Secretary to make any effectual changes in the organization of the Department itself, or do more than redistribute somewhat the functions among existing Bureau chiefs.

The system of organization indicated herein begins with the Secretary (who occupies a position at the confluence of all the powers confided to the Department) and supports him with some aids or advisers in such

number and of such character as shall seem judicious; (an Assistant Secretary of the Navy would seem to be an essential feature.) Then places one person at the head of each of the three natural divisions of the functions of the department, which may be stated to be finance, construction, and *personnel*; then subdivides the business of each division according to the subject-matter with which each deals. Thus the division of material and construction would necessarily have a subdivision or bureau for engineering, one for construction, one for equipment, and one for ordnance.

At present the four heads of these bureaus, instead of co-operating, work independently of each other and not always in harmony in producing their respective parts of a completed ship. After the "Omaha" had been commissioned and was ready for sea, it appeared that the several bureaus working independently upon her, had between them so completely appropriated her space that they had left her coal-room for not more than four days' steaming at her full capacity. Each bureau, too, finds it necessary to maintain its separate shops in the several navy-yards, each with a separate organization of foremen, quartermen, leading men, &c., so that shops doing precisely the same class of work—carpenter-shops and machine-shops, for instance, are commonly duplicated and sometimes triplicated in the same navy-yard with a corresponding multiplicity of foremen and organization expenses—a state of things which, under the present organization of the Department, it is almost impossible to correct.

If such an organization should commend itself to the law-making power and be once tried, I feel confident it would be of great benefit to the country.

It calls for no additional expenditures.

Our present departmental force is more than adequate to our needs if rearranged and systematized. Our policy as a nation is such as not to require a great naval force, but we need wisdom in expenditures and a force adequate for the enforcement of our views of right and justice.

To secure these results a reform in our organization is indispensable.

Very respectfully,

WILLIAM C. WHITNEY,
Secretary of the Navy.

APPENDIX.

No. 1.—ESTIMATES, SECRETARY'S OFFICE, ETC.

*Estimates of appropriations required for the service of the fiscal year ending June 30, 1887,
for the Navy Department.*

Detailed objects of expenditure, and explanations.	Estimated amount which will be required for each detailed object of expenditure.	Amount appropriated for the current fiscal year ending June 30, 1886.
OFFICE OF THE SECRETARY.		
Secretary	\$8,000 00	
Chief clerk.....	2,500 00	
Disbursing clerk.....	2,250 00	
Five clerks of class four.....	9,000 00	
One clerk of class four, in charge of files and records.....	1,800 00	
Three clerks of class three.....	4,800 00	
One stenographer.....	1,600 00	
One stenographer.....	1,400 00	
Two clerks of class two.....	2,800 00	
Six clerks of class one.....	7,200 00	
Four clerks, at \$1,000 each.....	4,000 00	
One telegraph operator.....	1,000 00	
Two messengers, at \$840 each.....	1,680 00	
Three assistant messengers, at \$720 each.....	2,160 00	
Two messenger boys, at \$420 each.....	840 00	
One messenger boy.....	240 00	
Three laborers.....	1,980 00	
One clerk of class two, for Inspection Board.....	1,400 00	
One laborer, for Inspection Board.....	660 00	
One clerk of class two, for Examining and Retiring Board.....	1,400 00	
One clerk of class one, in care of library.....	1,200 00	
One assistant messenger, in care of library.....	720 00	
	58,630 00	\$58,630 00
Assistant Secretary of the Navy, submitted, \$4,000.		
CONTINGENT EXPENSES.		
For stationery, furniture, newspapers, plans, drawings, drawing materials, freight, expressage, postage, and other absolutely necessary expenses of the Navy Department and its various bureaus and offices.....	18,500 00	11,000 00
PAY OF THE NAVY.		
Pay of officers on sea duty, officers on shore and other duty, officers on waiting orders, officers on the retired list, Admiral's and Vice-Admiral's secretaries, clerks to commandants of yards and stations, clerks to paymasters at yards and stations, inspections, receiving ships and other vessels, extra pay to men re-enlisting under honorable discharge; pay of petty officers, seamen, landsmen, and boys, including men in the engineer's force, and for the Coast Survey Service and Fish Commission, 7,500 men and 750 boys, at the pay prescribed by law	7,129,087 50	6,940,780 00
NOTE—The above estimate is based as follows:		
Pay of officers on the active list.....	\$3,633,800 00	
Pay of officers on the retired list.....	811,387 50	
Pay of petty officers and seamen.....	2,509,000 00	
Extra pay of petty officers and seamen, re-enlisting under honorable discharge, 695, at an average of \$100 each.....	69,500 00	
Pay of secretaries to Admiral and Vice-Admiral.....	5,000 00	
Pay of clerks to commandants and paymasters, shore stations and receiving ships.....	72,800 00	
Pay of clerks to paymasters on cruising vessels.....	86,600 00	
Total pay of the Navy.....	7,129,087 50	

Estimates of appropriations required for the service of the fiscal year, &c.—Continued.

Detailed objects of expenditure, and explanations.	Estimated amount which will be required for each detailed object of expenditure.	Amount appropriated for the current fiscal year, ending June 30, 1896.
PAY OF THE NAVY—continued.		
<p>The appropriations for the four items last mentioned have heretofore been made under "Pay, miscellaneous," but they should be under "Pay of the Navy." The estimate is for \$183,900, which is about the sum paid for those objects during the last fiscal year. Extra pay or bounty for re-enlisting is authorized by section 1573 of the Revised Statutes. Clerks to commandants of yards and stations and to paymasters are allowed, and their pay is fixed by sections 1386, 1387, 1388, and 1556 of the Revised Statutes. The Secretaries to the Admiral and Vice-Admiral are allowed by section 1367, and their pay fixed by section 1556 of the Revised Statutes. The sums paid to these persons come properly under the head of "Pay of the Navy," and not under a contingent or miscellaneous appropriation. There is an obligation of law to meet their pay by necessary appropriations. The estimates for "Pay, miscellaneous" have been reduced the amount asked for them under "Pay of the Navy."</p> <p>The actual increase in the estimate over the amount actually appropriated or expended during the past fiscal year for the several objects embraced under the heading "Pay of the Navy," is \$4,407 50.</p>		
PAY, MISCELLANEOUS.		
<p>For commission and interest, transportation of funds, exchange; mileage to officers while traveling under orders in the United States, and for actual personal expenses of officers while traveling abroad under orders, and for travelling expenses of apothecaries, yeomen, and civilian employes, and for actual and necessary traveling expenses of naval cadets while proceeding from their homes to the Naval Academy for examination and appointment as cadets, and for the payment of any such officers as may be in service, either upon the active or retired list, during the year ending June 30, 1896, in excess of the numbers of each class provided for in this act, and for any increase of pay arising from different duty, as the needs of the service may require; for rent and furniture of buildings and offices not in navy-yards; expenses of courts-martial and courts of inquiry, boards of investigation, examining boards, with clerks and witnesses' fees, and traveling expenses and costs; stationery and recording; expenses of purchasing-paymasters' offices at the various cities, including clerks, furniture, fuel, stationery, and incidental expenses; newspapers and advertising; foreign postage; telegraphing, foreign and domestic; telephones; copying; care of library; mail and express wagons, ferrage tolls, and livery and express fees; costs of suits; commissions, warrants, diplomas, and discharges; relief of vessels in distress, canal tolls, and pilotage; recovery of valuables from shipwrecks; quarantine expenses; care and transportation of the dead; reports, professional investigation, cost of special instruction, and information from abroad, and the collection and classification thereof.....</p>	\$278,580 00	\$375,000 00
<p>NOTE.—An estimate for the sum of \$183,900 for objects heretofore appropriated for under "Pay, miscellaneous" has been included under "Pay of the Navy," for reasons stated in the note under that head, thus eliminating from the miscellaneous and contingent appropriations items not properly belonging there, and leaving only such for which a specific estimate cannot well be made on account of their contingent nature. Had not this been done, an estimate of from \$450,000 to \$460,000 would have to have been made under "Pay, miscellaneous." The appropriations for this purpose for the last two or three fiscal years have been entirely inadequate, and the deficiencies range from \$50,000 to \$75,000 each year.</p>		
CONTINGENT, NAVY.		
<p>For all emergencies and extraordinary expenses, arising at home or abroad, but impossible to be anticipated or classified, exclusive of personal services in the Navy Department or any of its subordinate bureaus or offices, at Washington, D. C.....</p>	10,000 00	20,000 00
PRINTING AND BINDING.		
<p>Printing and binding for the Navy Department and its various branches, to be executed under the direction of the Public Printer.....</p>	63,000 00	59,512 50

REPORT OF THE SECRETARY OF THE NAVY

Estimate of the amount required to pay the officers of the United States Navy for the fiscal year ending June 30, 1887.

Grade.	Sea duty.			Other duty.			Waiting orders.		
	Number.	Pay per annum.	Total.	Number.	Pay per annum.	To	Number.	Pay per annum.	Total.
Admiral.....				1	\$13,000	\$13,000			
Vice-Admiral.....				1	8,000	8,000			
Rear-admirals.....	3	\$6,000	\$18,000	4	5,000	20,000			
Commodores.....	3	5,000	15,000	9	4,000	36,000	3	\$3,000	\$9,000
Captains (chiefs of Bureau).....				3	5,000	15,000			
Captains.....	9	4,500	40,500	25	3,500	87,500	8	2,800	22,400
Commanders (chief of Bureau).....				1	5,000	5,000			
Commanders.....	22	3,500	77,000	48	3,000	144,000	14	2,300	32,200
Lieutenant-commanders:									
After 4 years.....	19	3,000	57,000	23	2,600	59,800	14	2,200	30,800
First 4 years.....	8	2,800	22,400	9	2,400	21,600	1	2,000	2,000
Lieutenants:									
After 5 years.....	119	2,600	309,400	89	2,200	195,800	12	1,800	21,600
First 5 years.....	16	2,400	38,400	15	2,000	30,000	1	1,600	1,600
Lieutenants, junior grade:									
After 5 years.....	31	2,000	62,000	21	1,700	35,700	4	1,400	5,600
First 5 years.....	13	1,800	23,400	9	1,500	13,500	1	1,200	1,200
Ensigns:									
After 5 years.....	42	1,400	58,800	22	1,200	26,400	3	1,000	3,000
First 5 years.....	94	1,200	112,800	15	1,000	15,000	11	800	8,800
Naval cadets, undergraduates.....	67	950	63,650				7	500	3,500
Medical directors:									
Chief of Bureau.....				1	5,000	5,000			
After 20 years, date of commission as surgeon.....				12	4,000	48,000	2	3,000	6,000
Medical inspectors:									
Fleet surgeons.....	5	4,400	22,000						
After 20 years, date of commission as surgeon.....				9	4,000	36,000	1	3,000	3,000
Surgeons:									
Fourth 5 years after date of commission.....	7	3,700	25,900	6	3,600	21,600			
Third 5 years after date of commission.....	5	3,500	17,500	2	3,200	6,400	2	2,600	5,200
Second 5 years after date of commission.....	4	3,200	12,800	7	2,800	19,600	2	2,400	4,800
First 5 years after date of commission.....	10	2,800	28,000	5	2,400	12,000			
Passed assistant surgeons, after 5 years from date of appointment.....	31	2,200	68,200	26	2,000	52,000	6	1,700	10,200
Assistant surgeons:									
First 5 years after date of appointment.....	4	1,700	6,800	10	1,400	14,000			
Not in line of promotion.....	1	1,700	1,700	1	1,400	1,400			
Pay directors, after 20 years from date of commission.....				13	4,000	52,000			
Pay inspector:									
As chief of Bureau.....				1	5,000	5,000			
Fleet paymasters.....	4	4,400	17,600						
After 20 years from date of commission.....				5	4,000	20,000	3	3,000	9,000
Paymasters:									
Fleet paymasters.....	2	4,400	8,800						
After 20 years from date of commission.....	2	4,200	8,400	5	4,000	20,000	3	3,000	9,000
Fourth 5 years after date of commission.....	5	3,700	18,500	5	3,600	18,000	3	2,800	8,400
Third 5 years after date of commission.....	3	3,500	10,500	3	3,200	9,600	2	2,600	5,200
Second 5 years after date of commission.....	5	3,200	16,000	7	2,800	19,600	2	2,400	4,800
First 5 years after date of commission.....				1	2,400	2,400			
Passed assistant paymasters after 5 years from date of appointment.....	6	2,200	13,200	11	2,000	22,000	10	1,700	17,000
Assistant paymasters:									
After 5 years from date of appointment.....	7	1,900	13,300	7	1,600	11,200	3	1,200	3,600
First 5 years from date of appointment.....				2	1,400	2,800			
Chief Engineer, chief of Bureau.....				1	5,000	5,000			
Chief engineers:									
Fleet engineers.....	5	4,400	22,000						
After 20 years from date of commission.....				20	4,000	80,000	2	3,000	6,000
Fourth 5 years after date of commission.....	5	3,700	18,500	6	3,600	21,600			
Third 5 years after date of commission.....	4	3,500	14,000				3	2,600	7,800
Second 5 years after date of commission.....	3	3,200	9,600	6	2,800	16,800	5	2,400	12,000
First 5 years after date of commission.....	5	2,800	14,000	4	2,400	9,600			
Passed assistant engineers:									
Fourth 5 years after date of appointment.....	11	2,700	29,700	13	2,350	30,550	6	1,950	11,700
Third 5 years after date of appointment.....	14	2,450	34,300	10	2,250	22,500	2	1,900	3,800
Second 5 years after date of appointment.....	15	2,200	33,000	8	2,000	16,000	2	1,700	3,400
First 5 years after date of appointment.....	1	2,000	2,000	3	1,800	5,400			
Assistant engineers:									
After 5 years from date of appointment.....	42	1,900	79,800	15	1,600	24,000	10	1,200	12,000
First 5 years after date of appointment.....	6	1,700	10,200				5	1,000	5,000

Estimate of the amount required to pay the officers of the United States Navy, &c.—Continued.

Grade.	Sea duty.			Other duty.			Waiting orders.		
	Number.	Pay per annum.	Total.	Number.	Pay per annum.	Total.	Number.	Pay per annum.	Total.
Chaplains:									
After 5 years from date of commission.....	3	2,800	8,400	11	2,300	25,300	8	1,900	15,200
First 5 years after date of commission.....	1	2,500	2,500						
Professors of mathematics:									
After 15 years from date of appointment.....				4	3,500	14,000			
Third 5 years after date of appointment.....				3	3,000	9,000			
Second 5 years after date of appointment.....				3	2,700	8,100			
First 5 years after date of appointment.....				2	2,400	4,800			
Naval constructor, chief of Bureau.....				1	5,000	5,000			
Naval constructors:									
After 20 years from date of appointment.....				3	4,200	12,600			
Fourth 5 years after date of appointment.....				6	4,000	24,000			
Third 5 years after date of appointment.....				1	3,700	3,700			
Assistant naval constructors:									
After 8 years from date of appointment.....				3	2,600	7,800			
Second 4 years from date of appointment.....				2	2,300	4,400			
First 4 years after date of appointment.....				4	2,000	8,000			
Civil engineers:									
Third 5 years after date of appointment.....				3	3,000	9,000			
Second 5 years after date of appointment.....				7	2,700	18,900			
Boatswains:									
After 12 years from date of appointment.....	8	1,800	14,400	9	1,600	14,400	8	1,200	9,600
Fourth 3 years after date of appointment.....	1	1,600	1,600	1	1,300	1,300	1	1,000	1,000
Third 3 years after date of appointment.....	1	1,400	1,400	3	1,300	3,900	1	900	900
Second 3 years after date of appointment.....	2	1,300	2,600	2	1,000	2,000			
First 3 years after date of appointment.....	1	1,200	1,200						
Gunners:									
After 12 years from date of appointment.....	8	1,800	14,400	21	1,600	33,600	4	1,200	4,800
Fourth 3 years after date of appointment.....	1	1,600	1,600	2	1,300	2,600			
Second 3 years after date of appointment.....	1	1,300	1,300						
Carpenters:									
After 12 years from date of appointment.....	8	1,800	14,400	14	1,600	22,400	11	1,200	13,200
Fourth 3 years after date of appointment.....	3	1,600	4,800	3	1,300	3,900			
Third 3 years after date of appointment.....				5	1,300	6,500			
Second 3 years after date of appointment.....	4	1,300	5,200	2	1,000	2,000	1	800	800
Sailmakers:									
After 12 years from date of appointment.....	4	1,800	7,200	8	1,600	12,800	4	1,200	4,800
Fourth 3 years after date of appointment.....	2	1,600	3,200	1	1,300	1,300	4	1,000	4,000
Third 3 years after date of appointment.....				4	1,300	5,200			
Second 3 years after date of appointment.....							2	800	1,600
Mates.....	9	900	8,100	20	700	14,000	8	500	4,000
Naval cadets (under instruction at Naval Academy).....				201	500	100,500			

RECAPITULATION.

648 officers on sea duty.....	\$1,453,300 00
670 officers on other duty.....	1,636,850 00
198 officers on waiting orders.....	346,000 00
1,516	3,436,150 00
357 officers on retired list.....	811,357 50
74 naval cadets not at Academy.....	67,150 00
201 naval cadets at Academy.....	100,500 00
Petty officers, &c.....	2,500,000 00
Total amount required.....	6,945,157 50

Estimate of the amount required to pay retired officers of the United States Navy for the fiscal year ending June 30, 1887.

Grade.	No.	Pay per annum.	Total.	Grade.	No.	Pay per annum.	Total.
Rear-admirals.....	44	\$4,500 00	\$198,000 00	Pay directors, chiefs of Bureau.....	3	\$3,750 00	\$11,250 00
Do.....	4	3,750 00	15,000 00	Pay directors.....	6	3,300 00	19,800 00
Commodores.....	10	3,750 00	37,500 00	Pay inspector.....	1	3,300 00	3,300 00
Do.....	3	3,375 00	10,125 00	Paymaster.....	1	2,625 00	2,625 00
Do.....	2	2,625 00	5,250 00	Do.....	1	2,400 00	2,400 00
Captains.....	3	3,375 00	10,125 00	Do.....	1	1,400 00	1,400 00
Do.....	3	2,625 00	7,875 00	Passed assistant paymaster.....	1	1,650 00	1,650 00
Do.....	1	2,250 00	2,250 00	Do.....	1	1,500 00	1,500 00
Do.....	2	1,950 00	3,900 00	Chief engineer, chief of Bureau.....	1	3,750 00	3,750 00
Do.....	1	1,150 00	1,150 00	Chief engineers.....	7	3,300 00	23,100 00
Do.....	1	900 00	900 00	Do.....	5	2,625 00	13,125 00
Commanders.....	6	2,625 00	15,750 00	Do.....	1	2,400 00	2,400 00
Do.....	1	2,100 00	2,100 00	Do.....	1	2,100 00	2,100 00
Do.....	1	1,750 00	1,750 00	Do.....	1	1,200 00	1,200 00
Do.....	1	1,400 00	1,400 00	Passed assistant engineers.....	1	1,837 50	1,837 50
Do.....	1	1,150 00	1,150 00	Do.....	15	1,650 00	24,750 00
Do.....	2	900 00	1,800 00	Do.....	1	1,500 00	1,500 00
Lieutenant-commanders.....	11	2,250 00	24,750 00	Do.....	1	1,425 00	1,425 00
Do.....	1	2,100 00	2,100 00	Do.....	4	1,275 00	5,100 00
Do.....	1	1,900 00	1,900 00	Do.....	2	1,100 00	2,200 00
Do.....	4	1,100 00	4,400 00	Do.....	1	850 00	850 00
Do.....	1	1,000 00	1,000 00	Do.....	1	400 00	400 00
Do.....	1	700 00	700 00	Assistant engineers.....	13	1,425 00	18,525 00
Lieutenants.....	19	1,950 00	37,050 00	Do.....	7	1,275 00	8,925 00
Do.....	2	1,300 00	2,600 00	Do.....	3	950 00	2,850 00
Do.....	2	1,200 00	2,400 00	Do.....	1	850 00	850 00
Do.....	1	900 00	900 00	Do.....	1	600 00	600 00
Lieutenants, junior grade.....	3	1,500 00	4,500 00	Do.....	1	500 00	500 00
Do.....	10	1,300 00	13,000 00	Chaplains.....	7	2,100 00	14,700 00
Do.....	3	900 00	2,700 00	Professors mathematics.....	3	2,625 00	7,875 00
Ensigns.....	7	900 00	6,300 00	Do.....	2	2,025 00	4,050 00
Do.....	2	600 00	1,200 00	Do.....	1	1,800 00	1,800 00
Do.....	1	500 00	500 00	Naval constructor, chief of Bureau.....	1	3,750 00	3,750 00
Do.....	1	300 00	300 00	Civil engineers.....	2	2,625 00	5,250 00
Medical directors, chiefs of Bureau.....	2	3,750 00	7,500 00	Do.....	1	2,250 00	2,250 00
Medical directors.....	14	3,300 00	46,200 00	Boatswains.....	15	1,350 00	20,250 00
Do.....	4	3,150 00	12,600 00	Do.....	1	1,050 00	1,050 00
Do.....	1	2,775 00	2,775 00	Do.....	2	900 00	1,800 00
Do.....	1	2,400 00	2,400 00	Do.....	1	600 00	600 00
Medical inspectors.....	3	3,300 00	9,900 00	Gunners.....	16	1,350 00	21,600 00
Do.....	1	1,300 00	1,300 00	Carpenters.....	9	1,350 00	12,150 00
Surgeons.....	1	2,725 00	2,725 00	Sailmakers.....	12	1,350 00	16,200 00
Do.....	3	2,625 00	7,875 00	Do.....	1	600 00	600 00
Do.....	2	2,400 00	4,800 00	Petty officers, seamen, ordinary seamen, &c.....			2,400,000 00
Do.....	1	2,100 00	2,100 00	Seven hundred and fifty boys.....			100,000 00
Passed assistant surgeons.....	4	1,650 00	6,600 00				2,500,000 00
Do.....	1	1,100 00	1,100 00				
Assistant surgeons.....	2	1,425 00	4,275 00				
Do.....	1	1,275 00	1,275 00				
Do.....	1	950 00	950 00				
Do.....	1	850 00	850 00				

REPORT OF THE SECRETARY OF THE NAVY.

Pay of clerks to navy-yards and stations, receiving ships and other vessels.

Office, and where employed.	Pay.	Office, and where employed.	Pay.
PORTSMOUTH, N. H.		MARE ISLAND.	
First clerk to commandant.....	\$1,500	One clerk to paymaster receiving ship...	1,800
Second clerk to commandant.....	1,200	One clerk to pay office.....	1,800
One clerk to paymaster.....	1,400	First clerk to commandant.....	1,800
One clerk to paymaster, inspection.....	1,300	Second clerk to commandant.....	1,200
BOSTON.		One clerk to inspection.....	
One clerk to paymaster receiving ship...	1,600		1,300
One clerk to paymaster of inspection.....	1,600	NEW LONDON.	
One clerk to paymaster of yard.....	1,600	One clerk to commandant.....	1,500
One clerk to commandant.....	1,500	One clerk to paymaster.....	1,300
NEW YORK.		NEWPORT.	
One clerk to receiving ships.....	1,600	One clerk to paymaster receiving and training ship.....	1,300
First clerk to commandant.....	1,500	One clerk to paymaster of station.....	1,300
One clerk to inspector.....	1,600	One clerk to commandant training station.....	1,500
Second clerk to commandant.....	1,200	One clerk to Naval War College.....	1,500
One clerk to paymaster.....	1,600	NAVAL ACADEMY.	
LEAGUE ISLAND.		One pay clerk to paymaster of ships.....	1,300
One clerk to paymaster receiving ship...	1,600	One pay clerk to storekeepers.....	1,300
First clerk to commandant.....	1,500	One pay clerk to Academy.....	1,300
Second clerk to commandant.....	1,200	One clerk to commissary.....	1,300
One clerk to paymaster.....	1,600	KEY WEST.	
One clerk to paymaster, inspection.....	1,600	One clerk to commandant.....	1,500
NORFOLK.		One clerk to paymaster.....	1,300
One clerk to paymaster receiving ship...	1,300	NAVAL ASYLUM.	
First clerk to commandant.....	1,500	One clerk to commandant.....	1,500
Second clerk to commandant.....	1,200	One clerk to paymaster.....	1,300
One clerk to paymaster of inspection.....	1,300	FLAGSHIPS, ETC.	
One clerk to paymaster of yard.....	1,400	Ten clerks to paymasters of flagships, \$1,100 each.....	11,000
WASHINGTON.		Six clerks to paymasters of 2d rates, \$1,100 each.....	6,600
One clerk to paymaster receiving ship...	1,300	Nineteen clerks to paymasters of 3d rates, &c., \$1,000 each.....	19,000
First clerk to commandant.....	1,500	Total.....	109,400
Second clerk to commandant.....	1,200		
One clerk to paymaster, inspection.....	1,600		
One writer to paymaster's office.....	1,300		
One clerk to paymaster's office.....	1,600		
PENSACOLA.			
One clerk to paymaster.....	\$1,400		
One clerk to commandant.....	1,200		

No. 2.—SALE OF OLD VESSELS.

MEMORANDUM CONCERNING THE SALE OF OLD VESSELS UNDER THE ACTS OF CONGRESS, APPROVED AUGUST 5, 1882, AND MARCH 3, 1883.

The account of the Hon. William E. Chandler, printed on pages 220-224 of Volume I, Annual Report of the Department, showed a total unexpended balance, November 28, 1884, of the proceeds from the sale of old vessels, on deposit with the Treasurer of the United States, of \$105,517.32.

The annexed accounts, A and B (duplicates of those filed and settled in the office of the Fourth Auditor of the Treasury), show his further transactions to the date of his final settlement, and that he turned over, March 6, 1885, the balance to his credit with the Treasurer to the Hon. William C. Whitney, his successor in office, amounting to \$56,716.38.

The account herewith, C, of the latter, a duplicate of that filed in the Fourth Auditor's Office, with the necessary vouchers, exhibits his receipts and expenditures of the proceeds from the sale of old vessels, which came into his hands, to the 1st of October, 1885, and shows a balance on deposit with the Treasurer on that date of \$8,129.94.

The only other vessels sold, not included in any of these accounts, were the storeship *Onward*, at Callao, Peru, November 14, 1884, and the tug *Rose*, at Pensacola, August 12, 1885. Both of these vessels were sold at public auction, under written authority of the President; the former realizing \$1,808, which was covered into the Treasury without passing through the hands of the Secretary of the Navy, and the latter \$419.25, which has been deposited with the Treasurer, and for which the Secretary of the Navy will be accountable.

JNO. W. HOGG,
Chief Clerk.

NAVY DEPARTMENT, *October 1, 1885.*

A.—William E. Chandler, Secretary of the Navy, in account-current with the United States for proceeds of sales of old vessels.

Date.		Amount.	Total.
	Dr.		
1885.			
Jan. 1	To balance on hand from last account-current.....		\$23, 739 83
Feb. 14	To amounts accompanying the accepted bids for the purchase of the undermentioned old vessels under the Navy Department's advertisement, dated January 5, 1885, published in accordance with the fifth section of the act to supply deficiencies, approved March 3, 1883, for proposals which were this day opened and vessels awarded as per statement herewith, viz: Edward Le Bars, New York, purchaser of the U. S. S. Florida, for \$42,000; 10 per cent. received with his proposal E. Stannard, New York, purchaser of U. S. S. Colorado, for \$28,700; amount received with his proposal	\$4, 200 00 3, 000 00	7, 200 00
28	To amount received from Edward Le Bars, by Daniel W. Richards & Co., as balance of purchase-money of the U. S. S. Florida.....		37, 900 00
	Total		68, 739 83
	Cr.		
1885.			
Jan. 26	By bills for tools required in removing old vessels. Paid by Paymaster Edwin Putnam, Portsmouth, N. H., viz: Rider & Cotton, saw-files, voucher 165..... Rider & Cotton, round iron, voucher 166.....	53 85 44 19	98 04
	Total amount paid for tools.....		98 04
	By expense of removing, by breaking up, the U. S. S. Virginia, at the Boston navy-yard, for labor employed. Paid by Paymaster J. F. Tarbell, as follows: Pay-roll for first half of January, voucher 167..... Pay-roll for second half of January, voucher 168..... Pay-roll for first half of February, voucher 169.....	1, 353 04 1, 615 91 1, 286 48	4, 255 43
Jan. 21			
Feb. 6			
17			
	Total expense of Virginia in this account.....		4, 255 43
	By expense of removing, by breaking up, the U. S. S. Colossus at Brooklyn navy-yard, for labor. Paid by Pay Director C. H. Eldredge, viz: Pay-roll for January, voucher 170..... Pay-roll for February, voucher 171.....	202 40 61 04	263 44
Jan. 31			
Feb. 24			
	Total expense of Colossus in this account.....		263 44
	By expense of removing, by breaking up, the U. S. S. Java, at Brooklyn navy-yard, for labor. Paid by Pay Director C. H. Eldredge, viz: Pay-roll for January, voucher 172..... Pay-roll for February, voucher 173.....	5, 343 54 1, 446 54	6, 790 08
Jan. 31			
Feb. 24			
	Total expense of Java in this account.....		6, 790 08
	By bills for advertising sale of February 14, 1885, of old vessels, under Department's orders, viz: New York Herald, New York, voucher 174..... The Press, Philadelphia, voucher 175..... Evening Bulletin, Philadelphia, voucher 176..... The American, Baltimore, Md., voucher 177..... Commercial Advertiser, New York, voucher 178..... Boston Journal, Boston, voucher 179..... Daily Evening Traveller, Boston, voucher 180..... Morning Herald, Baltimore, voucher 181..... New York Republikaner, New York, voucher 182..... Marine Journal, New York, voucher 183..... The Item, Philadelphia, voucher 184..... Daily Evening Post, San Francisco, voucher 185..... Vallejo Chronicle, Vallejo, Cal., voucher 186..... North American, Philadelphia, Pa., voucher 187.....	98 60 43 20 34 20 26 00 42 40 22 75 30 67 19 50 88 80 37 75 99 20 34 28 17 50 36 80	
Feb. 11			
12			
17			
19			
Mar. 5			
	Total amount advertising bills.....		616 45
5	By balance, on deposit in Treasury of the United States on this date, to be transferred to the incoming Secretary of the Navy.....		56, 716 88
	Total.....		68, 739 83

B.—*William E. Chandler, Secretary of the Navy, in account-current with the United States for proceeds of sales of old vessels.*

Date.		Amount.	Total.
1884. DR.			
Oct. 1	To balance on hand from last account.....		\$105,517 32
1884. CR.			
Oct. 1	By Arthur Peterson, passed assistant paymaster, U. S. N. This amount charged to his account by accounting officers of the Treasury in settlement of previous account of the Secretary of the Navy; the amount having been erroneously disbursed by Passed Assistant Paymaster Peterson.....		88 80
Nov. 14	By bills paid during quarter for advertising sale of May 3, 1884, of old vessels, viz:		
21	National Republican, Washington, voucher 121	\$28 50	
21	Baltimore Sun, Baltimore, Md., voucher 122.....	72 00	100 50
21	By amount refunded to E. Stannard, Westbrook, Conn., as overpayment made by him September 24, 1883, on purchase of the U. S. S. Roanoke, paid by check No. 150323 on the Treasurer of the United States, Washington, D. C.....		05
Dec. 5	By amount deposited in the Treasury of the United States at Washington, D. C., as "Proceeds of sales of old vessels," per duplicate certificate of deposit No. 32164, herewith, voucher 123.....		122 11
Nov. 3	By bills for tools required in removing old vessels. Paid by Pay Director C. W. Abbot, Boston:		
4	Henry Brooks & Co., saws and axes, voucher 128.....	221 20	
6	B. Callender & Co., saw-handles, voucher 129.....	8 60	
6	James McCusker, maul-handles, voucher 130.....	30 00	
9	Paid by Pay Director A. H. Gilman, New York:		
9	Geo. H. Creed, saws and saw-files, voucher 135	125 52	
23	Paid by Pay Director C. W. Abbot, Boston:		
23	J. A. & W. Bird & Co., borax, voucher 131.....	2 50	
23	B. Callender & Co., saw-handles, &c., voucher 132.....	10 26	
23	James Gorman, saw-files, voucher 133.....	241 00	
Dec. 23	James McCusker, maul-handles, voucher 134.....	45 00	
Oct. 16	Paid by Paymaster Edwin Putnam, Portsmouth, N. H.:		
16	Rider & Cotton, saws, voucher 124.....	49 44	
Nov. 10	Rider & Cotton, saw-files, voucher 125.....	15 00	
Dec. 9	Rider & Cotton, sledge-handles, voucher 126.....	72 00	
9	Rider & Cotton, treenail-augers, voucher 127.....	23 50	
	Total amount paid for tools during quarter.....		839 02
	By expense of removing, by breaking up, the U. S. S. Pennsylvania at the Boston navy-yard, for labor employed. Paid by Paymaster J. F. Tarbell, as follows, viz:		
Oct. 15	Pay-roll for first half of October, voucher 136.....	4,609 65	
31	Pay-roll for second half of October, voucher 137.....	2,637 24	
Nov. 15	Pay-roll for first half of November, voucher 138.....	1,430 63	
	Pay-roll for second half of November, voucher 139.....	166 16	
	Total expense of Pennsylvania during this quarter.....		8,843 68
	By expense of removing, by breaking up, the U. S. S. Virginia at the Boston navy-yard, for labor employed. Paid by Paymaster John F. Tarbell, U. S. N., as follows:		
Oct. 15	Pay-roll for first half of October, voucher 140.....	130 25	
31	Pay-roll for second half of October, voucher 141.....	2,119 83	
Nov. 15	Pay-roll for first half of November, voucher 142.....	1,944 35	
30	Pay-roll for second half of November, voucher 143.....	445 84	
Dec. 31	Pay-roll for December, voucher 144.....	249 14	
	Total expense of Virginia during quarter.....		4,889 41
	By expense of removing, by breaking up, the U. S. S. Oregon, at the Boston navy-yard, for labor employed. Paid by Paymaster John F. Tarbell, U. S. N., as follows:		
Oct. 15	Pay-roll for first half of October, voucher 145.....	2,328 32	
31	Pay-roll for second half of October, voucher 146.....	2,873 44	
Nov. 15	Pay-roll for first half of November, voucher 147.....	3,434 17	
30	Pay-roll for second half of November, voucher 148.....	5,368 24	
Dec. 15	Pay-roll for first half of December, voucher 149.....	499 59	
31	Pay-roll for second half of December, voucher 150.....	544 56	
	Total expense of Oregon during quarter.....		15,048 32
	By expense of removing, by breaking up, the U. S. S. Massachusetts at Portsmouth navy-yard, for labor employed. Paid by Paymaster Edwin Putnam, U. S. N., as follows:		
Oct. 31	Pay-roll for the month, voucher 151.....	10,714 90	
Nov. 15	Pay-roll for the half month, voucher 152.....	1,308 88	
	Total expense of Massachusetts during quarter.....		12,023 78

B.—*William E. Chandler, Secretary of the Navy, in account-current, &c.—Continued.*

Date.		Amount.	Total.
	CR.		
	By expense of removing, by breaking up, the U. S. S. Plymouth, at Portsmouth navy-yard, for labor employed. Paid by Paymaster Edwin Putnam, U. S. N., as follows :		
Oct. 31	Pay-roll for month of October, voucher 153.....	4,611 99	
Nov. 15	Pay-roll for first half November, voucher 154.....	5,411 54	
30	Pay-roll for second half November, voucher 155.....	3,174 96	
Dec. 15	Pay-roll for first half December, voucher 156.....	3,945 43	
31	Pay-roll for second half December, voucher 157.....	670 93	
	Total expense of Plymouth during quarter.....		17,817 85
	By expense of removing, by breaking up, the U. S. S. Colossus, at Brooklyn navy-yard, for labor employed. Paid by Pay Director C. H. Eldridge, U. S. N., as follows:		
Oct. 31	Pay-roll for the month, voucher 158.....	4,839 54	
Nov. 30	Pay-roll for the month, voucher 159.....	3,775 38	
Dec. 31	Pay-roll for the month, voucher 160.....	3,394 16	
	Total expense of Colossus during quarter.....		11,449 08
	By expense of removing, by breaking up, the U. S. Java, at the Brooklyn navy-yard, for labor employed. Paid by Pay Director C. H. Eldridge, U. S. N., as follows:		
Oct. 31	Pay-roll for the month, voucher 161.....	2,575 20	
Nov. 30	Pay-roll for the month, voucher 162.....	2,885 49	
Dec. 31	Pay-roll for the month, voucher 163.....	5,082 25	
	Total expense of Java during quarter.....		10,542 94
Dec. 31	By expense of stripping the U. S. S. Colorado, ready for sale at the Brooklyn navy-yard, for labor employed. Paid by Pay Director C. H. Eldredge, per pay-roll, voucher 164.....		16 96
	By balance on hand, viz:.....		
	In hands of paymasters as agents.....	6,106 69	
	On deposit in the Treasury of the United States, Washington.....	17,633 13	
	Total balance on hand this date.....		23,739 82
			105,517 23

C.—*William C. Whitney, Secretary of the Navy, in account-current with the United States for "proceeds from sale of old vessels."*

Date.		Amount.	Total.
	DR.		
	<i>Cash receipts.</i>		
1885.			
Mar. 6	To amount transferred by William E. Chandler, former Secretary of the Navy, by his check on the United States Treasurer, No. 150350.....		\$56,716 38
Mar. 23	To amount received from E. Stannard, of New York, as balance due from him as purchaser of the U. S. S. Colorado, which was sold February 14, 1885, at navy-yard, New York, under the provisions of section 5 of the act of Congress making appropriations to supply deficiencies in the appropriations for the fiscal year ending June 30, 1883, approved March 3, 1883, as follows :		
	Whole amount of sale.....	\$26,700 00	
	Less amount received at time of sale, and accounted for by William E. Chandler, former Secretary.....	3,000 00	23,700 00
	Balance received by Secretary W. C. Whitney.....		
July 14	To amount received from Thomas Butler & Co., as purchasers of U. S. S. Niagara, which was sold May 6, 1885, at navy-yard, Boston, by public auction, by the written authority of the President of the United States, under the provisions of section 5 of the act of Congress making appropriations to supply deficiencies in the appropriations for the fiscal year ending June 30, 1883, approved March 3, 1883, as follows :		
	Whole amount of sale.....	12,300 00	
	Less commissions of Jerome S. McDonald, auctioneer, as fixed by Secretary of the Navy. Paid by Paymaster J. F. Tarbell, voucher 13.....	183 00	
	Balance received by Secretary W. C. Whitney.....		12,117 00
	Total.....		92,533 38

C.—William C. Whitney, Secretary of the Navy, in account-current, &c.—Continued.

Date.	Amount.	Total.
CR.		
<i>Cash expenditures.</i>		
1885.		
Mar. 11	By amount deposited in the United States Treasury to the credit of the United States, on account of miscellaneous receipts, proceeds of Government property, sale of old vessels, certificate of deposit No. 32850, voucher 1.....	51,716 38
13	By amount paid The Item, Philadelphia, for advertising "Proposals for purchase of vessels," under Navy Department's order of January 8, 1885, voucher 2.....	49 60
19	By amount paid through Paymaster John F. Tarbell, navy-yard, Boston, as labor in breaking up old vessels, as per pay-roll for second half of February, 1885, voucher 3.....	687 51
28	By amount paid Harper & Brothers for advertising "Proposals for the purchase of vessels" in Harpers' Weekly, under Navy Department's order of March 3, 1884, voucher 4.....	684 00
May 12	By amount paid through Pay Director C. W. Abbot for tools and materials used in breaking up and removing old vessels at navy-yard, Boston, as follows:	
	H. L. Fearing & Co., rope, voucher 5.....	275 96
	Geo. D. Putnam & Co., steel, voucher 6.....	287 21
	Geo. D. Putnam & Co., iron, voucher 7.....	148 23
	I. Reardon & Sons, tallow, voucher 8.....	5 65
	C. A. Whittmore & Co., oil, voucher 9.....	7 50
	B. Callender & Co., baskets, voucher 10.....	9 60
	B. Callender & Co., nails, voucher 11.....	4 60
	B. Callender & Co., augers, voucher 12.....	75 00
	Total paid by check on United States Treasurer, No. 150354, in favor of Pay Director C. W. Abbot.....	813 75
	By bills paid for advertising sale of U. S. S. Niagara, navy-yard, Boston, under Navy Department's order of April 15, 1885, as follows:	
July 27	The Herald, Boston, voucher 14.....	11 20
27	The Philadelphia Demokrat, voucher 15.....	21 00
27	The Globe, Boston, voucher 16.....	17 50
27	The Graphic, New York, voucher 17.....	23 20
16	The News, New York, voucher 18.....	34 80
27	The Boston Post, voucher 19.....	10 80
27	The Evening Telegram, New York, voucher 20.....	39 60
28	The Times, Philadelphia, voucher 21.....	16 80
29	The Journal of Commerce, New York, voucher 22.....	21 60
30	The World, New York, voucher 23.....	29 00
	Total.....	225 50
	By bills paid for advertising sale of tug Pilgrim, under Navy Department's orders of July 13, 1885, as follows:	
Sept. 2	The Baltimore Sun, voucher 24.....	24 00
17	The New York Evening Post, voucher 25.....	29 60
2	The Philadelphia Abend-Post, voucher 26.....	18 00
8	The New York Irish American, voucher 27.....	37 80
17	The Philadelphia Times, voucher 28.....	21 00
17	The Philadelphia News, voucher 29.....	24 60
2	The New York News, voucher 30.....	43 20
	Total.....	196 20
	(The above vessel was offered for sale at public auction, at navy-yard, League Island, Pa., August 12, 1885, by written authority of the President of the United States; but it was not sold, as the maximum bid was not considered a fair price.)	
	By bills paid for advertising sale of tug Rose, under Navy Department's order of July 13, 1885, as follows:	
Sept. 17	The Mobile Register, voucher 31.....	16 00
17	The Advance-Gazette, Pensacola, Fla., voucher 32.....	12 50
	Total.....	28 50
16	By amount deposited in the United States Treasury to the credit of the United States, on account of "Miscellaneous receipts, proceeds of sale of old vessels," certificate of deposit No. 34294, voucher 33.....	30,000 00
	Total expenditures.....	84,408 44
	On deposit in United States Treasury at this date.....	8,129 94
	Total.....	92,538 38

No. 3.—DEPOSITS FROM SALES OF GOVERNMENT PROPERTY.

Statement of deposits made on account of sales of Government property, Navy Department, from November 1, 1884, to November 1, 1885.

[Compiled in the Fourth Auditor's Office, by direction of the Secretary of the Treasury.]

Date of deposit.	Place of deposit.	By whom deposited.	Nature of property sold.	Amount covered to miscellaneous receipts.	Amount credited to appropriations.	Total amount deposited.
1884.						
Nov. 4	United States Treasury	W. B. Slack, quartermaster U. S. Marine Corps	Deserters' clothing	\$4 60		\$4 60
4	New Orleans	Arthur Peterson, passed assistant paymaster	Condemned stores	32 55	\$183 25	215 80
7	United States Treasury	H. A. Gill, disbursing agent U. S. Fish Commission	Equipment stores		41 86	41 86
8	do	W. B. Slack, quartermaster U. S. Marine Corps	Old pipe, paint-pots, and marine clothing	4 83		4 83
11	do	H. A. Gill, disbursing agent U. S. Fish Commission	Equipment stores		10 63	10 63
11	New York	G. H. Read, paymaster	Clothing sold to officers		1,000 30	1,000 30
13	First National Bank, New York	T. J. Cowie, assistant paymaster	Provisions issued to officers' messes		5 76	5 76
19	First National Bank, Portland, R. I.	Edwin Putnam, paymaster	Wood from old vessels	141 80		141 80
20	United States Treasury	W. B. Slack, quartermaster U. S. Marine Corps	Deserters' clothing	3 65		3 65
25	New York	G. H. Read, paymaster	Cuttings accumulated at naval clothing factory		280 70	280 70
29	United States Treasury	W. B. Slack, quartermaster U. S. Marine Corps	Trumpet	50		50
29	San Francisco	J. B. Redfield, paymaster	Hulka of Mohican and Modoc	2,202 30		2,202 30
Dec. 1	United States Treasury	W. B. Slack, quartermaster U. S. Marine Corps	Old carpet, furniture, and clothing	44 40		44 40
9	do	do	Old carpet and druzget	3 10		3 10
9	do	J. N. Speel, passed assistant paymaster	Gain on exchange	7 15		7 15
3	New York	C. H. Eldredge, pay director	Old material, shakings, flax clippings, &c.	1,213 51		1,213 51
5	United States Treasury	Secretary of the Navy	Clothing to officers	122 11		122 11
4	New York	G. H. Read, paymaster	Coal		934 69	934 69
10	United States Treasury	H. A. Gill, disbursing agent U. S. Fish Commission	Provisions to officers' messes		323 73	323 73
11	San Francisco	G. M. Stoney, lieutenant U. S. Navy	Provisions to officers' messes		44 08	44 08
24	United States Treasury	W. B. Slack, quartermaster U. S. Marine Corps	Condemned stores, clothing, &c.	100 80		100 80
1885.						
Jan. 5	First National Bank, New York	T. J. Cowie, assistant paymaster	Empty barrels and provisions	37 77		37 77
5	Boston	J. F. Tarbell, paymaster	Old wood from steamers Virginia, Oregon, and Pennsylvania	1,145 15		1,145 15
3	United States Treasury	H. A. Gill, disbursing agent U. S. Fish Commission	Coal		103 82	103 82
5	New York	G. H. Read, paymaster	Clothing to officers		1,186 08	1,186 08
10	Philadelphia	J. Foster, paymaster	Blank of wharf		160 00	160 00
13	United States Treasury	W. B. Slack, quartermaster U. S. Marine Corps	Fuel to officers	160 00		160 00

Month	Day	Description	Debit	Credit	Balance
Feb.	18	do			219 45
	19	do			26 80
	20	do			10 52
	21	do			38 40
	22	do			187 27
	23	do			30 30
	24	do			1,008 84
	25	do			5 16
	26	do			164 24
	27	do			20
	28	do			8,366 21
	29	do			183 18
	30	do			21 17
	31	do			687 89
	1	do			759 04
	2	do			27 75
	3	do			425 29
	4	do			113 13
	5	do			1,117 41
	6	do			1,796 13
	7	do			24,000 00
	8	do			30 54
	9	do			4,418 05
	10	do			5 04
	11	do			35 39
	12	do			95 47
	13	do			447 90
	14	do			784 53
	15	do			856 41
	16	do			12,963 15
	17	do			3 68
	18	do			1,501 64
	19	do			9,185 54
	20	do			75 54
	21	do			452 49
	22	do			1,620 54
	23	do			25 60
	24	do			51,716 38
	25	do			222 98
	26	do			10 38
	27	do			50 00
	28	do			14 32
	29	do			45 00
	30	do			79 59
	31	do			1,601 64
	1	do			12,126 99
	2	do			75 54
	3	do			452 49
	4	do			1,620 54
	5	do			25 60
	6	do			51,716 38
	7	do			222 98
	8	do			10 38
	9	do			50 00
	10	do			14 32
	11	do			45 00
	12	do			79 59

*\$252.11 clothing and small stores; \$502.03 ordnance material, proceeds of sales. †\$1,274.53 clothing and small stores; \$1,455.33 ordnance material and small arms.

Statement of deposits made on account of sales of Government property, Navy Department, from November 1, 1884, to November 1, 1885—Continued.

Date of deposit.	Place of deposit.	By whom deposited.	Nature of property sold.	Amount covered to miscellaneous receipts.	Amount credited to appropriations.	Total amount deposited.
1885.						
Mar. 21	United States Treasury	L. G. Boggs, passed assistant paymaster.	Premium on bills of exchange.	97 33	97 33
24	do	W. B. Slack, quartermaster U. S. Marine Corps.	Clothing and accoutrements.	32 10	32 10
31	First National Bank, New-York, R. I.	T. J. Cowie, assistant paymaster.	Empty barrels	4 64	4 64
Apr. 8	Philadelphia	J. Foster, paymaster	Rent of wharf	200 00	200 00
7	United States Treasury	J. C. Sullivan, passed assistant paymaster.	Condemned stores	236 57	227 10	463 67
9	New Orleans	A. Peterson, passed assistant paymaster.	One horse.	22 70	22 70
22	United States Treasury	J. W. Danenhower, lieutenant U. S. Navy.	Stores (Arctic)	43 10	43 10
25	do	W. B. Slack, quartermaster U. S. Marine Corps.	Fuel to officers.	1,201 97	1,201 97
6	do	W. B. Morgan, disbursing clerk U. S. Coast and Geodetic Survey.	Supplies (navigation)	219 41	219 41
21	do	do	Coal.	96 75	96 75
17	do	H. A. Gill, disbursing agent U. S. Fish Commission.	Material	28 01	28 01
15	do	do	Coal.	753 07	753 07
3	do	do	do	844 00	844 00
23	do	do	do	66 75	66 75
7	New York	G. H. Read, paymaster.	Clothing to officers	921 83	921 83
29	United States Treasury	Dorsey Clagett, secretary inaugural committee.	Flags lost.	257 96	257 96
1	New Orleans	A. Peterson, passed assistant paymaster.	Miscellaneous stores	368 39	1,296 77
5	New York	G. H. Read, paymaster.	Clothing to officers	921 38	921 38
1	United States Treasury	Secretary of the Navy.	Boilers of Monocacy	485 78	485 78
2	New York	C. H. Eldredge, pay director.	Old stores.	3,738 02	3,738 02
7	New Orleans	A. Peterson, passed assistant paymaster.	Old vessels	2,185 41	2,207 50	4,392 91
16	United States Treasury	Thomas J. Hobbs, disbursing clerk.	Bronze castings.	86 80	86 80
16	do	H. A. Gill, disbursing agent U. S. Fish Commission.	Repairs (construction and repair)	112 91	112 91
16	do	do	Repairs (steam-engineering)	173 90	173 90
21	First National Bank, Portsmouth, N. H.	E. Putnam, paymaster.	Two condemned horses.	83 00	83 00
21	United States Treasury	Chief Bureau of Ordnance.	Value of material loaned Soldiers' Home, Boston, unaccounted for.	127 74	127 74
20	do	G. A. Deering, paymaster	Freight on gold, premium on bills of exchange, brass tubes, old copper, &c.	2,928 41	2,928 41
20	do	H. T. Wright, paymaster.	Condemned provisions	62 44	62 44
20	do	J. A. Mudd, assistant paymaster.	Rent of lots at Yokohama	201 46	201 46
20	do	F. H. Swan, paymaster.	Premium on bills of exchange	131 67	131 67
20	do	C. S. Williams, assistant paymaster.	Old barrels	20 00	20 00
20	do	H. A. Gill, disbursing agent U. S. Fish Commission.	Coal

June 14	do	Secretary of the Navy	16,372 04	10,372 04
do	do	Seligman Brothers		
3	New York	C. H. Eldredge, pay director	898 93	846 30
3	United States Treasury	M. Seward, chief Bureau of Ordnance	81 84	81 84
3	New York	G. H. Read, paymaster		
do	do	do		
6	United States Treasury	J. C. Sullivan, passed assistant paymaster	374 82	374 82
9	do	W. B. Slack, quartermaster U. S. Marine Corps	131 26	131 26
11	do	M. Seward, chief Bureau of Ordnance	24 85	24 85
11	do	C. H. Eldredge, pay director	441 56	441 56
16	New York	J. H. Chapman, assistant paymaster	23 83	23 83
16	United States Treasury	H. A. Gill, disbursing agent U. S. Fish Commission	14 00	14 00
18	do	do	107 98	107 98
18	do	do	97 34	97 34
19	Baltimore	H. C. Machette, paymaster	80 13	80 13
19	United States Treasury	H. A. Gill, disbursing agent U. S. Fish Commission	1,415 85	1,415 85
25	Baltimore	F. C. Cosby, pay inspector	860 91	860 91
26	United States Treasury	G. A. Lyon, paymaster	24 56	24 56
30	Philadelphia	J. Foster, paymaster	91 81	91 81
do	do	W. Goldsborough, paymaster	200 00	200 00
July 1	New York	G. H. Read, paymaster	378 87	378 87
1	Baltimore	F. H. Arms, paymaster	451 14	451 14
2	First National Bank, New- port, R. I.	T. J. Cowle, assistant paymaster	292 40	292 40
11	United States Treasury	C. F. Goodrich, commander U. S. Navy	29 20	29 20
11	do	W. W. Woodhull, paymaster	45 00	45 00
21	do	Seligman Bros	3,123 69	3,123 69
21	do	E. N. Whitehouse, paymaster	26 83	26 83
23	New York	C. H. Eldredge, pay director	4,302 51	4,302 51
17	San Francisco	J. E. Redfield, paymaster	52 43	52 43
27	United States Treasury	H. A. Gill, disbursing agent U. S. Fish Commission	65 51	65 51
do	do	H. C. Machette, paymaster	57 26	57 26
do	do	H. A. Gill, disbursing agent U. S. Fish Commission	90 90	90 90
do	do	do	12 12	12 12
do	do	do	29 88	29 88
3	do	H. B. Lowry, quartermaster U. S. Marine Corps	12 60	12 60
do	do	do	377 48	377 48
do	do	C. H. Eldredge, pay director	4 09	4 09
4	New York	G. A. Bartlett, acting disbursing agent U. S. Coast and Geodetic Survey	2,522 86	2,522 86
do	do	do	114 00	114 00
4	United States Treasury	H. A. Gill, disbursing agent U. S. Fish Commission	326 78	326 78
13	do	T. J. Hobbs, disbursing clerk	10 19	10 19
18	United States Treasury	H. L. Snyder, chief engineer U. S. Navy	52 64	52 64
19	do	R. Frazer, passed assistant paymaster	100 00	100 00
22	do	C. H. Eldredge, pay director	368 00	368 00
25	New York	do		
		Bronze castings		
		Four American ensigns		
		Gain on bills of exchange		
		Deposits on sales, forfeited		

Statement of deposits made on account of sales of Government property, Navy Department, from November 1, 1884, to November 1, 1885—Continued.

Date of deposit.	Place of deposit.	By whom deposited.	Nature of property sold.	Amount covered by miscellaneous receipts.	Amount credited to appropriations.	Total amount deposited.
1885.						
Aug. 21	New Orleans	A. Peterson, passed assistant paymaster.	Wharfage of dredge-boat Bailey.	197 60	519 97	197 60
22	San Francisco	J. B. Redfield, paymaster.	Condemned stores.	176 82	696 79
27	United States Treasury	H. B. Lowry, quartermaster U. S. Marine Corps.	Condemned clothing.	5 82	5 82
31	New Orleans	A. Peterson, passed assistant paymaster.	Provisions to officers' messes.	125 88	125 88
Sept. 8	do	do	Repairs to British steamer "Ealing"; coal, oil, and candles.	61 85	61 85
16	United States Treasury	Secretary of the Navy	Old vessels.	30,000 00	30,000 00
18	New York	G. H. Read, paymaster	Clothing to officers.	476 24	476 24
22	do	A. J. Clark, pay inspector.	Working suits to Naval Academy.	205 92	205 92
25	do	Brown, Shipley & Co.	Interest on daily balances and gain on exchange.	1,039 48	1,039 48
29	United States Treasury	L. Hunt, assistant paymaster.	Premium on bills of exchange.	121 65	121 65
30	New York	A. H. Gilman, pay director.	Clothing lost in transit by Old Colony Steamboat Company and Pacific Mail Steamship Company.	863 61	863 61
29	United States Treasury	D. A. Smith, paymaster.	Condemned marine clothing	13 15	13 15
29	do	W. J. Thomson, paymaster.	Sale of "Onward"	1,908 00	1,908 00
30	First National Bank, New York, R. I.	T. J. Cowie, assistant paymaster.	Provisions to officers' messes	701 07	701 07
Oct. 3	New Orleans.	A. Peterson, passed assistant paymaster.	Condemned stores.	91 81	1,027 84	1,119 15
2	United States Treasury	J. A. Mudd, assistant paymaster.	Premium on bills of exchange.	21 12	21 12
8	Boston	A. S. Kenny, pay inspector	Security on boat loaned, forfeited.	60 00	60 00
12	Philadelphia.	J. Foster, paymaster	Rent of wharf.	200 00	200 00
9	New York	G. H. Read, paymaster.	Clothing to officers.	269 84	269 84
12	United States Treasury	E. Bellows, paymaster.	Condemned flour	1 51	1 51
12	do	T. T. Caswell, pay inspector.	Condemned marine clothing and premium on exchange.	296 27	296 27
12	do	C. W. Slamm, paymaster.	Condemned provisions	86 20	86 20
12	do	I. G. Hobbs, paymaster.	do	58 82	58 82
23	New Orleans.	A. Peterson, passed assistant paymaster	Old material.	511 86	511 86
27	United States Treasury	H. B. Lowry, quartermaster U. S. Marine Corps.	Fuel to officers.	202 68	202 68
31	New York	G. H. Read, paymaster.	Accumulated cuttings	121 25	121 25
30	United States Treasury	Secretary of the Navy	Tug Rose	419 25	419 25
14	do	M. Sicaud, chief Bureau of Ordnance	Gun-cotton discs	40 81	40 81
26	do	do	Transfer of Hotchkiss machine gun.	171 89	171 89
	Total			197,824 61	26,715 80	224,540 41

No. 4.—MOVEMENTS OF VESSELS.

NORTH ATLANTIC STATION.

The force on this station is still under the command of Acting Rear-Admiral James E. Jouett. The vessels composing it are the Tennessee, Brooklyn, Galena, Swatara, Alliance, and Yantic.

TENNESSEE.

Sailed from New York January 8; arrived at Hampton Roads the 10th, and sailed the 17th; arrived at Key West January 23, and at New Orleans February 4. Telegraphic orders were dispatched to her March 31, "Lose no time in getting to Key West; telegraph arrival; fill up with coal, and wait orders." Later instructions were sent same date to coal at New Orleans, and report when ready. Ordered to proceed to Pensacola to receive detachment of marines on April 2, and to proceed to Colon. Sailed April 3, and arrived at Colon April 10. A serious revolution had occurred on the Isthmus; the steamer Colon, of the Pacific Mail Line, had been seized, and the transit of the Isthmus closed. Previously to the arrival of the Tennessee, with Acting Rear-Admiral Jouett on board, the Galena, already at Colon, had restored the steamer Colon to her owners, but had been unable to prevent the burning of the town and the closing of the transit. The latter was reopened on April 11, by Acting Rear-Admiral Jouett. On 15th April a force of seamen and marines, under the command of Commander B. H. McCalla, reported to Admiral Jouett, to co-operate with the force of the North Atlantic Station in maintaining treaty obligations. The Tennessee remained in Colombian waters until July 15, when she sailed for Hampton Roads. She reached this port July 23, and sailed July 27, reaching New York July 28. Having been docked at the navy-yard, she sailed from New York August 16. On the 18th she reached Bar Harbor, and, sailing thence on the 27th, reached New York August 29. She proceeded to the navy-yard, and was docked on September 7. On October 31, her repairs having been completed, she left the navy-yard, and anchored in the North River.

BROOKLYN.

This ship was put in commission October 15, 1885, at the New York navy-yard.

SWATARA.

Sailed from New York for the West Indies December 16; visited Port of Spain, La Guayra, Carthagena, Porto Cabello, and arrived at Colon January 24. Sailed thence and reached Key West February 14, and New Orleans February 21. Sailed for Guatemala March 5, and returned

to New Orleans March 25. Dispatch sent March 31 to coal at once and report when ready. Sailed for Colon April 2, and arrived there April 9. The Swatara remained in Colombian waters, with the other vessels of the North Atlantic Station, visiting, as occasion required, the various ports, until July 14, when she sailed for Key West. She arrived at Key West July 20; sailed thence the 23d, and reached New York the 28th. On August 16 she sailed from New York, and reached New Orleans the 28th. Here, in compliance with the request of the United States Treasury, she was loaded with treasure, and on September 11 sailed from New Orleans in company with the Yantic for Washington. Reaching Washington September 25, the treasure was discharged, and she sailed for New York October 10. She arrived at New York October 12; sailed October 21, and reached Norfolk October 25.

GALENA.

This vessel sailed from New York for Pensacola December 5, 1884, and, touching at Key West, December 12, arrived December 15. She sailed the same day, and reached New Orleans December 16. On March 5 she sailed for Colon, and arrived there March 13. Telegraphed March 14 to remain at Colon until further orders. On March 30 a party of revolutionists, under the leadership of one Prestan, seized the steamship Colon, of the Pacific Mail Line. This vessel was restored to the rightful owners on the same day by the Galena. On March 31 the town of Colon was set fire to and partially destroyed by the revolutionists; the utmost exertions of the force landed from the Galena being able only to save a part of the town and all the property of the Pacific Mail Company from destruction. The Galena sailed from Colon on June 9; arrived at Kingston, Jamaica, June 13, and at Portsmouth, N. H., June 27. She sailed from Portsmouth August 17, and, having visited Bar Harbor and Eastport, returned to Portsmouth August 27. On November 5 she sailed from Portsmouth; reached Boston the same day; sailed thence November 6, and reached Norfolk November 9.

ALLIANCE.

The Alliance sailed from New York for a cruise in the West Indies on December 11; touching at St. John's, Point-à-Pitre, St. Pierre, and Santiago de Cuba, she reached Colon January 18. She sailed thence on January 23, and, touching at Cienfuegos and Key West, arrived at New Orleans February 17. Sailed for Key West March 22, and arrived March 27. March 31, telegraphed her, "Go direct to Colon with all practicable dispatch." She sailed on March 31 and reached Colon April 8. Sailing thence, June 4, she reached Key West June 7, and New York on June 18. Sailing from New York August 16, she touched at Bar Harbor and Eastport, and reached Norfolk August 31. Here she remained for extensive repairs.

YANTIC.

The Yantic sailed from New York December 1, and reached Christianstaed, Santa Cruz, December 13. Sailing thence on December 19, she touched at St. Thomas, Puerte Plata, Cape Haytien, Mole at St. Nicholas, Colon, Havana, Cardenas, and Key West, and reached New Orleans February 15. On March 16 telegraphed to her to prepare for orders to the coast of Guatemala; and she was ordered on the same

day to proceed to Livingston, and protect the interests of the United States until further orders. On March 23 she reached Key West, and sailed for Livingston, Guatemala, on the 26th. On the 8th of May she was ordered to Colon. Remaining in Colombiau waters until August 1, she was there employed in cruising between Livingston, Sabanilla, Carthagena, and Colon. She was then ordered to New Orleans. She reached the latter port on August 17, and, having been loaded with specie, which the United States Treasury wished to transport to Washington, sailed on September 11, in company with the Swatara, for Washington. She reached the latter port on September 25; and, having discharged her treasure, sailed for Norfolk, and reached that port on October 9.

SOUTH ATLANTIC STATION.

The squadron on this station consists of the Lancaster and Nipsic, and is under the command of Rear-Admiral Earl English.

LANCASTER.

The Lancaster, with Rear-Admiral English on board, arrived in the waters of this station on July 1, and Rear-Admiral English at once assumed command of the station; that office having been previously filled by the commanding officer of the Nipsic. On October 15 Admiral English was ordered to send the Lancaster on an extended cruise to Cape Town, Mozambique, Zanzibar, and other ports of the station lying to the eastward of Africa.

NIPSIC.

The Nipsic sailed from Montevideo on January 20, and reached Maldonado on the same day, and returned to Montevideo on the 23d. On March 27 she sailed from Montevideo, and reached Buenos Ayres on the 28th. On April 6 she sailed thence, and reached Colonia the same day. On May 15 she sailed from Colonia, and reached the anchorage in the Rio de la Plata the same day, and, sailing thence on the 27th, reached Montevideo the same day. On June 30 she sailed from Montevideo for Rio de Janerio, where she still remains.

EUROPEAN STATION.

The squadron on this station is at present under the command of Rear-Admiral Franklin, and consists of the Franklin, Quinnebaug, and Kearsarge.

LANCASTER.

The Lancaster, having been ordered to the South Atlantic Station, quitted the waters of the European Station on May 8. Previously to that time her movements were as follows: On December 5 she was ordered to visit the Congo River and vicinity in February. She sailed from Tangier November 9, and arrived at Gibraltar on the same day. Sailed from Gibraltar November 14, and arrived at Port Mahon the 19th; sailed the 26th, and arrived at Villerfanche the 28th. On the

9th February she sailed from Villefranche, and reached Gibraltar the 14th. Sailed thence February 19; and, having touched at Tangier, Senegal, and Libreville (Gaboon), she reached French Point, Congo, on April 28.

PENSACOLA.

The Pensacola was put in commission at Norfolk on April 4, 1885. She sailed from Hampton Roads on May 16; and, having touched at Funchal on June 10, reached Gibraltar June 14. Here Rear-Admiral Franklin, who went out in the Pensacola, assumed command of the European Station. The Pensacola, in company with the Kearsarge, made an extended cruise to the northward during the summer; leaving Gibraltar on July 2, they arrived at Cherbourg July 11, at Copenhagen July 26, at Stockholm August 4, and at Southampton August 26.

KEARSARGE.

In December of 1884, this ship was cruising on the west coast of Africa. She visited Porto Praya, Monrovia, Grand Bassa, Cape Palmas, Cape Coast Castle, and arrived at the Congo River on December 17. On January 8, arrived at Porto Grande. On May 20 she arrived at Saint Vincent, sailed thence on May 22, and reached Funchal May 29. Sailing from Funchal June 8, she reached Tangier June 12, and Gibraltar June 14. From the latter point she made the cruise to the northward already narrated, in company with the Pensacola.

QUINNEBAUG.

This vessel sailed from Villefranche February 16, and reached Smyrna February 24. Sailed thence March 7, and arrived at Constantinople March 9. From this port she visited Smyrna, Beirut, Acre, Haifa, Beirut, Jaffa, Port Said, and Alexandria—reaching the latter port May 17. She sailed from Alexandria June 25, and visited Haifa, Beirut, Smyrna, Chanak, and reached Constantinople on July 22. She sailed from the latter port on August 25, and visited Prinkipio, Buyukdire, Constantinople, Aggria Bay, Smyrna, and Kastio, Chios—reaching the latter port on September 28.

PACIFIC STATION.

The squadron on this station is under the command of Rear-Admiral McCauley, this officer having relieved Rear-Admiral Upshur at San Francisco on May 28, 1885. The squadron at present consists of the Hartford, Shenandoah, Mohican, Iroquois, Adams, Pinta, and Monongahela. The Lackawanna and Wachusett have been detached from the squadron during the year and put out of commission, and the Mohican and Adams have joined it.

HARTFORD.

In obedience to orders from the Department to proceed to San Francisco, the Hartford sailed from Valparaiso March 18, and reached Honolulu April 20; sailed thence on May 11, and reached San Francisco May 27. She sailed from the latter port September 1; and, having touched at Acapulco September 17, reached Panama October 3.

LACKAWANNA.

On January 2 the Lackawanna sailed from Panama with a party, under the direction of Civil Engineer Menocal, to survey the Nicaragua route for a ship-canal. She arrived at Corinto with this party on January 7. On February 1 she sailed thence and arrived at San José de Guatemala February 4. Sailed next day and reached Acapulco February 10. Sailed February 20 and reached San Francisco March 12. Was put out of commission at the Mare Island navy-yard on April 7.

SHENANDOAH.

Was at Iquiqui on January 6, and proceeded thence on a cruise southward as far as Valparaiso. Telegraphic orders sent March 14 to proceed to Panama and wait orders. The order was received the same day, and she sailed at once, reaching Callao March 29 and Panama April 6. Here she co-operated with the vessels of the North Atlantic fleet in keeping open the transit of the Isthmus of Panama in the manner already narrated. On May 22 she was ordered to proceed to Callao. She sailed on the 24th and reached Callao June 2. Owing to the disturbed condition of political affairs in Peru, she has remained at the latter port.

MOHICAN.

The Mohican was put in commission for her first cruise at Mare Island on May 25, 1885. She sailed from San Francisco June 27, and reached Panama August 18, having touched at Pichilique, Acapulco, and Corinto on her way down.

WACHUSETT.

The Wachusett sailed from Callao, in obedience to orders from the Department to proceed to Mare Island, on January 19, 1885, and arrived at Payta February 21. On March 14 she was ordered by telegraph to proceed to La Union, report arrival, and wait orders. She arrived at Panama on 19th March and was ordered on that day to fill up with coal and wait orders. On March 27 she was cabled to proceed to La Union. She arrived at La Libertad April 6, and returned to Panama on May 11, where she was ordered to remain. On July 25 she sailed from Panama, and, having touched at Acapulco on August 5, reached San Francisco August 22. On September 9 she was put out of commission at the Mare Island navy-yard.

IROQUOIS.

In December of 1884 this vessel was occupied in cruising in Australian waters. On January 15 she sailed from Auckland and arrived at Panama on April 26. On June 18 she was ordered to Guayaquil, sailing the next day. She sailed from Guayaquil for Payta on June 29, and arrived July 1. This vessel has also remained in Peruvian waters because of the disturbed condition of politics in that country.

ADAMS.

The Adams was put in commission at the Mare Island navy-yard on November 2.

PINTA.

The Pinta has been occupied throughout the year in cruising in Alaskan waters.

MONONGAHELA.

This vessel, the store-ship of the station, has remained throughout the year at Coquimbo, Chili.

ASIATIC STATION.

The Asiatic station has been throughout the year under the command of Acting Rear-Admiral J. L. Davis. The squadron consists at present of the Trenton, Omaha, Marion, Ossipee, Alert, and Palos. The Juniata and Enterprise have been detached and ordered to proceed home during the year, and the Omaha and Marion have joined the squadron.

TRENTON.

The Trenton sailed from Woosung for Corea December 13, 1884; and, sailing thence, reached Nagasaki December 27. On January 13 she sailed from Nagasaki, and reached Woosung on the 21st; and, sailing thence on February 5 reached Hong-Kong February 9. She sailed from Hong-Kong April 2; and touching at Amoy on April 4, arrived at Nagasaki April 14. She sailed thence on April 26, and relieved the Ossipee in Corean waters on May 3. She sailed from Chemulpo, Corea, on June 17, having been relieved by the Alert, and arrived at Nagasaki June 22. On August 27 she went to sea from Nagasaki in company with the Ossipee and Marion for a short drill in steam tactics, and returned to Nagasaki the 30th. On August 31 the Trenton sailed from Nagasaki, arrived at Hiogo September 3, and at Yokohama September 7. On September 14 she sailed for Tien-Tsin with Mr. Denby, United States minister to China, on board.

OMAHA.

The Omaha was put in commission at the Portsmouth navy-yard on April 16, 1885. She sailed thence on May 18 and reached Newport May 20, having touched at Provincetown on the way down. She proceeded to New York on May 22, and sailed thence for Gibraltar August 12. She reached Gibraltar September 1, sailed the next day, and arrived at Naples September 8. She sailed from Naples October 6, and arrived at Aden October 27.

JUNIATA.

Sailed from Nagasaki for Shanghai and Foochow December 4, arriving the 12th. Sailed from Pagoda anchorage, Foochow, April 7, and arrived at Sharp's Peak April 9. Sailed thence on the 10th and arrived at Shanghai April 14. Sailing thence for Nagasaki on May 20 she reached the latter port May 25, and sailing from that port July 1 she reached Shanghai July 3. She sailed from Shanghai July 5 and arrived at Sharp's Peak the 9th, and, sailing thence the next day, reached Hong-Kong July 13. On July 16 she sailed for home in obedience to orders received from the Department. She reached Singapore July 27, sailed thence July 30, arrived at Zanzibar August 23, sailed thence for Johanna Island August 28, and arrived at King William's Town October 16.

ENTERPRISE.

Sailing from Shanghai January 2, the *Enterprise* reached Chefoo January 4. Sailing thence she reached Amoy April 2, sailed April 5, and arrived at Sharp's Peak, mouth of the Min River, the next day. Sailing thence, she arrived at Pagoda anchorage April 28. She left the Pagoda anchorage July 2, and dropped down to Sharp's Peak, and sailed thence July 20, and arrived at Hong-Kong July 24, having touched at Amoy for coal. Sailed from Hong-Kong for home, in obedience to orders from the Department, July 28. She arrived at Sourabaya, Java, August 10; at Melbourne, Australia, September 17, and at Wellington, New Zealand, October 26.

MARION.

The *Marion* was put in commission at the Portsmouth navy yard on January 15, 1885. She sailed for Hampton Roads on February 25, and arrived on the 28th. On March 7 she sailed for Gibraltar, and arrived March 30. She touched at Port Said May 5, at Suakin May 21, at Aden May 27, at Colombo June 16, and at Singapore July 5. She arrived at Hong-Kong July 21; and sailing for Nagasaki July 29, arrived there on August 6. On August 27 she went to sea with the *Trenton* and *Ossipee* for a short drill in steam tactics. After this drill was over the *Marion* proceeded to Chemulpo, Corea, to relieve the *Alert*. She arrived there on September 1.

OSSIPEE.

The *Ossipee* sailed from Corea for Nagasaki on January 19, and arrived on the 22d. She returned to Corea on the 24th, arriving on the 30th. Sailing thence she reached Nagasaki May 12, and, sailing June 6, reached Shanghai June 14. She sailed from Shanghai August 8, and reached Nagasaki August 10. On August 27 she went to sea for a drill in steam tactics, and after this was over started for Yokohama, but, owing to the appearance of cholera on board, put into Hiogo.

ALERT.

The *Alert* remained at Canton until May 16, when she sailed for Nagasaki. She arrived at Nagasaki May 24, and sailed thence June 9, arriving at Chemulpo, Corea, June 15.

PALOS.

The *Palos* remained at New Chwang until April 21, when she sailed for Shanghai, arriving April 25. Sailing thence she reached Canton May 11. She sailed from Canton July 10, and arrived at Hong-Kong the same day; thence she proceeded, on July 15, to Sharp's Peak, reaching there on the 17th. From Sharp's Peak she proceeded to Foochow on July 20.

SPECIAL SERVICE.

POWHATAN.

The *Powhatan* sailed from the Norfolk navy-yard on a cruise on January 10. Touching at Cape Haytien, Nicola Mole, Port au Prince, Santo Domingo, Port Royal, and Kingston, she arrived at Colon March 7. On March 25 she went to Carthageua. Sailing thence she arrived at

Key West May 25 and at New York June 13. On June 26 she went to the navy-yard, and left it October 11. She sailed from New York for Hampton Roads October 14, and arrived on the 15th. On October 27 she sailed from Hampton Roads for Aspinwall.

RANGER.

The Ranger remained on the coast of Mexico and Central America, making surveys under the direction of the Navy Department until July 13, when she returned to San Francisco. On July 27 she went to the Mare Island navy-yard.

DESPATCH.

On April 2 the Despatch was ordered to Norfolk, and on the 3d to New York. She arrived in New York April 5. On May 6 she went to sea and proceeded to blow up a wreck off Cape Charles. She returned to New York on May 18, and, on June 11, accompanied the Dolphin on her trial trip. On July 15 she was placed temporarily at the disposal of the Board of Fortifications. After this service was over she returned to the navy-yard, and is now being prepared to accompany the North Atlantic squadron in their projected drill in Tampa Bay.

MICHIGAN.

The Michigan is cruising on the lakes.

APPRENTICE TRAINING SQUADRON.

PORTSMOUTH.

The Portsmouth left Norfolk on April 13, and arrived at Newport on the 26th. On May 11, this ship as senior officer, with the Jamestown and Saratoga in company, sailed from Newport; and, being separated in a gale in the Gulf Stream in the night of May 13, they proceeded separately to Fayal; the Portsmouth reaching there May 28, the Jamestown having arrived on the 26th, and the Saratoga a few hours before the Portsmouth. The squadron sailed from Fayal in company June 1, and reached Lisbon June 7; sailed thence July 1 and reached Funchal July 8; sailed thence July 25 and reached Fort Point Bay, Long Island, August 31. The Portsmouth arrived at Newport September 3, and sailed thence for Norfolk October 6. She arrived at Fort Monroe October 9, and went to the navy-yard the same day.

SARATOGA.

The Saratoga sailed from Norfolk April 13, and arrived at Newport the 26th. She sailed from Newport in company with the Portsmouth and Jamestown, on May 11, and made the cruise already narrated. On September 3 she arrived at Newport, and sailed for Norfolk October 6, arriving October 9.

JAMESTOWN.

The Jamestown sailed from Hampton Roads April 13, and reached Newport April 26. She sailed from Newport in company with the Portsmouth and Saratoga on May 11, and made the cruise already narrated. She arrived at Newport September 3; sailed thence October 6, and reached Norfolk October 9.

No. 5.—NAVAL ACADEMY.

REPORT OF THE BOARD OF VISITORS.

UNITED STATES NAVAL ACADEMY,
Annapolis, Md., June 6, 1885.

SIR: The Board of Visitors to the U. S. Naval Academy have the honor to submit the following report:

The Board was made up of the following gentlemen: Lieut. Col. Orlando M. Poe, U. S. A.; Hon. John R. Thomas, House of Representatives; Rear-Admiral C. R. P. Rodgers, U. S. N. (not present); Hon. Daniel W. Voorhees, U. S. Senate (not present); Hon. John C. Spooner, U. S. Senate (not present); Hon. Benjamin Le Fevre, House of Representatives; Hon. John G. Ballentine, House of Representatives; Prof. William G. Sumner, New Haven, Conn.; Mr. John N. A. Griswold, New York, N. Y.; Mr. William Reed, Baltimore, Md.; Hon. James S. Grinnell, Greenfield, Mass.; Hon. A. M. Craig, Galesburg, Ill.

The Board was organized on June 1 as follows:

Lieut. Col. O. M. Poe, president.

Hon. John R. Thomas, vice-president.

STANDING COMMITTEES.

(1) *Conditions of Admission and Dismissal at the Academy*: Judge A. M. Craig, Hon. John R. Thomas, Hon. Benjamin Le Fevre, Mr. William Reed, Senator John C. Spooner.

(2) *Subjects of Study and Standard of Scholarship*: Prof. William G. Sumner, Hon. John G. Ballentine, Mr. J. N. A. Griswold, Hon. James S. Grinnell.

(3) *Grounds, Buildings, and Sanitary Condition*: Hon. John G. Ballentine, Senator D. W. Voorhees, Hon. John R. Thomas, Hon. James S. Grinnell, Col. O. M. Poe.

(4) *Seamanship, Ordnance, and Navigation*: Mr. J. N. A. Griswold, Mr. William Reed, Hon. John G. Ballentine.

(5) *Discipline, Drill, Practical Exercises, Administration, and Police*: Hon. John R. Thomas, Judge A. M. Craig, Hon. John G. Ballentine.

(6) *Steam, Mathematics, Physics, and Mechanics*: Mr. William Reed, Senator John C. Spooner, Hon. James S. Grinnell.

(7) *English Studies, Modern Languages, and Drawing*: Senator D. W. Voorhees, Prof. William G. Sumner, Mr. J. N. A. Griswold.

(8) *Finance and Library*: Hon. Benjamin Le Fevre, Judge A. M. Craig.

(9) *Final Report and Selection of Orator to Address the Cadets on Friday, June 5*: Senator John C. Spooner, Prof. William G. Sumner, Senator D. W. Voorhees.

The recommendations of these committees are incorporated under corresponding heads of this report.

I.—CONDITIONS OF ADMISSION AND DISMISSAL.

Under the act of Congress one naval cadet is allowed in the Academy for every Member or Delegate of the House of Representatives, one for the District of Columbia, and ten at large. (Rev. Stat., sec. 1513, and act of Congress approved June 17, 1878.)

There are at present 325 Members and 8 Delegates in the House of Representatives. Allowing one cadet in the Academy for each Member, one for each Delegate, one for the District of Columbia, and ten at large, makes the number of cadets allowed at the Academy 344, should each district be represented as contemplated by the law.

Section 1514, Revised Statutes, provides that the Secretary of the Navy shall, as soon after the 5th of March in each year as possible, notify, in writing, each Member and Delegate of the House of Representatives of any vacancy that may exist in his district.

The nomination of a candidate to fill said vacancy shall be made upon the recommendation of the Member or Delegate, if such recommendation is made by the 1st day of July of that year; but if it is not made by that time, the Secretary of the Navy shall fill the vacancy.

The candidate allowed for the District of Columbia, and all the candidates appointed at large, shall be selected by the President.

Under the statute, candidates nominated before the 15th of May, in time to enable them to reach the Academy, are required to present themselves to the Superintendent on that date for examination for admission; but all who may be appointed after that date are required to appear for examination in the month of September.

The effect of the statute as it now stands is that a part of the class each year is admitted in May and a part in September. Upon investigation, the Board find that the practical operation of this practice under the statute is detrimental to the true interests of the cadets, and think that a change of the law in this regard is to be desired.

A mere suggestion would seem to be enough to show the injurious effects of the present system. It will be remembered that a cruise at sea is provided for the cadets each summer, beginning early in June and continued until September 1. Those who are admitted in May participate in this cruise, become familiar with the sea, and secure valuable practical instruction in regard to the management of a ship, and various other matters relating to the course of study, which gives them superior advantages in the study of the books, on their return to the Academy, over those who do not enter until September. Thus, a part of the class begin the course of instruction in the Academy with several months' valuable instruction in advance of the rest of the class, which places those who may enter in September at a great disadvantage in pursuing their studies, which they may never overcome. There are other reasons why this system should not be continued which will readily occur to any person who may give the subject consideration; but it will not be necessary to state them. The Board are fully satisfied that a change should be made, and to meet the difficulty they would suggest that a candidate for admission to the Naval Academy should be appointed at least one year before a vacancy occurs, as is done in the appointment of cadets to the Military Academy, under section 1317, Revised Statutes. And at the time a candidate is appointed the Board would also recommend that an alternate should be named, and that each should be notified and required to appear for examination in May next preceding the vacancy in June. In this way the entire class may be made up on or before the 1st day of June in each year, start together,

and all secure the benefit of the summer cruise at sea, and stand upon a perfect equality at the beginning of the course. If the candidate was appointed, as suggested, one year in advance of admission, he might have ample time to prepare for examination, would doubtless be much better prepared, and would not be likely to fail on examination, as often occurs when he has but a short notice of his appointment, as is the case under the present system.

In regard to the dismissal of cadets from the Academy, we find, upon investigation, in some cases when a cadet has been dismissed for cause, or allowed to resign to avoid dismissal, the same cadet has again been appointed by the Member of Congress in the district where he resides, and in this manner again returned to the Academy.

It is apparent that no school can be successfully managed unless those in control of the institution have the authority to enforce all rules and regulations necessary for the management of the institution; and it is also apparent that the power of suspension or dismissal is among those rules which may or ought to be enforced. But when the power has been properly exercised, if the candidate may be returned the authority to discipline is gone, and practically those in charge are powerless to exercise a salutary rule or regulation which is absolutely necessary in order to manage any school. We are of opinion that here is a wrong which ought to be corrected by proper legislation. In our judgment, the law ought to be so amended as to provide in all cases, where a cadet has been dismissed for cause, or allowed to resign to avoid a dismissal on account of bad conduct, that he should not be eligible thereafter to admission to the Academy.

There is perhaps another matter upon which it seems proper that something should be said. The cadets in the Military Academy at West Point are, by an act of Congress, designated as a part of the Army; but this Board are aware of no statute which directly provides that cadets in the Naval Academy are a part of the Navy. No reason is perceived why, under the law, the cadets at the Naval Academy should not occupy the same position to the Navy that the cadets at West Point do to the Army. One is a school provided by the Government for the education of cadets for the Army, while the other is an institution established by the Government for the education of the cadets for the Navy; and as to powers relating to the discipline of cadets, they should be both placed upon the same ground. The cadets at West Point, under the acts of Congress being a part of the Army, are subject to courts-martial, and the Board are of the opinion that if a similar act was passed declaring the naval cadets to be a part of the Navy, all rules and regulations established for the proper government and management of the Naval Academy might be much better enforced, and thus the Academy might be improved in its usefulness.

II.—SUBJECTS OF STUDY AND STANDARD OF SCHOLARSHIP.

If it is the desire of the Department to secure a thorough and satisfactory inspection of the course of study in the Academy, it would be necessary that the Board charged with that duty should visit the Academy at a time when it is carrying on its regular routine work, and should attend the section-room exercises. Under the actual circumstances, the Board have had recourse to the following means of informing themselves: They have examined with care the examination questions, which they have found to be searching and sufficiently numerous and severe to test the knowledge of the cadets. They have also read a number of

the papers written by the cadets in each department, and have satisfied themselves that the standard of marking is high and severe. They have also selected the papers to be read from those which received the highest marks and those which received the lowest, in order to obtain a fair judgment of the attainments of the whole class.

The cadets at this institution need to acquire a great number and variety of practical powers, and to become acquainted with a number of arts, at least to such a degree as to be able to give intelligent directions about them or to know when efficient work is done in them. Instruction and practice in these arts necessarily occupy a great deal of time, and must be taken into account in estimating the work done in the course of study. The Board have observed with great interest and pleasure that the cadets acquire high skill and training, which makes them very efficient men for any service which the country may require of them in their profession. With these arts and the literary acquirements to which the examinations bear testimony, the time must be very fully occupied. If a cadet on entering is only able to pass the examination prescribed for entrance, it does not seem possible that he can advance at the rate which the course assumes and demands. The entrance examination, as its conditions stand on the books, is far below that of the ordinary civil colleges and technical schools. This fact is supposed to favor a certain class of applicants; but it is believed that any such opinion is founded in error, and that no real kindness is done, probably rather the contrary. The Board therefore believe that the course of study is as full and as varied as it is possible to make it within a four-year limit. It is as strict and effective as that of the best civil institutions with which the Academy would properly be compared. It could not probably be carried out in its present scope if it were not that the number of students to an instructor is, on an average, only one-fourth or one-fifth of the number in the largest colleges. The Board are also satisfied that the marks are carefully determined by a high standard, and that every precaution is taken to prevent favoritism. The only suggestion which the Board would make for consideration is whether it would not be judicious to provide for graduate courses after the sixth year. A scheme or plan for such courses might be invited from the Academic Board.

III.—GROUNDS, BUILDINGS, AND SANITARY CONDITION.

The Board have carefully examined all the buildings devoted to public purposes at the Naval Academy, and while commending the good care taken by the authorities in the preservation of certain of these buildings, yet cannot forbear expressing their opinion that money is wasted which is bestowed on the preservation of the buildings on Stribling Row, known as the Cadet Old Quarters and Old Recitation Hall.

The Old Quarters from building one to nine Stribling Row are in very bad condition; the foundations have settled, the walls are cracked, the ceilings are falling, the wood-work decayed, and the brick-work crumbling.

The Old Recitation Hall is in a very unsafe and critical condition; walls are badly cracked from foundation to roof, and in some places bulged; ceilings are cracked and window-frames settled and out of plumb.

The paymaster's store-house is very unsafe and decayed in every particular; ceilings are falling, walls settled and cracked, wood-work rotten

(dry-rot), especially lower-floor joist, and in places the roof leaks like a sieve.

The quarters occupied by the cadets, known as the Upper or New Quarters, are not large enough to accommodate all the cadets, and are nearly a quarter of a mile from the Old Quarters, which makes it very inconvenient for the cadets and injurious to discipline.

The Board recommend that new quarters be erected on the ground now occupied by the Old Quarters (a group of three buildings, one with three stories and two with four stories each), and that a mess-hall and kitchen be erected in the rear of and separate from those proposed new quarters, as it has been found that the odors arising from the kitchen in the basement of the present new quarters are not conducive to the health and comfort of the cadets occupying those quarters.

The Board recommend further that as many of the officers attached as instructors, &c., to the cadets are obliged to rent quarters in Annapolis, owing to the present insufficiency of quarters for their use in the Academy, the present new quarters be remodeled and adapted for use as additional quarters for officers, professors, and others.

The Board further recommend that the new quarters for the use of the Superintendent be at once finished for occupancy, as each year's delay in this matter adds to the cost to the Government.

The grounds of the Academy are kept in a scrupulously neat and orderly condition, and reflect much credit on the officer in charge of same. This good appearance must benefit the mind and senses of the students, and is in every way calculated to do them good. In striking contrast with the charming view from the front windows of the new quarters is that seen from the rear windows of the same—rickety, tumble-down rookeries, dirty streets, and general unsightliness on the one hand, and a garden of delight on the other. The lands occupied by these rookeries, amounting to less than three acres, lie between the present western limits of the Academy and the Government farm, and could no doubt be purchased at a low figure. Sound economy and a desire for the welfare of the Academy demand that this land be purchased and added to the Academy grounds.

Many improvements have been made to the Government farm adjoining the Academy; a sea-wall (and drive) has been nearly completed along the entire shore front thereof, the lands graded and adorned with trees, shrubberies, &c., and terraces made about the portion of the farm known as the Government Cemetery.

The sanitary condition of the Academy is good.

IV.—SEAMANSHIP, ORDNANCE, AND NAVIGATION.

The Board have viewed with great satisfaction the exercises in steam-fleet maneuvers and seamanship, as witnessed in the operation of a miniature fleet consisting of eight steam-launches, which moved with great precision in different lines of battle, both for attack and defense.

The rather obsolete steamer Wyoming was got under way by the cadets, including the not altogether pleasant duty of firing up on the boilers and running the machinery; and exercises were had in sending up royal yards, making sail, reefing, and furling, all of which was performed in a highly satisfactory manner, showing that the practical part of an officer's education had not been neglected. The wind was too light for the Board to see how they would handle a ship under sail.

An exhibition was then had of target-practice with the guns manned entirely by cadets. The exercises were entirely satisfactory, showing

great proficiency in handling the guns and very creditable practice at the target, distance being 1,000 to 1,100 yards. The only source of regret, if any, was that the Board did not see a boat drill by landing field-guns from a vessel and attacking a supposed enemy on shore, thus testing efficiently the results of the beautiful drills seen on land.

There is little to be said on the subject of ordnance, except that the Academy ought to be supplied with sample pieces of the latest and most effective guns that have been adopted by our Board of Ordnance. It seems useless to exercise future officers with old, obsolete guns that they may never see in use, and have them practically ignorant of the management and power of modern artillery. The Board would suggest that the Academy be at once furnished with a Hotchkiss 2-inch gun, and also with one of the 6-inch modern steel guns, such as are now at the Experimental Battery at this place.

As regards the seamanship department, a great want is felt in the almost entire absence of models showing how iron vessels are constructed. A full supply of wooden models, showing the construction of wooden vessels in their different stages, are on hand, but they are utterly useless. What is wanted now are working-models, showing in detail the construction of the different types of iron vessels, more especially the heavy iron-clads.

The most remarkable need of the Academy, and, in the opinion of the Board, a very serious one, is for means of instruction about *the construction of modern ships of war of various classes*. The Board urge that steps be taken to supply this need. Too much of the apparatus of instruction in various departments is out of date. The Department of Construction is hardly represented at all.

V.—DISCIPLINE, DRILL, PRACTICAL EXERCISES, &C.

Under the administration of the present Superintendent and his excellent corps of assistants, the discipline of the Academy has reached its highest point of excellence, notwithstanding the fact of the imperfect state of the law governing the Academy. If naval cadets were by law made a part of the Navy, not as officers but as a part subject to the rules and regulations governing the Navy; or if, in other words, they were subject to trial by courts-martial for violations of the rules and regulations of the Academy, or for conduct unbecoming a naval cadet and a gentleman as has been suggested already under I, with reference to dismissal, the moral effect would be salutary, the Superintendent would find it much easier to maintain discipline, and much of the friction caused by lack of power to punish by sentence of court-martial would vanish instantly. We therefore earnestly recommend that the law be amended as above suggested.

For some time the practice of credit marks for good conduct has obtained, and the best possible results have followed. The hope of reward more than offsets the natural inclination to violate rules, and the result is a high average of good conduct in all the classes.

The inhuman, disgraceful, and unmanly practice of "hazing" seems to have well-nigh disappeared from the Academy, and the faithful and impartial execution of the law in that regard by the present Superintendent cannot be too highly commended.

The drills, both infantry and artillery, exhibit the most careful training, and the company and battalion maneuvers were creditable alike to officers and cadets.

The practical exercises consist in demonstrations of the theories

taught from the books, and serve to strengthen both mind and body and to fasten upon the memory indelibly the facts necessary to be remembered. The present system of practical exercises has developed a brain and brawn in the naval cadets peculiarly fitting them for officers who are to command ships and fight battles.

The administration and police are all that the most critical could ask, and meet the unqualified approval of the Board.

VI.—STEAM, MATHEMATICS, PHYSICS, AND MECHANICS.

The course in steam-engineering now given is in compliance with an act of Congress approved August 5, 1882. Previous to this time there was a distinct corps of cadet engineers whose whole time was devoted to the study of steam-engineering and the subjects connected therewith. Under the act of August 5, 1882, the above distinctive corps was abolished and all naval cadets now take the same course. The Board, while recognizing the wisdom of this change, would respectfully urge the adoption of a post-graduate course to fit more thoroughly for their profession those cadets who, after the completion of their six years' course, become engineers in the service. This post-graduate course is unquestionably necessary, and the plan would entail little or no extra expense on the Government.

The Board find the course of study pursued by the cadets under their able professors and instructors as thorough as the time the cadets can devote to the subject will allow; but the Board cannot too urgently recommend a post-graduate course in the higher branches of applied mathematics. This system would, it appears to us, make the Naval Academy one of the best, if not the best, institution of learning in the world.

The Board find the Department of Physics and Chemistry as complete as theoretical and practical instruction can make it; but they recommend that the present appropriation should continue from year to year, so that this department may be able to give the best instruction in these important and constantly changing sciences.

VII.—ENGLISH STUDIES, MODERN LANGUAGES, AND DRAWING.

English studies include, as the term is here used, history, grammar, rhetoric, naval and some mercantile law, and international law. The Board have felt a strong interest to see that this department should be fairly developed, for it is the one which might be most easily neglected in an institution of this kind. Examination papers are not careful exercises in composition; but are perhaps as fair tests as more set rhetorical exercises would be. The papers read by the Board include various kinds of rhetorical work, descriptions of machinery, statements of fact and history, argument, statements of law and regulations. The papers read would compare very favorably with those presented by a college class. The drawing exercises which were examined by the Board deserve especial commendation. When it is remembered that the young man who makes the drawing also makes the pattern, works the metal, fits the part to the engine of a steam-launch, works the engine, maneuvers the boat in a fleet of naval steam-vessels, lands a howitzer battery and fights a battle with it, it is plain that few young men enjoy such opportunities for acquiring valuable powers of various kinds as the young men at this institution.

VIII.—FINANCE AND LIBRARY.

The Board carefully examined the methods of purchases and expenditures in the several departments of the Academy coming under the head of Buildings and Grounds, and highly approve the economy and care exercised in this department.

In like manner they examined the mode of purchase for and issue to the cadets of articles of outfit, text-books, clothing, &c., and they commend the business-like manner in which these matters are conducted. The cadets obtain the benefit of wholesale rates on all their purchases.

The accounts of the cadets are kept in a thoroughly plain and comprehensive manner.

The commissariat of the Academy is well conducted, and the articles of food supplied the cadets all that the markets of Baltimore and Annapolis can afford, or that could be required for the health and well-being of young gentlemen of their age, habits, and requirements.

The library of the Academy is well supplied with the latest scientific and professional works published, both foreign and domestic. Its condition is excellent, and the Board recommend that Congress be urged to continue, and enlarge if necessary, the usual appropriation made for its support.

The Board at their meeting on June 5, adopted the following resolution, and ordered that it be inserted as part of the report of the Board:

The attention of the Board having been called to the fact that the Board of Visitors in June, 1883, recommended that the act of August 5, 1882, be amended, as a similar act in relation to cadets at West Point has been, so as not to include the cadets who had entered the service before the passage of said act:

Resolved, That we concur in this recommendation, and respectfully renew the same for the consideration of Congress.

Hon. John R. Thomas and Hon. Benjamin LeFevre dissented, and asked leave to make a minority report on this subject, which was granted.

Very respectfully,

ORLANDO M. POE, *U. S. A.*
 JOHN R. THOMAS,
House of Representatives.
 BENJAMIN G. LEFEVRE,
House of Representatives.
 JOHN G. BALLENTINE,
House of Representatives.
 W. G. SUMNER,
New Haven, Ct.
 JOHN N. A. GRISWOLD,
New York, N. Y.
 WILLIAM REED,
Baltimore, Md.
 JAMES S. GRINNELL,
Greenfield, Mass.
 A. M. CRAIG,
Galveston, Ill.

Hon. WILLIAM C. WHITNEY,
Secretary of the Navy.

REPORT OF THE SUPERINTENDENT.

UNITED STATES NAVAL ACADEMY,
Annapolis, Md., October 13, 1885.

SIR: I have the honor to report that the prescribed course of instruction has been carried out during the past year. Thirty-six cadets completed the four years' course in June last, six passing the required examination "with distinction" and nineteen "with credit," and were ordered from the Academy to perform two years' service afloat. Twenty of this class entered the Academy as cadet-midshipmen and sixteen as cadet-engineers.

The usual summer practice cruise was made by the cadets of the first, third, and fourth class, in the sailing practice-ship Constellation.

A copy of the report of the commanding officer of the Constellation is inclosed, marked A.

The cadets of the second class remained at the Academy during the summer months, and were daily instructed practically in mechanical work in the shops of the department of steam-engineering; they were also instructed practically in running and managing steam-launches, managing boats under oars and under sails, signaling, fleet tactics with steamers, howitzers afloat, target practice with mortars, machine guns, rifled howitzers, and great guns.

One cadet of the second class was dismissed in September for hazarding a candidate for admission. Other cadets were engaged in the affair, but sufficient evidence to bring them to trial by court-martial was not obtained.

Necessary repairs and improvements have been made to the public buildings, wharves, and grounds as far as practicable during the year, the most important of which have been the alteration and enlargement of the cadet sick-quarters, to enable the medical officers to isolate cadets who may have contagious diseases, and the renewal and rearrangement of part of the system of drainage of the Academy.

Sixty-eight candidates for admission presented themselves in May last and ninety-nine in September. Of this number seventy-four failed to pass the required mental examination and seventeen were rejected for physical defects.

The physical defects of three candidates were waived by the Navy Department, and one candidate who failed to pass the physical examination was admitted to the Academy by order of the Navy Department. Eight of the candidates who presented themselves September 1, and failed to pass the required mental examinations for admission were, by order of the Navy Department, re-examined September 25, in the branches in which they had failed; four of these candidates again failed to pass the required mental examinations.

It is believed that the short notice given to many candidates is one of the principal causes of the failure of so many to pass the required mental examination for admission to the Academy.

The records of the Academy show that during the years 1870 to 1885, inclusive, twenty-two hundred and eighteen candidates have presented themselves for examination for admission. Of this number one hundred and eighty were rejected for physical defects, and eight hundred and twenty-six failed to pass the required mental examination. One hundred and thirty-one of these candidates were between fourteen and fifteen years of age, three hundred and ninety-seven were between sixteen and sixteen years of age, seven hundred and four were between seventeen and seventeen years of age, and nine hundred and eighty-six were between seventeen and eighteen years of age.

Of those between fourteen and fifteen years of age sixty-two per cent. passed the required mental examination, of those between fifteen and sixteen years of age sixty per cent. passed, of those between sixteen and seventeen years of age sixty per cent. passed, and of those between seventeen and eighteen years of age only fifty-seven per cent. passed.

It is recommended that permits shall be issued to candidates one year in advance of the date at which they are to be examined, as is the case with candidates for the Military Academy at West Point, and that section 1514 of the Revised Statutes be modified to correspond with section 1317.

The recommendation made in the last annual report of the superintendent, that all candidates shall report for examination for admission on the 15th day of May in each year, is renewed.

For some years past two or more vessels have been used for the summer practice cruise of the cadets, but only one vessel was available for this purpose in June last, the practice-ship Dale having been found unfit for such service by a board of officers ordered by the Department, and no vessel having been furnished to take her place. Fortunately the small number of cadets then composing the first and fourth classes enabled all to be carried on board the Constellation.

The number of cadets to go on the next practice cruise renders it necessary that a ship to take the place of the Dale shall be fitted for a practice-ship and sent to the Academy by May next. It will be impossible to do justice to the cadets and to give them the required instruction with only one practice-ship.

The recommendation made in the last two annual reports of the superintendent, that the act of August 5, 1882, be so modified that the selection of cadets who are to fill vacancies in the lower grades of the line and Engineer Corps of the Navy and of the Marine Corps shall be made upon the completion of the four years' course, instead of upon the completion of the six years' course, is renewed.

Such a change would be in the interests of economy and efficiency, and would also be beneficial to the cadets to be discharged. From the average number of vacancies occurring each year, a cadet who has completed his four years' course can form a close estimate of his chance of getting an appointment in the Navy. Cadets who feel that there is no chance of their receiving an appointment take little or no interest in their duties on board ship, and only keep themselves up in professional matters sufficiently to pass such an examination at the end of the six years as will enable them to be honorably discharged and to receive one year's pay.

The class of cadets that completed the six years' course in June last is the first class that completed the four years' course after the passage of the act of August 5, 1882. Forty-three cadets reported for examination and twenty of them failed to pass the required written examination. Of those who failed all but one passed upon re-examination. Twenty-six of this class were honorably discharged and one was allowed to resign. Had these discharges been made at the end of the four years' course instead of at the end of the six-years' course, there would have been saved to the Government during the past two years the salaries of these twenty-seven cadets, less the salaries of the cadets that would have been appointed to the Academy in their places, amounting to \$24,300, and there would also have been saved the traveling expenses of these twenty-seven cadets from foreign stations to Annapolis, six of whom had to travel at Government expense from different parts of the European station, four from Aspinwall, four from the South Atlantic station, two from the Congo River, three from the Pacific station, and seven from different parts of the Asiatic station.

Your attention is respectfully called to the want of legislation, so far as the Naval Academy is concerned, upon the following points:

The oath to be taken by naval cadets when admitted to the Naval Academy.

The time that a naval cadet may be required to serve.

The reappointment of a naval cadet who has been dismissed from the Naval Academy.

The trial of a naval cadet by court-martial, except for the offense of hazing.

It is respectfully recommended that laws similar to those prescribed for the Military Academy at West Point, contained in sections 1320, 1321, 1323, 1325, and 1326 of the Revised Statutes, be enacted for the government of the Naval Academy.

I inclose herewith a statement (marked B) showing under each specific head of appropriation for the Naval Academy the amounts appropriated and expended and the balance unexpended during the fiscal year ending June 30, 1885.

A statement (marked C) of offers for supplies and service made during the preceding year.

A statement (marked D) showing the amount expended during the preceding fiscal year in building, repairing, and equipping vessels of the Navy, other than labor performed by enlisted men, and the value of articles received, expended, and on hand for this purpose.

There are no civilians employed at the Naval Academy on clerical duty paid from the appropriation, "pay of the Navy."

I am, sir, very respectfully, your obedient servant,

F. M. RAMSAY,
Captain, U. S. Navy, Superintendent.

CRUISE OF THE PRACTICE-SHIP CONSTELLATION.

UNITED STATES PRACTICE-SHIP CONSTELLATION,
Annapolis, Md., August 27, 1885.

SIR: I have the honor to submit the following report of the practice cruise of 1885.

The Constellation sailed from Annapolis on the 16th June with the following officers: Commander C. L. Huntington, commanding; Lieut. R. B. Ingersoll, executive officer; Lieut. G. W. Tyler, navigator; Lieut. E. B. Barry, watch officer; Lieut. J. W. Danenhower, watch officer; Lieut. H. C. Gearing, watch officer; Ensign J. G. Quinby, watch officer; Ensign C. S. McClain, watch officer; Ensign R. C. Smith, assistant to navigator; surgeon, G. A. Bright; passed assistant surgeon, J. W. Steele; Paymaster J. P. Loomis, commissary; chaplain, A. A. McAlister.

There were on board 123 naval cadets and a crew of 197 petty officers, seamen, and marines, and others. Six additional seamen were received on board at Hampton Roads, where the ship arrived on the 18th June.

Sailed from Chesapeake Bay June 22, and cruised between latitudes 40° N. and 37° N., and as far east as longitude 72° W., until July 12, and then sailed for Portsmouth, N. H., direct, arriving there on the 17th July.

Commodore Johnson and the other officers of the navy-yard offered every facility for viewing the various departments and workshops, and a detail of cadets under charge of an officer was sent to visit some point of interest every day.

On the 31st July sailed from Portsmouth for the cruising ground before mentioned; cruised until the 13th August, and on that day anchored in Lynn Haven Roads.

Sailed for Annapolis August 17, anchoring every night and spending several profitable days at the mouth of the Patuxent River, arriving at the U. S. Naval Academy August 27. About Nantucket Shoals and as far north as Cape Ann thick weather and heavy fogs were encountered; otherwise the weather was very favorable.

The cadets of the first class were divided into two parts, one for duty as junior watch officers and mates of decks, and the other as seamen petty officers. The parts exchanged duties every week. The other cadets had regular stations with the crew, and the eight yards were manned chiefly by them. Cadets of all classes, with very few exceptions, seemed fearless aloft.

The cadets have received the following practical instruction in seamanship:

Getting under way and coming to anchor under various circumstances. Loosing and furling, and making and shortening sail. Reefing and hoisting. Shifting topsails. Shifting fore-topsail, as in chase. Sending down light yards to windward. Sending down and up royal and top-gallant yards and masts. Sending down lower yard and topmast. Carrying out a bower anchor, weight 6,000 pounds, between two boats. Boat sailing. Heaving the lead. Knotting and splicing. Signaling. Tacking, wearing, box-hauling. Making up, setting, and taking in studding sails. Man overboard. Hoisting out and in boats. Placing a collision mat under bottom of the ship. Abandon ship.

Cadets of the first class were all given opportunities for working ship as officer of the deck, and all classes were required to submit seamanship notes every week, as, for instance:

Subjects for note-books for the week ending June 20, 1885.

First class.—Will make a note and submit on Saturday the manner of bringing to a chain; heaving up; catting and fishing an anchor and securing it for sea.

Third class.—All standing rigging; manner of fitting and order in which it goes over mast-heads. Sketch a lower mast-head.

Fourth class.—Parts of the ship: masts, yards, and sails; name the gear of a topsail and describe its use.

In navigation cadets of the third class received instruction as follows: Day's work, great circle, middle latitude, and mercator's sailing. Adjustment of the sextant. Longitude by time-sights of sun, moon, planets, and stars, and Sumner's lines. Latitude by meridian, altitude of sun, moon, and stars. φ - φ' method by sun and stars. Versed sine and circum-meridian method. Ship's position by twilight observation of two stars, and by cross-bearings of objects on shore. Compass errors. Time of sunset and high water. Log books.

Target practice with great guns was had every Monday, when practicable, and the cadets were instructed in plotting the fall of the projectiles on a vertical plane by the polar-distortion diagrams furnished by the Bureau of Ordnance.

There were three exercises at general quarters at night.

In target practice the firing was very good, showing the benefit of the progressive instruction received at the Academy.

In addition to their routine ship duties the officers all performed their duties as instructors faithfully and well.

The health of the cadets throughout the cruise was excellent, due in a great measure to the very superior mess arrangements of the commissary.

I am, sir, very respectfully, your obedient servant,

C. L. HUNTINGTON,

Capt. F. M. RAMSAY,

Commander, U. S. N., Commanding.

Superintendent United States Naval Academy.

B.—Statement of the appropriation of the Naval Academy for the fiscal year ending June 30, 1885.

Headings of appropriation.	Amount appropriated.	Amount expended to June 30, 1885.	Balance unexpended June 30, 1885.	Amount expended since June 30, 1885, for supplies ordered prior to June 30, 1885.	Amount of liabilities for supplies ordered prior to June 30, 1885.
For pay professors and others.....	\$53,559 00	\$50,699 79	\$2,859 21
For pay watchmen and others	23,044 00	21,805 17	1,238 83
For pay mechanics and others.....	14,583 60	14,040 24	543 36
For pay of steam-employés.....	7,669 50	7,209 18	460 32
For repairs.....	21,000 00	20,075 48	924 52	\$924 52
For heating and lighting.....	17,000 00	16,719 55	280 45	280 45
For library.....	2,000 00	1,274 47	725 53	725 53
For stationery, &c.....	2,000 00	1,994 41	5 59	\$5 59
For expenses of the Board of Visitors.....	1,500 00	1,476 57	23 43
For chemicals, apparatus, &c.....	2,500 00	1,829 61	670 39	670 39
Miscellaneous.....	34,600 00	31,554 21	3,045 79	1,945 79	1,100 00
For stores, steam-engineering.....	800 00	800 00
For material, steam-engineering.....	1,000 00	1,000 00

C.—Statement of offers for supplies and service for the Naval Academy, made during the fiscal year ending June 30, 1885.

[Schedule of offers for supplies for the United States Naval Academy, under advertisement June, 1884.]

Coal:

For 2,800 tons Cumberland coal:	
The Consolidation Coal Company, at \$2.59 per ton	*\$7,252 00
Ehlen Bros., at \$3.04 per ton	8,512 00
Black, Sheridan & Wilson, at \$2.95 per ton	8,260 00
S. M. Hamilton & Co., at \$2.75 per ton	7,772 00
West Virginia Central and Pittsburgh Railroad Company, at \$2.85 per ton	8,134 00
Baker, Whitely & Co., at \$2.95 per ton	8,260 00
For 600 tons anthracite coal:	
J. S. M. Basil, at \$3.98 per ton	*2,388 00
For 600 tons Newburg Orrel, or Youghiogheny gas coal:	
Newburg Orrel Coal Company, at \$4.15 per ton	*2,490 00
S. M. Hamilton & Co., at \$4.29 per ton	2,574 00
Black, Sheridan & Wilson, at \$4.25 per ton	2,550 00

[Under advertisement of September, 1884.]

For granite coping stone:

W. F. Weller	*980 00
McClenahan & Bro	1,100 00
J. E. Sudler	3,245 00
Berry & McFrederick	1,362 00

[Under advertisement of February, 1885.]

Lumber:

Otto Duker & Co	*452 00
Samuel Burns & Co	482 00
Jos. Thomas & Son	502 00
G. F. Sloan & Bro	457 00
Jos. Turner	514 00

Paints, oils, &c.:

Hirshburg, Hollander & Co	*875 97
Loud, Claridge & Co	949 97
W. H. H. Bixler	892 40
G. & N. Popplein, jr	892 80

* Accepted.

Paint-brushes:	
J. Bond Carroll & Bro.....	*\$102 12
W. H. H. Bixler & Co.....	119 10
Hirshburg, Hollander & Co.....	113 25
Cleaning material:	
Lord & Packham.....	*89 12
Loud, Claridge & Co.....	94 95
Brick:	
For 10,000 each, arch, paving, and dark red:	
George N. Potee.....	*310 00
W. H. Classen.....	317 50
Glass:	
Swindell Bros.....	*9 62
G. & N. Popplein, jr.....	10 00
W. H. H. Bixler.....	21 00
Hirshburg, Hollander & Co.....	10 45
Loud, Claridge & Co.....	11 25
Bar-iron and steel:	
C. Winternitz & Son.....	*51 43
J. Register & Son.....	52 60
Hardware:	
Anderson & Ireland.....	*125 75
W. H. H. Bixler.....	202 35
Rosendale cement, lime, plasterers' hair, &c.:	
Russell, Giese & Co.....	*154 33
G. M. Hay.....	158 33
J. S. M. Basil & Parlett.....	170 00
S. M. Hamilton.....	185 10
W. W. Clarke & Son.....	162 84
Portland cement:	
Russell, Giese & Co.....	*132 50
W. H. Classen & Co.....	135 00
S. M. Hamilton.....	140 00
W. W. Clark & Son.....	137 50
Stone coping:	
McClenahan Bros.....	*270 00
Myers & Keifer.....	585 00
W. F. Weller.....	294 00
Light builder's stone:	
McClenahan Bros.....	*340 00
Rubble building stone:	
McClenahan Bros.....	*240 00
Myers & Keifer.....	244 00
Gas, steam, and water pipe, and fitting:	
J. Register & Son.....	*768 50
T. C. Basshor & Co.....	801 08
Crook, Horner & Co.....	†662 48

[Under requisition No. 9, 1884.]

Cocoa mats:	
Lyon, Hall & Co.....	*\$14 00
John Turnbull.....	14 20
Lord & Packham.....	16 50

[Under requisition No. 22.]

Heavy wrought-iron pipe and fittings:	
T. C. Basshor & Co.....	*90 75
C. Y. Davidson & Co.....	93 09
J. Register & Son.....	96 27
For fish-trap for water-main, as per drawing and specification:	
Caroline Iron Works.....	*182 92
James Bates.....	250 00

* Accepted.

† Only a partial bid.

[Under requisition No. 25.]

Building gravel:		
Washington White.....	per bushel.....	\$0 12½
Washington White, per bushel.....	do.....	*10
D. J. Sanders.....	do.....	12

[Under requisition No. 27.]

Baltimore kitcheners:		
W. H. F. Wilson & Son.....		*90 00
Hutchinson Bros.....		90 00
Bartlett, Hayward & Co.....		100 00

[Under requisition No. 29.]

Ground glass:		
Baker Bros. & Co.....		45 00
Hirshburg, Hollander & Co.....		*42 50
George & N. Popplein, jr.....		52 50

[Under requisition No. 30.]

Dressed lumber:		
Otto Duker & Co.....		*43 47
Jos. Thomas & Son.....		48 68

[Under requisition No. 31.]

Sheepskins:		
George Appold & Sons.....		*2 75
Turned cedar posts:		
Jos. Thomas & Son.....	each.....	*1 50
Samuel Burns & Co.....	do.....	3 00
Otto Duker & Co.....	do.....	2 75
Pew ends for chapel:		
Jos. Thomas & Son.....		*22 00

[Under requisition No. 32.]

Gas fixtures for chapel:		
C. Y. Davidson & Co.....		*492 00

[Under requisition No. 34.]

Adjustable drawing-tables (patent):		
The Washburn Machine Shop.....	each.....	*8 00

[Under requisition No. 35.]

Bath-tub:		
J. Register & Son.....		*16 50
T. C. Baeshor & Co.....		17 75
C. Y. Davidson & Co.....		20 00

Glass for library windows:		
Swindell Bros.....		*36 59
Baker Bros. & Co.....		39 50
Hirshburg, Hollander & Co.....		43 69

[Under requisition No. 36.]

Cements:		
W. Wirt Clarke & Son.....		*114 00
Russell, Giese & Co.....		119 10
J. S. M. Basil & Parlett.....		123 90

Pine wood:		
John Kealy.....	per cord.....	*3 40
J. S. M. Basil & Parlett.....	do.....	3 50
John B. Flood.....	do.....	3 50
J. S. M. Basil.....	do.....	3 47

Oats:		
Mahool & Probest.....	per bushel.....	*40
H. B. Myers.....	do.....	42
J. S. M. Basil & Partett.....	do.....	40
John Kealy.....	do.....	41½

* Accepted.

Hay:		
J. H. Ridout	per ton	*\$18 00
Mahool & Probest	do.	20 00
J. S. M. Basil	do.	19 00
John Kealy	do.	18 00
H. B. Myers	do.	18 75
		19 75
		21 00
[Under requisition No. 38.]		
Bed slats:		
Otto Duker & Co		*12 00
Jos. Thomas & Son		18 00
Chairs:		
Heywood Bros. & Co		*44 00
[Under requisition No. 41.]		
Iron pipe:		
C. Y. Davidson & Co		*19 35
J. Register & Son		21 95
Iron pipe fittings:		
C. Y. Davidson & Co		15 69
J. Register & Son		*12 15
[Under requisition No. 45.]		
Globe-holders:		
C. Y. Davidson & Co		*2 75
Carr's radiators (for library):		
C. Y. Davidson & Co		*154 00
T. C. Basshor & Co		172 80
Carr & Co		192 00
Register & Son		175 00
[Under requisition No. 46.]		
Middlings:		
J. S. M. Basil	per ton	*18 90
John Kealy	do.	19 60
H. Ellenhouser	do.	19 00
[Under requisition No. 49.]		
Musical instruments and stores:		
W. A. Pond & Co		*50 45
Carl Fischer		92 24
[Under requisition No. 50.]		
Rosendale cement:		
J. S. M. Basil & Parlett†		*36 00
Russell & Giese		33 00
W. Wirt Clarke & Son		33 00
[Under requisition No. 56.]		
Chemical supplies:		
James W. Queen & Co		*309 55
J. & H. Berge		409 94
Bullock & Crenshaw		420 62
[Under requisition No. 67.]		
Slate and slating nails:		
Garthe & Lowenstein		*23 60
White lead:		
Hirshburg, Hollander & Co		*56 00
Baker Bros. & Co		57 00
G. & N. Popplein, jr.		57 50
[Under requisition No. 75.]		
Glass:		
Swindell Bros.		*10 46
Hirshburg, Hollander & Co		11 98
G. & N. Popplein, jr.		11 45

* Accepted.

† This firm agreed to deliver at the Academy; the other bidders, in Baltimore. Freight and hauling made this the lowest bid.

Gold-leaf and dryer:		
G. & N. Popplein, jr.....	-----	*\$10 25
Hirshburg, Hollander & Co.....	-----	12 00
[Under requisition No. 7, 1885.]		
Globes for gas-fixtures:		
Cornelius & Co.....	-----	*30 00
C. Y. Davidson & Co.....	-----	36 00
[Under requisition No. 11.]		
Composition nails:		
Cumberland, Dugan & Co.....	-----	*38 35
Anderson & Ireland.....	-----	41 00
[Under requisition No. 25.]		
Bath-boilers:		
J. Register & Son.....	-----	*18 80
Crook, Horner & Co.....	-----	18 81
Oak lumber:		
Otto Duker & Co.....	-----	*32 00
Samuel Burns & Co.....	-----	32 00
Jos. Thomas & Son.....	-----	36 00
[Under requisition No. 26.]		
Tin-plate:		
Keen & Haggerty.....	-----	*53 99
William Fuller & Co.....	-----	54 60
E. L. Parker & Co.....	-----	59 06
[Under requisition No. 34.]		
Building gravel:		
S. P. Kelly.....	per 1,000 bushels.....	*40 00
G. O. Ward.....	do.....	50 00
L. A. Shores.....	do.....	60 00
H. Campbell.....	do.....	60 00
T. H. Ward.....	do.....	77 50
W. White.....	do.....	70 00
T. Kelly.....	do.....	60 00
[Under requisition No. 35.]		
Tin roofing:		
W. H. F. Wilson & Son.....	-----	*29 00
J. H. League & Son.....	-----	31 00
[Under requisition No. 42.]		
Hauling dirt:		
John T. Bishop.....	per cart-load.....	*09
A. Meyett.....	do.....	20
Hauling sod:		
John T. Bishop.....	per cart-load.....	*20
A. Meyett.....	do.....	30
[Under requisition No. 45.]		
Bricks:		
George N. Potee.....	-----	*1, 275 00
H. W. Classen & Co.....	-----	1, 312 50
Mill-work for sick-quarters, as per specifications of architect:		
Otto Duker & Co.....	-----	*377 80
Jos. Thomas & Son.....	-----	362 85
Lumber:		
Otto Duker & Co.....	-----	*890 17
Samuel Burns & Co.....	-----	914 27
Jos. Thomas & Son.....	-----	1, 137 60
Stone work:		
M. Gault & Son.....	-----	*323 63
H. B. Hanna.....	-----	378 75
[Under requisition No. 47.]		
Castings for boiler fronts:		
James Bates.....	per pound.....	*02
H. C. Larrabee & Co.....	do.....	02½

*Accepted.

Estimates of appropriations required for the service of the fiscal year, &c.—Continued.

Detailed objects of expenditure, and explanations.	Estimated amount which will be required for each detailed object of expenditure.	Amount appropriated for the current fiscal year, ending June 30, 1886.
FOR PAY OF THE EMPLOYÉS IN DEPARTMENT OF STEAM-ENGINEERING.		
One master machinist, one boiler-maker, and one pattern-maker, at \$3.50 per day each (March 3, 1885).....	\$3,286 50	
Two machinists and one blacksmith, at \$2.50 per day each (same act).....	2,847 50	
Four laborers, at \$1.50 per day each (same act).....	2,034 00	
For additional pay to one master machinist, that he may be paid at the rate of \$4 per day (submitted).....	156 50	
(The master machinist in the department of steam-engineering is required to do the duty of foreman of the machine-shop, to assist in the practical instruction of the naval cadets in that department, and to make the necessary repairs to the engines and boilers of the vessels and launches.)		
For one master machinist for eleven days (extra time), at \$4 per day (submitted).....	44 00	
For one boiler-maker and one pattern-maker for eleven days (extra time), at \$3.50 per day each (submitted).....	77 00	
For two machinists and one blacksmith for eleven days (extra time), at \$2.50 per day each (submitted).....	82 50	
For four laborers for eleven days (extra time), at \$1.50 per day each (submitted).....	66 00	
(During eighty-five days of the year the practical instruction of the naval cadets in steam and machinery makes it necessary for the employés of the Department of Steam-Engineering to work two hours more per day than the period prescribed by section 3738, Revised Statutes. This extra time is equal to eleven working days.)		
For one molder, at \$2.50 per day (submitted).....	782 50	
(The services of a molder are necessary; one has been allowed, except during the past three years.)		
	8,876 50	\$7,668 00
For necessary repairs of public buildings, pavements, wharves, and walls inclosing the grounds of the Naval Academy, and for improvements, repairs, and furniture and fixtures (same act).....	21,000 00	21,000 00
For fuel for heating and lighting the Academy and school-ships (same act).....	17,000 00	17,000 00
FOR CONTINGENT EXPENSES—NAVAL ACADEMY.		
For purchase of books for the library (March 3, 1885).....	2,000 00	2,000 00
For stationery, blank-books, models, maps, and for text-books for use of instructors (same act).....	2,000 00	2,000 00
For expenses of the Board of Visitors to the Naval Academy (same act). For additional expenses of the Board of Visitors to the Naval Academy (submitted).....	1,500 00 1,000 00	
(The amount appropriated for the expenses of the Board of Visitors for the fiscal years ending June 30, 1884 and 1885, was sufficient for the maintenance of the Board while at the Academy, but was not sufficient to meet that expense and the mileage of the Visitors from and to their homes. The mileage of the ten members of the Board of Visitors present in 1883 was \$1,317.84. The other two members of the Board were not present, and drew no mileage. The mileage of the nine members of the Board of Visitors present in 1885 was \$796.48. The other three members of the Board were not present, and drew no mileage.)		
	2,500 00	1,500 00
For purchase of chemicals, apparatus, and instruments in the department of physics and chemistry, and for repairs of the same (same act).....	2,500 00	2,500 00
For purchase of gas and steam machinery, steam pipe and fittings, rent of buildings for the use of the Academy, freight, cartage, water, music, musical and astronomical instruments, uniforms for the bandsmen, telegraphing, for feed and maintenance of teams, for current expenses and repairs of all kinds, and for incidental labor and expenses not applicable to any other appropriation (same act).....	34,600 00	34,600 00
For stores in the department of steam-engineering (same act).....	800 00	800 00
For materials for repairs in steam-machinery (same act).....	1,000 00	1,000 00
For construction of a new set of quarters for cadets capable of accommodating three hundred cadets; to be built in accordance with general plan submitted to the Navy Department June 16, 1884 (submitted).....	120,000 00	

Estimates of appropriations required for the service of the fiscal year, &c.—Continued.

Detailed objects of expenditure, and explanations.	Estimated amount which will be required for each detailed object of expenditure.	Amount appropriated for the current fiscal year, ending June 30, 1886.
FOR CONTINGENT EXPENSES—NAVAL ACADEMY—continued.		
<p>The main building, now occupied as quarters by the cadets, accommodates about three-quarters of the average number at the Academy, the remainder being quartered in what are known as the "old quarters," situated nearly one-quarter of a mile distant from the main building. This main building is unsuitable for cadet quarters; it is badly planned, badly ventilated, would be a dangerous building in case of fire, is badly located, the rooms are too small, and it contains the mess-hall and kitchen, which cause the odors of food to pervade the building at all times.</p>		
<p>The "old quarters" are too small, are in very bad condition, and should be rebuilt.—(See Reports of Boards of Visitors, 1883, 1884, and 1885.)</p>		
<p>For headstones for the graves of sixty (60) sailors and marines buried in the naval cemetery at the Naval Academy, Annapolis, Md. who lost their lives by being wrecked in the U. S. S. Huron (submitted).....</p>	\$500 00	

RECAPITULATION.

Detailed objects of expenditure, and explanations.	Total amount to be appropriated under each head of appropriation.	Amount appropriated for the current fiscal year, ending June 30, 1886.
Pay of professors and others.....	\$52,708 00	\$53,559 00
Pay of watchmen, mechanics, and others.....	45,399 95	37,602 45
Pay of employés in department of steam-engineering.....	8,876 50	7,668 00
Necessary repairs to public buildings, &c.....	21,000 00	21,000 00
Fuel for heating and lighting Academy and school-ships.....	17,000 00	17,000 00
Purchase of books for the library.....	2,000 00	2,000 00
Stationery, blank books, maps, &c.....	2,000 00	2,000 00
Expenses of the Board of Visitors.....	2,500 00	1,500 00
Purchase of chemicals, &c.....	2,500 00	2,500 00
Purchase of gas and steam machinery, &c.....	34,600 00	34,600 00
Stores in the department of steam-engineering.....	800 00	800 00
Materials for repairs in steam-machinery.....	1,000 00	1,000 00
For construction of new set of quarters for cadets.....	190,384 45	181,229 45
Headstones for graves of wrecked sailors and marines.....	500 00	

Respectfully submitted.

F. M. RAMSAY,
Captain U. S. Navy, Superintendent.

UNITED STATES NAVAL ACADEMY,
September 26, 1885.

Hon. W. C. WHITNEY,
Secretary of the Navy, Washington, D. C.

No. 6.—BUREAU OF YARDS AND DOCKS.

BUREAU OF YARDS AND DOCKS,
NAVY DEPARTMENT,
Washington, D. C., October 13, 1885.

SIR: The following report of the work done under the cognizance of this Bureau for the fiscal year ending June 30, 1885, accompanied by (as part of this report) detailed statements of the expenditures, and the estimates in tabular form from the commandants of navy-yards for the fiscal year ending June 30, 1887, is herewith submitted.

These statements show a gross amount estimated for from the navy-yards as follows:

Improvements	\$7, 830, 631 91
Repairs and preservation	1, 224, 600 63
Naval Asylum	96, 661 00
Civil establishment	44, 008 00
General maintenance	470, 796 93
Grand total	9, 666, 698 47

The amount to be expended upon yards and stations will depend largely upon the policy which Congress may decide upon with regard to them.

In order that the matter may be fairly before it, I estimate for certain desirable improvements in addition to the necessary expenditures for repairs and preservation and maintenance.

The estimates of the Bureau are summarized as follows:

For support of Bureau of Yards and Docks	\$11, 990 00
For general maintenance and contingent	340, 000 00
For support of Naval Asylum	96, 661 00
For repairs and preservation	800, 000 00
For improvements at navy-yards	3, 768, 337 41
For civil establishment	68, 759 44
Total	5, 085, 737 85

The following tabulated statements show the amounts expended and estimates by the several navy-yards and stations and the Naval Asylum, under the principal heads of improvements, repairs and preservation, Naval Asylum (support of beneficiaries), civil establishment, general maintenance, and contingent, viz:

No. 1.—Report of expenditures at navy-yards and stations and Naval Asylum for the year ending June 30, 1885.

APPROPRIATIONS.

Yards and stations.	Yard improve- ments.	Repairs and pres- ervation.	General main- tenance.	Closed navy- yards.	Civil establi- shment.	Contin- gent.	Total.
Portsmouth, N. H.....	\$18, 959 84	\$22, 733 87	\$3, 474 55	\$503 31	\$45, 671 57	
Boston, Mass.....	3, 686 22	30, 258 65	\$254 71	2, 699 92	36, 899 50	
New London, Conn.....	3, 766 21	3, 766 21	
New York, N. Y.....	\$32, 183 00	33, 128 86	37, 856 13	4, 710 46	107, 328 45	
League Island, Pa.....	4, 915 89	14, 252 70	2, 417 25	21, 585 84	
Washington, D. C.....	860 60	20, 396 86	18, 014 91	2, 784 50	4, 688 75	
Norfolk, Va.....	32, 332 41	23, 306 80	2, 920 88	3, 404 01	61, 964 10	
Pensacola, Fla.....	680 44	11, 948 77	69 47	944 38	13, 643 06	
Mare Island, Cal.....	242, 821 27	19, 173 05	34, 028 97	3, 589 03	303, 433 35	
Sackett's Harbor, N. Y.....	389 75	389 75	
Key West, Fla.....	744 70	2, 365 95	3, 110 65	
Naval Asylum, Pa.....	56, 678 96	56, 678 96	
Wharf at Erie, Pa.....	500 00	500 00	
Port Royal, S. C.....	771 11	38 12	123 47	51 70	984 40	
Total.....	333, 264 94	134, 056 39	196, 546 18	324 18	23, 540 97	12, 968 80	702, 701 46

No. 3.—Detailed report from navy-yards and stations of expenditures under "repairs and preservation" during the fiscal year ending June 30, 1885.

Objects.	Portsmouth.	Boston.	New York.	League Island.	Washington.	Norfolk.	Pensacola.	Mare Island.	Key West.	Port Royal.	Total.
Yard buildings.....	\$2,886 56	\$475 76	\$13,249 16	\$208 27	\$7,389 80	\$6,697 26	\$51 51	\$3,117 90	\$744 70	\$29 58	\$34,320 59
Officers' quarters.....	1,363 20	900 42	3,214 52	25 11	2,912 83	377 45	179 74	617 29	8 54	9,592 19
Wharves, bridges, landings, and boats.....	1,598 31	1,473 69	270 53	2,317 55	2,230 50	226 84	3,770 49	8,897 00
Roads, walks, gutters, and drains.....	2,635 27	861 47	3,139 38	126 43	4,234 79	10,263 02	58 60	7,124 37	28,822 23
Fences and walls.....	352 44	6 56	244 68	30 59	1,004 60	266 32	85	892 79	2,788 86
Cranes, masts, and derricks.....	31 49	688 94	17 37	312 86	615 39	10 10	384 80	2,045 95
Furnaces, forges, heating apparatus, &c.....	2,027 62	37 08	527 29	18 20	298 15	687 00	40 00	3,635 48
Trucks and scales.....	2,169 00	471 29	693 19	16 30	182 90	1,446 50
Water and gas works.....	2,826 70	738 90	2,333 06	32 12	1,632 73	1,719 17	3 82	2,968 71	12,551 48
Dredging and scowging.....	67 80	3 00	490 99	1,412 28	823 21
Dry-docks.....	251 25	138 12	517 26	2,826 02	899 28	7,688 18	63 84	2,412 85
Miscellaneous repairs.....	6,032 81	460 02	7,275 45	1,362 25	92 14	73 90	25,347 80
Repairs to dikes.....	1,362 25
Total.....	18,459 84	3,686 22	33,128 86	4,915 89	20,396 86	32,332 41	680 44	19,173 05	744 70	38 12	134,056 39

No. 3.—Detailed report of expenditures under "general maintenance" received from yards and stations during the fiscal year ending June 30, 1885.

Objects.	Portsmouth.	Boston.	New London.	New York.	League Island.	Washington.	Norfolk.	Pensacola.	Mare Island.	Key West.	Sackett's Harbor.	Port Royal.	Total.
Freight and transportation.		\$175 00	\$14 00	\$690 42	\$24 00	\$398 44	\$496 98	\$22 50	\$2,563 82	\$30 50		\$63 76	\$3,667 24
Printing, stationery, and advertising.	\$493 19	329 09	19 79	725 53	396 90	13 76	145 25		722 16				3,678 83
Books, maps, models, and drawings.													159 00
Purchase and repair of fire-engines.		21 60		201 64	30 00	76	30 23	1,523 17	22 61	955 00			2,785 76
Machinery of every description and patent rights.	75			1 57	103 11	5 28	196 40		291 72				1,634 64
Repairs on steam fire-engines and attendance on same.	31				19 55		566 48		160 10				2,127 81
Purchase and maintenance of oxen, horses, pay of hired teams, tugs, &c.	4,089 92	3,163 53	720 42	6,038 42	4,353 98	2,898 95	2,806 82	2,181 68	5,196 70				31,450 42
Carts, timber-wheels, and tools of every description.	397 40	94 38		1,381 05	1,044 71	329 41	401 17	233 54	213 93				4,095 59
Postage on letters in public service and telegrams.	124 00	20 00	6 00	12 72	188 83	19 21	76 91		1,128 32				1,575 99
Furniture for Government houses and offices in navy-yards.	419 79	39 55		67 51	74 64	73 70	151 29	10 59	99 75			10 75	847 82
Coal and other fuel for yards and docks purposes.	2,945 74	3,184 38		3,114 04	467 76	1,318 46	2,918 22	145 59	5,064 85	29 60			11,275 72
Candles, oil, and gas.	661 01	877 62	10 00	2,750 84	111 09	810 60		250 44	5,064 85			48 97	13,553 14
Cleaning and clearing up yards and care of buildings.	597 05	4,475 76	180 00	4,904 19	319 27	3,220 04	988 64	462 73	4,388 31				19,535 99
Attendance on fires, lights, fire-engines and apparatus.	1,341 96	2,080 52		4,357 27	2,831 36	1,370 58	869 25	342 50	2,740 28				15,933 72
Incidental labor not chargeable to other appropriations.	3,983 53	2,290 36	626 00	175 62	1,674 01	2,174 51	1,675 55	2 77	1,578 65		389 75		14,570 75
Water tax.	100 00	3,205 76		4,774 94	50 91		50 91	33 60	4,999 93	52 20			13,217 34
Tolls and ferrisses.	4 32	509 90		107 50			197 50		2,760 00				3,579 22
Pay of watchmen.	7,487 40	9,087 48	2,150 00	6,353 62	1,448 00	5,333 62	11,734 80	6,543 00	2,160 50	1,298 75			53,636 55
Flags, awnings, and packing-boxes.	12 50	703 72		118 50	23 84	57 60	10 40		77 44				1,004 00
Rent of landings.	75 00				1,141 65								1,141 65
Rent of officers' quarters at Philadelphia.													
Total.	22,733 87	30,256 65	3,766 21	37,356 13	14,252 70	18,014 91	23,306 80	11,946 77	34,028 97	2,365 96	389 75	123 47	196,546 18

No. 4.—Detailed report of expenditures under "closed navy-yards" received from yards during the fiscal year ending June 30, 1885.

Object.	Boston.	Pensacola.	Total.
REPAIRS AND PRESERVATION.			
Yard buildings.....	\$66 31		\$66 31
Officers' quarters.....	52 44		52 44
Wharves, bridges, landings, and boats.....	18 42		18 42
Water and gas works.....	80 29		80 29
Miscellaneous repairs.....	37 25	\$22 74	59 99
Total	254 71	22 74	277 45
GENERAL MAINTENANCE.			
Incidental labor not chargeable to other appropriations.....		46 73	46 73
Total		69 47	324 18

No. 5.—Estimates received from navy-yards and Naval Asylum for the fiscal year ending June 30, 1887.

APPROPRIATIONS.

Yards and stations.	Yard improve-ments.	Repairs and pres-ervation.	General main-tenance.	Civil estab-lishment.	Total.
Portsmouth, N. H.....	\$9,500 00	\$87,000 00	\$51,340 00	\$3,400 00	\$151,240 00
Boston, Mass.....	2,852,521 30	240,569 85	74,800 00	7,256 25	\$3,175,147 40
New London, Conn.....		1,200 00	5,650 00		6,850 00
New York, N. Y.....	1,239,635 50	531,185 80	129,400 00	6,500 00	1,906,721 30
League Island, Pa.....	1,536,366 42	69,282 55	44,807 76	9,700 00	1,660,156 73
Washington, D. C.....	116,711 00	54,250 00	40,915 00	3,717 25	215,593 25
Norfolk, Va.....	1,545,116 92	92,124 90	50,000 00	5,334 50	1,692,576 32
Pensacola, Fla.....		31,886 10	14,373 82	1,200 00	47,459 92
Mare Island, Cal.....	497,260 90	101,162 79	56,234 85	6,900 00	661,558 54
Sackett's Harbor, N. Y.....		1,000 00			1,000 00
Key West, Fla.....	15,000 00	14,629 70	2,898 00		32,527 70
Naval Asylum, Pa.....	96,661 00				96,661 00
Port Royal, S. C.....	18,519 87	308 94	377 50		19,206 31
Total	7,927,292 91	1,224,600 63	470,796 93	44,008 00	9,666,698 47

No. 6.—Detailed estimates from yards and stations for works of improvement for the fiscal year ending June 30, 1887.

Yards, stations, and objects.	Estimates.	Total.
PORTSMOUTH, N. H.		
For cleaning three ponds.....	\$3,000 00	
For proposed reservoir.....	6,000 00	
For piping.....	500 00	
		\$9,500 00
BOSTON, MASS.		
For iron-plater's shop.....	120,713 89	
For water-pipes.....	49,607 00	
For cart-shed.....	10,408 45	
For erecting and copper shop.....	39,864 90	
For paving and grading.....	43,109 40	
For floating-gate, dry-dock (iron).....	30,782 88	
For officers' quarters, L, M, N, and O.....	28,610 00	
For rebuilding wharves.....	74,244 78	
For additional dry-docks.....	2,456,200 00	
		2,852,521 30
NEW YORK, N. Y.		
For general storehouse for yards and docks.....	84,752 00	
For general paint and oil storehouse.....	53,491 50	
For boiler-shop wing to machine-shop.....	73,000 00	
For repairs to dry-dock.....	125,000 00	
For repairs to cob-dock.....	255,750 00	
For one timber dry-dock.....	600,000 00	
For beef and pork packing-house.....	47,642 00	
		1,239,635 50

No. 6.—Detailed estimates from yards and stations for works of improvement, &c.—Cont'd.

Yards, stations, and objects.	Estimates.	Total.
LEAGUE ISLAND, PA.		
For storehouse for ordnance.....	182,414 47	
For storehouse for provisions and clothing.....	209,237 84	
For storehouse for equipment and recruiting.....	209,237 84	
For office building for yard paymaster.....	19,579 29	
For office building for medicine and surgery.....	19,579 29	
For office building for commandant.....	53,735 59	
For dwellings B and C.....	30,582 85	
For dwellings D and E.....	30,582 85	
For landing-wharf foot of Fifteenth street (dimensions, 75 by 400 feet)...	26,416 40	
For dredging and filling in.....	155,000 00	
For timber dry-dock (525 feet by 118 feet 4 inches by 23 feet 8 inches).....	600,000 00	
		1,536,266 43
WASHINGTON, D. C.		
For new ordnance machine-shop.....	95,000 00	
For extension of yard wall through marsh.....	21,711 00	
		116,711 00
NORFOLK, VA.		
For dry-dock.....	500,000 00	
For dry-dock pumps.....	52,600 00	
For extension of quay wall.....	384,400 00	
For railroad extension.....	47,479 87	
For electric lights.....	17,600 00	
For erecting shop No. 41.....	34,073 45	
For iron and steel construction shop.....	41,669 00	
For paint-shop.....	32,966 80	
For extension of boiler-shop.....	14,488 29	
For floating derrick.....	49,189 71	
For navy-yard extension.....	358,600 00	
For two officers' quarters.....	12,000 00	
		1,545,116 92
PORT ROYAL, S. C.		
For combined coal-shed and storehouse.....	10,962 60	
For boat-house.....	126 20	
For artesian well.....	592 20	
For flag-staff.....	93 80	
For quarters for commanding officer.....	6,725 07	
		18,519 87
KEY WEST, FLA.		
For purchase of Mallory lot.....	15,000 00	
		15,000 00
MARE ISLAND, CAL.		
For continuation of stone dry-dock.....	191,595 00	
For timber-shed.....	13,085 05	
For cisterns.....	46,346 30	
For rolling-mill for steam-engineering.....	40,000 00	
For boiler-shop for steam-engineering.....	4,200 00	
For wharves.....	110,743 81	
For landings.....	5,000 00	
For roads.....	42,517 50	
For gate and guard-house.....	20,000 00	
For gas-holder.....	16,664 09	
For gas mains and pipes.....	3,109 15	
For iron-plating shop.....	4,000 00	
		977,260 90
NAVAL ASYLUM, PHILADELPHIA.		
For support of beneficiaries, improvements, and all expenses.....	96,661 00	
		96,661 00
Total.....		7,927,292 91

No. 7.—Detailed estimates from navy-yards and stations for "repairs and preservation" for the fiscal year ending June 30, 1887.

Objects.	Portsmouth.	Boston.	New London.	New York.	League Island.	Washington.	Norfolk.	Pensacola.	Mare Island.	Sackett's Harbor.	Key West.	Port Royal.	Total.
Yard buildings.....	\$40,000 00	\$121,036 58	\$300 00	\$37,644 00	\$13,367 75	\$15,000 00	\$42,929 93	\$5,153 42	\$14,314 37		\$8,211 70	\$190 39	\$678,148 14
Officers' quarters.....	8,000 00	3,000 00	300 00	6,000 00	169 25	2,000 00		2,867 46	2,154 00			38 55	24,526 26
Wharves, bridges, landings, and boats.....	8,000 00	25,000 00	200 00	43,816 00	20,765 75	1,500 00	15,720 57	4,571 00	3,726 62				125,900 34
Roads, walks, gutters, and drains.....	4,000 00	22,500 00	100 00	134,429 80	1,260 00	5,000 00	11,910 00	5,16 60	7,200 60				191,912 40
Fences and walls.....	4,800 00	5,000 00	150 00	4,360 00	252 30	1,000 00		2,096 14	1,500 00				15,784 44
Granes, scows, and derricks.....	6,000 00	15,000 00		1,214 00	1,655 50	500 00	4,000 00		500 00				29,167 82
Furnaces, forges, heating apparatus, &c.....	2,500 00	1,000 00	50 00	7,000 00	552 00	750 00		303 75	1,500 00			38 00	13,688 75
Tracks and scales.....	200 00	10,000 00		1,000 00	1,260 00	2,500 00	3,164 00		2,326 80				21,252 80
Water and gas works.....	2,500 00	2,000 00		6,000 00	1,260 00	3,000 00	4,300 00	97 25	1,000 00		1,702 00		18,897 25
Dredging and scowling.....		5,000 00				20,000 00	5,300 00	15,697 20	4,441 00				50,438 20
Dry-docks.....	10,000 00						1,300 00		*60,000 00				92,333 27
Miscellaneous repairs.....	5,000 00	10,000 00	100 00	5,000 00	30,000 00	3,000 00	3,500 00	284 96	2,500 00			50 00	31,434 96
Dikes.....													30,000 00
Cistern.....													1,116 00
Total.....	87,000 000	240,569 85	1,200 00	531,185 80	69,282 55	54,250 00	92,124 90	31,886 10	101,162 79	1,000 00	14,629 70	308 94	1,224,600 63

* Sectional.

No. 8.—Detailed estimates for "general maintenance" received from yards and stations for the fiscal year ending June 30, 1887.

Objects.	Portsmouth.	Boston.	New London.	New York.	League Island.	Washington.	Norfolk.	Pensacola.	Mare Island.	Key West.	Port Royal.	Total.
Freights and transportation.....	\$100 00	\$200 00	\$25 00	\$1,000 00	\$100 00	\$15 00	\$100 00	\$2,000 00	\$50 00	\$10 00	\$4,700 00
Printing, stationery, and advertising.....	600 00	500 00	100 00	1,000 00	1,000 00	500 00	300 00	1,000 00	60 00	100 00	6,317 60
Books, maps, models and drawings.....	100 00	100 00	2,200 00	500 00	50 00	1,000 00	15 00	3,965 00
Purchase and repairs of fire-engines.....	2,000 00	1,000 00	9,000 00	342 10	6,500 00	5,000 00	500 00	19,468 10
Machinery of every description and part- out rigging.....	600 00	500 00	9,000 00	1,745 00	500 00	3,500 00	300 00	16,145 00
Repairs on steam fire-engines and attend- ance on same.....	500 00	2,500 00	3,500 00	1,197 20	500 00	1,000 00	1,500 00	10,796 20
Purchase and maintenance of horses and oxen, and pay of hired teams, &c.....	6,000 00	15,000 00	775 00	14,000 00	8,055 00	5,000 00	5,000 00	6,000 00	61,438 70
Carts, timber-wheels, and tools of every description.....	4,000 00	8,500 00	200 00	10,000 00	4,881 76	2,000 00	4,000 00	1,000 00	36,076 66
Postage on letters on public service, and telegrams.....	200 00	100 00	20 00	200 00	300 00	50 00	20 00	1,500 00	2,965 00
Furniture for Government houses and of- fices in navy-yards.....	2,500 00	1,500 00	7,500 00	2,385 00	3,000 00	3,980 00	4,300 00	26,306 20
Coal and other fuel for yards and docks purposes.....	5,000 00	4,000 00	100 00	5,000 00	3,850 00	2,000 00	1,000 00	800 00	22,024 00
Candles, oil, and gas.....	5,000 00	3,000 00	40 00	4,000 00	246 50	1,200 00	2,000 00	5,094 85	21,007 65
Cleaning and clearing up yards and care of buildings.....	6,000 00	15,000 00	25,000 00	4,200 00	5,000 00	3,000 00	6,000 00	66,427 67
Attendance on fires, lights, fire-engines, and apparatus.....	5,000 00	3,700 00	6,000 00	4,200 00	2,500 00	5,000 00	3,000 00	31,768 50
Incidental labor not chargeable to other appropriations.....	6,500 00	2,000 00	2,000 00	8,000 00	3,850 00	5,000 00	5,000 00	2,000 00	34,950 00
Water tax.....	100 00	5,000 00	7,000 00	5,000 00	17,223 40
Tolls and ferrisses.....	50 00	40 00	500 00	3,550 00
Pay of watchmen.....	6,840 00	12,000 00	2,300 00	20,000 00	7,300 00	8,000 00	10,000 00	12,000 00	86,508 00
Flags, awning, and packing-boxes.....	250 00	200 00	50 00	500 00	705 20	100 00	160 00	250 00	2,268 95
Total.....	51,340 00	74,800 00	5,650 00	159,408 00	44,807 76	40,915 00	50,000 00	14,873 82	56,224 85	2,898 00	377 50	470,796 98

The very limited appropriations made for the care and maintenance of yards the past few years has necessarily resulted in such a condition of decay in buildings, docks, and wharves that in order to put them in proper condition a liberal appropriation is absolutely necessary under the general heads of "maintenance" and "repairs and preservation," more particularly under the latter. Scarcely a week has passed since I assumed control of the Bureau that reports have not been received of buildings tumbling down, or liable to do so at any moment, roofs leaking to such an extent as to involve destruction of property, and in rainy weather preventing men from working; wharves rotten and falling into the water; others so defective that they cannot be used; stone dry-docks having to be shored up with timber, roads and ways broken in and in bad condition; water service defective on account of worn-out pipes, and a complaint of decay that implies general destruction.

It surely must appear to Congress that these vast establishments, such as our navy-yards are, cannot be kept in proper condition, available for the needs of the country, without sufficient means to repair the wharves and buildings so that they can be used at all times for the purpose intended. Much is yet to be done in the way of improvements to make any of our yards equal to all the demands that may be made upon them.

The appropriations have generally been well expended, but they have been so very small that little could be done.

There are in the different yards five hundred and five buildings of various sizes, some of them covering as much as 40,000 square feet of ground, and three stories high; in addition to these are several miles of wharves, besides stone dry-docks, with their appurtenances. Many of these buildings were built fifty to sixty years ago, and are from their age and want of care, consequent upon the need of funds, in a dilapidated condition. For the care of this vast amount of property only \$125,000 has been appropriated for the last two years; and considering that owners of property estimate that at least 1 per cent. of the value of a building is necessary every year to keep it in proper order, and that this property is worth not less than \$50,000,000, and could not be replaced for that sum, it at once appears how inadequate the appropriations have been.

Not less than \$800,000 should be appropriated yearly for the next three years to put the property in good condition, and I sincerely hope that this amount may be given.

Under the heads of the different yards I will respectfully offer my views on such of the estimates as seem to me deserving particular notice.

NAVY-YARD, PORTSMOUTH, N. H.

The floating dry-dock at this yard requires extensive repairs, and under the head of "repairs and preservation" \$10,000 is asked for this purpose. This sum is necessary to put it in serviceable condition, and I request that this amount may be made a special appropriation, in order that work may be commenced as early as possible.

The sum of \$9,500 is asked for under the head of improvements, to perfect the water system, now in the most defective condition.

NAVY-YARD, BOSTON, MASS.

The following items of improvements in this yard are considered absolutely necessary, viz: A renewal of water-pipes, for which \$49,607 is required; for a new cart-shed, \$4,000; floating gate for dry-dock,

\$30,762.88; repairs of officers' quarters, \$11,000; and repairs of wharves, \$50,000; amounting in the aggregate to \$145,369.88.

The necessity for a new floating gate for the dry-dock is absolute. The present caisson is of wood, and is in such bad condition that further repairs upon it are almost impossible.

The necessity for new water-pipes is also very great. Those now in use are constantly bursting, involving great waste.

The wharves, with one exception, are so rotten that they cannot be used, it being deemed dangerous for persons even to walk over them for fear of falling through.

NAVAL STATION, NEW LONDON, CONN.

No work of any kind has been done at this station during the fiscal year, and only such expenditure has been made as was absolutely necessary to care for public property and keep up communication between the station and New London.

I respectfully renew the recommendation of the former chief of this Bureau, Admiral Nichols, that if "nothing is to be done to improve this station, all the portable property be transferred to other yards or sold."

NAVY-YARD, NEW YORK.

The only work of improvement at this yard during the past year has been dredging the channel.

A contract was entered into for repairs to that portion of the cob-dock which most required it for \$47,574.26, and that work is now in progress.

Estimates for "improvements" are submitted and strongly urged for the following, viz:

A new dry-dock, \$700,000; repairs to and lengthening present stone dry-dock, \$331,000; boiler-shop wing to machine-shop, \$73,000, this amount to be made a special appropriation and immediately available; repairs to cob-dock, \$50,000; and for paint and oil storehouse \$25,000.

A new dry-dock at this yard is essential. The present dock is too short for the largest ships, and the masonry work is in such a shocking condition as to involve the necessity of using timber shores to keep the granite blocks from falling in. An estimate of \$700,000 is presented for the construction of a Simpson dock, to be built of timber. This amount would build a dock on an improved plan about 480 feet in length. In case this amount is appropriated and a new dock authorized to be built, the present dock would not require lengthening, and in that case \$155,000 would be sufficient to repair it and give a new caisson.

The estimate of \$50,000 for the cob-dock is to renew the crib-work where it is most defective. Within the past three months about 200 feet of defective crib-work gave way, owing to its rotten condition, and fell into the water.

The estimate for a paint and oil storehouse I most strongly urge in order that there may be some place where inflammable articles can be stored without danger from fire to the many valuable buildings in the yard, with their contents.

NAVY-YARD, LEAGUE ISLAND, PA.

This yard has been practically closed during the past year, and only so much of the appropriations expended as was absolutely necessary.

If the yard is to be improved and made available for work on vessels,

I would respectfully suggest that the following amounts be appropriated:

For office-building for commandant.....	\$15,000 00
For officers' quarters.....	38,000 00
For landing-wharf, foot Fifteenth street.....	26,416 40
For building Simpson dry-dock (timber).....	700,000 00
For dredging and filling in.....	155,000 00
An aggregate of.....	932,416 40

To make the plant now in the yard available for repairs of ships, a Simpson dry-dock is suggested as a necessity. Such a dock will cost about \$700,000, and would require about two years to complete.

NAVY-YARD, WASHINGTON, D. C.

At this yard no works of improvement have been undertaken. The small amounts appropriated for "repairs and preservation" and "general maintenance" have been economically expended.

The only improvements recommended are a new ordnance machine-shop and the extension of the yard wall; for the first, \$95,000, and the latter, \$21,711.

NAVY-YARD, NORFOLK, VA.

No works of improvement have been undertaken at this yard.

The expenditures under appropriation "repairs and preservation" were \$32,332.41, and under "general maintenance" \$23,306.80.

The very limited appropriations prevented necessarily the needed repairs being made in many of the buildings which should have been provided for.

The estimates of this yard for improvements recommended amount to \$1,545,116.92.

As this yard is of equal importance to any on the Atlantic coast, the expenditure of large amounts for its improvements is warranted, so that it may in all respects be put in the condition for carrying on all kinds of work of a first-class naval establishment.

Owing to its natural advantages in climate and location, it is especially recommended to the favorable consideration of Congress.

Among the many improvements suggested in the commandant's annual report, the Bureau specially commends as worthy of favorable consideration the following objects, which are regarded as essentially necessary, viz:

Dry-dock (timber).....	\$650,000 00
Pumps for dry-dock.....	52,600 00
Extension of quay wall.....	140,000 00
Railroad extension.....	47,479 87
Electric lights.....	17,600 00
Floating derrick.....	49,189 71
Two officers' quarters.....	12,000 00
Ordnance wharf at Saint Helena.....	15,000 00
Total.....	983,869 58

Another very important improvement, though not mentioned in the foregoing, is the extension of the present stone dry-dock, for which an appropriation of \$240,000 should be provided for.

The dry-dock, a stone structure, is in good condition, but, owing to its want of sufficient length, is not adequate to the future needs of the

service. This is the only dry-dock on the entire coast from Norfolk to the Rio Grande in which a ship of 300 feet length can be docked; and as it is contemplated to build ships in the future of greater length than this, and as those ships built of steel will require more frequent docking, owing to the readiness with which they foul, it is deemed eminently necessary that in addition to the extension of the stone dock at this yard a new dock of not less than 500 feet in length should be constructed on the "Simpson plan," that will answer for docking vessels of the length they are likely to be built.

The new pumps for the present dry-dock can be made available for the old dock as well as the new one.

An appropriation for the floating derrick is also urged upon Congress as a great necessity, considering the extended water front.

The extension of the railroad system is deemed of great importance in the interests of economy in money and a great saving in time. In these days of progress it appears absurd to see large weights such as boilers, guns, machinery, &c., hauled over plain roads by teams of oxen numbering from six to ten, at an expense that may well be avoided. It is therefore hoped that Congress will see the necessity of granting the appropriation asked for to extend the railroad system of the yard and thereby do away with the present expensive methods of carrying on the heavy transportation.

The other objects estimated for at this yard, but not particularly noted, are of great need and of equal importance to those specially dwelt upon, and it is the desire of the Bureau that they be appropriated for.

The commandant has estimated for \$92,124.90 under "repairs and preservation," and \$50,000 under "general maintenance."

NAVY-YARD, PENSACOLA, FLA.

This yard has been closed for all general work, and only the amount necessary to care for public property has been expended.

No expenditure is specially recommended for this yard. Under the general head of "repairs and preservation" expenditures will be made for the care of public property only as the necessity arises.

NAVAL STATION, KEY WEST, FLA.

The estimates for "repairs and preservation" at this yard are under the general head of appropriation for that purpose, and are only for possible contingencies that may arise involving expenditures to keep the public property in good order.

NAVY-YARD, MARE ISLAND, CAL.

I regret to say that the work on the stone dock has not progressed as rapidly as it should have done, owing to the necessity of taking so large an amount of the appropriation for the pumps. They are now being rapidly put in position, and when completed, which I hope will be by the 1st of February next, the dock will be ready for use, although not entirely completed.

The sum of \$191,595 is estimated for to finish it up, and I have to request that this amount be made immediately available, in order that there may be no delay in completing this important work and its surroundings.

Appropriations are asked for for the following additional items: Cis-

terms, \$46,346; boiler-shop for steam-engineering, \$4,200; wharves and landings, \$115,743.81; roads, \$15,000; gas-holder, \$16,664; gas mains and pipes, \$3,109.15; and iron-plating shop, \$4,000.

NAVAL STATION, PORT ROYAL, S. C.

The wharf at this station is nearly completed. Estimates are respectfully presented for \$4,000 for building a coal-shed and storehouse; \$592.20 for boring an artesian well; \$93.80 for flagstaff; and \$126.20 for a boat-shed.

NAVAL ASYLUM, PHILADELPHIA, PA.

The expenditures at this institution for the fiscal year ending June 30, 1885, are as follows:

Pay and pocket-money of beneficiaries.....	\$4,236 60
Tobacco.....	843 20
Clothing, boots and shoes.....	8,101 10
Subsistence.....	19,516 74
Paints, dry goods, lumber, coal, wood, provender, hardware, miscellaneous and house sundries.....	8,517 55
Total for support of beneficiaries.....	41,215 19
Pay of employes.....	8,502 99
Repairs and preservation of all kinds, painting, and for grates, furnaces, ranges, furniture and repairs of furniture.....	4,398 28
Water-rent and gas.....	1,521 41
Cemetery and burial expenses and head-stones.....	217 82
Improvement of grounds.....	498 75
Car-tickets.....	150 00
Ice.....	174 52
Total.....	56,678 96

Estimates are respectfully submitted for the Naval Asylum for the fiscal year ending June 30, 1887, as follows, viz:

Pay and pocket-money for beneficiaries.....	6,600 00
Clothing, boots and shoes.....	10,000 00
Tobacco.....	1,200 00
Provisions.....	24,000 00
Ice.....	400 00
Coal and wood.....	3,000 00
Dry goods, paints, lumber, provender, hardware, miscellaneous and house sundries.....	8,000 00
Total support of beneficiaries.....	53,200 00
Pay of employes.....	10,061 00
Water-rent and gas.....	1,800 00
Cemetery, burial expenses, and head-stones.....	350 00
Improvement of grounds.....	500 00
Repairs to buildings, furnaces, grates and ranges, furniture and repairs to furniture.....	8,000 00
Car-tickets.....	150 00
Music in chapel.....	600 00
Erecting brick building in rear of main building for kitchen, laundry, and servants' quarters.....	20,000 00
Fitting up bath-rooms with twelve tubs for beneficiaries' use.....	800 00
Removing laundry boilers and tubs to new building, and plumbing.....	400 00
Kitchen-range for new building.....	800 00
Total estimates for all purposes.....	96,661 00

There were on the rolls of this institution July 1, 1884, the names of 196 beneficiaries. During the fiscal year ending June 30, 1885, 23 have been admitted, 12 have died, and 5 have been dropped for continued absence without leave, 2 have been discharged at their own request, and 1 has been dismissed for misconduct, leaving on the rolls July 1, 1885, the names of 199 beneficiaries.

The general standing and character of the beneficiaries during the past year have been improved, and it gives me great pleasure to report this fact.

The general character of stores, provisions, and groceries furnished by the contractors has been good, and articles offered are rarely rejected by the inspecting officers.

The appropriation of money under the head of repairs of all kinds, &c., has been judiciously expended.

The present kitchen is utterly inadequate to its purpose; the mess-room of the beneficiaries is too small and overcrowded; the female attendants are lodged in the same corridors as the men, with only a light lattice door for separation; the matron has no suitable quarters, and there is not a single convenience for the beneficiaries or female attendants to bathe their persons.

The remedy for all these defects is to be found only in the erection of a new brick kitchen in the rear of the main building, to be provided with a coal-cellar, rooms for matron and her female attendants, and wash-room for the cooks, with laundry included; this will enable the mess-room to be enlarged by throwing the present laundry into it, and a bath-room for beneficiaries to be made out of the present wash-room.

As time passes extensive repairs are needed. New floors to the verandas and lower corridors are required; and if a new kitchen is not built the old one should be tiled throughout, and a new set of ranges must ere long be supplied.

There is only one clerk allowed to this institution, and his labors are often prolonged over the Sabbaths, and late at night. I specially recommend that an increase of salary be allowed to this much overworked and competent employé to the same grade as that of the commandant's clerk at the Mare Island navy-yard, \$1,800 per annum.

Attention is invited to the fact that when a pensioner enters this institution his pension is stopped and is covered in the hospital fund.

Inasmuch as these pensions are drawn from the "naval pension fund" in the Treasury, and this institution for these retired seamen is also supported out of that fund, it does not appear otherwise than just that these pensions should revert to the "naval pension fund," whence they are drawn. As it is now, the "naval pension fund" is undergoing depletion to build up and swell the "hospital fund." I submit that is a grave error.

An increase in the police force of the institution by the addition of one house corporal, and for advancing of the matron to \$40 per month, of the steward and master-at-arms to \$50 per month each, and of the house corporal to \$30.

CONTINGENT.

The sum required under this head, viz, \$40,000, is to meet unforeseen emergencies that may arise, calling for immediate outlay that has not been provided for.

GENERAL MAINTENANCE.

The most pressing and necessary expenditures of the different yards come under this head, such as repairs of fire-engines, purchases of horses

and oxen and maintenance of same, carts and tools, telegrams, coal, water, and gas, incidental labor, pay of watchmen, cleaning yards, and care of buildings, purchase of and care of machinery of every description, rents, &c., and all sundry expenses. The need for the amount (\$300,000) estimated is obvious and earnestly recommended.

The entire amount asked for by the Bureau is \$5,085,737.85, the detail of which is contained on tabulated sheets Nos. 1 to 6, inclusive, recapitulated as follows:

RECAPITULATION OF ESTIMATES.

Sheet No. 1. For support of Bureau of Yards and Docks.....	\$11,980 00
Sheet No. 2. For general maintenance and contingent.....	340,000 00
Sheet No. 3. For support of Naval Asylum.....	96,661 00
Sheet No. 4. For repairs and preservation.....	800,000 00
Sheet No. 5. For improvements at navy-yards.....	3,768,337 41
Sheet No. 6. For civil establishment.....	68,759 44
Total	5,085,737 85

Detailed estimates of appropriations required for the service of the fiscal year ending June 30, 1887, by the Bureau of Yards and Docks, Navy Department.

Detailed objects of expenditure, and explanations.	Estimated amount which will be required for each detailed object of expenditure.	Total amount to be appropriated under each head of appropriation.	Amount appropriated for the current fiscal year, ending June 30, 1886.
SALARIES.			
One chief clerk, March 3, 1885.....	\$1,800 00		
One draughtsman and clerk (same act).....	1,800 00		
One clerk of class four (same act).....	1,800 00		
One clerk of class three (same act).....	1,600 00		
One clerk of class two (same act).....	1,400 00		
One clerk of class one (same act).....	1,200 00		
One clerk (same act).....	1,000 00		
One messenger (same act).....	720 00		
One laborer (same act).....	660 00		
An increase of \$600 to salary of chief clerk is submitted.		\$11,980 00	\$11,980 00
GENERAL MAINTENANCE.			
For general maintenance of yards and docks, namely: For freights and transportation of materials and stores; books, maps, models, and drawings; purchase and repair of fire-engines; machinery; repairs on steam fire-engines, and attendance on the same; purchase and maintenance of oxen and horses, and driving teams, carts, and timber-wheels, and all vehicles for use in the navy-yards, and tools and repairs of the same; postage on letters and other mailable matter on public service, and telegrams; furniture for Government houses and offices in navy-yards; coal and other fuel; candles, oil, and gas; cleaning and clearing up yards, and care of public buildings; attendance on fires, lights, fire-engines, and apparatus; for clerical and incidental labor at navy-yards; water-tax, and for tolls and ferriages; rent of four officers' quarters at Philadelphia; for rent of eight officers' quarters in Washington; pay of watchmen in the navy-yards; and for awnings and packing-boxes, and advertising for yards and docks purposes (March 3, 1885).....	300,000 00	300,000 00	200,000 00
CONTINGENT.			
For contingent expenses that may arise at navy-yards and stations (March 3, 1885).....	40,000 00	40,000 00	20,000 00
	340,000 00	340,000 00	220,000 00

Detailed estimates of appropriations required, &c.—Continued.

Detailed objects of expenditure, and explanations.	Estimated amount which will be required for each detailed object of expenditure.	Total amount to be appropriated under each head of appropriation.	Amount appropriated for the current fiscal year, ending June 30, 1886.
NAVAL ASYLUM, PENNSYLVANIA.			
One superintendent (March 3, 1885).....	600 00		600 00
One steward, increase of \$120, submitted (same act).....	600 00		450 00
One matron, increase of \$120, submitted (same act).....	480 00		360 00
One chief cook, increase of \$120, submitted (same act).....	360 00		240 00
Two assistant cooks, increase of \$72 each, submitted (same act).....	480 00		336 00
One chief laundress (same act).....	192 00		192 00
Six laundresses, at \$168 each (same act).....	1,008 00		1,008 00
Four scrubbers, at \$168 each* (same act).....	672 00		2,016 00
Eight waiters, at \$168 each* (same act).....	1,344 00		1,440 00
Six laborers, at \$240 each (same act).....	1,440 00		360 00
One stable-keeper and driver (same act).....	360 00		480 00
One master-at-arms, increase of \$120, submitted (same act).....	600 00		300 00
Two house corporals, at \$360 each (same act).....	720 00		
Increase of one corporal at \$360 and increase of pay of other, \$60 (submitted).....			
One barber (same act).....	360 00		360 00
One carpenter (same act).....	845 00		845 00
		10,061 00	
For water rent and gas (same act).....	1,800 00		2,000 00
For cemetery burial expenses and head-stones (same act).....	350 00		350 00
For improvement of grounds (same act).....	500 00		500 00
For repairs to buildings, furnaces, grates, and ranges; furniture, and repairs of furniture (same act).....	8,000 00		4,500 00
For car-tickets (submitted).....	150 00		
For music in chapel (submitted).....	600 00		
		11,400 00	
For erecting brick building in rear of main building for kitchen, laundry, and servants' quarters (submitted).....	20,000 00		
For fitting up bath-rooms with twelve tubs for use of beneficiaries (submitted).....	800 00		
For removing laundry boilers and tubs to new building, and plumbing.....	400 00		
For kitchen range for new building.....	800 00		
For support of beneficiaries (same act).....	53,200 00		
		75,200 00	43,500 00
		96,661 00	59,867 00
REPAIRS AND PRESERVATION.			
For navy-yards and stations (March 3, 1885).....	800,000 00	800,000 00	125,000 00
FOR NAVY-YARDS AND STATIONS.			
Navy-yard, Portsmouth, N. H. :			
For water supply (submitted):			
For cleaning three ponds (submitted).....	3,000 00		
For building reservoir (submitted).....	6,000 00		
For piping for same (submitted).....	500 00		
		9,500 00	
Navy-yard, Boston, Mass. :			
For water-pipes and laying of same (submitted).....	49,607 00		
For cart-shed (submitted).....	4,000 00		
For floating gate for dry-dock, iron (submitted).....	30,762 88		
For officers' quarters, L, M, N, and O (submitted).....	11,000 00		
For rebuilding wharves (submitted).....	50,000 00		
		145,369 88	
Navy-yard, Brooklyn, N. Y. :			
For general paint and oil storehouse (submitted).....	25,000 00		
For boiler-shop wing to machine-shop (submitted).....	73,000 00		
For repairs to dry-dock and extension (submitted).....	331,000 00		
For repairs to cob-dock (submitted).....	50,000 00		
For building dry-dock, timber (submitted).....	700,000 00		
For dredging (March 3, 1885).....			
		1,179,000 00	39,600 00

*Formerly twelve scrubbers and waiters, at \$168 each.

Detailed estimates of appropriations required, &c.—Continued.

Detailed objects of expenditure, and explanations.	Estimated amount which will be required for each detailed object of expenditure.	Total amount to be appropriated under each head of appropriation.	Amount appropriated for the current fiscal year ending June 30, 1898.
FOR NAVY-YARDS AND STATIONS—continued.			
Navy-yard, League Island, Pa. :			
For office building for commandant (submitted).....	15,000 00		
For dwelling B, C, D, and E.....	36,000 00		
For landing wharf, foot of Fifteenth street.....	26,416 40		
For building a Simpson dry-dock (timber).....	700,000 00		
For dredging and filling in.....	155,000 00		
		932,416 40	
Navy-yard, Washington, D. C. :			
For new ordnance machine-shop (submitted).....	95,000 00		
For extension of yard wall (submitted).....	21,711 00		
		116,711 00	
Navy-yard, Norfolk, Va. :			
For building dry-dock, timber (submitted).....	650,000 00		
For pumps for dry-dock (submitted).....	52,600 00		
For extension of quay wall (submitted).....	140,000 00		
For railroad extension (submitted).....	47,479 87		
For electric lights (submitted).....	17,600 00		
For floating derrick (submitted).....	49,189 71		
For two officers' quarters (submitted).....	12,000 00		
For ordnance wharf at St. Helena (submitted).....	15,000 00		
		983,869 58	
Navy-yard, Mare Island, Cal. :			
For continuation of stone dry-dock, \$191,595, March 3, 1885 (submitted).....	191,595 00		220,000 00
For cisterns (submitted).....	46,346 30		
For boiler-shop for steam-engineering (submitted).....	4,200 00		
For wharves (submitted).....	110,743 81		
For landings (submitted).....	5,000 00		
For roads (submitted).....	15,000 00		
For gas-holder (submitted).....	16,664 09		
For gas mains and pipes (submitted).....	3,109 15		
For iron-plating shop (submitted).....	4,000 00		
		396,658 35	
For artesian well (March 3, 1885).....			10,000 00
For iron crane (same act).....			40,000 00
For sewerage system (same act).....			6,000 00
Naval station, Port Royal, S. C. :			
For combined coal-shed and store-house (submitted)....	4,000 00		
For boat-house (submitted).....	126 20		
For artesian well (submitted).....	592 20		
For flag-staff (submitted).....	93 80		
		4,812 20	
		3,768,337 41	306,000 00
CIVIL ESTABLISHMENT.			
Navy-yard, Portsmouth, N. H. :			
One clerk to civil engineer, at \$1,400 per annum (submitted).....	1,400 00		
One store and muster clerk, at \$1,300 per annum (submitted).....	1,300 00		
One writer, at \$1,017.25 per annum (submitted).....	1,017 25		
One mail messenger, at \$2.23 per diem (submitted).....	697 99		
One messenger, at \$2 per diem (submitted).....	626 00		
One foreman laborer, at \$4 per diem (submitted).....	1,252 00		
One pilot, at \$3 per diem (submitted).....	939 00		
		7,232 24	
Navy-yard, Boston, Mass. :			
One clerk to civil engineer, at \$1,400 per annum (submitted).....	1,400 00		
One store and muster clerk, at \$1,300 per annum (submitted).....	1,300 00		
One writer, at \$1,017.25 per annum (submitted).....	1,017 25		
One foreman, at \$4 per diem (submitted).....	1,252 00		
One mail messenger, at \$2.26 per diem (submitted).....	707 38		
One messenger, at \$1.76 per diem (submitted).....	550 88		
One messenger, at \$1.76 per diem (submitted).....	550 88		
One messenger, at \$1.76 per diem (submitted).....	550 88		
		7,829 27	

Detailed estimates of appropriations required, &c.—Continued.

Detailed objects of expenditure, and explanations.	Estimated amount which will be required for each detailed object of expenditure.	Total amount to be appropriated under each head of appropriation.	Amount appropriated for the current fiscal year, ending June 30, 1886.
CIVIL ESTABLISHMENT—continued.			
Navy-yard, Brooklyn, N. Y.:			
One clerk to civil engineer, at \$1,400 per annum (submitted).....	1,400 00		
One store and muster clerk, at \$1,300 per annum (submitted).....	1,300 00		
One writer, at \$1,017.25 per annum (submitted).....	1,017 25		
One writer, at \$1,017.25 per annum (submitted).....	1,017 25		
One general foreman, at \$5 per diem (submitted).....	1,565 00		
One mail messenger, at \$2.50 per diem (submitted).....	782 50		
One yards and docks messenger, at \$2.50 per diem (submitted).....	782 50		
One commandant's messenger, at \$2.50 per diem (submitted).....	782 50		
One captain's messenger, at \$2.50 per diem (submitted).....	782 50		
One bell-ringer and lamp-lighter, at \$2.26 per diem (submitted).....	707 88		
One foreman laborer, at \$4 per diem (submitted).....	1,252 00		
		11,888 88	
Navy-yard, League Island, Pa.:			
One clerk to civil engineer, at \$1,400 per annum (submitted).....	1,400 00		
One store clerk, at \$1,300 per annum (submitted).....	1,300 00		
One writer, at \$1,017.25 per annum (submitted).....	1,017 25		
One messenger and telegraph operator, at \$3 per diem (submitted).....	939 00		
One mail messenger, at \$1.91 per diem (submitted).....	597 88		
One messenger, at \$2 per diem (submitted).....	626 00		
One foreman laborer, at \$4 per diem (submitted).....	1,252 00		
		7,182 06	
Navy-yard, Washington, D. C.:			
One clerk to civil engineer, at \$1,400 per annum (submitted).....	1,400 00		
One store clerk, at \$1,300 per annum (submitted).....	1,300 00		
One writer to civil engineer, at \$1,017.25 per annum (submitted).....	1,017 25		
One messenger, at \$2.74 per diem (submitted).....	857 62		
One messenger, at \$2 per diem (submitted).....	626 00		
One messenger, at \$1.76 per diem (submitted).....	550 88		
One bell-ringer and lamp-lighter, at \$2 per diem (submitted).....	626 00		
One foreman laborer, at \$4 per diem (submitted).....	1,252 00		
One telegraph operator, at \$1.76 per diem (submitted).....	550 88		
		8,180 63	
Navy-yard, Norfolk, Va.:			
One clerk to civil engineer, at \$1,400 per annum (submitted).....	1,400 00		
One store and muster clerk, at \$1,300 per annum (submitted).....	1,300 00		
One writer, at \$1,017.25 per annum (submitted).....	1,017 25		
One draughtsman, at \$3.50 per diem (submitted).....	1,095 50		
One foreman laborer, at \$4.50 per diem (submitted).....	1,408 50		
Four messengers, at \$2 each per diem (submitted).....	2,504 00		
One pilot, at \$2.26 per diem (submitted).....	707 88		
		9,432 63	
Navy-yard, Pensacola, Fla.:			
One writer, at \$1,017.25 per annum (submitted).....	1,017 25		
One mail messenger, at \$2 per diem (submitted).....	626 00		
		1,643 25	
Navy-yard, Mare Island, Cal.:			
One clerk to civil engineer, at \$1,400 per annum (submitted).....	1,400 00		
One store and muster clerk, at \$1,300 per annum (submitted).....	1,300 00		
One writer, at \$1,017.25 per annum (submitted).....	1,017 25		
One draughtsman, at \$5 per diem (submitted).....	1,565 00		
One foreman mason, at \$3 per diem (submitted).....	1,878 00		
One quartermen brick mason, at \$5 per diem (submitted).....	1,565 00		

Detailed estimates of appropriations required, &c.—Continued.

Detailed objects of expenditure, and explanations.	Estimated amount which will be required for each detailed object of expenditure.	Total amount to be appropriated under each head of appropriation.	Amount appropriated for the current fiscal year, ending June 30, 1886.
CIVIL ESTABLISHMENT—continued.			
One quarterman stone mason, at \$5 per diem (submitted).....	1,565 00		
One pilot of tug, at \$4 per diem (submitted).....	1,252 00		
One mail messenger, at \$2.25 per diem (submitted).....	707 88		
Two messengers, at \$2.20 each per diem (submitted).....	1,377 20		
One bell-ringer, at \$2.25 per diem (submitted).....	707 88		
One foreman laborer, at \$5.50 per diem (submitted).....	1,721 25		
		16,055 46	
Naval station, Sackett's Harbor, N. Y.:			
One ship-keeper, at \$1 per diem (submitted).....	365 00	365 00	
Appropriation act March 3, 1885.....		68,759 44	24,000 00
<p>NOTE.—The clerks and writers only have heretofore been provided for under appropriation "civil establishment," but in accordance with section 3 of naval appropriation act approved 30th January, 1885, the Bureau has included the "specific estimates for civilian employes" heretofore paid from other appropriations. See section 3, appended.</p>			
<p>Sec. 3. That the Secretary of the Navy is hereby directed to report to Congress, at its next and each regular session thereafter, the amount expended during the prior fiscal year, from the appropriations for the pay of the Navy, Bureaus of Navigation, Ordnance, Equipment and Recruiting, Yards and Docks, Medicine and Surgery, Provisions and Clothing, Construction and Repair, and Steam-Engineering, for civilians employed on clerical duty, or in any other capacity than as ordinary mechanics and workmen, and to submit, under the estimates for pay of the Navy and for the respective Bureaus enumerated above, specific estimates for such civilian employes for the fiscal year eighteen hundred and eighty-seven, and each fiscal year thereafter.</p>			
<p>" Approved, January 30, 1885. " Official: Navy Department, January 31, 1885."</p>			

Accompanying this report is an abstract of offers for supplies received for furnishing articles coming under the cognizance of the Bureau of Yards and Docks, made in conformity to act of Congress approved March 3, 1843.

A statement showing the amounts expended under each specific head of appropriation during the fiscal year ending June 30, 1885, and the balances remaining unexpended June 30, as required by section 429, Revised Statutes.

Also a report showing amount expended during the fiscal year ending June 30, 1885, from appropriations pertaining to this Bureau for "civilians employed on clerical duty or in any other capacity than as ordinary mechanics and workmen at the several navy-yards, with estimates for the same for the fiscal year ending 30th June, 1887, in compliance with the third section of naval appropriations act approved January 30, 1885."

I am, very respectfully, your obedient servant,

D. B. HARMONY,
Chief of Bureau.

Hon. W. C. WHITNEY,
Secretary of the Navy,
Navy Department, Washington, D. C.

Report showing amount expended during the fiscal year ending June 30, 1885, from appropriations pertaining to the Bureau of Yards and Docks for civilians employed on clerical duty, or in any other capacity than as ordinary mechanics and workmen, at the several navy-yards, and submitting estimates for such civilian employes for the fiscal year 1887, in compliance with the third section of naval appropriation act approved January 30, 1885.

Navy-yards, and rating and rate of pay.	Amount paid to civilian employes during fiscal year ending June 30, 1885.	Estimates for civilian employes for the fiscal year ending June 30, 1887.	
		Rate of pay.	Amount.
NAVY-YARD, PORTSMOUTH, N. H.			
Clerk to civil engineer, at \$1,400 per annum.....	\$1,400 00	\$1,400 00	\$1,400 00
Store and muster clerk, at \$1,300 per annum.....	1,300 00	1,300 00	1,300 00
Writer, at \$1,017.25 per annum.....	801 69	1,017 25	1,017 25
Writer, at \$3 per diem.....	729 00		
Mail messenger, at \$2.23 per diem.....	640 01	2 23	697 99
Messenger, at \$2 per diem.....	426 00	2 00	626 00
Foreman laborer, at \$4 per diem.....	1,062 00	4 00	1,252 00
Pilot, at \$3 per diem.....	825 00	3 00	982 00
	7,213 70		7,232 24
NAVY-YARD, BOSTON, MASS.			
Clerk to civil engineer, at \$1,400 per annum.....	1,400 00	1,400 00	1,400 00
Store and muster clerk, at \$1,300 per annum.....	1,300 00	1,300 00	1,300 00
Writer, at \$3.26 per diem.....	1,015 49	*1,017 25	1,017 25
General foreman, at \$5 per diem.....	1,092 00		
Foreman laborer, at \$4.50 and \$4 per diem.....	1,238 75	4 00	1,252 00
Mail messenger, at \$2.26 per diem.....	824 90	3 26	707 38
Messenger, at \$1.76 per diem.....	513 50	1 76	550 88
Messenger, at \$1.76 per diem.....	513 04	1 76	550 88
Messenger, at \$1.76 per diem.....	508 36	1 76	550 88
	8,401 04		7,329 27
NAVY-YARD, BROOKLYN, N. Y.			
Clerk to civil engineer, at \$1,400 per annum.....	1,380 82	1,400 00	1,400 00
Store and muster clerk, at \$1,300 per annum.....	1,300 00	1,300 00	1,300 00
Writer, at \$1,017.25 per annum.....	1,011 68	1,017 25	1,017 25
Writer, at \$1,017.25 per annum.....	1,017 16	1,017 25	1,017 25
Draughtsman, at \$5 per diem.....	1,185 00		
General foreman, at \$5 per diem.....	1,185 00	5 00	1,585 00
Mail messenger, at \$2.50 per diem.....	890 42	2 50	782 50
Yards and docks messenger, at \$2.50 per diem.....	728 04	2 50	782 50
Commandant's messenger, at \$2.50 per diem.....	784 78	2 50	782 50
Captain's messenger, at \$2.50 per diem.....	695 74	2 50	782 50
Bell-ringer, at \$2.26 per diem.....	816 99	2 26	707 38
Foreman laborer, at \$4 and \$4.50 per diem.....	1,322 60	4 00	1,252 00
	12,298 23		11,396 88
NAVY-YARD, LEAGUE ISLAND, PA.			
Clerk to civil engineer, at \$1,400 per annum.....	1,400 00	1,400 00	1,400 00
Writer, at \$1,017.25 per annum.....	1,017 25	1,017 25	1,017 25
Messenger and telegraph operator, at \$3 per diem.....	819 00	3 00	980 00
Mail messenger, at \$1.91 per diem.....	655 88	1 91	597 88
Messenger, at \$2 per diem.....	589 00	2 00	626 00
Foreman laborer, at \$4 and \$5 per diem.....	1,354 00	4 00	1,252 00
Store clerk, at \$1,300 per annum.....		1,300 00	1,300 00
	5,835 13		7,132 00
NAVY-YARD WASHINGTON, D. C.			
Clerk to civil engineer, at \$1,400 per annum.....	1,400 00	1,400 00	1,400 00
Store clerk, at \$1,300 per annum.....	1,300 00	1,300 00	1,300 00
Writer to civil engineer, at \$3 per diem.....	683 75	*1,017 25	1,017 25
Draughtsman, at \$4.50 per diem.....	356 50		
Messenger, at \$2.74 per diem.....	808 73	2 74	857 00
Messenger, at \$2 and \$2.33 per diem.....	676 87	2 00	626 00
Messenger, at \$1.76 and \$2 per diem.....	583 48	1 76	550 88
Telegraph operator, at \$1.76 per diem.....	154 00	1 76	550 88
Bell-ringer, at \$1.76 and \$2 per diem.....	585 04	2 00	626 00
Foreman laborer, at \$4 per diem.....		4 00	1,252 00
	6,547 87		8,190 00

* Per annum.

Report showing amount expended during the fiscal year, &c.—Continued.

Navy-yards, and rating and rate of pay.

	Amount paid to civilian employes during fiscal year ending June 30, 1886.	Estimates for civilian employes for the fiscal year ending June 30, 1887.	
		Rate of pay.	Amount.
NAVY-YARD, NORFOLK, VA.			
Clerk to civil engineer, at \$1,400 per annum.....	1,399 98	1,400 00	1,400 00
Stores and muster clerk, at \$1,300 per annum.....	1,299 95	1,300 00	1,300 00
Writer, at \$1,017.25 per annum.....	1,015 54	1,017 25	1,017 25
Draughtsman, at \$3.50 per diem.....	271 25	8 50	1,095 50
General foreman, at \$5 per diem.....	1,220 00		
Foreman laborer, at \$4 and \$4.50 per diem.....	1,143 75	4 50	1,408 50
Writer, at \$1.50 per diem.....	284 75		
Messenger, at \$2 per diem.....	637 00	2 00	626 00
Messenger, at \$2 per diem.....	618 00	2 00	626 00
Messenger, at \$2 per diem.....	618 00	2 00	626 00
Messenger, at \$2 per diem.....	616 00	2 00	626 00
Pilot, at \$2.25 per diem.....	665 70	2 25	707 38
	9,790 87		9,482 63
NAVY-YARD, PENSACOLA, FLA.			
Writer, at \$1,017.25 per annum.....	955 75	1,017 25	1,017 25
Mail messenger, at \$2 per diem.....	453 00	2 00	626 00
	1,408 75		1,643 25
NAVY-YARD, MARE ISLAND, CAL.			
Clerk to civil engineer, at \$1,400 per annum.....	1,400 00	1,400 00	1,400 00
Store and muster clerk, at \$1,300 per annum.....	1,171 78	1,300 00	1,300 00
Writer, at \$1,017.25 per annum.....	1,017 25	1,017 25	1,017 25
Writer, at \$3.50 per diem.....	834 75		
Weighter and receiver, at \$3.50 per diem.....	888 50		
Leveler, at \$4 per diem.....	960 00		
Draughtsman, at \$5.50 per diem.....	1,691 25	5 00	1,565 00
Draughtsman, at \$5.50 per diem.....	1,264 00		
Foreman mason, at \$5 and \$6 per diem.....	1,404 00	6 00	1,878 00
Quartermen brick mason, at \$6 per diem.....	904 24	5 00	1,565 00
Quartermen stone mason, at \$5.50 per diem.....	836 24	5 00	1,565 00
Foreman laborer, at \$3.50 per diem.....	1,325 25	5 50	1,721 25
Pilot of tug, at \$4.80 per diem.....	1,365 80	4 00	1,252 00
Pilot of other tugs, at \$3 per diem.....	463 50		
Mail messenger, at \$2.74 per diem.....	1,000 10	2 25	707 38
Messenger, at \$2.20 per diem.....	509 50	2 20	688 80
Messenger, at \$2.20 per diem.....	190 10	2 20	688 80
Bell-ringer, at \$2.74 per diem.....	669 86	2 25	707 38
	17,896 12		16,053 46
PORT ROYAL, S. C.			
Draughtsman, at \$4.47 per diem.....	586 11		
SACKETT'S HARBOR, N. Y.			
Ship-keeper, at \$1 per diem.....	365 00	1 00	365 00

* Per annum.

Recapitulation of expenditures for civilian employes for fiscal year ending June 30, 1885, and estimates for the same for fiscal year ending June 30, 1887; per act approved January 30, 1885.

Navy-yards.	Expended, 1884-'85.	Estimates, 1886-'87.
Portsmouth, N. H.....	\$7,218 70	\$7,232 24
Boston, Mass.....	8,401 04	7,329 27
Brooklyn, N. Y.....	12,298 23	11,368 88
League Island, Pa.....	5,835 13	7,132 06
Washington, D. C.....	6,547 87	8,180 63
Norfolk, Va.....	9,790 87	9,432 63
Pensacola, Fla.....	1,408 75	1,643 25
Mare Island, Cal.....	17,896 12	16,053 46
Port Royal, S. C.....	586 11	
Sackett's Harbor, N. Y.....	365 00	365 00
Total.....	70,342 82	68,759 44

Statement of the appropriations for the Bureau of Yards and Docks for the fiscal year ending June 30, 1885, showing the amounts expended under each specific head of appropriation, and the balances remaining unexpended June 30, as required by section 429, Revised Statutes.

Appropriation for "general maintenance".....	\$200,000 00
Expended from July 1, 1884, to June 30, 1885.....	192,980 70
Balance on hand July 1, 1885.....	7,019 30
Outstanding obligations for gas, water, advertising, &c., will absorb nearly all of the above balance of appropriation.	
Appropriation for "repairs and preservation".....	\$125,000 00
Expended from July 1, 1884, to June 30, 1885.....	121,646 34
Balance on hand July 1, 1885.....	3,353 66
Which will be absorbed when outstanding liabilities for materials are paid.	
Appropriation for "civil establishment".....	\$24,000 00
Expended from July 1, 1884, to June 30, 1885.....	23,783 79
Balance on hand July 1, 1885.....	216 21
Which balance will revert to the Treasury.	
Appropriation for navy-yard, Brooklyn, N. Y.:	
"Dredging".....	\$30,000 00
Expended from July 1, 1884, to June 30, 1885.....	30,000 00
Appropriation for navy-yard, Brooklyn, N. Y.:	
"Cob dock".....	47,362 00
Expended from July 1, 1884, to June 30, 1885.....	2,133 03
Balance on hand July 1, 1885.....	45,228 87
Payment under contract for crib-work and piling will absorb the entire balance.	
Appropriation for navy-yard, Mare Island, Cal.:	
"Stone dry-dock".....	\$250,000 00
Expended from July 1, 1884, to June 30, 1885.....	186,141 18
Balance on hand July 1, 1885.....	63,858 82
Contract for pumping machinery and other outstanding liabilities will absorb the entire balance of this appropriation.	
Appropriation for contingent.....	\$15,000 00
Expended from July 1, 1884, to June 30, 1885.....	12,546 12
Balance on hand July 1, 1885.....	2,453 88
Nearly all of which will revert to the Treasury.	
Appropriation for Naval Asylum, Philadelphia.....	\$59,813 00
Expended from July 1, 1884, to June 30, 1885.....	46,054 45
Balance on hand July 1, 1885.....	13,758 55
After outstanding liabilities are paid about \$3,000 of the above balance of appropriation will revert to the Treasury.	

ABSTRACT OF OFFERS RECEIVED FOR FURNISHING SUPPLIES COMING UNDER THE COGNIZANCE OF THE BUREAU OF YARDS AND DOCKS, MADE IN CONFORMITY TO THE ACT OF CONGRESS, MARCH 3, 1843, FOR FISCAL YEAR ENDING JUNE 30, 1885.

Scale of offers for supplies for navy-yard at Portsmouth, N. H., under advertisement of July 11, 1884.

Corn-meal and oats:	
William A. Plaisted.....	*\$234 30
Hay:	
C. H. Bartlett.....	*324 50
E. J. Wilson.....	372 25
C. W. Cottle & Son.....	475 00
S. W. Junkins.....	392 00
Timothy Furbish.....	419 25

* Awarded.

Bituminous coal:	
J. Albert Walker	*\$1,071 60
E. F. Sise & Co.	1,190 04
Anthracite coal:	
J. A. Walker	*775 15

Scale of offers for supplies for navy-yard at Portsmouth, N. H., under advertisement of July 21, 1884.

Stationery:	
Mercer Goodrich	\$69 05
H. B. Buzzell & Son	*68 63
Lumber:	
John H. Broughton	*148 00
T. E. Call & Son	185 50
Linseed oil:	
Rider & Cotton	*26 55
William Winslow	28 35
W. J. Sampson & Co	26 55
Paints, oils, &c.:	
Rider & Cotton	89 23
W. J. Sampson & Co	*82 64
Iron pipe, coupling, &c.:	
Rider & Cotton	*56 75
Miscellaneous, requisition No. 3:	
Rider & Cotton	*40 45
Miscellaneous, requisition No. 4:	
Rider & Cotton	*276 01

Scale of offers for supplies for navy-yard at Portsmouth, N. H., under advertisement of July 25, 1884.

Twenty-five tons hay:	
S. W. Junkin	*\$374 75
Timothy Furbish	448 00
Provender:	
William A. Plaisted	*240 00
J. Brooks & Co	244 65

Scale of offers for supplies for navy-yard, at Portsmouth, N. H., under advertisement of August 27, 1884.

Stationery:	
Mercer Goodrich	*\$73 80
H. B. Buzzell & Son	109 59

Scale of offers for supplies for navy-yard at Portsmouth, N. H., under advertisement of September 8, 1884.

Fifteen hundred gallons gas oil:	
Rider & Cotton	*\$148 50
W. A. Wood & Co	150 00

Schedule of offers for supplies for navy-yard at Portsmouth, N. H., under advertisement of December 5, 1884.

Gas oil, requisition 28.	
Rider & Cotton	*\$99 00
George Dunbar & Co	115 00
Gas-pipe, &c., requisition 29:	
Rider & Cotton	*44 72
George Dunbar & Co	58 98
Window-shades, requisition 30:	
Mercer Goodrich	*25 00
George Dunbar & Co	29 25
Rider & Cotton	29 25

Schedule of offers for supplies for navy-yard at Portsmouth, N. H., under advertisement of December 11, 1884.

Brussels carpet, requisition 32:	
Ayres & Locke	*\$71 92
George B. French	73 66
John H. Pray, Sons & Co	74 24

* Awarded.

Schedule of offers for supplies for navy-yard at Portsmouth, N. H., under advertisement of January 23, 1885.

Meal and oats:	
J. Brooks & Co	*\$206 10
W. A. Plaisted	213 00
Hay:	
J. D. Plaisted	*386 25
T. Furbish	417 50
P. M. Langton	418 50

Schedule of offers for supplies for navy-yard at Portsmouth, N. H., under advertisement of February 3, 1885.

Lanterns:	
Rider & Cotton	*\$9 25
White lead, &c.:	
Rider & Cotton	*28 56
A. P. Wendell & Co	39 80
Hardware:	
Rider & Cotton	*58 24
A. P. Wendell & Co	69 13
Coal:	
J. A. Walker	*1,810 30
E. F. Sise & Co	2,855 75
Stationery, requisition 37:	
Mercer Goodrich	*107 85
H. B. Buzzell & Son	120 75
Stationery, requisition 38:	
H. B. Buzzell & Son	*32 60
Mercer Goodrich	35 00
Stationery, requisition 39:	
H. B. Buzzell & Son	*81 61
Mercer Goodrich	84 50
Stoves:	
J. P. Sweetzer	*114 00
Lumber:	
J. E. Call & Son	*128 00
G. A. Hammond	157 50

Schedule of offers for supplies for navy-yard at Portsmouth, N. H., under advertisement of February 16, 1885.

Pig-iron and gas oil:	
Rider & Cotton	*\$202 00

Schedule of offers for supplies for navy-yard at Portsmouth, N. H., under advertisement of March 10, 1885.

Lumber:	
John H. Broughton	*\$23 75
T. E. Call & Son	24 00
G. A. Hammond	30 00
Alcohol:	
Rider & Cotton	*13 50
Twenty-five brass tubes:	
Rider & Cotton	*74 88
Hardware:	
Prior & Mathews	*96 05
Rider & Cotton	102 45

Schedule of offers for supplies for navy-yard at Portsmouth, N. H., under advertisement of March 20, 1885.

Galvanized iron pipe:	
Rider & Cotton	*\$420 4'
John P. Sweetzer	454 8'

* Awarded.

Schedule of offers for supplies for navy-yard at Portsmouth, N. H., under advertisement of April 11, 1885.

Horse-collars, brooms, &c.:	
Rider & Cotton	*\$30 15
Cement and cement pipe:	
John A. Broughton	*161 75
Dennis Shea	163 75
Lead pipe:	
Rider & Cotton	*85 30
John P. Sweetzer	87 48

Schedule of offers for supplies for navy-yard at Portsmouth, N. H., under advertisement of May 11, 1885.

Fifteen tons hay:	
E. C. Spinney	*\$284 25
Ervin & Wilson	292 35
George L. Moulton	285 60
Corn-meal and oats:	
William A. Plaisted	*137 20
J. Brooks & Co	141 60
One 16-foot flag:	
George T. Vaughn & Co	13 65
T. S. Gay	12 50
Rider & Cotton	*10 50

Schedule of offers for supplies for navy-yard at Portsmouth, N. H., under advertisement of June 3, 1885.

Four barrels cement:	
John H. Broughton	*\$5 00
J. Albert Walker	6 40
Tin, screws, &c.:	
John P. Sweetzer	*19 70
Rider & Cotton	27 00

Schedule of offers for supplies for navy-yard at Boston, Mass., under advertisement of July 22, 1884.

Broken and stove coal:	
C. A. Campbell	*\$1,588 70
Provender:	
John Mullett	*925 00
Nathan Tufts & Son	934 00

Schedule of offers for supplies for navy-yard at Boston, Mass., under advertisement of September 5, 1884.

Stationery:	
J. L. Fairbank & Co	*\$101 25
Lime:	
N. Tufts & Son	*13 80
G. D. Putnam & Co	13 80
Shingles:	
James & Abbott	*224 00
Nails:	
G. D. Putnam & Co	*12 25

Scale of offers for supplies for navy-yard at Boston, Mass., under advertisement of September 15, 1884.

Stationery:	
J. L. Fairbanks & Co	*\$136 25

Scale of offers for supplies for navy-yard at Boston, Mass., under advertisement of December 16, 1884.

Provender:	
John Mullett	*\$1,095 00

* Awarded.

Scale of offers for supplies for navy-yard at Boston, Mass., under advertisement of February 5, 1885.

Four hundred and thirty tons coal:

J. A. Wellington & Co	*\$2,048 00
C. A. Campbell	2,055 40

Scale of offers for supplies for naval station at New London, Conn., under advertisement of August 2, 1884.

Provender:

Arnold Rudd	\$79 20
Smith & Caulkins	*77 85
James Greenfield	91 80

Scale of offers for supplies for naval station at New London, Conn., requisition No. 4.

Provender:

Smith & Caulkins	*\$174 85
------------------------	-----------

Signal oil:

C. A. Weaver & Co	*10 00
-------------------------	--------

Scale of offers for supplies for navy-yard at Brooklyn, N. Y., under advertisement dated July 28, 1884.

Coal:

C. H. Bass	\$1,538 20
S. G. French	1,543 15
A. P. Brown	*1,496 40
D. Babcock & Co	1,643 65
C. H. Raymond	1,616 20

Provender:

George W. Child	1,244 08
E. R. Shipman	*1,243 42

Stationery, lot 1:

George W. Pertain	39 91
Arthur & Bonnell	40 35
W. A. Wheeler & Co	43 10
Callahan & Gartland	*35 65
Collins & Sesnon	50 84
James R. Michael	100 00

Stationery, lot 2:

George W. Pertain	86 12
Arthur & Bonnell	96 35
W. A. Wheeler & Co	108 75
Callahan & Gartland	*68 35
Collins & Sesnon	85 03
James R. Michael	120 00

Stationery, lot 3:

George W. Pertain	68 94
Arthur & Bonnell	67 50
W. A. Wheeler & Co	79 95
Callahan & Gartland	58 40
Collins & Sesnon	*41 90

Scale of offers for supplies for navy-yard at Brooklyn, N. Y., under advertisement of August 11, 1884.

Spikes, cement, and slate:

D. Babcock & Co	*\$266 25
-----------------------	-----------

Scale of offers for supplies for navy-yard at Brooklyn, N. Y., under advertisement of September 11, 1884.

Miscellaneous:

Austin P. Brown	*\$105 75
D. Babcock & Co	139 25

Drain-pipe:

D. Babcock & Co	*89 00
Austin P. Brown	165 00

* Awarded.

Schedule of offers for dredging at navy-yard at Brooklyn, N. Y., under advertisement of September 15, 1884.

Dredging (per cubic yard, measured in scows):

Atlantic Dredging Company (per R. G. Packard, president).....	\$0 33
Moore & Wright.....	28
Elijah Brainard.....	30
Morris & Cumming Dredging Company.....	24½
Henry Dubois & Sons.....	18½
W. H. Beard.....	*16
William Harrigan.....	†14½

Scale of offers for supplies for navy-yard at Brooklyn, N. Y., under advertisement of January 14, 1885.

Provender:

E. R. Shipman.....	*\$154 24
--------------------	-----------

Scale of offers for supplies for navy-yard at Brooklyn, N. Y., under advertisement of February 7, 1885.

Coal scuttles:

D. Babcock & Co.....	*\$7 25
----------------------	---------

Horse blankets:

D. Babcock & Co.....	†179 10
----------------------	---------

Stationery:

Arthur & Bonnell.....	143 17
Callahan & Gartland.....	*142 00
Collins & Sesnon.....	155 64
G. W. Pertain.....	189 50

Coal:

D. Babcock & Co.....	1,570 25
C. H. Bass.....	1,337 65
C. H. Raymond.....	*1,324 15
S. G. French.....	1,412 90
Wynant & Terhune.....	1,448 40

Provender:

E. R. Shipman.....	*1,351 00
--------------------	-----------

Scale of offers for supplies for navy-yard at Brooklyn, N. Y., under advertisement of February 27, 1885.

Miscellaneous articles:

D. Babcock & Co., requisition No. 55.....	*\$77 90
D. Babcock & Co., requisition No. 57.....	*53 62
D. Babcock & Co., requisition No. 60.....	*184 75
D. Babcock & Co., requisition No. 61.....	*325 65
Austin P. Brown, requisition No. 62.....	*337 96
D. Babcock & Co., requisition No. 62.....	350 85
D. Babcock & Co., requisition No. 63.....	*36 06

Scale of offers for supplies for navy-yard at Brooklyn, N. Y., under advertisement of April 14, 1885.

Coal:

C. H. Bass.....	*\$378 00
C. H. Raymond.....	380 00
D. Babcock & Co.....	384 00

Scale of offers for supplies for navy-yard at Brooklyn, proposals invited April 21, 1885.

Sewer connections:

James Armstrong.....	*\$288 11
Lewis & Patterson.....	439 00

Scale of offers for supplies for navy-yard at Brooklyn, N. Y., on requisition No. 86.

Sewer pipes, &c., for stable:

F. A. Hutchinson.....	*\$185 00
E. A. Milne.....	242 00
James Armstrong.....	294 00

* Awarded. † Withdrawn. ‡ Not awarded; price excessive.

Scale of offers for supplies for navy-yard at Brooklyn, N. Y., under advertisement of May 1, 1885.

Crib-work and sheet-piling:		
John F. Dawson.....		\$62, 593 54
J. E. White.....		65, 900 00
Joseph Walsh.....		48, 000 00
James D. Learey.....		57, 390 00
Flaherty & O'Connell.....		*47, 574 26
William P. Kelly.....		52, 645 20
P. Sanford Ross.....		64, 890 00

Scale of offers for supplies for navy-yard at League Island, Pa., under advertisement dated July 18, 1884.

Stationery:		
Magee Printing House.....		*\$177 82

Scale of offers for supplies for navy-yard at League Island, Pa., under advertisement of July 25, 1884.

Provender:		
Paul J. Field.....		\$416 75
R. McKnight & Sons.....		*414 05
Coal:		
John Street, jr.....		*213 75
Patrick & Lipsett.....		272 85

Scale of offers for supplies for navy-yard at League Island, Pa., under advertisement dated February 7, 1885.

Astral oil:		
Darrah & Elwell.....		*\$39 75
John Jones.....		40 50
C. J. Field.....		42 00
Horseshoes, nails, &c.:		
Darrah & Elwell.....		44 65
Paul J. Field.....		47 26
C. J. Field.....		*36 60
Ice:		
Knickerbocker Ice Company.....	per 100 pounds..	*40

Scale of offers for supplies for navy-yard at League Island, Pa., under advertisement of February 12, 1885.

Stationery, requisition No. 26:		
Magee Printing House.....		\$64 90
John Wanamaker.....		*49 85
Stationery, requisition 27:		
Magee Printing House.....		*82 90
John Wanamaker.....		†77 99
Stationery, requisition 28:		
Magee Printing House.....		*6 97
John Wanamaker.....		†3 62
Oil lamps, &c.:		
Paul J. Field.....		*158 36
Charles J. Field.....		165 74
Coal:		
John Street, jr.....		*304 25
H. C. Cook.....		357 50
Provender:		
Paul J. Field.....		*313 96
R. McKnight & Son.....		371 25

Schedule of offers for supplies for Naval Asylum, Philadelphia, under advertisement dated December 8, 1884.

Stationery:		
Magee Printing House.....		*\$116 80
Miscellaneous articles, requisition 19:		
Charles J. Field.....		*100 81
Miscellaneous articles, requisition 20:		
Charles J. Field.....		*23 03

* Awarded.

† Incomplete.

*Schedule of offers for supplies for Naval Asylum, Philadelphia, under advertisement of February 26, 1885.***Removating mattresses and pillows:**

John M. J. German	\$210 24
J. W. Eagan & Co	160 92
William T. Bernstein & Co	124 44
V. Paulin	240 00
L. Adler	289 20
Dell Noblit & Co	*113 40
Amos Hilborn & Co	156 00
William McArthur & Co	356 40
John Wanamaker	157 20

*Schedule of offers for supplies for Naval Asylum, Philadelphia, under advertisement dated March 7, 1885.***Relaying hearths:**

Thomas A. Lynch	\$88 17
Rand & Harmer	149 00
John Williams	90 00
E. H. Benedict & Co	175 00
William H. Dennis	75 00
William Chestnut	*49 00
Thomas Gannon	99 00
F. B. Van Horn	40 00
P. F. Donnelly	100 00
John & Hunter	148 00

Plastering:

B. F. Stewart & Co	114 00
S. R. Dubbs & Co	120 00
E. Thompson	*114 00
E. H. Benedict & Co	120 00
James McConnell	120 00

Putting in water-closets:

McEwen & Magee	592 00
W. H. Green	600 00
Thomas Brown	583 24
McGuckin & Gill	634 00
D. D. Mullin	650 00
W. B. Dexey	490 00
William McCormick	550 00
R. E. Henderson	500 00
Rand & Harmer	*489 00
L. O. Howell, jr	583 00

Pointing wall:

Thomas Gannon	879 00
S. B. Davis & Sons	†140 00
F. B. Van Horn	315 00
T. A. Lynch	481 55
S. Dubbs & Co	*275 00
Rand & Harmer	670 00
John Williams	375 00
W. H. Dennis	300 00
William Chestnut	395 00
E. H. Benedict & Co	622 00
Johns & Hunter	550 00
P. F. Donnelly	345 00

Making harness:

D. Forrest	*68 75
John Hunter	80 00
W. H. Brady	100 00

Rebuilding laundry furnace:

Thomas Gannon	†18 00
F. B. Van Horn	59 00
P. F. Donnelly	40 00
T. A. Lynch	41 51

* Awarded.

† Irregular.

Rebuilding laundry furnace:	
Johns & Hunter	\$70 00
Rand & Harmer	38 00
John Williams	55 00
William Chestnut	*29 00
Repairing bedsteads:	
William F. Bernstein & Co	48 50
C. B. Newhauser	50 00
F. Iles	59 00
Scott & Hutchinson	*45 00
Strawbridge & Chase	49 50
Making ash-cart:	
C. B. Newhauser	*25 00
Scott & Hutchinson	50 00
Wilson, Childs & Co	34 00
Trees and seed:	
Henry A. Dreer	*28 75
Hand fire-grenades:	
F. Stephanie	*40 00

Schedule of offers for supplies for Naval Asylum, Philadelphia, under advertisement of April 9, 1885.

Books:	
John Wanamaker	*\$91 75
J. B. Lippincott & Co	102 65
Ice:	
Knickerbocker Ice Company	per ton.. *4 75
Wire cloth:	
C. J. Field	14 66
E. Darby & Sons	14 67
De Witt Wire Cloth Company	14 66
J. J. Shannon	14 60
P. J. Field	*14 48

Schedule of offers for supplies for Naval Asylum, Philadelphia, under advertisement of May 11, 1885.

Cleaning up cemetery lot:	
Mt. Moriah Cemetery Company	*\$62 00
Erecting tombstones:	
Dolan Bros	†78 00
E. Sprague & Co	†96 00
Bye & Carman	*72 00
Repairing chapel organ:	
John M. Kern	45 50
A. G. Ibach	20 00
Reuben Nichols	*20 00
Relaying brick pavements:	
E. J. Donnelly	165 00
Dolan Bros	395 00
J. J. Tevin	290 00
Thomas Gamon	*160 00
S. R. Dubbs	320 50
Building water-tank:	
Rand & Harmer	249 00
R. E. Henderson	*225 00
Repairing slop cart:	
Scott & Hutchinson	42 50
Newhauser Wagon Works	*27 50
Pointing walls:	
E. J. Donnelly	540 00
Dolan Bros	628 00
J. J. Tevin	500 00
S. R. Dubbs	610 00
E. H. Benedict	*500 00

*Awarded.

† Irregular.

Repairing roofs, &c.:	
Charles Donaghy	*\$115 00
James Donnell	200 00
W. H. Townsend	160 00
Kelly & Ottenger	265 00
Laying flagging:	
Dolan Bros	per linear foot... 99
John Maxwell's Sons	*90
J. J. Tevin	95 $\frac{1}{2}$
J. H. Comber	1 08
S. R. Dubbs	1 23 $\frac{1}{10}$
Cocoa matting, carpets, &c.:	
J. & J. Dobson	*368 82
John Wanamaker	410 72

Schedule of offers for supplies for Naval Asylum, Philadelphia, under advertisement of May 18, 1885.

Clothing:	
Jacob Reed's Sons	*\$6,585 00
John Wanamaker	6,647 00
Boots and shoes:	
William McKnight	*2,484 00
John Wanamaker	2,580 00
Provisions:	
Albert Seigel	*9,661 25
Daniel R. Paul	13,914 50
Thomas Bradley	10,120 58
Groceries:	
Robert McKeown	*10,698 50
Dry goods:	
S. S. Miller	*1,232 15
John Wanamaker	1,530 16
Bread:	
Gustav Menzel	2,180 00
Andrew Marshall	2,200 00
Philadelphia Home-made Bread Company	*2,100 00
Tobacco:	
J. Rinaldo Sank & Co	*992 00
M. A. Retten & Co	1,024 00
Coal and wood:	
John Street, jr	*2,554 50
H. C. Cooke	2,672 50
C. B. Norton & Co	†2,549 25
Frank K. Ward	2,655 05
Paints, oils, and glass:	
Wetherill Bros	†106 25
J. J. Shannon	*262 33
Louis M. Bean & Co	†284 22
Ice:	
Knickerbocker Ice Company	*285 00
Lumber:	
Elias Pohl	*510 00
J. W. Gaskill & Sons	545 10
Provender:	
Paul J. Field	*337 10
R. McKnight & Sons	372 50
Miscellaneous:	
J. J. Shannon	*740 72
Paul J. Field	951 91
Hardware:	
Samuel Goodall	*281 58
Paul J. Field	286 59
J. J. Shannon	281 69

* Accepted. † Informal.

Schedule of offers for supplies for navy-yard at Washington, D. C., under advertisement of July 19, 1884.

Five hundred tons Cumberland coal:	
A. J. Harper.....	\$1, 295 00
Johnson Bros.....	1, 500 00
Clark & Given.....	1, 275 00
A. P. Brown.....	1, 285 00
M. R. S. B. and Coal Company.....	1, 785 00
Stationery:	
V. G. Fischer.....	*218 17
W. Ballantyne & Son.....	231 72
Provender:	
R. C. Hewett.....	*795 00
W. S. Hoge.....	839 25
W. M. Galt & Co.....	815 62

Schedule of offers for supplies for navy-yard at Washington, D. C., under advertisement of December 4, 1884.

Paints, oils, and glass:	
Martin & Butler.....	*\$228 85
George Ryneal, jr.....	252 70
D. Shanahan.....	240 41
Hirshberg, Hollander & Co.....	279 96
F. Miller.....	272 87
Z. D. Gilman.....	235 23
Gas-pipe, fixtures, &c.:	
R. Leitch & Sons.....	*709 39
Henry McShane & Co.....	819 63
R. A. Robbins.....	1, 076 56
Hayward & Hutchinson.....	1, 078 60

Schedule of offers for supplies for navy-yard at Washington, D. C., under advertisement of January 23, 1885.

Provender:	
W. S. Hoge.....	\$841 50
R. C. Hewett.....	837 00
W. M. Galt & Co.....	*790 83

Schedule of offers for supplies for navy-yard at Washington, D. C., under advertisement of February 4, 1885.

Iron pipe:	
A. P. Brown.....	\$432 84
J. B. Kendall.....	315 49
Robert Boyd.....	375 50
R. Leitch & Sons.....	*273 37
Barber & Ross.....	328 49
E. G. Wheeler.....	347 66
Nason Manufacturing Company.....	403 23
Cement, lime, &c.:	
A. P. Brown.....	*95 00
Carriage-robe, &c.:	
Robert Boyd.....	92 60
E. G. Wheeler.....	*63 25
Lutz & Bro.....	67 20
Lumber:	
A. P. Brown.....	922 25
G. A. Shehan.....	604 50
Grayson & Cain.....	694 00
Wheatley Bros.....	646 00
J. W. Duryee.....	855 11
Willett & Libbey.....	*521 00
W. W. McCollough.....	556 00
Paris white, &c.:	
E. G. Wheeler.....	†142 00
Z. D. Gilman.....	*145 80

* Awarded. † Withdrawn.

Hardware:

A. P. Brown	\$97 30
Robert Boyd	77 05
Barber & Ross	85 59
E. G. Wheeler	*67 79

Schedule of offers for supplies for navy-yard at Norfolk, Va., under advertisement of July 22 1884.

Terra-cotta pipe:

George L. Neville	*\$240 00
Mayer & Co	296 00
Holmes & Weaver	336 00
Akron Sewer-pipe Agency	352 00

Scale of offers for supplies for navy-yard at Norfolk, Va., under advertisement of July 26, 1884.

Stationery:

Crump & Anderson	*\$375 88
Hume & Parker	389 58

Provender:

Evans, Burwell & Tazewell	1,373 93
A. H. Lindsay	1,401 58
J. G. Reid	*1,313 44

Schedule of offers for supplies for navy-yard at Norfolk, Va., under advertisement of August 25, 1884.

Material for stoves:

Holmes & Weaver	*\$105 83
-----------------------	-----------

Schedule of offers for supplies for navy-yard at Norfolk, Va., under advertisement of January 27, 1885.

Provender:

A. H. Lindsay	\$1,025 48
Ethuridge & Brooks	1,091 90
J. G. Reid	1,097 55½
Evans, Burwell & Tazewell	*954 08

Miscellaneous articles:

A. Wrenn & Son	*82 00
G. L. Neville	106 65

Schedule of offers for supplies for navy-yard at Norfolk, Va., under advertisement of March, 4, 1885.

Glass, varnish, bricks, &c.:

Mayer & Co	*\$130 50
G. L. Neville	186 50
R. J. Neely & Co	186 75
A. Buff	†101 25

Schedule of offers for supplies for navy-yard at Norfolk, Va., under advertisement of April 28, 1885.

Charcoal:

G. L. Neville	*\$4 75
---------------------	---------

Pine lumber:

R. J. Neely & Co	*122 22
A. H. Lindsay	189 00
A. A. McCullough	136 50
L. L. Neville	151 50

Tar, pitch, &c.:

G. L. Neville	38 25
Mayer & Co	35 00
E. V. White & Co	*34 55

Glue, glass, &c.:

G. L. Neville	99 50
Mayer & Co	99 70
A. Buff	97 95
E. V. White & Co	*94 95

* Awarded.

† Incomplete.

Fire-brick, &c.:	
G. L. Neville.....	\$76 7
Mayer & Co.....	*74 3
E. V. White & Co.....	81 4

Schedule of offers for supplies for navy-yard at Norfolk, Va., under advertisement dated May 16, 1885.

Repairs to furniture:	
H. R. Anderson & Co.....	*\$111 8
J. S. Crawford.....	115 7
H. Wertheimer.....	135 7

Schedule of offers for supplies for navy-yard at Pensacola, Fla., under requisition No. 1 July 9, 1884.

Provender:	
F. Bauer.....	\$218 0
J. O'Neal.....	*211 3

Schedule of offers for supplies for navy-yard at Pensacola, Fla., under advertisement of July 25, 1884.

Oils, &c.:	
J. O'Neal.....	\$127 50
McKensie, Oerting & Co.....	*125 70

Schedule of offers for supplies for navy-yard at Pensacola, Fla., under advertisement dated July 29, 1884.

Ice:	
Pensacola Ice Company, 1,120 pounds, at 3 cents.....	*\$33 60
Varnish:	
J. O'Neal.....	25 00
McKensie, Oerting & Co.....	*21 00
Provender:	
J. O'Neal.....	*211 30
McKenzie, Oerting & Co.....	230 95
Turpentine:	
J. O'Neal.....	65 00
McKensie, Oerting & Co.....	*24 00
Coal:	
J. O'Neal.....	*36 00
McKensie, Oerting & Co.....	42 00

Schedule of offers for supplies for navy-yard at Pensacola, Fla., under advertisement of January 14, 1885.

Provender:	
J. O'Neal.....	*\$440 90

Schedule of offers for supplies for navy-yard at Pensacola, Fla., under advertisement of February 16, 1885.

White lead, oils, &c.:	
J. O'Neal.....	*\$404 50
McKensie, Oerting & Co.....	408 35

Schedule of offers for supplies for navy-yard at Mare Island, Cal., under advertisement dated July 23, 1884.

Granite, requisition No. 1:	
James McCudden.....	*\$2,738 94
G. Griffith.....	2,798 50
Ice:	
Henry Connelly.....	*120 00
Stationery:	
Cunningham, Curtis & Welch.....	187 15
Dutton & Patridge.....	*173 11

* Awarded.

Granite, requisition No. 5:	
James McCudden.....	*\$28,347 00
G. Griffith.....	28,862 40
John Taylor.....	29,377 80
Granite, requisition No. 6:	
James McCudden.....	*23,500 00
John Taylor.....	27,500 00
G. Griffith.....	24,000 00
Wellington coal and charcoal:	
A. Powell.....	*1,230 00
James McCudden.....	1,235 00
William Walker.....	1,290 00
Drawing materials:	
Cunnington, Curtis & Welch.....	*126 64
Coal:	
James McCudden.....	*6,776 25
A. Powell.....	6,860 00
William Walker.....	7,075 00
Lumber:	
A. Powell.....	*1,497 50
James McCudden.....	1,520 00
J. P. Sheldon.....	1,540 00
William Walker.....	1,622 50
 <i>Schedule of offers for supplies for navy-yard at Mare Island, Cal., under advertisement of August 4, 1884.</i>	
One hundred tons cement:	
Scofield & Tevis.....	\$1,950 00
A. Powell.....	1,825 00
Holmes Lime Company.....	2,032 05
Richards & Harrison.....	1,837 00
James McCudden.....	*1,790 00
Harness:	
H. N. Cook.....	*213 20
Sieves:	
D. Rutherford & Co.....	51 00
T. H. Selby & Co.....	*49 50
Lead, oil, &c.:	
Sullivan & Ravels.....	†511 33
D. Rutherford.....	585 90
Coffin & Hendry.....	581 40
James Gallup & Co.....	515 24
Whittier & Fuller.....	*481 81
Rope:	
D. Rutherford.....	1,184 16
Coffin & Hendry.....	1,147 15
A. Powell.....	1,147 15
T. H. Selby & Co.....	1,128 65
James Gallup & Co.....	*1,119 40
Ramps, &c.:	
D. Rutherford & Co.....	177 27
T. H. Selby & Co.....	*167 28
Picks, &c.:	
Coffin & Hendry.....	*328 50
James Gallup & Co.....	330 00
D. Rutherford & Co.....	363 00
Lumber, requisition 31:	
James McCudden.....	440 00
J. P. Sheldon.....	500 00
A. Powell.....	*435 00
Lumber, requisition 32:	
James McCudden.....	270 00
J. P. Sheldon.....	276 25
A. Powell.....	*265 00

* Accepted.

† Irregular.

Schedule of offers for supplies for navy-yard at Mare Island, Cal., under advertisement dated August 12, 1884.

Oregon pine:	
A. Powell.....	\$275 00
James McCudden.....	*272 50
Turner, Kennedy & Shaw.....	280 00
Iron, steel, tubes, &c.:	
George W. Gibbs & Co.....	1,594 94
T. H. Shelby & Co.....	*1,512 08
Lumber:	
Turner, Kennedy & Shaw.....	323 75
A. Powell.....	310 62
James McCudden.....	*305 37
Leather:	
H. N. Cook.....	*29 60
Sand:	
A. Powell.....	1,100 00
James McCudden.....	1,150 00
Aden Bros.....	*1,000 00

Schedule of offers for supplies for navy-yard at Mare Island, Cal., under advertisement of August 13, 1884.

Fifty tons Wellington coal:	
James McCudden.....	*\$595 00
A. Powell.....	600 00
William Walker.....	612 50

Schedule of offers for supplies for navy-yard at Mare Island, Cal., under advertisement of September 1, 1884.

One hundred tons Portland cement:	
James McCudden.....	*\$1,700 00
Richards, Harrison & Sherwood.....	1,772 50
A. Powell.....	1,800 00

Schedule of offers for supplies for navy-yard at Mare Island, under advertisement dated September 13, 1884.

Five hundred redwood ties:	
James McCudden.....	\$130 00
A. Powell.....	*120 00
Fifty-five tons hay:	
James McCudden.....	*935 00
A. Powell.....	990 00
Aden Bros.....	990 00

Schedule of offers for supplies for navy-yard at Mare Island, Cal., under advertisement of September 18, 1884.

Brick, cement, lime, &c.:	
James McCudden.....	*\$388 25
A. Powell.....	398 25
Window-glass, oil, and lead:	
Whittier, Fuller & Co.....	*10 84
Hardware:	
Dunham, Carrigan & Co.....	*11 71

Schedule of offers for supplies for navy-yard at Mare Island, Cal., under advertisement of September 30, 1884.

Oregon pine and piles:	
James McCudden.....	*\$4,846 5
A. Powell.....	4,963 5
J. P. Sheldon.....	5,080 5
Reuton, Holmes & Co.....	5,061 5
Turner, Kennedy & Shaw.....	5,100 0
Iron and steel:	
T. H. Shelby & Co.....	*284 3
Shovels and glue:	
James Gallup & Co.....	*37 5

*Awarded.

Schedule of offers for supplies for navy-yard at Mare Island, Cal., under advertisement of October 6, 1884.

Sheet-iron and sheet-zinc:

T. H. Selby & Co	*\$218 25
W. W. Montague & Co	222 49

Schedule of offers for supplies for navy-yard at Mare Island, Cal., under advertisement of November 6, 1884.

Oregon pine plank:

A. Powell	*\$382 20
James McCudden	389 55
Turner, Kennedy & Shaw	390 00
John P. Sheldon	395 00

Files, nails, &c.:

James Gallup & Co	*54 01
Dunham, Carrigan & Co	58 10
D. Rutherford	61 10

Schedule of offers of supplies for navy-yard at Mare Island, Cal., under advertisement of November 7, 1884.

One hundred tons Portland cement:

James McCudden	*\$2, 249 00
A. Powell	2, 260 00
D. Rutherford & Co	2, 275 00

Schedule of offers for supplies for navy-yard at Mare Island, Cal., under advertisement of November 14, 1884.

Beach sand:

Aden Bros	*\$1, 000 00
A. Powell	1, 250 00
James McCudden	1, 150 00

Schedule of offers for supplies for navy-yard at Mare Island, Cal., under advertisement of December 6, 1884.

Fresh-water sand:

Aden Bros	*\$130 00
James McCudden	146 25

Iron pipe, rivets, and sheet-iron:

Dunham, Carrigan & Co	127 90
George W. Gibbs & Co	*121 45
T. H. Selby & Co	127 72

Schedule of offers for supplies for navy-yard at Mare Island, Cal., under advertisement dated December 9, 1884.

Lard and oil:

Whittier, Fuller & Co	*\$45 00
-----------------------------	----------

Miscellaneous articles:

James Gallup & Co	*85 82
Dunham, Carrigan & Co	92 13

Schedule of offers for supplies for navy-yard at Mare Island, Cal., under advertisement of January 3, 1885.

Portland cement:

James McCudden	*\$1, 115 00
J. C. Merrill & Co	†1, 042 50
A. Powell	1, 175 00

Schedule of offers for supplies for navy-yard at Mare Island, Cal., under advertisement of February 7, 1885.

Sulphate of copper:

J. J. Mark & Co	*\$30 00
-----------------------	----------

Forage:

James McCudden	*533 00
James Brownlie	562 50
A. Powell	625 00
Rider, Somers & Co	584 00

* Awarded.

† Irregular.

Schedule of offers for supplies for navy-yard at Mare Island, Cal., under advertisement of February 12, 1885.

Stationery:		
Cunningham, Curtis & Welch	-----	\$297 35
Dutton & Patridge	-----	*292 77

Schedule of offers for supplies for navy-yard at Mare Island, Cal., under advertisement of March 9, 1885.

Lumber, requisition No. 67:		
John P. Sheldon	-----	*\$115 87
Turner, Kennedy & Shaw	-----	117 00
Reuton, Holmes & Co	-----	119 25
William Walker	-----	117 00
A. Powell	-----	121 50
James McCudden	-----	117 00
Lumber, requisition 68:		
John P. Sheldon	-----	*167 37
Turner, Kennedy & Shaw	-----	169 00
Reuton, Holmes & Co	-----	172 25
William Walker	-----	169 00
A. Powell	-----	175 50
James McCudden	-----	169 00
Lumber, requisition 69:		
John P. Sheldon	-----	*45 00
Turner, Kennedy & Shaw	-----	46 00
Reuton, Holmes & Co	-----	47 50
William Walker	-----	56 00
A. Powell	-----	45 00
James McCudden	-----	45 00

Schedule of offers for supplies for navy-yard at Mare Island, Cal., under advertisement of March 19, 1885.

Three thousand pounds ice:		
Henry Connolly	-----	*\$90 00

Schedule of offers for supplies for naval station at Key West, Fla., under advertisement of February 14, 1885.

Illuminating oil:		
W. H. Monsalvage & Co	-----	\$15 00
W. D. Cash	-----	*12 50

Schedule of offers for supplies for naval station at Port Royal, S. C., under advertisement of November 1, 1884.

Materials for fence:		
N. Christenson	-----	*\$185 00
McLeod & Bro	-----	190 00

Scale of proposals for wharf at Port Royal, S. C., under advertisement dated January 26, 1885.

Building wharf:		
William F. Bowe. Time, four months; begin thirty days	-----	\$17,460 00
P. Sanford Ross. Time, four months; begin twenty days	-----	*14,630 00
H. W. Crouch & Bro. Informal; no price named.		

* Awarded.

No. 7.—BUREAU OF NAVIGATION.

REPORT OF THE CHIEF OF THE BUREAU.

NAVY DEPARTMENT, BUREAU OF NAVIGATION,
Washington, October 19, 1885.

SIR: I have the honor to submit the following report of the Bureau of Navigation for the past year, together with the estimates for its support, and for the expenditures that will be necessary for the fiscal year ending June 30, 1887. Included in this report and transmitted herewith are the reports and estimates of the several offices under its control, together with the statements required by section 429 of the Revised Statutes of the United States, and by the third section of the naval appropriation act approved January 30, 1885.

NAVIGATION.

Compasses.—During the past year 172 compasses have been repaired, and 24 new ones made and tested.

A compass station for the more accurate determination of the deviation of the compass has been established in Narragansett Bay, in the vicinity of the measured mile.

It seems proper here to refer to the preamble and resolutions of the Chamber of Commerce of New York, submitted to the Department in January last, pointing out the desirability of establishing a compass station near that city, by quoting extracts from a letter prepared in this Bureau for the information of the Secretary, as follows :

The importance to be attached to these resolutions cannot be overestimated. As every vessel of iron or steel may be stated to be a magnet of irregular shape which causes the deviations of the compass, all iron and steel vessels built for the merchant marine should be examined upon completion for the purpose of finding their magnetic poles and neutral lines. This examination would be a magnetic survey of the ship, and should be made in a dry-dock.

The primary object of such examination and survey is to determine the best location for the standard-compass, on which depends the safe navigation of the ship. Without this survey the standard-compass may often be located in a position which, though convenient and easily accessible, is the one most likely to cause shipwreck. After the standard-compass has been located the ship should be swung at a compass station for a table of deviations, her heeling error should be found, and her steering-compass compensated if required.

All of this work should be performed by naval officers, and the only expense to the owners would be that incurred in docking and that of the time lost at the compass station. These expenses are insignificant when compared with the cost of ship and cargo, and owners should be required by law to take these measures for the protection of the lives of passengers. As a portion of the preamble correctly states in substance, by means of such examinations and observations the navigation of the vessel would be changed from one of great doubt to one of comparative certainty. The absence of all such observations may readily account for the number of iron vessels of our merchant navy which have been wrecked within the past two years.

Compass stations should be established in the vicinity of our large sea-ports. I have already stated that this Bureau has not sufficient money to carry out a plan of this kind, but the sum of \$50,000 would be sufficient for the purpose, and I can recommend no ex-

penditure of money which should produce more substantial benefits than one of this kind, which would save money and lives.

With reference to the suggestion that the localities for the compass stations should be established and the buoys and beacons planted by the Treasury Department, I beg to state that the Navy Department should be charged with the entire subject, for the following reasons, viz:

That joint action on the part of officers, a portion of whom are under the control of one Executive Department and the remainder under another, is not likely to produce the best results;

That work of this character is properly under the control of naval officers, who now perform the duty for all naval vessels;

That, as the Navy Department has already the necessary instruments in its possession and officers familiar with the work, it will only be necessary to establish the stations.

It will be easy to comply with that portion of the resolution recommending the preparation for distribution in a popular form to those interested of existing information of the causes and nature of the deviations of the compass, and specific instructions to ascertain and correct them; for the Bureau possesses this information and the want of money alone prevents its publication. In addition to publishing this matter, I would suggest that a series of popular lectures could be prepared by officers in this Bureau, for delivery with practical illustrations at stated intervals, before an audience composed of officers of the merchant service and those connected with commerce. The preparation of such lectures would cost nothing—no doubt a room in a public building could be obtained for the purpose in New York—and the opportunities thus afforded for communication between the two services would be mutually beneficial.

The adoption of such resolutions as those herewith referred to by the New York Chamber of Commerce is therefore most opportune, and in conclusion I beg to suggest that the Chamber of Commerce be informed that the Navy Department is prepared to make the necessary magnetic examinations of iron and steel ships, to adjust their compasses, and will be glad to establish compass stations in proper localities, provided money can be obtained from Congress for that purpose.

The Bureau would have been unable to establish the one compass station in Narragansett Bay had it not been in possession of the buoys and the moorings required for the purpose.

The compass reports required from cruising vessels continue to be carefully examined and the calculations verified or corrected. From these reports it is proposed eventually to prepare a new variation chart. The most complete sets of these observations, illustrating the deviations of the compass in vessels of the United States Navy, have been arranged for publication as a professional paper.

Professional paper No. 17, "Magnetism of iron and steel ships," has been published and distributed among the officers of the Navy and merchant marine.

As the magnetism of steel ships is subject to great changes during construction, observations have been taken from time to time to determine the magnetic character of the steel cruisers now building. For these ships four compensating binnacles have been made in the Washington navy-yard from designs prepared in the Bureau.

Compass-testing house.—The work of erecting the compass-testing house, for which there is an appropriation of \$7,000, has begun. The foundations have been laid, the piers on which the instruments are to be mounted are in place, and the superstructure is being built. That the building may be completed and provided with the necessary equipment, an estimate for \$2,000 has been submitted.

Determination of longitudes.—The results of the observations made by naval officers for the determination of secondary meridians by means of the telegraph, in 1883-'84, have been published and distributed among libraries, geographical societies, observatories, and those interested in the subject.

The secondary meridians thus established are those of Vera Cruz, Guatemala, La Libertad, Paita, Lima, Arica, Valparaiso, and the national observatory of the Argentine Republic at Cordoba.

Signal books.—In consequence of the improvement in the construction and armament of war vessels and the consequent effect upon naval tactics, a revision of the signal books has become necessary, and officers are engaged in making the necessary changes.

Navigation supplies.—Through the courtesy of the Light-House Board the quantities of illuminating oils required for the Navy continue to be included in the supplies contracted for by the Light-House establishment. In consequence, naval vessels are supplied with better qualities of oils and with greater economy than if independent contracts were made by this Bureau.

Chronometers are expensive but necessary instruments, and ships must be supplied with them. There are now 240 chronometers in possession of the Bureau; of this number 132 have been condemned under the rule adopted that thirty years should be considered the lifetime of a Navy chronometer. As few new chronometers have been purchased during the past twenty years, the number available for issue will be still further reduced within the next few years.

It is proposed to purchase annually from chronometer makers in the United States, after a competitive trial of six months, a sufficient number of chronometers to replace those condemned from time to time.

The Omaha has been fitted with an incandescent electric light plant supplied by the Consolidated Electric Light Company of New York. The installation is reported to work satisfactorily. The Edison incandescent electric lights on board the Trenton continue to give satisfaction.

Additional books have been supplied to the libraries of cruising ships, and I desire to repeat the recommendation contained in the annual reports of this Bureau for the past two years, that such professional matter as is essential to naval officers and of value to the merchant marine and to the ship-building interests, be published. This cannot now be done for want of an appropriation.

Ocean surveys.—It is proposed that the Ranger shall be employed in sounding the Pacific Ocean off the coast of Lower California and Mexico, and in examining the North Pacific Ocean for the rocks and shoals which have been reported from time to time to exist in the track of vessels bound to and from San Francisco.

The old surveys of the coast of the Spanish Main are known to contain many errors, and as this coast is much frequented by merchant ships owned in the United States, it is proposed that the Thetis, which was transferred to the Navy for surveying purposes, shall be used to make the surveys necessary to correct them.

Upon the completion of this duty the Thetis should be sent to the South Pacific Ocean to examine the many dangers to navigation which are reported to exist in that section of the globe, and which are now shown on charts, but the existence of which has, in many cases, not been proven.

Publication of war records.—The work of classifying and copying the naval records of the war for publication has been continued as rapidly as the small force at the disposal of the Bureau will allow. It is important that provision should be made at once for an adequate clerical force to carry on this work, and estimates have been submitted therefor. Every year's delay in procuring and copying the papers now in private hands adds to the probability of their loss or destruction. The measures adopted by Congress to provide for the compilation of the Army records have produced a work which is indispensable to the study of the war and a source of satisfaction to the participants on both sides. No book ever published by the Government has met with so great a

popular demand. The naval records, although not so voluminous as those of the Army, are quite as important, and the same reason exists for their publication. Without them the narrative is incomplete. They have besides an importance of their own, distinct from that of the Army records, in that they contain nearly all that is known, in actual practice, of modern naval warfare, and their consequent value to the legislative and executive branches of the Government, to the naval service, and to the community at large, as an aid in forming opinions on naval matters, cannot be overestimated.

Department library.—During the past year the library has continued to receive valuable additions by gift and by purchase, and the classification and cataloguing of the books has been nearly completed. The reduction of the annual appropriation from \$2,500 to \$1,000, made by the appropriation act of last year, is a serious obstacle to the improvement and growth of the library, which has been steadily in progress since 1882. There is certainly no object for which money may be expended more productive of direct benefit than the formation and maintenance of the collection of books of professional reference for the Navy Department, and the crippling of this important work cannot be compensated by a saving to the Government of \$1,500. I therefore recommend that the appropriation of \$2,500 should be renewed.

I would also renew the recommendations in reference to binding made in my last annual report, as follows :

Under existing law, no binding can be done for any Department of the Government except in plain sheep or cloth. Exceptions to this rule have been made in favor of the Congressional Library and the libraries of the Department of State, the Patent Office, and the Office of the Surgeon-General of the Army. The restriction upon the character of the binding for other Department libraries is harmful to the interests of the Government by making it impossible to keep sets of volumes in a uniform binding, while the saving in expense is so small as to be wholly out of proportion to the resulting disadvantages; and it is clear that the reasons which exist for the exceptions in favor of the libraries of the Department of State, the Patent Office, and the Surgeon-General's Office apply with equal force to those of other Executive Departments.

Naval War College.—The first session of the Naval War College opened September 3, with a class of naval officers. The instruction consisted of full courses of lectures on marine international law and on military science, with lectures on the art of naval warfare, delivered by the officers connected with the college and by Rear-Admiral Ammen and Commander Taylor, United States Navy. Additional lectures on subjects bearing upon the course of study were given by General J. C. Palfrey, General George H. Gordon, and John C. Ropes, esq., who kindly volunteered their services without compensation.

In the course just ended, a successful beginning has been made of this highly important work. Owing to the short time for preparation, and to the fact that several of the special instructors whom it is intended to attach to the college have been necessarily occupied with duties to which they had previously been assigned, the course of instruction was not as complete as it is hoped ultimately to make it, but enough has been done to assure the final success of the institution. The War College, by giving officers an advanced course of instruction on subjects directly connected with the art of war, fills what has hitherto been a serious want in our system of naval education, and it can but commend itself to the earnest and hearty support of the Department and of Congress.

The report of the president of the college and the recommendations contained therein are fully approved by the Bureau.

HYDROGRAPHIC OFFICE.

The survey of the west coast of Central America has been continued as far south as the Gulf of Dulce by the officers of the *Ranger* during the past season. As correct charts extending from that point to Panama have been published from recent surveys made by English naval officers it is not considered necessary to extend the survey now under the direction of this Bureau farther south.

In this connection I beg to state that although a specific sum was asked for, no money was appropriated during the last session of Congress to complete the important survey of the west coast of Mexico and Central America. In consequence it is not possible to complete the publication of charts from the surveys recently made by the officers of the *Ranger*.

In order that the mercantile community may have the benefit of this work as soon as practicable, an estimate has again been submitted sufficient in amount to engrave and print these charts. It is unnecessary to state that charts of this locality are very much needed.

The improvements in the construction of the charts issued by the Hydrographic Office has increased the demand for those publications. Through the agency of the branch hydrographic offices in the cities of Boston, New York, Baltimore, New Orleans, and San Francisco, nautical information contained in the archives has been distributed to the officers of the merchant marine, and in return a vast amount of additional matter has been collected for the Hydrographic Office from the observations made by these gentlemen, who have been uniformly courteous in complying with the requests of the representatives from the branch offices who have visited their ships to obtain information likely to benefit commerce in general.

I desire to invite your attention to the building in which the engraving of copper plates and the printing of charts is carried on. As it is not fire-proof, the valuable plates must be stored in the Navy Department, and carried to and from the printing room when required for use. It is impossible to remove these soft copper plates from building to building without great risk of injury.

Special conditions of light, heat, and immunity from vibrations are required by engravers and draughtsmen for the production of the best work. None of these conditions exist in the building at present occupied by the division engaged in engraving and printing charts. From the offensive odors due to the cleaning materials required in the process of printing, the work cannot be done in the State, War, and Navy Department building without great inconvenience to its occupants. To remove these obstacles to good workmanship, and the loss due to injury of plates, a building especially adapted to the purpose should be constructed as soon as possible.

I beg to repeat the statement contained in the report of the Bureau for 1884, that nautical men generally favor the adoption of a universal system of marks and buoys for channels and harbors, and to renew the suggestion for an international congress to consider and recommend one system for adoption.

NAVAL OBSERVATORY.

The report of the Superintendent of the Naval Observatory gives in detail the astronomical work performed with the various instruments during the past year, the observations of the eclipse of March 16 last, and the distribution of correct time to the principal cities and sea-ports.

Appended thereto is a report of the work done for the Transit of Venus Commission, relating to the observations made in 1874 and 1882.

The general adoption of the system of standard time has created a demand for more accurate time. To answer this demand and to render service to the maritime community, time-balls have been erected at Boston, Newport, the New York navy-yard, Philadelphia, Hampton Roads, Savannah, New Orleans, and San Francisco. Through the courtesy of the Western Union and Baltimore and Ohio Telegraph Companies, these time-balls are connected with and dropped from the Naval Observatory daily at noon, the temporary use of the wires being given free of charge.

Requests have been received from the maritime bodies of other cities for the time service, but it has not been possible to comply with the requests for want of an appropriation. Indeed, were it not for the free use of the telegraph lines (and voluntary labor at Savannah and Hampton Roads) the cities already mentioned could not be supplied with the correct time. To comply with the requests for this service an estimate is submitted herewith.

The several recommendations contained in the report relative to the observations of the solar eclipse of August 29, 1886, to permanently fixing the status of the assistant astronomers, and for the recognition of the services of the instrument maker, Mr. W. F. Gardner, in perfecting the clock system for transmitting time from the Observatory to the various Government departments, are approved by the Bureau.

I desire to renew my recommendations of last year in regard to the Naval Observatory, as follows:

The necessity for an appropriation with which to begin the buildings for the new Naval Observatory upon the site selected by a commission appointed for the purpose and purchased by the Government, so often mentioned in previous reports, is more apparent than ever in consequence of the dilapidated condition of the buildings and the unhealthy and improper location of the present Observatory, and I again urge the importance of an appropriation for that purpose.

NAUTICAL ALMANAC.

The Superintendent of the Nautical Almanac reports the progress made during the past year in preparing the annual volumes in advance, and the work performed on astronomical tables and papers.

The American Nautical Almanac for 1888 and the Ephemeris for the same year were issued in the early part of 1885, and the type work of the volume for 1889 is nearly completed. The computations for 1890 and 1891 are in course of execution. The Atlantic Coaster's Nautical Almanac for 1886 is now in press, and that for the Pacific coast was issued in September last.

ESTIMATES.

In submitting the estimates for the support of the Bureau during the coming fiscal year, I have the honor to bring to your notice the following extract from my last annual report, viz:

I beg to invite your attention to the annual appropriations for this Bureau, which have steadily decreased in amount from \$192,500 for the fiscal year of 1866-'67 to \$100,000 for the year 1883-'84. Since the year 1866 the amount appropriated annually to carry on the work under the cognizance of this Bureau has been insufficient to supply our vessels with the best and most improved articles of navigation outfit. In consequence, however, of the quantity of supplies purchased during the civil war, and remaining on hand at its close, cruising ships have been furnished with instruments for navigation which, if not of the latest patterns, still answer the purpose for which they were purchased in the absence of better. But the supplies above mentioned have gradually been exhausted,

or have become obsolete and have been sold as "unserviceable," in compliance with the act of Congress approved August 5, 1802, which required all stores and supplies to be appraised and those found to be unserviceable to be sold.

The supply of articles of navigation outfit has still further decreased since the above was written, while the appropriation for the fiscal year ending June 30, 1885, was \$87,500, a reduction of \$12,500 on the amount for the previous year. The appropriation for the present fiscal year is \$87,500, which is \$42,500 less than the estimates.

I have submitted estimates for \$130,000, an amount which in my opinion is necessary for the efficient administration of this Bureau, and without which it will not be practicable to supply our cruising vessels with the improved outfits required for the safe navigation of modern ships of war.

Very respectfully, your obedient servant,

J. G. WALKER.

Chief of Bureau.

Hon. W. C. WHITNEY,
Secretary of the Navy.

Estimates of appropriations required for the service of the fiscal year ending June 30, 1887, by the Bureau of Navigation.

A.

FOR THE SUPPORT OF THE BUREAU OF NAVIGATION.

I.—SALARIES.

For salary of chief clerk (Revised Statutes, page 70, section 416, and act of March 3, 1885)	\$1, 800
For salary of one clerk of class three (act of March 3, 1885)	1, 600
For salary of one clerk of class two (act of March 3, 1885)	1, 400
For salary of one clerk of class two (act of March 3, 1885)	1, 400
For salary of one clerk of class one (act of March 3, 1885)	1, 200
For salary of one clerk (act of March 3, 1885)	1, 000
For salary of one copyist (act of March 3, 1885)	900
For salary of one assistant messenger (act of March 3, 1885)	720
For salary of two laborers (act of March 3, 1885)	1, 320
Total	11, 340
For increase of salary of chief clerk (submitted)	450
For increase of salary of clerk of class three (submitted)	200
For increase of salary of clerk of class two (submitted)	200
For increase of salary of clerk at \$1,000 (submitted)	200

B.

SALARIES, OFFICE OF NAVAL INTELLIGENCE.

For salary of one copyist (submitted)	\$900
For salary of one laborer (submitted)	660

C.

I.—SALARIES, OFFICE OF NAVAL RECORDS OF THE REBELLION.

For salary of one clerk of class one (act of March 3, 1885)	\$1, 200
For salary of two copyists, at \$720 each (act of March 3, 1885)	1, 440
Total	2, 640
For salary of one agent for the collection of Confederate records (submitted) ..	2, 000
For salary of one clerk of class three (submitted)	1, 600
For salary of one clerk of class two (submitted)	1, 400

For salary of one clerk of class one (submitted)	\$1,200
For salary of two clerks, at \$1,000 (submitted)	2,000
For salary of two copyists, at \$900 (submitted)	1,800
For salary of two copyists, at \$720 (submitted)	1,440

II.—CONTINGENT EXPENSES.

For stationery, traveling of agent, and other contingent expenses (submitted) ..	1,000
--	-------

D.

I.—SALARIES, LIBRARY, NAVY DEPARTMENT.

For salary of one laborer (submitted)	\$660
---	-------

II.—BOOKS.

For professional books and periodicals (act of March 3, 1885)	1,000
For professional books and periodicals (submitted)	1,500

Total	2,500
-------------	-------

NOTE.—The amount estimated for (\$2,500) is that appropriated previous to the current fiscal year. The reduced amount is totally inadequate to meet the necessities of the Department.

E.

I.—SALARIES, HYDROGRAPHIC OFFICE.

For salaries of two clerks of class two (act of March 3, 1885)	\$2,800
For salary of one clerk of class one (act of March 3, 1885)	1,200
For salaries of draughtsmen, engravers, copyists, copper-plate printers, printers' apprentices, assistant messengers, laborers, and watchmen in the Hydrographic Office (act of March 3, 1885)	41,140
Total	45,140
For salary of one clerk of class four (submitted)	1,800
For increase of \$200, to advance one clerk of second class to class three (submitted)	200
For watchman, additional engravers, and advance of others (submitted)	3,860

II.—CONTINGENT AND MISCELLANEOUS EXPENSES.

For purchase of chart-paper, copper-plates, electrotyping copper-plates, ink, and other materials in printing division; instruments and materials for drawing division; materials for and mounting charts; tools and materials for engravers; reduction of drawings by photography; photolithographing charts for immediate use; transfer of photolithographic and other charts to copper; repairs to printing-presses and other furniture and tools; extra drawing and engraving; translating from foreign languages in preparing charts and notices; purchase of foreign and other charts and hydrographic works for the use of vessels of the Navy and express and freight charges on the same; purchase of drawing-paper, drawing materials; surveying instruments and repairs of same to be furnished naval vessels while surveying; compiling and arranging data and printing and mailing Pilot Chart of North Atlantic Ocean, and purchase of professional works relating to hydrography, surveying and its kindred branches (act of March 3, 1885)	45,000
For rent of building for printing-presses, draughtsmen and engravers, storage of copper-plates and the materials used in the construction and printing of charts; gas, water, and telephone rents, and for repairs and heating of the rooms (act of March 3, 1885)	1,500
For contingent expenses of branch offices at Boston, New York, Philadelphia, Baltimore, New Orleans, and San Francisco, including furniture, fuel, lights, rent, care of offices, messenger service in boarding ships, car-fare and ferriage in visiting merchant vessels, freight, expressage, telegrams, and other necessary expenses incurred in collecting the latest information for the Pilot Chart, and for other purposes for which the offices were established (act of March 3, 1885)	7,000
Total	53,500

F.

I.—SALARIES, NAVAL OBSERVATORY.

For salary of one assistant astronomer (act of March 3, 1885).....	\$2,000
For salary of two assistant astronomers at \$1,800 (act of March 3, 1885).....	3,600
For salary of one clerk of class four (act of March 3, 1885).....	1,800
For salary of one instrument-maker (act of March 3, 1885).....	1,500
For salaries of four watchmen, including one for new Naval Observatory site (act of March 3, 1885).....	2,880
For salaries of one skilled laborer at \$1,000 and one skilled laborer at \$720 (act of March 3, 1885).....	1,720
For salaries of seven laborers at \$660 (act of March 3, 1885).....	4,620
Total	18,120
For increase to pay of one assistant astronomer (submitted).....	600
For increase to pay of two assistant astronomers, of \$400 each (submitted).....	800
For increase to pay of instrument-maker (submitted).....	200
For salaries of three computers, at \$1,200 each (submitted).....	3,600
For salary of one copyist and indexer for library (submitted).....	800

II.—CONTINGENT AND MISCELLANEOUS EXPENSES.

For miscellaneous computations (act of March 3, 1885).....	1,200
For books, periodicals, engravings, photographs, and fixtures for the library (act of March 3, 1885).....	1,000
For apparatus and instruments, and repairs of the same (act of March 3, 1885).....	2,500
For repairs of buildings, fixtures, and fences, including fixtures, fences, and house at new Observatory site, for fuel, furniture, gas, chemicals, stationery, freight, postage, and contingent expenses (act of March 3, 1885).....	3,900
For payment to Smithsonian Institution for freight on Observatory publications sent to foreign countries (act of March 3, 1885).....	136
Total	8,736

For increase of amount for repairs of buildings, fixtures, &c. (submitted).....	1,100
For apparatus and material for experiments in solar and stellar photography (submitted).....	1,000
For maintenance of time service (submitted).....	5,000
For air-tight case for standard clock.....	300
For 600 feet 3-inch cotton fire-house, with necessary couplings (submitted).....	600
Total	8,000

G.

I.—NAUTICAL ALMANAC.

For salaries of assistants in preparing for publication the American Ephemeris and Nautical Almanac, viz:	
Three assistants, at \$1,600 (act of March 3, 1885).....	\$4,800
Two assistants, at \$1,400 (act of March 3, 1885).....	2,800
Three assistants, at \$1,200 (act of March 3, 1885).....	3,600
Two assistants, at \$1,000 (act of March 3, 1885).....	2,000
One copyist (act of March 3, 1885).....	720
One assistant messenger (act of March 3, 1885).....	720
One laborer (act of March 3, 1885).....	660
For pay of computers on piecework in preparing for publication the American Ephemeris and Nautical Almanac, and in improving the tables of the planets (act of March 3, 1885).....	8,400
Total	23,700

FOR THE NAVAL SERVICE.

I.—NAVIGATION.

For foreign and local pilotage and towage of ships of war; services and materials in correcting compasses on board ship, and for adjusting and testing compasses on shore; nautical and astronomical instruments, nautical books, maps, charts, and sailing directions, and repairs of nautical instruments for ships of war; books for libraries for ships of war; naval signals and apparatus, namely: signal lights, lanterns, rockets, running lights, drawings and engravings for signal books; compass fittings, including binnacles, tripods, and other appendages for ships' compasses; logs and other appliances for measuring the ship's way, and leads and other appliances for sounding; lanterns and lamps and their appendages for general use on board ship, including those for the cabin, ward-room, and steerage, for the holds and spirit-room, for decks and quarter-masters' use; bunting and other materials for flags and making and repairing flags of all kinds; oil for ships of war other than that used in the engineer department, candles when used as a substitute for oil in binnacles and running lights, chimneys and wicks, and soap used in the navigation department; photographic instruments and materials; stationery for commanders and navigators of vessels of war, and for use of courts-martial; musical instruments and music for vessels of war; steering signals and indicators, and speaking-tubes and gongs for signal communication on board vessels of war; and for introducing and maintaining electric lights on board vessels of war (act March 3, 1885) ----- \$130,000

NOTE.—The amount asked for (\$130,000) is the same as that submitted for the current fiscal year, for which, however, only \$87,500 were appropriated. It is proposed to replace by new instruments of modern construction the old chronometers, sextants, spy-glasses, and other nautical, meteorological, and hydrographic instruments, most of which have been in service since the late war, and could only be made useful by frequent repairs. The same conditions prevail with the running lights, sounding, signaling, and illuminating implements, and logs for measuring the ship's way, now in service; and it is also proposed to introduce the electric light on several ships during the next fiscal year.

II.—OCEAN SURVEYS.

For special ocean surveys and the publication thereof (act of March 3, 1885) .. 30,000

NOTE.—Last year the sum of \$20,000 was asked for and \$10,000 appropriated; the amount estimated for the next fiscal year is \$30,000.

It is proposed to continue the U. S. S. Ranger in surveying on the Pacific coast; in sounding in the track of the Pacific Mail steamers, and examining reported rocks and shoals in the North Pacific Ocean; it is further proposed to have the U. S. S. Thetis make surveys and soundings along the Spanish Main, and eventually to transfer her to the South Pacific to examine the many reported dangers to navigation now on charts. The amount asked for includes also the publication of surveys, which involves the slow process of drafting and engraving; for which reason it is recommended that the appropriation be made continuous.

III.—PUBLICATION OF SURVEYS OF MEXICAN COAST.

For repairing and engraving on copper-plates the surveys of the Mexican coast (submitted) ----- 7,000

It is recommended that these appropriations be made continuous, as the work of surveying, drafting, and engraving may extend over the time to which the usual annual appropriations are limited.

IV.—OBSERVATIONS, TRANSIT OF VENUS.

For completing the reductions of the observations of the transit of Venus (to be expended under the direction of the Transit of Venus Commission) (submitted) ----- 3,000

V.—NEW NAVAL OBSERVATORY.

For commencing the erection of the new Naval Observatory and necessary buildings upon the site purchased under the act of Congress approved February 4, 1880 (21 Stat., page 64) (submitted) ----- 250,000

VI.—COMPASS-TESTING HOUSES.

For completing compass-testing houses and furniture for same (submitted)..... \$2,000

VII.—PUBLICATION OF PROFESSIONAL PAPERS.

For publication of professional papers (submitted)..... 12,000

VIII.—CONTINGENT, NAVIGATION.

For contingent expenses of the Bureau of Navigation, namely: For freight and transportation of navigation materials, postage and telegraphing on public business, advertising for proposals, packing-boxes, and materials, furniture, stationery, and fuel for navigation offices at navy-yards, and all other contingent expenses (act of March 3, 1885)..... 5,000

NOTE.—The amount under this head (\$5,000) is the same as asked for last year; the amount appropriated for the current year is \$4,000.

In the deficiency act of March 3, 1885, two items were appropriated to cover deficiencies in the years 1883 and 1884, and it is probable that in the final settlement of the contingent for the year ending June 30, 1885, a deficiency will result.

Since the Tallapoosa has ceased to carry freight, expenses under this head have naturally increased, and the practice of supplying our foreign squadrons with stores of American manufacture, such as lard oil, bunting, stationery, &c., entails increased freight bills.

IX.—NAVAL WAR COLLEGE.

For repairs and improvements on Naval War College buildings, heating, lighting, and furniture for same, books and stationery, freight, and other contingent expenses (act of March 3, 1885).....	8,000
For facing college building with Portland cement (submitted).....	2,850
For purchase of feed and maintenance of horses and mail-wagon, and attendance on same (submitted).....	1,550
For clerk to commandant or senior officer (submitted).....	1,000
For attendant on buildings (submitted).....	600
Total	14,000

X.—CIVIL ESTABLISHMENT.

New York navy-yard:	
For one clerk.....	1,400
For one writer.....	1,000
For one storekeeper.....	900
For one master of tugs.....	1,500
Portsmouth navy-yard:	
For one clerk.....	1,000
Boston navy-yard:	
For one storekeeper.....	900
League Island navy-yard:	
For one storekeeper.....	900
Norfolk navy-yard:	
For one clerk.....	1,200
Washington navy-yard:	
For one clerk.....	1,000
Mare Island navy-yard:	
For one clerk.....	1,000
Total	10,800

NOTE.—The amount appropriated for the current year (\$5,000) has been applied to the payment of the following clerks, viz:

Portsmouth.....	\$1,000
New York.....	1,400
Norfolk.....	1,200
Mare Island.....	1,000
Washington..... for four months.....	400

For the remaining eight months the person doing the clerical work at Washington is to be paid from the appropriation "Navigation," at \$3 per diem, as storekeeper or specialman; at Boston and League Island, one laborer each is

engaged in taking care of stores and keeping accounts at \$2 per diem from "Navigation." It is proposed to employ a properly qualified storekeeper at each of these yards in place of the laborers, at \$900 per annum.

The estimates submitted comprise also the pay of a writer and storekeeper at New York, who are now paid from "Navigation," as well as the pay of a master of tugs at New York, at \$1,500 per annum, who by Department's order of October 6, 1884, is paid alternately by Ordnance, Navigation, Construction and Repair, Equipment and Recruiting, and Steam-Engineering.

RECAPITULATION.

FOR THE SUPPORT OF THE BUREAU OF NAVIGATION.

A.—I. Salaries, Bureau of Navigation	\$11,346
Salaries (submitted).....	1,650
B.—I. Salaries, Office Naval Intelligence.....	1,560
C.—I. Salaries, Office Naval Records of the Rebellion.....	2,640
Salaries (submitted).....	11,440
II. Contingent expenses.....	1,000
D.—I. Salaries, library, Navy Department.....	66*
II. Books, library, Navy Department.....	2,500
E.—I. Salaries, Hydrographic Office.....	45,140
Salaries (submitted).....	5,668
II. Contingent and miscellaneous expenses, Hydrographic Office.....	53,540
F.—I. Salaries, Naval Observatory.....	18,120
Salaries (submitted).....	6,000
II. Contingent and miscellaneous expenses, Naval Observatory.....	8,736
Contingent and miscellaneous expenses (submitted).....	8,000
G.—I. Nautical Almanac.....	23,700
Total	201,946

FOR THE NAVAL SERVICE.

I. Navigation.....	130,000
II. Ocean surveys.....	30,000
III. Publication of surveys of Mexican coast.....	7,000
IV. Observations, Transit of Venus.....	3,000
V. New Naval Observatory.....	250,000
VI. Compass-testing houses.....	2,000
VII. Publication of professional papers.....	12,000
VIII. Contingent navigation.....	5,000
IX. Naval War College.....	14,000
X. Civil establishment.....	10,800
Total	463,800

Statement of amounts expended at navy-yards for the pay of persons employed on clerical duty during the fiscal year 1884-'85, and of the amounts required for the fiscal year 1886-'87 (act of January 3, 1885, section 3).

Navy-yards.	Appropriations.	Amounts expended, 1884-'85.	Amounts required for 1886-'87.
Portsmouth.....	Civil establishment.....	\$1,000 00	\$1,000 00
Boston.....	do.....		900 00
Do.....	Navigation.....	643 05	
New York.....	Civil establishment.....	1,400 00	4,800 00
Do.....	Navigation.....	1,879 30	
League Island.....	Civil establishment.....		900 00
Do.....	Navigation.....	616 00	
Norfolk.....	Civil establishment.....	1,200 00	1,200 00
Do.....	do.....	400 00	1,000 00
Washington.....	Navigation.....	609 00	
Do.....	Civil establishment.....	1,000 00	1,000 00
Mare Island.....			
Total civil establishment.....		5,000 00	10,800 00
Total navigation.....		3,747 35	
Grand total.....		8,747 35	

* This amount includes one clerk (\$1,400), one writer (\$1,000), one storekeeper (\$900), and one master of tugs (\$1,500).

Statement of labor, purchases, receipts and expenditures at navy-yards during the fiscal year 1884-'85 (Revised Statutes, section 429).

Objects.	Portsmouth.	Boston.	New York.	League Island.	Norfolk.	Washington.	Mare Island.	Total.
Expended for mechanics and laborers, in equipping vessels of the Navy, and in receiving and securing stores for the same purpose.....	\$808 12	\$674 69	\$10,896 46	\$18 10	\$763 81	\$6,316 47	\$894 37	\$20,302 02
Materials and stores purchased.....	5,664 88	21,749 19	16 14	420 56	189 17	606 45	28,646 39
Cost or estimated value of stores on hand July 1, 1884.....	16,546 44	23,261 38	84,967 83	15,868 76	30,989 16	32,684 20	44,856 90	260,724 67
Cost or estimated value of articles received in 1884-'85.....	16,495 20	8,068 45	100,275 30	1,944 49	16,363 43	25,167 79	18,728 88	187,086 54
Cost or estimated value of articles expended in 1884-'85.....	19,672 93	7,769 64	73,469 82	2,870 13	22,819 90	27,737 67	19,601 62	175,941 71
Cost or estimated value of articles on hand June 30, 1885.....	13,368 71	25,585 19	109,670 61	14,948 13	24,552 69	30,064 32	43,682 16	281,866 71
Amounts realized from sales of condemned materials during fiscal year 1884-'85.....	757 90	1 80	759 70

REPORT OF SUPERINTENDENT NAVAL WAR COLLEGE.

UNITED STATES NAVAL WAR COLLEGE,
Newport, R. I., September 30, 1885.

SIR: I have the honor to inform the Bureau that the first term of the War College ended to-day.

As a matter of record it may not be out of place to state that under date of May 3, 1884, the Department directed a board of naval officers to "report upon the whole subject of a post-graduate course * * * for officers of the Navy, &c." The report of the Board, dated June 13, recommended in the most emphatic terms the adoption of a post-graduate course; and on the 6th of October following, General Order No. 325 announced to the service the establishment of the United States Naval War College.

A copy of the report of the Board and the order authorizing the College are herewith appended as part of the record.

Soon after the promulgation of General Order No. 325, instructions were issued to the following named officers to prepare themselves for duty as members of the college faculty, to wit: Capt. A. T. Mahan, U. S. N., to prepare to instruct in naval history and naval tactics; Prof. James Russell Soley, U. S. N., to prepare a course of lectures in international law, and Paymaster R. W. Allen to prepare himself to instruct in naval law and the administration of justice.

In accordance with the recommendations of the Board, that the science and art of war "would be best taught by one learned in military science," the Department made application to the Hon. Secretary of War for the detail of an Army officer to take charge of that branch of the college course.

In compliance with this request, Lieut. Tasker H. Bliss, First Artillery U. S. Army, was assigned to the duty, and I may say here, in passing that the choice was an exceedingly fortunate one for the College. But Captain Mahan, who was at this time on the Pacific station in command of the U. S. S. Wachusett, was not ordered home in time to allow him to prepare his work, and Paymaster Allen was subsequently assigned to other duty, leaving Professor Soley and Lieutenant Bliss the only regular instructors.

To make good the deficiency, the services of other officers were asked for.

Medical Director Richard C. Dean was invited to give a course of lectures on naval hygiene; Rear-Admiral Daniel Ammen was requested to give a lecture on any topic connected with naval warfare he might select and Commanders Henry C. Taylor and William Bainbridge Hoff were asked for for similar service; but of the four officers named, but one Commander H. C. Taylor, was ordered by the Department. Rear-Admiral Ammen, being on the retired list, was not subject to orders; but he generously volunteered his services and to travel at his own expense.

As it was necessary to supply other lecturers besides the two regular instructors named, personal solicitation was resorted to with the happiest effect, as the following list will show:

Rear-Admiral Daniel Ammen read a lecture to the class on the 8th of September covering subjects of vital importance to the naval student and containing some valuable hints to naval officers.

September 17.—General J. C. Palfrey, formerly of the United States Army, but now a citizen of Boston, read a lecture on the Peninsular campaign of 1862.

... methods of
... visit cruisers,
... rigid meth-
... operative the
... list of the im-
... ally partially
... curriculum
... fare and in-

... to require
... courses of
... on the future.
... Department,
... and buildings
... has detailed
... faculty of the

... an, while the
... ortance. The
... DLER,
... of the Navy.

... DRON,
... (First rate),
... June 13, 1884.

... 3, to "report upon
... n, to be established
... ons for establishing
... tion, and an opinion
... following preliminary

... of the Department,
... A SCHOOL.
... officer demands a longer
... elete course of technical
... and assimilated with
... undergraduates of the

... experience at sea take up of
... ed a taste; it may be ord-
... or the languages. There
... themselves in the direction
... of an in- men who
... ity of the motive

... service of a
... , and it has
... how finds its
... ly to the
... doing for
... supply its
... h into a

In addition to the foregoing, there were read to the class four papers on naval topics.

There were no recitations required of the class, and no original papers called for.

Taken as a whole, there is every reason to be satisfied with the results of the term, and good grounds for expecting still better results in the future.

The full development of the college course must be a question of time. But with instructors deeply interested in their work and the many officers desirous of professional improvement, from which to form classes, that time need not be very far distant. Of the great influence on our future Navy even a moderate development of the course must exercise no one can doubt who has even a slight acquaintance with what has already been accomplished.

Estimates for further repairs and improvements of the college building and for books to complete the library have been submitted.

It is hoped that the Department will ask for the necessary appropriations of Congress and commend to that body the favorable consideration of this important institution.

Very respectfully, your obedient servant,

S. B. LUCE,

Commodore, U. S. Navy.

Capt. JOHN G. WALKER, *U. S. Navy,*
Chief of the Bureau of Navigation.

[Senate Ex. Doc. No. 68, Forty-eighth Congress, second session.]

Letter from the Secretary of the Navy, reporting, in answer to Senate resolution of the 4th instant, the steps taken by him to establish an advanced course of instruction of naval officers at Coasters' Harbor Island, Rhode Island.

NAVY DEPARTMENT,
Washington, February 11, 1885.

SIR: I have to acknowledge the receipt of a copy of a resolution adopted by the Senate on the 4th day of February, as follows:

"Resolved, That the Secretary of the Navy is hereby directed to report to the Senate what, if any, steps have been taken to establish an advanced course of instruction of naval officers at Coasters' Harbor Island, Rhode Island, and the reasons which have controlled the action of the Department."

The subject of an advanced course of instruction of naval officers was, May 3, 1884, committed by this Department to a Board consisting of Commodore S. B. Luce, Commander W. T. Sampson, and Lieut. Commander C. F. Goodrich, who on the 13th of June, 1884, made a report recommending the establishment of such a course of instruction in the science and art of military and naval warfare and in international law and history. The method recommended is carefully outlined in the report, a copy of which is annexed to this communication.

As it was deemed advisable that the course of study should be made to supplement the present instruction of naval officers in torpedoes at Newport, R. I., and that the place should be selected where the Department is already in possession of the necessary grounds and buildings, the Board recommended the establishment of the college of instruction at Newport.

In pursuance of the previous determination of the Department, and in accordance with the foregoing report, directions were given that preparation should be made for the course of instruction to be conducted at Coasters' Harbor Island, in Newport, by General Order No. 325, issued October 6, 1884, a copy of which is herewith transmitted.

The reasons which have controlled the action of the Department are to be found in the recognized necessity for an advanced course of military and naval education in the United States. There are now existing three schools for the purpose in the Army and one in the Navy. The latter is at the Torpedo Station at Newport, where a class of officers is assembled for a few months in each year for instruction in the art of manufacturing

and using torpedoes and torpedo explosives. The constant changes in the methods of conducting naval warfare imposed by the introduction of armored ships, swift cruisers, rams, sea-going torpedo-boats, and high-power guns, together with the more rigid methods of treating the various subjects belonging to naval science, render imperative the establishment of a school where our officers may be enabled to keep abreast of the improvements going on in every navy in the world. The Torpedo School only partially fulfills the imperative requirements. The college is intended to complete the curriculum by adding to an extent never heretofore undertaken the study of naval warfare and international law and their cognate branches.

The great surplus of officers in the Navy makes it especially appropriate to require that at all times some of them not needed for actual duty shall be engaged in courses of professional study calculated to improve and qualify them for better service in the future.

In instituting this school of instruction at Coasters' Harbor Island, the Department, acting within the scope of its powers, has simply utilized public grounds and buildings under its own immediate control for a wise and beneficial purpose, and has detailed naval officers who can readily be spared to constitute the president and faculty of the college.

Very little expense will be incurred in carrying out the Department's plan, while the benefits to be realized by the Navy and the country will be of great importance. The subject is commended to the notice and favor of Congress.

Very respectfully,

W. E. CHANDLER,
Secretary of the Navy.

The PRESIDENT PRO TEMPORE OF THE SENATE.

REPORT OF BOARD ON A POST-GRADUATE COURSE.

UNITED STATES TRAINING SQUADRON,
UNITED STATES FLAG-SHIP NEW HAMPSHIRE (First rate),
Newport, R. I., June 13, 1884.

Hon. WILLIAM E. CHANDLER,
Secretary of the Navy, Washington, D. C.:

SIR: The Board appointed by the Department under date of May 3, to "report upon the whole subject of a post-graduate course, or school of application, to be established by the Department for officers of the Navy, giving in detail the reasons for establishing such school, the scope and extent of the proposed course of instruction, and an opinion as to the best location therefor," have the honor to submit the following preliminary report.

If the recommendations contained herein meet with the approval of the Department, the Board is ready to develop the plan in greater detail:

FIRST.—THE REASONS FOR ESTABLISHING SUCH A SCHOOL.

The variety and extent of knowledge now required of a naval officer demands a longer period than was formerly considered necessary to cover a complete course of technical education. Of this knowledge certain branches are acquired and assimilated with greater ease by minds more matured than those of the average undergraduates of the Naval Academy.

It is found that numbers of young officers after a little experience at sea take up of their own accord those studies for which they have developed a taste; it may be ordnance, astronomy, electricity, steam, history, international law, or the languages. There are others who, possessed of undoubted ability, do not exert themselves in the direction of self-improvement for want of proper facilities, or, perhaps, of an incentive—men who could take a high stand in almost any branch were the opportunity offered or the motive power applied.

For years past the Bureau of Ordnance has recognized the existence in the service of a large amount of talent that could be utilized for its own special purposes, and it has always encouraged officers to qualify themselves in that particular line. It now finds its reward in a body of capable and efficient assistants.

The present admirable post-graduate course at the Torpedo Station is due solely to the enlightened policy of that Bureau.

In the establishment of the proposed school the Navy Department would be doing for all professional branches what the Bureau of Ordnance has been long doing to supply its own particular needs. It would, moreover, consolidate the instruction in each into a well organized and homogeneous system.

The Board is of the opinion that a cogent reason for such a school is that there may be a place where our officers will not only be encouraged, but required to study their profession proper—war—in a far more thorough manner than has ever heretofore been attempted, and to bring to the investigation of the various problems of modern naval warfare the scientific methods adopted in other professions.

Although the science of war cannot be mastered through the agency of books alone, yet a complete study of the operations of war, both on land and sea, by which the principles of the science have been illustrated practically, is absolutely essential to the proper education of the officer whose life is dedicated to the profession of arms.

Campaigns that have depended for success upon the co-operation of a fleet; campaigns that have been frustrated through the interposition of a fleet; the transfer by water of a numerous army to distant points and their landing on an enemy's coast under the guns of a fleet; the various results of the engagements between ships and shore batteries; naval expeditions which have ended in disaster that could have been foretold through an intelligent study of the problem beforehand; and the great naval battles of history, even from the earliest times, which illustrate and enforce many of the most important and immutable principles of war, should be carefully examined and rendered familiar to the naval student. For it is upon his professional skill in the larger operations of combining and utilizing to the best advantage the floating force of the country, as well as in the more restricted one of an isolated command, that our people must rely for the protection of their interests and the guarding of their extensive coasts and coasting trade from the depredations of an enemy.

The almost total absence of an adequate naval force adds to the burden of responsibility imposed upon our naval officers, and imperatively demands of them extraordinary exertion in the acquisition of professional knowledge in order to make such amends as they best may for the extreme paucity of the means furnished them. Here, then, is not simply a "reason," but an absolute necessity for the establishment of such a school as the order contemplates.

In regard to that valuable practical experience which can be gained only by service afloat, the American naval officer is at a great disadvantage. It is well known that the channel squadron of Great Britain and the squadron of evolutions of France, made up of line-of-battle ships of the most recent types, have long been the great naval war schools of their respective countries, while the naval officers of all maritime nations, great and small, including Chili, China, and Japan, enjoy the opportunities denied to our officers of duty on board of modern fighting ships. This very serious defect in our naval organization can only be partially remedied, if at all, by the proposed war school.

The bare statement that our naval officers not only do not study war as a science, but have no adequate school of practice, seems in these days of broad and liberal culture so extraordinary that it is alone, in the judgement of the Board, sufficient reason for the early founding of the institution which the Department now has under consideration.

But there are other weighty reasons.

Naval officers are often called upon on foreign stations to exercise diplomatic functions, and are not unfrequently required to settle or act upon questions involving nice points of international law. They should, therefore, be carefully prepared for this responsibility by an intimate knowledge of the enlightened neutrality policy which this country has had the honor of introducing and maintaining from its foundation, and of the principles of equity that have ever characterized, as well as of the instruments which control the intercourse of the United States with foreign powers.

Thorough instruction in international law may therefore be regarded as an essential feature in the higher education of the naval officer. This can best be supplied by a post-graduate course.

The study of war and law especially should be undertaken by minds more matured than can be found among the average undergraduates, and by deferring it to the time when the officer is about to assume the greater responsibilities of higher rank the full weight of these subjects is better appreciated, and their acquisition far more likely to engage his best energies.

A more extended course in mechanics, gun construction, &c., is necessitated by the very great advances that are being constantly made in ordnance; while recent hydrographic work, the exact determination of latitudes and longitudes, in the many cases where this still remains to be effected, the addition of iron ships to the Navy, involving the necessity of precise evolution of their magnetic constants, &c., show how imperative is the demand for higher instruction in surveying, nautical astronomy, and practical physics.

In giving prominence to the subjects of war and law, as studies to which the greatest importance should be attached, and to the acquisition of which the highest efforts, stimulated in what manner soever the Department may judge wisest, should be applied, the Board is by no means insensible to the great value to the country of work that may be

accomplished by the Navy in time of peace; work, too, such as may be strictly in the line of professional improvement, and such as, by training the faculties and extending the mental horizon, still further prepares the officer for the more varied demands made in time of war upon his intelligence and attainments. As the domain of human knowledge becomes more and more enlarged, the field of professional requirements expands to such an extent that it must be pastured out, as it were. Thus the tendency in the Navy, as in all other professions, is towards the formation of specialties. It is to the specialist that we are indebted, mainly, for the vast accessions which have been made of late years to the common stock of knowledge. But it is for the very reason that the victories won in peace and the great variety and attraction of the studies open to the naval officer may, and sometimes do, lead him away from his true pursuit, that we urge the early opening of a school where war, the one subject *par excellence* of the naval profession, may be taught as thoroughly as it can be taught outside of the stern school of the field of battle.

Failing to produce specialists in this one branch, we fail utterly in our whole system of naval education, for all others are but subordinate or accessory.

In the earnest prosecution of what is but a means to an end, the officer is too apt to lose sight of the ultimate object of all. Thus, electricity in its application to torpedoes, chemistry in its application to explosives, metallurgy in relation to ordnance, and steam as a motive power, are only means to the end for which a navy may be said to exist—success in war. The establishment of the proposed school, by opening to officers the higher branches, will serve to correct any misapprehension on this point and dissipate the haze which to a greater or less extent obscures the perception in regard to the true aim of naval education and duties of naval officers.

The war school will, moreover, furnish an admirable opportunity for healthy, intellectual development, and gratify the laudable desire so general among our officers for increased knowledge. While preventing erratic flights into fields of research unrelated to his calling, some of which might unfit him for its stern duties, the school will tend to hold the young officer to those lines of professional thought so eminently calculated to qualify him for his highest and most responsible duties.

That the study of war may well engage all the faculties of the brightest minds and be worthy of a special school is shown by the fact that in the world's history few have been found to whom can be assigned the proud title of master of the art.

SECOND.—OUTLINE OF THE PROPOSED COURSE.

It is assumed that six months will be needed for the work of the war school.

The course may, with propriety, be made to supplement the present instruction in torpedoes at Newport. The two together would cover a period of less than a year.

It is proposed to divide the teaching at the war school under two heads:

- A. The science and art of war.
- B. Law and history.

The course in "war" should include the following subjects:

1. Strategy and tactics.
2. Military campaigns.
3. Joint or opposed military and naval operations, treated from the military standpoint.
4. Disposition and handling of seamen landed for military service.
5. Elements of fortifications and intrenchments.
6. Naval strategy and tactics.
7. Naval campaigns.
8. Joint or opposed military and naval operations, treated from the naval standpoint.

As the principles underlying all hostile movements are at bottom the same, whatever be the nature of the field of action, the Board is of opinion that an intimate knowledge of military operations is essential to the naval strategist, and it suggests that the first five of the above-mentioned subjects would be best taught by one learned in military science.

The course in law and history ought to embrace—

1. International law.
2. Treaties of the United States.
3. Rules of evidence.
4. General naval history.
5. Modern political history.

The first subject is of the utmost importance in its bearing upon the action taken by our naval commanders abroad. In the judgment of the Board the most eminent authority of the day should be engaged to undertake the elucidation of its principles; and, also, to bring out clearly the nature and extent of our treaty obligations.

The third subject, on account of its relation to sound administration of justice and court-martial law, ought to be expounded by a distinguished member of the legal profession.

PRACTICAL EXERCISES.

The North Atlantic squadron affords the nearest approach to be found to a proper course in naval tactics. It should be assembled once a year, and during a stated period go through a series of fleet evolutions, gunnery practice with the latest types of ordnance, the landing of seamen for military operations, boat expeditions, torpedo attack and defense, &c., having the class on board for instruction.

It is to be hoped that at no distant day these exercises may be supplemented by practice with torpedo boats of exceptionally high speed.

In order to carry out the recommendations contained in the introductory portion of this report it will eventually become necessary to provide additional courses, which shall fit officers so desiring for the peculiar work exacted by the increased complexity of certain branches of the profession.

The following table contains the studies, &c., which we think should be completed by those who wish to qualify as specialists in ordnance, torpedoes, and hydrography.

In time it is probable that other courses may be found necessary.

1. *Theory.*

Ordnance.—Higher mathematics, physics, mechanics, chemistry, mechanical drawing.

Torpedoes.—Higher mathematics, physics, mechanics, chemistry, mechanical drawing.

Hydrography.—Higher mathematics, physics, nautical astronomy.

2. *Practice.*

Ordnance (at Washington naval arsenal and experimental battery).—Machinery, metal-working, ordnance, gun-construction, inspection of guns, fuses, small-arms, &c.

Torpedoes (at Torpedo Station).—Electricity in its various professional applications, explosives, torpedoes.

Hydrography.—Sketching, surveying, cartography, use of portable and fixed astronomical instruments.

The Board confines itself to pointing out the lines along which it is probable that these specialties will find their study—development; but it is not prepared to urge the immediate establishment of these courses as essential to the organization of the war school, which, as already shown, is a pressing necessity.

No one should be permitted to engage in these courses who cannot pass a satisfactory examination in those matters, now so well taught at the Naval Academy, and which are to be resumed in the post-graduate course. It is proposed to take the student exactly where Annapolis left him and carry him still further along the path of science under the care of eminent specialists in each branch and to afford him the advantage of the best apparatus and appliances available.

In the absence of material rewards and as an inducement to officers to undertake the serious labor involved in acquiring these specialties, the Board suggests that those who finish the instruction with credit should receive certificates of proficiency, and that a significant letter or other mark should be placed opposite their names in the Navy Register. In this connection, the Board ventures to express a hope that every officer's useful attainments, such as foreign languages, sketching, photography, draughting, surveying, painting, naval architecture, &c., may form a part of his record at the Navy Department, that his fitness for any special work may be known and utilized.

The Board is of the opinion that the facilities of the war school should be denied to officers below the grade of lieutenant, in order that a proper amount of preliminary sea service may be secured.

If these special courses are established, it may be well to allow any officers who desire it, and whose services the Department can spare for the time being, to attend the instruction in one or more of the subjects taught.

Instruction in modern languages, as well as in water colors and photography, is desirable, and would bring its own reward on the one hand in foreign service and on the other in military and naval reconnaissances. The Board believes these subjects may in time be added as optionals with advantage.

THIRD.—LOCATION.

In considering the location of the proposed war school the Board has felt that this important question must be mainly decided by the facilities for the required instruction presented by the various places which have suggested themselves, such as Washington, Annapolis, New York, Newport, and Boston.

It has been thought important that the place should be selected where the Depart-

ment is already in possession of the necessary grounds and buildings. This first condition appears to be satisfied by both Newport and Boston. At the former place, Coaster's Harbor Island would furnish a suitable location. At Boston it is assumed that the necessary accommodation could be had at the navy-yard.

When the more important matter of the facilities furnished by these two cities is considered each is found to have its claims, though they are quite different in character. Newport possesses a site at which the school could be permanently established, and where there is little probability that its welfare would clash with any other interest of the service. The Torpedo Station is already at this place, and it would be possible to so extend its facilities that the instruction in physical science might be given—although this would entail a considerable outlay for buildings, apparatus, &c., as well as a yearly expenditure for instructors. As practical exercises afloat ought to constitute a part of the course at the war school, Newport offers exceptional advantages.

Boston, on the other hand, possesses the facilities of a great university and technical schools, including eminent professors and excellent libraries. If these can be made available in providing the necessary instruction in science, it is thought that the scheme may be put into operation at once and at small expense. The character of the instruction aimed at in the proposed school is of the highest order and would demand the services of the ablest instructors in each department. It is for this vital reason that the Board is of the opinion that to secure such instructors all other considerations should be deemed subordinate.

In the case of the two main branches, the science of war and international law, the instructors should come to the school; while in the courses in science the pupils must go to the instructors, wherever such, together with the necessary laboratories, are to be found. The number of officers to take such science courses would probably not exceed five annually.

The Board therefore recommends that the war school be established at Newport, and that those officers who take these special courses in science avail themselves of the great institutions of learning at Boston.

In looking forward to the complete organization of the school the Board are of the opinion that the recommendation here made is not only practicable but would produce better results than any other plan.

Very respectfully submitted.

S. B. LUCE,
Commodore, U. S. Navy, President of the Board.
W. T. SAMPSON,
Commander, U. S. Navy, Member.
C. F. GOODRICH,
Lieutenant-Commander, U. S. Navy, Member.

ESTABLISHMENT OF NAVAL WAR COLLEGE.

GENERAL ORDER }
No. 325.

NAVY DEPARTMENT,
Washington, October 6, 1884.

A college is hereby established for an advanced course of professional study for naval officers, to be known as the Naval War College. It will be under the general supervision of the Bureau of Navigation. The principal building on Coaster's Harbor Island, Newport, R. I., will be assigned to its use, and is hereby transferred, with the surrounding structures and the grounds immediately adjacent, to the custody and control of the Bureau of Navigation for that purpose.

The college will be under the immediate charge of an officer of the Navy, not below the grade of commander, to be known as the president of the Naval War College. He will be assisted in the performance of his duties by a faculty.

A course of instruction, embracing the higher branches of professional study, will be arranged by a Board, consisting of all the members of the faculty, and including the president, who will be the presiding officer of the Board. The Board will have regular meetings at least once a month, and at such other times as the president may direct, for the transaction of business. The proceedings of the Board will be recorded in a journal.

The course of instruction will be open to all officers above the grade of naval cadet. Commodore S. B. Luce has been assigned to duty as president of the college.

WILLIAM E. CHANDLER,
Secretary of the Navy.

REPORT OF SUPERINTENDENT OF NAVAL OBSERVATORY.

UNITED STATES NAVAL OBSERVATORY,
Washington, October 5, 1885.

SIR: Pursuant to the Bureau's instructions of the 24th ultimo, I have the honor to submit herewith the report of the operations of the Naval Observatory during the past year.

Rear-Admiral S. R. Franklin, U. S. N., continued in the duties of Superintendent until the 31st March of the current year, when he was detached therefrom in order to assume command of the United States naval force on the European station. In the interim from that date until the 1st of June, 1885, Commander A. D. Brown, U. S. N., acted as Superintendent, when, under the orders of the Department, I assumed the duties of the office.

Finding everything pertaining to the organization of the institution, and the methods pursued, in as good working condition as the present means and force admit, no change has been made either in system or detail.

THE 26-INCH EQUATORIAL.

This telescope has continued in charge of Prof. A. Hall, U. S. N., who has been employed in observing the satellites of the large planets and in observation of double stars.

Though in constant use, the instrument, together with its micrometer, driving clock, and other apparatus, remains in good working order, and the dome, 43 feet in diameter, covering it, is now revolved with great ease by means of the 4 horse-power gas-engine which was connected with it in the latter part of 1884. The dome is now turned to any position required in a few minutes, and the work of observing is much facilitated. Mr. George Anderson has charge of the engine, and assists Professor Hall in the management of the dome.

The complete reduction and discussion of the observations made with this instrument have made good progress during the past year. This is due, in a great measure, to the efficient aid rendered by Lieut. W. H. Allen and Ensign J. A. Hoogewerff, U. S. N. These gentlemen have been very diligent in making the necessary computations, and have shown marked aptitude for the work.

The observations of the satellite of Neptune and those of the two outer satellites of Uranus have been discussed, and the masses of these planets deduced. These results have been published in Appendices I and II of the annual volume of the Observatory for the year 1881.

A discussion of all the observations of Iapetus, the outer satellite of Saturn, is now nearly finished, and will be ready for printing in a few weeks.

TRANSIT CIRCLE.

This instrument is in charge of Prof. J. R. Eastman, U. S. N., assisted by Assistant Astronomers Skinner, Winlock, and Paul, and has been employed, as in the last few years, in the observations of: (1) Stars of the

American Ephemeris for the determination of clock and instrumental corrections. (2) The sun, moon, and major and minor planets. (3) Miscellaneous stars, comprising those used as comparison stars in observations of minor planets and comets, and those necessary to complete the observations for the proposed catalogue of stars observed with the transit circle.

Since the last report 5,520 observations have been made. Of these, 90 were of the sun, 70 of the moon, 156 of the major planets, and 64 of the minor planets.

The labor of preparing the copy and reading the proof of the volumes for 1881 and 1882 has taken such a large portion of the time of the observers and computers that the computations for the work of 1883 and 1884 have been greatly delayed. These computations are now progressing as fast as possible with the present force.

THE 9.6-INCH EQUATORIAL.

This instrument remained in charge of Commander W. T. Sampson, U. S. N., with Prof. Edgar Frisby, U. S. N., as assistant, until October 28, 1884. Professor Frisby was placed in charge April 2, 1885.

The work of the instrument has been confined to: (1) Observations of comets, six of which have been systematically observed during the year. These observations have all been reduced to date, and published in various astronomical journals in this country and Europe; elements of Barnard's comets were computed, the first of which were published in the *Astronomische Nachrichten*. (2) Observations of asteroids, principally of such as could not be observed with the transit circle on account of their faintness or their position; thirty-five regular observations of asteroids were made, and twenty-one approximate positions of other asteroids obtained, so that they could readily be observed with the transit circle. (3) Occultations of stars by the moon, whenever practicable. (4) Doubtful observations of stars and asteroids made with other instruments were looked up and decided, this being probably one of the most important uses of the equatorial.

A few observations have been made of the variable star in the nebula of Andromeda, which show that the star is decreasing in brightness. Assistant Astronomer Winlock has made several observations of comets, with drawings of their physical peculiarities and changes of appearance.

THE PRIME VERTICAL INSTRUMENT.

The work of reducing the observations made in 1883-'84 by Lieut. C. G. Bowman and Ensign H. Taylor, U. S. N., for the determination of the constant of aberration, has been pursued. A selection was made of twelve stars of varying right ascension and well determined places, and the results obtained; the reduction of the remaining observations will be proceeded with as rapidly as possible.

In July of last year a communication was received from the president of the International Geodetic Conference, asking the co-operation of this Observatory with the Royal Observatory at Lisbon in the determination of the problem of the change of latitudes, the observations to be taken with the prime vertical instruments of the two observatories. Communication was opened and correspondence is still in progress with the director of the observatory at Lisbon, and preparations have been made to undertake the work here very soon after it is known that it will be begun at Lisbon.

ANNULAR ECLIPSE OF MARCH 16, 1885.

In February last a circular was issued by the Superintendent, giving the names of various points in the path of the annulus of the eclipse of March 16, and the approximate times of the beginning of the annular phase; this was distributed throughout the sections of the country interested, by means of the Pacific Railway companies. The Western Union Telegraph Company also had the courtesy to extend the facilities of their lines for the transmission of the noon signals on the 15th and 16th March as far west as Sacramento and Delta in California. This was successfully done, and all observers had accurate comparisons with the standard clock.

Reports were received from—

Mr. J. Blickensderfer, chief engineer, Union Pacific Railroad.

Mr. Francis D. Jones, Helena, Mont.

Mr. F. Hess, Fort Dodge, Iowa.

Mr. S. N. Griffith, Jamestown, Dak.

Mr. F. T. Taylor, Tacoma, Wash.

Mr. M. Winger, Cleveland, Ohio.

Mr. G. F. Goodhue, Bozeman, Mont.

Mr. William H. Kinnon, Bismarck, Dak.

Mr. W. W. Austin, Richmond, Ind.

Mr. William Hood, chief engineer, Central Pacific Railroad.

Mr. W. S. Palmer, Delta, Cal.

Mr. C. H. Rockwell, Delta, Cal.

Miss E. L. Muerner, Naperville, Ill.

Photographs were received from—

Mr. George L. Heath, Hastings, Mich.

Mr. — Bayne, Grand Rapids, Mich.

Mr. George P. Lovegrove, Lakeview, Oreg.

No unusual phenomena were observed.

Observations of the first contact were made at this Observatory by Professors Hall and Frisby and Assistant Astronomer H. M. Paul. The difference of right ascension of the second limbs of the moon and sun was observed by Lieutenant Bowman on the east transit, and by Assistant Astronomer W. C. Winlock on the west transit.

Ninety-nine photographs of the various stages of the eclipse were taken with the photo-heliographic apparatus of the Transit of Venus Commission by a party consisting of Commander Brown, Ensigns Winterhalter and Taylor, and Mr. W. F. Gardner. The exposures were made and the negatives developed by Ensign Winterhalter; one-half the plates used were coated with gelatine; the other had the Transit of Venus emulsion, being over two years old. A number of these plates have been measured by Ensigns Hogg and Taylor, and the results given to the Superintendent of the Nautical Almanac in accordance with his request.

The data will soon be published.

THE MERIDIAN TRANSIT INSTRUMENT.

Lieut. C. G. Bowman, assisted by Lieut. John Garvin, U. S. N., has remained in charge of this instrument. The work has consisted principally of daily observations and reductions for clock corrections in connection with the time service. Observations for the right ascension of the sun, moon, and major planets were taken until June of the present year, when they were discontinued. The standard clock has continued to perform well. The east transit clock has been much improved

an outer case with a considerable air space which has been built round it. The Kessels clock has during the present month been connected with the east transit chronograph, and as daily comparisons of the time of observation are made with it, it is expected that it will serve as a useful check upon the performance of the other clocks.

Lieut. L. L. Reamey, U. S. N., has been employed during the greater part of the year upon the reduction of the transit observations.

MURAL CIRCLE.

The work laid down in the programme for the mural circle has been transferred to the Repsold meridian circle at the Naval Academy, Annapolis, through the co-operation of Capt. F. M. Ramsay, U. S. N., the superintendent of that institution.

Prof. S. J. Brown, U. S. N., has been engaged in putting the instrument in order and in fitting up the observatory-room for the observations which will soon begin.

CHRONOMETERS AND TIME SERVICE.

This division of the Observatory has continued in charge of Lieut. E. C. Pendleton, U. S. N.

There are at present in the chronometer-room 240 chronometers, of which 21 are ready for issue, 30 are on trial, 57 require repairs, and 132 are condemned, to be used only as backs.

During the year 39 chronometers were issued and 49 were received from naval vessels and stations. Two chronometers that were purchased from M. F. Dent, of London, for use on the Greely relief ships *Bear* and *Thetis*, were received at the Observatory. Forty-five chronometers were sent to be cleaned and repaired, and 20 remain with Messrs. T. S. & J. D. Negus, and Messrs. John Bliss & Co., of New York, and Messrs. William Bond & Son, of Boston.

Two chronometers were loaned by order of the Bureau of Navigation—1 to the Signal Office, 1 to the Department of the Interior—and 2 were condemned.

The Bureau of Navigation having notified the chronometer makers of its intention to purchase 12 new chronometers after competitive trials, the firms of T. S. & J. D. Negus, John Bliss & Co., and William Bond & Son have signified their purpose to send to the Observatory about 40 chronometers. They will be delivered during the month of December. The trials will commence January 1, 1886, and continue for six months. No chronometer will be admitted to competition that is not essentially of American workmanship.

During the past year the demands upon the time service have greatly increased. In Washington, the number of clocks of the Gardner system in the various public offices has increased from 20 to 84. Under the arrangement with the several Departments, the Observatory is held responsible for the condition of these clocks, which, with the exception of those in the Interior Department, are visited weekly, inspected, and wound. The clock circuit being largely composed of overhead wires, is subject to various interruptions and interferences by reason of its situation relative to other wires, and requires constant care and attention. The local batteries in the various buildings also require to be looked after quarterly, and an appropriation has been asked for under the head of maintenance of time service to cover these and other expenses.

In this connection it may not be amiss to add that this clock system

is due to the inventive genius of Mr. W. F. Gardner, the instrument-maker of the Observatory. Mr. Gardner has been at considerable personal expense in perfecting this invention, which is becoming more and more valuable every day, both to the Government and the public, and it is submitted that he should receive due recognition therefor when Congress has an opportunity to look into the matter.

The plant at the Observatory has also been increased by the addition of a second transmitting clock and the purchase of electrical measuring instruments, by which the line can be tested at any time and faults detected. Their value has been shown by the detection of injuries to the Government cable on two occasions, the location of which could not otherwise have been determined. The battery requirements on account of the line have also been largely increased.

The adoption of the system of standard time created a demand for a more correct time than had been the case, and the noon signal from this point became of greater value than when the old system of local times was in vogue. To answer this demand, and also to render such service to the maritime community as they find in other countries, time-balls have been established by the Department at various points along the Atlantic sea-board, and it is intended, if the appropriation be made, to place additional ones at important commercial points. The advantage to the shipping community can hardly be overestimated. The Western Union Telegraph Company has given the use of its wires for the transmission of the necessary signals without charge. The correct time is thus given to the representatives of the Department at Boston, Mass.; Newport, R. I.; navy-yard, New York; Philadelphia, Pa.; navy-yard, Washington; Hampton Roads, Va.; Savannah, Ga.; New Orleans, La.

Three minutes before noon of each day (the busiest time of the twenty-four hours) are given up to these signals, and it is respectfully submitted that proper remuneration should be made to the telegraph company.

The branch observatory at Mare Island, which is fitted with a duplicate of the transmitting apparatus of this Observatory, has been connected with the mainland by a cable laid by the Western Union Company without any charge to the Department, and time signals are transmitted daily along the Pacific coast. A time-ball has been erected on the island for the benefit of the Vallejo shipping, and is dropped daily at noon of the one hundred and twentieth meridian. The Hydrographic Office time-ball at San Francisco is also dropped at the same instant by signal from the Mare Island Observatory.

The balls at Savannah and Hampton Roads are now hoisted daily by volunteer labor. It is respectfully submitted that a reasonable compensation should be paid for this service, which will be done from the time-service appropriation when made.

The growth of Washington has rendered the Observatory time-ball of but little account; hence in May last a proposal was made for its transfer to the central pavilion of the Navy Department. This was duly accomplished by the aid of Chief Engineer H. L. Snyder, U. S. N., the superintendent of State, War, and Navy Departments building, and since the 11th of July the ball has been dropped from the staff at that point. The one at the Observatory has been discontinued.

The total number of time-balls now dropped by this Observatory signal is eight, at the following points:

Philadelphia, Baltimore, New Orleans, at branch hydrographic of

ices; New York, Western Union building; Navy Department, Washington, navy-yard Washington, Hampton Roads, Savannah.

A ninth will soon be added at the torpedo station in Newport.

LIBRARY.

The library was in charge of Lieut. John C. Wilson, U. S. N., until the 30th ultimo, when, owing to ill health, he requested his detachment from the Observatory in order to take a sick leave. He was succeeded in the duties of librarian by Lieut. L. L. Reamey, U. S. N., transferred from the meridian transit instrument.

The library is increasing rapidly in bulk and value, and the lack of storage room and proper accommodations for those consulting its varied volumes becomes more apparent from year to year.

It contains, by actual count, 11,423 volumes; 2,283 pamphlets.

This is somewhat less in number of volumes than has been previously reported, but which is accounted for, in part, from the fact that in some instances paper-covered publications of two volumes when sent to the binder have been bound in one. The accessions to the library during the year have been as follows:

Volumes	441
Pamphlets	366
Total	807

Of these, there were received by exchange	579
By purchase	228

The present list of exchanges contains:

Foreign addresses	436
Domestic addresses	474

The following publications of the Observatory have been received from the Public Printer and distributed:

Programme of work for 1885.

Observations of the Minor Planets, Professor Frisby.

Circular preparatory to Observations of Solar Eclipse March 16, 1885.

Results of Observations of March 16, 1885.

Annual Volume for 1881.

Meteorological Observations, 1881.

Meteorological Observations, 1882.

Appendices I and II, Annual Volume, 1881.

The following communications from the Superintendent have been furnished for publication in the various astronomical journals:

Observations of Comet Wolf (Commander Sampson and Professor Frisby).

Observations of Hyperion (Professor Hall).

Observations of Minor Planets (Professor Frisby).

Observations of Satellites of Saturn and Companion of Sirius (Professor Hall).

Discussion of Proper Motion of Lacaille 16616 (Professor Frisby).

Observations of Comet Barnard (Professor Frisby).

The printing of the annual volumes, which had fallen far behind, has been somewhat advanced owing to the passage by Congress of a concurrent resolution for the publication of the volumes for 1881 and 1882.

The volume for 1881 has been printed and distributed as noted above, and that for 1882 is in the hands of the printer. The volume for 1883

will be ready next spring, and it is earnestly hoped that the additional computers estimated for will be granted, in order that the observations may be reduced and published within a reasonable time after they are made.

On January 1 Professor Eastman was, at his own request, relieved of the charge of the meteorological observations, and that work was transferred to the control of the officer in charge of the library, and the observations have been taken by the watchmen as usual.

PHOTOGRAPHY.

In the programme of work proposed for the current year it was stated that the work of taking sun photographs daily would be inaugurated as soon as practicable. The work of the Transit of Venus Commission has up to this time prevented any regular system being adopted. Such work, if pursued systematically and continuously, would put this institution on a footing in this regard more nearly equal to that of the larger foreign observatories where a large mass of data has been accumulated for future measurement, computation, and discussion, forming the basis of much information of value to the student of solar physics.

For purposes of co-operation in this scientific work, photographic observations in different parts of the world being supplemental to each other, it is also desirable that this work be begun, and sooner or later it will have to be taken up here in order to keep pace with the requirements of modern astronomical research and observation. It cannot, therefore, be begun too soon.

It is eminently desirable that this Observatory possess a collection of photographs of astronomical subjects, and so be enabled to solicit exchanges from astronomers abroad that are engaged in celestial photography. But we lack the means and equipment for printing and making photographic positives that can properly be used for such purposes of exchange.

Much work is desirable to be done in photographing star clusters, nebulae, and the spectra of sun-spots, stars, &c., and in the production of star maps by photography. Should a party from this Observatory be sent to observe the total eclipse of 1886, photographs of the phenomenon will have to be taken. The Observatory should at all times be prepared for such an occasion and have a staff drilled in photographic work, and this might be easily accomplished, as the number need not be great, and it could be made up of officers stationed here.

For all these purposes, and for work of a kindred nature, an estimate of \$1,000 has been submitted, which it is hoped will receive the favorable consideration of Congress.

Through the courtesy of Professor Baird, of the Smithsonian Institution, Ensign Winterhalter has received a course of instruction in photography, and is ready to prosecute work of this character.

NEW OBSERVATORY.

I beg to renew the recommendations of my predecessors for the removal, at an early day, of the plant of the Observatory to the new site selected and purchased for such purpose in 1871.

The plans, long since prepared, have received the approval of eminent scientific men of the country, and the work should be begun as the money is forthcoming.

fully three years to erect the buildings, transfer the plant, and get everything into good working order.

The National Academy has been requested by the Department to express its opinion officially as to the advisability of proceeding promptly with the erection of the building, and it cannot be doubted that it will express itself affirmatively in the matter.

The disadvantages of the present location have been so often and so forcibly described that the subject is worn almost threadbare.

To the foresight and energy of officers of the Navy is due the inception and development of this institution. It is emphatically the child of the Navy, and the service is much interested in its welfare and in every effort to extend the sphere of its usefulness. From its humble beginning in 1838 it has now grown to be one of the most important astronomical centers in the world, and it is to be hoped that Congress will recognize the good work hitherto done by granting the means to place the institution on a still higher plane than it now occupies.

BOARD OF VISITORS.

I also beg to renew the suggestion heretofore made that a board of visitors, composed of competent persons, be appointed annually to visit the institution and inquire into its workings, with authority to suggest such changes in the methods pursued, or such new lines of investigation, as it might deem proper to recommend. Perhaps the best constitution of such a board would be a committee of Congress, acting in conjunction with a number of gentlemen of well-known attainments and authority in the scientific world.

SOLAR ECLIPSE OF 1886.

A total eclipse of the sun will occur on the 29th of August, 1886. The line of totality passes over the equatorial portion of the Atlantic Ocean, and reaches the west coast of Africa near Benguela, in latitude 12° south. This port is easy of access, and as it is the healthy season, there would be no difficulty in sending a party out in a Government vessel. The duration of the totality at this point is four minutes and forty seconds, affording a more than usually good opportunity for photographic and spectroscopic observations. The question as to the propriety of applying for an appropriation to defray the expenses of an observing party has been referred by the Department to the National Academy and a report may soon be expected. Should it be favorable, I beg to recommend that a special application be made to Congress, as the funds ought to be available by February 1, 1886, at the latest.

MISCELLANEOUS.

During the year the names of 1,408 visitors have been recorded, and 1,137 permits were issued for night visitors, for whose accommodation the small equatorial is set apart. The presence of these visitors is not allowed to interfere with the regular work of the institution, and permits are only issued for one evening in each week, with exceptional instances.

The records kept by the several observers and watchmen show that about one night in eight is good for observing, while an exceptional night for astronomical work cannot be reckoned upon much as an once a month.

The status of the assistant astronomers at the Observatory is a very unsatisfactory one. Their duties demand a high degree of scientific ability and long training, and their services grow more and more valuable with increase of time. Nevertheless, not only is there no provision for increase of pay, but their positions have never been assured, but have depended from year to year on the chance of an appropriation. As a consequence, they have generally soon resigned to accept more lucrative positions elsewhere, mostly directorships of observatories, or professorships of astronomy in colleges and universities. Thus this Observatory loses their services when they have become the most valuable. In the twenty-four years that the assistant astronomers have been at this institution, there have been from the corps of three, eleven resignations and only four promotions, and of the latter only one in the last twenty years, facts which speak for themselves. It is respectfully urged that the Observatory should be able to offer sufficient inducements to secure the continued services of its trained assistants; and to that end I beg to recommend that they be recognized by statute as permanent attachés of the institution, with suitable and timely provision for longevity pay. The pay these gentlemen are now receiving is not an adequate compensation for the attainments they bring to their work, nor for the diligent and valuable service they render.

The position and responsibilities of the instrument-maker are of a peculiar and exacting character. Upon him depend the adjustment and the keeping in repair and good working order of all the instruments in use at the Observatory, and it is needless to add that the demands upon his time and attention are constant and unremitting. It is therefore urged that Congress may consider favorably the increase of pay asked for in his case.

In accordance with the recommendations contained in the last report a number of sextants, old and new, have been sent here by the Bureau for examination and report. Ensign A. G. Winterhalter is in charge of this work, and it is to be hoped that the system will not be again abandoned.

TRANSIT OF VENUS, DECEMBER 6, 1882.

The work of reducing the various observations of this transit has been carried on through the year under the immediate supervision of Prof. William Harkness, U. S. N., assisted by Messrs. Joseph A. Rogers, A. S. Flint, and Asaph Hall, jr. The details of this work will be found in the appended report of Professor Harkness.

Some \$30,000 worth of instruments belonging to the Transit of Venus Commission are stored here, and as they will not again be required by the Commission, I recommend that they be turned over to the Observatory for such uses as the Superintendent may judge best.

Very respectfully,

GEO. E. BELKNAP,
Commodore U. S. N., Superintendent.

Capt. J. G. WALKER, U. S. N.,
*Chief of Bureau of Navigation,
Navy Department, Washington, D. C.*

UNITED STATES NAVAL OBSERVATORY,
Washington, October 3, 1885.

SIR: I have the honor to submit the following report of the work done during the past year, under my supervision, for the Transit of Venus Commission.

The assistants engaged upon the work at the beginning of the year were Messrs. A. S. Flint and A. Hall, jr. Very fortunately an opportunity presented itself last winter of temporarily securing the services of Mr. Joseph A. Rogers to finish the photographic investigations which he left incomplete when he resigned on March 1, 1883. He was re-employed on December 16, 1884. Mr. Hall resigned his position on September 15, 1885, to accept a place in the observatory of Yale College. His loss is a matter of regret to the Commission, especially at this time, when the computations upon which he was engaged are nearing completion. Messrs Rogers and Flint are still in the employ of the Commission.

At the date of my last annual report experiments were in progress to determine whether or not the heliostat mirrors undergo any change of curvature when exposed to the sun's rays. As that question is of vital importance in the theory of the horizontal photo-heliograph, it was thought desirable to make the experiments both in the heat of summer and in the cold of winter. The work was done principally by Messrs. Flint and Hall, and was completed on February 23, 1885. Owing to press of other matters the discussion of the results has not yet been undertaken.

Mr. Rogers is now engaged in writing an account both of the processes employed in preparing and developing the dry collodion emulsion plates used with the photo-heliographs in observing the transit of Venus in December, 1882, and of the experiments which were executed to determine the best method of making pyroxyline for that purpose. Whenever photographs are required which must sustain the test of accurate measurement, the collodion emulsion process offers advantages so great that every effort should be put forth to increase its general availability. Some of our recent experiments incidentally tend in that direction, and although primarily made to clear up obscure points relating to the transit of Venus work, it is hoped they will facilitate the application of collodion emulsion in future operations requiring the use of photo-heliographs. In these experiments pyroxyline has been made from flax, jute, etc., as well as from cotton, which is the form of cellulose commonly preferred.

It will be remembered that wet bromo-iodide plates, made by the bath process, were used with the photo-heliographs in observing the transit of Venus in December, 1874, and the question naturally arises whether or not the negatives then obtained are strictly comparable with those made upon dry collodion emulsion during the transit of December, 1882. For the definitive settlement of that point recourse was had to photographs of the solar spectrum. In June, 1881, a set of such photographs was made upon wet bromo-iodide bath plates of the kind used in December, 1874, and similar sets are now being made with emulsions as nearly as possible in the same condition with respect to age, etc., as those actually employed in observing the transit of December, 1882. In order to show clearly the progressive action of the solar rays upon the silver salts, each set begins with the shortest exposure capable of producing an easily legible impression, and extends to exposures two or three hundred times as great. The negatives have not yet been subjected to critical examination, but the general result seems to be that,

while marked differences exist in the action of the spectrum upon the two classes of plates with the exposures given in the photo-heliographs, the effective rays are of substantially the same wave-length in both. The transit plates of 1874 and 1882 are therefore quite comparable in this respect, and there is no reason to apprehend systematic differences between them depending upon atmospheric dispersion. The spectrum photographs have also established the fact that the emulsion plates have a degree of sensitiveness not very different from that of bath wet plates.

Since the end of February, 1885, Messrs. Flint and Hall have been engaged pretty steadily in reducing the observations for time and latitude made at the various United States stations in December, 1882. These computations are now nearly completed, and to a considerable extent prepared for printing. It is expected that they will form Part III of the Transit of Venus Reports. No progress has been made in the reduction of the photographs during the current year, and it is not proposed to take them up again until after all the manuscript relating to time, latitude, and longitude has been prepared for the printer.

The work of printing Part II of the Transit of Venus Reports has recently been resumed, and will probably be completed at an early date. This part will form a volume of about five hundred quarto pages, and will contain the records of all observations made at the United States stations for observing the transit of 1874, together with the corresponding reductions and discussions, excepting only those relating to the photographs.

Very respectfully, &c.,

WM. HARKNESS,
*Professor of Mathematics, U. S. Navy, of Executive
Committee, U. S. Transit of Venus Commission.*

Prof. ASAPH HALL, U. S. N.,
President of Transit of Venus Commission.

Respectfully forwarded to the Superintendent of the Naval Observatory.

ASAPH HALL,
*Professor of Mathematics, U. S. N.,
President of Transit of Venus Commission.*

UNITED STATES NAVAL OBSERVATORY,
Washington, September 18, 1885.

SIR: No appropriation having yet been made for the erection of a new Naval Observatory upon the site purchased therefor under the act approved February 4, 1880, I have the honor to renew the estimate which was submitted by my predecessors in 1882, 1883, and 1884, and beg to request that it may be again submitted to Congress with the approval of the Department.

In anticipation of removal to the new site no money of any moment has been expended at the present location for repairs and improvements for several years. As a consequence thereof the buildings and appurtenances are fast getting into a dilapidated condition, hardly creditable to a national institution of such prominence and character; and unless Congress, in its wisdom, see fit to grant the money, or a part of it submitted in the estimate for the proposed new structures, then it is urged that a reasonable sum be appropriated for the purpose of improving the condition of things here at the old point.

The sum required for the new Observatory (\$586,138) is intended to cover all expenses of putting the establishment, on its removal, in perfect working condition in every way. It includes the erection of the Observatory buildings proper, quarters for the Superintendent, the observers, and others whose attendance is necessary at all times, especially during the night; the removal and remounting of the instruments, construction of roads, grading and fencing, and other details of like character.

Plans for the proposed building were prepared in 1881, under the supervision of the then Superintendent, the late Rear-Admiral John Rodgers, U. S. N. After completion they were submitted to some of the leading scientists of the country for examination, and, receiving their approval, were adopted by the Commission authorized by Congress to take cognizance of the matter. They are believed to be, in the main, all that is desirable.

The present location is unhealthy in the extreme, and those who are called upon for night service suffer more or less from malaria a good part of the time. Fogs, also, gathering over the Potomac at certain seasons of the year, frequently obstruct the observers, and many desired opportunities for astronomical work are lost in consequence. On the other hand, the terrene surroundings and influences and atmospheric conditions at the new site are very salubrious and favorable, and it is to be hoped that Congress will give such facts careful consideration when the estimate in question is laid before it.

I also submit, in connection with this subject, a communication from the late Supervising Architect of the Treasury to the Committee on Appropriations of the House of Representatives in 1882.

Very respectfully,

GEO. E. BELKNAP,
Commodore, U. S. N., Superintendent.

Capt. J. G. WALKER, U. S. N.,
Chief of Bureau of Navigation, Navy Department.

TREASURY DEPARTMENT,
OFFICE OF THE SUPERVISING ARCHITECT,
April 22, 1882.

SIR: In compliance with the request of your committee, conveyed by letter of the 12th instant, I have examined the plans and specifications for the proposed building for the Naval Observatory.

The present buildings are old and dilapidated, and the interests of the public service require that the new building should be erected as speedily as possible.

I estimate that the lowest amount that would reasonably serve for the first year's work would be about one-half of the amount proposed to be appropriated, say, \$275,000.

I think, however, the Government interests would best be served by an appropriation of the entire amount estimated for the work.

Very respectfully,

J. G. HILL,
Supervising Architect.

Hon. FRANK HISCOCK,
*Chairman Committee on Appropriations,
House of Representatives.*

REPORT OF SUPERINTENDENT NAUTICAL ALMANAC.

**NAUTICAL ALMANAC OFFICE, NAVY DEPARTMENT,
Washington, D. C., October 10, 1885.**

SIR: I have the honor to submit the following report of the work of this Office during the past year:

The American Nautical Almanac for the year 1888 was issued from the press in February, 1885, and the large-Ephemeris for the same year in May, 1885.

The Atlantic Coaster's Nautical Almanac for the year 1886 is now in press, and is expected to be ready by the middle of the present month. The Pacific Coaster's Nautical Almanac for the year 1885 was issued in December, 1884, and the corresponding publication for 1886 was issued during the last month.

Of the Almanac and Ephemeris for the year 1889, 284 pages are in type. This includes the whole of the American Nautical Almanac for that year, except the maps and introductory pages.

The computations for subsequent years make their regular progress. Those for the year 1889 are nearly complete, and those for 1890 and 1891 are in course of execution.

SALE AND DISTRIBUTION.

During the fiscal year 1885 the sale and distribution of publications was as shown in the following table:

Publications.	Sold.	Distrib- uted.
American Ephemeris.....	470	85
American Nautical Almanac.....	1,647	3
Atlantic Coaster's Nautical Almanac.....	908	15
Pacific Coaster's Nautical Almanac.....	225	None

In the year 1882 copies of Volume I of the Astronomical Papers were sent to Gauthiers Villars, Paris, and William Engelmann, Leipsic, for sale by them as agents on the same terms as the sales of publication in this country. Mr. Engelmann has recently reported ten copies sold, but no returns have been received from the Paris agent.

METHODS OF SELLING ALMANACS TO NAVIGATORS.

In connection with the work of this Office the subject which most requires the attention of the Department is the method of supplying navigators with nautical publications. On the plan now in operation each office which prepares and issues the publications is also charged with their sale, which is effected through agencies in the principal sea-port of the Union. In the case of this Office, the labor of keeping the multiplicity of accounts and carrying on the voluminous correspondence

thus arising is disproportionate to the amount realized from sales. As the various offices sell their publications through nearly the same agencies and, it is believed, on the same terms, economy and efficiency would be promoted by conducting all this business through a single agency.

I therefore beg leave to suggest to the Bureau the advisability of establishing an office or depot in the city of New York for the sale of all the nautical publications of the Navy Department, hoping that other Departments selling such publications would join in the system. Were such a depot established all publications designed for sale would be immediately dispatched to it, and the individual offices would be called on to respond only to requisitions from the depot.

THE COASTER'S NAUTICAL ALMANACS.

In my annual report of 1883 I set forth the evil rising from the multiplicity of nautical almanacs compiled from the Government publications and issued by dealers, not so much to make a profit on the sale as to advertise their business. Correspondence with the leading dealers showed, with a single exception, a willingness on the part of each to give up his own nautical almanac and accept a similar publication by the Government, provided all the other dealers would adopt the same course. The firm of John Bliss & Co., of New York, was the only one that objected to the proposed policy. As their objections did not seem strong enough to justify a change in the general policy of the Government during the past fifteen years of furnishing American navigators with all the nautical publications necessary for their use, the Coaster's Almanac was issued as an experiment in March, 1884. It was received with such strong expressions of favor and such assurance of large sales in every direction that no doubt was entertained of its coming into universal use. The hope that such would be the case has not, however, been verified, the principal reason being that the lack of unanimity among the dealers has resulted in a continuance of their almanacs, which are now sold at a nominal price, or issued gratuitously for advertising purposes.

ASTRONOMICAL RESEARCHES.

On assuming charge of this Office, in the year 1877, one of the first features of the work which struck the Superintendent was the fragmentary character of the astronomical tables used in preparing the Ephemeris. The only modern tables in use abroad were those of Le Verrier, and these were so far from meeting the present requirements of exact astronomy that it was deemed best to undertake the construction of new ones, which should correspond in every respect to the present refinements of astronomical observations. The results first necessary are accurate determinations of the elements and masses of the eight large planets. These require the re-reduction of the planetary observations made in the principal observatories of the world since 1750, and their comparison with Le Verrier's tables. This work at first went on very slowly, the means for prosecuting it being gained rather by economizing in other office expenses than by asking for larger appropriations.

This work has now reached a point at which its end can be foreseen. With the present appropriations the necessary computations may be completed in about four or five years. The results will, it is hoped, serve all the purposes of astronomy until at least the middle of the coming

century, and perhaps until its close. They will also enable a large and permanent reduction in the cost of preparing the ephemeris to be made.

The investigations required for this work are published in a series under the title of *Astronomical Papers of the American Ephemeris*. The first volume of these papers was completed in the year 1883, and Volumes II and III are now being issued in parts as different publications are ready. Two parts have been stereotyped since my last annual report, namely :

Volume II, Part III, *Measurements of the Velocity of Light*, by the Superintendent and Professor Michelson.

Volume III, Part IV, *On the Inequalities in the Moon's Motion* computed by Mr. Neison, by George W. Hill, assistant, *Nautical Almanac*.

The stereotyping of both these parts was completed some months since, but, through some unexplained delay in the Government Printing Office, neither has yet been issued.

In the yet unpublished computations progress has been made as follows :

Theory of Jupiter and Saturn.—Mr. Hill's work on the perturbations of these two planets was completed during the past summer. I have reason to believe that its value and durability will be more than proportional to the labor spent upon it.

Mass of Jupiter.—The work of computing the perturbations of Polyhymnia by Jupiter and the other planets, the commencement of which was reported last year, has been carried from the discovery of the asteroid in 1854 up to the opposition of 1888. It was carried so far forward because of the very near approach of the asteroid to Jupiter in 1885, the effect of which will be measured by observations when the planet reaches its perihelion in May, 1888. The work was done so far in advance because an opportunity was found for having it executed by a remarkably skilled mathematician, Prof. G. C. Comstock.

General perturbations of the four inner planets.—This work is being carried on in duplicate by Messrs. Prentiss and Corrigan, but owing to the unexpected labor encountered in certain operations of it, it is still incomplete.

Comparisons with observations.—The re-reduction of Maskelyne's Greenwich observations, from 1765 to 1811, has been prosecuted during the year, and is approaching completion. An ephemeris of the sun from 1765 to 1864 is also approaching completion, it being found more economical to compute a complete ephemeris than to determine the number by piece-meal for the separate observations. Preparations are being made for going on with the tabular computations upon Mercury, Venus, and Mars for the same period, a work which was interrupted in order to finish the solar ephemeris. This is now the heaviest part of the whole work which remains to be done.

Very respectfully, your obedient servant,

SIMON NEWCOMB,

Superintendent Nautical Almanac Office.

Commodore J. G. WALKER, U. S. N.,

Chief of Bureau of Navigation, Navy Department.

REPORT OF HYDROGRAPHER.

UNITED STATES HYDROGRAPHIC OFFICE,
BUREAU OF NAVIGATION, NAVY DEPARTMENT,
Washington, D. C., October 1, 1885.

SIR: I have the honor to submit the following account of the operations of this Office for the fiscal year ending June 30, 1885:

As this is the only establishment on this continent where charts of foreign waters are made, I have thought it appropriate also to make further recommendations as to its development and usefulness, so that it may be put on a footing commensurate with its importance.

In order to give a more comprehensive idea of the work performed, the different divisions of the office are referred to separately, while the detailed statement of the head of each division will be found in the appendix.

DIVISION OF CHART CONSTRUCTION.

This Division, described in the last annual report as the Drafting and Engraving Division, was moved in July to a small building on the corner of New York avenue and Seventeenth street. The Division of Plates and Printing was also transferred to the same building, to be consolidated later on with the first named, the two constituting what is now known as the Division of Chart Construction. The building now occupied is entirely unfitted for the purpose. Draftsmen and engravers should be surrounded by the most favorable conditions of light, ventilation, dryness of atmosphere and apparel, and freedom from vibration. The building in question has none of these qualifications, and is consequently a serious drawback to the execution of good work. A great deal of time is necessarily wasted in passing to and from this Division and the main Office, where the plates are stored, and the wear and tear on the plates that have to be transported back and forth is considerable. This separation of parts of the office which are so dependent upon each other has been a great disadvantage.

A new press has been added, which has greatly facilitated the operations of printing, and enabled the Office to fill orders which had been accumulating for some time.

Under the active supervision of an officer detailed for the purpose, everything that pertains to the printing of charts shows a very marked improvement on the work of previous years.

A great deal of time has been devoted to preparing plates for electrotyping and in removing defects resulting therefrom.

The process of electrotyping the copper plates has been continued, sixty-six altos and fifty-one basses having been completed.

This office should not be dependent on outside parties for this process, which is so necessary for the preservation of the plates. The cost of transportation to and from the electrotyping establishment in New York is large, and the risk of damage is very great to expensive plates. This may be avoided by having the proper apparatus in this Division. The process, taking into consideration the first outlay, would be than under the present system.

Much of the energy of this Division has been devoted to the correction of charts, and during the year nearly every plate in the Office has undergone alteration.

A series of great circle charts covering the navigable waters of the globe has been devised by Mr. G. Herrle, chief draftsman. The computations are all finished, and one of the plates, in the hands of the engraver, is well advanced. It is thought that these charts will be of great advantage to seamen taking long voyages, as the methods required for their use are of the simplest description.

A great circle protractor for the solution of problems in nautical astronomy, designed by Commander Sigsbee, U. S. Navy, is nearly engraved. A thorough investigation into the subject of geographical positions has been carried on, and the record resulting has been of great service in the compilation of new charts. This is now the Hydrographic Office standard for all determinations of latitude and longitude. A similar investigation into the subject of magnetic variation has been made for a like purpose with very important results.

The changes in the method referred to in the last annual report were made in the early part of the year and have been productive of the best results. Under the old system nearly the whole force was employed in the correction of old charts, latterly 75 per cent. of the energy of the Division has been available for the production of new ones. The detailed account of these new methods will be found interesting.

A complete history of the charts already in existence at the beginning of the year has been practically finished, and this record is now kept correct.

Special attention has been paid to the improvement of chart-making in the endeavor to keep this science abreast of the march of progress.

For such portions as can be subjected to rule, standards have been devised and adopted in order to have as little diversity as possible in the construction of different charts. Shore-lines have been made more conspicuous and the topography drawn with special reference to its value as an aid to navigation. In this connection an investigation has been made into all the methods of delineating irregularities of the surface of the earth, and, as a result, it has been decided to use contour lines for hills, with roulette shading on all large scale charts. Rules have been established with regard to lettering, the object being to secure uniformity and remove from that portion of the chart used by the navigator all unnecessary matter.

The change proposed in the compass has been made, and charts embodying the degree graduations on a true compass have been submitted to the maritime bodies of the sea-board cities through the Branch Offices, and to as many sea-faring men as possible with the almost universal verdict in its favor.

Many other changes have been made which are the result of careful study of the science of chart-making and a proper comprehension of the needs of seamen. For the detailed account of these changes, as well as of the various operations of this Division, I call special attention to the very comprehensive report of the officer in charge, to whose zeal and intelligence these improvements are largely due.

DIVISION OF SUPPLY.

This Division being the depository for the charts published by this Office, as well as for those received from the Coast and Geodetic Survey to be issued to our vessels, and being the real depot where the agents'

orders for charts are filled, its name was changed from Chart Division, as given in my report of last year, to Division of Supply.

The labor of keeping the stock of engraved charts corrected by hand for the small errors which are constantly reported has engrossed the energies of the force employed in this Division. This has interfered with the work of comparing old photolithographs on hand with later editions of charts of the same localities issued by other nations, and consequently the number of canceled lithographs is less than was anticipated. The increased number supplied to ships of war is due to the unusual number of engraved charts published during the year, while the greater number supplied to agents is a most gratifying proof of the growing estimation in which our charts are held by the merchant marine. The total number of copies issued, 24,725, though apparently less than that of the preceding year, 26,179, is accounted for by the fact that the outfits for the Branch Offices were comprised in the latter number. The increase in the number of copies issued to merchant vessels carrying meteorological journals is satisfactory evidence of the greater interest on the part of merchant captains in the meteorological work of the Office, each new observer being furnished with a set of general sailing charts. This also affords further proof of the growth of the popularity of our publications.

A set of index charts was designed in this Division during the year, and the investigation into the authenticity of reported dangers has been continued.

DIVISION OF ISSUE.

The duty of issuing to all United States vessels which receive charts from this Office, having been assigned to the Admiralty Chart Division, its name was changed to Division of Issue. As the publications of the British Admiralty form the greatest portion of the chart outfits of ships of war, it was thought best to hold this Division responsible not only for the original supply, but also for its continuance during remainder of commission.

This work, which requires the most constant attention, owing to its great importance, has been exceedingly well performed. The labor of keeping a record of the charts on board ship has been greatly facilitated by the new chart lists referred to in the last annual report, in the paragraph concerning the Admiralty Chart Division.

These catalogues have been completed and issued to all ships in commission. Navigators everywhere have received them most favorably, and they have proved of great assistance in the handling and keeping account of the chart outfit under the various conditions incident to ships in active service.

The examination of the old stock of British Admiralty Charts has been completed and those now on the shelves are of the latest editions. The number of copies has been reduced to the lowest limit considered advisable in view of any contingencies which might arise. The practice of ordering the latest edition of publications from London direct to ships of war has been continued throughout the year with most satisfactory results.

DIVISION OF BOOKS.

The work of cataloguing and arranging the books and pamphlets in order that they may be most available for the purposes of the office has been commenced. It is intended to brief the contents of all publications relating to hydrography. These abstracts, arranged alphabeti-

cally, will give references to data concerning the particular subject under discussion.

The number of books of reference has been increased, and lists have been prepared to show what books are still needed in order to make this collection more valuable. The appearance of new editions of sailing directions has been carefully noted, and the same system of ordering direct to the ships from London that is practiced by the Division of Issue has been adopted.

Of the ninety-nine different books of sailing directions issued to our ships, fifty-eight are English publications; the suggestion of the head of this Division, therefore, is most pertinent, that the Hydrographic Office should prepare a complete set of sailing directions for all parts of the globe in order to be independent of foreign publications.

In addition to other duties, the force of this Division has been engaged in compiling a supplement to the "Newfoundland and Labrador Pilot" and in comparing the different publications issued by the Office in order to prevent unnecessary repetition. It has been found that the same matter frequently appears in different books, and in order to lighten the labors of the navigator and to economize his space it is the intention to consolidate and, if possible, avoid duplication.

Particular attention is called to the report of the head of this Division, whose suggestions I most heartily indorse.

DIVISION OF NOTICES.

The acquisition of a cylinder press in the printing room attached to the Navy Department has greatly facilitated the issue of Notices to Mariners. In order to make these useful publications compare favorably in appearance with those of a similar nature issued by foreign governments, and at the same time to lessen the expense of postage, they have been printed upon a very fine and light quality of paper.

The demand for these Notices has steadily increased, and their distribution has been the means of obtaining for the Office an increased amount of information from the merchant marine.

To extend their usefulness still further it was thought advisable to issue a weekly edition, which is kept on file in all the United States consulates and in the offices of the principal English-speaking shipping merchants in all the seaboard cities of the world.

This edition has an alphabetical index of its contents on the first page, so that a shipmaster bound to any portion of the world can tell at a glance whether it contains matter of especial interest to him.

A large number of foreign notices to mariners has been received and all new information has been translated and published.

In accordance with the policy of the office the six volumes of light-lists, including all the light-houses of the world, were revised by the officer in charge of them, with commendable promptness and accuracy, and were ready for publication *and sent to the printer* before the first of July. With the valuable assistance of the officials of the Government Printing Office these were printed immediately and distributed to the agents and ships of war.

The files of foreign charts have been completed so that the office is now in possession of a most valuable collection of original charts issued by other governments, by means of which the examination of all matters pertaining to this branch of hydrography is greatly facilitated.

The securing and classification of original papers relating to surveys and to matters pertaining to hydrography in general, outside of books

nd pamphlets, has been carried on throughout the year, and at the same time a card catalogue has been completed which greatly simplifies the finding of desired documents.

DIVISION OF METEOROLOGY.

Owing to the small force of officers assigned to this Division it has been impossible to continue the publication of meteorological charts covering the South Atlantic and Indian Oceans. The demand for the North Atlantic meteorological charts mentioned in the annual report of last year has increased, and the recommendation of the officer in charge of this Division that the series for the South Atlantic should be prepared at once meets with my hearty approval. With the assistance of a few additional officers, this valuable publication could be got ready in a few months.

The preparation of the Monthly Pilot Chart of the North Atlantic has absorbed most of the attention of this Division, and the demand for it has increased in a very satisfactory degree. The effort to make it useful has been thoroughly appreciated by all seafaring men, and the support and assistance received from this class have been very considerable. The maritime papers and meteorological periodicals have referred to it constantly in flattering terms, and where accidents have occurred, through carelessness in going into the floating ice region, this chart has been quoted to show how such disasters could have been avoided.

The collection of data relative to trade-wind and fog limits, location of water-spouts, to the use of oil for calming the seas during gales of wind, and many other phenomena of interest and value to seamen has been continued assiduously. It is proposed to enlarge this chart so as to admit of certain changes which experience suggests, and to give more space for the reports received from the merchant marine.

A more detailed statement of the work of this division will be found in the appendix.

BRANCH OFFICES.

These useful adjuncts have continued to be of great assistance, not only to the main office, but also to the maritime communities in which they are located. The officers attached to them have been called upon to determine all kinds of nautical questions, and their influence in many instances has been most favorable. The routine established for them last year has been adhered to generally, although their increased efficiency and popularity have rendered some slight changes necessary.

The increase in the demand for charts has been partly due to the Branch Offices, while, to them, the greater number of notices to mariners and monthly pilot charts distributed can be almost entirely ascribed. Their principal function, however, is the collection of data, and the dissemination of useful information of all kinds to the merchant marine. The amount of work done in boarding vessels, correcting charts, adjusting barometers, etc., will be found detailed in the appendix.

The following comparison is made with a portion of the work of last year :

	1883-'84.	1884-'85.
Vessels boarded	4, 256	11, 750
Number of individuals to whom nautical information was given, not included in the preceding	2, 286	10, 870
Barometers corrected or compared	2, 062	5, 343

Fifteen thousand six hundred and fifty three Pilot Charts and 16,837 Notices to Mariners have been distributed during the year. It must be conceded that this is a very thorough demonstration of the usefulness of these offices. Without them it is fair to suppose that most of the seamen who have received information would have done without it, and consequently run greater risks. The collection of nautical information and its consequent dissemination from an authentic source must go a great ways toward decreasing the dangers of navigation, while it promotes the education of seamen and elevates the dignity of their profession.

The offices at Philadelphia, Baltimore, New Orleans, and San Francisco have increased their sphere of usefulness by controlling time-balls erected by the Hydrographic Office. On the maritime exchanges of those cities the first three receive their time directly from the National Observatory at Washington, while the last gets the time from the branch observatory recently established at Mare Island. These alone have been of great assistance to seamen in rating chronometers. The Branch Offices are invaluable, and should be maintained on a liberal footing.

GENERAL RECOMMENDATIONS.

In order to carry on the constantly expanding work of the Office with most economy to the Government, its various divisions, with one exception, should be in the same building. Owing to the disagreeable odor arising from the benzine used in printing, this sub-division of Chart Construction should not be placed in the same building with other work, but should be close to it and ventilated in such a manner that it may not be a public nuisance.

The working of the heavy presses jars the building in which they are placed so that at times it is impossible for engravers to work. As the copper plates are constantly required by the engravers, and must be stored in some safe place, and as any transportation is sure to scratch them more or less, it will be seen that the printing should be done in a specially constructed building very close to the main building. The latter should be designed with special reference to light, ventilation, and freedom from vibration in order that the best results may be obtained from the draftsmen and engravers. It should be sufficiently large to contain the whole working force and material of the Office, so that little time need be wasted in going between rooms where different documents are kept for reference.

It is recommended that Congress be asked to make an appropriation for a building which will be suitable for the needs of the Office.

In regard to the policy which should regulate the construction of charts, a careful study has demonstrated that the following should prevail:

In general the function of this Office should be the production of cheap and accurate charts, made especially with reference to the wants of a majority of the people who use them, and these should be taken up in the following order:

(1) The publication of the results of original surveys made by American officers.

(2) The republication in whole or in part, on a scale to be determined by the Office, of foreign surveys not republished by the British Admiralty, and which will be of service to American commerce. This republication should not be confined necessarily to the limits of the originals, but

would serve only as data from which to construct new charts suited to the needs of American navigators.

(3) New charts should be compiled from those of the British Admiralty, which are always good repositories of data. These should have proportions, scales, and a general comprehensiveness of detail suited to the peculiar needs of American commerce of which it is the province of this office to keep informed.

(4) By adhering closely to the policy suggested in the preceding paragraphs the time will arrive shortly when the final effort should be made to become wholly independent.

To be ready for any emergency, it will then be advisable to fill out all series, even though some localities not frequented by Americans may be covered. The Government will thus possess a set of charts covering the navigable waters of the globe. In furtherance of this plan, sets of charts for the West Indies, the north coast of South America, and the vicinity of Newfoundland have been outlined and are well advanced, and enough money should be asked of Congress to complete them immediately. The only work which should take precedence of this is that performed by the Ranger on the west coast of Central America during the last season.

It must be borne in mind that it is for the interest of the maritime communities, entirely independent of such a contingency as war, that this Government should possess the means of producing correct charts at all times. The navigators of the Navy are practically dependent to-day on Admiralty charts, which form 85% of the chart outfit of a ship of war cruising on the European station, 70% on the Asiatic, 30% on the Pacific, 40% on the South Atlantic, and even 25% on the North Atlantic or home station. These numbers do not represent the large proportion of foreign charts used by the merchant marine, as the vessels of the Navy are obliged to take many publications which the merchant vessels do not need. If these foreign charts were always the best, the question would present no difficulty from a commercial point of view, but owing to the changes which are being constantly made, it is impossible for agents in this country to keep a supply of the latest editions of charts made in England. As a matter of fact, the agent buys his supply, and, except in special cases, keeps it on his shelves until sold, no matter how many new editions may have appeared in the mean time. It is of frequent occurrence also that a chart needed cannot be found in this country, and the owners must take the risk of sending their vessel without or wait until one can be sent from England. As a consequence captains go to sea constantly from American ports without a proper supply, or with charts which have been condemned in England, and which, in many cases, expose them to most serious risks. It is obvious, then, that the Government should possess a complete set of copper plates and be prepared at all times to furnish the maritime community with the most accurate charts at short notice.

In the contingency of war, which would interfere with our supply, the copies of Admiralty charts always kept in this office would serve as models for photolithographs, which could be used in an emergency, but which would speedily become valueless as the number of corrections increase. Each copy of photolithographs has to be corrected by hand, while with engraved charts the plate from which the copies are taken is corrected. The Government is in no position to supply the deficiency, as the making of copper-plate engravings is a slow process.

All other nations of any importance are entirely independent in this respect. In view of any possible contingencies, it is recommended that

a set of charts connecting Lake Ontario with the ocean should be made at once. A plan for their construction has been elaborated in this Office, and in view of the fact that our only source of supply is the British Admiralty, it is very important that Congress be asked to make a special appropriation for this purpose.

The recommendations of previous years in regard to new surveys of the north coast of South America are of more force than ever, as will be seen in the report of the head of the Division of Chart Construction.

The attempt has been made to compile a set of new charts of the coast from Panama to Cayenne, and the result has been most unsatisfactory. About all that is known accurately is that existing charts are wrong. The *Thetis* should be sent there this winter to make a thorough survey, commencing at Aspinwall and working east.

The existence of the numerous reported dangers in the North Pacific should be determined at once by deep-sea soundings, and in this connection I wish to reiterate my recommendations of last year that every vessel of the Navy be provided with a deep-sea sounding apparatus and be required to sound at distances of at least 20 miles when there is no urgent necessity for a quick passage. Little time is necessary to take soundings in great depths, and an examination of any locality where a danger is supposed to exist can be very quickly made.

More data is necessary in regard to ocean temperatures. A ship should be fitted out expressly to make proper investigations into this subject and thus aid in the solution of the problem of ocean currents. Such a vessel could also carry on experiments to determine the laws of wave motion, which would be of great importance to the naval architect.

It gives me great satisfaction to state to the Bureau that I have received the most gratifying assistance and support from all the officers and employes attached to this Office. The interest taken in its reorganization and the cheerful performance of such a variety of duties as the necessities of the Office have often demanded, have been most noticeable.

The thanks of the Office are due particularly to the Department of State, the Coast and Geodetic Survey, the Light-House Board, the Government Printing Office, and to all foreign hydrographic offices and marine boards. Special thanks are also due to the different maritime bodies and the press of our seaboard cities.

Respectfully,

J. R. BARTLETT,
Commander U. S. N., and Hydrographer.

HYDROGRAPHIC OFFICE, UNITED STATES NAVY,
BUREAU OF NAVIGATION, NAVY DEPARTMENT,
Washington, D. C., September 29, 1885.

SIR: In obedience to the order of the Department for a statement in accordance with section 3664 of the Revised Statutes, to accompany the estimates of the Hydrographic Office, for contingent and miscellaneous expenses, showing the necessity or importance of an increase of \$24,600 over the sum appropriated for that purpose for the current fiscal year, I have the honor to submit as follows:

The necessities of the Office as now reorganized, with its branches in the maritime cities, and a decided policy chosen, that of advancing the

maritime interests of the country, require that the estimates should be increased from those of last fiscal year.

The purchase of charts and sailing directions furnished to our ships of war is a large item of expense to this Office, if the vessels are kept supplied as at present with only the latest editions; for the coming fiscal year at least \$7,000 will be needed in anticipation of fitting out additional vessels. The expense incurred during the last fiscal year was \$3,500.

The electrotyping of the engraved copper plates belonging to the Office should be continued in order to save them. About one-fifth of the plates have now been electrotyped, but under the present appropriation the work must be deferred. At least \$5,000 will be needed for this purpose.

For continuing the series of charts of the West Indies and around South America, \$10,000. The balance of the increase is for the various purposes named in the estimates, all of which require a larger amount if the Office is to be kept at its present standard.

The estimate for the Branch Offices has been increased by \$2,000. Up to the present time an enlisted man has been at each office; but these having been taken away, it will be necessary to employ an assistant messenger at \$720 for each of the six offices.

Additional quarters should be rented for the printing and engraving, and the estimate is therefore increased \$300.

In 1874 the appropriation for this Office was \$109,800; for the present year it is \$74,040. The work of the Office is steadily expanding, and appropriations should be made commensurate with its work and usefulness.

The necessities and sphere of this Office are given in detail in my annual report to the Bureau.

The estimate for the civil establishment of the Office has been increased from two clerks of class two and one clerk of class one, to one clerk of class four, one of class three, one of class two, and one of class one, an increase of one clerk of class four, and \$200 for one clerk from class two to class three.

This clerical force will only be commensurate with the work actually necessary to be performed. The correspondence with foreign offices, consuls, the commanders of our ships of war, and the merchant marine, the branch offices, merchants, and those interested in nautical matters; with the agents for the sale of charts, and keeping the accounts of the same, has increased, and with the present force cannot be properly done.

The present force of engravers should be increased by two additional, in order that as much work as possible should be done in the Office under immediate supervision.

The drafting, engraving, and printing of the Office is now performed in a rented building, but there is no watchman allowed to care for it out of office hours. It contains very valuable property, and a watchman should be allowed.

Very respectfully,

J. R. BARTLETT,
Commander, U. S. N., and Hydrographer.

Commodore J. G. WALKER, U. S. N.,
Chief of the Bureau of Navigation.

DIVISION OF CHART CONSTRUCTION,
Hydrographic Office, July 1, 1885.

SIR: I have the honor to submit the following report of this Division for the year ending June 30, 1885.

The Drafting and Engraving and Plate and Printing Divisions were consolidated near the end of the year under the title of the Division of Chart Construction. The reports, however, are made separately, and that of the officer in charge of plates and printing is appended as supplementary. At the time of the last annual report these Divisions were in the State, War, and Navy Department building, but were moved in July, 1884, to rented quarters at the corner of New York avenue and Seventeenth street.

CONSTRUCTION OF NEW CHARTS.

The following table shows the work done on new charts during the year. It also gives the condition of all unfinished charts.

Much attention has been paid to the construction of new charts, it being deemed better to devote more time to the engraving of new plates, of which the Office is in great need, and less to the making of corrections on the old ones now in the Office.

Record of work done on new charts in Division of Chart Construction during the year ending June 30, 1885.

Chart No.	Name.	When begun.	When finished.	Remarks.
950	St. Nicolas Mole, Haiti	June, 1884	Mar., 1885	Engraved.
951	Jacmel Harbor, Haiti	June, 1884	Jun., 1885	Do.
914	Santo Domingo Harbor, Haiti	Aug., 1884	May, 1885	Do.
935	Chucabua Bay, Mexico	Sept., 1884	Jan., 1885	Do.
937	Corinto Harbor, Mexico	Aug., 1884	May, 1885	Do.
939	La Libertad Harbor, Central America.	Sept., 1884	Feb., 1885	Do.
894	Caribbean Sea, western part	Jan., 1883	Sept., 1884	Do.
158	Port Jururu, Cuba	May, 1883	Oct., 1884	Do.
159	Port Rita, Cuba	May, 1883	Nov., 1884	Do.
160	Port Nipe, Cuba	May, 1883	Nov., 1884	Do.
161	P. Cabonico and Livisa, Cuba	Apr., 1883	Nov., 1884	Do.
796	China Sea, Sheet I	Oct., 1882	June, 1885	Do.
797	China Sea, Sheet II	Jan., 1883	June, 1885	Do.
798	China Sea, Sheet III	Dec., 1882	June, 1885	Do.
799	China Sea, Sheet IV	Jan., 1882	June, 1885	Do.
933	West coast of Mexico	Sept., 1882	Nov., 1884	Do.
932	do	Sept., 1882	July, 1885	Engraved, now in hands of electro typewriter.
446	Magellan Straits, Sheet I	Feb., 1883	May, 1885	Engraved.
446a	Magellan Straits, Sheet II	Feb., 1883	May, 1885	Do.
447	Magellan Straits, Sheet III	Feb., 1883	Apr., 1885	Do.
447a	Magellan Straits, Sheet IV	Feb., 1883	Apr., 1885	Do.
925	Savannilla Harbor, Colombia	Dec., 1883	June, 1885	Do.
21	North Atlantic Ocean, Sheet I	1876	Dec., 1884	Do.
21a	North Atlantic Ocean, Sheet I	1876	Dec., 1884	Do.
22	North Atlantic Ocean, Sheet II	Oct., 1879	Apr., 1885	Do.
22a	North Atlantic Ocean, Sheet II	Oct., 1879	Apr., 1885	Do.
823	South Pacific Ocean, Sheet I	1872	Jan., 1885	Do.
823a	South Pacific Ocean, Sheet I	1872	Jan., 1885	Do.
824	South Pacific Ocean, Sheet II	1872	Do.
824a	South Pacific Ocean, Sheet II	1872	Do.
825	South Pacific Ocean, Sheet III	1872	Do.
825a	South Pacific Ocean, Sheet III	1872	Do.
826	South Pacific Ocean, Sheet IV	1872	July, 1885	Engraved, requires still a few days work.
826a	South Pacific Ocean, Sheet IV	1872	July, 1885	Do.
954	Ports on south and west coast of Haiti.	June, 1884	Apr., 1885	Hellograved.
952	Ports on north and west coast of Haiti.	July, 1884	Apr., 1885	Do.
953	Ports on northwest coast of Haiti.	Aug., 1884	Jan., 1885	Do.
784	Callao Harbor, Peru	Nov., 1884	Apr., 1885	Do.
135	San Fernando Anchorage, Trinidad.	Nov., 1884	June, 1885	Do.

Record of work done on new charts in Division of Chart Construction, &c.—Continued.

Chart No.	Name.	When begun.	When finished.	Remarks.
108	Cays Flamande, Saint Louis and Meste Bays, Haiti.	June, 1884	Mar., 1885	Holograved.
149	Saint John's Harbor	May, 1884	Nov., 1884	Do.
251b	La Poile Bay	June, 1884	Sept., 1884	Do.
140	Bocas de Dragos and Port of Spain, Trinidad.	Jan., 1884	July, 1884	Do.
128	Port Hamilton	Jan., 1884	July, 1884	Do.
155	Louisburg Harbor	Feb., 1884	July, 1884	Do.
151	Pistolet Bay	Mar., 1884	Nov., 1884	Do.
794	Canada Bay	Jan., 1884	June, 1884	Do.
507a	Bay of Islands	May, 1883	Oct., 1884	Do.
261a	Port Basque	Feb., 1884	July, 1884	Do.
43	Grand and Lesser Caymans, West Indies.	Mar., 1883	Sept., 1884	Do.
127	Road Harbor	Jan., 1884	July, 1884	Do.
264	Point a Pitre	Apr., 1883	June, 1884	Do.
450a	Ports in Magellan Straits.	Dec., 1883	June, 1885	Do.
240	Chart of measured mile.	July, 1884	Aug., 1884	Photolithographed.
262	Polar regions.	Oct., 1884	Feb., 1885	Do.
147	Halifax Harbor.	June, 1884	Apr., 1885	Holograved.
245	Caribbean Sea, southwest part.	Feb., 1883	Nearly finished.
260	Port Plata, Haiti.	Sept., 1884	Do.
226	Tenacatita and Navidad Bays, Mexico.	Oct., 1884	Do.
228	Chamela Bay, Mexico	Nov., 1884	Do.
242	Nassau Harbor, West Indies	Jan., 1885	Do.
241	East coast of United States	Nov., 1883	In hands of lettering engraver.
243	do	Sept., 1883	Requires tinting only.
243	do	Sept., 1883	Do.
244	do	Nov., 1884	Nearly finished.
246	East part of Bahama Islands	Nov., 1883	This chart has been withdrawn, 244 being extended to include it.
246	West part of Island of Haiti and vicinity.	Nov., 1883	Nearly finished.
247	Cuba, western part	June, 1884	Ready for engraver.
248	Island of Haiti	Dec., 1884	Do.
226	Mouth of Amazon River	Jan., 1881	In hands of engravers.
221	West coast of Mexico	July, 1883	Do.
222	Hong-Kong Harbor, China	Apr., 1884	Do.
221	Vancouver's Island	July, 1885	Do.
227	Port of Vera Cruz, Mexico	Feb., 1885	Finished, except engraving of lettering.
224	San Juan del Sur, Central America.	Apr., 1885	Nearly finished.
274	San Lorenzo Bay, Central America.	Feb., 1885	In hands of engraver.
275	Port of Bahia, Brazil	Feb., 1885	Do.
271	Rio Janeiro Bay, Brazil	Feb., 1885	In hands of hellograver.
272	Rio Janeiro Harbor, Brazil	Feb., 1885	Do.
276	Paya Harbor, Peru.	Dec., 1884	Do.
277	St. Thomas Harbor, West Indies.	May, 1885	Do.
225	Virgin Passage, West Indies	Jan., 1885	Ready for engraver.
224	Northeast coast of Yucatan	Mar., 1885	Do.
222	North coast of Brazil	Feb., 1885	Do.
270	do	Mar., 1885	Do.
273	Gulf of Fonseca	Apr., 1885	Do.
279	Pisco Bay, Peru	June, 1885	Do.
278	Cartagena Harbor, Colombia	June, 1885	In hands of draftsman.
220	Entrance to Rio Plata	Aug., 1884	Nearly ready for engraver.
223	Circumpolar Chart	Mar., 1885	Nearly ready for lithographer.
264	North coast of Colombia	Jan., 1885	In hands of draftsman.
221	Newfoundland Banks	May, 1885	Do.
220	Port Barcelona, Spain	Nov., 1884	Withdrawn to await later information.
228	North coast of Guyana	Feb., 1885	Suspended to get more reliable data from Dutch Hydrographic Office.
221	Mediterranean, Sheet I	1874	In hands of engraver, will be finished about September 30, 1885.
223	Mediterranean, Sheet II	1874	Practically finished, waiting for 221.
223	Mediterranean, Sheet III	1874	Do.
23	South Atlantic Ocean, Sheet I	Dec., 1879	} Nothing has been done to these plates, as the ones they are to replace were still serviceable and other work was more important.
23a	do	Dec., 1879	
24	South Atlantic Ocean, Sheet II	Dec., 1880	
24a	do	Dec., 1880	
222	Channels between Baltic and North Seas.	Jan., 1880	Work discontinued in 1882.
222	North Sea	April, 1879	Work discontinued in 1880.
220	West coast of United States	Jan., 1881	Work discontinued in 1882.
221	do	Jan., 1881	Do.

CORRECTION OF CHARTS.

Much of the work of this Division consists of the necessary correction of charts for all new information which comes to the Hydrographic Office. Nearly every plate has received minor corrections during the year, and many have received extensive additions and alterations.

OTHER WORK OF DIVISION.

Forty-three plates have been electrotyped during the year, and much work has been done by the engravers in preparing them for electrotyping and in removing the defects caused by this process.

A series of five great-circle sailing charts has been projected and much work done on them. They are of the North Atlantic, South Atlantic, North Pacific, South Pacific, and Indian Oceans. The one of the North Atlantic is now in the hands of the engraver for the engraving of the projection lines, compasses, border, &c. The computations for all the projections and compasses are completed.

A great-circle protractor, for the solution of problems in great-circle sailing and other problems in nautical astronomy, designed by Commander C. D. Sigsbee, U. S. N., has been laid down on copper and nearly engraved.

Much work has been done in making researches and compilations of latitudes and longitudes, and a method of recording them has been instituted. Already much valuable information has been collected. This record is principally for use in the compilation of new charts, but it will soon become valuable for publication as the adopted positions of this Office, and for correcting previous publications now out of date or incorrect. The form in which these positions are recorded is shown by the following specimen page heading. In the column of remarks a very complete history of the sources, accuracy, and reliability of each position is recorded.

Record of longitudes used in the construction of the charts of the United States Hydrographic Office.

No.	General locality.	Name of place.	Description of observation spot.	Longitude from Greenwich.	Latitude.	Secondary positions upon which the longitudes depend.			Originally established difference of longitude.	Authority.		Remarks.
						Place.	Date.	Longitude.		Name.	Date.	

Attention has been paid to the investigation of magnetic variation. A method of recording all data obtained and all authorities on the subject has been devised, and the work of collecting it commenced.

CHANGES MADE IN ROUTINE OF THE DIVISION DURING THE YEAR.

A method of keeping charts corrected to date was a subject of early attention, and an entirely new system was devised. It has now been in successful operation about a year. Formerly nearly the entire force

was engaged in the correction of charts; since the change at least 75 per cent. has been available for work on new charts

In a general way this saving has been accomplished by a system of book-keeping. All information coming to this Division is first entered in an Information Book. From this it is entered in a Record of the Correction of Plates, wherein it is charged against every chart affected; and when a plate is corrected to date, for all the information against it the changes made are entered in this same book opposite the authority therefor, so that when any chart is to be corrected a complete history of all previous corrections and a complete list of those necessary to be made is at hand. This saves all duplication of work or comparison, and collection of data, thus greatly decreasing the work required of draftsmen. In the same book is kept a record of all the work done on any charts, who did it, how long it took, what was done, and how much it cost. This latter account of work done is supplemented by two other books called Record of Work Books.

The arrangement of these books is shown by the following headings:

Information Book.

Date of entry.	Information or data which may affect our charts.	Date of information.	Charts affected.	Remarks.

Record of the Correction of the Charts of the United States Hydrographic Office.

[Chart No. —. Title —. Limits —. Scale —.]

Plate No.	Sources from which the chart requires correction.	Record of work.			Cost of work.		Nature of corrections made or work done.
		Page of draftsman's record.	Page of engraver's record.	Date finished.	Drafting.	Engraving.	

Record of work in the Division of Chart Construction of the United States Hydrographic Office.

DRAFTSMEN.

Date of entry.	Chart No.	Locality.	Record of correction.		Record of construction.		Draftsman.	Began.	Finished.	Number of hours.	Revised.	Entered on engraver's record.
			Vol.	Page.	Vol.	Page.						

Record of work in the Division of Chart Construction of the United States Hydrographic Office.

ENGRAVERS.

Date of entry.	Chart No.	Locality.	Record of correction.		Record of construction.		Engraver.	Began.	Finished.	Number of hours.	Revised.	By whom revised.	Remarks.
			Vol.	Page.	Vol.	Page.							

In order that the history of charts hereafter made may be complete from their beginning, a book similar to the Record of Correction of Plates, called Record of Construction of Charts, is kept. In it all the data used or consulted in the compilation of new charts and all work done on them is recorded. The arrangement of this book is as follows :

Record of the Construction of the Charts of the United States Hydrographic Office.

[Chart No. —. Title ——. Limits ——. Scale ——.]

Plate No.	Sources from which chart is constructed.	Record of work.			Cost of work.		Nature of information used or work done.
		Page of drafter's record.	Page of engraver's record.	Date when finished.	Drafting.	Engraving.	

Special attention has been paid to the improvement of the appearance, uniformity, and utility of the new charts published. A standard method of treating every portion of the process of constructing a chart has been, as far as possible, devised and adopted. As to shore lines, topography &c., the object kept constantly in view has been that of usefulness to the navigator. The rule adopted for sanding is to carry it out to three fathoms, and where necessary to define channels of less than three fathoms, to sand out in a darker shade to one fathom. A very careful investigation has been made during the year into the different systems of delineating hill-work in use by other hydrographic offices, and it has been decided to adopt, as the most suitable for the needs of this office on large-scale charts, that of contour lines in conjunction with roulette shading. The new chart of No. 938, Chamela Bay, West Coast of Mexico, which is appended, is the first published in that style. It is not considered a good specimen of the style, having been published under the difficulties incident to first trials.

The following rules in regard to lettering have been adopted :

(1) Reduce the amount of lettering as much as possible in order to keep chart clear.

(2) Where possible, size and style of lettering are to conform to that in use by Coast and Geodetic Survey Office.

(3) All lettering referring to land to be vertical, and all lettering referring to water to be leaning, except soundings which are vertical.

(4) All lettering referring to aids to navigation to be in block letters.

(5) All lettering to be placed horizontally, as far as possible.

(6) All lettering to be placed on the land instead of the water where there is a choice.

Much of the information which formerly encumbered the body of the chart has been taken off, and given in tables, near the title.

As far as possible these tables have been made uniform with those on Coast and Geodetic Survey charts. The system of abbreviations of bottoms used on Coast Survey charts has also been adopted.

A standard for determining the style of border to be used on any chart and for the lettering appertaining to the border has been adopted. The appended lithograph of the standard borders will show how this is accomplished.

A new compass has been adopted both for harbor and sailing charts, the principal improvement being the division of the true compass into degrees. Illustrations of these compasses are appended.

A set of standard scales for harbor charts has been devised and the rule adopted to put the scale just inside the lower margin and in the middle of the chart. An investigation of the best scales on which to publish harbor charts has been made, and those of 1 inch, 2 inches, 3 inches, 4 inches, and 8 inches to the nautical mile have been adopted. The scale of 3 inches is to be used only when absolutely necessary. These were adopted because a navigator, knowing the scale to be 1, 2, 4, or 8 inches, can very easily estimate distances on the chart by the eye, and all harbors being on the same scale, or multiples of the same scale, he can compare the size of one harbor with that of another without difficulty.

The standard sheet of scales is appended.

ON THE SELECTION OF CHARTS TO BE PUBLISHED.

The object of the Hydrographic Office is to furnish cheap and accurate nautical charts. Heretofore this has been attempted almost exclusively by reproducing British Admiralty charts. But the original British charts are as intelligible and convenient for American seamen as our republications, especially if they are reproduced by lithographing or heliograving. It would be much cheaper and more satisfactory to buy the charts directly from the Admiralty office. If the object of thus reproducing Admiralty charts has been to become independent, it has failed. Comparatively few of the Admiralty charts have been canceled. The small number will become evident if those canceled by U. S. Coast Survey charts are left out of consideration. And if a fair comparison of all our duplicates with the Admiralty originals is made, and the poorest withdrawn from issue, this will become more apparent.

What charts should be published? First, those which are publications of our own surveys; second, foreign charts which are not republished by the Admiralty office, and which would be of use to American seamen. These charts should be republished because they are in foreign languages and scales, and therefore require translation. Third, such charts should be compiled as shall be cheaper, more accurate, more intelligible or of better limits and scales for our use than the existing Admiralty charts of the same localities. Fourth, when our list of charts

has become so large that it seems practicable to have a complete set of the world, or of any part of the world, to republish all charts, Admiralty or other, which may be necessary to complete the list and make us independent.

In a tabulated form these classes of charts are as follows:

- (1) Publication of original surveys by United States vessels.
- (2) Publication of foreign charts (not British) of foreign surveys.
- (3) Publication of such coast or sailing charts (compiled from all sources) as can be made better for our use than the existing Admiralty charts.
- (4) Publication of all charts necessary to complete a set of charts for the world, or for any special part of the world.

The past year has been spent in working on the first and third classes, considering the means too small to do anything with the second. A nearly complete set of charts has now been made or begun for the West Indies and for the vicinity of Newfoundland, so that it would seem desirable to publish all charts necessary to complete these sets, and the following list, recommended to be taken in hand, is selected with that object in view. There will only be the charts of the survey of the west coast of Mexico by the Ranger the past season, and perhaps a few important foreign charts which should take precedence of these.

Charts required to complete the set of harbor charts of the West Indies and the North Coast of South America.

Name.	Number of copies of old photolithograph edition on hand.	Remarks.
WEST INDIES.		
* Puerto Frances, Cuba.....	None.	Was on old H. O. 516.
* Port Santiago de Cuba, Cuba.....	88	
* Port au Prince and vicinity, Haiti.....	142	
* Port au Prince Harbor, Haiti.....	Only a poor plan now on H. O. 33; a general chart of another part of West Indies.
Cape Hayti Harbor, Haiti.....	
Monte Cristi to Fort Dauphin Bay and Fort Dauphin Bay, Haiti.....	138	
* Manzanillo Bay, Haiti.....	82	
* Caldera Bay, Haiti.....	16	
* Port San Juan, Porto Rico.....	137	
Gorda Sound, Windward Islands.....	181	
Christianstead Harbor, Windward Islands.....	110	Also a special chart of Santa Cruz Island.
* Orangetown Anchorage, Windward Islands Fal-mouth and English Harbors, Windward Islands.....	67	Also a special chart of Saba Island.
Plymouth Anchorage, Windward Islands.....	150	Also a special chart of Montserrat Island.
Basee Terre Road, Windward Islands.....	133	
Grande Bourg Marie Gal., Windward Islands.....	172	
* Saint Anne Anchorage and Port du Moule, Windward Islands.....	92	Would be better as separate charts.
* Salée River, Port Saint Marie, and Port. Louis, Petit Havre.....	
* Saint Francois and Goat Anchorages, Windward Islands.....	98	Would be better as separate charts.
Saint Pierre Road, Port Royal Bay, La Trinité Bay, and Cul-de-Sac Marin, Windward Islands.....	36	Would be better as separate charts.
Four ports on Sta. Lucia Island.....	131	Would be better as separate charts.
Kingston, Great Head, and Callagna Bays, Windward Islands.....	131	
Admiralty Bay, Windward Islands.....	171	
Carlisle Bay, Windward Islands.....	82	May be put on chart of Barbadoes.
Tobago Bay Anchorage, Windward Islands.....	161	May be put on chart of Grenadines.

Charts required to complete the set of harbor charts of the West Indies, &c.—Continued.

Name.	Number of copies of old photolithograph edition on hand.	Remarks.
WEST INDIES—Continued.		
Saint George Harbor and Port Egmont, Windward Islands.	134	
Courland Bay, and Rocky Bay, and Tobago Island, Windward Islands.	154	May be put on chart of Tobago.
Kingston, Port Royal, and Morant Cays, Jamaica.	137	
Morant Bay, Jamaica	179	
Port Morant, Jamaica	174	
Port Antonio, Anatto Bay, Saint Ann Bay, Falmouth Harbor, Savannah La Mar, and Black River, Jamaica.	173	
* Turk's Island, Hawk's Nest Anchorage, Cockburn Harbor, Mirapor vos. Crooked Island, and Crooked Island Anchorage.	85	Would be better as separate charts.
Matthew Town Road and Alfred Sound	156	
Acklin's Island Anchorage	None.	
Pelican and Little Harbors	None.	
Green Turtle Cay	None.	
Man-of-War Cay	None.	
Wide-Opening Ship Channel, Egg Island to Eleuthra, Royal Island Harbor, Fleeming Channel, and Great Stirrup Cay.	144	
Ragged Island Harbor, Clarence Harbor, Wax Cay Cut, Douglas Road, and Highbourne Cut.	135	
Salt Cay Anchorage and Hanover Sound.	143	
Great Exuma Harbor and Nurse Channel.	149	
Racoon Cut and Ragged Island Anchorage	151	
NORTH COAST OF SOUTH AMERICA.		
* Puerto Bello	51	
P. Escoces and Caledonia	138	
* P. Carreto, Candelaria Bay, and Port Cispata.	None.	Would be better as separate charts.
* Harbor of Cartagena	146	The lithograph is incorrect.
* Rio Magdalena, San Juan Bay, and Bahia Honda.	None.	Would be better as separate charts.
* Sta. Anna Harbor, Chichirivichi Bay, P. Tucacas, P. Cabello, P. Turiamo, La Guayra, Corsarios Bay, and Port El Roque.	24	Would be better as separate charts.
Orchilla Harbor	343	
P. Barcelona, P. Mochima, P. Obispo, P. San Juan Griego, P. Pampatar, P. Moreno, P. Santo Bay, Carupano Bay, Esmeralda Bay, Unare Bay and Cumana Anchorage.	112	The photolithograph plan of Cumana is incorrect.

The charts in the preceding list which are marked * are needed immediately, because the Office has none or the photolithographs are nearly exhausted. The estimated cost of publishing them is about \$8,000. Many are of small and unimportant ports, but are required to complete the set.

Those not marked * are charts of which enough copies of the old photolithographed editions are on hand to last some years, and are not immediately required. It would be a better policy, however, to commence replacing them at once by good engraved charts. The estimated cost of those not marked * is about \$15,000.

This list can be reduced, if required, by referring it to the proper authority for the rejection of such harbors and anchorages as have ceased to be of any commercial or naval value.

Charts required to complete our set of coast charts in the West Indies.

Name.	Number of old photolithographed edition on hand.	Remarks.
* Island of Puerto Rico	None.	Scale, $\frac{1}{2}$ inch.
* Anegada Passage	None.	Scale, $\frac{1}{2}$ inch.
* I-land of Barbuda	144	Scale, 1 inch.
* Island of Antigua	None.	Scale, 1 inch.
* Islands of Saint Eustatius, Saint Christopher, and Nevis	67	Scale, 1 inch.
Island of Montserrat	150	Scale, 1 or 2 inches.
Island of Dominica	128	Scale, $\frac{1}{2}$ or 1 inch.
Island of Martinico	117	Scale, 1 inch.
Island of Saint Lucia	131	Scale, 1 inch.
Island of Saint Vincent		Scale, 1 inch.
Island of Grenadines		Scale, 1 inch.
Island of Grenada		Scale, 1 inch.
Island of Barbadoes	83	
Island of Tobago	163	
Island of Trinidad	None.	Scale, $\frac{1}{2}$ inch. 2 sheets.
Island of Margarita and vicinity	112	
Island of Oruba	None.	
* Islands of Curaçao and Buen Ayre	None.	
Bahama Banks (4 sheets)	130	To replace H. O. 26a, 26b, 26c, and 26d; one sheet of these has been engraved already.
* Southwest coast of Jamaica	None.	
* Pedro Bank, Jamaica	None.	
South coast, Jamaica	176	
Southeast coast, Jamaica	137	

In the preceding list the charts marked * are wanted immediately, because the office has none or because the photolithographs are nearly exhausted. The estimated cost of publishing them is about \$10,000.

Those not marked * are charts of which enough copies of the old photolithographed charts are on hand to last some years, though it would be better to commence replacing them at once by good engraved ones. The estimated cost of those not marked * is about \$20,000.

See accompanying index chart of West Indies and north coast of South America for a graphic illustration of these required charts. The charts now on issue are shown by full lines, and those proposed above are shown in broken lines.

Charts required to complete our set of general coast charts around Newfoundland.

Name.	Number of old photolithographed edition on hand.	Remarks.
* Great Banks, Sheet I	}	{ To replace old H. O. 9, 15, and 16, and to extend new scheme of coast chart from Halifax to Saint John's, Newfoundland; scale $\frac{1}{4}$ inches.
* Great Banks, Sheet II		
* Gulf of Saint Lawrence		
* West Coast of Newfoundland, Sheet I	None.	Would take place of B. A. 283.
* West Coast of Newfoundland, Sheet II	None.	Would take place of B. A. 284 and 143.
* East Coast of Newfoundland, Sheet I	None.	Would take place of B. A. 285.
East Coast of Newfoundland, Sheet II	168	
East Coast of Newfoundland, Sheet III	167	
East Coast of Newfoundland, Sheet IV	178	
* South Coast of Newfoundland, Sheet I	None.	Would take place of B. A. 290.
* South Coast of Newfoundland, Sheet II	None.	Would take place of B. A. 293.
* South Coast of Newfoundland, Sheet III	None.	Would take place of B. A. 300.
* South Coast of Newfoundland, Sheet IV	None.	Would take place of B. A. 302.

In the preceding list of charts around Newfoundland those marked * are urgently needed in order to make the charts now in the Office of use, a broken set of coasting charts being almost useless. They should

Standard compass for sailing charts.

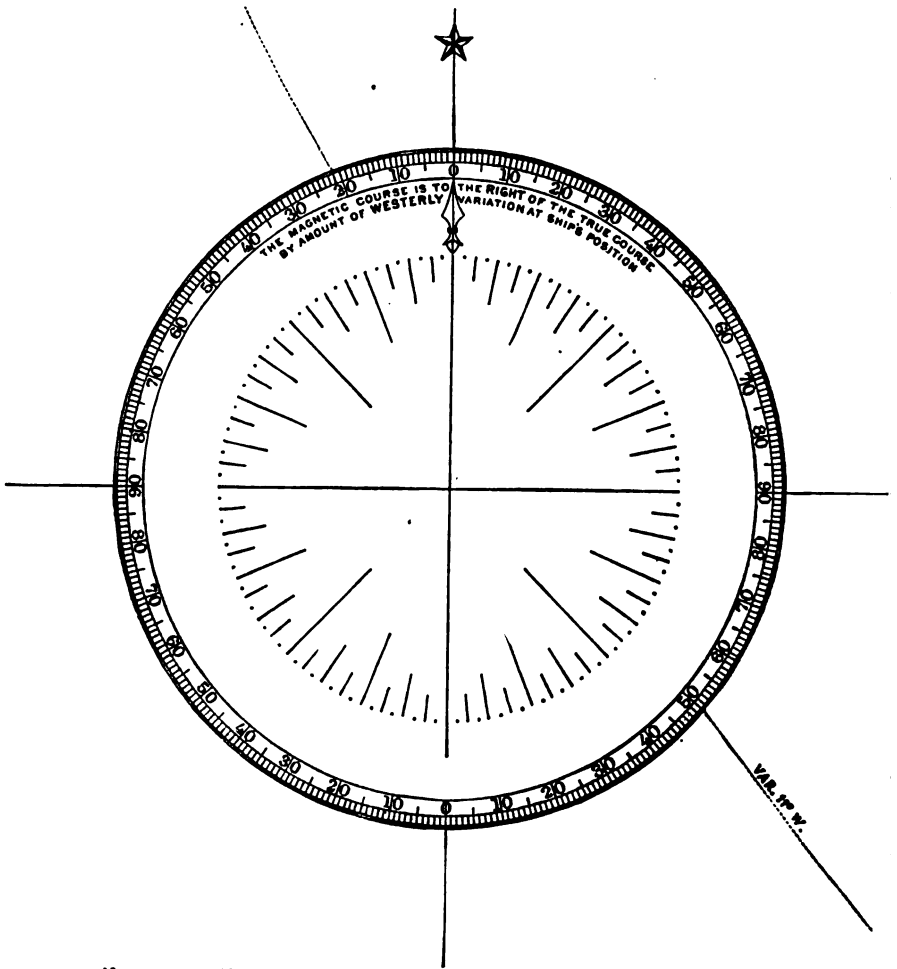

Face page 137

Standard compasses for harbor charts.

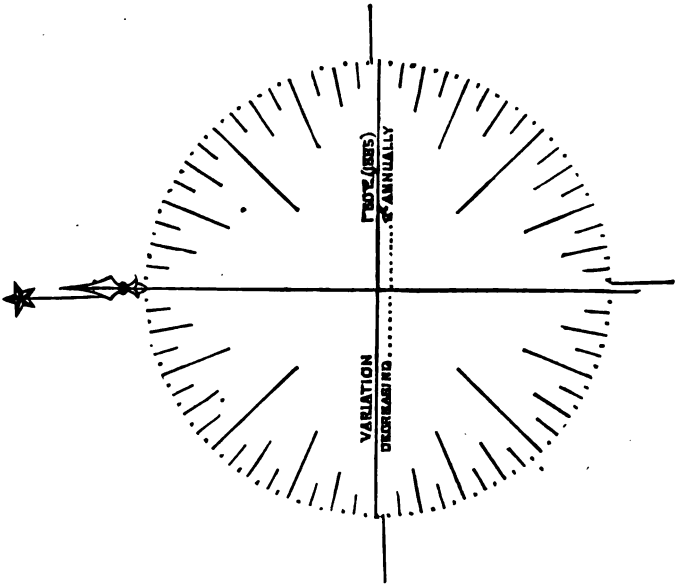
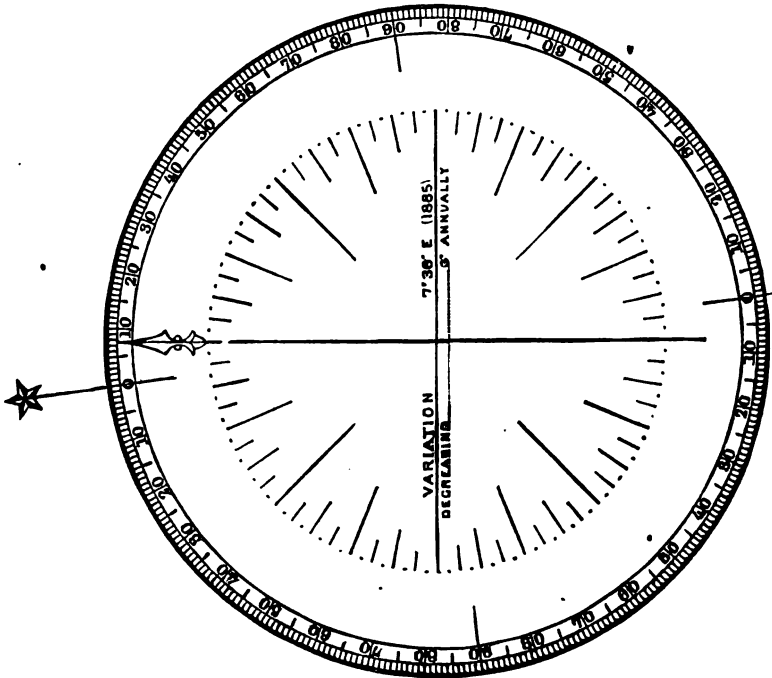

Transient harbor charts.

Small harbor charts.

and immediately. Those in the list not marked * are at lithographs which will last two or three years longer, but it is desirable to commence replacing them with copper-plates immediately. It is also deemed advisable to ask for a special appropriation to complete the charts of Newfoundland and vicinity, many more harbor and special coast charts have to be added to the foregoing list. The cost of the list as now made out would cost about \$15,000.

Charts required to connect Lake Ontario with the ocean.

Name.	We have—	Remarks.
Islands, B. A. 1134	None	} To complete general coast charts of Gulf of Saint Lawrence.
Edward Island, B. A. 2034	do	
New Brunswick, B. A. 1747	do	
New Brunswick, B. A. 1715	do	
West Gulf of Saint Lawrence, B. A.	do	
East Gulf of Saint Lawrence, B. A.	do	} To give general charts to Quebec.
General charts river Saint Lawrence, 1807, 309, and 310.	do	
General charts river Saint Lawrence, 1830 A, 2830 B.	do	
General charts river Saint Lawrence.	do	
		To give general charts to Lake Ontario.

It would seem desirable for this Government to have its own charts of the important waters as the gulf and river of Saint Lawrence, they are the outlet of the Great Lakes. The necessity would be very evident in case of war with England, our only source of supply would be cut off. The charts of the kind published by Engineer Bureau, War Department, only extend to the Saint Lawrence River ceases to be the northern boundary of New York. The charts of the preceding list cannot be published at present by this Office for want of funds, but a request might be made for a special appropriation to publish the charts necessary to connect the Great Lakes with the ocean. A special appropriation of \$50,000 is necessary to publish all the charts required between Lake Ontario and the ocean. The general list enumerated in the preceding list would cost about \$15,000.

SURVEYING WORK TO BE DONE BY UNITED STATES NAVAL VESSELS.

The greatest difficulty has been encountered in this Division in attempting to compile new coast charts of the north coast of South America from Panama to Cayenne. The positions which were determined by the Huron and others a few years ago were sufficient to show that existing charts were much in error, but not sufficient to enable these errors to be corrected with any certainty. An extended survey of that coast is recommended.

The islands of Santo Domingo and Porto Rico are also very inaccurately laid down on charts at present, and there is no late information available which to correct them.

Respectfully submitted.

JOHN H. FILLMORE,
Ensign, U. S. N.

Commander J. R. BARTLETT, U. S. N.,
Hydrographer.

DIVISION OF CHART CONSTRUCTION,
PLATE AND PRINTING ROOMS,
Hydrographic Office, July 1, 1885

SIR: I have the honor to submit the following report of the operations of this portion of the Division of Chart Construction for the year ending June 30, 1885:

The number of copper plates available for printing is 333. Of these there were printed 21,025 copies of charts for issue; also 4 proofs; total, 22,112.

The comparison with the two preceding fiscal years is as follows:

1882-'83.....
1883-'84.....
1884-'85.....

In addition the force of the Division was employed in miscellaneous printing as follows: Official letter paper, 13 reams; official note paper stamped, 8½ reams; official cards for correspondence, stamped, 1½ official envelopes, stamped, 7,319; forms of clouds, thermometer scales and deviation diagrams, 1,312.

I would recommend the establishment of an electrotyping plant reproducing plates. This could be done at less than one-half the present cost, the only important outlay being the cost of the battery; the pay of one good mechanic. The improvement of the quality of work and articles used is being constantly studied.

Respectfully submitted.

THOS. SNOWDEN,
Ensign, U. S. N.

Commander J. R. BARTLETT, U. S. N.,
Hydrographer.

DIVISION OF SUPPLY, HYDROGRAPHIC OFFICE,
July 1, 1885

SIR: The operations of this Division for the year ending June 30, 1885, have been as follows:

	Third quarter 1884.		Fourth quarter 1884.		First quarter 1885.		Second quarter 1885.	
	H. O. C.	C. S. C.	H. O. C.	C. S. C.	H. O. C.	C. S. C.	H. O. C.	C. S. C.
Copies of charts received:								
From printing room.....	4,157		4,231		5,851		7,212	
Photolithographed.....	100		761		296		600	
From Coast Survey.....		914		2,253		359		437
Total.....	4,257	914	4,992	2,253	6,147	359	7,812	437
Copies of charts issued:								
To naval vessels.....	537	353	2,102	2,068	752	114	1,586	536
To archives.....	17	9	35	18	50	13	34	6
To agents.....	2,527		1,956		2,413		2,297	
To merchant vessels.....	531		505		1,156		793	
To merchant vessels, meteorological charts.....	174		255		236		253	
To foreign hydrographers.....	317				87		83	
To home correspondents.....	180		96		96		300	
Miscellaneous.....	296	109	540	227	569	76	328	95
Total.....	4,579	471	5,447	2,313	5,359	203	5,676	637
Charts published.....	10		18		9		26	
Copies of charts condemned.....	437	48	130	40	234	28	330	1
Charts canceled.....	13		6		10		9	
Plans canceled.....							1	
Copies of canceled charts condemned.....	1,890		1,077		1,189		850	

It will be seen by the preceding table that the number of charts received and issued is much greater than that of the previous year, with the one exception of miscellaneous charts issued. This difference is due to fitting out the branch offices with complete sets of charts.

This Division has been engaged in keeping the charts corrected by hand, from information received from Notices to Mariners, the hydrographic information accompanying the Naval Intelligence reports from United States men-of-war, reports of United States naval officers, information received through the branch offices, and by comparisons with foreign charts of late surveys.

Of the charts issued, fully one-half require some hand correction; some of these are small, but all are important to the navigator. All charts have a standard which shows the latest information, and before issuing a chart it is compared and made to agree with the standard.

Before printing the plate charts the plate is corrected from the standard, and all corrections made to date of printing, hence the corrections for plate charts are never very great, and in case of extensive changes a new edition is printed at once and all old copies called in.

With the photolithographed charts all corrections have to be made by hand, and as these corrections have been accumulating since the publication of these charts, which in most cases was in 1873-'75, they have become too numerous to be handled in this manner. The hydrography has changed in many cases, especially at the mouths of rivers, new shoals and rocks have been discovered, and the longitude by recent determinations has been found to be erroneous in many places. All these errors, with constant alterations of lights and buoys, have made the cost of making these corrections far greater than the chart is worth. Most of the photolithographs are printed on paper that is not well adapted for erasures and corrections. As fast as these charts are compared with later surveys and found to need extensive corrections that are not in the interest of economy to make, they are canceled and a foreign chart taken up in its place for the use of United States vessels, while agents are informed that they may return any copies on hand.

The number of photolithographed charts on hand at present is 381; most of them have to be corrected before they are sent out, and many require quite extensive additions and corrections. Comparisons with late charts are being made as fast as possible, and no doubt many of these photolithographs will be condemned during the next year.

In addition to the regular work there has been prepared and published by this Division a complete set of index charts of the world, showing all charts published by this Office. These index charts are at present photolithographed, but it is hoped they can soon be engraved, when corrections and additions can be more easily made from time to time. The cost of engraving them will be very little in comparison to their usefulness.

During the year many reported dangers which have been shown on our charts for years have been removed, most of them from the sailing charts of the Atlantic Ocean. No reported danger was removed except after a careful investigation and study of all reports and authorities on the subject and there was absolutely no positive reason why it should be there. Many of the rocks formerly reported were undoubtedly floating ice, derelicts, buoys, or floating timber.

Respectfully submitted.

W. O. SHARRER,
Lieutenant, U. S. N.

Commander J. R. BARTLETT, U. S. N.,
Hydrographer.

DIVISION OF ISSUE, HYDROGRAPHIC OFFICE,
July 1, 1885.

SIR: I have the honor to submit the following report of the operations of this Division for the fiscal year ending June 30, 1885:

In addition to its ordinary duties this Division has had the issuing of all chart publications to naval vessels and others under the Government employ, such as those of the Coast Survey and Fish Commission.

At the time when the catalogue of charts for vessels on the several stations was divided into three parts, according to the offices of publication, the Hydrographic Chart Division furnished the Hydrographic and Coast Survey charts to the service, but upon the completion of the new edition, in which these charts were arranged with reference to their geographical position, it was thought advisable to place the whole system of issue under one head.

The Hydrographic Chart Division then became that of Supply, while the Admiralty took its present name and duties.

When an order is received to fit out a vessel, requisition is made on the Supply Division for Hydrographic and Coast Survey charts, which, when received, are carefully marked and assigned to their respective portfolios.

Two copies of the Catalogue for the Station are forwarded with the portfolios, one for the commanding officer and the other for the navigator; a third copy is kept in the Office, and is at all times a complete index of the charts on board.

All vessels to which charts are issued are now provided with the new edition which has proved of great service to the navigator, insuring accuracy in correcting charts as well as greater facility in their selection from the different portfolios. A supplement has been completed to be issued to flagships only. It is composed of two portfolios containing a sufficient number of charts to enable a vessel to go around the world or from one station to another.

The following table gives the number of charts issued to vessels on the different stations divided according to the offices of publication.

Office of publication.	North Atlantic Station.	South Atlantic Station.	European Station.	Asiatic Station.	Pacific Station.
United States Hydrographic Office	231	150	103	270	310
United States Coast Survey Office	288	40	40	77	108
British Admiralty Office	171	138	835	835	317
French Hydrographic Office	1	24	10
Indian Survey	4
Total.....	690	320	978	1, 210	708

It will be seen from this table that on two stations at least we are dependent upon foreign charts for navigation in those waters.

As the work of resurveying is being extensively carried out by foreign hydrographic offices, not only are new charts being published but great changes are found on the new editions of the old ones, and as our photolithographic charts can only be corrected by hand it will be necessary before many years to replace the latter by British Admiralty charts.

The Indian Survey charts issued refer to ports on the coast of India, while those of the French are surveys of the coasts of New Caledonia, Anam, and a small port on the west coast of Africa; these charts are

not of recent date, but are deemed of sufficient importance to be retained.

The force of the Division has been employed in the examination of charts received from abroad, and correcting them from the latest information, such as Notices to Mariners, Hydrographic Reports from United States Vessels, and complimentary charts sent by the British Hydrographic Office. When the latter charts show important additions the dispatch agent in London is instructed to forward copies to vessels on foreign stations.

Commanding officers are now required to report the latest date of correction on charts so that the office may be certain that the latest editions have been sent from London.

All ships in commission have been supplied with charts of the latest date.

The following summary shows the number of copies of charts received, issued, &c., for the year.

RECEIVED.

	Copies.
From J. D. Porter, agent for Admiralty charts, London.....	6,750
From United States vessels.....	389
From British Admiralty, complimentary.....	221
From miscellaneous.....	29
Total	7,389

ISSUED.

To United States vessels.....	3,612
To United States vessels through dispatch agent, London.....	987
To Division of Notices.....	1,647
Miscellaneous.....	196
Total	6,442

CONDEMNED.

Being unfit for use.....	2,003
--------------------------	-------

BALANCE.

On hand.....	12,076.
--------------	---------

Respectfully submitted.

J. RUSSELL SELFRIDGE,
Lieutenant, U. S. N.

Commander J. R. BARTLETT, U. S. N.,
Hydrographer.

DIVISION OF BOOKS, HYDROGRAPHIC OFFICE,
July 1, 1885.

SIR: I beg to submit herewith a report of this Division for the fiscal year ending June 30, 1885.

Books, pamphlets, and nautical forms.

	Third quarter, 1884.	Fourth quarter, 1884.	First quarter, 1885.	Second quarter, 1885.	Total for year.
Received from—					
Government Printer	2,532	500	300	342	3,672
Navy yards and vessels	2	134	79	2,560	2,775
Home agents	155		170	16	341
Foreign agents		5	175	101	281
Bureau of Navigation and other Government Departments	195	358	160	692	1,405
Total received during the year	2,884	977	884	3,711	8,476
Issued to, and expended—					
United States vessels	188	1,704	158	3,264	5,314
Agents	516	441	195	217	1,369
Main and Branch Hydrographic Offices	229	211	168	342	950
Home correspondents	44	4	9	16	73
Foreign correspondents	380	2		13	395
Miscellaneous	41	249	252	145	687
Canceled and condemned as unserviceable		58	140	251	449
Total issued and expended for the year	1,398	2,669	922	4,248	9,237

Books, pamphlets, and nautical forms on hand: For issue to vessels, 37,498; for reference, 950.

Preparing for publication: Supplement No. 1 to H. O. No. 73. Newfoundland and Labrador, 1884.

The following changes were made in the issuing list:

Books canceled or withdrawn.	Books placed on.
H. O. Nos. 30, 31, 32, 33, 33a, 33b (light lists 1 to 6, inclusive), corrected to July 1, 1883.	H. O. Nos. 30, 31, 32, 33, 33a, 33b (light lists 1 to 6, inclusive), corrected to July 1, 1884.
H. O. No. 55, Remarks upon Magellan Straits, Leferre, 1874.	
H. O. No. 44, supplement Navigation Magellan Straits, 1883.	B. A. South American Pilot, Part II, supplement, 1885.
B. A. South American Pilot, Part II, 1875.	
B. A. West India Pilot, Part I, 1883.	H. O. No. 64, Caribbean Sea and Gulf of Mexico, Vol. II, 1885.
B. A. Australian Directory, Vol. I, 1876.	B. A. Australian Directory, Vol. I, 1884.
B. A. West Coast of England, 1876.	B. A. West Coast of England, 1884.
B. A. Black Sea Pilot, 1871.	B. A. Black Sea Pilot, 1884.
B. A. British Channel, 1879.	B. A. Bristol Channel, 1884.
Book of the Stars (Proctor).	B. A. supplements 1 and 2 to China Sea Directory, Vol. I, 1884.
Nautical monographs, Nos. 1, 2, 3, 4.	B. A. Supplement 1 to China Sea Directory, Vol. II, 1884.
Memoir of the North Atlantic (Purdy and Findlay).	B. A. Fiji Islands and adjacent waters, supplement, 1884.
Lights on the Atlantic and Pacific coast of the United States.	B. A. Sailing Directions for Mauritius Islands, 1884.
	Eldridge United States Coast Pilot 1 and 2, 1884.

SUMMARY.

	Books, &c.
Received during the year	8,476
Issued, condemned, and expended	9,237
Withdrawn from issue, out of date	21
New books published by H. O.	1
New books or later addition placed on list	39
On hand for issue	37,998
On hand for reference	950

When books are canceled or withdrawn from issue, one copy is retained for reference, the rest destroyed and sold as waste paper.

During the latter months of the fiscal year just closed a new arrangement of storage of books for issue was inaugurated with a marked saving of time and labor in fitting out vessels, filling requisitions, and keeping corrected the various volumes of sailing directions necessary to the immediate outfit of five vessels of war.

The library of this Division, containing nearly a thousand works of reference, is being rearranged and catalogued upon a system that, while admitting of indefinite expansion, will always insure dispatch and accuracy in obtaining any information on hand pertaining to the various subjects relative to the work of the Hydrographic Office.

It is to be regretted that of the ninety-nine volumes of sailing directions issued to vessels of the United States, fifty-eight are English editions; of the remainder, published by this Government, many are either out of date or duplicates of recognized foreign standards.

Navigation of the Atlantic Ocean, Hydrographic Office Publication No. 45, edition of 1873, has run out, and being the best book at present issued on that subject, should be reprinted with such modifications as information since that date would necessitate.

I would respectfully lay before you the following facts and suggestions that have forced themselves upon the management of this Division during the past year, viz:

(1) Being, as previously cited, more or less dependent upon foreign sources for works on sailing directions, it would be to the decided advantage of the Government to be able to rely wholly upon its own departments for all information necessary to the safe movements of its own vessels, especially in times of war. With this end in view, to this Division should be intrusted the care of the compilation and revision of a new set of sailing directions, apportioning the work to the various branches of the Hydrographic Office, keeping constantly in sight the easiest facilities of obtaining the most accurate and recent information and the greatest dispatch. Having compassed our own, the Western Hemisphere, the work should extend east and west beyond our coast lines until meeting, be it in Europe or Asia, we have at command complete sailing directions of the world. Should such a plan be initiated the force of this Division must be at once increased to six officers, the present number being wholly inadequate for such an undertaking.

(2) In the preparation of such works great care should be taken to exclude all matter of an ephemeral nature, such as the position and colors of buoys and beacons, the colors and intensities of lights, the dimensions of incomplete harbor works and improvements, objects whose changes are so rapid that many would occur while the work is in press and upon whose accuracy reliance alone can be placed upon charts and light lists; these works should contain rather all such information as a commander of a vessel might require, and which from its peculiar nature could not be elsewhere embodied.

(3) The suppression and recall of all publications that are either out of date or duplicates, thus lessening materially the study and care of commanding officers, especially where the information in works on the same subject is at variance or missing.

(4) That in future a continuous numerical annotation be given to all books published by the Hydrographic Office, and that the use of subdivisions (*e. g.*, 30, 30a, 30b, &c.) be discontinued.

(5) That all agents and firms interested in the sale of nautical works

be requested to send constant information in regard to their newest publications, so that the library of the Office may purchase and contain the latest works on all matters pertaining to hydrography.

Respectfully submitted.

RICHARD G. DAVENPORT,
Lieutenant, U. S. N.

Commander J. R. BARTLETT, U. S. N.,
Hydrographer.

DIVISION OF NOTICES, HYDROGRAPHIC OFFICE,
July 1, 1885.

SIR: During the fiscal year ending June 30, 1885, five hundred and six notices to mariners, containing one thousand and twelve announcements, were issued. Two thousand one hundred and thirty foreign notices to mariners, in ten different languages, were received, and all containing new information translated and republished.

Six volumes of light-lists, embracing all the lights of the world, were corrected to July 1.

The domestic and foreign charts on file in this Division, eight thousand eight hundred and seventy-eight in number, were rearranged, all the old catalogues corrected, and a number of new catalogues made of foreign charts.

The care and arrangement of the archives of the Office having been assigned to an officer, I submit his report as supplementary to my own. Respectfully submitted.

W. H. PARKER,
Lieutenant U. S. N.

Commander J. R. BARTLETT, U. S. N.,
Hydrographer.

DIVISION OF NOTICES, ARCHIVES,
July 1, 1885.

SIR: The regular routine work of receiving, classifying, and filing away all documents, charts of surveys, data, reports, and other hydrographic information, for certain and convenient reference whenever needed, has been continued without interruption, and at the same time an entire rearrangement of all matter on hand has been pushed rapidly forward, and is now nearly complete. For this purpose a card catalogue has been substituted for the old arrangement, and whilst the former methods have been simplified, the convenience and certainty of reference have been increased.

In order to enhance still further the value of the cards, I would suggest that each should show on its face the source and date of the information, thus limiting to a minimum the documents to be consulted; and as the cards are all arranged alphabetically it would simplify matters to adopt a preferred spelling for all words in use by the Office. This would harmonize at once the many differences now existing in our sailing directions, light lists, charts, indices, and other publications, and increase the certainty of reference in all parts of the office. To more thoroughly harmonize such work the same general rules should govern all indexing.

It would be a saving in many ways to omit such reference words as Bay, Cape, Mount, Rio, River, Saint, Santo, San, St., Port, Porto, using only the proper name in every case.

The geographical sections should be exactly defined and limited by degrees of latitude and longitude; a chart of the world showing such limits is needed for constant use in this room. At present the limits are somewhat indefinite.

It is desirable that separate reports should be made on each special locality, and that one uniform style of paper be used.

Tracings should never be made on paper, as it is not suitable for preservation and after a few years breaks and crumbles away; cloth should be used.

Respectfully submitted.

G. A. MERRIAM,
Lieutenant, U. S. N.

Commander J. R. BARTLETT, U. S. N.,
Hydrographer.

DIVISION OF METEOROLOGY, HYDROGRAPHIC OFFICE,
July 1, 1885.

SIR: I have the honor to submit the following report: The greater part of the time of this Division has been given to perfecting and compiling the data for the monthly Pilot Chart of the North Atlantic, the continuation of the work on the meteorological charts of the North and South Atlantic Oceans, and the distribution of meteorological journals to the merchant marine of the United States and foreign countries, whose ship-masters have volunteered to make observations for the Office.

The Pilot Chart has been improved from time to time as changes have been suggested, and the appreciation of it by nautical people requires no stronger evidence than the constantly increasing demand that the Office is called on to meet.

The publication of information in regard to the use of oil to diminish the dangerous breaking of seas during gales of wind commenced on the Pilot Chart of January last, appears to have excited great interest among nautical men, and there can be but little doubt that it will eventually demonstrate to them a simple and ready means of materially decreasing the danger in the most violent storm.

One of the most interesting subjects for consideration which a study of the year's Pilot Charts suggests is the general circulation of the currents of the Atlantic as shown by drifting wrecks and buoys. While the movements of some of them have been very erratic, on a whole they confirm the truth of the theory of currents as delineated on the Pilot Chart. In many instances their movements have been evidently so much affected by winds that no correct estimate of the strength of the current can be made, except in the case of the derelict schooner *Twenty-one Friends*. This vessel was abandoned, water-logged off the coast of Virginia on March 24, in about latitude 36° 30' north and longitude 72° west. Being lumber laden she continued to float, and as her masts were carried away near the deck there was but little surface exposed to the influence of the wind. From March 24 to April 4 she drifted east-northeast 37 miles per day. From April 4 to April 14 the drift was in the same direction and 39 miles per day. From April 14 to April 28, east by north about 23 miles per day. From this point her reported

positions have been so irregular, and in some cases so conflicting, that her movements have been evidently affected by gales of wind, but from March 24 to April 28, an interval of thirty-five days, she drifted directly along the axis of the Gulf Stream, as indicated, a distance of nearly 1,200 miles, an average of 34 miles per day.

The schooner *Maggie M. Rivers*, abandoned near Cape Hatteras January 7, 1884, appears to have been driven directly across the Gulf Stream, and on February 6 was sighted in latitude 34° north and longitude $69^{\circ} 30'$ west, having passed out of the influence of the stream. She remained near this position until August, and being directly in the track of vessels coming onto the coast from the equator, was reported many times. After this she appears to have come under the influence of the Gulf Stream, and drifted rapidly to the northeast until the middle of September, when she was again driven south, and on November 13 was towed into Bermuda by H. B. M. S. *Canada*.

This case presents itself as one that should have demanded the attention of this Government. For nine months this vessel was drifting in the track of commerce, within two days' easy steaming of our coast, and it would seem a very appropriate duty for our men-of-war to search for and destroy such dangers when reported.

Almost the same thing occurred immediately after in the case of the derelict brig *O. B. Stillman*, which drifted in the same locality from October 9 to February 17, and was finally towed into Bermuda. During the past year there has been received but one report of a vessel having collided with a derelict; how many have not reached their destination from this cause? Certainly we cannot be altogether wrong in believing that some of the many reported as missing may have come to grief in this way.

During the season of tropical hurricanes there were two cyclonic disturbances that originated within the tropics, and one which appears to have developed off the coast of Florida, between Jacksonville and Savannah.

The logs of a large number of merchant vessels were consulted by the officers of the branch hydrographic offices, and the data extracted, in connection with the Signal Service reports, were sufficient to plot their tracks, as given on the Pilot Charts of November and December.

The first one appears to have developed in latitude 18° north, longitude 47° west, on September 3. It moved slowly to the northward and westward until it reached latitude 32° in longitude 57° west, where it curved to the northeast and passed over the Central Atlantic toward the European coast, the only remarkable feature about it being the very slow motion of its axis. From September 4 to 14 it only advanced at the rate of about 6 miles per hour.

On September 12 a disturbance appears to have moved off the coast of South Carolina, which rapidly developed a gale of hurricane force. It moved to the southeast on the 13th, to the south on the 14th and 15th, when it curved to the westward, and one of the reports shows that the center passed directly over a vessel on the 16th in latitude 27° north, longitude $75^{\circ} 30'$ west. It then recurved to the west and north, then north and east, crossing its track of the 13th and 14th of September between the 17th and 18th. At the time of the publication of the Monthly Pilot Chart the reports were not sufficient to trace its path beyond this point, but those subsequently received show that it moved to the northeast across the Atlantic nearly to the British Islands. The abnormal path of the storm must have been very confusing to mariners

within its influence and endeavoring to avoid the center. This a number failed to do, with disastrous results.

The third and last one appears to have developed between October 7th and 8th, near the western end of the island of Santo Domingo, from whence it moved to the north and west over the eastern end of Cuba. From the 9th to the 13th, it appears to have been passing over the Bahama Islands, and, curving to the north and east, no reports were received of it after the 17th.

The report of the steamship Cienfuegos presents the unusual facts of her having twice encountered the same hurricane. In the first instance, on the night of October 9th, while at anchor in the harbor of Santiago de Cuba, which port she left on October 13th, bound for Nassau. On October 14th, at midnight, she again experienced a hurricane from the west northwest, the center being nearly north of her. On the 16th she arrived off Nassau, but was unable to communicate with the harbor on account of the sea breaking on the bar.

The work on the South Atlantic meteorological charts is well advanced, but, owing to the reduced number of officers on duty in this Division, has been suspended. There are now on hand a large number of meteorological journals kept by merchant captains containing more or less data for these charts, which I would advise compiling.

In the squares along the great highways of commerce, between the equator and Cape Horn and the Cape of Good Hope, the data is very abundant, but along the African coast it is very meager. This is a part of the ocean seldom visited by vessels of our navy or merchant marine, and the only way that it can be obtained is from the British Government. Having had men-of-war on that coast for many years, and controlling the logs of large numbers of merchant steamers passing along that coast before the opening of the Suez Canal, the English Government probably has the desired information.

During this fiscal year one thousand and sixty meteorological journals have been issued to the merchant marine, and three hundred filled journals have been turned in.

Respectfully submitted.

SETH M. ACKLEY,
Lieutenant, U. S. N.

Commander JOHN R. BARTLETT, U. S. N.,
Hydrographer.

UNITED STATES BRANCH HYDROGRAPHIC OFFICE,
Custom-house, Boston, Mass., July 1, 1885.

SIR: In accordance with instructions I herewith forward a report of the work of the Boston branch of the Hydrographic Office, United States Navy, for the fiscal year ending June 30, 1885.

The number of vessels visited was 2,464, to the masters of which were explained the objects of the office, invitations extended to avail themselves of its uses, and all important information relating to their particular voyages obtained and given.

Four thousand three hundred and fifty merchants, mariners, and others were furnished with information on various topics, many of the questions being of a non-nautical nature, but in no case were the questioners disappointed.

The office has received during this time 138 important communications

from masters of vessels and others, the knowledge of which made public has been and is of value to seafaring people. In the matter of barometers, 2,028 have been corrected to correspond with the readings of the mercurial standard in this office.

Nearly 500 sailing charts were brought to this office for correction, of which number 364 were corrected free of charge; the remainder, on account of age, were found so inaccurate as to make the labor of correction almost equal to the construction of new charts, and the condition such as to make the charts practically useless.

The masters of 43 vessels were furnished with 120 meteorological journals, to whom were given, free of cost, 600 general sailing charts. Of the monthly Pilot Charts, 3,000 were distributed during the year. Ninety-three reports of the positions of icebergs and floes on and in the vicinity of the Grand Banks and of 427 derelicts and wreckages were received.

Previous to February 14, 1885, no record was kept of the following items, but since that date 2,532 copies of "Notices to Mariners," 243 copies of the Light-House Board's "List of Lights," and 1,502 "Day Marks" have been distributed. There have been received 372 trade-wind limit reports, the data more or less valuable of 43 storms, the positions and conditions of 106 separate fogs, and of 33 water-spouts. A great number of the publications from the various Departments of the Government have been furnished on application, no record of which has been kept.

This statement of work speaks for itself, but to show that the office and its practical work is thoroughly appreciated, I beg to submit a few extracts from letters received from Boston merchants.

Mr. Hunt, of the firm of Charles Hunt & Co., says :

We have never had occasion to regret our action, taken some time since, in petitioning for the continuance of your important office in this port, and we desire to repeat our high estimate of its value, and the importance attached to its work by those masters of vessels (to our consignment) who have availed of its privileges and been recipients of its favor.

Mr. Lombard, of A. C. Lombard Sons, says :

Your office has been of great benefit to us since its establishment here, and particularly to the masters of steamships and vessels of all nations to our care, in correcting charts, adjusting barometers, rating chronometers, &c. A number of our captains have told us it was far ahead of anything of the kind on the other side of the Atlantic. We believe the branch offices are daily growing in importance, and that every facility should be given by the Government to extend their field and increase their efficiency.

And Mr. Burt, of Burt, Alexander & Co., says :

The more fully the objects and scope of the office are known the value of the service increases. We rarely have a master arrive in port now that is not anxious to visit your office and obtain the information which you are so ready to furnish. The charts giving the "ice limits" and location of wrecks are considered very valuable by all mariners, and an increased interest has already been awakened to report any occurrences during their voyages which may be for the interest of the mercantile marine.

The office is almost daily in receipt of verbal testimonials commending the action of the Department in establishing these branches in the principal sea-ports, as it was a want long felt by merchants.

The efficiency of this branch will certainly increase if some means can be devised for the establishment of a comparatively rapid communication with the maritime interests of the sea-port towns of Gloucester, Portsmouth, Portland, Bath, Bangor, and Eastport to the northward, and Provincetown, Vineyard Sound, and Buzzard Bay ports to the southward.

The following recapitulation shows the work performed at this office from July 1, 1884, to June 30, 1885, inclusive:

Vessels visited.....	2,464
Information given to individuals.....	4,350
General information received.....	138
Barometers adjusted or compared.....	2,028
Sailing Charts corrected.....	364
Pilot Charts distributed.....	3,000
Ice reports.....	93
Wreck and wreckage reports.....	427
Buoys adrift.....	13
Meteorological journals afloat.....	120
Notices to Mariners distributed.....	2,532
Light Lists distributed.....	243
Buoy books distributed.....	1,502
Trade winds reported.....	372
Storms reported.....	43
Fogs reported.....	106
Water-spouts reported.....	33
Chronometers rated from October 30, 1884, to April 11, 1885, when rating was suspended.....	61

Respectfully submitted.

W. A. MARSHALL,
Lieutenant, U. S. N.

Commander J. R. BARLETT, U. S. N.,
Hydrographer.

UNITED STATES BRANCH HYDROGRAPHIC OFFICE,
MARITIME EXCHANGE,
New York, N. Y., July 1, 1885.

SIR: In accordance with instructions I forward herewith the report for the year ending June 30, 1885:

It has been the aim of this office to make masters of vessels comprehend that it is for their special benefit, being a mere medium and a very convenient one, by which each captain gives to all concerned the benefit of his personal experience by reporting any unusual occurrence immediately upon arrival in port. This information is put in proper shape and kept for reference, with copies for distribution, as well as all information in the possession of the Hydrographic Office.

The masters of all vessels arriving at the port of New York are informed of the existence of this office by an officer going on board, by letter or by card. In each case they are requested to call at the office, and are given some idea as to its object and benefits.

Upon the receipt of any report from the master of a vessel an acknowledgment is made and a Pilot Chart sent to him. Pilot Charts are given monthly to all the principal newspapers, exchanges, clubs, shipping firms, and agents, many of whom frame the charts and hang them in conspicuous places, where they can be examined by any one interested.

150 . REPORT OF THE SECRETARY OF THE NAVY.

The following table gives a summary of the work performed:

	1884.						1885.					Total.	
	July.	August.	September.	October.	November.	December.	January.	February.	March.	April.	May.		June.
Vessels visited	173	281	230	288	320	224	312	328	417	393	395	309	3,709
Vessels taking meteorological journals	5	6	7	6	5	4	10	30	30	15	10	30	156
Vessels returning filled meteorological journals	3	1	1	2	4	1	1	4	3	6	2	6	33
Meteorological journals issued	11	16	17	15	14	13	23	81	67	37	20	81	385
Meteorological journals returned filled	8	3	2	2	7	1	1	9	8	10	6	12	68
Storm journals issued	9	30	31	8	2	13	2	7					103
Storm journals returned filled			2	3	5			1		1			12
Barometers compared	25	35	23	17	21	12	15	31	61	124	155	213	723
Thermometers compared									26	25	36	52	139
Meteorological charts furnished vessels						12	48	36	72	24	24	72	264
Ocean charts furnished vessels	22	46	80	60	65	35	48	122	178	112	39	206	958
Vessels' charts corrected						1	1	1					4
Pilot charts distributed	307	418	258	311	382	396	390	404	535	417	538	497	4,832
Polar charts distributed													25
Lists of United States lights distributed	2	4	17	9	10	19	19	13	48	68	67	52	323
Lists of beacons and buoys distributed	5	9	11	27	69	142	135	140	211	209	238	150	1,355
Notices to mariners distributed	10	11	4	73	75	85	360	1,269	1,882	1,534	3,399	3,981	12,163
Information given to captains of vessels and others								117	193	301	424	564	1,569
Pamphlets distributed:													
Revolving Storms and how to avoid them													55
Magnetism of Iron Ships													30
Rules of the Road													100
Anti-corrosive and Anti-fouling Paints													12
Sound Signals													17
Annual Report of Hydrographer													6
Instruction to Mariners in case of Shipwreck													100
Coasters' Nautical Almanac, 1884													30
Reports received and forwarded to Washington:													
Storms at sea		3	3	17	21	12	7	1	1			1	66
Use of oil in gales									5	2	1		8
Wrecks	25	63	63	72	37	24	20	16	24	11	19	14	298
Buoys adrift	4	6	1	2	6	5	5	3	9	6	1	3	51
Water-spouts									5	2	3	5	15
Fog		1							3	1	12	16	33
Earthquakes at sea					1		1	1					3
Ice	8	24	6	11		1	1	31	34	31	91	81	319
Trade-wind limits	15	24	35	76	102	84	111	91	169	208	115	162	1,162

Respectfully submitted.

V. L. COTTMAN,
Lieutenant, U. S. N.

Commander J. R. BARTLETT, U. S. N.,
Hydrographer.

UNITED STATES BRANCH HYDROGRAPHIC OFFICE,
MARITIME EXCHANGE, 131 SOUTH SECOND STREET,
Philadelphia, Pa., July 1, 1885.

SIR: The following is a summary of the work done at this office from July 1, 1884, to July 1, 1885:

Reports, &c., forwarded:	
Storm reports	29
Limits of trades	67
Ice	162
Fogs	61
Water-spouts	11
Earthquakes	

Reports, &c., forwarded—Continued.

Electrical storms.....	2
Saint Elmo's fire.....	1
Wrecks.....	256
Buoys adrift.....	20
General information.....	7
Use of oil in gales.....	15
Intelligence reports.....	22
Articles distributed:	
Polar charts.....	25
Meteorological charts.....	36
Pilot charts.....	3,728
Soudan charts.....	10
General sailing charts.....	82
Notices to mariners.....	1,229
Light lists.....	262
Buoy books.....	811
Nautical almanacs.....	14
Monograph No. 4.....	25
Sound signals.....	92
Magnetism, iron ships.....	44
Tests of paints.....	10
Report of Secretary of Navy.....	14
Mercantile lists.....	1
Meteorological journals.....	43
Storm journals.....	59
Work done by the office:	
Vessels visited.....	1,538
Information to persons.....	3,360
Barometers corrected.....	682
Charts corrected.....	892
Sextants corrected.....	1
Thermometers corrected.....	13

The preceding list gives no adequate idea of the work of the office. In cases where several hours have been spent in overhauling and showing the latest charts, they are simply reported as single informations. In this manner captains have secured hundreds of corrections to their charts without actually bringing them to the office. In many instances, aggregating some hundreds, captains have selected the new charts desired for their proposed voyages by actual inspection of our charts, and have then gone to the dealers with the lists in their hands, thus saving both much time and annoyance.

Information upon a great variety of subjects has been given, until this office has become a bureau of information to residents of Philadelphia and vicinity, as well as to the shippers and owners and officers of vessels. Single reports to the Office of Naval Intelligence upon ship-yards, dry-docks, &c., occupied fully the time of one person for over a week. A good deal of time was spent in compiling voyages from the Atlantic ports of the United States to the East Indies. The time of the officer in charge of this office was partly occupied during several months in the experiments in electricity carried on by the Franklin Institute. These were of great interest to the naval service and owners of ocean steamers. A constant effort was made to board every vessel of any size arriving at Philadelphia. Their meteorological instruments were corrected, and any information of interest to maritime people obtained. The work of this office seems to be steadily increasing.

The publications of the Hydrographic Office are very highly appreciated. The North Atlantic Pilot Chart is received with increasing favor, and constant flattering comments are heard upon its appearance and great usefulness. No captain will leave port without it, and its sailing routes are generally followed, especially during the prevalence of ice in low latitudes. The demand for it from foreign vessel owners,

insurance companies, maritime associations, and institutions of learning is a gratifying evidence of its appreciation in Europe. No unfavorable comments have ever been heard.

The oil reports are very favorably received, and the knowledge conveyed has unquestionably been of great advantage to vessels in severe storms. There is a general desire for a pamphlet embodying these reports, and the conclusions drawn from them. Many vessels now take casks of oil to sea with them for the special purpose of use in storms. No seafaring person questions its utility.

If possible, fog limits, or the local amount of fog in each month in every square, should appear. More sailing routes are necessary, especially one for sailing vessels during the winter from Europe to the United States.

A request should be printed on the Pilot Chart for full and particular descriptions of all buoys sighted adrift.

The time-ball in the Maritime Exchange was dropped each week-day during the year. This, with the excellent chronometer always accessible to the public, has furnished correct time to hundreds of the business people in this part of the city. In April a time-ball was placed upon the roof of the building, which can be seen by most of the shipping in the river. This time ball is exceedingly useful to captains in giving the exact error of their chronometers.

The branch offices should be furnished with a similar library supplied to our men-of-war, together with a complete set of sailing directions of the world.

Respectfully submitted.

A. B. WYCKOFF,
Lieutenant, U. S. N.

Commander J. R. BARTLETT, U. S. N.,
Hydrographer.

UNITED STATES BRANCH HYDROGRAPHIC OFFICE,
Baltimore, Md., July 1, 1885.

SIR: I beg leave to submit the following report of the work of this office for the year ending June 30, 1885.

In compliance with the orders of the Navy Department dated March 8, 1885, a copy of which is appended, I relieved Lieut. J. M. Hawley, U. S. N., in charge of this office, on March 18, 1885.

I found the office on a firm footing, with Ensign W. S. Benson, U. S. N., as assistant (he having reported for duty on March 13, 1885); J. A. Foxcroft, clerk and boarding officer, and Christian H. Schaub as messenger and office boy.

The work of the office is kept up to date; all charts are corrected according to the Notices to Mariners received. All vessels arriving from foreign ports are visited, as well as all coasting steamers and many coasting schooners, and all the information that can be procured is obtained of them, and their barometers compared with a standard and corrected or the error given.

Shortly before I took charge a time-ball had been established on top of the Baltimore and Ohio Railroad building, corner of Baltimore and Calvert streets, and since I have been here has, with a few exceptions, worked satisfactorily, and is dropped daily (Sunday excepted) at noon of the seventy-fifth meridian.

The monthly Pilot Chart is much sought after, and copies are requested by merchants to send to their correspondents abroad. Many of the vessels use them as sailing charts in crossing the Atlantic, and the position of the ice as laid down on the Pilot Charts is of great value to ship owners and masters.

The master of an English steamer informed me that he came near losing the command of his vessel on his last voyage to England for deviating from the safe route as laid down on the May chart, and his owners have given strict orders that their vessels shall follow the routes as laid down on the Pilot Charts.

In addition to the usual work of the office reports on thirty-three foreign steamers on the docking and repairing facilities and on the supply and kinds of coal at Baltimore, have been furnished the Bureau of Naval Intelligence. Information of various kinds has been furnished individuals and corporations.

I would like to suggest that the marine insurance companies be requested to require their marine inspectors to examine the charts on board of the vessels they inspect, and report if they are corrected to date. The English Board of Trade requires that vessels should be supplied with charts corrected to date of sailing. In this country, in the absence of any law on the subject, the boards of underwriters are the only ones that could compel owners of vessels to have correct charts.

Since I have been in charge of this office three English steamers arriving in this port have run on shoals, caused by their not having proper charts.

The steamer *Midlothian* ran on Saint Laurent Reef, using an old "Imray" chart of the date of 1879.

The *Kate Fawcett* struck on the 15-foot patch off False Cape, Virginia, using an old "Imray" chart of 1878 of the Atlantic Ocean, as a coasting chart, and on which the shoal was not placed.

The *Viceroy* struck on the same patch, using the same chart, but of a later edition.

In conclusion, I acknowledge the uniform kindness and courtesy which I have received from the Board of Trade, the Corn and Flour Exchange, railroad officials, shipping agents, steamship companies, and others with whom I have been thrown in contact.

The following tables show the work done by this office for the year ending June 30, 1885:

GENERAL INFORMATION FORWARDED.

Non-existence of Isle Vert, Atlantic Ocean, reported by Captain Downie.

Unusual current reported off Cape Hatteras.

Reports on use of oil at sea in calming the water, 12.

Report on loss of the English bark *Erinna*.

Report on loss of the English steamer *Benwell Tower*.

Verification of Saint Laurent Reef, Caribbean Sea, reported by Captain Watson.

Phenomenal fall in temperature of water off the coast.

	Six months ending—		Total
	December 31, 1884.	June 30, 1885.	
Vessels visited	1,005	906	2,001
Pilot Charts distributed	1,214	1,289	2,503
Barometers examined and corrected	315	345	660
Light Lists distributed		245	245
Day Marks distributed		196	196
Notices to Mariners distributed		26	26
Meteorological journals placed aboard	10	22	32
Storm journals placed on board	12	3	15
Abstracts of logs copied	54	45	99
Special storm reports		29	29
Wrecks reported by	16	17	33
Ice reported by	5	43	48
Fog reported by		22	22
Buoys adrift reported	5	5	10
Limits of trade winds	82	117	199
Water-spouts reported	2	10	12
Information to masters, &c., at office	238	266	504

Respectfully submitted.

S. L. GRAHAM,
Lieutenant, U. S. N.

Commander J. R. BARTLETT, U. S. N.,
Hydrographer.

UNITED STATES BRANCH HYDROGRAPHIC OFFICE,
MARITIME ASSOCIATION,
New Orleans, La., July 1, 1885.

SIR: I have the honor to make the following yearly report:

This office was established during the quarantine season and at the time of my last yearly report, July 1, 1884, little could be said in regard to its future usefulness, except the promise given by the hearty interest taken by the business community in general, and especially by those interested in maritime commerce, such as ship agents, brokers, owners, and insurers. When they learned that the object was to place within easy reach of all citizens and mariners a copy of all charts, books, and other Government publications relating to navigation and commerce as a free library, with officers in charge to distribute and collect all information that could be of present or future use to commerce or science, give timely warning of new dangers, define the laws of nature, and thereby reduce the loss of life and property, they gave it a hearty welcome, and have ever been ready to advance its interest.

Three prominent associations, viz, The Mexican, Central American and South American Exchange, Cotton Exchange, and Maritime Association, desired to have the office located with them and offered the necessary space. The latter was selected as the most appropriate place on account of the similarity of interests, and the officers and members have done all in their power to make the duty successful and pleasant. Located in the center of the maritime business offices it is convenient to all and so arranged that charts, books, and instruments can be inspected, compared, or corrected with ease and rapidity.

The time-ball on the Cotton Exchange and operated from this office is of great service to the city and shipping. Information has been requested by individuals and corporations in various kinds of business, and I believe the office will steadily grow in favor as its object becomes better known.

During the summer months there was very little shipping in the port, and, with the exception of the New York steamer, it consisted of small steamers and sailing vessels engaged in trade with the islands and

coasts of the Gulf. Much valuable meteorological data might be collected by these vessels if they were better supplied with instruments and would keep the journals. They are constantly cruising, and the meteorological charts contain little information of that locality in comparison with other parts of the Atlantic, because large vessels and men-of-war have not been much in those waters. The demand for good coast and harbor charts of the Gulf and islands is increasing rapidly on account of the impetus given to trade by the employment of capital in various industries, such as railroads, mines, hard woods, and tropical fruits. The railroad facilities at New Orleans for rapidly distributing tropical fruits and perishable products throughout the West and South have created a growing demand that will continue till all land suitable for that purpose is under cultivation. The number and size of steamers increase with this demand.

In September the transatlantic steamers began coming in numbers, and during the year nearly every vessel was visited, the object of the office explained, information given and received. In many cases the information received in regard to cyclones, gales, trade-wind limits, and such subjects was not as complete as desired for computing the storm center, track, area, or discussing the effect on instruments. The masters had taken frequent observations of wind, weather, sea, and instruments, for their own guidance at the time, but did not record them, as they did not know that offices had been established to collect and make use of such data for future navigators. With very few exceptions the masters and officers at once recognized the value of such offices and promised their hearty co-operation in the future. Their subsequent visits proved their interest, and I believe their reports will be more numerous and complete, but in many cases they were too busy to think of the matter until after the occurrence, too late to give the data most wanted. Therefore, I think some method should be devised to call their attention to it at the proper time and make it as easy for them as possible. I can think of no better means of doing so than by additions to the Pilot Charts and a pamphlet for the captain's table. The officers in charge can call attention to the subject if they see the masters, but many of them are not seen by the officers, and the clerks are not well enough informed in professional matters to explain or discuss them. The Pilot Charts are very popular with the masters, and the agents and insurers are particular to see that they are supplied before sailing, and believe that they will save many vessels from destruction by their valuable warnings, any one of which would pay the expense of all the branch offices for many, many years. These charts are kept ready at hand by the masters, frequently consulted, and many plot their positions on them daily and compare their actual experiences with the mean of the experiences of the past as shown by the charts. Therefore, I believe the best method of calling their attention at the proper time to the subjects about which information is wanted, is to print or stamp it on these charts in the localities where they most frequently occur. I wrote such requests on the charts issued in regard to northers in the Gulf, trades on the limit line, cyclones off the Bahamas, ice off the Banks, rain in the rain belt, and others.

The pamphlet before referred to should state concisely just what information or data is wanted on each subject, without entering into a discussion of it. The master can then know just what is of value to observe during cyclones, northers, and other occurrences without overhauling several volumes on the laws of storms and sailing directions at a time when he has something more important to do, even if supplied with these books.

The commerce of this port is confined to the Atlantic. Foreign steamers generally make a straight run between Europe and the Gulf and pay little attention to meteorological changes, as nothing but very heavy gales, cyclones, and fogs affect them. For this reason there is little demand for meteorological charts and journals as compared with the other ports which send out numerous sailing vessels to all parts of the world. These vessels are generally supplied with foreign charts by the companies, but since this office was opened they have seen the Hydrographic Office charts, and the sale has increased considerably, particularly of the large-scale charts of the Florida coast and channel. This is where most accidents occur, and where they will continue to occur until masters see the necessity of losing a little time in swinging for compass deviations after leaving port with a new cargo in iron ships, and of sounding occasionally through the channel on account of irregular currents.

The following is an itemized statement of work performed :

Vessels visited.....	700
Information given to individuals.....	707
Barometers compared or adjusted.....	425
Charts corrected.....	2
Pilot Charts distributed.....	1,569
Notices to Mariners distributed.....	602
Light Lists distributed.....	154
Day Marks distributed.....	247
Polar Charts distributed.....	30
Valley of the Nile Charts distributed.....	9
Pamphlets on fog signals.....	8
Storm reports received and forwarded.....	8
Trade wind limits forwarded.....	38
Fog reports forwarded.....	1
Water-spouts.....	5
Wrecks.....	17
Buoys adrift.....	6
Abstracts from log-books.....	87
Sperm whale reports.....	3
Reports to intelligence office.....	2
Miscellaneous reports.....	4

Respectfully submitted.

W. P. RAY,
Lieutenant, U. S. N.

Commander J. R. BARTLETT, U. S. N.,
Hydrographer.

[U. S. Branch Hydrographic Office, Merchants' Exchange.]

SAN FRANCISCO, CAL., *July 21, 1885.*

SIR: I respectfully submit the following report of what has been accomplished in this office during the past year, and what should be done during the coming year:

Trade-wind limit reports received from merchant vessels and forwarded to main office.....	368
Earthquake reports forwarded to main office.....	1
Wreck reports forwarded to main office.....	9
General information received and forwarded to main office.....	12
Vessels visited.....	1,191
Information given to individuals.....	1,214
Barometers compared or adjusted.....	829
Thermometers compared.....	3
Charts corrected.....	15
Pilot-charts of North Atlantic distributed.....	70
Notices to mariners distributed.....	78
Storm journals distributed.....	22

Meteorological journals distributed	321
Light-lists of the United States distributed	97
Day-marks of the United States distributed	158
Filled storm journals forwarded to main office	1
Filled meteorological journals forwarded to main office	66
Meteorological charts distributed to masters of merchant vessels for the keeping of meteorological journals	30
Hydrographic Office sailing-charts distributed to masters of merchant vessels for keeping of meteorological journals	594
Hydrographic Office charts of the Arctic, showing the latest discoveries of Lieut. A. W. Greely, U. S. A., distributed	39
Charts of the Nile Valley and the Soudan distributed	9
Hydrographic Office publication on magnetism of iron and steel ships distributed	7
Number of meteorological journals unfilled returned to office	5

During the past year this office has sent to the main office a report on "Iron Ship-building on the Pacific Coast" and a report on the Oceanic Steamship Company's steamers Alameda and Mariposa. During the coming year the office should accomplish a great deal more. As it is becoming better known, its benefits are being taken advantage of by masters of merchant vessels, shipping-merchants, and insurance companies particularly, and by the public generally, whenever any event takes place of public interest and of a nautical nature. It is hardly possible to estimate in figures what should be accomplished.

In addition to the regular duties, I am engaged in compiling sailing directions for "Islands of the Pacific Ocean": this work should be completed during the coming year.

Time-signals are received here every day about noon, and at noon, from the observatory at the navy-yard, Mare Island; and a time-ball in charge of this office is dropped each day at noon from Telegraph Hill.

The time-ball is used by masters of merchant vessels to compare and rate their chronometers. It is also a benefit otherwise, as it is used by railroads, jewelers, chronometer and watch repairers, and by the public generally.

Chronometers are rated in the office by time-signals or by comparing with standard chronometer which is kept in the office. This benefit to the captains of merchant vessels will be more generally taken advantage of as it becomes more generally known. Time-signals and time-ball have been in operation since May last.

The assistance received from masters of merchant vessels has exceeded my expectations, but as the full object of the office cannot be accomplished without their help, it is necessary to enlist their interest in the work.

When sufficient data have been collected, so pilot-charts of the North Pacific can be published and distributed, as is done for the North Atlantic, masters of merchant vessels can then see additional benefit of the office to them, and will take greater interest in making reports of their voyages.

This office has a good field for getting masters of vessels to keep meteorological journals, but they are unwilling to buy thermometers, consequently many journals are sent in without complete data on temperatures. If sufficient money could be appropriated for the purchase of thermometers for masters of vessels who keep meteorological journals for the Hydrographic Office, the efficiency of the office in this particular would be considerably advanced.

Respectfully submitted.

J. B. MILTON,
Lieutenant, U. S. Navy.

Commander J. R. BARTLETT, U. S. N.,
Hydrographer.

No. 8.—BUREAU OF STEAM ENGINEERING.

NAVY DEPARTMENT,
BUREAU OF STEAM ENGINEERING,
Washington, October 15, 1885.

SIR: In obedience to your order of September 23, I have the honor to submit to the Department the annual report of this Bureau for the past year, together with the estimates for the fiscal year 1886-'87.

APPROPRIATION, STEAM MACHINERY, 1885.

Amount appropriated for temporary provision for six months ending December 31, 1884, act approved July 7, 1884.....	\$500,000 00
Additional appropriation for fiscal year ending June 30, 1885, act approved January 30, 1885	280,000 00
“And the unexpended balance of the appropriation of \$1,000,000, made by the act approved March 3, 1883, for engines and machinery for the double-turreted iron-clads be, and the same is hereby, reappropriated and made available during the last half of the year ending June 30, 1885,” act approved January 30, 1885	140,000 00
Total for fiscal year 1884-'85.....	920,000 00

EXPENDED TO OCTOBER 15, 1885.

For labor in navy-yards and stations, in constructing new engines, boilers, and their dependencies; repairing old boilers, machinery, &c., and fitting vessels for sea service; preservation of tools, handling and preservation of materials and stores.....	\$563,057 60
For purchase of materials, stores, machine-tools, freights, and incidental expenses	215,290 90
For payments on foreign stations, for repairs, materials, &c.	73,882 21
Total.....	852,230 71
Less repayments by transfers in the adjustments of appropriations	4,320 25
Total expenditure.....	847,910 46
Balance on hand.....	72,089 54

The larger portion of this balance of \$72,089.54, however, is covered by obligations of the Bureau for purchases, &c., at home and abroad, the vouchers for which have not yet been received or the accounts not yet settled.

APPROPRIATION, MACHINERY, DOUBLE-TURRETED MONITORS.

Amount appropriated for engines and machinery for the double-turreted iron-clads, act approved March 3, 1883.....		\$1,000,000 00
Expended to October 15, 1885, under contracts dated June 15, 1883:		
For the Puritau	\$402,147 23	
For the Terror	156,534 30	
For the Amphitrite	104,356 14	
Total	663,037 67	
The unexpended balance of this appropriation reappropriated and made available during the last half of the year ending June 30, 1885, under the appropriation, steam machinery, 1885, act approved January 30, 1885.....	140,000 00	
		<u>803,037 67</u>
Balance on hand.....		196,962 33
The balances yet due under the contracts for the completion of engines, &c., for these iron-clads are—		
On the Puritau	26,327 00	
On the Terror.....	52,178 02	
On the Amphitrite	104,356 18	
		<u>182,861 20</u>
Balance		14,101 13

This balance of \$14,101.13, however, will be required to pay for cost of steam trials and extras to contract of the above-named monitors.

APPROPRIATIONS FOR STEEL CRUISERS.

Appropriation of \$1,300,000, act approved March 3, 1883.		
Drawn out by Bureau of Steam Engineering for the machinery of the steel cruisers		\$386,748 00
Appropriated, act approved July 7, 1884, for steel cruisers' machinery..		620,000 00
Appropriated, act approved March 3, 1885 (deficiency), for completing new naval cruisers and dispatch boat (machinery).....		86,983 57
Total appropriated (machinery)		<u>1,093,731 57</u>

EXPENDED TO OCTOBER 15, 1885.

On the Atlanta.

Payments made on contract	\$212,310 00
Payments for extras to contract	3,246 23
Payment for "civilian expert"	421 00
Payments for draftsmen, writer, &c.....	1,317 00
Total	<u>217,294 23</u>

On the Boston.

Payments made on contract	\$213,030 00
Payments for extras to contract.....	3,264 23
Payment for Herreshoff launch	2,221 67
Payment for "civilian expert"	421 00
Payments for draftsmen, writer, &c.....	910 00
Total	<u>219,846 90</u>

On the Chicago.

Payments made on contract	\$206,420 00
Payments for extras to contract	3,318 23
Payment for "civilian expert"	589 50
Payments for draftsmen, writer, &c.....	1,148 00
Total	<u>211,475 86</u>

On the Dolphin.

Payments made on contract	\$122,760 00
Payments for extras to contract.....	7,060 15
Payments for "civilian expert".....	2,430 12
Payments for draftsmen, writer, &c.....	208 00
Total	132 458 27
Total payments	\$781,075 25
Balance on hand	312,656 31
AMOUNTS TO PAY BALANCES ON EXISTING CONTRACTS.	
Balance due on Atlanta.....	\$23,990 00
Balance due on Boston.....	23,270 00
Balance due on Chicago.....	133,090 00
Balance due on Dolphin.....	13,640 00
Total due (machinery)	193,980 00
Balance	118,676 31

It is expected that this balance (\$118,676.31) will be required to pay cost of steam trials, extras, "civilian experts," draughtsmen, writers, watchmen, &c., on the machinery of said steel cruisers.

GENERAL OPERATIONS OF THE BUREAU.

The following table will exhibit the character and cost, in labor and materials, of the work done under cognizance of this Bureau for the fiscal year ending June 30, 1885, upon the machinery, boilers, &c., with outfits, stores, &c., of naval vessels, and the expenditures for maintenance, &c., at the several navy-yards and stations:

Name of vessel.	Rate.	Engines, boilers, and machinery.	Stores and outfits.	Total.	Remarks.
Adams.....	Third.....	\$55,264 45		\$55,264 45	New boilers completed, new crank-shaft, and steam capstan furnished.
Ajax.....	Iron-clad.....	21 65	\$1,243 16	1,264 81	Care and preservation.
Alarm.....	Torpedo ram.....	637 88	217 88	855 76	Do.
Alert.....	Third.....	46 26	127 57	173 83	In service.
Alert.....	Fourth.....	919 59	680 14	1,599 73	Greely Relief Expedition ship.
Alliance.....	Third.....	23,047 81	2,932 74	25,980 55	Building new boiler and repairs.
Amphitrite.....	Iron-clad.....	69,570 76		69,570 76	Under contract for machinery.
Atlanta.....	Steel cruiser.....	4,997 70		4,997 70	Extras to contract.
Bear.....	Fourth.....	912 02		912 02	Greely Relief Expedition ship.
Boston.....	Steel cruiser.....	4,733 70		4,733 70	Extras to contract.
Brooklyn.....	Second.....	13,149 50	884 88	14,034 38	Extensive repairs made.
Camanche.....	Iron-clad.....	40 80		40 80	Care and preservation.
Canandaigua.....	Second.....	33 66		33 66	Do.
Catalpa.....	Tug.....	2,751 55	489 91	3,191 46	Slight repairs.
Chicago.....	Steel cruiser.....	1,796 21		1,796 21	Extras to contract.
Cohasset.....	Tug.....		3 72	3 72	In service.
Colorado.....	First.....	23 86		23 86	Care and preservation.
Constitution.....	Third.....	50 26		50 26	Heating apparatus.
Despatch.....	Fifth.....	5,973 53	1,731 24	7,704 77	Repairs made. In service.
Dolphin.....	Steel cruiser.....	3,373 34		3,373 34	Extras to contract.
Emerald.....	Tug.....	321 00		321 00	Slight repairs made. In service.
Enterprise.....	Third.....	27 58	839 55	867 13	In service.
Essex.....	do.....	6,190 76	1,431 87	7,622 63	General repairs being made.
Fortune.....	Tug.....	9,438 06	6 40	9,444 46	Putting in new boilers.
Franklin.....	First.....	616 58	1,357 93	1,974 51	Receiving ship Norfolk, Va.
Galena.....	Third.....	1,368 11	823 37	2,191 48	Slight repairs made. In service.
Hartford.....	Second.....	4,633 94	322 41	4,956 35	Repairs made. In service.
Intrepid.....	Torpedo ram.....	1,273 21		1,273 21	Changes being made in engines.
Iroquois.....	Third.....	90 11	1,197 65	1,287 76	In service.

Name of vessel.	Rate.	Engines, boilers, and machinery.	Stores and outfits.	Total.	Remarks.
Jamestown.....	Third.....	\$631 21	\$136 95	\$768 16	Heating apparatus. In service.
Jason.....	Iron-clad.....	595 79	595 79	Care and preservation.
Junista.....	Third.....	1,753 13	575 39	2,328 52	Slight repairs. In service.
Kearyarge.....	do.....	133 72	1,696 12	1,829 84	In service.
Lackawanna.....	Second.....	329 45	520 73	850 18	Slight repairs.
Lancaster.....	do.....	819 93	5,380 10	6,200 03	In service.
Leyden.....	Tug.....	451 79	451 79	Do.
Marion.....	Third.....	29,546 98	8,671 68	38,218 66	Repairs and new boilers put in.
Mayflower.....	Tug.....	1,085 37	221 45	1,306 82	General repairs made.
Montanmoh.....	Iron-clad.....	15,648 82	15,648 82	New turret machinery made.
Michigan.....	Fourth.....	36 54	29 18	65 72	In service.
Minnesota.....	First.....	211 01	774 86	985 87	Training ship.
Mohican.....	Third.....	42,785 30	5,812 45	48,597 75	New engines and boilers completed.
Monocacy.....	do.....	56,870 51	3,263 44	59,833 95	New boilers completed and put in.
Monongahela.....	Second.....	5 05	5 05	Store-ship, Coquimbo, Chili.
Montauk.....	Iron-clad.....	595 75	595 75	Care and preservation.
Monterey.....	Tug.....	1,834 52	1,834 52	Care and preservation. In service.
Nahant.....	Iron-clad.....	596 61	596 61	Care and preservation.
Nantucket.....	do.....	682 21	1,003 34	1,685 55	General repairs made.
Nellie.....	Tug.....	924 10	924 10	Repairs made. In service.
New Hampshire.....	Second.....	314 16	314 16	Training ship.
New York.....	First.....	2,247 98	2,247 98	New boilers completed.
Nina.....	Tug.....	4,964 50	593 86	5,557 86	General repairs made. In service.
Nipsic.....	Third.....	446 92	1,247 55	1,694 47	In service.
Omaha.....	Second.....	23,479 25	7,280 69	30,759 94	Repaired with new boilers.
Onward.....	Fourth.....	2 60	2 60	Do.
Osaipce.....	Third.....	41 02	1,155 41	1,196 43	In service.
Palos.....	Fourth.....	177 19	465 62	642 81	Do.
Passaic.....	Iron-clad.....	108 78	1,093 92	1,202 70	Care and preservation.
Pensacola.....	Second.....	33,647 18	15,636 65	49,283 83	Extensive repairs made and new steam capstan furnished.
Phlox.....	Tug.....	733 47	138 96	872 43	Slight repairs. In service.
Pilgrim.....	do.....	245 89	245 89
Pinta.....	do.....	2,118 15	1,580 48	3,698 63	In service.
Portsmouth.....	Second.....	3,212 56	191 57	3,404 12	Heating apparatus.
Powhatan.....	do.....	4,402 27	1,787 36	6,159 63	Repairs to engines and boilers. In service.
Puritan.....	Iron-clad.....	95 914 70	95 914 70	Under contract for machinery.
Quinnebang.....	Third.....	222 71	7,449 69	7,672 40	In service.
Ranger.....	do.....	9,014 98	3,494 92	12,509 90	Thorough repairs made. In service.
Rescue.....	Tug.....	294 41	294 41	In service.
Richmond.....	Second.....	1,373 18	519 10	1,892 28	Thorough repairs commenced.
Rocket.....	Tug.....	229 42	164 00	393 42	In service.
Saugus.....	Iron-clad.....	12 00	12 00	Care and preservation.
Shenandoah.....	Second.....	741 47	803 85	1,545 32	In service.
Snowdrop.....	Tug.....	2 25	2 25	Do.
Speedwell.....	do.....	1,221 31	779 44	2,000 75	Do.
Swatara.....	Third.....	50,708 52	3,483 02	54,196 54	New boilers completed. In service.
Tallahpoosa.....	Fourth.....	18,171 94	1,616 18	19,788 12	Thorough repairs made.
Tennessee.....	First.....	85,971 75	6,752 57	45,724 32	General repairs made. In service.
Terror.....	Iron-clad.....	104,356 30	104,356 30	Under contract for machinery.
Thetis.....	Fourth.....	616 94	616 94	Greely Relief ship.
Treaton.....	Second.....	2,543 32	2,932 23	5,475 55	Repairs made. In service.
Triana.....	Tug.....	5 16	5 16	In service.
Vandalia.....	Second.....	81,061 70	243 40	81,305 10	New boilers completed; repairs nearly completed; steam capstan furnished.
Vermont.....	do.....	6,935 97	6,935 97	Heating apparatus; receiving ship.
Wabash.....	First.....	109 54	963 26	1,072 80	Receiving ship, Boston, Mass.
Wachusett.....	Third.....	1,756 75	1,756 75
Wyandotte.....	Iron-clad.....	21 97	485 07	507 04	Care and preservation.
Wyoming.....	Third.....	33,587 32	33,587 32	Boilers put in.
Yantic.....	do.....	10,675 53	2,055 19	12,730 72	General repairs made.
Total.....		899,224 88	107,212 24	1,006,437 12	

Expenditures at navy-yards and stations not included in the amount expended on naval vessels.

Navy-yards.	Yard expenses.	Miscellaneous.	Total.
Portsmouth, N. H.	\$23,737 44	\$4,207 71	\$27,945 15
Boston, Mass	10,536 83		10,536 83
Brooklyn, N. Y.	44,424 73	39,833 46	84,258 19
League Island, Pa.	6,417 72	2,975 67	9,393 39
Washington, D. C.	17,436 18	26,504 32	43,940 50
Norfolk, Va.	57,947 90	7,010 26	64,958 16
Pensacola, Fla.	4,203 81	160 13	4,363 94
Mare Island, Cal.	76,758 67	6,672 91	83,431 58
New London, Conn.	916 12		916 12
Key West, Fla.	2,330 96	2,323 63	4,654 59
Foreign stations		1,153 62	1,153 62
Total	244,710 36	90,841 71	335,552 07

PRESENT CONDITION OF MACHINERY OF NAVAL VESSELS, WITH THE WORK REQUIRED ON EACH.

The following will show the present condition and the work required to be done to the machinery of naval vessels to fit them for efficient sea service, or to keep them on such duty during the next fiscal year, according to latest reports, with an approximate estimate of the cost of the same:

Adams (3d rate).—In service. In good condition.

Ajax (iron-clad).—In good state of preservation. Would have to be repaired with new boilers for sea service. (\$40,000.)

Alarm (torpedo ram).—In fair condition.

Alert (3d rate).—In service. In fair condition.

Alliance (3d rate).—General overhauling and repairs, with new boilers, commenced at the Norfolk navy-yard. (\$38,000.)

Brooklyn (2d rate).—Thorough overhauling and repairs just completed at the New York navy-yard.

Camanche (iron-clad).—Well preserved. Could be made ready for sea service at small cost. (\$2,000.)

Canonicus (iron-clad).—Would have to be repaired with new boilers for sea service. (\$40,000.)

Catalpa (tug).—In service. Ordinary repairs. (\$2,000.)

Catskill (iron-clad).—Well preserved. Could be made ready for sea service at small cost. (\$2,000.)

Cohasset (tug).—In service. In good condition.

Despatch (4th rate).—In service. In fair condition. Will require repairs incident to service. (\$5,000.)

Enterprise (3d rate).—Returning from full cruise. Will shortly require general overhauling and repairs. (\$10,000.)

Essex (3d rate).—Undergoing thorough overhauling and repair at the New York navy-yard. (\$20,000.)

Fortune (tug).—Repairs, with new boilers, nearly completed at the Norfolk navy-yard.

Franklin (1st rate).—In service as receiving-ship, Norfolk navy-yard. If fitted for sea would require new boilers (on hand) to be put in, and machinery thoroughly overhauled and repaired. To fit for sea service, \$30,000.

Galena (3d rate).—Undergoing general repairs at Portsmouth navy-yard. (\$4,800.) Will probably require, during the next fiscal year, new boilers. (\$65,000.)

Hartford (2d rate).—In service. Will soon require thorough overhauling and repair, with new boilers. (\$75,000.)

Intrepid (torpedo ram).—Requires to have completed certain designated alterations to fit her for a gunboat. (\$8,000.)

Iroquois (3d rate).—In service. In fair condition. Will require repairs incident to service. (\$10,000.)

Jason (iron-clad).—Well preserved. To prepare for sea service, \$2,000.

Juniata (3d rate).—Returning from full cruise. Will require general overhauling and repair. (\$20,000.)

Kearsarge (3d rate).—In service. Will shortly require general overhauling and repair, with new boilers. (\$65,000.)

Lackawanna (2d rate).—If ordered for sea service would require new boilers and thorough overhauling and repair. (\$75,000.)

Lancaster (2d rate).—In service. In fair condition. Repairs incident to service. (\$10,000.)

Lehigh (iron-clad).—In fair state of preservation. To make ready for service, \$3,000.

Leyden (tug).—In service. Repairs incident to continuous service, \$2,000.

Marion (3d rate).—In service. In good condition.

Mahopac (iron-clad).—In good state of preservation. To fit for service, \$3,000.

Manhattan (iron-clad).—In fair state of preservation. To fit for service. (\$4,000.)

Mayflower (tug).—In service. In good condition.

Michigan (4th rate).—In service. Repairs incident to service. (\$2,000.)

Minnesota (1st rate).—In service as gunnery training-ship. If ordered for regular sea service would require extensive repairs and new boilers. (\$75,000.)

Mohican (3d rate).—In service. In good condition.

Monocacy (3d rate).—In service. In good condition. Repairs incident to service. (\$5,000.)

Montauk (iron-clad).—In good condition. To fit for service. (\$2,000.)

Monterey (tug).—In service. Repairs incident to continuous service. (\$2,000.)

Nahant (iron-clad).—Well preserved. To fit for service. (\$2,000.)

Nantucket (iron-clad).—In good condition. To fit for service. (\$2,000.)

Nellie (tug).—In service. Repairs incident to service. (\$1,000.)

New York (1st rate).—Requires new machinery and new boilers (now on hand) to be erected on board the vessel at the New York navy-yard. (\$60,000.)

Nina (tug).—In service. In good condition.

Nipsic (3d rate).—In service. Will require shortly general overhauling and repair, with new crank-shaft. (\$15,000.)

Omaha (2d rate).—In service. In good condition.

Ossipee (3d rate).—In service. In good condition.

Palos (4th rate).—In service. Will shortly require general overhauling and repair, with new boilers. (\$28,000.)

Passaic (iron-clad).—In good condition. In service at the United States Naval Academy. Small repairs. (\$2,000.)

Pensacola (2d rate).—In service. In good condition.

Pinta (4th rate).—In service. In good condition.

Powhatan (2d rate).—In service. Boilers in bad condition. Requires thorough overhauling and repairs, with new boilers (material on hand). (\$60,000.)

Quinnebaug (3d rate).—In service. During the next fiscal year will require to be thoroughly overhauled and repaired, with new boilers. (\$75,000.)

Ranger (3d rate).—In service. In good condition. Repairs incident to continuous service. (\$10,000.)

Rescue (tug).—In service. Small repairs required. (\$500.)

Richmond (2d rate).—Undergoing general overhauling and repairs. Now having new boilers put in at the New York navy-yard. (\$35,000.)

Rocket (tug).—In service. In good condition.

Saugus (iron-clad). If ordered for sea service would require to have machinery repaired, and new boilers. (\$40,000.)

Shenandoah (2d rate).—In service. In fair condition. Will shortly require thorough overhauling and repair, and new boilers. (\$75,000.)

Speedwell (tug).—In service. In good condition. Repairs incident to continuous service. (\$2,000.)

Standish (tug).—In service. In good condition.

Swatara (3d rate).—In service. Will soon have to be thoroughly overhauled and repaired, and new boilers (on hand) put in. (\$20,000.)

Tallapoosa (4th rate).—Has been thoroughly repaired since being sunk, and is ready for service.

Tennessee (1st rate).—In service. To thoroughly fit for efficient sea service would require extensive repairs, with new boilers. (\$85,000.)

Trenton (2d rate).—In service. Repairs incident to continuous service. (\$16,000.)

Triana (tug).—Requires thorough repair and new boilers. (\$15,000.)

Vandalia (2d rate).—Thorough overhauling and repairs, with new boilers, nearly completed at the Portsmouth navy-yard.

Wabash (1st rate).—In service as receiving ship, Boston navy-yard. If ordered for sea service, would have to be thoroughly overhauled and repaired, with new boilers. (\$50,000.)

Wyandotte (iron-clad).—Ready for service.

Yantic (3d rate).—In service. Requires thorough overhauling and repairs. (\$8,000.)

DOUBLE-TURRETED MONITORS.

Amphitrite (3d rate).—Under contract with the Harlan and Hollingsworth Company. Will require about seven months to complete, working full force.

Miantonomoh (3d rate).—Engines, &c., in good condition. Requires to have turret machinery (just completed at the Washington navy-yard) put in. (\$5,000.)

Monadnock (3d rate).—Boilers completed, and at the Mare Island navy-yard, waiting appropriation to build engines, put in boilers, and fit for sea service. (\$210,000.)

Puritan (3d rate).—Under contract with John Roach. Engines, &c., completed and ready for service. Drainage and ventilating system nearly completed.

Terror (3d rate).—Under contract with Wm. Cramp & Sons. Will require about four months to complete, working full force.

NAVY-YARDS.

As no significant alterations have been made in the steam-engineering plant of the several navy-yards, or any considerable additions to it during the past year, little need be said here in relation to it more than to refer to the recommendations of previous reports of the Bureau and

of the late Commission on Navy-Yards, particularly regarding the necessity for a new boiler-shop at the New York navy-yard, the building of which is most earnestly urged.

This Bureau has yielded a large portion of its shop area and tools at the Washington navy-yard for ordnance purposes, and also afforded facilities for same purposes at the Boston navy-yard.

The floating derrick, referred to in my last report, was, on examination, found to be so thoroughly defective in all its parts that it was decided to build a new one entire, of steel; and a contract has been entered into with the Pusey and Jones Company, of Wilmington, Del., for its construction. When completed it will be a most useful appendage to the New York navy-yard for handling heavy weights.

The following is a schedule of the bids for building this floating derrick, under advertisement dated May 19, 1885:

Jacob A. Cole, Brooklyn, N. Y.....	\$74,440
*The Pusey and Jones Company, Wilmington, Del.....	60,680
The Harlan and Hollingsworth Company, Wilmington, Del.....	92,000
John H. Dialogue, Camden, N. J.....	66,286

ESTIMATES OF APPROPRIATIONS.

I have the honor to submit herewith the annual estimates of this Bureau for the fiscal year ending June 30, 1887.

The estimate for steam-machinery has been given more in detail than heretofore; and that for civil establishment specifically estimates for the civilian employes in the steam-engineering department of the several navy-yards, other than those employed as ordinary mechanics and workmen, and exhibits the amounts paid to such employes during the fiscal year ending June 30, 1885, as required by section 3 (naval appropriation) act of Congress approved January 30, 1885.

Very respectfully,

CHAS. H. LORING,
Chief of Bureau.

Hon. WILLIAM C. WHITNEY,
Secretary of the Navy.

* Contract awarded June 24, 1885.

Estimates of appropriations required for the service of the fiscal year ending June 30, 1887, by the Bureau of Steam-Engineering, Navy Department.

General object of expenditure, and explanations.	Estimated amount which will be required for each detailed object of expenditure.	Amount appropriated for the current fiscal year, ending June 30, 1886.
SALARIES.		
Chief clerk (March 3, 1885, 23 R. S., p. 70, sec. 416; p. 415, sec. 1)	\$1,800 00	
Chief draughtsman (same acts)	2,250 00	
Assistant draughtsman (same acts)	1,400 00	
Two clerks of class two (same acts)	2,800 00	
One clerk of class one (same acts)	1,200 00	
One assistant draughtsman	1,000 00	
One assistant messenger (March 3, 1885)	720 00	
Two laborers (same acts)	1,320 00	
	12,490 00	\$12,490 00
<p>NOTE—Anticipating work in the draughting-room of the Bureau on designs for machinery of the new-cruisers, it is respectfully submitted that there should be appropriated for—</p> <p>One assistant draughtsman..... \$1,200 00</p> <p>Without this there can be no lawful increase of the present civilian employés in the draughting-room.</p>		
STEAM-MACHINERY.		
For completion and repairs of machinery and boilers of naval vessels, including cost of new boilers, steam-steerers, steam-capstans, steam-windlasses, &c. (act approved March 3, 1885)	450,000 00	
For preservation of, and small repairs to, machinery and boilers in vessels in ordinary, receiving and training vessels, repair and care of machinery of yard tugs and launches, &c. (act approved March 3, 1885)	40,000 00	
For purchase, handling, and preservation of all materials and stores (act approved March 3, 1885)	200,000 00	
For purchase, fitting, and repair and preservation of machinery and tools in the navy-yards and stations, running yard engines, &c. (act approved March 3, 1885)	125,000 00	
For incidental expenses for naval vessels, yards, and the Bureau; such as foreign postage, telegrams, advertising, freight, photographing, books, stationery, and instruments (act approved March 3, 1885)	25,000 00	
	840 000 00	960,000 00
CONTINGENT.		
Draughting materials, instruments, &c., for the draughting-room (March 3, 1885)	500 00	1,000 00
INCREASE OF THE NAVY STEAM-MACHINERY.		
For steam-machinery of new vessels, types and dimensions to be determined hereafter (submitted)	3,750,000 00	
For completion and erection of engines, &c., connect with boilers, and make ready for sea service in U. S. ironclad Monadnock, at Mare Island, Cal., navy-yard (submitted)	206,000 00	
CIVIL ESTABLISHMENT.		
Navy-yard, Portsmouth, N. H. (March 3, 1885):		
One clerk to department, per annum	\$1,200 00	
One store clerk, per annum	1,000 00	
One assistant draughtsman, per annum	1,000 00	
One messenger, per annum	550 00	
	3,850 00	3,708 96
Navy-yard, Boston, Mass. (March 3, 1885):		
One clerk to department, per annum	1,200 00	
	1,200 00	1,199 97
Navy-yard, Brooklyn, N. Y. (March 3, 1885):		
One clerk to department, per annum	1,400 00	
One store clerk, per annum	1,200 00	
One draughtsman, per annum	1,500 00	
One writer, per annum	1,000 00	
One receiver and weigher, per annum	1,000 00	
Two messengers (\$600 each)	1,200 00	
	7,300 00	7,538 96

Estimates of appropriations required for the service of the fiscal year, &c.—Continued.

General object of expenditure, and explanations.	Estimated amount which will be required for each detailed object of expenditure.	Amount appropriated for the current fiscal year, ending June 30, 1886.
CIVIL ESTABLISHMENT—continued.		
Navy-yard, League Island, Pa. (March 3, 1885):		
One clerk to department, per annum	\$1,200 00	
		\$1,200 00
Navy-yard, Washington, D. C. (March 3, 1885):		
One clerk to department, per annum.....	1,200 00	
One store clerk, per annum.....	1,100 00	
One draughtsman, per annum.....	1,500 00	
One messenger, per annum	550 00	
		4,350 00
Navy-yard, Norfolk, Va. (March 3, 1885):		
One clerk to department, per annum.....	1,300 00	
One store clerk, per annum.....	1,100 00	
One assistant draughtsman, per annum.....	1,100 00	
One receiver and weigher, per annum.....	800 00	
Two messengers (\$550 each).....	1,100 00	
		5,400 00
Navy-yard, Pensacola, Fla. (March 3, 1885):		
One clerk to department, per annum.....	1,017 25	
		1,017 25
Navy-yard, Mare Island, Cal. (March 3, 1885):		
One clerk to department, per annum.....	1,400 00	
One store clerk, per annum.....	1,300 00	
One draughtsman, per annum.....	1,600 00	
One writer, per annum.....	1,100 00	
One receiver and weigher, per annum.....	1,000 00	
One messenger, per annum.....	600 00	
		7,000 00
		5,988 54
		31,817 25
		29,519 42

NOTE.—The total amount appropriated for civil establishment, for fiscal year ending June 30, 1886, was \$10,000. From this appropriation the "clerks to departments" only at the several navy-yards have been paid, while all the others enumerated above have been and are now paid from appropriation "steam-machinery," but are hereby specifically estimated for under "civil establishment," in accordance with act approved January 30, 1885, section 3.

No. 9.—BUREAU OF PROVISIONS AND CLOTHING.

Statement of appropriations for, and operations of, the Bureau of Provisions and Clothing for the fiscal year ended June 30, 1885.

PROVISIONS.

Amount expended by pay officers abroad:		
For commuted rations to officers.....	\$77,961 34	
For commuted rations to crews.....	313,996 26	
For commuted rations to marines.....	27,769 80	
For provisions purchased (including water).....	330,470 49	
For freight, labor, and expenses of storehouses.....	7,437 84	
	\$757,635 73	
Amount of commuted rations stopped on account of sick in hospital and credited to the hospital fund.....	11,986 69	11,986 69
Amount expended by Bureau:		
For commuted rations to officers.....	22,621 34	
For commuted rations to crews.....	4,608 06	
For provisions purchased (including water).....	297,631 36	
For freight, labor, and expenses of inspections.....	79,332 65	
	404,193 41	
		1,173,815 83
Amount appropriated for the year.....	1,100,000 00	
Deficiency, overpayment from general account of advances.....	73,815 83	1,173,815 83

CLOTHING FUND.

Balance on hand July 1, 1884.....	462,689 03	
Amount transferred from general account of advances to the clothing fund on account of issues on board ships during the fiscal years 1883-'84 and 1884-'85.....	236,095 31	
Amount received from sales of clothing.....	39,593 11	
	738,377 45	
Total amount received under clothing.....		738,377 45
Amount transferred from the clothing fund to general account of advances on account of purchases by pay officers abroad during the fiscal years 1883-'84 and 1884-'85.....	11,042 92	
Amount expended by the Bureau, as per requisitions.....	164,640 31	
	175,683 23	
Total amount expended.....		175,683 23
Balance on hand July 1, 1885.....	562,694 22	562,694 22
Amount transferred from the clothing fund to general account of advances on account of purchases by pay officers abroad during the fiscal year 1884-'85.....	11,042 92	
Cost of clothing issued on board ships during the fiscal year 1884-'85.....	205,098 77	
	216,141 69	
Cost of clothing purchased by pay officers abroad and paid for from general account of advances during the fiscal year 1884-'85.....	14,676 63	
Amount transferred from general account of advances to the clothing fund, on account of issues on board ships during the fiscal year 1884-'85.....	167,356 90	182,033 53
Balance due the clothing fund on account of the fiscal year 1884-'85.....	34,108 16	34,108 16

SMALL STORES FUND.

Balance on hand July 1, 1884	\$160, 709 13	
Amount transferred from general account of advances to the small stores fund on account of issues on board ships during the fiscal years 1883-'84 and 1884-'85	78, 119 43	
Amount received from sales of small stores	3, 253 93	
Total amount received		\$242, 082 49
Amount transferred from the small stores fund to the general account of advances on account of purchases by pay officers abroad during the fiscal years 1883-'84 and 1884-'85	8, 189 15	
Amount expended by the Bureau, as per requisitions	66, 982 89	
Total amount expended		75, 172 04
Balance on hand July 1, 1885		<u>166, 910 45</u>
Amount transferred from the small stores fund to general account of advances on account of purchases by pay officers abroad during the fiscal year 1884-'85	8, 189 15	
Cost of small stores issued on board ships during the fiscal year 1884-'85	70, 093 54	
		78, 282 69
Cost of small stores purchased by pay officers abroad and paid for from general account of advances during the fiscal year 1884-'85	14, 389 07	
Amount transferred from general account of advances to the small stores fund on account of issues on board ships during the fiscal year 1884-'85	53, 702 29	
		68, 091 36
Balance due the small stores fund on account of the fiscal year 1884-'85		<u>10, 191 33</u>

CONTINGENT.

Amount appropriated		35, 000 00
Amount expended by Bureau	26, 884 71	
Amount expended by pay officers abroad	6, 633 88	
		33, 518 59
Balance unexpended		<u>1, 481 41</u>

CIVIL ESTABLISHMENT.

Amount appropriated	6, 000 00
Amount expended	6, 000 00

Statement of the cost of stores at the several navy-yards and stations, pertaining to the Bureau of Provisions and Clothing, on hand July 1, 1884; received and expended during the fiscal year ended June 30, 1885, and on hand June 30, 1885.

	Provisions.	Clothing.	Small stores.	Contingent.
On hand July 1, 1884.....	\$130, 298 24	\$593, 559 16	\$84, 104 67	\$25, 800 66
Receipts fiscal year 1884-'85	330, 166 93	218, 984 42	61, 285 85	15, 323 01
On hand and received.....	460, 465 17	812, 543 58	145, 390 52	41, 123 67
Expended fiscal year 1884-'85	270, 727 88	279, 049 30	56, 366 30	14, 092 74
On hand June 30, 1885	189, 737 29	533, 494 28	89, 024 22	27, 030 93

Amount paid by the Bureau to employés other than mechanics and laborers during the fiscal year ended June 30, 1885, for the expenses of the inspections of provisions and clothing, in the receipt and care of stores, and for the expenses of the pay offices of the several navy-yards, from the appropriation "Civil Establishment"	\$8,000 00
Appropriation "Provisions"	27,520 72
	33,520 72

Amount paid by the Bureau to mechanics, laborers, and others during the fiscal year ended June 30, 1885, for the expenses of the inspections of provisions and clothing, in the receipt and care of stores, and for the expenses of the pay offices of the several navy-yards, from the appropriation "Provisions"	70,651 90
--	-----------

Estimates of appropriations required for the service of the fiscal year ending June 30, 1887, by the Bureau Provisions and Clothing.

General object of expenditure, and explanations.	Estimated amount which will be required for each detailed object of expenditure.	Total amount to be appropriated under this head of appropriation.	Amount appropriated for the current fiscal year, ending June 30, 1886.
A.—EXPENSES OF THE BUREAU OF PROVISIONS AND CLOTHING.			
For salary of chief clerk (July 5, 1862, 12 R. S., p. 511, sec. 3).....	\$1,800 00		
For salary of one clerk class four (July 23, 1866, 14 R. S., p. 208, sec. 8).....	1,800 00		
For salary of two clerks class three (July 23, 1866, 14 R. S., p. 208, sec. 8).....	3,200 00		
For salary of two clerks class two (July 23, 1866, 14 R. S., p. 208, sec. 8).....	2,800 00		
For salary of three clerks class one (July 23, 1866, 14 R. S., p. 208, sec. 8).....	3,600 00		
For salary of one clerk class one (March 3, 1885).....	1,200 00		
For salary of two copyists (March 3, 1885).....	1,800 00		
For salary of one messenger (March 3, 1885).....	720 00		
For salary of one laborer (March 3, 1885).....	660 00		
		\$17,580 00	\$17,580 00
B.—PROVISIONS NAVY, BUREAU PROVISIONS AND CLOTHING.			
For commutation of rations for 343 naval cadets and 757 officers on sea duty, 401,500 rations, at 30 cents.....	120,450 00		
For rations and commutation of rations for 8,250 men and boys and 1,000 marines, 3,376,250 rations, at 30 cents.....	1,012,875 00		
For commuted ration, stopped on account of sick in hospital and credited to the hospital fund.....	13,500 00		
For water for drinking and cooking purposes on board ships.....	15,000 00		
For labor and expenses of inspections (March 3, 1885).....	60,000 00		
		1,231,825 00	1,085,000 00
NOTE.—Amount appropriated for the fiscal year 1885.			
Balance on hand July 1, 1885.....	\$116,020 28		
Indebtedness outstanding against said balance July 1, 1885.....	186,939 05		
Amount overpaid, account fiscal year 1885.....	70,918 77		

which accounts for so much of the increase of \$136,000 over the amount appropriated for the current year. The estimate is based on the number of cadets allowed at the Naval Academy, on the number of men and boys allowed by law, and on the number of officers and marines on duty on board ships entitled to ration, as per the returns to the Bureau; which estimate, \$1,133,325, is larger than the whole amount appropriated for the current year. The amounts asked for for commutation of rations of sick in hospital, for water, and for labor and expenses of inspections, are based on the expenditure for the previous year; deducting \$25,000 from the latter, which is added to the estimates under "civil establishment," Sheet E, in compliance with section 3 act of Congress No. 19, approved January 30, 1885.

Estimates of appropriations required for the service of the fiscal year, &c.—Continued.

General object of expenditure, and explanations.	Estimated amount which will be required for each detailed object of expenditure.	Total amount to be appropriated under each head of appropriation.	Amount appropriated for the current fiscal year, ending June 30, 1886.
R.—PROVISIONS NAVY, BUREAU PROVISIONS AND CLOTHING			
—Continued.			
<p>Although the estimate for next year is greater than the amount appropriated for the current year, it is less than the estimate for the current year. On what data the amount appropriated was based the Bureau is not informed.</p>			
C.—CONTINGENT, BUREAU OF PROVISIONS AND CLOTHING.			
<p>For freight on shipments, candles, fuel, books and blanks, stationery, advertising, furniture for inspections and pay offices in navy-yards, expenses of naval clothing factory, foreign postage, telegrams, express charges, tolls, ferringes, car-tickets, yeomen's stores, iron safes, newspapers, loc. and other expenses not enumerated (March 3, 1885) ...</p>			
	\$30,000 00		\$50,000 00
<p>NOTE.—Amount appropriated for fiscal year 1885, \$5,000.</p>			
Balance on hand July 1, 1885.....	\$6,524 12		
Indebtedness outstanding against said balance..	5,042 71		
Balance now on hand.....	1,481 41		
<p>Although the amount appropriated for the year 1885 was sufficient for that year, as shown above, there was expended for the year 1884 the sum of \$37,663.40 out of the appropriation of \$40,000 for that year. To these expenditures is to be added the freight on provisions, heretofore paid out of the appropriation "provisions," estimated at \$15,000, but now chargeable to the appropriation "contingent." Adding this \$15,000 to the expenditures, as above noted, will make \$52,663.40, and \$48,518.59 for the fiscal years 1883-'84 and 1884-'85, respectively.</p>			
D.—CIVIL ESTABLISHMENT, BUREAU OF PROVISIONS AND CLOTHING.			
Navy-yard, Portsmouth, N. H.:			
One fireman, per diem \$2.....	626 00	\$626 00	
Navy-yard, Boston, Mass.:			
One writer in pay office, per annum.....	1,017 25		
One writer in inspection, per annum.....	1,017 25		
Two receivers in inspection, per diem \$3.....	1,878 00		
One fireman in inspection, per diem \$2.26.....	707 38		
		4,619 88	
Navy-yard, New York:			
One writer in pay office, per annum.....	1,017 25		
One writer in pay office, per annum.....	939 00		
One messenger in pay office, per diem \$2.50.....	782 50		
One writer in inspection, per annum.....	1,017 25		
One messenger in inspection, per diem \$2.50.....	782 50		
Three receivers in inspection, per diem \$4.....	3,756 00		
One assistant receiver in inspection, per diem \$3.50.....	1,095 50		
Two leading men in inspection, per diem \$2.50.....	1,565 00		
Seven pressmen in inspection, per diem \$2.76.....	6,047 16		
Superintendent coffee and spice mill, inspection, per diem \$3.....	939 00		
Box-maker, inspection, per diem \$3.....	939 00		
Coffee-roaster, per diem \$2.50.....	782 50		
Engine-tender, per diem \$3.26.....	1,020 38		
Fireman, per diem \$2.....	626 00		
Teamster, per diem \$2.50.....	782 50		
		22,091 54	
Navy-yard, Washington, D. C.:			
One writer in pay office, per annum.....	1,300 00		
Telephone operator, pro rata.....	225 00		
		1,525 00	
Navy-yard, Norfolk, Va.:			
One writer in pay office, per annum.....	1,017 25		
One writer in inspection, per annum.....	1,017 25		
One receiver in inspection, per diem \$3.....	939 00		
One assistant receiver in inspection, per diem \$2.50.....	782 50		
		3,756 00	

Estimates of appropriations required for the service of the fiscal year, &c.—Continued.

General object of expenditure, and explanations.	Estimated amount which will be required for each detailed object of expenditure.	Total amount to be appropriated under each head of appropriation.	Amount appropriated for the current fiscal year, ending June 30, 1886.
D.—CIVIL ESTABLISHMENT, BUREAU OF PROVISIONS AND CLOTHING—Continued.			
Navy-yard, Mare Island, Cal.:			
One writer in pay office, per annum.....	\$1,017 25		
One writer in inspection, per annum.....	1,017 25	\$2,034 50	
		34,652 92	
Naval clothing factory, New York:			
One cutter, per annum.....	1,800 00		
One machine operator, per diem \$3.50.....	1,095 50		
One writer, per diem \$3.25.....	1,017 25		
Two laborers, each per diem \$2.26.....	1,414 76	5,327 51	
		39,980 43	\$4,000 00
<p>NOTE.—The \$6,000 appropriated under "civil establishment" for the fiscal year 1885 was paid to the writers in the pay offices of the yards at Boston, New York, Washington, and Norfolk, and for a portion of the year to the writers in the inspections of provisions and clothing at the yards at Boston and New York; and the amount appropriated for the current fiscal year, \$6,000, will be expended for the same purpose.</p> <p>All of the positions "other than mechanics and laborers," for which estimates are submitted, are now filled, except the firemen at the navy-yards, Portsmouth and Boston, who are employed only when fires are necessary, and the telephone operator at the navy-yard, Washington, who is paid by this Bureau for a portion of the year only, and the employes are paid from the appropriation "Provisions," except the writers referred to above.</p> <p>The amount paid to these employes from the appropriation "Provisions," for the fiscal year 1885, for the number of days only actually employed was \$27,520.72.</p> <p>This estimate is for an annual salary for the writers, and for a per diem for 313 days for the remaining force; and is made in accordance with section 3 of the act of Congress No. 19, approved January 30, 1885.</p>			

* Previous estimates did not embrace this number of clerks in civil establishment.

Schedule of proposals for fresh provisions, navy bread, baking, and water received during the fiscal year ending June 30, 1884, the supplies to be delivered during the fiscal year 1884-'85.

Name.	Where to be delivered.	Fresh bread.	Fresh beef.	Vegetables.	Navy bread.	Baking flour.	Water.
		Per lb.	Per lb.	Per lb.	Per lb.	Per bbl.	Per gal.
James E. Chase*	Portsmouth, N. H.	\$0 05.49	\$0 09.49	\$0 01.50			
B. F. Muridge.....	do	08	11.50	01.50			
John Holland.....	do	06	11.75	01.75			
J. W. Hobbs *	Boston, Mass.		13½	04			
C. H. Flanders & Co.....	do		15½	04½			
H. P. Stevens.....	do		17	02½			
Austin & Graves *	do	06				\$1.75	
John Hanley.....	New York, N. Y.		10½	02			
John G. Allport & Co.....	do		10½	02			
James J. Lyons †.....	do		10.60	02.90			
C. Desmond †.....	do		11	02½			
Patrick Sullivan †.....	do		09½	01½			
John G. Burns †.....	do	03½					
James Godfrey †.....	do	06½					
Frank Fruin.....	do	06½					
John McNamara *.....	do	06½					
E. Treadwell's Son.....	do					1 17	
C. T. Goodwin & Son *.....	do					89	

* Contract awarded.

† Informal bids.

Schedule of proposals for fresh provisions, navy bread, baking, &c.—Continued.

Name.	Where to be delivered.	Fresh bread.	Fresh beef.	Vegetables.	Navy bread.	Baking flour.	Water.
		Per lb.	Per lb.	Per lb.	Per lb.	Per bbl.	Per gal.
John Hartman*	League Island, Pa.					\$1 40	
C. Strohmaier*	do	\$0 05½					
L. S. Boraef*	do		\$0 12½	\$3 04			
C. Heuizerling	Washington, D. C.	03.85					
Koller & Ginzert	do	03½					
F. G. Alexander	do		09.99	03½			
B. Charlton & Co*	do	03½				1 50	
C. C. Carroll*	do		09½	03			
George Seitz & Son†	do	03.90					
Isaac Gutman*	Norfolk, Va.		06.13	01½			
J. B. Kimberly	do	05½	10.73	03½			
George Berry	do		06.85	01.33			
Robert Searis	do		08.45	02½			
Frank Dusch	do		06.65	01.70			
S. Westheimer	do		06.66	01.95			
J. G. Codd A Bro.	do		07.10	02.10			
Louis Wasserman	do		06.45	01.75			
James Reid & Co*	do					2 00	
C. Cabler*	do	04½					
William Clark *	do						\$0 00½
William Clark *	Fortress Monroe, Va.						01
J. B. Kimberly *	do	04½					
C. T. Cabler	do	04.37½					
J. S. Bell *	Pensacola, Fla.		16	07			
J. O'Neal *	do				\$0 06½		
Moses White *	do	06					
A. Neuman	Mare Island, Cal.		14	03½			
John Faust *	do	05					
J. F. Tobin *	do		10.9	02½			
California Cracker Co *	do				04.4		
D. T. Brown, Jr.	do				05½		
Eclipse Cracker Co.	do				04.45		

* Contract awarded. † Informal bids.

Schedule of proposals for 3,000 yards cloth for caps under Bureau's advertisement dated July 9, 1884.

B. Y. Pippy & Co., per yard ----- *\$2 07

* Contract awarded.

Schedule of proposals for small stores under Bureau's advertisement dated July 21, 1884.

Names.	3,000 razors.	5,000 papers needles.	10,000 dozen eagle buttons.	1,000 mess-kettles.	500 mess-pans.	5,000 spoons.
	Each.	Pr paper.	Per doz.	Each.	Each.	Each.
J. H. Walker	\$0 29			†\$0 49	\$0 39	\$0 02½
Geo. H. Creed	27			51	37	02.4
W. A. Wheeler*	1 25	\$0 08.8	\$0 22½	*†49	39	02.8
H. T. Wakeman*	37½	{ 04 03 }	22	58	35	*‡ 25
A. P. Brown*	24	*†02	22½	49½	39½	02½
J. R. Michael*	*23	†02	*2 39	†49	*35	‡ 87
R. A. Robbins	{ 22 26½ }		21.8	49.9	36.9	02.4
C. A. Watson	{ No. 1 31½ No. 2 31 }					

* Contract awarded. † Tie bids; decided by lot. ‡ Per gross. § Bond. | Duty paid.

Schedule of proposals for Navy supplies under Bureau's advertisement dated July 26, 1884.

Name.	800 barrels pork.	10,000 pounds evaporated apples.	10,000 gallons beans.
R. A. Robbins.....	Per bbl. \$20 67	Per lb. \$16.9	Per gal. \$1 47
J. W. Buker.....	17 74	18 43	18 43
A. P. Brown.....	18 43	†13	18 47
David Babcock & Co.....	18 47	18	18 43
W. A. Wheeler.....	19 70	18	18 43
J. R. Michael*.....	*17 38	*†13	*18 43

* Contract awarded. † Tie bids; decided by lot. ‡ Per bushel.

Schedule of proposals for Navy supplies under Bureau's advertisement dated September 16, 1884.

Names.	1,500 barrels beef.	2,500 barrels pork.	120,000 pounds preserved meat.	50,000 pounds rice.	60,000 pounds pickles.	50,000 pounds tomatoes.	200,000 pounds sugar.
A. P. Brown†.....	Per bbl. \$15 93	Per bbl. \$16 43	Per lb. \$0 09.9	Per lb. \$0 05†	Per lb. \$0 05.7	Per lb. \$0 03.7	Per \$0 05.9
J. R. Michael†.....	16 59	16 14	10.9	06	06.2	03.2	06.24
R. A. Robbins†.....	16 59	16 29	12.39	06.7	07	03.2	06.24
D. Babcock & Co.....	16 58	16 29	12.39	06.7	07	03.2	06.24
R. M. Masterton†.....							
C. L. Todd*.....						*03.16	
F. Foehrenback & Co*.....		*13 99	13.45	*06.10	*06	04.43	*05.11
F. B. Thurber*.....	*13 99	*13 99	13.45	*06.10	06.30	04.43	*05.11
Armour, Plankinton & Co*.....		whole, 17 00 half, 9 00	(†)	06‡			
J. H. Jahn.....				06‡			
Rosster, Skidmore & Co.....	15 68	15 48	11.48		06		
J. W. Buker†.....							

* Contract awarded. † Not considered regular dealers. ‡ \$4.75 per dozen cans.

Names.	10,000 gallons vinegar.	5,000 yards blue cloth, trousers.	30,000 yards 6-4 11-oz. flannel.	5,000 yards Barnsley sheeting.	6,000 pairs calf shoes.	3,000 pairs kip shoes.	15,000 pairs woolen socks.
Thomas Kent.....	Per gal. \$0 11	Per yard. \$1 85	Per yard. \$0 83.9	Per yard. \$0 87	Per pair. \$2 08	Per pair. \$2 09	Per pair. \$0 24
A. P. Brown†.....	13	1 85	87	87	2 09	2 12	24
J. R. Michael†.....			89	87			
R. A. Robbins†.....			89	87			
Woodward & Lothrop.....			89	87			
Dean Woolen Company*.....		*1 79.94					
William McKnight.....					2 15	2 10	
O. W. Hayes.....				58‡			
J. Freeman & Co*.....				58‡	*1 99	*2 10	
George H. Creed†.....				61‡			
H. H. Tobey†.....				54‡			23
G. P. Ockershausen.....	15.90						
F. Foehrenback & Co*.....	*15						
F. B. Thurber.....	16‡						
H. Smith*.....				*57‡			
B. Y. Pippet & Co*.....		1 86	*81.9	59‡			*27.7
J. W. Buker†.....	14‡			59‡			

* Contract awarded. † Not considered regular dealers. ‡ For 11,900 yards. | For 18,100 yards.

Names.	5,000 blankets.	50,000 yards cotton duck.	100,000 pounds salt- water soap.	5,000 pocket hand- kerchiefs.	5,000 wisp brooms.	5,000 boxes blacking.	75,000 pounds can- dles.
	Each.	Per yard.	Per lb.	Each.	Each.	Each.	Per lb.
A. P. Brown †	\$1 95	\$0 10.37	\$0 3.59	\$0 07½	\$0 07½	\$0 02.69	\$0 11.4
R. G. Mitchell							13.90
J. R. Michael †	2 25	10	03.7	07½	09.74	02½	12.9
R. A. Robbins †		10.85	03.85		11	02.7	
C. W. Thorne & Co.		12½			09.9	*4 38	
G. K. Sheridan & Co*		*10.96					
A. Vanhagen			03.7				
A. L. Sherk & Bro*						*03½	
George H. Creed †		10.7			10		
H. H. Tobey †	2 08	10.26		15½	14		
Manhattan Oil Company *							*13½
B. H. Hewlet					**1 36	††4 95	
H. B. Clafin & Co.				12½	12½	03½	
George E. Ward					13½		
T. A. McKeone			03.86				
T. A. Ashburner	2 03½						
F. B. Thurber*			*03.7			04½	14.26
Paul J. Field					12½		
Colgate & Co.			03.97				
E. P. Cooley*					*09½		
J. E. Young*				*10½			
B. Y. Pippet & Co *	*1 93						

* Contract awarded. † Not considered regular dealers. ** Per gross. †† Per dozen.

Schedule of proposals for 100,000 pounds tobacco under Bureau's advertisement dated February 4, 1885.

Names.	100,000 pounds tobacco, per pound.	
	No. 1.	No. 2.
	Cents.	Cents.
St. Charles Tobacco Company †	24½	29
A. A. Motley & Co	50	
Christian Peper	40	
William Buchanan*	26.00	
P. Lorillard & Co	28	

* Contract awarded. † Not equal to standard.

Schedule of proposals for Navy supplies under Bureau's advertisement dated March 16, 1885.

Names.	10,000 pounds apples.	10,000 gallons beans.	60,000 yards ½ hannel.	10,000 B.S. neck- erchiefs.	5,000 scissors.	2,000 razor- strops.
	Per lb.	Per gall.	Per yard.	Each.	Each.	Each.
Michael Doyle	\$0 10					
San Francisco Pioneer Woolen Factory			\$0 89			
Clifton Silk Mills				\$0 93		
Kemp, Day & Co	*9½	\$0 25½		*75.9		
James R. Michael						
B. Y. Pippet & Co			86.74			
Wm. Holmead	9.9	24.4				
S. M. Milliken			*85			
F. B. Thurber	11.49	24.49				
A. P. Brown			85			
T. G. Hood				1 08		
William Gray	10.2	*23.9				
W. T. Rockwell					*90 18	*90 17½
Thomas Kent			184			
Paul J. Field					25.99	
R. A. Robbins				83		

* Contract awarded. † Informal.

Schedule of proposals for 100,000 pounds coffee under Bureau's advertisement dated April 23, 1885.

Wood & Acklin	per pound.	\$0 11.
J. R. Michael	do.	03. 66
Thurbur, Whyland & Co*	do.	03. 61
R. A. Robbins	do.	03. 90

* Contract awarded.

Schedule of proposals for fresh beef and vegetables and fresh bread for United States Naval Academy, Annapolis, Md., for fiscal year ending June 30, 1885.

Names.	Fresh beef.	Fresh vegetables.	Fresh bread.
	Per pound.	Per pound.	Per pound.
John Kealy	\$0 09½	\$0 03½	
Martin M. Smith*			\$0 04½
Jackson Brewer*	09	04	
Alex. Heyse			04
Lindenborn & Bro			04

* Contracts awarded.

Schedule of proposals for fresh beef and vegetables, fresh bread and water, United States Naval Station, Newport, R. I., for the fiscal year ending June 30, 1885.

Names.	Fresh beef.	Fresh vegetables.	Fresh bread
	Per pound.	Per pound.	Per pound.
Simson Davis			\$0 04½
William S. Bailey	\$0 12½	\$0 03	06½
Lawton Coggeshall*	12½	02½	06½

* Contracts awarded.

Statement of contracts made by the Bureau of Provisions and Clothing for and in behalf of the Navy Department during the fiscal year ending June 30, 1885.

Name.	Date.	Articles contracted for.	Price..	Where to be delivered.
1884.				
Austin & Graves	July 1	Baking flour..... per bbl.	\$1 75	Boston, Mass.
Do	July 1	Fresh bread..... per lb.	06	Do.
J. W. Hobbs	July 1	Fresh beef..... do.	12½	Do.
Do	July 1	Vegetables..... do.	04	Do.
John Hanley	July 1	Fresh beef..... do.	10½	New York, N. Y.
Do	July 1	Vegetables..... do.	02	Do.
J. McNamara	July 1	Fresh bread..... do.	06½	Do.
C. T. Goodwin & Son	July 1	Baking flour..... per bbl.	89½	Do.
John S. Bell	July 1	Fresh beef..... per lb.	16	Pensacola, Fla.
Do	July 1	Vegetables..... do.	07	Do.
J. O'Neal	July 1	Navy bread..... do.	06½	Do.
California Cracker Co	July 1	do..... do.	04½	Mare Island, Cal.
C. Strohmaier	July 1	Fresh bread..... do.	05½	League Island, Pa.
Moses White	July 1	do..... do.	06	Pensacola, Fla.
C. T. Cahler	July 2	do..... do.	04½	Norfolk, Va.
J. Reid & Co.	July 2	Baking flour..... per bbl.	2 00	Do.
J. B. Kimberly	July 2	Fresh bread..... per lb.	04½	Fortress Monroe, Va.
J. F. Tobin	July 2	Fresh beef..... do.	10½	Mare Island, Cal.
Do	July 2	Vegetables..... do.	02½	Do.
John Faust	July 2	Fresh bread..... do.	05	Do.
I. Gutman	July 3	Fresh beef..... do.	06½	Norfolk, Va.
Do	July 3	Vegetables..... do.	01½	Do.
C. C. Carroll	July 3	Fresh beef..... do.	09½	Washington, D. C.
Do	July 3	Vegetables..... do.	03	Do.
James E. Chase	July 3	Fresh beef..... do.	09½	Portsmouth, N. H.
Do	July 3	Vegetables..... do.	01½	Do.
Do	July 3	Fresh bread..... do.	05½	Do.
J. Hartman	July 3	Baking flour..... per bbl.	1 40	League Island, Pa.

Statement of contracts made by the Bureau of Provisions and Clothing, &c.—Continued.

Name.	Date.	Articles contracted for.	Price.	Where to be delivered.
	1884.			
William Clark.....	July 5	Juniper water per gall.	\$0 00½	Norfolk, Va.
Do.....	July 5	do..... do.....	01	Fortress Monroe, Va.
L. S. Boraef.....	July 7	Fresh beef..... per lb.	12½	League Island, Pa.
Do.....	July 7	Vegetables..... do.....	04	Do.
B. Charlton & Co.....	July 8	Fresh bread..... do.....	08½	Washington, D. C.
Do.....	July 8	Baking flour..... per bbl.	1 50	Do.
R. Y. Pippey & Co.....	Aug. 2	Cloth for caps, 3,000 yds., per yd.	2 07	New York, N. Y.
W. A. Wheeler.....	Aug. 8	Mess kettles, 1,000..... each.	49	Do.
J. E. Michael.....	Aug. 11	Razors, 3,000..... do.....	23	Do.
Do.....	Aug. 11	Eagle buttons, 1,000 doz., per gross.	2 39	Do.
Do.....	Aug. 11	Mess pans, 500..... each.	35	Do.
Do.....	Aug. 20	Pork, 800 bbls..... per bbl.	17 38	Do.
Do.....	Aug. 20	Beans, 10,000 galls..... per gall.	34	Do.
Do.....	Aug. 20	Evaporated apples, 10,000 lbs., per lb.	13	Do.
Do.....	Sept. 17	Coffee, 100,000 lbs..... per lb.	10, 30	Do.
Dean Woolen Company..	Oct. 15	Cloth for trousers, 500 yards, per yd.	1 79, 20	Do.
Armour, Plankinton & Co.	Oct. 17	Preserved meat, 120,000 pounds, per lb.	09, 100, 1000	Do.
J. Freeman & Co.....	Oct. 17	Calf shoes, 6,000 prs..... per pr.	1 99	Do.
C. L. Todd.....	Oct. 28	Tomatoes, 50,000 pounds, per lb.	03, 100	Do.
R. Y. Pippey & Co.....	Nov. 5	Flannel, 6-4, 11-ounce 30,000 yards, per yd.	81, ½	Do.
Do.....	Nov. 5	Blankets, 5,000..... each..	1 93	Do.
A. L. Sherk & Bro.....	Nov. 24	Blacking, 5,000 boxes..... each..	03½	Do.
Manhattan Oil Company.	Nov. 26	Candles, 75,000 pounds, per lb.	13½	Do.
F. B. Thurber.....	Nov. 28	Beef, 1,500 barrels..... per bbl..	13 99	Do.
Do.....	Nov. 28	Pork 2,500 barrels..... do.....	13 99	Do.
Do.....	Nov. 28	Rice, 50,000 pounds..... per lb..	06, 70	Do.
Do.....	Nov. 28	Sugar, 200,000 pounds..... do.....	06, 70	Do.
F. B. Thurber.....	Nov. 28	Salt-water soap, 100,000 pounds, per lb.	03, 70	Do.
J. E. Young.....	Nov. 29	Pocket handkerchiefs, 5,000, each.	10½	Do.
R. Y. Pippey & Co.....	Dec. 2	Woolen socks, 15,000 pairs, per pr.	27, 70	Do.
J. Freeman & Co.....	Dec. 3	Kipshoes, 3,000 pairs, per pr.	2 10	Do.
F. Foshrenbach & Co.....	Dec. 4	Pickles, 60,000 pounds, per lb.	06	Do.
Do.....	Dec. 4	Vinegar, 10,000 gallons, per gall.	15	Do.
R. P. Cooley.....	Dec. 8	Wisp brooms, 5,000..... each..	09½	Do.
G. K. Sheridan & Co.....	Dec. 27	Cotton duck, 50,000 yards, per yd.	10, 70	Do.
Henry Smith.....	Dec. 29	Barnesly sheeting (bond), 5,000 yards, per yd.	57½	Do.
William Buchanan.....	1885. Apr. 4	Tobacco, 100,000 pounds, per lb.	26, 20	Do.
Martin M. Smith.....	Apr. 15	Fresh bread..... per lb.	03½	Annapolis, Md.
Jaakson Brewer.....	Apr. 15	Fresh beef..... do.....	09	Do.
Do.....	Apr. 15	Vegetables..... do.....	04	Do.
Kemp, Day & Co.....	Apr. 20	Evaporated apples, 10,000 pounds, per lb.	09½	New York, N. Y.
J. E. Michael.....	Apr. 22	B. S. neckerchiefs, 10,000, each.	75, 70	Do.
W. T. Rockwell.....	Apr. 23	Scissors, 5,000..... each..	18	Do.
Do.....	Apr. 23	Razor-strops, 2,000..... do.....	17½	Do.
A. M. Milliken.....	Apr. 23	Flannel, 6-4, 11-ounce, 60,000 yards, per yd.	85	Do.
Lawton Coggeshall.....	Apr. 25	Fresh beef..... per lb.	12½	Newport, R. I.
Do.....	Apr. 25	Vegetables..... do.....	2½	Do.
Do.....	Apr. 25	Fresh bread..... do.....	06	Do.
Do.....	Apr. 25	Water..... per gall.	00½	Do.
William Gray.....	Apr. 27	Beans, 10,000 gallons..... do.....	23, 70	New York, N. Y.
Thurber, Whyland & Co.	May 21	Coffee, 100,000 pounds, per lb.	08, 100, 1000	Do.
Van Hagan Soap M'g Co.	June 9	Salt-water soap, 100,000 pounds, per lb.	3, 70	Do.

Statement of sales of condemned materials pertaining to the Bureau of Provisions and Clothing during the fiscal year ending June 30, 1885.

Where sold.	To whom sold.	Gross amount of proceeds.				Cost of sale.	Net proceeds.
		Provisions.	Clothing.	Small stores.	Contingent.		
Navy-yard, Portsmouth.....	Downs & Co., W. J. Hallett, H. Staples, H. C. Russell, L. E. Lunt, W. Muir, Rider & Cotton, J. Holan, Charles Lovell, H. C. Lovell, A. P. Wendall & Co., J. E. Chase, Charles Churchill, J. Sanders, J. Hughes, Mugridge & Co., J. H. Webster, W. A. Gilman, T. J. Sheehan, J. Molan, J. H. Powers, A. Robinson, A. H. Paine, E. C. Neeley, C. L. Hayes, Jos. Harlow, John Chickering.	\$163 42	\$435 16	\$115 76	\$101 72	\$18 51	\$797 55
Navy-yard, New York.....	Dryfuss, Buckley, Bannerman, Brady, Sleighman, Kane, Donovan, Miner, Fleet, Sleighman Bros., Stewart, Lackey, Rider & Cotton, Fry, Cohen, Kerrigan, Allen, Stoddard & Bro., McMahon, Fink, Hallett, Clark, Townsend, William Birch.	1,984 04	2,179 28	188 65	70 50	299 58	4,122 87
Do.....	Bannerman, Watts, Parker & Co., Sleighman, Allen, Kerrigan, Burris, Lackey, Doughter, Clapp, Gifford, McMahon, Lepson, Kelly.	422 00	350 30	17 65	1 87	46 59	745 23
Navy-yard, New York.....	C. Kerrigan, McMahon, Lacky, Doughter, Wilson.	2,622 64	141 93	9 48	249 05	99 78	2,522 86
Navy-yard, Washington.....	J. Dryfuss, H. Baum, Springman, S. Belber, C. A. Smith, W. H. Arnett, Carmon, Meredith, Cash, H. Bernheimer, E. G. Wheeler, Codd & Bro., M. Freidman, Lintz, H. Pincus, M. D. Eastwood, P. Turney, A. A. McCullough, Driefuss, J. C. Sykes, A. Cohen, Landsburg, J. Deggs, A. J. Pool, W. H. Palmer, C. Coles, J. Grant, J. Tischler, Pat O'Connor, J. Foreman.	5 06	1,456 96	1 05	173 00	27 37	378 15
Navy-yard, Norfolk.....	J. Dryfuss, Charles Hey, J. Woodman, A. C. Freidman, John Malon, O. J. Flemming, O. E. Malby, M. W. Burke, M. W. Castello, S. Kellum, Thomas Reed, J. A. Denson, S. Kullum, M. Kautman, D. M. Cherry, S. Freidlin, M. Teschler, W. H. Palmer, J. R. Peaden, T. Hartung, P. Turney, H. Baum, J. C. Brown, J. W. Windtger, J. Woodman, George A. Scott, John Milan, H. E. Culppeper, George Neville, R. W. Morris, M. Fuller, C. Huret.	44 91	1,456 96	1 05	173 00	49 07	1,626 85
Do.....	No names given.	336 30	2,719 41	283 42	2 70	186 29	3,158 54
Navy-yard, Pensacola.....	No names given.	33 55	175 60	9 65	3 00	215 80
Navy-yard, Mare Island.....	T. Kehoe, I. Malloy, B. Pasalqua, J. Wilman, J. Aden, C. B. Hars, A. Powell, J. Ford, C. O'Brien, J. Carman.	84 75	281 06	8 05	4 20	8 64	369 42
Do.....	B. Pasalqua, A. S. Carman, C. Hars, T. Kehoe.....	359 51	524 75	21 10	7 10	34 68	696 79
Naval Depot, Rio de Janeiro.....	No names given (furniture).....	178 52	2,948 40	762 22	40 95	232 08	4,409 47
Naval Depot, Nagasaki.....	No names given.....	77 63	9 60	2 05	38 90
Do.....	do.....	6 00	1,308 97	187 26	83 60	157 63	5 70
Do.....	No names given (furniture).....	100 18	426 62	157 18	1,487 45
United States ship "Galathea".....	J. J. Keppie, Shields, England.....	28 06	None	28 06

States ship Trustees	7 00				7 00
States ship Enterprise					3 06
States ship Quinnebang	17 50				
States ship Casuarie	36 20				
States ship Palos	4 32				
States ship Monowey	5 96				
Naval yard, New York, Groely relief stores.	2,861 72	8,536 97		7 50	773 02
Do.....	585 00				20 36
Total.....	7,261 73	28,676 81	1,662 13	1,760 13	1,999 44
					32,280 36

Cheap, Jack & Co, Shanghai.....
 Kenrick & Co, Shanghai.....
 F. W. Green, Lisbon, Portugal.....
 Frank Joseph, European Station.....
 No names given.....
 McMahon, Rannerman, Locket, Dryfuss, Hallet, Hoover, Seligman Brothers, Fiesk, Graham, Fitzgerald, Jackson, Frasier, Kerrigan, Kane, Allen, Southwick, Townsend, Gissading, Stowart, Nathan, W. James & Co.....
 Rannerman, Seligman, McMahon, Wilson.....

No. 10.—MARINE CORPS.

HEADQUARTERS U. S. MARINE CORPS,
COMMANDANT'S OFFICE,
Washington, D. C., October 1, 1885.

SIR: I have the honor to submit my annual report of the condition of the U. S. Marine Corps.

On October 1, 1885, there were 1,880 enlisted men in the Corps, 957 of whom were on board ships in commission, and 923 doing duty at the several shore stations.

During the past year there have been 596 enlistments, 62 re-enlistments, 7 enlistments from the Army, 17 deaths, 312 discharges, 399 desertions, and 9 enlisted men have been retired.

One captain (active list) has died, promoting one first and one second lieutenant. One staff major has been retired, having reached the age provided by law. One captain and assistant quartermaster has been promoted to be major and quartermaster, and one captain has been transferred from the line by appointment to be assistant quartermaster, thus promoting one first and one second lieutenant. One first lieutenant has been retired for disability, promoting one second lieutenant.

Congress having provided at its last session that the Corps shall be reduced to 75 officers on the active list, it is now in process of reduction, there being at present 82 officers.

In April last two battalions, which were assembled from the various shore stations and the receiving and training ships, were suddenly transferred for important duty on the Isthmus of Panama.

The Department has been informed of the satisfactory manner in which this duty was performed and of the creditable conduct of the officers and enlisted men.

I desire to express to the Department my own high appreciation of the prompt, cheerful, and efficient manner in which the officers and men did this duty, which was both arduous and dangerous, as was shown by the loss of several men from an epidemic of yellow fever. A longer stay would have caused great loss of life, which was happily averted.

This expedition has, however, shown in the strongest manner what I have for years stated to the Department, viz, that we have not enough officers and men. All the shore stations were nearly stripped and left without adequate protection.

The guards were withdrawn from numerous ships for the same purpose, resulting in much inconvenience to the service.

It has also shown that the Marine Corps should have a complete outfit of tents and camp equipage for 500 men, as well as woven cartridge belts for use in the field. With the limited appropriations granted us yearly it is impossible to purchase these things, and in a sudden emergency like the one referred to great inconvenience arises.

In my report of last year I referred to the lack of promotion and the

consequent hardship resulting. Some of the captains have been 21 years in that grade, with no immediate prospect of promotion. Several of the first-lieutenants have been twenty years in the service. Unless some increase in the higher grades is made and a better distribution of the number of officers allowed this state of affairs must continue, to the great discouragement of ambition and professional pride.

I again renew my recommendation that the sum of \$12,350 be appropriated to alter building No. 17, at the Norfolk navy-yard, into a barrack for the enlisted men stationed there. This estimate and plan were made by the civil engineer of the yard to meet a long-felt and absolute necessity.

The reports of inspections made during the year show a very satisfactory state of discipline and efficiency at all the posts of the Marine Corps and in the guards of vessels afloat.

An increase of 500 privates is urgently needed to make the Corps thoroughly efficient and give a proper relief to those returning from sea. With the limited number now allowed it becomes necessary to send men to ships who have not been long enough in service to be properly instructed as soldiers. They should be one year in garrison under instruction before going to sea.

Marked improvement has been made in target practice during the past year and the results are very satisfactory.

The estimates for the support of the Corps for the coming fiscal year were submitted in duplicate on the 29th ultimo, and I inclose herewith statements, as required in the Department's letter of August 21, in compliance with section 429, Revised Statutes.

Very respectfully, your obedient servant,

C. G. McCAWLEY,
Colonel-Commandant.

Hon. WM. C. WHITNEY,
Secretary of the Navy, Washington, D. C.

Statement of the amount of appropriation for pay of the Marine Corps for the year ending June 30, 1885, and the amount expended by the paymaster of the Marine Corps.

Appropriation for the year ending June 30, 1885.....	\$653, 075 00
Total amount disbursed by Maj. Green Clay Goodloe, paymaster, United States Marine Corps	425, 595 89
Balance	227, 479 11

The appropriation for pay of the Marine Corps being subject to requisitions drawn by pay officers of the Navy, I cannot state what amount of the entire appropriation remains unexpended. All marines serving afloat are paid by naval paymasters a portion of their pay, and all balances due them on being transferred ashore are paid by me.

Respectfully submitted.

GREEN CLAY GOODLOE,
Major and Paymaster, Marine Corps.

Hon. WILLIAM C. WHITNEY,
Secretary of the Navy.

*Estimates of appropriations required for the service of the fiscal year ending June 30, 1867,
by the paymaster, United States Marine Corps.*

General object of expenditure, and explanations.	Total amount to be appropriated under each head of appropriation.
MARINE CORPS.	
Pay of officers on the active list:	
For one colonel-commandant, one colonel, two lieutenant-colonels, one adjutant and inspector, one paymaster, one quartermaster, four majors, two assistant quartermasters, one judge-advocate-general United States Navy; nineteen captains, thirty first lieutenants and nineteen second lieutenants, per R. S., p. 271, secs. 1396, 1623; June 30, 1834, vol. 4, p. 713, secs. 4, 5; March 2, 1847, vol. 9, p. 153, sec. 3; August 5, 1854, vol. 10, p. 586, sec. 1; February 2, 1857, vol. 11, p. 163, sec. 1; July 17, 1862, vol. 12, p. 594, sec. 2; June 30, 1864, vol. 13, p. 144, sec. 1; March 3, 1865, vol. 13, p. 457, sec. 1; July 28, 1866, vol. 14, p. 334, sec. 37; July 28, 1866, vol. 14, p. 337, sec. 13; March 2, 1867, vol. 14, p. 422, sec. 37; July 15, 1170, vol. 14, p. 517, sec. 1; July 18, 1875, vol. 18, p. 301, sec. 7; Navy Regulations, July 18, 1816.....	\$181, 265 00
Pay of officers on the retired list:	
For one colonel, one quartermaster, three majors, two assistant quartermasters, four captains, one first lieutenant, and three second lieutenants	31, 250 00
Pay of non-commissioned officers, musicians, and privates:	
For one sergeant-major, one quartermaster-sergeant, one leader of the band, one drum-major, fifty first sergeants, one hundred and forty sergeants, one hundred and eighty corporals, thirty musicians, ninety-six drummers and fifers, and one thousand five hundred privates.....	388, 053 00
Pay of civil force:	
For ten clerks and two messengers, to wit: Four clerks at \$1,540.80 per annum; three at \$1,496.52, and three at \$1,237.12 per annum; one messenger at \$971.28 per annum, and one at \$1.75 per day.....	16, 085 00
Undrawn clothing:	
For payments to discharged soldiers for clothing undrawn.....	20, 000 00
Transportation:	
For transportation of officers traveling under orders without troops	3, 000 00
Commutation of quarters:	
For commutation of quarters for officers on duty without troops.....	4, 000 00
Total.....	643, 642 00

Respectfully submitted.

GREEN CLAY GOODLOE,
Major and Paymaster, Marine Corps.

HEADQUARTERS U. S. MARINE CORPS,
Commandant's Office, September 28, 1885.

Forwarded approved.

C. G. McCAWLEY,
Colonel Commandant, U. S. M. C.

HEADQUARTERS MARINE CORPS, QUARTERMASTER'S OFFICE,

Washington, D. C., September 28, 1885.

SIR: I have the honor to transmit herewith the annual estimates of appropriations required for the service of the fiscal year ending June 30, 1887 by the quartermaster's department of the Marine Corps.

I respectfully call your attention to the fact that these estimates vary from those submitted for the fiscal year ending June 30, 1886, as follows, viz: Rations are decreased \$3,398.15, based upon the actual contract price of 18 cents per ration, 1885-'86, as against 19 cents per ration, fiscal year 1884-'85. Clothing is increased \$2,081, in consequence of the introduction, by authority of the Navy Department, of a hand-made sewed shoe, at an increased cost per pair, in place of the wire-screwed shoe heretofore in use; also an increase in the number of overcoats to be manufactured, this last item being based upon the number actually issued during the fiscal year 1884-'85. The increased cost of material to be used in manufacturing clothing for fiscal year 1885-'86 over that obtained under contract during the fiscal year 1884-'85 makes the increased estimate absolutely necessary.

Fuel decreased \$600, based upon the reduction in number of commissioned officers; military stores decreased \$500; repair of barracks is increased \$1,202.

These estimates are based upon reports of boards of survey now on file in this office, and the amounts specified are actually required to preserve this Government property and to place it in a habitable condition. The opening of a depot of supplies at San Francisco, Cal., by authority of the Navy Department, has added \$480 to the amount to be expended under the above head.

Contingent increased \$1,066.20, based upon the actual increase paid fiscal year 1884-'85 over 1883-'84 at the different ports for water, gas, and straw.

The aggregate amount asked for fiscal year ending June 30, 1887, is \$269,199.67, being \$4,351.11 more than the amounts asked for fiscal year ending June 30, 1886.

Respectfully, your obedient servant,

H. B. LOWRY,
Quartermaster, Marine Corps.

The COLONEL-COMMANDANT U. S. MARINE CORPS.

Estimates of appropriations required for the service of the fiscal year ending June 30, 1887 by the Quartermaster's Department, Marine Corps.

General object of expenditure, and explanations.	Estimated amount which will be required for each detailed object of expenditure.	Total amount to be appropriated under each head of appropriation.	Amount appropriated for the current fiscal year ending June 30, 1886.
PROVISIONS.			
For 1,000 non-commissioned officers, musicians, and privates, 365 days, at 1 ration per day, is 365,000 rations; at 18 cents per ration, is	\$65,700 00		
For difference between the cost of rations at 18 cents and commutation at \$1, for one enlisted man employed as clerk to colonel commandant, 365 days, is 365 rations; at 82 cents per ration, is	299 30		
For difference between the cost of rations at 18 cents and commutation at 75 cents, for 9 enlisted men employed as clerks and messengers in commandant's, adjutant's, and inspector's, paymaster's, and quartermaster's offices, Washington, D. C., and assistant quartermaster's offices, Philadelphia, Pa., and San Francisco, Cal., 365 days, is 3,285 rations; at 57 cents per ration, is	1,872 45		
For difference between the cost of rations at 18 cents and commutation at 50 cents, for three enlisted men employed as above 365 days, is 1,095 rations; at 32 cents per ration, is	350 40		
		\$68,222 15	\$60,000 00

NOTE.—Commutation in lieu of rations in kind, at the rate of \$1, 75 and 50 cents, to the above enlisted men, is authorized by order of the Navy Department, 28th June, 1880, and 20th July, 1885.

Estimates of appropriations required for the service of the Marine Corps, &c.—Continued.

General object of expenditure, and explanations.	Estimated amount which will be required for each detailed object of expenditure.	Total amount to be appropriated under each head of appropriation.	Amount appropriated for the current year ending June 30, 1886.
CLOTHING.			
For 2,000 non-commissioned officers, musicians, and privates, at \$36.36 per annum, actual cost	\$72,720 00		
800 overcoats, at \$7.52 each	6,016 00		
3,000 pairs hand-sewed shoes, at \$2.96½ per pair	8,895 00		
		\$87,631 00	\$77,000 00
<i>NOTE.—Hand-sewed shoes to take the place of old pattern. By order Navy Department.</i>			
FUEL.			
For 3,794 cords of wood, as follows: 1 colonel-commandant, 1 colonel, 2 lieutenant-colonels, 4 majors, 3 staff majors, 2 staff captains, 12 captains, 15 first lieutenants, 10 second lieutenants, 1,000 non-commissioned officers, musicians, and privates, 6 hospitals, 1 armory, 5 mess-rooms for officers, 16 offices for commandant and staff and commanding officers of posts, 9 rooms for officers of the day, 9 guard-rooms at barracks and navy-yards, 4 stores for clothing and other supplies, one-fourth additional on 2,400 cords, the quantity supposed to be required in latitude north 36 degrees from 1st September to 30th April, 575 cords, amounting in all to 3,794 cords, at \$6 per cord		22,764 00	18,000 00
MILITARY STORES.			
For pay of one chief armorer, at \$3 per day, \$939; three mechanics, at \$2.50 each per day, \$2,347.50; in all	3,286 50		
For purchase of military equipments, such as cartridge-boxes, bayonet-scarbards, haversacks, blanket-bags, canteens, musket-slings, swords, drums, bugles, flags, and spare parts for repairing muskets, &c	9,000 00		
For purchase of ammunition	1,000 00		
For purchase and repair of instruments for band and purchase of music and musical accessories	500 00		
For purchase of tents and camp equipage	1,000 00		
		14,786 50	8,786 50
TRANSPORTATION AND RECRUITING.			
For transportation of troops and the expense of recruiting service		10,000 00	10,000 00
REPAIR OF BARRACKS.			
At Portsmouth, N. H., Boston, Mass., Brooklyn, N. Y., League Island, Pa., Annapolis, Md.; headquarters and navy-yard, Washington, D. C., Gosport, Va., and Mare Island, Cal	15,000 00		
For introducing steam heating apparatus in marine barracks Portsmouth, N. H., as per estimate	1,750 00		
For erection of a building for marine barracks, navy-yard, Pensacola, Fla., to take the place of one destroyed on account of yellow fever (appropriation to be immediately available)	2,000 00		
For placing tin roofs on marine barracks and officers' quarters at Washington, D. C.	1,200 00		
For rent of building used for manufacture of clothing, stowing supplies, and offices of assistant quartermaster, Philadelphia, Pa., and San Francisco, Cal	2,500 00		
For hire of quarters for 7 enlisted men employed as clerks and messengers in commandant's, adjutant and inspector's, paymaster, and quartermaster's offices, Washington, D. C., and assistant quartermaster's offices, Philadelphia, Pa., and San Francisco, Cal., at \$21 each per month	1,764 00		
For hire of quarters for 3 enlisted men employed as above, at \$10 each per month	360 00		
		24,574 00	10,000 00
<i>NOTE.—Hire of quarters at \$21 and \$10 per month for the above enlisted men, authorized by the order of the Navy Department, dated 28th June, 1886, and 30th July, 1885.</i>			

Estimates of appropriations required for the service of the Marine Corps, &c.—Continued.

General object of expenditure, and explanations.	Estimated amount which will be required for each detailed object of expenditure.	Total amount to be appropriated under each head of appropriation.	Amount appropriated for the current fiscal year ending June 30, 1886.
FORAGE.			
For forage in kind for 4 horses of the quartermaster's department and the authorized number of officers' horses.....		5,400 00	5,400 00
CONTINGENCIES.			
For gas and oil at Marine Barracks, Portsmouth, N. H.; Boston, Mass.; Brooklyn, N. Y.; League Island, Pa.; assistant quartermaster's office, Philadelphia, Pa., and San Francisco, Cal.; Annapolis, Md.; headquarters and navy-yard, Washington, D. C.; Gosport, Va.; Pensacola, Fla.; and Mare Island, Cal. (actual amount paid last year) ..	5,460 48		
For straw for bedding for enlisted men at the various posts (actual amount paid last year).....	1,093 53		
For water at Marine Barracks, Boston, Mass.; Brooklyn, N. Y.; Annapolis, Md.; and Mare Island, Cal. (actual amount paid last year)	1,344 12		
For furniture for Government houses	5,000 00		
For freight, for ferrriage, toll, cartage, funeral expenses of marines, stationery, telegraphing, rent of telephones, apprehension of deserters, per diem to enlisted men employed on constant labor, repairs of gas and water fixtures, office and barrack furniture, mess utensils for enlisted men, such as bowls, plates, spoons, knives, forks, &c., packing boxes, wrapping paper, oil-cloth, crash, rope, twine, carpenters' tools, tools for police purposes, purchase and repair of hose, repairs to public wagons, purchase and repair of harness, repair of fire extinguishers, purchase of hand grenades, purchase and repair of handcarts and wheelbarrows, purchase and repair of cooking stoves, ranges, &c., stoves where there are no grates, purchase of ice, towels, and soap for offices, improving parade grounds, repair of pumps and wharves, laying drains and water-pipes, introducing gas, and for other purposes	18,423 89	31,322 02	25,000 00
HIRE OF QUARTERS.			
For hire of quarters for officers serving with troops where there are no public quarters belonging to the Government, and where there are not sufficient quarters possessed by the United States to accommodate them		4,500 00	4,500 00
		269,199 67	

QUARTERMASTER'S DEPARTMENT, UNITED STATES MARINE CORPS,
Washington, D. O., September 28, 1885.

Respectfully submitted.

H. B. LOWRY,
Quartermaster, Marine Corps.

HEADQUARTERS UNITED STATES MARINE CORPS, COMMANDANT'S OFFICE,
September 28, 1885.

Forwarded approved.

C. G. McCAWLEY,
Colonel Commandant, United States Marine Corps.

Schedule of proposals received for supply of rations for the Marine Corps for the year 1885-'86, under advertisement from the Quartermaster's Office, dated May 12, 1885.

Names of contractors.	At Portsmouth, N. H.	At Charlestown, Mass.	At Brooklyn, N. Y.	At Philadelphia, Pa.	At Washington, D. C.	At Gosport, Va.	At Annapolis, Md.	At Pensacola, Fla.	At Mare Island, Cal.
	Cents.	Cents.	Cents.	Cents.	Cents.	Cents.	Cents.	Cents.	Cents.
C. E. Filler.....				21					
T. J. Mooney.....								20	
John Kealy.....							14.85		
Thomas Callahan.....						*3.87½			
Hugh McHatton.....	17.97							†28.50	
Thomas J. Barbour.....						14.74			
Levi W. Norton.....	19.97								
Kelly & McInnis.....									24.75
J. F. Tobin.....									15.75
John Mullitt.....		†15.18							
James Brownlie.....									24
John C. Gilbert.....	†17.25	15.75	15.23		15.10	15.77	16.60		
J. C. Ergood & Co.....	18.67	15.40	15.60	16.70	15.50	16.15	17.67		7.50
Frank Hume.....			17.39						
Samuel Kimberly.....			15.89	15.70		†13.89	17.29		
Barbour & Hamilton.....			†15.00	†15.00	†14.00	15.00	15.00		

* For bread.

† Accepted.

QUARTERMASTER'S OFFICE, U. S. MARINE CORPS,
Washington, June 17, 1885.

H. B. LOWRY,
Quartermaster, Marine Corps.

Schedule of proposals received for supplies for the Marine Corps under advertisement in viting proposals dated May 12, 1885.

Name.	Class.	Amount.
J. Rodel*.....	1	63,000.00
Horstmann Bros. & Co.*†	1, 2, 3	26,645.27
Pitkins & Thomas*.....	1	22,521.40
Thomas Kent*†	1	7,485.00
Rowland A. Robbins*†	1, 3	32,763.00
Charles W. Hayes*†	1, 3	7,121.33
James Tucker & Co.*†	1	2,965.00
Lyon Bros.*†	1	1,287.00
B. Y. Pippet & Co*†	1, 3	33,074.00
Frank T. Wendell*.....	1	415.00
Charles F. Bush*†	1	3,468.75
C. W. Thorn & Co.*†	3	3,517.33
Robert C. Kretchmar*†	3	264.25
Richard Levlcks, Son & Co.*†	1	688.00
T. A. Ashburner*†	1	27,723.85
Lewis Broe*†	1	12,035.00
John Welsh*†	1	2,684.38
Thomas G. Hood*†	1, 2, 3	10,610.67
James Symington*.....	1	16,414.00
Raymond & Whitlock*†	1, 2	2,173.13
R. Warlitzer & Bro.*†	1	263.00
James C. Cooley*.....	1	13,006.00
S. H. Heilbrun*†	1	3,780.00
F. W. Maurer & Son*†	2	311.50
S. F. Pioneer Woolen Factory*.....	1	29,730.00

* Bid for part of class.

† Awarded contract.

QUARTERMASTER'S OFFICE, U. S. MARINE CORPS,
Washington, D. C., June 23, 1885.

H. B. LOWRY,
Major and Quartermaster, Marine Corps.

Schedule of proposals received for supply of wood and coal to the Marine Corps under advertisement from Quartermaster's Office dated May 12, 1885.

Names of bidders.	Where to be delivered.	Wood.					Coal.			
		Oak, in stick.	Oak, sawed and split.	Pine, in stick.	Pine (kindling), sawed and split.	Red ash (egg).	Red ash (store).	White ash (egg).	White ash (store).	White ash (furnace).
		Per cord.	Per cord.	Per cord.	Per cord.	Per ton.	Per ton.	Per ton.	Per ton.	Per ton.
Johnson Bros.....	Offices and officers' quarters, Washington and Georgetown, D. C., and within one mile of limits of said cities.	\$5 50	\$6 00	\$4 50	\$5 50	*\$5 25	*\$5 90	*\$4 75	*\$5 50	*\$4 75
J. S. Killmon.....	do	6 22	7 20	5 32	6 00	5 54	6 30	5 40	5 50	5 40
T. B. Cross, jr.....	do	*4 88	*5 35	*4 13	*4 63	6 00	6 00	5 50	6 00	5 50
Johnson Bros.....	Marine Barracks and navy yard, Washington, D. C.	5 50	6 00	4 50	5 50	*5 25	*5 90	*4 75	5 50	4 75
Z. Williams & Son.....	do	*4 45	*5 00	*4 45
J. S. Killmon.....	do	6 22	5 32	5 52	5 52
T. B. Cross, jr.....	do	*4 54	*5 00	*3 98	*4 33
Frank K. Ward.....	Offices and officers' quarters and rendezvous, Philadelphia, Pa.	7 00	9 00	6 75	9 00	*5 24	*5 15
James J. Convery.....	do	*6 00	*8 00	*6 00	*8 00	5 25	5 25
Joa. S. M. Basil.....	Marine Barracks, Annapolis, Md.	4 48	5 98	3 48	5 98	5 68	*4 48	5 23
John Kealy.....	do	*3 85	*5 25	*3 45	*5 25	*5 40	4 63	*4 90	3 50
William G. Parker.....	Officers' quarters, Norfolk, Va.	*4 50	*6 00	*4 50	*5 50
Do.....	Marine Barracks, Norfolk, Va.	*4 00	*4 00	*5 50	*6 00
William H. Sise.....	Portsmouth, N. H.	7 90	9 76	5 76	7 51	5 38	*5 75
Levi W. Norton.....	Marine Barracks, Portsmouth, N. H.	7 25	9 25	5 50	7 00
C. E. Walker & Co.....	do	*7 00	*9 00	*5 50	*7 00	*5 00
Daniel Littlefield.....	do	7 90	9 75	5 75	7 50
J. A. Wellington & Co.....	Marine Barracks, Charlestown, Mass.	*7 75	10 25	*6 25	*8 75	4 95
C. A. Campbell.....	do	7 95	*9 95	7 45	9 40	*4 90
William D. Burns, jr.....	Marine Barracks, Brooklyn, N. Y.	*6 99	*7 49	*8 00	*9 00	4 49	4 49
Samuel G. French.....	do	7 90	8 90	10 75	11 50	4 88	*4 88
Frank K. Ward.....	Marine Barracks, League Island, Pa.	8 00	7 50	*5 24
James J. Convery.....	do	*7 50	*7 50	*4 95
Hugh McHatton.....	Marine Barracks, Pensacola, Fla.	*4 75	*5 75	*3 50	*4 50
William Wallace.....	Marine Barracks, Mare Island, Cal.	9 50	*10 25	9 50	11 25	14 00
Samuel G. French.....	do	19 00
James McCudden.....	do	*11 77
Aden Bros.....	do	*9 00	*11 00	*9 00	*11 00	14 00
A. M. Ebbetts.....	do	13 25

* Accepted.

H. B. LOWRY,
Quartermaster, Marine Corps

QUARTERMASTER'S OFFICE, UNITED STATES MARINE CORPS,
Washington, June 18, 1885.

A.—Abstract of receipts and expenditures on account of the quartermaster's department, United States Marine Corps, for the year ending June 30, 1885, appropriation 1884-'85.

	Appropriations.	Repayments from sale of fuel to officers.	Aggregate available.	Expenditures during fiscal year.	Balance of appropriation June 30, 1885.	Bills on file unpaid.
Contingencies	\$25,000 00	\$25,000 00	\$24,564 55	\$435 45	*9656 84
Provisions	60,000 00	60,000 00	59,984 08	15 94	75,085 33
Clothing	77,000 00	77,000 00	76,712 90	287 10
Fuel	18,000 00	\$2,652 86	20,652 86	18,573 49	2,079 37
Military stores	9,786 50	9,786 50	8,154 58	1,631 97
Transportation and recruiting	10,000 00	10,000 00	8,552 82	1,447 68	11,594 37
Repair of barracks	12,250 00	12,250 00	12,021 52	228 48	32,088 26
Forage	5,400 00	5,400 00	2,696 79	2,703 21
Total	217,436 50	2,652 86	220,088 86	211,250 16	8,829 70	11,149 68

* Due Quartermaster's Department United States Army for freight charges, drayage in camp, equipage for naval expedition to Aspinwall, and for repairs and expenses at Boston navy-yard.

† Due Bureau of Medicine and Surgery for rations stopped on account of naval hospitals. Due on reservation accounts to contractors for rations furnished.

‡ Due Bureau of Equipment and Recruiting, Navy Department, for transportation of relief crew to Iroquois. Due railroads for transportation of marines in connection with naval expedition to Panama.

§ Due for hire of quarters and repairs at Boston.

No. 11.—BUREAU OF EQUIPMENT AND RECRUITING.

NAVY DEPARTMENT,
BUREAU OF EQUIPMENT AND RECRUITING,
Washington, D. C., October 16, 1885.

SIR: I have the honor to submit the following report of the operations of this Bureau during the fiscal year ending June 30, 1885, and to inclose the estimates for the fiscal year ending June 30, 1887.

There was appropriated for the fiscal year ending June 30, 1885, the following:

Equipment of vessels.....	\$750,000
Transportation and recruiting.....	25,000
Contingent.....	10,000
Civil establishment, Bureau of Equipment and Recruiting.....	9,000
Naval training station, Coasters' Harbor Island.....	21,000
Steel cruisers.....	78,600

During the year there were fitted for service at the various yards, wholly or partially, and furnished with stores, 68 vessels, involving an expenditure of \$64,217.03 for labor, and for material the sum of \$459,233.91, making a total of \$523,450.94 from the appropriation "equipment of vessels." This appropriation, being \$146,000 less for the fiscal year than was asked for, has been exceeded about \$32,000. The increased consumption of coal in the North Atlantic and Pacific Squadrons, owing to the recent troubles on the Isthmus of Panama, and in the Asiatic Squadron by reason of the trouble between France and China, are largely responsible for the deficiency here reported.

The appropriation for transportation and recruiting was exceeded \$27,502.95, but mainly on account of the difficulties occurring recently on the Isthmus of Panama, and other unforeseen contingencies incident to the movement of ships in service abroad.

That for "civil establishment," being a specific appropriation for service, has not been exceeded. The same may be said for "Coasters' Harbor Island" at Newport. There will be a small unexpended balance to turn into the Treasury.

In the estimates for the year 1887 the Bureau submits an estimate of \$30,000 to make further necessary improvements at Coasters' Harbor Island, and to maintain in good condition those already made at that place.

COAL.

There have been purchased for the use of vessels in service abroad and at home 45,235 tons of coal, costing, including expenses of delivery and handling, \$379,619.43.

HEMP.

To meet the requirements of the service there were purchased during the year the following amounts of hemp :

Articles.	Quantity.	Value.
Manila hemp	pounds.. 180,300	\$26,467 14
American hemp	tons.. 40,111	10,205 31
Russia hemp	do.. 76,111	18,350 71
Total		49,023 16

The Bureau has been obliged to purchase abroad the steel-wire rope for the new cruisers on account of its inability to have wire of the necessary tensile strength, elastic range, and ductility manufactured in the United States. A contract was entered into during the year with a firm in Massachusetts, but after several failures had been made the Bureau was obliged to discontinue the contract. Rope manufactured abroad and delivered at New York navy-yard costs about 60 per cent. less than the lowest offer received for the wire alone in this country. The Government patronage being so small and uncertain, it is not to be wondered at that private firms are unwilling to undertake its manufacture.

ROPE-WALK.

The following amount of cordage, with the cost of labor and material, was manufactured during the fiscal year :

203,808 pounds manila	\$40,761 00
231,045 pounds hemp	52,738 15
8,559 pounds iron wire	2,142 73
1,205 pounds hide	1,205 00
144 pounds copper	86 40

96,933 68

When I assumed charge of the Bureau last year it was thought that the cost of rope manufactured at the Boston yard was greater than that supplied by private firms. Inquiry established the fact that the invoice prices of rope as fixed by the Bureau some years ago were much higher than the present market rates, and as no change had been authorized since, instructions were issued to the commandant that all rope manufactured in future was to be invoiced to vessels at the actual cost of its production. Complaints reached the Bureau that inferior rope was being made for the service, and to be satisfied upon this point an exhaustive trial was made at Watertown Arsenal with rope purchased outside and that made at the navy-yard. It was believed with one of the best plants for rope-making in the United States, with no expense of insurance to be met, with no taxes to pay upon its value, and with no profits to be declared, that the Bureau's loss of two hours per day would be more than offset by these expenses of the private manufacture. No comment is needed beyond the following tabulated results showing strength and cost of each specimen :

Report of mechanical tests made with the United States testing machine at Watertown Arsenal, Mass., of rope manufactured at the navy-yard, Boston, Mass., and of purchased rope of corresponding sizes.

Kind.	Size.	Cost per pound.	Strength.	Remarks.
	<i>Inches.</i>	<i>ts.</i>	<i>Pounds.</i>	
Hemp	4½	11	20,050	Made at navy-yard, Boston.
Do	4	11	15,400	Do.
Do	3½	11	10,300	Do.
Do	3	11	8,450	Do.
Do	2½	11	5,100	Do.
Do	2	11	3,980	Do.
Bolt rope	3½	15½	9,650	Do.
Do	3	15½	7,200	Do.
Do	2½	15½	5,180	Do.
Manilla	4½	13	16,800	Do.
Do	4	13	12,960	Do.
Do	3½	13	11,200	Do.
Do	3	13	9,650	Do.
Do	2½	13	7,460	Do.
Do	2	13	4,270	Do.
Hemp	4½	10½	13,500	Purchased.
Do	4	10½	11,400	Do.
Do	3½	10½	9,400	Do.
Do	3	10½	7,200	Do.
Do	2½	10½	5,150	Do.
Do	2	10½	2,640	Do.
Bolt rope	3½	14	8,000	Do.
Do	3	14	6,680	Do.
Do	2½	14	4,620	Do.
Manilla	4½	13	13,480	Do.
Do	4	13	11,980	Do.
Do	3½	13	10,750	Do.
Do	3	13	7,800	Do.
Do	2½	13	6,000	Do.
Do	2	13	3,500	Do.

FORGE, ANCHOR, SMITH AND CHAIN SHOPS, AND ROLLING-MILL AT WASHINGTON NAVY-YARD.

During the past fiscal year there has been manufactured in these shops the following:

ROLLING-MILL.

195,233 pounds chain-iron	\$6,718 66
216,974 pounds bar-iron	4,499 46
106,159 pounds plate-iron	4,054 93
Total cost	15,273 05

FORGE AND ANCHOR SHOP.

15,795 pounds iron forging	\$1,871 06
14 anchors, Government type, weighing from 500 to 6,500 pounds.....	4,324 81
6 anchors, Williams's pattern, weighing 5,000 to 6,500 pounds	5,618 43
Total cost	11,814 30

GALLEY SHOP.

3 galleys, No. 5	\$3,081 88
3 galleys, No. 4	3,984 38
Repairs to galleys of the Tennessee, Wyandotte, Trenton, Alliance, St. Louis, Pensacola, Saratoga, Brooklyn, Ajax, Tallapoosa, Iroquois, and Despatch, and for the Marine Corps and miscellaneous purposes, costing	2,376 79
Total cost	9,443 05

SMITH AND CHAIN SHOP.

540 fathoms 1½-inch chain for Boston and Atlanta	\$5,36
270 fathoms 2-inch chain for Chicago	3,39
210 fathoms 1-inch chain for Boston and Atlanta	715
210 fathoms 1-inch chain for Chicago and for general issue	685
440 fathoms boat-chains	430
9 sets chain appendages	140
Mooring swivels, devil's claws	235
30 boat anchors, from 32 to 98 pounds	395
42 grappels, from 8 to 100 pounds	169
Other miscellaneous work	878
Total cost	12,477

In connection with the plant at this yard, I would state that material improvement has been added in years. Practically, the plant stands as it did 25 years ago. The cost of producing material of the kinds needed is greater from that cause than if bought in the open market, though there is much doubt whether the purchased articles would be as good and reliable. It is believed that certain very necessary improvements can be added to the rolling-mill, to the forge-shop and to the machinery of this yard that will reduce the cost of bar-plate, and other iron very materially, and which would almost pay for themselves during the first year in the saving that would be effected.

The Bureau labors further under some disadvantage from the manner of working incident to a system which appears wrong when compared with the methods employed in most private establishments, where chain is made by expert workers, mostly Englishmen, who are paid by the weight of chain they produce. For example, in anchor-making certain parts are made by certain men. Some work palms and arms, others work shanks and stocks, and still others assemble and put all together. This goes on from apprenticeship up. From the puddling furnace to the completed anchor and chain all is done by labor skilled in but one branch of the art. With us when busy, separate gangs are required for the anchor and forge shops, the rolling-mill, the smith and chain shops, and when work is slack, that our gangs may not scatter by discharge, we are obliged to keep all these men going on reduced time by giving all work enough to hold them. It often happens, then, that the forge and anchor men are obliged to run the heating furnaces and rolling-mill, and the chainmen to do general smith work, and *vice versa*. But recently work was delayed on one chain-cable of the new cruisers because one chain-maker was drawn for jury duty. The greater difficulty, however, is the disadvantage of old-fashioned machinery and the older expensive methods of reworking the old scrap-iron upon which we depend almost entirely for our supply of iron for manufacturing purposes.

The Bureau would urge the necessity of keeping up a thoroughly equipped rolling-mill, chain and anchor shop at the Washington yard and above all things to possess a first class testing machine to prove its work and to make experiments and researches with a view to establishing standard tests for chains and anchors intended for the mercantile marine. A plant, so improved, if it was only occasionally used could be held as a check against possible combinations of private dealers.

The Bureau would suggest the great importance of some legislation looking to the proving of anchors and chains intended for our vessels of war and for those of the mercantile marine. The safety of property and life afloat are often as dependent upon strong chains and good anchors as upon strong engines and good boilers. Compulsory inspections and

of these articles will be the means of saving much to the Govern-
 ; as well as to the underwriters. The last resort of vessels is fre-
 tly her "ground-tackle;" it should therefore be of the best.
 The English Government requires all cables and anchors to be tested
 a fixed standard. All defective and inferior work is shipped abroad
 sold cheap. Much of it is said to find its way to our country to the
 detriment of our workers. The British Lloyds refuse first-class ratings
 vessels with untested chains. Excepting the Navy, most of the chain
 by the Light-House Board, the Engineer Department, U. S. A.,
 Coast Survey, and the Fish Commission, is made by the lowest-bid-
 offering, and is required to undergo variable tests, mostly, however,
 accordance with some foreign requirement. A law in this country
 requiring standard tests would protect owners and underwriters, and
 would be in the interest of every manufacturer against the inferior
 article purchased abroad.

This Bureau being the only department of the Government engaged
 in manufacturing chains and anchors, it is eminently proper that the
 inspections and tests here indicated be placed under its control and
 direction. As much experimental work on the tensile strength, ductility,
 elasticity, &c., of American iron and steel has been done under its direc-
 tion, there has been established for its own guidance the only stand-
 ard based on these results. They have been found to differ very ma-
 terially from the usual rules used in England. No expense will attend
 the passage of such a law beyond the travel of the inspecting officer.
 The expense to the owners of vessels or to underwriters will be nothing
 beyond postage.

TRAINING APPRENTICES FOR THE NAVY.

There are established at the larger sea-port towns receiving ships
 where apprentices may be enlisted for the Navy. During the year the
 number of applicants reached 3,754; the number rejected for various
 causes, 2,601; leaving the number accepted 1,153.

Of this number there were 394 who failed to report after examination,
 so that the number actually received into the service was 759.

The following affords an actual exhibit of the number of apprentices
 in the service on the last of the fiscal year: Number of apprentices
 on board stationary and cruising training-ships, 749; number on board
 cruising vessels of the general service, 528; total number in service,
 1,277.

Those on board the cruising vessels of the service were distributed as
 follows:

North Atlantic Station	126
South Atlantic Station	57
Pacific Station	77
European Station	81
Asiatic Station	187
<hr/>	
Total	528

The system at present in force after enlistment embraces, for a period
 of about six months, primary instruction in the ordinary branches of
 English education, and the preliminary instruction in knotting, splic-
 ing, boating, signals, &c., and infantry exercises on board the New
 Hampshire. Those qualified at the expiration of this period are trans-
 ferred to the cruising training-ships, and a further period of similar
 instruction is continued at sea. After their return from this course,

lasting several months, all found qualified are transferred to the cruisers of the general service, where their usefulness is found to be most marked. The cruising training-ships Portsmouth, Jamestown, and Saratoga have been kept at sea as much as practicable. In the early part of the year a cruise of several months' duration was made to the Windward Islands with very gratifying results. In May they sailed on a European cruise of several months' length, but had not returned at the end of the fiscal year, though excellent results have been reported from abroad.

TRAINING-SHIPS.

The cruising training-ships Portsmouth, Jamestown, and Saratoga are in such condition as to require constant repairs. The time is close at hand when they will be unseaworthy. When built, and for several years afterward, these were most excellent vessels for training purposes, but as steam has now become the principal motive power, and as war vessels are yearly growing more into machines with subsidiary sail power, it is believed that if we are to keep abreast of, and the apprentices are to be made familiar with, the improvements and requirements of the modern war ship in which they are to serve, with their complicated machinery for offensive and defensive purposes, their preliminary instruction should begin in a type of vessel more nearly like the modern war ship. In this view the cruising training-ships should be of the most modern type and construction. All that is now taught them on these old vessels could be as well taught on board the newest types, together with very much more that they can only learn now after their transfer. If the real usefulness of their lives is to be begun after their preliminary training ends in the training squadron, then we are wasting time in these old antiquated types of ships that have had no use in the battles of the last twenty-five years, but which bear about the same relation to the modern war ship that the ordinary "tallow dip" does to the electric light.

The Bureau would therefore urgently recommend for your consideration the construction of two composite vessels engined with auxiliary steam power and lifting screws, armed with modern guns and fitted with the newest torpedo attachments. The Bureau is of opinion that this would be a wise and economic measure, and would obviate the constant extensive and costly repairs of these old and almost obsolete training-ships.

SAIL LOFTS.

In the sail lofts at the various yards there have been expended for labor and material in making sails, awnings, hammocks, clothes bags, &c., the following :

For material	\$62,850 81
For labor	58,432 85
Total	121,283 66

PENSIONS.

Pensions under the sixth section of the act of March 2, 1867, sections 4756 and 4757, Revised Statutes of the United States.

Nature of claim.	Claims filed from March 2, 1867, to June 30, 1884.	Claims allowed and certified to Commissioner of Pensions from March 2, 1867, to June 30, 1884.	Claims disallowed from March 2, 1867, to June 30, 1884.	Claims pending June 30, 1884.
For service of twenty years.....	502	361	115	26
For service of ten years.....	486	297	144	45
For renewal of pension.....	118	110	5	3
For increase of pension.....	19	13	6	0
	1,125	781	270	74

Nature of claim.	Claims filed during fiscal year ending June 30, 1885.	Claims allowed and certified to Commissioner of Pensions during year ending June 30, 1885.	Claims disallowed during year ending June 30, 1885.	Claims pending June 30, 1885.
For service of twenty years.....	35	30	10	21
For service of ten years.....	29	29	22	23
For renewal of pension.....	5	7	1	0
For increase of pension.....	5	2	3	0
For arrears of pension.....	1	0	0	1
For review of claim.....	1	0	1	0
	76	68	37	45

RECAPITULATION.

Claims filed from March 2, 1867, to June 30, 1885, inclusive.....	1,201
Claims allowed during said period.....	849
Claims disallowed during said period.....	307
Claims pending June 30, 1885.....	45
	1,201

ENLISTED MEN.

On the 30th of June there were 8,203 men and apprentices. The average number has not exceeded the legal quota.

Men allowed.....	7,500
Men enlisted during fiscal year at rendezvous.....	1,762
Men enlisted on board vessels.....	2,953
Discharges during year.....	3,732
Desertions during year.....	941
Deaths.....	43
Men employed in Fish Commission.....	134
Men employed at Naval Academy (summer).....	300
Men employed at Naval Academy (winter).....	112
Men employed in Coast Survey.....	275

The Bureau would again reiterate the recommendation of previous reports, that the force employed at the Naval Academy, in the Fish

Commission, and Coast Survey be allowed independently of the 7,500 men intended for the general service. The increasing requirements of these services draw largely upon the quota established by law for the Navy, and is often the occasion of much embarrassment to the equipment of our war ships. The force for these services should be limited to 500 men, and should be known as "auxiliaries for special service;" otherwise when these men are supplied as required the force remaining is not sufficient to properly man the regular cruisers.

The cost of maintaining the Fish Commission from pay of Navy for the fiscal year was \$76,252.

The cost of maintaining the Coast Survey from pay of Navy for the fiscal year was \$256,176.

It is true that most of the work of the Coast Survey and of the Fish Commission is done with the aid of the officers and enlisted men of the Navy, but the Bureau does not think that it is understood by the public that these two services claim so much of the available force of the Navy as 409 men to perform their duties and draw so largely upon its appropriations to defray the expense of these two establishments.

The Bureau would renew its recommendation of last year for legislation to allow honorably discharged men to elect a home on board any of the receiving ships during the three months granted by law as the limit of time within which to re-enlist after discharge, the men so choosing a home to be entitled to one ration per day for their keeping and to be amenable to such regulations as the Bureau may establish while so residing. By this arrangement these men would be able to escape much discomfort now experienced in our larger cities, where many are driven by necessity after their discharge into miserable and uncleanly boarding places. Much benefit would accrue to the service in the improved character of its personnel if legislation could be secured to enable these honorably discharged men to take advantage of these vessels as homes during the three months allowed them to re-enlist after discharge.

The Bureau has anticipated to some extent the improvement now taking place in the various implements for offense and defense in use or to be used on board of our new war vessels by organizing a class of forty men, taken from the general service, one-half of which are now being trained in the use of all the electrical apparatus and fittings at the torpedo station at Newport; the other half are being trained in the use of tools, lathes, and other implements of the ordnance shops at the navy-yard, Washington. When each class shall have completed their course of training at Newport or at Washington they are to change stations, and ultimately they are to be transferred to the general service, where they can act as instructors to the crews, and their places are to be supplied by others drawn from the general service for similar instruction until a sufficiently large body of trained men shall have been secured.

I would suggest the importance of amending section 2166 of the Revised Statutes, referring to aliens in the Army becoming citizens, so as to include the Navy. Also that sections 4756 and 4757, relating to pensions, be amended so as to include men who have served as appointed petty officers, some of this worthy class of necessary men being now excluded from pension benefits by not having been enlisted.

The Bureau would again submit its recommendation of last year in relation to the matter of outfit for enlisted men of the Navy. It is believed if an outfit of clothing could be given as a gratuity to all sailors on enlistment that much of the desertion now occurring would be prevented. At the present time the clothing outfit of a recruit costs quite three months of his pay, which must be assumed as a debt to the Gov-

ernment. In many cases the clothes are worn out before they can be paid for by service, and while so indebted the recruit enjoys no privilege of liberty nor money for personal use. As a matter of course this system is looked upon as discouraging by the sailor, if not oppressive. Desertions follow, with theft of outfit, as a result of the present system. It is believed that if the enlisted men of the Navy were placed upon a somewhat similar footing with those of the Army and Marine Corps in the matter of a clothing outfit on enlistment there would be less frequent desertion and much more contentment with the service.

The Bureau has also in view the improvement in all mess conditions of the men by which better means of preparing, cooking, and serving their rations can be effected, and hopes to succeed in establishing a better system of cooking by training a few men annually in the art of combining to the best advantage the various articles of the Navy ration.

At present there are no libraries for the crews of our war vessels and no appropriation for this purpose, but as their better training would result with opportunities to improve their minds during some of the idle hours when off watch at sea or in port, I would respectfully urge a small appropriation to begin this important work. The Bureau would suggest \$10,000.

The Bureau would urgently recommend the importance of some legislation looking to the retirement of enlisted men of the Navy after thirty years of service, as in the Army and Marine Corps at present. Under existing laws the pension allowance of seamen is but a pittance to depend upon when no longer able to serve, and in cases where the disability of age prevents the recipient from adding something to this small allowance there is some distress. The Bureau believes that the exposure, privations, and hardships of the seaman incident to his life at sea or in unhealthful ports abroad entitle him to the same consideration as the marine who serves on board ship with him, and it would be a great relief to many of our worn-out old veterans if they could be assured of this care from the Government they have upheld through storm and fire during at least two of its wars. In their behalf the Bureau would intercede for an amendment to the statute passed February 14, 1885, to include the Navy.

One other matter of vital importance to the efficiency of the service and to the welfare of the men is that they should be permitted by law some system of savings bank similar to that enjoyed by their Army associates. This law for the Army was enacted in 1872, and has been commended in the highest terms as a means by which desertions have been largely checked and the *morale* of the Army much increased. By section 1305, Revised Statutes, any enlisted man of the Army is permitted to deposit his savings in sums not less than \$5 with any Army paymaster. The money so deposited is to be accounted for in the same manner as other public funds, and passes to the credit of the appropriation for the pay of the Army. These savings are not subject to forfeiture by sentence of courts-martial, but are forfeited by desertion, and are paid upon the final discharge of the soldier, or to his heirs if deceased. The Government is made liable by law for the amounts deposited. By section 1306 the rate of 4 per cent. interest per annum on such deposits has been established for any sum not less than \$50 so deposited for a period of six months or longer, to be paid the soldier when discharged.

The service of sailors being always without the United States, there are no opportunities to invest their earnings, as might sometimes occur

with their companion in arms of the Army, and unless some care of this sort be thrown around them by their Government most of their savings are squandered away from home or wrung from them after their return by unscrupulous boarding-house keepers.

I would earnestly recommend this matter to your attention with a view to securing such legislation on this subject as may place the sailor on an equal footing with his Army comrade.

In recruiting for the Navy it has been customary for years to read over to the recruit the shipping articles before they are signed, in order that he may thoroughly understand the responsibilities of the service he is about to undertake, but there is no authority of law for a commissioned officer of the Navy to administer the oath of allegiance to recruits, as prescribed for the Army in article 2, section 1342, Revised Statutes; and as there are no notaries public appointed on board receiving-ships or at naval rendezvous, the binding particulars of an oath cannot be lawfully prescribed, as everywhere else in the Government military service, as a necessary preliminary to appointment to place.

If the statute quoted could be made to include the Navy, oaths could be lawfully administered by commissioned officers of the Navy and the matter of enlistment thus given more solemnity and binding force than at present.

The Bureau has the honor to transmit herewith an itemed estimate of the additions to the plant at the Washington yard, showing in detail what is needed to modernize it so that all articles manufactured in future may be produced at much lower cost than is now possible, and would earnestly request their recommendation.

Very respectfully, your obedient servant,

W. S. SCHLEY,
Chief of Bureau.

Hon. WILLIAM C. WHITNEY,
Secretary of the Navy, Washington, D. C.

ADDENDA TO REPORT.

Statement showing amounts appropriated, amounts expended, balances on hand June 30, 1885, and estimates of the probable demands which may remain on each appropriation.

Appropriations.	Amount appropriated.	Amount expended.	Balance on hand June 30 1885.	Probable demands on appropriation
Equipment of vessels.....	\$750,000	\$682,122 21	\$67,877 79	\$103,901 43
Transportation and recruiting.....	25,000	21,921 44	78 56	27,534 29
Civil establishment.....	9,000	8,563 27	436 73
Contingent, Bureau of Equipment and Recruiting.....	10,000	9,983 00	17 00	3,984 40
Steel cruisers.....	78,600	60,318 89	18,281 00
Training station.....	21,000	18,048 07	2,951 93	2,377 16

Schedule of bids for water supply at Coasters' Harbor Island, under advertisement dated April 28, 1885.

Philip T. Conroy: \$1,750 for artesian wells; for piping, \$1.50 per foot.
 Manhattan Artesian Well Company: \$7,000, or \$5 per foot if under 1,000 feet.
 Jesse Button: \$10 per foot up to 1,000 feet; reservoir, \$500.
 Delbert L. Barker: *\$1,875 for five wells to furnish 30,000 gallons daily; reservoir, *\$502.16; overflow pipe, *\$473.04; suction pipe and trenching, \$2,143.80; for supply main, \$427.50.

*Accepted.

Statements showing amounts expended during fiscal year ending June 30, 1885, for wages of mechanics and laborers and for the purchase of materials for repairing or equipping vessels of the Navy, showing cost of stores received, expended, and on hand June 30, 1885.

Expended for wages of mechanics and laborers	\$244,282 00
Expended for the purchase of material, &c	300,014 54
Estimated value of stores on hand June 30, 1884	1,727,937 59
Received during fiscal year	699,957 60
Expended during fiscal year	892,627 10
Estimated value of stores on hand June 30, 1885	1,595,268 09

Estimate to modernize rolling-mill, forge, and anchor shops.

One testing machine (Emery)	\$30,000
One rotary squeezer, for puddle balls or 150-pound scrap piles	4,050
One steam-engine, suitable to drive same, cylinder 12 by 24 inches.	1,950
One heating furnace complete	710
One pair Gothic puddle rolls for old mill	} 1,452
One pair rolls for making 5-inch puddle bars, with guides and rest bars for both pairs	
One 12-inch three high guide rolling-mill complete, chilled rolls and all fittings	7,275
One steam-engine, suitable to drive the same, cylinder 18 by 22 inches and with extra heavy fly-wheel	4,000
One cast-iron straightening plate, 2 feet by 30 inches	289
Steel rails for hot bed	168
Freight and erection expenses on the above	1,000
Iron gib cranes	2,500
One pair rotary shears, for thin plate	500
Three new boilers set in masonry	5,000
	58,894

Schedule of bids for improvements at Naval Training Station, Coasters' Harbor Island, under advertisement dated August 25, 1884.

Names of bidders.	Water supply.	Steam-heating apparatus.	Two 60-horse power boilers.	Six hundred feet sewer pipe.	Electric lighting.	Remarks.
New England Weston Electric Light Company.					†\$7,480	For underground wires.
Do.					7,180	For overhead wires.
The Babcock & Wilcox Company.			*\$3,755			
Cremin & Butler				\$295		
Walworth Manufacturing Company.		*\$3,287				
Edison Company for Isolated Lighting.					*8,150	For underground wires.
Do.					7,850	For overhead wires.
Philip F. Conroy & Co.	*3,150	†2,100				

*Accepted.

†Incomplete.

*Estimates of appropriations required for the service of the fiscal year ending June 30, 1887,
by the Bureau of Equipment and Recruiting, Navy Department.*

Detailed objects of expenditure, and explanations.	Estimated amount which will be required for each detailed object of expenditure.	Amount appropriated for the current fiscal year ending June 30, 1886.
EQUIPMENT OF VESSELS.		
For coal for steamers' and ships' use, including expenses of transportation, storage, and handling; hemp, wire, hides, and other materials for the manufacture of rope and cordage; iron for the manufacture of anchors, cables, galleys, and chains; canvas for the manufacture of sails, awnings, bags, and hammocks; heating apparatus for receiving ships, and for the purchase of all other articles of equipment at home and abroad, and for the payment of labor in equipping vessels and manufacture of equipment articles in the several navy-yards (appropriated; 23 Rev. Stat., pp. 428-733, secs. 3709, 3747, 1).....	\$860,000 00	\$860,000 00
TRANSPORTATION AND RECRUITING.		
For expenses of recruiting for the naval service, rent of rendezvous, and expenses of maintaining the same, advertising for men and boys, and all other expenses attending the recruiting for the naval service, and for the transportation of enlisted men and boys, at home and abroad (appropriated; 23 Rev. Stat., pp. 428-721, secs. 3666, 1).....	30,000 00	30,000 00
CONTINGENT.		
For extra expenses of training ships, freight and transportation of equipment stores, printing, advertising, telegraphing, books and models, postage, forage, ice, apprehension of deserters and stragglers, continuous-service certificates, good-conduct badges, and libraries for enlisted men, school books for training ships, medals for boys, and emergencies arising under cognizance of the Bureau of Equipment and Recruiting, unforeseen and impossible to classify (appropriated, Rev. Stat., p. 721, sec. 3666; 23 Stat., p. 428, sec. 1).....	20,000 00	15,000 00
NOTE.—The amount appropriated under head of Contingent E. & R. for the past fiscal year has been found entirely inadequate to meet the requirements of the service, and a deficiency appropriation will be necessary to settle outstanding obligations incurred abroad. In view of the increased expenditures on account of advertising, and the additional item of "libraries for seamen" embraced in the estimate for the next fiscal year, it has been increased \$5,000 over the amount appropriated for 1886.		
NAVAL TRAINING STATION, COASTERS' HARBOR ISLAND.		
For extending wharf and dredging, repairs to main causeway, sea wall, roads, buildings, and grounds at the naval training station, and the necessary labor and implements required for the proper preservation of the same (appropriated; 23 Stat., p. 497, sec. 1).....	30,000 00	25,000 00
CIVIL ESTABLISHMENT.		
Navy-yard, Kittery, Me.:		
One clerk.....	1,200 00	
One writer.....	1,000 00	
Navy-yard, Charlestown, Mass.:		
One superintendent of rope-walk.....	1,800 00	
One clerk.....	1,400 00	
One clerk.....	1,200 00	
One writer.....	1,000 00	
Navy-yard, Brooklyn, N. Y.:		
One clerk.....	1,400 00	
One clerk.....	1,200 00	
Navy-yard, League Island, Pa.:		
One clerk (appropriated, R. S., 23, p. 428, sec. 1).....	1,200 00	
Navy-yard, Washington, D. C.:		
One clerk.....	1,400 00	
One clerk.....	1,200 00	
One writer.....	1,000 00	
Navy-yard, Norfolk, Va.:		
One clerk.....	1,200 00	
One writer.....	1,000 00	
Navy-yard, Pensacola, Fla.:		
One writer.....	1,000 00	

Estimates of appropriations required for the service of the fiscal year, &c.—Continued.

Detailed object of expenditure, and explanations.	Estimated amount which will be required for each detailed object of expenditure.	Amount appropriated for the current fiscal year ending June 30, 1888.
CIVIL ESTABLISHMENT—Continued.		
Navy-yard, Mare Island, Cal.:		
One clerk.....	\$1,200 00	
One writer.....	1,000 00	
	20,400 00	\$9,000 00
<p>NOTE.—The appropriation of \$9,000 for the past and current fiscal years, under head of "Civil Establishment E. & R.," has been sufficient only for the payment of one clerk at each of the several navy-yards. As this force is found to be entirely inadequate to the proper performance of the duties, an increased itemed estimate is submitted, which is intended to cover the total force employed in a clerical capacity at each of the several navy-yards. The amount expended from appropriations of this Bureau for objects enumerated in section 3, act of January 30, 1885, was \$23,969.75.</p>		
SALARIES.		
One chief clerk (March 3, 1885, Rev. Stat., p. 70, sec 416; 23 Stat., p. 414, sec. 1)	\$1,800 00	
One clerk of class four (March 3, 1885, Rev. Stat., p. 27, sec. 167; 23 Stat., p. 414, sec 1)	1,800 00	
One clerk of class three (March 3, 1885)	1,600 00	
Two clerks of class two (March 3, 1885)	2,400 00	
Three clerks of class one (March 3, 1885)	3,600 00	
Two copyists (March 3, 1885)	1,800 00	
One assistant messenger (March 3, 1885)	720 00	
One laborer (March 3, 1885)	660 00	
	14,780 00	14,780 00
EQUIPMENT PLANT, NAVY-YARD, WASHINGTON, D. C.		
One testing-machine. Emery (submitted)	\$30,000 00	
One rotary squeezer for puddle-balls or 150 pound scrap piles (submitted)	4,050 00	
One steam-engine suitable to drive same, cylinder 12 by 24 inches	1,950 00	
One heating-furnace complete (submitted)	710 00	
One pair Gothic puddle-rolls for old mill; one pair rolls for making 5-inch puddle-bars, with guides and rest-bars for both pairs (submitted)	1,452 00	
One 12-inch three high-guide rolling-mill complete, chilled rolls and all fittings (submitted)	7,275 00	
One steam-engine suitable to drive the same, cylinder 18 by 22 inches, and with extra heavy fly-wheel (submitted)	4,000 00	
One cast-iron straightening plate, 2 feet by 30 inches (submitted)	289 00	
Steel rails for hot-bed (submitted)	168 00	
Freight and erection expenses on the above (submitted)	1,000 00	
Iron gib-cranes (submitted)	2,500 00	
One pair rotary shears for thin plate (submitted)	500 00	
Three new boilers set in masonry (submitted)	5,000 00	
	58,894 00	
INCREASE OF THE NAVY.		
For complete equipment outfit of new steel vessels, including two composite bark-rigged sailing vessels, with auxiliary steam-power, for training squadron (submitted)	725,000 00	

No. 12.—BUREAU OF ORDNANCE.

BUREAU OF ORDNANCE, NAVY DEPARTMENT,
Washington City, October 15, 1885.

SIR: I have the honor to submit the annual report of this Bureau, and also to transmit estimates for the fiscal year ending June 30, 1887.

(1) Fuel, tools, material, and labor ; batteries of the new types for six ships now in service ; towards the general armament of the Navy with modern secondary batteries and small-arms ; proof of naval guns and their appendages ; modern armament of two practice-ships for the training-squadron, and establishment of a proving and ranging ground.....	\$1, 112, 750 00
(2) General repairs to ordnance buildings, magazines, and appendages.....	15, 000 00
(3) Freight and miscellaneous expenses.....	5, 000 00
(4) Civil establishment at navy-yards.....	23, 822 75
(5) General expenses of the torpedo-station ; purchase of a torpedo-boat, and of auto-mobile torpedoes.....	250, 500 00
(6) To supply the ordnance outfit of the monitor Miantonomoh.....	207, 000 00
(7) To supply the ordnance outfits of the monitors Puritan, Terror, Amphitrite, and Monadnock.....	866, 000 00
(8) For one 12-inch B. L. rifle.....	60, 000 00
(9) For the armament of the four new vessels authorized by act approved March 3, 1885.....	878, 770 00
(10) For the purchase of improved and more powerful machinery for the manufacture of cannon.....	50, 000 00
	3, 468, 842 75

CANNON.

TYPE GUNS.

Congress not having appropriated for the construction of any more type guns, no new ones have been commenced this year. The number of rounds fired by the first 6-inch gun, however, has been carried to 275. Its behavior has continued to maintain the merits of the design. A 5-inch gun has been completed and had a preliminary trial ; it has thus far proved satisfactory.

The construction of the first 8-inch gun has progressed considerably since last report. The rings have arrived from England and are being put on as rapidly as possible.

The introduction of the slow-burning brown (or cocoa) powder has rendered some additional hooping necessary on the chase of this gun, and the forgings for these hoops are being made as rapidly as possible, and when machined will be shrunk on. When this is done the gun will be completed at once and its ballistics determined.

The tubes and jackets of the first 10-inch guns are assembled, and most of the rings have very recently arrived from Europe. Certain chase and muzzle rings will be made in this country as soon as practicable.

The use of the new slow-burning powder has resulted in carrying the

highest pressures in the bores of guns much further along the chase than was the case when black powder only was used.

This fact calls for additional strength forward of the trunnions, and accordingly the 8-inch and 10-inch guns are receiving additional rings on the chase (as mentioned).

Forgings for the 10½-inch gun have been very recently received from Sir Joseph Whitworth & Co. Manufacture has not commenced, and no funds are now available for the purpose.

A preliminary computation and a drawing of the 16-inch gun (110 tons) have been prepared; and the latter will be found in Appendix.

The drawings and calculations of resistance for the strengthening of the 8-inch gun and for the construction of the 16-inch gun were made by Lieut. A. R. Couden, U. S. N., who has also done much other valuable work.

The winding of wire on the first 6-inch wire-wound gun has been completed. It was laid on with varying tension according to the formulas deduced by Ensign Philip R. Alger, U. S. N. The compression of the bore was very uniform, and in accordance with the anticipations of the Bureau. It is given in the Appendix.

The use of spring-firing attachments with the type guns has continued, and a good deal of experience has been gained with these rather troublesome apparatus. The one that promises best of those thus far tried is in a satisfactory state. A new design is represented in the Appendix. This promises well, is light and simple, and will be tried if occasion offers.

POWDER.

Within the past year very notable progress has been made in the development of powder for great guns.

After the purchase and arrival of the German brown (or cocoa) powder referred to in last report, the Bureau began experiments at the naval ordnance proving ground at Annapolis, with a view to the production of a domestic powder that would repeat the excellent results of the German sample. At first only moderate success was attained, but finally, by repeated trials at the proving ground, and by much practice there with samples made by the Messrs. Du Pont & Co., a specification was settled upon that is thus far uniform in its action and gives in the 6-inch gun most gratifying velocities for the pressures developed.

The characteristics of the grain as regards its rate of burning are under complete control in manufacture, and the photographs in the Appendix, page 237 (showing an unburned grain and two which were blown out partly consumed), illustrate the progressive nature of the combustion, there being an increasing surface outside of the prism as well as through the central perforation.

A series of trials are in progress with the German and domestic powder for the purpose of developing the comparative hygrometric qualities of the two and the rate of burning as affected by temperature. Thus far no unfavorable indications have been obtained with respect to the domestic grain.

The Bureau has ordered another sample lot, which will be delivered shortly, and it is to be hoped it will prove equal to that last fired. To successfully manufacture brown powder in our country is a point of the very greatest interest to us, and its importance cannot be overrated.

To be independent of foreign manufacturers for the supply of the only known powder that is really suitable for use in high-power guns as now

constructed, is a matter that should concern every American. Commander W. M. Folger, U. S. N., has had immediate direction of affairs relating to the development of this powder, and his course throughout is highly appreciated by the Bureau.

The highest results obtained with this powder in the six-inch gun are as follows:

Charge.	Muzzle velocity.	Pressure.
<i>Pounds.</i>		
62	2,036	15.8
51	2,021	15
50	2,011	14.3

The limited firing had with the five-inch gun has been equally favorable.

It is probable that the Bureau will ask the Messrs. Dupont to alter the size of the prism to one that will accommodate itself to a greater number of calibers of our guns.

Considerable work has been done in connection with the development of suitable powder for the Hotchkiss machine cannon, lately adopted in this and other countries. Specifications of black powder have been established for each caliber, which give results generally superior to those obtained abroad, and will enable us to make large quantities of powder for these very important guns at any time it may be required. An account of the trials (which took place at the naval ordnance proving ground) and the results obtained will be found in the Appendix, page 237.

The trials of small-arm powder commenced last year at the naval ordnance proving ground (detailed in the last report) have been prosecuted with the result of grading the powders used by private and other establishments and showing the relative values of different ammunition for naval purposes.

PROJECTILES.

Some slightly-improved forms of common shell have been introduced, with a view to more resistance in the gun and against targets.

Instructive practice has been had against an 8-inch compound armor plate, from the 6-inch B. L. high-power rifle, using tempered projectiles, some of carbon and some of Chrome steel. The results (which are detailed in the Appendix, pages 229 and 231) are instructive, showing the resisting power of the plate and the progress that has been made in the adaptation of the projectile to its purpose.

The great energy carried to the target by the modern projectile calls for the utmost resisting power on the part of the latter, and it is reasonable to suppose that considerable time will be required to develop the best temper and other conditions of metal to do effective work on hard-faced plates. It is not too much to say that the last six-inch shot tried by us have done fully as well as those thus far tried abroad, and it is thought that we shall speedily surpass the results now obtained.

The constant advance made in the resisting power of armor calls for continued effort to develop the power of the projectile, and this is a species of work which is not likely to be concluded until the resisting qualities of armor have reached their maximum, and been overcome by the projectile.

GUN-COTTON ARMOR-PIERCING SHELLS.

Some very important experiments were undertaken by the Bureau at the naval ordnance proving ground for the purpose of investigating the question of controlling the action of gun-cotton when used as the bursting charge of armor-piercing shells. These trials were mostly carried out with the six-pounder rapid-fire Hotchkiss gun against targets of from 3 inches to 6 inches thick. They were quite successful, and showed that the gun-cotton bursting charge could be so controlled that its tendency to detonation by shock of departure from the gun and of arrival against armor could be lessened sufficiently to render perforation by projectiles carrying such a charge quite practicable.

A "delayed-action" fuze has been devised, which accomplished explosion of the wet charge after the passage of the projectile through the plate, and is simple in structure and action.

This delayed-action fuze was used very successfully to explode several 8" muzzle-loading rifle shells (charged with gun cotton) in the explosion chamber, and the results were very favorable, the number of fragments obtained and character of fracture showing that complete detonation was obtained.

The scheme of experiments from which the foregoing results were obtained is very creditable to Commander Folger, by whom it was projected and conducted, and the results are extremely valuable, as they establish the principles upon which gun cotton can be safely used in light shells, and thus facilitate greatly the preparations for practice against armor with heavier shells.

GAS CHECKS.

Further and very extensive trials have been had with the De Bange gas check. Much of this practice has occurred in connection with the proof of the 6-inch guns for the new steel cruisers. The check was found to be more satisfactory than any other thus far brought forward; but occasionally it would stick badly in the chamber without apparent cause. The Bureau early replaced the tin and brass rings (used by the distinguished inventor) with steel, finding improved action; but still the behavior of the check called for improvement. Commander Folger has lately introduced an anti-friction washer, that he substituted for the spring which has heretofore been used on the mushroom stem. This new apparatus appears to be quite successful, and enables the operator to open the breech of the gun with ease after discharges which produce a chamber pressure of over 15 tons per square inch.

This is a very important step, and will be found figured in the Appendix, page 241.

GUN CARRIAGES.

Some alterations have lately been made in the design of the ordinary gravity-return broadside carriage.

They result in improved action, and the carriage as now arranged is shown in the Appendix.

The 8-inch barbette carriages of the Boston and Atlanta have been arranged to work by power, as shown in the Appendix.

A new design for 8-inch and 10-inch pivot carriages is shown in the Appendix. It affords a better support against and distribution of downward thrust than those now in vogue, and is strong and compact.

Preliminary designs of central-pivot carriages for the guns of the four cruisers authorized by the last Congress are figured in Appendix.

In originally designing all our gun carriages it was intended to use unhammered cast steel as much as possible, casting each part in a single piece with all the necessary projections and attachments in place.

Unfortunately it has been found that the steel cast in these somewhat complicated forms does not resist well the fire of light projectiles, being more or less cracked and broken by shot from the Hotchkiss and other guns.

For this reason the Bureau has been obliged in a measure to go back to wrought iron. It is believed, however, that the ductile qualities of unhammered steel (when cast into elaborate forms) may shortly be so improved as to render its use for gun carriages, &c., prudent.

Several new designs of mounts (or carriages) for machine cannon have been completed and are shown in the Appendix.

Some are for the decks of ships and some are for the tops.

All the new carriage designs are largely due to Lieut. Charles A. Bradbury, U. S. N.

HOTCHKISS GUNS.

Since last report the 47mm. and 57mm. rapid-fire Hotchkiss guns therein mentioned have been received, and used at the naval ordnance proving ground.

As previously stated, suitable black powders have been determined upon for each caliber.

As it is very desirable that manufacturers in our own country should be able to produce the Hotchkiss ammunition (of which immense quantities would be used in war on account of the rapid rate of fire of these guns), efforts have been persistently made by the Bureau to produce a quality of steel shells here that would be superior to those purchased abroad. This has been effected, and the Bureau has produced projectiles that have been fired several times through the maximum thickness of steel (about three inches) without practical deformation.

There is a system of "rolling" steel objects which has lately come forward, and appears to promise the comparatively cheap production of projectiles for machine and other cannon. Of course cast-iron shell do not offer any particular difficulty and are made at the Washington navy-yard when desired.

The Winchester Repeating Arms Company is engaged in some experiments on the drawing of solid cartridge-cases for Hotchkiss ammunition, and it is hoped that their efforts will be successful.

At the ordnance department of the Washington navy-yard work on the armaments of the new steel cruisers has been pushed as rapidly as possible, and also all of the matters incident to general work of the Navy. A small estimate for increase of machinery has been submitted this year. In case this Department were placed on a suitable footing, however, several heavy traveling and stationary cranes would be required, as well as a good deal of modern machinery. Much of the machinery we are now using is the property of the Bureau of Steam Engineering and the Bureau of Construction and Repair.

SEAMEN GUNNERS.

The instruction of seamen gunners by the Washington navy-yard

is still pursued

service men" has been added to them, at the request of the Bureau of Equipment and Recruiting, and a course of instruction for both has been arranged (and entered upon by the men) both there and at the torpedo station, Newport, R. I.

The time covered by instruction and practice at each place is about six months, and the resulting benefit to the service will of course be very great. It is proposed to increase the size of classes as much as practicable, and to supplement the instruction by the issue of "catechisms" on ordnance subjects for the use of the men on shipboard.

ARMAMENT OF THE NEW VESSELS.

Since last report five 6-inch and two 5-inch breech-loading high-power steel guns have been completed at the ordnance department of the Washington navy-yard, and are now at the naval ordnance proving ground, where they have fired ten proof rounds each. They perform satisfactorily, and several will be mounted on the Atlanta when she is ready to receive them.

Nineteen sets of steel forgings for 6-inch B. L. R., made by the Midvale Steel Company have passed inspection, leaving one set to be still delivered under their orders.

Of the two private works that are under contract to machine-finish and assemble forgings furnished by the Bureau, the South Boston Iron Works, of Boston, Mass., has received six sets of 6-inch forgings, and the West Point Foundry Association, of Cold Spring, N. Y., has received four sets. Both establishments have made satisfactory progress on their work, and will have several 6-inch guns finished ere long.

The forgings for 8-inch guns, to be machined by these companies, have just arrived from Sir Joseph Whitworth & Co., of Manchester, England. The parts are being prepared as rapidly as possible for shipment to the respective works.

This steel is more than a year overdue from the English maker, and the delay in its receipt furnishes an excellent argument for encouraging the establishment of heavy gun forging plant in the United States.

Two additional chase rings for each of the 8-inch guns of the Atlanta and Boston have recently been ordered from the Midvale Steel Company, and are yet to be received, after which these guns can be speedily finished.

The broadside carriages of the Atlanta and Boston are all finished, and the barbette-carriages are being pushed as rapidly as possible.

The brown powder for the great guns of the Atlanta has been ordered from the Rhenish Westphalian Company. It is hoped that that for the Boston and Chicago can be made in the United States.

The secondary batteries for these ships have mostly been delivered at the navy-yard, New York; the powder for them will be of domestic manufacture.

The search-light outfits have been all received.

ARMAMENT OF THE PROJECTED SHIPS.

When Congress at its last session appropriated for the construction of four additional vessels, there was no provision for their armament, but designs for their guns have all been made, and preliminary designs of the carriages. They are shown in the Appendix.

The secondary batteries and other ordnance outfit will be purchased when money becomes available for that purpose.

ARMAMENT OF THE DOUBLE-TURRETED MONITORS.

The Miantonomoh is now being armored at New York. Her armament should proceed at once. Two 10-inch guns are partly completed at the Washington navy-yard, which could serve for one of her turrets; but as they are to be subjected to a special test, pursuant to an act of the last Congress, it has been thought best to include in the estimate submitted the whole four guns for the vessel.

In case work on the other double-turreted monitors is to be continued, the preparation of their armament should be undertaken at once, as it is likely to take quite as long to supply the guns, &c., as to finish the vessels in other respects. To this end estimates have been submitted.

ARMAMENT FOR CERTAIN SHIPS NOW IN SERVICE.

The third-rate ships last built are good sea boats, have compound engines, and are in most important respects good examples of the best class of wooden vessels. They will last some years and must be depended upon to do most of the work of the Navy until a sufficient number of new ships are built to replace them. It appears desirable that they should receive a modern armament, as the impression they produce without it is but slight. When they are finally replaced the armament will answer for newer vessels.

There are eight of the class referred to, but the Bureau has submitted estimates for six, assuming that two may become unserviceable before their armament could be prepared.

HIGH POWER MUSKET.

Since last report a new musket of this kind has been made for the Bureau. It was manufactured by the Winchester Repeating Arms Company, from specifications by Commander William M. Folger, and its power and simplicity are very satisfactory, though it is considered that the limit of the former quality has not yet been reached.

The maximum recorded velocity is 2,030 foot seconds, steel bullet 400 grains, charge of powder 200 grains. The bullet perforates 1 inch of steel (at short range) with reserve of force sufficient to kill two men. It penetrates 40 inches into 1-inch pine boards.

The piece weighs 12 pounds 2 ounces, and can be fired from the shoulder, but is intended in service to be fired with a rest. The accuracy not being as great as desired the weight of barrel will be increased. (For report on this arm see Appendix, page 232.)

CLARK'S DEFLECTIVE TURRET.

The Pusey & Jones Company, of Wilmington, Del., have finished fitting the plates, backing and bracing of the target representing a section of the Clark defective turret, but the structure has not yet been set up at the naval ordnance proving-ground.

Owing to lack of funds it has not been possible to complete a 10-inch gun with which to test this target. The prospect is now that one will be completed ere long, when the structure will be put together and tested.

THE NAVAL ORDNANCE PROVING GROUND.

Besides the researches detailed in the foregoing pages as having been prosecuted at the Naval Ordnance Proving Ground, that most useful station under charge of Commander William M. Folger, U. S. N., has been engaged in a variety of work essential to the development of ordnance. The guns of the new armament thus far finished have been proved with the customary number of rounds. Several classes of guns have been ranged, numerous trials have been made as to the best composition and temper of steel for armor-piercing shells, and as to the resistance of steel plates (to the attack of projectiles) when treated by different methods.

The measurement of chamber pressures in the different classes of guns has received much attention; loading and reloading tools for light ammunition have been devised, gun-platforms have been built, butts reconstructed, target armor plates mounted and backed, machine-guns tested, &c.

A few trials (additional to those of last year) have been made with forged steel tempered 3-inch projectiles of different forms of head, fired against steel targets inclined 14° to the line of fire.

The results went to show that the cylindrical projectile (flathead) produced most effect. (See Appendix, page 233.)

NEW SITE FOR NAVAL ORDNANCE PROVING GROUND.

The present location of the Proving Ground is certainly unsuitable and must become more so as the development of ordnance progresses. The range is entirely over water, and its use is embarrassed by the neighborhood of a light-house near the batteries and of a large hotel about half way down the range, besides the number of oyster and fishing boats which are frequently anchored or moving about the range, causing expensive delays in the practice.

An over-water range is not convenient and all projectiles fired on it are lost. It is not possible to study the action and resistance of percussion and other fuzes on the farther parts of the range, and projectiles and the rotation bands cannot be examined after flight.

The defects of the present site are well set forth in the following extracts from a letter from the inspector of ordnance in charge:

I will refer again to the entire unsuitability of the position of the Proving Ground for the work now in hand and in immediate prospect. The oyster industry of Annapolis keeps the range crowded with small craft during eight months of the year, and weather most suitable for my work is precisely that which the oysterman needs in his calling. I am obliged either to drive these men from their fishing grounds, which is a great hardship to them, or wait until after their return in the evening, for an opportunity to fire, which entails extra expense to the Bureau, the work thus done being after the regular hour for closing has passed.

The frequent cases I have had of projectiles of smaller caliber leaving the butt, leads me to anticipate much annoyance and even danger from this cause to Greensbury Point light-house and to vessels at anchor in the roadstead. I have had frequent complaints from farmers in the neighborhood of fragments of projectiles passing dangerously near their habitations.

There have also been complaints from Horn Point of glass being broken and plastering knocked down from the violence of concussion at the discharge of the 6-inch caliber. It is unnecessary to note that these effects will be much increased in work with the larger guns.

It is urgently recommended that a more suitable position may be purchased by the Department in order that the needed experimental work and proof of guns may not be definitely interrupted.

TORPEDO TRIALS.

As a consequence of the trials held before the torpedo board last year, the Bureau decided to make three automobile torpedoes on the design of Capt. John A. Howell, U. S. N. Two of these were completed and trials were held partly in the Potomac and partly in the harbor of Newport, R. I. The trials showed that the torpedo possesses valuable qualities, chief among which is its strong directive force and its comparatively small size. Unfortunately, these two torpedoes were lost, but a third (which was then nearly finished) will soon be completed, and will be tried in a location where the chances of its loss will be at a minimum.

SWIFT TORPEDO BOAT.

The purchase of a swift torpedo boat from one of the most celebrated makers abroad is again urged. Such craft combine qualities which can only be judiciously united and skillfully and economically embodied by builders who have had large experience in this special branch of construction.

There are several firms abroad that have had such experience, and a really fine boat purchased from one of them would furnish us an example of the utmost progress that has thus far been made in this difficult branch of construction, and could be examined and tested by our ship-builders, and would doubtless be a source of great benefit to them in designing and competing for the numerous boats of this class we require immediately.

The size of these boats gradually increases abroad. A length of 110 feet has been thought sufficient heretofore, but now the more advanced firms are building a length of 120 and 140 feet and more. Boats even 200 feet long are being projected.

The sum asked for last year for a 110-foot boat has been increased so as to cover one of about 135 feet.

THE MEGAPHONE.

Last year the Bureau made a megaphone on a design by Lieut. B. A. Fiske, U. S. N., and placed it for trial on board of the U. S. S. Tallapoosa. When that vessel was sunk the megaphone was lost, and no definite conclusion was reached as to its useful qualities.

The Bureau has recently caused another one to be made on a design by the same officer, and will have it embarked upon some vessel in order to ascertain its capabilities as a detector of the approach of torpedo boats and counterminers (or other military expeditions) by night.

The intensity of sounds is greatly augmented in the instrument, and practice will be required to use it to advantage. As its employment in many of the circumstances of war might be very important, it is thought well to give it a service trial.

A drawing will be found in the Appendix, page 229. It is there combined with a large speaking trumpet.

APPARATUS FOR THE ELECTRICAL FIRING OF GREAT GUNS.

The attention of Lieut. B. A. Fiske, U. S. N., has been directed to the perfection of a suitable key-board "pistol" and connections to be used in the firing circuits on board the new steel ships for the electrical firing of great guns.

Both instruments will be found figured and described at page 228 of the Appendix. They are strong and simple.

THE TORPEDO STATION

has been under the charge of Commander William T. Sampson, U. S. N., since November 1, 1884.

The manufacture of gun cotton for the use of the Navy has been carried on during the year, and the product continues as good as formerly. The density has been somewhat increased, thereby gaining an increase of explosive force.

The tendency of the finished product to mold has been a source of some trouble, and efforts are making to prevent this action.

Two large magazines for the storage of gun cotton have been fitted up (on Rose Island) in the uncompleted casemates of the old fort at that point. This enables us to remove the store of gun cotton from the neighborhood of the public quarters, the machine and other shops on Goat Island, where the structures used are small and become too much heated in summer.

Gun cotton for safe military use is usually wet with about 20 per cent. of water. In this state it is most commonly detonated by means of a primer, which is chiefly composed of dry gun cotton. This last being more unsafe than the wet is a source of considerable care on board ship, and for this reason it has been sought to carry none but wet gun cotton, and to find some ready means to quickly dry enough of it on occasion to answer for dry priming to the wet mass in the torpedo. A small lamp stove has heretofore been used for this purpose, but as this arrangement is inconvenient some experiments were undertaken for the purpose of finding a simpler method. The trials are detailed in the Appendix, page 245, and have resulted in the use of calcium chloride, a much more convenient process than that in vogue heretofore.

New boat fittings for spar torpedoes have been designed.

It is thought that they will require less men for their use than those now in service, and are stronger; and extended trials are being held with them.

An improved action of the spar torpedo can also be had by packing the gun-cotton in a solid mass (instead of in a cluster of cylinders as heretofore).

The apparatus for "contact explosion" has also been made removable, so it can be attached to any service torpedo.

It has also been decided to substitute a compact form of voltaic battery (Le Clanché) for the hand dynamo machine heretofore used for the explosion of spar torpedoes.

The material embodying these designs and changes is shown and described in the Appendix, pages 242, 244.

The stock of machinery in the torpedo machine-shop is fair and in good condition, but the boiler of the shop is deficient in power, much deteriorated, and will last but a very short time longer. The boiler of the gun-cotton factory is worn out. The Bureau has arranged to replace them both, and the old boiler of the machine-shop will be used for heating purposes.

Small estimates for enlargement of the electrical laboratory, and one for a house for the manufacture of fuzes, have been submitted; both are necessary. Several valuable and necessary electrical instruments have been received during the year.

The Bureau wishes to call attention to the importance of furnishing the station with at least two steam launches of modern form, engines, and speed, with which to exercise the torpedo classes in the maneuvers which they will be expected to practice in time of war. The launches

at the station are old, slow, and worn out. They are useless now for the purposes for which they were originally intended, and must be replaced if efficiency is to be maintained.

INSTRUCTION.

The usual summer course of instruction was given to commissioned officers and gunners in matters bearing upon torpedo warfare. A class of twenty-five officers was present, and their attention and progress are commended by Commander Sampson.

The Bureau had previously decided to make a number of alterations in the course of study, and in the manner of giving instruction. More practical exercises were had than has heretofore been customary, and the course in theoretical electricity and chemistry was modified. Both the inspector and the Board of Visitors were gratified at the results, and recommend a continuance of the new programme, which gives, as remarked, much prominence to practical instruction.

Much instruction was given in the management and care of circuits and apparatus for electric lighting. This branch of knowledge is very essential, as modern ships will doubtless all be lighted by electricity.

In connection with the above and with military lighting, much exercise has been had with high-speed engines and with dynamos.

In order to afford an opportunity of further study to those who, by reason of inclination, mental equipment, and other circumstances, are available for the purpose, a second or advanced course of instruction is arranged to immediately follow the general summer course. This advanced course extends over nine months, and the aim is to give higher instruction in the theory of the sciences that bear upon torpedo warfare. This year five officers take the advanced course. They were selected from the summer class on recommendation of the inspector of ordnance in charge.

A class of seamen gunners and continuous-service men is now under instruction at the station. The course extends over a term of six months, and embraces practical instruction in matters pertaining to the manufacture, care, and use of service-torpedo material.

The conduct, attention, and progress of the men is commended by the inspector of ordnance in charge.

For several years the Bureau has been giving instruction at the station in submarine diving, an experienced instructor being employed each season for the purpose.

It is gratifying to find that the importance of this branch is appreciated by both officers and seamen, most of them having been down in the armor frequently. A practical acquaintance with submarine work will be a necessity for the torpedoist in time of war.

The report of the Board assembled by the Department to witness the final examination of the summer torpedo class will be seen in the Appendix, page 250. It contains many good suggestions, and the desire of the Board to give the Bureau unbiased criticism of the course of study and exercises is highly appreciated.

TORPEDO SEARCH LIGHTS.

The exercises at the station have developed certain facts with reference to powerful torpedo search lights, which Commander Sampson dwells upon in his report.

He thinks that to be effective the lights must be mounted near the water-line; that their usefulness is much abridged by even a moderate

motion (due to the sea), and that numbers of lights should be used instead of a few.

In the latter respect his experience is similar to that of officers abroad who have experimented in the same direction, and it is probable that some modification in the use of search lights will be introduced ere long. Quite possibly a greater number of less individual power will be found more effective than the few powerful ones now in use.

At the conclusion of his report Commander Sampson makes a few recommendations of general naval interest.

Most of the points he touches are such as naval officers have long been united upon. This Bureau has (in substance) repeatedly urged them in a manner more or less modified to meet the probabilities of obtaining the requisite appropriations, and some of them have a place on the present ordnance estimates.

Commander Sampson's report will be found in the Appendix, page 245. It is written with his usual ability, and his administration of the torpedo station during the year has been eminently satisfactory to the Bureau.

The following statements are appended, viz :

A.—Statement showing amount appropriated under each specific head of appropriation for the service of the Bureau of Ordnance, during the year ending June 30, 1885—expenditures during the same period and balance remaining on hand June 30, 1885. Amounts expended for material and labor, and what balance will be required to meet outstanding obligations made during the year.

B.—Statement of cost or estimated value of stores under the cognizance of the Bureau of Ordnance on hand at the several navy yards July 1, 1884—of articles received and expended from July 1, 1884 to June 30, 1885, and of those remaining on hand July 1, 1885.

C.—Statement of the number of days labor and cost thereof, from July 1, 1884, to June 30, 1885, at the respective navy-yards and stations, chargeable to the Bureau of Ordnance.

D.—Amount expended during the fiscal year ending June 30, 1885, from the appropriations under the Bureau of Ordnance for civilians employed on clerical duty, or in any other capacity than as ordinary mechanics and workingmen.

E.—Statement of sales at public auction of condemned material under the cognizance of the Bureau of Ordnance, during the year ending June 30, 1885, and net amounts realized therefrom.

F.—Statement of contracts entered into by the Bureau of Ordnance during the year ending June 30, 1885.

I am, sir, your obedient servant,

MONTGOMERY SICARD,
Chief of Bureau.

Hon. W. C. WHITNEY,
Secretary of the Navy.

A.—Statement showing amount appropriated under each specific head of appropriation for the service of the Bureau of Ordnance during the fiscal year ending June 30, 1885, expenditures during the same period, and balance remaining on hand June 30, 1885.

Appropriation.	Appropriated.	Expended.	Balance June 30, 1885.
Ordnance	\$125,000 00	\$117,736 88	\$7,263 12
Steel R. B. L. guns	41,632 50	40,002 99	729 51
Repairs ordnance	15,000 00	9,514 52	5,485 48
Contingent ordnance	3,000 00	3,000 00
Civil establishment	5,000 00	4,991 84	8 16
Torpedo corps	50,000 00	43,837 13	6,162 87
Steel cruisers, ordnance	500,000 00	308,306 32	191,693 68
Total	739,632 50	528,289 68	211,342 82

The amounts expended were—

For labor	\$22
For material, &c	27
	53

The balances remaining are all required to meet outstanding obligation the balance under appropriation "Civil Establishment," \$8.16.

B.—Statement of cost or estimated value of stores on hand at the several navy-yards 1884, of articles received and expended from July 1, 1884, to June 30, 1885, and of remaining on hand July 1, 1885, which are under the cognizance of the Bureau of Ordnance.

Navy-yard.	On hand July 1, 1884.	Receipts.	Expended.	On hand July 1, 1885.
Portsmouth	\$656,690 40	\$69,175 40	\$130,194 10	
Boston	2,331,438 34	1,492 30	5,219 33	
New York	3,112,763 59	329,979 22	132,921 42	
League Island	915,010 50	903 34	3,106 44	
Washington	1,209,922 13	348,152 58	212,453 20	
Norfolk	794,051 22	52,136 37	102,463 08	
Pensacola	305,084 53	207 35	1,386 37	
Mare Island	1,601,695 58	34,130 91	63,151 32	
Naval Ordnance Proving Ground, Annapolis	120,067 01	69,811 87	46,096 00	
Torpedo station	32,230 41	58,777 69	59,560 71	
Total	11,078,953 71	964,767 03	756,551 97	

C.—Statement of the number of days labor, and cost thereof, from July 1, 1884, to June 30, 1885, at the respective navy-yards, chargeable to the Bureau of Ordnance.

Navy-yard.	Number of days labor.
Portsmouth, N. H.	1,371½
Boston	1,286½
New York	8,013
League Island	889
Washington	79,658
Norfolk	3,933½
Pensacola	302
Mare Island	4,341½
Key West	31
Naval Ordnance Proving Ground, Annapolis	7,726½
Torpedo station	6,855½
Total	114,408½

NOTE.—This table includes the following amounts which are not included in Table A :
 At Naval Ordnance Proving Ground, Annapolis, from appropriation "testing Clark's deflective turrets"
 At Washington navy-yard, from appropriation "testing Clark's deflective turrets"
 At New York navy-yard, from appropriation "Relief of Lady Franklin Bay Expedition"

D.—Amount expended during the fiscal year ending June 30, 1885, from the appropriations under the Bureau of Ordnance for civilians employed on clerical duty, or in any other capacity than as ordinary mechanics and workmen.

Navy-yard.	Rating.	Amount paid.
Portsmouth, N. H.	1 storekeeper	\$927 00
Boston	1 writer (60 days)	185 60
New York	1 clerk	1,400 00
	1 storekeeper	871 50
	1 messenger	755 03
	1 master of tugs (3½ months)	444 87
League Island	1 storekeeper	801 62
Washington	1 clerk	1,500 00
	1 foreman	2,100 00
	1 quarterman	1,228 00
	do	987 56
	do	936 98
	1 leading man	1,064 00
	do	1,039 50
	4 temporary leading men	531 04
	1 draftsman	1,232 00
	do	819 00
	1 draftsman (6½ months)	500 00
	1 draftsman	936 00
	1 assistant draftsman	741 25
	1 storekeeper	997 32
	1 special ordnance man	917 76
	1 office boy	323 00
Norfolk	1 clerk	1,200 00
Mare Island	1 writer	891 84
	1 storekeeper	125 40
	1 draftsman (4 days)	24 00
	1 pilot (2 days)	6 00
Naval Ordnance Proving Ground, Annapolis	1 storekeeper (15 days)	37 50
Torpedo station	1 chemist	2,241 10
	1 clerk	1,184 00
	1 draftsman	1,170 63
	1 writer (42 days)	126 00
	1 submarine diver (4 days)	40 00
	Total	28,295 50

E.—Statement of sales at public auction of condemned material under the cognizance of the Bureau of Ordnance during the year ending June 30, 1885, and net amounts realized therefrom.

1884.		
August 30.	Condemned stores at Rio Janeiro, Brazil, by Passed Assistant Paymaster J. R. Martin	\$263 66
October 10.	Yoke of oxen at Naval Ordnance Proving Ground, Annapolis, by Paymaster F. H. Arms	65 80
1885.		
January 5.	Condemned material at Mare Island navy-yard, by Paymaster J. B. Redfield	502 02
1884.		
November 13.	Condemned stores at naval depot, Nagasaki, Japan, by Paymaster J. C. Sullivan	1,675 33
1885.		
January 5.	Condemned material at navy-yard, Pensacola, by Paymaster A. Peterson	368 39
	Total net proceeds	2,875 20

The names of the parties purchasing the above have not been reported to the Bureau.

F.—Statement of contracts made by the Bureau of Ordnance during the year ending June 30, 1885.

August 7, 1884,	with the West Point Foundry Association, of Cold Spring, N. Y., for the construction of 5 6-inch and 2 8-inch rifles	\$35,000 00
	The original bid for the above work was	37,000 00
August 7, 1884,	with the South Boston Iron Works, Boston, Mass., for the construction of 6 6-inch and 2 8-inch rifles	38,600 00
	The original bid for the above was	40,800 00

*Estimates of appropriations required for the service of the fiscal year ending June 30, 1887,
by the Bureau of Ordnance, Navy Department.*

Detailed objects of expenditure, and explanations.	Estimated amount which will be required for each detailed object of expenditure.	Amount appropriated for the current fiscal year, ending June 30, 1886.
SALARIES.		
Chief clerk (Mar. 3, 1885; R. S., 23, p. 70, sec. 416, p. 415)	\$1,800 00	
Draughtsman (Mar. 3, 1885; R. S., 23, p. 27, sec. 167, p. 415)	1,800 00	
One clerk of class three (Mar. 3, 1885; R. S., 23, p. 27, sec. 167, p. 415)	1,600 00	
One clerk of class two (Mar. 3, 1885; R. S., 23, p. 27, sec. 167, p. 415)	1,400 00	
One clerk at \$1,000 (Mar. 3, 1885; R. S., 23, p. 415)	1,000 00	
One assistant messenger (Mar. 3, 1885; R. S., 23, p. 27, sec. 167, p. 415)	720 00	
One laborer (Mar. 3, 1885; R. S., 23, p. 27, sec. 167, p. 415)	660 00	
	8,980 00	88,980 00
Increase submitted: To salary of chief clerk	450 00	
NOTE.—The chief clerk is required by law to act as Chief of Bureau, in case of vacancy or of the absence or sickness of that officer (in case no other appointment is made). His duties are as responsible and arduous as those of the chief clerks in the other Executive Departments who are required by law to perform the same functions, and who now receive a like compensation, viz, \$2,250 per annum.		
By promotion of above clerk of class three to clerk of class four	200 00	
One clerk of class one	1,200 00	
One copyist	900 00	
	2,750 00	
NOTE.—The work of the Bureau has increased greatly of late years, owing to the increasing elaboration of ordnance material, and the additional clerk and copyist asked for are needed.		
ORDNANCE AND ORDNANCE STORES.		
For procuring, producing, and preserving ordnance material; for the armament of ships; for fuel, tools, material, and labor to be used in the general work of the Ordnance Department; for furniture at magazines, at the ordnance dock New York, and at the naval ordnance battery and proving ground (appropriated; R. S., 23, p. 427, sec. 1)		
	177,500 00	
Main and secondary batteries complete, of the new types, for six of the ships now in service (submitted)		
	670,000 00	
Towards the general armament of the Navy with modern secondary batteries and small arms—		
30 machine cannon of modern caliber	93,000 00	
20 musket caliber machine-guns	55,000 00	
1,000 magazine rifles, equipments and ammunition	34,750 00	
400 naval cadet rifles	6,000 00	
200 revolvers and ammunition	3,500 00	
Proof of naval guns and their appendages	6,000 00	
Modern armament of two practice vessels for the training squadron	10,000 00	
Purchase of land for proving and ranging ground for naval guns, and for constructing buildings, butts, shelters, batteries, &c	57,000 00	
Total	1,112,750 00	146,000 00
REPAIRS ORDNANCE.		
Necessary repairs to ordnance buildings, magazines, gun parks, boats, lighters, wharves, machinery, and other objects of the like nature (appropriated; R. S., 23, p. 427, sec. 1)	15,000 00	15,000 00
CONTINGENT.		
Miscellaneous items, viz: For freight to foreign and home stations; advertising and auctioneers' fees; cartage and express charges; repairs to fire-engines; gas and water pipes; gas and water tax at magazines; toll, ferrage, foreign postage and telegrams to and from the Bureau, &c. (appropriated; R. S. 23, p. 427, sec. 1)	5,000 00	8,000 00
NOTE.—The Bureau again calls attention to the insufficiency of the amounts heretofore appropriated for the above objects. A deficiency of \$1,800 will accrue under this head (for the year 1884-'85) which it has been impossible to foresee.		
CIVIL ESTABLISHMENT.		
For the civil establishment under the Bureau of Ordnance, viz:		
Navy-yard, Portsmouth, N. H.:		
One writer (appropriated; R. S. 23, p. 427, sec. 1)	1,017 25	
Navy-yard, Boston, Mass.:		
One writer (appropriated; R. S. 23, p. 427, sec. 1)	1,017 25	

Estimates of appropriations required for the service of the fiscal year, &c.—Continued.

General object of expenditure, and explanations.

Estimated amount which will be required for each detailed object of expenditure.

Amount appropriated for the current fiscal year ending June 30, 1886.

NAVY-YARD, NEW YORK.

One clerk (appropriated; R. S. 23, p. 427, sec. 1)	\$1,400 00
One writer (appropriated; R. S. 23, p. 427, sec. 1)	1,017 25

NAVY-YARD, WASHINGTON, D. C.

One clerk (appropriated; R. S. 23, p. 427, sec. 1)	1,600 00
One writer (appropriated; R. S. 23, p. 427, sec. 1)	1,017 25
One writer (appropriated; R. S. 23, p. 427, sec. 1)	1,017 25
One draftsman (appropriated; R. S. 23, p. 427, sec. 1)	1,545 00
One draftsman (appropriated; R. S. 23, p. 427, sec. 1)	1,081 00
One draftsman (appropriated; R. S. 23, p. 427, sec. 1)	1,081 00
One draftsman (appropriated; R. S. 23, p. 427, sec. 1)	927 00
One assistant draftsman (appropriated; R. S. 23, p. 427, sec. 1)	772 00
One foreman (appropriated; R. S. 23, p. 427, sec. 1)	2,156 00

NAVY-YARD, NORFOLK, VA.

One clerk (appropriated; R. S. 23, p. 427, sec. 1)	1,200 00
--	----------

NAVY-YARD, MARE ISLAND, CAL.

One writer (appropriated; R. S. 23, p. 427, sec. 1)	1,017 25
---	----------

NAVAL ORDNANCE PROVING GROUND, ANNAPOLIS, MD.

One writer (appropriated; R. S., 23, p. 427, sec. 1)	1,017 25
--	----------

TORPEDO STATION, NEWPORT, R. I.

One chemist (appropriated; R. S., 23, p. 427, sec. 1)	2,240 00
One clerk (appropriated; R. S., 23, p. 427, sec. 1)	1,200 00
One draughtsman (appropriated; R. S., 23, p. 427, sec. 1)	1,500 00

23,822 75 \$5,000 00

NOTE.—The above estimate is made to conform to section 3 act approved January 30, 1885, and includes those heretofore employed and paid from appropriations "Ordnance" and "Torpedo Corps." The clerk at New York, Washington, and Norfolk, and the writer at Mare Island, only have been paid from "Civil Establishment" during the past year.

TORPEDO CORPS.

Labor, material, freight and express charges; general care of and repairs to grounds, buildings, wharves, &c.; boats; instruction; instruments, tools, furniture, experiments, and general torpedo outfits (appropriated, R. S., 23, p. 428, sec. 1)	65,000 00
For new ferry-launch (submitted)	7,000 00

NOTE.—The present ferry-launch has been in continuous use for many years, will not last much longer, and requires extensive repairs. At such times as she is under repairs there is no suitable boat to relieve her. The only regular communication with the mainland is by this ferry (submitted).

For two new boilers and setting (submitted)	2,500 00
---	----------

NOTE.—The present boiler for running the machine-shop is badly corroded, and cannot much longer perform the work it is required to do. The boiler of the gun-cotton factory is entirely worn out.

Building fuze-room, with drying apparatus (submitted)	700 00
Building coal-shed (submitted)	300 00
Purchase of a torpedo-boat and the working drawings of the same (submitted)	75,000 00

NOTE.—The purchase of a fast torpedo boat from one of the leading builders of the world will furnish our people with a type and example of the most advanced form of construction. This is a matter of the first importance.

For the purchase of auto-mobile torpedoes of the latest construction, and a set of launching apparatus, with working drawings therefor (submitted)	100,000 00
--	------------

250,500 00 60,000 00

NOTE.—The United States has no practical auto-mobile torpedo suitable for general use in warfare afloat, and is the only nation of any pretensions which is not thus provided.

Estimates of appropriations required for the service of the fiscal year, &c.—Continued.

General object of expenditure, and explanations.	Estimated amount which will be required for each detailed object of expenditure.	Amount appropriated for the current fiscal year ending June 30, 1890.
DOUBLE-TURRETED MONITORS—ORDNANCE.		
Amount required to supply the ordnance outfit of the Miantonomoh (now being armored) (submitted)	\$207,000 00	
To supply the ordnance outfits of the monitors Puritan, Terror, Amphitrite, and Monadnock (submitted)	866,000 00	
	1,073,000 00	
NOTE.—No torpedo outfit is estimated for. If an auto-mobile, similar to the Whitehead, should be used, \$100,000 additional would be necessary.		
STEEL RIFLED BREECH-LOADING GUNS.		
One 12-inch breech-loading rifle (submitted)	60,000 00	
NOTE.—In making the above estimates, the price of English steel has been used in calculating the cost of all 8-inch and 10-inch guns. If American steel could be used, the price of the steel for these calibers would be increased fifty per cent., making an increase in the estimate of about \$120,000.		
INCREASE OF THE NAVY—ORDNANCE.		
For the armament of the new vessels authorized by act approved March 3, 1885, viz:		
One cruiser of between 3,000 and 5,000 tons (submitted)	294,892	
One cruiser of between 3,000 and 5,000 tons (submitted)	306,428	
One heavily-armed gunboat of 1,600 tons (submitted)	183,098	
One light gunboat of 800 tons (submitted)	89,352	
	878,770	
MACHINERY FOR ORDNANCE.		
Towards the purchase and manufacture of improved and more powerful machinery for the fabrication of cannon, &c. (submitted)	50,000	

Estimates of appropriations for deficiency required for the service of the fiscal year ending June 30, 1885, by the Bureau of Ordnance, Navy Department.

[See Revised Statutes, title 41, page 720, sections 3660 to 3671; Statutes 18, chapter 129, page 370, section 3, act of March 3, 1875, and section 2, deficiency act of July 7, 1884.]

Detailed objects of expenditure, and explanations.	Estimated amount which will be required for each detailed object of expenditure.	Amount appropriated for the current fiscal year ending June 30, 1885.
CONTINGENT, ORDNANCE.		
To supply a deficiency in the contingent service of the Bureau for the fiscal year ending June 30, 1885 (July 7, 1884, R. S. 24, p. 262)	\$1,300 00	\$3,000 00
NOTE.—The Bureau has been unable to confine itself within the appropriation of \$3,000, the freight, advertising, and other bills at home and on foreign stations having been unusually heavy. It has unpaid bills in hand amounting to \$1,157, \$693.24 of which was incurred on account of transportation for the expedition to Aspinwall. The amount required also includes bills incurred on foreign stations, with the estimated amount of those yet likely to come in from abroad.		
STEEL CRUISERS.		
To make up a deficiency to cover obligations incurred by this Bureau for the armament of the steel cruisers authorized by act of March 3, 1883, to be made available immediately (March 3, 1883; R. S., 23, p. 477)	193,000 00	
NOTE.—By the act referred to \$1,300,000 was appropriated towards the construction of steel cruisers; \$234,000 of this sum was allotted by the Navy Department to this Bureau towards procuring the armament. Subsequently the Department withdrew \$193,000 of this allotment, which it was understood was to be given to other Bureaus. Previous to the withdrawal, obligations had been incurred (by Ordnance) covering the whole of the sum thus withdrawn, and as a new appropriation bill was pending, it was supposed that the Bureaus which received the \$193,000 would ask for that amount for the purpose of repaying "Ordnance." This, however, was not done, and therefore a deficiency exists to the amount stated.		

Respectfully submitted.

MONTGOMERY SICARD,
Chief of Bureau of Ordnance.

OCTOBER 1, 1885.

Manufactures and preparations at the navy-yards and stations for the year ending June 30, 1885.

ARTICLES UNDER PROPORTION TO EACH GUN.

- 7 8-inch M. L. R. sponge-covers, sheepskin.
- 2 8-inch M. L. R. straps, securing.
- 10 8-inch M. L. R. shrapnel.
- 37 8-inch M. L. R. shell.
- 1 8-inch M. L. R. rammer.
- 1 8-inch M. L. R. rammer-head.
- 30 8-inch M. L. R. tackles.
- 6 8-inch M. L. R. breechings.
- 1 set 8-inch M. L. R. taps and dies.
- 10 8-inch M. L. R. sponge-caps, canvas.
- 4 sets 8-inch M. L. R. gun-gripes.
- 1 8-inch M. L. R. impression instrument.
- 2 8-inch M. L. R. muzzle-bags.
- 3 8-inch M. L. R. sponges, bristle.
- 12 IX-inch M. L. S. B. wash-deck chocks.
- 181 IX-inch M. L. S. B. tackles.
- 22 IX-inch M. L. S. B. train-tackles.
- 53 IX-inch M. L. S. B. sponge-covers, canvas.
- 95 IX-inch M. L. S. B. sheepskin sponge-covers.
- 2 IX-inch M. L. S. B. sponges, sheepskin.
- 52 IX-inch M. L. S. B. muzzle bags.
- 87 IX-inch M. L. S. B. breechings.
- 1 XI-inch M. L. S. B. breeching.
- 2 sets XI-inch M. L. S. B. breechings, preventer.
- 6 VIII-inch M. L. S. B. sponge covers, sheepskin.
- 6 32-pounder M. L. S. B. covers for sponge head.
- 370 6-inch B. L. R. S. shell.
- 10 6-inch B. L. R. S. shrapnel, iron.
- 5 6-inch B. L. R. S. pivot bolts.
- 4 8-inch B. L. R. S. mushrooms.
- 1 6-inch B. L. R. S. mushroom nose plate and stem.
- 6 6-inch B. L. R. S. shot, steel.
- 1 6-inch B. L. R. S. loading scoop.
- 1 6-inch B. L. R. S. passing box.
- 8 6-inch B. L. R. S. sponges, sheepskin.
- 7 6-inch B. L. R. S. sponges, bristle.
- 280 6-inch B. L. R. S. shell boxes.
- 5 6-inch B. L. R. S. shot boxes.
- 2 6-inch B. L. R. S. impression instruments.
- 3 6-inch B. L. R. S. drill cartridges.
- 1 6-inch B. L. R. S. carriage, Dolphin.
- 1 6-inch B. L. R. S. carriage, gravity return.
- 3 6-inch B. L. R. S. carriages, broadside.
- 5 6-inch B. L. R. S. hooped.
- 1 6-inch B. L. R. S. pivot yoke.
- 1 set 6-inch B. L. R. S. pivot circles.
- 4 6-inch B. L. R. S. pivot-yoke bolts.
- 6 6-inch B. L. R. S. clevis bolts.
- 1 set 6-inch B. L. R. S. gun gripes.
- 668 6-inch B. L. R. S. pivot-circle screws.
- 1 6-inch B. L. R. S. breech-cover.
- 3 6-inch B. L. R. S. gas checks.
- 4 6-inch B. L. R. S. shell gauges.
- 1 6-inch B. L. R. S. pivot-socket.
- 3 6-inch B. L. R. S. tackles, shifting.
- 3 6-inch B. L. R. S. rammers.
- 1 6-inch B. L. R. S. gun-sling, chain.
- 2 6-inch B. L. R. S. tackles, out.
- 2 6-inch B. L. R. S. tackles, in.
- 1 6-inch B. L. R. S. tompion.
- 6 6-inch B. L. R. S. firing attachment.
- 2 6-inch B. L. R. S. sponge-covers, sheepskin.
- 3 6-inch B. L. R. S. sponge-caps, canvas.
- 25 6-inch B. L. R. S. mushrooms.
- 1 6-inch B. L. R. S. breech-sight.

- 3 6-inch B. L. R. S. breechings, wire.
- 2 6-inch B. L. R. S. cup gas checks.
- 1 set 6-inch B. L. R. S. elevating gear.
- 4 5-inch B. L. R. S. gas-check pass.
- 2 5-inch B. L. R. S. hooped.
- 2 5-inch B. L. R. S. trunnion sleeves.
- 1 5-inch B. L. R. S. mushroom.
- 51 5-inch B. L. R. S. shell.
 - 1 5-inch B. L. R. S. rammer head, bronze.
 - 3 5-inch B. L. R. S. sponges, sheepskin.
 - 3 5-inch B. L. R. S. sponge covers, sheepskin.
 - 1 5-inch B. L. R. S. rammer, wood.
 - 3 5-inch B. L. R. S. sponges, bristle.
 - 6 5-inch B. L. R. S. sponge caps, canvas.
 - 2 80-pounder B. L. R. P. sheepskin sponge covers.
- 270 80-pounder B. L. R. P. boxes, shot and shell.
 - 2 sets 80-pounder B. L. R. P. elevating gear.
 - 1 80-pounder B. L. R. P. Broadwell ring extractor.
 - 1 80-pounder B. L. R. P. rammer head.
 - 4 80-pounder B. L. R. P. breech sights.
 - 4 80-pounder B. L. R. P. rim-base sights.
 - 2 80-pounder B. L. R. P. breech covers, canvas.
 - 2 sets 80-pounder B. L. R. P. trunnion seats and cap squares.
 - 2 80-pounder B. L. R. P. shell loaders.
 - 1 80-pounder B. L. R. P. Broadwell ring.
 - 1 60-pounder B. L. R. P. rammer head.
 - 3 60-pounder B. L. R. P. securing straps.
 - 8 60-pounder B. L. R. P. train ropes.
 - 2 60-pounder B. L. R. P. sponges, bristle.
 - 3 60-pounder B. L. R. P. cup gas checks.
 - 5 60-pounder B. L. R. P. tackles, out.
 - 3 60-pounder B. L. R. P. tackles, in.
 - 8 60-pounder B. L. R. P. sheepskin sponge covers.
 - 1 60-pounder B. L. R. P. firing attachment.
 - 4 60-pounder B. L. R. P. pivot sockets.
 - 6 60-pounder B. L. R. P. sponge caps, canvas.
 - 1 60-pounder B. L. R. P. combination toggle.
 - 2 60-pounder B. L. R. P. sights, rim base.
 - 7 60-pounder B. L. R. P. breechings.
 - 2 60-pounder B. L. R. P. boxes breech sight.
 - 2 60-pounder B. L. R. P. breech-sight bars.
 - 3 sets 60-pounder B. L. R. P. sights.
- 14 60-pounder B. L. R. P. shell.
 - 4 60-pounder B. L. R. P. breech covers.
- 204 60-pounder B. L. R. P. boxes, shell.
 - 6 sets 60-pounder B. L. R. P. gun grips.
- 100 30-pounder B. L. R. P. shell boxes.
 - 2 30-pounder B. L. R. P. sponges, sheepskin.
 - 6 30-pounder B. L. R. P. cup gas checks.
 - 3 30-pounder B. L. R. P. tompons.
 - 9 30-pounder B. L. R. P. breeching thimbles.
 - 2 30-pounder B. L. R. P. vent impressions.
- 10 30-pounder B. L. R. P. tackles, side.
 - 6 30-pounder B. L. R. P. tackles, train.
- 12 30-pounder B. L. R. P. quins, chocking.
 - 3 30-pounder B. L. R. P. covers, sheepskin sponge.
 - 6 30-pounder B. L. R. P. loading scoops.
 - 4 30-pounder B. L. R. P. small-arm attachments.
 - 5 30-pounder B. L. R. P. elevating screws.
 - 3 30-pounder B. L. R. P. nose-plate wrenches.
 - 8 30-pounder B. L. R. P. breechings.
- 4 20-pounder B. L. R. B. breechings.
- 8 20-pounder B. L. R. B. sheepskin covers for sponge heads.
- 11 20-pounder B. L. R. B. sponge caps, canvas.
- 18 handspikes, ordinary.
- 43 handspikes, roller.
 - 6 division bags.
 - 1 gas check, 9-inch.
 - 4 impression takers.
 - 1 stop-leak mat.

- 7 division tubs.
- 73 buckets, fire.
- 1 electric firing attachment.
- 14 shell stands on bulwarks.
- 1 circuit closer for gun captains.
- 2 plans of magazine and shell rooms.
- 16 wash deck chocks.
- 39 quoins, chocking.
- 12 supply and reserve boxes.
- 30 swabs, gun.
- 51 selvagees for breeching.
- 6 targets, great gun.
- 12 sweep pieces.
- 23 shell whips.
- 23 sponges.
- 2 breast pieces.
- 6 bristle sponge heads.

HOWITZERS, MACHINE GUNS, EQUIPMENTS, ETC.

- 4 3-inch B. L. H. impression instruments.
- 1 3-inch B. L. H. dismantling bar.
- 1,086 3-inch B. L. H. shell sabots.
- 20 3-inch B. L. H. train ropes.
- 3 3-inch B. L. H. field-carriage wheels.
- 349 3-inch B. L. H. shrapnel.
- 694 3-inch B. L. H. shell.
- 20 3-inch B. L. H. tackles.
- 4 3-inch B. L. H. check ropes.
- 2 3-inch B. L. H. drag ropes.
- 80 3-inch B. L. H. shell boxes.
- 1 3-inch B. L. H. gun box.
- 15 3-inch B. L. H. screws, elevating.
- 12 3-inch B. L. H. handspikes, roller.
- 14 3-inch B. L. H. dummy shot.
- 13 3-inch B. L. H. hooks, drag rope.
- 28 3-inch B. L. H. blocks, metal.
- 29 3-inch B. L. H. sponge caps, canvas.
- 12 3-inch B. L. H. sponges, bristle.
- 8 3-inch B. L. H. rammer and sponges.
- 716 3-inch B. L. H. shell plugs.
- 4 3-inch B. L. H. haversacks.
- 886 3-inch B. L. H. followers.
- 8 3-inch B. L. H. pivot sockets.
- 3 3-inch B. L. H. sponge buckets.
- 1 3-inch B. L. H. pivot bolt.
- 1 3-inch B. L. H. cup gas check box.
- 1 3-inch B. L. H. hand grip.
- 1 3-inch B. L. H. gun cover.
- 3 12 pounder H. sheepskin sponge covers.
- 3 12-pounder H. sponge caps, canvas.
- 19 12-pounder rifle howitzer, canister.
- 4 24-pounder howitzer sweep pieces.
- 1 Hotchkiss 37^{mm}. revolving cannon chamber gauge.
- 1 Hotchkiss 47^{mm}. revolving cannon chamber gauge.
- 4 Hotchkiss cannon core mounts.
- 1 Hotchkiss cannon bristle sponge staff.
- 8 Hotchkiss 37^{mm}. cannon tripod mounts.
- 1 Hotchkiss 37^{mm}. revolving cannon cover.
- 1 Hotchkiss cannon tower mount.
- 1 Gatling gun cover.
- 2 Gatling gun drag ropes.
- 1 Gatling gun feed-case box.
- 2 Gatling gun check ropes.
- 1 Gatling gun haversack.
- 3 Gatling gun tripods.
- 2 arm chests, small.
- 1 set target screens.
- 1 set circles, tower mount.
- 33 chocks, deck field carriage.
- 1 shifting chock, boat carriage.

SMALL ARMS.

- 100 frogs, pistol.
- 30 frogs, revolver.
- 300 outlass scabbards.
- 52 single sticks.
- 7 target plates.
- 20,000 balls, rifle, caliber .45.

MAGAZINE STORES.

- 174 8-inch M. L. R. cartridge bags, 25 pounds.
- 336 8-inch M. L. R. cartridge bags, 30 pounds.
- 50 8-inch M. L. R. cartridge bags, 40 pounds.
- 448 8-inch M. L. R., burster bags.
- 40 8-inch B. L. R. S. powder cylinders.
- 270 VIII-inch (6,500 pounds) cartridge bags, 5 pounds.
- 64 VIII-inch (6,500 pounds) cartridge bags, 6 pounds.
- 270 VIII-inch (6,500 pounds) cartridge bags, 7 pounds.
- 320 80-pounder B. L. R. cartridge bags.
- 199 80-pounder B. L. R. bags, burster.
- 200 60-pounder B. L. R. cartridge bags.
- 51 60-pounder B. L. R. cartridge bags, 10 pounds.
- 120 60-pounder B. L. R. cartridge bags, 8 pounds.
- 223 60-pounder B. L. R. cartridge bags, 6 pounds.
- 1,281 60-pounder B. L. R. burster bags.
- 720 30-pounder B. L. R. burster bags.
- 410 30-pounder B. L. R. cartridge bags.
- 9,918 20-pounder B. L. R. B. cartridge bags.
- 400 20-pounder B. L. R. P. cartridge bags.
- 4,443 20-pounder B. L. R. B. followers.
- 1,400 20-pounder B. L. R. P. followers.
- 300 32-pounder M. L. S. B. cartridge boxes, 3 pounds.
- 250 32-pounder M. L. S. B. cartridge bags, 6 pounds.
- 700 32-pounder M. L. S. B. cartridge-bags, 4 pounds.
- 265 6-inch B. L. R. S. cartridge-bags.
- 50 6-inch B. L. R. S. burster-bags.
- 50 5-inch B. L. R. S. cartridge-bags.
- 995 3-inch B. L. H. cartridge-bags, 12 ounces.
- 635 3-inch B. L. H. cartridge-bags, 1 pound.
- 16 3-inch B. L. H. shrapnel charges.
- 130 3-inch B. L. H. bags, shell charge.
- 387 3-inch B. L. H. charges, saluting.
- 1 3-inch B. L. H. funnel.
- 220 12-pounder howitzer cartridge-bags, 10 ounces.
- 500 12-pounder howitzer cartridge-bags, 1 pound.
- 1,414 primers, shell, vent-closing.
- 55 blocks for steel vent-closing primers.
- 1 box for reloading tools, steel vent-closing primer.
- 9,473 primers, quill friction.
- 6 primers for percussion spring firing attachment.
- 4,779 fuses, Navy M. S. spherical.
- 560 fuses, Navy M. S. rifle.
- 1,251 fuses, Boxer.
- 52 stocks, Boxer fuse.
- 52 igniters, Boxer fuse.
- 10 fuses, base, experimental.
- 1,837 fuses, Bormann.
- 6,469 stocks, Bormann fuse.
- 5,100 rings, Bormann fuse stock.
- 660 adapters, fuse.
- 11 powder measures.
- 2 powder funnels.
- 2 powder chutes.
- 11 powder whips.
- 5 magazine hose.
- 8 magazine screens.
- 3 magazine candlesticks.
- 12 magazine dresses.
- 1 funnel, shell.

- 24 magazine lantern reflectors.
- 1 charger shell, 8 ounces.
- 1 charger shrapnel, 2½ ounces.
- 2 formers, cartridge-bag, 5-inch and 6-inch.
- 2 formers, cartridge bag, 60 and 80 pounds.
- 3 bags, cartridge, samples, 6-inch, 80 and 60 pounds.

MISCELLANEOUS.

- 1 8-inch model powder cylinder.
- 1 model gun and mount, Gatling.
- 25 specimens, 10-inch B. L. R.
- 4 tin cans.
- 3 water cans.
- 124 boxes, packing.
- 4 models of magazine, Lee rifle.
- 4 port sill sockets.
- 1 cover for deck-house launch.
- 1 shoe for cat-boat.
- 46 blocks, metal, large.
- 2 plates for powder pellets.
- 2 bullet molds.
- 1 set torpedo guys.
- 3 water-buckets.
- 8 castings, shot-bed.
- 2 steel rings, 10-inch B. L. R.
- 2 models, 6-inch powder cylinder.
- 1 toggle-block, 6-inch.
- 4 blocks for powder and shell whips.
- 1 gauge, 6-inch shell, inspecting.
- 1 gauge, 6-inch cartridge-bag.
- 8 drawing-boards.
- 26 castings, bronze.
- 24 cleats, breeching, beam.
- 13 steady rests.
- 1 lathe.
- 8 cranes.
- 1 former, revolver frogs.
- 102 lanyards, fire bucket.
- 473 lanyards, port.
- 200 lanyards, lock.
- 99 pounds lock lanyard stuff.
- 13,518 pounds bar-iron.
- 7,775 pounds bloom-iron.
- 20 specimens, metal.
- 1 pendulum, ship's.
- 1 stamp, anchor, ⅝ inch.
- 1 stamp, steel, ¼ inch.
- 1 speaking-tube.
- 1 compound target plate.
- 3 wooden cases.
- 121 rings, fire and sponge buckets.
- 1 percussion spring firing attachment.
- 220 rings, cartridge bag, 12-pounder light.
- 500 rings, cartridge bag, 24-pounder howitzer.
- 2 gun covers.
- 2 oil-tanks.
- 17 tallies for keys.
- 1 sail for boat.
- 115 lead vent-patches.
- 1 former, tinsmith's.
- 500 feet battens.
- 175 feet ash scotchman.
- 100 lids, shell-box.
- 1 cover, canvas, for dynamo.
- 3 boxes.
- 2 pairs beam calipers, 40 inches.
- 1 pair beam calipers, 20 inches.
- 2 shackle-plates, nuts and washers.

- 2 rings, star gauge.
- 2 spars for target frame.
- 1 box, iron, for boat.
- 1 hoisting spar.
- 3 calipers for interior measurements.
- 1 set gauges, fillet.
- 12 sheets iron gauges, fillet.
- 350 copper cylinders for crusher-gauge.
- 850 cylinders for crusher gauge.
- 1 box, packing, torpedo fuse.
- 1 water-cooler stand.
- 143 hooks, fire bucket.
- 195 hooks, magazine screen.
- 117 hooks, powder chute.
- 320 hooks, port lanyard.
- 8 hooks, train rope, 60-pounder.
- 4 hooks, copper and thimbles.
- 35 hooks, battle lantern.
- 150 hooks, rammer, and sponge.
- 1 table.
- 1 blue printing frame.
- 1 oil-tempering tank.
- 6 tin paint pots.
- 2 tin pans for lathes.
- 1 grindstone plate.
- 2 gun trucks.
- 1 joint sectional staff.
- 152 copper rivets.
- 1 cartridge box, experimental.
- 13 target frames.
- 3 locking levers for 80-pounder spring firing attachment.
- 2 eye bolts and shaft, 6-inch carriage.
- 9 beckets, battle axe.
- 6 shot beds.
- 2 bolts, 6-inch carriage.
- 1 reflective cylinder gauge.
- 1 port-sill pivot clamp.
- 4 bronze castings for 80-pounder elevating gear.
- 4 castors for table.
- 1 core box, 20-pounder, shell and sabot.
- 7 washers for 6-inch mushroom stem.
- 2 mushroom stems, rough, 6-inch.
- 12 castings, roller handspike pins.
- 12 castings, roller handspike.
- 48 castings, roller handspike coaks.
- 8 tool chests, armorer's.
- 2 sets armorer's tools.
- 11 sets screw-drivers and chisels, armorer's.
- 7 sets handles, hasps, &c., for armorer's chests.
- 8 sets De Bange check plates.
- 14 De Bange check pads.
- 18 bolts for securing Hotchkiss mount.
- 1 skeleton Hotchkiss gun and mount.
- 2 bronze caps for Clark's turret.
- 50 buttons, powder chute.
- 1 pattern and core box, steel shell.
- 6 patterns 6-inch shell.
- 1 pattern 8-inch tray.
- 1 pattern 6-inch tray.
- 1 pattern 3-inch cartridge bag.
- 2 patterns 8 inch cartridge bag.
- 2 patterns 30-pounder cartridge bag.
- 1 pattern 5-inch cartridge bag.
- 1 pattern, front transom, 8-inch half-turret carriage.
- 1 pattern 6-inch chamber gauge.
- 2 patterns 60-pounder burster bags.
- 1 pattern 60-pounder cartridge bag.
- 1 pattern 30-pounder burster bag.
- 1 set patterns tower mount and circles.
- 1 pattern for bronze caps for Clark's turret.

- 1 set patterns for cylinder, 6-inch carriage.
- 1 set patterns for shifting pivot and socket, 6-inch carriage.
- 1 set patterns for trunnion seats and caps, 8-inch barbette carriage.
- 1 set patterns for worm wheel, 8-inch barbette carriage.
- 1 pattern Hotchkiss mount and stand.
- 1 pattern 6-inch deck circles.
- 1 pattern 6-inch rammer head.
- 3 patterns 6-inch rear training transom.
- 1 set patterns, brackets and cylinders, 8-inch barbette carriage.
- 2 patterns 6-inch cartridge bags.
- 1 pattern 6-inch burster bag.
- 1 set patterns, bottom transom, 8-inch barbette carriage.
- 1 pattern 6-inch face plate.
- 1 pattern 6-inch bore gauge.
- 1 set patterns 8-inch B. L. R. S. shell.
- 1 pattern 20-pounder B. L. R. burster bag.
- 1 pattern for track of tower mount.
- 1 pattern for reflecting cylinder gauge.
- 1 pattern of ship's pendulum.
- 1 model 8-inch shot.
- 1 model 6-inch shot.
- 1 model of monitor turret.
- 1 model, wood, 5-inch.
- 1 model, wood, 8-inch breech mechanism.
- 1 template, side armor, 8-inch carriage.
- 1 former, 6-inch passing box.
- 1 set letters, &c., for marking Hotchkiss guns.
- 1 template for modified shield, 6-inch carriage.
- 1 skeleton, Atlanta's side.

Making miscellaneous patterns.

Repairs to stores on hand.

Repairs to stores for vessels fitting.

Repairs to stores for vessels in commission.

Repairs to buildings, wharves, shot-beds, gun-skids, &c

Guarding public property.

TORPEDOES.

- 3 batteries, boat, portable.
- 200 battery fittings.
- 12 blocks for detonators, wood.
- 3 sets boat fittings.
- 46 boxes, packing.
- 12 boxes for detonators, tin.
- 25 boxes, storage, gun-cotton magazine.
- 143 boxes for wet gun-cotton primers.
- 6 boxes, wire.
- 29 butts, secondary spar.
- 321 cans, distance.
- 278 cans, gun-cotton.
- 150 caps, fulminate.
- 8 caps, secondary spar.
- 180 caps, water.
- 1,000 pounds carbonic acid, liquid.
- 2,500 cases, fuse.
- 179 cases, primer.
- 152 cases and tripods.
- 7 cases and tripods for contact torpedoes.
- 17 cases without tripods for contact torpedo.
- 21 cases, torpedo.
- 35 connectors.
- 48 cots, rubber.
- 8 covers, canvas, for steel spars.
- 1,027 cylinders, gun-cotton.
- 99 detonators, dummy.
- 208 detonators, D. E.
- 45 detonators and splices.
- 6 dryers, gun-cotton.
- 240 pieces emery cloth.
- 234 flannels for galvanometer.
- 219 goggles.



Length of Tube 187.41

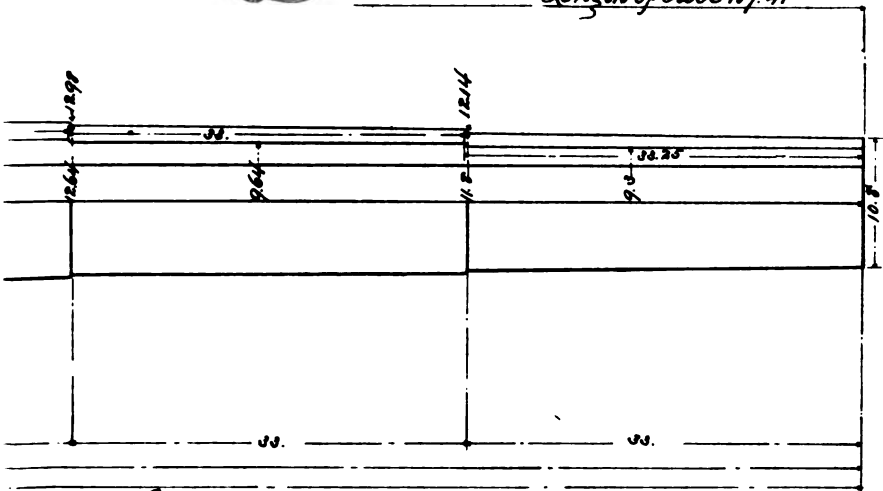

Richard
PERU.

BUREAU OF ORDNANCE.
NOV. 14. 1885.

ARK I

RG
H
RK

14.

17/20

ARK III.

20	H	19 25	I	12 75
19 5		19	18	12 5
	19 25			
14		14		

Approved

Montgomery
Chief of [illegible]

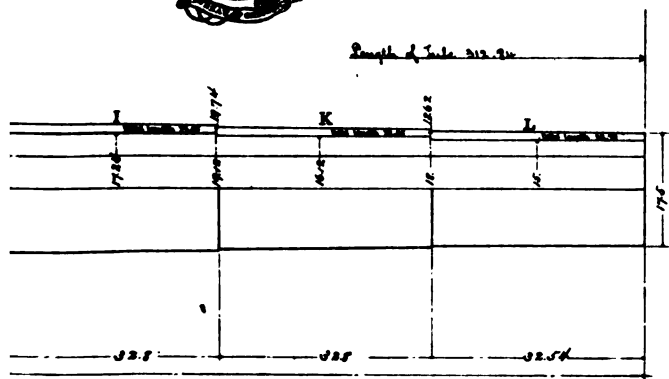

Bureau of Ordnance
November 7, 1885.

7
326

P. B. R.

Faint, illegible text or markings, possibly bleed-through from the reverse side of the page.

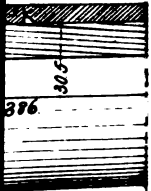

40.25

*of the
Bureau*

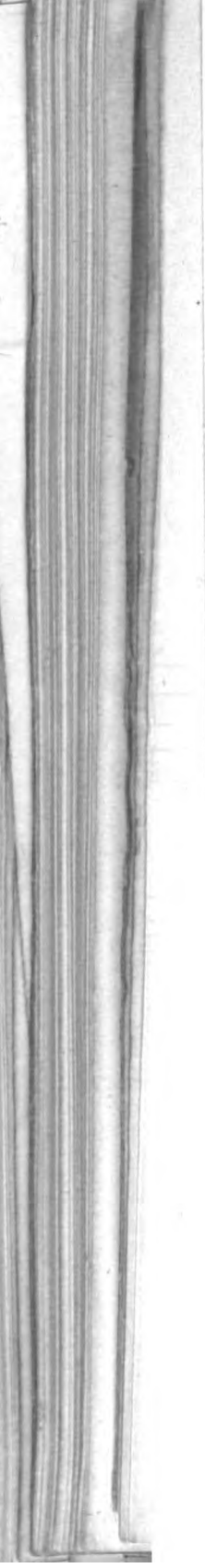

DRE



After Working
After putting on top
After putting on back
Before putting on back

After Working
Before Working

CHIEF OF BUREAU.

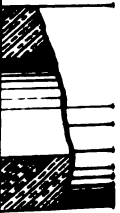
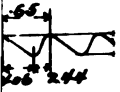

TACHA
FOR
PRACT



CHAPTER
T-
-
-
-

ATTACH
FOR
ET PRACT



DIAMETER
THE TAPER
AS THE
TAPER

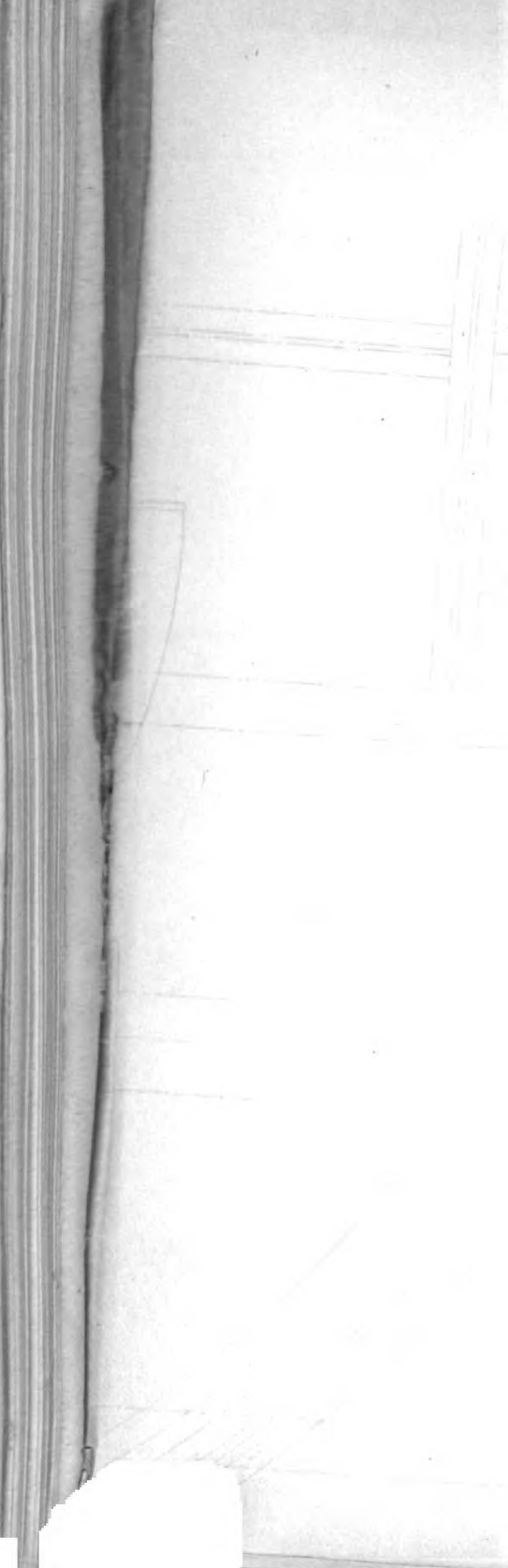

Handwritten text, possibly bleed-through from the reverse side of the page.





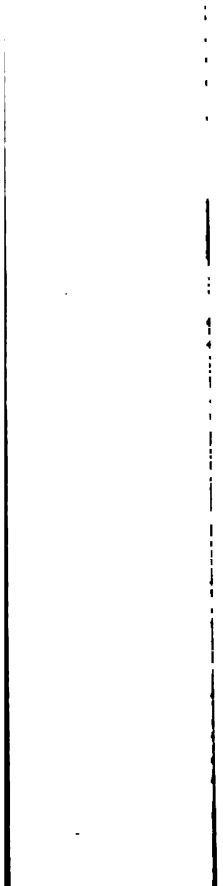
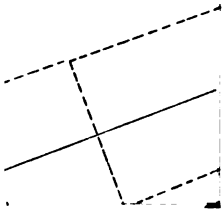





ARRIA

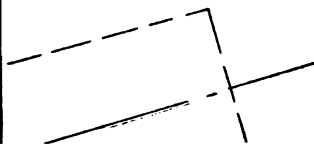



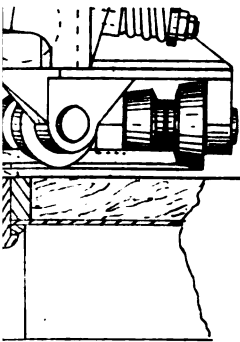





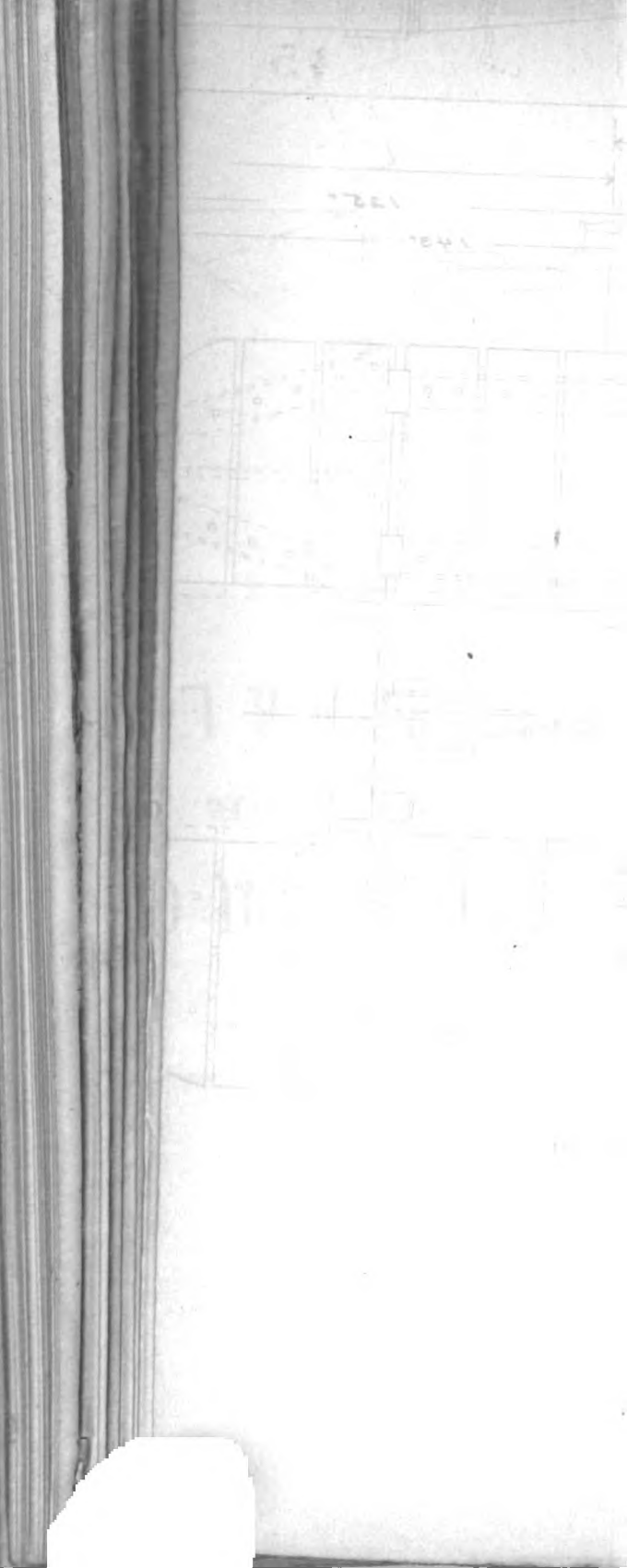



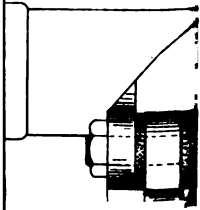
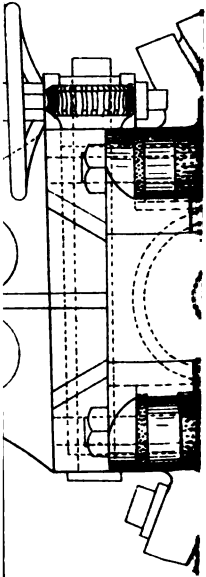



UNIVERSITY OF TORONTO

TOWER MOUNT FOR R.

Pivot fitted with J





MOUNT for RAPID FIRE GUN
with Sleeve and Gum Pack

TOP M



xl pt3 vl 49 1

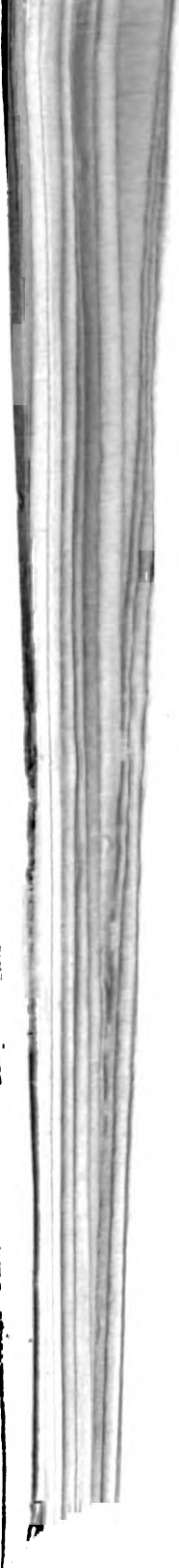

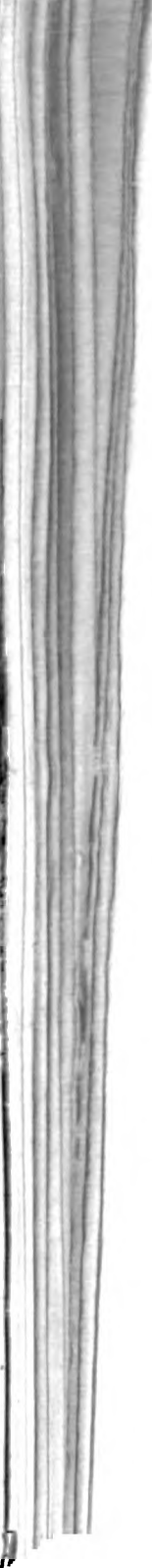

SINGL



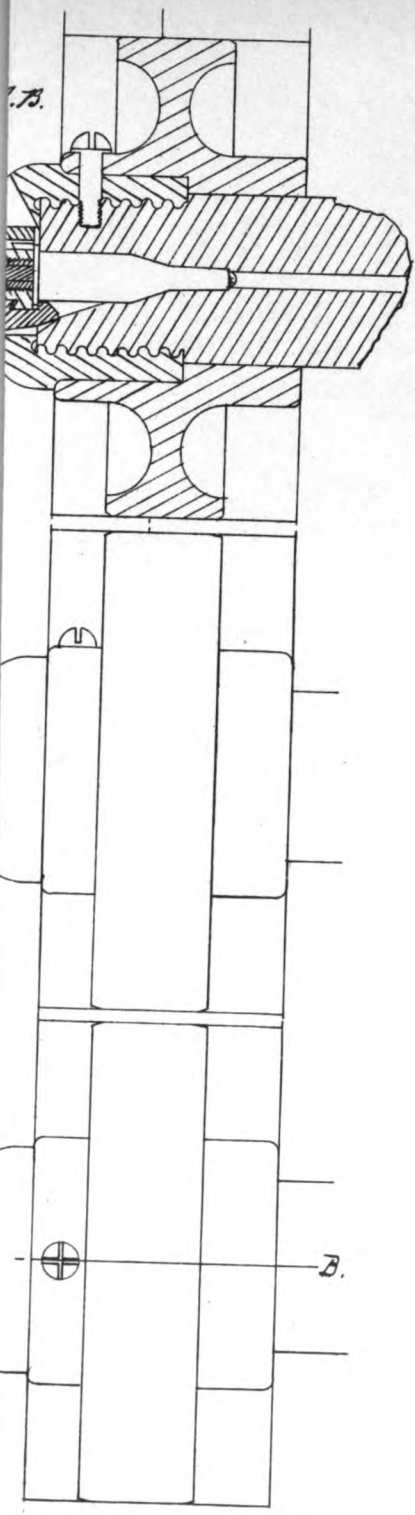

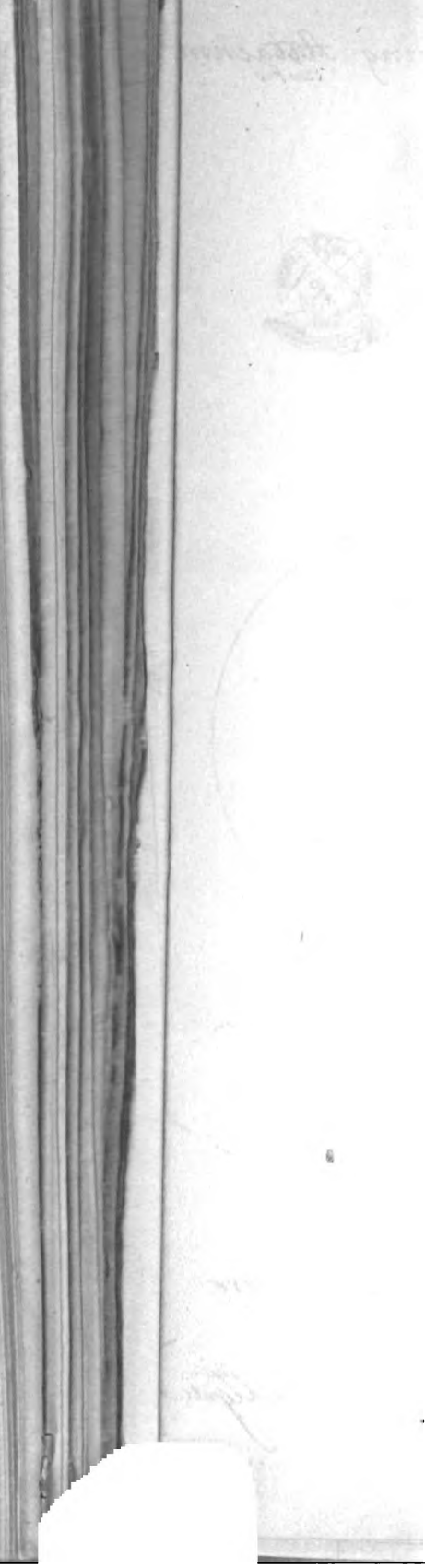



Sketch of experimental apparatus
for determining the
velocity of sound

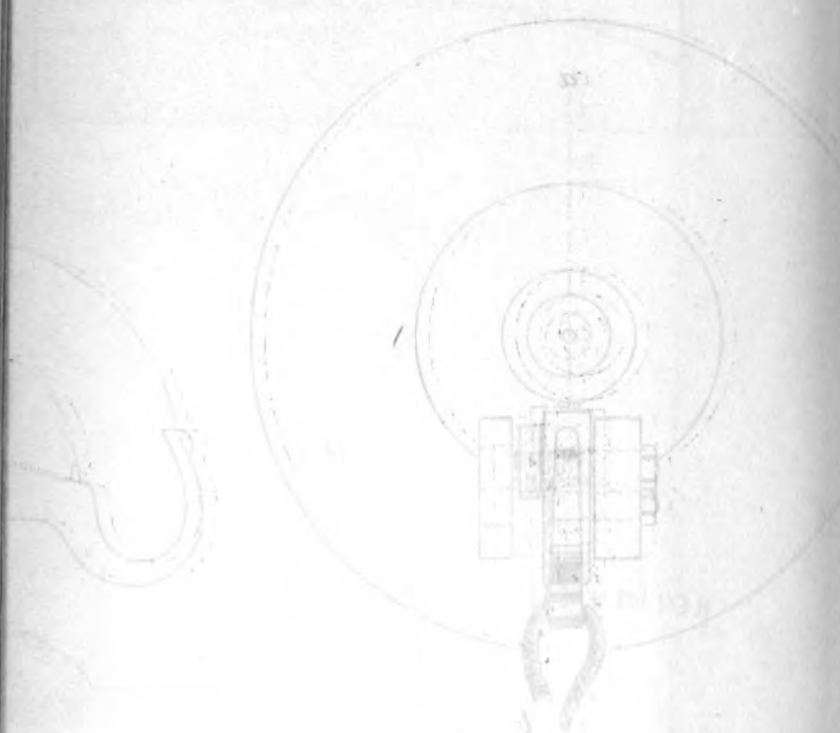

Apparatus for determining
the velocity of sound
by the method of
M. Colladon and
S. Sturson

HER

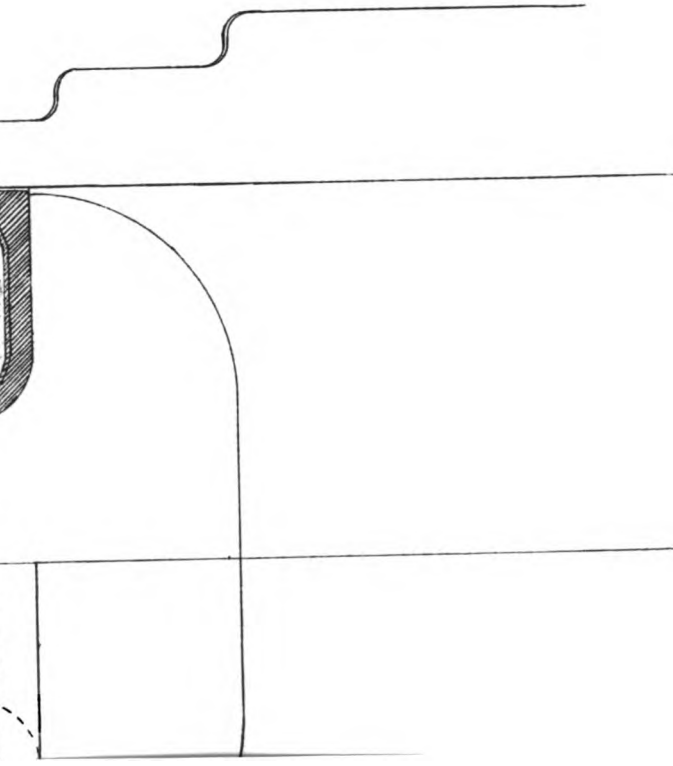







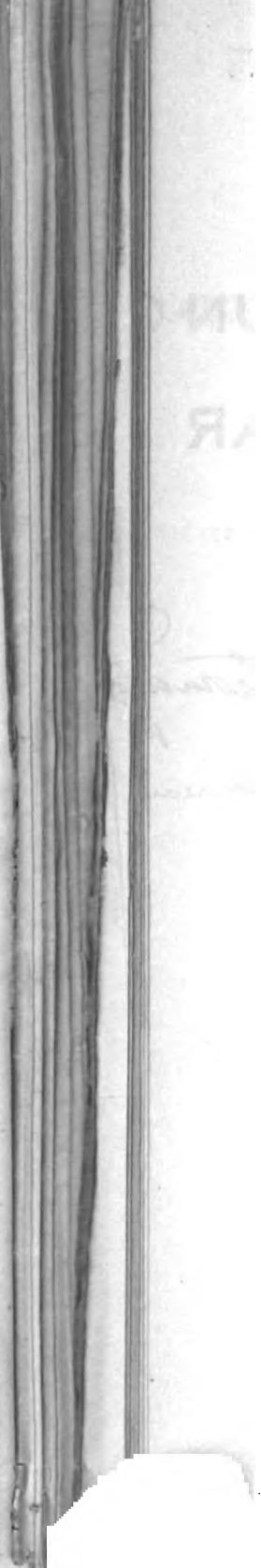



304
SPEEDO BOAT FITTING



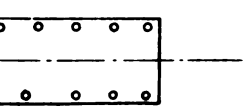
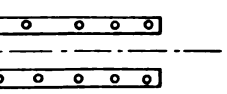
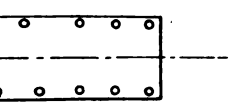
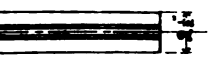
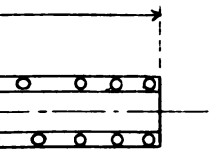

for experiment,
Wm. P. Beard

of Bureau of Ordnance.
 Febr. 16/85

STEEL SPAR FOR SPART

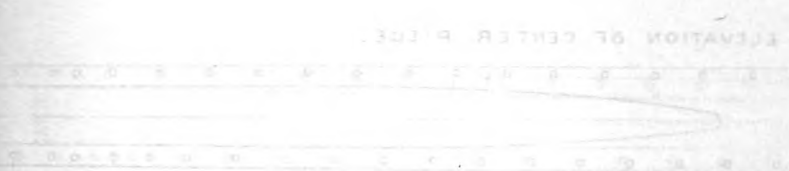

SECONDA



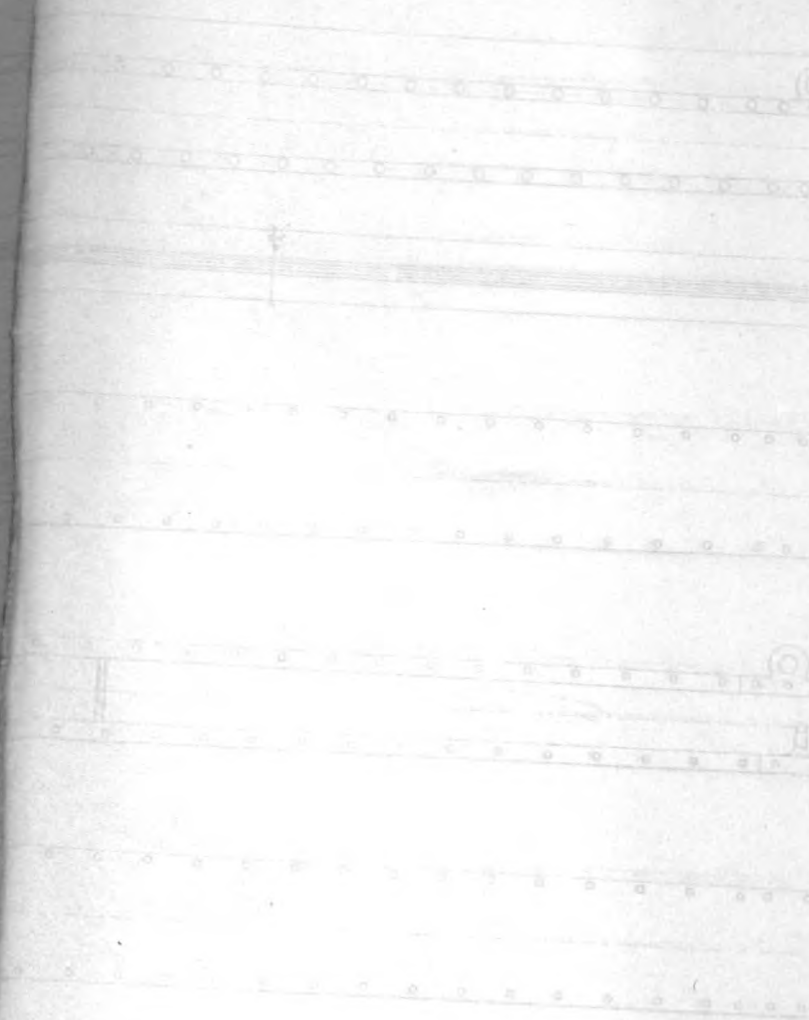

Handwritten text at the bottom of the page, possibly a page number or a reference number, appearing to be "148 iv fig 143 H".

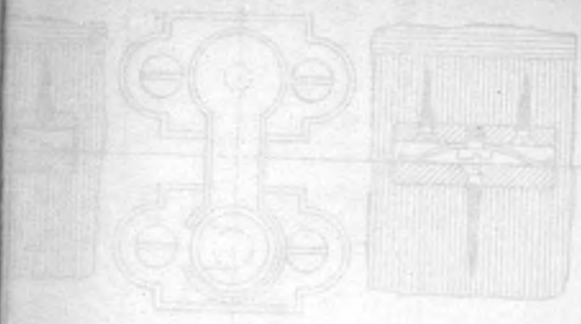

1881

1881

[Handwritten signature]

[Handwritten text]





100 100 100 100



LOCKER.

. NOV. 1865.

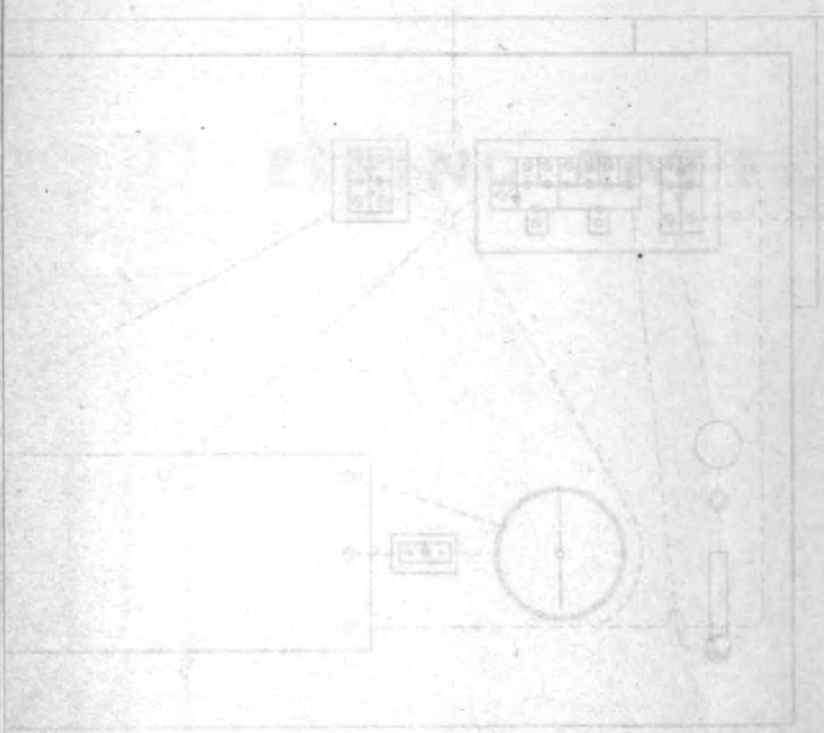

(98 to Cig. 1x3)

ases, dummy.
 ases, D. E., service.
 ases, D. E., station.
 ands.
 ands, detector.
 ands gun-cotton.
 and grenades.
 aniters, D. E.
 ays, secondary spar.
 yers for contact torpedoes.
 ounds mercury, fulminate.
 ounds nitro-glycerine.
 ns, torpedo.
 ns, safety, contact torpedoes.
 ates, galvanometer.
 ugs, igniter.
 imers, electric, cannon.
 ctifiers.
 eaving lines.
 eaving line weights.
 ds, filling.
 rews, binding.
 rew-drivers.
 rew posts and nuts.
 ells, detonator.
 ells, torpedo, experimental.
 ounds solder.
 ar bands.
 ars, boat, secondary.
 ars, ship's, secondary.
 ars, steel.
 anners, contact torpedoes.
 ndles, gun-cotton.
 rings, spare, contact torpedoes.
 ools thread, hemp.
 ne-ball apparatus.
 rpedoes, 75 pounds.
 rpedoes, gun, experimental.
 rpedoes, exercise.
 rpedoes, special.
 eces tubing, rubber.
 shers.
 res, earth.
 res, machine, connecting.
 res, spar, leading, boat.
 res, spar, leading, ship's.
 s wires, spar, leading, **contact torpedoes.**
 ools wicking, waxed cotton.
 enches, filling-hole plug, **gun-cotton.**
 pairs to deteriorated stores **on hand.**
 pairs to deteriorated stores **from ships.**
 pairs to tools, &c.
 pairs to boats, engines, boilers, &c.
 pairs to buildings, wharves, &c.
 arding public property.
 perimental work of all kinds: **Battery outfits, dynamo machines, electric**
batteries, electric lights and apparatus, explosives, electricity, fuses, steel
spars, instructions to torpedo class, exploding wrecks.

*LIST OF VESSELS FOR WHICH WORK HAS BEEN PERFORMED
THE FISCAL YEAR ENDING JUNE 30, 1885.*

Adams.	Galena.	Monongahela.	Sara
Alarm.	Hartford.	Montauk.	Sau
Alliance.	Independence.	Nahant.	Swa
Atlanta.	Iroquois.	Nantucket.	Tall
Boston.	Jamestown.	New Hampshire.	Te
Brooklyn.	Jason.	Omaha.	Tri
Chicago.	Lackawanna.	Palos.	Van
Cyane.	Marion.	Pensacola.	Ver
Despatch.	Michigan.	Pinta.	Yan
Dolphin.	Minnesota.	Portsmouth.	
Essex.	Mohican.	Powhatan.	
Franklin.	Monocacy.	Richmond	

Alaska exploring expedition.
 Naval expedition to the Isthmus of Panama.
 Relief of Lady Franklin Bay expedition to the Arctic regions:
 Thetis.
 United States Coast Survey steamer Patterson.
 United States Fish Commission steamer Albatross.

*DESCRIPTION OF ELECTRIC GUN-FIRING KEYBOARD, AND
CLOSERS FOR GUN-CAPTAINS TO BE USED IN CONNECT*

In the system of electrical gun-firing adopted by the Bureau for Boston it is possible to fire any of the guns either individually or from the fighting tower, to arrange the system so that the gun-captains can fire any gun, or to arrange the system so that some of the guns can be fired from the fighting tower and others fired by the gun-captains.

The plan of the keyboard on page — shows eight electro magnets, each having a resistance each, four being on each side of a central metallic strip which is secured to a central binding post marked "main," which is connected to the positive pole of the firing battery.

The current passes from the central strip through each of the electro magnets, and then to a metal stud secured near it, thence to the eight small studs (four on each side) shown in dotted lines, thence to the eight binding posts marked—

1 2 3 4 4 3 2 1
P P P P S S S S

Over the small studs are placed two keys, one end of each of which is connected to the central metallic strip. When either of these keys is pressed, the current goes directly to the four small studs under it, instead of first going through the corresponding electro-magnets. A screw is put through each of these keys, which can be fastened down permanently when desired. A spring, not shown, is put under each key up, normally.

When the current passes through any of the electro-magnets it is attracted to the armature. The movement of the armature towards the magnet forces the indicator arm, which carries on its face a number, 1, 2, 3, or 4. When the indicator arm reaches its extreme inner position, the indicator arm lies directly against the magnet, one-quarter of an inch distant from the stud near the magnet, thus showing the number on its face, and showing that the circuit is complete through the electro-magnet.

If the face of the indicator arm be now pressed, so that the arm is forced up against the stud, the magnet is short-circuited. A coil spring on the shaft of the indicator arm keeps that arm up, normally, and the armature away from the magnet. The indicator arm thus acts not only as an indicator, but as a gun firing key in each arm, so that it can be fastened down when desired.

The circuit closer for gun captains is shown on page . The terminal connected to the circuit of any gun, the current goes through the electro-magnet. However, the trigger is pressed, the electro-magnet is short-circuited, shown in connection with the trigger, so that the trigger can be pressed in the short-circuiting position.

When the commanding officer desires to control the whole battery from the fighting tower, the keys on the keyboard are unscrewed, and the triggers of the circuit closers are screwed down. When any gun is primed by putting in its primer, the keyboard shows that the circuit through this gun is complete, yet the resistance (50 ohms) of the electro-magnet is so great that the

SIDE VIEW OF ELECTRO-MAGNET
CURRENT OPEN.

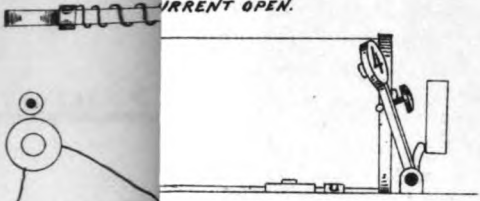

SIDE VIEW OF ELECTRO-MAGNET
CURRENT CLOSED.

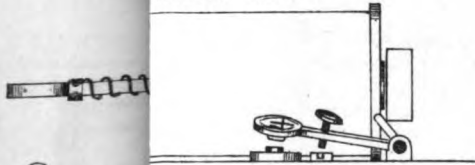

10. KEYBOARD

11. KEYBOARD

MEGAPHONE.



*Appt
signed*



When, however, the key corresponding is pressed, the electro-magnet is closed, and the current now is strong enough to fire. If a broadside key is pressed, the broadside guns ready will be fired.

If the commanding officer desires that the gun-captains shall fire by electricity, the circuit-closers are unscrewed and the keys of the keyboard are screwed in. In any gun is primed by putting in and securing its primer, the armature-closer shows that the circuit is complete. When the sights bear, a pull on the key short-circuits the electro-magnet and causes the firing of the gun.

If the commanding officer desires that the gun-captains shall fire some of the guns, the commanding officer himself shall control others, the only thing necessary is to combine the keys; that is, to screw down the keys on the keyboard corresponding to the guns to be fired by the gun-captains, liberating the other keys, and to screw down the triggers of the circuit-closers corresponding to the guns to be fired by the commanding officer, and liberating the other triggers.

THE MEGAPHONE.

The megaphone, as adapted to naval use, consists of two large ear trumpets, supported by a large speaking trumpet, and secured upon a bed which rests on the stanchion. Movement in altitude is obtained by means of a hinge and movement in azimuth is obtained by means of a sleeve, which rests on the stanchion.

The purpose of the Bureau is to employ the megaphone as a torpedo-boat detector, and a broad having shown that torpedo-boats are frequently heard before they are sighted, a secondary use of the megaphone will probably be in listening for and detecting the direction of fog signals, &c., experiments under orders of the Bureau showing that sounds from a distance can frequently be detected by its help which a naked ear could not detect.

Experiments with the large speaking trumpet showed that the volume of the voice coming from the axis of the trumpet is very much strengthened and the articulation is impaired, so it may be expected that the speaking trumpet will be of great use in giving orders to men at a distance.

NAVAL ORDNANCE PROVING GROUND, Annapolis, Md.

We have the honor to submit the following report of results, test of two water-tight tri-faced steel projectiles (ingot Nos. 4411 and 4306, Midvale) against an armor compound plate.

THE PROJECTILES.

Projectile of crucible metal; was treated in oil, and annealed in lime at Midvale. It showed C., 1.10; Mn., .195; Si., 210.

Test showed: tensile strength, 119,785; elongation, 16½ per cent.; reduction of area, 48 per cent.

Projectile cast at Midvale and furnished: tensile strength, 134,645; elongation, 5 per cent.; reduction of area, 5.12 per cent.

Projectile cast (at Washington navy-yard) in water, at 100 degrees and drawn blue 2 base.

Projectile of crucible metal; was treated in oil and annealed in lime at Midvale. No tests were made.

Test showed: tensile strength, 146,576; elongation, 3 per cent.; reduction of area, 48 per cent.

Projectile showed superficial defects, noted by the Inspector at Midvale. Retempered at 100 degrees and drawn dark blue 7 inches from base at N. O. P. G.

THE TARGET. PHOTOGRAPHS 4 a and b.

Target (5 by 3 inches) Brown compound plate, area 6 by 8 feet, backed by 20 inches of oak supported by a double series of 18-inches bracing, to which it was secured by steel bolts. These last extended through the wrought-iron portion of the target. A 1-inch skin plate bound the backing system together.

The target was distant from the piece 100 yards.

Round 1.—Projectile, ingot No. 4411; weight, 100 pounds; charge, 58 pound muzzle velocity; pressure, 13.1 tons. Energy at impact, total, 2730.5 foot Energy at impact, per inch of circumference, 145.8 foot-tons.

Results.—Photograph 5. The projectile broke up, the greater portion of the remaining in the target. This has been, since cooling, in a measure removed giving a fairly accurate estimate of the penetration to be made, which is considered greater than was at first supposed. The depth of the impact now measures 9½; and the indications are that a disk of wrought iron of considerable area has driven into the wood backing. Radial hair cracks extend as shown in Sketch 2 appended: *a* to left edge through the steel facing; *b* to upper edge; *c* 23 inches right above; *d* to right 42 inches; *e* right and below 29 inches; *f* below 26 inches. Diameter of impact, horizontal, 16 inches. Diameter of impact, vertical, 14 inches. As has been reported in foreign experiments, there was much chipping at the edges of impact, the fragments flying a considerable distance to the rear. Photograph 6 is of the cylinder (base) of the projectile, the largest fragment remaining. The backing, and supports were apparently uninjured.

Round 2.—Projectile, ingot No. 4206; weight, 100 pounds; charge, 58 pound muzzle velocity, 2025; pressure, 13.4 tons. Energy at impact, total, 2,760.6 foot Energy at impact, per inch of circumference, 147.4 foot-tons.

Results.—The projectile broke up, the head almost entire remaining in the target. It has proved impracticable to remove this fragment of the head, it being more intact than that of 4411. An estimate of the penetration from the known diameter of the head (allowing for upsetting) indicates that the results are fully equal, slightly more marked than at the previous round. The backing and plate are cracked one-half inch on the right side and a large amount of broken metal is plainly visible at the bulge. Radial cracks extend as shown in Sketch 2 appended; *a* to left and above 15 inches, *b* above 4 inches, *c* right and above 15 inches, *d* (development of round 1) extending through the entire plate and of a maximum width of one-quarter inch to right edge, *e* to the right and below 12 inches. Diameter of impact, horizontal, 16 inches; diameter of impact, vertical, 16 inches. Photograph 6 is of the target; photograph 7 is of the largest fragment of the projectile. The right outer upright of the backing is seriously cracked. The two main braces of the projectile supports are cracked. One bolt washer cracked at three corners. Opposite bolt No. 2, sketch 2.

Conclusions.—It is evident that the backing furnished a large portion of the resistant capacity of the target, and that without this addition the plate would have been pierced or rather broken through by either projectile. The action of the 1-inch skin plate transferring the shock to the whole structure, is especially apparent.

Of the two projectiles the performance of 4206 as to breaking up is distinctly defective. The fragments are larger and of the portion photographed there is less distortion. It is believed that where the plate exceeds in capacity the power of the projectile, or where, as in this case, the mass is small, the greater portion of the armor should be softened in drawing the temper.

The cracking feature of compound armor was illustrated in a marked manner each round, and it is believed that the metal portion of the target would have been demolished with the third round usually given a plate of the dimensions employed.

It is difficult to estimate, in the absence of comparative data with the ogival projectile, how much of this may have been due to the tri-faced point, and I venture to suggest that a test of each profile, i. e., blunt, sharp, and ogival be made a feature of the experiment.

I will note that the recent favorable results with small projectiles were obtained with Chrome metal, and that our earlier work, using carbon steel, showed the projectile defects illustrated in to-day's experiment.

It seems fair to anticipate that a similar improvement in performance will be obtained with the trial of Chrome steel for large projectiles already decided upon by the Bureau.

Respectfully, &c.,

W. M. FOLGER,

Lieutenant-Commander, Inspector of Ordnance, in charge
Capt. MONTGOMERY SICARD, U. S. N.,
Chief of Bureau of Ordnance.

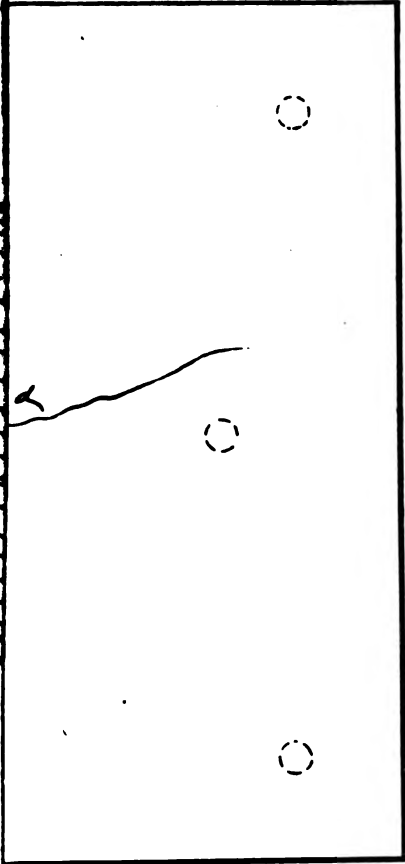
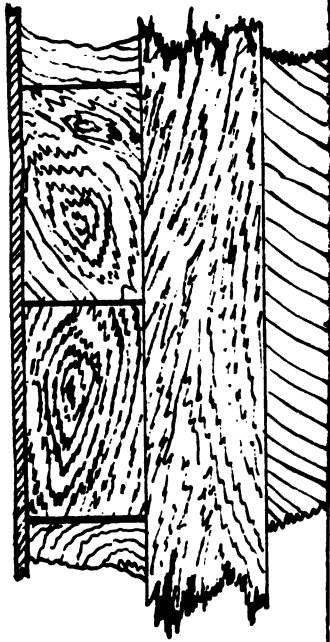

H Ex1 pt3 v1 4

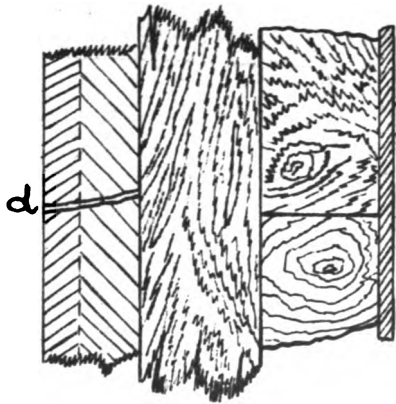
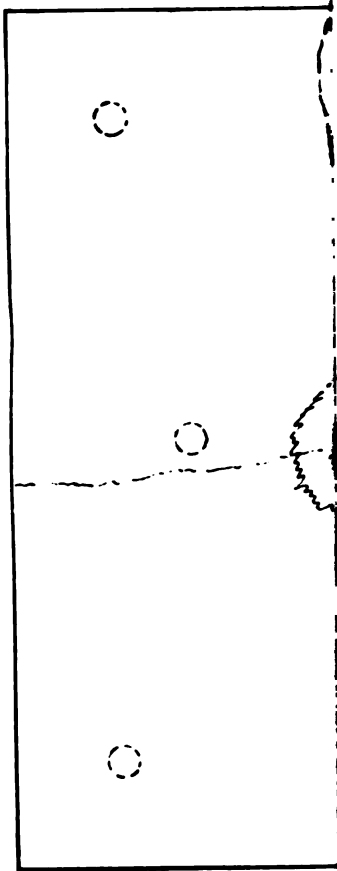

H Ex1 pt3 v1 49 1

1207
115NAVAL ORDNANCE PROVING GROUND,
Annapolis, Md.

SIR: I have the honor to submit the following report of the results of the firing trial on Friday the 10th instant, against the 8-inch Brown compound plate, of the two chrome steel projectiles (numbered 2 and 3) recently received from the Washington navy-yard.

The target, which was that used in the experiments of February 21, 1825, has already sustained the attack of two 6-inch carbon steel blunt tri-faced projectiles, and presented the conditions for resistance described in my No. 26 of the present year.

The projectiles were ogival-headed, the radius being two calibers and weighed 100 pounds.

No. 2 was tempered slightly softer than No. 3, employing with both the method at present in use at this station, which has already been described.

RESULTS.

Round 1.—Charge, 52 pounds N. G. Dupont's brown prismatic; projectile, No. 3; pressure, 15.8 tons; muzzle velocity, 2,037 f. s.; muzzle energy, 2,880.3 f. t.; striking velocity, 2,007 f. s.; striking energy, 2,795.6 f. t.

The impact, which is given the number (3) of the projectile, is shown in the here-forwarded sketch and photographs. Its depth is 8 inches, the plate being broken through rather than pierced; exterior diameter, 15 inches.

The steel face of the target below the impact is broken off, exposing the weld.

A target bolt near the impact was driven out, and to a distance 8 feet to the rear.

The backing shows exterior evidence of strain, but is not materially injured.

The projectile broke up into (about) 150 pieces, large and small, the heaviest of which, the rear portion of the cylinder shown in the photograph, weighed 48 pounds. A very large number of the fragments weighed (each) less than 1 ounce.

Round 2.—Charge 51 pounds, N. G.; projectile, No. 2; pressure, 15 tons; muzzle velocity, 2,021 f. s.; muzzle energy, 2,835 f. t.; striking velocity, 1,991 f. s.; striking energy, 2,752 f. t.

The impact is numbered 2 in sketch and photograph. Its diameter is 16 inches depth to portion of head remaining in the target, $5\frac{1}{4}$ inches; estimated total depth $6\frac{1}{4}$ inches.

The whole of the steel face between the two impacts is broken off, exposing a total area of about $4\frac{1}{2}$ square feet.

The lower portion of the plate is somewhat racked, the old crack, which partially separated it from the upper portion, having definitely widened.

The projectile broke into 120 (recovered) fragments, the largest of which weighed but 12 pounds.

The average weight of fragments was, in this case, considerably greater than the preceding.

There was no material injury done to the backing or target structure, the impact being at a point where nearly a maximum support was offered.

CONCLUSIONS.

It is not believed, in the present state of ordnance science, that any projectile will sustain unbroken an attack against a compound plate of nearly equal capacity.

The performance of the two projectiles tested is, however, considered as unsatisfactory.

Compared with the results of the trial of February 21, the diminished resistance offered being considered, the results are definitely inferior.

It is believed that the metal used and the temper methods employed were superior in the present trial. The proof of this exists in the prolonged experience we have had in their use. The calibers and the targets have been on a smaller scale, it is true, but the superiority to carbon steel and the earlier temper methods seems uncontested.

Your attention is respectfully directed to the profile of the blunt, tri-faced projectile, where, it will be observed, there is a considerably greater resistant strength, viz: (a) There is a slightly greater depth from the point to the core; (b) the cross-sectional area at, say, 3 inches from the point in the blunt tri-face is over 33 per cent. greater than in the ogival.

A tracing of the two heads, superimposed for better illustration, is herewith appended.

Considering the subject apart from the fact that I had the honor to suggest the

profile of the tri-faced as far as possible, it is believed that the cause of the difference in performance is to be found in the difference in profile and distribution of strength, the ogival point being crushed at the instant of impact.

Respectfully, &c.,

W. M. FOLGER,
Commander, Inspector of Ordnance in charge.

Capt. MONTGOMERY SICARD, U. S. N.,
Chief of Bureau of Ordnance.

1199.]

NAVAL ORDNANCE PROVING-GROUND,
Annapolis, Md.

SIR: In compliance with your instructions of the 9th instant, I have the honor to submit the following data regarding the experimental high-power musket manufactured by the Winchester Repeating Arms Company.

The breech system is that known as the Marlin, and is of the general principle of the lever, with a block moving in a vertical plane between the cheeks of the frame.

I think this general system should be considered as an essential feature, as giving greater strength than any other of the small-arm breech mechanisms.

GENERAL DATA.

Weights.

The piece	12 $\frac{2}{3}$ pounds.
The bullet	400 grains.
The charge	200 grains.

Lengths.

The piece	48 Inches.
The barrel	32
The cartridge	4.425
The bullet	1.582

The rifling.

The ratchet system with nine grooves and lands.

Diameter across lands45
Depth of grooves007
Width of lands (on the flat)03

The twist is increasing from zero to one turn in 30 calibers.

BALLISTICAL DATA.

The ballistic results furnished thus far are from experiments in a tentative way with the view of the development of the suitable charge and band conditions.

It is not considered that the most favorable performance has yet been attained, and it is requested that this report be considered as merely preliminary.

The maximum muzzle velocity recorded is 2,030 f. s.

The maximum penetration into wrought-iron—a 1.5 inch plate—is 1.25 inches.

The maximum penetration into steel—a 1-inch plate was pierced, with a reserve of force (measured by the penetration into wood) sufficient to kill two men.

The maximum penetration into wood—1-inch boards—40 inches.

Lacking opportunity, but few experiments have been made in the particular of accuracy; enough has been developed, however, to establish the fact that the piece is defective in this respect, the results at 500 yards being slightly less favorable than those furnished with the service infantry arm, where, with the extremely flat trajectory present, they should surpass these results.

The subject has received consideration, and I have about concluded that the cause of the large mean error is to be ascribed to vibrations of the barrel.

I think the results thus far furnished are promising, and, as you have probably noted, they surpass the work done in a similar direction in Germany and England.

Should you concur in this opinion of their value, I shall have the honor, as funds become available, to recommend the manufacture of another barrel, in which the

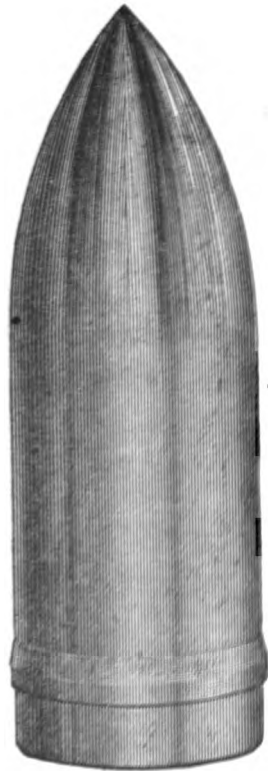
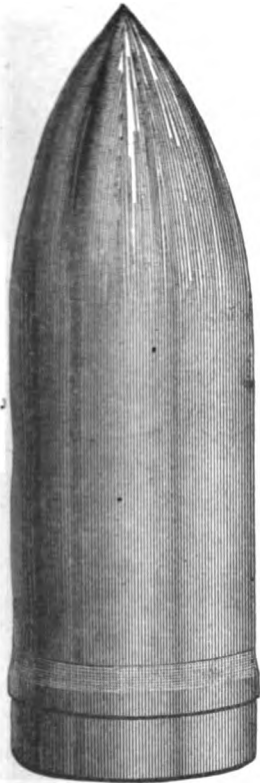

Face page 232

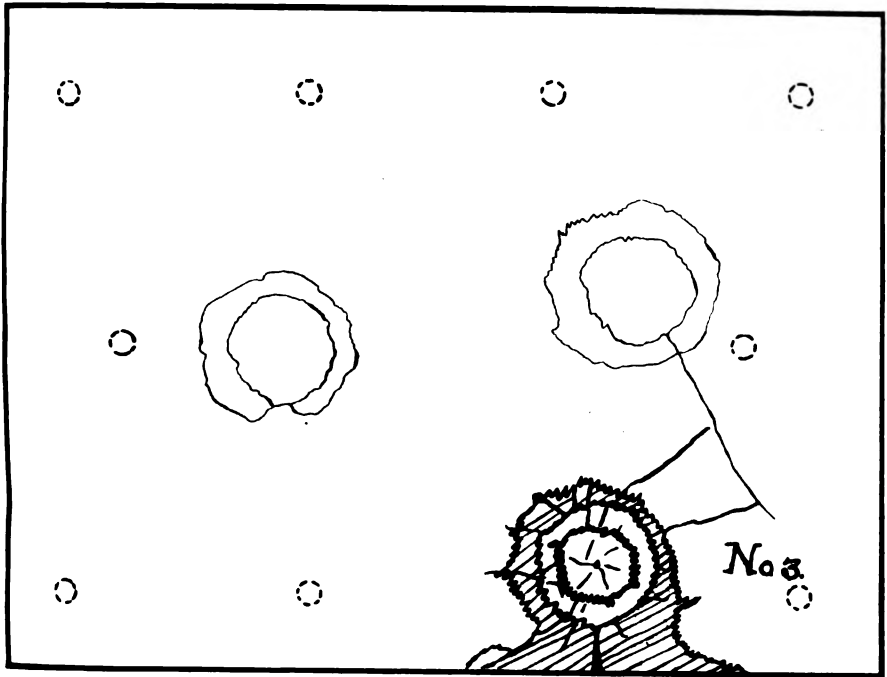

Red Experiments of Feb. 21. 1885.
Black. Experiments of July 10. 1885.

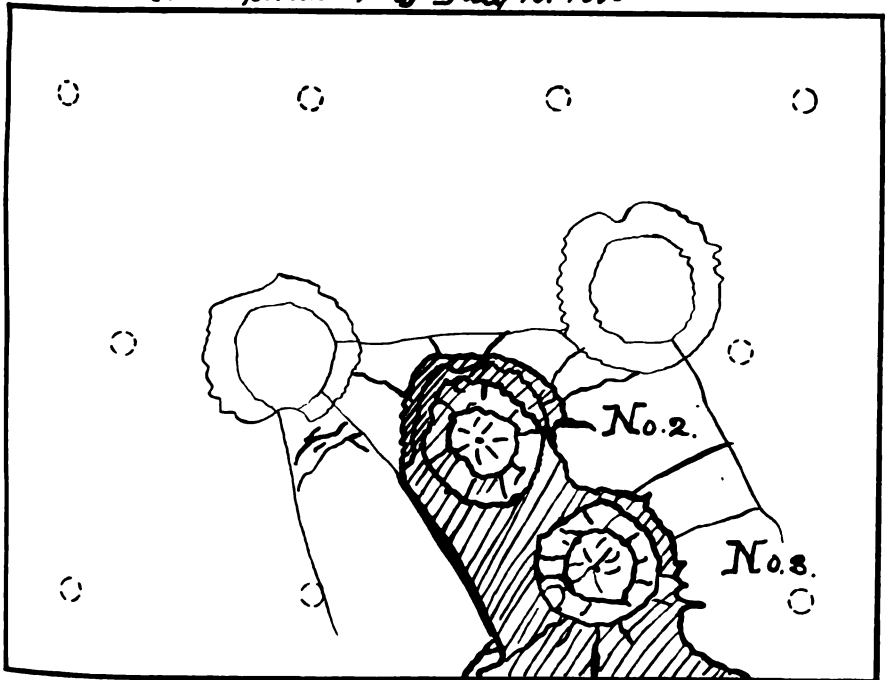

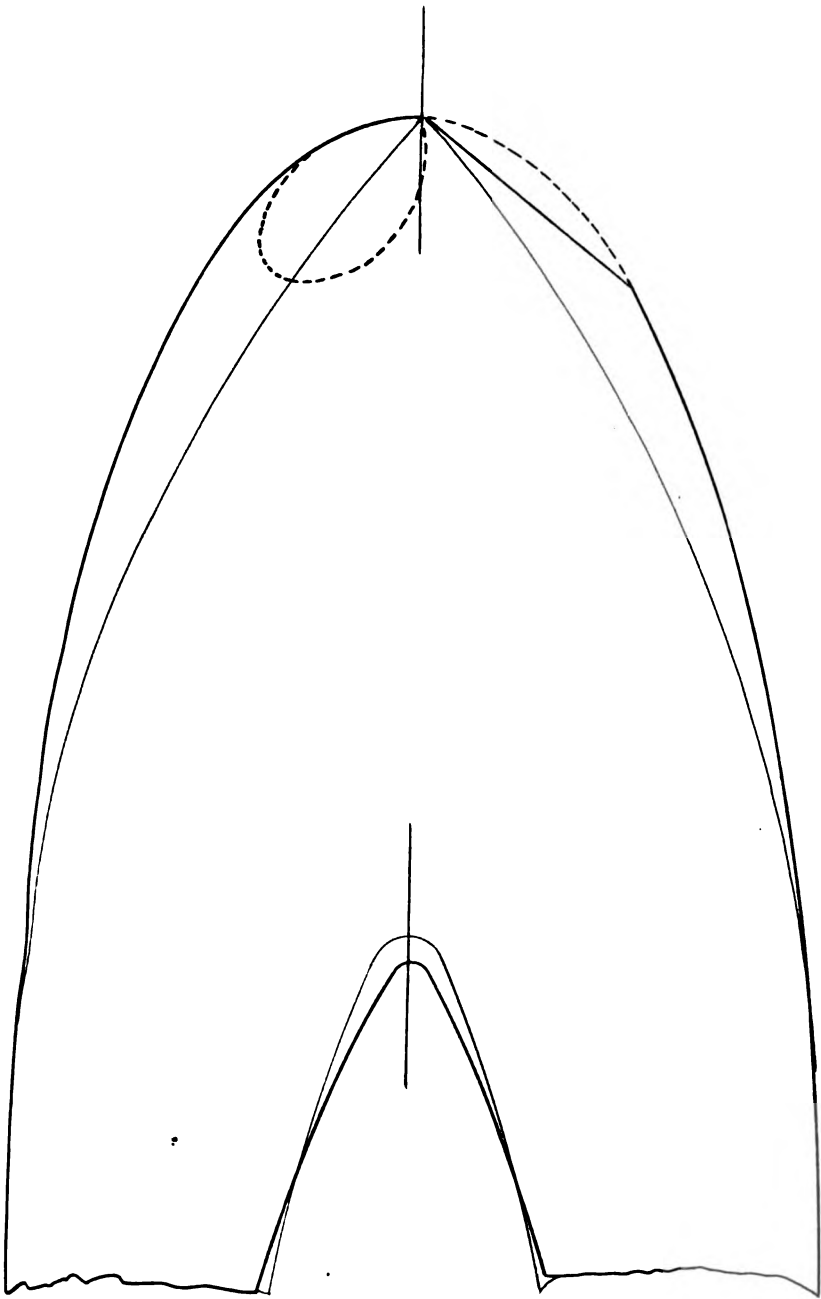

*Blunt Tri-faced and Ogival
heads Compared.*

H Ex1 pt3 v1 49 1

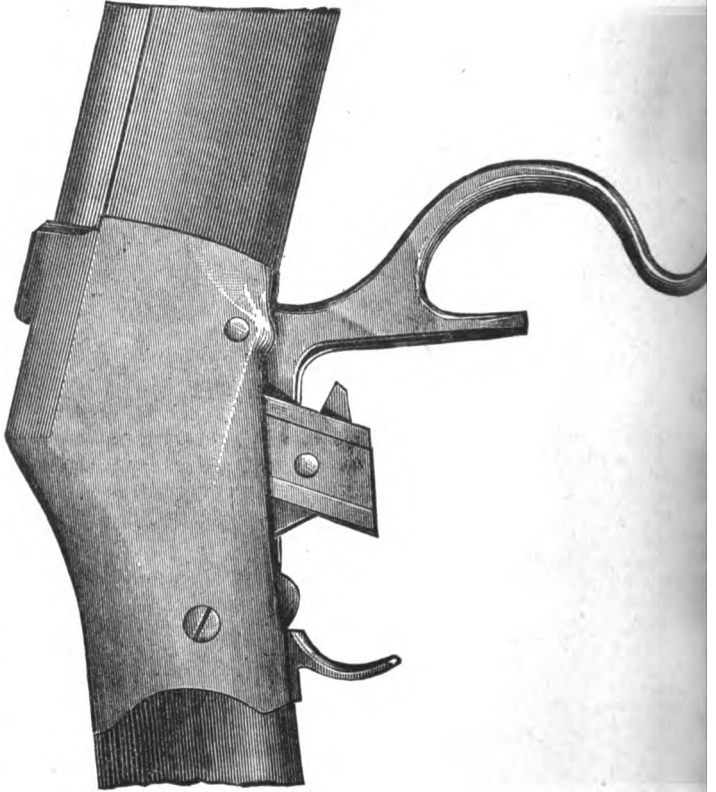
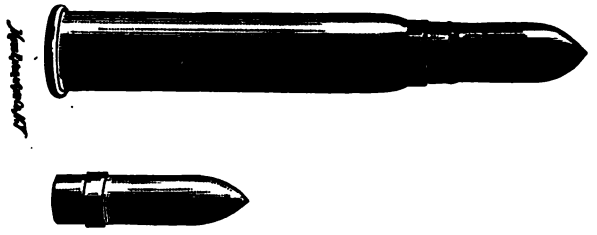
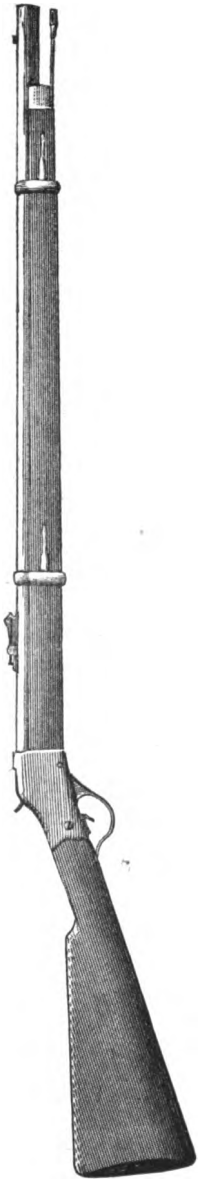

Face page 233

riding is modified in principle, and to which is added about six pounds in weight, which is to be distributed throughout the length.

It would seem now that the most advantageous development of the piece would be in the direction of a heavy sharpshooter's arm, to be distributed at suitable points about the ship. It would, of course, be used with a muzzle-rest, as the ship's rail. As a four or five barrel Gatling, it would also be a very effective arm against unarmored cruisers, in all emergencies of close action.

Herewith respectfully forwarded are photographs of the piece, its mechanism, and cartridge.

I am, sir, your obedient servant,

W. M. FOLGER,

Commander, Inspector of Ordnance in charge.

Capt. MONTGOMERY SICARD,
Chief of Bureau of Ordnance.

NAVAL ORDNANCE PROVING GROUND,
Annapolis, Md.

SIR: I desire to correct my recent statement that the breech system of the high-power musket was the Marlin. I was led to the belief that this was the case from a marked similarity with one of the Marlin make of gallery rifles.

Quoting from a letter received to-day from the Winchester Repeating Arms Company—

"Replying to your card of the 11th May, we would say that the system, as yet, has the name. It will, however, be called the 'Winchester single loader.' The patent covering the arrangement of block and hammer was taken out by John M. Browning, of Ogden City, Utah, October 7, 1879, No. 220271. Our Mr. Mason and Mr. Clough have changed it considerably. We are going to put it out as a cheap and well-made single-loading rifle. The frame which the high-power gun has is larger than that which our stock gun will have, of course.

"WINCHESTER REPEATING ARMS COMPANY."

I am, sir, your obedient servant,

W. M. FOLGER,

Commander, Inspector of Ordnance in charge.

Capt. MONTGOMERY SICARD,
Chief of Bureau of Ordnance.

NAVAL ORDNANCE PROVING GROUND,
Annapolis, Md.

SIR: I have the honor to submit the results of a comparative test of stepped-headed and cylindrical projectiles, designed for armor-piercing at low angles of impact. The projectiles used are shown in photograph No. 27, herewith, with others, respectfully forward.

It will be remembered that the stepped specimens, having been toughened in oil only, proved too soft for a trial upon an equal footing with the simple cylinder, and, in accordance with your instructions, their temper was drawn, and they were subsequently rehardened by the method employed at this station. They took the temper satisfactorily, without cracks or distortion. They were subsequently rebanded at the Washington navy-yard.

GENERAL DETAILS.

The piece: The 3-inch B. L. R., charge, 12 ounces; lot 2, No. 7; weight of projectile, 10 pounds; velocity at impact, 911 f. s.; energy at impact, 57.6 foot-tons.

The target. A 1.5-inch wrought-iron plate, braced and backed sufficient to eliminate flexure in any degree whatever. Distance from the muzzle, 30 feet; angle to the line of fire, 14 degrees. Results: (photographs 27, 28, and 29).

(Round 1. Projectile 1, photograph 27.)

Angles.

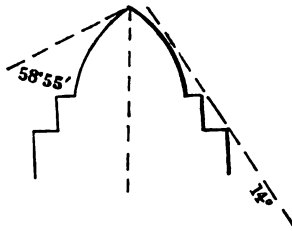

	Inches.
Length of impact	6.6
Width of impact	1.7
Maximum depth	0.375

The projectile scored out with slight damage to the target. The second step broke off (photograph 28), with indications of a flow of metal, showing that the temper was in a measure superficial. It was evident, as in the two subsequent rounds, with the stepped specimens, that the butt had swung in against the target, the rear cylinder being cracked from the base to the lower edge of the band. The projectile was otherwise uninjured and undistorted.

(Round 2. Projectile No. 2, photograph 27.)

Angles.

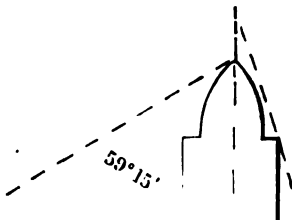

	Inches.
Length of impact	7.5
Width of impact	1.6
Maximum depth	0.25

The projectile scored out, doing slight damage to the target, and quite uninjured.

(Round 3. Projectile 3, photograph 27.)

15° Bearing angle of three points with axis.

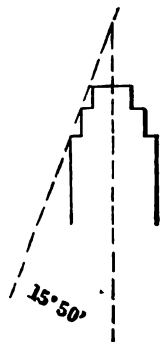

	Inches.
Length of impact	7.625
Width of impact	1.85
Maximum depth	0.44

It was quite evident, considering the character of this impact, that all cutting edges bit at practically the same instant, and mutually assisted in scoring out.

The third edge was broken off, as shown in photograph 28. The rear cylinder was cracked to the lower band edge.

(Round 4. Projectile No. 4, manufactured at Naval Ordnance Proving Ground. Chrome steel.)

	Inches.
Length of impact	6.25
Width of impact	3.00
Depth of impact	1.6

The projectile bit very well, and apparently expended the greater part of its energy upon the plate, cutting the latter completely through to the backing. It has not yet been recovered, the rainy weather not permitting digging into the butt. I shall have the honor to forward a supplementary report of its condition. It is quite unlikely, judging from the character of the impact, and the fact that it was much stronger in profile than the stepped specimens, that it is in any way injured.

CONCLUSIONS.

As you will doubtless appreciate, the advantage of the single cutting edge for very low angles is definitely illustrated.

Respectfully, &c.,

Capt. MONTGOMERY SICARD,
Chief of Bureau of Ordnance.

W. M. FOLGER,
Commander, Inspector of Ordnance in Charge.

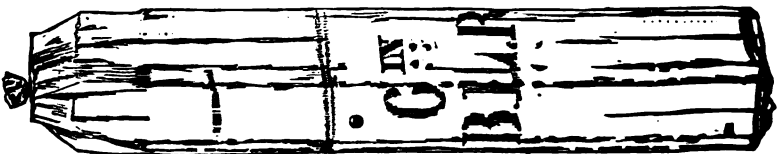
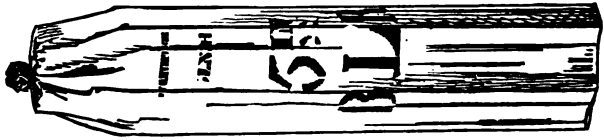
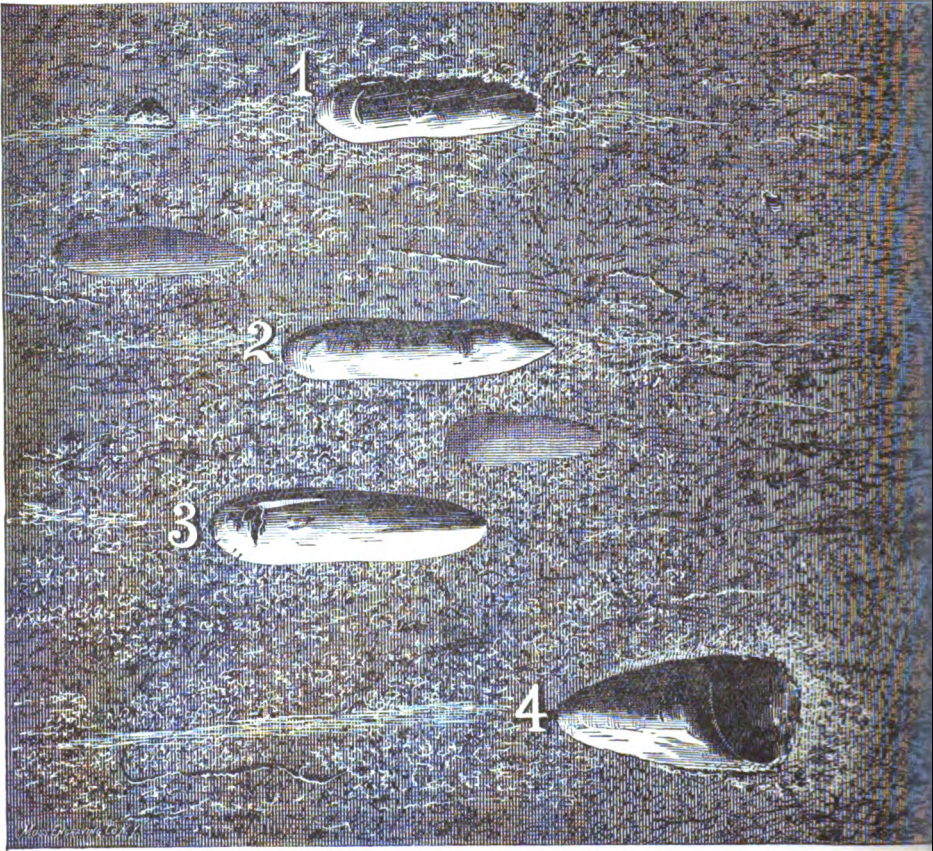

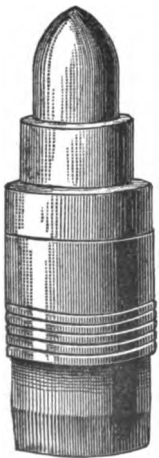
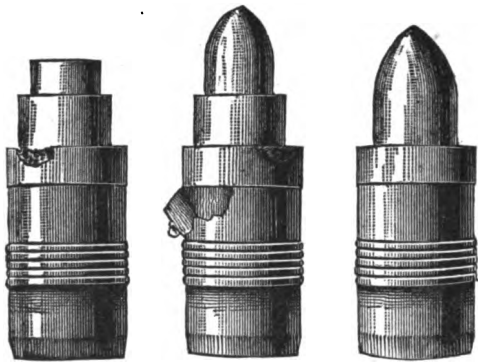

Face page 235

106
624NAVAL ORDNANCE PROVING GROUND,
Annapolis, Md.

SIR: The 3-inch cylindrical projectile mentioned in my No. 96 of the 30th ultimo has been recovered. It is quite uninjured and unchanged in dimensions. If rebanded it would serve for a second round.

Respectfully, &c.,

W. M. FOLGER,
Commander, Inspector of Ordnance in Charge.

Capt. MONTGOMERY SICARD,
Chief of Bureau of Ordnance.

102

NAVAL ORDNANCE PROVING GROUND,
Annapolis, Md.

SIR: Herewith respectfully forwarded for the Bureau files are photographs of 5-inch and 6-inch cartridges of prismatic powder. The 5-inch cartridge weighs 30.40 pounds, the total amount which it is possible to insert in layers symmetrically arranged, the powder being of the density used in the recent firing experiments. (O. P. Report, No. 15.)

I am, sir, your obedient servant,

W. M. FOLGER,
Commander, Inspector of Ordnance in Charge.

Capt. MONTGOMERY SICARD,
Chief of Bureau of Ordnance.

224
125NAVAL ORDNANCE PROVING GROUND,
Annapolis, Md.

SIR: I have the honor to inform the Bureau that the experiments in the development of the application of the electric light in photographing a desired point in the bore of a gun have progressed satisfactorily since my last report (June 16, 1885), and to submit the following description by Lieutenant Knight of the method he has designed, which, I believe, is entirely novel.

The object sought was to obtain an image of any point in full size or enlarged, instead of on the greatly reduced scale resulting from any method where the camera is placed outside of bore.

The essential point of the method, and that in which it differs from methods hitherto used, is the insertion of the camera itself with the reflector in the bore of the gun, the distance from the optical center of the lens to the inclined reflector on one hand and to the sensitive plate on the other having been previously determined, and the camera parts set at the proper point on a rigid carrying rod. In the most common case, where it is desired to photograph a part of the bore at its normal size, the distance of the sensitive plate from the lens should be twice the focal length of the lens, and that of the reflector should be twice such focal length minus the distance from the optical center of the reflector to the surface of the bore directly above it.

When it is desired to enlarge a point of the bore, the changes are easily calculated. The camera is made sufficiently small at its largest point (where it takes the sensitive plate) to enter easily in the bore. From this largest part it tapers toward the forward end, where it is only as large as is necessary to take the mounting of the lens. The end of the gun opposite to that from which the apparatus is to be inserted should be closed to light.

The uncovering and covering of the lens may be effected very simply by the use of a slide exactly similar to the ordinary drop-shutter for instantaneous views, but arranged to work sidewise by means of cords leading out on either side of the camera. In the absence of such an arrangement, the cap of the lens may be removed when

well inside the gun and replaced by the end of a cloth until the rod is inserted to the proper point, when the cloth is hauled off to the rear, the cap being replaced at the end of the exposure by withdrawing the camera far enough to reach the lens tube with the hand.

The rod carrying the camera and reflector having been inserted to the proper point and the lens uncovered, the rays from an electric light are thrown into the bore, over and around the camera. Care should be taken to keep the light moving to avoid danger of reproducing the shadow of the camera in the picture.

The arrangement above described could be easily made on board any ship where a lens is already supplied. The camera used at this station was made by an ordinary carpenter.

No plate-holder was used. The plate was inserted in grooves at the proper point inside the camera through a slit, which was protected after the insertion of the plate by a light tight slide.

The size of camera best suited to use with a 6-inch gun is $3\frac{1}{2}$ by $4\frac{1}{2}$ inches, outside dimensions, at the base. This will take a plate $3\frac{1}{2}$ by $4\frac{1}{2}$ inches, a regular commercial size.

It is believed that slow plates should be used, and the kind known as Carbutt's B is recommended.

Photographs of the slope of 6-inch No. 4, and of the erosion in the forward part of the chamber of the South Boston gun after one hundred and fifty-four rounds, are herewith forwarded in illustration of the method described.

I am, sir, your obedient servant,

W. M. FOLGER,

Commander, Inspector Ordnance in Charge.

Capt. MONTGOMERY SICARD,
Chief of Bureau of Ordnance.

2448
144

NAVAL ORDNANCE PROVING-GROUND,
Annapolis, Md.

SIR: I have the honor to submit the following summary of the work done at this station during the past year:

POWDER.

The most important subject for experimental development has been the powder for the armament of the new cruisers, that used in the antiquated batteries of the older vessels being entirely unsuited to the new conditions of high-power guns.

The German brown prismatic or "cocoa" powder, of which a certain amount has been purchased for experimental purposes, furnished favorable results in the 6-inch caliber, using excessive charges. Its superiority to the United States standard and experimental powders which had been previously suggested, and its almost general adoption abroad, lead to a persistent endeavor by the Bureau to reproduce its qualities at the Du Pont mills. These efforts, after numerous failures, have accomplished results which may be considered as definitely favorable.

A muzzle-velocity of over 2,000 feet per second with less than 15 tons chamber pressure per square inch, using charges of 50 pounds, with the service projectile of 100 pounds, has been obtained in the 6-inch steel B. L. guns.

The development of the ballistic qualities of the 5-inch gun not being a matter of immediate necessity, but a single sample of the new powder has been fired from this caliber.

This furnished a muzzle velocity of 1,960 feet seconds with 13.7 tons pressure, using a charge of 30 pounds, a the standard projectile of 60 pounds, which, considering the conditions, may be regarded as extremely favorable.

The characteristics of the grain, as regards its rate of burning, are under complete control in manufacture, and there are definite grounds for belief that the changes needed for the larger calibers of guns soon to be furnished for proof will present no difficulty.

A series of experiments to develop the comparative hygrometric qualities, and the rate of burning as effected by temperature, of the German and the domestic articles, has been in progress for some time, which thus far does not present any unfavorable feature in the domestic grain.

It is believed that a suitable brown prismatic powder may be developed for the 8-inch converted M. L. rifle, with which its ballistic qualities would be notably improved.

A. O. P. S. No. 135.

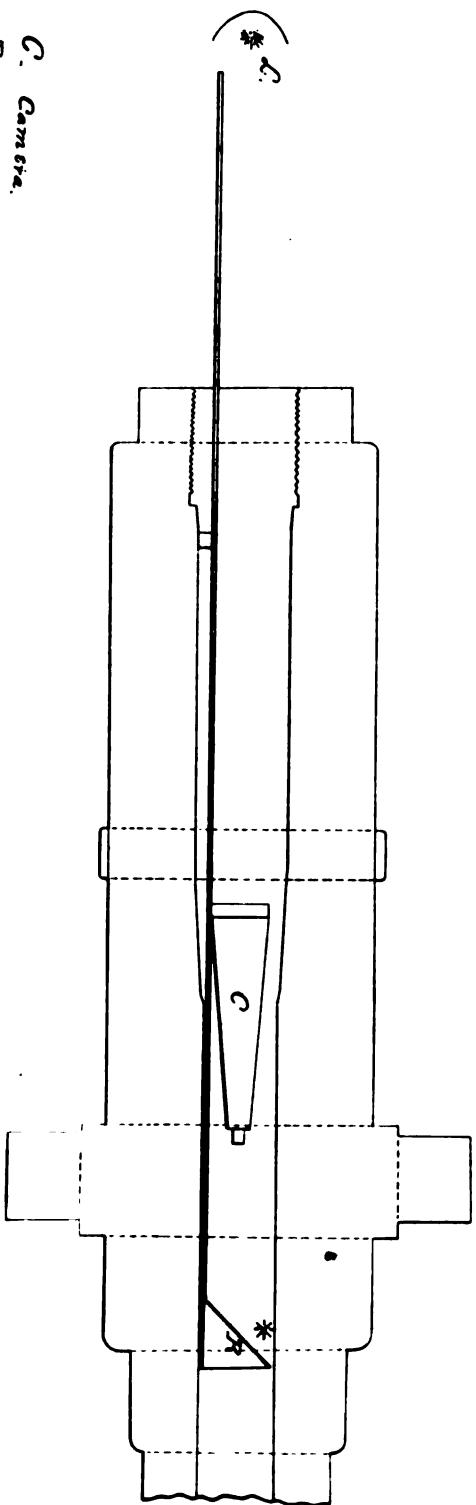

- C. - Cam shaft.
- R. - Ratchet.
- L. - Light.
- * - Object.

*From Adamses Pump Ground,
Annapolis, Maryland,
Sept 10, 1885.*

As you are aware, the composition and process of manufacture are a secret and the property of the Messrs. Du Pont. I will state, however, that the proportions of the ingredients are established on sound chemical principles, which have in view the reproduction of the most characteristic features of the German grain. The physical nature of the grain as affected by its density and the method of manufacture, which has a definite influence on the character of the combustion, resembles closely the German article.

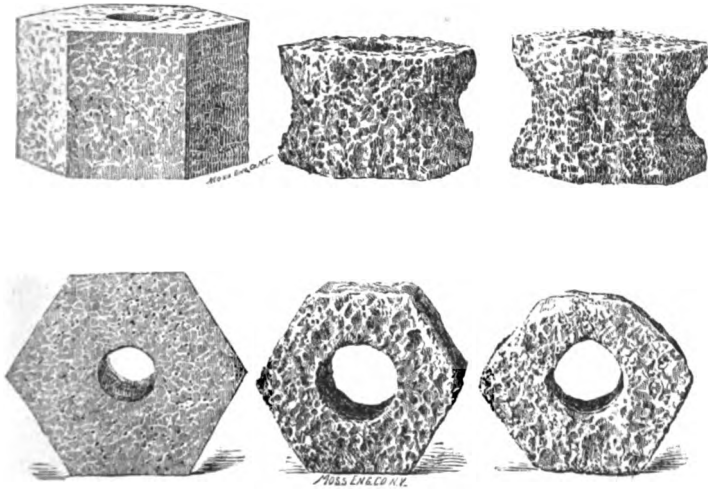

Photographs 1 and 2, showing an unburned grain and two others which were blown out partially consumed, illustrate the progressive nature of the powder. It will be observed that there is an increasing surface outside as well as through the central perforation.

The adoption, as a portion of the proposed new armament, of the various calibers of Hotchkiss guns, necessitated considerable experimental work in the development of their powers.

A suitable *black powder* has been produced for these guns by the Du Ponts, under the supervision of the Bureau's agents.

The results thus far reached are presented in the following table, and include all the classes of guns purchased to date:

Gun.	Charge.	Velocity.	Pressure.
	Grammes.	Fet.	Tons.
N. O. P. G., 57— R. F. G.	820	1, 884	12. 8
Hotchkiss, 57— R. F. G.	850	1, 837	14. 0
N. O. P. G., 47— R. F. G.	470	1, 728	10. 4
Hotchkiss, 47— R. F. G.	500	1, 706	11. 9
N. O. P. G., 47— H. R. C.	222	1, 487	12. 9
Hotchkiss, 47— H. R. C.	220	1, 484	13. 9
N. O. P. G., 37— H. R. C.	82	1, 318	10. 3
Hotchkiss, 37— H. R. C.	80	1, 319	7. 6(f)

Experiments have been instituted under your instructions tending to the manufacture in this country of the Lorenz principle in small-arm cartridges of compressed powder, with which favorable results have been obtained abroad.

It would be premature to promise a successful development, but there would seem to be no essential difficulty in obtaining as favorable showing as is claimed by the Rottweil-Hamburg firms.

HIGH EXPLOSIVES.

The work with the high explosives during the year has been mainly in the direction of the experimental employment of wet gun-cotton as the bursting charges of shells.

The study of the subject of the ignition of such charges has been pursued with

such results that the adoption of the principle developed for service use seems merely a question of time.

Arrangements are being made under your instructions to explode the experimental mortar torpedoes recently received from the Washington navy-yard.

ARMOR-PIERCING PROJECTILES.

The experimental development of suitable characteristics in metal, temper methods, and form of head has made satisfactory progress, mainly in the directions indicated in my reports of last year.

Two blunt tri-faced 6-inch projectiles tempered at this station were fired on February 21 against an 8-inch Brown (English) compound plate, backed with 20 inches of oak. The points of each pierced the plate but were arrested by the backing. Both projectiles broke up, as has, it is believed, been the invariable case on the attack of compound armor. (See $\frac{1}{2}$ p. 4).

Two ogival-pointed 6-inch projectiles were fired against the same plate on July 13, furnishing somewhat less favorable results. (See $\frac{1}{2}$ p. 7).

A sharp tri-faced 6-inch steel projectile was, on November 25, fired against the 8-inch Brown plate, and reached unbroken, but cracked (remaining in the plate), a probable penetration of 9 inches. The plate was badly shattered about the impact, and cracked through its entire thickness to the upper edge, Photograph 9.

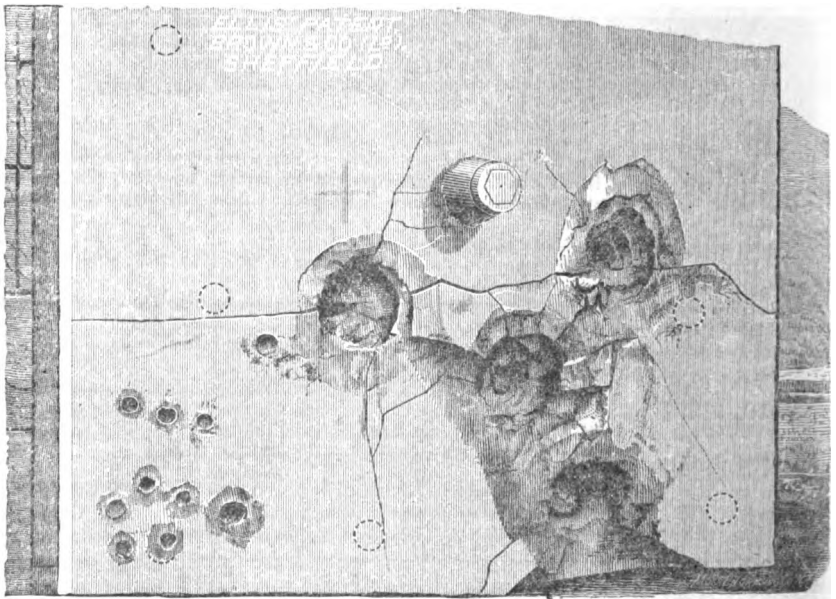

A large number of Hotchkiss armor-piercing projectiles, of calibers 37 millimeters to 57 millimeters, has been manufactured and fired against steel plates, in comparison with the standard Hotchkiss make, with results which have been uniformly favorable as regards armor-piercing qualities (fragments at explosive rupture not considered), to the naval ordnance proving ground production.

The superiority consisted mainly in the metal and temper conditions, it being found frequently possible to use an N. O. P. G. projectile three successive rounds after piercing a maximum thickness of shield, when the Hotchkiss specimen would be broken without explosive charge at the first round.

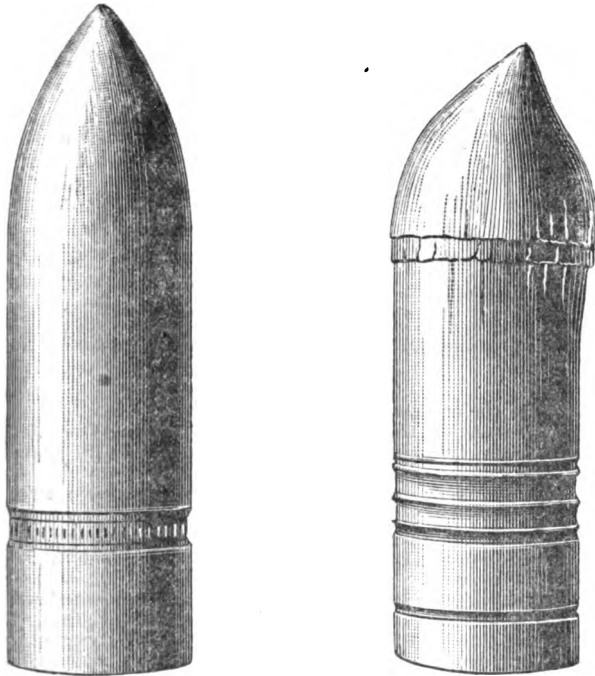

Photograph 10 is of a comparative test where the two (47 millimeters R. F.) were fired against 3 inches of steel. The N. O. P. G. projectile was quite unchanged in dimensions.

The ogival form of head is considered as more advantageous from an economical point of view in manufacture.

In accordance with your instructions, considerable study has been made of the cost of manufacture of steel ammunition.

The cost of the methods employed here are notably cheaper than Hotchkiss prices, and the results of a visit to the manufacturers of similar work at the North indicate that both projectiles and cases may be made at a reduction in cost.

The method recently patented by Mr. George F. Simonds, of Fitchburg, Mass., of rolling the projectile, of which mention has been made in special reports, furnishes features of unusual interest in this direction, and it is believed that the system will eventually be generally adopted on account of its economy and expedition in manufacture.

Photograph 11 illustrates samples of the work of the Simonds rolling-machine.

It may be mentioned, in connection with the subject of Hotchkiss ammunition, that a limited number of 57 millimeters and 47 millimeters R. F. common shell have been cast at the Washington navy-yard and banded at this station for an experimental test as to the effect upon range and accuracy of the N. O. P. G. band.

Fired at 3 degrees elevation these projectiles furnished the 57 millimeters a mean range of 2,081 yards; the 47 millimeters, of 1,808.7 yards. Hotchkiss standard com-

mon shell, at the same elevation, furnished, respectively, mean ranges of 2,123 and 1,809.2 yards.

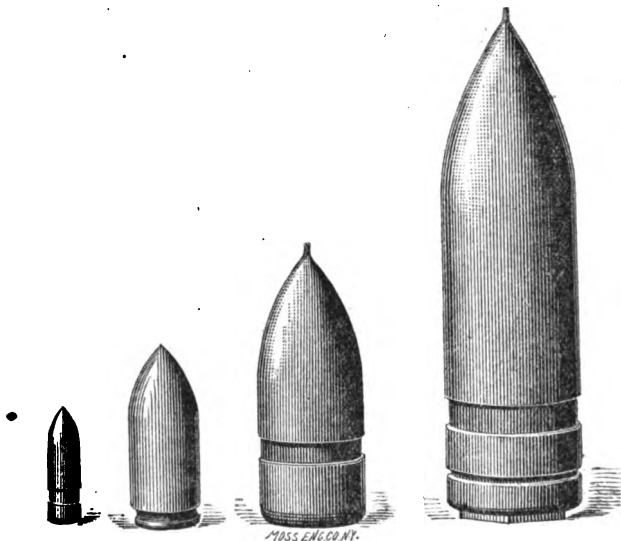

A number burst in the explosion-chamber furnished—
Caliber 47 millimeters, 81 fragments, of weights varying from .5 to 84 grammes with the 57 millimeters, 105 fragments, of weights from .5 to 181 grammes.

THE PROOF OF HIGH-POWER B. L. GUNS, RANGING, ETC.

Six 6-inch and one 5-inch guns of the standard naval types have been furnished for proof; three of the 6-inch and the 5-inch have withstood considerably more than the statutory proof of 10 rounds.

The necessity of making all of the experimental work connected with the development of the powder and the tests of carriages, of percussion-firing devices, and of projectiles with guns intended for service issue, is extremely regrettable, and Nos. 1 and 4 of the 6-inch caliber have been already subjected, the former to 275 rounds and the latter to 57 rounds.

The single 5-inch gun furnished has a record of 26 rounds. Six-inch No. 1 has been ranged at a muzzle velocity of 1,915 feet seconds, with German cocoa powder.

This work will, however, need to be repeated for the higher velocity furnished by the American powder.

The Hotchkiss 57-millimeter rapid-fire gun and the 47-millimeter and 37-millimeter revolving cannon have likewise been ranged, the former with the increasing velocity obtained with the American powder and the latter with velocities equal to those of the tables furnished by the Hotchkiss firm.

MISCELLANEOUS WORK.

The measurements of chamber-pressures in the Hotchkiss guns in the development of their powder presented some difficulty, it being inexpedient to place gauges in either the breech-blocks or chamber-walls, the guns being ultimately intended for service issue.

Assuming that the pressure on the base of the projectile was (nearly) two-thirds of that upon the bottom of the chamber, gauge-housings were manufactured of a form resembling the projectile. These, banded with the gauge in place, were made to weigh equal with the armor-piercing projectile of each caliber, care being taken to preserve the service density of charge in a proper allowance for the head of the gauge.

The housings were tempered, in order to lessen the wear consequent upon firing into the sand-butt. They were, of course, rebanded for each pressure round.

In order to verify the accuracy of the assumption as to the amount of the pressure upon the base of the projectile 6 rounds were fired from 6-inch and 5-inch B. L. guns, in which the projectiles were provided with base-gauges, the pressure upon the

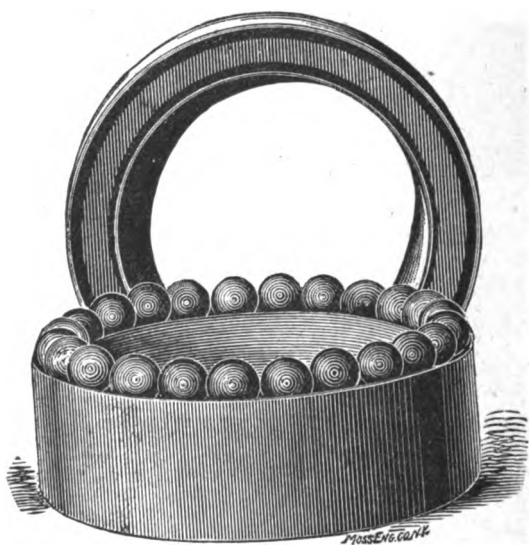

Face page 241

breech-plug being measured at the same time. The results are given in the following table:

Round.	Caliber.	Pressure.		Percentage of pressure on base of projectile to that in chamber.
		Chamber (mean of 3).	Base of projectile.	
		<i>Tons.</i>	<i>Tons.</i>	
1	5"	13.4	10.1	75.4
2	5"	12.9	8.28	64.2
3	5"	13.0	9.05	70.2
4	6"	13.85	10.7	77.3
5	6"	11.3	10.4	92.0
6	5"	9.9	7.0	70.0

The loading tools furnished by the Messrs. Hotchkiss & Co. proved to be somewhat inconvenient, their horizontal position frequently causing the grains of powder to be crushed in setting home the projectile. An upright loader was designed (N. O. P. G., No. 97), which has given satisfaction. It has the additional advantage of being suitable for all calibers with slight substitution of parts.

Two methods of reforming tools have been manufactured for the 57^{mm} cartridge-cases, and are now receiving an experimental test, to be reported upon as definite results are reached.

The gun-platform for the 8-inch B. L. R. is completed and in readiness for the piece. The pivot-socket is that which was in use with the 15-inch S. B. gun, and is believed to be sufficiently solid. Should this prove not to be the case, as there is nothing on record as to the method employed in placing this socket, the platform for the 10-inch B. L. gun is sufficiently near completion to be available for use.

The platform intended for the 10-inch gun in the work the Bureau has in prospect with the Clark defective turret is also in an advanced state.

The practice-butt has been increased in size in preparation for the work with the larger calibers. The material which I have been obliged to use for this purpose is, however, unsuitable, being a reddish clay.

As described in my No. 135, of September 10, Lieut. A. M. Knight, of this station, has perfected a method of photographing a desired portion of the bore of a gun by means of the electric light. The small dynamo-machine received from the torpedo station has been used for this purpose, but is of insufficient power to produce the best result.

The breech-mechanism of the B. L. guns has received considerable attention during the year. Several percussion-firing devices have been tested, that designed by Lieut. Charles A. Brabury being thus far the most promising. No definite conclusion has, however, yet been reached, the requirements of this apparatus proving more extended as our experience with the conditions increases.

The extended use of the Bureau design, a single cup on each side of the De Bange pad, instead of the combination of tin and brass used by its distinguished inventor, has given entire satisfaction, and may be considered as worthy of service adoption.

The subject of the jamming of the plug has received much study, and there are grounds for belief that the friction-roller device suggested in my No. 140 will prove effective in eliminating this effect, which appears to be general in foreign services. Photograph 15 is of the roller referred to, which replaces the spiral spring and washer hitherto used, and relieves the friction in opening consequent upon the pressure against the interior shoulder of the breech-screw, the pad starting with the pressure of the screw instead of that of the lever eccentric.

There has been no opportunity during the year to range the Gatling gun at high angles, the harbor having been dangerously crowded with vessels whenever the weather was found suitable for the work. It is not believed to be practicable to make the required measurements over water, and it is recommended, in the interests of accuracy, to delay the matter until a land range is available.

The only work during the year with machine-guns has been a test of a number of pieces presented for trial by the Gardner Gun Company of Cleveland, Ohio. The results of these trials are given in full in my No. 62.

I will call your attention to the necessity of another steam-launch at this station. In the event of an accident to the single one in use, or on occasions of its periodical laying up for repairs, there is no convenient means of crossing the Severn. Then, further, there is also frequent need of two boats, as in placing observers at range stations and in transporting material. Should you approve of this addition to the station facilities, it is recommended that the new boat be given an iron or steel hull for use in the ice in winter.

I will refer again to the entire unsuitability of the position of the proving-ground for the work now in hand and in immediate prospect. The oyster industry of Annapolis keeps the range crowded with small craft during eight months of the year, and weather most suitable for my work is precisely that which the oysterman needs in his calling. The frequent cases I have had of projectiles of smaller caliber leaving the butt leads me to anticipate annoyance from this cause.

There have been complaints from Horn Point of glass being broken and plastering knocked down from violence of concussion at the discharge of the 6-inch caliber. It is unnecessary to note that these effects will be much increased in work with the larger guns.

It is urgently recommended that a more suitable position may be purchased by the Department in order that the needed experimental work and proof of guns may not be definitely interrupted.

Respectfully, &c.,

Capt. MONTGOMERY SICARD,
Chief of Bureau of Ordnance.

W. M. FOLGER,
Commander, Inspector of Ordnance in Charge.

808
42

UNITED STATES TORPEDO STATION,
Newport, R. I.

SIR: During the past two months experiments have been made with a view of deciding upon the best method of packing gun-cotton in the service torpedo.

The best authorities upon gun-cotton are agreed that the more closely the charge surrounds the primer the more efficiently the primer will act. Abel and others have shown that one disk of gun-cotton will detonate another when separated from it by a distance of one inch or less when the two are resting upon the same solid support. But it has not been shown that the destructive action of a given quantity of gun-cotton depends upon the closeness with which it is packed within the limits above stated. Numerous experiments on a small scale made by different authorities have shown that the more rigid the connection between the parts of a charge of gun-cotton the more efficiently will the detonator act. In view of our very limited knowledge of the manner in which gun-cotton is detonated or the manner in which the detonation is propagated from one portion of the mass to another, I considered it desirable to make some comparisons between the present service torpedo and others containing the same quantity of gun-cotton but packed solidly about the primer. The preliminary trials were made on February 13 at Black Pond, about 10 miles from Newport, where the ice was 6 inches thick. The size of the crater is plainly marked by the circular opening, which is cleared in the ice, and by properly controlling the conditions of the experiment the size of the crater furnishes a means of comparing the forces acting. Thus if the charges are the same in quantity, submergence, depth of water, and thickness of ice the same, the only difference being in packing the gun-cotton in the torpedo, the resulting craters in two such cases will furnish a measure of the explosive force of the two torpedoes. It was found, however, that in order to secure a complete history of each explosive it was necessary to measure the height of the jet as well as the diameter of the crater. This could be best done by photographing the jet, and the following plan was adopted:

Two service torpedoes were prepared, and two other experimental ones, each containing the same quantity of gun-cotton as the service torpedo, but in which the gun-cotton was packed as solidly as possible in a sheet-iron case, a portion of the disks being cut into such forms as best to fill the spaces between the whole disks. The same quantity of dry primer was used in each and the same kind of detonator. It was planned to fire a pair of these (one exercise and one experimental) at the same time, both being submerged to the same measured depth below the surface of ice, and to photograph the jets by the instantaneous method when they reached their maximum height. In order that the photograph might be easily measured a vertical staff 44 feet high was placed midway between the two torpedoes, which were 200 feet apart, all three being on the same line, which line was perpendicular to the one joining the staff and the position of the camera. In this manner the staff was photographed on the same plate with the jets, and being of a known height it served as a scale by which the heights of the jets could be measured with all necessary accuracy. Although it is not practicable to take the photograph at the exact time of maximum height, yet as the two jets to be compared would be equally in error the comparative efficiency deduced therefrom would be practically correct.

Unfortunately, in the first set of experiments above referred to, the experimental torpedo of the first pair failed to detonate, and the service torpedo failed in the second pair, so that the craters only could be compared. The service torpedo which detonated produced a crater 33 feet in diameter and the experimental one a crater

35 feet in diameter. The relative efficiency of the two torpedoes is fairly represented by the squares of these numbers, or they are to each other as 1089 is to 122, or as 1 is to 1.13. In these experiments the ice was 10 inches thick, and the torpedoes were 8 feet below the upper surface of the ice. Although there is no more simple or accurate means of measuring the size of the crater than by forming it in ice where permanent record is made to be measured at leisure, yet the difficulty of obtaining ice over a sufficient depth of water and in a place where firing torpedoes would not be objectionable decided me to rely upon the photographs for size of crater as well as height of jet.

A second set of torpedoes were prepared, consisting of two service and two experimental ones in which the disks were packed in a single sheet-iron cylinder and tightly wedged by pieces of oak carefully formed to fill the spaces between the disks, so that the whole formed a solid mass about the primer case. Two casks were anchored 130 feet apart in 22 feet of water, and midway between them the sailing launch was anchored, the top of whose topmast was 45 feet from the water. When these distances were all determined a pair of the torpedoes were slung to the casks so that the center of each torpedo was 10 feet below the surface of the water. The camera, as before, was placed on a line perpendicular to the line joining the torpedoes and about 220 feet from each of them. The two were connected in series with a C machine and fired together and photographed as near the maximum height as possible.

The second pair were placed, fired, and photographed. In this case the height of the launch's mast, 45 feet, which was photographed in each case, served as a scale by which to measure the crater and heights of jet.

When these photographs were measured and the efficiency of the torpedoes compared, as in the first case above mentioned, it was found that the efficiency of the service torpedo was to the efficiency of the experimental one. in the first case, as 1 is to 1.29, and in the second as 1 is to 1.22; an agreement which my experience did not lead me to expect. The superiority of these last over the first experimental torpedoes is probably due to the fact that the last were much more solidly packed than where the interspaces were filled with pieces of gun-cotton. Although such a limited number of experiments cannot be considered conclusive in such a matter, yet when taken in connection with the allied experiments of Berthelot and others it appears that the efficiency of the service torpedo would be increased by packing the gun-cotton more closely about the primer. This whole matter has been submitted to the Board, and we recommend that the gun-cotton be hereafter pressed in cubical masses instead of cylinders. This would make it possible to pack a charge in a solid mass and a larger quantity in the same space now occupied by the service torpedo, or the same quantity in a smaller space and secure a more efficient torpedo.

Another advantage which would result from such a change would be a reduction in the size of the dry primer required. This question is now under investigation. The changes recommended would not only make the torpedo more compact but would cheapen its manufacture. If the Bureau should approve of this change, I will submit a drawing of the torpedo-case to be used. It would involve a change in the molding and pressing machines, but the expense would not be great. Information in detail on this point also will be furnished if the Bureau approves what is here submitted. It was thought better to press the gun-cotton into cubical masses of about the same weight as the present disks, rather than 10-inch cylinders, the full size of a torpedo, which would be an awkward size to handle, and necessitate at least two other forms to make the torpedo complete. A cubical mass 2.9 inches each side of cross-section and 2 inches high would be adapted to all uses. The present disks contain 19 cubic inches, those proposed would contain 17.

The experiments above referred to were carried out by Lieutenant-Commander Newell, assisted by the class and by Mr. Angstrom, who took the photographs.

Respectfully, your obedient servant,

W. T. SAMPSON,

Commander and Inspector of Ordnance, in charge of station.

Capt. MONTGOMERY SICARD, U. S. N.,
Chief of Bureau of Ordnance.

[Indorsed.]

A cubical torpedo has been made and experimented with to determine whether the proposed construction had the necessary strength, &c. It was subjected to several trials upon the fastest steam launch, finishing by running into the breakwater with the torpedo submerged. The secondary spar was bent through an angle of 45°, but the torpedo was not injured. Experiments have since been made in comparing the effects of the round and the square torpedo upon the steering of the boat. No difference could be detected.

I send to-day drawings of the cubical torpedo for the Bureau's approval. The case and necessary attachments for the spar are to be made of malleable iron or mits iron; the case to be tinned inside and outside. The gun-cotton is introduced through the opening for the primer case, the primer case being afterwards soldered in place.

The attachment for the spar is cast in two pieces, one being left upon the torpedo when packed and stored as a handle by which it may be lifted and moved about.

It is proposed to make a contact-firing arrangement which may be attached to any torpedo, thus making it possible to use all the torpedoes as service torpedoes or as contact torpedoes. The contact arrangement is very similar in detail to the one now in use except that it is all inclosed in a small metal box which is attached to the outside of the torpedo case by four screws.

A drawing of the torpedo with the contact attachment will be sent to the Bureau.

In accordance with the Bureau's suggestion contained in first indorsement upon Station letter of April 3, 1885, round torpedo cases are now being made upon the same principle as the above described, in which the gun-cotton disks (round) will be packed without using the tin cylinders. These cases to be used only until the present supply of round disks is exhausted.

W. T. SAMPSON,

Commander and Inspector of Ordnance, in charge.

812

40

UNITED STATES TORPEDO STATION,

Newport, R. I.

SIR: I have the honor to transmit herewith the report of a Board upon boat fittings for the spar torpedo. This question early engaged my attention, because the present spar had not proved satisfactory to the Bureau. It was only after I had decided in my own mind what ought to be the character of the spar that I appointed the Board to work out the question afresh and develop the details. There is hardly occasion to add to the report of the Board, but I might say that the proposed fitting would probably cost about the same as the present one. The spar is heavier than the present one, but it will stand a speed of 10 knots with a large margin of safety, while the present spar will always bend with a speed of 8 knots, and using the same construction its weight would have to be doubled to secure the strength of the proposed spar.

The proposed spar places the center of explosion only 22 feet horizontally from the bow of the boat, instead of 26. The maximum radius of the crater produced by a service torpedo is about 18 feet, so that the only danger to be anticipated to the boat is to result from her running into the crater after the explosion and receiving the falling water, and this depends upon the speed of the boat at the time of explosion and not materially upon the length of her spar. That no serious injury need be expected is shown by the experience of torpedo boat 46, in Min River last August. That boat was going at high speed when her torpedo fired, and the engines were not reversed until after the explosion. Notwithstanding the torpedo was placed under the counter of the Chinese vessel, where the column of water might be expected to be thrown back into the boat by the form of the ship, and notwithstanding the boat ran against the ship's side, she sustained no serious injury from the explosion; torpedo contained 32 pounds gun-cotton. The experience of that same torpedo-boat has suggested a slight change in the spar as represented in the drawings submitted. The bolt for the heel-rope should be placed in the end instead of the side of the spar, as shown in Plates 9 and 10, so that by cutting the heel-rope the spar can slide through its supports overboard. The French torpedo-boat, after firing her torpedo, had her boat spar foul the screw of the Chinese vessel so that she could not escape; if the spar had been fitted to slip overboard after its work was done the boat would have escaped without a shot being fired at her.

It is thought that with the mechanical advantage possessed by the proposed fitting in handling the spar, that one man would be sufficient for each torpedo, and if it should be decided that it was not prudent that a torpedo boat should be going at a high speed just before reaching her target, the whole fitting can be made much lighter than the present one and stronger. Considering the facility with which the torpedo can be run in or out, submerged or raised, when the boat is going at high speed, I do not think it necessary to submerge the torpedo until the moment before the enemy is reached. I may add that I had a specimen piece 10 feet long of such spar constructed for the purpose of testing it; for it was well known that the first experiments of the English with built-up spars were failures. The piece of spar constructed represented the outer end of the proposed spar. It was fitted with the usual secondary spar and a service torpedo fired from it at a depth of 10 feet in 12 feet of water. When the spar was carefully examined with hammer and chisel, it was found that four of the rivet-heads were broken off at different points along the spar, but none within a foot of the end next the torpedo. This result was partly as

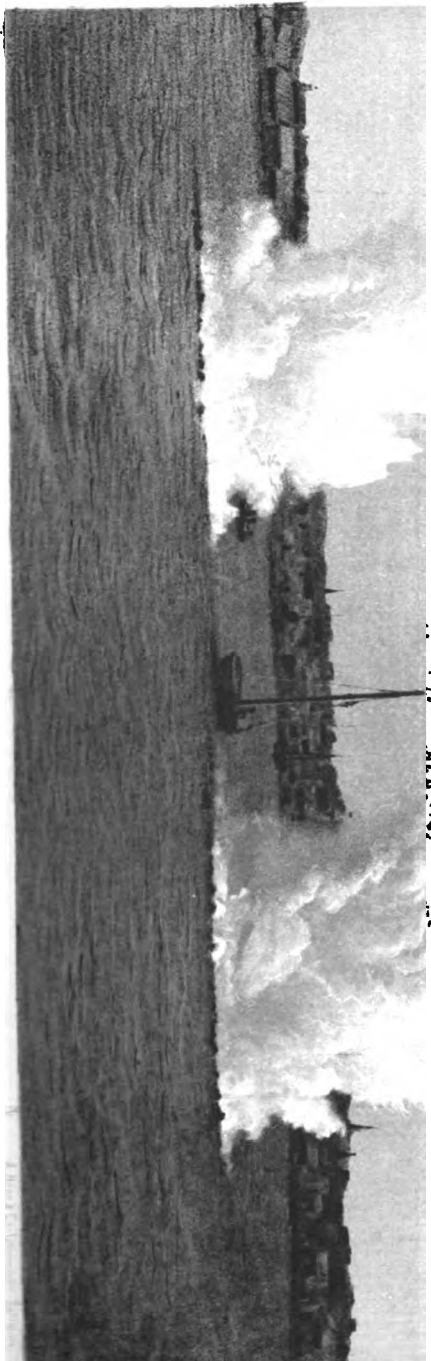

NO 1

EXPERIMENTAL TORPEDO.

314 1/2 LBS. GUN COTTON, PALM OIL SODIUM

DIAM OF COTTON 400

NO 1

SERVICE TORPEDO

314 1/2 LBS. GUN COTTON

DIAM OF COTTON 438

Depth of Water 10'

Position of Shot 100'

Direction of Shot 100'

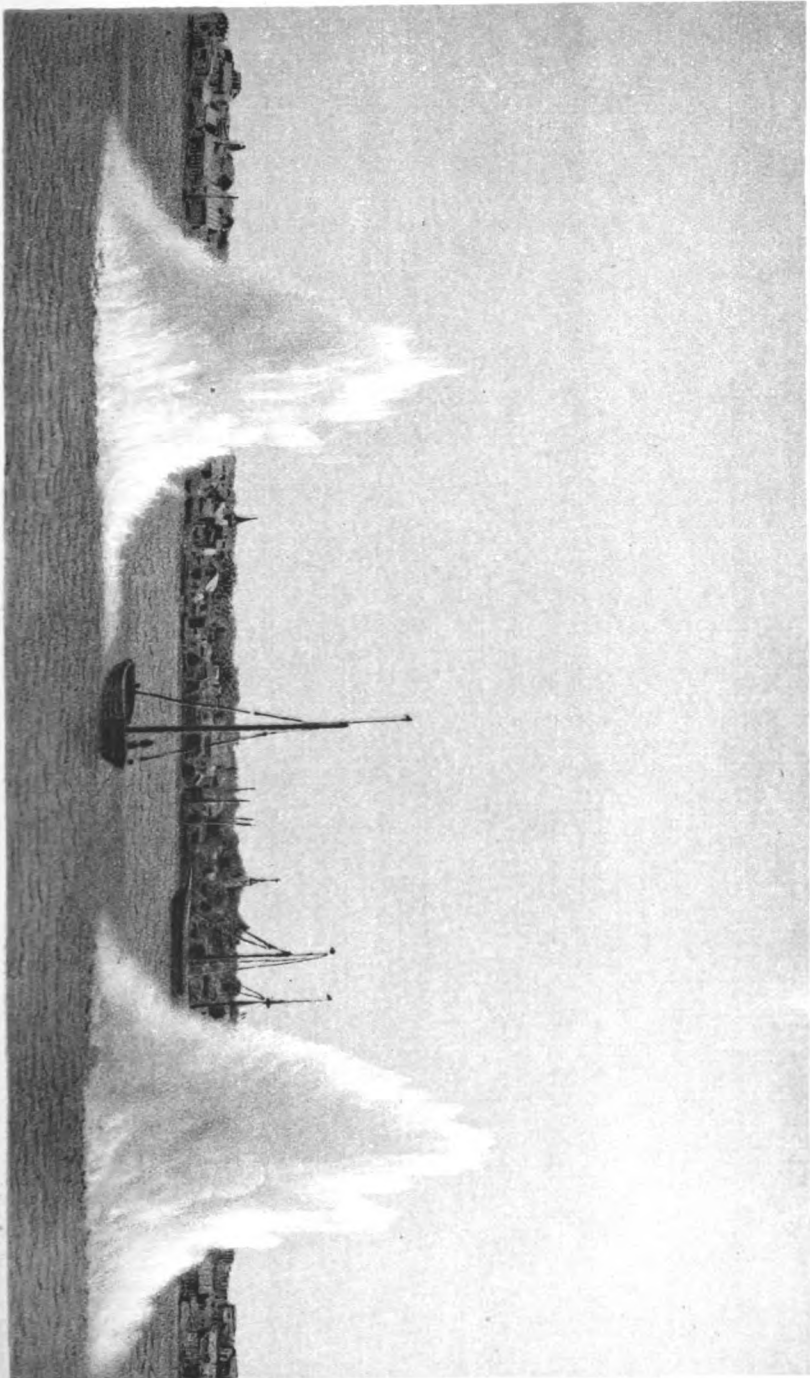

NO. 2.

EXPERIMENTAL TORPEDO.

DIAM. OF CHASER..... 31½
LINS. GUN COTTON..... 40.1
HEIGHT OF JET..... 61.3

NO. 2

SERVICE TORPEDO.

DIAM. OF CHASER..... 31½
LINS. GUN COTTON..... 48.1
HEIGHT OF JET..... 60.8

DEPTH OF WATER.....
SUBMERGENCE.....
RELATIVE EFFICIENCY..... 1.80 T.M.H.

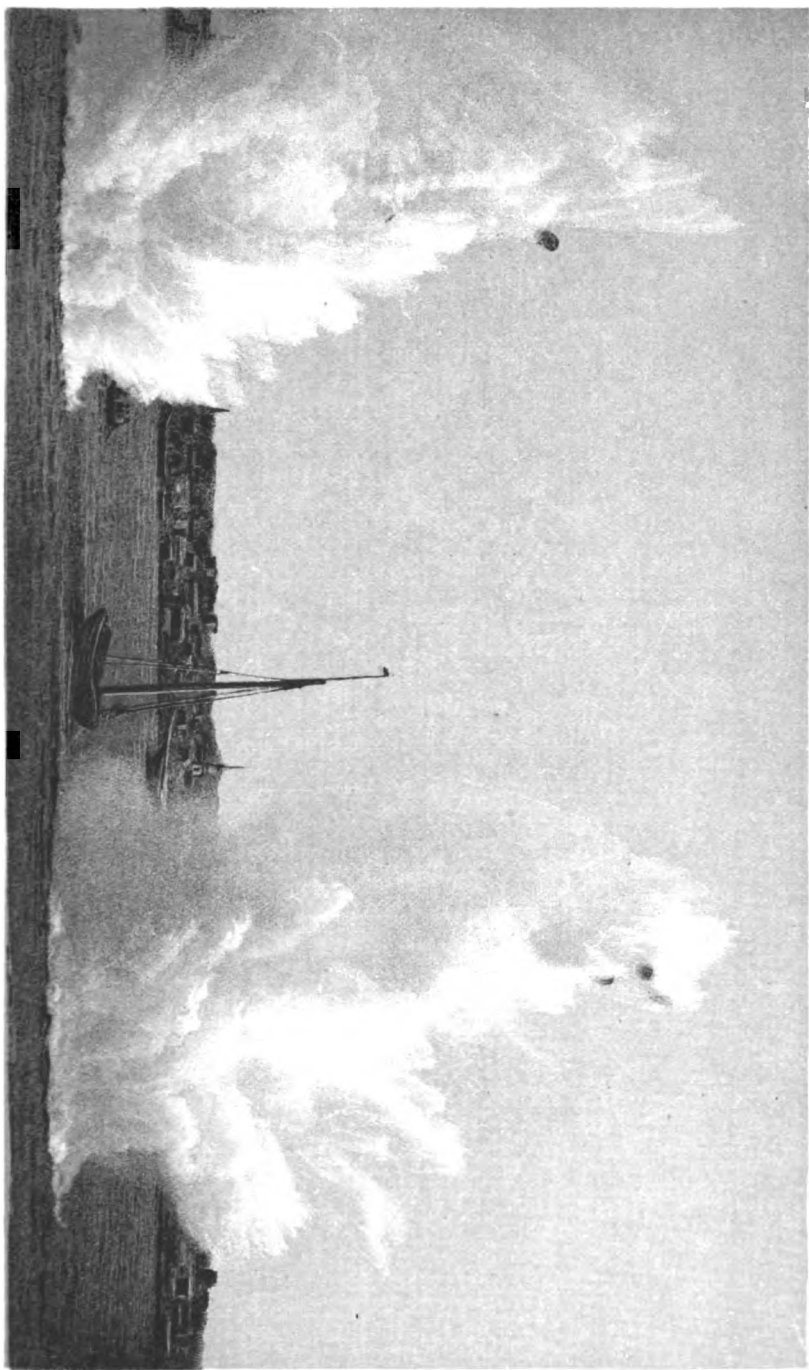

NO. 3

EXPERIMENTAL TORPEDO.

DIAM. OF WATER
31 1/2 LBS. (100 CUBIC INCHES)
DENSITY OF WATER
DENSITY OF TORPEDO
NO. 3

NO. 3

SERVICE TORPEDO.

DIAM. OF WATER
31 1/2 LBS. (100 CUBIC INCHES)
DENSITY OF WATER
DENSITY OF TORPEDO
NO. 3

NO. 2

DEPTH OF WATER

DEPTH OF WATER
DENSITY OF WATER
DENSITY OF TORPEDO
NO. 2

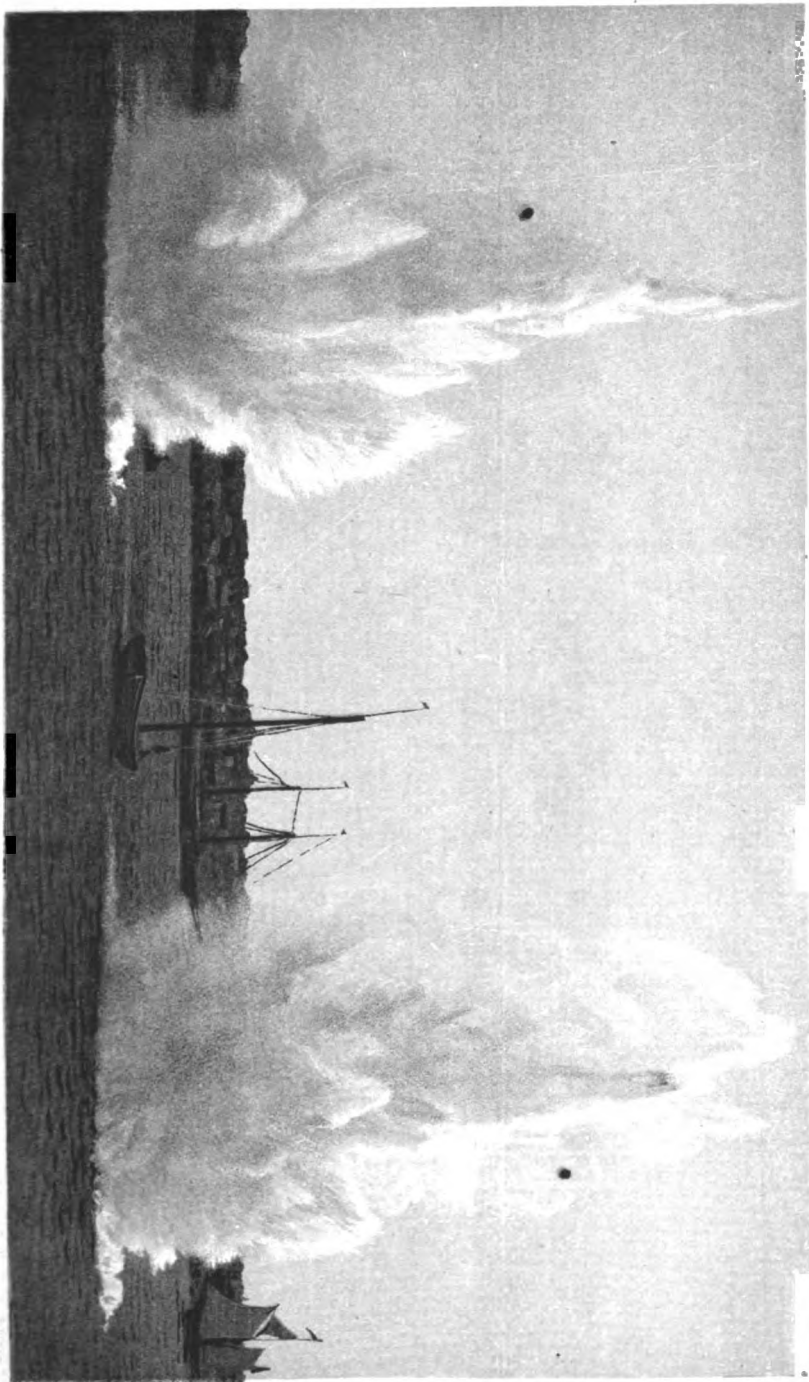

NO. 4
EXPERIMENTAL TORPEDO.
[NAME OF SYSTEM] 427
[TYPE OF WATER] 1 TO 1.100

NO. 1
SERVICE TORPEDO.
[NAME OF SYSTEM] 210
[TYPE OF WATER] 1 TO 1.100

[NAME OF WATER] 1 TO 1.100
[TYPE OF WATER] 1 TO 1.100

anticipated because the spar was hot-riveted. The rivets on one side were knocked out and replaced by cold rivets. The secondary spar was shortened 1 foot in order to give the spar a more severe test, and another torpedo was fired under the same conditions as before. After the second fire two more of the hot rivets were found to be broken, but the cold ones were intact. The remaining hot rivets were now replaced by cold ones, and another service torpedo fired under the same conditions as preceding one, the secondary spar being 1 foot shorter than now used. The spar was found uninjured. A fourth service torpedo was fired under the same conditions as the last, and as the spar did not show the slightest sign of weakness it was considered to have endured the test satisfactorily.

There is one point about the behavior of such a spar when submerged and being towed at considerable speed which can only be decided by experiment, that is its steadiness. It may have a tendency to wobble, but I would not anticipate any serious difficulty from such tendency.

Respectfully, your obedient servant,

W. T. SAMPSON,

Commander and Inspector of Ordnance, in charge of station.

Capt. MONTGOMERY SICARD, U. S. N.,

Chief of Bureau of Ordnance.

UNITED STATES TORPEDO STATION,
Newport, R. I.

SIR: I transmit herewith the report of a Board appointed to devise methods for drying gun-cotton.

It is proposed to restrict the processes to the two recommended by the Board—air drying and drying by exposure to calcium chloride.

The time required to perform the operation has not been stated because the percentage of moisture which the gun-cotton may be allowed to contain is not settled. The English rules and practice do not furnish a reliable guide in the matter. It may safely be said that the official rules prescribed for drying gun-cotton in the English service will not accomplish the drying as therein stated.

So far as our investigations have gone the percentage of moisture may be greatly in excess of the English rule, and yet the gun-cotton be detonated by the service detonator. It is, however, considered best that the rules here submitted should be adhered to until we have completed the investigation. Vessels which have already been supplied with drying apparatus may use it, although it is very troublesome.

Very respectfully, your obedient servant,

W. T. SAMPSON,

Commander and Inspector of Ordnance, in charge of station.

Capt. MONTGOMERY SICARD, U. S. N.

Chief of Bureau of Ordnance, Washington, D. C.

[Indorsed.]

Disks 1 inch and one-half inch in thickness have been pressed, and it is found that a disk one-half inch in thickness will dry in one-third the time required for a 2-inch disk. This is true whether the drier or chloride of calcium is used. A 1-inch disk requires six-tenths of the time to dry that is required by a 2-inch disk.

As these thin disks were pressed with the same pressure persquare inch as the 2-inch disks, the thin ones possessed greater density (in the case of the half-inch disks in the ratio of 1.12 to 1.18), and consequently they did not dry as readily as if they had been less dense. The half-inch disks are strong, and in other respects appear unobjectionable as primers. Over calcium chloride in a tank they will dry completely in less than four days, and probably for primers they would dry sufficiently in two days. This point will be reported upon as early as possible.

It is therefore recommended that primers be pressed in one-half inch disks.

W. T. SAMPSON,

Commander and Inspector of Ordnance, in charge of station.

UNITED STATES TORPEDO STATION,
Newport, R. I.

SIR: In obedience to the Bureau's order of September 30, I have the honor to submit the following report regarding this station and the work done and in progress during the past year:

I relieved Capt. T. O. Selfridge, in charge of the station, on November 1, 1884.

The officers attached to the station since that time have been—
Commander T. F. Jewell, assistant inspector of ordnance and instructor in electricity.

Lieut. Commander G. A. Converse (reported January 12), assistant inspector of ordnance and instructor in high-speed engines and diving.

Lieut. Commander J. S. Newell, assistant inspector of ordnance and instructor in torpedoes.

Lieut. Commander W. Maynard, assistant inspector of ordnance and assistant instructor in electricity and fuses.

Lieut. Commander G. A. Totten (reported June 4), assistant inspector of ordnance and assistant instructor in torpedoes.

Lieut. Karl Rohrer (reported September 16), assistant inspector of ordnance, in charge of gun-cotton laboratory.

Surgeon J. G. Ayers (reported April 9).

Past Assistant Paymaster F. H. Clark (reported February 17).

Assistant Paymaster J. Q. Lovell (reported July 24).

Gunner J. R. Grainger, in charge of magazine and storehouse.

Mr. J. Flenring White, chemist and instructor in chemistry and explosives.

Mr. Arendt Angstrom, in charge of drafting room and machine shop.

The force and resources of the station have been employed, as in former years, in the twofold duty of manufacturing and developing torpedoes and torpedo material for the service, and in instructing officers in the theory and use of torpedoes and the principles of torpedo attack. A class of seamen has also been instructed in the same subjects as far as its members are prepared to receive such instruction.

GUN-COTTON.

The gun-cotton factory has been running about ten months of the year, although at only one-half its capacity. Since the factory was started, in March, 1884, 17,936 pounds of gun-cotton have been manufactured.

	Pounds
During the same time there has been used for purposes of instruction.....	1,634
For experimental purposes	600
For torpedo outfits for three ships.....	2,637
For Naval Proving Ground and Artillery School	1,043
Leaving on hand.....	11,624
There was purchased in England 2,500 pounds, of which there has been used for the outfits of two vessels	1,460
The remainder was issued to the Greely Relief Expedition, and afterwards there was returned by the expedition to the station.....	*2,806
Of which there has been used for purposes of instruction, in addition to the quantity above named	1,378
Leaving on hand of the English gun-cotton.....	1,430

which will be used for instruction.

The processes of manufacture remain substantially the same as a year ago, except that the density of gun-cotton has been increased, experiments showing that the explosive energy increases with the density.

It has been found difficult to prevent the manufactured gun-cotton from molding. It is hoped, however, that past experience in packing may lead to such improvements as will prevent the development of this growth, which slowly destroys the gun-cotton.

Two capacious magazines have been constructed on Rose Island for the storage of the gun-cotton. The small wooden structures which had been previously used were found to become too warm during the summer months. Two of the large casements of the uncompleted fort have been fitted up for this purpose. Each is capable of containing 100 tons of explosive, or more than will ever be in store, but it was considered advisable to have a separate magazine for gun-cotton that had developed any mold and thus prevent, if possible, its extension to the other gun-cotton.

Extended investigations have been made and reported to the Bureau concerning the method of drying gun-cotton and the best method of packing it in the torpedo-cases, and these investigations have led to the adoption of changes in previous practice in these matters.

TORPEDO OUTFITS FOR SHIPS.

New boat-fittings for torpedoes are being made for trial with the expectation of diminishing the number of men required to properly handle the boat and torpedoes in

* Part of the gun-cotton for expedition was sent directly to New York, and was not taken up on the books here until the expedition returned.

action. It has also been recommended that the torpedo be so far modified in form as to place the explosive in a compact mass and to somewhat increase the quantity employed; also to make the contact circuit-closing arrangement attachable to any torpedo, and thus render it possible to use all torpedoes either as contact or service torpedoes.

The means of firing has been changed, by the Bureau's authority, to a voltaic battery in place of the heavier dynamo machine.

PLANT.

The machinery, tools, &c., used in the manufacture of torpedoes and their explosives are in good condition and will be quite satisfactory after certain changes, already recommended to the Bureau, have been made. The two boilers, however, are worn out from long use. The Bureau has authorized new ones, but no satisfactory bid for their construction has been received.

The buildings are all in good condition, but an enlargement of the electrical laboratory and a separate building for the manufacture of fuses will be recommended.

INSTRUMENTS, ETC.

The electrical, chemical, and other instruments employed, both in investigations and instruction, are in good condition.

During the past year the electrical apparatus has been increased by the addition of two Helmholtz galvanometers, by Elliott Brothers; one Edelman galvanometer, with vibration case to adapt it to magnetic measurements; one Hartman galvanometer; one reading telescope with glass and wood scales; one Kohlrausch rheometer. Only slight additions to the instruments will be required in the near future, but the building itself should be enlarged, as is elsewhere recommended.

TRIANA AND BOATS

which have been made under the special care of Lieutenant-Commander Converse have during the year been thoroughly overhauled. The hull of Triana inside below the water line has been carefully cleaned in every part and painted. The engines have been taken apart, valves reground, steam joints renewed, &c. The deck has been recalced and the deck and upper works painted. The vessel, machinery, and boilers are now in good condition, except where a few rivets in the hull have been broken by the explosion of torpedoes.

The two steam launches also used for purposes of instruction were placed in thorough repair before the summer course commenced, and although much shaken by the repeated explosions, will be again put in good repair. These boats, however, are entirely too slow and noisy for use as torpedo boats; others are recommended.

THE LIBRARY

has been arranged and partially catalogued by Lieutenant-Commander Maynard, in addition to his other duties. It has been increased by 134 volumes and 8 pamphlets. Of this number 4 are on the subject of explosives, 18 upon electricity, 17 upon chemistry, 16 upon physics and engineering, 79 upon miscellaneous subjects. The number of periodicals has been increased to 34, all relating more or less directly to the work of the station. It is confidently believed that in no other way will the service receive so large a return for a moderate outlay as in well-selected books and periodicals bearing upon this professional work. The library now contains 1,187 volumes. During the year 127 volumes have been bound. A card catalogue has been commenced and now numbers 1,400 cards.

SUMMER COURSE.

On June 1 the following officers reported for instruction in torpedoes:

In attendance.—Capt. Byron Wilson; Commanders Silas Casey and George W. Hayward.

Under instruction.—Lient. Commanders George W. Pigman, C. H. Rockwell, George E. Ide, and Lonis Kingsley; Lieuts. J. M. Miller, F. H. Delano, A. B. Speyers, J. J. Hunker, and C. A. Foeter; Lieuts (junior grade) John O. Nicholson and John A. Shearman; Ensigns Henry Minett, W. A. Gill, J. B. Cahoon, S. D. Greene, and J. B. Jackson; First Lient. G. F. Elliott, U. S. M. C.; Second Lient. F. E. Sutton, U. S. M. C.; Gunners R. H. Cross, T. B. Watkins, George Fouse, James Hayes, and C. B. Magruder.

In carrying out the views of the Bureau, and in accordance with the accumulated experience of the station, the course for the past summer was modified by making it consist of more practical work than formerly, and by reducing the study of theoretical chemistry and electricity, at the same time furnishing the class with printed copies of such lectures as were necessary in addition to the text-books used, and dispensing altogether with the copying which had proved so tiresome to previous classes. These changes, here roughly outlined, have proved to be a decided improvement, as was anticipated, and it is recommended that they be continued.

The ground covered by the summer course was much the same as in the past years, with the changes noted.

These changes have rendered it possible to give more time to the work of placing mines, in creeping and countermining, and in the use of search lights against torpedo boats. Our experience upon the last named subject has suggested one or two practical points which may be stated here.

(1) Search lights, to be most effective, must be mounted near the water-line in order that the beam may be nearly parallel to the surface of the water. A difference of 8 feet in the height of the light was found to make a marked difference in its efficiency.

(2) Search lights will be of comparatively little use when there is even moderate motion on the ship.

(3) To furnish protection against torpedo boats, the number of lights should at least equal the number of boats making the attack, and even when this is the case the chances are still greatly in favor of the attack.

The facilities for giving instruction in this course are good with a few exceptions, which should be remedied as soon as possible. The principal of these defects is the want of suitable torpedo boats for carrying the spar torpedo, and an opportunity to practice in the attack and defense of a vessel protected by the best modern appliances.

ADVANCED COURSE.

During the last year, from September until May, the class consisted of four members. This year there are five. As this course is intended to impart a thorough knowledge of the subjects taught, I would like to see carried out the recommendation made to the Bureau in a special report concerning the selection of the members for this course.

In both courses the officers have shown commendable zeal in availing themselves of the opportunities for acquiring information.

The plan of combining the commissioned and warrant officers in one class during the summer has worked well. The gunners did not receive instruction in high-speed engines, as it was not considered that they had the necessary preparation for such instruction nor was the knowledge likely to be required in their professional duties. This plan of associating the officers should be continued.

CONTINUOUS-SERVICE CERTIFICATE MEN.

Commencing on the 15th of June last, there has been received from time to time a selected class of seamen for instruction in torpedo work. The number has now reached twelve. The after-berth deck on board the *Triana* has been fitted for their accommodation. During the summer they participated in all of the work of the class of officers, and with them received special instruction in diving. They have all been down in the armor several times. Those who have joined since the course was finished have been instructed by those who had the advantage of a professional diver. It is intended to make this instruction continuous under the direction of Lieutenant-Commander Converse, so that it will not again be necessary to employ a professional diver to instruct.

During the summer six officers were down in the armor, some of them several times, and in four fathoms of water.

The continuous-service men are now assigned to different duties in connection with the manufacture of explosives, the manufacture and care of torpedoes and fittings, in experimental work with explosives, in the museum and the electrical laboratory. At each of these stations they remain one month receiving special instruction from the officers in charge of the department; at the end of the month the stations are changed, each man filling all the positions in turn. The men have shown themselves intelligent, obedient, and anxious to learn.

RECOMMENDATIONS.

I respectfully submit the following recommendations covering some of the more urgent needs of the station and service in connection with torpedoes:

(1) That there be purchased for the station two steam-launches specially made for carrying spar torpedoes. They should be built of steel not more than 45 feet long,

capable of carrying the service fittings for two torpedoes and a small steel shield not to weigh more than 350 pounds. They should have compound condensing engines capable of giving a speed of 15 knots. The success of a torpedo attack will in the future depend so much upon the speed of the boat that it is necessary to give officers an approximate idea of the conditions that will prevail in time of war. They should become accustomed to handling boats at high speed. This necessity is recognized and acted upon by every nation in the world except our own. This leads to my second recommendation.

(2) That every ship in the service, of 2,000 tons or more of displacement, be fitted with such a torpedo-boat as described above. It is folly to supply our ships with torpedoes to be used in such boats as are at present supplied to the service. Their lack of speed and noise of escaping would insure their destruction by a moderately watchful enemy. This appears such an urgent need that I hope the Bureau will strongly advocate the construction of at least fifty of these boats. There would be no difficulty in building them in this country; and they would form a powerful auxiliary in the defense of our coast.

(3) As the Bureau has repeatedly recommended the purchase of the Whitehead torpedo, it is only with a view of placing my opinion upon record upon the subject that I now recommend the purchase of at least ten first-class boats. These boats cannot now be built in this country, but there are builders who might succeed in securing in such small vessels a speed exceeding 20 knots if they had boats from the best English builders to guide them in the work. A prudent preparation for the future would require a large number of these boats. Both these last two recommendations may be considered as falling outside of my jurisdiction, but as they appear to me so important, I may be excused for making them.

(4) That a complete electric-light plant be purchased for the station. This is urged for several reasons; first, because it will soon become necessary to renew the lighting apparatus and it would be quite in the line of economy to light the island by electricity; second, the management of electric light circuits is one of the subjects that the Department expects to be taught at this station, and with a suitable plant such instruction can be given; without it it is not practicable. Our new ships are to be lighted in this way, and officers should be prepared to take proper care of them.

(5) That the Electrical Laboratory be increased so that proper use can be made of the instruments. The laboratory is a one-story building containing 977 square feet of floor surface, of which 665 square feet is occupied by the lecture and recitation room, leaving only 312 square feet for mounting the instruments. This is entirely inadequate and greatly reduces their usefulness or even renders it impossible to use them at all. The building should be increased by about 900 square feet of floor surface, which would require an addition of about 25 feet to the length of the building.

(6) That a separate small building be erected for the manufacture of fuses. The fuse-room is now in the machine-shop, and while only gunpowder fuses are manufactured it was quite safe to make them there. But since the present service detonator must be made of fulminate of mercury, a very dangerous explosive, I do not consider it prudent to carry on the work in such a valuable building as the machine-shop. For this purpose a small brick or wooden building, 20 by 20 feet, one story, would be sufficient.

(7) That a new ferry launch be purchased as early as practicable. The one now running has been in almost constant use for thirteen years, and is in many respects quite worn out.

Having been designated by the Hon. Secretary of the Navy on January 23, 1885, to represent the interests of the Navy Department in connection with the building of a sewer by the city of Newport through or across the breakwater at Goat Island, I have the honor to report that I have had several conferences with Colonel Elliott, Corps of Engineers, U. S. A., in reference to the matter. As indicated in the correspondence between Colonel Elliott and Mayor Franklin, of Newport, it was the intention to carry the main sewer of the city across the inner harbor of Newport, which was authorized by act of Congress approved December 20, 1884, through the breakwater and to terminate in 7 feet of water at a point 300 feet from the breakwater, the top of the sewer being only 1 foot under water at this point at mean low water, and consequently above water at low tides. The tracing of a portion of the harbor sent herewith shows the proposed direction and outfall of the sewer. As the effect upon the healthfulness of this island due to discharging the sewerage at this point depends upon the direction in which the currents carry the sewage, a series of observations were made extending over a considerable time to decide this question. A spar was anchored at the proposed outfall, and to it was attached a light cod-line 250 feet long, having floats at intervals. The direction and distance of these floats from the spar were plotted every hour.

The result of these observations was to establish the fact that during over 50 per cent. of the time the floats were driven in the direction of the island, thus showing that any floating refuse from the sewer would probably be deposited upon the west-

ern shore of this island. It would therefore appear desirable to carry the sewer out to deeper water and beyond the eddies which prevail at the proposed outfall. No action in the matter is demanded at present, because the city, at a recent election, declined to support a plan for raising the necessary funds to proceed with the work. As the matter now stands no steps will be taken by the city to construct the sewer until money is voted for the purpose.

Very respectfully submitted.

W. T. SAMPSON,

Commander and Inspector, in charge of Station.

Capt. MONTGOMERY SICARD, U. S. N.,

Chief of Bureau of Ordnance.

2256.

UNITED STATES TORPEDO STATION,
Newport, E. I.

SIR: In obedience to the Department's order of August 19, the Board appointed to witness the examination of the class of officers under instruction in the use and manufacture of torpedoes at Newport, R. I., have the honor to submit the following report:

The examination extended over two days and part of a third. It was conducted in writing, and practical experiments in illustration were successfully made.

The Board was pleased to find that the recommendation of the Board of last year as to a change in the manner of instruction had been carried out.

The practice of writing copious notes from oral lectures, and smooth copies of the same, has been discontinued and printed lectures largely substituted, while the subject-matter taught has been much more practical; a beneficial result largely arising from the regular meetings of the inspector in charge and the instructors to discuss and decide all important points in connection with the course.

The Board is decidedly of opinion that the present course for the summer term is a great improvement over any that has preceded it, and that with such minor changes from time to time as experience may suggest there is little that remains open to criticism.

The present class consists of twenty-seven members, which number could very profitably be reduced to fifteen, as it has been the experience this summer that the number falling to the share of each instructor is too unwieldy for individual instruction, which is absolutely necessary in many cases.

Only four officers of the present class will be retained for advanced instruction, and it is believed by the Board that the above number could be increased to advantage to the service at large. Those officers showing the greatest proficiency in the usual course should be selected for the advanced course, and the Board is of opinion that it would be an incentive to those officers who have taken the advanced course to have their names designated in some way in the Navy Register.

The results of the experiments of all kinds impressed the Board not only with the ability of the instructors and the zeal of the class, but with the unfortunate lack of the requisite plant for thorough practical instruction.

In the practice with search lights in discovering attacking launches as witnessed by the Board, the efficiency of the lights in the hands of skilled operators was very evident, but the results from an instructive point of view as regards actual warfare were unsatisfactory, as not one of the three attacking launches was the equal of a modern torpedo-boat, and the two search lights could not do themselves justice since their engine and governor is designed for 45 pounds of steam in the cylinder, and only from 40 to 45 pounds could be obtained in the Triana's boiler, which is some distance away.

The Board is of opinion that a more perfect torpedo plant should be furnished and maintained, especially in regard to torpedo launches of the latest type and a greater number of pulling boats.

If more material could be obtained and a larger force employed, the element of time would in a measure be overcome, which is a very important item, considering the necessary briefness of the summer course.

In connection with additional torpedo plant, the Board would also recommend an incandescent lighting plant for the torpedo station, such as would be fitted in a man-of-war, since instruction in its care and use has become an essential portion of an officer's education, and the plant will come under the care of officers on board ship who have charge of the electric outfit.

There has been no practical work undertaken in defending a vessel against an attack from torpedo boats and torpedoes, except by the use of search-lights; there are no means or facilities afforded at the station for this purpose, a defect which should be remedied.



An important point of instruction during the summer was with reference to operating against submarine mines and obstructions, and although little was done in this particular, owing to the want of proper means, still enough was accomplished to show the importance of having a knowledge in this respect, and to call the attention of the class to the great importance of the subject.

In conclusion, the Board would respectfully state that although a written examination possesses advantages over an oral one for the satisfaction of instructors or a permanent board of experts, still for a temporary Board, such as we represent, the mere witnessing of such an examination is not entirely satisfactory. We are of opinion that it would be advantageous to have a short oral examination of the class by the instructors in the presence of the Board, either in place of or in addition to the written one. While the schedule of instruction now pursued is eminently practical and satisfactory, and the officers under instructions seem pleased with it, a fair idea of the proficiency of the different members of the class can only be obtained by a careful study of the examination papers; these papers are necessarily quite voluminous, and as in addition the officers are detached on the day on which they have finished writing their last papers, any opportunity of conversation with them after their papers are examined is impossible.

We have the honor to be, very respectfully, your obedient servants,

L. A. KIMBERLY,

Commodore, U. S. N., President of the Board.

O. A. BATCHELLER,

Commander, U. S. N., Member.

F. M. BARBER,

Lieutenant-Commander, U. S. N., Member.

Capt. MONTGOMERY SICARD, U. S. N.,

Chief of Bureau of Ordnance, Navy Department, Washington, D. C.

NO. 13.—BUREAU OF CONSTRUCTION AND REPAIR.

NAVY DEPARTMENT,
BUREAU OF CONSTRUCTION AND REPAIR,
Washington, D. C., October 15, 1885.

SIR: In obedience to the Department's instructions of the 1st of August, 1885, I have the honor to submit my annual report for the fiscal year ended June 30, 1885, showing the work performed and the amounts expended, together with estimates of the amounts required for the purposes of this Bureau for the fiscal year ending June 30, 1887.

The estimates for the expenses of this Bureau, as given in the statement marked A, are in accordance with existing laws. The recommendations on this statement for increase of the salaries of the chief clerk of the Bureau, the draftsman, the assistant draftsman, and the assistant messenger are respectfully submitted to your favorable consideration.

The chief clerk, under the law, acts as chief of the Bureau in the absence of that officer, and must be competent to take charge of the Bureau. His duties are arduous, and fully deserve the salary herein estimated (*viz*, \$2,250), which is the same as that paid to chief clerks in other Departments who are authorized to act in the absence of their chiefs.

The draftsman has charge of the drawing-room; and, as his duties and responsibilities are certainly much greater and of more importance than those of the draftsman of the Bureau of Steam Engineering, who is paid \$2,250 per annum, this increase is submitted as just and proper in the case.

The assistant draftsman receives a smaller salary than is paid to per diem draftsmen in the navy-yards, while his duties are about the same. An increase of his salary is also submitted.

It is also recommended that the assistant messenger of the Bureau be restored to his former rank of messenger, with the pay thereof. He is an intelligent and capable man, and his long service in the Bureau makes him valuable.

The recommendation for three additional draftsmen is also submitted. This Bureau is now allowed but two draftsmen. In order to carry on the work of designing new ships, it is absolutely and indispensably necessary that the additional force asked for be allowed.

The estimate for the pay of clerks and writers at the several navy-yards, in statement marked E, is for services which are indispensable for the proper and systematic prosecution of the work which is to be done at the yards by this Bureau. Each and every clerk and writer has specific duties to perform, which are not affected by the quantity of work doing at the yard. The same number of blanks are to be filled, and the same number of reports have to be made and sent to the Bureau for its information, without regard to the quantity of work on hand.

The estimate marked B is for the general repair of vessels at navy-yards and on foreign stations, purchase of stores, materials, machinery, rights of patented articles, and tools of all kinds; preservation of materials and stores, and for the general care and protection of the navy in the line of construction and repair.

The appropriation for last year, under this estimate, was much too small to permit of carrying on the repairs of vessels at home and abroad, and purchasing the necessary materials, during the entire fiscal year; and work which was in progress was, consequently, almost entirely suspended, from time to time, for want of the necessary funds to complete it. It is more than probable that the same difficulty will occur this year.

Since the abolition, a few years since, of the custom of procuring our supplies by annual schedules, for want of sufficient appropriation, the stock has become so much reduced, from lack of funds to replenish it, that nearly all the materials now required for work have to be purchased for specific objects. The revival of the system of annual schedules would obviate this difficulty; it would induce greater competition in furnishing the annual supplies, and would give lumber materials an opportunity to become thoroughly seasoned before being used. For this purpose, and in view of the large amount of work which will doubtless have to be done in the navy-yards, the Bureau has asked for an increased appropriation, the amount asked for being none too large for the attainment of the desired object.

The estimate marked C is for completing the four double-turreted monitors, Puritan, Terror, Monadnock, and Amphitrite. The amount required for this purpose is \$2,923,656, divided as follows:

Puritan	\$955, 342
Terror	627, 288
Amphitrite	639, 584
Monadnock	701, 442
	2, 923, 656

The estimate marked D is for "Increase of the Navy," and asks for \$5,000,000 for building the hulls of new steel vessels, and \$150,000 for extra tools required in navy-yards for building iron and steel vessels.

It is recommended that the new steel vessels contemplated under this head consist of one of 2,000 tons, one of 2,400 tons, one of 3,600 tons, one of 5,000 tons, one of 7,500 tons, and two of 800 tons displacement.

The 7,500-ton ship should be a sea-going armored vessel of the following general dimensions, &c.:

Length between perpendiculars	feet..	320
Breadth, extreme	do ..	64
Mean draught	do ..	24
Displacement in sea water	tons..	7, 500

The ship should be designed with a covered gun deck.

The main battery should be equal to four 10-inch and six 6-inch breech-loading rifles. If this battery is agreed upon, the 10-inch guns should be mounted on the spar deck *en barbette* one on center line of ship forward to have direct-ahead fire to 50 degrees abaft the beam on either side; one on center line of ship aft, with direct-astern fire to 50 degrees forward of beam on either side, and one on either broadside, with an arc of 180 degrees fire; thus having three 10-inch guns direct ahead, direct astern, and on broadside. The barbettes for all 10-inch guns to be built of armor plates not less than 8 inches in thickness.

On the main or gun deck should be mounted the eight 6-inch guns, two so arranged as to have a direct-ahead and broadside fire, two a direct-astern and broadside fire, and the remainder mounted in broadside; all to be mounted on central pivot carriages, supporting segmental steel shields, not less than 3 inches in thickness.

The secondary battery should consist of fourteen Hotchkiss cannon and the necessary number of boat guns, and a full complement of torpedoes, to discharge both above and below water line.

The vessel should be built of steel, with bronze stem and stern post, and the bottom sheathed with yellow pine and coppered, as I deem this a matter of vital importance, in order that the vessel's bottom may be kept clean for a much greater length of time, obviating the necessity for going into dock to clean and paint the same so frequently, and the speed of the vessel not be impaired by fouling at a time when speed might be of the utmost importance.

The bow should be of a modified ram-shape, and possess sufficient strength that the vessel might be used as a ram. A double bottom should extend for the space occupied by the machinery and magazines. At the water line there will be a belt of armor not less than 10 inches in thickness and 8 feet in depth, tapered from the protective deck-line to 7 inches in thickness at the lower edge, and extending fore and aft for the length occupied by the engines, boilers, and magazines; the athwartship bulkheads at either end of belt to be 9 inches in thickness.

There will be a water-tight protective steel deck extending throughout the length of the ship, covering the engines, boilers, magazines, and steering gear, and strengthening the ram bow; this deck forward and abaft the armor belt to be in thickness 3 inches, and 2 inches over the armor belt amidships. To have a projecting main keel, also bilge keels, extending well fore and aft.

The vessel to be brig-rigged, with head booms, and to have a plain sail area of about 10,500 square feet.

The ship should have twin screws, with the latest and most improved types of engines and boilers, capable of developing 8,500 I. H. P., and with that power the vessel to have a speed on the measured mile trial at her normal draught of water of $16\frac{1}{2}$ knots. Capacity of coal bunkers, 1,200 tons.

The principal dimensions of the proposed 5,000-ton ship (for a belted cruiser) should be:

Length between perpendiculars.....	feet..	305
Breadth, extreme	do ..	57
Mean draught.....	do ..	21½
Displacement in sea water, about	tons..	5,000

The ship to be designed with a covered gun-deck.

The main battery should be equal to two 10 inch and eight 6-inch breech-loading rifled guns. The two 10 inch guns should be mounted on the spar deck, one forward and one aft, protected by steel shields or otherwise, as may be thought best; one of these guns to have a fire from direct ahead to 50 degrees abaft the beam on either side; the other to have a fire from direct astern to 50 degrees forward of the beam.

On the gun-deck there will be mounted eight 6-inch guns, two having a direct-ahead and broadside fire, two direct-astern and broadside fire, and the others in broadside with a train of fire of 70 degrees forward and abaft the beam. All the guns on the gun-deck to be mounted on central pivot carriages supporting segmental steel shields not less than 3 inches in thickness. The secondary battery to consist of not more than fourteen Hotchkiss cannon and the necessary boat guns.

To be fitted to discharge a full complement of torpedoes, both above and below the water line. The vessel should be built of steel, with a bronze stem and stern-post; bottom sheathed with wood and coppered.

The bow should be of a modified ram-shape, and possess sufficient strength that the vessel may be used as a ram. A double bottom should extend throughout the space occupied by the engines, boilers, and magazines. To be protected at the water-line by a belt of armor not less than 10 inches thick amidships, with a depth of 5½ feet, extending fore and aft for the length occupied by the engines, boilers, and magazines; also to have a water-tight protective steel deck extending throughout the length of the ship covering the engines, boilers, magazines, and steering gear, and strengthening the ram-bow; forward and abaft the armor belt to be 3 inches in thickness on most exposed parts; above armor belt amidship, 2 inches. To have a projecting main keel, also bilge keels, extending well forward and aft. To have two masts for signal purposes and for mounting machine guns in the tops.

The ship should have twin screws, with the latest and most improved types of engines and boilers, capable of developing at least 8,500 I. H. P.; the vessel to have a speed on the measured mile of 17½ knots; coal capacity, 1,000 tons.

The principal dimensions of the 3,600 ton cruiser should be:

Length between perpendiculars.....	feet..	300
Breadth, extreme.....	do...	46
Mean draught.....	do...	18½
Displacement in sea water about.....	tons..	3,600

The ship should be designed with a covered gun-deck.

The main battery should consist of two 8-inch and six 6-inch breech-loading rifled guns, the two 8-inch guns to be mounted on the spar-deck, on central pivot carriages, supporting segmental shields, or otherwise as may be decided upon; one on the center line of ship forward to have a direct-ahead fire to 50 degrees abaft beam on either side; and one on center line aft having direct-astern fire, and 50 degrees forward of beam on either side. The 6-inch guns to be mounted on the gun-deck, two to have a direct ahead and broadside fire, two a direct-astern and broadside fire, and the others in broadside with a train of 70 degrees before and abaft the beam; all to be mounted on central-pivot carriages, supporting segmental steel shields, of not less than 3 inches in thickness.

A full torpedo outfit to be provided. The secondary battery to consist of eight Hotchkiss cannon, and the necessary boat guns.

The vessel should be built of steel, with bronze stem and post, bottom sheathed with yellow pine and coppered. To have a protective steel deck the entire length of the vessel, and in thickness from 1½ to 2 inches on the most exposed parts, covering engines, boilers, magazines, and steering gear. The vessel to have a projecting main keel, also bilge keels extending well fore-and-aft.

To be fitted with two masts for signal purposes, and arranged to carry fore-and-aft sail, having an area of about 1,100 square feet, and fitted with military tops for machine guns.

The capacity of coal-bunkers to be from 600 to 750 tons.

The vessel to have twin screws, with the latest and most improved type of boilers and engines, capable of developing 7,500 I. H. P., and on normal draught of water the speed on the measured mile to be 18 knots.

The principal dimensions of the 2,400-ton cruiser should be:

Length between perpendiculars.....	feet..	250
Breadth, extreme.....	do...	42
Mean draught of water.....	do...	17
Displacement in sea water.....	tons..	2,400

The vessel to be designed with an open gun-deck, poop, and fore-castle; built of steel, with bronze stem and stern post; bottom sheathed with yellow pine and coppered.

The main battery should consist of eight 6-inch and two 5-inch breech-loading rifled guns, four of the 6-inch to be mounted in sponsons, two having a direct-ahead and broadside fire, and two a direct-astern and broadside fire; the remaining 6-inch placed in broadside, having an arc of fire of 140 degrees; all mounted on central pivot carriages, supporting segmental shields, or otherwise, as may be decided upon. The two 5-inch guns to be mounted in combined sponsons and recessed ports, under fore-castle deck, on central pivot carriages, having direct-ahead and broadside fire. The secondary battery to consist of eight Hotchkiss cannon, and the necessary number of boat guns. The necessary torpedo outfit will be provided. To have a protective deck over boilers, engines, and magazines. Double bottom to extend the length of the boiler and engine space. Bunker capacity about 450 tons of coal. To be bark-rigged, having a plain sail area of 14,500 square feet.

The ship to have a single screw, with engines and boilers of the latest and most improved type, capable of developing 3,500 I. H. P. The vessel at her normal draught on the measured mile trial to have a speed of 15½ knots.

The principal dimensions of the 2,000-ton cruiser should be:

Length between perpendiculars	feet..	215
Breadth, extreme	do...	40
Mean draught	do...	16
Displacement in sea water, about.....	tons..	2,000

The vessel to be designed with an open gun-deck, poop, and fore-castle. Built of steel, with bronze stem and stern post. Bottom sheathed with wood and coppered.

The main battery should be equal to eight 6-inch breech-loading rifle guns, four of which should be mounted on sponsons, two to fire direct ahead and in broadside, and two direct astern and in broadside, and four in broadside with a train of fire of 70 degrees before and abaft the beam; all to be mounted on central pivot carriages, supporting segmental steel shields of not less than 2 inches in thickness. Secondary battery to consist of six Hotchkiss cannon and the necessary number of boat guns.

The necessary torpedo outfit to be provided.

There will be a defective steel deck running the entire length of the boiler, engine, and magazine space.

The double bottom will extend the length occupied by boilers and engines.

To be barque-rigged, with a plain sail area of about 10,000 square feet. Bunker capacity, 300 tons of coal.

To have a projecting main keel, also bilge keels extending well fore and aft.

The ship to have a single screw, with boilers and engines of the latest and most modern type, capable of developing 2,300 I. H. P. The vessel to have a speed on the measured mile trial at her normal draught of water of 14 knots.

The two 800-ton ships are intended to take the places of the old wooden sailing ships in the training squadron, and should be of the following dimensions, &c.:

Length between perpendiculars	feet..	165
Breadth, extreme	do...	30
Mean draught	do...	12
Displacement in sea water.....	tons..	800

To be built with steel frames and beams, planked with two thicknesses of yellow pine and coppered. To be barque-rigged, having a plain sail area of about 7,000 square feet.

Coal capacity, 175 tons.

Engines and boilers capable of developing 1,000 I. H. P., and to have a speed of 12 knots. Single screw.

Battery to consist of four 5-inch low-powered breech-loading rifle guns, mounted in sponsons on central pivot carriages.

Secondary battery of such number of Hotchkiss cannon as may be deemed best to carry, and the necessary number of boat guns.

The Bureau has estimated for the necessary amount of money to complete the work in construction department on the double-turreted monitors Puritan, Terror, Amphitrite, and Monadnock, and trusts that Congress will appropriate the amount asked for (\$2,923,656), that these vessels may be completed. The machinery of the Puritan has been erected, and the dock trial had, and contracts have been made by the Bureau of Steam Engineering for the erection of the machinery in the Terror and Amphitrite, but the work under this Bureau remains at a stand-still.

I cannot too strongly urge the completion of these vessels, in all respects, at an early day, as they will afford as good vessels of their class as are owned by any nation, and are, in my opinion, the best type of coast and harbor defense vessels in existence to-day. It will require at least a year to obtain their side and turret armor after it is authorized. It therefore seems very necessary that money for armor, if for nothing more, should be appropriated at an early day, in order that contracts for securing it may be made with as little delay as possible. When completed we will have five splendid coast and harbor defense iron-clads. Should occasion require it, they can be sent to distant points; their seaworthiness has been well tested in the past.

The old sailing sloops of war Saratoga, Jamestown, and Portsmouth are rapidly approaching such a condition that, ere long, they will require larger expenditures of money for their repair than the law allows. The loss of these vessels would leave the service without suitable training ships. To meet this emergency I respectfully recommend the construction, at an early day, of two composite built, auxiliary steam-power, bark-rigged vessels, of fine models, 800 tons displacement, and light sparred, designed expressly for training boys for the naval service. An amount sufficient for this purpose is included in the estimate for "Increase of the Navy."

The armor for the turrets, pilot-houses and armored stack for the double-turreted monitor Miantonomoh, contracted for by this Bureau, through William H. Wallace & Co., with Messrs. John Brown & Co., of the Cyclops Works, and Messrs. Charles Cammell & Co., of Sheffield, England, have all been delivered at the Brooklyn navy-yard. The work of altering the decks and the internal arrangements of the vessel, to accommodate the new roller base turrets, is well in hand, and the turrets are in course of erection in the iron-plating shop of the yard.

The following statement will show the condition of vessels at the several navy-yards on the 1st of July, 1885:

NAVY-YARD, PORTSMOUTH, N. H.

Vandalia.—Estimated cost to complete, as reported by Naval Constructor T. E. Webb:

Labor	\$23,044 98	
Materials	6,136 76	
		\$29,181 74

The constructor states "the estimated time to complete this ship is forty-five days, with such a qualified and experienced force as can be economically employed."

Boston.—Steel cruiser, estimated cost to complete furniture, stores, blocks, boats, and spars, \$5,000; time, forty-seven days.

Constitution.—A sailing frigate, well housed over, and in fine condition for a receiving ship, but not in commission.

NAVY-YARD, BOSTON.

Wabash.—Receiving ship; requires to be sheathed, and the house over her to be extended as to cover the poop-deck. A survey has been held upon her, a copy of the report of which was sent to the Department under date of June 18, 1885. Estimated cost, \$11,894.20; time, two months.

NAVY-YARD, NEW YORK.

Tallapoosa.—The survey held on this vessel on November 29, 1884, estimated her repairs to cost \$43,336, and there has been expended since then the sum of \$22,814.46. It is estimated she can be completed in about sixty working days.

Richmond.—The survey held on this vessel, under date of October 2, 1884, estimated her repairs to cost \$48,624, and the time required to complete, with as many men as can be worked to advantage, three months.

The Department authorized the repairs under date of October 21, 1884, but the work has not yet been commenced.

Essex.—A survey was held on this vessel April 14, 1885, and the Board reported that the estimated cost of the repairs was \$41,731.69, and for the changes recommended \$2,170. The time necessary to make the repairs, with a strong force, is estimated to be ninety working days.

Brooklyn.—This vessel can be ready for sea in three weeks; the work remaining to be done being principally to replace some of her furniture which was taken for the Pensacola, and to finish the pantry. It is estimated that \$5,000 will complete it.

Nantucket.—Single-turreted monitor. This vessel is now in ordinary. Naval Constructor Mintoyné estimates that she can be put in condition for service by expending about \$1,294.50. Time, two weeks.

Intrepid.—This vessel was formerly built for a torpedo vessel, and is now being converted into a gunboat. She is of iron, and will make a valuable acquisition, as a gunboat, to the naval service. She was surveyed in July, 1883, and the cost of alteration, under this Bureau, was estimated at \$92,150. Up to the present time about \$14,115.07 has been expended upon her in labor and materials. The delay in completing this vessel has been caused by having to give preference to more important objects of work, and in consequence of limited appropriation. She could be finished in four months and launched if found necessary to do so.

Thetis.—This vessel requires renovating, repainting, docking, painting of bottom, cleaning and varnishing furniture, repairs to boats, minor repairs to hull, spars, and blocks, calking, &c. It is estimated the work will cost about \$4,000, and can be done in a short time if the vessel is wanted.

Miantonomoh.—The armor for the turrets of this vessel and the pilot-house plates have all been delivered. The alteration in the deck, to receive the after turret, is completed and the shell of the turret is being erected. The work of cutting out the deck for the forward turret is well in hand and the turret is in course of erection in the shop. The work should be completed this year.

Alarm.—Torpedo boat. Supposed to be ready for service. Now in ordinary.

Ticonderoga.—In ordinary. Condemned and recommended to be sold.

Alliance.—As the new boilers for this vessel are nearly ready at Norfolk, the Bureau recommends that she be sent there and docked, in order that the Bureau may have her surveyed. It is also recommended that the necessary repairs be made to this vessel at the Norfolk yard.

Vermont.—A wooden line-of-battle ship that has been put in condition for, and is now used as, a receiving ship. She requires some slight repairs and painting to complete her.

Catalpa.—A wooden tug, purchased during the war. This vessel has lately been surveyed, and the estimated cost for repairing her, under this Bureau, is \$4,932. The Bureau deems it unwise to put on this vessel the repairs called for, believing, if it is attempted, that the 20 per cent. allowed by law will be exceeded.

NAVY-YARD, LEAGUE ISLAND.

Saint Louis.—A sailing sloop of war, housed over, and in fair condition for a receiving ship, for which purpose she is now used.

Pilgrim.—Condemned by board of survey, and her name stricken from the register. Recommended to be sold.

Nahant, Jason, and Montauk.—Single-turreted monitors. In ordinary at the yard. The estimated costs to put them in condition for service, under this Bureau, are as follows:

Name.	Cost.	Time to complete.
		Days.
<i>Nahant</i>	\$35,806 06	60
<i>Jason</i>	36,113 36	60
<i>Montauk</i>	23,999 68	60

NAVY-YARD, WASHINGTON.

Wyandotte.—Single-turreted monitor. The estimated cost to put her in condition for service is \$17,255.

Saugus.—Single-turreted monitor. The cost to put her in condition for service would probably exceed \$200,000. The Bureau believes it would be injudicious to repair this vessel, and recommends that she be surveyed by the Board of Inspection, and, if condemned, that she be sold under the law of August 5, 1852.

Rescue.—An iron tug. Has been examined and found to be very unsafe for further service. This vessel should be surveyed by the Board of Inspection, under the law of August 5, 1882.

NAVY-YARD, NORFOLK.

Fortune.—An iron tug. This vessel is under repair, and the naval constructor estimates that it will require \$5,501 to complete her.

Speedwell.—An iron tug. The deck of this vessel requires calking, and some repairs of a minor nature to her boat davits, &c. Estimated cost, \$300.

Atlanta.—Steel cruiser. The furniture of this vessel, which was burned, will all have to be made anew. The naval constructor estimates that it will cost \$7,998.27 to complete it; time, 90 days. The blocks for this vessel are estimated to cost \$2,055 to complete them; time, two months.

Franklin.—Receiving ship. In fair condition for this purpose.

Mayflower.—An iron tug of the Speedwell class. She has been put in order, and is now in ordinary. The Bureau recommends that she be sent to the Washington yard, and when occasion requires she can be used for freighting or for yard purposes.

Ajax, Canonicus, Catskill, Lehigh, Mahopac, Manhattan.—Single-turreted monitors, iron hulls. These vessels are at City Point, on the James River. By the Bureau's order of the 28th of May, 1885, they were carefully examined, so far as it was possible without docking them, and the following are the estimated costs to put them in condition for service:

Name.	Cost.	Time to complete.
		Days.
<i>Ajax</i>	\$15,710 00	35
<i>Canonicus</i>	19,502 00	45
<i>Catskill</i>	6,625 00	35
<i>Lehigh</i>	10,526 00	36
<i>Mahopac</i>	7,853 00	35
<i>Manhattan</i>	10,445 00	36

In order to fully ascertain all the defects in these vessels, it would be necessary to dock them and examine them inside and out. This would involve opening up the vessels inside, so that they could be scaled and examined, which would doubtless show up many defects that would largely increase the estimates already made.

NAVY-YARD, MARE ISLAND, CAL.

Adams.—The assistant naval constructor at the Mare Island yard has carefully examined into the condition of the work on this vessel, and reports that, as near as can be ascertained, she will cost for labor and material to complete \$24,000, and that it will require four months to do the work.

Lackawanna.—This vessel has been surveyed, and the report is now in the Department, having been submitted for its information and action. The cost to fit this vessel for sea is estimated at \$70,000, or 16 per cent. of the cost of a new ship of this class.

The Bureau does not recommend the repair of this vessel, believing that if it is attempted the cost will very much exceed the limit of the law (20 per cent.), but recommends that she be used as a receiving ship, and that the present receiving ship, the *Independent*, be surveyed and sold.

Camanche.—A single-turreted monitor. Iron hull. Built in 1862. In ordinary. By report of a board of survey on this vessel in 1882 it was ascertained that it would cost \$3,460 to fit her for service, under this Bureau.

Cyane.—A wooden sailing sloop of war, whose name has been stricken from the register. She is now in ordinary, and ship-keepers are employed to take care of her. The Bureau recommends that she be sold under the act of August 5, 1882.

Ounalaska.—In ordinary. This vessel was seized on the Mexican coast for violation of the revenue laws, and turned over to the navy-yard.

Monadnock.—An iron double-turreted monitor, built at Vallejo. She is in an unfinished condition, and is moored alongside the wharf. No appropriation made to finish her as yet.

Independence.—An old wooden line-of-battle ship, in bad condition, and in need of extensive repairs to fit her for further use, even as a receiving ship. The Bureau recommends that she be surveyed under the act of August 5, 1882, and if condemned, as she should be, that she be sold, and the *Lackawanna* take her place as receiving ship.

In my opinion, it should be the policy of the Government to maintain one large navy-yard, combining in itself the advantages and facilities of all the others.

League Island was presented to the Government by the authorities of Philadelphia, who incurred considerable expense in purchasing the rights of other parties. This site was given with the understanding that a navy-yard would be established; and, acting upon the idea, the United States have already expended there more than a million of dollars.

The advantages of League Island have been fully discussed heretofore, by persons well qualified to judge, and the opinions of such well known naval officers as Admiral Porter, Vice-Admiral Rowan, Chief Naval Constructor John Lenthall, Chief Engineer J. W. King have always been in favor of locating a navy-yard at this place.

If I, on this occasion, enter more fully into details in reference to this location than to other yards, it is because of its importance, the large expenditures that will be necessary in the future, and the fact that most of the other navy-yards are long-established institutions and no argument is needed to show their necessity.

It has long been the opinion of experienced naval officers that the country needs at some point a large establishment possessing all the requirements for building and preserving an iron or steel navy, such as will be suitable for the future wants of this great nation. With the exception of League Island, all our navy-yards on the Atlantic coast are deficient in a fresh-water anchorage, one of the first requirements towards preserving iron or steel vessels laid up in ordinary. They are, besides, deficient in dock-yard accommodations, including means for docking ships and constructional resources.

At the close of the war the use of League Island became very apparent. The Government possessed a considerable number of iron-clads, which required to be laid up in fresh water and secure from floating ice. These vessels were, therefore, sent there, and remained, with little, if any, deterioration until required for service.

The Government must always expect to encounter opposition in the establishment of a navy-yard, when it may conflict with the interests of trade; for notwithstanding the absolute necessity for efficient naval stations for the protection of commerce and commercial cities, the com-

munity is generally ready to sacrifice the interests of the Government to their own particular benefit.

League Island is a very eligible situation for a navy-yard. It is contiguous to a large city where plenty of skilled labor can be procured at will, and where stores of all kinds can be obtained at short notice. It is within easy reach of the great coal and iron mines of Pennsylvania, and while the navy-yard was in course of construction access could be had to the great shops along the Delaware for such pieces of machinery as the yard could not supply. The defensible position of the island is well established, and no further outlay in that direction is required.

Since the introduction of steam vessels in war the policy in establishing navy-yards has changed, and it is considered wise to place them as far as possible from the sea. These places our own vessels would have no trouble in reaching under steam, while an enemy would be harassed at every step by guns, obstructions, submarine mines, torpedoes, &c. This is a very strong point in the selection of this site for a navy-yard, and is one in which several of our yards are deficient.

In a war like that through which we have passed a very considerable portion of an iron vessel could be procured at the ordinary private establishments, but in a war where we would have to compete with the navies of the great European powers we should be obliged to build such large and expensive structures that the work could best be performed by a properly organized Government establishment.

So rapidly has the science of building heavy iron war vessels advanced in Europe that we have been left far in the rear for want of means by which other nations have arrived at such perfection in naval architecture and ordnance. One of the greatest difficulties under which our Navy has labored is the want of a settled policy with regard to our navy-yards, and the class of vessels to be constructed.

A board of civil engineers has carefully examined this yard and procured all necessary information. An objection raised against League Island is the difficulty of building granite dry-docks there; but this difficulty is readily overcome by substituting a similar dock to the one now in use by the firm of Cramp & Sons, of Philadelphia, or the one at Erie Basin, Brooklyn, N. Y., where all the largest ocean steamers and war ships of foreign powers visiting the port of New York are docked, and have been for the past twelve years. These docks can be built at a less cost and in less time than a granite dock, and when completed have greater advantages, and, in my opinion, be better adapted for the purposes of our yards both in building and repairing ships. A dock of such design is very much needed at League Island, and no time should be lost in its commencement, as the yard without such an auxiliary loses much of its usefulness.

A great defect in laying out many of our navy-yards has been that little consideration was given to the future requirements of the Navy, and the yards have accordingly been built up just as circumstances at the moment might suggest.

In a message to Congress on the 8th of December, 1863, President Lincoln said :

The change that has taken place in naval vessels and naval warfare since the introduction of steam as a motive power for ships of war demands either a corresponding change in some of our existing navy-yards, or the establishment of new ones for the construction and necessary repair of modern naval vessels.

The necessity for such a navy-yard, so furnished, at some suitable place upon the Atlantic seaboard has, on repeated occasions, been brought to the attention of Congress by the Department.

The building, repairing, and fitting of naval vessels can now be done well and economically at this yard; the best evidence of which is the superior manner in which the work on the Juniata, Quinnebaug, and Ossipee has been executed, it not being excelled in any yard. The want of a good dock is seriously felt at this yard, which, with some modern tools for steel-ship building, would prepare the yard to commence such work.

The Bureau has again asked for an appropriation of \$150,000 to enable it to purchase some of the most necessary tools to equip the League Island, Boston, Norfolk, Portsmouth, and Mare Island navy-yards for the purpose of building and repairing iron and steel ships. With the exception of the need of a few of the improved modern tools for these purposes, and the erection of plate and angle iron furnaces, there is no private establishment in this country which has better facilities, in all respects, for steel-ship building than the yards mentioned, and few which have as good.

The Brooklyn navy-yard is now in condition to commence and carry on, with some rapidity, the building of steel ships. The greatest efforts should be made to put all the other yards in the same condition with as much dispatch as possible.

The Government has means and appliances for carrying on all kinds of work connected with building, repairing, fitting, and equipping vessels of war which no private establishment could afford to have, and the character of the work done in its yards has never been questioned.

In case of a foreign war the Government would find that the same facilities and help could not be afforded it by private ship-builders as was furnished during our civil war, as most of the firms which then carried on wooden-ship building have ceased to exist; and to-day there are but few firms which, in the event of war, could commence and carry on, with any degree of rapidity, the construction of steel armored or unarmored vessels of war. It therefore becomes a necessity for the Government to put its yards in condition at once to meet any demand that might, in an emergency, be made upon it.

In the event of an appropriation being made for more steel ships, the Bureau hopes that at least one-half of the ships may be built in our navy-yards, in competition, as to cost and character of work, with outside establishments. It does not wish to be understood as opposing the building of naval vessels by private establishments under contract; it believes that one-half of the vessels appropriated for should be built by contract, but in competition with the Government navy-yards. The cost of work in the navy-yards can thereby be reduced, and the contractors and workmen in private establishments educated up to the requirements of a vessel for the naval service, which, at the present time, are understood by so few, as the work and fittings incident to such a vessel differ so materially from those of a merchant ship. By this means, in the event of a sudden call for vessels, private ship-builders would be capable of furnishing suitable ships for the naval service, while the Department, Bureau, and inspectors would have much less trouble in the execution of the work, and there would be less litigation than heretofore during and after the completion of the contracts.

One of the serious drawbacks at the present time, and one which, in the event of war, would cause us the greatest difficulty, is the need of better docking facilities.

At the present time the Essex is in the only dock at the Brooklyn navy-yard, and it is wanted to dock the Thetis, the latter vessel must either be put in a private dock or wait for six weeks for the Essex to be

repaired, so that she can be floated. This is the first yard in the country in point of size and importance, and it should have at least three docks. There can be no excuse that there are not good locations for them, as there are as good locations at this yard as could be wished for. Two modern wooden docks could be built, and in two years be ready for use.

A short time since it became necessary to dock the Tennessee, which was then at Hampton Roads, and as the dock at the Norfolk yard would not take a vessel of her length she was sent to New York. Certainly this condition of affairs should not be allowed to exist very long. The present dock should be lengthened, and one modern wooden dock, if not two of them, should be built at the Norfolk yard. Everything possible should be done to put this yard in first-class condition.

While the Portsmouth yard has a balance dock and marine railway, which will permit of taking a vessel out of the water and hauling her ashore, leaving the dock free to put another vessel on, there could, and should, be extensive alterations made to better its facilities. The dock basin should be enlarged so that at the head of it there would be three lines of ship-ways for building vessels on. When completed the vessels would be pushed down on the dock by the immense hydraulic ram now used there and the dock floated, and, when out of the basin, the newly-constructed vessel put afloat without danger of straining, as is often the case when vessels are launched. Buildings could then be placed over these slips, and all the necessary tools for ship work placed in them, with machinery and the necessary line shafting.

Independent of this a modern wooden dock, at least 500 feet long, should be built between the navy-yard island and Seavey's Island, which could be readily done at comparatively small cost. The water at its entrance would be ample for all docking purposes, and the natural excavation which now exists between the islands, with its solid-rock bottom, would very much reduce the expected outlay for this work.

At the Boston yard, the present dock should be lengthened, and two additional modern wooden docks built, there being the best possible facilities for this so far as good locations are concerned. Nothing is being done at this yard except caring for the immense stock of Government property now on hand there, and keeping in order the machinery and tools. This is one of the best, and probably the second best yard in the country; and if any new ships are to be built in the future in our navy-yards this yard should be utilized for that purpose. It has a fine set of buildings, first-class tools, and facilities of all kinds for doing work, and in its vicinity are to be found the best artisans in the country.

The Mare Island yard being the only one on the Pacific coast, should receive especial attention. Nothing that is now needed, or will be wanted in the future, to put this yard in a thoroughly effective condition for building or repairing iron or steel vessels, should be neglected. Independently of the stone dock now nearly completed, there should be built two modern wooden docks at least 500 feet in length.

The greatest necessity exists for having better docking facilities in all the navy yards. This is rendered more important on account of the frequency with which the steel unsheathed vessels will be required to be docked to clean and paint their bottoms. In the event of a foreign war this great deficiency would be seriously felt; perhaps more so than any other of our present wants; it is therefore worthy of grave consideration whether immediate steps should not be taken to place our navy-yards, in this respect, in the most thorough condition of effectiveness. While other nations are increasing their docking facilities, which are

greater in one of the English dock-yards than in all of ours combined, we are doing nothing but theorizing.

The subject of building dry-docks is one which the Bureau of Yards and Docks has to deal with directly; but this Bureau having so long felt the necessity of having more docks to use, particularly larger and more modern ones, has undertaken to introduce the subject here.

The Naval Academy is much in need of another practice or school ship, to take the place of the Dale, which has been condemned; and I again recommend that the Ticonderoga, now at the Brooklyn yard, be converted and used for this purpose, by removing her boilers and engines, and making the berth deck continuous. She could be made to answer admirably, and could be utilized for the purpose for which such a vessel is needed; while, if sold, she will be entirely lost to the naval service, and the proceeds of sale would be turned into the Treasury.

In its last annual report the Bureau alluded to the mission of Naval Constructor Hichborn to Europe, collecting information and plans illustrating the most recent foreign practice in iron and steel ship-building. His report is now in the hands of the Department. It is eminently satisfactory, and is sure to be of great practical value. It considers the national dock-yards of Great Britain, Germany, Russia, and France, and contains descriptions, and in many places plans, of the important vessels building therein, devoting particular attention to such as seem to fulfill the peculiar requirements of our own service; and through his labors the Bureau is fully prepared to duplicate in all essential particulars the much-lauded Esmeralda or the Riachuelo, should it be decided that such vessels are required.

The details, fittings, and equipment of naval vessels abroad are fully treated of; and under this heading ventilation, sanitary arrangements, and the electric light receive due consideration.

The importance of torpedoes and torpedo boats led Constructor Hichborn to closely examine the yards of the well known English builders, Thornycroft & Garron, and to compare their practice, with the result that the Bureau is now in possession of information upon this class of construction which will be of great utility should it be required to protect our coasts with a suitable flotilla.

In the British private ship-yards Constructor Hichborn was accorded opportunities of making thorough examinations of the several systems upon which the business is conducted, and his notes upon the management of labor in ship-yards, its wages, and the regulations to which it is subject, will be found of special interest. Much time was devoted to observing the improvements in shipbuilding tools, and a very complete collection of photographs of yard machinery, with prices by the leading foreign makers, enhances the general value of his work.

A number of large iron and steel works were examined, when such inspection could be accomplished without interfering with the main purpose of the tour. The growing use of steel castings in naval architecture received due investigation, and the principal armor-plate mills were visited, and important knowledge gained as to the making, shaping, and bending of heavy armor.

The Bureau takes pleasure in stating that Naval Constructor Hichborn was the recipient of the kind attentions of the leading naval architects abroad, to whose courteous liberality his mission owes a portion of its eminent success.

It is respectfully recommended that the report of Constructor Hichborn may be printed, in order that all who are interested in the affairs of the naval service may be benefited thereby.

In its annual report for 1883 the Bureau made allusion to the important subject of the education and appointment of assistant naval constructors. The consideration of this matter is so urgent, and the consequences of the present system so grave, that it is necessary to treat the subject at some length. The rapid extension of scientific methods in naval architecture has long been recognized. This Bureau years since expressed its opinion that "the highest education which we can give our assistant constructors will not be more than sufficient to enable them in the future to compete on fair terms with the constructors of England and France. But the term education must be understood in its fullest and broadest sense as comprising not only the science of naval architecture but the most thorough practical acquaintance with ship-yard management and manipulation. It is in supplying this requirement that our present method of recruiting the corps signally fails."

If it were necessary to support with authorities a proposition so obvious as a necessity of a double education for the naval architect, an education of the hands and eye and mechanical perception, as well as the mathematical and abstract functions of the mind, I might with propriety quote Mr. E. J. Harland, of the distinguished firm of Harland & Wolff, of Belfast, Ireland, when, in a discussion in the Institution of Naval Architects, he says:

If the naval architect enters his profession and follows it out on scientific principles simply, he will make a great mistake; and if he follows it out from a shipbuilder's point of view he will make a mistake. He has to be scientific and he has to be practical. We must not lose ourselves in science. I should be the last man in the world to say a word against it, but I think at the present time we are apt to make too much of what is called education. We are educating our children above what it is probable they will ever be able to utilize in after life. I contend that the sons of shipbuilders are over educated, and are apt to lose themselves in figures, because they are apt to follow the easier course of study, having books and papers before them, and neglect the workshop, and neglect coming in contact with those merchants who have to consider most carefully what classes of vessels will pay the best. I say that if a shipbuilder does not combine in his profession all these varied and sometimes opposing forces he will make a serious mistake and lower the value of his profession, not only as a profession, but also the value of it to the commercial community.

These remarks from one of the most progressive builders of the age, the pioneer in the construction of high-speed transatlantic liners, while mainly directed to the private ship-builders, seems to me in a great measure pertinent to those who are intrusted with the building of vessels for national defense.

It is impossible on this occasion to deal adequately with so ponderous a subject as technical education; briefly, let me be understood as its advocate within all reasonable limits, and not its opponent.

But one whose life has been spent in the earnest pursuit of his profession cannot see with indifference its rising members compelled to devote exhausting effort and a profligate sacrifice of time to acquirements which, so far as actual ship-building is concerned, are empty accomplishments and mere abstractions. He cannot, for instance, see men spending four years at Annapolis learning languages and the sciences; then transferred to France and in the *École Polytechnique* pursuing similar studies for two years more—all of which six years' labor does not touch their profession, but is merely preparatory; and finally ending with two years at the School of Application, in Paris—one year to the marine engine and one to naval architecture. Yet this singular course is being followed by our two assistant constructors now in France. Suppose a clear statement of these facts was submitted to a committee of the leading practical men, such as actually conduct the great industries of the world, could any opinion be expressed other

than that such a course of education for any mechanical profession must be characterized as a marvel of perverted effort.

Valuable, nay, invaluable, as have been the deductions of science and especially of mathematical research as applied to naval architecture, I must express the opinion that much of what is considered deep professional learning is shallow scholastic pedantry, which can only embarrass its possessor when confronted with actual work. What is then required is the perfect knowledge of workmanship and material, the ready perception of their excellence or defect, knowledge of men and money, and fertility of mechanical resources. Yet in view of these most obvious and essential requirements, it is only necessary under our laws for a candidate to have passed creditably through the Naval Academy to be immediately appointed an assistant naval constructor; nor is there anything likely to prevent such men, without practical experience nor perhaps natural fitness, being intrusted at an early date with vast and complicated constructions of the future navy, and regulating the expenditure of large sums of the public money.

By foreign nations this matter is better understood. The indispensability of practical knowledge is recognized. With their constructors experience and theory go together. In the instruction of their rising men practice precedes theory, as it properly should. Thus in the English dock-yards every shipwright apprentice has before him the possibility of rising by diligence and application to the highest position and emoluments in the construction corps. By an admirable system of dock-yard schools, which all the apprentices are required to attend, and from which limited numbers of the most promising are, from time to time, selected for the advanced course at Greenwich, the Government secures the best material available for its future constructors, while the dock-yard employés are made an unusually intelligent class. In contrast to this, the Annapolis graduates are thrust upon the construction corps without practical knowledge of ship-yard procedure and devoid of that all-important quality, experience in the management of men; nor is there sufficient stimulus to obtain these qualities when they are once entered upon what is too probably an assured future.

The distinguished naval architects abroad, to whom the profession owes so much of its dignity and its wonderful advancement, are the offspring of no such system. Sir Edward J. Reed, Sir Nathaniel Barnaby, and William H. White, esq., the successive directors of naval construction of the Royal Navy, rose from dock yard apprentices under the wise policy which I have above described. They are typical naval architects, worthy of the emulation of the profession in all countries, and we cannot do better in a revision of the methods of recruiting the construction corps than to consider the admirable course by which such men have been produced. Our present system is calculated to develop a class of tyros in naval construction, who will discuss scientific ship-building with mystifying verbosity, but will handle real work with blundering incapacity and failure.

Accompanying this report please find the information called for by section 429, Revised Statutes, and the third section of the naval appropriation act approved January 30, 1885.

I am, sir, very respectfully, your obedient servant,

THEODORE D. WILSON,

Chief Constructor, U. S. Navy, Chief of Bureau.

Hon. W. C. WHITNEY,
Secretary of the Navy.

Vessels repaired at the different navy-yards during the fiscal year 1884-'85.

Alliance, Adams, Brooklyn, Constitution, Camanche, Dale, Despatch, Emerald, Fortune, Galena, Intrepid, Leyden, Marion, Mayflower, Miantonomoh, Minnesota, Mohican, Monongahela, Monterey, Nantucket, New Hampshire, Omaha, Passaic, Pensacola, Pulox, Pinta, Portsmouth, Powhatan, Ranger, Saratoga, Speedwell, Swatara, Tallapoosa, Tennessee, Vandalia, Vermont, Wyoming, Yantic.

Contracts made during the fiscal year 1884-'85.

Merritt Wrecking Organization contract; dated August 30, 1884; raising the Tallapoosa, \$35,000.

Sampson & Peterson; contract dated October 1, 1884; weatherboarding the New Hampshire, \$6,798.

Milliken & Smith; contract dated February 26, 1885; steel castings for the Miantonomoh; estimated cost, \$14,636.

Appropriations for fiscal year 1884-'85.

CONSTRUCTION AND REPAIR.

Appropriated		\$1,050,000 00
Expended:		
For labor at navy-yards and stations	\$695,954 88	
For the purchase of materials and tools for yards, advertising, foreign postage, telegrams, books, plans, instruments, &c., for drawing-room	290,499 08	
For bills paid on account foreign stations.....	36,394 40	
		<u>1,022,848 36</u>
Balance July 1, 1885		27,151 64

CIVIL ESTABLISHMENT.

Appropriated		20,000 00
Expended:		
For clerks and writers at navy-yards.....		17,815 25
Balance, July 1, 1885.....		<u>2,184 75</u>

STEEL CRUISERS.

Appropriated		996,857 23
Amount received from transfers.....		40,177 09
		<u>1,037,034 32</u>
Expended:		
On account of steel cruisers.....		740,933 05
Balance July 1, 1885		<u>296,101 27</u>

DOUBLE-TURRETED MONITORS.

Expended:		
On account of the Miantonomoh.....		174,733 86
Balance July 1, 1885.....		<u>27,280 07</u>

Cost of stores on hand at the different navy-yards.

PORTSMOUTH, N. H.

On hand July 1, 1884.....		\$578,562 00
Received during the year ending July 1, 1885.....		112,276 00
Total on hand and received.....		<u>690,838 00</u>
Expended during the year ending July 1, 1885.....		114,678 00
Total on hand July 1, 1885		<u>576,160 00</u>

BOSTON.

On hand July 1, 1884.....	\$1,291,432 00
Received during the year ending July 1, 1885.....	67,408 00
Total on hand and received	1,358,840 00
Expended during the year ending July 1, 1885.....	39,409 00
Total on hand July 1, 1885	1,319,431 00

NEW YORK.

On hand July 1, 1884.....	1,392,088 00
Received during the year ending July 1, 1885.....	255,973 00
Total on hand and received	1,648,061 00
Expended during the year ending July 1, 1885.....	267,213 00
Total on hand July 1, 1885	1,380,848 00

LEAGUE ISLAND.

On hand July 1, 1884.....	397,647 00
Received during the year ending July 1, 1885.....	2,847 00
Total on hand and received	400,494 00
Expended during the year ending July 1, 1885.....	9,442 00
Total on hand July 1, 1885	391,052 00

WASHINGTON.

On hand July 1, 1884.....	167,775 00
Received during the year ending July 1, 1885.....	121,033 00
Total on hand and received	288,808 00
Expended during the year ending July 1, 1885.....	71,263 00
Total on hand July 1, 1885	217,545 00

NORFOLK.

On hand July 1, 1884.....	629,493 00
Received during the year ending July 1, 1885.....	52,952 00
Total on hand and received	682,445 00
Expended during the year ending July 1, 1885.....	74,742 00
Total on hand July 1, 1885	607,703 00

PENSACOLA.

On hand July 1, 1884.....	334,696 00
Received during the year ending July 1, 1885.....	118 00
Total on hand and received	334,813 00
Expended during the year ending July 1, 1885.....	433 00
Total on hand July 1, 1885	334,380 00

MARE ISLAND.

On hand July 1, 1884.....	367,889 00
Received during the year ending July 1, 1885.....	44,242 00
Total on hand and received	412,131 00
Expended during the year ending July 1, 1885.....	51,634 00
Total on hand July 1, 1885.....	360,497 00

Amounts expended for civilians employed on clerical duty.

[Information called for under section 3, of the act approved January 30, 1885.]

Months.	Kittery.	Boston.	New York.	League Island.	Washington.	Norfolk.	Pensacola.	Mare Island.
1884.								
July	\$731 42	\$248 90	\$1,008 56	\$997 29	\$861 79	\$672 17	\$86 06	\$557 43
August	742 49	265 45	1,046 49	1,047 81	917 18	693 55	86 06	557 44
September	740 10	326 13	1,012 99	975 80	860 80	702 71	86 06	550 04
October	767 42	343 27	1,077 92	1,076 04	852 43	778 37	89 37	570 05
November	670 17	312 82	812 32	1,005 42	839 80	708 50	79 44	524 80
December	627 42	333 27	815 80	960 00	1,448 68	673 85	86 06	557 44
1885.								
January	630 85	343 27	682 47	988 48	1,536 15	614 16	86 06	40 03
February	565 43	286 98	745 45	863 62	1,463 23	617 56	79 44	888 39
March	617 49	248 90	812 49	999 16	1,421 79	677 26	86 06	179 05
April	649 10	245 07	789 60	1,147 76	1,843 74	656 63	86 06	550 04
May	527 61	238 90	702 56	1,192 73	1,612 80	596 22	86 06	682 73
June	515 98	245 09	773 60	1,232 41	1,679 83	679 96	86 06	224 92
	7,785 48	3,438 05	10,280 25	12,486 52	15,538 22	8,070 94	1,022 79	5,882 86

Total, \$64,504.61.

Estimates of appropriations required for the service of the fiscal year ending June 30, 1887, by the Bureau of Construction and Repair.

A.—SALARIES.

	Estimated amount which will be required for each detailed object of expenditure.	Total amount to be appropriated under each head of appropriation.	Amount appropriated for the current fiscal year ending June 30, 1886.
Chief clerk.....	\$1,800 00		
Draftsman.....	1,800 00		
One clerk of class four.....	1,800 00		
One clerk of class three.....	1,600 00		
One assistant draftsman.....	1,400 00		
One clerk of class two.....	1,400 00		
One clerk of class one.....	1,200 00		
One assistant messenger.....	720 00		
One laborer.....	660 00		
		\$12,380 00	\$12,280 00
Increase of salary of chief clerk (submitted).....	450 00		
NOTE.—The chief clerk, under the law, acts as chief of Bureau in case of the death, illness, resignation, or absence of that officer, and must be competent to take charge of the Bureau.			
The duties of this office are arduous, and fully deserve the salary herein estimated, it being the same amount (\$2,250) paid to chief clerks in other Departments who are authorized to act in the absence of their chiefs.			
Increase of salary of draftsman (submitted).....	450 00		
NOTE.—As the duties and responsibilities of the draftsman of this Bureau are certainly much greater and of more importance than those of the draftsman of the Bureau of Steam Engineering, who is paid \$2,250 per annum, this increase is submitted as just and proper in the case.			
Increase of pay of assistant draftsman, who now receives less than is paid per diem draftsmen in navy-yards, and whose duties are about the same (submitted).....	200 00		
Three draftsmen, at \$1,600 per annum (submitted).....	4,800 00		
Restoring assistant messenger to rank of messenger with pay of such (submitted).....	120 00	6,020 00	

B.—CONSTRUCTION AND REPAIR OF VESSELS.

Preservation and completion of vessels on the stocks and in ordinary; purchase of materials and stores of all kinds; labor in navy-yards and on foreign stations; purchase of machinery, rights of patented articles, and tools for use in shops; wear, tear, and repair of vessels afloat, and for general care, increase, and protection of the Navy in the line of construction and repair; incidental expenses, such as advertising, foreign postages, telegrams, photographing, books, plans, stationery, and instruments for drawing-room (appropriated).....	\$2,000,000 00	\$2,000,000 00	\$1,000,000 00
---	----------------	----------------	----------------

C.—DOUBLE-TURRETED MONITORS.

Completing four double-turreted monitors, as follows:			
Puritan (appropriated).....	\$955,342 00		
Terror (appropriated).....	627,288 00		
Amphitrite (appropriated).....	630,584 00		
Monadnock (appropriated).....	701,442 00		
		\$2,923,656 00	

D.—INCREASE OF THE NAVY.

Building of hulls of new steel vessels.....	\$5,000,000 00		
---	----------------	--	--

Estimates of appropriations required for the service of the fiscal year, &c.—Continued.

E.—CIVIL ESTABLISHMENT.

	Estimated amount which will be required for each detailed object of appropriation.	Total amount to be appropriated under each head of appropriation.	Amount appropriated for the current fiscal year ending June 30, 1886.
At the navy-yard, Kittery, Me.:			
One clerk to naval constructor (appropriated)	\$1,400 00	\$2,700 00	\$2,700 00
One clerk of store-houses (appropriated)	1,300 00		
Three writers, at \$1,017.25 each (submitted)	3,051 75	4,616 75	
One draftsman, equal to \$5 per day (submitted)	1,565 00		
At the navy-yard, Boston:			
One clerk to naval constructor (appropriated)	1,400 00	2,700 00	2,700 00
One clerk of store-houses (appropriated)	1,300 00		
Three writers, at \$1,017.25 each (submitted)	3,051 75	4,616 75	
One draftsman, equal to \$5 per day (submitted)	1,565 00		
At the navy-yard, Brooklyn:			
One clerk to naval constructor (appropriated)	1,400 00	2,700 00	2,700 00
One clerk of store-houses (appropriated)	1,300 00		
Three writers, at \$1,017.25 each (submitted)	3,051 75	6,081 75	
Two draftsmen, equal to \$5 per day each (submitted)	3,030 00		
At the navy-yard, League Island, Pa.:			
One clerk to naval constructor (appropriated)	1,400 00	2,700 00	2,700 00
One clerk of store-houses (appropriated)	1,300 00		
Three writers, at \$1,017.25 each (submitted)	3,051 75	4,616 75	
One draftsman, equal to \$5 per day (submitted)	1,565 00		
At the navy-yard, Washington:			
One clerk to naval constructor (appropriated)	1,400 00	3,434 50	3,434 50
Two writers, at \$1,017.25 each (appropriated)	2,034 50		
One clerk of store-houses (submitted)	1,300 00	2,865 00	
One draftsman, equal to \$5 per day (submitted)	1,565 00		
At the navy-yard, Norfolk:			
One clerk to naval constructor (appropriated)	1,400 00	2,700 00	2,700 00
One clerk of store-houses (appropriated)	1,300 00		
Three writers, at \$1,017.25 each (submitted)	3,051 75	4,616 75	
One draftsman, equal to \$5 per day (submitted)	1,565 00		
At the navy-yard, Pensacola, Fla.:			
One clerk of store-houses (submitted)	1,300 00	1,300 00	
At the navy-yard, Mare Island, Cal.:			
One clerk to naval constructor (appropriated)	1,400 00	2,700 00	2,700 00
One clerk of store-houses (appropriated)	1,300 00		
Three writers, at \$1,017.25 each (submitted)	3,051 75	4,925 75	
One draftsman, equal to \$6 per day (submitted)	1,878 00		
Total		53,278 00	*19,631 00

*\$20,000 was appropriated in bulk to the Bureau.

No. 14.—REPORT OF THE ADMIRAL OF THE NAVY.

OFFICE OF THE ADMIRAL,
Washington, D. C., November 30, 1885.

SIR: I have the honor to submit the following report of inspections since November, 1884:

Vessels in commission, inspected in order to ascertain their general efficiency.

Name.	Date of Inspection.	Name.	Date of inspection.
Essex	Jan. 2, 1885	Omaha.....	June 7, 1885
Marion	Feb. 17, 1885	Iroquois	
Lackawanna.....	Mar. 24, 1885	Brooklyn	Nov. 18, 1885
Pensacola	May 7, 1885		

Vessels examined under section 2, act of August 5, 1882.

Name.	Remarks.
Rose	Condemned and sold.
Wachusett	Condemned and not sold.
Pilgrim	Do.
Dale	Condemned as unfit for sea-service, but useful as a receiving ship, and is now so employed.

I beg leave to call your attention to the condition of the iron-clads at City Point, Virginia.

Name.	Remarks.
Saugus	Requires extensive repairs, the cost of which would not be less than \$196,000.
Wyandotte	Requires some small outlay to guard the vessel and her outfits from deterioration when she is laid up in ordinary.

The remaining iron-clads require repairs, as shown in the following table:

Name.	Estimated cost of repairs.	Time necessary.
Montauk	\$23,996 68	Sixty working days.
Jason	36,113 06	Do.
Nahant	35,806 06	
Ajax	15,710 00	Thirty-five days.
Canonicus	19,502 00	Forty-five days.
Catskill	4,625 00	Thirty days.
Lehigh	10,526 00	Six weeks.
Mahopac	7,853 00	Five weeks.
Manhattau	10,445 00	Six weeks.

The above-named iron-clads could be made very serviceable in time of war in protecting such places as must be subject to attack by light-armed cruisers; or if armed with rifled guns, they would be efficient protectors of the approaches to Washington.

This class of vessels, it is true, is rather out of date, but they have good hulls and engines capable of moving them from place to place; and if their boilers were in proper condition they would be useful in defending rivers and harbors where heavy iron-clads could not get at them.

All nations have vessels in their navies of a somewhat obsolete type, which, of course, are not as efficient as ships of later construction, but they do not throw them aside. On the contrary they keep them in good order and ready for service, for there would always be some position where they could be made useful especially when provided with long-range guns. We have such a shadow of a Navy that we cannot afford to throw away anything in the shape of an iron-clad, and those that we have for home defense are worth more than all the wooden vessels in the service.

These remarks are still more applicable to the *Amphitrite*, *Miantonomoh*, *Monadnock*, *Puritan*, and *Terror*, turreted vessels under construction, which, if finished will be valuable additions to the Navy. When they are finished and fitted with modern batteries, there will be no better vessels of this class in any navy, for home defense, which is the only service that should be expected of them, although their capacity to cross the ocean and encounter the most tempestuous weather has been fully demonstrated.

A few years ago, when we were on the verge of a war with Spain, the officers of the Navy would have been much better satisfied if these vessels had been in condition for service.

Should they now be completed they would give such a prestige to the Navy as it has not enjoyed for twenty years, and though far from furnishing all the power required for the protection of our coasts, their completion must show a desire on the part of Congress to begin the reconstruction of the Navy at the point where it is most needed, viz, the protection of our coast, which is now at the mercy of foreign powers.

With such a nucleus of a force as these monitors completed would present there would be much greater hesitation on the part of an enemy in molesting our sea-board cities.

It seems to me to be bad policy to leave the monitors in their present condition. We cannot afford to throw them away. We cannot sell them as they are, and they are deteriorating by being kept in an unfinished state.

From long continued observation I am satisfied that the strictures made in regard to the construction of these vessels are very unjust. As far as the work has gone they are better vessels than the originals which they represent, and which at the time they were built were considered to be remarkably efficient, either one of them being more than a match for any contemporary European iron-clad.

About three millions of dollars are, I believe, required to finish the iron-clads, and when they are completed and properly armed we will at least have taken an important step towards the resurrection of a Navy which at one time was one of the best equipped in the world.

Every year adds to the deterioration of the vessels in question, and consequently increases their cost. They are now in that state when they can be completed with all the modern improve

altering the work already done, and with but little more expense than was originally estimated.

It is very well to build cruisers, but the first consideration is the protection of our seaboard cities, which, at this moment, are defenseless, for it is well known that our forts could offer little resistance to powerful iron-clads.

These defensive works which were built years ago were quite equal to their purpose, but are now useless against the artillery of to-day. Their walls, pierced for guns long since out of date, could offer no resistance to an eight hundred-pound rifle shot, which would demolish everything in its path.

The best illustration I can give of the power of modern artillery when used against masonry is the attack of General Gillmore on Fort Sumter, when, with sixty rifled guns, the largest a hundred pounder, operated from a distance of five thousand yards, he reduced the work to a heap of ruins.

The forts defending the city of Alexandria, in Egypt, although built in the most scientific manner and armed with the best rifled guns, were so battered by a fleet of English iron-clads, that in a short time guns, forts, and city were at its mercy.

In considering our fortifications and naval vessels it is difficult to determine which are the most behind the times; but all the forts we have at the Narrows in New York Harbor and all our present available Navy could not prevent two first-class iron-clads from entering the harbor and laying the city under contribution.

These forts could not keep off our iron-clads if they belonged to an adversary; another fact which shows how useful the monitors would be in conjunction with the defenses on shore.

In other days, when wooden ships and smooth-bore guns decided matters on the high seas, ships could seek the protection of forts; but hereafter forts will require the aid of iron-clads to keep off other iron-clads.

Even wooden vessels have often proved more than a match for the strongest forts. Sir John Duckworth passed the batteries of the Dardanelles, which mounted guns throwing eight-hundred-pound balls of stone; Nelson with his fleet captured the defenses of Copenhagen; Lord Exmouth with his wooden ships swept the formidable batteries of Algiers from one end of the city to the other; the French at San Juan de Ulloa knocked those heavy works to pieces; and, to crown all, the wooden ships of the United States Navy, from 1861 to 1864, armed with smooth-bore guns, silenced and captured one fortification after another, though planned by the most skillful engineers and bravely and scientifically defended.

The present forts of the United States have fallen so much behind the times, that our engineers are quite aghast at the expense required to bring them up to the latest standard of efficiency.

Although our defensive system in fortifications and ships is the worst in the world, there is a chance to improve it by the completion of the monitors under discussion, and I earnestly hope that while we are appropriating money for cruisers—which may or may not answer the purpose of their construction—the iron-clads will not be neglected.

In all the calculations made year after year for the improvement of the Navy, the necessity of torpedo-boats seems to be ignored. We indeed take great pains to fit out our high-pressure steam-launches with clumsy apparatus supposed to be all-sufficient to destroy a ship. Foreign officers must smile when witnessing the vain efforts of these six-

knot launches to blow up a barrel which is intended to represent an iron-clad armed with a sufficient number of machine-guns to cripple an ordinary ship of war in ten minutes.

The time has passed when an ordinary steam-launch can excite much apprehension in the mind of any European officer who has been educated in a torpedo system that puts our crude and far from ingenious attempts to shame.

All foreign navies are at the present time giving great attention to the subject of torpedoes as the one thing likely to prove a match for the otherwise invincible iron-clad. Small torpedo-boats will be superseded in a great measure by the introduction of torpedo-ships, when every vessel will fire her own torpedoes, not only from her bow and stern, but from her sides under water.

Foreign naval powers do not build torpedo vessels by ones and twos, but by the quantity. Enter an English or French dock-yard port and you will find dozens of these formidable vessels flitting about like meteors, with speed greater than that of any others, and ever ready for active service.

This is the one thing the iron-clad of to-day has most to fear, since it is the most difficult to avoid.

In England the torpedo system has culminated in the Polyphemus, a ship on which the Government has spent, up to the present time, over a million dollars in experiments alone, endeavoring to combine in vessels of this class a system of torpedo attack the most destructive that has ever been devised.

These experiments will show that every ship of war should be a torpedo vessel as well as a gunboat and ram, and we could obtain much valuable information by having the officer detailed as naval attaché to the United States legation give his particular attention to this subject.

The Government of the United States makes no experiments in this direction, and therefore we should avail ourselves of what is being done abroad.

Private individuals in this country have received so little encouragement from Congress and from the Navy Department as to become discouraged, perhaps on the threshold of some important discovery. Instead of encouraging our own officers and citizens, we prefer to adopt the inventions of foreigners, which are no better than can be found at home, ignoring that which if encouraged would give us a fair start in the torpedo line.

We have now within the waters of this country one of the best devices for torpedo warfare ever yet invented. This is the Destroyer, a small vessel fitted with a submarine gun, the principle of which is, in my opinion, the groundwork of the torpedo-boat of the future.

Mr. John Ericsson has spent a fortune on this vessel of his invention, but his device does not seem to have met with that favor which would be expected from our intelligent naval officers.

Mr. Ericsson has been required to bear the expense of the exhaustive experiments which have been made before different naval boards, the only result of which has been to cause a doubt as to the benefit of so many Boards, and to disgust the ingenious inventor at the little encouragement he has received, to say nothing of actual damage inflicted.

Mr. Ericsson has, in the course of his life, been subjected to an immense amount of investigation, and now, in his eighty-third year, he naturally objects to further experiments at his own expense. After he had paid the expenses of one fair trial, the Government should pay for all the others.

The Destroyer is still in Mr. Ericsson's hands, after having proved herself a valuable invention, and it is due to this distinguished man, who did so much in 1862 to save the honor of our Government, that his vessel be purchased out and out, and that he be reimbursed for the expenses to which he has been subjected.

Such a course would encourage him and others to proceed with their inventions in the torpedo line, and Mr. Ericsson would doubtless bring his invention to perfection when he found himself reaping the reward to which he is entitled.

There should be established in the Navy a torpedo corps afloat, for coast and harbor defense. Districts should be designated from Maine to Texas, and officers should be attached to the corps for a period of at least three years each. The work could be established on a small scale at first, say at Boston and New York, and extended as necessity required.

This is the only way to familiarize officers of the Navy with the practical workings of the torpedo, and at the same time foster the different valuable inventions that may present themselves. Such trials of this great factor in war by those constantly employed in its application are the only methods of obtaining practical results. This kind of duty would be strictly professional, which can hardly be said of employment on the Fish Commission or as attachés of the Navy Department and Smithsonian Institution. Under such a system the torpedo would be thoroughly understood in the Navy, which is not the case at present, as little is learned from the few experiments witnessed at the torpedo station.

In time of war the defense of our coasts and harbors by torpedo boats will naturally come under the direction of sea-going people, *i. e.*, naval officers, and this kind of warfare is what an enemy will have most to fear, for although a ship at sea may be able to defend herself against the attacks of torpedo-vessels by means of her Hotchkiss guns, it would be much more difficult for her to do so if attacked in the narrow entrance to a harbor by boats darting from every quarter with a speed that would render escape impossible. Ships of war may pass unharmed over beds of torpedoes which from want of care or skill in their management have been rendered harmless, but they can hardly escape the assault of swift torpedo-boats in narrow or tortuous channels.

The question of torpedo-boats is so important that I do not hesitate to recommend that twenty of them be built without delay to be fitted with simple and well-tested apparatus, no vessel to be smaller than 150 tons displacement.

Twenty such vessels of great speed and fitted with the Ericsson torpedo would make it hazardous for an enemy cruising on our coast, and would be an excellent investment of money. At the same time I repeat my recommendation that Mr. Ericsson be paid the amount asked for from Congress by several Secretaries of the Navy, to reimburse him for his outlay in building the Destroyer, which in my opinion can be made the most efficient torpedo-boat that has yet been constructed.

I beg leave to call your attention to certain defects in our naval system which should be remedied. To be efficient the Navy should be organized in all its branches on a system where there could be no clashing of interests and where anomalous conditions could not exist.

At Newport, R. I., there are representatives of three branches of naval administration within a short distance of each other: The war college, under a rear-admiral; the apprentice training-ship *New Hampshire*, commanded by a captain; and the torpedo station, under a commander—three separate and distinct organizations.

The rear-admiral commanding the war college has no official recognition from either of his juniors, nor do these latter officers officially recognize each other. All this is contrary to what has always been the policy of the Navy, as in this case the true position of the ranking officer has been entirely ignored.

The war college is under the control of the Bureau of Navigation, the training-ship is under the Bureau of Equipment, and the torpedo station under the Bureau of Ordnance.

This classification is all very well so far as providing for the needs of the several Departments is concerned; but the senior officer, whoever he may be, should in such cases be recognized as the senior officer of the station, and should hoist his distinguishing flag as such.

Orders and communications should be forwarded through him, and he should be the officer called upon by the commanders of visiting ships of war.

The chances are that the war college will continue to be presided over by an officer senior in rank to the others; and for the sake of uniformity in the service, I recommend that he be made "senior officer of the station," and continue to make such recommendations for the benefit of the service as the Navy Department may from time to time require.

The way I have suggested seems to be the only one to arrange different departments so situated without ignoring rank in the Navy, the present course being the most injurious that could be adopted, as it is calculated to break down the discipline of the service, which always suffers when rank is ignored or where the position of a senior officer is not precisely defined.

Our Navy can only preserve its prestige by paying proper respect to rank, which has been gained by years of hard service, and it offers a bad precedent when an officer of high rank holds a position in no way superior to two others in his immediate vicinity, who are several grades below him.

There can be no valid reason why rank in one place should not have what it is entitled to as well as in another. It would be an anomaly for the commandant of the New York navy-yard to have a junior in command of the receiving-ship, and independent of his control, or to have the ordnance officer in independent command of Cob Dock. The recognition of seniority, under all circumstances, will be found the best system in the long run, and I therefore strongly advocate it.

The Naval War College of to-day is but the beginning of an institution that will in the future, I believe, confer great benefit on the service.

There are some officers who retard its progress by their opposition, yet no one can give a single good reason why such an institution should not be maintained.

I have had as much to do with graduates from the Naval Academy as any one, and I do not hesitate to say that the academic course does not and cannot thoroughly prepare an officer for all the high duties he will be called upon to perform.

If I were selecting officers in time of war I should certainly give the preference to those who had gone through a course at the torpedo school and war college, for the reason that in the studies which young officers will pursue at these post-graduate institutions they will have brought before them in practical form many things that they had previously only learned theoretically, and perhaps indistinctly remembered.

A naval officer of the present day to be eminent in his profession must be a constant student, and where could he have such an opportunity of becoming acquainted with all the improvements, modification

and experiences in the art of war as by a course of study at the war college? Officers of the Navy should seek all sources of information to fit themselves for the high duties of the future. Those who oppose this school because they can no longer benefit by it, or for other undefined reasons unworthy of consideration, should be content to let the Navy Department exercise its own judgment in the matter and not endeavor to throw obstacles in the way of a valuable institution.

No good reason can be advanced why our naval officers should not have an opportunity of perfecting themselves in professional matters, which will at least keep them on an equality with officers in foreign navies.

I consider that the education received by cadets at the Naval Academy is merely the groundwork to fit them for what they will have to learn practically in the future.

As the war college is made more attractive to students by the consideration of interesting professional subjects—on which few young officers are sufficiently well informed—it will afford full instruction in professional science, and impart that general information without which a naval officer cannot be considered fully qualified to supervise the important matters which constantly claim his attention.

Ever since you assumed charge of the Navy Department you must have perceived the necessity of reorganizing the whole Navy.

No material change has been made in the organization of the Navy Department since 1842, and the changes made at that time were not improvements.

A new arrangement of the service can easily be made without disturbing its balance, for the education of naval officers enables them to adapt themselves quickly to any change in the surrounding conditions.

The necessary reforms could best be ascertained by convening a board composed of the senior officers of the Navy, who have had long years of experience, who have the best interests of the service at heart, and who could not be deterred from plainly expressing their sentiments.

These reforms should extend to all branches of the military administration of the Navy, and by taking a fresh departure at this time the naval service might continue a number of years until changes more radical than any we have yet witnessed shall demand another reorganization.

The Navy has been allowed for years to run in a rut, and not even a formidable war could eliminate the defects from the bureau system.

In 1861 it was found necessary to call in an expert, an ex-naval officer, to supervise, as Assistant Secretary, the workings of the Bureaus, whose action for a long time had been far from harmonious.

The Bureau system would work well enough if the different departments were under the immediate supervision of a Board of Control, which, under the direction of the Secretary of the Navy, should have the management of such professional matters as might be unfamiliar to the head of the Department.

No better method of carrying on the *details* of naval administration could be desired than the Bureau system, but there should be a professional administrative board of officers not below the grade of commodore to aid the Secretary of the Navy in carrying on the duties of his office, ready at all times to furnish him with any information he might require relating to the service.

This is a method analogous to that which prevails in European navies, under which they have attained to a perfection which we can hardly hope to rival under our present circumstances.

When the present Bureau system was proposed it was the intention to thereby relieve the Board of Naval Commissioners of a great amount of detail labor which it was difficult for them to properly supervise. The commissioners were to remain as the administrative assistants of the head of the Department, to supervise all branches of the service under his direction. Owing, however, to the intrigues of an officer who desired to manage his own department without interference, the Board of Naval Commissioners was omitted from the new plan, which thus became like the play of Hamlet with Hamlet left out! .

No objection can be made to most of the officers who have served as chiefs of Bureaus; the fault is in the system.

The personnel of the Navy Department is sufficient to conduct the affairs of half a dozen navies if it was properly organized. In the latter case Advisory Boards outside the Department could be advantageously dispensed with. The chances are that better ships would be built by the Bureaus under the supervision of a Board presided over by the Secretary of the Navy than in any other way.

Such a system would preserve harmonious action, while the action of outside Advisory Boards leads to antagonism.

The Board of Navy Commissioners, by the judicious exercise of their authority, built up our Navy, and kept it in advance of others in regard to the efficiency of their ships.

Since the Board of Commissioners was abolished it has not been found possible with the Bureau system alone to keep our navy up to anything like an equality with the navies of other powers. If this were not the case, why is it that since the close of the civil war we have not constructed a single modern iron-clad or a cruiser that will compare with those of foreign navies?

At the present time we have literally nothing in commission but so-called "vessels of war" that can scarcely perform the duties of a peace establishment, and in case of a conflict with any naval power the aforesaid war vessels would have to go into retirement until peace was declared, the largest of them having neither speed nor battery that would enable her to contend successfully against a two-gun modern French or English gunboat.

The Bureaus, no doubt, do all they can under the present system to build up the Navy and keep it in order, but they do not advocate the introduction of a board of naval commissioners, which would lighten their labors and bring about a unity of action, such as is at present quite out of the question.

The Bureaus are not invested with separate authority by Congress, but are simply to perform such duties as are assigned them by the Secretary of the Navy. They can do little towards maintaining discipline, regulating the management of ships in commission or of navy-yards, for each chief of Bureau is absorbed in the duties of his own office, and the labor is so continuous that he has no time to turn his attention to general subjects connected with the Navy.

If a chief of Bureau had the time, he would have no power to carry out his plans, even if he were not considered as interfering in matters which did not concern him.

During a service of nearly fifty-seven years I have had ample opportunity of seeing the workings of our two systems of naval administration.

The system of Navy Commissioners was defective for want of the Bureaus to carry out the detail work of the service, while the Bureau system without a board of commissioners to advise the Secretary in matters

with which a civilian is not expected to be familiar is still more defective.

It has been proposed that the Secretary of the Navy should have a legally authorized adjutant or assistant secretary appointed from among the officers of the Navy, but the plan for a board of commissioners is superior to this arrangement in every respect. The one-man power as advisory is not so good as when the authority is divided among three persons, who are checks upon each other as regards favoritism and injustice.

Besides, the advice of three persons is more apt to be judicious than that of one alone.

I am an impartial judge in this matter, because it does not personally affect me. My position separates me from any connection with these posts, and my age precludes the idea of my undertaking any laborious duty. For upwards of a year I served in the Navy Department in the capacity of Assistant Secretary or adviser of the Secretary of the Navy on professional matters. That short period gave me a full knowledge of the defects of the Bureau system, and at the same time satisfied me that a naval officer, no matter what his rank might be, had no business in the Department as assistant secretary or professional advisor. He would soon lose all his friends and would make hosts of enemies. He would have to bear the blame if anything went wrong, and would receive no credit for any good that he might accomplish.

If I in a measure escaped such a fate, it was because I endeavored to interfere with no one in the Department, and my connection with it was comparatively brief.

The only thing I gained by my service there was an intimate knowledge of the workings of the Bureau system, and from that time to this I have constantly advocated a change, since I am of opinion that until a change takes place the Navy cannot be properly administered, and this I affirm without the least intention of depreciating the many able officers who have held the position of chief of Bureau; numbers of them have been my personal friends, and with all of them my relations have been pleasant.

I must beg leave to make a recommendation which I think, if acted upon, will increase the efficiency of the service and prove gratifying to its older officers. Until a recent period it has been customary to place only rear-admirals in command of squadrons, but as there are too few officers of this rank on the active list to follow out this rule, we are now adopting the plan of employing commodores with the appointment of acting rear-admirals.

This is a good idea, for by so doing the Department can avail itself of the services of a younger set of officers, to whom the duties of command afloat are more congenial than they are to those who have nearly reached the age for retirement; but it is unjust that an officer with the rank and command of a rear-admiral should not have the pay of that grade, without which he cannot properly maintain his position. He must either decline invitations which are given him as a mark of respect to his country or impoverish himself in the effort to properly reciprocate such civilities.

In the principal navies of the world the commanding officer of a fleet or squadron is allowed a sufficient sum, in addition to his pay proper, to enable him to return the civilities extended to foreigners, and he is required to expend this allowance in such a manner as to cement the friendly relations existing with the different countries. If such an allowance were made to our officers, a commodore could afford to accept

command of a squadron, but at present they cannot do so without the risk of seriously hampering themselves.

It is unjust to compel an officer to defray the expense of entertaining those who are in fact the guests of the nation out of his limited pay; and I think we are the only naval power that deals so illiberally with its officers in this particular.

I must further recommend that navy-yards and stations, instead of being under the command of commodores, should, as far as possible, be given to rear-admirals. Officers of the latter grade do not, as a rule, enjoy their rank more than a year or two before the time arrives for them to go on the retired list, and their last command, considering their years, should be at a shore station.

This seems to be the rule at the English and French naval stations, where the experience of many years has shown the justice and utility of such a course. In such matters as these our Navy suffers by comparison with others; for our system, or rather want of system, will not stand the test of criticism.

I had no opportunity this year of inspecting the North Atlantic squadron, as the vessels of which it is composed were scattered about, and the venerable flagship Tennessee was generally at a navy-yard repairing her boilers or patching the hull, which in a few years must be consigned to the scrap heap for want of repairs that are limited by law.

The place of the Tennessee should be filled. With the exception of the Trenton and the Lancaster she is the only ship of respectable size now afloat in the Navy. Her condition and that of other vessels is a sad commentary on naval management in the United States, which is supposed to be a progressive nation, but which, in fact, is woefully lacking in defenses of its coasts and commerce.

Our mercantile marine—what is left of it—has frequently to apply for assistance to foreign ships of war which assistance is cheerfully given.

It is sometimes intimated that the Navy is to enter upon a new era, that the service is to be rehabilitated, and that the flag of the Union is once more to be carried at the peak of such vessels as will command the respect of the world; but this cannot be done in a twelvemonth, nor in the way lately adopted by Congress of closely defining the character of the ships to be built.

While the Board of Navy Commissioners was in existence there was allowed by Congress for a series of years a certain amount to be annually expended for the general improvement and increase of the Navy. In that way we obtained a fleet of fifteen ships of the line, some thirty or forty other fine vessels, and a vast amount of valuable material accumulated year after year for contingencies, which supplied the Navy during the civil war, and without which the Navy Department would have been sadly hampered. The same method should be revived, and an amount annually appropriated by Congress for the gradual increase of the Navy, without attempting to define the tonnage of each vessel.

In the course of a year it may become important to change the general plan of a ship on the stocks, and the Navy Department should be left at liberty to construct vessels of a size and arrangement best suited to the circumstances existing.

So rapid are the changes in naval warfare, that what appears to-day a superior vessel may to-morrow be superseded by a different type.

I have read in the newspapers of several classes of vessels proposed for the Navy, but varying so greatly in tonnage as to multiply in too great a degree the different sizes.

There should be the following classes of cruising ships in the Navy:

Grade.	Tonnage.	Horse-power.	Speed.
Class 1	7,000	9,750	18
Class 1	5,000	6,800	18
Class 1	3,500	5,800	18
Class 1 (gunboats)	1,600	3,200	18

Any vessel that cannot make 18 knots an hour will in the future be next to worthless as a ship of war. Speed will be the great desideratum, and this is the object to which European navies are devoting their attention, with a view of competing with the transatlantic steamers, which in these days frequently average 18 knots an hour.

There is no reason why ships of war should not do as well, for they are seldom down to their load line, and their guns, ammunition, provisions, crew, &c., are not equal in dead weight to the cargoes of merchant steamers.

But these last-named vessels steam rapidly, because they have great horse-power and comparatively light engines of the best material and workmanship.

In this, then, lies the advantage of a first-class English merchant steamer over an American man-of-war. In the latter the machinery is so heavily built that with its weight and great friction is involved the question of cinematics, or loss of force, out of all proportion to the horse-power of a vessel.

It should be taken into consideration that a steel vessel of the largest class cannot be built in this country in less than two and a half years.

The case of the Chicago seems in point, for although authorized by the act of August 5, 1882, she is still on the stocks, and no man can tell when she will be finished. The Boston and Atlanta, authorized by the same act, are also unfinished.

This indicates a want of capacity on the part of the contractors to do the work, and it must appear that if hard pushed for vessels on the verge of war it would be next to impossible to supply promptly the needs of the Navy.

One great difficulty under which the Government labors is due to the fact that it has no complete building yard of its own wherein to construct ships of war at its pleasure and in a specified time. The navy-yard at Brooklyn, N. Y., is the only one fairly supplied with means to build a steel ship, and I am of opinion that at least one of the largest of the new vessels should be constructed there.

Those persons who are familiar with the difficulties encountered by the Navy Department during the civil war, in the attempt to obtain vessels from contractors at the time agreed upon, can realize what a benefit it would have been to the country had we possessed one first-class establishment for building steel ships, although ship-building in that material was then in its infancy.

Great efforts were made by the naval authorities at that time to induce Congress to appropriate money for the purchase of a proper site, for it was even then realized that a revolution was taking place in naval architecture, and that iron hulls must soon supersede those of wood.

Owing to the immense extent of coast that we had to blockade, the United States had to collect a large steam navy, and then we began to realize the necessity of a large building and repairing navy-yard.

It was very soon evident to the Navy Department that we could not depend upon our small naval establishments to build up a navy at short notice, and as no steps had been taken to establish the necessary machine-shops and foundries, we were thrown entirely into the hands of contractors, few of whom had the tools and machinery required to do the work called for by the exigencies of the times. Fortunately for us we were called upon to contend with an enemy far worse off than ourselves, with neither public nor private machine-shops of much account.

Had we been contending with a strong naval power we would feel to this day—perhaps for a century to come—the humiliation of having had our coasts and harbors occupied by the enemy and our seaboard cities laid under contribution to punish us for our temerity in going to war without any proper means of carrying on hostilities.

We met with great embarrassment during the civil war for want of a proper building-yard, but in case of a war within the next few years our embarrassment would be greater still, so great that we could stand very little chance against a great naval power.

We have navy-yards in abundance, but, with the exception of those at Boston, New York, and Norfolk, they are scarcely worthy the name.

The New York and Boston yards might in a year or so be made ready to build two or three iron ships each, which is the extent of their capacity.

The city of Philadelphia presented to the Government the site for a navy-yard at League Island, which was supposed to possess all the requirements of a first-class building-yard, not only on account of its favorable position for the safe-keeping of ships and its inaccessibility to an enemy, but for the facilities it offers for obtaining coal, iron, steel, and everything else used in the construction and equipment of ships of war.

Philadelphia is a city of machine-shops of all kinds, where the most skillful mechanics and laborers can be obtained at short notice; and with all the advantages it offers, including the surrounding fresh water, League Island is the one available site for a great manufacturing establishment which should build our ships in the future.

League Island has already some semblance of a navy-yard, and possesses some forty or fifty acres reclaimed from the river, but it lacks nearly everything necessary for a national building establishment, and the site, instead of improving, is retrograding every day.

If we expect to maintain our position among nations, we must keep an adequate naval force in commission.

Some people say we want only a small but efficient navy, as if a small navy could be efficient. It is small enough now, one would think, to suit the wishes of its strongest opponents. It would be pitiful to see it grow any smaller.

We should, then, after carefully maturing our plans, go to work and build up the League Island navy-yard, and thereby make the Government independent of all outside shipbuilders.

At the same time I am in favor of giving to contractors the construction of a fair proportion of our ships, to enable them to keep up their plant to what would be required should we be obliged to build and equip a large navy in case of war. But our few private yards would be of little use in building up a navy rapidly, as all of them at present combined do not possess the appliances of a single first-class ship-building yard in Great Britain. It will be long before we possess any-

thing like the facilities that Great Britain has; where we could now build one ship she could build a hundred.

This must indicate that in spite of our boasted power we are in some respects a comparatively small nation.

There is good reason to believe that with proper facilities the United States Government could build ships as cheaply as contractors, for it is not to be supposed that the latter do business without the expectation of good profits.

The great advantage the Government will have in possessing a first-class ship-building yard is the regulation of the time in which it can build vessels.

This cannot be done by contractors, for up to the present time we have built too few ships to make it worth their while to enlarge their establishments.

After the necessity of building up a navy was conclusively demonstrated by the events of the civil war, we have gone on for twenty years without giving the contractors work enough to enable them to keep out of debt.

We have now a number of vessels, unfinished by the contractors, lying on our hands and forming a considerable navy, which bids fair to remain uncompleted for a long time to come.

If we should ever be forced into a war with a naval power, we must expect exactly similar measures used against ourselves as we used against the South during the civil war; and those who suffered by a blockade, that indispensable war measure, can now realize the necessity of being prepared for such a contingency, and providing a plant with which to build our own ships and machinery and manufacture our own guns.

At present our contractors are in no condition to build up an efficient navy, and with all the haste we can make it will probably be a quarter of a century before the Navy can be placed in proper condition to meet the wants of the nation.

All this matter was fully discussed twenty years ago, when the citizens of Philadelphia gave the Government a place for a great national ship-yard, but the project of utilizing the gift has apparently died of inanition, and the Navy is left in worse condition than it has ever been in since its reorganization after the war of the Revolution.

The Government then has a free gift of six hundred acres of land, with a depth of water sufficient for the largest vessels, presented with the tacit understanding that Congress would make of it the largest naval ship-building establishment in the world.

The faith of the Government has not been kept with those who might easily have realized a large amount of money by selling this valuable location.

If the time has arrived when we may hope to see a new navy arise from the ruins of the old one, I recommend that League Island navy-yard be built up on a scale commensurate with the wants of the nation. If we are ever to have a navy there is no better time than the present for commencing operations.

It is hardly possible that any rivalry should now exist among the different States in regard to the location of such a manufacturing yard, for it has been decided again and again by boards of officers that League Island is the best place for such an establishment, with the recommendation that if not used as originally intended it should, as an act of justice, revert to its generous donors, who in their patriotic desire for the advancement of the country sacrificed personal interests of considerable moment.

ORDNANCE OF SHIPS.

In examining the report of inspection of the U. S. S. Brooklyn, I notice that her battery, which in 1865 was 26 guns, has been reduced to 12 9-inch smooth bores, 1 8-inch muzzle-loading rifle, 1 60-pounder breech-loading rifle, 4 Hotchkiss revolving cannon, and 1 Gatling gun. This allowance should be increased by an addition to the number of Hotchkiss machine guns.

We are forced to recognize the fact that the batteries of all our ships are very inferior according to the present standard. The Dahlgren guns, with which our vessels are armed, have no superior as smooth-bores, but they are only available at close quarters.

If we could choose a position against an unarmored enemy and engage at close quarters, the effect of our spherical shells with large bursting charges would be very destructive; but our vessels are so wanting in speed that it would be impossible to close with an enemy against his will.

This would be our condition if contending with an enemy of what is now called ordinary speed. Kept at long range, our men standing by their smooth-bore guns would be helplessly slaughtered. They could not return the enemy's fire, which they must receive with all the patience they can muster.

Until the Navy is provided with proper cannon it is necessary that some means be devised for supplementing the smooth-bore gun, and the readiest means at hand is to furnish to our ships a good supply of Hotchkiss guns, single shot and revolving.

I understand that it is intended to provide the new cruisers with powerful secondary batteries, consisting of the most powerful Hotchkiss guns with large quantities of ammunition.

This is a very important step, but if the secondary battery is considered so necessary for ships that are to be armed with the latest pattern of rifled cannon, it is still more essential that Hotchkiss guns should be supplied to vessels which have only smooth-bore guns for their armament, with the additional disadvantage of a low rate of speed.

I therefore recommend that all our ships be provided with as many of these revolving guns as can be usefully mounted, and that a large amount of ammunition may be carried for them, storage for many other articles to be made to give way.

The 57 millimeter Hotchkiss single-shot rapid-firing gun throws a 6-pound projectile with a velocity of 2,000 feet per second. The shell has a fair bursting charge and will pierce 2 inches of iron at a distance of 1,000 yards. This is a powerful weapon, and even at long range may do much more injury to an enemy than a smooth-bore gun.

The 47-millimeter Hotchkiss single-shot rapid-firing gun is also a most useful weapon; can be readily handled in the tops of a ship and would serve as an efficient armament for cutters and boats.

The 37-millimeter gun is also efficient, and I understand that this weapon is to form part of the armament of the new cruisers; but I urge that it be at once furnished to every ship in commission, together with an ample supply of ammunition.

As the manufacture of the new type of cannon is now fairly commenced, I recommend that no more conversions of cast-iron smooth-bores be made. The converted guns are at best poor makeshifts, and must be thrown aside as soon as we have a sufficient number of steel rifled guns to take their places. Every effort should be made to push forward the construction of the new guns.

The means now at the disposal of the chief of the Bureau of Ordnance are wholly inadequate. The length of time necessary to build a modern gun makes it essential to have many of them under construction at the same time; therefore prompt measures should be taken to place sufficient resources at the command of the chief of ordnance.

In this connection I would ask your particular attention to the report of the Gun-Foundry Board, which I consider presents a complete and satisfactory plan for action. The report was made by officers of the Army and Navy well qualified for the duty with which they were intrusted. I have yet to hear of any unfavorable criticisms on the report, which has found favor with Congress and the steel manufacturers of the country, and shows the way to establish the manufacture of steel in masses such as have heretofore been unknown in this country.

The plan set forth in detail by the Board will make us independent of foreign aid, as all the material will be provided by our own people; I consider the plan for the establishment of two gun foundries, one for the Army and the other for the Navy, as very judicious, and necessary to complete the work mapped out for the manufacturers. The members of the Board had the assistance of practical business men in making the recommendations embodied in the supplementary report, which provides a plan for immediate action.

As, in my judgment, the recommendations in the report of the Board embrace everything that is necessary in the premises, I recommend that Congress be urged to authorize the commencement of work on the basis therein indicated.

Nearly two years have been spent in the discussion of this matter, and now that the plan has been so fully explained and the project shown to be so necessary, it would seem that there is little more to be said on the subject.

COAST SURVEY.

The position of Superintendent of the Coast and Geodetic Survey has become vacant, and an opportunity is offered of organizing this branch of the public service on the only basis that will make it thoroughly efficient and enable it to perform what it was originally intended it should do, viz, furnish accurate charts and hydrographic information for the benefit of the Navy and the mercantile marine.

The very name, Coast Survey, implies that it should properly be under the supervision of the Navy Department and the work directed by a naval officer.

Some persons argue that the Coast Survey should be managed by "a purely scientific man of high attainments;" but it is much more desirable that it should be conducted by a person of administrative abilities, who could not only control the large naval element employed in this work, but could discipline the shore parties and obtain from them a proper amount of labor.

The Coast Survey originally extended only far enough back from the sea to establish primary and secondary triangulation stations, the secondary triangulation extending only about six miles from the coast-line. The topography was then put in with the plane-table and the entire work was essentially a survey of the coast for nautical purposes.

At the organization of the Survey much of the triangulation and topographical work and all the hydrography was performed by the Navy, and naval officers were employed at headquarters in the supervision of hydrographic work and in fitting out vessels manned by naval seamen.

Twelve vessels are at present employed in the Coast Survey, which are manned by 59 officers and 275 men of the Navy; the pay of the men amounting to \$256,176 annually. The most important work of the Survey is performed by this force.

One of the best Superintendents of the Coast Survey was the late Mr. C. P. Patterson, who, with the necessary scientific knowledge, combined a fine executive ability and a knowledge of naval affairs which enabled him to thoroughly understand the management of the naval element and control the disbursement of money in that and all other departments.

There is no doubt that under Mr. Patterson's management a larger amount of work, mostly naval, was done than during the incumbency of any other superintendent for the same length of time, and he made it so apparent that the Coast Survey should be attached to the Navy Department that the late Secretary of the Navy strongly advocated the project.

There are a hundred good reasons why the Coast Survey should be a part of the Navy and not one against it. The duty must be more thoroughly performed and work would be carried on more systematically and economically than at present without materially changing the method now in vogue, and I feel satisfied that after a careful investigation of the subject you will be convinced that the way to make the Coast Survey most useful to the country will be to have it under naval management and attached to the Navy Department, even although a cry may be raised that no officer of the Navy possesses the necessary scientific knowledge to direct operations.

This objection was urged when Mr. Patterson, who had formerly been an officer in the Navy, was appointed Superintendent, but he soon demonstrated his ability to deal with the theoretical work, and at the same time placed himself far in advance of the methods of his predecessors, by the practical measures which he introduced.

At his death, Mr. Patterson left the Coast Survey so well regulated that it would almost run of itself, yet more than half of his life had been spent in the Navy, and the special knowledge that so well fitted him for the position of Superintendent was there obtained.

There is no reason why a similar training should not develop like capabilities in other naval officers.

Having myself served on the Coast Survey for a period of three years and being quite familiar with the system of operations, I do not hesitate to give it as my opinion that the administrative ability of naval men will more than counterbalance any deficiency in theoretical science, if such deficiency should exist.

The power of maintaining discipline, a thorough knowledge of the objects of the Coast Survey, familiarity with hydrography, system in keeping accounts and records, and the absence of political or other bias to prevent inefficient persons being employed on the work, are all most important qualifications and they are more likely to be combined in a naval officer than in a civilian.

Moreover, the head of the Department under whom the Coast Survey was placed would become familiar with its details through the officer in command, who would naturally hold constant intercourse with his chief.

I affirm in good faith that a naval education peculiarly fits an officer for the Coast Survey. The main point is to administer affairs properly, and that depends very much upon the officer selected by the Department as superintendent, and I also assert that the coast survey can be

prosecuted by the Navy for a much less sum and in a more satisfactory manner than is the case at present.

I estimate the expenditures as one-third less than at present, as many temporary appointments now occupied by civilians must be filled by naval employes.

In view of all these considerations, I take the liberty of recommending the transfer of the Coast Survey to the Navy Department, and that an officer on the active list not below the grade of captain be appointed to superintend the work. I further recommend that the Geodetic Survey be separated from the Coast Survey and transferred to the Army.

I lately inspected the apprentice training-ship *New Hampshire*, at Coaster's Harbor Island, Newport, R. I., and found her condition all that could be desired. She is cleanly in all departments, and the boys are well disciplined, well instructed, and well fed. I wish I could add well clothed; but, owing to the boys being generally in debt for their outfit, and obliged to wear the Government canvas working suits, they become dissatisfied on the approach of winter with this uncomfortable-looking dress, and some have given that as a reason for deserting. Such causes of discontent should be eliminated, and in this instance the boys should be allowed a certain amount of money sufficient to supply each of them with two suits of clothes annually, this allowance to be continued after their transfer to a vessel of war.

Something is yet lacking to attach these boys to the Navy, although I do not know what it is. In the crew of the *Brooklyn* there were only six apprentices re-enlisted, which indicates that the boys do not continue in the service, certainly not in sufficient numbers to man our vessels with native-born seamen.

In the crew of the *Brooklyn*, exclusive of the marine guard, there were 244 persons, as follows:

Continuous service men	33
Men in service before	42
Native born (including apprentices)	106
Foreign born	133

Fortunately, at the present time we are enlisting a first-class set of foreign-born seamen—Swedes, Norwegians, and Danes—who are a great improvement on the generality of foreigners heretofore shipped in the Navy.

It is, however, desirable that our vessels of war should be manned by native-born seamen; but it seems unlikely that we shall succeed in this object until a fresh stimulus is given to our commercial marine.

The American sailor, like other people, is apt to go where he can command the highest wages, and the demand for his services is so great that he has no difficulty in getting good pay outside the Navy.

I have always asserted, and still maintain, that a cruiser to be an efficient vessel of war should have full sail-power, with masts so arranged that she could maneuver under sail sufficiently well to be able to tack and wear with the aid of one of her boilers.

A cruiser that is not provided with such sail-power cannot keep the sea for any length of time either in peace or war. She must stop frequently for coal, and, as I have noted in a previous report, "the powers of Europe in conference a few years ago declared coal to be contraband of war."

We have no colonies, and in case of war could not rely on obtaining coal at neutral ports, and vessels fitted with sail-power after the fashion of the *Boston* or *Atlanta* or even the *Chicago*, would not be able to get in or out of port after their coal was expended.

The persons who designed the above-named vessels must have known very little of the requirements of a cruiser. They might almost as well place a single stick in the middle of a ship and expect her to work under sail.

Our country is fruitful in experiments, but the notion of putting all the sail-power in the center of a ship, with a hybrid rig, would find no favor anywhere abroad, especially in vessels intended to cruise.

If men-of-war are intended only to grope along shore, they require no masts; a signal pole in the middle of a vessel being all-sufficient.

Any ship that we now possess, however old fashioned and wanting in speed, would make a better cruiser than either the Chicago, Boston, or Atlanta with the rig it is proposed to give them. No one of them could make any progress against a head wind, and this is true of every vessel fitted with such a hybrid rig.

No cruising ship, no matter what may be her size, should have less sail surface than five square feet to the ton. It does not follow that cruising vessels should be overweighted with masts and spars to enable them to carry sail.

When vessels were propelled by sail-power only, their masts and rigging were made heavy, as they depended on them to lie to in gales of wind and to claw off from a lee shore. With steam-power, vessels have no fear of lee shores, and in heavy gales can furl sail and lie to under steam.

But in making long voyages in time of war, vessels must have plenty of sail-power to carry them through favoring latitudes where it would be folly to waste their coal.

The masts of a steam vessel can be made much lighter than those of a sailing ship, and in case it is desired to steam against the wind all the spars except the lower masts can be on deck in half an hour, where they can offer no resistance to progress. All this a good sailor knows.

The Omaha, Capt. T. O. Selfridge, went lately under sail alone from New York to Gibraltar in 18 days. None of the hybrid rigs would ever get that far without using steam. The Omaha would, in fact, be a more efficient cruiser in time of war than any of the new vessels unless their rigs are changed.

It would be generally in moderate weather that cruisers would want to carry a great spread of sail, and under these circumstances their lighter masts would be sufficient for any amount of canvas. How absurd it would be to see a ship of war steaming along with trade winds that would propel her ten or twelve knots an hour, provided she had proper sail-power!

The best cruiser we should have in time of war under present conditions is the Trenton, which vessel can make thirteen knots under steam, and with sail alone has been known to make as much; therefore it cannot be looked upon as an advance in the construction of steam ships of war to fit them with hybrid rigs.

It would be interesting and instructive to look over the account of coal burned in 1863 and 1864 by vessels that never made use of their sails. The cost ran up to the millions. It is easy to see that cruising ships without proper sail-power would be the most expensive vessels in the world.

No nation can afford such wasteful expenditures. The naval powers of Europe make all possible use of their sails, and the commanding officers of their ships have to account for every ton of coal they use.

I might write at great length on this subject and present further arguments against the proposed plan for crippling the cruising ships of

the Navy, but I will rest satisfied with the hope that the vessels will be fitted with sufficient sail-power to enable them to make eight knots on the wind and eleven knots off the wind.

To show how little has been done for our Navy in the past twenty years, I append an extract from one of my former reports which embodies some interesting facts:

Tabulated form showing the expenditures of foreign nations for the maintenance of their navies during the last fifteen years, as well as the amounts expended for the construction of new ships since 1865; also a statement of the expenditures by the United States for the same purposes during the same periods of time.

Countries.	Approximate expenditures for maintenance of the Navy, 1869 to 1884.	Expenditures for construction of new vessels, 1865-'84.
England	\$805, 946, 430 00	\$91, 000, 000 00
France	630, 000, 000 00	121, 000, 000 00
Russia	845, 000, 000 00	83, 583, 180 00
Italy	142, 500, 000 00	38, 000, 000 00
Sweden	14, 804, 000 00
Germany	144, 000, 000 00	28, 978, 731 00
United States	253, 796, 613 82	4, 907, 454 00

I beg leave to apologize to you for obtruding upon you so long a report.

I have the honor to be, very respectfully, your obedient servant,
DAVID D. PORTER,

Admiral.

HON. WILLIAM C. WHITNEY,
Secretary of the Navy.

No. 13.—CONTRACTS FOR NEW STEEL CRUISERS.

The Naval Advisory Board to the Secretary of the Navy.

REPORT ON SECOND PRELIMINARY TRIAL OF THE DOLPHIN.

NAVAL ADVISORY BOARD, NAVY DEPARTMENT,
Washington City, March 17, 1885.

SIR: The Board has the honor to report that the preliminary trial of the Dolphin has been made in accordance with the ninth clause of the contract for the construction of that vessel, concluded 23d July, 1883.

As stated in our report of 24th November, 1884, the Dolphin was presented for preliminary trial on 20th November last, and while on trial on that date the thrust length of the steel shafting broke. A new thrust shaft was made of forged steel, as recommended by the Board, and approved by the Department in letters dated 28th November. This shaft, after being manufactured under the inspection of the Board, and tested in accordance with instructions approved by the Department on 5th December, 1884, was rejected for the reasons stated in the Board's letter to the Department of January 9, 1885. Then, in order to avoid delay, the Board recommended that this shaft be made of wrought iron, it being then the intention to retain the other steel shafts, the tests for their examination having so far developed no flaws; subsequently, however, in the examination of the broken shaft, such extensive additional flaws were discovered in the center of its length, and as flaws were also found in drilling the end of the intermediate shaft, the Board decided that the intermediate and steel propeller-shafts should be removed and replaced by iron ones, under the conditions approved by the Department for the steel shafting of the cruisers in its letter to the Board of 15th January, 1885. This decision was approved by the Department, and the Dolphin's shafting, as tried on the 10th instant, consisted of the original built-up crank-shaft, forged from steel blooms, with cranks of wrought iron and steel crank-pins and three lengths of forged scrap-iron shafts $13\frac{1}{2}$ inches in diameter. Certain changes in detail of the vessel have been made and completed, as approved by the Department since the first trial, all of which have tended to the increase of the efficiency of the vessel and contributed to the success of the trial, of which the results were, in detail, as follows:

The Dolphin, in charge of the contractor, Mr. John Roach, left the dock at the foot of Eighth street, on the East River, New York City, at 8.50 a. m., Tuesday, March 10, to make the preliminary trial in Long Island Sound.

The weather was clear; the thermometer showed 31° Fahrenheit; a stiff breeze blew all day from the NW., at the rate of about 30 miles an hour, according to the Signal-Office records; the tide was high at Ward's Island at 5.22 a. m.

The Dolphin's draught of water was 11 feet 7 inches forward, 14 feet 7 inches aft; 13 feet 1 inch mean; the displacement was 1,300 tons, or 200 tons less than the load displacement.

The degree of completeness, apart from the requirements of the contract, will be shown sufficiently by the following statement:

No armament, ammunition, provisions, or stores on board.

Whale-boat and large cutter at the davits.

Masts, spars, and rigging complete; no sails on board; water-tanks full, and about 120 tons of coal in the bunkers.

Anchors and chains on board.

The period of six consecutive hours, during which the engines were to be worked at full power, was begun when the buoy at Throg's Neck bore abeam at 9^h 58^m 4^s a. m. On passing Execution Rock Light, at 10^h 17^m 41^s, a straight course was laid for the Middle Ground Light, 30 $\frac{1}{2}$ nautical miles distant. The following is the full record of times observed when the objects bore abeam:

	Going east.	Going west.
Passed Throg's Neck at full speed.....	h. m. s. 9 58 04 a. m.	h. m. s. 3 37 40 p. m.
Passed Execution Rock Light at full speed.....	10 17 41 a. m.	3 09 03 p. m.
Passed Martincock Buoy at full speed.....	10 36 55 a. m.
Passed Eaton's Neck Light at full speed.....	11 20 05 a. m.	2 01 20 p. m.
Passed Middle Ground Light at full speed.....	12 15 02 p. m.	1 01 38 p. m.

At 12.35 p. m. the helm was put over 15° to return over the same course. After passing Execution Rock on the return, the helm was put hard over and the vessel turned at full speed, the complete circle being made in 7 minutes and 6 seconds.

At 3^h 5^m p. m. the six hours expired; the vessel, going at full speed, was off Riker's Island.

The speed of the vessel over the ground, as obtained from the distance by chart between Execution Rock and the Middle Ground Light, is 15.79 knots going east, and 14.53 going west, or a mean speed of 15.16 knots an hour. The record of speed is given merely for information, but is not regarded as a satisfactory measure of the vessel's performance through the water, owing to the unknown effect of the wind and tide.

For the first part of the eastward run the sea was quite smooth. About 12 m. the wind shifted more to the west, and on the westward run the sea was unusually heavy for the Sound.

The performance of the machinery is shown by the following result of the observations in engine and boiler rooms:

	Average for six hours.	Maximum.
Revolution per minute.....	74.18	77
Boiler pressure in pounds per square inch.....	81.5	85
Vacuum in inches of mercury.....	28.1	28.5
Temperature in engine-room.....	71.8	75
Temperature in forward fire-room.....	72.9	85
Temperature in after fire-room.....	68.5	75

	Mean for six hours.
Indicated horse-power developed in high-pressure, cylinder.....	1,040.28
Indicated horse-power developed in low-pressure cylinder.....	968.29
Total power developed by main engine.....	2,008.57
Total power developed by auxiliary engines { Blowers } { Pumps }	88.5
Mean collective horse-power developed.....	2,118.08
Maximum collective horse-power developed.....	2,378.00

The fuel used was the Welsh semi-bituminous coal, imported for the Greely relief expedition; the number of times that this coal has been trans-shipped has reduced the greater part of it to a fine powder, and therefore, the Board is of the opinion that with coal of the same or similar quality, but in better condition, the results would be improved. The fire-rooms were open and the draft was assisted by blowers.

The contract requires in regard to this trial that—

When the vessel is completed and ready for delivery, as required by the specifications, the same shall be subjected to a trial trip, under conditions prescribed by the Naval Advisory Board, and approved by the Secretary of the Navy, to test the machinery, engines, boilers, and appurtenances, and shall be accepted only on fulfillment of and subject to the conditions and agreements hereinafter set forth:

(1) That the working of said machinery in all its parts shall be to the satisfaction of the Naval Advisory Board.

(2) That the collective indicated horse-power developed by said engines under the prescribed conditions shall be two thousand three hundred (2,300), and maintained successfully for six (6) consecutive hours: *Provided*, That in case of the failure of the development of this power the vessel shall be accepted if it can be shown, to the satisfaction of the Naval Advisory Board and the Secretary of the Navy, that this failure was due neither to defective workmanship nor materials.

(10) If at and upon the trial trip before mentioned the hull and fittings are found by the Naval Advisory Board to be strong and well built, and in strict conformity with the contract, drawings, and specifications, the same shall be accepted, subject, however, to a reserve of eight thousand dollars (\$8,000) from the reservations hereinafter set forth.

The trial was made as recommended by the Board in its letter to the Department of 11th September, 1884, and approved by the Department in its letter to the Board of 25th October.

The machinery in all its parts worked smoothly, continuously, and satisfactorily throughout the trial, and the Board is of the opinion that the deficiency of 182 horses power from mean of 2,300 required by the contract for six consecutive hours was not due to defective workmanship nor materials, but that with better coal and a well trained engineer's force these results will be exceeded.

According to the records of the Board, the total weight of the machinery, engines, boilers, and appurtenances and spare parts, completed as required, including water in surface condensers and boilers, does not exceed the limit of 430 tons set by the contract. The Board finds that the hull and fittings are strong and well built, and in strict conformity with the contract, drawings, and specifications, and that the vessel will be completed in all respects as required by the contract on the 18th instant, except the following minor items, namely: adjusting the Hotchkiss gun centers and fitting the sideboards for dishes, which can only be completed after the vessel is at the navy-yard.

The Board therefore recommends that the *Dolphin* be accepted, subject to the provisions of the ninth and tenth clauses of the contract, and orders issued to the contractor for her delivery to the commandant of the New York navy-yard, as already agreed upon, on the 18th instant.

The Board will forward approved bills for the final payments in accordance with the memorandum submitted to the Department, being in amount the tenth payment on the contract and the amounts due for changes and additions as approved by the Department, less the reservation of \$8,000 to be withheld under the tenth clause of the contract,

and the amounts due the Government on approved changes in the original plans.

Very respectfully,

E. SIMPSON,
Rear-Admiral, U. S. N., President of the Board.
 HENRY STEERS,
Naval Architect.
 ALEX. HENDERSON,
Chief Engineer, U. S. N.
 J. A. HOWELL,
Captain, U. S. N.
 F. M. BARBER,
Lieutenant-Commander, U. S. N.
 F. L. FERNALD,
Naval Constructor, U. S. N.

Hon. W. C. WHITNEY,
Secretary of the Navy.

The Naval Advisory Board to the Secretary of the Navy.

INSTRUCTIONS FOR FITTING OUT THE DOLPHIN.

NAVAL ADVISORY BOARD, NAVY DEPARTMENT,
Washington City, March 17, 1885.

SIR: The Board respectfully suggests that instructions should be issued to the commandant of the New York navy-yard directing that in fitting out the Dolphin a careful, complete record shall be kept of the weight of every article placed on board or removed from the vessel up to the time that she is reported ready for final trial, when it should be properly prepared and classified and forwarded to this Board.

Very respectfully,

E. SIMPSON,
Rear-Admiral, U. S. N., President of the Board.

Hon. W. C. WHITNEY,
Secretary of the Navy.

John Roach to the Secretary of the Navy.

MORGAN IRON WORKS,
New York, March 19, 1885.

SIR: I beg to inform you that the U. S. S. Dolphin has been completed in all respects in accordance with the specifications, and certifies from the inspectors of hull and machinery have been forwarded to the Naval Advisory Board to this effect.

I am now prepared to deliver the vessel to navy-yard, in accordance with the terms of my contract with the Department.

Will you please give instructions to the commandant of the yard directing him to receive the vessel?

Yours, respectfully,

JOHN ROACH.

Hon. W. C. WHITNEY,
Secretary of the Navy, Washington, D. C.

The Secretary of the Navy to John Roach.

NAVY DEPARTMENT,
Washington, March 20, 1885.

SIR: I have the honor to acknowledge the receipt of your letter of March 19, informing me that the U. S. S. Dolphin has been completed in all respects in accordance with the specifications, and certificates from the inspectors of hull and machinery have been forwarded to the Naval Advisory Board, to this effect, and that you are prepared now to deliver the vessel in accordance with the contract, and request me to give instructions to the commandant of the yard directing him to receive the vessel.

I have looked over the papers presented by the Advisory Board, and find that the vessel did not upon her trial trip recently show 2,300 collective indicated horse-power developed by her engines, and maintained successively for six consecutive hours, as contemplated by the contract. It is, however, provided in the contract that, notwithstanding this failure, the vessel shall be accepted "if it can be shown, to the satisfaction of the Naval Advisory Board, and the Secretary of the Navy, that this failure was due neither to defective workmanship nor materials."

The Board has expressed its opinion that the deficiency of 182 indicated horse-power required was not due to defective workmanship nor materials; but that with better coal and a well-trained engineers' force this result would be exceeded.

I would suggest that another trial be had, under such conditions as shall be prescribed by the Department, for the purpose of demonstrating that this supposition is correct. In this and other regards, I am now looking somewhat into the matter before exercising so grave a responsibility as accepting the vessel.

I desire a statement from you of the full amount of your claim upon the Dolphin up to date.

Very respectfully, yours,

W. C. WHITNEY,
Secretary of the Navy.

JOHN ROACH,
New York City.

The Secretary of the Navy to the Naval Advisory Board.

APRIL 7, 1885.

SIR: After examining the contract and laws relating to the construction of the Dolphin, I am of opinion that the act performed by me in passing upon the final payment and plans is not a formal act, but one with reference to which I seem to have responsibility.

I have neither the time nor the expert knowledge with which to possess myself of the necessary information upon which to base a judgment, and while if I had been present in the Department during the construction of the vessel I should doubtless be possessed of a matured opinion and judgment upon the subject, under the present circumstances that is quite impossible.

In view of the fact that my formal act is required in addition to the act of the Advisory Board, it is quite evident it was not intended that I should rely solely upon the action of the Advisory Board in this matter; otherwise, the action of the Secretary would not be required. I have,

consequently, decided to designate three persons, who have not been connected with the construction, for the purpose of assisting me in the discharge of the duty which, without such aid, it is quite impossible for me to perform.

I desire to notify your Board of my action, that it may not be construed to arise from any intention to reflect upon the correctness of the conclusion to which the Advisory Board has come.

Very respectfully, yours,

W. C. WHITNEY,
Secretary of the Navy.

Rear-Admiral EDWARD SIMPSON, U. S. N.,
President Naval Advisory Board.

The Secretary of the Navy to John Roach.

NAVY DEPARTMENT,
Washington, April 7, 1885.

SIR: I have your letter of April 4, stating that "the insurance of \$285,000 on the Dolphin expires on the 9th instant, and cannot be renewed for less than thirty days, as the companies will not issue policies for a shorter period. Do you desire me to renew it?" In answer to which I would say that I have no request to make with reference to it except that until the steamship is accepted the contract provides that you shall keep her insured, which would seem to determine the matter.

I have no answer from you to my communication of March 20, in which I suggest that another trial trip of the Dolphin be held for the purpose of assisting in the determination of certain matters therein referred to.

Very respectfully, yours,

W. C. WHITNEY,
Secretary of the Navy.

JOHN ROACH, Esq.,
Morgan Iron Works, New York.

Instructions of the Secretary of the Navy to the Examining Board.

NAVY DEPARTMENT,
Washington, April 7, 1885.

The steamship Dolphin, built under contract between the Navy Department and Mr. John Roach, is presented for acceptance and final payment under her contract.

For the purpose of informing myself as far as possible of the facts necessary to the determination of the matter involved in her acceptance I hereby designate Capt. George E. Belknap and Commander Robley D. Evans to act with Mr. Herman Winter, of New York, as a Board of Examination to investigate and report to me—

1. Whether she has been constructed in accordance with the terms of the contract.

2. In view of the necessary limitations upon any investigation of a completed ship to report specifically what matters they are able to determine and how they determine them.

3. What matters are impossible of determination except as the work is going on.

The Board will be furnished such assistance, expert or otherwise, as they may desire, and has no responsibility for the success or failure of the ship if accepted by me.

W. C. WHITNEY,
Secretary of the Navy.

NAVY DEPARTMENT,
Washington, April 30, 1885.

SIR: In addition to the instructions heretofore given you with regard to the examination of the Dolphin, your Board will please report to me any defects which may attract your attention or which you may discover in the present condition of the boat, whether due to her design or plan, or to the execution thereof, specifying in detail her defects, if any, so as to convey intelligible information as to the cause in each case.

Very respectfully,

W. C. WHITNEY,
Secretary of the Navy.

Capt. GEORGE E. BELKNAP, U. S. N.,
President Board, &c., New York City.

John Roach to the Secretary of the Navy.

MORGAN IRON WORKS,
New York, April 16, 1885.

SIR: I am in receipt of your letter of 15th inst., informing me of the appointment of a Board to make examination of the Dolphin, and beg to say that I will, on their application, furnish them with every facility and opportunity in my power for such examination as they may desire.

Although it is customary to furnish the builders of vessels with a copy of the final reports made relating to construction and performance, I have as yet received no copy of the report of the Naval Advisory Board in this case, nor have I any information regarding it except what I have seen in the newspapers.

Will you please furnish me with a copy of the same?

Yours, respectfully,

JOHN ROACH.

Hon. W. C. WHITNEY,
Secretary of the Navy, Washington, D. C.

John Roach to the Secretary of the Navy.

MORGAN IRON WORKS,
New York, April 30, 1885.

SIR: I hoped to have had an opportunity of seeing you while in New York, but failed in my effort to do so. I wished to express my desire to conform in every detail with the conditions of my contract for the

Dolphin and the cruisers and to comply with any reasonable suggestion or wish you might make, even if not explicitly specified in the contract. I also asked my friend, Mr. Vanderpoel, to see you and look over the Dolphin contract, thinking that together you might more easily come to some definite understanding as to how I could comply with your wishes. I have been, since the trial on the 10th of March, at the expense of wharfage, insurance, and ship-keepers, but have no information from you or the Advisory Board as to what, if anything further, is required of me.

Will it be convenient for you to see me on this subject and the other contracts, if I come to Washington in the next few days?

Yours, very respectfully,

JOHN ROACH.

Hon. W. C. WHITNEY,
Secretary of the Navy, Washington, D. C.

The Secretary of the Navy to John Roach.

MAY 2, 1885.

SIR: I have your letter of April 30, in which you state that you had hoped to have seen me in New York recently; that you wished to express your desire to conform in every detail with the conditions of your contract for the Dolphin and the cruisers, and to comply with any reasonable suggestion or wish I might make, even if not explicitly specified in the contract. The letter also states that you have asked your friend, Mr. Vanderpoel, to see me and look over the Dolphin contract, thinking that together we might more easily come to some understanding as to how you could comply with my wishes. You state that you have been, since the trial on the 10th of March, at the expense of wharfage, insurance, and ship-keepers, but have no information from me or from the Advisory Board as to what, if anything further, is required of you. You ask whether it would be convenient for me to see you on this subject and the other contracts if you come to Washington in the next few days.

I will see you at any time that you make it convenient to come. I am somewhat surprised at the statement contained in this letter where you say that "since the trial on the 10th of March you have no information from me or from the Advisory Board as to what, if anything further, is required of you." On the 20th of March I received a letter from you dated the 19th, informing me of the result of the trial trip of the Dolphin, and requesting me to give instructions to the commandant of the navy-yard at New York to receive the vessel, stating that she had been completed in accordance with the contract and was ready for delivery. On that same day I addressed you a letter, calling attention to the fact that in one respect, specifically mentioned, her performances upon the trial did not exhibit the result called for by the contract, in which case the contract provided that she should be accepted notwithstanding this defect "if it can be shown to the satisfaction of the Naval Advisory Board and the *Secretary of the Navy* that this failure was due neither to defective workmanship nor materials." In that connection I said:

I would suggest that another trial be had, under such conditions as shall be prescribed by the Department.

I also stated in the letter :

In this and other regards I am now looking somewhat into the matter before exercising so grave a responsibility as accepting the vessel.

Up to the present time I have received no answer from you to the portion of that letter which suggests that another trial be held for my advisement. On the 7th of April I called your attention to this omission on your part in a letter as follows :

I have no answer from you to my communication of March 20, in which I suggest that another trial trip of the Dolphin be held for the purpose of assisting in the determination of certain matters therein referred to.

The contract provides "that it shall not, under any circumstances, be obligatory upon the party of the second part to accept the vessel or any part thereof to be constructed under this contract unless the same shall have been completed in strict conformity with this contract, under the supervision of the Naval Advisory Board, and in accordance with the provisions of the act of August 5, 1882, as modified by the act of March 3, 1883, hereinbefore referred to, and that this qualification shall be deemed and taken as applicable and applying to each and every clause, covenant, and condition, express or implied, in this contract contained."

A similar provision is found in the statute which authorized the construction of the boat. It was plainly my duty to take such steps as seem to me proper to ascertain whether the boat had been constructed in strict conformity with the contract. To aid me in determining these facts, I designated three persons of eminent fitness for the purpose of conducting an inquiry, which I personally had not the time nor the expert knowledge to make; and on the 24th of April, as I am informed, they addressed you a communication requesting you to prepare the Dolphin for a trial trip at sea at as early a date as possible.

I request an answer to these communications.

Very respectfully,

W. C. WHITNEY,
Secretary of the Navy.

JOHN ROACH, Esq.,
Morgan Iron Works, New York.

A. J. Vanderpool to the Secretary of the Navy.

NEW YORK, May 5, 1885.

DEAR SIR: I have given to Mr. Roach the substance of our interview on Saturday last. I called his attention to the point that he had not replied to your letter. He said that he did not understand from the letter that it called for a reply except as to his claim, which I understood him to say was already in your office, and would be found there by reference to the papers; that he understood from your letter that you were to determine and advise him, after looking into the matter further, whether a further trial would be required. In the next to the last paragraph of your letter you say, "I would suggest that another trial be had, under such conditions as shall be prescribed by the Department, for the purpose of demonstrating that this supposition was correct. In this and other regards I am now looking somewhat into the matter before exercising so grave a responsibility as accepting the

vessel," and Mr. Roach supposed that he would hear further from you in regard to it.

Mr. Roach has no recollection of having received your second letter. It was not brought to his attention at his office.

Mr. Roach himself will be in Washington in a day or two to confer with you.

Very respectfully, yours,

A. J. VANDERPOEL.

HON. WILLIAM C. WHITNEY,
Secretary of the Navy.

The Secretary of the Navy to John Roach.

NAVY DEPARTMENT,
Washington, May 22, 1885.

SIR: You will, I think, recognize that the performances of the Dolphin thus far impose upon me the duty of exercising an unusual degree of caution in dealing with her. What would have been reasonable prudence in me some weeks since would not be so now. It is quite possible that the difficulties encountered in making her go through a trial trip may have been due to accident and temporary causes; but you would not now expect her to be accepted without your having an opportunity to demonstrate beyond all question the high character of her work. I understood you to assent to this proposition in our conversation yesterday, and while I do not understand you now to claim for her the speed nor the horse-power contemplated, you do insist that so far as your part is concerned, that the plans have been properly executed.

I have given orders, in accordance with our arrangement yesterday, for a further trial to be held, under similar conditions as the last, on Thursday, the 28th instant. In addition to this, I must ask that she be put to a similar run at sea upon such day as you may name. I do not insist upon her full horse-power or fifteen knots speed upon this latter trial, if deemed by you too trying upon her new machinery. A speed of twelve knots will answer the conditions under which I wish to place her. She should be loaded to something near her lines; and the expense of this latter trial will be borne by the Government in case she is accepted.

Very respectfully,

WILLIAM C. WHITNEY,
Secretary of the Navy.

JOHN ROACH, Esq., *Morgan Iron Works, New York.*

John Roach to the Secretary of the Navy.

MORGAN IRON WORKS,
New York, May 25, 1885.

SIR: Your letter of the 22d instant, relating to trial trips of the Dolphin, is duly received.

Although I consider—and it appears very plain under the terms of the contract—that my liability ceased and all conditions required of me were complied with on the termination of the trial of March 10, still

I am very willing, as I have previously stated to you, to do all in my power to satisfy you as to the efficiency of the ship so far as I am responsible under my contract. For this purpose the trial on Long Island Sound will be made on the 28th instant, as you direct, and the other at as early a day thereafter as practicable.

Yours, respectfully,

JOHN ROACH.

Hon. W. C. WHITNEY,
Secretary of the Navy, Washington, D. C.

John Roach to the Secretary of the Navy.

MORGAN IRON WORKS,
New York, June 8, 1885.

SIR: I have your telegram of this date, regarding insurance and docking of Dolphin. I could not obtain insurance for the necessary amount in this country, covering all the risks of a trip at sea, and ordered it by cable from Liverpool, receiving cable reply that it had been effected. I will forward you to-morrow certificates of the agents here to that effect. The companies are aware that she has been aground.

I can arrange to dock the vessel on Wednesday, the 10th instant, or the trial can be made on Thursday, 11th instant, and the vessel docked on her return. I have no instruction as to the desired weight to be put in her, which Captain Belknap said would probably be sent me, and which I could be preparing. I cannot see where I have neglected attention to these matters, as, from my last conversation with Captain Belknap, on May 29, I understood that I was to receive a message from him when he could examine the vessel, and expected that this and the trip would have occurred last week, he suggesting Thursday as a convenient day, and we were ready at that time.

I have been waiting for some days for authority to dock the Atlanta, to put in shaft and propeller, having been advised by the Naval Advisory Board on the 1st instant that they had recommended that this be done in order to paint bottom at same time. The work on this vessel is being delayed in consequence.

Yours, respectfully,

JOHN ROACH.

Hon. W. C. WHITNEY,
Secretary of the Navy, Washington, D. C.

Report of the Examining Board on the trial and construction of the Dolphin.

NEW YORK, N. Y., June 15, 1885.

SIR: I have the honor to forward by the hands of Commander R. D. Evans, U. S. N., the report of the Board of Examination in the matter of the examination of the steam dispatch boat Dolphin, made in conformity with the Department's order of the 7th April, 1885, and its supplementary instructions of April 30, 1885.

Very respectfully, your obedient servant,

GEO. E. BELKNAP,
Commodore, U. S. N., President of Board.

Hon. W. C. WHITNEY,
Secretary of the Navy, Washington, D. C.

NEW YORK, N. Y., *June 15, 1885.*

SIR: The Board of Examination constituted by the Department's order of the 7th April, 1885, a copy of which is herewith appended marked A, to investigate and make report as to the construction of the steam dispatch boat *Dolphin*, built under contract between the Navy Department and Mr. John Roach, has the honor to submit the following report and addenda; and the Board understands that by the orders issued to it the report is to cover the following points:

- (1.) Has the *Dolphin* been constructed in accordance with the terms of the contract between Mr. John Roach and the Government?
- (2.) What defects, if any, whether of plan or execution, are apparent in the *Dolphin* from such examination as can now be made in her present completed state.
- (3.) What matters can be determined and what matters are incapable of determination in a completed ship.

The difficulties attending the examination of a completed ship are many and manifest. Whether the structure conforms to the plans cannot in the main be ascertained after the ship is closed up. The character of the workmanship is to a large extent also concealed, and the quality of the steel, iron, and other materials used in the construction of the ship, her engines, machinery, and fixtures is impossible of ascertainment.

To examine the *Dolphin* so as to fully answer the above inquiries and to locate accurately the causes of the weakness observed in her would necessitate the expenditure of a very large sum of money in taking out the machinery and opening up of the ship. Wherefore such examination as this Board has felt authorized to make can only develop such defects as cannot be concealed.

The *Dolphin* is intended for a dispatch boat. She has, and was intended to have, very little offensive power. Reliable speed is therefore her first and greatest requisite for usefulness. She must be able to possess this quality in all weather and under all conditions at sea.

The law authorizing the construction of the *Dolphin* provided for a "sea speed" of 15 knots per hour. A dispatch boat not having the ability to make that speed continuously in such weather as she may reasonably be called upon to encounter, would at this day not answer the purposes of the service.

That a boat of her size should possess this requisite speed it is absolutely indispensable that she should have great strength and stiffness. That the *Dolphin* has not the requisite strength and stiffness to enable her to make the speed required under the conditions she must be prepared to meet, admits of no doubt, in the opinion of the Board.

The Board witnessed her performance on the smooth waters of Long Island Sound on three occasions. The conditions were most favorable, but the speed attained, making proper allowance for tidal influences, was not in excess of 15 knots per hour, a result very far from promising a like speed on the sea under the conditions she must always be ready to meet in actual service; for in order that a vessel should keep up a sea speed of 15 knots per hour she should be able to make from 17 to 17½ per knots per hour in smooth inland waters like the Sound.

On the occasions referred to the vibration of the *Dolphin* when subjected to only that duty and test was very perceptible, and of a character to demonstrate inadequate strength and stiffness. Under such circumstances the floors of the engine-room were observed to spring severely. And this, let it be noted, occurred when she was subjected to much less

severe duty than she must be expected to encounter when actually engaged in the service for which she was intended.

These facts, so obvious to the Board, needed no corroboration, but corroboration was furnished on the second of the unsuccessful trial trips witnessed by the Board. On that occasion her after crank-pin became hot after a short run—even before the actual trial had begun. This pin had given no trouble on the previous trial, and the Board was informed by the contractor and his men that it had never before given any trouble. The only reason apparent for the trouble on this occasion, and the one to which it was doubtless due, is to be found in the following facts: On the previous unsuccessful trial about 40 tons of pig-iron had been put in the forward part of the ship to trim her. Five tons more were added on this occasion, and of course some portion of the coal had been consumed from her bunkers. Even these slight changes in the situation of weights were seemingly sufficient to alter her shape so as to cause this after crank-pin to heat almost at once.

Wherefore the question arises, is this structural weakness due to a fault of plan or execution, or does it proceed from both?

In justice to the contractor it is proper to state that the plans exhibited to the Board and those furnished the contractor are very meagre, and by no means provide for a vessel of adequate strength for the uses for which the Dolphin was intended.

While it is clear that the plans are at fault, and if carried out in the best manner would not produce a vessel of sufficient strength, yet it seems to the Board that the Dolphin exhibits a degree of weakness in excess of what can properly be entirely attributed to the defective plans. Wherefore the Board is of the opinion that the execution must be faulty in this regard, but it is impossible to state with exactness the degree of blame that might properly attach to the contractor in this precise respect without taking out the machinery and opening up the ship—a work, as previously stated, involving a large expenditure of money.

The contract, among other things, provides that "provision be made for closing the fire-room hatches and other openings sufficiently tight to maintain an air pressure equivalent to a head of water of 1 inch in the fire-room," and that the ship's engines shall in a trial trip of six hours indicate 2,300 mean horse-power.

With regard to the first stipulation, no attention seems to have been given for its proper observance, the contractor alleging that such pressure had been obtained on the first trial, witnessed by the Advisory Board, by using tarpaulins to cover the hatches, but owing to changes made by the Board, with regard to the blowers, he could not now get the pressure. It is only too evident that such an alleged contrivance was but a makeshift at best, and could be of no practical value.

With regard to the stipulation as to horse-power, two unsuccessful attempts to run the Dolphin in Long Island Sound for a period of six hours were witnessed by this Board. On the third trial the Dolphin succeeded in running the required six hours, and she subsequently made a fourth trial at sea from Sandy Hook to Barnegat Light and loaded to her sea displacement. The trip at sea, however, gave no test of her sea-going qualities, as the water was as smooth as had been previously found in the Sound.

On the first unsuccessful trip for the period she was running on the trial her engines indicated a mean collective horse-power of 2,088. On the second occasion her after crank-pin became heated, as previously stated, before the actual trial began. On the third occasion her engines indicated for the period of six hours a mean collective horse-power of

2,253; and on the fourth trial, the boilers making steam under natural draft alone, the horse-power developed by engines and pumps was 1,648.

On all these occasions great efforts were made by the contractor and his men to show the utmost power which could be developed. Her coal was of a superior quality, her engine and fire rooms in charge of regular engineers, and streams of water were kept playing on the journals to prevent heating; in short, her conditions in all respects were more favorable than those she can be expected to have when in service, especially when called upon to run day after day under the varying phases of wind, sea, and weather on the open ocean—the only test of real value in determining the qualities of a sea going vessel.

With regard to the general workmanship found on board the Dolphin the Board is of the opinion that it does not conform to the terms of the contract and specifications in many particulars, as will be seen by reference to the appendix marked 1, annexed to this report, giving in detail the proceedings and findings of the Board.

Since the Board began its detailed examination, the results of which are embodied in this report and its addenda, the contractor has been at work upon the vessel from time to time in remedying defects discovered by the Board, and the Dolphin is now in much better condition and appearance than when the Board first saw her, and in some important regards she is substantially improved.

For instance, she has been stiffened forward in the fore peak abreast the hawse pipes by a vertical plate brace, a point where special weakness was observed; in the after transom, where the reverse frames were cut off, the cut frames have been connected by a floor plate; the spar-deck and berth-deck have been calked fore and aft; the step of the mizzen-mast, which was weak and insecure by reason of defective support, has been strengthened to a degree promising perfect security; the skin of the vessel has been repainted at various points where the skin was accessible; the hold store-rooms, fore and aft, have been freshly painted and fitted with proper shelving, and other things have been done in the direction of making the Dolphin a much better ship than the Board found her on its first inspection.

In submitting this their report the Board feels that it can go no further in the discharge of its duty under the instructions governing its action, and has to regret that so much as to the vessel's strength rests upon opinion. Nothing short of a trial at sea for some time and in rough water can satisfactorily determine her actual strength or weakness; and in the absence of such trial or test—so much to be desired—this report embodies the most that the Board has been able to ascertain, but as the vessel has recently been on a reef in the East River it is necessary that she should be docked and her bottom examined. When this is done the Board will submit the result of such examination.

It is proper to state here that Commander Evans, of the Board, did not witness the third trial of the vessel in Long Island Sound, having been unavoidably detained by his duties pertaining to the inspectorship of the fifth light-house district at the date of the trial.

Respectfully submitted by your obedient servants,

GEO. E. BELKNAP,

Commodore U. S. N., President of Board of Examination.

R. D. EVANS,

Commander U. S. N., Member.

HERMAN WINTER,

Constructing Engineer, Member.

Hon. W. C. WHITNEY,

Secretary of the Navy, Washington, D. C.

APPENDIX I.

Memoranda of examination and trials of the steam dispatch boat *Dolphin*, made and witnessed by the Board of Examination constituted by the Department's order of the 7th April, 1885, a copy of which is herewith appended, marked A.

In submitting this detailed report or memoranda, the Board has first to remark that there were many difficulties in the way of making a full and complete investigation of an already constructed ship; that "matters impossible of determination, except as the work is going on," embrace the quality of steel and iron and other materials used in the construction of the vessel, her agencies and dependencies, and all processes of building from the keel upwards; that the main part of the work and its character, whether good or bad, can only be determined by taking the vessel and her machinery apart; and that so many changes have been made in the plans and details of construction since the vessel was put under contract, so many authorized departures from the original specifications binding the contractor, that it has been well nigh impossible to get at all the facts desirable, as, for instance, when, on various occasions, the Board has found the work performed to be different from that called for by the specifications, the contractor or his representatives have alleged or explained that the change had been made by authority of the Advisory Board, both written and verbal. To separate and distinguish clearly between the written and the alleged verbal authority given for the multiplicity of changes made, the Board has had no satisfactory means of doing, especially as regards the minor details of the vessel's construction and the seemingly authorized changes made in them.

The Board, after some delay in collecting the data necessary for its information, convened at New York on the 16th April, 1885, and was occupied more or less in the duties before it from that date until the 11th instant; and after careful examination of the vessel and trials under steam, together with all the facts obtainable with regard to the progress of her construction and the changes made from time to time in the original contract and specifications by authority of the Naval Advisory Board, find that, in its opinion, the vessel has not in all respects been constructed in accordance with the terms of the contract and specifications, in that, in various parts and particulars, "the materials and workmanship used and applied in the construction of the hull of said vessel, in details and finish," were not found to be "first-class and of the very best quality," as required and stipulated in said contract and its specifications.

And, to enumerate and specify as required by the Department's instructions, and as determined from the personal examination possible to make of a constructed ship, and by comparison with several recently-built steamships of the merchant marine, both foreign and domestic, to be found in this port, the Board further finds that, in its opinion, the steering apparatus is not "strong" nor "easy of adjustment," and is not in any way "protected from shot." The lead of the wheel ropes is bad, involving needless chafe at many points, and being exposed to the weather and constant wetting with sea-water throughout the length of the vessel from the stern to abreast the pilot-house, will be liable to speedy injury by rust. The 1-inch steel bolt connecting the wheel ropes to the chain round the quadrant on the rudder-head by a composition attachment will soon be so corroded by the action of salt water as to render it useless or unsafe for purposes of adjustment. The device for releasing the chains when changing from steam to hand power, and *vice versa*, is crude and difficult of manipulation, and much inferior to the arrangements for like purpose on board the best ships of the mercantile marine of the day. The wooden casing over the right and left hand screw steerer and the grating platform surrounding the wheel and apparatus are of weak and flimsy construction, and the after frame of the steerer is fitted to the stern upper works of the vessel in a very unworkmanlike manner. There is no way to ship the tiller, should such requirement arise, except by the removal of the hand-screw steerer from the rudder-head, together with its framing—a cumbersome detail at any time and a very grave matter to manage at sea in heavy weather. The tiller was not even on board ship, but the Board was told by one of the leading men or foremen of the works of the Messrs. Roach & Son that it was in the shop. The tiller was subsequently brought on board. The rudder indicator and annunciator required for the after bridge and the annunciator for the forward bridge are lacking. The after bridge is also unprovided with sounding or speaking tubes.

In the after transom three beams are unsupported by stanchions, rendering the deck above of doubtful strength to withstand the shock and strain of a heavy sea boarding the vessel at that point, a thing not unlikely to happen in scudding. In the same part of the hull two reverse frames are stopped short, and a space of about 4 inches separates them from the reverse frame, continuing to the deck-stringer above, thus weakening the frame at that important point.

The angle-iron truss forming support of mizzen-mast on port side is too light for

the purpose, and is also defective, having a split lengthwise in its web for a distance of about 6 inches.

The freeing ports amidships are so finished as to leave a water space of about 10 inches above the covering-plates forming the bottom of the hammock nettings. The port on the starboard side has the lower sill cemented on wood without any scupper or other arrangement for draining the water which in time will be likely to fill the space. The one on the port side was found to be uncemented, being simply closed with rough boards, but since the board noted such omission the cement has been put in.

The iron work of the vessel "where water may be liable to lodge," has not been cemented in all cases as required by the specifications, and the painting in some places has been neglected or slighted, as clearly shown by the rust observable on the metal.

The planking of the main deck is not of the "best quality," being knotty and shaky in parts, and not laid in the best manner, many of the wood screw bolts passing into the seams instead of into the body of the planks. The timber hatch coamings are too wide for good work and tightness, and the deck leaks fore and aft, as demonstrated by the rain-storm of the 1st ultimo.

Most of the coamings and hatches below the spar-deck, fore and aft the ship, are made in a rough and discreditable manner, patched with batten strips, and in no way conforming to the specifications calling for "workmanship of the most thorough character."

The planking of the berth deck is of inferior quality, rough and knotty in various parts, some places indicating sap, and calked in so poor a manner that the entire deck would leak like a sieve in case it became flooded with water, and so damage or destroy the perishable stores and equipments stowed below it in the hold, store-room, sail-room, bread-room, and the like. The Board was unable to find more than two thin threads of oakum in any of the seams, the specifications calling for not less than three threads, and it was an easy matter to pull the threads out by the yard in various parts of that deck. Some of the seams in the cabin did not seem to have been calked at all, and none of the seams of that part of the deck—cabin and ward-room—laid with white pine are painted, as required by the specifications. Such was the condition of the deck until the 11th ultimo, when the Board found a large gang of calkers on board at work on it. One effect of this calking, incomplete as it was, not extending into the wardroom, state-rooms, nor under bulkhead sills, was to make it difficult to shut down some of the hatches, to split or splinter to some extent the under side of the deck, and to start or drive out some of the wood-screw fastenings. In its fastenings this deck shows grave defects; the wood-screw bolts pass into the seams instead of into the body of the planks at many points, and in the opinion of the Board the deck can never be calked in a proper manner. The butt plates, called for in the specifications to be placed under each butt of deck planking, have not, so far as the Board could discover, been supplied. In this connection attention is invited to the contractor's explanatory letter of May 11, 1885, a copy of which is herewith appended, marked "I."

The hold floors do not conform to the specifications, in that there are not sufficient arrangements for entering the bilges for cleaning and painting at all points of the ship.

The deck houses are not fitted with water-tight doors, nor the dispensary with bottle-racks; the galley-room and several of the hold store-rooms have no shelving; the seamen's water-closet lacks full cemented lining; the bread-room is not tinned throughout nor in a thorough manner, and lacks "perfect water-tightness," as shown by the water stains and rusted sheets of tin (one broken through) in its after part—all in default of the specifications. No gratings had been fitted in the bread-room, but have now been supplied.

The painting in the cabin and wardroom does not show "workmanship of the most thorough character;" it is inferior, and the gilded moldings called for in the specifications are lacking, as well as the tiling on the floor of the cabin bath-room and water-closet.

The bunk-boards in the state-rooms are fitted in a rough and careless manner, and some other of the joiner work in the cabin and wardroom, and wardroom companion-way, cannot be considered, in minor details, as first-class work, especially as the bureaus in the state-rooms have no backs, the bulkheads being made to answer that purpose—a make-shift not known before to the naval service. The shutters do not seem strong enough to stand the hard usage of shipboard, and the state-room doors are not fitted with carrying rollers.

The wooden sheathing or ceiling of the sail-room is not carried up to the deck above to within 2 or 3 inches, leaving that space open for the access of vermin (rats) from the hold.

The bottom boards of the hammock nettings are about 3 inches below the level of the scuppers, making it impossible to drain them properly in case water gets into them, and the bottoms are not cemented. The wooden moldings of the nettings are

not of first-class finish, especially the end or upright moldings, which are of soft pine, put on in the roughest manner. The top rails are not neatly scarfed in all cases, and forward of the nettings on the port side a graving piece of soft pine set into the rail mars its appearance.

The water-tight covers on inner sides of hawse-pipes are roughly made and of insufficient strength. In some of the recently built merchant steamships the hawse-pipes are fitted with neat water-tight plugs, which answer their purpose admirably.

The sheathing of the chart-house deck is of inferior material and is not neatly laid. As to defects which may have been discovered by or have attracted the attention of the Board, as suggested in the Department's supplementary instructions of the 30th ultimo, a copy of which is herewith appended, marked B, the Board is of the opinion that the steering gear should have been arranged so as to have the wheel ropes lead under the main deck and to carry a tiller as well as quadrant or circle at its appropriate place in the after transom, and that the pilot-house should have been fitted with both steam and hand steering wheels, changeable from one to the other at a moment's notice, as provided on board merchant steamers of the best construction; and for such purpose the house should have been arranged, and made larger if found necessary. With the small steam steering wheel now in the house there is not sufficient room to get round the chart-table when working over a chart.

The bow of the ship does not seem to be strong enough to resist the shock and pressure of the sea when butting into it in heavy weather; and to prevent possible panting under such circumstances, double-angled stringers of the same size as the present upper and lower bilge keelsons should have been placed midway between the upper and lower decks from the inner part of the stem forging aft to the second collision bulkhead, with connecting intercostals making attachment to the skin of the ship as far as may be seen desirable, together with proper plate or angle breast-hooks within the collision compartment.

The armory is badly located and cramped for room, in that it is put up on the berth-deck at the after end of the wing passage and immediately adjacent to the steerage hatchway, which from the closeness of the latter to the port gangway will be likely to be one of the wettest parts of the ship in bad weather. Seas coming over the gangway would be almost sure to pour down that hatch, flooding the deck, including armory and wing passage space below.

The location of the dynamo, its engine, and switches of the electric-lighting apparatus must be regarded as unfortunate, as, being placed on the berth-deck, they are liable to be tampered with by evil-disposed men of the crew, especially as the switch-board has not been guarded with a protection frame. In the opinion of the board, the after end of the engine-room house might have been extended a little farther aft on the spar-deck, so as to accommodate the apparatus without adding excessive weight to that part of the ship. So located, the apparatus would have been under the eye of the officer of the deck at all times, and more space been left for the crew on the rather cramped quarters of the berth-deck.

The large house over the cabin companion-way is a needless incumbrance, adding weight to the ship, which could have been utilized to more efficient use elsewhere. It also takes up room better left for the work of the deck and the range of sight from that part of the vessel.

The present carriage of the boats just abaft the gangway is not good; for sea-stowage fittings should have been provided to carry them upon the rail or on light gallews-frames.

The construction is also defective in not finishing the berth-deck with water-ways and scuppers, the evidence of water collecting along the edges of the planking and bulkheads being already too apparent, as shown in the wing passage on berth-deck and under steerage hatch.

To avoid false closure of the water-tight doors, the door clamps should have been fitted with stops to prevent their excessive action in passing beyond the point needed to effectively close the doors.

In the matter of the battery, the construction of the vessel in not providing for a fire directly ahead with the 6-inch rifle must be regarded as a grave defect. Carrying but one effective gun, the greatest all-round range of fire possible should have been arranged for.

The pin rails have not been bored for belaying-pins, and the awning stanchions are not galvanized.

The ends of the planking on the berth and top-gallant fore-castle decks are not nibbed at the ends of the vessel, as they ought to be to insure good work and strength.

With regard to the engines, boilers, and main machinery of the vessel, the Board, so far as it has been able to determine from the examination possible to make under the circumstances, is of the opinion that their general construction and the character of the material of which they are made conforms to the terms of the contract and specifications and the various changes made by authority of the Naval Advisory

Board from time to time. But the Board submits that the examination shows some omissions and defects that require noting, as follows:

The engine bed-plate was designed to be supported on a wooden bed laid between the engine foundation and bed-plate, through which bolting passes for securing them together. Each bolt was to be fitted with an iron filler in lieu of the wood to make solid bolting, but the examination showed that some of the bolts lack such appliances, leaving to the wood alone the strain imposed by the working of the engine, the ultimate effect of which would tend to the loosening of the main connection and support.

The supports to the shaft alley are not first class in workmanship, the angles and brackets not being properly cut to fit down on the frame of the vessel so as to give the best support.

The engine-room floors cannot be regarded as of first-class workmanship and necessary convenience.

The steel shafting called for in the contract broke on the first trial trip proper of the vessel. The contractor furnished another shaft of the same material, constructed under the same faulty process as the first one, but the tests applied to this new shaft not being satisfactory to the Advisory Board, the contractor was permitted to substitute iron shafting in its stead; and it would seem that the extra expense involved in the change, including the tests applied to the rejected shafting, and which further determined the action of the Advisory Board with regard to the shafting of the Atlanta, Boston, and Chicago, the removal of the prior shafting and the putting in of the iron one, together with the cost of the necessary cutting away of the beams and planking on the berth and main decks and the enlargement of the stern and other bearings to take the larger diameter of the iron shaft, has been charged to the account of the Dolphin and against the Government. The Board is of the opinion that good and safe steel shafting, slightly modified from the specifications and drawings furnished the contractor, of the diameter required (13 inches), could have been made in this country, and that the cost of all shafting supplied the vessel, together with the incidental expenses connected with the removal of the broken shaft and the putting in of the new one, should have been borne by the contractor.

A compartment pump supplied to the vessel proved to be larger than was necessary. This pump was removed to be used in the Chicago, and a second and smaller one was put in its stead, the cost of which was charged to the Dolphin. No credit seems to have been given the vessel for the pump removed.

On the 24th ultimo a letter was addressed to Mr. Roach, the contractor, a copy of which is herewith appended, marked C, requesting him to prepare the Dolphin for a trial trip at sea, to which Mr. Roach replied by letter under date of the 29th ultimo, a copy of which is herewith appended, marked D.

Nothing more definite or satisfactory was heard from Mr. Roach until the morning of the 6th instant, when, meeting the Board on board the Dolphin, he remarked that he had just returned from Washington and exhibited a copy of the Department's orders to the Board of the 5th instant concerning the proposed trial trip.

Upon receipt of the Department's order in question, a copy of which is herewith appended, marked E, Mr. Roach was addressed, as per copies of letters marked F and G, and Rear Admiral E. Simpson, U. S. N., president of the Naval Advisory Board, was advised with regard to the matter, as per copy of letter marked H; and, in accordance with the arrangements indicated, the Board met on board the Dolphin on the morning of the 12th instant to witness the proposed trial down Long Island Sound, the run to be for six consecutive hours.

Chief Engineers Kierstead, Thomson, and Ziegler, U. S. N., accompanied the Board as experts to assist in determining the horse-power of the vessel. Lieut. T. C. McLean, U. S. N., also reported on board and was assigned to the duty of keeping the run of the vessel by patent log, and chart, and bearings. Of the Advisory Board only Mr. Henry Steers was present.

The Dolphin, in charge of a captain and pilot furnished by the contractor, the latter himself being on board, backed out from the dock at the foot of Eighth street, East River, at 9.10 a. m., and three minutes later proceeded up East River at good speed for the Sound. Execution Rock Light was reached at 10^h 38^m 52^s a. m., from which point departure was taken and the trial begun, the intention being to make a straight continuous run for the whole time and distance through the Sound.

The conditions of wind, sea, and tide were very favorable; the wind from point of departure of force from 1 to 2 from the southward and eastward to northward and eastward; the water smooth and of low temperature, and the tide at ebb, favoring the vessel at from one-half knot to 1 knot an hour. The barometer (aneroid) stood at 30.29; thermometer, 55. Draught of water forward, 12' 0"; aft, 14' 3"; mean, 13' 1¹/₂".

The draft in the furnaces was good, all the blowers running at high velocities, and the fuel used was George's Creek coal of excellent quality, clean, and burning with clear flame.

Eaton's Neck Point Light was passed at 11^h 42^m 51^s a. m., the vessel running at about

maximum speed. At 12^h23^m52^s p. m., when nearing the Middle Ground Light, the engines gave the first indication of trouble, and at 12.25 p. m. slowed down considerably, coming to a dead stop at 12.30 p. m., thus ending the trial.

The forward crank-pin had become heated and it became necessary to make temporary repairs to get back to the dock, which operation occupied 4 hours 51 minutes, when the vessel was started back for New York, arriving at the foot of Twenty-eighth street at 8.40 p. m.

The speed made by the vessel could only be determined with approximate accuracy on that part of the course between Execution Rock and Eaton Neck Light, and was as follows, as shown by bearings and patent log:

Speed per hour by taffrail log.....	14.5
Speed per hour by bearings.....	15.5
Difference.....	1.0

But the difference in favor of the distance run per hour as shown by bearing can readily be accounted for by the effect of the fair tide, so that the speed registered by the taffrail log doubtless indicated the approximate speed given the vessel by the power of the engines for the first hour of the run, during which hour, however, the engines were not worked up to their highest point of effort.

The average speed for the entire run, but not possible to determine with the approximate accuracy obtainable with regard to the result shown during the first hour's work, was 14.8 knots per hour nearly.

The taffrail patent log used was a new one of the American pattern, furnished from the navy-yard, and there is no good reason to question its approximately correct registration.

The mean indicated horse-power developed by this partial trial averaged for both high and low pressure cylinders.....	1,998
By blowers and pumps, approximately.....	90

Mean collective power.....	2,088
The highest number of revolutions per minute.....	78
The lowest number of revolutions per minute.....	68
Highest pressure of steam..... pounds..	87½

This data was determined by the experts ordered to assist the Board, and as all the conditions of the trial were so exceptionally favorable for the vessel, the Board is constrained to believe that her engines will never develop the power for six consecutive hours called for in the contract.

No arrangements were apparent for securing the air pressure in the fire-rooms as required by the terms of the contract, *i. e.*, "an air pressure equivalent to a head of water of 1 inch in the fire-rooms," and when the contractor's attention was called to that point he stated that such pressure had been obtained on the first trial of the ship witnessed by the Advisory Board, by covering the hatches with tarpaulins, but owing to changes made by the Advisory Board he could not now get the pressure. It is needless to say that the air pressure demanded by the contract could not be obtained by any such contrivance as the contractor alleges was used on the occasion of the first trial witnessed by the Advisory Board. On this provision of the contract the efficiency and safety of the vessel might depend in a great degree in cases of emergency.

The vibrations of the ship during the run were of such a nature as to indicate a lack of structural stiffness, which, in the opinion of the Board, will be likely to rack and weaken the ship, especially under full power in a seaway. The floors forming the engine-room foundations spring severely, even when running under ordinary power in smooth water, and, in the opinion of the Board, additional stiffness should be provided under the engines and intermediate between them and the after bulkhead of engine-room, in the way of webbed frames forming cross floors extending up to the lower deck stringers, and from this by suitable proportions to shape for passage-way to extend to main-deck stringers.

The working of the steam steering-engine caused a severe vibration of the after part of the vessel, due, in the opinion of the Board, to the unusual character of the steering apparatus applied for a naval vessel.

Report of this partial trial having been made to the Department, the Board was directed to continue the trial when ready, and arrangements were made with Mr. Roach to proceed with the next trial on Monday, May 18, at which date the Board met again on board the Dolphin for the purpose in question, and accompanied by the same officers as on the previous occasion, with the exception of Chief Engineer Ziegler, whose place had been taken by Passed Assistant Engineer Kearney. Mr. Henry Steers was also present again to represent the Advisory Board. At 8.13 a. m. the ship backed out from the wharf in charge of the contractor, and at 8.25 a. m. started ahead from abreast the foot of Twenty-third street at moderate speed. At 9.19, when within about a mile of Execution Rock Light, from which point the trial was to begin, the after crank-pin became hot, and the vessel had to stop, and finally came to anchor.

And here one great defect in the ship's steam working gear became but too apparent, for while the vessel has twenty-three separate engines on board, no provision has been made for turning the engines by steam power when the main engines are disabled, and, instead of the less than five minutes that ought to have sufficed for the turning of the engines into position to enable the crank-pin and brasses to be overhauled, it took one hour and a half to effect that purpose, although only a quarter of a turn of the engines was required and made.

The ship was not ready to proceed under steam again until 5.05 p. m., when the anchor was weighed and a course laid past Execution Rock to the northward and eastward until 6.16 p. m.; the vessel was then turned back, and at 8.18 p. m. brought to anchor for the night off the foot of Twenty-eighth street.

In weighing the anchor the Board noticed that when a swivel of the chain reached the barrel of the steam windlass the grip was not good, and that recourse was had to a preventer rope before the swivel could be made to bite and pass abaft the barrel. Such defect would be likely to prove a serious matter in lifting the anchor in rough water; the slipping and surging of the chain under such conditions would be apt to snap it.

The conditions of this attempted trial were all favorable—good breeze for draught, smooth sea, excellent coal, the best lubricant (cold pressed castor oil), and a well-skilled force of engineers and firemen to manage the engines and boilers. Each fire-room was in charge of the contractor's leading workmen—regularly certificated chief engineers of the merchant marine—and the engines were attended by the most trustworthy and competent machinists and engineers of the contractor's establishment. In short, no effort or precaution was spared on the part of the contractor to make the engines and dependencies do their desired work; but the 40 tons of pig-iron ballast, placed in the forward end of the ship on the trial of the 12th instant, and the 5 tons more of like ballast put on board in the same part of the vessel on the occasion of this second attempt, together with the lessened weight amidships in the amount of coal consumed from the bunkers in the running of the engines for many hours alongside the dock, as well as in the river and sound before the trials could be carried out, may have had something to do with the failure of the machinery to work properly. If such be the fact, it indicates nothing less than structural weakness of the vessel, confirmatory of the impressions of the Board as expressed in another part of this report.

And here the Board takes occasion to express the opinion that the engines and machinery generally are of such inconvenient design and so inconveniently located and arranged as to require much more than the usual number of engine and fire-room force to properly attend them. In fact, the force needed will doubtless be as large for this little ship as is required to care for the engines and dependencies of much larger vessels of the naval service.

After nightfall the Board had opportunity to observe the working of the electric lighting apparatus, when it became apparent that its machinery is cramped for room, and that no provision has been made to protect the machinist in charge from accident when the ship is laboring in a seaway.

A rod or rail should be put up parallel with the machinery to afford such absolutely necessary safeguard, for, as now arranged, there is no point in the room which the machinist could take hold of to prevent being thrown upon the rapidly moving engines by the rolling, lurching, and pitching motion of the vessel incident to service at sea. The Board also noticed two or three gallons of oily water swashing about the deck of the room with no means of carrying it off. The deck should be leaded and fitted with coamings, and provided with scupper to run the water into the bilge.

On the afternoon after this last attempted trial Mr. Roach, the contractor, called upon the Board and requested information as to future procedure with regard to the vessel, and was referred to the Department, the Board having no authority to arrange for other trials without further instructions. Subsequently the Board received instructions from the Department to witness another trial in the Sound on the 28th ultimo, and on that date the ship left the dock in the East River for its third effort before the Board, on which occasion the ship's draught, with 230 tons of coal in the bunkers, was, aft, 15 feet 5 inches; forward, 12 feet 2 inches; mean, 13 feet 9½ inches.

	<i>h.</i>	<i>m.</i>	<i>s.</i>	
Backed out from wharf at.....	9	29		a. m.
Took departure from Execution Rock Light.....	11	02	38	a. m.
Passed Matinicoek buoy.....	11	23	48	a. m.
Passed Eaton's Neck Light.....	12	10	06	p. m.
Passed Middle Ground.....	1	07	32	p. m.
Turned at Faulkner's Island.....	2	34	00	p. m.
Slowed from 75 to 74 turns in turning.				
Passed Middle Ground Light.....	4	14	21	p. m.
Six hours ended.....	5	02	35	p. m.

Wind from E. NE. to S. SE. during trial; force, 2 to 4.

Barometer, 30.21. Thermometer attached, 64°.

Anchored off foot Twenty-eighth street at about 8 o'clock p. m.

Highest steam pressure	pounds..	89
Lowest steam pressure	do.....	84
Highest vacuum	inches..	26½
Lowest vacuum	do.....	24
Highest feed temperature	degrees..	120
Lowest feed temperature	do.....	106
Highest number of revolutions		76
Lowest number of revolutions		72
Average		
Highest horse-power by card		2, 255
Approximate mean indicated collective horse-power		2, 169. 48
Average speed as shown by bearings	knots..	14. 93
But corrected for tide	do.....	14. 6

All conditions favorable; ebb tide, moderate breeze to light, smooth sea, and clear channel.

Ship deeper than on other trials and showed less vibration.

Link motion defective in still having too much jar.

Streams of water were pouring on the journals and crank-pins during the trial, and a large amount of oil was consumed in lubricating the machinery.

The Board found that shelving had been placed in the various store-rooms below; that a good deal of the iron-work had been freshly painted, the step of the mizzen-mast strengthened, and preparations going on to splice the two cut frames in transom.

Commander Evans, of the Board, was not present, being unavoidably absent on other duty.

Mr. Steers and Assistant Constructor Bowles represented the Advisory Board. Chief Engineers Kierstead and Thomson and Passed Assistant Engineers Perry and Kearney were on board to take data with regard to horse-power, &c., and Lieutenant McLean kept the run of the log and chart for distances. Mr. Roach, the contractor, was also on board.

Chief Engineer Morley, U. S. N., submitted the following memorandum concerning the grounding of the Dolphin on the 26th instant, when the contractor took the vessel out for a non-official trial:

"Ship backed out from the wharf at 5.45 a. m. Tide running flood and within about one hour and a half of high water. Ship was started ahead in channel while over reef; struck slightly, when engines were stopped. Ship was then drifting along the reef, broadside up the river. Struck quite heavily again and dragged along reef, the vessel careening to starboard about 30°. The engines had been started slowly while on reef and while drifting, but screw struck and engines were stopped. Ship finally became fast on reef off Tenth street, aground under cabin; 14 feet of water under starboard quarter, 18 feet under port quarter. Floated off by the tide and aid of tug at 6.40 a. m."

In view of the facts given in the foregoing memoranda, it would seem that the vessel should be docked before the proposed sea trial is made, and to prepare her for such trial all her boats should be carried, her sails bent, and sufficient weight put on board to represent her service outfit and crew.

Mr. Roach, the contractor, stated to the Board that he was ready and willing to put the ship in condition to make her satisfactory to the Government, no matter what the expense.

On the 11th instant the fourth and last trial witnessed by the Board was had at sea outside Sandy Hook, the ship having her sails bent, the boats hung to her davits, and weights placed in various parts of the hold and on deck to represent her armament, stores, and service equipment generally.

Ship's draught with bunkers full of coal and loaded with weights to represent service displacement:

	<i>ft. in.</i>
Forward	13 9
Aft	15 3
Mean	14 6

	<i>h. m. s.</i>
Started from foot of Eighth street about	9 12 00 a. m.
Took departure from Scotland Light-ship	10 47 30 a. m.
Barnegat Light abeam, distant about 3 miles	1 57 15 p. m.
Light abeam again after turning	2 01 00 p. m.
Six hours' run ended	4 47 30 p. m.
Passed Scotland Light-ship	4 49 15 p. m.

Barometer, 30.41. Thermometer attached, 65°.

Wind, south to east. Force, 2 to 3.

Passed the Despatch of Fort Richmond.

On arrival at Barnegat the Despatch was some 10 or 12 miles astern.

Highest steam pressure.....	pounds..	88
Lowest steam pressure.....	do.....	79
Highest vacuum.....	inches..	27
Lowest vacuum.....	do.....	25
Highest feed temperature.....	degrees..	120
Lowest feed temperature.....	do.....	94
Highest number of revolutions.....		72
Lowest number of revolutions.....		64
Average number of revolutions.....		66.77
Highest horse-power by card.....		1,947
Approximate mean indicated horse-power independently of auxiliaries.....		1,623
Approximate speed shown by bearings and influenced by fair tide.....	knots..	13.6

All conditions favorable for trial. Smooth sea, light breeze, and fair tide both ways, and in no sense could the trial be regarded as testing the seagoing qualities of the ship.

The fires were managed under natural draft.

The contractor and all the members of the Board were present, as well as Lieut. T. C. McLean, Chief Engineers Kierstead and Thomson, and Past Assistant Engineers Kearney and Perry, also Mr. Samuel Archbold, Mr. Henry Steers and Assistant Constructors Bowles and Gatewood, of the Naval Advisory Board, and Assistant Constructor Hanscom.

Link motion still defective.

Water was run upon the journals and crank-pins, and oil very freely used throughout the trial.

Considerable vibration still apparent.

The lubricant was olive oil.

It was found that since the last trial in the Sound the spar-deck had been calked fore and aft, the calking on the berth deck finished, the cut frames in the transom connected by stout floor-plate, the painting of the skin and frames in that part of the ship finished, as well as in the fore peak, and that all the wood work in the hold storerooms had been given a fresh coat of white paint, and the masts scraped and the weather cracks filled up with putty.

A.

NAVY DEPARTMENT, *Washington, April 7, 1885.*

The steamship *Dolphin*, built under contract between the Navy Department and Mr. John Roach, is presented for acceptance and final payment under her contract.

For the purpose of informing myself as far as possible of the facts necessary to the determination of the matter involved in her acceptance, I hereby designate Capt. George E. Belknap and Commander Robley D. Evans to act with Mr. Herman Winter, of New York, as a board of examination to investigate and report to me—

1. Whether she has been constructed in accordance with the terms of the contract.
2. In view of the necessary limitations upon any investigation of a completed ship to report specifically what matters they are able to determine and how they determine them.

3. What matters are impossible of determination except as the work is going on.

The Board will be furnished such assistance, expert or otherwise, as they may desire, and has no responsibility for the success or failure of the ship if accepted by me.

W. C. WHITNEY,
Secretary of the Navy.

B.

NAVY DEPARTMENT, *Washington, April 30, 1885.*

SIR: In addition to the instructions heretofore given you with regard to the examination of the *Dolphin*, your Board will please report to me any defects which may attract your attention or which you may discover in the present condition of the boat, whether due to her design or plan, or to the execution thereof, specifying in detail her defects, if any, so as to convey intelligible information as to the cause in each case.

Very respectfully,

W. C. WHITNEY,
Secretary of the Navy.

Capt. GEORGE E. BELKNAP, U. S. N.,
President Board, &c., New York City.

C.

NEW YORK CITY, *April 24, 1885.*

SIR: For the fuller information of the Board of Examination acting under the instructions of the honorable Secretary of the Navy, the Board has to request you to prepare the Dolphin for a trial trip at sea at as early a date as possible.

Respectfully, your obedient servant,

GEO. E. BELKNAP,
Captain, U. S. N., Senior Member of Board.

Mr. JOHN ROACH,
New York City.

D.

[Morgan Iron Works, foot Ninth street, East River.]

NEW YORK, *April 29, 1885.*

SIR: Your letter of 24th instant received, in which you say: "Acting under the instructions of the honorable Secretary of the Navy, the Board has to request you to prepare the Dolphin for a trial trip at sea at as early a date as possible." The Dolphin, so far as I know, requires no preparation for such a trial, excepting the necessary supply of coal and men. Having already made the trial provided for in my contract with the Navy Department, the engines performing satisfactorily, as reported by the Naval Advisory Board, I will communicate direct with the honorable Secretary of the Navy regarding the additional trial suggested.

Your address not being given in your letter, and not being aware until to-day that you were in Washington, I have been unable to forward my reply.

Yours, very respectfully,

JOHN ROACH.

Capt. GEORGE E. BELKNAP, U. S. N.,
Washington, D. C.

E.

NAVY DEPARTMENT, *Washington, May 5, 1885.*

SIR: I have been called upon to-day by Mr. Roach. I have assented that the trial trip shall take place in the Sound instead of at sea, the Advisory Board to be present, but the directions to be given by your Board. With these conditions she will be ready for trial within one week, the same to be for a six hours' run.

Very respectfully,

W. C. WHITNEY,
Secretary of the Navy.

Capt. GEORGE E. BELKNAP, U. S. N.,
President Board. &c., New York City.

F.

MILLS BUILDING, FLOOR 8,
New York, May 6, 1885.

SIR: The Board of Examination is advised by the honorable Secretary of the Navy, under date of the 5th instant, that the Dolphin will be ready for a six hours' trial in Long Island Sound within a week from that date, and I beg to inform you that the Board will be ready to meet you on board the Dolphin in readiness to make the trial in question on Tuesday, the 12th instant, at 9 o'clock a. m.

The Board is also advised that the Naval Advisory Board will be present on the occasion of the trial.

Respectfully, your obedient servant,

GEO. E. BELKNAP,
Captain, U. S. N., Senior Member of Board.

Mr. JOHN ROACH,
New York City.

G.

NEW YORK, *May 6, 1885.*

SIR: Referring to my letter of this date concerning the trial trip of the Dolphin on Tuesday next, the Board is of the opinion that the fuel used should be the semi-bituminous coal with which our ships are generally supplied, especially on foreign service.

Respectfully, your obedient servant,

GEO. E. BELKNAP,

Captain, U. S. N., Senior Member of Board.

Mr. JOHN ROACH,
New York, N. Y.

H.

MILLS BUILDING, FLOOR 8, ROOM 19,
New York City, May 7, 1885.

SIR: I have the honor to inclose for your information a copy of a letter of instructions from the Department concerning another trial trip of the steamship Dolphin, and beg to advise you that Mr. Roach, the contractor, has been informed that the Board of Examination will be on board that vessel in readiness for the trial in question on Tuesday next, the 12th instant, at 9 o'clock a. m.

Very respectfully, your obedient servant,

GEO. E. BELKNAP,

Captain, U. S. N., Senior Member of Board.

Rear-Admiral E. SIMPSON, U. S. N.,
President Naval Advisory Board, Washington, D. C.

I.

MORGAN IRON WORKS, FOOT NINTH STREET, EAST RIVER,
New York, May 11, 1885.

SIR: I desire to submit to your Board the accompanying blue prints of original plans of Dolphin, and to offer the following explanation of the details of construction wherein exceptions have been taken, viz: The reverse frame No. 130 was cut in contemplation of extending the berth-deck flat to the post, the reverse bars being required to be cut for this purpose. Subsequently it was decided to end this flat on bulkhead No. 128. Stanchions abaft this point to main-deck were not required by the plans or inspector, but were put elsewhere wherever directed, including six additional ones to main deck forward. The plates called for by specifications under butts of berth-deck plank were omitted at the discretion of inspector, the butts being cut diagonally to admit of fastening in each plank end. I find throughout the berth-decks forward and aft there are fourteen butts such as are referred to, which would have required about fourteen plates or 39 pounds of steel plates; the inspector, however, required me to put plates under all berth-deck hatch coamings, an item amounting in the aggregate to about 1,000 pounds of steel plates not called for in specifications or plan.

With reference to calking of decks, both main and berth decks were originally calked with two threads. The main-deck and berth-deck under bulkhead cleats were subsequently recalced, the former with two threads and the latter under bulkheads with one thread. It was then thought best by the inspector and Advisory Board to defer the recalcing of balance of berth-decks until the ship should be completed.

In the memoranda of work required to complete the vessel, made by the Advisory Board and the inspector at the conclusion of the last steam trial, nothing was said about recalcing, and I presume it may have been an oversight on their part. All the work in the bread-room, as far as sheathing with wood and tin is concerned, was completed in compliance with the wishes of inspector, but the grating was an oversight of my own, as I was furnished with the specifications; this grating, however, I have since furnished. The members of the Advisory Board and the inspector decided that it would be necessary to paint the awning stanchions, and preferred not to have them galvanized.

Additional beams on berth-deck for stiffening deck to resist calking were asked for by the inspector and furnished. The deck fastenings alleged to have been placed in the seams were put in diagonally, the deck being reamed and calked without any in-

terference from the deck screws. Aside from this the additional fastenings exacted by the inspector would compensate for any insufficiency.

Yours, respectfully,

JOHN ROACH.

Capt. GEORGE E. BELKNAP, U. S. N.,
Senior Member of Board.

Supplementary Report of Examining Board.

NEW YORK, June 23, 1885.

SIR: In obedience to the Department's order of the 20th instant, the undersigned members of the Examining Board visited the Dolphin on the 22d instant, in the dry-dock, Erie Basin, Brooklyn, N. Y., and found two garboard keel plates off on the starboard side and one plate off on the port side, under the engine-room.

These plates, which had been in contact with the rocks on the occasion of the vessel's grounding on the reef in the East River, seemed to be sound and free from cracks, thus indicating good material; but it was seen that some of the rivet holes of the keel, laps, and frames were unfair, and that clearly-defined lines and patches of rust on the center or keel plate and the floor plate showed that the space had not been properly cemented in all places.

Men were at work forcing the keel plates back into shape, under the inspection of Mr. Samuel Archbold, of the Naval Advisory Board, and Assistant Constructor Jno. F. Hanscom.

Mr. Sinclair Stewart, representing the Board of Underwriters, and Mr. Roach were also present.

The tail nut of the propeller shaft having been unscrewed, it was seen that the propeller hub had not been loosened from the shaft or in any way injured.

In parts of the vessel's bottom the plating showed wavy and unfair workmanship, especially along the seams.

Commander R. D. Evans, of the Board, did not receive his orders in time to be present at this inspection, having been at work in the Chesapeake in the performance of his duties as light-house inspector.

Very respectfully,

GEO. E. BELKNAP,
Commodore, President of Board.
HERMAN WINTER,
Constructing Engineer, Member.

Hon. W. C. WHITNEY,
Secretary of the Navy, Washington, D. C.

The Secretary of the Navy to the Attorney-General.

NAVY DEPARTMENT,
Washington, June 17, 1885.

SIR: Herewith I transmit a copy of the report of the board appointed by me on the 7th of April last to examine and report upon the dispatch boat Dolphin.

I desire you to examine this report and to advise me what upon the law applicable to the case is my duty in the premises. The facts and

circumstances connected with this examination and the matters with reference to which I desire advice are briefly stated as follows :

Immediately after my accession to this office papers were presented to me for my signature accepting the Dolphin in behalf of the Government. Upon a cursory examination of the papers, made for the purpose of determining to what extent I had responsibility in the matter, my attention was attracted to the singular looseness of the contract. There was a notable absence of effective stipulations, as it seemed to me. There was, however, one positive requirement contained in the ninth section of the contract, intended to insure a certain minimum power, which provided that upon her trial trip "the collective indicated horse-power developed by said engines under the prescribed conditions shall be two thousand three hundred, and maintained successfully for six consecutive hours; provided that, in case of the failure of the development of this power, the vessel shall be accepted if it can be shown to the satisfaction of the Naval Advisory Board and the Secretary of the Navy that this failure was due neither to defective workmanship nor materials." This trial having been had in Long Island Sound, under conditions favorable in the main, she had yet failed of meeting this requirement, having developed but two thousand one hundred and eighteen horse-power for the six hours. The Naval Advisory Board in referring to this had stated that they were of the opinion that this deficiency "was not due to defective workmanship nor materials, but that with better coal and a well-trained engineer's force these results will be exceeded." For the purpose of verifying this prediction and to satisfy myself, as appeared to be my duty, I wrote upon the 20th of March, suggesting to the contractor another trial. As the place of the trial had been fixed in Long Island Sound by the persons authorized under the contract to prescribe the conditions of the trial, and as the terms were not more severe than those exacted by other nations, I expected an immediate favorable reply to this reasonable request. It was acceded to on the 5th of May, over six weeks having elapsed.

In the mean while an examination of the dealings of the Department with the contractor, and especially the manner in which the reserved payments had been surrendered to the contractor, induced me to select three competent persons to make thorough examination for the purpose of my advisement as to (1) whether the contract had been properly performed; (2) as to defects in the vessel; (3) as to the responsibility for the defects observed, if any. The result of that examination, made with great patience and intelligence, is herewith submitted for your consideration.

I now desire an examination of the contract and the law by you, that I may be advised whether, representing the Government, I have on my hands what is in the nature of a bad bargain or a broken contract. The report demonstrates that the Government has not got in the Dolphin what Congress stipulated for and what should have been obtained.

There are three general subjects considered by the board: First, the speed; second, the strength; third, the general workmanship.

First, as to speed. The act of Congress under which the Dolphin was built provided for an appropriation "for one dispatch boat, as recommended by the Naval Advisory Board in its report of December 20, 1882." By referring to that report it will be found that the recommendation was for the construction of "one dispatch vessel or clipper, to have a sea speed of fifteen knots." A reference to the report of the Advisory Board then before Congress, and the testimony which had been taken by its committees upon the subject of the new cruisers, shows that

for a sea speed of fifteen knots, a smooth-water speed over measured distance of seventeen and one-half or eighteen knots is required. Similar vessels able to show a speed of eighteen and even nineteen knots were referred to before the Congressional committee as being in course of construction by other nations. It may, therefore, be said to have been the just expectation of Congress in appropriating for the *Dolphin*, considering the state of the art, that she would be able to show at least seventeen and one-half knots speed upon her trial. Her highest speed for six hours was fifteen knots, as you will observe by examining the report of the board, and she has not at any time developed and maintained for six hours the two thousand three hundred horse-power required by the contract. Instead of being a dispatch boat of fifteen knots sea speed, the result of these various trials indicates something between twelve and thirteen knots as her probable sea speed in service. In view of the purpose for which she was built—a dispatch boat—and the state of the art with reference to speed of such vessels, it is apparent that this contract has not produced the result intended by Congress.

Second. As to her strength: From the report of the board it would seem that the evidence upon this subject is somewhat meager and rests considerably upon opinion in the absence of a sufficient sea trial. The English rules in similar cases, as I am informed, generally provide for a run of two or three days at sea. The opinion is expressed by the board that she has not the requisite stiffness. This opinion is based upon the vibration of the ship when under way, and the yielding observed in her floors and the effect of an unequal load, as seen when a small quantity of pig iron was loaded on her forward, causing her machinery to get out of line and her journals to heat. Her last two trials, according to the report, were accomplished only with streams of water pouring upon her journals during the trips. These facts seem to the board to indicate great structural weakness, to what extent, only a sufficient sea trial will demonstrate.

Third. As to the general character of her workmanship: The contract provides specifically (3d section), "the materials and workmanship used and applied in the construction of the hull and machinery and fittings of said vessel, in details and finish shall be first-class and of the very best quality." The character of the material is substantially beyond inspection now. The general workmanship and finish is criticised by the board, but as the contractor has been steadily at work at this, and expresses willingness to make the details satisfactory, so far as he is able, I think the Department could doubtless deal with that matter without legal advice.

The whole matter comes in the end to this: The Government is not receiving what it expected and had a right to expect from the construction of this vessel. The question which I desire answered is, whether the Department has in the matter a bad bargain simply, which as between contracting parties it must stand to, or has it a broken contract entitling it to insist upon something better. In connection with this question I desire to be advised what is the effect of the circumstance that the construction has been supervised by Government officials, material passed as sufficient, and the workmanship similarly approved, from time to time during the construction. The contract provides for this supervision and inspection, and I am advised that it has taken place as the work has progressed. Upon this subject I call your attention to the fourteenth section of the contract, which provides "that it shall not, under any circumstances, be obligatory upon the party of the sec-

ond part to accept the vessel or any part thereof to be constructed under this contract unless the same shall have been completed in strict conformity with this contract, under the supervision of the Naval Advisory Board, and in accordance with the provisions of the act of August 5, 1882," &c.

If the supervision and inspection that has been had is a bar, so that the Department cannot go back and examine work passed and approved by its inspectors and by the Naval Advisory Board, that ends the consideration of the matter. If it is not a bar, how far is the contractor responsible for the speed, strength, and general workmanship of the vessel, and what are the remedies of the Department under the circumstances?

I the more willingly avail of the privilege of referring this matter to your judicial judgment and advice, lest that in a spirit of resentment at this result I should be unjust.

I have the honor to be, very respectfully yours,

W. C. WHITNEY,
Secretary of the Navy.

Hon. A. H. GARLAND,
Attorney-General.

The Attorney-General to the Secretary of the Navy.

DEPARTMENT OF JUSTICE,
Washington, June 30, 1885.

SIR: Your communication of the 17th June instant requests my opinion as to the rights and duties of the United States touching the dispatch boat *Dolphin*, recently constructed by Mr. John Roach under a written contract entered into between him and your predecessor, the honorable William E. Chandler.

This vessel, you inform me, has been found to be defective in three particulars, two of which are fundamental; that is to say, (1) she does not develop the power and speed which the contract calls for; (2) she is not staunch and stiff enough for the service expected of her; and (3) the general character of her workmanship does not come up to the requirements of the contract.

As to the defect in the article of speed. The act of Congress under which the vessel was built (22 Stat., 477) makes an appropriation for the construction of "one dispatch boat, as recommended by the Naval Advisory Board in its report of December twentieth, eighteen hundred and eighty-two." Upon reference to that report it will be found, as I am informed by you, that the Board recommended the construction of "one dispatch vessel or clipper, to have a sea speed of fifteen knots," and I take it as very clear that the recommendation became, by force of this reference to it, as much a part of the statute as though it had been recited therein word for word.

The contract contains no express covenant as to the speed of the vessel—unless one is necessarily involved in the stipulation for a "collective indicated horse-power" of two thousand three hundred—but its very first covenant is to construct a dispatch boat "in conformity with the aforesaid plans and specifications hereto annexed, and in accordance with the provisions of the acts of Congress approved August 5 and March 3, 1883, respectively, before mentioned and relating thereto,"

and I am of opinion that the covenant bound the contractor as effectively to make a ship "of the sea speed of fifteen knots" as though he had agreed to do so in express words.

It may be said, possibly, that the covenant as to power and speed is not absolute, but qualified by the provision that, if upon the trial trip the engines should not develop the full power called for by the contract, and the failure should not be due to "defective workmanship or materials," the ship should be accepted by the Government nevertheless.

This attempt to bind the Government to take from the contractor's hands a ship of less power and speed than what the act of Congress' peremptorily requires, is, in my opinion, utterly null and without effect. It was to the quality of speed more than any other that Congress was looking, as the terms "dispatch vessel or clipper," used in the report of the Advisory Board referred to in the law plainly show. Congress deemed that the service required a swift vessel of a sea speed of fifteen knots, and it directed such a vessel to be contracted for and built.

The contractor cannot be heard to allege ignorance of the very law under which the contract was made. He was bound to know the source and extent of the authority of the official with whom he contracted. "Individuals as well as courts," say the Supreme Court, "must take notice of the extent of authority conferred by law upon a person acting in an official capacity, and the rule applies in such a case that ignorance of the law furnishes no excuse for any mistake or wrongful act." (*Whiteside et al. v. The United States*, 93 U. S., 257; *Hawkins v. United States*, 96 U. S., 691; *The Floyd Acceptances*, 7 Wall., 666.)

With a full knowledge of the statute authorizing the construction of a dispatch boat of a designated speed and no other, and with the plans and specifications under which the work was to be done laid before him that he might bid with intelligence and safety, the contractor, if he had misgivings whether a vessel planned like the Dolphin would make the required speed, should have abstained from sending in proposals, knowing as he did, or ought to have done, that a ship defective in point of speed could not be accepted under the statute, whatever her merits might be in other respects.

Under any other view the most imperative requirements of Congress would be liable, at all times, to be evaded upon one pretext or another. I cannot conceive how it could be seriously urged that the United States is bound under the law in question to accept from the contractor any other sort of vessel than the one ordered by Congress to be built—namely, a dispatch boat or clipper of a sea speed of 15 knots; and the Dolphin having been found not to be a vessel of that description, as I must assume, it would seem to follow that nothing short of an act of Congress could authorize her acceptance.

I come now to consider the next objection, that the vessel is wanting in the necessary strength and stiffness. If this defect exists, as I must assume, it is fatal, whether due to the plans upon which the vessel was built or not, because, by the ninth clause of the contract, the contractor and his sureties stipulate "that the vessel constructed under this contract shall be sufficiently strong to carry the armament, equipment, coal, stores, and machinery prescribed by the Naval Advisory Board and indicated in the annexed drawings and specifications * * *."

Now, it is too plain for serious discussion that the contractor has by this covenant undertaken to make a ship for a specific purpose in accordance with given drawings and specifications, and has, to all intents and purposes, warranted that the ship so agreed to be built shall be "sufficiently strong" for that purpose. In a word, the contractor, by

this covenant, makes the plans of the Advisory Board his own, and agrees to construct a vessel of sufficient strength according to those plans.

Manifestly, then, the Dolphin, which I am bound to assume, in view of the report accompanying your communication, is anything but "sufficiently strong," cannot, for this reason alone, be accepted by you under the contract, the defect mentioned being fundamental in character.

The third objection, as to the general character of the workmanship of the vessel, I need not stop to consider, in view of your representation that, if the vessel is otherwise in accordance with the contract, this objection can be readily dealt with by you, the contractor being ready and willing to make the vessel satisfactory in this respect also.

As to whether the Government has been in any wise estopped or compromised by acts of acquiescence, approval, or acceptance by the Advisory Board or others, I am of opinion that the Government stands unaffected by any such acts. This must be the case necessarily, if the law authorizing the building of a dispatch boat is to have effect. Its language is that "no such vessel shall be accepted unless completed in *strict conformity with the contract*, with the advice and assistance of the Naval Advisory Board," * * * and consequently no acceptance of a vessel not built "*in strict conformity with the contract*" could bind the Government. Neither the Secretary of the Navy nor any officer under him had any dispensing power over this statute, the words of which, appearing as they do in a context displaying great solicitude for the protection of the public interests, cannot be taken in any other sense than as mandatory without a plain disregard of the legislative intention.

The power to accept a ship built under this law cannot be exercised unless the fact be that the ship was constructed in strict conformity with the contract, and the mere enunciation from any official quarter that the ship was so constructed, when in truth it was not, lends no validity whatever to a pretended act of acceptance. It was not the intention of Congress that the United States should be foreclosed or concluded in any such way, or that any departure from the contract, except as expressly provided for, should be condoned by the act or judgment of any official, and that it should be open, at all times, to show that a vessel alleged to have been built and accepted under the law was not so built and accepted. It was competent for Congress to create an extraordinary barrier of this kind against fraud and inefficiency, and it is the duty of those called upon to apply their language to do so in such a way as to make it effective.

The case of the Floyd Acceptances, already referred to, shows how difficult it is to bind the Government, by the acts of its officers, in the matter of contracting for and disbursing its moneys; and before that case was decided an opinion by one of my predecessors was given sustaining the view that was afterward adopted in that case. 10 Opin., 288.

After all, this is but an application of the general doctrine that the Government of the United States, in transactions of this character, is not ordinarily bound by an estoppel. *Fennemore v. United States*, 3 Dallas, 363; *Johnson v. United States*, 5 Mason, C. C., 425; *United States v. Collier*, 3 Blatch., C. C., 325; *Cook v. United States*, 12 *ib.*, 43, 61; *Herman Estoppel*, § 219; 10 Opin., 231; 12 *ib.*, 43.

These references show the application of this doctrine in almost every conceivable shape; and also, that in dealings with the Government, upon contracts, there is always a safeguard, until the final acceptance by the proper officer, and a disbursement of the money.

But aside from this consideration, suppose it was a case as between

individuals or private parties, I do not think that the party occupying the place of the Government would be estopped by the action of the Advisory Board, or any intermediate agent, by whatever name such agent might be known. In *Glacius v Black*, 50 N. Y., 145, the court of appeals of New York considered this question very elaborately, after very exhaustive argument, analyzing and applying many cases that were cited in argument, and by a unanimous opinion, Church, chief justice, speaking for the court, ruled as follows:

Where, by the terms of a contract for the repair of a building, it is stipulated that the material shall be of the best quality, and the work performed in the best manner, subject to the acceptance or rejection of an architect, all to be done in strict accordance with the plans and specifications, and to be paid for when done completely and accepted, the acceptance by the architect of a different class of work, or of inferior materials, will not bind the owner, and does not relieve the contractor from the agreement to perform according to the plans and specifications; the provision for acceptance is an additional safeguard against defects not discernible by an unskillful person.

This case, it is conceived, goes the full length to relieve the Government, in this instance, as against anything in the nature of an estoppel; and in this opinion (50 N. Y.) the court says: "*Fraud or mistake vitiates the certificate in those cases where a certificate is otherwise conclusive.*" So that, as upon a final inspection and trial of this vessel, it has been found that a certificate has been given, or an acceptance made, of work that did not comply with the requirements—and whether this was through fraud or mistake it matters not—that action is not conclusive, and the Government is not bound thereby, as an individual would not be in a similar case.

In *Bird v. Smith*, 64 E. C. L. R., 785, the contract was for the sale and delivery to the plaintiff of a quantity of iron rails, of certain weights, shapes, and dimensions, and to be inspected and certified as then agreed upon, and in quality equal to any rails made in Staffordshire. A plea that the rails were inspected, certified, and approved by an agent of the plaintiff, as provided in the contract, was held bad on demurrer, on the ground (among others) that each stipulation is in its terms distinct, and in its nature, as an absolute warranty for quality, may well be required, in addition to a provision for inspection and approval, to guard against defects which inspection cannot discover.

It is not deemed necessary to say more upon this feature of the case.

All that has been said thus far is based upon the idea that there is a valid, subsisting contract; but it is proper at this point to say that the provisions of the contract binding the United States to accept the vessel on the approval of the Naval Advisory Board are in my opinion void and inoperative, as shifting a high trust and duty from the Secretary of the Navy to the Board, in violation of the act under which the contract was made, which directs the Secretary of the Navy to invite proposals, which authorizes the Secretary of the Navy "to construct said vessels and procure their armament," which requires proposals for the work to be "subject to all such rules, regulations, superintendence, and provisions as to bonds and security for the due completion of the work as the Secretary of the Navy shall prescribe," and which authorizes the Secretary of the Navy to use for the purposes of the act the balance of an appropriation made for another object. In the face of these explicit provisions it seems to me impossible to reach any other conclusion than that Congress, after providing the Secretary of the Navy with abundant facilities for forming an intelligent judgment, intended that the full and ultimate responsibility of carrying out the law should be on him.

This, however, while proper to be mentioned, is perhaps not of much practical consequence, in view of the contractor's express covenant, already referred to, to do the work in accordance with the law authorizing it.

But beyond these questions there lies another of very great importance, not referred to in your communication or the report accompanying it, and that is whether there was any *valid contract at all* between Mr. Roach and the United States.

As we have seen, the Secretary of the Navy had no power to contract for a dispatch boat that would not make fifteen knots at sea, or to accept any boat not built "in strict conformity with the contract" he was authorized to enter into.

But the ninth clause of the contract provides that should the engines of the vessel contracted for fail to maintain successfully, on the trial trip for six consecutive hours, a power of two thousand three hundred horses, the vessel shall be accepted nevertheless, if it appear satisfactorily that the shortcoming was not owing either to defective workmanship or materials. In other words, it was to make no difference how much the engines should be wanting in power, and consequently how far short they should fall of propelling the ship at the speed required by the law, it being impossible to dissociate power from speed, if there was no defect in the workmanship or materials. The obvious intention of this was to relieve the contractor of all duty and responsibility as to the speed and power of the ship, and make it feasible to force upon the United States a ship wanting in the prime quality of speed and fundamentally different from what Congress authorized and was so desirous to secure. It needs no further discussion to show that what was thus attempted was wholly out of the question.

But the contract is an entirety, and does not admit of being broken up into fragments, so as that what is good may be enforced and what is bad rejected. The stipulation which was intended to relieve the contractor of responsibility for the power of the engines, and, as a necessary consequence, for the speed of the ship, forms a large and most important part of the consideration moving to him from the Government. It is impossible to say what was its bearing on the whole contract, nor is it material to do so, inasmuch as it and the other covenants of the Government constitute one entire and indivisible consideration, the invalidity or illegality of any element of which must necessarily vitiate the whole and abrogate the contract.

This is very well illustrated by the case of *Chater v. Becket* (7 T. R., 201), which is often referred to in illustration of the principle on which I rely. In that case a parol, and therefore invalid, promise to answer for the debt of another and a promise, entirely valid and meritorious, formed the consideration of the contract sued on; and in view of the defendant's contention that the consideration was void *in toto*, it was insisted, on the part of the plaintiff, that the defendant should be held answerable for so much of his contract as was valid, but it was said by the court in reply, that the agreement was entire, and that there could be no recovery on one part, the other part being illegal. As was said by Chief-Justice Gibson, "If any part of an *indivisible promise*, or any part of an *indivisible consideration* for a promise, is illegal, the whole is void." (*Filson v. Himes*, 5 Pa. St., 456.) In the latter case the consideration was, like that in the case before me, made up of several particulars, one of which was illegal; and the learned judge, referring to the illegal part, says, "Who can say from this how far the office entered into the defendant's computation of what he was to get for his \$500?"

I would refer also to the cases of *De Beerski v. Paige* (36 N. Y. 537); *Pettit v. Pettit* (32 Ala., 289); and *Doty v. Knox County Bank* (16 Ohio St., 134), as directly in point.

It follows, then, that no contract exists between Mr. Roach and the United States, and that the large sums of money which have been paid Mr. Roach have passed into his hands without authority of law, and are held by him as so much money had and received to the use of the United States, and may be recovered from him. And not only so, but the money thus paid him by officials holding a fiduciary relation to the Government having gone into the ship *Dolphin*, a court of equity will follow it there, and for that purpose entertain a proceeding against the ship itself. In support of this position I need do no more than cite the recent decision of the Supreme Court of the United States in the case of the *National Bank v. Insurance Company* (104 U. S., 55).

I have the honor to be, sir, your obedient servant,

A. H. GARLAND,
Attorney-General.

The SECRETARY OF THE NAVY.

Statement of Naval Advisory Board concerning the criticisms on the U. S. S. Dolphin.

The criticisms of the examiners are taken up as nearly as possible in the order which they occur in their report and its appendix; the remarks on each subject have been collected, quoted, and are immediately followed by our remarks.

STRUCTURAL STRENGTH.

To locate accurately the causes of the weakness observed in her would necessitate the expenditure of a very large sum of money in taking out the machinery, &c.

That the *Dolphin* has not the requisite strength and stiffness to enable her to make the speed required under the conditions she must be prepared to meet, admits of no doubt in the opinion of the Board.

On the occasions referred to (trials in Sound) the vibrations of the *Dolphin*, when subjected to only that duty and test, were very perceptible and of a character to demonstrate inadequate stiffness.

Under such circumstances, the floor of the engine-room was observed to spring severely. And this, let it be noted, occurred when she was subjected to much less severe duty than when actually engaged in the service for which she was intended. These facts, so obvious to the Board, needed no corroboration, but corroboration was furnished on the second of the unsuccessful trial trips witnessed by the Board. On that occasion her after crank-pin became hot after a short run—even before the actual trial had begun. This pin had given no trouble on the previous trial, and the Board was informed by the contractor and his men that it had never before given any trouble. The only reason apparent for the cause of the trouble on this occasion and the one to which it was doubtless due, is to be found in the following facts: On the previous unsuccessful trial about 40 tons of pig iron had been put in the forward part of the ship to trim her. Five tons more were added on this occasion, and, of course, some portion of the coal had been consumed from her bunkers. Even these slight changes in the situation of her weights were seemingly sufficient to alter her shape so as to cause this after crank-pin to heat almost at once.

Wherefore the question arises, Is this structural weakness due to a fault of plan or execution, or does it proceed from both?

In justice to the contractor, it is proper to state that the plans exhibited to the Board and those furnished to the contractor are very meager, and by no means provide for a vessel of adequate strength for the uses for which the *Dolphin* was intended.

While it is clear that the plans are at fault, and, if carried out in the best manner, would not produce a vessel of sufficient strength, yet it seems to the Board that the

Dolphin exhibits a degree of weakness in excess of what can properly be entirely attributed to defective plans. Wherefore the Board is of the opinion that the execution must be faulty in this regard; but it is impossible to state with exactness the degree of blame that might properly attach to the contractor in this precise respect without taking out the machinery and opening up the ship—a work, as previously stated, involving a large expenditure of money.

The Board * * * has to regret that so much of the vessel's strength rests upon opinion. Nothing short of a trial at sea for some time and in rough water can satisfactorily determine her actual strength or weakness.

Ad. p. 7. (Referring to the trial of May 12.)

The vibrations of the ship during the run were of such a nature as to indicate a lack of structural stiffness which, in the opinion of the Board, will be likely to rack and weaken the ship, especially under full power in a sea-way. The floors forming the engine-room foundations spring severely, even when running under ordinary power in smooth water, and in the opinion of the Board, additional stiffness should be provided under the engines and intermediate between them and the after bulkhead of the engine-room, in the way of webbed frames forming cross-floors extending up to the lower-deck stringers, and from this by suitable proportions to srape for passage-way to extend to main-deck stringers.

The working of the steam-steering engine caused a severe vibration of the after part of the vessel, due, in the opinion of the Board, to the unusual character of the steering apparatus applied for a naval vessel.

Ad. p. 8 and 9. * * * but the 40 tons of pig-iron ballast, placed in the forward end of the ship on the trial of the 12th instant, and the 5 tons more of like ballast, put on board in the same part of the vessel, on the occasion of this second attempt, together with the lessened weight amidships in the amount of coal consumed from the bunkers in the running of the engines for many hours alongside the dock, as well as in the river and Sound before the trial could be carried out, may have had something to do with the failure of the machinery to work properly. If such be the fact, it indicates nothing less than structural weakness of the vessel, confirmatory of the impressions of the Board, as expressed in another part of this report.

The above statements clearly bring against the Dolphin the most serious charge of structural weakness, due to faulty design and aggravated by defective workmanship.

The alleged evidence in support of this charge consists of (1) vibrations of the structure while under full speed; (2) heating of two crank-pins on two successive occasions. This evidence is presented and distinctly attributed to lack of structural strength; yet, in closing their report they state that they regret that the matter rests upon opinion, and that nothing short of a trial at sea for some time in rough water can satisfactorily determine her strength or weakness.

We now propose to show that the Dolphin is a strong, staunch vessel, and the above opinion was formed in the utter absence of positive evidence, and could not be derived from an examination of the facts.

As the absolute size of the vessel enters into a question of this kind, it is allowable to recall the dimensions of the Dolphin—240 feet length between perpendiculars, 32 feet beam, 19.8 feet depth, and 1,500 tons displacement.

In examining the strength of a complex structure, the first inquiry is naturally as to the strength of the material and the fastenings. The structure of the Dolphin is composed of the best quality of mild steel, and a most careful and elaborate series of tests on the whole of the frames, angles, and plates show an average ultimate tensile strength of 28.5 tons per square inch, and an average ductility in 8 inches of 25 per cent. The rivets, upon which the strength of the whole structure depends, are also of steel, and are probably the most reliable, uniform, and tough material ever used for the purpose. The shearing strength of a $\frac{3}{4}$ " steel rivet in a $1\frac{1}{8}$ " hole is found to be 12 tons, which exceeds by more than 20 per cent. the strength of the finest iron rivets.

Natural in order we examine the arrangement and distribution of the material, and will, therefore, briefly describe the structure of the ship.

The Dolphin is framed on the transverse system, commonly adopted in merchant vessels.

The side-bar keel is composed of a center plate, 33" deep and weighing 20 pounds per square foot, or $\frac{1}{2}$ " thick; of two side bars 9" by 22 $\frac{1}{2}$ pounds; of the rider plates at the top, each 12" wide by 15 pounds, and the continuous angles securing them to the middle plate and the reverse frames, each 5" \times 3" \times 10 pounds. The frames are spaced 22", from center to center, and are composed of 4" \times 3" \times 9 pounds frame, and 3 \times 2 $\frac{1}{2}$ \times 6 pounds reverse angles, with floors 18" deep and 12 $\frac{1}{2}$ pounds per square foot; the reverse frames being carried up to the main deck on every frame, except right fore and aft, where they are carried to the berth deck on alternate frames. The plating is worked in 14' 8" lengths, the garboards are 25 pounds per square foot, and the remainder of the bottom plating 17 $\frac{1}{2}$ pounds. The sheer strake is formed by a doubling strake 4 feet wide. The plating is double riveted at the edges and butts, except in the flush plating above the water, which is secured at the edges by single riveted edge strips, except at the sheer strake, where they are double riveted.

The spar deck beams are 7" T-bulb, 25 pounds per foot length, one on every alternate frame, or every 3' 8". The deck is plated throughout the length of the engine and boiler spaces, or 90 feet amidships, with 15-pound plating and single-riveted edge strips and treble riveted butt straps. Before and abaft the engine spaces the plating tapers to 10 pounds per square foot at the extremities and the stringer plates, which are 15 pounds amidships, to 12 $\frac{1}{2}$ pounds. The outer angle securing the stringer to the side of the deck is 3" \times 3 $\frac{1}{2}$ " \times 8 pounds, and the water-way is formed by two angles 3" \times 3" \times 8 pounds, and 2 $\frac{1}{2}$ " \times 2 $\frac{1}{2}$ " \times 5 pounds. The deck is laid with 3 $\frac{1}{2}$ " pine planking secured with wood screws.

The berth deck beams are of the T-bulb pattern 6" deep by 16 pounds per lineal foot. The stringer on this deck is 32" wide and 12 $\frac{1}{2}$ pounds per square foot, secured to the deck plating by short angles 3" \times 2" \times 6 pounds, and by a continuous angle of the same dimensions to the reverse frames. This stringer tapers to 10 pounds forward and aft, and in all places where it is cut for coal chutes or anything of the kind it is amply compensated by doubling plates. Forward and abaft the engine and boiler spaces a central tie plate 36" wide extends from aft to the collision bulkhead and forward to the stem.

In addition to the longitudinal strength provided by the decks, keel, and plating, there are three keelsons between the berth deck and the keel for this purpose and to stiffen the bottom. The upper bilge keelson consists of two angles 5 \times 3 \times 10 pounds per foot placed back to back and secured to each frame by a double reverse clip, long enough to take four rivets on the frame. This extends continuously from the stem where it forms the breast hook next below the berth deck to the after collision, or stuffing-box bulkhead, where it ends just below the berth deck.

The lower bilge keelson consists of intercostal plates, 12 $\frac{1}{2}$ pounds per square foot, secured to the outer plating and floors by short angles 3" \times 2 $\frac{1}{2}$ " \times 6 pounds per foot length, and to the reverse frames by two continuous angles 5" \times 3" \times 10 pounds. The angles of this keelson are continuous between the transverse bulkheads in the fore and after hold, about 45 feet from the stem and stern, where they join the orlop deck flat. The intercostal plates end forward at the forward fire room bulkhead, and aft at the after engine room bulkhead.

The side keelsons are made up similarly to the lower bilge keelson

except the plate is continuous at the top and jogged over the frames. The angles extend 10 feet forward and abaft the bulkheads in the fore and after hold and the plates extend to these bulkheads. These keelsons are not continuous through the engine room as they come too near the engine keelsons; therefore they continue one frame space into the engine room at each end, and are then replaced by a pair of $5'' \times 3'' \times 10$ pounds angles midway between the engine keelsons and the lower bilge keelsons.

The main transverse bulkheads in the ship are composed of plates weighing $12\frac{1}{2}$ pounds, tapering to 10 and $7\frac{1}{2}$ pounds at the top, except the collision bulkheads which are 15 pounds to 10; the plates are lapped and single riveted at the edges and butts, and stiffened by vertical $3'' \times 2\frac{1}{2}'' \times 6$ pound angles $30''$ apart. They are secured to the plating of the skin by $3'' \times 3'' \times 8$ pound angles. All the main bulkheads extend water-tight to the main deck, and are situated as follows: (1) Forward collision, 11 feet abaft the stem; (2) in fore hold between chain lockers and fore hold 47 feet abaft the stem; (3) $36' 6''$ abaft this is the bulkhead forming the forward end of the boiler compartment. This compartment is 48 feet long and separated from the engine compartment by a coal bunker, 11 feet long, formed by (4 and 5) two complete bulkheads. The other coal bunkers are at the sides and above the boilers, and in a bunker just forward of the boiler compartment on the berth deck.

The engine room is 29.5 feet in length along the keel and (6) the bulkhead at the after end extends to the berth deck, which is there plated water-tight from thence four frame spaces forward, from whence the bulkhead is carried to the main deck. (7) At 22 feet abaft the lower engine room bulkhead, or 45 feet from the stern post, comes that in the after hold which separates the cabin and ward room. The (8) after collision bulkhead is 17.5 feet from the stern post, but at the level of the berth-deck jogs six frame spaces aft to save room.

These are the principal structural arrangements of the vessel. The local strength has been carefully attended to in the hatch coamings of the engine and boiler hatches, the pillaring throughout, and especially around hatches and in the boiler spaces; the beams under the track of the pivot gun are $8''$ deep and closely pillared; an $8''$ I-beam forms a transverse tie in the center of the boiler space at the level of the berth deck. The boilers are set fore and aft on athwartship bearers of the usual form and of great strength, the reverse frames being doubled throughout the boiler compartments. The framing under the engines is formed by increasing the depths of the floors to $36''$ and their weight to 17 $\frac{1}{2}$ lbs, increasing the depth of the thrust block, center and side keelsons in the same proportion, and covering the whole with a $\frac{3}{4}''$ steel plate extending about 1 foot beyond the edge of the engine bed plate. The reverse frames being fitted at the usual height of the floors and doubled throughout the engine space.

We have compared the scantlings of the Dolphin with those prescribed by Lloyd's rules for a vessel of her dimensions, of the highest class 100 A, with the following result:

SCANTLINGS OF THE DOLPHIN.

Dimensions of ship for Lloyd's rules, 24½' length, 31' 86 molded breadth, 19' 8 molded depth. Half girth, 30'. Length = 12.37 × depth = 7.7 × breadth.

No. for frames, 65.73. Plating No. 16,103.

Parts.	Lloyd's iron.	Lloyd's steel.	Lloyd's steel, in pounds.	Specifications of Dolphin.
Frames	4" × 3" × 7/8"	4" × 3" × 7/8"	4" × 3" × 8.45 lbs	4" × 3" × 9 lbs.
Reverse frames	3" × 3" × 7/8"	3" × 3" × 7/8"	3" × 3" × 6 lbs.	3" × 2½" × 6 lbs.
Bulkheads	3"	1½" to 1½"	10" to 12½"	{ Collision 15 lbs } 10" to 12½ lbs.
Keel	8½" × 2½"	8½" × 2½"	8½" × 2½"	9" × 2½"
Born	8" × 2½"	8" × 2½"	8½" × 2½"	7" × 2½"
Stem frame	8" × 5"	8" × 5"	8" × 5"	8½" × 4½"
Carboards	1½"	1½"	22½ lbs	25 lbs.
			Bilge strakes, 20 lbs.	
Bottom plating	5/8" × 18"	7/8" to 1"	17.5	17.5 lbs.
Sheer strake	1½"	1½"	275 lbs	2 of 17.5 lbs.
Floors	19½" × 7/8"	19½" × 7/8"	19½" × 15 lbs.	18" × 12½ lbs.
Floors under engines and boilers	19½" × 7/8"		20 lbs	17½ lbs.
Upper deck planking	3½"	3½"	3½ lbs	3½"
Angles in lower stringers	4" × 4" × 3/4"	4" × 4" × 3/4"	4" × 4" × 10 lbs.	5" × 3" × 10 lbs.
Angles in upper stringers	4" × 4" × 3/4"	4" × 4" × 3/4"	4" × 4" × 10 lbs.	5" × 3" × 10 lbs.
Stringer on upper deck	52" × 1½"	52" × 1½"	52" × 22½	15 to 12½ lbs.
Iron deck	For length of ship 1"	1/2 length 1½"	1/2 l'gh 12½ lbs.	Full length, 15 to 10 lbs.
Plating for shaft alley	4" × 7/8"	4" to 7/8"	10 to 12½ lbs.	10 lbs.
Middle line keelson plate	1½"	1½"	20 lbs	20 lbs.
Flat plate at top of keelson plate	7/8"	7/8"	17.5 lbs	15 lbs.
Angles at top of keelson plate	5" × 3½" × 7/8"	5" × 3½" × 7/8"	5" × 3½" × 12 lbs	5" × 3" × 10 lbs.
Bilge keelsons	5" × 3½" × 7/8"	5" × 3½" × 7/8"	5" × 3½" × 12 lbs	5" × 3" × 10 lbs.
Midship beams	8" × 7/8" - 17.42 lbs.	Equivalent solid 8" × 24.59 lbs.	8" × 20 lbs.	7" × 5" × 25 lbs.
Frame spacing	2-3" × 3" × 7/8" - 7.07..		23"	22"

Showing that in all essential matters the requirements of Lloyd's are exceeded. The rules require in the engine space two web frames which have not been fitted; they could not be got in on the starboard side owing to the location of the pumps, and it was not considered necessary to do more than make the double reverse frames on four beams the same weight as the frame angles, on account of the unusually short length of the engine room, only 22 feet at the upper part. The rules require a heavier stringer plate on the upper deck than we have fitted, but on the other hand they require the deck to be plated for the full breadth of the ship for only one-half the length, whereas the Dolphin has a complete steel deck throughout her length.

It is proper to notice here that in designing a naval vessel which carries to a comparative extent a definite fixed load of small variation, it is always found desirable in some respects to depart from the requirements of the registration societies, which by their tables prescribe the scantling for a vessel of certain proportions which may be of any form as regards the lines and for any class of service from carrying coal to pig iron. Therefore, it is often possible in designing a vessel for the naval service to save weight in the hull to be efficiently used for other purposes; in fact, it is only by the most careful attention to matters of this sort that any progress can be made in ship design.

Having now sufficiently indicated the nature and particulars of the structure of the vessel, we will now discuss briefly the question of whether it is sufficiently strong to withstand the stresses to which it may be subjected. We are well aware that there is nothing that is more certain to bring to light any latent defects which may exist in a vessel, either local or structural, than heavy weather at sea, and that under these conditions weakness may develop itself in ships which

appear to be strong and well built; but here we have to deal with a question of structural strength, concerning which there are well-recognized methods of investigation; these have been followed out with care, and we have also made investigations quite beyond the ordinary course.

In discussing the strength of a vessel the absolute size is of considerable importance, for the parts of a ship are proportioned not only with regard to strength of the structure as a whole, but with regard to durability and local strength. It is found that the structural strength of small vessels is very much greater than large ones on this account, for small and large ships corrode equally fast and other local influences are independent of the size; therefore, in the Dolphin, comparatively a small vessel, if the local strength has been carefully attended to, we should *prima facie* expect to find her amply strong structurally.

The chief strains to which ships are subjected are thus described by Mr. White, in his Manual of Naval Architecture:

(1) Strains tending to produce longitudinal bending, "hogging" or "sagging," in the structure considered as a whole.

(2) Strains tending to alter the transverse form of the ship; i. e., to change the form of athwart sections.

(3) Strains incidental to propulsion by sails or steam.

(4) Strains affecting particular parts of a ship—"local strains"—tending to produce local damage or change of form, independently of changes in the structure considered as a whole.

Besides these there are other strains, of less practical importance, which are interesting from a scientific point of view, but need not now be discussed, as there is ample strength in the structure of all ships to resist them, and there is no necessity in arranging the various parts to make special provision against such strains.

The principal strains to which ships are subjected in still water are those due to the unequal distribution of weight and buoyancy, and though they are by no means so great as those experienced in a sea-way, still they bear directly on the case in point, where it is charged that a weight of 45 tons in the bow so deflected the ship and sufficiently affected the alignment of the machinery as to heat the crank-pin journal. These investigations also give us the means of comparing the strength of the Dolphin with other vessels under conditions usually considered to measure the strength necessary to meet the strains produced in a sea-way.

When the Dolphin floats in still water loaded as if fully equipped for sea, with bunkers full and water in the boilers, the curve of loads obtained from a comparison of the weight and buoyancy throughout the length shows that for 41.2 feet from extreme aft, or to about the after pillow-block of the main shaft, there is an excess of weight over buoyancy of 40 tons; from thence to the edge of the engine bed-plate the buoyancy exceeds the weight by 107 tons distributed over 52.5 feet of length. Throughout the engine space to about 6 feet forward of the midship coal-bunker the weight is in excess by 63 tons. Throughout the space occupied by the boilers the weight and buoyancy are nearly equal, the buoyancy having an excess of 15 tons over a length of 29 feet. From there through the forward coal-bunker to the center of the magazines the weight is in excess by 44 tons. Then over a length of 41.5 feet there is a slight excess of buoyancy of 38 tons, and from thence to the stem an excess of weight of 13 tons.

It will thus be seen that there is no very marked load at any point, nor any combination of loads and supporting forces to produce a large bending moment; in fact, the maximum bending moment in still water, which tends to hog the ship, or to bend her upwards in the center, is determined to be but 2,200 foot-tons, or 1-167th of the length \times displacement, or, in popular language, the moment that would be produced by

22 tons at the end of a lever 100 feet long. This occurs at 8 feet abaft the engine-room bulkhead, and produces a fiber stress in tension on the upper deck plating of 6-10ths of a ton per square inch, and a compression on the keel of 65-100ths tons per square inch. A fair working load for the metal would be 5 and 4 tons per square inch respectively, and thus the actual stress is hardly of any importance, which is what we expected to find.

The strains experienced in still water are much altered by the variations of the distribution of buoyancy when the vessel is rolling and pitching and traveling over waves. These various effects we cannot calculate, but we can take a case, which, though it does not presume to represent what the strains actually are, probably is a most unfavorable case as regards structural strength, namely, to suppose the ship to rest instantaneously on the crest and then on the trough of a wave of her own length.

When the Dolphin rests on the crest of a wave 240 feet long and 15 feet high, the maximum bending moment, which tends to hog the ship, amounts to 8,700 foot-tons, or 1-43d of the length \times displacement. This occurs just abaft the smoke-pipe, and produces a fiber stress in tension on the upper deck of 2.4 tons per square inch, and in compression on the keel of 2.5 tons per square inch.

In the hollow of a wave of the same dimensions, the tendency is to sag the ship, the maximum occurring at the same place and being in amount about 11,484 foot-tons, producing a tensile stress of 3.7 tons on the keel and a compression stress of 2.9 tons per square inch on the upper deck plating.

Many calculations similar to these have been published in regard to armored vessels, which have unusual and concentrated loads, but comparatively few are available for unarmored vessels comparable with the Dolphin.

The following is a table taken from a paper in the Transactions of the Institution of Naval Architects for 1874, on "the strength of iron ships," by Mr. W. John, then surveyor to Lloyd's:

This table shows the stresses experienced by a series of vessels from 100 tons to 3,000 tons burthen, with scantlings of first-class iron vessels of the time, their proportions being nearly eight breadths in length and eleven depths in length.

Tonnage of vessel.	Maximum tension on upper works, in tons per square inch.
100	1.67
200	2.36
300	3.09
400	3.55
500	3.95
600	3.72
700	4.57
800	4.59
900	4.8
1,000	5.19
1,500	5.34
2,000	5.9
2,500	7.08
2,000	8.09

By this method of measurement the Dolphin would be about 800 tons burden.

These stresses are all calculated supposing the maximum bending moment to be 1-35th of the length multiplied by the displacement, and that this is a reasonable assumption for comparison with the *Dolphin* is shown by the following table, compiled from White's *Manual of Naval Architecture* and other sources :

Name of ship.	Description of ship.	Waves used in calculations.		Maximum bending moment = weight \times length \div the numbers below.			Maximum tension in upper works in tons per sq. inch.
		Length.	Height.	Still water.	Wave crest.	Wave hollow.	
<i>Iris</i>	Twin screw steel high-speed dispatch vessel.	300	15	58	29	43	8
<i>Dolphin</i>	Single screw steel dispatch boat.	240	15	167	42.4	32	2.75
<i>Victoria and Albert</i> ...	Royal yacht, paddle, high speed.	300	20	139	43	23
Merchant steamer...	Sea-going cargo-carrier	360	16	109	37	83

In a continuation of this subject—"strains of iron ships"—in the *Transactions* for 1877, Mr. John says:

"There are not wanting illustrations to show that where the maximum strain on a wave the length of a vessel comes out between 8 and 9 tons per square inch, want of sufficient longitudinal strength soon becomes apparent, and strengthening has to be resorted to. And below this, where the exceptional strains under the same conditions show from 7 to 8 tons, there is sometimes evidence of longitudinal weakness, but it is often complicated with other symptoms of straining; and in vessels of the same type and general scantlings, where the local strength has been better attended to, no signs of longitudinal weakness have been observable. Of vessels where the maximum strain by the same formula came out between 5 and 7 tons per square inch, there are hundreds afloat that have been working for years, through all sorts of weather, showing no signs whatever of weakness."

These limits of strength, it should be borne in mind, are given for English iron, and the *Dolphin* is built of American steel, which is from 50 to 60 per cent. stronger material, making our safe limits for these unusual and occasional stresses from 7.5 to 10 tons, whereas the greatest we actually found under these conditions is less than 4.

We now propose to show that the statement that an unusual load of 45 tons in the bow of the *Dolphin* was sufficient to alter her shape so as to heat the after crank-pin cannot be true. It seems almost unnecessary to go to so much trouble for this purpose, because even if the shape of the vessel had altered, evidence of it would not have been given by the heating of the after crank-pin, as will be shown later.

We have demonstrated above that the *Dolphin* is structurally strong compared with the best modern practice. Now, in addition, we have constructed curves of weight and buoyancy in the exact condition of the vessel on the trial of May 12, when the after crank-pin heated. On this occasion the vessel was loaded with 45 tons of pig iron, the center of gravity of which was $11\frac{1}{2}$ feet from the stem. This does not seem in figures a very great weight, but when we realize that it was equivalent to that of a modern 10-inch rifled gun with its carriage and all attachments, or two 15-inch smooth bore guns placed on the top-gallant fore-castle, we can understand that it was a most extraordinary means of

bringing the vessel to her proper trim. The calculations show that in still water (the conditions of the trial) the maximum bending moment was 3,523 foot tons, 1-88th of length \times displacement, which produced a tensile strength on the upper deck plating of slightly less than one ton per square inch; whereas we should not expect to see any signs of longitudinal weakness until the stress was 7 or 8 tons per square inch. The increase of bending moment due to the ballast of 45 tons was 1,000 foot-tons, and produced an increase of stress of 3-10 of a ton per square inch.

Now, we do not mean to say that the foregoing shows that the ship could not have altered her shape at any part, for there might be some local weakness, which question we will consider later; but we do mean to say that it could not have been due to lack of structural strength, and that if it had been, the crank-pin would have been about the last place to show it; for the engine shaft is elastic and bends readily with the structure, and all structures of elastic materials yield under loads to a greater or less degree, but the shaft is supported in some parts by long rigid bearings fixed to the hull, and both theory and experience sustain the statement that excessive deflections of the vessel are first shown in the line shaft bearings. They would naturally be shown in the main bearings before the crank-pins, because the crank shaft when subjected to bending moments, which it is constantly by the action of the steam on the piston, yields by the minute opening or closing of the crank-arms, which must be considerable before the pins would be affected. Further, the engine bearers and bed-plate form the most rigid part of the vessel, and therefore would be the last to yield.

We do not contend that the above investigations are conclusive to the extent that the Dolphin could not have shown signs of weakness; what they do show is that the Dolphin is structurally strong, so far as relates to the severest strains experienced by vessels under any circumstances, namely, those due to inevitable unequal distribution of weight and buoyancy. If the Dolphin showed any signs of weakness it must have been local. Places are pointed out by the examiners which are thought to be weak, as in the bow and stern compartments, but these are effectually disposed of separately. They say that "the vibrations of the vessel were such as to indicate a lack of structural stiffness." Here is apparently a distinction between stiffness and strength, and "that the floors under the engine room were observed to spring severely." If there is any local weakness it would probably be in the engine room, as the forces acting there are greater than elsewhere; however, special means were taken to provide for them, as elsewhere described, and we believe that in this case they have mistaken the inevitable vibration and yield of the structure for a local weakness, and our calculations and observations on the vessel bear out this opinion.

Taking the engine bearers as a longitudinal girder supported at the ends loaded by the dead weight of the engines less the supporting buoyancy over a reasonable area of the bottom, and by the accelerating forces or virtual changes of weight due to the motion of the reciprocating parts, we find the maximum sagging moment to be 257 foot-tons, producing a fiber stress on the upper parts of $2\frac{1}{2}$ tons per square inch. Now, actually, this girder is partly fixed at the ends owing to its connection to the hull, and it is probable that the actual stress does not exceed five-eighths of this, thus giving a factor of safety far beyond the usual limits. There is, of course, a fluctuation of the stress due to the motion of the reciprocating parts through a range of $1\frac{1}{2}$ tons per square inch,

or from eight-tenths tons tension to seven-tenths compression, which tends to loosen the fastenings.

Again, to illustrate the great strength of the transverse floors, we have calculated the deflection produced by a working load sufficient to produce a stress of four tons per square inch on a floor, with its accompanying plating, angles, and covering plate, considered as a girder supported at the bilges. Allowances have been made for the losses of strength due to the fastenings, but the stiffness of the keel has been entirely neglected, thus constituting a most unfavorable case; we find that the maximum deflection due to this load, which is about five times the actual load, is but .081 inch, or about one-twelfth of an inch. When the engines are moving at the rate of 76 revolutions per minute the engine frame can be observed to move up and down, up as the low-pressure piston starts down, and this motion is coincident with a vibration observable throughout the ship. The maximum amplitude of this motion is estimated to be between one-thirty-second and one-sixteenth of an inch.

If any excessive deflection of the floors had occurred it would have communicated itself to the bilges and the bulkheads, but no deflection or vibration could be felt or perceived at either one of these places.

With this statement of facts, we will discuss the vibrations, which have been carefully noted, and premise our remarks with a quotation from the last volume of the Transactions of the Institution of Naval Architects:

All steamers, without exception, shake to a more or less degree when the engines are in motion. This phenomenon is usually considered as so natural that, in most cases, little or no attention is paid to it, and when ships with comparatively powerful engines show an unusually strong vibration, it is either looked upon as quite natural or the phenomenon is simply accounted for by saying the ship is of too weak construction. It will not have escaped the notice of those who have paid much attention to these vibrations that, not uncommonly, weakly-constructed ships with powerful engines exhibit only a small amount of shaking, and, conversely, that comparatively strongly-built ships are subjected to exceptionally violent vibration.

It is, in fact, quite easy to see on a simple analysis of the subject that the strength of a ship cannot be measured by the extent of the vibrations; for, when a force is applied to an elastic body it yields, and if the force is removed suddenly vibrations are set up which have a definite period. Now, if the force be also periodic the amplitude or violence of the vibrations will be greater or less according as the applications of the force and the period of the vibrations synchronize.

In the Dolphin, vibrations were observed in the hull, either on deck or below, of two apparently distinct systems, which are assigned to separate causes; the first was in a vertical plane, and corresponded to the motion observed in the engine framing. It appeared to be a maximum in amplitude just abaft the engines. As one goes forward, it perceptibly varies, decreasing until a few feet forward of the gun-pivot, where it is hardly apparent that there are any engines in the ship. From this point forward it increases again, becoming a maximum at the stem. The variation is similar going aft from the engines, but not the same, for there is no point where it entirely disappears, being a minimum not far from the mizzen mast and a maximum at the stern, where the amplitude appears to be slightly greater than at the bow. The same variation in the vibration is observable if one moves from the engine down the length of the shaft alley. This system of vibration is no doubt principally due to the alternating unbalanced forces produced by the acceleration of the reciprocating parts of the machinery, namely, the piston, piston-rods, and connecting rods. This will be understood

when it is known that as the low-pressure piston starts downward there is an upward force exerted on the bottom of 27 tons. These forces not only exert an alternate pull and thrust on the bottom, but the action of the two pistons of the high and low pressure cylinders form an alternating couple tending to rock the engine backward and forward.

The second system of vibrations are not so apparent except at the extremities of the vessel, and take place in a horizontal plane. They are due apparently to the intermittent action of the screw, due to the unequal pressure on the vertical blades, which is caused by the greater retardation of the water near the surface by the skin friction of the vessel.

In order to give a clear idea of the extent of these combined vibrations at the point where they were most marked, a glass of water was placed on the berth-deck a few feet forward of the screw; the glass was $3\frac{1}{2}$ inches in diameter across the top and was not held, but allowed to rest upon the deck. At the time the engines were making 76 turns by the watch, and the Sound was perfectly smooth so that the vessel had no perceptible rolling or pitching motion, the glass was gradually filled with water until the water touched the edge of a rule placed across a diameter. It would there remain so for any length of time without spilling a drop. This simple experiment, made on the trial of May 28, shows that the vibration so far from being excessive was very moderate. Even when the engines were suddenly put full speed astern and the rudder put hard over from side to side the vibrations were only sufficient to spill about $\frac{1}{3}$ of an inch out of the top of the glass.

Having now discussed the subject of strength thoroughly from an examination of the structure and from the circumstances of the trial we will conclude by stating that a searching examination of the hull of the vessel, while in dry-dock to repair some slight injuries incurred while aground on some rocks in the East River while under the contractor's charge, has not developed the slightest evidence of weakness in any parts or fastenings; the alignment of the engines remains perfect, and none of the signs by which experienced persons detect straining can be observed.

We now consider that we have shown, so far as it can be possible to show, that compared with other vessels the Dolphin is exceptionally strong structurally; that it is not reasonable to accept the fact of the heating of a crank-pin, to which engines, and particularly new ones, are at times liable, as evidence of weakness of any character; that vibrations are very moderate, unavoidable, easily explained, and cannot be regarded as evidence for or against the strength of the ship.

LOCAL STRENGTH.

Bow Compartment (Ad. p. 4). The bow of the ship does not seem strong enough to resist the shock and pressure of the sea when butting into it in heavy weather; and to prevent possible panting under such circumstances, double-angled stringers of the same size as the present upper and lower bilge keelsons should have been placed midway between the upper and lower decks from the inner part of the stem forging, aft to the second collision bulkhead, with connecting intercostals making attachment to the skin of the ship as far as may seem desirable, together with proper plate or angle breast-hooks within the collision compartment.

We are of the opinion that the strengthening of the bow of the Dolphin is ample not only to resist the pressure or impulsive force of the water in plunging into a head sea, but also to provide additional strength and such arrangements as would admit of ramming without excessive danger to the vessel. However, it may speak for itself; the stem is molded $7\frac{1}{2}$

inches, sided $2\frac{1}{2}$ inches; the collision bulkhead, consisting of 15-pound or $\frac{3}{8}$ -inch plating, is 10 feet abaft the stem at the load-line; between it and the stem are four frames consisting of $4'' \times 3'' \times 9$ pounds and $3 \times 2\frac{1}{2} \times 6$ pound angles, spaced 22 inches, apart. Stiffness is given by the following breast-hooks: at the spar-deck, by water-tight steel flat extending from the stem to the collision bulkhead made up of $12\frac{1}{2}$ pound or $\frac{5}{16}$ -plate secured to the side by $2\frac{1}{2} \times 2\frac{1}{2} \times 5$ -pound angles. Seven feet below this is precisely similar, flat at the level of the berth-deck which comes just to the water-line at the deep load draught. Two and a quarter feet below this is a breast-hook which is a continuation of the upper bilge stringer, and 3 feet below this is another breast-hook which is a continuation of the orlop-deck flat, and is connected to the stem by a short steel casting 2 inches thick; at this level the breadth of the vessel is 4 feet at the collision bulkhead and below this part the lower compartment is nearly filled with cement. All of this is covered by the outside plating, $17\frac{1}{2}$ pounds per square foot, or $\frac{7}{8}$ thick, double riveted at the edges and butts and rabbeted into the stem.

We have not the slightest fear that this plating will part—that is, move in and out under the pressure of the sea. This action is always observed below the water-line, and usually only in heavy, deep-draught vessels. We regard the additional stringer suggested to be put in between the spar and berth decks, at a height of 4 feet above the load-line, as unnecessary and useless to remedy even an imaginary defect.

A short angle-iron stiffener was shown on the original drawings in about this location, but it became inconvenient to fit it on account of the hawse pipes, and it was, therefore, omitted as superfluous.

Fore Peak.—In describing the defects made good by the contractor, "she has been stiffened forward in the fore peak abreast the hawse pipes by a vertical plate brace, a point where special weakness was observed."

The only possible case in which the vertical plate brace, fitted by the contractor in deference to the opinion of the examiners, will be of any value would be to merely stiffen the side when veering to the chain. It is stated that "special weakness was observed," which must be merely a matter of opinion, as there is not the slightest evidence of weakness, although the Dolphin has been at anchor many times.

Hawse Pipes (Ad. p. 4). The water-tight covers on inner sides of hawse pipes are roughly made and of insufficient strength. In some of the recently-built merchant ships these hawse pipes are fitted with neat water-tight plugs, which answer their purpose admirably.

These covers are made of $\frac{1}{4}$ -inch steel plate, tap-bolted to the inner flange of the hawse pipe, and they answer the purpose for which they were intended. The hawse pipes lead from a manger on the spar-deck under the top-gallant fore-castle, and therefore it is not necessary that they should be always perfectly water-tight. If it had been, the rubber plugs referred to, used in the Miantonomoh, would have been employed.

After Transom (Ad. p. 2). In the after transom three beams are unsupported by stanchions, rendering the deck above of doubtful strength to withstand the shock and strain of a heavy sea boarding the vessel on that point—a thing not unlikely to happen in scudding. In the same part of the hull two reverse frames are stopped short, and a space of about 4 inches separates them from the reverse frame, continuing to the deck stringer above, thus weakening the frame at that important point.

In the after transom where the reverse frames are cut off the cut frames have been connected by a floor plate.

The three beams here referred to as being unsupported by stanchions are of the steel T bulb pattern, 7 inches deep, and weigh 25 pounds per foot length. They are respectively $15\frac{1}{2}$, 18, and $19\frac{1}{2}$ feet long, spaced

44 inches apart, covered with 10 and 13 pound plating and 3½-inch planking. They are situated next abaft the after collision bulkhead. The deck-house covering the after hatch is one frame forward of this bulkhead, and it is beyond a doubt that a sea which would sweep away the house would not have the slightest effect on this deck, yet the house is considered amply strong to withstand any weather. We consider the stanchions quite unnecessary, and that the deck is amply strong to resist seas boarding the vessel at this point, which rarely occur in the heaviest weather to a well-handled ship.

The reverse frames referred to as cut off were cut in accordance with the original plans for the location of the steering gear, and were not connected after the change in the steering gear. They are the reverse bars on the frame forward of the stern-post; they extend only 2 feet below where they are cut down into the run of the ship, and it would not have made the slightest difference, and the local stiffness which they assist in providing would be ample if they were entirely omitted below this point.

Mizzenmast Step (Ad. p. 2). The angle-iron truss forming the support of the mizzenmast on the port side is too light for the purpose, and is also defective, having a split lengthwise in its web for a distance of about 6 inches.

The step of the mizzenmast, which was weak and insecure by reason of defective support, has been strengthened to a degree promising perfect security.

These remarks are just, and we are at fault in not having discovered that only a single angle, and that a defective one, had been fitted where two were required by the plans. This stiffener, however, forms but a small part of the step of the mizzenmast, which rests on the berth-deck central tie-plate, and is supported by the longitudinal shaft-alley bulkhead beneath.

SPEED.

Reliable speed is her first and greatest requisite for usefulness. She must be able to possess this quality in all weather and under all conditions at sea.

The law authorizing the construction of the Dolphin provided for a 'sea speed' of 15 knots per hour. A dispatch boat not having the ability to make that speed continuously in such weather as she may reasonably be called upon to encounter, would at this day not answer the purposes of the service.

The Board witnessed her performance on the smooth waters of Long Island Sound on three occasions. The conditions were most favorable, but the speed attained, making the proper allowances for tidal influences, was not in excess of 15 knots per hour, a result very far from promising a like speed on the sea under the conditions she must always be ready to meet in actual service; for in order that a vessel should keep up a sea speed of 15 knots per hour she should be able to make 17 to 17½ knots per hour in smooth inland waters like the sound.

Ad. p. 7. Second trial 12th May.

The speed made by the vessel could only be determined with approximate accuracy on that part of the course between Execution Rock and Eaton Neck Light, and was as follows, as shown by bearings and patent log:

Speed per hour by taffrail log	14.5
Speed per hour by bearings	15.5
Difference	1.0

But the difference in favor of the distance run per hour as shown by bearing can readily be accounted for by the effect of the fair tide, so that the speed registered by the taffrail log doubtless indicated the approximate speed given the vessel by the power of the engines for the first hour of the run, during which hour, however, the engines were not worked up to their highest point of effort.

The average speed for the entire run, but not possible to determine with the approximate accuracy obtainable with regard to the result shown during the first hour's work, was 14.8 knots per hour nearly.

The taffrail patent log used was a new one of the American pattern, furnished from the navy-yard, and there is no good reason to question its approximately correct registration.

Ad. p. 10. Sound trial 23th May.—Average speed as shown by patent taffrail log and substantially confirmed by bearings, 14.93 knots. But corrected for tide, 14.6 knots.

All conditions favorable : weak tide, moderate breeze to light, smooth sea and clear channel.

Ad. p. 11. Sea trial 11th June.—Average approximate speed as shown by patent log, 12.75. Approximate speed shown by bearings and influenced by fair tide, 13.6 knots.

All conditions favorable for trial—smooth sea, light breeze, and fair tide both ways—and in no sense could the trial be regarded as testing the sea-going qualities of the ship.

The speed being entirely dependent upon the design of the vessel was not included in any stipulations of the contract, and the whole responsibility for it rests upon the designers.

In our letter to the Department of 20th December, 1882, we stated that the dispatch boat should have a sea speed of 15 knots per hour. In designing the vessel and proportioning the power we regarded sea speed as that which the Dolphin would be able to make in fair weather for a continuous run of more than one day's steaming ; in fact, we expected the Dolphin to make the trip from New York to Key West, say, at that rate in good weather. It is absolutely necessary to presume good weather for the speed performance of a ship, for a heavy head sea and a gale of wind, or any of the various combinations of wind and weather that can be imagined, cannot be regarded as proper circumstances for a basis for a design. To say that the Dolphin should make 17 to 17½ knots per hour in smooth water in order to make 15 knots at sea is a broad generality which does not accord with any design or calculation that was ever made on the new vessels, or other similar vessels with which we are acquainted. The present recognized standard of speed, and which we see credited to vessels of all navies, is that which they obtain by taking the second mean of four runs back and forth over a measured mile, the turns being made at full speed. This is the test to which we expected to subject the Dolphin after she was commissioned and fully equipped. The contract intrusted the Advisory Board with the conduct and regulation of the trials, and when the question of the preliminary trial came up for consideration we decided that the vessel should not be run over the measured mile in the light condition and a record of speed obtained which could not be again obtained at the load draught. We considered, and so stated, that the records of speed in the Sound were merely approximate and could not be regarded as speed trials ; not only for the reason above stated, but that the method of taking the speed by sighting single points when they bear abeam, presuming a straight course, and using the best of taffrail logs, admit of errors which, when complicated by the unknown and indeterminate effect of tides and currents, makes the speed contain entirely too many elements of uncertainty. The trial over the measured mile eliminates many of these errors, and when carefully made it gives the most accurate measure of what speed can be obtained with a given power, and the custom is to make these trials at different powers and thus obtain a speed and power curve.

This we consider the only satisfactory method of measuring the speed, and by such a record our design showed that the Dolphin should make from 15.75 to 16 knots an hour for 2,300 I. H. P., at the load displacement of 1,500 tons with a clean bottom ; the trials which the Board made on the Dolphin on November 20, making 15.3 knots at 1,279 tons with 1,954 I. H. P., and on March 10, making 15.16 knots at 1,300 tons with 2,118 I. H. P., leads us to believe that our calculations would be fulfilled, and that the sea speed of 15 knots would be obtained. The speed on long runs compared with that over the measured mile depends

much more on the maintenance of the engine power than the action of the sea, and we consider that the requisite power can be maintained. It is quite impossible to expect the Dolphin, with her present design, to make 17 to 17½ knots, which would require 3,300 to 3,600 I. H. P., whereas our maximum is 2,300. When we came to examine the records of the speed made on these later trials of the Dolphin, they are in several instances so inconsistent with the statements made at the time of the trials, and the corrections for tide are made in such an arbitrary manner, that we hesitate to base any calculations upon them without a full record of times and distances, readings of the log, and the assumed corrections for tide. Again, we consider it an unusual thing to make positive statements in such an important matter as the speed of the Dolphin from the results given by a single untested patent log. There are matters, also, in the printed record which may be typographical errors, as they do not appear to admit of explanation. For the trial of May 28, the speed is given thus: "Speed of patent log, as substantially confirmed by bearings, 14.93 knots, but corrected for tide 14.6 knots."

Now, we have reason to believe that the log actually read 15.5 knots for the 6 hours. It then appears that this has, by some corrections not stated, been reduced to 14.93, and then, having presumably obtained the proper speed through the water, or the true speed, it is further reduced by a tidal correction of 33-100ths knots. We hesitate to say it was intended to mislead, but it is certainly an entire novelty in navigation.

INDICATED HORSE-POWER.

The contract requires * * * that the ship's engines should in her trial trip of six hours indicate 2,300 mean horse-power.

"With regard to the stipulation as to horse-power, two unsuccessful attempts to run the Dolphin in Long Island Sound for a period of six hours were witnessed by this Board. On the third trial the Dolphin succeeded in running the required six hours, and she subsequently made a fourth trial at sea from Sandy Hook to Barnegat Light and loaded to her sea displacement. The trip at sea, however, gave no test or her sea-going qualities, as the water was as smooth as had previously been found in the Sound."

"On the first unsuccessful trip, for the period she was running on the trial her engines indicated a mean collective horse-power of 2,008. On the second occasion her after crank-pin became heated, as previously stated, before the actual trial began. On the third occasion her engines indicated for the period of six hours a mean collective horse-power of 2,253; and on her fourth trial, the boilers making steam under natural draught alone, the horse-power developed by engines and pumps was 1,648."

"On all these occasions great efforts were made by the contractor and his men to show the utmost power which could be developed. Her coal was of superior quality, her engines and fire-rooms in charge of regular engineers, and streams of water were kept playing on the journals to prevent heating; in short, her conditions in all respects were more favorable than those she can be expected to have when in service, especially when called upon to run day after day under the varying phases of the wind, sea, and weather and on the open ocean—the only test of real value in determining the qualities of a sea-going vessel."

Ad. p. 7, second trial, 12th May.

The mean indicated horse-power developed by this partial trial averaged for both high-pressure and low-pressure cylinders.....	1,998
By blowers and pumps, approximately	90

Mean collective power	2,088
The highest number of revolutions per minute	78
The lowest number of revolutions per minute.....	68
Highest pressure of steam, 87½ pounds.	

These data were determined by the experts ordered to assist the Board, and as all the conditions of the trial were so exceptionally favorable for the vessel, the Board is constrained to believe that her engines will never develop the power for six consecutive hours called for in the contract.

Ad. pp. 9 and 10, second trial, 28th May.

Highest steam pressure.....	pounds..	89
Lowest steam pressure.....	do.....	84
Highest vacuum.....	inches..	26½
Lowest vacuum.....	do.....	24
Highest feed temperature.....	degrees..	120
Lowest feed temperature.....	do.....	106
Highest number of revolutions.....		76
Lowest number of revolutions.....		72

Average:

Highest horse-power by card.....	2, 255
Approximate mean indicated collective horse-power.....	2, 169.48

Ad. p. 11, sea trial, 11th June.

Highest steam pressure.....	pounds..	88
Lowest steam pressure.....	do.....	79
Highest vacuum.....	inches..	27
Lowest vacuum.....	do.....	25
Highest feed temperature.....	degrees..	120
Lowest feed temperature.....	do.....	94
Highest number of revolutions.....		72
Lowest number of revolutions.....		64
Average number of revolutions.....		66.77
Highest horse-power by card.....	1, 947	
Approximate mean indicated horse-power independently of auxiliaries.....	1, 623	

In reporting of the trial made by us on March 10, 1885, we stated that the mean collective indicated horse-power of the engines was 2,118, and that there was a deficiency of 182 horses power less than the 2,300 required by the contract; also, that in our opinion this defect was neither due to defective workmanship nor materials, but that with better coal and a well-trained engineer's force the result would be exceeded. This statement was meant to refer to the conditions which would obtain on the second trial required by the contract, when the ship was commissioned and fully equipped; therefore it is gratifying to find that on the six-hour trial in the Sound of May 28, with superior coal, but with the same undrilled engineer's force, the results of our trial were exceeded in regard to the power developed by amount of 135; namely, from 2,118 to 2,253 I. H. P.—that is, the mean power developed was 2 per cent. less than the contract required. This result, taken with the fact that the engines and boilers were not pushed to their full capacity, would seem to indicate a thoroughly successful result, which we believe it to be.

The statement of the examiners of the *Dolphin* that "great efforts were made by the contractor and his men to show the utmost power which could be developed" is not sustained by the steam-log of the trial, for the case stands actually that the revolutions of the engines at the beginning of the trial were 73 per minute, and they gradually and steadily increased throughout the run to 75 per minute at the end. The steam pressure remained very nearly constant throughout, but the blowers to assist the draft were run at only one-half power for the first five out of six hours of the run, showing that all the steam that was needed for the desired piston speed was obtained, and that there was no wish or attempt to exceed it. In fact, we have reason to believe that the contractor, in his excessive anxiety to give no chance for a recurrence of the hot journals of the two preceding trials, gave instructions that the full power should not be attempted. This we regret, for believing that the ship is amply strong, and knowing that the parts of the journals and pins are well-proportioned for higher speeds of piston, we think that if it were possible to heat the bearings merely by forcing the engines it ought to have been done.

To run water on the cranks is a precaution adopted in all steamers running at high speeds. All the high-power Atlantic liners run water on the journals from one side of the ocean to the other, and we should never except to run a full-power trial of a new engine without water.

The remarks quoted above as to the favorable conditions of the trial, and that from the results of such a trial one cannot predicate the average performance in actual service under varying conditions of wind and sea, are gratuitous. We prescribed a certain standard trial for engine power and machinery performance of six consecutive hours in smooth water, one recognized by governments and commercial bodies throughout the world; we expected to measure the power and nothing more; the contractor does not supply sea-going qualities, nor is the six-hour trial to test them. The engines were designed to develop this power under these circumstances, but with, of course, due reference to durability; the last trial showed that the power fell 2 per cent. below our estimate; we are not satisfied that this was the best performance even with the present screw, but we consider the result, as it is, one for congratulation rather than condemnation.

STEERING-GEAR.

The steering apparatus is not "strong" nor "easy of adjustment," and is not, in any way, "protected from shot." The lead of the wheel ropes is bad, involving needless chafe at many points, and, being exposed to the weather and constant wetting with sea-water throughout the length of the vessel from the stern to abreast the pilot-house, will be liable to speedy injury by rust. The 1-inch steel bolt connecting the wheel-ropes to the chain around the quadrant on the rudder-head by a composition attachment will soon be so corroded by the action of salt water as to render it useless or unsafe for purposes of adjustment. The device for releasing the chains when changing from steam to hand power, and vice versa, is crude and difficult of manipulation, and much inferior to the arrangements for like purposes on board the best ships of the mercantile marine of the present day. The wooden casing over the right and left hand screw-steerer and the grating platform surrounding the wheel and apparatus are of weak and flimsy construction, and the after frame of the steerer is fitted to the stern upper works of the vessel in a very unworkmanlike manner. There is no way to ship the tiller should such requirement arise except by the removal of the hand-screw steerer from the rudder-head, together with its framing—a cumbersome detail at any time and a very grave matter to manage at sea in heavy weather. The tiller was not even on board ship, but the Board was told by one of the leading men or foremen of the works of the Messrs. Roach & Son that it was in the shop. The tiller was subsequently brought on board.

Ad. p. 4. * * * the board is of the opinion that the steering gear should have been so arranged as to have the wheel ropes lead under the main deck and carry a tiller as well as a quadrant or circle at its appropriate place in the after transom, and that the pilot-house should have been fitted with both steam and hand steering wheels, changeable from one to the other at a moment's notice, as provided on board merchant steamers of the best construction, and for such purpose the house should have been arranged and made larger if found necessary. With the small steering wheel now in the house there is not sufficient room to get around the chart table when working over a chart.

The steering-gear of the Dolphin has been the subject of much consideration and discussion by this Board, and though we believe it to be strong and efficient, there is no doubt but that it can be improved.

The various criticisms of the Board of Examination would not, however, in their entirety, produce a steering gear that would give perfect satisfaction to everybody.

The specifications for the steering gear of the Dolphin stated, "the steering apparatus throughout to receive the most careful attention in order that it may be strong, easy of adjustment, and, as far as practicable, protected from shot."

The latter clause referred to the original design of the steering gear,

in which the steering engine was in the engine-room and the power was transmitted along the orlop deck by a shaft and bevel gears. It is thus seen that the gear was partially protected from shot. No steering gear in a single-screw vessel can be absolutely protected. This is the proper way to arrange the steering gear, and is very nearly the plan adopted in the English navy, where the engine is usually either in the engine-room or on the orlop or berth deck, with shaft and gears to work the valves and tiller. This plan is far superior to anything suggested by the board of examination; but, unfortunately, from lack of space in the engine-room, it was found necessary to remove the steering engine from the engine-room, and, once out of the engine-room, no place could be found for it in so small a ship except under the pilot-house, which is the ordinary place for it in the merchant service.

The present arrangement is as follows: A small hand-wheel in the pilot-house actuates valves of the two-cylinder Sickles steering engine, placed directly beneath it, in a small separate compartment, in the house on the spar deck. The $\frac{5}{8}$ -inch chain passing over the sprocket wheel of the engine leads athwartships in an iron casing in the deck around a 12-inch brass sheave near the water-ways, beyond which it is secured to the $2\frac{1}{2}$ -inch iron-wire wheel ropes which run alongside the hammock berthing, led over the 3-inch guide-rollers, taking the weight, and $3\frac{3}{4}$ -inch guide sheaves at the slight deflection of the lead where it passes through the Hotchkiss gun towers. At the after end the wire rope is secured to a $\frac{5}{8}$ -inch chain, which forms a gun-tackle purchase, the sliding block of which is secured by a turnbuckle for taking up the slack and a tripping arrangement to a $\frac{3}{4}$ -inch chain pendant which passes entirely around the wrought-iron tiller which forms a complete circle instead of the usual quadrant. In the forward quarters of this wheel are eyes for the relieving tackles and corresponding eyes in the sides of the ship.

This wheel, which was made extra strong, takes the place of the spare tiller. With the original steering arrangement there was a spare tiller, which is probably the one referred to by the Examining Board; but we are unable to see any use for it now, as there are at present four methods of taking hold of the rudder in order to control it.

The hand steering gear consists of the ordinary screw steerer, which takes directly hold of the rudder-head. It is furnished with a 5 foot 6 inch hand-wheel. The whole apparatus is of unusual strength; the main screw is 5 inches in diameter over all, the nuts are 9 inches long, and the connecting-rods $2\frac{1}{2}$ inches diameter, with 16-inch arm, the diameter of the rudder-head being 6 inches.

The hand steerer aft has great advantages, as it has no connection with any wheel ropes whatever. We did have still another wheel in the pilot-house, as suggested by the Examining Board, but it was found desirable to change the connection of the steering wheels with the engine; it was also found desirable to provide room for a new form of compass, lately introduced in the Navy. The hand-wheel was therefore left out. A chart-table in a convenient place is quite novel in the Navy, and the one in the Dolphin is doubtless open to criticism.

The present general plan of leading the wheel ropes is that common in the merchant service, and is to be commended for the ready accessibility of its parts. It usually gives satisfaction, but where there are large side and deck cargo ports on the upper deck, which would necessitate uncoupling the ropes when the ports are open, the plan recommended by the Examining Board is sometimes adopted. In the Dolphin, however, leading them under the main deck would have taken them through the coal-bunkers, engine and boiler compartments, where they

would have been very inaccessible, and a tube could not have been laid in the Dolphin's deck.

It is not an unusual thing to connect a steel bolt to a chain by means of a composition attachment, as it prevents sticking, and where not actually lying in water and where ordinary care is taken of it, as there ought to be in this case, there is no danger of its becoming useless or unsafe.

The device for releasing the chains when changing from steam to hand power is a simple trip-hook. It works very quickly when shifting from steam to hand, which is the time when quickness is wanted, for there is nothing to do but knock the link off. When shifting from hand to steam it takes longer, but there is very seldom so much necessity for haste.

The strength of the wooden casting over the right and left hand screw steerer and the grating platform surrounding the wheel and apparatus is simply a question of opinion. We consider them of ample strength; this applies also to the workmanship of the after frame of the steerer.

INDICATOR AND ENUNCIATOR.

Ad. p. 2. The rudder indicator and enunciator required for the after bridge and the enunciator for the forward bridge are lacking. The after bridge is also unprovided with sounding or speaking tubes.

The rudder indicator of the after bridge was not practicable after the change in the steering gear from the original to the present plan, and, therefore, was not fitted. The enunciators were omitted by the Board, as for this vessel the usual naval method of communication was preferred.

FREING PORTS.

Ad. p. 2. The freeing ports amidships are so finished as to leave a water space of 10 inches above the covering plates forming the bottom of the hammock nettings. The port on the starboard side has a lower sill cemented on wood without any scupper or other arrangement for draining the water which in time will be likely to fill the space. The one on the port side was found to be uncemented, being simply closed with rough boards, but since the Board noted such omission the cement has been put in.

The freeing ports referred to as having insufficient protection against lodgment of water were originally intended for a 3-inch rifle howitzer, and during the construction of the vessel were used for the passage of mooring chains while at the pier, and, as chafing planks were fitted completely covering the sill, the cement was overlooked. The contractor has made good this defect, so that further comment is unnecessary.

There is no water space under the sill of the freeing ports, as the whole is filled with white pine and covered with cement.

CEMENTING.

Ad. p. 2. The iron work of the vessel "where water may be liable to lodge" has not been cemented in all cases, as required by the specifications, and the painting in some places has been neglected or slighted, as clearly shown by the rust observable on the metal.

Regarding the lodgment of water in different parts of the vessel, it is excessively difficult to prevent it in every part without the use of large quantities of cement. The lodgment of water need not occur when the vessel is in commission.

It might be expected that a certain amount of rust on the vessel would be observed, inasmuch as some parts of the vessel have not been repainted for a year.

Ad. p. 3. The seamen's water-closet lacks a full cement lining.

Two holes, about 3 inches in diameter, were cut in the cement lining to rivet up a hammock-hook on the berth-deck and the workman had neglected to repair the cement.

PLANKING AND CALKING.

Ad. p. 2. The planking of the main deck is not of the "best quality," being knotty and shaky in parts, and not laid in the best manner, many of the wood screw bolts passing into the seams instead of into the body of the planks. The timber hatch coamings are too wide for good work and tightness, and the deck leaks fore and aft, as demonstrated by the rain-storm of the 1st ultimo.

Ad. p. 4. The sheathing of the chart-house deck is of inferior material and is not neatly laid.

Ad. p. 5. The ends of the planking on the berth and top-gallant fore-castle decks are not nibbed at the ends of the vessel, as they ought to be to insure good work and strength.

Ad. p. 3. The planking of the berth-deck is of inferior quality, rough and knotty in various parts, some places indicating sap, and calked in so poor a manner that the entire deck would leak like a sieve in case it became flooded with water, and so damage or destroy the perishable stores and equipments stored below it in the hold, store-rooms, sail-room, bread-room, and the like. The Board was unable to find more than two thin threads of oakum in many of the seams, the specifications calling for not less than three threads, and it was an easy matter to pull the threads out by the yard in various parts of that deck. Some of the seams in the cabin did not seem to have been calked at all, and none of the seams of that part of the deck—cabin and ward room—laid with white pine, are painted, as required by the specifications. Such was the condition of the deck until the 11th ultimo, when the Board found a large gang of calkers on board at work on it. One effect of this calking, incomplete as it was, not extending into the wardroom, state-rooms, nor under bulk-head sills, was to make it difficult to shut down some of the hatches, to split or splinter to some extent the under side of the deck, and to start or drive out some of the wood-screw fastenings. In its fastenings this deck shows grave defects, the wood-screw bolts passing into the seams instead of into the body of the planks at many points, and, in the opinion of the Board, the body can never be calked in a proper manner.

The planking of the decks was laid in March, 1884; the material is of the best quality, and the decks at that time presented a fine appearance, but have since not received proper care from the contractor, and after the exposure to the trying temperatures of four seasons and of the steam heat during the winter, their appearance was not of the best, though we are of the opinion that the decks are good and securely fastened, and will serve their purpose for years with the usual care, and are by no means in an unfit condition to remain in the ship, as this report would indicate.

It was no doubt the duty of this Board to see that the decks, and particularly the berth-deck, were recalced at the time of the acceptance, but in the pressure of other matters this was neglected.

BUTT-PLATES ON BERTH-DECK.

Ad. p. 3. The butt-plates called for in the specifications to be placed under each butt of deck-planking have not, so far as the Board could discover, been supplied. In this connection attention is invited to the contractor's explanatory letter of May 11, 1885, a copy of which is herewith appended, marked I.

These butt-plates are not of the slightest importance in regard to the strength of the vessel, as the deck is so cut up by bulkheads that there are very few butts throughout the length of the ship. They were

omitted without our knowledge, and would have been required when it was discovered soon after the deck was laid if it had been considered necessary. The decks are now stronger than the specifications would require, owing to the steel ledges and hatch-ties put in by the contractor.

COAMINGS AND HATCHES.

Ad. p. 2 and 3. Most of the coamings and hatches below the spar-deck, fore and aft the ship, are made in a rough and discreditable manner, patched with batten strips, and in no way conforming to the specifications calling for "workmanship" of the most thorough character.

These coamings and hatches are at the present time in a bad condition, but were well made originally.

The excessive heat of last summer and the wear and tear from the several steam trials have been sufficient to produce the conditions observed. This work should be replaced where necessary.

HOLD FLOORS AND CEILING.

Ad. p. 3. The hold-floors do not conform to the specifications in that there are not sufficient arrangements for entering the bilges for cleaning and painting at all points of the ship.

The specifications with regard to hold-floors are not strictly complied with. Instead of shutters of two thicknesses, they are of one thickness. They are supplied with lifting-rings, and the bilge is accessible out to the bilge keelsons. Between the two bilge keelsons the ceiling of the hold is solid, secured by bolts and nuts, and above the upper bilge keelson cargo-strips are used. Within the coal-bunkers the flat of floors is arranged similarly to that in the hold, and the balance of ceiling is fitted and secured as per specifications.

BREAD-ROOM.

Ad. p. 3. The bread-room is not tinned throughout nor in a thorough manner, and lacks perfect "water-tightness," as shown by the water-stains and rusted sheets of tin (one broken through) in its after part, all in default of the specifications. No gratings had been fitted in the bread-room, but have now been supplied.

The object of tinning a bread-room is simply to keep out rats. The only parts of the Dolphin's bread-room not tinned are one end and part of one side, both formed by steel bulkheads. The specifications do not require, nor has any attempt been made, to make the bread-room water-tight. If so, it would have been a water-tight steel tank with a water-tight door, whereas the door is of wood. The gratings for the bread-room were fitted, but had been in some way misplaced.

TILING.

Ad. p. 3. The tiling on the floor of the cabin bath-room and water-closet is lacking.

To properly fit this tiling it would have been necessary to cut off the reverse angles of frames, which was undesirable at this part of the vessel.

Considering this and the difficulty to be anticipated in the future in keeping the tiling water-tight at this part of the vessel, it was decided to omit it. This change was inadvertently omitted in the letter to the Department of April 20, 1885.

WATER-TIGHT DOORS TO DECK-HOUSES.

Ad. p. 3. The deck-houses are not fitted with water-tight doors.

The deck-houses are fitted, as required by the specifications, with closely-jointed doors, iron on iron houses and wood on the wooden one. They are precisely such as are customary in such places, and we are not aware that water-tight doors, such as are fitted in the hold, are ever required on vessels with high bulwarks, as in the *Dolphin*. It is also considered that it would be obviously inconsistent to fit water-tight doors to the houses where the hatches in the deck, with 12-inch coamings,, are fitted, as customary in the naval service, with tarpaulin canopies for ordinary weather, and with gratings so that the tarpaulins can be battened down in heavy weather.

Ad. p. 3. Bottle-racks in dispensary.

These were intentionally omitted from the vessel, as they would be required to suit the bottles when the vessel is commissioned.

PAINTING.

Ad. p. 3. The painting in the cabin and ward-room does not show "workmanship of the most thorough character;" it is inferior, and the gilded moldings called for are lacking.

The skin of the vessel has been repainted at various points where the skin was accessible; the hold store-rooms fore and aft have been freshly painted.

The ceiling of the deck is the only part of the wood-work in the cabin and ward-room which is painted, and that was carried out exactly as required and was considered when done as a neat, thorough piece of work; the gilded moldings were omitted by our instructions, as they did not correspond with the hard-wood finish.

JOINER-WORK.

Ad. p. 3. The bunk-boards in the state-rooms are fitted in a rough and careless manner, and some of the joiner work in the cabin and wardroom, and wardroom companion-way, cannot be considered, in minor details, as first-class work, especially as the bureaus in the state-rooms have no backs, the bulkheads being made to answer that purpose, a make-shift not known before in the naval service. The shutters do not seem strong enough to stand the hard usage of shipboard, and the state-room doors are not fitted with carrying rollers.

The wooden sheathing or ceiling of the sail-room is not carried up to the deck above to within 2 or 3 inches, leaving that space open for the access of vermin (rats) from the hold.

The joiner work of the cabins and wardroom of the *Dolphin*, which are finished in hard wood, is considered a handsome, workmanlike job; the minor details referred to seem to be not actual defects of bad material, joints, nor finish, but matters of opinion, for in regard to the details stated, our specific instructions have been followed—namely, the backs of the bureaus were omitted as they were to be fastened to the deck and fitted closely to the bulkheads in order to avoid the dirt-holes found under and behind bureaus as usually fitted in the Navy.

The state-room doors were not fitted with carrying rollers in order to avoid the rattle which invariably results from their use.

It is presumed that the shutters referred to are the sliding blinds over the air-ports. They are quite as strong as those fitted in railway carriages, and that would appear sufficient.

It would appear from the comments on the joiner work and other details that the whole was inferior to that usually fitted in the service;

whereas the contrary is the case, and we are confident of the accuracy of the statement to the effect that the conveniences and accommodations for both officers and crew in all respects as regards arrangements, details, and sanitary precautions, are far superior to any ship in the Navy.

HAMMOCK NETTINGS.

Ad. p. 3 and 4. The bottom boards of the hammock nettings are about 3 inches below the level of the scuppers, making it impossible to drain them properly in case the water gets into them, and the bottoms are not cemented. The wooden moldings of the nettings are not of first-class finish, especially the end or upright moldings, which are of soft pine, put on in the roughest manner. The top rails are not neatly scarphed in all cases, and forward of the nettings on the port side a graving piece of soft pine set into the rail mars its appearance.

The bottom of the hammock netting is formed by the deck stringer and is naturally below the level of the waterway and scuppers which are inboard of it. It would have required 9,400 pounds of cement to bring the bottoms of the nettings up to such a height that they could be drained into the waterways. It is considered that to expend this weight to accomplish an object easily secured by the most ordinary care of the officers in charge would have been absurd. The bottom boards of the nettings are loosely put in merely to protect the hammocks against the sharp edges of the steel angles and plates, and may be placed at any desired height.

ARMORY AND STEERAGE HATCH.

Ad. p. 4. The armory is badly located and cramped for room in that it is put up on the berth-deck at the after end of the wing passage, and immediately adjacent to the steerage hatchway, which, from the closeness of the latter to the port gangway, will be likely to be one of the wettest parts of the ship in bad weather. Seas coming over the gangway would almost be sure to pour down that hatch, flooding the deck, including armory and wing passage space below.

The armory consists merely of a set of covered racks for thirty rifles and bayonets and thirty revolvers. In the ordinary acceptation of the term there is no armory in the Dolphin, and there is no need of any. The contents of the rack would be stowed in an arm chest in any extraordinary weather when the steerage hatch was not closed; but as the main object of this passageway was for communication through the ship in bad weather, this would not often occur.

LOCATION OF DYNAMO.

Ad. p. 4. The location of the dynamo, its engine, and switches of the electric lighting apparatus must be regarded as unfortunate, as, being placed on the berth-deck, they are liable to be tampered with by evil-disposed men of the crew, especially as the switch-board has not been guarded with a protection frame. In the opinion of the Board, the after end of the engine-room house might have been extended a little farther aft on the spar-deck, so as to accommodate the apparatus without excessive weight to that part of the ship. So located, the apparatus would have been under the eye of the officer of the deck at all times and more space been left for the crew on the rather cramped quarters of the berth-deck.

Ad. p. 9. After nightfall the Board had opportunity to observe the working of the electric lighting apparatus, when it became apparent that its machinery is cramped for room, and that no provision had been made to protect the machinist in charge from accident when the ship is laboring in a sea-way.

A rod or rail should be put up parallel with the machinery to afford such absolutely necessary safeguard, for, as now arranged, there is no point in the room which the machinist can take hold of to prevent being thrown upon the rapidly-moving engines by the rolling, lurching, and pitching motion of the vessel incident to service at sea. The Board also noticed 2 or 3 gallons of oily water swashing about the deck of the room with no means of carrying it off. The deck should be leaded and fitted with coamings, and provided with scuppers to run the water into the bilge.

The location of the dynamo and engine was a matter of serious consideration by the Board. It was intended to locate it in the engine-room, but it was removed on account of lack of space. The space now allowed is much greater than it ought to be, and is double what would be allowed in a foreign man-of-war of that size. It was the intention of the Board to put a search-light apparatus in the same compartment, but it had to be left out on account of the excessive space occupied by the incandescent plant. The difficulty is that no electric lighting company in the United States will put its dynamo and engine in the limited space that is ordinarily allowed in a foreign man-of-war or merchant steamer, and guarantee the work. This is well shown in the Trenton and Omaha. It was the suggestion of the Bureau of Navigation that the electric plant of the Dolphin should be placed on the spar-deck in an extension of the engine-room hatch; but on account of the weight of the dynamo and engine and that of the extension of the house, and the expense, it was decided by the Board to locate it in its present position, which is a compartment taken from the coal-bunker and not from the berth-deck, though it opens into it. It is the custom of the service for all electric apparatus to be under the eye of the navigator and not of the officer of the deck. The suggestion of covering the floor of the dynamo room with lead is a good one, though it would be better to tile it, as a lead-covered floor would track foot-marks on the berth-deck. The suggestion of a hand-rail and a protective guard for the switch-board is also good. A scupper leading the oily water to the bilge should on no account be allowed, as it is contrary to the best practices of the service.

AFTER-DECK HOUSE.

Ad. p. 4-5. The large house over the cabin companion-way is a needless incumbrance, adding weight to the ship which could have been utilized to more efficient use elsewhere. It also takes up room better left for the work of the deck and the range of sight from that part of the vessel.

When the Dolphin is employed as a flag-ship, for which she is fitted, this deck-house will prove to be a great convenience to the fleet officer, as it provides a ready shelter from the weather, handy to the deck and after bridge.

SCUPPERS ON BERTH-DECK.

Ad. p. 5. The construction is also defective in not finishing the berth-deck with water-ways and scuppers, the evidence of water collecting along the edges of the planking and bulkheads being already too apparent, as shown in the wing passage on the berth-deck and under steerage hatch.

We were of the opinion when the specifications for the Dolphin were drawn that scuppers were impracticable, and water-ways unnecessary on the berth-deck of the Dolphin, and are still of that opinion. The deck is below the water-line, and scuppers could only lead into the bilge and thus lead the ventilation from the bilge to the berth-deck, which is now carefully conducted to the open air by valves in the spirketting of the spar-deck.

It should be remembered that the Dolphin has been completed for eight months, and does not receive the same care that she would in a navy-yard or if in commission.

WATER-TIGHT DOORS.

Ad. p. 5. To avoid false closure of the water-tight doors, the door-clamps should have been fitted with stops to prevent their excessive action in passing beyond the point needed to effectively close the doors.

If the clamps are kept properly adjusted by the set-screws provided for the purpose, false closure of the doors will not occur.

SHELVING.

The galley-room and several of the hold store-rooms have no shelving. The hold store-rooms have been fitted with proper shelving.

The hardwood drop shelf was fitted in the galley-room, and all store-rooms (excepting bread-room) on forward orlop-deck and cabin-locker on after orlop-deck were fitted with shelves prior to March 10, 1885. Since that date shelving has been placed in the ward-room, cabin, and paymaster's store-rooms and awning-room at the actual expense to the contractor of \$44.71.

BOATS, CARRIAGE OF.

Ad. p. 5. The present carriage of the boats just abaft the gangway is not good, for sea stowage fittings should have been provided to carry them on the rail or on light gallows frames.

The boats are carried and secured as is now customary in the Navy, but we are of the opinion that gallows frames may be better for the after boats.

BATTERY.

Ad. p. 5. In the matter of the battery, the construction of the vessel not providing for a fire directly ahead with the 6-inch rifle must be regarded as a grave defect. Carrying but one effective gun, the greatest all-around range of fire possible should have been arranged for.

The position of the 6-inch gun is that usual for a single spar-deck pivot-gun in the United States Navy and all other navies; but its train is rather greater, being from 70° forward of the beam to 63° abaft the beam on each side.

The gun is too heavy to mount either under the fore-castle or on it or on sponsons on the side of the ship. It represents with its carriage and attachments a weight of 24,343 pounds, with a vertical thrust, when fired, of 40 tons. Sponsons would be so large that the lower portion would interfere greatly with the ship's progress in a seaway. To leave the Dolphin without a fore-castle in order to get right-ahead fire would not be advisable in a dispatch boat, though most admirable in a vessel of the Boston and Atlanta type. Re-entrant ports are inadvisable in a vessel so fine forward as the Dolphin, as they would cut away a large portion of the present main deck, extending almost forward to the fore-castle, and would impair the seaworthiness of the vessel.

The Board dissents from the opinion that the Dolphin possesses but one effective gun. The tendency of modern thought is distinctively and decidedly in favor of the great value of machine-gun fire, and the Dolphin is, therefore, supplied with two 57^{mm} rapid-fire single-shot Hotchkiss cannon and four 47^{mm} revolving Hotchkiss cannon, calibers which have never been mounted in our Navy. The two 57's are mounted on the top-gallant fore-castle, where they sweep two-thirds of the horizon, firing 16 to 18 6-pound steel shell per minute, which can pierce a 4½-inch steel plate at the muzzle, and a 1-inch steel plate at 4,000 yards.

Two of the 47^{mm} revolvers are mounted in steel towers on the sides, just abaft the 6-inch gun, and have a range of fire from directly ahead to 80° abaft the beam. The other two are mounted in similar towers abaft the midships, and have a range from right astern to 80° forward of the beam. These guns throw a projectile weighing 2½ pounds at the rate of 44 per minute, having a proved destructive range of 4,000 yards and a penetration of 1½ inches of steel at 300 yards.

Although the extreme range of all modern ordnance is very great, the practical fighting range at sea does not much exceed 2,000 yards, and any shot from the Dolphin would penetrate an unarmored vessel at that distance.

In the light of the experiences of the bombardment of Sfax and Foo-Chow, to be found in the reports of the Intelligence Office in the Navy Department, it is believed that there are few naval officers who would criticise the Dolphin as possessing only one effective gun.

PIN RAILS.

Ad. p. 5. The pin rails have not been bored for belaying pins.

Because the Department furnishes the pins and the rails are to be bored to suit them.

AWNING STANCHIONS.

Ad. p. 5. The awning stanchions are not galvanized.

These stanchions were not galvanized in accordance with our instructions, as it was considered desirable to paint them.

ENGINE-BED PLATE.

Ad. p. 5. The engine-bed plate was designed to be supported on a wooden bed plate laid between the engine foundation and bed plate, through which bolting passes for securing them together. Each bolt was to be fitted with an iron filler in lieu of the wood, to make solid bolting; but the examination showed that some of the bolts lack such appliances, leaving to the wood alone the strain imposed by the working of the engines, the ultimate effect of which would tend to the loosening of the main connection and support.

If it were true that this method of fitting the engine bed plate resulted in a loosening of the fastenings of the engine to the hull, this would be a serious imputation as to the design and construction of the machinery. But this is far from being the case.

The specifications do not require horseshoes or fillers around any of the bolts; the contractor added them, however, for more than half the bolts. It is not at all at variance with established practice to set the engines on a layer of hard-pine wood, and many of the most powerful engines in our merchant vessels are fitted in this way without the use of iron fillers.

That the Dolphin's engine is most securely fastened is well illustrated practically by its so well withstanding the strain put upon it by the rupture of its shaft at nearly full power. The most minute examinations of the machinery immediately afterward, and carefully repeated since its numerous trials, fail to give the slightest indication that its strength and fastenings are not all sufficient to endure, for continuous service, the greatest strains that the full power of the engines can put upon it. The bed plates are secured to the keelsons by 80 bolts of $1\frac{3}{4}$ -inch diameter, spaced from 13 to 18 inches from center to center.

It requires no special professional knowledge to see that the cast-iron bed plate, which is of the usual form used in vertical engines, carrying the cylinders and forming the pillow blocks of the crank-shaft, and is a casting in the form of a longitudinal and transverse box frame, viz, 24 inches high and 10 inches wide, with walls $1\frac{1}{4}$ inches thick, and having bottom flanges, 5 inches wide by $2\frac{1}{2}$ thick, running all around the box frame on both sides, could not bend so as to effect the crank pins and cause their heating. The heating of this pin was unquestionably due

to the fact that the journal cap was screwed up too tightly. Before going on the trial this cap was removed for an examination of the crank pin, and in replacing it the brasses were screwed up together too tightly; it was simply this error, liable to happen to the most careful of engineers. Previous to this the pin had always worked well, and has since continued to do so.

SHAFT ALLEY.

Ad. p. 5. The supports to the shaft alley are not first-class in workmanship, the angles and brackets not being properly cut to fit down on the frame of the vessel so as to give the best support.

The support given by any bracket or angle is not that derived from cutting it to fit so that it takes weight on its edge, or end; in fact, the very best workmanship, in all structures rigidly secured by rivets, where the strength is merely that of the fastenings, is to provide simply sufficient metal to take the fastenings. Therefore, in shaft brackets, as in other places, we regard the workmanship as good and the structure strong.

ENGINE-ROOM FLOORS.

Ad., p 5. The engine-room floors cannot be regarded as of first-class workmanship and necessary convenience.

This allegation, that the engine-room floors are neither first-class in workmanship nor convenient, is not sustained by facts. Though the cast-iron corrugated or grooved flooring presents a better appearance (and makes a surer footing) than the wrought-iron plates with which the Dolphin is fitted, the latter were required in order to save weight, as they are much lighter per square foot than the cast-iron plates, and because they are more durable. It may be well stated here that it is only by a careful scrutiny of the weight of such small details that the weights of the machinery have been kept down and now stand at considerably less than the original estimate.

SHAFTING.

Ad., pp. 5 and 6. The steel shafting called for in the contract broke on the first trial-trip proper of the vessel; the contractor furnished another shaft of the same material, constructed under the same faulty process as the first one, but the tests applied to this new shaft not being satisfactory to the Advisory Board the contractor was permitted to substitute iron shafting in its stead; and it would seem that the extra expense involved in the change, including the tests applied to the new shafting, and which further determined the action of the Advisory Board with regard to the shafting of the Atlanta, Boston, and Chicago, the removal of the prior shafting and putting in of the iron one, together with the cost of the necessary cutting away of the beams and planking on the berth and main decks, and the enlargement of the stern and other bearings to take the larger diameter of the iron shaft, has been charged to the account of the Dolphin and against the Government. The Board is of the opinion that good and safe steel shafting, slightly modified from the specifications and drawings furnished the contractor, of the diameter required (13 inches), could have been made in this country; and the cost of all shafting supplied the vessel, together with the incidental expenses connected with the removal of the broken shaft and the putting in of the new one, should have been borne by the contractor.

This statement in regard to the change of shafts is so misleading and incorrect that it seems best to make a clear, full statement of the whole matter.

The thrust length of the steel shafting required by the specifications broke on the trial of November 20th; the contractor immediately ordered another steel shaft, which was inspected and tested by the Board and rejected on account of the great deviation from the required limits

of strength. After the shaft broke the contractor and the manufacturers of the shaft alleged that the failure was due to the design furnished by the Board; the contractor protested against the use of the remaining lengths and urged us to condemn them and recommend that the Government should replace them at its own expense; this the Board declined to do, believing that the failure was due to faulty workmanship, and not to the error in the design, and in any case would not take action without full actual information in regard to the conditions of the other shafts. Tests were, therefore, undertaken by cutting up and testing material for the broken shaft and trepanning the ends of the other lengths. While this was going on the thrust length was rejected, and although we believed that good steel shafts could be made in this country, it would take some time to actually determine the proper tests of strength and mode of manufacture, and, to avoid further delay in the completion of the vessel, we recommended that the contractor be allowed to put in an iron thrust-shaft; this he did entirely at his own expense in every detail. During this time the tests of the remaining length of steel shafts proceeded, and the results were such as to lead the Board to decide that, though we had not sufficient information to condemn them, none of the steel shafts should be used, unless they could be actually submitted to a twisting stress sufficient to prove them. It was found that this would subject the vessels to great delay in completion; therefore the Board recommended action that was approved by the Department, in the following terms:

“The contractor may put into the vessels iron shafts of approved manufacture, and if they stand during the trial trips and final trials they shall be accepted as a satisfactory fulfillment of the contract. The contractor shall allow the Government the difference between the cost of making the iron and steel shafting. The steel shafting shall be subjected to all reasonable tests for determining its strength; and those parts which stand such tests shall be taken by the Government and paid for as duplicate shafting at their cost to the contractor. If any parts are broken by reason of any extraordinary tests which could not fairly be insisted on for proof, considering the existing condition of steel manufacture in this country, the Government shall also pay the cost of such parts.”

This is the agreement that has been carried out on the *Dolphin*, and is being carried out on the other vessels.

In executing this agreement on the *Dolphin* the details were equitably arranged with due regard to a just interpretation of the contract. In the case of the *Dolphin* the shafts were completed, fitted, and in the ship, and had been tested by us at the contractor's expense under the terms of the contract. The tests now proposed were extraordinary and could not be reasonably required under the contract; therefore we recommended that the Department pay for these tests, and that as some of the shafts had to be taken out for the purpose, we also recommended that the Department pay half the expense of cutting the decks necessary to this removal, the contractor bearing the other half, as he had to pay the expense of removing and testing the broken shaft. We also agreed that the Department should pay the expense of removing and testing the steel shafts. The iron shafts put in were of larger diameter than the steel ones, and necessitated changes in the bearings and other parts of the ship which had been completed in accordance with the contract; therefore we agreed that the contractor should be compensated for the changes in these parts. We prescribed the tests referred to, that the steel shafts should be subjected to—a twisting stress equivalent to twice

the mean twist of the engines at maximum power. In all these matters of expense we made the estimates with the utmost care, and the account with the contractor stands thus:

Cost of changes in work already done	\$734 00
Excess of cost of steel over iron shafts	\$248 26
Trepanning and other tests of steel shafts	978 85
Docking to remove steel shafts	920 07
One-half cost of cutting decks to remove shafts	547 50
	<hr/>
	3,180 42
	248 26
	<hr/>
	2,932 16

The estimated actual cost of the steel line-shafting, which has to be paid for if it passes the test, is \$3,910.56.

COMPARTMENT PUMP.

Ad. p. 6. A compartment pump supplied to the vessel proved to be larger than was necessary. This pump was removed to be used on the Chicago, and a second and smaller one was put in its stead, the cost of which was charged to the Dolphin. No credit seems to have been given the vessel for the pump removed.

The facts of this matter are as follows, and show that neither has the Government been the loser to the slightest extent nor does any unjust or unfair charge remain against the Dolphin: When it was decided that the large pump supplied under the contract for the Dolphin should be discarded, it was found to be of the same size as are required for the Chicago, but not yet purchased by the contractor; it was therefore turned over to the Chicago and a credit obtained on the contract for the vessel of \$1,062.50. The second or smaller pump for the Dolphin was purchased for the Dolphin by the Bureau of Steam Engineering, and charged to its own annual appropriation, "Steam Machinery."

The first pump later proved unnecessary on the Chicago, as it was found desirable to supply two pumps of the same collective capacity as the three at first required, and consequently the third pump was turned over to the Bureau of Steam Engineering. All this was done with the full knowledge and approval of the Department.

AIR-TIGHT FIRE-ROOM.

The contract, among other things, provides that "provision be made for closing the fire-room hatches and other openings sufficiently tight to maintain an air pressure equivalent to a head of water of 1 inch in the fire-room."

With regard to (this) stipulation, no attention seems to have been given for its proper observance, the contractor alleging that such pressure had been obtained on the first trial witnessed by the Advisory Board by using tarpaulins to cover the hatches, but, owing to changes made by the Board with regard to blowers, he could not now get the pressure.

It is only too evident that such an alleged contrivance was but a makeshift at best and could be of no practical value.

Ad. p. 7. No arrangements were apparent for securing the air pressure in the fire-rooms as required by the terms of the contract, i. e., "an air pressure equivalent to a head of water of one inch in the fire-rooms," and when the contractor's attention was called to this point, he stated that such pressure had been obtained on the first trial of the ship witnessed by the Advisory Board, by covering the hatches with tarpaulins, but owing to changes made by the Advisory Board he could not now get the pressure. It is needless to say that the air pressure demanded by the contract could not be obtained by any such contrivance as the contractor alleges was used on the occasion of the first trial witnessed by the Advisory Board. On this provision of the contract the efficiency and safety of the vessel might depend in a great degree in cases of emergency.

In the original design of the Dolphin no special arrangements were made to provide air-tight fire-rooms; the maximum power of the engines was based upon a consumption of 20 pounds of semi-bituminous coal per square foot of grate per hour, which it was expected could be obtained with natural draught, assisted by the ship's ventilating fans; in case, however, that this should not prove sufficient, the precaution was taken to insert in the specifications the provision in regard to air-tight fire-rooms.

On the first trial of the Dolphin, in Delaware Bay, the draft was found insufficient, and temporary provisions was made to try the effect of making the fire-rooms air-tight; the result was such that it was regarded impracticable to attempt to make the fire-rooms air-tight either at the level of the top of the boilers or by making the deck-house doors and hatches tight.

It was therefore decided to use open fire-rooms and supply blowers of sufficient size to furnish the necessary draft, and this has been done. Although we do not regard the location of the blowers as the best that could have been devised, still it has been carried out in accordance with our instructions, and they work well. A more careful examination will show that attention has been paid to the matter of forced draft by the fitting of dampers, now removed, in the ventilators, ash-chutes, and uptakes.

STEAM TURNING GEAR.

Ad. p. 8. And here one great defect in the ship's steam-working gear became but too apparent, for while the vessel has twenty-three separate engines on board, no provision has been made for turning the engines by steam power when the main engines are disabled, and instead of the less than five minutes that ought to have sufficed for the turning of the engines into position to enable the crank-pin and brasses to be overhauled, it took one hour and a half to effect that purpose, although only a quarter of a turn of the engines was required and made.

It is quite true that there is in the Dolphin a large amount of machinery, probably much more than any vessel of the size in this country. The turning gear of the main engines received due consideration, and, as it was not regarded as essential to furnish it with steam-power, an additional engine was avoided. It may be noticed, however, that the Chicago, Boston, and Atlanta are the only vessels in the Navy fitted with steam turning-engines.

In making up the list of "twenty-three separate engines," we are compelled to conclude that the computers have counted each of the cylinders of the main engine as an engine, as well as each cylinder (4" by 4") of the two double-cylinder ash-hoisters; also each cylinder of the two cylinder engines for the windlass, steerer, and the feed-pumps as a separate engine. This is a full but not a fair count, for it leads one to believe that there is an engine for each of twenty-three distinct functions.

SWIVELS ON WINDLASS.

Ad. p. 8. In weighing the anchor the Board noticed that when a swivel of the chain reached the barrel of the steam windlass the grip was not good, and that recourse was had to a preventer rope before the swivel could be made to bite and pass abaft the barrel. Such defect would be likely to prove a serious matter in lifting the anchor in rough water. The slipping and surging of the chain under such circumstances would be apt to snap it.

In the Navy it is customary to fit a swivel at every other length of the chain. The wildcat of a windlass cannot be made to work efficiently where these swivels are employed; therefore, when we discovered this matter some months ago, orders were given to omit all swivels in the

chains except the one about two fathoms from the anchor. This was to be done for the Dolphin when she reached the navy-yard, as the chains were supplied by the Government.

GENERAL DESIGN OF MACHINERY.

Ad. p. 9. And here the Board takes occasion to express the opinion that the engines and machinery generally are of such inconvenient design and so inconveniently located and arranged as to require much more than the usual number of engine and fire room force to properly attend them. In fact, the force needed will doubtless be as large for this little ship as is required to care for the engines and dependencies of much larger vessels of the naval service.

The vague imputation that the engines and machinery are of such inconvenient design and so inconveniently located and arranged as to require much more than the usual number of engine and fire room force to properly attend them is not sustained by the examination of the facts.

The engines differ but slightly from the usual type of vertical inverted engines, and their arrangement affords unusual facilities for making every part accessible while the engines are in motion and for the usual examinations and repairs.

The arrangements of air and circulating pumps and separate feed pumps are, in our opinion, an advanced step in engineering, and the results of their various trials not only proved their good working in practice, but the per cent. of power absorbed by this auxiliary machinery is less than the practice of ordinary engines.

It is not practicable in the dimensions of breadth of the ship to concentrate the grate surface in one fire-room and retain the wing passages. The arrangement of blowers could be better, but this was shown by the result of experience, and regarding the statement "that the force needed will doubtless be as large for this little ship as is required to care for the engines and dependencies of much larger vessels," it is a matter of fact that, with the exception of the Trenton, 3,900 tons, this little vessel of 1,500 tons has more power than any vessel in the Navy. The engineer force in our service will probably be in proportion to the horse-power, as it is in the English navy.

It is to be borne in mind that, for the power indicated, the Dolphin's machinery occupies no more space than any inverted direct-acting double-cylinder engine in the United States; also, that the indicated horse-power per ton weight of engine is greater than any similar machinery in this country, and indicated horse-power developed per square foot of grate exceeds any data obtainable from any American vessel, excepting an exceptional small yacht or torpedo-boat.

LINK-MOTION.

Ad. p. 10. Sound trial, 28th May.
Link-motion defective, having too much jar.
Ad. p. 11. Sea trial, 11th June.
Link-motion still defective.

It might be supposed from the above remarks that there was some essential fault in the link-motion, which is, however, similar to hundreds of others, and though it has a disagreeable jar, due to the method of support and the arrangement of the reversing gear, it properly performs its duty in the regulation of steam and exhaust.

Board of Examiners to the Secretary of the Navy.

WASHINGTON, D. C.,
July 31, 1885.

Hon. WM. C. WHITNEY,
Secretary of the Navy,
Washington, D. C.:

SIR: The Board of Examination has before it the criticisms of the Naval Advisory Board of the 13th instant last, with regard to the steam dispatch boat *Dolphin*, and begs to transmit the following brief reply:

The Advisory Board has taken fifteen printed pages to show that the *Dolphin* ought to be "a strong, staunch vessel"; that is, that the plans provide for a vessel of sufficient strength.

Their reasoning is elaborate, and their defense of the vessel and her builder as good as could be made under the circumstances, but from some of the facts stated by them we draw very different conclusions.

As stated in its report of examination, this Board is satisfied that the strength of the vessel can be shown only in one of two ways—tear her to pieces or send her to sea in heavy weather. If the supervision and inspection of the workmanship and materials exposed for its examination can be taken as a criterion by which to judge the frame and its fastenings, no amount of plans and specifications, and no argument, no matter how full of quotations from the "Proceedings of the Institute of Naval Architects," can make her strong and staunch. We agree with the Advisory Board that she should have been strong and staunch; but we are of the opinion that many of their departures from Lloyds were not calculated to produce those desirable qualities.

When the *Dolphin* was docked after her so-called sea trial, she showed unfair lines on some parts of her bottom, and several plates being removed to be strengthened, a curious condition was disclosed, and well worth the serious attention of those responsible for her inspection. Some of the spaces between her frames were found to be covered to a very considerable thickness with a conglomerate formed of chips, ashes, and dirt of various descriptions, and on top of this undesirable coating for steel plates the cement was laid. After the plates were removed it took some time to dig out this dirt, which was in some places moist and mucky, in order to break through the cement. Whether the bottom is in this condition fore and aft can only be determined by taking up the cement and making thorough examination.

The criticism of this Board was generally addressed to the fact that she is weak structurally without regard to what she ought to have been by her design, and it is stated that she showed weakness beyond what would properly be attributable to her plans. The Board of Examination is still of this opinion.

The heating of the journal upon the second unsuccessful trial the Advisory Board say was due to the tightening of the brasses. Upon what authority this statement is made they do not say. As the persons signing it, with one exception, were not present at the trial, it can hardly be put forth as of their own knowledge. The Board of Examiners assert the contrary to be the fact from information carefully obtained at the time from both the contractor and the persons in his employ who had charge of the machinery. The engines had been running steadily and satisfactorily at the dock for many hours after the journal-cap was

screwed on before the ballast was shifted, and no signs of heating; but in a short time after the ballast was shifted, and without any change in other conditions, except that the vessel was steaming up the Sound in perfectly smooth water, the heating took place. After the weight was removed she made her third trial without the difficulty previously experienced.

It was of the opinion then, and the Board of Examination is still of the opinion, that the extra weight and its distribution caused the heating of the journals.

When indications of weakness appeared to it, the Board requested of the Secretary a trial at sea. The Advisory Board, on page 8 of their statement, seems to admit the wisdom of this request, suggesting that they are "well aware that there is nothing more certain to bring to light any latent defects which may exist in a vessel, either local or structural, than heavy weather at sea, and that under these conditions weakness may develop itself in ships which appear to be strong and well built." In answer to its request for a sea trial the Secretary advised it that under the contract the conditions of the trials were left to the Advisory Board largely, and that he doubted his power to exact a sea trial, the Board having fixed Long Island Sound as the place of trial. He subsequently informed it that he had requested the Advisory Board to unite with him in requesting a sea trial, but that they had refused. It was therefore obliged to take what it could get—a six-hours' run in smooth water under the New Jersey shore—no test whatever.

LOCAL WEAKNESS—THE BOW.

It specified that the bows of the ship were weak. The Advisory Board expresses the contrary opinion, but admits that "a short angle-iron stiffener was shown on the original drawings about this location, but it became inconvenient to fit it." The Advisory Board also says: "The only case in which the vertical plate-brace, fitted by the contractor in deference to the opinion of the examiners, will be of any value would be to merely stiffen the side when veering to the chain." It is stated that "special weakness was observed, which must be merely a matter of opinion, as there is not the slightest evidence of weakness, although the Dolphin has been at anchor many times."

The "examiners" never mentioned the subject of the weakness observed in the bows of the Dolphin to Mr. Roach, or any of his people, but some of them were present when the examination was made. The Board had no authority to ask or authorize any changes, and the vertical plate-support was put in by Mr. Roach in "deference" to his own opinion or that of his advisers. If, however, it serves to stiffen the sides when veering to the chain, it will have accomplished a most desirable end. It is true, as stated by the Advisory Board, that the Dolphin has been at anchor many times—at least a dozen—always in smooth water, and her bows have shown no weakness. The Advisory Board can hardly be serious in suggesting that the strength of her bows has thus been tested.

The Board of Examiners stated that the water-tight covers on hawse-pipes are roughly made and of insufficient strength. The Advisory Board replies that they "answer the purpose," and "that it is not necessary that they should be always perfectly water-tight." How they propose to make them water-tight when she needs them is not stated.

LOCAL WEAKNESS—THE STERN.

The Board of Examiners commented on the fact that two reverse frames are cut off and a space of 4 inches left without any apparent cause, thus weakening the frame. The Advisory Board states that they were "cut in accordance with the original plans for the location of the steering gear, and were not connected after the change in the steering gear," showing negligence in some one, poorly supplied by the opinion of the Board that the ship is sufficiently strong even with cut frames. The "examiners" never authorized the contractor to remedy this weakness, and it must have been done in "deference" to his own professional opinion or that of his advisers.

The Board of Examiners commented on the fact that "the angle-iron truss forming the support of the mizzen mast on the port side is too light for the purpose, and is also defective, having a split lengthwise in its web for a distance of about six inches." The Advisory Board replies that "these remarks are just, and we are at fault in not having discovered that only a single angle, and that a defective one, had been fitted when two were required by the plans." But no explanation is given of such an oversight. It was, however, made good presumably, in "deference" to the professional opinion of the contractor.

The Board of Examiners commented on the fact that three beams in the after transom were unsupported by stanchions. The Advisory Board replies that "we considered the stanchions quite unnecessary, and that the deck is amply strong to resist seas boarding the vessel at that point, which rarely occur in the heaviest weather to a well-managed ship." This could hardly have been the view taken by the Board when making the designs where the stanchions are indicated. Being on the plans the Board of Examiners expected to find them, and are of the opinion they would be of service in this as in other vessels which are no doubt well handled in heavy weather.

The Advisory Board concludes its criticisms of the Board of Examiners' report of the speed of the Dolphin in the following language: "Now we have reason to believe that the log actually read 15.5 knots for the six hours. It appears that this has, by some corrections not stated, been reduced to 14.93, and then having, presumably, obtained the proper speed through the water, or the true speed, it is further reduced by a tidal correction of 33-100th knots. We hesitate to say it was intended to mislead, but it is certainly an entire novelty in navigation." After a careful review of this part of its report, the Board of Examiners fail to find any novelties in navigation involved in its calculations, and are quite certain that the Advisory Board would have been safe in assuming that there was no intention to mislead; and, further, it stands prepared to show conclusively that the speed of the Dolphin was as indicated in its report.

SPEED.

The Naval Advisory Board says that the method of obtaining the speed, complicated by unknown and indeterminate effects of tidal currents, makes the speed contain too many elements of uncertainty. The method used by the Examining Board was that of the Advisory Board, and the results, though not exact, show that the speeds reported were not exceeded. The Advisory Board places sufficient reliance on similar determinations to base upon them the opinion that the steamer would make 15 knots sea-speed; that is, would steam from New York to Key West, at that rate, in good weather, at a displacement of 1,500

tons, though the Advisory Board's own reports show mean speeds not exceeding 15.3 knots at a displacement of 1,300 tons. The most favorable report of the Advisory Board is made for a displacement of only 1,279 tons when, in smooth water, in Long Island Sound, "the boilers furnished ample steam," and "the Board estimates that the speed through the water for one hour for which more accurate observations were obtained, was at the rate of 16 to 16½ knots." The Advisory Board remarks that it is unusual to base statements in regard to so important a matter as the speed of the Dolphin on the record of an untested taffrail log. The records of the taffrail log in the trials made by the Examining Board were found to present some anomalies which gave sufficient reason for throwing the results given out of the report. A careful examination of the log used in the trial of May 28 was made by the maker, who reported that it indicated too high a speed. In cutting out the record of the taffrail log, the figures expressing the speed shown by it were taken out, but the heading, "average speed shown by patent taffrail log," was accidentally confused with the following one, which referred to the mean speed for the whole trial, as found by comparisons of the number of revolutions made by the screw between certain points with the total number of revolutions made during the trial. As the distances between points taken gave the speeds over ground, a correction was made for the effects of tidal currents which was sufficiently liberal towards the steamer. In offering an explanation of how these estimates and corrections were made, a method is described which is entirely due to the ingenuity of the Advisory Board, and is "certainly an entire novelty in navigation," as the Advisory Board states. The fair inference from their criticisms on this important point—speed—is that their interpretation of average sea speed is not average speed at sea in all weathers, but a long run, say from New York to Key West, in good weather, and they express the opinion that the Dolphin will make an average of fifteen knots on such a trip. This Board confidently states that this was not the interpretation of average sea speed by the law-makers in providing money for the construction of this vessel, and it is not its interpretation of it. It believes, in view of the trials it witnessed, as also from the statement made to it by the "contractor, that he considered her a thirteen-knot boat;" that she will never, in actual service, with the present screw, sustain a speed of fifteen knots at sea in good or bad weather. This Board recited the efforts of the contractor to make the machinery develop the minimum requisite of 2,300 indicated horsepower, for six hours, and his failure to do so, and expressed the opinion that "her engines will never develop the power for six consecutive hours called for in the contract." In reply, the Advisory Board says, "the engines and boilers were not pushed to their full capacity." * * * "We have reason to believe that the contractor * * * gave instructions that the full power should not be attempted." To those who witnessed the efforts to make her indicate the power called for and necessary for her acceptance, this statement hardly seems serious. It is not the 2 per cent. deficiency that of itself is important, but the 2,300 was supposed to be the minimum limit, and she should have easily made it and the margin of power should have been above it. We read of vessels built for other Governments by contract, making from one to two knots above the contract speed.

This Board is of the opinion that the engineer and fire-room forces on duty on board the Dolphin during these trials can never be excelled, if ever equaled, in the naval service. To say that the contractor did not do his best to develop the highest attainable horse-power and speed would be to impugn his good sense and business methods.

STEERING-GEAR.

The objection made by this Board to the steering-gear is substantially admitted, but followed by the gratuitous statement that "the various criticisms of the Board of Examination would not, however, in their entirety, produce a steering-gear that would give perfect satisfaction to everybody." The Advisory Board seems to have misunderstood the duties of this Board. It was not ordered to design steering-gear for the Dolphin. Had it been so, its report would have been differently expressed. It seems by the original plan the steering-engine was to be placed in the engine-room, but the engine-room being too small, it could not be placed there, and was finally lodged under the pilot-house, a fair and tempting target for machine-guns and small arms.

The Board criticised the pilot-house as too small, &c. The Advisory Board admits the correctness of this, but only explains it on the ground that it was so designed, and further says that, "a chart-table in a convenient place is quite novel in the Navy, and the one on the Dolphin is doubtless open to criticism."

But the service was promised and expected many novel things in the new ships, among them pilot or chart houses of sufficient room for steering-wheels, compass and its binnacle, and chart-table. It would seem that the Dolphin's pilot-house was not built large enough to accommodate the compass and its compensating binnacle built for it, though that binnacle actually requires less space than the binnacles in general use in the service. The use of a box on a shelf to carry a binnacle is a contrivance not known to any naval vessels except tugs, nor is it known to the best merchant steamers of the day.

This Board found and reported that the rudder indicator and enunciator for the after bridge and the enunciator for the forward bridge had not been supplied. The Advisory Board admits that this is so, throws part of the blame on the unfortunate steering engine, and disposes of the rest by stating that they considered the usual naval method of communicating preferable. This Board is of the opinion that the "usual naval method of communication" is very defective.

The criticism of the Board on the freeing ports is answered by the Advisory Board with the statement that "the contractor has since made good the defect." Many other criticisms are answered in the same way, while many are unnoticed.

This Board stated that the seamen's water closet had not been cemented as required by the contract. The Advisory Board answers that "two holes, about three inches in diameter, were cut in the cement lining to rivet up a hammock-hook on the berth deck, and the workmen had neglected to repair the cement." This carelessness on the part of the inspector would have soon caused trouble, supposing only three inches of the lining exposed, but when this Board made its inspection not half of the surfaces to be cemented had been so treated.

In answer to the criticism of this Board on the planking and calking, the Advisory Board replies that though the decks had been disfigured and marred by the weather since being laid, yet they are of the opinion that the material was originally good and the work properly done, but they "have not received proper care from the contractor."

This Board, under its instructions, has not felt at liberty to fix blame upon anybody, though in view of the rough character of the work and the lack of preservative care that impressed the Board at the outset of its examination, the question frequently suggested itself as to what had been the duty and work of the officers under the direction of the Advisory Board, denominated as inspectors of hulls ?

This Board again asserts that the material was not of the best, and that the decks never were either properly calked or fastened. Only two small thin threads of oakum were used in the calking, and it is unable to understand how any professional man can consider a deck properly fastened when a large proportion of the fastening is placed in the seams instead of the body of the plank. That this was, and is now the condition of the Dolphin's decks, any one can see on the most casual inspection; and further, that some of the lag screws have been backed out or started by the calking lately attempted by the contractor. The Advisory Board alleges that the butt plates called for in the contract, and not found by this Board, are not of the "slightest importance." This Board is of the opinion that if they were of enough importance to be mentioned in the contract, that the contractor should have been required to place them.

JOINER-WORK.

This Board reiterates its opinion as to some of the details of the joiner-work in the cabin and ward rooms. It would seem, however, that the Advisory Board had authorized the departure from the specifications in those respects which the Board have noted; and while the construction of the bureaus without backs was an economical plan for the contractor, an examination of their insides would disclose unfinished work.

This Board witnessed on one occasion a number of joiners planing and scraping down the tops and edges of the ward room dining-table to render it more presentable in appearance, overhauling the state-room doors so that they would travel without jamming, and other work of a like character, though it did not observe any attempt to make good one of the bureaus in the cabin apartments which had one of its sides cut away in the roughest manner, the veneering all or mostly hacked off in fact, apparently to make the bureau fit in its intended place in one of the state-rooms.

The "conveniences and accommodations" in the cabin and ward-room are good, though the odors noticed as coming from the ward-room water-closets, located in the close and hot wing passage, and adjacent to the ward room pantry, did not suggest itself to this Board as a particularly healthful detail. As to the berth deck, the crew of eighty men or more will find exceedingly cramped quarters there, and petty officers of the first class would miss many of the "conveniences and accommodations" they have been accustomed to on board some of our older and larger ships.

BREAD-ROOM.

The Advisory Board says:

The object of tinning a bread room is simply to keep out rats; the only parts not tinned are parts formed by steel bulkheads. Specifications do not require nor has any attempt been made to make the bread room water-tight * * * the gratings had been in some way misplaced.

This Board is of the opinion that bread rooms are tinned to keep out dampness as well as vermin. When first examined the room was not completely tinned up to the deck above, but such defect was subsequently remedied by the contractor. In book of Hull Specifications, page 9, it is stipulated that "the workmanship throughout is to be of the most thorough character, and particular care is to be taken to insure fair lines, smooth surfaces, and perfect water-tightness"; and, as

dryness is an essential requisite of bread rooms, this Board assumes that, in the sense of keeping such parts of a ship free from water by reason of leakage through the sides of the vessel, or from the deck above, the phrase "perfect water-tightness," in that connection, was not misapplied. The bread room did show indisputable signs of leakage of water into it from the deck above, which defect was duly noted.

WATER-TIGHT DOORS.

The Advisory Board says that "it would be obviously inconsistent to fit water-tight doors to the houses where the hatches in the deck, with 12-inch coamings, are fitted, as customary in the naval service," &c.

This Board replies that the specifications read that "each deck-house is to be fitted with water-tight doors," and, as the engine is separated from the wardroom by a water-tight bulkhead, the point made as to the hatches would not seem to be well taken; and, conversely, if the contract called for water-tight doors in the deck houses, should not the hatches have had some protection other than that given?

ARMORY.

The Advisory Board says that "the armory consists of a set of covered racks for thirty rifles and bayonets and thirty revolvers. In the ordinary acceptance of the term there is no armory in the Dolphin, and there is no need of any."

This Board agrees to the statement that "there is no need of an armory on board the Dolphin," but noting in the contractor's account for "extras" an item of \$145 charged for the building of an armory, proceeded to look up, examine, and report upon the same.

DYNAMO.

The Advisory Board says: "It was intended to locate the electrical apparatus in the engine-room, but it was revoked on account of space. * * * The suggestion of covering the floor of the dynamo with lead is a good one. The suggestion of a hand-rail and a protective guard for the switch-board is also good. * * * The Bureau of Navigation suggested that the electric plant should be placed in the spar deck in an extension of the engine-room hatch, but on account of weight of dynamo and engine and that of the extension of the house and the expense, the Board decided to locate it in its present position. * * * It is the custom for the electric apparatus to be under the eye of the navigator and not of the officer of the deck." This Board answers that the dynamo, &c., might have been located on either end of the engine-room house without adding much more to the weight on the spar deck than could have been saved by omitting the needless house over the cabin companion way.

As a matter of remark, the forward part of the engine-room house now presents an unsightly appearance, due to the fact that after the completion of the house the forward part was cut away, to make more room for getting at the bonnet of the forward steam-chest, and the extension, had it been carried forward so as to cover the steerage hatch and inclose the mainmast, would have afforded ample room for the dynamo and engine, and have given the house a far better look than it now has, and with but little additional expense.

The Advisory Board could hardly have been serious when it suggested that "it is the custom of the service for all electrical apparatus to be

under the eye of the navigator, and not of the officer of the deck." So are the side lights, mast head lights, chronometers, binnacles, compasses, and all other apparatus, instruments, and appliances, pertaining to navigation "under the eye of the navigator"; but at the very time when some of these things are in special use the navigator is fast asleep in his bunk, while the officer of the deck is always on hand.

This Board further remarks that it was an unfortunate arrangement that took away from the already limited coal space of the vessel.

BATTERY.

With regard to the battery, this Board is fully in line with the current thought of the day as to the great value of machine-gun fire; indeed, it is so impressed by the lessons taught at the battles of Sfax and Foo Chow, especially the latter, which was purely naval, that it submits the opinion that, as against an active and intelligent enemy, directing the fire of Hotchkiss cannon from under the cover of protective towers or casemates, or guns of the Gatling, Nordenfeldt, or Maxim types, mounted in ship's tops, no crew could stand for a moment at the Hotchkiss cannon it is proposed to mount on the grating platforms which were pieced onto the Dolphin's top-gallant fore-castle after the near completion of that vessel; and unless the ship's 6-inch rifle is, besides its intended shields, to be protected from vertical fire, the same grave fault of mounting would seem to apply to it also.

Machine-guns, however, in their present development, notwithstanding their great range and penetrative power, must still be regarded as auxiliary to the heavy ordnance of still greater range and effectiveness forming the main batteries of ships of war, and, as the 6-inch rifle in question, the recent production of our naval Bureau of Ordnance, is the best and most effective rifled gun yet supplied our service, a gun, which in every factor and quality desirable in ordnance, is the equal, if not the superior, of any gun of like caliber yet fabricated abroad, it is no misnomer to style the main battery of a vessel, composed of one or more guns of such type and power, as the "effective battery" of the ship in contradistinction to the lighter and less effective armament the vessel may carry in the shape of machine-guns.

But, in view of the marked stress the Advisory Board lays upon the destructive range of Hotchkiss cannon, this Board begs to note—what it refrained from doing before—the extreme vulnerability of the Dolphin's engines and main machinery, which, being of the vertical type with large surfaces of exposure above the spar-deck, without any approach to adequate protection from heavy machine-gun fire, either horizontal or vertical, must be held to constitute one of the gravest defects of that vessel's design and construction, and surprising to contemplate when it is considered that the destructive power of Hotchkiss cannon was substantially known before the Dolphin's keel was laid.

In this connection it is pertinent to add that the Surprise, a dispatch-boat of about the same tonnage as the Dolphin, but reported to be much her superior in horse-power, speed, and general arrangement, recently built for the British navy, has horizontal engines, which, besides being below the water-line, have the further protection of an arched steel deck extending over them.

SHAFTING.

The sum and substance of the explanation about the shafting leaves it just where it was before. The contractor had contracted to supply steel shafting—a thing entirely practicable and in general use. He was

allowed to change to iron at considerable expense to the Government, some of the items of expense having been overlooked by the Advisory Board—one notably, the expense of tests of the steel shaftings, amounting probably to more than all those cited by them. This Board is of the opinion that this shafting can be of no possible value to the Government, being already condemned, besides being too small for the enlarged stern and other bearings.

AIR-TIGHT FIRE-ROOM.

The statement of the Advisory Board is an admission of what we stated as to air-tight fire-room. It is an expensive but important and well-approved method of obtaining artificial draft. It was provided for in the specifications to be employed in the event that the natural draft was insufficient. They say it proved insufficient, and a pure make-shift of using tarpaulins to cover the hatches was tried. They say "the result was such that it was regarded impracticable to attempt to make the fire-room air-tight." This resulted from their neglect in not making the necessary provision in the construction of the ship, and this it is that we comment upon and they fail to explain. The present appliance is in every way faulty and worthless.

This Board stated that the link-motion was defective. The Advisory Board replies: "It might be supposed from the above remarks that there was some essential fault in the link-motion, which is, however, similar to hundreds of others, and, though it has a disagreeable jar, due to the method of support and the arrangement of the reversing gear, it properly performs its duty in the regulation of steam and exhaust." This answer admits the faults, but attempts to justify them because hundreds of others seem to be in the same unfortunate condition. In the present advanced stage of the design and manufacture of such machinery this excuse does not seem to carry great weight. It is believed that the designs of the best engineers, and accepted generally by the profession, do not contain such faults.

This hurried reply to the document before us might be made much more complete and exhaustive than it now stands, but in view of the several admissions of the Advisory Board as to the substantial correctness of the report of examination, made by this Board on the 15th ultimo, it seems needless to cover the ground any further.

GEO. E. BELKNAP,
Commodore, U. S. N., President of Board of Examination.
R. D. EVANS,
Commander, U. S. N., Member.
HERMAN WINTER,
Constructing Engineer, Member.

The Secretary of the Navy to the assignees of John Roach.

NAVY DEPARTMENT,
Washington, July 25, 1885.

To George W. Quintard, esq., and another, assignees :

At our interview in New York on Wednesday last you requested me to take into consideration the condition of each of the contracts between the Government and Mr. John Roach pending and incomplete, and, in view of his assignment, make some suggestion as to the method of dealing with the whole subject. I gave you assurances that I would do

so and communicate after reaching Washington. As I view the matter, the rule which governs individuals in these business transactions should govern the action of the Department. At all events, if there is a different rule proper to be applied, I am not aware of it. My duty heretofore has seemed to be very simple and plain. It has been to insist upon the strict enforcement of contract obligations, as interpreted to me, without regard to consequences. That is the ordinary plain business method, a departure from which in a public officer can have no justification, and in like manner I know of no reason why the ordinary principle which actuates merchants in dealing with each other, and in accordance with which generous consideration is extended ordinarily to an unfortunate business associate, should not govern the action of the Department under similar circumstances. The business method of dealing with the matter, which would be pursued by private parties, would be, first, to become satisfied that the assignment was in good faith, and then consider the best method, from a business standpoint, of bringing about a settlement of current and incomplete contracts upon a fair and just basis for both parties.

If I have the power, therefore, I will enter into the consideration with you of the point to which the contracts have been performed, and endeavor to settle upon some just and fair basis for the disposal of the matters. Of this I informed you at our meeting in New York. This course, just and right under all circumstances, is compulsory upon the Government in the present case. The very liberal treatment which the contractor has heretofore received has left the Government without sufficient margin of moneys reserved to enable it to protect itself in the present situation. The contract provided that 10 per cent. should be retained from the bills as they came due, and held as security for the completion of the work. At the present time those reservations would have amounted to \$210,710. They have been surrendered to the contractor under circumstances not important to consider now, with the exception of \$26,670. In addition to this small sum of \$26,670 in our hands, there are unpaid bills for extras claimed on the ships amounting to \$26,688.95, and in dispute on the *Dolphin*, \$29,945.08. Altogether (mostly in dispute) \$83,304.03. As against this, four ships are in your hands, upon which over two millions has been paid, which must be completed to be valuable, liable to greater deterioration by neglect than all the moneys unpaid and in dispute would repay. It is of the utmost consequence to the Government, as it is to yourselves, that a just settlement of past transactions should be had and a new departure made.

I suggest as a practical method of arriving at a solution of the matter a meeting of yourselves and your counsel with the Attorney-General and myself, at which some practical method of dealing with the subject may be arrived at which shall be within my legal authority.

Very respectfully,

W. C. WHITNEY,
Secretary of the Navy.

The Secretary of the Navy to the Naval Advisory Board.

NAVY DEPARTMENT,
Washington, July 31, 1885.

SIR: I acknowledge the receipt of the communication of the Naval Advisory Board of July 13, covering criticisms of the report of the Examining Board upon the *Dolphin*, with the request that the same should be given equal publicity with their report. I have caused the same to

be printed, and send you herewith twenty copies for such use as you may choose to make of them, and shall give the matter to the newspapers to-morrow.

I can but express my surprise that your Board should have certified the vessel to me for acceptance with so many admitted defects as shown by your report to have existed.

Very respectfully,

W. C. WHITNEY,
Secretary of the Navy.

Rear-Admiral E. SIMPSON, U. S. N.,
President of the Naval Advisory Board.

Agreement entered into this 3d day of November, 1885, between parties of the first part, and the United States, by William C. Whitney, Secretary of the Navy, party of the second part.

Whereas the paper annexed hereto, marked Exhibit A, purporting to be a contract for the steamship *Dolphin*, was executed on the 23d day of July, 1883, as by said paper appear; and whereas questions have arisen between the parties thereto with reference to the same and the action of the respective parties thereunder, which questions are incapable of determination without judicial examination and decision, it is hereby mutually agreed:

First. Possession of the steamship *Dolphin* is transferred to the Secretary of the Navy, for the United States, with the right to take and deal with the same as if title thereto were fully vested in the United States; but such transfer shall not operate to constitute an acceptance under the alleged contract, or affect the consideration or adjudication of any question of law or fact arising upon any claim or defense now or hereafter in controversy between the parties, which shall be determined as if such transfer had not been made.

Second. The parties of the first part under such alleged contract to prosecute an action against the parties of the second part for the balance of the purchase money alleged to be due under said contract and for compensation for additional work and alterations made pursuant to the provisions of the said alleged contract.

In the event that a lien shall be determined to exist in favor of the United States upon said vessel, or in the event that the Government shall be found entitled to any money judgment or reclamation recoverable from the parties of the first part, or either of them, then, and in that event, the said steamship shall be first applied to the satisfaction of said lien or judgment, and the value of said steamship, at the time of such transfer, for the purpose of satisfying said lien, claim, or judgment, in lieu of being determined by judicial sale, shall be found by the court, upon proof to be advanced by the respective parties, and for the purpose of such determination her value shall be deemed to be the price specified for her in Exhibit A, plus amounts covered by orders issued by the Secretary of the Navy for alterations and additional work, minus whatever sum, if any, shall be found by the court necessary to have been expended in order to make said ship, when transferred to the Government, conform to and represent a full performance on the part of the parties of the first part of the obligations binding upon them in the construction thereof; and said steamship shall be deemed to have represented at the time of such transfer to the Secretary of the Navy the amounts thus determined in satisfaction of any lien, claim, or demand which the Government may maintain.

The Secretary of the Navy to John Roach and others.

NAVY DEPARTMENT,
Washington, October 1, 1885.

SIRS: Having heretofore communicated to your counsel the views of the Department with reference to what may reasonably be done by the Government in the matter of the steamship *Dolphin*, I now, in accordance with his request, embody the same for your consideration in this formal proposition.

It is of profit to no one that she should lie, as at present, unused, at constant expense, undergoing deterioration. She represents either a ship completed according to contract, which should be accepted by the Government (which is your claim), or she represents a property upon which the Government has a lien for amounts largely in excess of any sum likely to be realized from an enforcement thereof. In this latter event the ship must answer to the Government to whatever extent she will reach to pay. Having been built for a naval vessel, she is of very doubtful market value. In my judgment she should come to the Government, leaving it to be settled by judicial determination hereafter whether your claim is correct, that she should be accepted under the contract, or the claim of the Government is correct, that she must answer for the lien created by the moneys advanced in the course of her construction. Neither of us should object to a speedy and fair settlement of the questions at issue by judicial determination without unnecessary hardships to either. The important things, so far as I am able to see, to be covered by stipulations, are that the transfer of possession to the Government shall not work an acceptance under the contract, unless it is judicially determined that you are entitled to compel such acceptance. By instituting a suit for the balance of the purchase-money unpaid, that question can be speedily determined. In that event a judgment for the balance will settle the controversy; but in the event that the law and the facts should be found otherwise, the transfer of the ship to the Government shall then be considered to have been in recognition of the right of the Government to a foreclosure of its lien for moneys advanced in the course of construction; and in lieu of the hardships which would result from a judicial sale of a vessel not built for mercantile purposes (a harsh manner of liquidating the Government's claim), I can see no reason why the following should not be resorted to as a reasonable and just disposition of the question as to the value of the vessel for the purpose of satisfying the lien. Her value as a naval vessel shall be assumed to be the contract price. If she is found in all respects up to the requirements legally binding upon you in her construction, she is taken by the Government at that price, otherwise she is taken at such less sum as shall be found necessary to be spent upon her to make her up in all respects to such standard. In other words, the Government takes her, and will expedite a determination by the court whether she is taken and accepted as for a valid and completed contract, or in satisfaction of the lien, and the method of determining her value for the purpose of the lien is agreed upon reasonably and fairly. In all other respects the rights of the parties to be unaffected.

Very respectfully,

W. C. WHITNEY,
Secretary of the Navy.

Messrs. JOHN ROACH, LEVI KERR, and A. R. WHITNEY.

No. 16.

REPORT

OF THE

NAVAL ADVISORY BOARD

ON THE

MILD STEEL

USED IN THE CONSTRUCTION OF THE HULL, BOILERS,
AND MACHINERY

OF THE

DOLPHIN, ATLANTA, BOSTON, AND CHICAGO,

FOUR STEEL VESSELS CONSTRUCTED UNDER THE ACTS
OF AUGUST 5, 1832, AND MARCH 3, 1833.

PREPARED BY

ASSISTANT NAVAL CONSTRUCTOR R. GATEWOOD, U. S. N.,

FROM THE RECORDS OF THE BOARD.



WASHINGTON:
GOVERNMENT PRINTING OFFICE.

1885.

367

LETTER OF TRANSMITTAL.

NAVAL ADVISORY BOARD,
NAVY DEPARTMENT,
Washington City, July 27, 1885.

SIR: The Board respectfully forwards herewith its report on mild steel supplied for the construction of the Chicago, Boston, Atlanta, and Dolphin.

This report has been prepared in accordance with the synopsis presented with our letter to the Department of November 17, 1884, by Assistant Naval Constructor R. Gatewood, U. S. Navy, from the data contained in records of the Board.

Very respectfully,

E. SIMPSON,
*Rear-Admiral U. S. N.,
President of the Board.*

Hon. W. C. WHITNEY,
Secretary of the Navy.

369

5141 NAVY—24

INTRODUCTION.

THE INCREASING USE OF MILD STEEL IN THE UNITED STATES PRIOR TO ITS ADOPTION AS THE MATERIAL OF CONSTRUCTION FOR THE FOUR VESSELS APPROPRIATED FOR MARCH 3, 1883.

Mild Steel for Locomotive Boilers.—The advantages to be gained by the use for the fire-boxes of locomotives of a material sufficiently homogeneous to stand the heat of a coal fire with steam blast without the development of blisters, with consequent uncertain and generally short life, as with the iron plates then used, led the authorities of the Pennsylvania Railroad to construct in July, 1861, in its shops at Altoona, Pa., a fire-box of English (crucible) steel. Owing probably to improper manipulation, but, possibly, also to bad quality as well as too high carburization of the steel used, the first attempt was not successful, one of the plates, accidentally let fall after flanging, breaking in the most brittle fashion like glass. In 1865 a second fire-box was made, this time of American crucible steel, supplied by Hussey, Wells & Co. (now Hussey, Howe & Co.), of Pittsburgh, Pa., and was so successful in use that in the next year eighteen steel fire-boxes were constructed, seven of English steel and eleven of the above American steel; while, in June of the same year, 1866, an entire boiler was built of American metal. In 1867 eighteen fire-boxes were made of the same material.

From 1868 dates the decided use of steel for boiler construction by the Pennsylvania Railroad; in that year twenty-seven boilers of steel throughout, besides fifteen steel fire-boxes for iron boilers, being constructed. In 1869 thirty-seven steel boilers were constructed, and thereafter the number of iron boilers constructed diminished rapidly, the last one—a stationary boiler—being built in July, 1873. After 1868 all iron fire-boxes were replaced by steel as they came in for repairs, while improvement in quality of material and in workmanship is evident in the long life of these fire-boxes, from ten to even fifteen years, though not in such continued and severe service as is now common.*

All this success had been obtained with crucible steel of high cost, so that other railroads were naturally slow to undertake the change from iron to steel, although experimental boilers of steel from this time on commenced to appear on various roads. The Bessemer process was introduced into the United States in 1865, but soft steel so manufactured has not been used in locomotive-boiler construction to any extent. The open-hearth process, introduced in 1868, soon became the chief, and is

*The average life of a steel boiler on this road is now reckoned at thirteen years, while that of a fire-box is only six years, the longer fire-boxes, 113 by 36 inches, having the shortest life.

now almost the only, source of supply, steel of this manufacture practically entirely replacing crucible steel after 1875.

The use of steel for boilers on the Pennsylvania Railroad was not without incidental failure both under construction and in service, though the care of steel boilers in use seems to have been the subject of considerable attention and helps to account for their special immunity from accident. Up to 187 the steel was generally taken on the maker's guaranty, but from that year the testing of boiler steel became part of the regular routine work, and at present every sheet of boiler, fire-box, or tank steel used in the shops of the railroad, or in outside construction for them, is tested in the testing department of the road at Altoona, Pa. As the pioneer road in the use of steel in boiler construction, their specifications and method of test have been closely imitated by other prominent roads, and most of the high-grade mild steel made subject to test at the time of the adoption of this material for the construction of naval vessels was expected to fill these or similar specifications. Certainly not less than 7,500 tons of steel had been used in locomotive-boiler construction, of which probably 6,000 tons had been made to specifications and subject to test. The specifications and method of test in use are accordingly of interest as being those with which the steel manufacturers expressed familiarity and as being also probably the most rigid up to that time exacted.

SPECIFICATIONS FOR BOILER AND FIRE-BOX STEEL FOR THE PENNSYLVANIA RAILROAD.

(1) A careful examination will be made of every sheet, and none will be accepted that show mechanical defects.

(2) A test strip taken from each sheet lengthwise of the sheet, and without annealing, should have a tensile strength of 55,000 pounds per square inch, and an elongation of 30 per cent. in a section originally 2 inches long.

(3) Sheets will not be accepted if the tensile strength is less than 50,000 pounds or greater than 65,000 pounds per square inch, or if the elongation falls below 25 per cent.

(4) Should any sheets develop defects in working, they will be rejected.

(5) Manufacturers must send one test strip for each sheet (this strip must accompany the sheet in every case), both sheet and strip being properly stamped with the marks designated by this company, and also lettered with white lead to facilitate matching.

The method of test is as follows: Each steel manufacturer is furnished with a so-called "shear-mark," which, together with a letter indicating the position of the sheet in the boiler, must be stamped upon each sheet. In removing the test piece, the plate is sheared through the "shear mark" thus, so that, when received at the works, the test

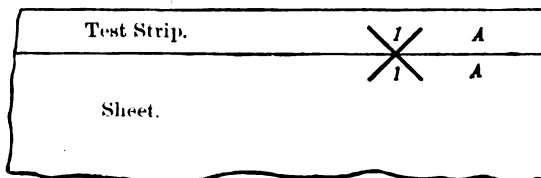

strips may be matched to the corresponding sheets. The piece is then shaped for test as in Fig. 1, in which it will be noticed that the 2-inch measured length for elongation includes $\frac{1}{4}$ -inch fillets at each end, and

that the proportion of the test piece is subject to important variation between the extremes of thickness of $\frac{1}{4}$ and $\frac{1}{2}$ inch.

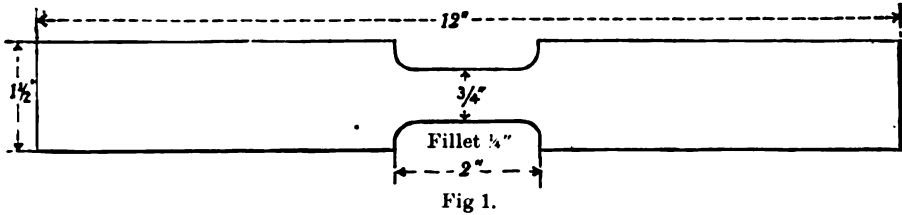

Fig 1.

The pieces are broken by continuous pull in a 100,000-pound Riehle hydraulic machine similar in all respects to that shown in Fig. 4, p. 403.

Similar specifications and methods of tests, with occasional slight individual modifications, are in use in most of our railroads, and in the large locomotive works for steel not specified for by the purchaser. A commendable tendency appears, however, towards the use of longer test pieces, as in the Chicago, Burlington, and Quincy Railroad, whose specifications are as follows:

A test strip lengthwise of the sheet, and without annealing, should have a tensile strength of 55,000 pounds per square inch and an elongation of 28 per cent. in a section originally 4 inches long. Sheets showing less than 50,000 pounds, or more than 60,000 pounds, or an elongation under 25 per cent., will be rejected. Samples to stand bending or hammering down, either hot or cold, after being chilled from a cherry red heat, without a flaw or crack.

Mild Steel for Stationary Boilers.—Information is not readily accessible as to the history or extent of the use of steel for stationary boilers, though thousands of tons have been so used, especially of late years. As to the degree of success obtained, Prof. R. H. Thurston mentions* that the manufacturing house of Kendall & Roberts, Cambridgeport, Mass., report that of several thousand boilers built of steel, they have never had one to fail or give any trouble. It is very likely that the supply of steel for this purpose is mainly under guaranty of the manufacturers.

Mild Steel for Naval Boilers.—The conditions under which this material was adopted and has been used by the Bureau of Steam Engineering, Navy Department, for the construction of naval boilers appear to have been as follows:

As early as April, 1875, samples of mild steel submitted by the well-known Otis Iron and Steel Company were tested at the Washington navy-yard, the tests being reported "very severe and in every way satisfactory." It would appear that up to this time requirements for tensile strength had not been exacted for boiler iron, but in 1877 efforts were made, by correspondence and public advertisement, to obtain for new boilers of the Nipsic a higher grade of iron than had hitherto been used, the specifications demanding "the very best quality of American flange iron, to stand a test of not less than 55,000 pounds to the square inch"—presumably in the grooved test piece then in general use—but without success. It was stated, however, that all the conditions could be met by using mild steel, and the Otis Iron and Steel Company again submitted samples of this material for test at the Washington navy-yard, the report on which (January, 1878) contains the opinion that "the advantages of this material for purposes under cognizance of the Bureau of Steam Engineering would be facility of working, security

*Trans. Am. Inst. Mech. Engrs., Vol. IV., 1883, p. 436.

against blisters in crown sheets of boilers, great tensile strength and consequent reduction in weight of boilers, and a longer life of boilers, on account of the corrosive action being less upon this material than upon ordinary iron." Shortly after (March, 1878), at the request of the authorities of the Fish Commission, mild steel was ordered as the material for new boilers for the Fish Commission steamer Lookout, built by agreement at the Washington navy-yard.

Meanwhile efforts were continued to obtain the higher grade of iron demanded for the Nipsic's boilers, and after the failure of numerous brands under test, samples of the well-known "Sligo" brand passed the tests. But the plates of this brand as supplied failed to meet the tests, and in view of the perfect working of the mild steel for the Lookout's boilers under construction, the agent was allowed to fill the contract with similar material.

Once in use, the material gave such satisfaction that no other has since been used. But before finally adopting it for general use, samples of various manufactures were sent to all the navy-yards for test in comparison with one another and with representative brands of iron, the reports being invariably favorable to the new material after due consideration of all qualities, including the higher cost of the steel.

Table 1. gives the chief items of information for the steel used for this Bureau up to January 1, 1884, from which it is seen that mild steel for 111 boilers, requiring 3,411,780 pounds—1,523 gross tons—had been supplied.

TABLE I.—Mild steel supplied to the order of the Bureau of Steam Engineering for construction of main steam boilers (excluding auxiliary and cutter boilers) up to January 1, 1884.

Date of order.	Vessel.	Number of boilers.	Weight of steel delivered.	Navy-yard.
1878.			<i>Pounds.</i>	
Nov. 1	Nipsic	*6	129,981	Washington.
1879.				
July 3	Mohican	18	156,939	Mare Island.
July 11	Iroquois	*6	154,638	Do.
Oct. 17	Despatch	*2	75,704	Washington.
1880.				
May 6	Ranger	*4	69,308	Mare Island.
May 10	Tallapoosa	*2	173,241	Washington.
June 30	Alert	*4	82,319	Mare Island.
June 30	Enterprise	*6	150,560	Washington.
June 30	Essex	16	164,607	New York.
June 30	Tuscarora	56	77,452	Mare Island.
Sept. 16	Snowdrop	*1	35,668	Norfolk.
Oct. 26	Fortune	12	65,423	Washington.
Oct. 26	Pinta	*2	84,335	Do.
Dec. 18	Ticonderoga	54	181,429	Do.
1881.				
May 9	Monongahela	74	189,511	Mare Island.
May 11	Ossipee	*4	181,324	Washington.
May 11	Rescue	*1	40,852	Do.
June 28	Marion	*8	176,761	Do.
Aug. 1	Pilgrim	*1	45,569	League Island.
Oct. 31	New York	16	299,141	Washington.
1882.				
June 28	Adams	16	130,035	Mare Island.
June 28	Alliance	16	129,252	Norfolk.
June 28	Benedic	54	203,634	Mare Island.
June 28	Powhatan	54	228,641	New York.
June 28	Vandalia	18	175,468	Norfolk.
	Total	111	3,411,780	

*Completed and in service.

† Completed, but not in service.

‡ Partially completed.

§ Not yet commenced.

¶ Partially completed for Monocacy.

This steel was first required to have a tensile strength of about 60,000 pounds to the square inch,* and to stand the severest flanging tests. In June, 1882, the requirements were "to stand the severest flanging tests, and have a tensile strength between 57,000 and 60,000 pounds to the square inch." In December, 1882, practically the same specifications were issued as subsequently adopted by this Board, viz: "To be of uniform thickness and smooth surface, to stand the severest flanging tests, and have a tensile strength between 57,000 and 60,000 pounds to the square inch, with a ductility in 8 inches of not less than 25 per centum."

Mild Steel for Bridges.—In the construction of the great Saint Louis bridge across the Mississippi River, in 1869, nearly 3,000 tons of steel were used, all crucible, and much of that description of crucible steel in which chromium, instead of carbon, is the chief hardening element. This steel is remarkable for its toughness, even in the harder qualities, but its cost is high. Its use at the time was considered a bold piece of engineering, and the experiment was not repeated.

The progressive use of mild steel for bridge building dates from 1879, when Bessemer plates and shapes were adopted for the roadway girders and the approaches of the East River suspension bridge. Thence, successively, railroad bridges in increasing number have been constructed of steel, as given in the accompanying Table II. Of course, the use of steel as wire is not here referred to, but only as worked in ordinary structural shapes. Open-hearth steel has been the preferred material, especially for tension members, a slightly harder grade being used than in ship construction, the general specifications being 70,000 to 75,000 pounds tensile strength, with 20 per cent. elongation of a $\frac{3}{4}$ -inch round in 8 inches. For compression members and pins, 80,000-pound steel, with correspondingly less elongation, is required. As illustrating the quality of material in use, extracts are given in the appendix (p. 577 *et seq.*) from the specifications for a railroad bridge recently constructed. Bridge specifications are not, however, generally so confining as to each individual quality of the material.

TABLE II.—Steel Bridges in the United States.

Date.	Bridges.	Steel manufacturer.	Weight of steel.	Description of steel.
			<i>Tons.</i>	
1869	Saint Louis Bridge	Butcher	2,900	Carbon and chrome.
1879-'83	East River Bridge	Cambria Iron Company	6,300	Bessemer.
1890	Plattsburgh Bridge	497	Siemens-Martin.
1861-'82	Bismarck Bridge	Spang Steel and Iron Company
1888	Blair Bridge	Cambria Iron Company	432	Open-hearth.
1883	Willamette Bridge	Spang Steel and Iron Company	600	Do.
1883	Niagara (new R. R.) Bridge	do	250	Do.
1883	Point Pleasant Bridge	do	Do.
1884	Henderson Bridge	Cambria Iron Company	100	Do.
1884	Henderson Bridge	do	900	Do.
1884	Port Deposit Bridge	Carnegie Brothers	5-6,000	Bessemer.

Mild Steel for Ship-Building.—The use of steel for ship-building was by no means so well advanced as in the other leading branches of iron construction. Only one establishment, the Pusey & Jones Company, of Wilmington, Del., appears to have given the subject practical attention, and they had constructed but five little river-steamers and six lighters with steel plating, most of which was imported. Neverthe-

* Presumably on a test piece 5 or 6 inches long, as these lengths were used by Boards reporting on the material.

less, they were in a position to express before the Congressional committee a decided opinion as to the reliability of steel hulls in collision and grounding, Mr. William Gibbons, president of the company, describing the behavior of one of these little vessels thus:*

“My company have built a number of steel vessels, several of which have been intended for the navigation of the river Magdalena, in the United States of Colombia. Parts of that river are rapid and full of rocks and snags, and the vessels were built of these sheets of steel, much thinner than we have ever used for iron vessels, and they have been thumped and banged against rocks and stones until one of those boats is all dinged, just as if you had taken a leather bag and kicked it about, yet there has been no sort of fracture.”

It is seen from Table III., believed to be a complete account of steel ship-building in the United States up to the date of writing, that the four vessels for the Navy were the first to be commenced of steel throughout, although smaller vessels have been completed before them. Other vessels are under construction, and the list will be materially increased by the end of 1885.

* “Reconstruction of the Navy,” H. R. Report No. 653, 47th Congress, 1st session, p. 122.

TABLE III. —Steel Ship Building in the United States.

Name of vessel.	Dimensions.			Displacement.		Type.	Owner.	Commenced.	Finished.	Description of steel used.	Tensile strength.	Ductility in 8 inches.
	Length.	Beam.	Depth.	Light.	Load.							
Tolima*	Ft. Ins.	Ft. Ins.	Ft. Ins.	Tons.	Tons.	Side-wheel steamer.	F. J. Cisneros, Barranquilla, U. S. Colombia.	1879	1879	Purchased through Agents.	55,000 to 60,000	Lbs. per sq. in. Perct.
Santa Marta*	100 0	24 0	4 0	100	100	do	do	1879	1879			
Bonoe de No- viembre*	60 0	15 0	3 0	26		Stern paddle-wheel steamer.	Government of U. S. of Colombia.	1879	1879	Unknown.		
Emilia (*) Du- ran, 2*	120 0	24 0	4 0	120		do	F. J. Cisneros	1881	1882			
4	40 0	10 0	3 0	13		Lighters	do	1881	1882	Domestic hearth.		
(*)	50 0	18 0	3 0	25		do	Junta de Canalizacion del Rio Magdalena.	1881	1882			
Olympian*	36 0	7 6	3 6	7		Propeller	do	1883	1883	Purchased through agents.		
Apure*	260 0	40 0	14 3	1,246	1,400	Side-wheel bay steamer.	Oregon Railway & Navigation Co.	1883	1883			
Libertad*	150 0	30 0	6 0	280		Stern paddle-wheel steamer.	General Steamship Co., Trinidad, W. I.	1883	1884	Domestic open-hearth.	65,000	16
Dolphin,†	75 0	17 0	4 0	40		do	do	1883	1884			
Atlanta,	240 0	32 0	19 9		1,500	Dispatch boat.	U. S. Navy	1883	1885	Over 60,000	Over 25	to 80.75
Chicago,	270 0	42 0	26 3		3,000	Protected cruiser	do	1883	1883			
Nourmahal	270 0	42 0	26 3		3,000	do	do	1883	1883	Over 60,000	Over 25	to 80.75
Electra	315 0	48 2	34 10		4,500	do	do	1883	1884			
Thors,	221 0	30 0	20 0	850	1,150	Propeller yacht.	William Astor, New York	1884	1884	Chiefly Bessemer	61,850	26
	161 0	23 0	14 3	350	450	do	E. T. Gerry, New York	1884	1884			
	301 6	88 0	25 6	1,000	3,530	Lake steamer.	Union Steamboat Co., Buffalo, N. Y.	1884	1885	Over 60,000	Over 25	to 80.75

* Built by Messrs. John Roach & Son.
 † Built by the Union Dry Dock Co.

* Built by the Pusey & Jones Shipbuilding Co.
 † Built by the Harlan & Hollingsworth Co.

REPORT ON MILD STEEL.

PART I.

CONSIDERATIONS LEADING TO THE USE OF MILD STEEL IN THE CONSTRUCTION OF THE VESSELS.

We have seen that a certain amount of progress had been made and experience obtained in the use of mild steel as a structural material in the United States, when such use on a large scale for the construction of the hulls of vessels of war was brought into prominent notice by the report of the Advisory Board, convened by the Secretary of the Navy June 29, 1881, to suggest the number and classes of vessels needed for the United States Navy, and commonly known as the first Advisory Board. This Board consisted of fifteen representative officers of the line and *matériel* corps of the Navy, and their report to the Department, November 7, 1881, developed the fact that the use of mild steel for construction of hulls had been carefully considered, as fully discussed as the means of information at the time allowed, and was the chief source of a difference of opinion so strong as to call for a divided report. The large majority of the Board reported favorably to the use of mild steel as a material for the hulls of the larger vessels at that time proposed, as follows:

The most difficult question brought before the Board for its decision has been that of the proper material of construction for the hulls of the vessels of the larger classes. It was at first decided that, since iron shipbuilding is now well developed in the United States, since the excellence and economy of this material for the hulls of vessels has long been indisputably established, and since iron vessels could be built with an absolute certainty that they would fully meet all requirements of efficiency, the Board should recommend iron as the material of construction.

Upon further investigation, however, the Board is of the opinion that, notwithstanding the greater cost of steel as a ship-building material, the lack of experience in the manufacture of steel frames in this country, and the experimental stage that steel shipbuilding is still passing through in Europe, it should be recommended as the material of construction for the hulls of the 15, 14, and 13 knot vessels, for the following reasons:

1st. The great saving realized in weight of hull, which, by making possible the acquirement of equal advantages on reduced dimensions, compensates in a great measure, if not entirely, for the difference in cost between steel and iron.

2d. The increased strength of hull and increased immunity from damage in grounding or in light collisions.

3d. The rapidly increasing success that attends the construction of steel hulls in Europe.

4th. The certainty that steel is in the very near future to almost entirely supplant iron in the construction of vessels.

5th. The impetus that such a step, taken by the Government, would give to the general development of steel manufacture in this country.

6th. The necessity that, when the ships recommended are completed, they shall in all respects be equal to, if not better than, any of their class in foreign navies.

Finally, that for the reputation and the material advantage of the United States it is of prime necessity that in this country, where every other industry is developing with gigantic strides, a bold and decided step should be taken to win back from Europe our former prestige as the best ship-builders of the world.

It is therefore the opinion of the Board that the 15, 14, and 13 knot classes of vessels should be built throughout of steel.

The considerations governing this report are plainly the extended and increasing use of steel for ship-building in Europe, and the belief, though upon no particular or extended evidence, that at least equally good material could be furnished of the necessary shapes and quality by American manufacturers without excessive cost.

While other points of uncertainty as to the new material were advanced in the minority report, it became evident, in subsequent discussion, that the adverse opinion of the three officers of the Construction Corps of the Navy, on the Board, as to the use of steel was based mainly upon the latter consideration, viz, uncertainty as to the ability of the American manufacturers to produce the desired material without excessive cost.*

The difference of opinion which caused a divided report of this Advisory Board was considered lamentable at the time, though possibly in the end it was not to be regretted, because, the matter coming in this shape before the Forty-seventh Congress, the Naval Committee of the House instituted an exhaustive examination as to the relative merits and probable difference of cost of puddled iron and ingot mild steel as constructive materials for ships of war. Prominent ship-builders and iron and steel manufacturers and workers gave evidence before the committee unanimously in favor of the use of mild steel, while actual experiments were made at the Washington navy-yard and conclusive testimony adduced as to the magnificent behavior of the mild steel exclusively used there for the boilers of naval vessels.†

Then followed the conference, above referred to, between the Senate and House Committees and the Advisory Board, at which the dissenting members, with but a single exception, expressed their conviction, in favor of the use of mild steel.

Accordingly the report of the House Committee on Naval Affairs accompanying H. R. Bill 5001, March 8, 1882, contains the following:

MATERIAL.

Your committee have been greatly aided by the report of both majority and minority, and we have felt entirely safe in following their views on all matters in which they agreed.

The only questions they disagreed upon, which in any way affect the report of this committee, are two in number, and are as follows: first, whether steel or iron shall be used in the construction of vessels recommended to be built; second, whether the second size vessel recommended shall be built with open or spar decks.

The first of these questions the committee felt called upon to decide for themselves, and, after carefully taking the opinions of the most extensive and experienced manufacturers of steel and iron in this country whom we could reach, we have unanimously decided that steel should be used instead of iron, and we are of the opinion that if the members of the Advisory Board could have had before them the same evidence as the committee had, and could have been as fully informed as to the progress, extent, and present condition of the manufacture of steel in this country, as the committee have been, they would have all united in recommending steel as the only proper material for the construction of vessels of war. We understand that the reason why all advocated the use of iron was because of a doubt whether steel of the requi-

* See "Reconstruction of the Navy," previously referred to, under heading, "Notes of a conference held in the office of the Secretary of the Navy between members of the Senate and House Committees on Naval Affairs, members of the late Advisory Board, and other officers of the Navy," p. 190 *et seq.*

† "Reconstruction of the Navy," H. R. Report No. 653, Forty-seventh Congress.

site quality could be produced in this country in sufficient quantity and at reasonable cost. But on these points there would seem to be no ground for reasonable apprehension, and we recommend steel without hesitation or doubt. The evidence taken by the committee is herewith reported, and we commend it to the consideration of Congress.

The committee were surprised and gratified to learn that the United States is today the second country in the world, if not indeed the first, in the extent of the manufacture of steel, and that steel of American manufacture is better than that made in Europe. Specimens of open-hearth steel (which is the best for ship-building purposes, as the evidence clearly shows) from several of the largest manufactories in the country were presented to the committee, and may now be seen in the committee-room. This class of steel is uniform in character, and has a tensile strength of from 55,000 to 63,000 pounds to the square inch, and a ductility of 30 per cent. It is capable of being folded cold under heavy hammers without crack or fracture. A portion of the committee visited the navy-yard at Washington for the purpose of witnessing experiments with this class of steel. Specimens taken from the scrap-heap of two different manufactories, that of Park Brothers & Co., of Pittsburgh, and the Otis Steel Company, of Cleveland, were submitted to the severe test named, and both exhibited equal ductility and strength. Another specimen, from the works of the Norway Iron Company at Boston, of equally good quality, was placed in the hands of the committee, and also specimens from Shoenberger & Co., of Pittsburgh.

Your committee have also before them numerous specimens of iron which has heretofore been used in the construction of vessels. The difference between steel as at present manufactured in this country, adapted for ship-building purposes, and iron, commonly used, is so great and so much in favor of steel that we would commit a great wrong should we leave the question open. As to the kind of steel which this country can produce, including Bessemer steel, we simply have to say that the production is unlimited. With their present facilities, besides supplying the demand for other purposes, it is believed from the evidence before the committee that the manufacturers of open-hearth steel in this country would be able to furnish 100,000 or 200,000 tons per year, superior to any made elsewhere in the world, should the Government demand so great an amount. It appears in the evidence that the Government has abandoned the use of iron for the manufacture of boilers, and for the last four years has made use exclusively of open-hearth steel for that purpose.

We call attention to the statement of Mr. George Wilson, superintendent of machinery at the Washington navy-yard, found on page 129 of the accompanying evidence. Mr. Wilson says:

"If you get a good piece of iron, and it does not break, there is no difference in the cost of working, but in the difficult flanges there is great liability of spoiling the iron. You will spoil about 10 per cent of the iron flanges. You may have men working ten days on a sheet of iron, and then have it spoiled. But we have never spoiled but one sheet of steel. In the many thousands that we have used in the last four years we have spoiled but one; and even that we could have used."

The committee are satisfied that in all respects steel is the best material for ship construction, and we therefore unhesitatingly recommend it.

While the danger of attempting to obtain too great economy of weight by using steel of too high tensile strength and consequent low working quality was made perfectly plain during the investigation, on the other hand it appears to have been thoroughly realized that the strength of the very softest grades was too low to obtain sufficient economy over iron to warrant the more expensive construction, and, in fixing the lower limits of tensile strength and ductility subsequently adopted, Congress was doubtless guided by the evidence before it as to the specifications in use in foreign navies and insurance societies, under which thousands of tons of shipping had been constructed.

The act of August 5, 1882, authorizing the construction of certain new vessels contains the following provision as to material: "Such vessels . . . to be constructed of steel, of domestic manufacture, having as near as may be a tensile strength of not less than 60,000 pounds to the square inch, and a ductility in 8 inches of not less than 25 per centum;" in which it will be observed that the lower limit of tensile strength, 60,000 pounds, or 26.70 tons, per square inch, lies between the 26 tons of the British Admiralty and the 27 tons of Lloyd's Insurance Registry, while the ductility required is one-quarter higher, thus showing the confidence acquired during its investigation, that our steel manufacturers

could produce a higher grade of material than is demanded for ship-building purposes in Europe, a conclusion fully borne out by the results embodied in this report.

The provision as to quality of material contained in the act of August 5, 1882, was continued in the act making appropriations for the naval service, approved March 3, 1883, under which the vessels now building were commenced.

Shortly after the passage of this act, the Board addressed the following circular letter, under date of March 21, 1883, to prominent steel and iron manufacturers relative to their capacity to furnish such material as would probably be required. No detailed information could be at that time furnished, since the designs of the vessels were not in a sufficiently forward state.

NAVAL ADVISORY BOARD, NAVY DEPARTMENT,
Washington City, March 21, 1883.

Messrs. ———— :

The Naval Advisory Board, wishing to obtain positive information with regard to the capability of American manufacturers for providing the material necessary for the construction of the unarmored cruisers to be built for the Navy, will be obliged if you will kindly answer the following questions at your earliest convenience.

Can you manufacture, with your present existing plant and appliances, the following specified shapes? The material to be of steel of domestic manufacture, having as near as may be a tensile strength of not less than 60,000 pounds to the square inch, and a ductility in 8 inches of not less than 25 per centum, viz :

ANGLES.

Size.	Weight per foot-length.	Size.	Weight per foot-length.
	<i>Pounds.</i>		<i>Pounds.</i>
2 by 2 inches.....	3½	5 by 3 inches.....	10
2½ by 2½ inches.....	4½	4 by 3 inches.....	10
2½ by 2½ inches.....	5	5 by 3½ inches.....	11
3 by 3 inches.....	7	4 by 3½ inches.....	12
3 by 3½ inches.....	8½	6 by 3½ inches.....	14

T BARS.

4½ by 3 inches.....	8½
---------------------	----	-------	-------

BULB BEAMS.

6 by 4½ inches.....	18	9 by 5½ inches.....	31
8 by 5 inches.....	23	10 by 5½ inches.....	32
9 by 5 inches.....	27		

Z BARS.

PLATES.

[From 8 to 30 pounds per square foot.]

Weight.	Size.
30-pound plates.....	5 by 16 feet.
22-pound plates.....	4½ by 16 feet.

Very respectfully,

R. W. SHUFELDT,
Commodore, U. S. N., President of the Board.

The replies which follow show both willingness and ability to undertake the work, with the exception, perhaps, of the larger deck-beams :

[Oliver Bros. & Phillips.]

PITTSBURGH, *April 17, 1883.*

DEAR SIR: We are prepared to roll steel plates and bars, and in that view request that you kindly mail us specifications of the sizes and quality of the above material required by the Government in the new vessels ordered by Congress to be constructed.

Yours truly,

OLIVER BROS. & PHILLIPS.

Hon. W. E. CHANDLER,
Secretary of the Navy, Washington, D. C.

[The Nashua Iron and Steel Company.]

NASHUA, N. H., *March 23, 1883.*

DEAR SIR: Yours of 21st instant at hand and in reply would say that with our present existing plant and appliances we can only manufacture the steel rectangular plates referred to, viz: 8 to 30 pounds per square foot. The 30 pound plates to be 5 by 16 feet; the 22 pound plates to be 4 by 16 feet.

Respectfully, your obedient servant,

J. D. SWAIN, *Superintendent.*

P. S.—We send you by mail to-day a small book giving list of goods we manufacture.

R. W. SHUFELDT,
Commodore, U. S. Navy, President Naval Advisory Board.

[Park, Brother & Co.]

PITTSBURGH, PA., *March 24, 1883.*

DEAR SIR: We are in receipt of your favor of 21st instant and in reply would say we are not prepared to make angles, T bars, or Z bars.

We are prepared to make bulb beams which we presume are not rolled to shape, and plates of the sizes, dimensions, and quality you require.

We shall be pleased at any time to make you an estimate of price.

Yours truly,

R. W. SHUFELDT, Esq.,
Commodore, U. S. Navy,
President Naval Advisory Board, Washington, D. C.

PARK, BROTHER & Co.

[Carnegie Bros. & Co., Limited.]

PITTSBURGH, *March 24, 1883.*

DEAR SIR: We are in receipt of your circular letter of 21st March. We are now prepared to roll nearly all the sizes of angles, tees, beams, &c., you specify, of steel. Those we cannot at present make we will have rolls for by the time the material is wanted.

We cannot, however, make plates exceeding 36 inches in width. We note your specification calls for 54 and 60 inch plates.

The steel we propose furnishing will meet all the specified requirements.

We shall be glad to make tender whenever called upon so to do.

Yours respectfully,

CARNEGIE BROS. & Co., LIMITED,
H. P. POPE.

R. W. SHUFELDT,
Commodore, U. S. Navy,
President Naval Advisory Board, Washington, D. C.

[Singer, Nimick & Co., Limited.]

PITTSBURGH, PA., *March 23, 1883.*

DEAR SIR: We have your favor of the 21st instant to hand; contents noted. We beg to say in reply, that we are not prepared to make the shaped material your specification before us describes.

Very truly yours,

SINGER, NIMICK & Co., LIMITED,
GEORGE SINGER,
Secretary & Treasurer.

R. W. SHUFELDT,
Commodore, U. S. Navy,
President Naval Advisory Board, Washington, D. C.

[A. R. Whitney & Co.]

NEW YORK, *March 26, 1883.*

DEAR SIR: We are not prepared to make the angles, Tees, and Z bars of steel, but can supply the plates. We can, however, supply the shapes of steel from Messrs. Carnegie Bros. & Co., Pittsburgh, to whom you have already applied, and who will quote you direct.

Yours truly,

A. R. WHITNEY & CO.

Commodore R. W. SHUFELDT,
Washington, D. C.

[A. R. Whitney & Co.]

NEW YORK, *April 12, 1883.*

GENTLEMEN: Since writing you we have arranged to make the steel shapes, as inquired for in your favor of 21st instant.

Yours truly,

A. R. WHITNEY & CO.

NAVAL ADVISORY BOARD,
Washington, D. C.

[The Midvale Steel Company.]

PHILADELPHIA, *March 24, 1883.*

DEAR SIR: Your esteemed favor of the 21st instant, regarding steel shapes and plates for ship-building purposes, came duly to hand and we note contents. The matter of rolling shapes from steel received much attention from this company, and in rolling such material for the superstructure and approaches of the Brooklyn Bridge, we made, we believe, the first lot of any amount of steel shapes ever manufactured in this country. Inclosed please find a blue print of the shapes rolled by us for the Brooklyn Bridge, for which we now have the required rolls. The shapes which you require for ship-building purposes, excepting the angles, are quite different from any we have yet manufactured, but we do not think there will be any serious difficulty in their production.

We are now, however, giving the matter our careful consideration; in the course of a few days can speak more clearly upon the subject, when we will again communicate with you. As regards the steel of which such shapes will be made, we think we will have no difficulty whatever in producing, uniformly, a metal showing the physical properties required. Our mill is not now equipped for rolling plates, having been altered to a bar-mill for the purpose of rolling the shape work above referred to. We would always be in a position to furnish hammered blooms of any specified quality of steel for rolling into plates. In manufacturing steel in the open-hearth furnace, it has always been our endeavor to produce certain definite grades, with the greatest possible regularity; and we would have no hesitation in undertaking to produce a thoroughly satisfactory article for ship-building purposes. We will write you more definitely in the near future about the shapes you may require. There would, of course, be no difficulty in rolling the angles.

Very respectfully,

R. W. DAVENPORT,
Superintendent.

R. W. SHUFELDT,
President of Naval Advisory Board, Washington, D. C.

[The Midvale Steel Company.]

PHILADELPHIA, *April 3, 1883.*

DEAR SIR: On looking more carefully into the matter of rolling the deck, or bulb beams, concerning which you inquired in your favor of March 21st, we find that, owing to the great width of flange required in the 8, 9, and 10 inch beams, it will require a very great pressure to bring the flanges up perfectly from a square steel billet or bloom, and we fear that, with the largest mill we have at present (which is a 23-inch mill, about the same size usually employed in rolling rails), we will not be able to do this work. As, however, we are anxious to turn our production in the direction of special steel shapes, we will keep the subject in mind, and will be much obliged if you could let us have a drawing showing the exact sections and shapes of steel bars which will probably be required in ship-building. We could, we think, make the 6-inch deck beams, as well as the angles, T, and Z bars mentioned.

We remain yours respectfully,

R. W. DAVENPORT,
Superintendent.

Commodore R. W. SHUFELDT, U. S. N.,
President Naval Advisory Board, Washington, D. C.

[Shoenberger & Co., Juniata Iron and Steel Works.]

PITTSBURGH, March 29, 1883.

DEAR SIR: Your favor of 21st instant came duly to hand and it gives us pleasure to tell you that we are prepared to roll any size steel plate you may require up to 100 inches in width, and at any time will be pleased to name you our lowest prices and give your orders attention.

We do not manufacture angles or bulb beams, which we understand are deck beams, but could easily furnish them to you by having them rolled here by other parties, except the 6 by 3½ angles; for these we could furnish 6 by 4.

We could also have the T bars rolled for you, but instead of 4½ by 3 we could furnish 4½ by 3½. We could also furnish 7, 8, and 9 inch deck beams, but not 6 and 10 inch, and the widest flange for both 8 and 9 inch deck beams is 4 inch, while you specify 5 inch. If, however, you would need a considerable quantity of the shapes, we could have rolls turned specially and furnish all the size shapes you specify.

Hoping we may hear from you when you are in the market,

Yours truly,

SHOENBERGER & CO.

P. S.—We would have answered you more promptly but were delayed in finding out about angles, &c.

Yours,

S. & CO.

R. W. SHUFELDT, Esq.,
Commodore, U. S. N., Washington, D. C.

It should be observed that these replies are by no means a complete measure of the ability of our manufacturers to perform the work, and in fact but one of the above firms, Messrs. Park, Bro. & Co., actually supplied material in any considerable quantity under subsequent contract.

The difficulty of producing the required quality of material does not seem at this time to have received any particular attention, the chief source of uncertainty being as to the rolling-mill capacity for some of the shapes, and whether or not the orders would be sufficiently large to warrant an overhauling of machinery and the manufacture of certain new rolls required.

The production of steel plates for boiler and other purposes had reached sufficient proportions to prevent any difficulty attaching to the mere rolling of the plates required. Several plate mills of 110 inches length between housings were in constant use, and one 120 inches long was available if necessary. Few of the shape mills, however, had any experience in working steel, except as rails, and the sufficiency of strength of the rolls and connections as used for iron was a matter of some uncertainty. The rolling of steel beams of any size had never been attempted so far as we know; certainly the best shapes and arrangement of passes was a matter of discussion and even of patent. At the time of this writing a 12-inch I beam is the largest section produced in steel, and that only in one mill, and from shaped blooms.*

Still there can be no doubt of the willingness of many of the shape manufacturers to undertake any reasonably large order at a price only sufficient to cover the actual cost of production, in order to gain experience and place themselves in a position to meet any subsequent demands. In many places the fact was fully realized that in the near future there would be a rapidly increasing demand for structural steel in shapes necessary for bridge, roof, and ship construction, which is even now the case.

In the matter of quality, the Board, even at this time, recognized the fact that trouble and serious obstruction might be caused by interpret

* Rolled at the works of A. & P. Roberts, Pencoyd, Pa., on a 23-inch mill, from shaped blooms supplied by the Pittsburgh Steel Casting Company.

ing the statute as requiring a ductility of 25 per cent. in 8 inches as a minimum. Only two out of the nine steel manufacturers replying to the circular letter had touched at all upon the quality demanded, and these only in a general way, apparently without definite knowledge and confident that there could be nothing excessive demanded. As no objection had been made to the possible exaction of these requirements as minima, a system of tests was devised accordingly and submitted to the Department with an accompanying letter containing the opinion that these requirements were perhaps higher than necessary to secure good material and suggesting an average ductility of 25 per cent., no single test falling below 23 per cent.

The system of tests as at that time proposed is as follows:

TESTS OF STEEL FOR CRUISERS.

Instructions to inspectors.

The following rules are prescribed in order to insure the fulfillment of the clause of the act of Congress of August 5, 1882. "Such vessels * * * to be constructed of steel, of domestic manufacture, having, as near as may be, a tensile strength of not less than 60,000 pounds to the square inch, and a ductility in 8 inches of not less than 25 per centum":

I. All ship-plates, beams, angles, rivets, bolts, boiler-plates, and stays, to be inspected and tested at the place of manufacture by a naval inspector of material, and to be passed by him, subject to restrictions hereinafter mentioned, before acceptance by the ship-builders, whether Government or private, for incorporation into said vessels.

II. Every plate, beam, and angle, supplied for these vessels, to be clearly and indelibly stamped in two places, and with two separate brands: (1st) With that of the maker, which shall distinguish the name of the manufactory or company. (2d) With the regulation brand of the naval inspector of material. The latter not to be stamped upon any of the above-mentioned material until it shall have passed the required inspection and tests, have been accepted by the inspector, and have been stamped with the maker's brand.

In case of small articles passed in bulk, the above-mentioned brands shall be applied to the boxing or packing material of the objects.

No steel material to be received at the building yards for incorporation into the vessels except it bear, either upon its surface or that of its packing, both of these brands as evidence that it has passed the necessary Government inspection.

SHIP-PLATES.

III. In every lot of 20 plates test pieces to be cut from two plates taken at random; two test pieces being cut from each plate, one in the direction of the rolling, and one at right angles to it, shaped according to the annexed sketch. These test pieces shall in no case be annealed.

The test pieces to be submitted to a direct tensile stress until they break, and in a machine of approved character.

The initial stress to be as near the elastic limit as possible; which limit is to be carefully determined by the inspector in a special series of tests. The first load to be kept in continuous action for five minutes. Additional loads to be then added at intervals of time as nearly as possible equal, and separated by half a minute; the loads to produce a strain of 5,000 pounds per square inch of original section of the test piece until the stress is about 50,000 pounds per square inch of original section, when the additional loads should be in increments not exceeding 1,000 pounds.

An observation to be made of the corresponding elongation measured upon the original length of 8 inches.

The final elongation to be that obtained at rupture. The loads applied shall never be calculated from the indications of the pressure gauge if a hydraulic press be used.

In order to be accepted, a test must show an ultimate tensile strength of at least 60,000 pounds per square inch, and a final elongation in 8 inches of not less than 25 per cent. Plates which show a strength greater than 60,000 pounds per square inch will be accepted, provided the ductility remains at least 25 per cent.

If the average of these four test pieces fall below either of the required limits these plates shall be rejected and another plate from the lot shall be tested; if it fails the lot shall be rejected, and if it is successful a third test shall decide.

QUENCHING TEST.

be cut from each plate, angle, or beam, and after heating to a water at a temperature of 82° Fahrenheit. Thus prepared it and the pieces under a press or hammer so that they shall be parts being in complete contact with each other, without pre-cracking.

must not have their sheared sides rounded off, the only treatment making off the sharpness of the edges with a fine file.

ANGLES, BEAMS, BULB BARS, T BARS, &C.

Every lot of 20 angles or beams, &c., test pieces to be cut from the webs of at random, one from each. These pieces to be fashioned in the same way, subjected to the same tests, both tensile and quenching, and to fulfill the requirements for acceptance as already prescribed for ship-plates.

Angle bars are to be subjected to the following additional tests: A piece cut from a bar in twenty to be opened out flat while cold under the hammer; a piece cut from another bar in the same lot shall be closed until the two sides touch while cold; a piece from a third bar of the lot to be bent cold into a ring so that one of the sides of the angle bar shall be kept flat and the other side forming a cylinder, of which the internal diameter shall be equal to 3½ times the breadth of the side which remains flat. The angle bars submitted to these tests must show neither cracks, cliffs, nor flaws.

Single T bars to be submitted to the following tests: A piece to be cut from the end of a bar taken at random from each lot of 20, and to be bent cold into a half ring, so that the web remaining in its own plane, the cross flanges shall form a half cylinder, of which the internal diameter shall equal four times the height of the web of the T bar.

At the end of another bar of the same lot the web to be split down its middle for a length equal three times its total depth, and a hole drilled at the end of the slit to prevent it spreading; the piece thus split to be opened out in its own plane, so as to make an angle of 45° with the rest, care to be taken that the part opened shall be kept straight, except that it must be joined to the rest of the bar by a band of small radius.

Bulb bars are to be subjected to the same tests as those prescribed for T bars, except that in bending one or more heats may be used.

All bars submitted to these tests must show neither cracks, cliffs, nor flaws.

RIVETS.

VI. One bar from every lot of twenty of the bars from which rivets are made shall be subject to the same tensile test as that required for the plate tests. All bars not fulfilling the requirements of tensile strength and elongation required for plates to be rejected.

From every lot of 500 pounds four rivets are to be taken at random and submitted to the following tests, one rivet to be used for each test: 1st. A rivet to be flattened out cold under the hammer to a thickness of one-half its diameter without showing cracks or flaws. 2d. A rivet to be flattened out hot under the hammer to a thickness one-third its diameter without showing cracks or flaws. 3d. A rivet to be bent cold into the form of a hook with parallel sides without showing cracks or flaws. 4th. A rivet to be tested by shearing by riveting it up to two pieces of steel which are to be submitted to a tensile strain, the rivet not to shear under a stress of less than 50,000 pounds per square inch.

BOILER PLATES.

VII. Each boiler plate must be subjected to the same tests and in the manner prescribed for ship-plates. The ductility in 8 inches must not be less than 25 per cent., and the ultimate tensile strength must not be less than 57,000 pounds and not more than 63,000 pounds, and the average at least 60,000 pounds.

The acceptance of material under these tests will not relieve the contractor from the necessity of making good any material which fails in working or may be rejected by the inspector.

But before finally adopting this system of tests, it was deemed expedient to place it before various ship-builders and steel manufacturers interested for criticism and suggestion, especially as the probability of the vessels being built by contract was very strong, in which event too

much time could not be allowed intended bidders to arrive at a definite and satisfactory understanding as to their supply of material.

Accordingly copies of the preliminary scheme of tests were sent out with accompanying letter :

NAVAL ADVISORY BOARD,
Washington, April 30, 1883.

Messrs. ——— :

The following tests inclosed herewith have been prepared in order to insure the fulfillment of the provisions of the act of Congress of August 5, 1882, relating to the construction of steel cruisers.

The Board will be glad to receive any suggestions from you before the final adoption of these rules.

Very respectfully,

R. W. SHUFELDT,
Commodore, U. S. Navy, Pres. Naval Advisory Board.

Replies came in slowly, as follows :

[The Harlan and Hollingsworth Company.]

WILMINGTON, DEL., May 1, 1883.

SIR: We beg to acknowledge the receipt of your communication of the 30th ultimo, with inclosure of "Instructions to Inspectors" regarding tests of steel for cruisers.

The matter shall have our careful attention.

We are, very respectfully, yours, &c.,

J. T. GAUSE,
Vice-President.

Commodore R. W. SHUFELDT, U. S. N.,
President Naval Advisory Board, Washington, D. C.

[The Pusey & Jones Company.]

WILMINGTON, DEL., May 2, 1883.

DEAR SIR: We have your favor of 30th ultimo, with inclosure of memorandum of tests which it is proposed to apply to the materials to be used in the construction of the new steel cruisers.

In a very few days we shall have the pleasure of submitting our views regarding them.

Very respectfully,

PUSEY & JONES CO.,
By W. G. GIBBONS, Pres.

Commodore R. W. SHUFELDT, U. S. N.,
President Naval Advisory Board, Washington, D. C.

[Black Diamond Steel Works. Park, Brother & Co.]

PITTSBURGH, May 5, 1883.

DEAR SIR: Your printed circular, inclosed under date of April 30, marked "Tests of Steel for Cruisers," came duly to hand and contents noted.

Thanking you for this copy of "Instructions to Inspectors," we beg to advise you we have no suggestion to submit, and subscribe ourselves,

Very truly,

PARK, BROTHER & CO.

Commodore R. W. SHUFELDT, U. S. N.,
President Naval Advisory Board, Washington, D. C.

[The Pusey and Jones Company.]

WILMINGTON, DEL., May 8, 1883.

DEAR SIR: We confirm our advices of 2d inst.; and now further referring to your circular letter relative to the tests which it is proposed to apply to the steel to be used in the construction of the vessels called for under act of Congress of August 5, 1882, we have to say that in our opinion a measure of ductility of 25 per cent. in 8 inches is incompatible with a tensile strength of 60,000 pounds to the square inch.

The very best grades of "fire-box steel" will, under favorable circumstances, show a measure of ductility as above; but it is not often found having so high a degree of tensile strength as 60,000 pounds when associated with so great a ductility.

We are further of opinion that in view of the difficulties attending the tests as described in the afore-mentioned circular letter—that is to say, in producing steel of a grade that will stand the tests successfully—very few of the steel manufacturers of this country would wish to undertake the task of furnishing the plates and bars required, even with the inducement of a price much above the ruling rate for ship plates.

It is unfortunate that Congress has so fenced in the testing of the materials as to make the procuring of them almost impossible, because steel can be had, possessing a less measure of ductility, that would endure all the strains that are likely to be applied to the ships in question. If we can serve you further please command us.

Yours truly,

THE PUSEY & JONES CO.,
By W. G. GIBBONS,
President.

Commodore R. W. SHUFELDT, U. S. N.,
President Naval Advisory Board, Washington, D. C.

[The Midvale Steel Company.]

PHILADELPHIA, May 26, 1883.

DEAR SIR: The Board's circular letter of April 30, regarding the proposed tests of steel for cruisers, came duly to hand. We have considered the matter with care, and think that the tests prescribed should certainly insure a first-rate quality of steel for the purpose in question.

The only criticism we have to make is in the test prescribed for boiler plate, which, when compared with the ship-plates in the matter of extensibility, appears to us to be too low; and we think boiler-plates showing a tensile strength of from 57,000 to 60,000 pounds per square inch should show a greater extension than 25 per cent.

Respectfully, yours,

R. W. DAVENPORT,
Superintendent.

Commodore R. W. SHUFELDT, U. S. N.,
President Naval Advisory Board, Washington, D. C.

[Army and Navy Supplies. Austin P. Brown, agent.]

WASHINGTON, D. C., June 6, 1883.

SIR: We have the honor to say, in answer to your letter of April 30, ultimo, regarding steel for new cruisers, that we have no suggestions to make regarding the printed instructions to inspectors inclosed therein, as, in our opinion, they are as perfect as is possible to make them.

Permit us to say in this connection that we are prepared to furnish ship and boiler plate, to stand the required tests, at the rate of from 50 to 75 tons per day.

Your letter was laid aside as not requiring an answer, and our only reason now for replying is that we are informed that you have not received all the information you desire regarding the ability of manufacturers to furnish the steel up to the full standard required by law, as regards tensile strength and elongation.

Very respectfully, your obedient servants,

OTIS IRON AND STEEL CO.,
By AUSTIN P. BROWN, *Agent.*

Admiral R. W. SHUFELDT, U. S. N.,
President Naval Advisory Board, Navy Department, Washington, D. C.

[The Harlan and Hollingsworth Company.]

WILMINGTON, DEL., June 7, 1883.

DEAR SIR: We have corresponded with all the manufacturers of steel in the United States regarding the tests required by the Naval Advisory Board for the steel to be used in the new cruisers, and we are clear in the conviction that the rule for 60,000 pounds tensile strength and an elongation of 25 per cent. in 8 inches cannot be adhered to.

There are very few makers of steel that admit that they can make steel to stand these tests.

The few who do admit it say that such steel will cost a great deal more money than if the tests were less severe.

Now, we fear that the difficulty will be that those parties who may obtain contracts for building these cruisers will have to pay an exorbitant price for the steel because of the severity of the tests in question.

We would suggest, to meet the difficulty, that the tensile strength be put at from

55,000 to 62,000 pounds per square inch, and that the elongation should be from 20 to 25 per cent. in 8 inches.

With this modification we believe the builders of the cruisers will be able to get steel at satisfactory prices, and from a sufficient number of makers to meet their requirements, and avoid any unnecessary delay in obtaining their materials.

Unless the tests were modified in the manner suggested, we should feel considerably embarrassed in making our bids.

Yours, &c.,

J. TAYLOR GAUSE,
President.

Hon. W. E. CHANDLER,
Secretary of the Navy, Washington, D. C.

P. S.—The following is copy of letter received, and which is a fair sample of the replies from the different makers:

“While we are prepared to make steel suitable for the purpose mentioned, yet we are not prepared to make steel that will show a uniform test of 60,000 pounds tensile strength, and a ductility of 25 per cent. in 8 inches.

“We can make steel with the ductility required, but it will not pull 60,000. Practically, steel required to have a ductility of 20 per cent. in 8 inches should range from 55,000 to 65,000, and 25 per cent. from 48,000 to 58,000.

“The Pennsylvania Railroad Company’s test for boiler plate is about as good and practical as any we know of, and if, with their long experience, it is found all right for boiler plate, it ought to answer for ship plate.

“SINGER, NIMICK & CO., LTD.”

[Shoenberger & Co.]

PITTSBURGH, June 9, 1883.

DEAR SIR: Will you have the kindness to let us know regarding the matter of steel plates for steel cruisers? When will the matter be decided, and when are the contracts to be let for the plates? Your reply will greatly oblige,

Yours truly,

SHOENBERGER & CO.

Commodore R. W. SHUFELDT, U. S. N.,
Washington, D. C.

[Park, Brother & Co.]

PITTSBURGH, PA., June 14, 1883.

DEAR SIR: We do not think we were definite enough in our letters to you regarding quality of steel, and now write to say that we are prepared to furnish steel to stand the required test; that is, 60,000 pounds tensile strength with an elongation of 25 per cent. in an 8-inch section.

We have heard recently that your Board had under consideration the propriety of reducing the requirements and making the elongation 20 per cent. instead of 25 per cent., but we can assure you of our ability to give you steel which will stand the maximum test.

Very respectfully,

PARK, BROTHER & CO.

R. W. SHUFELDT, Esq.,
Commodore U. S. Navy,
President Naval Advisory Board, Washington, D. C.

It is seen from these replies that while most of the steel manufacturers showed willingness to supply the material demanded, the shipbuilders expressed strong doubts as to the necessary certainty in manufacture and fears of excessive cost.

In order to arrive at a perfectly definite and satisfactory conclusion on this subject, it became necessary to undertake a complete investigation. If it should be found that the particular provision of the law, as regards tensile strength and ductility, could not be held to as lower limits (the view which had hitherto been taken of it) without serious difficulty, cost, and probable delay, then, under the authority of the phrase “as near as may be,” such modifications could be made as to remove the practical difficulties while obeying the spirit of the law’s requirements. Accordingly the following letter was addressed to the De-

partment, recommending a reduction of the ductility requirement to 20 per cent., for the reasons given:

NAVAL ADVISORY BOARD, NAVY DEPARTMENT,
Washington City, June 11, 1883.

SIR: Referring to our letter to the Department of 26th April, suggesting tests for steel, it was stated therein "the Board considers that the ductility required by law is perhaps higher than is necessary to insure good material, and will consider whether or not tests will be accepted as satisfactory which show an average ductility of 25 per cent., provided no actual test falls below 23 per cent."

In the formulation of these tests the Board considered the law as prescribing certain fixed lower limits of strength and ductility for the hulls of the vessels, and acted accordingly, though quite aware, as indicated in the above paragraph, that the test required was more severe than is demanded by foreign navies and registration societies.

The Board now learns that though the class of material has not been commonly produced in this country, still, as shown by the letters of steel companies, inclosed, it can be manufactured.

The Board is, however, of the opinion that a first-class material would be obtained by reducing the ductility to 20 per cent., that a possible delay in construction will be thus avoided, and a considerable reduction in the total cost of the vessels obtained.

If the Department authorizes this reduction, the Board recommends that the tests as thus amended, including a minor change in the quenching test, which follows necessarily upon a reduction in ductility, be inserted in the contracts.

Very respectfully,

R. W. SHUFELDT,

Bear-Admiral, U. S. N., President Naval Advisory Board.

Hon. W. E. CHANDLER,
Secretary of the Navy.

In reply, the honorable Secretary of the Navy expressed a wish to see the tests so arranged that the builders would not be at the mercy of a few steel-makers, as they feared, but considered a reduction of the ductility requirement to 20 per cent. as too great a variation from the statute, and suggested 60,000 pounds and 23 per cent. as the limits for the average of four test-pieces, with a recommendation that a lower limit of tensile strength and ductility be determined, below which no single test should fall, and suggesting 58,000 pounds and 21 per cent. for these limits.

Mr. Charles Cramp, one of the most prominent ship-builders, happening to attend soon after, stated his satisfaction with the requirements so changed and that a reduction in price would result. Under the first requirements he could obtain no quotations from makers, while in demanding under the Admiralty requirements he obtained ready replies.

The subject was again fully investigated, and, in order to appreciate the considerations governing the modifications subsequently made in the requirements as to tensile strength and ductility of ship material, it becomes necessary to follow out the comparison made with those in general use in Great Britain and France,* as given *in extenso* in the appendix. It will suffice to state them here in general terms with reference to the opposite graphic table.

REQUIREMENTS FOR MATERIAL IN GREAT BRITAIN.

British Admiralty requirements.—A tensile strength of 26–30 tons per square inch, with a ductility of 20 per cent. in 8 inches.

Lloyd's Insurance Registry.—A tensile strength of 27–31 tons per square inch, with a ductility of 20 per cent. in 8 inches.†

* The original French requirements are not given in the Appendix, but only those now in force. They may be sufficiently understood from the graphic table.

† Lloyd's Registry within the last few years has sanctioned a reduction of ductility to 16 per cent. in 8 inches, which is now incorporated in the "Rules." (See Appendix, page 574.)

Liverpool Underwriters' Registry.—A tensile strength of 28–32 tons per square inch, with no requirement as to ductility except that indirectly imposed by the ordinary temper and bending test.

These requirements are all extremely simple, and are supplemented by cold bending tests after heating the specimens to a red heat and suddenly cooling them in water, with such other special tests as may be desired by the inspector. The admiralty requirements had been in force since 1875, though the higher limit of tensile strength was not now rigidly adhered to. Lloyd's requirements were issued in 1877.

REQUIREMENTS OF THE FRENCH NAVY.

Although issued in May, 1876, these requirements show a thorough and masterly knowledge both of the properties of the material and of the suitable variation of, quality for different parts of the structure. Nor does their apparent lack of simplicity involve any proportionate increased cost. Thus, if we should start with a sufficiently thick ingot and roll it down, at one heat, to plates of successively diminishing thickness, removing test-pieces, at each thickness within the range contained within the requirement for ship-plate, they would show successively increasing tensile strength and diminishing ductility, following very much the same law as the minimum requirements; for the plate of each successive thickness has more work on it, is finished at a lower heat, and cools more rapidly than its predecessor.*

If our ingot be not sufficiently thick, the greatest thickness will not have the greatest ductility, on account of insufficient work to remove the effects of honeycombing or blow-holes. A corresponding humoring of the difficulties of manufacture is seen in the requirements for the heaviest boiler plate, for which both less tensile strength and less ductility are required than in the next less range of thickness. For strips and straps higher tensile strength and ductility are required than for the plates which they are to connect, which is plainly in accordance with increased strength of the whole structure. For beams the tensile strength is higher and ductility lower than for plates, indicating the proper use of a somewhat harder and ultimately stiffer material. Lastly, for angles, which always have a large amount of work of reduction from the ingot and yet cool in masses, and are thereby more or less annealed, a higher tensile strength and ductility is required than for plates—qualities which would naturally be obtained in the ordinary processes of manufacture, starting from the same material in the ingot, and which are also desirable for the purposes of corner connection and stiffening served by these shapes. Under these requirements, then, the difficulties of manufacture and the efficiency of the material in the structure are, in the main, reconciled and fit into one another without friction. It is seen, therefore, that these requirements admit of complete analysis and show an excellent balance in the quality of material for each purpose served. It should also be remembered that the Siemens-Martin process, by which the mild steel first used in the French navy was exclusively produced, had received its earliest development in France, while an experience of three years had been obtained in the dock-yards be-

* But these qualities also promote efficiency of the structure, inasmuch as the thicker plates, being generally in the skin plating (not the bottom plating, for the French, at that time, from considerations of corrosion, used iron for the wetted skin) or the notched stringer-plates, and from their very thickness suffering more in the working, evidently require to be softer than deck plating, which is not exposed in collision like skin plating, or than light bracket or bulkhead plating, whose chief requirement is stiffness.

fore the adoption of these requirements. Whence it would appear that they could not be too severe for good material, and might be taken as a reasonable minimum, although somewhat above the English specifications.*

MODIFICATIONS OF THE TESTS AS FIRST DRAWN UP.

The highest English specification with a ductility limit imposed was Lloyd's—a tensile strength of 60,480 pounds to the square inch, with a ductility of 20 per cent. in 8 inches. The most severe of the French requirements for ship-plate was 45 kilograms per square millimeter—63,990 pounds to the square inch—with a ductility of 20 per cent. in 200 millimeters.†

The material supplied to both must be more or less uniformly above requirements, and was produced without difficulty by European manufacturers. There could be nothing excessively severe in a requirement, based on that of the French navy, of a minimum tensile strength of 60,000 pounds to the square inch, with a corresponding increase of ductility from 20 to 23 per cent., while the average results of material made to such specifications would reach, and probably exceed, the requirements of the law in the quality of ductility.

Besides, it had always been the proud boast of American manufacturers that their iron was far superior to that in general use in Europe, and it was confidently stated that American steel deserved the same reputation.

With a change in the quenching test corresponding to the diminished ductility demanded, the final programme of tests was drawn up and approved June 18, 1883, as follows:

TESTS OF STEEL FOR CRUISERS.

Instructions to Inspectors.

NAVY DEPARTMENT,
Naval Advisory Board, June 18, 1883.

The following rules are prescribed in order to insure the fulfillment of the clause of the act of Congress of August 5, 1882—"Such vessels * * * to be constructed of steel, of domestic manufacture, having, as near as may be, a tensile strength of not less than sixty thousand pounds to the square inch, and a ductility in eight inches of not less than twenty-five per centum":

I. All ship-plates, beams, angles, rivets, bolts, boiler-plates, and stays to be inspected and tested at the place of manufacture by a naval inspector of material, and to be passed by him, subject to restrictions hereinafter mentioned, before acceptance by the ship-builders, whether Government or private, for incorporation into said vessels.

II. Every plate, beam, and angle supplied for these vessels to be clearly and indelibly stamped in two places, and with two separate brands: (1) With that of the maker, which shall distinguish the name of the manufactory or company; (2) with the regulation brand of the naval inspector of material. The latter not to be stamped upon any of the above-mentioned material until it shall have passed the required inspection and tests, have been accepted by the inspector, and have been stamped with the maker's brand.

In case of small articles passed in bulk, the above-mentioned brands shall be applied to the boxing or packing material of the objects.

No steel material to be received at the building yards for incorporation into the vessels except it bear, either upon its surface or that of its packing, both of these brands, as evidence that it has passed the necessary Government inspection.

* The French requirements, as recently modified by the ministerial circular of February 9, 1885 [see Appendix pp. 570-573], are in closer accord with the requirements adopted by the Board.

† 8 inches = 203.2 millimeters.

SHIP-PLATES.

III. In every lot of twenty plates test pieces to be cut from two plates taken at random; two test pieces being cut from each plate, one in the direction of the rolling and one at right angles to it, shaped according to the annexed sketch. These test pieces shall in no case be annealed.

The test pieces to be submitted to a direct tensile stress until they break, and in a machine of approved character.

The initial stress to be as near the elastic limit as possible; which limit is to be carefully determined by the inspector in a special series of tests. The first load to be kept in continuous action for five minutes. Additional loads to be then added at intervals of time as nearly as possible equal, and separated by half a minute; the loads to produce a strain of 5,000 pounds per square inch of original section of the test piece until the stress is about 50,000 pounds per square inch of original section, when the additional loads should be in increments not exceeding 1,000 pounds.

An observation to be made of the corresponding elongation measured upon the original length of 8 inches.

The final elongation to be that obtained at rupture. The loads applied shall never be calculated from the indications of the pressure-gauge if a hydraulic press be used.

CONDITIONS OF ACCEPTANCE.

In order to be accepted the average of the four test pieces must show an ultimate tensile strength of at least 60,000 pounds per square inch of original section, and a final elongation in 8 inches of not less than 23 per cent.

Lots of materials which show a strength greater than 60,000 pounds per square inch will be accepted, provided the ductility remains at least 23 per cent.

CASES OF FAILURE.

If the average of these four test pieces, numbered 1, 2, 3, 4 (called Test I.), fall below either of the required limits, the plates from which pieces 1, 2, 3, 4 were cut shall be rejected, and Test II. made, consisting of pieces 5 and 6, cut from a third plate. If the mean of the results of these two fall below either of the above limits, the entire lot shall be rejected. If it be successful, Test III., or the mean of pieces 7 and 8, cut from a fourth plate, shall decide.

If in any of Tests I., II., III. any single piece shows a tensile strength less than 58,000 pounds or a final elongation less than 21 per cent., the plate from which it was cut shall be rejected and that test considered to have failed, regardless of its average.

QUENCHING TEST.

IV. A test piece shall be cut from each plate, angle, or beam, and, after heating to a cherry red, plunged in water at a temperature of 82° Fahrenheit. Thus prepared it must be possible to bend the pieces under a press or hammer so that they shall be doubled round a curve of which the diameter is not more than one and a half times the thickness of the plates tested without presenting any trace of cracking.

These test pieces must not have their sheared sides rounded off, the only treatment permitted being taking off the sharpness of the edges with a fine file.

ANGLES, BEAMS, BULB BARS, T BARS, ETC.

V. In every lot of twenty angles or beams, &c., test pieces to be cut from the webs of two taken at random, one from each. These pieces to be fashioned in the same way and to be subjected to the same tests, both tensile and quenching, and to fulfill the same requirements for acceptance as already prescribed for ship-plates.

Angle bars are to be subjected to the following additional tests: A piece cut from one bar in twenty to be opened out flat, while cold, under the hammer; a piece cut from another bar in the same lot shall be closed until the two sides touch, while cold; a piece from a third bar of the lot to be bent cold into a ring, so that one of the sides of the angle bar shall be kept flat and the other side forming a cylinder, of which the internal diameter shall be equal to three and a half times the breadth of the side which remains flat. The angle bars submitted to these tests must show neither cracks, cliffs, nor flaws.

Single T bars to be submitted to the following tests: A piece to be cut from the end of a bar taken at random from each lot of twenty, and to be bent cold into a half-ring, so that, the web remaining in its own plane, the cross-flanges shall form a half-cylinder, of which the internal diameter shall equal four times the height of the web of the T bar.

At the end of another bar of the same lot the web to be split down its middle for a length equal three times its total depth, and a hole drilled at the end of the slit to prevent it spreading; the piece thus split to be opened out in its own plane, so as to make an angle of 45° with the rest, care to be taken that the part opened shall be kept straight, except that it must be joined to the rest of the bar by a bend of small radius.

Bulb bars are to be subjected to the same tests as those prescribed for T bars, except that in bending one or more heats may be used.

All bars submitted to these tests must show neither cracks, clefts, nor flaws.

RIVETS.

VI. One bar from every lot of twenty of the bars from which rivets are made shall be subject to the same tensile test as that required for the plate tests. All bars not fulfilling the requirements of tensile strength and elongation required for plates to be rejected.

From every lot of 500 pounds four rivets are to be taken at random and submitted to the following tests, one rivet to be used for each test: First, a rivet to be flattened out cold under the hammer to a thickness of one-half its diameter without showing cracks or flaws; second, a rivet to be flattened out hot under the hammer to a thickness one-third its diameter without showing cracks or flaws; third, a rivet to be bent cold into the form of a hook with parallel sides without showing cracks or flaws; fourth, a rivet to be tested by shearing by riveting it up to two pieces of steel which are to be submitted to a tensile strain, the rivet not to shear under a stress of less than 50,000 pounds per square inch.

BOILER-PLATES.

VII. *Each* boiler-plate must be subjected to the same tests and in the manner prescribed for ship-plates. The ductility in 8 inches must not be less than 25 per cent., and the ultimate tensile strength must not be less than 57,000 pounds and not more than 63,000 pounds, and the average at least 60,000 pounds.

The acceptance of material under these tests will not relieve the contractor from the necessity of making good any material which fails in working or may be rejected by the inspector.

R. W. SHUFELDT,

Rear-Admiral, U. S. Navy, President Naval Advisory Board.

Approved:

WILLIAM E. CHANDLER,
Secretary of the Navy.

With these provisions as regards material incorporated in the specifications under which bids were tendered, contracts were made with Mr. John Roach, representing the Delaware Iron Shipbuilding and Engine Works, Chester, Pa., and the Morgan Iron Works, of New York, on the 23d day of July, 1883, for the construction of the hulls of the Dolphin (1,500 tons), and Atlanta and Boston (3,000 tons each) and on July 26th for the Chicago (4,500 tons displacement).

PART II.

About the middle of August the first orders for material were issued from the ship-yard, and shortly after, the Board was notified by the contractor that subcontracts had been entered into with the Chester Rolling Mills, Chester Pa., Norway Iron and Steel Company, South Boston, Mass., Park Bros. and Co., Pittsburgh, Pa., for ship and boiler plate, and with the Phoenix Iron Company, Philadelphia, Pa., for angles, tees, and deck beams. Accordingly, on the 29th of August, Lieut. F. J. Drake, U. S. N., was ordered to visit Chester, Phoenixville, and Boston, to report upon the facilities afforded for carrying out the tests at each place, and to assume the duties of inspector at the latter. The facilities for testing appearing satisfactory, inspectors were ordered to each of the above-mentioned works, and to Pittsburgh, at the end of the first week in September, by which time it was expected that the manufacturers would be ready to turn out material. In addition to the general "Instructions to Inspectors" (p. 393), the following detailed instructions were issued :

DETAILED INSTRUCTIONS TO INSPECTORS OF MATERIALS.

NAVAL ADVISORY BOARD, NAVY DEPARTMENT,
Washington, September 13, 1883.

(1) The inspector will, as soon as practicable, after reaching his post, carefully examine all the appliances available for the proper inspection of material, consult with the superintendent as to making the tests, and make a special report to the Advisory Board of the kind and the efficiency of the apparatus and the arrangements which have been decided upon for making the different tests.

(2) At the end of each week he will make a general report to the Advisory Board of the work done at the foundry during the week, together with such information or suggestions as he may deem necessary in carrying out the work of inspection. At the end of each month he will send to the Advisory Board a summary of the tests made during the month, the summary being drawn up in accordance with the form hereto attached.

(3) He will keep a complete record of every piece of metal tested for the Government and for use in the construction of the new cruisers, whether such piece fulfills the requirements of a successful test or not.

(4) In case of any disagreement connected with the inspection of material, between the inspector and the superintendent of the foundry, the matter in dispute will be referred at once to the Advisory Board for settlement. It will be borne in mind that the Government has no contract with the foundry and exercises no control whatever beyond the actual inspection and stamping of the material ; whilst, therefore, the inspection must at all times be strict, every effort must be made by the inspector to have it carried on with the least possible interference or delay. The superintendent of the foundry will be consulted as to the times when the different tests should be made, and also with regard to any modifications in the system or appliances. The inspector will not attempt to exercise any control whatever over either the method of manufacture or the deliveries of material.

(5) The inspector will not permit the Government mark to be placed on any material or package intended for use elsewhere than in the building of the new cruisers, nor will he permit it to be placed on any material or package that has not been inspected by him personally and fulfilled the requirements of inspection.

(6) Whilst the inspector is to use his judgment with regard to the part of the material from which the test pieces are taken, he will in no case, except by the request or by the permission of the superintendent of the foundry, intrench upon the finished measurements of the piece in cutting his test pieces. Tests from pieces of the scrap may be made, and if they fulfill the requirements the article will be passed. If they fail to meet the requirements, however, the piece will not thereby be condemned. All condemnations of material will be made on the failure of pieces taken from the body of the material, and the superintendent of the foundry will be notified at once

Tensile test specimen.

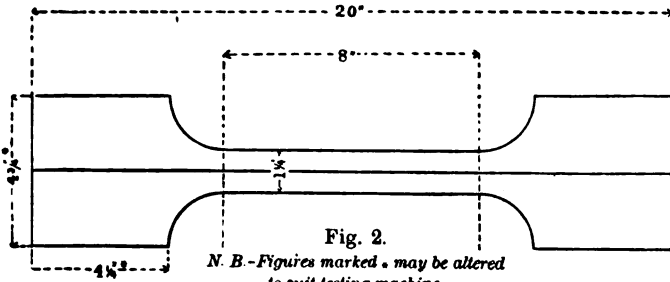

Rivet shearing test specimen.

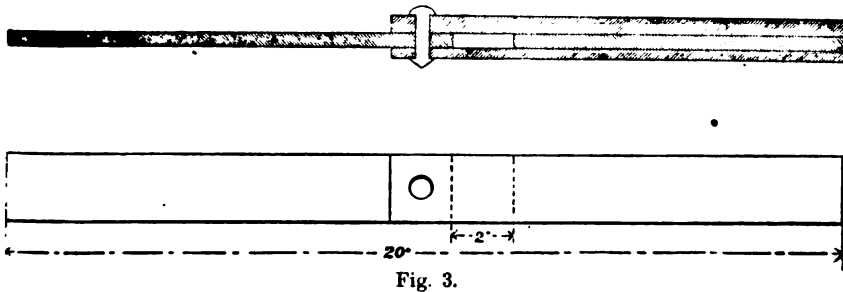

Width of plate to be not less than three times the diameter of the rivet. The inner end of the filling piece between the plates not to have an open space of more than 2 inches between it and the end of the single plate.

whenever a piece is condemned, and he will be given free access to the entire record of the test.

(7) Certain test pieces, after being tested, will be marked and carefully preserved in such a manner and place as to be readily accessible in case of necessity for a subsequent examination or comparison. These retained test pieces will consist of: all those tested for strength and elongation; all of those used in the quenching test which are cut from the same pieces of material as the tensile pieces; all rivets and sheared rivet samples; all pieces whose tests may give rise to dispute or protest on the part of either the inspector, the manufacturer, or the building contractor; such other pieces as the manufacturer may desire to have retained.

(8) Each retained test piece will have a register mark to distinguish it, which mark will be put upon the test piece itself, painted on the proper piece of material in small characters near the Government stamp, and will form a part of the inspector's record.

(9) The register mark will consist of a number and a letter, the number to denote the lot of material, and the letter the piece in the lot. Lots of material will be numbered consecutively in the order in which they are inspected, without regard to the description of the material. As each lot consists of twenty pieces, the individual pieces will be denoted by the first twenty letters in the alphabet. In marking the tensile test pieces which are cut across the grain of the material, a small cross (x) will be affixed to the register mark. The register mark of rivet bars and rivet test pieces will consist of the lot number alone.

(10) In case that the tensile pieces are cut from the material by punching, a margin of not less than one-eighth of an inch will be left between the shoulders of the test piece, which will be removed by the file, plane, or other smooth-cutting tool, in shaping and trimming the piece. This precaution need not be followed if the piece be cut out by planing, drilling, or sawing. In the accompanying sketch of the tensile test piece the width of the breaking section is fixed at $1\frac{1}{2}$ inch. If, however, the thickness of the test piece exceeds one-half inch, the width of the breaking section will be reduced to 1 inch, and if the thickness exceeds three-fourths of an inch, the width will be reduced to the thickness of the section.

(11) In making the tensile test, it will be borne in mind that the establishment of the elastic limit is of secondary importance; therefore no attempt need be made to get it with exactitude, although care should be taken that the first stress applied to the test piece shall be below its elastic limit.

(12) Owing to the possibility of the existence of faults in the different types of testing machines that may be used at the different factories, the tensile strength and elongation records will be checked by comparison with records from Washington. To accomplish this result, the inspector will, as soon as practicable after reaching his post, have four tensile specimens prepared from a single piece of steel, chosen with special regard to homogeneity of structure. These pieces all to be cut with the grain of the material, the width of the breaking section to be one inch and its area not greater than one-half of a square inch. Two of these specimens will be carefully tested in the machine as follows: The first weight applied to give a stress of 10,000 pounds to the square inch. At intervals of one minute an additional stress of 2,000 pounds per square inch of original section will be applied until the specimen is broken. Careful measurements will be made of the elongations caused by each stress. The two other specimens (finished at the foundry exactly like the first), together with the pieces of the broken specimens and a complete record of the tests, will then be forwarded together to the president of the Naval Advisory Board at Washington, where the tests will be checked by a Rodman testing machine.

(13) No piece used in the quenching test will be less than 10 inches in length and 2 inches in width. In bending a piece the inspector will not permit any nursing on the one hand or unfairly violent treatment on the other. If bent under the hammer, the blows should be delivered square to the surface. In all cases uniformity of treatment should be observed. If practicable it would be of advantage to have the same hammer-men do all the quenching test work.

(14) In testing the shearing strength of rivets, the test piece is to consist of a double lap-joint with a single rivet arranged as shown in the accompanying sketch. The plate-steel used is in no case to be less than one fourth of an inch in thickness, and, if practicable, it should not in any case be less than one-half the diameter of the rivet, in order to insure shearing the rivet instead of the plate. The distance of the nearest edge of the rivet hole to the end of the plate is not to be less than one and one-fourth diameters of the rivet. The sharp edges of the rivet hole are not to be filed down. Snap-riveted points will in no case be allowed in the tests, but invariably the point will be thoroughly and carefully worked down. The rivet holes may be either punched or drilled as desired, and the riveting may be either by hand or machine. Great care will be exercised in testing the sample to insure a fair stress on the rivet.

(15) All instruments, books, and stationery required for use in the inspection will be procured by requisition on the Advisory Board, and receipts will be rendered to the Board for all material received. Postage and telegraph expenses will only be reimbursed through bills made to and approved by the Advisory Board. Expenses for travel will only be reimbursed by the ordinary naval rule of mileage on orders from the Department. Unless absolutely impracticable, no official expense will be incurred by the inspector without preliminary authority from the Advisory Board.

(16) The inspector will be charged with ascertaining the average weight per foot of plate ordered, which will be obtained by weighing not less than 10 tons at a time when larger lots than 10 tons are delivered. In smaller deliveries than 10 tons, the whole lot will be weighed. The plates will be estimated by weight per superficial foot. The weight named will always be the greatest that will be allowed. For ship and boiler plates under 4 feet in width, a latitude of 5 per cent. below this will be allowed in plates one-half of an inch and upwards in thickness, and 10 per cent. in thinner plates. In plates for boilers over 4 feet wide and one-half of an inch thick and upwards a latitude of 2½ per cent. above and 2¼ per cent. below will be allowed for the springing of the rolls, and 5 per cent. above and 5 per cent. below will be allowed in thinner plates over 4 feet wide.

The inspector will consult the foundry order book for detailed information and will accept its weights and measurements as authority.

R. W. SHUFELDT,

Rear-Admiral, U. S. N., President, Naval Advisory Board.

Approved:

EARL ENGLISH,

Acting Secretary of the Navy.

Although numerous preliminary tests had been made, considerable delay was caused at first at the plate-mills by failure to meet the requirements. At Chester and South Boston there was such fear of not obtaining the required ductility that there was a decided tendency to make a steel of too low tensile strength, a tendency further increased at the former works on account of the mode of rapid testing with short test pieces which had been hitherto in use; and even with steel so soft the inspectors reported trouble with the quenching or temper test. At South Boston the difficulty was apparently found in the beating of the slabs before entering the plate-rolls, while considerable difference was found in the results of material from different parts of the same ingot, as given in detail, p. 532 *et seq.* At both mentioned works differences in temper tests were reported according as the pieces were heated in an ordinary heating furnace, a charcoal furnace without blast, or in a smith's fire with blast. These difficulties were by degrees overcome, both by greater care at the melting and heating furnaces and increasing familiarity with the tests. At the Chester Rolling Mills trouble was also reported in consequence of the requirements for strength and ductility across the grain, and some delay was caused by lack of system in carrying out the tests, while considerable opposition was experienced on account of somewhat too strong preconceived opinions as to the propriety of the requirements and the method of tests on the part of those having to do with the work. The first shipment was made from these works September 20, and from Boston September 26, and thereafter with considerable regularity.

At the Black Diamond Works, Pittsburgh, the work proceeded very slowly on account of the extreme caution of the manufacturers. Each heat was subjected to a preliminary test, and only such as appeared satisfactory were submitted to the inspector. Then, from some inexplicable cause, except that considerable lack of homogeneity was developed by the tensile tests, much of the material would not stand the quenching test, and it was not until October 10 that the first shipment was made.

At the Phoenix Iron Works, Phoenixville, Pa., there was no steel

plant, blooms to the required specification being supplied by the Cambria Iron Company, with works at Johnstown, Pa., about 250 miles distant, on the Pennsylvania Railroad. Although the first order from the shipyard had been received August 17, no blooms were received until a month later, September 17, though no particular difficulty appears to have been experienced in supplying the proper quality of steel at Johnstown. But, from temporary causes, the blooms were a week to ten days in traversing the distance between the two places, and considerable time was consumed in the necessary handling. Then, in endeavoring to carry out the tests, the small steam-hammers available were found inadequate for the ring test for angles, which had accordingly to be made at Chester, so that the first shipment was not made until September 28.

In consequence of the delays above mentioned, complaints were made by the contractor that on account of the severity and method of the tests, and consequent slow delivery of material, idle men and tools and empty slips were subjecting him to great additional expense. For a time determined efforts were made to break down the system of tests on the score of impracticability and expense, and it is to be regretted that these objections should have been urged as the cause of delays really due to tardiness and inexperience in manufacture.

After hearing the complaints of the contractor and certain of the steel manufacturers, the Board decided to abide by the requirements issued in accordance with the statutes, and for the fulfilment of which contracts had been made under bond, while making certain modifications in the system of tests in the direction of increased simplicity and efficiency. Accordingly, after many of these tests had been made without failure on the material delivered, the ring test was discontinued, and subsequently the close test of angles, which, being designed to detect readiness in the material, was considered unnecessary in connection with the open test. The inspector of shapes was also authorized to make the required tensile tests at Johnstown on each heat of steel, the flat pieces for test being so rolled as to have, as near as may be, the same work of reduction both of area and of thickness as in the finished shapes. The split tests for tees and deck-beams were omitted, since equivalent work was done on each end of deck-beams in forming the beam-arms in the shipyard, while, by agreement, an open and close test (see p. 542) for these shapes was substituted.

It had been urged that the arbitrary division of material into lots without regard to furnace run or heat might result in the acceptance of material not fulfilling the requirements for strength and ductility, while a failure of any lot to pass these tests would throw upon the manufacturer's hands a number of finished plates which could subsequently be disposed of only at a great loss. It was accordingly decided that a "lot of material" should consist of the total product of a furnace-heat without regard to the number of pieces, and the tensile tests be made from a plate rolled down from an ingot of the heat selected at random, the rest of the heat remaining in ingot form until acceptance under the tensile tests, in accordance with the following additional instructions:

NAVAL ADVISORY BOARD, NAVY DEPARTMENT,
Washington City, October 6, 1883.

INSPECTOR OF MATERIAL:

It having been found that the arbitrary division of material into lots of twenty pieces each may lead to the accidental acceptance of material which is not up to the requirements of tensile strength and ductility, it is decided that hereafter a lot of material shall consist of all plates and angles or other pieces which are made from the same heat.

In testing a lot the conditions of acceptance will be as prescribed in the "Tests of Steel, &c.," except that instead of selecting from the finished metal a plate or bar for test, the inspector may, if the manufacturer prefer this method, select at random an ingot from a heat and have it, or rather a portion thereof, rolled into a plate or bar, from which test-pieces shall be cut, provided always that the same amount of mechanical work is done upon them in rolling as is done upon the average finished plate or bar of the same weight per square or lineal foot.

The instructions for testing in this manner shall read as follows:

IN CASES OF FAILURE.

If the average of these four test-pieces, numbered 1, 2, 3, 4 (called Test I.), fall below either of the required limits, the ingot from which pieces 1, 2, 3, 4 were cut shall be rejected, and Test II. made, consisting of pieces 5 and 6, cut from a second ingot or a portion thereof. If the mean of the results of these two fall below either of the above limits, the entire lot shall be rejected. If it be successful, Test III., or the mean of pieces 7 and 8, cut from a third ingot, shall decide.

If in any of Tests I., II., III., any single piece shows a tensile strength less than 58,000 pounds, or a final elongation less than 21 per cent., the ingot from which it was cut shall be rejected and that test considered to have failed regardless of its average.

The quenching and other tests must still be made upon the finished material as prescribed.

If the manufacturers see fit to communicate the results of chemical tests to the inspectors, the Board will be glad to receive the information.

Very respectfully,

R. W. SHUFELDT.

Rear-Admiral, U. S. N., President of the Board.

Having abandoned the arbitrary division of material into lots, the tests across the grain, being now only representative of the condition of the individual plate tested, were omitted. Inasmuch as the tensile tests so made were fairly representative of the whole heat of steel, the individual test was omitted for the boiler-plates, which were tested in the same manner as ship-plate, and with the original limits of tensile strength and ductility, but omitting the required average strength of 60,000 pounds.

While omission of certain tests may be looked upon as a concession to the manufacturers, made entirely to hasten delivery and not to be repeated, in the main the changes amount to a recasting of the method for increased simplicity, and, to a certain extent, increased efficiency, while diminishing the amount of labor previously involved.

No change was made in the prescribed tests for rivets, except that, upon the recommendation of the inspector, the pieces were riveted up in single shear instead of double shear, thereby increasing the representative value of these tests.

So amended, the system of tests was carried out on all material subsequently delivered, and the increasing success of the manufacturers in meeting the specifications demonstrated the wisdom of the Board's conclusions that the chief difficulties and delays were due to inexperience, while the almost complete absence of failures in working the material in the shipyard, though by workman previously inexperienced in the treatment of steel, gave evidence of its high quality.

In the early parts of the work some difficulty was experienced in rolling light plates and angles within the prescribed limits, so that it was deemed advisable to allow plates of $12\frac{1}{2}$ pounds per square foot and less to vary between 3 per cent. above and 5 per cent. below the specified weight, and that the limits should be the same for angles of 6 pounds per lineal foot and less. The effect of this was not so much to produce material heavier than the specified weight, but, in removing the tendency to roll this material too light, the actual weights were brought more

nearly to the specified weights, on account of the increased confidence of the rollers in removing the fear of the rejection of the material were it a trifle heavy. This is a desirable condition, for in bulkhead plates and the lighter angles it is more important that the strength and stiffness designed to should be obtained than that the weight of hull should be so slightly increased.

Butt-straps, required in the specifications to be cut in the shipyard, were also allowed to be sheared out at the mills, with due regard to the direction of the grain.

In the matter of annealed material, the test pieces for tensile and cold tests, while allowed to be removed before annealing, were required to be treated in all respects like the corresponding plates, being placed in the annealing furnace along with them.

Under these arrangements, the inspection and delivery of material proceeded very satisfactorily, with the exception of the trouble with the quenching test at the Black Diamond Works, the probable cause of which will be specially considered later on.

Under a separate heading the manufacture and results of the steel produced at each of the works are given as completely in detail as appears desirable for the purposes of a general report, and, as the greater part of the material had been delivered and worked into hulls and boilers by that time, the results are given up to September 1, 1884. The information as to production, together with the chemistry of charge and product, is, in each case, as supplied by the manufacturer.

CHESTER STEEL.

(Lieuts. F. P. Gilmore and G. A. Bicknell, U. S. N., Inspectors.)

The material to be supplied consisted of boiler and ship plate made and rolled at the Chester Rolling Mills, Thurlow, Pa. The steel was made by the Siemens-Martin, or "pig and scrap," process in two 15-ton furnaces, designed by Mr. C. M. Ryder and erected in 1882, with straight high roof and curved sand bottom, 18 feet long from port to port, with hearth 12 feet long, of increasing width from port to center. The general design and arrangements of the furnaces are excellent, and embody principles only more recently developed in Europe. Siemens producers are used, but slight changes were completed in April, 1884, in one of the furnaces, adapting it to the use of vapor fuel, which, however, has not been used except for a few heats not for the cruisers.

The charge consisted of about 12 tons of pig-iron, steel scrap, shearings, muck bar, and charcoal-blooms, all charged cold in proportions based upon the indications of the tensile tests and varied from time to time.

As regards the production of this steel, Mr. P. G. Salom, chemist and superintendent of steel department, Chester Rolling Mills, in a paper before the American Institute of Mining Engineers (February, 1884), says:

¶ The first hundred heats, from No. 464 to No. 563, in addition to the usual amount of pig-iron, scrap, and shearings, contained charcoal-blooms and muck bar (gradually increased amounts of muck-bar and a corresponding diminution of blooms, which were at first charged in equal amounts). Nos. 564 to 619 were all made from muck-bar, with results equally if not more satisfactory than with blooms. Of the remaining heats, a few were made from all blooms, a few from all muck-bar, and the others from a mixture of the two.

Manganese was added to the bath before tapping.

The ingots were bottom cast with central runner and base plate, the sizes in general use being 40 inches by 18 inches by 7 and 9 inches thick. Plates $\frac{3}{16}$ inch thick were rolled from previously rolled slabs reheated, while plates $\frac{1}{4}$ to $\frac{1}{2}$ inch thick were rolled direct from the ingot. Plates more than $\frac{1}{2}$ inch thick were rolled from ingots 10 by 24 by 60 inches and 10 by 35 by 60 inches, these two molds being considered special sizes.

It may be here observed that the thirteen reductions from a 10-inch ingot to the $\frac{3}{16}$ -inch plates of the Dolphin's boiler-shells and protective deck of Atlanta and Boston, or the ten reductions to the 1-inch protective deck plates of the Chicago, are less than generally considered necessary in such cases in Europe, and the attention of the manufacturers may have to be called to the desirability of using thicker ingots, unless some method can be devised for obtaining sounder ingots without carrying too high silicon. The defects of a plate which has received too little work may not in general be detected by a few tests, and are undoubtedly rendered more apparent in flanging and working.

The mills used are 80 and 100 inches long between housings, with rolls 32 inches in diameter, in continuous connection, and driven by a Corliss horizontal engine, with 32-inch cylinder and 6-foot stroke, using steam of 70 pounds gauge-pressure, and running at about 54 revolutions, with fly-wheel 30 feet in diameter, weighing about 50 tons.

The testing machine (Fig. 4) is one of the many patterns of triple-lever machines, made by Messrs. Riehlé Bros., of Philadelphia. The straining mechanism consists of upper (the fixed) wedge-block supported by standards carried by the main frame-work, with lower block moving in slides in these standards and carried by four leading-screws attached to the cross-head of a hydraulic plunger beneath the platform of the machine. Power is applied through a hydraulic cylinder and pump, either by hand or belt and gearing, the three oil-valves being connected 120° apart to the crank shaft, thus giving continuous motion to the lower wedge-block. The throw of the pump can also be altered to suit the nature of the work. There are primary and jockey-weight beam-arms, with adjustable compensating attachment, and connected with the straining mechanism by double levers. The primary scale is divided into increments of 2,000 pounds up to 100,000 pounds, while the jockey-weight scale is divided into intervals of 10 pounds each up to 2,000 pounds.

For flat pieces the Riehlé patent high-faced wedge (Fig. 5) is used, which, being thicker along the middle, retains the piece in line upon the first pressure being applied. For rounds double angle-faced wedges are provided. Most of the tensile tests of rivet bar were made on this machine.

The specimens for tensile tests were removed by shearing, straightened cold, and cut out in a planing machine, and were fairly well shaped. Measurements for sectional area were made near each witness-mark, and in the center of the piece, in order to obtain the least value in the part to be stretched and to avoid marked differences along the length. The measured length was laid off with Brown & Sharp's long-slide micrometer gauge fitted with fine points, the witness-marks being light punch-marks. The thickness for sectional area at fracture was measured midway between one edge and the center, but with a square-jawed sliding gauge. The result on the average is believed to be very nearly correct.

The quenching pieces were at first heated in a smith's forge with cold blast, but subsequently in a small furnace attached to the annealing

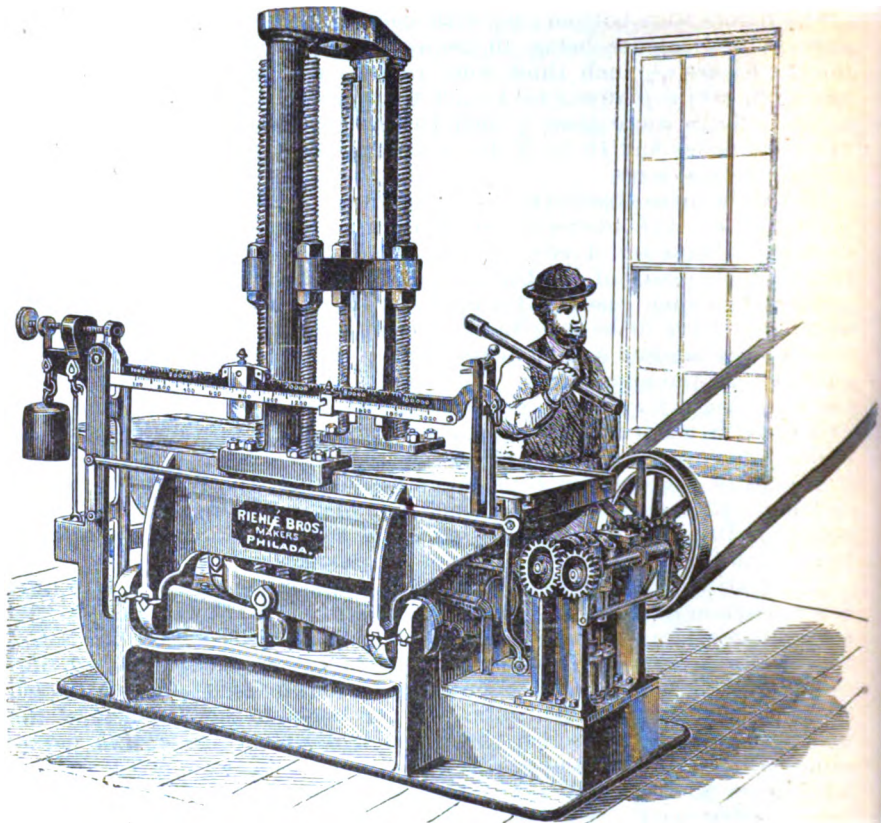

FIG. 4.—100,000 pounds Riehlé Hydranic Testing Machine used at Chester Rolling Mills.

DIMENSIONS.

Extreme height	8 ft. 3 in.
Extreme length	6 ft. 4 in.
Extreme width	3 ft. 6 in.

Weight, 7,225 lbs.

ADAPTATION.

Tensile specimens	10 in. to 4 ft. long.
Round "	2 in. diam. or less.
Square "	2 in. x 2 in. or less.
Flat "	3 in. or less x 1 in. or less.
Transverse specimens	12 in. to 5 ft. long.
" space	3 ft. 6 in. high x 11 in. wide.
Compressive specimens	3 ft. 6 in. long or less.
" surfaces	11 in. x 11 in.
Motion of plunger	12 in.



Fig. 5.—High Faced Wedge.

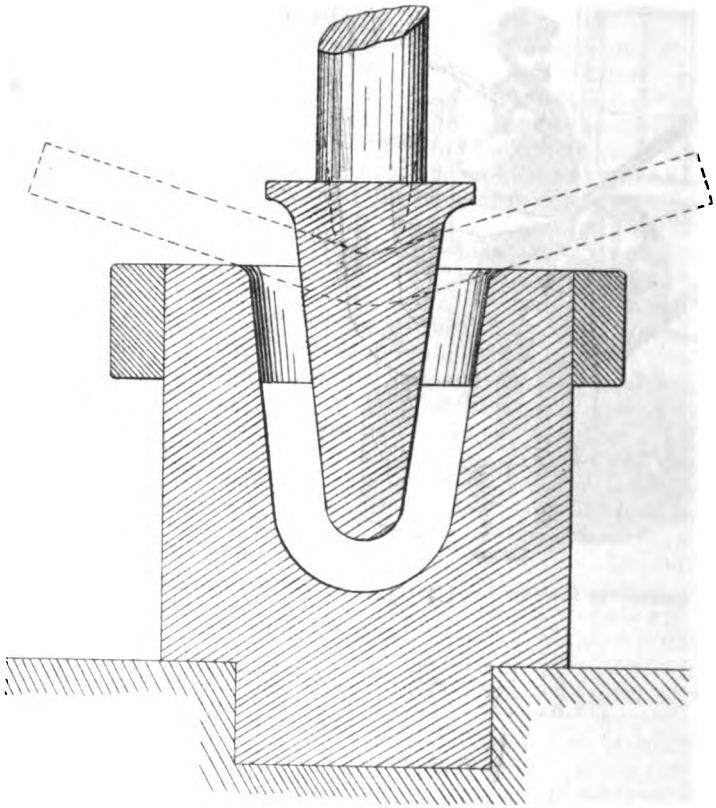

*Plate II.- Apparatus for Bending Quenching Test Pieces
at Chester Rolling Mills.*

H Ex1 pt3 v1 49 1

furnace, and originally intended for annealing small pieces. A bridge 3 or 4 inches high, between the fire and the hearth, prevented the flame from playing on the pieces, and the furnace was never smoky except immediately after firing. The pieces were inserted as left curved by the shears. Lieutenant Gilmore reported a difference in the behavior of pieces under the quenching test according as they were heated in the annealing furnace or at the forge, in the latter case becoming hard to scratch with a file, and at times highly tempered, brittle, and hard to work.

After being cooled in water at 82° Fahr., they were bent smoothly in a form, as shown in Plate II., by hydraulic power, in an apparatus devised out of an old punching machine.

Sufficient chemical information accompanies the record of tests to enable the curve of carbon properties, p. 554, to be constructed, which shows graphically the average behavior of this steel under tensile test. Discussion of this curve is reserved until that of the other steels can be considered. Drillings for chemical test were taken from small test ingot, ladled from the furnace while tapping.

The chemical methods in use are—for combined carbon, the color test (p. 546, 547), dissolving a standard each time; for manganese, by dissolving in acid protosulphate of iron the binoxide precipitated from nitric-acid solution by chlorate of potash, and treating with permanganate of potash; for phosphorus, the molybdate of ammonia method, weighing the yellow precipitate of ammonia. The magnesia method was sometimes used for checking results.

The total number of heats tested to September 1, 1884, is 297, of which 60, or 20.2 per cent., were rejected on the tensile tests. In justice to the manufacturers, it should be stated that many of these rejected heats were made before the inspection was commenced, and it may be said here that nowhere throughout this report are any invidious comparisons intended of the relative success of different manufacturers in producing material to the specifications. Individual circumstances largely control appearances in such matters. Of the material so accepted 1,616.17 tons were delivered at the ship-yard up to September 1, 1884, while 14.73 tons, or 0.91 per cent., of the amount delivered, failed on the quenching test.

In the following tables the results are given in the order of heat-numbers, which was not the order of testing. This arrangement is, however, at once more convenient and better illustrates the increasing success in meeting the requirements.

For heats tested with and across the grain the separate tests are given as reported; for the others the tests with the grain are averaged.

TABLE IV.—Tensile tests, Chester steel.

[SYMBOLS.—A., accepted; R., rejected; F., failed; S., ship quality; B., boiler quality; — in the direction of rolling; + across the direction of rolling.]

Heat number.	Carbon.			Manganese.			Phosphorus.			Average original width.	Average original thickness.	Average original area.	Average ultimate tensile strength per square inch.	Average final elongation.	Average final area.	Number of tests.	Accepted or rejected.
	Per cent.	Per cent.	Per cent.	Inches.	Inches.	Sq. ins.	Pounds.	Per cent.	Per cent.								
329				.990	.7350	.7276	54,100	28.00	33.00	1	R.						
342				.985	.7180	.7060	53,800	29.70	31.40	1	R.						
345				.990	.7000	.6930	51,600	30.46	44.20	1	R.						
350				1.125	.4775	.5294	54,835	25.78	43.50	4	R.*						
380				1.180	.5615	.6626	62,100	28.30	47.00	2	A. S.						
383				1.280	.4550	.5642	64,450	27.35	49.50	2	A. S.						
398				.960	.6800	.6528	55,100	28.06	33.00	1	R.						
412				.993	.6740	.6692	59,750	27.97	39.70	2	A. B.						
413				1.257	.5000	.6285	60,650	25.53	47.35	2	A. S.						
416				1.248	.6175	.7703	60,000	26.10	42.75	2	A. S. B.						
417				.993	.5910	.5869	58,250	28.70	41.00	2	A. B.						
427				1.030	.6860	.7066	54,700	29.45	33.30	1	R.						
435				.963	.7120	.6856	56,880	27.81	37.80	1	R.						
437				1.003	.5800	.5817	67,132	23.13	52.20	1	R.						
437				1.000	.5740	.5740	62,000	20.16	58.00	1	R.						
439				1.000	.7030	.7030	60,527	27.13	41.20	2	A. S. B.						
440				1.082	.4910	.5355	66,850	25.00	48.95	2	A. S.						
442				1.021	.5060	.5168	54,050	29.40	40.00	2	A. S. B.						
443				.998	.5060	.5020	56,670	28.20	41.00	1	R.						
444				1.270	.5410	.6653	58,500	27.63	47.75	2	A. B.						
446				1.133	.4375	.4957	59,725	25.16	46.85	2	A. B.						
451				.990	.8160	.8078	56,500	31.10	35.40	1	R.						
456				.995	.4570	.4547	58,500	25.38	39.00	1	R.						
459				.974	.4000	.4480	65,550	26.80	45.35	2	A. S.						
461				.948	.6750	.6296	61,483	26.19	48.60	2	A. S. B.						
462				.936	.6725	.6294	57,660	27.99	42.60	2	A. B.						
463				1.204	.4830	.5815	66,890	24.50	50.90	1	R.†						
463				1.217	.4850	.5902	63,876	20.30	53.70	1	R.†						
464				1.244	.4550	.5622	70,800	24.00	53.70	1	F						
464	.19	.37	.039	1.240	.4350	.5642	70,900	19.70	54.20	1	R.						
464	.19	.37	.039	.967	.7070	.6637	66,973	23.41	48.50	4	A. S.;						
465	.13	.38	.035	1.245	.4820	.6000	61,000	28.20	42.00	1	A. S. B.						
465	.13	.38	.035	1.250	.4120	.6025	59,580	24.72	47.00	1	A. S. B.						
467				.984	.3790	.5097	69,000	27.82	53.00	1	A. S.						
467				.972	.5010	.5745	67,467	21.43	55.10	1	R.						
469				.975	.4480	.4368	62,900	26.50	45.00	1	A. S. B.						
469				1.264	.6000	.7584	61,313	25.32	48.00	1	A. S. B.						
470				1.250	.5900	.7375	62,047	27.28	45.00	1	A. S. B.						
470				1.250	.5950	.7437	62,570	23.44	47.00	1	A. S. B.						
472				1.000	.4600	.4600	60,130	27.12	42.00	1	A. B.						
472				1.000	.4630	.4630	59,600	24.27	50.00	1	A. B.						
473				1.168	.4940	.5693	59,400	28.14	41.35	2	A. B.						
475				1.062	.4507	.4733	57,640	28.63	42.50	3	A. B.						
477				1.248	.4410	.5504	58,150	28.75	47.45	2	A. B.						
478				1.000	.6150	.6150	55,800	30.10	41.50	1	R.						
479				.999	.5290	.5244	55,400	26.90	39.00	1	R.						
480				1.018	.5600	.5756	59,000	29.68	43.70	1	R.‡						
480				1.000	.5640	.5640	57,400	28.61	52.70	1	R.						
481	.11	.36		1.000	.4750	.4750	55,000	24.05	45.00	1	R.						
482	.20	.38		1.060	.4950	.6266	63,828	26.70	48.50	1	A. S.						
482	.20	.38		1.060	.5040	.6390	64,500	21.00	57.00	1	A. S.						
483	.11	.36		1.235	.4850	.5941	55,200	27.60	41.30	1	R.						
484	.21	.40		1.205	.4180	.5036	71,000	23.52	54.20	1	R.						
484	.21	.40		1.254	.4400	.5517	70,980	21.10	62.60	1	R.						
485	.11	.34		1.250	.5070	.6367	55,200	28.40	39.60	1	R.						
486	.12	.37		1.135	.5000	.5675	63,665	28.43	48.20	1	A. S. B.						
486	.12	.37		1.240	.5730	.6361	61,400	22.45	67.40	1	A. S. B.						
487	.15	.37		1.190	.5750	.6842	60,140	27.13	40.75	1	A. S. B.						
487	.15	.37		1.249	.5860	.7219	60,950	26.05	46.50	1	A. S. B.						
489	.13	.40		1.246	.4810	.5903	59,280	25.31	42.10	1	R.¶						
489	.13	.40		1.253	.4730	.5926	57,880	32.18	52.50	1	R.¶						
490	.21	.56		1.287	.3390	.4123	73,500	20.75	46.00	1	R.						
491	.17	.60		1.260	.4080	.5140	64,000	25.20	60.00	1	R.						
491	.17	.50		1.262	.4110	.5186	63,000	25.58	48.20	1	A. S.						

* Final area for 3 tests only.
 † Two annealed plates accepted. See Annealing, p. 526.
 ‡ Retest allowed.
 § Would have been accepted for boiler metal when requirement of 60,000 pounds average tensile strength was waived.
 ¶ Subsequently accepted for boilers, and five plates shipped.

TABLE IV.—Tensile tests, Chester steel—Continued.

Heat number.	Carbon.		Manganese.		Phosphorus.		Average original width.	Average original thickness.	Average original area.	Average ultimate tensile strength per square inch.	Average final elongation.	Average final area.	Number of tests.	Accepted or rejected.
	Per ct.	Per ct.	Per ct.	Per ct.	Inches.	Inches.								
492	.13	.49					1.256	.2920	.3677	64,310	25.00	55.00	1	} A. S.
493	.13	.49					1.265	.2930	.3708	63,900	28.30	48.10	1	
493	.16	.53					1.260	.5090	.6413	68,600	24.78	55.00	1	} A. S.†
493	.16	.53					1.254	.3610	.4527	66,200	25.31	45.40	1	
493	.16	.53					1.250	.3670	.4587	65,600	25.06	46.80	1	} A. S. B.
494	.16	.50					1.234	.3885	.4792	65,900	24.92	46.55	1	
496	.13	.49	.062				1.250	.3420	.4275	61,500	24.62	45.30	1	} A. S.
496	.13	.49	.062				1.265	.3440	.4351	59,700	25.56	53.60	1	
497	.13	.46					1.254	.2960	.3701	62,900	24.50	46.00	1	} A. S.
497	.13	.46					1.250	.3150	.3937	61,700	23.14	50.70	1	
498	.16	.49	.058				1.250	.2690	.3362	71,555	19.75	54.25	2	} A. S.†
498	.16	.49	.058				1.113	.4720	.5286	64,450	24.71	46.55	4	
499	.15	.50	.031				1.243	.3853	.4782	64,850	24.65	47.50	4	} A. S.
500	.15	.49					1.125	.3890	.4238	64,695	25.15	47.27	4	
501	.14	.56					1.038	.3865	.4154	65,893	24.14	48.72	4	} A. S. B.
502	.15	.50					1.111	.4220	.4622	62,845	25.40	45.75	4	
503	.17	.58					1.120	.4430	.4946	72,500	23.85	56.10	4	} A. S.
504	.17	.45					1.000	.4840	.4837	64,200	24.90	47.55	2	
505	.15	.39					.985	.4575	.4506	61,700	27.55	42.90	2	} A. S. B.
506	.14	.43					.977	.4850	.4738	62,125	28.65	40.90	2	
507	.15	.54					1.205	.4290	.5166	65,800	24.80	50.00	2	} A. S.
508	.14	.49					1.250	.4750	.5038	62,550	26.80	49.10	2	
509	.12	.53					1.250	.4580	.5725	62,350	26.30	47.10	2	} A. S. B.
510	.15	.47					1.248	.4640	.5788	61,895	25.80	44.50	2	
511	.15	.48					1.000	.4725	.4725	61,150	26.55	46.95	2	} A. S. B.
512	.16	.48					1.000	.4870	.4870	64,450	24.55	46.20	2	
513	.14	.47					.986	.4630	.4555	60,900	26.20	44.40	2	} A. S. B.
514	.15	.40					.983	.4425	.4350	63,350	23.46	44.35	2	
515	.16	.53					1.236	.3825	.4728	68,100	24.63	51.70	2	} A. S.
516	.16	.43					1.229	.4775	.5863	63,500	26.62	43.85	2	
517	.22	.43					1.247	.4480	.5584	66,075	28.74	48.00	2	} A. S.
518	.19	.43					1.252	.4040	.5058	67,100	25.00	43.65	2	
519	.18	.49					.968	.4375	.4235	64,950	25.14	48.30	2	} A. S.
520	.15	.46					.977	.6875	.6717	62,100	25.60	50.40	2	
521	.14	.44					.975	.5910	.5745	63,850	27.05	44.85	2	} A. S.
522	.16	.46					.983	.6870	.6753	66,700	22.75	48.85	2	
523	.14	.58					.996	.7090	.7061	61,640	27.43	43.80	2	} A. S. B.
524	.14	.39					.988	.7095	.7006	61,100	26.60	47.85	2	
525	.16	.46					1.245	.5290	.6586	66,450	21.77	56.35	2	} R.
526	.14	.40					.965	.7015	.6769	60,370	24.73	48.25	2	
527	.14	.41					.976	.7055	.6886	63,285	24.05	50.45	2	} A. S.
528	.21	.46					.993	.7085	.7036	74,535	24.30	50.50	2	
529	.16	.40					.992	.6975	.6916	62,425	25.60	48.75	2	} A. S. B.
530	.18	.43					.983	.7015	.6892	69,650	23.13	47.80	2	
531	.16	.35					.997	.5760	.5740	65,745	25.07	50.80	2	} A. S.
532	.17	.35					.982	.5545	.5442	70,570	23.90	52.80	2	
533	.14	.30					.979	.8350	.8070	58,815	28.00	42.25	2	} A. B.
534	.12	.25					.975	.7170	.6987	57,275	28.40	40.50	2	
536	.11	.45					.908	.6965	.6319	54,100	28.64	42.50	2	} R.
537	.11	.36					1.248	.3715	.4636	60,510	26.80	42.75	2	
538	.11	.24					1.156	.4950	.5726	56,250	29.90	37.85	2	} R.
539	.14	.33					1.127	.4835	.5456	57,730	27.45	41.85	2	
540	.10	.31					1.281	.3580	.4586	62,050	24.62	50.05	2	} A. S.
541	.13	.29					1.230	.3445	.4237	60,275	25.05	44.25	2	
542	.14	.36					1.230	.3725	.4581	60,410	27.98	49.35	2	} A. S. B.
543	.15	.31					1.230	.4130	.5080	57,190	29.73	40.55	2	
544	.14	.27					1.210	.4630	.5602	54,800	30.00	43.30	1	} R.
545	.13	.32	.061				1.261	.3350	.4224	54,600	28.30	44.00	1	
546	.14	.29	.057				1.267	.3990	.5055	58,300	27.20	44.60	2	} A. B.
547	.15	.30	.058				1.259	.4300	.5413	57,450	30.85	38.50	2	
548	.16	.27	.069				1.251	.3535	.4420	59,150	29.30	40.95	2	} A. B.
549	.19	.31	.069				1.118	.4440	.4914	63,300	27.70	43.50	2	
550	.15	.40	.064				1.258	.3325	.4131	63,885	28.47	45.95	2	} A. S.
551	.11	.28	.075				1.250	.4320	.5400	54,900	31.25	39.10	1	
552	.13	.30	.075				1.157	.4125	.4770	57,570	28.64	43.75	2	} A. B.
553	.11	.25	.051				1.155	.3715	.4225	52,185	30.05	37.30	2	
554	.16	.42	.062				1.040	.4160	.4409	60,400	28.10	43.50	2	} A. S. B.
555	.14	.28	.064				1.090	.4055	.4114	59,000	28.63	43.45	2	
556	.15	.30	.043				.762	.6910	.5264	58,600	29.10	43.65	2	} A. B.
557	.14	.29	.050				1.281	.3650	.4677	57,090	27.72	44.65	2	

* Quenching test failed.
 † A second plate.
 ‡ Probably finished too cold.

TABLE IV.—Tensile tests, Chester steel—Continued.

Heat number.	Carbon.		Phosphorus.	Average original width.	Average original thickness.	Average original area.	Average ultimate tensile strength per square inch.	Average final elongation.	Average final area.	No. of tests.	Accepted or rejected.
	Per cent.	Per cent.									
558	.15	.38	.046	1.255	.8800	.4770	63,100	23.67	51.85	2	A. S.
559	.16	.27	.052	1.023	.8465	.3543	57,850	28.80	40.15	1	A. B.
560	.11	.30	.052	1.023	.3240	.3314	58,400	29.06	40.00	1	R.
561	.16	.39	.039	1.030	.4835	.4980	60,490	26.12	48.05	2	A. S. B.
562	.16	.28	.050	.990	.4725	.4678	57,750	29.05	41.55	2	A. B.
563	.14	.33	.044	.994	.4610	.4582	57,650	29.30	41.85	2	A. B.
564	.16	.40	.037	1.311	.3505	.4595	58,500	25.25	41.50	2	A. B.
565	.18	.39	.038	.990	.5390	.5330	60,545	28.45	43.55	2	A. S. B.
566	.20	.41	.039	.980	.5275	.5169	59,000	29.27	41.85	2	A. B.
567	.17	.27	.050	1.021	.5335	.5447	58,545	29.45	39.50	2	A. B.
568	.17	.42	.044	1.026	.4975	.5102	61,900	27.72	45.80	2	A. S. B.
569	.17	.44	.042	1.026	.3590	.3683	66,200	23.04	56.50	2	A. S.
370	.17	.42	.042	1.019	.3725	.3795	63,600	29.62	46.40	2	A. S.
571	.16	.41	.047	1.028	.5945	.6111	62,900	23.84	55.60	2	A. S.
572	.15	.37	.053	1.032	.5650	.5831	57,570	29.68	46.75	2	A. B.
573	.17	.29	.039	1.042	.7000	.7290	59,400	26.74	53.40	2	A. B.
574	.14	.35	.038	1.037	.7010	.7267	57,100	28.70	41.60	2	A. B.
575	.13	.30	.042	.828	.5685	.4704	59,350	26.55	40.85	2	A. B.
576	.14	.36	.048	.993	.5650	.5552	61,300	26.95	41.10	2	A. S. B.
577	.14	.39	.043	.970	.5500	.5335	57,050	30.45	39.00	2	A. B.
578	.14	.40	.050	.917	.5535	.5074	57,880	30.25	38.55	2	A. B.
579	.15	.37	.047	.794	.5405	.4339	60,100	26.95	41.45	2	A. S. B.
580	.17	.41	.042	.882	.7095	.6255	60,215	25.01	41.95	2	A. S. B.
581	.14	.33	.047	1.110	.7080	.7650	58,580	29.87	42.75	2	A. B.
582	.15	.36	.048	1.098	.5725	.6283	57,850	30.84	48.50	2	A. B.
583	.15	.32	.055	1.265	.5490	.6945	57,215	31.45	46.40	2	A. B.
584				1.258	.4735	.5954	78,100	22.61	58.00	2	R.
585				1.252	.4605	.5445	66,050	26.30	45.85	2	A. S.
586	.13	.33	.052	1.248	.4725	.5694	58,610	26.10	46.40	2	A. B.
587	.14	.33	.046	1.244	.4725	.5880	60,900	27.90	49.50	2	A. S. B.
588	.16	.43	.048	1.217	.4990	.6223	61,600	25.15	43.15	2	A. S. B.
589	.16	.49	.046	1.305	.4739	.6173	64,850	24.75	48.15	2	A. S.
590	.14	.39	.052	1.220	.4835	.5898	62,700	25.75	46.50	2	A. S. B.
591		.46	0.0	1.242	.4800	.6071	64,650	25.96	50.85	2	A. S.
592	.14	.41	.045	1.228	.5185	.6367	65,590	25.30	57.55	2	A. S.
593	.19	.44	.054	1.280	.5040	.6449	62,500	25.65	51.50	2	A. S. B.
594	.15	.42	.052	1.275	.4920	.6221	62,550	27.58	50.90	2	A. S. B.
595	.13	.36	.046	1.260	.4465	.5628	58,750	27.25	45.30	2	A. B.
598	.12	.34	.054	1.294	.5015	.6186	56,550	27.65	42.35	2	R.
599				1.218	.5075	.6183	32,500			2	R.*
600	.18	.40	.060	1.242	.5015	.6229	65,950	22.10	51.10	2	R.
601	.18	.37	.048	1.234	.4825	.5903	64,750	25.25	52.60	2	A. S.
603	.19	.73	.056	1.256	.4945	.6210	69,700	21.50	61.85	2	R.†
605	.17	.50	.044	1.185	.4390	.5392	64,600	24.45	60.60	2	A. S.
606	.14	.47	.042	1.175	.5090	.5980	65,000	19.70	60.00	1	R.
607	.15	.29	.018	.953	.7058	.6721	65,350	24.08	53.92	4	A. S.
608	.16	.27	.043	1.209	.5090	.6152	60,050	25.20	46.00	2	A. S. B.
609	.15	.29	.052	1.237	.5095	.6303	63,250	23.22	53.30	4	A. S.
610	.15	.38	.062	1.219	.4745	.5784	64,950	27.05	48.50	2	A. S.
611	.17	.38	.047	1.212	.4735	.5747	64,850	25.56	53.65	2	A. S.
612	.16	.32	.065	1.238	.4815	.5963	62,500	23.54	52.77	4	A. S.
613	.16	.39	.061	1.245	.4565	.5681	62,950	23.75	54.50	4	A. S.
614	.16	.39	.051	1.240	.4590	.5692	61,000	27.55	51.10	2	A. S. B.
615	.17	.41	.051	1.244	.4715	.5466	62,350	26.15	50.25	2	A. S. B.
616	.16	.41	.057	1.264	.5000	.6320	62,050	26.60	47.50	2	A. S. B.
618	.15	.45	.057	1.290	.5130	.6464	67,050	23.25	58.70	2	A. S.
619	.16	.36	.059	1.263	.5300	.6947	63,050	26.05	62.00	2	A. S.
620				1.254	.4945	.6249	73,000	23.30	55.30	2	A. S.
621	.15	.36	.048	1.247	.5425	.6763	62,750	24.85	48.80	2	A. S.
622	.17	.47	.051	1.250	.5195	.6744	63,350	26.57	51.25	2	A. S.
623	.15	.43	.060	1.246	.4835	.6023	63,300	26.75	52.80	2	A. S.
624	.15	.41	.052	1.249	.4860	.6066	68,200	27.44	52.05	2	A. S.
625	.16	.38	.061	1.260	.4665	.5879	66,300	25.60	51.25	2	A. S.
626	.19	.33	.045	1.258	.4650	.5849	68,070	23.10	53.22	4	A. S.
627	.19	.41	.050	1.250	.5110	.6388	71,700	25.20	56.45	2	A. S.
628	.12	.36	.053	1.250	.4940	.6175	58,000	26.40	48.70	2	A. B.
629				1.218	.5200	.6176	61,700	25.50	51.50	2	A. S.
630	.13	.49	.048	1.176	.5218	.6158	60,720	23.15	52.65	2	A. S.
631	.17	.44	.051	1.225	.4905	.5991	63,550	23.46	56.65	2	A. S.
632	.14	.34	.052	1.194	.4745	.5663	63,000	26.10	52.00	2	A. S.
633	.15	.41	.047	1.207	.4950	.5975	58,600	25.65	45.75	2	A. B.

* Broke in grips: cryst. fract.

† Fracture laminated.

TABLE IV.—Tensile tests, Chester steel—Continued.

Heat number.	Carbon.	Manganese.	Phosphorus.	Average original width.	Average original thickness.	Average original area.	Average ultimate tensile strength per square inch.	Average final elongation.	Average final area.	No. of tests.	Accepted or rejected.
	Pr. ct.	Pr. ct.	Pr. ct.	Inches.	Inches.	Sq. ins.	Lbs.	Per ct.	Per ct.		
634	.16	.45	.051	1.233	.5000	.6163	61,650	25.00	50.55	2	A. S.
635	.13	.36	.056	1.206	.4875	.5879	57,230	26.20	47.75	2	A. B.
636	.15	.39	.051	1.199	.4825	.5785	59,350	23.47	50.50	2	R.
637	.13	.31	.049	1.198	.4810	.5762	52,750	27.75	46.75	2	R.
638	.14	.39	.049	1.255	.5305	.6655	66,150	23.75	57.70	2	A. S.
639	.13	.36	.050	1.248	.5230	.6524	67,440	26.80	48.50	2	A. B.
640	.13	.30	.049	1.258	.4900	.6162	59,000	28.05	49.60	2	A. B.
641	.14	.42	.054	1.277	.4950	.6321	63,200	25.45	52.85	2	A. S.
642	.12	.24	.047	1.273	.4915	.6254	56,900	27.30	45.55	2	R.
643	.15	.30	.040	1.284	.4850	.6225	61,100	28.40	47.75	2	A. S. B.
644	.15	.41	.055	1.263	.4990	.6298	60,600	26.55	50.80	2	A. S. B.
645	.13	.33	.061	1.234	.5045	.6223	58,150	27.85	51.00	2	A. B.
646	.15	.83	.050	1.243	.4985	.6196	59,300	26.15	52.00	2	A. B.
647	.12	.38	.048	1.243	.4540	.5641	58,850	26.25	50.25	2	A. B.
650	.14	.34	.042	1.225	.5205	.6375	61,750	24.35	51.90	2	A. R.
652	.16	.31	.059	1.216	.4945	.6010	64,200	26.30	52.00	2	A. S.
659	.16	.29	1.242	.5130	.6371	61,915	27.45	48.00	2	A. S. B.
660	.16	.31	1.236	.4890	.6044	66,500	19.95	59.00	2	R.
666	.16	.31	1.182	.5293	.6256	63,617	24.57	49.67	2	(*)
661	.12	.27	1.199	.4925	.5768	67,230	23.35	56.00	2	A. S.
662	.12	.27	1.196	.4900	.5725	60,850	27.75	41.00	2	A. S. B.
663	.12	.33	1.180	.4925	.5811	62,800	29.40	44.00	2	A. S. B.
664	.13	.32	1.194	.5000	.5968	63,800	24.85	46.05	2	A. S.
665	.16	.38	1.200	.5165	.6256	67,200	27.50	50.65	2	A. S.
666	.15	.37	1.217	.5125	.6031	61,750	25.50	46.15	2	A. S. B.
667	.13	.33	1.238	.5150	.6374	60,750	24.45	48.60	2	A. S.
668	.17	.34	1.227	.5100	.6255	67,000	23.95	50.65	2	A. S.
669	.17	.36	1.220	.5185	.6326	65,150	24.75	48.10	2	A. S.
670	.12	.31	1.215	.4850	.5892	60,400	26.25	45.75	2	A. S. B.
671	.13	.31	1.207	.4820	.5815	62,000	27.95	44.50	2	A. S. B.
672	.15	.37	1.097	.5365	.5883	61,200	26.75	43.75	2	A. S. B.
673	.14	.35	1.091	.4950	.5398	60,450	30.25	41.00	2	A. S. B.
674	.13	.29	1.226	.4870	.5970	62,975	28.40	41.00	2	A. S. B.
675	.11	.29	1.227	.5500	.6754	59,700	29.65	40.50	2	A. R.
676	.14	.30	1.240	.5075	.6294	60,800	26.05	43.00	2	A. S. B.
677	.15	.34	1.239	.5185	.6424	62,300	27.25	44.25	2	A. S. B.
678	.13	.32	1.227	.4935	.6055	60,200	30.30	43.75	2	A. S. B.
679	.14	.35	1.227	.5365	.6545	63,200	27.50	46.13	2	A. S.
680	.16	.29	1.236	.4995	.6174	65,450	28.70	47.00	2	A. S.
681	.14	.34	1.238	.5195	.6428	62,650	29.25	44.00	2	A. S. B.
682	.14	.34	.9835045	.5005	56,000	28.15	42.15	2	R.
683	.13	.29	.9764915	.4802	57,050	25.45	44.70	2	A. B.
684	.12	.24	1.0185050	.5408	54,450	27.50	40.45	2	R.
685	.12	.30	1.0804825	.5018	55,350	27.25	42.65	2	R.
686	.12	.28	1.0964980	.5458	54,915	29.30	42.70	2	R.
687	.12	.32	1.0695120	.5468	57,500	28.95	46.00	2	A. B.
688	.12	.38	1.0824920	.5326	57,350	26.65	42.25	2	A. B.
689	.15	.37	1.1375470	.6117	59,340	24.80	46.35	2	R.
690	.14	.35	1.1634860	.5088	60,250	29.15	45.60	2	A. S. B.
691	.16	.39	1.1855035	.5816	60,850	24.70	51.10	2	A. S.
692	.15	.40	1.1305025	.5878	60,100	25.90	53.55	2	A. S. B.
693	.14	.36	1.1345000	.5870	58,750	25.00	51.15	2	A. S. B.
694	.15	.44	1.0355150	.5331	60,480	25.35	48.70	2	A. S. B.
695	.14	.37	1.0674820	.5140	58,070	25.65	46.00	2	A. B.
696	.14	.35	1.1475075	.5592	57,750	26.55	49.50	2	A. B.
697	.15	.36	1.1245155	.5794	62,785	25.95	53.50	2	A. S. B.
698	.10	.37	1.0905890	.6420	60,170	24.15	47.80	4	A. S.
699	.16	.44	1.0755010	.5518	63,250	25.40	52.50	2	A. S.
700	.16	.44	1.0234885	.5005	61,585	24.20	47.10	2	A. S.
701	.14	.42	1.0424820	.5020	60,505	26.35	48.50	2	A. S. B.
702	.16	.48	1.0334790	.4946	63,500	26.25	49.55	2	A. S.
703	.16	.40	1.1435325	.5991	61,665	25.35	49.35	2	A. S. B.
704	.16	.39	1.0255365	.5496	60,315	25.15	47.85	2	A. S. B.
705	.15	.41	1.0435450	.5680	58,075	28.70	42.00	2	A. B.
706	.16	.39	1.0565300	.5597	61,795	26.10	45.00	2	A. S. B.
707	.16	.45	1.1014780	.4784	60,325	26.90	48.10	2	A. S. B.
708	.15	.35	.9615175	.4971	61,135	25.20	46.00	2	A. S. B.
709	.15	.40	1.1174875	.6418	60,365	23.75	50.90	2	A. S.
710	.15	.37	1.3535000	.6763	57,550	24.85	44.70	2	R.
711	.16	.38	1.0055000	.5025	61,100	23.80	45.40	2	A. S.
712	.16	.39	1.0875083	.5321	59,225	26.55	48.00	4	R.†
713	.14	.34	1.0295065	.5196	58,400	24.35	41.50	2	A. B.
714	.17	.41	1.0295150	.5297	62,250	25.55	48.00	2	A. S. B.

* Annealed. Test plate only accepted.

† Two pieces gave less than 57,000 pounds.

TABLE IV.—Tensile tests, Chester steel.—Continued.

Heat number.	Carbon.			Average original width.	Average original thickness.	Average original area.	Average ultimate tensile strength per square inch.	Average final elongation.	Average final area.	No. of tests.	Accepted or rejected.
	Perct.	Perct.	Perct.								
717	.17	.46		1.160	5195	6023	62,050	24.35	49.50	2	A. S.
718	.16	.28		1.128	4875	5497	61,500	23.00	48.00	2	A. S.
719	.16	.35		1.106	5155	5702	60,850	24.50	54.70	2	A. S.
720	.16	.43		1.094	5135	5618	61,000	23.44	44.50	2	A. S.
721	.17	.40		1.022	5100	5210	60,500	25.30	51.00	2	A. S. B.
722	.15	.44		1.015	5105	5185	60,250	25.40	47.50	2	A. S. B.
723	.17	.47		.998	5050	5038	60,300	24.60	46.50	2	A. S.
724	.17	.46		.995	5165	5199	61,750	23.50	45.62	2	A. S.
725	.13	.22		1.224	5325	6518	55,200	28.70	43.50	2	R.
726	.12	.22		1.222	5275	6446	56,200	26.35	42.00	2	R.
727	.11	.41		.990	4770	4722	64,000	21.20	48.00	2	R.
728	.16	.42		1.027	6030	5213	62,250	19.20	48.00	2	R.
729	.13	.30		1.020	5110	5212	60,850	23.40	45.00	2	A. S.
780	.14	.20		1.015	5135	5183	62,000	23.65	41.00	2	A. S.
781	.14	.38		.999	5075	5065	62,850	23.95	49.00	2	A. S.
782	.13	.38		1.032	5188	5850	61,340	23.29	50.00	2	A. S.
783	.15	.48		1.048	5200	5497	63,850	23.90	47.00	2	A. S.
734	.16	.16		1.013	5425	5467	62,650	24.10	47.00	2	A. S.
735	.16	.40		.993	4990	4925	65,000	26.00	41.50	2	A. S.
736	.15	.41		1.125	5275	5910	61,750	24.80	42.00	2	A. S.
737	.15	.40		1.110	5250	5830	62,000	25.10	45.00	2	A. S. B.
788	.15	.48		1.055	5188	5485	64,375	22.58	47.25	2	R.
739	.15	.40		1.090	5450	5890	62,400	24.60	40.00	2	A. S.
740	.15	.39		1.080	5250	5670	63,400	25.05	41.00	2	A. S.
741	.15	.31		1.098	5125	5620	62,500	25.35	42.00	2	A. S.
742	.12	.42		1.023	5225	5340	61,200	24.85	44.00	2	A. S. B.
743	.14	.45		1.026	5063	5195	61,075	22.63	43.00	2	R.
744	.12	.39		.978	5275	5190	59,050	22.35	45.00	2	R.
745	.12	.36		1.050	4545	4770	61,100	23.40	45.00	2	A. S.
746	.15	.41		.968	5415	5240	63,500	19.95	55.00	2	R.
747	.15	.26		.943	5000	4720	63,300	24.45	47.00	2	A. S.
748	.15	.40		1.027	5030	5185	68,925	22.58	45.00	2	R.
749	.13	.41		1.050	4900	5150	62,500	25.90	43.00	2	A. S. B.
750	.13	.33		1.043	4980	5090	64,200	20.65	50.50	2	R.
751	.14	.39		.899	4933	4435	63,425	22.83	46.75	2	R.
758	.14	.41		1.038	5025	5210	61,100	23.25	46.50	2	A. S.
754	.14	.39		1.038	4925	5110	62,000	24.60	47.50	2	A. S.
755	.14	.40		.955	5100	4875	60,500	24.15	45.00	2	A. S.
756	.13	.26		.939	5135	4825	57,650	24.45	40.00	2	R.
757	.13	.31		.980	5025	4925	58,650	23.70	41.00	2	R.
758	.12	.27		.983	4980	4895	58,850	24.65	41.00	2	R.
759	.13	.31		.970	5585	5395	61,490	23.05	48.00	2	A. S.
767	.14	.45		.982	4950	4860	60,700	25.25	50.50	2	A. S. B.

* Rough surface.

† One piece had rough surface.

NORWAY STEEL.

(Inspector, Lieutenant F. J. Drake, U. S. N.)

The material to be supplied consisted of ship and boiler plate. The steel was made at the Norway Steel and Iron Works, South Boston, and rolled into slabs, as hereafter described, being reheated and rolled into plate at the Bay State Iron Works, about a mile and a half distant.

At the end of 1883, the firm of Naylor & Co., previously controlling the Norway Works, was dissolved, and the works passed into the hands of a stock company, known as the Norway Steel and Iron Company, with a change of officers and foremen. Beyond the time consumed in overhauling the furnaces no delay was caused, the new company continuing the contracts. The drop in the heat-numbers in the table of tests was due to this change of management.

The steel was produced by the Siemens-Martin, or "pig and scrap" process, in three 10-ton furnaces, erected in 1873, and of the following inside dimensions:

	Ft.	In.
Width, in plane of ports	13	0
Depth, front to back ports	7	3
Height, crown to bed-floor	4	4

Gas is supplied to each furnace by a group of four Siemens producers, arranged in a rectangle, with central shaft, and each group supplied with steam-blast from an independent boiler.

From Heat No. 1892 to No. 2411, inclusive, the charge consisted usually of about one-eighth preheated Lonsdale pig, one-half puddle balls, and three-eighths shearings and pit-* and wrought iron scrap.

From Heat No. 39, and subsequently, the composition was variable. The average weight of charge was 18,000 pounds.

Ferro-manganese was added to the bath about seven minutes before tapping; up to Heat No. 2411 from 130 to 160 pounds, subsequently 250 to 300 pounds.

The average time of a heat from charging to tapping was between five and a half and six hours.

Until June 14, 1884, including all heats between No. 1892 and No. 526, all ingots were top cast. Thence to August 1, some were top and some bottom cast, and subsequently, including all heats after No. 658, the bottom cast was alone used.

The molds in general use measured: inside, top 12 by 20½ inches; bottom, 13 by 21½ inches; depth, 60 inches, corresponding to a capacity of about 4,370 pounds. The ingots were stripped at a cherry heat, wash heated, and bloomed down to slabs from 4 to 7 inches thick and 21 inches wide, in a three high mill with collared rolls 58 by 30 inches, driven by a vertical condensing Corliss engine, 42 by 42 inches, of about 400 I. H. P., and using steam of 70 pounds, gauge pressure. These slabs are cut to length as required and sent to the Bay State Mills.

It will be observed that the average thickness of the ingots, 12½ inches, gives 25 per cent. more reduction than at the Chester Mills, which is better practice, though much depends on the conditions of casting.

Other molds, 8 by 26 by 60 inches and 10 by 26 by 60 inches, are occasionally used, and the corresponding ingots rolled down without blooming.

Throughout the supply of material under this inspection the upper third of the ingot was generally discarded on account of the unsatisfactory results obtained by special experiment on the corresponding rolled plate as described, p. 532, *et seq.*

At the Bay State Mills, the plate train is two-high, 110 by 30 inches, while a three-high mill, 91 by 30 inches, is used for finishing plates of less than 15 pounds per square foot. Both mills are driven from a single horizontal condensing simple engine, 39 inches diameter of cylinder, by 6 feet stroke, developing as high as 800 I. H. P.

This steel was tested at the Norway Works on a Riehle hydraulic machine of general design as shown in Fig. 6, of 50,000 pounds capacity, new and in good order. It is worked by hand through a single pump to a ram in the lower casing, the load being transmitted through the piece to a lever in the upper casing between stanchions, thence to the open lever at the top, thence down one stanchion to a third lever in

* Pit-scrap consists of the "skull," or layer of steel left on the bottom and sides of the ladle, the overflow of ingots, leakage into the pit, runners, &c.

the casing under the pump, thence up the scale stanchion to the scale beam. The beam is fitted with primary and jockey weights, reading to 10 pounds, and has adjustable compensating attachment. The grips consist of high-faced wedges $5\frac{1}{2}$ by $3\frac{1}{4}$ inches. The packings gave frequent trouble from leakage, necessitating stoppage and overhauling.

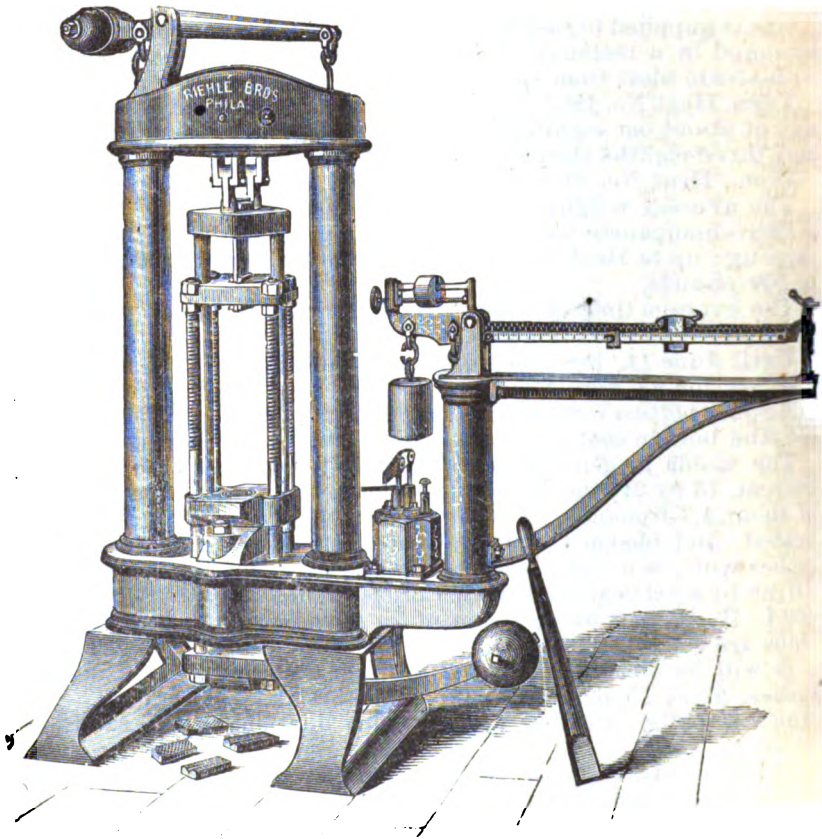

FIG. 6.—50,000 lbs. Riehle Hydraulic Testing Machine used at Norway Iron and Steel Works and at Black Diamond Steel Works.

DIMENSIONS.

Extreme height.....	8 ft.
Extreme length.....	7 ft.
Extreme width.....	2 ft. 6 in.
Weight.....	2,250 lbs.

ADAPTATION.

Tensile specimens.....	6 in. to 24 in. long.
Round specimens.....	1 in. diam. or less.
Square ".....	1 in. x 18 in. or less.
Flat ".....	2 in. or less x $\frac{3}{4}$ in. or less.
Transverse specimens.....	12 in. long.
Compression ".....	20 in. high or less.
" surfaces.....	6 in. x 6 in.
Motion of plunger.....	8 in.

The pieces for tensile test were straightened cold from the bent shearing, cut out on a planer, and laid off and measured before and after fracture with Brown & Sharp's gauges. The mean of several measurements was taken for thickness of fractured area.

The pieces for quenching test were cold straightened as left by the shears, and generally heated at a smith's forge, about twelve at a time and two or three deep, in an arched coke fire with closed mouth, but sometimes on a flat fire under a board with slight blast. On cooling in water at 82° F., they were bent under a steam-hammer with a light uniform stroke.

Sufficient chemical information accompanies the report of tests to enable the curve of carbon properties (p. 555) to be constructed, thus showing graphically the average behavior of this material under the tensile tests.

The chemical methods in use are:—for carbon, the color test; for manganese, a volumetric process devised by the chemist of the Norway Works, Mr. H. C. Babbitt, taking only from ten to fifteen minutes for a test, and said to give results which agree well with determinations of eminent chemists using the more common methods. Occasional checks for manganese are also made by the nitric acid and chlorate of potash process.

The total number of heats tested up to September 1, 1884, is 369, of which 61 or 18.7 per cent. were rejected. Of the 308 heats accepted for ship and boiler plate, the average tensile strength per square inch is 62,472 pounds, with a corresponding ductility of 25.56 per cent. in 8 inches. Of the material so accepted, 1,616.22 tons were delivered at the shipyard up to September 1, 1884, while 13.75 tons or 0.85 per cent. of the amount delivered was rejected on the quenching test. The percentage of loss due to rolling and shearing here is estimated at 27 per cent.

Several interesting special tests were made on this steel, which will be found later on under appropriate headings.

In the following table the tests are arranged in the order of heats. It will be noticed that many of the earlier heats, which were too soft for ship plate, for which they were run, would have met the requirements for boiler metal, not at that time ordered.

TABLE V.—Tensile tests Norway steel.

Heat number.	Carbon.	Manganese.	Phosphorus.	Average original width.	Average original thickness.	Average original area.	Average ultimate tensile strength per square inch.	Average final elongation.	Average final area.	Number of tests.	Accepted or rejected.
	Perct.	Perct.	Perct.	Inches.	Inches.	Sq. ins.	Pounds.	Per ct.	Per ct.		
1892	.14	.36770	.561	.432	57,779	29.0	48.0	8	R.
1893	.13	.32	1.002	.524	.524	61,500	27.0	43.0	4	A.
1891	.12	.52992	.420	.417	67,200	22.0	49.0	6	R.
1896	.12	.48	1.049	.520	.545	58,810	26.5	58.0	6	R.
1910	.15	.37	1.044	.525	.548	58,276	26.0	53.0	8	R.
1912	.14	.47	1.003	.423	.426	65,200	23.0	49.0	8	R.
1914	.16	.43	1.049	.447	.467	61,660	27.0	62.0	4	A.
1918	.13	.42	1.001	.465	.465	64,300	20.5	61.0	6	R.
1920	.13	.39	1.006	.526	.530	60,987	25.0	52.0	4	A.
1922	.12	.42977	.442	.415	57,200	26.0	51.0	8	R.
1981	.16	.47	1.004	.451	.453	61,090	24.0	51.0	6	R.
1941	.14	.47	1.018	.478	.488	60,739	23.7	49.0	6	R.
1963	.13	.39	1.023	.420	.430	60,474	25.5	52.0	4	A.
1986	.18	.23	1.003	.423	.426	60,040	25.5	47.0	4	A.
1988	.22	.34	1.004	.516	.518	59,200	25.5	48.0	8	R.

TABLE V.—Tensile tests, Norway steel—Continued.

Heat number.	Carbon.			Average original width.	Average original thickness.	Average original area.	Average ultimate tensile strength per square inch.	Average final elongation.	Average final area.	Number of tests.	Accepted or rejected.
	Per cent.	Per cent.	Per cent.								
1974	.18	.33		1.000	.512	.512	58,900	27.0	49.0	6	R
1975	.18	.31		.998	.510	.509	59,000	26.5	48.0	6	R
1995	.14	.26		.987	.437	.445	60,340	26.0	42.0	4	A
2009	.12	.33		.991	.434	.429	61,625	25.5	51.0	4	A
2013	.15	.23		.998	.450	.449	59,200	26.0	50.0	6	R
2051	.12	.44		.990	.415	.414	60,964	26.0	51.0	4	A
2053	.12	.35		.993	.408	.404	57,248	24.0	50.0	6	R
2055	.16	.42		.999	.490	.490	55,850	26.0	43.0	4	A
2057	.16	.36		.986	.463	.448	60,516	26.0	43.0	4	A
2059	.12	.35		.987	.489	.474	60,450	26.0	29.0	4	A
2063	.12	.33		.986	.462	.455	60,850	24.3	47.0	4	A
2064	.16	.46		.986	.401	.398	61,020	25.3	51.0	4	A
2066	.16	.43		.987	.405	.399	62,393	28.0	54.0	4	A
2070	.13	.45		.991	.465	.461	61,430	29.0	47.0	4	A
2088	.15	.23		.995	.458	.456	60,344	23.3	43.0	4	A
2091	.16	.40		1.001	.465	.465	63,685	26.0	46.0	4	A
2095	.16	.53		1.000	.470	.470	63,049	26.0	51.0	4	A
2097	.18	.36		.998	.432	.451	64,450	26.0	51.0	4	A
2099	.16	.36		.991	.423	.419	63,251	26.0	50.0	4	A
2109	.16	.40		.991	.461	.456	66,721	26.0	49.0	4	A
2111	.12	.46		.990	.464	.458	62,844	27.5	53.0	4	A
2113	.18	.50		1.020	.290	.565	65,791	26.0	60.0	4	A
2115	.13	.32		.983	.466	.460	60,500	26.5	49.0	4	A
2117	.15	.33		.990	.466	.461	60,610	27.0	46.0	4	A
2119	.14	.33		1.020	.290	.557	65,584	29.0	52.0	4	A
2136	.13	.35		1.225	.290	.355	63,680	25.2	59.0	4	A
2138	.18	.45		.984	.420	.417	69,556	25.5	58.0	4	A
2139	.15	.40		1.222	.296	.361	63,323	26.3	44.0	4	A
2140	.17	.37		1.222	.287	.351	63,092	27.5	54.0	4	A
2141	.14	.45		.990	.427	.422	65,198	25.2	51.0	4	A
2143	.14	.29		.986	.424	.420	60,197	25.5	55.0	4	A
2145	.13	.33		.988	.435	.429	62,544	26.0	45.0	4	A
2149	.17	.42		.986	.440	.433	64,908	25.0	46.0	4	A
2151	.15	.31		.988	.431	.419	61,435	27.0	40.0	4	A
2153	.21	.28		.986	.442	.433	71,660	21.3	46.0	6	R
2156	.12	.39		.993	.426	.424	60,862	25.5	44.0	4	A
2160	.13	.39		.985	.443	.436	61,530	28.0	49.0	4	A
2162	.16	.42		.984	.438	.432	60,688	26.2	48.0	4	A
2163	.15	.37		.985	.443	.430	61,300	25.5	50.0	4	A
2164	.16	.38		.983	.441	.434	62,180	27.5	52.0	4	A
2165	.15	.48		.983	.430	.420	63,560	23.0	49.0	6	R
2167	.14	.42		.980	.430	.421	60,615	26.0	50.0	4	A
2168	.13	.39		.979	.415	.406	61,520	25.5	48.0	4	A
2171	.16	.33		.978	.463	.450	60,590	25.5	46.0	4	A
2173	.15	.35		.982	.442	.434	62,220	26.3	44.0	4	A
2175	.17	.42		.989	.423	.418	61,497	26.0	56.0	4	A
2176	.18	.39		.979	.431	.421	63,050	25.5	43.0	4	A
2177	.12	.33		.977	.442	.414	56,745	30.0	40.0	6	R
2178	.17	.33		.988	.418	.413	63,270	23.0	50.0	6	R
2180	.15	.31		.991	.412	.410	59,862	25.0	52.0	4	R
2181	.14	.44		.989	.413	.409	58,996	27.0	53.0	8	R
2182	.14	.31		.988	.425	.420	57,562	25.5	43.0	6	R
2187	.14	.35		.988	.427	.418	61,091	26.5	40.0	4	A
2188	.13	.28		.992	.419	.415	58,800	26.0	49.0	6	R
2189	.15	.36		.992	.421	.418	59,100	25.5	50.0	4	R
2190	.14	.31		.990	.420	.416	60,752	26.5	50.0	4	A
2191	.15	.32		.985	.430	.427	63,967	25.2	50.0	4	A
2192	.13	.28		.990	.417	.414	63,094	27.0	43.0	4	A
2195	.15	.36		.990	.420	.416	60,190	27.5	37.0	4	A
2196	.20	.39		.986	.423	.418	60,938	26.5	41.0	4	A
2197	.16	.30		.987	.420	.413	61,031	25.5	41.0	4	A
2198	.12	.32		.986	.426	.420	61,304	25.5	43.0	4	A
2199	.19	.39		.982	.419	.410	64,070	27.5	47.0	4	A
2200	.23	.28		.978	.407	.398	65,190	25.0	51.0	4	A
2201	.19	.35		.990	.416	.413	63,271	25.0	45.0	4	A
2202	.12	.33		.990	.423	.418	61,417	25.0	44.0	4	A
2204	.14	.31		.979	.414	.403	64,127	25.0	43.0	4	A
2205	.18	.34		.984	.418	.411	62,246	25.0	48.0	4	A
2206	.15	.31		.989	.405	.403	61,267	25.5	49.0	4	A
2208	.12	.24		.982	.419	.411	60,142	26.0	30.0	4	A
2213	.12	.44		.985	.404	.404	60,315	28.5	45.0	4	A
2215	.12	.30		.986	.423	.417	60,565	27.0	40.0	4	A

TABLE V.—Tensile tests, Norway steel—Continued.

Heat number.	Carbon.			Average original width.	Average original thickness.	Average original area.	Average ultimate tensile strength per square inch.	Average final elongation.	Average final area.	Number of tests.	Accepted or rejected.
	Per cent.	Per cent.	Per cent.								
.....	.14	.29982	.471	.463	60,524	26.0	41.0	4	A.
.....	.18	.29985	.424	.418	62,872	25.5	54.0	4	A.
.....	.15	.39984	.404	.397	63,081	25.2	50.0	4	A.
.....	.14	.24967	.466	.454	60,285	28.2	50.0	4	A.
.....	.15	.39965	.422	.409	61,141	25.5	45.0	4	A.
.....	.15	.45983	.424	.419	65,796	26.0	45.0	4	A.
.....	.15	.27984	.470	.463	63,169	25.0	51.0	4	A.
.....	.14	.23967	.462	.456	63,078	26.0	53.0	4	A.
.....	.17	.33986	.464	.457	61,886	26.5	43.0	4	A.
.....	.16	.32981	.471	.463	62,050	26.0	42.0	4	A.
.....	.16	.30980	.430	.423	62,382	26.0	42.0	4	A.
.....	.14	.30979	.417	.412	61,939	26.0	49.0	4	A.
.....	.12	.30985	.422	.416	61,666	26.0	47.0	4	A.
.....	.15	.21	1.220	.244	.249	62,492	25.0	49.0	4	A.
.....	.15	.33	1.260	.255	.320	65,273	25.0	54.0	4	A.
.....	.15	.36	1.260	.245	.307	69,287	26.0	56.0	4	A.
.....	.19	.36	1.230	.253	.311	66,369	25.0	52.0	4	A.
.....	.17	.40	1.220	.240	.294	65,058	25.0	50.0	4	A.
.....	.19	.32	1.235	.249	.308	65,059	25.0	51.0	4	A.
.....	.18	.31	1.220	.242	.295	65,090	25.0	53.0	4	A.
.....	.16	.38	1.220	.230	.281	63,681	25.0	46.0	4	A.
.....	.19	.35	1.220	.239	.293	67,231	25.0	48.0	4	A.
.....	.18	.33	1.220	.245	.299	67,146	25.0	46.0	4	A.
.....	.15	.29	1.222	.249	.308	63,794	26.0	46.0	4	A.
.....	.13	.33	1.210	.238	.287	66,260	26.0	47.0	4	A.
.....	.15	.31	1.210	.243	.295	65,998	25.0	47.0	4	A.
.....	.14	.34	1.222	.241	.296	64,138	25.0	46.0	4	A.
.....	.14	.26	1.220	.245	.297	64,968	25.0	47.0	4	A.
.....	.14	.30987	.487	.480	66,404	25.0	50.0	4	A.
.....	.13	.31985	.475	.468	60,910	25.0	49.0	4	A.
.....	.15	.36983	.477	.469	62,330	25.0	43.0	4	A.
.....	.21	.41987	.473	.467	69,286	25.0	54.0	4	A.
.....	.16	.28980	.457	.449	67,682	25.0	53.0	4	A.
.....	.13	.36984	.460	.453	59,597	27.0	47.0	6	R.
.....	.18	.35983	.469	.461	62,424	25.0	48.0	4	A.
.....	.15	.32984	.457	.450	63,966	25.3	48.0	4	A.
.....	.13	.36983	.470	.462	60,677	25.0	53.0	4	A.
.....	.12	.27980	.460	.451	61,793	25.0	46.0	4	A.
.....	.18	.31982	.460	.452	60,712	26.0	47.0	4	A.
.....	.17	.31985	.490	.480	63,142	25.3	47.0	4	A.
.....	.18	.34981	.463	.454	63,496	25.5	47.0	4	A.
.....	.13	.33985	.458	.451	61,287	25.0	46.0	4	A.
.....	.15	.31987	.482	.476	61,585	26.0	49.0	4	A.
.....	.14	.27987	.306	.304	61,257	25.0	64.0	4	A.
.....	.18	.49982	.450	.441	64,820	25.5	45.0	4	A.
.....	.22	.36984	.473	.465	61,102	25.0	49.0	4	A.
.....	.15	.31981	.476	.466	61,358	26.5	49.0	4	A.
.....	.18	.33976	.455	.444	60,231	25.5	49.0	4	A.
.....	.17	.36979	.473	.463	62,485	25.5	47.0	4	A.
.....	.12	.38981	.477	.467	63,104	26.0	51.0	4	A.
.....	.13	.43977	.460	.450	61,957	25.5	53.0	4	A.
.....	.12	.35977	.467	.456	62,827	25.0	52.0	4	A.
.....	.18	.43975	.475	.463	61,965	25.0	51.0	4	A.
.....	.15	.38984	.421	.414	60,600	25.0	41.0	4	A.
.....	.18	.40986	.422	.417	64,825	25.0	41.0	6	R.
.....	.14	.33983	.421	.412	63,030	25.0	42.0	4	A.
.....	.15	.32976	.463	.453	61,944	25.5	41.0	8	A.
.....	.12	.46982	.426	.419	59,890	26.0	41.0	8	R.
.....	.13	.36985	.422	.417	60,849	26.0	42.0	4	A.
.....	.18	.35982	.412	.405	64,759	25.0	43.0	4	A.
.....	.18	.36983	.421	.413	61,930	26.3	45.0	4	A.
.....	.15	.30971	.469	.456	61,624	25.2	52.0	4	A.
.....	.18	.30976	.478	.466	62,221	25.2	53.0	4	A.
.....	.12	.35976	.490	.477	61,381	25.0	52.0	4	A.
.....	.12	.36981	.455	.444	58,000	22.5	39.0	6	R.
.....	.15	.35971	.300	.290	64,294	25.3	49.0	4	A.
.....	.18	.25976	.300	.294	63,207	25.2	53.0	4	A.
.....	.13	.30977	.476	.465	57,920	20.5	49.0	6	R.
.....	.13	.28970	.236	.229	62,158	25.0	53.0	4	A.
.....	.14	.27968	.244	.236	60,357	25.0	52.0	4	A.
.....	.13	.27989	.281	.279	60,837	25.0	53.0	4	A.
.....	.13	.36990	.245	.243	66,936	25.0	61.0	4	A.
.....	.14	.39979	.418	.409	58,180	20.5	48.0	6	R.
.....	.15	.34984	.241	.237	62,713	25.2	56.0	4	A.

TABLE V.—Tensile tests. Norway steel—Continued.

Heat number.	Carbon.		Phosphorus.	Average original width.	Average original thickness.	Average original area.	Average ultimate tensile strength per square inch.	Average final elongation.	Average final area.	Number of tests.	Accepted or re-perced.
	Per ct.	Per ct.									
2368	.14	.25976	.296	290	61,177	26.0	52.0	4	A
2369	.18	.30982	.446	438	57,999	21.0	44.0	6	A
2371	.14	.25976	.447	241	64,354	25.0	61.0	4	A
2373	.17	.40984	.418	412	58,006	31.2	46.0	8	A
2375	.15	.27984	.482	473	61,500	35.3	47.0	4	A
2377	.15	.31977	.800	293	62,498	25.2	50.0	4	A
2379	.19	.35975	.800	293	65,713	26.0	51.0	4	A
2381	.18	.35986	.291	287	66,368	25.5	53.0	4	A
2382	.18	.30983	.275	271	64,107	25.0	52.0	4	A
2384	.18	.45969	.297	295	65,026	25.2	53.0	4	A
2386	.17	.46981	.295	290	65,298	25.2	54.0	4	A
2387	.15	.31984	.299	295	63,739	26.3	50.0	4	A
2388	.27	.29974	.299	292	61,545	26.0	49.0	4	A
2390	.15	.30984	.472	464	61,000	26.0	55.0	4	A
2391	.18	.33980	.473	464	61,207	25.2	55.0	4	A
2393	.18	.37983	.472	463	66,047	25.0	58.0	4	A
2394	.16	.37978	.442	471	65,142	26.0	52.0	4	A
2395	.18	.30982	.472	461	60,623	26.0	52.0	4	A
2396	.19	.30982	.473	465	63,705	25.2	52.0	4	A
2397	.18	.28985	.242	263	63,546	25.3	51.0	4	A
2398	.12	.31974	.241	235	64,166	26.3	58.0	4	A
2401	.20	.30975	.247	242	64,039	25.5	55.0	4	A
2402	.31	.39979	.237	232	72,754	25.0	62.0	4	A
2403	.17	.35972	.238	231	70,096	26.0	62.0	4	A
2404	.16	.33982	.470	462	67,057	21.5	51.0	6	A
2405	.22	.36974	.238	228	64,456	25.5	54.0	4	A
2406	.23	.23975	.227	221	69,155	25.0	61.0	4	A
2407	.14	.34974	.237	231	66,350	25.0	56.0	4	A
2408	.21	.32988	.300	297	65,843	25.0	46.0	4	A
2409	.18	.30984	.282	277	69,250	25.3	52.0	4	A
2410	.18	.31982	.300	295	63,882	25.0	47.0	4	A
2411	.19	.35989	.284	293	63,630	26.2	50.0	4	A
39	.13	.32970	.300	290	60,089	27.0	50.0	4	A
40	.18	.33970	.303	294	62,280	25.2	53.0	4	A
41	.17	.18969	.291	281	60,190	26.0	54.0	4	A
43	.22	.30968	.299	290	62,170	25.3	52.0	4	A
44	.22	.20970	.304	295	64,700	24.0	51.0	4	A
45	.17	.23976	.287	280	60,694	26.5	52.0	4	A
46	.18	.32978	.298	293	65,781	23.0	53.0	4	A
64	.16	.38980	.811	305	61,303	26.5	46.0	4	A
65	.16	.31983	.280	280	60,845	28.2	52.0	4	A
66	.18	.33990	.299	299	60,552	27.0	49.0	4	A
67	.15	.26980	.305	299	60,291	26.2	46.0	4	A
68	.14	.38979	.301	294	58,462	28.0	48.0	6	R
69	.18	.37980	.283	280	61,230	21.0	54.0	8	R
70	.16	.40978	.812	305	60,270	27.0	49.0	4	A
71	.20	.25980	.296	290	61,750	24.5	50.0	4	A
72	.19	.35978	.303	297	62,934	24.0	49.0	4	A
73	.20	.27979	.293	290	61,285	25.0	49.0	4	A
99	.15	.32974	.298	291	61,634	25.5	50.0	4	A
100	.15	.32976	.284	278	60,324	25.5	53.0	4	A
107	.22	.38976	.301	294	61,750	26.0	50.0	4	A
110	.21	.45976	.293	286	66,513	24.5	52.0	4	A
111	.22	.17981	.303	298	63,281	24.0	52.0	4	A
112	.17	.46963	.281	271	62,263	27.0	50.0	4	A
113	.15	.45982	.297	293	60,797	25.5	48.0	4	A
114	.18	.39979	.300	294	62,174	26.5	46.0	4	A
115	.17	.36968	.277	268	63,329	25.2	52.0	4	A
116	.16	.34991	.306	304	60,269	25.3	47.0	4	A
117	.14	.39987	.275	271	60,088	27.0	50.0	4	A
118	.15	.39978	.285	279	62,948	28.0	50.0	4	A
119	.17	.23977	.308	302	60,695	26.5	50.0	4	A
120	.15	.27980	.287	281	60,697	26.5	50.0	4	A
176	.16	.46974	.290	281	64,368	24.2	57.0	4	A
178	.17	.43975	.308	300	60,337	24.3	49.0	4	A
180	.22	.47967	.296	283	63,041	23.5	51.0	4	A
181	.20	.47969	.292	282	60,129	27.0	51.0	4	A
182	.18	.46965	.289	279	63,389	25.5	51.0	4	A
184	.19	.43980	.285	285	62,728	24.5	56.0	4	A
186	.12	.51986	.380	325	57,993	26.5	50.0	6	R
187	.17	.29989	.310	307	59,331	25.5	49.0	6	R
188	.15	.43988	.388	334	58,175	24.3	44.0	8	R
189	.19	.45991	.330	326	64,160	24.2	49.0	4	A
190	.13	.35986	.383	329	60,420	24.0	47.0	4	A

TABLE V.—Tensile tests, Norway steel—Continued.

Heat number.	Carbon.		Manganese.		Phosphorus.	Average original width.	Average original thickness.	Average original area.	Average ultimate tensile strength per square inch.	Average final elongation.	Average final area.	Number of tests.	Accepted or re-jected.
	Perct.	Perct.	Perct.	Perct.									
191	.19	.51				.973	.327	318	63,945	24.5	49.0	4	A.
192	.19	.49				.971	.344	333	62,418	26.0	48.0	4	A.
193	.14	.50				.971	.350	340	56,994	25.3	44.0	6	R.
195	.19	.43				.967	.366	354	62,841	26.0	50.0	4	A.
196	.13	.43				.964	.344	336	60,269	26.0	48.0	4	A.
199	.12	.51				.977	.332	324	62,456	24.0	55.0	4	A.
200	.13	.43				.976	.335	327	62,543	21.5	52.0	4	R.
201	.16	.55				.978	.339	332	60,168	27.0	48.0	4	A.
202	.18	.35				.978	.340	329	60,222	26.0	48.0	4	A.
205	.17	.47				.978	.345	337	61,625	27.0	48.0	4	A.
207	.19	.53				.961	.330	317	63,013	25.0	47.0	4	A.
211	.13	.35				.956	.336	321	62,318	24.3	48.0	4	A.
212	.19	.49				.960	.334	321	61,423	24.3	45.0	4	A.
215	.17	.39				.964	.333	320	60,500	24.5	46.0	4	A.
209	.19	.37				.978	.369	361	63,347	25.0	48.0	4	A.
270	.21	.44				.980	.374	367	64,219	26.0	58.0	4	A.
271	.16	.41				.974	.382	371	60,511	25.3	51.0	4	A.
272	.17	.39				.973	.335	325	65,699	25.3	46.0	4	A.
274	.14	.40				.963	.333	321	60,875	30.0	46.0	4	A.
275	.15	.31				.974	.330	321	61,450	27.0	46.0	4	A.
276	.15	.30				.971	.328	319	64,583	26.5	47.0	4	A.
282	.18	.61				.968	.336	323	66,819	26.2	48.0	4	A.
294	.20	.59				.976	.331	323	71,702	22.3	49.0	6	R.
301	.21	.36				.967	.325	324	62,436	26.0	47.0	4	A.
306	.19	.42				.989	.344	340	62,575	25.3	44.0	4	A.
314	.17	.50				.987	.336	332	64,960	22.2	48.0	8	R.
323	.18	.38				.977	.345	337	59,980	27.0	46.0	4	A.
325	.14	.40				.977	.339	331	60,475	28.0	47.0	4	A.
327	.20	.40				.977	.328	320	60,990	27.0	48.0	4	A.
328	.19	.32				.993	.329	327	59,379	26.0	47.0	6	R.
329	.17	.47				1.005	.331	332	66,761	23.5	49.0	4	A.
330	.14	.52				1.001	.326	326	61,350	26.0	48.0	4	A.
341	.13	.37				1.007	.321	323	58,939	26.3	47.0	6	R.
344	.18	.39				1.006	.343	344	61,279	25.0	45.0	4	A.
346	.18	.29				.997	.335	334	60,597	26.0	45.0	4	A.
348	.15	.35				.996	.339	338	61,946	25.5	46.0	4	A.
350	.15	.35				.990	.333	333	62,152	24.5	47.0	4	A.
351	.19	.47				.977	.339	331	64,403	24.5	46.0	4	A.
352	.18	.47				.977	.340	331	61,882	27.0	44.0	4	A.
356	.17	.45				.960	.340	333	63,222	25.3	48.0	4	A.
357	.19	.34				.980	.340	333	65,946	25.0	45.0	4	A.
359	.14	.44				.980	.336	329	59,608	26.3	47.0	8	R.
360	.16	.39				.978	.328	320	60,544	25.5	47.0	4	A.
362	.13	.33				.980	.333	327	61,811	25.0	45.3	4	A.
364	.19	.47				.991	.355	350	65,727	24.0	45.0	4	A.
368	.21	.45				.962	.342	336	65,152	26.5	47.5	4	A.
371	.27	.47				.976	.325	319	70,532	24.0	49.0	4	A.
372	.18	.34				.983	.343	337	58,311	28.3	45.5	6	R.
373	.19	.32				.985	.350	345	62,839	23.0	45.0	6	R.
376	.17	.42				.978	.335	327	60,617	24.5	47.5	4	A.
380	.15	.34				.983	.345	341	60,887	24.3	45.5	4	A.
381	.13	.39				.982	.346	340	60,740	23.5	45.0	4	A.
382	.14	.27				.984	.340	335	65,660	21.3	57.0	6	R.
383	.18	.31				.981	.340	334	64,142	23.5	50.0	4	A.
386	.15	.49				.985	.341	336	63,027	25.0	46.0	4	A.
389	.18	.49				.976	.328	320	60,097	27.0	46.0	4	A.
392	.19	.37				.750	.608	457	58,822	27.0	47.0	4	A.*
394	.20	.37				.977	.323	318	62,338	25.2	48.0	4	A.
395	.15	.22				.978	.336	328	58,200	25.0	47.0	6	R.
396	.19	.43				.973	.348	338	64,174	25.0	46.0	4	A.
397	.17	.53				.974	.343	334	58,627	28.0	46.0	8	R.
398	.18	.43				.962	.346	339	60,888	27.3	47.0	4	A.
399	.23	.39				.979	.347	339	65,508	25.0	46.0	4	A.
410	.13	.30				.750	.593	445	60,398	25.0	46.0	4	A.
421	.19	.45				.975	.338	330	63,935	25.5	47.0	4	A.
422	.16	.55				.978	.345	337	57,688	27.0	45.0	6	R.
423	.18	.40				.970	.348	338	56,570	28.0	43.0	6	R.
424	.20	.37				.981	.358	326	63,650	24.5	47.0	4	A.
425	.18	.39				.977	.323	315	62,071	27.0	48.0	4	A.
426	.18	.57				.972	.345	335	63,054	25.3	45.0	4	A.
428	.17	.26				.973	.338	329	56,886	28.5	45.0	6	R.

* Boiler metal.

TABLE V.—Tensile tests, Norway steel—Continued.

Heat number.	Carbon.		Phosphorus.	Average original width.	Average original thickness.	Average original area.	Average ultimate tensile strength per square inch.	Average final elongation.	Average final area.	Number of tests.	Accepted or rejected.
	Perct.	Perct.									
446	.19	.39		.972	.332	.324	63,609	26.0	47.0	4	A.
448	.23	.41		.966	.348	.336	62,378	25.0	44.0	4	A.
450	.19	.50		.970	.349	.339	62,150	28.5	44.0	6	A.
452	.19	.45		.981	.383	.376	60,231	30.0	39.0	4	A.
454	.14	.45		.979	.368	.360	61,951	25.0	43.0	4	A.
455	.26	.40		.980	.380	.373	66,839	25.0	43.0	4	A.
456	.18	.41		.976	.375	.366	65,471	20.3	64.0	6	R.
457	.19	.41		.978	.365	.357	65,762	23.5	57.0	4	A.
458	.18	.37		.970	.359	.352	62,321	24.3	49.0	4	A.
459	.19	.39		.976	.367	.357	59,707	27.0	43.0	4	A.
460	.23	.56		.980	.382	.375	63,267	25.0	58.0	4	A.
462	.21	.44		.982	.395	.388	62,255	25.0	51.0	4	A.
464	.18	.40		.986	.358	.354	60,056	27.0	44.0	4	A.
466	.24	.44		.985	.350	.344	62,253	28.0	44.0	4	A.
467	.19	.51		.983	.366	.352	60,658	26.3	44.0	4	A.
468	.23	.43		.988	.336	.333	60,100	27.0	44.0	4	A.
469	.22	.40		.983	.350	.344	61,555	25.2	44.0	4	A.
470	.28	.48		.976	.373	.364	62,581	27.0	42.0	4	A.
471	.18	.42		.978	.353	.345	60,550	25.0	43.0	4	A.
472	.19	.46		.974	.374	.364	60,800	27.5	48.0	4	A.
473	.22	.47		.981	.360	.357	61,905	23.5	43.0	4	A.
474	.18	.31		.983	.340	.338	67,448	28.3	45.0	6	R.
475	.17	.49		.987	.362	.361	63,492	27.0	42.0	4	R.
476	.19	.50		.985	.313	.313	64,280	24.0	50.0	4	A.
478	.20	.60		.992	.357	.354	65,208	25.3	45.0	4	A.
483	.19	.47		.985	.360	.358	66,765	24.0	52.0	4	A.
495	.16	.48		.985	.360	.359	60,045	27.0	42.0	4	A.
496	.18	.52		.983	.361	.359	64,936	24.5	46.0	4	A.
497	.20	.44		.984	.382	.381	61,359	27.0	40.0	4	A.
498	.20	.39		.991	.366	.364	63,925	25.5	44.0	4	A.
499	.21	.51		.990	.367	.363	66,948	23.3	49.0	4	A.
500	.22	.54		.994	.366	.363	72,666	23.2	45.0	4	A.
501	.19	.50		.992	.379	.376	61,961	24.0	42.0	4	A.
502	.21	.55		.985	.364	.358	62,258	24.3	43.0	4	A.
503	.20	.44		.986	.298	.294	69,432	17.0	52.0	6	R.
505	.20	.51		.981	.337	.330	64,944	25.0	47.0	4	A.
506	.20	.58		.983	.356	.350	63,401	20.5	45.0	4	A.
507	.19	.64		.981	.337	.331	63,146	24.0	46.0	4	A.
508	.18	.45		.988	.346	.342	62,008	25.0	46.0	4	A.
509	.13	.46		.983	.313	.307	60,334	25.3	50.0	4	A.
510	.18	.53		.982	.341	.335	60,800	26.0	45.0	4	A.
511	.18	.40		.991	.364	.360	60,341	27.0	43.0	4	A.
512	.19	.47		.987	.325	.322	61,709	25.0	48.0	4	A.
515	.18	.45		.982	.342	.338	61,285	26.5	46.0	4	A.
519	.19	.42		.975	.357	.348	63,481	26.0	44.0	4	A.
520	.18	.50		.981	.347	.341	62,949	25.5	47.0	4	A.
524	.18	.55		.975	.346	.338	65,437	25.0	47.0	4	A.
526	.19	.39		.976	.330	.323	66,041	25.5	46.0	4	A.
658	.17	.43		.971	.420	.399	62,724	23.4	57.0	6	R.*
659	.18	.29		.973	.407	.396	60,193	28.7	52.0	4	A.
660	.15	.36		.975	.401	.392	60,552	25.0	51.0	4	A.
661	.18	.39		.977	.429	.419	61,781	25.2	50.0	4	A.
662	.11	.41		.975	.409	.398	61,442	25.5	53.0	4	A.
663	.18	.31		.968	.428	.414	56,506	24.3	52.0	6	R.
664	.11	.34		1.005	.400	.402	58,271	20.2	51.0	4	A.
665	.15	.41		1.060	.409	.433	56,448	27.5	50.0	6	R.
666	.16	.30		.969	.418	.418	58,710	27.5	51.0	4	A.
667	.11	.34		1.010	.397	.401	67,617	28.5	46.0	4	A.
668	.17	.40		1.022	.395	.403	61,744	28.2	53.0	4	A.
676	.16	.42		.969	.418	.405	62,500	27.8	50.0	4	A.
677	.14	.34		.969	.394	.391	58,950	28.0	50.0	4	A.
678	.12	.36		.972	.390	.379	58,080	26.0	51.0	4	A.
679	.12	.43		.970	.420	.407	56,334	25.5	50.0	6	R.

* Rejected for boiler metal.

BLACK DIAMOND STEEL.—PARK, BRO. & CO.

(Inspectors, Passed Assistant Engineer E. A. Magee and Assistant Engineer L. D. Miner, U. S. N.)

The material to be supplied consisted entirely of ship-plate, and was produced by the Siemens-Martin process in two 14-ton furnaces. The erection of these furnaces was commenced August 18, 1879, by Messrs. William Swindell & Bros., of Pittsburgh, the first cast being made in 1880. They were subsequently enlarged to 12 tons capacity, and finally, in September, 1883, to 14 tons each. They stand side by side in one pit of 33 feet and 25 feet semi-diameters, and are served by a single ladle, of 15 tons capacity, operated by a hydraulic crane in the center of the pit. The furnaces are 29 feet 7 inches long by 10 feet 1½ inches wide by 10 feet 8½ inches high over all, while the hearth measures 13 feet 6 inches by 10 feet 10½ inches.

Coal-gas was supplied by Siemens producers until February 25, 1884, since which time natural gas, led 18 miles by pipe from Murraysville, Pa., has been used at a pressure of 1 pound to the square inch. It may be interesting to state that its composition varies as follows:

	Per cent.
Marsh gas (CH ₄).....	42 to 88
Hydrogen	10 to 39

with carbonic acid (CO₂), carbonic oxide (CO), olefant gas (C₂H₄), and nitrogen in smaller and variable quantities. This gas is admitted cold at the ports of the furnace, the regenerators being used for the air only. It cannot be preheated, on account of the carbon thrown down from the marsh gas depositing itself in a hard layer on the checker-work, gradually clogging it. Nevertheless, it seems probable that the high proportion of hydrogen in the fuel ought, with proper management, to diminish the amount of oxidation in the bath and give a better quality of product, by affording higher temperature with the same amount of air than when ordinary producer-gas is used. No trouble is experienced from variations in its composition, and its use gives general satisfaction and results in a considerable saving in the cost of labor and fuel.

The charge for the mild steel supplied under the Board's inspection consisted of Ridgeway pig from Scotland, containing about 3¼ per cent. of silicon and .03 per cent of phosphorus; charcoal-blooms from Chateaugay, Franklin County, New York, containing .015 to .03 per cent. of silicon and .008 to .02 per cent. of phosphorus, with traces of sulphur—these blooms form the bulk of the charge—; steel scrap from plates of this quality, ferro-manganese, generally from Terrenoire, France, and containing 70 to 85 per cent. of manganese and .2 to .3 per cent. of phosphorus. The materials were all charged cold.

Experimental heats were made, using puddled bars from Ridgeway pig. The resulting steel was very soft, giving only 59,000 pounds tensile strength, with .16 per cent. of carbon and .28 per cent. of manganese.

As illustrative of good practice it may be stated that, in addition to those mentioned above, the following materials are used for making other grades of steel than that supplied under this inspection:—Puddle bar; old molds made of Bessemer iron, so that when worn out they may be broken up and used in the steel furnace; spiegeleisen from Northern Germany or the Edgar Thomson Steel Works at Braddock, Pa., and containing 4 to 5 per cent. of carbon, 12 to 20 per cent. of manganese, .5 to 4 per cent. of silicon, .14 to .20 per cent. of phosphorus; red

hematite iron ore from the mines of the Republic Iron Ore Company, Northern Michigan, and containing 64 to 68 per cent. of iron, 2.86 per cent. (or less) of silica, and .03 to .04 per cent. of phosphorus.

It is believed that the proportion of scrap and bloom to pig is always large, so that, although decarburization is assisted by the use of ore in small quantity, the process remains more the "pig and scrap" than the "pig and ore."

The average weight of seventeen heats of metal made under this contract was 27,546 pounds; average time from charging to tapping seven hours, making about fifteen heats from each furnace weekly. Ferro-manganese was added to the bath before tapping.

The size and shape of ingot vary with the plate to be produced, the shape being an approximate parallelepiped, with a taper of one in 60 for stripping, and are different for top and bottom cast. For top cast the molds are 12 by 16 inches at the top and 60 inches high; for bottom cast, a set of molds giving ingots 7 inches thick and 50 inches high by widths varying by 2-inch increments from 18 to 36 inches; also 10 by 24 by 50 inches and 10 by 30 by 50 inches. For bottom cast eight molds are grouped together, with central runner, on a base plate 6 feet 8 inches in diameter.

The inspector reports that it is not thought to effect the quality of the steel whether top or bottom cast is used. Large plates are, however, bottom-poured, and are finished at one heat at the rolls. Lighter plates are top-cast, the ingots worked under the hammer into slabs 6 inches thick and of other dimensions to suit the size of plate, reheated and finished. The hammers used are a 17-ton and a 5½-ton, made by Messrs. Wm. Bement & Sons, Philadelphia, 40 and 26 inches diameter, and 9 and 5½ feet stroke, and strike a blow of 90 and 25 tons, respectively, using steam of 90 to 100 pounds pressure by gauge. With the larger hammer, it is said an average of 40 tons of ingots can be converted into slabs every twenty-four hours.

Two plate-mills are in use. The smaller is an 86 by 26 inch mill with three two-high housings, one cogging and two finishing. It can take an ingot 7 inches thick.

The larger mill is of new pattern and has only been in operation since June 28, 1884. It is a 115-inch three-high mill, with top and bottom rolls 32 inches in diameter and center roll 20 inches. It can take an ingot 15 inches thick and roll plates up to 112 inches width down to $\frac{1}{8}$ inch thick, and of length only controlled by the size of furnaces and facilities for handling, the weight of ingot being limited to 4,500 pounds.

The mill shears have 94-inch knives and can cut plates up to 1 inch thick.

The testing-machine used was a Riehlé hydraulic of 50,000 pounds capacity and similar in all respects to that described as in use at the Norway Steel and Iron Works, and illustrated by Fig. 6. It gave considerable trouble from leakage. Pieces for tensile test were straightened cold as left by the shears and cut out in a shaping-machine. They were measured for original width and thickness near each witness mark and in the middle, and a mean taken. Measurements for thickness of fractured area were made at one edge and in the center by sighting with a scale divided into hundredths of an inch, and the mean taken; and the width was similarly measured, the possible error in final area being perhaps as great as 2 per cent. of the original area.

The pieces for quenching test were inserted in a furnace, bent as they came from the shears, brought to the required temperature, removed

and straightened, and plunged into water. The furnace was generally black, with a smoky flame in contact with the pieces. After hardening they were bent in a form under a steam-hammer to an included angle of about 120°, then around another form to about 20°, and finally directly under the hammer to the required curvature.

Considerable trouble was experienced from this test, which may have arisen from the pieces being heated for some time in contact with a smoky flame, occasionally high in impurities, readily absorbed at the surface of the metal. The irregularities of edge produced by shears are also often of such a kind, depending on the condition of the knives, as to make the piece peculiarly liable to tear from the sheared edges, and if there be any surface brittleness, fracture may be rapid with crystalline surfaces. In such a case, as here, better results would be obtained if the edges were smoothed off with a fine file, as allowed, and the heating done with a clear fire, the flame, if possible, being kept off the pieces.

The exact amount of material rejected on this test cannot be obtained, as it was not convenient to weigh any plates but those to be shipped.

No chemical information accompanies the record of test.

The total number of heats tested to September 1, 1884, was 65, of which 9, or 13.8 per cent., were rejected on the tensile tests. Of the 56 accepted heats the average tensile strength was 63,125 pounds per square inch, with a corresponding average ductility of 25.83 per cent. in 8 inches. Of the material so accepted 287.4 tons were delivered at the ship-yard up to September 1, 1884, while about 24 tons,* or 8.35 per cent., of the amount delivered failed on the quenching test.

The following table gives the result of tensile tests in the order of heats:

TABLE VI.—Tensile tests, Black Diamond steel.

Heat number.	Carbon.		Phosphorus.	Average original width.	Average original thickness.	Average original area.	Average ultimate tensile strength per square inch.	Average final elongation.	Average final area.	Number of tests.	Accepted or rejected.
	Pr. ct.	Pr. ct.									
280	1.250	297	.371	66,390	26.70	45.8	4	A.			
400	1.000	583	.583	64,815	24.37	50.0	4	A.			
412	1.017	610	.620	61,210	23.90	48.5	4	A.			
436	1.007	611	.611	61,177	23.60	50.0	4	A.			
437	1.242	286	.355	63,765	25.20	49.6	4	A.			
438	1.250	414	.517	61,587	24.50	48.7	4	A.			
452	1.005	595	.598	66,072	23.30	50.7	4	A.			
454	1.238	411	.508	61,665	24.80	48.3	4	A.			
456	1.262	402	.507	68,660	23.00	50.0	4	A.			
458	.997	600	.600	61,332	24.15	50.3	4	A.			
478	1.247	293	.365	72,485	24.60	50.0	4	A.			
482	1.261	467	.588	67,907	25.40	52.5	4	A.			
486	1.245	411	.511	64,460	26.20	48.0	4	A.			
492	1.243	412	.507	64,582	25.60	48.0	4	A.			
500	1.241	276	.356	62,452	25.80	45.8	4	A.			
513	1.253	294	.368	63,740	24.70	45.8	4	A.			
520	1.263	279	.352	60,642	26.31	43.0	4	A.			
545	1.262	352	.444	60,270	27.60	42.5	4	A.			
571	1.263	231	.291	60,605	24.74	47.2	4	A.			
581	1.272	348	.442	62,675	24.15	47.9	4	A.			
594	1.222	462	.564	62,195	26.00	52.3	4	A.			
597	1.238	463	.573	61,015	27.30	44.0	4	A.			
601	1.264	350	.442	65,772	20.78	50.5	4	R.			

*This amount is not accurate, being obtained from the proportionate number of plates which failed, the individual weight of such plates not being reported.

TABLE VI.—Tensile tests, Black Diamond steel.

Heat number.	Carbon.			Manganese.			Phosphorus.			Average original width.	Average original thickness.	Average original area.	Average ultimate tensile strength per square inch.	Average final elongation.	Average final area.	Number of tests.	Accepted or rejected.
	Pr. ct.	Pr. ct.	Pr. ct.	Inches.	Inches.	Sq. inch.	Pounds.	Per ct.	Per ct.								
606				1.263	.462	.583	64,435	24.90	48.8	4	A.						
610				1.235	.435	.537	64,430	26.52	47.4	4	A.						
612				1.265	.414	.523	69,115	23.06	53.0	4	A.						
616				1.233	.474	.584	59,460	28.46	45.1	4	A.						
638				1.268	.425	.538	64,537	26.03	48.9	4	A.						
640				1.257	.400	.603	64,740	26.91	47.8	4	A.						
642				1.254	.476	.596	63,227	26.28	47.0	4	A.						
681				1.257	.359	.451	61,545	22.21	43.0	4	A.						
684				1.251	.444	.605	62,290	25.62	51.0	4	A.						
696				1.254	.417	.522	62,665	27.21	47.0	4	A.						
703				1.249	.474	.592	63,352	23.77	47.9	4	A.						
712				1.259	.361	.454	62,755	25.99	46.0	4	A.						
716				1.014	.517	.324	60,962	23.78	43.0	4	†						
719				1.271	.504	.640	62,997	26.75	45.8	4	A.						
721				1.243	.492	.611	63,062	26.56	52.5	4	A.						
728				1.060	.541	.541	62,200	26.25	44.0	4	A.						
745				1.017	.577	.586	61,510	25.62	48.0	4	A.						
794				1.012	.529	.535	59,575	27.78	45.0	4	A.						
801				1.226	.467	.572	60,550	28.93	45.0	4	A.						
805				.970	.517	.501	63,795	28.30	43.0	4	A.						
814				.998	.516	.514	59,445	24.84	46.5	4	A.						
837				1.016	.529	.537	61,800	23.30	47.0	4	†						
841				1.028	.525	.540	60,640	27.29	45.9	4	A.						
843				1.006	.532	.536	59,090	26.40	42.9	8	A.						
862				1.005	.578	.581	58,917	29.23	43.2	4	A.						
881				1.011	.582	.589	62,682	25.65	47.1	4	A.						
888				1.227	.287	.351	64,402	22.99	46.4	4	A.						
891				1.008	.542	.546	62,697	26.57	48.7	4	A.						
922				1.253	.282	.353	62,955	27.03	47.0	4	A.						
923				1.253	.328	.411	61,575	28.96	44.3	4	A.						
924				.979	.693	.679	60,386	26.93	43.6	4	A.						
925				1.224	.240	.291	66,325	23.64	46.3	4	A.						
926				1.224	.282	.337	66,826	25.97	46.6	4	A.						
929				.991	.679	.674	59,835	27.24	42.7	4	A.						
930				1.225	.467	.572	58,070	29.80	39.9	4	A.						
937				1.227	.238	.293	65,002	26.65	46.9	4	A.						
942				1.254	.226	.284	62,062	24.15	43.6	4	A.						
951				1.243	.281	.351	63,932	25.67	46.3	4	A.						
954				1.243	.470	.585	60,742	27.22	45.8	4	A.						
1003				1.260	.369	.466	61,840	28.19	44.0	4	A.						
1004				1.262	.290	.369	63,655	23.64	47.1	4	A.						

* Annealed.

† One piece gave 20 per cent. elongation.

‡ One piece gave 14 per cent. elongation.

SUMMARY.

Number of heats.	Material.	Average original area.		Average ultimate tensile strength per square inch.		Average final elongation.		Average final area.		Number of tests.
		Sq. in.	Pounds.	Per ct.	Per ct.					
56	Accepted4998	63,125	25.83	47.16	233				
5	Rejected for lack of ductility4611	62,896	22.61	46.00	29				
3	Rejected for lack of tensile strength5759	58,812	29.16	43.10	12				
1	Rejected for lack of tensile strength and ductility8530	58,222	20.84	42.50	4				

CAMBRIA STEEL.

(Inspectors, Assistant Naval Constructor R. Gatewood and Assistant Engineer B. C. Bryan, U. S. N.)

The contract for all the angles, tees, and deck-beams (to which flat bars for edge strips were afterwards added), in amount between one and two thousand tons, required under this inspection, was given by the ship-building contractor to the Phoenix Iron Company of Philadelphia, with works at Phoenixville, Pa. Subcontract was entered into by this company with the Cambria Iron Company, Works at Johnstown, Pa., for the desired amount of material in blooms of required sizes, delivered at Phoenixville, and of such quality as to satisfy the former company that the finished material would meet the requirements. Accordingly, nineteen heats, from 4121 to 4286, inclusive, were first tested by the Phoenix Iron Company's inspector, samples being taken from a flat bar $2\frac{7}{8}$ inches by $\frac{5}{8}$ inch, for tensile strength and ductility, and for hardening qualities by the quenching test. The results of these tests are given in the table, p. 434, in comparison with the tests subsequently made on the finished material of the same heats. All heats subsequent to 4286, and including No. 4285, were tested at the Cambria Iron and Steel Works, under the Board's instructions of October 8 (pp. 399 and 400), the Government inspector accepting or rejecting heats to the Phoenix Iron Company's inspector, under the tensile tests, and the latter, after making a preliminary quenching test, notifying the Cambria Iron Company of the final acceptance or rejection of each heat. The first three heats so tested, 4285, 4301, and 4309, being intended partly for 7-inch deck beams, the test pieces were taken from plates 12 inches wide by $\frac{7}{8}$ inch thick. For convenience, a flat 6 inches by $\frac{7}{8}$ inch was afterwards taken for test in all cases (with a few accidental exceptions of thicker flats of the same width), as representing the average amount of work on the shapes required, the harder heats being preferably worked into blooms for deck beams, which have less work of reduction than the test piece.

The steel was made by the Siemens, or "pig, scrap, and ore," process—though in some of the heats little or no scrap was used—in two fifteen-ton Pernot revolving furnaces, with 16-foot pans, erected in 1878-'79. These furnaces, with a twelve-ton furnace with 14½-foot pan, now used for dephosphorizing pig-iron by the Krupp washer process, stand in line under one roof, and with charging platform at the same level on the opposite side from the pit, and so high that the tops of the regenerators, which are directly beneath the bearing platform, are four or five feet above the floor level. To each of the larger furnaces there is a separate circular pit sunk 5 feet below the floor level and supplied by independent hydraulic cranes, while a 25-ton Sellers steam crane serves for general purposes, and especially in connection with the washer furnace and its pig bed. Heating furnaces at the rear of the charging platform serve to preheat the pig for the charge. The scrap is charged cold. Gas is supplied by four Siemens producers to each furnace. A hydraulic lift supplies material for the charge and for the cupolas connected with the washing furnace.

The composition of the charges varied widely, except for heats 5216, 5219, 5220, 5221, 5253, and 5255, which consisted entirely of washed metal and hematite ore, and are comparatively low in phosphorus

(below .05 per cent.). There is nothing noteworthy in their tensile tests except an appreciable fall of the elastic limit.

An average of five ingots of 5,500 pounds each was obtained from each heat. The time from charging to tapping was eight hours.

Ferro-manganese was added before tapping, and the bath was then rabbled while the hearth revolved, insuring perfect homogeneity in this respect.

The ingots were all top cast and of uniform pattern, being 14 inches square at the top and $18\frac{1}{2}$ inches at the bottom, with corner fillets, and weighing 5,500 pounds each. One ingot of each heat was rolled down in the blooming mill as soon as possible after stripping, and two test billets removed, hammered down to slabs about 3 inches thick, reheated, and rolled down to 6-inch by $\frac{7}{8}$ -inch flats. The remaining ingots were allowed to cool off completely while awaiting the results of the tests, which being reported satisfactory, they were charged in gas furnaces, of which eight, with an aggregate capacity for sixty-four ingots, are worked in connection with the blooming mill.

The blooming train is two high, with collared rolls 40 inches in diameter, and is driven by a reversing engine with two cylinders 40 inches in diameter and 48 inches stroke, working at 90 revolutions, and geared to the roll train 3 to 1. Half the weight of the upper roll is supported by steelyards in the pit, and its height is controlled by screws worked by hydraulic cylinders, one on each housing, thus allowing several passes through each groove. Hydraulic jaws turn the ingot on the table on each side and direct it to the proper groove.

This mill blooms down to 7 by 7 inches, supplying, of course, unnumbered intermediate sizes. Blooms, of whatever final size, are cut to weight here by hydraulic shears, with due allowance for subsequent heating and rolling. A $2\frac{1}{2}$ ton steam-hammer, used for hot chipping, stands opposite to the shears.

The foundations for a new 48 inch blooming mill are complete, but its erection will probably not be proceeded with until the decision of Congress with regard to the establishment of a gun foundry, when certain alterations in the mill would render it useful in the manufacture of gun material, and especially of armor plate. Twelve Ggers soaking pits, which keep the ingot at a high temperature by its own heat in cooling in a non-conducting chamber, are placed back of the blooming mill, and have been used intermittently with little success, being too far from the Bessemer house to allow that certainty in handling necessary for working the pits alone without holding the furnaces in reserve for accident.

With the exception of blooms for 7, 8, and 9 inch deck beams, and 5 by 4 inch and 6 by $3\frac{1}{2}$ inch angles, all blooms, after coming from the blooming mill, were reheated and rolled down in a 21-inch three-high mill, to the sizes as under:

Finished shape.	Corresponding size of bloom.
2 by 2 inch angles and under.....	3 by 3 inches.
$2\frac{1}{2}$ by $2\frac{1}{2}$ inches	5 by 3 inches and $6\frac{1}{2}$ by 5 inches.
$2\frac{1}{2}$ by $2\frac{1}{2}$ inches to 5 by 4 inches	$6\frac{1}{2}$ by 5 inches.
5 by 4 inches and 6 by $3\frac{1}{2}$ inches.....	8 by 4 inches (hammered).
6-inch deck beams	$6\frac{1}{2}$ by 5 inches.
7, 8, and 9 inch deck beams.....	$7\frac{1}{2}$ by 7 inches.

The blooms were shipped under the inspection of the Phoenix Iron Company's inspector, and while the larger flaws had been chipped under

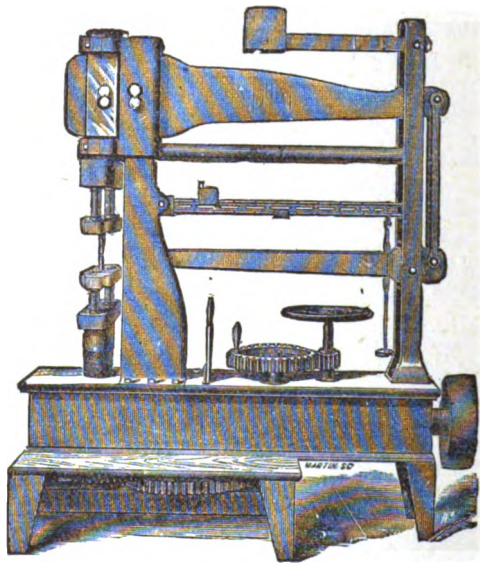

FIG. 7.—100,000 lbs. Gill Screw-Testing Machine used at Cambria Iron Works.

the hammer from the hot 7 by 7 bloom at the blooming mill, flaws in the cold blooms were chipped when considered necessary down to the solid metal.

At the Phoenix Iron Works angles of $2\frac{1}{2}$ by $2\frac{1}{2}$ inches and larger, and all tees and deck beams were rolled on a 20-inch three-high train, driven by a Corliss vertical tandem compound engine using steam of from 60 to 90 pounds pressure. For the deck beams a train of three sets was used, roughers, intermediates, and finishers, and the rolls were 22 inches from center to center, while stronger connections were fitted. The other shapes were rolled in two sets of rolls. This mill is served by four Siemens gas furnaces with aggregate capacity of 48 blooms of ordinary size.

Angles smaller than $2\frac{1}{2}$ by $2\frac{1}{2}$ inches were rolled on a 13-inch three-high mill driven by a Corliss engine of design similar to that of the larger mill. It is served by two smaller gas furnaces.

Both Wilson's and Siemens' producers are used at these works, preferably the former, and fine "buckwheat" anthracite coal has for some time been successfully used.

Flats were rolled on a 10-inch two-high mill, the metal being heated in furnaces using solid fuel.

As this was the first steel rolled at these mills, considerable trouble was experienced at first from overheating the material, but very soon the men exhibited a preference to rolling steel over iron, on account of the greater amount which can be turned out in the same time.

The capacity of the 20-inch mill with strengthened connections being just equal to the manufacture of the 8 and 9 inch deck beams required, a 24-inch mill is now in course of erection with capacity for the largest deck beams, and probably 15-inch I-beams. When it is considered that a 23-inch mill is considered necessary to roll a T-rail $4\frac{1}{2}$ inches high with a 4-inch flange, it appears quite a feat in the art of rolling to have made 9-inch deck beams over 50 feet long at one heat on a mill 3 inches smaller.

Testing at Johnstown.—Producing many grades of steel, from wire-stock and boiler and bridge metal through the grades for rails and the parts of agricultural implements up to the higher spring steels, the Cambria Iron Company has for some time been systematically testing each heat and blow. The testing laboratory is correspondingly well equipped, and the report of physical tests of steel supplied is complete, and, as latterly made, gives as much information from a single test as can well be obtained in the limited time. The laboratory is supplied with two testing-machines, a large horizontal Riehle of old pattern with a capacity of 150,000 pounds, worked by hand, and used chiefly for grading the Bessemer blows, and a Gill machine of 100,000 pounds capacity, worked by belt and gearing from a small vertical boiler and engine in the testing-room, and used for testing wire-stock (Bessemer and open-hearth), boiler, ship, and bridge material, spring steels, and the open hearth product generally. In this machine (see Fig. 7), the motion of the lower cross-head or wedge-block is given by a vertical screw of large diameter and fine pitch, moving in a nut turned by gearing from a shaft within the framework. This shaft revolves either by gearing from a hand-wheel for small motions, or through paper-faced friction-cones by belt and gearing from the engine. The load upon the test piece is transferred by the upper wedge-block to a lever at the top of the machine, and thence, through the lower lever shown in the cut, to the beam-arm. The load is gauged by a system of weights hanging by a stirrup from the end of the beam-arm, and giving increments of 10,000 pounds for each weight

added, a second weight sliding on the top of beam-arm gauging up to 10,000 pounds by increments of 1,000 pounds, while the jockey-weight, sliding on the under side of the arm, gauges to 1,000 pounds by increments of 10 pounds. The machine was well made and the beam-arm very sensitive. One advantage which this, in common with all screw-machines, has over the hydraulic machines, is that any failure to hold up a load once applied is due entirely to the yielding of the test-piece, and not to leakage of valves, so common in hydraulic machines. This renders observations for modulus of elasticity on the short test piece much more reliable by keeping the stress perfectly constant, and further allows the principal elastic limit (see p. 498) to be accurately obtained from the behavior of the beam-arm. The wedges are flat and single, that is, no liners are used, and are connected in pairs by sliding bars in the sides, which, with finger-holes near the top of the upper pair of wedges, enables this pair to be handled together, while the lower pair always remain in the wedge-block.

The tensile test pieces were cut out by a slotting-machine and were fairly well shaped. The measurements of the test piece were made by a special sliding micrometer-gauge—measuring to $\frac{1}{10000}$ th of an inch and tested for accuracy—to which the test-piece is brought, and the inspector reports that this is at once quicker and more accurate than measuring with the small portable gauges. The measured length, with intermediate inches when desired, was scrued in with the notched gauge described (p. 459), which, or a similar one, with vernier, was used for measuring elongations, reading off in per cent. directly.

Observations for stretch under stress below the elastic limit, whence the modulus of elasticity is obtained, were made by one of Olsen's electric contact micrometer-gauges (Plate IX.), reading to the $\frac{1}{10000}$ th of an inch. This instrument, though working well with rounds and squares, was not well suited for flat bars, in not affording proper bearings at the clamps, thus causing the arms to tip irregularly and not return exactly to the original reading on removing the stress. This may have been partially due to the fact that the initial stresses 30,000 and 35,000 pounds per square inch were somewhat higher than generally used in obtaining the modulus. These results, the only ones of the kind obtained during this inspection, are considered on page 502.

What may be called the principal elastic limit, or the point at which the strain becomes altogether disproportionate to the stress (see p. 498), was accurately noted in all tests made at Johnstown, and is contained in the tables, besides being plotted in average as a curve of carbon properties, the regularity of which is especially noticeable. In observing this quality, the cracking of the scale was always observed as complementary to the beam indications as described on page 497.

Measurements for final area were made by bringing the fractured piece to the micrometer-gauge and measuring the least width and thickness; the latter on each edge and in the center. The mean of the three thicknesses was taken as the mean thickness.

Testing at Phoenixville.—The testing-machine at the Phoenix Iron Works was supplied by Messrs. Rieblé Bros. & Co., and is illustrated by Fig. 8. It is a hydraulic machine of 150,000 pounds' capacity, worked by hand-lever through a coarse and a fine pump, thus not supplying continuous motion to the wedge-block. The load is transmitted by a double-lever system to the beam-arm, which is supplied with an adjustable compensating weight. The primary scale has a tipping weight, and is notched every 2,000 pounds up to 150,000 pounds; the jockey-weight

PLATE IX.

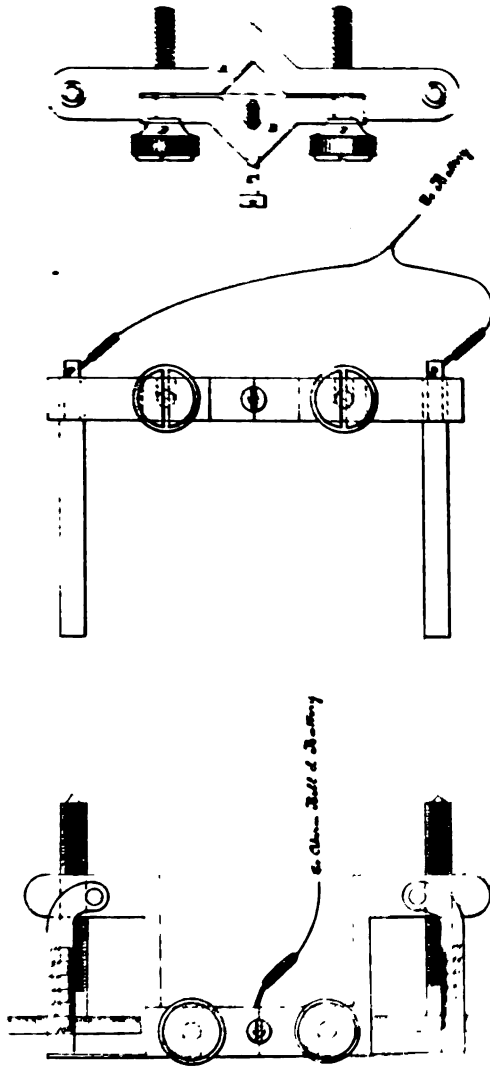

*Olsen Electric Contact Micrometer
used at the Cambria Iron Works.*

H Ext p3 v1 491

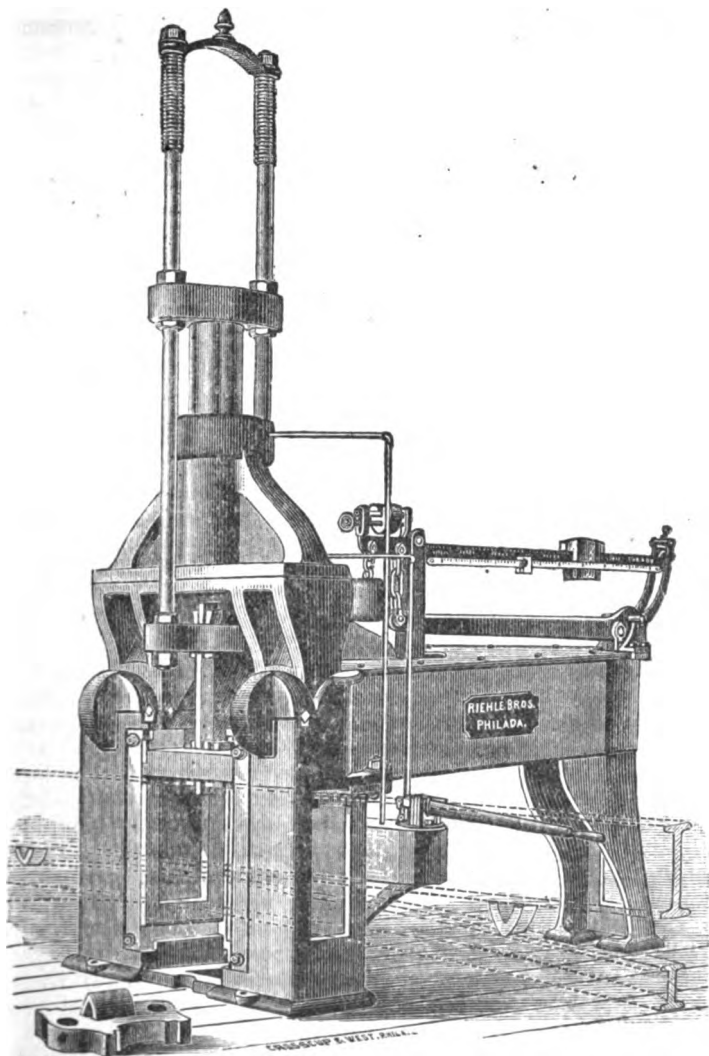

FIG. 8.—150,000 lbs. Riehlé Hydraulic Testing Machine used at Phoenix Iron Works.

DIMENSIONS.

Extreme height	11 ft.
Extreme length	8 "
Extreme width	5 "
Weight	10,735 lbs.

ADAPTATION.

Tensile specimens	12 in. to 4 ft.
Round "	2½ in. or less.
Square "	2 in. x 2 in.
Flat "	3¼ in. or less x 1 in. or less.
Transverse "	1 ft. to 4 ft.
Crushing "	2 ft. or less.
" surfaces	8 in. x 13 in.
Motion of plunger	18 in.

slides continuously on the side arm, which is divided by increments of 10 pounds up to 2,000 pounds.

The tensile test pieces were extremely well made, being cut out on a planing-machine by a careful workman. Measurements were made with a Prown & Sharp's screw-gauge of 1 inch gap and a sliding gauge of very fine workmanship. Here, as at Johnstown, the width and thickness of the specimen were measured at the middle of the length and near each witness mark, in order to find any defect of area at any one place sufficient to cause serious diminution of ductility. In measuring test pieces from the finished shapes, the thickness was obtained at equal distances from the two edges, on account of the taper in the thickness of angle flanges, &c. The fractured area was measured as at Johnstown, except that the gap-gauge was used.

The values of the principal elastic limit given in the tables for the finished material were obtained by noting the cracking of the scale on the piece, the beam indications with the slightly leaking valves not being reliable.

In making the quenching tests here, the pieces* were heated generally in a smith's forge with blast in a hollow fire, either roofed with wet coke or with a board laid over the top and covered with pressed coke. Sometimes they were heated in a small furnace burning soft coal. On one occasion about sixty pieces were placed five or six at a time on the top of a close anthracite fire under a small vertical shop boiler, being thus slowly heated to exactly the desired temperature and perfectly uniformly. All of these pieces failed to bend as required, some of them cracking all across with bright crystalline fracture at the first blow of the hammer and with no reduction at the fracture, while second pieces from the same bars heated as usual passed the test well. It is regretted that the cause of this behavior could not be exactly defined. It plainly consists in the surface absorption of some brittle making element from the fuel, most probably of sulphur, though it has been proposed that, the atmosphere surrounding the pieces being highly carbonaceous (the fire was dull, and the pieces were twenty to twenty-five minutes heating), the trouble might arise from a surface cementation or absorption of carbon itself. At all events this extreme case illustrates the well-known necessity of using pure fuel in heating, and especially in making expensive flangings, and points to a possible solution of some of the inexplicable fractures of such plates, while it conclusively shows that the circumstances of making this apparently simple hardening test need some attention.

A moderate blast was used in heating afterwards, and anything like a smoky fire avoided, with a very small proportion of failures.†

The pieces for this test were bent by a fuller under a small steam hammer in a hexagon form (used for shaping nuts) to an included angle of 60°, and then closed under the hammer tup to the desired extent.

* The pieces for quenching tests were always the crop-ends of bars, and were generally removed by the hot saw at the rolls. In the event of failure a second piece was taken from the perfectly sound bar.

† It may also be mentioned in this connection that the pieces of the finished material at Phoenixville behaved very much better under the test than pieces of the same heat tested at Johnstown by the Phoenix Iron Company's inspector, though the former had a rough-sheared edge, the corners only being slightly smoothed, while the latter were planed out. The pieces tested at Johnstown were generally heated in the gas-preheating furnace back of the open-hearth steel furnaces, and in an atmosphere of course as little oxidizing as possible. The only essential differences in physical condition were the hammering from 7 by 7 inch bloom to a 3-inch slab at Johnstown and one less heating than in most of the finished material.

The total number of heats tested by the Government inspector up to September 1, 1884, is 152, of which 19, or 12.5 per cent., were rejected, including three which, after passing the tensile tests, were rejected by the Phoenix Iron Company's inspector at Johnstown on his preliminary quenching test. Of the 133 accepted heats the average tensile strength was 64,020 pounds per square inch, with a corresponding average ductility of 25.52 per cent. in 8 inches. A complete summary of the results of the tensile tests is given on page 441. Of the material so accepted, 1,053 tons were delivered at the ship-yard up to September 1, 1884, while 3.41 tons, or .324 per cent., of the amount delivered was rejected on the quenching test, and 4.09 tons, or .388 per cent., on the quenching and cold tests. Particulars of these tests will be found in the general summary, p. 442.

Sufficient chemical information accompanies the report of tests to enable the curve of carbon properties (p. 556) to be constructed, illustrating the average behavior of this material under the tensile tests.

The chemical methods in use at the Cambria Iron Works for the soft steels are—for carbon, the color test; for manganese, the acetate of soda and bromine process; for phosphorus, the molybdate of ammonia process. Weighing the yellow precipitate after drying always for the same time at the same temperature. The piece for chemical test was always chipped from the bloom when cut to length at the blooming-mill.

The average carbon of accepted heats was .16 $\frac{1}{2}$ per cent.; average phosphorus for 17 heats, .0875 per cent.; average manganese for 50 heats, .443 per cent. This steel carries considerably higher phosphorus and manganese than that shipped by any of the other works, yet with no injurious results. It is to be remembered, however, that it was made by a different process.

Table VII. gives the results of all tensile tests made on the finished material at the Phoenix Iron Works. Lot 1 consisted of eight bars from Bessemer blooms ordered from the Pittsburgh Steel Casting Company, and is seen to be of very fine quality. The bar marked SP2 is one from two experimental blooms ordered from the Pennsylvania Steel Company, Steelton, Pa., and was of too soft material. Analysis gave C=.08, Mn=.0387, P=.044. Lots 18 and 23 are of Cambria Bessemer steel, giving the very excellent average of 66,148 pounds tensile strength with 24.98 per cent. ductility.

It may be remarked that notwithstanding the excellent tests obtained from Bessemer steel, the Phoenix Iron Company preferred to pay more for open-hearth blooms.

Piece 25 I, which gave the very fine result of 62,513 pounds tensile strength, with a final stretch of 30 $\frac{1}{2}$ per cent., upon subsequent special analysis gave C=.155, Mn=.534, P=.089, showing no peculiarity, the manganese alone being somewhat above the average.*

The figures for the chemical elements in the table are as supplied by the manufacturer, from analysis of a chipping from a bloom of the heat.

* Borings for this analysis were taken from that part of the piece which had necked as fracture.

TABLE VII.—Cambria steel. Tensile tests of finished material.

Heat.	Carbon.	Manganese.	Marks.	Original width.	Original thickness.	Sectional area.	Elastic limit per square inch.	Ultimate tensile strength per square inch.	Final elongation in 8 inches.	Final width of original thickness.	Final thickness of original thickness.	Final area of original area.	Time of test.	Size of bar tested.	Nature of steel and remarks.
S 1			A	1.260	.360	4.138		67,359	54.56	Per ct. 72.2	Per ct. 64.0	Per ct. 46.24	16	4 by 3 inch angle	Bessemer steel supplied by Pittsburgh Steel Casting Company. Bessemer steel supplied by Pennsylvania Steel Company. Heat unknown. Cambria O. H. Steel.
S 2			B	1.270	.380	4,823		64,865	54.38	74.9	67.6	56.61	14	do	
S 3			C	1.245	.327	4,088		62,860	51.31	72.3	64.3	46.41	15	do	
S 4			D	1.245	.327	4,088		62,753	51.63	71.5	64.2	45.87	12 1/2	do	
S 5			E	1.246	.340	4,236		63,136	51.80	72.4	63.3	47.95	15	do	
S 6			F	1.252	.339	4,214		63,386	52.80	72.8	63.8	50.86	13 1/2	do	
S 7			G	1.258	.310	4,083		63,625	52.62	73.5	64.6	47.51	12 1/2	do	
S 8			H	1.265	.318	3,985		63,160	52.83	73.3	65.0	47.64	13 1/2	do	
S 9			I	1.243	.322	4,002		63,442	51.62	76.3	71.3	64.38	15	do	
S 10			J	1.242	.318	3,949		63,652	52.40	72.5	62.9	47.57	14 1/2	do	
S 11			K	1.241	.318	3,946		63,217	52.08	72.5	60.8	44.08	14	do	
S 12			L	1.252	.327	4,094		63,217	52.08	73.9	68.1	61.06	15	do	
S 13			M	1.246	.306	3,813		64,254	50.94	74.1	69.3	51.32	14 1/2	do	
S 14			N	1.253	.315	3,947		64,479	52.27	72.3	69.8	51.22	14	do	
S 15			O	1.256	.315	4,148		67,838	52.40	77.4	71.2	63.13	16 1/2	do	
S 16			P	1.241	.318	3,883		63,830	54.38	74.1	64.8	48.00	14	do	
S 17			Q	1.236	.318	3,930		62,586	56.50	72.8	62.9	48.90	13	do	
S 18			R	1.221	.322	3,932		61,600	56.38	74.1	67.0	49.64	14	do	
S 19			S	1.250	.320	4,000		63,375	54.47	74.2	66.2	49.13	14	do	
S 20			T	1.250	.320	3,850		62,727	57.83	73.6	63.2	46.52	13 1/2	do	
S 21			U	1.238	.413	5,113		62,390	56.39	71.6	66.7	47.78	13 1/2	do	
S 22			V	1.200	.380	4,750		64,812	54.44	75.1	67.9	56.96	14 1/2	do	
S 23			W	1.245	.402	5,005		63,256	54.63	74.0	65.1	48.15	14 1/2	do	
S 24			X	1.246	.397	4,046		63,465	53.61	74.0	70.7	52.33	14 1/2	do	
S 25			Y	1.250	.391	4,676		62,448	53.15	72.0	67.8	48.48	13	do	
S 26			Z	1.249	.391	4,905		60,958	53.92	71.3	65.8	46.89	14	do	
S 27			AA	1.243	.396	4,768		61,464	53.97	71.8	65.3	46.89	13	do	

4186	71	60	14	H	1,293	895	4911	65,894	35,888	72.6	44.9	96.88	14	Do.
4187	27	68	15	C	1,248	845	4400	64,180	35,814	78.1	68.2	93.61	16	Do.
4188	14	68	16	D	1,250	870	4738	62,471	36,720	72.3	68.0	48.05	14	Do.
4189	15	26	16	L	1,210	840	4712	62,712	24,200	73.5	66.2	50.90	13	Do.
4190	15	35	17	B	1,250	848	4850	68,454	23,670	76.0	70.6	53.63	15	Do.
4191	15	30	17	Q	1,215	884	4777	61,784	23,600	74.7	68.9	51.50	14	Do.
B. S.	18	B	F	1,227	839	4160	67,067	23,458	77.1	63.7	48.84	16	Do.
B. S.	19	B	F	1,226	831	4038	66,794	23,454	77.1	74.7	49.59	16	Do.
4196	15	19	E	1,293	844	4466	67,032	24,068	74.5	67.1	51.97	16	Do.
4197	15	19	E	1,224	846	4162	65,833	23,729	72.8	70.3	51.83	15	Do.
4198	15	20	A	1,270	895	4458	67,814	25,78	72.0	68.8	49.09	15	Do.
4199	15	21	A	1,281	888	4760	68,710	25,33	71.6	68.2	49.18	15	Do.
4199	15	21	E	1,270	884	473	67,684	25,38	72.8	64.7	47.06	14	Do.
4200	15	22	A	1,291	878	4613	67,832	24.09	73.9	66.4	48.43	14	Do.
4201	15	22	M	1,234	873	4603	68,011	24.09	73.9	67.9	50.00	15	Do.
B. S.	23	C	1,222	872	4593	68,271	23.12	73.6	67.9	50.14	16	Do.
4202	18	23	C	1,214	877	4552	67,821	23.08	74.2	66.7	49.41	16	Do.
4203	18	25	H	1,242	840	4223	61,865	23,99	74.2	66.7	49.41	16	Do.
4204	18	25	I	1,250	873	4192	61,268	23.16	73.0	68.1	49.72	15	Do.
4205	18	25	I	1,249	884	4736	64,322	23.16	72.2	67.4	48.65	17	Do.
4206	18	25	I	1,243	888	4831	67,777	23.16	72.2	67.4	48.65	17	Do.
4207	18	25	N	1,245	888	4831	67,777	23.16	72.2	67.4	48.65	17	Do.
4208	18	26	H	1,261	885	4570	66,995	23.65	72.2	65.6	47.36	19	Do.
4209	18	26	H	1,250	885	4570	66,995	23.65	72.2	65.6	47.36	19	Do.
4210	18	26	H	1,250	885	4570	66,995	23.65	72.2	65.6	47.36	19	Do.
4211	18	26	H	1,250	885	4570	66,995	23.65	72.2	65.6	47.36	19	Do.
4212	18	26	H	1,250	885	4570	66,995	23.65	72.2	65.6	47.36	19	Do.
4213	18	26	H	1,250	885	4570	66,995	23.65	72.2	65.6	47.36	19	Do.
4214	18	26	H	1,250	885	4570	66,995	23.65	72.2	65.6	47.36	19	Do.
4215	18	26	H	1,250	885	4570	66,995	23.65	72.2	65.6	47.36	19	Do.
4216	18	26	H	1,250	885	4570	66,995	23.65	72.2	65.6	47.36	19	Do.
4217	18	26	H	1,250	885	4570	66,995	23.65	72.2	65.6	47.36	19	Do.
4218	18	26	H	1,250	885	4570	66,995	23.65	72.2	65.6	47.36	19	Do.
4219	18	26	H	1,250	885	4570	66,995	23.65	72.2	65.6	47.36	19	Do.
4220	18	26	H	1,250	885	4570	66,995	23.65	72.2	65.6	47.36	19	Do.
4221	18	26	H	1,250	885	4570	66,995	23.65	72.2	65.6	47.36	19	Do.
4222	18	26	H	1,250	885	4570	66,995	23.65	72.2	65.6	47.36	19	Do.
4223	18	26	H	1,250	885	4570	66,995	23.65	72.2	65.6	47.36	19	Do.
4224	18	26	H	1,250	885	4570	66,995	23.65	72.2	65.6	47.36	19	Do.
4225	18	26	H	1,250	885	4570	66,995	23.65	72.2	65.6	47.36	19	Do.
4226	18	26	H	1,250	885	4570	66,995	23.65	72.2	65.6	47.36	19	Do.
4227	18	26	H	1,250	885	4570	66,995	23.65	72.2	65.6	47.36	19	Do.
4228	18	26	H	1,250	885	4570	66,995	23.65	72.2	65.6	47.36	19	Do.
4229	18	26	H	1,250	885	4570	66,995	23.65	72.2	65.6	47.36	19	Do.
4230	18	26	H	1,250	885	4570	66,995	23.65	72.2	65.6	47.36	19	Do.
4231	18	26	H	1,250	885	4570	66,995	23.65	72.2	65.6	47.36	19	Do.
4232	18	26	H	1,250	885	4570	66,995	23.65	72.2	65.6	47.36	19	Do.
4233	18	26	H	1,250	885	4570	66,995	23.65	72.2	65.6	47.36	19	Do.
4234	18	26	H	1,250	885	4570	66,995	23.65	72.2	65.6	47.36	19	Do.
4235	18	26	H	1,250	885	4570	66,995	23.65	72.2	65.6	47.36	19	Do.
4236	18	26	H	1,250	885	4570	66,995	23.65	72.2	65.6	47.36	19	Do.
4237	18	26	H	1,250	885	4570	66,995	23.65	72.2	65.6	47.36	19	Do.
4238	18	26	H	1,250	885	4570	66,995	23.65	72.2	65.6	47.36	19	Do.
4239	18	26	H	1,250	885	4570	66,995	23.65	72.2	65.6	47.36	19	Do.
4240	18	26	H	1,250	885	4570	66,995	23.65	72.2	65.6	47.36	19	Do.
4241	18	26	H	1,250	885	4570	66,995	23.65	72.2	65.6	47.36	19	Do.
4242	18	26	H	1,250	885	4570	66,995	23.65	72.2	65.6	47.36	19	Do.
4243	18	26	H	1,250	885	4570	66,995	23.65	72.2	65.6	47.36	19	Do.
4244	18	26	H	1,250	885	4570	66,995	23.65	72.2	65.6	47.36	19	Do.
4245	18	26	H	1,250	885	4570	66,995	23.65	72.2	65.6	47.36	19	Do.
4246	18	26	H	1,250	885	4570	66,995	23.65	72.2	65.6	47.36	19	Do.
4247	18	26	H	1,250	885	4570	66,995	23.65	72.2	65.6	47.36	19	Do.
4248	18	26	H	1,250	885	4570	66,995	23.65	72.2	65.6	47.36	19	Do.
4249	18	26	H	1,250	885	4570	66,995	23.65	72.2	65.6	47.36	19	Do.
4250	18	26	H	1,250	885	4570	66,995	23.65	72.2	65.6	47.36	19	Do.
4251	18	26	H	1,250	885	4570	66,995	23.65	72.2	65.6	47.36	19	Do.
4252	18	26	H	1,250	885	4570	66,995	23.65	72.2	65.6	47.36	19	Do.
4253	18	26	H	1,250	885	4570	66,995	23.65	72.2	65.6	47.36	19	Do.
4254	18	26	H	1,250	885	4570	66,995	23.65	72.2	65.6	47.36	19	Do.
4255	18	26	H	1,250	885	4570	66,995	23.65	72.2	65.6	47.36	19	Do.
4256	18	26	H	1,250	885	4570	66,995	23.65	72.2	65.6	47.36	19	Do.
4257	18	26	H	1,250	885	4570	66,995	23.65	72.2	65.6	47.36	19	Do.
4258	18	26	H	1,250	885	4570	66,995	23.65	72.2	65.6	47.36	19	Do.
4259	18	26	H	1,250	885	4570	66,995	23.65	72.2	65.6	47.36	19	Do.
4260	18	26	H	1,250	885	4570	66,995	23.65	72.2	65.6	47.36	19	Do.
4261	18	26	H	1,250	885	4570	66,995	23.65	72.2	65.6	47.36	19	Do.
4262	18	26	H	1,250	885	4570	66,995	23.65	72.2	65.6	47.36	19	Do.
4263	18	26	H	1,250	885	4570	66,995	23.65	72.2	65.6	47.36	19	Do.
4264	18	26	H	1,250	885	4570	66,995	23.65	72.2	65.6	47.36	19	Do.
4265	18	26	H	1,250	885	4570	66,995	23.65	72.2	65.6	47.36	19	Do.
4266	18	26	H	1,250	885	4570	66,995	23.65	72.2	65.6	47.36	19	Do.
4267	18	26	H	1,250	885	4570	66,995	23.65	72.2	65.6	47.36	19	Do.
4268	18	26	H	1,250	885	4570	66,995	23.65	72.2	65.6	47.36	19	Do.
4269	18	26	H	1,250	885	4570	66,995	23.65	72.2	65.6	47.36	19	Do.
4270	18	26	H	1,250	885	4570	66,						

TABLE VII.—Cambria steel. Tensile tests of finished material—Continued.

Heat.	Carbon.	Manganese.	Markers.	Original width.	Original thickness.	Sectional area.	Elastic limit per square inch.	Ultimate tensile strength per square inch.	Final elongation in 8 inches.	Final width of original.	Final thickness of original.	Final area of original area.	Time of test.	Size of bar tested.	Nature of steel and remarks.
4260.	18	41 A.	1.242	.396	.4918	37,820	61,407	63.91	71.1	65.9	46.55	19	5 by 3 inch angle	Cambria O. H. steel.
4260.	18	41 M.	1.246	.421	5254	38,820	62,809	62.75	73.2	67.0	49.65	14	do	Do.
4256.	18	.26	42 E.	1.200	.397	5002	37,685	62,675	63.74	72.4	67.2	48.52	15	do	Do.
4256.	18	.26	42 J.	1.255	.396	4970	37,803	63,078	63.53	74.1	71.5	52.96	14	do	Do.
4256.	18	.26	43 B.	1.255	.408	5120	37,685	61,719	63.23	72.7	66.0	48.03	14	do	Do.
4256.	18	.26	43 C.	1.246	.409	5096	37,186	58,968	63.63	70.3	63.4	44.58	12	do	Do.
4261.	15	44 A.	1.255	.408	5120	37,805	62,685	63.82	71.4	65.7	46.80	14	do	Do.
4261.	15	44 H.	1.242	.406	5042	36,680	59,262	63.08	69.8	65.8	44.52	14	do	Do.
4257.	18	45 A.	1.255	.408	5120	37,680	67,186	63.63	71.3	71.3	53.29	17	do	Do.
4257.	18	45 J.	1.244	.411	5113	37,962	65,466	62.11	72.0	66.0	46.84	16	do	Do.
4263.	20	46 E.	1.255	.399	5007	39,145	65,708	62.81	70.1	66.2	46.64	17	do	Do.
4263.	20	46 F.	1.244	.396	4926	38,773	63,134	63.63	71.7	68.3	50.53	17	do	Do.
4262.	18	.34	47 A.	1.257	.414	5204	39,565	66,007	64.79	73.1	68.8	49.83	16	do	Do.
4260.	18	48 B.	1.257	.397	4990	37,775	62,725	63.60	72.2	68.3	47.82	14	do	Do.
4260.	18	48 E.	1.257	.410	5154	37,787	61,602	63.10	73.2	65.4	47.82	14	do	Do.
4263.	20	49 Q.	1.240	.383	4749	37,000	63,803	63.23	74.9	70.1	52.50	14	6 by 3 1/2 inch deck beam	Cambria O. H. steel. Broke through deep flaw.

Table VIII. affords a comparison of the tests of $2\frac{1}{2}$ by $\frac{5}{8}$ inch flats at Johnstown with tests of the same heats as finished material at Phoenixville. The form of test piece was the same in both cases. It is seen that with about 60 per cent. of the thickness and sectional area of the test pieces taken from the flats, about 70 per cent. of the reduction of area in the rolls from the ingot, and 63 per cent. greater reduction of thickness from the ingot, the finished material shows a gain of 2,359 pounds, or 3.85 per cent. in tensile strength, while the ductility remains unchanged. The interest of the comparison is, however, interfered with by the fact that the tests were made on different machines. Thus, taking the results of the special comparative tests of material on each machine with tests of corresponding pieces of the same material on the machine at the Washington navy-yard (p. 525), we find that the Gill machine at Johnstown showed 160 pounds less, while the Riehlé at Phoenixville showed 2,610 pounds more, than the Rodman at the navy-yard for results from 60,500 to 63,500 pounds. Thus the apparent excess of the Riehlé over the Gill machine between these loads is 2,770 pounds. It is not believed, however, that this difference is, even in great part, due to differences in the machines, for it will be observed that the lower tensile strength obtained from the Phoenixville material at the navy-yard is accompanied by considerably greater ductility.

If we admit the accuracy of the machines and neglect the influence of the difference in thickness of test piece, the gain of 3.85 per cent. in tensile strength of the finished material would appear to be due essentially to its increased work of reduction of thickness from the ingot, the proportion being 1.63 to 1.

Upon this comparison, taking the shapes in the table as a fair average for the whole order, was based the size of the flat, 6 inches by $\frac{1}{8}$ -inch, subsequently adopted as representing the average finished material for purposes of test, this flat having almost exactly the same amount of reduction of area from the ingot as the above average for finished shapes, while the reduction of thickness allows a margin in being less than the average for the finished shapes in the proportion of 37 to 42.3.

It may be remarked that if the probable influence on the ductility of the law of proportion of the test piece (to be discussed later) be taken into account, the ductility of the material tested at Johnstown would have been only 25.65 instead of 26.05 per cent. if tested in a piece of dimensions proportionate to those of the test pieces used at Phoenixville. The inference, therefore, is that the increased work of reduction from the ingot has affected an increase of both tensile strength and ductility.

TABLE VIII.—Comparative tests of material of the same heats, with different amounts of work of reduction from the ingot.

Heat.	Carbon.	Manganese.	Average sectional area.	Average ultimate tensile strength per square inch.	Average elongation in eight inches.	Time.	Average original thickness.	Average reduction from the ingot.	Average reduction of thickness from the ingot.	Number of tests.	Size of bars tested.
			Sq. inches.	Pounds.	Per cent.	Mins.					
4, 121	14	7698	60,372	28.37	25	610	142.5	26.23	1	Flat, 2 1/2" by 8 1/2"
4, 122	14	4842	62,978	28.68	14	388	97.0	41.24	2	Angle, II of 4" by 3" by 9 lbs.
4, 123	15	28	7690	59,485	28.75	21	610	142.5	26.23	1	Flat, 2 1/2" by 8 1/2"
4, 124	15	28	5011	62,377	25.33	13 1/2	410	100.0	39.80	3	Angle, II of 4" by 3" by 9 lbs.; I of 3" by 3" by 8 lbs.
4, 125	15	30	7875	64,592	23.50	20	825	142.5	25.60	1	Flat, 2 1/2" by 8 1/2"
4, 126	15	30	4816	64,592	23.25	15	387	100.0	41.26	4	Angle, II of 4" by 3" by 9 lbs.; I of 3" by 3" by 8 lbs.; I of 3" by 2 1/2" by 2 1/2" by 8 lbs.
4, 124	15	55	7506	60,119	28.12	20	605	142.5	26.45	1	Flat, 2 1/2" by 8 1/2"
4, 124	15	55	3968	63,988	25.40	14	821	142.5	40.85	2	Angle, II of 3" by 2 1/2" by 6 lbs.
4, 127	15	35	7638	61,589	26.25	20	620	142.5	25.81	1	Flat, 2 1/2" by 8 1/2"
4, 127	15	35	4797	64,411	23.89	15 1/2	384	112.5	41.68	4	Angle, II of 3" by 3" by 8 lbs.; I of 4" by 3" by 9 lbs.; I of 3" by 2 1/2" by 2 1/2" by 8 lbs.
4, 134	21	50	7688	60,839	22.87	18 1/2	615	142.5	26.02	1	Flat, 2 1/2" by 8 1/2"
4, 134	21	50	4907	63,703	24.24	15	394	97.0	40.60	2	Angle, II of 3" by 3" by 8 lbs.
4, 138	21	40	7844	62,468	25.50	17	625	142.5	25.60	1	Flat, 2 1/2" by 8 1/2"
4, 138	21	40	4807	63,807	23.60	13 1/2	387	97.0	41.35	3	Angle, II of 3" by 3" by 8 lbs.; I of 3" by 3" by 8 lbs.
4, 139	21	37	7530	61,752	24.80	13	600	142.5	26.67	1	Flat, 2 1/2" by 8 1/2"
4, 139	21	37	4261	62,764	26.17	14	340	127.0	47.05	7	Angle, III of 4" by 3" by 8 lbs.; II of 3" by 2 1/2" by 2 1/2" by 5 lbs.
4, 140	17	54	7812	62,084	23.00	16	630	142.5	25.81	1	Flat, 2 1/2" by 8 1/2"
4, 140	17	54	4329	64,193	27.64	14 1/2	347	116.0	43.24	2	Angle, 2 1/2" by 3" by 9 lbs.; 3" by 2 1/2" by 6 lbs.
4, 146	15	7380	62,331	24.75	22	600	142.5	26.67	4	Flat, 2 1/2" by 8 1/2"
4, 146	15	4772	62,807	23.50	14 1/2	388	97.0	41.24	1	Flat, 2 1/2" by 8 1/2"
4, 257	18	7370	63,597	28.50	22	832	142.5	26.13	1	Flat, 2 1/2" by 8 1/2"
4, 257	18	4879	65,914	26.79	17	390	73.0	41.03	8	Angle, III of 4" by 3" by 9 lbs.; II of 3" by 3" by 10 lbs.; I of 4" by 3" by 8 lbs.; I of 3" by 2 1/2" by 2 1/2" by 5 lbs.
4, 258	18	26	7900	60,400	25.60	19	635	142.5	25.20	1	Flat, 2 1/2" by 8 1/2"
4, 258	18	26	5947	61,610	23.54	14	403	87.0	39.70	4	Angle, IV of 3" by 3" by 10 lbs.
4, 260	18	7797	59,062	20.40	17 1/2	628	142.5	23.48	2	Flat, 2 1/2" by 8 1/2"
4, 260	18	4919	62,512	23.49	14	400	95.0	40.00	6	Angle, V of 3" by 3" by 10 lbs.; I of 2 1/2" by 2 1/2" by 5 lbs.
4, 261	13	7719	59,086	28.49	17 1/2	620	142.5	23.81	1	Flat, 2 1/2" by 8 1/2"
4, 261	13	5044	60,947	26.15	13 1/2	404	87.0	39.60	4	Angle, IV of 3" by 3" by 10 lbs.
4, 262	18	24	7874	62,879	26.80	22	635	142.5	25.20	1	Flat, 2 1/2" by 8 1/2"
4, 262	18	24	5525	66,296	25.85	17 1/2	441	100.5	36.28	8	Angle, II of 3" by 3" by 8 lbs.; I of 3" by 3" by 10 lbs.
4, 263	20	7874	62,250	24.50	21	635	142.5	26.20	1	Flat, 2 1/2" by 8 1/2"
4, 263	20	4863	64,180	26.39	16 1/2	377	81.5	42.45	6	Angle, 2 1/2" by 2 1/2" by 7 1/2 lbs.; 2 1/2" by 2 1/2" by 6 lbs.; II of 3" by 3" by 10 lbs.
4, 264	16	7628	60,420	26.00	19	620	142.5	25.81	1	Flat, 2 1/2" by 8 1/2"
4, 264	16	4334	64,353	27.07	16 1/2	320	106.0	44.97	3	Angle, II of 4" by 3" by 8 lbs.

Table IX. gives the results of tensile tests by heats at Johnstown, on material made after the instructions of October 6 were received. The average dimensions of test pieces are given, inasmuch as they are held to influence the results. Under the column headed "Elongation at maximum load" is given the stretch of the piece at the instant the beam drops with the maximum load; it is therefore a trifle greater than the extension corresponding to the highest point of the curve in a strain diagram. The corresponding stretched length was measured with an ordinary pair of dividers. The column of "Final stress in pounds per square inch of fractured area" was obtained by running down the weights while the piece was necking. This could not be done with the machine used so as to be strictly accurate for individual cases, but the average for each heat is believed to be fairly correct, except as affected by error in final area. The regularity is somewhat remarkable, the values ranging ordinarily from 100,000 to 110,000 pounds per square inch, and averaging 104,550 pounds for 31 accepted heats. Any marked defect in this quality would appear to indicate lamination or lack of uniform structure, since traces of lamination in the fracture are invariably accompanied by low values of final strength. We shall have something to say of this quality further on.

It will be observed that many of the failures towards the last are due to frequent breaks in the manufacture, the melters finding it very difficult to make a heat of soft steel of the required quality immediately after making a heat of spring steel in the same furnace.

The longest successful run is 32 heats.

TABLE IX.—Cambria steel. Tensile tests by Acete.

Heat.	Carbon.	Manganese.	Average original width.	Average original thick- ness.	Average sectional area.	Average elastic limit per square inch.	Average ultimate tensile strength per square inch.	Average final elongation in 8 inches.	Average final width of original width.	Average final thickness of original thickness.	Average final area of orig- inal area.	Average time of test.	First elongation under stress of 30,000 pounds per square inch.	Corresponding modulus of elasticity.	Average elongation at max- imum load.	Average final stress per square inch of fractured area.	Number of tests.	Accepted or rejected.	Remarks.
			Inches.	Inches.	Sq. ins.	Pounds.	Pounds.	Per ct.	Per ct.	Per ct.	Per ct.	Mins.							
4285.	.16		1.236	.4368	5423	37,760	62,147	24.15	73.62	70.35	51.62	16½					4	A.	Test-plate 12 inches by ½ inch.
4301.			1.239	.4368	5336	38,869	62,461	25.80	73.53	69.46	51.09	15					4	A.	Do.
4309.	.16		1.264	.4765	4747	43,860	66,322	24.06	74.74	70.64	52.94	17½					4	R.	Test-plate 12 inches by ½ inch. One piece gave 30.2 per cent elongation.
4324.	.14	.18	1.257	.4775	6011	49,402	64,149	24.53	73.39	69.98	51.37	16½					4	A.	One piece gave 20 per cent elongation.
4325.	.14		1.255	.4675	5967	42,015	63,874	23.25	73.50	65.06	47.73	15½					4	A.	
4330.	.16		1.247	.4648	5798	44,798	64,967	24.08	77.65	68.13	52.40	17					4	A.	
4331.	.14		1.245	.4716	5871	41,091	63,657	23.48	73.27	67.77	49.64	16½					4	A.	
4333.	.15		1.254	.4568	5681	44,536	63,465	24.85	74.96	60.60	46.75	16½					4	A.	
4333.	.14		1.244	.4757	5919	43,929	65,021	21.70	84.51	74.34	62.27	16½					3	R.	
4339.	.16		1.248	.4625	5774	40,807	65,791	22.85	76.82	73.14	57.99	17					4	A.	
4340.	.13		1.226	.4713	5777	38,168	59,321	25.90	72.08	62.76	45.47	15½					4	R.	
4341.	.14		1.256	.4560	5734	39,895	63,144	23.60	69.26	65.57	45.03	16½					4	A.	
4343.	.15		1.255	.4576	5756	42,899	64,452	23.48	76.65	71.90	54.88	16½					8	A.	
4348.	.13		1.246	.4415	5499	45,233	64,161	25.95	77.34	69.41	53.27	17½					4	A.	
4360.			1.247	.4283	5355	43,749	60,653	27.15	72.84	64.45	46.91	16½					4	A.	
4366.	.17		1.251	.4330	5416	43,864	66,065	24.98	74.15	70.24	52.05	16½					4	A.	Phosphorus .07 per cent.
4421.	.18		1.282	.4390	5569	43,156	65,568	24.73	72.95	64.50	49.05	16½					4	A.	
4423.	.20		1.258	.4365	5491	45,440	69,426	24.38	74.32	69.87	51.95	19½					4	A.	
4424.	.21		1.272	.4225	5373	47,218	69,796	23.58	76.39	68.44	51.95	19					4	A.	One piece gave 19.5 per cent elongation, breaking near shoulder.
4427.	.15		1.256	.4290	5388	45,093	63,844	22.90	73.84	64.10	47.27	17					4	A.	
4428.	.18		1.271	.4433	5610	44,745	67,796	22.90	73.89	68.51	51.60	19					3	R.	
4430.	.17		1.268	.4390	5509	42,445	65,289	25.88	73.92	69.53	51.39	17					4	A.	
4431.	.16		1.267	.4398	5519	44,930	68,280	23.90	77.87	73.12	57.30	18½					4	A.	
4432.	.16	.79	1.251	.4328	5412	41,119	65,597	24.23	76.27	67.58	51.55	19½					4	A.	
4433.	.15	.72	1.288	.4318	5337	40,065	62,910	24.90	76.01	72.18	54.17	16					4	A.	
4434.	.12	.81	1.266	.4478	5634	38,358	61,348	26.03	78.72	69.13	51.00	16½					4	A.	
4435.	.15		1.240	.4500	5690	43,116	63,649	25.40	75.09	69.72	62.25	17½					4	A.	

TABLE IX.—Cambria steel. Tensile tests by heats—Continued.

Heat.	Carbon.	Manganese.	Average original width.	Average original thick- ness.	Average sectional area.	Average elastic limit per square inch.	Average ultimate tensile strength per square inch.	Average final elongation in 8 inches.	Average final width of original thickness.	Average final thickness of original thickness.	Average final area of orig- inal area.	Average time of test.	Average elongation under first stress of 30,000 pounds per square inch.	Corresponding modulus of elasticity.	Average elongation at max- imum load.	Average final stress per square inch of fractured area.	Number of tests.	Accepted or rejected.	Remarks.
			Inches	Inches	Pounds	Sq. ins.	Perc.	Perc.	Perc.	Perc.	Perc.	Mins.	Perc.	Perc.	Perc.	Perc.			
4436.	.12	.42	1.251	.448	5549	64.251	25.95	74.24	87.45	50.10	181	181					4	A	
4437.	.17	.34	1.248	.4458	5564	63.603	26.75	76.70	85.81	46.47	16	16					4	A	
4438.	.18	.26	1.245	.4488	5542	65.290	25.95	78.01	70.75	53.97	174	174					4	A	
4439.	.16	1.255	.4435	5585	62.638	26.80	74.11	68.32	50.65	174	174					4	A	
4441.	.12	1.250	.4375	5469	61.577	23.95	75.20	67.70	31.20	161	161					4	A	
4445.	.18	1.230	.4450	5513	64.936	23.53	78.09	73.77	57.65	181	181					4	A	
4447.	.14	.54	1.230	.4350	5539	41.203	66.367	25.63	76.89	70.97	54.05	18					4	A	
4449.	.16	.42	1.238	.4550	5436	38.176	61.229	27.13	73.64	68.67	49.90	17					4	A	
4450.	.11	.49	1.248	.4400	5489	43.135	63.091	26.23	73.64	63.72	46.90	16					4	A	
4452.	.18	.64	1.244	.4300	5348	45.399	70.460	24.15	75.73	71.54	51.01	191					8	A	
4453.	.17	.37	1.244	.4500	5397	64.320	24.23	78.78	69.62	51.40	152	152					4	A	
4454.	.14	.29	1.241	.4400	5461	41.477	62.307	26.63	73.21	68.93	50.50	15					4	A	One piece broke through a flaw, with only 21.6 per cent elongation.
4457.	.16	1.245	.4400	5478	45.860	27.224	26.10	74.49	70.03	52.07	191					4	A	
4458.	.16	1.243	.4400	5478	45.860	26.10	73.84	69.69	51.45	167	167					4	A	
4459.	.15	.44	1.240	.4350	5394	45.094	65.230	26.20	73.37	68.78	49.35	17					4	A	
4460.	.16	1.235	.4523	5393	43.850	64.098	23.52	73.24	69.36	52.52	174					4	A	
4461.	.16	1.240	.4323	5363	43.574	64.824	24.73	73.96	71.58	52.82	174					4	A	
4462.	.17	.53	1.240	.4300	5343	39.989	62.807	27.85	72.83	64.86	49.36	161					4	A	
4465.	.13	1.240	.4450	5318	39.989	62.807	27.85	72.83	64.86	49.36	161					4	A	
4464.	.15	1.240	.4450	5318	39.989	62.807	27.85	72.83	64.86	49.36	161					4	A	
4468.	.12	1.245	.4300	5353	38.797	60.376	25.63	74.89	70.51	52.42	151					4	A	
4468.	.16	1.240	.4423	5467	38.164	62.621	27.00	69.72	63.63	44.62	141					8	A	
4468.	.16	1.240	.4400	5445	38.117	63.562	25.78	70.66	64.38	45.60	161					4	A	
4470.	.18	1.237	.4400	5445	38.117	63.562	25.78	70.66	64.38	45.60	161					4	A	
4476.	.14	1.246	.4300	5375	42.837	66.047	26.40	74.76	67.80	50.72	15					4	A	
4501.	.14	1.250	.4300	5375	42.837	66.047	26.40	74.76	67.80	50.72	15					8	A	
4503.	.16	1.235	.4000	4940	50.000	69.280	20.00	66.63	60.25	69.50	20					4	A	
4504.	.18	1.235	.4125	5065	46.339	68.420	24.20	77.73	73.38	56.77	181					1	R	
4505.	.16	1.236	.4175	5161	47.451	65.768	23.90	80.89	76.48	61.85	18					4	A	
4507.	.17	1.237	.4400	5331	39.012	61.339	26.23	74.48	72.98	54.37	151					4	A	
4508.	.13	1.235	.4400	5322	37.807	57.304	25.80	69.33	64.10	44.40	161					1	R	

4337.	1.260.	.6666.	43.178.	65.761.	22.98.	76.36.	71.22.	54.43.	17.	4.	A.
4545.	1.250.	4300.	5375.	40.674.	62.721.	32.08.	70.00.	68.38.	47.96.	4.	A.
4546.	1.250.	4300.	42.060.	63.908.	33.63.	74.60.	64.75.	54.75.	18.	4.	A.
4547.	1.250.	4400.	5300.	42.091.	63.786.	33.63.	69.81.	51.35.	16.	4.	A.
4548.	1.250.	4400.	5300.	40.481.	62.896.	33.43.	72.00.	65.90.	16.	4.	A.
4549.	1.255.	4350.	5450.	43.480.	63.774.	34.45.	75.69.	69.34.	17.	4.	A.
4551.	1.249.	4400.	5494.	40.792.	67.002.	34.68.	73.87.	69.12.	18.	4.	A.
4552.	1.250.	4400.	5500.	40.499.	63.273.	33.70.	73.80.	67.04.	13.	4.	A.
4553.	1.250.	4400.	5500.	40.999.	64.567.	33.15.	73.60.	69.12.	13.	4.	A.
4558.	1.245.	4175.	5198.	46.085.	60.244.	34.45.	79.31.	74.25.	16.	4.	A.
4561.	1.245.	4375.	5447.	41.215.	63.262.	33.00.	79.72.	78.09.	15.	4.	A.
4600.	1.258.	4200.	5281.	45.561.	63.706.	33.70.	74.95.	68.68.	15.	4.	A.
4674.	1.252.	4610.	8150.	37.858.	60.128.	35.93.	77.79.	75.21.	21.	4.	A.
4678.	1.253.	6250.	7629.	39.285.	64.133.	34.53.	79.47.	72.02.	21.	4.	A.
4681.	1.253.	6250.	7824.	38.370.	61.215.	35.33.	75.37.	73.40.	17.	4.	A.
4682.	1.254.	6250.	7689.	40.020.	63.163.	34.55.	82.93.	77.79.	17.	4.	A.
4684.	1.257.	6235.	7819.	37.313.	60.013.	35.48.	76.71.	73.90.	16.	4.	A.
4686.	1.254.	6285.	7852.	38.933.	62.268.	35.15.	74.47.	73.96.	15.	4.	A.
4700.	1.260.	4300.	5427.	43.023.	66.128.	33.90.	78.25.	74.53.	16.	4.	A.
4709.	1.262.	4542.	5734.	39.690.	60.605.	35.58.	75.34.	67.02.	15.	4.	A.
4711.	1.259.	4510.	5678.	39.765.	60.998.	35.48.	76.16.	72.00.	14.	4.	A.
4712.	1.256.	4439.	5578.	46.768.	70.824.	23.46.	78.70.	76.86.	20.	4.	A.
4713.	1.259.	4648.	5651.	40.040.	62.560.	22.98.	72.63.	74.05.	15.	4.	A.
4715.	1.001.	4350.	42.065.	63.690.	25.03.	72.94.	67.52.	49.27.	10.	4.	A.
4716.	1.261.	4265.	5379.	40.845.	63.533.	20.93.	74.24.	73.21.	17.	4.	A.
4718.	1.256.	4447.	5585.	43.470.	65.418.	25.15.	76.54.	69.81.	17.	4.	A.
4767.	1.268.	4148.	5281.	37.038.	58.920.	27.05.	72.44.	67.95.	15.	4.	A.
4779.	1.268.	4538.	5751.	37.498.	59.375.	27.43.	71.47.	64.51.	17.	4.	R.
4782.	1.240.	4560.	5694.	42.800.	64.890.	20.50.	78.06.	76.53.	10.	4.	R.
4784.	1.225.	4405.	5396.	42.210.	66.125.	24.35.	72.75.	51.67.	17.	4.	R.
4790.	1.260.	4438.	5591.	44.375.	64.608.	20.70.	76.18.	68.90.	16.	4.	A.
4823.	1.258.	4252.	5350.	30.140.	62.463.	27.83.	74.54.	70.95.	11.	4.	A.
4825.	1.257.	4408.	5540.	39.090.	63.220.	24.83.	78.55.	72.25.	21.	4.	A.
4843.	1.258.	4440.	5574.	41.580.	65.035.	27.18.	72.48.	66.67.	18.	4.	A.
4847.	1.258.	4335.	5402.	39.458.	62.473.	25.03.	77.21.	72.31.	18.	4.	A.
4849.	1.257.	4332.	5445.	45.125.	70.245.	23.75.	80.76.	76.22.	13.	4.	A.
4851.	1.260.	4352.	5483.	40.498.	62.620.	26.60.	75.21.	67.94.	15.	4.	R.
4853.	1.260.	4305.	5426.	41.608.	61.200.	24.90.	78.45.	67.60.	15.	4.	R.
4855.	1.249.	4357.	5666.	43.400.	65.618.	24.28.	79.04.	73.93.	10.	4.	A.
4857.	1.250.	4355.	5445.	43.250.	66.078.	24.20.	79.60.	72.67.	10.	4.	A.
4861.	1.249.	4318.	5398.	37.818.	61.235.	27.40.	73.72.	69.07.	17.	4.	R.
4873.	1.261.	4390.	5614.	38.760.	62.340.	28.17.	76.07.	60.77.	17.	3.	A.
4875.	1.250.	4390.	5488.	33.210.	55.400.	28.60.	68.56.	64.23.	14.	3.	A.
4876.	1.256.	4180.	5619.	37.638.	60.055.	26.68.	75.22.	70.98.	16.	3.	A.

Mean of two pieces.

Mean of three pieces.

For 25,000 pounds.

One piece gave 21 per cent elongation.

One piece broke through flaw, with only 20 per cent elongation.

Rejected on quenching test by Phoenix Iron Company's Inspector. One piece gave 20.4 per cent elongation.

Rejected on quenching test by Phoenix Iron Company's Inspector.

Mean of two pieces.
Mean of three pieces.
For 25,000 pounds.

Mean of two pieces.
Mean of three pieces.
For 25,000 pounds.

TABLE IX.—Cambria steel. Tensile tests by heats—Continued.

Heat.	Carbon.	Manganese.	Inches.	Average original width.	Average original thick-ness.	Sq. ins.	Average sectional area.	Pounds.	Average elastic limit per square inch.	Pounds.	Average ultimate tensile strength per square inch.	Average final elongation in 8 inches.	Average final width of original width.	Average final thickness of original thickness.	Average final area of orig-inal area.	Mins.	Average time of test.	Average elongation under first stress of 30,000 pounds per square inch.	Corresponding modulus of elasticity.	Average elongation at max-imum load.	Average final stress per square inch of fractured area.	Number of tests.	Accepted or rejected.	Remarks.	
4877	.16	1.255	4,290	40,845	65,985	25.15	75.00	70.16	52.75	181	19.43	108,275	4	A.	
4879	.15	1.254	4,340	39,640	63,850	25.93	74.26	71.36	52.27	181	21.53	103,475	4	A.	
4881	.14	1.265	4,328	38,068	61,540	25.58	73.00	69.03	50.42	17	19.68	105,400	4	R.	
4904	.15	1.248	4,535	44,343	66,095	23.18	77.66	74.85	58.12	17	4	R.	
4905	.14	.40	1.249	4,378	37,075	61,713	26.28	70.72	65.45	46.30	153	20.20	111,000	4	A.	
4907	.16	1.254	4,438	40,035	64,923	24.68	72.47	68.30	50.57	164	19.13	103,650	4	A.	
4908	.14	1.252	4,160	39,615	62,588	26.53	73.47	66.26	54.50	16	20.25	104,825	4	A.	
4917	.13	.43	1.245	4,520	41,520	62,070	20.70	73.12	68.20	55.27	19	18.20	101,300	1	R.	
4918	.14	1.244	4,373	39,639	62,818	25.43	75.52	72.41	55.42	17	20.55	100,193	4	A.	
4919	.14	1.245	4,450	39,639	64,093	24.94	76.52	72.41	55.42	17	20.23	101,150	4	A.	
4920	.14	1.244	4,380	38,593	62,390	27.80	71.46	64.55	48.15	173	20.83	113,150	4	A.	
4921	.15	1.247	4,337	39,875	61,690	24.23	73.69	67.37	49.67	173	20.15	107,875	4	A.	
4922	.16	1.254	4,220	38,925	60,743	25.10	78.57	74.27	64.85	201	19.00	104,250	4	A.	
4934	.16	1.256	4,405	41,628	63,875	24.15	78.57	74.27	64.85	201	19.00	99,630	2	R.	
4950	.17	.48	1.247	4,318	46,770	68,960	23.78	77.06	73.39	56.69	164	19.94	98,904	8	A.	
4951	.16	1.251	4,418	42,473	64,278	23.00	77.59	73.39	56.69	164	18.95	100,806	8	A.	
4982	.14	1.247	4,487	49,588	67,335	24.60	76.81	71.53	48.89	153	19.13	107,675	8	A.	
4983	.17	1.247	4,596	37,558	59,481	27.96	71.47	68.71	48.89	153	19.13	101,018	8	R.	
4984	.14	1.253	4,410	37,725	61,870	23.55	78.19	75.33	58.72	161	22.24	101,018	4	R.	
5008	.15	1.248	4,427	38,783	61,015	26.03	74.34	71.70	53.22	16	20.25	100,445	4	A.	
5015	.15	1.246	4,285	38,783	61,140	19.80	83.46	80.82	67.67	164	17.75	108,675	4	A.	
5016	.14	1.260	4,433	40,373	63,545	26.20	73.29	68.78	48.92	164	20.75	104,725	4	A.	
5216	.14	1.264	4,622	39,045	62,440	27.03	74.22	68.37	50.75	16	20.25	108,900	4	A.	
5219	.14	1.261	4,458	40,269	64,778	24.88	73.64	67.50	45.47	108,900	4	A.	
5220	.16	1.268	4,565	37,631	61,267	26.25	73.04	65.58	48.23	108,900	4	A.	
5221	.15	.49	1.260	4,423	38,178	62,608	25.54	73.64	66.90	48.87	108,900	4	A.	
5253	.19	1.251	4,373	39,182	60,756	24.48	78.92	68.05	52.39	102,561	4	A.	
5255	.14	1.248	4,463	40,443	62,279	25.68	73.74	68.82	50.45	105,963	4	A.	

* Mean of three pieces.

One piece gave 20.7 per cent. elongation

One piece gave 20.3 per cent. elongation.

The following general summary gives in brief the results of the physical tests of the Cambria open-hearth steel supplied :

Summary of tensile tests. Cambria open-hearth steel.

[NOTE.—Tensile tests by heats were made from 6-inch by $\frac{1}{16}$ -inch flat on Gill screw machine, at Cambria Iron Works, Johnstown, Pa. Tensile tests on finished material were made on Riché hydraulic machine at Phoenix Iron Works, Phoenixville, Pa.]

	Tensile tests by heats.				Tensile tests on finished accepted material.	Tensile tests on all accepted material.
	Accepted material.	Material rejected for lack of ductility.	Material rejected for lack of strength.	Material rejected on quenching test.		
Number of heats	114	10	6	3	19	133
Number of tests	483	21	22	12	91	574
Average carbon in per cent.	a .1605	.162	.1333	.1666	.1716	.1622
Average original width of cross-section	1.248	1.248	1.252	1.253	1.250	1.249
Average original thickness of cross-section4539	.4322	.4446	.4390	.3724	.4423
Average original area of cross-section5624	.5396	.5566	.5519	.4637	.5483
Average elastic limit in pounds per square inch	41,440	44,133	36,796	689,153	689,450	641,247
Average ultimate tensile strength in pounds per square inch	64,057	65,871	58,284	62,640	63,800	64,020
Average elongation in 8 inches in per cent	25.42	21.91	27.11	26.02	26.11	25.52
Average final width in per cent. of original width	e75.04	80.09	70.72	b74.47	78.14	f74.76
Average final thickness in per cent. of original thickness	e69.88	73.97	65.37	b68.51	66.97	f69.46
Average final area in per cent. of original area	52.85	60.36	46.35	53.62	49.12	52.32
Least modulus of elasticity	24,680,000	24,360,000	25,920,000	26,000,000	24,680,000	24,680,000
Greatest modulus of elasticity	30,890,000	31,475,000	27,060,000	27,120,000	30,890,000	30,890,000
Average modulus of elasticity	g27,720,000	h28,091,000	b26,490,000	b26,560,000	g27,720,000	g27,720,000
Average elongation at maximum load	i20.17	j18.85	k22.24	b20.84	i20.17
Average final strength in pounds per square inch of fractured area	l104,550	j98,402	k101,018	b106,459	l104,556
Average time of test in minutes	m17½	17½	15½	b16½	15	n17

g For 109 heats.
 h For 3 heats.
 i For 10 heats.
 j For 124 heats.

e For 113 heats.
 f For 132 heats.
 g For 42 heats.
 h For 5 heats.

i For 25 heats.
 j For 4 heats.
 k For 1 heat.
 l For 31 heats.

m For 107 heats.
 n For 126 heats.

SUMMARY OF TESTS AND INSPECTION.

The following general summary gives the principal particulars of tests and inspection in the aggregate. It is seen that out of 880 heats tested up to 1st September, 1884, only 146, or 16.6 per cent., were rejected, and this amount would have been further diminished if the orders for boiler steel could have been issued sooner, notably in the case of the Norway steel, many heats of which, too soft for ship metal, passed satisfactory tests for boiler metal, but were rejected for lack of orders. The very small amount of material rejected on the quenching test, after being accepted by heat tests, is still sufficient to call attention to the efficiency of this test; increasing familiarity of manufacturers with the requirements and method of tests would still further diminish the amount so rejected. The necessity for this test, nevertheless, exists in that it is applied to each piece and prevents all possibility of serious defect arising from treatment subsequent to casting or of mistake at works producing many grades of steel.

General summary of results for all steel plates and bars delivered up to September 1, 1884.

Manufacture of steel.	Weight in tons delivered up to September 1, 1884.		Average ultimate tensile strength per square inch.		Average final elongation.		Efficiency number.*		Energy required to break a bar 1 sq. inch sect. area and 8 inches long between filets. †		Weight in tons rejected on quenching test.		Number of heats accepted.		Number of heats rejected on tensile test.		Percentage rejected of total number of heats tested.		Amount rejected on quenching test in per cent. of total amount delivered.	
	Tons.	Pounds.	Per cent.	Per cent.	Per cent.	Per cent.	Per cent.	Per cent.	Per cent.	Per cent.	Per cent.	Per cent.	Per cent.	Per cent.	Per cent.	Per cent.	Per cent.	Per cent.	Per cent.	Per cent.
Chester Rolling Mills.	1,618.17	61,987	28.09	1,617,141	9,698															
Park, Bro. & Co.	287.40	93,125	25.83	1,630,519	9,783															
Norway Steel and Iron Co.	1,616.22	62,472	25.56	1,596,784	9,581															
Cambria Iron Co.	1,053.00	64,020	25.52	1,633,790	9,803															
Total	4,572.79																			
Average		62,698	25.755	1,619,560	9,685															

* Efficiency number = ultimate tensile strength × final elongation. See p. 515.

† On a basis of area of strain diagram = 0.9 of efficiency number. See p. 516.

Results for both tensile strength and ductility are necessary for an estimate of absolute quality of metal as distinguished from mere hardness or softness. Either result may be altered only by corresponding alteration of the other in material of given intrinsic quality; and, as extreme cases, if both be high the steel is good, if both be low the steel is poor. A single measure of intrinsic quality is available in the "ultimate resilience" or amount of work necessary to produce rupture of a piece of standard dimensions. An accurate value of this function can only be obtained from a strain diagram, which denotes the power of resistance of the material, as an indicator-card gives the power of overcoming resistance for an engine, and is equally a gauge of quality under standard conditions. Without automatic apparatus for describing them, a strain diagram is not to be obtained for each piece, but analysis of the diagrams made during this inspection (pp. 515 and 516) shows that, for unannealed material such as we are considering, in no particularly abnormal physical condition, the area of the strain diagram bears a pretty constant ratio to the product of its extreme dimensions, and may be taken as not far from 90 per cent. of the product of ultimate tensile strength and final elongation. The latter product, therefore, may be considered a more or less accurate measure of intrinsic quality for pieces of standard dimensions, and is called in the table the efficiency number.

While the measured length in all tests was the same (8 inches), the area and proportion of cross-section varied widely except in tests made at the Cambria Iron Works; so that, as the proportion of the test piece is held to affect the results for ductility, a comparison of the efficiency numbers in the table cannot be taken as a strict gauge of relative quality. The average sectional area of all tests is not far from .5 square inch, for which dimensions the average efficiency number is seen to be 1,619,560, in pounds per cent. Taking the area of strain diagram as 90 per cent. of the efficiency number in pounds per cent., and reducing to foot-pounds, we have 9,685 foot-pounds as the average ultimate resilience of a bar of one square inch sectional area 8 inches long, the ductility being reckoned on the basis of one-half a square inch of sectional area.

The above value of the efficiency number being for material accepted, and therefore of good quality, we see that, under these conditions of test, the minimum strength required for boiler plate, 57,000 pounds,

should be accompanied by a ductility of 28.4 per cent.; while the material of the maximum strength allowed, 63,000 pounds, should have 25.7 per cent. elongation. For ship material, 60,000 pounds should be accompanied by 27 per cent. elongation, while the minimum elongation of 23 per cent. should be associated with a tensile strength of 70,400 pounds. A good guide in fixing specifications is thus obtained, and the margin allowed manufacturers under any given specification can be appreciated.

For purposes of comparison with foreign results or specifications, the average results may be stated as a tensile strength of 62,698 pounds, or 28 tons, per square inch (= 44.09 kilograms per square millimeter) with a ductility in 8 inches of 25.755 per cent. on an area of one-half square inch.

STEEL IN THE SHIP-YARD AND BOILER-SHOP.

Of the total of 4,570 tons delivered, about 4,000 tons had been worked into hull and boilers by September 1, 1884. In the boiler-shops a certain amount of experience had already been obtained in treating the material. Although previously using steel for certain parts of boilers, the contractors, Messrs. John Roach & Son, had commenced constructing boilers entirely of steel (of somewhat softer quality than that for the cruisers) in 1882, using not far from 1,000 tons each in that and the next year.

In the ship-yard the workmen had little or no experience with the material. Yet the results obtained in point of failures of material under treatment in the ship-yard are particularly good. The bending of frames and all joggling were done hot; welding of beam-arms, and in most other places, was done with glut-pieces of iron between the steel surfaces, though the staple-angles in the wings of the double bottom were welded steel to steel. Boss-plates were shaped hot, without accident. But four failures were reported, and of these the cause was evident, as given in the table.

TABLE X.—Failures of steel in working up to September 1, 1884.

Date.	To be employed for—	Treatment when failure occurred.	Cause assigned.	Makers.
December 17, 1883.	Tube-sheet, Atlanta's boilers.	Being chipped hot near punched edge.	Chester Rolling Mills.
December 18, 1883.	Boss-frame, Dolphin...	Fairing by hydraulic fairing-machine.	Overheating..	Phoenix Iron Company.
January 12, 1884do.....do.....do.....	Do.
January 31, 1884 ..	2 shell-plates, Boston's boilers.	Cracked from outer row of rivet-holes to edge of plate.	Chester Rolling Mills.
February 23, 1884.	Front head, Boston's boilers.	Cracked from edge while flanging.	Do.
March 14, 1884	Back head, Atlanta's boilers.	Cracked from edge after riveting up.	Do.
March 24, 1884	2 tube-sheets, Chicago's boilers.	Flanging	Laminations..	Norway Steel and Iron Company.
March 27, 1884 ...	Back tube-sheet, Chicago's boilers.do.....do.....	Do.
April 16, 1884	3 back tube-sheets, Chicago's boilers.	Developed laminations in flanging.do.....	Do.
April 16, 1884	1 back tube-sheet, Chicago's boilers.	Developed laminations in flanging, and cracked from edge partially flanged.	Do.
May 10, 1884	2 superstructure beams, Atlanta and Boston.	Setting knee to shape.	Web cut too deep in removing bulb to say.	Phoenix Iron Company.

The chief source of trouble was in flanging the boiler-plates, failure frequently occurring from laminations in the edge of the plate. Some of the more or less unaccountable failures after treatment arising from a state of internal strain will be found.

It should be stated that the rivet-holes were punched in the boiler-plates of the Dolphin, Boston, and Atlanta, and drilled in those of the Chicago.

The first failure, reported December 17, 1883, is thus described by the inspector:

"The sheet had been partially flanged and punched for tube-hole cutter-guide; while cutting off a piece, marked A, hot, with a chisel, the sheet split $1\frac{1}{2}$ inches; while cooling the crack extended $4\frac{1}{2}$ inches, and when cold, as the sheet was being hauled over the ground, the crack extended 5 inches farther.

"The number of the sheet had been obliterated. Since the failure of that sheet, seven others have been subjected to the same punching, cutting, and flanging, and no failures have occurred."

A strip $1\frac{1}{2}$ inches wide was sheared from that portion which had been punched out by the lines of holes marked B and C in the diagram; it broke easily on bending, but after heating and quenching in water, it bent double under a sledge without fracture.

From each of the two steel plates of the Boston's boilers reported January 31, 1884, two pieces for tensile test were cut, as near as possible to the rivet-holes, and gave the following average results, with trifling variations for individual pieces: 59,275 pounds tensile strength, with 25.58 per cent. elongation, and a final area of 47.6 per cent.; perfectly consistent and normal, though the efficiency number is not particularly high and considerably lower than for the corresponding heat tests.

The heat test of the sheet reported February 23, 1884, gave 30.84 per cent. elongation, with a final area of 48.5 per cent., being heat No. 582 in the tables of Chester steel.

The total weight of material contained in the table of failures is less than 17,500 pounds, or about $7\frac{1}{4}$ tons, a very small per cent. of the amount delivered.

STEEL FOR RIVETS.

A built-up structure, such as ship or boiler, depends for strength almost entirely upon the resistance offered at the joints, which resistance, for most conditions of stress, is, or should be, made up equally of the resistances of plate and of rivet. When, in addition, we consider the severe treatment and liability to excessive internal strain to which a rivet is subjected in driving and setting, the necessity for careful selection of material and of quality is very apparent. There are two chief opposing conditions in the selection of rivet-metal, the one the great advantage gained in increased strength of joint by using metal of higher shearing strength with fewer or smaller rivets, the other the brittleness of heads and shanks of rivets developed in hard metal under severe treatment. It is a matter for careful consideration whether the first cannot be obtained in a higher degree than at present without too great development of the second.

The rivets supplied were all of steel made by the Bessemer process, chiefly by the Pittsburgh Steel Casting Company, though a few thousand pounds were made by the Burden Iron Company, Troy, N. Y. The steel supplied by the above company was delivered in billets, marked with the number of the blow, to the rivet manufacturers, each

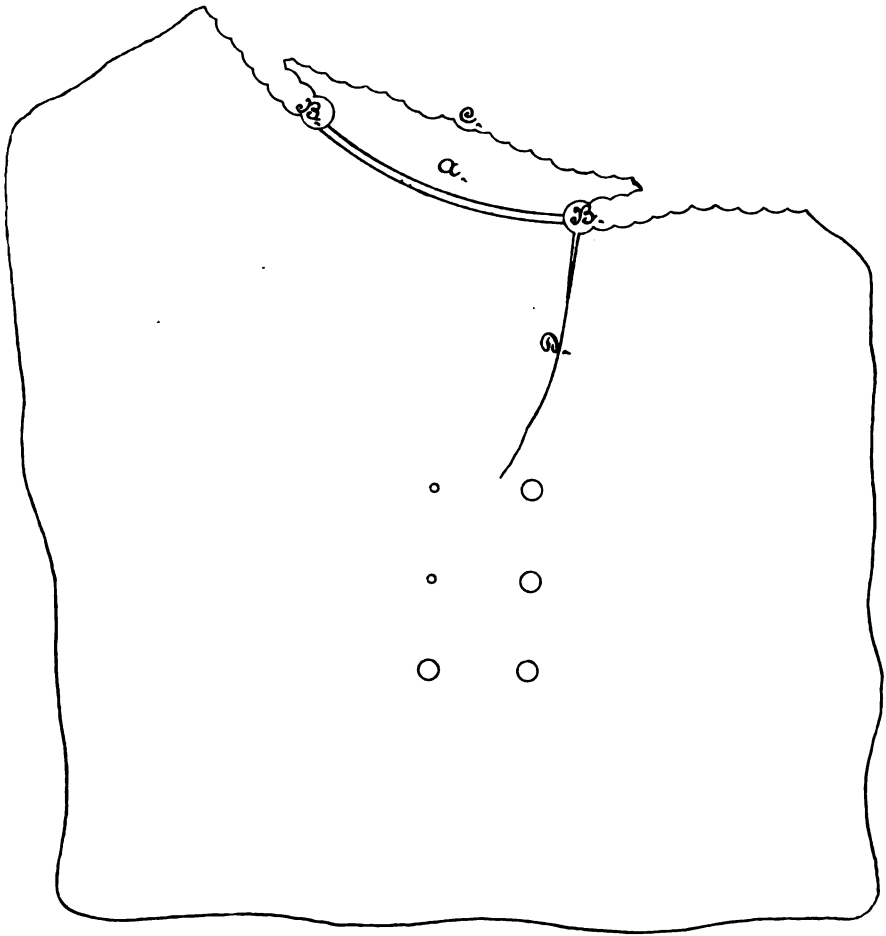
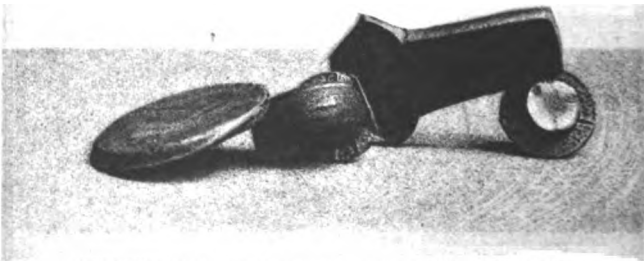

Fig. 9 - Illustrating failure of tube sheet of "Atlanta's" boilers.

H Ex1 pt3 v1 49-1



HAMMER AND TENSILE TEST PIECES $\frac{3}{4}$ " RIVETS.



HAMMER AND SHEAR TEST SPECIMENS $\frac{3}{4}$ " RIVETS



HAMMER TEST SPECIMENS $\frac{3}{4}$ " RIVETS.

blow rolling out into about 200 rivet-bars. The rivets first used were made by Jones & Laughlin, of Pittsburgh, Pa., of the steel mentioned, and the same metal was subsequently used at the Combination Steel and Iron Works, Lamokin, Pa., which later undertook the whole supply.

The high tensile strength, which from the first tests appeared necessary to obtain the shearing strength of 50,000 pounds per square inch demanded, was looked upon with some alarm for fear of trouble arising from brittle heads as reported in European practice. Somewhat less shearing strength was therefore allowed if accompanied by correspondingly lower tensile strength and greater ductility and reduction of area. The necessity for this, however, soon disappeared, the results of tests being quite up to the original requirements, while the high ductility and the especially high reduction of area showed a metal capable of great local distortion without fracture.

The amount of testing was then reduced, and instead of 20 rivet-bars constituting a lot for tensile test and 500 pounds of rivets a lot for shearing and hammer tests, 2 bars of sufficient length for tensile test were required to accompany each 1,000 pounds of rivets, being pieces of the bars from which the rivets in the correspondingly-marked kegs were made, and one test of each kind was made for each 1,000 pounds of rivets delivered at the works. As has been mentioned, also, the shearing specimens were riveted up in single shear instead of double shear, increasing the representative value of the test. The value of the shearing strength in single shear is somewhat greater with iron rivets in iron plates than in double shear in a variable ratio, approximately 10 to 9.5. The invariably low ratios of shearing to tensile strengths for the double-shear specimens of lots 9, 13, 33, and 40, in the table, appear to show a similar effect in steel rivets, though the single shear specimens of lot 33 show even a lower ratio than the double shear. It is, however, very difficult to obtain simultaneous shear of the two sides in a double-shear specimen.

Steel plates of ship or boiler quality and of thicknesses suitable to the length of the rivet were used in the shearing specimens.

The Board is particularly pleased with the uniformity and high value of shearing strength obtained, as associated, also, with a high value of those qualities which go to make a rivet work well and safely, and great credit is due the original manufacturers of the steel in producing a quality of metal so especially well adapted to this important purpose.

Tests and inspection of rivets.—The rivets, from whatever source, were generally tested at Chester by the inspectors at the Chester Rolling Mills, the shearing specimens being riveted up at the ship-yard. Table XI. gives a record of tests by lots, and includes a general summary of the various sizes, and in total, up to September 20, 1884. The amount rejected, 14,100 pounds, 10,000 pounds of which were rejected in the early part of the work, is only 3.87 per cent. of the total amount tested, and the results depart but little from specification. The ratio of shearing to tensile strength is given for each lot in the table, and its average value for each size, as shown by the summary, illustrates well the increase for smaller rivets.

The capacity for local distortion, as shown by the low value of the percentage of final area, is more markedly illustrated by the opposite photograph of specimens of hammer test pieces, which are not selected for their particular excellence, as these tests were invariably passed in the most satisfactory manner. The fracture of the tensile test piece illustrates that commonly obtained from this material.

TABLE XI.—Tests of rivets and rivet bars. Chester Rolling Mills.

Lot No.	Nominal size of rivet.	Tensile tests.						Shearing tests.						Hammer and bending tests passed or failed.	Accepted or rejected.	Manufacturer.	Remarks.	
		Inch.	Sq. in.	Pounds	Perct.	Perct.	Perct.	Inch.	Sq. in.	Pounds	Perct.	Ratio to tensile	Number of tests.					Passed or failed.
9	3/8	.683	.3773	60,030	26.78	41.6	4	P.	1.037	47,495	79.10	10	P.	P.	Jones & Laughlin	Double shears. Double shears; f-inch bar turned down.		
13	3/8	.704	.4584	70,120	24.10	55.7	2	P.	1.390	56,100	80.00	2	P.	P.	do	Single shears.		
14	3/8	.694	.3782	60,375	26.48	44.2	4	P.	.5185	55,917	73.64	6	P.	P.	do	Do.		
33	3/8	.720	.4071	57,263	26.50	41.8	4	P.	1.037	44,467	73.64	3	P.	P.	Jones & Laughlin and Burden Iron Company.	Double shears.		
40	3/8	.820	.5281	66,950	27.15	45.0	2	P.	.5185	46,450	76.94	6	P.	P.	Jones & Laughlin	Do.		
43	3/8	.844	.5592	61,800	30.30	42.8	2	P.	1.390	52,900	79.02	2	P.	P.	do	Do.		
46	3/8	.595	.2780	65,890	24.85	39.0	2	P.	.6003	54,400	88.08	2	P.	P.	Combination Iron and Steel Works.	Single shears from here on.		
47	3/8	.702	.3870	63,400	30.70	32.9	2	P.	.3712	55,633	84.44	3	P.	P.	do	Do.		
52	3/8	.700	.3850	62,650	29.95	32.9	2	P.	.5185	54,900	86.60	3	P.	P.	do	Do.		
53	3/8	.709	.3960	61,290	27.87	44.4	6	P.	.5185	48,500	77.42	3	P.	P.	do	Do.		
54	3/8	.699	.3847	62,160	27.48	37.3	5	P.	.5180	55,580	90.68	5	P.	P.	Jones & Laughlin.	Do.		
66	3/8	.721	.4072	59,000	27.60	36.0	1	P.	.5180	49,540	78.70	10	P.	P.	Burden Iron Company.	Do.		
60	3/8	.698	.3629	60,740	25.07	40.5	3	P.	.3710	56,140	88.14	1	P.	P.	do	Do.		
110	3/8	.632	.3140	63,012	28.32	43.4	10	P.	.5185	54,920	90.42	5	P.	P.	do	Do.		
111	3/8	.749	.4402	60,395	30.23	40.9	30	P.	.4277	50,712	80.50	17	P.	P.	do	Do.		
112	3/8	.875	.6013	59,850	29.38	42.8	4	P.	.5180	52,790	87.42	30	P.	P.	do	Do.		
123	3/8	.747	.4383	61,814	27.93	39.7	7	P.	.6900	52,167	87.20	8	P.	P.	do	Do.		
128	3/8	.746	.437	62,183	28.17	40.5	6	P.	.5056	56,143	90.84	7	P.	P.	do	Do.		
129	3/8	.760	.4410	69,000	26.66	43.6	5	P.	.5184	57,714	92.83	5	P.	P.	do	Do.		
130	3/8	.749	.4402	69,957	27.90	47.7	6	P.	.5350	55,200	79.31	7	P.	P.	do	Do.		
137	3/8	.744	.4348	70,250	28.30	44.2	8	P.	.5460	57,667	82.78	6	P.	P.	do	Do.		
146	3/8	.746	.4368	61,917	28.75	36.8	6	P.	.5180	53,675	76.41	8	P.	P.	do	Do.		
170	3/8	.765	.4490	60,000	28.00	43.0	1	P.	.5053	53,500	86.42	6	P.	P.	do	Do.		
171	3/8	.769	.4540	61,500	27.17	40.0	3	P.	.5180	53,000	88.39	1	P.	P.	do	Do.		
		.769	.4540	61,500	27.17	40.0	3	P.	.3710	54,323	86.24	3	P.	P.	do	Do.		
		.769	.4540	61,500	26.00	40.0	2	P.	.5180	50,000	78.74	2	P.	P.	do	Do.		
		.769	.4540	61,500	26.00	40.0	2	P.	.3710	54,000	84.58	2	P.	P.	do	Do.		

finch bar turned down.

172	58,000	1	P.	1	81.08	2,000	Do.
	51,800	3	P.	1	81.01	2,000	Do.
	23,000	1	P.	1	76.93	5,000	Do.
	51,800	1	P.	2	80.78	2,500	Do.
	37,110	1	P.	2	84.78	7,100	Do.
	6,000	1	P.	2	83.03	1,413	Do.
	51,333	2	P.	3	80.21	2,700	Do.
	0,000	1	P.	3	85.34	1,200	Do.
	51,900	1	P.	3	86.85	2,200	Do.
	40,400	1	P.	3	85.28	1,900	Do.
	31,800	1	P.	3	81.82	1,800	Do.
	39,000	1	P.	3	81.81	1,900	Do.
	5,500	1	P.	3	82.58	1,900	Do.
	38,750	2	P.	4	83.46	3,900	Do.
	52,000	3	P.	3	81.65	3,000	Do.
	4,000	1	P.	3	84.63	4,500	Do.
	52,000	1	P.	2	80.92	1,800	Do.
	5,500	1	P.	2	87.70	4,000	Do.
	40,000	1	P.	2	87.03	2,000	Do.
	52,000	1	P.	2	84.87	4,400	Do.
	37,250	1	P.	5	82.12	4,400	Do.
	51,840	1	P.	6	82.58	4,900	Do.
	38,000	1	P.	2	77.68	2,100	Do.
	24,850	1	P.	2	81.80	2,600	Do.
	51,840	4	P.	4	83.22	7,100	Do.
	38,800	3	P.	3	84.69	7,100	Do.
	24,850	1	P.	1	83.33	8,400	Do.
	69,000	1	P.	5	88.18	8,400	Do.
	51,840	1	P.	6	85.39	7,700	Do.
	38,070	1	P.	3	87.78	7,700	Do.
	69,110	1	P.	1	76.24	8,400	Do.
	51,800	1	P.	3	83.33	2,500	Do.
	37,110	1	P.	3	84.67	2,500	Do.
	20,000	1	P.	5	79.90	6,000	Do.
	51,800	1	P.	2	83.34	1,700	Do.
	24,800	1	P.	8	86.67	21,300	Do.
	51,800	1	P.	9	86.76	7,500	Do.
	27,110	1	P.	1	82.00	1,800	Do.
	69,000	1	P.	1	83.00	1,800	Do.
	51,800	2	P.	3	80.21	2,000	Do.
	37,100	1	P.	3	82.15	12,300	Do.
	51,800	1	P.	2	82.68	13,300	Do.
	38,550	1	P.	2	87.70	14,000	Do.
	51,800	1	P.	6	84.04	17,500	Do.
	4,000	1	P.	2	80.02	1,700	Do.
	40,000	1	P.	3	85.02	2,300	Do.

† One piece gave 20.7 per cent. elongation.

173	42,110	1	P.	1	49.0	25,000	Do.
	45,440	1	P.	3	24.31	65,000	Do.
	76,000	1	P.	3	28.00	82,500	Do.
	20,400	1	P.	3	26.30	45,000	Do.
	7,680	1	P.	3	26.33	65,000	Do.
	6,300	1	P.	1	24.30	49,000	Do.
	7,700	1	P.	1	24.30	49,000	Do.
	7,540	1	P.	3	28.33	44.3	Do.
	6,538	1	P.	1	27.00	45.0	Do.
	7,577	1	P.	2	28.40	41.0	Do.
	6,300	1	P.	2	26.00	41.5	Do.
	7,760	1	P.	2	27.00	40.0	Do.
	6,118	1	P.	2	24.65	42.0	Do.
	7,445	1	P.	1	28.00	40.0	Do.
	6,115	1	P.	1	25.00	41.7	Do.
	7,765	1	P.	3	28.67	40.7	Do.
	6,118	1	P.	1	25.00	43.0	Do.
	7,750	1	P.	1	28.50	41.5	Do.
	6,118	1	P.	2	28.00	44.0	Do.
	7,400	1	P.	1	27.00	40.0	Do.
	6,118	1	P.	4	25.50	40.3	Do.
	7,418	1	P.	4	27.23	50.0	Do.
	6,300	1	P.	2	28.00	44.2	Do.
	4,880	1	P.	1	25.00	41.0	Do.
	7,419	1	P.	4	27.83	42.7	Do.
	6,238	1	P.	3	26.83	44.3	Do.
	5,900	1	P.	1	27.50	36.0	Do.
	7,677	1	P.	1	24.30	45.0	Do.
	6,300	1	P.	5	25.47	44.0	Do.
	7,322	1	P.	3	25.00	40.0	Do.
	7,500	1	P.	1	28.03	42.0	Do.
	6,333	1	P.	3	25.50	33.0	Do.
	4,977	1	P.	2	27.75	40.3	Do.
	7,577	1	P.	6	27.00	40.3	Do.
	6,335	1	P.	2	28.70	39.0	Do.
	4,998	1	P.	7	28.70	41.3	Do.
	6,200	1	P.	1	28.00	30.0	Do.
	7,400	1	P.	1	28.00	41.0	Do.
	7,154	1	P.	3	27.20	43.7	Do.
	7,540	1	P.	2	27.20	45.7	Do.
	6,574	1	P.	3	28.00	47.4	Do.
	6,332	1	P.	5	27.00	38.5	Do.
	7,575	1	P.	2	27.11	46.3	Do.
	6,335	1	P.	2	28.30	40.0	Do.
	6,320	1	P.	2	26.00	42.0	Do.

* Accepted.

174	42,110	1	P.	1	49.0	25,000	Do.
	45,440	1	P.	3	24.31	65,000	Do.
	76,000	1	P.	3	28.00	82,500	Do.
	20,400	1	P.	3	26.30	45,000	Do.
	7,680	1	P.	3	26.33	65,000	Do.
	6,300	1	P.	1	24.30	49,000	Do.
	7,700	1	P.	1	24.30	49,000	Do.
	7,540	1	P.	3	28.33	44.3	Do.
	6,538	1	P.	1	27.00	45.0	Do.
	7,577	1	P.	2	28.40	41.0	Do.
	6,300	1	P.	2	26.00	41.5	Do.
	7,760	1	P.	2	27.00	40.0	Do.
	6,118	1	P.	2	24.65	42.0	Do.
	7,445	1	P.	1	28.00	40.0	Do.
	6,115	1	P.	1	25.00	41.7	Do.
	7,765	1	P.	3	28.67	40.7	Do.
	6,118	1	P.	1	25.00	43.0	Do.
	7,750	1	P.	1	28.50	41.5	Do.
	6,118	1	P.	2	28.00	44.0	Do.
	7,400	1	P.	1	27.00	40.0	Do.
	6,118	1	P.	4	25.50	40.3	Do.
	7,418	1	P.	4	27.23	50.0	Do.
	6,300	1	P.	2	28.00	44.2	Do.
	4,880	1	P.	1	25.00	41.0	Do.
	7,419	1	P.	4	27.83	42.7	Do.
	6,238	1	P.	3	26.83	44.3	Do.
	5,900	1	P.	1	27.50	36.0	Do.
	7,677	1	P.	1	24.30	45.0	Do.
	6,300	1	P.	5	25.47	44.0	Do.
	7,322	1	P.	3	25.00	40.0	Do.
	7,500	1	P.	1	28.03	42.0	Do.
	6,333	1	P.	3	25.50	33.0	Do.
	4,977	1	P.	2	27.75	40.3	Do.
	7,577	1	P.	6	27.00	40.3	Do.
	6,335	1	P.	2	28.70	39.0	Do.
	4,998	1	P.	7	28.70	41.3	Do.
	6,200	1	P.	1	28.00	30.0	Do.
	7,400	1	P.	1	28.00	41.0	Do.
	7,154	1	P.	3	27.20	43.7	Do.
	7,540	1	P.	2	27.20	45.7	Do.
	6,574	1	P.	3	28.00	47.4	Do.
	6,332	1	P.	5	27.00	38.5	Do.
	7,575	1	P.	2	27.11	46.3	Do.
	6,335	1	P.	2	28.30	40.0	Do.
	6,320	1	P.	2	26.00	42.0	Do.

finch bar turned down.

TABLE XI.—Tests of rivets and rivet bars. Chester Rolling Mills—Continued.

Lot No.	Nominal size of rivet,		Tensile tests.						Shearing tests.						Hammer and bending tests passed or failed.		Accepted or rejected.	Manufacturer.	Remarks.
	In.	Di.	Average diameter.	Average original area.	Average ultimate tensile strength per square inch.	Average final elongation.	Average final area.	Number of tests.	Passed or failed.	Nominal size of rivet hole.	Average shearing area.	Average ultimate shearing strength per square inch.	Ratio to tensile strength.	Number of tests.	Passed or failed.	P.			
198...	1	660	750	3415	68,500	25.00	43.0	2	P.	1 1/2	6900	52,000	78.20	2	P.			Combination Iron and Steel Works.	t-inch bar turned down.
199...	1	660	750	3420	67,000	27.00	43.0	1	P.	1 1/2	6900	52,000	78.20	2	P.			Do.	
199...	1	660	750	3420	68,000	25.50	42.0	1	P.	1 1/2	7000	55,000	80.90	1	P.			Do.	
199...	1	660	750	3430	65,000	27.00	43.0	1	P.	1 1/2	6600	51,000	80.95	1	P.			Do.	
198...	1	660	700	3360	67,000	27.00	40.0	2	P.	1 1/2	6900	52,000	78.20	2	P.			Do.	
198...	1	660	700	3360	66,500	27.00	40.0	2	P.	1 1/2	7000	52,500	78.20	2	P.			Do.	
198...	1	660	700	3370	65,000	24.00	40.0	2	P.	1 1/2	6900	52,000	78.20	2	P.			Do.	
198...	1	660	700	3400	70,000	27.75	42.8	2	P.	1 1/2	7000	52,000	78.20	2	P.			Do.	
198...	1	660	700	3370	67,300	28.17	40.7	2	P.	1 1/2	6900	52,000	78.20	2	P.			Do.	
198...	1	660	700	3370	69,000	27.67	42.0	2	P.	1 1/2	6900	52,000	78.20	2	P.			Do.	
198...	1	660	700	3400	67,333	27.67	42.0	2	P.	1 1/2	6900	52,000	78.20	2	P.			Do.	
201...	1	660	700	3390	67,500	28.00	43.0	2	P.	1 1/2	6900	52,000	78.20	2	P.			Do.	
201...	1	660	700	3420	67,000	27.50	43.0	2	P.	1 1/2	6900	52,000	78.20	2	P.			Do.	
202...	1	660	700	3420	66,000	28.00	43.0	2	P.	1 1/2	6900	52,000	78.20	2	P.			Do.	
202...	1	660	700	3420	66,333	28.67	43.6	2	P.	1 1/2	6900	52,000	78.20	2	P.			Do.	
208...	1	660	700	3453	65,000	28.00	44.0	2	P.	1 1/2	6900	52,000	78.20	2	P.			Do.	
208...	1	660	700	3453	65,000	28.00	44.0	2	P.	1 1/2	6900	52,000	78.20	2	P.			Do.	
208...	1	660	700	3453	65,000	28.00	44.0	2	P.	1 1/2	6900	52,000	78.20	2	P.			Do.	
208...	1	660	700	3453	65,000	28.00	44.0	2	P.	1 1/2	6900	52,000	78.20	2	P.			Do.	
204...	1	660	700	3450	65,000	28.00	44.0	2	P.	1 1/2	6900	52,000	78.20	2	P.			Do.	
204...	1	660	700	3450	65,000	28.00	44.0	2	P.	1 1/2	6900	52,000	78.20	2	P.			Do.	
204...	1	660	700	3450	65,000	28.00	44.0	2	P.	1 1/2	6900	52,000	78.20	2	P.			Do.	
204...	1	660	700	3450	65,000	28.00	44.0	2	P.	1 1/2	6900	52,000	78.20	2	P.			Do.	
205...	1	660	700	3450	64,500	27.90	43.0	2	P.	1 1/2	6900	52,000	78.20	2	P.			Do.	
205...	1	660	700	3450	64,500	27.90	43.0	2	P.	1 1/2	6900	52,000	78.20	2	P.			Do.	
206...	1	660	700	3450	63,500	28.00	43.0	2	P.	1 1/2	6900	52,000	78.20	2	P.			Do.	
206...	1	660	700	3450	63,500	28.00	43.0	2	P.	1 1/2	6900	52,000	78.20	2	P.			Do.	
206...	1	660	700	3450	64,000	28.00	43.0	2	P.	1 1/2	6900	52,000	78.20	2	P.			Do.	
218...	1	660	700	3450	64,000	27.90	40.9	2	P.	1 1/2	6900	52,000	78.20	2	P.			Do.	
218...	1	660	700	3450	64,000	27.90	40.9	2	P.	1 1/2	6900	52,000	78.20	2	P.			Do.	
219...	1	660	700	3450	63,000	28.33	43.7	2	P.	1 1/2	6900	52,000	78.20	2	P.			Do.	
219...	1	660	700	3450	63,000	28.33	43.7	2	P.	1 1/2	6900	52,000	78.20	2	P.			Do.	
219...	1	660	700	3450	63,000	28.33	43.7	2	P.	1 1/2	6900	52,000	78.20	2	P.			Do.	
219...	1	660	700	3450	63,000	28.33	43.7	2	P.	1 1/2	6900	52,000	78.20	2	P.			Do.	
220...	1	660	700	3450	63,000	27.04	38.6	2	P.	1 1/2	6900	52,000	78.20	2	P.			Do.	
220...	1	660	700	3450	63,000	27.04	38.6	2	P.	1 1/2	6900	52,000	78.20	2	P.			Do.	
220...	1	660	700	3450	63,000	27.04	38.6	2	P.	1 1/2	6900	52,000	78.20	2	P.			Do.	
220...	1	660	700	3450	63,000	27.04	38.6	2	P.	1 1/2	6900	52,000	78.20	2	P.			Do.	

221	747	4368	67,189	34,500	64.83	3	P.	1,000	do	Accepted.
	622	4045	67,500	34,500	67.60	2	P.	1,000	do	
222	500	1933	67,000	33,000	67.68	1	P.	1,500	do	
	634	3050	68,100	32,300	63.80	2	P.	1,000	do	
224	504	2070	63,400	34,000	68.33	1	P.	1,000	do	

* Accepted.

General summary.

ACCEPTED RIVETS.

Nominal size of rivet.	Average ultimate tensile strength per square inch.		Average elongation.		Average area.		Number of tests.		Average ultimate shearing strength per square inch.		Number of tests.		Ratio to tensile strength.	
	Pounds.	Per ct.	Pounds.	Per ct.	Average final.	Per ct.	Number of tests.	Pounds.	Per ct.	Number of tests.	Pounds.	Per ct.	Number of tests.	Per ct.
Inch.	65,200	28.35	43.67	34	52,960	34	52,960	81.27	29,119	34	81.27	29,119	81.27	29,119
	64,900	28.12	42.25	183	53,200	206	53,200	82.08	204,000	206	82.08	204,000	82.08	204,000
	64,553	28.58	41.88	101	54,758	107	54,758	84.84	93,925	107	84.84	93,925	84.84	93,925
	60,929	28.01	36.71	7	53,430	7	53,430	87.60	4,200	7	87.60	4,200	87.60	4,200
All	64,740	27.41	42.00	325	53,695	354	53,695	82.94	331,244	354	82.94	331,244	82.94	331,244

TABLE XII.—Tests of rivets and rivet bars, Pittsburgh, Pa.

Lot No.	Nominal size of rivet	Tensile tests.						Shearing tests.						Hammer or failed.	Accepted or rejected.	Manufacturer.	Remarks.
		Average original diameter.	Average original area.	Average ultimate tensile strength per square inch.	Average elongation.	Average final area.	Number of tests.	Passed or failed.	Nominal size of rivet hole.	Shearing area.	Ultimate shearing strength per square inch.	Ratio to tensile strength.	Number of tests.				
1	1/2	741	3305	62,955	27.38	43.19	2	P.	1/2	5150	51,510	81.68	1	P.	Pounds	Jones & Laughlin	ingle
2	1/2	745	4350	61,370	27.25	38.97	2	P.	5150	52,000	84.73	1	P.	P.	\$1,000	do	Do.
3	1/2	743	4330	62,695	29.06	37.53	2	P.	5150	52,000	82.84	1	P.	P.	\$1,000	do	Do.
4	1/2	744	4350	62,640	29.19	37.35	2	P.	5150	51,030	81.47	1	P.	P.	\$1,000	do	Do.
5	1/2	741	4305	61,085	28.13	38.55	2	P.	5150	51,750	84.72	1	P.	P.	\$1,000	do	Do.
6	1/2	741	4310	61,710	27.44	38.51	2	P.	5150	53,700	87.02	1	P.	P.	\$1,000	do	Do.
7	1/2	744	4355	60,780	28.44	44.41	2	P.	5150	52,970	87.15	1	P.	P.	\$1,000	do	Do.
8	1/2	738	4265	61,665	28.25	44.08	2	P.	5150	50,060	81.20	1	P.	P.	\$1,000	do	Do.
9	1/2	745	4350	63,445	27.58	38.17	2	P.	5150	52,970	83.48	1	P.	P.	\$1,000	do	Do.
10	1/2	743	4330	61,090	28.81	41.01	2	P.	5150	53,940	88.30	1	P.	P.	\$1,000	do	Do.
11	1/2	739	4260	62,965	27.81	38.75	2	P.	5150	53,450	84.59	1	P.	P.	\$1,000	do	Do.
12	1/2	718	4035	66,055	28.63	37.60	2	P.	5150	52,000	78.72	1	P.	P.	\$1,000	do	Do.
13	1/2	720	4180	64,090	27.76	37.25	2	P.	5150	53,450	83.40	1	P.	P.	\$1,000	do	Do.
14	1/2	720	4150	63,925	28.08	38.25	2	P.	5150	50,080	79.04	1	P.	P.	\$1,000	do	Do.
15	1/2	744	4340	63,230	28.33	44.45	2	P.	5150	50,060	80.38	1	P.	P.	\$1,000	do	Do.
16	1/2	731	4190	63,290	28.13	44.03	2	P.	5150	50,060	81.63	1	P.	P.	\$1,000	do	Do.
17	1/2	744	4340	61,185	28.50	39.00	2	P.	5150	50,080	82.03	1	P.	P.	\$1,000	do	Do.
18	1/2	748	4385	63,310	28.87	43.11	2	P.	5150	51,030	81.63	1	P.	P.	\$1,000	do	Do.
19	1/2	746	4365	60,490	28.87	36.95	2	P.	5150	52,000	83.97	1	P.	P.	\$1,000	do	Do.
20	1/2	746	4365	63,850	28.31	41.40	2	P.	5150	50,540	78.81	1	P.	P.	\$1,500	do	Do.
All		740	4293	62,462	28.47	39.77	40	P.	5150	51,732	82.63	20	P.	P.	\$19,300		

*A.

Table XII. gives the results of tests on $\frac{3}{4}$ -inch rivets supplied by Jones & Laughlin, and tested at Pittsburgh by the inspector there. The machine used was that of Park, Bro. & Co. The results agree well with those obtained from similar metal at Chester. The inspection at Pittsburgh was discontinued as a matter of convenience, the tests being subsequently all made at Chester.

STEEL FORGINGS.

Steel shafts have been the subject of special investigation and experiments not yet completed by the Board, and upon which report has been made to the Department. Apart from this class of forgings, the stems, stern-posts, and rudder frames of the vessels are of steel, forged either from scrap or bloom. By forgings from bloom is not meant from a solid piece of metal, but from a number of billets or blooms of convenient size; as they have not so many reheatings as a scrap forging their average quality is better.

Table XIII. contains the record of the physical tests of the larger forgings from scrap and bloom. While the scrap forgings do not give so high average strength or elongation as those from the blooms, they yet give very fair results, and considerably better than is to be expected from wrought iron similarly treated. The average results in the table show the forging from bloom to be about 15 per cent. better metal than that from scrap.

TABLE XIII.

Forging.	Forged from—	Original width.	Original thickness.	Original area.	Ultimate tensile strength, per square inch.	Final elongation in 8 inches.	Final area.
		Inch.	Inch.	Sq. inch.	Pounds.	Per ct.	Per ct.
Stem and stern-post.....	Scrap.....	748	748	5595	67,100	18.70	42.8
		750	740	5550	55,830	17.30	41.3
		784	738	5638	54,100	18.25	41.3
		768	738	5557	54,000	18.70	42.8
		750	750	5625	60,100	21.00	36.0
Do.....	Bloom.....	768	745	5707	58,000	24.65	40.0
		753	785	5534	58,700	23.40	34.0
		765	742	5676	57,500	20.30	37.3
		740	738	5461	67,000	18.06	63.0
Do.....	Scrap.....	740	737	5453	70,000	24.40	42.0
		737	737	5431	66,800	23.30	44.0
		741	741	5490	65,500	20.70	40.0
		744	736	5475	67,000	22.00	40.0
Do.....	Bloom.....	736	738	5446	67,000	22.70	39.0
		745	741	5510	68,000	22.80	41.0
		745	741	5483	68,000	20.10	40.0
Rudder frames—Boston and Atlanta.	Scrap.....	750	750	5625	58,666	23.90	55.0
		567	550	3120	58,680	24.30	35.0
Average.....	Scrap.....				60,768	19.75	44.74
Do.....	Bloom.....				63,037	22.12	38.41

* Piece defective, showing lamination on fracture.

Many smaller forgings from steel blooms or bars have been used in the construction of the machinery for all four vessels. It may be interesting to state these parts in detail, as follows:

STEEL PARTS IN THE MACHINERY OF THE DOLPHIN.

Open hearth steel supplied by the Nashua Steel Company, Nashua, N. H.—Connecting rods, caps, and bolts; piston rods, caps, and bolts; crankshaft pillow-block caps, and bolts; coupling bolts and cross-keys of line shafting; eccentric rods of main steam and cut-off valves; link bars, pins, connecting bolts, and link blocks of main steam valve gear;

reversing shaft and pins on arms of shaft; keys for securing condenser brackets to the condenser for support of engine cylinders.

STEEL PARTS IN THE MACHINERY OF THE BOSTON AND ATLANTA.

Crucible steel.—Main and cut-off valve stems; bolts for adjusting crank-shaft brasses; all set screws.

Open hearth mild steel, from Nashua, N. H.—Piston rods; main valve rock shafts; high pressure side rods; connecting rod bolts; crank-pins; radial faces of lugs on one disk of clutch-coupling; friction band; gibs and keys, and feathers; coupling bolts; wedges for crank-shaft pillow-blocks.

Cast steel from Chester, Pa.—Pinion on steam turning engine.

Cast steel from Spuyten Duyvil, N. Y.—Cross-heads of air and circulating pump rods.

STEEL PARTS IN THE MACHINERY OF THE CHICAGO.

Mild open hearth steel, from Nashua, N. H.—Bodies of main connecting rods, with their bolts, nuts, and keys; beam center and end pins; crank-shafts and crank-pins; piston rods: main cross-heads; loose couplings of main shafts; cross-heads of main and cut-off valves; gibs and keys of front links; binders of main crank-shafts, with bolts and nuts; bolts and keys of main shaft couplings; rock shafts for main and cut-off valve gear; reversing shaft and binders; main and cut-off rock shaft arms; rock shaft binders and bolts; Stevenson links and blocks; eccentric rods; straps, gibs, and keys for eccentric rods and cut-off rods; bolts securing the beam pillow-blocks to condensers; binders and bolts of beam pillow-blocks.

Crucible steel.—Rods connecting cut-off rock shafts with beam-center pins; valve stems; all set screws.

OPINIONS OF INSPECTORS AS TO DESIRABLE CHANGES IN THE REQUIREMENTS AND SYSTEM OF TESTS.

Before the officers engaged in the inspection of material at the mills and its subsequent working into hulls and boilers should have been detached and ordered to other duty, and in view of the possible action of Congress as to further steel construction for the Navy, the following letter was issued to all inspectors.

NAVAL ADVISORY BOARD, NAVY DEPARTMENT,
Washington City, April 24, 1884.

INSPECTOR OF MATERIAL:

SIR: It is the intention of the Board to compile a new circular for "Tests of steel for cruisers," in which the limits of strength and ductility must be adhered to as required by existing law.

You will please give the matter your careful consideration, and report to the Board on or before June 1, 1884, what changes in the present tests as altered by existing orders, and what additional tests, regulations, or restrictions, you consider desirable as suggested by your present duties.

You will please present your suggestions in a concise form ready to be introduced in the circular, and will state your reasons therefor briefly and concisely, and where necessary quote facts and figures from your reports.

Very respectfully,

E. SIMPSON,
Rear-Admiral, U. S. N., President of the Board.

Lieut. F. J. DRAKE, U. S. N.
Chief Engineer B. B. H. WHARTON, U. S. N.
Chief Engineer ISAAC R. McNARY, U. S. N.
Assistant Engineer B. C. BRYAN, U. S. N.
Chief Engineer A. W. MORLEY, U. S. N.
Assistant Naval Constructor J. F. HANSCOM, U. S. N.
Assistant Naval Constructor J. B. HOOVER, U. S. N.
Assistant Naval Constructor R. GATEWOOD, U. S. N.
Lieut. G. A. BICKNELL, U. S. N.

By the replies which follow the Board has been largely guided in its recommendations as embodied in the proposed new circular of "Tests of steel for cruisers." It will be noticed that the changes proposed by the inspectors are, in the main, either in the details of inspection or in the addition of working tests for boiler metal. The few proposed additional requirements for quality as determined by tensile tests are on somewhat debatable ground, and it is believed would result in appreciable increased cost without proportionate improvement of quality.

[Naval Advisory Board, Office of Inspector of Material, Norway Iron and Steel Company.]

SOUTH BOSTON, MASS., May 28, 1884.

SIR: In compliance with your letter of the 24th ultimo, relative to a new circular for "Tests of steel for cruisers," I would respectfully submit the following.

I am, sir, very respectfully, your obedient servant,

F. J. DRAKE,
Lieutenant, Inspector of Material

Rear-Admiral E. SIMPSON, U. S. N.,
President Naval Advisory Board.

(1) To be inserted after the words "ship plates," in article III., in lieu of "in every lot of 20, &c., * * * shaped according to the annexed sketch."

"Conditions of tests.—All material shall be tested by heats, as follows:

"A specimen bloom of not less than 600 pounds weight, shall be selected at random from each heat, to be cut from the upper third of the ingot. This bloom to be rolled into a plate of 20 pounds to the square foot. Eight test pieces shall be cut from it and shaped according to the annexed sketch—four for tensile stress and four for the heat-quenching test, the four latter, after heating to a cherry red, to be plunged in water at a temperature of 80°F. Thus prepared, it must be possible to bend the pieces under a press or hammer so that they shall be doubled, with faces touching throughout, without presenting any traces of cracking. These test pieces to have the sharpness of the outer edges of one sheared side only taken off with a fine file."

(2) To be inserted in paragraph under "Conditions of acceptance," after the words "original section," so as to read, "with a measured elongation in 8 inches of 18 per cent. at the point of failure, and a final elongation of not less than 23 per cent."

(3) To be inserted in lieu of article under "Cases of failure."

"If the average of these four test pieces, numbered 1, 2, 3, 4 (called test I.), falls below either of the required limits, the ingot from which the specimen bloom for pieces 1, 2, 3, 4 was cut shall be rejected, and test II. made, consisting of pieces 5 and 6, cut from the lower third of a second ingot of the same heat. If the mean of the results of these two falls below either of the above limits the entire heat shall be rejected.

"If it be successful, test III., or the mean of pieces 7 and 8, cut from the lower third of second ingot, shall decide.

"If in any of tests I., II., III., any single piece shows a tensile stress less than 58,000 pounds, or an elongation of less than 18 per cent. at point of failure, or a final elongation of less than 23 per cent., the ingot from which it was cut shall be rejected and the test considered to have failed, regardless of its average."

(4) To be inserted in lieu of Article VII.:

"Boiler plates.—Each heat for boiler plate must be subjected to the same tests and in the manner prescribed for ship plates. In each test piece the ductility in 8 inches at the point of failure must not be less than 20 per cent., and its final elongation not less than 25 per cent., and the ultimate tensile strength must not be less than 58,000 pounds and not more than 63,000 pounds, and the average of the tests at least over 60,000 pounds."

The above suggestions are based on facts, as determined by observation from the following heats, which have been accepted. If necessary, more can be quoted to sustain the average already given.

Sketch of test pieces.

Scale: $\frac{1}{2}$ full size.

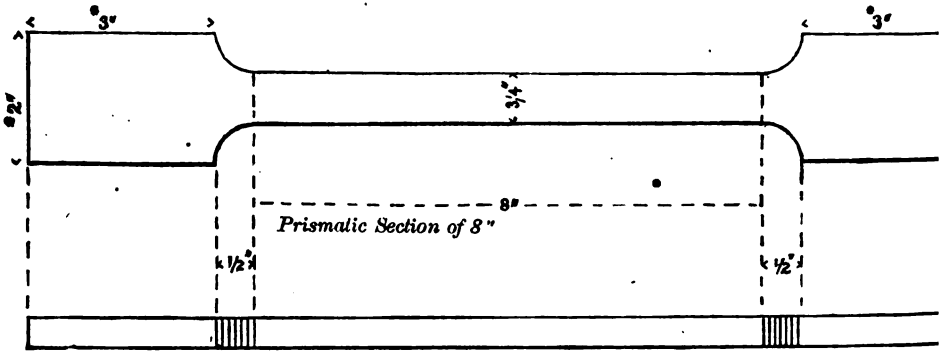

For the test machine.

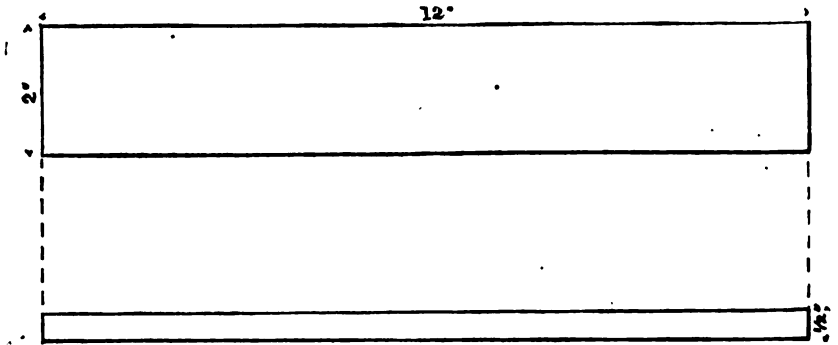

For the quenching test.

[The figures marked thus * may be varied to suit the size of test machine.]

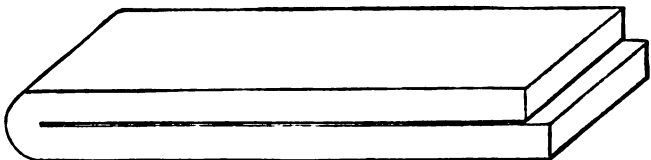

Heat-quenching test. To bend double, faces touching.

Number of heat.	Mean tensile strength of 4 test pieces.	Final elongation in original length of 8 inches.	Elongation at point of failure.	Analysis of—	
				Carbon.	Manganese.
	<i>Pounds.</i>	<i>Per cent.</i>	<i>Per cent.</i>		
39	60,090	27.25	21.00	13	38
43	62,000	25.50	18.25	22	30
45	60,600	26.75	20.75	17	23
64	61,300	26.75	21.00	16	38
65	60,900	28.25	22.00	16	31
66	60,600	27.00	20.25	18	33
67	60,300	26.50	20.00	15	26
90	61,800	26.75	19.75	15	32
112	62,200	26.25	20.00	17	46
114	61,800	25.75	18.00	18	39
118	62,900	27.75	21.75	15	39
120	60,660	26.75	19.50	15	27
182	63,300	25.75	19.00	18	46
182	62,400	26.00	20.50	19	49
185	62,800	26.00	20.00	19	43
285	61,600	27.50	21.00	17	47
278	60,840	29.75	22.75	14	40
275	61,400	27.00	20.25	15	31
325	60,700	28.00	21.00	14	40
327	60,900	27.00	19.50	20	40
344	60,600	26.00	20.00	18	29
353	61,900	26.50	19.50	18	47
380	60,400	26.25	20.50	15	34
390	60,090	26.75	19.50	18	49
468	60,400	25.25	23.00	13	38
410	60,880	27.50	23.50	18	43
442	62,070	26.75	21.50	18	39
450	60,860	26.50	20.25	19	50
452	60,230	26.88	24.00	19	45
470	62,500	26.75	21.50	23	48
Average	61,298	26.81	20.65	17	39

Of the 120 test pieces in the above given heats, only seven fall below 60,000 pounds, as follows:

	Pounds.
Heat No. 39, one test piece	59,966
Heat No. 66, one test piece	59,950
Heat No. 67, one test piece	59,826
Heat No. 325, one test piece	59,796
Heat No. 390, one test piece	59,904
Heat No. 390, one test piece	58,900
Heat No. 452, one test piece	59,625

I do not consider the present crude system of annealing plates of any value whatever, as I find from observations in testing that it does not improve the average elongation or lessen the average tensile stress.

I am, sir, very respectfully, your obedient servant,

F. J. DRAKE,
Lieutenant, Inspector of Material.

Rear-Admiral E. SIMPSON, U. S. N.,
President Naval Advisory Board.

[Naval Advisory Board, Office of Inspector of Material, at Chester Rolling Mills.]

CHESTER ROLLING MILLS, May 27, 1884.

SIR: In accordance with the Board's letter of April 24, 1884, I recommend the following changes:

(I.) In the paragraph headed "In cases of failure," substitute 22 per cent. for 21 per cent.

(II.) In paragraph IV., headed "Quenching test," add "one piece from each plate shall also be bent cold."

(III.) Paragraph VI., "Rivets," should read thus:

"Each 1,000 pounds of rivets from the same heat of metal shall constitute a lot, and be accompanied by two sample bars, each 18 inches long, for tensile test. These samples for tensile test shall be cut from the bars from which the lot of rivets is made, and be stamped with a number, which shall also be placed on each box or package of that lot.

"These samples to be subject to the same tensile test as that required for the plate test.

"The lot of rivets of which the sample bar does not fulfill the requirements of tensile strength and elongation required for plates is to be rejected.

"From each lot six rivets are to be taken at random and submitted to the following tests, two rivets to be used for each test:

"(1) Two rivets to be flattened out cold under the hammer to a thickness of one-half the diameter without showing cracks or flaws.

"(2) Two rivets to be flattened out hot under the hammer to a thickness of one-third the diameter without showing cracks or flaws.

"(3) Two rivets to be bent cold into the form of a hook with parallel sides without showing cracks or flaws."

REASONS.

Since the present inspection by heats or test plates from a sample ingot began, 262 heats have been inspected, and 42 heats have failed to meet the specifications. Of 150 heats ship, about 13 per cent. have failed; average of tests of tenacity 63,000; ductility 25.5. Of 70 heats boiler, the average of tests is—tenacity, 58,000; ductility, 27.5.

The fact that the average of this ship plate shows 25 per cent. ductility, and the proportion of failures is so small, shows that 23 per cent. is an easy standard to meet, and I think justifies the substitution of 22 per cent. for 21 per cent. in paragraph headed "In cases of failures," in the first change recommended.

Again, as originally required, one of the test pieces was to be cut transversely, and the ductility of such pieces is generally much less than those with the grain. To allow or direct the tests to be all longitudinal and leave the 21 per cent. as it was when half of the tests were across the grain is virtually to allow a metal of less ductility to be accepted. The result is that metal can pass which under the original wording could not pass.

I do not know that any advantages are gained by testing across the grain. But testing as is the practice here, I think each heat should be rejected whenever any piece shows less than 22 per cent. ductility.

In assigning a reason for the change II. it seems sufficient to notice that this test has been retained by the British Admiralty after a by no means inconsiderable experience, and I see no good reason why it should not be used for our metal. The failures of the plate to pass the quenching test here have amounted to less than 2 per cent.

Change III. is simply an attempt to indicate that the rivets in lots of 1,000 pounds should be accompanied by samples for tensile test of the bars from which the rivets are made. Selecting one bar from each twenty gives a varying ratio of amount of inspection for each size of rivet, while 1,000 pounds gives a definite one. The other change increases the hammer test from what is *now*, but not above what *was*, originally prescribed.

The fact is sufficiently well known that steel rivets riveted with ordinary care will shear according to their tensile strength in a similar way throughout. I consider the shearing test unnecessary.

Respectfully,

GEORGE A. BICKNELL,

Lieutenant, U. S. N., Inspector of Material.

Rear-Admiral EDWARD SIMPSON, U. S. N.,

President of the Naval Advisory Board, Navy Department, Washington.

[Naval Advisory Board, Office of Inspector of Material.]

PHENIXVILLE, May 26, 1884.

SIR: In reply to the Board's communication of the 24th April, relating to modifications of the existing test requirements for mild steel, I have the honor to state that, after careful consideration, I see no reason for any modification of the present requirements, which seem to cover the case completely, as regards material to be manufactured by parties unknown to the Board. Any concessions or simplifications should depend entirely on individual circumstances. Thus, if the shapes for additional vessels were to be made of Cambria open-hearth steel, rolled at the Phoenix Iron Works, there are certain changes which might be made with advantage, which would simplify the work and furnish more complete chemical information. These, however, should be made by arrangement, and should not take the form of the successive removal of particular tests from the requirements, but by substitution of an alternate system acceptable to all parties. For a general circular, I consider the present system simple and effective.

Without desiring to enter upon the general subject of the requirements of the law, as bearing on the quality of the material, I beg to suggest that a somewhat harder steel should be used for all shapes, whether for connecting or stiffening purposes, to be accompanied by a clause in the ship specifications requiring the use of improved

punches and shear-knives, a course now being adopted voluntarily in certain bridge works. In all cases, the upper limit of tensile strength should be imposed, both for shapes and plates, from considerations of elasticity; for, as will be seen from the reports of tensile tests, increased tensile strength is accompanied by a rapidly increasing value of the modulus of elasticity,* which may, in particular cases, be further affected by comparatively cold rolling. This consideration is much less important for shapes than for plates, because shapes cannot be rolled below a certain temperature without serious danger to the rolls, and they anneal much more in cooling.

Angles for water-tight work, and beams or frames behind armor or supporting a protective deck, form exceptions to the above considerations and should be made of material not harder than the plates they connect or support.

I have ventured to offer the above suggestions as being in the direction of increased efficiency of the hull and further reduction of scantling, especially in the plating, when backed by the stiffer frames and more rigidly connected at the angles, and after seeing all that this material will stand when tested to destruction.

I have the honor to further suggest that requirements for quality be issued for iron to be used. Thus, certain iron angles made here for the boilers of the Dolphin did not come under inspection.

Very respectfully, your obedient servant,

R. GATEWOOD,
Assistant Naval Constructor, U. S. N.

Rear-Admiral E. SIMPSON, U. S. N.,
President Naval Advisory Board.

[Morgan Iron Works.]

NEW YORK, May 29, 1884.

SIR: In obedience to your order of April 24, I have carefully considered the matter of tests of steel for cruisers, and have the honor to submit the following changes, as those taught me as desirable by my recent experience in testing steel. I also include my reasons for advocating such changes, and a list of articles with which I think each inspector should be provided:

I.—TENSILE TESTS.

(1) *Ship plates.*—From each of two plates from each heat of steel, two test pieces shall be cut, one from each end of the plate, one with and one at 90° to direction of rolling.

(2) *Boiler plates.*—From each end of each plate to be used for boilers, one test piece shall be cut, one piece being with and the other at 90° to the direction of rolling.

(3) *Angles, beams, channels, &c.*—From each heat of steel made for angles, beams, &c., a test ingot shall be cast, or a "billet" cut when ingot is bloomed. From this ingot or billet a plate may be rolled and test pieces cut therefrom; or square or round bars may be rolled and used for test pieces. Provided, always, that the steel in test pieces shall receive no more working than the finished material from the heat would have.

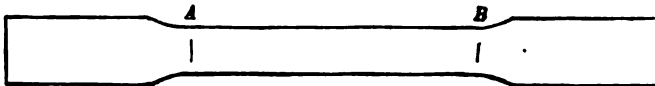

(4) *Form of test pieces.*—The test pieces for all plates shall be of the form shown in Fig. 1. The length, A B, must be sufficient to give 8 inches with parallel sides, and have sufficient material cut out to insure the piece from breaking in the grips. The width of piece must be sufficient to give between A and B an area of cross-section not less than $\frac{1}{4}$ or greater than $\frac{1}{10}$ square inch.

When plates are rolled from test ingots or billets for angles, &c., the test pieces shall conform to this pattern, but need only be cut in direction of rolling. If squares are used the side shall not exceed $\frac{1}{4}$ inch. If rounds are used the diameter shall not

* This conclusion must have been deduced from only a few heats, as the average rise in modulus of elasticity with increasing strength for this steel is very small.—N. A. B.

exceed $\frac{1}{2}$ inch; in all cases specimens to be long enough to measure elongation in 8 inches.

(5) *Requirements.*—Each test piece shall be submitted to direct tensile stress until it breaks, and in a machine of approved design. The initial stress to be 35,000 pounds per square inch. The first load to be kept in continuous action for one minute. "Additional loads, &c." (see Section III., Tests of Steel for Cruisers, June 18, 1883,) down to "Conditions of Acceptance." At end of first paragraph under "Conditions of Acceptance" add, "and elastic limit not less than 38,000 pounds per square inch. Cases of Failure: If the average of the four test pieces falls below any of the required limits the heat shall be rejected. In the case of boiler plates, if the average of the two pieces from a plate falls below any limit, the plates shall be rejected. If any single piece shows a tensile strength less than 58,000 pounds or a final elongation less than 21 per cent., the heat from which it came (or, in case of boiler plate, the plate from which it came) shall be rejected, regardless of its average."

II.—QUENCHING TEST.

See Section IV. of "Tests of Steel for Cruisers," June 18, 1884, after the words "without presenting any trace of cracking" insert the following: "Piece to be bent until it breaks or bends double, and fracture of break to be examined. If fracture is crystallized and not fibrous, another piece shall be treated in the same way, and if fracture is similar the inspector may reject the plate, bar, angle, &c., from which it was out."

III.—STAMPING AND ROLLING TEST PIECES.

A list of all ingots made from each heat for angles or beams, &c., must be furnished the inspector. Each ingot shall be stamped in his presence, with the number of the heat. He shall also see the test billet cut off, stamped, and rolled, and must stamp each plate or bar rolled from it, with a private stamp, in such a way that each test piece will have impression of stamp near one end.

Reasons.

I respectfully state that my reasons for advocating these changes are as follows:

For change in tensile test of ship plates, it reduces the number of pieces.

I have found that the difference caused in tensile strength by rolling at a full red or dull red heat is very marked.

I would call attention to the following heats made at Cambria Iron Works, Johnstown, Pa., for cruiser steel:

Number of heat.	Rolled at bright red heat.		Rolled at dull red.	
	Tensile strength.	Elongation.	Tensile strength.	Elongation.
	Pounds.	Per cent.	Pounds.	Per cent.
4452.....	70,245	25.9	70,573	22.4
4712.....	66,942	24.3	71,954	22.6
4951.....	63,135	24.9	64,060	22.8
4478.....	59,190	28.3	61,500	24.5

A difference is shown here of 2,400 pounds in ultimate strength and 3.8 per cent. elongation, when the difference in heating could scarcely be noticed by any one unaccustomed to heating or working steel. There would, according to this, be a difference in strength and elongation at different parts of a plate if it was not all rolled at a uniform heat. This is found to be true, though when such differences are large they may more properly be attributed to localization of carbon or other elements. In either case, the steel might do for angles and beams or even ship plates; but in boiler plates, where the failure of one sheet is almost sure to cause loss of life and serious damage, every plate should be tested. I have recommended, therefore, a piece to be cut from each end of each boiler plate, and tests for ship plates to come, one for each end of plates from which test pieces are cut. This would detect both the difference made by hot and cold rolling, and also the difference made by unequal diffusion.

I would also require, in specifications for boilers, that every boiler plate flanged,

punched, or heated locally must be annealed after such flanging, &c., has been done. This is required by Bureau Veritas, and Lloyd's rules.

The form of test piece is slightly changed to save labor. From a large number of test pieces, often over two hundred per day, broken in the testing room of Cambria Iron Company, I had occasion to observe that plain flat pieces, without any slotting off from grip ends, very seldom broke in the grips, which was also the case with round and square bars, sheared from rolled length without any further work on them. The original form of test piece, prescribed by the Board, requires a great deal to be slotted or planed off from grip ends; to save labor, I recommend that only sufficient be taken off to insure the piece from breaking in grips. I also found that the use of round or square bars would have saved much labor and expense to the manufacturers of the steel.

The area of cross-section is limited in each case because experience has shown that measuring elongation for the same length in all cases, the pieces having the greatest area will give greatest elongation. This has also been found the case and written on by M. J. Barba in "Memoires de la Societ  des Ing nieurs Civils" (*vide* "Mechanics," No. 117, March 29, 1884). M. Barba found as the result of many experiments:

Ratio length of piece to diameter.	Elongation.
	<i>Per cent.</i>
2.51	44.5
3.75	37.5
10.00	28.5

"These results are given as those of round bar-steel, but in the case of bars and plates a corresponding result is obtained."

I have therefore put a limit on the size of the area, since the elongation is to be measured always for 8 inches.

The initial stress is recommended to be 35,000 pounds per square inch, as this is 3,000 pounds below the lowest acceptable elastic limit, and experience has shown me that in calculating the modulus of elasticity for elongations, the results begin to vary very rapidly on approaching the elastic limit of low steel. Thirty-five thousand pounds per square inch seems to give very good results, for which I call attention to my reports of tests of steel at Johnstown, Pa., October, 1883, to April, 1884. The continuation of first strain is recommended to be one instead of five minutes, to save time; and this is an important item where, as at Cambria Works, the machine is in continuous use, and many pieces are to be tested.

It is also recommended to make elastic limit of 38,000 pounds to the square inch a requirement. I think a higher limit with same elongation preferable, but this is suggested to call the attention of the Board that steel can be made with a low elastic limit, not much better, if any, than good iron, and with sufficient strength and elongation to pass specifications.

It is recommended that the inspector be given power to inspect the fracture of a quenching test piece and reject the steel if the fracture is not in his opinion sufficiently good. This is recommended because I have found in quenching pieces a good many from poor heats which bent to requirements of specifications and broke just inside of them and I had not power from specifications to reject the heat. A retest is allowed to be sure that the test piece itself was not burned in heating for quenching. In regard to the system of stamping the test ingots and pieces, I simply wish to call the attention of the Board to the fact that a dishonest firm might make one good heat and use this for all future test pieces. The only way I see to prevent this, without taking the word of the firm, is the system of stamping I propose. This is more important than it would seem at first, for, unless the inspector is certain that his test piece comes from the heat he wishes to test, of course his results are useless. This system will require much careful attention and inspection, but if the word of the firm is to be taken, why inspect at all? Why not take their word that the steel is what is required, and save time and labor?

In conclusion, I would respectfully recommend that the following articles be furnished each inspector, or the inspectors at each place, viz: 1 pair of calipers; 1 four-foot rule (jointed); 1 steel tape for measuring angles, &c. (at least 50 feet); 1 gauge measuring to $\frac{1}{16}$ inch, for measuring test pieces; 1 gauge for measuring final elongation (see sketch A appended); 6 pocket note-books with soft backs, printed according to form B appended; 1 4-quire note-book for smooth work, printed according to form C appended; lead pencils, pens, &c.

If it is required to find elongation under first strain, the inspector should be furnished with an electric contact machine measuring to not more than 1/10000 (one ten-thousandth) inch, similar to that described in Thurston's "Materials of Engineering," Part II., p. 369. One thermometer for quenching tests, fitted with case to carry in pocket, should also be furnished each inspector who has quenching tests to make.

Very respectfully,

B. C. BRYAN,
Assistant Engineer, U. S. N.

Rear-Admiral E. SIMPSON, U. S. N.,
President of Naval Advisory Board,
Navy Department, Washington, D. C.

FORM B.

Date

Number of—		C	Mn	P	Si	S
Heat.	Piece.					
Original dimensions { — x — } { — x — } { — x — } { — x — }						
Mean dimensions						
Area section						
Elastic limit (per gauge)						
Elastic limit (per square inch)						
Ultimate strength (per gauge)						
Ultimate strength (per square inch)						
Fractured .. { Thickness { — } Dimensions { — } Mean — x —						
Reduced area						
Reduction of area (per cent)						
Total elongation (per cent)						
Time { Commence End						
Time of test						
Appearance of fracture						
Breaking weight per gauge						

Stress per gauge.

Elongation in 8 inches.

REMARKS

FORM C.

Tests of steel for —, made at —, by —.

Date.	Per cent. of—				Dimen- sions of section.	Area section.	Elastic limit.	Ultimate per cent.	Time.	Elongation for first strain — pounds.	Modulus of elasticity.	Elongation at maximum load.	Plastic strength.	Remarks.
	C.	Mn.	P.	Si.										
	Heat.	Mark.	Original.	Fractured.	Original.	Fractured.	Gauge.	Per square inch.	Gauge.	Per square inch.	Reduced area.	Elongation.	Per gauge.	Per square inch.

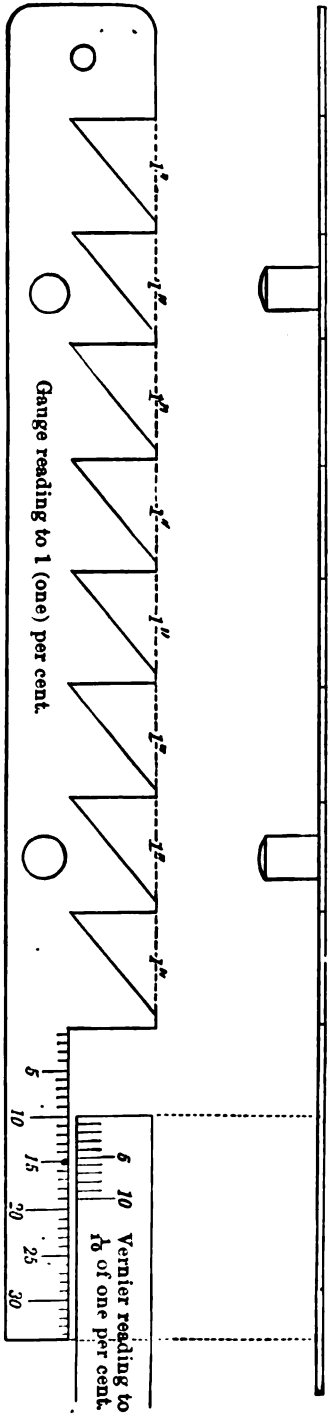

Gauge for measuring elongation in 8 inches (from design of J. C. Coffin, Johnstown, Pa.).

[Naval Advisory Board—Office of Inspector of Material.]

PITTSBURGH, PA., *May 23, 1884.*

SIR: In reply to the Board's circular letter of the 24th April, 1884, I have the honor to present the following:

"The initial stress to be as near the elastic limit as possible, which limit is to be carefully determined by the inspector in a special series of tests."

This article in the present circular is not enforced; the initial strain being used is 25,000 pounds per square inch.

Observations to be made of the elongations on a length of 8 inches corresponding to the initial stress, 40,000 pounds and 50,000 pounds per square inch, and after fracture.

The elongations previous to fracture have not been taken, owing to the difficulty and uncertainty without proper instruments. Four elongations would be registered, which would furnish sufficient data, and not be too bulky. These four elongations are about equidistant in regard to stress.

Very respectfully,

L. D. MINER, U. S. N.,
Inspector of Material.

Rear-Admiral E. SIMPSON, U. S. N.,
President of the Naval Advisory Board.

[Office of Inspector of Hulls for U. S. Navy, at the Delaware River Iron Ship Building Works.]

CHESTER, PA., *May 21, 1884.*

SIR: In compliance with your circular order of the 24th ultimo, I have to state that my duties as inspector of hulls do not warrant any suggestions as to changes in "tests of steel for cruisers," as modified by existing orders from the Board. On the contrary, the results of the work up to the present time go to show that the limitations of the various properties of the material have been wisely determined. Of all the plates, beams, angles, and rivets delivered here for the cruisers, the number of failures have been surprisingly few, and these, in my opinion, only when the pieces were subjected to unreasonable stress while cold. Opportunities for the observance of steel rivets which have been cut out, after having been riveted up, have been numerous, and in all cases have shown evidence of their superior strength and toughness. I am, therefore, as far as my duties enable me to judge, of the opinion that no changes in the existing specifications of tests, in so far as they apply to hulls, should be made.

Very respectfully, your obedient servant,

J. F. HANSCOM,
Assistant Naval Constructor, U. S. N., Senior Inspector of Hulls.

Rear-Admiral E. SIMPSON, U. S. N.,
President Naval Advisory Board, Navy Department, Washington, D. C.

[Office of Inspector of Hulls for U. S. Navy at the Delaware River Iron Ship Building Works.]

CHESTER, PA., *May 23, 1884.*

SIR: In compliance with instructions contained in Board's letter of the 24th ultimo, I have to state that my present duties as inspector of hulls suggest no reasons for recommending any changes in the "tests of steel for cruisers," as altered by existing orders, and indeed the success which has attended the working of this material for the hulls of the cruisers—the percentage of failures having been remarkably small—does not warrant me in suggesting the adoption of any additional tests, regulations, or restrictions.

Very respectfully, your obedient servant,

JOHN B. HOOVER,
Assistant Naval Constructor, U. S. N., Inspector of Hulls.

Rear-Admiral EDWARD SIMPSON, U. S. N.,
President Naval Advisory Board, Navy Department, Washington, D. C.

[Delaware River Iron Works.]

CHESTER, PA., *May 27, 1884.*

SIR: I have the honor to acknowledge the receipt of your communication of the 24th ultimo, relating to a new circular for "Tests of Steel for Cruisers," and to report what additional tests or regulations may be considered desirable as suggested by my present duties.

In obedience thereto, I have respectfully to report that, as regards the qualities of, and the manner of making the tests of, materials for the hulls of the cruisers, there are no changes I have to recommend.

In relation to the character of the material employed in their boiler construction, it has been suggested to me that if the limits of tensile strength of the plates were slightly reduced, with an additional increase in the percentage of ductility, a material superior in some particular respects to that now employed would be obtained.

Some of the advantages I claim, and to be greatly desired, are: avoidance of initial stress in the portions of the plates when locally heated, as in flanging; the temper of the material would be less altered round the rivet-holes, as in punching; the process of working more freely and perfectly accomplished; less liability to injury from heavy usage and improper working; can be worked and shaped to form required with greater facility; greater immunity from danger of fracture after boiler is completed.

A number of instances are known where boilers have fractured in testing at a much less pressure than that required to be imposed.

I think it necessary that the manner of making the tests of all boiler-plates be the same as at present prescribed.

I would recommend that the ultimate tensile strength be not less than 56,000 pounds and not more than 60,000 pounds; the ductility in 8 inches to be not less than 28 per cent.

With the increase in the percentage of ductility, the increase of thickness of the plate requisite for strength would be but slight, and necessary only in the cylindrical portion of the shell of the boiler; the strength and rigidity of the flat surfaces being dependent upon the usual methods of bracing. This additional thickness would compensate for corrosion.

All portions of the boilers to be made of the same kind and quality of material.

Very respectfully, your obedient servant,

A. W. MORLEY,

Chief Engineer, U. S. N., Inspector of Machinery.

Rear-Admiral E. SIMPSON, U. S. N.,

President Naval Advisory Board.

[Morgan Iron Works.]

NEW YORK, May 29, 1884.

SIR: In answer to the Board's order of April 24, 1884, to present in a concise form any additions I may think desirable to introduce in a new circular for "Tests of Steel for Cruisers," I have to recommend the following tests for boiler-plates:

From one plate rolled from each ingot, a test piece 6 inches wide and 19 inches long must be sheared off cold.

This test piece must then be heated at one end to a bright red heat for not less than one-third of its length nor more than one-half its length, and, while hot, the part marked A in the drawing must be bent round a curve of which the diameter is not more than one and one-half times the thickness of the plate under test.

After the plate is cold and unannealed, holes must be punched of one-eighth of an inch greater diameter than the thickness of the plate, and spaced three diameters from center to center on a line one and one-half times their diameter from edge of the plate, the center of first hole to be three diameters from center of inner curve of bend.

Where the edge of the doubled part meets the surface of the plate, a row of intersecting holes (B) must be punched cold, cutting the plate from its edge to the middle, and then the flange (C), unannealed, is to be bent cold, to a right angle with the plate, with the same curve as A. All plates accepted must show neither cracks nor flaws after these tests.

If a piece fails, all the plates rolled from the same ingot must be tested.

REASONS.

The necessity of an addition to the admirable tests ordered by the Board is proved by the numerous failures of material having the inspector's mark. In my opinion the tests should be as severe as the punishment which the metal receives during the ordinary operations in making a boiler.

The test I propose is practicable and not expensive; it will show in one piece the effects of shearing, punching, bending hot and cold, and also local heating. Good mild steel suitable for boilers should stand this test in addition to those now in force.

Very respectfully,

ISAAC R. McNARY,

Chief Engineer, U. S. N.

Rear-Admiral E. SIMPSON, U. S. N.,

President Naval Advisory Board.

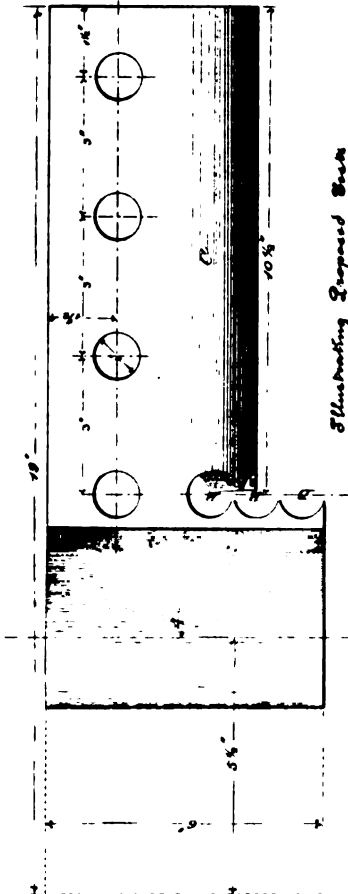

Illustrating Proposed Back
Steel Boiler Plate.

Jesse B. McHenry,
Chief Engineer, U. S. N.

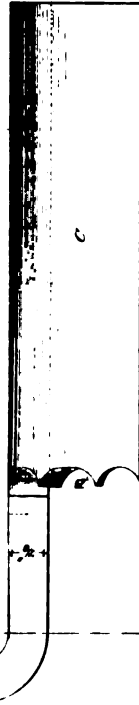
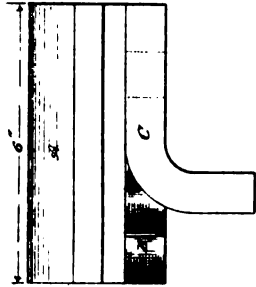

[Morgan Iron Works.]

NEW YORK, *May 27, 1884.*

SIR: In reply to your letter of April 24, I would state that I have carefully considered the matter of "Tests of Steel for Cruisers" more especially with reference to material used for boilers, and I have little to add to a subject which has been so much discussed of late years.

So far as my experience goes with boiler-plates of mild steel, I do not think it has yet been made with that certainty as to its homogeneity that is desirable for full confidence in it. I think this is more a question of the thorough mixing of the ingredients in the furnace previous to the casting of the ingots than their quantity or quality. Of course the better the ingredients the better, as a whole, the resulting material.

I think that greater stress should be laid on the elastic limit when tests are made, as practically that is the measure of strength. Reduction in the tensile strength and elongation required by existing specifications should not be thought of, but rather an increase of the former demand, for I can see no advantage to be gained by the use of this material over that of wrought iron if the tensile strength of the former remains equal to or little superior to that of the latter.

In the working of these plates for boilers, it appears to be a fact that when they have stood well the tests, both cold and hot, they fail when worked at a heat not luminous, or what is known as a "black heat." This must take place to a greater or less degree during the process of flanging and local heating in fitting up. A remedy for this, to a degree at least, would be the flanging of the plates at the time and place of manufacture, where facilities are better for total and even heating and cooling. This would also obviate much of the delay and expense of rejecting the plates at the time and place of manufacture of boilers, or much of the flanging could be done with the plate cold. If a plate is capable of being bent cold to the degree required by the specified tests of the Board without injury, why should it require heating for flanging where the bend is less? I am of the opinion that all rivet, stay, and brace holes should be drilled, and where plates are lapped or butt-strapped one plate should be used in place as a template for drilling the others. I would advocate this apart from any consideration as to the effect upon the plates of punching, and with a view to the accuracy of the holes in the plates and straps with regard to each other, and, as a consequence, the banishment of the drift-pin from the boiler-shop. In the case of steel shafts it is a question whether they should possess great elongation, especially when obtained at the expense of hardness and rigidity. I would prefer they should have a high elastic limit with a moderate elongation.

Very respectfully,

B. B. H. WHARTON,
Chief Engineer, U. S. N.

PROPOSED NEW CIRCULAR OF TESTS.

From the foregoing reports of inspectors, and some of the general results obtained from time to time during this inspection, a new circular has been compiled, embodying certain alterations in the system of tests without any change of requirements. The principal alterations will be found in the shape and proportions of the test piece, in the method of removing and stamping the test specimens, and in following out the material of each heat, and in the return to the individual test for boiler-plate.

TESTS OF STEEL FOR CRUISERS.

Instructions to Inspectors.

NAVY DEPARTMENT,
Washington, ——— 188—.

The following rules are prescribed in order to insure the fulfillment of the clause of the act of Congress of August 5, 1882, "Such vessels * * * to be constructed of steel of domestic manufacture, having as near as may be a tensile strength of not less than 60,000 pounds to the square inch, and a ductility in 8 inches of not less than 25 per centum."

I. All ship plates, beams, angles, rivets, bolts, boiler-plates, and stays to be inspected and tested at the place of manufacture by a naval inspector of material, and to be passed by him, subject to restrictions hereinafter mentioned, before acceptance by the ship-builders, whether Government or private, for incorporation into said vessels.

II. Every plate, beam, and angle supplied for these vessels to be clearly and indelibly stamped in two places and with two separate brands: (1) with that of the maker, which shall distinguish the name of the manufactory or company, (2) with the regulation brand of the naval inspector of material. The latter not to be stamped upon any of the above-mentioned material until it shall have passed an inspection for surface or other defects of manufacture and the physical tests, have been accepted by the inspector, and have been stamped with the maker's brand.

In case of small articles passed in bulk, the above-mentioned brands shall be applied to the boxing or packing material of the objects.

No steel material to be received at the building yards for incorporation into vessels except it bear, either upon its surface or that of its packing, both of these brands, as evidence that it has passed the necessary Government inspection.

III. The weight of all plates, beams, angles, &c., must be obtained by the inspector of material before delivery.

Plates of $12\frac{1}{2}$ pounds per square foot and less, and strips and bars of 6 pounds per lineal foot and less, may be accepted if the weights vary between 3 per cent. above and 5 per cent. below the specified weights.

All other plates and shapes may be accepted if the weights vary between the specified weights and 5 per cent. below them.

All plates and shapes not being within the limits here specified may be rejected.

TESTS.

All material except boiler plates should be tested by heats, as follows:

A specimen ingot or bloom shall be selected and rolled into a plate or bar and test pieces cut therefrom, provided always that the test pieces shall have received no more working than that which the finished material from the heat would receive.

Four test pieces of the form shown in Fig. 1 for plates—a square or round, in condition as finished at the rolls, may be used for tests of shapes—shall be made and tested for each heat.

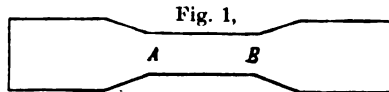

The length A B must be at least 8 inches of uniform cross-section of which the area should not be less than $\frac{1}{2}$ or more than $\frac{1}{16}$ of 1 square inch.

The reduction of breadth throughout the length A B should be just sufficient to prevent failure in the grip.

The test pieces must not be annealed unless the finished material is to be annealed.

Each test piece shall be submitted to a direct tensile stress until it breaks, and in a machine of approved character.

The initial stress to be 30,000 pounds per square inch.

The first load to be kept in continuous action for one minute. An observation to be made of the corresponding elongation measured upon the original length of 8 inches.

The stress to be then increased slowly until the principal elastic limit is determined, after which additional loads will be added at intervals of time as nearly as possible equal, and separated by half a minute; the loads to produce an increase of stress of 5,000 pounds per square inch of original section of the test piece until the stress is about 50,000 pounds per square inch of original section, when the increments of stress should not exceed 1,000 pounds per square inch. Upon close approach to the probable ultimate strength, the load to be increased gradually and its maximum value carefully noted.

The final elongation to be that obtained after rupture.

A list of all ingots made from each heat must be supplied to the inspector. Each ingot should be stamped in his presence with the number of the heat. He should also see the test plate or billet cut off, stamped, and rolled, and place a private stamp upon it in such a way that each test piece will have the impression of the stamp near one end.

CONDITIONS OF ACCEPTANCE.

In order to be accepted, the average of the four test pieces must show an ultimate tensile strength of at least 60,000 pounds per square inch of original section, and a final elongation in 8 inches of not less than 23 per cent.

Material which shows a strength greater than 60,000 pounds per square inch will be accepted, provided the ductility remains at least 23 per cent.

CASES OF FAILURE.

If the average of these four test pieces, numbered 1, 2, 3, 4, (called Test I.), fall below either of the required limits, the ingot from which pieces 1, 2, 3, 4 were cut shall be rejected, and Test II. made, consisting of pieces 5 and 6, cut from a second ingot. If the mean of the results of these two fall below either of the above limits, the entire lot shall be rejected. If it be successful, Test III., or the mean of pieces 7 and 8 cut from a third ingot shall decide.

If in any of the Tests I., II., III., any single piece shows a tensile stress less than 58,000 pounds or a final elongation less than 21 per cent., the ingot from which it was taken shall be rejected and that test considered to have failed, regardless of its average.

QUENCHING TEST.

IV. A test piece shall be cut from each plate, angle, or beam, and after heating to a cherry red, plunged in water at a temperature of 82° F. Thus prepared it must be possible to bend the pieces under a press or hammer so that they shall be doubled round a curve of which the diameter is not more than one and a half times the thickness of the piece tested without presenting any trace of cracking.

These test pieces must not have their sheared sides rounded off, the only treatment permitted being taking off the sharpness of the edges with a fine file.

Inspectors may require a cold bending test when considered necessary.

ANGLES, BEAMS, BULB BARS, T BARS, &c.

V. Angle bars are to be subjected to the following additional tests: A piece cut from one bar in twenty to be opened out flat while cold under the hammer; a piece cut from another bar in the same lot shall be closed until the two sides touch while cold.

Bulb and T bars are to be submitted to a closing test similar to that prescribed for angle bars.

Bars submitted to these tests must show neither cracks, clefts, nor flaws.

RIVETS.

Each 1,000 pounds of rivets from the same heat of metal shall constitute a lot and be accompanied by two sample bars, each 18 inches long for a tensile test. These samples for tensile test shall be cut from the bars from which the lot of rivets is made and be stamped with a number which shall also be placed on each box or package of that lot.

These samples to be subject to the same tensile test as that required for plates.

The lot of rivets of which this sample bar does not fulfill the requirements of tensile strength and elongation required for plates is to be rejected.

From each lot six rivets are to be taken at random and submitted to the following tests, two rivets to be used for each test:

(1) Two rivets to be flattened out cold under the hammer to a thickness of one-half the diameter without showing cracks or flaws.

(2) Two rivets to be flattened out hot under the hammer to a thickness one-third the diameter without showing cracks or flaws.

(3) Two rivets to be bent cold into the form of a hook with parallel sides without showing cracks or flaws.

BOILER PLATES.

Two tensile test pieces shall be cut from each plate rolled for boilers and one quenching test piece, which shall be tested as before described; except that, in the tensile tests, the initial stress may be 25,000 pounds to the square inch.

The ductility in 8 inches must not be less than 25 per cent., and the ultimate tensile strength must not be less than 57,000 pounds, and not more than 63,000 pounds; and no single piece must show a less tensile strength than 57,000 pounds to the square inch.

No steel for boilers which is to be worked at a heat or to be annealed after working in the boiler shop shall be annealed at the works.

The acceptance of material under these tests will not relieve the contractor from the necessity of making good any material which fails in working or may be rejected by the inspector.

PROPOSED DETAILED INSTRUCTIONS TO INSPECTORS OF MATERIAL.—In accordance with the experience gained, the method of conducting the tests and inspection may with advantage be modified as contained in the following instructions. The principal changes are in the method of conducting the tensile tests, the addition of a cold bending test under certain conditions, and more explicit directions as to the quenching test.

DETAILED INSTRUCTIONS TO INSPECTORS OF MATERIAL.

NAVAL ADVISORY BOARD, NAVY DEPARTMENT,
Washington, ———, ———, 188—.

In addition to the instructions contained in the requirements for "Tests of Steel for Cruisers," inspectors will be guided by the following :

(1) TESTING APPARATUS AND METHODS OF TESTS.

The inspector will, as soon as practicable, after reaching his post, carefully examine all the appliances available for the proper inspection of material, consult with the superintendent as to making the tests, and make a special detailed report to the Advisory Board of the kind and efficiency of the apparatus and the arrangements which have been decided upon for making the different tests. Such report to include a description of the testing machine to be used, accompanied by a cut, or if possible, detailed drawings from the maker; whether the machine is worked by hand or power; if hydraulic, the condition of the pumps, valves, leading pipes, plunger packing, &c.; the method of holding the pieces in straining, a record of any dead weight tests for accuracy which may have been made at the works, and the feasibility of repeating them; the measuring instruments in use or available; the proposed method of heating the pieces for quenching test, and, if in a furnace, a description of it, including whether or not the pieces will be in direct contact with the flame, the kind of fuel used, and the degree of control exercised over the flame; the proposed method of bending such pieces, and, in the case of inspectors of material for shapes or rivets, the methods of making the special tests required for such material; and finally whether or not all such facilities and proposed methods are sufficient for, and in accordance with, the determinations of such quantities and the observance of such precautions as are contained in the requirements of "Tests of Steel for Cruisers" or hereafter in these instructions, together with such other matters as he may consider of importance.

(2) METHODS OF MANUFACTURE.

He will render himself as familiar as possible with the principles and details of manufacture of the material at the works at which he is stationed, paying special attention to the manipulation and heating of the material. But he will take care to conduct his inquiries only so far as he may be willingly accorded facilities by responsible persons. In no case shall he attempt to exercise any control whatever over the manufacture beyond the actual testing, inspection, weighing, and stamping of the material, except as regards annealing of steel intended for certain parts of boilers, as duly specified in the "Tests of Steel for Cruisers," and as hereafter mentioned.

(3) RECORD OF INSPECTION.

He will keep a complete record of every piece of metal tested for the Government, in accordance with the blank forms and note books furnished, with such other items as he may deem necessary, whether such piece fulfills the requirements of a successful test or not.

(4) REPORTS.

At the end of each week he will make a detailed report of tests and inspection to the Advisory Board, together with such information or suggestions as he may deem necessary in carrying out the work.

(5) ALLOTMENT OF MATERIAL — REGISTER MARKS.

For purposes of recognition and record, all plates, beams, and bars are to be divided into lots of twenty pieces as finished by the rolls, and each piece and its corresponding test piece or pieces marked with a distinguishing register mark, consisting of a number and one of the first twenty letters of the alphabet, the number to denote the lot, and the letter the individual piece in the lot. Lots of material shall be numbered consecutively in the order in which they are inspected, ship and boiler material separately; and, as far as possible, all the pieces of a lot shall be from the same cast or heat, the heat number being rigidly followed from the cast to the finished product.

The register mark of rivet bars and rivets will consist of the lot number alone.

The register mark shall be legibly painted on each piece of material, plates near one corner, angles on the inside, beams on the web; the paint to be mixed with

benzine or such other substance as will effectually resist the action of the weather for a long time; the corresponding test pieces to have the register mark stamped cold near one end. In the case of test pieces taken across the direction of rolling, a cross (+) will be affixed to the register mark on the test specimen.

(6) REMOVAL OF TEST PIECES.

While the inspector is to use his judgment as to the part of the material from which the test pieces are taken, he will in no case, except by the request or permission of the superintendent or other responsible officer of the works, intrude upon the finished measurements of the piece in removing them. As far as possible, pieces of the scrap will be taken, and, if they fulfill the requirements, the piece will be passed. Should they fail, however, the piece need not thereby be condemned; but the inspector, if he so desires, or at the request of the superintendent, may make a second test of a piece taken from the body of the material. Test pieces, especially of shapes, may be removed by the hot saw, with due precaution as to the correspondence of the piece and test specimen. Pieces for cold bending, opening, or closing tests are preferably so removed, and, if removed by shearing, no part of the test piece should have been under the shear-knife.

In removing the tensile test pieces from the specimen plate of a heat of material for ship plate, the original top and bottom of the ingot shall be noted and the pieces numbered systematically accordingly. Similarly for boiler plate, the pieces being removed as far as possible from diagonally opposite corners.

(7) CONDEMNATION OF MATERIAL AND CASES OF DISAGREEMENT.

All condemnations of material will be immediately reported to the superintendent of the works, or his authorized representative, who shall have access to the entire record of tests and weights. Test pieces connected with such cases shall be preserved until their removal is authorized by the Board.

In case of any disagreement arising during the inspection, the matter shall be at once referred to the Advisory Board for settlement. It is, of course, preferable that all tests shall be made in the presence of a qualified representative of the management of the works.

(8) THE TENSILE TEST.

(a) *Tensile test pieces.*—In removing such pieces from plates, care should be taken that they are curved as little as possible, and in subsequent cold straightening they should not be treated in such a way as to materially hammer-harden them: If removed by punching, a margin of not less than one-eighth of an inch will be left all around the finished dimensions, to be removed by a cutting tool in shaping. All other tensile test pieces requiring to be shaped should be removed by a cutting tool, and should have been perfectly straightened while hot as finished by the rolls. When the modulus of elasticity is to be determined, the degree of straightness of the piece should be carefully noted.

As the original sectional area of the pieces is to lie between certain limits, it is suggested, for convenience in the preparation of the pieces, that a series of wooden templates be prepared of dimensions suitable to graded thicknesses and marked accordingly with distinguishing marks to be placed on the specimens after straightening, for the guidance of the mechanic in roughing them out.

(b) *Measuring the piece.*—The original sectional dimensions of the prismatic portion of the piece shall be obtained in at least three places, viz, in the middle and near each witness mark. If the sectional area at the middle be the least of the three, the corresponding dimensions shall be taken for test. If either of the other sections be less than at the middle, a mean shall be taken between the dimensions of the least section and at the middle. In any case should the difference between the sectional areas in any two places be greater than 3 per cent. of the greatest area, the test piece shall be discarded as unfit for test.

(c) *Extension under initial stress and modulus of elasticity.*—In placing the piece in the grips, care should be taken that it is perfectly central, and the grips must not be so made, or allowed to get into such a condition, as to hold a flat piece chiefly on one side. When the initial extension is to be measured, a stress of about 10,000 pounds to the square inch shall be put on and removed to tighten the piece in the grips and remove low initial strains.

Suitable and approved apparatus being obtained or provided, the extension in the measured length of 8 inches under the initial stress of 30,000 pounds or 25,000 pounds to the square inch, as prescribed in the "Tests of Steel for Cruisers," shall be measured, if possible, within the one minute allowed for such initial straining. Then the

modulus of elasticity will be 240,000 or 200,000 pounds, for ship and boiler material respectively, divided by the corresponding observed extension and be recorded to the nearest 1,000 pounds. Great care should be exercised in making this observation that the proper stress is uniformly maintained and the measuring apparatus is in no way disturbed.

(d) *Principal elastic limit.*—The elastic limit is to be obtained as follows: The load being slowly increased above the initial load, the beam closely following the pump or screw so as practically to maintain a balance at all times, there comes a time when the beam momentarily no longer rises to the pump or screw. At the same time, scrutiny of the surface of the test piece shows that the adhering mill scale is just commencing to flake off, generally near the fillets. Both indications should be observed when practicable. The corresponding stress will be recorded as the elastic limit, and should be obtained to the nearest 10 pounds.

(e) *Ultimate tensile strength, or tensile limit, and the corresponding extension.*—Further increase of stress having been applied by such increments and at such intervals of time as prescribed in the "Tests of Steel for Cruisers," when, in the judgment of the inspector, further stated increment of stress would pass or closely approach the maximum resistance of the piece, the increase of stress shall be applied continuously, following the pump or screw, until the maximum indication is obtained and the beam drops. At the same time, the extension of the piece should be measured as carefully and accurately as possible. The ultimate strength should be recorded to the nearest 10 pounds.

(f) *Final strength or resistance.*—Following tensile limit, the extension of the piece should proceed slowly and uniformly, and a practical balance should be maintained by the beam so that at the moment of rupture the corresponding resistance may be accurately obtained. This load divided by the fractured area subsequently obtained gives the actual resistance of the metal to separation, and should be recorded to the nearest 100 pounds.

(g) *Final elongation.*—In removing the pieces from the grips, care should be taken that the fractured surfaces are not abraded or struck against any hard substance, so that the two parts may be neatly fitted together. The fitting is best done in a suitable frame and so that the fractured area can be immediately measured without change of position. When fitted, the parts may be lightly taped together. The increase of length may be measured either directly in per cent. by suitable scale with vernier attachment, reading to the nearest tenth of 1 per cent., or in inches to the nearest thousandth, with subsequent division by 8 to reduce to per cent. All elongations after rupture, or at tensile limit, should be recorded to the nearest tenth of 1 per cent.

(h) *Final area in per cent. of original area.*—The pieces having been fitted together, as above described, the width of the least section will be measured and its thickness at each edge and at the middle in the plane of least width. Then the sum of the thicknesses at the edges, plus 4 times that at the middle, divided by 6 will be the mean thickness, to be multiplied by the least width, as measured, to obtain the fractured area; the fractured area to be divided by the original area, and the quotient, expressed in per cent. to the nearest tenth, entered in the proper column.

(i) *Fracture.*—The fractured surfaces will be examined with a pocket lens and any evidences of lamination will be recorded. The nature of the fracture also, whether bright or silky, dull, fine or coarse crystalline, and the arrangement of the surface of fracture, whether plane, double plane, cup, or irregular, will also be noted.

(9) THE QUENCHING TEST.

In making this test, it is necessary to observe certain precautions. If the pieces are heated in a furnace, the flame should be kept neutral, i. e., neither smoky nor cutting, and, if possible, they should be heated by radiation only, out of contact with the flame. If heated in a smith's forge, the fire should be covered or built up, and the blast regulated so that the flame is neither smoky nor cutting. In such a fire only coke should be used, and a green or fresh fire will not give the best results. Especial care should be taken that the pieces are uniformly heated. A low cherry red is the desirable temperature, and the pieces should in no case be allowed to cool down from a higher temperature before being placed in the water.

No piece used for quenching or cold bending test may be less than 10 inches in length and 2 inches in width, except in case of angles too small to allow this width, when the greatest width possible is to be taken.

In bending all pieces, the inspector will not permit any nursing on the one hand or unfairly violent treatment on the other. If the bending is done under the hammer, the blows should be delivered as square to the surface as possible. In all cases uniformity of treatment should be observed.

(10) COLD BENDING TESTS.

Should any plate, beam, or bar be finished at the rolls at a very dull red or colorless temperature—or for other sufficient reason—a piece shall be removed as prescribed

for the quenching test, and must bend cold to the same extent without crack or fracture, except that such pieces may be removed by a cutting-tool, or, if removed by shearing, the sheared edges may be ground off to any desired extent. In case of failure, the piece shall be rejected.

(11) SPECIAL COLD TESTS OF ANGLES, BEAMS, AND TEES.

The length of pieces for these tests may be not less than 8 inches, to be removed and prepared as previously stated. If bent under a hammer, the blows should be delivered square to the surface.

While the apparent severity of these tests is recognized, no material which has successfully passed the other tests will fail under them unless it be badly laminated or threaded with dirt. In case of failure, the piece shall be rejected and another piece of the same lot tested. Should the failures be numerous, the fact will be immediately reported, and the inspector shall call the attention of the manufacturer to it so that steps may be at once taken to obtain sounder ingots or blooms.

(12) TEST PIECES TO BE RETAINED.

All tensile test pieces, and such other test pieces as may have given rise to dispute or disagreement between the inspector and the authorities of the works, shall be retained until such time as the Advisory Board may permit their removal. Other pieces, which may present any features of special interest in the judgment of the inspector, or have been the subject of special mention or report by him, shall likewise be retained.

(13) ANNEALED PLATES.

Ship's plates may be annealed at the discretion of the manufacturer, but the inspector will understand that no boiler material may be annealed unless expressly authorized by the Board or by the inspector of machinery under its instructions.

(14) GENERAL INSPECTION.

The inspector, or his duly qualified assistant, shall see each plate as finished by the rolls, and each bloom or bar on commencing a rolling, or in case of any difficulty in the rolling, and shall exercise a general supervision at all times as to the condition of the piece as finished by the rolls, especially observing any fluting of plates due to irregular wear of the rolls, any evidences of overheating or too cold finishing, any severe mechanical treatment in straightening at a black heat or when cold. Cold plates should be carefully examined on each side for signs of lamination, or fine cracking, sand or scale marks, scabs, and surface defects generally. Plates must not be cut too near any locally defective portion. Shapes will be likewise examined for surface defects, and, in addition, the width of flanges will be measured, with special attention to symmetry of sections for beams and tees; shaded backs of angles and grooved fillets from careless dressing of the rolls are to be avoided. In all such cases, and others which may arise during this inspection, affecting the excellence of the finished material for the purpose intended, the inspector must exercise his judgment as to the magnitude of the defect, and consult with the responsible parties in regard to rectifying the trouble or rejecting the piece, except in such cases as may be provided for by appropriate test.

(15) WEIGHING MATERIAL.

Each plate, or all the parts into which a plate as finished by the rolls may have been cut, will be weighed, and must fall within the specified limits. In weighing shapes, all beams and bars of the same size and weight per foot of the same rolling should be weighed separately, in quantities, as far as possible, of not less than 2,000 pounds net at one time. The limits of weight may not be satisfied by mixed loads of light and heavy bars; and no single bar which there is reason to believe is without the prescribed limits may be shipped without the special permission of the Advisory Board. In commencing a rolling of shapes, or after the setting of the rolls has been interfered with, the inspector shall inform himself of the results of the sample pieces weighed for the guidance of the roller, and such bars as there is reason to believe do not satisfy the requirements in this regard may be rejected for that order. But every piece rolled, unless defective in shape or finish, should be tested for quality. It should be noted, however, that all parts of a beam or bar will not weigh alike, and the front end will generally be the lightest.

(16) STAMPING THE MATERIAL.

The inspector will be provided with two stamps, the Naval Inspection brand and one of his own initials, both of which shall be affixed to each piece of material when ready for shipment, but only after having passed satisfactory tests and inspection and being within the prescribed limits of weight. Such stamps shall be affixed as near as possible to the register mark for the better identification of the piece.

NOTE.—As soon as possible after reaching the works, the inspector shall request the Superintendent to have made, or otherwise obtain, a special sledge of about the ordinary size and weight, of soft iron or very soft steel, as the stamps are expensive and necessarily of too high temper to absorb the work of many blows from a hard-faced sledge without breaking up.

(17) INCIDENTAL EXPENSES, INSTRUMENTS, STATIONERY, &c.

All instruments, books, and stationery required for use in the inspection will be procured by requisition on the Advisory Board, and receipts will be rendered to the Board for all material received.

Incidental postage and telegraph expenses will only be reimbursed through bills made to, and approved by, the Advisory Board.

Expenses for travel will only be reimbursed by the ordinary naval rule of mileage on orders from the Department.

Unless absolutely impracticable, no official expense will be incurred by the inspector without a preliminary authorization from the Advisory Board.

_____, U. S. N., *President of the Naval Advisory Board.*

Approved:

_____,
Secretary of the Navy.

RECORD OF TESTS.

For the better record of tensile tests, inspectors should be supplied with note-books ruled in accordance with the sample page (Plate V.)—filled in for better illustration—which shall form part of the inspector's records and be signed by him at the end of each series of tests reported in tabular form to be described. The items in the note-book are believed to contain all necessary information of the circumstances and details of tests, and can be at any time referred to in the event of any discrepancy arising, or for more particular information on any point not contained in the tabular form. The page should be printed on one side only, the other being used for remarks and the details of calculation. This paper of good quality should be used, so that many tests may be recorded in a single book, which may yet be conveniently carried on the person. Printed copies of the requirements of "Tests of Steel for Cruisers" and of the "Detailed Instructions to Inspectors of Material" should be bound in the note-book, together with several blank pages for the entry of any subsequent instructions.

The condensed tabular form for report and record (Plate VI.) contains the chief features and results of tests, and is believed to embody as much information as can be obtained under the circumstances of an ordinary test. The results so recorded are in a form suitable for analysis.

PLATE V.

Date, 9 | 19 | 84.

Heat.—5565 Piece.—4 Condition.—Straight.

Carbon .22%	Manganese .54%	Phosphorus	%	Stress per sq. in.	Gauge load.
Initial extension .00805 E=29,815,000				30,000	16,044
		Original width.	Original thickness	35,000	18,719
Marked end		1.244	× .433	45,000	24,079
Middle		1.240	× .432	50,000	26,749
Unmarked end		1.234	× .432	51,000	27,279
Taken as		1.238	× .432	52,000	27,809
Sectional area		5348		53,000	28,339
Elastic limit (gauge)	22,800			54,000	28,869
" " (per sq. in.)	42,635			55,000	29,399
Ult. ten. str. (gauge)	35,890			56,000	29,929
" " (per sq. in.)	67,050			57,000	30,459
Ext. at tensile limit	1.54 ins. 19.25%			58,000	30,989
Final elongation	— ins., 23.3 %			59,000	31,519
Time	Commence 2 hrs. 8½ mins			60,000	32,049
	End 2 hrs. 21 mins			61,000	32,579
	Of test 12½ mins			62,000	33,109
Final gauge load	31,000			63,000	33,639
" stress per sq. in.	104,870			64,000	34,169
Fractured area.—				65,000	34,699
<i>a</i> ₁ =	319			66,000	35,229
<i>a</i> ₂ .803 4 <i>a</i> ₃ =	1.212				
<i>a</i> ₃ =	311				
<i>a</i> ₄ =	6) 1.842				
Mean thickness....	.807				
Fract. width.....	.963				
" area.....	.2956 Ditto % 55.28				
Fracture.—Silky, irregular cup.					

PLATE VI.

Tensile tests.

Heat	Marks.	Original section.		Fractured section.		Elastic limit	Ultimate tensile strength.	Klastic ratio.	Final elongation.	Final area in per cent of original	Modulus of elasticity.	Elongation at ten- sile limit.	Stress at rupture.		Time of test.	Appearance and nature of fracture.	Remarks.		
		Width.	Thick- ness.	Area.	Width.								Thick- ness at edges and center.	Area.				Lbs. per sq. in. of original area.	Lbs. per sq. in. of fractured area.
4908	2 14	1.254	.417	.5229	.936	.272	2646	40,160	62,700	64.06	25.5	50.60	30,200,000	12.0	54,120	108,950	17	Silky-plane	
						.308													

PART III.

COMMERCIAL TESTING.

The primary object of all commercial testing is to insure sufficiency of strength in the finished structure, and, in general, also, the manufacturer desires to protect himself from the delays and additional expense due to failures of material in working. The nature of these tests, therefore, is always such as to subject the material to extreme cases of the stresses developed in the structure and during construction. The application of mathematical theories and special systems of scientifically-conducted tests allow the structural stresses to be resolved into the three principal stresses of tension, compression, and shearing, and certain permissible limits of corresponding resistance to be applied in each case. Whenever possible, loads producing sufficiently extreme stresses are applied to the finished structure, notably in the case of boilers and bridges, when the manufacturer becomes specially interested in the qualities of resistance of the materials employed, and, if responsible, resorts to preliminary testing in order to insure them. When the structure cannot conveniently or at small expense be subjected to sufficiently extreme stress to insure at once the excellence of material and workmanship, it becomes necessary for the manufacturer to work to specifications supplied by the consumer, who must then ascertain that the material possesses the requisite qualities by such tests as he may deem necessary. Even when the structure can be subjected to proof, the large direct and incidental cost of failure under proof, or subsequently, very generally makes it desirable for the consumer to supply specifications, by which course, also, he largely controls the cost of production.

Accordingly many systems of small testing have been used, in which, by tests carried out on representative small pieces, it is sought to insure efficiency of strength and other qualities in the structure. As to just how far the results of these tests are representative of the material in the structure and should form the basis of designs, engineers differ, and special tests on a large scale are required to give them definiteness. The differences thus developed are due to three main causes—(1) lack of knowledge of the laws governing stress and strain in pieces of different sizes and proportions, (2) want of uniformity in the quality of the material, and (3) initial stresses set up in manufacture. Of these the first presents a large field for special inquiry by no means exhausted; the second may be covered, to a certain extent, by properly-devised tests on a commercial basis, but is well supplemented by special research as to the main causes; to avoid the third constitutes good workmanship, the chief source of reputation to the manufacturer. The last cause of difference is evidently widely variable, though mechanical appliances are narrowing its limits. It constitutes one of the chief necessities for the requirement of high ductility so common in connection with the material for built-up structures. Could these initial stresses be avoided, a much harder and stronger material could be used in the large majority of structures, with a diminished factor of safety and great consequent lightness. But the average conditions of working often necessitate a quality of material such that it may undergo

considerable strain or distortion without approaching dangerously near its ultimate strength. In some cases, also, as in the bottom plating of vessels subject to grounding, in those portions of a boiler in contact with the fire, or in the plating and framing behind armor in armor-clad vessels, the quality of high ductility in the material is especially necessary for the purpose served.

Accordingly, requirements for tensile strength and ductility, varying with the nature of the work and its intended cost, have for some time been demanded, the pieces for test being generally small and of conventional, but by no means uniform, pattern. In a sense, the results so obtained may be considered as gauging the intrinsic quality of the material, so that they are frequently deemed as affording a measure of its fitness for the other principal stresses of compression and shearing, especially as direct tests of the corresponding resistances are more elaborate and costly. The tensile test has thus become the chief, and in some cases the only, measure of quality, and many machines designed to subject pieces of various sizes and proportions to more or less accurately-gauged tensile stress have been constructed and are in use.

In compression, the results obtained from small pieces bear such an uncertain relation to the resistance of large pieces, and the tests require such care and accuracy, that such tests are not in general use, except perhaps for the materials of masonry.

In shearing or torsion the relation of resistance to that under tension is better known and more definite, so that the sufficiency of the latter test is more apparent. In the case of rivets, however, especially of steel, subjected to combined and frequently high initial stresses, it often becomes necessary to test them under, as near as may be, the conditions of practice.

When metal is to be flanged or bent cold or hot, or suddenly cooled from a heated state, corresponding tests, developing extreme stress, are frequently made, both in order to insure freedom from failure under treatment, and sufficiency of strength in the final condition.

A complete system of commercial small tests for metal structures consists therefore of—

(1) The tensile test, with requirements for ultimate tensile strength and final elongation or ductility—sometimes also conceived to be measured by the reduction of area—and in some cases, for the refined qualities of elastic limit and modulus of elasticity, the latter the measure of stiffness.

(2) For rivets, shearing tests approximating to the conditions of practice; and, incidentally, tensile tests as a general measure of quality.

(3) Hot or cold bending tests, or both.

(4) Tests for hardening quality on rapid cooling, sometimes, though erroneously, called "temper tests," but better known as "quenching tests."

Any or all of these tests may be carried out on a greater or less number of specimens, with corresponding representative value.

A variety of other tests has been proposed, and some are in more or less extended use. Such are tests of the change of condition due to punching and shearing, transverse tests for rolled beams, direct torsional tests, tests for wearing quality, and the well-known impact or "drop" test for rails.

The above system of tests has never, we believe, been applied to other material than mild steel, though the tests under each heading have been separately used for a variety of materials. Owing to the irregularity of this metal, as produced by the best makers, but also largely to in-

experience in its treatment, in the early stages of its manufacture and use, mild steel was much more elaborately tested than the iron which it replaced, and especially so for ships and marine boilers. When adopted for these constructions, the various governments and marine insurance societies using it or sanctioning its use, after elaborate preliminary tests, exacted more or less rigid requirements of the nature above described; and, while in some cases they have been somewhat relaxed, they are still very generally demanded and are frequently extended. The requirements of the French navy, the first to use mild steel extensively for ship construction, are given in the Appendix, together with those of the British admiralty and the various insurance registries, and have been already discussed. The experience with the material in this country in boiler, bridge, and ship construction, prior to the adoption of mild steel for the hulls of ships for the United States Navy, has been considered in the Introduction, while the considerations governing the requirements adopted by the Department, with their subsequent modifications, the chief features in the production of steel made under the Board's supervision, with the results in detail and summary, have been given at length.

Much of the success of testing as a guide to construction depends upon the details of the work. Different men with different methods will show very different results from the same material. In order to make the results obtained at different works directly comparable and of standard value, it was therefore necessary to specify the exact method of testing, and leave as little as possible to accident or the individual judgment of the inspector, the disagreeable necessity for which so often arises in most inspection. The system of tests, besides insuring the desired quality of material, has also produced information of theoretical value. We have spoken of commercial tests, or tests on a commercial and comparatively inexpensive basis, as distinguished from scientific tests made purely for purposes of investigation. The possible useful application of the results of commercial testing to the solution of certain problems of great theoretical importance, always within the limits of the essential nature of each test, is advanced in this report from certain results of great theoretical interest to be hereafter considered. The very large amount of commercial testing done as compared with the relatively limited extent of testing for scientific inquiry constitutes in itself a great advantage and emphasizes the desirability of obtaining the maximum of information from the tests commonly made. Besides which, there are so many conflicting causes governing the behavior of metals, that numbers of tests are always necessary for a fair idea of average or extremes of any one quality.

THE TENSILE TEST.

Presupposing the general use of machines accurately gauging the load and under reasonable control, the various forms of specimen and methods of testing in use, with their consequent effect on both tensile strength and ductility, render it necessary in each case to specify accurately the conditions of test. As yet the results of any one system are not directly comparable with those of any other. The necessity, from an engineering point of view, of standardizing the test piece and the method of test is very generally recognized, but the loss of value of the tests already made on any system to be discarded, and the lack of facilities in many places for carrying out tests on any of the systems most generally favored by those who have studied the subject, have so far prevented it.

Plate VII.

(1). Groove Form.

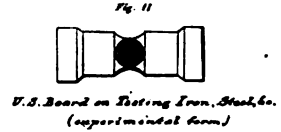
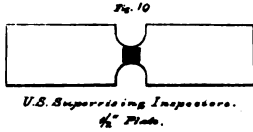

(2). Short Filleted Form.

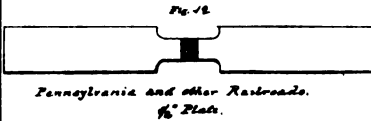

(4). Long Filleted Form.

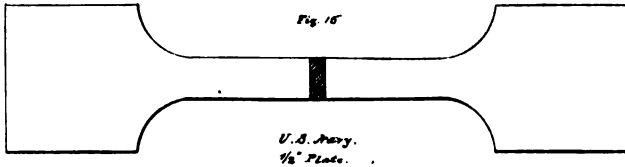
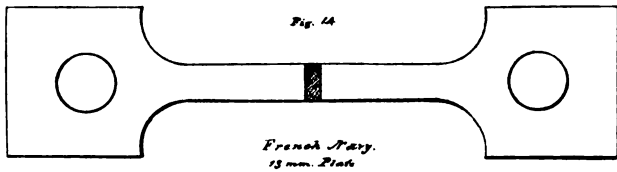

Test pieces.—The principal forms of test piece which are or have been used in this country are—

(1) The groove form (Figs. 10 and 11), both flat and round, drilled or rimed out for the former and turned out for the latter. The only result generally desired from this test is the tensile strength, though the fractured area is sometimes obtained, and the ductility arbitrarily measured on an original length of one inch laid off equally on each side of the least width. This form of specimen has the advantage of being easily taken from small pieces, and, for materials of small ductility, the value of the tensile strength so obtained is practically correct. For ductile materials it gives much higher tensile strength and area of fractured section than long parallel-sided pieces, though the amount of the difference does not seem to lie altogether in the ductility. As so used for plates of wrought iron and the mild steels it is sometimes called the "marine test," presumably from its use in testing ship and boiler plate. It doubtless owes its very general use to the ease and cheapness of preparing specimens for test.

(2) The short filleted form (Figs. 12 and 13), both flat and round, as given for the Pennsylvania and other railroads, and very generally used for ordnance purposes.* Like the preceding, it has the advantage of being easily taken from comparatively small pieces. Both tensile strength and fractured area for ductile material are much nearer the results from long pieces than in the groove form and more uniform, but are still too high. The ductility is somewhat arbitrary, in that the measured length includes the short end fillets, which are in a different condition of stress from the straight portion. Being very largely dependent on the proportions of the test piece, the ductility results from these specimens always read very high, especially for the softer materials. This form is cheaper to fashion than the long filleted form, which is perhaps the only excuse for its use in testing boiler material.

(3) The straight-sided form, of any length and any cross-section, provided it be uniform along the length, and either planed out or in condition as finished at the rolls or under the hammer. As planed out on the edges, it is in very general use among bridge engineers for plates and shapes of soft metal, and in the rough-finished state is much used in steel works for grading the metal.

In many respects this is the very best form of test piece, involving small cost to fashion, and allowing each portion of the measured length to be subjected to the same stress and equally free to strain or change its form. About its only disadvantage is the danger of breaking in the grips, a real source of trouble with hard steels, but which can only occur with soft steels in case of malformation of test piece or lack of homogeneity in the material; and if the first be true to any extent, the specimen is not suitable for test. It is worthy of remark that unless the test is affected by one or other of these causes, soft material shows a very strong tendency to break in the middle of the length, and will never break in the grips.

(4) The long filleted form (Figs. 14 and 15), generally adopted, in a length of 8 inches between fillets, for ship purposes. The history of this form is about as follows:

In the first lever machines, before the use of wedge or friction grips, the most convenient way of applying stress was by a pin and hole connection (Fig. 14), which plainly necessitated a spreading of the ends.

* It may be remarked that the results of Sir J. Whitworth's famous fluid-compressed steel are always from a test piece of this kind.

In some cases the ends were further supported by welding or riveting on additional thicknesses. Kirkaldy's early results were so obtained, and the method is still used. When the French navy commenced using mild steel, they adopted this form for the above reason, and the English admiralty officers, after investigating the French system and methods of tests, adopted the same form, and, as near as may be, the same dimensions, for the sole purpose of obtaining uniformity. Thence it came into general use, until the mass of results obtained renders it inexpedient to make a change. Of course it has the advantage that the piece cannot break in the grips unless very lacking in homogeneity.

Six, ten, and twelve inch lengths between fillets are sometimes used, but no very satisfactory formula has been devised for reducing the results to a basis of the same length or to that of any of the other forms.

In using comparatively long straight-sided test pieces, it is necessary to carefully examine them, and measurements should be made in several places along the length in order to guard against an appreciable defect of area at any point, thereby causing only local stretching with consequent small final elongation as measured for the whole length, as well as an error in the record of stress proportionate to such defect of area. This is particularly necessary where there are minimum requirements for individual pieces.

Table XIV.* shows the various proportions of round test pieces (other than the grooved form) in general use in this country and in Europe, and illustrates the different ductilities to be obtained from the same piece of mild steel in different forms. The difference of tensile strength would also be appreciable in some cases, but there is not sufficient information on the point for accurate comparison.

Table XV.* gives the dimensions of the various flat test pieces in general use.

* Much of the information in both tables is taken from a recent paper before the British Institution of Civil Engineers on "The Adoption of Standard Forms of Test Pieces for Bars and Plates," by William Hackney, B. Sc., Assoc. M. Inst. C. E.

TABLE XIV.

Engineer or administration using test piece.	Authority.	Length.	Diameter.	Ratio of diameter to length.	Estimated ultimate strength of same if cut into a test portion.
Sir Joseph Whitworth, Bart., M. Inst. C. E.* Woolwich Arsenal, test pieces used for— Steel Wrought iron Cast iron	Minutes of Proceedings Inst. C. E., vol. xlii, p. 107. Colonel Maitland, Superintendent of the Royal Gun Factories (private) letter, August 26, 1831.	Inches. 2 2 2 mm. 150	Inch. 0.798 0.833 0.764 1.066 mm. 25	1 to 2.506 1 to 3.75 1 to 2.65 1 to 1.88 1 to 6.00	Per cent. 44.5 37.5 43.5 52.0 32.0
Austro-Hungarian State Railway Vaine du Crenset	Tests of Reochitz iron, published at the Paris Exhibition, 1878. (Les Métaux, par H. Lebauteur, Paris, 1878, p. 113.) Tests published at the Vienna Exhibition, 1873. (On certain matters affecting the use of steel. By E. Marché, Paris, Journal of the Iron and Steel Institute, 1878, p. 417.)	100 100	15 15	1 to 6.6 1 to 6.6	31.0 31.0
Compagnie de Terre-Noire Société John Cockerill, Seraing, Belgium Professor K. H. Thurston	P. Enverre, Mémoires de la Société des Ingénieurs civils, 1877, p. 329. (Minutes of Proceedings Inst. C. E., vol. xlii, p. 390.) E. Marché, <i>loc. cit.</i> Les Métaux, par H. Lebauteur, p. 296. Report of Board on Testing, &c., 1881, vol. ii, pp. 293-396	150 Inches. 6 mm. 200	Inch. 22 to 20 0.625 and 0.798 mm. 25	1 to 7.5 1 to 9.6 1 to 7.52 1 to 8.0	30.9 to 30.2 28.5 to 30.2 29.8
United States Board on Testing Iron, Steel, and other Metals. Test pieces used for steel. Colonel Rosert Compagnie de Terre-Noire R. Pink Hirdle, Westphalia Sir W. Fairbairn	Révue d'Artillerie, May, 1875, p. 134. (Minutes of Proceedings Inst. C. E., vol. xlii, p. 417.) Les Métaux, par H. Lebauteur, p. 72 The dephosphorization of iron in the Bessemer Converter. (Journal of the Iron and Steel Institute, vol. i, 1880, p. 57.) British Association Report, 1869	200 150 Inches. 8 Sw./feet. 5	20 15 Inch. 0.772 to 0.69 mm. 25	1 to 10.0 1 to 10.0 1 to 10.36 to 1 to 11.59	28.2 28.2 27.9 to 27.2
K. Styffe. Cambria Iron Works. Test pieces for steel United States Navy Department. Test pieces for steel rivet bar.	Iron and Steel, by K. Styffe. Translated by C. P. Sandberg, p. 16. United States Naval Inspector of Material Present report	Inches. 8 8	0.750 0.500 to 0.875	1 to 10.67 1 to 9.14 to 1 to 16	27.7 23.0 to 26.3

TABLE XIV—Continued.

Engineer or administration using test piece.	Authority.	Length.	Diameter.	Ratio of diameter to length.	Estimated ultimate strength of same stretching of mild steel if cut into a test piece of each portion.
Pennsylvania Railroad *	Various specifications.....	Inches. 2	Inch. { 0.625 to 0.750 }	1 to 2.66 to 1 to 3.2	Per cent. 43.5 to 40.5

* In the test pieces used by Sir J. Whitworth and the Pennsylvania Railroad, the measured length of 2 inches includes sharp fillets at the ends (in the Pennsylvania Railroad to 1/4 inch radius), so that their comparative extensions are somewhat less than as given in the table. Thus Sir J. Whitworth's should probably read 40.5, and the Pennsylvania Railroad's 39.0 to 36.0 per cent.

TABLE XV.

Engineer or administration using test strip.	Authority.	Length.	Width.	Ratio of width to length.
London and Northwestern Railway Company, Crewe Works.	Extended report on steel for ship-building. (Lloyd's Register of British and Foreign Shipping, No. 391, 6th December, 1877, p. 7.)	2"	(f)	
Sheerness and Chatham Dockyards. Tests of steel and iron boiler plates made at Sheerness in 1875, and at Chatham in 1879.	On the comparative endurance of iron and mild steel when exposed to corrosive influences, by D. Phillips. (Minutes of Proceedings, Inst. C. E., vol. lxx, p. 96.)	4"	1.51" to 1.5"	{ 1 to 2.6 1 to 2.65 1 to 1.0
Mr. W. Parker	On the use of steel for marine boilers. (Transactions of the Institution of Naval Architects, vol. xix, 1878, p. 175.)	4"	4" to 2.7"	{ 1 to 1.5 1 to 5 1 to 10
Usine du Crensoët. The majority of French railway companies. Test strips for boiler-plates.	Prof. L. Gruner (Private Letter, December 17, 1882)	100mm 200mm	20mm 20mm	
Ministère de la Marine Française. Circular dated May 10, 1878.	Sur les Expériences de Résistance des Matériaux en France et aux États Unis, par H. Tresca. (Annales du Conservatoire des Arts et Métiers, 1877.)	200mm	{ Thickness. Width of strip. Under 5mm 20mm 5 to 18mm 30mm 18mm and above. Thickness of the plate. 70.2mm	{ 1 to 6.6 to 1 to 10 1 to 2.85
Jern Kontoret, Stockholm	Expériences de force et de traction sur ces tôles Suédoises produites par des procédés divers, faites aux frais du Comptoir des Forges (Jern Kontoret). Stockholm, 1878.	8"	(f)	
British Admiralty	Steel for ship-building. By Henry H. West. (Transactions of the Institution of Naval Architects, 1880.)	8"	(f)	
Lloyd's Register of British and Foreign Shipping.	On the mechanical and other properties of iron and mild steel. (Journal of the Iron and Steel Institute, vol. li, 1878, p. 394.)	10"	(f)	1 to 16
Mr. D. Adamson	Organ für die Fortschritte des Eisenbahnwesens, Supplement, 1880. (Minutes of Proceedings, Inst. C. E., vol. lxx, p. 439.)	400mm	25mm	
German Railway Union. Tests made between 1876 and 1878.	Steel in construction. By Albert F. Hill. (Engineer's Society of Western Pennsylvania. Engineering News (New York) May 15, 1880, p. 170.)	For 3" plate, 18" For 4" plate, 15" For 5" plate, 12"	1 1/4" 1 1/2" 1"	1 to 12 1 to 12 1 to 6
Albert F. Hill	Experimental inquiry into the mechanical properties of Fagersta steel. London, 1873, p. 25.			
Mr. D. Kirkaldy. Usual standard form for plate specimens.	United States naval inspector of material	8"	3" and 1" □	{ 1 to 8 to 1 to 10.67 1 to 6.4 1 to 8
Cambria Iron Works. Test pieces for steel	Present report.	8"	1" to 1.25"	
United States Navy Department. Test strips for steel plates and shapes.	Various specifications	2" (incl. 3/4" fillet).	{ Thickness. Width. 1/4" on laps. 1 1/4" 1/2" to 1"	{ 1 to 1.33 1 to 2.66
Pennsylvania Railroad.				

THE LAW OF PROPORTION.

The most remarkable set of experiments as to the influence of form are those made by M. J. Barba, chief engineer of the great French steel works of MM. Schneider, at Creusot, from which he deduces a law of symmetry, expressing the identity of the percentages of ultimate stretching in test pieces of the same metal and similar in form.*

We reproduce the following tabular information taken from the paper on "The Adoption of Standard Forms of Test Pieces for Bars and Plates," before referred to, as giving the chief results of his experiments: The test pieces used were of the pattern shown in Fig. 16.

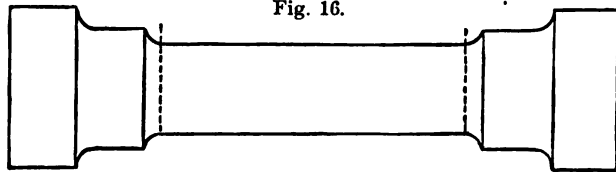

TABLE XVI.

A billet of extra soft steel was hammered to an octagon of 80 by 80 millimeters, rolled to a bar 30 millimeters in diameter, and very carefully annealed. Three test pieces were then cut from it in the lathe and broken, with the following results:

Numbers of test bars.	Diameters.	Lengths between datum points.	Limit of elasticity.	Breaking load.	Total stretch.	Stretch.
	<i>Millimeters.</i>	<i>Millimeters.</i>	<i>Kil. per sq. millimeter.</i>	<i>Kil. per sq. millimeter.</i>	<i>Millimeters.</i>	<i>Per cent.</i>
1.....	20	200	24.8	37.6	62.0	31.6
2.....	10	100	24.7	36.8	30.5	30.5
3.....	5	50	24.8	37.7	15.7	31.4

TABLE XVII.

Experiments repeated on test pieces of two harder grades of steel, cut from bars rolled to 40 millimeters in diameter, annealed, and turned down to same proportion of diameter to length.

(a) MILD STEEL.

Numbers of test bars.	Diameters.	Lengths between datum points.	Ratio of diameter to length.	Limit of elasticity.	Breaking load.	Final area of original area.	Total stretch between datum points.	Stretch.
	<i>Millimeters.</i>	<i>Millimeters.</i>		<i>Kil. per sq. millimeter.</i>	<i>Kil. per sq. millimeter.</i>	<i>Per cent.</i>	<i>Millimeters.</i>	<i>Per cent.</i>
1.....	6.90	50	} 1 to 7.24 }	24.0	42.2	30.7	16.4	32.8
2.....	10.35	75		24.0	42.0	31.0	24.9	33.2
3.....	13.80	100		24.2	42.1	30.3	33.0	33.0
4.....	17.25	125		23.9	41.7	31.4	41.8	33.5
5.....	20.70	150		23.8	41.6	30.8	50.4	33.6
6.....	24.15	175		24.0	40.9	30.3	58.0	33.2
7.....	27.60	200		24.1	40.0	31.2	66.0	33.0
8.....	31.05	225		24.0	39.6	30.5	76.5	34.0
Means.....				24.0	41.3	30.8		33.3

* "Résistance des Matériaux. Épreuves de résistance à la traction. Étude sur les allongements des métaux après rupture." Par J. Barba. Mémoires de la Société des Ingénieurs Civils, 1880, Part I, p. 662.

TABLE XVII.—Continued.

(b) HARD STEEL.

Numbers of test parts.	Diameters.	Lengths between datum points.	Ratio of diameter to length.	Limit of elasticity.	Breaking load.	Final area of original area.	Total stretch between datum points.	Stretch.
	<i>Millimeters.</i>	<i>Millimeters.</i>	} 1 to 7.24 }	<i>Kil. per sq. millimeters.</i>	<i>Kil. per sq. millimeters.</i>	<i>Per cent.</i>	<i>Millimeters.</i>	<i>Per cent.</i>
1.....	6.90	50		32.7	64.8	68.5	10.0	20.0
2.....	10.35	75		36.6	64.9	62.0	14.1	18.8
3.....	13.80	100		35.7	63.8	62.6	18.2	18.2
4.....	17.25	125		38.0	63.3	61.6	22.7	18.1
5.....	20.70	150		40.6	63.5	68.2	27.0	18.0
6.....	24.15	175		38.1	62.0	64.2	31.7	18.1
7.....	27.60	200		38.1	68.2	65.6	39.0	19.5
8.....	31.05	225		Not tested.				
Means.....			37.1	63.6	63.9		18.6	

When, on the other hand, the test pieces used are either of different diameters and equal lengths, or of different lengths and equal diameters, the percentages of ultimate stretching, when portions of the same bar are tested, are very different.

M. Barba gives the following results (Tables XVIII. and XIX.):

TABLE XVIII.—Test pieces of equal length between the datum points, but varying from 5 to 20 millimeters in diameter.

(a) SOFT STEEL.

(Pieces cut from the same bar of extra soft steel as that used in the experiments of which the results are given in Table XVI.)

Numbers of test bars.	Diameters.	Length between datum points.	Limit of elasticity.	Breaking load.	Total stretch between datum points.	Stretch.
	<i>Millimeters.</i>	<i>Millimeters.</i>	<i>Kil. per sq. millimeter.</i>	<i>Kil. per sq. millimeter.</i>	<i>Millimeters.</i>	<i>Per cent.</i>
1.....	20	100	25.0	37.0	37.5	37.5
2.....	10	100	24.8	36.9	30.2	30.2
3.....	5	100	25.2	37.6	25.0	25.0

(b) HALF-HARD STEEL.

1.....	20	100	34.5	59.3	25.9	25.9
2.....	10	100	33.5	59.4	21.0	21.0
3.....	5	100	33.0	60.0	17.0	17.0

TABLE XIX.—Ten test pieces of equal diameter and similar in form at the ends, but varying from 50 to 500 millimeters in length between the datum points.

Numbers of test pieces.	Dimensions.		Resistance.		
	Diameter.	Lengths.	Limit of elasticity.	Breaking-load.	Contraction of area.
	<i>Millimeters.</i>	<i>Millimeters.</i>	<i>Kil. per sq. millimeter.</i>	<i>Kil. per sq. millimeter.</i>	<i>Per cent.</i>
1 to 10.....	17.2	50 to 500	23.7	37.0	68.3

ULTIMATE STRETCHING OF EACH TEST PIECE.

[The lengths of the test pieces between the datum points are given in millimeters.]

	Total millimeters.	Per cent.
50 (= 2.91 diameters)	21.0	42.0
100 (= 5.81 diameters)	32.0	32.0
150 (= 8.72 diameters)	44.0	29.3
200 (= 11.6 diameters)	54.5	27.2
250 (= 14.5 diameters)	66.5	26.6
300 (= 17.4 diameters)	78.0	26.0
350 (= 20.3 diameters)	88.0	25.1
400 (= 23.3 diameters)	100.0	25.0
450 (= 26.2 diameters)	112.0	24.9
500 (= 29.1 diameters)	124.1	24.8

M. Barba quotes the experiments, Table XX., to show that the law of similarity, as he calls it—that is, the law that test pieces similar in form give the same percentage of ultimate stretching, whatever their size may be—prevails equally in flat and in cylindrical test pieces, if cut from the same bar and not reduced to the different sizes by hammering or rolling.

TABLE XX.

Numbers of test pieces.	Dimensions of test pieces.				Resistance.		Ultimate stretching.	
	Widths.	Thick- nesses.	Ratio of width to thick- ness.	Length between datum points.	Limit of elasticity.	Breaking load.	Total stretch between datum points.	Stretch.
	Milli- meters.	Milli- meters.		Milli- meters.	Kil. per sq. millimeter.	Kil. per sq. millimeter.	Milli- meters.	Per cent.
1.....	20	5	} 4 to 1 {	.50	16.8	37.2	19.5	39
2.....	40	10		100	17.1	38.2	39.0	39
3.....	60	15		150	20.7	38.9	58.5	39
Means.....					18.2	37.4		39

Table XXI., also from M. Barba's paper, gives the percentages of ultimate stretching of test strips of steel plate of equal length and thickness but differing in width.

TABLE XXI.

Numbers of test strips.	Dimensions of test strips.				Resistance.		Total stretching.	
	Widths.	Thick- nesses.	Ratio between width and thick- ness.	Length between datum points.	Limit of elasticity.	Breaking load.	Measured on a length of—	
	Milli- meters.	Milli- meters.		Milli- meters.	Kil. per sq. millimeter.	Kil. per sq. millimeter.	50 milli- meters.	100 milli- meters.
1.....	10	10	1	100	24.8	38.4	18.8	31.0
2.....	20	10	2	100	24.6	40.1	22.5	34.0
3.....	30	10	3	100	25.4	39.4	24.0	35.0
4.....	40	10	4	100	25.0	39.8	26.0	37.2
5.....	50	10	5	100	24.6	38.1	28.0	39.0
6.....	60	10	6	100	24.9	37.7	30.5	40.8
7.....	70	10	7	100	24.8	37.8	28.5	38.5
8.....	80	10	8	100	23.5	38.4	26.0	34.5
Means.....					24.7	38.7	25.5	36.2

This seems to show that, for this hardness of steel and for plates 10 millimeters thick, when the ratio of width to thickness is as 6 to 1 the maximum elongation takes place.

Examination of this table, however, shows that the increase of ductility follows very nearly the law for rounds, if the effective diameter of the flat be taken as the mean of its width and thickness, until a width of 60 millimeters is reached; it is very probable that the ductility of the wider pieces was influenced by the method of holding the ends. Indeed it is very difficult to devise a grip for short wide pieces of plate which shall at the same time equally distribute the stress and not constrain the reduction and consequently the stretch.

As further bearing upon the accuracy of the comparison of results from flats and rounds by taking the mean of the two sectional dimensions of the flat for its effective diameter, and affording direct information as to the sufficiency of a standard test piece, say a $\frac{3}{8}$ -inch round, deduced, the following Table XXII. is given, being a comparison of the results of a number of heats of Cambria steel as flats and as rounds tested on the same machine. The column of elastic ratios is given as constituting a measure of physical condition, which, upon the average, is seen to be identical for the material in the two forms. Heat 5585 is omitted from the average, the differences being beyond the limit of error; the flat pieces showed evidence of fine lamination and were probably taken from too near the top of the ingot. The result is seen to be slightly higher elastic limit, ultimate tensile strength, final elongation, and reduction of area from the flats. With the exception of the reduction of area, the method of measuring which was somewhat uncertain and inaccurate, the results are very much as would be expected from the experiments on the effect of length of test piece to be later described. The higher tensile strength of the flats is also notable as corroborating the results of these experiments. As a conclusion from this comparison, it may be stated that the results of this material as $\frac{3}{8}$ -inch rounds would probably be practically identical with those of the $\frac{1}{8}$ -inch flats; and it appears probable that the effective diameters as described give a sufficiently accurate basis of comparison in all ordinary cases.

TABLE XXII.—Comparison of results of tensile tests of the same material as flats and as rounds.

Heat.	Shape.	Size of piece from which test piece was taken.		Effective diameter.	Ratio of measured length to effective diameter.	Elastic limit per square inch.	Ultimate tensile strength per square inch.	Elastic ratio.	Final elongation.	Final area.	Appearance of fracture.
		Inches.	Ins.								
5565	Flat	6 by $\frac{1}{8}$.8365	9.563	44,030	66,469	66.24	24.43	54.64	Silky. Silky; piece somewhat pitted.	
	Round		.7435	10.760	43,135	64,555	66.84	26.05	50.70		
	Difference					895	1,914	.60	1.62		3.98
5567	Flat	6 by $\frac{1}{8}$.8459	9.450	41,576	65,475	63.50	25.25	50.44	Silky. Do.	
	Round		.7475	10.700	42,630	63,205	65.38	25.20	52.25		
	Difference				1,054	270	1.88	.05	1.81		
5568	Flat	6 by $\frac{1}{8}$.8440	9.479	37,850	60,839	62.22	28.13	51.01	Silky. Do.	
	Round		.7420	10.780	38,390	59,550	64.47	27.90	47.10		
	Difference				540	1,289	2.25	.23	3.91		
5578	Flat	6 by $\frac{1}{8}$.8345	95.86	46,515	67,100	60.32	24.18	55.09	Silky. Silky and crystalline.	
	Round		.7410	108.00	42,090	63,620	64.15	23.80	60.20		
	Difference				4,425	1,480	5.17	.38	5.11		

TABLE XXII.—Comparison of results of tensile tests of the same materials as flats and as rounds—Continued.

Heat.	Shape.	Size of piece from which test piece was taken.	Effective diameter.	Ratio of measured length to effective diameter.	Elastic limit per square inch.	Ultimate ten. strength per square inch.	Elastic ratio.	Final elongation.	Final area.	Appearance of fracture.
		Inches.	Ins.		Pounds.	Pounds.	P. ct.	P. ct.	P. ct.	
5580	Flat	6 by $\frac{7}{8}$.8510	9.402	38,406	61,779	62.17	26.60	51.04	Silky. Do.
	Round	$\frac{3}{4}$.7480	10.700	41,530	62,690	66.25	24.30	57.60	
	Difference				3,124	811	4.08	2.30	6.56	
5581	Flat	6 by $\frac{7}{8}$.8456	9.462	38,892	61,578	63.16	27.20	47.09	Silky. Do.
	Round	$\frac{3}{4}$.7425	10.775	39,490	61,770	63.93	24.80	52.10	
	Difference				598	197	.77	2.40	5.01	
5583	Flat	6 by $\frac{7}{8}$.8449	9.470	45,000	68,120	68.20	24.75	55.05	Silky. Do.
	Round	$\frac{3}{4}$.7450	10.740	42,210	67,330	62.70	22.60	58.60	
	Difference				2,880	790	3.50	2.15	3.55	
5585	Flat	6 by $\frac{7}{8}$.8423	9.498	34,020	58,734	57.94	26.85	52.70	Silky. Do.
	Round	$\frac{3}{4}$.7475	10.700	45,860	62,330	70.38	25.90	47.50	
	Difference				9,840	3,596	12.44	.95	5.20	
5586	Flat	6 by $\frac{7}{8}$.8424	9.497	42,680	68,856	61.09	25.50	53.23	Silky. Do.
	Round	$\frac{3}{4}$.7420	10.780	41,620	67,070	62.05	24.80	46.70	
	Difference				1,060	1,786	.06	.70	6.53	

AVERAGE.

[Exclusive of heat 5585.]

8	Flat	6 by $\frac{7}{8}$		9.490	41,880	65,026	64.41	25.75	52.20	
9	Round	$\frac{3}{4}$		10.754	41,387	64,224	64.44	24.93	53.16	
	Difference				493	802		.82	.96	

The extreme case of the groove form giving much higher values for tensile strength, and incidentally for final area, and the natural probability that these effects would follow a regular law, induced the Board to make a series of experiments to determine the nature of the effect of change of length. Accordingly, the part numbered 10 of annealed plate 678 W, originally intended for the Chicago's boilers, and which had been cut up for other tests (p. 529), being considered sufficiently homogeneous, test pieces numbered 1 to 24, consecutively, were removed, as shown, Fig. 20, and variously shaped for test, the results being given in Table XXIII. Plate VIII. shows its graphic representation, in which the groove form is taken as the zero of length. The final elongation for the groove form is obtained by subtracting unity from the reciprocal of the ratio of fractured to original area and writing the decimal as per cent., and represents, therefore, the differential extension at the bottom of the groove. The dotted terminal line is in accordance with the experiments, but the results for final area in the grooved form being in this case believed to be abnormal, the solid lines show the results of an average of many tests in groove form from this plate.

The curves show at a glance the nature and probable amount of difference in results from test pieces of various proportions in use for boiler plate. Thus this plate tested by the United States Supervising Inspector would give about 63,000 pounds tensile strength and 50 per

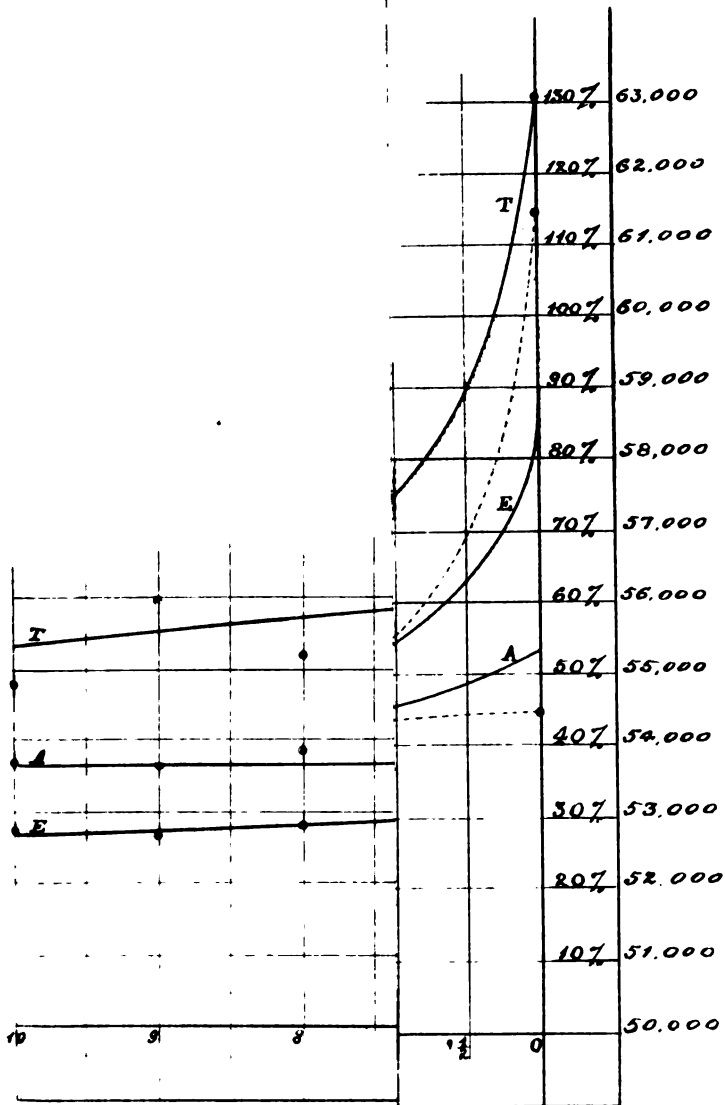

H Ex1 pt3 v1 49 1

cent. reduction; tested for the Pennsylvania Railroad, it would show about 56,500 pounds, with 36 per cent. elongation; while, as tested under this inspection, the result should be 55,700 pounds, with 27.9 per cent. elongation. The difficulty of the steel manufacturer in working to such discrepant specifications is evident.

An unexpected decrease of tensile strength for lengths greater than about 3 inches is a feature of the corresponding curve. The cause of this is naturally looked for in the condition of the plate, but on referring to Fig. 20, it is seen that while Nos. 17 and 18 are near the edge of the plate, Nos. 19 and 20 are in the center and adjacent to Nos. 3 and 4, and that Nos. 23 and 24, the 10-inch lengths, are adjacent to Nos. 7 and 8, the 2½-inch lengths, the difference of tensile strength being 1,450 pounds. This result requires corroboration before being accepted.

TABLE XXIII.—Showing effect of length of test piece.

ANNEALED BOILER PLATE OF CHESTER STEEL.

Original length between witness marks.	Number of piece.	Original width.	Original thickness.	Original sectional area.	Ultimate tensile strength per square inch.	Final elongation.	Final area.	Average tensile strength per square inch.	Average elongation.	Average final area.																																																																																																																																																																																																		
Inches.		Inches.	In.	Sq. ins.	Pounds	Pr. ct.	Pr. ct.	Pounds.	Pr. ct.	Pr. ct.																																																																																																																																																																																																		
Groove	1	0.990	.660	.6534	63,330	41.0	47.0	63,065	40.5	46.0																																																																																																																																																																																																		
	2	0.995	.660	.6567	62,800	40.0	45.0				1½	3	0.990	.665	.6583	56,660	49.0	44.0	56,660	49.0	43.5	4	0.990	.665	.6583	56,660	49.0	43.0	2	5	1.021	.665	.6790	56,400	42.0	43.0	56,600	44.0	41.5	6	1.021	.661	.6750	56,800	46.0	40.0	2½	7	0.968	.668	.6466	56,200	40.0	39.0	56,200	40.0	40.0	8	0.968	.668	.6466	56,200	40.0	41.0	3	9	1.015	.660	.6700	56,400	38.0	39.0	56,400	38.0	39.5	10	1.015	.660	.6700	56,400	38.0	40.0	4	11	0.960	.655	.6420	56,300	34.0	39.0	56,200	34.5	38.0	12	0.960	.660	.6470	56,100	35.0	37.0	5	13	0.970	.650	.6300	56,300	33.0	37.0	56,445	33.0	37.0	14	0.970	.650	.6300	56,500	33.0	37.0	6	15	1.037	.650	.6740	55,700	29.0	36.7	55,700	29.5	36.9	16	1.037	.647	.6710	55,700	30.0	37.0	7	17	1.000	.645	.6450	56,000	28.5	39.0	56,250	28.5	39.5	18	1.000	.642	.6420	56,500	28.5	40.0	8	19	0.933	.664	.6185	55,200	27.4	40.0	55,200	27.9	38.5	20	0.933	.664	.6185	55,200	28.4	37.0	9	21	0.962	.655	.6301	56,000	28.0	35.0	55,955	26.6	36.4	22	0.964	.653	.6295	55,910	25.1	37.8	10	23	1.000	.663	.6630	54,750	27.8	37.7	54,750	27.4	36.8	24	1.000	.663
1½	3	0.990	.665	.6583	56,660	49.0	44.0	56,660	49.0	43.5																																																																																																																																																																																																		
	4	0.990	.665	.6583	56,660	49.0	43.0				2	5	1.021	.665	.6790	56,400	42.0	43.0	56,600	44.0	41.5	6	1.021	.661	.6750	56,800	46.0	40.0	2½	7	0.968	.668	.6466	56,200	40.0	39.0	56,200	40.0	40.0	8	0.968	.668	.6466	56,200	40.0	41.0	3	9	1.015	.660	.6700	56,400	38.0	39.0	56,400	38.0	39.5	10	1.015	.660	.6700	56,400	38.0	40.0	4	11	0.960	.655	.6420	56,300	34.0	39.0	56,200	34.5	38.0	12	0.960	.660	.6470	56,100	35.0	37.0	5	13	0.970	.650	.6300	56,300	33.0	37.0	56,445	33.0	37.0	14	0.970	.650	.6300	56,500	33.0	37.0	6	15	1.037	.650	.6740	55,700	29.0	36.7	55,700	29.5	36.9	16	1.037	.647	.6710	55,700	30.0	37.0	7	17	1.000	.645	.6450	56,000	28.5	39.0	56,250	28.5	39.5	18	1.000	.642	.6420	56,500	28.5	40.0	8	19	0.933	.664	.6185	55,200	27.4	40.0	55,200	27.9	38.5	20	0.933	.664	.6185	55,200	28.4	37.0	9	21	0.962	.655	.6301	56,000	28.0	35.0	55,955	26.6	36.4	22	0.964	.653	.6295	55,910	25.1	37.8	10	23	1.000	.663	.6630	54,750	27.8	37.7	54,750	27.4	36.8	24	1.000	.663	.6630	54,750	27.0	36.0														
2	5	1.021	.665	.6790	56,400	42.0	43.0	56,600	44.0	41.5																																																																																																																																																																																																		
	6	1.021	.661	.6750	56,800	46.0	40.0				2½	7	0.968	.668	.6466	56,200	40.0	39.0	56,200	40.0	40.0	8	0.968	.668	.6466	56,200	40.0	41.0	3	9	1.015	.660	.6700	56,400	38.0	39.0	56,400	38.0	39.5	10	1.015	.660	.6700	56,400	38.0	40.0	4	11	0.960	.655	.6420	56,300	34.0	39.0	56,200	34.5	38.0	12	0.960	.660	.6470	56,100	35.0	37.0	5	13	0.970	.650	.6300	56,300	33.0	37.0	56,445	33.0	37.0	14	0.970	.650	.6300	56,500	33.0	37.0	6	15	1.037	.650	.6740	55,700	29.0	36.7	55,700	29.5	36.9	16	1.037	.647	.6710	55,700	30.0	37.0	7	17	1.000	.645	.6450	56,000	28.5	39.0	56,250	28.5	39.5	18	1.000	.642	.6420	56,500	28.5	40.0	8	19	0.933	.664	.6185	55,200	27.4	40.0	55,200	27.9	38.5	20	0.933	.664	.6185	55,200	28.4	37.0	9	21	0.962	.655	.6301	56,000	28.0	35.0	55,955	26.6	36.4	22	0.964	.653	.6295	55,910	25.1	37.8	10	23	1.000	.663	.6630	54,750	27.8	37.7	54,750	27.4	36.8	24	1.000	.663	.6630	54,750	27.0	36.0																																
2½	7	0.968	.668	.6466	56,200	40.0	39.0	56,200	40.0	40.0																																																																																																																																																																																																		
	8	0.968	.668	.6466	56,200	40.0	41.0				3	9	1.015	.660	.6700	56,400	38.0	39.0	56,400	38.0	39.5	10	1.015	.660	.6700	56,400	38.0	40.0	4	11	0.960	.655	.6420	56,300	34.0	39.0	56,200	34.5	38.0	12	0.960	.660	.6470	56,100	35.0	37.0	5	13	0.970	.650	.6300	56,300	33.0	37.0	56,445	33.0	37.0	14	0.970	.650	.6300	56,500	33.0	37.0	6	15	1.037	.650	.6740	55,700	29.0	36.7	55,700	29.5	36.9	16	1.037	.647	.6710	55,700	30.0	37.0	7	17	1.000	.645	.6450	56,000	28.5	39.0	56,250	28.5	39.5	18	1.000	.642	.6420	56,500	28.5	40.0	8	19	0.933	.664	.6185	55,200	27.4	40.0	55,200	27.9	38.5	20	0.933	.664	.6185	55,200	28.4	37.0	9	21	0.962	.655	.6301	56,000	28.0	35.0	55,955	26.6	36.4	22	0.964	.653	.6295	55,910	25.1	37.8	10	23	1.000	.663	.6630	54,750	27.8	37.7	54,750	27.4	36.8	24	1.000	.663	.6630	54,750	27.0	36.0																																																		
3	9	1.015	.660	.6700	56,400	38.0	39.0	56,400	38.0	39.5																																																																																																																																																																																																		
	10	1.015	.660	.6700	56,400	38.0	40.0				4	11	0.960	.655	.6420	56,300	34.0	39.0	56,200	34.5	38.0	12	0.960	.660	.6470	56,100	35.0	37.0	5	13	0.970	.650	.6300	56,300	33.0	37.0	56,445	33.0	37.0	14	0.970	.650	.6300	56,500	33.0	37.0	6	15	1.037	.650	.6740	55,700	29.0	36.7	55,700	29.5	36.9	16	1.037	.647	.6710	55,700	30.0	37.0	7	17	1.000	.645	.6450	56,000	28.5	39.0	56,250	28.5	39.5	18	1.000	.642	.6420	56,500	28.5	40.0	8	19	0.933	.664	.6185	55,200	27.4	40.0	55,200	27.9	38.5	20	0.933	.664	.6185	55,200	28.4	37.0	9	21	0.962	.655	.6301	56,000	28.0	35.0	55,955	26.6	36.4	22	0.964	.653	.6295	55,910	25.1	37.8	10	23	1.000	.663	.6630	54,750	27.8	37.7	54,750	27.4	36.8	24	1.000	.663	.6630	54,750	27.0	36.0																																																																				
4	11	0.960	.655	.6420	56,300	34.0	39.0	56,200	34.5	38.0																																																																																																																																																																																																		
	12	0.960	.660	.6470	56,100	35.0	37.0				5	13	0.970	.650	.6300	56,300	33.0	37.0	56,445	33.0	37.0	14	0.970	.650	.6300	56,500	33.0	37.0	6	15	1.037	.650	.6740	55,700	29.0	36.7	55,700	29.5	36.9	16	1.037	.647	.6710	55,700	30.0	37.0	7	17	1.000	.645	.6450	56,000	28.5	39.0	56,250	28.5	39.5	18	1.000	.642	.6420	56,500	28.5	40.0	8	19	0.933	.664	.6185	55,200	27.4	40.0	55,200	27.9	38.5	20	0.933	.664	.6185	55,200	28.4	37.0	9	21	0.962	.655	.6301	56,000	28.0	35.0	55,955	26.6	36.4	22	0.964	.653	.6295	55,910	25.1	37.8	10	23	1.000	.663	.6630	54,750	27.8	37.7	54,750	27.4	36.8	24	1.000	.663	.6630	54,750	27.0	36.0																																																																																						
5	13	0.970	.650	.6300	56,300	33.0	37.0	56,445	33.0	37.0																																																																																																																																																																																																		
	14	0.970	.650	.6300	56,500	33.0	37.0				6	15	1.037	.650	.6740	55,700	29.0	36.7	55,700	29.5	36.9	16	1.037	.647	.6710	55,700	30.0	37.0	7	17	1.000	.645	.6450	56,000	28.5	39.0	56,250	28.5	39.5	18	1.000	.642	.6420	56,500	28.5	40.0	8	19	0.933	.664	.6185	55,200	27.4	40.0	55,200	27.9	38.5	20	0.933	.664	.6185	55,200	28.4	37.0	9	21	0.962	.655	.6301	56,000	28.0	35.0	55,955	26.6	36.4	22	0.964	.653	.6295	55,910	25.1	37.8	10	23	1.000	.663	.6630	54,750	27.8	37.7	54,750	27.4	36.8	24	1.000	.663	.6630	54,750	27.0	36.0																																																																																																								
6	15	1.037	.650	.6740	55,700	29.0	36.7	55,700	29.5	36.9																																																																																																																																																																																																		
	16	1.037	.647	.6710	55,700	30.0	37.0				7	17	1.000	.645	.6450	56,000	28.5	39.0	56,250	28.5	39.5	18	1.000	.642	.6420	56,500	28.5	40.0	8	19	0.933	.664	.6185	55,200	27.4	40.0	55,200	27.9	38.5	20	0.933	.664	.6185	55,200	28.4	37.0	9	21	0.962	.655	.6301	56,000	28.0	35.0	55,955	26.6	36.4	22	0.964	.653	.6295	55,910	25.1	37.8	10	23	1.000	.663	.6630	54,750	27.8	37.7	54,750	27.4	36.8	24	1.000	.663	.6630	54,750	27.0	36.0																																																																																																																										
7	17	1.000	.645	.6450	56,000	28.5	39.0	56,250	28.5	39.5																																																																																																																																																																																																		
	18	1.000	.642	.6420	56,500	28.5	40.0				8	19	0.933	.664	.6185	55,200	27.4	40.0	55,200	27.9	38.5	20	0.933	.664	.6185	55,200	28.4	37.0	9	21	0.962	.655	.6301	56,000	28.0	35.0	55,955	26.6	36.4	22	0.964	.653	.6295	55,910	25.1	37.8	10	23	1.000	.663	.6630	54,750	27.8	37.7	54,750	27.4	36.8	24	1.000	.663	.6630	54,750	27.0	36.0																																																																																																																																												
8	19	0.933	.664	.6185	55,200	27.4	40.0	55,200	27.9	38.5																																																																																																																																																																																																		
	20	0.933	.664	.6185	55,200	28.4	37.0				9	21	0.962	.655	.6301	56,000	28.0	35.0	55,955	26.6	36.4	22	0.964	.653	.6295	55,910	25.1	37.8	10	23	1.000	.663	.6630	54,750	27.8	37.7	54,750	27.4	36.8	24	1.000	.663	.6630	54,750	27.0	36.0																																																																																																																																																														
9	21	0.962	.655	.6301	56,000	28.0	35.0	55,955	26.6	36.4																																																																																																																																																																																																		
	22	0.964	.653	.6295	55,910	25.1	37.8				10	23	1.000	.663	.6630	54,750	27.8	37.7	54,750	27.4	36.8	24	1.000	.663	.6630	54,750	27.0	36.0																																																																																																																																																																																
10	23	1.000	.663	.6630	54,750	27.8	37.7	54,750	27.4	36.8																																																																																																																																																																																																		
	24	1.000	.663	.6630	54,750	27.0	36.0																																																																																																																																																																																																					

TENSILE TESTS BY INCREMENTS AND BY CONTINUOUS LOADS.

Next to the form of test piece, the subject most in dispute is the method of applying stress as regards time; that is, whether by regular increments at regular intervals or continuously at approximately uniform speed of ram or screw. It is claimed that in continuous testing both time and power are saved and the capacity of the machine in amount of work correspondingly increased, and this method is accordingly the more generally used, especially in grading steel at the works, while the Board has adopted the method of increments. As a matter of fact, if anything like a complete record of each test is kept, the time taken up in making the necessary calculations for the results of each piece—which, to avoid error, should always be made before commencing to strain the next—even with the various tables used as aids

to calculations, reduces the difference of time to a very small amount, because in testing by increments much of this work can be done while straining the piece. Thus, the modulus of elasticity, the elastic limit, ultimate tensile strength, and extension at tensile limit, can all be recorded by the time the piece breaks, and there remain only the final measurements of elongation and fractured area and the quantities depending on them.

But the cause of the original adoption of the method of increments was in order to obtain, as nearly as may be, uniformity in the method of testing by different inspectors on different machines, in the absence of any conclusive information as to the effect of different methods of testing on the results. These considerations still hold, but the method has been so far modified as to substitute for the five minutes of initial strain one minute, or such other time as may be necessary to measure the initial extension, and, in order to obtain the principal elastic limit, regular increments are only to be applied beyond that stress.

As regards the effect on the results, it is believed that, in general, for this material under increasing stress, marked differences will be caused only by differences in the application of stress very near and beyond the tensile limit. The following considerations lead to this opinion.

It would appear* that as regards capacity for sustaining a stress beyond the elastic limit without increased distortion for a long time, the metals may be divided into two distinct classes: (1) the "iron" class, which will sustain a static load even near its ultimate strength for any length of time without increased distortion, and (2) the "tin" class, which undergoes a gradually increasing distortion under stresses which are only a fraction of those required to break such metals quickly. The difference is due to the existence at such stresses in the latter class of the quality of viscosity to a greater or less degree, and their apparent ultimate strength depends entirely upon the opportunity afforded to flow under the stress, and, therefore, upon the time of action of the load, or each load in breaking by increments.

But it has been shown by Tresca that all sufficiently ductile materials, including steel, presumably harder than the mild quality under consideration, can be brought to the plastic or viscous condition by the proper application of stress, as illustrated in the cold drawing of lead pipes under compression. It is well known that in such a state the strength of such soft steels as we are considering is seriously affected by the opportunity afforded for relief, by flow, of the internal strains produced by drawing out either under compression or tension, for the principal stresses are interchangeable in their effects upon plastic materials. Thus it is within the experience of all wire mills where testing is done that steel wire as fresh drawn is both weaker and less ductile than after several months of rest.

We shall see when considering the extension diagrams (p. 502 *et seq.*), that a condition of flow appears to be reached, probably in most cases, slightly before tensile limit in mild steel, to a varying extent in different heats, and, of course, with different degrees of hardness. It would accordingly appear that the conditions of straining from just before tensile limit up to rupture may slightly affect the apparent ultimate

* See papers before the American Society of Civil Engineers, by Prof. R. H. Thurston entitled, "Note on the Resistance of Materials, as Affected by Flow and by Rapidity of Distortion" (March 1, 1876), and "The Ratio of Set of Metals Subjected to Strain for Considerable Periods of Time." (December 6, 1876.)

strength and to a greater degree the contraction of area and that part of the final extension which is due to the flow of the material while necking. We might expect to find that if, at this time, strain is brought on by a series of jerks as in a common hand-hydraulic machine using one pump, the material is not given time to flow, and the ultimate tensile strength and final area will be higher and final elongation generally lower than with continuous and slowly applied strain. If, however, the jerks are sufficiently rapid from the beginning, that element of the extension which consists of the more or less uniform extension over the whole length may be so much increased as actually to make the final elongation measured on the whole length greater, but the ultimate strength and final area will be larger as before. In ordinary testing the differences cannot be great, and many experiments are necessary to conclusively establish them, but it is seen that such differences as may be observed are probably due to the method of applying strain whether smoothly or by jerks, the ultimate strength and final area being increased by the latter method, provided the material does not exhibit viscosity much below tensile limit, when the time of absolute straining becomes important. The two essential elements of the elongation are differently affected and the combined action becomes one of difference, the figure being higher for very rapid or impulsive application, less for jerky action not sufficiently rapid to be reckoned impulsive, and higher again for smooth, slow application of strain.

Attention is called to the fact that study of extension diagrams, such as those referred to, under these different conditions would throw probably considerable light on the subject, and also on the relative condition of viscosity of different pieces of metal.

It is conceivable, however, that the intrinsic nature of the material may be such that the effects of viscosity may appear for stresses considerably removed from tensile limit. Thus Commander L. A. Beardslee, U. S. N., has observed that one of the softest and most ductile specimens of chain iron tested by him at the Washington navy-yard exhibited a perceptible increase of resistance under rapid extension, as in the "tin" class.

If, indeed, the extension be very rapid or explosive from the beginning, it is conceivable that the time allowed for flow at any one point may be so small that the phenomenon of multiple necking, hereafter mentioned as occurring in as many as three places in a well-shaped piece of mild steel under slow test, may, so to speak, hold for all points, and the piece be drawn out or flow equally all along, thereby exhibiting a very great final extension, though, of course, with comparatively small contraction of area. This phenomenon, in fact, is reported by Col. E. Maitland, B. A., Superintendent of the Royal Gun Factory at Woolwich, England, thus: "Soft, untempered steel, having in the machine an elongation of 30 per cent.,† had in the drop test an elongation of 38 or 40 per cent.; when tested by gunpowder, the elongation was 45 or 46 per cent.; and with gun-cotton, it actually rose to 60 per cent."

If the rapid or explosive force had been applied only after necking had begun, with appreciable local reduction of area, the effect would have been very different.

Table XXIV. gives the results of some tests made at the Chester Rolling Mills for information as to the effect of ordinary differences of time.

* See discussion on the paper on "The Adoption of Standard Forms of Test Pieces for Bars and Plates."

† The elongations are for the short test pieces given in Table XIV. as in use at Woolwich Arsenal.

The slow tests were made by increments, in accordance with the general method pursued in this inspection. When tensile limit was approached, the machine was run slowly and steadily until fracture, the weights being adjusted so as to practically maintain a balance at all times. In the fast pull the same power was applied throughout, the rapidity of ram near and beyond tensile limit being greater than in the slow test. The results for ductility and final area are somewhat interfered with by laminations in one of the pieces broken by fast pull, the differences for ductility and final area being thereby increased. The results are illustrative of the conclusions above arrived at, the fast pull giving higher strength and less ductility with greater final area. The differences in the results of the slow tests with the grain from the original heat tests, as well as those in the two pieces for heat test, are suggestive of the lack of homogeneity commonly met with in plates.

TABLE XXIV.—Comparison of results of same material by fast and slow tensile tests.

[Heat, 705; carbon, .16 per cent.; mang., .40 per cent.]

ORIGINAL HEAT TEST.																																																																																																											
Marks.	Original width.	Original thickness.	Original area.	Ultimate tensile strength per square inch.	Final elongation.	Final area.	Time of test.	Average tensile strength per square inch.	Average final elongation.	Average final area.																																																																																																	
	Inches.	Inches.	Sq. ins.	Pounds	Per ct	Per ct.	m. s.	Pounds.	Per ct.	Per ct.																																																																																																	
705.....	1.150	.530	.5909	80,750	25.00	51.00																																																																																																					
705.....	1.185	.535	.6072	82,580	25.70	48.00																																																																																																					
SLOW PULL, LENGTHWAYS.																																																																																																											
1.—705 G.....	1.011	.530	.5358	59,500	28.0	47.0																																																																																																					
2.—705 G.....	1.005	.530	.5326	59,300	28.0	47.0		59,400	27.0	47.0																																																																																																	
FAST PULL, LENGTHWAYS.																																																																																																											
3.—705 G.....	1.048	.531	.5564	60,020	24.0	*53.0	2 30																																																																																																				
4.—705 G.....	1.010	.531	.5363	59,680	24.6	42.0	2 30	59,840	24.3	47.5																																																																																																	
* Piece showed laminations in fracture.																																																																																																											
SLOW PULL, CROSSWAYS.																																																																																																											
1.—705 C.....	1.000	.528	.5280	59,090	22.3	47.0																																																																																																					
2.—705 C.....	1.045	.532	.5560	58,900	24.0	47.0		58,995	23.15	47.0																																																																																																	
FAST PULL, CROSSWAYS.																																																																																																											
3.—705 C.....	1.022	.530	.5416	59,630	22.0	50.0	2 30																																																																																																				
4.—705 C.....	1.038	.530	.5501	59,080	21.5	54.0	2 30	59,355	21.75	52.0																																																																																																	
<table border="1" style="width: 100%; border-collapse: collapse;"> <tr> <td rowspan="5" style="writing-mode: vertical-rl; transform: rotate(180deg);">Butt End.</td> <td style="width: 10%;"></td> <td style="width: 10%;"></td> <td style="width: 10%;"></td> <td style="width: 10%;"></td> <td style="width: 10%;"></td> <td style="width: 10%;"></td> <td style="width: 10%;"></td> <td style="width: 10%;"></td> <td style="width: 10%;"></td> <td style="width: 10%;"></td> <td style="width: 10%;"></td> </tr> <tr> <td></td> <td style="writing-mode: vertical-rl; transform: rotate(180deg);">1.—705 C</td> <td style="writing-mode: vertical-rl; transform: rotate(180deg);">2.—705 C</td> <td style="writing-mode: vertical-rl; transform: rotate(180deg);">3.—705 C</td> <td style="writing-mode: vertical-rl; transform: rotate(180deg);">4.—705 C</td> <td colspan="6"></td> <td></td> </tr> <tr> <td></td> <td colspan="4"></td> <td colspan="6" style="text-align: center;">1.—705 G</td> <td></td> </tr> <tr> <td></td> <td colspan="4"></td> <td colspan="6" style="text-align: center;">2.—705 G</td> <td></td> </tr> <tr> <td></td> <td colspan="4"></td> <td colspan="6" style="text-align: center;">3.—705 G</td> <td></td> </tr> <tr> <td></td> <td colspan="4"></td> <td colspan="6" style="text-align: center;">4.—705 G</td> <td></td> </tr> <tr> <td></td> <td colspan="4"></td> <td colspan="6"></td> <td></td> </tr> <tr> <td></td> <td colspan="4" style="text-align: center;">705</td> <td colspan="6"></td> <td style="text-align: center;">705</td> </tr> </table>												Butt End.													1.—705 C	2.—705 C	3.—705 C	4.—705 C													1.—705 G												2.—705 G												3.—705 G												4.—705 G																				705										705
Butt End.																																																																																																											
		1.—705 C	2.—705 C	3.—705 C	4.—705 C																																																																																																						
						1.—705 G																																																																																																					
						2.—705 G																																																																																																					
						3.—705 G																																																																																																					
					4.—705 G																																																																																																						
	705										705																																																																																																
Top End.																																																																																																											

	Ultimate tensile strength per square inch.	Final elongation.	Final area.
	<i>Pounds.</i>	<i>Per ct.</i>	<i>Per ct.</i>
Average heat test	61,665	25.35	49.50
Average slow pull	59,198	25.08	47.00
Average fast pull	59,598	23.03	49.75
Difference fast over slow	+400	-2.05	+2.75

Table XXV. shows the mean results of some experiments presented by Mr. William Denny to the Institution of Naval Architects in 1880. The tests were made with a hydraulic machine.

TABLE XXV.

	Ultimate strength per square inch.	Elongation in 8 inches.	Time.
	<i>Pounds.</i>	<i>Per cent.</i>	<i>m. s.</i>
HARD STEEL.			
Mean of six experiments, plate $\frac{1}{2}$ inch thick ...	91,011	11.96	1 30
Mean of six experiments from same plate	89,286	11.48	11 50
SOFT STEEL.			
Mean of two experiments, plate $\frac{1}{2}$ inch thick ..	65,296	23.55	1 30
Mean of two experiments from same plate ...	64,176	23.55	4 43
Do	64,736	22.7	13 11

It is seen that the very rapid testing gave higher results for ultimate strength and ductility, as would be expected. The contraction of area is not given, but was probably less in the rapid testing.

Table XXVI. gives the results of some experiments on steel similar to that for the cruisers, made at the Cambria Iron Works by Mr. C. A. Marshall, engineer of tests, and given in the discussion on Mr. P. G. Salom's paper before the American Institute of Mining Engineers, referred to on page 402. The conditions of tests are thus described:

Upon the point of time, I present tests of two heats of our steel, similar to that made for cruisers, with statement of speed and times from passing elastic limit to breaking. Specimens are alike throughout, being $\frac{7}{16}$ inches thick and planed to $1\frac{1}{2}$ inches width.

TABLE XXVI.

Heat number.	Elastic limit per square inch.	Ultimate strength per square inch.	Elongation in 8 inches.	Reduction.	Time.	Total time of test.
	<i>Pounds.</i>	<i>Pounds.</i>	<i>Per cent.</i>	<i>Per cent.</i>	<i>m. s.</i>	
5017	42,080	65,150	24.8	47.1	3 10	Say 7 minutes.
5017	41,930	65,550	25.6	47.1	3 10	Do.
5018	38,450	61,830	27.2	50.3	3 30	Say 7 $\frac{1}{2}$ minutes.
5018	37,870	61,670	28.5	50.0	3 40	Do.
5017	42,070	66,450	26.6	46.8	14 0	22 minutes.
5017	42,400	66,530	26.2	49.3	13 0	23 minutes.
5018	38,280	62,410	28.7	52.0	11 0	19 $\frac{1}{2}$ minutes.
5018	39,000	62,000	26.3	48.8	10 0	17 $\frac{1}{2}$ minutes.

The speed of screw was throughout about $\frac{1}{4}$ inch per minute. In the first four tests the pulling was continuous after passing the elastic limit. The last four were tested in accordance with the requirements of the Naval Advisory Board. A strain of 30,000 pounds per square inch was left on for five minutes, elastic limit taken, and subsequent strain applied in increments at half-minute intervals.

The difference in tensile strengths in these tests may not be due altogether to the conditions of testing, but chiefly to difference of quality or physical condition. Thus, if we take the elastic limits as a measure of this condition, an artifice which we shall hereafter consider, and these values were obtained under identical circumstances in each case, and alter the figures for tensile strength proportionally so as to bring all the pieces of each heat to the same basis of elastic limit or assumed physical condition, we shall have the following averages without alteration in the values for elongation and reduction, which are apt to be affected by small differences of dimension as well as by the conditions of test:

TABLE XXVII.

Heat number.	Elastic limit taken as basis per square inch.	Corresponding ultimate strength per square inch.	Final elongation in 8 inches.	Reduction of area.	Time from elastic limit to rupture.	Total time of test.
5017	<i>Pounds.</i> 42, 235	<i>Pounds.</i> 65, 620	<i>Per cent.</i> 25. 20	<i>Per cent.</i> 47. 10	<i>m. s.</i> 3 10	Say 7 minutes.
5018	38, 640	62, 525	27. 85	50. 15	3 35	Say 7½ minutes.
Average		64, 075	26. 52	48. 63	3 22	Say 7¼ minutes.
5017	42, 235	66, 490	26. 4	48. 05	13 30	22½ minutes.
5018	38, 640	62, 205	27. 5	50. 40	10 30	18½ minutes.
Average	40, 438	64, 347	26. 95	49. 22	12 0	20½ minutes.

The average difference in tensile strength is now 270 pounds in favor of the increment testing, but while one heat gives a difference one way, the other reverses it. The real difference due to the manner of testing is probably inappreciable.

THE PHYSICAL AND CHEMICAL CONDITION OF THE TEST PIECE.

Another very prominent source of discrepancy in results from different pieces of material from the same heat is the difference in condition of the test pieces. These differences arise from four main causes, viz: (1) inequalities in the chemical composition of different parts of the same heat and especially of different parts of the same ingot; (2) inequalities in physical homogeneity in different parts of the ingot, arising from varying extent of liberation of occluded gases in cooling; (3) varying amount and nature of work of reduction from the ingot; (4) difference in heating and in the temperature of finishing, as well as all the conditions of cooling and subsequent treatment.

The first is due either to the irregular diffusion of manganese by being added to the charge too soon before tapping, a very rare occurrence now, or more generally to the phenomenon of hard centers or the segregation of the hardening elements to the center and top of the ingot during cooling. This latter condition is very generally prevalent to a greater or less extent, and sometimes very seriously so. It is promoted by very high temperature of cast and subsequent slow cooling, and is especially noticeable in Bessemer steel. It may easily affect the chemical results obtained from the same piece according to the depth of drilling and shape of point of drill, and give rise to very anomalous conclusions.

The second source of discrepancy alters the physical homogeneity from point to point as the first does the chemical quality, and somewhat in the same manner, the top of the ingot, especially when top cast, being much more honeycombed than the bottom, and, although more numerous near the sides of the ingot, the blow-holes are generally much larger and more injurious near the center.

The effect of work of reduction at a heat is generally to increase both tensile strength and ductility, the product of the two being considerably increased. If the material be originally much honeycombed as cast, both qualities are much increased and the contraction of area likewise. For this reason, a certain minimum amount of work of reduction is generally considered necessary in order to obtain practical homogeneity of structure, and for ship and boiler plate at least twenty reductions of thickness are deemed necessary in most of the large steel works in Great Britain. If the ingot be reduced in both width and thickness, or edged down, as in shapes or merchant steel and wire rod, less reduction is allowable, and it is then reckoned as reduction in area of cross-section.

The conditions of heating undoubtedly affect the physical structure, from the extreme of overheating to comparatively cold forging or rolling, but the subject is too complex for treatment here. At whatever temperature worked, the temperature at which the piece is finished and allowed to cool off, together with the conditions of cooling, very seriously affect the physical tests. Thus if a plate or flat cools, as is generally the case, in contact at various points with a cast-iron straightening plate, necessarily a good conductor, cooling is more rapid at the points of contact and over the surface towards the plate, and initial strains are set up sufficient to warp the piece and even cause failure when these strains are reversed in straightening or subsequent cold shaping, and this effect is greater the higher the temperature of finishing. Another curious case is that of a deck beam which leaves the rolls comparatively straight, but with bulb, web, and flange, all at different temperatures and therefore contracting unequally on cooling, as evidenced by the considerable camber of the cold beam from the greater contraction of the bulb, finished at the highest temperature. A very complex, though regular, condition of strain must be set up, especially near the fillets joining the web to bulb and flange.

From all these causes, widely differing results are easily obtained by the same experiments from material of the same heat, and it remains to be seen if there is no basis to which the condition of the piece may be reduced. We shall consider this point more fully in studying the curve of carbon properties of the Cambria steel; it will suffice now to state the principal points.

For difference of chemical composition there can be no measure other than actual analyses of the test piece. Laminations, arising from blow-holes or other cause, will generally appear in the fracture and particularly affect the contraction of area. The condition as to internal strain, or comparative annealing, arising from whatever cause, can probably be measured for any known quality of metal by the elastic ratio or the ratio which the principal elastic limit bears to the ultimate tensile strength. Thus if we have a large average of results for material of given chemical quality, any departure from the average as to physical condition, other than lack of homogeneity, will be fairly well indicated by difference of elastic ratio from its average value. This proposition will be fairly well established later on, and its importance will be readily appreciated.

STRAINING THE PIECE.

In placing the piece between the grips it is necessary that the line of resultant tensile resistance of the piece shall lie in the line of the resultant load producing stress, unless the cross-heads are held more rigidly than is usual, otherwise a cross-breaking is set up. The less ductile the material the more important it is that this condition may obtain. Thus if a filleted test piece of spring steel, taken from a bar of tapering thickness, be placed in an ordinary machine, centrally from edge to edge, its line of resultant tensile resistance may yet be so much out of center, on account of the unequal thicknesses at the two edges, that fracture will occur on the fillet where the sectional area is much larger than in the straight-sided portion. In such ductile material as mild steel for ships and boilers, the consequent effect would be very small or negligible, but in the less ductile materials it must be looked out for.

On the first application of stress the piece stretches in a more or less regular manner, the strain being proportional to the stress producing it. In short pieces of unannealed material this elastic extension as measured by electric contact instruments (see page 501) does not generally appear so regular as to produce a straight-line diagram, but lack of perfect straightness of test piece and the irregular hold of roughened grips under light load may produce apparent irregular extension or unequal distribution of stress, and consequent strain, in the cross-section, affecting the hold of the index arms. In fact, these considerations certainly prevent much reliance being placed upon individual results for modulus of elasticity obtained from short pieces, and would appear to make the average value too small. If, however, the modulus is desired, the piece must be straight—should have been perfectly straightened at the finishing heat at the rolls; cold straightening to any extent may affect the result. The stress for which the extension is to be noted must not be too near the principal elastic limit, generally about 10,000 pounds below its probable value, and the measuring apparatus, both for load and extension, must be both delicate and reliable. It is particularly necessary that the load should be uniformly maintained while the extension is measured, and there is consequent difficulty in obtaining consistent results on most of the hydraulic machines in use on account of leakage in the plunger packing or, more generally, in the pumps. Inasmuch as the elastic extensions are extremely small, a very valuable addition to such machines would be a valve of special design and workmanship, so as to be, and remain, perfectly tight, inserted between the cylinder and pumps, and an attachment to the main cylinder consisting of a small cylinder with screw piston, or otherwise designed, for producing small changes of volume or pressure. Such an attachment would also be of great value in determining the limit of elasticity.

After taking the readings for modulus of elasticity, a gradual increase of stress at length produces a slightly disproportionate extension, the corresponding value of the stress being taken as the limit of elasticity for such uses of the material as will permit of little or no permanent set in use, with comparatively high working loads, such as for ordnance and spring steels. For the mild steels used for structural purposes, we prefer to call this the *first* elastic limit, and it may be mentioned that its value may, to a certain extent, be affected by any lack of coincidence of the resultant lines of action of the load and of the tensile resistance. Further increase of stress causes a point to be reached where the extension

becomes entirely disproportionate, a very slight increase of stress producing an extension no longer requiring micrometric measurement to be appreciated. This point we will call the *principal* elastic limit, and for structural steels it is the only one which need be taken into account. From this point the strain diagram, as ordinarily constructed (see page 513, *et seq.*), accurately represents the behavior of the material at the elastic limit, frequently becoming nearly parallel to the axis of extensions. It is this feature which allows it to be easily obtained for the soft steels under continuous test, because in a screw, or a tight hydraulic machine, the beam refuses to hold up the load, and, if the piece still retains a coating of mill-scale, which is usually the case in testing plates and shapes, the brittle scale commences to crack, generally near the fillets. In the ordinary test of plates, where the test pieces are removed by shearing, the effect of the bending on shearing and the subsequent cold straightening may be such as to largely remove this peculiarity of the diagram by originally straining the material beyond its elastic limit.

The cracking of the scale on a mild steel test piece at and beyond the elastic limit illustrates the homogeneity of the material, for it proceeds in cross-lines on the surface, making, as nearly as may be, an angle of 45° with the direction of tensile stress—the lines of maximum shearing stress in a homogeneous material—and therefore, parallel or at right angles to each other. The same thing may be even better seen on the surface of the side in tension of a bar under transverse test; on the compression side of such a bar the scaling takes place at right angles to the stress.

After a certain amount of stretching at the elastic limit, depending both on the chemical quality of the steel and its previous treatment (possibly also on the method of manufacture in the furnace), the relation between the stress and strain is shown by a line generally regular, concave to the axis of extensions, and of diminishing curvature, until, near the maximum load, the curve becomes very flat, rendering the extension at the highest point difficult to measure with accuracy. When this highest point is just reached the piece is said to be at the "point of failure," or at "tensile limit." The corresponding value of the ordinate of the strain diagram is the "ultimate tensile strength," always the chief feature, and sometimes the only one, determined by the tensile test. This value is sometimes erroneously called the "breaking strain," but "breaking" would better apply to the load at fracture, and "strain," in scientific language, denotes the effect of the stress and not the stress itself.

Some experimenters, notably Sir William Fairbairn, have gone so far as to consider the condition of the piece at "tensile limit" as final, at least for structural purposes, and confine their record to ultimate strength and extension at tensile limit. It has been urged that it denotes the extreme values to which the material can ever be strained, for any appreciable time, without rupture, and that the rivets would become seriously started in boilers and the skin-plating of ships causing excessive leakage. The difficulty of measuring the corresponding elongation with the necessary accuracy has as yet prevented requirements being based on the condition at tensile limit. Both at the Norway and Cambria Iron Works, the elongation at tensile limit was measured, giving values fairly uniformly below the final elongation (see Table IX. and p. 455). The condition of the material at this point of failure is peculiar. The piece commences to heat up at the point where necking subsequently occurs slightly before the maximum load is actually reached.

Also, after commencing to neck at one place, the piece sometimes gains strength there sufficiently to neck and actually break in another place as many as three such neckings having been observed in well-shaped 8-inch pieces.

On passing the point of failure, the scale-beam drops and the gauge load to the point of fracture continuously diminishes, the piece draws out or necking, generally over a short length, and fracture taking place on a considerably reduced area in the mild steels. The metal is in more or less plastic state, flowing like lead under pressure—not like under a constant stress, but with increasing resistance from unit of area. The amount of this increase of resistance, and an idea of its rate, may be obtained from Table XXXII. of tests made on the Rodman machine at the Washington Naval Arsenal, for comparison with the results on the same material on other testing machines. The average value of the resistance per square inch actual at tensile limit, for the representative pieces, is about 78,000 pounds, while at rupture it has risen to something over 110,000 pounds.

THE ELASTIC LIMIT.

No term expressive of physical quality of material has so confused a meaning as elastic limit. Its original definition is that stress which slowly applied and removed, will produce no permanent distortion. The value obtained under this definition in actual testing is uncertain depending on the delicacy of the apparatus employed and whether or not the piece was originally perfectly straight and its section has been uniformly strained, and requires great care on the part of the experimenter. The same objections apply to the definition adopted by Wertheim and several other physicists as the stress which produces a permanent elongation of .00005 of the original length. In certain experiments on cold-rolled iron and steel, Thurston has adopted a different *permissible permanent set*.* Such definitions are essentially arbitrary.

The elastic limit is also sometimes understood to mean the stress which, although not causing fracture at once, will do so if repeated a sufficient number of times. Plainly, to obtain results under this definition is impossible in any system of commercial tests. Spangenberg reasoning from his own and Wöhler's experiments, concludes that the working strength of wrought iron is less than its elastic limit as determined by first appreciable permanent set.

Styffe propounds a much more satisfactory definition thus: † "If an iron or steel bar be gradually extended by successive loads, which at first are so small that they occasion no perceptible permanent elongation, but are gradually increased, and are always allowed to operate for as many minutes as each additional weight is per cent. of the entire load, then the author regards as the 'limit of elasticity' that load by which, when it has been operating by successive small increments, as above described, there is produced an increase in the permanent elongation which bears a ratio to the length of the bar equal to .01 (or approximates most nearly to .01) of the ratio which the increment of weight bears to the total load." Although complicated in expression, the value so obtained is believed to be truly indicative of a definite quality of the material. To obtain it in practice, the curve of permanent set is

* On the Strength, &c., of Cold-Rolled Iron and Steel. Pamphlet, 8 vo., Pittsburg 1878.

† Iron and Steel, by K. Styffe, translated by C. P. Sandberg, p. 30.

awn and the value corresponds to a certain inclination of its tangent and almost invariably occurs at a point of great change in its rection. It is interesting to note that, at the limit so obtained, "the permanent elongations begin to be so great that they become of practical importance;"* and in bars which have not been freed from the scale formed during annealing, the limit may be observed by the scaling beginning to peel off." It will be remembered that this differential action of the scale cracking was successfully made use of in determining the elastic limit at the Cambria Iron Works.

From two of the above definitions based, one upon first appreciable permanent set and the other on a distinct peculiarity in the curve of permanent set, are derived two definitions applicable to the conditions of continuous testing and in very general use. The first of these, adopted and used by Kirkaldy, may be defined as the stress beyond which equal increments of stress cease to produce uniform increments of stretch. It is evidently based upon the conception that the elastic curve is a straight line, or the strain directly proportional to the stress, so that any departure from a uniform rate of extension under uniformly increasing stress must be caused by the production of permanent set. This assumption is by no means strictly correct even theoretically, since recent determinations show that the elastic curve, although comparatively straight, is seldom perfectly so, its exact nature being somewhat capricious, involving uncertain conditions of physical structure and initial strains. Further, the point so determined is not generally indicative of a sufficiently definite quality of material, and appears to be particularly affected by certain kinds of mechanical treatment not materially affecting the other properties of the metal. The second derived definition applicable to continuous testing is that stress at which the increase of extension becomes altogether disproportionate to the increase of stress. The corresponding feature of the strain diagram for ordinary wrought iron and steel is very marked, occurring as either a sudden change of direction without contra-flexure, as in Fig. a, or with contra-flexure, as in Fig. b.

It is interesting to state that of these, Thurston† considers the second indicative of lack of homogeneity across the direction of rolling, the blow-holes of the casting drawing out into long microscopic or less than microscopic capillary openings. The deduction is made by analogy from the diagrams produced by fibrous woods, such as locust and hickory. While very suggestive, it can scarcely be considered as established.

Where this peculiarity is marked, it is evident that the elastic limit so determined must agree very closely with that obtained from Styffe's definition, and is equally representative of a definite quality of the material.

Comparatively cold finishing or cold straightening, and any lack of uniformity of the metal or in the trans-



Fig. a.

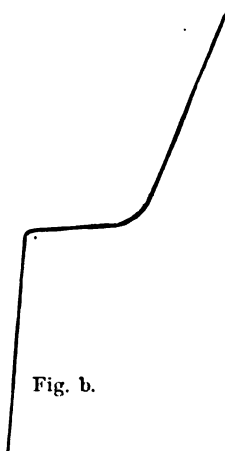

Fig. b.

* Presumably for metal to be used for structural purposes.

† Materials of Engineering, Part II, p. 531.

mission of stress to it, will affect the sharpness and extent of the irregularity. Graphitic carbon and high phosphorus would also appear to influence it.

It is evident that the altogether disproportionate extension at this point must cause adhering mill-scale of very low ductility to crack off; and, as previously remarked, in cracking it follows the lines of maximum distortion. The indication is of great value in commercial testing when the scale has not been removed in shaping the test piece, and indeed constitutes something of an argument in favor of using test pieces as nearly as possible in condition as finished at the rolls. A more generally observed indication depending on the same peculiarity of the strain diagram is the fact that, if the ram or screw of the testing-machine moves slowly and uniformly while the beam is kept balanced, at this point the beam will suddenly drop and will not lift again until the piece has been extended beyond the irregularity and increase of stress and of strain resume a normal proportion. For ordinary structural wrought iron and steel these two indications of the beam dropping and the scale cracking are generally sufficient to determine the elastic limit under this definition with great accuracy. The elastic limit determined from one or other or both of these indications, and which we will call the *principal elastic limit*, is that generally used for structural material in this country. In Great Britain, Kirkaldy's method is very generally adopted.

We have the means of comparing results for the same material under the three definitions most in use. Thus the Norway steel pieces in Tables XXXI. and XXXII. gave an average for two pieces of 33,707 pounds per square inch, or 53.5 per cent. of the ultimate strength, by the method of first appreciable permanent set at the Washington Naval Arsenal; 32,325 pounds per square inch, or 51.44 per cent. of the ultimate strength by the peculiarity of the strain diagram; and the inspector making the tests at the works and using Kirkaldy's method reports 26,190 pounds per square inch, or 41.67 per cent. of the ultimate strength. The need for the general adoption of some one or other definition is evident from these differences.

The difference between determinations under the first two of these definitions—first permanent set and peculiarity in the strain diagram—is not always in the same direction as above. In Table XXXI., the elastic limit for the pieces tested at the mills is as given by strain diagram; for those tested at Washington, the method of first permanent set was used. The Chester steel gives practically the same absolute value, but a greater ratio, by permanent set; the Norway steel is as above, both value and ratio greater by permanent set; one piece of Black Diamond steel showed abnormal results by permanent set, the other gave less value and ratio by permanent set; the Cambria steel gives much less value and ratio by permanent set, the average differences being 3,870 pounds per square inch and 5.18 per cent.

Adopting the principal elastic limit as that indicative of the proper quality for structural steel, examination of the above tables referred to shows that if a requirement for elastic limit were to be exacted, unless it were placed much lower than generally reckoned, the manufacture of some of the steels delivered would have to be radically changed. Thus, for the bridge steel (App., p. 577), the elastic ratio demanded for 80,000-pound compression metal is 62.5 per cent., and for 70,000-pound tension-metal 57.14 per cent., and it is very generally reckoned that ship-steel should give an elastic ratio of from 55 to 70 per cent., averaging somewhat above 60 per cent.

Engineers are now very generally of opinion that permissible working loads should be determined with reference to the elastic limit, having regard to fluctuation of stress and the general duty required of the piece. Other qualities being equal, material of relatively high elastic limit would therefore be desirable.

On the other hand, this can be carried too far. Steel can be made with high elastic ratio by carrying too high phosphorus and keeping the other hardening elements and impurities as low as possible; but such metal, though it may give very fair results by ordinary tensile tests, is said to be lacking in "body," will not stand much working or many heats, and is more liable to snap under sudden application, or fluctuation, of stress.

Relatively high elastic ratio for metal suitable for ship-building, when finished, cooled, and subsequently treated in a normal fashion, is to be obtained generally in two ways, by carrying comparatively high phosphorus with low silicon and by great amount of reduction or mechanical work from the ingot. Opinions may differ on the first point for reasons above stated; but for ship metal made by the open-hearth process, with silicon not above .04 per cent., it would appear that the phosphorus may be carried with advantage to very near the Bessemer limit of .1 per cent.

Considerations of safety in working are generally those borne in mind as controlling the amount of mechanical work necessary, but indirectly the elastic ratio is undoubtedly affected. The comparatively high ratio reckoned on for mild steel in Great Britain is largely due to the method of manufacture, the reductions of thickness from the ingot rarely falling below 20, and much of it generally under the hammer. Kirkaldy,* experimenting on the open-hearth steel plate of the Steel Company of Scotland for the Board of Trade, obtains the following results of 48 tests under his definition:

Thickness of plate.	Mean elastic stress per square inch.		Mean ultimate stress per square inch.		Mean elastic ratio.	
	Length-wise.	Cross-wise.	Length-wise.	Cross-wise.	Length-wise.	Cross-wise.
	<i>Pounds.</i>	<i>Pounds.</i>	<i>Pounds.</i>	<i>Pounds.</i>	<i>Per cent.</i>	<i>Per cent.</i>
$\frac{1}{4}$ inch	42,560	42,780	69,430	70,880	61	60
$\frac{1}{2}$ inch	35,390	35,170	64,730	64,060	54	55
$\frac{3}{4}$ inch	35,390	34,940	66,080	65,180	53	53
1 inch	33,375	33,150	62,720	62,720	53	52
Total mean...	36,510	36,510	65,630	65,410	55	55

It is seen that a difference of 8 per cent. of elastic ratio, or nearly 15 per cent. of its mean value, exists between the 1-inch and the $\frac{1}{4}$ -inch plate, and that the ratio rises continuously as the thickness diminishes and very rapidly below $\frac{1}{2}$ -inch thickness, owing, doubtless, to lower temperature of finishing and more rapid cooling. It is probable that the mean value of 55 per cent. under this definition would correspond to not less than from 60 to 62 under the definition commonly used in this country for structural material, and the difference is apt to be greater when the metal has been worked under the hammer.

The results of the Cambria steel well illustrate the general conclusions. Being made into shapes, the work of reduction was very great; little of it failed in the working, and none without evident cause; its average results on tensile test are perhaps rather better than those of the other

* Merchant Shipping Experiments on Steel, Parliamentary Paper, C. 2897, London, 1881.

steels; it was undoubtedly made cheaper; less was rejected on test; yet its phosphorus will probably average .085 per cent., and its average elastic ratio was about 64.5 per cent. Similar information is not available for the other steels, but 10 heats of Norway steel gave an elastic ratio of 53.74 per cent., while the average phosphorus is believed to be below .055. Recent heats of Chester steel are much higher in phosphorus than most of the steel delivered from these works, ranging from .057 to .1 per cent., as we think with advantage for the purpose to be served.

For boiler metal or ship-steel to stand flanging or hot working, the phosphorus should not generally exceed .06, the lower the better, and under ordinary methods of manufacture comparatively high phosphorus is not at all admissible for such material. On the other hand, a great increase in the work of reduction is highly advisable and may even be necessary for the thick plates used in marine boilers.

MODULUS OF ELASTICITY.

Within the elastic limit, the relation of stress and strain, is approximately that of direct proportion, being expressed by the simple equation $p = E e$, p being the stress, e the corresponding change of unit length in the line of force producing stress, and E a factor commonly called the modulus of elasticity, and evidently constituting a measure of stiffness or resistance to distortion. If $e=1$, $p=E$, or if it were possible without passing the limit of elasticity to double the original dimension under tension, the quantity E would be the stress necessary. For such materials as mild steel the measure of the stiffness is very great, and, under ordinary stresses, the corresponding extension is very small. The shorter the length strained, the more difficult is the exact measurement of the extension, so that in any system of commercial testing it is very difficult to obtain correct values of the modulus with the short pieces necessarily employed. In such cases, errors themselves very small may produce serious discrepancies in the results, and to avoid them much greater nicety in the construction and manipulation of instruments is required than can usually be obtained at steel works. Accordingly such determinations are generally reserved for the careful and exact tests of scientific experimenters.

Of late, however, attention is being directed extensively to the qualities of materials under stresses approximating to the working loads, which themselves are now based more frequently from consideration of elastic limit than, as formerly, of ultimate strength. In trussed structures, as roofs, and more especially bridges, the considerations governing the transmission of static stress from member to member, the strength of long columns or compression members, the development and transmission of internal oscillations, and the desirability of reducing deflection in many cases, would appear to be attracting attention especially to stiffness and elastic limit, so that requirements for the latter are very generally exacted, and for modulus of elasticity have been demanded (see Appendix p. 577.) In the determination of this very important quality, if only a satisfactory apparatus can be devised, the immense amount of material tested for commercial purposes affords means of investigating extreme values and the law of variation with reference to general quality and method of manufacture, such as cannot be obtained with the limited testing of specialists. Immediate point is given to this investigation at the present time by the facts that the wear of steel rails appears to be influenced by the intrinsic stiffness of the material, and the strength of long columns is very considerably dependent

on this quality. The solution of the question as to the most suitable material for these purposes is evidently of the greatest importance.

Whatever apparatus be employed, the total error of determination will be influenced by the straightness of the piece, its lack of homogeneity or the unequal transmission of stress from the grips to all parts of the section, the absolute length of the measured part, the stress selected for the observation of extension, and variations of temperature. The apparatus should be easily applied and removed, should read to the necessary degree of fineness, and its accuracy should not be influenced by the amount of stress to which the piece is subjected; it should take account of lack of homogeneity or unequal transmission of stress, and not be seriously influenced by changes of temperature in recording its indications. Finally, it should not be too costly or liable to get out of order.

Numerous devices have been employed in this country, in general either depending on delicacy of touch or of sight with the means of producing small motions, or on the enlargement, by levers or other means, of the small extensions to be measured. Having pointed out the needs of the case, it is unnecessary to describe them, as all are deficient in one or more points, and we will confine ourselves to the instrument used during this inspection at the Cambria Iron Works, and which has been more generally used than any other, the Olsen electric-contact micrometer.

The micrometer consists of two frames, one to be secured to the upper part of the piece and the other to the lower, the length between the holding screws being that adopted for test. The upper frame consists of a brass arm, A, with removable clamp piece B, both made with right-angle bends at the center, being originally intended for squares and rounds. When flats are tested, the angle on the arm is filled by the insertion of a piece, as shown by the broken line. The frame is secured to the piece by the screw C, set up tight against the piece, the reaction holding the clamp B against the milled-head screws D, which are adjustable to suit the thickness of the piece tested. Contact is therefore by the set-screw point on one side and considerable pressing area on the other. From the ends of the arm extend $\frac{3}{8}$ -inch brass rods, carried by insulated gutta-percha sleeves e, and projecting above sufficiently for the insertion of wires to the battery. The lower part is similarly secured to the piece, but the arm is differently shaped, as shown, with broad split ends, in which work $\frac{3}{8}$ -inch screws of the very best manufacture, 50 threads to the inch, with micrometer heads 2 inches in diameter, divided on the circumference into 200 equal parts. The micrometer circle is read in connection with the fixed scale, divided into fiftieths of an inch—the pitch of the screw. Reading to the nearest division of the micrometer head, therefore, the 0.0001-inch can be recorded, and the eye can determine the next place of decimals fairly accurately. An electric wire leads from the lower frame to an alarm bell in circuit with a battery and the rods of the upper frame. The apparatus being attached to the piece centrally and so that the set screws are the proper distance apart—determined by a shorter rod or scale of suitable length being just capable of insertion without pressure between the surfaces of the clamp pieces—the screws are turned in succession until the point just touches the end of the insulated rod, contact being noted by the ring of the bell, the corresponding readings are noted, and the screws run down to avoid any pressure or contact due to tilting of the arms as the piece is strained. The proper stress is then applied,

new readings taken, and the mean taken of the extensions noted by the two screws.*

The trouble with this apparatus is the uncertain effect of the friction of the surfaces of frame and piece in contact as the one surface elongates and the pressure between them diminishes. There is reason to believe that on the average this results in too great a value of the extension, especially in filleted pieces, and a correspondingly low value for the modulus, the average defect in the steel tested at Johnstown being reckoned at about 300,000, or more. The lowest modulus recorded was 24,360,000, but as no special precautions were taken to have the pieces perfectly straight, or any estimate made as to the effect of observed curvature, this is not to be taken as reliable, the real minimum probably being considerably above this. The highest value for a heat was 31,475,000 (heat 4950, mean of two pieces), and the mean value for 42 heats 27,720,000. From the observed defect of the micrometer and general lack of perfect straightness of the pieces it is believed that this value is too small by about 600,000, and it is probable that the value for this steel varied from 26,000,000 to 31,500,000—rarely approaching the latter—with an average of 28,250,000.

As affected by the conditions of finishing and subsequent treatment, it appears that this steel cold-rolled has a modulus about 500,000 less, and annealed about 1,000,000 more, than in the average condition of finishing at the rolls.

As affected by change of carbon, the curve of carbon properties (Plate XXVI.) shows a slight rise, with increase of carbon, over the range of tests. As the modulus closely follows the density of material of given nature, it is believed that it may reach a maximum value for this steel at from .30 to .35 per cent. of carbon, but must diminish with further increase.

The modulus of elasticity of mild steel in compression is generally taken the same as for tension. This was very closely true in some tests of shaft steel recently made on the Emery machine at the Watertown Arsenal for this Board.

Mr. James Christie, from some recent experiments on Bessemer steel of structural quality,† gives the value of the modulus under compression much less than under tension. Thus for .12 carbon steel he obtained for E in tension 27,030,000 to 32,780,000, with an average value of 30,135,000; while for compression the values were 15,132,000 to 24,490,000, with an average of 20,478,000. This result is anomalous, and should be very carefully verified before being accepted.

THE EXTENSION OF THE PIECE.

The total extension of the piece is made up of three elements, the elastic extension, always a very small quantity; the extension under increasing load up to tensile limit, generally considered as fairly uniform over the length, and constituting the most important part of the total extension; and the extension on flow or necking.

An idea of the disposition of the total extension along the length, together with the relative amounts of the two chief elements, may be obtained from Plates X., XI., and XII., extension diagrams for two pieces each of three heats of Cambria steel. Although selected at random, both the quality of the heats and the behavior of individual pieces are

* Before affixing the micrometer to the piece a stress of about 8,000 pounds to the square inch was very generally applied and removed, in order to tighten the grips and remove initial strains, which sometimes seriously affect the very first extension under low stress.

† Trans. Am. Soc. Civil Engrs., Vol. XIII.

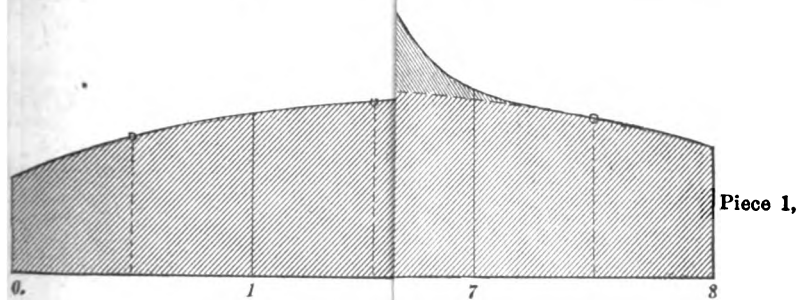
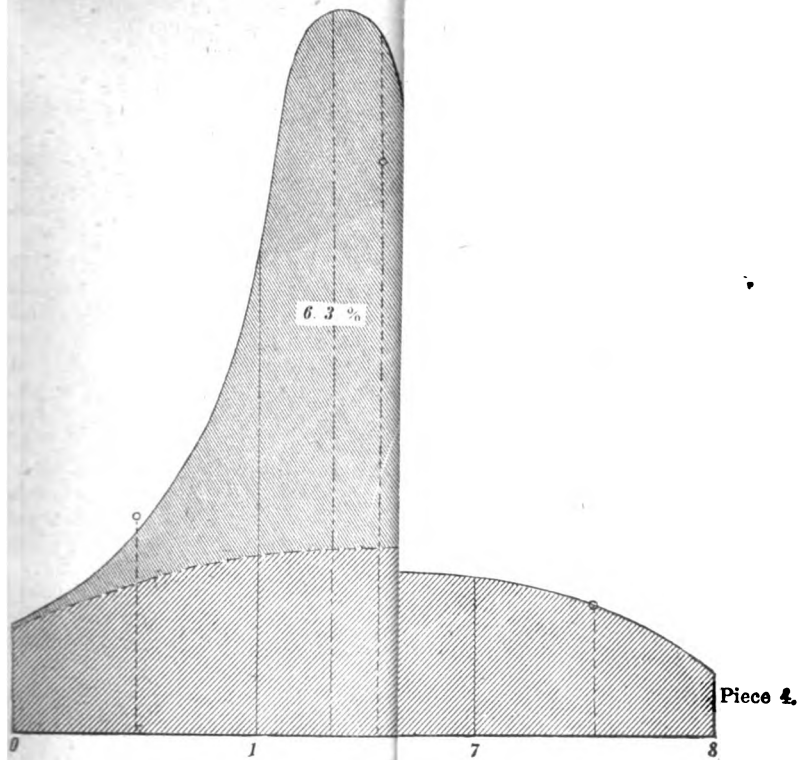

Heat.	Marks.	Carbon.		Manganese.	W Time of Test.	Appearance and Nature of Fracture.
		Per ct.	Per ct.			
5565	1	.22	.54	15½	Silky-irregular	
"	4	"	"	12½	"-irreg'r-cup	

MURPHY CO., N. Y.

Scale 5" = 1" Extension.

EXTENSION
HEAT

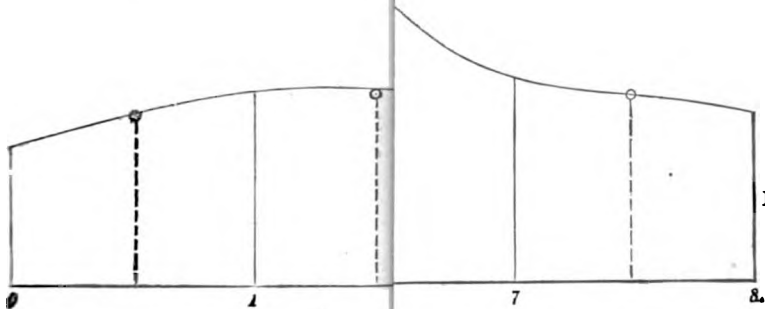

Piece 2.

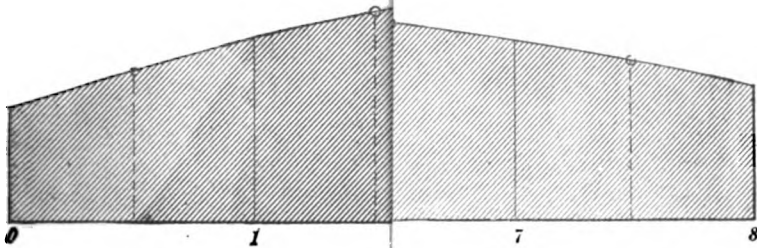

Piece 3.

Heat.	Marks.	Carbon.		Manganese.		Time of Test.	Appearance and Nature of Fracture.
		Per ct.	Per ct.	Per ct.	Per ct.		
5567	2	.22	.50	30	14	Silky-plane.	
"	3	"	"		14½	" "	

EXT

Scale 5"=1" Extension.

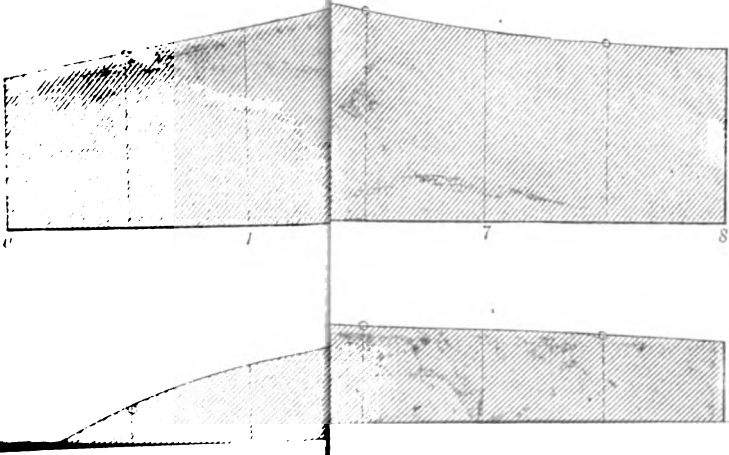

Piece 2,

fairly representative. Heat 5565 is comparatively hard, having a strength of 67,000 pounds; 5567 is softer, having a strength of 65,800 pounds; while 5569 is near the limit of ship metal, having a strength of 60,600 pounds. The fractures of 5565 are near the end, the others near the middle, except that of 5567-2 which very well illustrates a hard spot. The diagrams are obtained by measuring the extension of each inch and setting up the corresponding value as ordinate in the middle of its inch. The highest point is at the fracture, and is obtained by subtracting unity from the reciprocal of the fraction for final area. Then the mean ordinate of the curve over each inch must be the measured extension for that inch, and by trial and error, with the aid of a planimeter, a curve may be obtained fulfilling this condition. The two essential elements of extension are then represented by a curve on the whole length as base—and which may be called the “body” curve—topped by the peaked or wave-like curve of flow, and the first curve is sufficiently defined to allow the line of separation to be distinctly drawn. It is not, however, correct to consider the area of the first as the extension at tensile limit, as might naturally be supposed. A comparison of the diagrams with the tables shows that it is very probable that flow commences somewhat before tensile limit is reached. Thus the area of the body curve of piece 5565-1 is 18.24 per cent., while the extension at tensile limit as measured is exactly 20 per cent. Similarly for 5565-4, the figures are 17.2 per cent. and 19.25 per cent., respectively, the mean difference for the heat being 1.9 per cent., which represents the amount of stretch due to flow before the elongation at tensile limit was measured. For piece 5569-3 the difference is only .83 per cent. It will be noticed that for these three pieces the body curve is practically flat-topped.

Pieces 5567-3 and 5569-2 illustrate an essentially different behavior. The body curves have considerable spring, and their areas are in excess of the measured extensions at tensile limit by .6 and 2.43 per cent., respectively, showing that the flow has not been confined to a short length only, but is made up itself of two elements, the one extending over the greater part of the length of the piece and the other the ordinary local necking.

The length of the piece affected by the local flow is pretty constant for the first-mentioned pieces, being 3 to $3\frac{1}{4}$ inches for pieces 5565-4 and 5569-3, and $2\frac{3}{4}$ inches for piece 5565-1. In the pieces developing the double flow the length affected by the strictly local flow is less, being 2 to $2\frac{1}{4}$ for piece 5567-3, and only $1\frac{1}{2}$ for piece 5569-2.

The absolute value as well as the proportion of the extension due to local flow is variable, as shown by the figures, being less in the pieces developing double flow; from 6.3 per cent. in 8 inches, or 26.81 per cent. of the total, for piece 5566-4, to 3.74 per cent. in 8 inches, or 13 per cent. of the total, for piece 5569-2.

Piece 5567-2* illustrates the effect of a hard spot near the center of the piece. The extension and reduction of area have been interfered with; but the area of the flow curve is greater than in the other cases, although the line of separation cannot be exactly defined. The effect on the flow and the reduction of area is indeed very much as if the length of the test piece had been 4 inches instead of 8, the hard spot acting as a fillet or other increase of area.

Attention is called to the effect of the fillets at the ends, although the pieces were at least $8\frac{1}{2}$ inches between fillets. Especially noticeable is piece 5569-3, in which one witness mark was accidentally put slightly

*This piece measured very uniformly along the length, so that the effect is not due to excess of resisting area over any short length, but to lack of homogeneity.

up on the fillet. It is perfectly evident that the effect of the fillet must be always to slightly diminish the ductility if the piece is exactly 8 inches long between fillets.

As has been remarked, the condition of the piece at tensile limit is considered final by some experimenters, and it has been proposed to base specifications accordingly.

For the representative steels in Table XXXII. the value of the extension after tensile limit is 4.54 per cent. in 8 inches, or 19.98 per cent. of the whole extension, for the Norway steel; 5.64 per cent. in 8 inches, or 21.63 per cent. of the whole extension, for the Cambria steel flat; 5.07 per cent. in 8 inches, or 22.94 per cent. of the whole extension, for the Black Diamond steel; 6.66 per cent. in 8 inches, or 26.28 per cent. of the whole extension, for the Chester steel; and 9.64 per cent. in 8 inches, or 31.43 per cent. of the whole extension, for the Cambria steel deck beam; the average value being 6.31 per cent. in 8 inches, or 24.45 per cent. of the whole extension; or, roughly, one-fifth to one-quarter of the total extension of an 8-inch piece occurs after tensile limit. The extension before tensile limit is much more uniform, being 18.18 per cent. for the Norway steel; 17.03 for the Black Diamond steel; * 18.68 per cent. for the Chester steel; 20.38 per cent. for the Cambria flat, and 21.03 per cent. for the Cambria deck beam.

The average value of the extension at tensile limit for 23 accepted heats of Cambria steel given in Table IX. is 20.18 per cent. in 8 inches, the corresponding average total extension being 25.3 per cent., whence the average value of the extension beyond tensile limit is 5.12 per cent. in 8 inches, or 20.24 per cent. of the total extension.

Very similar results were obtained with the somewhat softer Norway steel, the average value of the extension at tensile limit for 30 heats given by Lieutenant Drake in his special report on proposed modifications of tests (p. 455) being 20.65 per cent. in 8 inches, with a corresponding average total extension of 26.81 per cent., whence the average value of the extension during necking is 6.16 per cent. in 8 inches, or 22.98 per cent. of the total extension.

FRACTURE.

Rupture of the piece is accompanied by a sharp report, except when, from some lack of homogeneity, it occurs by a tear from one point with a dull thud. This suddenness prevents the action from being closely examined, but its nature is easily seen in breaking pieces punched or drilled in the center, which part more slowly. Rupture is then seen to occur by a sliding action, or shearing on a quasi plane, or combination of planes, making a pretty definite angle with the direction of the straining force. Of course we speak of the mild steels as giving way in this fashion. The lack of homogeneity in puddled iron, due to the interposition of layers of slag, generally prevents this action from extending continuously across the piece, and breaks it up into such a large number of discontinuous and irregularly disposed facets of fracture, that the governing law is not apparent. Nevertheless specimens of pure well-worked irons exhibit the tendency distinctly. The harder steels and iron do not rupture in this way, but with a square crystalline fracture. The appearance of the fracture of the soft steels is largely due to the exact conditions of rupture. Thus, if the action be one of pure shearing, the fracture shows fine and silky, just as the hardest steels

* It is 18.76 per cent. for one piece of this steel, and the behavior of the other piece was somewhat abnormal.

SHOWING FLOW OF METAL
IN TENSILE TEST PIECES OF CHESTER STEEL.

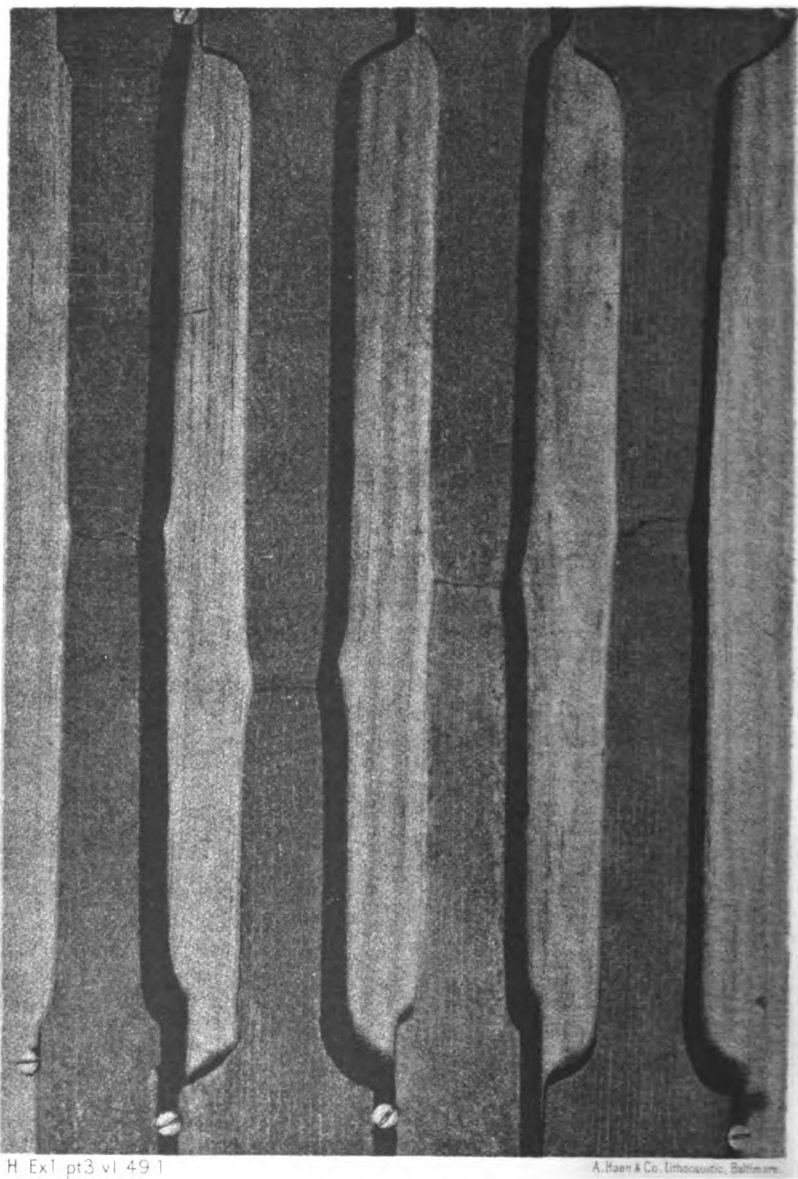

H. Ex1 pt3 vl 49 1

A. Haen & Co. Lithographic, Baltimore.

show when sheared, and the same steel if necked and broken across suddenly will show a crystalline fracture of course. A crystalline fracture shows an essentially different action in breaking, and whether due to intrinsically different physical structure or to the conditions of fracture, it probably indicates the existence of variable resistance round any point in the metal.

The fracture of mild steel of good quality under tensile test is on a plane or planes making a more or less constant angle with the direction of the straining force. In rounds, as in rivet-bar, the cone of shearing is generally very perfect for some distance in from the edges, when it is topped by a collection of smaller facets lying across the section. An analogous section in flat bars is what is called a "cup" fracture, of equally inclined opposite planes from each wide side toward the central plane, with generally side or closing facets from the short sides of the section, like a ridge roof with end slopes. In flats the fracture is also frequently a continuous surface, nearly plane, across the thickness. Of the two kinds of fracture, the plane and the cup, the former probably denotes the greater homogeneity across the thickness of the metal. The larger number of fractures are distinctly one of these or a combination of the two. On the angles of fracture and the stresses producing rupture we shall have more to say later.

The thickness of the fracture in flat pieces is not uniform across the width, there being a considerable hollow towards the center of the fracture in the locally stretched part, the thickness being frequently 10 per cent. less than at the edges in the fractured area of pieces originally $1\frac{1}{2}$ inches by $\frac{7}{8}$ inch. The narrow side is also hollowed, but not appreciably.

The nature of the flow of the metal near the fracture is well illustrated in the opposite photographs of several samples of Chester steel by the position and arrangement of the originally equidistant scribe lines. It will be observed that the bowed cross-lines still cut the long lines at right-angles, and, since the density of the metal is found to be practically unaltered, the action is precisely similar to the flow of water in a smooth pipe of the form of the broken test piece.

MEASUREMENT OF FINAL ELONGATION.

In making this measurement and that of final area, the use of forms to hold the two parts together when fitted saves time and promotes accuracy. The use of a direct vernier, such as described, p. 168, is also advisable as eliminating probability of error in subsequent division in rapid work. Care should be taken in removing the pieces from the machine to keep the fractured surfaces from striking anything, so that they will fit well. If the piece has torn from one point, the two parts will not be in a straight line when fitted as well as possible; in such a case they should be placed straight so as to touch at one edge, elongation measured, and the opening at the other measured and subtracted from the elongation before obtained.

MEASUREMENT OF FINAL AREA.

Some confusion has perhaps been caused by the use, in the records of tests, of the final area in per cent. of original area instead of reduction of area as commonly used in this country. The former is the more scientific function, has always to be obtained in order to get the latter, and amounts only to the substitution of a negative instead of a positive

scale of quality. The French call this quality the "striction" of the piece, and we have—

$$\begin{aligned} \text{Striction} &= \text{final area in per cent. of original area,} \\ &= 100 - \text{reduction of area in per cent.} \end{aligned}$$

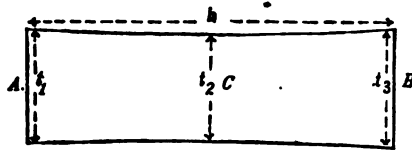

To measure the final area, the pieces should be fitted, the least width measured, and the thickness at each edge, and in the center in the plane of least width. On account of the hollow in the section it is necessary to introduce a formula for the mean thickness. This is best done by applying Simpson's rule for three ordinates. Thus, if t_1 t_2 t_3 be the thickness at A, C, and B, respectively, and b the least width, we shall have—

$$\text{Final area} = \frac{b}{6} (t_1 + 4t_2 + t_3)$$

The slight calculation necessary arranges itself easily in the note-book thus, taking piece 4908-2, Plate VI., as example:

t_1	= .300
$t_2 = .272$	$4t_2 = 1.088$
t_3	= .308
	6) 1.696
Mean thickness	= .283
Fractured width	= .936
Fractured area	= .2646

On account of the curvature of the section, it will very much increase the accuracy of measurement if screw-gap gauges with round bearing surfaces are used.

As at present obtained, the fractured area is a very indefinite quality, few experimenters obtaining it in the same way.

At the Chester Rolling Mills, measurement for mean thickness was made half way from the center to one side on one-half of the piece.

At the Black Diamond Works, the mean of the thicknesses in the middle and at one side was taken. These both presuppose that the two edges will measure the same, which they will not generally do, but supposing $t_1 = t_3$, the error in mean thickness by the latter method is $\frac{t_1 - t_2}{6}$, or 1-6th the hollow of section.

At the Cambria Iron Works, the mean of the three thicknesses was taken as the mean thickness, the error being $\frac{t_1 - 2t_2 + t_3}{6}$, or one-third the mean hollow of the section.

At none could the pieces be measured as fitted together, one part only being measured, thus giving additionally high results for final area.

TABLE XXVIII.

CAMBRIA STEEL.	Original Section.			Fractured Section.		
	Average Original Width.	Average Original Thickness.	Ratio Width Thickness.	Final Width in per ct. of Original Width.	Final Thickness in per ct. of Original Thickness.	Ratio Final Width Final Thickness.
Tests of Finished Material ..	Inch. 1.250	Inch. .3724	3.357	Per ct. 73.14	Per ct. 66.97	Per ct. 91.57
Tests by Heats (113 heats)...	1.248	.4539	2.750	75.04	69.88	93.14
Certain Selected Tests(6 heats)	1.254	.6293	1.993	77.79	74.33	95.55
Four Special Tests(Table XXXI)	1.001	.4722	2.120	69.09	63.20	91.48

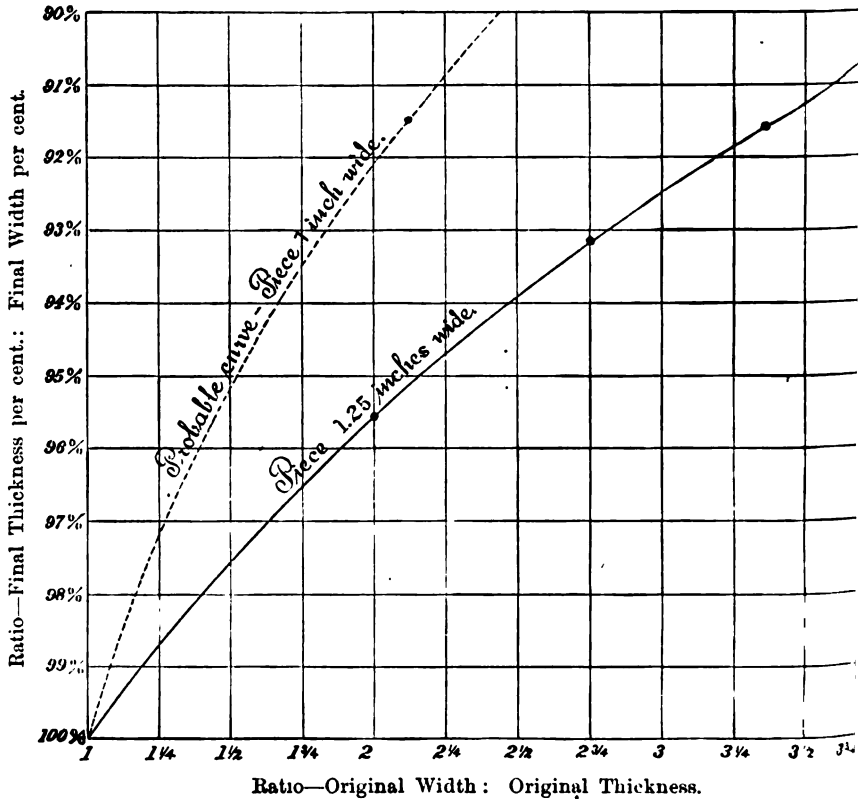

FIG. 17.

Diagram illustrating relative reduction of width and of thickness for 8-inch flat piece.

Identical and more correct methods will be used by all inspectors for any future work under the Board.

PROPORTIONATE REDUCTION OF WIDTH AND OF THICKNESS IN THE SECTION.

The reduction of area of a flat piece of rectangular section of greater width than thickness is not made up of equal reductions of width and of thickness, the reduction of the latter being invariably the greater. The proportion, with a given length of test piece, appears to depend upon the absolute size of the section and the ratio of its two dimensions. It may also be somewhat affected by the nature of the work of reduction in rolling. Table XXVIII. gives the results of numerous tests of Cambria steel in pieces $1\frac{1}{4}$ inches wide, of varying thicknesses, the ratio of width to thickness varying from 3.36 to 2,* and the diagram of Fig. 17 illustrates graphically the relation between the percentages of final width and final thicknesses. The curve terminates, of course, for a ratio of width to thickness of unity, or 100 per cent. The actual curve through the four spots, by accident or otherwise, is a circle, and construction on a smaller scale shows its highest point to be 85.75 per cent. for a ratio of width to thickness of $8\frac{1}{4}$ to 1, or for a thickness of .15 inch in a piece $1\frac{1}{4}$ inches wide. The four special tests of Cambria steel in Table XXII., for pieces 1.001 inches wide, sectional area .4727 square inches, and ratio of dimensions in original section 2.12, give an average of 91.47 per cent. for the ratio of final percentages of thickness and width. The dotted curve through the corresponding spot is the probable curve for pieces 8 inches long and 1 inch wide. The average value for all the tests in that table is 91.92 per cent., with about the same ratio of dimensions in the original section as for the Cambria steel.

The difference in surface of the width and of the thicknesses, the pieces being planed out on two sides only, may possibly influence the effect above considered.

FRACTURE BY SHEAR.

It has been stated that rupture of the mild steels generally occurs by a sliding action, or shearing, on a quasi plane, or combination of planes, making a pretty definite angle with the direction of the straining force. Frequently the surface of fracture is sufficiently defined to admit of fairly accurate measurement, and a number of fractures of Cambria steel were so measured and the results tabulated. The mean angle of the fractured surface with the straining force as so measured is not 45° , as it would be if the material were perfectly isotropic when rupture occurs. There is reason to believe that this material is practically isotropic under strains considerably above the elastic limit, and even perhaps approaching tensile limit, but during necking the action of the flow produces a stringing of particles, so that the surface of the piece treated with acids shows a kind of fiber. This fiber should not, however, be confused with that developed by good fibrous iron. The union of one fiber or line of particles with adjacent ones is much more complete in the steel, in which there is no slag interposing between the fibers, while the iron is never without it.

How far the lack of isotropic quality at rupture will affect the disposition of conjugate stresses is as yet impossible to say; from the bearing of the results of independent tests upon the conclusion to be arrived at from an investigation of the stress under which fracture occurs on the assumption of isotropism, the effect is probably small.

* The six selected heats are 4674, 4678, 4681, 4682, 4684, 4686, the test plates for which were accidentally rolled too thick.

If P (Fig. 18) be the force producing principal stress (tensile) at the moment of fracture; A_r , the fractured area measured at right angles to the line of action of the force P ; and φ the mean angle of the fractured area with the line of force, then the mean shearing stress on the plane of fracture in a perfectly isotropic body will be given by

$$P_s = \frac{P}{2A_r} \sin 2\varphi, \text{ or } = \frac{P}{\frac{2A_r}{\sin 2\varphi}} \cdot$$

Let $A B C D$ (Fig. 19) be the fractured surface, approximately plane; $a b c d$, the corresponding area—commonly called the fractured area—at right angles to the line of force producing stress; Φ , the complement of the angle between the two planes, or the angle of $A B C D$, with the line of force.† The thicknesses ad , bc , on the edges, and ef at the middle of the fractured area are not equal, ef being especially less than the other two on account of the invariable hollow of the section towards the center. The value also of the angle made by the line of force with the edges AD and BC and with the corresponding center line EF is not generally the same. So that the mean value of the function

$$\frac{2A_r}{\sin 2\varphi}$$

must be obtained by integrating over the surface.

Accordingly, let t_1 , t_2 , t_3 and φ_1 , φ_2 , φ_3 be the values of the thickness and angle at G , I , and H , respectively; then, applying Simpson's rule for three ordinates, we have

$$\frac{2A_r}{\sin 2\varphi} = \frac{GH}{3} \left\{ \frac{t_1}{\sin 2\varphi_1} + \frac{4t_2}{\sin 2\varphi_2} + \frac{t_3}{\sin 2\varphi_3} \right\}$$

and

$$P_s = \frac{P}{\frac{GH}{3} \left\{ \frac{t_1}{\sin 2\varphi_1} + \frac{4t_2}{\sin 2\varphi_2} + \frac{t_3}{\sin 2\varphi_3} \right\}}$$

whence, by substituting the proper numerical values and performing the operations indicated, the numerical value of the shearing stress under which rupture occurred can be obtained for any measured fracture.

An interesting derived function is the mean angle of fracture, by which is meant the angle which upon being inserted with the ordinary fractured area in the function

$$\frac{2A_r}{\sin 2\varphi}$$

will give it the value obtained by integration.

The calculation in a particular case arranges itself as follows:

NUMERICAL EXAMPLE.

Piece 5221-2 in Table XXIX.

t_1 329 log. = 9. 51720

$2\varphi_1$..102° log. sin. = 9. 99040

9. 52680

* See any standard text-book on the strength of materials.

† It makes no difference which of the two angles is used, since the sine of twice the angle is the same in either case.

Number corresponding = .33635..... $\times 1 = .33635$

t_2310 log.=9.49136
 $2\varphi_2$..110° log. sin.=9.97299

 9.51857

Number corresponding = .32990..... $\times 4 = 1.31960$

t_3330 log.=9.51851
 $2\varphi_3$..101° log. sin.=9.99195

 9.52656

Number corresponding = .33617..... $\times 1 = .33617$

3)1.99212

.66404 log.=9.82219
 .973 log.=9.98811

Corresponding co-log. = .18970..... Log. $\frac{2A_r}{\sin 2\varphi}$ 9.81030

P...31,000...log.=4.49136

log. $P_s = 4.68106$
 $P_s = 47,980$ pounds per square inch.

Mean angle.

Co-log. $\frac{2A_r}{\sin 2\varphi} = .18970$

A_r3079 log.=9.48841
 2 log.= .30103

9.97914 corresponding to $2\varphi = 107^\circ 37'$, or $\varphi = 53^\circ 48\frac{1}{2}'$

Table XXIX. gives the results* of the tests with measurements of fractured area and derived quantities. The measurements for thickness of fractured section will give a very fair idea of the amount of hollow commonly found with this proportion of test piece. The less thickness at center is generally accompanied by the greater angle with the line of force, in twelve cases out of the fourteen the angle at the center exceeding the mean for the edges, and in only three is it exceeded by the angle at any edge. The mean angle of the surface with the line of force is seen to vary from $49^\circ 20'$ to $61^\circ 18'$, a range of 12° , and its probable average value is $53^\circ 40'$. From the fact that the angle at the center exceeds the values at the edges, it is probable that the mean angle for round pieces, breaking with a cup fracture, will slightly exceed this value.

*In the calculation of these results the methods proposed in this report have been adopted, so that certain columns differ from those in the table of tests for this steel.

TABLE XXIX.—Fracture by shear.

Heat.	Mark.	Original section.			Fractured section.					Elastic limit per square inch.	Elastic ratio.	Final elongation.	Final width.	Mean final thickness.	Final area.	Modulus of elasticity.	Elongation at tensile limit.	Load at rupture.		Shearing stress produced by rupture on the area of fracture per square inch.	Ratio: Shearing stress divided by apparent tensile stress.
		Width.	Thickness.	Area.	Thickness at edges and middle.	Angle of surface at edges and middle.	Angle of surface at edges and middle.	Mean angle of surface with line of force.	Area.									Per gauge.	Per square inch of final area.		
4879	1	1.247	.436	5.437	.310 376 307 322 322	53 15 53 45 55 15	53 58	2650	38,440	62,730	61.28	25.7	74.10	65.79	48.74	29,810,000	20.9	29,000	109,440	52,060	82.99
4879	2	1.246	.435	5.420	.296 315 310	49 30 49 30 50 00	49 20	2829	39,490	63,480	62.20	22.8	76.50	68.24	52.20	27,740,000	21.0	30,400	107,450	53,116	83.67
4879	3	1.262	.431	5.439	.315 306 315	53 15 50 00 50 00	52 16	2731	40,450	63,430	63.77	26.8	74.96	66.98	50.20	26,230,000	22.2	30,400	111,310	53,874	84.93
4879	4	1.261	.434	5.472	.283 312 315	50 00 51 30 50 45	50 18	2750	40,200	63,770	63.04	28.4	74.36	67.55	50.25	27,900,000	22.0	29,600	107,650	52,914	82.97
4907	2	1.257	.440	5.530	.284 313 315	50 45 53 30 52 10	56 48	3115	40,320	65,090	61.95	24.7	77.41	72.76	56.32	29,630,000	18.0	32,000	102,730	47,070	72.32
4908	1	1.251	.417	5.217	.305 300 273	50 00 50 00 54 45	53 41	2691	38,240	62,500	61.85	27.0	74.74	69.01	51.53	28,130,000	20.0	28,000	104,050	49,654	79.45
4908	2	1.254	.417	5.239	.308 310 310	53 30 50 00 55 45	61 18	2646	40,160	62,700	64.06	25.5	74.64	67.79	50.60	30,200,000	19.0	28,300	106,950	45,058	71.87
4908	4	1.251	.415	5.191	.290 305 333	59 20 53 00 49 30	57 50	2648	40,460	62,920	64.30	23.60	73.62	69.28	51.01	33,000,000	22.0	27,000	101,950	45,960	73.05
4918	2	1.242	.438	5.140	.310 323 329	50 30 49 20 50 45	50 8	3015	38,940	62,690	62.12	25.4	76.82	72.15	55.42	28,270,000	20.0	30,300	100,500	49,443	73.87
4918	3	1.245	.437	5.441	.323 340 316	50 45 53 30 55 00	56 23	3153	40,070	63,050	63.55	24.0	76.63	75.62	57.95	29,590,000	19.0	30,600	97,060	47,670	75.60
4919	3	1.245	.445	5.540	.316 339	55 00 53 46	58 43	3102	41,380	64,450	64.13	23.6	76.96	72.76	55.99	29,090,000	18.6	31,400	101,200	48,287	74.92

4919..	4	1.245	.445	.5540	.964	{ .338 .298 .288 .288 51 45 }	{ 53 00 53 00 51 45 }	.3017	40,980	63,900	64.13	28.4	76.63	71.09	54.46	24,870,000	21.4	30,400	100,760	46,430	72.67	
4922..	2	1.342	.432	.5065	.960	{ .328 .308 .328 .328 51 45 }	{ 49 45 51 00 51 45 }	.2778	37,650	59,360	63.43	28.0	71.67	72.26	51.76	25,400,000	23.0	27,000	97,190	47,550	86.11	
5321..	2	1.200	.448	.5583	.973	{ .329 .310 .350 51 00 50 30 }	{ 53 00 53 00 53 40 }	.3079	38,096	62,254	62.16	24.0	77.22	71.45	55.17	27,746,000	31,000	100,660	47,980	77.09	
		Average by tests (14).....								63,028		23.5			52.97					49,076	77.89	
		Average by heats (7).....								62,660		23.24			53.80						48,842	77.00
		Probable average.....								62,930		23.88			53.35						48,780	77.45

A curious counterpart of the fracture of mild steel by tension is found in that of short pieces of cast iron by true compression. Hodgkinson, experimenting on cast iron of the same manufacture in pieces of "length not more than about three times the diameter," finds that "the strength for a given base is pretty nearly the same," and in gun metals with low graphitic carbon the value is about that of the final strength of the mild steel per square inch of fractured area, from 100,000 to 115,000 pounds per square inch, although the distortion in the cast iron is of course small. Fracture of such pieces of cast iron takes place either by wedges sliding off, or by top and bottom forming pyramids and forcing out the sides, of which we find analogues in the plane and cup fractures of mild steel. Further, the angle of the wedge is nearly constant, a mean for 21 cylinders being $55^{\circ} 32'$, very nearly the angle which we have obtained for the fracture of mild steel flat pieces, and still nearer the probable value for rounds. Thus, besides the disposition of conjugate stresses being similar but opposite, fracture occurring by shearing in both cases, the very close accord of the angle of fracture points to analogous structure with respect to the resistance offered to the opposite stresses of tension and compression for the mild steel and cast iron respectively.

For the average quality of the steel represented in Table XXIX. the shearing stress on the fractured area at rupture was 48,730 pounds, with an average ratio to the ultimate tensile stress of 77.45 per cent. An average has been taken by tests on account of the complex way in which the results for the fracture are obtained and consequent liability to individual error, and also by heats, without regard to the number of tests, in order to take into account the variation of intrinsic quality. The probable average has been taken between the two. If we consider the method of obtaining it as satisfactory, it should represent the resistance of the material to unsupported or theoretical shearing, that is, shearing uninfluenced by the method of applying the forces.

SHEARING STRENGTH OF RIVETS.

The shearing resistance of a rivet is seriously interfered with by the compression between the rivet and the bearing sides of the hole, the effect being to increase the shearing resistance offered per unit of area as the size of the rivet diminishes. Difference of quality between plate and rivet, proportion of thickness and diameter, and the sharpness of the edges of the hole, will also somewhat affect the shearing resistance. Under the ordinary conditions of ship and boiler work, the quality of plate and rivet being not very different—although the quality of the metal in the walls of the hole has frequently been affected by punching and insufficient riming—and the proportion of bearing and shearing areas being fairly uniform, it is known that the smaller rivets give considerably higher shearing resistance than larger ones of the same quality. The difference has, so far as we know, never been experimentally quantified, and it is believed that the following investigation will afford valuable information.

At the end of the tables of tests of rivets (pages 449 and 450) will be found the average ratio of shearing to tensile strength for each size tested. In combining the results of tests of $\frac{3}{4}$ -inch rivets, at Pittsburgh, with those for the same size at Chester, a representative value will be given to the former of double that due to the proportionate number of tests, inasmuch as they were carefully and independently obtained. In connection with the values so determined for the different sizes, we will

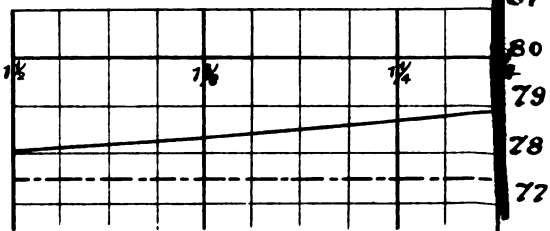

Cuts
of Shear
for 279

Ratio of Shearing to Tensile Strength ~
Per Cent ~

H Exl pt3 vl 49 1

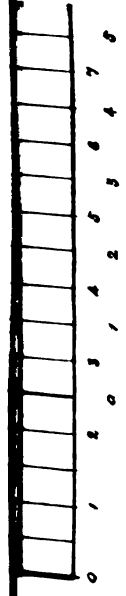



A vertical ruler with numerical markings from 0 to 8. The markings are as follows:

0
1
2
3
4
5
6
7
8

same that the value of the ratio of unsupported shearing obtained for the Cambria steel under tension will hold for the Bessemer steel of the same quality, there is yet not so much of assumption in this as would at first sight appear, since the value of the ratio is probably dependent on the physical structure of the metal, and within ordinary limits would be only influenced by quality as determined by tensile test, in so far as the difference of quality influences the physical structure. To this value of the ratio for unsupported shearing, that of large rivets or closely-fitting pins must approach as the size increases, so that it corresponds to the value for an indefinitely large rivet or pin. Further, it is believed that for diameters below $\frac{1}{2}$ inch the ratio rises less rapidly, though to what extent is not known, and it would have added much to the completeness of the results if $\frac{1}{4}$ -inch rivets had been tested under the same conditions.

Table XXX. contains the values obtained as described, and Plate XIII. is a graphic representation of the results. From this, the probable resistance of a rivet of given size, made from mild steel bar, showing similar results on tensile tests, may be obtained, and the variation due to size of rivet to be allowed in specifications exacting lower limits of tensile and shearing resistances may be determined and appreciated.

TABLE XXX.

Size of rivet.	Ratio of shearing to tensile strength.
	Per cent.
$\frac{1}{2}$ inch	87.69
$\frac{3}{8}$ inch	84.84
$\frac{1}{4}$ inch	82.20
$\frac{3}{16}$ inch	81.27
Unsupported shearing ..	77.45

In the consideration of individual results it must be remembered that the tensile test of rivet-bar is particularly liable to be affected by variation in the condition of finishing at the rolls, while the rivets also cool in the holes under variable conditions. In ship and boiler work, the strength of any part rarely depends on a single rivet, and average results are directly applicable.

STRAIN DIAGRAMS.

In accordance with Section 12, Detailed Instructions to Inspectors of Materials (p. 398), tensile tests were made of certain pieces for comparison with similar tests made on the Rodman machine at the Washington naval arsenal, the corresponding strain being noted for each stress. From the reported results the strain diagrams in Plates XIV., XV., XVI., XVII., XVIII. were plotted.

The principal features of the strain diagram have been pointed out and partly discussed under the head of Straining the Piece. Complete information at and beyond tensile limit was not obtained for each steel, neither is the elastic limit as definitely determined in all cases as is desirable. In such cases the curves are drawn as appeared most probable, and are shown dotted where particularly uncertain. The extensions of pieces 4823-1 and 4823-2 Cambria steel, tested at Johnstown, were obtained with the electric contact micrometer, and although prob-

ably fairly correct below the elastic limit, at and beyond that point the method of clamping the index-arms to the piece with a considerable surface of contact seriously affects the readings, and it is believed that the irregularities shown by the spots are due rather to this defect in the micrometer* than to the behavior of the material. For this reason also the elastic limit determinations for these pieces are perhaps somewhat untrustworthy, and not as accurate as if simpler methods of measurement had been used.

Table XXXI. contains particulars of the tests with certain derived quantities. As gauged by the ultimate tensile strengths, the steels are seen to be directly comparable, and while the tests of each manufacture are too few to admit of strictly quantitative comparison, the principal points can be noted.

TABLE XXXI.—Analysis of results of strain diagrams of special tensile tests.

Marks.	Manufacturer.	Tested at—	Chemical analysis			Original width.	Original thickness.	Original area.
			Carbon.	Manganese.	Phosphorus.			
486-C.....	Chester Rolling Mills	Chester Rolling Mills.	Pr. ct. .12	Pr. ct. .37	1.000	.5060	.508
486-D.....	do	do	.12	.37	1.000	.5070	.507
36 U 1.....	Norway Steel and Iron Company.	Norway Steel and Iron Works.	*.16	*.36985	.4220	.410
36 U 3.....	do	do	.16	.36996	.4250	.429
P. S. 2.....	Cambria Iron Company	Phoenix Iron Works.	.14	.386	.082	1.003	.5120	.513
P. S. 4.....	do	do	.16079	1.000	.5156	.515
4823-1.....	do	Cambria Iron Works..	.19	.600	.055	1.003	.4270	.428
4823-2.....	do	do	1.003	.4290	.430
E. A. M. 1.	Park Bro. & Co	Black Diamond Steel Works.996	.4820	.480
E. A. M. 2.	do	do997	.4750	.473

Marks.	Elastic limit.	Ultimate tensile strength.	Elastic ratio.	Final elongation.	Final area.	Area of strain diagram.	Work required to break a bar of 1 square inch sectional area 8 inches long.	Ratio—Area str. diag.	
								U. L. T. S. × Elong.	
486-C.....	Lbs. per sq. in. 51,600	Lbs. per sq. in. 83,930	Per ct. 49.43	Per ct. 24.40	Per ct. 56.70	(t)
486-D.....	81,550	68,800	49.45	25.31	44.30	(t)
36-U 1.....	32,500	63,460	51.21	27.50	1,571,600	10,473	90.16
36 U 3.....	32,150	62,244	51.66	24.35	1,367,000	9,116	90.34
P. S. 2.....	38,800	63,776	60.84	24.94	56.40	1,429,200	9,528	86.85
P. S. 4.....	38,000	62,258	61.04	27.05	53.92	1,530,800	10,205	90.38
4823-1.....	42,500	63,590	66.54	26.40	49.60	1,513,800	10,062	90.16
4823-2.....	44,000	63,470	69.82	24.40	51.50	1,412,400	9,416	91.39
E. A. M. 1.	36,250	62,800	57.73	23.25	(t)
E. A. M. 2.....	39,000	64,370	60.59	26.40	(t)

* Heat determinations.

† Strain diagram incomplete.

‡ Broke through flaw.

* This defect in the electric contact micrometer has been carefully remedied in a new instrument designed and in use by Mr. C. A. Marshall, engineer of tests, Cambria Iron Works, by using point bearings only to secure the gauge to the piece, the index-arms being steadied by springs with roller bearings against the piece. This new instrument is quite perfect.

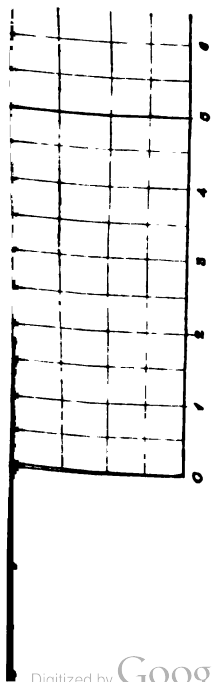

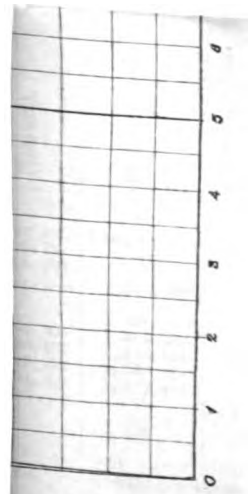

sealed

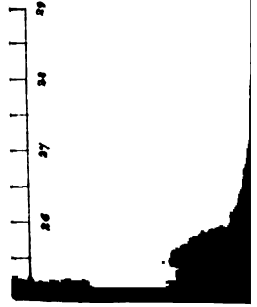



aled



The most notable and important difference appears in the elastic ratio, which has a very low value for the Chester and Norway steels, 49.44 and 51.43 per cent., respectively. These ratios are both perhaps somewhat lower than usual, the average elastic ratio of ten heats of Norway steel (unannealed), including that given by these tests, being 53.74 per cent. Both of these are "pig and scrap" steels and contain probably not above 0.05 per cent. of phosphorus. They are also noticeable for the almost complete lack of sudden extension at elastic limit, and it is not thought that the cold straightening to which the pieces had been subjected is altogether sufficient to account for this. In the Norway steel, whose tests with strain curves are given under the head of "annealing," this peculiarity is by no means so marked, although the curve at elastic limit is not so flat as is commonly the case. The Black Diamond steel, reported as made by the "pig and scrap" process and with low phosphorus, shows the higher value for elastic ratio of 59.16 per cent., very nearly approaching the value of 60.94 for the "pig and ore" Cambria steel of comparatively high phosphorus from the deck-beam web. As has been remarked, the values for the Cambria steel from the flat are somewhat unreliable; if correct as taken, they are evidence of comparatively cold finishing or rapid cooling after finishing, as the phosphorus, which notably raises the elastic ratio, is low. The comparatively high manganese of these pieces may, however, have influenced the result.

Although the elastic limits of the Chester and Norway steels are low, the extensions immediately following the elastic limit are much less than the other two steels, so that no work area is lost.

The behavior at and beyond tensile limit is probably very similar for the steels, except the Cambria pieces P. S. 2 and 4, which appear to show a longer necking or flow, with correspondingly flatter curves after the limit. The exact nature of the curves beyond tensile limit is not determined; it is generally taken somewhat as shown in these curves, and is probably influenced by the rapidity and uniformity of extension. The strain diagrams of Norway steel, Plates XIX., XX., and XXI., the part of the curve was obtained by three determinations for each piece, and the result is shown as a comparatively straight line. The straight line of flow was obtained with some shaft metal tested the same inspector.

The area of the strain diagram is a measure of the work expended in breaking the piece, and, to a certain extent, may be taken as a measure of the capacity of the material for absorbing mechanical energy. Six of the strain diagrams of tests made for comparison of machines are sufficiently complete to be integrated, giving an average value of 70,700 pounds per cent., or 9,805 foot-pounds, of work expended in breaking a bar of one square inch sectional area, 8 inches long, the ductilities being on the basis of the actual areas of the pieces tested. Similar results for nine heats of Norway steel unannealed, given in Table XXVII., are 1,529,336 pounds per cent., or 10,192 foot-pounds. The probable average value for all the material accepted, as given in the General Summary, p. 442, is 9,685 foot-pounds. With the increased ductility from the larger sectional area of one square inch, it appears probable that about 10,000 foot-pounds will, on the average, be actually necessary to break the standard bar of general ship quality. Although the conditions are largely arbitrary, it may be interesting to state that this denotes a capacity to absorb energy at the rate of 4,424 foot-tons per ton weight, assuming one cubic foot to weigh 488.3 pounds.

It will be observed from the last column of Tables XXXI. and XXXVII. that the area of the strain diagrams would appear to be a pretty con-

stant fraction of the product of the extreme dimensions, the fraction averaging 90.26 per cent. for the six pieces in Table XXXI., with small variation, and 88.42 per cent. for the nine heats of unannealed Norway steel in Table XXXVII., though the curve of flow in the latter is drawn differently and so as to give less work area. As ordinarily drawn, the area of the strain diagram for steel of this quality may very fairly be taken as 90 per cent. of the product of tensile strength and ductility in an 8-inch piece of about one-half square inch original sectional area. Accordingly, admitting that capacity to absorb energy is the best single measure of intrinsic quality, we may use instead, as a conventional measure, the product of tensile strength by ductility, since the ratio of the two is practically constant. The average value of this function, under the name of "efficiency number," for all the steels delivered, is given in the General Summary, p. 442, and may be taken as a basis of specification.

This conception of classifying structural metal by its ultimate resilience or work capacity, and conventionally by the efficiency number, was first propounded by Tetmajer,* who gives as a limiting value of the efficiency number for the standard bar of malleable cast metal (iron or steel), 1 foot long and 1 square inch sectional area, 12,250 foot-pounds. The average value for the steel delivered under this inspection, in such a standard piece, would be about 14,750 foot-pounds. We have pointed out the advantages of the method, and sought to establish it for ship and boiler metal.

*Eisenbahn, Zurich, October 15, 1881, p. 92. Also Thurston's Materials of Engineering, Part II., p. 358-359.

Tables of stress and strain.

CAMBRIA SHIP STEEL.

[Pieces taken from web of 8-inch deck beam. Tested on Riehle machine at Phoenix Iron Works. Measurements of strain taken with fine needle- and pencil-point dividers.]

Piece P. S. 2.			Remarks.	Piece P. S. 4.			Remarks.
Stress applied per square inch.	Extensions.			Stress applied per square inch.	Extensions.		
<i>Pounds.</i>	<i>Inches.</i>	<i>Per ct.</i>		<i>Pounds.</i>	<i>Inches.</i>	<i>Per ct.</i>	
10,000-18,000	(*)	(*)	38,800 pounds E. L.	10,000-18,000	(*)	(*)	E. L.
20,000	(†)	(†)		20,000	(†)	(†)	
20,000-38,000	(‡)	(‡)		20,000-38,000	(‡)	(‡)	
38,000	.02	.25		38,000	.053	.66	
40,000	.165	2.06		40,000	.170	2.13	
42,000	.185	2.31		42,000	.217	2.71	
44,000	.220	2.75		44,000	.252	3.15	
46,000	.255	3.19		46,000	.286	3.58	
48,000	.300	3.75		48,000	.320	4.00	
50,000	.350	4.37		50,000	.375	4.69	
52,000	.405	5.06		52,000	.427	5.34	
54,000	.440	5.50		54,000	.530	6.63	
56,000	.562	7.02		56,000	.633	7.91	
58,000	.675	8.44		58,000	.750	9.38	
60,000	.820	10.25		60,000	.920	11.50	
62,000	1.085	13.56	62,000	1.224	15.30		
63,776	1.450	18.13	62,258				
58,440	1.965	24.94	2.164	27.05		
			Ultimate strength.			Ultimate strength.	
			Final load and elongation.			Final elongation.	

* Not appreciable.

† First appreciable.

‡ Not accurately measurable.

Tables of stress and strain—Continued.

CAMBRIA SHIP STEEL.

[Pieces taken from 6 inches by $\frac{7}{8}$ inch flat. Tested on Gill machine at Cambria Iron Works. Measurements of strain up to stress of 56,000 pounds per square inch taken with Olsen electric contact micrometer.]

Piece 4823-1.				Piece 4823-2.			
Stress applied per square inch.	Extensions.		Remarks.	Stress applied per square inch.	Extensions.		Remarks.
	Lbs.	Pr. ct.			Corresponding value of E.	Lbs.	
10,000	00280	28,570,000	10,000	00295	27,120,000
12,000	00340	28,240,000	12,000	00350	27,425,000
14,000	00400	28,000,000	14,000	00405	27,650,000
16,000	00460	27,825,000	16,000	00460	27,830,000
18,000	00515	27,960,000	18,000	00520	27,690,000
20,000	00570	28,070,000	20,000	00575	27,825,000
22,000	00620	28,385,000	22,000	00635	27,715,000
24,000	00680	28,235,000	24,000	00700	27,430,000
26,000	00735	28,295,000	26,000	00760	27,370,000
28,000	00790	28,355,000	28,000	00820	27,320,000
30,000	00845	0.106	28,400,000	30,000	00890	0.111	26,965,000
32,000	00900	28,445,000	32,000	00965	26,825,000
34,000	00955	28,490,000	34,000	01100	24,725,000
36,000	01020	28,230,000	36,000	01240	
38,000	01105		38,000	01445	
40,000	01380	0.173		40,000	01900	0.237	
42,000	01755	0.220		42,000	02765	0.346	
			42,500 pounds E. L.	44,000	04365	0.546	E. L.
44,000	09400	1.175		46,000	10670	1.334	
46,000	26565	3.321		48,000	27630	3.454	
48,000	41915	5.240		50,000	31680	3.961	
50,000	47725	5.966		52,000	35960	4.495	
52,000	51405	6.426		54,000	41845	5.236	
54,000	57420	7.180		56,000	48145	6.018	
56,000	65325	8.166		58,000	8.700	
58,000	8.700		60,000	10.500	
60,000	10.500		62,000	13.000	
62,000		63,470	20.25	Ultimate strength.
63,590	20.50	Ultimate strength.	53,250	24.40	Final load and elongation.
61,250	26.40	Final load and elongation.				

Tables of stress and strain—Continued.

CHESTER SHIP PLATE.

Tested on Riché machine at Chester Rolling Mills. Measurements taken with Brown & Sharp's micrometer gauge.]

Piece 486 C.			Piece 486 D.			
Stress applied per square inch.	Extensions.		Stress applied per square inch.	Extensions.		Remarks.
<i>Pounds.</i>	<i>Inches.</i>	<i>Per ct.</i>	<i>Pounds.</i>	<i>Inches.</i>	<i>Per ct.</i>	
10,000			10,000			
13,950			13,945			
21,860			17,890			
25,810			21,835			
29,765	.02	.25	25,780			
			29,725	.02	.25	
33,715	.07	.87	33,670	.07	.87	31,550 pounds E. L.
37,667	.12	1.50	37,615	.12	1.50	
41,620	.16	2.00	41,555	.17	2.12	
45,572	.23	2.87	45,500	.23	2.87	
49,525	.32	4.00	49,450	.31	3.87	
53,473	.44	5.50	53,390	.45	5.62	
57,425	.61	7.62	57,335	.62	7.75	
61,380	.92	11.50	61,280	.93	11.62	
63,930			63,800			
	1.952	24.40		2.025	25.31	

Tables of stress and strain—Continued.

BLACK DIAMOND SHIP PLATE.

[Tested on Riché machine at Black Diamond Steel Works, Park, Bro. & Co. Measured length for elongations, 7.99 inches.]

Piece E. A. M. 1.				Piece E. A. M. 2.			
Stress applied per square inch.	Extensions.		Remarks.	Stress applied per square inch.	Extensions.		Remarks.
Pounds.	Inches. (")	Per ct. (%)		Pounds.	Inches. (")	Per ct. (%)	
10,000-33,000				10,000-33,000			
33,333	.03	.25		33,795	.02	.25	
35,420	.03	.38		35,900	.03	.38	
			36,250 pounds E. L.	38,020	.04	.50	
37,500	.15	1.88		40,130	.17	2.13	
39,590	.18	2.25		42,240	.20	2.50	
41,670	.21	2.63		44,350	.23	2.88	
43,750	.24	3.00		46,460	.25	3.13	
45,830	.28	3.50		48,580	.29	3.63	
47,920	.32	4.00		50,690	.33	4.13	
50,000	.37	4.63		52,800	.39	4.88	
52,080	.43	5.38		54,910	.47	5.88	
54,170	.50	6.25		57,030	.53	6.63	
56,250	.60	7.50		59,140	.66	8.25	
58,330	.71	8.88		61,250	.83	10.38	
60,420	.92	11.50		63,370	1.16	14.50	
62,500	1.35	16.87		65,480	1.23	15.00	
62,800			Ultimate strength.	67,580	1.36	17.00	
	1.86	23.25	Final elongation.	69,690	1.52	19.00	
				71,800	1.60	20.00	
				73,910	2.11	26.40	Ultimate strength.
							Final elongation.

* Not measurable.

Tables of stress and strain—Continued.

NORWAY SHIP PLATE.

[Tested on Richlé machine at Norway Steel and Iron Works. Measurements taken with Brown & Sharp's micrometer gauge held to the piece. Measured length for elongation, piece 36 U 1=8.001; piece 36 U 3=8.002.]

Piece 36 U 1.			Piece 36 U 3.				
Stress applied per square inch.	Extensions.		Remarks.	Stress applied per square inch.	Extensions.		Remarks.
Pounds.	Inches.	Per ct.		Pounds.	Inches.	Per ct.	
10,000	.002			10,000	.001		
11,822	.003			12,009	.002		
12,846	.004			14,018	.003		
15,789	.006			16,028	.006		
17,692	.009			18,037	.006		
19,615	.011	.14		20,047	.007	.09	
21,538	.013	.16		22,056	.008	.10	
23,461	.014	.17		24,066	.009	.11	
25,384	.016	.20		26,075	.011	.14	
27,307	.021	.26		28,085	.013	.16	
29,230	.028	.35		30,094	.016	.20	
31,153	.032	.40		32,104	.020	.26	
			32,500 pounds E. L.				32,150 pounds E. L.
33,076	.046	.58		34,113	.052	.65	
35,000	.071	.89		36,122	.086	1.07	
36,923	.094	1.18		38,132	.108	1.35	
38,846	.114	1.44		40,141	.134	1.68	
40,769	.140	1.75		42,151	.166	2.08	
42,692	.168	2.10		44,160	.196	2.45	
44,615	.200	2.50		46,170	.241	3.01	
46,538	.241	3.01		48,179	.284	3.55	
48,461	.288	3.60		50,189	.341	4.26	
50,384	.335	4.19		52,198	.404	5.05	
52,307	.389	4.86		54,209	.479	5.99	
54,230	.469	5.86		56,217	.582	7.28	
56,153	.572	7.15		58,226	.748	9.35	
58,076	.618	7.66		60,236	.943	11.79	
60,000	.892	11.15		62,244	1.624	20.30	Ultimate strength.
61,922	1.294	16.17		62,009	1.948	24.35	Final load and elongation.
63,846	1.898	23.72	Ultimate strength.				
65,769	2.300	27.50	Final load and elongation.				

*.713 probably.

†8.90 probably.

TESTS FOR COMPARISON OF MACHINES.

The tests made on the Rodman machine at the Washington Naval Arsenal in accordance with section 12, Detailed Instructions, while supplying much interesting information, are of little use for the purpose intended. From some misunderstanding as to the instructions, they were not made in the same way as the corresponding tests at the works, but after the ordinary method of testing adopted there for ordnance metal. The elastic limit was determined by successive application and removal of stress, noting the first permanent set; thence continuously to tensile limit where elongation and resisting area are measured. In Table XXXII. of these tests, a derived column is given of what would be the volume of the piece at this point if the resisting area were uniform all along the piece and equal to that measured. Low percentage of volume shows unequal extension, and corresponding contraction of area, along the length, and such lack of uniformity is noticeable in the Norway pieces and especially in one piece of Black Diamond Steel, which also gives extremely low elastic limit. Such results, with well-shaped pieces, show lack of homogeneous quality of the metal. It is a curious and suggestive fact that the values of the percentage of volume at tensile limit follow exactly the order of final elongation, adding somewhat to the argument as to the finality of the condition of the piece at tensile limit. At rupture the stress was noted, and notwithstanding the varying ductilities and contractions of area, the stress per square inch of actual area is seen to be very uniform. The thickness of final area was taken as the mean of three measurements, one at each edge and at the middle. The other leading features derived from this table are referred to under appropriate headings.

Table XXXIII. is a comparison of results on the different testing-machines with those on the Rodman, two tests for each steel on each of the two machines compared. On account of the difference of methods of testing and the absence of comparative strain diagrams, no nice comparisons can be attempted. On the basis of ultimate tensile strength the Norway and Cambria machines give practically the same results as the Rodman; all the others read too high. But a comparison of ductilities and efficiency numbers obtained shows such variation in some cases as to throw serious doubts on the value of any comparison, while illustrating the necessity of a standard method of making the test. The most remarkable differences are the diminished ductility of the Norway metal and the increased ductility of the Cambria metal from the Phœnix Iron Works in the tests on the Rodman. The reduction of efficiency number of the one is about equal to the increase for the other, so that these steels were affected in exactly opposite ways by the difference of method in testing.

It may be safely stated that none of the machines differ sufficiently from the standard Rodman for the difference to be detected by any such method of comparison, and dead-weight test will alone show such differences as can ordinarily be expected to exist.

TABLE XXXIII.—Comparative tensile tests of the same material on the machine at the works and on the standard Rodman.

Manufacturer.	Tested at—	Testing-machine.		Carbon.	Manganese.	Phosphorus.	Original width.	Original thickness.	Original area.	Elastic limit per square inch.	Ultimate tensile strength per square inch.	Elastic ratio.	Final elongation.	Final area.	Efficiency number.
		Per cent.	Pounds												
Chester Rolling Mills	Chester Rolling Mills	12	37	1.000	5065	5108	31,575	83,865	49.45	24.86	50.50	1,587,300	24.86	50.50	1,587,300
Do	Washington	12	37	1.005	5083	5108	31,617	60,748	52.05	25.34	45.55	1,538,950	25.34	45.55	1,538,950
Norway Steel and Iron Company	Norway Steel and Iron Works	16	36	.991	4253	4195	32,825	62,853	51.44	25.93	45.55	1,630,250	25.93	45.55	1,630,250
Do	Washington	.16	.36	.992	4215	4183	33,707	63,003	53.50	23.72	47.78	1,431,350	23.72	47.78	1,431,350
Park, Brother & Co	Black Diamond Steel Works	.16	.36	.986	4788	4767	37,625	63,585	59.16	24.83	47.78	1,570,600	24.83	47.78	1,570,600
Do	Washington	.15	.39	1.000	4900	4898	30,278	62,395	48.60	23.10	48.02	1,377,200	23.10	48.02	1,377,200
Cambria Iron Company	Phoenix Iron Works	15	39	1.001	5138	5145	38,400	63,017	60.94	26.00	55.16	1,637,150	26.00	55.16	1,637,150
Do	Washington	15	39	.999	5160	5155	34,852	60,528	57.50	30.67	41.89	1,855,900	30.67	41.89	1,855,900
Do	Cambria Iron Works	19	60	1.003	4280	4298	43,250	63,530	68.08	25.40	50.55	1,613,650	25.40	50.55	1,613,650
Do	Washington	19	60	1.004	4285	4302	39,055	63,990	61.06	28.06	48.46	1,667,250	28.06	48.46	1,667,250

* First elastic limit, corresponding to first appreciable permanent set.

ANNEALING.

The Board's experience with annealing has been of a contradictory nature; still it throws some light on the subject and introduces some important facts as to the possible effect of the process as commonly carried out. The process of annealing boiler-plate at the works consists in slowly heating the plates in batches in large furnaces to a cherry-red temperature,* and allowing them to cool slowly on the bed-floor of the foundry, usually under a layer of ashes. Ordinary precautions are taken to insure uniform heating and subsequent cooling of all parts of the plate, and to avoid all possibility of overheating in any part.

During the ordinary inspection, certain heats were annealed wholly or in part, either to bring up deficient ductility in metal intended for ship plate or to lower the tensile strength of metal just above the limit for boiler material. Table XXXIV. gives the corresponding results of tests, from which it appears that the average effect on the Chester steel is a reduction of about 5 and 19 per cent., respectively, in the original values for tensile strength and final area, and an increase of 12.5 per cent. in the original value for ductility in 8 inches, the average original area being practically identical for both conditions. The very considerable decrease in final area will account for much of the increase in final elongation, leaving that element of extension which is practically uniform along the length approximately unchanged. We have then a considerable diminution of tensile strength and increase of capacity for local distortion. It will be observed also that, roughly speaking, these changes are greatest in those heats which originally appeared the softest. Especially noticeable is heat 640, soft and not annealed for any defect of quality. The increase of efficiency number in all except this heat should be a measure of the improvement effected by the process, provided there has been no essential molecular change. In heat 640 this number remains practically the same.

* To make annealing thoroughly effective in removing internal strains, this temperature should not be less than that at which the plate was finished

TABLE XXXIV.—Showing effect of annealing various heats of steel.

CHESTER STEEL.

Heat	Condition.	Carbon.		Manganese.		Phosphorus.		Original width.	Original thickness.	Original area.	Ultimate tensile strength per square inch.	Final elongation.	Efficiency number.	Final area.	Number of tests.	Decrease in ten-sile strength.		Increase in final elongation.		Decrease in final area.	
		Per cent.	Per cent.	Per cent.	Per cent.	Original value.	Per cent.									In 8 inches.	Per cent.	Original value.	Per cent.	Original value.	Per cent.
463	Unannealed.							1.211	.4440	.8559	65,383	22.40	1,464,500	51.85	27	1,033	1.58	0.60	2.68	5.15	9.98
	Annealed.							1.250	.4965	6112	64,350	23.00	1,490,000	46.70	27						
619	Unannealed.		.16	.86				1.170	.6090	7018	63,067	25.70	1,620,700	59.67	3	3,817	6.05	2.65	10.31	15.57	26.40
	Annealed.							.965	.7275	7181	59,250	28.85	1,679,400	44.10	2						
640	Unannealed.		.13	.80				1.258	.4900	6182	59,000	28.05	1,654,700	49.60	2	4,380	7.42	2.20	7.84	12.85	25.91
	Annealed.							.724	.7413	5362	54,620	30.25	1,328,000	36.75	4						
680	Unannealed.		.16	.81				1.236	.4890	6044	68,500	19.95	1,328,000	59.00	2	2,883	4.34	4.62	23.16	9.33	15.81
	Annealed.							1.182	.5293	6256	63,617	24.57	1,563,000	46.67	3						
684	Unannealed.		.13	.32				1.194	.5000	5968	63,400	24.85	1,585,300	46.05	2	3,482	6.46	4.63	18.63	7.80	16.94
	Annealed.							.744	.7198	5355	60,318	29.48	1,778,000	38.25	4	3,119	5.17	2.94	12.52	10.14	18.94
Average.....																					

BLACK DIAMOND STEEL.

610	Unannealed.							1.264	.4180	.5280	67,680	22.84	1,545,600	53.90	4	3,250	4.80	3.68	16.11	6.50	12.06
	Annealed.							1.235	.4350	.5870	64,430	26.52	1,708,500	47.40	4						

TABLE XXXV.—Showing effect of annealing certain plates intended for Chicago's boilers.

Heat.	Carbon		Manganese		Original heat tests.				Annealed plates.				Differences.																				
	Per ct.	Per ct.	Inch.	Sq. inch.	Original thickness.	Original area.	Ultimate tensile strength per square inch.	Final elongation.	Final area.	Inch.	Sq. inch.	Original thickness.	Original area.	Ultimate tensile strength per square inch.	Final elongation.	Final area.	Decrease of tensile strength per square inch.	Increase of final elongation in 8 inches.	Decrease of final area in per cent of original area.														
671	.13	.31	1.213	.482	.5846	61,600	30.0	42.0	671-O.	1.035	.657	.6799	54,000	54,000	27.0	36.0	84.0																
			1.143	.617	.7052	53,170	29.8	35.5	671-F.	1.143	.617	.7052	53,170	53,170	27.2	34.0	84.0																
			1.190	.617	.7342	52,700	29.8	37.7	671-E.	1.190	.617	.7342	52,700	52,700	29.8	37.7	81.0	1.10	7.85														
			.932	.580	.5405	56,400	28.4	35.7	671-G.	.932	.580	.5405	56,400	56,400	28.4	35.7	81.0																
673	.14	.35	1.093	.495	.5410	60,400	32.0	42.0	673-R.	1.020	.585	.5967	54,130	54,130	32.1	38.0	88.0																
			1.068	.495	.5395	60,500	28.5	40.0	673-L.	1.068	.585	.6245	54,400	54,400	32.0	37.1	87.1																
			1.038	.560	.5796	57,400	30.7	35.8	673-T.	1.038	.580	.6090	55,000	55,000	30.7	39.3	89.3																
			1.040	.565	.5676	53,600	31.0	38.7	673-U.	1.040	.565	.5676	53,600	53,600	31.0	38.7	85.8	5.817	3.08														
675	.11	.29	1.228	.550	.6754	60,500	31.0	40.0	675-S.	1.015	.600	.6120	53,500	53,500	30.7	37.7	89.2																
			1.225	.550	.6738	58,900	28.3	41.0	675-V.	1.015	.600	.6120	53,500	53,500	30.7	37.7	89.2																
			1.038	.573	.5947	53,020	30.5	35.0	675-X.	1.038	.573	.5947	53,020	53,020	30.5	35.0	88.8																
			1.175	.575	.6756	54,300	29.8	39.0	675-Y.	1.175	.575	.6756	54,300	54,300	29.8	39.0	89.0	5.567	2.80														
678	.13	.32	1.230	.492	.6050	61,000	30.0	45.5	678-N.	1.040	.600	.6240	53,000	53,000	30.7	38.3	86.5																
			1.224	.495	.6080	59,400	30.6	42.0	678-O.	1.040	.600	.6240	53,000	53,000	30.7	38.3	86.5																
			1.125	.615	.7103	53,500	29.3	42.3	678-P.	1.125	.615	.7103	53,500	53,500	29.3	42.3	84.3	7.237	5.80														
			1.125	.620	.6975	52,630	28.7	36.7	678-W.	1.125	.620	.6975	52,630	52,630	28.7	36.7	84.7	6.080	4.75														
Average of four heats																	60,588	29.54	42.44														

The single annealed heat of Black Diamond steel shows results very similar to the average for the Chester metal.

Certain sheets in the externally fired boilers of the Chicago besides bearing the shell stresses are exposed to the action of the flame, so that

it was deemed advisable to carefully anneal them. The heat tests in the unannealed condition had been very excellent—from 59,700 pounds, with 29.65 per cent. stretch (efficiency number 1,770,105) to 62,000 pounds with 27.95 per cent. stretch (efficiency number 1,732,900)—so that there seemed amply sufficient margin of tensile strength to allow for annealing. The test pieces were cut from the side of each plate and annealed with it. The results of the corresponding tests are compared with the original heat tests in Table XXXV. The average loss of tensile strength, 6,680 pounds, very much exceeded what was to be expected, and, while accompanied by considerable diminution of fual area, the final elongation remains practically unchanged, so that the percentage of uniform stretch along the length has been probably diminished. The average efficiency number will be found to have seriously diminished. The annealing had effected a radical change in the material, and so reduced the tensile strength that the plates could not be used.

The process has not even produced uniformity in the same plate, 673—T showing 3,800 pounds difference between the two tests. It was accordingly decided to examine what differences existed in one of the plates of lowest tensile strength. Plate 678 W being selected, double pieces were cut out for test from symmetrically opposite portions

of the plate, both with and across the direction of rolling, and numbered from 1 to 10. One of each pair of pieces was shaped as usual, and the other was rimmed out to the groove form.* G and C denote with and across the grain respectively, and symmetrically opposite pieces are placed together in the table, the better to indicate variation of quality.

* From the section numbered 10, the pieces were subsequently taken for the tests on the influence of length of test piece, and are shown dotted, numbered 1 to 24.

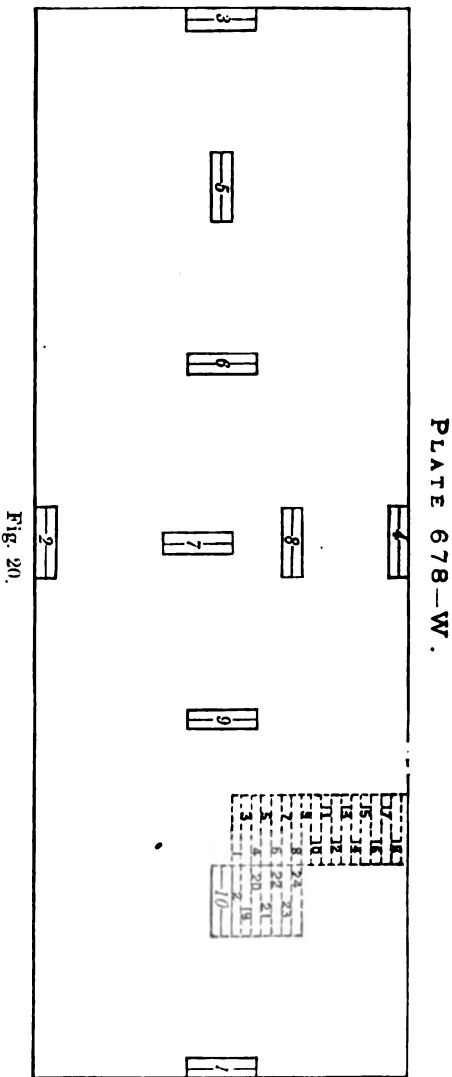

Fig. 20.

PLATE 678-W.

The average of the five tests with the grain is 54,521 pounds tensile strength, and 28.76 per cent. elongation, as compared with 53,050 pounds and 29 per cent. of the two pieces annealed with the plates. The maximum difference of tensile strength with the grain is 5,200 pounds, between pieces G2 and G4, and the lowest value 52,100 pounds. The average tensile strength across the grain is 55,530 pounds, or 1,000 pounds in excess of that with the grain, and with slightly less variation. The results in the groove form show differences in about the same proportion, though not for the same portions of the plate. Thus the lowest tensile strength in the groove form is in piece C1, side by side with that showing the highest value in the 8-inch length.

TABLE XXXVI.—Tests for homogeneity of one of the annealed plates intended for Chicago's boilers.

Marks.	8-inch length.						Groove form.				
	Original width.	Original thickness.	Original area.	Ultimate tensile strength.	Final elongation.	Final area.	Original width.	Original thickness.	Original area.	Ultimate tensile strength.	Final elongation.*
C 1.....	1.063	.662	.6736	57,300	29.1	40.8	.640	.075	.432	59,500	27.5
C 3.....	1.123	.668	.7501	52,780	31.2	43.1	.600	.068	.401	60,200	25.0
C 5.....	1.095	.690	.7227	64,780	30.3	41.0	.609	.080	.414	65,450	28.0
C 10.....	1.000	.668	.6680	55,538	30.9	44.2	.646	.066	.430	62,000	30.0
C 6.....	1.312	.664	.6720	55,350	27.5	46.9	.604	.080	.411	65,000	28.5
C 9.....	1.071	.675	.7229	54,910	29.0	51.0	.639	.070	.422	63,000	26.2
C 2.....	.980	.640	.6242	67,300	28.0	43.5	.604	.030	.418	60,200	32.0
C 4.....	1.035	.630	.6520	52,100	26.5	36.0	.650	.038	.414	64,000	27.5
C 7.....	1.055	.660	.6963	57,300	27.5	51.0	.650	.063	.416	64,000	25.5
C 8.....	1.015	.665	.6750	52,888	30.1	36.2	.622	.068	.415	64,000	31.0

* On a 1-inch length disposed equally about the plane of least area.

In a special report on the subject of annealing as carried out at the mills, the inspector at the Norway Steel and Iron Works shows conclusively that the effect of annealing is frequently the reverse of what is to be expected. Curves A, B, C, Plate XIX., are strain diagrams, each plotted from the mean of four test pieces for unannealed boiler plate from three heats. The results are analyzed in Table XXXVII., showing excellent quality, while the curves give evidence of comparative homogeneity of the metal. From the middle of a plate of each of heats 274, 275, and 276, 8 test pieces were taken, four of which were subjected to the usual process of annealing by placing them in the annealing furnace with plates being annealed, and afterwards on the bed floor of the foundry to cool, observing the same course of treatment as that to which boiler plates are ordinarily submitted. Curves D, E, F, Plate XX., are the strain diagrams for the unannealed material, each being plotted from the mean of four pieces. Curves D', E', F', are the strain diagrams for the corresponding annealed pieces. The results, as arranged for comparison in Table XXXVII., show very unexpected changes. The tensile strength and elastic limit have been increased, the latter in a greater ratio, so that the elastic ratio is increased. The stretch is much diminished, the final area increased, and the uniform elongation along the length is probably much less. The work capacity, as measured by the strain curve, is very much diminished, so that the effect has not been one of simple hardening, but the intrinsic quality has been seriously lowered.

The inspector reports that of twenty-five other heats tested before and after annealing, nine-tenths showed an average of 5 per cent. increase in tensile strength with a decrease in elongation of 4 per cent. in 8 inches, and recommends that boiler plate be not so annealed.

TABLE XXXVII.—Analysis of tests with strain diagrams accompanying Lieut. F. J. Drake's special report on annealing.

Heat.	Condition.	Strain diagram.	Carbon.			Phosphorus.	Elastic limit per square inch.	Ultimate tensile strength per square inch.	Elastic ratio.	Stress at rupture per square inch of original area.		Final elongation.	Final area.	Area of strain diagram.	Work required to break a bar of 1 sq. inch sectional area and 8 inches long.	Ratio: Area str. diag. Ult. T. S. X Elong'n.
			P. ct.	P. ct.	P. ct.					Lbs.	Lbs.					
302	Unannealed.	A	.19	.37	.059	32,200	60,000	53.67	45,830	23.30	43.01	481,033	9,873	87.23		
410	do	B	.13	.30	.060	34,000	61,800	55.02	46,250	27.70	41.01	508,855	10,050	88.15		
687	do	C	.12	.43	.060	36,500	60,900	59.93	47,500	28.00	41.01	543,290	10,289	90.50		
	do	D	.14	.40	.057	30,600	60,080	50.95	47,000	30.25	44.01	618,450	10,756	89.09		
274	Annealed.	D'				34,100	62,970	54.15	53,800	25.75	50.01	452,350	9,682	89.58		
275	Unannealed.	E	.15	.31	.056	30,200	60,300	50.08	46,800	29.25	43.71	572,900	10,488	89.17		
	Annealed.	E'				36,700	64,000	57.34	54,000	22.75	50.01	287,050	8,580	88.33		
276	Unannealed.	F	.15	.30	.060	35,000	61,000	57.38	50,800	28.00	44.21	583,300	10,555	92.70		
	Annealed.	F'				39,200	62,120	63.11	51,000	23.00	48.01	277,850	8,519	89.44		
282	Unannealed.	G	.18	.61	.048	33,000	63,800	51.72	51,000	27.50	50.01	495,133	9,987	85.22		
	Annealed.	G'				31,120	60,800	51.18	47,800	29.75	48.01	569,450	10,463	86.77		
366	Unannealed.	H	.21	.45	.050	35,000	64,320	54.42	52,000	26.60	48.01	488,430	9,923	86.90		
	Annealed.	H'				32,300	61,000	52.05	48,000	28.30	47.01	519,200	10,128	88.01		
455	Unannealed.	I	.26	.40	.056	35,500	67,900	52.28	57,000	25.00	43.01	472,620	9,817	86.76		
	Annealed.	I'				32,800	62,100	52.82	51,100	27.00	41.01	474,050	9,827	87.93		

That these effects are due essentially to the method of annealing as there practiced appears from the following experiments: A sheet iron cubic box was made, 2 feet on the side, with hanging door in one face and top perforated with half-inch drilled holes, to allow the escape of gases. From a plate of each of heats 282, 366, and 455, which were comparatively high in carbon and manganese, were cut two sets of triplicate test pieces having contiguous sides. One set of three pieces from each plate was heated in a small furnace to a very light cherry red and placed in the annealing box on a bed composed of equal parts of pulverized charcoal and lime and allowed to cool. The results arranged for comparison in Table XXXVII. are as ordinarily to be expected, and are very comparable to those of Table XXXIV. for the Chester and Black Diamond metals. The ultimate strength and elastic limit are diminished in about the same ratios, from 6 to 7 per cent., so that the elastic ratio is but slightly diminished; the final elongation is increased 2.08 per cent. in 8 inches, while the final area is less by 2½ per cent. of original area, so that the uniform elongation along the length is probably somewhat greater. The work capacity has been increased, showing improvement in intrinsic quality. Curves G, H, I, Plate XXI., for the unannealed, and G', H', I', for the annealed material, illustrate the changed behavior under stress.

The conclusion arrived at from a consideration of the results of annealing plates which have not been punched or otherwise worked so as to necessitate the removal of purely local strains is that the effect is as apt to be deleterious as beneficial, as the process is ordinarily carried out. Good metal shows little improvement in any case; and while inferior metal may be doctored up to show somewhat better test, the improve-

* A somewhat greater decrease in elastic ratio is to be expected.

ment in intrinsic quality is uncertain; but the fact that, as commonly done, annealing *may* continually and with reasonable certainty lower the working quality, and sometimes excessively so, should prevent any general resort to the practice for boiler- or other plate at the mills. It should also be remembered that each time a plate is heated and cooled without work upon it, it becomes more liable to damage from the next heat. Thus parts of flanged boiler plates may have been four times so heated before being worked in, if the plate was annealed before delivery.

Upon examining the different causes of the effects observed at the Norway and Chester works, the necessity of certain further precautions will appear. In the first place, the fuel should be comparatively free from ordinary impurities, and the flame should be kept neutral. The results will undoubtedly always be better if the furnace is so designed that the products of combustion are kept as much as possible out of contact with the material. While the heating up should be rather slow, the metal must not be soaked, and indeed should remain in the furnace the shortest time required to effect the desired results. Further, the temperature ordinarily applied is too high, and especially apt to be so locally. It need not be very much above the temperature of finishing at the rolls, and should never be above a medium cherry. It cannot be too carefully borne in mind that the temperature at which the original physical structure is destroyed and replaced by a coarser and weaker structure is considerably below bright yellow, and the metal should never be heated so high in annealing.

QUENCHING TESTS OF PIECES FROM DIFFERENT PARTS OF THE SAME INGOT AND OF SIMILAR PIECES DIFFERENTLY HEATED.

In consequence of the difficulty with the quenching test at the Norway works, in the early part of the inspection, certain tests were made by the inspector there as to the differences caused by taking the specimens from different parts of the plate with reference to original position of the ingot, and as to the effects of different methods of heating the pieces for test.

Pieces representing the upper and middle and lower end of the same ingots were taken for six heats and submitted to the quenching test with the following results. The pieces were all 2 inches wide and 10 or 12 inches long:

Quenching test.

[From upper end of ingot.]

No. of heat.	Thickness.	Behavior under test.
1	.562	Cracked nine-tenths of width on outer face, sides parallel.
2	.563	Cracked all across, sides parallel.
3	.563	Cracked one-third of width on outer face, ends touching.
4	.562	Broke suddenly at 35° opening.
5	.500	Cracked one-half inch on outer face at 90° opening.
6	.563	Satisfactory.

[From middle of ingot.]

1	.495	Commenced to crack at 50° opening.
2	.452	Satisfactory.
3	.516	Commenced to crack when requirement was reached.
4	.521	Cracked one-half inch on outer face, ends touching.
5	.515	Satisfactory.
6	.510	Broke at 60° opening.

Quenching test—Continued.

[From lower end of same ingots.]

No. of heat,	Thick-ness.	Behavior under test.
1	.497	Commenced to crack on both edges, ends touching.
2	.490	Satisfactory.
3	.500	Do.
4	.516	Do.
5	.520	Do.
6	.516	Cracked one third of outer face, ends touching.

The difference in behavior due to position in the ingot is very marked, the upper ends giving very unsatisfactory results, while all the pieces from the lower end passed the test, except, perhaps, No. 6 heat.

The average tensile tests for the middle and lower thirds of the ingot were as follows:

No. of heat.	Ultimate strength.	Final elongation.
	<i>Pounds.</i>	<i>Per cent.</i>
1	61,259	26.12
2	61,667	27.12
3	58,699	26.50
4	58,277	26.00
5	60,067	26.00
6	63,150	19.00

Many plates being subsequently rejected on this test, additional experiments were made, including effect of different methods of heating. Pieces were taken from portions of plates representing what were originally the top, middle, and bottom of ingots from five heats of good quality—the tensile tests for four of these heats will be found in the table for Norway steel—and bent cold as finished, and after quenching from a cherry red, heated in a smith's fire with blast and in a still charcoal fire. Corresponding pieces were also cut from the slabs before rolling into plates (see p. 411) and submitted to quenching test with invariably satisfactory results.

It appears that 2 heats, 1995 and 2009, gave invariably satisfactory results from all parts of the ingot, and however heated. The cold tests place the other three heats in the order of excellence 1993, 2013, 1974.



The pieces being heated with blast and quenched, their order of excellence is 1993, 1974, 2013, with little difference between the last two. The pieces being heated in a still charcoal fire, their order of excellence is 1993, 2013, 1974. So that the order of excellence from each method of test is practically the same. But little difference appears due to difference in heating, the blast giving perhaps slightly better results than the charcoal fire.

As to position in the ingot, the cold-bending tests show no noticeable difference; in the quenching test with blast, the upper end gives the best results and the lower end the worst; in the quenching tests with charcoal fire, there is but little average difference. As the lower end of the ingot is generally expected to give the best results, the inspector concluded, on examining the heating furnace and method of heating, that the temperature at the back of the furnace was frequently too high and the flame too cutting. The attention of the heaters was called to this fact, and with increasing familiarity with the test, the difficulty soon disappeared.

EFFECTS OF PUNCHING.

A few tests were made at Chester on the effect of punching, with and without countersinking, the ship plate of heat 486, that used for the special tests with strain diagram, Plate XVI. The results, as shown in Table XXXVIII., show a reduction of strength of $14\frac{1}{2}$ per cent., due to ordinary punching of an $\frac{1}{8}$ hole, only $4\frac{1}{2}$ per cent. if the hole be partially countersunk, as practiced at the ship-yard, and an increase of 2.12 per cent. for a $\frac{3}{8}$ hole countersunk through. The thickness in each case was .51 inch and the width over all 2 inches. The relative size of punch and die, and consequent spread of hole, is not known. These results are as generally to be expected, the loss of strength being perhaps rather less than usual.

TABLE XXXVIII.—Showing effect of punching, with and without counterstinking, Chester steel plate.

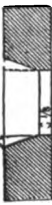
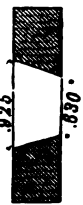
Heat.	Treatment.	Original dimensions of test piece.	Effective dimensions of test piece.	Effective sectional area.	Tensile strength.	Ductility in 8 inches.	Reduction of strength.	Cross section through center of hole (half size).	Remarks.
486	Unpunched plate, four tests.	2.00 x .507	1.00 x .507	.5070	64,200	Per cent. 25.15	Per cent.		Carbon, .12 per cent.; manganese, .37 per cent.; for heat.
486	Punched, 1/4-inch hole	2.00 x .510	1.313 x .510	.6696	55,000	14.33		
486	Punched, 1/4-inch hole, and countersunk as at ship-yard.	2.00 x .5106215	61,400	4.36		Commenced to crack at part of hole not counter-sunk, at 58,200 pounds per square inch.
486	Punched, 1/4-inch hole, and countersunk through.	1.986 x .5106168	65,560	*2.12		Commenced to crack at small edge of hole, at 61,660 pounds per square inch.

* Increase.

As is well known, the loss of strength from ordinary punching is due to the formation of a thin ring of highly strained metal forming the walls of the hole, of thickness depending on various circumstances, chief among which are the degree of hardness of the plate, its thickness, and the relative size of punch and die. The harder the steel, the thicker the plate, and the larger the die relatively to the punch,* the thicker is the overstrained ring of metal, and the greater the amount of subsequent riming or drilling necessary to remove it. M. Barba considered the removal of .04 inch of metal by cutting tool from a sheared edge or the walls of a punched hole sufficient to remove the bad effect in plates of ship or boiler quality not more than $\frac{1}{2}$ inch thick. An extension of the investigation with steel of harder quality, by Mr. A. F. Hill, C. E.,† develops the following results. Strips of plates, $\frac{1}{4}$, $\frac{3}{8}$, and $\frac{1}{2}$ inch thick of open hearth steels of .30, .40, and .50 per cent. carbon were punched with $\frac{3}{8}$ inch holes, and tested with various amounts of riming. Enlargement of diameter by .04 inch effected the restoration only of the $\frac{1}{4}$ inch and $\frac{3}{8}$ inch plates of .30 C., and of the $\frac{1}{4}$ inch plates of .40 C. Enlargement by .06 inch restored the $\frac{1}{2}$ inch plate of .30 C., the $\frac{3}{8}$ inch plate of .40 C., and the $\frac{1}{4}$ inch plate of .50 C. Enlargement by .08 inch restored the $\frac{1}{2}$ inch plate of .40 C. and the $\frac{3}{8}$ inch plate of .50 C., while the $\frac{1}{4}$ inch .50 C. plate required an enlargement of fully .1 inch.

The effect of a hole produced by a cutting tool in a steel plate is to increase the ultimate strength of the net section, and while the effect of punching is always to overstrain the adjacent material, yet if the damage to the material is equal to or less than the gain due to difference of distribution of the resisting area owing to the presence of the hole, no apparent loss of strength will ensue. Again, plates of the same thickness, giving almost identical results on tensile test, frequently show very different results on punching. Some unknown element of chemical quality or physical structure causes the difference. Plates, therefore, do not always show an apparent loss of strength due to punching. Table XXXIX. gives the results of testing some $\frac{1}{8}$ inch flats of Cambria steel from two comparatively hard heats, punched with $\frac{3}{8}$ inch holes not rimed. Careful measurements were made of the resisting areas, as shown on the sections, from which, also, it is seen that the average spread of the holes, owing to the clearance of the punch in the die, is about $\frac{1}{16}$ inch.

* While a relatively large die increases the thickness of the overstrained ring, and consequently the amount of riming necessary for its complete removal, the loss of strength due to such taper holes is less than with the proportions of punch and die commonly used.

† Vol. XI., Trans. Am. Inst. Mining Engineers.

TABLE XXXIX.—Showing effect of punching Cambria steel fast.

Heat.	Treatment.	Original dimensions of piece.	Effective sectional area.	Apparent elastic limit.	Ultimate tensile strength.	Elastic ratio.	Ductility.	Reduction of strength.	Time of test.	Cross-section through center of hole, full size.	Remarks.
		In. In. Sq. in.	Lbs.	Lbs.	Per cent.	Per cent.	Per cent.	Per cent.	Min.		
5565	Unpunched, 4 tests	1.240 x .433	.5386	44,030	66,469	66.24	24.43	15		Carbon, 22 per cent; manganese, .54 per cent. Fracture silky-plane. Somewhat laminated on one side. Opening of inner edge of hole 0.15 inch on each side.
5565	Punched, 1/4-inch hole	1.738 x .436	.4714	49,872	66,334	75.18	15.5	.20	9 1/2		Fracture silky-plane. Opening of inner edge of hole 0.15 inch on one side and 0.105 inch on the other.
5565	do	1.773 x .438	.4816	53,011	64,118	82.68	15.0	3.54	8		Fracture silky-plane. Opening of inner edge of hole 0.15 inch on one side and 0.105 inch on the other.
5565	Average punched4765	51,442	65,226	78.90	15.25	1.87	8 1/2		Rise of elastic ratio, 12.66 per cent. Carbon, 22 per cent; manganese, .50 per cent. Fracture silky-plane. Opening of inner edge of hole 0.11 inch on each side.
5567	Unpunched, 4 tests	1.243 x .449	.5580	41,576	63,475	68.50	25.25	15 1/2		Rise of elastic ratio, 10.92 per cent.
5567	Punched, 1/4-inch hole	1.607 x .454	.4299	49,314	65,270	75.56	14.63	.34	8		Rise of elastic ratio, 11.79 per cent.
5567	do	1.602 x .448	.4220	48,104	65,640	73.29	15.5	1.27	9 1/2		Fracture silky-plane on one side, irregular on the other. Opening of inner edge of hole 0.15 inch on one side and 0.11 inch on the other.
5567	Average punched4260	48,709	65,455	74.43	15.07	nil	8 1/2		Rise of elastic ratio, 10.92 per cent.
5567	Average, both tests punched.95		Rise of elastic ratio, 11.79 per cent.

* In 8 inches. † Increase. ‡ In 4 inches.

Stresses were applied as usual in this inspection. The hole in each case commenced to elongate under a stress about the elastic limit of the unpunched metal, although the beam gave no indication of disproportionate extension until a considerably higher stress was applied; but the elevation of apparent elastic limit is believed to depend somewhat on the rapidity with which stress is applied, being less with more rapid application. The average rise of apparent elastic ratio is seen to be nearly 12 per cent., an increase of nearly one-fifth. The walls of the hole commenced to crack at a stress somewhat below the maximum, and fracture occurred slowly and by visible shear with silky plane surfaces. The difference of extension of the metal of the walls of the hole and at the edges is very noticeable, as seen in the column of remarks, making any measurement of reduced area of very uncertain value. The extension of the punched pieces is given for 4 inches, but is really confined to the metal immediately adjacent to the holes.

The average loss of tensile strength for one heat is *nil*, and for the other only 1.87 per cent., being then all in one piece. The average loss for both heats is only .95 per cent., or about 650 pounds.

A comparison of these results with those in Table XXXVIII. shows that while these flats were slightly thinner, they were also of slightly harder quality, but had received very much more mechanical work in the rolls. The proportion of net to original section is rather less in the Cambria pieces, giving the metal a slight advantage. But speaking broadly, this steel shows no reduction of strength due to punching, and its chief peculiarity is the very large amount of mechanical work which it has received, rendering a connection between the two qualities highly probable.

Few subjects stand more in need of exhaustive treatment than this of the effect of punching, and it may even fall within the province of the steel manufacturer, favorably situated for such work, to supply the solution as to the proper manufacture of metal to suffer the minimum of injury under ordinary conditions.

NEW SECTIONS.

In connection with the manufacture of material, certain new sections of deck beams and T rolled in steel are worthy of attention. Of the beam sections in general use in this country for iron, the large majority are deficient in width of flange, so much so that there is frequently not room enough to stow the rivets unless the very greatest care is exercised in punching and fitting. This small width of flange, together with the very round form of the bulb generally used in connection with it, makes the section deficient in lateral stiffness, one of the main causes of ultimate rupture; and this is also sometimes further aggravated by extreme thinness of web or stem, frequently such indeed that the beam cannot be straightened or cambered without fluting, very much diminishing its initial stiffness.

Again, the design of these sections has been based largely on the consideration that the ultimate resistance of wrought iron to compression is considerably less than to tension, the area of the flange being correspondingly increased over that of the bulb. But it would appear that the behavior of the metal under these strains within the elastic limit should control the design, as actual rupture of the section in the ship is not to be contemplated, being in all cases preceded by too great deflection, if the quality of the metal be good. Also, it is a significant

fact, that under the conditions of practice the capacity of iron and steel to stand repeated applications of the same stress within the elastic limit is greater for compression than for tension. Thus in riveted girders of wrought-iron, in which the flanges are proportioned so as to be theoretically of equal strength, fracture nevertheless almost invariably occurs on the tension side under repeated application of load.

For steel the elastic limit and behavior within it may be taken as practically the same for tension and compression, so that, from what has been said about repeated applications of stress, steel beams should generally have a greater area of bulb than of flange. This is not, however, practicable in any but the deeper beams.

In order to intelligently arrange the sizes and weights of beams in any case, beyond thumb-rule or the ordinary good practice, it is necessary to remember that, of whatever pattern, the rolls are always designed for a given weight, for which also the parts of the section are proportioned to what may appear to be the best advantage. If it be desired to make a heavier beam, the rolls are spread; if a lighter, they are screwed together. The distance apart of the rolls is generally considered to affect all parts of the section alike, within certain limits, or the increase of width of flange and bulb and of thickness of web will be identical.* On account of the greater length of web, however, the difference of weight will chiefly arise from the change of thickness of the web. Thus, if, for the weight to which the rolls are designed, the thickness of web is suitable for the transmission of stress from flange to bulb by its resistance to shearing and buckling, any increase of weight will diminish the efficiency of the beam per pound weight, inasmuch as the efficiency of the metal added to the web to resist transverse straining of the beam is only one-third of an equal addition to the flanges. It accordingly happens that a beam of given depth and weight from one manufacturer may have considerably less absolute strength and stiffness than a lighter beam, of the same depth but of different pattern, from another maker. Thus, unless the beams are to be made according to special pattern, which will rarely be the case, the exact weight per foot should be decided with reference to the design of the rolls. For instance, consider the 8-inch 27-pound beam (Table XL.) used amidships on certain decks of the Atlanta, Boston, and Chicago, in comparison with the 24½-pound beam of the same pattern used at the extremities of the same decks. The exact weight of the heavier beam in accordance with the actual section used for calculation is 27.3 pounds, that of the lighter 24.45 pounds, so that the heavier beam weighs 11.65 per cent. more than the lighter. The moments of resistance are respectively 16.52 and 15.90, or the heavier beam is only 3.9 per cent. stronger or stiffer, since the moment of resistance is a better measure of stiffness than of ultimate strength. The rolls were designed for 25 pounds, for which weight the parts are considered well proportioned, and it is seen that the increase of strength for increased weight is altogether disproportionate. The relative efficiency of the two sections may be seen from the last columns to be as .605 to .65, or the heavier beam is 6.9 per cent. less efficient than the lighter. This efficiency as gauged by the moment of resistance per pound weight per foot may be apparently much increased by rolling the section below the designed weight, but only at the expense of diminished ultimate

*The truth of this proposition will depend on the details of the roll passes, as the flanges may not fill the grooves in the last few passes, in which case practically no difference in width of flange will occur over a considerable range of weight.

strength of the section from lack of strength and stiffness of the web under heavy strains. Where stiffness alone is to be considered, this may generally be done with advantage, and indeed is contemplated in such reductions as above mentioned. But without inordinate expense, the manufacturer cannot make rolls to suit each individual case, unless the order be large, and it frequently happens, as shown, that the lighter beam may be practically as stiff and as strong as the heavier.

The foregoing considerations have been based upon the qualities of the beams unsupported by plating. When so supported, the maximum efficiency demands diminished flange area, larger fillets under the flange, thicker webs, and especially larger bulbs. The plating in fact virtually increases the flange area resisting compression, calling for corresponding increase on the tension side of the girder and in the connecting web. The beams supporting protective deck-plating should be designed with this in view, and such beams generally have an angle, or one-sided, flange. Such beams, as well as those subjected to violent and vibratory strains and generally supported by plating—at least over the parts most severely strained—are usually comparatively deep, so that the better to satisfy the average conditions the deeper beams should not have increased width and area of flange, but heavier webs and especially larger bulbs. Where the depth of beam is to be diminished from considerations of space, it may well happen that under plating some of the deeper rail patterns may be used to advantage, being at least, weight for weight, preferable to tees or double angles, while having sufficient flange area for connection to the plating.

As regards the pattern of steel beams, the flanges should not have more taper in thickness than is necessary for rolling, in order to increase the lateral stiffness. The metal of the bulb, on the other hand, is more efficient when concentrated, but by a flat pear-shaped bulb the virtual depth of the beam is increased, while connection with the pillars is more effective, and, as worked into carlings around mast-holes, &c., plating may be more readily secured by tap-rivets. Under the conditions of the metal in the web of a beam, it is probable that with steel of ordinary ship quality the thickness need be no greater than is common in well-designed iron beams. With steel of harder quality, the webs should be thicker; or it may be considered advisable in deep beams to increase the amount of reduction in the last pass (generally very small) and cut or stamp the rolls so as to leave vertical ribs in the web to increase the stiffness, where such projections will not interfere with the faying of the connecting pieces.

Plate XXII. shows the sections rolled under this inspection, illustrating some of the above remarks. Actual sections are shown except for the light 8-inch beam. Of the 7, 8, and 9 inch beams, the flanges are rolled for 5 inches, the bulbs are pear-shaped and perfectly flat on the under side, the webs terminate in deep fillets and are considered well proportioned for the weights for which the rolls were designed, viz. the 7-inch for 25 pounds, the 8-inch for 25 pounds, and the 9-inch for 28 pounds. The flanges have as little taper as was deemed safe in rolling, but this may be reduced with advantage. The 6-inch 16-pound beam was finished on rolls which had been used for iron. Considerably increased efficiency is apparent in the 18 pound 6-inch beam rolled especially for this order, but from trouble in the details of rolling the bulb-fillet on one side is misshapen. The size of the bulb of this beam may be increased with advantage.

Table XL. contains the chief properties of some of these sections, ac-

accompanied by those of iron beams of approximately the same weight rolled at one of our most prominent mills. These are not given for comparison of efficiencies, because generally designed for much weights, but to illustrate general features and clearly show the differences which may arise between beams of the same weight and different patterns. The properties are as given in the manufacturer's hand-book. By the moment of resistance is meant the bending moment which will produce a stress of 1 pound per square inch on the extreme fiber.

TABLE XL.—*Properties of certain beam sections.*

Nominal size of beam.	Area of section.		Corresponding weight per foot.	Thickness of web.	Width of flange.	Width of bulb.	Neutral axis above bottom of bulb.	Moment of inertia about neutral axis.	Radius of gyration.	Moment of resistance.
	S. ins.	Lbs.								
9 inches by 5 inches by 31 pounds ¹	8.97	30.41	.563	5.08	2.12	4.03	99.90	3.34	28.28	
9 inches by 30 pounds ²	9.00	*20.51	.625	3.97	1.97	4.60	91.90	3.20	20.00	
8 inches by 5 inches by 27 pounds ³	8.05	27.30	.531	5.00	2.04	4.40	72.68	3.00	16.52	
8 inches by 27 pounds ⁴	8.10	*27.46	.712	3.96	1.71	4.49	61.60	2.76	13.75	
8 inches by 5 inches by 24½ pounds ⁵	7.21	24.45	.437	5.60	2.00	4.31	68.55	3.08	15.90	
8 inches by 24½ pounds ⁶	7.38	*25.02	.614	3.88	1.61	4.49	57.30	2.79	12.75	
7 inches by 5 inches by 25 pounds ⁷	7.12	24.14	.458	4.90	2.08	3.87	51.05	2.68	13.19	
7 inches by 23 pounds ⁸	6.90	*23.40	.625	3.75	1.75	3.98	43.00	2.50	10.80	
6 inches by 3½ inches by 16 pounds ⁹	4.82	16.34	.417	3.48	1.35	3.53	24.31	2.24	6.80	

* Weight if rolled in steel.

¹ Used for gun-deck beam, Chicago.

² Iron, as manufactured at Union Iron Mills.

³ Berth and spar decks, amidships, Chicago; berth and main decks, amidships, Boston and Atlanta.

⁴ Iron, as manufactured at Union Iron Mills.

⁵ Berth and spar decks, fore and aft, Chicago; berth and main decks, fore and aft, Boston and Atlanta.

⁶ Iron, as manufactured at Union Iron Mills.

⁷ Main-deck beam, Dolphin.

⁸ Iron, as manufactured at Union Iron Mills.

⁹ Berth-deck beam, Dolphin.

Plate XXII. shows the section of the 4½" by 3" tee used for bulb head stiffeners and in other places on the larger vessels. The primary object of such a section in ship construction at the present time being to serve as an edge strip across the joint of bulkhead plates while the stem acts as a stiffener, the flange is made broad and of parallel thickness slightly in excess of ordinary bulkhead plating, while the stem or tongue is only as deep as the deep flange of angles used for stiffening purposes. The stem of a tee should have the least possible taper consistent with good rolling so as to throw the metal as far out as possible.

The open and close tees for deck beams and tees are illustrated by broken lines. In the tee, the stem may also be laid flat on one side of the flange.

PROPOSED SECTIONS.

There seems no reason why in future construction advantage should not be taken of some sections of great efficiency and lightness which have for some time been used in Europe. The more important of these is the 6-inch Z (Plate XXIII.) extensively used in the main framing, where only one thickness of plating is worked, and around magazines,

PLATE XXIII.

T Bar

6" x 3 1/2" x 3' x 15' Hk.

*Proposed Stem Sections
in Steel.*

Angle Butt

5" x 2 1/2" x 11' Hk.

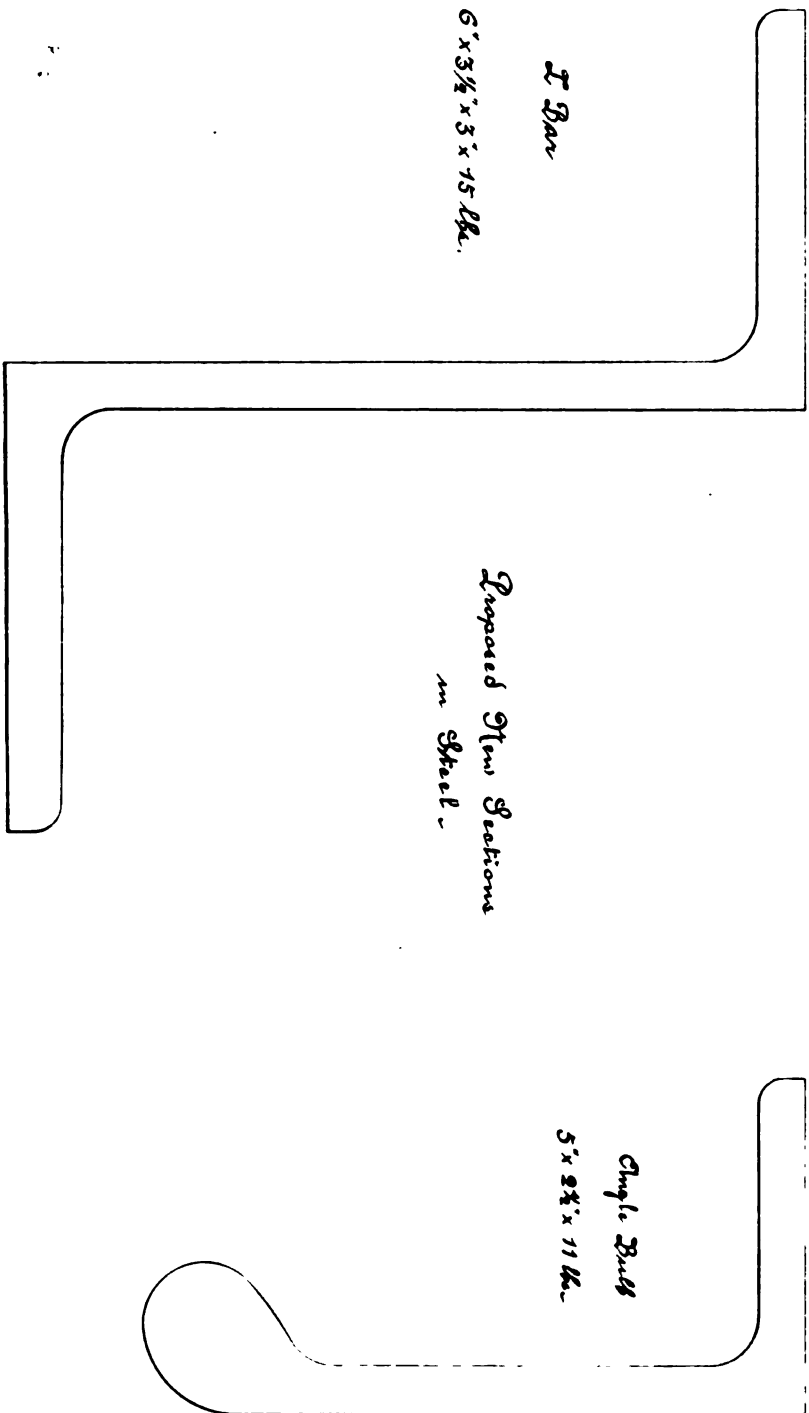

Handwritten scribbles and marks on the right edge of the page.

Plate XXI

To accompany Report on Mill Steel.

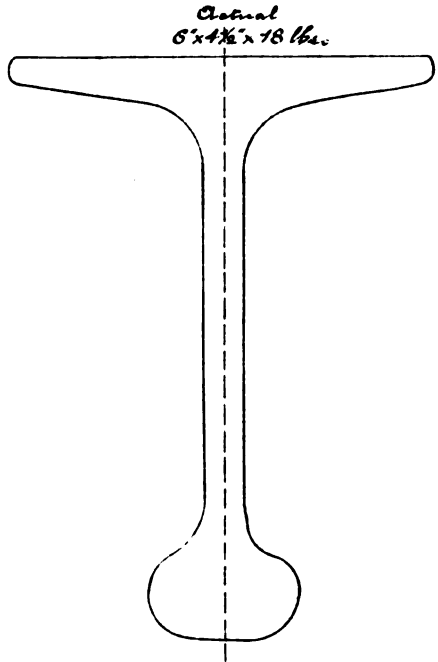
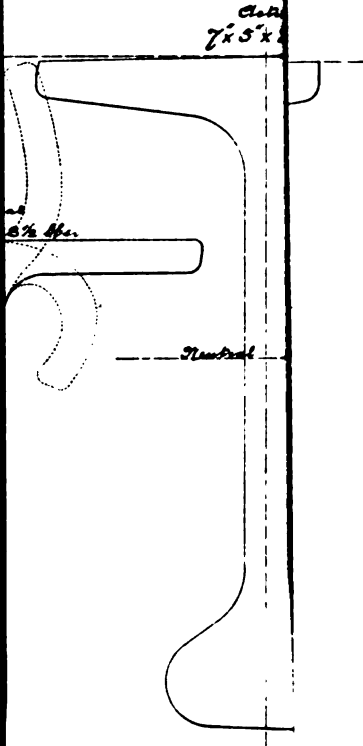

shaft alley and other important vertical bulkheads. This section of 15 pounds may be considered as replacing two angles back to back, 4 by 3 inches by 8 pounds, and 5 by 3-inches by 10 pounds, riveted through the lap. Although more difficult to bend than single angles, the saving in weight and in punching, fitting, and riveting, more than counterbalances this difference. In the present state of supply of ship material, competition not being particularly active for steel shapes, its cost at the mills should be very little more than the average. It is more easily rolled than the channel section and, in 1872, 6-inch Z bars with $2\frac{3}{4}$ -inch flanges were rolled in iron by the Phoenix Iron Company for certain bridge-builders. Other sizes of Z bar, in frequent use in Great Britain, are 10-inch by $3\frac{1}{2}$ -inch by $3\frac{1}{2}$ inch by 19.8 pounds and 5-inch by 3 inch by $2\frac{1}{2}$ -inch by 12 pounds, especially the former for longitudinal stringers, frames behind armor, &c.

Under light decks and platforms, especially where light plating is worked, a section more efficient as a stiffener and stronger than an angle is obtained in the angle bulb (Plate XXIII.), the size generally used being 5-inch by $2\frac{1}{2}$ -inch by 11 pounds. The bulb may be on either side of the web but is preferably on the same side as the flange. Another size of angle bulb, invariably used under armor-decks in the iron-clad of the British navy, is 9-inches by $3\frac{1}{2}$ -inches by 24 pounds.

CHEMICAL REQUIREMENTS.

For certain classes of steel, requirements limiting the amounts of certain chemical elements, notably carbon and phosphorus, have for some time been exacted. In steel rails, the carbon, phosphorus, silicon, and manganese have all been restricted at times, and now many mills work more or less closely to chemical formulæ. Some railroads place both higher and lower limits to carbon, and frequently a definite higher limit to phosphorus, an element always supposed below a certain extreme amount. The governing considerations are, in the order of importance, wear, brittleness, and stiffness, but the virtues of many of the particular formulæ proposed are purely fanciful. It has indeed not yet been decided which will wear best, so-called hard or soft rails, and opinion fluctuates as reports are received from the authorities of prominent railroads in this and other countries favoring one or the other general quality. In fact, while it is recognized that the conditions of traffic doubtless influence the best average quality, little has been done to give definition to current ideas. The most remarkable and elaborate work on this subject was done by Dr. C. B. Dudley, chemist to the Pennsylvania Railroad, and formed the subject of papers read before the American Institute of Mining Engineers in 1878 and 1881, and which provoked long and valuable discussion. It may be interesting to state that as the result of his investigations the following limiting chemical specifications were proposed as being best adapted for the conditions of traffic on the Pennsylvania Railroad:

Phosphorus, not above 0.10 per cent.; silicon, not above 0.04 per cent.; carbon, between 0.25 per cent. and 0.35 per cent., with an aim at 0.30 per cent.; manganese, between 0.30 per cent. and 0.40 per cent., with an aim at 0.35 per cent.; sulphur and copper, no specifications.

The difficulty and expense of carrying out on the material of rails a system of tests of representative value at all proportionate to those in use for structural steel, have driven consumers to specifications containing chemical requirements, which have, however, increased value in this case from the uniformity of treatment of rail metal subsequent

to tapping, arising from the large scale on which the manufacture is carried on and the precision and smoothness of working necessary in the face of active competition.*

But structural steel has also been occasionally subjected to chemical requirements. For "fire-box metal," or the parts of a boiler in contact with the flame, it has long been recognized that low phosphorus is highly desirable in steel as in iron. If the percentage of phosphorus be much above .05 per cent. in such material, internal strains appear to be produced under the ordinary conditions of working, causing rapid deterioration and sometimes sudden failures. Accordingly such material is generally purchased with explicit agreement or general understanding that this limit is observed.

Certain bridge engineers have of late undertaken to exact chemical requirements for bridge steel, and the specifications of the railroad bridge across the Ohio River at Henderson, Ky., extracts from which are given in Appendix, p. 577, *et seq.*, contain requirements for higher and lower limits of carbon for both tension and compression metal and the .10 per cent. limit for phosphorus, together with what are believed to be the most elaborate physical tests ever applied to structural material. Whatever opinion may be entertained as to the necessity of such requirements, or indeed of their propriety in the present state of our knowledge of the subject, they at least mark a tendency in the direction of chemical specifications, and the steel has been successfully made to them.

While the possibility of chemical specifications being relied upon for structural steel is very remote, yet, in originating requirements for material it becomes necessary, especially in connection with intended cost, to appreciate the margin allowed the manufacturer; and although, as we have seen, the physical qualities of steel are affected in many ways, some little understood, by treatment subsequent to tapping, yet, at any particular works, the methods and appliances in use, if not the best, cannot be altered without serious expenditure of time and money, so that for range of physical quality the manufacturer relies solely on the ingredients and proportions of the charge and subsequent treatment in the furnace. With this as the preliminary consideration, an analysis of the results of tensile tests on a chemical basis was undertaken. While, in order to avoid the region of debate, the Board confines itself to the most general discussion of the results, yet it will be readily understood that for even a general analysis of, and useful deduction from, a large number of tests as contained in lengthy tables, an amount of arithmetical labor is necessary such as to deter any but the most persistent investigator from the attempt, so that a summary upon any acceptable basis may well form a valuable addition to the itemized results.

But before proceeding to such a consideration of the results, it becomes necessary to examine the ground work in stating and considering the methods of chemical analysis commonly used in American steel works. While the differences arising are rarely comparable to those obtained from physical tests under different systems, they are yet considerable, and offer almost as much field for discussion, both as to the

* In general for this class of steel the number of points, or hundredths of 1 per cent. of carbon may be fairly used as the gauge of mere hardness or softness, with the restriction that the phosphorus, the other chief hardening agent, is within the Bessemer limit of 0.10 per cent. For such steel also the percentage of phosphorus is taken as an inverse measure of intrinsic quality, so much so that, as this element is not removed in the ordinary Bessemer process, pig-iron containing sufficient silicon for the blow, and not more than the above-mentioned amount of phosphorus, is termed Bessemer pig, and forms a separate class in the trade.

most suitable methods and the results of any one method in the hands of different individuals. Considerations of expense largely control the choice of method and, to a certain extent, the manipulation under the method chosen.

METHODS OF CHEMICAL ANALYSIS USED IN AMERICAN STEEL WORKS.

A complete analysis commonly consists of determinations of combined carbon, phosphorus, manganese, sulphur, and silicon, although sometimes extended to include graphitic or dissolved carbon, copper, nickel, and cobalt. The amount of chemical analysis made on each heat or blow of steel depends very much upon the experience of the melters, the variety of product, the degree of knowledge of the ingredients of the charge, and finally upon individual practice. But few of the above determinations are ever made except in particular cases, and much steel is not sampled for the chemist at all. A general knowledge of the ores, with a few special analyses, suffices, as a rule, for an estimate of such elements as copper, nickel, and cobalt, the variation of which is of no consequence if the maximum probable quantity present be not too great. Careful account is generally taken of the pig used directly or to be puddled, with respect to the elements commonly included in a complete analysis, and the scrap used, if its history is not known, is sampled as completely as deemed necessary. The ferro-manganese and spiegeleisen are bought on analysis for certain elements carefully determined and the average amount of the other principal elements is taken account of. Thus much chemical work is generally done to obtain a more or less accurate knowledge of the composition of the charge.

The open-hearth process effects practically the complete* elimination of manganese and silicon and the reduction of carbon to the desired extent; the necessary amount of manganese is subsequently added with a small increase of carbon and silicon. The other elements are generally not affected. The product is therefore tested almost invariably for carbon and frequently for manganese. When boiler metal is aimed at, the exact amount of phosphorus may also be determined.

The Bessemer process generally effects the complete* removal of silicon and manganese and, in this country, of carbon, the two latter elements being then added to the desired extent. A certain amount of silicon being necessary for the "blow," this element is generally determined for the pig used, though much may be told from its fracture. A specially large number of silicon determinations are made when the "direct" process is worked, the metal being taken fluid from the blast furnace to the converter, no mixing being possible. The same determinations are generally made for Bessemer as for open-hearth steels.

In the basic Bessemer, or Thomas-Gilchrist, process, phosphorus must be added to the number of elements removed, and becomes the subject of careful study in charge and product.

COMBINED CARBON.

Mr. J. Bludgett Britton's Modification of Eggertz's† method (*vid. Jour. Franklin Institute*, May, 1870), is in general use, almost every chemist

* By complete elimination or removal as here used is meant the reduction below certain very small quantities.

† Dr. Eggertz's original method is as follows: "Dissolve in the cold 1-10 grm. of steel in from 1½ to 5 cubic centimeters of nitric acid (1.2 sp. gr.); place in water bath at 80° C.; cool, and pour off solution; pour a few drops of nitric acid on the residue in

introducing individual peculiarities of manipulation. It consists of a comparison of colors of solutions, in nitric acid of definite strength, of the steels analyzed with those of standard steels or with derived solutions.

A solution of coffee or caramel in weak alcohol—or better, a mixture of the two, as the mixture does not change color so quickly as the single solution—is made of such strength that its color corresponds exactly with that of a solution of 1 gram of standard steel (combined carbon accurately determined by special method), in 15 cubic centimeters of nitric acid (1.2 specific gravity). A second standard steel is taken with about .10 per cent. more carbon and 15 cubic centimeters of its darker solution is diluted with weak alcohol until its color corresponds with that of the lower carbon steel, the exact amount of the alcohol used being noted. The intervening standards, generally 2 points, or .02 per cent., apart, are then made by diluting 15 cubic centimeters of the solution corresponding to the higher carbon steel with proportionate amounts of alcohol. Similarly standard solutions for the next range of 10 points, or .10 per cent., of carbon may be obtained. The solutions, in test tubes of exactly the same diameter and hermetically sealed, are placed in the order of color in a tube rack with a space between each pair for the insertion for comparison of the nitric acid solution of the steel to be analyzed. The lowest color in a rack much used for soft steels is frequently given by a piece of selected colored glass in distilled water. A piece of tracing paper, ground glass, or a porcelain plate is attached to the back of the rack for the better definition of the colors. When not in use, the rack should be kept in a dark place and should be tested for change of color at least once a month.

The estimation of the carbon in a number of samples is conducted as follows:

One gram of each steel, finely divided (preferably by drill or other cutting tool), is added gradually to 10 cubic centimeters of nitric acid (1.2 specific gravity) in a tube, 1 to 1½ inches diameter, surrounded with cold water. When solution is almost complete the tubes are placed in a water bath containing water at 80° C. and heated for one hour, cooled rapidly in cold water, and filtered through a filter paper 9 centimeters in diameter, not previously moistened, into tubes of the same diameter as in the standard rack. When the solutions have reached a fixed temperature the carbon is determined by a comparison of shades.

Absolute uniformity of manipulation is necessary with this method, especially with the very soft steels, which give a very light solution.

The exact strength of the acid used, its purity, the exact amount of acid used, the size of the drillings, the heat at which solution takes place, the rapidity of solution, the length of time the tubes stand before being placed in the hot-water bath, the exact temperature of the bath, any variations of that temperature, the length of time in the bath, the amount of evaporation, the temperature of filtration, the length of time between filtration and comparison of colors, the temperature of comparison, the exact size and thickness of the tubes used, with any variation of each, the light in which comparison is made, all affect the apparent amount of combined carbon present.

When the doubtful representative value of the sample for chemical test as generally taken with respect to the pieces subjected to physical test is considered, especially in view of the recently discovered prevalence of hard centers or fluming of the impurities to the top and center

the tube and heat carefully over a lamp until there is no further liberation of gas; cool and add to the former solution. The liquid is now diluted until its color corresponds exactly with the standard which is of such a strength that 1 c. c. represents .0001 grm. of carbon." This method is not so accurate as Mr. Britton's modification.

of the ingot, it is evident that averages of many tests are necessary for consistency of results for steel of any one manufacture, and accurate comparison of independent results for steel of different manufactures is very difficult if not impossible.

PHOSPHORUS.

To the chemist, as to the steel manufacturer and worker, this element has very treacherous qualities, and the greatest care is necessary for its accurate determination. Several methods are in use, of which the chief are, in the order of accuracy, the molybdate and magnesia method, with various modifications, the direct molybdate or yellow precipitate method, and the acetate or citric acid method. The first two are the most commonly used.

Molybdate and magnesia method.—Dissolve 3 to 5 grams of steel in nitric acid (1.2 specific gravity), using about 15 cubic centimeters per gram of steel. When solution is complete, add 5 cubic centimeters of hydrochloric acid; evaporate to dryness and heat on the hot plate or sand bath until all the acid is driven off. The hydrochloric acid prevents the formation of basic salts. Dissolve in concentrated hydrochloric acid, using only a small amount, boil for a few minutes, and evaporate quite low. Evaporate twice with 30 cubic centimeters of nitric acid, taking care not to render the iron oxide insoluble in nitric acid; dilute, and filter from silica. The filtrates and washings, which need not exceed 150 cubic centimeters, are neutralized completely with ammonia and a slight excess added. The precipitate is dissolved with concentrated nitric acid and the solution brought to a reddish yellow color; add ammonium molybdate solution in large excess (20 cubic centimeters per gram of steel), heat the beaker for fifteen to twenty minutes at 80° C., allow to stand at about 50° C. from an hour to an hour and a half, until the yellow precipitate has entirely settled to the bottom, and filter. Thoroughly wash the precipitate with an acid solution of ammonium nitrate—made of 325 cubic centimeters of nitric acid (1.2 specific gravity), 100 cubic centimeters ammonia (0.96 specific gravity), and 100 water—and dissolve with dilute ammonia on the filter; acidify with hydrochloric acid, and add ammonia to the very slightest perceptible excess. Heat the solution on the steam bath until all odor of ammonia is removed and a slight flocculent precipitate has separated; filter, add ammonia to the filtrate, and precipitate with magnesia mixture, stirring briskly for several minutes.

The flocculent precipitate (often spoken of by mistake as silica) sometimes contains a trace of phosphorus, which can be regained by dissolving in warm nitric acid, precipitating with molybdate solution, and, after fifteen or twenty minutes, filtering off the precipitate, which is then dissolved in ammonia and added to the main solution.

If the final precipitation is to take place rapidly, the solution should not exceed 30 cubic centimeters. As soon as the liquid above the precipitate is perfectly clear, it may be filtered. In this case, as with the yellow precipitate, clear liquid indicates complete precipitation. Now filter through a 7-centimeter paper, and wash with a solution of 1 part alcohol, 1 part ammonia (0.96 specific gravity), and 2 parts water, by bulk; transfer to a crucible, wet, and turn on the full heat of a Bunsen burner until the paper begins to char, when the flame is turned low and the carbon burned off at a dull red heat.

Weigh the precipitate as pyrophosphate of magnesia as soon as cold. (See Vol. X., Trans. Am. Inst. Mining Engrs., p. 330.)

Another way of working the molybdate and magnesia method, used in several steel works, is as follows:

Dissolve the steel in nitric acid; evaporate to dryness and heat in an air bath at 120° C. for several hours; dissolve in hydrochloric acid; filter; expel hydrochloric with nitric acid; precipitate in small bulk, made nearly neutral by ammonia, with ammonium molybdate solution; filter, and wash with acid ammonium nitrate; dissolve with ammonia; precipitate with magnesia mixture; filter and wash with ammonia-alcohol or dilute ammonia; ignite and weigh as pyrophosphate. (*Ibid.*, p. 323.)

Either of these two methods give accurate results if ordinary care is used in the manipulation. The points to be watched are to have the solution free from hydrochloric acid or chlorides and to have only enough free nitric acid present to keep the iron oxide in solution when precipitating with ammonium molybdate solution. The presence of

a large excess of ammonium nitrate hastens the complete separation of the yellow precipitate, and, to a certain extent, neutralizes the deleterious effect of chlorides. The first method requires from twelve to thirty hours; the second, forty-eight to seventy-two, with no greater accuracy.

A modification of the molybdate and magnesia method used at, at least, one steel works is as follows:

Dissolve in nitric acid; evaporate to dryness and render silica insoluble on sand bath; take up in hydrochloric acid; evaporate low and add ammonia in excess. Dissolve precipitate formed in concentrated nitric acid and filter from silica; precipitate with molybdate solution; filter, and wash with dilute molybdate solution; dissolve with ammonia; precipitate with magnesia mixture, and let stand two to three hours; filter and redissolve precipitate with hydrochloric acid (1 in 2); add citric acid; neutralize with strong ammonia, adding one-third volume in excess, and let stand four hours or more; filter, and wash with dilute ammonia; ignite, and weigh. The results are too low and entirely untrustworthy. (See Vol. X., Trans. Am. Inst. Mining Engrs., p. 203.)

Yellow precipitate method.—The Eggertz direct, commonly called the yellow precipitate, method is used in many steel works from the rapidity with which it can be worked. The results are not generally accurate unless all the conditions of manipulation are carefully systematized. The method is as follows:

Dissolve 1 gram of steel in nitric acid, evaporate to dryness, and heat on a hot plate or sand bath until free from acid; take up in concentrated hydrochloric acid, and evaporate low; add 5 cubic centimeters of nitric acid, dilute slightly, and filter from silica; evaporate solution to 20 cubic centimeters, add 20 cubic centimeters of molybdate solution, and stir. Heat to about 40° C. until precipitation is complete, and filter through weighed or counterbalanced filter papers; wash precipitate with water containing 1 per cent. of nitric acid until a drop of the filtrate leaves only a slight ring on being evaporated to dryness on a watch glass. Dry at 110° C. until a slight stain appears on the filter paper. One and sixty-three hundredths per cent. of the weight of the precipitate is calculated as phosphorus. (Chemical News, Vol. VIII., p. 254.)

The Brushing method (Trans. Am. Inst. Mining Engrs., Vol. X., p. 167) is the same as the above except that a larger quantity of steel is used and as much as possible of the dried precipitate is brushed from the filter paper and weighed on a watch glass, the remainder adhering to the filter paper being considered unworthy of attention. This method is in use, though no chemist taking pride in his work would introduce mechanical defects into chemical methods.

The yellow precipitate method as described gives low results on account of the incomplete precipitation of phosphorus in presence of hydrochloric acid, the error increasing with the amount of phosphorus. If the phosphorus is low—below .07 per cent.—fairly accurate results may be obtained by twice washing the precipitate with nitric acid to remove the hydrochloric, keeping the amount of free nitric acid down to about 5 cubic centimeters. When the phosphorus is from .07 to .12 per cent., the analyses will then show too much phosphorus, the error being as great as .01 per cent. at the higher figure; and if .15 per cent. of phosphorus be present the error becomes .02 per cent. If, however, the amount of free nitric acid present be increased to 10 cubic centimeters, the analyses will show too low. It would thus appear that when the approximate amount of phosphorus is known, reasonably accurate results may be obtained by varying the manipulation. But the general question is in dispute.

The causes of variation in results by this method are the amount of nitric acid present, the amount of iron per cubic centimeter, the temperature of precipitation, the strength of the molybdate solution, the amount of hydrochloric acid, and the impossibility of freeing the pre-

precipitate from adhering impurities by washing with water containing 1 per cent. of nitric acid.

In comparing the molybdate and magnesia and the yellow precipitate methods, the most striking difference is that, whereas in the molybdate and magnesia method 27.93 per cent. of the magnesium pyrophosphate weighed is phosphorus, in the yellow precipitate or direct method only 1.63 per cent. of the ammonium-molybdenum-phosphate is phosphorus, the apparent risk of error being therefore as 17 to 1 against the molybdate and magnesia method. But this is not the case, since the composition of magnesium-pyrophosphate is constant, while that of the ammonium-molybdenum-phosphate is variable, being affected by the amount of free nitric acid present as mentioned.

Citric acid or basic acetate method.—Though in use at few steel works, this method is employed by many commercial chemists. It is essentially as follows:

Dissolve 5 grams of steel in concentrated nitric acid to which a few drops of hydrochloric acid have been added; replace nitric completely with hydrochloric acid and filter from silica; dilute filtrate to 600 cubic centimeters, and add ammonia until a slight cloud forms; add 7 to 10 cubic centimeters concentrated ammonium sulphite, and boil until sulphurous acid is removed; cool by placing containing beaker in water, and add ammonia in just excess enough to produce a greenish precipitate. Add 40 cubic centimeters of acetic acid, and boil about 20 minutes; if the precipitate, after boiling 5 minutes, is very small or light-colored, add a few drops of ferric chloride and boil again. Filter the precipitate as hot as possible, and wash slightly with hot water. Dissolve in as little hot hydrochloric acid as possible, wash filter with a solution of 2 or 3 grams of citric acid in a little water, and complete washing with hot water. Evaporate filtrate and washings to 30 cubic centimeters, add excess of ammonia, cool, and add 6 to 8 cubic centimeters of magnesia mixture, stirring until the precipitate appears. Let stand in a cool place for 16 or 18 hours; filter, and wash slightly with dilute ammonia; dissolve with dilute hydrochloric acid on filter, wash with solution of $\frac{1}{4}$ to 1 gram of citric acid, and complete washing with hot water; cool, add ammonia, and cool again; add a few drops of magnesia mixture, stirring until the precipitate appears. Let stand 6 or 8 hours; filter, and wash with dilute ammonia; ignite and weigh as magnesium pyrophosphate.

The majority of chemists using this method obtain low results. The causes of error seem to be the incomplete precipitation of phosphorus as basic phosphate of iron and the well-known solubility of ammonium-magnesium-phosphate in citrate of ammonia.

MANGANESE.

The following method proposed by Mr. S. A. Ford (*Trans. Am. Inst. Mining Engrs.*, Vol. IX., p. 397) is the most convenient and accurate for the determination of this element, and is much used:

Dissolve 1 gram of steel in concentrated nitric acid (1.4 specific gravity), bring to a violent boil, and throw in chlorate of potash until the yellow fumes cease; add a little more chlorate of potash, and boil a minute or two, filter through asbestos, and wash with hot concentrated nitric acid until free from iron. Dissolve the binoxide of manganese in hydrochloric acid, filter from asbestos, and wash with hot water; nearly neutralize with ammonia; add a very small quantity of acetate of soda and boil; filter, and wash lightly with hot water; redissolve the small quantity of oxide of iron in hydrochloric acid, again nearly neutralize with ammonia, and add a small crystal of acetate of soda; boil and filter. Unite the two filtrates, add an excess of phosphate of soda, then an excess of ammonia, and boil. When the precipitate is completely down and has assumed the silky appearance of ammonium-manganous phosphate, filter, wash with hot water, ignite, and weigh as manganous pyrophosphate.

It should be remarked that asbestos often contains magnesia and lime which are liable to contaminate the final precipitate.

A very convenient method for the determination of manganese believed to have been devised by Mr. Setterwald, of the Vulcan Steel

Works, Saint Louis, but published by Mr. Fred. H. Williams (Trans. Am. Inst. Mining Engrs., Vol. X., p. 100) is given as follows:

Prepare two standard solutions, the first a permanganate solution of such strength that 1 cubic centimeter is equivalent to 1 milligram of iron, and the second an oxalic acid solution such that 1 cubic centimeter is equivalent to 3 cubic centimeters of the permanganate solution.

Dissolve one or two grams of steel in concentrated nitric acid, and add chlorate of potash until the binocide of manganese is completely precipitated; filter through asbestos, wash with hot water, and place precipitate and asbestos in a beaker; add a measured quantity of the standard oxalic acid solution slightly in excess of what the binocide is capable of oxidizing; dilute to 60 cubic centimeters, add 3 or 4 cubic centimeters of concentrated sulphuric acid, heat to 70° or 80° C., and titrate with permanganate solution. Calculate the weight of iron equivalent to the oxalic acid oxidized by the binocide, and the amount of manganese may be obtained from the proportion 112: 55:: weight of iron oxidized: x = weight of manganese. The method gives slightly low results, and may be improved by substituting a standard solution of ferrous sulphate for that of oxalic acid.

The Acetate Methods.—The two allied acetate methods are in very extensive use, viz., the ammonia and bromine, and the fixed alkali and bromine.

The ammonia and bromine method is as follows:

Dissolve in aqua regia or nitric acid, evaporate to dryness, and render silica insoluble; take up in hydrochloric acid, and filter; dilute to 1 liter, and neutralize with ammonia and carbonate of ammonia; add acetate of ammonia in excess, boil until the iron separates, and filter; redissolve in hydrochloric acid and repeat the separation as before. Cool the combined filtrates, and add bromine and strong ammonia. When the manganese oxide has separated, boil, filter, wash, dry, and weigh as Mn_2O_4 .

In the fixed alkali and bromine method, carbonate of soda replaces ammonia and carbonate of ammonia, and acetate of soda is used instead of acetate of ammonia; no strong base is added after addition of bromine.

Almost every chemist has his own modifications of these methods, the results obtained varying from very low, through accuracy, to very high, according to individual modifications and the skill of the manipulator. (See Trans. Am. Inst. Mining Engrs., Vol. X., pages 105–9, 173, 191, and 194.)

Volhard's manganese method is used to a limited extent. (Trans. Am. Inst. Mining Engrs., Vol. X., page 203.) It is as follows:

Dissolve 1.2 grams of steel in a porcelain dish with 25 cubic centimeters of a mixture of one part of concentrated sulphuric acid and four parts of nitric acid (1.2 specific gravity); boil down until fumes of sulphuric acid come off for two minutes, while carbonaceous matter is being destroyed. Dissolve in hot water, and wash into a flask graduated to hold 300 cubic centimeters; add zinc oxide, held in suspension in water, shaking the flask during the operation, cool, dilute with cold water to the mark, mix thoroughly, and filter. Pour off 200 cubic centimeters of the filtrate, representing .8 grams of steel, into a 500 cubic centimeter flask, add one drop of nitric acid (1.4 specific gravity), and titrate with permanganate. Then $\frac{1}{10}$ of the strength in iron equals the strength of the permanganate in terms of manganese. The method should give fairly accurate results with good manipulation for steels low in carbon.

SILICON.

Dr. T. M. Drown's method is in general use. (Trans. Am. Inst. Mining Engrs., Vol. VII., page 437, and Vol. VIII., page 508). The determination is simple and rapid:

Dissolve in nitric acid (1.2 specific gravity), add excess of sulphuric acid, and evaporate until fumes of sulphuric acid are giving off. Dissolve the ferric sulphate in water, and filter off the silica, washing with hot water and hydrochloric acid until free from iron; ignite, and weigh as silica.

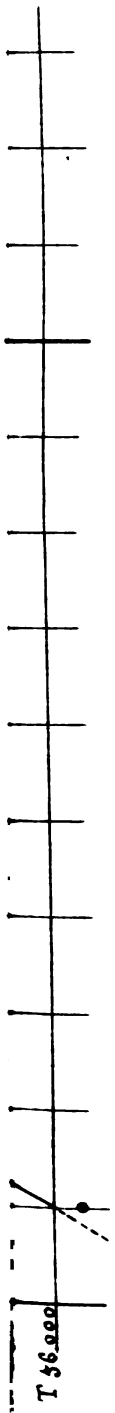

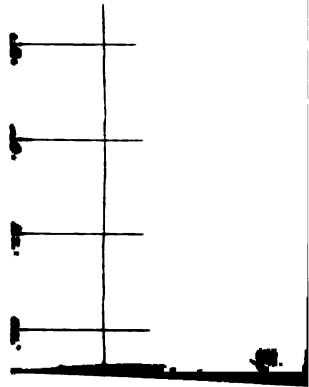

Cambria Steel.

- T • Tensile Strength
- L x Elastic Limit.
- R • " Ratio.
- D • Final Elongation.
- A • " Area.
- E • Modulus of Elasticity.

SULPHUR.

Dr. Drown's method (Trans. Am. Inst. Mining Engrs., Vol. II., page 224) is as follows:

Place 5 grams of steel in a 200 cubic centimeter flask and connect with a series of three absorption bottles containing permanganate of potash (1 gram in 200 cubic centimeters of water); add hydrochloric acid slowly to the steel (previously covered with water) so that not more than two bubbles of gas pass off per second. When the evolution of gas ceases in the cold, boil the solution in the flask for some minutes. Aspirate 500 cubic centimeters of air through the apparatus; fill the flask with hot water, and continue the aspiration until 1,500 cubic centimeters of air has been drawn through. Place the permanganate in a beaker, acidify with hydrochloric acid (if the permanganate contain silica or other impurities, evaporate to dryness and take up in hydrochloric acid), and precipitate with barium chloride in boiling solution. Weigh as barium sulphate.

Bromine in hydrochloric acid solution is used by many chemists instead of the permanganate, the manipulation being essentially the same.

Both methods give reliable results with careful manipulation, and they have almost entirely replaced the older methods of solution in nitro-hydrochloric acid with direct precipitation and absorption in an alkaline solution of silver or lead.

COPPER.

Occasional analysis is necessary for copper in steel of unknown manufacture or known to contain it in considerable quantity. Of the several methods in use, only two require mention:

(1) Dissolve 5 to 10 grams of steel in aqua regia; evaporate to dryness, and render silica insoluble; take up in a small quantity of hydrochloric acid, and reduce with excess of sulphurous acid; boil off the excess of sulphurous acid; dilute largely and pass sulphuretted hydrogen through the solution, at first in the cold, and finally at 60° C., to complete saturation. Filter, and dissolve the copper sulphide in nitric acid; replace the nitric acid with a few drops of concentrated sulphuric acid, and evaporate until fumes come off; dilute, and precipitate copper in a platinum dish by a weak battery.

(2) Dissolve 5 grams of steel in 10 cubic centimeters of concentrated sulphuric acid diluted with 100 cubic centimeters of water; add 2 cubic centimeters of a concentrated solution of thio-sulphite of soda, stirring well; boil for 15 minutes and filter. Dissolve the sulphide of copper in aqua regia, and evaporate with 2 cubic centimeters of sulphuric acid until white fumes are given off; cool, dilute with water, and add an excess of ammonia; allow to settle; filter, and wash with water containing ammonia. Evaporate the excess of ammonia from the filtrate, acidify with sulphuric acid, and precipitate the copper with hyposulphite of soda; filter, wash with hot water, ignite, and weigh as oxide of copper. (Trans. Am. Inst. Mining Engrs., Vol. XI., page 300.)

OXIDE OF IRON.

This substance is one of the chief causes of general bad quality of steel; yet no method for its accurate determination has as yet been devised. Many of the failures of material after flanging at a heat or exposed to the flame in a boiler are ascribed to the presence of oxide of iron in considerable quantity, and with some plausibility, and under such circumstances its accurate determination would be of the greatest value. No matter how uniform the physical treatment of material, the self-sufficiency of chemical specifications can never obtain until oxide of iron can be accurately determined.

CURVES OF CARBON PROPERTIES.

Analysis of the results of tensile tests on the basis of increasing

amounts of carbon, as ordinarily determined for each heat, depends upon the existence of a sufficient number of tests and range of carbon to eliminate by average the effects of the other chemical elements and the accidents of manufacture and of test, while permitting the prominent features to be brought out. Many changes must be adopted in the method of chemical analysis and physical tests in ordinary use at steel works before anything like an adequate solution can be attempted. Thus a different and more satisfactory method of carbon determination for structural steel, or a suitable modification of the prevailing color test, is imperative; the adoption of a standard test piece is no less necessary; and, finally, the chemical determinations must be made, not from the little test ingot taken from the bath in the furnace, nor yet from the chip of a bloom during manufacture—though this is immensely preferable to the former—but from the actual plate or bar subjected to physical test, and, if possible, from a test piece itself. The necessity in well-ordered works of immediate chemical analysis by which to run the furnaces is by no means so urgent as formerly considered. Of the elements commonly analyzed for, carbon, manganese, and phosphorus, only the carbon can be rapidly determined, and the suitability of the metal to stand the physical requirements cannot be at all accurately measured by such individual analysis as is commonly made. The final disposition of the metal, if made subject to requirements, must await the results of the physical tests, and the connection between the ingredients and manipulation of the charge in the furnace and the physical qualities of the wrought metal cannot be examined until the physical tests are known.

These remarks apply to all special and structural steels made by any process. The system of most steel works in this respect is only suited to Bessemer rail, wire rod, or nail manufacture, or other loosely graded product, and needs radical change in the directions indicated if any reasonable certainty in the manufacture of high-grade special or structural steels is to be attained.

Of the steels manufactured under this inspection, the results of all chemical work done in connection with the Chester and Cambria steels have been kindly supplied by the manufacturers; the carbon and manganese of every heat of Norway steel were also readily supplied. Of the chemistry of the Black Diamond steel nothing is known, except as given in the general statement of the materials used in its manufacture. In the analysis of the Chester results, all the heats are not included, as complete chemical information had not been obtained when the curves for this steel were constructed. The chemistry of the Cambria steel is very incomplete, even the carbon not being determined for every heat. The great variety of product of these works limits the amount of chemical work for any one class of product, although collectively a great amount of chemical work is done and the laboratory is specially well equipped; further, after a few careful analyses for a given class of product, much chemical work is not thereafter deemed necessary. Heats rejected on a single test are not included in the table for this steel. Except for a few special heats, no phosphorus determinations were supplied for the Norway steel.

The pieces for chemical analysis of the Chester steel were test ingots taken from the furnace during tapping.* For the Norway steel, chips from the slabs as sent to the Bay State Works (see p. 410) were generally used. For the Cambria steel, chips from a bloom—generally 7 by 7

* A piece of the test plate is now used at these works.

inches—were taken. The methods of chemical analysis in use at each of the above works have been given in connection with the manufacture of the steels, but are again stated under each heading.

The results of test for each percentage of carbon being averaged as given in the first columns of the tables, the corresponding spots were set off on the diagram, each marked with its number of heats. To obtain the mean curve the spots were taken in groups of three consecutively, thus: C. 10, C. 11, and C. 12; C. 11, C. 12, and C. 13; &c., and each spot having the weight corresponding to the number of heats of that carbon, the center of gravity of each group was obtained, giving a series of first derived spots. If these spots are not sufficiently regular to pass a curve, the method is repeated, obtaining a series of second derived spots. In general this is not necessary and can only be done at the sacrifice of local features, the tendency being evidently to flatten the curve. The solid drawn portions of the curves are considered well defined by the derived spots; the dotted terminals are probable.

The last columns in the tables give the results obtained from the curves, and the summaries show the leading features. The average changes for a point of carbon are taken as far as possible between points in the same phase on the successive hummocks or wave-like portions of the curves.

Of the Chester and Norway steels the tensile strength, ductility, and final area are the only properties plotted. For the Cambria steel, the elastic limit, elastic ratio—as obtained from the curves of ultimate strength and elastic limit—and the modulus of elasticity are added. The latter is drawn as a straight line, the irregularity of the spots and small number of heats not producing a sufficiently definite curve. Much importance is not to be given to it.

TABLE XLI.—*Drillings for analysis taken from small test ingot removed from the furnace while tapping.*

CARBON PROPERTIES OF CHESTER STEEL.

[Chemical methods: For combined carbon, the color test, dissolving a standard each time; for manganese, by dissolving in acid proto-sulphate of iron the binocide precipitated from nitric acid solution by chlorate of potash and treating with permanganate of potash; for phosphorus, the yellow precipitate method. Magnesia method occasionally used as a check.]

Number of heats.	Carbon.		Phosphorus.	Average original sectional area.	Tests.				Plotted curves.	
	Per ct.	Per ct.			Per cent.	Sq. inches.	Average ultimate tensile strength per square inch.	Average final elongation.	Average final area.	Ultimate tensile strength per square inch.
1.....	.10	.310		.4586	62,050	24.62	50.05		29.05	41.80
6.....	.11	.313	.0593 for 5	.4937	55,724	29.28	39.92	56,000	28.20	43.82
7.....	.12	.351	.0505 for 4	.6180	58,226	27.18	45.29	57,570	27.60	44.55
11.....	.13	.340	.0491 for 10	.5491	58,352	26.72	46.73	59,050	27.25	45.36
27.....	.14	.375	.0486 for 16	.5942	60,569	26.90	46.18	60,390	28.85	46.75
28.....	.15	.383	.0518 for 21	.5719	61,618	26.75	46.16	61,530	26.50	46.88
24.....	.16	.393	.0528 for 17	.5641	62,517	25.65	49.46	62,520	26.05	49.39
13.....	.17	.404	.0461 for 10	.5492	63,333	25.89	50.45	63,600	25.60	50.75
5.....	.18	.416	.0487 for 3	.5719	65,169	24.81	48.71	65,150	25.10	50.66
6.....	.19	.447	.0548 for 5	.5812	67,062	24.69	51.69	67,100	24.75	50.66
1*.....	.20	.410	.0390	.5169	59,000	29.27	41.85		24.45	50.36
1.....	.21	.480		.7036	74,535	24.30	50.50		24.25	49.73
1.....	.22	.430		.5584	66,075	23.74	48.00		24.05	49.06

* Omitted as beyond the limits of error.

SUMMARY.

Number of heats (omitting .20 carbon).....	130	
Average manganese.....	.3813	per cent.
Average phosphorus.....	.0511	per cent. for 91 heats.
Average original sectional area.....	.5702	square inch.
Average increase of tensile strength per .01 per cent. carbon.....	1,387.5	pounds.
Average decrease of final elongation per .01 per cent. carbon.....	.425	per cent.
Average increase of final area per .01 per cent. carbon.....	.600	per cent.

TABLE XLII.—Drillings for analysis generally taken from slab 21 inches wide by 4 inches to 7 inches thick.

CARBON PROPERTIES OF NORWAY STEEL.

[Chemical methods: For combined carbon, the color test; for manganese, a special volumetric process, checked occasionally by the nitric acid and chlorate of potash method.]

Number of heats.	Carbon.	Manganese.	Tests.			Plotted curves.		
			Average ultimate tensile strength per square inch.	Average final elongation.	Average final area.	Ultimate tensile strength per square inch.	Final elongation.	Final area.
	Per cent.	Per cent.	Pounds.	Per cent.	Per cent.	Pounds.	Per cent.	Per cent.
3	.11	.363	59,110	28.75	50.00	59,500	28.25	47.40
29	.12	.377	60,703	25.68	47.35	60,600	25.65	48.80
33	.13	.355	61,460	25.27	49.40	61,300	25.50	49.50
36	.14	.351	61,514	25.83	49.31	61,620	25.65	49.00
53	.15	.339	61,863	25.63	48.03	61,760	25.85	48.70
31	.16	.394	61,866	26.09	48.61	61,890	26.00	48.80
31	.17	.381	62,061	25.51	44.53	62,110	25.80	49.35
66	.18	.380	62,343	25.49	48.92	62,670	25.50	49.10
40	.19	.423	63,349	25.08	47.58	63,150	25.20	48.00
15	.20	.425	63,672	24.92	47.40	63,700	24.80	47.60
10	.21	.421	65,660	24.67	49.35	64,030	24.70	48.40
11	.22	.363	63,263	24.61	49.00	64,160	24.75	49.50
7	.23	.397	64,026	25.57	50.00	64,290	25.20	49.30
1	.24	.440	62,253	28.00	44.00	64,460	25.50	48.30
1	.26	.400	66,839	25.00	43.00	65,520	23.35	48.30
1	.27	.470	70,582	24.00	49.00	66,200	24.90	49.25
1	.31	.390	72,754	25.00	62.00	67,800	25.25	52.50

SUMMARY.

Number of heats.....	369
Average manganese.....	3778 per cent.
Average phosphorus (believed to be) not above.....	.06
Average increase of tensile strength per .01 per cent. carbon.....	419 pounds.
Average decrease of final elongation per .01 per cent. carbon.....	.078 per cent.
Average increase of final area per .01 per cent. carbon.....	.116 per cent.

TABLE XLIII.—Drillings for analysis generally taken from 7" by 7" blooms.

CARBON PROPERTIES OF CAMBRIA STEEL.

[Chemical methods: For combined carbon, the color test; for manganese, the acetate of soda and bromine process; for phosphorus, the molybdate of ammonia and yellow precipitate method.]

Number of heats.	Carbon.		Results of tests.										Results from plotted curves.				
	Pr. ct.	Sq. in.	Average original area.	Average elastic limit.	Average ultimate tensile strength.	Average elastic ratio.	Average final elongation.	Average final area.	Average modulus of elasticity.	Elastic limit.	Ultimate tensile strength.	Elastic ratio.	Final elongation.	Final area.	Modulus of elasticity.		
1	08	5281	37,038	58,920	62.87	27.05	49.25		
2	10	5584	41,450	61,544	67.35	25.98	50.88	27,930,000 for 1	38,450	58,300	65.95	26.80	51.00	27,480,000		
3	11	5890	84,603	61,303	64.60	25.63	52.12	27,550,000 for 1	38,835	59,270	65.53	26.65	51.00	27,490,000		
4	12	5636	40,222	61,368	65.55	26.78	47.75	25,920,000 for 1	39,230	60,280	65.10	26.45	51.00	27,510,000		
5	13	5781	40,391	63,023	64.09	25.75	52.18	27,920,000 for 14	39,650	61,200	64.73	26.20	51.20	27,510,000		
6	14	5476	51,542	63,616	65.30	25.24	51.59	27,660,000 for 5	40,060	62,100	64.52	25.95	51.35	27,530,000		
7	15	5689	41,318	64,923	63.98	25.15	53.11	27,860,000 for 5	40,900	63,690	64.30	25.70	51.60	27,530,000		
8	16	5683	41,318	63,913	64.64	25.39	53.50	28,394,000 for 5	41,400	64,290	64.40	25.50	52.25	27,540,000		
9	17	5450	42,825	66,012	65.18	24.40	54.88	26,720,000 for 4	41,860	64,700	64.49	25.35	52.80	27,550,000		
10	18	5410	42,850	66,473	65.19	24.40	54.88	26,720,000 for 4	42,300	65,180	64.70	25.20	53.30	27,570,000		
11	19	5548	42,850	66,473	64.47	24.53	54.82	27,223,000 for 3	43,600	65,350	63.90	24.80	54.10	27,580,000		
12	20	5548	42,850	66,473	64.47	24.53	54.82	27,223,000 for 3	43,770	66,150	63.90	24.75	54.30	27,580,000		
13	21	5548	42,850	66,473	64.47	24.53	54.82	27,223,000 for 3	43,770	66,150	63.90	24.75	54.30	27,580,000		
14	22	5548	42,850	66,473	64.47	24.53	54.82	27,223,000 for 3	43,770	66,150	63.90	24.75	54.30	27,580,000		
15	23	5576	43,174	67,630	65.83	23.82	54.47	28,740,000	44,150	67,100	63.65	24.70	54.10	27,610,000		
16	24	5396	42,210	66,123	65.84	23.35	51.67	28,140,000	44,150	67,100	63.65	24.70	54.10	27,630,000		
17	24	5396	42,210	66,123	65.84	23.35	51.67	28,140,000	45,250	68,123	66.43	24.60	53.80	27,650,000		

* Omitted as beyond the limits of error. Subsequent analysis of a test piece gave .14 C.

SUMMARY.

Number of heats	120
Average manganese (believed to be) about	.450 per cent.
Average phosphorus (believed to be) about	.085 per cent.
Average original sectional area	.5777 square inch.
Average increase of elastic limit per .01 per cent. carbon	453 pounds.
Average increase of tensile strength per .01 per cent. carbon	653 pounds.
Average decrease of final elongation per .01 per cent. carbon	.133 per cent.
Average increase of final area per .01 per cent. carbon	.187 per cent.

The average steepness of the curves of tensile strength is very different, being especially great for the Chester steel. Other things being equal, the less mechanical work to which the material of the chemical sample has been subjected the steeper the curves should be, the effect of work of reduction being to increase the combined carbon, as shown by color tests,* but the conditions are so variable that this effect has never been quantified. Again, the condition of the metal in the little test ingot as used at Chester is not the same as in the plate ingots, cast and cooled under very different circumstances. Some idea of this effect may be obtained by considering the tensile strengths which would correspond to complete absence of carbon in each of the three steels. Carbonless Cambria steel, the other elements remaining the same, should have a tensile strength of about 53,250 pounds, with a possible error of about 1,000 pounds. The Norway steel should give about 55,750 pounds, with a possible error of about 750 pounds. The Chester steel would give the extremely low value of about 40,500 pounds, with a possible error of about 500 pounds. It is therefore probable that the Chester curve loses its steepness rapidly below .10 per cent. carbon.

The steepness of the curves would further appear to be influenced by the amounts of other elements present. Thus the Cambria and Norway steels had both been worked a good deal when the piece for chemical test was removed, the Cambria having received the most work, as it had also in the pieces tested. Yet the difference in steepness is sufficiently great to render it probable that the higher phosphorus and, perhaps, manganese of the Cambria steel have increased the rate of increase of strength per point of carbon.

It will also be observed that in the Chester steel, as well as, more imperfectly, in the Norway steel, increasing carbon is accompanied by increasing manganese, due probably to diminished oxidation in the furnace.

As possibly affecting the general character of the curves, the average sectional area was obtained for the Chester and Cambria steels. As has been shown (Plate VIII.), the apparent tensile strength of the Chester steel may be influenced by the proportions of the test piece, even with an 8-inch length. This effect seems to hold good in the curve for this steel, in which it will be noticed that the effect of correcting for difference of sectional area from the average value would be to bring the spots nearer the mean curve. No such result appears to hold for the Cambria steel.

For all the steels, the sinuous nature of the curves for tensile strength, ductility, and final area is the most notable feature apart from the differences of average steepness. This is particularly remarkable in the Norway steel. The humps and hollows agree very well in the various curves for the same steel. Thus a hump in tensile strength lies under a corresponding hump in final area and under a hollow in elongation. In other words, the intrinsic quality, as measured by efficiency number, has undergone a more gradual change with change of carbon than any single property. And in each steel this property will be found to have increased with increasing carbon, pointing to the advisability of using higher carbon metal as far as improving workmanship will permit.

The curves of Cambria steel are much increased in value by the curves of elastic limit and elastic ratio. Although the original spots for elastic limit appear somewhat irregular, the first derived spots lie

* Thus it is not uncommon for rail metal of about .40 carbon in the ingot to show 3 to 4 points higher in the bloom and 2 to 3 points higher yet in the finished section.

with almost perfect regularity on the curve drawn, itself the most regular of all the properties.

The derived curve of elastic ratio forms a very valuable basis from which to measure the physical condition of the metal as regards roll hardening from cold finishing, or rapid cooling after finishing, and possibly other disturbing causes. Under the average conditions of finishing, it is seen that for each carbon there is a corresponding value of elastic ratio, any departure from which measures the difference of physical condition from the average. Thus, if the elastic ratio be higher than corresponds to the observed tensile strength, it is strong evidence that the steel is intrinsically softer than as indicated by ultimate strength alone, and has been hardened in the rolls or in cooling. This effect may, however, be interfered with by comparatively small variations of other chemical elements besides carbon, notably phosphorus; and as illustrating the method by which these or similar curves obtained under more standard conditions may be employed for quantifying some of the conditions known to affect the physical tests of the metal, it may be as well to state the method of procedure in such a case.

In analyzing the results of physical test of a piece of steel of known chemical composition made and tested under standard conditions, it is first necessary to examine the elongation and final area for evidence of dirtiness or lamination in the piece—the fracture should also have been examined for evidences of lamination; if these two qualities are sufficiently near the average we may proceed, otherwise little useful result can be obtained. Departures from the average values of phosphorus and manganese are next examined, and it is here necessary to digress to note the nature of the effects produced by variations of these elements under ordinary circumstances.

As a hardener, phosphorus is generally considered to be even more effective than carbon, but its secondary effects are very different. Other things remaining the same, increase of phosphorus, besides raising the tensile strength, notably raises the elastic ratio, diminishes elongation, and more especially diminishes the reduction of area. Its effect in diminishing elongation, and probably also reduction of area, appears to be largely dependent on the amount of other elements present, especially of silicon. For convenience, the latter element must be supposed to vary little, and be present in quantity not above .04 per cent., as is common in open-hearth steels. The effect of phosphorus is then identical in nature to that of cold rolling or finishing, and is to be taken account of in much the same manner. Thus, in estimating the effect of departure from the normal elastic ratio, the influence of variations of phosphorus will have been taken account of. Further, high phosphorus metal is more influenced by cold rolling than steel with less of that element. Once quantified, under the condition of low silicon, the effect of a given absolute amount of phosphorus may probably be relied upon as practically constant.

Not so with the other most variable element, manganese. The basis from which the effect of variation is to be estimated is itself variable. To illustrate this, it is only necessary to make use of observed variations in the rolling quality of the metal, which is especially influenced by manganese. Thus, of two steels of precisely the same final composition with respect to carbon, phosphorus, manganese, and sulphur, but made from different stock, or in different ways, one may roll well and the other badly. What is sufficient manganese for one is insufficient for the other. This difference arises either from the different conditions in which the manganese may exist in the steel—the most prob-

able cause—or the variable amounts remaining of the oxide of iron whose hot-shortening effect the manganese counteracts. Under average conditions of any given method of manufacture, it is probable that a certain amount of manganese is necessary to prevent hot shortness, which may be called the *saturating* amount of manganese, while only the excess over this amount is free to influence the properties of strength and toughness. In different manufactures, the point of “saturation” of manganese will probably be different, while two heats of the same manufacture may be expected to vary from one another in this respect, depending on the stock and treatment in the furnace. The effect of excess of manganese above this point is certainly to increase the tensile strength, but its influence in other respects is not so decided.

To quantify the effects of phosphorus or manganese above or below the average amounts, we must have a few tests of steel varying only in the amount of one of these elements from the average, from which, by comparison with the carbon curve, a derived curve can be constructed for the effect of such variations.

The same method must be used to quantify the effect of departure from the normal elastic ratio previously corrected for variation of phosphorus.

By this method of comparison very fair results have been obtained from the Cambria curves, but the number of tests with special chemical determinations is too limited for perfect accuracy. Of these a few may be instanced. Thus,

(Piece 4503—1.)

Phosphorus	per cent..	.084
Manganese	do....	.488
Ultimate tensile strength.....	pounds..	69,230
Elastic limit.....	do....	50,000
Corresponding elastic ratio.....	per cent..	72.22
Final elongation.....	do....	20.00
Final area.....	do....	69.50

An inspection of these results shows, from the high elastic ratio, low ductility, and reduction of area, that the high tensile strength is due to cold finishing or other mechanical hardening, since the phosphorus and manganese are very near the average values. Careful determination of combined carbon in the test piece itself gave .14 per cent., for which the tensile strength should be 62,900 pounds, with a normal elastic ratio of 64.39 per cent. Thus the increase of elastic ratio to 72.22 per cent., or by 7.83 per cent., has raised the tensile strength 6,330 pounds. This increase of tensile strength with increase of elastic ratio is not probably at a uniform rate, but more rapidly as the elastic ratio rises.

Again,

(Piece 4875—1.)

Phosphorus	per cent..	.084
Manganese	do....	.208
Ultimate tensile strength.....	pounds..	55,400
Elastic limit.....	do....	33,210
Corresponding elastic ratio.....	per cent..	59.95
Final elongation.....	do....	28.60
Final area.....	do....	44.00

This steel shows low manganese and low elastic ratio, the latter probably corresponding to comparatively rapid and hot finishing. Accurate carbon determination of the test piece gave .10 per cent., for which the normal elastic ratio is 65.53 per cent. Estimating the effect of defect of

elastic ratio below normal value as somewhat less than that of excess, the difference of tensile strength corresponding to the defect of elastic ratio of 5.58 per cent. may be stated at about 3,000 pounds; or, under average conditions of finishing, the tensile strength would be about 58,400 pounds. As the tensile strength under these conditions, with average manganese, would be 59,270 pounds, the defect of .24 per cent. of manganese below the average of .45 per cent. diminished the tensile strength by not more than 870 pounds, provided none of the defect of elastic ratio is due to the low manganese. An equal excess of manganese above the average value has a much greater influence on the tensile strength, the *saturating* amount for this steel being believed to be near .40 per cent.

If we now consider the special tests of this steel taken from the deck-beam web, as given in Table XXXI.—the tests from the flat given in the same table have been mentioned as showing probable cold straightening or other treatment such that the elastic limit is not sufficiently marked—we have for the mean of the two pieces—*

Phosphorus080
Manganese (one piece)386
Ultimate tensile strength	pounds.. 63,017
Elastic ratio	61.18
Final elongation	26.00
Final area	55.16

This steel shows slight departure from average conditions in manganese, phosphorus, and elastic ratio. The defect of manganese of .064 per cent. may be credited with about 200 pounds tensile strength. The normal elastic ratio corresponding to the tensile strength so increased to 63,217 pounds is about 64.35 per cent. The defect, therefore, is to be taken as 3.17 per cent., probably affecting the tensile strength by about 1,000 pounds. So that bringing this steel up to the average conditions the tensile strength would be about 64,217 pounds, corresponding to .16 carbon. The carbon of one piece was .14 per cent. and of the other .16 per cent.

The above special cases have been considered only in order to clearly show the method of comparison. Many of the assumptions made, though formed on much more extended comparison, are still crude. Above all, the condition of the manganese is always uncertain, and something of the history of the stock and working in the furnace is necessary for any nice estimate of its effect. Nevertheless, the consistency of the physical and chemical condition of steel of this manufacture, tested as this was under fairly standard conditions, is truly surprising, and the method is highly suggestive of that which should be pursued in treating the results of steel of given manufacture tested physically and chemically under absolutely standard conditions, with special regard to the chemical determinations being made on the metal of the test piece itself. Under such circumstances alone can the complex influences affecting the behavior of a piece of steel be separately quantified and nicely balanced, and, from comparison of such results from steels of different manufacture, conclusions of the very highest interest may be also expected.

Combination or comparison of the curves obtained for the three steels is not possible with any accuracy, the conditions of physical treatment, manufacture, and carbon determinations being too widely different. It

* For particularly careful determinations of phosphorus and manganese in these and other pieces, the Board is much indebted to Mr. F. E. Bachman, chemist to the Phoenix Iron Company, and for specially determined carbons to Mr. T. T. Morrell, chemist to the Cambria Iron Company.

appears probable, however, that open-hearth mild steel of about .07 per cent. phosphorus, tested under the average conditions of this inspection, should show an average increase of tensile strength of not far from 650 pounds per square inch for an increase of .01 per cent. of carbon in the finished product with a simultaneous decrease of from .10 to .12 per cent. of final elongation in a piece of average dimensions, 60,000 pounds tensile strength and 27 per cent. elongation corresponding to about .10 per cent of carbon by color test in the test piece itself.* Large variations from these average results are to be expected from varying conditions of treatment and manufacture.

* It has long been known that the rate of increase of tensile strength itself increases with increasing carbon.

APPENDIX.

TESTS FOR PLATE, BEAM, ANGLE, BULB, AND BAR STEEL, USED IN BUILDING SHIPS FOR HER MAJESTY'S NAVY.

ADMIRALTY, November 3, 1880.

Strips cut lengthwise or crosswise to have an ultimate tensile strength of not less than 26, and not exceeding 30, tons per square inch of section, with an elongation of 20 per cent. in a length of 8 inches. The beam, angle, bulb, and bar steel to stand such forge tests, both hot and cold, as may be sufficient, in the opinion of the receiving officer, to prove soundness of material and fitness for the service.

Strips cut crosswise or lengthwise $1\frac{1}{2}$ inches wide, heated uniformly to a low cherry red and cooled in water at 80° Fah., must stand bending in a press to a curve of which the inner radius is one and a half times the thickness of the steel tested.

The strips are all to be cut in a planing machine, and to have the sharp edges taken off.

The ductility of every plate, beam, angle, &c., is to be ascertained by the application of one or both of these tests to the shearings, or by bending them cold under the hammer.

All steel to be free from lamination and injurious surface defects.

One plate, beam, or angle, &c., is to be taken for testing from every invoice, provided the number of plates, beams, or angles, &c., does not exceed fifty. If above that number, one for every additional fifty or portion of fifty. Steel may be received or rejected without a trial of every thickness on the invoice.

The pieces of plate, beam, or angle, &c., cut out for testing are to be of parallel width from end to end, or for at least 8 inches of length.

Plates will be ordered by weight per superficial foot: the weight named will always be the greatest that will be allowed for ship plates and for boiler plates under 4 feet in width; a latitude of 5 per cent. below this will be allowed for rolling in plates $\frac{1}{2}$ an inch in thickness and upwards and 10 per cent. in thinner plates. In plates for boilers over 4 feet wide and $\frac{1}{2}$ inch thick and upward a latitude of 2 $\frac{1}{2}$ per cent. above and 2 $\frac{1}{2}$ per cent. below will be allowed for the springing of the rolls, and 5 per cent. above and 5 per cent. below will be allowed in thinner plates over 4 feet wide. The average weight per foot of the plates ordered is to be ascertained by weighing not less than 10 tons at a time when larger parcels than 10 tons are delivered; if these 10 tons exceed the due weight (calculated as stated above), or are more than the beforementioned percentage below it, the whole may be rejected. In smaller deliveries than 10 tons the average is to be ascertained by weighing the whole parcel. The same conditions as to latitude and mode of ascertaining weight apply also to other descriptions of steel in the contract.

ADMIRALTY SPECIFICATIONS OF STEEL FOR BOILERS.

STEEL PLATES, BARS, RIVETS, &C.

The whole of the material used in boilers is to be obtained from steel makers whose names are to be submitted for approval. The steel is to be subject to the usual tests at the works of the manufacturer, under the supervision of the resident Admiralty overseer.

TESTS FOR STEEL PLATES, ANGLE, TEE, AND BAR STEEL.

The tests are as follows: Strips cut lengthwise or crosswise, to have an ultimate tensile strength of not less than 26 tons, and not exceeding 30 tons per square inch of

section, with an elongation of 20 per cent. in a length of 8 inches. The angle, tee, and bar steel and rivets to stand such forge tests, both hot and cold, as may be sufficient, in the opinion of the overseer, to prove soundness of material and fitness for the service intended.

Strips cut lengthwise or crosswise, $1\frac{1}{2}$ inches wide, heated uniformly to a low cherry-red, and cooled in water of 82° Fahr., must stand bending double in a press to a curve, of which the inner radius is one and a half times the thickness of the steel tested.

The strips are all to be cut in a planing machine, and to have the sharp edges taken off.

The ductility of every plate, angle, &c., is to be ascertained by the application of one or both of these tests to the shearings, or by bending them cold by the hammer.

All steel is to be free from lamination and injurious surface defects.

The pieces of plate, angle, &c., cut out for testing are to be of parallel width from end to end, or for at least 8 inches of length.

STEEL FOR FURNACES. TESTS.

The furnaces and combustion chambers are to be made of steel of special soft quality. In addition to the above tests, these plates are to be tested by welding and forging, and some of the welded pieces are to be broken in the testing machine to ascertain the efficiency of the welding. The tensile strength of these plates must not exceed 25 tons per square inch.

STEEL CASTINGS. TESTS.

All steel castings for engines are to satisfy the following conditions: Tensile strength between 28 and 32 tons per square inch, with an extension in 8 inches of length of at least 10 per cent. Bars of the same metal $1\frac{1}{2}$ inches square should be capable of bending cold without fracture, through an angle of 90° , over a radius not greater than 2 inches. Test pieces are to be taken from each important casting.

ADMIRALTY INSTRUCTIONS FOR TREATMENT OF MILD STEEL.

(1) All plates or bars which can be bent cold are to be so treated; and if the whole length cannot be bent cold, heating is to be had recourse to over as little length as possible.

(2) In cases where plates or bars have to be heated, the greatest care should be taken to prevent any work being done upon the material after it has fallen to the dangerous limit of temperature known as a "blue heat"—say from 600° to 400° F. Should this limit be reached during working, the plates or bars should be reheated.

(3) Where plates or bars have been heated throughout for bending, flanging, &c., and the work has been completed at one heat, subsequent annealing is unnecessary.

(4) Where simple forge-work has been done, such as the formation of the joggles, corners, and easy curves or bends, on portions of plates or bars, and the material has not been much distressed, subsequent annealing is unnecessary.

(5) Plates or bars which have had a large amount of work put upon them while hot, and have had to be reheated; should be subsequently annealed. It is preferred that this annealing should be done simultaneously over the whole of each plate or bar when this can be done conveniently. If it is inconvenient to perform the operation of annealing at one time for the whole of a plate or bar, portions may be annealed separately, proper care being taken to prevent an abrupt termination of the line of heat. If the severe working has been limited to a comparatively small part of a plate or bar, annealing may be limited to the parts which have been heated, the same care being taken to prevent an abrupt termination of the line of heat.

(6) If desired, exceptionally long or quickly curved bars, such as frames, may be formed of shorter pieces, with the butts suitably shifted and strapped.

(7) In cases where any bar or plate shows signs of failure or fracture in working, the details of the cases should be forwarded to the admiralty, in order that instructions may be given as to the disposal of the bar or plate.

(8) It is not necessary to anneal plates or bars after punching, as a means of making good damage done in punching. For plating which forms an important feature in the general structural strength, such as the outer bottom plating, deck plating, deck stringers, &c., all butt straps shall have the holes drilled or be annealed after the holes are punched. In outer bottom plating, the holes, which are to be countersunk, should be punched about $\frac{1}{4}$ inch less in diameter than the rivets which are used, the enlargement of the holes being made in the countersinking, which should in all cases be carried through the whole thickness of the plates.

(9) Snap riveting is only to be employed for the internal work on transverse bulk-heads, floors, framing, and other subordinate parts of the structure, but on stringers, deck plating, and other parts subjected to considerable tensile strain countersunk riveting is to be used, and the holes treated similarly to those in the outside plating.

(10) It is important that the whole surface of the bottom plating should be thoroughly cleared of the scale formed in manufacture before any paint or composition is put upon it. Detailed instructions as to the methods of removing the scale are given on NS. 3,590 of January 24, 1881.

ADMIRALTY, September 1, 1881.

BRITISH ADMIRALTY CODE OF TESTS FOR STEEL RIVETS.



(1) The rivets are to be made at the works of a firm approved of by the controller of the navy, and in strict accordance with the dimensions given in the schedule and with the drawings hereunto annexed. Each rivet is to be marked in one place with the broad arrow. They are to be supplied of any length demanded.

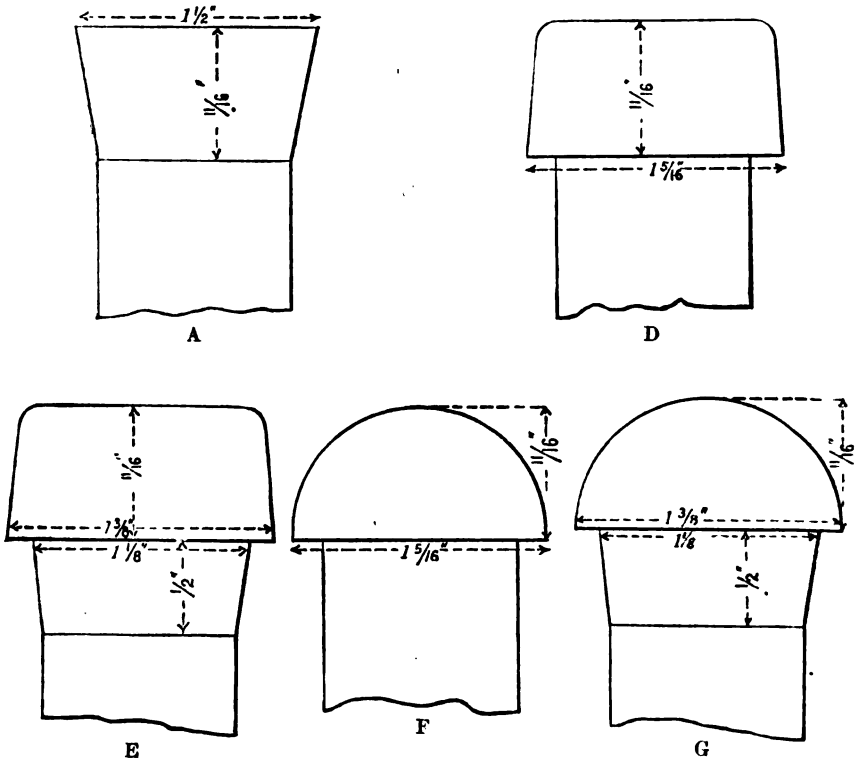

Drawings of 1-inch rivets of the several descriptions specified in the schedule herewith.

(2) The rivets are to be made from steel bars having an ultimate tensile strength of not less than 26 and not more than 30 tons per square inch, with a minimum elongation of 20 per cent. in a length of 8 inches. A portion of one bar to be taken for testing from every fifty, or portion of fifty, before making into rivets.

Pieces cut from every bar, heated uniformly to a low cherry-red, and cooled in water of 82° F. must stand bending in a press to a curve of which the inner radius is equal to the radius of the bar tested.

TESTS.

(3) The whole of the said rivets are to be properly heated in making, and care is to be taken that the finished rivets cool gradually. The rivets are to stand the following forge tests:

(a) Bending cold without fracture in the manner shown in Fig. 1 in the annexed diagram, where the line A B equals one diameter of the rivet.

(b) Bending hot without fracture in the manner shown in Fig. 2.

(c) Flattening of the rivet head, while hot, in the manner shown in Fig 3, without cracking at the edges. The head to be flattened until its diameter is $2\frac{1}{4}$ times the diameter of the shank.

(d) The shank of the rivet to be nicked on one side and bent over to show the quality of the material.

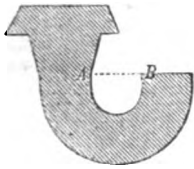

Fig. 1.



Fig. 2.

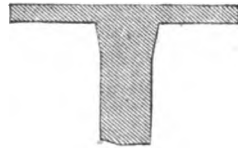

Fig. 3.

One rivet in every hundred to be forge-tested as a sample.

(4) Any such person or persons as their lordships shall from time to time direct or appoint shall be suffered to enter into and inspect the manufactory or works belonging to the maker of the rivets when the said rivets are being manufactured. And such inspector shall be at liberty to test the material to be supplied, in any manner he may see fit, and a proper testing machine shall be kept at the works for this purpose, at the expense of the contractor. Rivets which have passed inspection by the inspector shall be marked by the contractor in any manner the inspector may desire, and when so marked shall not be subject to rejection.

The materials and labor necessary to carry out tests are to be found by the contractor.

Schedule of dimensions.

Diameter of rivet.	With pan or snap heads and straight necks to drawing D or F.		With countersunk heads to drawing A.		With pan or snap heads and conical necks to drawing E or G.			
	Diameter of head.	Depth of head.	Diameter of head.	Depth of head.	Diameter of head.	Depth of head.	Diameter under head.	Depth of cone.
Inch. 1½	1½	1			2	1	1½	½
1¼	1¼	¾	1¼	¾	1½	¾	1½	⅝
1½	1½	¾	1½	¾	1¾	¾	1½	½
1	1¾	¾	1½	¾	1½	¾	1½	½
¾	1¾	¾	1½	¾	1½	¾	1½	⅝
½	1¾	⅝	1½	⅝	1¾	⅝	1½	¾
¾	¾	¾	1	⅝	¾	¾	1½	⅝
½	¾	¾	¾	¾	¾	¾	¾	¾
¾	¾	¾						
¾	¾	¾						
¾	¾	¾						
¾	¾	¾						

TESTS FOR PLATE AND OTHER IRON USED IN BUILDING SHIPS FOR HER MAJESTY'S NAVY.

ADMIRALTY, July 3, 1880.

PLATE-IRON (FIRST CLASS).

B. B.

Tensile strain per square inch.—Lengthways, 22 tons; crossways, 18 tons.

Forge test (hot).—All plates of the first class, of 1 inch in thickness and under, should be of such ductility as to admit of bending hot to the following angles: Lengthways of the grain, 125 degrees; across, 90 degrees.

Forge test (cold).—All plates of the first class should admit of bending cold, without fracture, as follows:

For plate-iron of first class, or B. B., and of middle class.

Thickness of plate.	With the grain.	Across the grain.	Thickness of plate.	With the grain.	Across the grain.
	Through an angle of—	Through an angle of—		Through an angle of—	Through an angle of—
1 inch.....	0	0	$\frac{5}{8}$ inch.....	0	0
	15	5	$\frac{3}{4}$ inch.....	30	12 $\frac{1}{2}$
$\frac{3}{4}$ inch.....	15	5	$\frac{1}{2}$ inch.....	35	15
$\frac{1}{2}$ inch.....	20	7 $\frac{1}{2}$	$\frac{3}{8}$ inch.....	42 $\frac{1}{2}$	17 $\frac{1}{2}$
$\frac{1}{4}$ inch.....	20	7 $\frac{1}{2}$	$\frac{1}{4}$ inch.....	50	20
$\frac{3}{8}$ inch.....	22 $\frac{1}{2}$	10	$\frac{3}{8}$ inch.....	60	25
$\frac{1}{2}$ inch.....	25	10	$\frac{1}{2}$ inch.....	70	30
$\frac{3}{4}$ inch.....	27 $\frac{1}{2}$	12 $\frac{1}{2}$			

PLATE-IRON (MIDDLE AND SECOND CLASS).

B.

Tensile strain per square inch.—Lengthways, 20 tons; crossways, 17 tons.

Forge test (hot).—All plates of the second class, of 1 inch in thickness and under, should be of such ductility as to admit of bending hot, without fracture, to the following angles: Lengthways of the grain, 90 degrees; across grain, 60 degrees.

Forge test (cold).—All plates of the second class should admit of bending cold, without fracture, as follows:

For plate-iron of second class, or B.

Thickness of plate.	Width of grain.	Across the grain.	Thickness of plate.	Width of grain.	Across the grain.
	Through an angle of—	Through an angle of—		Through an angle of—	Through an angle of—
1 inch.....	0	0	$\frac{5}{8}$ inch.....	0	0
	10	$\frac{3}{4}$ inch.....	25	7 $\frac{1}{2}$
$\frac{3}{4}$ inch.....	10	$\frac{1}{2}$ inch.....	30	10
$\frac{1}{2}$ inch.....	15	$\frac{3}{8}$ inch.....	37 $\frac{1}{2}$	12 $\frac{1}{2}$
$\frac{1}{4}$ inch.....	15	$\frac{1}{4}$ inch.....	45	15
$\frac{3}{8}$ inch.....	17 $\frac{1}{2}$	5	$\frac{3}{8}$ inch.....	55	17 $\frac{1}{2}$
$\frac{1}{2}$ inch.....	20	5	$\frac{1}{2}$ inch.....	65	30
$\frac{3}{4}$ inch.....	22 $\frac{1}{2}$	7 $\frac{1}{2}$			

Plates, both hot and cold, should be tested on a cast-iron slab, having a fair surface, with an edge at right angles, the corner being rounded off with a radius of half an inch.

The portion of the plate tested, for both hot and cold tests, is to be 4 feet in length, across the grain, and the full width of the plate with the grain.

The plate should be bent at a distance of from 3 to 6 inches from the edge.

It is intended that all the iron shall stand the forge tests herein named, when taken four-feet in lengths, across the grain, and the whole width of the plate along the grain, whenever it may be necessary to try so large a piece, but a smaller sample will generally answer every purpose.

All plates to be free from lamination and injurious surface defects.

One plate to be taken indiscriminately for testing from every thickness of plate sent in per invoice, provided they do not exceed fifty in number, or portion of fifty.

Where plates of several thicknesses are invoiced together, and there are but few plates of any one thickness, a separate test for plates of each thickness need not be made; but no lot of plates of any one thickness must be rejected before one of that lot has been tested.

MOLDED IRON.

Including angle, bulb, tee, angle-bulb, tee-bulb, channel, and other descriptions of molded iron of ordinary form.

Tensile strain per square inch with the grain, for every description, 22 tons.

The ductility and other qualities of the iron should be such as to admit of its being bent hot and cold in the following manner, without fracture:

ANGLE-IRON.

Forge test (hot). - Angle-iron should be tested hot by being bent, thus:

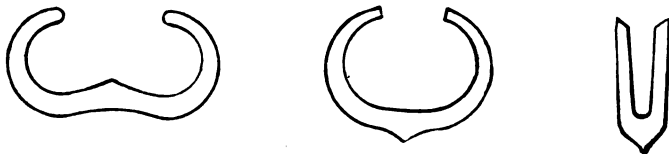

and also by being flattened, thus:



and the end bent over, thus:

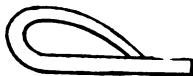

Forge test (cold). - Angle-iron should also be notched and broken across cold, to show the quality of the iron, and one flange should be cut off and bent cold, thus:



TEE-IRON.

Forge test (hot). - Tee-iron should be tested hot by being bent, thus:



Forge test (cold).—The cold test for tee-iron should be similar to that for angle-iron.

TEE-BULB IRON.

Forge tests (hot and cold).—Tee-bulb iron should be tested hot by cutting off the bulb and testing the remainder in the same manner as tee-iron, and the bulb should be notched on one side and broken cold to show the quality of the iron.

ANGLE-BULB IRON.

Forge tests (hot and cold).—Angle-bulb iron should be tested in the same manner as angle-iron, after the bulb has been cut off, and the bulb itself should be tested similarly to that of the tee-bulb iron.

BULB IRON.

Forge tests (hot and cold).—Bulb iron should be tested hot by cutting off the bulb and bending with the web across the grain, thus:



and the bulb should be notched on one side and broken cold, to show the quality of the iron.

CHANNEL IRON.

Forge tests (hot and cold).—Channel iron should be tested hot by being bent thus:



and one of the flanges should be cut off and bent cold, as for angle iron. A sample should be notched and broken cold, to show the quality of the iron.

OTHER DESCRIPTIONS OF MOLDED IRON.

Other descriptions of molded iron should be tested in a similar manner to the foregoing, according to the form.

All molded iron to be free from lamination and injurious surface defects.

One sample should be taken indiscriminately for testing from every description of molded iron included in one invoice, provided the number of bars of the same kind so included does not exceed fifty; and if this number is exceeded, one sample is to be taken for every additional fifty or portion of fifty.

BAR AND OTHER IRON.

Including flat or round bar, molding, wash-bar, half-round, and segmental iron, nail-rod iron, hoop-iron, &c.

In this kind of iron that marked "Best Best" should in every case stand a tensile strain, with the grain of 22 tons per square inch, and the whole of the iron should stand such forge tests, both hot and cold, as may be deemed expedient.

The foregoing tests, and such others as may be considered necessary by the controller of the Navy and the overseer, are to be carried out by, and at the expense of, the ship contractors.

TESTS FOR BOILER-PLATE IRON.

Tensile strain per square inch.—Lengthways, 21 tons; Crossways, 18 tons.

Forge test (hot).—All plates of one inch in thickness and under should be of such ductility as to admit of bending hot, without fracture, to the following angles: Lengthways of the grain, 125 degrees; across the grain, 100 degrees.

Forge Test (cold).

Thickness of plate.	With the grain.	Across the grain.
	Through an angle of—	Through an angle of—
	°	°
1 inch.....	15	5
$\frac{1}{8}$ inch.....	17.5	6.5
$\frac{1}{4}$ inch.....	20	7.5
$\frac{3}{8}$ inch.....	22.5	9
$\frac{1}{2}$ inch.....	25	10
$\frac{5}{8}$ inch.....	28	11.5
$\frac{3}{4}$ inch.....	32.5	12.5
$\frac{7}{8}$ inch.....	37.5	14
1 inch.....	42.5	17.5
$\frac{1}{8}$ inch.....	48.5	20
$\frac{1}{4}$ inch.....	55	25
$\frac{3}{8}$ inch.....	65	30
$\frac{1}{2}$ inch.....	75	35

REQUIREMENTS FOR STEEL FOR HULLS AND BOILERS OF SHIPS FOR THE FRENCH NAVY.

[No. 52.—The minister of marine and of the colonies to the vice-admirals commanding in chief, maritime prefects, the directors of the establishment d'Indret, and the Forges de la Chaussade. *Second direction*, material; fourth bureau, general supplies; first bureau, naval construction.]

Classification of steel plates and rolled bars—Instructions as to their use and the tests to which they are to be subjected for acceptance.

PARIS, February 9, 1885.

GENTLEMEN: The somewhat extended trial which the navy has made of the circular of May 11, 1876, modified by that of May 7, 1877, permits me to state that the conditions relating to the tensile tests, besides assigning practically too narrow limits to the manufacture, correspond to a quality of steel which was not always sufficiently mild for the purpose intended.

The progress realized for several years in this branch of metallurgy has led me to omit from the new circular the gradations of price assigned to the different classes of steel plates; they were exaggerated, and would occasion, if continued, a sensible loss to the treasury. It is sufficient, in taking account of the difficulties of manufacture, to establish wide divisions, much more simple, for each of which the contractors must fix distinct prices in their tenders.

The new circular contains also certain modifications of less importance, which will be made sufficiently evident by a comparative examination.

Consequently I have decided that the following instructions shall replace those of May 11, 1876, and of May 7, 1877. Its insertion in the official bulletin of the navy will be sufficient notification.

Receive, &c.,

A. PEYRON.

Classification of plates, and of strips and straps, according to their dimensions.

(February 9, 1895.)

Plates are defined by a width greater than 400 millimeters (15½ inches). The denomination of strips and straps [bandes ou couvre-joints] is reserved for those whose width does not exceed 400 millimeters.

SUBDIVISION OF PLATES.

Plates will form four divisions—thin plates, medium plates, thick plates, and extra wide thick plates—as follows:

(1) *Thin* plates, from 1½ millimeters [.059 inch] thick to 4 millimeters [.1575 inch], exclusive, of 1.60 meters [63 inches] maximum width and 7 meters [22 feet 11.6 inches] maximum length.

(2) *Medium* plates, from 4 millimeters [.1575 inch] to 8 millimeters [.315 inch] thick, exclusive of 1.80 meters, [70½ inches] maximum width and 8 meters [26 feet 3 inches] maximum length.

(3) *Thick* plates, from 8 millimeters [.315 inch] thick and above, of 1.80 meters [70½ inches] maximum width, and 10 meters [32 feet 9½ inches] maximum length.

(4) *Extra wide thick* plates of 8 millimeters [.315 inch] and over in thickness, between 1.80 meters [70½ inches] and 2.10 meters [82½ inches] wide, and a maximum length of 10 meters [32 feet 9½ inches].

Plates not rectangular, but with straight sides, may be demanded, and will be paid for at the rate of 3 francs per 100 kilograms [about ¼ cent per pound] more than the rectangular plates from which they were cut.

SUBDIVISION OF STRIPS AND STRAPS.

(1) *Thin* strips, from 1½ millimeters [.059 inch] to 4 millimeters [.1575 inch], exclusive, and of 7 meters [22 feet 11½ inches] maximum length.

(2) *Medium* strips, 4 millimeters [.1575 inch] to 8 millimeters [.315 inch] thick, exclusive, and of 8 meters [26 feet 3 inches] maximum length.

(3) *Thick* strips, 8 millimeters [.315 inch] and over thick, and of 10 meters [32 feet 9½ inches] maximum length.

Forms of tenders, inserted after the conditions of contract, will be made so that bidders may affix a price for each of these subdivisions.

Extra thin plates and strips below 1½ millimeters [.059 inch] thick, and thin, medium, and thick plates and strips, which, by their width and length, may not be comprised in the above classification, will be the subject of special contracts.

TESTS OF ACCEPTANCE.

To insure the quality of steel plates and strips, three kinds of tests will be made: (1) cold tests; (2) hot tests; (3) temper tests.

(1) *Cold tests*.—The object of these tests will be to determine the resistance of the metal to rupture and its capacity for elongation both with and across the grain (always provided the width is sufficient).

The mean results of resistance and elongation in these two directions will be separately obtained, by at least five tests for each.

For these tests, pieces will be cut from a certain number of sheets or strips taken at random from each delivery. These pieces will be fashioned so as to have a rectangular section of which the smaller side is the thickness of the piece, and the longer side will be 30 millimeters [1.181 inch] for plates of 4 millimeters [.1575 inch] and over, and 20 millimeters [.7874 inch] for plates of less than 4 millimeters [.1575 inch], i. e., for plates called *thin*. However, for plates of 20 millimeters [.7874 inch] and over, the width should be equal to the thickness, so that the section of the piece will be a square of side equal to the thickness.

The length of the prismatic portion taken for tension will be always exactly 20 centimeters (7.874 inches) laid off by two punch marks, and terminating in fillets, so that rupture may always take place between the punch marks.

On no account may the pieces be reheated after being removed from the sheets.

Each piece shall be subjected to an initial load determined so as to produce a stress equal to eight-tenths of the breaking stress calculated according to the accompanying tables. This first load will be maintained in action for one minute, unless the piece continues to stretch after this lapse of time, when no further load will be added until the elongation ceases.

At intervals of a quarter of a minute successive loads will be added of one-half kilo-

gram per square millimeter (711 pounds per square inch); these intervals may always be prolonged when necessary, i. e., so that no additional load may be added while the piece continues to stretch under the preceding load. The elongation corresponding to each load will be noted as measured on the length of 20 centimeters between punch marks.

No test piece considered satisfactory is to break under the initial load, whatever the corresponding elongation; nor give a final elongation less than eight-tenths of the final elongation demanded, whatever may be the corresponding breaking load.

The least mean breaking loads per square millimeter of original section, and the least elongations per cent. demanded of pieces subjected to test, are given in the annexed Table I. for plates, and in Table II. for strips and straps.

It will be observed that for plates no distinction is made between the results demanded with and across the grain. The figures of Table I. are to be obtained for both directions.

Not so for strips. Here, indeed, from the method of rolling, the strength and elongation with the grain should be greater than across it; besides, for narrow strips, in most cases test pieces cannot be taken across the grain. Accordingly Table II. has different figures for the two cases.

TABLE I.—Plates.

Thickness.		Ship plates.			Boiler plates.		
		Least mean stress.		Least mean final elongation.	Least mean stress.		Least mean final elongation.
Millimeters.	Inches.	Kilos. per sq. mm.	Lbs. per sq. inch.		Per cent.	Kilos. per sq. mm.	
1½ to 2	.069 to .079, exclusive	47	66,830	10			
2 to 3	.079 to .118, exclusive	46	65,420	13			
3 to 4	.118 to .1575, exclusive	45	63,990	16			
4 to 6	.1575 to .236, exclusive	45	63,990	18	45	63,985	22
6 to 8	.236 to .315, exclusive	43	61,150	21	42	59,720	25
8 to 20	.315 to .787, exclusive	42	59,730	22	42	59,720	26
20 to 30	.787 to 1.181, inclusive	42	59,730	24	40	56,890	26

A reduction will be allowed in the least mean resistance up to 2 kilograms (2,844 pounds) provided this deficiency is compensated for by such an increase of elongation that the sum of the resistances and elongations is not less than as given in the table.

Not the least reduction of elongation will be allowed.

TABLE II.—Strips or straps.

Thickness.		Lengthways.			Crossways.		
		Least mean stress.		Least mean final elongation.	Least mean stress.		Least mean final elongation.
Millimeters.	Inches.	Kilos. per sq. mm.	Lbs. per sq. inch.		Per cent.	Kilos. per sq. mm.	
1½ to 4	.069 to .1575, exclusive	47	66,830	13	45	63,990	12
4 to 6	.1575 to .236, exclusive	46	65,410	19	44	62,570	17
6 to 8	.236 to .315, exclusive	44	62,570	22	42	59,720	20
8 to 20	.315 to .787, exclusive	43	61,140	23	41	58,300	21
20 to 30	.787 to 1.181, inclusive	43	61,140	25	41	58,300	23

A reduction will be allowed in the least mean resistances to the same extent and with the same compensation of elongation as for plates.

(2) *Hot tests.*—The test will consist in forming from a piece of plate of suitable dimensions a hemispherical cup, with a flat rim retained in the original plane of the plate.

The diameter of the hemisphere, measured on the inside, is to be equal to forty times the thickness of the plate, and the width of the flat circular rim is to be ten times this thickness. This flat rim is to join on to the spherical part by a bend, of which the radius, measured on the inside of the angle, shall be, at most, equal to the thickness of the plate.

Besides this, for plates of more than 5 millimeters thickness there shall be fashioned a box with a square base, with the sides at right angles with the plane of the plate; the base of this box shall have for its side thirty times the thickness of the plate, and the raised rims, measured on the inside, shall have for their height ten times this thickness. The bottom of this box shall be pierced in the middle with a circular hole, with edges raised at right angles to the plane of the bottom, and on the opposite side to that of the rim of the box. The diameter of this hole, measured on the inside after the work is done, is to be twenty times the thickness of the plate, and the height of the raised edge is to be five times this thickness. All angles are to be rounded, their internal bend having for radius the thickness of the plate.

The pieces so fashioned, with all the precautions required in working steel, must present neither flaws nor cracks even after cooling in a strong current of air.

The box test is not obligatory, but is left to the discretion of the engineer in charge.

(3) *Temper test.*—For these trials, pieces will be cut from the sheets presented for acceptance 26 centimeters (10½ inches) long by 4 centimeters (1.575 inches) wide, both with and across the direction of rolling; for strips and straps they will be taken only lengthways. The pieces prepared for these tests are not to have their long edges rounded off, the only treatment permitted being to remove the sharpness of the edges with a fine file. They will be uniformly heated so as to be brought to a low cherry red, and then plunged in water at 28° centigrade. Thus prepared they are to take under a press, without sign of rupture, a permanent bend of least internal radius not exceeding the thickness of the piece tested.

Similar pieces when taken from boiler plates must stand, under a press, without sign of rupture, being folded over flat, so that the two halves shall be in perfect contact with one another.

Plates which will not satisfy the conditions detailed above will be rejected.

ROLLED BARS.

To insure the quality of the different kinds of rolled bars of steel, three kinds of tests will be made as for plates: cold tests, temper tests, and hot tests.

(1) *Cold tests.*—The object of these tests will be to determine the resistance of the metal to rupture and its capacity for elongation. For this purpose, pieces will be cut from the webs under the same conditions as for steel plates. The thickness shall be that of the webs, the width the same as for steel plates of the same thickness, i. e., 30 millimeters for webs of 4 millimeters in thickness and over, and 20 millimeters for webs less than 4 millimeters thick.

The initial load will be determined so as to produce a tensile stress equal to eight-tenths of the breaking stress calculated from the following table.

The tests will be then conducted as prescribed for plates.

No piece considered satisfactory is to break under the initial load nor give a final elongation less than eight-tenths of the mean final elongation required.

The least mean stresses per square millimeter of original section, under which the pieces may break and the corresponding least elongation are given in the following table:

Thickness of webs.		Angles, bulb-bars, and plain T-bars.			Bulb-beams H, U, and Z-bars.			Angles for boilers.			
		Least mean stress.	Least mean final elongation.		Least mean stress.	Least mean final elongation.		Least mean stress.	Least mean final elongation.		
M. m.	Inches.	Kilos per sq. m. m.	Lbs. per sq. in.	Per ct.	Kilos per sq. m. m.	Lbs. per sq. in.	Per ct.	Kilos per m. m.	Lbs. per sq. in.	Per ct.	
2 to 4.	.079 to .1575, exclusive...	46	65,410	18	46	65,410	16	46	65,410	21
4 to 6.	.1575 to .236, exclusive...	44	62,570	22	44	62,570	20	44	62,570	26
6 to 8.	.236 to .315, exclusive...	44	62,570	22	44	62,570	20	44	62,570	26
8	.315 and over.....	42	59,720	24	44	62,570	22	42	59,720	26

The same reduction of 2 kilograms in the minimum breaking stresses is allowed as for plates, under the same conditions of increase of the corresponding final elongation. No reduction whatever is allowed in the elongations.

(2) *Temper tests.*—For these tests there shall be cut from the webs of bars presented for acceptance strips 26 centimeters (10½ inches) long and 40 millimeters (1.575 inches) wide, with the same precautions as for plates. As for the latter, they will be heated to a low cherry red and plunged into water at 26° centigrade. They must be able to take under a press a permanent set of internal radius not greater than 1½ times the thickness of the bar tested, except for angles for boilers. These must stand being bent to an inner radius at least equal to their thickness.

(3) *Hot tests.*—Angles will be subjected to the following tests:

A piece cut from the end of a bar taken at random from each delivery shall be formed into a ring such that one flange remaining in its own plane, the other flange forms a cylinder of internal diameter equal to three and a half times the width of the flange remaining flat. A piece cut from the end of another bar shall be opened out until the two faces are practically in the same plane. A piece from the end of a third bar shall be closed until the two flanges are in contact. The angles subjected to these tests must show neither cracks, cliffs, nor flaws.

Channel () and Z bars will be subjected to the same tests, the middle web being split for a suitable distance so as to get an angle with equal flanges.

Single T bars will be subjected to the following tests:

A piece cut from the end of a bar taken at random from each delivery shall be formed into a half ring such that the central flange remaining in its own plane the other may form a half cylinder of internal diameter equal to 4 times the depth of the T.

At the end of another bar taken by chance from the same delivery the central flange will be split up the middle for a length equal to 3 times the total depth of the bar and a hole drilled at the end of the slit to prevent its spreading; the piece so separated shall be opened out in its own plane to an angle of 45° with the other flange. Care must be taken to keep the flange opened out reasonably straight, it being joined on to the rest of the bar with a curve of small radius.

The bars subjected to these tests must show neither cracks, cliffs, nor flaws.

Bulb T and I beams will be subjected to the following tests: At the end of a bar selected at random from each delivery, the central web will be split up the middle for a length equal to three times the total depth of the bar, and a hole drilled at the end of the slit to prevent its spreading; then one of the two parts shall be opened out at one or more heats, the central flange remaining in its own plane, so that the two pieces make an angle of approximately 45° with each other. For bulb bars the part bent out shall be that which carries the bulb. Care must be taken to keep the part worked sensibly straight, and to join it on to the rest of the bar with a curve of small radius.

Angles and molded bars which will not satisfy these conditions will be rejected.

A. PEYRON.

Minister of Marine and of the Colonies,

PARIS, February 9. 1885.

TESTS OF STEEL REQUIRED BY LLOYD'S REGISTER OF BRITISH AND FOREIGN SHIPPING.

The steel to be used in ships building for classification in the register book will be required to withstand the whole of the following tests, to be applied at the steel works under the personal inspection of the society's surveyors, to samples selected by them from every charge or cast employed in the manufacture of the material, and these samples, when marked by them for testing, should be followed by the surveyors through the different stages of preparation until the tests are completed.

The committee will require that every plate, beam, and angle supplied for these ships shall be clearly and distinctly stamped by the manufacturer in two places, where the brand cannot be conveniently sheared off, after they have been tested, the brand to be similar to the following, thus: Denoting that a shearing from the plate or an-

R

gle so marked has successfully been bent cold after being tempered as described in the temper test which follows, and that the plate or angle in question is capable of withstanding the whole of the tests hereafter described; and the committee will require the surveyors when in constant attendance at the steel works to satisfy themselves, so far as may be practicable, that these conditions are being complied with in a *bona fide* manner.

Should the samples selected by the surveyor not fulfill the test requirements, the plates or angles from which they were cut are to be rejected, and further tests are to be made before any material from the same charge can be accepted.

When one of the society's surveyors is not in constant attendance at the steel works for the purpose of seeing the material tested, the committee will require that tensile and temper tests shall be applied either at the steel works or at the ship-yard to not less than one plate, angle bar, or bulb plate, in every batch of 50, or a batch of less number; but the surveyor is not to select samples for testing until the material has been tested, stamped, and appropriated by the manufacturer. The samples when marked by the surveyor for testing are to be followed by him when practicable through the different stages of preparation until the tests are completed. Should the samples tested not fulfill the test requirements, the whole of the material from the charge which produced the samples which failed to withstand the tests prescribed is to be rejected or retested, and further tests are to be applied to a sample from each of the other charges of which the batch is composed. In the event of any of these samples also failing, the whole of the material from the same charge or charges is to be rejected as in the first instance.

Before these sample tests have been applied to a batch of steel submitted for check testing, the surveyor is to be furnished with a certificate by the manufacturer to the effect that the society's requirements as to the testing of steel have been complied with in the case of the batch in question.

In the event of material failing, in any case, to withstand the prescribed tests, the brands approved by the committee and stamped on the plates, beams, and angles by the manufacturer are to be defaced by punch marks extending beyond the brand in the form of a cross, thus: denoting that the material is rejected.



The society's surveyor will require to have every facility placed in his way for tracing all plates, beams, and angles to their respective charges, and to be furnished with two copies of the advice notes of the material, one of which, when he shall have been satisfied with the results of the tests applied to the material, he is to sign, to be forwarded by the manufacturers to the ship-builders, and the other of which is to be retained by himself.

TESTS.

Strips cut lengthwise or crosswise of the plate, and also angle and bulb steel, to have an ultimate tensile strength of not less than 27, and not exceeding 31 tons per square inch of section,* with an elongation equal to at least 16 per cent. on a length of 8 inches before fracture.

Strips cut from the plate, angle or bulb steel, to be heated to a low cherry-red, and cooled in water of 82° Fahrenheit, must stand bending double round a curve of which the diameter is not more than three times the thickness of the plates tested.

In addition to this, occasional angle bars should be subjected to a cold test by having pieces cut off and bent flat and then doubled backwards.

RIVETS.

The steel used for rivets to be of special quality, soft and ductile, and samples of the rivets should be tested by being bent both hot and cold, by flattening down the

* Steel angles intended for the framing of vessels, and bulb steel for beams, may have a maximum tensile strength of 33 tons per square inch of section, provided they be capable of withstanding the bending tests, and of being efficiently welded.

MEM.—No reduction will be allowed in the sizes of rivets from those which would be required by the rules for the vessels if built of iron.

heads, and by occasional forge tests, in order to satisfy the surveyors of their thorough efficiency.

BOILERS MADE OF STEEL.

The use of steel will be sanctioned in the construction of boilers intended for vessels classed or proposed for classification in the Society's Register Book, provided the boilers be constructed in accordance with the requirements of the rules, and the following conditions be fulfilled.

The material is to have an ultimate tensile strength of not less than 26 and not more than 30 tons per square inch of section, with an ultimate elongation of not less than 20 per cent. in a length of 8 inches. It is to be capable of being bent to a curve, of which the inner radius is not greater than one and a half times the thickness of the plates or bars, after having been heated uniformly to a low cherry-red and quenched in water of 82° F.

Steel rivets are to be considered as part of the material, and in addition to being subjected to a shearing test, they must be capable of withstanding the same tests as the plates are required to undergo.

Samples for testing are to be selected from each batch of plates submitted for approval, care being taken in the selection that, as far as possible, each cast or furnace charge, from which the material has been produced is represented. In addition to these tests, the temper test is to be applied to samples taken from every plate intended to be used in the furnaces and combustion chambers of the boilers.

The society's surveyor will attend at the steel works when necessary, and select the samples for testing before the plates are sheared to size, and these samples when marked by him for testing should, as far as practicable, be followed by the surveyor through the different stages of preparation until the tests are completed.

The society's surveyor will require to have every facility placed in his way for tracing all plates to their respective charges, and to be furnished with two copies of the advice notes of the material, one of which, when he shall have been satisfied with the results of the tests applied to the material, is to be signed and forwarded to the boiler manufacturer, and the other is to be retained by himself.

The samples are taken for testing in order that the general quality of the material may be ascertained, and if any sample should fail to fulfill the conditions laid down, the plate from which the sample is taken must be rejected; and further tests should be made before any material made from the same cast or charge as the failing sample can be approved.

All the holes in steel boilers should be drilled, but if they be punched the plates are to be afterwards annealed.

All plates that are dished or flanged, or in any way heated in the fire for working, except those that are subjected to a compressive stress only, are to be annealed after the operations are completed.

No steel stays are to be welded.

Unless otherwise specified, the rules for the construction of iron boilers will apply equally to boilers made of steel.

“LIVERPOOL UNDERWRITERS' REGISTRY.” (RULES FROM SEPTEMBER 1, 1882, to AUGUST 31, 1883.)

VESSELS BUILT OF STEEL.

SECTION 24. The whole of the material used in construction of the hulls of such vessels, except where otherwise specified, or by special sanction of the committee, must be of steel of “mild” quality, and capable of withstanding the following tests:

Samples are to be selected by the surveyor, in such numbers as he may deem necessary, but samples must be taken at least from every cast, and from every fifty plates or bars, and tested as follows:

Strips cut lengthways and crossways of plates, and lengthways of bulbs, bars, and angles, are to have an ultimate tensional resistance of not less than 30 tons per square inch. The prepared parallel part of the tension sample must not be less than eight inches long. Strips cut lengthways and crossways of plates, and lengthways of bulbs, bars, and angles, are to be heated to a full red and quenched in water, and then bent cold double without fracture, with a curvature of which the inner radius does not exceed one and a half times the thickness of the sample.

Strips with sheared edges undressed, heated and quenched as above described, and similar strips without any tempering, are, at the discretion of the surveyor, to be

tested by being bent cold without fracture through an angle of not less than 120° , with a curvature at the angle of which the inner radius does not exceed one and a half times the thickness of the sample.

Occasional samples of plates, bulbs, bars, and angles are to be punched and sheared, in accordance with ordinary ship-building practice, and are then to be treated in ordinary ship-yard fashion, under the direction of the surveyor, without failure in any respect.

Angle and tee bars are to be submitted to opening and closing and ram's horn tests, as the surveyor may direct.

Rivet-steel may be of about 28 tons per square inch tensional resistance, and both the material and the manufactured rivets must be subjected to such hot and cold bending and other tests as the surveyor may direct.

In the event of any samples failing in any of the foregoing tests, the plates, bulbs, bars, and angles from which they are taken shall be rejected, and such further tests made as the district chief surveyor may direct, under the circumstances, before any material from the same cast may be accepted.

If desired, the steel may be tested in the presence of the surveyor at the steel-maker's works, in which case invoices in duplicate are to be furnished for certification by the testing surveyor, and every facility is to be afforded him for identification of the plates and bars with the representative test samples and the respective casts from which they have been made. The steel is not to be used at the ship-yard until it has been satisfactorily tested and the invoice, certified by the surveyor, has been produced.

Should any of the material fail in any way in course of being worked into the ship, the surveyor is to be at liberty to submit it to such further tests as the circumstances may dictate, reporting the results to the district chief surveyor, who may reject any defective material, notwithstanding any previous certificate of satisfactory testing.

"BUREAU VERITAS" RULES FOR 1882.

STEEL VESSELS.

ARTICLE 33, SECTION 1. The scantlings of steel vessels will generally be regulated by the rules for the construction of iron vessels.

SEC. 2. The steel used in the construction of the vessels must comply with the following requirements:

(1) All steel plates, angles, and bulbs to be legibly stamped with a special mark, which shall indicate the guarantee of the manufacturer that the material is of the quality required by the rules. This mark to be so placed that it will be visible on the plate or bar, when riveted up in the ship.

(2) The steel to have an ultimate tensile strength of from 27 to 32 tons per square inch, and an elongation at rupture of at least 20 per cent. on a length of 200 millimeters ($7\frac{7}{8}$ inches).

(3) Strips about 2 inches wide, cut from the plates, bulbs, and angle bars, after being heated to a dull red and cooled in water at 28° C. (82° F.), shall withstand, without fracture, being doubled over and closed until the width of the opening near the bend is equal to three times the thickness of the sample tested.

SEC. 3. The following reductions may be allowed:

(1) 18 to 25 per cent. on the outside plating, sheer strakes, garboards, water-tight bulkheads, stringers, ties, and keelsons.

(2) 10 to 15 per cent. on the thickness of the floors, bulbs, and angles. These reductions may be greater should the system of construction followed provide a moment equivalent to that exacted in iron vessels.

SEC. 4. The diameter of the rivets, their spacing, and the system of riveting, also the width of laps and butt-straps, should be determined according to the rivets for iron vessels, from the tabular scantlings, and irrespective of the scantlings allowed. The butts of the outside plating to be treble riveted for half the vessel's length amidships, when the number is 200,000 or above, and for two-thirds the length when the number is 300,000 or above.

SEC. 5. Forged iron will be accepted for keel bars, stem, and stern post, for the rudder-head and frame and for pillars.

SEC. 6. A midship section and a longitudinal section, of vessels to be built of steel, shall accompany the request for classification, in order to be submitted for the approval of the Direction.

EXTRACTS FROM SPECIFICATIONS OF RAILROAD BRIDGE OVER THE OHIO RIVER AT HENDERSON, KY.

WROUGHT IRON.

Elastic limit to be not less than 26,000 pounds per square inch.

Iron for tension members, best double-rolled, refined iron, to stand the following tests:

Full-size pieces of flat, round, or square iron, not over $4\frac{1}{2}$ square inches sectional area, shall have an ultimate tensile strength of not less than 50,000 pounds, and shall stretch not less than $12\frac{1}{2}$ per cent. in the whole length.

Bars of more than $4\frac{1}{2}$ square inches sectional area will be allowed a reduction of 1,000 pounds per square inch, for each additional square inch, down to a minimum of 46,000 pounds.

When tested in specimens taken from the above, the ultimate tensile strength shall not be less than 52,000 pounds, with 18 per cent. stretch for bars whose original area was $4\frac{1}{2}$ square inches or less, and for bars whose original area was greater than $4\frac{1}{2}$ square inches, a reduction of 500 pounds for each additional square inch of section will be allowed down to a minimum of 50,000 pounds.

From angle or shape iron, not less than 50,000 pounds, with 15 per cent. stretch in 8 inches.

From plate, not less than 48,000 pounds, with 15 per cent. of stretch.

Iron for tension members must bend cold to 180° to a curve whose inner diameter is 2 thicknesses. Cooled off with ice to 30° F., nicked on both sides, and bent under a sledge, it shall bend and break gradually with uniform fibrous fracture. Specimens from angles, plates, and shape iron shall bend cold to 90° to inner diameter of not more than 3 thicknesses.

STEEL.

To be manufactured by the open-hearth process. Bessemer steel will not be accepted.

A small ingot shall be cast from every charge, and a sample bar, $\frac{1}{2}$ -inch, rolled from it. If this bar fails to meet requirements of laboratory tests the whole charge shall be rejected.

Ingot of each cast, and blooms and finished pieces, shall be marked with the number of the cast.

Steel used in compression members, bearing plates, pins, and rollers shall contain not less than .34 per cent. nor greater than .42 per cent. carbon, and not more than .10 per cent. of phosphorus.

A sample bar, $\frac{1}{2}$ -inch in diameter, shall bend to 180° around its own diameter.

The same bar in a lever machine shall show an elastic limit of not less than 50,000 pounds, and an ultimate tensile strength of not less than 80,000 pounds, with an elongation of 15 per cent. in 8 inches, and a reduction of area of at least 30 per cent. at fracture. Shall be incapable of tempering.

Steel for rivets and eye-bars shall contain not more than .26 per cent. carbon and less than .10 per cent. phosphorus. A $\frac{1}{2}$ -inch round bar shall close to 180° , and in a lever machine shall have an elastic limit of not less than 40,000 pounds, and an ultimate tensile strength of not less than 70,000 pounds, with an elongation of not less than 20 per cent. in 8 inches, and a reduction of area of not less than 40 per cent. at fracture. In full-size bars, this steel shall show an elastic limit of not less than 36,500 pounds, and an ultimate tensile strength of not less than 66,000 pounds, with an elongation of not less than 10 per cent., and for strains greater than 30,000 pounds shall have modulus of elasticity of from 28,000,000 to 30,000,000.

All plates to be rolled in a universal mill.

Steel for pins shall not be hammered, but rolled in Gothic rolls.

Riveted steel work.—The holes shall be punched enough smaller than the diameter required for the rivet to admit of $\frac{1}{8}$ -inch riving all around after assembling. Sharp edges of round hole to be trimmed to a slight fillet under rivet heads, and the piece riveted together without being taken apart. All rivets in steel members will be of steel.

Annealing.—After working, eye-bars shall be annealed by heating them to a uniform dull red heat and allowing to cool slowly.

Friction rollers.—Wrought iron—pressure in pounds per linear inch of rollers shall not exceed $\sqrt{540000} \times d$, where d = diameter of roller in inches. For steel rollers an addition of 25 per cent. may be made to the above pressures.

Pitch of rivets.—In compression members, from center to center not more than 6 inches, or 16 times the thickness of any of the joined plates, and for a distance of two

diameters from the ends to be 4 diameters of rivet; in no case shall the pitch be less than 4 diameters of rivet.

Distance between edge of any piece and center of rivet hole must not be less than $1\frac{1}{2}$ inches except in bars less than $2\frac{1}{4}$ inches wide; where practicable it shall be at least 2 diameters of rivet.

Pin strains.—For shearing not greater than 7,000 pounds for wrought iron, or 10,000 pounds for steel. Maximum fiber strain from bending shall not be greater than 15,000 pounds for wrought iron, or 20,000 for steel.

Bearing strain on area = diameter by thickness of head, shall be not greater than 12,000 pounds for wrought iron or 18,000 for steel.

Rivets.—Shearing stress not greater than 7,000 pounds for wrought iron or 10,000 pounds for steel; bearing strain 10,000 pounds for wrought iron and 15,000 pounds for steel, for all rivets in bearing and splice plates; elsewhere 12,000 pounds for iron and 18,000 for steel.

Combined strains.—In members subjected to combined compression and tensile strain the maximum compressive stress shall be not greater than 7,000 pounds per square inch.

Tensile strains.—For wrought iron tension members and rolled beams 10,000 pounds. Bottom flanges of riveted girders 8,000 pounds net section.

Steel tension members 14,000 pounds.

Compressive strains.—In steel compression members up to 16 diameters in length 14,000 pounds. For a greater ratio, $\frac{1}{4}$ ths of the results for wrought iron as given in table accompanying.

Factor of safety, 5.

δ for STEEL.

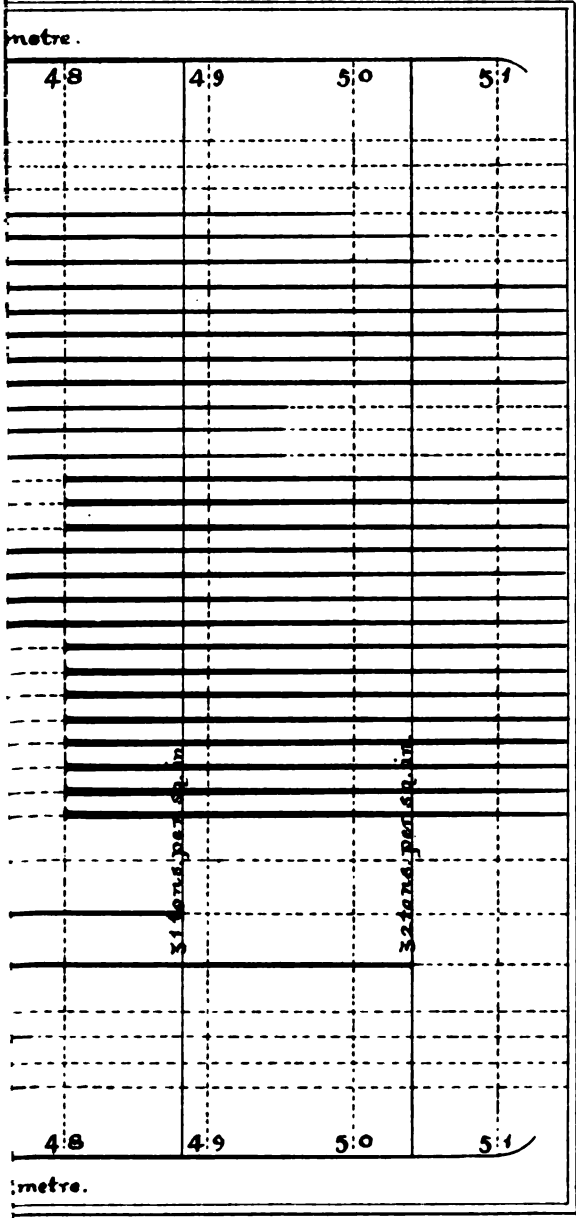

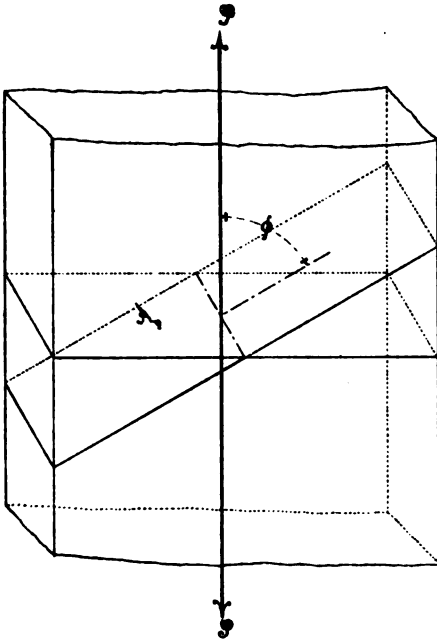

Fig. 18

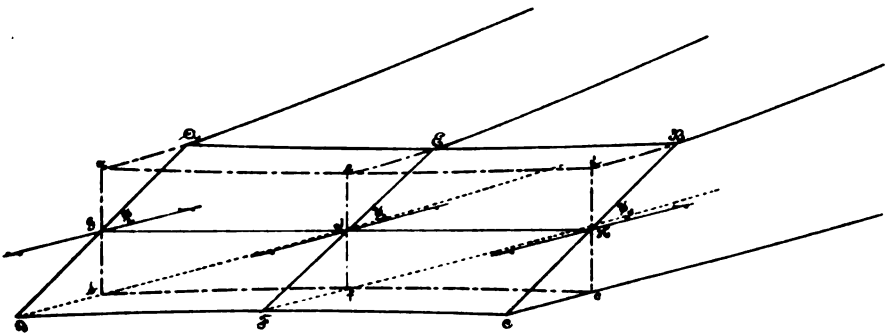

Fig. 19

CONTENTS OF THE ANNUAL REPORT OF THE SECRETARY OF THE NAVY, 1885.

	Page.
Vessels in commission, squadrons, &c.....	III
Yards and Docks, remarks on the report of Chief of the Bureau of.....	IV
Dry-docks at the yards, construction of recommended.....	IV
Equipment and Recruiting:	
Remarks on the report of Chief of the Bureau of.....	V
New training vessels recommended.....	V
Navy plant for Washington yard.....	V
Apprentices, number received in 1885.....	V
Fish Commission and Coast Survey, supply of men for.....	V
Aliens, enlistment of, in the Navy.....	VI
Seamen:	
Retirement of, suggested.....	VI
Administering the oath to, by officers.....	VI
Clothing outfit recommended.....	VI
Savings-bank system.....	VI
Navigation:	
Remarks on the report of Chief of Bureau of.....	VI
Thetis, fitting out the, for surveying duty.....	VI
Compass-testing house, erection of.....	VI
War records, provision for publication of.....	VII
Ordnance:	
Remarks on report of Chief of Bureau of.....	VII
Ordnance proving ground, improvement of.....	VII
Seamen gunners, instruction of.....	VII
Midvale Steel Company, forgings constructed at.....	VII
South Boston and West Point Foundries, construction of guns by.....	VII
Armaments for double-turreted monitors.....	VII
Steel for armor plating; projectiles and gun-cotton.....	VIII
Clark's defective turret, trial of.....	VIII
Howell torpedo, experiments with.....	VIII
Torpedo station, work, examinations, &c., at.....	VIII
Construction and Repair:	
Remarks on report of Chief of Bureau of.....	VIII
League Island as a naval station, docks, &c.....	VIII
Steam Engineering:	
Remarks on report of Chief of Bureau of.....	VIII
New boiler-shop at Norfolk needed.....	IX
Medicine and Surgery:	
Remarks on report of Chief of Bureau of.....	IX
Quarantine hospital, Widow's Island, established.....	IX
Hospital at Yokohama, admission of merchant seamen to.....	IX
Frauds in Bureau, conviction of parties.....	IX
Museum of Hygiene, valuable additions to.....	IX
Marine Corps:	
Remarks on report of commandant of.....	IX
Increase recommended.....	IX
Service of marines on the Isthmus of Panama.....	IX
Hydrographic Office:	
Improvements made and work performed at.....	IX
Mexican and Central American coasts, survey of.....	X
Fire-proof building for Hydrographic Office needed.....	X
Naval Academy:	
Remarks on report of Superintendent of.....	X
Improvements, quarters, &c., recommended.....	X
Admission of cadets, change suggested.....	X
Assignment of four-years' cadets to staff and line.....	X

	Page
Naval Observatory:	
Remarks on report of Superintendent of	X
Extension of time service	X
Construction of new observatory	X
Naval War College, progress made at.....	XI
Sale of old vessels and other Government property	XI
Decoration Day, pay to employes of yards on	XI
Appropriations and expenditures.....	XII, XIII, XIV
Estimates for 1886-'87	XV
Disturbances at Panama, action of the Department	XV
Additional new cruisers, measures taken	XVII
Dolphin, Boston, Atlanta, and Chicago, action of the Department.....	XIX
Promotions in the service, subject to receive attention.....	XXV
New ships, future appropriations for	XXV
New Orleans Exhibition, fleet at	XXVI
Provision recommended for official courtesies	XXVI
Organization of the Department reviewed.....	XXVII
Suggestions to improve it.....	XXVIII, XXXII, XXXVII, XL
Purchases for the Navy, improvements suggested.....	XXIX
Material and construction for the Navy	XXXII
Education of constructors and engineers.....	XXXIV
Private enterprise, encouragement of.....	XXXVI
General policy of the Department, shape and direction of.....	XXXVII
Omaha, expenditures on, in repairs.....	XXXIX

**LIST OF PAPERS ACCOMPANYING VOLUME I, REPORT OF THE
SECRETARY OF THE NAVY, 1885.**

No.		Page.
1.	Secretary's office, estimates, &c	1
2.	Sale of old vessels and other Government property	7
3.	Deposits in the Treasury, sale of Government property, &c	12
4.	Movements of vessels, detailed statement	17
5.	Naval Academy, reports of Board of Visitors, Superintendent, &c.....	25
6.	Bureau of Yards and Docks, report of Chief, &c.....	46
7.	Bureau of Navigation, report of Chief, &c	83
8.	Bureau of Steam Engineering, report of Chief, &c.....	158
9.	Bureau of Provisions and Clothing, estimates, &c.....	168
10.	Marine Corps, report of commandant, &c	180
11.	Bureau of Equipment and Recruiting, report of Chief, &c	189
12.	Bureau of Ordnance, report of Chief, &c.....	202
13.	Bureau of Construction and Repair, report of Chief, &c	252
14.	Report of the Admiral of the Navy	279
15.	Steel cruisers, action of the Department concerning	291
16.	Mild steel, report of Naval Advisory Board.....	369

INDEX TO APPENDIX.

	Page
Academy. (See Naval Academy.)	
Admiral of the Navy, annual report	279
Almanac. (See Nautical Almanac.)	
Apprentices, training of	193
Assistant Secretary of the Navy, estimate for	1
Astronomers at Observatory, increase of salary recommended	112
Astronomical researches by Nautical Almanac Office	117
Armament for new ships, preparation of	207
Board of Visitors to the Academy—	
Report of.....	25-32
Expenses of, 1885.....	45
Cadets at the Naval Academy—	
Number of.....	26
Appointment of, one year in advance.....	26, 33, 34
Dismissal of, suggestions as to.....	27
Hazing, remarks of Board of Visitors.....	30
Discharge at end of four-year's course.....	34
Graduates, selection of, for line and staff.....	34
Trial of, by court-martial.....	30, 35
Oath to be taken by.....	35
Cannon for the Navy, preparation of	202, 207
Civil establishment, estimates for—	
Yards and Docks.....	61
Navigation.....	93
Equipment and Recruiting.....	200
Steam Engineering.....	166
Provisions and Clothing.....	171
Ordnance.....	216
Construction and Repair.....	269, 271
Charts, construction and issue by Hydrographic Office	119-157
Chains and anchors, manufacture of	191
Chronometers and time-service, issue and establishment	85, 88, 107
Coal for the Navy, purchase of	189
Coast Survey—	
Supply of men to, by Navy.....	196
Attachment of, to the Navy.....	287
Coaster's Harbor Island, estimate for training-station	200
Coasters' Almanac, sale and distribution of	117
Constellation, cruise of practice-ship	35
Compasses, repaired and tested	83
Compass-testing house, estimate for completing	93
Compass station—	
Established at Narragansett Bay.....	83
Necessity of, near New York City.....	83
Construction and Repair, Bureau of—	
Report of the Chief.....	252-266
Appropriation and expenditures.....	267
Stores on hand at the yards, cost, &c.....	267
Estimates for 1887.....	270, 271
Contracts entered into.....	267
Constructors, assistant, education of	265
Contingent expenses, estimates for—	
Secretary's office.....	1
Yards and Docks.....	59
Navigation.....	93
Equipment and Recruiting.....	200
Steam Engineering.....	166
Provisions and Clothing.....	171
Ordnance.....	216, 219
Observatory.....	91
Hydrographic Office.....	90

	Page.
Contingent expenses, estimates for—Continued.	
War College	93
War Records	90
Marine Corps	185
Nautical Almanac	91
Library	90
Contracts, offers, and awards—	
Naval Academy	37
Bureau of Provisions and Clothing	172-178
Bureau of Yards and Docks	66-82
Marine Corps	186
Bureau of Equipment and Recruiting	199
Bureau of Construction and Repair	267
Bureau of Steam Engineering	165
Deficiency, estimate for—	
Contingent, Ordnance	219
Steel cruisers	219
Defective turrets, Clark's	208
Docks, necessity for, for the Navy	261
Dolphin and other vessels, action in regard to	291
Double-turreted monitors, estimate for	166, 218, 270
Eclipse of 1885 and 1886, observations as to	106, 111
Electrical firing of projectiles	210
Electric lights on naval vessels	85
Enlisted men—	
Number of, in the Navy	195
Saving-bank system for	197
Retirement of, recommended	197
Pensions and clothing for	197
Oath of	198
Equatorials, observations with, at Naval Observatory	104, 105
Equipment and Recruiting, Bureau of—	
Report of the Chief	189
Offers for supplies and contracts made	198, 199
Estimates for objects under the Bureau	200, 201
Appropriations and expenditures	198
Fish Commission, supply of men to, by Navy	196
General maintenance, yards and docks, estimates for	59
Gas-checks, trials made with	205
Government property, statements as to sale of	7-11, 12-16, 178, 215
Gun-carriages, alterations in designs	205
Gun-cotton, experiments with	242
Hazing, remarks of Board of Visitors as to	30
Heinp for the Navy, purchase of	190
Hotchkiss guns, purchase of	206, 285
Huron, estimate for head-stones for graves of those lost in the	45
Hydrographic Office—	
Estimate for salaries, &c.	90
Report of the hydrographer	119
Accompanying reports	128-157
Operations of branch offices	123, 147, 157
Illuminating oils, procurement of	85
Increase of the Navy, estimates for	159, 166, 201, 218, 270
League Island, importance of, as a naval station	260
Library, Navy Department—	
Estimates for	90
Improvement of	86
Binding for	86
At the Naval Observatory, increase of	100
Longitudes, determination of	84
Magazine rifles, estimate for	216
Machine cannon and guns, estimate for	216
Magnetism of ships, professional papers on	84
Megaphone, trial of	210
Meteorology, publications of Hydrographic Office	123, 145
Marine Corps:	
Report of colonel commandant	180
Estimates for quartermaster department	182-185
Pay department	181-182
Offers and award of contracts	186
Appropriations and expenditures	188

	Page.
Meridian transit instrument, work performed with	106
Mexican coast, publication of surveys of, estimate	92
Mild steel, report of Naval Advisory Board on	369
"Miscellaneous receipts," deposits on account of	12
Mural circle, programme for	107
Muskets of high power, use of	208
Movement of vessels, statement of	17
Nautical Almanac Office—	
Estimates for salaries, &c	91
Report of superintendent	116
Sale and distribution of almanacs	116, 117
Naval Cadets. (See Cadets.)	
Naval Academy—	
Board of Visitors, report of	25-32
Admission and dismissal of cadets	26
Number of cadets at the Academy	26
Studies and standard of scholarship	27
Grounds, buildings, and sanitary condition	28
Seamanship, ordnance, and navigation	29
Discipline, drill, practice, &c	30
Steam, mathematics, and physics	31
Finance and library	32
Report of the Superintendent	33-35
Cruise of practice-ship Constitution	35
Appropriations and expenditures	37, 45
Offers for supplies and contract awarded	37
Estimates for 1867, for pay of persons at	42, 45
For contingent and other expenses	44
For new quarters for cadets	45
For headstones at cemetery	45
Navigation, Bureau of—	
Report of the Chief	83-89
Estimates for objects under the Bureau	89-94
Expenditures for labor, &c., 1885	94, 95
Civil establishment, employes	93
Naval Asylum—	
Estimates for 1887	60
Offers for supplies and contracts made	75
Expenditures at	50, 57
Remarks of Bureau of Yards and Docks, regarding	57
Naval Observatory—	
Report of Superintendent	104
Estimates for salaries, &c	91
Estimate for new observatory	92
Work performed with telescopes at	105, 106
Library, extent of	109
Photography, application of	110
Board of Visitors, recommended	111
Assistant astronomers, increase of salary recommended	111
Naval War College—	
Report of Superintendent	96
Estimates for	93
Executive document on subject of	98
Report of board on post-graduate course	96
General order, establishing	103
Remarks of the Admiral of the Navy	277
Navy-yards—	
Expenditures, &c., at, closed	49
Expenditures at, 1885, under Yards and Docks	46-48
Estimates for improvement and preservation	49-51, 60, 61
Estimates for general maintenance	52
Recommendations of Chief of Bureau Yards and Docks as to	53-59
Civil establishment at	61-65, 93, 166, 169, 200, 216, 271
Notices to Mariners, issue of, by Hydrographic Office	122-124, 144
Observatory. (See Naval Observatory.)	
Ocean surveys—	
Estimates for, &c	92
Further prosecution of	85
Old vessels, statements as to sale of	7-11
Old property, deposits from sale of	12

	Page.
Ordnance, Bureau of—	
Report of the Chief	202
Appropriations and expenditures	213, 214
Stores on hand, value of	214
Labor and cost thereof, 1885	214
Sales of condemned materials	215
Estimates for objects under the Bureau	216-219
Manufactures at the yards	220-227
Work performed on vessels	228
Report of experiments, &c., at ordnance proving-ground	228-241
Report of experiments, &c., at torpedo station	241-251
Ordnance proving-ground, Annapolis—	
Experiments, &c., at	228-241
Estimates for improvements	216
Pay of the Navy—	
Estimate for 1887	1
Estimate for officers on active list	3
Estimate for officers on retired list	5
Number and rank of officers paid from	3-5
Pay, miscellaneous—	
Estimate for 1887	1
Clerks, &c., paid from	6
Photography, application of, at Observatory	110
Pilot-chart, distribution of, by Hydrographic Office	124, 147-157
Powder, development of, for great guns	203
Prime vertical instrument, reducing observations with	105
Printing and binding, estimate for 1887	2
Private enterprise, encouragement of	276
Projectiles, introduction of into the Navy and tests	204, 229
Professors and others at the Naval Academy, estimates for pay of	42
Professional Papers, estimate for publishing	93
Provisions and Clothing, Bureau of—	
Estimates for provisions, clothing, &c.	168-171
Estimates for salaries	170
Estimates for civil establishment	171
Proposals and award of contracts	172-178
Sale of old materials	178
Stores expended and on hand	169
Rebellion Records, publication and classification of	85, 89
Revolvers and rifles, estimate for	216
Rope-walk, Boston yard, operations of	190
Roach contracts, action of Department on	291
Salaries, estimates for—	
Secretary's office	1, 2
Yards and Docks	59
Navigation	89
Equipment and Recruiting	201
Steam Engineering	166
Provisions and Clothing	170
Ordnance	216
Construction and Repair	270
Observatory	91
Nautical Almanac	91
Hydrographic Office	90
Library	90
War College	93
War Records	89
Office of Naval Intelligence	89
Sale of old vessels—	
Account of	7-11
Old materials and other public property	12-16, 178, 215
Deposits on account of	12
Sailing Directions, preparation and issue by Hydrographic Office	122
Search lights, development of	212
Signal books, preparation of	85
Seamen gunners, training of, for the Navy	206
Secretary of the Navy—	
Assistant, estimate for	1
Salaries of employes, estimate for	1

	Page.
South American coast, survey of.....	128
Squadrons—	
Movements of vessels of.....	17 24
Standard time, extension of system.....	88
Steam-Engineering, Bureau of—	
Report of the Chief.....	158
Appropriations and expenditures under the Bureau.....	158, 159
Estimates for salaries, &c.....	166
Estimates for steam-machinery.....	166
Estimates for increase of the Navy.....	166
Estimates for civil establishment.....	166
Repairs on vessels.....	160
Condition of machinery of vessels.....	162
Steel cruisers—	
Appropriation for.....	159, 198, 213, 267
Expenditures on.....	159, 198, 213, 267
Action on contracts for.....	291
Deficiency estimate for.....	219
Stores, expenditure of.....	42, 94, 169, 214
Storm reports prepared by Hydrographic Office.....	150
Supplies, offers for and contracts made.....	37, 165, 172, 186, 199, 267
Telescopes at Observatory, work performed with.....	105, 106
Time-service, increase of standard.....	107
Torpedo Corps—	
Estimates for.....	217
Estimates for torpedoes and torpedo vessels.....	210, 217, 276
Instructions to officers and men.....	212
Examination of class.....	250
Training of apprentices for the Navy.....	193
Training-ships for the Navy.....	194
Training station, Coaster's Harbor Island—	
Offers for supplies for.....	199
Estimate of appropriations for.....	200
Transit of Venus—	
Estimates for.....	92
Work in connection with.....	112, 113
Transit circle, operations with, at Naval Observatory.....	104
Transit instrument, meridian, work performed with.....	106
Vessels—	
Sale of old, account of.....	7-11
Report of movements of.....	17-24
Repairs on machinery of.....	161
Condition of machinery of.....	162-164
Repairs required on (under Construction and Repair).....	257
Repaired at the yards (under Construction and Repair).....	267
At the Academy, expenses.....	42
Recommended for the Navy by the Admiral.....	282
War College. (<i>See</i> Naval War College.)	
War Records, compiling, estimates for, &c.....	85, 89
Yards and Docks, Bureau of—	
Report of the Chief.....	46-63
Estimates for 1887.....	46, 49-52, 59-63
Expenditures, 1885.....	53-59, 66
Offers for supplies, and contracts made.....	66-62
Civil establishment, estimates, &c.....	61-65

