



This is a digital copy of a book that was preserved for generations on library shelves before it was carefully scanned by Google as part of a project to make the world's books discoverable online.

It has survived long enough for the copyright to expire and the book to enter the public domain. A public domain book is one that was never subject to copyright or whose legal copyright term has expired. Whether a book is in the public domain may vary country to country. Public domain books are our gateways to the past, representing a wealth of history, culture and knowledge that's often difficult to discover.

Marks, notations and other marginalia present in the original volume will appear in this file - a reminder of this book's long journey from the publisher to a library and finally to you.

Usage guidelines

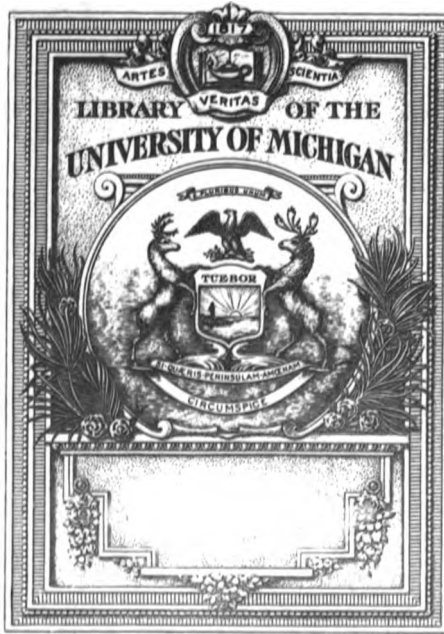
Google is proud to partner with libraries to digitize public domain materials and make them widely accessible. Public domain books belong to the public and we are merely their custodians. Nevertheless, this work is expensive, so in order to keep providing this resource, we have taken steps to prevent abuse by commercial parties, including placing technical restrictions on automated querying.

We also ask that you:

- + *Make non-commercial use of the files* We designed Google Book Search for use by individuals, and we request that you use these files for personal, non-commercial purposes.
- + *Refrain from automated querying* Do not send automated queries of any sort to Google's system: If you are conducting research on machine translation, optical character recognition or other areas where access to a large amount of text is helpful, please contact us. We encourage the use of public domain materials for these purposes and may be able to help.
- + *Maintain attribution* The Google "watermark" you see on each file is essential for informing people about this project and helping them find additional materials through Google Book Search. Please do not remove it.
- + *Keep it legal* Whatever your use, remember that you are responsible for ensuring that what you are doing is legal. Do not assume that just because we believe a book is in the public domain for users in the United States, that the work is also in the public domain for users in other countries. Whether a book is still in copyright varies from country to country, and we can't offer guidance on whether any specific use of any specific book is allowed. Please do not assume that a book's appearance in Google Book Search means it can be used in any manner anywhere in the world. Copyright infringement liability can be quite severe.

About Google Book Search

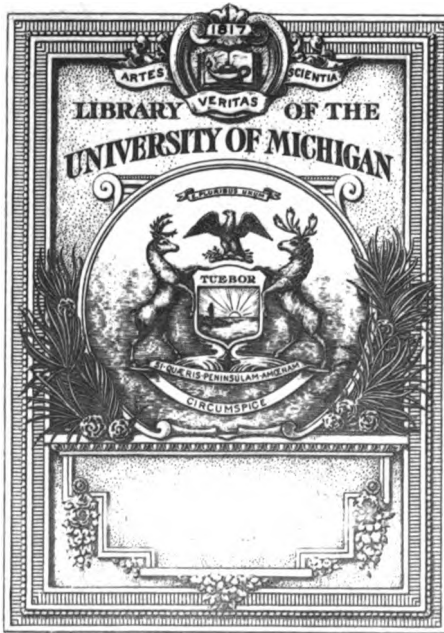
Google's mission is to organize the world's information and to make it universally accessible and useful. Google Book Search helps readers discover the world's books while helping authors and publishers reach new audiences. You can search through the full text of this book on the web at <http://books.google.com/>



THE GIFT OF
Jean M. E. Cooley

VA
52
.A1

4:30 . . .



THE GIFT OF
Jean M. E. Cooley

VA
52
A1

Handwritten marks or characters.

U.S. Navy Dept.

ANNUAL REPORT

OF THE

SECRETARY OF THE NAVY

FOR



THE YEAR 1887.



**WASHINGTON:
GOVERNMENT PRINTING OFFICE.
1887.**

GIFT
DEAN M. F. DOOLEY
9-13-1932

REPORT
OF
THE SECRETARY OF THE NAVY.

NAVY DEPARTMENT,
Washington, December 6, 1887.

To the President :

It is with much satisfaction that the Department is able to report upon the occurrences of the past year. Many difficulties have stood in the way of the creation of a creditable new navy. During the last year many of these have been removed, and if it is the will of the country that we should be possessed of a navy able to maintain, when required, the honor and dignity of the Government, it can now readily be created.

When the last annual report of the Department was made this country lacked three manufactories necessary to the construction and armament of a modern war vessel, viz, that of steel forgings for the heavier guns, that of armor for iron-clad vessels, and that of the secondary batteries (machine and rapid-fire guns), an essential portion of the armament. Now all three manufactories are in process of construction under contracts with the Department.

It was a fatal mistake for this country to be dependent upon any other nation for its implements of war. Aside from all questions of national dignity and pride, such implements are contraband in time of war, and could not then be procured from abroad, while the time required to prepare a plant would make it impossible to extemporize a manufactory for the occasion, and yet, without armor, and without higher-powered guns, in the present state of the art no respectable contest could be carried on, and the country would be substantially defenseless.

The ease with which these difficulties were finally solved was most surprising, and furnished another and most notable illustration of the enterprise and courage of our business class.

Two special boards, the Gun Foundry Board, reporting in 1884, and the Board on Fortifications and other defenses, reporting in January, 1886, and two special committees of Congress, reporting also in 1886, had thoroughly investigated the problem of how to bring about the domesticating of these industries, and had substantially agreed in their recommendations. But the large public expenditures contemplated, in the neighborhood of \$35,000,000, served to delay Congressional action, and the final adjournment of the last Congress without any provision for our coast defenses seemed to have postponed indefinitely the desired result.

The Navy Department had, in the summer of 1886, as an experiment, consolidated in one advertisement all of its requirements for armor and gun-steel for ships of war then authorized, stipulating that it should be of domestic manufacture and giving an average of two and a half years in which to produce and deliver it, which covered the time necessary for the procurement of a plant. A period of about seven months was allowed for the submission of bids, in order to afford an opportunity for full investigation by expected bidders. The Department also opened correspondence upon the subject with the principal steel manufacturers of the country. The interest awakened by the discussion and investigations already had was stimulated somewhat by the influence of the Department, and resulted, when the bids were opened, in a contract with the Bethlehem Iron Company, under which a plant for the production of armor and gun-steel is being erected at Bethlehem, Pa., second to none in the world, it is believed. (Appendix, p. 459.) The efforts of the Department were generously seconded by the Naval Appropriations Committees of the two Houses, the sum of \$4,000,000 having been inserted in the appropriation acts for the purpose indicated.

The bids were opened on the 22d day of March last, and, coming at a time when the failure of Congress to make provision for the country's defense was being generally regretted, caused a feeling of quite universal congratulation throughout the country. It marked a most important step in the progress toward national independence, most sincerely desired, it is believed, by the larger portion of our people.

The policy which had thus been so successfully pursued in the matter of armor and gun-steel was also followed in the matter of secondary batteries, and with a like result.

The Department declined to make any purchases of the Hotchkiss arms, previously adopted for our secondary batteries, except upon condition that a manufactory was established in this country, and, by the accumulation of orders, the inducement became in time sufficient to secure the desired result.

It is also gratifying to report that the representatives of the Hotchkiss company have ascertained that with the superior tools in use in this country in the manufacture of arms, the secondary batteries of ships can be made here and sold at prices less than we have paid for their foreign-made arms, and as low as they are produced there for any foreign Government. And such are the prices made to us by the company

In like manner the contracts for armor and gun steel are made at prices within 25 per cent. of the European price for the similar article, not greater than the difference in labor between the two countries, notwithstanding the heavy outlay for plant (estimated at \$2,500,000) necessary to be made to undertake the contract.

These gratifying results have been greatly stimulated by the ship-building interest of the country. My attention was early called to the fact that our ship-builders were shut out from building for any foreign Government by reason of the fact that neither armor nor gun steel nor secondary batteries could be supplied in this country. The construction of war-vessels for other countries has been a large industry for the ship-builders of Great Britain.

It is believed that our private ship-yards can produce war ships equal and perhaps superior to those produced elsewhere when these industries shall have been established. The ship-builders have, therefore, zealously co-operated with the Department in stimulating and furthering this object.

It is notable in this connection that the efforts of the Department to raise the standard of the material for the ships has resulted in a class of material believed to be superior to that ever produced for any similar purpose.

Some slight delay in construction of the cruisers under contract has doubtless resulted, and much jarring and unpleasantness at first; but, at the present time, all concur that the quality of the steel has been improved and that more reliable processes have come to light, and all dissatisfaction has disappeared. Especially has the steel made upon the Pacific coast been notable for its quality, and the construction of the cruisers there may mark an important event in its industrial history.

THE NEW NAVY.

All of the unarmored vessels heretofore authorized by Congress are in course of construction. The following table embraces the necessary information concerning them. It includes those already completed.

UNARMORED

Name.	Type.	Keel laid.	Where built.	Condition.	Dimensions.			Displacement.	Collective power or speed in each case.
					Length between perpendiculars.	Beam.	Mean draught.		
					Feet.	Feet.	Feet.	Tons.	
Dolphin	Dispatch vessel.	1883	Roach's	Commissioned ..	240	32	14½	1,485	*2, 240
Boston	Protected cruiser.	1883	do	do	270	42	17	3,189	*3, 780
Atlanta	do	1883	do	do	270	42	17	3,189	*3, 356
Chicago	do	1883	do	Awaiting trial..	315	48½	19	4,500	15,000
Charleston	Protected cruiser.	1887	Union Iron Works.	Building	300	46	18½	3,730	7,000
Baltimore	do	1887	Cramp's	do	315	48½	19½	4,413	8,000
Gun-boat No. 1...	Cruiser	1887	do	do	230	36	14	1,700	3,000
Gun-boat No. 2...	do	1887	Columbian Iron Works, Baltimore.	do	175	31	11½	890	11,100
Newark	Protected cruiser.	1887	Cramp's	do	310	49½	18½	4,083	8,500
Cruiser No. 4	do	1887	do	do	315	48½	19½	4,324	(§)
Cruiser No. 5	do	1887	Union Iron Works.	do	310	49½	18½	4,083	(§)
Gun-boat No. 3...	Cruiser	1887	N. F. Palmer, jr. & Co., Chester, Pa.	do	230	36	14	1,700	3,400
Gun-boat No. 4...	do	1887	do	do	230	36	14	1,700	3,400
Dynamite cruiser	do	1887	Cramp's	Building	246½	26½	9	725	(¶)
1st-class torpedo boat	do	do	Herreshoff's	Awarded	138	14½	3½	99	(¶)

* Indicated horse-power on trial.

† Guaranteed.

‡ Guaranteed. Indicated horse-power.

§ Guaranteed speed, 19 knots.

¶ Guaranteed speed, 20 knots.

¶ Estimated by bidder, 23 knots.

STEEL VESSELS.

Type of engines.	Weight of machinery, etc.	Batteries.		Total contract cost of hull and machinery.	Date of act authorizing building.	Contract executed.	Time to complete from date of contract.
		Main.	Secondary.				
Single screw vertical compound.	Tons. 411	1 6" B. L. R.	2 Gatlings 2 6-pdrs. 4 47"= R. C.	\$315,000	Aug. 5, 1882 Mar. 3, 1883	July 23, 1883	Mo.
Single screw horizontal compound.	698	2 8" B. L. R.. 6 6" B. L. R.	2 Gatlings 2 6-pdrs. 2 3-pdrs. 2 1-pdr. 2 47"= R. C. 2 37"= R. C.	619,000dodo
....do.....	698	Same as Boston.	Same as Boston.	617,000dodo
Twin screw, compound overhead beam.	930	4 8" B. L. R.. 8 6" B. L. R. 2 5" B. L. R.	2 Gatlings.... 2 6-pdra. 2 1-pdra. 4 47"= R. C. 2 37"= R. C.	889,000do	July 26, 1883
Twin-screw horizontal compound.	710	2 8" B. L. R ... 6 6" B. L. R.	2 Gatlings 4 6-pdrs. 2 3-pdrs. 1 1-pdr. 4 37"= R. C.	1,017,000	Mar. 3, 1885	Dec. 28, 1886	18
Twin-screw horizontal triple expansion.	900	4 8" B. L. R ... 6 6" B. L. R.	2 Gatlings 4 6-pdra. 2 3-pdra. 1 1-pdr. 4 37"= R. C.	1,325,000	Aug. 3, 1886	Dec 17, 1886	18
do.....	390	6 6" B. L. R.	2 Gatlings 2 6-pdra. 2 3-pdra. 1 1-pdr. 2 37"= R. C.	455,000	Mar. 13, 1885	Jan. 31, 1887	12
Single screw horizontal compound.	130	4 6" B. L. R.	2 Gatlings ... 2 3 pdrs. 1 1-pdr. 2 37"= R. C.	247,000do	Dec. 22, 1886	12
Twin-screw horizontal triple expansion.	850	12 6" B. L. R ..	2 Gatlings 4 6-pdra. 2 3-pdra. 1 1-pdr. 4 37"= R. C.	1,248,000	Mar. 3, 1885 Mar. 3, 1886	Oct. 27, 1887	24
....do	900do	Same as Baltimore.	1,350,000	Mar. 3, 1887	Oct. 27, 1887	24
....do.....	900	12 6" B. L. Rdo	1,428,000do	Oct. 26, 1887	24
....do.....	340	Same as No. 1.	Same as No. 1.	490,000do	Nov. 15, 1887	18
....do.....	340dodo	490,000do	Nov. 15, 1887	18
Twin screw, vertical, triple expansion.	247	3 dynamite guns, 10 1/2" caliber.	2 Gatlings. 2 3-pdrs. 1 1-pdr. 2 37"= R. C.	Including dynamite guns, etc. 350,000	Aug. 3, 1886	Feb. 11, 1887	12
Twin screw, vertical, quadruple expansion.	47	4 automobile torpedoes.	2 3-pdra.	82,750	Aug. 3, 1886		

VIII, REPORT OF THE SECRETARY OF THE NAVY.

The most notable fact connected with the work of the last year concerns cruisers Nos. 4 and 5, in the foregoing table. Congress by the legislation of last winter put to the test the ability of the Department and of American ship-builders to construct cruisers having the highest standards. The law provided as follows;

The contracts for the construction of said cruisers shall contain provisions to the effect that the contractor guaranties that when completed and tested for speed, under conditions to be prescribed by the Navy Department, the vessel shall exhibit a maximum speed of at least nineteen knots per hour; and for every quarter knot of speed so exhibited above said guaranty the contractor shall receive a premium, over and above his contract price, of fifty thousand dollars, and for every quarter knot that said vessel fails of reaching said guaranteed speed there shall be deducted from the contract price the sum of fifty thousand dollars.

The requirements of the law have been observed and these cruisers are now under contract with adequate security for the attainment of the results guaranteed. American ship-builders have in these contracts placed themselves in line with the foremost in the world.

These results were extremely gratifying to the Department. Both bidders for these ships bid to reach the speed upon the plans submitted by the Department. The plans purchased abroad constituted the basis of the plans submitted to competition, but by the modifications made and being made they are now beyond identification. Thus the result will be as was originally contemplated, viz, adopting at the outset the best known methods, native invention will enable us to improve upon them and to keep pace with the most forward.

The following were the bids received for the contracts awarded during the past year. A star marks the successful bid.

Tabular statement of proposals received and opened August 8, 1887, for the construction of the cruiser Newark, authorized by the acts of March 3, 1885, and March 3, 1887, and of the two cruisers and the two gun-boats authorized by the act of March 3, 1887.

CRUISER NO. 1 (NEWARK).

* The William Cramp & Sons Ship and Engine Building Company, Philadelphia, Pa. (hull to be constructed according to the Department's plans and specifications; machinery to be constructed on bidder's plans and specifications)	\$1, 248, 000
--	---------------

CRUISER NO. 4.

The William Cramp & Sons Ship and Engine Building Company, Philadelphia, Pa. (hull and machinery to be constructed according to Department's plans and specifications)	1, 410, 000
Same company (hull and machinery to be constructed according to bidder's plans and specifications)	1, 325, 000
* Same company (hull and machinery to be constructed according to bidder's plans and specifications)	1, 350, 000
Same company (hull to be constructed according to Department's plans and specifications; machinery according to bidder's plans and specifications)	1, 405, 000
The Union Iron Works, iron-steamship builders, San Francisco, Cal. (hull and machinery to be constructed according to Department's plans and specifications)	1, 428, 000

CRUISER No. 5.

The William Cramp & Sons Ship and Engine Building Company, Philadelphia, Pa. (hull and machinery to be constructed according to Department's plans and specifications)	\$1,410,000
Same company (hull and machinery to be constructed according to bidder's plans and specifications)	1,325,000
Same company (hull and machinery to be constructed according to bidder's plans and specifications)	1,350,000
Same company (hull to be constructed according to Department's plans and specifications, machinery according to bidder's plans and specifications)	1,405,000
*The Union Iron Works, iron steamship builders, San Francisco, Cal. (hull and machinery to be constructed according to Department's plans and specifications)	1,425,000
Award directed by the President, under power conferred by the act of March 3, 1887. (See Appendix A., p. xlv.)	

GUN-BOAT No. 3.

The William Cramp & Sons Ship and Engine Building Company, Philadelphia, Pa. (hull and machinery to be constructed according to Department's plans and specifications)	495,000
* N. F. Palmer, jr., & Co., New York, N. Y. (hull and machinery to be constructed according to Department's plans and specifications).....	490,000

GUN-BOAT No. 4.

The William Cramp & Sons Ship and Engine Building Company, Philadelphia Pa. (hull and machinery to be constructed according to Department's plans and specifications).....	\$495,000
* N. F. Palmer, Jr., & Company, New York, N. Y. (hull and machinery to be constructed according to Department's plans and specifications).....	490,000

Tabular statement of proposals received and opened November 1, 1887, for the construction of a first-class torpedo boat, authorized by the act of August 3, 1886.

The Vulcan Iron Works, Chicago, Ill	\$84,800
*The Herreshoff Manufacturing Company, Bristol, R. I.....	82,750

THE ARMOR-CLADS AND MONITORS.

By the act of August 3, 1886, the Department was authorized to construct two armor-clad vessels, each of about 6,000 tons, and each to cost, exclusive of armament, not exceeding \$2,500,000.

As explained in the last annual report of the Department, it was decided to invite the submission of plans for these vessels by naval architects in civil life at home and abroad, and a prize of \$15,000 was offered for any accepted design. Plans were received from various sources and much interest was elicited. A board of naval experts was appointed to consider the same and the award was unanimously made to the Barrow Ship-building Company, of England, for plans prepared by the eminent naval architect, Mr. William John. One of these vessels will therefore be built upon the plans of the Department and one upon those of the successful competitor.

The completion of the double-turreted monitors will be somewhat delayed from the necessity of obtaining the armor from the Bethlehem Iron Company under the contract referred to heretofore. Meanwhile the matter is receiving careful attention. It is not deemed desirable to order work begun upon these vessels in the navy-yard until they can be pushed to completion.

COAST AND HARBOR DEFENSE APPROPRIATION.

Congress at its last session appropriated the sum of \$2,000,000 for coast and harbor defense vessels. This is the only appropriation heretofore made for a new navy, the disposition of which has not as yet been determined by the Department.

A board of officers was appointed on the 18th day of August last to consider the subject, and they have reported, but the recent unavoidable absence of the head of the Department has prevented a proper review of the matter. Bids were opened upon the 1st day of November last for the construction of one first-class torpedo boat, and two bids were found to have been received; one from the Herreshoff Company, of Rhode Island, and one from the Vulcan Iron Works, of Chicago. As both offer ample guaranties, and the plans submitted with the bids in each case are satisfactory, both offers may be accepted. If so, one will be paid for out of the appropriation for harbor defense boats. Beyond this the Department is not disposed to go in the construction of these unprotected torpedo boats. It is believed that at present the facts are against them.

If one should sum up the results of the naval maneuvers of the last year or two and admit the just consequences of the facts developed at the trials, it would be admitted that the range of usefulness of the unprotected torpedo boat is certainly very limited. When they can be seen they can be easily destroyed by machine and rapid-fire guns. This rules out all day fighting. No fleet has for years in its maneuvers wasted time experimenting with the use of torpedo boats in day fighting. The electric search light has, judged by the later trials, made their usefulness at night extremely doubtful. They are of value only upon occasions when they are invisible to an enemy. Such occasions are rare. The smoke of battle might conceal them, and for a nation having large classes of fighting ships they might prove of consequence, but that is not our situation at present. Now and then an unusual night, dark and foggy, would impair the efficiency of the electric search light, and an occasion favorable for these boats be presented. But the statement of the fact that they are of value only upon rare and accidental occasions should rule them out as a reliable weapon for coast and harbor defense. A nation can not select the nights when it will defend its harbors. The occasions when it must be chosen by its adversary.

The foregoing observations only shift the problem a little. *The weapon carried by the torpedo boat is the most destructive known. Tor-*

pedoes—projectiles of all kinds containing high explosives—are incomparably the most powerful known. The abandonment of the unprotected boat does not involve the abandonment of the projectile. The facts concerning the unprotected torpedo boat have not as yet been generally formulated into the conclusions above stated, but a careful study of the facts has brought about a settled conviction upon the subject which will govern the action of this Department.

In what way, then, shall the high explosive projectiles be carried so as to certainly reach the object of attack in spite of machine and rapid-fire guns? One method possibly now taking practical shape is that of the submarine boat. Elsewhere in this report will be found a reference to the latest and probably the most promising trial of this class of boat thus far had. A number of claimants are pressing different devices for these boats. In order to ascertain whether any known and certain results have yet been reached in the progress of this branch of the art, the Department has, with the aid of the chief of the Bureau of Ordnance, prepared an advertisement inviting all persons who offer to guaranty the results of their work to submit proposals to the Department upon the 1st day of March next. It will serve to sift the claims and may result in an effective and operative submarine torpedo boat. It is reasonably certain that boats entirely submerged, except as to a turret, small and protected against machine-gun fire, are practicable.

The pneumatic dynamite gun is a weapon claiming consideration in this connection. Its range is such as to avoid the necessity of approaching closely to the object of attack, but the Department does not feel authorized to expend anything further upon this weapon until a trial shall have been had of the guns upon the boat now being built. If this trial should be favorable to the gun, it would remove many doubts and difficulties. This will be known within the next few months.

If these various devices fail, *protected boats* can be built of small tonnage, of light draught, proof against machine-gun fire.

To sum up this matter, the Department deems it unwise to follow at present the course of the European powers in building *unprotected* torpedo boats. It recognizes the power of the dynamite projectile, and believes it practicable to embody it in such manner as to insure that it will reach any desired object of attack in spite of known weapons, and upon that problem it is engaged.

THE CONSOLIDATION OF NAVAL STORES.

In the last two annual reports of the Department the necessity for a better system of handling the stores and supplies and for making the purchases of the Department has been fully explained. During the last year a new system has been inaugurated. There will hereafter be accountability for the property and a responsible head to the business. Requisitions for goods are to be made on the Paymaster-General, who

becomes responsible for the purchases being honestly made, and his subordinates at the yards and stations transact the business and keep the accounts. The reduction in the expense of handling and caring for the stores, including clerks, has been over 25 per cent. (Appendix, p. 476.)

THE SINGLE-TURRETED MONITORS.

I find myself unable to concur in the recommendation that the single-turreted monitors be repaired and made ready for coast-defense vessels.

An examination of their characteristics shows that outside of the ships in our own Navy, no antagonist could probably be found against which they could stand for a moment. They were good vessels for their time, but are entirely obsolete. The Admiral of our Navy, speaking upon this matter in 1876, said :

Our monitors are protected by only about 4 inches of laminated plates, have a speed of less than 8 knots, with a tonnage of from 480 to 1,750 tons, and are armed with smooth-bore guns that will not penetrate the 4-inch solid iron plates at 900 yards (which the lightest iron-clads of foreign nations carry, backed by oak), while the lightest foreign iron-clads average about 4,000 tons displacement, a speed of 12 knots, and their guns will send projectiles through the thickest turrets our vessels carry, and they would run over and sink our squadron of small fry with hardly a scratch on their paint work.

This comparison was made in 1876. If made in 1887, it would be still stronger. A first-class modern iron-clad could safely anchor, surrounded by a fleet of these monitors, without any danger of injury to herself, and any one of her guns could send a projectile clean through the monitor from stem to stern.

It would be little less than murder to send men in these at the present time to encounter any recently built iron-clad.

I appreciate fully that it is only as a temporary expedient that it is suggested, and with the thought that in the absence of anything else these might be better than nothing. This has been the theory upon which over fifty, and probably seventy-five, millions have been spent since the close of the war. *It is time to stop it, and be content only with the best.* If every dollar is made to count upon something of real value waste will stop, and not before.

THE HARTFORD.

Congress, at its last session, appropriated specifically for the repair of certain vessels, including the *Hartford*. When she was stripped it was found that her repairs would largely exceed the estimate which the Department had submitted to Congress, and upon which the appropriation was based.

The specific appropriation becoming exhausted, the power of the Department to go further was doubtful, inasmuch as the authority to expend the general appropriation of this Department "for repairs of ves-

sels" is limited to those not requiring an expenditure of 20 per cent. of the value of a new vessel of the same character.

It was decided, therefore, to suspend work, and allow the matter to be resubmitted to Congress.

THE TENNESSEE.

Among the vessels dropped from the Navy Register and sold during the past year is the *Tennessee*.

The account of the sale is stated elsewhere.

The history of this vessel is quite interesting and most illustrative. She had a short life, but, as a consumer of money, a brilliant one. Her hull was built and she was equipped in the New York navy-yard. Her machinery was designed and built under contract by the eminent engineer, Mr. John Ericsson, costing \$700,000. Her total original cost was \$1,856,075.81. Upon her trial trip, in January, 1867, she ran about 1,000 miles. She attained a speed of 16 knots and made a run of 15 knots per hour for four hours. She encountered a perilous storm, described as a hurricane, which continued over twenty-four hours. The ship suffered considerably. The report of her commander says:

The engines moved off finely and worked perfectly during all the storm * * * her machinery is as perfect as it need to be. It has undergone the severest test and not once found wanting. She is the fastest ship I have ever seen.

The chief engineer says:

If the strength and workmanship of the machinery can not be depended upon then no reliance is to be placed upon the performance of any steam machinery with which I am acquainted.

Two years afterwards she underwent what was called "repairs," and the sum of \$576,799.61 was spent upon her; all but \$73,000 of this was put on her hull and equipment. It was the full price of a new wooden hull of her size at that time. This was from 1869 to 1871. She then made a cruise of three months and went into the hands of Mr. John Roach to enable him to take out the machinery and boilers of John Ericsson and substitute others of superior character. It was among other things expected to give the ship a 14½-knot speed for twenty-four hours. When she had her trial of this new machinery in 1875 her maximum speed was 10½ knots, and she had had put upon her an expense of \$801,713.60 in addition to the value of her machinery and boilers taken in trade by Mr. Roach at \$65,000. This machinery had cost \$700,000; had not been in actual service six months; had never been surveyed and condemned by a board of Government officers, nor its value fixed by any Government board, but it was sold to Mr. Roach as old iron.

That is to say, between 1869 and 1875 the *Tennessee* had had three months' service and had cost in repairs and improvements \$1,443,513.21.

This was largely in excess of a fair price for a new ship of her characteristics.

Twelve years afterwards (on April 4, 1887) she is condemned by the Statutory Board as unseaworthy and not worth repairing and ordered sold, having had put upon her between 1875 and 1887 the additional sum of \$577,716.17. She brought \$34,525 at the auction sale. She had cost the Government \$3,800,000 in round numbers and had done about ten years of active service, outside of repair shops and navy-yards.

It is often the subject of wonder what has become of the \$70,000,000 spent upon war vessels since the close of the war, in view of the fact that there is now no Navy. This bit of history will serve as an illustration.

THE PNEUMATIC GUN.

The pneumatic dynamite gun has been developed by private enterprise to the point where it merits immediate attention. The constant strife for mastery between the offensive and the defensive implements of war results periodically in new devices, changing entirely existing conditions. The improvements in armor and in the range and power of guns may be said to have kept pace each with the other. But as the weak point of an iron-clad is in its unprotected bottom, invention has been directed to torpedoes and torpedo-boats, and these have been almost a mania with European powers during the last five years.

Meanwhile the development of the machine gun, and the introduction of steel nettings as a protection against the approach of the torpedo-boat or the torpedo have limited so greatly the range of usefulness of the torpedo-boat as to have caused a considerable distrust of its availability as a weapon. The principal difficulty is that its range of torpedo fire is so short that it is obliged to approach within a few hundred feet of the object of attack, which subjects it to destruction by machine guns.

The pneumatic dynamite gun attacks the problem by a new method. The company has demonstrated that by the use of pneumatic power projectiles containing large quantities of high explosives can be fired with safety and considerable accuracy a distance of between one and two miles.

Whatever destruction a torpedo can do this projectile can do if accurately placed. Against its method of attack neither nets nor machine guns are of any considerable use. It can be fired at such a distance as to be beyond the effective range of machine guns and the line of flight of its projectile escapes nets. There are questions yet to be settled before its efficiency for naval purposes can be fully determined. This invention, like every other, has its own peculiar problems to solve, but the zeal and intelligence thus far given to the development promise ultimate success.

It will at once be apprehended that in order to insure immersion of the projectile (necessary to the highest destructive power of the dynamite) the line of flight of the projectile must be in the arc of a circle—

similar to mortar fire. To drop a projectile at any given point with such a line of flight has hitherto been deemed impracticable. The first impression of every expert has been to reject the gun for probable inaccuracy. The company has, however, claimed that by the use of pneumatic power an absolutely accurate and determinate force is employed and this element of uncertainty removed. The demonstration has reached this point, that, given a fixed platform for the gun, as would be the case in coast defense, and opportunity for previous experiment to determine range, projectiles can be lodged at any desired point with great accuracy. The force can be gauged to a pound.

For coast and harbor defense, to be fired from land batteries, its accuracy is substantially established, but for naval purposes other elements of difficulty intervene. The movement of the vessel destroys the possibility of availing of a range previously determined by experiment. An accurate range-finder is necessary. Those hitherto employed for determining the distance of objects have required a longer base-line than can be had on board ship. Other difficulties also arise for consideration. However, the problems to be solved to make it thoroughly successful for naval purposes are receiving the most zealous and persistent study, and it is believed by those interested that in time all will be worked out.

This gun developed to its present point exclusively in this country and by private enterprise promises to be the most notable event of the year. The claim made for it is quite revolutionary. It is claimed that by increasing the caliber of these guns an accurate range of from three to four miles can be had from a land battery, and that projectiles can be used containing not less than 400 pounds of high explosives. The present demonstration where the accurate range of one mile is shown renders the claim not greatly improbable.

The importance of this matter is somewhat due to the fact that the guns are not difficult of construction, nor, compared to other weapons, expensive, and could be made at any one of a dozen steel manufactories with their present plant; and unless there is something very greatly wrong in the assumed destructiveness of torpedoes and high explosive projectiles the gun must be ranked as of extreme importance.

The experiments witnessed by officers of the Department and their report will be printed in the appendix to this report. (Appendix, p. 483.)

THE NAVAL RESERVE.

The policy of this country has always been opposed to the establishment of large permanent naval and military organizations. This policy for a country with a great coast line and important commercial interests almost necessitates the maintenance of auxiliaries in the way of naval and military reserves. The land forces have such auxiliaries in the shape of State militia or national guards. These constitute large bodies of troops, well organized and equipped, thoroughly well trained and dis-

ciplined, ready to take the field and to become a part of a regular military establishment when required.

A public feeling seems to exist for the creation of a naval reserve.

Committees of the Chambers of Commerce of New York and San Francisco have passed resolutions urging the organization of such a force, as a means for providing for the coast defense and meeting the increased demands of the regular naval establishment for men and vessels upon the outbreak of war. Inquiries have also been made at the Department from cities of the Great Lakes, and meetings have been held in cities of the South indorsing the formation of such a national organization.

The Department has informed itself fully of the different systems of organization for coast defense and naval reserves at present in force in foreign countries, and is prepared to formulate a general plan for a similar organization to meet the requirements and conditions of our own institutions. It should resemble in organization that of the militia or national guard, rest upon the foundation of local interest, contemplate the employment and rapid mobilization of steamers enrolled on an auxiliary navy list, and be calculated to produce the best results upon a comparatively small national expenditure. I ask for this question the earnest consideration of Congress.

It may not be out of place as a branch of this subject to call attention to one of the incidental consequences of the policy pursued by other countries in this matter of a naval reserve. In time of war troop ships or transports are in great demand. Several European Governments make an annual contribution, based on tonnage, to companies constructing new vessels. The consideration to the Government is a counter agreement, permitting the Government to take such a vessel for a transport in time of war upon terms named in the agreement. The Government officials are also consulted as to her mode of construction, and she goes on to the naval reserve list. These payments are incidentally in the nature of a subsidy to the ship-owner, and this, with the liberal payments for Government transportation of mails, etc., keeps a large fleet of merchantmen afloat as a reserve ready for a time of war. Without ships and trained seamen there can be no naval reserve.

A notable illustration of the generosity and courage with which England pushes her shipping interest is seen in the manner in which she is at this moment dealing with the trade of the North Pacific. It has been thus far principally under the American flag and contributory to San Francisco and the United States. The British Government and Canada together are proposing for the establishment of a line of first-class steamers from Vancouver to Japan. The subsidy is likely to be \$300,000 annually—£45,000 from England and £15,000 from Canada. There will also be contributed from the naval reserve fund probably \$5 per ton annually for each ship constructed for the route, which will in-

crease the sum by probably \$125,000. Under such competition it is quite easy to conjecture what will become of the American flag and our resources in the way of a naval reserve in the North Pacific.

WAR VESSELS IN COMMISSION.

The North Atlantic Squadron remains under the command of Rear-Admiral Stephen B. Luce, and consists at present of the following vessels: *Richmond* (flag-ship), *Atlanta*, *Ossipee*, *Galena*, *Yantic*, and *Dolphin*. The *Tennessee* was put out of commission at the navy-yard, New York, January 20, 1887, and the vessels above mentioned, with the exception of the *Galena* and *Yantic*, have joined the squadron during the past year. The *Richmond*, *Galena*, and *Yantic* made a cruise to the West Indies last winter, and the entire squadron has cruised along the coast of North America as far as the Gulf of St. Lawrence, one of the ships going up the St. Lawrence River to Quebec and Montreal.

In September last the squadron was ordered to Philadelphia to participate in the ceremonies attending the centennial anniversary of the adoption of the Constitution of the United States, after which it assembled at Newport for fleet drills and maneuvers in connection with the course of instruction at the Naval War College. The vessels of the squadron are now at New York and Norfolk preparing for winter cruise.

The South Atlantic Squadron continues under the command of Rear-Admiral Daniel L. Braine, and is composed of the *Lancaster* (flag-ship), *Tallapoosa*, and *Alliance*. The latter vessel joined the squadron in June last, having sailed from the United States for her station via the Mediterranean Sea, Suez Canal, and east coast of Africa, and having visited en route the principal ports on the coasts of South Africa, Madagascar, and the Comoro Islands. The *Lancaster* and *Tallapoosa* have been employed during the year in the waters of Brazil, Uruguay, and the Argentine Republic.

Rear-Admiral John Lee Davis remained in command of the Asiatic Station until November 22, 1886, when he was relieved by Rear-Admiral Ralph Chandler, who continues in command of the United States naval force on that station. The squadron is now composed of the *Brooklyn* (flag-ship), *Omaha*, *Marion*, *Essex*, *Monocacy*, and *Palos*. The *Marion* is now at Panama for new officers and men, and will, when they have been received on board, return to her station via the Sandwich Islands. The vessels of the squadron, during the past year, have been actively employed in the waters of China and Japan; and one or more of the ships have, during the unsettled condition of affairs in Corea, been kept in Corean waters for the protection of our interests in that recently opened country. The *Brooklyn* and *Essex* have joined the squadron since my last report. The *Ossipee* has returned to the United States, and been assigned to duty on the North Atlantic Station.

The Pacific Squadron is now under the command of Rear-Admiral Louis A. Kimberly, Rear-Admiral E. Y. McCauley having been detached therefrom November 6, 1886. The squadron consists of the *Vandalia* (flag-ship), *Juniata*, *Mohican*, *Iroquois*, *Adams*, *Alert*, *Pinta*, and store-ship *Monongahela*. The *Hartford*, needing extensive repairs, was sent to the navy-yard, Mare Island, Cal., and put out of commission January 14, last. The *Vandalia*, *Juniata*, and *Alert* have joined the squadron during the past year. The *Mohican* has returned from her cruise to the islands of the South Pacific. The vessels of the squadron have cruised during the year along the west coasts of Mexico and Central and South America, and owing to the disturbed condition of affairs in the Sandwich Islands it was deemed advisable to send Admiral Kimberly with his flag-ship and three other vessels of his command to Honolulu for the protection of American interests. Three of the vessels of the squadron are still in Hawaiian waters, and will remain there until affairs become tranquil. The *Adams* has recently been dispatched from Honolulu to the Samoan Islands at the request of our consul at Apia. The *Pinta* is still employed exclusively in Alaskan waters.

Rear-Admiral S. E. Franklin, having reached the age of retirement on the 24th of August last, he was that day succeeded in command of the European Station by Acting Rear-Admiral James A. Greer. The *Kearsarge* has returned to the United States and been put out of commission. The force on this station now consists of the *Pensacola* (flag-ship) and *Quinnebaug*. The *Pensacola* has been ordered to the United States, to arrive in January next, for relief officers and men. Both vessels have been actively engaged in cruising in the Mediterranean during the year, and the *Quinnebaug* has also made an extended cruise along the west coast of Africa.

The vessels of the training squadron remain the same as in my last report. The three cruising ships, the *Saratoga*, *Jamestown*, and *Portsmouth*, have made the annual practice cruises to the West Indies and to Europe.

The vessels on special service are the *Despatch* on the Atlantic coast, the *Ranger* in the Pacific, engaged in surveying and sounding on the coast of Lower California, and the *Michigan* on the northwestern lakes.

The *Thetis* was put in commission at the navy-yard, New York, in January last for special service in the North Pacific Ocean. She left Hampton Roads, Virginia, May 7, 1887, and arrived at San Francisco October 17, en route to Alaska.

The *Trenton*, *Boston*, *Enterprise*, and *Nipsic* have recently been put in commission, but not yet assigned to any squadron.

[A detailed report of the movements of the vessels will be found in the Appendix, p. 16.]

APPROPRIATIONS AND EXPENDITURES, 1887.

Amount of appropriations for the fiscal year 1887.....	\$13,189,153.72
Drawn from said appropriations to June 30, 1887	10,835,102.25
<hr/>	
Balance undrawn July 1, 1887	2,354,051.47
Due general account of advances to June 30, 1887	1,712,146.03
<hr/>	
	641,905.44
In hands of disbursing officers June 30, 1887.....	292,969.07
<hr/>	
Actual balance available unexpended July 1, 1887.....	934,874.51
Amount drawn to November 30, 1887.....	\$1,035,585.40
Refunded during same period.....	236,044.15
<hr/>	
	799,541.25
<hr/>	
	135,333.26
In hands of disbursing officers October 31, 1887	29,258.96
<hr/>	
Balance available December 1, 1887.....	164,592.22

This balance will be still further reduced by outstanding liabilities.

The following table exhibits the appropriations, expenditures, and balances under each particular head of appropriation.

Statement of appropriations and expenditures for the fiscal year ending June 30, 1887.

	Appropriations for fiscal year ending June 30, 1887.	Amount drawn during fiscal year ending June 30, 1887.	Balances undrawn June 30, 1887.
Pay of the Navy.....	\$7,000,000.00	\$5,661,074.88	\$1,338,925.12
Pay, miscellaneous.....	225,000.00	217,273.09	7,726.91
Contingent Navy.....	10,000.00	3,765.50	6,234.50
Pay of the Marine Corps.....	649,842.00	539,550.81	110,091.19
Pay civil members Naval Advisory Board.....	5,500.00	5,010.40	489.60
Quartermaster's department of the Marine Corps.....	199,646.50	192,876.18	6,770.32
Naval Academy.....	189,931.97	188,714.25	317.72
Navigation and navigation supplies.....	83,500.00	53,884.35	29,615.65
Naval War College.....	6,000.00	5,505.10	494.90
Ordnance and ordnance stores.....	109,300.00	105,233.72	4,066.28
Repairs (Ordnance).....	15,000.00	12,545.42	2,454.58
Torpedo Corps.....	58,500.00	46,688.38	11,811.62
Equipment of vessels.....	782,200.00	600,564.20	181,635.80
Transportation and recruiting (Equipment and Recruiting).....	25,000.00	24,165.99	834.01
Naval training station, Coaster's Harbor Island, R. I.....	8,000.00	5,668.55	2,331.45
Maintenance yards and docks.....	170,000.00	159,372.69	10,627.31
Navy-yard, Brooklyn, N. Y.....	100,000.00	81,623.47	18,376.53
Navy-yard, Mare Island, Cal.....	213,598.00	89,663.40	123,931.60
Repairs and preservation at navy yards.....	125,000.00	123,380.86	1,619.14
Naval Asylum, Philadelphia, Pa.....	63,067.00	46,976.40	16,090.60
Surgeons' necessaries and appliances.....	55,000.00	37,703.72	17,296.28
Naval hospital fund.....	30,000.00	29,999.60	.40
Repairs (Medicine and Surgery).....	15,000.00	14,887.42	112.58
Provisions, Navy.....	1,052,000.00	801,948.57	250,051.43
Construction and repair.....	900,000.00	852,736.84	47,263.16
Steam machinery.....	763,000.00	704,646.73	58,353.27
Contingent (Bureaus).....	119,500.00	74,413.51	45,086.49
Civil establishment at yards and stations.....	216,671.25	205,228.22	11,443.03
	<hr/>	<hr/>	<hr/>
	13,189,153.72	10,835,102.25	2,354,051.47
Deduct amount due general account of advances June 30, 1887.....			1,712,146.03
			<hr/>
			641,905.44
In the hands of disbursing officers June 30, 1887.....			292,969.07
			<hr/>
			934,874.51

The total amount of the appropriations above given for current expenses exceeds that stated on page 14 of the last annual report \$253,595, on account of a different classification of objects.

ESTIMATES AND APPROPRIATIONS, 1888 AND 1889.

The estimates for the Navy and Marine Corps (including salaries and contingent, Navy Department) for the current fiscal year amounted to \$25,589,479.02, and the appropriations to \$26,182,723.79.

The estimates for the fiscal year ending June 30, 1889, amount to \$23,427,940.13, or \$2,161,538.89 less than the estimates, and \$2,754,783.66 less than the appropriations for the current fiscal year.

The following table is a comparative exhibit of the appropriations for 1888 and the estimates for 1889:

Appropriations for 1888 and estimates for 1889 for the Navy and Marine Corps.

Current expenses.	Appropriations 1888.	Estimates for 1889.
Pay of the Navy.....	\$7,000,000.00	\$7,082,404.00
Pay, miscellaneous.....	205,000.00	225,000.00
Contingent, Navy.....	7,000.00	7,000.00
Contingent, Bureaus.....	120,500.00	135,500.00
Civil establishment, yards and stations.....	199,132.84	214,235.64
Marine Corps, pay.....	651,062.88	663,781.43
Marine Corps, quartermaster's department.....	240,028.02	228,560.55
Naval Academy.....	203,880.45	195,813.45
Bureau of Navigation:		
Navigation and navigation supplies.....	83,500.00	130,000.00
Ocean surveys.....	5,000.00	10,000.00
Publication of surveys of Mexican coast.....	5,000.00	10,000.00
Coaster's Harbor Island.....		12,400.00
Bureau of Ordnance:		
Ordnance and ordnance materials.....	128,400.00	170,000.00
Repairs.....	15,000.00	15,000.00
Torpedo Corps.....	57,800.00	89,500.00
Bureau of Steam Engineering:		
Steam machinery.....	675,000.00	800,000.00
Bureau of Construction and Repair:		
Construction and repair.....	900,000.00	900,000.00
Bureau of Provisions and Clothing:		
Provisions.....	1,121,000.00	1,217,476.50
Bureau of Yards and Docks:		
General maintenance.....	170,000.00	230,000.00
Naval Asylum.....	63,167.00	90,111.00
Repairs and preservations.....	450,000.00	400,000.00
Bureau of Medicine and Surgery:		
Medical department.....	57,500.00	60,000.00
Naval hospital fund.....	30,000.00	30,000.00
Repairs.....	15,000.00	25,000.00
Bureau of Equipment and Recruiting:		
Equipment.....	625,000.00	725,000.00
Transportation and recruiting.....	25,000.00	30,000.00
Training station, Coaster's Harbor Island.....	14,000.00	30,000.00
Total current expenses.....	13,066,121.79	13,716,782.57
OTHER OBJECTS.		
Increase of the Navy.....	11,048,362.00	
Bureau of Ordnance.....	\$2,600,000.00	
Bureau of Construction and Repair.....	3,000,000.00	
Bureau of Steam Engineering.....	1,500,000.00	
Improvements at yards and stations:		6,500,000.00
Bureau of Yards and Docks.....	955,591.56	
Bureau of Construction and Repair.....	235,000.00	
Naval Academy:		1,190,591.56
Purchase of ground.....	108,000.00	
Steel practice ship.....	275,000.00	
Converting hospital into quarters.....	10,000.00	
		393,000.00

Appropriations for 1888 and estimates for 1889 for the Navy and Marine Corps—Cont'd.

Current expenses.	Appropriations 1888.	Estimates for 1889.
OTHER OBJECTS—continued.		
New Naval Observatory (Navigation)	\$60,000.00	\$300,000.00
Naval hospital park, Norfolk (Medicine and Surgery)	5,000.00	5,000.00
New barracks at Norfolk	\$60,000.00	
New barracks at League Island	20,000.00	
		80,000.00
Bureau of Ordnance:		
Main and secondary batteries for four new ships, in service	445,000.00	
General armament, modern secondary batteries, and small arms	233,250.00	
Modern guns and ammunition for cadets at Naval Academy	\$69,000.00	
Modern guns and ammunition for training squadron	65,000.00	
Proof of naval armament	6,000.00	
		818,250.00
Navy Department:		
Salaries and contingent	314,896.00	364,316.00
Printing and binding	60,000.00	60,000.00
Purchase of the <i>Stiletto</i>	25,000.00	
Repair of <i>Hartford</i> and other vessels (Construction and Repair)	200,000.00	
Hospital and wharf, Widow's Island (Medicine and Surgery)	50,000.00	
Proving ground, Annapolis (Ordnance)	40,000.00	
Testing torpedoes (Ordnance)	50,000.00	
Relief acts	20,880.00	
Contingent (Provisions and Clothing) (special)	20,000.00	
		60,000.00
Total for all purposes	26,182,723.79	23,427,940.18

Of the amount appropriated for the *current* expenses of the present fiscal year, there has been drawn from the Treasury, after deducting sums refunded from July 1 to October 31, 1887, \$2,833,040.65, or \$865,563.29 less than during the same period of the past fiscal year.

SALES OF CONDEMNED VESSELS.

The following-named vessels, stricken from the Navy Register under the provisions of the act of August 5, 1882, as "unfit for further service," have been sold during the year, as authorized by the act of March 3, 1883, viz: The *Tennessee*, *Pouhatan*, and *Ticonderoga*, at New York, and the *Cyane*, *Shenandoah*, *Lackawanna*, and *Wachusett*, at Mare Island. Proposals were invited for these vessels by public advertisement, and opened July 30. There was no offer for the *Tennessee*. The Government received for the six others \$91,180, which was \$22,180 in excess of their appraised value. Of the amount so received \$1,791.13 were paid for advertising, \$72,004 have been covered into the Treasury as "miscellaneous receipts," and \$17,384.87 retained on deposit with the United States Treasurer, to be used should it be determined to break up the hulk *New York*, on the stocks at the Brooklyn navy-yard, and the *Antietam* now at the League Island yard, and to cover outstanding advertising bills.

The *Tennessee* was reappraised and, by authority of the President, and in pursuance of the act of March 3, 1883, sold at public auction September 15, for \$34,525, which was \$6,525 in excess of her reappraised value. The net amount realized from the sale of the *Tennessee*,

after payment of the auctioneer's commission, was \$33,661.88, which has been deposited in the Treasury and will be covered in as "miscellaneous receipts." The *New York* was offered at auction at the same time, but no bid received equal to her appraised value.

As soon as temporary provision can be made at League Island for the Marine guard quartered on the *Antietam* (no longer suitable for that purpose), it is proposed to offer her for sale.

A detailed account of the receipts and expenditures by the Secretary of the Navy, connected with the sale of condemned vessels, will be found in the appendix (p. 8).

SALES OF GOVERNMENT PROPERTY.

A detailed statement of the receipts from the sales of Government property pertaining to the Navy, as shown by deposits in the Treasury, from November 1, 1886, to November 1, 1887, will be found in the appendix. The total deposits, which embrace premium on exchange, rents, and articles supplied other departments of the Government, amounted to \$247,876, of which \$189,630.74 were covered into the Treasury as "miscellaneous receipts," and \$58,245.26 credited to the appropriations to which they belong, in accordance with law. This statement does not embrace the amounts received from the large sales at Portsmouth, N. H., Boston, and San Francisco, which have not yet been deposited in the Treasury, and may amount to \$100,000, or more; the accounts not having been fully adjusted and outstanding advertising and other bills paid. It includes, however, the sum of \$72,004 of the amount mentioned in this report as realized from the sale of condemned vessels. (Appendix, p. 10.)

AUTHORITY TO CONSTRUCT NEW SHIPS.

It has not been the custom of the Department of late years to specify the forms and characteristics of vessels recommended to be built. It has seemed wise to leave these matters to the disposition of Congress. The Department is prepared to proceed with the construction of armor clad vessels and recommends the commencement of two additional ones to cost exclusive of armament not exceeding \$6,000,000, one to be built by contract and one in one of the navy yards.

It also asks for authority to build three more fast cruisers of the highest type.

Attention is called to the report of the chief constructor where it is stated that in six years but four of the present cruising ships will remain serviceable. The present Navy, in other words, will have disappeared at that time. (Appendix, p. 286.)

DEVELOPMENTS OF THE YEAR.

The steam trials of the year have indicated the great increase in speed and ratio of power to displacement in vessels recently designed. In

some cases this has been obtained by sacrificing many other qualities which are essential in a war vessel.

Among the fastest vessels tried during the year may be mentioned—

The *Dogali*, a lightly protected steel cruiser of 2,000 tons' displacement, built by Armstrong, Mitchell & Co., and purchased some months since by the Italian Government. This vessel is reported to have developed a speed of 19.6 knots on the measured mile trial with 7,600 I. H. P.

The Chinese cruisers recently completed at Elswick, and now in China, present some remarkable features. They are of but 2,300 tons displacement, very effectively protected by internal armor (protective deck), carry a heavy battery of three 8-inch and two 6-inch B. L. R., besides the secondary battery, and are said to have developed a speed of over 19 knots, and more than 6,000 I. H. P. (The vessels were probably light when tried.)

The *Undaunted*, one of the new class of English belted cruisers, a vessel of about 5,000 tons, developed, on a four-hours' forced-draft trial, an average speed of 18.9 knots, with 8,602 I. H. P., the vessel being brought to her normal load displacement.

The *Galatea*, of the same class, which has just completed her trials, under the same conditions, has attained an average speed of 19 knots, with 9,200 I. H. P.

But the most remarkable vessel produced during the year is the Spanish cruiser *Reina Regente*. This vessel, built by Messrs. Thomson of Clydebank, was tried in October last, sixteen months after her keel was laid. She displaces about 5,000 tons at normal draught, is most effectively protected by internal inclined armor (protective deck), carries an exceedingly heavy battery, among which are four 9.45-inch B. L. R., handles with great rapidity and ease, possesses an unusually great radius of action, and has developed the greatest speed yet attained by any general-service fighting-ship. The official report of the *Reina Regente's* trials for two hours under forced draft, and displacement at 4,900 to 5,000 tons, announces the mean speed as 20.6 knots, with about 11,500 I. H. P. On the natural-draft trial the speed developed was 18.7 knots, and I. H. P. 7,780.

If the expectations entertained for the new cruisers, 4 and 5, and the *Baltimore*, now under contract, are realized, it is believed that they will prove as efficient as any other vessels of the same class and date of design.

The cruisers in process of construction in France and Germany correspond closely with our new cruisers in size, speed, and battery power.

Triple-expansion engines, with high piston speed and systems of forced draft are now in universal use in all modern war ships.

In a few vessels of recent design the number of propellers has been increased to three.

The important developments of the year in the United States leading to the early domestic supply of gun forgings, guns, and armor are referred to in detail elsewhere.

Competition among the manufacturers of steel battering shell abroad has produced projectiles giving wonderful, although somewhat inconsistent, results. One of a lot of 200 Holtzer 12-inch chrome-steel shell (ordered by the Admiralty), and recently tried in England, was fired through a new Brown 16 inch compound plate and 10 feet of solid backing, and was stopped by an old armor plate in the rear. The plate was broken in two parts, and cracks were developed over its surface; the frame at the back was broken, and the plate moved back bodily 4 or 5 inches. The projectile was found to be so little deformed that it might have been fired again.

Rapid-fire guns are being rapidly developed and are fast assuming an importance which will permit them to form the principal batteries of certain classes of vessels.

The higher calibers are the 9-pounder and 33-pounder Hotchkiss, and the 30-pounder and 70-pounder Armstrong. These guns are built wholly of steel, and retain the peculiar features of rapid loading, extracting, and pointing of the smaller calibers.

The Armstrong 30-pounder has been recently tried. The gun was fired ten aimed rounds in forty-seven seconds. The initial velocity obtained is reported as 1,900 foot-seconds, with a powder pressure of about 14 tons; the weight of powder charge being 9 pounds. The weight of this gun is 1.7 tons, and the estimated penetration in wrought iron about 7 inches.

The 70-pounder Armstrong (weight 3 tons) has also been fired with a charge of 34 pounds and a projectile of 70 pounds, giving a velocity of 1,950 foot-seconds. The builders believe this gun can be fired at the rate of eight or ten rounds per minute, and that the penetration in wrought iron will be more than 10 inches.

The establishment of the home manufacture of rapid-fire and revolving cannon is of great importance to the country. Reference is made elsewhere to the contract made with the Hotchkiss Ordnance Company for the manufacture of the Hotchkiss guns in the United States.

The manufacture of another gun of the rapid-fire type, the Driggs-Schroeder, of American invention, has been undertaken by a prominent firm. A 3-pounder gun of this model has been built and is now at the Naval Ordnance Proving Ground for trial.

The manufacture of the new brown powder has been successfully developed by Messrs. Du Pont, and the American powder is found upon trial to give results quite as good if not better than those obtained from similar powder purchased abroad.

The pneumatic gun spoken of in my report of last year has been tried before a naval board, and comment upon it is made elsewhere.

In Europe the work of constructing fast torpedo boats has remained in the hands of private builders. The unprecedented speed of 26.18 knots has been attained by the *Ariete*, a 147-foot twin-screw boat built by Thornycroft & Co. for the Spanish admiralty. Messrs. Yarrow & Co. have also completed two single-screw 135-foot boats for the same Government, named the *Azor* and *Halcon*, which on trial, carrying 17 tons, recently developed, respectively, 24 and 23½ knots, which is the best result attained so far by boats of that size. Earlier in the year this firm also built for Italy two twin-screw boats 140 feet long, of 100 tons displacement, which made 24.96 and 25.1 knots for six runs over the measured mile.

Other firms in England and many prominent ones on the continent continue to supply remarkably fast and able boats. The accompanying table shows the number owned or building in October, 1887:

Nation.	Deep-sea class (over 130 feet in length).	First class (from 100 feet to 130 feet in length.)	Second class (less than 100 feet in length and including torpedo boat carried on board ship).	Third class (steam launches and cutters fitted with torpedoes).	Building or ordered.
England.....	2	49	80	420	10 first class.
France.....	5	20	50	129	5 deep-sea, 42 first class.
Italy. (Total number to be 190 by 1898, ten of which are to be deep-sea class.)	2	38	23	150 steam launches to be increased to 250 by 1898.	2 deep-sea, 43 first class.
Russia.....	2	23	34	138 steam launches fitted with spar torpedoes.	2 deep-sea, 3 first class.
Germany.....	3	47	48	2 deep-sea, 19 first class.
Austria.....	2	18	8	2 deep-sea.
Turkey.....	19	2 submarine.	2 deep-sea, 15 first class.
Spain.....	6	7	2	50 to be built.
Greece.....	6	31
Denmark.....	5	2 submarine.	11	5 mining-boats..
Sweden and Norway.....	12	6	1 mining-boat...	14 first class, 14 second class.
Holland.....	3	20
Portugal.....	3	2	3 first class.
Japan.....	1 armored	4	4	17 first class.
China.....	1	17	6
Brazil.....	5	15
Argentine Republic.....	4
Chili.....	9
English Colonies.....	2	1	3

During the present year there is a falling off in the numbers built, but this is partly due to the fact that heavy orders given to different firms in 1886 have been nearly all filled, and more particularly because professional opinion has apparently succeeded in making itself heard in condemnation of most of the torpedo-boats heretofore built. The verdict is that in order to attain the remarkable speeds called for by the conditions of modern warfare, these vessels have been built of too light and delicate construction, and a greater tonnage is desirable for

those intended for service on the high seas. The tendency now is to exceed lengths of 130 feet and to arm the boats efficiently with machine and rapid-fire guns for self-defense against others specially fitted to attack them. The French *Ouragan*, 151 feet long, and the Yarrow and Thornycroft 140 and 147 foot boats, and the still larger "turnabout" boats of J. S. White, constitute a type now being studied; but it seems probable that for actual sea service proper they will attain a size corresponding to the *Rattlesnake* type in England, *Bombe* in France, *Destructor* in Spain, *Iljin* in Russia—that is, of 300 to 600 tons displacement, which brings them more properly in the domain of torpedo vessels. Smaller boats will be built of such size as to be useful for harbor defense, and to be carried by the larger vessels of the fleet. Of these a type is being produced capable of steaming at the rate of 17 knots an hour, and yet weighing only 11½ tons, and suitable for the general service of a ship in times of peace.

In view of the great number of machine and rapid-fire guns now carried, the question is also being raised whether a partial protection of the motive machinery is not essential. The first step in this direction has been taken by the Japanese Government, who have lately received from Yarrow & Co. a 166-foot boat, in which the boilers are covered by 1-inch steel armor. This will prove inadequate as against the latest developments of machine guns. The result of the last year's consideration of the question is that the torpedo-boat has lost ground.

The transportation of torpedo-boats across country by rail has lately been effected in France in a manner full of tactical interest. The carriage of a 108-foot boat, weighing about 40 tons, from the Mediterranean to the Channel, supplementing the performance of the same journey by canal two years ago, at once doubles the defensive power on either coast, and illustrates the extremely valuable sphere of boats built of a size to render such transit possible. This feature commends itself as possessing peculiar interest in the United States.

While some first-class torpedo-boats are found to be too small for efficient service at sea, those for harbor defense are yet so large as to lose the valuable feature of invisibility, and many authorities are beginning to maintain that these should have the power of going under water if required. The largest and most powerful submarine vessel ever yet constructed is the "Nordenfolt," launched in March last by the Barrow Ship building Company. The length of this torpedo-boat is 123 feet, and displacement when wholly immersed 243 tons. It is always buoyant and is submerged by the power of propellers acting in a vertical direction; should any part of that apparatus get out of order, therefore, the boat would rise to the surface. Two large forced-draft boilers furnish steam for propulsion at the surface; for under water service two additional reservoirs are installed, which, together with the boilers, contain enough superheated steam and water to drive the engines for 20 miles with the fires out. The ordinary coal capacity is 8 tons, which will

carry the boat 1,000 miles at 8 knots an hour; 20 tons more can be stowed in ballast tanks. At a preliminary trial she made a speed of 6 to 8 knots with the fires out and only the two turrets showing; with a less displacement and fires lighted she made 13 to 14 knots.

The two turrets and the upper part of the turtle-back are plated with 1-inch steel. The offensive power is vested in two tubes and four fish torpedoes; for defense two machine guns will be carried.

But three finished torpedoes have been presented to the Torpedo Board by inventors, viz, the Patrick torpedo, the Howell torpedo, and the Hall torpedo. Some preliminary trials of the Patrick torpedo have been made before the board, and a programme of further trials submitted. This torpedo of American invention has great promise and should be encouraged. Trials with the other torpedoes have not as yet been made, as the owners have not announced themselves ready.

Steel-wire nets continue to be an increasing factor in protecting vessels from attacks of automobile torpedoes and torpedo boats, and experiments have been made in England and France to test their efficiency under different circumstances. These have shown that for ships at anchor or at low speed (not exceeding 5 knots) the nets carried at a distance from 25 to 30 feet (and even less) from a ship's side furnish an effective protection against such attacks.

REPORT OF THE ADMIRAL.

The report of the Admiral of the Navy, dated July 6, 1887, presents important observations and reflections in reference to the naval regulations, the Engineer Corps, coast defenses, the enrollment of seamen, the condition of the commercial marine, and the reorganization of the Navy. Tables are given exhibiting the work, during the past year, of the boards of inspection and survey, and attention is specially directed to the condition of the single-turreted monitors. In reference to the subject of coast defenses, the Admiral presents cogent arguments in support of his position, that a necessity exists for putting the nation in a better state of defense, and expresses it as his opinion that the first step towards the protection of our coasts should be the construction of heavy iron-clads ready at a week's notice to anchor off our shores and resist an approaching enemy. (Appendix, p. 27.)

BUREAU OF YARDS AND DOCKS.

The Chief of the Bureau of Yards and Docks, Commodore D. B. Harmony, gives a detailed report of expenditures and improvements at the navy-yards and naval stations during the past year, and submits estimates of the amounts required during the coming year for the maintenance, preservation, repair, and improvement of the yards. Among these recommendations may be noted: the repair of the water-supply system at the Boston yard; a new boiler-shop and the repair of the cob-dock at New York; dredging and filling in Philadelphia; the com-

pletion of the railroad extension, the erection of a building for iron and steel shops, and the adaptation of the wet basin for a fitting-out basin, at Norfolk; the construction of a wharf, the extension of the quay wall, and the removal of the gas-holder at Mare Island. The report also deals with the condition of the Naval Asylum, and renews the recommendations previously made for certain small but much needed improvements, including the discontinuance of the objectionable title of "asylum," the erection of a new kitchen, and an increase of pay of certain employés.

Special attention is called to the considerations presented in the report in reference to the provision of additional facilities for naval work on the Pacific coast, especially in the neighborhood of Puget Sound, the great coal and iron region of the future upon this coast. Apart from this question of an additional naval station, measures should certainly be taken to place the only naval station now existing upon the coast, that at San Francisco, in a fully equipped condition.

Another and most important subject, referred to in the report is the question of making available our naval resources on the Gulf coast. The necessity for a naval station upon the shores of the Gulf is imperative. It appears to the Bureau that Pensacola, though defective in some respects, combines many advantages for a naval station, and that, by the removal of the yard to the upper part of the bay, railroad connections can be made and other important benefits secured. (Appendix, p. 94.)

BUREAU OF ORDNANCE.

The report of the Chief of the Bureau of Ordnance, Commodore Montgomery Sicard, contains a summary of operations in the Bureau second in importance to none over which the Department has charge, and illustrating the remarkable development which the affairs of the Navy have undergone during the past year. The steadiness and persistence of method pursued in the Bureau produce results of uniform certainty, and in consequence the efforts of the Department in this direction have met with the most gratifying success. Not the least important or successful work of the Bureau has been the preparation of information, specifications, and rules for the assistance of bidders and for the conduct of the trials and tests of the numerous articles of ordnance contracted for by the Department.

The chief of these papers are as follows: Circular and specifications concerning the requirements to be observed in designing an armored cruiser and an armored battle ship; circular of information and tests to be applied to American armor plates to be furnished under the act of Congress approved March 3, 1885; circular of information and tests concerning armor and gun steel, prepared for the use of bidders and others under the large contract that was recently awarded to the Bethlehem Iron Company; circular concerning the requirements and trials of a proposed steel torpedo boat; instructions in relation to

the trial of the torpedo boat *Stiletto*; rules of procedure laid down for the guidance of the Torpedo Board in its trials of torpedoes under the act of Congress approved August 3, 1886; specifications for buildings and traveling cranes for the gun factory, and for machine tools for the same establishment, and specifications for Hotchkiss cannon and ammunition; and specifications for steel-cast guns. All these papers required great care in preparation, and some of them involved unusual difficulty, from the novel questions involved, and the want of adequate information in the country.

In reference to the manufacture of cannon during the past year, those originally commenced for the *Chicago*, *Boston*, *Atlanta*, and *Dolphin* have been finished, with the exception of six, which can be completed in a few months. The delay has been chiefly owing to lack of funds, and an appropriation for this purpose is urgently required.

For the armament of the ships since authorized, contracts have been made for gun forgings as follows: For thirty-two 6-inch with the Midvale Steel Works, and for forty-six 6-inch, four 8-inch, twenty-four 10-inch, and two 12-inch with the Bethlehem Iron Company. The Midvale forgings are now beginning to come in, and will be taken in hand at once in the shops at the Washington navy-yard, the contract requiring that the whole number shall be delivered by February, 1889. The Bethlehem Company's contract requires that their plant shall be ready to make deliveries by August 1, 1888, and it is thought that by this time the supply of forgings will be sufficient for the armament of all the vessels thus far authorized, except the harbor defense vessels directed by the act of March 3, 1887, the designs of which are not yet sufficiently developed to admit of fixing the armament.

The guns which have thus far been finished have been subjected to thorough trial, including the statutory tests, with most satisfactory results.

The estimates submitted under "Increase of the Navy" for the coming fiscal year are intended to cover the armament of the *Charleston*, *Baltimore*, *Miantonomoh*, four gun-boats, dynamite cruiser, torpedo boat, *Newark*, Cruiser No. 4, and Cruiser No. 5, and three-fourths of the armament of the four monitors now building.

Additional estimates have also been submitted for supplying with a modern armament four of the present third-rates, which would thus be made efficient vessels; and for the provision of modern guns for use at the Naval Academy and in the training-ships, where they are urgently needed.

Much indispensable and excellent work has been done during the year at the Naval Ordnance Proving Ground. The Bureau has been conducting a search for a new site for a proving ground, appropriated for at the last session of Congress, which shall be free from the objections of the present site, and hopes shortly to reach a satisfactory decision.

The extensive changes necessary to complete the new gun factory at the Washington navy-yard are in progress, and the work will be pushed forward as rapidly as possible.

The development of a suitable slow-burning powder for high-power guns has presented many difficulties, but a satisfactory result has recently been reached, the details of which will be found in the Bureau's report. The efforts of the manufacturers to turn out sound cast-steel projectiles have so far been unsuccessful, but must still be continued in the hope of ultimate results, as the production of such projectiles of proper quality is a necessity. The work on gun-carriages shows good progress. Those of the *Atlanta* have been placed on board and have worked satisfactorily. The bronze deck-circles for the carriages proved not to be sufficiently strong, nor strongly enough fastened down to the deck of the ship to sustain the shock from the recoil of such powerful guns, and they will be replaced by steel circles now in the course of preparation. The bronze circles used at the proving ground stood the shock from the same guns, and the difference in the result on board is believed to be largely due to the spring of the deck and sides of the ship.

An important arrangement has been made with the Hotchkiss Company for furnishing ninety Hotchkiss guns of various calibers, with ammunition, on the condition that the work should be done in the United States. This action will result in the permanent establishment of a new and most useful branch of manufacture in this country. Consideration has also been given to the improvement of fuzes and small-arms, and at the instance of the Bureau a new sample revolver has been designed, embodying several special features, which is now under examination.

The subject of torpedoes has engaged closely the attention of the Bureau, and a torpedo board, acting under instructions carefully framed, has been convened, and is now considering the various plans and designs submitted to it. A circular stating the requirements of the torpedo boat authorized by the act of August 3, 1886, has been issued and proposals have been advertised for, which were opened November 1. A programme for the official trial of the *Stiletto*, for the purchase of which an appropriation was made March 3, 1887, has been prepared by the Bureau.

The Torpedo Station, under the efficient charge of Commander C. F. Goodrich, has continued its important investigations and manufactures, and the course of training for officers has been improved and made more practical. Classes of enlisted men have received valuable instruction both at the Torpedo Station and at the Washington navy-yard, and the importance of the training so given is shown in the eagerness of commanding officers to obtain these men in their crews. It is highly desirable that similar instruction in gunnery should be given on board a ship specially devoted to this purpose; that the crews of all vessels should have a systematic course of instruction in the use of the

armament before the vessels go abroad or on general service; and that prizes should be awarded to enlisted men for excellence in target practice and ordnance exercise, such as are given in all the other principal navies.

Designs for using pneumatic pressure for maneuvering an 8-inch gun-carriage have been submitted by the Pneumatic Gun Carriage and Power Company and referred to the Bureau, which is still in communication with the company concerning them.

A method has been devised by the Bureau of registering the results of target practice by instantaneous photography, the details of which will be found to be of interest.

In view of the great increase of work in his office, the Chief of the Bureau recommends an addition to the clerical force. This addition is urgently required.

Under authority conferred by act of Congress, approved March 3, 1887, making an appropriation "for the purchase and completion of three steel-cast rough-bored and turned, 6-inch, high-power rifle cannon, of domestic manufacture, one of which shall be of Bessemer steel, one of open-hearth steel, and one of crucible steel," the Bureau, under direction of the Department, prepared specifications and proposals for these guns. In answer to the advertisement, dated June 23, 1887, two bids were received, one for the rough-bored and turned casting of Bessemer steel and the other for the rough-bored and turned casting of open-hearth steel. Contracts have been awarded in both cases. (Appendix, p. 230.)

BUREAU OF EQUIPMENT AND RECRUITING.

In the report of Commodore W. S. Schley, Chief of the Bureau of Equipment and Recruiting, will be found a statement of the supplies purchased and manufactured by the Bureau during the past year, including coal, hemp, cordage, anchors, chains, and galleys, sails and other canvas work, and rigging. The concentration of the manufacturing operations of the Bureau at the Boston yard has been accomplished successfully and at small expense by the transfer of such tools as were needed to the new equipment depot, leaving only minor repairs and supplies to be obtained at other stations by ships in commission. Great economy and simplification of business have been secured by this centralization.

The training of apprentices has been successfully carried on at the headquarters of the service at Newport, under Capt. A. R. Yates. As this is the great nursery of trained seamen, its wants should receive the fullest attention. The recent progress of naval science has made special training for seamen a necessity. After a period of schooling and of instruction in the elementary duties of a sailor at the station, the apprentices are sent abroad in the training ships on a cruise. The old ships used for this purpose require constant repair, and are too antiquated for purposes of modern training, which require a knowledge

of modern guns and machinery, of torpedoes, and of electric lights. With this view the Bureau urgently recommends the immediate construction of two steam training-ships, bark-rigged, and engined with modern machinery, fitted with torpedoes and all other modern appliances. A swimming school is also badly needed at the training station.

The number of enlisted men and apprentices on June 30, 1887, was 8,342. The number allowed by law has not been exceeded during the fiscal year, but the service is much cramped by reason of the numbers (about 700 per annum) diverted from cruising service for the Coast Survey, the Fish Commission, and the Naval Academy. It is clear that these men should be in addition to the regular force of seamen. About 40 men have been placed under instruction during the past year at Washington in the care and use of machinery, tools, guns, ammunition, search-lights, etc., and at Newport in torpedoes. This course has proved to be invaluable.

Certain recommendations of a detailed character, and of very great importance to the welfare of enlisted men, are made by the Bureau. Among them are the following: That honorably-discharged men who so elect should be allowed to find a home on board receiving-ships until their next term of enlistment, instead of being forced to seek lodgings in the unwholesome resorts where they are usually to be found; that section 1306 of the Revised Statutes be amended to extend to seamen the privilege of interest on deposits of their pay with the paymasters; that the benefits of retirement and naturalization now granted by law to enlisted men in the Army be extended to the same class and under the same conditions in the Navy; that commissioned naval officers be authorized to administer to recruits the oath of allegiance; that allowances for outfits be made to apprentices, thus removing an intolerable burden; and that promotion to grades of the line, under well-defined limitations and restrictions, be open to a certain number of selected apprentices in each year. (Appendix, p. 128.)

BUREAU OF STEAM-ENGINEERING.

The report of Engineer-in-Chief George W. Melville, Chief of the Bureau of Steam-Engineering, describes the work of the Bureau during the past year, including the preparation of plans for triple-expansion machinery for Cruisers Nos. 1, 4, and 5, and for two armored cruisers. Plans have also been prepared adapting the machinery of "No. 27" design to Cruisers Nos. 4 and 5, to conform to the law under which the latter are to be built. Similarly the machinery of Gun-boat No. 1 is being adapted to Nos. 3 and 4. Preliminary work has also been done on designs for machinery for the monitor *Monadnock* and for the new tugs whose construction is recommended, and plans have been prepared for alterations in machinery of the *Hartford*, *Kearsarge*, and *Swatara*. The usual repairs and alterations to the machinery of vessels have been

made at the different yards, as necessity arose, and a variety of work has been done for other Bureaus, among the items of which may be mentioned the construction of a 100-ton steel crane at Mare Island for the Bureau of Yards and Docks. A compound condensing engine and boiler were also made for the surveying-launch *Cosmos*, of the Coast Survey.

Detailed statements will be found in the report of the progress of work on the machinery of the vessels under contract.

In the report of the Bureau will be found a number of valuable observations accompanied by recommendations in reference to the engineer force, the care, preservation, and operation of the machinery of ships of the Navy, and the business of the Bureau. Among the points noted are the insufficient numbers of the personnel of the Engineer Corps; the ill effects of the present system of educating cadets who are to become engineer officers; the anomalous position of those officers who are borne on the register as cadet engineers; the inadequacy of the engineer force on shipboard, and the injury arising from its diversion to other employments; the necessity of an increase in the number of machinists, and of an improvement in their manner of living on board ship; the disadvantages resulting from the nominal assignment of particular boilers to particular ships; the complication of authority in reference to machinery used for various purposes on shipboard; the inadequacy of inspections as at present conducted by fleet-engineers; the errors likely to result from the composition of boards of survey; the necessity of repeated trials of engines working under full power; the defects of the present system, under which the Bureau can not communicate directly with engineer officers, at sea and at navy-yards; the importance of furnishing intending bidders with general specifications in advance; the necessity of better provision for the care of machinery on board vessels in ordinary; and the insufficiency of present arrangements for the proper handling of material at navy-yards.

The Bureau makes an important recommendation in reference to experiments for the determination of doubtful points in steam engineering, advising that an appropriation of \$25,000 be made for this object, and calls attention to the liberality of J. M. Forbes, esq., in offering his yacht, *Sheerwater*, to the Bureau for the purpose of experimenting with the Belleville boiler, with which it is supplied. Another growing necessity is that for an instrument depot, in order that instruments may be compared with a standard and kept in condition for immediate issue.

For the six tugs recommended by the Bureau of Construction, the Engineer-in-Chief advises engines of simple pattern but of the most recent type. The old single-turreted monitors, as a temporary expedient, should also have improved appliances, and an estimate of \$185,000 is recommended for this purpose.

In order to be ready for any emergency, additions of modern tools should be made to the shop machinery at the navy-yards. Complete hydraulic boiler-making outfits are recommended for New York, Norfolk, and Mare Island. Testing machines are urgently needed, and it is recommended that one be built immediately at the New York yard. Each Bureau using steam machinery at the yards now has its own steam-generating plant, and in the opinion of the Bureau, economy demands that one central boiler-station should be created at each yard as the old boilers wear out. The New York navy-yard now requires a new boiler-shop, and a considerable increase of tools. Additions are needed to the boiler-shop at Norfolk, and a new building for the rolling-mill machinery at Mare Island. A hydraulic boiler-making plant should also be procured for the purpose of making heavy steel boilers at the latter yard. Other items of machinery and tools required will be found in the estimates accompanying the Bureau report.

It is recommended, in view of the large amount of technical work in the Bureau, that an engineer assistant to the Chief of the Bureau be authorized by law. (Appendix, p. 340.)

BUREAU OF CONSTRUCTION AND REPAIR.

Important operations of the Bureau of Construction and Repair are referred to in detail in the report of the Chief of the Bureau, Chief Constructor Theodore D. Wilson, showing the work performed and amount expended during the past year and estimates of amounts required for the next year. The great increase in the labors of the head of this Bureau would seem to require the appointment of an assistant chief, in accordance with the recommendation made in the Bureau report. The Bureau also recommends that two composite single-screw vessels, of about 1,000 tons each, be built to replace the wooden sailing ships now used as training ships, which can not much longer be kept in service. Recommendation is also made for the immediate construction of experimental works, to cost \$60,000, for use in the determination of resistance and other qualities of ships by means of models. Such works now form an important part of the designing branch of foreign naval establishments, and the Bureau is convinced of their permanent value.

During the past year the *Tennessee* and *Shenandoah* have been condemned as unfit for further use in the naval service.

The sloop of war *Hartford* is likely to be condemned, the cost of her repairs exceeding the 20 per cent. limit prescribed by law. Her live-oak frames are sound, and in the opinion of the chief constructor she could be repaired within the amount of \$175,000 called for by the Board of Survey, and he accordingly asks that special authority for her repairs may be given. It is also recommended that the single-turreted monitors should be put in perfect repair. It is estimated that this can be done at an expense of \$500,000. The Department's views on this subject have been stated in another part of the report.

The necessity of additional tugs is pointed out, and it is recommended that six such vessels, of about 200 tons displacement, should be built for towing and other purposes at the navy-yard.

The appropriation contained in the act of August 3, 1886, for the purchase of tools for ship-building is now available, the character and location of the tools required having been decided upon by boards, and the tools being now under advertisement. The amount appropriated has been divided equally between the yards at New York and Norfolk. It is deemed highly desirable that a similar equipment should be provided for the Mare Island navy-yard, that being the only establishment where the building and repairing of vessels can properly be conducted upon the Pacific coast line, thousands of miles in extent. The great natural advantages of this yard, its mild climate both in summer and winter, the depth of water along its front, its freedom from danger of attack by sea, and the immunity of vessels lying there from corrosion, give it remarkable advantages as a place for the construction of modern ships. To carry out this plan the chief of the Bureau urgently recommends that the sum of \$175,000 be appropriated for the purchase of the latest-designed ship-building tools for improving the plant at this yard.

In the appendix to the report of the Bureau of Construction and Repair will be found a detailed statement of the highest interest in reference to the ships now in the Navy and those under construction. The armored ships of the list comprise the five double-turreted monitors, one projected battle ship, and one projected cruiser, in addition to thirteen single-turreted monitors. The unarmored steel and iron vessels include, besides eight vessels on the old Navy list, the following: The *Chicago*, *Boston*, *Atlanta*, and *Dolphin*, contracted for in July, 1883; five protected cruisers, namely, the *Newark*, *Charleston*, *Baltimore*, Cruiser No. 4, and Cruiser No. 5; four cruisers of smaller size, designated gun-boats Nos. 1 to 4; one dynamite cruiser, and one torpedo-boat. Of wooden steamers fit for cruising purposes, there still remain 23; of wooden sailing vessels, 10; and of tugs, 12.

It is the opinion of the chief constructor that of the above-mentioned wooden steamers the *Trenton*, *Omaha*, and *Vandalia*, second rates, could probably be continued in service nine years longer; the *Lancaster*, with new boilers, six years; the *Brooklyn* and *Richmond* five years; and the *Pensacola* three years. Of the third rates, the *Mohican* can be continued in service nine years; the *Adams*, *Alliance*, *Essex*, *Kearsarge*, *Enterprise*, *Tallapoosa*, *Yantic*, and *Nipsic*, five years; the *Juniata*, *Ossipee*, *Swatara*, *Galena*, and *Marion*, four years. The *Quinnebaug* and *Iroquois* will probably be condemned by law on the survey.

It will thus be seen that in three years we shall have 20 of these vessels remaining; in six years, but 4; and in nine years, our entire wooden navy will have disappeared.

In reference to the new vessels, attention is called to the minutely detailed statements annexed to the report, from which the following summary is made :

The armored cruiser, a twin-screw turret vessel of the belted-cruiser type, is now building at the navy-yard, New York. She is to have a displacement of 6,648 tons, and a speed of 17 knots.

The armored battle ship, a twin-screw vessel of the belted type, is to be built at Norfolk on the design of the Barrow Shipbuilding Company of England. She is to have a displacement of 6,300 tons and a speed of 17 knots, her vital parts being protected by a steel armor belt 12 inches thick, terminating at each end by a steel breastwork 6 inches thick extending diagonally across the vessel.

The *Newark* is a twin-screw protected cruiser, built of mild steel throughout, and containing all the latest improvements in naval construction, ordnance, and steam engineering. She is to have a speed of 18 knots, and be of about 4,000 tons displacement. She is to be built by the William Cramp & Sons Ship and Engine Building Works, Philadelphia.

The *Charleston* is now building at the Union Iron Works, San Francisco, Cal. She has a central open superstructure, twin screws, and two masts with military tops, in which machine guns are mounted. She is built upon the plans of the swift Japanese cruiser *Naniwa Kan*, built by Sir William G. Armstrong, with such modifications as are rendered necessary by the conditions of the United States service, and the substitution of 8-inch for 10-inch rifles. Her displacement is 3,730 tons, and her speed 18.9 knots.

The *Baltimore*, a twin-screw steel cruiser of 4,400 tons displacement and estimated speed of 19 knots, with a heavy steel protective deck, is now building at the William Cramp & Sons Ship and Engine Building Works, Philadelphia.

Cruiser No. 4 is similar in general construction to the *Baltimore* and will have a displacement of 4,324 tons. The contract for her construction has been awarded to Messrs. William Cramp & Sons.

Cruiser No. 5 is of the same general dimensions as the *Newark*, but much greater power is provided, and a decided modification is made in the battery arrangement and rig by mounting 4 of the 12-guns on the poop and forecastle decks and having a three-masted schooner rig. The contract for building this vessel has been awarded to the Union Iron Works, California.

The two vessels last named are to have a speed of 19 knots.

Gunboats Nos. 1, 3, and 4, although styled gunboats, are but little smaller than the *Swatara* class of vessels, and in offensive and defensive power and speed are immeasurably their superiors. They are twin-screw, partially-protected cruisers, with a displacement of 1,700 tons, and a speed of 16 knots. No. 1 is building at the William Cramp & Sons Ship and Engine Building Works, Philadelphia. The contract for Nos. 3

and 4 has been awarded to N. F. Palmer, jr., & Co., of New York, and will be built at Roach's ship-yard, Chester, Pa.

Gun-boat No. 2 is a single-screw gunboat, built entirely of steel, and is now under construction by the Columbian Iron Works and Dry Dock Company, Baltimore.

The dynamite cruiser is a vessel in many respects similar to the English torpedo cruisers, except that the torpedoes are discharged through the air instead of through the water. The contract for this vessel has been made with the Pneumatic Dynamite Gun Company, of New York, and she is building at Cramp's ship-yard, Philadelphia.

The *Chicago*, a partially protected steel cruiser, and the *Boston* are now finishing at the New York navy-yard. The *Atlanta* and *Dolphin* are completed. Five double-turreted monitors are now awaiting completion. (Appendix, p. 286.)

BUREAU OF PROVISIONS AND CLOTHING.

The report of Paymaster-General James Fulton, Chief of the Bureau of Provisions and Clothing, gives a succinct statement of the part performed by the Bureau in the important change effected by the Department, by which the purchase, care, and issue of stores are concentrated under this Bureau. Under the operation of the order making the transfer, the Bureau has been organized in two divisions—one of purchase and supplies, the other of accounts and audit—both under the charge of experienced pay officers of the Navy. In view of the arduous character of the work and the high order of ability required for it, the Chief of the Bureau recommends that authority be given to detail a pay officer of the Navy as assistant paymaster-general, and that this officer, as well as the chiefs of divisions, should have a fixed tenure of office, and should receive the highest sea-pay of their grades.

The policy of reducing the quantity of clothing, small stores, and provisions carried in stock has been continued, by which a reduction of \$100,000 has been effected.

The consolidation of stores and supplies under the charge of one general store-keeper, at each navy-yard and on board each ship, has been completed. Additional space has thus been economized, the clerical and other force has been reduced, and responsibility put in the hands of bonded officers. A system of transfers has been introduced with great benefit to the Government, which obviates the purchase of stores by one Bureau when another has a surplus of the same stores on hand. A careful system of checks and safeguards has been devised, by which fraudulent practices are prevented, and at the same time any interference with the Bureaus in the use of their stores has been guarded against. A uniform method of book-keeping has been adopted, securing greater accuracy and more rigid accountability. Abstracts of returns of stores are kept at the Bureau, by which the total amount and value of naval property on hand may be ascertained at once, and a gen-

eral appropriation book is also kept, in which daily balances under each head of appropriation are stated. The work of consolidating different Bureau estimates for the same articles has been nearly completed, enabling the Department to invite bids for all articles in one advertisement, while a uniform and commercial classification will enable merchants to bid on the articles they deal in without including others in which they do not. The combination of all supplies under one schedule in the manner indicated will effect a great saving in the expenses for purchase and care of stores.

To complete the system, the Chief of the Bureau in his report recommends that appropriations be made in future for stores and materials "for the Navy," instead of for the different Bureaus as heretofore. The report recommends that the act of August 5, 1882, in reference to the sale of condemned articles, be amended so as to conform to the act of March 5, 1875, in reference to the sale of ordnance material, the latter being found to be more advantageous to the Government.

It is further recommended that the act of March 3, 1843, in reference to proposals for supplies, be amended so as to authorize the expenditure for advertising of only a certain percentage of the amount estimated as the cost of the articles to be purchased.

Among other recommendations the most important are the following: That the nominal losses from the desertion of enlisted men before their indebtedness for outfit is discharged, be charged to pay of the Navy instead of to the clothing and small stores funds, as is the present practice of the accounting officers of the Treasury; that issues of clothing and small stores to prisoners be charged to the account of the latter; that the sum of \$24,500, required for the business of the storekeeper at the Naval Academy, be transferred by law from pay of the Navy to a special fund for this purpose; that a commercial description and classification of tobacco furnished to the Navy be adopted by law as a standard; that the number of assistant paymasters be increased to 25, and that appointments be made in future from graduates of the Naval Academy, subject to examination by a board of paymasters, as now provided by law; that the acceptance of corporate sureties of undoubted solvency on the bonds of disbursing officers be authorized; and that when accounts are settled under an official bond, and a new bond has been given and accepted, the old bond should be canceled. (Appendix, p. 397.)

BUREAU OF NAVIGATION.

The Chief of the Bureau of Navigation, Commodore J. G. Walker, submits the annual report of the operations of his Bureau, together with the estimates for its support and that of the offices under it, including those of the superintendent of compasses, naval inspector of electric lighting, Naval War College, Hydrographic Office, Naval Observatory, and Nautical Almanac Office.

Attention is called to the increased importance of the work of determining the magnetic character of naval vessels, upon the thorough-

ness and correctness of which the safety of the ships when under way must largely depend, and recommendations are made in reference to the location of the engines and dynamos of electric-lighting plants on ship-board. The necessity of subjecting the revisions of the signal book to practical tests is pointed out, and it is recommended that trials be made with four of the larger tugs for this purpose. In reference to the continuance of ocean surveys, it appears highly desirable that the rocks and shoals reported to exist in the Pacific Ocean and in the Caribbean Sea, but not put down on the charts, should be searched for and located. During the past year many floating wrecks have been reported to the Department, and requests have been received for their removal and destruction. In many instances the presence of these wrecks involves serious danger to property and life, lying as they do in the neighborhood of our large commercial ports or in the track of transatlantic steamers. It is suggested that a small vessel should be employed throughout the year for the destruction of derelicts, thus removing a serious obstacle to navigation and performing a work of great benefit to the commerce of the country.

Attention is especially called to the active movement among officers of the merchant marine, yachtsmen, and others connected with seafaring pursuits, having for its object the formation of a naval reserve, composed of officers and men willing to subject themselves to annual specified drills and temporary service in a sea-going or coast-defense vessel, with or without compensation for the period actually under instruction or service. It is believed that a first reserve, of small numbers, can be composed of officers and men who have passed some years in the regular service, and afterwards have gone into kindred occupations in civil life; but a large and efficient auxiliary force could be obtained with great advantage, as a second reserve, from the merchant marine, the coasting trade of both sea and lake coasts, the fishermen, the Light-House and Life-Saving Services, and from yachtsmen. There seems to be little doubt that a project having for its end the formation and classification of a naval reserve would be favorably received by that large body of Americans who are more or less acquainted with seafaring life, either from necessity or choice, and who are second to none in patriotic desire for the success of our Navy. As the disposition of all classes concerned is now highly favorable to the proposed movement, the present moment is an auspicious one for taking the necessary action.

Attention is called to the insufficiency of the appropriation for navigation supplies referred to in previous reports. With the growing demands of the naval service, it appears that a moderate increase in the provision for this branch of supply is necessary. (Appendix, p. 145.)

HYDROGRAPHIC OFFICE.

The report of the Hydrographer, Commander J. R. Bartlett, shows that the Hydrographic Office has continued during the past year to

maintain its previous high standard of efficiency. In chart construction the work has been mainly directed to the charts of the West Indies, the west coast of Mexico and Central America, and the region of Newfoundland and the Gulf of St. Lawrence.

The set of general sailing charts of the west coast of North America is complete, and that of the west coast of Mexico and Central America is well advanced. The policy of keeping the expenses of the correction of charts down to the lowest possible limit and still maintain their efficiency has been adhered to. At the end of the fiscal year there were 53 engraved plates of charts and 4 miscellaneous plates finished, and 56 new charts on hand unfinished. All the charts from the *Ranger's* survey to the end of the last season are now complete and on issue. The number of copper and steel chart plates available for printing is now 393.

The record of longitudes and the investigations of magnetic variation have been continued with satisfactory results, and the work has been of great service in the settlement of technical questions incident to chart construction. A record of doubtful dangers in the Atlantic Ocean has been prepared, and investigation of the depths of the sea has been continued.

Gnomonic or great-circle sailing charts of the North and South Atlantic have been finished and placed on issue. Similar charts of other oceans will be published as fast as possible. These charts have been received with great favor by ship-masters making long passages, and the highest testimony is given of their accuracy and utility.

The supply of charts to naval vessels has continued as usual, 7,570 Hydrographic Office charts and 4,022 foreign charts having been issued to United States vessels.

Publication has continued as far as the means at the disposal of the office would allow. There can be no question as to the necessity of having a complete set of Sailing Directions published by the Government as soon as possible, and preparations have been made to push this work with great vigor during the coming year. Certain improvements have been made in the Notices to Mariners.

The Pilot Chart, one of the most important of the Hydrographic Office publications, is received with constantly increasing favor, and is now regarded by mariners as indispensable; it has even been used for purposes of instruction in the interior.

The hydrographer dwells on the usefulness of the branch offices in obtaining materials for the Pilot Chart and in other important works of the Hydrographic Office. Additional appropriations are necessary to maintain these offices on a proper footing, and the extraordinary solicitude felt by the maritime community in reference to them makes it highly desirable that their wants should be fully supplied. As an illustration of the remarkable extent of the work performed by these offices, it may be stated that during the past year visits were made under their direction to 15,000 vessels, 7,000 instruments were adjusted, 4,000 charts

corrected, 19,000 Pilot Charts distributed; information was furnished on application to over 100,000 persons engaged in maritime pursuits, and 24,000 reports were collected and forwarded, containing maritime information.

The most important recommendation made by the Hydrographer is that for a separate building for the Hydrographic Office. The greater portion of its operations partakes more of the character of the shop than the office. For this purpose the rooms connected with the clerical offices of the Department are unsuitable, and the use of temporary buildings adjoining involves transportation of plates, resulting in serious injury, which can only be repaired at considerable expense.

The office further recommends the employment of a vessel to carry on a survey of the coast of South America and the West Indies, the undertaking of deep-sea surveys in the Pacific, the determination of reported dangers, and the systematic destruction of derelicts. Application having been made by the local authorities at Norfolk, Va., and Portland, Oreg., for the establishment of branch offices at those places, it would seem desirable that provision should be made as soon as possible for this purpose. (Appendix, p. 165.)

NAVAL OBSERVATORY.

The report of Capt. R. L. Phythian, Superintendent of the Naval Observatory, describes the operations that have been conducted during the past year with the various instruments, including the great and small equatorials and the transit circle, and also that branch of the Observatory work relating to time service and chronometers.

The Observatory having been invited to participate in the proceedings of the congress which was to meet at Paris, April 16, 1887, Lieut. A. G. Winterhalter was detailed by the Department to attend upon its sessions, and was present as representative of the Observatory. During his absence Lieutenant Winterhalter has transmitted interesting and valuable communications which will finally be embodied in his full report.

Plans for the new observatory, which have been prepared by Mr. Richard M. Hunt, of New York, are now completed. As soon as practicable after the completion of the specifications work on the observatory will be begun. (Appendix, p. 211.)

NAVAL WAR RECORDS.

Attention has been called in previous reports to the necessity of increasing the clerical force engaged in the compilation and arrangement of the War Records for publication. The recommendations for the vigorous prosecution of this work are renewed.

NAVAL ACADEMY.

The report of Commander William T. Sampson, Superintendent of the Naval Academy, shows the number of cadets at the opening of the last academic year, the percentage of failures, and the number now in

the Academy, and refers to various improvements which have taken place or been recommended in the course and methods pursued at the institution. Five cadets have been tried for hazing during the past year, in accordance with the provisions of the statute. The salutary effects of this policy are apparent; no cruel or degrading instance of this offense has taken place for a long period; the construction placed upon the law by the court and the Department has effectually suppressed the tendency to this objectionable practice, and it is the Superintendent's intention to bring to trial every form of hazing, no matter how trifling.

In conformity with the act of Congress of May 20, 1886, requiring instruction to be given to cadets in the "physiological effects of alcohol and other stimulants," a new department, that of physiology and hygiene, has been added to the course of study, with the surgeon of the Academy at its head.

Improved text-books on ordnance and gunnery, embracing the latest advances in the science, have been prepared at the Academy and printed for the use of the cadets; a revised edition of the Regulations has been issued; the usual increase has been made to the library; and a novel feature has been introduced in the practice cruise by assigning credit for practical work. It is thought that manual skill in the machine-shop, activity aloft as a sailor, and officer-like bearing in the performance of duty should have a more direct influence in determining class standing than has heretofore been the case.

Although it is the opinion of the Academic Board that important changes should be made in the course of instruction, action on the subject has been postponed until the question of the length of the academic course shall have been decided. It is urgently recommended that the course be reduced to four years, as provided in the bill presented by the naval committee at the last Congress. It is further suggested that those cadets who fail to obtain positions in the naval service after four years at the Academy and two years at sea, are well qualified for positions in the Revenue Marine Service.

The Superintendent dwells upon the importance of selecting suitable seamen for details at the Academy, the close relation between the sailor and the future officer making it a matter of great importance that the men employed for this purpose should be of exceptional character and ability.

Two other important recommendations are made by the Superintendent in connection with the estimates for the coming fiscal year. The first is for an appropriation of \$108,000 for the purchase of 5 acres of land, more or less, which separates the Academy grounds from the rest of the Government property, and thus limits the space available for drills and exercises. The second recommendation to which attention is called is for an appropriation of \$275,000 for a modern practice vessel for use at the Academy, armed with modern guns, and fitted with a modern engine. (Appendix, p. 79.)

BUREAU OF MEDICINE AND SURGERY.

The report of the Surgeon-General of the Navy exhibits the satisfactory condition of this Bureau.

I approve the requests for increased appropriations for "Repairs of the naval hospitals," and for an additional clerk in the pension division of the office.

In accordance with the authority granted at the last session of Congress, a naval sanitarium has been established at Widow's Island, Penobscot Bay, Maine, where a commodious building has been erected with suitable wharf and landing-place. The necessary improvements of the island are being made and will be completed in the coming spring, as well as the interior fitting and furnishing of the hospital. The amount expended will be kept within the sum appropriated for the purpose.

I commend again to the consideration of Congress the representations made as to the necessity of legislation to improve the condition and advantages of the medical corps of the Navy. (Appendix, p. 416.)

MARINE CORPS.

The report of Col. C. G. McCawley, commandant of the Marine Corps, states the number of enlisted men in the Corps on October 1, 1887, as 1,893, of whom 930 were on board ships in commission, and 963 doing duty at shore stations.

A point has now been reached when an increase in the number of officers and men is absolutely required by the demands of the service. It is not possible for the present limited complement to perform efficiently the duties imposed on it. The number of second lieutenants is now 15, and is subject to a further reduction. At the same time promotion in the higher grades is blocked.

The number of enlisted men is also inadequate. At none of the shore stations are there enough men to carry on the duty, and numerous vacancies exist in the guards of vessels which it is impossible to fill. On the Pacific station alone there are no less than 30. The small numbers in the corps and consequent overwork lead to frequent desertions.

In view of these facts, I strongly recommend that the number of officers be increased and that the complement of enlisted men be raised by the addition of 500 privates.

The barracks and quarters at the Norfolk yard are totally inadequate, and at League Island the rotten hulk *Antietam*, lying in the mud with 10 feet of water in her hold appears to be the only place available for quartering the men. Elementary considerations of health and humanity would seem to require an immediate provision for remedying this condition of affairs. (Appendix, p. 451.)

WM. C. WHITNEY,
Secretary of the Navy.

APPENDIX A.

Correspondence relating to the Award of the Contracts for the Construction of Cruisers No. 4 and No. 5.

NAVY DEPARTMENT,
Washington, August 13, 1887.

To the PRESIDENT :

SIR : Herewith I submit the papers showing the result of the recent bidding for the construction of cruisers Nos. 4 and 5. A question arises under these bids requiring your decision. Congress in appropriating for these ships directed that one of them should be built "on or near the coast of the Pacific Ocean or the waters connected therewith." It was further provided, however, as follows :

If it shall appear to the satisfaction of the President of the United States, from the biddings for said contract when the same are opened and examined by him, that said vessel can not be constructed at a fair cost on or near the coast of the Pacific Ocean, . . . he shall authorize the construction of said vessel elsewhere in the United States.

Three forms of bidding for the ships recently advertised were permitted and invited by the Department, of which an explanation is necessary. In all contracts of this character made in the last two years the Department has required definite results to be guaranteed by the contractor—results fixed at about the highest point reached by the best ship-builders in the world. In the matter of machinery the point was fixed at about 10 horse-power to each ton of machinery. This marked a wide departure from the previous practice of the Department—nearly doubling the requirements. The guaranty required from the contractor has been in each case coupled with severe penalties for failure and adequate premiums for success.

It will be seen that an essential feature of this method of contracting is that the contractor should be permitted to have something to say with reference to the plans. The amount of his compensation being dependent upon the results attained, and the merit of the ship depending upon the merit of the plans, the contractor is pecuniarily interested in improving the plans. He is made a partner with the Government to raise the character of the ship.

The Department therefore opens the door to private enterprise in this matter by allowing more than one form of bidding. It submits to competition its own plans, and invites bidding upon them; but it permits any ship-builder who thinks they can be improved to suggest alternative plans for accomplishing the same result, becoming himself responsible pecuniarily for their success.

The system necessarily avoids the ruts common with Government work, for as the art changes and improves, the Government, by constantly holding out premiums for improved results is the first to secure them.

The conditions of the recent letting were much more exacting than previously imposed.

Congress, in authorizing the construction of cruisers Nos. 4 and 5, prescribed that the contractors should assume to guaranty a speed of 19 knots per hour, with a penalty of \$50,000 for each quarter knot of failure in speed, and an equal premium for each quarter knot of excess in speed attained. This, under the trial conditions laid down by the Department, constituted a demand for cruisers the equal and probably the superior of any heretofore built.

The contracts were, however, bid for by two responsible concerns. Bids were permitted to be made in three ways: at what price the bidder would build the ship guarantying the speed upon either—

1st. The Department's plans of hull and machinery.

2d. The bidder's plans of hull and machinery.

3d. The Department's plan of hull and the bidder's plan of machinery.

The bids were as follows:

Name of bidder.	Cruiser.	Class of bid.	Price.
The Union Iron Works	4 or 5	1	\$1,425,000
The William Cramp & Sons	4 and 5	1	1,410,000
Do	4 and 5	2	1,350,000
Do	4 and 5	2	1,325,000
Do	4 and 5	3	1,405,000

I have compared, with the aid of the chiefs of the Bureaus of Construction and Steam Engineering, the various plans, and in accordance with their advice I respectfully recommend that one ship be built upon the Department's plans, and that for the other one the bid of William Cramp & Sons for \$1,350,000 be accepted. With this latter bid original designs are submitted.

These plans differ somewhat from those of the Department. The proposed ship is larger in tonnage, with thicker protective deck, lighter in construction in parts, and stronger in others. A cheaper mode of construction is adopted in some respects, but none but approved practices are employed. The hull designed by the Bureau is more expensive to build, but which is the better on the whole no one can, at the present time, safely predict. I think there is every advantage in building both, and I so recommend.

As to the comparison of the bids submitted for the Bureau's ship, the bid of Cramp & Sons is \$18,000 lower than that of the Union Iron Works, San Francisco.

You are to say whether from the bidding it appears that the bid of the Union Iron Works is a fair price for the work.

It was clearly not intended that the lowest bidder should necessarily be entitled to the contract, for this rule was easy to state, and had been the law in previous cases. On the contrary, Congress apparently had in view the difference in the conditions of the different parts of the country for this work, and intended to permit the President to consider these differences in determining upon what should be deemed a fair price.

This difference of \$18,000 in the bids will not cover the difference in freight against California upon materials necessary at the present time to be purchased in the East.

Very respectfully,

W. C. WHITNEY,
Secretary of the Navy.

EXECUTIVE MANSION,
Washington, August 15, 1887.

Under the provisions of the act of Congress authorizing the construction of the ships herein referred to, which act requires that one of said ships should be built on the coast of the Pacific Ocean or the waters connected therewith, unless the same cannot be there constructed at a fair cost; and the bid of the Union Iron Works of San Francisco being within \$18,000 of the lowest bid for the ship to be constructed according to the plans of the Navy Department, which sum of \$18,000 does not more than cover the difference against the Pacific coast of the cost of necessary transportation of materials, and the bid by said company not appearing to be in excess of the fair cost of said ship, I do hereby, pursuant to said statute and in accordance with the manifest intention of Congress in the premises, authorize and direct that the contract for the construction of the ship within named to be built according to the plans of the Navy Department, be given to the said the Union Iron Works of San Francisco.

GROVER CLEVELAND.

APPENDIX.

No. 1.—ESTIMATES, ETC., SECRETARY'S OFFICE.

*Estimates of appropriations required for the service of the fiscal year ending June 30, 1889,
by the Navy Department.*

Detailed objects of expenditure and explanations.	Estimated amount which will be re- quired for each detailed object of expenditure.	Total amount to be appropriated under each head of appropriation.	Amount appropri- ated for the cur- rent fiscal year ending June 30, 1888.
SALARIES, OFFICE OF SECRETARY.			
Secretary (act March 3, 1887).....	\$8,000.00		
Chief clerk (same act).....	2,500.00		
Disbursing clerk (same act).....	2,250.00		
Two clerks of class four (same act).....	3,600.00		
One clerk of class four, in charge of files and records (same act).....	1,800.00		
Two clerks of class three (same act).....	3,200.00		
Two clerks of class two (same act).....	2,800.00		
Two clerks of class one (same act).....	2,400.00		
One clerk of class one, formerly appropriated for the Lib- rary* (same act).....	1,200.00		
One clerk of class one, formerly appropriated for in office of Judge-Advocate-General † (same act).....	1,200.00		
Two clerks, at \$1,000 each (same act).....	2,000.00		
One telegraph operator (same act).....	1,000.00		
One carpenter (same act).....	900.00		
Two messengers, at \$840 each (same act).....	1,680.00		
Three assistant messengers, at \$720 each (same act).....	2,160.00		
Two messenger boys, at \$420 each (same act).....	840.00		
One messenger boy, at \$240 (same act).....	240.00		
One laborer, at \$660 (same act).....	660.00		
One stenographer, at \$1,600, transferred to office of Naval Intelligence (same act).....	1,600.00		
One clerk of class two, for Inspection Board (same act).....	1,400.00		
One clerk of class one, for Examining and Retiring Board, formerly appropriated class two (same act).....	1,200.00		
One laborer, for Inspection Board (same act).....	660.00		
Two clerks of class four, for Office of Detail (same act).....	3,600.00		
One clerk of class four, for Office of Detail, formerly appro- priated for in Bureau of Provisions and Clothing (same act).....	1,800.00		
One clerk of class three, for Office of Detail (same act).....	1,600.00		
One clerk of class two, for Office of Detail, formerly appro- priated for Examining and Retiring Board (same act).....	1,400.00		
		\$51,630.00	\$51,630.00
OFFICE OF JUDGE-ADVOCATE-GENERAL.			
One clerk of class four (act March 3, 1877).....	1,800.00		
One clerk of class four, formerly appropriated for in office of Secretary of the Navy; (same act).....	1,800.00		
One clerk of class three (same act).....	1,600.00		
One clerk of class one (same act).....	1,200.00		
Two clerks of class one, formerly appropriated for in office of Secretary of the Navy; (same act).....	2,400.00		
One clerk, at \$1,000 § (same act).....	1,000.00		
One copyist, at \$720 ¶ (same act).....	720.00		
One laborer, at \$660 (same act).....	660.00		
		11,180.00	11,180.00

* Transferred from the Library.

† Transferred from office of Judge-Advocate-General.

‡ Transferred from Secretary's Office.

§ Formerly appropriated for in the office of the Secretary of the Navy.

¶ Formerly appropriated for in the office Naval Records.

Estimates of appropriations required for the service of the fiscal year, etc.—Continued.

Detailed objects of expenditure and explanations.	Estimated amount which will be required for each detailed object of expenditure.	Total amount to be appropriated under each head of appropriation.	Amount appropriated for the current fiscal year ending June 30, 1888.
CONTINGENT EXPENSES.			
Stationery, furniture, newspapers, plans, drawings, drawing materials, horses, carriages, freight, expressage, postage, and other absolutely necessary expenses of the Navy Department and its various Bureaus and offices (act March 3, 1887)		\$13,000.00	\$11,000.00
PAY OF THE NAVY.			
For the pay of officers on sea duty; officers on shore and other duty; officers on waiting orders; officers on the retired list; Admiral's and Vice Admiral's secretaries; clerks to commandants of yards and stations; clerks to paymasters at yards and stations; inspections; receiving-ships and other vessels; extra pay to men re-enlisting under honorable discharge; pay of petty officers, seamen, landsmen, and boys, including men in the engineer's force, and for the Coast Survey Service and Fish Commission, seven thousand five hundred men, and seven hundred and fifty boys, at the pay prescribed by law (act March 3, 1887)		7,082,404.00	7,000,000.00
PAY, MISCELLANEOUS.			
For commissions and interest; transportation of funds; exchange; mileage to officers while traveling under orders in the United States, and for actual personal expenses of officers while traveling abroad under orders; and for traveling expenses of apothecaries, yeomen, and civilian employes, and for actual and necessary traveling expenses of naval cadets while proceeding from their homes to the Naval Academy for examination and appointment as cadets; for rent and furniture of buildings and offices not in navy-yards; expenses of courts-martial and courts of inquiry, boards of investigation, examining boards, with clerks' and witnesses' fees, and traveling expenses and costs; stationery and recording; expenses of purchasing paymaster's offices of the various cities, including clerks, furniture, fuel, stationery, and incidental expenses; newspapers and advertising; foreign postage; telegraphing, foreign and domestic; telephones; copying; care of library, including purchase of books, prints, and periodicals; ferrage, tolls, and express fees; cost of suits, commissions, warrants, diplomas, and discharges; relief of vessels in distress; canal tolls and pilotage; recovery of valuables from shipwrecks; quarantine expenses; reports; professional investigation; cost of special instruction at home or abroad, including maintenance of students and information from abroad, and the collection and classification thereof, and other necessary incidental expenses (act March 3, 1887)		225,000.00	205,000.00
NOTE.—The estimate for "Pay, miscellaneous," is \$20,000 more than appropriated for the fiscal year ending June 30, 1888. It is believed that at least \$225,000 will be required for the fiscal year ending June 30, 1889. The actual expenditure, as shown by accounts settled by the accounting officers under "Pay, miscellaneous" for the fiscal year ending June 30, 1887, was \$227,054.83, and it is not probable that those for the fiscal year ending June 30, 1888, will be much less when all the accounts are adjusted.			
CONTINGENT, NAVY.			
For all emergencies and extraordinary expenses, arising at home or abroad, but impossible to be anticipated or classified, exclusive of personal services in the Navy Department or any of its subordinate bureaus or offices, at Washington, District of Columbia		7,000.00	7,000.00
PRINTING AND BINDING.			
Printing and binding for the Navy Department, to be executed under the direction of the Public Printer (act March 3, 1887)		48,000.00	48,000.00

REPORT OF THE SECRETARY OF THE NAVY.

Estimate of amount required to pay the officers of the United States Navy for the fiscal year ending June 30, 1889.

Grade—Active list.	Total number.	Sea duty.			Other duty.			Waiting orders.		
		Number.	Pay per annum.	Total.	Number.	Pay per annum.	Total.	Number.	Pay per annum.	Total.
Admiral	1				1	\$13,000	\$13,000			
Vice-Admiral	1				1	8,000	8,000			
Rear-admirals	6	4	\$3,000	\$24,000	2	5,000	10,000			
Commodore, chief of Bureau	1				1	5,000	5,000			
Commodores	9	1	5,000	5,000	7	4,000	28,000	1	\$3,000	\$3,000
Captains, chiefs of Bureau	2				2	5,000	10,000			
Captains	43	9	4,500	40,500	28	3,500	98,000	6	2,800	16,800
Commander, chief of Bureau	1				1	5,000	5,000			
Commanders	84	22	3,500	77,000	47	3,000	141,000	15	2,300	34,500
Lieutenant commanders:										
After 4 years from date of commission	48	11	3,000	33,000	24	2,600	62,400	11	2,200	24,200
First 4 years after date of commission	28	15	2,800	42,000	10	2,400	24,000	3	2,000	6,000
Lieutenants:										
After 5 years from date of commission	186	91	2,600	236,600	83	2,200	182,600	12	1,800	21,600
First 5 years after date of commission	64	31	2,400	74,400	31	2,000	62,000	2	1,600	3,200
Lieutenants, junior grade:										
After 5 years from date of commission	20	10	2,000	20,000	8	1,700	13,600	2	1,400	2,800
First 5 years after date of commission	56	32	1,800	57,600	24	1,500	36,000			
Ensigns:										
After 5 years from date of commission	30	20	1,400	28,000	10	1,200	12,000			
First 5 years after date of commission	153	105	1,200	126,000	22	1,000	22,000	26	800	20,800
Naval cadets, undergraduates	69	63	850	50,850				6	500	3,000
Medical directors:										
Chief of Bureau	1				1	5,000	5,000			
After 20 years from date of commission as surgeon	14				12	4,000	48,000	2	3,000	6,000
Medical inspectors:										
Fleet surgeons	2	2	4,400	8,800						
After 20 years from date of commission as surgeon	13	3	4,400	13,200	7	4,000	28,000	3	3,000	9,000
Surgeons:										
Fleet surgeons	1	1	4,400	4,400						
Fourth 5 years from date of commission as surgeon	10	3	3,700	11,100	7	3,600	25,200			
Third 5 years from date of commission as surgeon	8	4	3,500	14,000	4	3,200	12,800			
Second 5 years from date of commission as surgeon	12	5	3,200	16,000	4	2,800	11,200	3	2,400	7,200
First 5 years from date of commission as surgeon	19	6	2,800	16,800	8	2,400	19,200	5	2,000	10,000
Passed Assistant surgeons:										
After 5 years from date of appointment	50	23	2,200	50,600	23	2,000	46,000	4	1,700	6,800
First 5 years from date of appointment	9	6	2,000	12,000	3	1,800	5,400			
Assistant surgeons:										
First 5 years from date of appointment	22	11	1,700	18,700	10	1,400	14,000	1	1,000	1,000
Not in line of promotion	2	1	2,100	2,100	1	1,800	1,800			
Pay director, chief of Bureau	1				1	5,000	5,000			
Pay directors, after 20 years from date of commission as paymaster	12				9	4,000	36,000	3	3,000	9,000
Pay inspectors:										
Fleet paymaster	1	1	4,400	4,400						
After 20 years from date of commission as paymaster	12	2	4,400	8,800	8	4,000	32,000	2	3,000	6,000
Paymasters:										
After 20 years from date of commission as paymaster	8	1	4,200	4,200	4	4,000	16,000	3	3,000	9,000
Fourth 5 years from date of commission as paymaster	11	5	3,700	18,500	5	3,600	18,000	1	2,800	2,800
Third 5 years from date of commission as paymaster	7	2	3,500	7,000	4	3,200	12,800	1	2,600	2,600

Estimate of amount required to pay the officers of the United States Navy, etc.—Continued.

Grade—Active list.	Sea duty.			Other duty.			Waiting orders.			
	Total number.	Number.	Pay per an- num.	Total.	Number.	Pay per an- num.	Total.	Number.	Pay per an- num.	Total.
• Paymasters—Continued.										
Second 5 years from date of commission as paymaster.	14	4	\$3,200	\$12,800	9	\$2,800	\$25,200	1	\$2,400	\$2,400
First 5 years from date of commission as paymaster.	4	1	2,800	2,800	3	2,400	7,200			
• Fleet paymaster.	1	1	4,400	4,400						
• Passed assistant paymasters:										
After 5 years from date of commission.	21	10	2,200	22,000	8	2,000	16,000	3	1,700	5,100
First 5 years from date of commission.	4	1	2,000	2,000	2	1,800	3,600	1	1,500	1,500
• Assistant paymasters:										
After 5 years from date of commission.	13	6	1,900	11,400	6	1,600	9,600	1	1,200	1,200
First 5 years from date of commission.	2	1	1,700	1,700	1	1,400	1,400			
• Chief engineers:										
Chief of Bureau.	1				1	5,000	5,000			
Fleet engineers.	3	3	4,400	13,200						
After 20 years from date of commission.	20	3	4,400	13,200	13	4,000	52,000	4	3,000	12,000
Fourth 5 years from date of commission.	9	3	3,700	11,100	3	3,600	10,800	3	2,800	8,400
Third 5 years from date of commission.	7	1	3,500	3,500	5	3,200	16,000	1	2,600	2,600
Second 5 years from date of commission.	11	5	3,200	16,000	5	2,800	14,000	1	2,400	2,400
First 5 years from date of commission.	19	9	2,800	25,200	5	2,400	12,000	5	2,000	10,000
• Passed assistant engineers:										
Fourth 5 years from date of appointment.	15	6	2,700	16,200	7	2,350	16,450	2	1,950	3,900
Third 5 years from date of appointment.	28	12	2,450	29,400	13	2,250	29,250	3	1,900	5,700
Second 5 years from date of commission.	22	13	2,200	28,600	5	2,000	10,000	4	1,700	6,800
First 5 years from date of commission.	14	8	2,000	16,000	6	1,800	10,800			
• Assistant engineers:										
After 5 years from date of commission.	47	23	1,900	43,700	21	1,600	33,600	3	1,200	3,600
First 5 years from date of commission.	9	8	1,700	13,600	1	1,400	1,400			
• Cadet engineers.	22	20	950	19,000	2	500	1,000			
• Chaplains:										
After 5 years from date of commission.	21	7	2,800	19,600	8	2,300	18,400	6	1,900	11,400
First 5 years from date of commission.	2	1	2,500	2,500				1	1,600	1,600
• Professors of mathematics:										
After 15 years from date of commission.	6				6	3,500	21,000			
Third 5 years from date of commission.	3				3	3,000	9,000			
Second 5 years from date of commission.	3				3	2,700	8,100			
• Chief constructor, chief of Bu- reau.	1				1	5,000	5,000			
• Naval constructors:										
Fourth 5 years from date of commission.	2				2	4,000	8,000			
Third 5 years from date of commission.	6				5	3,700	18,500	1	2,700	2,700
• Assistant naval constructors:										
After 8 years from date of commission.	3				3	2,600	7,800			
Second 4 years from date of commission.	4				4	2,200	8,800			
First 4 years from date of commission.	3				3	2,000	6,000			
• Civil engineers:										
Third 5 years from date of commission.	4				3	3,000	9,000	1	2,100	2,100
Second 5 years from date of commission.	6				4	2,700	10,800	2	1,800	3,600

Estimate of amount required to pay the officers of the United States Navy, etc.—Continued.

Grade—Active list.	Total number.	Sea duty.		Other duty.		Waiting orders.			
		Number.	Pay per annum.	Number.	Pay per annum.	Number.	Pay per annum.	Total.	
Boatswains:									
After 12 years from date of appointment.....	21	5	\$1,800	\$9,000	15	\$1,600	\$24,000	1 \$1,200	\$1,200
Fourth 3 years from date of appointment.....	2	1	1,600	1,600				1 1,000	1,000
Third 3 years from date of appointment.....	5	1	1,400	1,400	2	1,300	2,600	2 900	1,800
Second 3 years from date of appointment.....	4				3	1,000	3,000	1 800	800
First 3 years from date of appointment.....	3				2	900	1,800	1 700	700
Gunners:									
After 12 years from date of appointment.....	31	9	1,800	16,200	19	1,600	30,400	3 1,200	3,600
Fourth 3 years from date of appointment.....	1	1	1,600	1,600					
Second 3 years from date of appointment.....	1				1	1,000	1,000		
First 3 years from date of appointment.....	2	1	1,200	1,200	1	900	900		
Carpenters:									
After 12 years from date of appointment.....	32	7	1,800	12,600	19	1,600	30,400	6 1,200	7,200
Fourth 3 years from date of appointment.....	4	2	1,600	3,200	2	1,300	2,600		
Third 3 years from date of appointment.....	9	1	1,400	1,400	8	1,300	10,400		
Second 3 years from date of appointment.....	3	1	1,300	1,300	1	1,000	1,000	1 800	800
First 3 years from date of appointment.....	2	1	1,200	1,200	1	900	900		
Sailmakers:									
After 12 years from date of appointment.....	17	5	1,800	9,000	10	1,600	16,000	2 1,200	2,400
Fourth 3 years from date of appointment.....	8	3	1,600	4,800	3	1,300	3,900	2 1,000	2,000
Third 3 years from date of appointment.....	3				2	1,300	2,600	1 900	900
Mates	36	4	900	3,600	28	700	19,600	4 500	2,000
	1540	678		1,430,550	691		1,625,800	180	316,700

Total pay for 1,549 officers on active list \$3,373,050
 Pay for 225 naval cadets, under instructions at Naval Academy, at \$500 per annum 112,500
 3,485,550

REPORT OF THE SECRETARY OF THE NAVY.

Estimate of the amount required to pay retired officers of the United States Navy for the fiscal year ending June 30, 1899.

Grade.	No.	Pay per annum.	Total.	Grade.	No.	Pay per annum.	Total.
Rear-admirals.....	52	\$1,500	\$234,000	Passed assistant paymas-			
Commodores.....	15	3,750	56,250	ters.....	1	\$1,650	\$1,650
Captains.....	9	3,375	30,375	Do.....	1	1,500	1,500
Do.....	2	2,250	4,500	Assistant paymasters.....	1	1,425	1,425
Commanders.....	8	2,625	21,000	Chief engineers.....	1	3,750	3,750
Do.....	4	1,750	7,000	Do.....	10	3,300	33,000
Lieutenant-commanders...	12	2,250	27,000	Do.....	4	2,625	10,500
Do.....	3	2,100	6,300	Do.....	3	2,400	7,200
Do.....	7	1,500	10,500	Do.....	1	2,100	2,100
Lieutenants.....	21	1,950	40,950	Do.....	1	1,600	1,600
Do.....	2	1,800	3,600	Passed assistant engineers.	2	2,025	4,050
Do.....	4	1,300	5,200	Do.....	8	1,838	14,704
Do.....	1	1,200	1,200	Do.....	6	1,650	9,900
Lieutenants, junior grade...	10	1,500	15,000	Do.....	6	1,500	9,000
Do.....	2	1,350	2,700	Do.....	2	2,100	2,200
Do.....	3	1,000	3,000	Do.....	1	1,225	1,225
Do.....	2	900	1,800	Do.....	1	1,000	1,000
Ensigns.....	3	1,050	3,150	Assistant engineers.....	16	1,425	22,800
Do.....	3	900	2,700	Do.....	5	1,275	6,375
Do.....	3	700	2,100	Do.....	2	950	1,900
Do.....	3	600	1,800	Do.....	3	850	2,550
Medical directors.....	2	3,750	7,500	Chaplains.....	7	2,100	14,700
Do.....	18	3,300	59,400	Professors of mathemat-			
Medical inspectors.....	3	3,300	9,900	ics.....	3	2,625	7,875
Do.....	1	2,200	2,200	Do.....	1	2,025	2,025
Surgeons.....	3	2,625	7,875	Do.....	1	1,800	1,800
Do.....	1	2,400	2,400	Naval constructors.....	1	3,750	3,750
Do.....	2	2,100	4,200	Do.....	1	3,000	3,000
Passed assistant surgeons...	3	1,650	4,950	Civil engineers.....	2	2,250	4,500
Do.....	2	1,500	3,000	Boatswains.....	18	1,350	24,300
Do.....	1	1,100	1,100	Do.....	1	1,050	1,050
Assistant surgeons.....	3	1,425	4,275	Do.....	3	900	2,700
Do.....	1	1,275	1,275	Gunners.....	18	1,350	24,300
Do.....	1	950	950	Carpenters.....	8	1,350	10,800
Do.....	1	850	850	Sailmakers.....	12	1,350	16,200
Pay directors.....	3	3,750	11,250	Do.....	1	800	800
Do.....	7	3,300	23,100	Total.....	378		893,754
Pay inspectors.....	2	3,300	6,600				
Paymasters.....	1	2,775	2,775				
Do.....	1	2,400	2,400				
Do.....	1	1,400	1,400				

Secretaries and clerks: Number of secretaries and clerks, and their pay, allowed commandant of yards and stations, to pay officers of yards, inspections, and on receiving-ships and cruising vessels.

Number and designation.	Where employed.	Pay.
2 secretaries, \$2,500 each.....	To Admiral and Vice-Admiral	\$5,000
1 first clerk to commandant.....	Navy-yard, Portsmouth, N. H.....	1,500
1 second clerk to commandant.....	do.....	1,200
1 clerk to paymaster of yard.....	do.....	1,400
1 clerk to inspection of provisions and clothing.....	do.....	1,300
1 first clerk to commandant.....	Navy-yard, Boston, Mass.....	1,500
1 clerk to paymaster of yard.....	do.....	1,600
1 clerk to inspection of provisions and clothing.....	do.....	1,600
1 clerk to paymaster of receiving-ship.....	do.....	1,600
1 first clerk to commandant.....	Navy-yard, New York.....	1,500
1 second clerk to commandant.....	do.....	1,200
1 clerk to paymaster of yard.....	do.....	1,600
1 clerk to inspection of provisions and clothing.....	do.....	1,600
1 clerk to paymaster of receiving-ship.....	do.....	1,600
1 first clerk to commandant.....	Navy-yard, League Island, Pa.....	1,500
1 second clerk to commandant.....	do.....	1,200
1 clerk to paymaster of yard.....	do.....	1,600
1 clerk to inspection of provisions and clothing.....	do.....	1,600
1 clerk to paymaster of receiving-ship.....	do.....	1,600
1 first clerk to commandant.....	Navy-yard, Norfolk, Va.....	1,500
1 second clerk to commandant.....	do.....	1,200
1 clerk to paymaster of yard.....	do.....	1,400
1 clerk to inspection of provisions and clothing.....	do.....	1,300
1 clerk to paymaster of receiving-ship.....	do.....	1,300
1 first clerk to commandant.....	Navy-yard, Washington, D. O.....	1,500

REPORT OF THE SECRETARY OF THE NAVY.

Secretaries and clerks: Number of secretaries and clerks, and their pay, etc.—Continued.

Number and designation.	Where employed.	Pay.
2 second clerks to commandant (\$1,200)	Navy-yard, Washington, D. C.	\$2,400
1 clerk to paymaster of yard	do	1,600
1 clerk to inspection of provisions and clothing	do	1,600
1 clerk to paymaster of receiving-ship	do	1,300
1 second clerk to commandant	Navy-yard, Pensacola, Fla	1,200
1 clerk to paymaster of yard	do	1,400
1 first clerk to commandant	Navy-yard, Mare Island, Cal	1,800
1 second clerk to commandant	do	1,200
1 clerk to paymaster of yard	do	1,800
1 clerk to inspection of provisions and clothing	do	1,300
1 clerk to paymaster of receiving-ship	do	1,800
1 clerk to commandant	Naval Station, New London, Conn	1,500
1 clerk to paymaster of station	do	1,300
1 clerk to commandant	Training Station, Newport, R. I.	1,500
1 clerk to paymaster of receiving-ship	do	1,300
1 clerk to paymaster of station	Torpedo Station, Newport, R. I.	1,800
1 clerk to superintendent	War College, Newport R. I.	1,500
1 clerk to commandant	Naval station, Key West, Fla	1,500
1 clerk to paymaster of station	do	1,800
1 clerk to paymaster of ships	Naval Academy, Annapolis, Md	1,300
1 clerk to storekeeper	do	1,300
1 clerk to commissary	do	1,300
1 clerk to paymaster of Academy	do	1,300
1 clerk to commanding officer	Naval Asylum, Philadelphia	1,500
1 clerk to paymaster	do	1,300
10 clerks to paymasters of flag ships	\$1,100 each	11,000
6 clerks to paymasters of second-rate ships	\$1,100 each	6,600
19 clerks to paymasters of third-rate, training, and store ships	\$1,000 each	19,000
Total		113,100

RECAPITULATION.

	No.	Total pay.
Officers on active list	1,549	\$3,373,050
Naval cadets under instruction	225	112,500
Officers on retired list	378	893,754
Secretaries and clerks	87	113,100
		4,492,404
Pay of petty officers and seamen		\$2,500,000
Extra pay of petty officers and seamen re-enlisting under honorable discharge, 900, at an average of \$100 each		90,000
Total		7,082,404

Schedule of bids and statement of contracts awarded and entered into to supply ice and to wash towels for the Navy Department during the fiscal year ending June 30, 1888.

ICE FOR THE DEPARTMENT—YEAR 1887-'88.

Bidder.	Date of advertisement.	Date of proposal.	Amount of bid.	When awarded contract.	Date of contract.
Independent Ice Company	May 26, 1887	June 28, 1887	20 cts. per 100 lbs.	June 28, 1887	July 21, 1887
Great Falls Ice Company	May 26, 1887	June 28, 1887	38 cts. per 100 lbs.

WASHING TOWELS FOR YEAR 1887-'88.

Bidder.	Date of advertisement.	Date of proposal.	Amount of bid.	When awarded contract.	Date of contract.
Portland Steam Laundry	June 1, 1887	June 27, 1887	75 cents per 100	June 29, 1887	Failed to enter into contract and declared defaulter August 8, 1887.
Edward Campbell	June 1, 1887	June 6, 1887	90 cents per 100	Aug. 9, 1887	Aug. 19, 1887.
Mrs. Mary Byrnes	June 1, 1887	June 28, 1887	\$2.50 per 100

No. 2.—SALE OF CONDEMNED VESSELS.

William C. Whitney, Secretary of the Navy, in account current with the United States, for proceeds of sales of condemned vessels, under public advertisements of April 25 and August 15, 1887, inviting written proposals, and in pursuance of the acts of August 5, 1882, 22 Stats., p. 296, and March 3, 1883, 22 Stats., p. 599.

DEBITS.

Proposals received and accepted.

1887.		
Aug. 5.	Check accompanying proposal of W. E. Mighell, for the <i>Cyane</i> , collected and deposited with Treasurer United States, certificate of deposit No. 3607	\$4,520.00
5.	Check accompanying proposal of Burdett Pond, for the <i>Powhatan</i> , collected and deposited with Treasurer United States, certificate of deposit No. 3607	3,700.00
5.	Check accompanying proposal of Thomas Butler & Co., for the <i>Teonaderoga</i> , collected and deposited with Treasurer United States, certificate of deposit No. 3607	15,900.00
18.	Check accompanying proposal of W. T. Garratt & Co., for the <i>Shenandoah</i> , collected and deposited with Treasurer United States, certificate of deposit No. 3604	3,600.40
18.	Check accompanying proposal of W. T. Garratt & Co., for the <i>Lackawanna</i> , collected and deposited with Treasurer United States, certificate of deposit No. 3604	3,600.40
18.	Check accompanying proposal of W. T. Garrett & Co., for the <i>Wachusett</i> , collected and deposited with Treasurer United States, certificate of deposit No. 3604	3,300.20
18.	Check from Burdett Pond, balance on <i>Powhatan</i> , collected and deposited with Treasurer United States, certificate of deposit No. 3604	14,555.00
	Balance due on <i>Shenandoah</i> , \$14,401.60; <i>Lackawanna</i> , \$14,401.60; and <i>Wachusett</i> , \$13,200.80; deposited by W. T. Garratt & Co., with United States assistant treasurer, at San Francisco Cal. Letter of W. T. Garrett & Co., with indorsement of Treasurer United States	42,004.00
		<u>\$91,180.00</u>

CREDITS.

For publishing advertisement of April 25, 1887.

Date of checks.		
1887.		
Aug. 6.	To Army and Navy Register, of Washington, D. C., voucher No. 1.	116.60
10.	To American Graphic Company, of New York, voucher No. 2	312.00
11.	To Army and Navy Journal, of New York, voucher No. 3	140.00
11.	To Post Publishing Company, of Boston, Mass., voucher No. 4	80.60
11.	To Marine Journal, of New York, voucher No. 5	126.00
11.	To Evening Post, of New York, voucher No. 6	150.80
19.	To Journal of Commerce, of New York, voucher No. 7	140.40
29.	To Bolano Times, Vallejo, Cal., voucher No. 8	46.20
Sept. 22.	To Herald, Boston, Mass., voucher No. 9	92.63
23.	To News, New York, voucher No. 10	206.70
26.	To Picayune, New Orleans, La., voucher No. 11	70.20
26.	To Examiner, San Francisco, Cal., voucher No. 12	60.00
Oct. 5.	To Sun, Baltimore, Md., voucher No. 13	115.50
		<u>*1,657.63</u>
<i>For publishing advertisement of August 15, 1887.</i>		
13.	To Herald, Boston, Mass., voucher No. 14	17.50
17.	To Star, New York, voucher No. 15	28.30
17.	To Marine Journal, New York, voucher No. 16	26.00
19.	To Herald, New York, voucher No. 17	61.20
		<u>133.50</u>

Aug. 12.	Deposited with Assistant Treasurer United States, and covered into United States Treasury by warrant No. 1085, third quarter, 1887, as miscellaneous receipts	42,004.00
Oct. 29.	Covered into United States Treasury, per certificate of deposit No. 40552, as miscellaneous receipts	30,000.00
	Balance due the United States on deposit with the Treasurer United States	17,384.87
		<u>89,388.87</u>
		<u>\$91,180.00</u>

* There is a bill of the Chronicle, San Francisco, Cal., for publication of the advertisement of April 25, 1887, not yet settled.

Schedule of bids received under the advertisement of the Secretary of the Navy, of April 25, 1887, and opened after 12 m., July 30, 1887, for the purchase of condemned vessels.

Number.	Name and address of bidder.	Vessels and appraised value and amount of bid.						
		Tennessee, \$35,000.	Powhatan, \$17,000.	Ticonderoga, \$15,000.	Lackawanna, \$12,000.	Shenandoah, \$12,000.	Wachusett, \$10,000.	Cyane, \$3,000.
1	Samuel P. Hedges, Greenport, Long Island, N. Y.		\$18,022.20					
2	W. E. Mighell, 102 Stewart street, San Francisco, Cal.				\$17,020	\$16,020	\$13,020	\$4,520
3	E. S. Davis, Vallejo, Cal.							3,175
4	Burdette Pond, Meriden, Conn.		18,255.00					
5	Thomas Butler & Co., 249 Causeway street, Boston, Mass.		18,100.00	\$15,900				
6	W. T. Garratt & Co., San Francisco, Cal.				18,002	18,002	16,501	4,501

Opened by John W. Hogg, chief clerk, July 30, 1887, by direction of the Secretary of the Navy, in the presence of—

- W. S. SCHLEY,
Chief Bureau Equipment and Recruiting.
- T. D. WILSON,
Chief Bureau Construction and Repair.

Of the proposals mentioned in the above schedule, the following are hereby accepted:

W. E. Mighell, for the <i>Cyane</i>	\$4,520.00
Burdette Pond, for the <i>Powhatan</i>	18,255.00
Thomas Butler & Co., for the <i>Ticonderoga</i>	15,900.00
W. T. Garratt & Co., for the <i>Shenandoah</i>	18,002.00
W. T. Garratt & Co., for the <i>Lackawanna</i>	18,002.00
W. T. Garratt & Co., for the <i>Wachusett</i>	16,501.00

NAVY DEPARTMENT, August 1, 1887.

W. C. WHITNEY,
Secretary of the Navy.

No. 3.—DEPOSITS FROM SALES OF GOVERNMENT PROPERTY.

Statement of deposits on account of sales of Government property, Navy Department, from November 1, 1886, to November 1, 1887.

[Compiled in the Fourth Auditor's Office, by direction of the Secretary of the Treasury.]

Date of Deposit.	Place of deposit.	By whom deposited.	Nature of property sold.	Amount covered to miscellaneous receipts.	Amount credited to the appropriation.	Total amount deposited.
1886.						
Nov. 1	First National Bank, Newport, R. I.	George W. Simpson, assistant paymaster.	Provisions to officers' messes.		\$154.32	\$159.32
2	United States Treasury	John Corwine, passed assistant paymaster.	Gain on exchange.	\$180.88		180.88
3	do	E. B. Rogers, passed assistant paymaster.	Gain on exchange and sale of mutilated coin.	161.12		161.12
3	do	A. D. Bache, paymaster.	Premium on gold.	37.38		37.38
3	do	Livingston Hunt, assistant paymaster.	Gain on exchange.	826.68		826.68
6	do	L. A. Fralley, paymaster.	do	477.66		477.66
6	do	J. H. Stevenson, pay inspector.	Sale of condemned provisions.	4.00		4.00
6	do	George R. Watkins, paymaster.	Gain on exchange.	520.95		520.95
6	do	George W. Beaman, paymaster.	do	74.85		74.85
9	do	M. Sicaud, chief bureau of ordinance.	do		32.50	32.50
17	The Norfolk National Bank, Norfolk, Va.	H. C. Machette, paymaster.	Ammunition furnished State of Virginia.	38.48		38.48
23	New York	George H. Read, paymaster.	Sale of cuttings (clothing).		283.90	283.90
3	do	Arthur Burtis, paymaster.	Rent and privileges at Wallabout.	156.25		156.25
3	do	George W. Simpson, assistant paymaster.	Provisions to officers' messes.		19.88	19.88
Dec. 1	First National Bank, Newport, R. I.	F. H. Clark, passed assistant paymaster.	Gun-cotton furnished J. J. Blakey.		5.50	5.50
6	do	do	do		2.00	2.00
7	United States Treasury	H. T. Wright, paymaster.	Material furnished private parties.		468.02	468.02
9	New York	George H. Read, paymaster.	Clothing sold to officers and men.		433.63	433.63
9	United States Treasury	H. B. Lowry, major and quartermaster, U. S. Marine Corps.	Condemned marine clothing.	8.52		8.52
11	do	do	do		60.20	60.20
23	First National Bank, Newport, R. I.	George W. Simpson, assistant paymaster.	Provisions to officers' messes.		108.01	108.01
24	United States Treasury	G. A. Bartlett, disbursing clerk, U. S. Coast and Geodetic Survey.	Material for steam launch.			
27	do	do	do			
28	United States Treasury	Arthur Burtis, paymaster.	Rent and privilege at Wallabout.			
28	do	H. R. Sullivan, assistant paymaster.	Gain on exchange.			
28	do	T. T. Caswell, pay inspector.	do			
28	do	A. K. Michler, passed assistant paymaster.	do			
28	do	J. E. Tolfree, paymaster.	do			
28	do	J. A. Fralley, paymaster.	do			
28	do	George H. Frith, paymaster.	do			

Date	Account	Particulars	Debit	Credit	Balance
1887.	30	G. M. Stoney, Hentzest mission.	2491.00		2491.00
	31	H. A. Gill, disbursing agent, U. S. Fish Com- mission.	150.00		150.00
	31	H. R. Lowry, major and quartermaster, U. S. Marine Corps.	10.00		10.00
Jan.	3	do	10.00		20.00
	5	H. A. Gill, disbursing agent, U. S. Fish Com- mission.	400.00		400.00
	4	H. R. Lowry, major and quartermaster, U. S. Marine Corps.	400.00		800.00
	6	George H. Reed, paymaster.	1.97		1.97
	7	United States Treasury	585.32		585.32
	17	do	45.75		45.75
	17	do	3.26		3.26
	17	do	298.42		298.42
	20	do	78.04		78.04
	12	New York	929.00		929.00
	24	United States Treasury	1,441.69		1,441.69
	24	do	20.31		20.31
	26	do	7.50		7.50
Feb.	3	First National Bank, Newport, R. I.	10.45		10.45
	5	United States Treasury	143.39		143.39
	9	Philadelphia	192.00		192.00
	10	United States Treasury	59.50		59.50
	21	do	200.00		200.00
	21	do	342.37		342.37
	28	do	694.98		694.98
	10	do	135.11		135.11
Mar.	2	do	990.00		990.00
	2	New York	77.01		77.01
	2	First National Bank, Newport, R. I.	305.28		305.28
	4	United States Treasury	100.99		100.99
	5	Boston	253.95		253.95
	9	New York	6,269.88		6,269.88
	22	United States Treasury	681.25		681.25
	23	do	2.94		2.94
	13	do	1.33		1.33
	13	do	9,439.45		9,439.45
	13	do	241.20		241.20
			27,826.10		27,826.10
			6,010.66		6,010.66
			33,836.76		33,836.76

* Exchange, \$19.93. Oil, \$57.00.

* Exchange, \$605.03. Steam Engineering, \$59.82.

No. 3.—DEPOSITS FROM SALES OF GOVERNMENT PROPERTY.

Statement of deposits on account of sales of Government property, Navy Department, from November 1, 1886, to November 1, 1887.

(Compiled in the Fourth Auditor's Office, by direction of the Secretary of the Treasury.)

Date of Deposit.	Place of deposit.	By whom deposited.	Nature of property sold.	Amount covered by miscellaneous receipts.	Amount credited to the appropriation.	Total amount deposited.
1886.						
Nov. 1	First National Bank, Newport, R. I.	George W. Simpson, assistant paymaster.....	Provisions to officers' messes.....		\$159.32	\$159.32
3	United States Treasury	John Corwin, passed assistant paymaster.....	Gain on exchange.....	\$180.88		180.88
3	do	E. B. Rogers, passed assistant paymaster.....	Gain on exchange and sale of mutilated coin.....	161.12		161.12
3	do	A. D. Bache, paymaster.....	Premium on gold.....	37.38		37.38
3	do	Livingston Hunt, assistant paymaster.....	Gain on exchange.....	826.68		826.68
6	do	L. A. Frailey, paymaster.....	do	477.66		477.66
6	do	J. H. Stevenson, pay inspector.....	Sale of condemned provisions.....	4.00		4.00
6	do	George R. Watkins, paymaster.....	Gain on exchange.....	520.95		520.95
6	do	George W. Beaman, paymaster.....	do	74.85		74.85
6	do	M. Sicard, chief bureau of ordinance.....	do	32.50		32.50
17	The Norfolk National Bank, Norfolk, Va.	H. C. Machette, paymaster.....	Ammunition furnished State of Virginia.....			
23	New York	George H. Read, paymaster.....	Sale of horse (Bureau Yards and Docks).....	38.48		38.48
3	do	Arthur Burtis, paymaster.....	Sale of cuttings (clothing).....		283.90	283.90
3	do	George W. Simpson, assistant paymaster.....	Rent and privileges at Wallabout.....	156.25		156.25
Dec. 1	First National Bank, Newport, R. I.	F. H. Clark, passed assistant paymaster.....	Provisions to officers' messes.....		19.88	19.88
1	do	do	Gun-cotton furnished J. J. Blakely.....		5.50	5.50
6	do	do	do		2.00	2.00
7	United States Treasury	H. T. Wright, paymaster.....	Material furnished private parties.....		466.02	466.02
9	New York	George H. Read, paymaster.....	Clothing sold to officers and men.....		453.63	453.63
9	United States Treasury	H. B. Lowry, major and quartermaster, U. S. Marine Corps.....	Condemned marine clothing.....	8.32		8.32
11	do	do	do	60.20		60.20
23	First National Bank, Newport, R. I.	George W. Simpson, assistant paymaster.....	Provisions to officers' messes.....		103.51	103.51
24	United States Treasury	G. A. Bartlett, disbursing clerk, U. S. Coast and Geodetic Survey.....	Material for steam launch.....		150.00	150.00
27	do	do	do		1,350.00	1,350.00
28	New York	Arthur Barlis, paymaster.....	Rent and privileges at Wallabout.....	497.42		497.42
28	United States Treasury	H. E. Sullivan, assistant paymaster.....	Gain on exchange.....	646.81		646.81
28	do	T. T. Caswell, pay inspector.....	do	135.68		135.68
28	do	J. K. Michler, passed assistant paymaster.....	do	49.58		49.58
28	do	J. E. Tolfree, paymaster.....	do	200.40		200.40
28	do	L. A. Frailey, paymaster.....	do	80.73		80.73
28	do	George H. Griffing, paymaster.....	Gain on exchange and material steam engine.....	904.85		904.85
28	do	John Fury, paymaster.....	Gain on exchange and condemned oil.....	107.83		107.83

REPORT OF THE SECRETARY OF THE NAVY.

30	do	U. M. Stoner, lieutenant-in-charge.	2,000.00	2,000.00	9.92	2,000.00	9.92
31	do	H. A. Gill, disbursing agent, U. S. Fish Commission.	8.05	8.05			
1887.							
Jan.	2	H. K. Lowry, major and quartermaster, U. S. Marine Corps.	8.70	8.70	5.55		
	5	H. A. Gill, disbursing agent, U. S. Fish Commission.	1.97	1.97			
	4	H. B. Lowry, major and quartermaster, U. S. Marine Corps.	585.32	585.32			
	6	George H. Read, paymaster.	45.75	45.75			
	7	F. H. Arms, paymaster.	3.26	3.26			
	17	E. R. Sullivan, assistant paymaster.	206.42	206.42			
	17	E. B. Rogers, assistant paymaster.	76.04	76.04			
	20	H. B. Lowry, major and quartermaster, U. S. Marine Corps.	929.00	929.00			
	12	Arthur Burtis, paymaster.	1,441.60	1,441.60			
	24	Brown, Shipley & Co., fiscal agents.	20.31	20.31			
	24	H. A. Gill, disbursing agent, U. S. Fish Commission.	7.50	7.50			
	26	H. B. Lowry, major and quartermaster, U. S. Marine Corps.	10.45	10.45			
Feb.	2	do	143.39	143.39			
	3	First National Bank, Newport, R. I.	192.00	192.00			
	5	United States Treasury	59.50	59.50			
	9	do	200.00	200.00			
	10	Philadelphia.	342.37	342.37			
	21	United States Treasury	694.98	694.98			
	21	do	135.11	135.11			
	28	do	990.00	990.00			
	10	do	77.01	77.01			
Mar.	2	New York	305.28	305.28			
	4	First National Bank, Newport, R. I.	100.99	100.99			
	4	United States Treasury	253.95	253.95			
	5	Boston.	6,269.88	6,269.88			
	9	New York	681.25	681.25			
	22	United States Treasury	2.94	2.94			
	22	do	1.33	1.33			
	12	do	9,439.45	9,439.45			
	12	do	241.20	241.20			
			27,826.10	27,826.10	6,010.68	33,836.78	

† Exchange, \$19.93. O.H. \$37.00.

* Exchange, \$905.03. Steam Engineering, \$59.82.

REPORT OF THE SECRETARY OF THE NAVY.

Statement of deposits on account of sales of Government property, Navy Department, etc.—Continued.

Date of deposit.	Place of deposit.	By whom deposited.	Nature of property sold.	Amount covered to miscellaneous receipts.	Amount credited to the appropriation.	Total amount deposited.
1887.						
Mar. 18	Boston	A. S. Kenny, pay inspector.	Ordnance material, act March 3, 1875.	\$31.20	\$3,257.54	\$3,257.54
22	The Norfolk National Bank, Norfolk, Va.	H. C. Machette, paymaster.	Condemned horse.			31.20
22	United States Treasury	J. E. Toifree, paymaster.	Gain on exchange.	1,688.92		1,688.92
30	do	H. T. Wright, paymaster.	Bronze to M. Lisbarger, act March 3, 1875.	21,847.84		21,847.84
22	do	G. A. Bartlett, disbursing clerk, U. S. Coast and Geodetic Survey.	Coal to <i>Endeavor</i> .	21,145.20		145.20
29	do	do	Coal to <i>Albatross</i> .		211.63	211.63
29	The Norfolk National Bank, Norfolk, Va.	G. E. Hendee, paymaster.	Clothing, Navy.		69.85	69.85
31	First National Bank, Newport, R. I.	George W. Simpson, assistant paymaster.	Provisions to officers' messes.		100.51	100.51
Apr. 11	Philadelphia.	George Cochran, pay inspector.	Rent of wharf.	200.00		200.00
12	United States Treasury.	J. B. Redfield, paymaster.	Gain on exchange.	59.10		59.10
9	Baltimore	H. C. Machette, paymaster.	Ordnance material, act March 3, 1875.	4,899.94		4,899.94
9	New York.	J. H. Stevenson, pay inspector.	Clothing cuttings.	403.22		403.22
13	United States Treasury.	Henry F. Picking, commander.	Caps, etc., furnished Light-House Board.	161.30		161.30
16	do	H. A. Gill, disbursing agent, U. S. Fish Commission.	Log-book and log-paper for <i>Grampus</i> .	5.33		5.33
20	do	C. W. Slamm, paymaster.	Sale of whale-boat.	28.95		28.95
20	do	A. J. Pritchard, pay inspector.	Gain on exchange.	116.69		116.69
22	The Norfolk National Bank, Norfolk, Va.	H. C. Machette, paymaster.	Condemned provisions.	543.79		543.79
22	do	do	Small stores.		13.30	13.30
22	do	do	Clothing, Navy.		449.90	449.90
23	United States Treasury.	M. Sicard, Chief Bureau Ordnance.	Ordnance material, act March 3, 1875.	1,400.00		1,400.00
11	do	G. A. Bartlett, disbursing clerk, U. S. Coast and Geodetic Survey.	Coal to <i>Bonche</i> .	435.65		435.65
25	do	H. B. Lowry, major and quartermaster, U. S. Marine Corps.	Condemned marine clothing and furniture.	24.76		24.76
27	do	do	do.			
20	New York.	J. E. Cann, passed assistant paymaster.	Stores sold to steamer <i>Louis Huller</i> .	17.00		17.00
30	First National Bank, Newport, R. I.	G. W. Simpson, assistant paymaster.	Provisions to officers' messes.	4.69		4.69
30	San Francisco.	J. Q. Barron, paymaster.	Clothing, Navy.	116.05		116.05
30	do	do	Small stores.	558.61		558.61
30	do	do	Condemned provisions.	59.19		59.19
30	New York.	Herbert Burtis, paymaster.	Rent, etc., Wallabout.	372.33		372.33
30	United States Treasury.	H. A. Gill, disbursing clerk, U. S. Fish Commission.	Coal to <i>Albatross</i> .	690.75		690.75
May 6	do	do	do.	105.81		105.81

11	do	H. B. Lowry, major and quartermaster, U. S. Marine Corps.	Gas oil.....	102.60	192.00
13	New York	Arthur Burtis, paymaster	Condemned provisions.....	149.19	149.19
13	do	do	Clothing, Navy.....	796.45	796.45
13	do	do	Small stores.....	25.83	25.83
10	United States Treasury	G. A. Bartlett, disbursing clerk, U. S. Coast and Geodetic Survey.	Coal to <i>Blake</i>	71.20	71.20
18	do	R. W. Allen, paymaster	Gain on exchange.....	9.51	9.51
18	do	J. Macmahon, paymaster	do.....	513.78	513.78
23	do	J. Pury, paymaster	do.....	75.24	75.24
19	Philadelphia	G. Cochran, pay inspector	Obsolete and unserviceable articles.....	84.82	84.82
26	United States Treasury	Brown, Shipley & Co., United States fiscal agents.	Gain on exchange and interest on daily balance on exchange.....	3,145.45	3,145.45
28	do	J. E. Volfree, paymaster	Gain on exchange.....	172.73	172.73
26	do	H. R. Sullivan, assistant paymaster	Old material.....	100.40	100.40
June 1	do	H. B. Lowry, major and quartermaster, U. S. Marine Corps.	Condemned stores.....	8.75	8.75
1	do	H. R. Smith, passed assistant paymaster.	Gain on exchange.....	12.41	12.41
1	First National Bank, Newport, R. I.	W. B. Wilcox, assistant paymaster	Provisions to officers' messes.....	92.66	92.66
2	New York	J. H. Stevenson, paymaster	Working suits.....	78.05	78.05
4	United States Treasury	G. A. Bartlett, disbursing clerk, U. S. Coast and Geodetic Survey.	Coal to <i>Blache</i>	291.60	291.60
3	The Norfolk National Bank, Norfolk, Va.	G. E. Hendee, paymaster.	Clothing, Navy.....	293.81	293.81
6	do	H. C. Machette, paymaster	Boats, condemned material, boilers, etc.	19,000.00	19,000.00
6	do	do	Ordinance material, see March 2, 1875.....	5,000.00	5,000.00
25	do	do	Condemned stores and supplies.....	6,600.00	6,600.00
10	do	G. A. Bartlett, disbursing clerk, U. S. Coast and Geodetic Survey.	Coal to <i>Blake</i>	338.40	338.40
10	do	do	Salt-water soap to <i>Blake</i>	4.50	4.50
10	do	do	Condemned marine clothing.....	6.42	6.42
13	The Norfolk National Bank, Norfolk, Va.	H. B. Lowry, major and quartermaster, U. S. Marine Corps.	Empty barrels.....	9.62	9.62
16	United States Treasury	G. E. Hendee, paymaster.	Coal to <i>Albatross</i>	108.43	108.43
14	Boston	H. A. Gill, disbursing agent, U. S. Fish Commission.	Condemned horse.....	47.29	47.29
23	United States Treasury	A. S. Kenny, pay inspector	Coal.....	4.87	4.87
24	do	H. A. Gill, disbursing agent, U. S. Fish Commission.	Old copper.....	15.84	15.84
25	do	W. B. Wilcox, assistant paymaster	Provisions to officers' messes.....	71.42	71.42
30	United States Treasury	H. B. Lowry, major and quartermaster, U. S. Marine Corps.	Condemned property.....	38.38	38.38
July 8	Philadelphia	George Cochran, pay inspector	Wharf rent.....	200.00	200.00
13	United States Treasury	G. A. Bartlett, disbursing clerk, U. S. Coast and Geodetic Survey.	Material furnished in construction steam launch.....	574.12	574.12
13	do	do	do.....	1,625.50	1,625.50
15	San Francisco	J. Q. Barton, paymaster	Two condemned horses.....	32.33	32.33
				33,912.65	49,803.16

* Steam Engineering, \$51.81. Construction and Repair, \$12.98. Gain on exchange, \$35.60.

Statement of deposits on account of sales of Government property, Navy Department, etc.—Continued.

Date of deposit.	Place of deposit.	By whom deposited.	Nature of property sold.	Amount covered to miscellaneous receipts.	Amount credited to the appropriation.	Total amount deposited.
1887.				\$893.50		\$893.50
July 20	New York	Arthur Burris, paymaster	Rent, etc., Wallabout	893.50		893.50
July 29	First National Bank, Newport, R. I.	W. B. Wilcox, assistant paymaster	Provisions to officers' messes		75.38	75.38
Aug. 2	United States Treasury	W. W. Galt, passed assistant paymaster	Condemned marine clothing	4.90		4.90
2	do	A. K. Michler, passed assistant paymaster	Gain on exchange	30.46		30.46
2	do	R. W. Allen, paymaster	do	64.72		64.72
2	do	J. Macmahon, paymaster	do	225.87		225.87
2	do	J. Furey, paymaster	do	24.10		24.10
2	do	M. K. Calvert, assistant paymaster	Condemned marine clothing	7.90		7.90
2	do	J. E. Tolfree, paymaster	Gain on exchange	344.22		344.22
2	do	H. B. Lowry, major and quartermaster, U. S. Marine Corps	Condemned marine clothing	16.84		16.84
2	do	do	Fuel to officers	1,120.05		1,120.05
4	The Norfolk National Bank, Norfolk, Va.	H. C. Machette, paymaster	Condemned horse	18.15		18.15
8	United States Treasury	G. A. Bartlett, disbursing clerk, U. S. Coast and Geodetic Survey	Stores furnished steam launch		7.75	7.75
12	San Francisco	W. C. Whitney, through W. T. Garrett & Co	Sale of <i>Shenandoah</i> , <i>Lackawanna</i> , and <i>Wachusett</i>	42,004.00		42,004.00
18	National Bank of Commerce, New London, Conn.	C. W. Littlefield, passed assistant paymaster	Barrel flour to schooner <i>Francis Butler</i>		4.65	4.65
31	First National Bank, Newport, R. I.	W. B. Wilcox, assistant paymaster	Provisions to officers' messes		97.49	97.49
Sept. 2	The Norfolk National Bank, Norfolk, Va.	H. C. Machette, paymaster	Ordnance material, act March 3, 1875		6,008.54	6,008.54
2	New York	Arthur Burris, paymaster	Government property	21,679.00		21,679.00
8	United States Treasury	H. A. Gill, disbursing agent U. S. Fish Commission	Articles furnished commission		14.58	14.58
6	New York	Arthur Burris, paymaster	Government property	8,549.02		8,549.02
16	do	do	do	7,100.00		7,100.00
19	do	do	do	12,242.73		12,242.73
24	United States Treasury	H. A. Gill, disbursing agent, U. S. Fish Commission	Ensigns furnished <i>Albatross</i>		159.06	159.06
27	First National Bank, Newport, R. I.	W. B. Wilcox, assistant paymaster	Provisions to officers' messes		61.88	61.88
27	United States Treasury	C. P. Thompson, paymaster	Gain on exchange	60.91		60.91
24	New York	Arthur Burris, paymaster	Government property	2,000.00		2,000.00
23	do	J. H. Stevenson, pay inspector	Clothing to officers and men		686.53	686.53
23	do	H. B. Lowry, major and quartermaster U. S. Marine Corps	Condemned articles	82.50		82.50
28	United States Treasury	H. A. Gill, disbursing agent, U. S. Fish Commission	Gain on exchange and interest on balances	1,604.91		1,604.91
Oct. 8	do	Brown, Shipley & Co., fiscal agents	Nine elms scapatoe		27.00	27.00
16	do	H. A. Gill, disbursing agent, U. S. Fish Commission				

15	Philadelphia	George Cochran, pay inspector	What front	200.00	200.00
16	New York	J. H. Stevenson, pay inspector	One hundred and seventy-five working suits	168.51	168.51
20	United States Treasury	H. B. Lorry, major and quartermaster, U. S. Marine Corps	Condemned property	260.04	260.04
29	do	I. A. Fraley, paymaster	Gain on exchange	803.11	803.11
29	do	Secretary Navy	Old vessels	30,000.00	30,000.00
29	do	H. R. Smith, passed assistant paymaster	Gain on exchange	85.41	85.41
	Grand total			127,861.99	8,431.42
				189,680.74	156,245.26
					247,876.00

No. 4.—MOVEMENTS OF VESSELS.

NORTH ATLANTIC STATION.

The vessels on this station still remain under the command of Rear-Admiral Stephen B. Luce. They are the *Richmond* (flag-ship), *Atlanta*, *Ossipee*, *Galena*, *Yantic*, and *Dolphin*. The *Tennessee* being unfit for further service in the Navy has been put out of commission.

TENNESSEE.

The *Tennessee*, then the flag-ship of Rear-Admiral Luce, arrived at the navy-yard, New York, October 30, 1886, and was put out of commission at that place on the 20th of January last. Her officers and men were transferred to the *Richmond*.

RICHMOND.

The *Richmond* was put in commission at the navy-yard, New York, January 20, 1887, and sailed from that port for a cruise to the West Indies March 28 following. She arrived at Bermuda April 3, and after a visit of four days sailed for St. Thomas, where she arrived April 12. Thence she proceeded to Martinique, reaching that port on the 19th. She left there on the 21st and arrived at Curaçao two days later. Sailing thence on the 28th, she arrived at Key West May 5, and from thence sailed on the 13th for Hampton Roads, Va., where she arrived May 23, having touched at Matanzas en route. Went to Norfolk on the 24th, and after remaining in that port two days sailed for New York, where she arrived May 29. From New York she proceeded on the 14th of June to New Haven, where she, with the *Galena*, *Ossipee*, and *Yantic*, participated in the ceremonies attending the unveiling of the soldiers and sailors' monument. Sailed thence June 18, and after visiting New London and Greenport arrived at Newport June 25. She left Newport June 28, and touching at Boston, Portsmouth, N. H., Portland, Widow's Island, and Bar Harbor, arrived at Halifax July 24. She sailed from that port August 11 for Newport, where she arrived on the 30th of that month, having visited Bar Harbor, Southwest Harbor, and Buzzard's Bay on her return. Sailed thence September 10 and arrived at Philadelphia on the 12th of that month, and in company with the other vessels of the squadron participated in the ceremonies attending the centennial celebration of the adoption of the Constitution of the United States. She remained in Philadelphia until the 24th of September, when she sailed for Newport, where she arrived September 28.

ATLANTA.

The *Atlanta* left New York July 6, 1887, for Newport to adjust her compasses. She arrived at that place the following day, and on the

21st of that month reported for duty in the North Atlantic squadron. She sailed for Bar Harbor August 3, and having visited Gloucester, Portsmouth, N. H., and Rockport, arrived at her destination August 14. She proceeded thence to Southwest Harbor, sailing August 25 and arriving the same day. Sailed on the 27th, and touching at Buzzard's Bay arrived at Newport August 30. She remained at Newport until September 10, when she sailed in company with the flag-ship for Philadelphia, at which port she arrived September 12. She sailed thence on the 24th of that month and arrived at Newport on the 28th, having picked up on the way and towed into Lewes, Del., the wreck of a lumber-laden schooner, which had for some time past proved a danger to navigation off the coast of New Jersey. Sailed for New York October 26, arriving the next day. After receiving a supply of coal she returned to Newport, where she arrived November 4.

OSSIPEE.

The repairs to the *Ossipee* having been completed, she sailed from Norfolk June 8, 1887, and from Hampton Roads June 16 for New Haven, arriving the following day. Proceeding thence on the 18th, she arrived the same day at New London, and left again on the 20th for Greenport, arriving there the same day. Sailed for Newport on the 25th, and from that place for Boston on the 28th, reaching there the next day. She remained at Boston until July 10, and then left for Halifax, at which port she arrived on the 13th of that month. Sailing again July 18 she visited Hawkesbury, Port Hastings, Cascumpeque Bay, and returned to Halifax July 28. Sailed thence August 11, in company with the flag-ship, and arrived at Bar Harbor two days later. She left that port August 19 for the navy-yard, Portsmouth, N. H., for repairs, where she arrived August 20. She left the navy-yard September 7, and joined the squadron at Newport the next day. Sailed thence on the 10th, and arrived at Philadelphia September 12, where she remained until September 24, when she left for Newport, and arrived there on the 26th. Went to sea October 15, to destroy a wreck off Shinnecock Light, and after removing this danger to navigation returned to Newport October 17. Sailed for New York October 26, and arrived the next day, and after receiving a supply of coal again returned to Newport, where she arrived November 1.

GALENA.

The *Galena* sailed from Portsmouth, N. H., December 15, 1886, and arrived the same day at Boston. Sailed thence on the 17th for Norfolk, where she arrived December 23, having touched at Newport en route. She sailed from Norfolk January 11, 1887, for a cruise to the West Indies; arrived at St. Thomas January 18, where she remained until the 22d, when she sailed for Santa Cruz, arriving the same day. Thence she proceeded January 25 to Martinique, and reached that port two days later. From Martinique she visited Bridgetown, Port of Spain, Curaçao, Savanilla, and Carthagena, and arrived at Aspinwall March 6. She remained in Colombian waters until April 18, when she sailed for Washington, D. C., where she arrived May 2, having visited Havana en route. Sailed May 23 and reached Hampton Roads the next day. After remaining in that port three days she sailed for New York, arriving there May 31. Went to New Haven June 14, and thence proceeded, in company with the flag-ship, on the 18th of that month to New London, Greenport, and Newport, arriving at the latter place June 25.

She sailed from Newport June 28, and arrived at Boston next day. She left that port July 2 for Halifax, where she arrived two days later. Sailing thence July 8, she visited Hawkesbury, Quebec, Montreal, and Habitant's Bay, and returned to Halifax August 8. She sailed from that port August 11, in company with the flag-ship; visited Bar Harbor, Southwest Harbor, and Buzzard's Bay, and arrived at Newport August 30. Sailed September 8 and reached New York the following day, and left that port September 11 for Philadelphia, arriving on the 12th. She left Philadelphia September 24, and arrived at New York two days later. Thence she proceeded to Newport, where she arrived September 29. Went to New York October 23 for coal, and returned on the 26th.

YANTIC.

The *Yantic* remained in Colombian waters until January 9, 1887, when she sailed for Key West, at which port she arrived January 16. Sailing again February 8, she arrived at Havana the same day. She left that place February 12, and visited the following ports, St. Thomas, Christiansted, San Juan, Samana, San Domingo, Jacmel, Port au Prince, St. Marks, Cape Haytien, Santiago de Cuba, and Cienfuegos, returning to Key West April 11. She sailed April 14, and arrived at Pensacola on the 18th of that month. Sailed again on the 25th; touched at Key West on the 28th, and arrived at Norfolk, Va., May 4. She left Hampton Roads, Va., May 27, and reached New York four days later. Sailed thence June 14, and arrived the same day at New Haven, and after a visit to that port of six days left for Gardiner's Bay and Newport, arriving at the latter place June 25. Leaving Newport on the 28th of June, she visited Boston and Portland, and arrived at Halifax July 20, where she remained until the 28th of that month, and thence proceeded to Hawkesbury, Georgetown, Summerside, Charlottetown, and Bar Harbor, arriving at the latter place August 10. Sailed on the 25th, and arrived the same day in Southwest Harbor, where she remained until the 27th, when she left for Newport, at which port she arrived August 30. She remained at Newport until September 10, when she sailed for Philadelphia, in company with the flag-ship, arriving at that port September 13. Sailed for Norfolk, for repairs, September 22, and reached there two days later.

DOLPHIN.

The *Dolphin* being ready for sea, she was on the 15th of January last assigned to duty on the North Atlantic Station, and sailed from Norfolk on the 19th of that month for Newport, where she arrived the following day. Sailed on the 27th of January, and arrived at New York on the 28th. She remained at New York until May 7, when she went to Norfolk, and thence returned to New York May 11. She sailed from New York August 6, and, after visiting Salem and Belfast, arrived at Bar Harbor August 14. Sailed August 25 in company with the flag-ship; visited Southwest Harbor and Buzzard's Bay, and arrived at Newport August 30. She sailed from Newport September 7, and arrived at Washington on the 10th. Sailed the following day for Philadelphia, and reached that port on the 13th, having stopped at Norfolk on the way. She left Philadelphia on the 24th, and arrived off Alexandria, Va., on the 25th and at Norfolk on the 27th. After remaining in that port two days she sailed for Newport, where she arrived September 30. Sailed November 2 for Boston for coal, arriving the next day; returned to Newport November 7.

SOUTH ATLANTIC SQUADRON.

The squadron on this station consists of the *Lancaster* (flag-ship), *Alliance*, and *Tallapoosa*, and still continues under the command of Rear-Admiral Daniel L. Braine.

LANCASTER.

The *Lancaster* sailed from Montevideo December 10, 1886, and arrived the same day at Maldonado, where she remained until March 15, 1887, when she returned to Montevideo. She sailed thence May 6 and arrived at Rio Janeiro on the 18th of that month, having touched at Isla Grande en route. Left Rio de Janeiro August 10, accompanied by the *Alliance* and *Tallapoosa*, for Estrella Bay for squadron drills and exercises, returning to Rio de Janeiro August 21. Here she received new officers and men sent from the United States in the *Trenton*, and sailed November 11 for Maldonado.

ALLIANCE.

The *Alliance* arrived at Gibraltar December 15, 1886, on her way to join the South Atlantic station, under orders to investigate en route the reported fraudulent sale in 1884 of the American schooner *Emma Jane* by her master at the island of Johanna, and to make inquiry concerning the report that vessels under the American flag were engaged in transporting slaves from the east coast of Africa to Madagascar and adjacent islands. She sailed from Gibraltar December 21, and passing through the Mediterranean, Suez Canal, and Red Sea, arrived at Aden January 26, 1887. Thence proceeded to Zanzibar, arriving February 23. She left that port on the 27th of that month, and arrived at the island of Johanna March 3, where she seized a part of the outfit of the *Emma Jane*. Sailing thence she visited Madagascar and Mozambique, and returned to the island of Johanna March 21; then proceeded to the island of Mayotta, arriving on the 24th. After a stay of three days at that place she sailed for St. Mary's, Madagascar, where she arrived April 1. Leaving that port on the 3d of April, she visited Tamatave, Port Louis, Mauritius, Nos Vey, St. Augustine, Tullear Bay, and Mourandava, arriving at the latter place May 12. She left Mourandava three days later and visited Port Natal, Port Elizabeth, and Cape Town, reaching the latter named port June 5. Sailed thence June 25 and arrived at Rio de Janeiro on the 25th of the following month. Left Rio de Janeiro in company with the flag-ship August 10 for Estrella Bay, where she arrived the same day, returning to Rio on the 21st of that month. She sailed from that port September 17 and arrived at Bahia September 24, where she remained until the 28th, when she sailed for Pernambuco. From thence she proceeded to Santos and Santa Catharina, arriving at the latter place November 11.

TALLAPOOSA.

The *Tallapoosa* sailed from Montevideo in company with the flag-ship December 10, 1886, and arrived the same day at Maldonado, where she remained until February 1, 1887, when she returned to Montevideo. She remained in the vicinity of that port and Maldonado until the 17th of February and then sailed for Buenos Ayres, at which port she

arrived the next day. She sailed thence May 7 for Rio de Janeiro and arrived there May 16, having visited Isla Grande en route. She left Rio de Janeiro August 10 in company with the flag-ship for Estrella Bay, where she remained until the 20th of that month, when she returned to Rio de Janeiro. She sailed from that port on the 10th of September, and arrived at Montevideo on the 17th. Left September 21 and arrived the same day at Colonia; remained in that port until the 26th, when she sailed for Paysander, where she arrived the next day; thence proceeded to Buenos Ayres, Santos, and Maldonado, arriving at the latter place November 18.

EUROPEAN STATION.

Rear-Admiral Samuel R. Franklin having been detached from duty on the 24th of August last, the force on this station is now under the command of Acting Rear-Admiral James A. Greer, and consists of the *Pensacola* (flag-ship) and *Quinnebaug*.

PENSACOLA.

The *Pensacola* sailed from Villefranche November 13, and arrived at Palermo November 16; sailed thence on the 23d for a cruise to the eastward; arrived at Malta on the 25th, where she remained until December 6, when she sailed for Alexandria, where she arrived December 11. She remained at Alexandria until February 7, 1887, when she sailed for Piræus, where she arrived three days later. She sailed thence April 2, and arrived at Leghorn April 7; thence proceeded to Villefranche, arriving at that port May 5. Sailing from Villefranche June 9, she visited Spezia, and again returned to Leghorn, arriving June 27; sailed September 1, and arrived at Gibraltar September 22, having touched at Marseilles, Barcelona, Valencia, and Malaga. Sailed thence September 25, and arrived the same day at Tangier. Left the following day and arrived at Algiers September 28; proceeded from that port to Alexandria, where she arrived October 12.

QUINNEBAUG.

The *Quinnebaug* sailed from Genoa November 11, 1886, and arrived at Gibraltar on the 17th of that month. She sailed thence November 23 for a cruise along the west coast of Africa; arrived at Teneriffe December 2; sailed four days later and arrived at Sierra Leone December 14, where she remained two days, then visited Manna River and arrived at Monrovia December 19. After a stay of a week at Monrovia she visited Junk River, Grand Bassa, Siron, Cape Palos, Cavally, and Libreville, arriving at the last-mentioned port January 3, 1887. She left there on the 6th of that month, and touching at Banana Point and Freetown, arrived at Porto Grande February 4. She remained at Porto Grande until February 14, when she sailed for Funchal, where she arrived February 22. She sailed again March 7, and reached Gibraltar on the 11th of that month. She left that port on the 17th and visited Tangiers, Barcelona, and Marseilles, and arrived at Villefranche April 2; sailed thence April 8, and arrived at Leghorn the next day. She returned to Villefranche May 5. She remained at that port until June 2, when she sailed for Lisbon, where she arrived June 18, having visited Spezia, Gibraltar, and Tangiers en route. She received at Lisbon new officers

and men sent from the United States in the vessels of the training squadron and left that port July 16 for Cadiz, arriving there on the 19th. Proceeding thence, July 24, she visited Tangiers and Gibraltar. She sailed from the later port August 2, and after touching at Algiceras and Cadiz again returned to Gibraltar, arriving September 13. Went to Almeria September 14, and returned to Gibraltar September 19, from which port she sailed September 25 for a cruise to the eastward; visited Tangiers, Oran, Bona, Tunis, and Tripoli, and arrived at Alexandria October 16.

PACIFIC STATION.

The force on this station is now commanded by Rear-Admiral Louis A. Kimberly, who succeeded Rear-Admiral E. Y. McCauley. The latter officer was detached November 6, 1886. The following vessels compose the squadron: *Vandalia* (flag-ship), *Juniata*, *Adams*, *Mohican*, *Alert*, *Iriquois*, *Pinta*, and *Monongahela*. The *Hartford* was sent to the navy-yard Mare Island, Cal., and put out of commission January 14, 1887.

VANDALIA.

The *Vandalia* sailed from New York for the Pacific Station August 14, 1886, and arrived at Montevideo October 19, where she remained until November 9, when she left for Valparaiso, arriving at that port December 16. She sailed thence January 18, 1887, and reached Talcahuano two days later. Thence she proceeded February 2 to Coquimbo, arriving February 5. She remained at Coquimbo until March 10, when she sailed for Panama, where she arrived on the 27th of that month. On April 11 Rear Admiral Kimberly assumed command of the Pacific Squadron and hoisted his flag on board this vessel. The *Vandalia* sailed from Panama May 18 and arrived at Payta May 24. Sailed on the 23d of June and reached Callao three days later. She left that port July 21 and arrived at Honolulu August 27.

JUNIATA.

The *Juniata* sailed from New York for the Pacific Station August 16, 1886; arrived at Porto Grande September 24 and reached Rio de Janeiro October 24. She sailed thence November 3, and reached Montevideo on the 26th of that month. Thence she proceeded December 18, and arrived at Maldonado the next day. Sailed for the Falkland Islands December 26, and after remaining there about two weeks left for Sandy Point, where she arrived January 26, 1887. Sailing thence she visited Talcahuano and Coquimbo, arriving at the latter place March 18. She left Coquimbo April 7, and after visiting Caldero and Iquique, arrived at Pauama May 27, at which port she remained until July 2, when she sailed for a cruise along the west coasts of Central America and Mexico; visited Punta Arenas, Corinto, and Acapulco, and sailed from the latter port for Honolulu August 6, where she arrived September 11.

ADAMS.

The *Adams* sailed from Panama February 17, 1887, and arrived at Acapulco on the 26th of that month. Sailed thence March 20, and arrived at Mazatlan April 5, having touched at Manzanillo and San Blas. She remained at Mazatlan until April 16, when she sailed and

visited the following ports: Guaymas, La Paz, and Acapulco, arriving at the latter port May 5. Proceeding thence on the 15th of that month, she arrived at Honolulu June 14, having touched at Hilo en route. She remained at Honolulu until October 2, when she sailed for the Samoan and Tonga Islands.

MOHICAN.

The *Mohican* sailed from Apia September 17, 1886, and after visiting the principal ports in the Tonga group, returned to Apia October 6, following. She remained in Samoan waters until October 22, when she sailed for Tahiti, where she arrived November 11. She left Tahiti on the 16th of that month for Easter Island, arriving there December 17. Sailed thence December 31, and arrived at Valparaiso January 14, 1887, where she remained until January 29, when she left for Panama, at which port she arrived April 2, having visited the following places en route: Coquimbo, Caldero, Iquiqui, Arica, and Callao. She left Panama April 30, and, having visited various ports on the coasts of Salvador and Nicaragua, returned to Panama May 22. From Panama she visited Payta, arriving June 7, and sailed from that port July 5 for Callao, where she arrived three days later. Proceeded thence on the 17th of August to Ancon, and, after a stay at that port of five days, returned to Callao, where she remained until September 10, when she sailed for Honolulu, arriving there October 13.

ALERT.

The *Alert* was put in commission at the navy-yard, Mare Island, Cal., January 15, 1887, and sailed from San Francisco February 23, for Panama to join the Pacific Station. She visited the following places en route: Mazatlan, Acapulco, San José de Guatemala, La Libertad, La Union, Amapala, Corinto, and Punta Arenas, arriving at Panama May 7. She remained at that port until May 27, when she sailed for Payta, where she arrived June 1. Sailed June 21, and reached Callao on the 26th of that month. Proceeded thence August 17, and arrived at Payta on the 22d. Left Payta October 14 for Callao, and is now in that port.

IROQUOIS.

The *Iroquois* sailed from Callao November 13, 1886, and arrived at Mollendo on the 16th; sailed thence November 28, and after visiting Arica, Iquiqui, Caldero, Huasco, Carrizal, and Coquimbo, arrived at Valparaiso December 15; sailed thence January 27, 1887, and arrived at Talcahuano two days later. She left that port February 16, visited Pinco, and returned to Talcahuano the same day; left on the 18th and visited Lota, and again returned to Talcahuano, reaching that port February 21; proceeding thence March 1, she touched at Juan Fernandez, Mas-á-Fuera, Valparaiso, Coquimbo, and Caldero, arriving at the latter place March 19; sailed April 12th and arrived at Iquiqui three days later; thence proceeded to Panama, where she arrived May 6. She remained at Panama until June 27, when she sailed for Payta, reaching that place July 5. She sailed July 11 and arrived at Callao on the 15th of that month, where she remained until September 26, when she returned to Payta; sailed October 14, and arrived at Callao five days later, and thence sailed, November 6, for San Francisco.

PINTA.

The *Pinta* has been employed throughout the year in cruising in Alaskan waters.

MONONGAHELA.

The *Monongahela* is the store-ship for the Pacific squadron, and has remained throughout the year at Coquimbo, Chili.

HARTFORD.

The *Hartford* arrived at San Francisco December 26, 1886, having touched at the following ports en route from Callao: Salavery, Payta, Acapulco, and San Diego. She arrived at the navy-yard, Mare Island, December 30, and went out of commission January 14, 1887.

ASIATIC STATION.

Rear-Admiral Ralph Chandler assumed the command of the force on this station November 22, 1886, relieving Rear-Admiral John Lee Davis, who had been in command three years. The squadron is composed at present of the following vessels: *Brooklyn* (flag-ship), *Omaha*, *Marion*, *Essex*, *Palos*, and *Monocacy*.

BROOKLYN.

The *Brooklyn* left Port Said October 4, 1886, passed through the Suez Canal on the 4th and 5th, and arrived at Aden October 13, where she remained but one day, and then proceeded to Muscat. She arrived at that port October 22 and sailed on the 27th for Bushire, where she arrived October 31. She remained in that port until November 25, when she sailed for Karachi, arriving there December 2. She left the next day and reached Bombay December 6. After a visit of three weeks to that port she sailed for Colomba, where she arrived December 31. Sailing thence on the 5th of January, 1887, she visited Trincomalee, Georgetown, Pulo Penang, and arrived at Singapore January 27. She left that port February 2, and, after a visit to Sarawak, arrived at Batavia February 11. Sailed from Batavia February 23, and arrived at Manila March 5. After remaining in that port five days she sailed for Yokohama, where she arrived March 31, having touched at Sian-chi, Amoy, and Nagasaki en route. Rear-Admiral Chandler transferred his flag from the *Marion* to this vessel April 4, 1887. She remained at Yokohama, undergoing repairs, until July 19, when she sailed for Nagasaki, at which port she arrived July 25. Sailed August 6 and arrived at Kobe on the 8th. Left August 17 and arrived at Nagasaki on the 20th, where she remained ten days, and then sailed for Chemulpo, arriving September 1. Sailed thence September 15 and arrived at Nagasaki two days later.

OMAHA.

The *Omaha* left Chemulpo October 11, 1886, for Chefoo, and returned to Chemulpo October 29. Sailed for Nagasaki October 31, and thence returned to Chemulpo. She remained at that port until December 20, when she sailed for Yokohama, where she arrived on the 26th of that month. Leaving Yokohama February 19, she visited Kobe and Naga-

saki, and returned to Yokohama March 16. Proceeded thence March 23, and arrived at Chemulpo on the 30th, having stopped one day at Nagasaki. She remained at Chemulpo until April 4, and thence proceeded to Nagasaki, where she arrived two days later. Sailed from that port May 1, and arrived at Yokohama May 10, having touched at Kobe en route. Left Yokohama June 27, and arrived at Nagasaki three days later. Sailed August 8, visited Chefoo and Chemulpo, and returned to Nagasaki August 29. Left for Chemulpo September 23, and arrived there on the 26th of that month.

MARION.

The *Marion* arrived at Yokohama November 5, 1886, from Nagasaki. She remained in that port until February 22, 1887, when she sailed for Nagasaki, where she arrived March 5, having touched at Kobe en route. Sailed on the 13th of that month and returned to Yokohama on the 17th, having again visited Kobe during the trip. She left Yokohama May 10, and arrived at Chemulpo May 16, where she remained until the 30th of June, when she sailed for Nagasaki, at which port she arrived July 2. Sailed on the 6th of August and arrived at Kobe on the 8th, and leaving that port on the 23d arrived at Yokohama two days later. Sailed thence September 2 for Panama for new officers and men; arrived at Acapulco October 20; sailed on the 25th and reached Panama November 1.

ESSEX.

The *Essex* sailed from Colombo December 6, 1886; arrived at Singapore on the 18th of that month, and at Hong-Kong January 17, 1887. Sailed January 23 for Yokohama, where she arrived February 7, having stopped at Amoy and Nagasaki en route. Left that port April 3 for Nagasaki, and sailed thence for the southeast coast of Formosa to search for the missing American bark *Abbie Carver*; arrived at Kobe April 6, sailed on the 10th, and reached Nagasaki April 12; left the same day and arrived at Kelung April 16. Sailed the same day and visited Samasana and Black Rock Bay, and again returned to Kelung, arriving at that port April 20. Thence she proceeded to Shanghai, where she arrived on the 24th of that month. She remained at Shanghai until May 8, and then sailed for Nagasaki, reaching there the 13th. From Nagasaki she went to Kobe, and then to Yokohama, arriving at the latter place June 3. Sailed July 2, visited Nagasaki, and thence proceeded on the 18th to Chemulpo, where she arrived July 21. From that port she proceeded to Chefoo, and returning to Chemulpo arrived August 25. Sailed September 28, and arrived at Nagasaki on the 30th. She left Nagasaki about October 15 for Ponapi, East Caroline Group, to investigate the reported massacre of Spaniards at that place and to afford protection to American missionaries.

PALOS.

The *Palos* sailed from Canton October 30, 1886, and arrived at Hong-Kong the next day. Sailed November 6 for Shanghai, where she arrived on the 16th of that month, and after a stay of two days left for Tientsin, arriving November 26. She remained at Tientsin until March 22, 1887, when she sailed for Nagasaki, where she arrived March 27. She left Nagasaki May 1, and arrived at Yokohama May 10, having touched at Kobe en route. She sailed August 5 for Kobe, and from that place August 17 for Nagasaki, arriving August 21.

MONOCACY.

The *Monocacy* sailed from Hong-Kong November 9, and reached Canton the next day. She remained in the vicinity of the ports above mentioned until about March 30, 1887, when she sailed for Yokohama, where she arrived April 8. This vessel is in need of extensive repairs.

OSSIPEE.

The *Ossipee* sailed from Aden December 2, 1886, and, passing through the Red Sea and Suez Canal, arrived at Port Said December 12. Sailed thence December 16, and visited Naples, Algiers, Gibraltar, Fredericksted, and St. Thomas; arrived at New York February 15, 1887. Sailed thence, March 3, for Norfolk, where she arrived the next day.

SPECIAL SERVICE.

The vessels on special service at present are the *Ranger*, *Despatch*, *Michigan*, and *Thetis*.

RANGER.

The *Ranger* returned to San Francisco June 26, 1887, and arrived at the navy-yard, Mare Island, Cal., July 7. She remained at Mare Island until October 25, when she went to San Francisco, and sailed from that port November 2 to resume her work on the coast of Lower California.

DESPATCH.

The *Despatch* left New York March 24, 1887, and during the year has visited at various times the following ports: Norfolk, Washington, Annapolis, Bridgeport, Portsmouth, N. H., Bar Harbor, and Boston. She is now at New York.

MICHIGAN.

The *Michigan* has been employed during the past year cruising on the northwestern lakes.

THETIS.

The *Thetis* was put in commission at the navy-yard, New York, January 15, 1887, and sailed from that port March 24 following for Norfolk, arriving two days later. She left Norfolk April 8 and anchored in Hampton Roads the same day. She sailed thence May 7, and reached Bridgetown May 19. She left that port on the 25th and arrived at Rio de Janeiro June 17, where she remained until the 27th of that month, when she sailed for Montevideo, arriving there July 7. Thence proceeded, July 23, to Valparaiso, where she arrived August 23, having touched at Sandy Point en route. She sailed from Valparaiso August 31 and arrived at Callao September 8. She remained in that port ten days, and then sailed for San Francisco, where she arrived October 13, having stopped two days at San Diego. From San Francisco she proceeded on the 19th of October, to the navy-yard, Mare Island, Cal., and arrived at that place the same day.

TRENTON.

The *Trenton* was put in commission at the navy-yard, Norfolk, May 16, 1887, and sailed from that port July 25 with the relief officers and men for the *Lancaster*. She arrived at St. Vincent August 18, and at

Rio de Janeiro September 10. She remained at the latter port until September 24, when she sailed for New York, where she arrived November 3, having stopped two days at St. Thomas en route.

APPRENTICE TRAINING SQUADRON.

The cruising ships of this squadron are the *Saratoga*, *Jamestown*, and *Portsmouth*.

SARATOGA.

The *Saratoga*, the senior officer's ship, sailed from Hampton Roads, Virginia, accompanied by the *Jamestown* and *Portsmouth*, for the usual cruise to the West Indies, December 22, 1886, and arrived at Bridgetown, Barbadoes, January 18, 1887, where she remained until February 1, when she sailed for port of Spain, where she arrived on the 3d of that month. She then visited the Windward Islands, and sailed from St. Thomas for Newport April 3, arriving there on the 17th. Sailed for Lisbon June 9, having on board a part of the relief officers and men for the *Quinnebaug*; arrived at Lisbon July 9. She sailed from that port August 13; arrived at Madeira on the 19th of that month, where she remained until August 28, when she left for the United States, arriving at New York September 29. Sailed for Newport October 5, arriving there the following day. She returned to New York October 27, and left for Norfolk November 4, where she arrived four days later.

PORTSMOUTH.

The *Portsmouth* sailed from Hampton Roads, Virginia, December 22, 1886, and made the cruise to the West Indies and to Lisbon above narrated. She sailed from Lisbon August 13, 1887, and arrived at Cadiz on the 15th of that month. Left three days later and joined the other vessels of the squadron at Madeira August 25. She remained in that port until August 28, when she sailed for New York, arriving there September 29. Proceeded thence to Newport, October 6, and reached that place the following day. Left October 23, and arrived at New York, October 27.

JAMESTOWN.

The *Jamestown* sailed from Hampton Roads, Virginia, December 22, 1886, and made the cruise to the West Indies, to Lisbon, and to Madeira, and arrived at New York September 29. She remained at New York until November 4, when she sailed for Norfolk, where she arrived on the 8th of that month.

No. 5.—REPORT OF THE ADMIRAL OF THE NAVY.

OFFICE OF THE ADMIRAL,
Washington, D. C., July 6, 1887.

SIR: I beg leave to forward my report for 1887 a little in advance of time, owing to the fact that there are several important matters contained in it relating to the Navy which I hope you may take into consideration.

There are defects in the organization of the Navy, as well as in its ships, which latter at the present moment are reduced to a minimum number, and the subjects now under discussion, if properly settled, will go far towards advancing the Navy, which is open to improvement from several quarters.

These remarks apply to the *personnel* of the Navy as well as to the ships, for no matter how complete the vessels they cannot be efficient unless there is a harmonious working of all their parts. Every department on board a ship of war bears so close a relation to every other that to make a good and solid system requires more than ordinary care that the different branches do not clash. But I am of the opinion that a little forethought on the part of those in authority, a little compromise here and a little there, with the certain establishment of the necessary power in the hands of commanding officers of vessels and commanders-in-chief, will make our naval corps the most harmonious body afloat.

NAVAL REGULATIONS.

The first thing required is a proper set of regulations. Those at present in use have been constantly altered and amended during the past eleven years until they have become, in some cases, almost unintelligible, and, without attempting to point out discrepancies, which would make this report too voluminous, I would beg leave to suggest that a board of three or more officers, not below the grade of captain, be charged with the duty of revising the regulations for the Navy. Several boards have been employed on this work, but for some reason or other it has never been satisfactorily completed, and on one occasion, where there was a mixed board, no conclusion was arrived at acceptable to either class of officers composing it. The present regulations do not meet all the cases that come before a commander-in-chief, or a commander of a vessel, and the result is misunderstandings among the different corps, each failing to appreciate their respective functions. All this would be brought into proper condition when regulations suited to the "new Navy" which we are promised shall be issued for use in the first ship that sails from the United States.

ENGINEER CORPS.

I beg leave to draw your attention to a matter which, in my opinion and that of many others well qualified to judge, requires the serious consideration of the Navy Department, for as it now stands it is seriously impairing the efficiency of the Navy.

The Navy is made up of different departments, and the duties of each of these are so different that it requires a separate education for the several classes of officers. It has been attempted to combine several of these departments, so that all the duties should be performed by one officer, a kind of economy that must react against the discipline of the Navy and create confusion. In 1866, while I was Superintendent of the Naval Academy, and while the Navy was undergoing a reduction, the condition of the Engineer Corps began to attract serious attention, and it was generally admitted that the officers of the corps were equally with the line officers entitled to the benefit of an education at the Naval Academy, in order that they might cope with the highest branches of engineering and construction, which, at the present day, are so essential to their profession.

A great many utopian theories have been broached in regard to the Engineer Corps and the manner of educating its officers, but of this we may be certain, the profession requires an amount of ability which will secure perfect management of the machinery on which depends the efficiency of our ships of war, for it will not do to trust the main dependence of a vessel to mere tyros without that practical skill which can only be acquired by long and earnest application on shipboard and in machine shops.

When a young man receives an appointment at the Naval Academy it is generally with the idea that he will enter the line, or combatant division, should he graduate, a profession for which his tastes and inclinations suit him, but after leaving the Academy and passing two years at sea, he may find himself, after undergoing an examination, appointed to the Engineer Corps without any knowledge of the duties of that branch, except such as he may have picked up during his four years' service at the Academy and his short cruise at sea. To make a good line officer, engineer, and marine officer, all in one, is hardly within the bounds of possibility. It is as much as one man can do to become a good deck officer, proficient in the management of a ship under sail and steam, and it is this part of the profession that requires all the knowledge of a seaman. It is not probable that an officer will gain a sufficient knowledge of the nautical part of his profession by passing half of his time in the engine room and the other half on deck.

The duties of an engineer officer and of a line officer are entirely distinct from each other, and it would be much better for the Navy for them to remain so, for the attempt to combine these different qualifications in one officer will produce a hybrid, neither a good line officer nor a good engineer. When two men ride a horse one must ride behind, and in a ship of war one class of officers must necessarily have more authority and responsibility than another. This authority naturally falls on the line officer, or combatant, who must always be ready to undertake any duty however perilous, must be full of resources and be equal to all the emergencies of a seaman's life.

To be called "one of the best deck officers in the service" was in former days the highest ambition of an officer, and it will naturally be supposed that an officer with such a reputation would make an equally good one as captain. This would, however, hardly be the case if to the

responsibilities of a deck-officer were added the intricate duties of the engineer department of a ship. It would be as difficult to efficiently combine the duties of line officer and engineer as to mix oil and water—you would have mere superficial persons, jacks-at-all-trades and good at none.

It is the duty of every line officer to know how to navigate and fight his ship, but to do this it is not at all necessary that he should be an engineer or that he should undertake to manage the engines at the same time he was directing operations on deck. In time of battle the services of good engineers are especially required, particularly now that the nations of Europe are building huge steel monsters filled with complicated machinery calculated to puzzle even an expert, to say nothing of an officer who obtained all his knowledge of the subject from the obsolete engine at the Naval Academy, which was put up by myself in 1865 to give the cadets a general idea of a marine engine and how to manage it in time of necessity.

The duties of naval engineers are now of a higher order than have ever before been required of them, and every year adds to the qualifications necessary for the efficiency of this class of officers. Hence it will need all the ability of any man to perfect himself in the profession of a naval engineer, and should our Government adhere to the notion that the present system at Annapolis is the best for educating engineers it will find out its mistake when the new ships come into port badly out of repair or else fail to come into port at all, leaving it to be conjectured whether they went upwards or downwards previous to their final disappearance.

It is no disparagement to the abilities of the line officers of the Navy to say that they cannot become as skillful in the management of engines as persons whose natural talents and inclinations have led them to choose that profession, and there is no doubt that every cadet at the Naval Academy would be much better satisfied to enter the service as a line officer than to be forced into another employment for which he has no taste and in which he will probably never rise above mediocrity.

In the new system of building vessels of war the responsibilities of engineers have greatly increased. It is no longer in the matter of running engines alone that they are called upon to show their efficiency. An engineer must now be able to superintend the various details of construction, testing materials, &c., and it is absolutely necessary that the best combatant seaman officers should be selected for the command of the deck, and the best theoretical and practical engineers for the management and care of the engines. It is by no means necessary that engineers should be trained in seamanship, for, as was demonstrated on a late occasion, when necessity requires it engineers can turn their hands to other duties on shipboard besides those in which they have been professionally educated.

Seamanship is an art that requires all the intelligence, time, and strength of a man to perfect himself in, and notwithstanding the vast importance of steam in ships of war, seamanship should be carefully cherished, since there is a greater demand than ever before for the exercise of its highest knowledge in handling huge ships and maneuvering fleets. For this reason all a line officer's time must be devoted to the study and practice of his own particular profession if he desires to excel. He may secure an intelligent understanding of the theory and practice of the marine steam-engine, but he must not expect to fill the place of an engineer.

In all departments of the Navy it would be well to study the system pursued by mercantile marine companies, who, conducting their business with a view to pecuniary profit, have doubtless given the matter close consideration. No steamship company would accept a mate for an engineer, nor could a person obtain a license for both employments. Only in the Navy would such an idea be tolerated. Even there, in time of war, none but experts would be trusted with the management of the engines, and these could hardly be found among the combatant officers. Engineers are a class *sui generis*, and to keep them thoroughly efficient they should be fitted for their particular line of duty, as is done in the case of line officers and naval constructors.

The advocates of the amphibious officer whom it is proposed to fasten on the Navy, argue that their scheme will promote "harmony" in the service. It certainly will not promote harmony in the working of the engine, and I think it doubtful if it realizes expectations in any other quarter. The safest plan will be to keep the Engineer Corps intact and give its officers every opportunity to perfect themselves in the higher branches of their profession, of which they should be proud, not only for what it has accomplished in the past, but for what it will be able to do in the future, now that occasion is afforded for a free scope for their usefulness.

An act of Congress, approved July 4, 1864, authorized the Secretary of the Navy "to provide by regulations to be issued by him for the education of such midshipmen or others, at the Naval Academy, as show a peculiar aptitude therefor as naval constructors or civil or steam engineers, and may form a separate class for this purpose, to be styled cadet engineers, or otherwise afford to such persons all proper facilities for such a scientific mechanical education as will fit them for such profession."

At the time this law was enacted there were no facilities for carrying out its provisions, and the then Secretary of the Navy did not deem it advisable to introduce a new system into the Navy while so many of the best practical engineers were volunteering for the service. In 1866, however, while I was superintendent of the Naval Academy, Mr. Secretary Welles, at my recommendation, established a class there, including sixteen third assistant engineers and four cadet engineers. All the former had been students at the best schools of technology, notably that at Boston.

This class was farther advanced in mathematics, mechanical drawing, &c., than any that has ever been at the Naval Academy, and in these subjects could obtain no farther instruction at Annapolis. The formation of this class was a step in the right direction. The sixteen third assistant engineers from the schools of technology all passed a most creditable examination, and were absorbed into the Navy. The cadet engineers did not turn out so well, as two of them were rejected on their final examination, and but one of them is now in the service. The plan of forming a class of engineers at the Naval Academy, composed of young men who have graduated at the best schools of technology, is undoubtedly the wisest, in order to promote the efficiency of the Engineer Corps of the Navy; and the vacancies occasioned by death, resignation, retirement, &c., should be filled in this way.

The act appropriating for the support of the Navy, approved August 5, 1882, was a serious blow to the efficiency of the service. It was not intended that the part relating to the Engineer Corps should go into effect, and the best interests of all concerned would be promoted by its repeal. Common sense tells us that the members of a profession who

are required to manage machinery of the most intricate kind should have the opportunity to receive a training adequate to their duties. This can only be secured by a course at the best schools of technology and a training in machine shops, in addition to a term of two years at the Naval Academy, supplemented by a course of instruction abroad. The course of instruction abroad will assist very much in forming what is greatly needed in the Navy—a class of engineer constructors; but it should always be borne in mind that the knowledge of the marine engine, with its many intricacies, cannot be readily mastered, and the grandest instrument in the world is best left to those whose whole time and attention is devoted to developing its progress.

Engineers should superintend the construction of engines and manage them; constructors should design and build ships, and line officers should manage the vessels when they are ready for sea. Such an arrangement of duties will be more apt to insure "harmony" in the Navy than the plan which is now in operation.

COAST DEFENSES.

Since the adjournment of Congress the press of the country has urged, with a unanimity never before exhibited, the necessity of putting the nation in a state of defense.

We are no better off to-day in the matter of ships of war than we were in July, 1883, when contracts were awarded for building the Chicago, Boston, Atlanta, and Dolphin. This was nearly four years ago and none of the above-named vessels can yet be called "completed," which proves that it takes a long time to build steel vessels of war, and that by following the methods heretofore pursued it will take many years to build up a Navy even of moderate size, and that if we wish to place the country in a state of defense within a reasonable time we must proceed on a more rapid system.

That we shall soon be obliged to have an efficient Navy does not admit of doubt, and while we are undertaking to repair the negligence of the past twenty-five years we might as well endeavor to do it with the intelligence and rapidity of which our people are capable. We cannot, like England and some other nations, depend much on the assistance of our ocean steamers in time of war, as we have too few of these to rely on, and such vessels as we have in the coasting trade, with few exceptions, have not the strength to undergo the wear and tear required of ships of war.

I refer to this matter because many of our legislators seem to be under the impression that our coast-wise steamers can be converted into vessels of war in case of an emergency. They can, no doubt, be utilized in some instances, but taking into consideration their general light construction and the want of protection for their engines, our present American merchant vessels will play a very inferior part in war with a first class naval power. Eventually, under the fostering care of our Government, our merchant steamers may be so constructed as to be readily utilized in time of war, but up to the present writing no step has been taken to resuscitate an ocean commerce that might become of the utmost importance to us in time of war.

When we reflect upon the guns and ships that are being built abroad, it is almost enough to deter us from attempting to compete with foreign nations. In 1863-'64 we led them all and made a complete revolution in the construction of vessels of war, and I am satisfied that we are competent to do so again if we trust our own mechanical genius and

take those long strides in ship-building and gunnery for which we were once famous. When a foreign Government builds an exceptionally fast vessel or an exceptionally good gun we should go to work and endeavor to exceed it, however difficult the task may appear.

From a late number of a New York paper, I take the following extract:

Every year the weight of European ordnance is increased. One of the latest Krupp's is a 139-ton gun 52½ feet in length, employing 1,069 pounds of prismatic powder in a service charge, and discharging a projectile of 2,314 pounds, capable of penetrating wrought-iron plates nearly 4 feet in thickness. Not satisfied with this achievement the gunmakers are planning another monster, which is to weigh 150 tons and to fire a 1½-ton shell. The penetrating power of artillery has been increased tenfold within twenty years and the maximum point of efficiency is still a matter of conjecture.

The futility of attempts to defend the American seaboard with costly fortifications, when the weight, caliber, and destructive power of modern ordnance are increasing year by year, needs no extended demonstration. A defenseless country requires big guns and fully-equipped gun factories, but permanent fortifications are out of the question in the progressive state of military science.

The above is a text on which an instructive commentary might be written. It suggests that instead of relying on a weak class of vessels, which some persons suppose will be sufficient for our necessities, we shall have to depend for the defense of our coasts on ships large enough to carry these immense pieces of ordnance.

For the full protection of the coast there should be three lines of defenses: First, the outer line, combining the heaviest iron-clads, guns, and torpedo boats; second, fortifications, on which the vessels can fall back in case of reverse; third, an army to meet the enemy in case he attempts a landing; but it may be remarked that without the first line the second and third will be of very little use. This is a fact which requires no demonstration. It is recognized by all foreign powers and must be by our Government, should the latter ever seriously undertake the defense of our seaboard.

There seems to be a substantial unanimity among all political parties in favor of placing the country in a proper state of defense. Therefore, it is difficult to understand why the work is not done, or why money is so sparingly appropriated by Congress that we make little or no headway, when every establishment with means at hand to build a vessel of war and every navy-yard that has the plant should be set to work to increase the number of vessels in the Navy.

When we examine the many elaborate reports that have been made within the last four years in relation to our national defenses, and read the uniform testimony given by naval officers who are well informed on the subject, together with that of officers of the Army and eminent civilians, it seems to me that the weakness of our condition should be viewed by the country with more gravity than has hitherto been the case.

At this moment the following-named harbors are entirely defenseless against a single armor-clad: New York, Boston, San Francisco, lake ports, Hampton Roads and Norfolk, New Orleans, Philadelphia, Washington, Baltimore, Portland, Me., Rhode Island ports, Key West, Charleston, Mobile, Savannah, Galveston, Pensacola, Wilmington, N. C., San Diego, Cal., and Portsmouth, N. H., to say nothing of many other places of greater or less importance.

Without exaggeration, two heavy armor-clads could commence at the easternmost one of the above-named ports and proceed along the coast to Texas, laying them all under contribution. We claim to possess a certain amount of defense in the shape of torpedoes, but in time of war

they would be useless in the absence of proper fortifications and guns, more particularly in default of an armor-clad fleet.

We have so much to do in the way of building forts and ships and making guns for the land and naval defenses, and have so little time to do it all in, that it will be well to compare our national defenses with those of some other power, to show what others have done while we have been taking our repose. Our people seem to think that we are so far removed from Europe that we are beyond the reach of its armies and navies, forgetting that it is possible to step on board one of the great ocean grayhounds at New York on Monday morning and land in England on Saturday night; and although we might not be assailed quite so rapidly as that, the mere fact that it takes so little time under favorable circumstances to cross the Atlantic shows how short is the distance between ourselves and the possessors of the heaviest ships and guns.

We may keep clear of entangling alliances, but, no matter what our desires may be, we cannot avoid complications with foreign powers. We have an experience of this sort at the present time, and no one can tell whether the small cloud now gathering on the eastern horizon may not soon extend over the whole heavens. War often comes when least expected, and, even when anticipated, those who look forward to it can hardly realize that it is coming until it is upon them. For the event of war we are no more prepared than we were a year ago, although it is true we have made a beginning to repair simply the waste in our Navy for the last twenty-five years.

To show how little attention is paid to the defense of our coasts, I beg leave to exhibit to you, for the purpose of contrast, the weight that is attached to these matters abroad. The statement will show the country how much behindhand we are in regard to that on which our honor and safety depends as compared with those even who have less at stake than ourselves.

To take Great Britain as an example, with the coasts and harbors of the British Islands included between latitude 50° and 59° north and longitude 2° east and 11° west. The area of the British Islands is 115,840 square miles, while that of the United States is 3,602,990 square miles; that is, the size of these islands, the center of the imperial power, is thirty-one times less than the area of the United States. Please notice the difference in the care taken to protect the homes of British subjects from that given to guard the citizens of the United States, who, relying on the protection that they suppose will be afforded them, have built up great cities all along our coast and dotted the intermediate territory with homesteads, all of which are at the mercy of a foreign foe.

The geographical situation of the British Islands gives them a guarantee of independence and protection to their inhabitants greater than any other people enjoy, but this would not avail were it not for the indomitable energy of the Britons, who, occupying a strong position in the first place, have left nothing undone to render it impregnable. The same reasons that exist for the elaborate defenses of Great Britain obtain in this country in an equal degree. We are very much alike in many respects, both being naturally great commercial nations, desirous to carry our products to every part of the world, Great Britain succeeding in all she undertakes, and we constantly failing for want of that Governmental protection which every people have a right to claim.

Great Britain is separated from the continent of Europe by a wide moat, which enables her to defy attack. Her principal ports bristle with guns of the latest pattern, mounted on the most approved fortifi-

cations, while the moat and all its surroundings is guarded by the following :

Class.	No. of vessels.	No. of guns.
Armored turret ships.....	26	171
Armored barbette ships.....	9	90
Armored casemate ships.....	10	157
Belted cruisers.....	8	93
Torpedo rams.....	2	2
Unarmored cruisers.....	62	724
Gun vessels and cruising gunboats.....	65	271
Gunboats for coast and river service.....	40	64
Total.....	222	1,572

These embrace all classes from the 110-ton (16½-inch) to the 20-pounder howitzer. In addition, the English navy is provided with 153 torpedo vessels of all classes, some of which are armed with small rifled cannon (6-inch or less), and nearly all carry machine guns. It will be observed that no account is taken of the older classes of ships, of which, according to a French author, there are 336 steamers and 120 sailing ships, fully capable of giving a good account of themselves.

The United States is separated from Europe by a wide moat, but this, instead of being a protection, is a disadvantage. The ocean affords a highway upon which, unseen until close upon us, an enemy can marshal his hosts and attack us in fifty vulnerable points at once. A war against us would terminate very quickly, as, without ships or guns, what could we do ?

The forces charged with the defense of Great Britain's impregnable fortresses comprise the coast-guard fleet, the Channel fleet, and the land defenses, which are at all times ready for service and are never permitted to fall off in strength or efficiency. This system may be compared to that of a city with policemen on their beats, while ours is like the old plan, where superannuated watchmen dozed away a night on a door-step. The movable land forces of Great Britain are confined to special troops always ready to be forwarded to threatened points at short notice. The Channel fleet constitutes a reserve of heavy armor-clads, torpedo vessels, and fast dispatch vessels, ready at all times to proceed to any indicated point. Under these circumstances, the British can afford to await attack, while their naval forces elsewhere are ready to add their strength to those above mentioned. Any attempt made by a foreign power against the British islands would probably result in the destruction of the attacking fleet, which might not even have the opportunity to bombard the land fortifications or throw destructive missiles into the seaboard cities.

Now, sir ; the first step towards the protection of our coasts should be the construction of a squadron of heavy armor-clads, that could be ready at a week's notice to anchor off our shores and resist an approaching enemy. If defeated, this force could retire to the protection of the forts, where, united, they would probably offer more than twice the resistance they could offer singly. I call these defenses the great line of protection, which, if broken, would render the attack of an enemy no longer doubtful. I want to see the possibility of such a result prevented, and to have our nation of sixty millions of intelligent people placed in such a position that the strongest powers of Europe could not prevail against them.

The first element of success in this undertaking is the construction of a proper fleet of armor-clads, while experimenting with fast cruisers, for although the latter will have their appropriate place in time of war, they can never, by themselves alone, keep an enemy's fleet from our shores. Armor-clads are very expensive articles, but who shall count the cost of a Navy to such a country as ours, for when that right arm of the national defense is properly organized and built up again, the world will be careful not to assail us, and the inhabitants of our seaboard towns and cities will be secure from an enemy's shot and shell.

At the present writing it would be impossible for any power to invade England, unless the British fleet could first be destroyed, and this fleet is of such strength that no European nation could contest its superiority. About the time of the breaking out of our civil war the appearance of rifled guns in service caused the English Government to reflect on the condition of their land defenses, which had become somewhat dilapidated. They had such confidence in their great fleets that they were disposed to undervalue the necessity of guns on shore, but now they saw the need of fortifying their coasts in a modern manner. Heretofore the navy had been, as we may say, the sole dependence of the people of Great Britain against invasion, and was entirely competent to the duty. Without the navy the guns of the land defenses would have been comparatively useless.

When the events of war in the United States made it evident that the character of naval ships and guns must change, Great Britain and the other countries commenced building powerful iron-clads and forts, making a complete alteration in their national defenses, while we, exhibiting an apathy not warranted by the circumstances of the case, permitted our Navy and land fortifications to go to ruin, a fact that is generally taken to mean that the nation itself is falling into decay. Dilapidated forts, obsolete guns, worthless ships, in short, an absence of warlike appliances, are among the things which denote the decadence of a country, and such signs should not exist in a nation like this, which in so many other ways is quite up to the world's standard.

In the short period between 1861 and 1872, during which time the British Government was employed in strengthening their fleet and covering the coasts from the approaches of an enemy, some \$60,000,000 was expended on land defenses alone, to say nothing of the navy. National defenses are costly, and more so in this country than elsewhere, but they are necessities not to be dispensed with. Once built and properly cared for, they will endure for a great length of time, and they will secure the honor of the nation, which should be paramount to every other consideration.

It is not likely that the present system of ships, ordnance, and fortifications will undergo any radical changes within the next decade. The greatest advance in ship construction will probably be in the way of speed, so that a few years hence a first-class ship of war, in my opinion, will have a speed of 23 knots. Notwithstanding her huge armored navy, Great Britain is not disposed to run any risks, as she is constantly strengthening her forts or adjuncts, behind which the ships can retire in case of necessity.

Compare what Great Britain has done in a few years with what we have failed to do. At the present time among the strong points on the coast of Great Britain are Lowestoff, defended by three heavy forts; Harwich, at the mouth of the Stour; the estuary of the Thames and that of the Medway, protected by the batteries of Shoeburyness, the

works on the island of Grain, and, at Sheerness, with a second line of defense on the Thames, consisting of six forts below Gravesend.

The fortifications of Dover are founded upon the works of past ages, armed with the latest style of ordnance, at a cost of \$3,000,000.

The roadstead of Portland is defended by heavy batteries and armored works, overlooked by Verner citadel, and further protected by the forts at Weymouth.

The works erected up to 1870 for the defense of Plymouth cost over \$7,000,000. The entrance is defended by Forts Cawsand and Picklecomb, a heavy work on the breakwater; Fort Bovisand, the batteries on Saint Nicholas Island, those of Eastern King and Western King, and, finally, by the Garden Batteries, altogether forming a chain of works of which in this country we have no conception. The fortifications are of granite, with walls nearly 10 feet in thickness, and proof against the heavy projectiles of modern war vessels. The embrasures of the forts are covered with shields of the Drummond-Jervis type, 60 centimeters in thickness. The armament is composed of 150 heavy rifled guns that will pierce naval armor of 30 centimeters thickness at a distance of 2,000 yards. Such works as these are truly formidable and, with the aid of a small naval force, sufficient to prevent a good-sized fleet from effecting an entrance. The English, with their powerful fleets, may not need all these land batteries, but they go on the principle that an ounce of prevention is worth a pound of cure, and the presence of such works prevents attack.

The land side of this maritime establishment is as well protected as the water front. On a strong position between the rivers Plym and Tamar are 16 detached forts, 160 feet above the sea-level. On the culminating point of these great works stands Fort Crownhill, armed with 38 heavy guns. It will be noticed what importance one nation attaches to the protection of her maritime establishment, while we, with as much at stake, attach apparently no importance whatever. We have seen how Plymouth is defended, while the navy-yard at New York, our largest establishment of the kind, and costing of itself over \$20,000,000, is not protected by a single gun of recent pattern.

The naval establishment would, of course, be the first thing aimed at by an enemy, and the forts at the Narrows could not prevent the passage of a couple of good iron-clads to New York City. We have but one harbor from which an enemy's fleet seeking protection in bad weather could be excluded, and that is Hampton Roads. The defenses of this place, although once formidable, are not suitable to the necessities imposed by modern warfare, and an enemy's fleet of heavy armor-clads could anchor with impunity within range of the guns of Fort Monroe.

Pembroke roadstead, in Great Britain, is defended by the most powerful works, sufficient to drive off any fleet. The estuary of the Mersey, leading to the port of Liverpool, is thoroughly guarded by armored forts.

Portsmouth, like Plymouth, is fortified with all the science of war. In late years a line of detached forts has been erected, 1,000 yards apart, each of which is armed with eighty pieces of ordnance of large caliber. This is a style of defense of which we seem to have no idea, and the necessity of it will probably occur only with the near approach of danger.

The forts above mentioned, not being considered sufficient to give the dock-yard perfect protection, a second line of defense has been erected nearer the sea, which is probably as formidable as the other. Then let us look at the entrance of the harbor. On the west side it is

defended by Fort Monckton and Block-House Fort, while on the east side the defenses comprise King's Bastion, the battery of Southsea Castle (32 heavy guns), Lump's battery (14 guns), the two batteries of Eastney, and, finally, Fort Cumberland, which also protects the entrance into Langston Bay. All these works combine their action with the "sea forts," Spithead and Horse-Sand, which would render it impossible for an enemy to land troops to attack this important naval depot. At the west end of the Isle of Wight is the Solent channel, which is narrow and well defended by the cross-fire of a considerable number of batteries, while the eastern passage to Spithead Roads is protected by the fire of four large armored forts built in the sea on sand-banks—Forts Spit-Sand, Horse-Sand, No-Man Sand, and St. Helena. This last, which joins with Fort Bembridge in defending Brading Bay, is armed with 15 rifled cannon of the largest caliber in casemates and also furnished with two turrets.

England depends on her navy to do the real work of defense, and that principle should govern this country also. We are essentially a maritime nation, and likely to become a great commercial one, and our marine interests simply require the fostering care extended by foreign powers to place us on a par with the most powerful.

It would require a greater space than the limits of this document to particularize what other nations have done, and what we have failed to do, but there is scarcely a point in Great Britain where an enemy could land that is not protected with adequate land defenses, strong as their navy is considered to be, and in case of war-clouds appearing on the horizon, the people are not thrown into a panic, for they feel that their country is secure from invasion. This statement applies not only to Great Britain proper, but also to her possessions abroad. What has been done by Great Britain has already cost many millions of dollars, and will cost many millions more, but such an investment is the best that any country can make.

To place our country in condition to protect the seaboard, to have ships that can bid defiance to European navies, in short, to adopt a complete system of national defense, will require an immense amount of money, but no nation can better afford it, which makes our apathy seem all the more strange. Comparatively few of our legislators are military men, and with the many matters which engross their time, it is hardly to be expected that they should be fully acquainted with the requirements for national defense, and vote large sums of money for ships and forts, the necessity for which is not, to them, apparent; hence it behooves every military and naval officer to do his utmost to lay before members of Congress such information as will assist them in forming just conclusions in regard to a subject of such vital importance to the country.

On the whole, Congress has been liberal to the Navy, when we take into consideration the fact that the ship builders of the country have not offered such facilities for constructing vessels of war as would have been expected of so intelligent a class of citizens. Up to this time Congress has had no assurance that ships would be built in due season, even if money was appropriated, but all that will mend when the ship-builders of the United States feel that there is a determination on the part of Congress to construct a new Navy. Capital will come forth from its hiding places and ship-building establishments will spring up in many ports where they do not now exist, while those already in being will assume greater proportions.

One great source of the national strength lies in our ship-yards, and now that steel has taken the place of wood, in them are the foundations

of our naval defense. The more good ship-yards we have, the better able we will be to conquer if war is forced upon us. It therefore behooves Congress to make larger appropriations in order to have more yards employed at the same time, for it is just as easy to construct two vessels as it is one; and at this moment, when there is a depression in the building interest, it would infuse new life into many industries throughout the country to give the ship-builders such a start as would establish them on a substantial basis. So many other interests are connected with ship construction proper that the United States would feel the reaction from one end to the other.

When these yards once begin to enlarge and to employ great numbers of workmen throughout the year, there will come a reaction from another quarter. Ships will become cheaper, and our people will invest their money in steam vessels until, like Great Britain, we have a first-class steam mercantile marine, which would be a great assistance to the Navy in time of war.

We have seen, on a late occasion, when England was threatened with war by a great nation, how she immediately converted a dozen or more fast transatlantic steamships into vessels of war, and peace was soon assured. The value to the United States of fostering private ship-yards cannot be overestimated, for unless we pursue this policy we will some day find ourselves in a condition where it will be impossible for us to maintain the national honor.

At this time there is real distress felt in our private ship-building establishments all over the country, and, as a public man, you must be aware how necessary it is for the Government to foster private works on which so much depends, for even in so small a matter as the gradual increase of our Navy, it would be impracticable to use the several navy-yards in their present condition to construct steel ships. They could better be used for equipping ships after they are built, as when once more we have a supply of naval vessels, it will be as much as our navy-yards can do to fit them out and keep them in repair.

It would be advisable for the Government to keep always on duty in the different navy-yards a class of skilled mechanics. If these are not sure of permanent employment they will naturally stray away to better locations. It is a loss to the Government to frequently change its employés, and it will therefore be well to have as much of the work done at the navy-yards as they are capable of performing. It is not only a large number of mechanics who are thrown out of employment at our private ship-yards who are now suffering, but also those who depend on the Government yards, and if at this moment Congress would embrace the opportunity to build up the Navy, it could be done cheaper than would be possible in a few years from now. If it was known that a fixed amount, say \$10,000,000, would be appropriated every year until the Navy was in a condition to meet the requirements of the country, we should in a few years possess a class of mechanics not excelled by any in the world.

How much better it would be for us to support a class of skilled mechanics to enrich the country with their labor and build up the national defenses than to do as some other nations are doing and support large bodies of idle soldiery. Our Treasury is filled with gold, and it seems contrary to common sense to have it lying useless in the vaults when there are so many of the sons of toil unemployed and such vast quantities of material unused. The mechanics of the country, by the exercise of their skill, would turn all the materials to good account in the

construction of steel or iron ships and every blow they struck would be a blow for the protection of their country.

There would be another object gained by the Government fostering private ship-yards, it would place them nearer an equality with those of Great Britain, and nations on the American continent, instead of going abroad to have ships built, would come to the United States. A new industry would be opened to us, for the difference in price would be so small that the people of the Western continent would prefer to purchase their ships in this country.

It is a well-known fact that the variation in strength between English and American iron is much in favor of the latter. The tensile strength of English iron is 45,000 pounds to the square inch, while American iron will bear a strain of 60,000 pounds. This great superiority in material, taken in connection with cheaper production in the United States, which will result from increasing facilities as the Government encourages private ship-yards, will make this country a market for the purchase of ships fairly competing with Great Britain. Should Great Britain become involved in a European war, her ship-builders will have as much as they can do, and then our own will have an opportunity.

History repeats itself about every twenty-five years, and there is no reason why Americans, who formerly built the finest ships in the world and covered the ocean with their commerce, should not do so again. It cannot be possible that a people who lately held a foremost maritime position have so degenerated that they are willing to see the grand prize wrenched from their grasp without a struggle to regain that prestige, once their greatest pride. The ship-yards on the Pacific coast, of all places, should receive the encouragement of the Government, since in that quarter our naval defenses are especially weak.

San Francisco is at this moment open to the attack of any ordinary foe, and the same is true of every town along that coast. In case of war the highway to China and Japan would be closed against us, and the great railroads, built under the plea of bringing the commerce of the East through the United States, would fail in the objects for which they were designed.

The vast regions of Oregon and Washington Territory have not an effective gun mounted along their shores, and although we claim the ownership of the country it is ours only as long as we remain at peace, for, in case of hostilities, almost any power could hoist its flag on our northwest coast under the guns of a few ships. Our magnificent inland waters, including the Straits of Fuca, Haro, Rosario, and Puget Sound, with the numerous harbors and islands, are all at the mercy of any power that chooses to take them, and a country which forms a part of our great Anglo-Saxon empire is as unprotected as if it belonged to the Fiji Islanders.

In time of war, the ports on our Northwest coast would be so many harbors of refuge for an enemy in which to refit and procure supplies and then operate against our territory. Independently of the outlying islands on our coast and the British possessions, from which this country can be assailed in time of war, and where British fleets can refit and carry on operations against the United States, Great Britain has established at Esquimalt, on the Strait of Fuca, a naval depot provided with guns of the heaviest caliber and surrounded by strong permanent fortifications. Mark the difference between the action of Great Britain and that of the United States. See how the former stretches her arm over her possessions and secures them from invasion. Even in

obscure places she builds forts and dock-yards in order to maintain fleets ready to act in any required direction.

What effect the action of Great Britain near our Northwest possessions may have in the future it is impossible to foresee, but if there is a necessity for such preparations on one side of the line, there should be a corresponding manifestation on the other. Of course any nation has a right to build on her own soil such forts, arsenals, and dock-yards as she may think proper, and Great Britain is only doing what the United States should do. In twenty years from to-day the Northwest coast will be peopled with a million inhabitants claiming the protection of the American flag, and perhaps failing to secure it when most needed. At present we have not a vessel deserving the title of "ship of war" on the coast.

Mare Island should be made the central naval depot for our possessions on the Pacific. We should quadruple the working capacity of the navy-yard at that place, and build enough dry-docks to accommodate a large naval force. We should do all that an intelligent people would deem it desirable to do, and above all should attend to the land defenses in that quarter.

Land defenses at present do not hold the same position or carry the same weight as in former days when ships were mostly of wood, and one gun on a fort was considered a match for five on shipboard. During the last quarter of a century iron and steel monsters with impenetrable hulls have been constructed, carrying guns up to one hundred and ten tons in weight, firing a projectile of eighteen hundred pounds, with an extreme range of nine and three-quarters statute miles. The character of war is changed, and instead of ships having to depend on forts, forts will have to depend upon ships to assist them in extremity. When the outer line of defense, the naval force, is broken by the enemy, it will have to fall back upon the forts, or take up a position in channels only known to pilots and assist the forts with a cross fire the enemy might not be able to stand. At all events the enemy's ships could not take position to enfilade the weak points of land defenses while a force of heavy armor-clads was enfilading them at the same time. This will explain why a fort can be made so very much more formidable by the addition of a naval force which can shift its position; therefore, although great necessity exists for land defenses on the coast of the United States, as elsewhere, it is plain that it would be folly to depend solely on them.

Hence I would advise that we do not lose any time in building an armor-clad fleet while we are constructing steel cruisers, for without armored vessels our forts would be comparatively useless to defend our harbors or points from which our great cities could be assailed.

San Francisco is a place that an enemy could attack from outside the entrance to the port. Now, here is our chief city on the Pacific coast, with a population of a quarter of a million, with no defenses at all worthy of the name. San Francisco has one of the finest harbors in the world, with ample depth of water for the largest class of ships. As matters stand at present, the Bay of San Francisco could be entered by an enemy's fleet and the surrounding country laid waste, and even if the entrance to the harbor is properly defended by forts, the city could be shelled from outside the heads near Point Lobos.

This is an example of a city that cannot depend upon its forts no matter how strong they may be, and this great emporium of our trade with the Indies would be at the mercy of a ship of war with one or two high powered guns on board. This would be a sad state of affairs in-

deed, and would speak badly for the intelligence of our people in not making proper preparations for war.

The circumstances of her case require San Francisco to have the best equipped naval establishment in the country. Four of the heaviest armor-clads should be built and equipped with the most approved ordnance for the defense of the city. The Union Iron Works would be capable of fulfilling the contract, and in four years, which is the shortest time in which the work could be completed, we would not only have a powerful floating defense for the northwest coast but the construction company would be provided with a plant that would enable it to carry on all the work required by the Government. It is reported that the Union Iron Works are proposing to erect a plant that will produce all kinds of manufactures in steel, and, if possible, to rival Krupp's great foundry—an additional reason for protecting San Francisco so that such an important manufacturing place would be secure.

The naval force I have proposed for the defense of San Francisco is little enough for such a city and for a State that has added so many hundreds of millions of dollars to our national wealth.

New York is the commercial metropolis of the Union, where the wealth of the country is centered. At this place an enemy would aim his first blow, yet here we are least prepared, all things considered, for defense. The great bay below the Narrows and behind Sandy Hook would at present offer safe rendezvous for a hostile fleet, for we have not a single gun to prevent its advance, and the harbor would be heretically sealed.

It has been proposed to defend the entrance by Sandy Hook with 400 guns. That is a good idea, but the East channel still offers a highway having 27 feet of water at mean high water, and 30 feet at spring tides. This channel is over 3 miles from where a fort could be erected at Sandy Hook, and it can easily be understood that little attention would be paid by a fleet of armor-clads to a series of fortifications so far away, as they would only be liable to damage from chance shots. Unless the channel at the Narrows was obstructed, the armored fleet could steam into the harbor of New York, for only part of the guns at the Narrows could be brought to bear on ships approaching by the East channel.

This is one view of the case; but if a fleet of enemy's armor-clads assemble off the harbor of New York, it would not be necessary for them to enter the harbor proper to enable them to bombard the city. Within a short distance of Coney Island is a "pocket," open to the sea, with not less than 31 feet therein at high water. In this "pocket" a fleet could ride in safety and with guns of the present type, for instance the 16½-inch (110-ton) rifle, they could throw projectiles to a distance of nearly ten miles. This would embrace a large part of the city of New York; Brooklyn, including the navy-yard and the Brooklyn Bridge; part of Jersey City, including the Southern railroad docks; nearly all of Staten Island; Bergen Neck, and many other important points.

It would be a one-sided affair altogether, for the enemy's ships would be so far out of reach of the guns at the "Narrows" that they would be likely to receive little damage, presenting, at a distance of five or six miles, but small shifting targets for our artillery, while the armor-clads would have an immense area over which to distribute their shells, including three cities. This shows that it is impossible to protect New York by forts alone, and that we must have there the heaviest armor-clads, mounting the most powerful guns, to guard against all contingencies. We would have no difficulty in building such ships for coast and harbor

defense to carry even the 110-ton rifled gun, as they would not be cruising ships proper, but could proceed from one part of our coast to another to defend particular points or drive off the enemy from places where he may have sought shelter.

In providing for a navy the most indispensable part should be first attended to. A nation should be able to protect itself before taking the initiative against an enemy's commerce. The same conditions do not prevail at present as in 1812 when we covered the seas with small and swift privateers to prey on the commerce of Great Britain. Many of these vessels could outsail fast frigates. Privateering in those days was at a premium, for most of the prizes could be got into port. At the present time, if prizes were captured by private armed vessels they would have to be destroyed. This would not pay the owners of letters-of-marque, and Congress would be obliged to give a heavy bonus for such vessels, which would lead to many complications. Besides, private armed steamers could not keep the sea for want of coal and would soon be swept from the ocean by the "commerce-destroyers" that would be sent against them. It is not likely that the part of the Alabama will ever again be played except against a nation that has no ships to protect her commerce, a contingency that is not likely to occur.

Taking this view of the matter, I earnestly recommend that while we are building swift and powerful cruisers, we should at the same time construct a fleet of heavy armor-clads. The latter vessels, when built, will outlast all the present generation if laid up in fresh water and properly cared for. There will be no decay in them as was the case in the old-time wooden ships, the average life of which was not over eight years, consequently the large annual expenditure of money for repairs will not be required as in the old vessels when the hull was pulled to pieces and as much money spent as would have been required for an entire new vessel. That day is over, and the Navy will no longer suffer from the heavy bills for "repairs" which once ran the expenses up to so large a figure.

Ships once laid up require nothing more than an occasional coat of paint and the ordinary repairs of engines when vessels return from a cruise. There will be no large gang of mechanics ready to bore into a wooden hull to find decayed spots. Now that the steel plates defy the blacksmith's cold-chisel there will be little repairing of hulls, and no such bills as were paid in 1864, when \$24,000,000 were spent in the repair and preservation of our naval vessels, and in 1870, when nearly \$4,000,000 more were similarly expended. The repairing necessary for wooden vessels made a great leak in the naval appropriations which could not be avoided; but the building of heavy armor-clads, such as I recommend, will do away with such expenses, and in ten years forty millions of money will be saved to the Government, a sum quite equal to the cost of the armored ships themselves.

This is a practical and economical view of the matter, but a higher view than that should be taken by the American people: the duty they owe themselves in protecting their flag, their soil, and their honor, and showing the world that they have a proper sense of the value of all these things.

What I have said concerning the defenses of New York applies in a still stronger degree to Boston. That city, up to within a few years past, was proof against an enemy's fleet, but the first heavy rifled guns that were put afloat rendered useless the batteries in Boston Harbor except for the firing of salutes. A single enemy's ship armed with a high-powered gun would have a fine target in the dome of the State

House and could drop incendiary shells into every hole and corner of the ancient city—the cradle of liberty.

I do not profess to have any more patriotism than any other citizen, but I must say I am surprised that the citizens of Massachusetts, whose whole coast is open to the inroads of an enemy, have not shown more solicitude in regard to their unprotected condition and have not made more urgent demands on Congress to protect their cities and towns. An enemy's fleet will no longer need to enter the harbor of Boston, for it could lie outside Deer Island and make its demands. The fleet would run no risk from sunken torpedoes; indeed, those bug-bears, which lose so much of their value in presence of a heavy naval force provided with appliances for their removal, might as well not be planted unless backed by armor-clads and torpedo boats in sufficient numbers. Now, at Boston, the second commercial city of the Union, heavy armored vessels are as essential as at New York; but why enumerate, when it is as plain as daylight that all along our coasts the armor-clad system must constitute our first line of defense, which, if driven in, will fall back upon the fortifications and make our harbors secure, provided our forts are properly constructed and armed?

It took Great Britain, France, and Germany ten years to place their sea-coasts in condition to repel ordinary attacks, and it will require all our energy and skill to place our defenses on a footing to insure us partial safety, and, be it remembered, we are actually doing nothing in that direction at the present time. In case of war much will be demanded of the Navy; but at present we have nothing to work with. With forty heavy armor-clads and sixty powerful cruisers the officers of the Navy might hope to give a good account of themselves. This will always be demanded of them by the American people, no matter under how adverse circumstances the Navy may have to fight.

Some people talk about "a small but efficient Navy," as if any navy in these days could be small and efficient at the same time. The excellence of a navy depends not only on the efficiency of its ships, but also in the possession of a sufficient number to carry out a decisive policy. We might with better propriety use the expression "a small but efficient Army," for our Army, though absurdly small, can readily be enlarged, since our militia system enables us to create a land force in a wonderfully brief space of time. That we have so small an Army, maintained at so little cost compared with other nations of our commercial importance, is an additional reason why a larger amount of money should be given to the Navy, so that we may at least have one arm of the national defense on which to depend in time of peril.

This is a matter in which the whole country is interested. It is a national, not a political, question, and although naval officers may hope for future benefit when they will be able in time of peace to learn the management of the great ships they will be called upon to take into action in time of war, yet not one of them should feel any more interest in seeing the Navy built up than the humblest citizen who has a proper pride in the history of our country.

ENROLLMENT OF SEAMEN.

In the power given by the Constitution to Congress to maintain a Navy is included the power to take advantage of everything that will help to make that maintenance complete. Particularly after ships have been built there should be no obstacles in the way of manning them. The Government must, of course, depend on the mercantile ma-

rine to man the Navy, and the seamen of the mercantile marine are as much bound by compulsory service if they fail to volunteer as the militia is bound for military duty, yet up to the present time there has been no permanent act for the enrollment of seamen in accordance with these ideas.

In case of war we might or might not obtain a supply of seamen for our ships. It would depend upon whom we went to war with and whether the enemy had a large commerce from which the sailor could hope to glean a fair share of prize money, for a prospect of hard knocks and no prize money is not particularly inviting. Seamen as a class are as patriotic as any other citizens, but in the matter of pay and prize money they are apt to lay aside sentimentality. As long as his physical ability remains, the sailor is made use of, but when broken down he is thrown aside with as little hesitation as an old horse is turned out to die. Seamen are generally shrewd enough to understand that if they do not look out for themselves no one will look out for them, and so it will happen in time of war, that they will hang around Government recruiting stations resisting all solicitations to enlist until they can make terms that will insure something for a rainy day if happily they escape the perils of war and the clutches of rapacious land-sharks.

Seamen are not compelled to perform any duty corresponding to that of the militiaman, who is regularly enrolled, must encamp and drill at stated times, and is under the supervision of commanding militia officers, as carefully as the *Landwehr* of Germany or the *Garde Nationale* of France. A sailor can ship in the Navy or not, as it suits him, and it is a well-known fact that in our civil war, although the Navy stood in great need of seamen, and it was found difficult to fully man the vessels, thousands of men from the mercantile marine enlisted in the Army to secure the large bounties, and were glad afterwards to be transferred from the Western Army to fill up the deficiencies in the gunboats.

When mariners are unemployed no exemption is provided for them by the acts of Congress, and so it happened that a class of experts on the sea, who as such are fostered by the nations of Europe, and from which only a supply can be obtained in an emergency, were withdrawn from the element to which they properly belonged. Many were drafted into the Army, though no doubt the bounty money had its effect in reconciling the sailors to their anomalous condition, but if obliged to serve at all their services should have been in the Navy, where their aid was so sorely needed. As the case stood, a hardship was inflicted, not only on the seamen, but also on the Navy.

It has ever been the policy of the United States to foster the sources which supply seamen, for which reason this class of persons was exempted from militia duty by act of Congress in 1792. Besides this, bounties have been paid to fishermen, the object of these laws being to secure for the Navy, when needed, the services of our seamen, which object was defeated when so many of them were forced into the military service. Petty officers, seamen, and marines, serving on foreign stations, were drafted into the Army and put to great inconvenience to obtain relief, and while calls were frequently made for soldiers by the Government, there was no act of Congress to encourage the enlistment of seamen.

This state of affairs will always tend to the prejudice of the Navy, and a special law should be enacted requiring the enrollment of every mariner serving on board vessels of the United States, including ocean

steamers, vessels in the foreign and coastwise trade, vessels on the lakes, fishermen, yachtsmen, &c., on the plan of the royal naval reserve of Great Britain, which will be one of the strongest supports of that nation in time of war. England has at present 200,000 merchant seamen in her naval reserve, with which to man her war vessels. We at one time during the civil war were in great straits for seamen, but could only obtain 36,000, when we required at least 20,000 more in order to man over 600 vessels of war.

The bill introduced into Congress at its last session by Senator Whitthorne is a move in the right direction. Its object is to increase the naval strength of the country, and the methods proposed are in accordance with those adopted by the great powers of Europe, in default of which, in time of war, they could not man their navies without resorting to the odious system of impressment. This bill of Senator Whitthorne's, launched upon the troubled waves of an expiring Congress, was favorably reported by the Naval Committee of the Senate, and it is sincerely hoped by officers of the Navy that it will yet become a law. Its provisions not only include manning the Navy in time of war, but also instructing, in time of peace, the officers and men of our mercantile marine, always the great support and dependence of the Navy. Without the services of the officers of the mercantile marine who volunteered for the Navy during the civil war, we could not have carried on those extensive naval operations which surprised the world.

All these matters come within the purview of the Constitution which provides for the manning of a Navy, and the author of the bill to which I have referred has shown a high degree of judgment and patriotism in taking his position on this question and others therewith connected. I urgently recommend that Senator Whitthorne's bill should be enacted into a law without delay. Its passage would have a most beneficial effect upon the Navy, and there are features in it looking towards the re-establishment of the mercantile marine. Those who have the patriotism to follow up this idea and secure the passage of the bill will have a much better title to the gratitude of the country than those who by their course in Congress have contributed to keep our ocean commerce in the background. Besides, if, in time of war, we should issue letters of marque and reprisal, which it is always our policy to do, we would have a class of vessels on hand already officered and manned by persons instructed in the management of naval ordnance and familiar with naval regulations.

OUR COMMERCIAL MARINE.

At one time the ocean commerce of the United States was second only to that of Great Britain, and our energetic merchants pushed their ventures to the remotest parts of the world. Our mercantile marine received some severe blows from "orders in council," from hostilities with France and Great Britain, and from Algerine corsairs, but such was the energy of our people that our shipping soon recovered its importance. But within the last twenty-five years the United States mercantile marine, from one cause and another, has decreased so materially that the matter has become a source of the greatest uneasiness to those conversant with the subject, and fears are expressed that our foreign shipping interests will never again raise their heads.

Our law makers are partly responsible for the decline in our ocean shipping, for while every other nation with any claim to commercial importance has strained every nerve to increase its commerce the United States has done nothing. The result is that foreign powers have mo-

nopolized the American carrying trade. One or two steam lines, owing to adventitious aid, for a short time managed to compete for a share of the profits of the ocean trade, but this lasted but a short time and now they scarcely pay expenses.

It is a national calamity to see out steam mercantile marine falling away in the manner it has done, and it is a great misfortune to the Navy, which ought to be able to depend on this service for a supply of seamen and fast vessels, as other nations do in time of war. Ours is the only case of a nation in modern times with a great commercial marine which has been allowed to fall into a state of decay for no perceptible reason beyond the fact that it has not been fostered by Government, and merchants finding that their ships had no protection on the high seas have withdrawn their capital from the ocean and invested it in more lucrative business on shore.

All modern nations have made strenuous efforts to enlarge their ocean commerce, and Great Britain, France, Italy, and Germany have in the last twenty years made great strides in that direction, leaving the United States far astern in the race, with no prospect of overtaking their competitors until such Government aid is supplied as is necessary to give our ocean commerce a fresh start.

When sail was the great motive power, we held our own and steadily gained upon our great rival in ocean commerce, and although we were the first to make use of steam, and use it now on our coasts, lakes, and rivers on a larger scale than any other country, yet we are to-day lowest on the list of commercial nations owning lines of ocean steamers. Great efforts have been made by advocates of free trade to abolish our old shipping laws, under which our people not only built vessels for themselves but supplied them to foreigners. The effect of the passage of such a measure by Congress would be to strike a final blow at our shipping interests, and throw them completely into the hands of our British rivals, giving them all our ocean carrying trade, and closing the ship-building yards of this country. In case of war with Great Britain we could neither build nor repair iron vessels in this country.

Owing to differences of opinion between free traders and protectionists our ocean commercial marine has gone to the wall, for those disposed to embark in the carrying trade declined to take the risk when they saw the growth of free-trade ideas on this side of the Atlantic, thinking it hopeless to contend with the British on the ocean when aided by such a prevalence of British opinions in the United States. But people are beginning to give more attention to this subject, which is not simply a matter of private thought, but one of national importance when we consider the immense assistance a great commercial marine would be to the United States in time of war, a misfortune to which we are at all times liable. If we have hitherto been fortunate in escaping foreign wars, it is principally because other nations have found their trade with us too lucrative to be interfered with.

At present there is a great desire in this country to share with others in the foreign trade, and it is strongly urged that the Government should give its aid in resurrecting our ocean commercial marine, since it is very evident that our shipping cannot be revived without the same assistance that was given the ocean steam lines of Great Britain, France, Italy, Germany, and, latterly, Spain. Heretofore, when it has been proposed in Congress to grant Government aid to assist in putting afloat lines of ocean steamers, questions of free trade and tariff have been introduced to kill the measure, and foreigners who do not wish any competition with their lucrative business, and have plenty of money

with which to operate, are always ready to show how much more advantageous it is to Americans that they should have the carrying trade. Foreigners generally argue that they receive no "subsidies," but who knows but themselves what assistance they receive from their Governments?

They carry the United States mails at a low figure to keep American vessels from being built to carry them. It costs them little or nothing to carry the mails and they can well spare the small amount of room required. That lines of American steamers should carry the mails is doubtless the desire of every American, and the feeling on this subject is increasing all over the country. At the same time every merchant knows that a line of American ocean steamships cannot be maintained without subsidies from the Government. In regard to this a misapprehension prevails among the uninformed, who consider it a proposition for the Government to "foster monopolies."

Now, there is a great difference between granting a subsidy and fostering a monopoly. In the latter case, the sole power and permission to deal with a certain place or in a certain article is granted, while the case of a subsidy is simply an assistance to an enterprise from which a return is expected, and such subsidies as I have advocated should not be confined to any particular line of steamers, but should be given to all ship-owners who are willing to make their ships conform, in a prescribed degree, to the requirements of a vessel of war, said ships to be constructed under the supervision of the Secretary of the Navy.

This is what other commercial nations do, and it is only justice to the Navy and the country that we should pursue a course that will double or treble the number of our cruisers in time of war. One way of granting a subsidy would be to enact the "tonnage bill" several times brought before Congress. This bill provides that 30 cents per ton shall be allowed every vessel propelled by sail or steam and built and owned in the United States and trading with foreign countries, for every thousand miles sailed or steamed, the contract to hold good for a term of years, with such restrictions regarding the vessels as the Government shall impose.

This would be the simplest plan for resurrecting the mercantile marine and the Government would have at its disposal a class of vessels little inferior to the regular cruising ships of war. In fact, the chances are the steam merchant vessels would be superior in speed, which should be the chief desideratum with commerce destroyers. By a proper subsidy, such as I have indicated, many industries would be assisted, those of iron and steel, coal mining, ship-yards, canvas, boat building, hardware, glass making, pottery, furniture, painters, engine builders; in short, a hundred different branches of trade which combine to make a complete vessel, industries that are now languishing for want of this very stimulus which they would enjoy but for the lack of forethought in those who should labor to advance every employment in which our citizens are engaged.

It is not so much the building proper of American steamships that makes them cost more than vessels constructed abroad, as it is the expense of fitting them out, for there is not sufficient competition in this country to bring that kind of work down to the standard of foreign countries where labor is so much cheaper. Ships built in Great Britain cost ten per cent. less, but when the better finish of American ships and the superiority of our iron is considered, the statements that it would be better for us to build ships on the Clyde or Mersey are seen to be fallacious.

With all these facts staring our legislators in the face, they should not hesitate a moment between the proposition to abolish the shipping laws so that vessels could be built abroad for us by British mechanics, and that to foster the industries of our own country and have our ocean steamers constructed in the United States under the supervision of naval officers, so that the Government would have vessels of suitable character to perform the service required of them as commerce destroyers in time of war.

This argument doubtless conflicts with the theories of the free-traders of Great Britain and the United States, who require that England shall do all our carrying trade and reap the profits, but, leaving sentimentality out of the question, we will get better ships built in our own country, although the first cost may be rather more, and we shall have the satisfaction of knowing that the vessels can, if necessary, be used for naval purposes. This is what advocates for increasing our naval resources aim at in supporting the subsidy measure, for we see how little disposition there has been in this country to build up a Navy adequate to its wants and dignity, but the officers of the Navy hope to see some plan adopted without delay, by which, in event of war, they can afford necessary protection to our own commerce and inflict damage on that of the enemy.

There is a growing feeling in the country with regard to the neglect which has been manifested in building up our ocean mercantile marine, and it is to be hoped that this feeling will spread until the thousands of unemployed workmen have a chance to earn good wages and the American ocean steamers have a fair share of the \$150,000,000 annually paid to foreigners for carrying our goods.

By the course we have pursued in this country we have actually given protection to foreign steamships at the expense of our own. The wharves of New York are decorated with foreign flags, while hardly an American ensign can be seen floating above a steamer suitable for conversion into a vessel of war. This is free trade with a vengeance, all on one side and for the benefit of other nations. We ship our goods in foreign bottoms and foreigners get the lion's share of the profits. No American steamships are employed in foreign trade, because subsidized ships can drive them off and carry freight cheaper.

It may be denied that these foreign lines are subsidized, but we know they started on a subsidy, which their Government wisely allowed them, and with that aid and the opposition our ship-owners met with in this country, owing to a want of liberality on the part of Congress, European steam lines can increase and multiply without opposition from the United States. It does not appear to have occurred to our people how this liberality of foreign nations will react against us some day. These lines of foreign steamships have all the ocean traffic in their hands. They have a perfect right to it, no doubt, as long as they find no one to dispute it. New York, to all appearances, is a foreign port, and owes much of her prosperity to the great ships which steam in and out of the harbor almost as often as the trains run up and down the elevated railroad.

Many of these ocean steamers are grand structures of great speed and strength and well calculated for commerce destroyers. They could outstrip any cruisers we now have afloat, whatever we may do in the future. Here is a great fleet of steamships built with all the skill of British artisans that could in ten days' time be metamorphosed into vessels of war, armed with heavy guns, ready to blockade our ports and sweep what commerce we have left from the sea, or to encounter our

ships in battle. In the ordinary course of events this is not likely to happen, for the interests of Great Britain and the United States are too closely interwoven to make a conflict of arms between them probable, but war has occurred before and may occur again, and I wish particularly to draw attention to a naval power right in our midst, built up and fostered by this country and ready to be used against us. The protection that has been given these foreign lines consists in the repudiation by our legislators of the claims of our own ship owners and failing to grant them assistance to enable them to compete with other nations.

I append the names of a few of these great British ships to show what an auxiliary Navy might at this moment have been ours had we taken time by the forelock and devoted our attention to the building up of our own mercantile marine instead of that of foreigners. The list here given includes only a portion of the vessels that can be converted into ships of war, but the fleet would be a powerful one if we could control it:

Name of ship.	Tons.	Name of ship.	Tons.
Aurania	7269	Arizona	5147
Bolivia	4050	British Queen	3558
Britannic	5004	City of Richmond	4623
City of Montreal	4489	City of Chicago	5202
City of Rome	8144	Celtic	3867
Devonia	4270	Denmark	3724
England	4838	Etruria	7718
Egypt	4670	Furzeada	5405
Helvetia	4588	Holland	3848
Servia	7392	State of Nebraska	3986
Umbria	7718	Wisconsin	3700
Wyoming	8238		

These facts may be deemed suggestive, and when I mention that the *Etruria*, one of the above-named ships, lately made 496 knots in twenty-four consecutive hours, or over twenty knots an hour, the importance of building similar vessels for our mercantile marine may be estimated. No matter how great a fleet of war vessels a nation may possess, a strong commercial marine is a great addition to it, a matter which is perfectly understood in Europe. Whenever we have been engaged in war our mercantile marine has very greatly contributed to our success. The vessels I have mentioned in the foregoing list form but a small portion of the fleet of clippers which seem at present to have the exclusive right to transport American merchandise across the ocean, and the fact that not a single line of American steamers is employed in transporting material to Europe, is a serious reflection on the enterprise of our citizens and an evidence of neglect on the part of Congress.

As people begin to examine more closely into the subject, the cry of "monopoly" has less weight. Shipping leagues are springing up in all parts of the United States, and the potent arguments advanced at their meetings are sweeping away the clouds of prejudice and showing the public the true state of affairs. The word "subsidy," so long a bugbear to our legislators, has begun to lose some of its terrors, and they see in the term "subvention" (a Government aid or bounty) or "postal appropriation" no signs of monopoly in England, while at present we are practically insuring a monopoly in this country to foreign steamship lines.

There is no doubt that the new view of this matter which is taking possession of the American mind has brightened the prospects of our mercantile marine, and it is to be hoped that the many gloomy years in which our commerce has been at a low ebb may be succeeded by a pe-

riod of wise legislation in which only a national feeling will prevail. I look for this as hopefully as I do for generous appropriations for the Navy when Congress again assembles.

A closer examination of this subject than has heretofore been given it by the majority of our statesmen will show the loss this country has sustained by a failure of Congress to act in the premises. In the last eight years no less than *one billion two hundred millions of dollars* have been paid to foreign steamships, a sum almost equal to our national debt, and a burden that is only made tolerable owing to the immense resources of our country. We should be still further depleted but for the fact that we are sustained by the tariff on foreign merchandise and the protection of our manufactures, which prevents us from being undersold by foreigners and enables us to give employment to our working people, so that with all our drawbacks we grow rich.

It would be hardly fair to accuse the American people of a want of energy for failing to revive their ocean commerce when they are exhibiting so much of this quality in other directions in developing the resources of the country. It seems to be a law of nature that decadence shall overtake every nation in the course of time, but there is no instance on record of a nation giving up her position in the race for supremacy without a struggle to retrieve herself. The decadence which has afflicted our ocean carrying trade is not for want of energy on the part of our people, or for the want of laws, but perhaps from a plethora of both which has hampered those who would have labored for its revival.

This country was not formed by Government but was built up by the independent efforts of a series of individuals who have led the way in all great enterprises, and in the early days of the Republic never thought of asking Government aid; but during the great crisis in our history, when all the men and money of the country had to be employed to save it from destruction, the nations of Europe, while we were hampered with difficulties at home, got so far ahead of us in the race for commercial supremacy that they have ever since maintained the lead.

The tendency in this country has been not to foster and encourage enterprise, but to limit and destroy it by laws specious enough in reading, but which are like the ashes of Dead Sea fruit when placed to the lips. To this system of legislating down hill and closing the door tightly year after year against the applications of those who stand ready to enter into the business of reviving the commercial marine, is due the fact that our ocean-carrying trade has passed into European hands, and that we are likely to be left with half a dozen machine shops to help us build a Navy in times of war, or repair the small one on which, in ordinary times, we seem doomed to rely.

While our present illiberal policy is pursued we stand no chance of ever becoming anything more than a fifth-rate power upon the ocean. If we go on at the present rate our country will lose much of the strength which it owes to the cohesion of its individual atoms, and, like a soulless machine working on at random, it will meet the fate of many other nations that have flourished for a time and then fallen by their own weight.

Laying aside all arguments in favor of a mercantile marine, it is necessary for the assistance of the Navy in time of war. We need additional and enlarged markets for our surplus products, but foreign vessels with their subsidies are fast closing all the channels of trade against us, and our manufacturers, who would otherwise help to supply the world, are shut off by British rivals. British steamships have taken

possession of all the routes of trade fostered by the British Government and protected by British guns. This is creditable to the British Government which looks out for the interests of Englishmen all the world over, and it would seem as if the parent stock of the English-speaking race had more energy than their transatlantic offspring, for their steam mercantile marine not only monopolizes the foreign trade of the United States, but encircles the earth, for there is not a port in the world where there is a chance of finding a market for manufactured articles that a British steamship does not penetrate.

All that is left to us in the way of foreign commerce are the gleanings in the by-ways of trade about which our great rivals give themselves little concern, and a few second-rate vessels may now and then be encountered trying to make a living under our flag, struggling along like the crows at Pensacola, which have to go to sea to get something to eat. That kind of commerce is of little benefit to a nation. It is necessary to move on the great thoroughfares of the ocean to have an extensive trade, and Great Britain, in recognition of this fact, pays her steam lines liberal subsidies.

As the great highways of ocean trade are not frequented by American steamships, inquiry ought to be made as to why this is the case and remedies adopted to cure the evil, especially as regards those routes where exports from the United States should naturally be carried in our own vessels, but in 1880, when this country had had ample opportunity to revive her commercial marine, we find the Americans transported goods to the value of \$280,000,000 while foreign vessels, mostly steamships, carried \$1,309,466,596, the percentage being in 1856, 75, and in 1880, 17 per cent. This was a tremendous change for a country in regard to which a well-known statistician observes: "At the beginning of the nineteenth century the commerce of the world seemed to be passing into American hands, American shipping having increased fivefold in twenty years," yet this once flourishing state of affairs seems to be forgotten by our legislators, which is the more remarkable considering the highly intelligent character of our members of Congress generally.

It was natural to suppose that when this falling off of our commercial marine took place Congress would take advantage of the authority given by the Constitution to regulate commerce with foreign nations, and build it up again. The words of the Constitution are ample warrant for Congress to provide that our ships should receive a fair share of the ocean carrying trade, and there is just as much power to regulate our ocean commerce as to regulate commerce between the several States of the Union; but to prevent complications with foreign powers and to avoid laying imposts on foreign vessels that would conflict with treaties, we must give our citizens sufficient subsidies to enable them to build and run lines of steamships equal to any afloat.

What would ten millions a year be to this country if given by Congress to help build up our commercial marine? It would more than return the equivalent in the shape of customs dues. It would more than pay if we could retain in the United States twenty out of the one hundred and fifty millions which are yearly carried out of the country for freights without benefit to our citizens. Why should not American commerce be allowed the same opportunities that are afforded the other industries of the country, which have reached a development such as the most far seeing never dreamed of? We are not tied down by foreign subsidized competitors on land, and therefore our progress has been marvelous, and so it would be upon the ocean if the bonds were once cut which confine our ship-builders,

We will take, for instance, the French merchant steamships of over 8,000 tons, which of late years have become a feature in trans-Atlantic travel. These vessels were encouraged by their Government as a set-off to the British steamships, which it was seen could be turned into vessels of war at short notice in case of hostilities with France, just as on a late occasion the Russians, when threatened with a war with England, fitted up several large steamers in this country as commerce destroyers. France pays to these steamers \$14,000 for every round trip between Havre and New York. What chance could an American line have against such a competition as that, receiving no assistance from Government and probably not being paid to carry the mails, which the foreigners would carry for nothing rather than an American ship should receive aid from the Government? Even giving us "free ships and free materials" would not surmount the difficulty.

Foreigners know this, and do not object to our having fast ships built on the Mersey and the Clyde, as they are aware that we could not run them with any profit handicapped as we would be by the many advantages possessed by the steamers of Europe. Foreign governments must have lines of fast ships as offsets to each other in time of war, and are willing to pay for them, but even with governmental aid the profits of these vessels are not excessive, about 6 per cent. being the usual limit. Without the subsidy, there would be no profit. If there be any lines which do not receive Government aid, it is because they received it until they were able to get along without further assistance. At one time the Cunard line, with its magnificent fleet, netted 26 per cent. If this line should, for any cause, fail to pay a fair dividend, it will be for the interest of Great Britain to subsidize it again.

After all, the amount required to subsidize a line of steamers is not so very great. Suppose the United States started to subsidize forty ocean steamers the size of those that now cross the Atlantic. Putting the vessels at 8,000 tons each, and allowing 30 cents per ton for every 1,000 miles traveled, the expense would be \$2,400 per 1,000 miles for the 3,000 miles, or \$7,200 for the voyage, return trip the same, or \$14,400 for the round trip. Assuming eight round trips a year would give \$115,200 annually for each steamer, or for the whole forty vessels \$4,608,000 for a grand fleet of ships worthy of this Republic, any two of which would be worth more in time of war than all the cruisers we have at present in the Navy.

Yet \$4,500,000 is no great amount for a nation to pay that has so many millions locked up in her Treasury doing no good, while every legitimate opportunity should be taken to enlarge the avenues of trade by land and sea in order that our country may fulfill the grand destiny marked out for it.

Besides my interest as a citizen in the advancement of the country, I am specially concerned in behalf of the Navy, and am endeavoring to show for how small a sum an auxiliary naval force can be maintained. We spend more than the amount I have mentioned in public buildings, and treble the sum in river and harbor improvements, and I would inquire which of these three appropriations would be of the greatest benefit to the country, to say nothing of the more important part we would play in foreign countries? In time of war this great adjunct to our Navy would commit havoc on the enemy's commerce all over the world, while the heavy ships were defending our coasts. This is a grand picture to contemplate, but I fear a delusive one. Judging from the past, we are not equal to the occasion.

Notwithstanding our former experience, we seem to have learned nothing, and, as regards our commercial marine, are actually in a worse condition than we were in 1812. Speaking interestedly, I look at the loss to the Navy through the lack of energetic action on the part of our people and of unwise legislation on the part of Congress. I refer to the want of means to properly man a great fleet in time of war, which under present circumstances would be impossible, no matter how many naval ships we might build. A navy cannot be improvised or built at short notice, a fact which all history demonstrates, but it requires some strong incentive to build it up, such as a powerful enemy near at hand, a commerce to protect, or injuries to avenge, and those nations that have dominated the world for so many years have attained their naval greatness only through a long course of training and learning how to turn to account every possible factor in the event of war. After a long series of hostilities between Great Britain and France, the conviction was forced upon the latter nation that the only way to compete with her rival was to build a navy of equal force. When this scheme was proposed in the French Assembly, Mirabeau remarked :

The English war marine has grown to what it is, like the English oaks of which the ships are built, through the slow progress of a thousand years. You cannot have a navy without sailors, and sailors are made through the dangers of the deep, from father to son, until their home is on the wave. You cannot build up a navy at once by a simple act of legislation.

These memorable words are as true to-day as they were when uttered.

We must not expect to go on from year to year neglecting everything that tends to increase the naval strength of our country and then by some spasm of legislation create at once a navy or mercantile marine. In the case of a mercantile marine there will have to be overcome the opposing elements that have stood for years in the way of a great industry, and the first step should therefore be to appropriate money liberally, for money is the Archimedean lever that moves the world. No meager aid should be doled out to repair the mischief created by unwise economy in the past, but such assistance should be given as will infuse life into every part of the Republic and give employment to hundreds of thousands who to-day are without encouragement to ply their trades, a body of mechanics of whom the country may be proud, and upon whom the Government must rely in time of war.

It is the interest of a commercial nation to have as great a balance of trade in its favor as possible. Great Britain, with this idea in view, is constantly increasing her tonnage, and endeavors to have all her imports and exports carried in her own vessels, thus realizing nearly the entire selling price of her exports in foreign markets, and for her imports pays only the selling price in those same markets. If we had our own vessels, with which to carry on our trade, most of the freight charges would be retained or returned to this country, whereas \$150,000,000 are annually retained or returned to England. With many people this is a mere matter of "sentiment." They do not care how it is done so that they get their goods to a market, utterly ignoring the question of patriotism which should ever animate the hearts of Americans. But even in the breast of the most callous there must occasionally be a feeling of regret at the thought of our flag disappearing from the ocean, like a meteor that flashed for a moment over the surface of the waters and then disappeared forever.

But there is yet hope. We are still the young giant among nations, whose muscles are temporarily relaxed, and the time may yet come when the American mind, grasping the situation of affairs, will exert

its powers to place upon the ocean a fleet of steamers that will be the pride of the nation, and will inaugurate a new era more striking than any previous event in our commercial history.

Many persons who cannot be moved by argument or touched by an appeal to their patriotic sensibilities can be convinced by an array of statistics which will show how the country is suffering, and how we are handicapped by foreign nations. Not only our traditional commercial rival, Great Britain, but the other nations of Europe have taken the lead of us on the ocean. It is no longer said, "All the foreign commerce of the world is passing into American hands," but "All American ocean commerce is passing into the hands of foreigners." These are facts easily substantiated.

In the first place, I propose to show that the great ocean steam marine of Great Britain owes its existence solely to subsidies, although many efforts have been made to prove the contrary. Parliamentary papers prove that the system is more than a century old, which shows that British statesmen were wiser in days of old than we are at present, notwithstanding the example we have had before us. Great Britain started with the idea of building up her industries on a basis that would eclipse all other countries, and her ocean marine was so essential a part of British greatness that from the first it received the most particular attention. The following taken from the reports of the "American Shipping and Industrial League," will show how much British commerce owes to subsidies (see 22d British Report of Commission of Revenue Inquiry), viz:

The attention of the commissioners of "fees and gratuities" in the year 1788 was drawn to the expenditure, which had been increased in the packet service during several years preceding their inquiry, an expenditure, according to their expression, "so enormous as almost to surpass credibility," the sum of \$5,200,000, giving an annual expenditure (in a period of seventeen years) the sum of \$305,000.

Here is official British investigation and evidence of shipping subsidy by England, viz:

1770 to 1788.....	\$5,200,000
This continued until next examination by committee of finance, 1797, which shows that, instead of being stopped, it was increased, averaging up to 1810 \$392,200 yearly, or, in all, 1798 to 1810.....	8,628,200
The committee (1810) also increased the subsidy to \$523,000 per year, and continued increasing until 1816, making a total of.....	4,725,000
After which it fell off for three years, 1817 to 1820, to.....	1,655,000
The spirit of subsidy again arose from 1821 to 1830, and paid.....	5,855,000
<hr/>	
Making in the first sixty years a payment of.....	25,063,000

It was at this time (1830) that the British commissioner of revenue made an especial investigation "for the purpose of inquiring into collection and management of public revenue," and then began the heavy subsidizing of steamships to over \$500,000 per annum, as follows, viz:

1830 to 1837.....	\$6,000,000
From general post-office, 1837 to 1849.....	25,000,000
From mercantile marine fund, 1823 to 1848.....	37,500,000
From general post-office:	
1850 to 1859 (over).....	60,000,000
1860 to 1869.....	50,000,000
1870 to 1885.....	70,000,000
<hr/>	
Total assistance from British treasury to her shipping.....	273,563,000

This does not include "amounts especially authorized" by Parliament from time to time, or added from "mercantile marine fund," or amounts made up by the British system of "averaging and adjusting the accounts of her mail steamship companies," in order to enable them to declare an annual dividend of at least 8 per cent.

In order to anticipate the plea that such was the case, but that England does not now subsidize, the following is taken from official publications :

British mail subsidy.

[Report of the British Postmaster-General, 1885.]

Line of packets.	Contracts.		Payment.
	Commencement.	Termination.	
Australia:			
Point de Galle and Melbourne, Singapore and Brisbane, San Francisco, and Sydney	Contracts with colonial governments.		
Brazil, River Plate, and Chili:			
Bi-monthly from Southampton	Sept. 1, 1876 ..	On six months' notice ..	£4, 888
Fortnightly service from Liverpool	July 1, 1878 ..	On six months' notice ..	8, 370
Cape of Good Hope and Natal:	Contracts with colonial governments ..		2, 774
Cyprus and Alexandria:			5, 213
East Indies, China, and Japan:	Feb. 1, 1880 ..	Six months' notice	300, 000
Europe:			
Dover and Calais			12, 034
Dover and Ostend			4, 500
Malta, &c			640
North America:			
United States	Dec. 1, 1877 ..	On six months' notice ..	96, 590
Halifax, Bermuda, and Saint Thomas	Jan. 1, 1878 ..	On twelve months' notice ..	17, 500
Pacific	July 1, 1878 ..	On six months' notice ..	3, 418
West Indies:			
Bi-monthly service	Jan. 1, 1880 ..	On December 31, 1885 ..	80, 500
Non-contract service			415
Additional services:			
Liverpool and Puerto Cabello, Tampico, and Santa Martha	Oct. 1, 1881 ..	On six months' notice ..	764
Batavia and New Orleans	Contract with Honduras Government terminating September 30, 1889		1, 800
Turk's Island and Saint Thomas	Contract with Turk's Island Government		800
West coast of Africa:	No contract		9, 082
Total			608, 788

Detailed statement from "financial account" shows £774,626, or \$3,870,000.

By reference to Secretary Evarts's letter (Com. Rel., 1879, p. 26) the detailed "table of trade of West Indies" shows that only one-half of Great Britain's trade is with her own possessions, hence one-half only of her subsidy can be credited to the benefit of her colonies.

This settles the subsidy or subvention matter, or whatever name we may choose to call it, and should close the door against the schemes of foreign agents who are plotting to keep lines of American steamships from showing themselves on the ocean so that we may confine our shipping to the small vessels that creep along our coast. One would think that any American with proper pride of country would burn with indignation at the idea of our playing such an insignificant part—a game in which we may get the shell while our rivals secure the oyster. Consider for a moment the result of our submitting so long to this iron rule which affects every industry in the United States.

The number of steam vessels in the world is given in the following table, which is taken from the *Repertoire Général* of the Bureau Veritas published during the present year, and includes all steamers of whatever class above 100 tons burden :

Flag.	Number.	Gross tons.	Flag.	Number.	Gross tons.
British	4, 906	6, 545, 615	Argentine	22	13, 120
French	468	745, 680	Chinese	9	11, 832
German	529	601, 075	Turkish	17	11, 770
American	379	506, 668	Hawaiian	12	10, 127
Spanish	356	399, 577	Peruvian	5	5, 951
Dutch	167	210, 549	Haytian	4	4, 067
Italian	158	204, 058	Zanzibar	2	2, 828
Russian	218	145, 447	Uruguay	4	2, 396
Norwegian	275	147, 011	Roumanian	3	2, 125
Swedish	329	137, 377	Tunisian	2	1, 762
Austrian	105	135, 145	Honduras	1	969
Danish	174	127, 830	Persian	1	838
Belgian	62	111, 746	Venezuelan	3	838
Japanese	101	92, 479	Costa Rican	2	719
Greek	57	54, 614	Siamese	2	547
Brazilian	82	49, 216	Ecuador	1	329
Egyptian	28	32, 674	San Domingo	1	167
Portuguese	27	26, 515			
Chilian	23	24, 925			
Mexican	12	18, 456			
			Total	8, 547	10, 408, 938

This statement shows at a glance the sorry figure which our country cuts in the enrollment, and it must be remembered that of the 379 steamers with which the United States are credited (which includes tugs, river boats, and old, obsolete craft of all sorts), but 101 are actually fitted to navigate the open ocean, and only 15 can be properly classed as ocean-sailing steamers. This last class are those running from New York to Aspinwall and Brazil, and from San Francisco to Panama, Australia, and China and Japan. All the others are coastwise vessels.

I give below a list of American steamers which make up the 101 vessels referred to above. In compiling it I have rejected all vessels built previous to 1865, all wooden and paddle steamers, and all below 1,000 tons :

List of iron and steel steamers of over 3,000 tons.

When built.	Name.	Tons.	When built.	Name.	Tons.
1863..	Alameda	3, 158	1875..	City of New York	3, 019
1878..	City of Para	3, 532	1874..	City of Peking	3, 079
1878..	City of Rio de Janeiro	3, 548	1875..	City of Sydney	3, 019
1884..	El Dorado	3, 531	1884..	El Paso	3, 531
1884..	Eureka	3, 531	1882..	Excelsior	3, 264
1878..	Illinois	3, 101	1873..	Indiana	3, 101
1883..	Mariposa	3, 158	1873..	Ohio	3, 101
1872..	Pennsylvania	3, 104	1883..	San Pablo	3, 119
1882..	San Pedro	3, 119			

Total, 17 steamers, 57,012 tons. Other nations have 484 steamers of over 3,000 tons.

Between 2,000 and 3,000 tons.

When built.	Name.	Tons.	When built.	Name.	Tons.
1873	Acapulco	2,572	1883	Advance	2,604
1893	Alamo	2,943	1876	Algiers	2,287
1881	Alleghauy	2,014	1881	Berkshire	2,014
1879	Chalmette	2,983	1884	Chatham	2,729
1882	Chattahoochee	2,676	1883	Cienfuegos	2,332
1879	City of Alexandria	2,480	1880	City of Augusta	2,870
1877	City of Macon	2,093	1882	City of Puebla	2,841
1877	City of Savannah	2,029	1877	City of Washington	2,618
1879	Clyde	2,017	1873	Colima	2,906
1879	Colorado	2,765	1873	Colon	2,695
1880	Columbia	2,722	1885	Comal	2,934
1879	Decatur H. Miller	2,296	1883	Finance	2,603
1873	Grenada	2,572	1882	Guyandotte	2,351
1884	H. F. Dimmock	2,626	1883	Lampasa	2,943
1875	Loce Star	2,255	1880	Louisiana	3,000
1876	Morgan City	2,217	1853	Nacooche	2,689
1875	New York	2,284	1880	Newport	2,735
1877	Niagara	2,265		Onoka (lake steamer)	2,100
1878	Oregon	2,335	1885	Philadelphia	2,099
1882	Queen of the Pacific	2,728	1876	Rio Grande	2,566
1882	Roanoke	2,354	1882	San Blas	2,075
1882	San José	2,081	1882	San Juan	2,076
1881	San Marcos	2,839	1884	Santa Rosa	2,417
1879	Santiago	2,359	1878	Saratoga	2,426
1884	Seneca	2,729	1881	Starbuck	2,157
1878	State of California	2,266	1882	Tallahassee	2,060
	Toga (lake steamer)	2,000	1881	Umatilla	2,181
1881	Walla Walla	2,135	1881	Willamette	2,562

Total, 56 steamers, 138,155 tons. Other nations have 1,819 steamers of from 2,000 to 3,000 tons.

Between 1,000 and 2,000 tons.

When built.	Name.	Tons.	When built.	Name.	Tons.
1877	Aranas	1,157	1880	Breakwater	1,045
1841	Caracas	1,589	1884	City of Topeka	1,057
1872	City of San Antonio	1,605	1875	City of Atlanta	1,621
1880	City of Columbia	1,878	1874	City of Chester	1,106
1874	City of Panama	1,490	1868	Costa Rica	1,457
1870	Georgia	1,900	1878	Gate City	1,993
1878	General Whitney	1,848	1873	George W. Elder	1,709
1872	George W. Clyde	1,805	1866	Harlan	1,163
1873	Johns Hopkins	1,471	1873	Knickerbocker	1,642
1879	Manhattan	1,525	1872	New Orleans	1,440
1881	Ozama	1,028	1873	Richmond	1,438
1873	State of Texas	1,549	1883	Spartan	1,596
1882	Valencia	1,598	1871	William Crane	1,417
1869	William Lawrence	1,047	1877	Yaquina	1,241

Total, 28 steamers, 41,415 tons. Other nations have over 2,600 steamers of from 1,000 to 2,000 tons.

RECAPITULATION.

Class.	No.	Tons.
Steamers over 3,000 tons	17	57,012
Steamers between 2,000 and 3,000 tons	56	138,155
Steamers between 1,000 and 2,000 tons	28	41,415
Grand total	101	236,582

This is a very poor exhibit of American sea-going steamers. It shows very few above 3,000 tons, and not all of these are employed. A line of steamships was started from Philadelphia to Europe, consisting of the *Illinois*, *Indiana*, *Ohio*, and *Pennsylvania*, each of 3,100 tons, but it was soon found that they could not compete with foreign lines for causes already stated. Then they were purchased by the Pennsylvania Railroad Company and started out again on a quixotic career. The same result followed, and the company had to withdraw and lay them up—a long row of hulks now, looking very much like those of the Navy laid up in “Rotten Row.” Their short existence indicated that the national spirit which influenced a portion of our citizens met with no corresponding feeling in other quarters, and these vessels became the victims of that temerity which now and then animates citizens anxious to redeem our commerce and place the flag once more upon the sea.

The above tables show what an increase there has been in foreign tonnage, owing to the system of subsidies. In addition to this, in 1860, ships built of iron were gaining in popular favor abroad, an idea that was encouraged in England because ships could be built of a material of which England had an abundance, whereas her supply of timber was limited. In the mean time, the United States, with plenty of timber, but building no iron ships, began to feel the effects of the new mode of construction in Great Britain, and in consequence were compelled to accept low rates of freight, and, at length, to sell their ships, so that in 1865 we had but one-third of our foreign commerce, while that of Great Britain had largely increased.

The iron ships were encouraged by the British Government, for it was seen what a preponderance in tonnage would soon be given their mercantile marine, while the United States did nothing to encourage ship-building, except forbidding registers to foreign-built vessels, and no plant existed in the country for turning out such ships as were being multiplied in Great Britain. It would seem as if our countrymen were so bewildered by the number and size of the steamers constructed abroad, and so delighted at the luxurious accommodations afforded European travelers at so reasonable a rate, that they became converts to the English idea, forgetting that the advent of these steamers was a death-blow to the hope of reviving our ocean steam marine.

Since that time the decline of our vessels has continued, and at present the tonnage of this country engaged in foreign trade is less than it was in 1810, and if no remedy is applied, it will ere long disappear from the ocean. The advocates of free ships contend that the existing state of affairs is largely owing to our navigation laws, and that the only remedy is to authorize the building of our vessels on the Clyde and Mersey; but I think it safe to say that the repeal of our navigation laws would result in the destruction of our coastwise carrying trade, and that the art of ship-building would be one of the lost arts as far as we are concerned. The best argument against this plan is that the nation which has so nearly succeeded in driving us from the ocean is a strong advocate for free ships.

Our present facilities for building iron and steel ships are poor enough, as is shown by the fact that none of the builders could contract at once for the ships lately authorized by Congress and agree to finish them in a stated time, while in England such contracts would be accepted in a week, and the ships would be in commission in eighteen months. From this circumstance arises the desire of many people to have our ships built abroad instead of devoting their energies to increasing the facilities at home, when the same results would follow here as now obtain in Great Britain.

But suppose we could purchase a ship in England for \$600,000 that would cost \$700,000 in this country. Would it be any profit to the United States that the purchaser gained \$100,000 while the nation lost \$600,000 spent in foreign labor and material? Would it not be better to retain the money at home and circulate it among our mechanics and laborers? In such matters we might well take a leaf from England's book. She spares no effort to keep her laboring people employed in building up her great commercial marine and invincible navy.

I remember when American merchants were the most prominent men all along the Pacific coast of this continent, and our flag, waving at the peak of our splendid ships, outnumbered all others four to one. Americans held nearly all the trade, and then it was foreigners cried out that it was all passing into our hands. But to-day how great the difference. There are no American merchants to speak of; they have handed over all their right and title to trade to the British merchants, to whom are consigned the numerous steamships loaded with goods, among which none from our country will be found. England has captured our trade, and we are now, like the little fish that follow in the wake of the shark, gaining a scanty subsistence from the monster's leavings.

EAST INDIA TRADE.

It has been the ambition of the leading commercial nations for centuries to control the trade with the East Indies. The nation that could do it would dominate the commercial world.

In the palmy days of our commerce, when our great clipper ships made such quick passages from China and India to England and the United States, there seemed a fair prospect of the bulk of the trade falling into American hands, but the building of great ocean steamships and the granting of generous subsidies by the British Government put a stop to all this. America, with the best of iron and the best of mechanical skill, could not compete with her rival. Trip-hammers do not grow spontaneously, and a plant such as was established in England can only be provided by great capitalists backed by the aid of Government.

Driven from the ocean, we tried what could be done on land, and by Government assistance built the railroads to the Pacific, part of the straight and short road to India, China, and Japan. The project then was to subsidize a line of steamers from San Francisco to China and Japan, and the great trade with those countries would be ours; the time from New York to Hong-Kong would be thirty-four days, whereas by the old route around the Cape of Good Hope, eighty-six days were required, with all the vicissitudes of weather and climate. We subsidized a line of steamers which was eminently successful as long as the subsidy lasted, but at length the British put steamships on this route, which curtailed American profits very materially, and the stoppage of the subsidy to the Pacific Mail Steamship Company reduced its line to an ordinary affair and our promised wealth flowed into British coffers.

Thus the hopes of American trade with Japan, particularly, turned out delusive, and the matter stands about as follows:

Foreign commerce of Japan.

Country.	Imports.	Exports.	Total.
Great Britain	\$15, 878, 000	\$3, 084, 000	\$18, 962, 000
United States	1, 533, 000	10, 854, 000	12, 387, 000
France	3, 128, 000	7, 048, 000	10, 176, 000

So with the short, straight route to Japan, we lost the race, and when the Pacific Mail Steamship Company's line runs down for want of subsidies, all the carrying trade will pass into British hands.

The imports of China and Hong-Kong, together with all other Asiatic countries, amounted, in 1879, to \$754,669,000, of which amount Great Britain had \$281,631, France, \$22,893,000, and the United States, \$17,510,000. The exports were \$772,766,000; to Great Britain, \$220,806,000, and to the United States, \$53,838,000, showing that in the China trade the Americans fared no better than in the trade with Japan, notwithstanding our straight line to the Indies, all of which is because the English have a system which enables them to secure the greatest portion of the ocean carrying trade, while we have no system whatever.

England is now beating us with our own weapons. The Canadian Pacific Railroad will soon be in complete operation, and Canada has paid this tribute to England, not perhaps with the idea of diverting all the trade through the Dominion, but with the hope of obtaining a large share of it. Canada offers to pay \$75,000 a year to a line of steamers between Vancouver's Island and Hong-Kong to connect with the railway, and \$125,000 a year to an Australian line on condition that the British Government pay \$225,000 yearly to the former line. Should this arrangement be effected, the Canadian Pacific Railroad Company's purposes will be aided by an annual grant of \$425,000, at 3 per cent., the equivalent of a cash subsidy of \$14,000,000. Great Britain's contribution will secure her a military route well worth the money.

Thus Great Britain, either to secure the trade of a country or a military route to her possessions, merely applies the subsidy touchstone to all corporations that tend to strengthen the Empire. This line at once becomes a powerful competitor with the American lines, which will soon go to the wall unless proper support is given them. The Canadian Pacific Railroad is not likely to yield in itself any profit for many years, but it will put a stopper on American lines of steamships in the Pacific, and so far cripple our naval resources in that quarter.

By the simple process of paying a small subsidy, Great Britain controls a line of railroad across the continent, maintains a strong military and naval depot at Vancouver Island, and runs a line of steamers to China and Japan, which will enable thousands of the Chinese coolies, who have struck such terror into the inhabitants of our Pacific States, to invade our country from the north. We have held the subsidy business to be of no account, but it has done wonders for the British mercantile marine, and I see no reason why it should not do the same for that of the United States.

The British system of keeping up her lines of ocean steamers is never lost sight of nor neglected. It is as carefully looked after as her navy, for the navy could not get along in case of a great war without the aid of the merchant steamers. In looking back at the marine history of England, it is noticeable that the decade embraced between the years 1840 and 1850 effected a revolution in the affairs of her ocean commerce. At that epoch feuds were entertained that the commerce of Great Britain was on the decline, owing principally to the rapid growth of the United States as a maritime power. Mr. Cunard, who had built the first four steamships to run from England to America, under an annual Government subsidy of \$400,000, was enabled to have his compensation increased to \$500,000, or more than 50 per cent. of the cost of the four steamers. Six years later, when two new vessels were added to the line, the subsidy was increased to \$700,000, and was continued for fif-

teen years. The Peninsular and Oriental Steamship Company received subsidies to the extent of \$1,000,000, and the Royal Mail Steamship Company was established by the same means, which made these lines such a financial success that the fears of Great Britain losing her ocean supremacy were allayed and a turning point noted in the history of her commercial marine.

Since that period the attention of the British Government has been constantly applied to the extension of their steam tonnage—so much so that the business of building steamers was rather overdone, and finally there were at least 1,000,000 tons more than could be profitably used. This superfluity was the origin of the great clamor that broke out a few years ago in favor of “free ships.” The British hoped to sell us their surplus vessels, and the free traders of this country were in favor of a law which would permit us to purchase them and sail them under the American flag, apparently oblivious to the fact that the steamers could not be run in opposition to those of Great Britain without the subsidies which had caused the success of the latter.

Notwithstanding the surplus of steam merchant vessels in Great Britain, the building of iron and steel ships went on, while very few were constructed on this side of the ocean. The following table will show the effect of government aid to British ocean steamers :

Iron vessels built.

	Steamers.
1880, registered	406
1881, registered	465
1882, registered	543
1883, registered	678
1884, registered	537

We can hardly realize in this country such a wonderful activity in ship-building. There must be powerful inducements to continue ship-building even with a surplus of vessels on hand. The purchase by Americans of their superfluous ships was expected in England to open a still more lively competition in the ship building industry, the English knowing that every vessel sold by them would be finally laid up in this country, and be so much steam tonnage out of their way. “Free ships” would have brought disaster on those who purchased them, and all those industries connected with iron-ship building in the United States would have been destroyed.

The following exhibit of over one hundred and seventy-five industries benefited by home ship-building, which will astonish many, even the best informed, has been kindly prepared and furnished by the Messrs. Harlan and Hollingsworth Company, every item of which represents a bona fide disbursement in shipping. (Extracted from the publications of the American Shipping and Industrial League.)

- | | |
|----------------------|----------------------|
| 1. Coal-miners. | 21. Designers. |
| 2. Iron-miners. | 22. Draftsmen. |
| 3. Paddlers. | 23. Gold-beaters. |
| 4. Rollmen. | 24. Folders. |
| 5. Furnacemen. | 25. Inspectors. |
| 6. Millmen. | 26. Cabinet-makers. |
| 7. Riveters. | 27. Upholsterers. |
| 8. Calkers. | 28. Flag-makers. |
| 9. Fitters-up. | 29. Decorators. |
| 10. Boiler-makers. | 30. Potters. |
| 11. Blacksmiths. | 31. Glass-blowers. |
| 12. Hammermen. | 32. Brass-founders. |
| 13. Machinists. | 33. Loam-molders. |
| 14. Millwrights. | 34. Cupola-tenders. |
| 15. Ship-carpenters. | 35. Foundrymen. |
| 16. Joiners. | 36. Brass-finishers. |
| 17. Stair-builders. | 37. Engineers. |
| 18. Painters. | 38. Stokers. |
| 19. Tanners. | 39. Pattern-makers. |
| 20. Laborers. | 40. Carvers. |

- | | |
|--|--|
| <ul style="list-style-type: none"> 41. Brass-workers. 42. Wire-workers. 43. Riggers. 44. Cutlers. 45. Silversmiths. 46. Compass-adjusters. 47. Instrument-makers. 48. Sheet-brass workers. 49. Boiler-tube makers. 50. Brass-tube makers. 51. Tin-makers. 52. Plumbers. 53. Steam-fitters. 54. Gas-fitters. 55. Coppersmiths. 56. Lead-workers. 57. Gum manufacturers. 58. Spring-makers. 59. Canvas-makers. 60. Spinners. 61. Wire-rope makers. 62. Stevedores. 63. Bell-hangers. 64. Rope-makers. 65. Sheet-iron makers. 66. Sheet-iron workers. 67. Bricklayers. 68. Boiler-coverers. 69. Lamp-makers. 70. Mariners (sailors). 71. Pilots. 72. Chair-makers. 73. Anchor-makers. 74. Steelshape finders. 75. Windlass manufacturers. 76. Scale-makers. 77. Wood-working-machine builders. 78. Model-makers. 79. Sawyers. 80. Paper-makers. 81. Brick-makers. 82. Jewelers. 83. Hand-tool makers. 84. House-furnishers. 85. Spar-makers. 86. Oil manufacturers. 87. Ship-chandlers. 88. Shipsmiths. 89. Mattress-makers. 90. Mold-loft workers. 91. Tallow and soap makers. 92. Coopers. 93. Block-makers. 94. Life-boat builders. 95. Stove-makers. 96. Sail-makers. 97. Safe-makers. 98. Pump-makers. 99. Nail-makers. 100. Life-preserver makers. 101. Blanket manufacturers. 102. Muslin manufacturers. 103. Cement-makers. 104. Cargent-makers. 105. Galvanizers. 106. Hardware-makers. 107. Oakum-makers. 108. Pitch and tar makers. 109. Electricians. 110. Safety-valve makers. | <ul style="list-style-type: none"> 111. Machine-tool makers. 112. Saw-mills. 113. Watchmen. 114. Printers. 115. Bookbinders. 116. Heaters. 117. Makers of electrical apparatus, annunciators, &c. 118. Storekeepers. 119. Book-keepers. 120. Clerks. 121. Insurers. 122. Brokers in metals. 123. Custom-house brokers. 124. Paint manufacturers. 125. Leather-belt makers. 126. Steel-rail mills. 127. Typewriters. 128. Artists. 129. Time-keepers. 130. Telegraphers. 131. Distiller manufacturers. 132. Screw-makers. 133. Grindstone-makers. 134. Emery-wheel dealers. 135. Saw manufacturers. 136. Spar dealers. 137. Electric-lighting plant furnishers. 138. Manufacturers of blowing engines. 139. Bolt and nut works. 140. Engravers on metal. 141. Steam-steerer manufacturers. 142. Steam-launch builders. 143. Brass-whistle makers. 144. Tug-boat owners. 145. Metallic-packing manufacturers. 146. Sash and blind makers and turners. 147. Mirror-makers. 148. Fire-brick and fire-clay makers. 149. Bell-founders. 150. Marble cutters and furnishers. 151. Makers of holts and lifting-jacks. 152. Tile-makers. 153. Dealers in brushes and artists' supplies. 154. Signal-light makers. 155. Makers of marine-governors. 156. Makers of inspirators. 157. Makers of ejectors. 158. Makers of engine-indicators. 159. Makers of wire-cloth and netting. 160. Mineral-wool manufacturers. 161. Nickel and silver platers. 162. Ice-machine makers. 163. Yacht cannon makers. 164. White-lead manufacturers. 165. Oil-cloth manufacturers. 166. Dealers in machinists' and iron workers supplies. 167. Lumber dealers. 168. Cotton factors. 169. Jute dealers. 170. Rosin dealers. 171. Hemp-growers. 172. Cereals. 173. Salt dealers. 174. Rubber. 175. Tarpaulin. 176. Cooks. 177. Waiters. |
|--|--|

Over 200 in all.

The ship-builder, in fact, is the greatest consumer and the largest benefactor of every producer—of all other industrial consumers in the world.

To enumerate all the instances where the British lines of steamers have been made successful through Government subsidies would occupy too much space. I will confine myself to the most important cases :

Details of the agreement entered into between the British Admiralty and the owners of the White Star and Cunard Companies, by which certain of their vessels are placed at the disposal of the Government on specified terms, are contained in a late parliamentary paper. The White Star Line agrees to hold at the disposition of the Government for purchase or hire, at the option of the Admiralty, to be exercised from

time to time during the continuance of the agreement, the following vessels *Britannic*, value £130,000; *Germanic*, £130,000; *Adriatic*, £100,000; *Celtic*, £100,000. In the event of purchase the foregoing prices were to be held as the values of the vessels on the 1st of January, 1887, plus 10 per cent. for compulsory sale, less an abatement of 6 per cent. per annum on the depreciated annual value for the period that might elapse between the 1st of January, 1887, and the date of purchase by the Government. In the event of charter by the Admiralty, the rate of hire of the before-mentioned vessels was fixed at the rate of 20s. per gross registered ton per month, the owner providing the crew, or at the rate of 15s. per gross registered ton per month, the Admiralty finding the crew, all risks of capture and of hostilities being assumed by the Admiralty. The company has determined to build one or two vessels of high speed and of such a type and speed as will render them specially suitable for service as armed cruisers, and in accordance with the plans and specifications submitted and approved by the Admiralty. In consideration of this the Admiralty will have to pay to the company an annual subvention at the rate of 15s. per gross registered ton per annum. On the 8th of February the Admiralty accepted similar proposals made by the Cunard Line in respect to the following vessels: *Etruria*, value £310,000; *Umbria*, £301,000; *Aurania*, £240,000; *Servia*, £193,000; *Gallia*, £102,000; a subvention of 15s. per gross registered ton per annum to be paid to the company on account of the *Etruria*, *Umbria*, and *Aurania* during the continuance of the postal contract, and in the event of the termination of that contract before these three vessels received five years' payment, the company to be entitled to receive for the balance a subvention at the rate of 20s., the five vessels being still held at the disposition of the Government. In the event of the Cunard Company building new vessels for the mail service, they will submit the plans to the Admiralty for approval.

The subvention will amount to about £6,500 for each of the new vessels of the White Star Line, so long as they carry the mails, or £8,500 should the mails be withdrawn. The annual charge for the retention of the Cunarders *Etruria*, *Umbria*, and *Aurania* is stated at £5,400 each. The Admiralty announces that they are ready to make the same arrangements as with the White Star Company for the first ten steamers that may be offered by any of the British steamship companies.

Only such ships are subsidized as have been carefully constructed under naval supervision, and are fully qualified for the duty of commerce-destroyers, troop-ships, store-ships, &c.

Since writing the above I have learned that three Cunard steamers have been purchased by the Canadian Pacific Railroad Company to ply between Vancouver and Hong-Kong, and the first voyage will commence at once.

It has been the custom in this country to have vessels that were paid to carry the mails inspected by the post-office officials, but such an inspection would merely show whether the vessels were seaworthy, not that they were able to carry guns. There is an impression existing in the minds of those who have not paid much attention to the subject, that the ordinary merchant steamer can, in an emergency, be readily converted into an efficient vessel of war. During the civil war we used a great many of these converted vessels, and although they answered the purpose of blockading the Southern ports very well, yet in the only case where one of them encountered a fairly armed cruiser she went to the bottom in fifteen minutes. Out of all the vessels in the American steam lines, of which I have given a list, there is not one which could be converted into an efficient cruiser without undergoing extensive alterations.

The merchant vessels we employed in the late war generally carried light 32-pounders and howitzers, but in future wars the smallest piece of ordnance likely to be used, with the exception of machine and rapid-firing guns, would be the 6-inch rifle. Vessels as at present constructed in the mercantile marine could not long endure the concussion of the 6-inch rifle, and if the 6-inch rifle would break down their decks, how much more would they feel the 8-inch guns, of which it would be desirable to have one or two on board each commerce-destroyer. Hence the Navy should not rely on those steamers we have now employed on our coast, or even some of those in use on the open ocean.

FRENCH SUBSIDIES.

For many years France tried the policy of free ships and free raw material, but finding that by so doing she was sacrificing her own interests and supporting the iron manufacturers of England, a law was passed in 1881 by the French Assembly, which changed the aspect of affairs in the mercantile marine of that country. When the bounty law was enacted the total shipping of France amounted to 914,373 tons. During the first year after the adoption of the law 161 steam vessels, of 122,276 tons, and 1,050 sailing vessels, of 39,733 tons, were added to the mercantile marine. This is pretty good proof of the efficacy of a bounty law to build up shipping, although so large an annual increase in French commerce has not taken place since 1881, owing to the business stagnation and the fact that there is now tonnage enough to carry on the trade.

The bounty allowed by the French Government is a liberal one, both to steam and sailing vessels. It amounts to 17½ per cent. on the total cost price of a steamer; thus on a vessel of 8,000 tons, costing \$900,000, the bounty would be \$157,500. No vessels of this country could compete against such a subsidy as that, and, therefore, it has never been attempted.

The same law repealed the act granting free entry to imported articles included in the building of ships, thus encouraging French industries. It also provides that for any modification or alteration of a ship whereby her tonnage is increased, bounty shall be paid on the increased tonnage. Besides the above, the owner of a steamship is allowed a compensation of 8 francs per hundred kilograms of new boilers of French make, weighed without the pipes. A compensation is allowed for the burden laid on the mercantile marine employed in foreign commerce, for the recruiting of sailors for the navy by a navigation bounty, given for a period of ten years from the date of enactment. Bounties on steamships are increased 15 per cent. in cases where the plans of the vessels have been approved by the Government.

A comparison of the French carrying trade during four years will show the effect of the bounty law upon the shipping of France:

Table showing the volume of trade in French vessels.

	1881.		1882.		1883.		1884.	
	Number.	Tons.	Number.	Tons.	Number.	Tons.	Number.	Tons.
Trade at French ports with:								
French colonies.	1,437	990,180	1,489	1,024,375	1,569	1,030,989	1,383	1,010,577
Sea fisheries . . .	456	54,212	504	58,839	585	64,664	628	72,575
European foreign countries.	7,291	2,111,209	6,792	1,988,971	6,792	2,049,925	5,526	1,990,005
Countries beyond Europe..	767	763,961	783	950,782	879	1,165,411	793	1,107,819
Total	9,951	3,919,662	9,568	4,023,017	9,759	4,410,999	8,430	4,181,576

CLEARANCES.

	1881.		1882.		1883.		1884.	
	Number.	Tons.	Number.	Tons.	Number.	Tons.	Number.	Tons.
Trade at French ports with:								
French colonies.	1,625	1,112,004	1,690	1,102,092	1,703	1,273,278	1,691	1,257,042
Sea fisheries . . .	353	42,198	499	57,104	549	57,744	600	65,017
European foreign countries.	5,297	1,319,209	4,933	1,369,113	5,059	1,536,790	4,445	1,502,616
Countries beyond Europe.	821	881,414	842	1,056,844	895	1,221,824	759	1,094,582
Total	8,126	3,354,915	7,964	3,585,153	8,296	4,089,636	7,495	3,919,257

These tables show the great increase of the sea trade since 1880 under the French bounty system, for under the fostering care of the Government French vessels already perform 35 per cent. of the carrying trade with foreign countries. It does not require much calculation to show what the result would be to the commercial marine of the United States by the operation of a similar law. The story is told in France. That country has relieved herself of the burden of employing the mechanics of foreign countries to construct her merchant ships. She has built up her private ship-yards and consequently increased her naval power—depending chiefly on her own industries to make her a great commercial nation in time of peace and to build up a most powerful navy in time of war.

A result of the French bounty law has been that fine fleet of 8,000 ton steamers running from Havre to New York, equal in every respect to the best British merchant vessels and which would make admirable commerce destroyers. By the same law the French have built up that powerful fleet, the Messageries Maritimes, consisting of 61 vessels of 157,620 tons, many of which could be converted for national purposes in time of war.

SUBSIDIES BY OTHER POWERS.

Italy for some years tried free trade in ships, but at the expense of her ship-building establishments. The Italian Government pays now a subsidy of 8,000,000 francs to the Florio and Rubattino line of steamers for carrying the mails. This line consists of 90 steamers of from 500 to 5,000 tons, which ply to ports of the Mediterranean, India, and China. Since 1885 a new law, similar to that of France, has been enacted in Italy to encourage the Italians to build their own steamers.

Ten years ago Germany had but a small commercial marine, but she now owns 529 steamers, aggregating 601,975 tons. Most of this tonnage is in large vessels purchased abroad, but extensive subsidies have been allowed by the Government under which the German steam lines have been extended to all parts of the world.

And so it will be found that it is owing to the subsidies granted by foreign Governments that the great steam lines are enabled to hold their own in the thoroughfares of trade, while for want of this assistance to American steamers, our flag is seldom seen in those thoroughfares, nor will it be until our countrymen realize the necessity of adopting the system in use abroad.

To show how the commercial marine of the United States has fallen behind the other properties of the country, I will quote some suggestive figures. During the last twenty-five years the value of the property has increased more than three fold, from \$16,000,000,000 to \$50,000,000,000, the population during the same time has nearly doubled, the manufacturing products trebled, the farm products doubled, and railroad mileage quadrupled.

In 1860 we had vessels to the extent of 2,496,804 tons in foreign trade. In 1856 there were built 306 ships and barks, 103 brigs, 394 schooners, and 497 sloops, a total of 404,054 tons. Thirty years later, in 1886, we built 8 ships, 1 brig, 275 schooners, and 191 sloops.

In 1856 our foreign commerce amounted to \$591,000,000. In 1886 it was nearly three times that sum. In 1856 we carried most of our commerce in our own ships. Now it is carried in foreign ones.

When we built ships they were the staunchest and fastest in the world, and it is fair to suppose that if we could again compete with

foreign countries we should exhibit as much enterprise in building steamers as we did formerly in building sailing ships. We build the most magnificent river steamers in the world. Why could we not build the best sea-going ones?

These remarks concerning the necessity of building up the United States steam commercial marine, without which we cannot be considered a strong naval power, might be extended indefinitely. I consider the whole matter more particularly from a naval standpoint, although there are a multitude of reasons for building up our ocean-carrying trade. Compare its present condition with the wonderful increase in our other industries since the civil war, and you will see that we have paid out to foreign ship-owners at least \$3,000,000,000, and, worse than that, have lost the prestige which was formerly our country's pride.

I hope you will excuse me for taking up your time with matters which may not appear purely naval, but this is so much a naval question that without the resurrection of our mercantile marine we cannot become a strong naval power. When our mercantile marine is once established on a sure basis there will be no difficulty in Americans enjoying their fair share of the carrying trade. Traffic will follow the flag, as it did in the days of old, when the stars and stripes floated at the mastheads of the finest ships in the world. The cry that we have no foreign trade because we are a manufacturing nation will no longer be heard, for our steamships will carry these same manufactures to the remotest parts of the earth.

But to attain this desired end certain facts must be kept in view. Great Britain pays for ocean mail service to her steamships, not to mention other aids, \$3,500,000 annually. The United States paid last year for foreign mail service \$327,000—less than one-tenth the amount paid by Great Britain—and of that sum \$278,717.41 went to foreign vessels, leaving but a little over \$48,000 paid to Americans.

At this moment we are indebted to the Brazilian Government for aid to enable us to run a line of American steamships to Brazil, said Government paying \$88,000 annually to the steamship company for carrying the mails, while the United States offers but \$5,000! The Argentine Republic offered \$100,000 annually to an American company to carry the mails, while the United States offered \$3,000, and in consequence of the want of liberality on the part of the United States the line cannot be established.

These facts are significant and offer a full explanation of the causes why the United States make so poor a show of steamships upon the ocean. This deficiency will continue until our law-makers take a more liberal view of the situation.

REORGANIZING THE NAVY.

When the Navy is fairly re-established, the ocean steam marine is given an opportunity of attaining its proper level, and an adequate naval reserve is formed, there will be required a reorganization of the service. The days of old-fashioned ships have passed away. The pot-metal guns of twenty-five years ago will be melted up and a new system of ordnance will rule the hour. New kinds of ships, new kinds of guns, including machine and rapid-firing guns and torpedoes, will take the place of old means of offense and defense.

All the changes above mentioned will have to be met by corresponding changes in naval routine, and much time will be needed to bring

the Navy up to high-water mark. When a commanding officer is ordered to a ship, the difficulties of the situation will at once be apparent, although if he is a competent person he will be able to dispose of them, but the manning of a vessel and the general routine are matters that should not be left to the discretion of any single officer. These duties should be regulated by a board of officers, partly adopting ideas from European navies, but principally relying on our own intelligence as we have done heretofore.

The *personnel* of the Navy requires the most careful reorganization, and means should be adopted to infuse new life into it. As regards promotion the service is at a standstill. Many officers who are ensigns should be lieutenants, lieutenants should be lieutenant-commanders, the latter should be commanders, and commanders captains. A captain should be able to reach the grade of rear-admiral by the time he attains the age of fifty-two years, so that the Government could obtain some service from him in that grade. Under present circumstances it often happens that an officer goes upon the retired list as soon as he is promoted to the grade of rear-admiral, having attained the age of sixty-two years. No officer should be over forty years of age when commissioned a captain, or thirty-five when promoted to commander. The officers in the lower grades should be young men in robust health, active and energetic, to enable them to perform the varied duties of their profession, and should not be allowed to remain too long without promotion.

The men who commanded our ships and squadrons in the war of 1812 were of ages included between twenty and thirty-eight years, and the brilliant results of our naval operations during that war is a fair argument in favor of young men for such positions. I will not pretend to say just how such a desired end can be attained, but the necessity for some action in this direction is more apparent every year. Some sacrifices will have to be made for the general benefit of the service, but the Navy cannot continue on and be thoroughly efficient under the present rule when the new style of fighting demands that every department of a ship shall be managed by men of vigor and ability.

A law providing that commissioned officers of the Navy, with good records, be allowed to retire from active duty after thirty years' service with promotion to the next higher grade, would afford a great relief and help bring about a more rapid promotion, so that in the course of a few years we might expect to see a more hopeful feeling among the younger officers. The older ones have the goal of their ambition in sight and may hope ultimately to reach it, but to the younger ones, at the present time, the prospect is not cheering. Some of the more aspiring are seeking in private employment the advancement they fail to receive in the Navy.

BOARDS OF INSPECTION AND SURVEY.

The following tables exhibit the work, since November, 1886, of the boards of inspection and survey, of which Rear-Admiral James E. Jouett is president of the board for the Atlantic coast and Commodore John Irwin that for the Pacific. The provision of the law of August 5, 1882, requiring a triennial inspection of the ships of the Navy has, as far as practicable, been complied with. A few yet remain to be examined, but they are mostly unimportant vessels, and orders have been given that will complete this duty during the present summer.

List of inspections since November, 1886.

Name.	When inspected.	Remarks.
<i>Vessels in commission inspected for general efficiency.</i>		
Kearsarge	Nov. 18 and 19, 1886	End of cruise; recommended for repair.
Dolphin	Dec. 9 and 10, 1886	Just fitted out.
Tennessee	Dec. 21 and 22, 1886	End of cruise; unfit for repairs.
Hartford	Dec. 29 and 30, 1886	End of cruise; recommended for repairs.
Galena	Jan. 7 and 8, 1887	Just refitted.
Alert	Feb. 7 to 11, 1887	Just fitted out
Ossipee	Feb. 21 and 23, 1887	End of cruise; recommended for repairs.
Richmond	Mar. 24 and 25, 1887	Just fitted out.
T. etis	Apr. 12, 1887	Just fitted out.
Ossipee	June 14 and 15, 1887	Repairs completed; recommissioned.
<i>Receiving ships.</i>		
Saint Louis	Dec. 17, 1886	Unfit for sea service, in tolerable condition for present duty.
Minnesota	June 3, 1887	Unfit for sea service, in tolerable condition for present duty. Requires repairs to the extent of \$3,500.
Dale	June 7, 1887	Unfit for sea service, in good condition for present duty.

Vessels examined in accordance with section 2, act of August 5, 1882, and recommended as unfit for further repair.

Name.	When inspected.	Remarks.
<i>Condemned and appraised.</i>		
Pilgrim	Feb. 16, 1887	Appraised value, \$2,000.
Tennessee	Mar. 23, 1887	Appraised value, \$35,000.
Ticonderoga	do	Appraised value, \$15,000.
Powhatan	do	Appraised value, \$17,000.
Cyane	Mar. 30, 1887	Appraised value, \$3,000.
Laokawanna	do	Appraised value, \$12,000.
Shenandoah	do	Appraised value, \$12,000.
Wachusett	do	Appraised value, \$10,000.
<i>Condemned, but not yet appraised.</i>		
Catalpa	June 3, 1887	Repairs would exceed the 20 per cent. limit.
Rescue	June 7, 1887	Do.

Vessels examined under the same act and recommended for repairs.

Name.	Station.	When inspected.	Estimated cost of repairs
<i>Iron-clads.</i>			
Wyandotte	City Point, Va.	May 6, 1887	\$21,700
Mahopac	do	do	28,000
Canonicus	do	do	41,000
Lehigh	do	do	23,000
Manhattan	do	do	47,500
Catskill	do	do	23,500
Ajax	do	do	36,000
Camanche	Mare Island, Cal.	May 11, 1887	9,543
Nantucket	New York, N. Y.	June 3, 1887	25,000
Jason	Philadelphia, Pa.	June 4, 1887	33,500
Montank	do	do	23,000
Nahant	do	do	33,000
<i>Torpedo boats and tugs.</i>			
Alarm	New York, N. Y.	June 3, 1887	13,000
Intrepid*	do	do	do
Nina (tug)	do	do	1,000

* Being altered to a gunboat.

Appraised in accordance with the provisions of the act of March 3, 1857 (Navy appropriation bill).

Name.	Date.	Remarks.
New York.....	June 16, 1857.....	Appraised value, \$3,000.

IRON-CLADS.

I beg leave to draw your attention to the general condition of the single-turreted monitors. Those now lying in fresh water at City Point, Va., on the James River, are the *Ajax*, *Wyandotte*, *Mahopac*, *Canoncius*, *Lahigh*, *Manhattan*, and *Catskill*. Distributed among these vessels, to keep them in good order, are five officers and sixty-nine men. The expense of taking care of them is about \$25,000 a year, which is rather a large amount to pay for vessels that are being allowed to go to decay for want of proper repairs. If there is no intention of repairing them, I would recommend that the crew list be reduced by four ordinary seamen and a landsman, and that their places be supplied by two more carpenters, which would enable the officer in charge to keep their wood-work in order and to calk and patch their-decks.

These vessels are as valuable to-day as ever they were for harbor defense, should they receive the necessary repairs, and in time of war would assist materially in defending the approaches to the capital, which, be it remembered, was captured in 1814 by a small army landed from a few vessels of war. The *Potomac* is no better defended now than it was then—in fact, it is not defended at all. I would renew my recommendation of last year that these monitors be put in repair. With strict economy this can be done for the small sum of \$220,200. Before the monitors could be moved by their own steam it would be necessary to tow them to a dry dock and there commence work on them, as it would be dangerous to open the sea and water valves while they are in the water. The actual defects of the vessels cannot be discovered until they are docked.

At Mare Island, California, the *Camanche* is ready for use as far as her boilers and engines are concerned, but she will require an expenditure of \$9,545 to prepare her for actual service. It is a pleasure to say that this vessel has been well cared for.

The general condition of the *Nantucket*, at the New York navy-yard, is bad and shows lack of care. This neglect should be avoided in the future, if the vessel is to be kept from going to decay, in order to preserve her for such use as she is capable of rendering in time of need. The estimated cost to put the *Nantucket* in condition for active service is \$25,000.

At the League Island navy-yard, Philadelphia, are moored the *Jason*, *Montauk*, and *Nahant*, and their condition is worse than that of the *Nantucket*. The Board of Inspection and Survey reports that they are not cared for properly, and, save in the engineer's department, are in an uncleanly state. Rubbish and sweepings were found in the bilges and on the lower decks, and their guns are in a bad condition and show great neglect. Cementing has protected the bottom plates of these vessels, and the rust of the hulls inside is partially covered with paint. The iron frames at and near the floor are, however, much in need of paint in many places, rusting having occurred underneath the whitewash. The estimated cost for repairs to these vessels is \$300,000.

The *Passaic*, at the Naval Academy, Annapolis, Md., and the *Saugus*, at the Washington navy-yard, have not recently been inspected by the board, but as the former is used as a practice vessel for the naval cadets it is fair to suppose that she is in a better condition than her sister ships, and I judge that \$25,000 would render her effective for active service. The *Saugus* is borne on the Navy Register as condemned, and I am informed that she has been stripped with a view to her sale, but as this condemnation has not been made in the manner contemplated by the law of August 5, 1882, orders for a formal survey have been given to the board.

The grand total for the repair of all these iron-clads is \$369,745, a sum insignificant in comparison with the results which would be gained by its expenditure. In recommending that these vessels be placed in order, I take it for granted that they will be supplied with a modern armament, without which they could not be considered efficient for harbor defense.

I have the honor to be, very respectfully, your obedient servant,

DAVID D. PORTER,
Admiral, U. S. Navy.

The SECRETARY OF THE NAVY.

No. 6.—NAVAL ACADEMY.

REPORT OF THE BOARD OF VISITORS.

UNITED STATES NAVAL ACADEMY,
Annapolis, Md., June 11, 1887.

SIR: The Board of Visitors to the U. S. Naval Academy has the honor to submit the following report:

The Board consisted of the following gentlemen: Commodore D. B. Harmony, U. S. N.; Hon. George Gray, U. S. Senate; Hon. N. W. Aldrich, U. S. Senate; Hon. H. A. Herbert, House of Representatives; Hon. Nathan Goff, House of Representatives; Hon. J. D. Sayers, House of Representatives; Hon. William A. Wallace, of Pennsylvania; Hon. H. S. Van Eaton, of Mississippi; President D. C. Gilman, Johns Hopkins University; Col. A. S. Morgan, of Arkansas; Hon. Thomas A. Logan, of Ohio; Prof. W. G. Sumner, Yale College.

The Board was organized on June 4, as follows:
President, Commodore D. B. Harmony, U. S. N.
Vice-President, Hon. George Gray, U. S. Senate.

STANDING COMMITTEES.

(1) *Conditions of admission to and discharge from the Academy*: Hon. H. A. Herbert, Hon. N. Goff, Col. A. S. Morgan, Commodore D. B. Harmony.

(2) *Subjects of study and standard of scholarship*: President D. C. Gilman, Senator G. Gray, Prof. W. G. Sumner.

(3) *Grounds, buildings, and sanitary condition*: Hon. J. D. Sayers, Hon. William A. Wallace, Hon. T. A. Logan.

(4) *Seamanship, ordnance, and navigation*: Commodore D. B. Harmony, Hon. N. Goff, Hon. H. S. Van Eaton.

(5) *Discipline, drill, practical exercises, administration, and police*: Hon. N. Goff, Hon. William A. Wallace, Commodore D. B. Harmony.

(6) *Steam, mathematics, physics, and mechanics*: Prof. W. G. Sumner, Col. A. S. Morgan, Hon. T. A. Logan.

(7) *English studies, modern languages, and drawing*: Hon. William A. Wallace, Hon. H. S. Van Eaton, President D. C. Gilman.

(8) *Finance and library*: Hon. H. A. Herbert, Hon. J. D. Sayers.

(9) *Final report and selection of orator to address cadets on 10th June*: Senator G. Gray, President D. C. Gilman, Prof. W. G. Sumner, Hon. Nathan Goff, Col. A. S. Morgan.

Senator N. W. Aldrich and Hon. N. Goff did not appear at the Naval Academy during the sessions of the Board.

The recommendations of these committees, as acted upon by the Board, are incorporated under corresponding heads of this report.

I.—CONDITIONS OF ADMISSION TO AND DISCHARGE FROM THE NAVAL ACADEMY.

The Board is of opinion that it would be advisable to so amend the regulations governing the admission of cadets to the Academy as to give to the Academic Board the same power to pass upon the physical as upon the intellectual examination of applicants.

When the reports of the examinations by the several professors in their respective branches now come in it often happens that the Academic Board, in looking at results in the aggregate, decides that deficiencies in one or more branches are more than counterbalanced by excellence in others. In such cases the cadet is, very properly, passed, as the intellectual capacity of the applicant is of even greater importance than the excellence of his previous training. In like manner, it seems to the Board that in deciding upon the question of admission the intellectual capacity and equipment of an applicant ought to be considered in connection with his physical development, and there seems to be no good reason why the Academic Board, with the assistance of its medical staff, should not pass upon the whole question, having at the same time power to exercise due discretion in the premises.

There seems now to be some doubt as to the present relation of cadets to the Government, and the Board is of opinion that at the time of their admission they should be regularly mustered into the service of the Government and made subject to the articles of war.

II.—SUBJECTS OF STUDY AND STANDARD OF SCHOLARSHIP.

The Board has informed itself in regard to the course of study pursued by the cadets, and sees no grounds to criticise it.

The professors and instructors show great zeal and interest in their work, and vie with each other in their efforts to develop the work in the several departments so as to make the Academy as efficient as possible.

The Board is very decidedly of the opinion that since the law now provides that naval constructors and naval engineers, as well as officers of the line, shall be taken from the graduates of this Academy, the education of the cadets intended for these several corps should be, as far as possible, specially adapted to fit them for their intended occupations.

The advantages of educating specially are now so well understood and so universally acknowledged that no argument in favor of the general proposition seems necessary; and it is quite apparent that the reasons which now commend it generally to experienced educators apply nowhere with more force than here. The importance of a thorough technical education for those who are in the future to build our ships and plan or supervise the construction of engines to run them cannot be overestimated.

The Board thinks the present course in the Academy for the first three years is well adapted to lay broadly the foundation for a subsequent technical education in any and all of the branches of our naval service. This three years' coeducation of our future naval officers of all branches of the service is well adapted also to promote that *esprit de corps* which should unite all who are in our naval service. In the fourth year, however, we think a cadet should begin that special education which is to fit an officer for the branch of the service he is to enter.

The Board, therefore, recommends that the studies of the fourth year be arranged by the Academic Board in groups; that one of these shall

have especial reference to the training required for service in the line, and others to the training required for service as naval engineers, naval constructors, and other like officers; that near the end of the third year every cadet shall be called upon to indicate which of the prescribed courses of the fourth year he desires to follow, and that with the approval of the Academic Board he shall be allowed to exercise his choice.

This arrangement, it is believed by the Board, will be also desirable for those who, under existing law, are not to receive commissions, as it will enable them, subject to the approval of the Academic Board, to direct their studies in such manner as shall appear best adapted to their probable future avocation.

The Board also concurs in the recommendation made by the Academic Board and by the last Board of Visitors, that cadets should graduate at the end of their four years' course in the Academy, and be then either commissioned into the Navy or discharged and permitted to begin life for themselves.

For those who are eventually to be remanded to civil life a two years' cruise is unnecessary; it is even a hardship, for it not only deprives them of time, which is invaluable, but, except as to that small number who may subsequently take to the sea, it tends to unfit them for other occupations.

The advantages to the Government of dropping the two years' course seems also to be obvious.

It would be economy, because we should then be paying all cadets at the same rate, viz, \$500 each per annum, whereas those taking the two years' cruise are now paid \$900 each per annum.

It would also save the heavy expenses now incurred in sending cadets home at the end of two years for examination.

A still greater advantage to the Government would result from the fact that the graduating class would be one-third larger.

This would give the Government a larger number from which to select its best men, and at the same time enable it to educate and distribute throughout the Union a larger number of young men whose moral influence and technical skill in time of peace and usefulness in case of war would be of great value.

Some remarks upon the difficulty of accomplishing all that is desired in the time allowed will be found below, under No. 6, the heading "steam, mathematics, physics, and mechanics."

III.—GROUNDS, BUILDINGS, AND SANITARY CONDITIONS.

Marine barracks.—A close inspection of this building disclosed to the Board that the ground upon which it stands is what is commonly called "made ground," and that the foundation is so infirm as to have yielded to the constant and heavy pressure from above. The consequence has been that, though the building is of recent construction, two of the main walls, running at right angles to each other, are separating, and unless immediate and substantial repairs are made there is great danger of the building falling to the ground.

To be more specific, the wall in the rear of the right wing needs bracing; the ceiling is badly cracked and has fallen in many places; all the steam pipes need repairing; the floors are rapidly decaying, some of them being unfit for use; new timbers and joists are required; the steam heaters are too small for the quarters; the roof is leaking badly; the lightning rods are not properly put up and should be changed; and the water pipes are so worn as to be scarcely serviceable. This building and also the officers' quarters should be repainted.

The new cadet quarters.—The Board is informed that the walls of this building are 24 inches thick at the bottom and 20 inches thick at the top; yet the construction has been so faulty that a crack, plainly discernible, has opened in the ceiling of the fourth story, about 30 feet from the northeast end. This crack is to be seen in the ceiling of each lower story at about the same place as in the upper story, and runs south and across the building in each story to the outer wall and thence down the outer wall and on its outside to the ground, constantly increasing in size.

The Board is informed that the ground upon which this portion of the building stands is "made ground," and it is more than probable that the fissure is the result of an insecure foundation. Should a very heavy storm occur it is possible, if not altogether probable, that this portion of the building will give way, not only endangering the safety of the entire building, but the lives of the occupants.

There should be no delay in making the necessary repairs so as to render the building entirely secure against such an accident. The floors were found to be everywhere rough, worn, and in a bad condition; the material out of which they were constructed was inferior, and the workmanship rough and careless. They should be replaced.

There are 104 rooms occupied by the cadets, 12 of which are too large. The wardrobes in these rooms are poorly constructed out of inferior wood, and annually cost in the way of repairs more than they are now worth.

The basement floor is of rough brick, unevenly laid. It should be covered with a heavy coating of cement.

The room used for carving at meals is a mere passage-way, used in entering and going out of the building, and also for access to a water-closet near by. Cleanliness demands that a change should be made.

There are three stairways leading from each story to the ground, by which the building can be easily emptied within three minutes should a fire break out. In addition to these facilities other means should be provided by which, if the stairways were destroyed, the inmates could escape speedily and without difficulty.

The blackboards used by the cadets are of wood, illy-jointed, for which slate should be substituted.

The building is badly arranged for cooking purposes. The smell from the cook-room, the Board is informed, sometimes penetrates all of the rooms, from top to bottom.

With the correction of these defects, which may be made at a comparatively small cost, the Board is of the opinion that the building may be made entirely suitable for its present purposes, and thus the necessity of erecting new quarters be, for the present, obviated.

Although the Board reached this conclusion in regard to the advisability of repairing the "new quarters," it is to be noticed that further accommodations are urgently needed for quarters, for mess-hall, and for recitation rooms. Parts of the "new quarters" are used for each of these three purposes.

The recitation rooms in that building and elsewhere are quite unfit for the use of the cadets and need to be replaced by modern buildings and apparatus. A group of buildings should be constructed on a plan so as to utilize the present buildings in the most economical manner, and to provide for the separation of quarters, mess-hall, and recitation rooms.

It is suggested that a plan of this sort should be made after examination of the halls recently constructed for such purposes in the leading colleges.

The unoccupied hospital.—This and the buildings connected therewith have not been used for several years past. With the exception of the galleries, stairways on the outside, and the wooden supports and fixtures which have been exposed to the weather, the buildings appear to be in good condition, and should be put to some use.

At present they are under the charge of a single person employed to take care of them.

They were originally well built and can be made very serviceable at a small cost to the Government.

The Board accordingly recommends that these buildings be properly repaired and used as quarters for such officers and instructors of the Academy as are not provided with rooms within the Academy walls.

Purchase of additional ground.—There is a small tract, consisting of about 5 acres, fronting on the river and bounded on three sides by the Academy grounds. This tract belongs to private individuals; it should become the property of the Government; it is a necessity to the Academy, not only in order that all of the property belonging to the Academy may lie continuously together, but also it is the proper place upon which should be gas-works for the use of the Academy.

The Board recommends its purchase.

Buildings for commissary and general storekeeper, and cadet store, tailoring room, and offices.—The duties relating to these rooms and offices, in addition to the laundry and mess establishments, all devolve upon one officer. It will be seen at a glance that they are not only many but also very different. It is, therefore, very important that there should be as much concentration as may be possible, not only for his own convenience but also for the benefit of those who are directly interested in the success of the service. The buildings in which these offices and rooms are located, and in which the public and the cadet stores are deposited, are scattered over the Academy grounds, rendering it physically impossible for the officer in whose charge they are, and who is directly responsible for their proper safe-keeping and distribution, to give them that constant and close supervision which they should have. Again, many of these rooms and offices are in a most wretched condition, not only wholly unfit for the uses for which they are intended, but also in the highest degree unhealthy.

The order of the Secretary of the Navy of December 14, 1886, in regard to property and stores at all yards and stations is as follows:

As soon after the 1st of January proximo as may be practicable, the work of concentrating said stores in the buildings designated will be commenced and completed at the earliest date consistent with due economy.

This order, it is believed, applies as well to the Academy as to the other branches of the Naval Department, but to this date, for reasons stated, has not been executed.

The interest of the Academy, the Board believes, imperatively demands an early compliance with the spirit and the letter of this order.

The Board is of the opinion that an entire building should be allotted to the commissary and general storekeeper as a building in which to maintain his necessary offices, and to hold the cadet store, the tailoring establishment, and such other stores as are under his control, and for whose preservation and distribution he may be responsible.

Paymaster's office.—This is in a building with a leaky roof. The floor is in a bad condition, the size of the rooms is entirely insufficient for the business done, and there is great want of the proper facilities for paying off labor rolls. The stairway leading to the offices is narrow and inconvenient for the purpose.

The location of this office in a suitable and better building is also recommended.

Office of the superintendent of grounds and buildings.—The Board is of opinion that this officer should be required to submit to the Board of Visitors, on the first day of its organization, an itemized statement of his expenditures, with outstanding liabilities, showing upon what buildings and for what purposes the sum annually appropriated by Congress for repairs, furniture, etc., has been expended.

This recommendation is made for the reason that such appropriation is not specific, but in bulk, and it is proper that the Board of Visitors should be advised upon the subject.

The Board has found the grounds and the buildings, except as herein mentioned, in good order, and take pleasure in expressing the opinion that such condition is to be attributed to the energy, attention, and supervision of the Superintendent of the Academy and of the superintendent of the buildings and grounds.

IV.—SEAMANSHIP, ORDNANCE, AND NAVIGATION.

The Board has given special attention to the very important branches under this heading, and recognizes to the fullest extent the fact that proficiency in them insures the successful management of war vessels under all circumstances.

The careful practical instruction given in these branches, the zeal and efficiency of the heads of departments and their assistants, were remarked with great satisfaction.

Skill in tactics under steam was demonstrated in the maneuvers of twelve steam cutters, and showed a high degree of excellence and precision.

The steamer *Wyoming* was gotten under way by the cadets, and the exercises under sail were executed by them entirely in such a manner as to convince the Board of the thoroughness of the instruction in seamanship. It is to be regretted that there is not stationed at this Academy a suitable vessel of modern type, complete in all her appointments, to supersede the *Wyoming*, a relic of past times and obsolete methods.

The great gun exercises, firing at target, drill of the battalion, and the various exercises in fencing and small-arms were very satisfactory, and reflect great credit on the department of ordnance and gunnery. The disadvantage under which this department labors in not having at its command the means of showing the cadets the latest improvements in all branches of ordnance is noteworthy, and suitable provision should be made at once for furnishing new guns and the latest system of small-arms to the Academy in order that its graduates may be prepared to teach their uses on board ships which will be supplied with them.

Navigation, both theoretical and practical, is so thoroughly taught that it leaves nothing to be desired in this department.

V.—DISCIPLINE, DRILL, PRACTICAL EXERCISES, ADMINISTRATION AND POLICE.

Under the administration of the present Superintendent of the Naval Academy and his predecessor the discipline has reached a very high standard.

The system of assigning merit and demerit marks to the cadets, their classification into conduct grades, and the methods of determining their relative excellence in scholarship, show the best possible results.

The conduct records exhibit a marked absence of serious offenses; those noted are chiefly of a trivial character.

The Board is gratified to state that the inhuman and cowardly practice of hazing is almost obsolete.

The opportunities enjoyed by the cadets are such as prepare them to perform their duties as representatives of their Government in a creditable manner abroad as well as at home.

The tactical drills in infantry and artillery show very careful training and are creditable alike to officers and cadets.

The Superintendent and his assistants are to be congratulated upon the success of their efficient methods and careful supervision.

VI.—STEAM, MATHEMATICS, PHYSICS, AND MECHANICS.

The instruction in these departments appears to the Board to be very thorough, and as comprehensive as the present circumstances of the Academy will permit.

But inasmuch as by the existing laws all cadets are required to take the same course instead of taking special courses, there can not possibly be given to the separate studies time enough to make them as complete as they should be. The results obtained, therefore, must be judged by that fact, and so considered are all that could be expected.

If the system of a post-graduate course in all of the higher branches shall be adopted, as recommended, the Board is satisfied that its benefits will become speedily manifest in each of these divisions.

Although they are now hampered by want of time, the proficiency attained by the classes is noticeable and gratifying.

The course of steam engineering includes the practical operations of the art. Its details are fully exemplified and cover the supposed contingencies of actual service. Blacksmithing and boiler making are carried on. Engines are worked in the shops and in the steam launches. Several of the launches are run by engines constructed by the cadets. The pattern shops show creditable specimens of their skill in wood-working.

In the department of steam engineering nothing, apparently, but more time for the course is required to make it complete.

The department of physics and chemistry is well administered, but, unavoidably, is now too limited; the requirements of these sciences are broad and of continuously increasing importance. The scope of the course should be correspondingly widened and longer time given to it.

The department of mathematics is admirably conducted, but like the other lacks time to carry out within the limits of the course what the professors in charge consider necessary.

A post-graduate course here, embracing the higher requisites of modern naval architecture and of applied mechanics, is particularly desirable and is strongly recommended.

VII.—ENGLISH STUDIES, MODERN LANGUAGES, AND DRAWING.

The Board has examined and considered the methods of instruction pursued at the Academy in the branches of "English studies, modern languages, and drawing," and is of the opinion that the amount and character of the work performed can not be improved upon or increased under existing circumstances, and therefore has no recommendation to make.

The Board is gratified to learn that opportunities are now afforded for instruction in German as well as in French and Spanish. A great amount of scientific discovery is first published to the world in the German tongue, a fact which makes a knowledge of this language particularly important to all who have a predilection for advanced study.

VIII.—FINANCE AND LIBRARY.

The Board has looked into the accounts of the commissary, who is now, by order of the Secretary of the Navy, purchasing agent and general storekeeper of the Government at the Academy.

His accounts seem to be well and correctly kept, but the Board does not think he has been furnished with sufficient facilities for doing his general business. He should have more help, better and more furniture, and care should be exercised to give him better and more complete control of the business intrusted to him by order of the Department.

The cadets are furnished with a sufficiency of wholesome and well-cooked food, at what appear to be reasonable prices.

The washing of the cadets is well and cheaply done in a steam laundry supported by the cadets out of their pay.

The Board examined the store which furnishes the cadets with clothing, books, and other necessaries, looked over the accounts, which are well and plainly kept, and observed the prices of goods, which appear to be reasonably low. The store seems to be well managed and the working capital furnished by the Government (\$24,500) appears from the books to be intact.

The plan is to have the cadets pay out of their annual allowance of \$500 for their food, clothing, books, and other necessaries. The Government furnishes a store-house, a clerk, and responsible paymaster to control the store, and the cadets are charged 5 per cent. advance upon wholesale prices to cover losses. This seems to be a sufficient percentage, as the losses are not large, occurring principally on books dropped from the course of study.

The books of the officer who pays all Government money appear to be well and correctly kept and his business is well conducted. The manner of keeping accounts with the cadets is admirable.

The library is especially valuable in technical books; it is well arranged and well conducted. The accommodations, however, for the books on hand are insufficient, but it is believed the appropriation made at the last session of Congress will erect an addition which will suffice for many years. The Board has examined the plans which have been prepared for the proposed addition to the present building and think the designs are judicious.

In conclusion, the Board desires to express the satisfaction with which it has observed on every hand the evidences of careful administration and the zealous attention to the promotion of the ends for which the Academy was founded.

Respectfully submitted.

D. B. HARMONY,
Commodore, U. S. Navy, President.

GEO. GRAY,
U. S. Senate, Vice-President.

HILARY A. HERBERT,
House of Representatives, Member.

JOSEPH D. SAYERS,
House of Representatives, Member.

WILLIAM A. WALLACE, *Member.*

H. S. VAN EATON, *Member.*

D. C. GILMAN, *Member.*

A. S. MORGAN, *Member.*

THOS. A. LOGAN, *Member.*

W. G. SUMNER, *Member.*

Hon. W. C. WHITNEY,
Secretary of the Navy, Washington, D. C.

REPORT OF THE SUPERINTENDENT.

UNITED STATES NAVAL ACADEMY,
Annapolis, Md., October 13, 1887.

SIR: The following report may be considered to embrace the various recommendations and reports which have been submitted to the Department for approval from time to time during the past year.

The following table shows the number of cadets at the opening of the academic year, October 1, 1886, and at the end of the year, with the percentage of failures in each class:

Class.	Number October, 1886.	June, 1887.	Loss dur- ing year.
			<i>Per cent.</i>
First	46	*44	5
Second	49	37	25
Third	57	43	24½
Fourth	85	54	36

* Graduated.

In May last, 69 candidates were examined and 35 passed. In September, 96 were examined and 61 passed.

The total number of cadets now in the Academy is 229.

First class	37
Second class	42
Third class	53
Fourth class	97

The high standard of academic merit has been maintained during the year, while the conduct of the cadets has, in general, been excellent.

In March, one cadet was tried for hazing, found guilty, and dismissed. One case of hazing was reported during the summer practice cruise, which was brought before a court at the termination of the cruise. This cadet was also dismissed. Three cases occurred in the fourth class during September, on board the *Santee*. These cadets were tried and found guilty. In view, however, of the mildness of the offense and probably, also, because there seemed to be an impression among the cadets that those of the fourth class who entered in May could not, according to the legal definition, haze cadets of the same class who entered in September, the court did not recommend their dismissal. No cruel or degrading instance of this offense has taken place for a long period; the strict construction placed upon the law by the court and the Department has effectually suppressed the tendency to this objectionable practice; and it is the Superintendent's intention to bring to trial every form of hazing, no matter how trifling.

In conformity with the act of Congress requiring instruction to be given to all classes of cadets in "the physiological effects of alcohol and other stimulants, and their effects upon the human system" (approved May 20, 1886), a department of physiology and hygiene was added to the course of study. The surgeon of the Academy was made head of the department and a member of the Academic Board.

Instruction was given by means of lectures and recitations from a text-book. A French manikin, a skeleton, charts, magic-lantern views, etc., were obtained to facilitate the instruction.

The principal text-books in ordnance and gunnery have been revised. The work on Exterior Ballistics has been printed and issued to the cadets. The Text-book on Ordnance and Gunnery and the work on the Elastic Strength of Guns are now in the hands of the printer, and will be ready for issue November 1.

Only small editions of these books (all of which were prepared at the Academy) are published, in order that they may embrace the latest advances in the science of gunnery and gun construction.

A revised edition of the Academy Regulations has been prepared and is now in the hands of the Government Printer.

The library, which contained 28,275 volumes on October 1, 1886, was increased 980 volumes during the year. The addition to the library building provided for in the last appropriation is nearly completed, and will furnish accommodation for the books for the next quarter of a century.

The course of instruction has continued without material change, except in the case already noted of the department of physiology and hygiene. It is, however, the unanimous opinion of the Academic Board that important changes should be made; at the same time it is considered inexpedient to make any change until the course of instruction be reduced to four years, as recommended in my last report. Changes in the course of studies involve disadvantages at all times, and should only be made when necessary; for this reason the Board is disinclined to make any recommendation in the matter until the important question of the length of the course can be finally decided.

I therefore urgently recommend that the course be reduced to four (4) years, as provided in the bill presented by the Naval Committee last winter.

The general character of the summer practice cruise was somewhat modified by the plan of assigning marks for the practical work of cadets of the first class.

The plan has worked well, as shown by the report of the officer commanding, and it proposed to extend it to other classes and other work.

It is thought that manual skill in the machine shop, activity aloft as a sailor, and officer-like bearing in the performance of duty should have a more direct bearing in determining the class standing than has heretofore been the case.

The recommendation of the commanding officer of the practice cruise regarding the method of detailing men for that cruise, is fully approved, and I would urgently suggest that an exception be made in the case of the Academy with reference to general-service men, and that a limited number of selected men be detailed for the Academy, these men to constitute the leading men of the practice cruise. They have a great influence even upon the moral character of the cadets, not to mention their many important functions in assisting the young men in learning their profession.

This must be the case when a hundred or more cadets are placed on board ship for several months to perform the same duties as the men. This close relation between the sailor and the future officer is of incalculable advantage to the latter in assisting him to learn the little matters of a sailor's profession, and in bringing the young officer into complete sympathy with the men he must learn to command. The advantage of having good men is manifest, and the injury which may be done by bad and incompetent men is equally apparent.

It is unnecessary to repeat the recommendations which were submitted with the annual estimates.

Of the 31 members of the class who passed their final examination in June, after two years at sea, 20 were admitted to the service, and 11 were honorably discharged.

I respectfully suggest that those cadets who fail to obtain positions in the Naval Service, after four years at the Academy and two years at sea, are well qualified for positions in the Revenue Service. This subject has been considered by the Department before, and a similar recommendation has been made in connection with other changes, involving a transfer of the Revenue-Marine Service to the Navy Department. Without any reference to the merits of such a change, I think it would be a source of economy, aside from its other advantages, if graduates of the Naval Academy were appointed to fill vacancies in the Revenue-Marine Service, which, probably, could be accomplished by an understanding between the two Departments interested and without legislation.

Respectfully submitted.

W. T. SAMPSON,
Commander, U. S. Navy, Superintendent.

The SECRETARY OF THE NAVY,
Washington, D. C.

UNITED STATES NAVAL ACADEMY,
Annapolis, Md., October 1, 1887.

SIR: I transmit herewith the annual estimates for the Naval Academy for the fiscal year ending June 30, 1889. In addition to the usual appropriation, the following items require special explanation:

For a practice vessel for the Academy \$275,000

There is not at the Academy a single example of modern ordnance except a 37^{mm} Hotchkiss, a Gatling, and a small Gardner gun, all loaned by the Bureau of Ordnance.

The target practice with rifled guns is now, and, for years past, has been confined to the obsolete Parrott gun. Within three years, three of these guns have burst while in use by the cadets; though no fatal accident has occurred it has become necessary to limit the practice to the smallest caliber which is considered the least dangerous.

Nor is there at the Academy an example of a modern marine engine. As the main object of this institution is to prepare its graduates to perform their duties at sea, it is evident that they should be instructed in the use and care of modern ships and their equipment.

Under the wise and persistent efforts of the Department, the Navy will shortly be composed entirely of modern vessels armed with high powered guns and equipped with modern appliances. It would, therefore, seem most necessary that the cadets should be supplied with the only means by which they can obtain a practical knowledge of these important elements of their profession. The graduates who are to become engineers should be instructed not only in the principles of compound engines, forced draft, etc., but should have actual practice in these modern, but now universal tools, and methods.

The vessel proposed, it is thought, would combine in the most thorough and practical manner all the advantages required. The vessel would be small, and could, therefore, be used daily without great expense. The engine should be triple-expansion, and an example of the most advanced ideas in marine engines. The battery should be composed of light guns of high power, in order that the ammunition might not be expensive.

It is believed that such a vessel, with a battery composed principally of rapid-firing guns—either 6 or 9 pounders—would also be more efficient as a cruiser than if armed with heavier guns. This vessel could be built under the direction of the Department, as other vessels are building, and when completed, turned over to the Academy. The service would have added another efficient vessel to the list, and the object secured of having proper means for instructing the cadets.

It is to be noted that no money appropriated by Congress for the construction of guns or building engines is available for supplying the Academy with these indispensable means of education.

For the purchase of land adjacent to the Academy, and which separates it from another portion of the Government property..... \$103,000

This recommendation has been repeatedly made, and the grounds of the Academy have been added to by the purchase of portions of this property as it became absolutely necessary. There still remains 5.03 acres between Hanover street and the river, which separates the Academy grounds proper from the (about) 11 acres of Government land on the same side of the river. The walls of the Academy inclose about 50 acres, but the 11 acres above referred to are of no service while cut off by the private property lying between it and the Academy. The discipline of the institution requires that the cadets should be kept within its limits, except upon special occasions, so that the space available for exercises, drills, and sports is now too limited.

A chart of the property is sent herewith, which will make plain the relative positions of the Government and private property. The portion which it is recommended to purchase lies between Hanover street and the river—5.03 acres—together with the small triangle of 1.64 acres bounded by Hanover and Wagner streets and the Government property.

This property is occupied by a large number of inferior buildings. The price asked by the various owners is considered just and reasonable, except in two or three cases—notably the Gas-light Company.

All the lands and improvements should, however, be judicially appraised and condemned, to insure fair dealing with the Government. The total amount asked by the owners is \$103,000, which is, probably, \$15,000 in excess of what it would be sold for.

The 5.03 acres between Hanover street and the river is valued at \$89,000; this portion contains the gas-works, which are most overestimated in value.

For converting the abandoned hospital into quarters for instructors..... \$10,000

This estimate is made at the earnest recommendation of the last Board of Visitors.

Preliminary designs and estimates have been made for the work of remodeling the building so that it would accommodate eight small families.

The cost would certainly be less than what would be required to erect new quarters for the same number of persons. At the same time, the hospital is at a considerable distance from the Academy, and during a portion of the year would be difficult of access.

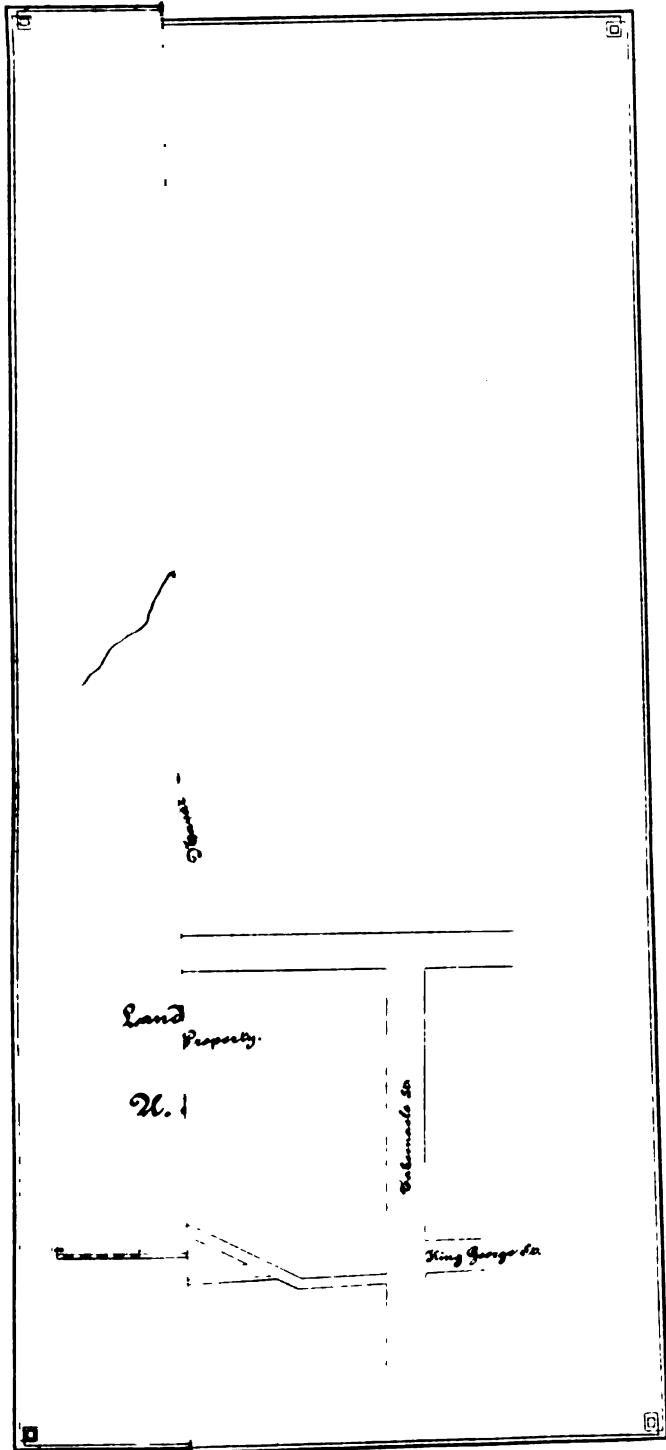
It is thought that the same amount of money used to erect additional quarters within the grounds would be more satisfactory.

Respectfully submitted.

W. T. SAMPSON,

Commander, U. S. Navy, Superintendent.

The SECRETARY OF THE NAVY,
Washington, D. C.



Land Property.

N. 1

Richmond St.

King George St.



Estimates of appropriations required for the service of the fiscal year ending June 30, 1889, by the United States Naval Academy.

Detailed objects of expenditure, and explanations.	Estimated amount which will be required for each detailed object of expenditure.	Total amount to be appropriated under each head of appropriation.	Amount appropriated for the current fiscal year ending June 30, 1888.
FOR PAY OF PROFESSORS AND OTHERS.			
One professor of mathematics and one of physics, at \$2,500 each (appropriated)	\$5,000.00		
Three professors (assistants), viz, one of chemistry, one of French and Spanish, and one of English studies, history, and law, at \$2,200 each (appropriated)	6,600.00		
Five assistant professors, viz, one of English studies, history, and law, three of French, and one of drawing, at \$1,800 each (appropriated).....	9,000.00		
One sword-master, at \$1,500, and two assistants, at \$1,000 each (appropriated).....	3,500.00		
One boxing-master and gymnast (appropriated).....	1,200.00		
One assistant librarian (appropriated)	1,400.00		
One secretary to the Naval Academy (appropriated).....	1,800.00		
Three clerks to the Superintendent, at \$1,200, \$1,000, and \$800, respectively (appropriated)	3,000.00		
One clerk to the commandant of cadets (appropriated).....	1,200.00		
One clerk to paymaster (appropriated).....	1,000.00		
One dentist (appropriated)	1,600.00		
One baker (appropriated)	600.00		
One mechanic in department of physics and chemistry (appropriated).....	730.00		
One cook (appropriated).....	325.50		
One messenger to the Superintendent (appropriated)	600.00		
One armorer (appropriated)	529.50		
One gunner's mate (appropriated).....	489.50		
One quarter-gunner (appropriated).....	409.50		
One cockswain (appropriated).....	489.50		
One seaman in department of seamanship (appropriated)...	349.50		
One attendant in department of astronomy, and one in department of physics and chemistry, at \$300 each (appropriated)	600.00		
Six attendants at recitation rooms, library, store, chapel, and offices, at \$300 each (appropriated).....	1,800.00		
One band-master (appropriated).....	528.00		
Twenty-one first-class musicians, at \$348 each (appropriated)	7,308.00		
Seven second-class musicians, at \$300 each (appropriated)...	2,100.00		
		\$52,119.00	
Additional pay to one assistant professor of French (submitted)	400.00		
Additional pay to first clerk to Superintendent (submitted)	300.00		
Additional pay to second and third clerks to Superintendent, at \$200 each (submitted)	400.00		
One assistant in library (submitted).....	900.00	2,000.00	
Special course of study and training of naval cadets, as authorized by act of Congress, approved August 5, 1882 (appropriated)	5,000.00	54,119.00	\$52,119.00
		5,000.00	5,000.00
FOR PAY OF WATCHMEN, MECHANICS, AND OTHERS.			
Captain of the watch and weigher, at \$2.50 per diem (appropriated).....	912.50		
Four watchmen, at \$2 per diem each (appropriated).....	2,920.00		
Foreman of gas and steam-heating works of Academy, at \$5 per diem (appropriated)	1,825.00		
Labor at gas-works and steam buildings, for masons, carpenters, other mechanics, and laborers, for care of buildings, grounds, wharves, boats, etc. (appropriated)	37,864.95		
One attendant in the purifying house of the gas-house, at \$1.50 per diem (appropriated).....	547.50		
		44,069.95	44,069.95
FOR PAY OF EMPLOYÉS IN DEPARTMENT OF STEAM ENGINEERING.			
For pay of mechanics and others in department of steam engineering (appropriated)	7,824.50	7,824.50	7,824.50

Estimates of appropriations required for the service of the fiscal year, etc.—Continued.

Detailed objects of expenditure, and explanations.	Estimated amount which will be required for each detailed object of expenditure.	Total amount to be appropriated under each head of appropriation.	Amount appropriated for the current fiscal year ending June 30, 1886.
REPAIRS AND IMPROVEMENTS.			
For necessary repairs of public buildings, pavements, wharves, and walls including the grounds of the Naval Academy, and for improvements, repairs, and furniture and fixtures (appropriated)	\$21,000.00	\$21,000.00	\$21,000.00
HEATING AND LIGHTING.			
For fuel and for heating and lighting the Academy and school-ships (appropriated)	17,000.00	17,000.00	17,000.00
FOR CONTINGENT EXPENSES.			
For purchase of books for the library (appropriated)	2,000.00	2,000.00	2,000.00
For stationery, blank-books, models, maps, and for text-books for the use of instructors (appropriated)	2,000.00	2,000.00	2,000.00
For expenses of the Board of Visitors to the Naval Academy, being for mileage and \$3 per diem for each member for expenses during actual attendance at the Academy (appropriated)	1,500.00	1,500.00	1,500.00
For purchase of chemicals, apparatus, and instruments in department of physics and chemistry, and for repairs of the same (appropriated)	2,500.00	2,500.00	2,500.00
For purchase of gas and steam machinery; steam-pipe and fittings; rent of buildings for use of the Academy; freight; cartage; water; music; musical and astronomical instruments; uniforms for the bandmen; telegraphing; for feed and maintenance of teams; for current expenses and repairs of all kinds; and for incidental labor and expenses not applicable to any other appropriation (appropriated)	32,000.00	32,000.00	32,000.00
For stores in department of steam-engineering (appropriated)	800.00	800.00	800.00
For materials for repairs in steam machinery (appropriated)	1,000.00	1,000.00	1,000.00
To complete boat-house for steam-launches (submitted)	5,000.00	5,000.00
For the construction and armament of one steel practice vessel of 800 tons (submitted)	275,000.00	275,000.00
For purchase of land adjacent to Naval Academy (submitted)	108,000.00	108,000.00
For converting abandoned hospital into quarters for instructors (submitted)	10,000.00	10,000.00
RECAPITULATION.			
For pay of professors and others		54,112.00	52,112.00
special course of study		5,000.00	5,000.00
pay of watchmen, mechanics, and others		44,000.25	44,000.25
pay of employes in department steam-engineering		7,824.50	7,824.50
repairs and improvements		21,000.00	21,000.00
heating and lighting		17,000.00	17,000.00
contingent expenses		41,800.00	41,800.00
completing boat-house		5,000.00
steel practice vessel		275,000.00
purchase of land adjacent to Academy		108,000.00
converting abandoned hospital into quarters		10,000.00

REPORT OF THE SECRETARY OF THE NAVY.

85

Statement of the appropriation of the Naval Academy for the fiscal year ending June 30, 1887.

Headings of the appropriation.	Amount appropriated.	Amount expended to June 30, 1887.	Balance unexpended to June 30, 1887.	Amount expended since June 30, 1887, for supplies ordered prior to June 30, 1887.	Amount of liabilities for supplies ordered prior to June 30, 1887.
Pay of professors and others.....	\$51,758.52	\$50,717.11	\$1,041.41		
Pay of watchmen, mechanics, and others.....	44,122.45	44,058.76	63.69		
Special course of instruction of cadets.....	5,000.00	508.00	4,496.99	\$2,351.48	\$2,144.91
Pay of steam employes.....	7,851.00	7,804.50	46.50		
Repairs.....	21,000.00	20,813.89	686.11	661.70	24.41
Heating and lighting.....	17,000.00	16,814.20	185.80	170.20	15.60
Library.....	2,000.00	1,063.38	936.62	175.83	760.79
Stationery.....	2,000.00	1,081.13	918.87	410.25	508.62
Expenses of the Board of Visitors.....	1,500.00	1,377.24	122.76		
Chemical apparatus, etc.....	2,500.00	2,480.96	.04		
Miscellaneous.....	32,000.00	31,467.18	532.82	521.45	11.37
Stores, steam engineering department.....	800.00	770.25	20.75	7.50	13.25
Materials, steam engineering department.....	1,000.00	964.71	15.29		15.29
Headstones for the lost of the Huron.....	500.00	500.00			

Statement of offers for supplies and service for the Naval Academy made during the fiscal year ending June 30, 1887.

[Schedule of offers for supplies under advertisement July, 1886.]

Plumber's supplies. Class 1:		
*William E. Bird & Co. (A).....		\$401.17
*William E. Bird & Co. (a).....		769.70
*William E. Bird & Co. (b).....		180.00
*William E. Bird & Co. (c).....		99.20
Gutta Percha Manufacturing Company (c).....		179.25
Towner, Landstreet & Co. (c).....		108.50
Range fittings and utensils (B):		
*J. E. A. Cunningham.....		249.10
Bar iron and metals. Class 2:		
*C. Winternitz & Sons (A).....		66.66
*Keen & Hagerty (B).....		266.29
Gas fixtures, etc. Class 3:		
*C. Y. Davidson & Co.....		390.67
H. W. Webb & Sons.....		480.34
P. Kries & Sons (incomplete).....		330.05
Paints, oil, varnish, brushes, etc. Class 4:		
Oils and dry colors (A ¹):		
*G. & N. Popplein, jr.....		513.14
Hirshberg, Hollander & Co.....		526.61
Lawrence & Co. (irregular).....		471.92
Oil, varnish, etc. (A ¹):		
*Hirshberg, Hollander & Co.....		297.75
G. & N. Popplein, jr.....		302.75
Lawrence & Co. (irregular).....		263.75
Brushes (B):		
*Hirshberg, Hollander & Co.....		133.50
G. & N. Popplein, jr. (for glue brushes only).....		2.25
Glass and sundries (C):		
*Hirshberg, Hollander & Co.....		61.15
Swindell Brothers (incomplete).....		58.85
G. & N. Popplein, jr. (incomplete).....		3.57

*Accepted.

Brick, stone, cement, plaster, hair, lime, sand, feed, and terra-cotta pipe.	Class 5:
Bricks (A):	
*George N. Potee, delivered at Naval Academy.....	\$1,167.50
W. W. Clarke & Son, delivered at wharf in Baltimore.....	1,105.00
Stone (B):	
*McLenahan & Bro	903.00
†1,000 bushels building sand (C):	
W. W. Clarke & Son.....	58.05
John Kealey.....	60.00
S. M. Hamilton & Co.....	60.00
Cement, plaster, and hair (D):	
*W. W. Clarke & Son.....	566.00
Fahey & Co	647.00
Russell, Giese & Co.....	575.00
S. M. Hamilton & Co.....	591.75
H. W. Classen & Co.....	614.75
John Kealey (incomplete).....	7.50
J. J. Kelly (incomplete).....	5.75
Basil & Parlett (incomplete).....	409.75
F. L. Merchant & Co. (incomplete).....	217.50
200 bushels lime (E):	
*J. S. M. Basil & Parlett, delivered at Naval Academy	66.00
J. J. Kelly, delivered at wharf in Baltimore.....	80.00
Fahey & Co., delivered at wharf in Baltimore	64.00
W. W. Clarke & Son, delivered at wharf in Baltimore	55.00
Russell, Giese & Co., delivered at wharf in Baltimore	80.00
S. M. Hamilton, delivered at wharf in Baltimore	70.00
H. W. Classen & Co., delivered at wharf in Baltimore.....	66.00
Feed (F):	
*Wright & Sparks (by lot).....	767.00
John Kealey.....	767.00
Fahey & Co	775.00
H. N. Richers & Co	836.00
Terra cotta pipe (G):	
*W. W. Clarke & Son.....	21.21
Wright & Sparks.....	21.42
Balto. Retort & F. B. Co.....	24.56
S. M. Hamilton & Co	45.22
H. W. Classen & Co.....	28.50
Hardware. Class 6:	
*Anderson & Ireland.....	269.27
H. W. Webb & Sons.....	273.92
Sash weights (a):	
*James Bates	18.96
Anderson & Ireland.....	22.43
H. W. Webb & Sons	23.11
Lumber, etc. Class 7:	
Lumber (A):	
*William D. Gill.....	818.50
Otto Duker & Co	830.70
Jos. Thomas & Sons	942.87
John Kealey (incomplete).....	805.50
Mantels (B):	
*William D. Gill.....	149.36
Otto Duker & Co	307.60
Instrument-makers' tools. Class 8:	
*Anderson & Ireland.....	270.29
Carpets, etc. Class 9:	
*Lyon, Hall & Co.....	666.16
W. & J. Sloan.....	743.50
G. S. Griffith & Co.....	699.82
John Wanamaker.....	765.04
Headstones, bluestone and slate. Class 10:	
Headstones for the Huron graves (a):	
*C. E. Ehmann.....	420.00
Bevan & Sons	496.00
Anchor Slate Company.....	480.00

* Accepted.

† Not awarded; price excessive.

Acadstones, bluestone and slate. Class 10—Continued.

North River bluestone (b):
 *Anchor Slate Company \$44.80
 C. E. Ehmann 60.30

Slate (c):
 *Anchor Slate Company 45.00
 Garthe & Lowenstein 55.00
 C. E. Ehmann 255.00

Hauling and shells and gravel. Class 11:

Hauling coal (A):
 *John T. Bishop per ton.. \$0.34 .25 & .40
 J. H. Vansant do37 .37 & .28
 John Kealey do58 & .90

Oyster shells (B):
 *John T. Bishop per bushel.. \$0.01½ & .02½
 John Kealy do02½ & .02½

Hauling sod and earth (C):
 *John T. Bishop per load.. \$0.19 .06 & .09
 John Kealey do30 .20 & .37

1,500 bushels Cedar Point gravel (D):
 *L. H. Shores \$97.50
 John Kealey 180.00

[Under advertisement of November, 1886.]

Machine tools. Class 1:

1 iron planer; to plane 28 inches wide, 28 inches high, and 8 feet long:
 †Manning, Maxwell & Moore \$775.00
 Morton, Reed & Co 555.00
 Reuter & Mallory 900.00
 S. C. Forsaith & Co 692.00
 W. C. Codd 749.00
 E. L. Jackson & Co 965.00
 Hill, Clarke & Co 600.00
 E. Harrington & Sons 850.00
 E. L. Jackson & Co. (irregular) 630.00
 E. L. Jackson & Co. (irregular) 790.00
 Maxwell, Manning & Moore (irregular) 740.00
 Detrick & Harvey (irregular) 865.00
 Detrick & Harvey (irregular) 1,215.00

Machine-shop supplies. Class 2:

‡Reuter & Mallory (incomplete) 323.53
 ‡J. Regeester & Sons (incomplete) 67.44
 ‡W. G. Wetherall (incomplete) 55.55

Foundry, blacksmith, and boiler shops supplies. Class 3:

‡C. Winternitz & Sons (incomplete) 192.43
 ‡Reuter & Mallory (incomplete) 486.95
 ‡William E. Bird & Co. (incomplete) 71.87
 ‡E. L. Jackson & Co. (incomplete) 210.73
 W. G. Wetherall (incomplete) 242.68
 J. Regeester & Sons (incomplete) 157.85
 A. W. Smith & Co. (incomplete) 126.87

Plumbers' supplies. Class 3 (A):

*William E. Bird & Co 103.92
 J. Regeester & Sons 124.13
 E. L. Jackson & Co. (incomplete) 109.23

T-iron, 1,043 feet. Class 4:

*William G. Wetherall per lb.. .02⁹/₁₆
 C. Winternitz & Sons do02⁹/₁₆
 Reuter & Mallory do03½

Pattern-shop supplies and tools. Class 5:

*Anderson & Ireland 81.95

Lumber. Class 6:

*Otto Duker & Co 139.62
 William D. Gill 166.62

*Accepted.
 † Accepted as best fitted for purposes required.
 ‡ Accepted in part.

Glass. Class 7:	
*Hirshberg, Hollander & Co	\$160.45
G. & N. Popplein, jr.	188.45
500 feet 2½-inch fire hose and couplings. Class 8:	
† Eureka Fire Hose Company	400.00
Morton, Reed & Co	350.00
G. F. Patterson (No. 1)	400.00
G. F. Patterson (Nos. 2 and 3)	350.00
J. Register & Sons	315.00
Boston Belting Company (No. 1)	375.00
Boston Belting Company (No. 2)	250.00
New York Belting Company	350.00
Towner, Landstreet & Co	285.00
E. L. Jackson & Co. (No. 1)	400.00
E. L. Jackson & Co. (No. 2)	350.00
William E. Bird & Co	400.00

[Under advertisement of April, 1887.]

Coal; 200 tons Youghiogheny gas coal:	
*G. Meredith & Co. (delivered at depot in Annapolis)	790.00
G. Meredith & Co. (delivered at Naval Academy)	860.00
Ehlen Bros (delivered at depot in Annapolis)	800.00
Black, Sheridan & Wilson (delivered at depot in Annapolis)	800.00
Diggs Bros., ¾-inch screened (delivered at depot in Annapolis)	820.00
Diggs Bros., 1¼-inch screened (delivered at depot in Annapolis)	840.00

[Under requisition No. 10.]

Hemp rope, small stuff, etc.:	
*C. A. Jones & Co	100.70
Loud, Claridge & Co	109.10
Slover & Tyler	104.02
Four boatswains' whistles:	
*C. A. Jones & Co	12.00
Anderson & Ireland	20.00

[Under requisition No. 11.]

Twine and duck:	
*William J. Hooper & Son	21.21
C. W. Lord & Co	23.85
Klinefelter Bros. (incomplete)	15.21
Fids, palms, thimbles, clews, etc.:	
*Slover & Tyler	30.79
Loud, Claridge & Co	43.65
H. B. Newhall & Co. (incomplete)	35.87

[Under requisition No. 35.]

Copper lightning-rod for sick quarters:	
*William H. F. Wilson & Son	28.75

[Under requisition No. 41.]

Lime, per bushel:	
*H. W. Classen & Co35
Basil & Parlett40
Portland cement, per barrel:	
*H. W. Classen & Co. (German)	2.60
Russell, Giese & Co. (English)	2.60

[Under requisition No. 42.]

Rosendale cement, per barrel:	
*Russell, Giese & Co	1.10
H. W. Classen & Co	1.25

*Accepted.

† Accepted as conforming to requirements.

Plaster, per barrel:	
*Russell, Giese & Co	300-pound barrels..... \$1.75
H. W. Classen & Co	250-pound barrels..... 1.60
Basil & Parlett.....	do..... 1.75
[Under requisition No. 56.]	
Parallel bars, Indian clubs, dumb-bells, etc.:	
*John Gloy	46.30
Boston Supply Company	72.35
Fred. Medart	58.50
[Under requisition No. 64.]	
Lumber:	
*Otto Duker & Co	78.30
W. D. Gill	78.46
S. Burns & Co.....	82.05
[Under requisition No. 66.]	
Two Carr's 24-tube steam radiators:	
*A. & W. S. Carr Company	42.60
Thomas C. Basshor & Co.....	46.50
William E. Bird & Co	90.00
[Under requisition No. 67.]	
Box coils, screen, slab, etc:	
*Bartlett, Hayward & Co., of ordinary pipe	308.50
of extra heavy pipe	407.10
E. L. Jackson & Co., of ordinary pipe.....	353.70
of extra heavy pipe	464.82
William E. Bird & Co., of extra heavy pipe	433.42
[Under requisition No. 87.]	
Roofing and spouting house at farm and addition to building on wharf:	
*W. H. F. Wilson & Son	123.60
Carr Bros.....	149.00
Jas. H. League	151.64
[Under requisition No. 101.]	
Hopper-valve closets and sheet lead:	
*J. Register & Sons	93.15
C. Y. Davidson & Co.....	106.72
[Under requisition No. 109.]	
Marble and encaustic tiles, and marble hearths:	
*Thomas J. Walsh.....	286.50
J. J. Carroll	299.00
Hugh Sisson & Sons (incomplete).....	218.00
Sharpless & Watts (incomplete)	42.50
[Under requisition No. 128.]	
One and one-half dozen sets transom pivots and 4 dozen maple door-stops:	
*Anderson & Ireland	1.13
F. H. Davidson	2.06
[Under requisition No. 130.]	
Locks, hinges, etc:	
*Yale and Towne Manufacturing Company	298.96
C. Y. Davidson & Co	228.27
Anderson & Ireland (incomplete).....	146.58

* Accepted.

[Under requisition No. 134.]

One dozen turned cedar posts :	
*Jos. Thomas & Sons.....	\$18.00
Wm. D. Gill	30.00
Otto Duker & Co	30.00

[Under requisition No. 151.]

Slabs, basins, cocks, etc. :	
J. Register & Sons	28.90
P. Kries & Sons.....	29.75
The J. L. Mott Iron Works.....	29.86

[Under requisition No. 158.]

Thirty-one pairs trousers for bandmen and buglers :	
*Liberty Woolen Mills (contractor for marine clothing) :	
For cloth	\$79.20
For making.....	29.80
	<hr/>
	109.00
Raymold & Whitlock.....	162.75

[Under requisition No. 163.]

Galvanized sheet-iron :	
*Keen & Hagerty (No. 20 best), per pound.....	.04 ⁵ / ₈
E. L. Jackson & Co.....	.05

[Under requisition No. 163.]

One steam radiator, complete :	
*William E. Wood & Co	15.00
A. & W. S. Carr Company.....	26.50
J. Register & Sons	20.50

[Under requisition No. 169.]

Four door-hangers :	
*F. H. Davidson & Co	25.60
Anderson & Ireland.....	28.00

[Under requisition No. 172.]

Nineteen window-shades, complete :	
*P. Hanson Hiss & Co	35.50
L. A. Dieter & Co.....	35.50
Jacob Myers.....	40.00

[Under requisition No. 175.]

Two dozen sets shutter-fastenings :	
*Anderson & Ireland.....	4.60
F. H. Davidson	5.00

[Under requisition No. 180.]

One beveled mirror-plate :	
*William D. Gill	21.50
William Mann	24.00
Hirshberg Bros. & Hollander.....	29.50

(Under requisition No. 206.)

Two mirror frames :	
*William D. Gill	60.00
Otto Duker & Co	63.50
Joseph Thomas & Sons.....	98.00

* Accepted.

[Under requisition No. 209a.]

Window shades complete:	
*Jacob Myers, each	1.75
L. A. Dieter, each	2.15

[Under requisition No. 270.]

200 feet cherry lumber:	
*William D. Gill	18.00
Otto Duker & Co	22.00

[Under requisition No. 310.]

101 pieces assorted pine lumber:	
*William D. Gill	90.96
Otto Duker & Co	93.13
Joseph Thomas & Sons	111.14

[Under requisition No. 331.]

Parts for repair of lawn-mowers:	
*Graham, Emlen & Passmore	21.43
Cottingham & Co	36.74
Whitman Sons & Co	41.45

[Under requisition No. 370.]

Castings and grate-bars:	
*H. C. Larabee	per pound.. .02
James Bates	per pound.. .02½

REPORT OF COMMANDANT OF CADETS.

UNITED STATES SHIP CONSTELLATION,
Annapolis, Md., September 1, 1887.

SIR: In addition to the weekly reports of progress and the final standing of cadets heretofore submitted, I have the honor to make the following report of the practice cruise just ended:

The *Constellation* sailed from Annapolis on the 15th of June, having on board:

Naval cadets:	
First class	35
Third class	54
Fourth class	34
Blue jackets (including officers' attendants)	187
Marines	16
Officers	14
Total	34

The sailing orders directed me to cruise principally in Gardiner's bay, going into New London or Newport once a week. The ship cruised in Chesapeake bay and at sea until July 3, when we anchored in the harbor of New London. From that date the order to cruise in Gardiner's bay, making port once a week, was carried out as strictly as possible; but on several occasions the ship was detained at New London on account of fogs. In Gardiner's bay we had uniformly good weather, with sufficient wind for maneuvering, and I strongly recommend that during future cruises the practice ship should make port not oftener than once a fortnight. The ship made two visits to Newport, and the cadets of the first class visited the Torpedo station and were kindly shown its many interesting features.

Two details were made of the first class. Those of one detail performed duty as midshipmen, and the others were stationed as petty officers in different parts of the ship. The two parts of the class alternated in their duties weekly. The cadets of the third and fourth classes were stationed in the different parts of the ship, their watch numbers alternating with the blue jackets, so that on the topsail yard, for instance, every other man was a cadet, and they performed all of the duties of sailors except cleaning ship.

When cruising in Gardiner's bay it was customary to attend to the ordinary duties of clearing ship in the morning watch, and after breakfast get under way and cruise until noon, then anchor for dinner; after dinner get under way and cruise until about 5 p. m., when the ship was brought to anchor for the night. Cadets were encouraged to go boat sailing, and in addition were exercised in sailing and pulling boats. Cadets of the first class were in charge of the decks during the maneuvers, and the third and fourth class were exercised at sail or spar drill on the mizzen-mast, with few exceptions, daily. The regulations of the Academic Board assigning a multiple for seamanship on the practice cruise to the first class, and directing that a lesson should be given out every day to be learned from observation on board ship, was strictly carried out.

The class was divided into five sections, one to each watch officer, and the note-books were examined and marked daily, except Saturday, when the recitation was oral, and in the form of a review. No text-books were allowed. Once a fortnight a board consisting of the executive officer and the watch officers met, and assigned marks for the performance of such duties as had come under their several observations, the average being the mark for general aptitude, and at this time the officers changed sections.

I think most highly of this plan; the assigning a value to the practical work of their profession was a great incentive to industry and attention to duty, and if a cadet cannot acquire a fair knowledge of practical seamanship in this way, it is because he has no aptitude for a naval career.

I think it would be advantageous to carry the idea still further, and make practical study and exercise in seamanship count from the entrance into the Academy of each cadet.

During the cruise, the ship was gotten under way and brought to anchor under about every circumstance likely to occur in service, and cadets were required to explain the reasons for any particular method used. They were encouraged to ask questions. A list of lessons is appended.

For the third and fourth classes weekly subjects for note-books were assigned.

The first class was also instructed in practical navigation, particularly in the use of instruments and charts, and while cruising in the bay some of them were constantly at work plotting the ship's position by cross bearings.

A list of subjects taught is appended.

On the 25th and 26th of July the ship was thoroughly inspected by the board of inspection, of which Rear-Admiral Jouett is the senior member. Although but little attention had been paid to gunnery drills during the cruise, the cadets acquitted themselves creditably, owing to the thorough instruction given them at the Academy.

I have had the honor of commanding the practice ship during three cruises, and my experience teaches me that the plan of detailing one

hundred and fifty or more general-service men every year for the practice cruise is not a good one. The work for the sailors is much harder than in a regular cruiser, and it is a difficult matter, at times, to keep the distinction marked between the enlisted man and the cadet. I respectfully suggest that a smaller ship than the *Constellation*, with a full complement of sailor petty officers, and perhaps twenty seamen, would be preferable.

These men should be permanently attached to the Academy, and I think the service might better spare them than to be obliged to furnish a much larger number every year for a short three months' cruise.

The practice ship should be a sailing ship. Cadets will then take more interest in learning seamanship on board such a vessel than in a steamer, and they will never, after graduating, have so good an opportunity. Those who have a predilection for the sea will have their fondness for it confirmed by some experience in the old fashioned way of handling ships, with which all the best traditions and romance of the sea are connected.

On the 12th of August the *Constellation* sailed from New London, arriving in Hampton Roads on the 17th, and at Annapolis on the 27th. On the 28th the cadets disembarked, and the cruise ended.

The general conduct of the cadets was very good, and I heard many words of commendation of their general appearance and gentlemanly bearing, both at New London and Fortress Monroe.

It is my duty to commend the great interest and zeal shown by Lieutenant Leutze, the executive officer, who assisted me very materially in carrying out the plan of instruction of the cadets.

Very respectfully, your obedient servant,

C. L. HUNTINGTON,

Commander, Commanding.

Commander W. T. SAMPSON, U. S. N.,
Superintendent U. S. Naval Academy.

No. 7.—BUREAU OF YARDS AND DOCKS.

BUREAU OF YARDS AND DOCKS,
NAVY DEPARTMENT,
Washington, D. C., October 15, 1887.

SIE : The following report of the operations of this Bureau, and tabulated statements of the expenditures for the fiscal year ending June 30, 1887, is hereby respectfully presented. Accompanying these are submitted to your consideration the estimates for the fiscal year ending June 30, 1889.

The amount of estimates submitted by the commandants of the different navy-yards and stations are as follows, viz :

For improvements	\$3, 378, 406. 82
For general maintenance	405, 326. 82
For repairs and preservation	1, 063, 767. 50
For Naval Asylum	129, 611. 00
For civil establishment	68, 670. 54
Grand total.....	5, 045, 782. 68

After a careful examination of these estimates submitted from the various yards and stations, the Bureau has made a very material reduction in the amounts asked for under the various appropriations, and submits the following estimates :

For support of Bureau of Yards and Docks.....	\$10, 980. 00
For improvements at navy-yards	955, 591. 56
For general maintenance and contingent	260, 000. 00
For repairs and preservation	400, 000. 00
For support of Naval Asylum.....	90, 111. 00
For civil establishment.....	54, 101. 01
Total.....	1, 770, 783. 57

The tabulated statements that follow this report show in detail the amount of expenditures and estimates for the several navy-yards and stations and the Naval Asylum under the various heads of "Improvements," "Repairs," "Support of the Naval Asylum," "Civil establishment," "General maintenance," and "Contingent."

The several appropriations made for the fiscal year ending June 30, 1887, have been expended with the greatest economy, and as much done as was possible with this limited amount to arrest the deterioration of the Government property under the control of this Bureau, the sum, however, being so small it had but little effect.

The increased appropriation made for the present fiscal year will enable attention to be paid to some of the more pressing wants, but is insufficient, unless continued from year to year, to arrest and repair this long-continued state of deterioration.

Your attention was called to this condition of affairs last year in the statements made by me in my annual report, some of which I will repeat:

Under these circumstances I hope that the attention of Congress will be earnestly called to the urgent necessity for an appropriation of adequate amounts to repair and preserve our defective wharves, water-front, and buildings, and to put in order and extend our meager docking facilities.

True economy, good administration, and proper attention to the present as well as the future needs of our naval establishment alike require it.

When one compares the condition of our naval stations in the large ports with the private and corporation property in their proximity, it compels a sense of humiliation, both to the private citizen and naval officer, and seems to indicate a state of bankruptcy rather than the wealth and power of a great nation.

For the reasons mentioned it is hoped that Congress will be urged to grant to this Bureau the entire amount asked for under the heads of "Repairs and preservation" and "Maintenance."

The water-front of our navy-yards, as a rule, affords insufficient space for vessels repairing, fitting out, or discharging stores, and as a large proportion of this water-front and wharfage is of timber, and subject to decay, etc., this already inadequate wharfage is still further reduced, and a constant demand is made upon the appropriation for "Repairs and preservation" for this purpose alone. It is considered, therefore, by this Bureau, to be both advisable and economical that appropriation should be made from time to time by Congress of moderate amounts to gradually construct permanent water-front of stone or concrete, and to reduce either what will be a yearly large expenditure of money, or, wanting that, a state of dilapidation.

Estimates accompany this report for an extension of the permanent water-fronts of the important navy-yards at Norfolk, Va., and Mare Island, Cal.

At the last session of Congress an appropriation was made for two timber dry-docks, to be located at such navy-yards as the Secretary of the Navy should direct. In accordance with this requirement, the dry-docks were located by your order at the navy-yards at Brooklyn, N. Y., and Norfolk, Va., and the sites duly selected. The appropriation becoming available at the beginning of the present fiscal year, these works are under contract for an amount within the appropriation, and will provide in part for an urgent need, leaving, however, the Atlantic coast south of Norfolk and the entire Gulf coast still unprovided with any docking facilities, public or private, for vessels of and above 4,000 tons. This matter is further discussed under head of "Navy-yard, Pensacola."

Under the heads of the different navy-yards and stations that now follow I submit my views upon such objects and estimates as are deemed worthy of special mention.

NAVY-YARD, PORTSMOUTH, N. H.

During the last fiscal year the boilers and pumps of the floating balance-dock have been put in good working order, and an amount has been allotted from the appropriation of "Repairs, etc.," for the present year to complete the repairs and put the entire structure in good condition. The principal source of supply for fresh water at this station is from the ponds at Seavey's island. It is stated that this source of supply will be ample if the ponds are cleaned and an additional reservoir and piping is furnished. An estimate of \$6,350 for this purpose is submitted.

NAVY-YARD, BOSTON, MASS.

During the last fiscal year but little was expended at this yard, the available funds not permitting a large allotment, but a larger amount will be assigned from the increased appropriations of this year, in addition to the amounts especially appropriated for rebuilding some of the wharves and for the floating gate. For the purpose of rebuilding this latter structure an appropriation of \$31,000 was made by the last Congress, to be immediately available. Proposals were asked for this purpose, using iron as a material, on May 25 and June 30, 1887. At the latter time the plans were modified in some non-essential particulars to reduce the cost, but in both instances the bids were in excess of the amount appropriated, being \$37,800 at the first and \$33,500 at the second opening. Under the circumstances it was determined to rebuild the caisson of wood with our own force at the navy-yard, and this work is now in progress. In accordance with your directions one of the buildings at this yard has been altered by this Bureau, and adapted in a satisfactory manner as a naval prison, and is now ready for use.

I desire to renew again the estimate for repairing and replacing the water pipes of this yard; \$32,000 is asked for this purpose, the need of which is urgent, as large quantities of water are continually wasted, and the whole system is in a bad condition. An estimate of \$25,000 is submitted for rebuilding wharves, the whole amount asked for last year not having been granted, Wharf No. 5 especially being so unsafe as to be out of service. An estimate of \$28,610 is also submitted for rebuilding quarters for four officers. The houses L, M, N, and O being in such condition that either their complete reconstruction or the erection of other quarters as substitutes should be undertaken.

NAVY-YARD, NEW YORK.

The following are the works of improvement that have been in progress during the past fiscal year at this important yard:

The work of dredging the Wallabout channel, removing broken crib-work that had fallen into the channel, and dredging out the cob-dock basin, referred to in my last annual report, was continued and completed as far as the funds would permit, on October 19, 1886. By that time a total amount of 216,731 cubic yards of material had been removed, the Wallabout channel having been dredged to the depth required, and a mooring area of $5\frac{1}{2}$ acres obtained in Whitney basin, which is now used for vessels in ordinary. A new entrance-way into the basin was also completed December 4, 1886, of sufficient width and of a uniform depth of 18 feet. This involved some sheet-piling and crib-work at the inner end, which was finished in May, 1886. The work upon the repairs of the granite dry-dock it still in progress, a number of delays having occurred, among which were the constant demand for the use of the dock and the difficulty of obtaining the proper hydraulic cement. The work is now progressing favorably, and it is hoped that the dock will be ready for use early in the coming month of December.

Two new boilers obtained from the Bureau of Steam Engineering without cost, of a type no longer used afloat, have been substituted for a boiler disabled from constant use at the dry-dock.

Buildings Nos. 2 and 7 have been altered and refitted under the direction of this Bureau, by your order, No. 2 for a general store-house

and No. 7 for various offices formerly located in No. 2. This work has been performed in a satisfactory manner.

Your attention is respectfully called to the following estimates, which are selected by me from a number made from this yard as being necessary and important: Fifty thousand dollars (\$50,000) is asked for continuing the repairs to the cob-dock, a large part of the crib-work being in danger of falling into the channel at any moment. A sum of \$68,340.47 is asked for a boiler-shop wing to the machine-shop. This addition is needed by the department of steam engineering at this yard for convenience and additional space, the construction of all boilers being concentrated at this yard and at Norfolk, Va. In addition estimates are submitted as follows:

For a general paint and oil store.....	\$25,000.00
Beef and pork packing house	20,000.00
One building for four officers' quarters	28,000.00

NAVY-YARD, LEAGUE ISLAND, PA.

If this yard is to be retained and used for naval purposes, another wharf is needed at the foot of Fifteenth street, for which the sum of \$26,000 is asked, and an estimate of \$30,000 is submitted for the erection of four officers' quarters in place of houses now rented in the city of Philadelphia at a distance from the navy-yard.

To make this yard available for building and repairing vessels, one of the first requisites will be additional dredging and filling in. In case this action is determined upon, a further estimate of \$155,000 for this purpose is submitted.

NAVY-YARD, NORFOLK, VA.

The importance of this yard, with its fine position, mild climate, and abundant natural resources within control, cannot be overestimated, and it is earnestly recommended that every opportunity should be taken to make its equipment ample in all particulars.

No funds having been appropriated, there have been no works of improvement undertaken or in operation for the fiscal year just ended.

The repairs upon the various buildings and wharves were limited to those most urgently needed on account of the want of funds.

The amount appropriated for railroad extension by the last Congress being insufficient, an additional amount of \$25,000 is asked for to complete the system.

It having been determined to build an armored vessel at this navy-yard, an estimate is hereby submitted of \$75,000 to provide a permanent building, for iron and steel shops, to contain such portion of the plant as needs such shelter.

An estimate is also submitted for the extension of the quay wall along the water front; this matter has been referred to in a preceding paragraph, and the erection of this permanent wall will be found economical, especially at this station. The wet-basin, constructed for the preservation of timber, which divides this navy-yard into nearly two parts, is becoming of less and less importance for its original purpose. Its position would make it available for a fitting-out basin, and in this manner the available water frontage of the yard and the convenience of transportation would be materially increased. An amount of \$50,000 is asked for, to be expended towards this purpose.

The following amounts are required to prosecute works of improvement much needed at this yard :

For boiler-shop extension.....	\$14,488
For the erection of quarters for two officers not now provided for.....	15,000
For providing a system of water-pipes.....	17,811

NAVY-YARD, MARE ISLAND, CAL.

This navy-yard is our only naval station on the shores of the Pacific. It would be our only base for naval operations for the defense of the ports of this coast, for the protection of our Pacific trade, and for the assertion, if it should become necessary, of the dignity and strength of the nation upon this the greatest of all ocean areas. At present European naval powers are rapidly acquiring the insular countries of this part of the world, their movements advancing so far as to make among themselves a virtual partition of the western Pacific, and extending so far of late as to practically annex groups of islands where American trade and civilizing influences had been heretofore paramount. In considering these movements the possibility does not seem a distant one that our extreme western territory may be hampered and surrounded by the possessions of aggressive naval powers. This, in addition to the immense development upon land and sea in the Pacific that will follow the opening of an interoceanic canal, will force upon this country a greater naval activity, for which we should be prepared. Not only should the question be considered of the establishment of additional naval resources in the waters of Puget Sound, the great coal and iron regions of the future upon this coast, but measures should be taken to place this our only naval station now existing upon the coast in a fully equipped condition. When the emergency arises, and the strain and stress of preparation or actual war is upon us, there will be no time for the establishment of the necessary works, which require considerable time for construction and a continuous though not extravagant expenditure of money.

During the past fiscal year the work upon the new dry-dock at this yard has progressed as rapidly as the weather and the delay of one of the contractors, M. J. Kelly, has permitted. The work has been confined to the dressing and setting of the granite lining of the dock chamber. This work, however, does not interfere with the use of the structure, and on the 30th October, 1886, the first ship, the U. S. S. *Independence*, was docked in a most satisfactory manner, everything in the flooding, the working of the caisson, and the pumping out of the dock proving a gratifying success.

On October 13, 1886, proposals were opened for the supply of the granite required to finish the dock, and notwithstanding the low price of the previous year, \$1.29 per cubic foot, the Bureau was much pleased in being able to award this the last contract for granite at the lower rate of \$1.27 per cubic foot, to M. J. Healey & Co., who have since proven in every way satisfactory contractors. The work is being pushed forward to completion as rapidly as the circumstances will allow.

The construction of the iron crane or shears, the commencement of which was referred to in my last annual report, has been finished, and this fine hoisting apparatus of iron and steel, with a lifting capacity of 100 tons, was put in place on the 10th of last March. The entire cost was \$44,375, the construction being made at the shops of the navy-yard under the direction of Chief Engineer G. F. Kutz, U. S. Navy, the foundation being placed and the final erection made under the su-

provision of Civil Engineer Wolcott, U. S. Navy. This yard has now a hoisting-shears, with sliding back leg, superior to that of any other of the navy-yards, and the successful construction and erection of this apparatus within the navy-yard entitle those engaged upon it to much credit.

The work upon the artesian well was renewed by a bondsman of the failing contractor, and has reached a depth of 1,330 of the 1,500 feet contracted for, but without obtaining any satisfactory flow of water.

The water-front of the yard has been dredged to a depth of 25 feet at low tide and the necessary repairs made to the buildings, wharves, and roads, including the alterations necessary to adapt one of the buildings for a general store-house. An estimate is submitted for \$4,200 to complete the floor of the boiler shop and lay the foundation for the heavy tools now on hand and awaiting this work.

The appropriation of a sum of \$16,664.09 for the removal of the gas-holder from its present place and its erection in another locality is again urgently requested. The present condition of affairs is unsafe and involves danger of explosion, which in working hours might cause both loss of life and property.

An estimate is submitted for a sum of \$30,000 to build a wharf from the coal-house to the foundry, as at present this important part of the yard has no direct access to the water, which forces much laborious hauling of heavy machinery, material, and tools from a distant wharf. In addition, an estimate of \$110,000 is submitted for the further extension of the permanent water front or quay wall from the unfinished end of the existing wall. These improvements along the water front will give a straight front and prevent the formation of eddies and consequent deposit of mud.

Estimates are submitted for the additional purposes mentioned below :

One 12-ton swinging crane	\$4,000
For improvement of roads	15,000
For pile-driver	5,000
For boat landings	5,000
For gate and guard house	10,000
For crane scow	7,000
For mud scow and ash-lighter.....	4,500

NAVY-YARD, PENSACOLA, FLA.

The Navy-Yard Commission in its report made in 1883 pronounces the present site of this yard untenable and indefensible in time of war; but recognizing the necessity for a navy-yard on the Gulf, they recommended the appointment of a commission to select a site within the lines of defense on Pensacola Bay or in some other locality. This opinion coincides with that of many other competent authorities.

The necessity for a naval station upon the shores of the Gulf, properly equipped, is imperative for the future, not only from the possibilities likely soon to arise in these waters and the adjoining West Indian countries and seas, but also because a station is needed as a base for the naval defense of our own coasts and the protection of the outlets of our Gulf and Mississippi trade. England, France, and Spain have naval stations upon adjacent islands, and at Martinique, a French island not far distant, is the only dock capable of taking a vessel of over 4,000 tons south of Norfolk and Bermuda along the North American coast.

Pensacola, although defective in some respects, combines more advantages for a naval station than that afforded by a detached, exposed, position like Key West or a site upon the uncertain and varying banks of a swift river like the Mississippi.

The site of the yard should be moved to the upper part of the bay and nearer the city, where railroad connections can be readily made. The docking facilities at the yard now consist of fragmentary portions of what was intended to be a large sectional dry dock. The parts now at the navy-yard, though cared for as much as possible, suffer deterioration, from year to year, and would involve a cost of more than \$75,000 to put in working order, and, furthermore, would then only have a lifting capacity of 1,400 tons. There being no deep basin prepared for its reception, the sections would have to be moored at some distance from the yard front, in order to be placed in a sufficient depth of water. It would be much more advantageous and permanent to construct an excavated dock upon a newly selected site.

I have not deemed it wise under these circumstances to expend any more money than is necessary for the care of property at this place, or to submit any estimates until the question of the site is finally settled.

NAVAL STATIONS, ETC.

Naval station, New London, Conn.—No work of any kind has been done or proposed at this station, and the expenditures incurred were only such as were found necessary to care for the property now there.

Navy-yard, Washington, D. C.—This yard has been set aside as an ordnance-manufacturing yard. This Bureau has, however, been called upon to expend sums for maintenance, and for the repairs that were necessary from time to time. An estimate is submitted for \$15,000 for dredging the channel to the yard, and for \$3,000 to provide a substantial fence along the east side, now entirely open.

Naval station, Port Royal, S. C.—The storehouse and shed, reported last year as contracted for, has been finished in a satisfactory manner, with suitable room for stores, and with a storage capacity for 1,500 tons of coal. Cisterns were also built to catch the rain from the roof, and a railway is being constructed for the transportation of coal from the shed to the wharf. Estimates are submitted for an artesian well, for fencing, and for a boat-house, the total amount being \$1,628.

Naval station, Key West, Fla.—Only the repairs absolutely necessary for the proper care of the building and coaling facilities have been expended here. An estimate for \$8,000 is here submitted for the erection of quarters for two officers. It is no more than bare justice that the hardships of the officers who are stationed here should be relieved to an extent in this manner. The facilities for living here in a decent manner are at best but meager, and the recent calamities of fire and yellow fever in this place aggravate this want. An estimate of \$30,000 is submitted for the purchase of an adjustable stern dock for this place, which now has no provision whatever for docking.

Naval station, Sackett's Harbor, N. Y.—This station has been closed for many years, and only the amounts necessary for the care of the little property here has been expended at this place.

NAVAL ASYLUM, PHILADELPHIA, PA.

The expenditures at this institution for the fiscal year ending June 30, 1887, are as follows:

Pay and pocket money for beneficiaries.....	\$5,772.79
Tobacco	1,004.56
Clothing, boots, and shoes.....	7,607.72
Subsistence	20,008.11
Paints, dry goods, lumber, coal and wood, provender, hardware, miscellaneous and house sundries.....	9,740.56

For support of beneficiaries..... 44,133.74

Pay of employes.....	\$9,243.50
Repairs to buildings, for grates, ranges, furniture, and repairs to furniture.....	3,586.80
Water rent and gas.....	1,545.62
Cemetery, burial expenses, and headstones.....	346.57
Improvement of grounds.....	498.60

Total expenditure for year 1886-'87..... 59,354.83

Estimates are respectfully submitted for the Naval Asylum for fiscal year ending June 30, 1889, as follows:

For pay and pocket money for beneficiaries.....	\$6,600.00
For clothing, boots, and shoes.....	10,000.00
For tobacco.....	1,100.00
For provisions.....	24,000.00
For ice.....	400.00
For coal and wood.....	3,000.00
For stores of dry goods, paints, lumber, provender, hardware, miscellaneous and house sundries.....	8,000.00

Total support of beneficiaries..... 53,100.00

For transportation of indigent and destitute beneficiaries to Asylum.....	500.00
For pay of employes.....	10,061.00
For water rent and gas.....	1,800.00
For cemetery, burial expenses, and headstones.....	350.00
For improvement of grounds.....	500.00
For repairs to buildings, furnaces, grates, ranges, furniture, and repairs to furniture.....	4,500.00
For music in chapel.....	600.00
For erecting brick building in rear of main building for kitchen, laundry, and servants' room.....	17,500.00
For fitting up bath-room with twelve tubs for beneficiaries.....	800.00
For removing range, laundry, boilers, and tubs to new building, and for plumbing.....	400.00

Total for year ending June 30, 1889..... 90,111.00

Capt. Joseph S. Skerrett, U. S. Navy, who has carefully administered the affairs of this institution for the past fiscal year, reports that the conduct of the beneficiaries has been, on the whole, commendable during that time. An increased gratuity has been given those men who are deserving, adding in this way materially to their comfort.

As large a liberty as is consistent with good order and administration and a proper accountability is granted the beneficiaries, and the constant endeavor of the Bureau is to make of the institution a comfortable home for disabled men of the Navy and Marine Corps. In this connection it is again recommended that the name of the Asylum be changed to the "U. S. Naval Home," in order to more exactly describe the character and represent the intentions of its foundation. The institutions for similar purposes for the regular and volunteer soldiers of the United States now bear the name of homes.

The following statement shows the changes during the past fiscal year:

On rolls July 1, 1886.....	201
Admissions, year ending June 30, 1887.....	21
Readmissions.....	1
	<hr/>
Died during fiscal year ending June 30, 1887.....	28
Dropped for absence without leave.....	1
Transferred to Government Hospital for Insane.....	1
	<hr/>
	30

On rolls July 1, 1887..... 193

Owing to the unusual number of deaths, there has been a slight reduction in the number of inmates, and though this death rate is not ex-

pected to continue, still there seem to be sufficient data to allow the formation of the opinion that there will be no material increase in the number during the next few years; consequently provision for the further comfort and good care of these aged and deserving beneficiaries of the nation now engages the consideration of the Bureau and the authorities of the institution. To this end the purchase of improved laundry apparatus was authorized during the past fiscal year, which is now working most successfully and economically.

I again ask the appropriation of the amount (\$17,500) estimated to be necessary for the erection of a brick building in the rear of the Asylum.

This has been repeatedly urged as necessary by the various governors for the greater comfort of the inmates of the Asylum, the present kitchen and laundry being situated in the basement, directly under the quarters of the officers and men, rendering them hot and uncomfortable in summer and vitiating the air of the building at all times. By the removal of the kitchen and laundry to the new building this will be obviated; proper quarters will be set apart for the female employés, and increased bathing facilities can be furnished to the institution.

The Bureau approves of the repeated recommendation of the governor of the Asylum for increase of pay of the employés; especially is this necessary in regard to the chief cook and assistant cooks. It is a matter so directly connected with the daily life of the inmates that pay commanding a better grade of employés in this particular will be felt most sensibly and constantly by them.

An estimate for \$500 is given for the transportation of men who have been granted a permit to enter the Asylum, but who, being out of service, are, from poverty, unable to pay their transportation to the Asylum.

The Bureau has no means whatever to defray these expenses, and it is but justice that the disabled servant of the nation should not be compelled to beg for means to reach the Asylum after he has received a permit to enter.

In closing this reference to the Naval Asylum, as a matter of justice to the inmates, I would call attention to the generous expenditure made by the trustees of a somewhat similar institution, the "Sailors' Snug Harbor of New York," for grounds, buildings, and comfortable appliances for their disabled inmates. It is true that this institution is richly endowed, but as its wealth can not compare with the wealth of our Government, neither should its generosity exceed that of the national generosity towards men who have been for many years faithful and disabled servants.

I trust that you will cause a comprehensive examination of this whole subject to be made, which should, in the opinion of the Bureau, result in the removal of this institution to a suburban site, and insure its establishment upon a more modern and generous footing.

CONTINGENT.

The sum of \$40,000 required under this head is to meet unforeseen emergencies and accidents that may arise, calling for an immediate outlay.

GENERAL MAINTENANCE.

For this an amount of \$220,000 is asked, as the most pressing and necessary expenditure of the different yards come under this head, such as repairs of fire engines, purchases of horses and oxen, and their main

tenance, carts and tools, coal, water and gas, telegrams, incidental labor, pay of watchmen, cleaning yards, the care of buildings, purchase of and care of machinery of every description, rents, etc. The need for the amount estimated is consequently obvious. On account of the reduced appropriations of the past few years, there has been a deficiency caused in the live stock, vehicles, in furniture especially, and general cleaning and care of the yards.

REPAIRS AND PRESERVATION.

The amount asked (\$400,000) under this head is reduced to what is considered necessary for the purposes referred to in the first part of this report. With this amount regularly given the Bureau hopes to restore the various objects under its care to a proper condition.

The entire amount asked for by the Bureau is \$1,770,783.57, the detail of which is contained in the tabulated statements Nos. 1 to 6:

1. For support of Bureau of Yards and Docks.....	\$10,980.00
2. For general maintenance and contingent.....	260,000.00
3. For support of Naval Asylum.....	90,111.00
4. For repairs and preservation.....	400,000.00
5. For improvements at navy-yards.....	955,591.56
6. For civil establishment.....	54,101.01
Total.....	1,770,783.57

Accompanying this report is an abstract of offers for supplies received for furnishing articles coming under the cognizance of the Bureau of Yards and Docks, made in conformity to the act of Congress approved March 3, 1843.

A statement showing the amount expended under each specific head of appropriation during the fiscal year ending June 30, 1887, and the balances remaining on hand June 30, as required by section 429, Revised Statutes, is appended.

Also a report showing the amount expended during the fiscal year ending June 30, 1887, from appropriations pertaining to this Bureau for civilians employed on clerical duty or in any other capacity than as ordinary mechanics and workmen at the several navy-yards, with estimate for the same for the fiscal year ending June 30, 1889, in compliance with the third section of naval appropriation act approved January 30, 1885.

Very respectfully, your obedient servant,

D. B. HARMONY,
Chief of Bureau.

Hon. WM. C. WHITNEY,
Secretary of the Navy.

*Estimates of appropriations required for the service of the fiscal year ending June 30, 1887
by the Bureau of Yards and Docks, Navy Department.*

Detailed objects of expenditure, and explanations.	Estimated amount which will be required for each detailed object of expenditure.	Total amount to be appropriated under each head of appropriation.	Amount appropriated for the current fiscal year, 1887.
SALARIES.			
One chief clerk (March 3, 1887)	\$1,800.00		
One draftsman and clerk (same act)	1,800.00		
One clerk of class four (same act)	1,800.00		
One clerk of class three (same act)	1,600.00		
One clerk of class two (same act)	1,400.00		
One clerk of class one (same act)	1,200.00		
One mail messenger (same act)	720.00		
One laborer (same act)	660.00		
		\$10,980.00	\$11,931.00
GENERAL MAINTENANCE.			
For general maintenance of yards and docks, namely: For freight and transportation of materials and stores; books, maps, models, and drawings; purchase and repair of fire engines; machinery; repairs on steam fire engines and attendance on the same; purchase and maintenance of oxen and horses, and driving teams; carts and timber-wheels, and all vehicles for use in the navy-yards, and tools and repairs of the same; postage on letters and other mailable matter on public service sent to foreign countries, and telegrams; stationery; furniture for Government houses and offices in the navy-yards; coal and other fuel; candles, oil, and gas; cleaning and clearing up yards and care of buildings; attendance on fires; lights, fire engines, and apparatus; for incidental labor at navy-yards; water-tax and tolls and ferrage; rent of four officers' quarters at Philadelphia, Pa.; for pay of watchmen in navy-yards, and for awnings and packing-boxes, and advertising for yards and docks purposes (March 3, 1887)	220,000.00	220,000.00	170,000.00
CONTINGENT.			
For contingent expenses that may arise at navy-yards and stations (March 3, 1887)	40,000.00	40,000.00	20,000.00
		260,000.00	190,000.00
NAVAL ASYLUM.			
One superintendent (March 3, 1887)	600.00		600.00
One steward, increase of \$120, submitted (same act)	600.00		480.00
One matron, increase of \$120, submitted (same act)	480.00		360.00
One chief cook, increase of \$120, submitted (same act)	360.00		240.00
Two assistant cooks, at \$240 each, increase of \$72 each, submitted (same act)	480.00		336.00
One chief laundress (same act)	192.00		192.00
Six laundresses, at \$168 each (same act)	1,008.00		1,008.00
Four scrubbers, at \$168 each (same act)	672.00		672.00
Eight waiters, at \$168 each (same act)	1,344.00		1,344.00
Six laborers, at \$240 each (same act)	1,440.00		1,440.00
One stable keeper and driver (same act)	360.00		360.00
One master at arms, increase of \$120, submitted (same act)	600.00		480.00
Two house corporals, at \$360 each, increase of \$60 each, submitted (same act)	720.00		600.00
One barber	360.00		360.00
One carpenter	845.00		845.00
For transportation of indigent and destitute beneficiaries to the Naval Asylum, submitted	500.00		
For water rent and gas (same act)	1,800.00		1,800.00
For cemetery, burial expenses, and headstones (same act)	350.00		350.00
For improvement of grounds (same act)	500.00		500.00
For repairs to buildings, furnaces, grates, ranges, furniture, and repairs of furniture (same act)	4,500.00		4,500.00
For music in chapel (same act)	600.00		600.00
For erecting brick building for kitchen, laundry, and dormitories for female employes, submitted	17,500.00		

* By direction of the honorable Secretary of the Navy, one clerk of \$1,000, has been transferred to the Bureau of Provisions and Clothing.

Estimates of appropriations required for the service of the fiscal year, etc.—Continued.

Detailed objects of expenditure, and explanations.	Estimated amount which will be required for each detailed object of expenditure.	Total amount to be appropriated under each head of appropriation.	Amount appropriated for the current fiscal year ending June 30, 1888.
NAVAL ASYLUM.			
For removing range and laundry machinery to same, submitted.....	\$400.00		
For fitting up bath-rooms for beneficiaries, submitted.....	800.00		
For support of beneficiaries (same act).....	53,100.00		\$48,100.00
		\$90,111.00	63,167.00
REPAIRS AND PRESERVATION.			
For navy-yards and stations (March 3, 1887).....	400,000.00	\$400,000.00	450,000.00
NAVY-YARDS AND STATIONS.			
Navy-yard, Portsmouth, N. H.:			
For water supply (submitted).....			
For cleaning ponds (submitted).....	1,500.00		
For building reservoir (submitted).....	4,500.00		
For piping for same (submitted).....	350.00		
		6,350.00	
Navy-yard, Boston, Mass.:			
For water-pipes and laying of same (submitted).....	32,000.00		
For building officers' quarters (submitted).....	28,610.00		
For rebuilding wharves (submitted) March 3, 1887....	25,000.00		
		85,610.00	25,000.00
For rebuilding floating gate dry-dock (same act).....			\$1,000.00
Navy-yard, Brooklyn, N. Y.:			
For repairs to cob-dock (submitted).....	50,000.00		
For paint and oil store (submitted).....	25,000.00		
For boiler shop, wing to machine shop (submitted)....	68,340.47		
For beef and pork packing house (submitted).....	20,000.00		
For one building for quarters for four officers (submitted).....	28,000.00		
		191,340.47	
Navy-yard, League Island, Pa.:			
For four quarters for officers (submitted).....	30,000.00		
For building Fifteenth Street wharf (submitted).....	28,000.00		
		56,000.00	
Navy-yard, Washington, D. C.:			
For dredging (submitted).....	15,000.00		
For fencing on east side (submitted).....	3,000.00		
		18,000.00	
Navy-yard, Norfolk, Va.:			
For iron and steel shop (submitted).....	75,000.00		
For railroad road extension (submitted).....	25,000.00		
For extending quay wall (submitted).....	150,000.00		
For boiler-shop extension (submitted).....	14,488.00		
For two officers' quarters (submitted).....	15,000.00		
For water system (submitted).....	17,811.00		
For altering timber deck into a fitting-out basin (submitted).....	50,000.00		
		347,299.00	
For railroad extensions and engine house (March 3, 1887).....			20,000.00
For two timber dry-docks (same act).....			1,100,000.00
Navy-yard, Mare Island, Cal.:			
For finishing boiler and machine shop (submitted)....	4,200.00		
For boat landings (submitted).....	5,000.00		
For roads (submitted).....	15,000.00		
For gate and guard house (submitted).....	10,000.00		
For removing gas-holder (submitted).....	16,664.00		
For extending wharf from coal house to foundry (submitted).....	30,000.00		
For extension of quay wall (submitted).....	110,000.00		
For crane scow (submitted).....	7,000.00		
For pile-driver (submitted).....	5,000.00		
For twelve-ton swinging crane (submitted).....	4,000.00		
For mud-scow (submitted).....	4,500.00		
		211,364.00	
For cisterns (March 3, 1887).....			44,344.00

Estimates of appropriations required for the service of the fiscal year, etc.—Continued.

Detailed objects of expenditure, and explanations.	Estimated amount which will be required for each detailed object of expenditure.	Total amount to be appropriated under each head of appropriation.	Amount appropriated for the current fiscal year ending June 30, 1888.
NAVY-YARDS AND STATIONS—continued.			
Naval station, Port Royal, S. C.:			
For fencing (submitted).....	\$228. 00		
For artesian well (submitted).....	1, 000. 00		
For boat-house (submitted).....	400. 00		
		\$1, 628. 00	
Naval station, Key West, Fla.:			
For two officers' quarters (submitted).....	8, 000. 00		
For one adjustable stern dock (submitted).....	30, 000. 00		
		38, 000. 00	
		955, 591. 56	\$1, 222, 364. 00
CIVIL ESTABLISHMENT.			
Navy-yard, Portsmouth, N. H.:			
One clerk to civil engineer, at \$1,400 per annum (March 3, 1887).....	\$1, 400. 00		
One mail messenger, at \$600 per annum (same act).....	600. 00		
One foreman laborer and head teamster, at \$4 per day* (same act).....	1, 460. 00		
One messenger (janitor), at \$600 per annum (same act).....	600. 00		
One pilot, at \$3 per diem (same act).....	1, 095. 00		
		5, 155. 00	
Navy-yard, Boston, Mass.:			
One clerk to civil engineer, at \$1,400 per annum (same act).....	1, 400. 00		
One writer, at \$1,017.25 per annum, submitted (same act).....	1, 017. 25		
One foreman laborer, at \$4 per diem, (March 3, 1887).....	1, 252. 00		
One mail messenger, at \$2.26 per diem* (same act).....	824. 90		
One messenger to commandant, at \$1.76 per diem (same act).....	550. 88		
One messenger to captain, at \$1.76 per diem (submitted).....	550. 88		
One messenger to civil engineer, at \$1.76 per diem, (March 3, 1887).....	550. 88		
		6, 144. 79	
Navy-yard, Brooklyn, N. Y.:			
One clerk to civil engineer, at \$1,400 per annum (same act).....	1, 400. 00		
One writer, at \$1,017.25 per annum (same act).....	1, 017. 25		
One writer, at \$1,017.25 per annum (submitted).....	1, 017. 25		
One foreman laborer, at \$4.50 per diem (March 3, 1887).....	1, 408. 50		
One mail messenger, at \$2.50 per diem* (same act).....	912. 50		
One messenger to commandant, at \$2.50 per diem* (same act).....	912. 50		
One messenger to captain, at \$2.25 per diem (same act).....	704. 25		
One messenger to civil engineer, at \$2 per diem* (same act).....	626. 00		
One draftsman, at \$5 per diem (same act).....	1, 565. 00		
One superintendent of teams, or quartermaster, at \$4 per diem (same act).....	1, 252. 00		
		10, 815. 25	
Naval station, Sackett's Harbor, N. Y.:			
One ship keeper, at \$1 per diem* (March 3 1887).....	365. 00		
		365. 00	
Navy-yard, League Island, Pa.:			
One clerk to civil engineer, at \$1,400 per annum (same act).....	1, 400. 00		
One writer and telegraph operator, at \$1,017.25 per annum (submitted).....	1, 017. 25		
One foreman laborer, at \$4 per diem, (March 3, 1887).....	1, 252. 00		
One mail messenger, at \$2 per diem (same act).....	780. 00		
One messenger, at \$1.76 per diem (submitted).....	550. 88		
		4, 950. 13	
Navy-yard, Washington, D. C.:			
One clerk to civil engineer, at \$1,400 per annum, (March 3, 1887).....	1, 400. 00		
One messenger to commandant, at \$2 per diem (submitted).....	626. 00		
One messenger to civil engineer, at 1.76 per diem (March 3, 1887).....	550. 88		
One foreman laborer, at \$3.50 per diem (same act).....	1, 095. 50		
		3, 672. 38	

Estimates of appropriations required for the service of the fiscal year, etc.—Continued.

Detailed objects of expenditure, and explanations.	Estimated amount which will be required for each detailed object of expenditure.	Total amount to be appropriated under each head of appropriation.	Amount appropriated for the current fiscal year ending June 30, 1888.
CIVIL ESTABLISHMENT—continued.			
Navy-yard, Norfolk, Va. :			
One clerk to civil engineer at \$1,400 per annum (same act)	\$1,400.00		
One writer, at \$1,017.25 per annum (same act)	1,017.25		
One foreman laborer, at \$4 per diem (same act)	1,252.00		
One mail messenger, at \$2 per diem* (same act)	730.00		
One messenger, at \$2 per diem (same act)	626.00		
One messenger, at \$3 per diem (same act)	620.00		
One pilot, at \$2 per diem (same act)	707.38		
One assistant draftsman, at 3.50 per diem (submitted)	1,095.50		
		\$7,454.13	
Navy-yard, Pensacola, Fla. :			
One clerk to civil engineer, at \$1,200 per annum (March 3, 1887)	1,200.00		
One messenger, at \$2 per diem (same act)	626.00		
One lamp lighter, at \$1.50 per diem* (submitted)	547.00		
		2,373.50	
Navy-yard, Mare Island, Cal. :			
One clerk to civil engineer, at \$1,400 per annum (March 3, 1887)	1,400.00		
One writer, at \$1,017.25 per annum (same act)	1,017.25		
One draftsman, at \$5 per diem (same act)	1,565.00		
One foreman laborer, at \$5.50 per diem (same act)	1,721.50		
One foreman mason, at \$6 per diem (same act)	1,878.00		
One pilot, at 4.80 per diem (same act)	1,502.40		
One mail messenger, at \$2.74 per diem* (same act)	1,000.10		
One messenger, at \$2.20 per diem (same act)	688.60		
One bell-ringer, at \$2.25 per diem (same act)	707.38		
One lamp lighter, at \$2.20 per diem (same act)	688.60		
One janitor, at \$1,000 per annum (submitted)	1,000.00		
		13,168.83	
Total.....		54,101.01	\$45,893.09

*Including Sundays.

No. 1.—Report of expenditures at navy-yards, stations, and Naval Asylum for the year ending June 30, 1887.

Yards and stations.	Appropriations.					Total.
	Yard improvements.	Repairs and preservation.	General maintenance.	Civil establishment.	Contingent.	
Portsmouth, N. H.		\$17,549.54	\$17,636.86 ^{1/2}	\$4,388.99		\$41,575.39 ^{1/2}
Boston, Mass.		8,435.02	21,732.99	7,333.42	\$6,678.06	44,179.49
New London, Conn.		141.10	4,188.12			4,329.22
New York, N. Y.	\$64,561.47	28,470.08	31,259.86	9,688.80		133,980.21
League Island, Pa.		9,891.62	13,750.16	4,926.29		28,568.07
Washington, D. C.		14,377.92	14,082.55	5,544.80	979.45	34,984.72
Norfolk, Va.		20,000.91	25,767.74	7,680.18	917.46	54,946.29
Pensacola, Fla.		2,025.10	12,077.17	1,643.25		15,695.52
Mare Island, Cal.	138,673.19	20,368.60	30,401.19	13,344.62		202,782.60
Sackett's Harbor, N. Y.		161.10	365.00			526.10
Key West, Fla.		694.67	1,367.96			1,062.63
Naval Asylum, Pa.	\$59,354.83					59,354.83
Wharf at Erie, Pa.					500.00	500.00
Port Royal, S. C.	6,347.02	1,741.81	954.21			9,043.04
Total	298,936.51	124,352.47	173,633.81^{1/2}	56,530.35	9,074.97	632,428.11^{1/2}

* This amount is for the entire support of the Naval Asylum, is a separate appropriation, and placed under this head for convenience only.

No. 2.—Detailed report from navy-yards and stations of expenditures under "Repairs and preservation" during the fiscal year ending June 30, 1887.

Objects.	Portsmouth.	Boston.	New London.	New York.	League Island.	Washington.	Norfolk.	Pennsylvania.	Mare Island.	Key West.	Sackett's Harbor.	Port Royal.	Total.
Yard buildings.....	\$2,611.27	\$2,800.33	\$54.80	\$5,216.66	\$2,887.20	\$4,828.57	\$2,533.88	\$88.48	\$2,042.27	\$24,068.63
Officers' quarters.....	548.55	1,091.61	37.48	1,664.61	585.72	2,107.85	2,552.05	416.39	2,593.20	\$1,741.81	13,478.77
Wharves, bridges, landings, and boats.....
Roads, walks, gutters, and drains.....	380.99	77.50	48.82	4,781.80	2,404.83	79.44	410.69	439.58	1,797.92	10,421.66
Fences and walls.....	1,986.33	150.57	9,614.12	227.70	2,185.92	890.68	192.17	6,789.38	23,056.87
Cranes, scows, and derricks.....	94.06	118.65	3.90	525.99	1,240.78	811.86	262.99	2,550.23
Furnaces, forges, heating apparatus, &c.....	44.32	284.33	89.83	123.75	107.20	648.43
Tracks and scales.....	3,250.72	938.47	1,053.83	50.34	490.77	474.23	69.72	638.42	6,966.20
Water and gas works.....	3.00	827.24	126.57	13.02	9.00	325.96	804.79
Dredging and scowling.....	5,503.07	8,555.19	1,733.26	1,822.89	1,191.01	73.15	2,513.29	15,896.86
Dry-docks.....	515.50	11.81	72.60	599.41
Miscellaneous repairs.....	1,229.65	538.93	13.00	294.04	2,075.62
Repairs to dikes.....	1,776.56	321.15	2,491.70	129.16	712.83	11,162.89	403.75	2,986.33	\$394.67	\$161.10	20,690.14
Transfers to other departments.....	19.02	124.64	8,956.20	8,956.20
Total.....	17,549.54	8,435.02	141.10	28,470.08	9,891.62	14,377.92	20,600.91	2,025.10	20,363.60	594.67	161.10	1,741.81	124,352.47

No. 3.—Detailed report of expenditures under "General maintenance" received from yards and stations during the fiscal year ending June 30, 1887.

Objects.	Portsmouth.	Boston.	New London.	New York.	League Island.	Wash- ington.	Norfolk.	Pensa- cola.	Mare Island.	Key West.	Sack- ett's Harbor.	Port Royal.	Total.
Freight and transportation	87.45	81.50	60.45	6541.44	84.18	817.27	96.03	82.55	\$1,108.88	\$1,000.75
Printing stationery and advertising	258.78½	231.78	51.02	900.57	383.06	200.79	759.43	77.44	\$1,323.19½	\$3,148.19½
Books, maps, models, and drawings	6.50	3.00	182.17	\$3,191.87
Purchase and repair of fire-engines	208.79	101.08	8.18	44.81	2,711.26	974.85	1,822.90	5,565.88
Machinery of every description and pat- ent tools	68.12	40.18	14.67	185.29	224.06	105.40	191.27	828.99
Repairs on steam-engines and attend- ance on same	75.86	1,104.00	97.84	24.23	2.48	1,788.05	48.80	3,140.76
Purchase and maintenance of oxen and horses, pay of hired teams, &c.	3,379.27	3,471.85	257.25	5,284.80	4,317.84	3,776.27	4,384.51	1,467.95	6,683.70	32,892.94
Carts, timber-wheels, and tools of every description, and coal cars	242.60	301.35	67.00	3,062.13	905.52	857.15	1,468.29	885.55	296.78	8,099.37
Postage on letters on public service and telegrams	124.00	20.00	6.00	16.00	4.81	17.64	30.00	374.99	592.44
Furniture for Government houses and offices in navy yards	475.34	412.88	173.35	948.84	298.41	1,815.95	1,807.05	1,253.05	146.23	7,874.10
Coal and other fuel for yards and docks purposes	3,387.45	4,128.00	42.50	2,262.83	373.45	2,060.89	380.22	84.50	1,098.03	12,785.47
Candles, oil, and gas	807.37	345.07	8.68	3,482.77	117.86	441.73	2,949.63	235.15	3,021.72	11,451.97
Cleaning and clearing up yards and care of buildings	208.01	3,193.95	688.50	1,113.98	602.73	2,683.57	2,350.86	1,441.57	3,304.36	15,861.53
Attendance on fires, lights, fire-engines, and apparatus	1,347.31	490.72	2,880.50	2,509.00	256.54	664.18	2,039.64	2,004.45	12,195.84
Incidental labor not chargeable to other appropriations	3,255.89	646.00	52.00	640.76	94.43	18.00	109.20	3,549.06	8,780.34
Water tax	2,128.74	4,157.85	50.40	50.40	78.40	1,960.00	8,401.89
Tolls and forrage	12.00	28.00	329.50	161.87	2,760.00	3,291.37
Pay of watchmen	3,640.00	5,887.40	2,190.00	5,940.00	1,460.00	1,585.96	5,968.76	3,198.00	3,007.50	32,462.63
Flags, awnings, and packing boxes	42.42	77.12	29.37	215.94	84.33	29.78	14.05	15.62	54.96	596.09
Rent of landings	75.00	75.00
Rent of officers' quarters, Philadelphia, Pa	2,146.23	2,146.23
Transfers to other departments	7.17	58.37
Pay of teamsters	1,410.50	1,410.50
Total.....	17,638.86½	21,732.99	4,188.12	31,259.86	13,750.16	14,062.55	25,767.74	12,027.17	30,401.19	1,387.98	865.00	954.21	173,638.81½

No. 4.—*Estimates received from navy-yards, stations, and Naval Asylum for fiscal year ending June 30, 1889.*

Yards and stations.	Appropriations.				Total.
	Yard improve-ments.	Repairs and preservation.	General main-tenance.	Civil estab-lishment.	
Portsmouth, N. H.....	\$12,430.00	\$20,950.00	\$18,945.00	\$5,155.00	\$57,480.00
Boston, Mass.....	317,702.89	321,850.00	60,500.00	8,125.50	708,178.39
New London, Conn.....		7,025.00	4,904.00		11,929.00
New York, N. Y.....	1,001,552.37	336,429.22	93,500.00	14,077.00	1,445,558.59
League Island, Pa.....	935,476.27	108,377.80	48,923.86	10,952.00	1,103,729.93
Washington, D. C.....	21,711.00	55,800.00	19,390.00	3,828.88	100,729.88
Norfolk, Va.....	651,872.00	61,300.00	72,119.30	9,253.88	794,545.18
Pensacola, Fla.....		54,174.72	19,523.16	2,350.00	76,047.89
Mare Island, Cal.....	407,434.29	91,343.25	64,450.00	14,928.28	578,155.82
Sackett's Harbor, N. Y.....		1,000.00			1,000.00
Key West, Fla.....	28,000.00	5,137.50	1,574.00		34,711.50
Naval Asylum, Pa.....	129,611.00				129,611.00
Port Royal, S. C.....	2,228.00	380.00	1,497.50		4,105.50
Total.....	3,508,017.82	1,063,767.50	405,326.82	68,670.54	5,045,782.68

No. 5.—*Detailed estimates from yards and stations for works of improvement for the fiscal year ending June 30, 1889.*

Yards, stations, and objects.	Estimates.	Total.	
PORTSMOUTH, N. H.			
For water supply.....	\$6,350.00	\$12,430.00	
For hydrant system.....	6,080.00		
BOSTON, MASS.			
For iron-plating shop.....	120,713.89	317,702.89	
For water-pipes.....	49,607.00		
For cart-shed.....	10,408.45		
For paving and grading.....	43,109.40		
For erecting and copper-shop.....	39,864.90		
For officers' quarters, L, M, N, and O.....	28,610.00		
For timber wharf No. 5.....	25,389.25		
NEW YORK, N. Y.			
For improving Whitney or Cob-dock basin.....	334,250.52		1,001,552.37
For repairs to cob-dock.....	198,800.00		
For general paint and oil store.....	81,508.38		
For boiler-shop wing to machine-shop.....	68,340.47		
For bridge to connect cob-dock with navy-yard.....	11,383.00		
For boat builders' shop and storage house.....	67,492.00		
For beef and pork packing house.....	47,642.00		
For new pumping engines.....	40,000.00		
For dry-dock caisson.....	30,000.00		
For proposed railroad through yard.....	53,566.00		
For anchor hoy, or steam-derrick lighter.....	35,000.00		
For electrical plant for lighting the yard.....	12,600.00		
For 4 new officers' quarters.....	28,000.00		
LEAGUE ISLAND, PA.			
For office building for yard paymaster.....	19,579.29	935,476.27	
For office building for medicine and surgery.....	19,579.29		
For office building for commandant.....	53,735.59		
For dwellings B and C.....	30,582.85		
For dwellings D and E.....	30,582.85		
For landing wharf foot Fifteenth street (dimensions 75 by 400 feet).....	26,416.40		
For dredging and filling in.....	155,000.00		
For timber dry-dock—525 feet by 118 feet 4 inches by 33 feet 8 inches.....	600,000.00		
WASHINGTON, D. C.			
For extension of yard wall through marsh.....			21,711.00

No. 5.—Detailed estimates from yards and stations for works of improvement for the fiscal year ending June 30, 1889—Continued.

Yards, stations, and objects.	Estimates.	Total.
NORFOLK, VA.		
For iron and steel shop.....	\$75,000.00	
For railroad extension and engine-houses	25,000.00	
For extension of quay wall.....	150,000.00	
For erecting shop.....	34,073.00	
For extension to boiler-shop	14,488.00	
For paint-shop.....	20,500.00	
For 2 officers' quarters.....	15,000.00	
For system of water-pipes.....	17,811.00	
For deep water fitting-out basin.....	300,000.00	
		\$651,872.00
MARE ISLAND, CAL.		
For iron-plating shop.....	5,755.40	
For timber shed, extension of.....	13,905.05	
For rolling mill, for steam engineering.....	40,000.00	
For boiler and machine shop for steam engineering.....	4,200.00	
For landings.....	5,000.00	
For roads.....	33,509.75	
For gate and guard-house.....	20,000.00	
For gas-holder.....	16,664.09	
For wharf from coal-house to foundry.....	30,000.00	
For extension of quay wall.....	210,000.00	
For large crane scow for lightering heavy articles.....	7,000.00	
For floating pile-driver.....	5,000.00	
For ash lighter and mud scow.....	4,500.00	
For erection of 3 12-ton swinging cranes along the water front.....	12,000.00	
		407,434.20
KEY WEST, FLA.		
For the purchase of the Mallery lot.....	20,000.00	
For two 2 houses for officers' quarters.....	8,000.00	
		28,000.00
PORT ROYAL, S. C.		
For sea-wall.....	600.00	
For barbed-wire fencing.....	228.00	
For artesian well.....	1,000.00	
For boat-house.....	400.00	
		2,228.00
NAVAL ASTLUM, PHILADELPHIA.		
For support of beneficiaries, improvements, and all expenses.....		129,611.00
Total.....		3,508,017.82

No. 6.—Detailed estimates from navy-yards and stations for "Repairs and preservation" for the fiscal year ending June 30, 1889.

Objects.	Portsmouth.	Boston.	New London.	New York.	League Island.	Washing- ton.	Norfolk.	Pensa- cola.	Mare Island.	Sackett's Harbor.	Key West.	Port Royal.	Total.
Yard buildings.....	\$5,000.00	\$150,000.00	\$500.00	\$147,633.30	\$16,285.70	\$15,000.00	\$25,000.00	\$12,504.76	\$14,058.25	\$912.50	\$50.00	\$387,236.51
Officers' quarters.....	1,500.00	4,850.00	700.00	1,260.00	1,068.25	2,000.00	3,000.00	6,946.73	3,485.00	50.00	24,864.98
Wharves, bridges, landings, and boats.....	1,000.00	16,500.00	5,000.00	36,361.46	54,248.68	2,500.00	5,000.00	11,880.63	8,500.00	490.00	150.00	136,580.74
Roads, walks, gutters, and drains.....	2,000.00	18,000.00	150.00	104,102.30	601.00	5,000.00	5,000.00	616.60	7,000.00	25.00	142,494.90
Fences and walls.....	500.00	2,000.00	400.00	13,376.00	291.20	700.00	4,700.00	3,113.51	1,298.00	25.00	30,897.71
Cranes, scows, and derricks	200.00	72,000.00	1,076.00	3,706.00	500.00	2,000.00	1,107.12	250.00	30.00	80,863.12
Furnaces, forges, heating apparatus, etc.....	3,300.00	4,000.00	175.00	3,225.66	558.00	600.00	600.00	557.09	1,400.00	14,415.75
Tracks and scales.....	50.00	3,500.00	2,857.00	1,630.00	1,000.00	500.00	250.00	50.00	11,927.00
Water and gas works.....	5,500.00	15,000.00	9,870.00	2,500.00	5,000.00	689.11	2,200.00	40,780.11
Dredging and scowling.....	3,000.00	14,000.00	25,000.00	5,000.00	15,697.20	64,697.20
Dry-docks.....	300.00	15,900.00	2,590.00	\$5,500.00	72,800.00
Miscellaneous repairs.....	1,600.00	10,000.00	100.00	1,867.50	1,000.00	3,000.00	1,083.98	3,000.00	\$1,000.00	3,220.00	24,814.48
Dikes.....	30,000.00	30,000.00
Cisterns.....	1,515.00
Total.....	20,850.00	321,850.00	7,025.00	396,429.23	108,377.80	56,800.00	61,300.00	54,174.73	91,843.25	1,000.00	5,187.50	380.00	1,068,767.50

* Sectional dock.

No. 7.—Detailed estimate for "General maintenance" received from yards and stations for the fiscal year ending June 30, 1869.

Objects.	Portsmouth.	Boston.	New London.	New York.	League Island.	Wash- ington.	Norfolk.	Pensacola.	Mary Island.	Key West.	Port Royal.	Total.
Freight and transportation.....	\$25.00	\$300.00	\$10.00	\$1,000.00	\$150.00	\$20.00	\$100.00	\$25.00	\$3,000.00	\$100.00	\$4,630.00
Printing, stationery, and advertising.....	250.00	250.00	75.00	5,000.00	1,200.00	500.00	200.00	175.00	1,000.00	15.00	4,245.00
Books, maps, models, and drawings.....	5.00	100.00	1,000.00	550.00	50.00	1,095.50	100.00	2,900.50
Purchase and repair of fire-engines.....	200.00	500.00	3,500.00	336.20	500.00	2,000.00	1,244.50	300.00	\$250.00	8,680.70
Machinery of every description, and patent rights.....	100.00	200.00	8,000.00	1,755.00	500.00	4,000.00	350.50	1,500.00	16,414.50
Repairs on steam-engines and attendance on same.....	100.00	2,000.00	5,000.00	1,212.20	500.00	8,000.00	368.60	6,000.00	23,180.80
Purchase and maintenance of oxen and horses, pay of hired teams, etc.....	3,500.00	7,000.00	300.00	10,000.00	9,835.00	5,000.00	9,000.00	1,674.50	10,000.00	150.00	56,479.50
Carts, timber-wheels, and tools of every description.....	350.00	6,000.00	150.00	5,000.00	5,907.76	2,000.00	10,000.00	989.00	750.00	100.00	31,246.76
Postage on letters on public service, and telegrams.....	150.00	50.00	15.00	500.00	150.00	20.00	100.00	250.00	1,235.00
Furniture for Government houses and offices in navy-yards.....	60.00	1,200.00	500.00	5,000.00	2,390.00	2,500.00	7,000.00	1,421.72	4,500.00	100.00	25,211.72
Coal and other fuel for yards and docks.....	3,500.00	3,500.00	60.00	6,000.00	3,400.00	2,000.00	1,000.00	135.00	800.00	200.00	595.00
Candles, oil, and gas.....	800.00	2,500.00	40.00	4,000.00	216.50	1,500.00	3,000.00	381.49	4,000.00	7.50	20,245.49
Cleaning and cleaning up yards, and care of buildings.....	1,000.00	1,400.00	700.00	20,000.00	4,200.00	3,000.00	6,891.00	1,901.00	6,000.00	547.50	58,239.50
Attendance on fires, lights, fire-engines, and apparatus.....	1,400.00	3,700.00	5,000.00	4,200.00	1,000.00	3,130.00	2,582.25	3,130.00	24,012.25
Incidental labor, not chargeable to other appropriations.....	3,250.00	2,000.00	650.09	4,000.00	5,400.00	500.00	3,000.00	500.00	3,000.00	22,800.00
Water tax.....	5,000.00	75.00	4,000.00	1,500.00	117.60	5,000.00	36.50	15,729.10
Tolls and ferrage.....	15.00	30.00	500.00	300.00	3,000.00	3,945.00
Pay of watchmen.....	3,650.00	12,000.00	2,199.00	10,000.00	7,300.00	11,502.50	7,578.00	12,000.00	1,395.00	67,624.80
Flags, awnings, and packing-boxes.....	50.00	200.00	100.00	500.00	701.20	190.00	300.00	70.00	250.00	20.00	50.00	2,841.20
Total.....	18,945.00	90,500.00	4,904.00	93,500.00	48,923.86	19,380.00	72,116.30	19,523.16	61,450.00	1,574.00	1,497.50	405,826.82

Report showing amount expended during the fiscal year ending June 30, 1887, from appropriations pertaining to the Bureau of Yards and Docks, for civilians employed on clerical duty, or in any other capacity than as ordinary mechanics and workmen, at the several navy-yards, and submitting estimates for such civilian employes for the fiscal year 1889, in compliance with the third section of naval appropriation act approved January 30, 1885. (For a year of 365 days.)

Navy-yards and rating, and rate of pay.	Amount paid to civilian employes during the fiscal year ending June 30, 1887.	Estimates for civilian employes for the fiscal year ending June 30, 1889.	
		Rate of pay.	Amount.
PORTSMOUTH, N. H.			
Clerk to civil engineer, at \$1,400 per annum	\$1,399.93	\$1,400.00	\$1,400.00
Store clerk, at \$1,300 per annum	1,271.46		
Mail messenger, at \$2.20 per diem	688.60	600.00	600.00
Foreman laborer and head teamster, at \$4 per diem*	1,320.00	4.00	1,400.00
Messenger (janitor), at \$2 per diem	618.00	600.00	600.00
Pilot, at \$3 per diem*	1,091.00	3.00	1,095.00
	6,388.99		5,155.00
BOSTON, MASS.			
Clerk to civil engineer, at \$1,400 per annum	1,399.97	1,400.00	1,400.00
Store clerk, at \$1,300 per annum	1,299.97		
Writer, at \$1,017.25 per annum	1,017.23	1,017.25	1,017.25
Foreman laborer, at \$4 per diem	1,144.00	4.00	1,252.00
Mail messenger, at \$2.26 per diem*	824.90	2.26	824.90
Messenger to commandant, at \$1.76 per diem	549.12	1.76	550.88
Messenger to captain, at \$1.76 per diem	549.12	1.76	550.88
Messenger to civil engineer, at \$1.76 per diem	549.12	1.76	550.88
	7,333.42		6,144.79
NEW YORK, N. Y.			
Clerk to civil engineer, at \$1,400 per annum	1,400.00	1,400.00	1,400.00
Store clerk, at \$1,300 per annum	1,300.00		
Writer, at \$1,017.25 per annum	967.74	1,017.25	1,017.25
Writer, at \$1,017.25 per annum	426.42	1,017.25	1,017.25
Foreman laborer, at \$4.50 per diem	1,156.50	4.50	1,408.50
Mail messenger, at \$2.50 per diem*	912.50	2.50	912.50
Messenger to commandant, at \$2.50 per diem*	885.00	2.50	912.50
Messenger to captain, at \$2.25 per diem	709.64	2.25	704.25
Messenger to civil engineer, at \$2 per diem	611.00	2.00	626.00
Draftsman, at \$5 per diem	1,290.00	5.00	1,565.00
Superintendent of teams, at \$4 per diem		4.00	1,252.00
	9,688.80		10,815.25
SACKETT'S HARBOR, N. Y.			
Ship-keeper, at \$1 per diem*	365.00		365.00
LEAGUE ISLAND, PA.			
Clerk to civil engineer, at \$1,400 per annum	1,400.00	1,400.00	1,400.00
Writer and telegraph operator, at \$1,017.25 per annum	1,017.25	1,017.25	1,017.25
Foreman laborer, at \$4 per diem	1,252.00	4.00	1,252.00
Mail messenger, at \$2 per diem	722.00	2.00	720.00
Messenger, at \$1.76 per diem	535.04	1.76	550.88
	4,926.29		4,950.13
WASHINGTON, D. C.			
Clerk to civil engineer, at \$1,400 per annum	1,399.99	1,400.00	1,400.00
Store clerk, at \$1,300 per annum	534.25		
Writer, at \$1,017.25 per annum	1,011.67		
Mail messenger, at \$2.50 per diem	375.00		
Messenger to commandant, at \$2 per diem		2.00	626.00
Messenger, at \$1.76 per diem	215.00		
Messenger to civil engineer, at \$1.76 per diem	227.04	1.76	550.88
Bell-ringer, at \$1.76 per diem	550.88		
Foreman laborer, at \$3.50 per diem	1,110.37	3.50	1,095.50
Writer and telegraph operator, at \$3 per diem	120.00		
	5,544.80		3,672.38

* Including Sundays.

Report showing amount expended during the fiscal year ending June 30, 1887, etc.—Cont'd.

Navy-yards and rating, and rate of pay.	Amount paid to civilian employes during the fiscal year ending June 30, 1887.	Estimates for civilian employes for the fiscal year ending June 30, 1887.	
		Rate of pay.	Amount.
NORFOLK, VA.			
Clerk to civil engineer, at \$1,400 per annum	\$1,398.93	\$1,400.00	\$1,400.00
Store clerk, at \$1,300 per annum	1,300.45		
Writer, at \$1,017.25 per annum	1,017.25	1,017.25	1,017.25
Foreman laborer, at \$4 per diem	1,247.00	4.00	1,252.00
Mail messenger, at \$3 per diem*	730.00	2.00	730.00
Messenger, at \$2 per diem	628.00	2.00	628.00
Messenger, at \$3 per diem	628.00	2.00	638.00
Pilot, at \$2.26 per diem	708.64	2.26	707.38
Assistant draftsman, at \$3.50 per diem		3.50	1,095.50
	7,660.18		7,454.13
PENSACOLA, FLA.			
Writer, at \$1,017.25 per annum	1,017.25		
Messenger, at \$2 per diem	628.00	2.00	628.00
Clerk to civil engineer, at \$1,200 per annum		1,200.00	1,200.00
Lamp-lighter, at \$1.50 per diem*		1.50	547.50
	1,643.25		2,373.50
MARE ISLAND, CAL.			
Clerk to civil engineer, at \$1,400 per annum	1,398.98	1,400.00	1,400.00
Store clerk, at \$1,300 per annum	1,300.00		
Writer, at \$1,017.25 per annum	1,017.16	1,017.25	1,017.25
Draftsman, at \$5 per diem	1,525.00	5.00	1,565.00
Foreman laborer, at \$3.50 per diem	1,716.00	5.50	1,721.50
Foreman mason, at \$6 per diem	1,854.00	6.00	1,878.00
Pilot, at \$4.80 per diem	1,507.20	4.80	1,502.40
Mail messenger, at \$2.74 per diem*	1,000.10	2.74	1,000.10
Messenger, at \$2.20 per diem	688.60	2.20	688.60
Bell-ringer, at \$2.26 per diem	707.38	2.26	707.38
Lamp-lighter, at \$2.20 per diem	629.20	2.20	688.50
Janitor, at \$1,000 per annum		1,000.00	1,000.00
	13,344.62		13,168.83

* Including Sundays.

Recapitulation of expenditures for civilian employes for fiscal year ending June 30, 1887, and estimates for the same for fiscal year ending June 30, 1889, per act approved January 30, 1885.

Navy-yards.	Expenditures, 1886-'87.	Estimates, 1888-'89.
Portsmouth, N. H.	\$6,388.99	\$5,155.00
Boston, Mass.	7,833.42	6,146.79
Brooklyn, N. Y.	9,688.80	10,815.25
Sackett's Harbor, N. Y.	265.00	265.00
League Island, Pa.	4,928.29	4,950.13
Washington, D. C.	5,544.80	3,671.88
Norfolk, Va.	7,660.18	7,454.13
Pensacola, Fla.	1,643.25	2,373.50
Mare Island, Cal.	13,344.62	13,168.83
Total	56,895.35	54,100.51

Statement of the appropriations for the Bureau of Yards and Docks for the fiscal year ending June 30, 1887, showing the amounts expended under each specific head of appropriation and the balances remaining unexpended June 30, as required by section 429, Revised Statutes.

Appropriation for general maintenance, 1887	\$170,000.00
Expended from July 1, 1886, to June 30, 1887	159,372.69
Balance on hand July 1, 1887	10,627.31
Balance will be entirely absorbed.	
Appropriation for repairs and preservation, 1887	125,000.00
Expended from July 1, 1886, to June 30, 1887	123,380.86
Balance on hand July 1, 1887	1,619.14
Balance will be entirely absorbed.	
Appropriation for civil establishment, 1887	62,000.00
Expended from July 1, 1886, to June 30, 1887	56,667.42
Balance on hand July 1, 1887	5,332.58
which will revert to the Treasury.	
Appropriation for contingent, 1887	20,000.00
Expended from July 1, 1886, to June 30, 1887	19,801.00
Balance on hand July 1, 1887	199.00
which will revert to the Treasury.	
Appropriation for navy-yard, Brooklyn, N. Y., 1887 :	
Repairing granite dry-dock	100,000.00
Expended from July 1, 1886, to June 30, 1887	28,796.80
Balance on hand July 1, 1887	71,203.20
which will be absorbed in completing the necessary repairs.	
Appropriation for navy-yard, Mare Island, Cal., 1887 :	
Granite dry-dock	191,595.00
Expended from July 1, 1886, to June 30, 1887	67,663.40
Balance on hand July 1, 1887	123,931.60
which will be expended in completing the dock.	
Appropriation for navy-yard, Mare Island, Cal., 1887 :	
Iron crane	22,000.00
Expended from July 1, 1886, to June 30, 1887	22,000.00
Appropriation for Naval Asylum, Philadelphia, Pa., 1887 :	
Amount	63,067.00
Expended from July 1, 1886, to June 30, 1887	46,976.40
Balance on hand July 1, 1887	16,090.60
After outstanding liabilities are paid about \$3,700 will revert to the Treasury.	
Appropriation for navy-yard, Mare Island, Cal., 1886 :	
Granite dry-dock	220,000.00
Expended from July 1, 1886, to June 30, 1887	204,520.00
Balance on hand July 1, 1887	15,480.00
Payment under contract for granite will absorb the balance.	
Appropriation for navy-yard, Mare Island, Cal., 1886 :	
Iron crane	40,000.00
Expended from July 1, 1886, to July 1, 1887	22,375.35
Balance on hand July 1, 1887	17,624.65
which will revert to the Treasury.	

Appropriation for navy-yard, Mare Island, Cal., 1886:	
Artesian well	\$10,000.00
Expended from July 1, 1886, to June 30, 1887	3,400.00
	6,600.00
Balance on hand July 1, 1887.....	
which will be nearly absorbed if contract for well is completed.	
Appropriation for naval station and coaling depot, Port Royal, S. C.:	
Coaling dock and naval storehouse	24,000.00
Expended to June 30, 1887	22,067.38
	1,932.62
Balance on hand July 1, 1887.....	
which will be nearly all absorbed when outstanding obligations are paid.	

ABSTRACT OF OFFERS RECEIVED FOR FURNISHING SUPPLIES COMING UNDER THE COGNIZANCE OF THE BUREAU OF YARDS AND DOCKS, MADE IN CONFORMITY TO THE ACT OF CONGRESS APPROVED MARCH 3, 1843, FOR FISCAL YEAR ENDING JUNE 30, 1887.

Scale of offers for supplies for navy-yard at Portsmouth, N. H., under advertisement dated July 12, 1886.

Hay and straw. Requisition No. 1:	
James D. Plaisted	*\$903.50
Corn meal and oats. Requisition 2:	
J. Brooks & Co.	*1,052.10
Oils. Requisition 4:	
Rider & Cotton.....	*662.00

Scale of offers for supplies for navy-yard at Portsmouth, N. H., under advertisement dated September 15, 1886.

Bricks. Class 1:	
* John H. Broughton.....	*50.00
Thomas E. Call & Son	50.00
Oak and hard wood. Class 5:	
* George A. Hammond.....	*281.00
White pine, spruce, etc. Class 6:	
* John H. Broughton.....	*846.75
Thomas E. Call & Son	860.00
George A. Hammond.....	947.00
Hair and plaster. Class 7:	
John H. Broughton	45.20
* Thomas E. Call & Son	*39.60
Cement. Class 8:	
John H. Broughton	23.50
† Thomas E. Call & Son	13.75
* Rider & Cotton.....	23.25
Gravel and sand. Class 9:	
John H. Broughton.....	36.00
* Thomas E. Call & Son.....	24.00
Iron, nails, etc. Class 11:	
* Rider & Cotton.....	258.62
Files. Class 14:	
* Rider & Cotton.....	60.81
Paints, oils and glass. Class 15:	
Rider & Cotton.....	357.00
* A. L. Cutter & Co	351.85
E. and F. King & Co.....	394.18
Ship chandlery. Class 16:	
* Rider & Cotton.....	218.03
Hardware. Class 17:	
* Rider & Cotton.....	499.00
Provender. Class 21:	
* Rider & Cotton.....	22.40
Belting, etc. Class 23:	
* Rider & Cotton.....	513.76

* Awarded.

† Informal.

Iron-work, piping, etc. Class 25 :	
*Rider & Cotton	\$500.62
Machinery and tools. Class 32 :	
*Rider & Cotton	377.56
Alcohol, etc. Class 33 :	
*William Ward & Sons	38.75

Schedule of offers for supplies for navy-yard, Boston, Mass., under advertisement dated August 25, 1886. Opened September 18.

Provender. Requisition No. 6 :	
*John Mullett	\$1,840.16
Nathan Tufts & Son	1,874.10
Brushes. Requisition No. 9 :	
*Murphy, Leavens & Co.	9.52
Gould & Co	11.25
G. D. Putnam & Co.	14.43
Glass. Requisition No. 10 :	
*E. E. Rider	57.43
R. Sherburne	57.80
F. M. Smith	64.62
†Lambert Bros	66.50
Lumber. Requisition No. 11 :	
*L. Lovejoy & Co	296.00
Paints. Requisition No. 12 :	
*W. W. Lawrence & Co	105.55
E. and F. King & Co	115.23
Gould & Co	117.10
A. L. Cutter & Co	118.15
E. E. Rider	123.30
G. Dunbar & Co	132.10
Paints. Requisition No. 13 :	
*W. W. Lawrence & Co	113.50
E. E. Rider	129.40
Gould & Co	127.03
E. & F. King & Co	141.61
G. Dunbar & Co	146.00
A. L. Cutter & Co	149.70
Blankets, etc. Requisition No. 14 :	
*G. D. Putnam & Co	58.55
Lead. Requisition No. 15 :	
*Chadwick Lead Works	205.50
Boston Lead Manufacturing Company	206.25
E. E. Rider	221.80
Plumbers' materials. Requisition No. 16 :	
*H. H. Weeden	120.64
Iron, etc. Requisition No. 17 :	
*G. D. Putnam & Co	59.80
G. Dunbar & Co	62.50
P. F. McDonald	70.00
Soap, brooms, etc. Requisition No. 18 :	
*John Mullett	67.75
Tools. Requisition No. 19 :	
*B. Callender & Co	17.97
G. D. Putnam & Co	18.19
Brass, etc. Requisition No. 20 :	
*G. D. Putnam & Co	32.17
G. Dunbar & Co	32.54
Sand and gravel. Requisition No. 21 :	
*Berry & Ferguson	43.12
P. O. Riordon	62.50
Hose. Requisition No. 22 :	
*G. Dunbar & Co	505.50
G. D. Putnam & Co	620.25
Eureka Fire Hose Company	748.25
Gutta Percha and Rubber Company	798.25
American Fire Hose Manufacturing Company	916.85
M. I. Ward	1,014.92
Conant Rubber Company	1,058.35

* Awarded.

† Informal.

Plumbing materials. Requisition No. 23 :	
*G. D. Putnam & Co	\$109.73
Plumbing materials. Requisition No. 24 :	
*G. D. Putnam & Co	24.65
Plumbing materials. Requisition No. 25 :	
*O. D. Putnam & Co	105.94
Pipe, etc. Requisition No. 26 :	
*Berry & Ferguson	29.02
G. D. Putnam & Co	31.80
F. M. Smith	40.70
Alcohol. Requisition No. 27 :	
*F. M. Smith	92.19
Howe & French	92.40
Hardwood seats. Requisition No. 28 :	
*B. Callender & Co	12.75
Files. Requisition No. 29 :	
†M. C. Warren & Co	14.59
*G. D. Putnam & Co	15.72
E. E. Rider	16.16
John Hallihan	19.55
Hardware. Requisition No. 30 :	
†M. C. Warren & Co	47.24
*G. D. Putnam & Co	47.71
B. Callender & Co	48.85
Window line, etc. Requisition No. 31 :	
*B. Callender & Co	14.97
G. D. Putnam & Co	15.94

Schedule of offers for construction of an iron floating gate or caisson for the dry-dock at the navy-yard, Boston, Mass., under advertisement dated April 25, 1887.

Iron floating gate or caisson :
 Atlantic Works, Boston \$37,800.00

Being the only bid received, and being in excess of the appropriation, was not accepted.

Schedule of offers for construction of an iron floating gate or caisson for the dry-dock at the navy-yard, Boston, Mass., under advertisement dated June 7, 1887.

Iron floating gate or caisson :
 The Atlantic Works, Boston, A. D. Hibbard, president..... \$33,500.00

No award made, proposal exceeding appropriation \$2,500.

Schedule of offers for supplies for Brooklyn Navy-Yard under advertisement dated August 27, 1886.

Provender. Requisition No. 5 :	
E. R. Shipman	\$1,998.90
C. L. Rickerson	1,846.25
*John Moonan	1,822.60
Harness leather, etc. Requisition No. 6: No bids.	
Sulphate copper, etc. Requisition No. 7 :	
James J. Donovan	871.30
*F. T. Witte Hardware Company	790.33
John Swan & Co	913.34
H. T. Wakeman	852.13
W. A. Wheeler	1,048.22
Drawing materials. Requisition No. 9 :	
John Swan & Co	51.63
A. V. Benoit	44.08
Callahan & Gartlan	50.10
Keuffel & Esser	46.17
*F. E. Brandis	42.78
Paints. Requisition No. 10 :	
James J. Donovan	1,065.40
W. A. Wheeler	1,153.90
George H. Creed	1,041.80
W. W. Laurence & Co	1,063.48
*C. T. Reynolds & Co	1,002.53

*Awarded.

†Informal.

F. M. Smith	\$1,072.47
R. A. Robbins	1,017.30
* W. P. Feeny	
* Pleasants & Woodworth	
Timber. Requisition No. 11:	
† James W. Duryee	3,884.00
Eppinger & Russell	3,925.00
Watson & Pittinger	4,015.00
* J. C. Staples	
Building materials. Requisition No. 12:	
† Sweeney Bros	1,521.80
Hardware. Requisition No. 14:	
James J. Donovan	1,746.38
F. T. Witte Hardware Company	1,684.88
† John Swan & Co	1,583.06
W. A. Wheeler	2,035.90
H. McShane & Co	1,774.50

Schedule of offers for supplies for Brooklyn navy-yard under advertisement dated December 2, 1886.

Portland cement. Requisition 42:	
† Johnson & Wilson	per barrel.. \$2.15
Howard Fleming	do... 2.34
Sinclair & Balsen	do... 2.35
James J. Donovan	do... 2.70
Rosendale cement. Requisition 42:	
James J. Donovan	1.50
Broken stone. Requisition 45:	
B. G. Bailey	per cubic yard.. 2.50
E. J. McKeever	do... 1.95
A. J. Howell	do... 1.95
† Thos. Quillan	do... 1.50
M. F. Fitzsimons	do... 1.95
J. A. Bowker	do... 2.30
Thos. Hayden	do... 2.19
Sand. Requisition 45:	
B. G. Bailey	per cubic yard.. 1.00
E. J. McKeever	do... 1.00
A. J. Howell	do... .79
Thos. Quillan	do... .90
M. F. Fitzsimons	do... .90
† J. A. Bowker	do... .75
Thos. Hayden	do... .99
Granite. Requisition No. 46:	
Mount Waldo Granite Works	per cubic foot . 2.25
Bodwell Granite Company	do... 2.77
Nolan & Son	do... 1.56
† W. S. White	do... 1.29
Booth Bros	do... 1.74
B. G. Bayley	do... 2.50
C. F. Stoll	do... 2.50
Dressed granite. Requisition 47:	
† Nolan & Son	per cubic foot.. .93
W. S. White	do... 1.05
Booth Bros	do... 1.10
Thos. B. Dillon	do... 1.73
John Brew	do... 1.85
Timber. (Lot.) Requisition 49:	
Damat & Pell	1,945.90
South Brooklyn Saw-Mill Company	1,140.44
J. C. Staples	1,187.16
† J. W. Duryee	1,056.00
Gaskets. (Lot.) Requisition 50:	
J. A. Donovan	333.50
R. A. Robbins	366.85
† Jno. Swan & Co	299.00
Thos. F. Stevenson	391.00

* Informal.

† Awarded.

Wire rope. (Lot.) Requisition 50 :

J. J. Donovan.....	\$191. 00
*R. A. Robbins.....	186. 90
Jno. Swan & Co.....	210. 00
J. A. Roeblings Son's Co.....	193. 50
Thos. F. Stevenson.....	227. 50
F. M. Smith.....	187. 32

Iron, &c. (Lot.) Requisition 50:

J. J. Donovan.....	223. 40
R. A. Robbins.....	206. 00
Jno. Swan & Co.....	192. 00
Thos. F. Stevenson.....	272. 34
F. M. Smith.....	216. 25
*J. W. Soper.....	177. 57

Schedule of offers for supplies for Brooklyn navy-yard on Requisition No. 15, April, 1887.

For 1,800 feet cast-iron water pipe and 650 pounds pig lead :

*Jas. J. Donovan.....	\$614. 13
Richard W. Creed.....	641. 50
Jas. O. Morse.....	708. 25
John Swan & Co., pipe alone.....	594. 00
W. A. Wheeler, pipe alone.....	644. 00

Schedule of offers for the construction and completion of two timber dry-docks to be located at the New York and Norfolk navy-yards, respectively, under advertisement dated April 19, 1887. Bids opened June 29, 1887.

NEW YORK NAVY-YARD.

Amount of bid for dock 480 feet long:

† O'Connell & Coffey.....	\$525, 000. 00
---------------------------	----------------

NEW YORK AND NORFOLK NAVY-YARDS.

Amount of bid for docks 480 feet long and over for \$1,105.83 per lineal foot:

‡ J. E. Simpson & Co. (Bid for two docks 480 feet long each).....	\$1, 061, 600. 00
---	-------------------

Scale of offers for supplies for Naval Asylum, Philadelphia, under advertisement dated May 24, 1887. Bids opened June 22, 1887.

Clothing. Class 1, A :	
*Jacob Reed's Sons.....	\$4, 804. 00
Clothing. Class 2, B :	
*Jacob Reed's Sons.....	3, 314. 50
Boots and shoes. Class 2 :	
*H. D. Connor.....	1, 430. 00
Jas. McKnight.....	1, 442. 00
Provisions. Class 3 :	
*Thomas Bradley.....	10, 070. 87½
Albert Sigel.....	10, 270. 25
Daniel Snyder.....	10, 976. 00
Groceries. Class 4.	
Mitchell, Fletcher & Co.....	11, 735. 05
Chas. Laurence & Co.....	10, 602. 90
Jas. G. Boyle.....	13, 203. 92
Wm. Deering.....	11, 617. 83
*Robert McKeown.....	10, 225. 12
Dry goods. Class 5 :	
*Thomas G. Hood.....	1, 248. 21½
§ Henry C. Harper.....	1, 153. 25¾
Bread. Class 6 :	
*Geo. W. Wauklin.....	2, 050. 00

* Awarded.

† Plans not favorably considered, and returned to the bidders.

‡ Awarded, and the two docks to be 500 feet long each.

§ Received too late.

Tobacco. Class 7:	
M. A. Rettew & Co	\$952. 00
*Jos. Hollard	918. 00
Coal and wood. Class 8:	
Fox & Chapman	2, 492. 50
*Frank K. Ward	2, 420. 00
Paints, oil, and glass. Class 9:	
†Wetherill & Brother	230. 75
*J. J. Shannon & Co	486. 76
Ice. Class 10:	
*Knickerbocker Ice Company	360. 00
Lumber. Class 11:	
*Elias Pohl	500. 00
†S. G. Morton Maule	510. 60
Provender. Class 12:	
*Paul J. Field	214. 40
Wm. Brown	224. 50
Newspapers, periodicals, etc. Class 13:	
*Chas. T. Adams, jr	208. 08
Miscellaneous. Class 14:	
J. J. Shannon & Co	468. 61
*Samuel I. Goodall	457. 19
Paul J. Field	543. 70
Pickering & Colescott	622. 55
Hardware. Class 15:	
J. J. Shannon & Co	367. 18
*Samuel I. Goodall	276. 69
Paul J. Field	315. 90

Schedule of offers for supplies for navy-yard at League Island, Pa., under advertisement dated August 25, 1886.

Provender. Requisition No. 1, class No. 1:	
Paul A. Swartz	\$590. 44
*Charles J. Field	541. 35
P. J. Field	556. 72
Wm. Brown	550. 95
Axle grease, soap, etc. Requisition No. 4, class 4:	
Charles J. Field	41. 81
*S. I. Goodall	35. 44
P. J. Field	45. 75
Lumber and nails. Requisition No. 5, class 5:	
Elias Pohl	605. 00
*J. W. Gaskill & Sons	570. 10
Sperm oil, etc. Requisition No. 6, class 6:	
Chas. J. Field	53. 63
*S. I. Goodall	38. 90
P. J. Field	63. 70
Flags, awning cloth, etc. Requisition No. 7, class 7:	
Darrah & Elwell	112. 00
*Fred. M. Smith	83. 21
Paints, etc. Requisition No. 8, class 8:	
*S. I. Goodall	98. 40
†F. W. Devos & Co	98. 76
Astral oil. Requisition No. 9, Class 9:	
P. J. Field	174. 00
*C. R. Smith & Co	132. 00
Miscellaneous. Requisition No. 10, Class 10:	
†Charles J. Field	55. 55
*S. I. Goodall	147. 90
P. J. Field	160. 36

Schedule of offers for supplies for navy-yard at Washington, D. C., under advertisement dated August 21, 1886.

Feed. Requisition No. 4:	
*W. M. Galt & Co	1, 006. 58
R. C. Hewett & Co	1, 272. 00

*Awarded.

† Informal.

‡ Incomplete; informal.

Linseed oil. Requisition No. 5:		
Z. D. Gilman		\$69. 00
D. Shanahan		69. 00
†E. E. Rider		66. 00
*J. H. McGill		65. 25
W. B. Price Manufacturing Company		70. 50
W. W. Lawrence & Co.		69. 00
Sperm oil, etc. Requisition No. 6:		
*Z. D. Gilman		80. 60
Jas. M. Hodges		81. 30
†E. E. Rider		78. 92
†W. P. Feeney		29. 88
†J. H. Winkelman & Co.		42. 25
Paint brushes, etc. Requisition No. 7:		
Z. D. Gilman		97. 08
Jas. M. Hodges		87. 15
D. Shanahan		85. 65
†E. E. Rider		84. 58
*J. H. McGill		82. 16
W. B. Price Manufacturing Company		82. 35
Miscellaneous hardware. Requisition No. 8:		
†E. E. Rider		143. 48
*Jas. B. Lambie		151. 75
Upholstering goods. Requisition No. 9:		
*Julius Lansburg		79. 17
†Petersen & Childs		55. 53
W. B. Moses & Son		108. 23
Lead pipe, etc. Requisition No. 12:		
†E. E. Rider		316. 25
*Jas. B. Lambie		337. 96
Paints, oils, etc. Requisition No. 13:		
Z. D. Gilman		852. 10
Jas. M. Hodges		1, 015. 28
†E. E. Rider		852. 69
J. H. McGill		836. 59
W. B. Price Manufacturing Company		845. 09
John Lucas & Co.		871. 90
*W. W. Lawrence & Co.		825. 95
†W. P. Feeney		77. 30
George Ryneal, jr.		862. 90
D. Shanahan		891. 17
Alcohol. Requisition No. 13:		
*Barbour & Hamiltou		115. 00
Asphaltum paint. Requisition No. 14:		
D. Shanahan		820. 00
*W. P. Price Manufacturing Company		780. 00
W. W. Lawrence & Co.		845. 00
Sand. Requisition No. 15:		
J. B. Kendall		165. 00
*John Miller		135. 00
†E. E. Rider		180. 00
W. B. Price Manufacturing Company		450. 00
James Holloran		190. 00
Poplar, etc. Requisition No. 16:		
*W. W. McCollough		39. 96
White pine, etc. Requisition No. 17:		
W. W. McCollough		510. 50
*John Miller		427. 90
<i>Schedule of offers for supplies for navy-yard, Norfolk, Va., under advertisement dated August 21, 1886.</i>		
Hay, etc. Requisition No. 3:		
Neimeyer & Co		1, 160. 00
Evans & Burwell		1, 134. 81
T. R. Cooke & Co.		1, 213. 80
Etheridge & Brooks		1, 157. 10
*A. H. Lindsay		1, 103. 04
†J. G. Reid		819. 20

*Awarded.

†Bids withdrawn.

‡Informal.

Electric fire-alarm. Requisition No. 5:	
*G. L. Neville.....	\$40. 66
Mayer & Co.....	75. 02
Files. Requisition No. 6:	
*G. L. Neville.....	16. 91
Mayer & Co.....	22. 02
R. B. Allen.....	23. 87
E. J. Griffith & Co.....	17. 85
Paints and oils. Requisition No. 7:	
G. L. Neville.....	65. 00
Mayer & Co.....	75. 00
E. J. Griffith & Co.....	62. 50
W. P. Feury.....	63. 00
*M. A. & C. A. Santos.....	52. 05
Grates. Requisition No. 8:	
G. L. Neville.....	129. 30
*M. F. Weaver.....	69. 65
Packing, etc. Requisition No. 9:	
*G. L. Neville.....	181. 30
Mayer & Co.....	188. 30
R. B. Allen.....	182. 88
Iron, etc. Requisition No. 10:	
G. L. Neville.....	41. 94
Mayer & Co.....	49. 38
*E. J. Griffith & Co.....	40. 25
Ship-chandlery. Requisition No. 11:	
*G. L. Neville.....	387. 45
Mayer & Co.....	448. 55
E. J. Griffith & Co.....	402. 35
Hardware. Requisition No. 12:	
G. L. Neville.....	386. 09
Mayer & Co.....	397. 89
*E. J. Griffith & Co.....	347. 90
Hardware. Requisition No. 13:	
*G. L. Neville.....	514. 21
Mayer & Co.....	607. 01
E. J. Griffith & Co.....	611. 07
Paints, etc. Requisition No. 14:	
G. L. Neville.....	438. 35
Mayer & Co.....	488. 85
†W. P. Furing.....	45. 80
*M. A. & C. A. Santos.....	419. 73
†W. W. Lawrence & Co.....	376. 90
Lumber. Requisition No. 15:	
G. L. Neville.....	442. 68
*R. J. Neely & Co.....	411. 00
Lime. Requisition No. 16:	
G. L. Neville.....	19. 00
Mayer & Co.....	23. 50
*Newmeyer & Co.....	18. 00
Etheridge & Brooks.....	18. 20
Iron, etc. Requisition No. 17:	
*G. L. Neville.....	69. 56
Mayer & Co.....	91. 50
E. J. Griffith & Co.....	76. 65
E. V. White & Co.....	76. 75
Hard-wood. Requisition No. 18:	
†G. L. Neville.....	112. 50
Mayer & Co.....	148. 00
*R. J. Neely & Co.....	120. 00
Slate. Requisition No. 19:	
*G. L. Neville.....	110. 00
Mayer & Co.....	135. 00
White pine. Requisition No. 20:	
*G. L. Neville.....	190. 00
Mayer & Co.....	205. 00
R. J. Neely & Co.....	204. 50

*Awarded.

† Informal.

* Received too late.

REPORT OF THE SECRETARY OF THE NAVY.

Scale of offers for supplies for navy-yard at Pensacola, Fla., under advertisement dated August 23, 1886. Bids opened September 22, 1886.

Oil, hay, corn, and oats, etc. Requisition No. 1:		
*J. O. Neal	\$1,076.25
†McKenzie, Oerting & Co.	966.27
*John Mooney	1,191.85
Bunting, varnish, turpentine, etc. Requisition No. 2.		
*J. O. Neal	142.00
‡McKenzie, Oerting & Co.	129.95
†Avery & Woolfolk	107.70
*John Mooney	116.77
Harness, leather, rubber, flock-drilling, etc. Requisition No. 3:		
*J. O. Neal	139.00
McKenzie, Oerting & Co.	130.13
†Avery & Woolfolk	129.53
*John Mooney	124.53
Dump-carts, corn brooms, etc. Requisition No. 4:		
*J. O. Neal	365.00
McKenzie, Oerting & Co.	311.00
†Avery & Woolfolk	304.60
W. B. Hilliard	260.00
John Thompeon	52.00
*John Mooney	413.71
Brushes, oil, etc. Requisition No. 5:		
*J. O. Neal	110.00
†McKenzie, Oerting & Co.	102.93
Avery & Woolfolk	121.86
*John Mooney	71.60
Hair, cloth, rep, etc. Requisition No. 6:		
*J. O. Neal	153.95
†McKenzie, Oerting & Co.	215.95
*John Mooney	200.78

Scale of offers for supplies for navy-yard at Mare Island, Cal., under advertisement dated August 30, 1886.

Requisition.	Class.	Articles and name of contractor.	Offer.
IRON.			
9	A	Huntington, Hopkins & Co.	\$152.00
9	A	Thos. H. Selby & Co.	205.95
10	A	Thos. H. Selby & Co.	193.75
10	A	Huntington, Hopkins & Co.	178.79
STEEL.			
9	B	Huntington, Hopkins & Co.	1825.19
9	B	Thos. H. Selby & Co.	844.75
HARDWARE.			
7	C	Huntington, Hopkins & Co.	917.95
7	C	Winchell & Edgcombe	1562.77
7	C	Hawley Brothers' Hardware Company	607.17
9	C	Huntington, Hopkins & Co.	297.39
9	C	Winchell & Edgcombe	289.67
9	C	Hawley Brothers' Hardware Company	1272.04
10	C	Huntington, Hopkins & Co.	273.46
10	C	Winchell & Edgcombe	1269.90
11	C	Huntington, Hopkins & Co.	40.00
11	C	Winchell & Edgcombe	*8.00
11	C	Hawley Brothers' Hardware Company	50.00
LUMBER.			
7	D	Renton, Holmes & Co.	50.00
7	D	A. Powell	47.50
7	D	James McCudden	142.50
7	D	Turner, Kennedy & Shaw	47.50
9	D	Renton, Holmes & Co.	\$195.00
9	D	A. Powell	324.00
9	D	James McCudden	1314.50
9	D	Turner, Kennedy & Shaw	340.00
10	D	Renton, Holmes & Co.	497.50
10	D	A. Powell	486.85
10	D	James McCudden	1467.50
10	D	Turner, Kennedy & Shaw	523.00

* Informal. † Awarded. ‡ Awarded in part. § Accepted.

Scale of offers for supplies for navy-yard at Mare Island, Cal. &c.—Continued.

Requisition.	Class.	Articles and name of contractor.	Offer.
CHARCOAL.			
7	E	A. Powell	\$18. 00
7	E	Aden Brothers	19. 00
7	E	James McCudden	*17. 00
LIME, PLASTER, AND HAIR.			
7	F	A. Powell	375. 00
7	F	Aden Brothers	312. 50
7	F	James McCudden	*281. 25
9	F	A. Powell	165. 00
9	F	Aden Brothers	187. 50
9	F	James McCudden	*123. 75
10	F	A. Powell	4. 00
10	F	Aden Bros	4. 00
10	F	James McCudden	*4. 00
BRICK.			
9*	G	Aden Bros	42. 50
9*	G	A. Powell	42. 50
9*	G	James McCudden	40. 00
FEED.			
3	H	A. Powell	1,327. 50
3	H	Aden Bros	1,321. 00
3	H	James McCudden	*1,321. 00
3	H	James Brownlie	1,333. 00
METALS.			
10	I	Thomas H. Selby & Co.	*183. 27
HOSE.			
7	J	W. T. I. Schenck	*1,558. 00
9	J	W. T. I. Schenck	*100. 00
7	K	Harness, etc., no bids received.	
PAINTS, OILS, BRUSHES, ETC.			
7	L	Sullivan & Co.	308. 40
9	L	Whittier, Fuller & Co.	*243. 00
9	L	Sullivan & Co.	85. 00
9	L	Whittier, Fuller & Co.	72. 50
10	L	Sullivan & Co.	485. 26
	L	Whittier, Fuller & Co.	*470. 79
GLASS.			
9	M	Sullivan & Co.	*9. 00
9	M	Whittier, Fuller & Co.	12. 00
10	M	Sullivan & Co.	18. 45
10	M	Whittier, Fuller & Co.	*18. 50
DRY GOODS.			
7	N	S. Dannenbaum	*103. 25
7	N	G. Berson	109. 94
8	N	J. Dannenbaum	*453. 05
8	N	F. S. Chadborne & Co.	497. 57
8	N	G. Berson	506. 20
11	N	S. Dannenbaum	*203. 70
11	N	G. Berson	230. 95
STATIONERY.			
6	O	Edward Denny & Co.	197. 25
6	O	H. S. Crocker & Co.	*182. 17
12	O	Edward Denny & Co.	*95. 00
TELEGRAPH SUPPLIES.			
7	P	California Electric Works	†254. 03
7	P	Sunset Telegraph Company	*418. 58
PIPE AND FITTINGS.			
10	Q	Huntington, Hopkins & Co.	*219. 48
COOKING UTENSILS.			
11	R	John Brownlie	*36. 58
CHANDLERY.			
7	S	Huntington, Hopkins & Co.	102. 00
7	S	James Gallup & Co.	*80. 00
9	S	Huntington, Hopkins & Co.	667. 50
9	S	Jas. Gallup & Co.	*632. 20
9	S	Hawley Brothers' Hardware Company	671. 40
PACKING.			
10	T	No bids received.	

* Accepted.

† Informal.

Scale of offers for 49,000 cubic feet dressed or dimension granite for United States navy-yard, Mare Island, Cal., under advertisement dated September 6, 1886.

[Per cubic foot.]

	Dressed granite.	Dimension granite.
M. J. Kelly.....	\$2.60	\$2.19
M. J. Healey & Co.....	*2.37	1.27
Davis Tillson.....	2.70	1.70
Bodwell Granite Company.....	2.90
Mount Waldo Granite Works.....	2.95	1.75
Jas. McCudden.....	3.10	2.50
G. Griffith.....	2.95	2.45

Scale of offers for constructing a frame store-house at naval station, Port Royal, S. C., under advertisement dated September 11, 1886.

Constructing frame store-house:
 N. Christensen..... *\$5,081.00

*Awarded.

No. 8.—BUREAU OF EQUIPMENT AND RECRUITING.

**BUREAU OF EQUIPMENT AND RECRUITING,
NAVY DEPARTMENT,
Washington, D. C., September 1, 1887.**

SIR: I have the honor to submit the following report of operations of the Bureau for the fiscal year ending June 30, 1887, and to inclose estimates for the fiscal year ending June 30, 1889.

For the year ending June 30, 1887, the following amounts under the several headings were appropriated:

Equipment of vessels.....	\$782,200
Transportation and recruiting.....	25,000
Contingent.....	20,000
Civil establishment.....	16,800
Training station (for boys), Coaster's Harbor Island.....	8,000

At the various yards, to wholly or to partially refit vessels, and to supply them with stores, there was an expenditure of \$70,677.92 for labor, and \$357,137.80 for material, aggregating \$427,815.72, from the appropriation "Equipment of vessels."

I am glad to be able to report that the appropriations for the year were found sufficient, and that there are considerable unexpended balances to turn back into the Treasury under the several headings.

COAL.

For the supply of vessels on foreign and home service 47,713 tons of coal were purchased, costing, including all expenses of handling and delivery, \$301,540.73. The price of coal purchased was cheaper by a few cents per ton than that delivered in the previous fiscal year.

HEMP.

To manufacture cordage needed on board the different vessels in commission, and at stations, required the purchase of the following amounts of hemp:

Kind.	Quantity.	Value.
Manila hemp.....pounds..	896,318	\$72,265.34
Russian hemp.....tons..	203,111	41,821.08
American hemp.....do....	22,111	5,816.08

ROPEWALK.

During the year the following amount of cordage was manufactured at the Boston yard, costing, including labor:

335,009 pounds manila rope.....	\$43,511.17
70,311 pounds hemp rope.....	8,606.54
16,665 pounds wire rope.....	3,166.35
29,479 pounds small stuff.....	4,376.02

The price of material has varied but little from that of last year, so that the Bureau has been able to maintain the market price in its manufacture. During the year the Light-House Board was supplied with quite a large amount of cordage, and the Bureau stands ready to supply the Revenue Marine, the Life-Saving Service, or the Coast Survey with a superior quality of manila, hemp, or wire rope, at market prices.

FORGE, ANCHOR, SMITH, AND CHAIN SHOPS, AND ROLLING-MILL.

In obedience to General Orders Nos. 354 and 356, the several shops under the control of this Bureau at the Washington yard, for the manufacture of anchors, chains, and galleys, were transferred to the Boston yard, and only such tools, hammers, and other implements as would increase the efficiency of the Boston plant were transferred. In reorganizing this yard the commandant was instructed how to determine the actual value of all products, and in future there will be no difficulty on this point.

During the transfer of plant, which was done at small expense, the manufacture of various articles ceased, hence the only production and outlay to report in the rolling-mill, forge and anchor shops, and galley shop is \$20,316.88 for material and labor.

The Bureau has been obliged to refit the blacksmith shop at the Boston yard, and to purchase an inexpensive testing machine, and to build a testing trench to test safely all work to be turned out, as the old testing machine at the Washington yard was a relic of the past, and so entirely past all repair that it would have been a waste of money to spend anything upon this machine whose indications have not been reliable for fifteen years past, at least, and which for a number of years has been worthless except as old iron.

Under the terms of General Order 356, it is intended to manufacture all anchors, all chains, all galleys, all sails, all rigging, all cordage, all awnings, all hammocks, all bags, all windsails, all sail and mast covers, and all hammockcloths that are to be used in the service at the Boston yard, leaving the minor repairs only to yards where ships may fit out, as well as the manufacture of such small things as tarpaulins, wheel covers, hatch hoods, reel covers, etc. This centralization of the Bureau's business will make it much more economical to administer, and will keep a small force continuously employed in all the branches of its work, rather than a larger force scattered over the several yards working on half or quarter time.

SAIL-LOFTS.

In making sails, awnings, bags, hammocks-cloths, and other canvas work at the several yards the following expenditures were made:

For material.....	\$37,743.27
For labor.....	39,558.23

RIGGING-LOFTS.

In fitting rigging for vessels at the several yards preparing for sea, the following expenditures were necessary:

For material	\$37, 811. 97
For labor.....	38, 365. 87

TRAINING APPRENTICES FOR THE NAVY.

Coaster's Harbor Island.—The permanent headquarters of this service has been for the past year under the command of Capt. A. R. Yates, U. S. Navy. His zealous attention to the arduous duties of this station, and his efficient administration of its affairs, are worthy of the Bureau's commendation. As much work in dredging channels, extending wharf, repairing walls, and in general maintenance of station as the very limited appropriation allowed has been done, but there is still needed a complete natatorium, with heating attachment so arranged as to raise the temperature of the water during the winter, that instruction in swimming, an important feature of the education of boys, may be continued the year round. If this instruction be limited, as now, only to the summer season, those apprentices enlisting during the fall and winter months would leave the training station in the early summer of the following year without any instructions in one of their most important needs.

The great progress in all matters of naval science and of naval construction has made preliminary training for the duties of the seamen of the naval service an absolute necessity, in order to comprehend the various appliances now used in propulsion, in lighting, in handling guns, in boats, and in torpedoes of the modern ships. This training station for boys is, therefore, to become the great nursery upon which we are to depend for trained seamen, and in this view will need other additions to its appliances to give the needed instruction.

At present, after enlistment on board the *Minnesota* at New York, the *Wabash* at Boston, the *Saint Louis* at Philadelphia, the *Dale* at Washington, and the *Michigan* on the Lakes, these lads are sent to the headquarters at Coaster's Harbor Island, where they remain usually about six months, to be taught the elements of arithmetic, geography, history, writing, the primary duties of the young sailor, such as splicing and knotting ropes, handling the palm and needle, heaving the lead, boxing the compass, reefing and furling sails, pulling in boats, drilling at great guns, at artillery, and at infantry drills. This instruction is supplemented by gymnastic exercises, small-sword drills, and a class of boys who exhibit taste for the bugle are trained in the bugle-calls used in the service. Swimming is taught them in the summer months.

This course of instruction is so well divided up, that each week includes some training in each of the subjects enumerated above.

This preliminary headquarter training being acquired, the apprentices best qualified are transferred to the cruising training ships *Saratoga*, *Portsmouth*, and *Jamestown*, and are sent abroad in the winter months to the West Indies, and in the summer to Europe, to learn at sea the duties of a sea-life in the somewhat higher duties of the sailor.

The following exhibit shows the number of apprentices in the service June 30, 1887:

Number on board stationary and cruising training ships.....	534
Number on board cruising ships of the general service.....	550
Total.....	1 084

On board the cruising ships of the general service they are distributed as follows:

North Atlantic station	147
South Atlantic station	96
Pacific station	137
European station	46
Asiatic station	124
Total	550

During the year there were 2,003 applicants for enlistment as apprentices. Of this number there were 1,427 rejected on account of physical disqualification and 66 for other causes, making the number accepted 510; of these 125 failed to report for enlistment after examination, so that the number actually received into the service was 385.

During the last winter the cruising training squadron, consisting of the *Portsmouth*, *Jamestown*, and *Saratoga*, under Commander C. H. Davis, U. S. Navy, were sent to cruise among the Windward Islands of the West India group. The results of such cruises, and the time spent at sea in making the passages out and back, were shown in the inspection of all the ships. The condition of efficiency and good order of this squadron reflects much credit upon the commanding officer, who has been most careful and attentive in all matters.

Cruising training ships.—The Bureau would again bring to your attention the most absolute need of two modern steam cruising ships to take the place of the three training ships now in use—the *Portsmouth*, *Jamestown*, and *Saratoga*. These ships need constant repairs to keep them efficient, so that the time spent at the yards is lost to our training. Perhaps there is no development of the modern ships quite equal to the new high-powered machines to give them speed, and unless we can include the training of firemen for these high-powered ships, it would not be overstated to say that until the men are trained to convert the greatest amount of coal into energy on a given grate surface these new ships at the outset of their cruises must lose much of their effectiveness. Either their training for this duty must begin before the modern vessel comes into service or afterwards; if the latter, then the vessel must be inefficient until the engineer's force is trained to usefulness. This would be fatal in case of war.

The whole problem is changed in these latter days. Ships are constructed with all sorts of new conditions; sail is only subsidiary, and of little importance now. Hence, most of the instruction heretofore given to attain efficiency in handling it must be given up to instructing the crews in the use of new guns, and the machinery for manipulating them, for torpedoes and electric work, and its various applications on board ships, and for such training of the engineer force of our ships as will enable us to develop the full capacity and power of the new machines.

With this view the Bureau would urgently recommend for your consideration the immediate construction of two steam training ships of about 900 to 1,000 tons displacement, to be bark rigged and engined with modern machinery, to be fitted with electric plant to light them throughout, and to be fitted with torpedo attachments, in order that the requirements of a modern war ship may be taught from the beginning rather than to have to begin this instruction after reaching the new ships. I hardly think it needs any argument to prove that boys trained as they are at present, in accordance with old methods, are not what the new conditions of the service demand. While trained only to the

duties of sea-life, their real education must be deferred until they are transferred to the new ships. It is this feature of the case which urges action.

PENSIONS.

The following table exhibits the pension cases submitted to the Bureau during the fiscal year, under the sixth section of the act of March 2, 1867, sections 4756 and 4757, Revised Statutes of the United States:

	Claims pending July 1, 1866.	Claims filed during year ending June 30, 1867.	Claims allowed during year ending June 30, 1867.	Claims disallowed during year ending June 30, 1867.	Claims pending June 30, 1867.
For service of twenty years	40	26	27	18	30
For service of ten years	30	21	12	19	29
For renewal of pension	1	15	13	1	2
For increase of pension	2	6	3	3	3
For restoration of pension	0	3	3	0	0
For review of claim	0	1	0	1	0
Total	01	72	57	42	64

ENLISTED MEN.

On June 30 there were 8,342 men and apprentices in the service. The number allowed by law has not been exceeded during the fiscal year.

Men allowed	7,500
Men enlisted at the different navy-yards	2,211
Men enlisted on board ships	2,283
Discharges during the year	3,827
Honorably discharged and continuous-service men in Navy, June 30	1,523
Desertions during the year	773
Deaths during the year	60
Men employed in Coast Survey	275
Men employed in Fish Commission	136
Men at Naval Academy (winter)	94
Men at Naval Academy (summer)	281
Number of men enlisted during year under C. S. C.	597
Number of men who enlisted and who were formerly apprentices	88
Cost to maintain men in Coast Survey for the fiscal year	\$151,051.31
Cost of maintaining men in Fish Commission for the fiscal year	\$65,679.97

In making the various inspections of receiving ships during the year, the Bureau has observed the attention to cleanliness and order paid by their commanding and other officers. The men enlisted are carefully examined in accordance with prescribed regulations, and only those whose physical standard is up to the regulation are selected. I have found the officers of these vessels much interested in their duties, and in many ways have devised means to improve the training of men after enlistment. The men themselves are, as a rule, well behaved and orderly, and in most cases respond readily to the interest manifested in them. The vessels for recruiting and receiving men are the *Wabash*, at Boston, Capt. J. N. Miller; the *Vermont*, at New York, Capt. W. A. Kirkland; the *St. Louis* at Philadelphia, Capt. H. B. Seeley; the *Dale*, at Washington, Commander Yates Stirling; the *Franklin*, at Norfolk,

Capt. G. C. Wiltse; the *Independence*, at Mare Island, Commander John W. Philip. Most of the vessels enumerated are old frigates converted to the purposes of recruiting, and are commodious and in fair order of preservation.

The efficiency of the enlisted men of the general service is testified to at almost all inspections of vessels preparing for, or returning from, foreign service by the board of inspection. The better care of men, their better ration, and more attention to their comforts, are the means by which so desirable a condition is brought about. The improved condition of the new ships now coming into service will enable the commanding officer to add still more to the men's comfort.

ADVANCED COURSE OF INSTRUCTION FOR SEAMEN.

During the year there have been placed under instruction about 40 men taken from the general service. The object sought in this course of training has been to bring a limited number of the men of the service into contact with the every-day needs of the new vessels. At the Washington yard they remain for a period of about six months, and are trained in the use of tools, the manner of building up the new guns, with their various attachments, breech-blocks, etc., how to manage and control their machinery, the preparation of the new ammunition, the management of machine guns, and the control and care of search lights. At Newport a further training of six months is given to electric work of every character; to diving, to torpedoes, to printing, to the preparation of torpedo outfits, to the management of dynamos, to lighting electrically, to the fabrication of nitro-glycerine and other high explosives. Each class, as trained, is transferred to the general service as seaman gunners, and, in time, its members are made use of to train the crews of ships to which transferred.

RECOMMENDATIONS.

The force of men attached to the Naval Academy, the Coast Survey, and the Fish Commission taken from the number, 7,500, allowed by law, often cramps the Bureau in fitting out additional vessels for service. I would recommend that 700 men additional be asked for for this special service.

Honorably discharged men are granted by law a gratuity of three months' pay if they present themselves at any rendezvous and re-enlist within three months from date of discharge. The evident object of this law is to encourage men once in the service to continue in it, and the payment of three months' gratuity on re-enlistment at any time within the statutory limit actually assumes the man to have continued in the service during this interval. This being the case, the Bureau would recommend for your consideration some legislation to allow these honorably discharged men to elect a home on board any of the receiving ships during these three months, the men desiring this privilege to be entitled to one ration per day for maintenance, and to be amenable to such regulations while there as the Secretary may establish. Such legislation would save many valuable men to the Navy, and would give them relief from the uncleanly and miserable boarding places of our large cities.

In 1872 a law was enacted by which the enlisted men of the Army were allowed to deposit their savings in sums not less than \$5 with any

Army paymaster. These savings are not subject to forfeiture by sentence of courts-martial, but are forfeited by desertion, and are paid the soldier on final discharge, or to his heirs if deceased. Section 1306 establishes the rate of 4 per cent. interest per annum for any sum not less than \$50 deposited for a period of six months or longer, to be paid when discharged. As a matter of discipline on board ships it is necessary to retain a large proportion of the pay of enlisted men, while the manifest impropriety of paying out large sums of money monthly to men who have no opportunity at sea to send it home, or to spend it for their needs, hardly requires discussion, but there would be much danger that gambling, fraud, or theft would result, to the injury of discipline and to the prejudice of good order. I would recommend that section 1306 be limited to apply to the enlisted man's pay only, otherwise it might be possible to deposit a friend's money and thus obtain interest, contrary to the good intent of the law.

On the 14th of February, 1885, Congress passed an act creating a retired list for the enlisted men of the Army and Marine Corps, after thirty years of service. Upon application to the President, men having such service are placed on the retired list with 75 per cent. of the pay of the rank in which retired. The Bureau would recommend to your consideration such amendment of the statute as will include the sailor, whose life of exposure on the high seas, or to the contagious epidemics of foreign ports, or to the special privations of his life on board ships in foreign ports, where most of his duty is done beyond the public observation, would appear to merit the same fostering care of his Government.

Section 2166 of the Revised Statutes confers citizenship upon aliens serving in the Army who may be honorably discharged at the expiration of enlistments. The Bureau is convinced that the omission to include men serving in the Navy was unintentional, and the recommendation of this matter to your consideration is respectfully made.

Article 2, section 1342, of the Revised Statutes, authorizes commissioned officers of the Army to administer the oath of allegiance to recruits. As this statute limits this authority to officers of the Army, we are without lawful authority to exact this oath from men enlisting for the Navy. Everywhere else in the military or naval service the oath of allegiance is required as a necessary preliminary to place. The Bureau would recommend the amendment of the above section to include the Navy.

The question of allowing apprentices an outfit of clothing is again urgently recommended. These lads receive only small pay (\$9, \$10, \$11 per month) during their training and when serving on board the regular cruisers, but the same rigid rule of neatness in dress required of others is applied to them. It often results, then, during their minority that many of them hardly earn money enough to keep themselves properly clothed. But a greater trouble occurs when they begin their service and are compelled to draw an outfit of uniform clothing, which costs on the average about \$45. As the regulations prohibit the issue of money to persons in debt, or any gratification of leave of absence on shore during the period of indebtedness, it results that these lads are kept confined to the ship in which they may serve, or within the limits of a shore command, until the debt to the Government is liquidated. The dispiriting effect of this upon young growing boys may be imagined, but to be deprived of a small amount of spending money and all liberty during this interval of indebtedness is so discouraging that desertion often happens with theft of outfit, which is generally disposed of in or-

der to secure the means to get away. I would recommend, then, an allowance of \$45 worth of clothing be given each apprentice when regularly enlisted and installed on board the training ship *New Hampshire*.

Another matter of vital importance to the enlisted men of the service is their accession to the privileges of promotion to grades of the line. In some foreign services, as well as in our own Army, there is promotion for those enlisted men who, in battle or in peace, distinguish themselves. Under our form of government, which places no limit to the ambition of the worthy and efficient in their callings, it does seem to me inconsistent that the Navy should be the only service in which the career of enlisted men, however worthy or however heroic, should be limited to that of warrant officers. I would recommend, then, that from those apprentices who have served faithfully and efficiently until twenty-one years of age, and who shall re-enlist for three years, and shall have passed with credit and distinction through the advanced course of instruction at Washington and at the Torpedo Station, and shall be proficient in seamanship, navigation, and gunnery, two of the most distinguished in their studies and in moral qualifications be examined yearly for admission to the grade of ensign in the line of promotion. It needs no argument to prove that a measure of this kind would tend greatly to improve the *morale* of the enlisted man, but outside and beyond this, it would be but an act of duty and justice to a class in the service who have contributed so largely in the past to our victories in war.

These matters are held to be of vital importance to the efficiency of the service, to the contentment and welfare of the men, and, if adopted, will be the means by which desertion will be largely checked and the *morale* of the service much increased. The Bureau feels certain that it will only be necessary to call the attention of Congress to these matters to secure for the sailor the same benefits as has been awarded to his companion in arms of the Army and Marine Corps.

During the administration of Secretary Chandler permission was granted to Mr. W. A. Whaley to build a cottage on Coasters Harbor island. This building is well constructed, and would be useful to the purposes of the station. I recommend, therefore, to your consideration, an appropriation of \$2,500, or as much thereof as may be found necessary by a board to reimburse Mr. Whaley for his outlay.

Very respectfully, your obedient servant,

W. S. SCHLEY,
Chief of Bureau.

Hon. WM. O. WHITNEY,
Secretary of the Navy.

*Estimates of appropriations required for the service of the fiscal year ending June 30, 1889,
by the Bureau of Equipment and Recruiting, Navy Department.*

Detailed objects of expenditure, and explanations.	Estimated amount which will be required for each detailed object of expenditure.	Total amount to be appropriated under each head of appropriation.	Amount appropriated for the current fiscal year ending June 30, 1888.
SALARIES.			
One chief clerk (appropriated; R. S., p. 70, sec. 416; March 3, 1887, pamphlet edition, p. 620)	\$1,800.00		
One clerk of class four (same act; R. S., p. 27, sec. 167; pamphlet edition, p. 620)	1,800.00		
Two clerks of class two (same act; R. S., p. 27, sec. 167; pamphlet edition, p. 620)	2,800.00		
Three clerks of class one (same act; R. S., p. 27, sec. 167; pamphlet edition, p. 620)	3,600.00		
Two copyists, at \$900 each (same act; R. S., p. 27, sec. 167; pamphlet edition, p. 620)	1,800.00		
One assistant messenger (same act; R. S., p. 27, sec. 167; pamphlet edition, p. 620)	720.00		
One laborer (same act; R. S., p. 27, sec. 167; pamphlet edition, p. 620)	660.00		
		\$13,180.00	\$14,780.00
NOTE.—One clerk of class three (finance clerk) formerly provided for in this Bureau has been transferred to the Bureau of Provisions and Clothing, by order of the Secretary of the Navy.			
CIVIL ESTABLISHMENT.			
Navy-yard, Portsmouth, N. H.:			
One clerk (appropriated; pamphlet edition, p. 584)	1,200.00		
Navy-yard, Boston, Mass.:			
One superintendent of ropewalk (same act)	1,875.00		
One clerk (same act)	1,400.00		
One clerk (same act)	1,300.00		
One writer (same act)	950.00		
Navy-yard, New York:			
One clerk (same act)	1,200.00		
Navy-yard, League Island, Pa.:			
One clerk (same act)	1,200.00		
Navy-yard, Norfolk, Va.:			
One clerk (same act)	1,200.00		
Navy-yard, Mare Island, Cal.:			
One clerk (same act)	1,200.00		
		11,525.00	11,525.00
CONTINGENT.			
For extra expenses of training ships, freight and transportation of equipment stores, printing, advertising, telegraphing, books, and models; postage on letters sent abroad, ferrisage, ice, apprehension of deserters and stragglers; continuous service certificates, good conduct badges, and libraries for enlisted men; school books for training ships, medals for boys, and emergencies arising under cognizance of the Bureau of Equipment and Recruiting, unforeseen and impossible to classify (appropriated; R. S., p. 721, sec. 3666; pamphlet edition, p. 584)		20,000.00	15,000.00
NAVAL TRAINING STATION, COASTERS' HARBOR ISLAND.			
For building natatorium, dredging channels, repairs to main causeway, roads and grounds, extending sea wall, including the cost of purchase of such buildings and implements, and the employment of such labor as may be necessary for the proper care and preservation of the same; for repairs and improvements on buildings; heating, lighting, and furniture for same; books and stationery, freight, and other contingent expenses; purchase of food and maintenance of live stock and mail wagon, and attendance on same (appropriated; pamphlet edition, 585)		30,000.00	14,000.00

Estimates of appropriations required for the service of the fiscal year, etc.—Continued.

Detailed objects of expenditure, and explanations.	Estimated amount which will be required for each detailed object of expenditure.	Total amount to be appropriated under each head of appropriation.	Amount appropriated for the current fiscal year ending June 30, 1886.
EQUIPMENT OF VESSELS.			
For coal for steamers and ships use, including expenses of transportation, storage and handling; hemp, wire, and other materials for the manufacture of rope and cordage; iron for the manufacture of anchors, cables, galleys, and chains; canvas for the manufacture of sails, awnings, bags, and hammocks; water for steam launches; heating apparatus for receiving-ships, and for the purchase of all other articles of equipment at home and abroad, and for the payment of labor in equipping vessels and manufacture of equipment articles in the several navy-yards (appropriated; R. S., p. 733, sec. 3709, 3747; pamphlet edition, p. 583)		\$725,000.00	\$625,000.00
TRANSPORTATION AND RECRUITING.			
For expenses of recruiting for the naval service, rent of rendezvous, and expenses of maintaining the same; advertising for men and boys, and all other expenses attending the recruiting for the naval service, and for the transportation of enlisted men and boys at home and abroad (appropriated; R. S., p. 721, sec. 3686; pamphlet edition, p. 583)		30,000.00	25,000.00

Schedule for furnishing supplies at navy-yard, Portsmouth, N. H., under advertisement dated October 6, 1886.

Requisition No. 162. Gromets:	
*George T. Vaughen & Co	\$471.92
Rider & Cotton	488.65
Requisition No. 165. Lumber:	
(No bids received.)	

Schedule of bids for furnishing supplies at navy-yard, Boston, Mass., under advertisement dated October 25, 1886.

Requisition No. 36. Tar:	
*Geo. D. Putnam	\$550.00
Chapman & Soden	600.00
Requisition No. 37. Wire:	
*J. A. Roebing's Sons' Company	500.00
Requisition No. 38. Burlaps:	
*George D. Putnam	250.00
MacIntire, Laurie & Co	270.00

Under advertisement dated December 3, 1886.

Requisition No. 53. Casting:	
*George D. Putnam	\$7.50
Requisition No. 54. Oil, etc.:	
*George D. Putnam	399.50
Requisition No. 55. Brushes, etc.:	
George D. Putnam	66.00
*Anstin & Fellows	63.75
Requisition No. 56. Lumber:	
*L. Lovejoy & Co	23.40
Requisition No. 57. Belting, etc.:	
*George D. Putnam	25.85
Requisition No. 58. Wire:	
*J. A. Roebing's Sons' Company	550.00
Trenton Iron Company	560.00

*Awarded.

Schedule of bids for furnishing supplies at navy-yard, Norfolk, Va., under advertisement dated December 3, 1886.

Requisition No. 63. Tar oil:		
Elliott & Walke	\$60.00
Fred M. Smith	27.00
Mayer & Co	45.00
E. V. White & Co	45.00
George L. Neville	30.00
Requisition No. 63. Scrub brushes:		
Elliott & Walke	14.40
*Fred M. Smith	7.20
Mayer & Co	18.00
E. V. White & Co	15.00
George L. Neville	14.40
Requisition No. 63. Palms, etc.:		
Elliott & Walke	1,112.10
William A. Wheeler	815.20
Fred. M. Smith	842.76
Mayer & Co	1,090.60
E. V. White & Co	1,086.50
*George L. Neville	795.42
Requisition No. 64. Stoves, etc.:		
*W. H. Barnard & Co	163.75
George L. Neville	185.75
Requisition No. 65. Rugs, etc.:		
*H. Wertheimer	835.44
Ames & Stevens	838.54
George L. Neville	1,457.00

Schedule of bids for furnishing supplies at navy-yard, Mare Island, California, under advertisement dated December 1, 1887.

Requisition No. 307. Wood, etc.:		
A. Powell	\$235.00
*James McCudden	230.00
Aden Brothers	240.00
Requisition No. 312. Ship chandlery:		
†James Gallup	117.00
Requisition No. 313. Ship chandlery:		
*James Gallup	183.00
Requisition No. 314. Ship chandlery:		
*James Gallup	77.00
Requisition No. 316. Cooking utensils:		
†John Brownlie	57.65
Requisition No. 317. Furniture materials:		
*S. Dannenbaum	202.85
Requisition No. 318. Wood, etc.:		
A. Powell	27.00
*James McCudden	26.00
Aden Brothers	27.60
Requisition No. 319. Furniture:		
†John Brownlie	58.50
Requisition No. 319. Furniture material:		
†S. Dannenbaum	4.00
Requisition No. 320. Ship chandlery:		
†James Gallup	48.00
Requisition No. 321. Ship chandlery:		
†James Gallup	14.50
Requisition No. 322. Stationery:		
†Cunningham, Curtis & Welch	70.95
Requisition No. 323. Stationery:		
†Cunningham, Curtis & Welch	37.15
Requisition No. 324. Furniture material:		
*S. Dannenbaum	17.28
Requisition No. 325. Stationery:		
†Cunningham, Curtis & Welch	12.00

*Awarded.

†Rejected.

‡Informal.

Requisition No. 326. Ship chandlery :	
†James Gallup	\$110. 92
Requisition No. 327. Ship chandlery :	
†James Gallup	42. 35
Requisition No. 328. Cooking utensils :	
†John Brownlie	16. 70
Requisition No. 329. Ship chandlery :	
†James Gallup	18. 00
Requisition No. 329. Furniture :	
†John Brownlie	9. 00

Schedule of bids for furnishing hemp at navy-yard, Boston, Mass., under advertisement dated June 21, 1886.

For 25 tons American hemp :	
†H. B. Nelson & Bro	per ton.. \$212. 80
M. T. Whiton & Co	do..... 227. 75
†A. D. Weld's Sons	per ton.. 225. 00
For 100 tons Russia hemp :	
M. T. Whiton & Co	per ton.. 219. 50
†A. D. Weld's Sons	do..... 215. 00
For 100 tons American hemp :	
M. T. Whiton & Co	per pound.. .08 ⁷ / ₁₆
†A. D. Weld's Sons	do..... .08 ¹ / ₄

Schedule of bids for furnishing leading hose, etc., at navy-yard, New York, under advertisement dated October 27, 1886.

James J. Donovan	\$4,215. 00
Boston Belting Company :	
Linen	5,262. 50
Cotton	4,262. 50
Eureka Fire Hose Company	3,511. 25
Boston Woven Hose Company	3,380. 00
George H. Creed :	
Linen	3,795. 00
Cotton	4,145. 00
William A. Wheeler	3,715. 00
Gutta Percha and Rubber Manufacturing Company :	
†Linen	2,950. 00
Cotton	3,100. 00
Rowland A. Robbins	3,480. 00

Schedule of bids for furnishing hemp at Boston, Mass., under advertisement dated January 17, 1887.

For 150 tons manila :	
Plymouth Cordage Company	per pound.. .08 ¹ / ₁₆
Charles Boyce :	
†Light color	do..... .08 ¹ / ₄
Zebu	do..... .08 ¹ / ₁₆
For 50 tons Russia :	
Chas. Boyce	per ton.. 204. 00
Aaron D. Weld's Sons	210. 00
†Patrick Dougherty	196. 00

Schedule of bids for dredging at Coaster's Harbor Island, B. I., under advertisement dated February 10, 1887.

	Per cubic yard.
Hartford Dredging Company	\$0. 45
†Charles W. Anthony 36
Jno. P. McDermott 44
Staples & Phillips 45

Schedule of bids for furnishing hammock and bag canvas, and twine, under advertisement dated March 4, 1887.

William A. Wheeler	\$6,775. 20
†Andrew D. Jones	6,531. 40

* Rejected. † Awarded. ‡ Informal. § Awarded by lot.

James R. Michael	\$6, 531. 40
Mount Vernon Company	6, 531. 40
Rowland A. Robbins	6, 531. 40

Schedule of bids for furnishing continuous service certificate, under advertisement dated May 23, 1887.

John F. Paret :	
No. 1	\$4, 350. 00
No. 2	4, 200. 00
J. C. Entwisle	3, 200. 00
E. E. Rider	2, 870. 00
Thomas B. Penick	3, 090. 00
V. G. Fischer :	
No. 1	4, 250. 00
No. 2	3, 900. 00
No. 3	3, 600. 00
No. 4	3, 100. 00
No. 5	3, 000. 00

(No award.)

Schedule of bids for furnishing china, glass, and plated ware, under advertisement dated May 25, 1887.

For 4 sets chinaware for commanding officer of squadron :	
*James M. Shaw & Co	\$199. 48
For 8 sets of chinaware for commanding officer of vessel :	
*James M. Shaw & Son	356. 88
For 4 sets of glassware for commanding officer of squadron :	
*James M. Shaw & Co	237. 36
For 8 sets of glassware for commanding officer of vessel :	
*James M. Shaw & Co	340. 08
For 4 sets of plated ware for commanding officer of squadron ; for 8 sets of plated ware for commanding officer of vessel :	
Timothy Dixon	3, 800. 00
*Meriden Britannia Ware Company	2, 741. 6

Schedule of bids for furnishing hemp at Boston, Mass., under advertisement dated May 23, 1887.

For 50 tons Russia :	
P. Doughty	per ton.. \$197. 00
*A. D. Weld's Sons	do.... 195. 00
For 150 tons manila :	
D. G. Bacon & Co	per pound.. .08½
*Ira Bursley	do.... .07½

*Awarded.

Statement of sales of condemned materials under cognizance of Bureau of Equipment and Recruiting during fiscal year ending June 30, 1887, showing the material sold, the parties buying the same, and the amount realized therefrom.

Date of sale.	Where sold.	Materials sold.	Purchasers.	Amount realized.
1887.				
Jan. 3	Boston, Mass	50,000 pounds Russia tow	Sewall & Day	\$3,375.00
3	do	20,000 pounds Russia tow	do	1,000.00
3	do	33,805 pounds Russia tow	do	1,901.53
3	do	815 pounds American tow	do	45.84
3	do	22,350 pounds Russian tyers ..	Cordage Company	782.25
3	do	4,405 pounds manila tyers	S. A. Conney	143.90
3	do	2,515 pounds Russian shakings ..	C. J. Flynn	56.59
3	do	7,135 pounds manila shakings ..	do	198.10
	Total			6,403.21
May 24	Norfolk, Va.	Lot shakings (17,745 pounds) ..	J. W. Woodman	288.85
24	do	1,505 pounds manila hawsers ..	M. Ashe	75.25
24	do	192 pounds marline, etc	T. J. Morecock	16.32
24	do	1,820 pounds bolt rope	Nolan Bros	57.40
24	do	2,240 pounds soft worming	W. H. Corey	95.20
24	do	9,770 pounds L. H. hemp	P. O'Connor	525.14
24	do	40 pounds wire rope	W. H. Corey	1.96
24	do	2 cargo pendants	Thomas Cashin	9.00
24	do	689 pounds manila rope	F. Moran	51.68
24	do	1,192 pounds hide rope	S. Friedman	68.54
24	do	Lot oil cloth	J. Dreyfus	19.00
24	do	Lot of hose, etc	Nolan Bros	14.00
24	do	4 boat stoves, etc	J. Samuels	1.25
24	do	24 drying stoves	J. W. Woodman	3.25
24	do	Lot dlah covers, etc	J. Samuels	4.25
24	do	Lot slop jars, etc	G. W. Whitehurst	2.00
24	do	4 water coolers, etc	J. Codd	2.70
24	do	Lot life-preservers	S. Benzinger	6.25
24	do	10 heating stoves	J. Dreyfus	7.50
24	do	3 stoves	S. Friedman	17.00
24	do	Lot tin utenalls	J. Codd	2.25
24	do	380 hand and leg irons	J. Schrader	17.10
24	do	14 scouse kettles, etc	J. Codd	7.25
24	do	Hack-saw, etc	J. Dreyfus	5.50
24	do	1,575 pounds devil's claws	J. W. Woodman	12.20
24	do	3 rope-laying machines	J. McHugh	7.00
24	do	Lot cooking utenalls	J. Codd	4.25
24	do	do	J. Dreyfus	1.00
24	do	2 bake ovens	W. A. Anderson	5.75
24	do	Lot chambers, etc	J. Codd	10.00
24	do	12 pea jackets bags	J. Dreyfus	21.00
24	do	730 pounds pump leather	S. Benzinger	140.00
24	do	2,050 pounds iron (old)	J. W. Woodman	11.27

Statement of sales of condemned materials, etc.—Continued.

Date of sale.	Where sold.	Materials sold.	Purchasers.	Amount realized.
May 24	Norfolk, Va.....	Lot thimbles (2,167 pounds)...	C. Cole.....	\$27. 00
25	do	1 anchor, etc.....	J. Scradeg	31. 50
24	do	6,622 pounds shackles.....	H. J. Hallett.....	149. 00
25	do	3,650 pounds hooks, etc	do	73. 00
24	do	890 pounds miscellaneous iron	J. W. Woodman	4. 45
25	do	8,225 pounds mooring swivels	Nolan Bros	71. 97
24	do	4,050 pounds scrap iron	W. J. Hallett	36. 45
25	do	{8,120 pounds miscellaneous } chain.	do	121. 80
24	do	11 silver calls, etc.....	Lintz	4. 80
25	do	Lot curtains	J. Codd	6. 00
24	do	do	Lintz	5. 25
25	do	Lot rugs, etc	A. J. Dalton	7. 50
24	do	Lot glass and chinaware	W. T. Boole.....	5. 00
25	do	Lot mattress covers, etc	J. Lawder	5. 75
24	do	1 anchor	Nolan Bros	67. 00
25	do	1 anchor	Nolan Bros	51. 00
24	do	do	do	40. 00
25	do	do	W. H. Corey	45. 00
24	do	do	do	41. 00
25	do	do	do	41. 00
24	do	do	do	31. 00
25	do	do	do	34. 00
24	do	do	do	19. 00
25	do	do	do	22. 00
24	do	do	do	26. 00
25	do	do	do	19. 50
24	do	do	do	21. 00
25	do	do	do	55. 00
24	do	do	do	38. 00
25	do	do	do	23. 00
24	do	do	do	11. 00
25	do	do	do	30. 50
24	do	do	do	22. 50
25	do	do	do	16. 00
24	do	do	do	30. 50
25	do	do	J. Dreyfus.....	14. 00
24	do	do	L. Foreman.....	6. 50
25	do	do	J. Schrader.....	75. 00
24	do	do	P. O'Connor	41. 00
25	do	do	do	41. 00

Statement of sales of condemned materials, etc.—Continued.

Date of sale.	Where sold.	Materials sold.	Purchasers.	Amount realized.
May 24	Norfolk, Va.	1 anchor	Emmons	\$42.00
24	do	do	do	19.00
24	do	do	J. Baker	18.00
25	do	do	do	16.50
24	do	do	do	18.00
25	do	do	do	64.00
24	do	do	do	31.50
25	do	do	Donovan & Son	27.00
24	do	do	do	25.00
25	do	do	W. A. Power	23.00
24	do	do	do	20.00
24	do	do	do	16.50
24	do	do	do	22.50
24	do	do	do	25.00
24	do	do	do	24.00
24	do	do	do	17.00
24	do	do	do	11.50
24	do	do	do	11.00
24	do	do	do	16.00
24	do	do	do	21.00
24	do	do	do	16.00
24	do	do	M. Burke	40.00
25	do	do	W. J. Hallett	13.00
24	do	do	do	34.00
24	do	do	do	22.00
24	do	do	do	25.00
24	do	do	do	10.00
24	do	do	do	14.50
24	do	do	do	21.00
24	do	1 hawser	J. Baker	67.00
24	do	do	do	70.00
24	do	do	J. Schrader	30.00
24	do	Lot manila junk	M. Burke	444.13
24	do	Lot hemp junk	Donovan & Son	338.85
24	do	Lot bolt rope	M. Kelly	155.22
25	Total			4,690.80

Statement of expenses attending sales at public auction.

Sale of January 3, 1887, at navy-yard, Boston, Mass.:	
Globe Newspaper Publishing Company	\$4. 50
Post Publishing Company	4. 80
Auctioneer's fee	124. 03
Total expenses	<u>133. 33</u>
Sale of May 24 and 25, 1887, at navy-yard, Norfolk, Va.:	
Labor	\$26. 23
Auctioneer's fees	94. 59
Advertising	34. 38
Total expenses	<u>155. 20</u>

No. 9.—BUREAU OF NAVIGATION.

BUREAU OF NAVIGATION, NAVY DEPARTMENT,
Washington, October 25, 1887.

SIR: I have the honor to submit the annual report of the operations of the Bureau of Navigation for the past year, together with the estimates for its support, and that of the offices under it, and for the expenditures which will, in my opinion, be necessary for the naval service during the fiscal year ending June 30, 1889.

Included in this report, and transmitted herewith, are the reports of the Superintendent of Compasses; the Naval Inspector of Electric Lighting; the Naval War College; the Hydrographic Office; the Naval Observatory, and the Nautical Almanac Office.

Compasses.—Forty-nine boat compasses have been repaired, sixteen new boat compasses have been purchased, and twenty-six steering-compasses of the old pattern have been sent to the maker for conversion into the new form since my last annual report.

The model of compensating binnacle devised in the Bureau is in use on board the *Atlanta*, *Boston*, and *Dolphin*, and two of them have been set up on board the *Chicago*, in positions determined by a series of experiments to be the most favorable with respect to the magnetic field of that vessel. Recent observations taken on board the *Atlanta* at Newport in determining and compensating her compass errors are of special interest to the service, and are valuable as indicating the probable changes which will take place in the magnetic conditions of the steel cruisers now being built. As soon as these additional ships are sufficiently advanced, observations to determine their magnetic forces will be begun and continued from time to time until the vessels shall be completed.

In connection with this examination of the magnetic character of the vessels of the service, which was inaugurated after the keels of the steel cruisers, first authorized, were laid, I desire to call attention to the increased amount of work now required of the superintendent of compasses and his assistants (under the immediate supervision of the Chief of Bureau), and to the character of this work, upon the thoroughness and correctness of which the safety of a ship, when under way, must largely be due.

Navigation Supplies.—The contract for installing a duplicate incandescent electric light plant in the steel cruiser *Chicago*, referred to in the last annual report, was awarded to the Edison Manufacturing Company, which submitted the lowest bid for the work. This plant will light the ship thoroughly, or it will run the search lights. It may be well to state that there now seems to be no necessity for supplying separate incandescent and search light plants to ships of war, since the incandescent plants submitted will serve for both purposes, and thus save the additional weight and space allotted for a plant for search lights.

I would also call attention to the importance of locating the engines and dynamos of electric lighting plants below the water-line on all ships, and below the protective decks in ships so constructed.

Your attention is invited to the accompanying annual report from Lieutenant-Commander R. B. Bradford, the naval inspector of electric lighting.

Signal books.—The publication of the revised General Signal Book has been retarded by the inability to subject the proposed modifications of the Tactical Signal Book to practical trials, and I refer to the recommendation contained in the last annual report as to the desirability of obtaining four of our larger tugs for the purpose of collecting data relating to the maneuvering of ships to determine the tactics likely to be followed by success if carried out in battle.

Libraries.—Additional professional books have been added to the libraries of cruising ships and three professional papers have been published, or are now in print. The first, No. 21, entitled "The Working of Steel," is reprinted from the proceedings of the Institution of Civil Engineers, London, and is a lecture by C. E. Stromeyer, associate member of the Institution of Civil Engineers. No. 22 is entitled "Modern Fleets" and "Compass Disturbances in Iron Ships," containing two papers; the first, reprinted from the Proceedings of the Royal United Service Institution, is a lecture by Commander Charles Campbell, R. N., and the second is a lecture delivered at the Naval War College, by Lieutenant Cornwell, U. S. Navy, late superintendent of compasses. No. 23 is entitled "The Resistance of Ships," and is a republication of the valuable papers by the late W. R. Froude, esq., on that subject, together with one upon the general subject by his son, R. E. Froude, esq.

Ocean Surveys.—Commander F. A. Cook, in the *Ranger*, has continued the work of sounding in the Pacific ocean, off the coast of Lower California, and of triangulating the coast from well-established points. The surveys of the coast to the northward of Sebastiano Viccaino bay have been engraved in the Hydrographic Office and are on issue, as well as all previous surveys of this coast to the southward of that locality.

It is important that the rocks and shoals which have been reported to exist in the Pacific ocean should be searched for and located, if found to exist, and that the errors on the charts of the Spanish Main, republished from the old Spanish surveys, should be corrected.

These reported dangers and the incorrect charts threaten our commerce in the West Indies, the Caribbean sea, and ships bound to and from San Francisco, and have been referred to in previous reports.

Department Library.—Additional professional books have been purchased for the library, but the collection is limited by the reduction of the annual appropriation referred to in my report for 1886.

Naval War Records.—The limited force of clerks and copyists now provided by Congress for collecting, arranging, and copying the naval war records prevents this important work from being pushed to completion as rapidly as the circumstances demand. Reference to this fact has already been made in previous annual reports.

Naval War College.—The repairs to the basement of the college building, referred to in my last annual report as being in progress, have been completed. It had been the intention to repair the roof and attic of the main building, as well as the out-buildings attached to the college, and to light the buildings throughout, this year; but, in consequence of the fact that the Bureau has been unable to use a portion of the amount appropriated by the last Congress in the act making appropriations

for the naval service under the head of "Naval training station, Coaster's Harbor Island, R. I.," specifically "for repairs and improvements on buildings, heating, lighting, and furnishing the same, etc.," this necessary work has not been done. In other respects the buildings are in excellent condition, and well adapted for the purpose of training officers for the ordeal of war.

The third term of the college opened September 5, with a class of twenty-two officers of the Navy and Marine Corps, and will close December 22 next. The course was opened with a lecture by Commander Sampson, superintendent of the Naval Academy, relative to the objects for which the college was established, and the necessity for its continuation. A list of the subjects treated by the several officers who will lecture during the present term will be found in the programme for the college which accompanies this report, all of which treat very closely of the art of war. It is the intention of Rear-Admiral Luce, commanding the North Atlantic station, to supplement by practical exercises ashore and afloat in Narragansett bay the theoretical instruction which will be given in the lectures.

Hydrographic Office.—I beg to refer to the report of the Hydrographer for a detailed account of the operations of this important office during the past year. The branch offices established at Boston, New York, Philadelphia, Baltimore, New Orleans, and San Francisco, continue to increase in popularity with sea-faring men and those connected with commerce, and have undoubtedly been the means of supplying much valuable information to seamen, who have in general cordially co-operated with officers attached to the branch offices, and expressed their willingness to aid in collecting meteorological and other data relating to the ocean.

In this connection I would recommend that two more branch offices be established, one on the Atlantic and one on the Pacific coast; but the amount appropriated for the offices already established is entirely inadequate, and they could not be carried on were it not that office space has been generally furnished free of cost to the Government. The barge office in New York, built several years ago, for the examination of incoming passengers and their baggage, would afford sufficient accommodation for the branch office in that city. As the barge office is no longer used for its original purpose, its transfer to the Navy Department would afford conveniences for the collection and distribution of information of use to mariners, which it is impossible to obtain in its present location in the Maritime Exchange.

The present quarters assigned to the Hydrographic Office, within the Navy Department and without, are entirely too cramped for the officers and employés to properly carry on the hydrographic work; and I would suggest that an appropriation be recommended to construct a building especially adapted to its work, and that an increased appropriation be obtained for the purpose of renting a building of sufficient size until a new building can be completed.

Nautical Almanac.—The detailed report of the Superintendent supplies information as to the progress made in the preparation and sale of the annual publications of this office.

The party of astronomers sent to Japan by the National Academy of Sciences, under the direction of Prof. D. P. Todd, to photograph the phases of the solar eclipse which occurred on the 19th of August last, received the aid of this Bureau by the loan of astronomical instruments, and the volunteer services of two naval officers, Lieutenant Southland and Passed Assistant Engineer Pemberton. One of the best points

in that country was selected for this purpose, but the expedition was not successful in obtaining satisfactory results in consequence of the unfavorable meteorological conditions which prevailed during a portion of the period of the eclipse.

Naval Observatory.—The report of the Superintendent contains a record of the astronomical work performed by the staff of officers and assistants under his control. The examination of nautical instruments intended for issue to the service continues to prove by its results the advantages to be derived from careful and uniform technical inspection at a central station. Many of the sextants which have been mentioned in reports as available for issue have been found to be in such condition that their use would involve likelihood of serious errors in observations at sea, and I desire to renew my recommendation that authority be obtained to destroy unserviceable chronometers and sextants for reasons contained in previous annual reports.

Mr. R. M. Hunt has, with the approval of the Department, been employed as architect of the new Naval Observatory, authority for which is contained in the last two naval appropriation bills, and he is at present engaged in preparing the plans and specifications for the buildings. No other steps have been taken to erect the Observatory, in consequence of the fact that in pursuance of the law which limits the cost to \$400,000, there can be no expenditure of money until the complete plans and specifications are ready for the contractors, a clause providing that "no work shall be done thereon except under a contract which shall provide for the completion of the same upon plans previously adopted."

Derelicts.—During the past year many wrecks, or portions of wrecks, both floating and submerged, have been reported to the Department by the captains of incoming steamers, and requests have been received from maritime associations and others for their removal or destruction. For want of a proper vessel it has frequently been impracticable to comply with these requests, although in many instances these wrecks were very dangerous to both property and life, being off our largest ports, or in the direct route taken by the transatlantic or coasting steamers filled with valuable cargoes and carrying thousands of passengers.

It is believed by many that a floating and abandoned wreck was the cause of the loss of the *Oregon* in 1886; and such may have been the case.

A small vessel could be employed on this service with but little cost and without an additional appropriation, since no special contrivances are necessary for the complete destruction of the derelicts. I would suggest that such a vessel stationed at New York (or Norfolk in winter) would have sufficient work to keep her employed throughout the year in destroying the numerous wrecks abandoned off our Atlantic and Gulf coasts, or brought there by ocean currents, and in thus removing serious obstacles to safe navigation would be of great service to the commerce of the country.

Naval Reserve.—I have the honor to bring to your notice for consideration the somewhat extended movement among officers of the merchant marine (many of whom served in the Navy during the civil war), among yachtsmen, and among others connected with the sea-faring interests, having for its object the formation of a second reserve for the Navy, composed of officers and men willing to subject themselves to annual specified drills and temporary service in a sea-going or coast-defense vessel, with or without compensation for the period actually under instruction or service.

The first and most efficient reserve would come properly from officers and men who have served some years in the regular service, and after having been thoroughly trained, have resigned or left the Navy to accept positions in civil life; but who would be the first to offer their services in case of need. But the number of men from whom this reserve would be drawn is not large and could furnish but a very small proportion of the officers and men who will actually be required for active service at a date more or less remote, for, unfortunately, history teaches that no nation yet has been exempt from wars for any lengthy period.

For a second reserve, however, it is most probable that a large and efficient auxiliary force could be obtained from the merchant marine, from the coasting trade of both sea and lake coasts, from the fishermen, from the Light-House and Life-Saving Services, and from yachtsmen. From a preliminary inquiry already made by direction of the Department, it is believed that a project having for its end the formation and classification of a naval reserve would be favorably received by that large body of Americans who are more or less acquainted with sea-faring life, either from necessity or choice, and who are second to none in patriotic desire for the success of our Navy. This proposed formation of an efficient reserve to supply the needs of the naval service in time of war, is more urgently pressed upon your attention at this time, because the disposition of the classes referred to is now manifestly in its favor, and because the tendency of the governmental administration of other maritime countries is distinctly in the direction of placing the Navy in charge of all coast and harbor defenses.

RECOMMENDATIONS.

In conclusion I have the honor to call your attention to the quotations below, taken from my annual reports for the past three years, and to renew the recommendations heretofore submitted, as follows:

I beg to invite your attention to the annual appropriations of this Bureau which have steadily decreased in amount from \$192,500 for the fiscal year of 1866-'67, to \$100,000 for the year 1883-'84. Since the year 1866 the amount appropriated annually to carry on the work under the cognizance of this Bureau has been insufficient to supply our vessels with the best and most improved articles of navigation outfit. In consequence, however, of the quantity of supplies purchased during the civil war and remaining on hand at its close, cruising ships have been furnished with instruments for navigation which, if not of the latest patterns, still answer the purpose for which they were purchased in the absence of better. But the supplies above mentioned have gradually been exhausted or become obsolete, and have been sold as "unserviceable," in compliance with the act of Congress approved August 5, 1882, which required all stores and supplies to be appraised, and those found to be "unserviceable" to be sold. (Report of 1884.)

The supply of articles of navigation outfit has still further decreased since the above was written, while the appropriation for the fiscal year ending June 30, 1885, was \$87,500, a reduction of \$2,500 on the amount of the previous year. The appropriation of the present fiscal year is \$87,500, which is \$42,500 less than the estimates.

I have submitted estimates for \$130,000, an amount which, in my opinion, is necessary for the efficient administration of this Bureau, and without which it will not be practicable to supply our cruising vessels with the improved outfits required for the safe navigation of modern ships of war. (Report of 1885.)

I beg leave to bring to your attention the suggestions and recommendations which have been submitted in previous annual reports relating to the ill effects likely to result from delay in obtaining for publication in the Naval War Records the papers now in private hands, and necessary for a complete narrative of the operations of the Navy during the civil war; to the advantages to be derived from placing the library of the Navy Department on the same footing regarding the binding of books as the libraries of the Department of State, the Patent Office, and the Surgeon-General's Office; to the remarks relating to the character of the building in which the engraving of plates and printing of charts is carried on for the Hydrographic Office, which prevents the plates from being stored there, and subjects them to risk of injury on removal, and which causes loss and inferior work on account of the unfavorable conditions of light and temperature, and the large amount of vibration; to the im-

portance of establishing compass stations at the large sea-ports of the Atlantic and Pacific coasts, for the purpose of determining the compass errors in ships of the merchant marine; to the advisability of extending the system of time-balls for the benefit of the maritime community; to the suggestion favoring an international congress to consider the adoption of a universal system of marks and buoys for channels and harbors, and to the suggestion as to the desirability of increasing the pay of the instrument-maker of the Naval Observatory. (Report of 1886.)

Very respectfully, your obedient servant,

J. G. WALKER,
Chief of Bureau.

The SECRETARY OF THE NAVY.

*Estimates of appropriations required for the service of the fiscal year ending June 30, 1889,
by the Bureau of Navigation.*

A.

FOR THE SUPPORT OF THE BUREAU OF NAVIGATION.

I.—SALARIES.

Chief clerk (March 3, 1887).....	\$1,800
One clerk of class three (same act).....	1,600
One clerk of class two (same act).....	1,400
One clerk of class two (same act).....	
One clerk of class one (same act).....	1,200
One clerk, at \$1,000 (same act).....	
One copyist (same act).....	900
One assistant messenger (same act).....	720
Two laborers (same act).....	1,320
One laborer (formerly appropriated for in the office of the Secretary of the Navy, same act).....	660
Total	9,600

NOTE.—By direction of the Secretary of the Navy, one clerk of class two has been transferred to the Bureau of Provisions and Clothing, and one clerk at \$1,000 to the office of Naval War Records.

B.

SALARIES, OFFICE OF NAVAL WAR RECORDS.

One clerk of class one (March 3, 1887).....	\$1,200
One clerk, at \$1,000 (formerly appropriated for in the Bureau of Navigation, same act).....	1,000
One copyist, at \$720 (same act).....	720
(The other copyist formerly appropriated for under this head has been transferred to the office of the Judge Advocate-General of the Navy.)	
Total	2,920

NOTE.—The following additional estimates are submitted:

One agent for the collection of Confederate records.....	1,800
One clerk of class two.....	1,400
Two copyists, at \$900 each.....	1,800
Two copyists, at \$720 each.....	1,440
Total	6,440

C.

I.—SALARIES, LIBRARY, NAVY DEPARTMENT.

* One clerk, at \$1,000 (March 3, 1887).....	\$1,000
One assistant messenger, at \$720 (formerly appropriated for in the office of the Secretary, same act).....	720
One laborer, at \$660 (formerly appropriated for in the office of the Secretary, same act).....	660
Total	2,380

* This clerk was transferred to the library from the Secretary's office. The clerk of class one, formerly appropriated for in the office of the Secretary, "in care of library," has been transferred to that office.

II.—BOOKS, LIBRARY, NAVY DEPARTMENT.

For professional books and periodicals (March 3, 1887).....	\$1,000
For professional books and periodicals, additional (submitted).....	1,500
Total	2,500

NOTE.—The amount estimated for (\$2,500) is that appropriated previous to fiscal year 1885-'86. The reduced amount is inadequate to meet the necessities of the Department.

D.

I.—SALARIES, HYDROGRAPHIC OFFICE.

Two clerks of class two (March 3, 1887)	\$2,600
One clerk of class one (same act).....	1,200
One assistant messenger (same act).....	720
One watchman (same act).....	720
Draftsmen, engravers, assistants, computers, custodian of archives, copyists, copper-plate printers, apprentices, and laborers in the Hydrographic Office (same act)	46,580
Total	52,020

NOTE.—In the estimates enumerated above the following additional amount is submitted:

Additional engravers.....	\$6,580
---------------------------	---------

II.—CONTINGENT AND MISCELLANEOUS EXPENSES.

For purchase of chart paper, copper-plates, steel-plates, electrotyping copper-plates, cleaning copper-plates, ink and other materials for printing charts; instruments, drawing paper, tools, and materials for drawing and engraving charts; materials for and mounting charts; reduction of charts by photography; photolithographing charts for immediate use; transfer of photolithographic and other charts to copper; repairs to printing presses and other furniture and tools; extra drawing and engraving; translating from foreign languages; expert work in compiling and arranging data for charts, sailing directions and other nautical publications; purchase of foreign and other charts and hydrographic works for the use of vessels of the Navy, and freight and express charges on same, as well as on the materials before named; purchase of drawing-paper, drawing-materials, surveying instruments and care and repair of same, to be furnished to naval vessels engaged in surveying; expert marine meteorological and other work in the preparation of the Pilot Chart and supplements, and the printing of the same; and purchase of works and periodicals relating to hydrography, marine meteorology, navigation and surveying (March 3, 1887)	\$30,000
For rent of building for printing-presses, draftsmen and engravers, storage of copper-plates and materials used in the construction and printing of charts, and for repairs and heating of the same, and for gas, water, and telephone rates, and for expense of removal (same act).....	6,500
Contingent expenses of branch offices at Boston, New York, Philadelphia, Baltimore, Norfolk, New Orleans, San Francisco, and Portland, Oreg., including furniture, fuel, lights, rent, and care of offices; car-fare, and ferrage in visiting merchant vessels; freight, express, telegrams and other necessary expenses incurred in collecting the latest information for the Pilot Chart, and for other purposes for which the offices were established (same act)	11,000
Total	47,500

III.—CONTINGENT EXPENSES.

For stationery, packing-boxes, furniture, freight, expressage, postage, and other absolutely necessary expenses (submitted).....	4,000
--	-------

IV.—PRINTING AND BINDING.

For printing and binding (March 3, 1887).....	12,000
---	--------

E.

I.—SALARIES, NAVAL OBSERVATORY.

One assistant astronomer (March 3, 1887).....	\$2,000
Two assistant astronomers at \$1,800 each (same act).....	3,600
One clerk of class four (same act).....	1,800
One instrument maker (same act).....	1,500
Four watchmen, including one for new Naval Observatory grounds (same act).....	2,880
One skilled laborer, at \$1,000; one skilled laborer, at \$720 (same act).....	1,720
Seven laborers, at \$660 each (same act).....	4,620
Total	18,120

NOTE.—The following additional estimates are submitted: .

Increase to pay of one assistant astronomer.....	\$600
Increase to pay of two assistant astronomers of \$400 each.....	800
Increase to pay of instrument-maker.....	500
Three computers, at \$1,200 each.....	3,600
One laborer for care of compass-houses.....	660
One copyist and indexer for the library.....	800
Total	6,960

II.—CONTINGENT AND MISCELLANEOUS EXPENSES.

Miscellaneous computations (March 3, 1887).....	\$1,200
Books, periodicals, engravings, photographs, and fixtures for the library (same act).....	1,000
Apparatus and instruments, and for repairs of the same (same act).....	2,500
Repairs of buildings, fixtures, and fences; for fuel, furniture, gas, chemicals, stationery, freight, foreign postage, expressage, fertilizers, plants, and all contingent expenses (same act).....	3,900
Payment to Smithsonian Institution for freight on Observatory publications sent to foreign countries (same act).....	136
Extension and maintenance of time service (submitted).....	5,000
Total	13,736

F.

SALARIES, NAUTICAL ALMANAC OFFICE.

Salaries of assistants in preparing for publication the American Ephemeris and Nautical Almanac, viz:	
Three assistants, at \$1,600 (March 3, 1887).....	\$4,800
Two assistants, at \$1,400 (same act).....	2,800
Three assistants, at \$1,200 (same act).....	3,600
Two assistants, at \$1,000 (same act).....	2,000
One copyist and type-writer (same act).....	900
One assistant messenger (same act).....	720
One laborer (same act).....	660
Pay of computers on piece-work in preparing for publication the American Ephemeris and Nautical Almanac and improving the tables of the planets (same act).....	8,400
Total	23,880
Increase of one assistant from \$1,600 to \$1,800 (submitted).....	200

FOR THE NAVAL SERVICE.

I.—NAVIGATION.

Foreign and local pilotage and towage of ships of war; services and materials in correcting compasses on board ship, and for adjusting and testing compasses on shore; nautical and astronomical instruments; nautical books, maps, charts, sailing directions, and repairs of nautical instruments for ships of war; books for libraries of ships of war, and professional papers; naval signals and apparatus, namely: signal lights, lan-

terns, rockets, running lights, drawings and engravings for signal books; compass fittings, including binnacles, tripods, and other appendages of ships' compasses; logs and other appliances for measuring the ship's way, and leads and other appliances for sounding; lanterns and lamps and their appendages for general use on board ship, including those for the cabin, wardroom, and steerage, for holds and spirit-room, for decks and quarter-masters' use; bunting and other materials for flags, and making and repairing flags of all kinds; oil for ships of war other than that used in the engineer department; candles when used as a substitute for oil in binnacles and running lights; chimneys and wicks, and soap used in the navigation department; stationery for commanders and navigators of vessels of war, and for use of courts-martial; musical instruments and music for vessels of war; steering signals and indicators, and speaking-tubes and gongs for signal communication on board vessels of war; photographic instruments and materials; and for introducing and maintaining electric lights on board vessels of war (March 3, 1887)..... \$130,000

II.—OCEAN SURVEYS.

Special ocean surveys and the publication thereof (March 3, 1887)..... *\$10,000

III.—PUBLICATION OF SURVEYS OF MEXICAN COAST.

Repairing and engraving on copper plates the surveys of the Mexican coast (March 3, 1887)..... *\$10,000

IV.—TRAINING STATION, COASTER'S HARBOR ISLAND.

Repairs and improvements on buildings for training naval officers, at Coaster's Harbor Island; heating, lighting, and furniture for same; books and stationery; freight and other contingent expenses; purchase of feed and maintenance of horses and mail wagons, and attendance on same (submitted)..... \$12,400

V.—CONTINGENT NAVIGATION.

Contingent expenses of the Bureau of Navigation, namely: Freight and transportation of navigation materials; postage and telegraphing on public business; advertising for proposals; packing-boxes and materials; furniture, stationery, and fuel for navigation offices at navy-yards, and all other contingent expenses (March 3, 1887)..... \$5,000

VI.—CIVIL ESTABLISHMENT.

New York navy-yard:
 1 clerk (March 3, 1887)..... \$1,400
 1 writer (same act)..... 1,000
 1 storekeeper (same act)..... 900
 1 master of tugs (same act)..... 1,500
 Portsmouth navy-yard:
 1 clerk (March 3, 1887)..... 1,000
 Norfolk navy-yard:
 1 clerk (March 3, 1887)..... 1,200
 Washington navy-yard:
 1 clerk (March 3, 1887)..... 1,000
 Mare Island navy-yard:
 1 clerk (March 3, 1887)..... 1,000
 Training station:
 1 clerk (submitted)..... 1,000
 Total..... 10 000

VII.—NEW NAVAL OBSERVATORY.

For continuing the erection of the new Naval Observatory and necessary buildings upon the site purchased under the act of Congress approved February 4, 1880 (21 Stat., p. 64, and acts of July 26, 1866, and March 3, 1887)..... \$300,000

* NOTE.—It is recommended that these appropriations be made continuous, as the work of surveying, draughting, and engraving may extend over the time to which the usual annual appropriations are limited.

RECAPITULATION.

FOR THE SUPPORT OF THE BUREAU OF NAVIGATION.

A—I. Salaries, Bureau of Navigation	\$9, 600
B—I. Salaries, Office of Naval War Records.....	2, 920
Salaries (submitted)	6, 440
C—I. Salaries, library Navy Department.....	2, 380
II. Books, library Navy Department	1, 000
Books (submitted)	1, 500
D—I. Salaries, Hydrographic Office	52, 020
II. Contingent and miscellaneous expenses, Hydrographic Office	47, 500
III. Contingent expenses, Hydrographic Office.....	4, 000
IV. Printing and binding, Hydrographic Office.....	12, 000
E—I. Salaries, Naval Observatory.....	18, 120
Salaries (submitted).....	6, 960
II. Contingent and miscellaneous expenses, Naval Observatory.....	13, 730
F—I. Salaries, Nautical Almanac Office	23, 886
Salaries (submitted)	200
Total	202, 256

FOR THE NAVAL SERVICE.

I. Navigation	130, 000
II. Ocean surveys.....	10, 000
III. Publication of surveys of Mexican coast.....	10, 000
IV. Training station, Coaster's Harbor Island.....	12, 400
V. Contingent navigation	5, 000
VI. Civil establishment	10, 000
VII. New Naval Observatory.....	300, 000
Total	477, 400

*Schedule of bids received and contracts made during the fiscal year ending June 30, 1887.*FOR REPAIRS TO BUILDING ON COASTER'S HARBOR ISLAND, UNDER ADVERTISEMENT
DATED AUGUST 16, 1886.

Basement and pantry:	
* Peter Knowe	\$3, 299. 00
James Dowling	3, 879. 50
† David P. Albe	3, 230. 30
William Hamilton	3, 950. 00
Exterior walls of main building:	
Peter Knowe	1, 849. 00
James E. McCoy	1, 909. 23
Michael F. Murphy	1, 490. 00
William Hamilton	1, 875. 00
Roof:	
Peter Knowe	299. 00
James Dowling	268. 00
David P. Albe	512. 00
William Hamilton	295. 00
Out-buildings:	
Peter Knowe	209. 00
James Dowling	126. 00
David P. Albe	149. 00
William Hamilton	200. 00

NOTE.—Contract made for repairs to basement and pantry only.

FOR INSTALLING AN ELECTRIC LIGHTING PLANT ON BOARD THE U. S. S. CHICAGO,
UNDER ADVERTISEMENT OF NOVEMBER 2, 1886.

† Edison United Manufacturing Company	\$8, 280. 00
Brush Electric Company	\$11, 300. 00
United States Electric Lighting Company.....	13, 775. 00
Sawyer-Man Electric Company	\$20, 958. 34

* Accepted.

† Informal; no sureties.

‡ Accepted modified to \$8,045.

§ Or \$10,020.

|| Or \$20,708.34; or \$20,458.34; or
21,458.34.

Mather Electric Company	\$10,632.50
Mitchell, Vance & Co. (fixtures).....	1,468.68
Williams, Page & Co. (fixtures).....	2,133.80

FOR LANTERNS AND LAMPS. UNDER ADVERTISEMENT DATED DECEMBER 18, 1887.

William Porter's Sons:		
50 box-lamps for lard oil,	each..	\$22.75
25 box-lamps for kerosene.....	do.....	20.00
25 single-burner swinging lamps	do.....	9.90
* 200 dark-deck lanterns.....	do.....	3.39
* 288 globes for same.....	do.....	.16
Rowland A. Robbins:		
200 dark deck-lanterns.....	each..	3.57
288 globes for same.....	do.....	11.90
Manhattan Brass Company:		
* 50 box-lamps for lard oil	each..	22.75
* 25 box lamps for kerosene.....	do.....	20.00
* 25 single-burner swinging lamps.....	do.....	9.90

† FOR INSTALLING AN ELECTRIC-LIGHTING PLANT ON BOARD THE U. S. S. MIANTONOMO, UNDER ADVERTISEMENT DATED JUNE 1, 1887.

Edison United Manufacturing Company.....	†\$10,890.00
Brush Electric Company	†10,680.00

FOR 5,000 GALLONS LARD OIL, UNDER ADVERTISEMENT DATED MAY 16, 1887.

* N. K. Fairbank & Co.....	per gallon..	\$0.49½
Armour & Co.	do.....	.52½
Manhattan Oil Company.....	do.....	.57½

Statement of the amounts expended at the different navy-yards under appropriation "Civil Establishment, 1886-'87" (third section, act January 30, 1885).

Portsmouth	\$975.12
New York	4,631.24
Washington	999.98
Norfolk.....	1,200.01
Mare Island.....	1,000.00
Total	8,806.35

REPORT OF THE SUPERINTENDENT OF COMPASSES.

COMPASS OFFICE,
BUREAU OF NAVIGATION, NAVY DEPARTMENT,
Washington, October 1, 1887.

SIR: I beg leave to submit the following report of work done in the Compass Office during the past year:

Forty-nine boat compasses have been repaired and sixteen new boat compasses have been purchased. These instruments were inspected in February last, and were found to conform in every respect to the standard adopted by the Bureau. They have been distributed to the various navy-yards for issue to the service. Twenty-six standard (7½-inch) compasses are now undergoing repairs at the establishment of Messrs. E. S. Ritchie & Sons, Brookline, Mass.

Mr. E. S. Ritchie is perfecting a new azimuth circle, with which experiments will be made as soon as practicable, with the view of its adoption in the naval service.

* Accepted.
† Contract not awarded.

‡ Or \$12,624.
§ Or \$12,650; or \$15,050.

Compass inventories and deviation tables of the various ships in commission have been received during the year, verified in this office, and filed for future use. The deviation tables and accompanying observations were used in calculating the variation in different parts of the world, in continuance of the plan heretofore designed, to be used in correction of the variation charts.

The compass-testing houses are finished, and observations for the magnetic elements are now being regularly made. This office ceased its direct connection with this work, which is now under the direction of the Superintendent of the Naval Observatory, in June last.

The following is the list of instruments received in the office during the year:

Four vertical force instruments, from J. White, Glasgow.

Two dip circles, from Kew Observatory, England.

Two large and four small bubble clinometers, Colonel Evelyn's patent, from London, England.

Fifteen azimuth circles, six heeling magnets, and sixty-five magnets for compensation of semicircular errors, from Ritchie & Sons, Brookline, Mass.

Six alidade plates, from Maurice Joyce, Washington, D. C.

Three horizontal circles for vibration experiments and four levels, from Fauth & Co., Washington.

Five compensating binnacles have been constructed at the navy-yard, Washington. One of these was sent to the *Atlanta*, another to the *Boston*; two are set up on board the *Chicago*, and the remaining one is in the compass office, being used for experiment and instruction. Each of the steel vessels—the *Atlanta*, *Boston*, *Chicago*, and *Dolphin*—has now two of these binnacles.

During the passage of the *Chicago* from Chester, Pa., to New York both her steering and standard compasses were compensated approximately by the method which is used when the deviation on one heading only can be ascertained.

There was not time to regularly swing the ship for a deviation table on thirty-two points, but the observations were sufficient to indicate the efficiency of the compensating binnacles now in use. A special report concerning these observations was made to you at the time, and a record of the results, as well as those obtained later after a large quantity of ballast iron was put on board the *Chicago* at the New York navy-yard, are retained in this office.

I would respectfully call your attention to some of the deviation curves of the U. S. S. *Atlanta*, drawn by Lieut. E. C. Pendleton, the navigator of that vessel, which have been lately sent to the Bureau for record.

They will prove, I think, of so great interest to the service that I append them to this report.

The *Atlanta* was swung for compass deviation both before and after great-gun practice. The change in the magnetic condition of this vessel, and therefore in her deviation tables after the firing of her guns, was of course to be expected. The small deviations of her standard compass prove the excellence of the position selected for this compass. They are, in fact, so small at the present time that the question may well arise whether it is necessary to compensate them at all.

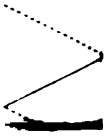
As soon as the ships now building are in a sufficiently advanced state, observations for their magnetic forces will be begun and repeated at intervals as the construction advances, in order that this office may be in possession of a complete magnetic history of these vessels.

I.

—

Σ

II.



In conclusion, I have the honor to renew the recommendation of Lieut. C. C. Cornwell in the last annual report, that arrangements may be made for supplying the iron-built vessels *Alert*, *Ranger*, and *Michigan* with binnacles by which the large compass deviations, which now must be allowed for, may be overcome.

Very respectfully, your obedient servant,

W. H. SCHUETZE,

Lieutenant, U. S. Navy, Superintendent of Compasses.

The CHIEF OF THE BUREAU OF NAVIGATION.

REPORT OF THE INSPECTOR OF ELECTRIC LIGHTING.

OFFICE OF NAVAL INSPECTOR
OF ELECTRIC LIGHTING, 19 MANN AVENUE,
Newport, R. I., October 5, 1887.

SIR: In obedience to your order of September 26, 1887, I have the honor to submit the following report of work performed at this office to date, and in addition I beg to place before you some general remarks concerning the subject of electric lighting for naval purposes.

Duties.—This office was established by order of the honorable Secretary of the Navy under date of January 6, 1887. The present Inspector had been performing for some time previous to this order, in accordance with special instruction from the Bureau, much the same duty as he is now performing. This may be summarized in a general way, as follows:

(1) The preparation of detailed specifications for installing ships of war and naval stations.

In preparing these specifications the first duty is to examine the ship and locate every lamp, determine its candle power and kind of fixture. From these data follows the number of switches, junction boxes, and the capacity of the dynamos. The size of the engine depends, of course, upon the power of the dynamo. If the ship has not been constructed, then these data must be obtained by careful study of detailed plans; even then the specifications must be sufficiently elastic to introduce other lamps that may be found necessary during the progress of the work. If without plans, then only a general estimate of the number of lamps required can be made from the tonnage of the proposed ship, and in such cases important details must be omitted. Having obtained the number of lamps, they are divided into sections, each section having a complete and separate circuit from the dynamo room. These must be arranged with a view to safety, central control, economy, and convenience. Upon the total amount of current required for each section depends the size or conductivity of the insulated wires. It will thus be seen that there is an intimate connection between all the parts of the system. Besides a tabulated statement of the above all materials must be fully described. To decide just where lights are required, what their power must be, and the exact spot each can be placed without interfering with other details, in such a complicated machine as a modern man-of-war, requires an intimate professional knowledge of a ship, its organization and police. Probably the officer best qualified to perform this duty, provided he has sufficient technical knowledge on the subject of electric lighting, is one who has performed the duties of an executive officer. That a ship may never be without means of operating

her electric lamps it may be laid down as a rule that there should be at least two dynamos with separate engines, and all appurtenances complete, so that in event of an accident to one the other will be available. If there is sufficient space available it is better to have in large ships even more than two plants complete, and in any event when there are two or more, they should, if possible, be duplicates in every respect. It does not follow, however, that each dynamo must be large enough to operate all of the lamps in the ship; if it will operate those generally in use it is sufficient.

(2) The inspection of materials and work during the progress of the installation of ships and stations.

This requires the presence of an officer on the spot, who should be subject to direction from this office where the specifications and designs are prepared, and to which all important difficulties ought to be referred. Electric lighting engineers and the manufacturers of lighting apparatus are prone to regard a ship as similar to a house, nor can they understand the various vicissitudes that the different parts of a lighting plant will be subjected to afloat. It is impossible to make a landsman, or even a seaman who has not had experience with electric circuits on board ship for some time at sea, understand the great difficulty of preserving the insulation of electric conductors on shipboard. Therefore the wiring of a ship and all that pertains to the proper insulation of all conducting metal should be most zealously watched by one who is familiar with the behavior of ships at sea. The great enemy of conductors on shipboard is salt water; it will soon corrode entirely through an ordinary-sized copper wire when exposed in the open air; the residue, being a semi-conductor, is greatly heated by the passage of an electric current, and may generate flame if surrounded by any combustible matter. Again, salt water may corrode any two conducting surfaces that are touching and not soldered, so that the resistance is great enough to cause an electric arc, which may ignite burning material near. These difficulties must be guarded against by one who knows where to expect that salt water will find its way during gales of wind and on other unusual occasions. It has been truly said that electric lights are the safest means of illumination known when properly installed, and the most dangerous when badly installed.

(3) To design special appliances required for, or in connection with ship lighting.

To accomplish some of the results already alluded to as necessary on board ship, requires special appliances, such as water-tight switches, junction-boxes, fixtures, sockets, and lamps, which are not found in the market. I have designed some of these and had them constructed by contractors for lighting work, and there is here a wide field for future labor.

(4) To keep fully informed on the progress of electric lighting and all appurtenances connected therewith, that are applicable for naval purposes.

The very rapid progress made in electric lighting, the constant introduction of new methods and materials, requires much study, a close attention to the periodicals devoted to the subject and a large amount of correspondence, in order to be sufficiently well informed to take advantage of the latest and best devices for the naval service.

(5) To prepare forms for reports and records.

(6) To examine all reports and records in order to profit by the experience of the service while providing for future installations.

Previous to the detailed specifications prepared in this office, the contracts for lighting ships contained only general requirements. The result was work too inferior in detail to be efficient.

If any further evidence of the necessity of some one who shall carefully look after the interests of the electric plant of naval ships is required, reference is made to the fact that in all of the Roach cruisers the dynamos and their appurtenances are placed on the berth deck, well above the water-line, while there is ample space below, now devoted to stores, provisions, cordage, canvas, etc., requiring no protection. There is probably nothing, after the motive machinery and ammunition, the protection of which is more important than that of the electric-lighting plant. Imagine what disaster might take place upon the sudden extinguishing of all lights in the closed fire and engine rooms, ammunition rooms, and passages when in action, and yet this may be accomplished by a single machine-gun projectile entering the dynamo room. That the dynamos were not placed below the water-line when the ships were designed was most likely because there was no one at hand to urge its importance.

Ships now lighted by electricity.—It is hardly necessary to prepare any argument in favor of lighting ships by electricity. Although the first application of incandescent electric lighting to the general illumination of steamships occurred only six years ago, at present no tramp steamer is complete without it. For some time it was thought that men-of-war could not be so lighted, as the discharge of heavy guns would destroy the incandescent filaments. So far as known the *Trenton*, which was installed early in 1883, was the first cruising man-of-war in the world to be so fitted, and the experiment proved such a success as to practically settle the question in our service. At present the *Trenton*, *Omaha*, *New Hampshire*, *Dolphin*, *Atlanta*, and *Boston* are so lighted.

The *Trenton* has a single Edison incandescent plant on board, and although very heavy and cumbersome compared with plants now manufactured, it has always been thoroughly efficient. The dynamo is shunt wound, of 100 volts and 120 ampères, and rated as a 150 16-candle-light machine. The engine is a 9½-inch by 12-inch Armington & Sims, horizontal and belted. During the past year, when this ship was refitted, her installation was thoroughly repaired by the Edison Company in accordance with specifications prepared at this office. The ship was entirely re-wired, great attention being paid to insure insulation, 39 new lamps were added, and fixtures repolished and repaired. The dynamo and engine were overhauled and found in excellent condition. There are now a total of 286 lamps on board, and the plant is in much better condition than when originally installed. It is confidently expected that it will continue efficient as long as the ship is fit for service.

The *Omaha* has a single Sawyer-Man dynamo on board, which is rated as a 100 16-candle-light machine. It is driven by an Armington & Sims horizontal belted engine. There are about 160 Sawyer-Man lamps installed. This installation has generally given satisfaction, except the dynamo, which is apparently of bad mechanical construction.

The *New Hampshire*, a training hulk, is lighted by the Edison system. A single shunt-wound dynamo of 100 volts and 240 ampères, rated as a 300 16-candle-light machine, is located in a house on the dock near the ship. It is driven by a 9½-inch by 12-inch Armington & Sims horizontal belted engine. I have never inspected the installation of this ship, but judging from a cursory examination while on board, I am of the opinion that in its present condition it is unsafe. The danger to be apprehended is from fire. The insulation of the conductors used is very poor. They are led about the ship without molding or other pro-

tection, and frequently cross with but little separation of the conductors. I feel sure that this work would not pass the inspection of any capable electrical engineer. There are about 300 lamps installed ashore and afloat at the Training Station.

The *Dolphin* has on board an Edison shunt-wound dynamo of about 100 volts and 80 ampères, which is rated as a 100 16-candle-light machine. It is driven by a 6½-inch by 8-inch Armington & Sims horizontal belted engine. The ship is installed with 100 lamps. The work of the installation was performed by the builder, the hull specifications simply requiring the ship to be lighted by electricity. In some respects the installation was an expensive one, and probably intended to be of the best quality. As a matter of fact, however, much of the work and material connected with it is very inferior, owing to a want of technical and professional supervision. That the plant has been kept in an efficient condition is entirely owing to the exertions of the officer in charge, who is an accomplished electrician and mechanic.

The *Atlanta* has a shunt-wound Weston dynamo of 110 volts, which is rated as a 150 16-candle-light machine. It is driven by a 9½-inch by 12-inch Armington & Sims horizontal belted engine. There are 289 lamps of the Weston pattern installed. This installation was made under the general supervision of the present Inspector, and completed last year. The contract, however, was concluded in October, 1884, and the plant was out of date long before it was placed on board. The first attempt to introduce water-tight junction boxes was in this ship. The plant is very efficient, but requires care and skilled labor to keep it in order, the chief difficulties arising from defective insulation. On this score the specifications were not sufficiently rigid.

The *Boston* has a compound-wound Brush dynamo of 92 volts and 98 ampères, which is rated as a 150 16-candle-light machine. It is driven by a 10-inch by 12-inch Straight Line, horizontal, belted engine. This engine is very heavy and cumbersome, and inferior for dynamo work on board ship for many reasons. There are 266 lamps, of the Swan pattern, installed. The contract for this installation was made at the same time as that for the *Atlanta*, and the same general remarks applied to that ship apply to this. This installation was completed last April. It was carried on under the general supervision of the present Inspector. My experience with these two ships causes me to believe that when work of this kind is going on there should be a professional Inspector present all of the time. The wiring of the *Boston* was especially well done and careful attention given to insulation. The engine, however, is not satisfactory in its performance, and it is feared that the dynamo is not entirely self-regulating.

The *Chicago*.—During the past year a contract has been made with the Edison Company to install the ship with over 400 incandescent lamps and a duplicate plant. Each dynamo is to be of 100 volts and 160 ampères, compound wound, and rated a 200 16-candle-light machine. Each dynamo will be driven by a 12½-inch by 10-inch Armington & Sims horizontal belted engine. The entire plant will occupy a space of about 20 by 6 feet, and weigh 16,400 pounds. This is the first ship to have a duplicate plant, and it is expected that electric lights can be relied upon for use at all times, except in action, when the plant is liable to destruction on account of its exposed position. The specifications for this contract were prepared at this office, and great attention was paid to the size and insulation of the conductors as well as the insulation of all other points. The dynamos will be provided with tachometers, volt and ampère meters, and the engines with steam separators and other improvements. New forms of water-tight junction boxes

and switches have been devised for this ship, which are expected to be very efficient. The installation, under the local supervision of Lieut. T. E. D. W. Veeder, U. S. Navy, formerly an assistant in this office, is now rapidly approaching completion, and it is confidently expected to be very much superior to any ship installation now existing in the Navy.

New ships.—Specifications have been prepared for all ships now under contract to be built or completed, except gun-boat No. 2. The Board on additional ships did not consider it wise to install this vessel with electric lights. In this respect I beg to differ with the Board. Small ships are notably uncomfortable and badly ventilated; their ports and hatches are required to be kept closed much more than those of large ships, keeping out the light and air; in such ships electric lights are not only a source of great comfort, but greatly improve their sanitary condition and add largely to their efficiency. I trust that when this ship is completed a space will be found in her where at least a single small plant can be placed. I regard it as a very bad plan to prepare specifications for lighting a ship when she is designed. By the time the ship is ready to be installed the specifications are two or three years old, and therefore can not include the latest improvements. There is no branch of science, perhaps, that is making more rapid progress than electric lighting. Another consideration quite as important is that under these circumstances no advantage can be taken of the experience gained in the mean time on board of other ships. In the specifications for lighting the new ships efforts have been made to secure a plant which will be efficient for producing electricity for any purpose for which it may be required, as well as compact and light.

Electric conductors in ships.—I am firmly convinced that the installation of all electric wires on board ships should be under the supervision of one officer. Besides the electric lighting conductors large numbers of others are led about the ships for signal-bells, search lights, guns, and torpedoes. These should be carefully located so as not to interfere with each other and yet each receive proper consideration; all should also be placed where they will be protected. In English ships these different circuits are designated by different colored paints. In some of the Roach cruisers there are large numbers of conductors with very inferior insulation, consisting of cotton soaked in paint, or some tar mixture, led about the ship without being inclosed in wooden molding, or protected from chafe, abrasion, or water. I venture to predict that it will be found impossible to keep them in an efficient condition when cruising at sea.

Electric lights at naval stations.—I am of the opinion that the same reasons which cause the very rapid adoption of the electric light in factories, foundries, workshops, public streets and squares, and small towns render it very advantageous for navy-yards. The possibility of carrying on all sorts of work at night by means of this light, alone renders it necessary to a station that may be called upon for great efforts in times of emergency. For police purposes it is also very valuable.

Naval War College and New York Navy-yard.—I have collected the necessary data to install the Naval War College with electric lights, the current to be taken from the Training Station dynamo.

I have under consideration plans for installing the New York Navy-yard with electric lights, are lights being intended for use outside and incandescent lights for dwelling-houses and offices.

Outside works.—At present no rules have been laid down by marine insurance companies with a view of requiring a safe installation on

board steamships. Although but recently established, and but little known, much interest has been manifested in the work of this office by those interested in the subject of safe installations. As an illustration I may say that I have recently received letters from the general manager of the Providence and Stonington Steamship Company, asking for a copy of specifications used for installing war ships in order to aid him in procuring a safe installation of a steamer now building. There promises to be a field for much useful labor in this direction.

Search lights.—There are but three ships in the Navy installed with a search-light plant, viz: the *Trenton*, *Atlanta*, and *Boston*. The plant for these ships was purchased four years ago and is now obsolete in type, although efficient. The *Chicago* will soon be installed with a similar plant, purchased at the same time. Each plant consists of two series-wound Gramme dynamos of about 55 volts and 45 ampères, driven by a Brotherhood engine connected directly to an armature shaft common to both dynamos. It will be observed, generally speaking, that series-wound dynamos are used for arc lighting and shunt wound for incandescent lighting, the voltage of the former being only about one-half of the latter. The search-light plant is, like a gun, for use during war only, while the incandescent plant is in constant use. It has been considered that both were necessary and could not be combined, as, for instance, in the *Atlanta*, where there are a single incandescent and two search-light dynamos. Should anything happen to the former, the ship must go without incandescent lights. Recently, in accordance with a suggestion from this office, the search-light dynamos have been connected in series and used with excellent results as a duplicate, or day plant, for operating a limited number of incandescent lamps; this, however, is a makeshift. The compound-wound dynamo, which has now been successfully used for sometime, is a machine almost equally well adapted for use with arc or incandescent lamps, and is exclusively used abroad in foreign navies. The last ship installed, the *Boston*, has a dynamo of this type for incandescent lighting, and the *Chicago* will have two. By the use of this type of dynamo the whole number can be reduced, since duplicates can be utilized for running the search lights during the short time they are needed. This naturally brings up the subject of concentration in the management and installation of these two plants, which should become one. At present they are under two different Bureaus.

Increasing demand for electricity in ships.—The size of electrical plants placed on board ships is constantly increasing in order to satisfy the demand for a greater amount of electricity. No less than four powerful search lights are installed in all large new ships, and, in addition to these, a new French armor-clad is being installed with a sufficient number of arc lights to illuminate a circle around her of large diameter. It is probable that electric motors for training guns, hoisting ammunition, etc., will soon be used. Her Majesty's ship *Trafalgar*, recently launched, is to have on board for all purposes three dynamos of 80 volts and 400 ampères each, or a total output of 96,000 watts.

Office and assistants.—At present the office of the Inspector is confined to a single room in a private house. It is already overflowing with plans, models, samples, records, and electrical literature, and ought to be enlarged. There was formerly attached to the office an assistant, Lieutenant Veeder, U. S. Navy, but it was found necessary to order him to the *Chicago* as local Inspector and superintendent of her installation. The present occupant of the office performs all duties from Inspector to mail carrier. The amount of clerical work is so large that no time remains for study, which is very necessary to keep pace with the times. The

services of a copyist, who should, if possible, be a stenographer and type-writer, are very much needed.

Very respectfully, your obedient servant,

R. B. BRADFORD,
Lieutenant-Commander, U. S. Navy,
and Naval Inspector of Electric Lighting.

CHIEF OF THE BUREAU OF NAVIGATION.

REPORT OF PRESIDENT OF NAVAL WAR COLLEGE.

U. S. NAVAL WAR COLLEGE,
Newport, R. I., October 4, 1887.

SIR: I have the honor to submit the following report of the third annual session of the Naval War College:

The term began September 5, 1887, and is expected to last until December 22. The course of lectures, which is given in fuller detail in the annexed programme, is based upon that of the past two years, but with considerable development. Subjects before treated have been enlarged and recast, and much new matter has been introduced, all bearing upon the practical question of carrying on naval war to the best advantage.

The number of officers attending instruction this year is 22, viz: 5 commanders, 4 lieutenant-commanders, 8 lieutenants, 3 ensigns, and 2 marine officers. Letters have been received from three captains and one commander expressing their wish to attend and regret at being unavoidably prevented.

In accordance with the understood wishes of the Department, the aim has been to limit the effort of the college to subjects bearing practically, and for the most part directly, upon the successful conduct of war on the sea by naval officers. It is proper to remark that this matter, the art of naval war, has never received systematic treatment, and, so far as is known, amid all the immense activity now bestowed upon the development of the material of war, nowhere in the world is there an organized attempt being made to effect such treatment except at the Naval War College.

In consequence, there is an entire lack of text-books upon which to base a course of instruction. It is as yet the singular position of the college among educational institutions that it has, first of all, to collect, digest, and arrange, in suitable form for instruction, the branches which it has to teach. There is nothing in the range of naval literature to place alongside of the many and elaborate treatises on the art of war on land in its various branches. Much indeed has been written, but what has thus been produced is for the most part fragmentary, representative of special views, partial and unsystematic in treatment. No attempt has been made to bring the whole subject under review in an orderly, well-considered method. This deficiency, which so clogs the movement of the college, is among the strongest arguments for its establishment, except with those who are ready to maintain that naval men do not need to study methodically the higher branches of their business.

The bearing of the different subjects of the programme upon the practice and art of war is for the most part apparent; nor does it seem necessary to renew the explanation given last year of such as were less obviously essential to military seamen. It may be remarked, however, that naval hygiene is intimately connected with the efficiency of ships and fleets, and that the responsibility for the health of the crews rests ultimately upon the commanding officer, who, however he may ordinarily be guided by the opinion of the surgeon, must be able on occasion to overrule intelligently the professional bias of the latter. The

consideration of the results of an isthmian canal is designed to familiarize the minds of officers with the great issues that are maturing in the waters of Central America; the importance of those regions from the point of view of military control, if not of war; and also incidentally to awaken attention to the close connection between the commercial and naval interests of a country.

At the date of writing, the North Atlantic fleet, under the command of Rear-Admiral Lucé, is in port, and various practical exercises are now in course of arrangement by the vessels under his orders, which will serve to illustrate and give point to teaching given orally in the lecture-room, as well as diffuse information connected with the new material of the Navy, more rapidly than could otherwise be done. Thus that squadron will co-operate with the ends of the college in accordance with the original plan, and, it may be believed, to the benefit of the officers both of the fleet and of the class.

I renew my suggestion of last year as to the wisdom of providing some means for carrying on ramming duels. The deadly character of the blow of a ram seems to have taken hold of men's minds to the exclusion of the thought that this weapon will require, for its successful use, a trained skill equal to that of the swordsman.

I have the honor to be, very respectfully, your obedient servant,
A. T. MAHAN,
Captain, President War College.
Capt. J. G. WALKER, U. S. Navy,
Chief of Bureau of Navigation.

UNITED STATES NAVAL WAR COLLEGE.

The annual course of lectures will begin September 5 and end December 22. There will be two lectures each day, except Saturday and Sunday.

September, 1887.—Opening address by Commander Sampson, Superintendent of the Naval Academy.

Naval Gunnery, treated with special reference to the influence of the gun upon Naval Tactics. Lieut. J. F. Meigs. Eighteen lectures.

Development of Modern Naval Tactics, and current theories respecting them. Commander W. B. Hoff. Eight lectures.

Duties of the General Staff. Lieut. C. C. Rogers. Four lectures.

International Law. Prof. J. R. Soley. Eight lectures.

October, 1887.—International Law. Prof. J. R. Soley. Twelve lectures.

Tactics of the Gun. Lieut. J. F. Meigs. Four lectures.

Naval Strategy and the Strategic Features of the Gulf of Mexico and the Caribbean Sea. Capt. A. T. Mahan. Three lectures.

Tactics of the Ram. Commander P. F. Harrington. Five lectures.

Tactics of the Torpedo. Lieut. D. Kennedy. Three lectures.

Naval History. Capt. A. T. Mahan. Ten lectures.

Coast Defenses. Lieut. C. G. Calkins. Four lectures.

November, 1887.—Coast Defenses. Lieut. C. G. Calkins. Eight lectures.

Defense of the Sea Coast of the United States. Gen. H. L. Abbott, U. S. Engineers. Five lectures.

Naval History. Capt. A. T. Mahan. Eight lectures.

Military History, Strategy, and Tactics. Lieut. T. H. Bliss, U. S. Army. Twelve lectures.

The Preservation and Care of Iron Ships, and the Injuries to which they are liable. Assistant Naval Constructor R. Gatewood. Four lectures.

The Naval War Game. Lieut. McCarty Little. Six lectures.

December, 1887.—Naval Hygiene. Medical Director R. C. Dean. Six lectures.

Military History. Lieut. T. H. Bliss, U. S. Army. Twelve lectures.

The present condition of Commerce and Commercial Routes between Europe and the Pacific, with an estimate of the effect produced on them by a Trans-Isthmian Canal, including a view of the military and political conditions of the Pacific Ocean, Gulf of Mexico, and the Caribbean Sea. Lieut. Commander C. H. Stockton. Six lectures.

Approved.

J. G. WALKER,
Chief of Bureau.

BUREAU OF NAVIGATION, NAVY DEPARTMENT,

September 2, 1887.

ANNUAL REPORT OF THE HYDROGRAPHER TO BUREAU OF NAVIGATION.

UNITED STATES HYDROGRAPHIC OFFICE,
BUREAU OF NAVIGATION, NAVY DEPARTMENT,

October 1, 1887.

SIR: I have the honor to submit the following account of the operations of this office for the fiscal year ending June 30, 1887:

The interesting and valuable appended reports of the chiefs of divisions and of the officers in charge of the branch hydrographic offices will give a very complete account of the operations of the office, and will satisfy you, I am sure, that its work is increasing in usefulness and that the support you have invariably given it has been deserved. I shall refer in a general way to the work accomplished and projected.

CHART CONSTRUCTION.

The force has consisted of 14 draftsmen, 17 engravers, 5 printers, 1 office attendant, 1 plate cleaner, and 1 laborer. The work of the Division has been mainly directed to the charts of the West Indies, the west coast of Mexico and Central America, and the region of Newfoundland and the Gulf of St. Lawrence. Almost all the charts which were in hand but unfinished at the close of the last fiscal year have been completed and published. The set of general sailing charts of the east coast of North America is practically complete, and that of the west coast of Mexico and Central America is well advanced. The policy of keeping the expense of the correction of charts down to the lowest possible limit and still maintain their efficiency has been adhered to. Of the total amount of money expended in the actual drawing and engraving of charts and work directly kindred thereto, only $4\frac{3}{10}$ per cent. has been expended for corrections. There were 53 engraved plates of charts and 4 miscellaneous plates finished, and 56 new charts in hand unfinished, at the end of the fiscal year. The carefully prepared list in the report of the chief of this Division will show what charts are now selected for publication and upon which work will be commenced as soon as those now in hand are finished.

All the charts from the *Ranger's* survey, up to last season, are now complete and on issue. Work has been commenced on several of the harbor charts resulting from last season's work. The number of copper and steel chart plates available for printing is now 393. During the year 34 electrotype altos and 5 bassos were received. 22 blank plates were purchased and 32 more were made available by scouring down and polishing condemned plates.

The comparison of this year's printing with that of last year shows a small increase.

The work upon the record of longitudes and upon the investigation of magnetic variation has been continued by Mr. G. W. Littlehales with

most satisfactory results. This work has been of great service in the settlement of technical questions incident to the construction of charts. A record of doubtful dangers in the North and South Atlantic oceans has been prepared. This, in connection with the record of deep-sea soundings, is of great value in reaching a conclusion as to whether these dangers actually exist. Investigation as to the depths of the sea, referred to in the last annual report, has been continued. Sheets showing the soundings made by the vessels of different nationalities in different parts of the oceans have been kept posted to date, and also a record of the history of each sounding.

Gnomonic or great-circle sailing charts of the north and south Atlantic have been finished and placed on issue. Similar charts of other oceans will be published as fast as possible. Those already published have been received with great favor by the masters of ships making long passages. The New York Branch Office reports that "The gnomonic chart issued by the Hydrographic Office has undergone a severe test of its accuracy and utility. The charts presented by this office to those captains of transatlantic steamers who could travel a great circle have found much favor. Numerous reports have been received from captains who made use of these charts on every trip, which testify to their value for accuracy and to their usefulness in lessening the labor of computations on the great-circle route." These charts, which were designed by Mr. Gustave Herrle, chief draftsman, present undoubtedly the simplest method yet found for practical use in great circle-sailing, and reflect great credit upon the designer.

The work of computing and recording distances between different points on the earth's surface was transferred to this Division in the early part of the year, and has been systematically carried on ever since. Minor changes have been made in the organization of the Division, and investigations have been continued of the use of machines for engraving, with very encouraging results. No charts have been heliographed, as the reasons for the recommendations made in the past with regard to this and also with regard to contract engraving have been further strengthened by the experience of the past year. The efficient organization of this Division is mainly due to the intelligent and energetic efforts of Ensign J. H. Fillmore, who was detached, at his own request, in May, 1887. I regretted exceedingly to be obliged to lose his services, and trust that his valuable work may receive that acknowledgment from the Department which it justly deserves. This Division is now in charge of a lieutenant.

DIVISION OF SUPPLY.

The number of charts issued by this Division, the principal function of which is to supply the demand for Hydrographic Office charts, has been 600 copies less than last year. This is due to the fact that the practice of issuing charts to ship-masters who kept meteorological journals has been restricted, and journals are now only issued to the masters of American ships. The number of copies supplied to agents was about the same as last year, although the increase in the demand for engraved charts and the decrease in the demand for photolithographs has been very noticeable. The engraved charts of the banks of Newfoundland, east coast of the United States, and West Indies are in greatest demand. In several cases where the office has issued engraved charts covering several photolithographs, the demand for the

photolithographs has almost entirely ceased, demonstrating the advisability of continuing the policy insisted upon in previous reports, of supplanting these photolithographs with engraved plates as soon as possible. The attempt to lessen the number of hand corrections made on charts has been only partially successful. The large and somewhat irregular orders from the agents render it impossible to keep a small supply on the shelves, and the larger this supply the more copies there are requiring correction. The officer in charge of this Division makes various recommendations which will facilitate and forward his work, all of which I indorse most heartily. In addition to the routine work, a chart catalogue, embracing new and important changes, was prepared and published. The number of copies of charts issued to naval vessels during the year was 7,570 and the number issued to agents for sale was 7,202. This Division has been in charge of a lieutenant, assisted by two draftsmen, one clerk, one light colorist, and a laborer.

DIVISION OF ISSUE.

During the year the *Alert*, *Alliance*, *Atlanta*, *Dolphin*, *Juniata*, *Ossipee*, *Richmond*, *Thetis*, and *Vandalia* have been completely fitted out with charts, and the *Trenton*, *Constellation*, and *Fortune* have received partial outfits. The vessels in commission have been constantly supplied with new editions of charts as fast as they have appeared. The recommendation that the station catalogues be revised is indorsed, and this work will be taken in hand at once. The work of the Division, which was somewhat in arrears, has been brought up by the addition of another draftsman, and the force is now adjusted to the work required. The number of British Admiralty charts received from London has been 3,742, and the number distributed to United States ships has been 4,022. The number of copies of British Admiralty charts on hand is 11,426, and during the year 3,186 received hand correction. This Division has been in charge of a lieutenant, assisted during most of the year by two draftsmen and a laborer.

DIVISION OF BOOKS.

In this Division 1,501 books and pamphlets of reference have been catalogued, and the preparation of data for the several new books of sailing directions and supplements to many already issued has been continued. A history of the Hydrographic Office has been prepared and published. The policy of supplanting foreign works, heretofore issued by the Navy Department to ships of war as sailing directions and aids to navigation, by publications of this office has been carried forward as well as the force and means at the disposal of the Hydrographer would allow. There can be no question as to the necessity of having a complete set of sailing directions published by the Government as soon as possible, and preparations have been made to push this work with great vigor during the coming year. A few copies of books of reference which the different divisions of this office need constantly have been bought and deposited in this Division. Great care has been taken in selecting only such works as are required for frequent reference, and all exchanges which do not refer to the work of the office have been discouraged. The total number of books of reference now on hand is 4,031. The work of supplying the ships of war and the sales agents with nautical publications has been very effi-

ciently carried on by this Division, which has been in charge of a lieutenant, assisted during the greater portion of the year by one lieutenant and one ensign.

DIVISION OF NOTICES.

In order to meet the shipping interests more effectually and at the same time more economically, a further modification was made in the printing and issuing of the Notices to Mariners. While the weekly edition of the notices was continued as usual, the paragraphs relating to the same general locality were grouped and issued as extracts. This plan enables a ship-master to take only such paragraphs as refer to his projected voyage. The branch offices report that this manner of distributing information is very acceptable to the maritime community, and, although increasing their work, they recommend its continuance.

The usual number of notices in foreign languages has been received and translated, and the six volumes of light lists were revised and published.

Additions have been made to the files of foreign charts, the classification and filing away of which, together with the numerous documents relating to hydrography, has been carried on most efficiently by the Custodian of the Archives.

DIVISION OF MARINE METEOROLOGY.

Owing to the small force available the work of this Division has been limited during the past year. The attention of the officer in charge has been mainly directed to the preparation of the Pilot Chart and the Weekly Supplement, and many matters of great importance have been unavoidably neglected. Preparations have been made by means of which it is hoped that this Division may be placed on a footing commensurate with its importance to the Navy and to the entire maritime community.

The donation of a set of charts as a recognition of services rendered by shipmasters in keeping meteorological journals should be supplemented by the loan by the Government of good instruments. This work is now done almost gratuitously and at great inconvenience; its value should be recognized in some more appreciable manner.

The Pilot Chart and Weekly Supplement, issued under the superintendence of the chief of this Division, continue to be popular. The reports of the officers in charge of the branch offices will give an idea of the usefulness of these publications.

The account of wrecks destroyed by the Department will be in the report of the chief of this Division, who furnished the information which enabled the Department to locate them.

The question of marine meteorology has never received the attention that its importance demands, and the support of the Bureau is earnestly solicited in order that this work may be placed on a proper footing.

BRANCH OFFICES.

The work of the branch offices has been very satisfactory. The reports from each show a continual increase in the scope and value of their operations. All unite in testifying to the usefulness of the Pilot Chart and Weekly Supplement, which they have enabled the main office to place on their present footing.

The Boston office reports a scarcity of ice and fog reports on account of the fact that the steamers follow the safe route laid down on the Pilot Chart, and thus reduce the chance of meeting these obstructions to a minimum. The distribution of the Pilot Chart has been extended into the interior, many teachers now using it for purposes of instruction. The publication of the Notices to Mariners in the form of extracts has had good results and is commended, and the experience of this branch seems to show that the plan of distributing charts to shipmasters as a compensation for the keeping of meteorological journals might well be replaced by the issuance, under proper restrictions, of good instruments for the purpose of insuring better observations.

In the New York branch the cramped space referred to in last year's report has been relieved somewhat by an allowance on the part of the Maritime Association of additional room. This small increase has greatly facilitated the work. The effect of the dissemination of the value of oil as a means of safety during gales of wind at sea has been apparent. Many firms are now manufacturing a special oil for this purpose, and also devices for distributing the oil. At the instigation of the Light-House Board this branch has made an investigation also into the relative value of electric and oil lights for light-houses, and the establishment of an electric light on the hills of Navesink. Owing to the fact that New York is the principal sea-port of the country, and that its configuration is peculiarly adapted to show the value of any system of lighting, it is a good point for such an examination, and thus the value of this investigation can scarcely be overestimated. The reports of ice and fogs were very numerous and much activity was displayed in stimulating the shipmasters to send them in. Through the energy of the officer in charge reports have been forwarded not only from all the American ports, but from Denmark, Germany, Norway, and Great Britain. The subject of removing derelicts has received serious consideration. This branch has kept the main office continually informed of their position, and has never ceased to advise their destruction. The subject of tides in New York harbor and vicinity has received much attention. The many questions referred to the branch offices for an opinion on this subject have been decided by consulting tables issued by the Coast and Geodetic Survey. The office is continually referred to by people desiring information upon all subjects, particularly such as refer to marine insurance, and the officers have been frequently called upon to give evidence before the courts of admiralty. The necessity of a uniform system of universal buoyage seems to grow more apparent every year. The importance of this subject seems to be impressed very forcibly upon the officer in charge of the New York branch office. The interesting report of this officer, which is appended, will repay a careful perusal.

The Philadelphia office reports that the efforts of that branch are appreciated and that the amount of information received is steadily increasing. Attention is again called to the sunken wrecks on the New Jersey and Delaware coasts, and especial attention is called to the wreck of the British steamer *Brinkburn*, which has been the means of seriously damaging several vessels which have run into it. In addition to the routine work of this branch a revision of Vancouver Island Pilot has been made, and a compilation of sailing directions for the Red sea, Gulf of Aden, and Persian gulf is now in progress.

The operations of the Baltimore branch were hampered during the latter part of the fiscal year through the lack of funds, but through the courtesy of the collector of customs and of the tug-boat owners most of the arrivals were visited by the boarding officer. This office is not

situated in a very favorable location, and it is intended to remove it at the earliest possible moment. The officer in charge also makes the recommendation that American vessels should be supplied with instruments for taking observations. Many captains express a willingness to observe for the office, but are deterred from doing so from the fact that they have no proper instruments. This branch was influential in having a bell buoy moored off False Cape, where last year eight or nine steamers struck on the shoal. Since the bell buoy was placed there no report has been received of a vessel striking these shoals. Also, through the influence of this office, a mid-channel buoy was placed at the entrance of Chesapeake bay, as a result of the danger of heavily-laden vessels touching at the head of the Middle Ground. In addition to other duties the compilation of the Navigation of the Caribbean Sea and Gulf of Mexico, vol. 1, was finished, and the compilation of vol. 5, Coasts and Islands of the Mediterranean Sea, is in progress.

The New Orleans branch has secured the co-operation of agents in Pensacola, Fla., and Galveston, Tex., and reports that they have been of great assistance in forwarding the work of the branch office. Knowledge of its purposes and objects seems to be pretty well disseminated throughout the Gulf ports, and accounts of its value to the maritime community there have been numerous and gratifying. As illustrating the general importance of these offices, the shipping agents of the various railroads at Kansas City, Mo., desiring information as to the temperature of the sea-water likely to be experienced by vessels going from New Orleans to Liverpool during each month in the year, communicated with the branch office for the purpose of getting the desired information. This enabled the railroad companies to consider the feasibility of making large shipments of salt meat to Liverpool by way of the port of New Orleans.

The San Francisco branch reports a considerable increase in the work over that of last year. The press of San Francisco has been very favorable to this work, and has been of great assistance in publishing items for the office and in calling attention to its facilities. The officer in charge seems to think that ship-masters do not consult the office as much as they should in the matter of aids to navigation, and recommends again that some pressure should be brought to bear upon the underwriters and ship-owners to urge the ship-masters to avail themselves of this privilege. The underwriters of San Francisco have already issued a circular on the subject. The issue of special bulletins for the Pacific coast was commenced in December, and has been highly appreciated by the shipping community. These are published from time to time as sufficient data accumulate, and contain accounts of all wrecks and of every obstruction and danger along the Pacific coast. The officer in charge of this office, in obedience to orders from the Department, visited San Pedro, San Diego, Portland, and Port Townsend, and made an exhaustive report on the advisability of establishing a branch hydrographic office at each of these places. The charts of the coast of Mexico and Central America, resulting from the surveys of Commanders Philip and Clark, have been favorably received. The necessity of charts on a larger scale of the Pacific coast of North America seems to be very great. "During the past winter the number of disasters on the coast of Oregon and Washington Territory and Vancouver island, especially in the vicinity of Cape Flattery, has been unprecedented, and the loss of life and property has been very great." The commendations of the work of this branch have been very general, and exhibit a very satisfactory appreciation of the efforts of the Department to assist the maritime community on the Pacific coast.

The following is a summary of the work of the branch offices:

Vessels visited.....	15,607
Barometers and thermometers compared and adjusted.....	7,377
Charts corrected for captains.....	4,181
Pilot Charts distributed.....	19,425
Notices to Mariners distributed.....	188,060
Beacon and Buoy Lists distributed.....	11,733
Information furnished to different individuals.....	101,098
Reports forwarded on storms at sea, trade-wind limits, fog, ice, wrecks, water-spouts, buoys adrift, use of oil at sea, electric storms, unknown rocks and shoals, meteorological journals issued, pamphlets on the use of oil, etc., distributed, and general information on matters of interest to navigation..	24,061

MISCELLANEOUS.

The system of engraving by contract, which was condemned in last year's report, has not been entirely done away with. Owing to the lack of room, it was impossible to carry out the plan I had intended, of having all this work done under the immediate supervision of the chief of the Division of Chart Construction. As long as the Hydrographic Office is restricted to its present quarters a portion of the engraving work must be done by outside parties, resulting in a loss to the Government which in some cases amounts to a large percentage of the sums expended. The experience of the office proves that the work can be done in the office not only in a more satisfactory and uniform manner, but also cheaper. The publication of the records of longitude and variations referred to in last year's report has been delayed on account of the lack of clerical force to get them in shape for the printer. These important works, which in their present form are only available for the work of this office, should be issued for the benefit of all chart-makers and investigators into these subjects. The very creditable survey by the officers of the *Ranger* on the west coast of Lower California has been continued and has extended from San Quentin bay to Lagoon head. The charts already issued as the results of this survey have found great favor on the Pacific coast and have fully justified the expense attending this most excellent hydrographic examination. The following surveys, reconnaissances, and determinations have been made by U. S. naval officers during the year:

U. S. S. *Ranger*, Commander F. A. Cook, commanding, has completed the survey of the west coast of Lower California from San Quentin bay to Lagoon head, comprising—

Primary triangulation.....linear miles..	960
Coast line.....do.....	270
Fathom lines.....do.....	1,080
Topography.....square miles..	1,744
Hydrography.....do.....	3,037
Number of soundings taken.....	24,296
Special survey of Rosario bay and Sacramento reef:	
Coast line.....linear miles..	27
Fathom line.....do.....	300
Topography.....square miles..	65
Hydrography.....do.....	200
Number of soundings.....	5,000

U. S. S. *Tallapoosa*, Capt. William Whitehead; sounding out of Santo Alberto channel, Brazil.

U. S. S. *Galena*, Commander C. M. Chester; soundings from Trinidad to Curaçao.

U. S. S. *Juniata*, Commander G. T. Davis; soundings from New York to Montevideo.

U. S. S. *Essex*, Commander T. F. Jewell; sounding in bay of Bengal.

U. S. S. *Albatross*, Lieut. Commander, Z. L. Tanner; deep sea soundings in North Atlantic ocean.

The following officers have sent in valuable hydrographic information, viz: Tracings of new foreign surveys, recent changes in aids to navigation, reports on searches for doubtful dangers, astronomical determination of positions and establishment of magnetic variation: Capt. E. E. Potter, Capt. G. W. Dewey, Capt. H. L. Howison, Commander L. Kempff, Commander B. F. Day, Commander J. D. Graham, Commander G. W. Coffin, Commander C. D. Sigsbee, Commander G. T. Davis, Commander F. M. Green, Commander T. F. Jewell, Commander Thomas Nelson, Lieut. Commander Z. L. Tanner, Lieut. F. M. Symonds, Lieut. W. O. Sharrer, Lieut. J. M. Hawley, Lieut. F. H. Lefavor.

The following masters of American and foreign ships have sent in various hydrographic information: Messrs. J. M. Lukey, Block, Andrews, Baker, Neville, Crossland, Rowell, M. Kaldagar, Jones, Acock, Looker, Field, Smith, Symes, Gibson, Warner; Commander L. A. Gove, Chilean Navy; Admiral Mason S. Cooper, San Domingo Navy. Mr. James Jackson, secretary of French Geographical Society, sent list of soundings in Gulf of Guinea.

Considering the arduous character of the duties of the navigators of ships, much material has been forwarded by them in regard to changes in the aids to navigation and other matters of interest to seamen relating particularly to navigation. An order was issued during the year by the Secretary of the Navy transferring this branch of the intelligence report from the intelligence officer to the navigator, and while the effects of this have not been fully shown as yet, it is hoped that it may be the means of exciting more interest on the part of navigators in work which properly belongs to them. The receipt of all matters of this kind has been promptly acknowledged and the material has been immediately incorporated into the publications of the office. The attempt has been made in this way to make the navigators feel that their efforts are appreciated, and will be made immediately available to the rest of the maritime world.

GENERAL RECOMMENDATIONS.

The recommendations contained in the last year's report, and in those of the previous years that the Hydrographic Office has been under my direction, are all earnestly reiterated. To call them more particularly to your attention, I will give a brief summary of such as seem to me of the greatest importance. The necessity for a separate building for the Hydrographic Office becomes yearly more apparent. The greater portion of its operations partake more of the character of a shop than of an office in the usual acceptation of the term. The drafting and engraving of charts, the handling and storage of heavy copper plates, and printing form the principal work of the office. All this is of a character which renders it highly important to keep it away from quarters where men are engaged in clerical work not incidental to the production of charts. The copper plates are expensive and require continual handling, they are easily scratched, and therefore the amount of transportation to which they should be subjected should be reduced to a minimum. The draftsmen and engravers should not be subject to jar and, in order to do their work properly, should have the proper kind of light and the best of ventilation. It would be a measure of economy for the Government, therefore, to have constructed a building especially designed for this work, which must continue indefinitely in the future, and which should be surrounded by every safeguard against fire and every facility for the production of the highest class of work of this kind. Buildings which will fulfill all the requisites of this

office could be constructed for \$200,000, and it is earnestly requested the Congress may be asked to appropriate this sum for this specified purpose.

The Hydrographic Office is doing its best, with the means at its disposal, to diminish the number of charts it is obliged to buy from the British Admiralty in order to supply deficiencies in its own set. This set is far from being complete, and it will be good policy to place more funds at the disposal of the Hydrographer in order that this very important work should be carried to an early completion. New surveys of the coast of South America and some portions of the West Indies are very necessary. The *Dolphin* was prepared with the necessary outfit, and instructions to carry on a survey on the Spanish Main, which has been long contemplated by this office. Her unavoidable failure to get on the ground and do the work was the cause of great disappointment to the large interest which carries on trade with this portion of the world, and it is recommended that a ship be fitted out especially for this work and sent there to do it as soon as possible. The deep-sea survey of the Pacific should be undertaken as soon as possible. The discussion about the laying of a telegraph cable from some portion of the American continent to the Sandwich Islands brings this very prominently into view. While examining the great number of dangers alleged to exist in the Pacific, a ship fitted with the proper apparatus would accomplish the double purpose of ascertaining the configuration of the ocean bed, and marking or definitely determining the non-existence of reported dangers which are a continual bugbear to the seafarer. At least one ship should be fitted out and kept at this particular work in the Pacific. The suggestion that a small steamer be fitted out for the purpose of blowing up wrecks along the coast has received an additional degree of force from the experience of the past year. As the report of the chief of the Division of Meteorology will show, vessels have been wrecked all along our coasts, and in many instances have caused the wreck of others. The Department could easily gain credit with the maritime community by guarding its interests in this respect, and would really accomplish a valuable humanitarian work. The subject of calling an international convention for the purpose of destroying derelicts by each maritime nation is also again presented. This can only be effectually done by some combined effort to clear the ocean of these obstructions, which are a constant menace to life and property. The experiences of merchant ship-masters in using oil during gales of wind at sea have been published on the Pilot Chart during the past year, and the value of this agent is now generally recognized. It would give it a standing, however, if the Department would direct the captains of men-of-war to make exhaustive experiments whenever the opportunity presented itself. The favorable indorsement of this by scientific naval officers would give it a standing which nothing else ever can. The subject of the inspection of the chart outfit of merchant ships is also again presented. In relation to this matter the following extract from the finding of a naval court, held at the consulate at Yokohama, Japan, to investigate the cause of the loss of the bark *Afton*, will be interesting:

The master, Gilmour, considers that the cause of the accident was inaccurate marking of his chart, but the court is of a different opinion. It appears from his own testimony that he had no sailing directions for the north Pacific amongst his books. Had he taken the ordinary precaution to provide himself with so indispensable a guide for the voyage he was prosecuting he would not have approached so close to Lsiansky island from the south; and he had no sheet charts, but only a general chart of the north Pacific, published in 1883, on which later emendations and corrections had not been entered up. In a chart belonging to one of the members of the court, published

only a year later, three important corrections concerning the spot where the ship was lost are noted. The court is therefore of the opinion that the ship was not provided with the proper charts for the voyage on which she was engaged and that the loss of the ship is primarily due to Captain Gilmour's neglect to provide himself with the proper sailing directions and charts.

It is recommended that a branch office be established at Norfolk, Va., and also one at Portland, Oreg. The authorities most interested in the establishment of these offices have requested it and the recent tours of inspection of Lieutenant Milton prove that a branch office at Portland, Oreg., would be of great value to the Pacific coast and would be highly appreciated by the maritime community of that section.

In conclusion it gives me great pleasure to state that the officers and employes attached to the Hydrographic Office have been, without exception, of great assistance in carrying on its duties and that they are worthy of the attention and commendation of the Bureau. The thanks of the Hydrographic Office are due particularly to the Department of State, the Coast and Geodetic Survey, the Geological Survey, the Light-house Board, the Government Printing-Office, and to all foreign hydrographic offices and marine boards. Special thanks are due to the masters of ships who have taken an interest in the work of the Hydrographic Office—if the number were not so great I should take great pleasure in mentioning them by name in this report. The different maritime bodies of the coast and the press of the seaboard cities have been uniformly kind in their notices, and have been of great assistance in many ways.

In closing this, my fifth annual report on the operations of the Hydrographic Office, I wish to place on record my appreciation of the very efficient aid rendered me by my assistant, Lieut. G. L. Dyer, U. S. Navy, who has devoted himself with great ability and untiring zeal to every duty which I have called upon him to perform. To him is due a large share of whatever success may have been attained in my efforts to reorganize this office and put it upon a substantial basis for doing thorough and effective work, and I wish to acknowledge my indebtedness to him not only for the faithful execution of important administrative details, but also for valuable suggestions by which I have been materially aided in carrying out my plans.

Very respectfully,

J. R. BARTLETT,
Commander, U. S. Navy, Hydrographer.

Commodore J. G. WALKER, U. S. Navy,
Chief of Bureau of Navigation.

DIVISION OF CHART CONSTRUCTION,
Hydrographic Office, July 1, 1887.

SIR: I have the honor to submit the following report of operations for the fiscal year ending June 30, 1887:

There have been employed in the Division during the year 11 draftsmen, engaged in preparing new charts for publication, and in revising and correcting charts on issue before printing; 1 draftsman engaged in recording new data received, and in recording revisions or corrections to be made on charts; 1 draftsman engaged in compiling geographical positions, and in compiling and investigating magnetic variations; 1 draftsman engaged in preparing sounding sheets of the Atlantic oceans, and in preparing for publication the work of the Northern Alaskan Exploring Expedition, commanded by Lieut. G. M. Stoney, U. S. Navy; 1 record clerk; 15 engravers and 2 apprentice engravers, engaged in engraving new charts, and in engraving corrections on charts on issue; 3 printers, 2 assistant printers, and 1 office attendant engaged in print-

ing charts for issue; 1 laborer engaged in scouring down condemned plates for re-engraving, and 1 laborer employed as messenger.

The work of the division has been mainly directed to the charts of the West Indies, of the west coasts of Mexico and Central America, and of the region of Newfoundland and the Gulf of St. Lawrence, in pursuance of the policy outlined in previous reports.

Almost all the charts represented at the close of the last fiscal year as being in hand, but in an unfinished condition, have now been completed and published. The work on the general sailing charts has so far progressed that the office set of general sailing charts as far as St. John's, Newfoundland, is practically complete. The work on the west coast of Mexico and Central America has gone far toward the completion of a complete set of charts between the boundary of the United States and Panama.

The following table will set forth the work in detail:

Charts finished during the fiscal year ending June 30, 1887.

No.	Title.	Begun	Finished	Remarks.
986	Port Cispatá, United States of Colombia.....	Apr., 1885	July, 1886	Engraved.
980	Avatoru Pass and Anchorage, Painotou Group.....		July, 1886	Do.
989	Coacarias Bay, Venezuela.....	May, 1885	July, 1886	Do.
984	Port Carreto, United States of Colombia.....	Apr., 1885	July, 1886	Do.
983	Port Turiamo, Venezuela.....	May, 1885	July, 1886	Do.
985	Candelaria Bay, United States of Colombia.....	Mar., 1885	Aug., 1886	Do.
987	Bahía Honda, United States of Colombia.....	Apr., 1885	Aug., 1886	Do.
990	Cumana Anchorage, Venezuela.....	May, 1885	Aug., 1886	Do.
970	Northeast coast of Brazil, Paranhíba River to Pernambuco.	Feb., 1885	Aug., 1886	Do.
994	Great-circle Sailing Chart of North Atlantic Ocean.....	Feb., 1885	Sept., 1886	Do.
930	Río de la Plata and Approaches.....	Aug., 1884	Oct., 1886	Do.
193	Tampico Harbor, Mexico.....	Nov., 1884	Oct., 1886	Do.
991	Puerto Cabello, Venezuela.....	July, 1885	Oct., 1886	Do.
957	Crooked Island Anchorage, Bahamas Islands.....		Oct., 1886	Do.
931	West Coast of Central America, Ocosingo River to San Juan del Sur.	July, 1883	Nov., 1886	Do.
929	Harbor of Hong-Kong and Approaches, China.....	Apr., 1884	Nov., 1886	Do.
1000	Turk's Island, West Indies.....	Aug., 1885	Nov., 1886	Do.
1002	Ancagada Passage, with Adjacent Islands.....	July, 1885	Dec., 1886	Do.
958	Porto Bello, United States of Colombia.....	Feb., 1884	Dec., 1886	Do.
964	North Coast of Colombia and Venezuela.....	Jan., 1885	Dec., 1886	Do.
1012	Port au Prince, Hayti.....	Mar., 1880	Dec., 1886	Do.
1003	Santiago de Cuba.....	July, 1885	Jan., 1887	Do.
1079	St. Pierre Roadstead, Martinique.....	July, 1886	Jan., 1887	Do.
1028	Port Elena, West Coast Costa Rica.....	Aug., 1886	Jan., 1887	Do.
1021	Cul do Sac Marin, Martinique.....	May, 1886	Feb., 1887	Do.
1035	Urita Bay, West Coast Costa Rica.....	Sept., 1886	Feb., 1887	Do.
1001	Island of Puerto Rico and Vicinity.....	July, 1885	Feb., 1887	Do.
995	Great-circle Sailing Chart, South Atlantic Ocean.....	Feb., 1885	Feb., 1887	Do.
1011	St. Eustatius, St. Christopher, Nevis, and Monserrat.....	Nov., 1885	Feb., 1887	Do.
1023	Port San Blas, West Coast Mexico.....	Aug., 1886	Feb., 1887	Do.
1028	Muretelago Bay, West Coast Costa Rica.....	Aug., 1886	Feb., 1887	Do.
996	Likiep Group, Marshall Islands.....	Nov., 1885	Mar., 1887	Do.
999	Coxen Hole and Port Royal Harbor, Roatan Island.....	Sept., 1886	Mar., 1887	Do.
1027	Juanilla Bay, West Coast of Costa Rica.....	Aug., 1886	Mar., 1887	Do.
1029	Portrero Grande Bay, West Coast of Costa Rica.....	Aug., 1886	Mar., 1887	Do.
1033	Hallena Bay, West Coast of Costa Rica.....	Aug., 1886	Mar., 1887	Do.
961	Southern part of Vancouver Island and Adjacent Coast, entrance of Juan de Fuca Strait to Nanaimo Harbor.	July, 1885	Mar., 1887	Do.
1007	Pacific Coast of Mexico and Central America, Panama to San Blas.	Oct., 1885	Mar., 1887	Do.
997	Port Chagres, North Coast of Panama.....	Dec., 1886	Apr., 1887	Do.
998	Whale Cay Channel and Green Turtle Cay, Cay Anchorage, Little Bahama Bank.	Oct., 1886	Apr., 1887	Do.
1015	Approaches to Port au Prince, Hayti.....	Apr., 1886	Apr., 1887	Do.
1025	Salinas Bay, West Coast of Nicaragua.....	Aug., 1886	Apr., 1887	Do.
1030	Port Culebra, West Coast Central America.....	Sept., 1886	May, 1887	Do.
1034	Gulf of Nicoya, West Coast of Central America.....	Sept., 1886	May, 1887	Do.
1036	El Rincon Harbor, West Coast of Central America.....	Aug., 1886	May, 1887	Do.
982	Pernambuco, Brazil.....	June, 1885	May, 1887	Do.
1006	Pacific Coast of the United States and Mexico, San Francisco to San Blas.	Apr., 1886	June, 1887	Do.
1022	Fort de France, Martinique.....	July, 1886	June, 1887	Do.
1021	Mazatlan Harbor, Mexico.....	Aug., 1886	June, 1887	Do.
1032	Piedra Blanca Bay.....	Nov., 1886	June, 1887	Do.
1059	Puerto Nuevo, West Coast of Central America.....	Nov., 1886	June, 1887	Do.
1040	Bahía Honda, West Coast of Central America.....	Nov., 1886	June, 1887	Do.
1047	Jamestown Harbor, Caroline Islands.....	Jan., 1887	June, 1887	Do.

Miscellaneous plates engraved during the year.

Index chart for Section VI of the Catalogue of Charts, and for the Sailing Directions for the West Coast of Mexico and Central America.

New Standard Compass plate.

New Seal plate.

New charts in hand unfinished at the end of the fiscal year ending June 30, 1887.

No.	Title.	When begun.	Remarks.
23	South Atlantic, Sheet I	Dec., 1879	These plates have been laid aside, as the need for them is not great, and other work is more important.
23a	South Atlantic, Sheet I	Dec., 1879	
24	South Atlantic, Sheet II	Dec., 1879	
24a	South Atlantic, Sheet II	Dec., 1879	
968	North coast of Guyana, Orinoco River to Maraca Island.	Feb., 1885	
980	Great Bank of Newfoundland, with Adjacent Coast, Cape Bonavista to Cape St. Mary.	May, 1885	In engraver's hands, awaiting information from Dutch Hydrographic Office before completion. In lettering engraver's hands.
981	Southeast Coast of Nova Scotia and Newfoundland, Cape St. Mary to Halifax, with Outer Banks.	May, 1885	Will be published in September, 1887.
1004	Antigua Island, West Indies	Sept., 1885	Ready for engraving.
1005	Island of Trinidad, West Indies	July, 1885	Will be published in August, 1887.
1008	Harbor of Aspinwall	Oct., 1885	Ready for lettering engraver.
1009	Island of Martinique	Nov., 1885	Will be published in October, 1887.
1010	Island of Barbados	Nov., 1885	In lettering engraver's hands.
1018	Gulf of St. Lawrence	May, 1885	In topographic engraver's hands.
1014	Caldera Bay, Hayti	Apr., 1886	Ready for lettering engraver.
1016	San Juan del Sur to Judas Reef	June, 1886	In hands of contract engraver. Nearly finished.
1017	Judas Reef to Burica Point	June, 1886	Do.
1018	Burica Point to Morro Puercos	Apr., 1886	In engraver's hands.
1019	Morro Puercos to Pinas Bay	Oct., 1885	Will be published in August, 1887.
1031	Protrero and Braxillito Baya, West Coast of Central America.	Aug., 1886	Will be published in July, 1887.
1037	Gulf of Dulce, West Coast of Central America	Jan., 1887	In hands of contract topographic engraver.
1038	Parida and Palenque Anchorages, West Coast of Central America.	Oct., 1886	Will be published in July, 1887.
1039	Puerto Nuevo, West Coast of Central America.	Sept., 1886	Do.
1041	Coiba Island, West Coast of Central America	Nov., 1886	In hands of contract topographic engraver.
1042	Panama Bay and Tobago Islands	Jan., 1887	In hands of topographic engraver.
2p	General Chart of North Atlantic Ocean	Dec., 1886	Do.
3p	General Chart of South Atlantic Ocean	Feb., 1887	Do.
4p	Todos Santos Bay	Nov., 1886	Ready for draftsman.
5p	Sunda Straits	Oct., 1885	Ready for engraving.
7p	Santa Ana Harbor, Curaçao	Mar., 1887	Do.
8p	Cockburn Harbor	June, 1887	In draftsman's hands.
9p	Grand Manan Island	Mar., 1887	In hands of topographic engraver.
10p	Coatzacoalcos River	Feb., 1887	Will be published in July, 1887.
11p	San Diego to San Quentin	Apr., 1887	Ready for draftsman.
12p	Soledad Bay and Santo Tomas Anchorage, West Coast, Lower California.	Apr., 1887	Will be published in July, 1887.
13p	Colnett Bay, Lower California	Apr., 1887	In hands of lettering engraver.
14p	San Quentin Bay, Lower California	Apr., 1887	Ready for draftsman.
15p	Miquelon Harbor, Miquelon Islands	Mar., 1887	In hands of lettering engraver.
16p	Prince Edward Island and Vicinity	Mar., 1887	Ready for engraving.
17p	St. Pierre Harbor, Miquelon Islands	Mar., 1887	Do.
18p	Miquelon Islands	Apr., 1887	Do.
19p	Northeast Coast of New Brunswick, Cape Despair to Point Escumencac.	Apr., 1887	Do.
20p	Southeast Coast of Newfoundland, Trinity Harbor to Cape St. Mary.	May, 1887	In draftsman's hands.
22p	Belize Harbor, Honduras	May, 1887	Do.
23p	South Coast of Newfoundland	June, 1887	Do.
24p	Port St. Andrew	June, 1887	Do.
25p	L'Etang Harbor	June, 1887	Do.
26p	Northwest Coast of Newfoundland and Adjacent Coast of Labrador.	June, 1877	Do.
27p	Cause Harbor, Nova Scotia	June, 1887	Do.
	Great-circle Sailing Chart of North Pacific Ocean.		Do.
	Great-circle Sailing Chart of South Pacific Ocean.		Do.
	Great circle Sailing Chart of Indian Ocean		Do.
	North Atlantic Ocean, western sheet, southern part.	Apr., 1884	Ready for engraving.
	North Atlantic Ocean, eastern sheet, southern part.	Apr., 1884	Do.
	Index chart for vol. 1 of the Hydrographic Office Sailing Directions for the Caribbean Sea and Gulf of Mexico.	June, 1887	In draftsman's hands.

CORRECTION OF CHARTS.

During the year some minor changes, chiefly in the methods of co-operation with the Division of Supply, were made in the system of correcting charts. All corrections are made with certainty as far as it is rendered possible by the available information in the possession of the Office. The majority of plates have received corrections during the year, and in a few instances the corrections made were extensive. Of the total amount of money expended in the actual drawing and engraving of charts, and work directly kindred thereto 4 $\frac{3}{10}$ per cent. have been expended for correction.

SELECTION OF CHARTS.

Charts which are now selected for publication and upon which work will be commenced as soon as those now in hand are finished :

Title.	Remarks.
Northeast coast of Newfoundland, Great Harbor Deep to Fogo Island.	The H. O. has no chart covering this ground.
Southwest Coast of Newfoundland.....	Do.
Magdalen Islands.....	Do.
Southern Coast of Labrador, St. Augustine River to Washsheecostia River.	Do.
Southern Coast of Labrador, Cape Whittle to Pashasheeboo Point, with Eastern Part of Anticosti.	Do.
Southern Coast of Labrador, Pashasheeboo Point to Magpie Bay, with Western Part of Anticosti and Northeast Extremity of New Brunswick.	Do.
River St. Lawrence, Magpie Bay to Point des Monts.....	Do.
River St. Lawrence, Point des Monts to River Saguenay.....	Do.
River St. Lawrence, River Saguenay to Quebec.....	Do.

Title.	No. photolithographic copies on hand.
Honduras Gulf.....	76
Port Cortes, Omoa Harbor, and Hospital Bight.....	137
Coast of Honduras, Negro Head to Turneff Cays.....	90
Bay of Campeche.....	92
Campeche Anchorage.....	158
Entrance to Lagoon de Terminos.....	89
Alvarado Harbor, Mexico.....	107
Ports in Chiriqui Lagoon.....	80
Gulf of Dulce (east coast).....	
Chincorro Bank and Chincorro Anchorage.....	80
Puerto Frances, Cuba.....	None.
Monte Christi to Fort Dauphin Bay, and Fort Dauphin Bay, Hayti.....	None.
Mazanillo bay, Hayti.....	60
Port San Juan, Puerto Rico.....	112
Christiansted Harbor, Windward Islands.....	72
Falmouth and English Harbors, Windward Islands.....	134
Bease Terre Road, Windward Islands.....	119
Grand Bourg, Windward Islands.....	162
St. Anne anchorage and Port du Moule, Windward Islands.....	79
Port St. Marie, Windward Islands.....	87
Port Louis, Windward Islands.....	87
Petit Havre, Windward Islands.....	87
St. Francois and Galet Anchorages.....	87
Kingston, Port Royal, Morant Cays, Jamaica.....	113
Mira por Vos Passage, Bahama Islands.....	None.
Courland Bay and Rockly Bay and Tobago Island, Windward Islands.....	135
Acklin's Island Anchorage, Bahamas.....	None.
Pelican and Little Harbors, Bahamas.....	None.
Man-of-war Cay, Bahamas.....	None.
Wide Opening, Bahamas.....	127
Ship Channel, Bahamas.....	127
Egg Island to Eleuthera, Bahamas.....	127
Royal Island Harbor, Bahamas.....	127
Floeming Channel, Bahamas.....	127
Great Stirrup Cay, Bahamas.....	127
Salt Cay Anchorage and Hanover Sound.....	125
Island of Barbuda.....	136
Island of Dominica.....	108
Island of Grenada.....	105
Island of Margarita and Vicinity.....	None.
Island of Orube.....	None.
Islands of Curaçao and Buen Ayre.....	None.

The following is a list of plans and harbor charts proposed for publication. They are all of places on the coast of Nova Scotia and the shores of the Gulf of St. Lawrence. All these charts form a necessary part of the outfit of ships of the North Atlantic squadron, and are all issued to the ships. The office should be able to issue them from its own resources.

Title.	Would replace—
NOVA SCOTIA.	
Sable Island.....	B. A. 2171
White Haven.....	B. A. 2249
Gaysborough Harbor.....	B. A. 2288
Country Harbor.....	B. A. 2547
Nicomtau Bay and Parts Adjacent.....	B. A. 2673
Beaver Harbor.....	B. A. 2683
Sheet Harbor, Mushaboon Harbor and Spry Bay.....	B. A. 2687
Ship Harbor.....	B. A. 2624
Petitcodiac River and Cumberland Basin.....	B. A. 354
CAPE BRETON ISLAND.	
Madame Island and Lennox Passage with Southern Entrance to Gut of Canso.....	B. A. 3736
Scatarl Island and Menadon Bay.....	B. A. 3736
Sydney Harbor.....	B. A. 2643
Bras d'Or Lake.....	B. A. 3736
Little Bras d'Or Lake and St. Anne Harbor.....	B. A. 2687
St. Anne's Bay.....	B. A. 3222
Mabou Harbor.....	B. A. 2626
Port Hood.....	B. A. 2615
MAGDALEN ISLANDS.	
Amherst Harbor.....	B. A. 1143
Grand Entry Harbor.....	B. A. 1144
PRINCE EDWARD ISLAND.	
Casoupeque Harbor.....	B. A. 2627
Richmond Bay.....	B. A. 1863
Boughton or Grand River.....	B. A. 2705
Cardigan Bay.....	B. A. 2629
Murray Harbor.....	B. A. 1973
Hillsborough Bay.....	B. A. 1723
Charlottetown Harbor.....	B. A. 1789
Crapaud Road.....	B. A. 2630
Bedeque Harbor.....	B. A. 1942
GULF OF ST. LAWRENCE.	
Bay of Seven Islands.....	B. A. 1125
Cawee Island, Egg Island.....	B. A. 1149
Mount Louis Bay.....	B. A. 1153
Gaspé and Mal Bays.....	B. A. 1163
Passaic Bay, Heron Island, Dalhousie Harbor.....	B. A. 1715
Caraquette Harbor, Shippigan Harbor, Miscon Harbor.....	B. A. 2628
Miramichi Bay.....	B. A. 2187
Richibucto River.....	B. A. 2189
Buctouche River.....	B. A. 1909
Cocagne Harbor.....	B. A. 1941
Shediac Bay and Harbor.....	B. A. 1943
Pugwash Harbor.....	B. A. 2606
Wallace Harbor.....	B. A. 2606
Tatamagouche Bay and River John.....	B. A. 1932
Caribou Harbor.....	B. A. 1977
Pictou Harbor.....	B. A. 1909
Merigomish Harbor.....	B. A. 1909
Antigonish Harbor.....	B. A. 2655
Pompiquet and Tracadie Harbors.....	B. A. 2633

RANGEE'S WORK.

All the charts from the U. S. S. *Ranger's* survey up to last season are now completed and on issue. Work has been commenced on several of the harbor charts resulting from last season's work.

ELECTROTYPING AND PRINTING.

During the year there were received 34 electrotype alfos and 5 bassos; 22 blank plates were purchased, and 38 were made by scouring down and polishing condemned plates; 10 engraved plates were withdrawn

from use. The number of copper and steel chart plates available for printing is 393; from these were printed 17,528 copies of charts for issue, and 984 proofs. There were also printed from miscellaneous engraved plates 2,885 copies. The comparison of this year's printing with that of preceding years is as follows:

	Copies.
1882-'83	12, 180
1883-'84	16, 910
1884-'85	22, 112
1885-'86	18, 640
1886-'87	20, 413

In addition, the force of printers was employed in miscellaneous printing and stamping as follows:

Official letter paper	reams.. 10½
Official note paper	do .. 8
Official cards for correspondence	1, 394
Official envelopes	4, 024

Summary.

	Total to June 30, 1886.	Finished during the year.	Condemned during the year.	Total to June 30, 1887.
Engraved chart plates.....	351	52	10	393
Altos of engraved chart plates.....	74	34		108
Basans of engraved chart plates.....	64	5		69
Impressions of engraved plates for issue.....				20, 413
Proofs of engraved plates for office use				984

LONGITUDES.

The work upon the Record of Longitudes by Mr. G. W. Littlehales has been continued. This work is now double the size which it had assumed at the close of the last year. It has been of eminent service in rendering possible a speedy and accurate settlement of important questions arising in relation to the construction of nearly every chart.

MAGNETIC VARIATIONS.

The collection of data for the investigation of the magnetic variation and other elements has been continued; and much valuable magnetic information has been collected. The thorough and systematic discussion of these data by Mr. G. W. Littlehales has resulted in information of great value, and enabled the chart variation of all new charts issued to be fixed with accuracy. The forms in which these observations are now recorded are shown by the following specimen-page headings:

Record of magnetic observations at sea.

From lat. — to lat. —.

Finding longitude.	Lat.	Long.	Variation.	Date.	Observer.	Ship.	Remarks.
--------------------	------	-------	------------	-------	-----------	-------	----------

Record of magnetic observations, shore station.

No.	General locality.	Name.	Lat.	Long.	Variation.	Dip.	Horizontal intensity.	Total intensity.	Date.	Name.	Reference.	Remarks.
-----	-------------------	-------	------	-------	------------	------	-----------------------	------------------	-------	-------	------------	----------

DOUBTFUL DANGERS.

A Record of Doubtful Dangers in the North and South Atlantic Oceans has been prepared from all available sources. It locates each danger or supposed danger, gives a description of the circumstances under which it was first seen or supposed to have been seen, and tells whether its existence was afterwards confirmed by search or report. Alphabetical and graphic indexes have been prepared to render the benefits of the book more readily and completely available, and to present a comprehensive idea of the number and distribution of these reported dangers. A good idea of the reliability of the reports of ocean dangers in general can be gained by consulting the Record of Deep-sea Soundings in connection with this book.

DEEP-SEA SOUNDINGS.

The investigations into the depths and formation of the beds of the Atlantic, Pacific, and Indian Oceans have been continued. The sounding sheets are now nearly complete to date. A record has been compiled consisting of a complete history of each sounding. These sounding sheets should be photolithographed and issued to all maritime nations. Vessels engaged in sounding the depths of the ocean would then be enabled to make their results more profitable by directing attention to the unsounded regions.

GNOMONIC CHARTS.

The great-circle sailing chart of the South Atlantic Ocean has been finished and is on issue. The engraving of the projection upon the plate for the Indian ocean is nearly complete. An alto of this plate will be made as soon as the projection is engraved, and 2 bassos, electrotyped from it, will be used for the North and South Pacific Oceans, respectively. The necessary drawings for these charts will be ready as soon as the plates are available.

DISTANCES.

The work of computing and recording the distances between different points and places on the earth, for which the Office is frequently called upon, was transferred to this division at the beginning of the year, and distances have been supplied during the year to the committees of Congress and to the various Bureaus of the Government.

GENERAL REMARKS.

In furtherance of the efforts in securing uniformity and good appearance in the charts, punches have been made, suitable in size to the various grades of scales upon which the charts are constructed, representing the conventional signs for ordinary, lighted, whistling, and bell buoys; for rocks awash and submerged; for observation spots; and for anchorages.

There is also in course of preparation a sheet of standard hydrographic and topographic signs.

Investigations into the further use of machines for engraving have been encouraged, in the hope of accomplishing more complete uniformity and greater economy in chart making.

By reference to the table setting forth the work upon new charts during the past year, it will be seen that none have been heliographed. The recommendations made in the past with regard to this and to contract engraving are upheld and strengthened by an examination of this year's work.

It is recommended that a repository be established in the Division of Chart Construction for the reception of foreign charts which have been replaced by later editions in the Archives and the Division of Issue. Charts of this class have hitherto been condemned and destroyed. In making use of the information given by foreign charts it is frequently imperative, in order to deal competently with the subject in hand, that the information given by previous editions of the same charts should be under consideration. The establishment of such a repository will enable the Division to effect a speedy settlement of many perplexing difficulties arising in construction of new charts and the correction of those on issue.

I have no important recommendation to make beyond that of providing suitable quarters for carrying on the work of the Division.

Respectfully submitted.

CHAS. LAIRD,
Lieutenant, U. S. Navy.

Commander J. R. BARTLETT, U. S. Navy,
Hydrographer.

DIVISION OF SUPPLY,
Hydrographic Office, July 1, 1887.

SIR: I have the honor to make the following report of the operations of this Division for the fiscal year ending June 30, 1887:

The number of charts issued is 600 less than last year, owing to a fewer number of complimentary charts having been sent to merchant vessels. There were 1,682 more charts issued to United States vessels. A full set of charts sent to Yale College, with 348 supplied at one time to Division of Chart Construction, make the list of miscellaneous charts issued 1,018 in excess of last year.

The number supplied to agents remains about the same. The copies of engraved charts ordered by them have increased considerably, while the photolithographs have decreased. Of 376 plate charts in the office 93 were not called for, but of the remaining number 6,482 copies were ordered. Of 324 photolithographs 169 were not called for, and of the remaining number only 720 copies were ordered.

The engraved charts of the Banks of Newfoundland, east coast of the United States, and West Indies are in greatest demand, the number supplied to agents being far in excess of last year. For the east coast of the United States alone there were 1,469 charts issued to them.

A comparison of the expenditure of photolithographs for the last two years shows a falling off in charts 26^b, 26^c, 26^a, covering the Bahama banks. This was probably caused by the extension of plate chart 944 to cover the banks, which has made it the most desirable chart. With the exception of these charts the decrease in the photolithographs was caused by the exhausting of the editions of charts 225, southwest coast of Alaska; 351, Barbados; 353^b, Trinidad, western portion; and 912, Arctic sea.

It has required the strictest attention to work on the part of the draftsman in charge of Hydrographic Office charts to prevent the accumulation of corrections. An accurate account of work done shows that there are some 2,000 different copies of charts corrected every month. The attempt has been made to reduce this number by keeping a smaller number of engraved charts on hand, but large orders from agents have not made it practicable. To lessen this work as much as possible, I desire to make the following recommendations: The expenditures for several years having shown that chart 325, Tagus river and Lisbon harbor, and 543, Singapore strait, are in considerable demand,

and as corrections have greatly increased until now there are 57 different hand corrections to be made on the latter, I would recommend that engraved charts be substituted for them. Index chart "O", covering the West Indies, has accumulated 122 hand corrections in all. To lessen the labor required a new index has been prepared, and I would recommend that this be published as soon as practicable.

The charts kept for issue to United States vessels have been rearranged and shelved to conform with the station catalogues and lists made for the guidance of the messenger of the Division in fitting out ships. The charts kept for general supply, owing to want of space on some of the shelves, are scattered in every conceivable way about the room. To facilitate the finding of a chart, and to practically do away with a shelf list, I would recommend a remodeling of the shelves, so that the charts could be arranged in geographical order. In the case of the Coast Survey charts, which are so arranged, it very rarely happens that a shelf list is needed.

The comparison of charts with British Admiralty and other foreign charts has steadily progressed. In this connection I desire to say that at present canceled British Admiralty charts are frequently sent first to the Division of Chart Construction and for some time are not available for correcting charts in this Division. As it is of the greatest importance that charts should go out of the office correct I would like to suggest that the Custodian of Archives be furnished with a list of canceled British Admiralty charts and be directed to forward to Division of Supply such charts as soon as they have been noted and returned by Division of Issue.

The branch offices and United States vessels have been regularly supplied with new and corrected charts.

The chart catalogue, embracing new and important changes, was prepared for publication in this Division.

The following is the general statement of charts received, issued, published, and canceled:

	Third quarter, 1886.		Fourth quarter, 1886.		First quarter, 1887.		Second quarter, 1887.		Total.
	H. O. C.	C. S. C.	H. O. C.	C. S. C.	H. O. C.	C. S. C.	H. O. C.	C. S. C.	
Copies of charts received—									
From printing room	3,407		2,906		4,573		4,297		15,183
From Coast Survey		1,067		529		822		1,009	3,427
Total	3,407	1,067	2,906	529	4,573	822	4,297	1,009	18,610
Copies of charts issued:									
To naval vessels	1,379	895	1,287	715	597	319	1,364	1,014	7,579
To archives	11	11	17	7	30	20	25	16	137
To agents	1,393		1,717		1,880		2,232		7,292
To merchant vessels	29		108		100		100		337
To merchant vessels meteorological charts	210		300		204		253		967
To foreign hydrographers			56		168		168		392
To home correspondents	140		127		197		168		632
Miscellaneous	416	127	608	159	1,020	234	1,333	200	4,086
Total	3,578	1,033	4,220	881	4,176	673	5,642	1,230	21,333
Charts published	10		11		17		15		53
Copies of charts condemned	47	35	85	46	124	38	77	17	469
Charts canceled	3								3
Copies of canceled charts condemned	248		317		656		950		2,179

Very respectfully,

Commander J. R. BARTLETT, U. S. Navy,
Hydrographer.

N. E. NILES,
Lieutenant, U. S. Navy.

DIVISION OF ISSUE,
Hydrographic Office, July 1, 1887.

SIR: I have the honor to make the following report for the year ending June 30, 1887:

During the year the following ships have been furnished with an allowance of charts as per catalogue of the stations, viz:

Alert, Alliance, Atlanta, Dolphin, Juniata, fitted out July, 1886, for the Pacific station, and again in April, 1887, for the Asiatic station; *Ossipee, Richmond, Thetis, Vandalia*, also the *Trenton, Constellation*, and *Fortune*, with partial outfits. The vessels in commission have been kept supplied with all new charts and also with the latest edition of charts on issue.

It has been the custom for this Division to enter and keep accounts of all complimentary charts received from the British Admiralty. As they now go to the Division of Notices, I recommend that that Division take them up on its books.

I desire to bring to your notice that the station catalogues were printed some years ago. On account of there being so many new charts issued by this office I recommend that the catalogues be revised.

The work of the Division has been much facilitated by the addition of another draftsman, so that now the work can be kept up to date. The following summary shows the number of charts received, issued, etc., during the year:

Received:

From J. D. Potter, agent for Admiralty charts, London	2,230
From B. F. Stevens, United States dispatch agent, London	1,331
From British Admiralty (complimentary).....	181
From United States vessels.....	1,224
From Division of Supply, Hydrographic Office.....	3,474
From Division of Supply, Coast Survey.....	2,853
Total	11,293

Issued:

To United States vessels from this Office, British Admiralty.....	2,691
To United States vessels from this Office, Hydrographic Office.....	3,474
To United States vessels from this Office, Coast Survey	2,853
To United States vessels through B. F. Stevens.....	1,331
To Archives	290
To branch hydrographic offices	400
To Naval War College	121
To Division of Chart Construction.....	129
To miscellaneous	31
Total	11,320

Condemned	1,914
Total on hand.....	11,426

During the year there were 52 Notices to Mariners, which affected 1,226 different British Admiralty charts. There were 3,186 charts which received hand correction.

Respectfully,

F. E. SAWYER,
Lieutenant, U. S. Navy.

Commander J. R. BARTLETT, U. S. Navy,
Hydrographer.

DIVISION OF BOOKS,
Hydrographic Office, July 1, 1887.

SIR: I have the honor to submit the report of this Division for the fiscal year ending June 30, 1887.

In addition to its duties as stated in my last report, the following work was done. Fifteen hundred and one books and pamphlets of reference were card catalogued, a history of the Hydrographic Office was completed, and the data for several books of sailing directions and supplements to many others were prepared.

The compilation of the Hydrographic Office set of sailing directions was so well advanced that of the 58 English books on similar subjects, mentioned in my report for 1885, there remain but 12 which are not canceled, or soon to be canceled by our publications now in hand.

The 1873 edition of that very valuable Hydrographic Office work No. 45, the "Navigation of the Atlantic Ocean," becoming exhausted, it was reprinted.

Office room for the Division of Meteorology was made by removing one set of shelves from the store-room part of this Division; this I could do, because the condensation in the form of supplements, which the Division of Books has been engaged in for the past two years, enabled me to remove from the "dark room" all the back numbers of the Hydrographic Notices and Notices to Mariners. This space and that made by striking unnecessary books from the issuing list afforded storage room for the books which were on this set of shelves.

The storage and recording all books, pamphlets, etc., on issue or for reference in the division, in appropriate books or on cards was finished, thus completing the work inaugurated by me of organizing the division on such a basis that fitting out ships, filling orders, and answering queries can be done with dispatch and accuracy.

I beg leave to make the following suggestions:

(1) Completing the Hydrographic Office set of sailing directions should be pushed, and until finished the personnel of this division should be composed of at least three officers, one clerk, and one laborer.

(2) All unbound books, etc., now or which may hereafter be deposited here for reference should be bound, particularly those on meteorology.

(3) I would further urge the recommendations made in my last two reports.

The accompanying lists will show in detail the labor of this Division during the past fiscal year.

The following-named books, pamphlets, and nautical forms, published during the past year, have been deposited in this Division for general issue and use in the office:

1. Supplement to the General Examination of the Pacific Ocean (H. O. No. 5) Compiled in Division of Books.
2. Supplement to the Directory for Coast of Alaska and Bering Sea (Bureau of Navigation No. 20). Compiled in Division of Books.
3. Supplement to the General Examination of the Atlantic Ocean (H. O. No. 22). Compiled in Division of Books.
4. Supplement to the General Examination of the Indian Ocean (H. O. No. 24). Compiled in Division of Books.
5. Supplement to the General Examination of the Mediterranean Sea (H. O. No. 25). Compiled in Division of Books.
6. Light List No. 1 (H. O. No. 30). Compiled in Division of Notices.
7. Light List No. 2 (H. O. No. 31). Compiled in Division of Notices.
8. Light List No. 3 (H. O. No. 32). Compiled in Division of Notices.
9. Light List No. 4 (H. O. No. 33). Compiled in Division of Notices.
10. Supplement to the English Channel, Part II (H. O. No. 35). Compiled in Division of Books.

11. Supplement to the Coasts and Islands of the Mediterranean Sea, Part I (H. O. No. 37). Compiled in Division of Books.
12. Supplement to the Coasts and Islands of the Mediterranean Sea, Part II (H. O. No. 38). Compiled in Division of Books.
13. Supplement to the Reported Dangers to Navigation in the North Pacific Ocean (H. O. No. 41). Compiled in Division of Books.
14. Supplement to the Coasts and Islands of the Mediterranean Sea, Part III (H. O. No. 42). Compiled in Division of Books.
15. Supplement to the Coast of South America, Part I (H. O. No. 43). Compiled in Division of Books.
16. Supplement to the Navigation of the Atlantic Ocean (H. O. No. 45). Compiled in Division of Books.
17. Navigation of the Atlantic Ocean (H. O. No. 45). Revised in Division of Books.
18. Supplement to the West Coast of Africa, Vol. 2 (H. O. No. 47). Compiled in Division of Books.
19. Supplement to the West Coast of Africa, Vol. 3 (H. O. No. 48). Compiled in Division of Books.
20. Supplement to the Azores or Western Islands (H. O. No. 50). Compiled in Division of Books.
21. Supplement to the Madeiras, the Salvages, and the Canary Islands (H. O. No. 51). Compiled in Division of Books.
22. Supplement to the Northwest, West, and South Coasts of Spain and the Coast of Portugal (H. O. No. 52). Compiled in Division of Books.
23. Supplement to the Cape de Verde Islands (H. O. No. 53). Compiled in Division of Books.
24. Supplement to the Sailing Directions for the Rio de la Plata (H. O. No. 61). Compiled in Division of Books.
25. Supplement to the Caribbean Sea and Gulf of Mexico, Part II (H. O. No. 64). Compiled in Division of Books.
26. Supplement to the Coasts and Islands of the Mediterranean Sea, Part IV (H. O. No. 68). Compiled in Division of Books.
27. Supplement to the Sailing Directions for the Kattogat Sound, the Great and Little Belts (H. O. No. 70). Compiled in Division of Books.
28. Light List No. 5 (H. O. No. 74). Compiled in Division of Notices.
29. Light List No. 6 (H. O. No. 75). Compiled in Division of Notices.
30. Practical Hints in regard to West India Hurricanes, 2d edition (H. O. No. 77). By Lieut. G. L. Dyer, U. S. Navy.
31. The Use of Oil to Lessen the Dangerous Effect of Heavy Seas, 2d edition (H. O. No. 83). By Lieut. E. B. Underwood, U. S. Navy.
32. History of the Development and Founding of the Hydrographic Office. Compiled in Division of Books. By Lieut. W. S. Hughes, U. S. Navy.
33. Errata to American Practical Navigator (Bowditch). Compiled in Division of Books.
34. Book of Angles. By Lieut. Robt. G. Peck, U. S. Navy.
35. Book of Soundings. By Lieut. Robt. G. Peck, U. S. Navy.
36. Hydrographer's Report for fiscal year ending June 30, 18'6.
37. Catalogue of Charts, Plans, and Sailing Directions. Compiled in Division of Supply.
38. Supplement to the Atlantic Coast Pilot, Division "A," U. S. Coast and Geodetic Survey. Compiled in Division of Books.
39. Supplement to the Africa Pilot, Part III (British Admiralty). Compiled in Division of Books.
40. Supplement to the West Coast of Hindostan Pilot (British Admiralty). Compiled in Division of Books.
41. Supplement to the Black Sea Pilot (British Admiralty). Compiled in Division of Books.
42. China Sea Directory, Vol. 2 (British Admiralty). Compiled in Division of Books.
43. Supplement to the Saint Lawrence Pilot, vol. 2 (British Admiralty). Compiled in Division of Books.
44. Supplement to the Mediterranean Pilot, vol. 4 (British Admiralty). Compiled in Division of Books.
45. Supplement to the North Pacific Director (A. G. Findlay). Compiled in Division of Books.
46. Supplement to the Indian Archipelago, China, and Japan (A. G. Findlay). Compiled in Division of Books.
47. Supplement to the Sailing Directions for the Indian Ocean (A. G. Findlay). Compiled in Division of Books.

Books and pamphlets compiled in this Division and in the hards of the Public Printer:

1. West Coast of Mexico from the boundary line between the United States and Mexico to Panama (H. O. No. 84). By Lieut. F. E. Sawyer, U. S. Navy.
2. Supplement to the Reported Dangers to Navigation in the North Pacific Ocean (H. O. No. 41b).
3. Supplement to the Reported Dangers to Navigation in the South Pacific Ocean (H. O. No. 41a).
4. Supplement to the Coast Pilot of California, Oregon, and Washington Territory, U. S. Coast and Geodetic Survey.
5. Supplement to the Bay of Bengal Pilot (British Admiralty).
6. Supplement to China Sea Directory, Vol. II (British Admiralty).
7. Supplement to the West Coast of England (British Admiralty).
8. Supplement to the Australian Directory Vol. II (British Admiralty).

Books and pamphlets compiled in or under the supervision of this Division and ready for printing when appropriations for new fiscal year become available:

1. The Islands in the Pacific Ocean, Part I (H. O. No. 79). By Lieut. J. B. Milton, U. S. Navy, B. H. O., San Francisco. Revised and arranged in Division of Books by Lieuts. F. E. Sawyer and W. S. Hughes, U. S. Navy.
2. Vancouver Island and British Columbia (H. O. No. 81). By Lieut. W. P. Conway, U. S. Navy, B. H. O., Philadelphia.
3. Caribbean Sea and Gulf of Mexico (Vol. I, 2d edition, H. O. No. 85). By Lieut. S. L. Graham, U. S. Navy, B. H. O., Baltimore. Revised and arranged in Division of Books by Lieut. F. E. Sawyer, U. S. Navy.
4. Supplement to the North Atlantic Coast Pilot, Division "B," U. S. Coast and Geodetic Survey.
5. Supplement to the Baltic Sea and Gulf of Finland (British Admiralty).

Books and pamphlets preparing in or under the supervision of this Division:

1. St. Lawrence Bay and River, including Nova Scotia and Bay of Fundy. By Lieut. John Downes, U. S. Navy, B. H. O., Boston.
2. The Coast of South America, Part I.
3. The Coast of South America, Part II.
4. The Islands in the Pacific Ocean, Part II. By Lieut. J. B. Milton, U. S. Navy, B. H. O., San Francisco.
5. The Islands in the Indian Ocean. By Lieut. F. E. Sawyer, U. S. Navy, Division of Issue.
6. The Persian Gulf, Gulf of Aden, and Red Sea Pilot. By Lieut. W. P. Conway, U. S. Navy, B. H. O., Philadelphia.
7. Coasts and Islands of the Mediterranean Sea, Part V. By Lieut. S. L. Graham, U. S. Navy, B. H. O., Baltimore.
8. Coast of the North Sea from Dunkerque to and including Denmark. By Ensign F. R. Wall, U. S. Navy, B. H. O., New Orleans.

SUMMARY FOR YEAR.

Number of copies of books, pamphlets, and nautical forms on hand for issue to vessels July 1, 1886.....	44,684
Number of copies of books, pamphlets, and nautical forms received during fiscal year ending June 30, 1887.....	22,442
Total number of copies on hand and received	67,126
Issued	30,351
Remaining on hand for issue July 1, 1887.....	36,775
Books of reference:	
On hand July 1, 1886.....	2,530
Received during the year.....	1,501
On hand July 1, 1887.....	4,031
Books, pamphlets, and nautical forms published:	
Prepared and in hands of Public Printer.....	8
Prepared and ready for printer.....	5
Preparing.....	8
New, or later editions placed on issuing list	65

In conclusion, I take pleasure in saying the officers and employes attached to this division have performed their various duties with interest and zeal.

Respectfully submitted.

R. G. DAVENPORT,
Lieutenant, U. S. Navy.

Commander J. R. BARTLETT, U. S. Navy,
Hydrographer.

DIVISION OF NOTICES AND ARCHIVES,
Hydrographic Office, July 1, 1887.

SIR: I have the honor to make the following report for the fiscal year ending June 30, 1887:

The regular routine work of issuing Notices to Mariners has been continued.

A large number of foreign Notices to Mariners have been received, and all information translated and published.

Six volumes of Light Lists have been revised and corrected to date.

A number of foreign charts have been received, thus keeping the files of the office complete.

The reception, classification, and filing away of all documents relating to hydrography has been carried out as usual.

Respectfully submitted.

W. H. PARKER,
Lieutenant-Commander, U. S. Navy.

Commander J. R. BARTLETT, U. S. Navy,
Hydrographer.

DIVISION OF MARINE METEOROLOGY,
Hydrographic Office, July 1, 1887.

SIR: Having been but a short time in charge of this Division, I can only refer briefly to its work during the last fiscal year, as indicated by the records of the office, and the greater portion of my report must be devoted to general considerations relative to the successful prosecution of work in ocean meteorology.

Owing to the small force available for this Division, it has been impossible to do more than the mere routine work in connection with the issue and return of meteorological journals, and the publication of the Monthly Pilot Chart and Weekly Supplement. There have thus accumulated more than fifteen hundred ship's logs, which contain an immense amount of valuable data, carefully observed and recorded on board vessels in every ocean. This information, collected with so much trouble, should be collated, compared, and published at once, to lessen the dangers of navigation; otherwise it loses much of its value. During the past year alone 527 meteorological journals were turned in, representing careful and laborious observations made day after day during voyages of the following vessels: 142 British, 127 American, 18 German, 13 Norwegian, 6 Italian, 5 Hawaiian, 3 Austrian, 3 Danish, 3 Swedish, 1 Dutch. I can not urge too strongly the importance of putting all this material in such shape that it can be made of some practical use, so that masters of vessels may see that their labor has not been in vain.

The next step in advance will be to loan standard meteorological instruments to all captains who agree to keep journals for this office, as is already done by the principal commercial nations. In this way more shipmasters would be willing to keep the journals, appreciating as they do the value of accurate instruments. Considering the advantages which result from such a system, it would seem as though the comparatively small expense involved would be amply justified.

The Pilot Chart of the North Atlantic ocean, issued the first day of each month, has constantly increased in usefulness and has met with the heartiest commendation from masters of vessels, maritime exchanges, and boards of underwriters everywhere. In addition to its primary object of serving as a track chart for vessels, with graphic data regarding ocean currents, prevailing winds and calms, storm tracks, latest reported position of wrecks, icebergs, etc., and the best routes of ocean travel for the current month, it also furnishes a most valuable means of calling attention to the results of work in other divisions of the Hydrographic Office, such as Notices to Mariners, charts published or canceled, sailing directions issued, changes in lights and buoys, as well as other matters of interest, such as reported shoals, submarine earthquakes, discussions of the laws of storms, and rules for action in West Indian hurricanes. The publicity given by means of the Pilot Chart to the benefits derived from using oil to quiet heavy seas has resulted in such an awakening of interest in this subject among the commercial nations of the world that hundreds of reports are received by this office alone every year of vessels having used it to great advantage, and treatises have been published on this subject in every language, in all of which due credit has been given to the U. S. Hydrographic Office. The Pilot Chart possesses special advantages in giving publicity to information of this kind, owing to the fact that it is constantly in use and the vessel's position is plotted on it every day, so that each item is read and thought over day after day and leaves an impression not soon forgotten, a result not easily secured in any other way. The importance and value which this publication has already attained demands that every possible effort should be made to make it more and more perfect, both in reliability of the meteorological data, the completeness and accuracy of the plotted tracks and latest reported positions of derelicts, wreckage, and ice, and the best routes for steamers and sailing vessels along the great lines of ocean traffic during each month of the year. Many vessels, on the completion of their voyage, return the Pilot Chart which they have used, with their track plotted on it, together with meteorological observations made on the trip. This furnishes data of considerable value, and I would recommend that special efforts be made to induce all vessels to do so, that the results may be studied and used in preparing the charts for the following year. It would be of great advantage if each copy of the Pilot Chart that is issued to a sea-going vessel could be printed on a better and tougher quality of paper, or even backed with linen, in order to stand the wear to which it is necessarily subject. While no fault can be found with the admirable manner in which the chart is now lithographed, it could not fail to add greatly to the economy, convenience, and efficiency of publication if it could be carried on in this office, instead of by contract with outside parties.

Along the Atlantic and Gulf coast there are now branch hydrographic offices at only five ports, Boston, New York, Philadelphia, Baltimore, and New Orleans. Numerous reports are constantly received by this

division from each of these branch offices, and the barometers and thermometers of vessels entering and leaving port are compared with standards, so that the observations made in the journals can be corrected for instrumental errors. Without such comparison, meteorological observations are of little value, and both for this reason and because many more reports would be received I would urge the desirability of establishing such branch offices at all the principal ports. It is important, also, that greater use of the telegraph should be authorized, whenever a decided advantage can be gained by such use.

The weekly supplement to the Pilot Chart is very useful to coasting vessels and transatlantic steamships, containing as it does all the latest authentic reports regarding dangers, derelicts, wrecks, and ice, and giving early and accurate information regarding changes in lights and buoys. Many of the derelict vessels reported each week in the supplement as dangerous obstructions to the coasting trade could be readily destroyed if a suitable vessel were provided for the purpose, ready to act at a moment's notice, as has already been pointed out in your last annual report. These derelicts, drifting as they do under the combined and varying influences of current, tide, and wind, are peculiarly dangerous, as their probable position at any time is always extremely uncertain, and they often show so little surface above water as to be invisible till close at hand. Several have been destroyed or towed into port this year by the U. S. S. *Despatch*, as shown by the following reports :

List of wrecks and obstructions to navigation removed by the U. S. S. Despatch, Lieut. W. H. Emory, commanding.

July 18. Wreck with three masts showing above water, latitude $40^{\circ} 06' N.$, longitude $73^{\circ} 10' W.$, blown up with two torpedoes and all dangers to navigation removed.

July 19. Another similar wreck, $39^{\circ} 34' N.$, longitude $73^{\circ} 46' W.$, destroyed with six torpedoes after some difficulty. Probably the *Helena Maria*, sunk by collision June 25.

July 20. A wreck with mast showing 20 feet out of water, latitude $39^{\circ} 23' 30'' N.$, longitude $73^{\circ} 40' 20'' W.$, blown up with two torpedoes, and all obstruction to navigation removed.

Thorough search made for other wrecks, but owing either to inaccurate reports or rapid drift, they could not be found.

September 11. Derelict schooner *Abbie Dunn*, 50 miles off Montauk point, towed into Newport, R. I.

September 22. Wreck of sunken schooner *Lucy D.* destroyed in latitude $42^{\circ} 27' N.$, longitude $70^{\circ} 22' 30'' W.$, and all obstructions to navigation removed.

November 24. Unsuccessful search of four days for derelict schooner *Altavelia*.

Finally, I would respectfully urge the importance of a complete and well-arranged library of works relating to marine meteorology. Such a library to be effective, must be complete, accessible, and thoroughly catalogued. Under the present conditions the work of this Division is very much embarrassed and often seriously delayed. The quarters now occupied are altogether insufficient, being small, poorly lighted, and inconvenient in every way; until more room and better facilities are provided the work must be carried on much less effectively than its importance would seem to demand.

Respectfully submitted.

EVERETT HAYDEN,
Ensign, U. S. Navy (Retired).

Commander J. R. BARTLETT, U. S. Navy,
Hydrographer.

U. S. BRANCH HYDROGRAPHIC OFFICE,
Custom-House, Boston, Mass., July 1, 1887.

SIR: I have the honor to submit the following report of the work of this office for the fiscal year ending June 30, 1887:

The very decided increase in the demand for Hydrographic Office publications is the best possible evidence of the growing popularity of the branch offices, although verbal testimony to the same end is by no means wanting.

The Pilot Chart grows steadily in favor among the maritime people, and judging by the comments of those making regular use of it, there would appear to be but little room for improvement in its details.

It has been more than once suggested to me that its value to transatlantic vessels would be decidedly enhanced if the dates of passing and the approximate sizes of bergs could be shown on the chart, as the subsequent changes in size and position could then be judged of with some degree of accuracy. While realizing the impossibility of doing this during the "ice" months, owing to the quantities of ice represented, yet the suggestion seemed a good one and worthy of consideration at times when the bergs are not very numerous.

As a rule, the regular lines of steamers coming to this port make use of the safe route as laid down on the chart; indeed, it is an order of more than one of the companies that their steamers shall follow it implicitly, or at least shall go nothing to the northward of it. The result of this has been a scarcity of ice and fog reports.

In addition to its legitimate use as aid to navigators, it would appear to have an educational value as well in the eyes of many landsmen, as several copies are forwarded regularly from this office to New England towns, where they are used in the schools for the purpose of instructing the children in matters relating to the sea.

The distribution from this office also includes many private individuals all over the New England States, who have specially requested that the chart be forwarded to them regularly, and the list is constantly growing.

The weekly supplement to the Pilot Chart has proved a great benefit to the sea-faring community. Its issue from this office has increased during the year from fifty to two hundred copies per week, and no master of a vessel who is aware of the existence of the office considers his outfit complete without the latest chart and supplement. The latter is mailed regularly each week to all the shipping firms, agents, etc., and by them posted in conspicuous places for the benefit of all interested parties.

The printing of the Notice to Mariners in extract form has had very satisfactory results. Although the work of the office has been very greatly increased by the sorting of these extracts, yet this is offset in a degree by the facility with which the master of a vessel is supplied with all information bearing on his voyage, without loss of time and the labor of going over our list of notices, which were necessarily adjuncts of the old arrangement. Added to these advantages is that of the great saving in time and labor to the recipient of the notices, to say nothing of the waste of material under the old system.

Owing to the unfortunate loss of the office aneroid barometer, and the apparent dislike of captains to moving their instruments from on board their vessels, our opportunities for comparing and setting barometers have been very few during the last three months of the fiscal year.

With the idea of extending the benefits of this office to some of the more important New England sea-ports, I recently addressed the following letters to the principal shipping firms and to the leading newspapers of the several towns, calling attention to the office and its objects, and placing it at the service of all interested people:

U. S. BRANCH HYDROGRAPHIC OFFICE,
Custom-House, Boston, Mass., ———, 188—.

SIR: In the interest of ship-owners, agents, and masters, it is my desire to extend the usefulness of the branch Hydrographic Office, at the present time limited to a great extent to the city of Boston, to the shipping communities of as many of the New England sea-ports as possible.

In order to help the good work, I request you to give a small amount of your time and space to explain the objects of the office, and to call attention among the shipping people to the benefits which it extends to them, free of all charge.

One of the principal objects of the office is the collection and dissemination of information of importance to navigators. This is gathered from every possible reliable source, put into proper printed form, in the shape of "Notices to Mariners," is distributed to all who may be sufficiently interested to call or write for it.

In addition to the Notices to Mariners, a copy of the latest Pilot Chart of the North Atlantic ocean, a copy of the latest supplement to the same, and lists of lights, buoys, beacons, etc., of the coasts of the United States will be supplied free of charge, to any owner, agent, or master of a vessel who will take the trouble to state the time of the vessel's departure and her probable or possible route.

The office was established for the benefit of sea-faring men, and I trust they will not hesitate to make use of it.

Very respectfully,

JOHN DOWNES,
Lieutenant, U. S. Navy.

U. S. BRANCH HYDROGRAPHIC OFFICE,
Custom-House, Boston, Mass., ———, 188—.

SIR: Your attention is respectfully called to the objects of this office and the benefit it extends, free of all charge, to the captains, as well as the owners and agents, of vessels.

There is kept constantly on hand a full supply of Notices to Mariners, containing accurate accounts of all newly-discovered dangers to navigation throughout the world, of the establishment of new lights and other aids to navigation, and of all alterations in existing aids, as well as much other information of importance to navigators.

Correct lists of lights and of buoys, beacons, stakes, and other day-marks of the coasts of the United States are always accessible for reference.

A note from the owner, agent, or captain of any outgoing vessel addressed to this office, stating the probable or possible route of the vessel during her voyage, will receive immediate attention and a full assortment of Notices to Mariners bearing on the vessel's route, lists of lights, buoys, etc., a copy of the latest Pilot Chart of the North Atlantic ocean, and a copy of the latest supplement to the Pilot Chart will be forwarded by return mail.

Up to the present time the usefulness of this office has been limited, to a great extent, to the city of Boston, but it is desired to extend its benefits to as many as possible of the New England sea-ports.

Very respectfully,

JOHN DOWNES,
Lieutenant, U. S. Navy.

The result has not been so marked as I had hoped it would be, but this is explained in part by the fact that, although many of the cities are large ship-owning centers, the majority of the vessels sail to and from the larger sea-ports of Portland, Boston, etc.

Another reason for the lack of interest shown is that the advantages of the office can not be properly appreciated without actual experience of its benefits.

My efforts met with some success, however. Several communications were received acknowledging the receipt of the circulars, and in a few

cases we have had calls for information and publications from people to whom the circulars were addressed.

It would be of great service if something in the nature of an agency could be established in each of the larger sea-ports through which to reach the maritime community directly. This might be effected through the agencies for the sale of Hydrographic Office publications already established, and in such a way as to bring little or no additional labor on the agents. No efforts should be spared in endeavoring to extend the influence of the Hydrographic Office beyond the cities in which the branch offices are located.

I would most earnestly recommend the adoption of a more liberal policy towards masters of vessels taking the Hydrographic Office meteorological journals. It has been the experience more than once in this office that captains have positively declined to take the books because of the expense of a reliable hygrometer, without which the record loses much of its value.

Would it not be wise to discontinue the practice of issuing charts, with which every master is bound to supply himself whether he takes the books or not, and in place thereof to issue a good hygrometer with each set of books, taking a receipt of the same, and with the understanding that the instrument is to become the captain's personal property if the record he has kept proves satisfactory? I believe the adoption of this plan would result in a considerable increase of the number of journals issued, and a great improvement in the records turned in.

If possible, the practice of rating chronometers should be revived in the branch offices. For various reasons many masters of vessels will not take their instruments to chronometer-makers. These men would often, to my certain knowledge, bring them to this office but for the order which forbids our receiving them. Thus the chronometer people gain nothing and many captains are deprived of the opportunity to obtain a reliable rate before proceeding to sea.

The work of the Boston branch of the Hydrographic Office has increased to such an extent during the past year as to render an assistant in the office almost a necessity.

There is constant employment for two people in overhauling and sorting Notices to Mariners, in mailing Pilot Charts, supplements, and notices, in correcting charts, light lists, sailing directions, etc., in attending to the wants of visitors to the office, in overhauling the records of incoming vessels and making them up in the form of reports for forwarding to Washington, and in keeping up the office records.

The work of ship visiting in Boston is carried on under great disadvantages, owing to the character of the water front, which is so distributed among the various sections of the city (Boston proper, East Boston, South Boston, and Charlestown) and Chelsea, and the means of communication between them being, for our purposes, very unsatisfactory, necessitating long detours with a great amount of walking or else quite a heavy expense for car-fares, that I feel called upon to repeat my recommendation made last year, that a small steam-launch be placed at the disposal of the office for a few hours each day. Much time and labor may thus be saved, and the records of the office greatly benefited in the increasing number of vessels visited and the improved chances of obtaining data of importance. Many vessels arrive and depart again before a visitor can board them.

The following table shows the work of the office for the year in detail.

	1886.						1887.						Total.
	July.	August.	September.	October.	November.	December.	January.	February.	March.	April.	May.	June.	
Vessels visited.....	260	228	267	224	202	268	226	222	221	213	218	221	2,770
Vessels taking meteorological journals.....		1		2	2		1	1	2		3		12
Vessels turning in filled meteorological journals.....	1	9	1	6	2	2		2	1	1	6		24
Meteorological journals issued.....	2	3		5	5		1	4	3	1	10		34
Meteorological journals (filled) turned in.....	1	5	1	13	4	3		2		2	13	3	47
Barometers compared or adjusted.....	218	197	222	174	170	206	205	210	190	92		6	1,890
Thermometers compared.....								3					3
Meteorological charts furnished vessels.....		12			12						12		36
Ocean charts furnished vessels.....	6			7	6	6		11	8		14		58
Sailing charts corrected for captains of vessels.....			4	1		3			1		3	2	14
Correction on office charts (Notices to Mariners).....	76	85	54	106	61	85	63	57	53	54	86	64	844
Pilot Charts distributed.....	550	510	590	551	525	675	650	650	650	700	700	650	7,401
Telegraph charts of the world distributed.....													32
United States light lists distributed.....	29	29	68	55	30				67	148	133	94	659
United States buoy books distributed.....	179	169	314	320	307	228	223	253	318	59	116	207	2,693
Notices to Mariners distributed.....	88	117	876	631	922	2,057	1,991	4,084	6,888	6,239	7,618	8,416	40,827
Information furnished to individuals.....	506	439	564	603	467	685	823	991	1,284	936	1,051	1,204	9,553
Pamphlets distributed:													
Use of Oil.....		3	73	72				60	30				238
West India Hurricanes.....		24	155	63									242
Sound Signals.....		2	6						1				9
Rules of the Road.....		14	20	6									40
Annual Report of the Hydrographer.....								20					20
Reports forwarded to Washington:													
Storms.....	20	28	42	42	41	58	54	48	61	76	48	42	560
Trade-wind limits.....	97	44	54	44	52	30	48	47	52	50	68	70	662
Wrecks and wreckage.....	49	20	51	28	23	42	18	39	24	38	28	18	378
Buoys adrift.....	6	2	4	1	4	2		3	2	3	2	1	24
Water-spouts.....	6	2	4	1	4		1	3	5	6	2	5	42
Fogs.....	44	34	39	7	17	5	14	16	11	17	26	42	272
Ice.....	3	3	1	2		1		16	11	17	26	42	76
Electrical storms and other phenomena.....	2	10	7	5	7	7	7	7	9	19	5	3	88
Whales.....	20	15	8	12	7	2		4	1	1	5	3	78
Letters on the use of oil.....	1	2	10	15	2	4	3	8	5	9	5		64
General information.....	1	4	5		7		1		3	7	2	1	31

Respectfully submitted.

JOHN DOWNES,
Lieutenant, U. S. Navy.

Commander J. R. BARTLETT, U. S. Navy,
Hydrographer.

UNITED STATES BRANCH HYDROGRAPHIC OFFICE,
Maritime Exchange, New York, July 1, 1887.

SIR: In obedience to circular dated June 7, 1887, I have the honor to submit the annual report of this office for the fiscal year ending June 30, 1887.

Realizing the absolute necessity of enlarged quarters to properly perform the duties of this office, which have multiplied greatly since its

establishment, I addressed a letter, of which the following is a copy, to the Directors of the Maritime Association of the Port of New York :

UNITED STATES BRANCH HYDROGRAPHIC OFFICE,
Maritime Exchange, New York, September 8, 1886.

GENTLEMEN: The space on the floor of the Exchange now allotted by your honorable board to the Hydrographic Office is totally inadequate for the requirements, owing to the increase in number of sailing directions, charts, and other publications on nautical subjects, that it has been found necessary to keep on hand to furnish the growing demand for information, necessitated by the more extended field of operation occupied and the greater aggregation of individual inquiries, due to the wide-spread and growing popularity of this office amongst masters of vessels and the maritime community generally.

I would suggest that we be allowed the space bounded by a line running from the center of the east door to the center of the clock, then to the southern wall of the floor proper. This is the space your president suggested we should have when it was expected rent would be paid.

Should this, in your opinion, be asking too much, then I would suggest the following addition to the present quarters: Starting at the point on the southern partition under the clock, run a line directly out to the intersection of one from the center of the east door, along the line to the western extremity of the present office, and then joining that extremity, forming an "L."

In its present situation it is beyond question an established fact that the Hydrographic Office and the New York Maritime Exchange are of mutual service. It now remains for you to decide whether this service is of such benefit to your Exchange as to justify you in granting the increased quarters asked for, or, on the other hand, if, considering the request too great, you, by refusing it, deprive the Exchange of increased facilities of the Hydrographic Office.

Yours, respectfully,

V. L. COTTMAN,
Lieutenant, U. S. Navy.

The BOARD OF DIRECTORS
OF THE MARITIME ASSOCIATION OF THE PORT OF NEW YORK.

In answer a small additional space was granted, which enabled the placing of a chest for the preservation of charts and a table for the use of same. This increase in quarters, though small, has greatly facilitated the workings of this office.

The following circular was addressed to masters of vessels, the intention being to obtain exhaustive and reliable data on the "use of oil":

UNITED STATES BRANCH HYDROGRAPHIC OFFICE,
Maritime Exchange, New York, ——— —.

Capt. _____,
Master of _____ :

SIR: I am collecting information in regard to the use of oil to lessen the dangerous effect of heavy seas. Should you have made the experiment will you kindly give me the benefit of your valuable experience by sending a detailed account of the mode of using, kind of oil, date, and length of time used, amount of oil expended, and description of weather, wind, and sea, with particulars as to the effect upon the sea and such recommendations as to kind of oil, method of using, etc., as your experience leads you to judge the best.

Very respectfully,

V. L. COTTMAN,
Lieutenant, U. S. Navy.

As a result I find that the revival by the Hydrographic Office of this simple experiment has been the means of saving valuable ships and cargoes, of rescuing the crews of wrecked vessels, and of lessening the dangers and discomforts of heavy storms. Though no claim was made for originality in the subject, the work of the Hydrographic Office in continually calling attention to the feasibility and utility of the method has been the cause of widespread praise, and the efforts to disseminate the useful information obtained have met with approval on all sides. Its effect is apparent in the business world, as firms are

manufacturing and have placed upon the market oil which is claimed to have all the requisite virtues for this special purpose. Oil breakers (so termed) and other arrangements for distributing the oil in gales are now manufactured both at home and abroad.

The Light-House Board being desirous of obtaining opinions as to the relative value of electric and oil lights for light-houses and to the establishment of an electric light on the Highlands of Navesink, this office addressed a circular on the subject to all captains whose experience with the systems of electric lighting would make their information of value. Over two hundred opinions were gathered by letters or interviews, and the mass of evidence on this important subject is of great worth. Probably no sea-port in the United States offers such a field for search on the various systems of lighting for navigating purposes. The men in command of the ocean steamers are those whose ability and knowledge in their profession are unexcelled the world over, and such opinions coming from those whose great experience and observation warrant the ground they hold, must necessarily be of great weight.

On the approach of the "ice season" this office issued circulars asking for reports on ice and fogs and for the earnest assistance and cooperation of all captains in the work. These circulars were not only placed on board all the steamers of the transatlantic lines, but were also sent to Portland, Me.; St. John, N. B.; Montreal, Halifax, and other places where vessels were likely to have encountered ice in their various trips. The results have been most satisfactory, reports having been forwarded to this office from all above-mentioned ports, and from Denmark, Germany, Norway, and Great Britain. The data thus obtained are more complete and by far more reliable than of any other season. It became apparent some time since that the pilot charts, unless corrected to date of issue, would not show on their faces the latest reported positions of these obstructions to navigation. As these charts are issued the first of the month, it is but natural that towards the middle of the month many reports of ice should be received which ought to be placed upon the charts issued for guidance in regard to the limits of ice. This office suggested the issue on the weekly supplement of all the reports of ice received during the week. In a measure this proved satisfactory, as steamers sailing on Saturday were furnished with copies of these supplements giving the latest reports. The vessels leaving during the week on other days were deprived of this valuable information. To supply the want this office procured two stamps, representing icebergs and field ice respectively, and placed upon each chart issued the position of each berg and floe as reported to date of issue. The magnitude of this work is apparent, when it is considered that during the months of March, April, May, and June, over 40 bergs and field ice were plotted on each chart, and the average issue was 900 charts per month. Though the labor was excessive and hard to keep up, the results have been most satisfactory, and have amply repaid for all the pains taken, as captains, owners, and agents have expressed in glowing terms their appreciation of the work. We have been in receipt of communications from vessels in southern ports asking for the latest reported position of ice; cables from Europe have been brought to this office, and answers sent on the information given here; advice asked, given, and followed as to the safe route. Agents and captains of vessels on the eve of sailing obtain the latest reliable reports, which has tended to make the work so far this season most eminently satisfactory.

The gnomonic chart (North Atlantic) issued by the Hydrographic Office has undergone a severe test of its accuracy and utility. The

charts presented by this office to captains of those transatlantic steamers who could travel the great circle have found much favor. Numerous reports have been received from captains who make use of these charts on every trip, and testify to their value for accuracy and usefulness in lessening the labor of computations on the great-circle route.

The subject of removing derelicts from the pathways of commerce on the high seas is one which demands serious consideration. These great dangers, when bottom up or nearly submerged, give no notice at night of their being approached, and the disasters caused by their presence are alarmingly on the increase. Occasionally some venturesome captain stops long enough to fire the derelict he has met, but these events are few and far between, and it is doubtful if the plan is a good one, as the wreck in many cases burns to the water's edge, the flames are put out, and the hull turns bottom up, becoming a greater danger than before. The experiments made by the U. S. S. *Despatch* were most satisfactory, and the use of torpedoes to destroy these great obstacles seems a most admirable plan and one much to be recommended.

The subject of tides in New York harbor and vicinity is one which has occupied much time. The papers which were supposed to publish reliable information on the subject were found to be strangely at variance. After consulting pilots, authorities, and all tide tables published, I have found the tables issued by the U. S. Coast and Geodetic Survey furnish the best data, and have urged the use of the same to all who desire the information, and have shown the several papers where corrections were necessary. The want of a clear central tide-gauge in New York is greatly felt. I would recommend the establishment of one on the Romer near the beacon. An iron frame, painted in broad stripes of some easily distinguishable color, would not be expensive, and would be a valuable improvement.

This office in its work is naturally thrown much in contact with what properly comes under the head of the Coast Survey. A very small minority of mariners only understand that they are two separate branches of the Government. All information which could assist the hydrographic inspector of the Coast Survey in the compilation of the new Coast Pilot has been gladly given and time spent in collecting data for the subject. As a medium this office has received and investigated reports of uncharted dangers in the vicinity of New York which have come before the courts of admiralty. Both sides in the controversies have referred to the New York branch hydrographic office for authority as to facts. The discovery of the rock off Lawrence point, East river, recently located by the Coast Survey, may be cited as one of the points in question, and tends to show the value and forethought of the establishment of the branch offices, where notice can be brought officially to the proper authorities of these reported dangers.

Though hardly coming in the province of this report, I would beg leave to call attention to the recent numerous cases of the stranding of ocean steamships on the south shore of Long Island. These cases are without exception those of foreign vessels, so that whatever inquiries are made have been under the jurisdiction of their respective consuls.

It will be apparent that it is impossible to get the log-books of the vessels, even if the captains were disposed to permit their being overhauled. The general cause stated is an alleged unusual northerly set, though a seaman-like use of the lead would in each case have given notice of the dangerous proximity of the land. Pilots differ very much in their statements regarding this set, but reports have been received from agents, who have gleaned the knowledge or information from beach-

men on the south shore of Long Island, that the flood, after a westerly wind sometimes runs with a velocity of 6 knots between Fire island and Shinnecock. This statement is widely different from the information contained in the Atlantic Coast Pilot. It is to be hoped that observations may be taken to establish the true state of the case, and that the new Coast Pilot will furnish the much desired information. The conditions of the tides and currents, with all the requisite knowledge for navigating the approaches to the metropolis of America, should be known at least to the officers of the Government.

I am greatly in favor of the periodical issue of circulars calling attention to the advantages offered by the various branch offices. Shipmasters at this time, when competition is high and freights are low, are a very busy set of men, and are apt to neglect to procure information which they need and which can be furnished by these offices. The advantages of boarding each vessel cannot be overestimated, but with the present force in this office and the miles of water front in New York it is impossible to have the work done in at all a thorough manner.

The reports received in this office are constantly referred to by people desiring information on all subjects. Authority is desired for all statements, and many questions are decided on the authority of the office. Many points which affect marine insurance companies are brought to us for solution. The reports of the Office of Naval Intelligence are eagerly sought for, and such documents as are in the possession of this office have been in demand. There are often questions and subjects the discussion of which requires much time and labor. These, though not showing on the weekly reports, form a great element of the usefulness of this office.

The officers attached to this branch are still frequently called upon to give evidence before the courts of admiralty, the number of cases being far in excess of that of the previous year.

The subject of "the laws of storms" is one which occupied the attention of this office to a great degree, many interesting cases having been gone over, charts constructed, storm tracks traced, handling of vessels commented upon, and in each case the doubting captain has been forced to acknowledge that the matter has been presented to him in a different light from his generally accepted ideas on the subject.

The Pilot Chart has such a worldwide reputation that it seems superfluous to add more testimony to its use and accuracy. From all sources come golden opinions as to its worth and of the energetic working of a Government which issues gratis such a valuable publication. Numerous captains have informed us that they have vainly endeavored to find errors in the monthly chart, but are forced to acknowledge that it is eminently correct. I would suggest the placing of the 35° W. curve of variation upon it.

While the young captains who are coming to the front believe in the true compass only on charts, there are many of the older seamen who are not ready for the change. I would suggest the placing of the magnetic compass inside the true, as I am informed by the chart agents that the absence of the magnetic compass interferes with the sale of charts. All charts should show on their faces, and not in the tabulated forms, the character and arc of visibility of each light.

The War Department presents each vessel built on the Lakes with a set of Army charts, and I would recommend the giving to each vessel launched on the Atlantic and Pacific seaboard a set of Hydrographic Office charts, linen backed.

The United States consuls do not seem to have been thoroughly instructed about forwarding mail matter. We inform all captains that

journals and reports, if given to the consuls, will be forwarded without postage, and we are daily in receipt of reports from all parts of the globe, through captains who have, in accordance with our instructions, taken their reports to the consuls to be forwarded, and have been informed by the latter that they had no authority to forward the same without postage and have received no instructions to that effect.

I would suggest the careful overhauling of the tracks to and from the equator as placed on the Pilot Charts; many captains are of the opinion that the equator (when bound south) should be crossed generally further to the eastward than is shown. It will be well to inquire into this matter, as the tracks given in Hydrographic Office publication No. 45 differ materially in some cases from those given on the charts.

With the permanent establishment of a head of the Meteorological Division I would suggest the looking up of the route to Japan via Cape Horn. Only three reports have come to this office of this route: One from the American bark *W. B. Flint*, one from the American ship *John T. Berry*, and the other from the British bark *Mary A. Troop*. The captains of these vessels are all in favor of the route at the proper time of the year. The several tracks have been plotted on the track chart of the world and show many points to recommend the route.

It would be well to furnish each branch office with track charts of the world on which shall be drawn all tracks recommended by the Hydrographic Office at all seasons. Sailing directions are useful adjuncts, but these tracks will show graphically just what captains desire, and coming from a higher authority will be appreciated.

It is to be regretted that the want of funds has restricted the workings of this office. Many opportunities have been lost through the lack of necessary money.

Copies of all reports received at this office relating to the displacement of buoys or beacons, irregularities of lights, etc., are at once forwarded to the inspector of the third district for his information. It seems pre-eminently necessary that the branch offices should at once be informed by the local inspectors of the placing of all aids to navigation as soon as located. Much annoyance is caused by want of a thorough system in such cases; the first notice frequently comes through the newspapers, and as numerous typographical errors creep into the nautical reports, the information contained can not be relied upon. The inspector of the third district always supplies this office at once, with notices of any changes made in the district. The placing of the combination buoy off Cape Hatteras was first heard of through the *New York Herald*, nearly six weeks after it had been located.

As the U. S. Hydrographic Office is very young compared with similar bureaus of other nations, it is not to be expected that its charts can as yet cover the navigable waters of the globe. Care should be taken to supply the branch offices with foreign charts (preferably British Admiralty) which will afford the requisite information of all ports not embraced within the limits of the Hydrographic Office charts. The branch offices should at once be able to answer all questions and to supply all information concerning the charted ports of the world. Captains much prefer gaining this information from the charts themselves than from all the sailing directions ever written.

The second pamphlet on the "use of oil," like its predecessor, has been in great demand, is widely circulated and much appreciated.

The polyconic projection as employed by the U. S. Coast and Geodetic Survey is a mystery to by far the greater majority of mariners; there are some who have given the subject their attention, but the cases which have come under our observation of captains who know anything about

the method are few and far between. This office has endeavored to give such practical instruction on the subject to applicants for information as would enable the recipient to use the charts at least intelligently. Applications for information on this subject have been on the increase, but the charts constructed on this system of projection, despite the advantages claimed for them, do not seem to be popular. As, however, the greater number of the charts of the coast of the United States and all the harbor charts are polyconic projections, captains, unless they purchase Imray's or Eldridge's publications, must take those of the Coast Survey or be without.

In order to meet the views of the general purchasers of charts, all ocean charts should be issued on the scale of Hydrographic Office charts Nos. 955 and 956; this also applies to a general chart including the West Indies alone. The present editions of Hydrographic Office charts Nos. 21, 21^a, 22, 22^a, 23, 24 do not meet with the approval of captains, as the scale is not large enough for their purposes.

I would again recommend the issue by the Hydrographic Office of a chart on a large scale of Sunda straits; the British Admiralty chart is in every way most excellent, but its cost in the United States is a very objectionable feature. The charts of the Hydrographic Office on large scales which have been issued have met with great approval, as their cheapness places them within the reach of all.

A uniform system of buoyage is much to be desired; shapes should be employed as well as colors as an additional safeguard. Colors can not always be distinguished. With the present system the color alone determines the side on which the buoy is to be passed, paint soon wears off and the navigator is left in doubt. All wreck-marking vessels should be painted green, with an arrangement of signals by day and lights by night, showing on which side the vessel is to be passed; wreck-marking buoys should be of the uniform color, green.

The following copy of an extract from the report of the superintendent of the New York Maritime Exchange is a sample of the many communications relative to the work of this office:

A most important feature of the exchange has been the active operations of the branch Hydrographic Office. Its work now requires the detail to it of four naval officers, who visit vessels, procure data, and are prepared at a moment's notice to give the latest information as to dangers of ocean navigation, or the buoys, lights, channels, etc., of any port or coast. A chart is kept posted on which is delineated not only the safe route to Europe, but the position of ice, floating wrecks, and other obstacles reported. United States and foreign charts and text-books, including sailing directions, light-house lists, and other works of reference, all carefully corrected to date, are available for free inspection. Besides visiting 6,190 vessels during the year, the officers gave information to 48,921 applicants upon our floor, against 10,618 the year before. The quarters assigned by the association were enlarged during the year, but are again becoming uncomfortably outgrown.

In conclusion, I would state that the New York branch of the Hydrographic Office is now, without doubt, established on a firm basis. A comparison of the table with that of last year shows a steady increase in work of all descriptions which pertain to this branch. The confidence of the public seems to have been fully gained and the work appreciated for the good it has done. Though the office space has been enlarged, it is yet very inadequate for the workings of an office of this description. After having established a reputation of which this office may be pardonably proud, we feel that we have arrived at that stage when a step backward cannot be thought of. Much is yet to be accomplished which would be of value to navigators and the Bureau. To progress in the ratio of the past two years requires extended quarters and an addition to the working force. The Exchange does not feel itself in a position to furnish increased quarters unless compensated for the same. A consid-

eration of the following recommendations is most earnestly urged, viz: In addition to the present office, a second room on the floor of the Exchange should be obtained in which to keep the charts and sailing directions. This room should be under the immediate supervision of the officer in charge, and can be used as the place where all discussions on nautical matters should take place. By this means the routine work of the office will not be interfered with. The present office should be occupied by two officers, either two lieutenants or a lieutenant and ensign, with the messenger. In this place should be kept all matters for distribution, with the office records. Two officers will be fully occupied in collecting data, making out reports, and furnishing vessels with the outfit given by the Hydrographic Office. For the outside work I would strongly recommend the employment of enlisted men of good character and intelligence. There can be no question that New York is the great maritime center of this country, and more information is to be gathered here than at any other place. There are in the service excellent men, who could be employed in this work, and such positions held out as an incentive for good-conduct men would without doubt be productive of excellent results; either make the position permanent or for a term of years. It may be offered as an objection to this plan that there are not men in the service who are sufficiently educated to discuss with captains the more complex questions of chart construction, routes, storms, compass errors, chronometer ratings, etc. That is not the object intended. The great point is to advertise the office and to keep its workings before the captains by continual reminders. I feel confident that there are numerous graduates of the apprentice system who, possessing the brightness of American youths, could be easily and quickly taught to read and compare barometers, to take trade-wind limits from logs of vessels, to thoroughly understand the plottings of derelicts, ice, etc., on charts, so they could bring back reliable and intelligent reports. In addition to these duties, they should be instructed to inform all captains that the officers attached to the branches are at all times in readiness to discuss matters pertaining to the profession which these messengers are not able to handle. By this means a greater number of captains will be brought in contact with the practical workings of the office and the mutual benefits will be greater. In the Signal Service sergeants and corporals perform just such work as we desire done by enlisted men. It is a fact that the Signal Corps contains in its ranks many who are recent graduates of high schools and even colleges; but a greater number of their men are old soldiers, who have proved themselves most thoroughly adapted for the work, and I am yet to be convinced that the rank and file of the Army exceeds in intelligence that of the Navy. I am well aware that to follow these recommendations would require a more extensive appropriation than Congress has as yet deemed is deserved by the branch offices. But it must be remembered that this work is still in its infancy; that its onward progress despite all obstacles has been most satisfactory, and that in the future, which without doubt awaits the energetic workings of the Hydrographic Office, the efforts made to equal the results obtained by foreign nations will be appreciated and the necessary appropriations granted.

Thanks are due for much assistance and courtesy received from officers and members of the New York Maritime Exchange, for the support of the press, for reports received from the branch office of the Signal Service in this city, and to all who have helped by encouragement or approbation the work of the New York Branch Hydrographic Office.

The following table presents in detail and aggregate the work accomplished during the year:

	1886.						1887.						Total.
	July.	August.	September.	October.	November.	December.	January.	February.	March.	April.	May.	June.	
Vessels visited.....	486	520	530	559	476	532	502	513	685	670	579	687	6,739
Vessels furnished with meteorological journals.....	2	1	1	3	2	1	1	2	2	1	2	4	22
Vessels returning meteorological journals.....	13	9	3	6	5	4	6	9	14	8	4	14	105
Meteorological journals issued.....	6	3	2	8	7	2	1	3	7	1	4	13	57
Meteorological journals returned.....	21	12	24	12	14	4	11	14	24	16	8	26	186
Sailing charts furnished vessels taking meteorological journals.....	10	9	42		24	18	37	4	36	4	10	45	329
Meteorological charts furnished to vessels returning meteorological journals.....		36	12	84	48	12	24	36	48	60	36	60	456
Storm journals issued.....												25	25
Vessels' charts corrected.....	87	7	6	2	4	4	5	15	16	10	23	20	199
Office charts corrected.....	66	79	59	102	61	67	63	57	67	61	86	63	841
Barometers compared.....	76	122	96	232	223	228	59	127	297	183	101	181	1,925
Thermometers compared.....	93	150	21	122	129	106	85	86	80	9	57	151	1,089
Telegraph charts issued.....													50
Track charts issued.....													50
Annual report of Hydrographer distributed.....													40
Lists of United States merchant vessels distributed.....													25
Hydrographic Office catalogues distributed.....													6
Aids to Navigation distributed:													
Pilot Charts.....	762	966	817	736	851	924	826	847	906	861	886	1,015	10,397
Weekly Supplements.....	501	459	739	736	608	742	630	660	867	1,225	1,007	1,164	9,428
Light lists.....	128	94	156	126	118	3	3	7	80	109	116	112	1,052
Buoy and Beacon lists.....	280	498	498	454	408	474	445	220	333	238	288	255	4,391
Variation charts.....													50
Gnomonic charts.....													50
Practical hints on West India hurricanes.....		50	137	126	80	3	2	1	2			115	516
Use of oil to lessen dangerous effects of heavy seas.....			93	129	140	100	40	340	193	92	107	112	1,346
Magnetism of iron ships.....													6
Tide tables.....													30
Rules of the road at sea.....	84	169	137	126	124	159	115	65	114	86	105	100	1,397
Notices to Mariners.....	7,140	7,897	5,859	4,409	6,057	7,970	12,090	5,701	9,206	6,319	7,808	10,693	91,149
Information to masters of vessels and others.....	3,536	2,553	2,277	4,378	3,240	4,264	3,610	5,297	10,594	14,077	15,761	13,752	83,345
Reports collected and forwarded:													
Storm at sea.....	3		88	22	15	4	14	6	6	2	1		81
Trade-wind limits.....	116	35	77	56	76	132	157	145	151	154	155	126	1,382
Waterspouts.....	2	1	5	5	3	3	1	4	3	3	3	2	35
Fog.....	58	23	45	18	22	13	9	7	7	39	66	47	354
Ice.....	41	17	7	11	5	2		81	182	83	83	63	595
Earthquakes.....		1	5		2	1	1		1				11
Shoals.....	2	1	4	2	3	8		1	1	2	1		25
Soundings.....													5
Currents.....													6
Temperature of water.....													4
Unusual phenomena.....	2	3	8	2	1	2	1	1	3	5		2	30
Track charts.....							7	5	2	2	4	1	21
Abstract logs.....	8	5	2		2		1		1	2	2	7	30
Buoys adrift.....	34	4	11	7	9	27	14	9	10	18	17	18	178
Wrecks, derelicts, etc.....	51	36	47	54	71	83	59	72	26	121	73	92	785
Whales.....													10
Use of oil in gales.....	3		2	5	4	13	4	7	2	6	3		49

Respectfully submitted.

V. L. COTTMAN,
Lieutenant, U. S. Navy.

Commander J. R. BARTLETT, U. S. Navy,
Hydrographer.

UNITED STATES BRANCH HYDROGRAPHIC OFFICE,
*Maritime Exchange, 131 South Second Street,
Philadelphia, Pa., July 1, 1887.*

SIR: I have the honor to submit the following report of the operations of this office for the fiscal year ending June 30, 1887.

In obedience to orders from the Navy Department I assumed charge on November 1, 1886. The messenger had been in charge since Lieutenant Barroll, U. S. N., was detached September 9, 1886. During this interval but little work was done, as there was no intelligent person to attend the office while the messenger was visiting vessels and collecting information.

Ensign J. H. Hetherington, U. S. Navy, was ordered to duty here in December last, and has been of valuable assistance.

Whenever practicable all vessels, foreign as well as coastwise, have been visited, and all vessels have been supplied with the latest hydrographic information regarding changes in the localities to which they were bound.

The boy employed here was discharged in December last. Since that time many vessels were not boarded, as the messenger's work along the wharves was necessarily interrupted daily by having to return to the office at noon to hoist the time-ball.

The use of a steam cutter one or two days every week would greatly facilitate the collection of information, as many vessels anchor in the stream several days before going alongside the wharves. There are a number of wharves, both in the Delaware and the Schuylkill, which can at present only be reached by a walk of two or three miles.

During the months of May and June, no car-fare being allowed, the number of vessels visited is less than it otherwise would have been.

Masters of vessels and others seem to appreciate the efforts of the branch offices and endeavor to assist us in every way. On several occasions information has been received from captains of vessels in foreign ports.

The monthly Pilot Chart is of great value and is steadily growing in favor, as is shown by the increased distribution of them. I would recommend that they be furnished this office on the first day of every month, as they are expected then, and it does the office injury to disappoint applicants for them. If practicable to print the monthly average of the barometer in each square of 5° it would increase their usefulness.

Hydrographic Office chart No. 944, lately issued, is very popular with masters of vessels bound to the West Indies or the Gulf of Mexico.

Some measure should be taken by the Government to remove the wreck of the English steamer *Brinkburn* and the sunken schooners off the New Jersey and Delaware coasts. They are a constant menace to navigation, and several vessels have lately struck on the *Brinkburn* with serious damage.

In addition to the work properly pertaining to the office a compilation or revision of Vancouver Island Pilot has been made, and Sailing Directions for the Red Sea, Gulf of Aden, and Persian Gulf are now in progress.

The services of a boy are greatly needed to run errands, clean the office, etc. Since December last the office has been cleaned through the kindness of the Maritime Exchange.

I am under many obligations to the Maritime Exchange of this city and others interested in maritime affairs for assistance in carrying on the work of the office.

The following is a detailed statement of the work performed during the year.

	1886.						1887.						Total.
	July.	August.	September.	October.	November.	December.	January.	February.	March.	April.	May.	June.	
Reports forwarded:													
Trade winds	9	10	2	1	4	18	12	16	13	28	17	15	145
Ice	27	7	1	3	4			27	70	34	49	48	270
Wrecks	57	31	34	36	50	73	43	41	59	96	74	78	672
Fogs	1			1				1				1	10
Buoys adrift	11	3	3	6	3	6	2	2	9	8	9	12	74
General information	1			1			1						9
Water-spouts		1		3	4	1	1	4		3		2	22
Whales				1	1			2	1		2	3	11
Meteorological journals			2			1	2						5
Ports described	1												1
Storms			1		2	4						1	8
Meteors			1										1
Location of fishing fleet			1								1		2
Use of oil in storms				3	1	2	1	2	3	1		3	16
Tide rips				1								1	5
Currents					5								5
Lights out of order					1							1	2
Storm journals						2							2
Bottles picked up					1			1					4
Shoals reported					1				1	2			4
St. Elmo's fire								1					1
Track charts								1	2		1	1	5
Mackerel								1					1
Charts, etc., distributed:													
Pilot Charts	329	343	255	236	302	356	206	297	363	328	390	450	3,945
Supplements to pilot charts						89	384	590	626	481	516	633	3,129
Notices to Mariners	441	339	415	631	446	481	367	645	1,518	2,187	3,341	7,376	18,187
Light-lists	25	34	33	34	27	31	39	18	34	24	39	48	306
Buoy books	93	81	27	137	52	30	38	53	302	134	145	221	1,322
Hints on West India hurricanes		13	47	33	10	17	7	17	30	9	19	18	220
Pamphlets on use of oil			33	35	10	26	9	58	72	22	37	30	332
Meteorological charts		12		12				3				13	37
Meteorological journals				6						3	3	7	20
General sailing charts					15		1	16		16	11		58
Telegraph charts											23	16	39
Report of the Hydrographer								12					12
List of United States vessels											2	2	4
Work done:													
Vessels visited	137	126	48	33	110	180	127	121	170	170	205	107	1,622
Information given to individuals	387	354	254	303	318	385	281	298	422	288	306	360	3,962
Barometers compared	60	46	29	22	47	61	52	63	102	94	91	101	772
Chronometers compared				1	4			4	1	14	8	10	42
Letters to captains	99	132	25	52	27	24					9	2	370
Office charts corrected	60	78	48	85	64	55	59	32	76	29	57	66	709
Office light-lists corrected	25	34	33	34	27	31	39	19	34	24	33	42	380
Vessels' Light-Lists corrected								28	59	44	44	48	223
Buoy-books corrected						10	32	76	256	107	123	187	791
Ships' charts corrected			3										3

Respectfully submitted.

W. P. CONWAY,
Lieutenant, U. S. Navy.

Commander J. R. BARTLETT, U. S. Navy,
Hydrographer.

U. S. BRANCH HYDROGRAPHIC OFFICE,
Board of Trade Building, Baltimore, Md., July 8, 1887.

SIR: During the past year the regular work of this office has been performed as well as its situation would permit. Upon the completion of the new post-office building in this city, and the removal of that office from its present location in the custom-house to it, I hope that a portion of the latter building can be procured for the use of this office, where all masters of vessels can be seen when they appear to report their arrival.

On account of the appropriation for the branch offices being exhausted, the work of the office has been reduced during the months of May and June, but through the courtesy of the collector of customs at this port, and of the tow-boat owners, the boarding officer has been enabled to visit the most important arrivals.

The time-ball has worked satisfactorily, with one or two exceptions, the Baltimore and Ohio Telegraph Company having furnished, free of cost, an attendant to hoist the ball for the past two months, this office being without funds to pay one.

During the past year but six meteorological journals were issued from this office, and those to old observers. The great majority of American vessels from this port are not supplied with instruments for taking observations, yet many masters of them express a willingness to keep the journals if supplied with the proper instruments.

Last year eight or nine steamers struck on the shoal off False cape, of which reports were forwarded to your office. This office called the attention of the Board of Trade of this city to this dangerous place. The president of that body in his annual report states:

Shoal off False cape.—Some eight or nine steamers bound to or from this port have, within the past eighteen months, struck upon a shoal off False cape, Virginia. There should be something to indicate this dangerous point. Our committee on foreign commerce appealed to the Light-House Board to take the necessary steps to warn vessels of it, but as yet nothing has been accomplished. We would insist upon the placing of a buoy and light at that point, otherwise some disaster will occur there.

On December 20 a bell buoy was moored off False cape, and since that time this office has not heard of a single vessel striking the shoals. Attention having been called by the pilots and masters of steamers to the danger of heavily-laden vessels taking the ground at the head of the Middle-Ground entrance of Chesapeake bay, the attention of the light-house inspector of this district was called to the matter. A mid-channel buoy was placed there on June 26, and from the reports received it supplies a long-felt want. This office should be supplied with the coasting charts of the British Admiralty, covering such parts of the world which are not embraced by the Hydrographic Office charts; also the sailing directions of those parts of the world of which our office has not yet published descriptions.

During the year the compilation of the Navigation of the Caribbean Sea and Gulf of Mexico, Vol. I, was finished and forwarded to your office. The compilation of Vol. V, Coasts and Islands of the Mediterranean Sea, which has been assigned to this office, is in progress.

The report of the Board of Trade contains the following:

Branch Hydrographic Office.—The Branch Hydrographic Office, in charge of Lieut. S. L. Graham, still occupies a portion of our rooms. The work has been greatly appreciated, and has been of much benefit to mariners visiting this port, who have been kept advised of derelict vessels, wrecks, and other dangers, and had their charts corrected and barometers and chronometers adjusted.

The following is a tabulated statement of the work performed by this office for the year ending June 30, 1887:

	1886.						1887.						Total.
	July.	August.	September.	October.	November.	December.	January.	February.	March.	April.	May.	June.	
Vessels boarded.....	184	186	190	187	179	177	213	218	196	175	100	88	2,093
Barometers adjusted.....	53	45	50	62	48	41	67	45	64	51	35	32	593
Information given to masters and others.....	84	90	97	108	103	106	110	136	126	107	109	152	1,328
Chromometer comparisons given.....	10	18	42	52	54	63	71	67	78	61	67	98	685
Pilot Charts issued.....	290	317	280	250	250	275	300	253	247	270	305	310	3,347
Weekly supplements to Pilot Charts issued.....	374	278	348	338	414	325	498	507	616	696	579	704	5,877
Day marks of United States issued.....	53	90	153	141	121	151	153	125	145	113	88	174	1,507
Light-Lists of United States issued.....	19	26	22	29	34	29	12	31	32	39	32	44	345
Extracts of Notices to Mariners issued.....	33	43	48	51	91	56	1,329	5,462	2,025	4,765	4,643	15,451	33,997
Cable charts issued.....			2								22		22
Hints on West India hurricanes issued.....		10	24	32	23	9	6		3				107
Fog-signals issued.....		5		8	6			8	2	4			33
Pamphlets on the use of oil issued.....		3	18	32	27	14	15		9	12			6
Regular reports:													
Wrecks.....	7	4	2	4	6	4	11	5	5	12	8	11	79
Limits of trade-winds.....	7	14	12	16	13	14	17	13	6	9	8	6	136
Equatorial rains.....	3	2	3	5	4	5		5	3	3	3	3	39
Ice.....	5	4	2				1	5	17	2	7		43
Fog limits.....	13	11	18	7	13	8	5	3	2	1	13	11	115
Storms at sea.....	1	4	4	10	2	8	11	9	5	5	7	4	70
Reports on the use of oil in heavy seas.....	3			4	1	1	6	3	2				20
Whales.....	11	11	14	4	7	12	3	2	1	1	3	4	73
Buoys adrift.....	1	2	2	2			2			1	1	2	13
Water-spouts.....		2			2		2	2		1			9
Charts corrected.....											3	2	5
Miscellaneous reports:													
Development of shoals in Monocoy passage.....													1
Report on light at Cape Spear, N. F.....													1
Foreign coal reports for office of naval intelligence.....													3
Earthquake reports.....													2
Report on Broad Hill creek, Del.....													1
Eclipse report.....													1
Reports on various parts of West Indies, including Port Antonio.....													2
Reports on various lights of West Indies.....													1
Reports on Tandjong Priok, Batavia.....													1
Meteorological phenomena and electric storms.....													3
Current and tide reports.....													3
Report on remarkable extent of Gulf weed.....													1
Report on shoal water at entrance of Chesapeake bay.....													1

There have also been issued from this office six meteorological journals, with which twenty sailing charts have been given.

There have been returned through this office fourteen meteorological journals, filled by observers.

There have also been issued from this office many publications of general interest of which no record has been kept.

Respectfully submitted.

S. L. GRAHAM,
Lieutenant, U. S. Navy.

Commander J. R. BARTLETT, U. S. Navy,
Hydrographer.

U. S. BRANCH HYDROGRAPHIC OFFICE,
Maritime Association, New Orleans, La., July 1, 1887.

SIR: The following is a report of this office for the fiscal year ending June 30, 1887:

The office was in charge of an assistant from the beginning of the year until October 26, when I assumed charge. I opened communication with the ship agents L. M. Merritt, of Pensacola, Fla., and Ross, Keene & Co., of Galveston, Tex., for the purpose of interesting them in the work of this office, which was fully explained. Their co-operation was asked and readily granted, so that now all ship-masters at those ports have the opportunity of availing themselves of all the information distributed from the branch offices. Captains of vessels arriving at other Gulf ports have been informed of the office and its purpose and furnished with the information in its possession, thereby extending the work over the entire Gulf coast.

All vessels arriving at this port have been visited. The ignorance spoken of in the last annual report as existing among a portion of the maritime community as to the purposes of the offices has almost entirely disappeared. Those who are in the slightest degree interested in nautical affairs begin to realize the value of the offices to commerce, and take every opportunity to avail themselves of the information furnished.

Illustrating the various uses, aside from the regular work, to which the office may be put, is the case of the shipping agent of the various railroads at Kansas City, Mo., who wished to obtain information as to the temperature of the sea-water likely to be experienced by vessels from this port to Liverpool during each month of the year, in order to consider the feasibility of making large shipments of salt meat to Liverpool via this port. After trying for nearly two months to obtain the information elsewhere, he was finally directed here, where the information was easily compiled and willingly furnished.

Owing to the fact that the issue of meteorological journals has been confined to American vessels whose itineraries extend to other waters than the North Atlantic and that none of those vessels visit this port, no journals have been issued by this office.

The popularity of the Pilot Chart continues to increase, and few captains think of going to sea without one.

It is recommended that each office be furnished with a stout chart of the coast, similar to that in use by the Signal Service, for placing weather symbols, to be exhibited in a conspicuous place, and the position of derelicts, buoys adrift, etc., be shown thereon by small printed tags (furnished with pins for attaching them to the chart), showing the condition of the coast, as often as new information may be gathered from the weekly supplement and the Pilot Chart.

The time-ball has been dropped by the time-signals from Washington, and the results have been good considering the long distance, the average weekly failure being 1.56.

The following is a summary of the work done for the year :

	1886.						1887.						Total.
	July.	August.	September.	October.	November.	December.	January.	February.	March.	April.	May.	June.	
Storm reports			8	5	16	33	25	8	12	9	2	1	114
Trade-wind limits	1			2	12	11	7	14	5	4	2		61
Whale					1		1						3
Fog							1	3	2		1		7
Water-spout		1		2		2	1	1			3		10
Earthquakes													2
Supplements to Pilot Chart	78	57	76	95	93	196	163	154	155	195	150	156	1,574
Audibility fog signals	10	9	13	12	18								62
Wreck reports	4	4	2	12	21	9	5	14	9	9	2	2	87
Buoys adrift				1						1			3
Light-house reports				1						1			5
Use of oil on water			18	29	35	24	9	9	10	11	7	10	157
West India hurricanes		9	29	32	23	23	28	8	10	12	7	10	186
Vessels visited	44	27	34	67	71	106	82	76	74	62	38	38	719
Information to individuals	183	115	118	180	117	121	133	89	144	113	75	110	1,446
Barometers compared or adjusted	37	24	24	63	62	75	59	54	48	49	33	33	561
Cable charts distributed	1											4	17
Pilot charts distributed	65	68	61	105	86	115	108	114	109	98	95	112	1,276
Notices to Mariners distributed	37	20	20	78	26	55	363	256	223	203	158	242	1,661
Meteorological charts distributed									12	24	12		48
Hydrographer's annual report	1		2			9	5	3					20
Meteorological journals forwarded					2				5				14
Light-lists distributed	11	8	7	19	22	11			12	27	19	16	146
Day-marks distributed	48	34	54	79	141	95	59	36	48	22	17	32	665
Chronometers rated					3	1			4				13
Chronometers compared	15	9	9	9	11	10	9	9	15	12	4	10	122
Reports on the use of oil				3	1	1			2				7
Electrical storm	1												1
Current reports		3			3			1					7
Shoal reports				1			1						2
Opinion gnomic chart		1											1
Track chart steamship <i>Caribbean</i> forwarded					1								1
Track chart bark <i>Clementina</i> forwarded							1						1
Track chart steamship <i>Orane</i> forwarded									1				1
Track chart bark <i>Sydon</i> forwarded									2				2
Extract log steamship <i>Carmona</i> forwarded							1						1
Extract log steamship <i>Statesman</i> forwarded								1					1
Discolored water report								1					1
Report of soundings								1					1
Breakwater destroyed									1				1
Hydrographic Office charts distributed									4				4
Valley of Nile charts distributed											1		1

Respectfully submitted.

F. R. WALL,
Ensign, U. S. Navy.

Commander J. R. BARTLETT, U. S. Navy,
Hydrographer.

U. S. BRANCH HYDROGRAPHIC OFFICE,
Merchants' Exchange, San Francisco, Cal., July 1, 1887.

SIR: I respectfully submit the following report of the work of this office for the year ending June 30, 1887:

The tabular statement shows a considerable increase in almost every item over that of last year. While this increase is very satisfactory, still further improvement and development in many directions can be made by more liberal appropriations.

It is the regular routine of this office as soon as vessels are chartered to send them Notices to Mariners and other publications and items that pertain to their next voyage. In addition to this a summary of all Notices to Mariners and the special extracts that are of importance to vessels sailing from this port are published in the daily papers. In this way the maritime community is possessed of the knowledge of all changes in aids to navigation and of all discoveries of rocks, shoals, and other dangers.

The regular routine of the office in visiting all vessels from foreign ports, as well as coasters, comparing and adjusting barometers is kept up.

During the past year there has been a small increase in the number of aids to navigation brought to the office for correction; but that benefit which is offered to shipmasters is not taken advantage of to the extent that it should be. On this subject, I repeat my suggestion of last year, that the underwriters and ship-owners urge the shipmasters to avail themselves of this privilege. The underwriters of this city, as shown in my last report, issued circulars on the subject.

In December last, at your suggestion, the issuing of special bulletins from this office was commenced. These bulletins were issued from time to time as data sufficiently accumulated; they contained accounts of all wrecks, of every obstruction and danger along the Pacific coast, and other matters of interest to seamen relating to the subject of navigation in the Pacific ocean. They became highly appreciated by the shipping community; many of them being sent by the insurance companies to their representatives in the eastern cities and in Europe. They were disseminated over the entire coast from San Diego to Puget sound. In April the issuing of these bulletins had to be discontinued on account of the appropriation for maintenance of the office becoming exhausted. Altogether 2,600 of these bulletins have been issued and distributed.

During part of April and the months of May and June the usefulness of the office has been somewhat impaired on account of lack of funds. In this connection I quote from the last annual report of the chamber of commerce of this city:

Whereas the Navy Department has informed the U. S Branch Hydrographic Office, in this city, that the present appropriation of \$5,000 per year for the maintenance of the six branch offices is inadequate, and that \$10,000 is required: Therefore,

Resolved, That our Senators and Representatives in Congress be requested to endeavor to have such appropriation increased to \$10,000.

Resolved, That a copy of these resolutions be transmitted to our Senators and Representatives in Congress.

The following is from the reports of the president of the chamber:

The usefulness and importance of this office to the maritime community has steadily increased since its opening, and it is hoped that more liberal appropriations for its maintenance will be made by Congress.

The time signals are still received in the office, from the naval observatory at Mare Island, and the time ball on Telegraph hill continues to work with great satisfaction. The Gardner clock in this office, which is set correct each day at noon by the time signal, works well, and the office is sought by a great portion of the business community for correct time.

In obedience to the Department's order, I have visited San Pedro, San Diego, Portland, and Port Townsend to report on the advisability of establishing branch hydrographic offices, chart agencies, etc. A special report of the execution of these orders has been submitted to the Department.

The issuing of charts by the Hydrographic Office of the coasts of Mexico and Central America, the surveys of Commanders Philip and Clark, has filled a long-felt want. Frequent applications continue to be made for charts on a larger scale of the coasts of California, Oregon, and Washington Territory and of the Aleutian islands, especially for one taking from Ounimak pass to Amgoutha pass, inclusive.

During the past winter, the number of disasters on the coasts of Oregon, Washington Territory, and Vancouver island, especially in the vicinity of Cape Flattery, has been unprecedented, and the loss of life and property has been very great. Many of these disasters happened to heavily laden coal vessels from Puget sound and Nanaimo. They occurred mostly in heavy southeast and southwest gales that are prevalent on this coast during the winter season. I think many of these disasters have happened for the reason that the ship-masters are afraid of the west and southwest coast of Vancouver island, it being a lee shore during these gales. If sailing directions in pamphlet form and charts on a large scale of Clayoquot and Barclay sounds and of other indentations on this coast were issued, I believe the ship-master would be able to run for an anchorage in one of these places in cases of emergency, and thus save his vessel and many lives. In April the American bark *Elsinore* became disabled in the same gale in which the American ship *St. Stephen* was lost, and ran for Barclay sound, where she found anchorage and laid until she could obtain assistance.

The following are copies of communications received at this office, which show in a measure the benefit it is to the maritime community:

NEW ZEALAND INSURANCE COMPANY,
San Francisco, March 25, 1887.

DEAR SIR: Permit me to acknowledge the many courtesies extended by you to my staff and myself, in the shape of furnishing information as to localities, and pointing out dangers in navigation not shown on our office charts, and other attentions useful to marine underwriters.

I wish also to witness to the daily convenience your branch has been to the marine interests of this port.

Yours, faithfully,

HUGH CRAIG,
Manager.

Lieut. J. B. MILTON, U. S. Navy,
Merchants' Exchange, U. S. Branch Hydrographic Office, San Francisco.

SAN FRANCISCO, *April 14, 1887.*

DEAR SIR: We take much pleasure in commending the efficient manner in which the Branch Hydrographic Office in your charge at this port has been maintained, and we are much indebted to the office for information furnished, and for the universal courtesy of those in charge to us and the masters of vessels in our employ.

We remain, dear sir, yours, faithfully,

WILLIAMS, DIAMOND & Co.

Lieut. J. B. MILTON, U. S. Navy,
Branch Hydrographic Office, City.

OFFICE OF THE CALIFORNIA INSURANCE COMPANY,
San Francisco, Cal., June 6, 1887.

MY DEAR SIR: Allow me to express to you the valuable services this company has received from your office; the benefits to be derived therefrom we find to be almost indispensable to our marine department.

I am, dear sir, very sincerely yours,

WM. H. C. FOWLER,
Secretary.

Lieut. J. B. MILTON,
Branch Hydrographic Office, City.

7898 N—14

OFFICE OF THE BOARD OF MARINE UNDERWRITERS OF SAN FRANCISCO,
San Francisco, June 7, 1887.

DEAR SIR: I have been requested to express to you, on behalf of the Board, their full appreciation of the advantages that your office has placed before underwriters, especially by keeping for ready reference a complete set of charts duly corrected to date, and the convenience of a more or less complete reference library on nautical affairs. The establishment of special bulletins on this coast has been a marked advance in the usefulness of the office, and we regret that these have had to be discontinued for the present owing to the lack of funds.

In conclusion, I am instructed to thank you for the courtesy and attention the members of this board have always received from you.

I am, dear sir, yours faithfully,

EDM. L. WOODS,
Secretary.

Lient. J. MILTON, U. S. Navy,
Branch Hydrographic Office, San Francisco.

During the time I have been in charge of this office I have received universal kindness and courtesy from the different boards and exchanges of the city and from the press of the coast, and to them I am greatly indebted.

Following is a tabulated statement of the work of the office for the year:

	1886.						1887.						Total.
	July.	August.	September.	October.	November.	December.	January.	February.	March.	April.	May.	June.	
Storm reports forwarded									1				1
Trade-limit reports	27	39	36	37	38	3	6	25	25	16	15	8	275
Abstract of logs		1					2		2				5
Earthquake reports	1		2	3				1				2	10
Wrecks	4	4		2	1	13	15	7	4	13	10	4	77
Buoys adrift							5	3					9
General information		1			2		1		3				10
Vessels visited	124	90	76	142	95	108	100	86	94	116	17	76	1,124
Information given to individuals	97	112	307	158	80	129	101	109	113	99	78	81	1,464
Barometers compared or adjusted	62	46	41	72	54	45	74	51	40	1	29	11	537
Charts corrected	2		2	6			2	2			1		10
Pilot Charts distributed	14	5	5	7	7	7	7	7	7	8	8	8	90
Notices to Mariners	21	13	14	22	62	36	21	151	231	506	517	645	2,239
Meteorological journals issued	1	4	3	6	1	5	2	3	3	5	2	4	39
Meteorological journals forwarded (filled)	3	7	3	23	12	5	11	2	3	4	6	6	85
Meteorological charts distributed		8		3		4		1	3				18
Light-lists of United States distributed	12	1	3	1					37	127	3		184
Light-lists Nos. 1, 2, 3, 4, 5, and 6 distributed	1	1	1	1	1	2							7
Day-marks	19	3	2	10	8	4		2	75	235	6		364
Meteorological journals returned (unfilled)					2	2				1	1		4
Chronometers rated	1		2		2		3						8
Hydrographic Office charts distributed	4	6		9		9		2		10	5	6	53
Light-lists corrected	2												2
Greely charts distributed								1					1
Submarine-cable charts distributed												25	25
Pamphlets on the use of oil distributed				1	12		27	24	12	7	13	21	117
Report of unusual phenomena forwarded									1				1
Special bulletins distributed						830	900	300		600			2,630
Annual report of Hydrographer distributed							20						20

Respectfully submitted.

J. B. MILTON,
Lieutenant, U. S. Navy.

Commander J. R. BARTLETT, U. S. Navy,
Hydrographer.

REPORT OF SUPERINTENDENT OF NAVAL OBSERVATORY.

U. S. NAVAL OBSERVATORY,
Washington, October 5, 1887.

SIR: In obedience to the Bureau's order of the 26th of September (No. 2995b), I have the honor to submit the annual report of the Observatory.

PERSONNEL.

Since the last report, the following changes have occurred, viz: Reported for duty, Capt. R. L. Phythian, as Superintendent, November 15, 1886. Commander Allan D. Brown was detached as Superintendent, and resumed duties as assistant superintendent November 15, 1886. Lieut. H. W. Schaefer reported October 25, and Lieut. Wm. P. Elliott December 18, 1886. Lieut. Wm. E. Sewell reported May 2, 1887, and was detached July 12, with orders to the Mare Island navy-yard. Ensign J. H. Rohrbacher reported January 25, and was detached February 1, with orders to special duty at the Navy Department. Lieut. B. W. Hodges reported June 20, and Ensigns A. B. Clements and V. O. Chase reported April 1 and July 25, respectively.

DISTRIBUTION OF WORK.

The work of the Observatory is at present distributed as follows:

Chronometers and time service.—Lieut. S. C. Paine and Ensign A. N. Mayer.

East transit.—Lieuts. L. C. Heilner and B. W. Hodges.

Inspection of instruments.—Lieut. A. G. Winterhalter and Ensign A. B. Clements.

Compass-houses.—Lieuts. H. W. Schaefer and Wm. P. Elliott.

Great equatorial.—Prof. Asaph Hall and Lieut. W. H. Allen.

Transit circle.—Prof. J. R. Eastman, Assistant Astronomers A. N. Skinner, Wm. C. Winlock, and H. M. Paul, and Mr. Wm. M. Brown, computer.

9.6-inch equatorial.—Prof. Edgar Frisby.

Repsold circle (Naval Academy).—Prof. S. J. Brown; Ensigns W. G. Richardson and V. O. Chase.

Library.—Vacant.

Photography.—Lieut. A. G. Winterhalter.

Instrument-maker and electrician.—William F. Gardner.

Clerk.—Thomas Harrison.

The meteorological observations are made by the watchmen (Messrs. Horigan, Cahill, and Henderson), under the supervision of the officer in charge of the library.

Prof. William Harkness is also attached to the Observatory for special duty as a member of the Transit-of-Venus Commission, to which commission and its computers the Observatory affords office room.

PROGRAMME OF WORK.

In January last the programme of work was distributed to correspondents for their information, being as follows:

The great equatorial.

Observations of double stars will be continued. Observations of previous years will be discussed if time and force will permit.

Continuation of measurements of the fainter stars in the Pleiades. Completion of these observations if possible.

Observations of the conjunction of the five inner satellites of Saturn, with the minor axis of the ring, and the angles of position and the distances of the faint satellite Hyperion.

Reduction and discussion of the observations of former years as time and force will permit.

The small equatorial.

Observations of comets whenever possible.

Observations of stars that need to be identified for the preparation of the third edition of Yarnall's Catalogue, now in progress.

Observations of stars and asteroids for identification for the transit circle, and of such asteroids as can not be observed with that instrument.

Observations of occultations of stars by the moon whenever practicable.

The transit circle.

Completion of the observations of miscellaneous stars for the proposed Transit Circle Catalogue; concurrently with these, observations of the sun, moon, and planets.

After the completion of the above observations (which, it is hoped, will be accomplished by the 1st of March) the instrument will be dismantled for repairs, and will thereafter be used in observations of—

The sun daily.

The moon throughout the whole lunation.

The planets, major and minor.

Stars of the American Ephemeris, required for the determination of instrumental and clock corrections.

Miscellaneous stars, as may be deemed advisable.

The observations of preceding years will be reduced as rapidly as possible.

The transit instrument.

Observations for the correction of the standard mean time clock daily.

The Repsold circle (at Annapolis).

Observations of the 303 southern stars.

The 59 refraction stars of the Leiden Observatory.

Auxiliary stars of the Berlin Jahrbuch.

Time service and chronometers.

Daily comparison of all chronometers on hand.

Daily noon signals over the wires of the Western Union and Baltimore and Ohio Telegraph Companies (Sundays excepted).

Correction, daily, of the clocks upon the Observatory—Department time lines in the city of Washington.

Dropping daily (Sundays excepted) of time-balls at noon of the 75th meridian at the following points:

Wood's Holl, Mass., under the auspices of the Fish Commission.

Newport, R. I., under the auspices of the Torpedo Station.

New York city, under the auspices of the Western Union Telegraph Company.

Philadelphia, Baltimore, and New Orleans, under the auspices of the Hydrographic Office.

Washington, Hampton Roads, and Savannah, under the auspices of the Observatory.

Time-balls will also be dropped from the branch observatory at the navy-yard, Mare Island, on Telegraph hill, San Francisco, through the branch hydrographic office, and at the navy-yard, at noon of the 120th meridian, daily (Sundays excepted).

The time service will be extended to such other points as may be deemed best, as funds will permit.

Test in the temperature room of such chronometers as have been repaired during the past year, including the plotting of their rate curves, with the necessary computations therefor.

Miscellaneous.

The examination of nautical instruments will continue.

Photographs of the sun will be taken daily, when practicable, with the photo-heliograph of Transit-of-Venus Commission pattern.

Meteorological observations will be made as usual.

THE GREAT EQUATORIAL.

This instrument is in good working order. The dome and shutters and the apparatus for moving the dome are also in good condition.

During the past year observations of the outer planets have been made, and a few observations of the planet Venus when near elongation. Observations of some of the principal double stars have been continued as in former years. The observer hopes soon to undertake again the observation of a list of double stars for the comparison of constant errors in such measures.

For several years past particular attention has been given to the appearances of Saturn's ring, the shadows, and the ball of the planet. Some drawings have been sketched, and it is expected that these will be ready for publication during the coming year, together with notes on Saturn by various observers since the mounting of this telescope.

The dimensions of the ring have been measured during several past oppositions for the purpose of comparison with former measures.

Lieut. Wm. H. Allen has continued to assist in the reduction and discussion of the observations made with this instrument, and has taken part in the observations.

The gas-engine for moving the dome is in charge of Mr. George Anderson. There has been no hindrance to work on account of this method of moving the dome, and the use of the engine is a great relief from the former method by hand, which had become very laborious.

THE TRANSIT CIRCLE.

The transit circle was employed on observations of stars of the American Ephemeris, the sun, moon, and planets, and such miscellaneous stars as were necessary to complete the data for the Star Catalogue.

From October 14, 1886, to date, the whole number of observations with the transit circle was 2,640. Of these, 69 were of the sun, 51 of the moon, 122 of the major planets, 8 of the minor planets, and 3 of comets.

The observations for 1885 are ready for the apparent place-sheets, and will be taken in hand as soon as the computer can be spared from the mean place reductions of 1884. But little work has been done on the observations for 1886.

It is impossible to bring up properly the computing and copying now in arrears without a greater force of experienced computers. In this connection I respectfully urge that the additional computers asked for in the estimates for the coming fiscal year be appropriated for.

THE 9.6-INCH EQUATORIAL.

This instrument has been used in the observation of comets, occultations of stars by the moon, and anonymous stars in Yarnall's Catalogue.

One night in each week has been set apart for the accommodation of visitors.

Forty-four observations of comets have been made, and three occultations have been observed; they are all reduced to date, and can soon be made ready for the printer.

The observations of comets have all been sent to astronomical journals for publication.

The revision of Yarnall's Catalogue is nearly completed. Every anonymous star in the catalogue has been carefully examined and compared with the observing books and with all known existing catalogues; the

mistakes have all been corrected, and when necessary for the purpose of verification the stars have been re-observed with the equatorial.

Over 2,000 of these anonymous stars have been examined; 1,571 have been identified and named from other catalogues; 842 corrections have been made, and 72 stars have been re-observed.

The work of examining all the other stars for the purpose of detecting small mistakes is progressing favorably, and it is believed that the whole work will very soon be ready for the printer.

CHRONOMETERS AND TIME SERVICE.

Chronometers have been received, cleaned, issued, etc., during the year, as follows:

	Cleaned.	Issued.	Received from service.	Condemned.
Box chronometers.....	32	23	21	5
Hack chronometers.....	4	8	4	
Pocket chronometers.....	2			
Watches.....			3	

The following disposition has been made of chronometers belonging to the Navy:

	Issued.	On trial.	Under repairs.	Awaiting repairs.	Loaned.	Ready for issue.
Box chronometers.....	149	5	45	24	3	52
Hack chronometers.....	68			128	3	6
Pocket chronometers.....	1	1		1		4
Pocket hack chronometers.....				4		2
Watches.....				4		

Of these, 29 box, 7 hack, and 2 pocket hack chronometers are at the observatory at Mare Island ready for issue to ships in the Pacific. Forty-nine of the box chronometers have been in use over thirty years, and will probably soon be placed on the "hack" list; they should be replaced as soon as practicable. Of the small number awaiting repairs, more than half will probably fail to pass successfully the examination and trial.

The temperature room was in use from December 10, 1886, to April 12, 1887. Forty box chronometers and 1 pocket belonging to the Navy, and 4 box chronometers belonging to Bond, of Boston, and Heinrich, of New York, passed through the trial, all but 4 successfully. (See Lieutenant Paine's report of temperature trial, July 8, 1887, which is appended—A.)

During the summer the temperature room has undergone some changes which, it is believed, will add to its efficiency. The ice-box has been removed to the top of the house, the space between the roof and the ceiling of the room has been packed with sawdust, 6 inches more of sawdust packed about the sides, which have also been lined with thick paper, the door and window have been doubled, and the boiler has been changed for a smaller heating apparatus, which it is believed will give the necessary amount of heat with less danger of fouling, and which, as far as it has been tried, works satisfactorily.

Owing to the irregularity of the time signals received over the Western Union wires, the time ball at Newport has been discontinued. The ball at Wood's Holl has also been dropped very irregularly, otherwise the time-ball service has been satisfactory. Time has been sent out daily at noon over the Western Union and Baltimore and Ohio wires, and only on one occasion did they fail to receive the noon beat. The greatest error transmitted amounted to 1.03^s ; the average error was 0.16^s .

The clock line now controls 249 clocks in Government buildings, and 33 outside. Owing to storms, lightning, and other accidental disturbances, there have been numerous breaks in this line, but as a rule the line was repaired before noon. On three days, however, none of the clocks were corrected, and on six other days but a portion of them. The Gardner apparatus in clocks and time balls continues to work satisfactorily.

EAST TRANSIT INSTRUMENT.

Daily observations, when practicable, have been taken for the correction of the standard mean-time clock; 231 observations with a total of 1,645 transits were made. The performance of the standard clock is very satisfactory; changes of temperature affect the rate but slightly; the variations of its rate follow so closely the variations of the barometer that during the year the greatest error in the assumed clock correction was 0.59^s , after an interval of four days without observations, and only four times the error amounted to 0.5^s . An additional mean-time clock (Howard No. 626) was put in circuit, and comparisons taken since May 8 show a satisfactory performance. The sidereal clocks, with the exception of the Kessel clock, are performing well. The condition of the east transit instrument is good.

EXAMINATION OF INSTRUMENTS.

This division has been under the general supervision of the assistant superintendent, Commander A. D. Brown, whose report is appended (B).

COMPASS HOUSES.

These were transferred to the care of the Observatory on June 18, 1887.

In House No. 1 are located the following instruments:

Large declination magnetometer with transit telescope for reading (Fauth & Co.); Kew unifilar magnetometer (Elliott Bros., 42); dip or inclination circle (Dover, Charlton, Kent, Circle No. 85).

In the basement of House No. 2 is located the set of self-recording magnetographs of the Kew pattern. This instrument is in adjustment, and determinations of the scale coefficients have been made. The temperature coefficients will be obtained from the curves themselves, after a sufficient series has been tabulated.

A daily determination of the absolute declination will be made from the reading of the large magnetometer for comparison with the declination magnetograph, and the weekly determination will be made from readings with magnet direct and inverted. The horizontal force and inclination will be determined weekly.

EEPSOLD CIRCLE AT ANNAPOLIS.

The observations with this instrument have been largely confined to the "303 south stars" for the continuation of the southern zones. In

all 3,300 observations have been made, not including observations for instrumental constants. The reduction of these observations is nearly completed. There remains yet to be done some work in the reduction of right ascensions and the application of systematic differences in declination to reduce the position to the Auwers system.

THE LIBRARY.

The library contains 11,532 volumes and 2,569 pamphlets. The accessions during the year have been 334 volumes and 130 pamphlets; a total of 464.

The number of addresses upon the issuing (exchange) list is 931, of which 425 are foreign and 506 domestic.

The following publications have been issued :

- (1) Appendix III to the volume for 1883.
- (2) Report of the Superintendent, 1886.
- (3) Programme of Work for 1887.
- (4) Refraction tables, U. S. Naval Observatory.

INTERNATIONAL ASTRONOMICAL CONGRESS AT PARIS.

The Observatory having been invited to participate in the proceedings of the congress which was to meet at Paris on the 16th of April, 1887, Lieut. A. G. Winterhalter was, on the 19th of the preceding month, detailed by the Department to attend upon its sessions, and he was present as a representative of the Observatory. Subsequently that officer, under the orders of the Department, visited Nice, Genoa, London, Brussels, Copenhagen, Kiel, Hamburg, and other places for the purpose of collecting information useful to the Observatory. At intervals during his absence Lieutenant Winterhalter has transmitted interesting and valuable communications, which, upon his return, will be embodied in the full report he will then make.

NEW NAVAL OBSERVATORY.

The plans for the new Naval Observatory which are being prepared by Mr. Richard M. Hunt, of New York, are nearly completed and will be submitted for approval at an early day. As soon as practicable, after the acceptance of the plans, work on the Observatory will be begun.

MISCELLANEOUS.

The names of 1,659 visitors have been recorded during the year, and 1,578 permits for night visitors have been issued.

A memorandum kept concerning the state of the "seeing" on each night shows that there were 168 nights on which there was no "seeing," 113 on which it was poor, 63 on which it was fair, but 19 on which it was good, and only 2 on which it was very good.

Very respectfully,

R. L. PHYTHIAN,
Captain, U. S. Navy, Superintendent.

The CHIEF OF THE BUREAU OF NAVIGATION,
Navy Department.

APPENDIX A.

[Report of Lieut. Sumner C. Paine.]

U. S. NAVAL OBSERVATORY,
Washington, July 8, 1887.

SIR: I have the honor to submit the following report of the trial of chronometers for the year 1886-'87:

The chronometers remained in the temperature room from December 16, 1886, to April 12, 1887, during which time they were subjected to temperatures varying from 47° to 90°, and to hygrometric conditions from 47.1 per cent. to 80.2 per cent. After removing them from the temperature room they were run in natural temperatures until July 21, 1887.

The hygrometric test, like the tests of previous years, developed the fact that no general rule can be laid down for the performance of chronometers subjected to different degrees of moisture. Of the 41 box and pocket chronometers on trial, 17 box gained at 80.2 per cent. and lost at 47.1 per cent.; 9 box and 1 pocket lost at 80.2 per cent. and gained at 47.1 per cent.; 8 box lost at both 80.2 and 47.1 per cent., and 6 box gained at both percentages; 25 box and 1 pocket returned to original rates during the last week of the test; 9 box returned to original rates within 0.5^s; 10 box ultimately regained original rates, and 5 box changed rate slightly, probably owing to "acceleration."

The performance of the following chronometers was unsatisfactory: 2,149 Bliss, 3,276 Charles Frodsham, 259 James Munroe (Fosler), and 466 Crisp. The first two were resprung last year and should be returned to the firms who repaired them. I would recommend that the Munroe and Crisp be surveyed with a view to condemn them for use as sea going chronometers.

I inclose a table showing the performance of the chronometers throughout the trial.

Very respectfully,

SUMNER C. PAINE,

Lieutenant, U. S. Navy, in charge of Chronometers.

Capt. R. L. PHYTHIAN, U. S. Navy,
Superintendent U. S. Naval Observatory.

Record of trial of repaired chronom

Explanation of abbreviations in first column: [Bl., repaired by John Bliss & Co. ;

Time.....		*Dec. 16 to Dec. 23.	Dec. 24 to Dec. 31.	Jan. 5 to Jan. 12.	Jan. 13 to Jan. 20.	Jan. 21 to Jan. 28.
Temperature.....		47°. 09	54°. 06	69°. 98	84°. 95	89°. 97
Hygrometer.....		70. 2	69. 2	70. 2	69. 0	69. 5
<i>Chronometer maker.*</i>		<i>Chron.</i>				
		<i>No.</i>				
N.	T. S. & J. D. Negus	1615	+0 319	+0. 417	+0. 107	+0. 340
Bl.	James Munroe (Fosler)	264	-1. 753	-1. 047	-0. 404	-0. 981
N.	T. S. & J. D. Negus	1215	-2. 396	-1. 511	-0. 679	-1. 053
Bl.	James Munroe (Fosler)	262	+1. 819	+1. 596	+1. 429	+1. 733
Bo.	Wm. Bond & Son	290	-0. 181	+0. 524	+0. 429	-0. 053
N.	T. S. & J. D. Negus	1447	-1. 039	-0. 261	-0. 250	-0. 053
N.	Do	1339	-1. 146	-0. 011	+0. 679	+0. 019
N.	Do	1442	-0. 896	+0. 024	-0. 179	-1. 124
N.	Do	729	-2. 324	-1. 261	-1. 393	-2. 160
N.	Do	1126	-1. 324	-0. 547	-0. 143	-0. 803
N.	Do	259	-1. 753	-2. 226	-1. 964	-2. 553
N.	Do	1408	-2. 396	-1. 369	-1. 179	-1. 946
N.	Do	1195	-1. 539	-0. 476	-0. 500	-1. 339
Bo.	Barraud	2609	-1. 574	-0. 190	+1. 000	+0. 733
Bo.	Dent	2684	+0. 140	+1. 096	+1. 500	+0. 233
N.	T. S. & J. D. Negus	1094	-1. 896	-0. 547	+0. 607	+0. 447
N.	Do	1311	-0. 324	+1. 346	+1. 008	+0. 601
N.	Do	1439	-0. 860	-0. 047	+0. 796	+0. 447
N.	Do	1464	-2. 574	-1. 547	-0. 857	-1. 696
Bo.	Wm. Bond & Son	293	-1. 681	-0. 190	+1. 500	+1. 947
Bl.	James Munroe (Fosler)	251	+0. 319	+1. 131	+0. 607	+0. 804
N.	T. S. & J. D. Negus	734	-2. 110	-1. 154	-0. 786	-1. 696
N.	Do	1630	-2. 217	-0. 619	+0. 500	-0. 017
N.	Do	953	-0. 039	+0. 840	+1. 250	-0. 196
Bo.	Wm. Bond & Son	322	-0. 539	+0. 381	-0. 357	-1. 124
Bl.	John Bliss & Co	2825	-1. 967	-1. 119	-1. 393	-0. 910
Bl.	Do	2149	-1. 253	-0. 190	+0. 693	+0. 340
Bl.	M. F. Dent	25508	-0. 967	+0. 060	+1. 214	+1. 019
Bo.	Charles Frodsham	2831	-1. 646	-0. 797	-0. 296	-1. 446
N.	T. S. & J. D. Negus	959	-1. 360	-0. 154	-0. 321	-2. 267
Bo.	Poole	3581	-3. 646	-2. 404	+0. 250	+0. 233
N.	T. S. & J. D. Negus	1256	-3. 146	-1. 604	-0. 536	-1. 017
Bo.	Wm. Bond & Son	307	+3. 104	+3. 881	+2. 464	+1. 840
Bo.	Charles Frodsham	3306	-2. 717	-1. 726	-0. 714	-0. 533
Bl.	John Bliss & Co	2817	-4. 681	-4. 261	-3. 643	-2. 731
N.	T. S. & J. D. Negus	1145	-2. 360	-1. 333	+0. 179	-0. 624
Bl.	W. B. Crisp	466	-0. 574	+0. 381	+0. 457	+0. 304
N.	T. S. & J. D. Negus	1453	-3. 360	-2. 297	-0. 714	-1. 696
Bo.	D. McGregor	K	-0. 253	-0. 369	-0. 821	-2. 660
Bo.	Charles Frodsham	2009				-4. 864
N.	T. S. & J. D. Negus	3276	+1. 353	+2. 417	+2. 929	+2. 637
N.	T. S. & J. D. Negus	5699	-1. 074	+0. 096	+0. 536	-0. 124

* December 16 to April 21

eters, December, 1886-June, 1887.

Bo., repaired by William Bond & Son; N., repaired by T. S. & J. D. Negan.]

Jan. 29 to Feb. 5.	Feb. 6 to Feb. 13.	Feb. 15 to Feb. 22.	Feb. 24 to March 3.	March 4 to March 11.	March 12 to March 19.	March 20 to March 27.	March 28 to April 4.	April 5 to April 12.	Relative number.
85°. 08	70°. 05	54°. 98	47°. 09	70°. 00	70°. 03	70°. 02	70°. 02	70°. 49	
70. 2	69. 3	70. 2	68. 0	68. 7	80. 2	70. 9	47. 1	70. 4	
+0.207	+0.663	+0.733	+0.854	+1.101	+0.741	+1.069	+0.753	+0.573	1
-1.257	-0.873	-0.981	-1.503	-0.327	+0.349	-0.074	-0.676	-0.106	2
-1.257	-0.873	-1.589	-2.289	-0.577	+0.063	-0.574	-0.569	-0.570	3
+1.937	+2.056	+2.233	+2.390	+2.101	+2.134	+1.604	+0.753	+1.394	4
-0.507	+0.127	-0.160	-0.610	-0.006	+0.277	+0.211	-0.354	+0.430	5
-0.186	-0.444	-0.624	-1.324	-0.327	-0.187	-0.074	-0.390	-0.249	6
-0.221	+0.163	-0.589	-1.253	+0.566	+0.563	+0.604	+0.431	+0.537	7
-1.150	-0.337	-1.017	-1.253	-0.684	-0.366	-0.574	-0.390	-0.713	8
-2.614	-1.980	-2.553	-3.289	-2.041	-2.223	-1.967	-2.104	-1.891	9
-0.757	+0.199	-0.910	-1.896	-0.399	-0.651	-0.324	-0.533	-0.499	10
-2.186	-2.087	-2.481	-2.039	-1.291	-1.116	-1.217	-0.926	-1.927	11
-2.579	-1.623	-2.017	-3.003	-1.506	-1.294	-1.289	-1.533	-1.284	12
-1.757	-0.909	-0.410	-1.181	-0.827	-0.759	-0.539	-1.211	-0.820	13
+0.136	+6.377	-0.660	-1.753	+0.744	+0.813	+0.890	+0.753	+0.823	14
+0.029	+1.341	+1.233	+0.640	+1.709	+1.349	+1.497	+2.039	+1.644	15
+0.314	+0.734	+0.090	-1.574	+0.709	+1.134	+0.890	+0.110	+0.716	16
+0.314	+1.063	+1.411	+0.533	+1.780	+1.099	+1.497	+1.896	+1.716	17
+0.094	+0.050	-1.089	-1.717	+0.637	+0.599	+0.461	+0.217	+0.787	18
-2.007	-1.337	-2.303	-3.181	-1.077	-0.868	-0.967	-1.497	-1.141	19
+1.779	+1.591	+0.090	-1.146	+1.494	+1.706	+1.569	+1.030	+1.251	20
+0.493	+0.199	+0.733	-0.289	+0.173	-0.330	-0.181	+0.003	-0.213	21
-1.971	-0.659	-1.553	-2.396	-1.113	-0.937	-0.574	-0.747	-0.713	22
+0.136	+0.501	-0.060	-1.574	+0.566	+0.277	+0.247	+1.074	+0.287	23
-0.614	+0.779	+0.411	-0.896	+0.851	+0.553	+0.211	+0.360	+0.037	24
-1.484	-1.123	-1.410	-1.967	-0.541	-0.723	-0.646	-0.676	-0.584	25
-1.114	-1.587	-1.303	-2.146	-1.613	-0.509	-0.503	-1.319	-0.356	26
-0.114	+0.841	-0.339	-0.824	+0.994	+1.670	+1.640	+1.360	+1.859	27
+0.814	+1.734	+0.376	-0.717	+2.244	+2.349	+2.420	+1.753	+2.216	28
-1.696	-1.087	-1.624	-2.431	-1.006	-1.901	-1.181	+0.789	-0.891	29
-2.507	-1.087	-1.339	-1.789	-0.577	-1.151	-0.717	-1.176	-0.570	30
+0.171	+0.234	-1.231	-2.396	-0.256	-0.544	-0.431	-0.211	-0.356	31
-1.364	-0.623	-2.267	-3.396	-0.399	-0.794	-0.824	-0.640	-0.391	32
+1.921	+2.913	+2.876	+2.497	+2.780	+3.241	+2.854	+4.217	+3.073	33
-1.079	-1.909	-3.624	-4.646	-1.756	-1.366	-1.431	-1.497	-1.606	34
-2.507	-2.837	-3.553	-3.860	-2.541	-1.366	-1.074	-1.961	-1.570	35
-0.793	+0.341	-1.231	-1.753	+0.209	+0.063	+0.319	-0.033	+0.144	36
-0.543	-0.194	-2.124	-2.396	-0.077	-0.014	-0.360	+0.074	-0.213	37
-2.329	-1.551	-2.874	-3.824	-1.363	-1.009	-1.039	-1.783	-1.320	38
-4.079	-2.587	-1.589	-1.539	-1.791	-1.544	-1.646	-1.354	-1.963	39
+1.850	+0.806	+0.067	+2.176	+3.601	+3.134	+3.426	+3.217	+1.073	40
-0.579	+0.734	+0.304	-0.967	-0.149	-2.901	-2.181	-0.961	-0.106	41

in temperature room.

Record of trial of repaired chronometers,

Explanations of abbreviations in first column: Bl., repaired by John Bliss & Co.;

Time		{*April 12 to April 19.	April 19 to April 26.	April 26 to May 3.	May 3 to May 10.	May 10 to May 17.
Temperature		64°. 11	61°. 02	64°. 69	73°. 86	71°. 96
Hygrometer		66. 4	65. 8	67. 0	69. 6	69. 0
<i>Chronometer maker.</i>		<i>Chron. No.</i>				
N.	T. S. & J. D. Negus	1815	+1.537	+1.543	+1.583	+1.190
Bl.	James Munroe (Fosler)	264	-0.606	-0.600	-0.514	-0.274
N.	T. S. & J. D. Negus	1215	-0.820	-0.921	-0.729	-0.631
Bl.	James Munroe (Fosler)	262	+1.609	+1.686	+1.700	+1.690
Bo.	Wm. Bond & Son	290	+0.501	+0.436	+0.450	+0.619
N.	T. S. & J. D. Negus	1447	-0.391	+0.007	-0.086	+0.440
N.	Do.	1339	+0.573	+0.721	+1.057	+1.151
N.	Do.	1442	-0.249	+0.507	+0.950	+0.261
N.	Do.	729	-1.820	-1.921	-1.836	-2.167
N.	Do.	1126	-0.391	-0.386	-0.407	-0.131
N.	Do.	259	-0.713	-1.421	-0.800	-0.846
N.	Do.	1408	-1.677	-1.707	-1.514	-1.524
N.	Do.	1195	-0.320	-0.029	-0.014	-0.703
Bo.	Barrand	2009	+0.537	+0.400	+0.700	+0.976
Bo.	Dent	2684	+1.930	+2.079	+2.236	+1.904
N.	T. S. & J. D. Negus	1094	+0.251	+0.150	+0.521	+0.833
N.	Do.	1311	+2.109	+2.150	+2.200	+2.119
N.	Do.	1450	+0.430	+0.507	+0.879	+1.297
N.	Do.	1464	-1.499	-1.600	-1.371	-1.167
Bo.	Wm. Bond & Son	293	+0.930	+0.614	+0.950	+1.781
Bl.	James Munroe (Fosler)	251	+0.180	+0.936	+1.307	+0.476
N.	T. S. & J. D. Negus	734	-0.284	-0.886	-0.800	-1.000
N.	Do.	1630	+0.537	+0.650	+0.664	+0.726
N.	Do.	953	+0.644	+0.721	+0.771	+0.654
Bo.	Wm. Bond & Son	232	-0.677	-0.457	-0.229	-0.374
Bl.	John Bliss & Co	2825	-0.784	-0.707	-0.729	-1.181
Bl.	Do.	2149	+0.966	+1.329	+1.807	+1.654
Bl.	M. F. Dent	25568	+1.823	+1.643	+1.807	+2.154
Bo.	Charles Frodsham	2831	+0.073	+0.400	+0.567	+0.011
N.	T. S. & J. D. Negus	950	-1.070	-0.957	-0.871	-1.203
Bo.	Poole	3381	-0.141	-0.279	+0.057	+0.226
N.	T. S. & J. D. Negus	1256	-1.106	-1.493	-1.407	-0.417
Bo.	Wm. Bond & Son	307	+3.787	+3.680	+3.629	+2.083
Bo.	Charles Frodsham	3306	-1.799	-2.380	-1.764	-1.096
Bl.	John Bliss & Co	2817	-2.034	-2.314	-2.229	-1.667
N.	T. S. & J. D. Negus	1145	-0.070	-0.136	+0.164	+0.226
Bl.	W. B. Crisp	466	-0.641	-1.029	-0.943	-0.524
N.	T. S. & J. D. Negus	1453	-1.749	-1.993	-1.764	-1.167
Bo.	D. McGregor	K 2009	-2.034	-1.671	-1.657	-2.096
Bo.	Charles Frodsham	3276	+3.573	+3.686	+3.629	+3.690
N.	T. S. & J. D. Negus	5690	+0.073	-0.457	+0.343	+1.389

* April 12 to June 21

December, 1886—June, 1887—Continued.

Bo., repaired by Wm. Bond & Son; N., repaired by T. S. & J. D. Negus.

May 17 to May 24.	May 24 to May 31.	May 31 to June 7.	June 7 to June 14.	June 14 to June 21.	Tempera- ture of compensa- tion.	Tempera- ture constant.	First trial Number.	Final trial Number.	Relative number.
74°. 79	72°. 37	71°. 80	72°. 37	70°. 21					
70.1	71.	71.7	73.1	71.					
+1.276	+1.359	+1.444	+1.137	+1.321	99.698	+ .000170	7.376	8.3364	1
-0.206	-0.391	-0.306	-0.291	-0.500	69.001	- .00177	7.756	8.5954	2
-0.367	-0.356	-0.377	-0.115	-0.429	72.564	- .00255	11.025	12.0651	3
+1.954	+1.823	+1.944	+1.059	+2.286	71.875	+ .000609	10.949	12.1792	4
+0.811	+0.690	+0.087	-0.113	-0.107	64.696	- .00145	10.069	12.2591	5
+0.490	+0.304	+0.587	+0.357	+0.571	51.810	+ .000296	10.763	12.4927	6
+1.204	+1.180	+1.266	+1.244	+1.107	71.192	- .00275	11.517	12.6569	7
-0.841	-0.463	-0.377	-0.470	-0.679	65.684	- .00248	10.564	13.7538	8
-2.081	-2.177	-1.949	-1.684	-1.714	66.080	- .00204	12.956	14.8462	9
-0.117	+0.304	+0.230	+0.066	-0.214	69.740	- .00347	14.791	15.6509	10
-0.796	-0.820	-1.663	-1.399	-0.750	69.811	- .00149	13.283	15.6326	11
-1.439	-1.463	-1.199	-1.327	-1.571	66.286	- .00256	15.612	16.6316	12
-0.760	-0.641	-0.591	-0.720	-1.000	55.792	- .001295	16.055	17.2749	13
+1.061	+1.037	+1.123	+1.101	+1.071	74.713	- .00303	17.456	17.9260	14
+1.954	+2.180	+2.266	+2.224	+1.929	64.973	- .00346	18.011	19.0110	15
+0.811	+0.891	+0.873	+0.923	+0.750	73.836	- .00263	18.272	19.0523	16
+1.990	+2.037	+1.980	+1.887	+1.893	65.231	- .00312	18.697	19.3968	17
+1.419	+1.251	+1.306	+1.137	+1.286	75.345	- .00256	18.335	19.5448	18
-1.296	-1.177	-1.056	-1.149	-1.107	70.341	- .00351	18.951	20.0111	19
+2.061	+1.859	+1.944	+1.923	+2.107	81.263	- .00232	20.212	21.0921	20
+0.240	+0.430	+0.409	+0.066	+0.500	72.747	+ .00171	18.636	21.1760	21
-1.010	-0.801	-0.699	-0.684	-0.536	67.921	- .00386	19.513	21.8930	22
+0.507	+0.323	+0.301	+0.280	+0.250	73.151	- .00369	21.227	22.8167	23
+0.811	+0.644	+0.623	+0.530	+0.321	65.074	- .00399	24.629	25.7965	24
-0.367	-0.427	-0.341	-0.399	-0.679	56.085	- .00117	24.788	26.0181	25
-1.224	-1.034	-0.837	-0.684	-0.600	68.010	+ .00168	25.593	27.1628	26
+1.847	+1.716	+1.587	+2.173	+2.071	71.492	- .00418	25.204	27.6743	27
+1.954	+2.001	+2.266	+2.340	+2.000	72.881	- .00402	27.183	28.0329	28
-0.081	-0.070	-0.199	-0.363	-0.679	68.066	- .00311	29.394	31.2943	29
-1.403	-1.284	-1.127	-0.934	-1.143	62.855	- .00383	29.576	31.5555	30
+0.276	+0.359	+0.194	-0.006	+0.214	79.489	- .00354	30.365	32.0847	31
-0.367	-0.463	-0.341	-0.256	-0.357	73.167	- .00469	32.664	34.8137	32
+2.240	+2.406	+2.409	+2.351	+2.714	23.764	- .000266	32.278	35.6678	33
-1.153	-1.391	-1.341	-1.399	-1.000	86.102	- .00192	36.052	36.0718	34
-1.617	-1.667	-1.063	-1.470	-1.214	288.413	- .0000082	39.242	40.0623	35
+0.276	+0.251	+0.409	+0.351	+0.214	71.721	- .00555	41.059	42.5391	36
-0.617	-0.499	-0.341	-0.684	-0.357	73.411	- .00366	43.919	45.2467	37
-1.117	-1.427	-0.949	-1.041	-1.214	71.835	- .00517	45.143	46.4531	38
-2.439	-2.427	-2.103	-1.756	-2.464	50.960	- .00209	44.911	46.5212	39
+2.254	+4.144	+3.194	+3.994	+3.464	14.529	+ .000215	46.616	48.8655	40
+0.490	+0.180	+0.301	-0.184	-0.179	67.079	- .00315	61.165	65.3350	41

in chronometer room.

Record of trial of repaired chronometers,

Explanations of abbreviations in first column: Bl., repaired by John Bliss & Co.:

Time		{*April 12 to (April 19.	April 19 to April 26.	April 26 to May 3.	May 3 to May 10.	May 10 to May 17.
Temperature		64°. 11	61°. 02	64°. 69	73°. 86	71°. 96
Hygrometer		66. 4	65. 8	67. 0	69. 6	69. 0
	<i>Chronometer maker.</i>	<i>Chron. No.</i>				
N.	T. S. & J. D. Negus	1615	+1. 537	+1. 543	+1. 593	+1. 190
Bl.	James Munroe (Fosler).....	264	-0. 606	-0. 600	-0. 514	-0. 274
N.	T. S. & J. D. Negus	1215	-0. 820	-0. 921	-0. 729	-0. 631
Bl.	James Munroe (Fosler).....	262	+1. 609	+1. 686	+1. 700	+1. 690
Bo.	Wm. Bond & Son	290	+0. 501	+0. 436	+0. 450	+0. 619
N.	T. S. & J. D. Negus	1447	-0. 391	+0. 007	-0. 086	+0. 440
N.	Do.....	1339	+0. 573	+0. 721	+1. 057	+1. 151
N.	Do.....	1442	-0. 249	+0. 507	+0. 950	+0. 261
N.	Do.....	729	-1. 820	-1. 921	-1. 836	-2. 167
N.	Do.....	1126	-0. 391	-0. 386	-0. 407	-0. 131
N.	Do.....	259	-0. 713	-1. 421	-0. 800	-0. 846
N.	Do.....	1408	-1. 677	-1. 707	-1. 514	-1. 624
N.	Do.....	1195	-0. 320	-0. 029	-0. 014	-0. 703
Bo.	Barraud	2609	+0. 537	+0. 400	+0. 700	+0. 976
Bo.	Dent	2684	+1. 930	+2. 079	+2. 236	+1. 974
N.	T. S. & J. D. Negus	1094	+0. 251	+0. 150	+0. 521	+0. 833
N.	Do.....	1311	+2. 109	+2. 150	+2. 200	+2. 119
N.	Do.....	1459	+0. 430	+0. 507	+0. 879	+1. 297
N.	Do.....	1464	-1. 499	-1. 600	-1. 371	-1. 167
Bo.	Wm. Bond & Son	293	+0. 930	+0. 614	+0. 950	+1. 761
Bl.	James Munroe (Fosler).....	251	+0. 180	+0. 936	+1. 307	+0. 476
N.	T. S. & J. D. Negus	734	-0. 284	-0. 866	-0. 800	-1. 060
N.	Do.....	1630	+0. 537	+0. 650	+0. 664	+0. 736
N.	Do.....	953	+0. 644	+0. 721	+0. 771	+0. 654
Bo.	Wm. Bond & Son	232	-0. 677	-0. 467	-0. 229	-0. 374
Bl.	John Bliss & Co	2825	-0. 784	-0. 707	-0. 729	-1. 181
Bl.	Do.....	2149	+0. 966	+1. 329	+1. 807	+1. 654
Bl.	M. F. Dent	25568	+1. 823	+1. 543	+1. 807	+2. 154
Bl.	Charles Frodsham.....	2831	+0. 073	+0. 400	+0. 557	+0. 011
N.	T. S. & J. D. Negus	950	-1. 070	-0. 957	-0. 871	-1. 203
Bo.	Poole	3381	-0. 141	-0. 279	+0. 057	+0. 226
N.	T. S. & J. D. Negus	1256	-1. 106	-1. 493	-1. 407	-0. 417
Bo.	Wm. Bond & Son	307	+3. 787	+3. 686	+3. 629	+2. 063
Bo.	Charles Frodsham.....	3306	-1. 799	-2. 386	-1. 704	-1. 096
Bl.	John Bliss & Co	2817	-2. 034	-2. 314	-2. 229	-1. 667
N.	T. S. & J. D. Negus	1145	-0. 070	-0. 136	+0. 164	+0. 226
Bl.	W. B. Crisp	466	-0. 641	-1. 029	-0. 943	-0. 524
N.	T. S. & J. D. Negus	1453	-1. 749	-1. 993	-1. 704	-1. 167
Bo.	D. McGregor	K 2006	-2. 034	-1. 671	-1. 657	-2. 096
Bo.	Charles Frodsham	3276	+3. 573	+3. 686	+3. 629	+3. 690
N.	T. S. & J. D. Negus	5669	+0. 073	-0. 457	+0. 343	+1. 369

* April 12 to June 11

December, 1886—June, 1887—Continued.

Bo., repaired by Wm. Bond & Son; N., repaired by T. S. & J. D. Negus.

May 17 to May 24.	May 24 to May 31.	May 31 to June 7.	June 7 to June 14.	June 14 to June 21.	Tempera- ture of compensa- tion.	Tempera- ture constant.	First trial Number.	Final trial Number.	Relative number.
74°. 79	72°. 37	71°. 80	72°. 37	70°. 21					
70.1	71.	71.7	73.1	71.					
+1.276	+1.359	+1.444	+1.137	+1.321	99.698	+ .00170	7.376	8.3364	1
-0.206	-0.391	-0.306	-0.291	-0.500	69.001	- .00177	7.756	8.5854	2
-0.307	-0.356	-0.377	-0.115	-0.429	72.564	- .00255	11.025	12.0651	3
+1.954	+1.823	+1.944	+1.959	+2.286	71.875	+ .000809	10.949	12.1792	4
+0.811	+0.680	+0.087	-0.113	-0.107	64.696	- .00145	10.069	12.2591	5
+0.490	+0.304	+0.587	+0.367	+0.571	51.810	+ .000296	10.763	12.4927	6
+1.204	+1.180	+1.266	+1.244	+1.107	71.192	- .00275	11.517	12.6569	7
-0.841	-0.463	-0.377	-0.470	-0.679	65.684	- .00248	10.564	13.7538	8
-2.081	-2.177	-1.949	-1.684	-1.714	66.080	- .00204	12.956	14.3462	9
-0.117	+0.304	+0.230	+0.066	-0.214	69.740	- .00347	14.791	15.6509	10
-0.796	-0.820	-1.663	-1.399	-0.750	69.811	- .00149	13.283	15.8326	11
-1.439	-1.403	-1.199	-1.327	-1.571	66.286	- .00256	15.612	16.6316	12
-0.760	-0.641	-0.591	-0.720	-1.000	55.792	- .001295	16.055	17.2749	13
+1.061	+1.037	+1.123	+1.101	+1.071	74.713	- .00303	17.456	17.9260	14
+1.954	+2.180	+2.266	+2.224	+1.929	64.973	- .00346	18.011	19.0110	15
+0.811	+0.891	+0.873	+0.923	+0.750	73.836	- .00263	18.272	19.0523	16
+1.960	+2.037	+1.980	+1.887	+1.393	65.231	- .00312	18.997	19.3968	17
+1.419	+1.251	+1.306	+1.137	+1.286	75.345	- .00256	18.335	19.5448	18
-1.296	-1.177	-1.056	-1.149	-1.107	70.341	- .00351	18.051	20.0111	19
+2.061	+1.859	+1.944	+1.923	+2.107	81.283	- .00232	20.212	21.0921	20
+0.240	+0.430	+0.409	+0.066	+0.500	72.747	+ .00171	18.636	21.1760	21
-1.010	-0.891	-0.690	-0.684	-0.536	67.021	- .00386	19.513	21.3930	22
+0.597	+0.323	+0.301	+0.280	+0.250	73.151	- .00369	21.227	22.8167	23
+0.811	+0.644	+0.673	+0.530	+0.321	65.674	- .00399	24.629	25.7985	24
-0.367	-0.427	-0.341	-0.399	-0.679	56.085	- .00117	24.788	26.0181	25
-1.224	-1.044	-0.627	-0.684	-0.500	68.016	+ .00168	25.593	27.1628	26
+1.847	+1.716	+1.567	+2.173	+2.071	71.492	- .00418	25.204	27.6743	27
+1.954	+2.001	+2.266	+2.316	+2.000	72.891	- .00402	27.183	28.0329	28
-0.081	-0.070	-0.199	-0.363	-0.670	68.066	- .00311	29.394	31.2943	29
-1.403	-1.284	-1.127	-0.934	-1.143	62.855	- .00383	29.570	31.3555	30
+0.276	+0.359	+0.194	-0.066	+0.214	79.469	- .00354	30.365	32.0847	31
-0.367	-0.463	-0.341	-0.256	-0.357	73.167	- .00469	32.634	34.8137	32
+2.240	+2.406	+2.409	+2.351	+2.714	-23.764	- .000266	32.278	35.6678	33
-1.153	-1.391	-1.341	-1.399	-1.000	86.102	- .00192	36.052	36.0718	34
-1.617	-1.667	-1.663	-1.470	-1.214	288.413	- .0000082	39.242	40.0023	35
+0.276	+0.251	+0.409	+0.351	+0.214	71.721	- .00555	41.959	42.5391	36
-0.617	-0.499	-0.341	-0.684	-0.357	73.411	- .00366	43.019	45.2487	37
-1.117	-1.427	-0.949	-1.041	-1.214	71.835	- .00517	45.143	46.4531	38
-2.439	-2.427	-2.163	-1.756	-2.464	50.960	- .00209	44.911	46.5212	39
+2.954	+4.144	+3.194	+3.994	+3.464	14.529	+ .000215	46.616	48.8655	40
+0.490	+0.180	+0.301	-0.184	-0.179	67.079	- .00315	61.165	65.3350	41

in chronometer room.

APPENDIX B.

[Report of Commander Allan D. Brown.]

U. S. NAVAL OBSERVATORY,
Washington, September 26, 1887.

SIR: The work of the division of verification of instruments has been carried on under my general supervision by Lieutenant Winterhalter, until April 1, and by Ensign Clements since that date.

CLASS A.—SEXTANTS AND OCTANTS.

There have been received for examination 147 sextants; of these, 42 were new instruments recently purchased by the Bureau; 38 were the old ones referred to in the last report as having been examined, and since repaired by R. Merrill's Sons, of New York; and 67 were old ones to be inspected as to their fitness for repairs.

There have been examined 4 (on hand at the date of the last report) by Lieutenant Winterhalter; 8 new and 38 repaired ones mainly by Ensign Clements; and 67 old ones.

There have been sent to the navy-yard at New York, for issue, 4 new and 23 repaired ones; to be repaired, 54; condemned, 28.

CLASS B.—THERMOMETERS.

There have been examined three Peabody metallic thermometers; and also (at the request of the supervising surgeon-general of the Marine-Hospital Service) 130 clinical thermometers belonging to that service.

The Peabody thermometers were compared with the standards in daily use with results that could hardly be said to be favorable to them as instruments of precision.

The clinical thermometers were compared with the Fahrenheit and Centigrade standards of the Observatory, made by H. J. Green, of New York. In preparation for this work, a testing case was constructed upon the general plan of the temperature room used for testing chronometers as outlined in the last report. In this case (which is heated by means of water circulating through a pipe in a small gas stove of the American Meter Company's pattern), was placed a glass vessel containing water; this became gradually and uniformly heated, so far at least as could be determined by the standard thermometers, which read to the tenth of a degree. The standards were equally immersed at opposite extremities of the vessel, and the bulbs of the clinicals were suspended at the same depth. Each of the 130 instruments (save 1 broken and 3 that were defective) was compared at every two degrees, making about 1,000 readings in all. After examination they were returned to the Supervising Surgeon-General, with a certificate attached to each one.

This examination showed most conclusively the necessity that exists for the careful inspection of such instruments. Seven were found to be entirely unreliable; 58 were found to be unreliable at some point short of their full graduation, and but 61, or less than 50 per cent. of those examined, were found to be correct throughout their whole range.

CLASS C.—SPY-GLASSES.

One spy-glass by Elliott Brothers and three by Negretti and Zambra were examined early in the year by Lieutenant Winterhalter. As a

result of this examination, a memorandum concerning the construction of such glasses was sent to the Bureau, and forwarded to the manufacturers for their guidance. Twenty-five have recently been received from Elliott Brothers, and have been examined; they were found to possess an excellent optical performance, but there were some points about the mechanical construction that could have been improved. As a whole, they are unquestionably superior to those that have lately been issued to the service.

CLASS D.—STATION POINTERS.

No instruments of this class have been examined.

CLASS E.—CLINOMETERS.

Four Evelyn's patent ship-clinometers, made mainly in accordance with the drawings and specifications mentioned in the last report, have been examined and found suitable for issue.

CLASS F.—BAROMETERS.

One holosteric barometer by Keuffel and Esser was examined early in the year by Lieutenant Winterhalter, and an exhaustive report thereon made to the Bureau.

CLASS G.—BINOCULARS.

Two binoculars by Chevallier and 2 by Hurlimann (the property of the Light-House Board) were examined by Lieutenant Winterhalter, and a memorandum concerning them sent to the Bureau.

The total number of instruments examined is as follows:

Class A. Sextants	117
Class B. Thermometers	133
Class C. Spy-glasses	20
Class D. Station Pointers	0
Class E. Clinometers	4
Class F. Barometers	1
Class G. Binoculars	4
Total	288

There remain on hand to be examined: Class A, sextants, 34.

Very respectfully,

ALLAN D. BROWN,
Commander, U. S. Navy, Assistant Superintendent.

The SUPERINTENDENT.

APPENDIX C.

[Report of Prof. William Harkness, of the Transit of Venus Commission.]

U. S. NAVAL OBSERVATORY,
Washington, September 28, 1887.

SIR: I have the honor to submit the following report of the work done during the past year, under my supervision, for the Transit of Venus Commission:

The assistants employed at the beginning of the year were Messrs. A. S. Flint and Herbert C. Wilson. Mr. H. P. Tuttle was engaged on

January 5, 1887, and Mr. Wilson resigned on July 31, 1887, to become assistant director of the Carleton College Observatory, at Northfield, Minn. Messrs. Flint and Tuttle are still in the service of the Commission.

On April 27, of the present year, Mr. Joseph A. Rogers filed his report with the Commission. It covers 229 pages of manuscript, and embraces a complete account not only of his official photographic work in connection with the total solar eclipse of July 29, 1878, and the transits of Mercury and Venus, but also of many experiments carried out at his own private expense. Both from a theoretical and practical point of view he has investigated the conditions necessary for the successful production of pyroxyline suitable for astronomical photography, and although difficulties still remain, much that was heretofore obscure has now been made clear. It is believed that this investigation will have an important bearing on future work, for in all cases not demanding the most extreme sensitiveness collodion is certainly superior to gelatine.

The work done by Messrs. Flint, Wilson, Tuttle, and myself may be summarized as follows :

The scale-values of the bubble tubes of the engineer's levels, and also those of the latitude and striding levels belonging to the meridian instruments, and the revolution values of the screws of the double-image micrometers belonging to the equatorial telescopes have been submitted to a final revision and discussion. The reduction of the latitudes of all the stations, and the embodiment of the observations in tables for the printer, have been completed. The reduction and tabulation of the time-observations have also been completed, with the exception of four nights' work at Wellington, which is required for determining the instants of certain occultations ; the tables of chronometric corrections and comparisons have been made out, and the chronometric longitudes measured in 1874-'75 have been recomputed. The double-image micrometer measurements of intervals between Venus and the sun's limb, widths of cusps, and diameters of Venus, both in 1874 and 1882, have all been reduced and tabulated ; and, finally, the stars whose occultations were observed in 1882 have been identified.

The observations to determine the azimuths and levels of the axes or the photo-heliographs, and the intervals between the objectives and reticule-plates of these instruments, have been reduced and tabulated for all the stations except the Lick Observatory, from which the necessary data have not yet been received. The reduction and discussion of the experiments made in 1883-'85 to determine the radii of curvature of the heliostat mirrors, has recently been resumed, and is now nearly completed. Speaking generally, it shows that when exposed to the sun's rays the Lick mirror alone remained sensibly unchanged, while all the others became more concave—the increase of their versed sines on a chord of 5 inches being about the one-hundred-thousandth part of an inch for the Commission's mirrors, and four times that amount for the Princeton mirror.

As soon as the reduction of the observations for time and geographical position was practically completed the photographs were again taken up, and the work accomplished upon them since the beginning of the present year is as follows :

(1) *Quantities depending upon the tabular positions of the sun and Venus.*—The geocentric right ascensions and declinations of the sun and Venus have been computed by a special process for each twentieth minute

of Greenwich sidereal time, from $18^{\text{h}} 40^{\text{m}}$ to $1^{\text{h}} 20^{\text{m}}$, and from them the geocentric position angles, and distances of Venus, relatively to the sun's center, have been computed and tabulated for every minute of Greenwich sidereal time, from $19^{\text{h}} 00^{\text{m}}$ to $1^{\text{h}} 00^{\text{m}}$. From the same data the parallactic elements P , P' , R , R' , O , and O' , the quantities Δs and Δp , and the numbers whose sums will form the coefficients of the unknown quantities in the final normal equations derived from the photographs, have also been computed for each station for every twentieth minute of the time during which photographs were actually made; and the latter quantities have been interpolated to every fifth minute of time for seven of the stations. Further, the altitude, azimuth, and parallactic angle of the sun at each station have been computed for every twentieth minute of the time during which photographs were made; and the angle subtended upon the reticule-plate between the plumb line and the minor axis of the image of the sun, together with the differential coefficients of that angle, have also been computed for every twentieth minute for all the stations where needed, except the Lick Observatory.

(2) *Quantities depending upon the photographs.*—The rectangular co-ordinates of the center of Venus and the center of the plate relatively to the sun's center were long since computed from the plate measures for all the photographs except those taken in New Haven. During the present year these co-ordinates have been computed for the New Haven station, and have been tabulated for all the stations. The further reduction of these co-ordinates has been proceeded with, and at the present date the distances in scale divisions between the centers of the images of the sun and Venus, and the angles subtended at the center of the sun's image between the plate-holder plumb-line and Venus, have been computed for all the plates. The position angles and distances of Venus relatively to the sun's center, upon which the absolute terms of the observation equations for finding the solar parallax will depend, have not yet been obtained; but the coefficients of the unknown quantities in these equations have been interpolated for all the photographs taken at Washington, Cedar Keys, San Antonio, Cerro Roblero, and Wellington.

From the foregoing statement it will be apparent that the reduction of the United States transit of Venus observations is fast drawing to a close, and it is believed that if no unforeseen obstacle arises the value of the solar parallax deducible from them will be obtained about the end of the present calendar year.

Since the date of my last report the observations on terrestrial magnetism, made in 1874, at Peking, Nagasaki, Kerguelen island, Queens-town, and Chatham island have been reduced, and the tidal observations made at Kerguelen island have been partially reduced.

Very respectfully,

WM. HARKNESS,

*Professor of Mathematics, U. S. Navy,
Of Executive Committee of Transit of Venus Commission.*

Capt. R. L. PHYTHIAN, U. S. Navy,
*Superintendent Naval Observatory,
President of Transit of Venus Commission.*

REPORT OF SUPERINTENDENT OF NAUTICAL ALMANAC.

NAUTICAL ALMANAC OFFICE, NAVY DEPARTMENT,
Washington, D. C., October 5, 1887.

SIR: In compliance with the order of the Bureau I have the honor to submit the following report of the work of this office during the past year.

PRINTING.

The American Nautical Almanac for the year 1890 was issued from the press in March, 1887.

The printing of the American Ephemeris for 1890, which should have appeared in June last, has not yet been completed.

The same is true of the Atlantic and Pacific Coaster's Nautical Almanacs for the year 1888, which should now be ready, but which the Public Printer has not yet supplied.

Of the Almanac and Ephemeris for the year 1891, 110 pages are in type. The printing has fallen in arrears about three months during the past two years.

DISTRIBUTION.

During the fiscal year ending June 30, 1887, the sale and distribution of the preceding publications were as follows:

Publications.	Sold.	Distrib- uted.
American Ephemeris.....	546	753
American Nautical Almanac.....	1,969
Atlantic Coaster's Nautical Almanac.....	730
Pacific Coaster's Nautical Almanac.....	422

The proceeds of sales, amounting to \$1,373.47, have, in compliance with law, been deposited in the Treasury to the credit of the appropriation for public printing and binding.

The diminution in the sales of the American Nautical Almanac, which continues from year to year, is an index to the diminution in the number of American ships engaged in foreign trade.

COMPUTATIONS.

The annual routine of computations has been carried on as usual. The volume for 1891 is complete, except some portions which it is not necessary to prepare long in advance of printing. All the computations for 1892 are in their usual state of forwardness. The lunar and solar ephemerides for 1893 are in course of preparation for use in subsequent computations during the next year.

NEW TABLES OF THE PLANETS.

Owing to the magnitude of this work I deem the present an appropriate time to submit a more complete statement of its condition than is contained in former annual reports. The general object of the work is the determination of the elements of all the large planets from the best and most recent observations, and the construction of tables founded on uniform data.

The whole work is divided into four sections, namely:

First. The computation of the general perturbations of the planets.

Second. The re-reduction of the older observations and the discussion of the later ones with a view of reducing them all to a uniform system.

Third. The computation of tabular places of the planets from Leverrier's tables up to the year 1864.

Fourth. The final discussion of all the results.

General perturbations.—The work now in hand consists in the determination of the perturbations of the four inner planets. Fourteen pairs of planets come into play in this part of the work, counting as separate pairs the mutual actions of two planets on each other. The computations have been made in duplicate by Mr. R. W. Prentiss and Mr. S. J. Corrigan. The failing health of the latter resulted in his resignation on June 29 last. His place was filled on July 1 by the appointment of David Barcroft, Ph. D.

On twelve of the fourteen pairs the work has been completed by Mr. Prentiss, but some small discrepancies remain to be investigated. The incomplete perturbations are those of Venus and Mars by Jupiter.

Reduction of observations.—The question to what extent it is necessary to re-reduce the old observations is one which must be determined very largely by circumstances, rather than by any general rule. I shall therefore state what has been done, and what it is proposed to do with each series of observations.

As stated in my last annual report, Maskelyne's Greenwich observations from 1765 to 1811 have been completely re-reduced with modern data.

The observations of Bradley, 1750–1762, were not taken up for the reason that the observations of the stars by that astronomer were being completely re-reduced by Dr. Arthur Auwers, secretary of the Academy of Sciences, of Berlin. Learning that the planetary observations were not included in Dr. Auwers' work, I made an arrangement with him, by authority of the Bureau, for having them reduced under his direction at the expense of this office. On the completion of the reduction, however, Dr. Auwers liberally presented it to the office as a contribution from himself to its work.

It is still an open question whether it is necessary to re-reduce Pond's observations, 1812 to 1830, or whether the application of the small corrections required to Airy's reduction will suffice. I shall probably adopt the latter course to save time. Since 1830 the Greenwich observations have been so completely reduced by Airy as to need no discussion except that necessary to reduce them to the adopted standard system.

The Paris observations since 1800 were completely reduced by Leverrier. The accuracy of his star places is such that it has been deemed sufficient to apply only the mean reduction to the adopted system.

Probably the same course will be adopted with Bessel's Königsberg observations, 1814–1845.

The re-reduction of Piazzini's observations at Palermo, 1791–1813, has been long desired by astronomers. Investigations preliminary to this work have been made under my supervision by Mr. Cleveland Keith. The results have been applied to reduce all the declinations of the sun and planets observed by Piazzini. The right ascensions are now in hand.

The question whether to include Taylor's Madras observations is not yet decided. The principal importance of this series arises from the great number of observations of Mercury, which cannot well be observed in the higher latitudes of Europe. Their introduction will necessarily cause some delay in the completion of the work. Against this we have to cite the fact that the longer the completion is delayed, the

greater the number of modern accurate observations which can be utilized.

The same remark applies to Littrow's Vienna observations, which are, however, few in number.

Of other, and especially of recent observations, it is unnecessary to speak, as their introduction offers no difficulty.

Computation of tabular places.—This is the most laborious and difficult part of the work, and, had Leverrier's printed tables been used without modification, it would have been quite impracticable with the office force at command. The plan was therefore adopted of retabulating the perturbations of the sun, Mercury, Venus, and Mars, from Leverrier's fundamental formulæ, omitting terms less than $0''.05$, and including only tenths of seconds in the tables. With the tables of the sun a complete ephemeris of the sun's longitude and radius vector was computed for Greenwich mean noon from 1765 to 1864, inclusive, a period of one century.

Tables were also constructed for changing the sun's longitude to right ascension and declination, and for reducing the latter from Greenwich mean noon to Greenwich apparent noon, as well as from Greenwich apparent noon to apparent noon at the principal observatories. The right ascensions and declinations for Greenwich apparent noon have been completed for the dates of observation at the principal observatories up to the year 1838.

In the case of the planets Mercury, Venus, and Mars, a slightly different system is adopted according as the date of observation precedes or follows 1830, January 1, when an accurate ephemeris was introduced into the Berliner Jahrbuch. For the earlier period it was necessary to compute either ephemerides for Greenwich mean noon, including each series of observations, or to compute the place for the moment of each separate isolated observation. In the latter case the computation had to be made in duplicate, but in the former it was generally considered that the daily difference would afford a sufficient check.

From and after 1830 it is necessary to compute the geocentric place only at such intervals that the difference between the ephemeris and the Berliner Jahrbuch, or the British Nautical Almanac, can be interpolated to intermediate dates. On this system the heliocentric places of the three planets have been finished up to 1864, with the exception of the dates of the Palermo and Madras observations.

In the case of Venus and Mars the geocentric places for Greenwich mean noon are nearly complete, but still await the laborious work of interpolation to the moment of observation. In the case of Mercury the work has been done for different series of observations in a somewhat unsystematic way. The comparison with observation is, however, nearly complete in the case of the Greenwich and Paris observations up to 1830, and is about half done for the other observations.

In the case of Mercury and Venus general tables are formed by which the coefficients for correcting the elements can be taken out at sight. This does away with the labor of computing these coefficients for each observation. I have not yet decided whether such tables are necessary in the case of Mars.

From the best estimate I can now form, the equations of condition for correcting the elements of the four inner planets will be ready for solution towards the end of the year 1889. They will however, involve extended discussion and comparison in order to get the results in the final form for publication.

The outer planets.—Of the work upon the four outer planets, I have to report that Mr. Hill's new theory of Jupiter and Saturn is in the

hands of the printer, and that Mr. Hill is engaged in the construction of the tables and ephemerides for finally correcting the elements of these two planets.

On Uranus and Neptune nothing has yet been done.

The lunar theory.—The principal work on hand in connection with the lunar theory is the comparison of Hansen's tables with observed occultations since 1750. The computations necessary for this purpose have been almost entirely made by officers of the Navy attached to the office from time to time. The last officer engaged upon it was Lieut. C. H. Amsden, U. S. Navy. Since his relief and retirement on account of failing health, nothing has been done on the work.

Mass of Jupiter.—Yet another branch of the planetary work is the determination of the mass of Jupiter from the motions of Polyhymnia. As stated in previous reports, the perturbations of this planet have been computed from the epoch of its discovery in 1854 up to October, 1888. The work awaits observations during the opposition of September and October of 1888, after which the final discussion can be taken in hand

ECLIPSE EXPEDITION TO JAPAN.

Among the most valuable data for correcting the elements of motion of the sun and moon are to be placed the accurate observations of solar eclipses, and especially the determination of the path of the shadow along the surface of the earth in central eclipses. The horizontal photo-heliograph, devised and constructed for the observations of the transit of Venus, affords a method of making these determinations with greater precision than any before available. It was therefore desirable to make arrangements for photographing the total eclipse of the sun which passed from Central Russia to Japan on August 19 last. No Government appropriation being available for the expense of sending out an expedition, an inquiry was addressed by me to the trustees of the Bache fund of the National Academy of Sciences to learn whether a grant of the necessary funds could be made by them. An affirmative reply being received, the matter was referred to the Bureau with a request for the loan of the necessary instruments from those which belonged to the Transit of Venus Expeditions, and for authority to act in the matter. Some other instruments necessary or useful to the expedition were loaned by the Coast and Geodetic Survey, the Geological Survey, and the Johns Hopkins University.

The expedition was placed in charge of Prof. David P. Todd, of Amherst College, who had volunteered his services for the work.

On the arrival of the expedition at Yokohama every possible assistance was rendered by the minister of the United States as well as by the Government and scientific authorities of Japan. By authority of the Department two officers of the Navy were detailed from the Asiatic squadron to assist in the work. The necessary preparations were all made with great efficiency and success; but the intervention of clouds during the critical hours of the eclipse frustrated, to a great extent, the objects of the expedition. A few photographs were taken through or between the passing clouds, but I can not yet decide whether they admit of precise measurement.

Very respectfully, your obedient servant,

S. NEWCOMB,
Superintendent Nautical Almanac.

To the CHIEF OF THE BUREAU OF NAVIGATION,
Navy Department.

No. 10.—BUREAU OF ORDNANCE.

BUREAU OF ORDNANCE, NAVY DEPARTMENT,
Washington City, October 17, 1887.

SIR: I have the honor to submit the annual report of this Bureau, and also to transmit estimates for the fiscal year ending June 30, 1889:

(1) Fuel, tools, material, and labor; prizes for enlisted men; batteries of the new types for four ships now in service; towards the general armament of the Navy with modern secondary batteries and small-arms; proof of naval armaments, and for modern guns and ammunition for instructing the cadets of the Naval Academy and the apprentices of the training squadron	\$988,250
(2) General repairs to ordnance buildings, magazines, and appendages	15,000
(3) Freight and miscellaneous expenses	5,000
(4) Civil establishment at navy-yards	24,525
(5) General expenses of the torpedo station; new landing stage; completing repairs to sea-wall; quarters for surgeon; two steam launches for instruction and experiment; and for correcting the sanitary condition of the cottages used as quarters at the station.....	89,500
(6) Towards the armament of vessels authorized	2,000,000
	3,122,275

CANNON.

The cannon that were originally commenced for the *Chicago*, *Boston*, *Atlanta*, and *Dolphin* have been nearly all finished, there remaining incompleated but one in the hands of the navy-yard, Washington, three at the South Boston Iron Works, and two at the West Point Foundry. These will all be completed in a few months.

For the armament of the ships since authorized to be built contracts have been made by the Department for gun-forgings as follows:

Caliber of gun.	Number of sets of forgings.	By whom to be furnished.
6-inch	32	Midvale Steel Company.
6-inch	46	Bethlehem Iron Company
8-inch	4	Do.
10-inch	24	Do.
12-inch	2	Do.

The 6-inch forgings under the Midvale contracts are beginning to come in, and will be taken in hand in the finishing shops of the Washington navy-yard at once. The whole number to be delivered under the contract with this firm must come in by February, 1889.

The plant of the Bethlehem Iron Company should be prepared to make the first deliveries of forgings by August 1, 1888, according to the terms of the contract, and when this company gets to work it is

thought that the supply of forgings both for large and small calibers will be ample.

In addition to the usual proof of the guns thus far finished, the "statutory test" of the 6-inch and 8-inch calibers has taken place. This consisted in a series of 10 rounds for each caliber, delivered as rapidly as possible, using the highest service charges.

The guns, their carriages and equipments, sustained this test without the least difficulty, and in the most successful manner. It took place in the presence of a board ordered by the Department for the purpose at the Naval Ordnance Proving Ground.

The guns of the *Atlanta* and *Boston* have been, besides, fired a large number of times in ranging and in practical tests, etc. No defects have been developed, and all have stood the work most satisfactorily.

Since last report the two 8-inch guns of the *Boston* have been finished and proved. They are hooped to the muzzle, and are fine specimens of work. The 8-inch guns of the *Chicago* are being machined by the South Boston Iron Works and by the West Point Foundry Association (two at each place). These firms have not been very prompt in executing the work, but it now approaches completion at West Point Foundry and is making progress at the South Boston Iron Works.

Of the two 10-inch guns that have been for some time in course of manufacture, one is completed and is at the proving ground being mounted for proof. The other is nearly finished.

A third 10-inch gun is commenced at the Washington navy-yard, and will be pushed to completion as fast as practicable. It is made from certain 10½-inch forgings that were obtained some time since in England, when it was intended to arm the monitor *Puritan* with guns of that caliber; but this intention being afterwards abandoned by the Department, the forgings in question became available for conversion into a 10-inch gun.

POWDER.

The specifications for American brown powder for 6-inch guns having been settled (as mentioned in the report of last year), the Messrs. DuPont were asked to undertake the development of a powder suitable for use in the chamber of the 8-inch gun, which was intended to burn about 125 pounds at a density of .95 behind a 250-pound projectile. This work has been considerably delayed by the manufacturers, who furnished several samples which, though they came near to the specifications, did not come up to them; but they have just submitted a sample which performs satisfactorily, and a sufficient quantity for the 8-inch guns of the *Boston* and *Chicago* is ordered. The manufacture of these slow-burning powders for high-power guns, particularly of the larger calibers, is difficult and subject to unavoidable delays, due to the difficulty of dealing with violent forces set at work, and of properly regulating and controlling them; but the Messrs. DuPont have been very successful with the new powders as a general rule, and we have no reason to anticipate any really serious trouble in obtaining powder of proper quality for the larger guns. We have a supply for trial in the 10-inch gun, and it will be proved as soon as that gun is mounted.

A suitable powder for the 5-inch guns has also been developed this year.

In the work with American brown powder at the proving ground for the past year no deterioration of the powder has been noticed, and it is hoped from this that it may prove to have good keeping qualities,

though a greater length of time and service at sea is necessary in order to settle this point.

The best results we have obtained thus far with 8-inch and 5-inch American brown powder are as follows :

Gun.	Powder.	Charge.	Projectile.	Muzzle velocity.	Pressure per square inch.
		Pounds.	Pounds.	Foot-seconds.	Tons.
8-inch B. L. R. (30 cal.)	American brown (DuPont & Co.).	113	250	2,008	15.5
5-inch B. L. R. (30 cal.)do.....	80½	60	2,011	14.2

German brown powder in the 8-inch B. L. R. gave the following : Charge 123 pounds, projectile 250 pounds, muzzle velocity 2,013 fs., pressure 15.5 tons per square inch.

PROJECTILES.

The manufacture of cast-iron projectiles for the new guns still goes on at the Washington navy-yard, but the Bureau regrets to state that its efforts to procure cast-steel projectiles of the proper quality has met with little or no success. The companies that have furnished them have been uniformly unsuccessful in their attempts to cast the projectiles sound. There is no difficulty in getting the necessary strength, and the extensibility required is not great, but nearly all the castings fail on the water test, being more or less porous. One or two of the firms are still trying to turn out sound shells, and it is to be hoped that they will succeed, as we must depend upon steel for war projectiles.

The Bureau has purchased a few armor-piercing shells from the St. Chamond company in France. These are of 6-inch, 8-inch, and 10-inch caliber, and are intended for use against sample armor plates, etc. It is greatly desired, however, to encourage the production of armor-piercing projectiles in the United States. The Chrome Steel Company, of Brooklyn, N. Y., has made for the Bureau a number of very good 6-inch armor-piercing-shell forgings, but those attempted for the 8-inch caliber were not so good. It is hoped that other attempts will be more successful.

Chrome steel seems to be best adapted to the manufacture of armor-piercing projectiles, and the Bureau has made many most excellent shells for the Hotchkiss guns from this metal. The Simonds Rolling Machine Company, of Fitchburgh, Mass., makes forged steel Hotchkiss projectiles on their patent, rolled to size, and requiring only to be bored and being slightly finished on the point. They use either carbon or chrome steel.

CARRIAGES.

The 6-inch and 8-inch carriages of the *Atlanta* have been placed on board that ship and have worked in a perfectly satisfactory manner.

The deck circles for these carriages were made of bronze and proved not to be sufficiently strong, nor strongly enough fastened down to the deck of the ship to properly sustain the jump and shock of recoil of such powerful guns as were mounted upon them ; they will, therefore, be replaced by steel circles, which are now being prepared. It is, however, proper to remark that the bronze circles when used on the solid deck at the proving ground supported the shock of recoil of the same guns per-

fectly well. The difference in behavior in the two cases is thought to be largely due to the spring of the decks and sides of the ship on receiving the shock of recoil.

Work on the 8-inch central pivot carriages of the *Chicago* has made satisfactory progress, and the steel circles for them have been furnished and have endured successfully a severe ballistic test, showing that the steel promises good ability to hold together under the shock of impact of Hotchkiss projectiles. This is a very important point gained, and will enable the Bureau to use cast-steel of the same quality for some of the principal parts of the carriages now about to be built for the new ships. Photographs of the pieces tested will be found in the appendix.

The type of 6-inch central pivot carriages for use in the ships now building is shown in the appendix, and it will be observed that all the bottom and breast transoms are of cast-steel, as also the brackets.

Some five years ago the Bureau made cast-steel carriages for the ships then building, but it was obliged to abandon their further manufacture at that time, owing to the inability of the steel makers to get ductility enough into the metal to enable it to support a proper ballistic test. This difficulty seems now, however, to have been largely obviated, and cast-steel will be used again, as above described.

The hydraulic carriage and loading apparatus for 10-inch guns, referred to in the last report of the Bureau, is nearly finished, and the most important parts of it have been shipped to the proving ground at Annapolis for use in the approaching trial of the 10-inch gun. Such parts of it as have thus far been tried with hydraulic pressure have performed satisfactorily. Three other carriages and loading apparatus on the same design are being brought forward in the shops of the Washington navy-yard. All four are intended for the *Miantonomoh*. They were figured in the appendix to the report of last year.

The work on carriages is largely due to Lieuts. Charles A. Bradbury and N. E. Mason, U. S. Navy, whose assistance is highly appreciated by the Bureau.

MACHINE GUNS AND CANNON.

Last year through the efforts of the Bureau, the Winchester Repeating Arms Company and the Union Metallic Cartridge Company had both been induced to produce metallic cartridge cases for 37-millimeter Hotchkiss guns, and the former firm also made 3-pounder and 6-pounder cartridge cases. As projectiles and powder were both easily manufactured, Hotchkiss ammunition of the above calibers could thus be produced in this country.

A few months after this result was obtained, the Hotchkiss Ordnance Company, of Paris, France, sent an agent to the United States for the purpose of endeavoring to establish a factory for the production of their guns and ammunition. This opportunity was improved by the Department, and an arrangement was made with the company for furnishing 90 Hotchkiss guns of the various calibers, from 57 to 37 millimeters, both inclusive, together with a good supply of ammunition, and with the proviso that all the work should be done in the United States. This judicious action will result in the permanent establishment of a most useful branch of manufacture in our country. The specifications for the guns and ammunition are about finished; the drawings have been prepared by the company, and the production of their gun steel is being commenced by the Midvale Steel Works, at Philadelphia, Pa.

The 9-pounder and 33- and 40-pounders on the rapid-fire principle, are now being developed abroad.

With regard to musket caliber machine guns, there have been no new developments or progress lately.

FUSES.

Several officers of the Navy have proposed alterations in the service percussion fuses, and new time and combination fuses have also been presented, and some of the devices possess merit.

SMALL-ARMS.

The Bureau has been for some time aware that a new revolver would soon be necessary for the service, the stock now on hand, which has come down from the war, being old, insufficient, and behind the present point of development. Accordingly the Colt's Patent Fire-Arms Manufacturing Company have been asked to design a pistol embodying the best points of their standard make, together with certain other features laid down by the Bureau. A sample pistol was made accordingly, and is now under examination.

It is apparent that a reduction in the caliber of small-arms is impending, and it is not the policy of the Bureau to purchase any greater number of muskets of .45 caliber than are necessary for current use. All the principal military powers are now at work upon rifles of .30 caliber, more or less, and it is thought that this country will soon be obliged to follow their example.

ARMAMENT OF THE NEW VESSELS.

Owing to lack of funds it has been impossible for the Bureau to advance the armament of the *Chicago* and *Boston* as fast as desirable. The appropriation "Steel cruisers" under which this work was heretofore performed, has long been entirely exhausted, and what was possible has been done under the appropriation "Ordnance." This appropriation is, however, at all times, so slender as to be of but little use for the purpose of fitting such ships as the ones in question. Additional money for the completion of the armament of these vessels was asked for at the last session of Congress, but failed to pass; it is urgently required, and should be again asked for as soon as Congress assembles.

The guns of the *Boston* are all finished, as also the 5-inch guns of the *Chicago*. The 6-inch guns of the *Chicago* are very nearly completed, but the 8-inch guns will not be finished for some three or four months, and her 8-inch carriages and most of her other equipments cannot be finished unless more money is appropriated.

ARMAMENT OF THE SHIPS NOW BUILDING, OF THE PROJECTED SHIPS, AND OF THE MONITORS.

The contracts made with the Midvale Steel Company and the Bethlehem Iron Company (referred to on page 1 of this report) will furnish forgings sufficient for manufacturing the guns of all the vessels thus far authorized, except the harbor-defense vessels mentioned in the act of March 3, 1887, sec. 3.

The designs of the latter ships are not yet fully developed, so it has not been possible to fix their armament.

Work on the carriages for two of the gun-boats has been commenced at the Washington navy-yard, and others will be taken in hand as

soon as occasion requires. They can easily be prepared by the time the guns are ready.

The estimates submitted under increase of the Navy for the fiscal year ending June 30, 1889, are intended to cover the expense of arming the following vessels: *Charleston*, *Baltimore*, *Miantonomoh*, four gun-boats, dynamite cruiser, torpedo-boat *Newark*, Cruiser No. 4, Cruiser No. 5, and three-fourths of the armament of the four monitors now building. It is thought that all these vessels except the monitors will be so far advanced by the above-mentioned time as to require for their use all the money that is to be allowed ordnance on their account. It is considered that the monitors will be about half finished at the same time, and that three-fourths of their ordnance allowance should be available. The armored cruiser and armored battle-ship are not estimated for this year, but should be next year.

THE NEW GUN FACTORY.

Intimately connected with the question of armament of the new ships is that of the construction of the new gun factory in the navy-yard, Washington. Several plans were entertained and carefully discussed for the arrangement of the buildings of the factory, and the Department finally decided to utilize the large building that had formerly been a forge and anchor shop, and to equip it for the manufacture of 6-inch and 8-inch guns, while immediately adjoining its north end a new and large building should be erected for finishing guns of the largest size.

The floor of the forge and anchor shop was to be lowered, the roof raised 6 feet, and a 40-ton traveling crane introduced, running the whole length of the shop.

In the large building a 110-ton traveling crane was to be introduced, and a shrinking pit for all classes of guns was to be located at the south end. A large shop immediately adjoining, to the west, was to be fitted up as a carriage and projectile shop and to be equipped with a 25-ton traveling crane.

The other buildings on the west side of the yard were to be utilized, some as foundry and finishing shops for small parts, and others as carpenter, pattern shops, etc.

In these shops it was proposed to install the machine tools shown in the appendix.

These plans are now being carried out, and the plans and sections of the shops as proposed will be found figured in the appendix.

When the factory is completed as above it is estimated that it will be able to turn out each year the following guns (ordinary working time): Six-inch, 25; 8-inch, 4; 10-inch, 6; 12-inch, 4, or a proportionate number of any given calibers.

Work on the alterations was begun in May, 1887, and the clearing out of the forge and anchor shop and digging out the old foundations and pipe connections under the floor was found to be an exceedingly laborious task. This has, however, been completed; the foundations for the 40-ton-crane supports have been mostly laid, and the work in that building will not hereafter offer so much difficulty.

The excavation for the foundation of the large gun shop is three-fourths completed, and the material for its construction has been advertised for and some of it delivered.

The traveling cranes are advertised for, and the machine tools will be speedily. The work of construction will be pushed forward as rapidly as practicable.

The report of Civil Engineer A. G. Menocal, U. S. Navy, as to the progress made on the buildings of the factory, together with estimates of cost, will be found in the appendix, page 257.

ARMAMENT FOR CERTAIN SHIPS NOW IN SERVICE.

The third-rate modern ships last built are good sea-boats, have compound engines, and are in most important respects good examples of the best class of wooden vessels. They will last some years, and must be depended upon to do most of the work of the Navy until a sufficient number of new ships are built to replace them.

It appears desirable that they should receive a modern armament, as the impression they produce without it is but slight.

When they are finally replaced the armament will answer for newer vessels.

There are eight of the class referred to, but the Bureau has submitted estimates for four, assuming that four may become unserviceable before their armament could be prepared.

The modern armament of six of these vessels was included in the estimates made last year.

It is considered very urgent that some breech-loading guns of suitable weight and of modern construction should be built for use at the Naval Academy and on the ships of the training squadron for the exercise of the young officers and apprentices and their instruction in the use of the modern weapons that they must soon handle in service. Suitable secondary batteries and small-arms should also be supplied for this purpose, and the Bureau has inserted an item to this effect in the estimates about to be submitted to Congress.

SPECIFICATIONS, CIRCULARS, ETC.

A very considerable part of the work of the Bureau during the past year has been the preparation of information, specifications, and rules for the assistance of bidders and for the conduct of the trials and tests of the numerous ordnance articles which have lately been contracted for by the Department.

The chief of these papers are as follows: Circular and specifications concerning the requirements to be observed in designing an armored cruiser and an armored battle ship; circular of information and tests to be applied to American armor plates to be furnished under the act of Congress approved March 3, 1885; circular of information and tests concerning armor and gun steel that was prepared for the use of bidders and others under the large contract that was recently awarded to the Bethlehem Iron Company; circular concerning the requirements and trials of a proposed steel torpedo boat; instructions in relation to the trial of the torpedo boat *Stiletto*; rules of procedure laid down for the guidance of the Torpedo Board in its trials of torpedoes under the act of Congress approved August 3, 1886; specifications for buildings and traveling cranes for the gun factory, and for machine tools for the same establishment, and specifications for Hotchkiss cannon and ammunition.

All these papers required thought, care, and time for their preparation, and several of them offered unusual difficulty, on account of the novel character of the questions involved, and the want of information in this country touching the subjects of which they treated.

The Department is particularly to be congratulated upon the placing of the large and important contract for supplying the new Navy with

gun steel and armor. As the Bureau prepared the data, circular, and inspections, which contributed so much to the information of bidders concerning these new branches of manufacture, it feels a natural pleasure in the success of the whole undertaking.

In the preparation of the above-mentioned papers, and in every other kind of work during the year, Lieut. A. R. Couden, U. S. Navy, has borne a very prominent part. His services have been of great value to the Bureau and to the Navy.

Lieut. Charles A. Stone has done valuable service, as also Lieut. W. W. Kimball.

THE NAVAL ORDNANCE PROVING GROUND

Has continued to do most satisfactory work, though owing to lack of funds its sphere has been very much circumscribed. It has proved the powder and guns that have been completed during the past year, ranged the guns, tested gun-carriages, steel carriage castings, thin steel plates, and small projectiles, and has done such other work in that line as from time to time became necessary. It is just about to undertake the test of the 10-inch gun and carriage.

During the year American brown powder for the 5-inch and 8-inch high power rifles has been developed, and a supply ordered for service.

An electric searcher and photographer for the bores of cannon has been devised, which promises to be very useful to the Bureau in manufacturing work. It will be found figured in the appendix.

In ranging the new 5-inch gun the work could only be carried to 3,700 yards on account of the presence of such numbers of fishing boats on the range. It is hoped, however, soon to complete the range table.

For the same reason the ranging of the new 8-inch rifle was very greatly delayed, and calculation had to be chiefly relied upon for marking the sight-bars.

A great deal of work has been done in proving and testing the ammunition of ships returned from service, and in testing military devices submitted by private inventors and manufacturers.

A set of reloading tools for Hotchkiss ammunition has been perfected at the proving ground and at the Washington navy-yard. The devices are thought to be simple and effective.

The proving ground is also preparing for the test of the Clark deflective target. The neighborhood of the town and other buildings and the proximity of two light-houses to the range make it necessary to provide very fully for the confinement of the shot within the shelter to be erected about the target. Great care will be observed in this matter, and it is thought that no danger will ensue from the trial.

Lieut. Austin M. Knight, U. S. Navy, continues in charge of the proving ground, and performs excellent work. His annual report will be found in the appendix, page 260.

At the last session of Congress the sum of \$40,000 was appropriated for the purchase of a new site for a proving ground and for the erection thereon of certain buildings. The Bureau has been endeavoring to find a suitable place for the new site, but thus far without much success. Most of the region conveniently accessible from Washington (and the proving ground should not, if practicable, be removed very far from that place) is too thickly populated, and the land is too high in price, while the neighboring waters are used for fishing and oystering to such an extent as to seriously interfere with such work as is done at a proving and ranging ground; still, it is thought a suitable site can be found, and the search will continue,

TORPEDO TRIALS.

In order to allow torpedo inventors and others to present fully their designs and devices for trial, with a view to selecting torpedoes under the act of Congress approved August 3, 1886, a Torpedo Board was organized, and all persons interested were (by advertisement in the public press) informed of the fact, and notified to put themselves in communication with the Board. This has been done to a limited extent, but no torpedo suitable for adoption has thus far been brought forward for trial.

The Bureau's instructions to the Board will be found in the appendix, page 279.

The Board is still in session.

TORPEDO BOARD.

Plans and designs of torpedoes have been submitted by the following persons and firms, viz: H. Berdan, Louis Bagger, Dana Dudley, Bradley A. Fiske, W. L. D. O'Grady, Rudolph M. Hunter, Remington & Pen-thorne for H. P. Griswold, Nicholas K. Halpine, Martin E. Hall, Alfred P. S. Miller, F. H. Paine, Benjamin C. Pole, J. N. Patrick.

Finished torpedoes have been presented by the Patrick Torpedo Company, the Howell Torpedo Company, and by Lieut. M. E. Hall, U. S. Navy.

Some preliminary trials of the Patrick torpedo have been made before the Board, and a programme of further trials has been submitted to the company, with a request that they be carried out at an early date.

Trials with the other torpedoes have not as yet been made, the owners not being fully prepared.

SPECIAL INSTRUCTION OF CONTINUOUS-SERVICE MEN.

The instruction of enlisted men at the Washington navy-yard and at the Torpedo Station has been successfully pursued during the past year, the men under instruction acquitting themselves very well.

It is impossible to overestimate the importance of this instruction, or the value to the Navy of the men who have been thus trained. They have a readiness with tools, and in handling electrical plant, artillery, torpedoes, and small-arms, which was quite unknown to the old man-of-wars-man, and captains of ships are eager to get them among the number of their crews. It is thought the number instructed should be as large as practicable, and that the scope of the instruction should be enlarged so as to take in gunnery also, including the service, pointing, and firing of great and of smaller guns.

This latter instruction can not be thoroughly and practically given without the use of a ship for gunnery practice. The same vessel could be used as an ordnance experimental ship for the trial of new forms of guns, carriages, projectiles, and other ordnance material. Such a ship has long been a desideratum of the Bureau, and it is urgently recommended that one of the smaller vessels be assigned to that service.

GENERAL INSTRUCTION AND EXERCISES OF THE CREWS OF CRUISING SHIPS.

The introduction into the service of modern guns and their elaborate ammunition and fittings directs attention to the necessity of a very

full and complete instruction in the exercise of these arms in target practice, and in the care and management of the material generally; furthermore the cost of modern ammunition prohibits its being thrown away in practice from want of sufficient preliminary instruction and careful training. A very full consideration of this matter by the Bureau has resulted in the opinion that the crews of ships should have a systematic course of instruction in the use of the armament as soon as the vessels are commissioned, and before they go abroad or on general service. Accordingly, a scheme for such instruction has been drawn up and the Bureau will submit it to the Department and recommend its adoption.

It may be remarked that the same programme of instruction and practice should be applied to the old ships, for although their ordnance fittings have not the same effectiveness and power as those of the new vessels, the instruction to the crew would have the same value.

In the estimates for the next year the Bureau has inserted an item for the purchase of prizes and medals to be awarded to the enlisted men of the Navy who acquit themselves the most creditably in target practice and ordnance exercises. Such prizes are given each year in all the principal navies, and they are a powerful incentive to effort. Certainly nothing can be more important in the Navy than excellence in marksmanship and in gunnery generally.

PHOTOGRAPHING TARGET PRACTICE.

The Bureau has devised a method of registering the results of target practice by means of instantaneous photography. The necessary apparatus will be issued to service as soon as prepared, and will, it is thought, be very convenient for use, especially at sea.

The method, in its simplest form, consists briefly in taking an instantaneous photograph of the target and of the point of fall of each shot as it strikes the water, the photograph to be taken from a boat which holds herself reasonably near the target and about 90° from the line of fire. One dimension of the target being previously fixed (usually the height of the staff) it becomes easy to measure for each round the distance of the point of fall from the target, and the camera and paper are to be so arranged that successive photographs can be taken as rapidly as desired; but one boat is required and her distance from target and ship need not be known, as each photograph carries with it its own scale.

The distance from the boat of both target and ship can be sufficiently well fixed by the view itself by means of standard scales of height previously determined for the camera.

The same general method can also be applied with the camera aloft, provided a reference scale of distances is prepared beforehand, using the instrument at the height at which it is intended to observe the gun practice.

The best application of the last arrangement would probably be when the ship is moving at speed, the distance of the target constantly changing, and the range comparatively short; in such a case the record of practice would be complete, and the plan is calculated to be useful, particularly in the case of practice with the secondary battery.

In case it is found convenient to have the recording camera quite small, an enlarging instrument might be used afterward.

SUBAQUEOUS BOATS.

Subaqueous boats for use in naval warfare have for a very long time been considered a great desideratum, and many of different types have been designed and built since the time of Bushnell (in the time of the American Revolution), who first gave impetus to this branch of attack and defense.

Development has been retarded heretofore by the want of a convenient practical motor which could give speed and certainty to the movements of the vessel, both above and below the surface of the water.

Of late years invention has made considerable progress in this direction, and methods of generating power in the subaqueous vessel (by means of steam and otherwise) without the assistance of a fire and air draft have been devised, some of which promise well.

The Department, considering that the time had arrived for endeavoring to make progress in submarine work of this kind, some time since directed the Bureau to prepare an advertisement and circular to be issued for the purpose of drawing the attention of those interested in subaqueous work to the requirements of the Department in this particular, and pointing out the general direction in which advance in invention should be made. These papers have been prepared, and the circular will be found in the appendix, page 273.

TORPEDO BOAT.

Under authority conferred by the act of Congress entitled "An act to increase the naval establishment," approved August 3, 1886, the Department advertised for proposals, July 22, 1887, for a torpedo boat for the United States Navy, to be built in accordance with a "circular showing the general requirements to be fulfilled in the design and performance of a steel twin-screw sea-going torpedo boat."

The circular was prepared by the Bureau, and approved by the Department July 22, 1887. The proposals in answer to the advertisement have not yet been opened.

STEAMER STILETTO.

Congress having made an appropriation to enable the Secretary of the Navy to purchase the steamer *Stiletto* for use as a torpedo boat for experimental purposes (act approved March 3, 1887), the Bureau, under direction of the Department, caused to be prepared a form for official trial of this boat, which will be found in the appendix, page 277.

In the preparation of specifications for the torpedo boat and the programme of trial of the *Stiletto* the Bureau had the valuable assistance of Lieut. Commander G. A. Converse, U. S. Navy.

PNEUMATIC GUN-CARRIAGE.

The Department referred to the Bureau designs for using pneumatic pressure for manoeuvring an 8-inch Navy gun-carriage. The designs were submitted by the Pneumatic Gun-Carriage and Power Company, and the Bureau is still in communication with the company concerning them.

STEEL CAST GUNS.

Under authority conferred by act of Congress, approved March 3, 1887, making an appropriation "for the purchase and completion of

three steel cast rough bored and turned, 6-inch, high power rifle cannon, of domestic manufacture, one of which shall be of Bessemer steel, one of open-hearth steel, and one of crucible steel," the Bureau, under direction of the Department, prepared specifications and proposals for these guns. In answer to the advertisement, dated June 23, 1887, two bids were received, one for the rough bored and turned casting of Bessemer steel and the other for the rough bored and turned casting of open-hearth steel. These bids have not yet been acted upon.

TORPEDO STATION.

The Torpedo Station has continued under the very efficient charge of Commander C. F. Goodrich, U. S. Navy, and all its affairs have been carried on by him to the entire satisfaction of the Bureau and in furtherance of its orders and views.

The gun-cotton factory has not been in operation much lately, a supply of this explosive sufficient for the immediate needs of the Navy having been accumulated. It is thought that a cheaper grade of acid and cotton than heretofore can hereafter be used in the production of this explosive.

The transportation companies of the country show great unwillingness to transport gun-cotton, thinking it dangerous, whereas it is (as prepared by the Navy Department) absolutely harmless. The Bureau is in correspondence with the board of underwriters of New York on this subject, and it is hoped that some change in the transportation rules in this regard may be the result.

The present factory at the Torpedo Station is not adapted to the safe manufacture of large quantities of gun-cotton, as it was erected in a tentative and experimental way. A larger factory (with the different processes of manufacture separated in different buildings) should be erected at some point on the Atlantic coast, and one of the same kind on the Pacific coast. Gun-cotton is the safest high explosive for military use yet introduced, and is employed for such purposes by all the principal powers of Europe. Its importance to this country in time of war would be very great. The expense of these factories would not be large.

During the year a naval defensive mine (two sizes) has been designed. It will be found figured in the appendix. It is hoped that this mine will prove useful in the defense of fleets and ships at anchor, and it will be introduced as soon as manufactured, and as soon as funds will allow.

It has for some time been apparent that all the dynamos on board ships should be of the compound type, and of the same electric motive force. The determination of the proper form has long engaged the attention of the torpedo station, and will be made the subject of future efforts until a proper type has been settled upon.

An installation for the electric lighting of the Torpedo Station has now been erected, and works very satisfactorily. It has proved to be of great use in the instruction of officers and men of the Navy, in care, management, and repair of electric-lighting circuits, and it will be still more useful in the future. For purposes of instruction part of it has been put up in the same way as is practiced on shipboard.

Researches ordered last year by the Bureau as to a proper motor for manoeuvring guns by electrical power have been pushed forward at the station as fast as circumstances would permit. The question offers several points of difficulty, but it is hoped that they will be speedily overcome.

Several very important questions on the efficacy of the torpedo service have been decided this year at the station. They are mentioned in the report of Commander Goodrich. (See appendix.)

Two steam launches are very desirable for use at the station in the exercise of officers and men in torpedo service. The item has been inserted in the estimates.

The course of instruction for officers and men at the station has been made more practical than ever. Torpedoes and their management have been given the first place and the most time (as their relative importance demands). Questions in the tactics of the torpedo were given out to each member of the class at the beginning of the course, and also at the examination, and their solution furnished a most excellent mental exercise for the officers engaged. It must be remembered, however, that the course of instruction (for all) at the station extends only over three months, and though very much is done in that time, it is virtually impossible to cover all the ground in an entirely satisfactory manner. It is believed, however, that the course is about as comprehensive and suitable as could be devised, with the time at our disposal.

The usual class of enlisted men have received a valuable training in practical torpedo and electrical work, as elsewhere stated.

The number of officers at the Torpedo Station is inadequate to the very important work that they have to perform, and it is very desirable that at least three more be furnished at once. The annual report of Commander Goodrich will be found on page 261 of the appendix. It is excellent in all respects, and will well reward perusal.

All the officers of the station have performed their duties to the entire satisfaction of the Bureau, and the classes under instruction have been attentive and industrious.

The report of the Board ordered to witness the examination of the class of officers at the station will be found in the appendix, page 272. It is an interesting document, and the Board seem to have been highly pleased with what they saw.

The clerical force of the Bureau has performed its duties with intelligence and zeal; but the present extensive elaboration of ordnance material, the largely-increased appropriations for the armament of new ships, and the multifarious details in connection therewith, render it physically impossible for the small number of clerks and one draughtsman now allowed to properly keep up with all the work of the Bureau, and the increase of two first-class clerks, one copyist, and one assistant draughtsman, asked for in the estimates, is urgently recommended.

The following statements are appended, viz :

- A.—Statement showing amount appropriated under each specific head of appropriation for the service of the Bureau of Ordnance during the year ending June 30, 1887, expenditures during the same period, and balance remaining on hand June 30, 1887, amounts expended for material and labor, and what balance will be required to meet outstanding obligations made during the year.
- B.—Statement of the number of days' labor and cost thereof from July 1, 1886, to June 30, 1887, at the respective navy-yards and stations, chargeable to the Bureau of Ordnance.
- C.—Amount expended during the fiscal year ending June 30, 1887, from the appropriations under the Bureau of Ordnance for civilians employed on clerical duty, or in any other capacity than as ordinary mechanics and workingmen.
- D.—Statement of contracts entered into by the Bureau of Ordnance during the fiscal year ending June 30, 1887, with schedule of bids upon which the same were based.
- E.—Statements of sales of condemned material under the cognizance of the Bureau of Ordnance, during the year ending June 30, 1887, and net amounts realized therefrom.

The usual statement of cost or estimated value of stores on hand, received and expended during the year ending June 30, 1887, is omitted, as the accounts thereof were transferred to the general store-keepers January 1, 1887.

I am, sir, your obedient servant,

MONTGOMERY SICARD,
Chief of Bureau.

HON. W. C. WHITNEY,
Secretary of the Navy.

A.—Statement showing the amount appropriated under each specific head of appropriation for the service of the Bureau of Ordnance during the fiscal year ending June 30, 1887, expenditures during the same period, and balance remaining on hand June 30, 1887.

Appropriation.	Appropriated.	Expended.	Balance June 30, 1887.
Ordnance	\$109,300.00	\$105,233.72	\$4,066.28
Repairs, ordnance	15,000.00	12,545.43	2,454.58
Civil establishment	23,204.00	22,851.89	352.61
Contingent ordnance	4,000.00	3,988.52	11.48
Torpedo Corps	58,500.00	46,688.38	11,811.62
	210,004.00	191,307.43	18,696.57

The amounts expended were:*

For labor	\$129,783.60
For material, etc	61,523.83
	191,307.43

The balances remaining are all needed to meet outstanding obligations or future requirements, except the balance under appropriations "repairs" and "civil establishment."

B.—Statement of the number of days' labor and cost thereof from July 1, 1886, to June 30, 1887, at the respective navy-yards and stations chargeable to the Bureau of Ordnance.

Navy-yards.	Number of days' labor.	Cost of same.
Portsmouth	675	\$2,551.90
Boston	1,451	8,430.83
New York	10,443	28,068.15
League Island	624	1,231.65
Washington	91,351	210,093.73
Norfolk	4,304	8,436.21
Pensacola	313	504.36
Mare Island	3,133	8,720.95
Key West, Fla.	31	75.00
Naval Ordnance Proving Ground	8,020	10,577.20
Torpedo Station	9,185	25,305.70
	129,530	296,290.68

* Exclusive of expenditures from special appropriations, new steel cruisers, etc.
† Includes labor on the new steel cruisers, etc.

C.—Amounts expended during the fiscal year ending June 30, 1887, from the appropriations under the Bureau of Ordnance, for civilians employed on clerical duty, or in any other capacity than as ordinary mechanics and workmen.

Navy-yard.	Rating.	Amount paid.
Portsmouth, N. H.....	1 writer	\$975.33
Boston, Mass.....	1 writer (2 months).....	169.09
New York.....	1 clerk.....	1,300.27
	1 writer	1,017.25
Washington	1 clerk.....	1,591.59
	1 writer	1,018.85
	1 writer	1,011.83
	1 draughtsman	1,548.76
	1 draughtsman	1,065.91
	1 draughtsman	994.98
	1 draughtsman	996.27
	1 assistant draughtsman.....	772.69
	1 foreman	2,154.07
	1 special office hand	567.09
	1 special office hand	555.25
	1 assistant storekeeper.....	624.09
	1 draughtsman (110 days).....	885.00
	1 assistant draughtsman	310.25
	1 telegraph operator (2 months).....	150.00
	1 quartermen B. & I. finishers.....	1,232.09
	1 quartermen B. & I. finishers.....	1,015.49
	1 quartermen B. & I. molders	1,017.12
	1 leading man pattern-makers	1,034.25
	1 leading man laboratorians	1,036.00
	1 superintendent of new construction for ordnance plant (45 days).....	455.00
	1 leading man of joiners on ordnance plant (46 days).....	147.69
	1 quartermen of laborers on ordnance plant (34 days).....	71.46
	1 quartermen of laborers on ordnance plant (10 days).....	21.00
Norfolk.....	1 clerk.....	1,134.91
Mare Island.....	1 writer	958.90
Naval Ordnance Proving Ground.....	1 writer	999.98
Torpedo Station	1 chemist.....	2,500.00
	1 clerk	1,200.00
	1 draughtsman	1,500.00
		31,471.82

D.—Abstract of offers for furnishing supplies for the several navy-yards by contract, under the Bureau of Ordnance, during the fiscal year ending June 30, 1887, noting contracts awarded thereon.

Nor navy-yard, Portsmouth, N. H. :

Under advertisement dated August 9, 1886.

Canvas, paints, etc. :

*Rider & Cotton..... \$262.50

Spruce poles, boards, and lime:

*Geo. A. Hammond..... 52.25

John H. Broughton..... 69.50

For navy-yard, New York:

Under advertisement dated August 10, 1886.

Hardware:

Geo. H. Creed..... 1,367.46

*John Swan & Co..... 1,347.41

A. F. Brombacher & Co..... 1,687.24

W. A. Wheeler..... 1,471.60

Oils, etc.:

*Geo. H. Creed..... 166.00

W. A. Wheeler..... 194.50

Acids, etc.:

*Geo. H. Creed..... 55.75

W. A. Wheeler..... 90.50

Miscellaneous articles:

Geo. H. Creed..... 1,138.15

*W. A. Wheeler..... 862.50

* Awarded,

For navy-yard, New York—Continued.

Fire-buckets, etc.:		
Geo. H. Creed	\$1,428.00	
R. A. Robbins	977.52	
*W. A. Wheeler	877.50	
Cordage, etc.:		
Geo. H. Creed	440.83	
*R. A. Robbins	287.48	
W. A. Wheeler	322.95	
Paints:		
Geo. H. Creed	699.40	
*R. A. Robbins	641.01	
W. A. Wheeler	772.72	
C. T. Reynolds & Co	695.81	
Alcohol:		
†W. A. Wheeler	30.00	
Candles:		
*Geo. H. Creed	147.50	
R. A. Robbins	157.81	
W. A. Wheeler	102.50	
Lumber, etc.:		
J. W. Duryee	729.10	
*Watson & Pittinger	648.90	
Type-writer, etc.:		
*Arthur & Bonnell	110.00	
Hose, etc.:		
Geo. H. Creed	314.00	
R. A. Robbins	260.70	
*W. A. Wheeler	231.00	

Under advertisement dated September 11, 1886.

Sheet piling, etc. Ordnance Dock:		
J. D. Leary	5,940.00	
W. Roosevelt	6,388.00	
M. Engle	5,357.00	
J. E. White	9,106.44	
Frank Pidgeon	9,250.00	
J. W. Flaherty	5,089.56	
T. A. Walsh	7,300.00	
James Dubois	6,593.00	
John Kelly	8,000.00	
*Thos. O'Connell	4,595.00	
Richard Cronin	6,225.00	
J. E. Howard	5,341.00	

For navy-yard, Norfolk, Va.:

Under advertisement dated August 9, 1886.

White pine:		
*G. L. Neville	4,850.00	
Iron, tools, etc.:		
G. L. Neville	40.41	
Mayer & Co	38.99	
*E. J. Griffith & Co	30.34	
E. V. White & Co	56.65	
Elliott & Walke	42.05	
Twine, etc.:		
*G. L. Neville	4.20	
Mayer & Co	15.25	
E. J. Griffith & Co	4.40	
E. V. White & Co	4.65	
Elliott & Walke	6.40	
Oil, turpentine, etc.:		
*G. L. Neville	91.15	
Mayer & Co	99.25	
E. V. White & Co	97.55	
Elliott & Walke	110.75	

* Awarded.

† Not awarded; no license.

For navy-yard, Norfolk, Va.—Continued.

Brooms:

G. L. Neville	\$2.40
Mayer & Co	2.40
*E. J. Griffith & Co	1.74
E. V. White & Co	2.00
Elliott & Walke	2.40

Soap:

G. L. Neville	1.70
Mayer & Co	1.40
*E. J. Griffith & Co75
E. V. White & Co	2.20
Elliott & Walke	1.00

Ink:

G. L. Neville	3.00
*Mayer & Co	1.50
Elliott & Walke	3.00

Brushes:

*G. L. Neville	1.60
Mayer & Co	3.60
E. J. Griffith & Co	2.45
E. V. White & Co	2.25
Elliott & Walke	2.25

Tallow:

*G. L. Neville	7.00
Mayer & Co	7.00
E. V. White & Co	8.00
Elliott & Walke	10.00

Single-stick blades:

*G. L. Neville	25.00
Mayer & Co	25.00
E. J. Griffith & Co	25.00

Beeswax:

G. L. Neville	15.00
*Mayer & Co	14.00
E. V. White & Co	20.00
Elliott & Walke	15.00

Yellow pine:

*G. L. Neville	10.00
----------------------	-------

Fire-bricks, etc.:

*G. L. Neville	10.00
----------------------	-------

Iron tacks:

G. L. Neville60
Mayer & Co60
*E. J. Griffith & Co24

Brooms:

G. L. Neville	4.80
Mayer & Co	4.20
*E. J. Griffith & Co	3.48
E. V. White & Co	4.00
Elliott & Walke	4.50

Tools, blocks, etc.:

G. L. Neville	17.80
Mayer & Co	17.70
*E. J. Griffith & Co	16.23
E. V. White & Co	28.30
Elliott & Walke	20.45

Whitewash brushes:

E. J. Griffith & Co	3.75
G. L. Neville	3.75
*E. V. White & Co	2.25
Mayer & Co	3.00
Elliott & Walke	4.50

Common soap:

G. L. Neville50
*Mayer & Co25
E. J. Griffith & Co	1.90
E. V. White & Co40
Elliott & Walke50

*Awarded.

For navy-yard, Norfolk, Va.—Continued.

Oars:	
G. L. Neville	\$3.84
*Mayer & Co.	3.60
E. V. White & Co	3.84
Elliott & Walke	4.20
Halliards:	
G. L. Neville	2.50
*Mayer & Co.	2.25
Elliott & Walke	3.75
Iron pipe:	
*G. L. Neville	10.00
Paint brushes, etc.:	
G. L. Neville	18.75
*Mayer & Co.	17.75
E. V. White	20.90
Elliott & Walke	20.50
Vinegar:	
G. L. Neville	6.25
*Mayer & Co.	5.00
Lanterns:	
*G. L. Neville	5.00

For navy-yard, Washington :

Under advertisement dated September 24, 1886.

Lumber:	
*W. W. McCullough	1,497.00
Geo. A. Shehan	1,629.00
John Miller	1,881.00
J. M. Duryce	2,061.50
Willett & Libbey	2,156.25
Hardware:	
*R. A. Robbins	949.48
F. M. Smith	1,060.69
J. B. Kendall	976.25
G. L. Neville	1,214.29
John Swan & Co.	1,102.79
Paints, oils, etc.:	
*W. B. Price Manufacturing Company	179.32
J. Lucas & Co	208.42
F. M. Smith	218.16
Z. D. Gilman	198.41
Molding sand, etc.:	
*Whitehead Bros	398.25
J. B. Kendall	429.25
Charcoal:	
*J. F. Clarke	140.00
Hamilton Bros	600.00
J. B. Kendall	160.00
Bricks:	
*J. B. Kendall	35.00
Files:	
R. A. Robbins	811.18
F. M. Smith	924.20
*T. Somerville & Sons	755.37
F. T. Witte Hardware Company	853.07
J. B. Kendall	882.70
G. L. Neville	939.22
John Swan & Co.	969.16
J. W. Soper	932.36
Morley Bros	819.00
Pig-iron:	
M. Lissberger	1,375.00
*J. B. Kendall	1,318.75
Copper and tin:	
R. A. Robbins	368.97
*M. Lissberger	365.88
G. L. Neville	375.00

*Awarded.

For navy-yard, Washington—Continued.

Steel:

*Esherick & Co.....	\$476.75
F. M. Smith.....	478.15
J. B. Kendall.....	509.20
G. L. Neville.....	647.00
Sanderson Bros.....	749.50

Pulley blocks:

R. A. Robbins.....	153.30
Crook, Horner & Co.....	210.00
F. M. Smith.....	134.26
F. T. Witte Hardware Company.....	143.80
J. B. Kendall.....	133.75
G. L. Neville.....	137.80
J. A. Baker.....	169.00
*J. W. Soper.....	107.50
S. C. Forsaith Machine Company.....	134.40
Morley Bros.....	112.00

Universal chucks:

R. A. Robbins.....	225.60
Crook, Horner & Co.....	228.80
F. M. Smith.....	257.88
F. T. Witte Hardware Company.....	246.40
J. B. Kendall.....	226.00
*John Swan & Co.....	211.20
S. C. Forsaith Machine Company.....	225.28

Reamers and drills:

R. A. Robbins.....	473.39
Crook, Horner & Co.....	451.47
F. M. Smith.....	475.39
F. T. Witte Hardware Company.....	446.63
J. B. Kendall.....	441.10
*G. L. Neville.....	370.78
John Swan & Co.....	438.00
S. C. Forsaith Machine Company.....	465.62

Emery wheels:

*J. B. Kendall.....	122.40
John Swan & Co.....	153.88
S. C. Forsaith Machine Company.....	144.06
Morley Bros.....	125.00

Belting:

R. A. Robbins.....	136.72
Crook, Horner & Co.....	150.00
F. M. Smith.....	158.30
*J. B. Kendall.....	132.00
J. A. Baker.....	191.00
S. C. Forsaith Machine Company.....	148.25
M. Lindsay.....	159.00
Morley Bros.....	174.00

Leather:

R. A. Robbins.....	387.00
*F. M. Smith.....	328.00

Sheepskins:

*N. T. Metzger & Bro.....	122.00
R. A. Robbins.....	135.00
J. B. Kendall.....	145.00
G. L. Neville.....	150.00
Z. D. Gilman.....	175.00

Sperm and lard oil:

A. G. Belden & Co.....	520.00
*N. T. Metzger & Bro.....	462.85
W. B. Price Manufacturing Corapany.....	517.50
Francis Miller.....	539.00
F. M. Smith.....	508.00
Z. D. Gilman.....	487.00

Eldorado oil:

A. G. Belden & Co.....	38.00
N. T. Metzger & Bro.....	25.49

*Awarded.

For navy-yard, Washington—Continued.

El Dorado oil—Continued.

W. B. Price Manufacturing Company.....	\$30.00
Francis Miller.....	40.00
Poole & Brooke.....	26.50
F. M. Smith.....	30.00
J. A. Baker.....	32.00
Z. D. Gilman.....	26.50
*Morley Bros.....	25.00

Brooms:

N. T. Metzger & Bro.....	81.45
*Poole & Brooke.....	81.40
J. B. Kendall.....	97.90

Canvas, etc.:

*R. A. Robbins.....	90.85
F. M. Smith.....	108.40

Wood:

Johnson Bros.....	215.00
*G. L. Sheriff.....	212.50

For navy-yard, Mare Island, California.

Under advertisement dated August 13, 1886.

Lumber:

*William Walker.....	49.00
James McCudden.....	62.50
A. Powell.....	65.00

Paints, etc.:

*Whittier, Fuller & Co.....	182.50
†Sullivan & Co.....	144.77

Hardware:

*Huntington, Hopkins & Co.....	24.60
--------------------------------	-------

For the Naval Ordnance Proving Ground, Annapolis, Md.

Under advertisement dated August 12, 1886.

Lumber:

*William D. Gill.....	347.00
S. Burns & Co.....	356.50
P. M. Womblo.....	467.50

Hardware, tools, etc.:

*Clendennin Bros.....	224.22
-----------------------	--------

Chrome steel:

*Chrome Steel Works.....	48.00
--------------------------	-------

Oil, alcohol, etc.:

John J. Thomsen.....	276.81
G. F. Rieffe.....	276.87
The W. B. Price Manufacturing Company.....	318.83

Photographic supplies:

*Bachrach & Bro.....	174.90
----------------------	--------

Charcoal:

*J. F. Shields.....	2.50
---------------------	------

For torpedo station, Newport, R. I.

Under advertisement dated August 21, 1886.

Kerosene oil:

No bids.

Engine, lard, sperm and linseed oils:

G. D. Putnam & Co.....	224.00
J. M. K. Southwick (31 gallons to barrel).....	179.80
*Vacuum Oil Company (50 gallons to barrel).....	203.00
‡Mason, Chapin & Co.	
§Geo. Dunbar & Co.	

Bertram oil polish:

*G. D. Putnam & Co.....	5.85
J. M. K. Southwick.....	6.00
‡Geo. Dunbar & Co.....	5.22

Lumber:

*Swinburne, Peckham & Co.....	1,335.16
-------------------------------	----------

Malleable iron:

No bids.

Tool steel, iron, etc.:

‡J. M. K. Southwick.....	581.00
--------------------------	--------

*Awarded.

§ Received after time.

† Bid on part only.

‡ Exorbitant

‡ Incomplete.

For torpedo station, Newport, R. I.—Continued.

Tool steel, iron, etc.—Continued.

* Brown & McClure.	
* Geo. Dunbar & Co.	
Bolts, ends and nuts:	
† Geo. D. Putnam & Co.....	\$32.00
J. M. K. Southwick.....	108.00
† Geo. Dunbar & Co.....	56.00
Steel tubes:	
No bids.	
Small chain:	
§ J. M. K. Southwick.....	13.00
Iron pipe:	
Walworth Manufacturing Company.....	124.80
Geo. Dunbar & Co.....	137.28
Twine, yarn, etc.:	
† G. D. Putnam & Co.....	54.30
J. M. K. Southwick.....	56.70
G. Dunbar & Co.....	52.36
Bunting:	
¶ G. D. Putnam & Co.....	16.50
J. M. K. Southwick.....	27.00
G. Dunbar & Co.....	15.00
Cotton waste:	
¶ G. D. Putnam & Co.....	532.50
J. M. K. Southwick.....	660.00
† Massasoit Manufacturing Company.....	610.00
G. Dunbar & Co.....	517.50
Chemicals:	
** Mason, Chapin & Co.....	64.60
†† McKesson & Robbins.....	98.90
Kerite wire:	
No bids.	
Rubber washers, etc.:	
†† G. D. Putnam & Co.....	220.60
† Hall Rubber Company.....	255.96
†† Hodgman Rubber Company.....	141.95
†† Geo. Dunbar & Co.....	
Sheet zinc, copper, brass, etc.:	
G. D. Putnam & Co.....	188.90
†† J. M. K. Southwick.....	251.70
** Holden & Herrick.....	157.00
†† Geo. Dunbar & Co.....	
Brass castings:	
† Fred Fuller.....	276.00
Paints, etc.:	
* Geo. D. Putnam & Co.....	296.97
W. H. Green.....	398.62
** Merrill, Dexter & Co.....	
** Mason, Chapin & Co.....	
** Geo. Dunbar & Co.....	
Eckstein's white lead:	
† G. D. Putnam & Co.....	175.00
W. H. Green.....	181.23
Mason, Chapin & Co.....	192.50
† Merrill, Dexter & Co.....	175.00
† Geo. Dunbar & Co.....	
Window glass:	
G. D. Putnam & Co.....	26.25
W. H. Green.....	30.47
Swinburne, Peckham & Co.....	23.00
Merrill, Dexter & Co.....	21.90
† Mason, Chapin & Co.....	18.17
Hardware, etc.:	
† G. D. Putnam & Co.....	331.89
J. M. K. Southwick.....	404.57

* Received after time.

† Awarded.

‡ Informal, etc.

§ Exorbitant.

|| After time.

¶ Rejected. Not to advantage of Government.

** Incomplete.

†† Rejected.

‡‡ Too high.

For torpedo station, Newport, R. I.—Continued.

Hardware, etc.—Continued.	
* Swinburne, Peckham & Co.....	\$302.80
* A. C. Titus & Co.....	80.13
† Geo. Dunbar & Co.....	
Oats and corn:	
‡ J. G. Stevens	124.80
Candlestick globes:	
‡ Swinburne, Peckham & Co.....	3.60
Tallow, etc.:	
‡ Geo. D. Putnam & Co.....	18.00
Geo. Dunbar & Co.....	19.25
Belt lacing, etc.:	
‡ Geo. D. Putnam & Co.....	16.00
Swinburne, Peckham & Co.....	18.00
Geo. Dunbar & Co.....	16.50
Paper fasteners:	
No bids.	
Tape and thread:	
No bids.	
Soap:	
No bids.	
Gelatine, soda, etc.:	
§ McKesson & Robbins	
Kerite cells:	
No bids.	
Charcoal, etc.:	
No bids.	
Matches:	
No bids.	
Methyl:	
‡ Mason, Chapin & Co.....	61.87
Merrill, Dexter & Co.....	72.00
Cast-iron:	
§ Fred. Fuller	150.00
Lime and cement:	
‡ Swinburne, Peckham & Co.....	162.50
Brick:	
No bids.	

E.—Statement of sales of condemned material under the cognizance of the Bureau of Ordnance during the year ending June 30, 1887, and net amounts realized therefrom.

Condemned bronze, under Bureau's advertisement of January 31, 1887:	
37,545 lbs. at Boston navy-yard. Purchased by T. Butler & Co. Net proceeds	\$3,257.54
270,072 lbs. at Washington navy-yard. Purchased by M. Lissberger. Net proceeds	21,847.84
77,490 lbs. at Norfolk navy-yard. Purchased by M. Lissberger. Net proceeds	6,299.94
Scrap iron at the Washington navy-yard, under Bureau's advertisement of June 21, 1887, 250,000 pounds (more or less). Purchased by J. Dreifus & Co., of Alexandria, Va., at \$18 per ton. (Account not yet closed.)	
Old ferry launch at Torpedo Station, Newport, R. I., under advertisement of June 16, 1887. (Account not yet closed.)	

* Incomplete. † Received too late. ‡ Awarded. § Informal.

Tabulated statement of proposals opened November 1, 1887, for the construction and erection of three overhead traveling cranes, and their supports, and the frame for a gun shop at the navy-yard, Washington, D. C.

Supports for one 40-ton overhead traveling crane :

Post & McCord, New York, N. Y.....	\$26,400.00
W. G. Coolidge & Co., Chicago, Ill.....	25,000.00
Same company (combined bid) †.....	24,935.00
A. & P. Roberts & Co., Philadelphia, Pa*.....	24,117.80
One 40-ton overhead traveling crane :	
The Yale and Towne Manufacturing Company, Stamford, Conn....	24,880.00
The Morgan Engineering Company, Alliance, Ohio*.....	24,750.00
Iron frame for a 12-inch gun-shop and supports for 110-ton overhead traveling crane in same :	
Post & McCord, New York, N. Y.....	57,930.00
W. G. Coolidge & Co., Chicago, Ill.....	55,000.00
Same company (combined bid) †.....	54,950.00
A. & P. Roberts & Co., Philadelphia, Pa.*.....	53,089.50
Materials for supports for one 25-ton overhead traveling crane :	
Post & McCord, New York, N. Y.....	16,120.00
A. & P. Roberts & Co., Philadelphia, Pa.....	13,954.00
W. G. Coolidge & Company, Chicago, Ill.*.....	13,800.00
Same company (combined bid) †.....	13,765.00
One 25-ton overhead traveling crane : ‡	
The Morgan Engineering Company, Alliance, Ohio.....	17,750.00
The Yale and Towne Manufacturing Company, Stamford, Conn.....	16,100.00
One 110-ton overhead traveling crane :	
The Yale and Towne Manufacturing Company, Stamford, Conn.....	71,945.00
The Morgan Engineering Company, Alliance, Ohio*.....	67,500.00

Tabulated statement of proposals opened September 20 1887, for unforged steel castings for 6-inch guns.

Bessemer-steel casting, rough-bored and turned :	
The Pittsburgh Steel Casting Company, Pittsburgh, Pa.*.....	\$3,300.00
Open hearth steel casting, rough-bored and turned :	
The Standard Steel Casting Company, Thurlow, Pa.*.....	5,300.00

* Accepted.

† The "combined bid" was to be the contract price, provided the bidder was awarded the contract for constructing all the articles for which he bid under his "combined bid."

‡ Under consideration.

Estimates of appropriations required for the service of the fiscal year ending June 30, 1889, by the Bureau of Ordnance, Navy Department.

Detailed objects of expenditure, and explanations.	Estimated amount which will be required for each detailed object of expenditure.	Total amount to be appropriated under each head of appropriation.	Amount appropriated for the current fiscal year ending June 30, 1888.
SALARIES.			
Chief clerk (act March 3, 1887; R. S., p. 70, sec. 416; Stat. L., 24, p. 621, sec. 1).....	\$1,800 00		
Draughtsman (same acts).....	1,800 00		
One clerk of class three (act March 3, 1887; R. S., p. 27, sec. 167; Stat. L. 24, p. 621, sec. 1).....	1,600 00		
One clerk of class two (same acts).....	1,400 00		
One clerk at \$1,000 (same acts).....	1,000 00		
One assistant messenger (same acts).....	720 00		
One laborer (same acts).....	660 00		
		\$8,980 00	\$8,980 00
Increase submitted:			
To salary of chief clerk.....	450 00		
<p><i>NOTE.</i>—The chief clerk is required by law to act as chief of Bureau in case of vacancy, or of the absence or sickness of that officer (in case no other appointment is made). His duties are as responsible and arduous as those of the chief clerks in the other Executive Departments, who are required by law to perform the same functions, and who now receive a like compensation, viz, \$2,250 per annum.</p>			
One assistant draughtsman.....	1,400 00		
Two clerks of class one.....	2,400 00		
One copyist.....	900 00		
	5,150 00		
<p><i>NOTE.</i>—Owing to the present extensive elaboration of ordnance material, and the largely increased appropriations for the fitting of new ships, it is physically impossible for the limited force now allowed to properly perform the clerical work of the Bureau, and the increase asked for is urgently recommended.</p>			
ORDNANCE AND ORDNANCE STORES.			
<p>For procuring, producing, preserving, and handling ordnance material; for the armament of ships; for fuel, tools, material, and labor to be used in the general work of the Ordnance Department; for furniture at magazines at the ordnance dock, New York, and at the naval ordnance battery and proving ground, and for prizes to enlisted men for excellence in ordnance exercises and target practice (act March 3, 1887; p. 582, sec. 1).....</p>			
	170,000 00		
Main and secondary batteries complete of the new types for four of the ships now in service (submitted).....	445,000 00		
Towards the general armament of the Navy with modern secondary batteries, and small arms:			
30 machine-cannon of modern caliber (submitted).....	93,000 00		
18 musket-caliber machine guns (submitted).....	49,500 00		
1,000 magazine rifles, equipments, and ammunition (submitted).....	34,750 00		
400 naval cadet magazine rifles (submitted).....	6,000 00		
3,000 revolvers and ammunition (submitted).....	50,000 00		
Proof of naval armaments (act March 3, 1887; R. S., p. 582, sec. 1).....	6,000 00		
For modern guns and ammunition for instructing the cadets of the Naval Academy (submitted).....	60,000 00		
For modern guns and ammunition for instructing the apprentices of the training squadron (submitted).....	65,000 00		
		988,250 00	126,400 00
REPAIRS, ORDNANCE.			
Necessary repairs to ordnance buildings, magazines, gun-parks, boats, lighters, wharves, machinery, and other objects of the like character (act March 3, 1887; R. S., p. 583, sec. 1).....		15,000 00	15,000 00
CIVIL ESTABLISHMENT.			
Navy-yard, Portsmouth, N. H.:			
One writer (act March 3, 1887; R. S., p. 583, sec. 1).....	500 00		
Navy-yard, Boston, Mass.:			
One writer (same act).....	500 00		

Estimates of appropriations required for the service of the fiscal year, etc.—Continued.

Detailed objects of expenditure, and explanations.	Estimated amount which will be required for each detailed object of expenditure.	Total amount to be appropriated under each head of appropriation.	Amount appropriated for the current fiscal year ending June 30, 1888.
CIVIL ESTABLISHMENT—continued.			
Navy-yard, New York, N. Y.:			
One clerk (same act)	\$1,400.00		
Navy-yard, Washington, D. C.:			
One clerk (same act)	1,600.00		
One writer (same act)	1,017.25		
One writer (same act)	1,017.25		
One draughtsman (same act)	1,545.00		
One draughtsman (same act)	1,081.00		
One draughtsman (same act)	1,081.00		
One draughtsman (same act)	1,081.00		
One draughtsman (same act)	1,081.00		
One assistant draughtsman (same act)	772.00		
One foreman (same act)	2,156.00		
One copyist (same act)	720.00		
One copyist (same act)	720.00		
One telegraph operator (same act)	900.00		
Navy-yard, Norfolk, Va.:			
One clerk (same act)	1,200.00		
Navy-yard, Mare Island, Cal.:			
One writer (same act)	1,017.25		
Naval Ordnance Proving Ground, Annapolis, Md.:			
One writer (same act)	1,017.25		
Torpedo Station, Newport, R. I.:			
One chemist (same act)	2,500.00		
One clerk (same act)	1,200.00		
One draughtsman (same act)	1,500.00		
		\$24,525.00	\$24,525.00
CONTINGENT ORDNANCE.			
Miscellaneous items, viz: Freight to foreign and home stations, advertising, cartage and express charges, repairs to fire-engines, gas and water pipes, gas and water-tax at magazines, toll, ferrage, foreign postage, and telegrams to and from the Bureau (same act)		5,000.00	5,000.00
TORPEDO CORPS.			
Labor, material, freight and express charges, general care of and repairs to grounds, buildings and wharves, boats, instruction, instruments, tools, furniture, experiments, and general torpedo outfits (same act)	60,000.00		
New landing stage (submitted)	1,000.00		
Completing repairs to sea-wall (submitted)	3,000.00		
NOTE.—The amount appropriated for this item last year (\$3,000) will be inadequate, as the quantity of stone in the old wall appears less than was supposed when the original estimate was made.			
Quarters for surgeon (submitted)	8,000.00		
NOTE.—As the number of enlisted men under instruction at the station is increasing, the constant presence of a surgeon is desirable.			
Two service steam launches for experimenting with and instruction in service torpedo fittings (submitted)	10,000.00		
For correcting the sanitary condition of the cottages used as quarters at the station (submitted)	7,500.00		
		89,500.00	57,800.00
NOTE.—The bath-rooms and water-closets adjoin and open into the sleeping rooms. It is proposed to locate them in small L's to be built in the rear, thus removing what has been found a source of illness in the past.			
INCREASE OF THE NAVY ARMAMENT.			
Towards the armament, of domestic manufacture, for the vessels authorized by the act of March 3, 1885; of the vessels authorized by sections 1 and 2 of the act of August 3, 1886; of the unfinished monitors mentioned in section 3, of the same act, and of the <i>Mission</i> and of the vessels authorized by the act approved March 3, 1887, except the floating batteries or rams or other naval structure to be used for coast and harbor defense (submitted)		2,000,000.00	2,128,362.00

DEFICIENCIES.

Estimates of appropriations for deficiency required for the service of the fiscal years ending June 30, 1886-'87, by the Bureau of Ordnance, Navy Department.

[See Revised Statutes, Title 41, page 720, sections 3660 to 3671; Statutes 18, chapter 129, page 370, section 3, act of March 3, 1875, and section 2, deficiency act of July 7, 1884, 23 Stat., 254.]

Detailed objects of expenditure, and explanations.	Estimated amount which will be required for each detailed object of expenditure.	Total amount to be appropriated under each head of appropriation.	Amount appropriated for the fiscal year for which the appropriation is required.
CONTINGENT—ORDNANCE.			
To supply a deficiency in the appropriation for the contingent service of the Bureau of Ordnance for the fiscal year ending June 30, 1887 (July 26, 1886, R. S., 24, p. 151, sec. 1). (See appended statement, marked A)		\$1, 195. 05	\$4, 000. 00
To supply a deficiency in the appropriation for the contingent service of the Bureau of Ordnance for the fiscal year ending June 30, 1886 (March 3, 1885, R. S., 23, p. 423, sec. 1). (See appended statement, marked B)		1, 109. 70	3, 000. 00

A.—Statement of outstanding unpaid bills, approved by the Bureau of Ordnance, to meet which a deficiency appropriation is required.

APPROPRIATION CONTINGENT, ORDNANCE, 1887.

To whom due.	For what purpose.	Amount.
Baltimore and Ohio Telegraph Company	Telegrams	\$0. 48
George W. Knox	Freight	13. 91
Army and Navy Register	Advertising	16. 80
South Boston Iron Works	Freight	44. 58
J. H. Johnson & Co.	do	123. 00
Metropolitan Steamship Company	do	2. 00
Jackson & Co.'s Express	do	1. 00
Western Union Telegraph Company	Telegrams	7. 24
N. Y. and B. Transportation Line	Freight 41
Do	do	1. 30
George W. Knox	do 82
Do	do	15. 20
Rackett & Bro.	do	32. 50
Adams Express Company	do 70
Do	do	3. 20
Chesapeake and Potomac Telephone Company	Rental	37. 50
Adams Express Company	Freight	1. 95
A. F. Gomes	do	10. 85
Do	do	5. 75
Do	do	4. 60
Western Union Telegraph Company	Telegrams	1. 09
George W. Knox	Freight	5. 20
Evans, Ball & Co.	do	52. 79
N. Y. and B. Transportation Line	do	1. 92
Western Union Telegraph Company	Telegrams	2. 93
George W. Knox	Freight 90
H. Welch, postmaster, Annapolis	Rent of post-office box	1. 50
Baltimore and Ohio Express	Freight	7. 65
Pennsylvania Railroad Company	do	3. 44
Adams Express Company	do 75
Baltimore and Ohio Railroad	do 75
Sunset Telephone Company	Rental	15. 00
Inland and Seaboard Coasting Company	Freight	102. 36
George W. Knox	do	65. 00
Adams Express Company	do	9. 35
Inland and Seaboard Coasting Company	do	00. 18
Metropolitan Express	do	4. 15
Old Colony Railroad Company	do 65
Adams Express Company	do 95
Do	do 50
George W. Knox	do	4. 26
Adams Express Company	do	1. 85
George W. Knox	do	2. 85
Washington Line Steamers	do	11. 53
Old Colony Steamboat Company	do	3. 06
Do	do	3. 20
Pacific Coast Steamship Company	do	4. 85
Estimated liabilities not yet presented		500. 00
Total		1, 195. 05

B.—Statement of outstanding unpaid bills, etc.—Continued.

APPROPRIATION CONTINGENT, ORDNANCE, 1888.

To whom due.	For what purpose.	Amount.
Malden and Melrose Gas-Light Company	Gas at Nitre Depot	\$14.00
Chelsea Gas-Light Company	Gas at Chelsea	8.25
Western Union Telegraph Company	Telegraphing	3.00
Do	do	.00
George W. Knox	Freight	1.00
Adams Express Company	do	8.00
Inland and Seaboard Coasting Company	do	1.75
George W. Knox	do	89.21
Do	do	50.78
Do	do	252.52
Patton, Vickers & Co	do	79.16
A. and E. Railroad Company	do	3.35
Inland and Seaboard Coasting Company	do	119.10
Westcott Express Company	do	1.40
C. H. Mallory & Co	do	11.91
Metropolitan Steamboat Company	do	3.50
Baltimore and Ohio Telegraph Company	Telegrams	.50
Sunday Gazette	Advertising	16.00
George W. Knox	Freight	1.78
Do	do	7.43
Sunday Herald	Advertising	12.00
Army and Navy Register	do	13.20
National Republican Company	do	8.51
Do	do	9.05
Inland and Seaboard Coasting Company	Freight	1.50
Washington Post	Advertising	7.20
Do	do	7.87
Do	do	9.00
Western Union Telegraph Company	Telegraphing	1.21
Baltimore and Ohio Telegraph Company	do	6.70
George W. Knox	Freight	2.91
N. Y. and B. Transportation Line	do	5.51
Baltimore and Ohio Railroad Company	Expressage	.95
George W. Knox	Freight	9.90
Army and Navy Register	Advertising	12.00
Adams Express Company	Freight	6.70
Do	do	6.70
Old Dominion Steamship Company	do	47.43
Evening Star	Advertising	13.20
Do	do	15.00
Do	do	12.00
Chesapeake and Potomac Telephone Company	Rental	62.50
Adams Express Company	Expressage	.60
Western Union Telegraph Company	Telegraphing	1.16
Adams Express Company	Expressage	10.50
A., B. and W. Railroad	Freight	64.87
George W. Knox	do	6.06
Do	do	1.29
Do	do	8.50
Do	do	3.40
Do	do	1.44
Evening Star	Advertising	23.40
Inland and Seaboard Coasting Company	Freight	24.11
Adams Express Company	do	2.25
Do	do	.50
Do	do	.25
A., W. and B. Railroad Company	do	3.81
Western Union Telegraph Company	Telegraphing	1.13
A., W. and B. Railroad Company	Freight	8.00
Total		1,108.70

APPENDIX.

UNITED STATES NAVY-YARD, WASHINGTON.

CIVIL ENGINEER'S OFFICE, *October 31, 1887.*

SIR: In compliance with the instructions from the Bureau of Ordnance, contained in its telephone message of October 19 instant, and referred to this office, I respectfully submit herewith plans and cross-sections of the proposed "gun-carriage shop, the 8-inch-gun shop, and the 12-inch-gun shop," and also estimated cost for the completion of the same, exclusive of tools, together with a statement of the progress of the work and the actual expense incurred in connection therewith, up to the 15th of October, 1887:

8-inch-gun shop (old anchor shop).

Estimated cost:		
Clearing out.....	\$9,085.00	
Excavating 3,915 cubic yards.....	3,915.00	
		\$13,000.00
Reconstruction:		
Removing cross and north walls.....	400.00	
Two new roof trusses, in place	1,500.00	
Raising roof 6 feet	7,000.00	
Repairs to roof.....	1,000.00	
Sky-lights, removing old ventilator and framing new	3,600.00	
Glazing sky-lights (contracted for).....	4,000.00	
Floor.....	12,484.00	
Necessary alteration to doors.....	800.00	
Total cost of alterations to building		30,784.00

40-ton crane supports.

Foundations:		
Excavations	\$4,176.00	
Piles	1,620.00	
Timber	605.00	
Iron	1,411.00	
Concrete	3,668.00	
Pumping and incidentals.....	2,500.00	
Total		13,980.00
Superstructure:		
460,508 pounds iron erected, at 4 cents.....		18,420.00
Total cost of building and superstructure.....		76,184.00

The work of clearing out the building consisted in the removal of the heavy machinery and tools, such as steam hammers, iron rolling mill, boilers, swinging cranes, pumps, furnaces, air-blowers, engines, etc., etc., together with their stacks, foundations, steam, water, and air pipes, and large quantities of coal, coke, scrap-iron, etc., forming altogether a mass of iron and masonry which have been both tedious and expensive to handle. Attached to this report will be found a list of the material removed, and it will be observed that large quantities of old bricks and stone will be useful in the work of reconstruction.

The work of clearing out is nearly completed, and the expense for labor and material under that head (to October 15 instant) amounts to \$8,361, leaving \$724 from the estimated cost for its final completion, which I regard as sufficient.

The work of excavation is practically finished, and the actual expense for labor and tools amounts to \$3,915 (or \$1 per cubic yard).

The work of reconstruction has been fairly begun. Twenty concrete foundation piers for the crane supports have been practically completed, and the pits for 14 more are now ready for the concrete or foundation piles. Much difficulty has been met

with in the excavation of these pits on account of the old concrete and stone foundations for the support of machinery, which extended to considerable depth. Where no pile foundation is needed the concrete piers have not been constructed until the ground has been thoroughly tested as to its sustaining power per square foot.

The work has been well done, and now that the tedious and expensive operation of clearing out and preparation has been practically finished, and the building materials are on hand, operations will be pushed forward more rapidly and at less expense.

The work of reconstruction, including crane supports, has already cost for labor and material \$4,820.60, making the total disbursement on this building to the 15th October, \$17,563.11; material purchased, but in store, is not included in this amount.

12-inch-gun shop.

Estimated cost:

Excavation and clearing of site	\$12,246.00
Retaining-wall and steps	5,117.46
Shrinking-pit	15,000.00
Concrete, in foundation and floor	6,753.00
Granite	3,381.16
Brick-work	12,331.12
Lumber-work	13,446.84
Slating	2,678.50
Glazing	3,614.40
Tin-work	781.00
Hardware	1,000.00
Minor iron-work	1,147.50
Iron frame and roof	24,820.84
Painting	2,712.00
Plumbing, ventilation, drains, etc	5,000.00

Total..... \$110,029.82

110-ton crane supports.

Excavation	\$900.00
Iron-work for anchors	746.42
Concrete in foundation piers	949.50
Concrete molds and incidentals	1,500.00
Superstructure	16,277.64

Total..... 20,373.56

Grand total for the building 130,403.38

The work on this building has been confined to the preparation of the site, by removing 1,461 tons of coal, the excavation of about 1,500 cubic yards of material, including an old retaining-wall about 225 feet long, and beginning the construction of the retaining-wall on the east side.

The actual expense for labor and material has been \$11,144, of which \$10,496.88 has been charged to clearing out the site and excavation, and \$467.12 to the construction of the retaining-wall. Much of the material for the building is now on hand and the balance has been covered by requisitions. The work is being pushed forward as rapidly as possible.

Gun-carriage shop.

Estimated cost:

Removing cranes and machinery	\$6,000.00
Removing cross wall	200.00
Removing old trusses and replacing with new ones north and south ends	2,000.00
New truss over cross-wall	800.00
Removing floors and foundations of machinery	2,000.00
Tearing down chimneys and brick-work repairs	1,000.00
Repairing slate roof	500.00
Blacksmithing—miscellaneous	1,500.00
Removing rubbish, incidentals, etc	1,000.00
Excavation, 1,057 cubic yards, at \$1	1,057.00
Floor (new)	8,481.52

Total..... \$24,538.52

25-ton crane supports.

Foundations:	
Excavation	\$2,000.00
Piles	3,727.50
Timber	1,182.30
Iron	2,345.00
Concrete	2,085.45
Pumping, etc	2,500.00
Superstructure:	
308,901 pounds iron, at 4 cents	12,356.04
	26,202.29
Total	50,740.81

Work has not yet been commenced in this shop. The foundation piers for the crane-supporting columns will rest on pile foundation, and the driving of piles will be commenced as soon as the pile-driver and engine can be withdrawn from the 8-inch gun shop. The necessary material has been required, and much of it is already on hand, but none has yet been expended.

Recapitulation.

Anchor shop (8-inch-gun shop)	\$76,184.00
Twelve-inch-gun shop	130,403.38
Gun-carriage shop	50,740.81
	257,328.19
Add 10 per cent. for contingencies	25,732.81
	283,061.00

Respectfully submitted.

A. G. MENOCAI,
Civil Engineer, U. S. N.

Capt. R. W. MEADE, U. S. N.,
Commandant.

Respectfully forwarded to the Bureau of Ordnance.

R. W. MEADE,
Captain, Commandant.

APPENDIX.

Materials removed in the work of clearing out anchor shop (8-inch-gun shop).

Scrap iron	tons.	125
Miscellaneous iron, comprising anvils, anvil-blocks, piping, foundations, plates, etc	tons.	650
Machinery of different kinds, consisting of engines, pumps, boilers, rolling-mills, etc	tons.	2,900
Assorted lumber, consisting of cranes, bracing in roof, benches, offices, etc., the greater part of which has been utilized as scaffolding	feet.	190,000
Fire-brick, from old furnaces (as rubbish)	number.	32,000
Old brick, now being used in walls after raising roof	do.	230,000
Coke (for use in furnaces)	tons.	220
Dirt representing 8,062 cubic yards	loads.	12,714
Brick and stone foundations (405 cubic yards)	do.	644

Have removed enough broken brick (not suitable for building purposes) to make 150 yards concrete for retaining wall at site of 12-inch-gun shop.

Removed from site of 12-inch-gun shop.

Coal, pertaining to Bureaus Equipment and Steam Engineering	tons.	1,461
---	-------	-------

NAVAL ORDNANCE PROVING GROUND, ANNAPOLIS, MD.

OCTOBER 13, 1887.

SIR: The following summary is respectfully submitted of the work of this station during the present year:

POWDER.

At the time of preparation of my last annual report the development of a domestic brown powder for the 6-inch caliber of the new steel rifled ordnance had been successfully completed.

The only sample of 8-inch powder tested had fallen slightly short of the Bureau's requirements, but no material difficulty was anticipated in effecting the slight improvement necessary.

The difficulty has proven somewhat greater than was expected, however, a considerable number of trial samples, variously modified in composition, having successively failed by a very small margin. The velocity required—2,000 foot-seconds \pm 15 foot-seconds—was repeatedly exceeded; but the pressures, though moderate, were higher than was admissible under the Bureau's specifications for service powders, which fix the limit of pressure at 15 tons.

Various circumstances, moreover, have combined to delay the manufacture of experimental samples, and it is only since the beginning of the present month that the specifications as to both velocity and pressure have been simultaneously fulfilled.

The powder for the 5-inch caliber was perfected without difficulty and with very little delay. The first trial sample tested gave the following results, which have been easily duplicated under the recent orders from the Bureau:

Charge, 30 $\frac{1}{2}$ pounds.

Projectile, 60 pounds.

Initial velocity, 2,011 foot-seconds.

Pressure, 14.2 tons.

In view of the approaching trial of the first 10-inch guns, a sample of powder for this caliber has been manufactured and is now ready for test.

GUNS.

The proof of the guns for the armament of the new cruisers has been continued, and in the case of the *Atlanta* and *Boston*, completed. In addition to the proof rounds prescribed by the Bureau these guns have almost without exception fired a large number of rounds in the tests of material, in ranging, and in other current work of the station. In the tests of experimental powders the pressures have risen much above the service limit, but without developing any defect either in the guns themselves or in the working of their breech mechanism.

After the highest pressures that have been developed the breech has been found to open as easily as after ordinary rounds.

The careful inspection and star-gauging to which each gun is subjected before issue from this station for service shows that up to the present time all have stood the test most satisfactorily.

In this connection I will refer to the recent completion and satisfactory tests of an apparatus for searching and photographing the bores of guns by an electric light. This is a combination of a design developed two years ago (N. O. P. G., No. 135, of September 10, 1885) for photographing, and one proposed more recently for searching, the bore. Should the use of the searcher reveal any defect the camera can be at once attached and the defect photographed either in full size or on a scale enlarged or reduced.

RANGE TABLES.

Firing has been done from the 5-inch B. L. R. for the construction of two range tables with 2,000 foot-seconds and 1,700 foot-seconds, respectively, up to ranges of 3,700 yards. No opportunity has been found to fire with safety at greater distances than this, but it is hoped that this can be done during the next few weeks, when the necessary calculations and reductions will be made and the results tabulated.

There being very little prospect of an opportunity to fire the 8-inch B. L. R. for range, without serious danger to the vessels and fishing boats which habitually occupy our line of fire, two range tables for these guns have been calculated for use provisionally. The method used was that of Stacci, and the results are believed to be practically accurate within ordinary fighting ranges. Such firing as has been done from these guns down the range shows the flight of the service projectile to be smooth.

Much of the work of the station during the year has consisted of testing material for the old armament of the service, powder and projectiles for 8-inch M. L. R. and

60-pounder B. L. guns, ammunition returned from ships going out of commission, etc. Various samples of powder for machine and rapid-firing guns have been fired, and several specimens of material intended for use in gun carriages have been subjected to test under the impact of armor-piercing projectiles from rapid-firing guns.

Under the direction of the Bureau a large number of tests have been made of ordnance material submitted by private inventors and manufacturers. Among these may be mentioned: Plates of compound steel from Benj. Atha & Co. and the Pittsburgh Steel Casting Company; powder from the Laffin and Rand Powder Company; 3-pounder projectiles and .45 caliber steel bullets from the Simonds Manufacturing Company; a magazine rifle from Colt's Arms Company; movable base cartridges from Mr. G. W. Morse; spiral-pointed 3-pounder projectiles from Mr. D. L. Kennedy; leather-board paper shields from Lieut. Commander A. J. Iverson, U. S. Navy; and a rapid-firing 3-pounder gun from Lieut. W. H. Driggs and Lieutenant Schroeder, U. S. Navy.

Reports of all these tests have been duly made to the Bureau. Preparations have been begun for the test of the Clark defective target by opening the firing butt to admit of setting the target into it and by considerably increasing the thickness of the earth at the rear of the butt to arrest the projectile after impact. The situation of the proving ground with reference to residences and other buildings, especially to two light-houses, which are almost directly on the prolongation of the line of fire, and the constant presence on or near that line of several hundred fishing boats and numbers of larger craft, makes this test a peculiarly hazardous one, and calls for the exercise of extreme precautions. In the plan for sheltering the target, proposed and approved by the Bureau, it is believed that all danger of accident has been eliminated as far as it can be foreseen.

Preparations have been made for receiving and handling the 10-inch B. L. R. with its carriage and appendages. The construction of a platform for mounting this gun has been nearly completed and the firing butt considerably strengthened to resist the penetration of projectiles of this caliber.

By direction of the Bureau certain special experiments have been undertaken in instantaneous photography, but these have not yet progressed sufficiently far to admit of a report.

A set of tools for reforming and reloading Hotchkiss ammunition in service, designed under the direction of the Bureau, in part at this station and in part at the Washington navy-yard, has been tested and modified until found satisfactory.

By a number of parts small in comparison with those of the tools sold under patents by Hotchkiss & Co., all the operations of reforming and reloading are quickly and effectively done.

Respectfully, etc.,

AUSTIN M. KNIGHT,

Lieutenant, Inspector Ordnance, in Charge.

CHIEF OF BUREAU OF ORDNANCE,
Navy Department, Washington, D. C.

TORPEDO STATION, NEWPORT, R. I.

OCTOBER 13, 1887.

SIR: I have the honor to submit the following report of the work done at this station during the past twelve months, premising that much of it was planned by my predecessor, Commander Sampson.

Since the date of the last annual report the station has lost, through detachment, the valuable services of Lieutenant-Commander Newell and Lieut. J. A. Shearman. The officers at present are:

Lieutenant-Commander G. A. Converse, principal assistant inspector of ordnance, instructor in high-speed engines.

Lieut. Karl Rohrer, assistant inspector of ordnance, superintendent of the gun-cotton factory.

Lieut. J. B. Murdock, assistant inspector of ordnance, instructor in electricity.

Lieut. G. F. W. Holman, assistant inspector of ordnance, instructor in torpedoes.

Lieut. Hamilton Hutchins, assistant inspector of ordnance, instructor in electricity. Surgeon John C. Wise.

Passed Assistant Paymaster F. H. Clark.

Prof. Charles E. Munroe [S. B. Harv.], chemist to Torpedo Corps.

Gunner A. A. Phelps.

BUILDINGS AND PLANT.

The very extensive repairs to all the buildings on the island, for which preparations had been made by Commander Sampson, were inaugurated and completed last fall.

The energies of the station since then have been, in the main, devoted to putting the plant on a more satisfactory basis, so that manufactures may proceed with increased economy and dispatch. To this end the shafting has been changed in the carpenter-shop to permit belting direct, new machine tools, received from the Boston navy-yard, have been mounted, the blacksmith-shop moved to what was formerly the boiler-room, a tinsmith's shop fitted in the room adjoining the boilers, a new coal-shed and fuse-room constructed, the tool-room in the machine-shop enlarged, and a photographic dark-room prepared. The old blacksmith-shop has been devoted to dynamo-machines, all of which are now assembled in one place, to the great convenience of experiment and operation. Among these machines the only new one is a 200-light compound Westinghouse dynamo, mounted on the same bed plate with and directly coupled to a Westinghouse automatic engine. This dynamo, while largely used for instruction, as being of a type especially adapted to ship use, is also employed for lighting the buildings on the island. Its behavior is in all respects satisfactory.

The installation of the electric light in the various buildings is nearly completed. A few incandescent lamps are placed about the grounds to secure a moderate but well-distributed illumination, and two arc lamps are to be mounted in important open spaces, all to be run simultaneously by the Weston machine.

The enlargement of the electrical laboratory is well advanced.

In the matter of manufacture, articles have been made in larger quantities than was the previous custom, with a view of securing a prudent reserve coupled with greater economy of fabrication. The results which have followed justify the expectations that were entertained in this respect.

The securing of an adequate water supply has long been a burning question at the station. An extra appropriation for making connection with the water system of Newport was granted at the last session of Congress. How best to use this money has been a constant study. It is believed that a speedy solution, which will stand the test of time, will shortly be reached. In the mean while, with the Bureau's approval, an effort has been made to save the large amount of water now wasted by exhausting from the various steam-engines into the atmosphere. An old boiler has been turned into a condenser, an unused Sewell pump mounted to circulate salt water, while a smaller second-hand, but still serviceable, Sewell pump has been adapted as an air-pump, and two water-tanks turned into a hot-well and feed-water filter. It is confidently expected that a notable economy of fuel will be effected and the life of the boilers prolonged through the use of either rain-water or water of condensation free from scale or dirt, and raised to a comparatively high temperature by passing through a feed-water heater before entering the boilers.

From the circulating pump a branch delivery pipe passes up through the machine-shop, and is provided at each floor with a valve and a length of fire-hose. Near each valve is an electric call for ringing a gong in the condenser-room and ordering the attendant there to turn on a powerful stream of water. This ever-ready provision for extinguishing fire in the machine and carpenter shops is in my opinion alone sufficient to warrant the expense of the whole undertaking.

The erection of a 4-ton platform scale has greatly simplified the weighing of heavy or bulky articles, and has particularly expedited the receipt of the year's supply of coal.

This paragraph of my report would be incomplete without mention of the singularly efficient aid I have derived in a great variety of ways from the principal assistant inspector of ordnance at the station, Lieutenant-Commander Converse.

GUN-COTTON FACTORY.

Enough gun-cotton has been made, amounting to 7,500 pounds, to supply current wants of the service and to demonstrate the efficiency of the apparatus for making gun-cotton in blocks rather than in disks of the old pattern. I have been greatly assisted in my efforts to reduce the cost of manufacture of this important material by the intelligent and persistent efforts of Lieut. Karl Rohrer, the officer in charge of this factory.

An experiment in this connection was made on a suitable scale, which showed that it is possible to produce a satisfactory gun-cotton, by the use of acid, very much cheaper than that heretofore employed. A similar trial will, at the first opportunity, be made with cotton-waste of less value. Should this prove as successful as the preceding, the station will be able to supply gun-cotton of proper quality at about one-half the value of the old staple.

The substitution of gun-cotton blocks for gun-cotton disks has led to a wonderful diminution of volume, and to so decided an increase in density and efficiency, as to fully warrant the adoption of this pattern.

A certain economy and marked simplification in the torpedo outfit have been obtained by packing the gun-cotton directly in the torpedo cases instead of in maga-

since, as formerly, and in filling the primer case with wet disks, that may be dried for use as primers when required.

Through lack of Government transportation I have been unable to carry out the Bureau's order to send a lot of gun-cotton torpedoes to Mare Island. There is, indeed, no gun-cotton on the west coast of America except that on board of the *Vandalia*; a lamentable fact, calling for speedy action.

By careful watching, and by seizing the opportunities as they offered, I have succeeded in sending gun-cotton outfits as needed to New York and Norfolk in naval vessels, and to maintain at the latter point the emergency supply which the Bureau has directed. At New York double the regular amount is now held in reserve. While all this has been accomplished, there are yet at the station ten outfits of torpedoes filled with gun-cotton and ready for shipment at a day's notice.

It is proper to call public attention to the refusal of the transportation companies to accept our service-torpedo explosive as freight; a refusal which, while legal, is not justified by the nature of the substance rejected. Wet gun-cotton is absolutely safe in handling, is extremely difficult of ignition, and when ignited is not dangerous. Detonation alone can make it harmful, and detonation, under the circumstances, is a practical impossibility. The Bureau's efforts to secure acceptance of wet gun-cotton by freighting corporations can not be too soon successful.

Owing to the nature and construction of the gun-cotton factory, special precautions have been taken to guard against the occurrence of any accident. Regarded, as it always has been, as a purely experimental plant, it does well enough, but as a manufactory of gun-cotton on a large scale, or even in continuous operation, the building is very ill-arranged. The approved practice is to separate the different processes in disconnected structures, thus localizing the risks. I should not think it prudent to undertake the making of gun-cotton in great quantities in the present factory.

There are many reasons, strategic and industrial, why provision ought to be made elsewhere for the speedy erection of adequate plants for the production of the service high explosives. There should be at least one such factory near the eastern coast of the United States and one on the Pacific slope.

TORPEDO OUTFITS FOR SHIPS.

There have been no material changes in the service fittings or in the torpedo outfit generally. A few minor modifications, conceived with the hope of economy and simplicity, have been introduced. Of these the Bureau has been made aware from time to time. The most important of these is the strengthening, with but slight increase of weight, of the boat-fitting arms, which experiment showed to be lacking in stiffness.

The proposed naval-defense mines have been the subject of much consideration and experiment. The project now only awaits the formal approval of the Bureau to receive the last tests on a practical scale prior to being adopted into the service as standard.

The addition of these mines to the outfits of ships will necessitate the increase of the annual appropriation for the maintenance of the Torpedo Corps.

I am obliged to report that the "diving lamp" is not yet ready for issue. One such lamp has been made and tried, so far with great success, but, while reasonably certain that no changes in it will be found necessary, I am loath to recommend its definite adoption for the service until it has been subjected to further and exhaustive experiments. The failure of the station to secure this year a launch dynamo suitable for both arc and incandescent lights has prevented my pushing this important question to a close. I look for its complete settlement within a few months.

In this connection I beg to remark that so long as the different ships have dynamos of different types, and, worse still, of different electro-motive forces, it will be difficult to make the proposed launch dynamo fit into the general plan of a vessel's installation. It may not be out of place to mention that the Bureau has approved of placing one or more launch dynamos on board every ship, for use in diving and other submarine work—dynamos which can operate each about thirty incandescent lamps. It may be remarked that they would be of great service on magazines or even possibly day-lighting circuits. The latter use imperatively demands the adoption of a standard difference of potential for all dynamos and incandescent lamps in the Navy.

Under the head of outfits for ships it may be well to point out our continued lack of an automobile torpedo.

ELECTRICAL LABORATORY.

When the laboratory enlargement is completed it will be desirable to add slightly to the present number of electrical instruments, not much required, but it would seem prudent to move in this direction, and thus fit the laboratory for work of any description which may be called for by service requirements. I may with propriety remark that the station has made great strides in electrical development since the arrival of Lieutenant Murdock. Not only is this seen in material matters, but in the efficiency of the instruction of officers and enlisted men.

It is believed that all of the officers who completed the course of instruction last summer are competent to assume charge of the electrical lighting apparatus on board ship. Of course some gained more acquaintance with the subject than others, but all were made more or less familiar with the rules to be observed and the mode of operating ships' illuminating and search-light plants.

The subject of electric motors has received much thought. Steps have been taken to secure one or more for use in training the heavy guns of the *Chicago*.

TRIANA AND BOATS.

The *Triana* is in good condition. All of the boats at the station have been well cared for and are efficient.

The launch *Success* has received a new boiler. The new ferry-launch, built by Messrs. Pusey & Jones, of Wilmington, has already done good service, justifying her design and testifying to the excellent workmanship of her constructors. She is an iron boat about 50 feet long, propelled by twin screws, each driven by a pair of compound engines. She burns little coal, and requires but enough water to replace waste. She is of course a great improvement on the old craft, which, by direction of Congress, was sold at auction, bringing an insignificant sum.

I venture to renew the recommendation of past years, that the station be supplied with one, or preferably two, service steam launches. Without such conveniences the instruction must still be carried on in the boats now here, which are not of regular type. Makeshifts in so important a matter as the familiarizing of officers and men with the use of an instrument of warfare are to be deprecated.

LIBRARY AND RECORDS.

During the fiscal year ending the 1st of July last, 367 books and pamphlets were added to the library, the entire library rearranged, and 100 volumes, principally periodicals, bound. The card catalogue has increased by about 900 reference cards.

The current periodical literature has been indexed according to a set of rules prepared for the purpose. Each officer at the station is responsible for the indexing of certain of these periodicals, so that nothing of value can escape recording. The cards are conveniently marked by abbreviations of titles, etc., as well as of the characteristics of the articles to be indexed. The whole is presented topically. This catalogue alone embraces 1,175 reference cards, covering the periodicals received since January 1 last.

Many back volumes of professional journals relating to the objects of the station are incomplete, and efforts should be made to secure the missing numbers and bind them for protection. Indeed, full sets of the leading scientific and professional periodicals ought to be in the station library, especially as Newport is quite deficient in reference volumes of this nature. With these in our possession it will be possible to discover what work has been done elsewhere on the topics with which the station deals, and time and money saved which is now likely to be spent in going over the ground already covered.

Congress might very properly grant a special sum, of, say, \$2,000, to fill our deficiencies. I venture in this connection to refer to the vast benefits which have accrued to the Naval Academy from having an annual amount to be spent solely for the increase of the library at that institution, and a second annual amount devoted to the purchase of chemical and philosophical apparatus. Under the existing régime the improvement of these powerful aids to correct and speedy results can only be effected at the sacrifice of something else equally valuable. The immediate want is always provided for even if more important matters pertaining to a general policy, but of which the outcome is more remote, have to be surrendered.

The Bureau is respectfully invited to consider the advisability of obtaining annually an allowance, of, say, \$1,000, for increase of the library, and \$1,000 for the purchase of chemical and philosophical apparatus.

A great deal of work has been done toward arranging and indexing the records of the station by a system which renders them easily accessible for inspection and reference. This task is never lost sight of, and is resumed from time to time as opportunity offers, for much remains to be done.

INSTRUCTION.

The advanced course of instruction was attended by Commander F. J. Higginson, Lieut. G. F. W. Holman, Lieut. [J. G.] Hamilton Hutchins, Ensign G. W. Denfeld.

The officers began their studies on November 20, 1886, and completed them on June 1, 1887.

Ensign Lopez commenced the course, but was shortly afterwards detached and sent to sea.

In addition to following the prescribed curriculum, the members of the advanced class (Commander Higginson excepted) gave much aid to the researches of the station as associates of the Experiment Board, thus joining practice to theory in a manner suited to largely increase the value of the time they passed here.

Lieutenants Holman and Hutchins have, since the first of June, done regular duty at the station, while Ensign Denfeld's detachment has deprived it of the services of an officer who by mental habit and special training was peculiarly fitted to help in pushing to a conclusion several of the many professional problems assigned to the station for solution.

The summer course was pursued by the following officers :

In attendance.—Capt. Lester A. Beardslee, Commander Francis J. Higginson, Commander James S. Green.

Under instruction.—Lieut. Commander E. W. Watson; Lieutenants Richardson Clover, Lucien Young, C. P. Emerich; Lieutenants (junior grade) J. M. Bowyer, Cameron McR. Winslow, J. C. Gilmore, H. Henderson; Ensigns W. N. Constant, Simon Cook, R. C. Smith, J. A. Dougherty, Joseph S. Jayne; First Lieut. Samuel Mercer, U. S. Marine Corps.; Second Lieut. Charles H. Lauchheimer, U. S. Marine Corps; Gunner William Halford; Acting Gunner John Westfall; Acting Boatswain Thomas M. Johnson.

The course, which was submitted to and approved by the Bureau, was laid out with a view to great practicability. Instruction in torpedoes as being the main object was made to dominate. Instruction in electricity and explosives was so arranged as to expedite and assist the torpedo instruction. The value of this course was the subject of investigation by the Board of Visitors. The result of their labors is embodied in their report. The schedule of instruction is given herewith.

Assignment of time.

JUNE.

Day of month.	Nature of instruction.	Department.	Nature of instruction.	Day of course.
	A. M.		P. M.	
1	Class reports			
2	Lecture—Introduction, currents, Ohm's law.	Electricity.	Lecture—General review of chemistry.	1
3	Lecture—Magnetic effects of currents.	Chemistry.	Lecture—General review of chemistry.	2
6	Lecture—Batteries	Electricity.	Lecture—Combustion and explosion.	3
7	Lecture—Farmer's A and C machines.	Chemistry.	Lecture—Explosives of gunpowder class.	4
8	Lecture—Gunpowder torpedo instructions.	Torpedoes.	Lecture—Gunpowder torpedo instructions.	5
9	A. Practical—Farmer's A and C machines.	Electricity.	B. Practical—Farmer's A and C machines.	6
	B. Practical—Gunpowder igniters.	Fuses.	A. Practical—Gunpowder igniters.	
10	A. Practical—Preparing G. P. torpedo, use of machines, etc.	Torpedoes.	B. Practical—Preparing G. P. torpedo, use of machines, etc.	7
13	B. Practical—Batteries	Electricity.	A. Practical—Batteries	8
14	Practical—Exploding G. P. torpedoes.	Torpedoes.	Practical—Exploding G. P. torpedoes.	9
15	Practical—Making and exploding improvised torpedoes.	Torpedoes.	Practical—Making and exploding improvised torpedoes.	10
16	Lecture—Dynamoes	Electricity.	A. Practical—Dynamoes	11
17	Lecture—Explosives of chlorate class.	Fuses.	B. Practical—Gunpowder fuses	
20	Lecture—Nitro-ethers—Nitro-glycerine and dynamite.	Electricity.	A. Practical—Dynamoes	12
21	Lecture—Nitro-ethers—Gun-cotton.	Chemistry.	B. Practical—Gunpowder fuses	
22	Lecture—Nitro-ethers—Gun-cotton.	Chemistry.	Practical—Explosives of chlorate class.	13
23	A. Practical—Manufacture of gun-cotton.	Chemistry.	Practical—Nitro-ethers—Nitro-glycerine and dynamite.	
24	B. Practical—Armington and Sims engine.	H. S. Eng's.	Practical—Nitro-ethers—gun-cotton	14
27	Lecture—G. C. torpedo outfit, ship's and boat's fittings.	Torpedoes.	B. Practical—Manufacture of gun-cotton.	
28	Lecture—Preparation of G. C. torpedo for service.	Torpedoes.	A. Practical—Armington and Sims engine.	15
29	Lecture—Explosives of fulminate class.	Chemistry.	Lecture—G. C. torpedo outfit, ship's and boat's fittings.	
30	A. Practical—Preparation of G. C. torpedo for service.	Torpedoes.	Lecture—Preparation of G. C. torpedo for service.	16
31	B. Practical—Launches' engines	H. S. Eng's.	Practical—Explosives of fulminate class.	
30	B. Practical—Preparation of G. C. torpedo for service.	Torpedoes.	A. Practical—Preparation of G. C. torpedo for service.	17
	A. Practical—Launches' engines	H. S. Eng's.	B. Practical—Launches' engines	
30	A. Practical—Launches' engines	H. S. Eng's.	B. Practical—Preparation of G. C. torpedo for service.	18
			A. Practical—Launches' engines	
30			B. Practical—Preparation of G. C. torpedo for service.	19
			A. Practical—Launches' engines	
30			B. Practical—Preparation of G. C. torpedo for service.	20
			A. Practical—Launches' engines	
30			B. Practical—Preparation of G. C. torpedo for service.	21
			A. Practical—Launches' engines	

Assignment of time—Continued.

JULY.

Day of month.	Nature of instruction.	Department.	Nature of instruction.	Day of month.
1	Lecture—Explosives	Chemistry.	Lecture—General theories of explosions.	22
5	Lecture—Permanent wires, splicing, etc.	Torpedoes.	Lecture—Permanent wires, splicing, etc.	23
6	A. Practical—Use of permanent wires, splicing, etc.	Torpedoes.	B. Practical—Use of permanent wires, splicing, etc.	24
	B. Practical—Herschhoff engines.....	H. S. Eng's. Electricity.	A. Practical—Dynamoes	
7	A. Practical—Use of permanent wires, splicing, etc.	Torpedoes.	B. Practical—Use of permanent wires, splicing, etc.	25
	B. Practical—Brass G. P. igniters.	Fuses.	A. Practical—Brass G. P. igniters.....	
8	Lecture—Search lights	Electricity. H. S. Eng's. Torpedoes.	B. Practical—Dynamoes	26
11	Lecture—Firing boards, firing plates, etc.	Torpedoes.	A. Practical—Herschhoff engines.....	27
12	A. Practical—Use of firing apparatus.	Torpedoes.	Lecture—Firing-boards, firing-plates, etc.	28
	B. Practical—Preliminary instruction in diving.	Diving.	B. Practical—Use of firing apparatus.	
13	A. Practical—Use of firing apparatus.	Torpedoes.	A. Practical—Preliminary instruction in diving.	29
	B. Practical—Diving in shoal water.	Diving. Electricity.	B. Practical—Use of firing apparatus.	
14	Lecture—Units	Electricity.	A. Practical—Testing dynamoes	30
15	Lecture—Accidents, their history, etc.	Fuses. Torpedoes.	B. Practical—Testing dynamoes	31
18	Lecture—Incandescent lights.....	Electricity. Fuses. Torpedoes.	A. Cannon primers	32
19	A. Practical—Firing exercise G. C. torpedoes from boats.	Torpedoes.	Lecture—Accidents, their history, etc.	33
	B. Practical—Westinghouse engines A. Practical—Firing service G. C. torpedoes from boats.	H. S. Eng's. Torpedoes.	A. Practical—Incandescent lights..	
20	B. Practical—Brotherhood engines.	H. S. Eng's. Torpedoes.	B. Practical—Cannon primers	34
	A. Practical—Firing exercise G. C. torpedoes from tug.	Torpedoes.	B. Practical—Firing exercise G. C. torpedoes from boats.	
21	B. Practical—Diving in shoal water.	Diving.	A. Practical—Westinghouse engines	35
	A. Practical—Diving in shoal water.	Diving.	B. Practical—Firing service G. C. torpedoes from boats.	
22	B. Practical—Firing exercise G. C. torpedoes from tug.	Torpedoes.	A. Practical—Brotherhood engines.	36
	Lecture—Electrical measurements.	Electricity. Diving.	A. Practical—Firing service G. C. torpedoes from tug.	
25	Lecture—Electrical measurements.	Electricity. Diving.	B. Practical—Diving in shoal water.	37
26	Lecture—Electro-magnetic induction.	Electricity. Diving.	A. Practical—Diving in shoal water.	38
	Lecture—Defense against torpedoes	Torpedoes.	A. Practical—Measurement of currents.	
27	Lecture—Characteristics of defensive mines.	Torpedoes.	B. Practical—Diving in shoal water.	39
	Lecture—Characteristics of defensive mines.	Torpedoes.	B. Practical—Measurement of currents.	
28	Lecture—Defense against torpedoes	Torpedoes.	A. Practical—Diving in shoal water	40
29	Lecture—Characteristics of defensive mines.	Torpedoes.	Lecture—Defence against torpedoes	41
	Lecture—Characteristics of defensive mines.	Torpedoes.	Lecture—Characteristics of defensive mines.	41

AUGUST.

1	Practical—Laying out defensive mines.	Torpedoes.	Practical—Laying out defensive mines.	42
2	Practical—Laying out defensive mines.	Torpedoes.	Practical—Laying out defensive mines.	43
3	Practical—Laying out defensive mines.	Torpedoes.	Practical—Laying out defensive mines.	44
4	Practical—Laying out defensive mines.	Torpedoes.	Practical—Laying out defensive mines.	45
5	Practical—General experiments.....	Practical—General experiments	46
8	Lecture—Removal of obstructions..	Torpedoes.	Lecture—Removal of obstructions..	47
9	Lecture—Telephones, telegraphs, bells.	Electricity. Diving.	A. Practical—Measurement of E. M. F.	48
	Practical—Exercises in blowing up obstructions.	Torpedoes.	B. Practical—Diving in deep water.	
10	Lecture—Electric motors.....	Electricity. Diving.	Practical—Exercises in blowing up obstructions.	49
11	Lecture—Electric motors.....	Electricity. Diving.	B. Practical—Measurement of E. M. F.	50
	Lecture—Electric motors.....	Electricity. Diving.	A. Practical—Diving in deep water.	

Assignment of time—Continued.

AUGUST—Continued.

Day of month.	Nature of instruction.	Department.	Nature of instruction.	Day of month.
12	Lecture—Alternate current dynamo.	Electricity. Diving.	A. Practical—Measurement of resistance.	} 51
15	Lecture—Clearing passages through submarine mines.	Torpedoes.	B. Practical—Diving in deep water. Lecture—Clearing passages through submarine mines.	
16	Lecture—Torpedo boats.....	Torpedoes.	Lecture—Torpedo boats.....	53
17	Lecture—Magnetism.....	Electricity. Diving.	B. Practical—Measurement of resistance.	} 54
18	Practical—Clearing passages through submarine mines.	Torpedoes.	A. Practical—Diving in deep water. Practical—Clearing passages through submarine mines.	
19	Practical—Clearing passages through submarine mines.	Torpedoes.	Practical—Clearing passages through submarine mines.	56
22	Practical—Clearing passages through submarine mines.	Torpedoes.	Practical—Clearing passages through submarine mines.	57
23	Lecture—Electro-chemistry.....	Electricity. H. S. Eng's.	A. Practical—Telegraphs and telephones.	} 58
24	Lecture—Statical electricity.....	Electricity. H. S. Eng's.	B. Practical—Brotherhood engines. B. Practical—Telegraphs and telephones.	
25	Examination.....	Torpedoes.	A. Practical—Brotherhood engines.	60
26	Examination.....	Electricity.	Examination.....	61
29	Examination.....	Chemistry.	Examination.....	62
30 } 31 }	Practical exercises before Board of Visitors.	Practical exercises before Board of Visitors.	63 } 64 }

The course differed from that of any previous year in being more systematic and practical; in avoiding duplication of teaching, and in the introduction of themes on the tactics of the torpedo submitted at the close of the course in answer to questions asked at its beginning. Much good flowed from the constant presence in the minds of the class of a definite application of the subjects taught.

A false impression prevails that the torpedo station undertakes to turn out trained officers in the short space of three months. The fact is that the time is primarily devoted to familiarizing the class theoretically and practically with service appliances. To this end a certain amount of teaching in electricity and chemistry is necessarily included. A few lectures are also given on leading torpedoes, American and foreign, of various types, not issued to the Navy.

As in former years, the members of the class displayed marked interest in submarine diving. Only five decided not to go down in the suit.

At the close of the term the class were first examined by their instructors on the following topics:

Torpedoes.

- (1) Describe in detail and show the arrangement of the permanent fittings supplied to ships.
- (2) Trace the circuits from the battery to and from the torpedo, using the firing-plate; also from an "A" machine to torpedo and back, using firing-key.
- (3) Describe the gun-cotton torpedo fittings supplied for boats and show how they are intended to be used.
- (4) Prepare and explode from a boat a contact torpedo (pattern B), giving each step in detail, and showing the circuit when firing "at will," and upon contact.
- (5) What are the different classes of submarine mines and under what circumstances would each class be used?
- (6) Explain the different methods of clearing passages through submarine defenses.
- (7) What qualities should a torpedo-boat possess? Name them in the order of their importance.

Electricity.

- (1) How does the M. C. L. cell differ from the Leclanché, and what care does it require on shipboard?
- (2) State the general principle of electro-magnetic induction. How is it utilized in a dynamo? State briefly the advantages and disadvantages of series, shunt, and compound dynamos for ship use.

- (3) What are the advantages and disadvantages of alternate current dynamos ?
- (4) State briefly what special arrangements should be made in a ship installation of the electric light to secure good working and durability.
- (5) What are the advantages and disadvantages of series motors ? Of differential motors ?
- (6) How would you improvise a firing battery aboard ship ?
- (7) The specific resistance of pure copper being 1640, what is the resistance at 55° F. of 569 feet of wire .35 millimeter in diameter, having a conductivity of 96 per cent. pure copper ?
- (8) Calculate the gross and commercial efficiencies of a compound dynamo (long shunt) from the following data :
- H. P. applied, 25.
 Difference of potential at terminals, 101 volts.
 Current in external circuit, 150 amperes.
 Resistance of armature, .008 ohms.
 Resistance of series field coils, .021 ohms.
 Resistance of shunt field coils, 5.6 ohms.

Explosives.

- (1) How is fulminate of mercury made ? How are detonators issued to the service ? Where are detonators to be stowed ?
- (2) On inspection of a jar of dry gun-cotton primers, the litmus paper which has been stowed with the gun-cotton is found to be nearly white, and in some strips to have a slight pink tinge. The primers are reddish colored, and give off an odor of carbolic acid. When distilled water (containing 4 ounces of carbonate of soda and 2 ounces of carbolic acid to the gallon) is poured on the primers the water becomes colored yellow. What should you infer from these observations and what would you do ?
- (3) An exercise torpedo is primed with one dry primer and the remaining space filled with wet gun-cotton. On firing only a slight report is heard and red fumes rise to the top of the water. On recovery the torpedo is inspected, and it is found that the torpedo case is bulged opposite the primer and the seam opened at that place ; a number of small holes are pierced in the bottom of the case ; the primer disk is broken up and partially burned ; the adjoining disk is broken up ; the remaining disks are intact. A detonator was used to fire the torpedo. Explain this.
- (4) Describe the processes used at the torpedo station and at Vonges for making nitro-glycerine.
- (5) What is dynamite ; how is it made ; what advantages and disadvantages does it possess for use in torpedoes ; how is it to be tested ; how is it to be thawed when frozen ?
- (6) What is explosive gelatine ; how is it made ; what is its relative value as an explosive agent when compared with nitro-glycerine and gun-cotton ; why is it not used as a service explosive ?
- (7) Point out the distinctions between combustion, explosion, and detonation. Give examples of each of these phenomena.
- (8) What is "cocoa powder" ? Point out how the advantages of a "high initial velocity with a low pressure" are secured. What is the source of the charcoal used in the German cocoa ?
- (9) What is meant by "explosions by influence ?" Cite some examples where this principle has been applied in practice.
- (10) What is "picric powder" ; for what use has it been proposed ; how is "picric acid" made ?
- This was followed by a series of practical illustrations.

PRACTICAL EXERCISES BEFORE THE BOARD OF VISITORS.

Torpedoes.

- (1) Describe the principle and action of the Howell torpedo, illustrating by use of the torpedo in museum.
- (2) Describe the Whitehead torpedo, using diagram in museum.
- (3) Improvise an observation mine and lay it out.
- (4) Explode an exercise G. C. torpedo from a boat.
- (5) Explode a service G. C. torpedo from a boat.
- (6) Improvise a torpedo and explode it from a boat.
- (7) Blow up a boom (2 officers).
- (8) Break a chain cable (2 officers).
- (9) Lay out and explode countermines (8 officers).
- (10) Lay out and explode a mine, using alidades (3 officers).

Electricity.

- (1) Operate a service search-light apparatus, consisting of hand lamp, Mangin projector, Brotherhood engine, and Gramme dynamo (2 officers).
- (2) Operate a hand lamp with an alternating current (2 officers).
- (3) Operate a service automatic lamp in the Mangin projector, using Gramme dynamo (2 officers).
- (4) Derive the external characteristic of Siemen's dynamo (2 officers).
- (5) Wire up, test, and operate a circuit of six incandescent lights (3 officers).
- (6) Describe the installation of incandescent lights at the torpedo station.
- (7) Given two push buttons, two electric bells, a battery and wire; connect them so that each button will ring the bell at either end of the line, using the least wire possible.
- (8) Given the same as the preceding; connect so that each button will ring both bells.

Explosives.

- (1) Conduct the Board of Visitors through the gun-cotton factory, and explain to them all the processes employed for the manufacture of gun-cotton.
- (2) With the apparatus before you, describe the "heat" and "solubility" tests for gun-cotton as applied at this station.
- (3) With the apparatus before you, describe the different methods employed for drying wet gun-cotton primers.
- (4) Make a bonfire and place upon it a full box of wet English gun-cotton. When the gun cotton is partially consumed, extinguish the remainder and detonate several of the unconsumed disks (2 officers).
- (5) Make an inspection of service torpedoes and of several jars of dry primers.
- (6) Fill two exercise torpedo cases with rack-a-rock. Detonate one and fire the other (2 officers).

Fuses.

- (1) Make a wooden-case igniter, a brass-case igniter, and a gunpowder fuse.
- (2) Make an electric cannon primer.
- (3) Make a detonator plug, bridge it, and describe the manufacture of detonators.

High-speed engines.

- (1) Explain the working of the Armington & Sims engine.
- (2) Explain the working of the Brotherhood engine.
- (3) Explain the working of the Herreshoff engine.
- (4) Explain the working of the Westinghouse engine.

Diving.

- (1) Go down in a diving suit.
- (2) Attend the diver.

The exercises were assigned to the class by the Board of Visitors. Every one of these exercises was conducted wholly by the officers under instruction.

To the torpedo instructor, Lieut. J. A. Shearman, is largely due the encouraging results of the summer term.

THE CARD SYSTEM.

By direction of the Bureau, a new system of accounting for labor and material used in manufacture was introduced last winter. The scheme is a modification of that proposed by Captain Metcalfe, of the Ordnance Corps, U. S. Army. The results are gratifying in the extreme. It is not to be assumed that even yet the actual working is totally free from embarrassment. So radical a departure from old methods can not be instituted without some friction, but the difficulties in practice are being gradually removed.

The station's experience with the new plan of store-keeping is very favorable. Great simplification in detail is, however, both desirable and feasible. The new order of things can not last if it remains as now needlessly complicated.

TIME-BALL SERVICE.

Noon signals from Washington are supposed to be transmitted over the line of the Western Union Telegraph Company to drop the time ball at the station.

The time service has been so irregular and unsatisfactory, owing to negligence on the part of the company, that for weeks at a time the ball has not been dropped. In-

deed for a certain period I discontinued all attempts to give the correct time to the shipping community, and what might have been a convenience degenerated into a reproach. Matters are on a better basis now, and it is hoped that the service may continue unimpaired.

EXPERIMENTS.

In compliance with the Bureau's wishes I formed certain of the officers of the station last December into an experiment board. The other officers here and the class under advanced instruction during the winter and spring were made associate members.

To this board are submitted from time to time all questions to which the answers must be derived from experiment. Careful consideration and full discussion of the elements of each problem, a study of previous work in the same direction, unity of action, prompter results, and a complete record in each instance have accompanied this move.

Among the researches already brought to a successful issue may be mentioned the following:

(a) To determine the permissible limits of electrical resistance of service fuses and detonators.

(b) How little fulminate of mercury will detonate perfectly dry gun-cotton.

(c) How little fulminate of mercury will detonate atmospherically dry gun-cotton.

(d) To devise means for the rapid production of detonators of a definite and uniform quality.

(e) To determine the adaptability of gun-cotton in the frozen state to torpedoes.

(f) To determine the length of time a gun-cotton torpedo may remain primed under service conditions and yet be certain to explode.

Others equally important are in progress. To some it is not discreet to draw attention.

Of the authorized researches a large proportion have as their ultimate goal the elimination of every chance of failure to explode a torpedo at the desired moment, by demonstrating practically why it is that apparatus which invariably works well in expert hands at the torpedo station occasionally works badly in less skillful hands in the service.

For example, the solution of question *d* above, due mainly to the skill of the chemist, has given the service stable fulminate of the most perfect nature and maximum strength. As the very soul of the torpedo, the detonator must be all that can be desired. Those of the present make can not be improved, so far at least as the fulminate is concerned.

In the course of the experimentation with gun-cotton many interesting phenomena were observed. Some of these were, with the Bureau's consent, made known to the public by Professor Munroe in an address before the American Association for the Advancement of Science, arousing great interest through their bearing on the molecular action due to detonation. When the investigation is complete a thorough report will be made. A practical recommendation, based on similar experiments, is the employment of a high explosive of uniform quality for testing the integrity of masses of steel, iron, and other metals, and for revealing their intimate structure. It is not impossible that, eventually, no large casting will be accepted which has not successfully resisted the shocks of small quantities of gun-cotton detonated upon the points where the weaknesses are likely to occur. Should this anticipation be realized, the engineering fraternity will be indebted to the careful observation and valuable suggestions of the chemist in the torpedo corps to whose great industry, ability, and skill I desire to bear official testimony.

The station has within the past year proposed a practical method of charging armor-piercing projectiles of large caliber with the service high explosive.

This section of my report would be incomplete if I failed to refer to the unnecessary yet widespread belief in the instability of gun-cotton, a belief which has led in some instances to its condemnation and destruction. A very extended investigation of this subject has been conducted within the past year. A large number of specimens of gun-cotton, which have been stored here for years and subjected to artificial conditions of heat, cold, moisture, and dryness much more severe than any that could possibly be encountered in the Navy, have, when tested by service methods as well as by more delicate chemical means, shown not the slightest signs of decomposition or even deterioration.

We are thus confirmed in our original confidence in compressed gun-cotton as incomparably the safest and most stable of all explosive substances.

THE OBJECTS OF THE STATION.

I deem it a duty to repeat my conviction already expressed to the Bureau, a conviction which I believe the Bureau shares, that an earnest effort must be made to prevent the station from drifting away from the objects for which it was established.

These objects, placed in the order of their importance, are—

- (1) Experiment.
- (2) Manufacture.
- (3) Instruction.

The growing demands in the service for officers and men trained in the use of torpedoes, high explosives, and electrical appliances has resulted in the expansion of the teaching given here during the summer months into a continuous school for seamen and an almost continuous school for officers. It is then hardly to be wondered at that the Navy at large commonly designates this as the "torpedo school."

The school feature is of great benefit to the Navy, but it should not be allowed to absorb all the energies of the station. Yet this outcome is seriously threatened so long as provision for this function is not specifically made by increasing the staff of officers on duty here. The torpedo station has often been reproached for its barrenness of results, but results do not generate themselves; they come as the sequel to persistent unremitting effort. It is obvious that the need of daily instruction must thrust aside the more important yet less exacting need of research just so long as the capacities of the station are so restricted that one or the other, but not both, may be supplied. I know that since my arrival no pains have been spared to utilize every available moment for experiment, and yet I am profoundly dissatisfied with the showing for the last year—it falls so far short of what I desire. I am at present powerless to move in all directions at once with proper speed.

There are now required at the station three young officers suitably instructed in their respective duties, viz:

An assistant for general experimental work, photography, etc.

Two assistants to the instructor in torpedoes, one to teach the seamen and the second to teach the officers, leaving their principal free to supervise the instruction and to conduct torpedo experiments.

The need of additional officers will be more keenly felt when the station enters upon the question of using high explosives from powder guns. Indeed, it is only proper to state that this development of naval science has been retarded by their absence, and yet it is universally conceded that no more pressing line of research exists to-day.

PUBLICATIONS.

By the transfer of an old ship's printing outfit from the Bureau of Navigation and, with the co-operation of the Bureau of Equipment and Recruiting, a small printing office has been established here where one or two members of each class of seamen under instruction can be trained for the duties of ship's printer, thus bringing within the reach of the enlisted man a rate, coupled with good pay, which eventually may always be filled by a combatant.

While inaugurated with a view of benefiting the naval service, this printing office has, incidentally, been of great service to the station. Lecture notes, schedules of lectures, rules and precautions for the guidance of officers under instruction and for the conduct of manufactures, etc., have been printed by enlisted men, of whom two have already been certificated to the Bureau of Equipment and Recruiting as competent printers.

At present these men are well advanced in the publication of a torpedo catechism, 170 odd pages being already completed.

CONTINUOUS-SERVICE MEN.

Two classes have been carried over the course in torpedoes and diving. The methods of the past year have been adhered to with encouraging results.

Great attention has been given to training these men in running dynamos, in wiring up electric-light circuits, and in operating search lights. For many months seamen under instructions have operated alone and successfully the electric-lighting plant of the station and one or more are constantly on watch at night in the dynamo room.

Several have been pronounced skilled enough to take charge of a ship's installations as electrical machinists. The enlisted men, graduates of this station, now employed on board of cruising vessels in this capacity, are uniformly spoken of in terms of praise.

VOLUNTEER TORPEDO CORPS.

Steps have been taken to inaugurate a course of instruction for volunteer torpedoists. There is much good-will on the part of the seafaring community, and it is believed that, next year, a class can be formed and put through the practical work authorized by the Bureau. The movement will doubtless afterwards grow rapidly until the possession of a certificate as torpedoist will be common along our coast.

RECOMMENDATIONS.

(1) For the immediate wants of the station, in experiments and instruction, two of the larger size service steam launches are greatly needed.

(2) The addition to the fleet of more first-class torpedo-boats.

(3) The continuation and expansion of the present interesting and valuable researches in the properties of explosive substances.

(4) The enlarging of the old torpedo boat-house to receive the *Stiletto* and other second-class torpedo-boats.

(5) A large appropriation will be required to purchase and experiment with nets for the defense of ships against torpedo attacks. Our own experience is insufficient to demonstrate the need or value of this adjunct to naval warfare, which commands so much attention abroad, and which we can not afford to ignore.

(6) A renewal of the sum (\$3,000) appropriated last year to repair the sea-wall. This work has been carried on under the kind advice of Maj. W. R. Livermore, United States Corps of Engineers, whose professional opinion on the subject is contained in a separate communication.

(7) The landing stage at the island is old and infirm. It should be replaced at once by an iron float.

(8) The building of a marine railway capable of hauling up torpedo-boats of the first class and under.

(9) The erection of a small dwelling for the surgeon, whose constant presence will become necessary as the station expands and the number of enlisted men on duty here increases.

(10) Provision for a sick ward for, say, four enlisted men and one officer.

(11) I cannot express too strongly my condemnation of the plumbing arrangements in the cottages here. The water-closets adjoin the principal sleeping apartments and are an ever-present source of danger. No board of health would, in the present condition of the art, countenance this plan which passed unchallenged when the houses were built. The closets should be removed to the rear of the dwellings in L's run out for the purpose.

As I shall not benefit personally by the change I can urge it with the more propriety.

Respectfully submitted.

C. F. GOODRICH,

Commander, and Inspector of Ordnance, in charge of Torpedo Station.

CHIEF OF THE BUREAU OF ORDNANCE,
Navy Department, Washington, D. C.

UNITED STATES TORPEDO STATION,
Newport, R. I., August 31, 1887.

SIR: The Board directed by the honorable Secretary of the Navy, in an order dated August 22, to witness the examination of the class of officers just completing the course of instruction at the torpedo station, and to report upon the results of the examination, has the honor to submit the following:

The Board met at the station on the 29th instant, and was afforded every facility by the commandant and by the officers of the station for the prosecution of its inquiries.

The written examination papers and the very complete series of exercises and experiments carried out in the presence of the Board by the members of the class show that the course of instruction has been a very useful and practical one, so far as the facilities of the station will allow, embracing such work as will likely be met in active service.

The practical exercises, as witnessed by the Board, indicated a thorough knowledge on the part of the class of the various appliances used. These exercises included, in general terms, the use of service and exercise spar torpedoes, the laying out and exploding of submarine mines, the making and use of improvised torpedoes and mines, the use of gun-cotton to destroy obstructions and defenses, the operation of service search lights, incandescent lights, and dynamo machines, as well as other experiments designed to show the knowledge of the class in the practical use of electrical apparatus. The manufacture of service gun-cotton was explained to the Board by the class, and numerous experiments were made illustrating the familiarity of the members with the necessary tests, care in handling, and use of this explosive. The Board witnessed also the making of service fuses, igniters, detonators, and electric primers; and a thorough knowledge was shown by the class of the principles and working of high-speed engines.

A majority of the members of the class has had experience in diving and attending divers, a practical illustration of which was given,

stability, great

flows:

per hour when
"covered."
at 8 knots per

hours at full
maintain at
When
8 knots mean
without using air
thirty hours at

crew.

"covered" or "sub-
to turn in a circle
without reversing her

able to pass from

quickly a minimum

" runs must at all
minimum efficiency and
After the boat
that part of the
conditions for submerged
be longer than twice

desired depth within the
not considered that this
stability of the boat.

when the boat is on
stability must in great
of buoyancy normally
be necessary to sacrifice
upon the bottom for the

stability must be sufficient
the machinery and torpedo
still, but not on the bottom ;
than sufficient for the pur-
the boat is "submerged" and

ly strong to withstand an ex-
150 feet.

on of a ship running at speed
certainty does carrying
an-cotton mode in which
signer, to be remarked
range accuracy, will be
which torpedoes
ative over-water
use.

vided with means
der to see the ob-
ould also be pro-
y of the compass,
the crew so as to
within the boat
below, or lateral ;
etermined depth ;
ons exterior to
case of dis-

pinion, they
less success
upon the basis
y or omit, as

that the balance of qualities is such that everything will be carried properly and safely; and such additional information must be included as may be necessary to enable the Department to readily determine the character of the proposed vessel and the correctness of the calculations upon which the design is based.

The contractor must furnish, at his own expense, all working drawings necessary to the complete construction of the vessel, and the expense of all trials, before final acceptance of the vessel under the contract, must also be borne by the contractor.

Proposals must be made in accordance with forms which will be furnished on application to the Bureau of Ordnance, and must state the time within which the bidder will complete, for delivery, the vessel which he proposes to construct.

Each proposal must be accompanied by a certified check, payable to the order of the Secretary of the Navy, for an amount equal to 5 per cent. of the bid. The check received from the successful bidder will be returned to him on his entering into a formal contract for the due performance of the work and giving bond for the same, with security to the satisfaction of the Secretary of the Navy, in a penal sum equal to 60 per cent. of the amount of his bid; but in case he shall fail to enter into such contract and to give such bond within thirty days after notice of the acceptance of his proposal, the check accompanying such proposal shall become the property of the United States.

All checks accompanying proposals which are not accepted will be returned immediately after the award shall have been made.

Payments under the contract will be made in five equal installments, as the work progresses, upon bills duly certified. The last payment will be made upon the acceptance of the boat after trial. Twenty-five per cent. of each installment will be reserved until the final acceptance of the boat by the Department.

Proposals must be made in duplicate, inclosed in envelopes marked "Proposals for a submarine torpedo-boat," and addressed to the Secretary of the Navy, Navy Department, Washington, D. C.

The Secretary of the Navy reserves the right to reject any or all bids as in his judgment, the interests of the Government may require.

WILLIAM C. WHITNEY,
Secretary of the Navy.

GENERAL REQUIREMENTS.

The design for a submarine or diving boat to be acceptable to the Department should show the manner in which it is proposed the vessel shall be maneuvered under all conditions; but more especially how she is to be brought into action from a distance.

The most desirable qualities to be possessed by such a vessel while approaching a hostile ship under way are, speed, certainty of direction, invisibility, and safety from the enemy's fire; the design and description should plainly show the amount of each of these qualities that the boat would possess, and the advantage that results from diminishing any one for the purpose of increasing any other.

The Department has no knowledge of any method by which certainty of approach to an object constantly moving and constantly changing its direction of motion can be secured, unless the object is kept constantly in view or lost sight of for brief intervals only; consequently, if no novel method for insuring certainty of approach (when submerged) be devised, a design showing, at the expense of invisibility, great speed for use outside the range of effective hostile fire would be desirable; providing always that submergence to a safety depth can be quickly secured, and certainty of approach still be retained when coming within the danger zone. Within the danger zone a part of the speed of approach may be given up for the sake of obtaining water cover, provided certainty of approach can be still maintained until the object of attack is so near that this certainty is virtually secure even when the boat is deeply submerged for the purpose of obtaining total invisibility or for delivering the attack at a vulnerable point.

The following definitions are adopted for convenience in describing the conditions under which submarine boats generally move:

"*Surface*," i. e., with free-board or awash.

"*Covered*," i. e., protected by at least 3 feet of water over the highest point of the shell, not necessarily cut off from connection with the atmosphere, and furnishing a view of the object of attack through air.

"*Submerged*," i. e., at any safe depth, cut off from communication with the atmosphere, and affording no view of the object of attack other than one through water.

Any boat not designed for running "submerged" can not be considered submarine; and she should be able to run in at least one of the other ways mentioned in order to be satisfactorily effective.

The features essential to the usefulness of a submarine boat designed for offensive warlike purposes are in general terms held to be—

Great safety, facility, and certainty of action when "submerged," fair speed when "covered," good speed when running on the "surface," a fair endurance of power and

stores, great ease of manœuvering under all conditions, sufficient stability, great structural strength, and fair power of offense.

The Department would particularize as to these qualities about as follows :

(1) *Speed*.—The boat should be capable of making at least 15 knots per hour when running on the "surface," and at least 12 knots per hour when running "covered." When running "submerged" she should have a mean speed of at least 8 knots per hour.

(2) *Power endurance*.—She should be able to run for about thirty hours at full power, on the surface or "covered," while at the same time she should maintain at its greatest efficiency the power that is to be used for "submerged" running. When "submerged" she should be capable of running at least two hours at 8 knots mean speed. If intended for "covered" and "submerged" work *only* (without using air draught), she should be capable of running in that condition about thirty hours at full power.

She should carry about ninety hours' provisions and water for the crew.

(3) *Ease of manœuvering*.—When running on the surface, "covered" or "submerged," the boat should be able, when working at full power, to turn in a circle of a diameter not greater than four times her length, and this without reversing her engines.

If designed to run part of the time on the surface, she should be able to pass from the surface to the covered plain in thirty seconds.

When below the surface, she should be able to make very quickly a minimum change of 10 degrees in direction in the vertical plane.

The conditions necessary for furnishing power for "submerged" runs must at *all* times during the working endurance be maintained at their maximum efficiency and ready for *instant use* until the first "submerged" run is commenced. After the boat has again made communication with the air the time of renewing that part of the power that was used while "submerged," or rearranging the conditions for submerged running, which were altered during submergence, should not be longer than twice the period of the submerged run.

While lying still the boat must be able to maintain any desired depth within the limits of safety from crushing pressure upon the shell. It is not considered that this requirement can be fulfilled simply by varying the specific gravity of the boat.

(4) *Stability*.—This quality must be possessed in good measure when the boat is on the "surface;" and when "covered" or "submerged" the stability must in great part depend upon "normal buoyancy"—i. e., a certain amount of buoyancy normally remaining in the boat and never given up, unless it should be necessary to sacrifice buoyancy in order to sink from under an obstruction or to lie upon the bottom for the purpose of conserving power.

The amount of this normal buoyancy and consequent stability must be sufficient to allow the necessary movement of the crew in working the machinery and torpedo appliances while the boat is "submerged" and lying still, but not on the bottom; and it is thought this amount of buoyancy will be more than sufficient for the purpose of successful and convenient navigation when the boat is "submerged" and moving at moderate speeds.

(5) *Structural strength*.—The shell should be sufficiently strong to withstand an exterior water-pressure, due to a submergence of at least 150 feet.

(6) *Power of offense*.—Against any part of the bottom of a ship running at speed the boat must be able to deliver, with reasonable certainty, torpedoes carrying charges equal in minimum effect to 100 pounds of gun-cotton. The mode in which this requirement is to be met is left entirely to the designer, but it is to be remarked that the method which gives the greatest under-water range, with accuracy, will be preferred. Rapidity of rate of delivery, extension of angle through which torpedoes can be delivered, number of torpedoes that can be carried, and effective over-water delivery are all important factors for determining the power of offense.

Besides the foregoing principal requirements, the boat must be provided with means for the attainment of the following objects: Enabling the commander to see the object of attack when running "covered," and an all-around view should also be provided, if practicable; compensating or otherwise *insuring the accuracy of the compass*, when "submerged," and under all conditions; purifying the air for the crew so as to allow at least twelve hours' submergence; keeping the temperature within the boat down to 100 degrees Fahr.; getting away from obstructions—above, below, or lateral; pulling out of mud; automatically preventing a dive below a predetermined depth; preventing the fouling by lines or other obstructions of any working parts exterior to the shell proper; lighting the interior, and for the escape of the crew in case of disaster.

These qualities are expected by the Department both because, in its opinion, they are necessary and because they have already been attained with more or less success in submarine structures now extant. But as the bids are to be made upon the basis of guaranteed results bidders are at liberty, in their proposals, to modify or omit, as

they may think proper, any of the qualities mentioned herein, always excepting qualities of workmanship and material used in the construction of the hull, engines, power generators, and other mechanism.

Any valuable qualities not enumerated by the Department (which limits itself to pointing out those that appear to be the most useful) will be fully considered and given due weight in deciding upon the design to be adopted.

As the Department does not define the means by which results are to be attained, it will accept no responsibility as to the efficiency of the methods proposed to be used.

Designs must be accompanied by written explanations fully setting forth the operation of the boat and appendages, and stating all the advantages of the proposed vessel.

The bidder to whom the award is made will furnish detailed drawings and specifications of his boat, and the contract will be based on these. They must not differ in any important way from the general design and explanation submitted with the proposal.

QUALITY AND WORKMANSHIP.

All material is to be of the best quality, of domestic manufacture, and subject to the tests and inspection laid down in the appended instructions concerning tests to be applied to steel for use in the construction of the hull and machinery of a torpedo-boat, approved by the Secretary of the Navy July 15, 1887.

The workmanship shall be of the highest class, and subject to the inspection of officers designated for the duty. Such inspectors shall have free access to the works of the builders at all times, for the purpose of witnessing and examining the progress of the vessel and machinery, and they are to be afforded every facility and assistance for inspecting and for ascertaining that the work is done in accordance with the terms of the contract.

GENERAL REMARKS.

Conditions will be inserted in the contract requiring, upon the completion of the boat, trials sufficient to test her efficient operation, and to insure that the contract has been properly performed, and that the guarantees assumed by the contractor have been complied with.

A boat rejected under the contract may have exhibited certain important qualities in a much greater degree than was contemplated by the contract, or she may embody devices and improvements novel and very valuable, but not called for by the contract.

In such a case the Department might possibly be disposed to purchase the boat, but such a course will not be pursued unless the advantages to the Department are of the most obvious character.

The Department limits the maximum displacement to 200 tons when the vessel is "submerged," and it puts the displacement at so large a figure in order that designers may not be hampered in attaining good speeds by lack of space for motors; but it is thought that designs showing about 90 tons displacement will give the best results. No bidder is limited to the submission of a single design, but each is invited to submit as many as he may see fit. Independent drawings and explanations, and a separate proposal for building the vessel shown, must accompany each design.

The foregoing statement of "general requirements" is intended only as suggestive, and as embodying for the benefit of bidders the views of the Department as to what ought to be accomplished by any person assuming to offer a plan for an effective submarine torpedo-boat; but the Department is of the opinion that results already attained justify the purchase of a sub-marine boat though the exact requirements of the circular may not be guaranteed. Bidders are therefore invited to submit their designs even though these may show qualities less desirable or less difficult to attain than those hereinbefore described; they should be careful to state what matters are guaranteed.

All bids will be considered without regard to the residence of the bidder, but the boat must be of domestic manufacture.

No bid will be accepted that does not offer guarantees of results approximating to those stated in this circular, nor unless accompanied by plans justifying, in the opinion of the Department, a reasonable expectation that results guaranteed will be attained.

All other bids will be rejected.

WILLIAM C. WHITNEY,
Secretary of the Navy.

OFFICIAL TRIAL OF ———

NARRAGANSETT BAY, ———, 188—.

Details of boat.

Length, ——— feet ——— inches; beam, ——— feet ——— inches; maximum draught, ——— feet ——— inches.

Propeller, ——— blades; diameter, ——— feet ——— inches; pitch, ——— feet ——— inches.

Builders represented by ———.

Navy Department represented by ———.

Total number of persons on board ———.

Programme.

(1) Three runs are to be made over a measured mile course before, and three runs after, a three-hour trial. The second mean of speeds for each set of runs over the measured mile will be taken as the true speed for that set.

(2) The number of revolutions of propeller required to run one knot in still water will be calculated for each set of runs over the measured mile.*

(3) The slip of the propeller for each set of runs over the measured mile will be determined; † and the mean of the two determinations will be taken as the slip of the propeller during the three-hour trial.

(4) The average speed during the three-hour trial will be determined from the number of revolutions made by the engines, the pitch of the propeller, and the mean slip. ‡

*Formula used for finding the number of revolutions of engines required to run one knot in still water.

Let x = number of revolutions per knot in still water.

n = velocity of tide in knots per second.

R = number of revolutions per knot with the tide.

R_1 = number of revolutions per knot against the tide.

t = time in seconds per knot with the tide.

t_1 = time in seconds per knot against the tide.

Then the distance run by the boat with the tide, due to propulsion, in knots = $1 - nt$.

And the distance run by the boat against the tide, due to propulsion, in knots = $1 + nt_1$.

The number of revolutions made will be:

$$R = x(1 - nt) \dots \dots \dots (1)$$

$$R_1 = x(1 + nt_1) \dots \dots \dots (2)$$

$$\therefore \frac{R}{R_1} = \frac{1 - nt}{1 + nt_1}$$

Or,

$$R + Rnt_1 = R_1 - R_1nt$$

Or,

$$n(Rt_1 + R_1t) = R_1 - R$$

$$\therefore n = \frac{R_1 - R}{Rt_1 + R_1t} \dots \dots \dots (3)$$

From (1)

$$s = \frac{R}{1 - nt} \dots \dots \dots (4)$$

$$\therefore s = \frac{R}{1 - t \left\{ \frac{R_1 - R}{Rt_1 + R_1t} \right\}} = \frac{Rt_1 + R_1t}{t_1 + t} \dots \dots \dots (5)$$

† Slip (expressed as a fraction of product of revolutions and pitch of propeller), = $\frac{xp - d}{xp}$; in which:

d = 6080 feet (one knot).

p = pitch of propeller in feet.

x = number of revolutions per knot in still water as determined for each set of runs over measured mile.

The above fraction multiplied by 100 will give the percentage of slip.

‡ Average speed during the three-hour trial = $\frac{Np(1 - \text{mean slip})}{6080 + 3}$; in which:

N = number of revolutions made during the 3-hour trial.

p = pitch of propeller in feet.

6080 = number of feet in one knot.

3 = number of hours.

Record of trial.

—, 188—

No. of runs.	Pressure in boilers.	Pressure in receiver.	Vacuum in condenser.	Air pressure in fire-room.	Revolutions of engines.		Observed time.	Speed due to time.	First mean speeds.	Second mean speeds.
					Per mile.	Per minute.				
Before 3 hours.										
1										
2										
3										
Mean.										
After 3 hours.										
1										
2										
3										
Mean.										
3 hours—record taken every 20 minutes.					For 20 minutes.	Per minute.				
1st							Slip, 1st 3 runs, [loaded] — per cent.			
2d							Slip, 2d 3 runs, [after 3 hours] — per cent.			
3d										
4th										
5th										
6th										
7th										
8th										
9th										
Mean.							Mean slip — per cent. True mean speed, 3 hours — knots.			

Turning trials.

Full speed:

To starboard:

Time for complete circle, — seconds.
Diameter of complete circle, — feet.

To port:

Time for complete circle, — seconds.
Diameter of complete circle, — feet.

Half speed:

To starboard:

Time for complete circle, — seconds.
Diameter of complete circle, — feet.

To port:

Time for complete circle, — seconds.
Diameter of complete circle, — feet.*Stopping trial.*Time required to stop boat, engine reversed at "full speed ahead," — seconds.
Distance required to stop boat, engine reversed at "full speed ahead," — feet.*Draught of water.*

Before trials:

Forward, — feet — inches.
Aft, — feet — inches.

After trials:

Forward, — feet — inches.
Aft, — feet — inches.*Displacement of boat.*Displacement at beginning of trials, — tons.
Displacement at end of trials, — tons.
Mean displacement during trials, — tons.

*Engines, condenser, and boiler.***Engine :**

Diameter of high-pressure cylinder, — inches.
 Diameter of low-pressure cylinder, — inches.
 Stroke of piston, — inches.

Condenser :

Area of condensing surface, — square feet.

Boiler :

Area of grate surface, — square feet.
 Area of water-heating surface, — square feet.
 Area of steam-superheating surface, — square feet.

On three-hour trial :

Mean indicated horse-power developed in H. P. cylinder, —.
 Mean indicated horse-power developed in L. P. cylinder, —.
 Total mean indicated horse-power developed by engine, —.
 Mean number of revolutions of propeller per minute, —.
 Mean pressure of steam in boiler, in pounds, per square inch, —.
 Mean pressure of steam in receiver, in pounds, per square inch, —.
 Mean vacuum in condenser, in inches of mercury, —.
 Mean pressure of air in fire-room, in inches of water.

*Coal-endurance and steaming distance.***Coal capacity :**

In bunkers, — tons.
 In bags, — tons.
 Total coal capacity at L. W. L., — tons.

Full speed :

Time corresponding to above quantity of coal, — hours.
 Distance corresponding to above quantity of coal, — knots.
 Mean distance per ton of coal, — knots.

Half speed :

Time corresponding to above quantity of coal, — hours.
 Distance corresponding to above quantity of coal, — knots.
 Mean distance per ton of coal, — knots.

NOTE.—Each ton of coal added to the above total will increase the mean load water draught — inches and add about — knots to the steaming distance at full speed, and — knots at half speed.

Observations.

Weather : ————
 Boat : ————
 Engines : ————
 Boilers : ————
 Miscellaneous : ————
 Result of trial : ————
 Indicator cards from engine : ————

INSTRUCTIONS FOR THE TORPEDO BOARD.

(1) The naval appropriation bill, approved July 26, 1886, under "increase of the Navy," section 10, provides as follows:

"That towards the construction and completion of the vessels hereinbefore mentioned, including the vessels and guns mentioned in section 9, the sum of two million five hundred thousand dollars is hereby appropriated, of which not more than seventy-five thousand dollars may be expended in manufacturing, purchasing, and experimenting with torpedoes of domestic manufacture."

(2) The torpedo board will be guided by the provisions of the above section (so far as they relate to torpedoes) and by these instructions.

(3) In pursuance of the foregoing provision of the law, the Bureau published the following advertisement:

BUREAU OF ORDNANCE, NAVY DEPARTMENT,
 Washington, September 8, 1887.

To whom it may concern :

The Navy Department has appointed a board, before which persons interested in the development of torpedoes, for naval use, can exhibit their torpedoes, models, and designs, and perform such practical experiments as may appear advisable.

Those who wish to avail themselves of this opportunity should communicate with the undersigned, who will give such further information as may be necessary in the premises.

MONTGOMERY SICARD,
 Chief of Bureau.

(4) For the particular inquiry to be undertaken by the board, it will be assumed that a torpedo for naval purposes is a weapon for the attack of a vessel at or below the water-line, seeking by means of the effect of an explosive charge to admit water into the hull, and adapted to use from a vessel either of the usual kind or of special design.

(5) The objects to be examined under the above definition are as follows: Finished torpedoes, working models, and designs (drawings or plans).

(6) The board will not report an opinion on any object that is not complete in its way. *i. e. :*

(7) The finished torpedoes must be of service size and construction, with proper appliances for launching them from a vessel.

(8) Working models must be made to a convenient scale, and must represent, as nearly as practicable (in miniature), the proposed finished service weapon and its launching apparatus.

(9) Designs (drawings) must be made to a convenient scale, in full detail, and must represent exactly and clearly the manner in which all the operations of the proposed torpedo are to be performed.

(10) The person who presents the torpedo, model, or design to the board, and who makes the explanations, guarantees, etc., is for convenience called the owner.

Finished torpedoes.

(11) When an owner submits a torpedo to the Board he will be required to describe and explain everything about the torpedo and its appendages, and it will be examined by the Board. If the Board so requires, the owner will furnish a written description of the mechanism and its action. In any event he must inform the Board in writing exactly what he claims his weapon can perform, and must also define the scope of its usefulness; that is, whether it will act efficiently under the general conditions prevailing at sea or whether it is intended for use in smooth water or in special circumstances only.

(12) After full investigation the Board will decide, by vote, whether the torpedo shall be tried (or experimented with). In its conclusion on this point it will be governed by the possible adaptability of the weapon to naval use, having in view the qualities hereinbefore referred to and such others as they may think to be of importance, considering, duly, the cost of the trial to the Government as compared with the probable value of the torpedo to the Navy. If a majority of the Board shall vote against a trial it will not take place.

(13) Trials will be held at such times and places as the Board may designate. In this matter owners will be accommodated as much as a proper regard for the interests of the Government will allow.

(14) The Government will provide such a vessel and crew as it considers suitable, from which the trials will be made. It will also furnish the labor for installing and working the torpedoes and their appendages, provided the cost is not excessive in the opinion of the Board. Torpedoes, etc., must be delivered alongside, and must also finally be removed at the expense of the owner.

(15) The vessel will furnish steam at normal pressures, if such is required for working the torpedo. If any other power is required it must be furnished by the owner.

(16) Torpedoes (or models) and all their fittings and appendages, while being tried or experimented with, should be at all times operated by the owner.

(17) If, however, the owner desires the board, or any members thereof, or any person or persons in the employ of the Government, to make the experiments or trials for him, he will so request in writing. Such request must clearly and definitely release the Government and the persons whose services are desired from all responsibility for loss or injury to the torpedo or its appendages.

(18) The Government will not, under any circumstances, be in any way responsible for the loss or injury to any torpedo or its appendages.

(19) If the owner does not desire to make or continue the trials on any particular day, his wishes in the matter will be regarded. But he must, if so requested, present satisfactory reasons therefor in writing to the Board.

(20) If the Board considers that other or further experiments or trials than those herein laid down would be of use in determining the value of the torpedo or model, they will be undertaken if the Bureau consents after receiving from the Board a recommendation to that effect, with reasons therefor, and an estimate of the probable cost.

(21) Among the qualities that should be possessed by a torpedo adapted to naval warfare, the following appear to be the most essential, and each must be reported upon:

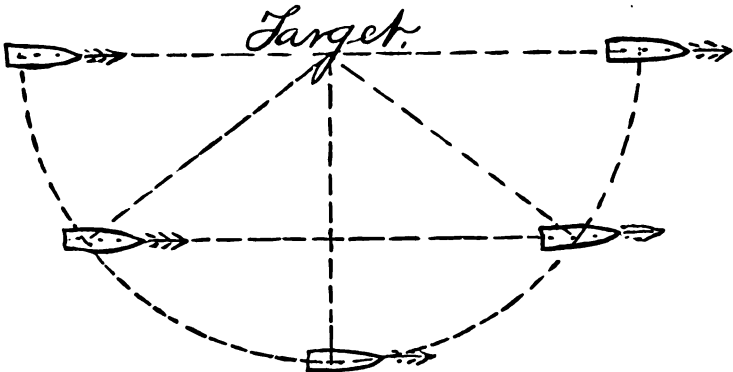
(22) Accuracy.

(23) Certainty of operation; (a) certainty of launching and starting on the course; (b) certainty of explosive action on contact with the target.

(24) Velocity.

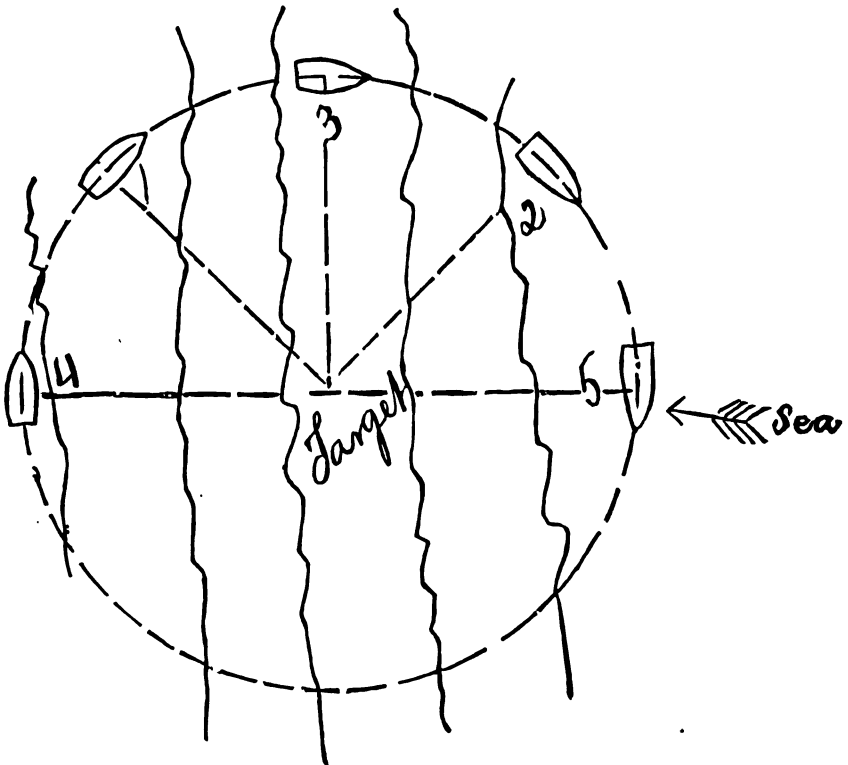
- (25) Range.
- (26) Ability to break through or avoid hostile defensive obstructions.
- (27) Destructiveness.
- (28) Safety in handling.
- (29) Ability to keep in readiness for immediate action.
- (30) Facility of manipulation.
- (31) Simplicity.
- (32) Ability to be operated with safety from an enemy's fire.
- (33) Simplicity and efficiency of the launching apparatus.
- (34) Noiselessness.
- (35) The Bureau attaches very considerable importance to the qualities in paragraphs 32 and 33; for, if there are no practical means by which the torpedo can be efficiently, safely, and conveniently launched in the more important directions desirable in active service, this fact would detract very greatly from its usefulness; and if it could not be held conveniently in the launching position under the circumstances in which it is supposed to be used, or be readily pointed, or be sheltered properly from the fire of an enemy (great guns and machine-guns) until the vessel that carries it should arrive within working range, it would fall far short of being an effective weapon.
- (36) In connection with the qualities enumerated, the Board will note and report on the following points, and any others that may appear pertinent:
- (37) Is the torpedo very difficult of manufacture, and is great accuracy of manufacture necessary in order to obtain uniform results?
- (38) Is great structural strength necessary?
- (39) What effect has the motion of the vessel at sea on the preparation of the torpedo, and on the torpedo itself when in position for firing, and what effect has the motion of the vessel on facility of pointing?
- (40) Is the preparation of the torpedo for action an elaborate process, and while it is being handled and when in position for service are the vessel and her crew reasonably safe from injury?
- (41) Is much care necessary in order to keep the torpedo in a proper state for speedy use?
- (42) Is the actuating apparatus or material reasonably safe and harmless, both when loaded and when in store, and does it probably deteriorate or dangerously change with time or with the changes of temperature and other conditions incident to service?
- (43) Can the torpedo be made innocuous (automatically) at the end of the flight?
- (44) Is the torpedo adapted for "exercise" practice? Is the motive power readily supplied in sufficient quantity to allow frequent exercise? Is exercise expensive, and can the torpedo be recovered and practice with it be resumed speedily?
- (45) Can the torpedo be conveniently and safely packed for transportation?
- (46) What is the probable cost to manufacture the torpedo, with launching apparatus and other appendages complete.
- (47) Although, owing to the diverse characteristics of the torpedoes that may be offered to the inspection of the Board, it is not possible for the Bureau to lay down any rigid rules for the conduct of the trial, the following programme is given as an example of what would seem to be a systematic investigation into the behavior of torpedoes on such a trial as it is the intention of the Bureau to hold, and the Board is expected to conduct its investigation in as nearly similar a manner as the circumstances of each case will warrant, the object being to bring out clearly the advantages and disadvantages of each system that is admitted to trial:
- (48) After an examination of the mechanical detail of the torpedoes, and the methods of carrying, loading, and launching, the Board should proceed to the actual trial of those that they decide are possibly adapted to use in naval warfare, as before defined.
- (49) In order that a correct idea may be formed of the character of the flight of each torpedo, and also of the distance at which practice should take place in the sea trials, some preliminary runs should be had in smooth water (against a target), either from the vessel (held in a fixed position) or from a wharf, float, or other convenient place. In this way the readiness with which each torpedo starts, its most effective range, and the time of flight to that and to shorter range, can be ascertained.
- (50) A target should be employed at the longest range, and also at some of the shorter ones, and boats and range-stakes at right angles to the line of flight would be useful in marking the intervals of time on the trajectory.
- (51) Having thus obtained the absolute and comparative ranges, velocity, accuracy, etc., under perfectly favorable conditions, it would appear best next to ascertain (in smooth water and without current) what deviations from the line of sight may be expected when the torpedoes are launched from a ship moving at a speed past a fixed target at a range which has been decided upon as the most effective for each torpedo.
- (52) Discharges should thus be made at the target when bearing abeam, four points on the bow, four points on the quarter, and also when directly ahead and astern.

is considered that these runs are stated above in the order of their importance and of the difficulty of successful operation. (See Sketch 1.)



Sketch 1.

(53) This experiment will probably bring the deviations and errors of flight peculiar to each torpedo, unaffected by any other condition than the speed of the vessel. It is probable that information enough would thus be accumulated to enable the Board to proceed in an economical and efficient manner with the regular trials at sea, and these trials are the ones which are to finally determine the merits of the torpedoes.



Sketch 2.

(54) The next point that it appears necessary to investigate is the effect of the sea upon the flight of the torpedoes, and for this purpose positions should be selected from which runs toward a target could be made, having the sea directly ahead, four points on the bow, abeam, four points on the quarter, and directly astern of the torpedo while running, the vessel and target to be both in a state of rest.

(55) Sketch 2 shows five positions that seem suitable for this experiment. They are in the order of their apparent importance, and are so numbered.

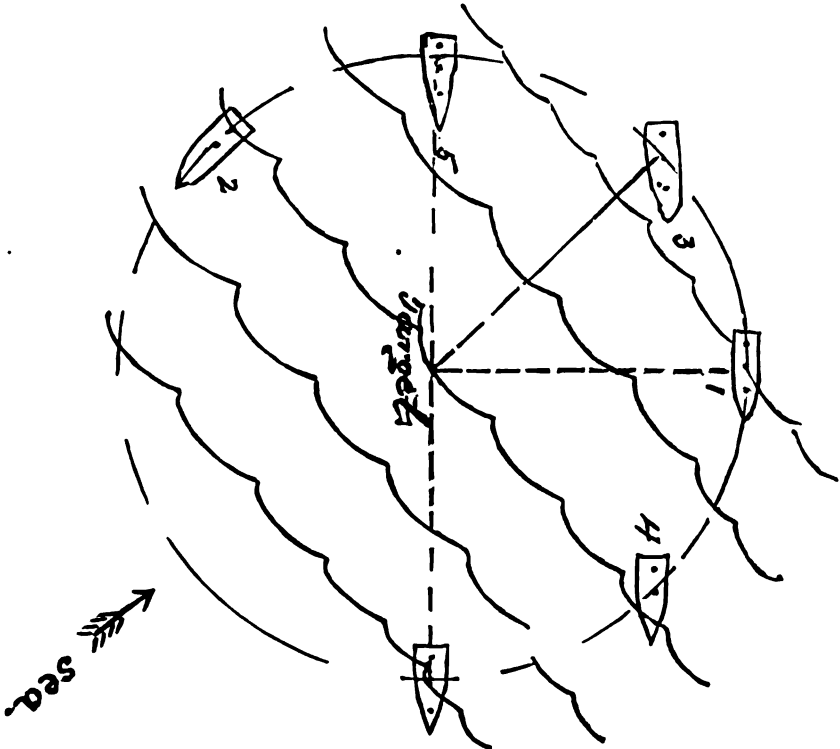
(56) The effect of the sea alone on the flight being thus recorded, it remains to ascertain the deviation due to launching the torpedoes in a seaway from the vessel at speed against a target at rest, the object of this part of the trial being to get such a direction of sea as regards the keel and the line of flight as will most clearly exhibit the directive force of the torpedo and operate most to throw it from the intended line of flight.

(57) Perhaps the position that would best accord with the above design would be when running a ship with the sea four points on the bow, the torpedo being launched directly abeam and on the side from which the sea comes.

(58) Thus circumstanced, it appears probable that the deflective force of the sea running along the ship's side and the movements of the vessel herself, in rolling and pitching, would be about as unfavorable to accuracy as could well be obtained, unless running the ship directly head to sea and launching abeam should be found more unfavorable.

(59) After a sufficient number of runs have been made as above, the torpedo might be launched four points on the bow and then four points on the quarter of the ship, the angle of the ship's keel with the sea remaining about four points.

(60) Sketch 3 shows the several positions above described, which are numbered in the order of their apparent importance; also two others, 5 and 6, which are less difficult.



Sketch 3.

(61) There are, no doubt, other positions from which valuable data could be obtained, and if any torpedo possesses any particularly distinguishing qualities (such as range or speed), this fact should be made to appear (by experiment) for what it is worth.

(62) It is probable that a set of trials as nearly like the foregoing as the varying natures of the torpedoes will permit would show what value there may be in the several weapons as naval torpedoes, and, in connection with such other experiments as the Board may find it advisable to make, would afford data from which a conclusive report could be drawn.

(63) It is very important to have a convenient target, and the following is suggested as likely to answer the purpose:

A line of suitable size, with wooden or cork floats at intervals, to which should be attached a muslin or net screen (the lower edge loaded with leaden weights) hanging down some 12 feet below the surface. This could be kept stretched out in the sea trials by a boat or drag at one end. The length of the target should be about 70 feet. This need only be used for the subaqueous torpedoes. Those that run on the surface might be run at the space between two barrels made fast to a line with the same interval.

(64) Those surface (or other) torpedoes that have detachable (or falling) magazines must be specially tested, in order to ascertain whether such magazines work certainly and properly.

(65) It is of great importance to obtain the velocity and energy of the torpedoes at different points of the flight; and the striking energy at the working range is of essential importance, as it is a measure of the ability of the torpedo to break through defense nets, etc. This point must, if practicable, be determined by actual experiment, which may be made in smooth water if thought best. (It might be combined with the first trials.)

(66) When the runs are made from the vessel at speed, it will be necessary to observe carefully the direction of the flight, as that duty will then offer more difficulty than in the other experiments. This may perhaps be partly effected from aloft, or an observing boat may be stationed at the point where the discharge is to take place, or near the target.

(67) In the case of subaqueous torpedoes, both in smooth and in rough water, every effort must be made to ascertain whether they keep a constant depth of submersion, and to value such oscillations as may occur. This can be ascertained by one or more muslin targets placed in the line of flight between the point of start and the final target.

(68) The steadiness of flight must be carefully observed on all occasions.

(69) If the owner disclaims, in writing, the utility of his torpedo in a moderate sea, such as frequently prevails in bays or roadsteads, and if the Board considers that it could probably be conveniently and effectively launched, directed, and used in smooth water from a vessel of not too elaborate design, the torpedo may be tried from a fixed station or from the shore, should the owner so request, and if such a course would be convenient to the Board. But in this case the report must always distinctly state that it was not tried from a vessel, and proper weight must be given to the altered conditions that such a trial would entail.

(70) If any torpedo cannot be conveniently and effectively used while the vessel is in motion, that fact must always be mentioned in the report.

Models.

(See paragraph 8.)

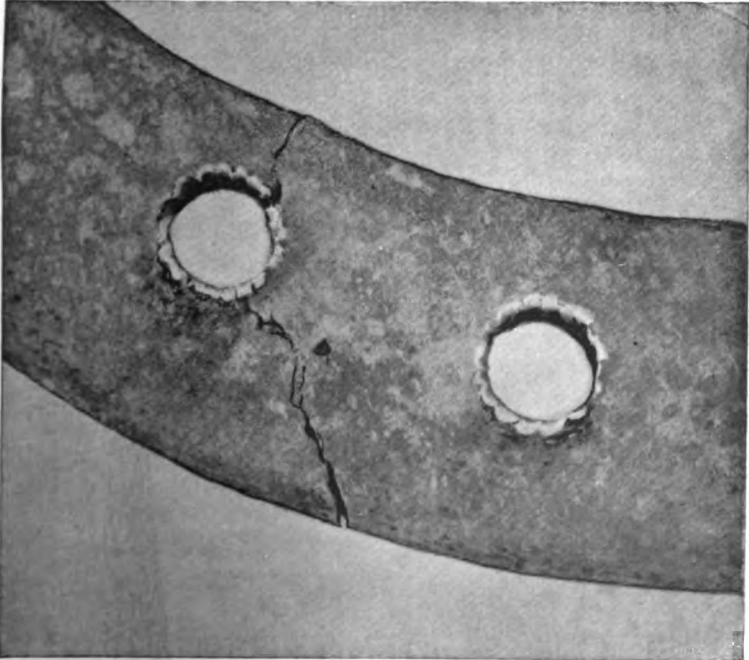
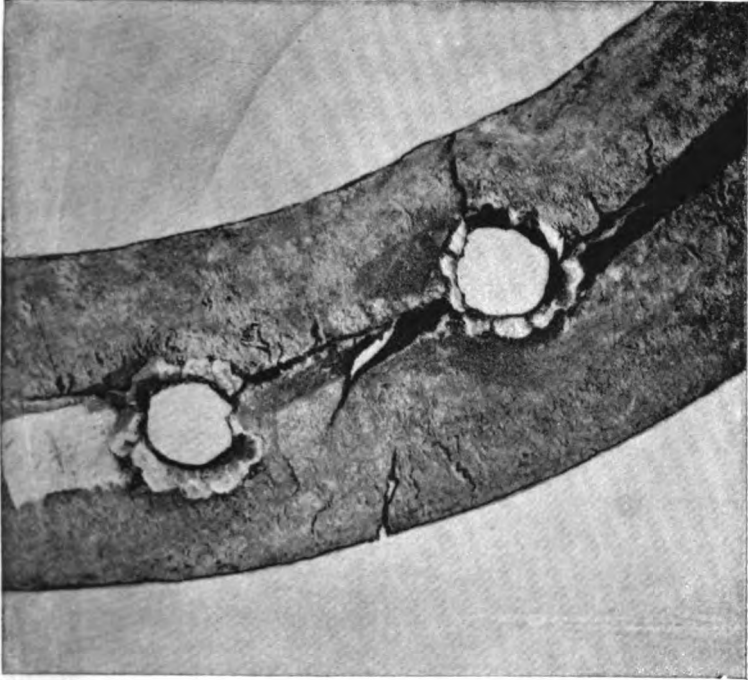
(71) The trials of models will be carried out the same as those with torpedoes proper so far as possible.

Designs.

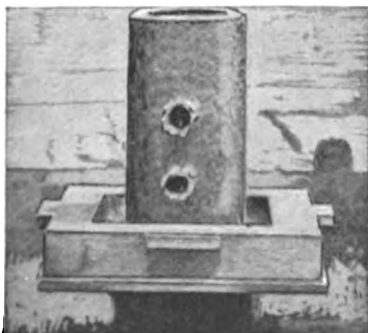
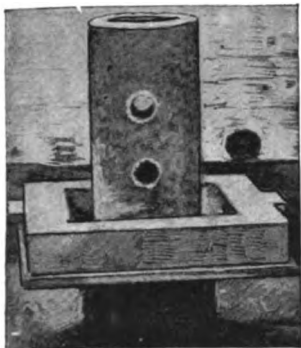
(See paragraph 9.)

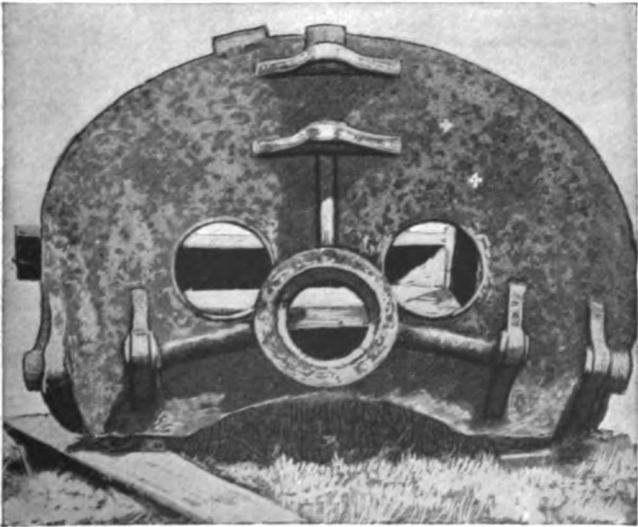
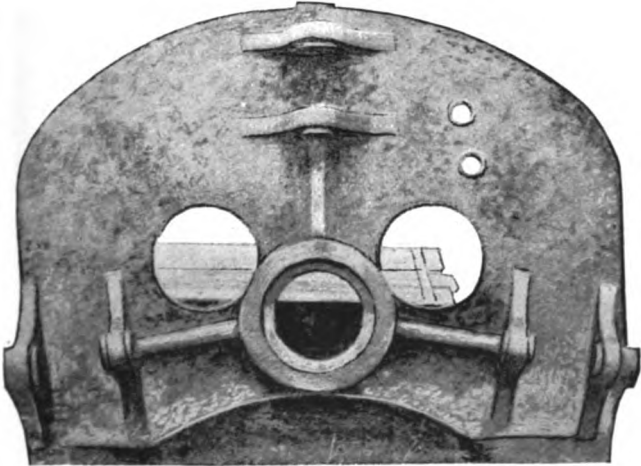
(72) The designs submitted to the Board must be accompanied by a detailed explanation, in writing, of all the parts and their functions, and of the action as a whole. All parts, including the launching apparatus, must be fully worked out and delineated, and the weight and volume of the whole must be stated. None of these details will be taken for granted by the Board.

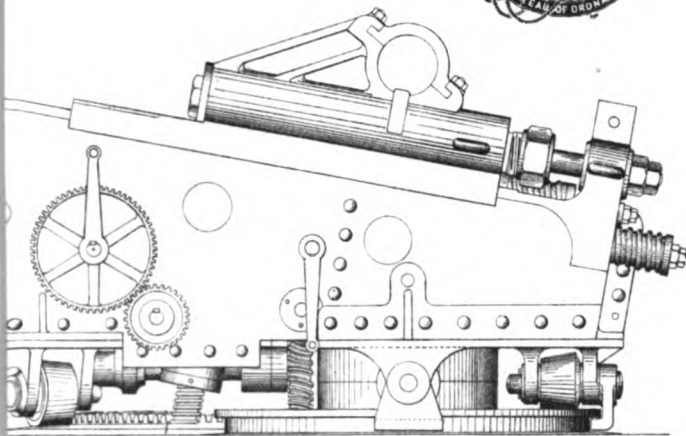
(73) If the performance of a model or the character of a design is so satisfactory as to cause the Board to unanimously decide that a service torpedo constructed on the same plan would be a thoroughly effective weapon of direct and evident practical value to the Navy in war, either for general service afloat or for harbor defense only, and in all essentials, for either purpose, superior to any finished weapon within its knowledge, the owner will be requested to furnish a written statement, signed by himself, setting forth distinctly and definitely the precise movements that will be performed and the results that will be obtained by his torpedo under the circumstances of wind, sea, current, etc., which he is willing to encounter. If this statement thoroughly covers the ground of general applicability, usefulness, and value as aforesaid, the Board will invite the owner to submit a formal agreement to furnish a strong and workmanlike service torpedo on the design, stating a price to be paid therefor and time of delivery. The whole record, so far as relates to the torpedo under considera-









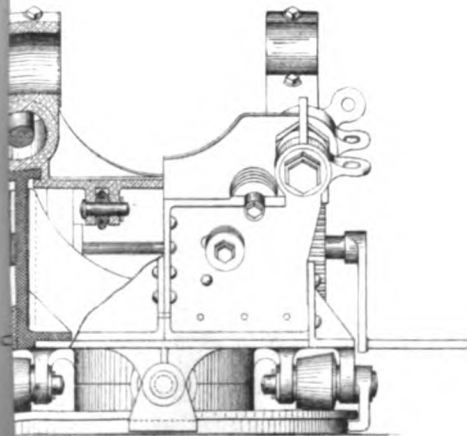


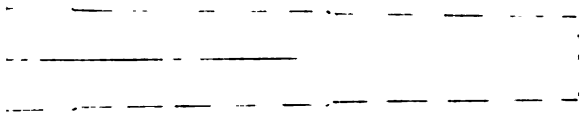
CENTRAL PIVOT CARRIAGE

FOR

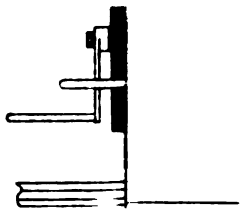
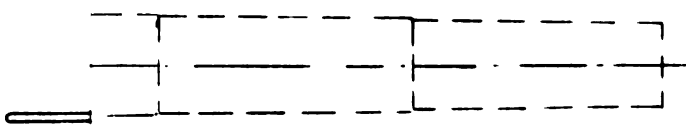
6-inch B. L. R.

(MARK III.)

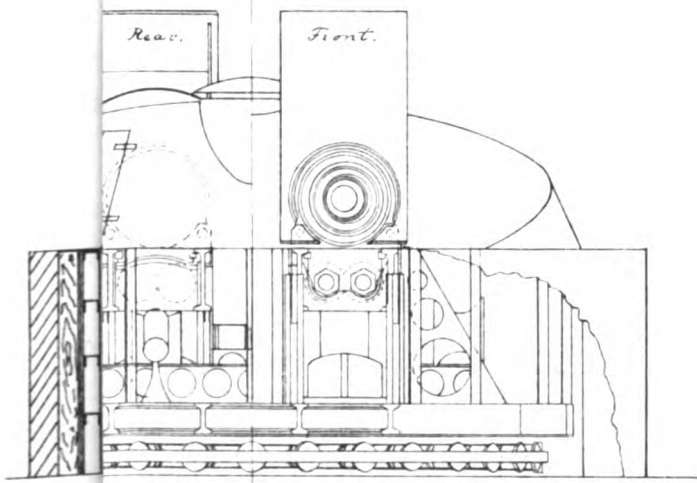
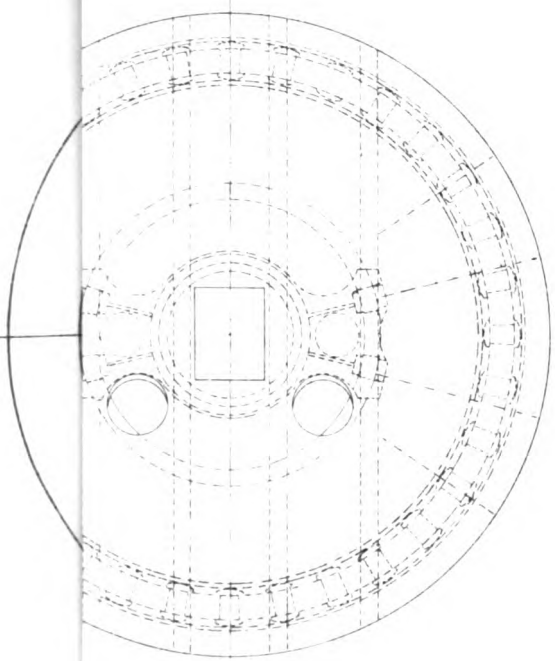




PRELIMINARY DESIGN
 OF
CENTRAL PIVOT CARRIAGE
 FOR
6-inch B. L. R.
 (COMBINED HYDRAULIC & PNEUMATIC CONTROL)



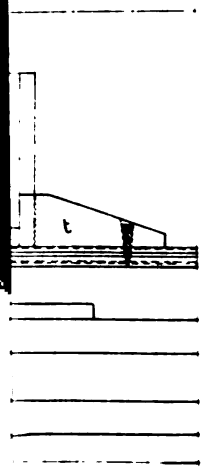




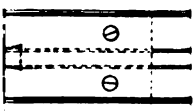
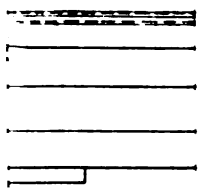
TUS

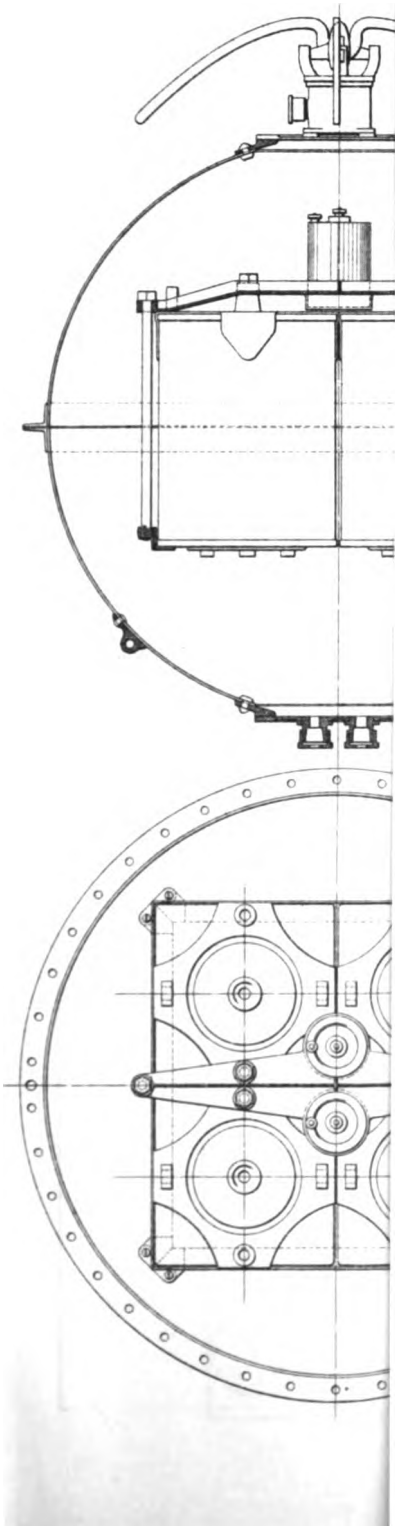
HE BORE

HT

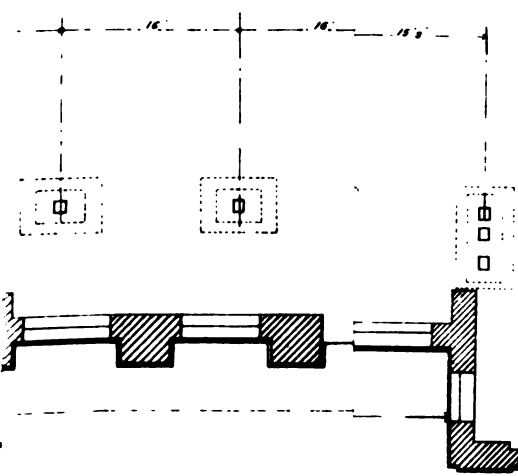
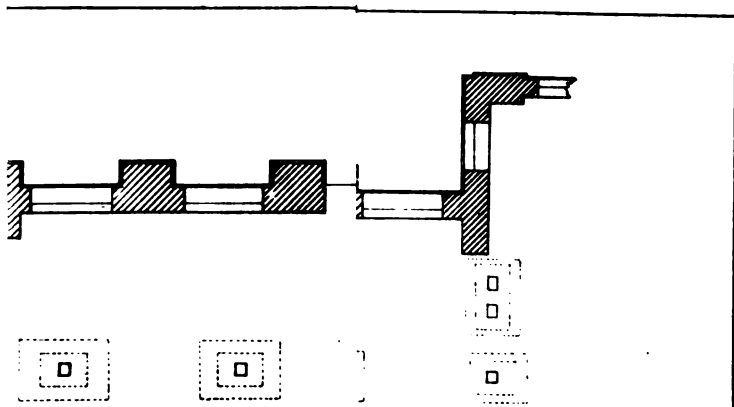


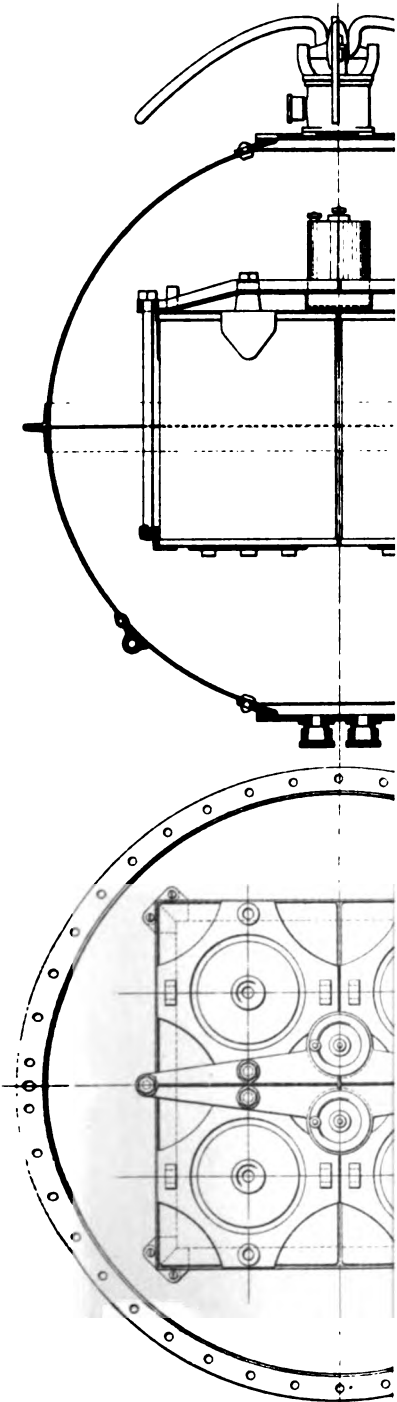
Apparatus in B



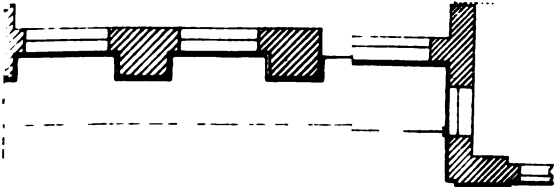
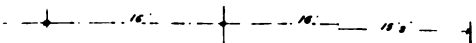
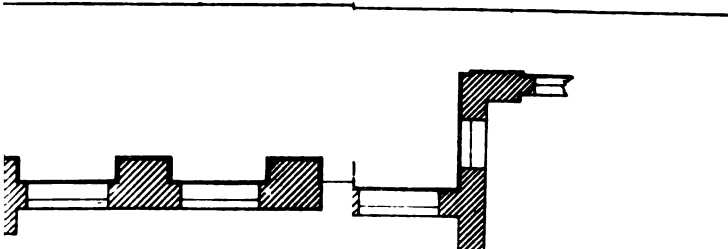


1
2
3
4
5
6
7
8
9
10
11
12
13
14
15
16
17
18
19
20
21
22
23
24
25
26
27
28
29
30
31
32
33
34
35
36
37
38
39
40
41
42
43
44
45
46
47
48
49
50
51
52
53
54
55
56
57
58
59
60
61
62
63
64
65
66
67
68
69
70
71
72
73
74
75
76
77
78
79
80
81
82
83
84
85
86
87
88
89
90
91
92
93
94
95
96
97
98
99
100









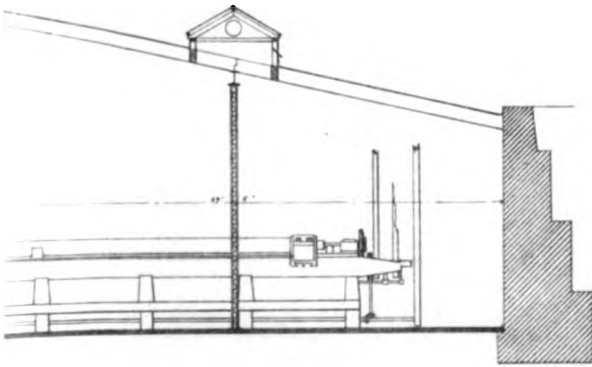


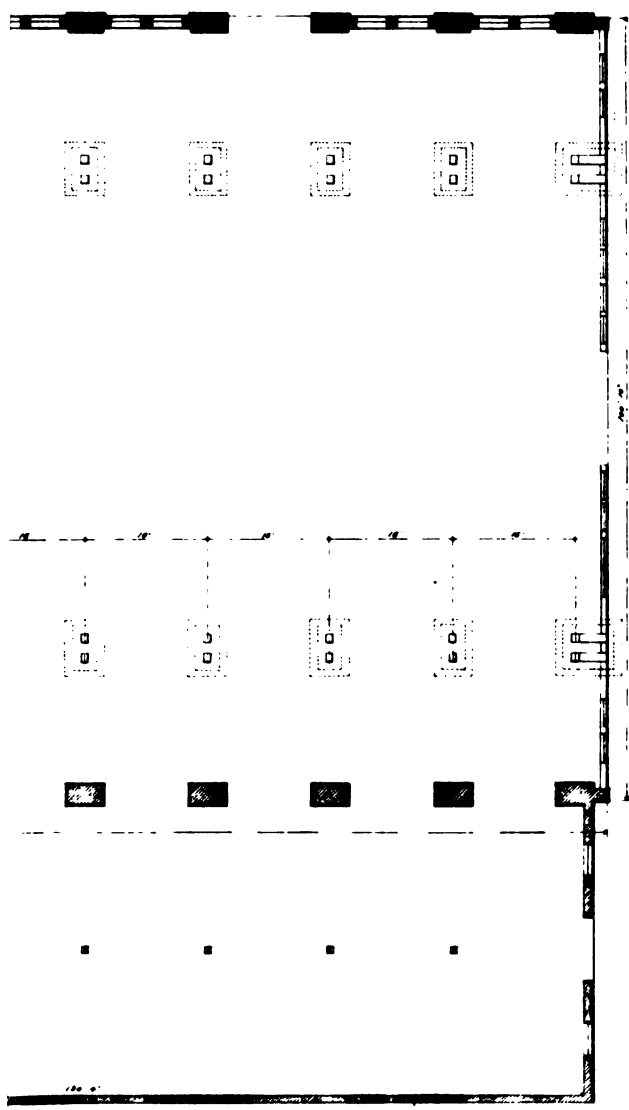
PROPOSED 12" GUN SHOP

U.S. NAVY YARD

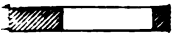
WASHINGTON, D.C.

1887









tion, will then be submitted to the Bureau, which will consider the expediency of making a contract for the purchase of a single torpedo for trial as aforesaid.

(74) Owners are not to be allowed to decide as to the nature of the trials (except as provided in paragraphs 18 and 70) nor as to the programme.

(75) All finished torpedoes must be presented within one year from the date of these instructions, and all persons who propose to submit torpedoes (finished weapons) must notify the Board to that effect within three months. All models and designs must be submitted within six months.

(76) The Bureau desires it to be distinctly understood that every precaution must be taken to guard effectually the vessel and all those embarked in her against injury from the torpedoes and their appliances, and the Board will be especially careful to make all reasonable preparations for safety, and to allow no person (civilian or otherwise) to expose himself to serious risk.

(77) The Board will keep a complete record of its proceedings, which will form its report. This record will be kept separately for each torpedo, model, and design, and will in each case set forth clearly the conclusions and recommendations of the Board, with the reasons therefor, and will include a complete description of the object under consideration. If any member or members dissent in opinion from the report of the majority, the reasons for such dissent will be given over the proper signatures. In the reports on finished weapons that are tried to a conclusion the Board will state distinctly whether, in its opinion, they are or not adapted to naval warfare. But no torpedo shall be reported as being so adapted unless it has been successfully tried from a vessel, and with a proper and practical launching apparatus.

MONTGOMERY SICARD,
Chief of Bureau.

BUREAU OF ORDNANCE, NAVY DEPARTMENT,
Washington, D. C., April 4, 1887.

Barbette mount for 10-inch and 12-inch B. L. E.

The carriage and general arrangements are similar to those of the turret mount of 10-inch B. L. E., figured in the report last year, the turn-table taking the place of the roller base and floor of the turret.

The shield is intended for protection against the fire of machine and rapid-fire guns.

Central pivot gun carriage for 6-inch B. L. E. (combined hydraulic and pneumatic control).

In this carriage the cylinders to the front of the trunnions are hydraulic, while those to the rear are pneumatic.

The hydraulic cylinders are intended to control the recoil, and the pneumatic cylinders to return the gun to battery and hold it there. An air pump, to be worked by hand, is attached to the slide for the purpose of supplying initial air pressure to the pneumatic cylinders, and also for making good the waste, when necessary.

This design has the advantage that the recoil is in the direction of the axis of the bore when the gun is fired, and the axis of the gun is brought much closer to the axis of the recoil cylinders than in previous designs.

No. 11.—BUREAU OF CONSTRUCTION AND REPAIR.

NAVY DEPARTMENT,
BUREAU OF CONSTRUCTION AND REPAIR,
October 25, 1887.

SIR: In obedience to the Department's instructions I have the honor to submit my annual report for the fiscal year ending June 30, 1887, showing the work performed and the amount expended, together with estimates of the amounts required for the purpose of the Bureau for the fiscal year ending June 30, 1889.

The estimates for the expenses of this Bureau, as given in the statement marked A, are in accordance with existing laws.

In view of the additional duty this Bureau is called upon to perform in the designing and building of new vessels for the Navy, and as this duty will probably increase in the future, it seems for the best interest of the Government that an assistant chief of this Bureau should be authorized by law, who will be empowered to act in the absence of the Chief of the Bureau, and otherwise assist in the numerous duties devolving upon him.

I have, therefore, to earnestly recommend that an assistant chief of Bureau of Construction and Repair be authorized, to be selected from the Corps of Naval Constructors not below the rank of commander, at an extra compensation of \$800 per annum in excess of his regular pay.

An estimate is submitted for a chief draughtsman of this Bureau, this rating having been for several years allowed* in the Bureau of Steam Engineering.

Mr. William T. Powell, the present head draughtsman of this Bureau, is in every way qualified for this position, not only from his ability to make the calculations and carry out the practical work required in one holding so responsible a position, but also that, from his long experience in the designing of men-of-war, his opinion is of the greatest value in all that pertains to their fitting and equipment. The establishment of the rating of chief draughtsman and the appointment of Mr. Powell to that position would be an act of justice to one whose long, faithful, and efficient services at a small rate of remuneration entitle him to a substantial advancement.

The estimate in statement marked C is for the pay of clerks and writers at the several navy-yards whose services are indispensable for the proper and systematic prosecution of the work which is required to be done at the yards by the Bureau.

The estimate marked B is for the general repair of vessels at navy-yards and on foreign stations, purchase of stores, material, machinery, rights of patent articles, and tools of all kinds, preservation of materials and stores, and for the general care and protection of the Navy in the line of construction and repair; and the estimate marked D, for the

hulls and outfits of new vessels, and the improvement of the plants at the navy-yards.

I renew my recommendation of last year that two composite, single-screw bark-rigged vessels of from 800 to 1,000 tons each be built to replace the *Saratoga*, *Portsmouth*, and *Jamestown*, wooden sailing ships of war, used as training ships, that cannot possibly be kept in service much longer.

The Bureau recommends the immediate construction of experimental works to cost \$60,000, for use in the determination of the resistance and other qualities of ships by means of models.

Such tanks as are recommended now form an invaluable and important part of the ship-designing branch of foreign naval establishments, and the Bureau is convinced of their permanent value in designing high-speed vessels and in analyzing the results of ships' trials.

The system is in theory comparatively simple, being that of towing a paraffine model of 10 feet length in a covered tank about 300 feet long, and measuring the resistance at different speeds. The models being made of paraffine and shaped by machinery are very cheap, but the dynamometrical apparatus is costly, being of exceeding delicacy and in all respects automatic.

ERRATA.

Page 321.—Endurance table of Newark, first two speeds are 18½ and 18 knots.

Page 336.—Thirty-ninth line, "cylinders are of 52 inches" should read "cylinders are 45 and 78 inches diameter by 57 inches stroke."

6 inches of water. I have lately made a personal examination of this vessel and find that her live-oak frames above and below water are sound. I am of the opinion that she can be repaired within the amount, \$175,000, called for by the board of survey, and request that special authority for her repair be asked.

She would then, apart from the claim she has upon the reverence of the American people as Farragut's flag-ship, be valuable for service as a cruiser for several years, and ultimately should be preserved as a monument to those whose blood was shed upon her decks, and as a reminder to the future, that wooden and old-fashioned though she may be called, she came out victorious in battles with both iron-clads and forts.

Appended hereto, marked E, is a list of vessels which have been repaired at the different navy-yards during the fiscal year 1886-'87; also a statement, marked F, of expenditures under the different appropriations during the year.

Appended hereto, marked G, is a list of the contracts made by the Bureau during the past fiscal year for materials and supplies for the several navy-yards.

The adaptability of the monitor to coast and harbor defense leads me to call your attention to the single-turreted monitors in the possession of the United States. They are now a considerable expense to the Navy, as they must be taken care of, and not being in proper repair

they are of no use to the country. If these vessels are to be kept on the naval list, they should be placed in perfect repair and be fitted with such modern rifles as they are capable of carrying. Within six months all of these vessels could be put in the same state of efficiency as they were at the time of their construction, at an expenditure of about \$500,000.

This would give thirteen coast-defense vessels actually available, armed with 15-inch smooth-bore guns. These guns could be replaced as rapidly as possible by rifles. By no other means could the same amount of money be spent to give the country such a valuable return.

Appended hereto, marked H, is a list of the vessels of the U. S. Navy, divided into groups under the heads of "Armored vessels," "Steel and iron unarmored vessels," "Wooden steam vessels," "Sailing vessels," and "Tugs."

The fact that the Navy is about to be increased by a number of valuable and efficient steel and iron vessels, which are new to the service and the country generally, has led me to prepare descriptions and drawings of all new vessels built, building, or appropriated for; information of this kind having been repeatedly called for by the Department, committees of Congress, and the public generally, and as reliable data has been wanting upon such matters, I believe this will supply a long-felt want.

All the tugs now belonging to the Navy, as will be seen from the appended table of tugs, are old, most of them being relics of the last war; they are unhandy and unsuited to the needs of our navy-yards, and require extensive repairs from year to year.

There should be built for use in towing and for other purposes at the navy-yards, at least half a dozen smaller tugs of about 200 tons displacement.

Appended hereto, marked I, is a statement of the condition of the various vessels now building for the Navy, under contract, up to October 1, 1887.

During the past year the *Tennessee* and the *Shenandoah* have been condemned as unfit for further use in the naval service.

The *Tennessee* was first called the *Madawaska*, and was designed and built at the Brooklyn navy-yard under the direction of Naval Constructor B. F. Delano, being launched in 1865. In 1869 she was timbered up to the necessary height to allow a spar-deck to be put on her. She was a first-rate wooden frigate of 4,840 tons displacement, 335 feet long between perpendiculars, 45 feet 2 inches wide, with a mean draught of 21 feet 8 inches. She was fitted with compound back-acting engines, with cylinders of 40 and 78 inches in diameter, by 40 inches stroke. These engines were capable of developing 3,200 indicated horse-power at 52 revolutions per minute, giving a speed of 13.9 knots per hour. She carried 380 tons of coal. She was ship-rigged, the area of the 10 principal sails being 22,500 square feet.

The battery consisted of 2 8-inch rifles on pivot mounts, and 2 100-pounder rifles on the broadside on the spar-deck, 1 60-pounder on the fore-castle, and 18 IX-inch smooth-bores on the gun-deck. Her officers and crew numbered 480, all told.

On account of her roomy and comfortable quarters for officers and crew and her fine qualities as a sea-boat she was a general favorite in the service. She was sold September, 1887, for \$34,525.

The *Shenandoah* was a second-rate ship of 2,100 tons displacement, designed by Naval Constructor H. Hoover at the navy-yard, Philadelphia, and launched December 8, 1862. She was 225 feet long between

the perpendiculars, 38 feet 4 inches extreme beam, and 16½ feet mean draught of water. The stem was made nearly plumb by Mr. Fox, the Assistant Secretary of the Navy, who intended her to be used as a ram. Her model was above the average of vessels of her date. Her engine was of the back-acting type, with 42-inch cylinders by 30-inch stroke. Speed, 12 knots; coal capacity, 365 tons of hard coal, sufficient for seven and one-half days' steaming at full power.

Her sailing and other sea-going qualities are reported as excellent. The area of her 10 principal working sails was 14,975 square feet. She was first put in commission in 1863, and carried at that time 4 9-inch broadside and 3 11-inch pivot guns. On the last cruise she carried 6 IX-inch broadside, 1 60-pounder, and 2 8-inch rifles. Her officers and crew numbered, all told, 242. She was sold at the navy-yard, Mare Island, California, August, 1887, for \$18,002.

To give effect to the clause in the act of August 3, 1886, appropriating \$150,000 for the purchase of tools for ship-building, boards were appointed to decide upon the character and location of tools in the construction department of the navy-yards at New York and Norfolk, \$75,000 being allotted to each yard. These tools are now under advertisement, and we shall soon be in possession of two yards thoroughly equipped for building steel and iron vessels of war of every size and type.

The navy-yard, Mare Island, being the only one on the Pacific coast but little argument is required to demonstrate that it should be supplied with a complete outfit of ship-building tools at an early date. An equipment should be provided for the Mare Island yard similar to those being advertised for to be furnished to the navy-yards at New York and Norfolk, it being the only Government establishment where the building and repairing of vessels can properly be conducted, upon a coast-line of thousands of miles in extent.

During my late visit to California, and to this yard in particular, I was exceedingly interested in its location and facilities, it being on an island at the junction of the Sacramento and Napa rivers, with the city of Vallejo opposite the yard, containing the homes of most of the working force and considered a very healthy place of residence.

The climate is such that there are but few days in the year which prevent outside work being carried on, and this fact, in spite of the high wages which are paid on the Pacific coast, causes the actual price of work done there to compare favorably with that of eastern yards.

It is perfectly practicable to conduct ship-building without the shelter of ship-houses, which are expensive, both in first cost and repairs, and do not favor rapidity of construction or excellence of workmanship on account of the darkness.

The temperature in winter is never cold, nor in summer is it warm enough to make outside labor uncomfortable.

The water front of the yard has an abundant depth of water, from 24 to 26 feet, and if necessary can be increased by dredging. This yard is not exposed to attack from the sea, and the water being fresh is preservative of the hulls of steel or iron vessels from corrosion, and of wooden ones from the depredations of the teredo. The place has made wonderful progress since its commencement, and at the present time has many elegant workshops ready for the reception of modern tools. The ship-fitters' building is a very substantial structure with 18-inch brick walls, the main portion being about 200 feet in length and 76 feet wide. This shop has never been provided with tools of any kind and contains no appliances with the exception of about 700 feet of bending

slabs. To properly fit out this shop for the building of modern steel ships a large number of the latest improved machines should be purchased, composed of planers, shears, punches, large and small rolls, overhead drilling machines, furnaces for plate and angle irons, large and small forges, steam-hammers, cranes of various sizes, overhead traveling cranes and surface railroads, pulleys, shafting, belting, etc., with an engine of about 250 horse-power. The boilers at the new dry-dock, being of sufficient capacity, can be utilized for that shop.

If fitted with such tools the work of building the hulls of two ships, as well as their machinery, at the same time could be readily carried on. The yard is already provided with a 30-ton steam-hammer, a large foundry with heating furnaces, and cranes by which all the heavy castings and forgings required could be produced.

Plans are now being prepared for the location of the necessary tools, so arranged that the work follows naturally from one machine to the other in its course toward the building slips, convenient to which the buildings are situated.

A large granite dry-dock 500 feet in length is nearly completed, and will give facilities to Mare Island which no other navy-yard in the country at the present time possesses.

In view of the above facts, I have most urgently to recommend that the sum of \$175,000 be appropriated for the purchase of the latest designed ship-building tools for improving the plant at this yard.

The outlook for the Navy in the near future is a very hopeful one, and with the completion of the vessels now projected, the Navy will consist of a number of modern vessels admirably adapted to the varied needs of the service.

The character of the work being done on the vessels now building, and those lately completed, shows that our ship-builders are able to turn out vessels of war second to none in the world.

The establishment of the gun factory at Washington, and introduction by the Bethlehem Iron Works of a plant to furnish heavy armor and gun forgings, makes the United States absolutely independent of other countries in the construction and armament of her ships of war, and if the work of rebuilding the Navy is only kept up as it is now going, we shall soon have a Navy that will be a credit as well as a protection to our country and our country's interests.

I am, sir, very respectfully, your obedient servant,

THEODORE D. WILSON,
Chief Constructor, U. S. Navy.

Hon. W. O. WHITNEY,
Secretary of the Navy.

A.—Estimates of appropriations required for the service of the fiscal year ending June 30, 1889, by the Bureau of Construction and Repair.

Detailed objects of expenditure, and explanations.	Estimated amount which will be required for each detailed object of expenditure.	Total amount to be appropriated under each head of appropriation.	Amount appropriated for the current fiscal year ending June 30, 1888.
SALARIES.			
Chief clerk (appropriated; R. S. 1886-'87, p. 621, pamphlet edition)	\$1,800.00		
One draughtsman (same act)	1,800.00		
One assistant draughtsman (same act)	1,600.00		
One assistant draughtsman (same act)	1,400.00		
One clerk of class four (same act)	1,800.00		
One clerk of class three (same act)	1,600.00		
One clerk of class two (same act)	1,400.00		
One clerk of class one (same act)	1,200.00		
One assistant messenger (same act)	720.00		
One laborer (same act)	600.00		
One chief draughtsman, increase (submitted)	700.00		
		\$14,680.00	\$12,980.00
CONSTRUCTION AND REPAIR OF VESSELS.			
B.—Preservation and completion of vessels on the stocks and in ordinary; purchase of materials and stores of all kinds for steam steerers, pneumatic steerers, steam capstans, steam windlasses, and other steam auxiliaries; labor in navy-yards and on foreign stations; purchase of machinery and tools for use in shops; wear, tear, and repair of vessels afloat, and for general care, increase, and protection of the Navy in the line of construction and repair; incidental expenses, such as advertising, freight, foreign postage, telegrams, photographing, books, plans, stationery, and instruments for drawing room (appropriated; R. S., 1886-'87, p. 587 pamphlet edition)....	900,000.00	900,000.00	900,000.00
CIVIL ESTABLISHMENT.			
C.—At the navy-yard, Portsmouth, N. H. (appropriated):			
Two writers at, \$1,017.25 each	2,034.50		
One clerk to naval constructor	1,400.00		
At the navy-yard, Boston, Mass. (appropriated):			
One clerk to naval constructor	1,400.00		
At the navy-yard, Brooklyn, N. Y. (appropriated):			
One clerk to naval constructor	1,400.00		
Three writers, at \$1,017.25 each	3,051.75		
At the navy-yard, League Island, Pa. (appropriated):			
One clerk to naval constructor	1,400.00		
At the navy-yard, Washington, D. C. (appropriated):			
One clerk to naval constructor	1,400.00		
At the navy-yard, Norfolk, Va. (appropriated):			
One clerk to naval constructor	1,400.00		
Two writers, at \$1,017.25 each	2,034.50		
At the navy-yard, Pensacola, Fla. (appropriated):			
One writer, at \$1,017.25	1,017.25		
At the navy-yard, Mare Island, Cal. (appropriated):			
One clerk to naval constructor	1,400.00		
Two writers, at \$1,017.25 each	2,034.50		
One writer at navy-yard, Brooklyn, N. Y. (submitted) ..	1,017.25		
One writer, at navy-yard, League Island, Pa. (submitted) ..	1,017.25		
One writer at navy-yard, Norfolk, Va. (submitted)	1,017.25		
One writer at navy-yard, Mare Island, Cal. (submitted) ..	1,017.25		
		24,041.50	20,982.75
IMPROVEMENT OF THE PLANT AT THE NAVY-YARD, MARE ISLAND, CAL.			
D.—Extra tools required to put the yard in condition for building and repairing iron and steel ships (submitted) ..	175,000.00	175,000.00	

Estimates of appropriations required for the service of the fiscal year, etc.—Continued.

Detailed objects of expenditure, and explanations.	Estimated amount which will be required for each detailed object of expenditure.	Total amount to be appropriated under each head of appropriation.	Amount appropriated for the current fiscal year ending June 30, 1887.
IMPROVEMENT OF THE PLANT AT THE NAVY-YARD, NEW YORK.			
Construction of experimental works for use in the determination of the resistance and other qualities of ships by means of models (submitted)	\$60,000.00	\$60,000.00	
INCREASE OF THE NAVY.			
On account of hulls and outfits of new ships heretofore or hereafter authorized by Congress (submitted)	3,000,000.00	3,000,000.00	
		3,235,000.00	

E.—Vessels repaired at the different navy-yards and stations during the fiscal year 1886-'87.

Name.	Amount.	Name.	Amount.
Tennessee.....	\$1,135.96	Deepatch.....	\$1,001.59
Trenton.....	70,402.06	Thetis.....	52,431.29
Lancaster.....	2,222.13	Dolphin.....	11,822.11
Brooklyn.....	12,008.18	Canonius.....	855.43
Pensacola.....	2,822.10	Comanche.....	2,122.52
Hartford.....	4,216.59	Miantonomoh.....	19,082.73
Richmond.....	49,228.71	Fortune.....	682.19
Vandalia.....	1,046.77	Leyden.....	871.31
Juniata.....	425.62	Mayflower.....	2,282.56
Swatara.....	39,374.12	Monterey.....	672.29
Galena.....	19,080.96	Pinta.....	722.24
Mohican.....	379.20	Speedwell.....	172.11
Kearsarge.....	12,962.12	Franklin.....	262.50
Adams.....	1,200.76	Wabash.....	10,129.09
Alliance.....	3,144.84	New Hampshire.....	7,084.77
Essex.....	9,228.75	Vermont.....	682.21
Enterprise.....	31,916.40	Constellation.....	632.05
Nipelo.....	48,006.18	Independence.....	2,182.25
Alert.....	81,926.49	Portsmouth.....	7,082.28
Ranger.....	12,058.04	Jamestown.....	2,082.28
Yantic.....	4,684.02	Saratoga.....	2,374.73
Tallapoosa.....	2,599.95	St. Louis.....	1,242.57
		Total.....	563,122.63

F.—Amounts expended under the different appropriations during the fiscal year 1886-'87.

Appropriation "Construction and Repair":		
Appropriated		\$900,000.00
Expended for labor at navy-yards and stations.....	\$717,186.37	
Expended for the purchase of materials and tools for yards, advertising, foreign postage, books, telegrams, plans, instruments for drawing-room.....	102,532.75	
Expended for bills paid on account of foreign stations..	33,018.72	
		<u>852,737.84</u>
Balance July 1, 1887		<u>47,262.16</u>
Appropriation "Repairs of Vessels":		
Appropriated		200,000.00
Expended for labor	\$103,149.72	
Expended for materials	8,497.85	
		<u>111,647.57</u>
Balance July 1, 1887		<u>88,352.43</u>

Appropriation "Civil Establishment":

Appropriated	43,000.00
Expended for clerks and writers at navy-yards	42,745.82
Balance July 1, 1887	254.18

Appropriation "Increase of the Navy," vessels, March 3, 1885:

Expended during the year	28,770.90
--------------------------------	-----------

Appropriation "Vessels and Monitors," act August 3, 1886:

Expended during the year	21,415.05
--------------------------------	-----------

Appropriation "Steel Cruisers":

Balance July 1, 1886	24,647.46
Appropriated	95,861.00
Expended during the year	120,508.46
Balance July 1, 1887	120,445.36
Balance July 1, 1887	63.10

Appropriation "Care of Monitors":

Appropriated	5,000.00
Expended during the year	4,848.50
Balance July 1, 1887	151.50

G.—List of contracts made by this Bureau for materials for the several navy-yards during the fiscal year 1886-'87.

Name of contractor.	Date of contract.	Amount.
American Manufacturing Company, New York	Nov. 23, 1886	\$38.00
Geo. H. Creed, New York	Nov. 19, 1886	181.25
Thomas E. Call and Son, Portsmouth, N. H.	Nov. 26, 1886	566.25
Church and Stevens, Washington, D. C.	Nov. 23, 1886	1,968.00
B. Callender & Co., Boston	Nov. 20, 1886	485.02
James J. Donovan, New York	Nov. 20, 1886	9,461.30
Dannat and Bell, New York	Nov. 18, 1886	5,629.00
Jos. W. Duryea, New York	Nov. 19, 1886	2,915.70
A. C. Dietz and Co., San Francisco	Nov. 26, 1886	450.00
Excelsior Varnish Works, New York	Nov. 17, 1886	774.00
W. and E. S. Foye, San Francisco	Nov. 24, 1886	2,164.99
Forsyth Machine Company, Manchester, N. H.	Nov. 19, 1886	37.25
Chas. J. Field, Philadelphia	Nov. 22, 1886	282.16
Samuel J. Field, Philadelphia	Nov. 22, 1886	268.80
E. J. Griffith and Co., Norfolk, Va.	Nov. 13, 1886	18.56
J. W. Gaskill and Son, Philadelphia	Nov. 24, 1886	8,704.96
G. W. Gibbs, San Francisco	Nov. 28, 1886	530.96
James Gallup, San Francisco	Nov. 26, 1886	1,065.12
Hamilton Bros., Waterborough, Me.	Nov. 23, 1886	8.83
Hanson & Co., San Francisco	Nov. 30, 1886	1,240.00
George A. Hammond, Elliot, Me.	Nov. 26, 1886	898.50
Hawley Bros. Hardware Company, San Francisco ..	Nov. 24, 1886	1,022.42
W. W. Lawrence, Pittsburgh, Pa.	Nov. 22, 1886	2,335.81
Mayer & Co., Norfolk, Va.	Nov. 18, 1886	466.96
Morley & Co., East Saginaw, Mich.	Nov. 18, 1886	579.30
James McCuider, Vallejo, Cal.	Nov. 24, 1886	6,763.50
George L. Neville, Norfolk, Va.	Nov. 19, 1886	5,184.57
C. D. O'Sullivan, San Francisco	Nov. 24, 1886	954.67
A. Powell, San Francisco	Nov. 27, 1886	11,354.74
Rider and Cotton, Portsmouth, N. H.	Nov. 19, 1886	6,820.33
Rowland A. Robbins, New York	Nov. 18, 1886	10,052.94
Fred. M. Smith, New York	Nov. 18, 1886	1,917.97
South Brooklyn Saw-mill Company, Brooklyn, N. Y.	Nov. 19, 1886	7,750.00
Thomas A. Selby, San Francisco	Nov. 27, 1886	1,060.50
W. F. Whittier, San Francisco	Nov. 24, 1886	1,100.73
Total		96,672.56

H.—Tables of vessels

ARMORED

DOUBLE-

Name of vessel.	Type.	Keel laid.	Where built.	Condition.	Length between perpendiculars.		Mean draught.	Displacement.	Max. indicated horse-power.
					Ft.	Breadth.			
Puritan	Double-turreted monitor.	1875	Boach's yard, Chester, Pa.	Awaiting completion.	280	60	Ft. In. 18 2	Tons 6000	3500
Miantonomoh	do	1874	do	do	250	55½	14 1½	3815	1426
Ampbitrite	do	1874	Harlan & Hollingsworth, Wilmington, Del.	do	250	55½	14 1½	3815	1600
Monadnock	do	1874	U. S. navy-yard, San Francisco.	do	250	55½	14 1½	3815	600
Terror	do	1874	Cramp's, Philadelphia, Pa.	do	250	55½	14 1½	3815	1000
Armored battle-ship.	Belted		U. S. navy-yard, Norfolk, Va.	Preparing ways.	290	64½	22 6	6300	8000
Armored cruiser.	do		U. S. navy-yard, New York.	do	310	57	21 6	6648	8750

SINGLE-TURRET

Ajax	Single-turreted monitor.	1862	Snowdens & Mason, Pittsburgh, Pa.	In ordinary.	225	43½	13 6	2100	340
Camanche	do	1862	Donahue, Ryan & Secor, Jersey City, N. J.	do	200	46	11 6	1875	340
Canonicus	do	1862	Harrison Loring, Boston, Mass.	do	225	43½	13 6	2100	340
Catskill	do	1863	John Ericsson, Brooklyn, N. Y.	do	200	46	11 6	1875	340
Jason	do	1862	John Ericsson, Chester, Pa.	do	200	46	11 6	1875	340
Lehigh	do	1863	John Ericsson, Chester, Pa.	do	200	46	11 6	1875	340
Mahopac	do	1862	Z. & F. Secor, Jersey City, N. J.	do	225	43½	13 6	2100	340
Manhattan	do	1862	Perine, Secor & Co., Jersey City, N. J.	do	225	43½	13 6	2100	340
Montauk	do	1862	John Ericsson, Brooklyn, N. Y.	do	200	46	11 6	1875	340
Nahant	do	1863	Harrison Loring, Boston, Mass.	do	200	46	11 6	1875	340
Nantucket	do	1863	Atlantic Works, Boston, Mass.	do	200	46	11 6	1875	340
Passaic	do	1862	John Ericsson, Brooklyn, N. Y.	do	200	46	11 6	1875	340
Wyandotte	do	1862	Miles Greenwood, Cincinnati, Ohio.	do	225	43½	13 6	2100	340

of the U. S. Navy.

VESSELS.

TURRETED.

Type of engine.	Speed in knots.	Batteries.		Armor.		Cost of hull and machinery.	Date of act authorizing building.
		Main.	Secondary.	Sides.	Turrets and barbets.		
Twin-screw horizontal compound.	13	4 10" B. L. R.	26-pdrs. R. F., 2 8-pdrs. R. F., 2.37" R. C., 2 Gat- lings.	12"	11 1/2"	To complete \$3,173,046.	Mar. 3d, '85, Aug. 3d, '86, Mar. 3d, '87.
Twin-screw inclined compound.	10.5do.....	26-pdrs. R. F., 2.37" R. C., 2 Gat- lings.	7"	11 1/2"		Mar. 3d, '85, Aug. 3d, '86, Mar. 3d, '87.
.....do.....	12do.....do.....	7"	11 1/2"		Mar. 3d, '85, Aug. 3d, '86, Mar. 3d, '87.
.....do.....	12do.....do.....	7"	11 1/2"		Mar. 3d, '85, Aug. 3d, '86, Mar. 3d, '87.
.....do.....	12do.....do.....	7"	11 1/2"		Mar. 3d, '85, Aug. 3d, '86, Mar. 3d, '87.
Twin-screw vertical triple expansion.	17	2 12" B. L. R. 6 6" B. L. R.	4 6-pdrs., 4 3-pdrs., 2 1-pdrs., 4.47" R. C., 4.37" R. C., 4 Gat- lings.	12"	12"	\$2,376,000	August 3, 1886.
.....do.....	17	4 10" B. L. R. 6 6" B. L. R.	4 6-pdrs., 4 3-pdrs., 4.47" R. C., 4.37" R. C., 4 Gat- lings.	11"	10 1/2"	2,484,503	Do.

ED MONITORS.

Single-screw grasshopper.	5.6	2 15" S. B.....	None	5"	10"	626,582.24	April 17, 1863.
.....do.....	5.6do.....do.....	5"	11"	613,164.98	Do.
.....do.....	6do.....do.....	5"	10"	622,963.22	Do.
.....do.....	6do.....do.....	5"	11"	427,766.78	Do.
.....do.....	5.6do.....do.....	5"	11"	422,766.73	Do.
.....do.....	5.6do.....do.....	5"	11"	422,726.28	Do.
.....do.....	6do.....do.....	5"	10"	635,374.55	Do.
.....do.....	6do.....do.....	5"	10"	623,873.27	Do.
.....do.....	5.6do.....do.....	5"	11"	423,027.49	Do.
.....do.....	5.6do.....do.....	5"	11"	413,515.14	Do.
.....do.....	5.7do.....do.....	5"	11"	406,061.37	Do.
.....do.....	5.6do.....do.....	5"	11"	423,171.69	Do.
.....do.....	6do.....do.....	5"	10"	633,327.84	Do.

H.—Tables of vessels of the

UNARMORED STEEL

Name.	Type.	Keel laid.	Where built.	Condition.	Dimensions.			Displacement.	Max. indicated horse-power.
					Length between perpendiculars.	Beam.	Mean draught.		
					Feet.	Feet.	Feet.	Tons.	
Chicago	Protected cruiser.	1888	Roach's	Commissioned.	315	48½	19	4,500	*5,000
Boston	do	1882	do	do	270	42	17	3,189	3,780
Atlanta	do	1882	do	do	270	42	17	3,189	3,511
Dolphin	Dispatch vessel.	1882	do	do	240	32	14½	1,486	2,240
Newark	Protected cruiser.		Cramp's	Building	310	49½	18½	4,063	*3,500
Charleston	do	1887	Union Iron Works.	Building	300	46	18½	3,730	*7,500
Baltimore	do	1887	Cramp's	do	315	48½	19½	4,413	*10,500
Cruiser No. 4	do		do	Building	315	48½	19½	4,413	*10,500
Cruiser No. 5	do		Union Iron Works.	do	310	49½	18½	4,063	*10,500
Gun-boat No 1	Cruiser	1887	Cramp's	Building	230	36	14	1,700	*3,400
Gun-boat No. 2	do	1887	Columbian Iron Works, Baltimore.	do	175	31	11½	890	*1,300
Gun-boat No. 3	do		N.F. Palmer, jr., & Co., Chester, Pa.	Building	230	36	14	1,700	†3,400
Gun-boat No. 4	do		do	do	230	36	14	1,700	†3,400
Dynamite cruiser		1887	Cramp's	Building	246½	36½	9	725	*3,300
1st-class torpedo boat.				Bids received..	135	15	3½	100

*Estimated.

†Guaranteed.

U. S. Navy—Continued.
AND IRON VESSELS.

Type of engines.	Speed in knots.	Batteries.		Total contract cost of hull and machinery.	Date of act authorising building.	Contract signed.	Time to complete from date of contract.
		Main.	Secondary.				
Twin screw compound, overhead beam.	14.0	4 8" B. L. R. 8 6" B. L. R. 2 5" B. L. R.	2 6-pdrs..... 4 47" R. C. 2 37" R. C. 2 1-pdra. 2 Gatlings.	\$889,000	Aug. 5, 1883 Mar. 3, 1883	July 26, 1883	Mo.
Single screw horizontal compound.	14.0	2 8" B. L. R. 6 6" B. L. R.	2 Gatlings..... 2 6-pdrs. 2 2-pdra. 2 47" R. C. 2 37" R. C. 2 1-pdra.	619,000	Same as Chicago.	July 23, 1883
.....do.....	16.33	Same as Boston.	Same as Boston.	617,000do.....do.....
Single screw vertical compound.	15.5	1 6" B. L. R.	4 47" R. C. 2 6-pdra. 2 Gatlings.	315,000do.....do.....
Twin screw horizontal, triple expansion.	18.0	12 6" B. L. R.	4 6 pdrs..... 4 37" R. C. 1 1-pdr. 2 2-pdra. 2 Gatlings.	1,248,000	Mar. 3, 1885 Mar. 3, 1886	Oct. 27, 1887	24
Twin screw horizontal compound.	18.0	2 8" B. L. R. 6 6" B. L. R.	4 6-pdrs..... 4 R. C. 2 2-pdra. 1 1-pdr. 2 Gatlings.	1,017,000	Mar. 3, 1885	Dec. 28, 1886	18
Twin screw horizontal, triple expansion.	19.0	4 8" B. L. R. 6 6" B. L. R.	2 Gatlings..... 4 6-pdra. 2 2-pdra. 1 1-pdr. 4 37" R. C.	1,325,000	Aug. 3, 1886	Dec. 17, 1886	18
.....do.....	19.0	12 6" B. L. R.	Same as Baltimore.	1,350,000	Mar. 3, 1887	Oct. 27, 1887	24
.....do.....	19.0do.....do.....	1,428,000do.....	Oct. 26, 1887	24
.....do.....	16.0	6 6" B. L. R.	2 Gatlings..... 2 6-pdra. 2 2-pdra. 1 1-pdr. 2 37" R. C.	455,000	Mar. 3, 1885	Jan. 31, 1887	12
Single screw horizontal compound.	12.0	4 6" B. L. R.	2 Gatlings..... 2 2-pdra. 1 1-pdr. 2 37" R. C.	247,000do.....	Dec. 22, 1886	12
Twin screw horizontal, triple expansion.	16.0	Same as No. 1.	Same as No. 1.	490,000	Mar. 3, 1887	Nov. 15, 1887	18
.....do.....	16.0do.....do.....	490,000do.....	Nov. 15, 1887	18
Twin screw vertical, triple expansion.	20.0	3 dynamite guns 10 1/2" caliber.	2 2-pdra..... 1 1-pdr. 2 R. C. 2 Gatlings.	*350,000	Aug. 3, 1886	Feb. 11, 1887	12
.....do.....	22.0	3 automobile torpedoes.	2 2-pdra.....	90,000do.....do.....

* Including dynamite guns, etc.

H.—Tables of vessels of the
UNARMORED STEEL AND

Name.	Built.			Condition.	Rig.
	When.	Where.	By whom.		
Ranger	1873-1876	Wilmington, Del.	Harlan & Hollingsworth.	Surveying North Pacific.	Bark
Alert	1873-1875	Chester, Pa.	John Roach	Pacific Station	do
Monocacy	1863	Baltimore, Md..	A. and W. Denmead & Son.	Asiatic Station	Schooner ...
Michigan	1844	Eric, Pa	United States	Northwest'n Lakes.	Barkentine.
Palos	1865	Boston	James Tetlow	Asiatic Station	Schooner ...
Pinta	1865	Chester, Pa.	Reaney, Son & Archbold.	Pacific Station	do
Intrepid	1874	Boston	United States	Undergoing alterations, navy-yard, New York; work suspended.	Brig.
Alarm	1874	New York	United States	In ordinary, New York.

*Anthracite.

U. S. Navy—Continued.

IRON VESSELS—Continued.

Dimensions.				Indicated horse-power.	Speed in knots.	Batteries.		Coal capacity in tons.	Complement.	
Length between perpendiculars.	Breadth.	Mean draught.	Displacement in tons.			Main.	Secondary.		Officers.	Men.
175	33 0	12½	1,020	365	10.0	1 60-pdr. Parrott.....	*126	21	127
175	33 0	12½	1,020	396	10.0	1 XI" S. B.	1 13" rifle	*183	21	127
						2 IX" S. B.	1 12-pdr.			
						1 60-pdr. B. L. R.	1 Gatling			
255	35 0	9	1,370	350	11.2	4 8" Dahlgren	2 37 ^{mm} R. C.	†224	12	114
						2 60-pdr. P. R.	2 20-pdr. how. B.			
						2 24" howitzers.	1 45 Gat.			
163½	27 1½	9	685	305	10.5	4 30-pdr. B. L. R.	2 12-pdr. how.	*185
							2 37 ^{mm} R. C.			
137	26 0	9½	420	246	10.35	4 24-pdr. J. A. D.	1 12-pdr. how.	*102	9	48
						2 20-pdr. howitzers.	2 Gatlings.			
						1 12-pdr. howitzer.	1 45 Gatling			
						2 12-pdr. howitzers..	2 37 ^{mm} H. R. C.			
170	25 ¾	11	1,150	1,812	10.6	1 Gatling	*111	8	37
							*180
156½	28 0	10½	800	600	10.0	1 XV" S. B.	*40.5

† Bituminous.

H.—Tables of vessels of the

WOODEN STEAM

Name.	Built.			Condition.	Rig.
	When.	Where.	By whom.		
Trenton	1873-1877	New York.....	United States	Special service, Atlantic.	Ship
Lancaster.....	1858	Philadelphia.....	do.....	Flag-ship, South Atlantic station.	do
Brooklyn	1858	New York	Westervelt & Co ...	Flag-ship, Asiatic station.	do
Pensacola.....	1858-1862	Pensacola.....	United States	Flag-ship, European station.	do.....
Hartford.....	1858	Boston.....	do.....	Repairing, Mare Island	do
Richmond	1858	Norfolk.....	do	Flag-ship, North Atlantic station.	do
Ossipee	1861	Kittery.....	do	North Atlantic station.	Bark.....
Omaha.....	1867-1869	Philadelphia.....	do	Asiatic station	do
Vandalla	1872-1876	Boston.....	do	Flag-ship Pacific station.	do
Juniata.....	1862	Philadelphia.....	do	Pacific station	Ship.....
Quinnebaug ..	1871-1877	do	do	European station	do
Swatara	1872	New York.....	do	Repairing navy-yard, Portsmouth N. H.	do
Galena	1871-1878	Norfolk.....	do	North Atlantic station.	do
Marion	1871-1875	Kittery	do	Asiatic station	Bark.....
Mohican.....	1872-1883	Mare Island.....	do	Pacific station	do
Iroquois.....	1858	New York.....	do	do	Ship
Kearsarge.....	1861	Kittery	do	Repairing navy-yard, Portsmouth, N. H.	Bark.....
Adams	1874-1876	Boston.....	Donald McKay and United States.	Pacific station.....	do

U. S. Navy—Continued.

VESSELS.

Dimensions.				Indicated horse-power.	Speed in knots.	Batteries.		Coal capacity.	Complement.	
Length between perpendiculars.	Breadth.	Mean draught.	Displacement in tons.			Main.	Secondary.		Officers.	Men.
Ft. In.	Ft.	Ft. In.								
253 0	48	20 6	2,900	2,414	12.6	2 20-pdr. rifles 10 8" M. L. R.	2 3" rifles 1 12-pdr. Howitzer. 1 short Gatling.	*237	29	387
235 8	46	19 3	2,250	783	9.6	8 8" M. L. R. S 2 8" M. L. R. pivot.	4 37" H. R. C. 2 20-pdrs. B. L. R. 1 8 H. L. Howitzer. 1 L. Gatling.	*288	22	322
233 4	43	19 6	2,900	1,116	10	12 IX" S. B. 1 8" M. L. R. can. 1 60-pdr. B. L. R.	4 37" H. R. C. 2 20-pdrs. B. L. R. 1 12-pdr. L. 1 45 cal. L. Gatling. 1 5" B. L. R.	†230	23	268
230 8	44½	18 7	2,000	680	9	12 IX" M. L. S. B. 2 80-pdrs. B. L. R. 2 80-pdrs. B. L. R.	2 36-pdrs. H. R. F. G. .. 1 45 long Gatling. 1 8" How. B. L. R.	*285	36	351
225 0	44	18 6	2,900	1,024	9	12 IX" S. B. M. L. 1 8" M. L. R. 1 60-pdr. B. L. R.	2 20-pdr. B. L. R. 2 3" B. L. H. 2 45 cal. Gatling.	*240	32	285
225 0	42½	17 4½	2,700	602	9.5	12 IX" S. B. 1 8" M. L. R. 1 60-pdr. B. L. R.	2 20-pdr. B. L. R. 4 37" H. R. C. 1 3 B. L. R. 1 45 S. Gatling. 2 12-pdr. Howitzer.	*265	29	321
205 0	38	16 6	1,900	715	10.5	6 IX" S. B. 1 8" M. L. R. 1 60-pdr. B. L. R.	4 37" H. R. C. 1 short Gatling. 1 60-pdr. B. L. R.	*226	20	194
250 6	38	16 6	2,400	953	11.3	10 IX" S. B. Dn 1 VIII" R. C. pivot. 1 60-pdr. B. L. R.	4 37" H. R. C. 2 20-pdr. B. L. R. 1 8" B. L. R. 1 Gatling.	*150	22	269
216 0	39	17 3	2,100	1,147	12	6 IX" S. B. 1 8" M. L. R. 1 60-pdr. B. L. R.	1 8" B. L. R. 1 12-pdr. Howitzer. 1 20-pdr. B. L. H. 2 45 L. Gatling. 1 45 Gatling.	*180	27	184
205 6	38	16 6	1,900	494	8.8	6 IX" S. B. 1 8" M. L. R. 1 60-pdr. B. L. R.	1 3 B. L. H. 1 12-pdr. M. L. R. 2 20-pdr. B. L. R. 1 Gatling.	*220	21	179
216 0	37	16 6	1,900	984	10.5	6 IX" S. B. Dn 1 8" M. L. R. 1 60-pdr. B. L. R.	1 3" L. Howitzer 1 4½" M. L. Howitzer. 1 12-pdr. Howitzer.	*180	19	176
216 0	37	16 6	1,900	680	10.1	6 IX" M. L. S. B. 1 8" M. L. R. 1 60-pdr. B. L. R.	1 3" R. S. Howitzer .. 1 12-pdr. S. B. Hwtser. 2 20-pdrs. B. L. Hwtser. 1 45 Gatling.	*196	26	188
216 0	37	16 6	1,900	778	9.5	6 IX" S. B. Dn 1 8" M. L. R. 1 60-pdr. B. L. R.	1 3" B. L. R. 2 20-pdra. B. L. R. 1 12-pdr. Howitzer. 1 45 Gatling.	*170	24	190
216 0	37	16 6	1,900	753	11.25	6 IX" S. B. 1 8" M. L. R. 1 60-pdr. B. L. R.	1 3" B. L. R. 2 12-pdr. S. B. Hwtser. 1 S. Gatling.	*185	18	176
216 0	38	16 6	1,900	613	10.65	6 IX" S. B. 1 8" rifle 1 60-pdr.	1 12-pdr. Howitzer .. 2 37" H. R. C. 1 3" B. L. H. 1 short Gatling.	*162	21	193
198 10	38½	15 3	1,575	1,202	10.7	1 XI" S. B. pivot 4 VIII" S. B. 1 VIII" M. R. C. pivot 1 30-pdr. M. S. R.	1 12-pdr. Howitzer .. 1 45 L. Gatling.	*128	16	176
198 6	33	15 9	1,560	843	11.1	4 IX" S. B. 2 8" M. L. R. 1 60-pdr. B. L. R.	1 3" B. L. H. 1 45 short Gatling.	*165	21	191
185 0	35	14 3	1,375	550	9.8	4 IX" S. B. M. L. 1 8" M. L. R. 1 60-pdr. M. L. R.	1 3" B. L. R. 1 12-pdr. Howitzer. 2 37" H. R. C. 1 Gatling.	*150	20	16

* Anthracite.

† Bituminous.

H.—Tables of vessels of the

WOODEN STEAM

Name.	Built			Condition.	Rig.
	When.	Where.	By whom.		
Alliance	1873-1876	Norfolk	United States	South Atlantic station	Bark
Essex	1874-1876	Kittery and Boston.	Donald McKay and United States.	Asiatic station	do
Enterprise	1873-1876	Kittery	John W. Griffiths and United States.	Repairing at navy-yard, New York.	do
Nipsic	1873-1879	Washington	United States	Asiatic station	Bark
Tallapoosa	1874	Baltimore	C. W. Booz & Bro...	South Atlantic station	Schooner
Yantic	1864	Philadelphia	United States	North Atlantic station	Bark
Despatch	1874	Purchased from Henry C. Smith, N. Y.	Special service	Schooner
Franklin	1855-1865	Kittery	United States	Receiving ship, Norfolk, Va.	Ship
Wabash	1854	Philadelphia	do	Receiving ship, Boston.	do
Minnesota	1855	Washington	do	Receiving ship for boys, New York.	do

U. S. Navy—Continued.

VESSELS—Continued.

Dimensions.				Indicated horse-power.	Speed in knots.	Batteries.		Coal capacity.	Complement.	
Length between perpendiculars.	Breadth.	Mean draught.	Displacement in tons.			Main.	Secondary.		Officers.	Men.
Ft. In. 185 0	35	Ft. In. 14 3	1,375	668	9.98	1 60-pdr. B. L. R. 1 8" M. L. R. 4 IX" S. B. Dn.	1 8" B. L. R. 1 M. L. Howitzer. 1 45 long Gatling.	*150	18	160
185 0	35	14 3	1,375	505	10.4	4 IX" S. B. 1 8" M. L. R. 1 60-pdr. B. L. R.	1 8" B. L. Howitzer. 1 12-pdr. Howitzer. 1 short Gatling.	†180	15	179
185 0	35	14 3	1,375	790	11.4	4 IX" S. B. Dn. 1 8" B. L. R. 1 60-pdr. B. L. R.	1 8" B. L. R. 2 12-pdrs. S. B. How. 1 45 short Gatling.	†130	18	164
185 0	35	14 3	1,375	839	10.7	1 8" M. L. R. 4 IX" S. B. 1 60-pdr. B. L. R.	1 8" rifle 112-pounder. 1 Short Gatling.	*132	23	161
240 0	35	10 0	1,270	872	12.1	1 8" rifle 5 60-pdr. M. L. R.	412-pdrs. R. H. 1 8" B. L. H. 1 45 Gatling.	*201	13	143
180 0	30	12 2	900	225	8.3	2 IX" Dn. 1 8" M. L. R.	1 12-pdr. light. 1 8" B. L. H. 1 45 Gatling.	*117	20	134
174 0	25½	12 4	560	518	12.6	1 60-pdr. B. L. R. 1 8" B. L. R.	1 45 Gatling. 1 12-pdr. Howitzer. 2 20-pdrs. B. L. E.	6		75
265 9	54½	24 3	3,170	1,050	9	22 IX" S. B.	6 12-pdrs. Howitzer.			
262 7	51½	23 0	4,650	950	9.15	18 IX" S. B. 2 20-pdrs. B. L. R. P.	1 long Gatling			
264 8½	51½	23 0	4,700	1,000	9.25	18 IX" S. B. 1 60-pdr. B. L. R. 2 20-pdrs. B. L. R. P.	2 8" rifles 112-pdr. Howitzer. 1 short Gatling.			

* Anthracite.

† Bituminous.

H.—Tables of vessels of

WOODEN SAIL

Name.	Built.			Rig.
	When.	Where.	By whom.	
Constellation	1854	Gosport	U. S.	Ship
Constitution	1797	Boston	U. S.	do
Independence	1837	do	U. S.	do
Monongahela	1863	Philadelphia	U. S.	Bark
Portsmouth	1843	Kittery	U. S.	Ship
Jamestown	1845	Gosport	U. S.	do
Saratoga	1842	Kittery	U. S.	do
St. Louis	1823	Washington	U. S.	do
St. Mary's	1844	do	U. S.	do
Dale	1839	Philadelphia	U. S.	do

IRON AND WOOD

Name.	Built.			Material.
	When.	Where.	By whom.	
Catalpa	1854	Purchased	Wood
Cohasset	1861	do	do
Fortune	1865	Boston	James Tellow	Iron
Leydon	1866	do	do	do
Mayflower	1866	do	do	do
Monterey	1863	Purchased	Wood
Nina	1865	Chester, Pa.	Beaney Son & Archbold	Iron
Rescue	1861	Purchased	do
Rocket	1863	do	Wood
Speedwell	1865	Boston	James Tellow	Iron
Standish	1865	do	do	do
Triana	1864	New York	William Perine	do

the U. S. Navy—Continued.

ING VESSELS.

Condition.	Dimensions.				Batteries.		Comple- ment.	
	Length between perpendiculars.	Breadth.	Mean draught.	Displacement in tons.	Main.	Secondary.	Officers.	Men.
Practice ship, Naval Academy.	176	42	20	1,186	10 VIII" S. B.	2 20-pdrs. 2 12-pdra.	15	203
Portsmouth, N. H.	175½	45	20	2,200	4 32-pounders S. B.	1 12-pdr.		
Receiving ship, Mare Island.	189	51½	21½	3,270	6 32-pounders	1 Gatling		
Store ship, Pacific station.	225	38	16½	2,100	1 60-pounder rifle	1 12-pdr.		
Apprentice training ship.	153	38½	16½	1,125	2 VIII" S. B.	2 20-pdr. Parrotts 1 Gatling	15	210
.....do	163½	36	16	1,150	1 60-pounder B. L. E.	1 3" B. L. H. 2 20-pdr. B. L. R.	17	247
.....do	147½	36½	16	1,025	11 VIII" S. B.	1 Gatling. 1 8" rifle.	18	275
Receiving ship, League Island.	126½	34½	15½	830	1 60-pounder B. L. E.	2 20-pdrs. 1 3" rifle.		
Public marine school, New York.	150	37½	15½	1,025	None	1 Gatling.		
Receiving ship, Washington, D. C.	117½	32½	14½	675	8 VIII" S. B.	None		
					8 32-pounders	None		

STEAM TUG BOATS.

Rig.	Indicated horse-power.	Dimensions.				Speed in knots.	Coal supply.
		Length between perp's.	Breadth.	Mean draught.	Displacement in tons.		
		Ft.	Ft.	Ft.			
.....		97	19½	6½	188		
Schooner	340	137	26	9½	450	10.	
.....do	340	137	26	9½	450	10.	
.....do	338	137	26	9½	450	10.6	
.....do	340					8.5	
Schooner	340	137	26	8½	357	10.	
.....		84½	18	8	190		
.....	147	85½	18½	7	187	8.5	
Schooner	340	137	26	9½	450	10.	
.....do	340	137	26	9½	450	10.	
.....do	340	137	26	9½	450	10.	

WOODEN SAILING VESSELS.

The wooden fleet, so fast disappearing, deserves more than a passing mention. Our wooden ships have been in years past the pride of this country, and when abroad they were visited, admired, and copied by the naval architects of other nations. The vessels built after the model of the *Merrimac* by the English were looked upon as their crack ships.

The class of vessels comprising the *Hartford*, *Brooklyn*, *Pensacola*, *Richmond*, and *Lancaster* has been a most valuable one. They were built in 1855-'56, and since then have been kept constantly employed in peace and war, making, after each refitting, cruises of many thousands of miles, and at present are the most serviceable ships upon the available list of the Navy.

The remaining wooden vessels have, with the few named above, formed the available navy of the United States since the war.

The *Trenton*, launched in 1876, represents the latest and best type of wooden steam cruiser, and will be useful and valuable as a cruiser for several years to come.

The *Trenton*, *Omaha*, and *Vandalia*, second rates, can probably be continued in service nine years longer; the *Lancaster*, with new boilers, six years; the *Brooklyn* and *Richmond* five years, and the *Pensacola* three years.

Of the third rates the *Mohican* can be continued in service nine years, the *Adams*, *Alliance*, *Essex*, *Kearsarge*, *Enterprise*, *Tallapoosa*, *Yantic*, and *Nipsic* for five years; the *Juniata*, *Ossipee*, *Swatara*, *Galena*, and *Marion* four years longer. The *Quinnebaug* and the *Iroquois* will probably be condemned by law on survey.

It will thus be seen that in three years we shall have twenty-one of these vessels remaining, in six years but four, and in nine years the entire wooden navy will have disappeared.

I.—Condition of the various vessels now building for the Navy.

No. 80.]

OFFICE OF INSPECTOR OF HULLS FOR U. S. NAVY,
WILLIAM CRAMP & SONS, SHIP AND ENGINE BUILDING WORKS,
Philadelphia, Pa., October 18, 1887.

SIR: In compliance with the Bureau's order of October 15, I have to submit the following report of the progress of the work up to October 1 upon the U. S. S. *Baltimore* (Cruiser No. 3) building at these works:

Items.	Degree of completion.	Items.	Degree of completion
Vertical keel	Completed.	Plating for crown of forward magazine	One-tenth.
Flat keel	Do.	Beams for crown of after magazine	Nine-tenths
Stem below protective deck	Completed and ready to go in place.	Plating for bottom of after magazine	Do.
Stem, upper piece	Nine-tenths.	Outside plating below protective deck	Four-tenths
Stern post	Do.	Inner bottom plating, etc.	Six-tenths.
Framing below protective deck and in wake of double bottom	Do.	Breast hooks below protective deck	Completed.
Transverse framing before and abaft double bottom and below protective deck	Completed.	Forward magazine bottom plating	Four-tenths
Framing above protective deck	Five-tenths.*	Bulk-head No. 15	Eight-tenths
Upper deck beams	Seven-tenths.*	Bulk-head No. 25	Five-tenths
Berth deck beams	Five-tenths.*	Bulk-head No. 29½	Four-tenths
Protective deck beams	Nine-tenths.	Bulk-head No. 53	Five-tenths
Protective deck plating	Three-tenths.	Bulk-head No. 52	Four-tenths
Forward platform beams	Nine-tenths.	Bulk-head No. 60½	Five-tenths
Aft platform beams	Do.	Bulk-head No. 63	Eight-tenths
Beams on magazine bottom, aft	Completed.	Bulk-head No. 76	Three-tenths
Beams for crown of forward magazine	Nine-tenths.	Bulk-head No. 88	Nine-tenths
		Fastenings for bulk-head doors	Two-tenths

* Not in ship.

Items.	Degree of completion.	Items.	Degree of completion.
Engine and boiler bearers	One-tenth.	Angles for auxiliary boilers	One-tenth.
Sluice valves and cocks	Five-tenths.	Angles for first-room blowers	Do.
Coal bunker bulk-head angles	Two-tenths.	Steering gear	Two-tenths.*
Thrust bearers for shafts	Four-tenths.	Man-hole plates for inner bottom	Three-tenths.*
First longitudinal	Completed.	Brass riding bits	Five-tenths.*
Second longitudinal	Do.	Side lights	Three-tenths.*
Third longitudinal	Seven-tenths.	Rudder carrier	One tenth.*
Fourth longitudinal	Three-tenths.	Holes in bottom plating for valves	Are cut.
Drainage underneath inner bottom	Do.	Sky-lights	Completed.*
Suction pipes underneath inner bottom for deck pumps	Five-tenths.	Wardroom and steering bulk-heads	Completed, in paint shop.
Deck stanchions	One-tenth, being worked in shop.	Pilot-house	Three-tenths.*
		Berths, drawers, etc.	Five-tenths.*

* Not in ship.

U. S. S. GUN-BOAT NO. 1.

Items.	Degree of completion.	Items.	Degree of completion.
Vertical keel	Completed.	Girders to water-tight deck	One-tenth.
Flat keel	Do.	Upper deck stringer plates and stringer bars	Eight-tenths.
Stem	Nine-tenths.	Engine and boiler bearers	Four-tenths.
Stem-post	Do.	Breast hooks below water-tight deck	Completed.
Transverse frames, floor-plates, etc	Do.	Gutter and water way bars (upper deck)	Five-tenths.
Upper deck beams	Do.	Hatch coamings and sky-lights	Seven-tenths.*
Water-tight deck beams	Do.	Pilot-house	Three-tenths.*
Berth deck beams	Five-tenths.*	Ward room and steering bulk-heads	Seven-tenths.*
Fore-deck beams	Nine-tenths.	Berths and drawers	Do.*
Fore-castle deck beams	Do.	Cabin under poop deck	Two-tenths.*
Platform deck beams	Five-tenths.*	Side lights	Do.
First longitudinal	Nine tenths.	Ladders, etc., for side lights	Three-tenths.*
Second longitudinal	Do.	Steering gear	One-tenth.*
Third longitudinal	One-tenth.	Rudder carrier	Eight-tenths.
Fourth longitudinal	Do.	Brass riding bits	Three-tenths.*
Outside plating	Nine-tenths.	Sluice valves and cocks	One-tenth.
Transverse bulk-heads	Seven-tenths.	Boiler and engine inclosures	Do.
Coal bunker, and other fore-and-aft bulk-heads	One-tenth.	Magazines and shell rooms	Two-tenths.
Water-tight plating	Do.		
	Eight-tenths.		

* Not in ship.

DYNAMITE-GUN CRUISER.

Items.	Degree of completion.	Items.	Degree of completion.
Keel	Completed.	Outside plating	One-tenth.
Stem	Nine-tenths.	Engine foundation	Two-tenths.
Stem-post	Do.	Transverse bulk-heads	One-tenth.
Transverse frames and floor plates	Do.	Rudder	Five-tenths.*
Upper deck beams	Do.	Lower deck beams	Do.*
Fore-castle deck beams	Do.	Berth deck beams	Do.*
Center keelson	Two-tenths.	Protective deck	Do.*
First longitudinal	One-tenth.	Sky-lights	Two-tenths.*
Second longitudinal	Do.	Sluice valves and cocks	One-tenth.
Third longitudinal	Do.		

* Not in ship.

Very respectfully, your obedient servant,

JOHN B. HOOVER,

Assistant Naval Constructor, U. S. N., Superintending Constructor.

Chief Constructor T. D. WILSON, U. S. N.,

Chief of Bureau of Construction and Repair, Navy Department, Washington, D. C.

OFFICE OF NAVAL CONSTRUCTOR,
SUPERINTENDING HULLS OF VESSELS FOR U. S. NAVY, UNION IRON WORKS,
San Francisco, October 15, 1887.

SIR: In compliance with your telegram of this date, concerning the condition of the work on Cruiser No. 2 on the 1st instant, I have to report as follows:

Steel stern-post, vertical keel, and flat keels, except forward pieces, in place. All frames below protective deck and abaft No. 74 erected. All longitudinals and their connecting angles fitted. Garboards and two strakes of bottom plating on each side, between frames Nos. 20 and 74, in place. Transverse bulk-heads on frames Nos. 10, 15, and 74, and longitudinal bulk-heads between frames 10 and 24 aft and 59 and 74 forward, fitted. All Z-bar frames above protective deck, except ten, bent. Plates for several transverse bulk-heads were laid off, ready for shearing and punching. Riveting of frames, keels, etc., about seven-tenths finished.

Forgings for side ladders, awning and guard-rail stanchions, ring and eye bolts for deck service, hinges for battle-hatches and coal-chutes, and for various coal-chute fittings, anchor davits and fittings, flag-staffs, hammock hooks, canopy frames, all complete. Deck stanchions five-tenths completed, and numerous small fittings completed.

Brass castings for man-holes in water bottom and hatch-covers finished; air-ports four-tenths finished; deck lights eight-tenths finished; guard rail and bridge stanchions, and also many small fittings, in rough.

Lower piece of cast-steel stem was out of the sand, and upper piece molded.

Pattern for shaft brackets and rudder were in the foundry.

The hydraulic steering gear was well advanced; the pistons and rods, links, cross-heads and pins, auxiliary rudder-head, yoke for main rudder-head, cylinders, and bed-plate, were about seven-tenths finished.

I estimate that in addition to the 93 tons of material placed upon the blocks, 83 tons of material of various kinds had been worked into the hull or partially worked in on the first instance.

Chief Engineer Smith verbally informs me that he has, in obedience to an order from the Bureau of Steam Engineering, reported the condition of the machinery to that Bureau.

Very respectfully, your obedient servant,

F. L. FERNALD,

Naval Constructor, U. S. Navy, *Superintending Hull.*

Chief Constructor T. D. WILSON, U. S. Navy.

Chief of the Bureau of Construction and Repair,

Navy Department, Washington, D. C.

Report of Assistant Naval Constructor R. Gatewood, U. S. Navy, on the condition of the work on the hull of Gunboat No. 2, October 15, 1887.

MATERIAL.

Rolled steel.—The first orders for this material were issued February 14. The first shipment was received May 27. Thence at intervals, up to date, there have been received 167.53 tons. Of this material essential to progress of hull, and among the earliest orders, there are yet wanting a few frame angles, and a number of floor-plates and lower plates of bulk-heads, and no rivets have been received except some made by mistake at the manufacturer's from material not inspected, and which were returned.

STEEL FORGINGS.

Stem.—This forging arrived from the Duquesne Forge, Pittsburgh, Pa., on May 25. Invoice weight, 2,435 pounds.

Rudder pintles.—About 75 pounds of forged steel in stock have been used for rudder-pintles.

STEEL CASTINGS.

The steel casting for the stern-frame arrived from the Midvale Steel Works, Philadelphia, June 25. Invoice weight, 6,720 pounds.

The steel casting for the rudder-frame arrived from the same works July 23. Invoice weight, 3,397 pounds.

CAST-IRON.

About 160 pounds of cast-iron have been worked into the fittings.

COMPOSITION.

About 155 pounds of composition have been worked into fittings.

SPELTER.

About 300 pounds of spelter have been used in galvanizing floor-plates and lower plates of bulk-heads.

TIMBER.

A certain amount of timber has been used in making the scribe board and molds, and for keel-blocks. This is only partly chargeable to the ship, and is generally reckoned under the head of working charges.

Stores.—Certain tools, punches, shear knives, bolts and nuts, bending slab, and other appliances, etc., have been made and expended, or are in use. These are also generally reckoned as working charges.

LABOR.

Mold loft.—The lines of the vessel, with the usual building lines, have been laid down in the loft, and are raced in on the scribe-board, with the exception of the stern framing.

Carpenters.—Molds have been made to the frames and floors, stem, stern-post, and keel-plates. The keel-blocks have been laid and lined, and stem and stern frame partly set and shored.

Pattern shop.—The following patterns have been made: stern-frame, rudder-frame, stern-tube, cot-hooks, poop-deck guard-rail stanchion, rudder-carrier, coaling-scuttle, brass sleeves for rudder pintles, air port, mooring bitt, and wrench to coaling scuttle.

Foundry.—The following castings have been made: One cast-iron coaling-scuttle, solid cover and grating; a number of brass cot-hooks, of which it is doubtful how many will finish up sufficiently well; one brass air port, frame, and stopper; three brass poop-deck guard-rail stanchions.

Machine shop.—The stern frame and stem have had rabbets planed and chipped, and holes drilled for fastenings; lugs of stern-frame have been lined and bored for pintles; rudder-frame has been bored for shrinking in two pintles; three pintles turned.

Fitting shop.—Ten cot-hooks have been machined; one coaling-scuttle fitted up; one guard-rail stanchion turned; one air-port partly machined.

Blacksmith shop.—One set of three each of clamps, pins, and collars for coaling-scuttle have been forged.

Coppersmith and sheet-iron shop.—Forty-three floor-plates and lower plates of bulk-heads have been galvanized.

Boat-yard.—Eleven outer and eleven inner keel-plates have been finished complete and placed on the blocks ready for riveting; one of these has to be replaced, having been found defective.

Sixty-eight pieces (all) of 5-inch Z-bar for frames below water-tight deck have been bent, and forty-two pieces of 4-inch Z-bar for frames above water-tight deck.

The 5-inch bars are in hand, being knuckled, punched, and assembled at scribe board. Thus eight have been cut to high floors in engine room, twenty long frames have been knuckled at the middle line and set, ten short frames have been cold set, and four complete frames, with the floor plates, are screwed together ready for riveting.

Ten bars of frame angle and ten of reverse frames for the frames forward and abaft the engine and boiler rooms have been bent and beveled at the slab.

Forty-three floor-plates and lower plates of bulkheads have been laid off and trimmed complete and galvanized, and four high floors are complete except galvanizing and punching.

Rigger labor and handling.—A certain amount of this class of labor has been expended in unloading and handling material and erecting stem and stern frame.

Report from the commandant of the navy-yard, New York, showing work to be done, with probable time and cost to complete the Chicago and Boston from October 20, 1887.

U. S. S. BOSTON.

Overhaul controllers on fore-castle; secure kedge-anchors; field-carriage; limber and chain chests in place on outside of superstructure; put brass treads on mahogany ladders and toe pieces on all coamings at head of ladders; secure coal-chutes on in-

side of fire-room inclosures; rig scupper-pipe forward of after barrette to carry off water from starboard after scupper of spar-deck; raise gangway and door-sills on spar-deck to prevent water from running over; the screws for the top-mast fid are too large and should be changed or fitted; make and put up bulletin boards; paint ship inside and out; the white paint inside to have two coats and glosses; gild shield and scroll on bow; put a davit in fore hatch for hoisting provisions, etc., out of fore hold; also davits in forward and after hatches on spar-deck for hoisting ammunition; arrange starboard quarter davits to hoist life-boat outside; have half cradles fitted on round of superstructure for inner quarter boats; the backstay bolts may require shifting; put additional cross-bars for gratings and mess-tables and arrange to lock gratings in place so they will not roll out at sea; put up racks for one hundred and ninety muskets on main deck and revolvers in armorers chests; fit grating to top of locker-hatch shutter; fit gutter on top of six-pounder; sponsons to prevent water from running in on gun; hand holes and scuppers are required for port sails, and lariards of upper half ports should be fitted with hooks or cleats changed.

Fit wire cat or fish pennants with blocks, etc., complete; fasten the rudder gaskets on the iron shutters, gun-ports, and air-ports, and provide spare gaskets of all sizes; put hinged table on bulk-head near executive officer's office; build pigeon-holes and provide key-boards for both paymaster and executive officer; the lower grating of the starboard gangway is mounted too high aft; part of the iron of the same gangway is missing; case in scuppers and distiller outlet to water-line and put lips under all other outlets on outside of ship; extra cleats are required for cat and falls, stay-sail-sheets, fore and main-tack and sheets, yard and mast-ropes; provide can hooks and pinch-bar for fore hold; provide hard-wood cocks for flood cocks of forward magazine and shell room; provide brass belaying-pins; put pin bands around masts on each side of both fire-rails; wing out the top of the chart-house so as to make a bridge of it and put rail around it all; put coamings under floor of starboard after and port forward machine-gun-towers on main deck to direct water to scuppers; overhaul and alter awning stanchions and braces, they are so light as to bend easily; bore scuppers in sockets of all stanchions; a few bolts and nuts for stanchion braces are wanting; replace iron sheer-railings with new ones, stronger and shaped to the rigging; rig small tent-awnings over wardroom skylights and cut scuppers in the corners of the hatches; a small catamaran is requested; provide two additional iron chocks for steam capstan; fit cradles for launch spars; take off present main-sheet sheaves and place eye-bolts for clamp-blocks instead; additional chafing battens required on chart-house; hinge shaft-alley ventilator on quarter deck; put up saddles and becketts for fire hose, nozzles, and wrenches; put up axes on masts, etc.; refit interior of chart-house; one tip piece and brass sill wanting at door.

Put in two tanks for electrical and cylinder oil and two for tar oil and coal tar; shift tow-line reels outboard so as to make room for gangway in forward compartment of berth deck; repair bracket for Lewis bolt on starboard side of spar-deck; provide furniture for warrant officers; several gun-port hinges are broken, the metal seems too soft; ports need fitting and port bucklers are required; hooks for ports should be stronger; cleats for upper half port lanyards of forward and after shifting guns should be replaced by eye-bolts on bulk-heads; rollers for lanyards are needed in bulkheads; overhaul and change flood cocks and outlets of magazines and shell rooms and fit drain and pet-cocks to flood-pipes; cleat and eye-bolts required in tops and on cross-trees; fit ring-bolts and cleats for anchor lashing; fit cabin bath-room door to slide; overhaul and polish all hard-wood furniture and bulk-heads; put all pumps in satisfactory working order; locate and stop leaks and tighten all loose bolts and rivets of sides and deck; repair decks where needed; repair rail on port forward Hotchkiss tower; two spare rollers for fore-castle capstan are requested; the rollers are too near the chain-plates and should be changed if practicable; change ladders and fittings leading from compartment No. 22; put awning band on ventilator between smoke pipes; provide ice-chest for steering and warrant officers' messes, and put drip-pans on them and on the cabin and wardroom ice-chests; a cracked wooden knee on port after-rail requires repairs; fit boxes to pockets in capstans; the ash and garbage shutter on gun deck are loosely joined and permit dirty water to run over the deck; screw-bolt wanted for one bulk-head air-port on berth deck; overhaul sluice-valves, particularly to compartments 10 and 11; bath-tub discharge pipe in seamen's head should be refitted, made larger and straighter.

Move fore brace further aft on rail; change sheaves of hand-wheel ropes on deck so as to take cross out of the rope; brass chafing battens required on two doors of gun-deck; also brass pieces to prevent finger marks; the tops and crosstrees are not square; the gun ports need heavier clamps; put in securing eye-bolts for arms-chest; repair flood of fixed (after) ammunition room, and alter the outlets, as they can not now be kept closed; put brass toe plates on bulk-heads where there are ladders; paint after shell-room, fixed ammunition and all ordnance store-rooms; gun-cotton room requires flood and outlet; magazine and shell-room ladders should be made more secure; steel deck over forward ordnance store-room is sprung; fit spare article

boxes in after end of hammock netting, also on gun-deck; fill up after part of shaft alley with cement; make locker for dynamo room, with deck, etc.; reset the blower engines; provide an additional gangway forward; the fire main and the pipes to engines are too small; make a book case for ship's library; strainers for spar-deck scuppers made with larger holes; the after shell-room flood-cock in wardroom pantry should be securely boxed in and locked, and the form of the lever changed; the after magazine flood-cock locker should also have a cock; provide hand-grip to raise hatch over small compartments underneath after shell-room; fit rack for tools in after ordnance store-room (steerage orlop); fit light-box covers with bars, staples and locks; compressor tackle on berth deck will not hook; a half a dozen hose-pipe caps are required—two are already lost; a number of the upper half port laneyards have bad leads; the rollers should be shifted and the guides fitted; the iron shutters to fore hatch are fitted so that one of them can not be fully opened nor the canopy shipped.

A new life-rail stanchion is requested for forecastle to replace one lost overboard; both shell-room hatch covers require hooks to hook them up when open; the travelers on the powder and shell trollies need fitting, as they do not work freely now; overhaul and refit davit sleeves, pins, and levers; the hangers for the tables and benches on the gun-deck need to be lowered about 2 inches to permit the tables and benches to go in without injury to the electric wiring (nearly completed); fit gratings under 6-pounder carriage mounts; fit small catches on wardroom water-closet outlet handles; lengthen the side-light boxes (running lights); provide a swinging electrolier for engine room; hard-wood finish on inside of pantries; put up a neat set of hammock numbers; shoe lockers in firemen's wash room; firemen's clothes locker in boiler inclosure; hose reels and racks to put up; brass hooks in cabin airports; forward ladder to alter; boiler inclosure bulkhead to be lined with asbestos; marine cap lockers to alter; wardroom center-table; sash for gun-deck ports; turpentine, alcohol and chemical chest; additional hammock hooks; shelves in general store rooms; bath-tub to fit forward; gig to finish; 13-foot dinghy; to replace compressor battens in Hotchkiss gun towers; two sets of light davits for swinging dinghy and fifth cutter with fittings complete.

Estimated cost to complete above:

Labor	\$10,840.42
Material	2,276.00
Total	\$13,116.42

Time required, sixty working days with present force.

U. S. S. CHICAGO.

Calking spar-deck: sky-lights varnished; search-light dynamo room; electric store room; touching up outside (paint); bridge decks to paint; five additional valves in drainage system; steel masts; other spars; blocks; furniture; miscellaneous fittings of furniture, cushions, etc., on board; boats (one catamaran to build); cooperage; stepping and wedging of masts and bowsprit and replacing pantry work and casing in wardroom; fitting down, drilling, and securing of gun circles and central pivot sockets (for 8-inch guns) including all similar work for machine guns; fittings of port shutters and port sills to yokes; barbetstes and fittings in tops; docking ship; painting throughout.

Estimated cost to complete above:

Labor	\$14,458.44
Material	3,737.00
Total	18,195.44

Time required, ninety days.

The estimated cost to complete the U. S. S. *Chicago* is exclusive of changes and additions recommended by the Naval Advisory Board under date of January, 1887, at an estimated cost of \$1,581, and not yet acted upon by the Department.

Very respectfully,

SAM. H. POOK,
Naval Constructor, U. S. Navy.
 J. F. HANSCOM,
Assistant Naval Constructor, U. S. Navy,
Inspector for Naval Advisory Board.

DESCRIPTIONS AND PLATES OF THE NEW VESSELS OF THE NAVY.

ARMORED CRUISER.

This is a twin screw armored turret vessel of the belted cruiser type, the vital parts being protected by a belt of armor from shot and shell, sufficient in length to insure stability even if the ends are riddled above the under water protective decks extending from the ends of the belt to the extremities of the vessel. This vessel will have great coal endurance, good steaming and maneuvering qualities, every modern improvement in offensive and defensive *materiel* and every appliance to insure the comfort and health of officers and crew. She is building at the U. S. navy-yard, New York.

This vessel in general appearance resembles the Brazilian armored cruiser *Blacocha*, but is larger and carries heavier guns and thicker armor, besides having greater endurance.

General dimensions.—Length between perpendiculars, 310 feet; breadth, extreme, 57 feet; mean draught of water, 21½ feet; displacement to above draught, 6,648 tons; indicated horse-power, 8,750; speed, 17 knots; thickness of armor belt, 11 inches; thickness of turret armor, 10½ inches; thickness of breastwork armor, 10½ inches; tons per inch at load water line, 32.32; area load water plane, 13,576; area immersed midship section, 1,080; sail area, 7,135 square feet; transverse metacenter above center of G., 3.45 feet; longitudinal metacenter above C. G., 322.4 feet; moment to change trim 1 inch, 561.66 foot tons; complement, 300.

Scantling and general construction.—The vertical keel is 20 pounds per square foot and 36 inches deep, angles at top 3 by 3 inches of 7 pounds per foot, at bottom 4 by 3 inches of 9 pounds per foot. The outer flat keel is 25 pounds and the inner 20 pounds per square foot. The stem, stern-post, and rudder frame are of cast steel.

Below the protective deck, in wake of the double bottom, the frame angle, 4 by 3 inches of 9 pounds per foot, extends from the protective deck to the vertical keel. The reverse bar, from the protective deck to the third longitudinal, is 5 by 3 inches, of 9 pounds per foot; from the longitudinal to the keel there are floor-plates of 12½ pounds per square foot; above this 10 pounds, with half staple angles 3 by 3 inches of 7 pounds per foot around the upper edges and sides. Above the protective deck and at the ends of the frames are Z-bars 6 by 3½ by 3 inches of 14 pounds per foot, with lower ends opened for a floor-plate of 10 pounds per square foot. The frame spacing is 4 feet in wake of the double bottom, 3 feet at the ends.

In wake of the double bottom there are four longitudinals on each side, of 15-pound plating amidships, reduced to 12½ pounds at the ends, with lower edges slotted over the continuous frame angles. The outer angles in the longitudinals, to have the flange next the bottom plates continuous, angles at top and bottom, being 3 by 3 inches of 7 pounds per foot. Intermediate longitudinal frames are introduced in wake of the engines, boilers, and shaft bearers.

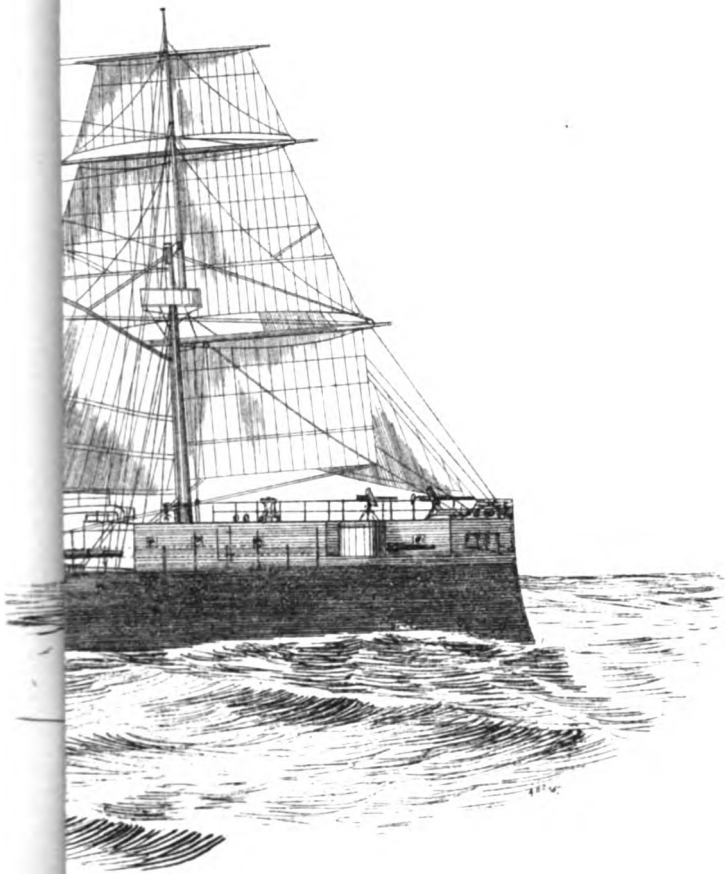
Before and abaft the double bottom the longitudinals are formed of continuous 12½-pound plates.

The beams of the superstructure deck are angle bulbs, 6 by 3 inches, of 15 pounds per foot; of the main deck of angle bulb 9 by 3½ inches, of 27 pounds per foot; of the berth deck, in wake of armor belt, of angle-bars 10 by 3½ inches of 28 pounds per foot; before and abaft armor belt, of angle bulbs 7 by 3½ inches of 20 pounds per foot; of protective deck, forward and abaft the armor belt, of angle bulbs 10 by 3½ inches of 28 pounds per foot; of the platforms, of angle bars 5 by 3 inches of 10 pounds per foot. The bridge beams for supporting the chart-house to be angle bulbs 8 by 4½ inches of 18 pounds per foot. To support the two torpedo-boats, girder beams are worked of 15 pounds plating, 15 inches deep, with double angles 3 by 3 inches of 7 pounds per foot at top and bottom.

The bottom plating below the main deck is 20 pounds per square foot, with a double sheer strake and double strake in wake of the chafe of the anchors and for strengthening the ram bow. The sides of the superstructure are 17½ pounds, increased to 20 pounds in wake of the flash of guns. The inner bottom is 12½ pounds, except the flat keelson plate, which is 15 pounds. Bilge keels extend for a length of 160 feet on both sides, projecting 2 feet.

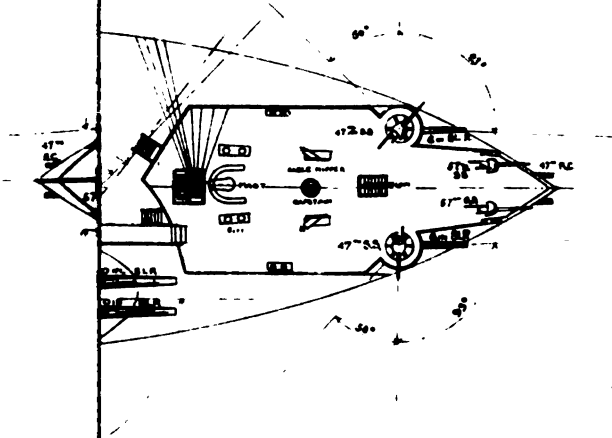
The stringers to the central superstructure deck to be 34 inches wide by 15 pounds; to forward and after superstructure deck, 16 inches wide by 12½ pounds; to main deck, 20 pounds per square foot, 60 inches wide amidships, tapering to 42 inches at the ends; the berth deck, forward and abaft the armor belt, 15 pounds per square foot, tapering from 48 to 40 inches.

PLATE 1



ARMORED CRUISER.

PLATE 2



ARMORED CRUISER



The transverse water-tight bulk-heads, from the bottom to the berth deck, to be 10 pounds per square foot; from the berth deck to the main deck to be 8 pounds per square foot.

The wing passage bulk-heads are of 12½-pound plating; the bottom plates of the coal-bunker bulk-heads 12½ pounds, the remainder 10 pounds; the fore and aft bulk heads between engine-room 12½ pounds at the bottom, above this 10 pounds; shaft alley bulk-heads, 10 pounds.

Water-tight doors are fitted in bulk-heads above and below the water-tight deck, fitted to open or shut from the berth deck and from the platforms where situated.

The 6-inch guns to be supported by partial cylinders 6 feet in diameter, of 15-pound plating, stiffened by angles 3 by 3 inches of 7 pounds per foot.

Armored protection.—For a length of about 180 feet amidships there is a water-line belt of vertical steel armor extending from 3 feet above to 4 feet below the water-line, 11 inches thick from top to 1 foot below the water, tapering from this point to 6 inches at the bottom. The wood backing is 8 inches thick. The plating behind armor is in two thicknesses of 20 pounds each, stiffened by horizontal angle-bars 6 by 3½ inches, of 12 pounds per foot, placed on the outside of the plates, and by 12½-pound plates worked intercostally between the frames.

The athwartship armor bulk-head at the forward end of the armor belt is 6 inches thick, the backing plates to be of 10 and 20 pounds.

The revolving turrets are protected by 10½-inch steel armor, the gun-port plates being 11½ inches.

The revolving parts of the turrets and the spaces required for loading are protected by fixed breastworks of oval shape 10½ inches thick.

There is an armored conning tower 10 inches thick located on the central superstructure, elliptical in shape, 10 feet 6 inches by 9 feet. An armored tube 4½ inches thick runs from this tower to the armor deck, to protect steering-gear, speaking-tubes, etc.

The armor deck plating in wake of the armor belt to be worked in two thicknesses of 40 pounds each, or two inches in all, so disposed that one layer of plating forms edge strips and butt-straps for the other.

The armor deck slopes from the top of the belt at its after end, the slope being 4 inches thick. The under-water deck at the end is 2 inches thick, protecting magazine and steering gear, and so worked as to give great stiffness to the ram bow. Cofferdams are built above the engine and fire room hatches to a height of 3 feet above the berth deck.

General equipment.—The vessel is bark-rigged, spreading 7,135 square feet of canvas. The fore and main masts are fitted with military tops, each mounting two machine guns. The rigging of the vessel is brought down in such a manner as not to interfere with the fire of the guns. In addition to the armored conning tower there is a wooden chart-house, fitted with chart tables, speaking-tubes, indicators, steering-wheels, etc., for use when not in action. A steam steering engine is fitted in addition to the hand steering, and there are steam capstans, windlasses, and hoists. The forward hawse pipes are so formed as to be adapted to a stockless anchor, the entrance being enlarged to take the shank and flukes of the anchor, and the anchor stows itself automatically within the skin of the ship on being hove up. This does away with catting and fishing. Shutters will be fitted over the mouth of the hawse pipes. There are 174 water-tight compartments in the vessel. Ample provision is made for natural light and ventilation by means of sky-lights, side lights, and cowls. The artificial ventilation is by a carefully considered scheme, utilizing frame space, louvres, and cowls, communicating with all parts by ducts leading to the blowers. The vitiated air of the engine-room is withdrawn by the fans used for forced combustion. The explosive gases of the coal bunkers are led into the funnel casings and fresh-air pipes led to the upper deck.

The pumping and draining system is very elaborate, every compartment of the vessel being in connection with the powerful steam and hand pumps.

The electric plant consists of four sets of dynamos and engines, so connected that any one can supply all of the circuits for the incandescent lamps. There are three search-lights, any of which can be connected with any dynamo. These dynamos supply light for internal illumination, side lights, headlights, and lights in magazines and bunkers.

In addition to the usual allowance of boats supplied to a man-of-war, including steam launch and cutter, there are two large torpedo boats about 60 feet long.

Quarters for officers and crew.—This vessel is fitted as a flag-ship.

The admiral's and captain's cabins, state-rooms, offices, bath-rooms and pantries are under the after superstructure deck.

The wardroom is divided by an athwartship bulk-head. The forward room, which is 33 feet long, with a mean width of 17 feet, is fitted for mess purposes with tables sideboards, etc. The afterroom is 19 feet long, and has a mean width of 9 feet.

There are 18 state-rooms, each entered direct from the wardrooms.

Forward of the wardroom are the steerage, warrant officer's state-rooms and mess-room, lavatories and pantries, and armory.

The wardroom, steerage, and warrant officer's water-closets, engineer's and ordnance workshops, paymaster's and executive officer's offices and firemen's wash-rooms are located on berth deck, over the boiler space.

The sick bay and dispensary are opposite the forward turret breastwork on the berth deck.

The crew's water-closets are in the extreme forward compartment on the berth deck, entered from the main deck.

The galley is located in the after end of the central superstructure.

The forward berth deck, and within the central and forward superstructures, are reserved for the accommodation of the crew.

The height in the clear between the berth deck plank and bottom of main deck beams is 7 feet 10 inches.

The height in clear between the main deck plank and bottom of superstructure decks is 6 feet 8 inches.

Machinery.—The vessel will have 2 vertical inverted triple expansion engines in separate water-tight compartments, capable of developing 8,750 horse-power. The cylinders are 35½, 57, and 88 inches in diameter respectively, with a stroke of 36 inches.

There are 8 cylindrical return tubular boilers, 14 feet 8 inches diameter, and 10 feet long, each having 3 furnaces, the total grate surface being 552 square feet.

The fire-rooms are not put under pressure, but the forced draught is secured by leading air to the under side of the grate-bars, forced through ducts by 4 blowers of 26,000 cubic feet capacity per minute.

There are 2 three-bladed screws with a diameter of about 15 feet.

The coal at normal draught is 400 tons, but the bunker capacity is 822 tons. The endurance and radius of action at different speeds with 400 tons of coal are: At 17 knots per hour, 960 knots; at 15 knots per hour, 1,617 knots; at 10 knots per hour, 4,250 knots.

Armament.—The main battery consists of four 10-inch and six 6-inch breech-loading guns.

The 10-inch guns are mounted in pairs in turrets protected by 10½ inches of steel armor.

The turrets are placed *en echelon* so that four guns can be fired ahead or astern. Each has a complete broadside-train on one side of 180 degrees and on the other side of over 60 degrees. Each turret has two loading positions. The guns are loaded, elevated, and trained by the latest and most approved systems, all machinery being protected by oblong breastworks 10½ inches thick.

The 6-inch guns are mounted on central-pivot carriages, protected by segmental steel shields 2 inches thick. Two 6-inch guns are placed directly forward and two directly aft, having a train each of 147 degrees. A 6-inch gun is mounted on each side of the central superstructure having a train of 130 degrees. The forward and after guns can be converged at a point 150 feet from their respective ends. The four 10-inch and two 6-inch guns can be fired directly ahead or astern, and the broadside fire of four 10-inch and three 6-inch guns can be converged at a point 100 feet from the side.

The secondary battery is so disposed as to secure a heavy bow and stern fire. It consists of four 57^{mm} rapid-fire guns, four 47^{mm} rapid-fire guns, four 47^{mm} revolving cannon, nine 37^{mm} revolving cannon, and four Gatling guns.

There are seven torpedo launching tubes or guns, three below the water and four on the berth-deck.

The 10-inch guns fire a projectile of 500 pounds weight with 250 pounds of powder, and have a maximum effective range of about 9 miles.

The weight of shot that can be fired ahead or astern from the main battery is 2,300 pounds, and either side 2,300 pounds.

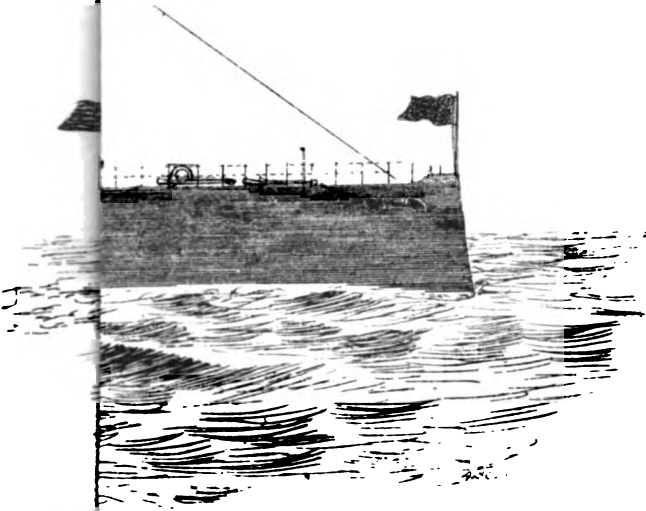
THE ARMORED BATTLE SHIP.

This twin-screw vessel, to be built at Norfolk on the design of the Barrow Shipbuilding Company, is of the belted type; that is, with a belt of armor amidships to protect the vitals of the ship and under-water decks from the ends of the armor to the extremities of the vessel.

Length between perpendiculars, 290 feet; breadth, extreme, 64 feet 1 inch; depth molded to upper deck, 39 feet 8 inches; draught of water forward, 22 feet; draught of water aft, 25 feet; draught, mean, 22 feet 6 inches; displacement to above draught, 6,300 tons; transverse metacenter above center of gravity, 3 feet 1½ inches; longitudinal meta center above center of gravity, 237 feet; tons per inch at load-line, 30; moment to change the trim 1 inch in foot-tons, 432; indicated horse-power, 5,600; maximum speed, 17 knots; complement, officers and men, 300.

Scantling and general construction.—The vertical keel is 20 pounds per square foot reduced to 11½ pounds at ends, 39 inches deep amidships, with double angles at top

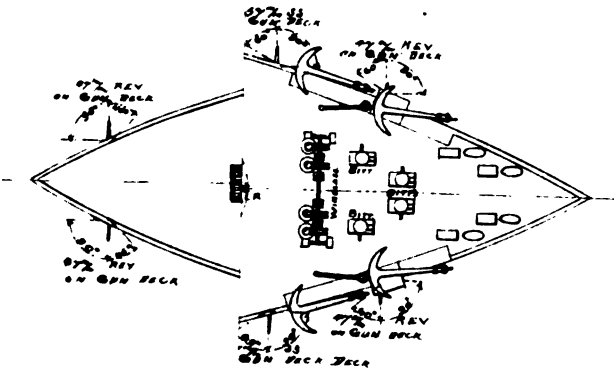
PLATE I



ARMORED BATTLE SHIP.



PLATE 2



ARMORED BATTLE SHIP.



$3\frac{1}{2}$ by 3 inches of 8 pounds per foot, and at the bottom $4\frac{1}{2}$ by $3\frac{1}{2}$ inches of 12 pounds per foot.

The outer flat keel plate is 25 pounds per square foot, the inner $17\frac{1}{2}$ pounds per square foot.

The transverse framing in wake of and below the armor belt has an outer angle of 4 by $3\frac{1}{2}$ inches of $8\frac{1}{2}$ pounds per foot, and an inner angle of 4 by 3 inches of 8 pounds per foot, extending from the vertical keel to the fourth longitudinal, with bracket plates of 10 pounds per foot secured to the longitudinals by angle clips of 3 by 3 inches, of 7 pounds per foot.

From the fourth longitudinal to the armor shelf, the outer and inner angles are $3\frac{1}{2}$ by 3 inches of 8 pounds per foot, with a 10-pound plate between, lightened with holes.

The framing above and before and abaft the armor belt consists of **Z** bars 6 by $3\frac{1}{2}$ by 3 inches of 15 pounds per foot, with lower ends, where landing on the armor deck, secured by a 15-pound plate, and where coming down to the keel, split and a 10-pound floor plate riveted in.

There are four longitudinals on each side in wake of the double bottom, the inner two of 12 $\frac{1}{2}$ -pound plating, the outer two of 15-pound plating, with $3\frac{1}{2}$ by 3 inches of 8 pounds per foot angles on the outer edges, and 3 by 3 inches of 7 pounds per foot angles on the inner edges. At the extremities there are three longitudinals, the first and second from the keel being 12-pound plates, extending above the floors, with double angles 4 by 3 inches of 10 pounds on the upper edges.

The outer longitudinal is a **Z** bar 10 by $3\frac{1}{2}$ by 3 inches of 20 pounds per foot scoring over the frames, with a reversed angle on the back $3\frac{1}{2}$ by 3 inches of 7 pounds per foot.

The bottom plating is $17\frac{1}{2}$ pounds per square foot up to the armor belt and protective deck, above them 15 pounds increased to 60 pounds, in wake of the machine guns. The inner bottom is 10 pounds per square foot.

The bridge deck beams are angle bulbs 5 by 3 inches of 9 pounds per foot, the upper deck beams 9 by $5\frac{1}{2}$ inches of 30 pounds per foot, reduced to 8 by $5\frac{1}{2}$ inches of 22 pounds per foot at the ends, the main deck beams 9 by $5\frac{1}{2}$ inches of 30 pounds per foot, reduced to 8 by $5\frac{1}{2}$ inches of 22 pounds per foot at the ends, the berth deck beams in wake of the armor belt 9 by $3\frac{1}{2}$ inches of $24\frac{1}{2}$ pounds, reduced to 6 by 5 inches of 16 pounds before and abaft the armor belt. The protective deck beams before and abaft the belt are 9 by $3\frac{1}{2}$ inches of $24\frac{1}{2}$ -pound angles.

The bulk-heads are 10 to 15 pounds, well stiffened by **Z** bars and angles. There are two masts with military tops.

Armored protection.—The vital parts of the vessel are protected by a steel armor belt 12 inches thick, 2 feet above and $4\frac{1}{2}$ feet below the water. This embraces the engines, boilers, and magazines, and is terminated at each end by a steel breastwork 6 inches thick, extending diagonally across the vessel. The backing is of wood 6 inches thick, behind which are two thicknesses of 25-pound plating.

The shelf plate is 25 pounds, and back of the plating behind the backing are worked two horizontal girders formed of 15-pound plating, secured to the plating behind the backing by $3\frac{1}{2}$ by 3 inches of 8-pound angles, and to a 15-pound plate at their inner edges by similar angles.

An armored protective deck is worked over the armor belt, sloping down from the ends of the belt to the bow and stern. This deck is throughout 3 inches in thickness.

The lower parts of the turrets and the machinery for working the guns are inclosed in armored redoubts 12 inches thick, backed by 6 inches of wood. The turrets are plated with 12-inch armor.

There is an armored conning tower 12 inches thick placed forward on a level with the bridge, with an armored tube leading from it 3 inches thick. The ammunition hoists are 6 inches thick.

Armament.—The main battery consists of two 12-inch guns in turrets, and six 6-inch guns protected by shields. The 12-inch guns are mounted in turrets placed *en echelon* to give each a fore-and-aft fire; each has a complete broadside fire on one side and has a train on the opposite side 40° for the forward gun and 70° for the after gun.

A 6-inch gun is placed forward and one aft on the same level as the 12-inch guns, having each a train of 120° . The remaining four 6-inch guns are mounted in sponsons of the main-deck, two having a train from directly forward to 25° abaft the beam, and two from directly aft to 25° forward the beam.

On the main-deck the secondary battery consists of four 6-pounders, four 3-pounders, and four 47^{mm} revolving cannon, protected by $1\frac{1}{2}$ -inch steel plating. Two Gatlings and two 37^{mm} revolving cannon are placed on the bridge deck, and two 1-pounders are placed on the flying bridge. Two Gatlings with two 37^{mm} revolving cannon are fought in the military-mast tops to repel boarders and torpedo-boat attacks. Two 37^{mm} rapid-fire guns are fitted in the steam-cutters. The magazines for the main battery are placed in the center of the vessel below the protective deck. The ammuni-

tion for the secondary battery is stowed in magazines placed forward and aft, the ammunition being passed up to the main deck through an armored tube 3 inches thick. Torpedoes can be projected through six tubes, one through the bow, one through the stern, two through the side aft above water, and two through the side forward below water.

Machinery.—The motive power is furnished by two triple-expansion engines, placed in separate water-tight compartments. The cylinders are 36, 51, and 78 inches in diameter, with a stroke of 39 inches. There are four double-ended boilers 14 feet in diameter by 17 feet long. The steam pressure is 150 pounds; grate surface, 504 square feet; indicated horse-power, with an air pressure of 2 inches of water, 8,600.

At the normal draught of 22 feet 6 inches the coal supply is 500 tons. With this supply the endurance is for a speed of 17 knots, 1,110 knots; 15 knots, 2,050 knots; 12 knots, 3,170 knots.

With a coal supply of 850 tons the endurance is, for a speed of 16.5 knots, 2,190 knots; 14.75 knots, 3,900 knots; 11.8 knots, 6,000 knots.

Quarters for officers and crew.—This vessel is fitted as a flag-ship.

Directly aft on the gun-deck is the admiral's private cabin; forward of this his dining-saloon and sleeping-cabin; next, the admiral's bath and water-closet and pantry. Forward of these are similar accommodations for the captain.

Forward of this is an open space extending across the vessel, with two passages leading forward from it. These passages inclose the wardroom, and the state-rooms open into them from the outer sides. There are nine state-rooms opening into these passages.

Beyond the wardroom bulk-head is a large open space, which can be used by the steering officers.

The crew are berthed forward on the gun and berth decks. The seamen's heads are on the berth-deck.

U. S. MONITOR PURITAN.

The *Puritan* is a low freeboard twin screw-monitor. The vessel is built of iron throughout, armored with a steel armor belt extending the entire length of the vessel, and carries four 10-inch guns, in two armored turrets and an efficient secondary battery. She has a powerful ram very strongly secured, and is fitted with steam steering gear and steam windlass. On top of the armor belt is worked an armor deck 2 inches in thickness.

The principal dimensions are as follows: Length between perpendiculars, 280 feet; length on load line, 291 feet; length over all, 295 feet 8½ inches; breadth extreme, 60 feet 1¼ inches; depth from base line to top of main deck beams, at middle line, 20 feet 9 inches; draught, 18 feet 2¼ inches; area of greatest immersed transverse section, 1,037 square feet; displacement to L. W. L., 6,060 tons; tons per inch at load line, 33.64 tons; moment to alter trim 1 inch in foot tons, 609; indicated horse-power, 3,600; metacentric height, 10.2 feet; maximum speed, 13 knots; armor on sides, 12 inches; armor on turrets, 11¼ inches.

Scantling and general construction.—The outer flat keel is of iron 45 pounds per square foot or 1½ inches thick; the inner plate is 40 pounds per square foot or 1 inch thick, both outer and inner keels having treble chain riveted butt straps of 45-pound plating. The vertical keel is of 40-pound plating with treble chain riveted double straps of 25-pound plating, with angles 5 by 4 inches by ¾ inch at the bottom and ¾ by ¾ by ¼ inches at the top.

The garboard strakes are 1½ inch thick or 32½ pounds per square foot, the next strakes to them 35 pounds from these up to the three strakes next below the armor shelf which are 30 pounds worked flush with outer seam strip 10¼ by 1½ inches, the outer strakes are 30 pounds per square foot or ¾ inch thick, and the inner 1¼ or 2½ pounds.

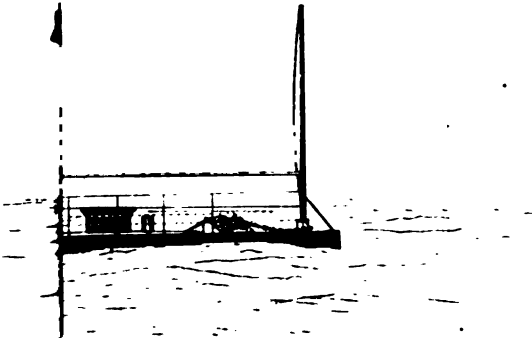
The butt straps are 1½ inch thicker than the plates they connect and are treble chain riveted and the edges are double chain riveted.

The stem is the best hammered iron, forged to shape, the head 3 feet 4 inches wide and 17½ inches thick, tapered below the armor and the lower end flattened to receive the plates and angles of the keel. The stem is rabbeted to receive the double plating wake of ram, the skin plating back of the armor, and the outer thickness of the armor plating, and there is a flange on the after part to receive the vertical keel plate. The head of the stern post is 5 by 12 inches, tapered in the siding to 5¼ inches at the heel.

The frame angles are 5 by 4 by 1½ inches, reverse angles 3½ by 3½ by ½ inches, and the floor plates are 20 pounds per square foot; solid frames are worked every 20 feet.

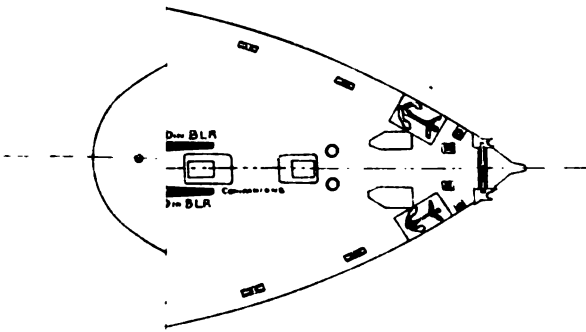
The longitudinals are of 20-pound plating, worked along the center of each outer course of plating, with 3½ by 3½ by 1½ inch angles at the top and bottom. The double bottom is of 20-pound plating, with 30-pound double riveted butt straps on the under side plates worked flush with seam strips of 32½-pound plating worked on top.

PLATE I



U.S. IRON CLAD PURITAN

PLATE 2



U.S. IRON-CLAD "PURITAN"

The armor shelf formed of 35-pound plating, the outer edge connected to the bottom plating by an angle 6 by 4 by $\frac{1}{8}$ inch, and the under edge to the double bottom by a 4 by 4 by $\frac{1}{8}$ inch angle, double riveted butt straps of 35-pound plating on the under side.

Plating below armor 30 pounds, worked in one width, secured to the armor deck and shelf plate by 6 by 4 by $\frac{1}{8}$ angles. The framing back of armor is of 25-pound plating, secured to the plating behind armor and the armor shelf by 6 by 4 by $\frac{1}{8}$ inch angles, double riveted to the main deck beam ends.

In the double bottom there are 50 water-tight compartments, in the hold 29, and on the berth deck 20. Bulk-heads formed of 10-pound plating, calked and stiffened.

It will be seen that this vessel is heavily scantled, the hull comparing admirably with vessels of the present day as regards structural strength, durability, and workmanship.

Hurricane deck.—The hurricane deck is 9 feet 6 inches above the main deck, supported on combined stanchions and ventilators. The framing is of bulb angles and a 1 $\frac{1}{2}$ -inch white pine deck is worked and covered with canvas. When at sea the water can pass freely under this deck, the connection with below being made by extending trunks up from the main deck hatches.

This deck extends from turret to turret and has the hammock boxes along the sides. The boats are stowed on a level with this deck, being lifted by high swinging davits pivoted on the main deck.

A bridge is run out on each side on a level with the deck.

Armor.—The side armor is of steel and is to extend in a complete belt around the ship, 7 feet deep amidships. The thickness is to be 12 inches amidships well backed by yellow pine, reduced at the ends to 8 inches; secured by bolts tapped into the armor at the back.

The turret armor will be 6 feet 2 inches deep and 11 $\frac{1}{4}$ inches in thickness, except the port plates, which are 12 $\frac{1}{4}$ inches. The backing to be 10 inches.

The conning towers are 12 inches thick on sides, 6 feet in diameter, with 8 sight holes at the top and 1 at the bottom. The plating on the top is 2 $\frac{1}{2}$ inches in thickness. The smoke-pipe is protected by armor 10 $\frac{1}{4}$ inches thick, and the ventilator by 9 $\frac{1}{4}$ -inch armor. The main deck is of two 1-inch wrought-iron plates, with a wood flat 3 $\frac{1}{4}$ inches thick worked over it.

Ventilation and drainage.—The vessel will have large centrifugal fans for supplying fresh air and exhausting the foul, while the system of drainage and pumps is similar to that of modern double-bottom ships of this type.

The vessel will be lighted throughout by the incandescent system of electric lighting, and will be supplied with electric search lights. The armor deck is pierced at a number of points and fitted with deck lights; these are fitted with armored covers, and so arranged that ventilating funnels can be fastened to them.

Offense and defense.—The low freeboard of this vessel, 30 inches subtending a vertical arc of less than 2 minutes, at the distance of a mile shows how very uncertain must be the firing at a vessel like the *Puritan*, for an error of this very small amount would cause the shot to pass over the vessel or else strike the water in front when it would ricochet over. The turrets subtend horizontal angles of about a quarter of a degree at the distance of a mile. This shows the great disadvantage at which a high freeboard vessel would be placed in a combat with the *Puritan*. Carrying in her turrets four 10-inch breech-loading rifles, elevated, trained and loaded by machinery protected by 11 $\frac{1}{4}$ inches of steel armor, and firing a projectile weighing 500 pounds with 250 pounds of powder, capable of piercing 23 inches of wrought iron at the muzzle or 17 $\frac{1}{4}$ inches at a distance of a mile, the *Puritan* need fear but few vessels afloat.

In addition to the heavy guns in the turrets she carries a powerful secondary battery consisting of two 6-pounder rapid and two 3-pounder rapid fire Hotchkiss rifles, two 37^{mm} revolving cannon, and two Gatlings, also a torpedo net of heavy steel rings, which can be rigged out at a distance from the vessel all around, hanging down into the water, so protecting the vessel from torpedo attacks, and a powerful search light for use at night.

Four hundred tons of coal can be carried at normal draught, giving this vessel a great endurance, enabling her to steam from Norfolk to Panama or Havana, and still have coal left to take her through an engagement.

The *Puritan* compares more than favorably with the *Conqueror*, one of England's modern turret vessels, and with the *Tonnerre* of the French navy.

Machinery.—The motive power is furnished by two direct acting horizontal compound engines placed in a water-tight compartment. The cylinders are 50 and 86 inches in diameter by 42-inch stroke. There are 10 return fire tube boilers with a grate surface of 700 square feet. Working pressure, 80 pounds.

The two screws are of the Hirsch pattern, made of cast-iron, four-bladed, 15 feet in diameter, and 23 feet mean pitch.

Quarters for officers and crew.—On the after berth deck are located the quarters for the officers, consisting of cabin, state-rooms, pantry, and bath-room for the command-

ing officer, and wardroom accommodations for 13 officers. Forward of the wardroom and separated by a transverse water-tight bulk-head is the steerage with accommodations for 10 officers; also the wardroom and steerage pantries, paymaster's office. The officers' water-closets, armory, lamp room, etc., are forward of a portion of the after coal bunker with doors entering from the wing passage.

The forward berth deck is devoted almost exclusively to the accommodation of the crew and is fitted up with all necessary lockers, mess tables, etc., as is usual in the U. S. Navy. A wing passage on either side connects the forward and after berth deck, and also affords an opportunity for examining the armor, etc.

U. S. MONITOR MIAANTONOMOH AND CLASS.

The *Miantonomoh* and class are low freeboard, twin-screw, double-turreted iron-clads of the monitor type, and are of the following dimensions:

Length between perpendiculars, 250 feet; length on load water line, 259 feet; length over all, 262 feet; beam extreme, 55.5 feet; depth of hold, 14 feet; draught (load), 14.14 feet; freeboard, 25 inches; displacement in tons at load draught, 3,815 tons; displacement per inch at load draught, 27.67 tons; metacentric height, 7.96 feet; area of midship section, 716.5 square feet; indicated horse-power (actual), 1,426; speed (actual), 10.5 knots.

The hull is built of iron throughout on the cellular system, and divided by numerous bulkheads into 87 water-tight compartments, the double bottom being 2 feet 4 inches in depth at the center line, extending for a length of 223 feet, or from the forward collision bulk-head to within 11 feet of the stern post, and divided into 46 compartments by transverse water-tight floors and the center vertical keel; on this inner bottom extending to the armor deck is located the machinery space for a length of 84 feet amidships. This space is divided into engine and boiler rooms, coal bunkers, and wing passages connecting the forward and after berth decks, making in all 14 water-tight compartments.

The capacity of coal bunkers is 332 tons, equal to 6 days' steaming at full power,

Forward and aft the machinery space the ship is divided vertically by the berth deck, and between this deck and the inner bottom are located the magazines, shell rooms, loading rooms, turret-manipulating machinery, water-tanks, chains, and all stores; this space is divided into 20 water-tight compartments.

Berth-deck.—On the after berth-deck are located the quarters for the officers, consisting of a cabin and state-rooms, bath-room and pantry for the commanding officer. Separated from the cabin by a transverse water-tight bulk-head is the wardroom, consisting of 5 state-rooms on either side, and a central country 21.5 by 20.5 feet. Forward of and separated from this by a transverse water-tight bulk-head are located the steerage and pantries, water-closets, and armory. In addition to these quarters a wooden structure on top of and supported by each turret, contains 5 rooms for use in ordinary weather, or when living in tropical climates.

On the forward berth-deck are located the windlass, galleys, dispensary, and paymaster's office; the remaining space is devoted to the crew and fitted up with all necessary mess-tables, lockers, hammock-boxes, etc., as usual in the U. S. Navy.

On these decks both forward and aft are located the powerful steam wrecking-pumps, and Downton hand-pumps with their connections to the water-tight compartments throughout the ship.

As all the living spaces are below the water-line no recourse can be had to natural ventilation when at sea. In order that a good supply of fresh air may be had, powerful centrifugal blowers have been fitted, with a capacity of 20,000 cubic feet of air per minute, down from an armored ventilator 5 feet in diameter with its connections 12 feet above the bridge-deck, and discharging into ducts leading into all living spaces. These spaces are lighted by deck-lights through the armor-deck, fitted with cowls which may be used as down-casts when lying in comparatively still water. At such times by an arrangement of valves the blowers may be used as exhaust-fans, the fresh air being received through the deck-light cowls and hatches, the vitiated air being exhausted into the fire-room or the atmosphere.

The ship will be lighted throughout by the incandescent electric lighting system. The height in the clear under the beams in living spaces is 7 feet.

Scantlings.—The outer flat keel-plate is 40 pounds per square foot or 1 inch thick, and the inner plate $\frac{3}{4}$ inch thick, as is the garboard. The remaining inner strakes are $\frac{3}{8}$ inch and the outer ones $\frac{1}{2}$ inch thick, the plating being worked lap-straked.

The vertical keel is of 1 inch thickness, with angles of 4 by 4 by $\frac{3}{8}$ inches at the bottom and 3 by 3 by $\frac{1}{8}$ inches at the top.

The gutter-plates of $\frac{3}{8}$ inch in thickness, the remainder of inner bottom being of $\frac{1}{8}$ -inch plating worked flush to armor-shelf with straps on upper side.

The longitudinals are five in number on each side and $\frac{1}{8}$ -inch plating, stiffened by 3 by 3 by $\frac{1}{8}$ inch angle-irons, spaced 2 feet apart with angles of 3 by 3 by $\frac{1}{8}$ inches at top and bottom.

The transverse framing consists of an outer frame of $4\frac{1}{2}$ by 3 by $\frac{3}{16}$ inch angle-bar, worked continuously from armor-shelf to vertical keel, spaced 24 inches from center to center, and a reverse bar of 3 by 3 by $\frac{3}{16}$ inches continuous from keel to armor-shelf. These bars are connected by bracket floor-plates of $\frac{3}{16}$ inch thickness.

The armor-shelf is $\frac{3}{4}$ -inch plating connected to the outer plating and armor-skin by angles 4 by 4 by $\frac{3}{8}$ inches, and to the transverse framing by clips of angle-iron 4 by 3 by $\frac{3}{8}$ inches.

The armor-skin of plating $\frac{3}{4}$ inch in thickness, stiffened by angles on the side next the armor by angles of 6 by 4 by $\frac{3}{8}$ inches, heeled to the armor-shelf by gusset-plates of $\frac{1}{2}$ inch thickness; on the inner side the stiffeners are of the same size and extend below the armor-shelf 2 $\frac{1}{2}$ feet, thereby scarfing with the transverse framing.

The main-deck beams are of 10 by $4\frac{1}{2}$ by $\frac{1}{2}$ inches T-bulb iron, spaced 2 feet apart, supporting an armor-deck 1 $\frac{1}{2}$ inches in thickness.

The berth-deck beams are of angle-iron 6 by 4 by $\frac{3}{16}$ inches, spaced 2 feet apart.

The stem is of forged iron 4 by 12 inches, of ram shape, the point being 10 feet below the load-line, and thoroughly backed and stiffened by knees, armor, double skin plating, breast-hooks, etc., to form a powerful weapon of offense. The stern-post is of forged iron 12 by 4 inches, formed with a lug to carry the rudder, which is of forged iron frame, to which are attached side plates, the space between being filled with white pine. This rudder has an area of 74 square feet and is connected to ordinary hand steering-gear, also with steam steering-gear, which may be controlled from the armored pilot-house on top of the forward turret.

The hurricane deck is 9 feet 6 inches above the main deck, supported on combined stanchions and ventilators like the *Puritan's*.

Offense and defense.—The main battery is similar to that of the *Puritan*—that is, four 10-inch breech-loading rifles in revolving turrets, protected by 11 $\frac{1}{2}$ inches of steel armor. The secondary battery consists of two 6-pounder rapid-fire rifles, two 37^{mm} revolving cannon and two Gatlinga. She also carries a torpedo-net and search-lights.

Two hundred rounds are carried for the 10-inch guns, and 245 tons of coal at normal draught. The free-board is 25 inches.

She has an armor belt of iron 7 inches in thickness amidships, reduced to 5 inches at the extremities (the remaining three monitors are to have a steel belt of same thickness, in place of iron), extending the entire length of and protecting completely all parts of the vessel, being about 4 feet below and 25 inches above the water-line, making the total depth about 6 feet. The conning towers are 9 inches in thickness, placed on top of each turret, which are of roller-base type carrying armor 11 $\frac{1}{2}$ inches in thickness. The smoke-pipe is protected by armor 10 $\frac{1}{2}$ inches in thickness and the ventilator by 9 inches of armor. On top the side armor, for the whole length of vessel, is worked an armored deck 1 $\frac{1}{2}$ inches in thickness.

Vessels of this class are the *Terror*, *Amphitrite*, and *Menadnock*.

The turret armor of the *Miantonomoh* is compound, while that of the other vessels of this class is to be of steel throughout.

Machinery.—The engines are of the twin screw, direct-acting compound type. The cylinders of one engine are placed opposite and inclined to those of the other engine, with the high-pressure cylinder of one opposite the low-pressure cylinder of the other.

The cylinders are 32 and 48 inches in diameter by 42-inch stroke. Steam is supplied to these engines by 6 return-fire tube boilers of 12 feet 4 $\frac{1}{2}$ inches diameter by 9 feet 10 inches long, and are placed just forward of the engines, three on each side of the vessel with the fire-room between them. The two after boilers are arranged to be worked as auxiliary boilers when necessary. Total grate surface, 369 square feet; total heating surface, 8,781. Ratio grate to heating surface, 1 to 23.79. Working pressure, 80 pounds.

The two screws are of the Hirsch pattern, in diameter 12 feet and 19 feet mean pitch.

NEWARK.

The *Newark* is a twin screw protected cruiser, having a poop and fore-castle deck with an open gun-deck between. The vessel is built of mild steel throughout, and contains all the latest improvements in naval construction, ordnance, and steam engineering.

The engines, boilers, magazines, shell-room, torpedo-spaces, and steering-gear are placed below a protective steel deck extending throughout the length of the vessel. The engines and boilers are further protected on both sides and from above by a coal space or bunkers, which serve both as an extra armor and as fuel stores.

The principal dimensions and results of calculations are as follows:

Length extreme, 328 feet; length on load water-line, 310 feet; breadth molded, 49 feet; breadth extreme, 49.14 feet; depth from flat keel-plates to under side of the spar-deck, 31.80 feet; draught of water mean, 18.825 feet; displacement in tons to L. W. L., 4,087.93; tons per inch at L. W. L., 24.96; area of load water plane, 10,484 square feet; area of immersed midship section, 807.23 square feet; area of nine prin-

cipal sails, 11,932 square feet; transverse metacenter above C. G., 3.314 feet; longitudinal metacenter above C. G., 347.755 feet; moment to alter trim 1 inch, 381.69 foot tons; coefficient of fineness of displacement, .498; indicated horse-power natural draught, 6,000; indicated horse-power forced draught, 8,500; maximum speed per hour, 18 knots; complement, 300.

Scantling and general construction.—The outside plating from the keel, to and including the first strake above the protective deck, is $17\frac{1}{2}$ pounds per square foot, or about $\frac{7}{8}$ of an inch in thickness, lap-jointed and double riveted at the edges and butt. Above the protective deck the plating is 13 pounds per square foot, or about $\frac{3}{4}$ of an inch in thickness, flush-jointed with single-riveted edges.

The sheer-strake is doubled for about 186 feet amidships, and a double plate is also worked at the water-line for 147 feet amidships.

The flat keel is made up of two plates, the outer 20 pounds per square foot, or about $\frac{1}{2}$ of an inch in thickness, and the inner $17\frac{1}{2}$ pounds per square foot, or about $\frac{7}{8}$ of an inch in thickness. The vertical keel plate is $17\frac{1}{2}$ pounds per square foot, with 3 by 3 by 7 pound angles along the upper edge and $3\frac{1}{2}$ by 3 inches by 8 pounds along the lower edge.

The butts of the vertical keel are double strapped and treble chain riveted. Each butt of the flat keel has a $17\frac{1}{2}$ pound butt-strap, triple chain riveted.

The inner-bottom plating is $12\frac{1}{2}$ pounds per square foot, except the gutter and wing plates, which are 15 pounds per square foot.

The stem, stern-post, and rudder-frame are of cast steel.

The transverse frames are spaced 3 feet between centers. The framing throughout the double bottom, below the protective deck, is on the bracket system, the frame bar being $4\frac{1}{2}$ by 3 inches of 9 pound, the reverse bar $4\frac{1}{2}$ by 3 inches of 8 pound, and the brackets of $12\frac{1}{2}$ and 10 pound plating.

Above the protective deck, and forward and abaft the double bottom, the frames are Z-bars 6 by $3\frac{1}{2}$ by 3 inches of 14 pounds, the lower part being split and opened to take the plate of the usual frame and reverse angle, the upper angle of the alternate frames extending across the keel about 2 feet, and being connected to the angle on the oppositeside by a butt-strap. Floor-plates of 10 pounds per square foot are worked between the angles formed by opening the bars, connected by clips to the longitudinals and vertical keel.

The first and second longitudinals within the double bottom are formed by continuous plates 15 pounds per square foot, or about $\frac{3}{4}$ of an inch in thickness, 34 inches and $28\frac{1}{2}$ inches in depth, respectively, slotted over the frame angles.

The horizontal flanges of the outer angles are continuous, the vertical flange being scored at the frames. The angle-bars on the inner edge are continuous. Both outer and inner edges are 3 by 3 inches of 7 pounds. Forward and abaft the double bottom the inner angle of the first longitudinal is intercostal, connected over the reverse bar by lozenge-shaped straps. The inner edge of the second longitudinal is a continuous Z-bar 5 by 3 inches by $2\frac{1}{2}$ inches by 12 pounds, which is gradually twisted as the longitudinal approaches the stem, and connected to a horizontal plate abaft of and connected to the ram-plate. Abaft the double bottom a flat plate 12 inches wide is secured to the intercostal angle and reverse bars.

The third and fourth longitudinals are of Z-bars 12 by $3\frac{1}{2}$ by 3 inches of $22\frac{1}{2}$ pounds, the inner flange continuous, and the outer scored over the frames, a continuous angle 5 by 3 inches of 10 pounds being worked on the inner edge of the Z- and reverse angles.

The main bulk-heads are 10 and 8 pound plating, stiffened by vertical angles $3\frac{1}{2}$ by $2\frac{1}{2}$ inches of 8 pounds. The plates are all worked flush, single riveted, with horizontal T stiffeners $4\frac{1}{2}$ by 3 inches of $8\frac{1}{2}$ pounds as seam strips on the side opposite to the vertical stiffeners.

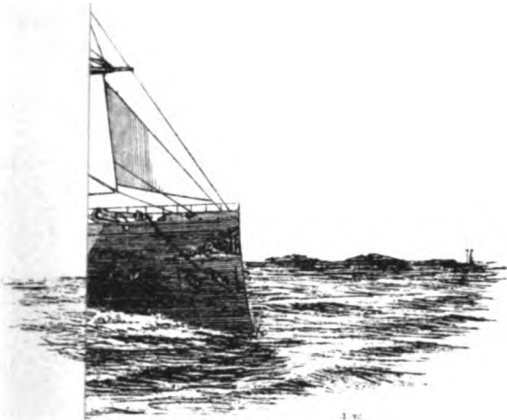
The ceiling on the berth-deck and poop is of $2\frac{1}{2}$ -pound plating, fitted to the frames in such a manner that it can be removed easily for cleaning and painting the outside plating. Four belt frames of $12\frac{1}{2}$ -pound plates and $2\frac{1}{2}$ by $2\frac{1}{2}$ inches of 5-pound angles are worked on the berth-deck as stiffeners to the side.

The stringers to poop and fore-castle decks are 24 inches wide and $12\frac{1}{2}$ pounds per foot. Between the stiffeners at the ends the plating is 10 pounds, and in wake of capstan, bitts, and compressors $12\frac{1}{2}$ pounds. The tie-plates are 8 pounds.

On the poop, fore-castle, and bridges immediately over the guns the plating is $12\frac{1}{2}$ pounds.

The gun-deck stringer is 20 pounds and 60 inches wide amidships, reduced to 15 pounds and 42 inches at the ends. The berth-deck stringers are worked in two strakes of 10-pound plating, each strake about 54 inches wide, the outer strake tapering to 28 inches at the ends. The tie-plate is 12 inches by 15 pounds, and between the tie and stringer plates is worked 5-pound plating.

The rudder and steering-gear are entirely below the water-line and are under the protective deck. Steam steering-wheels are located in pilot-house and armored conning tower, and on the gun-deck just forward the after bridge is a combined steam



REFERENCES

- A - CONCASTLE
- B - BRIGS
- C - POOP DECK
- D - LONG RANGE GUN
- E - CHART AND PULPIT
- F - 12" SEAMING MACHINES
- G - 5" M. M. MACHINES
- H - VI IN B. L. RIFLES
- J - FURLOIN
- K - MAIN TOP
- L - MIZEN TOP
- M - 37" REVOLVING GUN
- N - 20 FT CUTTER
- O - 32 FT LAUNCH
- P - 24 FT LUTHER
- Q - 28 FT STEAM WAGON
- R - 24 FT WHALL
- S - SMOKE-PIPER
- Y - MIZEN BITTS



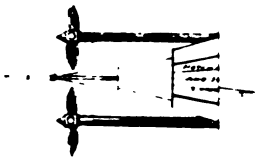
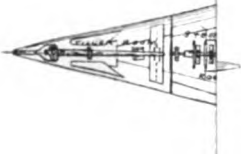
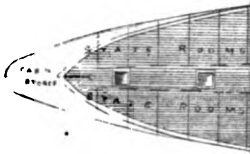
REFERENCES

- U - SEAMENS HEAD.
- Z - RIDING BITTS.
- C - HAWSE-PIPER
- Q - WINDLASS.
- G - FIFF RAILS.
- F - MAGAZINE SCUTTLE
- SHELL-ROOM SCUTTLE ON PORT SIDE.
- 9 - GALLERY.
- 7 - FIRE-ROOM HATCH & BUNKERS
- U - STEERING WHEEL.
- 8 - ARMORY, EXECUTIVE OFFICERS OFFICE OPPOSITE
- 6 - VI IN B. L. RIFLES
- 2 - CAPTAINS PENTON ADMIRALS PENTON OPPOSITE
- 3 - CAPTAINS OFFICE, ADMIRALS OFFICE OPPOSITE
- CAPTAINS STATE-ROOM ADMIRALS STATE-ROOM OPPOSITE
- 9 - CAPTAINS CABIN
- T - ADMIRALS CABIN
- AVATORY, AND SMOKING ROOM ADMIRAL'S OPPOSITE

U. S. S. NEWARK

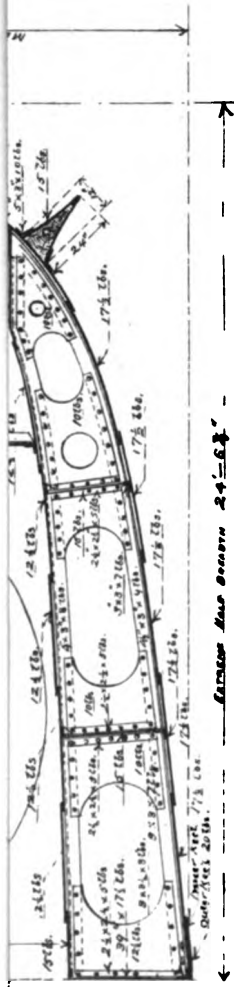


PLATE 2.



U.S.S. NEWARK.

PLATE 3.

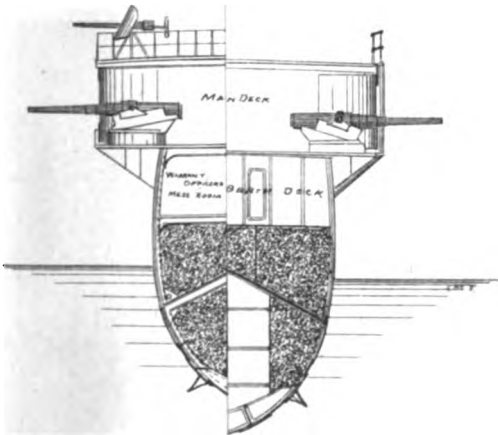
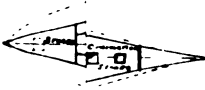
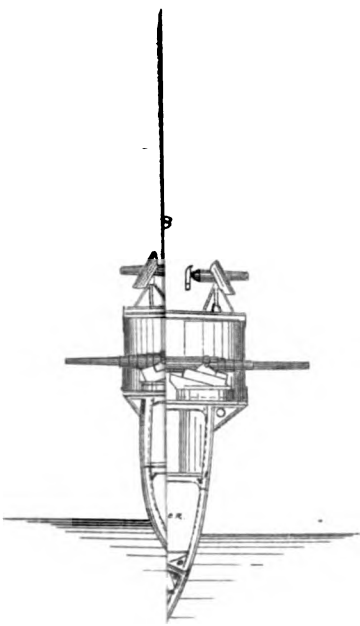


MIDSHIP SECTION.



U.S.S. NEWARK.

PLATE 4.



FR 34.



U.S. S. NEWARK.

and hand steering-wheel, and the vessel can also be steered by hand or steam from below the protective deck aft.

Rig.—The rig is that of a bark without head-booms. Sail is supplied merely as an auxiliary power for cruising purposes, the area of plain sail being 11,932 square feet.

Coal endurance.—The coal supply at normal draught is 400 tons, but the vessel has a bunker capacity of 850 tons. The following table shows the radius of action and endurance at different speeds :

Endurance table of Newark.

Speed.	I. H. P.	Coal.		Distance per day.	On normal supply of 400 tons.		On full capacity of 850 tons.		Coal per I. H. P. per hour.
		Per hour.	Per day.		Distance can steam.	Days.	Distance can steam.	Days.	
<i>Knots.</i>					<i>Knots.</i>		<i>Knots.</i>		
1	8 500	7.96	191.00	444	930	2.10	2 076	4.46	2.1
1	7 700	5.50	132.00	432	1 309	3.03	2 792	6.44	1.6
17	6 250	4.46	107.04	408	1 526	3.74	3 244	7.95	1.6
16	5 100	3.64	87.40	384	1 757	4.57	3 734	9.71	1.6
15	4 100	2.93	70.30	360	2 047	5.69	4 350	12.09	1.6
14	3 300	2.36	56.60	336	2 375	7.07	5 047	15.02	1.6
13	2 600	1.86	44.70	312	2 800	9.00	5 950	19.12	1.6
12	2 100	1.50	36.00	336	3 200	11.11	6 800	23.61	1.6
11	1 680	1.20	28.80	336	3 667	13.88	7 788	29.50	1.6
10	1 350	1.02	24.48	294	3 922	16.34	8 333	34.72	1.7
9	1 000	.80	19.20	216	4 539	21.00	9 634	44.60	1.8
8	750	.66	15.84	192	4 906	25.71	10 489	51.63	2.0

Machinery.—The motive power is furnished by two triple expansion engines, in separate water-tight compartments. The cylinders are 34, 48, and 76 inches diameter, by 40-inch stroke. The four boilers are 13½ feet in diameter by 19½ feet long, designed for a steam pressure of 160 pounds; grate-surface, 540 square feet.

These engines are capable of developing 8,500 horse-power under forced draught, the air being driven into the fire-rooms by blowing-fans. Steam starting and reversing gear, ash-hoisting engines, steam turning-gear for the main engines, distilling apparatus, a windlass for hoisting the anchors and other heavy weights, and a steam winch for boats and light weights will be fitted.

Lighting, ventilating, and drainage.—The exhaust system of ventilation which has been found very efficient in our Navy has been adopted for the *Newark*, and special attention is paid to the ventilation of the coal-bunkers.

The vessel is to be lighted throughout by the incandescent system of electric lighting, and will be supplied also with electric search-lights.

Throughout the length of the vessel and on both sides are 41 air-ports, each having a light 12 inches in diameter, and in addition to these there are 7 coaling-ports on each side, having lights in them 10 inches in diameter. These ports can all be opened and used as ventilators. Under the poop and fore-castle on each side are fourteen air-ports, with lights 12 inches in diameter.

A very complete system of drainage has been provided, by which the total power of steam and circulating pumps can be concentrated on any main or intermediate compartment. In addition to the steam pumping system there are four hand-pumps on the berth-deck, which have independent suction to each main compartment of the double bottom. These pumps deliver into the fire-main or directly overboard, as required, and can be used for flooding any compartment or flushing the drain-pipes.

A fire-main extends along the berth-deck, with stand-pipes to the gun-deck, poop, and fore-castle, having cocks for these at intervals. This main is supplied by one of the large steam-pumps or by any or all of the hand-pumps. The vessel will also be supplied with ten lift-pumps for salt water to supply seamen's head, officers' closets, galleys, sick-bay, etc., and one fresh-water lift-pump to deliver to galley, daily supply tanks, etc.

Quarters for officers and crew.—The *Newark* is fitted as a flag-ship. The space under the poop is converted into quarters for the admiral and captain. In the wardroom there are fourteen state-rooms, each entered from a passage about 5 feet wide along the middle line of the vessel. Forward of the state-rooms, a space 13½ feet long and the entire width of the ship is reserved for mess purposes, and fitted with tables sideboards, and safes. Forward of the wardroom are the steerage, pantries, lavatories, warrant officers' state and mess rooms, and wardroom, steerage, and warrant officers' water-closets. The sick-bay and dispensary are in the extreme forward com-

partment. The remainder of the space on this deck is reserved for the accommodation of the crew. The height in the clear between the berth-deck and the gun-deck beams is 6 feet 7½ inches. The crew's head is in the forward compartment of the gun-deck, entered either by a water-tight door through the bulk-head or by a hatch from the fore-castle.

Water-tight compartments in the hull.—The vessel has a double bottom extending throughout the space reserved for the engines and boilers, or about 127 feet, the depth between the inner skin and outer skin plating being about 39 inches. This double-bottom space is divided into 12 water-tight cells by means of solid floors and vertical keel.

The engine and boiler space is divided into 17 water-tight compartments, by means of athwartship bulk-heads and longitudinal bulk-heads, when all doors are closed, each engine being in a separate compartment.

There are 12 complete water-tight bulk-heads, extending from the inner skin of the double bottom, and from the outside plating before and abaft to the protective deck, and, by means of bulk-heads and water-tight platforms, the space below the protective deck is divided into 70 water-tight compartments when all the water-tight doors are closed. If all the water-tight doors below the protective decks were left open there are still 37 water-tight compartments.

The space between the protective and berth deck is divided into 72 water-tight compartments when all the doors are closed; with doors open there are 46 compartments.

On the berth-deck there are 6 water-tight athwartship bulk-heads, dividing it into 7 water-tight compartments. All the openings from the berth-deck to the engine and boiler rooms are protected by coffer-dams, while all scuttles and hatches to store-rooms are water-tight.

Thus, below the gun-deck, when all the water-tight doors are closed, there are 147 distinct water-tight compartments, but when all the water-tight doors are open, which should never occur when the vessel is in commission, there are still 85 water-tight compartments.

Protective deck.—The protective deck extends throughout the length of the vessel. Amidships longitudinally for 163 feet the deck is worked 15 inches above the load water-line. Forward it slopes down to 4½ feet below the water-line to strengthen the stem, and abaft it slopes to 3 feet below the water.

Athwartships the deck is worked flat to within 11 feet of the sides, where it bends down, striking the sides at 4 feet 3 inches below the water-line. The horizontal portion is about 2 inches thick, increased 1½ inch over the steering-gear, and the inclined sides are about 3 inches thick. Armor shutters and scuttles of the same thickness as the deck are fitted at all hatchways and openings.

With a view to making the bottom plating below the protective deck secure from injuries occurring to the parts above, the plating is not worked across the edge of the deck, but is stopped, and a strip of steel about 3½ inches wide is inserted.

Coal armor.—The space between the vertical longitudinal bulk-heads extending on each side, and throughout the length of the machinery spaces and the sides of the vessel will be filled with coal, forming a coal-armor belt amidships 9 feet thick, and forward and aft about 7 feet thick, extending 5 feet above the load water-line.

Armament.—The main battery of the *Newark* consists of twelve 6-inch breech-loading rifles mounted in sponsons on central pivot carriages, with circular 2-inch steel shields fitted to each carriage to protect the gun's crew as well as the mechanism of the gun and carriages from machine-gun fire.

The forward two guns, one on either side, are placed under the fore-castle deck and train from 70° abaft the beam to 95° forward, thus having a cross fire of 5° converging at 111 feet forward the stem. The after two guns are placed under the poop, and can be trained from 70° forward of the beam to 93° abaft, thus having a cross fire of 3° converging at 243 feet abaft the stern.

The second pair from forward, together with the second pair from the stern, are placed under bridges, the forward guns training from 93° forward the beam to 70° abaft and the after ones from 70° forward to 93° abaft; giving a fire of four forward guns and four after guns in a line parallel to the keel. The forward four guns can be concentrated at 112 yards forward the stem, and the after guns at 118 yards astern.

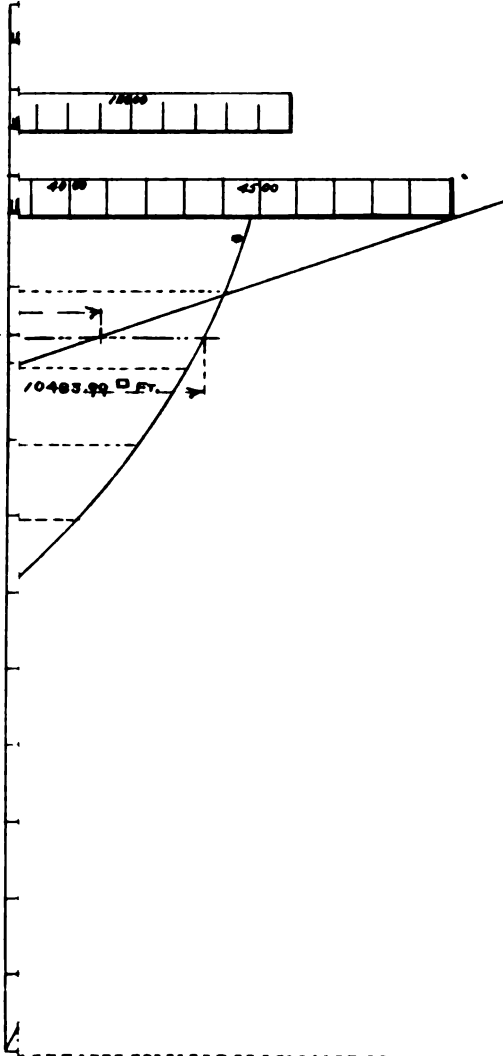
The remaining four guns are mounted on the sides and train from 70° forward to 70° abaft the beam.

All the guns on one side can be concentrated on an object 30 feet from the side. The centers of the trunnions are 16½ feet above the water.

The shell of the main battery weighs 100 pounds, the powder charge 50 pounds, and will pierce about 13 inches of iron at the muzzle.

The secondary battery consists of four 6-pounders, 57mm single shot guns; four 37mm Hotchkiss revolving cannon; one 1-pounder on a rail mount; and two short Gatlings on rail mounts. One of the 37mm guns is mounted in each of the fore and

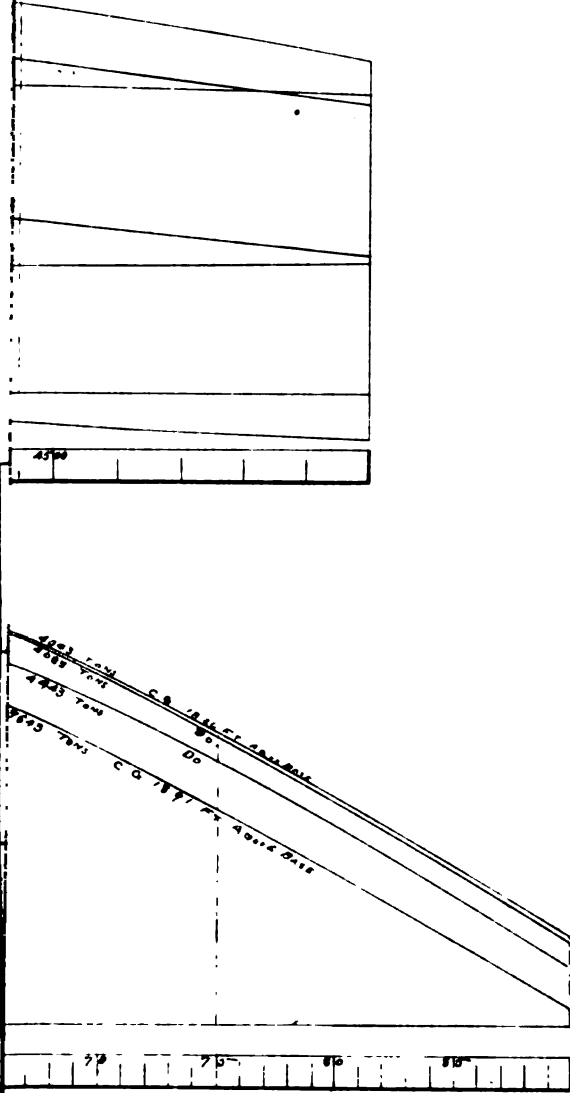
SCALE FOR MEAN DRAFT. (FEET)



U.S.S. NEWARK.

PLATE 6.

SCALE OF FEET FOR RIGHTING ARM.

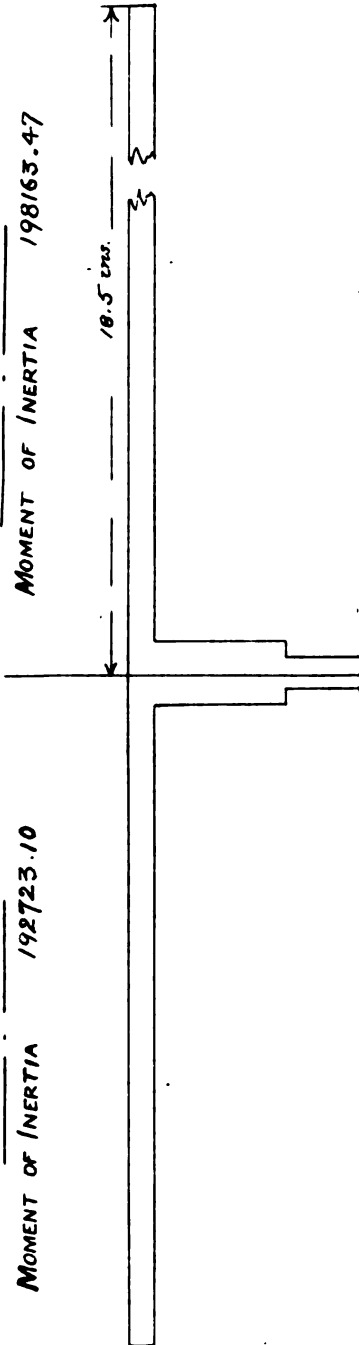


U.S.S. NEWARK.



ONE SIDE OF HOGGING GIRDER
MOMENT OF INERTIA 192723.10

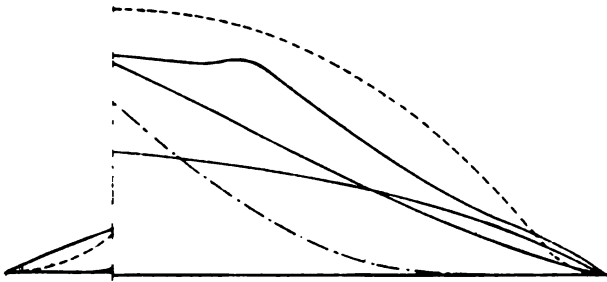
ONE SIDE OF SAGGING GIRDER
MOMENT OF INERTIA 198163.47



U.S.S. NEWARK.



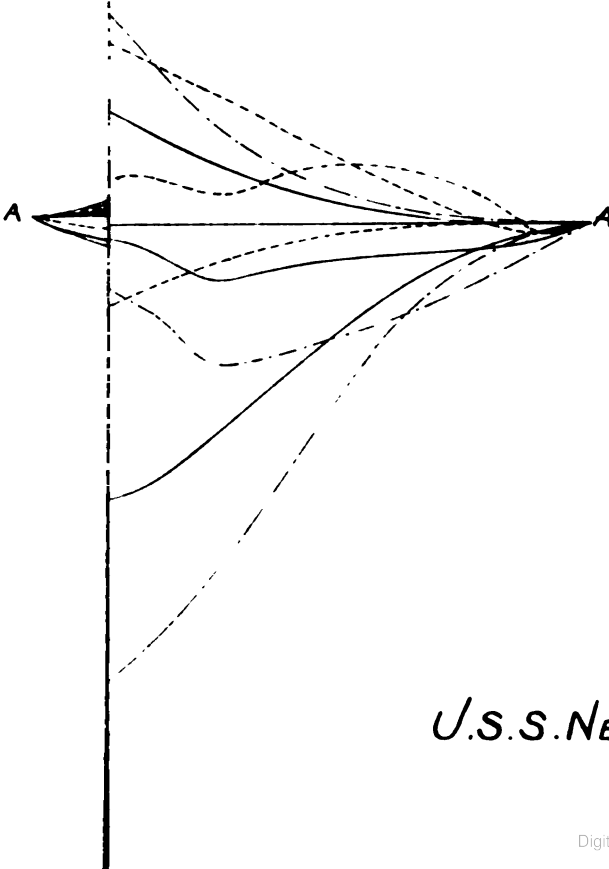
PLATE 8.



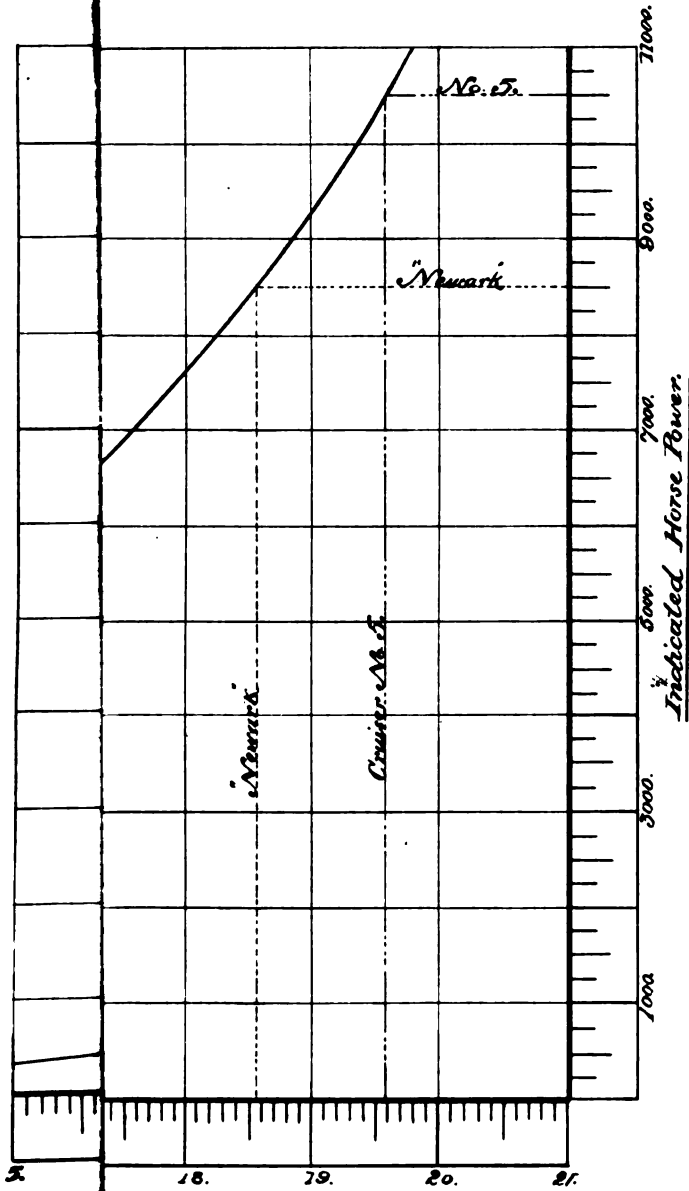
U.S.S. NEWARK.

SCALES.

CURVES OF LOADS 1 INCH = 12 TONS.
CURVES OF SHEERING STRESSES, IN STILL WATER 1 INCH = 120 TONS.
Do. , ON WAVE CREST, AND IN HOLLOW OF WAVE, 1 INCH = 180 TONS.
CURVES OF BENDING MOMENTS, IN STILL WATER 1 INCH = 9000 FT. TONS.
Do. ON WAVE CREST, AND IN HOLLOW OF WAVE, 1 INCH = 12000 FT. TONS.
ON LINE A.A. 1 INCH = 30 FEET



U.S.S. NEWARK.



aft tops, forming in connection with the other machine guns a protection against boarding parties and torpedo boats.

Torpedo outfit.—The vessel has six above-water training torpedo launching tubes worked on the berth deck. Auto-mobile torpedoes will be provided, and besides these tubes there will be a complete outfit of boat-spar torpedo gear and charges.

Magazines, shell rooms, etc.—The magazines, shell rooms, fixed ammunition rooms, and torpedo magazines are situated in the hold directly abaft the machinery and boiler spaces, separated from the forward boiler room by an athwartship coal bunker and from the after engine room by a handing room. The flats below them are watertight, and the tops of all magazines and shell rooms are 5½ feet below the water line.

Results of calculations.—The plates accompanying the drawings of the *Newark* are introduced to show to what extent the calculations for strength and stability are carried. Plate V is a graphic statement of the geometric qualities of the vessel, such as the displacement and areas of water planes at all draughts, the locus of the center of buoyancy and metacenter and other qualities that can be calculated direct from the lines of the vessel.

Plate VI shows the curves of stability, the lower being the ordinary curve of stability, upon which is shown the righting lever acting at various degrees of inclination measured along the base line. The weight of the vessel into the righting lever at any angle is the measure of the moment of the couple tending to force the ship back to her upright position. The upper figure shows what are known as cross curves of stability, from which the stability of the vessel at all displacements can be taken by measuring along the base line.

Plate VII shows the hogging and sagging girders. When a vessel is in the hollow of a long wave the amidship portions are not supported as in still water, and there is a tendency to bend down at the middle or sag; when on the crest of a wave the ends are not supported as in still water, and there is a tendency to bend up at the middle, or hog.

The materials entering into the construction of the vessel present different degrees of resistance to hogging and sagging strains, and the figures show the shape of steel girders equivalent in strength to the vessel in the two positions on a wave 310 feet long and 20 feet high.

Plates VIII and IX show the curves of buoyancy or upward supporting force at every point in the length, and also the curve of weights, or downward force, at every point. From the two is taken the curve of loads, and from this the curves of shearing force and bending moment are easily arrived at.

Plate X shows the speed curve of this vessel, which also holds for cruiser No. 5. The horse-power necessary for any speed can be measured at once from this curve.

U. S. S. CHARLESTON.

This vessel is now building at the Union Iron Works, San Francisco, Cal. She has a central open superstructure, twin screws, and two masts, with military tops, in which machine guns are mounted. She is building upon the plans of the swift Japanese cruiser *Naniwa Kawa*, built by Sir Wm. G. Armstrong, with such modifications in quarters as are rendered necessary by the conditions of the U. S. service and the substitution of 8-inch for 10-inch rifles.

Principal dimensions.—Length over all, 320 feet; length on load line, 300 feet; breadth, 46 feet; draught of water forward, 17 feet 6 inches; draught of water aft, 19 feet 6 inches; mean draught, 18 feet 6 inches; displacement to mean load line, 3,730 tons; tons per inch at load line, 23.35 tons; indicated horse-power, natural draught, 5,000; indicated horse-power, forced draught, 7,650; maximum speed in knots, per hour, 18.9; complement, 325.

Scantling and general construction.—The vertical keel is of 20-pound plating, 36 inches deep amidships, reduced to 30 inches before and abaft the double bottom; double angles on the lower edge 3 by 3½ inches of 8½ pounds per foot, and on the upper edge 3 by 3 inches of 7 pounds per foot.

The flat keel is formed of two thicknesses of plate, outer 25 pounds and the inner 20 pounds. The stem, stern-post and rudder-frame are cast steel. The stem is ram-shaped and specially strengthened by attachment to the protective deck, keel plates, and breast hooks.

The longitudinal and transverse framing below the protective deck and in wake of the double bottom is as follows:

The transverse frames spaced 4 feet apart have frame angles of 5 by 3 inches of 10 pounds per foot, worked from keel to deck in one length; between the longitudinals are plate frames, 10 pounds per square foot, attached to the longitudinals by 2½ by 2½ inches of 4 pound angles. On the inner edge of the plates angles, 3 by 3 inches of 7 pounds, are worked between the longitudinals; from the outer longitudinal, a reverse bar, 4 by 4 inches of 10 pounds per foot, is worked up to the protective deck.

Three longitudinal frames are fitted on each side throughout the double bottom. The outer is a flange plate of 15 pounds per square foot, with a 3 by 3½-inch of 10-pound angle in short lengths on the outer edge. The outer two longitudinals are of 12½ pounds with short lengths of angles, 3 by 3 inches of 7 pounds, on the outer edges, and continuous angles, 3 by 3 inches of 7 pounds, on the inner edges.

The transverse framing before and abaft the double bottom and below the protective deck is formed of Z steels, 6 by 3½ by 3 inches of 14 pounds per foot, spaced 3 feet apart, each frame in one length from keel to protective deck. Floor plates of 12½ pounds are fitted to each frame, the lower edges of the bar being split to form the frame and reverse frame.

The transverse framing above the protective deck is formed of 6-inch Z bars of 14 pounds per foot worked from protective deck to upper deck, the heel attached to the protective deck by bracket plates of 15 pounds with angles of 3 by 3½ inches of 10 pounds.

Deck beams are as follows:

Spar-deck under breastwork and roller path, 9 by 5½ inches, T bulb, 30 pounds to the foot; elsewhere, 8 by 5 inches, T bulb, 27 pounds to the foot.

Main-deck amidships, 8 by 5 inches, T bulb, 27 pounds to the foot, reduced at the ends.

Protective deck, 9 by 3½ inches, angle bulb, 25 pounds to the foot, reduced at the ends.

The bottom plating for a length of about 160 feet amidships is 20 pounds from the keel to the sheer strake, the latter is 30 pounds; before and abaft these limits the plating is 17½ pounds, except the sheer strake which is 25 pounds.

The plating is doubled where ending at the stem and stern frames, in wake of the chafe of the anchors and where the shaft tubes leave the run of the ship.

The gutter plate of the double bottom is 15 pounds, the remainder 12½ pounds.

Plating of all bulk-heads between the main and protective decks to be 10 pounds; the side coal-bunker bulk-heads are continuous, the transverse bulk-heads being stopped against and attached to them.

The stiffeners to the bunker bulk-heads to be 3 by 3 inches of 7 pounds; to all the other bulkheads 2½ by 2½ inches of 4½ pounds, all spaced 24 inches.

Below the protective deck the main transverse bulk-heads are 12½ pounds, all others 10 pounds; stiffeners, 3 by 3 inches of 7 pounds per foot, spaced 24 inches.

The upper deck plank is 3 inches thick by 5 inches wide; the main deck plank 3 inches by 6 inches wide, and that of the platforms 2 inches thick.

Vertical bulk-heads and intermediate deck beams are worked under the racers of the 6-inch guns. A tube 10 feet inside diameter, ¾-inch plate, is worked under the 8-inch guns, and intermediate beams are worked under the racers, and the bulk-heads under the guns specially stiffened.

A chart and wheel house is built under the bridge containing brass-mounted steering wheels, engine telegraphs, steering lever, indicators, speaking-tubes to the conning tower and other parts of the vessel, folding chart-table, chart-lockers, telescope-racks, etc.

A conning tower is worked on the bridge of mild steel, 2 inches thick on the vertical sides, the cover to be ¾ inch.

Fitted with steering lever, engine telegraphs, indicator, and speaking-tubes. The floor to have a grating for communication with the chart-house.

Hydraulic steering-gear is to be fitted to this vessel, with wheel or levers in the conning tower and chart-house. The steering-gear is placed under the protective deck well below the water.

Lighting, ventilation, and drainage.—Two electric, incandescent, electric-lighting plants are arranged to work on the same circuit, each capable of providing at least 3,200 candle-power of light. The lamps are to be so placed as to fully light up all parts of the ship, including coal bunkers, magazines, shell and ammunition rooms, running lights, and lights for use on deck and aloft.

Provision is made for draining water from the store-rooms, chain lockers, coal bunkers, and all other compartments of the vessel to places from which the water can be pumped by hand or steam.

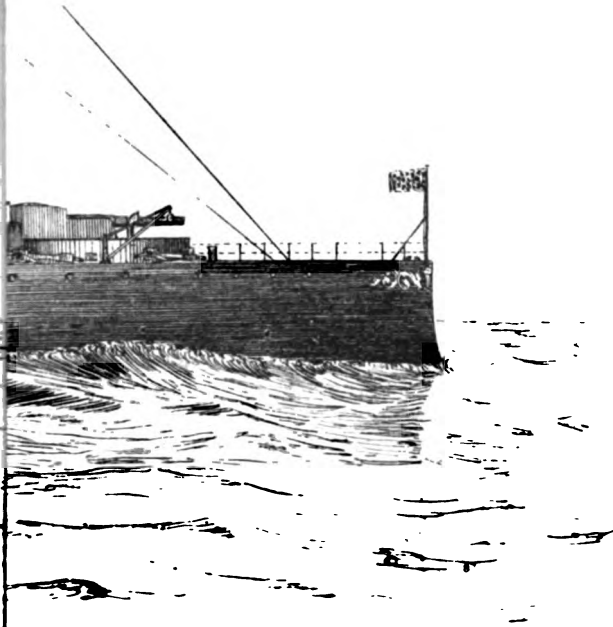
The ventilation of the living and storage spaces is by the exhaust system, and while natural ventilation is used as far as possible, artificial exhausts are provided for all compartments below the spar-deck by means of two blowers of 10,000 cubic feet capacity per minute.

The foul air of the coal bunkers is led into the funnel casing, and the bunkers have fresh-air pipes with large mouths opening into the hammock berthing.

The horizontal plating of the protective deck is 2 inches thick, the sloping sides 3 inches. This deck extends from stem to stern.

Quarters for officers and crew.—The quarters for the officers and crew of this vessel are all on the berth deck. The captain occupies the after part, having a large cabin; also two state-rooms and water-closets, with office and pantry forward of the trans-

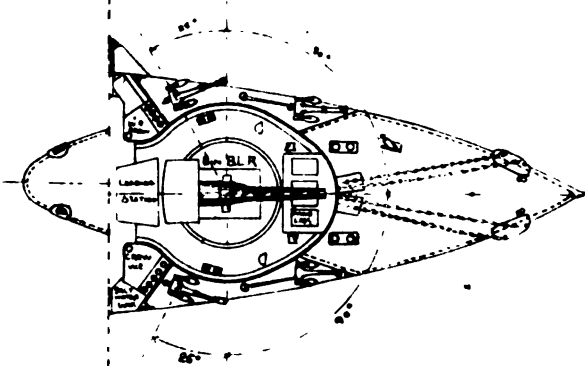
PLATE 1.



U.S.S. CHARLESTON



PLATE 2.



USS CHARLESTON



verse bulk-head, which separates his quarters from the wardroom. The latter has two staterooms only, on the starboard side, at the after end and forward of which is an inclosed dining room for the wardroom officers. This room is 29½ feet long by a mean width of 14 feet. Adjoining this at the forward end is the wardroom pantry, next again, the steerage wash room, connecting with an inclosed steerage for the accommodation of the junior officers. On the port side are eleven state-rooms arranged in an unbroken line. Forward of the steerage inclosure is the steerage pantry; also navigator's office, with the armory next the center bulk-head. Forward of the wardroom and steerage and separated therefrom by a transverse bulk-head is the warrant officers' quarters, paymaster's office, ordnance workshop, wardroom, steerage, and warrant officers' water-closets; also firemen's washroom.

The galleys for the officers and crew are in the center of the vessel, inclosed in a steel bulk-head, and join the chimney over the auxiliary boiler inclosure. The sick bay and dispensary are also on this deck, but placed in the bow of the vessel.

The berthing space for the accommodation of the crew is quite limited, and the general arrangement of the rooms, particularly the wardroom, is unlike any other vessel in this Navy.

The head room, or height in the clear under the beams, is 6½ feet, and there are a great number of air ports and lights through the vessel's side.

Armament.—The main battery consists of two 8-inch breech-loading rifles, mounted at each end of the superstructure in light barbettes about 3 feet high. Six 6-inch rifles are mounted on the same deck, three on a side, in projecting sponsons.

The secondary battery consists of four 6-pounders, rapid-fire rifles, six Hotchkiss revolving cannon, and four Gatlings. Four above-water torpedo guns or launching tubes are fitted.

Machinery.—The motive power is furnished by two horizontal compound engines placed in separate water-tight compartments and developing 7,500 indicated horse-power under forced draught. Each engine has a high and low pressure cylinder of 44 and 85 inches in diameter with a stroke of 36 inches. The crank shafts are a single forging of steel. The circulation and air pumps are worked by independent engines. The screws are three-bladed, about 14 feet in diameter.

There are six main boilers in two separate water-tight compartments, all with one smoke-pipe. Those in the forward compartment to be 11 feet in diameter and in the after compartment 11 feet 6 inches.

Air is driven into each fire room to maintain an air pressure of 2 inches of water.

There will be a steam-starting and reversing gear, distilling apparatus, auxiliary bilge and fire pumps, ash-hoisting engines, a windlass for hoisting the anchor and for other heavy work, a steam winch for hoisting boats and other light work, and steam turning gear for the main engines.

The coal supply at normal draught is 328 tons, but the bunker capacity is 800 tons. The following table shows the endurance and radius of action at different speeds:

I. H. P.	Speed.	Coal per hour.	Distance can steam on 328 tons.	Distance can steam on 800 tons.	Coal per hour per I. H. P.
	<i>Knots.</i>	<i>Tons.</i>	<i>Knots.</i>	<i>Knots.</i>	<i>Pounds.</i>
7,650	18.9	7.51	805.14	2,012.85	2.2
6,000	17.5	5.62	995.75	2,491.12	2.1
5,000	16.5	4.46	1,183.71	2,959.60	2.0
2,750	13.0	2.45	1,697.93	4,244.89	2.0
1,200	10.0	1.07	2,900.60	7,476.60	2.0

U. S. S. BALTIMORE.

This vessel is now building at the Wm. Cramp & Sons' Ship and Engine Building Works, Philadelphia. She is a twin-screw steel cruiser, with a heavy steel protective deck.

The principal dimensions are as follows: Length over all, 335 feet; length between perpendiculars, 315 feet; beam molded amidships, 48 feet 6 inches; mean draught of water, 19 feet 6 inches; displacement, 4,400 tons; tons per inch at load water line, 25.7; transverse metacenter above center of gravity, 2.1 feet; indicated horse-power, natural draught, 7,500; indicated horse-power, forced draught, 10,750; maximum speed per hour in knots, 19; complement, 300.

Scantling and general construction.—The vertical keel is 20 pounds per square foot, 36 inches deep amidships reduced to 30 inches before and abaft the double bottom. Angles on the lower edge, 3½ by 3 inches of 8 pounds per foot; on the upper edge, 3 by 3 inches of 7 pounds.

The outer flat keel plate is 25 pounds, the inner 20 pounds, per square foot. The stem, stern-post, and rudder frame are of cast steel.

The transverse frames in wake of the double bottom and below the protective deck are spaced 4 feet. A frame angle-bar, 5 by 3 inches of 10 pounds per foot, is worked in one length from keel to protective deck. Plate frames of 10 pounds per square foot, lightened by holes, to be placed between the longitudinals and attached thereto by angles of 2½ by 2½ inches of 4½ pounds per foot.

On the inner edge angle-bars, 3 by 3 inches of 7 pounds, are worked in short lengths between the longitudinals.

Three longitudinal frames are fitted on each side throughout the length of the double bottom. The inner is a flange plate 15 pounds per square foot, with a water-tight shoe of 3 by 3 inches of 10 pounds per foot worked around the frames to secure it to the outer skin. The outer two longitudinals are of 12½ pound plates with short lengths of angles 3 by 3 inches of 7 pounds per foot on the outer edges and continuous angles 3 by 3 inches of 7 pounds per foot on the inner edge.

The transverse frames before and abaft the double bottom and below the protective deck are spaced 3 feet, each frame being in one length from keel to protective deck. The frames are Z-bars 6 by 3½ by 3 inches of 14 pounds per foot, with lower end split to insert a 10-pound floor plate.

The transverse frames above the protective deck are 6-inch Z-bars of 14 pounds per foot, worked in one length from the protective deck to the upper deck. The heels are split and attached to the protective deck by a bracket plate of 15 pounds.

The beams to the poop and forecastle are of angle bulbs 7 by 3 inches of 16 pounds per foot; upper deck and main deck amidships, T bulb, 8 by 5 inches of 27 pounds per foot, reduced at the ends; to the protective deck amidships, angle bulb, 9 by 3 inches of 25 pounds per foot; platform beams, 4½ by 3 inches of 10 pounds per foot; skid beams for boats, of bulb pattern, 9 by 5 inches of 21 pounds per foot.

The bottom plating for about 160 feet amidships is 20 pounds up to the sheer-strake, which is 20 pounds per square foot. The plating before and abaft these limits is 17½ pounds up to the sheer-strake, which is 25 pounds. Plating of poop and forecastle, 15 pounds per square foot.

The gutter or flat keelson plate is 15 pounds per square foot and 36 inches wide in wake of double bottom, at ends reduced to the width of the angles on the upper edge of the keel. The remainder of the double bottom to be 12½ pounds, except the upper bounding strakes on each side, forming the shoveling flats, which are 15 pounds.

The deck stringers to poop and forecastle are 36 inches wide and 12½ to 15 pounds per square foot, except under the guns where they are 20 pounds; to the upper deck 54 inches wide by 20 pounds per square foot, tapering to 36 inches by 15 pounds under the poop and forecastle; on the berth deck in the wake of the coal bunkers 10 pounds all over, with 3-foot-wide stringers of 15 pounds per square foot before and abaft the bunkers.

The protective deck plating is worked generally in two thicknesses, the edges and butts being so disposed that one layer of plating may form edge strips and butt straps for the other. The horizontal plates to be in two thicknesses of 50-pound plating, or about 2½ inches thick. At the knuckle it is about 3½ inches thick, and on the slopes two thicknesses of 20 pounds are worked, making the deck about 4 inches thick.

The plating on all bulk-heads between the main and protective deck is of 10 pounds per square foot, stiffened by angles 24 inches apart; below the protective deck main transverse bulk-heads to be of 12½-pound plating; wing passages and subordinate bulk-heads to be of 10-pound plating.

The bilge keels extend over about 140 feet of the length amidships, projecting 21 inches clear of the bottom.

The deck plank to the poop and forecastle to be 6 inches wide by 3 inches thick, except in the wake of the guns where it is thickened up to a level surface under the racers; to upper deck, 6 inches wide by 3 inches thick; to berth deck, the same as the upper deck; to the platform, 2 inches thick.

The 8-inch guns on the poop and forecastle are supported by steel bulk-heads of 15-pound plating, and intercoastal beams directly under the racers.

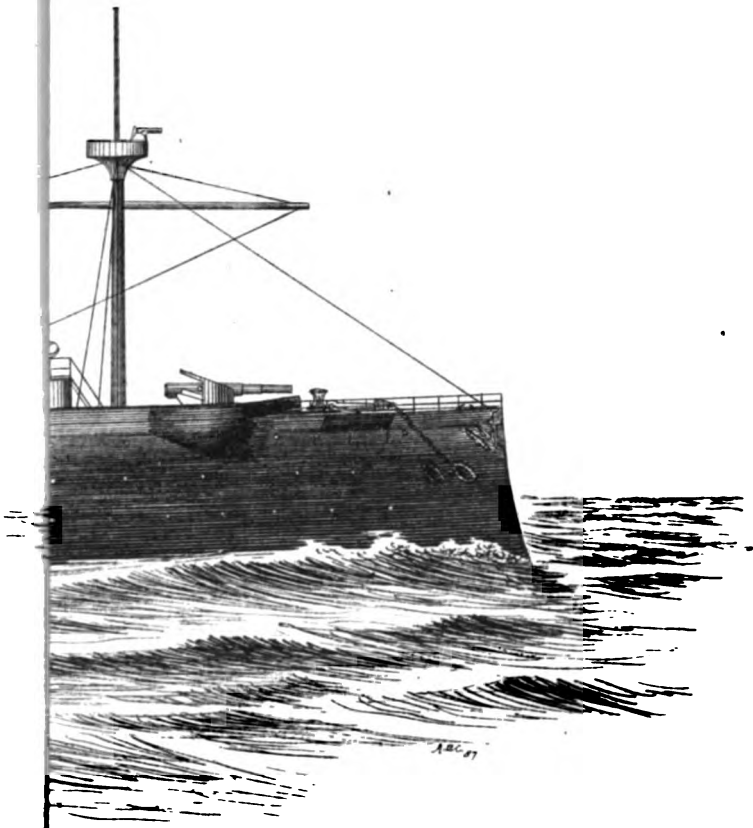
The 6-inch guns are supported by vertical bulk-heads of 15-pound plating, stiffened by 3 by 3 inch of 7-pound angles, spaced 18 inches, worked between the berth and upper decks.

The rudder and steam steering gear are placed below the water-line, under the protective deck worked from the chart house and conning tower.

There are two masts fitted with military tops.

The coal supply at the normal draught is 400 tons, the bunker capacity 850 tons. The following table shows the radius of action and the endurance at different speeds:

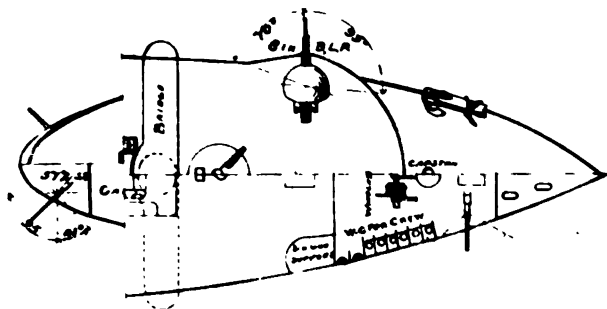
PLATE I



U.S.S. BALTIMORE



PLATE 2.



U.S.S. BALTIMORE.

Endurance of "Baltimore."

Speed.	I. H. P.	Coal.		Distance per day.	On normal supply of 400 tons.		On full bunker capacity, 850 tons.		Coal per I. H. P. per hour.
		Per hour.	Per day.		Distance can steam.	Days.	Distance can steam.	Days.	
<i>Knots.</i>		<i>Tons.</i>	<i>Tons.</i>	<i>Knots.</i>	<i>Knots.</i>		<i>Knots.</i>		<i>Pounds.</i>
19	10,000	9.82	235.68	456	771	1.69	1,637	3.59	2.20
18	8,100	5.79	138.96	432	1,244	2.88	2,644	6.12	1.60
17	6,600	4.71	113.04	408	1,444	3.54	3,068	7.52	1.60
16	5,250	3.30	79.20	384	1,939	5.05	4,120	10.73	1.60
15	4,250	3.00	72.00	360	2,002	5.56	4,255	11.81	1.60
14	3,450	2.46	59.04	336	2,275	6.77	4,834	14.39	1.60
13	2,800	2.00	48.00	312	2,599	8.33	5,522	17.70	1.60
12	2,250	1.61	38.57	288	2,886	10.02	6,132	21.29	1.60
11	1,750	1.25	30.00	264	3,480	13.33	7,395	28.32	1.60
10	1,400	1.03	25.02	240	3,838	15.99	8,165	33.98	1.65
9	1,100	.83	19.92	216	4,337	20.08	9,216	42.67	1.70
8	820	.65	15.60	192	4,905	25.60	10,445	54.40	1.80

Quarters for officers and crew.—This vessel is fitted as a flag-ship.

The captain's cabin and other rooms are under the poop deck.

The admiral's cabins are located at the after end of the berth deck, and next to them on each side forward are two state-rooms, also lavatories, pantry, and office. Forward of these and separated by a transverse bulk-head is the wardroom with eight state-rooms on each side. Forward of this again is the steerage, the starboard side of which is devoted to the accommodation of the junior officers, having a bath-room and pantry adjoining same. The port side is taken up by the warrant officers' quarters, paymaster's office, dispensary, and surgeon's examining room, the latter a new feature in our naval vessels. The blowers for ventilating the living and other spaces are located on each side of the vessel amidships, and the firemen's wash rooms in the center adjoining the fire room hatches. Great space is available on this deck for berthing the crew, and all state-rooms, quarters, etc., are well lighted by side lights or sky-lights; the height in the clear under the beams is 6½ feet. The fore-castle deck is about 86 feet in length, and under it the space is divided by steel transverse bulk-head. The forward compartment contains the water-closets for the crew, also the windlass and two 57^{mm} guns. The after compartment contains the galley inclosure and the officers' closets.

Machinery.—The motive power is furnished by two triple expansion engines, placed in separate water-tight compartments, capable of developing 10,750 horse-power with forced draught.

The cylinders are 42, 60, and 94 inches in diameter, with 42 inch stroke.

There are 2 three-bladed screws, about 14 feet 6 inches in diameter.

There are 4 double-ended horizontal return tubular boilers 14 feet 8 inches in diameter, each having at each end 4 corrugated furnaces 3 feet in diameter.

Lighting, ventilation, and drainage.—Two electric plants of the most approved pattern, the lightest and most compact and best adapted for marine work, are to be placed in the vessel. Each engine to be so arranged as to drive either dynamo separately, or both together. The dynamos to be of the same electromotive force, each to be capable of producing 3,200 candle-power of light, so constituted that lights of 10, 16, 32, and 50 candle-power can be used on the same circuit, with an independent control over each lamp. All parts of the ship are fully lighted by the incandescent lamps, including coal bunkers, magazines, shell and ammunition rooms, running lights, and lights for use on the upper deck and aloft.

Recourse is had to natural ventilation as much as possible for the living and storage spaces by means of pipes, louvres, and cowls.

Artificial ventilation is provided for all compartments below the living deck by means of 2 blowers of 10,000 cubic feet capacity per minute, so arranged with reversible valves as to exhaust from or force air to the several parts of the vessel, and to deliver into the lower parts of the engine room or the open air.

Pipes to be led from the upper part of the coal bunkers to the smoke-pipes to create an exhaust draught to carry off the gases generated in the bunkers.

A steam bilge-pump is placed in each engine room, having suction from the sea, the engine room bilge, the ship's drainage system, and the boilers each delivering into the fire main or overboard. The general nature of the suction from the steam-pumps is as follows: A pipe about 12 inches in diameter, with cocks and stop valves, is fitted above the double bottom leading to each principal compartment of the hold, so that any compartment may be drained. An independent 6-inch bilge-pipe is placed in

the fire and engine rooms, connected with the bilge and auxiliary fire and main fire engines. Each compartment of the double bottom to be furnished with its own suction attached to a steam-pump so that it can be readily filled through this suction or pumped out by steam power.

The hand-pumps are two 7-inch pumps to drain from the principal compartments in the hold and from the sea, to deliver overboard or to rising mains which will furnish a supply of water for wash deck and fire service; two 5-inch pumps to draw from the sea to supply salt water to baths, cisterns, and water-closets; two 3-inch pumps reserved for fresh-water service.

A steam windlass is fitted on the forward gun-deck, worked by an independent engine, fitted with warping ends on each side for taking hawsers, to be worked by hand power when required. A capstan to be located above the windlass and connected to it, to work by steam or hand power. A small steam winch will be fitted on the gun-deck for warping ship, lifting boats and weights.

Armament.—The main battery consists of four 8-inch B. L. R's, mounted on the poop and forecastle 26½ and 28 feet respectively above the water; six 6-inch B. L. R's, mounted 18 feet above the water in sponsons, having a train of 155 degrees from the line of the keel for the forward and after pairs and a train of 130 degrees for the guns in the waist. The secondary battery consists of six 6-pounders, rapid-fire guns, six Hotchkiss revolving cannon, and four Gatlings.

Five above-water torpedo launching tubes or guns are fitted, two fixed tubes forward firing directly ahead, and one fixed, one aft, and a training tube on each bow.

An armored conning tower 3 inches thick to be fitted on the forecastle with a horizontal cover one inch thick, with openings in the sides for outlooks. Engine telegraphs, a steering-wheel, an indicator, and speaking-tubes to be fitted within the tower.

CRUISER NO. 4.

This vessel and cruiser No. 5 are generally spoken of as the "Nineteen knot cruisers."

No. 4 is similar in general construction and scantling to the Baltimore, and will be fitted as a flag-ship, but is so far modified as to carry a battery of twelve 6-inch guns, and to have a three-masted schooner rig spreading about 5,600 square feet of sail. The contract has been awarded to Wm. Cramp & Sons.

Length, extreme, 335 feet; beam, 48 feet 6 inches; mean draught of water, 19 feet 2½ inches; displacement, 4,324 tons; tons per inch at load line, 25.3; transverse metacenter above C. of G., 2.2 feet; indicated horse-power, force draught, 10,500; maximum speed per hour, 19 knots; complement, 300.

Machinery.—The motive power is furnished by two triple expansion engines placed in separate water-tight compartments. The cylinders are 38, 56, and 86 inches by 40 inch stroke.

The boilers are 14 feet in diameter and 20 feet long, designed to carry steam at 160 pounds pressure. The grate surface is 624 square feet.

CRUISER NO. 5.

This vessel is similar to the Newark in scantling and general construction, drainage, ventilation, and dimensions, but the forward and after sponsons, as in the Newark, are removed, and the guns mounted in them are mounted on the poop and forecastle decks. The forward and after remaining sponsons can thus be brought in as shown on the plans of this vessel.

The contract has been awarded to the Union Iron Works, California.

Length, extreme, 328 feet; length on load water-line, 310 feet; breadth molded, 49 feet; breadth extreme, 49 feet 2 inches; depth from flat keel plate to under side of spar deck, 31.8 feet; draught of water mean, 18.825 feet; displacement in tons to L. W. L., 4,082.93; tons per inch at L. W. L., 42.96; area of immersed midship section, 807.23 square feet; area L. W. L., 10,480 square feet; sail area, 5,410 square feet; transverse metacenter above C. G., 3,314 feet; longitudinal metacenter above C. G., 347.722 feet; moment to alter trim 1 inch, 381.69 foot tons; coefficient fineness of displacement, .498; indicated horse-power, natural draught, 7,500; indicated horse-power, forced draught, 10,500; maximum speed in knots, 19 knots; complement, 300.

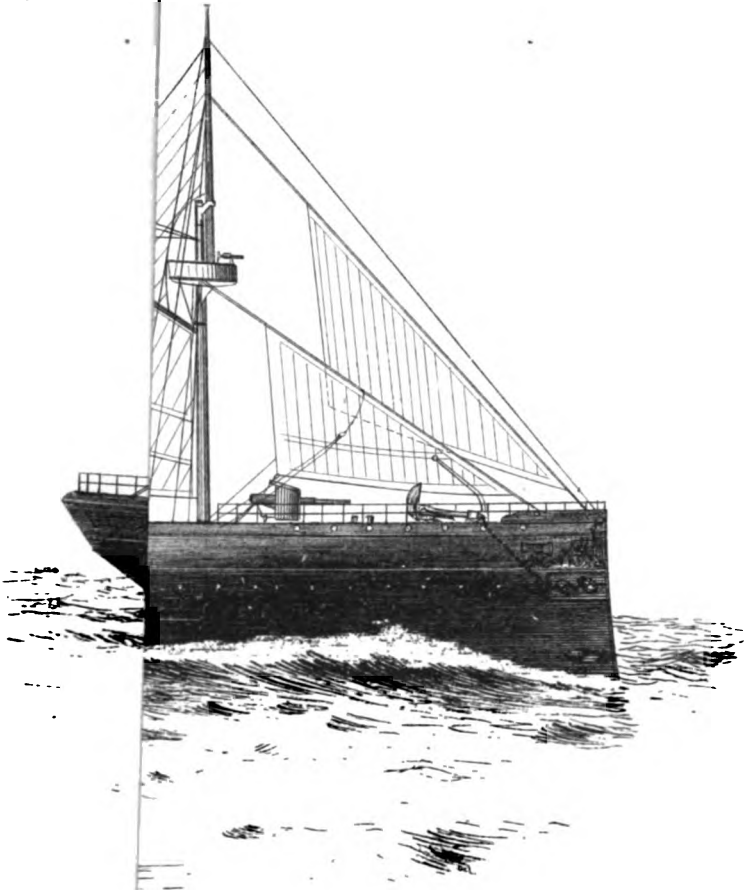
Rig.—The rig is that of a three-masted schooner without head boom, sail being simply an auxiliary power. The sail area is 5,410 square feet.

The protective deck amidships is 21 inches above the water-line and is worked generally as in the Newark, though not so thick at the ends.

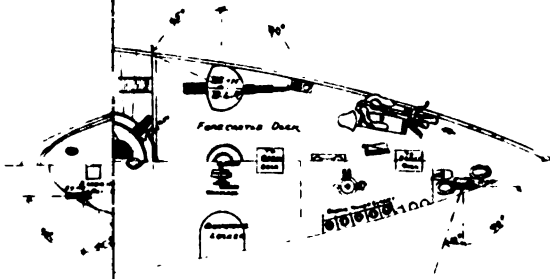
Armament.—The main battery of Cruiser No. 5 consists of twelve 6-inch B. L. R., mounted on central-pivot carriages, supporting segmental shields 2 inches in thickness for the purpose of protecting the gun's crew, as well as the mechanism of the gun-carriages from machine-gun fire.

The two guns forward are mounted, one on either side, upon the forecastle deck, and train from 65° abaft the beam to 115° forward. The fire from these guns, when at greatest depression, will converge at the water-line 80 feet forward of the stem,

PLATE I



UNIV.
OF
ZICH.
CRUISER No. 5.



CRUISER No 5.

and when the axis of the guns are parallel with the water-line, and at all degrees of elevation, they will have a converging fire through an arc of 50°.

The after two guns are mounted on the poop deck, in a similar manner to these just described, their arc of fire being from 70° forward of the beam to 115° abaft, and at greatest depression the fire from them will converge at the water-line 76 feet abaft the stern; they will also have an arc of converging fire similar to that given for the forward guns.

The second pair from forward, together with the second pair from aft, are placed under bridges, the forward guns training from 93° forward of the beam to 70° abaft, and the after ones from 70° forward of the beam to 93° abaft, giving a fire of four forward and four after guns in a line parallel to the keel, also a converging fire at the water-line 112 yards forward of the stem and 118 yards abaft the stern, respectively.

The remaining four guns are mounted in sponsons on the sides, and train from 70° forward of the beam to 70° abaft.

All the guns on one side can be concentrated on an object 50 feet from the ship's side.

Each of the shell for the main battery weigh 100 pounds, and the powder charge 50 pounds, making the weight of a single broadside thrown 600 pounds; these shells have a penetration of about 13 inches of iron at the muzzle. Secondary battery the same as the *Nerark*.

Machinery.—The motive power is furnished by two triple-expansion engines in separate water-tight compartments. The cylinders are 42, 60, and 94 inches in diameter by 42-inch stroke.

There are four boilers of the double-ended horizontal-return-tubular type, 14 feet 8 inches diameter, to carry steam at 135 pounds pressure, grate surface 600 square feet.

There will be steam starting and reversing gear, ash-hoisting engines, and steam-turning gear for engines.

The screws are 3-bladed, about 14 feet 6 inches in diameter.

Endurance of Cruiser No. 5.

Speed.	I. H. P.	Coal.		Distance per day.	On normal supply, 350 tons.		On full capacity, 850 tons.		Coal per hour per I. H. P.
		Per hour.	Per day.		Distance can steam.	Days.	Distance can steam.	Days.	
<i>Knots.</i>		<i>Tons.</i>	<i>Tons.</i>	<i>Knots.</i>	<i>Knots.</i>		<i>Knots.</i>		<i>Pounds.</i>
19 ⁴	10,500	10.31	247.44	468	659	1.41	1,605	3.43	2.2
19	9,500	6.78	162.72	456	982	2.15	2,385	5.23	1.6
18	7,700	5.50	132.00	432	1,145	2.66	2,782	6.44	1.6
17	6,250	4.46	107.04	408	1,335	3.27	3,244	7.95	1.6
16	5,100	3.64	87.40	384	1,563	4.00	3,734	9.71	1.6
15	4,100	2.93	70.30	360	1,791	4.98	4,350	12.09	1.6
14	3,300	2.36	56.60	336	2,078	6.19	5,047	15.02	1.6
13	2,600	1.86	44.70	312	2,450	7.88	5,950	19.12	1.6
12	2,100	1.50	36.00	288	2,800	9.72	6,800	23.61	1.6
11	1,680	1.20	28.80	264	3,209	12.15	7,788	29.50	1.6
10	1,350	1.02	24.48	240	3,432	14.30	8,333	34.72	1.7
9	1,000	.80	19.20	216	3,909	18.38	9,634	44.60	1.8
8	750	.66	15.84	192	4,294	22.50	10,489	54.63	2.0

Quarters for officers and crew.—The captain's cabins are at the after end under the poop deck, and are extended from side to side; in the after one is worked two 37^{mm} Hotchkiss revolving guns. Forward of the cabins on each side of the vessel are the captain's state-rooms, bath-rooms, and closets, captain's office, also executive officer's state-room and office, armory, and signal lockers. These rooms are all large, well-lighted and ventilated by large side-lights, and the height in the clear under the beams is 7 feet.

The wardroom is at the after end of the berth deck, and has seven rooms on each side. The table will occupy the forward part of this room, and the pantry is here fitted within a gun-support and on the port side.

Forward of the wardroom and separated by a transverse steel water-tight bulk-head is the steerage; the whole starboard side for its 27 feet of length is devoted to the accommodation of the junior officers. The steerage, pantry, and lavatory join steerage at each end. The port side is occupied by the wardroom lavatory and warrant officers' quarters.

Forward of the steerage and separated by a transverse steel water-tight bulk-head is the steerage and wardroom water-closets on the port side; on the starboard side is

the paymaster's office. In the midship part of this deck are located the blowers for ventilating the living and other spaces throughout the vessel; here also are the engineers' workshop, and firemen's wash-room on each side. The sick bay and dispensary are at the port side of this berth deck, separated by a steel water-tight bulk-head from the crew's berthing place, which is just abaft it. In this space are the fittings for operating a torpedo-tube on each side, and similar fittings aft near the officers' water-closets. The height in the clear under the deck beams throughout the berth deck is 6 feet 7½ inches, and all rooms and quarters are well lighted by means of numerous side-lights, skylights, or other openings.

The crew's water-closets are located forward of a transverse steel water-tight bulk-head at the fore part under the fore-castle deck. This place has been isolated as much as possible, and it is thought that all objectionable features have been overcome.

The great height between decks, 7 feet 10 inches, the absence of wood deck plank, and the presence of numerous large air-ports through the vessel's side, and two large ventilators overhead fitted with appropriate cowls, seem to warrant every satisfaction. Here also are worked two 37^{mm} Hotchkiss revolving guns. Under the after part of the fore-castle is the windlass, also the lamp-room and boatswain's locker, each within a steel bulk-head forming supports for the guns above.

The galley and fittings are located under the forward bridge and inclosed by a steel bulk-head, well lighted and ventilated by skylights and air-ports. Above this on top of the bridge is the armored pilot-house, and wooden pilot house adjoining same.

The chart house is under the after bridge, and is fitted with table, compass, and chronometer lockers, etc.

GUN-BOATS NOS. 1, 3, AND 4.

These vessels, though they are styled gun-boats, are but little smaller than the *Serrata* class of vessels, and in offensive and defensive power and speed are immeasurably their superiors.

They are twin-screw coal-protected cruisers, with poop and fore-castle decks, with an open gun deck between.

Forward and aft throughout the length of the vessel is a ¾-inch water-tight deck, under which are placed the machinery, magazines, and steering-gear.

The principal dimensions are as follows: Length between perpendiculars, 226 feet; depth of hold to under side of spar deck amidships, 18 feet 9 inches; draught of water forward, 13 feet; draught of water aft, 15 feet; mean draught of water, 14 feet; displacement in tons to L. W. L., 1,703 tons; tons per inch at L. W. L., 13.72 tons; area load water-line, 5,765 square feet; area immersed midship section, 435.3 square feet; sail area, 6,352 square feet; transverse metacenter above center of gravity, 2.58 feet; longitudinal metacenter above center of gravity, 260 feet; moment to alter trim 1 inch, 160 feet tons; indicated horse-power, natural draught, 2,200; indicated horse-power, forced draught, 3,300; maximum speed per hour in knots, 16; complement, 150.

Scantling and general construction.—The outside plating is as follows: Garboards, 15 pounds or about ¾-inch; remainder to main deck, except doubling strakes amidships, 14 pounds; above upper or main deck, 10 pounds.

The plating up to the water-tight deck to be lap-jointed and single-riveted at the edges. Above the water-tight deck amidships the plating is flush-jointed with single-riveted strips at the edges. All plates are double-riveted at the butts. In the wake of the torpedo-ports and the machine-guns the plating is 40 pounds, or 1 inch in thickness, as a protection against machine-gun fire.

Transverse water-tight bulkheads have bottom plating 10 pounds, 8½ at the middle, and 7 pounds above, lap-jointed, lap-butt, and single-riveted and stiffened by vertical angle-bars, 3 by 2 inches by 4½ pounds per foot, spaced 30 inches apart.

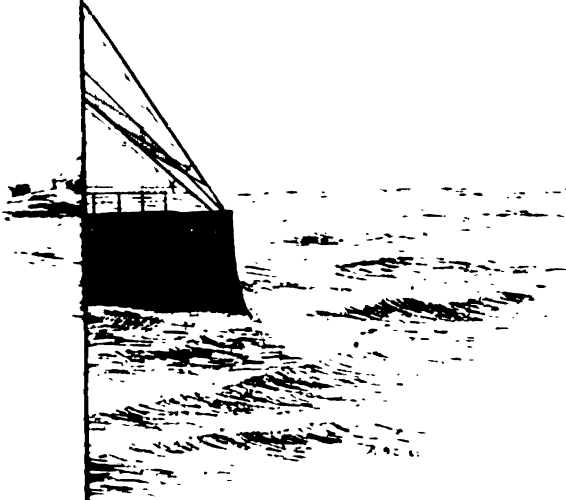
The flat keel-plates are in two thicknesses of 15 pounds per square foot. The vertical keel is of 15 pounds per square foot, about 25 inches deep, extending generally about 4 inches above the floor-angles, with two continuous angle-bars on the upper edge, 3½ by 3 inches of 8 pounds per foot. The stem and stern posts are of cast steel.

The transverse frames are Z-bars, 6 by 3 by 3 inches of 14½ pounds per foot, the lower ends split up to the turn of the bilge and spread out to form the main and reverse bars, the reverse bar to stop below and the outer bar just above the second longitudinal, the remainder of the outer bar to the keel being formed of an angle 3 by 3 inches of 7 pounds per foot, the reverse bar to scarf in a similar manner but to extend across, passing through the vertical keel.

The floor plates are 12 pounds per square foot, and generally 21 inches next to the vertical keel, to which they are connected by half-staple angles 3 by 2½ inches of 6 pounds per foot, lightened by holes except in wake of water-tight bulk-heads. Double reverse frames are fitted in wake of the engine and boiler spaces. Under the engines the floors are to be increased in depth to connect directly with the engine-bed plate, and where saddles are required under the boilers the floors are to be of sufficient depth to form them.

Above the water deck the frames are generally of Z-bars 5 by 3 inches of 12 pounds per foot, with bracket plates of 10 pounds connecting the heels, with the lower parts flanged to connect with the deck.

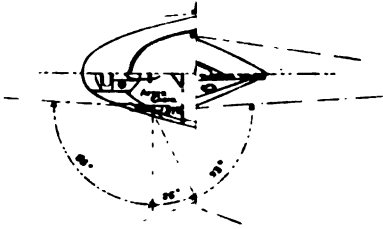
PLATE I



GUN-BOATS, No 1, 371



PLATE 2



GUN-BQTS No 1, 3 & 4.



The main-deck beams are of the T-bulb pattern, 6 inches deep by 4½ inches flange, not to exceed 16 pounds per foot; to have a round of 6 inches in 36 feet, turned down 18 inches with a piece welded in, lightened with holes and securely riveted to the frames.

Forward and aft for about 30 feet from the ends of the beams are angle bulbs 6 by 2½ inches of 11 pounds per foot.

The water-tight deck beams are angle bulbs 5 by 2½ inches of 11 pounds per foot, arched with a spring of 3 feet in the greatest width.

The berth-deck beams are angles 3½ by 2½ inches of 7 pounds per foot. The poop and fore-castle beams are angle bulbs 5 by 2½ inches of 11 pounds per foot, except in wake of guns, where they are T-bulb 6 by 4½ inches of 16 pounds. The beams to the platforms are 3 by 2 of 5 pounds per foot angles, with the ends secured to bulk-heads by gussets or clips.

The first longitudinal from the keel is twisted forward to connect with the breast-hook, and is of intercostal plates of 10 pounds per foot, with intercostal angles of 3 by 3 inches of 7 pounds, connecting the upper edge to the flat plate 12 inches wide of 15 pounds per square foot, and with an angle on the lower edge 3 by 3 inches of 7 pounds per foot, the upper flange intercostal and the lower continuous.

The second longitudinal is water tight throughout the boiler space, forward of 10-pound intercostal plates, connected to the bottom plating, floor plates and fore-and-aft angles on the top of reverse bars by staple angles 3 by 3 inches of 7 pounds per foot.

The third longitudinal is of Z-bar 10 by 3 by 3 inches of 19 pounds per foot, with continuous inner flange, the bar slotted down over the frames, with a continuous angle 4 by 3 inches of 8 pounds per foot, worked on the inner edge. The fourth longitudinal is similar to the third.

Coal bunkers and other fore-and-aft bulk-heads to have bottom plates 10 pounds per square foot, with remaining strakes of 7 pounds per square foot, stiffened by angles 3 by 2 inches of 4 pounds per foot, bounding angles generally 2½ by 2½ inches of 5 pounds per foot, all openings fitted with water-tight doors.

Bilge keels projecting 18 inches with ends neatly tapered down will extend for about 100 feet on each side.

The stringers to poop and fore-castle decks are 7½ pounds; to the main deck, 15 pounds by 40 inches, reduced to 12 pounds by 30 inches at the ends; to the berth deck 10 pounds by 14 inches. Carlings on the berth deck and under the poop deck are of 2½-pound plating.

Hatches to the water-tight deck are fitted with coamings extending 18 inches above the upper deck, made of 7½-pound plates, the hatches closed by water-tight shutters. The engine and boiler hatch inclosures extend to the height of the hammock berthing, and are of 10-pound plates.

A conning tower, oval in shape, is built on the fore-castle deck, athwartship, 7½ feet by 4 feet fore and aft, 5 feet 4½ inches above the deck, with a cover with a vertical travel of 3 inches. The tower is fitted complete with steam steering wheel, engine-room telegraphs, and speaking-tubes. A wood pilot-house is fitted forward of the conning tower with plate-glass windows, steam steering wheel, engine-room telegraphs, tell-tale for the rudder, chart-table, and transom-seat.

Rig.—The rig is that of a three-masted schooner, spreading about 6,300 square feet of canvas.

Coal endurance.—The normal coal supply is 200 tons, but the bunker capacity is 400 tons. This coal is disposed in wake of the machinery and boiler so as to give the greatest protection. The following table shows the radius of action and endurance at various speeds:

Endurance of gun-boats Nos. 1, 3, and 4.

Speed.	I. H. P.	Coal.		Distance per day.	On coal supply 893 tons.		Coal per I. H. P. per hour.
		Per hour.	Per day.		Distance can steam.	Days.	
<i>Knots.</i>		<i>Tons.</i>	<i>Tons.</i>	<i>Knots.</i>	<i>Knots.</i>		<i>Pounds.</i>
16	3,300	2.6	61.7	384	2,419	6.3	1.75
15	2,620	1.75	42	42	360	8.35	1.50
14	2,000	1.33	31.92	336	4,136	12.31	1.50
13	1,600	1.07	25.68	312	4,773	13.3	1.50
12	1,230	.82	19.7	288	5,750	20	1.50
10	650	.46	11.01	240	8,542	35.59	1.60
8	375	.26	6.24	192	12,092	62.98	1.80
6	200	.17	4.08	144	13,870	96.38	2

Quarters for officers and crew.—Under the poop deck are located the captain's quarters, which consist of two cabins with commodious closets and bath; also state-room and pantry. The executive officer's office and the armory are under the fore end of this deck, and between them and the captain's quarters is a large room for manipulating torpedoes, extending like the cabins for the whole breadth of the vessel; the chart and other lockers are also beneath here. These quarters are well lighted by numerous side lights and sky-lights, and the head room under beams nearly 7 feet in the clear. The fore end is protected from the weather and strengthened for the support of the guns on the poop deck by an athwartship water-tight bulk-head of steel, abaft of which is the companionway to the wardroom. Two 37^{mm} Hotchkiss guns are mounted in the after cabin, and a stern torpedo tube is also worked here.

The wardroom is at the after end of the berth deck, and has ten rooms, five on each side. Forward of this, and separated by a steel water-tight bulk-head, is the steerage, the starboard side of which is made into one large room for the accommodation of the younger officers. Forward of this again, and separated by another steel water-tight bulk-head, is the steerage pantry. The port side of the steerage is devoted to the wardroom pantry, steerage wash room, paymaster's office, and lockers or room for hanging sea clothes. Water-tight doors are placed in these water-tight bulk-heads to afford the necessary communication. These rooms, etc., are all well lighted by means of side and sky-lights, and the head room clear of the beams is 6½ feet.

The crew's quarters are on the forward part of this berth deck, and are divided by athwartship steel water-tight bulk-heads, fitted with the necessary communicating water-tight door. The dispensary is located here, also the mess lockers. The quarters are well lighted by hatches and numerous side lights, and the head room under the beams is 6½ feet in the clear. The firemen's wash rooms, also the armorers' and engineers' workshops are located in the central part of this deck.

Great space and accommodation are also provided for the crew under the fore-castle deck. The water-closets for both officers and crew are here located, also the crew's wash-rooms, windlass, and galley inclosure. Two 47^{mm} Hotchkiss guns are located here in the bow, and a large space left for the manipulation of torpedoes on each side.

Machinery.—The motive power is furnished by 2 triple-expansion engines, placed in two separate water-tight compartments, developing 2,200 horses with forced draught, and 3,300 horses with natural draught.

The cylinders are 22, 31, and 50 inches diameter, with 30-inch stroke, fitted with piston valves. The air, circulating, and bilge pumps will be driven independently of the main engines. There are two 3-bladed screws about 10½ feet diameter.

There are 4 cylindrical horizontal boilers, 9 feet 6 inches diameter and 17 feet 6 inches long, with a grate surface of 220 square feet. The speed will be upwards of 16 knots.

Lighting, ventilating, and drainage.—There will be an installation of electric light on board, consisting of two sets of dynamos furnished with all articles necessary to render the system efficient. The dynamos are so arranged as to be connected with the incandescent lights or the search light on the upper deck. The dynamos are each to be capable of supplying a current at least 80 volts and 100 ampères, with an armature speed of not more than 400 revolutions per minute. The search lights are of 25,000 candle-power. Means are provided for securing natural ventilation in the living and storage spaces, utilizing frame spaces, together with louvers and cowls fitted along the top, sides, and such ducts as are necessary to effect communication with the spaces below. Also vitiated air is exhausted from the engine-room by means of the fans that are fitted for obtaining forced draught in the fire-rooms. Automatic valves are fitted in ventilation-pipes where they pass through water-tight bulk-heads to prevent the flood of water from one compartment to another. Escape for the explosive gases generated in the bunkers is provided for by means of inlet and outlet pipes, and trunks leading to the funnel casings.

Provisions are made for closing in air tight the fire-rooms to leave the furnaces the only means of escape for the air under pressure.

There is a steam-pump in each engine compartment, fitted to be used as bilge or fire pumps; also one 7-inch and two 5½-inch pumps for draining the water-tight compartments, engine and shaft bearers, platforms, etc., delivering overboard or into the fire-main. The fire-main is worked nearly the whole length of the ship, and can be charged with water at a high pressure from the steam-pumps, being also connected with the hand-pumps and fitted with the necessary nozzles and hose.

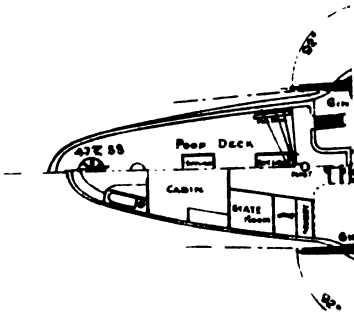
Armament.—The main battery is composed of six 6-inch breech-loading rifles, two on the fore-castle and two on the poop, with the line of fire about 18 feet above the water. One is mounted on each side in the waist in a sponson, at a height of about 10 feet, having an arc of fire of about 70 degrees forward and 70 degrees abaft the beam. The guns are mounted on the central-pivot carriages, with 3-inch segmental shields. The forward two guns concentrate at 300 feet forward the stem and the after

PLATE 1.



GUN-BOAT No 2.

PLATE 2



GUN BOAT No. 2.

two at 300 feet abaft the vessel, while three guns on one side can be concentrated at a point 100 feet from the side of the vessel.

The secondary battery consists of eight rapid-fire guns and revolving cannon on rail and tripod mounts.

Torpedo outfit.—The vessel has eight torpedo guns or launching tubes, fixed ones, in the stem and stern, and three training tubes on each side. Auto-mobile torpedoes will be fired from these tubes, and there will be a complete outfit of boat, spar torpedo, gear, and charges.

Gunboat No. 1 is building at the William Cramp & Sons' Ship and Engine Building Works, Philadelphia.

The contract for gun-boats 3 and 4 has been awarded to N. F. Palmer, jr., & Co., of New York, and they will be built at Roach's ship-yard, Chester, Pa.

GUN-BOAT NO. 2.

This vessel is building at the Columbia Iron Works and Dry Dock Company, Baltimore.

This is a single-screw gun-boat, built entirely of steel.

The principal dimensions are as follows: Length between perpendiculars, 175 feet; beam, 31 feet; depth of hold amidships, 15 feet 7 inches; mean draught, 11 feet 7 inches; area of load water plane, 3,894 square feet; tons per inch at load water line, 9.3; area of midship section, 289.5 square feet; transverse metacenter above center of gravity, 3.4 feet; longitudinal metacenter above center of gravity, 232 feet; moment to alter trim 1 inch, 84.6 foot tons; indicated horse-power, natural draught, 900; indicated horse-power, forced draught, 1,350; maximum speed per hour in knots, 13; complement, 100.

Scantling and general construction.—The bottom plating is 15 pounds per square foot; for a length of 109 feet amidships the sheer strake is doubled and a double strake is worked at the water line.

Plating 17½ pounds per square foot, to be worked over the shaft tubes. The plating is increased to 40 pounds per square foot in wake of the 6-inch and machine guns, and 15 pounds where subject to the blast of the 6-inch guns, the rest of the hammock berthing and bulwark plating to be 10 pounds per square foot. The inner plating below the berthing to be 2½ pounds, except in wake of the rigging where it is to be 15 pounds per foot for securing the chain plates.

The flat keel is in two thicknesses of 15 pounds each; the vertical keel 15 pounds and generally 17 inches deep. The stem is of hammered steel, and the stern frame and rudder are of cast steel.

The frames below the water-tight deck, to within about 60 feet of the ends, are spaced 18 inches and are of Z-bars 5 by 3 by 2½ inches of 12 pounds per foot, split up from the middle line to the lower turn of the bilge; above the water-tight deck the frames are Z-bars 4 by 3 by 2½ inches of 11 pounds per foot. The frames are secured to the water-tight deck by flanged-bracket plates. At the ends the frames are formed of 3 by 3 inches of 7 pounds per foot angles, with reverse angles of 2½ by 2½ inches of 3 pounds per foot. The floors are of 8½ pounds.

The transverse water-tight bulkheads are of 8½ to 6½ pound plating, except the collision and stuffing-box bulk-heads, which are 11 pounds below the berth deck. Fore and aft bulk-heads are from 8½ pounds at the bottom to 5 pounds at the top.

Two longitudinals are worked on each side under the engines, boilers, and magazines, the first of intercostal plates 12½ pounds per square foot, with a plate 12½ pounds per square foot, 7 inches wide at the top; the second is of intercostal plates 10 pounds per foot, extending 5½ inches within the frames, with a fore-and-aft angle on the top 3 by 3 inches of 6 pounds per foot.

The beams to fore-castle and poop are 4 by 3 inches of 7½ pounds per foot; to spar deck, angle bulbs 6 by 3 inches of 16 pounds, except under the guns, where they are T-bulbs 7 by 5 inches of 20 pounds per foot; to berth deck angle bulbs 5 by 2½ inches of 10 pounds per foot, to water-tight deck angle bars 4½ by 3 inches of 8 pounds; to platforms, angle bars 2½ by 2½ inches of 3½ pounds.

The stringers to poop and fore-castle are 12 inches by 7 pounds to the spar deck, 20 inches by 15 pounds, amidships, reduced to 15 inches by 12 pounds at the ends; the berth deck 8½ pounds by 12 inches, tapered at the ends to 9 inches.

The plating to poop and fore-castle is 2½ inches thick by 4½ inches wide; to main deck 6 inches wide by 3½ inches thick; to berth deck, 4½ inches wide by 2½ inches thick; to platforms, 1½ inches thick.

There is a steam windlass and capstan, but no steam steering-gear.

A water-tight steel deck is worked over the engines and boilers, 8 inches above the load-water line amidships, sloping to 30 inches below at the sides; to be 12½ pounds per square foot between longitudinal coal-bunker and bulk-heads 15 pounds from these bulk-heads to the sides of the vessel. Shell-proof grating bars, 2 inches apart

and 3 inches deep by $\frac{3}{4}$ of an inch thick, to be fitted to the chimney, ventilating pipes and trunks, engine hatches, and other openings.

Rig.—The rig is that of a barkentine, spreading 4,850 square feet of canvas.

Coal endurance.—The normal coal supply is 100 tons, surrounding and protecting the engines and boilers. The following table shows the radius of action and endurance at different speeds :

Endurance of gun-boat No. 2.

Speed.	I. H. P.	Coal.		Dis- tance per day.	On coal supply 168 tons.		Coal per I. H. P. per hour.
		Per hour.	Per day.		Dis- tance can steam.	Days.	
<i>Knots.</i>		<i>Tons.</i>	<i>Tons.</i>	<i>Knots.</i>	<i>Knots.</i>		<i>Pounds.</i>
12	1,300	1.276	30.6	238	1,580	5.5	2.2
11	750	.700	16.8	264	2,040	10	2.1
10	550	.500	12	240	3,360	14	2
9	420	.375	9	216	4,032	18.7	2
8	300	.281	6.7	192	4,785	24.9	2.1
7	210	.215	5.46	168	5,468	32.55	2.3

Machinery.—The motive power is supplied by a horizontal back-acting compound engine, capable of developing 1,300 horse-power under forced draught. The cylinders are 25 and 46 inches in diameter with a stroke of 33 inches.

There are two cylindrical horizontal fire-tube boilers 8 feet 8 inches diameter by 18 feet 4 $\frac{1}{2}$ inches long. The steam pressure is 100 pounds and the grate surface 93 square feet. There is a single three-bladed screw about 9 feet 9 inches diameter.

Ventilation and drainage.—Ample natural ventilation of all living and storage spaces is provided, and vitiated air is drawn from the engine room and shaft alley by means of fans fitted for securing forced draught in the fire rooms.

There is a steam pump fitted to be used as a bilge or fire pump; also three 5 $\frac{1}{2}$ -inch hand pumps. A 3-inch fire main is worked nearly the whole length of the vessel, charged with water at a high pressure from the steam pump and connected with all the hand pumps.

Armament.—The main battery consists of four 6-inch B. L. R. guns, mounted two on each side in sponsons, the guns about 10 feet 8 inches above the water. Six-pounder rapid-fire guns are mounted on the poop and forecabin and a 37^{mm} revolving cannon on the rail in each waist.

Quarters for officers and crew.—The captain's quarters consist of a fore and after cabin, state-room, office, and pantry, together with bath and closet complete, all placed under the poop deck. The armory, chart room, and paymaster's office are also under this deck and at the forward part. These quarters are well lighted by numerous side and sky-lights, and the head room under the beams is about 6 $\frac{1}{2}$ feet in the clear.

The wardroom is located on the after berth deck, and has four state-rooms on each side. Forward of this is the sterge and pantries, all being well lighted. The head room is the same as in the cabins.

The forward berth deck is devoted to the berthing of the crew, and separated by two transverse water-tight bulk-heads. The dispensary is located in the after compartment, and the quarters are well lighted by numerous side ports and hatches. Under the forecabin decks is located the water-closets, windlass, and galley. Here also is a large space for berthing a portion of the crew in pleasant weather.

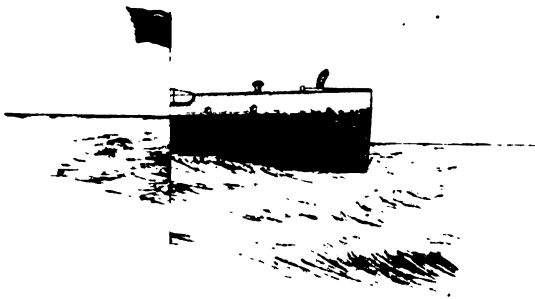
THE DYNAMITE CRUISER.

This novel vessel is in many respects similar to the English torpedo cruisers, except that the torpedoes are discharged through the air instead of through the water.

The contract for this vessel is with the Pneumatic Dynamite Gun Company, of New York, and she is building at Cramp's ship-yard, Philadelphia.

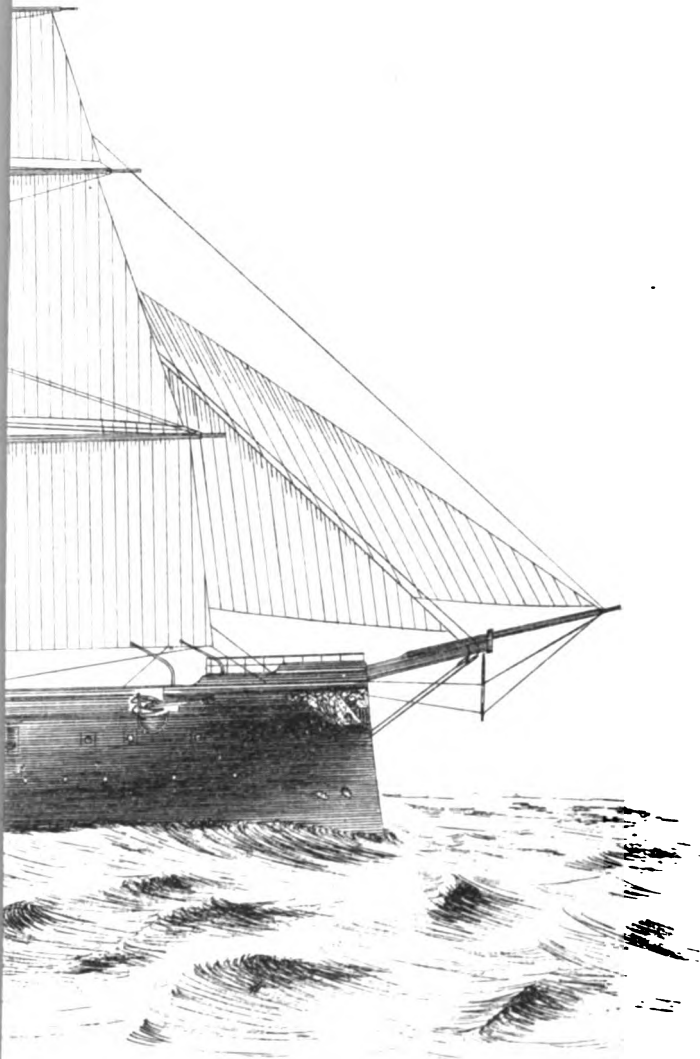
Length between perpendiculars, 246 feet 3 inches; length over all, 252 feet 4 inches; breadth, 26 feet 5 inches; depth, 14 feet 1 inch; mean draught, 9 feet; displacement, 725 tons; tons per inch at load line, 10.15; area midship section, 177.5 square feet.

Scantling and general construction.—There is an ordinary bar keel 6 inches deep and 1 $\frac{1}{2}$ inches thick, with an inner vertical keel of 10-pound plating, lightened between frames by holes about 9 inches in diameter. This plate extends above the floor plates, which are 10 to 15 pounds per square foot, and has along its upper edge double angles 3 by 2 $\frac{1}{2}$



DYNAMITE-GUN CRUISER

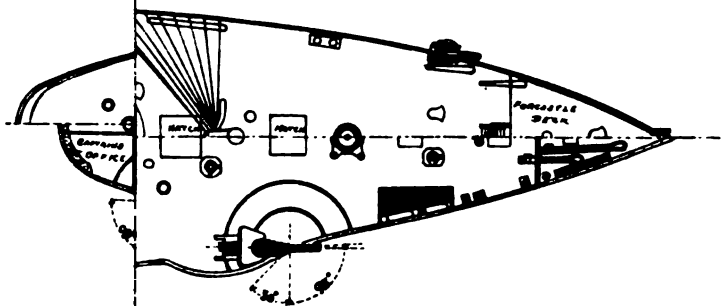
PLATE 1



U. S. S. CHICAGO.



PLATE 2.



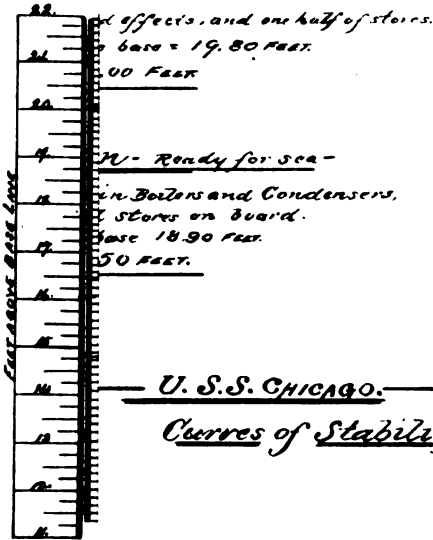
U.S.S. CHICAGO.



Is, Clowchers, Chains:

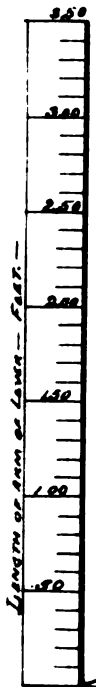
base = 19.82 feet.

FEET.

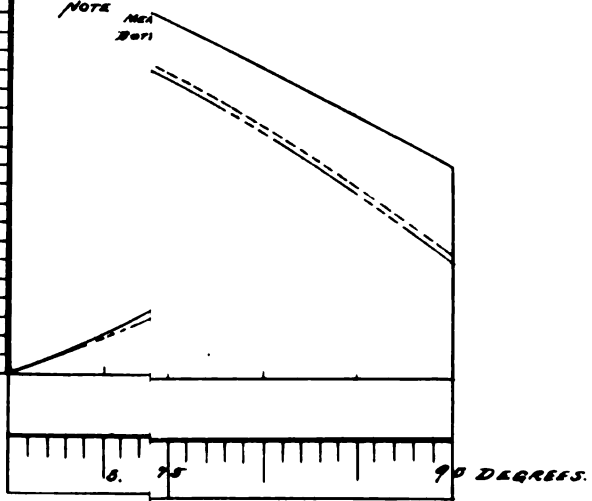


U. S. S. CHICAGO.

Curves of Stability etc.



NOTE Max Defl



inches of 7 pounds per foot. A vertical inner keelson plate is run along on top of the floors, lapping on the vertical keel where it extends above the floors. This keelson plate is 18 inches deep and 15 pounds per square foot, with double angles along the upper edge 3 by 2½ inches of 7 pounds per foot.

The frames are spaced 21 inches, frame angles 3 by 2½ of 7 pounds per foot, reverse angles, 2½ by 2½ inches of 4 pounds per foot.

The garboards are 15 pounds per square foot, and remainder of the bottom plating 10 pounds amidships, reduced at the ends, with a doubling sheer strake of 12½ pounds for about three-fifths the length amidships. The stem and stern post are of cast steel. The upper deck plating is 7 pounds to the square foot, with planking of 2½-inch wide white pine, beams 3 by 2½ inches of 7-pound angles.

The first longitudinal is formed of 10-pound plate, with double angles on the upper edge above the floor and single angle on the lower edge of 3 by 2½ inches of 7 pounds per foot. The second longitudinal is formed of an angle 10 by 3 inches, with double angles on the upper edge 3 by 2½ inches of 7 pounds per foot. The two side stringers on each side are formed of 6 by 3 by 3 inches of 14 pound Z-bars, together with 3 by 2½ inches of 7-pound per foot angles.

There is a captain's saloon, pantry, and state-room aft, just forward of which are the wardroom and four state-rooms.

The crew are berthed forward of the fire room.

Armament.—This vessel is armed with three pneumatic dynamite guns of 10½-inch caliber, to throw shells containing 200 pounds of dynamite a distance of a mile, capable of being discharged once in two minutes. Ten dynamite projectiles are carried for each gun. The range can be varied at will from 1 mile to 200 yards by varying the amount of air entering from the firing reservoir. The guns are not movable in the ship, but are fixed at an incline so that for training the vessel must be turned, but as she has twin screws this is readily accomplished. To insure the safety of the crew while handling the shells and loading and firing the guns, a light protective deck is worked over the lower parts of the guns, protecting the loading-gear, compressors, etc.

The conning tower raised above the spar-deck, and just in rear of the guns, is built of 1-inch plates, with a light hood on top. The vessel has a steam steering apparatus.

The guns are placed side by side in the forward part of the vessel. They are made in single sections with flange connections, their length in all being about 54 feet. The shells are fired by fuzes igniting on impact or by fuzes formed of a composition which ignites on being wet, so that the charge explodes after the shell sinks below the surface of the water.

The shells containing the dynamite are projected by means of compressed air. There is a main reservoir down near the keel and a firing reservoir near the breech of the guns from which air is let into the guns in the rear of the projectile. The pressure in the main reservoir is about 2,000 pounds. It is confidently expected that when this vessel is completed the United States will have in its possession a vessel capable of placing with considerable accuracy an aerial torpedo charged with a high explosive within the range of 2 miles. In addition to the three dynamite guns, a powerful secondary battery is carried, consisting of two 3-pounders, one 1-pounder, two 37^{mm} revolving cannon, and two Gatlings.

Machinery.—The motive power is furnished by two triple-expansion engines developing about 3,200 indicated horse-power. There are four cylinders to each engine. The high-pressure cylinder is 21½ inches in diameter, the intermediate 31, and the two low-pressure cylinders 34 inches. There are four boilers in independent fire rooms, about 19½ feet long and 9 feet in diameter; grate surface, 200 square feet. The speed is to be at least 20 knots.

U. S. S. CHICAGO.

The *Chicago* is a coal-protected steel frigate, built of mild steel of domestic manufacture. She was built at Roach's ship-yard, Chester, Pa., and is now finishing at the New York navy-yard.

Length between perpendiculars, 315 feet; length over all, 334 feet 4 inches; depth from garboard strake to under side of spar deck, 34 feet 9 inches; height of gun-deck port sill from L. W. L., 10 feet; height of spar-deck port sill from L. W. L., 18 feet 6 inches; breadth, extreme, 48 feet, 2½ inches; mean draught of water, 19 feet; displacement, 4,500 tons; area of plain sail, 14,880 square feet; complement, 300; indicated horse-power, 5,000; maximum speed in knots per hour, 14; capacity of coal bunkers, 940 tons; transverse metacenter above center of gravity, 2.5 feet.

Scantling and general construction.—The vertical keel is 20 pounds per square foot, with double angles at the top 3 by 3 inches of 7 pounds, and at the bottom 3 by 3 inches of 8½ pounds. The inner and outer plates of the flat keel are 25 pounds each.

The outside plating is 23 pounds per square foot, with a double sheer strake for about 250 feet amidships, and a double plate at the water line aft about 70 feet from the stem. The inner bottom is 10 to 12½ pounds, increased to 15 pounds on the shelving flats.

The transverse frames are spaced 4 feet apart in wake of the double bottom, and 3½ feet elsewhere. Throughout the double bottom the framing is on the bracket system, angles 5 by 3 inches of 10 pounds per foot, and brackets 12½ pounds per square foot.

The first two longitudinals within the double bottom are 15-pound plates, with inner continuous angles 2½ by 2½ inches of 5 pounds per foot, and outer intercostal angles 3 by 3 inches of 7 pounds per foot. The third longitudinal is composed of 15-pound plating, with staple angles 2½ by 2½ inches of 5 pounds. There is a fourth longitudinal stiffener worked fore and aft just above the turn of the bilge.

The bulk-heads are of 10 to 12½-pound plating, stiffened by vertical angles 3 by 3 inches of 7 pounds per foot.

The stringers to the spar deck are 17½ pounds by 11 feet wide; to the gun deck, 12½ pounds by 14 feet wide amidships, reduced to 10 pounds at the ends; to the berth deck before and abaft the protective deck, 15 pounds per square foot by 3 feet wide.

A protective deck 1½ inches thick is worked for 136 feet amidships over the machinery, and a flat 1½ inches thick protects the steering gear, which is well below the water.

Rig.—The rig is that of a bark spreading 14,880 square feet of sail.

Lighting, ventilation, and drainage.—The vessel is fitted with an incandescent lighting plant, supplying lights for internal illumination, including the magazines coal bunkers, and storage spaces, and also for deck, side, and head lights.

Two large blowers placed on the berth deck draw air through fore and aft ducts, with branches leading to all living spaces and store-rooms. A separate system ventilates the engine and boiler compartments. The foul air escapes from the coal bunkers by pipes leading into the funnel casings, and fresh air is supplied to them by pipes leading from the topsides.

The pumping and drainage system is very complete, every compartment of the vessel being in connection with powerful steam and hand pumps.

Armament.—The main battery consists of four 8-inch, eight 6-inch, and two 5-inch breech-loading rifles.

The 8-inch guns are mounted in half-turrets on the spar deck, 24½ feet above water. The forward guns train from 3 degrees across the bow to 60 degrees abaft the beam, and the after guns from 3 degrees across the stern to 60 degrees forward the beam.

Six 6-inch guns are mounted in broadside ports on the gun deck with a train of 120 degrees. A 6-inch gun is mounted on either bow with a train of from 3 degrees across the bow to 52 degrees abaft the beam. There are two 5-inch guns on the gun deck aft with about the same train.

The secondary battery consists of four 47^{mm} and two 37^{mm} revolving cannon.

Machinery.—The motive power is furnished by two compound overhead beam engines. The cylinders are of 52 inches. There is an independent double-acting compound and a circulating pump placed beside each condenser.

There are two four-bladed screws having a diameter of about 15½ feet. There are five double-ended boilers placed back to back. The boilers are 24 feet 8 inches long, 9 feet in diameter, and are externally fired.

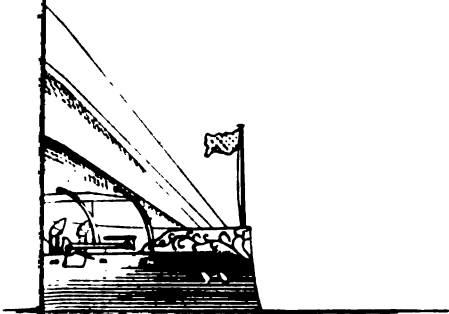
The following table shows the endurance at various speeds :

Speed.	I. H. P. aggregate.	Coal consumed.		Distance can steam.	
		Per I. H. P. per hour.	Per day.	Days.	Knots.
<i>Knots.</i>		<i>Tons.</i>	<i>Tons.</i>		
16	5, 141. 4	2. 375	130. 8	6. 36	2, 443. 6
15	4, 236. 5	2. 40	108. 9	7. 64	2, 750. 4
14	3, 444. 7	2. 45	90. 39	9. 20	3, 091. 2
13	2, 755. 6	2. 55	75. 26	11. 05	3, 447. 6
12	2, 168. 6	2. 65	61. 55	13. 52	3, 893. 8
11	1, 671.	2. 80	50. 11	16. 6	4, 382. 4
10	1, 255. 2	3. 00	40. 35	20. 62	4, 948. 8

Quarters for officers and crew.—The quarters of the admiral and captain, placed aft on the gun-deck, are both airy and spacious, and although the emplacement of the 5-inch B. L. R.'s is in proximity, the quarters are so arranged that these guns heighten the effect rather than otherwise. Just forward of the admiral's and captain's quarters are located the state-rooms of the navigator, executive officer, paymaster or surgeon, and chief engineer; also the armory.

On the forward gun-deck is a large space for berthing the crew, which is fitted up in the manner prevailing in the U. S. Navy.

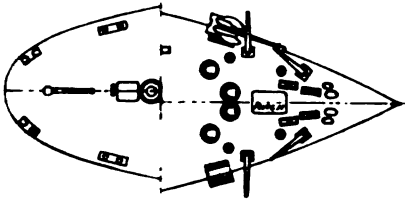
PLATE 1



U. S. S. BOSTON OR ATLANTA



PLATE 2.

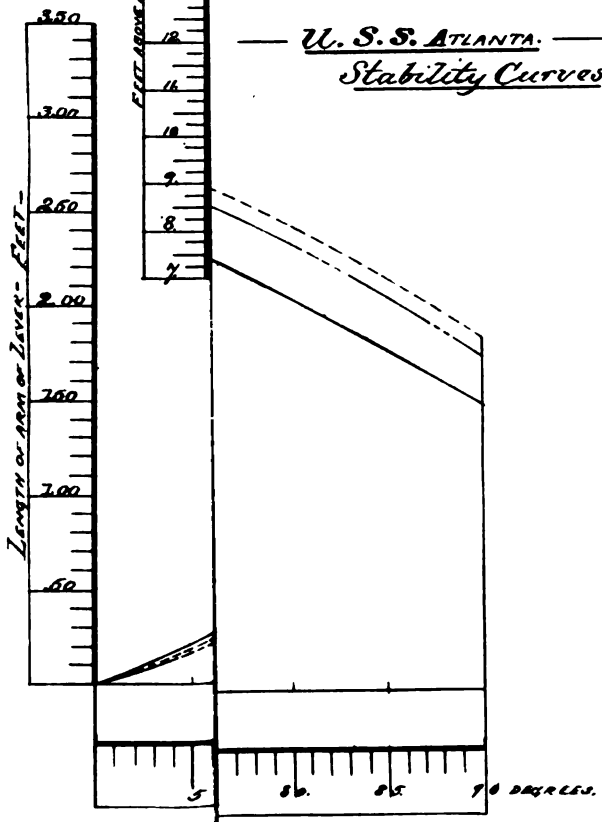


U.S.S. BOSTON OR ATLANTA.



The following weights to go on board,
 and condensers - 96 tons. Ordnance 182 tons.
 - Total Displacement - 3180 tons.
 - 91 feet. Metacentric height 2.85 feet.
 - without water (108 tons) in boilers and
 - ent - 2592 TONS, C.G. above base 15.95 feet.
 - one half (62 tons) of stores consumed,
 - TONS, C.G. above base 15.07 feet.
 - feet.

— U. S. S. ATLANTA. —
Stability Curves.



19
18
17
16
15
14
13
12
11
10
9
8
7
F.E.E.T. ABOVE BASE LINE

Particular attention has been paid to the natural ventilation of this deck by means of large skylights, hatches, and air ports.

The air ports are 22 inches square, in the shutters of which are fitted falling circular lights of 10 inches sight.

The wardroom, located on the after berth deck, consists of six state-rooms on either side, and a country 13 feet in a fore-and-aft direction by the full width of the ship at warships.

Directly forward of the wardroom comes the steerage and warrant officers' accommodations, which are fitted up in the style usual in the U. S. Navy. On the forward berth deck are located the sick bay, dispensary, paymaster's office, prison, etc., the remaining unencumbered space on this deck being devoted to the crew and fitted up with wire lockers, mess tables, etc., as is customary in United States vessels of war.

The water-closets for the officers are located on the forward gun-deck, while those for the crew are on the forward spar-deck, under a short foreccastle deck. Most approved sanitary measures have been adopted to keep these closets free from noxious odors. The height between decks in all living-spaces is 6½ feet in the clear under the beams.

U. S. S. BOSTON AND ATLANTA.

These vessels are central superstructure, single deck, steel cruisers. They were built at Roach's ship-yard, Chester, Pa.

The *Atlanta* is completed and the *Boston* completing at the New York yard.

Length between perpendiculars, 270 feet; length over all, 283 feet; beam, 42 feet; mean draught, 17 feet; displacement, 3,189 tons; sail area, 10,400 square feet; meta-centric height, 2.85 feet.

Scantling and general construction.—The vertical keel is 17½ pounds per square foot and about 40 inches deep, double angles on upper edges 3 by 3 inches of 7 pounds per foot, on lower edge 3 by 3½ inches of 8½ pounds per foot.

The outside plating, including the flat keels, is 20 pounds per square foot. The inner bottom is 10½ pounds, except at the center and shoveling flat where it is 15 pounds. Within the double bottom the frame angles are 5 by 3 inches of 10 pounds per foot, the reverse angles are 4 by 3 inches of 8 pounds per foot, with bracket plates of 12½ pounds per square foot, spaced 4 feet apart.

Forward and abaft the double bottom the transverse frames will consist of frame and reverse angles as within the double bottom, with floor plates 12½ pounds per square foot, spaced 3½ feet apart.

The two longitudinals within the double bottom are of 12½-pound plating, with 2½ by 2½ inches of 7-pound angles, the inner edge, and 3 by 3 inches of 7-pound angles on the outer edge.

The third longitudinal forming the outer boundary of the double bottom will be composed of intercostal plates of 15 pounds per square foot and staple angles 2½ by 2½ inches of 5 pounds per foot. The fourth longitudinal is composed of a continuous 15 pound plate scored over the frames, and outer intercostal angles on the inner edge 3 by 3 inches of 7 pounds per foot.

The superstructure deck beams are of T-bulbs 6½ by 4½ inches of 18 pounds per foot; the main-deck beams of T-bulbs 8 by 5 inches of 27 pounds per foot; the berth-deck beams of T-bulbs 8 by 5 inches of 27 pounds per foot, and the orlop deck beams of angles 6 by 3½ inches of 12 pounds per foot.

The stringer to the superstructure deck is 15 pounds per square foot; to the main deck 15 pounds by 33 inches wide, tapering at the ends; to the berth deck before and abaft the protective deck, 15 pounds by 30 inches wide.

The protective plating over the engines and boilers is in two thicknesses of 30-pound plating, making in all a thickness of about 1½ inches. The armor shutters or bars are fitted to all the hatchways in the protective plating, the shutters to be 1½ inches thick, and the bars 4 inches deep by ½-inch thick.

The main bulk-heads are to be 12½ pounds per square foot below the berth deck and 10 pounds above; other bulk-heads, 10 pounds per square foot. Bulk-heads are stiffened by angles 3 by 3 inches of 7 pounds per foot.

Quarters for officers and crew.—The captain's cabin is at the fore end of the superstructure; just abaft is the state-room, and in rear of this is the cabin, bath, and water-closet.

The wardroom has twelve state-rooms. Forward of the wardroom are the steerages, on starboard side, and the wardroom pantry, steerage bath, and warrant officers' state-rooms on the port side. The wardroom bath and water-closets are just abaft the wardroom, separated from it by a water-tight bulk-head. Forward there is a sick bay, dispensary, and paymaster's office, the remaining space being for the crew, except the forward compartment, which contains the head. The head contains a wash trough and bath tub in addition to the seats. The head is constantly flushed by water from the distiller. There is a berthing space for part of the crew under the superstructure.

Armament.—The main battery consists of two 8-inch and six 6-inch breech-loading rifles.

Just forward of the superstructure, on the port side, an 8-inch gun is mounted in a barbette 3 feet high and 2 inches thick, having a train of from 40 degrees abaft the beam on the port side to 30 degrees abaft the beam on the starboard side. Just abaft the superstructure on the starboard side is an 8-inch gun in a similar barbette with a train of from 40 degrees forward the starboard beam to 30 degrees forward the port beam.

Two 6-inch guns are mounted on each broadside, one forward in the starboard angle of the superstructure, shifting to a forward or a broadside port, and one aft in the port angle of the superstructure, shifting to an aft or broadside port.

The secondary battery consists of two 6-pounder rapid-fire guns, mounted in broadside ports; two 3-pounder rapid-fire guns, and two 47^{mm} revolving cannon in towers; two 1-pounders on top of starboard forward and port after tower; a 37^{mm} revolver in each top and two Gatlings on rail mounts.

Machinery.—The motive power is furnished by a three-cylinder compound horizontal back-acting engine. The high-pressure cylinder is 54 inches in diameter, and the low-pressure cylinders 74 inches in diameter; stroke, 42 inches. There are eight horizontal return tubular boilers, 11 feet 8 inches in diameter by 9 feet 9 inches long. Grate surface, 382 square feet.

The *Atlanta* was given a six-hours' trial April 14, 1887, when the mean speed of the vessel was 15.43 knots and the mean horse-power (aggregate) 3,356 I. H. P.; maximum speed, 16.33 knots, and maximum power (aggregate) 3,511 I. H. P. Consumption of coal per I. H. P. per hour (mean) 2.633 pounds, New River coal.

The following steaming distances are calculated for a mean displacement of 2,943 tons, on a coal supply of 491 tons, the bunker capacity:

Speed.	I. H. P., aggregate.	Coal, per I. H. P., per hour.	Coal, total, per hour.	Days steaming.	Distance steamed, nautical miles.
<i>Knots.</i>			<i>Pounds.</i>		
15	3, 113	2.5	7, 780	5.89	2, 120
14	2, 545	2.3	5, 850	7.834	2, 732
13	2, 097	2.3	4, 820	9.5	2, 964
12	1, 604	2.5	4, 150	11.043	3, 176
11	1, 338	2.7	3, 610	12.7	3, 350
10	1, 067	3.0	3, 200	14.133	3, 390

The six hours' trial of the *Boston* showed a mean indicated horse-power of 3,780, with a mean speed of 13.8 knots. The bottom was very foul, and much greater speed can be confidently counted with a clean bottom.

U. S. S. DOLPHIN.

This is a single-screw dispatch vessel, built at Roach's yard, Chester, Pa.

Length between perpendiculars, 240 feet; length over all, 265.5 feet; breadth, 32 feet; mean draught, 14.25 feet; displacement, 1,455 tons; indicated horse-power, 2,240; maximum speed, 15½ knots.

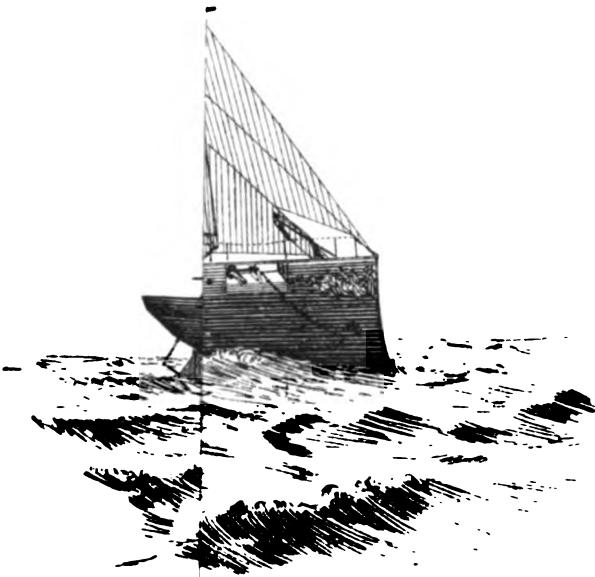
Scantling and general construction.—The vertical keel is 20 pounds per square foot, with side bars 9 inches wide of 22½ pounds per square foot, and continuous angles at the top 5 by 3 inches of 10 pounds per foot. The stem and stern are iron forgings. The transverse frames, spaced 22 inches, are of frame angles 4 by 3 inches of 9 pounds per foot, with reverse angles 3 by 2½ inches of 6 pounds per foot, with 12½-pound floor plates.

The garboards are 25 pounds per foot tapering to 20 pounds at the ends, the remainder of the outside plating being 17½ pounds reduced to 15 pounds at the ends.

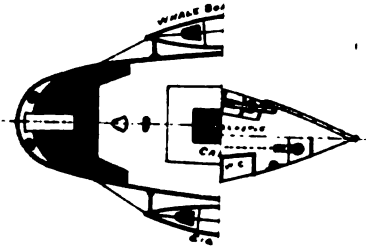
The first longitudinal is composed of an intercostal plate of 15 pounds per square foot, extending 5 inches above the frames, with outer intercostal angles 3 by 2½ inches of 6 pounds per foot, and continuous angles 5 by 3 inches of 10 pounds on the inner edge. The second longitudinal has an intercostal plate of 12½ pounds, outer angle 3 by 2½ inches of 6 pounds, inner continuous angles 5 by 3 inches of 10 pounds per foot. The bilge stringer consists of two continuous angles 5 by 3 inches of 10 pounds per foot.

The stringer and plating on the main deck, in wake of the engine and boiler hatches, is 15 pounds, reduced at other parts to 10 pounds; the berth deck stringer is 12½ pounds by 30 inches wide. There are five transverse water-tight bulk-heads dividing the vessel into six main water-tight compartments.

PLATE I

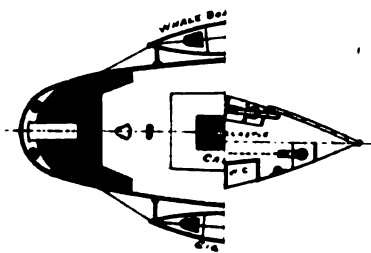


U. S. S. DOLPHIN.



U. S. S. DOLPHIN.





U. S. S. DOLPHIN.



There is a flush open spar deck, except a central deck house near the cabin gangway, and one around the boiler and engine hatches.

The rig is that of a three-masted schooner.

Machinery.—The motive power is furnished by a single screw two-cylinder compound vertical direct acting engine. The cylinders are 42 and 78 inches in diameter by 48-inch stroke.

There are two single-ended boilers 11 feet in diameter by 9 feet 6 inches long, and two double-ended boilers 11 feet in diameter by 18 feet 3 inches long.

The screw has four blades with a diameter of 14 feet 3 inches, and a pitch of 2 feet 4 inches.

Armament.—The armament consists of one 6-inch breech-loading rifle mounted on a shifting pivot carriage on the spar deck, two 6-pounder rapid-fire guns mounted on the topgallant forecastle, and four 47^{mm} revolving cannon mounted at the extremities of each bridge in fixed armored towers.

Quarters for officers and crew.—There is a large saloon with transom sofas on each side, just forward of and opening into which are two state-rooms. Aft the saloon there is a passage way, along which are three state-rooms, a bath and water-closet, and a pantry. Forward the saloon is the wardroom, with three state rooms each side. Forward of the wardroom are the pantries, bath-rooms, water-closets, etc.

Forward of the engine and fire room bulk-heads is the crew space.

The crew consists of 80 men and 18 apprentices.

There are 10 officers.

No. 12.—BUREAU OF STEAM ENGINEERING.

NAVY DEPARTMENT,
BUREAU OF STEAM ENGINEERING,
Washington, November 2, 1887.

SIR: I have the honor to submit to the Department the annual report of this Bureau, together with the estimates for the fiscal year ending June 30, 1889.

APPROPRIATION STEAM MACHINERY, 1887.

Amount appropriated for fiscal year ending June 30, 1887, act approved July 26, 1886..... \$763, 000. 00

EXPENDED TO NOVEMBER 1, 1887.

For labor in navy-yards and stations in repair of steam machinery, boilers, etc., of naval vessels; fitting for sea service; and preservation of tools, handling and preservation of materials, stores, etc.....	\$520, 640. 43	
For purchase of materials, stores, machine tools, freights, and incidental expenses	196, 981. 66	
For payments on foreign stations, for repairs, materials, freights, and incidental expenses	31, 469. 85	
Total	749, 091. 94	
Less repayments by transfers in the adjustments of appropriations	13, 317. 88	
Total expenditure		735, 774. 06
Balance on hand		27, 225. 94

OBLIGATIONS OF THE BUREAU TO BE PAID FROM THIS BALANCE.

Approved requisitions for materials unfilled.....	\$3, 564. 24	
Foreign bills in course of adjustment.....	12, 789. 05	
		16, 353. 29
Balance remaining to credit of this appropriation		10, 872. 65

APPROPRIATION FOR STEEL CRUISERS.

Total amount appropriated for machinery as per last annual report, dated November 10, 1886	\$1, 051, 731. 57	
Amount transferred from appropriation "Steam machinery, 1886," for completion of cruiser machinery, by order of Navy Department.....	\$25, 000. 00	
Balance in hands of paymaster.....	10, 230. 25	
Amount expended		14, 769. 75
Total		1, 066, 501. 32

EXPENDED TO NOVEMBER 1, 1887.

On the Atlanta.

Payments made as per last annual report	\$268,514.09
---	--------------

On the Boston.

Payments made as per last annual report	266,566.56
---	------------

On the Chicago.

Payments made as per last annual report....	\$332,558.50	
Paid from appropriation "Steel cruisers" since last report.....	38,187.66	
Paid from appropriation "Steam machinery, 1886," transferred as above.....	14,769.75	
		385,515.91

On the Dolphin.

Payments made as per last annual report	141,424.93	
Paid for steel shafts.....	4,396.24	
		145,821.17
Payments for stationery for offices at Chester, Pa		2.18

Total expended from this appropriation.....	1,066,499.91
---	--------------

Balance on hand.....	1.41
----------------------	------

APPROPRIATION MACHINERY DOUBLE-TURRETED MONITORS.

Balance on hand November 10, 1886, as per last annual report.....	\$115,452.32	
(No payments made under this appropriation during the fiscal year.)		
The balances yet due under the contracts for the engines, etc., for these iron-clads are:		
For the <i>Terror</i> , William Cramp & Sons	52,178.02	
On the <i>Amphitrite</i> , Harlan & Hollingsworth Company.....	52,178.11	
		104,356.13

Balance to credit of this appropriation.....	11,096.19
--	-----------

The balance of \$11,096.19 will be required to pay for cost of steam trials of the vessels, and extras to contracts, when completed.

GENERAL OPERATIONS OF THE BUREAU.

During the past year plans have been prepared by the Bureau for triple expansion machinery for cruisers Nos. 1, 4 and 5, and for two armored cruisers. One of the latter designs, of 8,500 I. H. P., is now being worked out in detail, preparatory to being built at the New York navy-yard. Plans have also been prepared adapting the machinery of No. 27 design to cruisers Nos. 4 and 5, and to conform to the law under which the latter are to be built. Similarly, the machinery of gun-boat No. 1 has been adapted to gun-boats Nos. 3 and 4. Preliminary work has been done on designs for machinery for the monitor *Monadnock*, also on designs for machinery for new tug-boats for which an appropriation is recommended. Plans have been prepared for alterations in machinery, with forced draught, for the *Hartford*, *Swatara*, and *Kearsarge*, the two latter vessels being now under repair at Portsmouth, N. H., and the former awaiting repairs at Mare Island, Cal. In the case of the *Swatara*, two of the eight boilers built for her have been left out and blowers added to make up the deficiency. The steam drums have also been omitted and a centrifugal separator added. The system of forced draught used

will be the same as that applied last year to the *Alliance*, and which has proved very successful. The coal supply of the *Suatarata* is considerably increased, while the power will be greater than before. The old engines of the *Kearsarge* were found to be unfit for further service and have been taken out. As the hull will not last very long, it was considered inexpedient to build new engines for her, and so the engines which were some years ago taken out of the *Nantasket* have been put into her. These engines are much smaller than those taken out, but are the best that could be put in under the circumstances. The boilers, also, are not such as would be used if the condition of the hull were such as to justify the building of new and more modern machinery. Four cylindrical boilers have been used for this purpose which the Bureau has been enabled to utilize by omitting two from the *Alliance* and two from the *Suatarata*, and using forced draught.

In the *Kearsarge* mild forced draught will be used. Work has also been done on plans for new compound condensing steam launch engines with improved boilers. Machinery has been designed and built at Mare Island for a large surveying launch for the Coast Survey, for use in the waters of Alaska, which has given very good results, considering the limited amount of money which was available for the purpose. The floating derrick at the New York yard, which was unfortunately wrecked last summer, is being repaired. Some slight modifications have been made in the design in order to minimize the chance of another disaster from improper handling. Such machines should never be manipulated by people unaccustomed to their working.

The operations of the Bureau, other than those here specified, will be found under the appropriate heads.

PERSONNEL OF THE ENGINEER CORPS.

The number of engineer officers, already inadequate to the requirements of the service, is rapidly becoming still smaller, as the limit made by Congress a few years ago has not yet been reached in the process of reduction, and no appointments are made to the lower grades. The whole number of engineers in the service on the 1st of October of this year was 223. Of this number, 113 were at sea or proceeding to or returning from stations; 81 were on shore duty connected with naval affairs; 8 on duty at colleges; 4 sick and on leave of absence; and 1 under suspension, leaving only 16 waiting orders and available for a call of duty. The Bureau being already embarrassed in the assignment of officers in such a manner that the machinery of vessels in commission may be properly cared for, and at the same time the multifarious duties on shore properly attended to, it is difficult to foresee what is to be done when the personnel of the Engineer Corps becomes reduced to the legal limit of 170, and when the number of engineers required on board of each vessel in commission will be so much greater, on account of their complicated machinery, than any vessels now in service. The number of engineers detailed to duty as professors of marine engineering at colleges has had to be reduced, and such details will very soon have to be stopped altogether, unless some provision is made for stopping the decrease in the personnel of the corps. The reduction in the number of Passed Assistant Engineers makes promotion very slow for the Assistants, and has a very discouraging effect upon them. I would recommend that, if possible, the number of Passed Assistant Engineers should be increased to the former number of 100. The least that should be done, however, is the immediate stopping of the reduction and the annual ap-

pointment of a sufficient number to the lower grade to make up for natural loss. This becomes the more important when an inspection of the ages of the officers in the upper grades of the corps shows that in a few years the loss by retirement will become very great. Although it will, under existing circumstances, be several years before any appointments can be made to the corps, I would call attention to the fact that such appointments must be made from the graduates of the Naval Academy, who are not qualified by the present course of instruction for performing the duties of engineers. I can not deplore too strongly the abolition of the former course of instruction for cadet engineers. The inadequacy of the present academic course to the proper instruction of officers for the various corps has been clearly perceived by the present Superintendent of the Naval Academy, who last year recommended that the cadets should be divided at the end of the third year, and thereafter study only the profession of the corps for which they may be selected. I would go still further than this, as I consider one year's technical education too little for engineer students, and would recommend that the separation take place at the end of the second instead of the third year. At the end of the second year, all the students not required to make up for loss in the various corps, making due allowance for possible loss during the remainder of the academic course, might be discharged from the service, making room for a new lot. In this way, double the present number of students would be available from which to select cadets to fill vacancies, thus giving better officers to the service, while the instruction during the last two years could be more thorough and in every way more satisfactory.

I would call attention to the anomalous position held by those officers who are now borne on the Navy Register as Cadet Engineers. They were dropped from the service by a misinterpretation, on the part of the Navy Department, of a part of the naval appropriation bill approved August 5, 1852. These gentlemen have, at three separate times, brought suit before the Court of Claims, the decision of the court in each case being to the effect that their discharge from the service was illegal. The last two decisions of the Court of Claims were confirmed by the United States Supreme Court. Each of these decisions was made by the unanimous voice of the respective court. Upon the base of these decisions and a subsequent opinion of the honorable Attorney-General, these gentlemen have had their names restored to the Navy Register, but they still hold the rank of Cadet Engineer, although others of the same classes who were not discharged hold the rank of Assistant Engineer. A joint resolution was introduced in the last Congress to remedy this, and received a unanimously favorable report from the Naval Committees of both the Senate and House of Representatives. I would recommend that the Department should invoke legislation by the approaching Congress to restore these gentlemen to their legal rights.

I would also call attention to the injustice done to all engineer graduates of the Naval Academy in the assignation to them of relative rank. Engineer students formerly entered the Academy upon a more advanced examination than was required for students of the line, and were graduated at a corresponding advanced date. Under existing law, however, they do not rank with the class of Line Officers with whom they were graduated, but *after* the class with which they entered the Academy, and which was subsequently graduated. The reason for ranking after this class is that the entrance examination for Cadet Midshipmen took place each year a short time before the examination for Cadet Engineers, and the appointment of the cadets of the two corps thus differed by a

few days. This, however, was enough to make the first man in the engineer class rank after the last man of the class of Cadet Midshipmen which left the Academy two years after the former. Both the Navy Department and Congress have been from time to time appealed to to correct this injustice by making all graduates of the Naval Academy rank with each other according to relative merit at graduation, but none of these efforts have thus far proven successful. These officers are put to great inconvenience by being thus left behind other officers of the service with whom they first entered upon the regular duties of the Navy as commissioned officers. I would recommend that in their case also the Department should invoke the assistance of Congress.

As the duties of the Engineer-in-Chief frequently call him away from Washington, leaving behind him a large amount of technical work, it is in my opinion, desirable that he should be provided with an engineer assistant, who would in his absence become responsible for the work of the Bureau. The necessity for such an assistant has already been recognized in the case of the Bureau of Medicine and Surgery, the chief of which is allowed by law an assistant selected from the Medical Corps of the Navy. I would earnestly recommend that steps be taken to secure, in like manner, an assistant to the Chief of the Bureau of Steam Engineering.

I would call attention to the various ways in which commanding officers interpret the duties of engineers on board ship. Some very rightly leave the arrangement of watches and the distribution of duties to the Chief Engineer, holding the latter strictly responsible for the faithful performance of the duties of his subordinates and for the efficient working of the machinery. Many commanding officers, however, arrange these details to suit themselves, often requiring the engineers to stand regular watches in the engine-room at all times, day and night, whether there is anything to demand their attention or not.

Standing a watch, as does the officer of the deck, with duties pertaining to military routine to perform, is one thing; and standing watch as engineers are frequently required to do, over a mass of cold cast iron, is quite another. The latter is neither inspiring nor healthful to the victim. The arrangement of these details should be left to the Department, commanding officers being allowed to change them only in case of emergency. The number of engineers sent to each ship should be arranged according to the importance and complication of the machinery, and nobody is more competent to judge of this than the Bureau of Steam Engineering. Where the number of engineers is sufficient, they should be required to stand watch, but when under steam on the main engines only. No engineer should be required to stand a watch except when there are duties to perform which demand an engineer's constant attention. The idea that an officer is not doing his full share of duty when he is not as uncomfortable as it is possible to make him is too prevalent in the service. It will be found that engineers will take more interest in their duties and perform them much more satisfactorily when they are not required to perform imaginary duties for which no necessity exists.

I can not too strongly express my satisfaction at the course pursued by the present administration in sending officers abroad for the purpose of study. In the case of engineers, these studies should not be of a theoretical nature, as these officers have already received a sufficient groundwork of that sort, but should be in the nature of practical application, as in the case of an Assistant Engineer who is at present occupied in the daily work of an eminent engineering firm on the Clyde. I

consider that, to keep fully abreast of the times, at least three engineers should be kept abroad in addition to those engaged in study, one in Great Britain and two on the continent, to keep the Department posted on the most recent engineering matters. Much of the information that now comes to us, filtered through the daily and professional press and through non-professional observers, would be of real value if it could be obtained at first hand by observers capable of properly treating the subjects under consideration.

ENGINEER'S FORCE ON BOARD SHIP.

The number of men in the engineer's force on board nearly all vessels is entirely inadequate to the proper performance of the necessary work.

As an instance of the inconsistent way in which men are apportioned to the different vessels, it may be mentioned that the *Boston* and *Atlanta* have each a smaller engineer's force than the *Trenton*, which has similar machinery but a quarter less power. Moreover, the machinery of the former vessels is in several water-tight compartments, and for this reason alone needs more men than the latter, which is all in one compartment. Another case is that of the *Alliance*, which has fewer boilers than others of her class, but is able by forced draught to develop more power; nevertheless she is allowed fewer coal-heavers than her sister ships. To make matters worse, the importance of the work of these men in the engineer's department is in many cases made secondary to that of work on deck. The firemen are kept on deck by the hour and exercised in the manipulation of the spars and sails, while the work below is neglected. Not very long ago, on board a ship which is full of machinery, the chief engineer complained that he was unable to do the necessary overhauling and repairs, as he was not allowed the use of his men. The reply of the commanding officer was that the presence of the men at the drills could not be dispensed with, and that if repairs to the engines were necessary they could be done at night. The result of such action is inefficiency of the motive power and unduly rapid deterioration of the boilers and machinery. The average life of our boilers is less than it should be, and many of our engines, although originally economical, have become wasteful of fuel simply from want of attention, while the labor which should be used on them is diverted into other channels. This must all be changed, and changed quickly, if our vessels are to be kept in effective condition. The Department enlists men for the engineer's force for the purpose of manipulating and taking care of the machinery, and they should not be employed for other purposes while this work remains undone. None of these men should be employed in any work other than that for which they were intended, without the previous statement of the engineer in charge that his department is in such a state that their services can be spared, this statement to be recorded in the steam log-book. The coal-heavers should be considered as a permanent part of the engineer's force, as was intended when the rating of Coal-Heaver was established.

As the number of engineers in the service is becoming too small to allow of a complement on board all vessels, the number of machinists should be increased. On all vessels where there are less than three assistant engineers there should be at least three machinists. The rating of Coppersmith, which was abolished several years ago, should be re-established, and one of that rate allowed to each of the vessels of recent type. When under way the coppersmith would do the work of an oiler or water-tender, so that no addition to the number of men would be

required, but simply the additional pay, which should be sufficient to make the pay at least \$60 per month. The Blacksmiths, who were recently taken away from the engineer's force and put under charge of the Executive Officer, should be returned, as nine-tenths of all the blacksmith's work on board ship is in connection with the engineer's work, and the blacksmith should be available to do this work when necessary.

The recent order of the Department, transferring the custody of stores on board ship to the Paymaster, directs that the Engineer's Yeoman shall "be attached to the pay department." This is variously interpreted on board different vessels, on some his services being entirely lost to the engineer. The former duties of the engineer's yeoman were to take care of the engineer's stores and keep the accounts of the same; to have charge of tools, issue them when required for use, and take care of them when returned; and to do the writing required in keeping the steam log-book and in making out the various reports required in connection with the machinery. The engineer's stores, such as oils, tallow, packing, waste, etc., are of such a nature that they must necessarily be kept in special receptacles in or near the engine-room, and there must be at all times when work is going on some one on hand to issue them as required. I can see no reason why the yeoman, doing this work as heretofore, can not at the same time perform the other duties formerly devolving upon him, the only difference being that he is now responsible to, and keeps the stores for the paymaster instead of the engineer. This is done on board some ships with apparent satisfaction to everybody concerned, and I would recommend that the order of the Department in this regard be so far modified as to direct that in all cases the engineer's yeoman shall be under the orders of the paymaster so far as the engineer's stores are concerned, but that he shall continue to perform his other duties for the engineer as heretofore. Should it be considered inadvisable to do this, I would recommend that a tool-keeper with the same pay as the ship's writer be allowed.

It is impossible to get as good a class of machinists and other petty officers of the artificer class as is desirable. This is not so much on account of the pay—although this should be greater in some cases—as the conditions of life to which these men are subjected on board ship. Few mechanics who can earn good wages on shore are willing to go to sea when they must swing in a hammock, eat out of a tin pan, assist in all sorts of drudgery, be "horsed" around generally, and be permitted to go ashore only at long intervals. The services of good men are necessary to the efficiency of our ships, and every effort should be made to obtain such. The petty officers of the higher grades should be kept apart from the other men as much as possible, otherwise they lose to a great extent their influence over them. I see no reason why the machinists, together with a few certain other petty officers, should not have a place on the berth-deck partitioned off for their use where they could have comparative privacy. This could be very easily done on some of the more recent vessels where the division of the vessel by numerous water-tight bulk-heads lends itself to such an arrangement. These men should also be allowed greater privileges than the minor enlisted men in the matter of "liberty" on shore. They should be furnished with lockers in which to properly keep their clothing, and with facilities for maintaining a decent mess. I am confident that attention to these matters would result in the procuring of a much better class of petty officers than can at present be obtained.

BOILER CONSTRUCTION.

An absurd practice has grown up in the navy-yards—I know not why—of always charging boiler construction to some certain ship, although she may eventually go to some other yard and take other boilers, and the boilers supposed, by navy-yard tradition, to belong to her go into some other ship. This practice would be rational in the case of a ship which required a boiler designed especially for her, as in the later ships, but in no other. A ship with boilers charged to her may be wrecked, or upon arriving home her hull may be found rotten and be condemned. Then, although her boilers will go into the next ship that comes along wanting boilers of that type, there is always somebody to raise a hue and cry about the wastefulness of naval methods. There is no more reason why a boiler, which might go into any one of a number of ships, should be said to belong to one of those ships any more than to another, any more than that one particular gun out of a hundred just like it should be kept for one particular vessel to sail into port and claim it. It has been the aim of the Bureau in past years to have the boilers and engines of each class of vessels as nearly interchangeable as possible. For instance, the *Vandalia*, *Quinnebaug*, *Swatara*, *Galena*, *Marion*, *Mohican*, *Adams*, *Alliance*, *Essex*, *Enterprise*, *Nipsic*, *Alert*, and *Ranger* all have boilers alike, there being from four to eight in each vessel.

It is impolitic to wait until a vessel arrives at a navy-yard for repairs before the construction of her new boilers is begun. The vessel, in such case, would be thrown out of use too long a time while waiting for their completion. In the merchant marine such a policy would not be thought of. A merchant steamer is never laid up but for a very short time for a change of boilers; only long enough to take the old ones out and put in the new ones, which are ready to hand. Of the class of vessels above referred to as having similar boilers, several will need new boilers in a year or two, the *Galena* and *Essex* probably being the first. Two boilers of this sort are now on hand at Norfolk and four at New York. Enough more should be built at such times as boiler-maker's work may be slack in these yards to increase the number on hand at each place to six, so as to be ready for the next ship; but, for the reasons given above, they should not be charged to any ships until put in, but the work should be charged to the boilers themselves.

There are now lying at the Mare Island navy-yard, six boilers built for the uncompleted double-turret monitor *Monadnock*. These boilers have never been put in for the reason that no money has been available to complete the hull or to build engines for her, and it was expedient to keep the boilers on shore where they could be better preserved than in the vessel. The boilers and intended engines, at the time the vessel was designed, represented the highest skill of the marine engineer's art, but in the rapid advance of engineering science their type has become antiquated. The designed engines were of a type which could only be put into a single compartment, and all the boilers were intended to be put into one compartment. The development of the science of naval warfare, particularly that pertaining to the ram and torpedo, will not permit of such a distribution of machinery in a modern war ship; everything must be divided up as much as possible in separate water-tight compartments. It becomes advisable, therefore, when machinery for the *Monadnock* is built, to thus divide it, and also to divide the boilers into at least two groups. The boilers and machinery should also be of the most modern, and consequently economical type. The only ob-

struction to this is the fact that the boilers of old type are on hand; this being one of the special cases where a certain boiler will fit only a few ships. The only other vessels that these boilers would be useful to are the *Miantonomok*, *Amphitrite*, *Terror*, and *Trenton*. The first will probably not need new boilers for several years; the second and third are not yet quite completed; but the *Trenton* will need new boilers at the end of her present cruise. I would recommend, therefore, that she end, if possible, her cruise on the Pacific coast, where she could take these boilers, thus permitting the adoption of a more modern type of both boilers and engines in the *Monadnock*. It would be even better to dispose of the present boilers by sale—as they could be utilized in any one of a number of merchant steamers—than to cripple the *Monadnock* by tying her down to a design made twelve years or more ago.

The case of the *Monadnock's* boilers is one that might be ascribed by malcontents to wasteful naval methods; but an analysis of the case will show that it is caused by the failure of former Congresses to appropriate money to complete the vessel. Had the vessel been completed at the time that was expected when she was commenced, these boilers would probably have been worn out long ago in service, and I might now be submitting an estimate for new ones instead of recommending their displacement by others of more modern design.

MISCELLANEOUS.

I would call attention to the fact that at present four different Bureaus furnish steam machinery to ships, and that three Bureaus are charged with the care of it on board ships in commission. The Bureau of Steam Engineering is at present charged only with the motive machinery, while on board modern ships are found steam capstans, windlasses, steering engines, ventilating fans, electric-light engines and dynamos, turret machinery, gun-training engines, and steam, pneumatic, and hydraulic gear for various purposes, which come under the care of other Bureaus. Many of these machines are, on board ship, placed in the care of officers who are but novices in engineering matters, and require a force to assist them which would in great part be rendered unnecessary if this machinery were under the charge of the engineers, whose force would require but little addition to enable it to undertake the additional duties. Although in most, if not all cases, the fitting up of the auxiliary machinery of various sorts on board ship is done by the Bureau of Steam Engineering, and although the services of the engineers of the ships are brought into requisition when repairs are necessary, yet this work is done for other Bureaus which are charged with the care of these machines. I would recommend that this incongruity be summarily abolished, and that in the interest of economy, harmony, and efficiency, all machinery be placed under the charge of the engineers, who are the only officers in the service who are fitted by education, training, and experience to assume such trust.

The duties of the Fleet Engineer have been from time to time so abridged that at present, apart from the charge of the machinery of the ship on which he serves, they practically amount to nothing except a farcical "inspection," which is made at the same time the Commanding Officer of the Fleet makes his periodical "inspection." At such a time the ships are made to appear as different as possible from what they are under the ordinary conditions of service, and the crew is in holiday attire, prepared for exhibition drills on deck. Facilities should be afforded the Fleet Engineer to make a practical inspection of the machinery

of each ship of the fleet at least once a year while under way; also to inspect it when the ordinary work is going on in port, so that he may become better acquainted with the condition of the machinery than he can by simply looking at it at a time when its chief merits are supposed to be judged by the brilliancy of its polish. In order that these inspections can be properly carried out, an assistant engineer should be attached to every flag-ship for staff duty. He would assist the Fleet Engineer in his inspections, where, being a much younger and more active man, his services would be of great value. He would also inspect the log-books and other periodical reports of the engineers of various ships—a duty to which the Fleet Engineer could not devote sufficient time—and thus see that the instructions of the Department are carried out.

Paragraph 14, page 118, of the Navy Regulations provides that in the case of any important accident or derangement occurring to the machinery of a steamer "A survey will be held upon it by a board composed of one line officer and at least two engineers, who will report in writing the nature and extent of the accident or derangement, the cause, the probable time of repair, and to whom, if to any one, blame is to be attributed, etc." It is seldom if ever the case that more than two engineers, the minimum allowed, are put upon such a board. We then have, in case, as often happens, of a difference of opinion between the two engineers, the anomaly of a person not educated in engineering matters having the deciding vote on a technical question. I would recommend that this regulation be so far modified as to provide that such boards should always, when possible, be composed entirely of engineers, in order that there may be a greater probability of the actual facts in such cases being represented to the Department.

Our ships, after their first trials, are seldom if ever run at full power; hence it is never certain that the machinery will be equal to such a task when required, and the engineer's force, from lack of experience, is likely to be found wanting at a critical moment. If it is necessary for the efficiency of a vessel that its crew should be frequently drilled in the manipulation of the sails, guns, and small-arms, it would be but reasonable to suppose that the firemen, and others of the engineer's force, would need some practice to enable them to become as proficient in their duties as the standard of excellence would require. It is a comparatively easy matter to run the machinery at two-thirds power; it is the last half-knot that counts. Every ship in commission should be tried at least once every six months, and more frequently, if possible, for eight hours under full power. It would be better if a longer run could be made, but the number of men allowed will not permit of it, as at full power the watches have to be doubled and the men can not stand the strain. A part of this run should be made over a measured base in order to determine the exact speed. Each ship should also, once a year, be subjected to a progressive speed trial, over a measured base if possible. The results of these trials would give to the Department a good idea of the efficiency of the machinery, and would be useful in many ways. A carefully kept record of the performance of each vessel is of the greatest use to the Department, both in proportioning the machinery of new vessels and in improving that of existing ones. Records of speed and power, in order to be comparable, should be those pertaining to performances in smooth water. But it is seldom that all the conditions at sea are favorable to a record of this kind, and consequently the best records would be those made while running in inland waters. Unfortunately, as the speed of our ships at such times is not generally noted, not being necessary for purposes of navigation, the chance of

reliable data is lost. I would recommend that whenever possible the speed of vessels in rivers or other inland waters be ascertained as carefully as possible by patent log or such other means as may be practicable; also, when opportunity occurs, that the speed be measured between landmarks, provided that the amount of current can be accurately ascertained, or that the measurement of speed can be made at slackwater. In this way much valuable information could be gained without attending expense, and without interfering with the ordinary duties of vessels.

It is of the greatest importance that exhaustive experiments be made on some of the doubtful points of modern high-speed marine engineering. Among these I would mention as the more prominent: the most efficient amount of heating surface for a given power at a given rate of combustion with forced draft; the ratio of the volume of the combustion chamber to the volume of the gases passing through it in a given time; the best form and dimensions of high-speed blowing fans; the absolute and relative economy of triple and quadruple expansion engines at various pressures, with and without steam jackets, and with both dry and superheated steam; the strength of various full-sized forms in cast and forged steel, and in various high-strength alloys, under various conditions of working and cooling; the strength of large specimens of thick steel boiler plate to determine how close to finished dimensions it may be safe to shear the plates; the strength of riveted joints in very thick steel boiler plates; the potential and economical performance, and the endurance, of various recently introduced boilers of the coil, pipe, and tubulous types; the most efficient proportions of high-speed screw propellers for given powers and speed. All these questions lie, in great part, beyond the range of theory, although certain data, when obtained, can be applied by theoretical methods to cases differing considerably from those of the experiments. It is much cheaper to spend a comparatively small amount of money in making such experiments in a scientific manner than to follow blindly in the wake of what somebody else is said to have done, and to find too late that our efforts are not as successful as expected. Every step should be a step in advance. This Bureau is in constant receipt of letters from engineers, scientists, and institutions of learning, asking to be supplied with the latest publications of the results of the Bureau's experiments. These requests result from a knowledge of what was done in former years, and show of what value such experiments were considered to be. It was by means of knowledge derived from the experiments that we were able, twenty years ago, to produce a vessel whose speed was far ahead of that of any other sea-going steamer then in existence, and whose continuous speed *at sea* has never yet been exceeded by a recorded performance of any foreign naval vessel. The results of many former experiments are among the classics of engineering literature, and are to-day considered, the world over, as the most reliable data obtainable on their respective subjects. Among these I may cite as the more prominent: the experiments of Isherwood on the expansion and superheating of steam and on the screw propeller, and of Loring and Emery on the absolute and relative economy of the simple and compound engines. The Bureau has been very fortunate within a few days in having offered to it, by J. M. Forbes, Esq., of Boston, the use of his yacht, the *Shearwater*, for the purpose of experimenting with the Belleville boiler with which it is equipped. This offer is very opportune, as, without doubt, in the near future some boiler of the type of which the Belleville is an example, must be adopted for naval use in order to meet the increasing demand for high powers with light weights; and relia-

ble data on the performances of such boilers are scarce. But public spirited liberality, such as shown by Mr. Forbes, is too rare to be expected in all the cases upon which experiments are advisable. I would recommend that the Experimental Board be again organized, and that steps be taken to secure, if possible, an appropriation to defray the expenses of experiments and a publication of the results. Appropriations for such purposes are not without precedent. Congress has frequently sanctioned the expenditure of money for experiments of various sorts, sometimes for purposes of general experiment, and sometimes for trials of the inventions of individuals. As a case of the latter, I may mention an appropriation of \$25,000 made a few years ago for the purpose of experimenting with the defective armor invented by Chief Engineer N. B. Clark, U. S. Navy. In the present case, however, it would be difficult to specify in detail just what amount would be needed for each individual experiment, and I would therefore recommend that an appropriation of \$25,000 be asked for to be expended in such manner as the Department may direct.

As there is a constantly increasing necessity for accurate instruments for use in the engineering department on board ship, such as steam indicators, steam, vacuum, and air-pressure gauges, high and low grade thermometers, pyrometers, speed indicators, barometers, anemometers, etc., and as there is but little reliability in such instruments as at present supplied, I would recommend the establishment at the Department or at the New York navy-yard of an instrument depot under the charge of this Bureau. An engineer should be detailed for this special work, so that about the only extra expense would be the wages of a skilled instrument-maker. This expense, however, would be but slight in proportion to the importance of the results, and would be partly balanced by the saving over the present cost of purchase and repair of instruments. In this way all instruments used by the Bureau would be standardized and kept in condition for immediate issue when required, with an assurance of their reliability.

The Bureau finds itself greatly embarrassed in the care of machinery of ships in commission by the way in which its instructions are frequently nullified by other authority. The issue of an order by a Bureau becomes farcical when there are no adequate means of enforcing its observance; it is much like the enactment of a law without an accompanying provision for a penalty for its infraction. Among other abuses of this kind I may mention the case of an order of the Bureau, of long standing, that boilers must not be filled with water for trimming ship; also an order limiting the minimum time in which steam should be raised. There are but few ships in commission to-day on board of which one or both of these instructions is not at some time or other deliberately disregarded and the lives of the boilers thereby shortened. I would suggest, as an aid in remedying this state of affairs, that military traditions and customs be so far set aside as to require the Chief Engineer of each ship, whenever he is ordered to disobey the instructions of the Department, to immediately make a special report of the same direct to the Bureau, at the same time giving a copy of the report to his commanding officer, so that if an emergency existed which would justify the overstepping of the limits of his instructions, he may be enabled to explain it to the Department. I would also recommend that this Bureau be allowed to communicate directly, in all technical matters, with its representatives on board ship, thus insuring a much more satisfactory knowledge of the state of affairs than is now available at the Department.

I would recommend that hereafter, when proposals are invited for building ships and machinery, the intending bidders who wish to furnish machinery of their own design, be furnished in advance with general specifications to which they must conform. This would not in the least confine them in their choice of type or dimensions, but would put all bidders on an equal footing by specifying what degree of workmanship, quality of material, and special conveniences would be required. When the only requirement is a certain maximum performance of speed or power, a great many details necessary to economy, durability, accessibility, convenience of repair, and ease of handling with a small number of men—so necessary in naval vessels—may be omitted. As each contractor is naturally anxious to make the lowest bid, he of course leaves out all that he can without endangering the success of the contract trial, thereby cutting the price down to a minimum. In such cases, it is found that there is always more or less difficulty between the Department and the contractors in finally agreeing upon what shall be included in the contract. As such agreements must be, to a great extent, matters of compromise, much is left undone which must be made good after the vessel is accepted by the Government; while, as it is often necessary to make considerable additions to the contractors' plans before they can be accepted, justice is no more done to the contractors than to the Government.

I would recommend that hereafter when vessels are lying in ordinary at the navy-yards at Portsmouth, New York, Norfolk, or Mare Island, an engineer be ordered to each yard for the special duty of taking care of their machinery. Each vessel should have from two to six enlisted firemen, according to the amount of machinery, detailed under the control of the engineer, to keep the machinery in working order, instead of laying it up as at present. It would be found that the cost of keeping the machinery in condition for use in this way would be less than overhauling and getting it ready for sea after being laid up for a time, as at present in vogue.

I would recommend that, for the six tugs which the Chief Constructor recommends to be built, engines of simple pattern but of the most recent type be constructed. Such machinery will cost at least twice as much as the low class of machinery usually put into tugs. The high-priced machinery will, however, in the long run be more economical and in every way satisfactory. Each tug should be fitted with a powerful fire-pump and with a pump of large capacity for wrecking purposes.

The only armored vessels that we now possess in a state of completion are the old single-turret monitors. They are, to be sure, of antiquated type, but would have to be depended upon in case of a declaration of war before other coast-defense vessels are built. They are slow; but for a small outlay could be given fair speed by fitting the boilers with forced draft applied directly to the ash-pits, and substituting surface for jet condensers on such vessels as are fitted with the latter. These changes could be made for \$5,000 on each of the five vessels now having surface condensers, and for \$10,000 on each of the eight others; provided, however, that the work could be concentrated at one navy-yard, as the reduplication of the additional machinery would tend to economy. Two of these monitors need new boilers, which would cost \$40,000 for each vessel. If we were possessed of other vessels for coast defense, I would not recommend spending a dollar on any of these old craft; but, under the circumstances, to add to our security until better vessels can be built and equipped, I would recommend that the above-mentioned changes be made, and that a sum of \$185,000 be appropriated for this purpose.

NAVY-YARDS.

The work of the Bureau in the navy-yards during the past year has consisted principally in repairs to existing machinery of naval vessels and putting in boilers already built. The shops of the New York and Norfolk yards are now being put in readiness for building two new armored vessels, a cruiser on the Department's plans at the former place and a battle-ship on the plans of the Barrow Shipbuilding Company at the latter. The equipment of the engineering departments at the navy-yards is, with the exception of a few machines required at Norfolk, sufficient to build these or larger engines, some of the largest naval engines ever built being constructed at the yards more than twenty years ago, with the existing plant. The shop machinery is, however, the worse for wear, and is not up to modern requirements in the matters of rapidity of work and economy of production. In order to be prepared for any emergency, when machinery would have to be built rapidly in large quantities, additions of modern tools should be made. The greatest lack at the navy-yards in the way of modern machinery is in boiler-making plant, capable of dealing rapidly and efficiently with the thick steel boiler-plates made necessary by the introduction of the high steam pressures now carried. I would recommend the immediate addition to the plants at New York, Norfolk, and Mare Island of complete hydraulic boiler-making outfits capable of dealing with the heaviest plates. The larger machines at the Boston yard in the former steam-engineering shops, including some of the largest of their kind in the country, are of no use for equipment purposes, as that Bureau has no work to do of the class for which these machines were intended. I would therefore recommend that a sufficient number of men be employed under the direction of the chief engineer of that yard to keep such machinery in working order, so that if, in case of emergency, it should be found advisable to again use the yard for general purposes the machine tools could be put in use at short notice.

One of the greatest difficulties in the way of making machinery as light as desirable is the uncertainty as to the strength of the various parts. By testing small specimens of various materials we are enabled to tell approximately what will be the strength of the structure into which these materials enter, provided that all parts are equal to the sample. But there is a possibility of hidden flaws and imperfections of workmanship, as well as inequalities in the composition of the material, which must be provided for. This is done by using a "factor of safety;" in other words, by making the structure heavier than necessary. If a designer were sure that all parts of his engine would be tested by the application of a greater stress than would ever be put upon them in actual practice, he would cut down his "factor of safety" to barely enough to cover the test strain, and would consequently be able to get more powerful engines on a given weight. The necessity for thus testing, or rather proving, full-sized members is beginning to be recognized by engineers. The Union Bridge Company, for instance, has just built a testing machine capable of exerting a stress of 600 tons, and of taking in bridge members 40 feet in length. It is, however, a comparatively cheap machine, being very simple in design, and not having the extreme delicacy of the Watertown machine, but is entirely sufficient for the purpose for which it was intended. A somewhat similar machine, with the addition of mechanism for testing shafts, both by torsion and bending, would be of the greatest use where very light machinery for naval vessels is built. All parts of machinery which could be so tested

would not only be proved beyond the working stress, but by measurements of change of form the probable ultimate strength would be determined, and all parts not up to the requirements would be rejected. Such a machine should be of sufficient power to not only prove the specimens, but, in the event of indication of weakness, test them to destruction to determine the cause of failure, and thus add to the stock of knowledge on such matters. The Union Bridge Company's machine, above referred to, is built with this object in view, eye-bars of about 16 square-inches in cross-section having been tested to rupture. I consider the plant of each navy-yard incomplete without a machine of this kind, and would recommend that one be immediately built for the New York yard, of a sufficient capacity to prove all piston-rods, connecting-rods, columns, and tie-rods used in engine frames, and shafting of large sizes. I have no doubt that this machine would prove so useful that we would before long have one in each yard.

I would recommend that, for the purpose of facilitating the transaction of business, this Bureau be authorized to communicate directly with its representatives at the navy-yards in regard to all details of work being carried on, and on all matters of technical information, a press copy of such communications being sent in all cases to the commandant of the navy-yard, as a matter of record, instead of the original communication going to him for the formality of his signature. The Bureau is often embarrassed by the delay thus caused, communications being seldom delayed less than one day, and often longer under the present system. There is too much of the military principle at our yards to enable them, as manufacturing concerns, to carry on their business with proper economy or dispatch.

I would call attention to the inapplicability of all our navy-yards to the proper handling of material. We have not a single yard where a vessel can be hauled into a slip in front of the shops to have her boilers and engines put in, then moved along to a convenient place to receive her battery, and finally passed on to the fitting-out wharf, still being at all times convenient to all these places, so that the lighter work may be done without traveling long distances. At the New York yard, for instance, the absurdity exists of the steam engineering department, with the heaviest weights, except perhaps those of ordnance, to handle, being situated in the building farthest from the point where ships lie when overhauling, while the store-houses, with only packages to handle, are close aboard. Of course this state of things could only be remedied now at enormous expense, but a great deal could be done to facilitate the handling of material with the work distributed as at present. The present facilities would be found entirely inadequate in time of war, and would have to be supplemented by railway tracks and equipment for handling heavy weights.

The steam-generating plant in all our navy-yards is very defective and uneconomical. Each Bureau has its own boilers, frequently several in different places. This requires a large original outlay, a great cost of repair and renewal, a large number of men for firing the boilers, and is wasteful of fuel. I would recommend, therefore, that no further additions or renewals of the present steam-generating plant be made at any navy-yard, but that at each yard a central boiler station be begun, and the plant be added to as the old boilers wear out. The central station would be connected, with all places where steam is required for power or heating, by underground pipes. This is in accordance with the most recent practice of engineers having charge of large manufacturing establishments. Not only would the running expense be greatly reduced,

but the cost of repairs would be much less than at present, the work of boiler inspection facilitated, and the danger from fire diminished. I would recommend that \$20,000 be appropriated to begin such a change at the New York yard, with like sums for the Portsmouth, Norfolk, and Mare Island yards.

A synopsis of the principal work done at the various navy-yards, together with an account of the expenditures at each yard, other than for work done on naval vessels, will be found below. A list of the additional machine tools recommended for the various yards is also given, with an estimate of cost.

NEW YORK NAVY-YARD.

At this yard during the last fiscal year the machinery of the *Enterprize*, *Nipsic*, *Essex*, and *Thetis* was thoroughly overhauled. The overhauling of the machinery of the *Richmond* was completed and work in the way of preservation, overhauling, and repairs was done on the machinery of the *Alarm*, *Alliance*, *Atlanta*, *Brooklyn*, *Boston*, *Cohasset*, *Catalpa*, *Despatch*, *Dolphin*, *Essex*, *Enterprise*, *Galena*, *Intrepid*, *Juniata*, *Leyden*, *Miantonomoh*, *Minnesota*, *Nantucket*, *Pensacola*, *Svatara*, *Tennessee*, *Trenton*, *Ticonderoga*, and *Vandalia*. The machinery of the *Powhatan* was dismantled preparatory to her sale. Work was done on the outfit of the *Chicago*. A number of steam launches were overhauled and repaired.

The work done for the other Bureaus was, briefly, as follows:

Ordnance.—Steam fittings of dynamos and gun-training engines of the *Boston*; covering steam-pipes of training engines of the *Atlanta*, mounting the guns of the *Atlanta* with the floating derrick.

Yards and Docks.—Made patterns and cast dry-dock derrick; connected new dry-dock boiler with engine; repaired and retubed several boilers; made small castings.

Navigation.—Repaired sounding machines and made various articles used in connection with same.

Equipment and Recruiting.—Made boilers, pipes, and other fittings for ship's galleys; made various small articles of outfits; slight repairs to derrick; repaired *Nipsic's* rudder chains; repaired boiler.

Medicine and Surgery.—Made alterations in boiler and heating apparatus.

Provisions and Clothing.—Repairs to engines and boilers.

Construction and Repair.—Made various articles of composition and cast-iron, such as stanchions, fife-rails, belaying-pins, cleats, chain-pipes, valves, bells, deck-light covers, sheaves, journal-boxes, rudder heads, ash-chutes, manhole plates, boat fittings, etc.; made white-metal washstand tops; repaired shop boilers; used floating derrick for fitting masts, hoisting boats, and for various purposes.

The following machine tools were added to the Bureau's shops during the year: One horizontal boring mill, 2 emery wheels for grinding tools, 1 universal milling machine, 1 universal grinder, 1 lathe of 18-inches swing and 6 feet bed, 1 upright boiler rolls, 1 plate-planing machine, 1 rod-turning machine, 1 radial drill press, 1 knife grinder, 1 carving and molding machine, reamers, cutters twist drills, taps, dies, and miscellaneous small tools for general purposes.

The cranes in the foundry were taken apart, and repaired where needed; repairs were also made on various lathes, planers, slotters, shapers, and other tools.

I would renew the recommendation which has been made in several previous reports, that a new boiler shop be built at this yard, as the building now used for that purpose is entirely too small and not adapted to the work. I would recommend that an appropriation be asked for to purchase the following tools, in order to put the shops in condition to handle work more rapidly and with greater economy than at present. The prices noted are the list prices of the best makers, except those for the bending press and the testing machine, which are estimated :

One vertical boring, turning, and facing machine	\$18,000
One screw-cutting lathe, 72-inch swing, 50 feet centers	7,000
One surface-grinding machine	800
One tool grinder	300
One shaft straightening machine	800
Four lathes, 20-inch swing	3,200
Four lathes, 30-inch swing	6,400
One hydraulic riveting machine	6,200
One hydraulic flanging machine	5,500
One overhead crane for riveting machine	4,350
One accumulator	1,600
One special duplex hydraulic pressure pump	900
One overhead traveling crane	10,000
One 600-ton proving and testing machine	30,000
One hydraulic bending press for heavy boiler-plates	10,000
Cost of setting the above machines, foundations, pipes, belting, etc	20,000
Total	125,130

The expenditures of the Bureau at this yard, other than those for work done on the machinery of naval vessels, are as follows:

Civil establishment, clerks	\$6,073.69
Office expenses	560.15
Handling stores, writers, receivers, etc	6,153.10
Care and repair of, and additions to, shop tools	36,159.62
Running and firing yard engines and boilers and repairs to same	3,885.31
Repairs and maintenance of yard steam launches and ferry	1,262.87
Repairs to old derrick	1,259.90
Work on new derrick	2,874.21
Preservation of boilers and machinery	6,256.51
Machinery and stores shipped to other stations	17,096.36
Experimental purposes, testing shafts of new cruisers, etc	5,773.14
Handling coal and lumber	810.12
Draughting material	116.46
Surveys	477.71
Transporting stores in changing store-house	647.70
Breaking up old material	483.92
Repairing stores	161.45
Taking stock, weighing, etc	266.95
Incidental expenses	2,106.09
Holidays	3,586.98
Miscellaneous	3,948.25
Total	99,960.44

PORTSMOUTH NAVY-YARD.

During the year the old boilers were taken out of the *Swatara* and new ones put in. Work was begun on a thorough overhauling and repairing of the engines. The old engines and boilers of the *Kearsarge* were taken out, preliminary work done towards putting in new boilers and the old engines of the *Nantasket*. Repairs were made on the *Galena*, *Yantic*, and *Leyden*; also on several steam-launches.

Work was done for other Bureaus as follows:

Yards and Docks.—Hydrant and pipe work; fittings for steam fire engine; repairs to engine house boiler; gas retorts: pipe fittings.

Equipment and Recruiting.—Put up new boiler for heating rigging loft; repaired rudder chains for *Galena*; made turnbuckles and other fittings for rigging.

Construction and Repair.—Made castings for air ports; also miscellaneous castings.

Navigation.—Repaired binnacle, lamps, oil cans, etc.

The following tools are recommended to be added to the plant:

One turret-head bolt-cutting machine	\$380
One horizontal nut tapper.....	365
One magnetic metal separator	135
Eighteen assorted lathe chucks.....	380
One band saw	225
One wood turning lathe.....	250
Total	1,735

The expenditures at this yard for the year, other than those for work done on naval vessels, are as follows:

Civil establishment, clerks.....	\$2,300.00
Civil establishment, draughtsmen, messengers, etc.....	1,286.95
Office expenses.....	292.62
Handling stores.....	2,213.33
Care and repair of shop machinery and additions to same	14,672.62
Running, firing and repairing yard engines and boilers.....	3,219.54
Care and repair of boilers and machinery of yard steam launches.....	774.18
Stores for issue, and care of same	573.09
Steam boilers and machinery for launches for general service.....	2,377.53
Holidays	1,121.65
Miscellaneous.....	1,830.32
Total	30,661.83

NORFOLK NAVY-YARD.

During the last fiscal year the machinery of the *Trenton* was thoroughly overhauled and repaired, and that of the *Ossipee* and *Dolphin* extensively repaired. Minor repairs were made on the machinery of the *Ajax*, *Alliance*, *Constellation* (launch), *Despatch*, *Fortune*, *Franklin*, *Galena*, *Jamestown* (distiller), *Lancaster* (launch), *Mayflower*, *Michigan* (launch), *Mahopac*, *Manhattan*, *Richmond*, *Speedwell*, *Thetis*, *Triana* (launch), and *Yantic*.

At this yard all new boilers and engines for steam launches on the Atlantic coast, except such as are procured by contract, are built.

The work done for other Bureaus was briefly as follows:

Ordnance.—Repairing gun-carriages and fittings for the *Dolphin*; repairing gun carriages and overhauling three-cylinder Brotherhood engine for search-light plant of the *Trenton*; repairing gun-carriage fittings for the *Yantic*.

Navigation.—Overhauling and repairing engines for dynamos of incandescent-light plant of the *Trenton*.

Equipment and Recruiting.—Repairing galley of the *Trenton* and minor repairs.

Construction and Repair.—Miscellaneous iron castings for marine railway and ship-fitting shop, and fittings for shop boilers.

Yards and Docks.—Repairs to dry-dock boilers.

The following machinery was added to the shop plant during the year: 1 milling machine, 1 vertical drill, 1 pipe-cutting machine, 1 surface-grinding machine, 1 universal grinding machine, 1 pipe-threading machine, 1 vertical boring and milling machine, 1 plate planer, 1

riveting machine, 1 steam hammer and crane, 1 forge and blower, 1 bandsaw sharpener.

Additions are needed to the boiler-shop and machine-shop; the latter addition to be used as an erecting shop. The least expensive way of doing this, and which I would recommend, is the building of a corrugated iron roof on steel trusses spanning the space between the machine and boiler shops and resting on the present walls; this, with the addition of end walls, could be done at a small expense.

The following tools should be added to this plant to facilitate rapid and economical work:

Two drilling machines.....	\$660
Two emery tool grinders	590
One trueing tool for emery wheels.....	35
One vertical bending rolls, heavy	4,500
One hydraulic riveting machine.....	6,200
One hydraulic flanging machine.....	5,500
One hydraulic plate-bending machine	10,000
One hydraulic overhead crane for riveting machine	4,350
One hydraulic accumulator	1,600
One pressure pump	900
One overhead traveling crane	10,000
Cost of setting the above machines, foundations, pipes, etc.....	15,000
Total.....	59,415

The expenditures of the Bureau at this yard, other than for repairs to machinery of naval vessels, are as follows:

Civil establishment, clerks	\$5,292.85
Draughting.....	191.09
Writers, messengers, receivers, etc	603.98
Handling stores.....	6,461.91
Superintendence of shops	1,253.10
Care and repair of shop tools and additions to same.....	19,185.64
Running and firing yard engines and boilers	4,650.12
Repairs to yard engines and boilers and additions to same	2,614.36
Care and repair of machinery of yard steam launches.....	1,941.35
Moving and handling machinery	314.28
Preservation of machinery	112.05
Melting down old material.....	27.84
Building and repairing steam-launch machinery for general service	5,952.77
Holidays	2,642.89
Miscellaneous.....	8,673.02
Total.....	59,907.25

MARE ISLAND NAVY-YARD.

During the last fiscal year the machinery and boilers of the *Alert* and *Ranger* were thoroughly overhauled and put in perfect condition. Repairs to the engines and work on new boilers for the *Hartford* was commenced, but was suspended when it was found that the repairs to the hull would probably exceed the legal limit.

Slight repairs were made on the *Camanche*, *Pinta*, *Monterey*, and *Nellie*. The principal work done for other Bureaus was the construction of a 100-ton steel crane for the Bureau of Yards and Docks. Various minor jobs were done for the same and other Bureaus. A compound condensing engine and boiler with forced draught were made for the surveying launch *Cosmos* for the Coast Survey.

A number of new tools were added to the plant, the principal ones being as follows: One horizontal boring mill; one slotting machine; one bolt-cutting machine; six engine lathes; two drilling machines.

A small steam hammer which was on hand has been erected. Work on the rolling-mill machinery has proceeded as opportunity offered. A railroad track with turn-table has been constructed to facilitate the transportation of large castings from the foundery to the tools in the machine-shop.

A new building is badly needed for the rolling-mill machinery, which is now nearing completion. This machinery will be very useful in working up, at little expense, the scrap material, which is now as good as wasted.

No new tools are needed at present in the machine-shop, but a hydraulic boiler-making plant should be procured for the purpose of making heavy steel boilers, for which the following is an estimate:

Hydraulic riveting machine	\$6,200
Hydraulic flanging machine	5,500
Overhead crane for riveting machine	4,350
Accumulator	1,600
Special duplex hydraulic pressure pump	980
Hydraulic bending press	10,000
Freight and handling of the above, foundations, setting, etc.	8,000
Total	36,630

The expenditures for the year, exclusive of those charged to vessels, are as follows:

Civil establishment, clerks	\$2,601.59
Draughting	1,372.60
Office expenses, writers, messengers, etc., including writer at store-house ..	2,411.96
Handling stores	1,578.84
Care and repair of shop tools	15,478.72
Running and firing yard engines and boilers	5,534.95
Care and repair of yard steam launches, boilers, and engines	943.24
Purchase of stores for issue	3,274.27
Fitting up launch boilers for general service	560.47
Repairing launch engines for general service	620.79
Fitting up rolling-mill machinery	6,146.16
Turn-table and railroad track	676.91
New tools in shops	29,892.16
Holidays	1,352.80
Miscellaneous	21,799.44
Total	94,253.90

BOSTON NAVY-YARD.

This yard having been turned over to the Bureau of Equipment and Recruiting, but little work has been done there during the year other than care and repair of machinery and moving stores and material.

The expenditures during the year have been as follows:

Civil establishment, clerks	\$1,108.46
Office and store-house expenses, handling stores, etc	1,895.29
Value of tools, appliances, and machinery, transferred to the Bureau of Equipment and Recruiting	94,111.45
Care and repair of shop machinery	3,919.61
Running and firing yard engine and boilers, with repairs to same	655.34
Repairs to engines and boilers of yard steam launches	28.45
Total	101,718.60

LEAGUE ISLAND NAVY-YARD.

This yard not being at present used for general naval purposes, no work has been done on vessels, with the exception of such as is necessary to the preservation of the machinery of the armored vessels laid up there.

The expenditures for the year, other than those for work done on naval vessels, are as follows :

Civil establishment, clerks	\$1, 108. 48
Office expenses, draughting, and handling stores	2, 019. 95
Care and repair of shop machinery	1, 269. 27
Value of stores transferred to other stations, and to other Bureaus	3, 742. 66
Miscellaneous	105. 10
Total	8, 245. 46

WASHINGTON NAVY-YARD.

This yard having been transferred to the Bureau of Ordnance, but little work was done there during the past year by the Bureau, other than slight repairs, building of steam-launch machinery, and preparing stores and machinery for shipment to other yards.

The expenditures during the year, other than those for work done on naval vessels, are as follows :

Civil establishment, clerks	\$1, 776. 50
Office expenses, draughting, messengers, etc	703. 63
Superintendence of shops	507. 50
Care and repair of tools and machinery in shops	981. 18
Running and firing yard engines and boilers, with repairs to same	701. 90
Repairs to engines and boilers of yard steam launches	167. 91
Working up scrap-iron, manufacturing bar-iron, etc.	1, 785. 83
Machinery for steam launches for general service	7, 699. 78
Experimental work, testing, etc	3, 921. 36
Blue printing designs for new cruisers	1, 405. 49
Taking inventory of stores, handling stores and material, and shipping the same to other stations	9, 478. 05
Holidays	418. 41
Miscellaneous	1, 121. 26
Total	30, 668. 00

PENSACOLA NAVY-YARD.

No work has been done at this yard during the year on machinery of naval vessels. The work of the Bureau has consisted principally in the care and preservation of the shop plant.

The expenditures were as follows :

Civil establishment, writer	\$915. 05
Office expenses	237. 43
Handling stores	534. 18
Care and repair of shop machinery	1, 514. 97
Running, firing, and repairing yard engines and boilers	467. 23
Care and repair of boilers and machinery of yard steam launches	1, 139. 18
Miscellaneous	1, 482. 82
Total	6, 283. 06

NAVAL STATION, NEW LONDON, CONN.

No work was done by the Bureau at this station except for the care and repair of the steam launches in use at the station.

The expenditures for this and for stores and outfit for the launches and for miscellaneous purposes amounted to \$1,111.12½.

NAVAL STATION, KEY WEST, FLA.

No work was done by the Bureau at this station except in the care and repair of the machinery in the shop and the shipment of stores.

The expenditures were as follows :

Care and superintendence of machine-shop	\$1,713.50
Repairs of machinery and miscellaneous expenses.....	31.43½
Shipment of stores.....	26.95
Total.....	1,771.18½

WORK DONE ON THE MACHINERY OF NAVAL VESSELS:

The following shows, briefly, the character and amount of work done on the machinery of all vessels, whether in commission, laid up for repairs, or in ordinary, during the fiscal year ending June 30, 1887. The cost of the work, together with that of stores and outfits, will be found in the succeeding tabular statement :

Adams.—Repairs incident to continuous service. All repairs, with two slight exceptions, made by the engineer's force on board.

The greater part of the repairs was made to the steam-launch machinery. Ship in continuous commission.

Ajax.—Preservation of machinery.

Alarm.—Preservation of machinery.

Alert.—Thorough overhauling of and repairs to engines and boilers. The valve faces and cylinders were turned up, condenser tubes cleaned and retinned, engines aligned, new pipes and boiler tubes and a new steam pump put in, and minor repairs made. The work was done at the Mare Island navy-yard. Minor repairs were also made by the force on board. Ship in continuous commission.

Alliance.—Alterations to boilers and steam drums; new cut-off valve; ventilating screens fitted in fire-rooms; alterations in forced-draft details; repairs incident to service. The work was done at the New York navy-yard. Ship in continuous commission.

Atlanta.—Feed tank cut down and position of feed pump changed; a Stratton separator put in; telescopic oiling gear fitted and a new pattern of cylinder relief valves put in; minor changes and repairs. The work was done at the New York navy-yard.

Boston.—A Stratton separator put in; telescopic oiling gear fitted and new cylinder relief valves put in; valve motions readjusted and crank-shaft bearings refitted; connections made to dynamo engines; minor repairs. The work was done at the New York navy-yard.

Brooklyn.—Auxiliary boiler put in; alterations to boiler bracing; minor repairs. The work was done at the New York navy-yard. The boilers were scaled by the force on board; repairs to pumps and boilers were made by outside parties. Ship in continuous service.

Catalpa.—Engines and boilers thoroughly overhauled at the New York navy-yard.

Chicago.—Making outfit and stores at the New York navy-yard.

Cohasset.—New grate bars; minor repairs.

Despatch.—Engine overhauled and boilers repaired. Steam-launch machinery generally overhauled and repaired. Ventilators, piston springs, crank-pin braces, cross-head and link braces, lignum-vitæ in stern bearing, keys in propeller, and holding-down bolts, all new, were made. Minor repairs. The work was done at the New York navy-yard. Main valve-stem repaired, new Herreshoff boiler fitted in steam launch, and minor repairs by force on board.

Dolphin.—Old steering engine removed and new one put in, and boilers repaired at the Norfolk and New York navy-yards.

Enterprise.—Thoroughly overhauled. Engines aligned, condenser cleaned, stern bearing refitted, boilers and pipes repaired. New drain traps and connections; a new feed tank put in. The work was done at the New York navy-yard.

Essex.—Boilers calked and patched and minor repairs made by the force on board. One boiler retubed by force from shore. Ship in continuous commission.

Fortune.—Minor repairs incident to service.

Franklin.—Preservation of machinery.

Galena.—Boilers retubed, patched, and overhauled generally, and new felt covering put on. Main bearings of engines refitted and small repairs made to main and auxiliary engines. The work was done at the Portsmouth navy-yard. Minor repairs were made by the engineer's force on board. Ship in continuous commission.

Hartford.—Numerous repairs to boilers, steam-launch machinery thoroughly overhauled, and minor repairs to main engines by engineer's force on board. After going out of commission, work was begun on repairs at the Mare Island navy-yard, but subsequently discontinued.

Intrepid.—Preservation of machinery.

Iroquois.—Tubes in all boilers expanded, pistons lined up, and minor repairs to engines, boilers, distillers, and launch machinery, all done by the force on board. Ship in continuous commission.

Jamestown.—Repairs to distiller.

Jason.—Preservation of machinery.

Junata.—Steam connections made from auxiliary boiler to capstan, steam-pipes repaired, condenser repacked, and minor repairs. The work was done at the New York navy-yard. Boilers patched and otherwise repaired by the engineer's force on board. Ship in continuous commission.

Kearsarge.—Engines and boilers removed from the ship, preparatory to putting in a pair of engines taken out of the *Nantasket*. New boilers in readiness to be put in. Repairing at the Portsmouth navy-yard.

Lancaster.—Extensive repairs to boilers and launch machinery, and minor repairs to engines made by the engineer's force on board. Parts of auxiliary pumps repaired on shore. Ship in continuous commission.

Leyden.—New safety-valves on boilers. Sea-valves repaired. Repairs to engine and boilers incident to continuous service. The work was done at the Portsmouth navy-yard.

Marion.—Small repairs to engines and boilers by the force on board. Repairs to cross-head slide and steam-chests were made by parties on shore. Ship in continuous commission.

Mayflower.—Repairs incident to service were made at the Norfolk navy-yard.

Miantonomoh.—Repairs and preservation of machinery.

Michigan.—Engines thoroughly overhauled and repaired, and repairs to steam launch. All work was done by the engineer's force on board, with the exception of small work sent from navy-yards.

Minnesota.—New grate-bars. Repairs to boilers. Steam launch repaired. The work was done at the New York navy-yard.

Mohican.—Boilers patched, tubes expanded and minor repairs; leaks in valve-chests repaired; steam-launch machinery thoroughly overhauled, and minor repairs made by the engineer's force on board. Clutch-coupling and one check-valve repaired on shore. Ship in continuous commission.

Monocacy.—Ordinary repairs executed by the force on board. Air-pump rebored and piston refitted by parties on shore. Ship in continuous commission.

Montauk.—Preservation of machinery.

Monterey.—New crank-shaft; broken cylinder repaired, and minor work done at the Mare Island navy-yard.

Nahant.—Preservation of machinery.

Nantucket.—Preservation of machinery.

Nellie.—Engines and boilers thoroughly overhauled at the Mare Island navy-yard.

Nipsic.—Thoroughly overhauled. Engines lined up; new drain traps and connections; new feed tank, spare crank-shaft and crank-pin brasses made, and a new crank-shaft put in. All work was done at the New York navy-yard.

Nina.—Slight repairs incident to continuous service.

Omaha.—Extensive repairs to auxiliary and launch boilers, repairs to engine cross-heads, and minor repairs made by the engineer's force on board. Slight repairs to launch engine were made on shore. Ship in continuous commission.

Ossipee.—General overhauling of engines and boilers; new boiler-tubes and new socket-bolts put in; furnace-sheets refitted and riveted; pistons removed and fitted with new packing-rings; links refitted; engines aligned; clutch-coupling repaired; all pumps put in order; new portions of pipes put in; main injection-valve repaired; distilling apparatus overhauled; capstan engines repaired; main bearings overhauled; condenser tubes cleaned, and minor repairs. The work was done at the Norfolk navy-yard.

Passaic.—Slight repairs made by the engineer's force at the Naval Academy.

Patos.—Extensive repairs to boilers; new tubes; boilers scaled; general overhauling and lining up of engines; new stays to tube-sheets, and minor repairs made by the engineer's force on board. Crank-shaft and clutch-coupling overhauled; valve-gear repaired; main feed-pump and outboard-valves repaired, and boiler-tubes brazed by workmen from shore. Ship in continuous commission.

Pinta.—Repairs to main feed-pipes and minor repairs to engines; new socket-bolts in boilers; steam-launch machinery thoroughly overhauled, and new feed-water heater fitted in the steam-launch by the engineer's force on board. Ship in continuous commission.

Pensacola.—Extensive repairs to boilers, cross-head and crank-pin brasses refitted; smoke-pipes strengthened; new oiling apparatus fitted to cranks; main-valve equilibrium-rings refitted; minor repairs to engines, and steam-launch machinery thoroughly overhauled; all by the engineer's force on board. Ship in continuous commission.

Phlox.—Repairs incident to continuous service. The work was done by the engineer's force at the Naval Academy.

- Portsmouth.*—Slight repairs to sea-valves.
- Powhatan.*—Dismantled machinery preparatory to selling.
- Puritan.*—Preservation of machinery.
- Quinnebaug.*—New packing-rings fitted to high-pressure valve; new seats to cylinder relief-valves; distiller thoroughly overhauled and new connections made by the engineer's force on board. Extensive repairs to back connections of boilers; boilers patched; two boilers scaled; main valve-gear overhauled; feed and blow pipes repaired; all by workmen from shore. Ship in continuous commission.
- Ranger.*—General repairs to engines and boilers at the Mare Island navy-yard. Minor repairs to engines and boilers by the engineer's force on board. Slight repairs were made on shore for which facilities did not exist on board.
- Rescue.*—Repairs incident to service.
- Richmond.*—Engines thoroughly overhauled; smoke-pipe hoisting-gear remodeled; new fire-room floor; new feed and blow pipes; steam capstan put in and connected; new distiller, and new crank-shaft put in at the New York navy-yard. Minor repairs to engines, boilers, and steam-launch machinery made by the engineer's force on board.
- Rocket.*—Slight repairs incident to continuous service.
- Speedwell.*—Slight repairs and preservation of machinery.
- Standish.*—Repairs made by the engineer's force at the Naval Academy.
- Suatarra.*—Engines generally overhauled and aligned; new crank-shaft put in; new main brasses fitted; piston-rods trued and fitted with new metallic packing; main valves refitted; new outboard delivery-valve put in; new tube-sheets fitted in condenser; area of old propeller reduced; the old boilers, 10 in number, removed and 6 new ones put in; new boiler-saddles; a Stratton separator fitted in main steam-pipe; new uptakes and air-ducts fitted for forced draft. Minor repairs made to main and auxiliary machinery. Steam-launch machinery overhauled. The work was done at the Portsmouth navy-yard.
- Tallapoosa.*—Boilers patched and minor repairs made to main and auxiliary engines by the engineer's force on board.
- Tennessee.*—New boiler for steam launch; preservation of and repairs to machinery.
- Thetia.*—Engines and boilers thoroughly overhauled; condenser cleaned; spare crank-pin brasses made; new seat for high-pressure valve; reversing-gear repaired; new steam windlass put in; ash-hoisting engine put in; speaking-tubes and bell-pulls put in, and minor repairs made. The work was done at the New York navy-yard.
- Trenton.*—Thorough overhauling of engines and boilers; extensive repairs to boilers; new boiler-tubes; new boiler-braces; new feed and blow pipes; new fire-room floors; condenser-tubes taken out, cleaned, and replaced; new condenser-tube packing; cylinders rebored; new cut-off valve-stem put in; centrifugal pumps extensively repaired; new feed-pump valves put in; extensive repairs to auxiliary pumps; new oiling gear fitted; new cross-tail and one new cross-head fitted; crank-pin and crank-shaft brasses overhauled and renewed; new piston packing put in; new steam-launch boiler put in, and numerous minor repairs. The work was done at the Norfolk navy-yard.
- Vandalia.*—Old crank-shaft removed and one taken from the *Plymouth* put in; injection-valve and steam-pipe altered; crank-shaft and crank-pin brasses fitted at the New York navy-yard. Holding-down bolts of boilers renewed, joints in main steam-pipes remade, new cross-head gibs fitted, and cylinder-head repaired by the engineer's force on board. Ship in continuous commission.
- Vermont.*—Repairs to ferry scow.
- Wabash.*—Preservation of machinery.
- Wyandotte.*—Preservation of machinery.
- Wyoming.*—Slight repairs made by the engineer's force at the Naval Academy.
- Yantic.*—Repairs to engines and boilers incident to continuous service and steam-launch machinery extensively repaired at the Portsmouth navy-yard. Continuous repairs to boilers made by the engineer's force on board. Ship in continuous commission.

Cost of work done under cognizance of this Bureau for fiscal year ending June 30, 1887, upon machinery, boilers, etc., with outfits, stores, etc., of naval vessels; and the expenditures for maintenance, etc., at the several navy-yards and stations.

Name.	Machinery, boilers, etc.	Outfits, stores, etc.	Total.
Adams	\$107.77	\$1,750.31	\$1,858.08
Ajax		1,198.54	1,198.54
Alarm	558.88		558.88
Alert	12,646.31	6,845.82	19,492.13
Alliance	7,639.11	5,456.51	13,095.62
Atlanta	23,191.45	12,886.98	36,078.43
Boston	23,326.22	2,530.28	25,856.50
Brooklyn	10,268.50	2,640.80	12,909.30
Campanche	72.96		72.96
Catalpa	417.44	176.04	593.48
Chicago	1,080.78	564.50	1,645.28
Cohasset	33.25		33.25
Despatch	6,913.31	1,066.08	7,979.39
Dolphin	3,983.92	5,462.93	9,446.85
Enterprise	42,342.10	123.48	42,465.58
Essex	23,790.54	4,864.03	28,654.57
Fortune	933.32	1,781.57	2,714.89
Franklin	45.22	1,156.65	1,201.87
Galena	10,478.57	1,935.00	12,413.57
Hartford	6,914.74	487.38	7,402.12
Intrepid	91.48		91.48
Iroquois		2,264.23	2,264.23
Jamestown	1.98	71.97	73.95
Jason	747.28	49.40	796.68
Junia	376.33	2,787.58	3,163.91
Kearsarge	2,925.10	816.57	3,741.67
Lancaster	614.87	3,267.13	3,882.00
Leyden	734.42	69.30	803.72
Mahopac	33.20		33.20
Marion	1,343.66	1,070.10	2,413.76
Manhattan	33.21		33.21
Mayflower	1,591.24	299.19	1,890.43
Miantonomoh	900.99		900.99
Michigan	45.47	267.07	312.54
Minnesota	236.97	751.00	987.97
Mohican		2,127.81	2,127.81
Monocacy	184.83	414.39	599.22
Monongahela		184.80	184.80
Montauk	602.20	49.45	651.65
Monterey	1,442.01		1,442.01
Nahant	642.52	49.45	691.97
Nantucket	502.44		502.44
Nellis	688.10		688.10
New Hampshire	1.39	27.23	28.62
Nipsic	37,643.95	100.96	37,744.91
Nina	2,277.37	314.23	2,591.60
Omaha	122.61	1,214.31	1,436.92
Ossipee	23,484.11	3,008.81	26,492.92
Palos	380.74	1,620.22	2,000.96
Pinta	281.15	853.50	1,134.65
Pensacola	483.32	1,889.88	2,373.20
Phlox	62.02	174.41	236.43
Portsmouth	3.00	18.54	21.54
Pilgrim		11.90	11.90
Powhatan	891.46		891.46
Paritan	3,262.10		3,262.10
Quinnebang	4,232.88	5,938.29	10,171.17
Ranger	9,511.67	1,892.50	11,404.17
Rescue	7.42	38.07	45.49
Richmond	42,718.68	7,842.65	50,561.33
Rocket	71.17	127.28	198.45
Shenandoah	30.54	16.02	46.56
Speedwell	49.56		49.56
Standish	4.55	102.02	106.57
Swatara	33,170.08	800.20	33,970.28
Tallahposse	11.90	2,396.06	2,407.96
Tennessee	1,907.95	2,487.22	4,395.17
Thetis	18,063.00	5,355.53	23,418.53
Ticonderoga	353.28		353.28
Trenton	90,311.72	1,340.38	91,652.10
Triana	694.65		694.65
Vandalia	1,768.31	1,983.44	3,751.75
Vermont	225.23	717.83	943.06
Wabash	454.02	644.24	1,098.26
Wyoming	64.60	46.00	110.60
Yantic	2,624.99	1,930.36	4,555.35
Total	463,147.49	107,046.32	570,193.81

Expenditures at navy-yards and stations, not included in the amount expended on naval vessels.

Navy-yard, etc.	Amount.	Navy-yard, etc.	Amount.
Portsmouth, N. H.....	\$30,661.83	Mare Island, Cal.....	\$64,253.00
Boston, Mass.....	101,718.60	New London, Conn.....	1,111.12
Brooklyn, N. Y.....	99,960.44	Key West, Fla.....	1,771.18
League Island, Pa.....	8,245.46	Annapolis, Md.....	820.46
Washington, D. C.....	30,668.80		
Norfolk, Va.....	59,997.25	Total.....	435,407.10
Pensacola, Fla.....	6,288.06		

The details of these expenditures at navy-yards are given somewhat at length in the text of the report.

PRESENT CONDITION OF THE MACHINERY OF NAVAL VESSELS, WITH THE WORK REQUIRED ON EACH.

The following will show the present condition of the machinery of naval vessels and the work required to be done to fit them for efficient sea service, or to keep them on such duty during the next fiscal year, according to latest reports, with an approximate estimate of the cost of the same:

Adams (3d rate cruiser).—In commission on the Pacific station in good condition. Repairs incident to service, \$500.

Ajax (single-turret monitor).—In ordinary at City Point, Va. Engines in fair condition. Would need new boilers and overhauling of engines to prepare for sea service, at a cost of \$40,000.

Alarm (torpedo ram).—In ordinary at the New York navy-yard. Could be made ready for sea service for about \$1,800.

Alert (3d rate cruiser).—In commission on the Pacific station in good condition. Repairs incident to service, \$500.

Alliance (3d rate cruiser).—In commission on the South Atlantic station in good condition. Repairs incident to service, \$500.

Atlanta (2d rate, partially protected cruiser).—In commission on the North Atlantic station in good condition. Repairs incident to service, \$1,000.

Boston (2d rate, partially protected cruiser).—In commission on the North Atlantic station in good condition. Repairs incident to service, \$1,000.

Brooklyn (2d rate cruiser).—In commission on the Asiatic station. In good condition, except slight repairs to boilers needed, at a cost of \$1,000.

Camanche (single-turret monitor).—In ordinary at the Mare Island navy-yard. In good condition and could be made ready for about \$2,000.

Canonicus (single-turret monitor).—In ordinary at City Point, Va. Engines in fair condition. Would need new boilers and general overhauling of engines to prepare for sea service, at a cost of \$40,000.

Catalpa (tug).—In service at the New York navy-yard. Boilers and machinery in good condition, but old. Repairs incident to service, \$1,000.

Catskill (single-turret monitor).—In ordinary at City Point, Va., in good condition. Could be made ready for about \$2,000.

Colasset (tug).—In service at the training station, Newport. Machinery in fair condition, but defects in hull will probably not warrant any great expenditure. Repairs incident to service, \$2,000.

Dolphin (dispatch vessel).—In commission on the North Atlantic station in good condition. Repairs incident to service, \$2,500.

Despatch (dispatch vessel).—In commission on special service on the Atlantic coast. Boilers in fair condition. Engines in good condition, but badly out of line; they require to be taken out and rebudded. This and minor repairs at a cost of \$5,000.

Enterprise (3d rate cruiser).—Has just gone into commission at the New York navy-yard after thorough overhauling and repairs.

Essex (3d rate cruiser).—In commission on the Asiatic station. Engines in good condition. Will need new boilers at the end of the present cruise. Cost, including boilers now on hand for this class of vessel, \$50,000.

Fortune (tug).—In commission on special service along the Asiatic coast. Engines and boilers in fair condition. This vessel, being now in constant use, should have a surface condenser put in with new air and circulating pumps, at a cost of \$7,000.

Franklin (old type frigate).—Receiving ship at the Norfolk navy-yard. Boilers have been condemned. New boilers suitable for this vessel are on hand, but as the hull has so deteriorated since they were built it will not be advisable to put them in except in case of emergency. These boilers can be put into some other vessel requiring this type of boiler. A new boiler is needed for heating purposes. One on hand could be put in for less than \$1,000.

Galena (3d rate cruiser).—In commission on the North Atlantic station; has been in continuous commission since she was built and is a very serviceable vessel; requires general overhauling and repairs to engines, with new crank-shaft and new boilers, at a cost of \$65,000.

Hartford (2d rate cruiser).—At the Mare Island navy-yard. Engines require extensive repairs; new boilers needed; the material for these boilers is on hand and the boilers partly constructed. The material on hand is worth \$10,000. The additional cost to put vessel in condition for sea would be \$45,000. It has not yet been decided whether the vessel is to be repaired or not.

Intrepid (torpedo ram).—At the New York navy-yard. The boilers were taken out to permit of alterations to hull. It is doubtful if the hull will be launched again. At an expense of about \$25,000 the engines and boilers might be adapted to a light-draught river gunboat, such as is needed for Chinese waters.

Iroquois (3d rate cruiser).—In commission on the Pacific station. Repairs incident to service, \$2,000. The hull will probably not last long enough to warrant extensive repairs to the machinery should any defects not now known show themselves.

Jason (single-turret monitor).—In ordinary at the League Island navy-yard. In good condition. Machinery could be got ready in five days' time at a cost of \$2,000.

Juniata (3d rate cruiser).—In commission on the Pacific station. Crank-shaft slightly defective, but will probably last during the present cruise. Boilers need slight repairs. Minor repairs incident to continuous service, cost \$5,000.

Kearsarge (3d rate cruiser).—Repairing at the Portsmouth navy-yard. The old engines and boilers were useless and have been taken out. The engines taken out of the old *Nantasket* are being put in. Four boilers, which had become available by omitting two from the *Alliance* and two from the *Scatarata*, when forced draft was applied to these vessels, are being put in. Repairs will be completed during the present fiscal year with money now available. The total cost of these repairs will not exceed \$50,000.

Lancaster (2d rate cruiser).—In commission on the South Atlantic station. Engines need slight repairs. Boilers are in bad condition and will soon have to be replaced. Cost of repairs, including boilers now on hand, \$60,000.

Lehigh (single-turret monitor).—In ordinary at City Point, Va. In good condition. Machinery could be got ready for \$3,000.

Leyden (tug).—In service at the Portsmouth navy-yard. Machinery in fair condition. Repairs incident to service, \$1,500.

Mahopac (single-turret monitor).—In ordinary at City Point, Va. Machinery in good condition. Could be made ready for \$3,000.

Manhattan (single-turret monitor).—In ordinary at City Point, Va. Machinery in fair condition. Could be made ready for \$4,000.

Marion (3d rate cruiser).—On return from the Asiatic station, to take new crew at Panama and return to station. Machinery in good condition. Requires slight additions to valve-gear and repairs incident to service at a cost of \$2,500.

Mayflower (tug).—In use at the Norfolk navy-yard. In good condition. Repairs incident to service, \$1,500.

Michigan (4th rate paddle-wheel steamer).—In commission on the Great Lakes. Machinery in good condition. Repairs incident to service, \$2,000.

Miantonomoh (two-turret monitor).—At the New York navy-yard awaiting turrets. Machinery will require cleaning and adjusting before being in condition for sea service; the turret engines put in place and connected, and the heating apparatus put in order at a cost of \$3,000.

Minnesota (old-type frigate).—Receiving ship for boys at New York. Boilers are worn out. The condition of the hull will not warrant any outlay on the machinery.

Mohican (3d rate cruiser).—In commission on the Pacific station. Machinery in good condition. Repairs incident to service, \$500.

Monocacy (3d rate paddle-wheel steamer).—In commission on the Asiatic station on river service. Engines and boilers in good condition. Minor repairs needed, but condition of hull will probably not warrant any outlay on the machinery after the present year.

Montauk (single-turret monitor).—In ordinary at the League Island navy-yard. In good condition. Could be got ready for \$2,000.

Monterey (tug).—In service at the Mare Island navy-yard.

Nahant (single-turret monitor).—In ordinary at the League Island navy-yard. Machinery in good condition. Could be made ready in five days' time at a cost of \$2,000.

Nantucket (single-turret monitor).—In ordinary at the New York navy-yard. Machinery in good condition. Could be made ready for \$2,000.

Nellie (tug).—In service at the Mare Island navy-yard. Repairs incident to service, \$500.

Nipsic (3d rate cruiser).—Has been thoroughly overhauled and repaired at the New York navy-yard and has just gone into commission.

Nina (tug).—In service at the New York navy-yard. Repairs incident to service, \$1,000.

Omaha (2d rate cruiser).—In commission on the Asiatic station. Machinery in good condition, minor repairs only being needed. Repairs incident to service, \$5,000.

Ossipee (3d rate cruiser).—In commission on the North Atlantic station. Machinery has just been overhauled and repaired at the Norfolk navy-yard and is in good condition. Needs new set of crank-pin brasses and minor repairs incident to service, at a cost of \$5,000.

Palos (4th rate steamer for coast and river service).—In commission on the Asiatic station. Machinery and boilers have been put in a fair state of repair and are probably good for two more years of service. Repairs incident to service, \$2,000.

Pinta (similar to *Palos*).—In commission on the Pacific station. Machinery in fair condition. Repairs incident to service, \$2,000.

Passaic (single-turret monitor).—In service at the Naval Academy. Machinery is in sufficiently good order for present use, but should be overhauled if required for sea service. Cost, \$2,000.

Pensacola (2d rate cruiser).—In commission on the European station. Engines require extensive overhauling and repairs. Both smoke-pipes need renewing. Boilers weak and unreliable and require constant repairs. The steam-launch boiler will soon need extensive repairs. Estimated cost of repairs, including cost of boilers already built, \$75,000.

Quinnabaug (3d rate cruiser).—In commission on the European station. The boilers have been lately repaired and are good for one year more, but will not last longer. This ship has been kept in continuous commission ever since she was built, about ten years ago, and has not been properly overhauled since. More money has been spent in a patchwork sort of way than would have sufficed to give a thorough overhauling. Her machinery should be repaired at a navy-yard without delay, if the condition of the hull should warrant any outlay. Estimated cost of extensive repairs to engines, with new boilers, \$75,000.

Ranger (3d rate cruiser).—In commission on surveying service on the Pacific coast. The machinery has been lately overhauled and put in good condition. Repairs incident to service, \$500.

Rescue (tug).—In service at the Washington navy-yard. Machinery in fair condition. Should defects occur, it is doubtful if the condition of the hull will warrant any outlay for repairs. Repairs incident to service, \$500.

Richmond (2d rate cruiser).—In commission on the North Atlantic station. Has been lately overhauled and new boilers have been put in. Repairs incident to service, \$1,000.

Rocket (tug).—In service at the Boston navy-yard. Machinery in fair condition. Should defects occur, it is doubtful if the condition of the hull will warrant any outlay for repairs. Repairs incident to service, \$500.

Speedwell (tug).—In ordinary at the Norfolk navy-yard. Will need new boilers if the vessel is to be again put in service, but it is doubtful if the condition of the hull will warrant any great outlay. Estimated cost of repairs, \$20,000.

Standish (tug).—In service at the Naval Academy in good condition. Repairs incident to service, \$500.

Swarara (3d rate cruiser).—Repairing at the Portsmouth navy-yard. New boilers have been put in, with forced-draft appliances, and engines thoroughly overhauled. The repairs are nearly completed.

Tallapoosa (3d rate paddle-wheel steamer for river service).—In commission on the South Atlantic station; machinery in good condition; repairs incident to service, \$500.

Thetis (3d rate vessel for special service).—In commission for special service on the Pacific coast; main boilers and engines are in good condition, but a new auxiliary boiler is needed for distilling and heating; estimated cost, including repairs incident to service, \$5,000.

Trenton (2d rate cruiser).—In commission on special service; has been thoroughly overhauled and repaired, but needs a new cross-tail, the present one being temporary; a new cross-tail is forged and ready to be fitted; repairs incident to service, \$1,500.

Triana (tug).—In service at Newport; engines in good condition, but new boilers will soon be needed; cost, \$15,000.

Vandalia (2d rate cruiser).—In commission on the Pacific station; boilers are in good condition; feed-pump needs repairs, otherwise the engines are in good condition; the steam capstan needs overhauling and repairs; cost, \$2,000.

Wabash (old type frigate).—Receiving-ship at the Boston navy-yard; engines and boilers condemned; it will not pay to put in new machinery.

Wyoming (3d rate cruiser).—In service at the Naval Academy; needs slight repairs for present service at a cost of \$1,000.

Yantic (3d rate cruiser).—In commission on the North Atlantic station; a general overhauling of the machinery is necessary; boilers in very bad condition; repairs are being made at the Norfolk navy-yard, which will enable the boilers to last another year; cost, \$8,000.

MACHINERY OF VESSELS UNDER CONTRACT.

The state of the work done up to October 15 on the machinery of vessels building under contract is as follows:

Amphitrite (two-turret monitor).—Building at the works of the Harlan and Hollingworth Company, Wilmington, Del.; machinery nearly completed, only minor fittings remain to be done; will be ready for trial in a short time.

Terror (two-turret monitor).—Building at the works of the Wm. Cramp & Sons' Ship and Engine Building Company, Philadelphia, Pa.; machinery completed and awaiting trial. A board of naval engineers has been appointed to conduct the trial. It is necessary to make a dock trial instead of the one at sea, as required by the contract, as the vessel is not completed, and could not be specially fitted out for a trial trip except at large expense to the Government.

Chicago (partially protected cruiser).—Built by the Delaware River Iron Works. Machinery built from design of the Naval Advisory Board. The machinery is very nearly ready for trial.

Cruiser No. 2 (protected cruiser).—Machinery designed by Hawthorne & Co., Newcastle-on-Tyne; building at the Union Iron Works, San Francisco, Cal.

The high-pressure cylinders, with covers and liners, have been cast and nearly fitted. One low-pressure cylinder has been cast and the other molded. The valve-chest bonnets, man-hole covers, and piston-rod stuffing-boxes have been completed. The patterns for the cast-steel pistons and cross-heads are ready for the molds. The connecting-rods are nearly completed. The crank-shaft and crank-pin brasses have been lined with white metal, and are nearly completed. The steam and hydraulic cylinders of the reversing engine have been cast and bored and the smaller gear partially finished. The safety-valves and chests have been cast and faced. The crank-shaft pillow-blocks and bed-plates have been cast and faced and the caps of the main bearings fitted. The line-shaft bearings, thrust bearings, and stern-pipe stuffing-boxes have been cast. Bed-plates have been cast for erecting the engines upon in the shop. The air-pump trunks and valve-seats have been cast and finished. One main pumping-engine is ready for casting. The minor parts of these pumps are finished. The auxiliary bilge-pumps are ready for erecting. The steam cylinders of the turning-engine, steam-winch, and blowing-engines have been cast and bored, and numerous other details completed. The feed-pumps are partly completed. No work has been done on boilers on account of delay in receipt of the steel plates. Part of the plates are on hand and all of the tubes. Work on the steam-piping is proceeding.

The following changes in design have been proposed by the contractors and approved:

The inner stern-tubes to be made of composition instead of cast-steel.

The details of main valve-gear changed so as to give more port opening and a better distribution of power in the two cylinders.

Additional ties between the reversing cylinders and the reversing quadrant bearings.

Pitch of screw-thread on connecting-rod bolts to be less than specified.

Shells of condensers to be of sheet copper instead of sheet brass, as it was impossible to obtain the latter of sufficient size.

Crank-shaft brasses to be fitted up and bored out in place in the engine on the erecting floor instead of in the shop.

Centrifugal oiling gear to be added to the crank-pins of the pumping-engines.

Slight changes in the air-pump pistons, and the valves to be of hard rubber in place of flap valves.

In place of the one fly-wheel on each feed-pump, with the prolongation of the shaft supported in a bearing on the coal-bunker bulk-head, two overhanging fly-wheels of smaller size to be put on each pump.

Cruiser No. 3 (protected cruiser).—Machinery designed by Humphreys, Tennant & Co., Deptford, England; building by the William Cramp & Sons' Ship and Engine Building Company, Philadelphia, Pa.

The two high-pressure cylinder-casings have been fitted with the linings, two intermediate and one low-pressure cylinders are ready for their linings, and the other

low-pressure casing is cast. The linings are being turned. Four pistons are being turned. Eight stay-rods for engine frame are rough-turned. Eccentrics, eccentric rods, and straps are well advanced. Crank-shaft and crank-pin brasses are lined with Parson's white metal. All propeller-shaft casings are on hand, except two, and partly finished. Condenser-shell plates are planed and are being fitted. Air-pump pistons nearly finished. Owing to the failure of steel castings for crank-shaft pillow-blocks and bed-plates, no advance has been made with these parts. The circulating-pump engines are well advanced. The auxiliary air-pump and engine are being machined. The casing for the auxiliary circulating-pump is cast. Turning and reversing engine-shafts turned. Feed, fire, and bilge pumps well advanced. Two Kingston blow-valves finished; two injection and two pump suction-valves nearly finished. About two-thirds of the boiler-plates are on hand, and some bent, flanged, and drilled.

The following changes in the design have been proposed by the contractor and approved:

Diameter of main boiler-tubes (outside) reduced from 2½ to 2¼ inches, and the number of tubes increased from 868 to 948.

The cast-steel main crank shaft pillow-block frames to be cast in four parts for each engine instead of two, on account of the difficulty of casting.

An adjustable shoe to be fitted to each main piston to increase the bearing surface, and light sectional packing-rings substituted for the single wide ones.

The cylinder-linings changed from cast-steel to cast-iron.

White metal in crank-shaft and crank-pin brasses to be fitted in raised blocks instead of continuous lining.

Provision made for circulating water through crown brasses of crank-shaft and through main cross-head slides.

Raised facings around bolt-holes in cylinder and bed-plate flanges dispensed with.

Circulating-pump runners to be keyed on their shafts instead of cast on.

Division-plates in condenser each made in two parts instead of one.

Expansion joints in the high-pressure cylinders modified so as to give a proper control of the bolts and nuts securing them.

The cylinder-covers modified to suit changes in pistons.

Man-hole frames on boilers to be made of cast instead of plate steel.

Engines to be bedded on iron instead of wood.

Grate-bars to be built up instead of as in original design.

Crank-shaft pillow-block frames changed to facilitate casting, the first casting having been condemned as defective.

Condenser tube sheets changed from cast Muntz metal to composition.

Naval brass to be used in place of Tobin's metal.

Crank-shaft pillow-block frames again changed to facilitate casting, the second attempt at casting having failed.

Gun-boat No. 1.—Building at the works of the Wm. Cramp & Sons' Ship and Engine Building Company, Philadelphia, Pa., machinery built from the contractor's design.

Two high-pressure, one intermediate, and two low-pressure cylinder casings have been faced, bored, and fitted with their linings. Two high-pressure valve-chests fitted up. All pistons have been finished, except fitting shoes to followers. One cross-head is being turned. Connecting-rods are finished. Two high-pressure valves have been finished. Four valve-chest bonnets, four radius links, and five pieces of metallic packing have been finished. Work is progressing on details of valve-gear. Two reversing cylinders have been bored and faced, and work progressing on details. Work progressing on tie-rods of engine-frames. Crank-shaft pillow-block frames have been faced, and main and rock shaft brasses fitted. Eccentric sheaves have all been fitted. Eccentric-rods in progress. Four blowing engine cylinders bored and faced, bed-plates planed, work progressing on piston-rods, cross-heads, and other details. Cranks and shafts of pumping-engines partly finished. Circulating pump engine cylinders bored and faced, fly-wheels finished, details in progress. Part of the boiler-plates are bent, flanged, and drilled.

The following changes have been proposed by the contractor and have been allowed:

Outboard valve-chest bonnets changed from stuffing-boxes to inside guides.

Valve-stems increased in size at stuffing-boxes.

One feed-tank instead of two small ones.

Fire-pump suction to have independent valves on ship's side instead of bolted to main injection valves. Similar changes with regard to the fire-pump discharge-valves.

Auxiliary exhaust pipe to be decreased in size.

Main cylinder heads to be made of steel instead of cast iron.

Dimensions of stern-tube changed.

Dimensions and spacing of combustion-chamber stays changed.

Naval brass to be substituted for Tobin's metal.

Dynamite gun-boat.—Contract sublet to the William Cramp & Sons' Ship and Engine Building Company, Philadelphia, Pa., machinery being built on the builder's design.

Four low-pressure cylinders have been bored and faced and steam passages chipped. Two high-pressure and five low-pressure valve-chest bonnets have been turned and bored. Boiler-plates are partly on hand, and some bent, flanged, and fitted.

Gun-boat No. 2—Building at the works of the Columbian Iron Works and Dry-Dock Company, Baltimore, Md. Machinery from designs made by the Bureau of Steam Engineering in conformity with recommendation of the Board on Additional Vessels.

The high-pressure cylinder is finished and the low-pressure nearly so; cross-head guides cast and nearly finished; tube-plates and water-chests of condenser cast and partly finished; the sheet-brass parts of condenser shaped and ready for building up; valve-chest liners in place; rock-shaft bearings finished; air-pump rod finished; main stuffing-boxes finished; low-pressure piston partly finished; piston-rods, side rods, and air-pump connecting-rod turned; connecting-rod bolts made; connecting-rod brasses finished. No work has been done on the boilers.

The only change which has been proposed by the contractor is the system of shaft-pit forced draft as used by the Bureau of Steam Engineering on the *Alliance*, instead of the air-tight fire-room.

ADDITIONAL ESTIMATES.

The amount of money required for carrying out the various recommendations included in this report is as follows, being in addition to the annual estimates herewith submitted:

For increase of navy-yard shop plant, including a testing-machine at the New York yard, as elsewhere specified in detail.....	\$222,910.00
To begin the erection of central steam-generating plant at the navy-yards at Portsmouth, New York, Norfolk, and Mare Island.....	80,000.00
For increasing the efficiency of the machinery of the present monitor fleet as a temporary expedient.....	185,000.00
For purposes of investigations and experiments, such as specified in the body of the report.....	25,000.00
Total.....	512,910.00

I have the honor to submit herewith the schedules of bids for supplies for the fiscal year ending June 30, 1887, and the estimates for appropriations for this Bureau for the fiscal year ending June 30, 1889.

Very respectfully,

GEO. W. MELVILLE,
Chief of Bureau.

Hon. W. C. WHITNEY,
Secretary of the Navy.

Estimates of appropriations required for the service of the fiscal year ending June 30, 1889, by the Bureau of Steam Engineering.

Detailed objects of expenditure, and explanations.	Estimated amount which will be required for each detailed object of expenditure.	Total amount to be appropriated under each head of appropriation.	Amount appropriated for the current fiscal year ending June 30, 1888.
SALARIES.			
Chief clerk (act March 3, 1887)	\$1,800.00		
One clerk of class two (same act)	1,400.00		
		\$3,200.00	\$3,200.00
One clerk of class two (same act)	[See note.]		1,400.00
NOTE.—By direction of the Hon. Secretary of the Navy, one clerk of class two (the finance clerk) has been transferred to the Bureau of Provisions and Clothing.			
One clerk of class one (same act)	1,200.00		
One assistant messenger (same act)	720.00		
Two laborers (same act)	1,520.00		
		3,240.00	3,240.00
Drafting room :			
Chief draftsman, per annum (same act)	2,250.00		
Chief draftsman, per annum increase (submitted)	258.00		
One draftsman (act March 3, 1887)	1,400.00		
One draftsman (same act)	1,000.00		
		4,900.00	4,650.00
	11,240.00		
		11,840.00	12,490.00
STEAM MACHINERY.			
For completion, repairs, and preservation of machinery and boilers of naval vessels, including cost of new boilers, steam steerers, pneumatic steerers, steam capstans, steam windlasses, and other steam auxiliaries (act March 3, 1887)	450,000.00		
For preservation of and small repairs to machinery and boilers in vessels in ordinary, receiving and training vessels; repair and care of machinery of yard tugs and launches (same act)	40,000.00		
For purchase, handling, and preservation of all materials and stores (same act)	200,000.00		
For purchase, fitting, repair, and preservation of machinery and tools in the navy-yards and stations; running yard engines (same act)	100,000.00		
For incidental expenses for naval vessels, yards, and the Bureau, such as foreign postage, telegrams, advertising, freight, photographing, books, stationery, and instruments (same act)	10,000.00		
	800,000.00	800,000.00	675,000.00
CONTINGENT.			
For contingencies, drawing materials, and instruments for the drafting room (same act)	500.00	500.00	500.00
INCREASE OF THE NAVY—STEAM MACHINERY.			
On account of the steam machinery of new ships heretofore or hereafter authorized by Congress (submitted)	1,500,000.00	1,500,000.00	
CIVIL ESTABLISHMENT.			
Navy-yard, Portsmouth, N. H. :			
Clerk to department, per annum (act March 3, 1887)	\$1,200		
Messenger, per annum (same act)	600		
Assistant draftsman, per annum (submitted)	1,100		
	2,900.00	2,900.00	
(This draftsman should be allowed, as the work at this yard is seriously embarrassed for want of the services of a draftsman.)			
Navy-yard, Brooklyn, N. Y. :			
Clerk to department, per annum (act March 3, 1887)	\$1,400		
Draftsman, per annum (same act)	1,500		
Messenger, per annum (same act)	50		
Writer, per annum (same act)	1,000		
Assistant draftsman, per annum (submitted)	1,100		
	5,600.00	5,600.00	

Estimates of appropriations required for the service of the fiscal year, etc.—Continued.

Detailed objects of expenditure, and explanations.	Estimated amount which will be required for each detailed object of expenditure.	Total amount to be appropriated under each head of appropriation.	Amount appropriated for the current fiscal year ending June 30, 1886.
CIVIL ESTABLISHMENT—continued.			
Navy-yard, Norfolk, Va.:			
Clerk to department, per annum (act March 3, 1887)	\$1,300		
Assistant draftsman, per annum (same act)	1,100		
Messenger, per annum (same act)	600		
Writer, per annum (submitted)	1,000		
	\$4,000.00	\$4,000.00	
<i>(This writer should be allowed, as his services are greatly needed at this yard to assist in keeping the important records and reports up to date.)</i>			
Navy-yard, Pensacola, Fla.:			
Writer, per annum (act March 3, 1887)	1,000.00	1,000.00	
Navy-yard, Mare Island, Cal.:			
Clerk to department, per annum (act March 3, 1887)	\$1,400		
Draftsman, per annum (same act)	1,500		
Messenger, per annum (same act)	600		
Writer, per annum (same act)	1,000		
	4,500.00	4,500.00	
	18,000.00	18,000.00	17,200.00

Schedule of bids opened July 27, 1886, for engineer's supplies at the navy-yards named, under advertisement dated June 25, 1886.

PORTSMOUTH, N. H., NAVY-YARD.

Class No 2. Boiler iron:		
*A. F. Brombacher		\$12.10
George L. Neville		20.16
Rider & Cotton		16.80
C. C. Loring & Co		16.80
William A. Wheeler		18.48
Class No. 4. Bar and sheet iron:		
A. F. Brombacher		102.00
*E. E. Rider		78.00
George Dunbar & Co		109.10
Rider & Cotton		92.00
William A. Wheeler		207.50
Class No. 5. Boiler steel:		
*A. F. Brombacher		2.50
E. E. Rider		5.00
George Dunbar & Co		4.25
Rider & Cotton		4.25
Class No. 6. Bar steel:		
A. F. Brombacher		25.50
George L. Neville		30.00
*Montgomery & Co		12.75
George Dunbar & Co		22.67
Thomas Turton & Sons		21.00
Rider & Cotton		22.50
Class No. 7. Brass:		
E. E. Rider		40.50
George L. Neville		51.00
*Montgomery & Co		29.25
George Dunbar & Co		57.68
Rider & Cotton		48.50
† Patterson Bros		29.25
William A. Wheeler		29.81

*Awarded.

† Informal.

Class No. 8. Copper:	
A. F. Brombacher.....	\$101.70
E. E. Rider.....	93.22
Clendenin Bros.....	96.05
*Taunton Manufacturing Company.....	85.88
George L. Neville.....	113.00
George Dunbar & Co.....	99.58
Park Bro. & Co.....	85.88
Rider & Cotton.....	90.40
Wallace & Sons.....	90.40
William A. Wheeler.....	96.05
Class No. 9. Tin, zinc, etc.:	
A. F. Brombacher.....	25.50
*William A. Wheeler.....	22.50
E. E. Rider.....	24.00
Clendenin Bros.....	22.50
George L. Neville.....	27.00
George Dunbar & Co.....	23.62
Rider & Cotton.....	22.50
Class No. 13. Iron pipe and fittings:	
George D. Putnam & Co.....	143.95
E. E. Rider.....	151.94
George L. Neville.....	167.80
George Dunbar & Co.....	150.36
Nason Manufacturing Company.....	148.27
Morris Tasker & Co.....	155.94
†William Edgar Bird & Co.....	135.92
William A. Wheeler.....	154.11
Class No. 14. Brass pipe and fittings:	
George D. Putnam & Co.....	439.00
George L. Neville.....	457.47
‡George Dunbar & Co.....	184.90
‡Bridgeport Brass Company.....	362.50
American Tube Works.....	453.00
†William A. Wheeler.....	427.00
Class No. 17. Rivets:	
A. F. Brombacher.....	10.75
E. E. Rider.....	12.50
George L. Neville.....	12.50
George Dunbar & Co.....	10.62
Frederick M. Smith.....	13.49
†Rider & Cotton.....	9.37
William A. Wheeler.....	13.75
Class No. 18. Bolts and nuts:	
A. F. Brombacher.....	50.40
George D. Putnam & Co.....	56.68
E. E. Rider.....	69.73
George L. Neville.....	97.40
George Dunbar & Co.....	48.71
Frederick M. Smith.....	58.72‡
John Swan & Co.....	46.94
†American Bolt Company.....	42.03
Rider & Cotton.....	52.33
William A. Wheeler.....	59.76
Class No. 19. Steam radiators:	
Walworth Manufacturing Company.....	84.00
George D. Putnam & Co.....	88.00
E. E. Rider.....	91.80
George L. Neville.....	100.00
S. C. Forsyth Machine Company.....	92.00
Manning, Maxwell & Moore.....	76.00
George Dunbar & Co.....	85.80
Nason Manufacturing Company.....	96.60
John Swan & Co.....	80.00
†William Edgar Bird & Co.....	6.00
Class No. 22. Jacks:	
George D. Putnam & Co.....	461.00
E. E. Rider.....	421.50
George L. Neville.....	426.48

*Awarded by lot.

†Awarded.

‡Informal.

Class No. 22. Jacks—Continued.	
S. C. Forsaith Machine Company.....	\$441.44
Manning, Maxwell & Moore.....	378.68
*George Dunbar & Co.....	372.60
†James W. Soper.....	89.68
Rider & Cotton.....	413.90
William A. Wheeler.....	423.00
Class No. 23. Engineers' tools:	
George L. Neville.....	280.74
S. C. Forsaith Machine.....	325.35
Manning, Maxwell & Moore.....	236.72
George Dunbar & Co.....	234.96
†James W. Soper.....	105.96
*John Swan & Co.....	224.99
Rider & Cotton.....	230.31
William A. Wheeler.....	262.80
Class No. 25. Files:	
E. E. Rider.....	87.82
George L. Neville.....	73.74
S. C. Forsaith Machine Company.....	89.48
*Manning, Maxwell & Moore.....	65.22
Montgomery & Co.....	66.12
George Dunbar & Co.....	196.19
Thomas Turton & Son.....	30.06
John Swan & Co.....	71.64
Rider & Cotton.....	131.56
William A. Wheeler.....	117.25
Class No. 26. Nails:	
George Dunbar & Co.....	4.92
*John Swan & Co.....	4.35
Rider & Cotton.....	4.44
Class No. 27. Screws:	
A. F. Brombacher.....	83.51
*George D. Putnam & Co.....	75.38
E. E. Rider.....	76.01
George L. Neville.....	84.72
George Dunbar & Co.....	95.82
John Swan & Co.....	78.79
Rider & Cotton.....	76.76
William A. Wheeler.....	122.69
Class No. 28. Engineers' instruments:	
*John Swan & Co.....	22.55
Rider & Cotton.....	43.98
Class No. 29. Lanterns, etc.:	
*John Swan & Co.....	2.50
Rider & Cotton.....	10.00
William Porter's Sons.....	15.00
Class No. 31. Lead:	
E. E. Rider.....	142.00
Clendenin Bros.....	149.60
*Geo. L. Neville.....	110.00
N. Y. Co-operative Lead Works.....	127.50
M. Lissberger.....	140.00
George Dunbar & Co.....	138.75
Fred. M. Smith.....	133.60
Rider & Cotton.....	133.00
William A. Wheeler.....	180.00
Class No. 37. Charcoal:	
*E. E. Rider.....	50.00
George Dunbar & Co.....	60.00
Hamilton Bros.....	82.50
Class No. 39. Lumber:	
*W. W. McCullough.....	155.00
Geo. L. Neville.....	180.00
Class No. 40. Paints and oils:	
E. E. Rider.....	114.42
Geo. L. Neville.....	128.45
*William Waterall & Co.....	110.00
Rider & Cotton.....	115.95
William A. Wheeler.....	156.00

*Awarded.

†Informal.

Class No. 44. Tallow, etc. :	
Edward C. Street	\$58. 12
George Dunbar & Co.....	43. 75
* Rider & Cotton	42. 50
Class No. 45. Waste:	
E. E. Rider.....	86. 00
* Montgomery & Co	80. 00
George Dunbar & Co.....	82. 50
Bay State Belting Company	90. 00
Fred M. Smith.....	87. 00
John Ellies & Co.....	85. 00
Springfield Waste Company	90. 00
John Swan & Co.....	85. 00
Rider & Cotton.....	84. 50
William A. Wheeler.....	92. 50
Class. No. 46. Hemp and cotton packing :	
*George Dunbar & Co.....	15. 87
William A. Wheeler.....	25. 00
Class No. 47. Rubber:	
New York and Boston Rubber Company.....	89. 00
George L. Neville.....	52. 00
Manning, Maxwell & Moore.....	76. 00
G. P. and Rubber Manufacturing Company.....	404. 00
George Dunbar & Co.....	66. 50
* Bay State Belting Company.....	51. 50
James F. Brooke Rubber Company.....	83. 00
Revere Rubber Company.....	69. 75
Rider & Cotton.....	83. 00
David A. Woodhouse.....	62. 25
Trenton Rubber Company.....	58. 50
Wm. Edgar Bird & Co.....	52. 50
Wm. A. Wheeler.....	77. 50
Class No. 48. Miscellaneous Packing :	
Geo. D. Putnam	186. 60
† New York and Boston Rubber Company.....	107. 30
Geo. S. Neville.....	147. 30
Manning, Maxwell & Moore.....	239. 25
G. P. and Rubber Manufacturing Company.....	219. 00
Geo. Dunbar & Co.....	194. 70
Bay State Belting Company.....	190. 65
H. W. Johns Manufacturing Company.....	254. 62
Jas. F. Brooke Rubber Company.....	196. 50
† Revere Rubber Company.....	125. 55
Rider and Cotton.....	178. 06
David A. Woodhouse.....	202. 20
* Trenton Rubber Company.....	146. 25
William Edgar Bird & Co.....	225. 30
William A. Wheeler.....	224. 70
Class No. 51. Engineers' stores :	
George D. Putnam & Co.....	701. 12
George L. Neville.....	650. 80
George Dunbar & Co.....	645. 13
Rider & Cotton.....	630. 42
* William A. Wheeler.....	583. 62
Class No. 52. Brushes:	
George D. Putnam & Co.....	219. 00
* George L. Neville.....	166. 30
George Dunbar & Co.....	273. 28
Rider & Cotton.....	207. 96
Class No. 53. Lubricant :	
George D. Putnam & Co.....	20. 88
E. E. Rider.....	22. 75
George Dunbar & Co.....	22. 50
* Rider & Cotton.....	20. 50
William A. Wheeler.....	26. 00
BOSTON, MASS., NAVY-YARD.	
Class No. 12. Iron tubes :	
Walworth Manufacturing Company.....	37. 54
George D. Putnam & Co.....	34. 41

* Awarded.

† Informal.

Class No. 12. Iron tubes—Continued.	
E. E. Rider	\$34.41
C. C. Loring & Co	37.53
William Edgar Bird & Co.....	34.41
William A. Wheeler.....	53.18
Nason Manufacturing Company	40.66
*Morris Tasker & Co.....	32.68
George L. Neville.....	68.80
†George Dunbar & Co	32.84
Class No. 13. Iron pipe and fitting:	
†Walworth Manufacturing Company.....	102.81
George D. Putnam & Co	106.16
William A. Wheeler.....	128.90
Nason Manufacturing Company.....	103.29
*Morris Tasker & Co	97.29
George Dunbar & Co.....	119.97
Class No. 14. Brass pipe and fitting:	
George D. Putnam & Co.....	8.19
William A. Wheeler.....	23.73
George L. Neville	12.18
†George Dunbar & Co.....	7.62
Class No. 23. Engineers' tools:	
George D. Putnam & Co	20.30
William A. Wheeler.....	26.85
†George Dunbar & Co.....	17.50
Class No. 26. Nails:	
George D. Putnam & Co	2.40
†George Dunbar & Co.....	1.50
Class No 28. Engineers' instruments:	
George D. Putnam & Co	45.00
E. E. Rider	48.84
Charles J. Tagliabue.....	46.50
William A. Wheeler.....	46.20
†Oswald Oelschlagler	32.66
Class No. 34. Sand, lime, etc.:	
†George D. Putnam & Co	22.00
*Boston Fire Brick Company.....	5.50
George L. Neville	30.00
Class No. 40. Paints and oils:	
George D. Putnam & Co	158.05
†E. E. Rider	144.95
William A. Wheeler.....	166.00
William Waterall & Co	152.70
Class No. 41. Sperm oil:	
George D. Putnam & Co	86.00
Fred M. Smith.....	93.66
†Manhattan Oil Company.....	82.50
George L. Neville.....	125.00
Edward C. Street.....	87.00
Wakeman & Fierz.....	87.00
George Dunbar & Co.....	94.00
Class No. 44. Tallow, etc:	
†George D. Putnam & Co	6.75
Class No. 45. Waste:	
Springfield Waste Company.....	43.75
George D. Putnam & Co	48.75
E. E. Rider.....	43.75
W. A. Wheeler.....	46.25
Fred M. Smith.....	43.50
John Ellice & Co	41.25
George Dunbar & Co.....	40.62
†Montgomery & Co	39.37
Class No. 46. Hemp and cotton packing:	
George D. Putnam & Co	6.75
†William A. Wheeler.....	6.25
George Dunbar & Co.....	6.94
Class No. 47. Rubber:	
Revere Rubber Company.....	7.87
George D. Putnam & Co	5.66

Informal.

†Awarded.

Class No. 47. Rubber—Continued.

David A. Woodhouse.....	\$9.60
Trenton Rubber Company.....	4.95
William Edgar Bird & Co.....	15.75
William A. Wheeler.....	10.80
*The Conant Rubber Company.....	4.35
New York and Boston Rubber Company.....	8.85
Gutta-Percha and Rubber Manufacturing Company.....	12.00
George Dunbar & Co.....	8.38
Bay State Belting Company.....	6.90

Class No. 50. Hose and fittings:

James F. Brooke Rubber Company.....	380.00
Revere Rubber Company.....	268.00
George D. Putnam & Co.....	380.00
E. E. Rider.....	232.00
*Trenton Rubber Company.....	160.00
William Edgar Bird & Co.....	280.00
Wm. A. Wheeler.....	312.00
Conant Rubber Company.....	372.00
New York and Boston Rubber Company.....	392.00
Rowland A. Robbins.....	340.00
George L. Neville.....	198.00
Gutta-Percha and Rubber Manufacturing Company.....	340.00
Bay State Belting Company.....	320.00
George Dunbar & Co.....	308.00

Class No. 51. Engineer's stores:

*George Dunbar & Co.....	15.03
Geo. D. Putnam & Co.....	15.45

Class No. 52. Brushes:

George D. Putnam & Co.....	61.39
George L. Neville.....	92.00
*Austin & Fellows.....	43.90
George Dunbar & Co.....	54.22

Class No. 57. Lard oil:

E. E. Rider.....	248.00
*Manhattan Oil Company.....	204.00
George L. Neville.....	232.00
Edward C. Street.....	220.00
Wakeman & Fierz.....	208.00
George Dunbar & Co.....	232.00

BROOKLYN, N. Y., NAVY-YARD.

Class No. 2. Boiler iron:

A. F. Brombacher.....	3,682.80
George H. Creed.....	3,632.00
*American Manufacturing and Supply Company.....	3,462.05
George L. Neville.....	5,288.00
William A. Wheeler.....	3,477.20
C. C. Loring & Co.....	4,062.20
Milliken, Smith & Co.....	3,846.00

Class No. 4. Bar and sheet iron:

A. F. Brombacher.....	1,109.60
*American Manufacturing and Supply Company.....	949.60
William A. Wheeler.....	1,251.75
Milliken, Smith & Co.....	965.35

Class No. 6. Bar steel:

A. F. Brombacher.....	172.50
E. E. Rider.....	161.00
James J. Donovan.....	172.50
*George H. Creed.....	158.70
American Manufacturing and Supply Company.....	172.50
Thomas Trnrtton & Sons.....	287.50
John Claffy.....	276.00
William A. Wheeler.....	313.50

Class No. 8. Copper:

A. F. Brombacher.....	1,905.50
Clendenin Brothers.....	1,907.50

*Awarded.

Class No. 8. Copper—Continued.

J. J. Donovan	\$1,888.00
Geo. H. Creed	1,965.50
American Manufacturing and Supply Company	1,868.87
*Taunton Copper Manufacturing Company	1,807.80
Geo. L. Neville	1,982.00
†Thos. J. Pope & Bro.	1,035.00
M. Lissberger	1,915.50
Park Bro. & Co	1,807.80
Wallace & Sons	1,824.00

Class No. 9. Tin, zinc, etc.:

A. F. Brombacher	1,386.13
E. E. Rider	1,397.75
†Clendenin Brothers	1,350.00
J. J. Donovan	1,443.50
G. H. Creed	1,360.00
American Manufacturing and Supply Company	1,406.50
Rowland A. Robbins	1,471.00
Geo. L. Neville	1,408.00
M. Lissberger	1,487.50
Wm. A. Wheeler	1,379.50

Class No. 10. Brass and copper tubes:

J. J. Donovan	776.25
American Manufacturing and Supply Company	855.00
*Rowland A. Robbins	742.50
Geo. L. Neville	900.00
Wm. A. Wheeler	742.50
American Tube Works	765.00

Class No 13. Iron pipe and fitting:

Walworth Manufacturing Company	777.24
Geo. D. Putnam & Co	782.64
J. J. Donovan	688.26
Thos. Somerville & Sons	703.98
Geo. H. Creed	659.80
Geo. L. Neville	823.49
Nason Manufacturing Company	680.90
†Jacob Jamer	656.52
Wm. A. Wheeler	709.20
Morris, Tasker, & Co	665.17
Wm. Edgar Bird & Co	660.95

Class No. 14. Brass pipe and fitting:

Walworth Manufacturing Company	1,921.23
Geo. D. Putnam & Co	1,965.23
J. J. Donovan	1,822.81
†Geo. H. Creed	1,627.17
American Manufacturing and Supply Company	1,752.80
Rowland A. Robbins	1,830.28
George L. Neville	2,342.11
Jacob Jamer	1,963.60
William A. Wheeler	1,667.78
William Edgar Bird & Co	1,736.25

Class No. 17. Rivets:

A. F. Brombacher	227.40
J. J. Donovan	250.00
†George H. Creed	218.00
American Manufacturing and Supply Company	231.00
Rowland A. Robbins	248.40
George L. Neville	230.55
Fred. M. Smith	242.76
William A. Wheeler	249.75

Class No. 18. Bolts and nuts:

A. F. Brombacher	654.75
George D. Putnam & Co	658.25
E. E. Rider	774.40
J. J. Donovan	677.50
American Manufacturing and Supply Company	670.00
†George H. Creed	609.00
Rowland A. Robbins	716.31

*Awarded by lot.

†Informal.

‡Awarded.

Class No. 18. Bolts and nuts—Continued.

Fred M. Smith	\$713.69 [†]
American Bolt Company	617.50
William A. Wheeler	695.50
Milliken, Smith & Co	676.75

Class No. 21. Felting:

J. J. Donovan	700.00
American Manufacturing and Supply Company	872.50
George L. Neville	737.20
*De Long, French and De Long	619.00
Fred. M. Smith	716.10
H. W. Johns Manufacturing Company	980.00
Chalmers Spence Company	710.00
Julius E. Hintze	699.20
W. A. Wheeler	970.00

Class No. 23. Engineer's tools:

*J. J. Donovan	1,972.95
†J. W. Soper	461.65

Class No. 23A. Engineer's tools:

*J. J. Donovan	362.10
George H. Creed	405.11
Pratt and Whitney Company	786.93

Class No. 24. Forges:

J. J. Donovan	2,088.00
*George H. Creed	1,872.00
American Manufacturing and Supply Company	2,016.00
Rowland A. Robbins	1,915.20
George L. Neville	2,027.52
S. C. Forsaith Machine Company	2,064.00
Manning, Maxwell & Moore	1,920.00
Montgomery & Co	2,040.00
John Swan & Co	2,064.00
John Claffy	2,016.00
David A. Woodhouse	1,968.00
Keystone Portable Forge Company	1,920.00

Class No. 25. Files:

*Bernard B. Neal	350.91
J. J. Donovan	451.10
George H. Creed	364.75
George L. Neville	673.30 ⁴
Montgomery & Co	376.97
J. W. Soper	333.26
William A. Wheeler	530.46
A. Flagler	382.08

Class No. 26. Nails:

Bernard B. Neal	84.45
A. F. Brombacher	83.05
J. J. Donovan	83.35
*George H. Creed	79.80
American Manufacturing Supply Company	86.35
John Swan & Co	88.25
John Claffy	97.75
William A. Wheeler	111.75
A. Flagler	88.25

Class No. 27. Screws:

Bernard B. Neal	284.65
A. F. Brombacher	256.70
George D. Putman & Co	260.52
J. J. Donovan	261.58
*George H. Creed	244.50
American Manufacturing and Supply Company	288.45
George L. Neville	284.36
S. C. Forsaith Machine Company	264.40
John Swan & Co	267.80
William A. Wheeler	354.65
A. Flagler	258.76

Class No. 28. Engineer's instruments:

Bernard B. Neal	159.60
J. J. Donovan	159.60

* Awarded.

† Informal.

Class No. 28. Engineer's instruments—Continued.	
George H. Creed	\$127.20
American Manufacturing and Supply Company	180.00
Rowland A. Robbins	167.76
Montgomery & Co	231.84
*E. W. Wagner	109.44
John Swan & Co	161.28
A. Flagler	151.20
Class No. 29. Lanterns, etc :	
J. J. Donovan	257.60
American Manufacturing and Supply Company	245.00
Rowland A. Robbins	244.86
*Knapp Manufacturing Company	219.20
John Swan & Co	267.80
William Porter's Sons	243.00
Class No. 29A. Lamps:	
E. E. Rider	612.00
*Wm. Porter's Sons	552.00
Class No. 31. Lead:	
A. F. Brombacher	195.00
E. E. Rider	210.00
Clendenin Bros.	217.20
J. J. Donovan	187.50
Thos. Somerville & Sons	210.00
Geo. H. Creed	186.00
American Manufacturing and Supply Company	209.40
Rowland A. Robbins	177.00
Geo. L. Neville	179.70
*New York Co-operative Lead Works	174.00
M. Lissberger	202.50
Fred M. Smith	191.40
Wm. A. Wheeler	247.50
Class No. 32. Crucibles:	
A. F. Brombacher	183.00
Geo. D. Putnam & Co	176.16
E. E. Rider	177.12
*J. J. Donovan	133.44
Geo. H. Creed	163.72
American Manufacturing and Supply Company	186.90
Rowland A. Robbins	170.38
Geo. L. Neville	176.40
Manning, Maxwell & Moore	186.84
Montgomery & Co	179.88
Wm. A. Wheeler	184.20
A. Flagler	183.84
David A. Woodhouse	213.60
Class No. 33. Brick:	
E. E. Rider	70.00
J. J. Donovan	66.00
Geo. H. Creed	60.00
†American Manufacturing and Supply Company	67.00
Geo. T. Noe	79.00
Geo. L. Neville	100.00
Fred M. Smith	67.92
John Claffy	80.00
Class No. 34. Sand, lime, etc.:	
J. J. Donovan	201.10
Geo. H. Creed	212.80
*American Manufacturing and Supply Company	170.00
Class No. 37. Charcoal:	
E. E. Rider	400.00
J. J. Donovan	330.00
*G. H. Creed	300.00
American Manufacturing and Supply Company	400.00
J. H. Rapp's Sons	400.00
Saml. G. French	600.00
Class No. 38. Wood:	
George H. Creed	375.00
J. H. Rapp's Sons	437.50
*Samuel G. French	372.00

*Awarded.

†Awarded by lot.

Class No. 39. Lumber:	
J. J. Donovan.....	\$1,510.00
American Manufacturing and Supply Company.....	1,678.20
W. W. McCullough.....	1,945.00
George L. Neville.....	2,130.00
*Jos. W. Duryee.....	1,371.50
Wheatley Brothers.....	1,600.00
Jas. W. Gaskell & Son.....	1,462.00
Class No. 40. Paints and oils:	
E. E. Rider.....	2,258.63
J. J. Donovan.....	2,203.20
*George H. Creed.....	1,969.13
American Manufacturing and Supply Company.....	2,078.55
George L. Neville.....	2,332.05
William Waterall & Co.....	2,319.97
William A. Wheeler.....	2,397.26
W. W. Lawrence & Co.....	1,997.23
Class No. 41. Sperm oil:	
George D. Putnam & Co.....	9,430.00
East Brooklyn Lubricating Company.....	9,085.00
J. J. Donovan.....	8,970.00
Manhattan Oil Company.....	8,452.50
*American Manufacturing and Supply Company.....	8,337.50
Edward C. Street.....	9,430.00
Frederick M. Smith.....	10,605.30
Class No. 42. Olive oil:	
†East Brooklyn Lubricating Company.....	770.00
J. J. Donovan.....	1,332.50
*Manhattan Oil Company.....	1,316.00
American Manufacturing and Supply Company.....	1,377.25
Edward C. Street.....	1,419.25
†N. W. Allen.....	1,235.50
†A. G. Belden & Co.....	1,276.00
Class No. 43. Cylinder oil:	
East Brooklyn Lubricating Company.....	962.00
J. J. Donovan.....	1,145.00
*Manhattan Oil Company.....	607.50
American Manufacturing and Supply Company.....	720.00
Edward C. Street.....	996.00
Wakeman & Fierz.....	996.00
New York Refining Company.....	832.00
Henry F. Evans.....	903.00
Frederick M. Smith.....	974.92
N. W. Allen & Co.....	1,205.00
A. G. Belden & Co.....	1,050.00
Class No. 44. Tallow:	
E. E. Rider.....	162.00
J. J. Donovan.....	152.00
G. H. Creed.....	125.50
*American Manufacturing and Supply Company.....	114.00
Rowland A. Robbins.....	137.00
Edward C. Street.....	185.50
Fred. M. Smith.....	137.72 [†]
Class No. 45. Waste:	
Geo. D. Putnam & Co.....	937.50
E. E. Rider.....	850.00
J. J. Donovan.....	800.00
T. Somerville & Sons.....	850.00
Geo. H. Creed.....	800.00
American Manufacturing and Supply Company.....	800.00
Rowland A. Robbins.....	840.00
Geo. L. Neville.....	849.00
Montgomery & Co.....	787.50
Fred. M. Smith.....	794.00
*John Ellice & Co.....	785.00
Springfield Waste Company.....	875.00
John Swan & Co.....	850.00
John Claffy.....	1,050.00
Wm. A. Wheeler.....	850.00

*Awarded.

†Informal.

Class No. 47. Rubber:	
Geo. D. Putnam & Co.....	\$1,101.00
Thos. Somerville & Sons.....	570.00
New York and Boston Rubber Company.....	804.50
Geo. H. Creed.....	738.75
*American Manufacturing and Supply Company.....	420.00
Rowland A. Robbins.....	807.00
Geo. L. Neville.....	455.50
Manning, Maxwell & Moore.....	697.00
G. P. and Rubber Manufacturing Company.....	3,630.00
Jas. F. Brooke Rubber Company.....	841.00
John Claffy.....	656.50
Revere Rubber Company.....	616.50
Wm. A. Wheeler.....	604.00
David A. Woodhouse.....	566.00
Trenton Rubber Company.....	541.00
Wm. Edgar Bird & Co.....	436.50
Class No. 48. Miscellaneous packing:	
Geo. D. Putnam & Co.....	889.00
American Manufacturing and Supply Company.....	671.74
*Geo. L. Neville.....	497.50
Manning, Maxwell & Moore.....	901.50
H. W. Johns Manufacturing Company.....	775.50
† Revere Rubber Company.....	360.00
Wm. A. Wheeler.....	1,097.50
David A. Woodhouse.....	1,015.00
Wm. Edgar Bird & Co.....	1,045.00
Trenton Rubber Company.....	515.00
Class No. 49. Belting:	
A. T. Brombacher.....	722.27
E. E. Rider.....	731.20
J. J. Donovan.....	759.80
Thos. Somerville & Sons.....	848.00
Geo. H. Creed.....	764.00
American Manufacturing and Supply Company.....	820.00
Rowland A. Robbins.....	796.25
*Geo. L. Neville.....	674.00
S. C. Forsaith Machine Company.....	729.00
Manning, Maxwell & Moore.....	734.00
Montgomery & Co.....	723.00
John Claffy.....	779.00
Wm. A. Wheeler.....	791.00
Class No. 50. Hose and fittings:	
Geo. L. Putman & Co.....	830.00
E. E. Rider.....	942.50
N. Y. and Boston Rubber Co.....	1,105.00
George H. Creed.....	890.00
American Manufacturing and Supply Company.....	810.00
Rowland A. Robbins.....	890.00
George L. Neville.....	800.00
*S. C. Forsaith Machine Company.....	728.75
Manning, Maxwell & Moore.....	925.00
G. P. and Rubber Manufacturing Company.....	1,100.00
James F. Brooke Rubber Company.....	1,030.00
John Claffy.....	1,170.00
Revere Rubber Company.....	770.00
William A. Wheeler.....	885.00
David A. Woodhouse.....	850.00
William Edgar Bird & Co.....	767.50
Class No. 51. Engineer's stores.	
*Bernard B. Neal.....	1,207.65
J. J. Donovan.....	1,254.84
George H. Creed.....	1,242.34
Rowland A. Robbins.....	1,264.44
William A. Wheeler.....	1,455.65
Class No. 52. Brushes:	
Bernard B. Neal.....	290.79
J. J. Donovan.....	347.65

* Awarded.

† Informal.

Class No. 52. Brushes—Continued.

*George H. Creed.....	\$270.66
American Manufacturing and Supply Company.....	355.08
Rowland A. Robbins.....	280.52
George L. Neville.....	356.00
Fred. M. Smith.....	343.10 ^{1/2}
William A. Wheeler.....	392.62
A. Flagler.....	291.30

Class No. 53. Canvas:

E. E. Rider.....	120.00
*J. J. Donovan.....	96.00
George H. Creed.....	153.60
Rowland A. Robbins.....	145.92
American Manufacturing and Supply Company.....	172.80

Class No. 55. Machine tools:

E. E. Rider.....	395.00
J. J. Donovan.....	400.00
*Geo. H. Creed.....	353.00
S. C. Forsaith Machine Company.....	449.00
Manning, Maxwell & Moore.....	392.00
Springfield Glue and Emery Wheel Company.....	390.00

Class No. 57. Lard oil:

E. E. Rider.....	455.00
*East Brooklyn Lubricating Oil Company.....	301.00
J. J. Donovan.....	343.00
Manhattan Oil Company.....	346.50
American Manufacturing and Supply Company.....	357.00
Geo. L. Neville.....	385.00
Edward C. Street.....	371.00
N. W. Allen & Co.....	434.00

LEAGUE ISLAND, PA., NAVY-YARD.

Class No. 13. Iron pipe and fittings:

Paul J. Field.....	4.80
Samuel J. Goodall.....	2.64
E. E. Rider.....	2.04
George L. Neville.....	6.00
*Charles J. Field.....	1.38

Class No. 23. Engineer's tools:

Paul J. Field.....	12.70
Samuel J. Goodall.....	12.36
George L. Neville.....	15.75
Charles J. Field.....	8.99
S. C. Forsaith Machine Company.....	13.25
*Manning, Maxwell & Moore.....	7.18

Class No. 39. Lumber:

Elias Pohl.....	37.00
*J. W. Gaskill & Sons.....	23.00
W. W. McCullough.....	40.00
George L. Neville.....	60.00

Class No. 40. Paints and oils:

Samuel J. Goodall.....	63.00
E. E. Rider.....	59.00
*William Waterall & Co.....	58.20
George L. Neville.....	86.00

Class No. 41. Sperm oil:

Samuel J. Goodall.....	78.40
Fred. M. Smith.....	74.92 ^{1/2}
*Manhattan Oil Company.....	62.40
George L. Neville.....	100.00
Edward C. Street.....	64.00
Wakeman & Fierz.....	72.00

Class No. 45. Waste:

Springfield Waste Company.....	70.00
Paul J. Field.....	97.50
E. E. Rider.....	72.50
Fred. M. Smith.....	79.00

* Awarded.

Class No. 45. Waste—Continued.

John Ellice & Co	\$77.50
George L. Neville	80.00
*Charles J. Field	59.00
Montgomery & Co	75.00

Class No. 51. Engineer's stores:

Paul J. Field	2.50
Samuel J. Goodall	1.00
E. E. Rider	1.75
George L. Neville	4.00
*Charles J. Field	58
Montgomery & Co	1.10

WASHINGTON, D. C., NAVY-YARD.

Class No. 1. Pig-iron :

E. E. Rider	2,300.00
*James B. Kendall	1,990.00
George L. Neville	2,150.00
M. Lissberger	2,500.00

Class No. 5. Boiler steel:

A. F. Brombacher	480.64
*E. E. Rider	440.98
Milliken, Smith & Co	600.80
George L. Neville	841.12
William A. Wheeler	570.76
C. C. Loring & Co	570.76

Class No. 6. Bar steel:

A. F. Brombacher	142.85
*E. E. Rider	105.00
J. B. Kendall	137.25
E. G. Wheeler	138.20
George L. Neville	198.25
William A. Wheeler	150.00
Thomas Turton & Sons	251.00

Class No. 8. Copper:

E. E. Rider	1,060.00
J. B. Kendall	1,100.00
*Clendenin Brothers	1,045.00
George L. Neville	1,068.00
Thomas J. Pope & Brother	1,080.00
Wallace & Sons	1,100.00
M. Lissberger	1,060.00

Class No. 9. Tin, zinc, etc:

E. E. Rider	522.50
J. B. Kendall	532.00
*Clendenin Brothers	512.70
E. G. Wheeler	545.00
Geo. L. Neville	530.00
M. Lissberger	530.00
William A. Wheeler	560.00

Class No. 10. Brass and copper tubes:

J. J. Donovan	687.36
Geo. L. Neville	859.20
† Bridgeport Brass Company	644.40
* American Tube Works	644.40
William A. Wheeler	655.14

Class No. 13. Iron pipe and fittings:

Walworth Manufacturing Company	108.45
Geo. D. Putnam & Co	113.35
Thos. Somerville & Sons	105.25
Geo. L. Neville	124.69
* Wm. Kirkup & Sons	87.38
Robert Leitch & Sons	100.31
† W. C. Codd	63.17
William A. Wheeler	95.34

Class No. 16. Pumps:

E. E. Rider	898.00
E. G. Wheeler	896.98

* Awarded.

† Informal.

Class No. 16. Pumps—Continued.	
Thos. Somerville & Sons	\$891.00
Geo. L. Neville	960.00
S. C. Forsaith Machine Company	918.00
Henry R. Worthington	1,044.00
W. C. Codd	1,892.44
*Geo. F. Blake Manufacturing Company	816.00
William A. Wheeler	948.00
Class No. 17. Rivets:	
A. F. Brombacher	37.90
J. B. Kendall	38.75
Geo. L. Neville	40.00
*Fred. M. Smith	36.80
William A. Wheeler	50.00
Class No. 18. Bolts and nuts:	
E. E. Rider	55.20
*J. B. Kendall	52.85
Geo. L. Neville	66.73
Fred. M. Smith	57.55
American Bolt Company	58.63
William A. Wheeler	78.75
Class No. 23. Engineer's tools:	
J. B. Kendall	345.98
Geo. L. Neville	361.89
*S. C. Forsaith Machine Company	330.80
†Jas. W. Soper	147.54
Class No. 25. Files:	
*Bernard B. Neal	71.02
J. B. Kendall	84.24
E. G. Wheeler	89.06
George L. Neville	88.96
S. C. Forsaith Machine Company	107.50
Manning, Maxwell & Moore	70.19
Montgomery & Co.	89.94
Thomas Turton & Sons	165.60
Fred. M. Smith	90.98 ¹ / ₂
Jas. W. Soper	96.89
W. C. Codd	119.10
N. W. Allen & Co.	106.46
William A. Wheeler	129.56
Class No. 26. Nails:	
Bernard B. Neal	14.92
J. B. Kendall	18.94
*E. G. Wheeler	14.02
George L. Neville	17.45
Class No. 27. Screws:	
Bernard B. Neal	35.94
A. F. Brombacher	35.86
*J. B. Kendall	35.62
E. G. Wheeler	39.82
George L. Neville	37.28
Montgomery & Co.	37.66
William A. Wheeler	57.45
Class No. 28. Engineer's instruments:	
Walworth Manufacturing Company	262.20
George D. Putnam & Co.	358.20
E. E. Rider	222.30
Thomas Somerville & Sons	221.10
George L. Neville	225.12
S. C. Forsaith Machine Company	358.29
Manning, Maxwell & Moore	205.38
†W. C. Codd	180.00
*William A. Wheeler	188.10
Class No. 29. Lanterns, etc.:	
E. E. Rider	28.32
*J. B. Kendall	24.00
William Porter's Sons	25.08

*Awarded.

†Informal.

Class No. 31. Lead:	
E. E. Rider	\$27.50
J. B. Kendall	27.25
Clendenin Brothers	27.50
*E. G. Wheeler	24.95
Thomas Somerville & Sons	27.50
George L. Neville	28.50
M. Lissberger	2- 75
Robert Leitch & Sons	27.50
William A. Wheeler	36.25
Class No. 32. Crucibles:	
*E. E. Rider	51.40
J. B. Kendall	53.50
E. G. Wheeler	55.50
R. A. Robbins	51.50
George L. Neville	53.50
Manning, Maxwell & Moore	56.00
Montgomery & Co	53.80
W. C. Codd	73.50
† J. A. Emerick & Co	50.90
David A. Woodhouse	64.00
J. W. Paxson & Co	51.70
W. A. Wheeler	56.00
Class No. 33. Brick:	
*J. B. Kendall	182.00
Richard Rothwell	250.00
George L. Neville	238.00
Fred. M. Smith	204.98
Class No. 34. Sand, lime, etc.:	
E. E. Rider	1,430.00
J. B. Kendall	1,514.75
George L. Neville	1,699.00
J. A. Emerick & Co	1,208.75
*J. W. Paxson & Co	1,181.00
Class No. 36½. Coke:	
*E. E. Rider	222.50
Stephenson Brothers	320.00
A. E. Williams & Co	270.00
George L. Neville	312.00
Class No. 37. Charcoal:	
*E. E. Rider	85.00
Johnson Brothers	210.00
J. B. Kendall	89.50
George L. Neville	135.00
Class No. 38. Wood:	
Johnson Brothers	215.00
*Stephenson Brothers	212.50
William H. Baum	225.00
Geo. L. Neville	250.00
Class No. 39. Lumber:	
*W. W. McCullough	461.50
George L. Neville	875.00
Wheatley Brothers	625.00
J. W. Gaskill & Son	572.00
Class No. 40. Paints and oils:	
E. E. Rider	31.37
*J. B. Kendall	24.60
George L. Neville	29.00
William Waterall & Co	26.65
Class No. 44. Tallow, etc.:	
E. E. Rider	12.00
J. B. Kendall	13.10
Z. D. Gilman	13.50
† George L. Neville	12.00
Edward C. Street	15.60
Class No. 47. Rubber:	
*J. B. Kendall	22.00
E. G. Wheeler	27.50

* Awarded,

† Informal.

‡ Awarded by lot.

Class No. 47. Rubber—Continued.	
Thomas Somerville & Sons.....	\$32. 00
Rowland A. Robbins	39. 60
George L. Neville	25. 00
Manning, Maxwell & Moore.....	35. 00
Gutta-Percha and Rubber Manufacturing Company	200. 00
W. C. Codd	30. 00
N. W. Allen & Co	64. 00
James F. Brooke Rubber Company	35. 00
Revere Rubber Company	33. 00
Trenton Rubber Company.....	28. 00
William Edgar Bird & Co.....	23. 00
William A. Wheeler.....	35. 00
Class No. 49. Hose and fittings:	
E. E. Rider	107. 38
J. B. Kendall.....	107. 04
E. G. Wheeler.....	112. 24
Thomas Sommerville & Sons.....	120. 60
* George L. Neville.....	102. 70
S. C. Forsaith Machine Company.....	113. 52
Manning, Maxwell & Moore.....	108. 60
Montgomery & Co	103. 12
W. C. Codd	123. 60
John Claffy.....	123. 00
N. W. Allen & Co.....	122. 04
Wm. A. Wheeler.....	127. 52
Class No. 51. Engineer's stores:	
E. E. Rider	214. 53
* J. B. Kendall.....	195. 42
Geo. L. Neville	208. 00
J. A. Emerick & Co.....	225. 70
J. W. Paxson & Co.....	217. 20
Class No. 53. Canvas:	
E. E. Rider	5. 00
* J. B. Kendall.....	4. 50
Geo. L. Neville.....	6. 25
Class No. 54. Alcohol:	
* Z. D. Gilman	60. 00
Class No. 56. Lard oil:	
E. E. Rider	54. 00
Geo. L. Neville	60. 00
* Edward C. Street	44. 00
Buxton, Heins & Co.....	90. 00
Wakeman & Fiers	60. 00
Fred. M. Smith	66. 00
N. W. Allen & Co	70. 00
Poole & Brooke	51. 00
W. C. Codd.....	64. 00

NORFOLK, VA., NAVY-YARD.

Class No. 1. Pig-iron:	
E. E. Rider.....	1, 150. 00
J. B. Kendall.....	1, 300. 00
Mayer & Co	1, 225. 00
Geo. L. Neville.....	1, 150. 00
* Thos. W. Godwin.....	1, 137. 50
Class No. 2. Boiler iron:	
Mayer & Co	1, 244. 62
* Geo. L. Neville	1, 013. 73
Thos. W. Godwin & Co	1, 110. 37
Elliott & Walke.....	1, 166. 00
C. C. Loring & Co	1, 457. 50
Wm. A. Wheeler.....	1, 457. 50
Milliken, Smith & Co.....	1, 311. 75
Class No. 4. Bar and sheet iron:	
J. B. Kendall.....	288. 65
Mayer & Co	322. 00
* Geo. L. Neville.....	285. 75
Elliott & Walke.....	321. 90
Wm. A. Wheeler.....	468. 75

*Awarded.

Class No. 6. Bar steel:	
E. E. Rider	\$126.49
J. B. Kendall	145.89
Mayer & Co	128.90
George L. Neville	150.25
Thomas W. Godwin & Co	172.90
W. C. Codd	174.75
* William A. Wheeler	116.46
Class No. 7. Brass:	
E. E. Rider	210.00
J. B. Kendall	196.88
Mayer & Co	199.50
* George L. Neville	178.50
E. J. Griffith & Co	225.75
T. W. Godwin & Co	262.50
Elliott & Walke	199.50
William A. Wheeler	194.25
Class No. 8. Copper:	
E. E. Rider	1,010.25
J. B. Kendall	1,129.37
Mayer & Co	1,044.50
Taunton Copper Manufacturing Company	942.20
George L. Neville	1,042.50
† Thomas J. Pope & Bro	200.00
E. J. Griffith & Co	1,268.50
T. W. Godwin & Co	1,122.25
‡ Park, Brother & Co	942.20
Elliott & Walke	1,201.50
Wallace & Sons	976.00
Class No. 9. Tin, zinc, etc.:	
E. E. Rider	759.00
J. B. Kendall	756.50
Mayer & Co	786.00
George L. Neville	755.45
Thomas W. Godwin & Co	771.00
† W. C. Codd	196.00
Elliott & Walke	787.00
* William A. Wheeler	755.00
Class No. 13. Iron pipe and fittings:	
Walworth Manufacturing Company	964.33
George D. Putnam & Co	968.83
Thomas W. Somerville & Sons	936.36
Mayer & Co	650.37
George L. Neville	1,018.13
Thomas W. Godwin & Co	923.28
William Kirkup & Sons	862.39
Elliott & Walke	856.44
* W. Edgar Bird & Co	846.73
Wm. A. Wheeler	915.74
Class No. 14. Brass pipe and fitting:	
George D. Putnam & Co	430.38
* Mayer & Co	391.75
George L. Neville	414.56
E. J. Griffith & Co	501.28
Thomas W. Godwin & Co	575.40
William Kirkup & Sons	590.06
Elliott & Walke	451.15
William A. Wheeler	514.68
Class No. 15. Small engine:	
E. E. Rider	270.00
Mayer & Co	265.00
* George L. Neville	260.00
E. J. Griffith & Co	290.00
S. C. Forsaith Machine Company	300.00
Manning, Maxwell & Moore	275.00
Class No. 16. Pumps:	
E. E. Rider	708.00
* J. J. Donavan	715.00
Mayer & Co	800.00

* Awarded.

† Informal.

‡ Awarded by lot.

Class No. 16. Pumps—Continued.	
George L. Neville.....	\$765.00
Thomas W. Godwin & Co.....	780.00
S. C. Forsaith Machine Company.....	790.00
*Nason Manufacturing Company.....	127.50
W. C. Codd.....	782.50
Class No. 17. Rivets:	
Bernard B. Neal.....	16.00
Mayer & Co.....	16.00
George L. Neville.....	16.08
E. J. Griffith & Co.....	19.60
† Thomas J. Godwin & Co.....	15.20
Elliott & Walke.....	20.00
William A. Wheeler.....	21.60
Class No. 18. Bolts and nuts:	
Bernard B. Neal.....	200.00
E. E. Rider.....	169.20
J. B. Kendall.....	150.00
Mayer & Co.....	201.50
Bowland A. Robbins.....	152.85
George L. Neville.....	176.45
E. J. Griffith & Co.....	223.50
Thomas W. Godwin & Co.....	192.00
Fred. M. Smith.....	145.09 [†]
† American Bolt Company.....	130.00
Elliott & Walke.....	232.00
N. W. Allen & Co.....	196.50
William A. Wheeler.....	170.00
Class No. 20. Expanders:	
Walworth Manufacturing Company.....	135.00
E. E. Rider.....	121.50
J. J. Donovan.....	150.00
Mayer & Co.....	150.00
George L. Neville.....	124.50
E. J. Griffith & Co.....	150.00
Thomas W. Godwin & Co.....	120.00
S. C. Forsaith Machine Company.....	178.50
Manning, Maxwell & Moore.....	151.20
† J. W. Soper.....	84.00
W. C. Codd.....	144.00
Elliott & Walke.....	210.00
W. Edgar Bird & Co.....	142.80
William A. Wheeler.....	1.0.00
Class No. 21. Felting.	
E. E. Rider.....	1,368.00
J. B. Kendall.....	1,400.00
Mayer & Co.....	1,624.00
George L. Neville.....	1,243.04
Thomas W. Godwin & Co.....	1,624.00
De Long, French & De Long.....	1,133.04
† Frederick M. Smith.....	1,046.40
H. W. Johns Manufacturing Company.....	1,566.40
Chalmers Spence Company.....	1,176.00
Julius E. Hintze.....	1,188.00
Elliott & Walke.....	1,560.00
N. W. Allen & Co.....	1,824.00
William A. Wheeler.....	1,608.00
Class No. 23. Engineer's tools:	
† Bernard B. Neal.....	944.69
Mayer & Co.....	961.26
George L. Neville.....	967.92
E. J. Griffith & Co.....	1,066.01
Class No. 24. Forges:	
Mayer & Co.....	142.50
George L. Neville.....	126.72
E. J. Griffith & Co.....	147.00
Thomas W. Godwin & Co.....	72.00
† S. C. Forsaith Machine Company.....	55.50

* Informal.

† Awarded.

Class No. 24. Forges—Continued.

Manning, Maxwell & Moore.....	\$120.00
Montgomery & Co.....	129.00
W. C. Codd.....	120.00

Class No. 25. Files:

*Bernard B. Neal.....	108.04
E. E. Rider.....	136.68
J. B. Kendall.....	126.86
Mayer & Co.....	150.96
George L. Neville.....	131.72
E. J. Griffith & Co.....	145.00
Thomas W. Godwin & Co.....	160.36
Manning, Maxwell & Moore.....	120.02
Montgomery & Co.....	116.22
Thomas Turton & Sons.....	209.10
Frederick M. Smith.....	126.73 [†]
James W. Soper.....	143.60
W. C. Codd.....	177.12
Elliott & Walke.....	176.00
N. W. Allen & Co.....	156.80
W. A. Wheeler.....	218.70

Class No. 26. Nails:

Mayer & Co.....	4.35
*George L. Neville.....	4.32
E. J. Griffith & Co.....	4.92
Elliott & Walke.....	10.80

Class No. 27. Screws:

Bernard B. Neal.....	124.05
*E. E. Rider.....	123.78
Mayer & Co.....	143.19
George L. Neville.....	137.97
E. J. Griffith & Co.....	165.29
Thomas W. Godwin & Co.....	155.88
Elliott & Walke.....	175.27
N. W. Allen & Co.....	396.00
W. A. Wheeler.....	219.58

Class No. 28. Engineer's instruments:

*Mayer & Co.....	194.45
George L. Neville.....	243.54
E. J. Griffith & Co.....	238.03
Thomas W. Godwin & Co.....	271.86
W. A. Wheeler.....	222.39

Class No. 29. Lanterns:

*Bernard B. Neal.....	65.55
Mayer & Co.....	95.00
George L. Neville.....	114.25
William Porter's Sons.....	153.20

Class No. 29 A. Lanterns:

E. E. Rider.....	228.48
Mayer & Co.....	221.00
George L. Neville.....	210.00
*William Porter's Sons.....	202.00

Class No. 32. Crucibles:

†E. E. Rider.....	35.10
J. B. Kendall.....	36.00
Mayer & Co.....	39.60
Rowland A. Robbins.....	35.10
George L. Neville.....	35.82
E. J. Griffith & Co.....	39.60
Thomas W. Godwin & Co.....	43.90
Manning, Maxwell & Moore.....	37.80
Montgomery & Co.....	36.00
W. C. Codd.....	48.60
Elliott & Walke.....	45.00
David A. Woodhouse.....	43.20
J. W. Paxson & Co.....	35.10
William A. Wheeler.....	37.60

*Awarded.

†Awarded by lot.

Class No. 33. Brick:	
E. E. Rider	\$52.50
J. B. Kendall	38.00
Mayer & Co.	45.00
George L. Neville	41.48
E. J. Griffith & Co.	40.00
*Fred. M. Smith	34.87
Neimeyer & Co.	49.90
Elliott & Walke	47.50
N. W. Allen & Co	45.00
Class No. 34. Sand, lime, etc.:	
J. B. Kendall	91.00
Mayer & Co.	64.00
*George L. Neville	60.10
Neimeyer & Co.	71.30
J. W. Paxson & Co.	71.30
Class No. 37. Charcoal:	
E. E. Rider	540.00
Mayer & Co.	450.00
George L. Neville	359.97
Neimeyer & Co.	600.00
*I. Bass & Bro.	330.00
George W. Taylor & Co.	435.00
Elliott & Walke	352.50
Class No. 38. Wood:	
Mayer & Co.	450.00
*George L. Neville	324.00
† R. J. Neely & Co	324.00
Neimeyer & Co.	390.00
George W. Taylor & Co.	349.00
John W. Oast & Bro	375.00
Class No. 39. Lumber:	
W. W. McCullough	1,809.00
George L. Neville	1,995.00
R. J. Neely & Co.	1,869.00
Jos. W. Duryee	1,852.00
Wheatley Bros.	1,995.00
*J. W. Gaskell & Sons	1,793.00
Class No. 40. Paints and oils:	
E. E. Rider	769.60
Z. D. Gilman	779.50
Mayer & Co.	819.00
George L. Neville	711.25
E. J. Griffith & Co.	799.00
William Waterall & Co	751.00
*W. W. Lawrence & Co.	640.75
William A. Wheeler	800.50
Class No. 44. Tallow, etc.:	
E. E. Rider	221.50
Manhattan Oil Company	178.50
Mayer & Co.	192.50
*George L. Neville	175.00
Edward C. Street	243.25
Wakeman & Fierz	244.00
Fred M. Smith	186.70
Class No. 45. Waste:	
E. E. Rider	425.00
J. B. Kendall	445.00
Thomas W. Somerville & Sons	475.00
Mayer & Co.	437.50
George L. Neville	443.75
E. J. Griffith & Co	500.00
Thomas W. Godwin & Co	462.50
*Montgomery & Co	400.00
Fred M. Smith	405.50
John Ellice & Co	412.50
Springfield Waste Company	450.00
W. C. Codd	440.00

*Awarded.

† Withdrawn.

Class No. 45. Waste—Continued.

Elliot & Walke	\$450 00
N. W. Allen & Co	456.25
William A. Wheeler	450.00

Class No. 47. Rubber:

*J. B. Kendall	90.75
Thomas W. Somerville & Sons	131.00
New York and Boston Rubber Company	161.00
Mayer & Co	110.25
Rowland A. Robbins	151.75
George L. Neville	91.00
E. J. Griffith & Co	134.00
Thomas W. Godwin & Co	127.00
Manning, Maxwell & Moore	159.00
G. P. Rubber Manufacturing Company	644.00
W. C. Codd	126.75
J. T. Brooke Rubber Company	161.00
Revere Rubber Company	139.00
Elliott & Walke	135.00
N. W. Allen & Co	244.00
Trenton Rubber Company	110.00
W. Edgar Bird & Co	101.00
William A. Wheeler	155.50

Class No. 50. Hose and fittings:

New York and Boston Rubber Company	624.25
Mayer & Co	302.25
Rowland A. Robbins	568.50
*George L. Neville	256.60
E. J. Griffith & Co	397.10
Thomas W. Godwin & Co	269.10
S. C. Forsaith Machine Company	339.30
Manning, Maxwell & Moore	494.05
Gutta-percha and Rubber Manufacturing Company	659.50
James Brooke Rubber Company	617.25
Revere Rubber Company	437.90
Elliott & Walke	392.25
N. W. Allen & Co	445.21
David A. Woodhouse	495.55
W. Edgar Bird & Co	455.35
William A. Wheeler	531.00
Trenton Rubber Company	303.25

Class No. 51. Engineers' stores:

Bernard B. Neal	755.90
*Mayer & Co	668.25
George L. Neville	792.26
E. J. Griffith & Co	807.15
William A. Wheeler	1,120.25

Class No. 52. Brushes:

Bernard B. Neal	116.00
Z. D. Gilman	228.60
Mayer & Co	123.00
J. S. Johnson & Co	176.00
*George L. Neville	106.80
E. J. Griffith & Co	131.50
W. W. Lawrence & Co	186.00
William A. Wheeler	163.00

Class No. 53. Canvas:

E. E. Rider	156.00
Mayer & Co	154.50
T. S. Johnson & Co	211.50
Rowland A. Robbins	149.40
*George L. Neville	149.00
William A. Wheeler	232.50

Class No. 54. Alcohol:

*J. B. MacNeal & Co	236.00
William A. Wheeler	300.00

* Awarded.

PENSACOLA, FLA., NAVY-YARD.

Class No. 4. Bar and sheet iron :	
A. F. Brombacher.....	\$38. 75
Avery & Woolfolk	40. 00
C. McK. Oerting	47. 50
J. O. Neal.....	82. 50
William A. Wheeler.....	60. 00
Henry Horsler & Co	50. 00
Mayer & Co	60. 00
*Cavanagh, Barney & Co	32. 50
Class No. 13. Iron pipe and fittings:	
Avery & Woolfolk	115. 00
C. McK. Oerting	55. 00
E. E. Rider	170. 00
J. O. Neal	150. 00
William A. Wheeler.....	68. 00
George L. Neville.....	90. 00
Cavanagh, Barney & Co	600. 00
*William Kirkup & Son.....	52. 00
Class No. 17. Rivets:	
Avery & Woolfolk	10. 00
*C. McK. Oerting.....	8. 75
J. O. Neal	13. 75
William A. Wheeler.....	12. 50
Henry Horsler & Co	10. 00
Mayer & Co	10. 00
George L. Neville.....	12. 50
Cavanagh, Barney & Co	11. 25
Class No. 23. Engineers' tools:	
Avery & Woolfolk	182. 20
C. McK. Oerting	136. 62
J. O. Neal	133. 20
William A. Wheeler.....	224. 60
S. C. Forsaith Machine Company.....	136. 80
*Cavanagh, Barney & Co	131. 90
Class No. 25. Files:	
*Avery & Woolfolk	72. 43
C. McK. Oerting	98. 75
E. E. Rider.....	102. 06
J. O. Neal	103. 95
William A. Wheeler.....	101. 24
Thomas Turton & Son	122. 90
James W. Soper	79. 47
Mayer & Co	96. 22
George L. Neville.....	122. 20
S. C. Forsaith Machine Company.....	105. 42
Cavanagh, Barney & Co	150. 44
Class No. 26. Nails:	
Avery & Woolfolk	22. 50
*C. McK. Oerting	17. 96
J. O. Neal	28. 25
W. A. Wheeler.....	37. 50
Henry Horsler & Co	25. 25
Mayer & Co	35. 00
Cavanagh, Barney & Co.....	27. 50
Class No. 27. Screws:	
A. F. Brombacher.....	45. 40
Avery & Woolfolk	75. 75
C. McK. Oerting	54. 43
*E. E. Rider.....	43. 45
J. O. Neal	61. 55
W. A. Wheeler.....	93. 50
George L. Neville.....	106. 00
Cavanagh, Barney & Co.....	76. 75
Class No. 31. Lead:	
Avery & Woolfolk	15. 00
C. McK. Oerting	11. 62½
J. O. Neal	11. 75

* Awarded.

Class No. 31. Lead—Continued.

*Clendenin Brothers.....	\$11.25
William A. Wheeler.....	15.00
Henry Horsler & Co.....	12.36
Mayer & Co.....	15.00
Cavanagh, Barney & Co.....	15.00

Class No. 34. Sand, lime, etc.:

Avery & Woolfolk.....	30.00
C. McK. Oerting.....	33.00
J. O. Neal.....	30.00
*J. W. Paxson & Co.....	18.00
William A. Wheeler.....	34.50
Mayer & Co.....	30.00
Cavanagh, Barney & Co.....	19.50

Class No. 40. Paints and oils:

Avery & Woolfolk.....	69.00
C. McK. Oerting.....	62.65
E. E. Rider.....	66.65
J. O. Neal.....	71.25
William A. Wheeler.....	89.75
Henry Horsler & Co.....	67.20
*William Waterall & Co.....	53.40
Cavanagh, Barney & Co.....	64.30

Class No. 48. Miscellaneous packing:

H. W. Johns Manufacturing Company.....	303.00
Avery & Woolfolk.....	480.00
C. McK. Oerting.....	459.00
G. D. Putnam & Co.....	360.00
J. O. Neal.....	915.00
Trenton Rubber Company.....	486.00
William A. Wheeler.....	396.00
Chalmers Spence Company.....	307.15
Henry Horsler & Co.....	591.00
Mayer & Co.....	378.75
George L. Neville.....	405.00
*Manning, Maxwell & Moore.....	282.75
Cavanagh, Barney & Co.....	727.50

Class No. 51. Engineer's stores:

Avery & Woolfolk.....	63.55
*C. McK. Oerting.....	51.00
J. O. Neal.....	76.15
William A. Wheeler.....	104.75
Henry Horsler & Co.....	79.00
Mayer & Co.....	66.15
Cavanagh, Barney & Co.....	57.15

Class No. 52. Brushes:

Avery & Woolfolk.....	29.40
*C. McK. Oerting.....	16.80
J. O. Neal.....	24.00
Cavanagh, Barney & Co.....	19.56

Class No. 53. Canvas:

Avery & Woolfolk.....	22.00
*C. McK. Oerting.....	21.00
E. E. Rider.....	24.00
J. O. Neal.....	27.00
William A. Wheeler.....	27.00
Cavanagh, Barney & Co.....	22.00
Henry Horsler & Co.....	22.50

Class No. 54. Alcohol:

C. McK. Oerting.....	49.80
*J. O. Neal.....	47.00
Henry Horsler & Co.....	53.00
Cavanagh, Barney & Co.....	50.00

KEY WEST, FLA., NAVAL STATION.

Class No. 13. Iron pipe and fittings:

*William Edgar Bird & Co.....	10.37
William A. Wheeler.....	26.43

*Awarded.

Class No. 13. Iron pipe and fittings—Continued.	
Mayer & Co	\$15.78
George L. Neville	28.28
S. C. Forsaith Machine Company	26.04
Class No. 23. Engineer's tools:	
*William A. Wheeler	22.95
Class No. 28. Engineer's instruments:	
E. E. Rider	72.00
William A. Wheeler	51.00
*Oswald Oelchlager	30.00
George L. Neville	75.00
Class No. 40. Paints and oils:	
E. E. Rider	89.75
William A. Wheeler	121.25
*William Waterall & Co	84.50
Mayer & Co	106.25
Class No. 46. Hemp and cotton packing:	
William Edgar Bird & Co	188.00
William A. Wheeler	210.00
Mayer & Co	240.00
*Rowland A. Robbins	120.00
George L. Neville	260.00
Manning, Maxwell & Moore	212.00
Class No. 48. Miscellaneous packing:	
H. W. Johns Manufacturing Company	106.25
James T. Brooke Rubber Company	87.50
Revere Rubber Company	77.50
Trenton Rubber Company	62.50
William Edgar Bird & Co	67.50
William A. Wheeler	75.00
Boston Rubber Company	66.25
Mayer & Co	112.50
*Rowland A. Robbins	60.00
George L. Neville	125.00
Manning, Maxwell & Moore	85.00
Gutta-Percha and Rubber Manufacturing Company	75.00
Class No. 51. Engineers' stores:	
William A. Wheeler	135.00
Mayer & Co	143.00
*Rowland A. Robbins	105.50
George L. Neville	178.00
Class No. 56. Lubricants:	
E. E. Rider	50.00
Manhattan Oil Company	43.75
Mayer & Co	50.00
George L. Neville	100.00
Edward C. Street	40.00
*Buxton, Heins & Co	37.50

MARE ISLAND, CAL., NAVY-YARD.

Class No. 1. Pig-iron:	
†J. MacDonough & Co	1,187.50
*George W. Gibbs & Co	1,225.00
Class No. 4. Bar and sheet iron:	
Huntington, Hopkins & Co	495.20
Thomas H. Selby & Co	484.14
Dunham, Carrigan & Co	433.34
*George W. Gibbs & Co	386.20
Class No. 6. Bar steel:	
*Huntington, Hopkins & Co	431.10
Thos. H. Selby & Co	498.82
Geo. W. Gibbs & Co	464.96
†Thos. Turton & Sons	262.43
Class No. 23. Engineers' tools:	
*Huntington, Hopkins & Co	680.05
Dunham, Carrigan & Co	725.50
†Jas. W. Soper	600.49
S. C. Forsaith Machine Company	878.08

* Awarded

† Informal.

Class No. 25. Files:		
Huntington, Hopkins & Co.....		\$146.44
Thos. H. Selby & Co.....		163.18
Dunham, Carrigan & Co.....		145.79
Geo. W. Gibbs & Co.....		144.92
Thos. Turton & Sons.....		230.55
French & Linforth.....		150.51
*Jas. W. Soper.....		134.50
Class No. 26. Nails:		
*Huntington, Hopkins & Co.....		3.00
Dunham, Carrigan & Co.....		3.48
Class No. 27. Screws:		
*Huntington, Hopkins & Co.....		27.30
Dunham, Carrigan & Co.....		41.10
Class No. 32. Crucibles:		
Huntington, Hopkins & Co.....		142.50
*Jas. Gallup.....		115.50
Class No. 34. Sand, lime, etc.:		
*Aden Bros.....		249.30
Jas. McCudden.....		252.00
A. Powell.....		280.00
Class No. 37. Charcoal:		
Aden Bros.....		50.00
*Jas. McCudden.....		45.00
A. Powell.....		50.00
Class No. 38. Wood:		
*Aden Bros.....		161.00
Jas. McCudden.....		168.00
A. Powell.....		168.00
Class No. 39. Lumber:		
Jas. McCudden.....		550.00
*A. Powell.....		515.00
W. W. McCullough.....		642.50
Class No. 40. Paints and oils:		
*Whittier, Fuller & Co.....		211.50
†Sullivan & Co.....		209.75
Jas. Gallup.....		214.85
Class No. 47. Rubber:		
Huntington, Hopkins & Co.....		275.00
Thos. H. Selby & Co.....		350.00
Jas. T. Brooke Rubber Company.....		370.00
*Trenton Rubber Company.....		230.00
Dunham, Carrigan & Co.....		360.00
Revere Rubber Company.....		247.50
Jas. Gallup.....		260.00
Gutta-Percha and Rubber Manufacturing Company.....		1,500.00
Class No. 49. Belting:		
*H. N. Cook.....		572.00
Huntington, Hopkins & Co.....		587.50
Thos. H. Selby & Co.....		672.00
Dunham, Carrigan & Co.....		569.00
†S. C. Forsaith Machine Company.....		546.20
Jas. Gallup.....		671.18
Class No. 51. Engineers' stores:		
*Huntington, Hopkins & Co.....		41.00
Dunham, Carrigan & Co.....		44.70
Class No. 52. Brushes:		
*Whittier, Fuller & Co.....		31.50
Sullivan & Co.....		36.00

*Awarded.

†Informal.

No. 13.—BUREAU OF PROVISIONS AND CLOTHING.

NAVY DEPARTMENT,
BUREAU OF PROVISIONS AND CLOTHING,
Washington, October 11, 1887.

SIR: I have the honor to submit herewith a report of the operations of this Bureau for the fiscal year ending June 30, 1887, together with tabulated statements pertaining thereto, viz:

Schedules of proposals received for furnishing supplies, statement of contracts made, and account of sales of condemned stores for same period, numbered 1 to 14 inclusive; also estimates of appropriations under cognizance of this Bureau for fiscal year ending June 30, 1889, marked A, B, C, and D.

REORGANIZATION OF THE BUREAU.

Under the operation of the order transferring the purchase, care, and issuance of stores, together with the charge of books and audit, to this Bureau, it has been organized into two divisions, viz, division of purchase and supplies, and division of accounts and audit; both under the charge of experienced pay officers of the Navy.

This duty is of an exceedingly arduous character, and requires ability of a high order to properly execute it.

I would recommend that legislative authority be given you to detail a pay officer of the Navy as Assistant Paymaster-General, with authority to act during the absence, from any cause, of the chief of Bureau.

Existing law provides that during such absence of the chief, the chief clerk, or chief of another Bureau shall act.

It is manifestly more in accordance with business principles that the acting chief of Bureau should be an officer of experience in the service, both at sea and on shore and in the Bureau itself.

The act approved 27th February, 1877, confers this authority in the Bureau of Medicine and Surgery, where it is found to operate satisfactorily.

The complex duties devolved upon the Bureau of Provisions and Clothing makes such provision of law even more necessary.

To enable the Bureau to obtain the best results these three officers should have a fixed tenure of office, and receive as compensation during such service the highest sea pay of their grades.

This additional compensation involves but a small amount of money, but such recognition would encourage officers to undertake the exhausting labor incident to the positions.

SUPPLIES.

The Bureau has continued the policy of reducing the quantity of clothing, small stores, and provisions carried in stock inaugurated during your administration.

By exacting a strict accountability for the necessity of purchases and utilizing the stores on hand, a reduction of over \$100,000 has been effected.

CONCENTRATION OF STORES.

Under your order of November 17, 1886, the work of consolidating and arranging the various naval stores and supplies belonging to the Navy Department, under the charge of one general storekeeper at each yard and station, and on board the various ships in commission, was entrusted to this Bureau and the pay corps.

An appropriation was made by Congress of the sum of \$20,000 to be allotted to the work of arranging the various storehouses and moving the stores thereto. Work was commenced January 1st last and completed during the current fiscal year, within the limits of the aforesaid appropriation.

This consolidation has rendered available a large number of storehouses at each yard, and caused a very considerable reduction in the clerical and other force heretofore required for their care and preservation, resulting in a large saving to the Government, while enforcing a strict and rigid responsibility for them by a bonded officer.

I beg to submit an outline of the plan adopted for the practical operation of this order.

With your support and the hearty co-operation of the various Bureaus, together with such additional legislation as I have the honor to recommend, it is believed it will accomplish all that you require.

A system of transfers of property pertaining to one Bureau for the use of another has been effected, by which the accumulation of surplus property under one Bureau, while another is necessitated to purchase the same stores, will be avoided in the future, to the great benefit of the Government.

While the general charge and issuance of all stores has been intrusted to a bonded officer, care has been taken to surround the purchase and inspection of all stores with such safeguards as will, it is believed, render fraudulent practices impossible. Care has been taken that the purchasing officer shall procure such articles as may be required, if by open purchase, after public competition, while he is precluded from either receiving them or passing upon their quality.

Boards of inspection have been organized at each yard and station—one member being selected from the Bureau representatives who require the articles—invested with authority to inspect and examine all the stores and supplies purchased for the use of the Navy, and to see that the articles are in accordance with the specifications, while the quantities agree with the amounts charged on the public bills.

Care has been taken to leave the respective Bureaus perfectly free to use these stores without interference, the general storekeeper having no authority over them, other than to see that the requisitions calling for them are in due form, and receipts given by the proper persons.

Statutory boards have been convened at the several yards and stations to survey and appraise the large accumulation of old and unserviceable material. From their reports, inventories have been compiled, and auction sales are being held, after due advertisement, to dispose of them.

I respectfully recommend that Congress be requested to amend the act approved August 5, 1882 (Vol. 22, Stats. at Large), which directs that the sale of all condemned articles shall be at public auction, to conform with the act approved March 5, 1875, providing in case of ordnance

material, that they may be sold at public sale, after due advertisement for proposals. This latter plan is found to be much more advantageous to the Government.

The removal of this accumulation of material, much of which has been in store for twenty years, will make valuable space available for other purposes. Business methods have been introduced which will result in keeping the stores and materials left on hand in such quantities only as the necessities of the service require.

A uniform system of book-keeping has been adopted, by which an account of the various stores pertaining to the different Bureaus, now concentrated in storehouses under the charge of bonded officers, can be accurately kept, and the Department maintain a system of rigid accountability for all its property.

Separate ledgers for purchased, manufactured, and condemned articles; record books for buildings, grounds, tools, machinery, plant and ships, have been prepared for the use of the several general storekeepers, who are required to make timely returns of this property with its appraised value, and separate returns of all receipts and expenditures of stores under each Bureau; showing the amounts expended for "use," as well as that transferred, and therefore still available for expenditure for "use." These quarterly returns are to be accompanied with all the papers and vouchers necessary for their proper examination and settlement.

A system of abstracting these returns in the Bureau has been adopted by which it will be possible to tell at once the total amount and value of all the naval property on hand, or that of any one item or Bureau.

A general appropriation book showing all the appropriations made by Congress under the respective Bureaus is also kept. All expenditures authorized by chiefs of Bureau are duly charged against the respective appropriations, and daily balances available stated.

Under your order transferring the duty of procuring all supplies for the Navy to this Bureau, the work of consolidating the various estimates made by the chiefs of Bureau has been nearly completed, and the aggregate of each article stated; so that one advertisement for all the articles needed, in lieu of separate advertisements for each Bureau, has been possible, thereby effecting a considerable saving in expense, while a uniform and commercial classification will enable merchants to bid on articles they deal in without including others in which they do not.

In order to complete the system inaugurated by you, and outlined above, I respectfully recommend that Congress be requested to appropriate for all stores and material "for the Navy," in lieu of for the different Bureaus of the Navy Department as heretofore.

I append a partial list of classes with the number of articles under each class, which are common to Bureaus, where manifest economy would result from such appropriation.

Each chief of Bureau would be required to estimate, as heretofore, for all the various articles and money needed. These estimates would then be combined in one schedule and submitted to Congress, together with the Bureau estimates from which it was compiled. Congress would then have ample information before it to consider the estimates and make such changes as might be considered advisable under each Bureau, and the Bureaus would have a stated amount to control as before.

Besides the saving of stores purchased by duplication under the present method, this change would decrease the store-rooms and stores now necessary on board ships; and would obviate the necessity of keeping

separate ledgers and returns for each Bureau ; thus making possible a still further reduction in expense of care and issuance of stores.

The following is the list referred to, of naval stores common to two or more Bureaus :

Classes.	Number of articles in each class.	Classes.	Number of articles in each class.
Apparatus (fire).....	8	Metals.....	29
Brushes.....	31	Naval stores.....	4
Building material.....	21	Oils, lubricants, etc.....	21
Canvas.....	3	Pipe and fittings.....	13
Chemicals, drugs, paints, etc.....	101	Supplies (engineers').....	39
Fittings, boiler, and engine.....	26	Supplies (plumbers').....	13
Fuel.....	5	Tools and hardware.....	239
Furniture, office, etc.....	10	Wood and willow ware.....	17
Lamps and lanterns.....	6	Miscellaneous articles.....	25
Leather, rubber, and belting.....	21		
Lumber and timber.....	24	Total.....	681
Machinery and machine tools.....	20		

ADVERTISING.

I would recommend that the act approved March 3, 1843 (Vol. 5, Stats. at Large), relative to advertising for proposals for supplies, be amended so as to authorize you to expend for advertising only a certain percentage of the amount of the estimated cost of articles to be purchased. Under the present law, making it mandatory to advertise in certain specified channels, it is possible to expend in advertising nearly or quite as much as the value of the purchase.

CLOTHING FUND.

The "clothing" and "small stores" funds of the Navy are being gradually depleted, under a recent decision of the accounting officers of the Treasury.

When a recruit enters the Navy, either as an apprentice or under an enlistment, the paymaster is required to furnish him with an outfit, consisting of mattress, blankets, and uniform clothing, together with certain articles of small stores deemed necessary for his health and comfort. The value of this outfit averages about \$40, which is charged to the recruit's account. Should he desert before his indebtedness to the Government is liquidated, the auditing officers now charge such indebtedness to the clothing fund.

Again, when enlisted men are court-martialed and punished by imprisonment for a term of years, the clothing and small stores deemed necessary for their health during such confinement have been furnished by paymasters of receiving ships, and the value charged to the funds above named.

The amounts thus charged during the past fiscal year amount to a considerable sum, and there is no way in which to reimburse these funds for this expenditure by transfer of money from other appropriations. I recommend that the Government, in the case first cited, assume the loss outright, through appropriation "Pay of the Navy," instead of assuming it finally through the depletion of the clothing fund. In fact the loss is merely nominal, as the amounts due deserters and forfeited to the Government are about equal to the indebtedness of the same.

In the second instance, the value of the issues should be charged to the prisoner's account, and the balance of the pay due him, after deducting these charges, should be forfeited to the Government.

CLOTHING FUND, NAVAL ACADEMY.

Section 4 of the act of March 2, 1867, provides that "the store-keeper at the Naval Academy shall be detailed from the Paymaster's Corps, and shall have authority, with the approval of the Secretary of the Navy, to procure clothing and other necessaries for the midshipmen and cadet engineers—now Naval cadets—in the same manner as supplies are furnished to the Navy."

Under the direction of a former Secretary of the Navy, the sum of \$24,500 was transferred from pay of the Navy to the cadets' store-keeper, to constitute his capital to transact the various duties devolved upon him. This sum has remained, without change, in the custody of the cadets' store keeper, and used as indicated above.

The act of June 19, 1878, prohibits the use of any money appropriated for "Pay of the Navy," except for the pay of the officers and men of the Navy.

I therefore respectfully recommend that Congress be requested to legalize the present use of this sum, by transferring \$24,500 from "Pay of the Navy" to a fund to be designated "Clothing and other necessaries for naval cadets."

TOBACCO.

Under the provisions of act of Congress approved March 3, 1881, it is provided that "the lowest bid for furnishing tobacco equal to the U. S. Navy standard now in use shall be accepted."

As the said U. S. Navy standard is not described or provided for in commercial terms, it is difficult for the Bureau to determine at this date what the U. S. Navy standard of 1881 is.

I therefore recommend that a commercial description and classification be adopted by Congress, which shall be recognized as Navy standard in the future.

PAY CORPS.

Under the operation of the law of 1882, reducing the three lower grades of the Pay Corps ten numbers each, the grade of assistant paymaster has been reduced to fifteen members, thirteen of whom are on duty, one on waiting orders, and one on leave. This grade is to be reduced to ten before there can be any new appointments, which will not be accomplished for several years to come.

The Bureau is of the opinion that the interests of the service would be greatly promoted if there were assistant paymasters available for assignment to duty as assistants to officers in the higher grades of the corps, particularly to those assigned to duty as general storekeepers, who would thus have the benefit of bonded and responsible assistants in the performance of their arduous duties. This association would be of equal benefit to the younger officers, through the business training and experience they would receive.

The Bureau recommends that the number of assistant paymasters be increased to twenty-five, being a present increase of ten, and that all appointments hereafter be made from graduates of the Naval Academy, subject to examination by a board of paymasters, as now provided by law.

DISBURSING OFFICERS' BONDS.

The Bureau repeats the following recommendation of its former chief, relative to disbursing officers' bonds, with a hope that legislation may soon be had on this important subject:

In connection with the subject of disbursing officers' bonds, the Bureau respectfully recommends the desirability of a modification of the laws governing the same, to the extent of authorizing the acceptance of corporate sureties, when of such character as to be of undoubted solvency.

The inconvenience and embarrassment attending the securing of private sureties in the periodical renewal of bonds is quite seriously felt by many disbursing officers, who, from causes incident to frequent changes of duty and station, are deprived of opportunity of establishing in a community friendly or social relations of a duration sufficiently extended to warrant them in soliciting a favor which embodies the strongest test of friendship.

After a pay officer has satisfactorily settled his accounts under an official bond, and after he has entered into a new bond for the further faithful performance of the duties of his office, the accounting officers of the Treasury should be required to cancel the old bond or return it to the pay officer. It is manifestly unjust to the officer and his sureties for the Government to retain the old bond for all time, reserving the right, as it does, of opening the accounts to which it pertains at any future period. In the language of a former distinguished Attorney-General (Taney), "The officers of the Government are not bound, from the nature of our institutions, to perpetuate an act of injustice in the name of the United States."

Indeed, the statutes have provided limitations for the prosecution of a certain class of offenders, and there is no reason why the same protection should not be extended to persons who are not offenders, but who are faithful servants of the Government.

I have the honor to be, very respectfully, your obedient servant,
JAMES FULTON,
Paymaster-General, U. S. Navy.

Hon. W. C. WHITNEY,
Secretary of the Navy.

Statement of "Provisions" appropriation for fiscal year ending June 30, 1887.

To amount appropriated for fiscal year.....	\$1,052,000.00	
To amount refunded for provisions sold to officers' messes.....	9,661.38	
		<u>1,061,661.38</u>
By amount of provisions, including water, purchased by Bureau.....	144,743.92	
By amount of provisions, including water, purchased by paymasters of ships.....	193,214.86	
		<u>337,958.78</u>
By amount paid for commuted rations to officers, crew, and marines, and on account of sick in hospitals.....	604,144.59	
By amount paid for labor and expenses of inspection provisions and clothing.....	47,588.89	
By amount paid on claims settled by Fourth Auditor Treasury.....	1,797.41	
		<u>961,408.29</u>
By balance of appropriation unexpended.....	70,261.00	
		<u>1,061,661.38</u>

Statement of stores in stock, etc.

Amount of provisions on hand, in store, and in transit, July 1, 1886.....	145,798.04	
Amount of provisions on hand on board ships July 1, 1886.....	100,749.94	
		<u>246,547.98</u>
Amount of provisions on hand, in store, and in transit, June 30, 1887.....	108,664.79	
Amount of provisions on hand on board ships June 30, 1887.....	85,371.44	
		<u>194,036.23</u>

Statement of "Contingent" appropriation for fiscal year ending June 30, 1887.

To amount appropriated for fiscal year		\$50,000.00
By amount of contingent stores purchased by Bureau	4,097.80	
By amount of contingent stores purchased by paymasters of ships	2,114.48	
By amount paid for freight on shipments	14,745.46	
By amount paid for advertising	2,553.07	
By amount paid for foreign postage, telegrams, and other incidental expenses	7,383.76	
	<hr/>	30,894.57
By balance of appropriation unexpended		19,105.43
		<hr/> <hr/>
		50,000.00

Statement of stores in stock, etc.

Amount of contingent stores on hand in store July 1, 1886	24,256.58	
Amount of contingent stores on hand on ships July 1, 1886	17,565.74	
	<hr/>	41,822.32
Amount of contingent stores on hand in store June 30, 1887	18,485.33	
Amount of contingent stores on hand on ships June 30, 1887	18,090.33	
	<hr/>	36,575.66
		<hr/> <hr/>

Statement of special "Contingent" appropriation for expense of consolidating and arranging stores and other property.

To amount of appropriation for 1887 and 1888		\$20,000.00
By amount expended to date, October 1, 1887	17,934.10	
By balance of appropriation unexpended	2,065.90	
	<hr/>	20,000.00
		<hr/> <hr/>

Statement of "Civil Establishment" appropriation for fiscal year ending June 30, 1887.

To amount appropriated for fiscal year		\$35,000.00
By amount expended	29,855.28	
By balance of appropriation unexpended	5,144.72	
	<hr/>	35,000.00
		<hr/> <hr/>

Statement of clothing fund for fiscal year ending June 30, 1887.

To amount to credit of fund, including unadjusted balance, July 1, 1886 ..	\$568,202.43	
To amount of stock on hand, in store, and transit July 1, 1886 ..	\$532,581.44	
To amount of stock on hand on board ships	208,331.08	
	<hr/>	735,912.52
To amount of stock received from purchase by Bureau	149,170.93	
To amount of stock received from purchase by paymasters of ships	2,096.48	
	<hr/>	151,267.41
To amount received from issues, sales, and transfers		209,560.56
		<hr/>
		1,664,942.92
		<hr/> <hr/>
By amount of stock purchased during year		151,267.41
By amount of stock issued to officers, crew, and marines	196,303.07	
By amount of stock sold for cash	8,983.17	
By amount of stock transferred to other Bureaus	340.54	
By amount of stock condemned and sold, net proceeds	3,893.78	
	<hr/>	209,560.56
By amount of loss on sales of condemned stock	8,189.18	
By amount of loss on stock condemned as worthless	118.49	
By amount of loss on issues on board ships	1,782.95	
By amount of loss by reduction of prices through deterioration	52,580.64	
	<hr/>	62,671.56
By amount of surplus fund covered into the Treasury		250,000.00
By amount to credit of fund, including unadjusted balance, June 30, 1887 ..	305,066.81	
By amount of stock on hand, in store, and in transit June 30, 1887	\$477,420.36	
By amount of stock on hand on board ships June 30, 1887	268,956.22	
	<hr/>	696,376.58
		<hr/> <hr/>
		991,443.39
		<hr/> <hr/>
		1,664,942.92

Statement of small stores fund for fiscal year ending June 30, 1887.

To amount of credit of fund, including unadjusted balance, July 1, 1886 ..	\$173,782.08	
To amount of stock on hand, in store, and in transit July 1, 1886	\$80,751.32	
To amount of stock on hand on board ships July 1, 1886	43,428.68	
	124,180.00	297,962.68
To amount of stock received from purchase by Bureau	41,925.79	
To amount of stock received from purchase by paymasters of ships	8,143.12	
		50,068.91
To amount received from issues, sales, and transfers		61,642.15
		409,674.14
By amount of stock purchased during year		50,068.91
By amount of stock issued to officers, crew, and marines	50,456.63	
By amount of stock sold for cash	4.64	
By amount of stock transferred to other Bureaus	2,020.15	
By amount of stock condemned and sold, net proceeds	161.75	
		61,642.15
By amount of loss on sales of condemned stock	1,490.45	
By amount of loss on stock condemned as worthless	198.04	
By amount of loss on issues on board ships	476.76	
		2,165.25
By amount of surplus fund covered into the Treasury		75,000.00
By amount to credit of fund, including unadjusted balance, June 30, 1887 ..	103,467.41	
By amount of stock on hand, in store, and in transit June 30, 1887	\$75,531.90	
By amount of stock on hand on board ships June 30, 1887	41,797.62	
	117,329.42	220,796.83
		409,674.14

Schedule of proposals for fresh provisions, Navy bread, baking, and water received during the fiscal year ending June 30, 1886, to be delivered during fiscal year 1887.

Name.	Where to be delivered.	Fresh beef, per pound.	Fresh vegetables, per pound.	Fresh bread, per pound.	Navy bread, per pound.	Baking flour, per barrel.	Water, per gallon.
		Cents.	Cents.	Cents.	Cents.		Cents.
John O. Downes*	Portsmouth, N. H.	.11	.03	.07			
C. E. Langton	do	.12	.03	.08			
C. A. Simonds*	Charlestown, Mass.	.06	.01				
M. J. Doran	do	.07	1.00			\$1.32	
Austin & Graves.	do			.05			
Thomas Gladding*	Newport, R. I.	.14					
L. Coggehall*	do		.03	.06			.00
W. S. Bailey	do	.15	.04	.06			
James J. Lyons	New York	.06	.01				
John Hanley*	do	.06	.00				
J. McNamara	do			.02			
N. Thompson	do			.02			
Anton Behlen*	do			.02			
J. O. Dougherty†	do			.02			
C. T. Goodwin & Son	do			.02			
E. Treadwell's Son*	do					1.49	
L. S. Horace†	do					1.47	
William Schabinger*	League Island	.12	.04				
J. Hartman*	do			.05			
C. E. Lyman*	Washington, D. C.	.10	.05			1.00	
J. T. Varnell & Son	do	.10	.05				
C. E. Koller*	do			.03			
B. Charlton & Co.*	do			.04		1.75	
Jackson Brewer*	Annapolis, Md.	.07	.03				
John Kealy	do	.08	.02				
Alexander Heise*	do			.03			
M. M. Smith	do			.04			
C. T. Cabler*	Norfolk, Va.			.08			
James Reid & Co*	do					2.00	
D. Lathrop	do			.03			
William Clark*	do						.00
Isaac Gutman	do	.05	.01				
W. H. Kimberly	do	.08	.01				
S. Westheimer	do	.00	.01				
L. Wasserman	do	.01	.01				
Franck Dusch.	do	.05	.01				

* Contracts awarded.

† Per bushel.

‡ Less hoop poles.

Schedule of proposals for fresh provisions, Navy bread, baking, etc.—Continued.

Name.	Where to be delivered.	Fresh beef, per pound.	Fresh vegetables, per pound.	Fresh bread, per pound.	Navy bread, per pound.	Baking flour, per barrel.	Water, per gallon.
J. O'Neal*	Pensacola, Fla.	Cents.	Cents.	Cents.	Cents.		Cents.
J. S. Bell*	do	.11	.05½				
C. Corner	do	.14	.06				
R. M. McDavid	do	.13	.05½				
J. Mooney*	do				.04½		
Moses White*	do			.05½			
J. F. Tobin*	Marine Island, Cal.	.10½	.02½				
F. Uri & Co	do	.14	.05				
Simon & Newman	do	.12½	.07				
Groedel & Reinhold	do	.13	.06				
John Faust*	do			.05½			
D. F. Brown	do			.06			
California Cracker Company*	do				.04		

* Contracts awarded.

Schedule of proposals for Navy supplies under Bureau's advertisement dated July 3, 1886.

Names.	200,000 pounds sugar, per pound.	7,000 pairs calf shoes, per pair.	70,000 yards cotton duck, per yard.	10,000 pairs cotton socks, per pair.	200,000 pounds salt-water soap, per pound.	1,000 mess kettles, each.
John L. Judge.....	Cents.		Cents.	Cents.	Cents.	Cents.
G. A. Jahn.....	.06½					.90
Henderson & Stoutenborough*						.50
George H. Creed.....					.03,75	.48,75
G. M. Rosenblatt.....				.15½	.04,75	.54,75
B. Y. Pippet & Co.*.....					.02,75	.48,75
Fred. M. Smith.....						.52,75
F. T. Witte Hardware Co.*.....						.52,75
F. A. McKeone.....						.52,75
Wm. A. Wheeler*.....	.06½					.52,75
W. E. Gray.....						.52,75
J. R. Michael.....			.10,75			.52,75
A. Van Hagen*.....					.02,75	.52,75
Thurber, Whyland & Co.*.....	.06,75					.52,75
J. S. Barron & Co.....						.48,75
R. A. Robbins.....					.02,75	.48,75
Water Repellant Shoe and Leather Co.....		\$1.75				
J. Freeman & Co.*.....		*1.74,75				

Names.	1,000 mess-pans, each.	3,000 tin pots, each.	3,000 tin pans, each.	5,000 boxes black-ing, each.	3,000 jack-knives, each.	Lot miscellaneous articles, for the lot.
John L. Judge.....	Cents.	Cents.	Cents.	Cents.	Cents.	
Rothschild Bros. & Co.....	.60	.18		.03		
W. F. Rockwell.....					.40	
Henderson & Stoutenborough*	.30	.06½				
Cheesebrough Manufacturing Co.*.....				.02,75		
George F. Nye.....				.02½		
George H. Creed.....	.33,75	.05,75	.05,75			\$447.34
Fred. M. Smith.....	.35,75	.07,75	.07,75			
F. T. Witte Hardware Co.*.....	.38,75	.05,75	.05,75	.02,75	.39,75	*402.51
Wm. A. Wheeler*.....	.37,75	.06,75	.06,75	.03,75		1439.95
Thurber, Whyland & Co.*.....						1488.18
J. S. Barron & Co.....	.33,75	.05,75	.05,75	.02,75		

* Contracts awarded.

† Less hoop poles.

Schedule of proposals for Navy supplies under Bureau's advertisement, dated August 24, 1886.

Names.	10,000 pounds rice, per pound.	15,000 pounds pickles, per pound.	2,000 pounds tea, per pound.	30,000 pounds assorted vegetables, per pound.	10,000 pounds split peas, per pound.
John D. Gilmer*	Cents. .07½	Cents. .08½	Cents. .40	Cents. 1.07½	Cents. .04½
Thurber, Whyland & Co.*	.05½		*.39½	*1.07½	*.02½
M. Kattenhorn*	.04½		*.28½	*1.07½	
F. H. Leggett & Co			.38		.02½
F. Foehrenbach & Co.		.06			
C. L. Todd	.04½				
Kemp, Day & Co	.05½	.06½	.44½	.07½	.02½
R. G. Thomas			.35		
G. A. Jahn	.05½				
Henry Adams, jr	.04½		.37½		
W. R. Soper*		*.05½			

Names.	10,000 pounds bacon, per pound.	8,000 gallons beans, per gallon.	5,000 gallons molasses, per gallon.	3,000 gallons vinegar, per gallon.	3,000 spoons, each.
John D. Gilmer*	Cents.	Cents. * 25½	Cents.	Cents. .20	
Thurber, Whyland & Co			.20½		
M. Kattenhorn			.24½		
F. H. Leggett & Co			.33		
Geo. P. Ockershausen*			*.21		
F. Foehrenbach & Co.*				*.13½	
C. L. Todd				.19	
Fred. M. Smith					100.99
Kemp, Day & Co.*	*.10½	.27½	.31		
F. T. Witte Hardware Co					.27.56
J. M. Shaw & Co.*					*.58.56
G. A. Jahn			.22		
Paul J. Field					14.14
Henry Adams, jr			.26½	.16½	

*Contract awarded.

† Tie bids decided by lot.

‡ Lot.

§ Per M.

|| Gross.

Schedule of proposals for Navy supplies under Bureau's advertisement, dated November 20, 1886, opened December 22, 1886.

Name of bidders.	20,000 pounds oatmeal, per pound.	800 barrels pork, per barrel.	15,000 pounds rice, per pound.	3,000 pounds evaporated apples, per pound.	3,000 pounds evaporated peaches, per pound.	10,000 pounds canned tomatoes, per pound.	30,000 pounds canned corned beef, per pound.	20,000 pounds canned fresh beef, per pound.
Henry Adams*	Cents.		Cents. * 03. ³⁵ / ₁₀₀					
H. F. Chapman		\$15. 35					.07 ¹⁰ / ₁₀₀	.07 ¹⁰ / ₁₀₀
Armour & Co.*		*14. 30					.07 ¹⁰ / ₁₀₀	.07 ¹⁰ / ₁₀₀
French & Co.*						.04 ¹ / ₁₀₀		
M. Kattenhorn	* 04 ¹ / ₁₀₀		.04 ¹ / ₁₀₀			.06		
J. D. Gilmor		14. 35				.04 ¹ / ₁₀₀		
W. A. Wheeler		10. 00						
C. L. Todd			.04 ⁷ / ₁₀₀			.03 ¹ / ₁₀₀		
Kemp, Day & Co.*	.05 ¹ / ₁₀₀		.04 ¹ / ₁₀₀	.15 ¹ / ₁₀₀	* 39 ¹ / ₁₀₀	.04		
Cutting Fruit Packing Co								.07
Thurber, Whyland & Co.*	.05 ⁷ / ₁₀₀		.04 ¹ / ₁₀₀			.04 ¹ / ₁₀₀	* 06. ³ / ₁₀₀	* 06. ³ / ₁₀₀
William Gray*				* 14 ¹ / ₁₀₀		.02 ¹ / ₁₀₀		
E. L. Allen*				.17				

Name of bidders.	30,000 pounds canned ham, per pound.	15,000 pounds bacon, per pound.	1,000 pounds tea, per pound.	15,000 pounds pickles, per pound.	10,000 pounds canned vegetables, per pound.	3,000 pounds cranberry sauce, per pound.	10,000 yards cloth for trousers, per yard.	10,000 pairs woolen socks, per pair.
Henry Adams	Cents.	Cents.	Cents. .36 ⁷ / ₁₀₀	Cents.	Cents.	Cents.		Cents.
James Symington							\$2. 43	
Armour & Co.*	* 14. ⁴ / ₁₀₀					* 12 ¹ / ₁₀₀		
French & Co.*								
Foehrenbach & Co.*				* 07 ¹ / ₁₀₀				
M. Kattenhorn			.31		* 06 ¹ / ₁₀₀			
J. D. Gilmor*			* 28		.07 ¹ / ₁₀₀	.16		
J. R. Michael					.07 ¹ / ₁₀₀			.35 ¹ / ₁₀₀
Kemp, Day & Co.*		*10 ¹ / ₁₀₀	.38	.07 ¹ / ₁₀₀	.07 ¹ / ₁₀₀			
Thurber, Whyland & Co.			.56		.07 ¹ / ₁₀₀			
William Gray			.36					
B. Y. Pippet & Co.*							†2. 19	* 31 ¹ / ₁₀₀
San Francisco Pioneer Woolen Factory*							*†2. 19	

* Contract awarded.

† Tie bid awarded by agreement of parties.

408 · REPORT OF THE SECRETARY OF THE NAVY.

Schedule of proposals for Navy supplies under Burcau's advertisement, dated November 20, 1886, opened December 22, 1886—Continued.

Name of bidders.	5,000 B. S. neckerchiefs, each.	3,000 yards tan duck, per yard.	3,000 spoons linen thread, per spool.	3,000 spoons cotton thread, per spool.	1,000 papers needles, per paper.	1,000 razor-straps, each.	3,000 shoe-brushes, each.	3,000 wash-brushes, each.
	Cents.	Cents.	Cents.	Cents.	Cts.	Cents.	Cents.	Cents.
Charles E. Fales.....								
M. C. Paterson.....	\$1.15							
Wechsler & Abraham			.06½		.03½			
Blank & Voelbel*							*.16½	
J. R. Michael*.....	*.87½	*.13½	*.05½		.03½	.24		
Fred. M. Smith*.....		.05½	.05½	*.02½	*.01½	.24	.27½	.17½
W. A. Wheeler.....		.16	.05½	.03½	.03½	.25	.25	†.12½
F. T. Witte Hardware Co							.35	
J. S. Barron & Co.*							.17½	*.17½
B. Y. Pippey & Co.....	.88	.14			.02½			
T. G. Hood.....	1.14½	.14½						
George T. Noe.....				.03½				
J. R. Torrey & Co.*.....						*.22		

Name of bidders.	500 mess-kettles, each.	3,000 tin pots, each.	2,500 tin pans, each.	3,000 spoons, each.	2,000 forks, each.	3,000 boxes blacking, per box.	14,000 pieces worsted tape, per piece.
	Cents.	Cents.	Cents.	Cents.	Cents.	Cents.	Cents.
J. S. Mason & Co*.....						.03	*
Chesebrough Manufacturing Co						*.02½	
Henderson & Stontenborough*	*.47	*.05½	*.04½	.02½	.02½		
Wechsler & Abraham			.06½				.05½
William Vogel & Bros.....	.48½	.05½					
J. M. Shaw & Co.*.....				*.02½	.03½		
J. R. Michael.....						.02½	.03½
Fred. M. Smith*.....	.48	.05½	.06	.02½	*.02½		*.02½
Horstman Bros. & Co.....						.03½	.03½
W. A. Wheeler.....	.49	.06½	.06½	.02½	.02½	.03½	.04
F. T. Witte Hardware Co.....	.55	.08	.05½	.03	.03	.03½	
J. S. Barron & Co.....	.48½	.05½	.05½	.02½	.02½		
T. G. Hood.....							.03½
George T. Noe.....						.02½	
Rothschild Bros. & Co.....						.04	

* Contract awarded.

† Bid withdrawn.

Schedule of proposals for 100,000 pounds tobacco under Bureau's advertisement, dated March 16, 1887.

	Cents.	Cents.	Cents.	Cents.
Wilson and McCallay Tobacco Company	B. 23	C. 26	G. 24	
Boykins, Bland & Co.....	25			
P. Lorillard & Co.....	Y W. 28	W X. 27	Z Y. 24½	X Z. 24
J. B. Pace Tobacco Company.....	24			
Perkins & Ernst*.....	Garland 30	Butterfly 28		
Berry Brothers*.....	23½			
W. Smith & Co.*.....	25			
Ford, Moorman & Co.....	A. 24½	28½	30	
W. T. Hancock.....	24½			
Myers Brothers & Co.†.....	22½			
C. W. Spicer, agent*.....	A. 28	S. 25½		
William Buchanan.....	27			

* Not sufficient surety.

† Contract awarded.

Schedule of proposals for Navy supplies under Bureau's advertisement, dated May 2, 1887.

Names.	30,000 pounds corned beef, per pound.	30,000 pounds lard, per pound.	1,000 gallons split peas, per gallon.	16,000 pounds rice, per pound.	50,000 pounds butter, per pound.	3,000 pounds tea, per pound.	200,000 pounds sugar, per pound.	5,000 gallons molasses, per gallon.	3,000 gallons vinegar, per gallon.	75,000 pounds coffee, per pound.	2,000 yards tan duck, per yard.	3,000 yards cloth for caps, per yard.
Thurber, Whyland & Co.*	\$43.74½	Ots.	Ots. 20½	Ots. 57½	Ots. 29½	Ots. 37½	Ots. 5½	Ots. 37½	Ots. 15½	Ots. 28½		
Henry Adams, jr.*				57½	27	33			13			
Edin Butter Company*												
Edselheimer Brothers												
Rowland A. Robbins*											14½	\$2.08
E. B. Hozier*			19	5½		28½			16			
Kemp, Day & Co.	10½		21	5½		33		20½	24½			
Higbie, Smith & Co. §					25½			32½				
R. Y. Pippey & Co. §												2.56
J. R. Michael*											16	
West & Melchers					28							

Names.	150,000 pounds S. W. soap, per pound.	5,000 cotton handkerchiefs, each.	2,000 thimbles, each.	3,000 jack-knives, each.	3,000 scissors, each.	5,000 dozen dead-eye buttons, per dozen.	1,000 mace-kettles, each.	1,000 mace-pans, each.	3,000 tin pots, each.	3,000 tin pans, each.	5,000 pieces tape, per piece.
Van Haagen Soap Manufacturing Company	\$0.03½	Ots.	Ots.	Ots.	Ots.		Ots.	Ots.	Ots.	Ots.	Ots.
Henry Seymour					74						
F. T. Witte Hardware Company*				45	65						
W. F. Rockwell											
Rowland A. Robbins*	02½										
Abraham Wolf	08½					44	83	13			
R. M. Colgate	17,240.00										
A. Jeffrey							40½	30½	5½	47½	
J. S. Barron & Co.*											
J. H. Draeher	03½										
J. R. Michael*		11	3	39		11.63					17½

* Contract awarded.
† Dozen.

‡ 1.50 for barrel.
§ Informal.

|| Lot.
¶ Great gross.

Schedule of proposals for ice under Bureau's advertisement, dated May 19, 1887.

Names.	Boston, 28,080 pounds.	New York, 63,000 pounds.	League Island, 51,645 pounds.	Annapolis, 134,400 pounds.	Norfolk, 47,000 pounds.	Pensacola, 40,320 pounds.	Mare Island, 19,500 pounds.	Key West, 7,300 pounds.
A. F. Tift								* \$73.00
E. E. Saunders & Co.						* 75		
Drivers Union Ice Company	* 36							
Knickerbocker Ice Company, New York		* 15						
Patrick Lyons					80			
Knickerbocker Ice Company, Philadelphia			* 40					
John K. Gann					* 70			
Henry Connolly							* 3	
John B. Flood				25				
J. S. N. Beall				* 23				

* Contract awarded.

Schedule of proposals for supplies under Bureau's advertisement, dated May 23, 1887.

Names.	25,000 yards bleached duck, per yard.	5,000 yards burlaps, per yard.	3,000 yards enameled cloth, per yard.	500 pounds camphor, per pound.
J. R. Michael.....	Cents. 23 ⁰⁰ / ₁₀₀	Cents. 05 ⁰⁰ / ₁₀₀	Cents. 26 ⁰⁰ / ₁₀₀	Cents. 25 ⁰⁰ / ₁₀₀
R. W. Creed.....		Cents. 05 ⁰⁰ / ₁₀₀	Cents. 25 ⁰⁰ / ₁₀₀	Cents. 25 ⁰⁰ / ₁₀₀
R. A. Robbins.....	Cents. *22 ⁰⁰ / ₁₀₀	Cents. *03	Cents. 26 ⁰⁰ / ₁₀₀	Cents.

* Contract awarded.

Statement of contracts made by the Bureau of Provisions and Clothing for and in behalf of the Navy Department during the fiscal year ending June 30, 1887.

Names.	Date.	Articles contracted for.	Price.	Where to be deliv- ered.
William Schabinger.....	June 13	Fresh bread... per pound..	\$0.05	League Island, Pa.
Lawton Coggeshall.....	June 14	do..... do.....	.06	Newport, R. I.
Do.....	June 14	Fresh vegetables..... do.....	.08 ⁰⁰ / ₁₀₀	Do.
Do.....	June 14	Fresh water... per gallon.....	.00 ⁰⁰ / ₁₀₀	Do.
Thomas Gladding.....	June 14	Fresh beef... per pound.....	.14	Do.
John S. Bell.....	June 15	Fresh beef..... do.....	.11	Pensacola, Fla.
Do.....	June 15	Fresh vegetables..... do.....	.05 ⁰⁰ / ₁₀₀	Do.
Moses White.....	June 15	Fresh bread..... do.....	.05 ⁰⁰ / ₁₀₀	Do.
John Mooney.....	June 15	Navy bread..... do.....	.04	Do.
Anstin & Graves.....	June 15	Fresh bread..... do.....	.05 ⁰⁰ / ₁₀₀	Charlestown, Mass.
Do.....	June 15	Baking flour..... per bbl.....	1.32	Do.
Alex. Helse.....	June 15	Fresh bread... per pound.....	.03	Annapolis, Md.
Jackson Brewer.....	June 15	Fresh beef..... do.....	.07 ⁰⁰ / ₁₀₀	Do.
Do.....	June 15	Fresh vegetables..... do.....	.08	Do.
William Clark.....	June 16	Fresh water... per gallon.....	.00 ⁰⁰ / ₁₀₀	Norfolk, Va.
Isaac Gutman.....	June 16	Fresh beef... per pound.....	.05 ⁰⁰ / ₁₀₀	Do.
Do.....	June 16	Fresh vegetables..... do.....	.01 ⁰⁰ / ₁₀₀	Do.
C. T. Cabler.....	June 16	Fresh bread..... do.....	.03 ⁰⁰ / ₁₀₀	Do.
C. A. Simonds.....	June 16	Fresh beef..... do.....	.06 ⁰⁰ / ₁₀₀	Charlestown, Mass.
Do.....	June 16	Fresh vegetables..... do.....	.01 ⁰⁰ / ₁₀₀	Do.
C. E. Koller.....	June 19	Fresh bread..... do.....	.03 ⁰⁰ / ₁₀₀	Washington, D. C.
C. E. Lyman.....	June 21	Fresh beef..... do.....	.10	Do.
Do.....	June 21	Fresh vegetables..... do.....	.05	Do.
B. Charlton & Co.....	June 22	Baking flour..... per bbl.....	1.75	Do.
John O. Downs.....	June 22	Fresh beef... per pound.....	.11	Portsmouth, N. H.
Do.....	June 22	Fresh vegetables..... do.....	.03	Do.
Do.....	June 22	Fresh bread..... do.....	.07	Do.
John Faust.....	June 23	do..... do.....	.05 ⁰⁰ / ₁₀₀	Mare Island, Cal.
James Reid & Co.....	June 24	Baking flour..... per bbl.....	2.00	Norfolk, Va.
J. F. Tobin.....	June 24	Fresh beef... per pound.....	.10 ⁰⁰ / ₁₀₀	Mare Island, Cal.
Do.....	June 24	Fresh vegetables..... do.....	.02 ⁰⁰ / ₁₀₀	Do.
California Cracker Co.....	June 28	Fresh Navy bread..... do.....	.04	Do.
L. S. Borsef.....	July 1	Fresh beef..... do.....	.12 ⁰⁰ / ₁₀₀	League Island, Pa.
Do.....	July 1	Fresh vegetables..... do.....	.04	Do.
Myers Bros. & Co.....	July 1	Tobacco, 100,000 pounds. per pound.	.25	New York.
E. Treadwell's Son.....	July 7	Baking flour..... per bbl.....	1.47	Do.
John Hartman.....	July 13	do..... do.....	1.60	League Island, Pa.
Anton Behlen.....	July 15	Fresh bread... per pound.....	.02 ⁰⁰ / ₁₀₀	New York.
John Hanley.....	July 21	Fresh beef..... do.....	.06 ⁰⁰ / ₁₀₀	Do.
Do.....	July 21	Fresh vegetables..... do.....	.00 ⁰⁰ / ₁₀₀	Do.
Henderson & Stoutenborough	July 12	1,000 mess-pans..... each.....	.80	Do.
Thurber, Whyland & Co.....	July 13	200,000 pounds coffee... per pound.	.06 ⁰⁰ / ₁₀₀	Do.
J. R. Michael.....	July 16	70,000 yards cotton duck, per yard.	.10 ⁰⁰ / ₁₀₀	Do.
Chesbrough Mfg Co.....	July 17	5,000 boxes blacking. per box.....	.02 ⁰⁰ / ₁₀₀	Do.
J. Freeman & Co.....	July 18	7,000 pairs calf shoes... per pair.	1.74 ⁰⁰ / ₁₀₀	Do.
F. T. Witte Hardware Co.....	July 19	1,000 mess-kettles..... each.....	.48 ⁰⁰ / ₁₀₀	Do.
Do.....	July 19	3,000 tin pots..... each.....	.05 ⁰⁰ / ₁₀₀	Do.
Do.....	July 19	3,030 tin pans..... each.....	.05 ⁰⁰ / ₁₀₀	Do.
Do.....	July 19	3,000 jack-knives..... each.....	.39 ⁰⁰ / ₁₀₀	Do.
B. Y. Pippet & Co.....	July 20	10,000 pairs cotton socks per pair.	.15 ⁰⁰ / ₁₀₀	Do.
Geo. H. Creed.....	July 24	Miscellaneous articles... lot.....	447.24	Do.
A. Van Haagen.....	Sept. 6	Salt water soap. per pound.....	.02 ⁰⁰ / ₁₀₀	Do.
J. M. Shaw & Co.....	Sept. 25	3,000 spoons..... lot.....	68.75	Do.
Geo. P. Ockershausen.....	Sept. 25	5,000 gallons molasses... per gallon.	.21	Do.

Statement of contracts made by the Bureau of Provisions and Clothing, etc.—Continued.

Names.	Date.	Articles contracted for.	Price.	Where to be delivered.
Thurber, Whyland & Co.....	Sept. 27	10,000 pounds split peas, per pound.	\$0.02 ¹⁵ / ₁₀₀	New York.
Kemp, Day & Co.....	Sept. 27	10,000 pounds bacon, per lb.	.10 ⁰ / ₁₀₀	Do.
Martin Kattenhorn.....	Sept. 28	2,000 pounds tea..... do	.28 ⁰ / ₁₀₀	Do.
Do.....	Sept. 28	30,000 pounds assorted vegetables, per pound.	.07 ¹¹ / ₁₀₀	Do.
F. Fochrenbach & Co.....	Oct. 5	3,000 gallons vinegar... per gallon.	.18 ¹ / ₂	Do.
Henry Adams, jr.....	Oct. 7	10,000 pounds rice... per lb.	.04 ¹⁵ / ₁₀₀	Do.
J. D. Gilmor.....	Oct. 7	8,000 gallons beans... per gallon.	.25 ¹ / ₂	Do.
W. R. Soper.....	Oct. 7	15,000 pounds pickles... per pound.	.05 ¹ / ₂	Do.
F. Fochrenbach & Co.....	Dec. 27 do.....	.07 ¹ / ₂	Do.
French & Co.....	Dec. 27	3,000 pounds cranberry sauce, per pound.	.12 ¹ / ₂	Do.
Henry Adams, jr.....	Dec. 27	15,000 pounds rice... per lb.	.03 ⁸⁵ / ₁₀₀	Do.
J. M. Shaw.....	Dec. 27	3,000 spoons..... each	.02 ⁷⁵ / ₁₀₀	Do.
Henderson & Stoutenborough	Dec. 28	500 mess-kettles..... do	.47	Do.
Do.....	Dec. 28	3,000 tin pots..... do	.05 ¹ / ₂	Do.
Do.....	Dec. 28	2,500 tin pans..... do	.04 ¹ / ₂	Do.
Cheesebrough Manufacturing Company.	Dec. 28	3,000 boxes blacking... do	.02 ¹ / ₂	Do.
Thurber, Whyland & Co.....	Dec. 29	20,000 pounds canned beef, per pound.	.06 ²¹ / ₁₀₀	Do.
Do.....	Dec. 29	20,000 pounds canned fresh beef, per pound.	.06 ¹¹ / ₁₀₀	Do.
Armour & Co.....	Dec. 30	800 barrels pork.... per bbl.	14.30	Do.
Do.....	Dec. 30	30,000 pounds canned ham, per pound.	14.48	Do.
Martin Kattenhorn.....	Dec. 31	20,000 pounds oatmeal.. per pound.	.04 ¹ / ₂	Do.
Do.....	Dec. 31	10,000 pounds assorted vegetables, per pound.	.06 ¹ / ₂	Do.
Blank & Voelbel.....	Jan. 3	8,000 shoe brushes... each	.16 ¹ / ₂	Do.
Kemp, Day & Co.....	Jan. 3	15,000 pounds bacon... per pound.	.10 ¹ / ₂	Do.
Do.....	Jan. 3	3,000 pounds evaporated peaches, per pound.	.39 ¹ / ₂	Do.
J. R. Torrey & Co.....	Jan. 5	1,000 razor straps... each	.23	Do.
San Francisco Pioneer Woolen Factory.	Jan. 5	10,000 yards cloth for trousers, per yard.	2.19	Do.
B. Y. Phippy & Co.....	Jan. 6	10,000 pairs woolen socks, per pair.	.31 ¹ / ₂	Do.
J. D. Gilmor.....	Jan. 7	1,000 pounds tea.... per lb.	.28	Do.
William Gray.....	Jan. 8	3,000 pounds evaporated apples, per pound.	.14 ¹ / ₂	Do.
Do.....	Jan. 8	10,000 pounds tomatoes.. per pound.	.02 ¹ / ₂	Do.
J. S. Barron & Co.....	Jan. 10	3,000 wisp brooms.... each	.17 ¹ / ₂	Do.
Fred. M. Smith.....	Jan. 11	3,000 spools cotton thread, each.	.02 ¹ / ₂	Do.
Do.....	Jan. 11	1,000 papers needles... each	.01 ¹ / ₂	Do.
Do.....	Jan. 11	2,000 forks..... do	.02 ¹ / ₂	Do.
Do.....	Jan. 11	14,600 pieces worsted tape, each.	.02 ¹ / ₂	Do.
J. R. Michael.....	Jan. 12	5,000 B. S. neckerchiefs, each	.87 ¹ / ₂	Do.
Do.....	Jan. 12	3,000 yards tan duck.... per yard.	.13 ¹ / ₂	Do.
Do.....	Jan. 12	3,000 spools linen thread, each.	.05 ¹ / ₂	Do.
Myers, Bros. & Co.....	Apr. 28	100,000 pounds tobacco.. per pound.	.22 ¹ / ₁₀₀	Do.
F. T. Witte Hardware Company.	June 9	3,000 pairs scissors... each	.65	Do.
E. E. Hosier.....	June 9	1,000 gallons split peas.. per gallon.	.19	Do.
Do.....	June 9	3,000 pounds tea.... per lb.	.28 ¹ / ₂	Do.
Do.....	June 9	5,000 gallons molasses.. per gallon.	.29 ¹ / ₂	Do.
J. S. Barron & Co.....	June 9	1,000 mess-kettles..... each	.40 ¹ / ₁₀₀	Do.
Do.....	June 9	1,000 mess-pans..... do	.30 ¹ / ₁₀₀	Do.
Do.....	June 9	3,000 tin pots..... do	.05 ¹ / ₁₀₀	Do.
Do.....	June 9	3,000 tin pans..... do	.04 ¹ / ₁₀₀	Do.
R. A. Robbins.....	June 9	3,000 yards tan duck.... per yard.	.14 ¹ / ₁₀₀	Do.
Do.....	June 9	3,000 yards cloth for caps, per yard.	2.68	Do.
Do.....	June 9	150,000 pounds salt water soap, per pound.	.02 ¹ / ₁₀₀	Do.

Statement of contracts made by the Bureau of Provisions and Clothing, etc.—Continued.

Names.	Date.	Articles contracted for.	Price.	Where to be delivered.
Thurber, Whyland & Co.....	June 9	30,000 pounds canned beef, per pound.	\$0.07 ⁷⁵ / ₁₀₀	New York.
Do.....	June 9	200,000 pounds sugar...per pound.	.05 ⁷⁵ / ₁₀₀	Do.
Do.....	June 9	3,000 gallons vinegar...per gallon.	.15 ⁷⁵ / ₁₀₀	Do.
James E. Young.....	June 9	5,000 cotton handkerchiefs, each.	.07	Do.
James R. Michael.....	June 9	2,000 thimbles.....each...	.03	Do.
Do.....	June 9	3,000 jack knives.....do....	.80	Do.
Do.....	June 9	5,000 dozen D. E. buttons, per great gross.	1.65	Do.
Do.....	June 9	5,000 pieces tape...per doz...	.17 ⁷⁵ / ₁₀₀	Do.
Henry Adams.....	June 9	15,000 pounds rice...per lb...	.05 ⁷⁵ / ₁₀₀	Do.
Elgin Butter Company.....	June 9	50,000 pounds butter...per pound.	.27	Do.

Statement of sales at navy-yards of condemned materials, pertaining to Bureau of Provisions and Clothing, during the fiscal year ending June 30, 1887.

Where sold.	To whom sold.	Gross amount of proceeds.				Cost of sale.	Net proceeds.
		Provisions.	Clothing.	Small stores.	Contingent.		
Navy-yard, New York.	Burns, Plyer, Galvin, Seligman, Brady, Dogherty, Bannerman, Driscoll, Kerrigan, Rider & Cotton, Townsend, Plyer, Carberry, Hurley, McMahon, Allen, McGann.	\$1,396.50	\$1,687.56	\$66.00	\$2.75	\$121.62	\$2,066.19
Do.....	Townsend, McMahon, Timony, Soligman, Kerrigan, Downs, Burns, Kane Bros., Driscoll, Godfrey.	152.00	816.88	26.50	1.00	24.91	971.47
Navy-yard, Norfolk.	J. W. Woodman, John Codd, E. C. Sykes, Lintz, J. L. Bunting, W. H. Bunting, Chas. Hey, P. O'Connor, J. Einstein, M. Freidman, L. Freidman, S. Freidman, W. H. Carry, Sherrick, Jos. Brown, Thos. Reed, H. C. Machette, H. Osterhaus, Bloomfield, Jos. R. Peaden, W. H. Palmer, Rufus Parks, Freedowski, W. H. Degges, M. F. Parker.	415.64	461.44	13.64	142.09	25.82	1,068.99
Navy-yard, Mare Island.	B. Pasalagna, J. Reddan, W. A. Smith, W. Mighill, S. Morris, T. Kehoe, T. King, J. Aden, J. Melerce, E. Supple, T. Willman, J. Hammill, R. Johnson, P. Baker, G. Hare, J. Cunningham, J. Deering, A. Newcombe, W. Sargent, A. N. Crawford, J. Black.	389.66	556.61	59.15	8.00	25.33	988.69
Total.....	2,353.80	3,522.49	165.29	153.84	197.68	5,987.74

Estimates of appropriations required for the service of the fiscal year ending June 30, 1889, by the Bureau of Provisions and Clothing, Navy Department.

Detailed objects of expenditure, and explanations.	Estimated amount which will be required for each detailed object of expenditure.	Total amount to be appropriated under each head of appropriation.	Amount appropriated for the current fiscal year ending June 30, 1888.
SALARIES.			
One chief clerk (act of March 3, 1887; R. S., 24, pp. 70, 621, Secs. 416, 1)	\$1,800.00		
Two clerks of class three, at \$1,600 each (same acts)	2,200.00		
Two clerks of class two, at \$1,400 each (same acts)	2,800.00		
Four clerks of class one, at \$1,200 each (same acts)	4,800.00		
Two copyists, at \$900 each (same acts)	1,800.00		
One assistant messenger (same acts)	720.00		
One laborer (same acts)	660.00		\$17,580.00
One clerk of class three, previously appropriated for in Bureau Equipment and Recruiting (same acts) *	1,600.00		
One clerk of class two, previously appropriated for in Bureau Steam Engineering (same acts) *	1,400.00		
One clerk of class two, previously appropriated for in Bureau of Navigation (same acts) *	1,400.00		
One stenographer, at \$1,400, previously appropriated for in Secretary's Office (same acts) *	1,400.00		
One clerk of class one, previously appropriated for in Secretary's Office (same acts) *	1,200.00		
One clerk, at \$1,000, previously appropriated for in Bureau Yards and Docks (same acts) *	1,000.00		8,000.00
One clerk of class four (submitted)	1,800.00		
Four clerks of class one, at \$1,200 each (submitted)	4,800.00		
		\$30,380.00	25,580.00
NOTE.—The employment of the five additional clerks submitted herein is rendered necessary by the concentration in this Bureau of the business of the general purchasing and supplying of stores and materials for the Navy, and the examining and auditing accounts and returns pertaining thereto.			
PROVISIONS			
Provisions and commutations of rations for 8,250 men and boys and 1,000 marines—3,376,250 rations, at 30 cents each (R. S., p. 723, Secs. 3709, 3747, act May 12, 1879, vol. 21, p. 3; Sec. 1, act March 3, 1887, vol. 24, p. 587.)	1,012,875.00		
Commutation of rations for 225 naval cadets and 712 officers on sea duty—342,005 rations, at 30 cents each (same acts)	102,601.50		
Water for drinking and cooking purposes on board ships (same acts)	12,000.00		
Labor and expenses of † general store-houses (same acts) ..	90,000.00	1,217,476.50	1,121,000.00
CORRINGENT.			
Freight on shipments; candles, fuel, books and blanks, stationery, advertising, furniture for † general store-houses, and pay offices in navy-yards; expenses of naval clothing, factory and machinery for same, foreign postage, telegrams, express charges, tolls, ferrriages, yeomen's stores, iron-safes, newspapers, ice, and other necessary incidental expenses (R. S., p. 721, Sec. 3666, act March 3, 1887, vol. 24, p. 587)		40,000.00	50,000.00
CIVIL ESTABLISHMENT.			
Navy-yard, Portsmouth, N. H.:			
Two book-keepers in general store-houses at \$1,200 each per annum (act June 30, 1885; vol. 23, p. 295, sec. 3; act March 3, 1887, vol. 24, p. 587)	\$2,400.00		
Two assistant book-keepers in general store-houses at \$1,000 each per annum (same acts)	2,000.00		
One bill clerk in general store-house at \$1,000 per annum (same acts)	1,000.00		
One shipping clerk in general store-houses at \$1,000 per annum (same acts)	1,000.00		
One receiving clerk in general store-houses at \$1,000 per annum (same acts)	1,000.00		
One assistant receiving clerk in general store-houses at \$720 per annum (same acts)	720.00		

* Transferred to Bureau of Provisions and Clothing.
 † Formerly designated as inspections of provisions and clothing.

Estimates for Bureau of Provisions and Clothing, etc.—Continued.

Detailed objects of expenditure, and explanations.	Estimated amount which will be required for each detailed object of expenditure.	Total amount to be appropriated under each head of appropriation.	Amount appropriated for the current fiscal year ending June 30, 1884.
CIVIL ESTABLISHMENT—continued.			
Navy-yard, Boston, Mass.:			
One book-keeper in general store-houses at \$1,200 per annum (same acts).....	\$1,200.00		
One receiving clerk in general store-houses at \$1,000 per annum (same acts).....	1,000.00		
One assistant shipping clerk in general store-houses at \$720 per annum (same acts).....	720.00		
One writer in pay office at \$1,000 per annum (same acts).....	1,000.00		
Navy-yard, New York, N. Y.:			
Three book-keepers in general store-houses at \$1,200 each per annum (same acts).....	3,600.00		
Two assistant book-keepers in general store-houses at \$1,000 each per annum (same acts).....	2,000.00		
Three receiving clerks in general store-houses at \$1,000 each per annum (same acts).....	3,000.00		
Two assistant receiving clerks in general store-houses at \$720 each per annum (same acts).....	1,440.00		
Three shipping clerks in general store-houses at \$1,000 each per annum (same acts).....	3,000.00		
Two bill clerks in general store-houses at \$1,000 each per annum (same acts).....	2,000.00		
One assistant bill clerk in general store-houses at \$720 per annum (same acts).....	720.00		
Two leading men in general store-houses at \$2.50 each per diem (same acts).....	1,565.00		
Five pressmen in general store-houses at \$2.75 each per diem (same acts).....	4,303.75		
One superintendent of coffee and spice mills in general store-houses at \$3 per diem (same acts).....	939.00		
One box-maker in general store-houses at \$3 per diem (same acts).....	939.00		
One coffee-roaster in general store-houses at \$2.50 per diem (same acts).....	782.50		
One engine tender in general store-houses at \$3.26 per diem.....	1,020.38		
One fireman in general store-houses at \$2 per diem (same acts).....	626.00		
One teamster in general store-houses at \$2.50 per diem (same acts).....	782.50		
One messenger in general store-houses at \$2.50 per diem (same acts).....	782.50		
One writer in pay office at \$1,000 per annum (same acts).....	1,000.00		
One messenger in pay office at \$2.50 per diem (same acts).....	782.50		
Navy-yard, League Island, Pa.:			
One book-keeper in general store-houses at \$1,200 per annum (same acts).....	1,200.00		
One receiving clerk in general store-houses at \$1,000 per annum (same acts).....	1,000.00		
One assistant shipping clerk in general store-houses at \$720 per annum (same acts).....	720.00		
Navy-yard, Washington, D. C.:			
One book-keeper in general store-houses at \$1,200 per annum (same acts).....	1,200.00		
One stationery clerk in general store-houses at \$1,200 per annum (same acts).....	1,200.00		
One bill clerk in general store-houses at \$1,000 per annum (same acts).....	1,000.00		
One shipping clerk in general store-houses at \$1,000 per annum (same acts).....	1,000.00		
One receiving clerk in general store-houses at \$1,000 per annum (same acts).....	1,000.00		
One assistant receiving clerk in general store-houses at \$720 per annum (same acts).....	720.00		
One writer in pay office at \$1,000 per annum (same acts).....	1,000.00		
Navy-yard, Norfolk, Va.:			
Two book-keepers in general store-houses at \$1,200 each per annum (same acts).....	2,400.00		
Two assistant book-keepers in general store-houses at \$1,000 each per annum (same acts).....	2,000.00		

Estimates for Bureau of Provisions and Clothing, etc.—Continued.

Detailed objects of expenditure, and explanations.	Estimated amount which will be required for each detailed object of expenditure.	Total amount to be appropriated under each head of appropriation.	Amount appropriated for the current fiscal year ending June 30, 1888.
CIVIL ESTABLISHMENT—continued.			
Navy-yard, Norfolk, Va.—continued.			
One bill clerk in general store-houses at \$1,000 per annum (same acts).....	\$1,000.00		
One shipping clerk in general store-houses at \$1,000 per annum (same acts).....	1,000.00		
One receiving clerk in general store-houses at \$1,000 per annum (same acts).....	1,000.00		
One assistant receiving clerk in general store-houses at \$720 per annum (same acts).....	720.00		
One writer in pay office at \$1,000 per annum (same acts).....	1,000.00		
Navy-yard, Pensacola, Fla.:			
One assistant receiving clerk in general store-houses at \$720 per annum (same acts).....	720.00		
Naval Academy, Annapolis, Md.:			
One assistant receiving clerk in general store-houses at \$720 per annum (same acts).....	720.00		
Torpedo Station, Newport, R. I.:			
One receiving clerk in general store-houses at \$1,000 per annum (same acts).....	1,000.00		
Navy-yard, Mare Island, Cal.:			
Two book-keepers in general store-houses at \$1,200 each per annum (same acts).....	2,400.00		
Two assistant book-keepers in general store-houses at \$1,000 each per annum (same acts).....	2,000.00		
One receiving clerk in general store-houses at \$1,000 per annum (same acts).....	1,000.00		
One shipping clerk in general store-houses at \$1,000 per annum (same acts).....	1,000.00		
One bill clerk in general store-houses at \$1,000 per annum (same acts).....	1,000.00		
One assistant bill clerk in general store-houses at \$720 per annum (same acts).....	720.00		
One writer in pay office at \$1,000 per annum (same acts).....	1,000.00		
		\$72,043.13	\$70,000.00

No. 14.—BUREAU OF MEDICINE AND SURGERY.

NAVY DEPARTMENT,
BUREAU OF MEDICINE AND SURGERY,
Washington, D. C., October 15, 1887.

SIR: I have the honor to submit the report of this Bureau for the past year, together with estimates for the fiscal year ending June 30, 1889.

Estimates of appropriations required for the service of the fiscal year ending June 30, 1889, by the Bureau of Medicine and Surgery, Navy Department.

Detailed objects of expenditure, and explanations.	Estimated amount which will be required for each detailed object of expenditure.	Total amount to be appropriated under each head of appropriation.	Amount appropriated for the current fiscal year ending June 30, 1888.
SALARIES.			
Chief clerk (act March 3, 1887, R. S. 24, p. 621, sec. 392).....	\$1,800.00		
One clerk of class three (same act).....	1,600.00		
One clerk of class two (same act).....	1,400.00		
One clerk of class one (same act).....	1,200.00		
One clerk (same act).....	1,000.00		
One assistant messenger (same act).....	720.00		
One laborer (same act).....	690.00		
One janitor for Naval Dispensary (same act).....	600.00		
One laborer for Naval Dispensary (same act).....	480.00		
		\$9,460.00	\$9,460.00
One clerk of class one, for service in Pension division of Bureau; to enable the Bureau to promptly supply information from its records in reply to inquiries from the Commissioner of Pensions (submitted).....	1,200.00		

Estimates of appropriations required, etc.—Continued.

Detailed objects of expenditure, and explanations.	Estimated amount which will be required for each detailed object of expenditure.	Total amount to be appropriated under each head of appropriation.	Amount appropriated for the current fiscal year ending June 30, 1888.
MEDICAL DEPARTMENT.			
For surgeons' necessaries for vessels in commission, navy-yards, naval stations, Marine Corps, and Coast Survey, and for the civil establishment at the several naval hospitals, navy-yards, Naval Laboratory, Museum of Hygiene, and Naval Academy (act March 3, 1887; R. S. 24, p. 586, sec. 391)		60,000.00	57,500.00
NAVAL HOSPITAL FUND.			
For maintenance of the naval hospitals at the various navy-yards and stations (same act)		30,000.00	30,000.00
CONTINGENT EXPENSES.			
For freight or expressage on medical stores, toll, ferrriages, and expenses of messengers; transportation of sick and insane patients; care, transportation, and burial of the dead; advertising, telegraphing, rent of telephones, purchase of books and stationery, postage, and purchase of stamps for foreign service; expenses attending the Medical Board of Examiners; rent of rooms for Naval Dispensary and Museum of Hygiene; hygienic and sanitary investigations and illustration; hygienic and sanitary instruction; purchase and repairs of wagons and harness; purchase and care of horses and cows, and feed for same; trees, plants, garden-tools, and seeds; furniture and incidental articles for the Museum of Hygiene, Naval Laboratory, Naval Dispensary Washington, sick quarters at Naval Academy and marine barracks, and dispensaries at navy-yards and naval stations; washing for the medical department at Museum of Hygiene, Naval Laboratory, Naval Dispensary Washington, sick quarters at Naval Academy and marine barracks, dispensaries at navy-yards and naval stations, and ships and rendezvous, and all other necessary contingent expenses (same act)		25,000.00	25,000.00
REPAIRS.			
For necessary repairs of naval laboratory, naval hospitals, and appendages, including roads, wharves, outhouses, sidewalks, fences, gardens, farms, and cemeteries (same act)		25,000.00	15,000.00
For continuing the improvement of the naval hospital park at Portsmouth, Va. (same act)		5,000.00	5,000.00

NAVAL HOSPITAL FUND.

The condition of this fund is as follows, viz :

Balance on hand October 1, 1886.....	\$163,782.27
Transferred to the credit since October 1, 1886, by the Fourth Auditor..	89,522.26
Credit by appropriation for fiscal year 1888.....	30,000.00
Total.....	283,304.53
Expended since October 1, 1886.....	69,314.87
Balance on hand October 1, 1887.....	213,985.66

NAVAL HOSPITALS.

The request for increased appropriations for the preservation and repair of the several naval hospitals must be again repeated. These buildings have been in service for many years, and the work of restoring roofs and improving the systems of plumbing and drainage is urgently demanded.

At the naval hospital, Yokohama, Japan, the privilege accorded to the consul-general of sending sick and disabled men from the United States merchant service to be cared for in the hospital has been exercised throughout the year.

NAVAL SANITARIUM, PENOBSCOT BAY.

At the last session of Congress the sum of \$50,000 was appropriated "for the construction of a naval hospital and sanitarium and wharf for landing on Widow's Island, Penobscot bay, Maine, said sum to be in full for all expenses of erecting and furnishing said sanitarium, including all necessary improvements on the island."

Plans for the hospital building prepared by Passed Assistant Surgeon Heffenger, U. S. Navy, were approved by the Department, and a contract was made, after due advertisement, with Messrs. Wm. H. Glover & Co., of Rockland, Me., 31st May, 1887, to erect a building at the cost of \$35,400, which sum was subsequently increased \$200 to substitute copper for tin in the covering of the roof, which seemed necessary from the very exposed condition of the island, and \$469.50 for the construction of the well-head and force-pump to supply the water-tanks of the building.

Dr. Heffenger was assigned to superintend the work, and Mr. Cox, carpenter, was subsequently sent to assist him in that duty. The work of blasting rock for a foundation was begun immediately, and the construction has proceeded without delay. The first payment of \$10,647 was made in August. The walls were completed and the building roofed in, and the second payment made October 13, 1887.

The building will be completed, weather permitting, by December 15, 1887.

The plans for the wharf of sunken cribs, with boat-house and float and ladder, were kindly made by Mr. Mackay, of the Bureau of Yards and Docks, with the approval of Commodore Harmony, and the contract for building was awarded to F. E. Hitchcock, of Maine, for \$2,185. The work proceeded without delay, and was accepted and paid for October 15, 1887.

It may be found necessary to place a suitable crane derrick on the end of the wharf for lifting heavy articles from lighters, which can be done in the coming spring.

The work of clearing up the island and planting trees has been interfered with by the presence of workmen and the spreading out of building materials. It will be renewed and completed in the spring of 1888, at which time the interior of the hospital will be fitted up and properly furnished for occupation.

I visited the island in August, before the claims for first payment of money under the contracts were approved, and carefully inspected the construction. Dr. Heffenger has been very thorough in his duty of superintendence, and was able to commend entirely the work done by the contractors,

The wooden building erected in the spring of 1885 has been removed to a position below the hospital terrace, and will be useful as a barrack for the men landed on the island from infected vessels who do not require hospital treatment.

PENSION CASES.

The number of letters relating to application for pensions received and answered during the year was nearly 2,300.

The request for another clerk for this division of work is again repeated.

A special allowance of \$1,000 is asked for, to be placed to the credit of the Bureau, for the purpose of having medical journals, abstracts, and case papers rebound at the Government Printing Office.

MUSEUM OF HYGIENE.

On July 1 the Museum of Hygiene was removed to a large and commodious building in New York avenue, near the Navy Department, where it is well established, with room for its increasing collection.

Dr. Turner's report is presented herewith.

Tentative experiments have been made at the museum upon the steel used in the new guns for the Navy in order to determine the chemical value of the steel.

These examinations have been limited to the determination of the amount of carbon, silicon, phosphorus, and sulphur existing in the samples presented. The investigation is interesting and important, as the presence of these bodies is known to affect the physical properties of steel.

MEDICAL CORPS OF THE NAVY.

The condition of the Medical Corps of the Navy, which was represented to you last year and commended in your yearly report to the attention of Congress, urgently calls for legislative action. The numbers are still diminishing. There are now twelve vacancies for assistant surgeons. The loss of members in the active list of the corps during the year amounted to nine officers; and only six assistant surgeons were appointed, one of whom has since resigned to enter the Medical Department of the Army.

A bill to improve the condition of this department of the Navy has been prepared to be submitted for your approval on the meeting of Congress.

INSANE OF THE NAVY.

There were sixty-nine patients belonging to the Navy treated in the Government Hospital for the Insane, in the District of Columbia, for the year ending September 30, 1887 :

Remaining in hospital September 30, 1886	60
Admitted during the year ending September 30, 1887	9
Total under treatment	69
Discharged during the year:	
Recovered	6
Improved	1
Died	4
	— 11
Remaining in hospital September 30, 1887 :	
Officers	7
Enlisted	51
	— 58

In consequence of the inability, from the want of accommodation, of the Asylum for the Insane at Napa, Cal., to receive any longer the insane patients from the Navy, the Bureau has directed the transfer of all of the insane of the Navy on the Pacific coast to the Government asylum near Washington, D. C.

GENERAL AGGREGATE—SICK.

The tabular statements of sick, etc., have been compiled from the reports of sick from the several naval stations within the United States, and from vessels on the home and foreign stations for the year ending December 31, 1886.

Force afloat—General aggregate, 1886.

Classification of diseases.	Remaining from last year.	Admitted.	Discharged to duty.	Invalided.		Died.	Remaining at the end of the year.	Tot. number of sick days.
				To hospital.	From service.			
Zymotic diseases	15	976	895	74		10	12	3, 256
Constitutional diseases	29	915	745	169	4		17	2, 133
Diseases of the nervous system	4	877	306	57	5	5	5	2, 273
Diseases of the eye	3	101	91	12				232
Diseases of the ear	3	39	36	6				44
Diseases of the teeth		15	15					
Diseases of the circulatory system	3	62	30	23	3	3		
Diseases of the respiratory system	21	706	566	125	3	3		
Diseases of the digestive system	28	1, 519	1, 443	71	1	7		
Diseases of the genito-urinary system	28	766	705	70	1			
Diseases of the locomotive system	1	37	28	32				
Diseases of the integumentary system	23	821	794	32				
Diseases of the absorbent system	13	215	183	36				
Non-malignant tumors and cysts		14	13	1				
Poisons		144	141	2		1		
Violent diseases and deaths	29	1, 583	1, 495	47		28	45	14, 388
Feigned diseases		1	1					1
Total	191	8, 284	7, 513	733		18	51	74, 714

Force afloat—Detailed statement.

Diseases.	Remaining from last quarter.	Admitted.	Discharged to duty.	Invalided.		Died.	Continued to next quarter.	Total number of sick days.
				To hospital	From service.			
GENERAL DISEASES.								
<i>Zymotic diseases.</i>								
Catarrhus epidemicus		5	5					22
Cachexia malarialis		1	1					3
Diphtheria	1	1	4					28
Erysipelas		10	8					23
Febriola		171	170					23
Febris continua simplex	4	145	144					23
Febris enterica		28	11					7
Febris flava		2	2					7
Febris intermittens	5	354	330	15			8	1, 716
Febris remittens	3	173	144	26		2	4	1, 682
Febris typho-malarialis		2	2					8
Malaise		1	1					3
Morbilli		1	1					12
Parotitis		27	22					243
Phagedaena putris		5	3	5				121
Scarlatina		5	3	2				86
Vaccina	2	42	43	1				23
Varicella		3	3	2				3
Varioloides		1	1			1		6
<i>Constitutional diseases.</i>								
Adynamia	1	109	79	27	2		2	1, 207
Anæmia	1	3	4					47
Atrophia		1	1					1
Diabetes		4	3	1				16
Hydrops		4	3	1				23
Lumbago	2	90	86	6				643
Podagra		11	9			1		177
Rheumatismus acutus	2	245	212	31			4	2, 488
Rheumatismus chronicus	4	185	144	41			4	1, 748
Rheumatismus gonorrhoeus		11	8	3				183

Force afloat—Detailed statement—Continued.

Diseases.	Remaining from last quarter.	Admitted.	Discharged to duty.	Invalided.		Died.	Continued to next quarter.	Total number of sick-days.
				To hospital.	From service.			
GENERAL DISEASES—Continued.								
<i>Constitutional diseases—continued.</i>								
Rheumatoid arthritis.....		1	1					18
Scrofula.....		2	1					2
Senectus.....		2	1	1				51
Syphilia consecutiva.....	4	171	128	42			5	2,293
Syphilia primitiva.....	6	75	65	14	1		1	1,507
Torticollis.....		1	1					3
LOCAL DISEASES.								
<i>Diseases of the nervous system.</i>								
Apoplexia.....		2				2		3
Cephalalgia.....	1	57	65	2			1	211
Cerebritis.....		1	3	1				17
Concussio spinalis.....		3	3					89
Congestio spinalis.....		1	1					6
Convulsio.....		18	16	2				88
Dementia.....		9	2	7				88
Epilepsia.....	1	18	11	6	1	1		272
Hysteria.....		2	1	1				10
Imbecillitas mentis.....		1				1		20
Insolatio.....		4	3			1		6
Insomnia.....		1	1					7
Irritatio spinalis.....	1	2	1	2				72
Mania.....		9	1	8				116
Me-lancholia.....		9	4	4			1	45
Meningitis.....		2	2	1		1		14
Nausea.....		1	1					1
Nausea marina.....	1	30	30				1	87
Neuralgia.....		123	115	6	2			654
Neuritis.....		3	3					23
Paralysis.....		14	6	7			1	668
Pleurodynia.....		19	17				2	137
Sciatica.....		11	4	6			1	404
Vertigo.....		37	32	3	1		1	201
<i>Diseases of the eye.</i>								
Asthenopia.....		6	5	1				41
Conjunctivitis.....	1	50	58	2				540
Ectropium.....		1	1					13
Foreign body in cornea.....		1	1	1				1
Hemeralopia.....		1	1					3
Iritis.....	1	14	12	3				161
Keratitis.....		2	2					29
Myopia.....		1	1					1
Ophthalmia.....		2	2					8
Ophthalmia gonorrhoeica.....		2	1	1				16
Ophthalmia tarai.....		1	1					5
Presbyopia.....		1	1					1
Ptoxis.....		2	2	1				16
Retinitis.....		1	1					2
Ulcus cornea.....		7	5	2				67
<i>Diseases of the ear.</i>								
Otalgia.....	1	15	15	1				94
Otitis.....	1	21	19	3				110
Otorrhoea.....	1	2	2	1				7
Surditas.....		1	1	1				10
<i>Diseases of the teeth.</i>								
Odontalgia.....		14	14					39
Parulis.....		1	1					5
<i>Diseases of the circulatory system.</i>								
Aneurysma.....		5	3	1		1		31
Angina pectoris.....		1	1					3

Force afloat—Detailed statement—Continued.

Diseases.	Remaining from last quarter.	Admitted.	Discharged to duty.	Invalided.		Died.	Continued to next quarter.	Total number of sick-days.
				To hospital.	From service.			
GENERAL DISEASES.								
<i>Diseases of the circulatory system—Continued.</i>								
Hypertrophia cordis.....	1	2	2	1	25
Morbi valvularum cordis.....	19	9	9	1	162
Palpitatio.....	1	22	13	7	2	1	256
Phlebitis.....	1	1	14
Syncope.....	1	5	5	1	17
Varix.....	7	4	3	45
<i>Diseases of the respiratory system.</i>								
Asthma.....	22	10	10	1	1	315
Bronchitis acuta.....	2	207	187	20	1	1,711
Bronchitis chronica.....	4	34	23	13	1	1	530
Catarrhus bronchialis.....	5	217	220	2	1,017
Catarrhus nasalis.....	49	47	2	158
Epistaxis.....	3	1	2	6
Hæmoptysis.....	21	14	7	243
Laryngitis.....	13	12	1	57
Phthisis pneumonica acuta.....	0	1	5	231
Phthisis pneumonica chronica.....	2	31	7	25	1	457
Pleuritis.....	5	41	35	11	711
Pneumonia.....	3	50	29	27	1	2	725
<i>Diseases of the digestive system.</i>								
Ascites.....	1	1	63
Catarrh intestinalis.....	2	2	16
Catarrh gastrohepatio.....	1	1	14
Cardialgia.....	1	1	7
Colica hepatica.....	1	1	19
Cholera morbus.....	1	82	82	1	218
Cirrhois hepatis.....	1	1	2	83
Colica.....	2	140	147	2	2	485
Congestio hepatis.....	10	10	32
Constipatio.....	28	27	1	157
Diarrhœa acuta.....	9	552	555	4	2	2,140
Diarrhœa chronica.....	14	8	5	86
Dysenteria acuta.....	1	72	65	4	1	3	574
Dysenteria chronica.....	2	7	6	3	248
Dyspepsia.....	1	49	44	4	1	1	629
Emesis.....	1	1	1
Enteritis.....	14	12	1	1	179
Fistula ani.....	11	4	6	151
Gastritis.....	9	8	1	70
Gastrodynia.....	6	5	1	14
Gastralgia.....	2	2	13
Gastroduodenitis.....	1	1	1
Hæmatemesis.....	3	2	1	22
Hæmorrhœis.....	53	45	7	1	250
Hepatitis acuta.....	2	2	27
Hepatitis chronica.....	5	1	2	2	39
Hernia.....	1	33	17	15	2	368
Icterus.....	1	34	30	3	2	424
Occlusio.....	1	1	6
Perityphlitis.....	1	1	4
Pharyngitis.....	58	58	228
Prolapsus ani.....	6	5	1	41
Ptyalism.....	1	1	20
Tonallitis.....	9	291	280	11	9	1,708
Vermes.....	17	17	80
<i>Diseases of the genito-urinary system.</i>								
Albuminuria.....	1	7	4	3	1	130
Balanitis.....	14	14	76
Chancroides.....	8	164	140	22	1	9	653
Cystitis.....	23	16	5	2	373
Dysuria.....	3	3	39

Force afloat—Detailed statement—Continued.

Disease.	Remaining from last quarter.	Admitted.	Discharged to duty.	Invalided.		Died.	Continued to next quarter.	Total number of sick days.
				To hospital.	From service.			
GENERAL DISEASES.								
<i>Diseases of the genito-urinary system—Continued.</i>								
Enuresis.....		14	12	2				33
Epididymitis.....	1	49	46	3			1	589
Gonorrhoea.....	9	324	320	10			3	4,149
Hæmaturia.....	1	4	2	3				53
Hydrocele.....		8	6	2				53
Ischuria.....		4	3	1				34
Nephritis.....		3	2	1				30
Orchitis.....	5	112	109	7			1	1,456
Paraphimosis.....		9	7	1			1	104
Phymosis.....	2	6	7	1				127
Prostatitis.....		2	1	1				23
Urethra strictura.....		14	9	5				187
Varicocele.....	1	6	4	3				119
<i>Diseases of the locomotive system.</i>								
Arthritis.....		3	2				1	44
Ankylosis.....		1		1				1
Bursitis.....		1	1					7
Coxalgia.....		2		2				150
Myalgia.....		3	3					7
Necrosis.....		1	1					19
Periostitis.....		3	3					74
Synovitis.....	1	21	17	4			1	298
Talipes valgus.....		2	1	1				11
<i>Diseases of the integumentary system.</i>								
Abcessus.....	10	211	200	8			4	2,051
Acne.....		1	1					1
Anthrax.....	1	17	16	2				201
Bubo.....		2	2					21
Bunion.....		1	1					16
Cellulitis.....		1	1					18
Ecthyma.....		2	2					7
Eczema.....	2	39	35	5			1	359
Epithelioma.....		1		1				6
Erythema.....		9	9					70
Furunculus.....	3	304	304				3	2,001
Herpes.....		11	10	1				106
Impetigo.....		2	2					7
Lichen.....		2	2					6
Onychia.....		13	13					84
Paronychia.....	2	43	43				2	416
Pemphigus.....	1	3	4					43
Perio.....		1	1					2
Porrigo.....		1	1					26
Psoriasis.....		1	1					8
Rupia.....		2	2					22
Scabies.....		18	14	2			2	114
Tinea.....		2	2					20
Ulcus.....	4	111	100	11			4	1,905
Unguis involutus.....		11	9				2	84
Urticaria.....		10	8	2				31
Verruca.....		2	2					18
<i>Diseases of the absorbent system.</i>								
Adenitis.....	13	212	181	35			9	4,449
Lymphangitis.....		2	2	1				9
<i>Non-malignant tumors and cysts.</i>								
Adenoma.....		1	1					6
Cystis.....		4	4					45
Fibroma.....		6	5	1				127
Lipoma.....		2	2					36
Polypus.....		1	1					8

Force afloat—Detailed statement—Continued.

Disease.	Remaining from last quarter.	Admitted.	Discharged to duty.	Invalided.		Died.	Continued to next quarter.	Total number of sick days.
				To hospital.	From service.			
POISONS.								
Alcoholismus acutus	1	115	115			1		115
Alcoholismus chronicus		11	10	1				11
Colica pictonum		1	1					1
Delirium tremens		4	3	1				4
Vulnus venenatum		7	7					7
Ebriositas		5	5					5
Opium habit		1			1			1
VIOLENT DISEASES AND DEATHS.								
Abrasio	1	75	74					75
Ambustio		75	73					73
Concussio cerebri	1	9	6	2		2		13
Congelatio		3	3					3
Contusio	4	413	403	6		1	7	421
Explosio		1	1					1
Aciim affectus		1	1			1		1
Dislocatio		1	1					1
Fractura	6	87	58	23		3	8	107
Fractura luxatio		1	1					1
Luxatio	2	25	24	2			1	29
Stremma	5	338	331	6	1		6	351
Submersio		16	1			15		16
Subluxatio		1	1					1
Vulnus contusum	3	215	208	3				216
Vulnus incisum	2	134	132	1				135
Vulnus laceratum	5	132	128	2		1		137
Vulnus punctum		55	49	2				56
Vulnus sclopetarium	1		1					1
FEIGNED DISEASES.								
Mania, etc		1	1					1
Total	191	8,284	7,513	733	18	51	160	74,714

Navy yards and stations.—General aggregate, 1886.

Classification of diseases.	Remaining from last year.	Admitted.	Discharged to duty.	Invalided.		Died.	Remaining at the end of the year.	Total number of sick days.
				To hospital.	From service.			
Zymotic diseases	2	244	214	30	1	1		1,446
Constitutional diseases	6	177	150	29	3	1		1,482
Diseases of the nervous system	2	273	261	14				273
Diseases of the eye	1	44	42	3				46
Diseases of the ear		3	2					3
Diseases of the teeth		23	23		1			23
Diseases of the circulatory system	1	21	16	3	1	2		23
Diseases of the respiratory system	8	360	325	34			7	2,588
Diseases of the digestive system	3	475	436	35	1	1	5	2,119
Diseases of the genito-urinary system	3	87	58	27	1		4	380
Diseases of the locomotive system		9	7	2				201
Diseases of the integumentary system	1	121	110	9	1		2	321
Diseases of the absorbent system		14	4	10				110
Non-malignant tumors and cysts		2	2					2
Poisons	1	50	41	9		1		260
Violent diseases and deaths	4	222	209	15		1	1	1,769
Feigned diseases								
Total	32	2,125	1,900	220	9	9	19	13,556

Navy-yards and stations—Detailed statement.

Diseases.	Remaining from last quarter.	Admitted.	Discharged to duty.	Invalidated.		Died.	Continued to next quarter.	Total number of sick-days.
				To hospital.	From service.			
GENERAL DISEASES.								
<i>Zymotic diseases.</i>								
Catarrhus epidemicus		3	3					11
Cholera epidemica		13	13					76
Cachexia malarialis		1	1					5
Diphtheria		1	1					5
Erysipelas		5	2	3				14
Febricula		18	18					48
Febris continua simplex		7	5	2				80
Febris enterica		2	1			1		120
Febris intermittens	2	145	126	21				526
Febris remittens		25	23	2				221
Febris typho-malarialis		1				1		156
Morbilli		8	6	2				111
Parotitis		1	1					5
Roseola		1	1					3
Vaccina		13	13					65
<i>Constitutional diseases.</i>								
Adynamia	1	29	27	3				219
Anæmia		2	2					10
Diabetes		1	1					8
Lumbago	1	16	16	1				88
Podagra		5	4			1		41
Rheumatismus acutus	3	52	52	3				310
Rheumatismus chronicus		88	80	5	3			428
Syphila consecutiva	1	14	7	8				180
Syphila primitiva		18	10	8				194
Torticollis		1	1					3
Tuberculosis		1		1				1
LOCAL DISEASES.								
<i>Diseases of the nervous system.</i>								
Apoplexia		4	1	3				7
Cephalalgia		196	196					331
Convulsio		2	2					15
Dementia		1		1				13
Epilepsia		4		4				9
Inaaliatio		1	1					14
Insomnia		3	3					6
Locomotor stæxia		1	1					2
Mania		2		2				13
Melancholia		1	1					5
Myelitis	1		1					181
Nouralgia		88	87	1				127
Nourasthenia		1	1					3
Paralysis		5	2	3				71
Pleurodynia		6	6					20
Sciatica	1		1					31
Vertigo		8	8					25
<i>Diseases of the eye.</i>								
Amaurosis		1	1					9
Conjunctivitis	1	25	25	1				232
Hæmeralopia		2	2					32
Hordeolum		4	4					14
Iritis		3	2	1				16
Keratitis		2	2					60
Ophthalmia		1	1					5
Retinitis		1	1					12
Sclerotitis		1	1					18
Trachoma		1	1					4
Ulcus corneæ		3	2	1				65
<i>Diseases of the ear.</i>								
Otalgia		1	1					3
Otitis		1	1					11
Surditas		1			1			24

Navy-yards and stations—Detailed statement—Continued.

Diseases.	Remaining from last quarter.	Admitted.	Discharged to duty.	Invalided.		Died.	Continued to next quarter.	Total number of sick days.
				To hospital.	From service.			
LOCAL DISEASES—Continued.								
<i>Diseases of the teeth.</i>								
Odontalgia.....		23	23					20
<i>Diseases of the circulatory system.</i>								
Aneurysms.....		2				3		3
Angina pectoris.....		2		2				11
Hypertrophja cordis.....	1		1					80
Morbi valvularum cordis.....		5	4		1			115
Palpitation.....		8	7	1				26
Syncope.....		13	2					5
Varix.....		2	2					1
<i>Diseases of the respiratory system.</i>								
Asthma.....		2	2					80
Bronchitis acuta.....	5	70	66	8			1	485
Bronchitis chronica.....		4	3	1				20
Catarrhus bronchialis.....	1	123	107	14			2	585
Catarrhus nasalis.....	1	117	118					430
Hæmoptysis.....		3	2	1				11
Laryngitis.....		12	10	1			1	56
Phthisis pneumonica acuta.....		2		1		1		21
Phthisis pneumonica chronica.....	1	14	8	4		1	2	543
Pleuritis.....		6	4	1			1	185
Pneumonia.....		8	5	3				116
<i>Diseases of the digestive system.</i>								
Cholera morbus.....		16	16					43
Colica.....		21	21					55
Congestio hepatis.....		2	2					9
Constipatio.....		36	36					73
Diarrhœa acuta.....	1	160	146	15				565
Diarrhœa chronica.....		5	3				2	80
Dysenteria acuta.....		14	12	2				73
Dysenteria chronica.....		2	1	1				20
Dyspepsia.....		52	48	3			2	164
Enteritis.....		1	1					5
Fistula ani.....		1	1					46
Gastritis.....		6	3	3				27
Gastrodynia.....		1	1					1
Hæmatemesis.....		1				1		1
Hæmorrhœis.....	1	15	16					167
Hepatitis acuta.....		1	1					46
Hernia.....		2	1			1		28
Icterus.....		3	3					21
Nausea.....		1	1					1
Pharyngitis.....		72	65	7				271
Rhagades ani.....		1					1	23
Splenitis.....		1	1					16
Stomatitis.....		1	1					30
Tonsillitis.....	1	56	52	5				254
Typhlitis.....		3	3					21
Vermes.....		1	1					7
<i>Diseases of the genito-urinary system.</i>								
Albuminuria.....		2		2				9
Balanitis.....		3	3					26
Chancroides.....	3	15	12	5			1	120
Cystitis.....		6	4	1			1	78
Enuresis.....		1	1					4
Gonorrhœa.....		38	24	13			1	478
Hæmaturia.....		1	1					10
Hydrocele.....		1	1					5
Nephritis.....		3		3				10
Nephritic colic.....		1	1					3
Orchitis.....		13	10	1	1		1	202
Urethræ strictura.....		2	1	1				3
Variocelæ.....		1		1				6

Navy-yards and stations—Detailed statement—Continued.

Diseases.	Remaining from last quarter.	Admitted.	Discharged to duty.	Invalided.		Died.	Continued to next quarter.	Total number of sick-days.
				To hospital.	From service.			
LOCAL DISEASES—Continued.								
<i>Diseases of the locomotive system.</i>								
Arthritis		2	2					23
Necrosis		1	1					78
Synovitis		6	4	2				100
<i>Diseases of the integumentary system.</i>								
Abcessus		27	23	4				171
Anthrax		1					1	7
Clavus		7	7					25
Ecthyma		1	1					8
Eczema		8	8					91
Furunculus		41	41					151
Herpes		2	2					8
Lichen		2		2				4
Paronychia		3	3					25
Pernio		1	1					4
Rhus poisoning		1	1					10
Scabies		1		1				1
Tinea		2	2					21
Ulcus	1	12	9	2	1		1	341
Unguis involutus		8	8					46
Urticaria		4	4					13
<i>Diseases of the absorbent system.</i>								
Adenitis		14	4	10				110
<i>Non-malignant tumors and cysts.</i>								
Fibroma		1	1					46
Lipoma		1	1					7
POISONS.								
Alcoholismus acutus	1	31	23	9				108
Alcoholismus chronicus		15	14			1		110
Colica pictonum		3	3					24
Venena		1	1					8
VIOLENT DISEASES AND DEATHS.								
Abrasio		14	14					86
Ambustio		5	5					27
Congelatio		1	1					14
Contusio		70	67	3				439
Fractura		8	6	2				106
Luxatio		1		1				1
Strangula	2	60	59	3				541
Vulnus contusum		25	23	2				168
Vulnus incisum	1	15	14	2				130
Vulnus laceratum	1	19	17	2			1	165
Vulnus punctum		4	3			1		17
Total	32	2,125	1,900	220	9	9	19	13,566

Naval hospitals—General aggregate, 1886.

Classification of diseases.	Remaining from last year.	Admitted.	Discharged to duty.	Invalided.		Died.	Remaining at end of year.	Total number of sick days.
				To hospital.	From service.			
Zymotic diseases.....	14	97	84	6	4	6	11	1,220
Constitutional diseases.....	28	231	164	12	41	4	33	1,710
Diseases of the nervous system.....	10	84	80	16	20	3	25	7,163
Diseases of the eye.....	4	16	13	1	3		3	1,211
Diseases of the ear.....		8	5		2		1	280
Diseases of the teeth.....								
Diseases of the circulatory system.....	5	45	15	3	14	11	9	4,504
Diseases of the respiratory system.....	18	169	108	9	29	17	24	5,504
Diseases of the digestive system.....	14	135	93	7	27	1	31	4,982
Diseases of the genito-urinary system.....	23	104	91	4	13	5	13	4,712
Diseases of the locomotive system.....	2	9	5	1	3		3	573
Diseases of the integumentary system.....	2	49	41		3		12	3,573
Diseases of the absorbent system.....	5	48	37		7	1	8	2,073
Non-malignant tumors and cysts.....								
Poisons.....		30	25			1	4	424
Violent diseases and deaths.....	10	67	64		5		8	524
Foreign diseases.....								
Total.....	139	1,092	775	58	171	49	178	56,000

Naval hospitals—Detailed statement.

Diseases.	Remaining from last quarter.	Admitted.	Discharged to duty.	Invalided.		Died.	Continued to next quarter.	Total number of sick days.
				To hospital.	From service.			
GENERAL DISEASES.								
<i>Zymotic diseases.</i>								
Erysipelas.....		6	3	1		1	1	160
Febricula.....		3	3					438
Febris continua simplex.....	3	7	7	1	2			294
Febris enterica.....	3	8	5	1		3	2	917
Febris intermittens.....	4	35	35		1		3	850
Febris remittens.....	4	24	21	2	1	1	3	19
Febris typhus.....		1	1					14
Febris typho-malarialis.....		1	1					2
Morbilli.....		1					1	74
Parotitis.....		6	5	1				1
Phagedæna putris.....		1					1	4
Roseola.....		1	1					46
Scarlatina.....		2	1			1		45
Vaccina.....		1	1					
<i>Constitutional diseases.</i>								
Adynamia.....	3	34	23	1	6		7	1,495
Atrophia.....		1			1			83
Carcinoma.....		2				2		4
Diabetes.....		1	1					85
Epithelioma.....		1	1					4
Lumbago.....		8	6	1			1	300
Podagra.....		1	1					21
Rheumatismus acutus.....	2	40	31	2	4		5	2,019
Rheumatismus chronicus.....	5	48	33	7	7		6	2,318
Rheumatismus gonorrhœicus.....		2	1				1	16
Scrofula.....		3	1		2			77
Senectus.....	2	9	4			2	4	811
Syphilis consecutiva.....	11	59	39	1	19		11	4,256
Syphilis primitiva.....	4	22	23		1		2	1,206
Tuberculosi.....		1					1	89

Naval hospitals—Detailed statement—Continued.

Diseases.	Remaining from last quarter.	Admitted.	Discharged to duty.	Invalided.			Continued to next quarter.	Total number of sick days.
				To hospital.	From service.	Died.		
LOCAL DISEASES.								
<i>Diseases of the nervous system.</i>								
Apoplexia		4	3				1	133
Cephalalgia		2			1		1	141
Cerebritis		1					1	182
Congestio spinalis		4					1	136
Convulsio		4		1				141
Dementia	3	8	4	4	2		2	1,072
Epilepsia	1	11	6	4	5		1	512
Hysteria		1	1					84
Irritatio spinalis		2			2			118
Mania		9		8	1			536
Melancholia		5	1	2	1		1	181
Meningitis		1	1					13
Neuralgia		10	7		1		2	292
Neurasthenia		1	1					55
Paralysis	4	16	2	1	2	3	12	2,662
Pachymeningitis	1						1	365
Sciatica	1	5	2		2		1	373
Vertigo	1	3	1		3			113
<i>Diseases of the eye.</i>								
Amanrois		1		1				172
Asthenopia	1	1			1		1	386
Choroiditis	1	4	4				1	105
Iritis	1	4	3				1	263
Keratitis	1	1	1		1			83
Ophthalmia	1	1	1					10
Ophthalmia gonorrhoeica		2	2					37
Retinitis		2						152
Ulcus corneae		2	1		1			103
<i>Diseases of the ear.</i>								
Otitis	6	6	3		2		1	357
Otorrhoea	1	1	1					29
Surditas	1	1	1					22
<i>Diseases of the circulatory system.</i>								
Aneurysma		6	1	1		2	2	317
Angina pectoris		1	1					89
Dilatatio cordis		2	1	1				22
Hypertrophia cordis		2			2			49
Morbi valvularum cordis	3	23	8		6	9	4	1,072
Palpitatio		6	1		3		2	336
Pericarditis	1	1	1		1			169
Syncope		1	1					36
Varix	1	4	2		3			290
<i>Diseases of the respiratory system.</i>								
Asthma	1	13	9		2	1	2	714
Bronchitis acuta	1	26	17	1	1	2	6	1,276
Bronchitis chronica	3	19	15	1	6			1,295
Catarrhus bronchialis		12	10				2	271
Catarrhus nasalis		3	1		1		1	66
Emphysema		1				1		39
Epistaxis		1	1					10
Hæmoptysis		7	4		3			338
Laryngitis		2	1			1		96
Phthisis pneumonica acuta	1	3			1		2	618
Phthisis pneumonica chronica	5	49	15	4	13	3	10	2,397
Pleuritis	2	8	8		1	1		457
Pneumonia	5	24	27	3	1	7	1	1,467
<i>Diseases of the digestive system.</i>								
Abdominal tumor	1		1					57
Cirrhosis hepatis		1				1		1
Colica		3	1				1	21

Naval hospitals—Detailed statement—Continued.

Diseases.	Remaining from last quarter.	Admitted.	Discharged to duty.	Invalided.		Died.	Continued to next quarter.	Total number of sick days.
				To hospital.	From service.			
LOCAL DISEASES—Continued.								
<i>Diseases of the digestive system—Continued.</i>								
Congestio hepatis.....		2	2					185
Constipatio.....		3	1		2			140
Diarrhœa acuta.....		20	10	1				360
Diarrhœa chronica.....	3	10	9	2				1,085
Dysenteria acuta.....	1	4	4				1	220
Dysenteria chronica.....		3	2		1			202
Dyspepsia.....	1	12	6		4			404
Enteritis.....		1	1					23
Fistula ani.....		5	4				1	215
Gastritis.....	1	5	3		1			140
Gastrodynia.....		1						26
Hæmorrhœis.....	1	13	9		2		3	781
Hepatitis chronica.....	1	2	1		1		1	202
Hernia.....	1	22	3	3	15		2	825
Icterus.....		2	1					18
Perityphlitis.....	1		1					68
Pharyngitis.....		6	5				1	47
Prolapsus ani.....		1	1					47
Tonsillitis.....	3	19	13	1	1		2	520
Typhlitis.....		1	1					12
<i>Diseases of the genito-urinary system.</i>								
Albuminuria.....	1	8	5	1	1	2		200
Chanoroides.....	5	22	16		4		7	1,262
Cystitis.....	1	10	10		1		1	457
Enuresis.....		2		1	1			121
Epididymitis.....		2	2					50
Fistula vesicæ.....	1		1					72
Fistula urethræ.....		1				1		9
Gonorrhœa.....	7	27	31				3	901
Hæmaturia.....		2	1		1			23
Hydrocele.....		2	1				1	34
Iscburia.....		1	1					17
Nephritis.....	1	5	2		1	2	1	208
Orchitis.....	1	6	7	1	1			205
Paraphimosis.....		1	1					47
Phymosis.....		1	1					12
Prostatitis.....		1	1					38
Pyelitis.....	1				1			18
Urethræ strictura.....	4	9	11	1	1			480
Varicocele.....		2			2			20
<i>Diseases of the locomotive system.</i>								
Arthritis.....	1				1			11
Ankylosis.....	1	1	1		1			60
Coxalgia.....		2		1	1			42
Ostitis.....		1	1					41
Synovitis.....		5	3				2	362
<i>Diseases of the integumentary system.</i>								
Abscessus.....	3	14	13				4	651
Anthrax.....	1	2	3					110
Eczema.....	1	6	4				3	262
Erythema.....		1						30
Herpes.....		2	1				1	97
Lichen.....		2	2					75
Prurigo.....		1	1					46
Scabies.....		4	4					61
Ulcus.....	2	14	11		3		3	1,050
Unguis involutis.....		2	2					106
Urticaria.....		1			1			22
<i>Diseases of the absorbent system.</i>								
Adenitis.....	5	48	37		7	1	8	2,067

Naval hospitals—Detailed statement—Continued.

Diseases.	Remaining from last quarter.	Admitted.	Discharged to duty.	Invalided.		Died.	Continued to next quarter.	Total number of sick-days.
				To hospital.	From service.			
POISONS.								
Alcoholismus acutus.....		29	24			1	4	247
Alcoholismus chronicus.....		1	1					87
VIOLENT DISEASES AND DEATHS.								
Ambustio.....	1		1					17
Concussio cerebri.....		1	1					9
Concussio spinalis.....		1	1					37
Contusio.....	3	16	16		2		1	583
Fractura.....	2	19	15		2		4	1,124
Luxatio.....	1	3	3		1			169
Stemma.....	1	12	13					511
Vulnus contusum.....	1	6	6				2	79
Vulnus incisum.....	1	1	2					32
Vulnus laceratum.....		5	3				1	226
Vulnus punctum.....		3	3					41
Total	139	1,092	775	58	171	49	178	56,668

The whole number of persons examined for the naval service during the year 1886.....	9,568
Number accepted.....	5,577
Number rejected.....	3,991
Color-blind.....	84
Rejected per thousand.....	417+
Color-blind per thousand.....	8+

Report of vaccination.

	Success-ful.	Unsuccess-ful.
No evidence of previous vaccination.....	273	402
Presenting good cicatrices.....	1,160	2,044
Evidence of former attack of small-pox.....	63	163

Ratio per thousand of admissions for each class of disease of the force afloat.

Classes of disease.	Ratio.	Classes of disease.	Ratio.
Zymotic diseases.....	105.42	Diseases of the locomotive system.....	4.04
Constitutional diseases.....	99.46	Diseases of the integumentary system...	89.78
Diseases of the nervous system.....	40.53	Diseases of the absorbent system.....	24.25
Diseases of the eye.....	10.95	Non-malignant tumors and cysts.....	1.48
Diseases of the ear.....	4.46	Poisons.....	15.42
Diseases of the teeth.....	1.59	Violent diseases and deaths.....	171.38
Diseases of the circulatory system.....	6.91	Feigned diseases.....	.10
Diseases of the respiratory system.....	76.70		
Diseases of the digestive system.....	164.57	Total	901.50
Diseases of the genito-urinary system.....	84.46		

SUMMARY.

Daily average number of sick.....	204.69
Daily average each case was under treatment.....	8.81
Admissions per thousand of mean strength.....	901.59
Invaliding per thousand of mean strength.....	79.89
Deaths per thousand of mean strength.....	5.42

Very respectfully, your obedient servant,

F. M. GUNNELL,
Surgeon-General, U. S. Navy.

Hon. W. C. WHITNEY,
Secretary of the Navy.

CONTRACTS.

JULY 1, 1886, TO JUNE 30, 1887.

Proposals for repairs at Naval Hospital, Chelsea, Mass., October 11, 1886.

Bidders.	Amount.
T. R. Garrity & Co.*	\$4, 125
J. P. Conlon	4, 800
J. F. Cronin	4, 241
T. P. Healy	4, 684
William Dwyer	5, 988
D. A. Horgan	4, 750
Smith & Forbes	6, 300
Durham House Draining Company †	

* Contract awarded.

† Bid informal.

Proposals for furnishing hardware, paints, oil, glass, and lumber at Naval Laboratory, Brooklyn, N. Y., December 23, 1886.

Bidders.	Class I.— Hardware.	Class II.— Paints, oils, and glass.	Class III.— Lumber.
	Amount.	Amount.	Amount.
Dannat & Pell*			\$345. 20
J. W. Duryee			380. 92
F. W. White Hardware Company	\$375. 20		
A. F. Brombacher & Co.*	324. 88		
Tapscott & Hibberd	377. 93	\$38. 40	
Jno. Swan & Co	378. 98	34. 25	
A. Lagusky		49. 10	
F. M. Smith*		33. 74	

* Contracts awarded.

Proposals for furnishing bottles to the Naval Laboratory at Brooklyn, N. Y., January 17, 1887.

Bidders.	Amount.
Haggerty Bros. & Co.*	\$583. 00
Henry Allen	650. 00

* Contract awarded.

Proposal for changing drainage system at Naval Hospital, Norfolk, Va., January 18, 1887.

Bidder.	Amount.
Jas. J. Lawler & Co	\$2, 145. 00

There being but the one bid, the contract was awarded to J. J. Lawler & Co.

Proposals for furnishing paints, oils, etc., to Naval Hospital at Norfolk, Va., February, 24, 1887.

Bidders.	Amount.
Stevenson Bros. & Co.*	
Hugh Niabilt	\$241.25
Jas. Bradford †	214.87
August Buff †	218.16
Maltby & Cory	241.48
George L. Neville	231.63

* Bid informal. † Bid not signed. ‡ Contract awarded.

Proposals for furnishing range and hot-water boiler to the Naval Hospital, Philadelphia Pa., March 23, 1887.

Bidders.	Amount.
G. W. Hartman	\$498.00
Robt. E. Henderson	475.00
W. H. Harrison & Bro	473.00
Shook & Kryder	520.75
W. B. Hixey*	487.00
Chas. Williams' Sons	445.00

* Contract awarded.

Proposals for supplying the Naval Hospital, Portsmouth, N. H., for the fiscal year 1886-'87.

Articles.	C. E. Langton.	Norton and Gerrish.	Articles.	C. E. Langton.	Norton and Gerrish.
CLASS I.			CLASS I—Continued.		
Bacon, shoulder, sugar-cured	per lb. \$0.08	\$0.11	Potatoes, sweet	per bbl. \$3.00	\$4.00
Beans, string	per bush. .50	2.00	Pork, salt	per lb. .10	.09
Beef, corned, Baltimore, ex family,	per lb. .12	.11	Pork, fresh	do. .14	.14
Beef, roasting (exclusive of flank neck, shoulder, or round pieces),	per lb. .20	.19	Pork-sausage	do. .14	.12
Beef-steak, prime cuts	per lb. .25	.24	Pork-steak	do. .14	.14
Beef, round, clear, no shin or flank,	per lb. .15	.17	Squash	per 100 lbs. 2.00	2.00
Beef shins	per lb. .05	.06	Tomatoes, fresh	per bush. .50	1.20
Beets	per bush. .50	.40	Turkey, killed and dressed	per lb. .25	.25
Cranberries	do. 2.00	3.00	Turnips	per bbl. .75	.90
Carrots	per bbl. .75	.75	CLASS II.		
Cabbage, large heads	per doz. 1.20	1.10	Ale, Philadelphia	per doz. 1.50	1.50
Chickens, full-grown, killed and dressed	per lb. .23	.24	Axle-grease	per box. .25	.25
Corn, sweet, ears	per 100. .25	.15	Apples	per bbl. 2.00	2.50
Fish, salt	per lb. .06	.05	Apples, dried, medium, white, per bush	2.00	2.25
Fish, fresh	do. .06	.05	Beer, lager	per doz. .63	.63
Greens	per bush. .25	.50	Brooms, corn, No. 1, patent	do. 3.00	3.50
Hams, prime, sugar-cured	per lb. .16	.15	Buckets, water, oak, 3-hoop	do. 1.50	4.25
Lard, prime, in tubs	do. .10	.09	Bath-brick	do. .60	.65
Liver, fresh	do. .05	.05	Brushes, stove	do. 1.00	2.25
Mackerel, No. 1	per 1/2 bbl. 1.50	12.00	Brushes, scrubbing	do. 1.00	2.25
Mutton, prime, fore and hind quarters in equal number	per lb. .16	.15	Brushes, dust, long-handled	do. 2.00	3.00
Mutton-chops	do. .16	.19	Barley, pearl	per lb. .08	.06
Onions	per bush. 1.00	1.00	Bluing, laundry, pint bottles, per doz	1.00	1.00
Oysters, fresh and large, per solid quart	.35	.35	Chocolate, Bakers	per lb. .38	.42
Parsnips	per bush. .50	2.40	Corn-meal, yellow, bolted per 100 lbs	2.00	1.60
Peas, green	do. .50	2.00	Coffee, prime Rio, whole, roasted, per lb.	.25	.28
Potatoes, Irish, early rose	per bbl. 2.00	2.15	Corn, canned, 2-lb. tins	per doz. 1.00	.20
			Clothes-pins	per gross. .25	1.20

Proposals for supplying the Naval Hospital, Portsmouth, N. H., etc.—Continued.

Articles.	C. E. Langton.	Norton and Gerrish.	Articles.	C. E. Langton.	Norton and Gerrish.
CLASS II—Continued.			CLASS II—Continued.		
Candles.....per lb.	\$0.18	\$0.18	Vanilla, essence, 4-oz. bottles, per doz.	\$1.50	\$2.00
Crackers, water.....do.	.08	.08	Wax tapers, lighting.....per box.	.25	1.50
Farina.....do.	.08	.10	Yeast-powder, 4-oz. bottles, per doz.	1.00	1.50
Flour, best quality.....per bbl.	8.00	7.25	CLASS III.		
Gelatine, 2-oz. packages.....per doz.	1.50	1.50	Butter, choice, new creamery, per lb.	.35	.30
Hominy.....per lb.	.02	.03	Cheese, prime.....do.	.18	.13
Lemon essence, 4-oz. bottles, per doz.	2.50	2.40	Eggs, fresh and large.....per doz.	.30	.28
Lemons.....do.	.28	.25	CLASS IV.		
Lye, concentrated.....do.	2.00	1.80	Ice.....per 100 lbs.	.10	.35
Macaroni.....per lb.	.15	.17	CLASS V.		
Mustard, Coleman's best.....do.	.25	.25	Milk, pure.....per qt.	.07	.07
Molasses.....per gal.	.58	.50	CLASS VI.		
Matches, safety.....per gross.	1.20	1.05	Bread, fresh, 1-pound loaves, per lb.	.07	.07
Oatmeal.....per 100 lbs.	5.00	4.50	CLASS VII.		
Oranges.....per doz.	.15	.30	Bran.....per 100 lbs.	.50	1.10
Oil, sperm.....per gal.	.30	1.60	Corn (horse-feed).....per bush.	.50	.70
Peaches, canned, 2-lb. tins, per doz.	1.00	1.35	Corn-meal, unbolted, yellow, per 100 lbs.	.50	1.00
Pepper, black, ground.....per lb.	.30	.30	Feed, fine.....per 100 lbs.	.50	.50
Peas, canned, 2-lb tins.....per doz.	.75	1.65	Hay, loose, best timothy.....do.	.50	.75
Pickles, mixed.....per lb.	.04	.06	Hay, baled, best timothy.....do.	.50	.75
Powder, baking, Royal.....do.	.40	.50	Oats, No. 1, white.....per bush.	.50	.50
Powder, Persian insect.....per lb.	.50	.55	Straw, baled.....per 100 lbs.	.50	.65
Prunes.....do.	.05	.07	Shorts.....per bush.	.40	.50
Rice, choice.....do.	.07	.08	Screenings.....do.	.45	.00
Raisins, layer.....do.	.18	.16	CLASS VIII.		
Salt, table.....do.	.02	.01½	Gas.....per 1,000 feet.
Salt, coarse.....per bush.	.50	.50	CLASS IX.		
Soap, laundry, Higgins' best, per lb.	.09	.09	Water.....per 100 gals.	1.00
Soap, salt-water.....do.	.05	.06			
Soap, toilet.....per box.	.25	.25			
Soap, soft.....per bbl.	1.00	2.00			
Starch, corn.....per lb.	.12	.10			
Sapallo.....per doz.	1.25	1.25			
Starch, laundry.....per lb.	.09	.08			
Spices, assorted.....do.	.45	.45			
Sugar, white, standard block, do.	.10	.10			
Sugar, granulated, standard, do.	.10	.09			
Sugar, yellow, light.....do.	.08	.07			
Soda, washing.....do.	.06	.04			
Tapioca.....do.	.06	.06			
Tea, Oolong, best.....do.	.60	.65			
Tomatoes, 2-lb. tins.....per doz.	1.00	1.00			
Vermicelli.....per lb.	.15	.16			
Vinegar, best cider.....per gal.	.25	.22			

Classes I, II, IV, V, VI, VII, and IX were awarded to Chas. E. Langton; Class III was awarded to Norton and Gerrish.

Proposals for supplying the Naval Hospital, Chelsea, Mass., for the fiscal year 1886-87.

Articles.	C. A. Simonds.	M. J. Doran.	A. J. Bacon.	M. Wachter.	H. P. Stevens.	French Bros.
CLASS I.						
Bacon, shoulder, sugar-cured..... per pound..	\$0.05	\$0.08	\$0.08½	\$0.08	\$0.08
Beans, string..... per bushel..	1.00	.60	.7525	1.00
Beef, cooned, Baltimore, ex. family... per pound..	.07	.09	.0606	.06
Beef, roasting (exclusive of flank, neck, shoulder, or round pieces)..... per pound..	.09	.08	.0908½	.10
Beef-steak, prime cuts..... do..	.15	.22	.2215	.20
Beef, round, clear, no shin or flank..... do..	.07	.15	.1007	.10
Beef shins..... do..	.02	.02	.01½03	.03
Beets..... per bushel..	.00	.40	.4025	.60
Cranberries..... do..	.75	1.50	.7575	2.00
Carrots..... per barrel..	.50	1.00	.6050	1.00
Cabbage, large heads..... per dozen..	.00	1.00	.6050	1.00
Chickens, full-grown, killed and dressed... per lb..	.18	.17	.1618	.25
Corn, sweet, ears..... per 100..	2.00	1.00	.7575	1.25
Fish, fresh..... per pound..	.04	.07	.0404	.05
Fish, salt..... do..	.01	.05	.0102	.04
Greens..... per bushel..	.10	.50	.3010	.50
Hams, prime, sugar-cured..... per pound..	.10	.12½	.10½10	.11
Lard, prime, in tubs..... do..	.06	.08	.0506½	.08
Liver, fresh..... do..	.03	.05	.0503	.05
Mackerel, No. 1..... per ¼ barrel..	7.25	3.00	10.00	3.50	4.00
Mutton, prime, fore and hind quarters in equal number..... per pound..	.09½	.10	.1009	.09
Mutton-chops..... do..	.12	.15	.1512½	.12
Onions..... per bushel..	.00	.58	.9075	1.00
Oysters, fresh and large..... per solid quart..	.28	.35	.3225	.35
Paranips..... per bushel..	.75	.50	.3025	.60
Peas, green..... do..	1.00	1.00	1.0050	1.00
Potatoes, Irish, early rose..... per barrel..	1.85	1.75	1.80	1.85	2.00
Potatoes sweet..... do..	2.25	2.50	2.00	1.50	3.00
Pork, salt..... per pound..	.07	.08	.08½06	.08
Pork, fresh..... do..	.07	.09	.0806	.09
Pork-sausage..... do..	.08	.09	.0806	.09
Pork-steak..... do..	.07½	.09	.0906	.09
Squash..... per 100 pounds..	2.50	1.50	.7550	1.50
Tomatoes, fresh..... per bushel..	.75	.50	.5025	.50
Turkey, killed and dressed..... per pound..	.17	.17	.1816½	.20
Turnips..... per barrel..	.70	1.00	1.0050	1.25
CLASS II.						
Ale, Philadelphia..... per dozen..	.75	2.00	1.0075	.50
Axle-grease..... per box..	.12	.20	.1010	.08
Apples..... per barrel..	1.70	1.75	1.50	1.75	2.00
Apples, dried..... per pound..	.07	.04	.0403	.06
Beans, dried, mediums, white..... per bushel..	1.68	1.00	1.35	1.50	2.00
Beer, lager..... per dozen..	.70	.55	.5070	.50
Brooms, corn, No. 1, patent..... do..	2.20	3.00	2.50	1.50	2.00
Buckets, water, oak, 3-hoop..... do..	2.00	6.00	6.00	1.00	3.50
Bath brick..... do..	.40	.60	.4050	.60
Brushes, stove..... do..	2.25	1.50	1.50	1.25	1.75
Brushes, scrubbing..... do..	1.45	1.50	1.25	1.00	1.50
Brushes, dust, long-handled..... do..	5.80	8.50	8.00	7.50	3.00
Barley, pearl..... per pound..	.03½	.06	.0402	.05
Bluing, laundry, pint bottles..... per dozen..	1.00	.80	2.00	1.00	1.00
Chocolate, Baker's..... per pound..	.39	.38	.4233	.42
Corn-meal, yellow, bolted..... per 100 pounds..	1.25	1.75	1.25	1.00	1.00
Coffee, prime Rio, whole, roasted..... per pound..	.15	.15	.1812	.15
Corn, canned, 2-pound tins..... per dozen..	.90	1.10	.9090	1.10
Clothes-pins..... per gross..	.80	.15	.1010	.75
Candles..... per pound..	.15	.13	.2015	.15
Crackers, water..... do..	.15	.06	.0510	.12
Farina..... do..	.10	.10	.0910	.12
Floor, best quality..... per barrel..	5.50	5.50	5.00	5.50	6.00
Gelatine, 2-ounce packages..... per dozen..	1.00	1.50	1.2575	1.50
Hominy..... per pound..	.03	.03	.03½02	.05
Lemon essence, 4-ounce bottles..... per dozen..	1.20	3.00	1.0050	4.00
Lemons..... do..	.15	.20	.1520	.25
Lye, concentrated..... do..	.75	1.75	1.1575	.50
Macaroni..... per pound..	.11	.12	.1008	.11
Mustard, Coleman's best..... do..	.15	.23	.2318	.40
Molasses..... per gallon..	.20	.40	.3525	.40
Matches, safety..... per gross..	.55	.50	.7550	.50
Oatmeal..... per 100 pounds..	3.25	3.00	3.00	3.00	3.00

Proposals for supplying the Naval Hospital, Chelsea, Mass., etc.—Continued.

Articles.	C. A. Simonda.	M. J. Doran.	A. J. Bacon.	M. Wachtler.	H. P. Stevens.	French Bros.
CLASS II—Continued.						
Oranges..... per dozen	\$0.20	\$0.30	\$0.15		\$0.20	\$0.25
Oil, sperm..... per gallon	.70	1.00	.60		.70	1.00
Peaches, canned, 2-pound tins..... per dozen	1.30	1.60	.90		1.00	1.50
Pepper, black, ground..... per pound	.15	.23	.20		.12	.20
Peas, canned, 2-pound tins..... per dozen	1.10	1.75	1.25		.90	1.50
Pickles, mixed..... per pound	.05	.50	.04		.03	.30
Powder, baking, Royal..... do	.40	.43	.38		.25	.40
Powder, Persian insect..... per pound	.15	.35	.15		.50	.25
Prunes..... do	.06	.05	.11		.05	.08
Rice, choice..... do	.06	.08	.06		.06½	.08
Raisins, layer..... do	.14	.12	.15		.10	.15
Salt, table..... do	.01	.01	.01½		.01½	.01
Salt, coarse..... per bushel	.35	.40	.01½		.15	.50
Soap, laundry, Higgins's best..... per pound	.05½	.06	.05		.05½	.06
Soap, salt-water..... do	.04	.06	.03		.02	.03
Soap, toilet..... per box	.10	.50	.10		.10	1.00
Soap, soft..... per barrel	2.00	3.25	.75		1.50	1.00
Starch, corn..... per pound	.08	.07	.08		.09	.08
Sapolo..... per dozen	1.00	1.00	.98		.75	1.00
Starch, laundry..... per pound	.04	.05	.04½		.04	.05
Spices, assorted..... do	.40	.25	.12		.25	.30
Sugar, white, standard block..... do	.08½	.07½	.07		.05	.08
Sugar, granulated, standard..... do	.07½	.06½	.07½		.07½	.08
Sugar, yellow, light..... do	.06	.06	.05		.03	.06
Soda, washing..... do	.01½	.02	.01½		.01	.02
Tapioca..... do	.04½	.06	.04½		.02	.07
Tea, Oolong, best..... do	.35	.50	.30		.28	.45
Tomatoes, 2-pound tins..... per dozen	.80	1.10	.90		.60	1.10
Vermicelli..... per pound	.09	.10	.10		.03	.08
Vinegar, best cider..... per gallon	.13	.16	.14		.12	.13
Vanilla essence, 4-ounce bottles..... per dozen	2.25	4.00	1.25		.25	5.00
Wax tapers, lighting..... per box	.10		.25		.10	.10
Yeast-powder, 4-ounce bottles..... per dozen	.90		.40		.10	1.00
CLASS III.						
Butter, choice, new creamery..... per pound	.25	.25	.28		.25	.35
Cheese, prime..... do	.06	.11	.10		.02	.10
Eggs, fresh and large..... per dozen	.25	.24	.25		.26	.35
CLASS IV.						
Ice..... per 100 pounds	.20½	.13	.20		.12½	.15
CLASS V.						
Milk, pure..... per quart	.04½	.05½	.04½		.04½	.06
CLASS VI.						
Bread, fresh, 1-pound loaves..... per pound	.04	.03½	.03	\$0.03½	.03½	.04
CLASS VII.						
Bran..... per 100 pounds	1.50	.90	.40		.10	1.00
Corn (horse feed)..... per bushel	.70	.60	.60		.55	.70
Corn-meal, unbolted, yellow..... per 100 pounds	.95	1.05	1.05		.25	1.00
Feed, fine..... do		.95	1.00		.15	.75
Hay, loose, best timothy..... do		1.00	.75		.25	1.00
Hay, baled, best timothy..... do		1.00	.75		.25	1.00
Oats, No. 1, white..... per bushel	.55	.49	.58		.53	.55
Straw, baled..... per 100 pounds		1.10	1.00		.25	.30
Shorts..... per bushel	.28	.25	.55		.25	1.15
Screenings..... do		.45	.30		.10	1.00
CLASS VIII.						
Gas..... per 1,000 feet						2.25
CLASS IX.						
Water..... per 100 gallons						.62

Classes I, II, IV, V, VII were awarded to H. P. Stevens; Class III was awarded to M. J. Doran; Class VI was awarded to A. J. Bacon.

Proposals for supplying the Naval Hospital, Brooklyn, N. Y., for the fiscal year 1-86-'87.

Articles.	W. H. Belford.	John McNamara.	W. J. Belford.	John Hanley.	J. J. Lyons.	W. Wright.	H. Scheinbeck.	John Reis.	George W. Childs.	John C. Williams.	Ridgewood Ice Co.	A. Koch.	A. Behlen.
CLASS I.													
Bacon, shoulder, sugar-cured.....				\$0.07	\$0.0675			\$0.10					
Beans, string.....				.85	.05			.10					
Beef, corned, Baltimore, ex. family.....				.0775	.06			.10					
Beef, roasting (exclusive of flank, neck, shoulder, or round pieces).....				.115	.11			.16					
Beef-steak, prime cuts.....				.13	.13			.18					
Beef, round, clear, no shin or flank.....				.095	.095			.14					
Beef shins.....				.04	.04			.03					
Beets.....				.50	.10			.20					
Branberries.....				.50	.25			.50					
Carrots.....				.20	.25			.10					
Cabbage, large heads.....				.70	.70			.125					
Chickens, full-grown, killed and dressed.....				1.15	.12			.18					
Corn, sweet, ears.....				.50	.10			.50					
Fish, fresh.....				.054	.05			.054					
Fish, salt.....				.035	.055			.04					
Greens.....				.09	.05			.20					
Hams, prime, sugar-cured.....				.11	.125			.12					
Lard, prime, in tubs.....				.075	.09			.08					
Liver, fresh.....				.02	.015			.01					
Mackerel, No. 1.....				.350	1.25			3.00					
Mutton, prime, fore and hind quarters in equal number, per pound.....				.08	.075			.14					
Mutton-chops.....				.07	.08			.16					
Onions.....				.50	.50			.75					
Oysters, fresh and large.....				.60	.10			.30					
Peanut-pieces.....				.75	.10			.10					
Peas, green.....				1.05	1.00			3.25					
Potatoes, Irish, early rose.....				2.00	1.50			.20					
Potatoes, sweet.....				.08	.08			.11					
Pork, salt.....				.06	.08			.06					
Pork, fresh.....				.07	.08			.12					
Pork sausage.....				.40	.08			.08					
Quash.....				.50	.10			.10					
Tomatoes, fresh.....				.35	.25			.10					
Turkeys, killed and dressed.....				.12	.14			.18					
Turkeys, killed and dressed.....				.15	.20			.10					
Turkeys, killed and dressed.....													

Proposals for supplying the Naval Hospital, Brooklyn, N. Y., for the fiscal year 1886-'87—Continued.

Articles.	W. H. Bellford.	John McNamara.	W. J. Bellford.	John Hanley.	J. J. Lyons.	W. Wright.	R. Schrenbeck.	John Reis.	George W. Childs.	John C. Williams.	Ridgewood Ice Co.	A. Koch.	A. Rehlen.
CLASS II.													
Ale, Philadelphia.....	per dozen.....	\$0.50					\$0.85	.50					
Axle-grease.....	per box.....	.05					.12½	.12					
Apples.....	per barrel.....	1.60					1.70	3.00				1.65	
Apples, dried.....	per bushel.....	.034					.10	.12				.08	
Beans, dried, mediums, white.....	per bushel.....	1.55					1.65	1.75				1.75	
Beer, lager.....	per dozen.....	.60					.50	1.50				.60	
Brooms, corn, No. 1, patent.....	do.....	2.50					2.00	.50				2.75	
Buckets, water, oak, 3-hoop.....	do.....	2.20					2.00	.50				2.00	
Bath brick.....	do.....	.30					.40	.45				.42	
Brushes, stove.....	do.....	1.25					2.00	1.00				2.00	
Brushes, scrubbing.....	do.....	1.00					1.00	.90				1.00	
Brushes, dust, long-handled.....	do.....	1.50					2.75	1.00				2.00	
Barley, pearl.....	per pound.....	.034					.024	.02				.02	
Bluing, laundry.....	per dozen.....	.75					.60	.75				.85	
Chocolate, Baker's.....	per pound.....	.35					.40	.45				.40	
Cocoa, Baker's.....	per pound.....	1.60					1.80	2.00				2.50	
Com-meal, yellow, bolted.....	per 100 pounds.....	1.60					.60	.50				.50	
Coffee, prime Rio, whole, roasted.....	per pound.....	1.00					.85	1.40				1.15	
Corn, canned, 2-pound tins.....	per gross.....	1.00					.12	.15				.15	
Clothes-pins.....	per pound.....	.124					.12	.15				.15	
Candles.....	per pound.....	.04					.07	.08				.08	
Crackers, water.....	do.....	.06					.07	.08				.08	
Carina.....	do.....	.06					.07	.08				.08	
Flour, best quality.....	per barrel.....	6.75					6.00	7.00				6.00	
Gelatine, 2-ounce packages.....	per dozen.....	.50					1.00	.50				.50	
Hominy.....	per pound.....	.034					.03	.08				.04	
Lemon essence, 4-ounce bottles.....	per dozen.....	.65					1.00	.50				1.00	
Lemons.....	do.....	.25					.25	.40				.25	
Lye, concentrated.....	do.....	1.25					1.00	.90				1.25	
Macaroni.....	per pound.....	.044					.10	.12				.10	
Mustard, Coleman's best.....	do.....	.23					.23	.55				.80	
Molasses.....	per gallon.....	.40					.45	.55				.60	
Matches, safety.....	per gross.....	1.00					.70	.75				1.10	
Oatmeal.....	per pound.....	.034					.03	.05				.035	
Oranges.....	per dozen.....	.25					.30	.50				.30	
Oil, sperm.....	per gallon.....	1.25					1.60	1.00				1.00	

Peaches, canned, 2-pound tins..... per dozen.....	1.70	1.50	2.00
Pepper, black, ground..... per pound.....	.22	.85	.25
Pean, canned, 2-pound tins..... per dozen.....	1.00	1.75	2.00
Pickles, mixed..... per dozen.....	.08	.04	.08
Powder, baking, Royal..... per pound.....	.40	.60	.43
Powder, Persian insect..... do.....	.80	.50	.75
Prunes..... do.....	.04	.07	.06
Rice, choice..... do.....	.04	.12	.06½
Raisins, layer..... do.....	.15	.20	.15
Salt, table..... do.....	.01	.02	.015
Salt, coarse..... do.....	.70	.50	.40
Soap, laundry, Higgins's best..... per bushel.....	.05	.08	.06½
Soap, salt-water..... do.....	.05	.01	.06½
Soap, toilet..... do.....	.25	.35	.25
Soap, soft..... per box.....	1.60	1.50	1.25
Starch, corn..... per barrel.....	.07	.14	.08
Sapolo..... per dozen.....	.75	1.00	.85
Starch, laundry..... per pound.....	.04	.06	.05
Spices, assorted..... do.....	.30	.40	.40
Sugar, white, standard, block..... do.....	.07	.05	.07½
Sugar, granulated, standard..... do.....	.07	.11	.07
Sugar, yellow, light..... do.....	.06½	.12	.06
Soda, washing..... do.....	.04	.04	.015
Tapioca..... do.....	.05	.10	.03
Tea, Oolong, best..... do.....	.27	.50	.85
Tomatoes, 2-pound tins..... per dozen.....	1.05	1.40	.95
Vermicelli..... do.....	.10	.12	.15
Vinegar, best cider..... per gallon.....	.134	.25	.18
Vanilla essence, 4 oz. bottles..... per dozen.....	1.55	1.90	2.10
Wax, tapers, lighthouse..... per box.....	.25	.15	.15
Yeast-powder, 4-oz. bottles..... per dozen.....	1.20	.10	.10
CLASS III.			
Butter, choice, new creamery..... per pound.....	.23	.30	.27
Cheese, prime..... do.....	.02	.03	.02
Eggs, fresh and large..... per dozen.....	.24	.33	.27
CLASS IV.			
Ice..... per 100 pounds.....	0.24½	.22	\$.0.20
CLASS V.			
Milk, pure..... per quart.....	\$.0.045	.04½	\$.0.04½
CLASS VI.			
Bread, fresh, 1-pound loaves..... per pound.....	\$.0.03	\$.0.03½	\$.0.03

Proposals for supplying the Naval Hospital, Philadelphia, Pa., for the fiscal year 1886-'87.

Articles.	John T. Strickland.	Ewd. Sheeler.	Articles.	John T. Strickland.	Ewd. Sheeler.
CLASS I.			CLASS II—Continued.		
Bacon, shoulder, sugar-cured, per pound	\$0.12		Coffee, prime Rio, whole, roasted, per pound		\$0.20
Beans, string per bush	.30		Corn, canned, 2-lb tins, per doz.		1.00
Beef, corned, Baltimore, ex. family per pound	.12		Clothes-pins per gross		.20
Beef, roasting (exclusive of flank, neck, shoulder, or round pieces) per pound	.20		Candles per lb.		.15
Beefsteak, prime cuts per lb.	.25		Crackers, water do.		.10
Beef round, clear, no shin or flank, per pound	.16		Farina do.		.06
Beef shins per lb.	01½		Flour, best quality per bbl.		8.00
Beets per bush	.15		Gelatine, 2-oz. packages, per doz.		1.55
Cranberries do.	1.20		Hominy per lb.		.03
Carrots per bbl.	.15		Lemon essence, 4-oz. bottles, per dozen		1.75
Cabbage, large heads per doz.	1.33		Lemons per doz.		.25
Chickens, full-grown, killed and dressed per lb.	.22		Lye, concentrated do.		.75
Corn, sweet, ears per 100	1.00		Macaroni per lb.		.15
Fish, fresh per lb.	.14		Mustard, Coleman's best do.		.20
Fish, salt do.	.10		Molasses per gall.		.40
Greens per bush	.10		Matches, safety per gross.		1.50
Hams, prime, sugar-cured, per lb.	11½		Oatmeal per 100 lbs.		.04
Lard, prime, in tubs do.	.04		Oranges per doz.		.40
Liver, fresh do.	02½		Oil, sperm per gal.		.70
Mackerel, No 1 per ½ bbl.	12.00		Peaches, canned, 3 lb. tins, per dozen		2.00
Mutton, prime, fore and hind quarters in equal number, per pound	.12		Pepper, black, ground per lb.		.18
Mutton chops per lb.	.20		Peas, canned, 2-lb. tins per doz.		1.60
Onions per bush	2.25		Pickles mixed per bucket.		1.25
Oysters, fresh and large per 100	1.00		Powder, baking, Royal per lb.		.25
Paranips per bush	.20		Powder, Persian insect do.		.60
Peas, green do.	.50		Prunes do.		.10
Potatoes, Irish, early rose do.	1.25		Rice, choice do.		.07
Potatoes, sweet do.	1.20		Raisins, layer do.		.25
Pork, salt per lb.	.14		Salt, table do.		.02
Pork, fresh do.	.07		Salt, coarse per bush.		.50
Pork-sausage do.	.12		Soap, laundry, Higgins' best, per pound		04½
Pork-steak do.	.15		Soap, salt-water per lb.		.02
Squash per 100 lbs.	.40		Soap, toilet per gross.		2.25
Tomatoes, fresh per bush	1.00		Soap, soft per bbl.		1.20
Turkey, killed and dressed, per pound	.20		Starch, corn per lb.		.07
Turnips per bush	.50		Sapolo per doz.		.65
CLASS II.			Starch, laundry per lb.		.06
Ale, Philadelphia per doz.	\$0.90		Spices, assorted do.		.20
Axle grease per box	.10		Sugar, white, standard block, per pound		.09
Apples per bbl.	3.50		Sugar, granniated, standard, per pound		.08
Apples, dried per lb.	.10		Sugar, yellow, light per lb.		.06
Beans, dried, medium, white, per bushel	2.40		Soda, washing do.		.02
Beer, lager per doz.	.90		Tapioca do.		.06
Brooms, corn, No. 1, patent, per dozen	2.50		Tea, Oolong, best do.		.45
Buckets, water, oak, 3-hoop, per dozen	1.90		Tomatoes, 3-lb. tins per doz.		.95
Bath-brick per doz.	.35		Vermicelli per lb.		.15
Brushes, stove per dozen	3.00		Vinegar, best cider per gall.		.22
Brushes, scrubbing, hog bristle, large size, per dozen	3.50		Vanilla, essence, 4-oz. bottles, per dozen		3.50
Brushes, dust, long handled, per dozen	9.00		Wax tapers, lighting per box		.20
Barley, pearl per lb.	03½		Yeast powder, 4-oz. bottles, per dozen		1.25
Bluing, laundry, pint bottles, per dozen	1.00		CLASS III.		
Chocolate, Baker's per lb.	.40		Butter, choice new creamery, per pound	\$0.38	
Corn meal, yellow, bolted, per 100 pounds.	1.80		Cheese, prime per lb.	.04	
			Eggs, fresh and large do.	.35	
			CLASS IV.		
			Ice per 100 lbs.	.35	

Proposals for supplying the Naval Hospital, Philadelphia, Pa., etc.—Continued.

Articles.	John T. Strickland.	Ewd. Sheeler.	Articles.	John T. Strickland.	Ewd. Sheeler.
CLASS V.			CLASS VII—Continued.		
Milk, pure.....per qt.....	\$0.07½		Hay, loose, best timothy..do.....	\$1.05	
CLASS VI.			Hay, baled, best timothy..do.....	1.00	
Bread, fresh, 1-pound loaves, per pound.....	.00		Oats, No. 1, white...per bush.....	.46	
CLASS VII.			Straw, baled.....per 100 lbs.....	1.00	
Bran.....per 100 lbs.....	.70		Shorts.....per bush.....	.75	
Corn (horse-feed).....per bush.....	.70		Screenings.....do.....	.60	
Corn meal, unbolted, yellow, per 100 pounds.....	1.15		CLASS VIII.		
Feed, fine.....per 100 lbs.....	.80		Gas.....per 1,000 ft.....		
			CLASS IX.		
			Water.....per 100 gals.....		

Classes I, III, IV, V, VI, VII were awarded to John T. Strickland; Class II was awarded to Edward Sheeler.

Proposals for supplying the Naval Hospital, Washington, D. C., for the fiscal year 1886-'87.

Articles.	Browning & Middleton.	F. P. Seibert.	J. B. Bryan.
CLASS I.			
Bacon, shoulder, sugar-cured.....per pound..	\$0.08	\$0.08	\$0.07
Beans, string.....per bushel..	1.50	.25	1.75
Beef, corned, Baltimore, extra family.....per pound..	.08	.07	.08
Beef, roasting (exclusive of flank, neck, shoulders, or round pieces), per pound.....	.15	.12½	.16
Beef-steak, prime cuts.....per pound..	.19	.18	.18
Beef, round, clear, no shin or flank.....do.....	.15	.12½	.12½
Beef shins.....do.....	.05	.04	.03
Beets.....per bushel..	1.50	1.00	1.00
Cranberries.....do.....	2.50	1.00	2.13
Carrots.....per barrel..	1.50	1.00	5.50
Cabbage, large heads.....per dozen..	1.20	1.50	.75
Chickens, full-grown, killed and dressed.....per pound..	.16	.16	.18
Corn, sweet, ears.....per 100.....	1.25	1.00	1.40
Fish, fresh.....per pound..	.125	.14	.12
Fish, salt.....do.....	.06	.06	.06
Greens.....per bushel..	.75	.25	.37½
Hams, prime, sugar-cured.....per pound..	.125	.13	.12½
Lard, prime, in tubs.....do.....	.085	.08	.07½
Liver, fresh.....do.....	.10	.05	.08
Mackerel, No. 1.....per ¼ barrel..	6.00	10.00	8.50
Mutton, prime, fore and hind quarters in equal number...per pound..	.15	.13	.15
Mutton-chops.....do.....	.15	.15	.15
Onions.....per bushel..	2.00	1.00	2.50
Oysters, fresh and large.....per solid quart..	.31½	.25	.28
Parsnips.....per bushel..	.75	.40	1.00
Peas, green.....do.....	1.00	.90	1.25
Potatoes, Irish, Early Rose.....per barrel..	2.50	2.75	2.70
Potatoes, sweet.....do.....	2.50	1.50	3.50
Pork, salt.....per pound..	.115	.08	.09
Pork, fresh.....do.....	.115	.10	.12
Pork-sausage.....do.....	.115	.10	.12
Pork-steak.....do.....	.115	.10	.12
Squash.....per 100 pounds..	4.00	.50	3.50
Tomatoes, fresh.....per bushel..	1.25	1.00	.85
Turkeys, killed and dressed.....per pound..	.20	.20	.16
Turnips.....per barrel..	1.00	.50	2.00

Proposals for supplying the Naval Hospital, Washington, D. C., etc.—Continued.

Articles.	Browning & Middleton.	F. F. Salbert.	J. B. Bryan.
CLASS II.			
Ale, Philadelphia.....	per dozen..	00.75	\$1.00
Axle-grease.....	per box..	.08	.07
Apples.....	per barrel..	3.00	3.45
Apples, dried.....	per pound..	.05	.049
Beans, dried, mediuma, white.....	per bushel..	2.00	1.75
Beer, lager.....	per dozen..	.70	.69
Brooms, corn, No. 1, patent.....	do.....	3.00	3.50
Buckets, water, oak, 3-hoop.....	do.....	1.75	5.40
Bath-brick.....	do.....	.37½	.75
Brushes, stove.....	do.....	1.50	2.38
Brushes, scrubbing.....	do.....	1.25	2.25
Brushes, dust, long-handled.....	do.....	12.00	12.50
Barley, pearl.....	per pound..	.05	.07
Bluing, laundry, pint bottles.....	per dozen..	.75	1.50
Chocolate, Baker's.....	per pound..	.38	.38
Corn-meal, yellow, bolted.....	per 100 pounds..	1.25	1.24
Coffee, prime Rio, whole, roasted.....	per pound..	.16	.145
Corn, canned, 2-pound tins.....	per dozen..	.95	.90
Clothes-pins.....	per gross..	.20	.24
Candles.....	per pound..	.10	.11
Crackers, water.....	do.....	.07	.08
Farina.....	do.....	.10	.11
Flour, best quality.....	per barrel..	6.00	5.38
Gelatine, 2-oz. packages.....	per dozen..	1.62½	1.50
Hominy.....	per pound..	.02	.03
Lemon essence, 4-oz. bottles.....	per dozen..	2.50	3.25
Lemons.....	do.....	.25	.22
Lye, concentrated.....	do.....	.75	.92
Macaroni.....	per pound..	.11	.10
Mustard, Coleman's best.....	do.....	.25	.40
Molasses.....	per gallon..	.40	.39
Matches, safety.....	per gross..	1.25	2.25
Oatmeal.....	per 100 pounds..	3.50	3.25
Oranges.....	per dozen..	.35	.37
Oil, sperm.....	per gallon..	1.00	1.50
Peaches, canned, 3-pound tins.....	per dozen..	1.50	1.00
Pepper, black, ground.....	per pound..	.25	.24
Peas, canned, 2-pound tins.....	per dozen..	2.00	1.90
Pickles, mixed.....	per pound..	.10	.10
Powder, baking, Royal.....	do.....	.44	.42
Powder, Persian insect.....	do.....	.40	.40
Prunes.....	do.....	.05	.05
Rice, choice.....	do.....	.055	.06
Raisins, layer.....	do.....	.14	.14
Salt, table.....	do.....	.01	.00½
Salt, coarse.....	per bushel..	.25	.29
Soap, laundry, Higgins' best.....	per pound..	.06½	.05
Soap, salt water.....	do.....	.08	.18
Soap, toilet.....	per box..	.25	.15
Soap, soft.....	per barrel..	2.00	2.75
Starch, corn.....	per pound..	.06	.065
Sapolo.....	per dozen..	.90	.96
Starch, laundry.....	per pound..	.04	.04½
Spices, assorted.....	do.....	.50	.30
Sugar, white, standard block.....	do.....	.08	.08
Sugar, granulated, standard.....	do.....	.08	.07½
Sugar, yellow, light.....	do.....	.055	.0545
Soda, washing.....	do.....	.015	.02
Tapioca.....	do.....	.05	.06½
Tea, Oolong, best.....	do.....	.40	.42
Tomatoes, 2-lb. tins.....	per dozen..	.90	.92
Vermicelli.....	per pound..	.12	.10
Vinegar, best cider.....	per gallon..	.20	.14
Vanilla, essence, 4-oz. bottles.....	per dozen..	3.00	4.80
Wax tapers, lighting.....	per box..	.12	.12
Yeast powder, 4-oz. bottles.....	per dozen..	.87½	.90
CLASS III.			
Butter, choice new creamery.....	per pound..	.30	.30
Cheese, prime.....	do.....	.10	.12
Eggs, fresh and large.....	per dozen..	.25	.22
CLASS IV.			
Ice.....	per 100 pounds..	.45

Proposals for supplying the Naval Hospital, Washington, D. C., etc.—Continued.

Articles.	Browning & Middleton.	F. P. Selbert.	J. B. Bryan.
CLASS V.			
Milk, pure..... per quart.....	\$0.06		
CLASS VI.			
Bread, fresh, 1-pound loaves..... per pound.....	.04½		
CLASS VII.			
Bran..... per 100 pounds.....	.95		
Corn (horse-feed)..... per bushel.....	.50		
Corn-meal, unbolted, yellow..... per 100 pounds.....	1.25		
Feed, fine..... do.....	1.75		
Hay, loose, best timothy..... do.....	1.25		
Hay, baled, best timothy..... do.....	1.25		
Oats, No. 1, white..... per bushel.....	.55		
Straw, baled..... per 100 pounds.....	1.25		
Shorts..... per bushel.....	.20		
Screenings..... do.....	.30		
CLASS VIII.			
Gas..... per 1,000 feet.....			
CLASS IX.			
Water..... per 100 gallons.....			

Class I was awarded to F. P. Selbert; Classes II, IV, V, VI, and VII were awarded to Browning & Middleton; Class III was awarded to J. B. Bryan.

Proposals for supplying the Naval Hospital, Norfolk, Va., for the fiscal year 1886-'87.

Articles.	George Barry.	Conrad Horst.	C. R. Robertson.	O. & J. Williams.	John A. Codd.	Kato C. Brady.	Thos. J. Barlow.	L. Morris.	C. R. Nash.	W. G. Maupin.	R. T. Meles.
CLASS I.											
Bacon, shoulder, sugar-cured..... per pound.....	\$0.10	\$0.11	\$0.10½		\$.095		\$0.07½				
Beans, string..... per bush.....	1.50	1.60	1.59		2.00		.70				
Beef, corned, Baltimore, extra family..... per pound.....	.085	.089	.0862½		.088		.07				
Beef, roasting (exclusive of flank, neck, shoulder, or round pieces) per pound.....	.125	.126	.1299		.128		.07½				
Beef steak, prime cuts. do.....	.125	.126	.1299		.128		.07½				
Beef, round, clear, no shin or flank..... per pound.....	.125	.126	.1299		.128		.07½				
Beef shins..... do.....	.064	.07	.065		.07		.03				
Beets..... per bushel.....	1.50	1.50	1.55		1.75		.70				
Cranberries..... do.....	2.00	2.40	2.50		4.00		2.00				
Carrots..... per barrel.....	5.00	5.10	5.75		4.50		1.50				
Cabbage, large heads, per dozen.....	1.00	1.20	1.10		1.50		1.00				
Chickens, full-grown, killed and dressed. per lb.....	.21	.22	.23		.20		.18				
Corn, sweet, ears..... per 100.....	2.00	2.20	2.25		1.85		1.00				
Fish, fresh..... per pound.....	.08	.080	.080		.084		.05				
Fish, salt..... do.....	.07	.074	.075		.084		.04				
Greens..... per bushel.....	.40	.60	.50		.50		.40				
Hams, prime, sugar-cured, per pound.....	.16	.17	.17		.17		.13				

Proposals for supplying the Naval Hospital, Norfolk, Va., etc.—Continued.

Articles.	George Berry.	Conrad Horst.	C. R. Robertson.	O. & J. Williams.	John A. Codd.	Kate C. Brady.	Thos. J. Barlow.	L. Morris.	C. R. Nash.	W. G. Maupin.	R. T. Mules.
CLASS I—Continued.											
Lard, primo, in tubs.. per lb	\$0.10	\$0.11	\$0.105	\$0.094	\$0.08
Liver, fresh..... do	10	11	10	09	08
Mackerel, No. 1 per barrel	10.50	12.75	10.60	11.00	10
Mutton, primo, fore and hind quarters in equal number..... per pound	.125	.126	.1299128073
Mutton-chops..... do	.125	.126	.129912808
Onions..... per bushel	2.50	3.31	2.60	2.25	1.25
Oysters, fresh and large, per solid quart	.30	.35	.323025
Parsnips..... per bushel	.50	.60	1.00	1.0070
Peas, green..... do	1.00	1.20	1.25	1.2090
Potatoes, Irish, early rose, per barrel	3.50	3.60	3.75	4.00	2.70
Potatoes, sweet, per barrel	2.50	2.60	2.65	2.00	2.25
Pork, salt..... per pound	.10	.11	.100909
Pork, fresh..... do	.125	.13	.129912809
Pork-sausage..... do	.125	.125	.130912809
Pork-steak..... do	.125	.126	.129912809
Squash..... per 100 pounds.	2.00	2.40	2.25	1.7590
Tomatoes, fresh, per bushel	1.50	1.70	1.60	2.0090
Turkey, killed and dressed, per pound	.25	.26	.282318
Turnips..... per barrel	1.25	1.80	1.35	1.35	1.50
CLASS II.											
Ale, Philadelphia..... per doz60	\$0.60
Axle-grease..... per box07	.07
Apples..... per barrel	2.50	3.50
Apples, dried, per pound05	.04
Beans, dried, mediums, white..... per bushel	2.00	1.85
Beer, lager..... per dozen60	.60
Brooms, corn, No. 1, patent..... per dozen	3.50	2.75
Buckets, water, oak, 3-hoop, per dozen	3.50	1.95
Bath-brick..... per dozen25	.23
Brushes, stove..... do	1.00	1.75
Brushes, scrubbing..... do	1.00	1.80
Brushes, dust, long-handled..... per dozen	6.00	6.00
Barley, pearl..... per pound05	.052
Bluing, laundry, pint bottles..... per dozen	1.25	.75
Chocolate, Baker's..... per lb40	.40
Corn-meal, yellow, bolted, per 100 pounds	1.00	.75
Coffee, primo Rio, whole, roasted..... per pound16	.153
Corn, canned, 2-pound tins, per dozen	1.10	1.10
Clothes-pins..... per gross39	.20
Candles..... per pound15	.15
Crackers, water..... do07	.063
Farina..... do06	.06
Flour, best quality per bibi	6.00	6.00
Gelatine, 2-ounce packages, per dozen	1.50	1.25
Hominy..... per pound02	.03
Lemon essence, 4-ounce bottles..... per dozen	2.00	2.00
Lemons..... do25	.25
Lye, concentrated..... do90	.88
Macaroni..... per pound09	.12
Mustard, Coleman's best, per pound50	.40
Molasses..... per gallon40	.40
Matches, safety..... per gross90	.90
Oatmeal..... per 100 pounds	4.00	4.00
Oranges..... per dozen40	.35
Oil, sperm..... per gallon	1.50	1.25

Proposals for supplying the Naval Hospital, Norfolk, Va., etc.—Continued.

Articles.	George Berry.	Conrad Horst.	C. R. Robertson.	O. & J. Williams.	John A. Codd.	Kate C. Brady.	Thos. J. Barlow.	L. Morris.	C. R. Nash.	W. G. Manpin.	R. T. Mules.
CLASS II—Continued.											
Peaches, canned, 2-pound tins..... per dozen							\$1.40	\$1.50			
Pepper, black, ground, per pound.....							.25	.24			
Peas, canned, 2-pound tins, per dozen.....							1.40	1.65			
Pickles, mixed..... per pound.....							.07	.07			
Powder, baking, Royal do.....							.40	.40			
Powder, Persian insect, per pound.....							.30	.40			
Prunes..... per pound.....							.07	.08			
Rice, choice..... do.....							.07	.07			
Raisins, layer..... do.....							.14	.15			
Salt, table..... do.....							.01	.01			
Salt, coarse..... per bushel.....							.30	.30			
Soap, laundry, Higgins' best, per pound.....							.07	.06			
Soap, salt-water..... do.....							.10	.05			
Soap, toilet..... per box.....							.25	.20			
Soap, soft..... per barrel.....							1.50	1.25			
Starch, corn..... per pound.....							.08	.08			
Sapallo..... per dozen.....							.00	.90			
Starch, laundry..... per pound.....							.05	.04			
Spices, assorted..... do.....							.25	.25			
Sugar, white, standard block, per pound.....							.08	.07			
Sugar, granulated, standard, per pound.....							.07	.07			
Sugar, yellow, light, per lb.....							.06	.06			
Soda, washing..... do.....							.02	.01			
Tapioca..... do.....							.08	.08			
Tea, Oolong, best..... do.....							.40	.42			
Tomatoes, 2-pound tins, per dozen.....							.90	.88			
Vermicelli..... per pound.....							.09	.12			
Vinegar, best cider, per gallon.....							.20	.20			
Vanilla, essence, 4-oz. bottles, per dozen.....							3.00	2.75			
Wax tapers, lighting, per box.....							.05	.04			
Yeast powders, 4-ounce bottles, per dozen.....							.90	.90			
CLASS III.											
Butter, choice, new creamery, per pound.....				\$0.24	\$0.38		.25	.29			
Cheese, prime..... per pound.....				.10	.10		.10	.07			
Eggs, fresh and large, per dozen.....				.19	.20		.20	.19			
CLASS IV.											
Ice..... pounds.....							.25	\$0.40	\$0.2655		
CLASS V.											
Milk, pure..... per quart.....							\$0.07	.09			
CLASS VI.											
Bread, fresh, 1-pound loaves per pound.....							.04				\$0.04
CLASS VII.											
Bran..... per 100 pounds.....				.85			.90	.75			
Corn (horse-feed) per bush.....				.68			.65	.65			
Corn-meal, unbolted, yellow, per 100 pounds.....				1.10			1.00	1.00			
Feed, fine..... per 100 pounds.....				1.00			.80	.75			
Hay, loose, best timothy, per 100 pounds.....				.85			.75	.90			

Proposals for supplying the Naval Hospital, Norfolk, Va., etc.—Continued.

Articles.	George Berry.	Conrad Horst.	C. B. Robertson.	O. & J. Williams.	John A. Codd.	Kate C. Brady.	Thos. J. Barlow.	L. Morris.	C. R. Nash.	W. G. Maupin.	R. T. Mules.
CLASS VII—Continued.											
Hay, baled, best timothy, per 100 pounds				\$0.90			\$0.75	\$0.95			
Oats, No. 1, white, per bush				.44			.45	.44			
Straw, baled, per 100 lbs.				.68			.50	.52			
Shorts, per bushel				.30			.25	.30			
Screenings, do.				.50			.50	.40			
CLASS VIII.											
Gas, per 1,000 feet.											
CLASS IX.											
Water, per 100 gallons.											

Classes I-VI were awarded to Thomas J. Barlow; Classes II-VII were awarded to L. Morris; Class III was awarded to O. & J. Williams; Class IV was awarded to W. G. Maupin; Class V was awarded to Kate C. Brady.

Proposals for supplying the Naval Hospital, Pensacola, Fla., for the fiscal year 1886-'87.

Articles.	E. A. Philbrick.	T. J. Mooney.	Articles.	P. A. Philbrick.	T. J. Mooney.
CLASS I.			CLASS I—Continued.		
Bacon, shoulder, sugar-cured, per lb.	\$0.09	\$0.10	Tomatoes, fresh, per bush	\$1.50	\$0.50
Beans, string, per bush	1.50	2.75	Turkey, killed and dressed, per lb.	.15	.19
Beef, corned, Baltimore, extra family, per lb.	.10	.11	Turnips, per bbl.	2.00	3.00
Beef, roasting (exclusive of flank, neck, shoulder, or round pieces), per lb.	.13	.14	CLASS II.		
Beef-steak, prime cuts, do.	.13	.14	Ale, Philadelphia, per doz.	1.50	1.50
Beef, round, clear, no shin or flank, per lb.	.13	.14	Axle-grease, per box	.10	.10
Beef shine, per lb.	.05	.05	Apples, per bbl.	2.50	2.50
B-ets, per bush	1.50	2.00	Apples, dried, per lb.	.08	.08
Cranberries, do.	3.25	3.00	Beans, dried, medium, white, per bush	2.50	2.50
Carrots, per bbl.	3.00	2.75	Beer, lager, per doz.	1.00	1.00
Cabbage, large heads, per doz.	2.00	2.40	Brooms, corn, No. 1, patent, do.	3.50	3.50
Chickens, full-grown, killed, and dressed, per lb.	.15	.16	Bucketa, water, oak, 3-hoop, do.	2.00	2.00
Corn, sweet, ears, per 100.	1.00	1.75	Bath-brick, do.	.75	.75
Fish fresh, per lb.	.04	.04	Brushes, stove, do.	2.00	2.20
Fish, salt, do.	.08	.08	Brushes, scrubbing, do.	2.00	3.00
Greens, per bush	1.00	1.00	Brushes, dust, long-handled, do.	1.50	2.50
Hams, prime, sugar-cured, per lb.	.12	.12	Barley, pearl, per lb.	.05	.05
Lard, refined, in tubs, do.	.09	.09	Bluing, laundry, pint bottles, per doz.	1.50	1.50
Liver, fresh, do.	.10	.14	Chocolate, Baker's, per lb.	.40	.35
Mackerel, No. 1, per 1/4 bbl.	6.00	1.70	Corn-meal, yellow, bolted, per 100 lbs.	1.75	1.70
Mutton, prime, fore and hind quarters in equal number, per lb.	.14	.15	Coffee, prime Rio, whole, roasted, per lb.	.15	.14
Mutton-chops, do.	.14	.17	Corn, canned, 2-lb tins, per doz.	1.80	1.80
Onions, per bush	1.50	1.60	Clothes-pins, per gross	.50	1.00
Onions, fresh and large, per solid qt.	.20	.55	Candles, per lb.	.18	.17
Parsnips, per bush	1.50	.90	Crackers, water, do.	.10	.10
Peas, green, do.	1.50	2.75	Farina, do.	.05	.05
Potatoes, Irish, early rose, per bbl.	2.75	2.50	Flour, best quality, per bbl.	7.00	6.50
Potatoes, sweet, do.	2.00	2.00	Gelatine, 2-oz. packages, per doz.	1.00	1.00
Pork, salt, per lb.	.08	.10	Hominy, per lb.	.04	.04
Pork, fresh, do.	.13	.14	Lemon-essence, 4-oz. bottles, per doz.	2.00	2.00
Pork sausage, do.	.15	.17	Lemons, do.	.30	.30
Pork steak, do.	.13	.14	Lye, concentrated, per doz.	1.20	1.20
Squash, per 100 lbs.	1.10	1.90	Macaroni, per lb.	.15	.20
			Mustard, Coleman's best, do.	.40	.40

Proposals for supplying the Naval Hospital, Pensacola, Fla., etc.—Continued.

Articles.	B. A. Philbrick.	T. J. Mooney.	Articles.	P. A. Philbrick.	T. J. Mooney.
CLASS II—Continued.			CLASS II—Continued.		
Molasses..... per gal.	\$0.50	\$0.55	Wax tapers, lighting..... per box.	\$0.25	\$0.20
Matches, safety..... per gross.	1.20	1.10	Yeast powder, 4-oz. bottles. per doz.	1.20	1.00
Oatmeal..... per 100 lbs.	4.50	4.50	CLASS III.		
Oranges..... per doz.	.10	.40	Butter, choice, new creamery, per lb.	.32	.24
Oil, sperm..... per gal.	.70	.75	Cheese, prime..... per lb.	.15	.15
Peaches, canned, 2-lb. tins..... per doz.	2.00	1.75	Eggs, fresh and large..... per doz.	.25	.25
Pepper, black, ground..... per lb.	.25	.25	CLASS IV.		
Peas, canned, 2-lb. tins..... per doz.	2.00	2.30	Ice..... per 100 lbs.	1.00	.80
Pickles, mixed..... per lb.	.06	.05	CLASS V.		
Powder, baking, Royal..... do.	.40	.20	Milk, pure..... per qt.	.15	.15
Powder, Persian insect..... per lb.	.25	.25	CLASS VI.		
Prunes..... do.	.10	.10	Bread, fresh, 1-pound loaves. per lb.	.06	.05
Rice, choice..... do.	.08	.08	CLASS VII.		
Raisins, layer..... do.	.20	.20	Bran..... per 100 lbs.	1.25	1.00
Salt, table..... do.	.04	.03	Corn (horse-feed)..... per bush.	.73	.70
Salt, coarse..... per bush.	.50	.55	Corn-meal, unbolted, yellow, per 100 lbs.	1.00	1.00
Soap, laundry, Higgins' best..... per lb.	.05	.05	Feed, fine..... per 100 lbs.	.50	.70
Soap, salt water..... do.	.05	.06	Hay, loose, best timothy..... do.	1.00	1.20
Soap, toilet..... per box.	.10	.10	Hay, baled, best timothy..... do.	1.25	1.20
Soap, soft..... per bbl.	1.00	.90	Oats, No. 1, white..... per bush.	.60	.55
Starch, corn..... per lb.	.15	.15	Straw, baled..... per 100 lbs.	1.00	1.00
Sapolo..... per doz.	1.00	1.00	Shorts..... per bush.	.50	.50
Starch, laundry..... per lb.	.07	.06	Screenings..... do.	.20	.20
Spices, assorted..... do.	.30	.35			
Sugar, white, standard block..... do.	.10	.10			
Sugar, granulated, standard..... do.	.09	.09			
Sugar, yellow, light..... do.	.08	.08			
Soda, washing..... do.	.04	.05			
Tapioca..... do.	.08	.08			
Tea, Oolong, best..... do.	.50	.50			
Tomatoes, 2-lb. tins..... per doz.	1.20	1.10			
Vermicelli..... per lb.	.15	.15			
Vinegar, best cider..... per gal.	.30	.30			
Vanilla, essence, 4-oz. bottles..... per doz.	1.20	1.20			

Classes I and III awarded to B. A. Philbrick ; Classes II, IV, V, VI, and VII awarded to T. J. Mooney.

Proposals for supplying the Naval Hospital, Mare Island, Cal., for the fiscal year 1886-'87.

Articles.	Kelly and McInnis.	J. F. Tobin.	James Brownlie.	Scott & Ford.
CLASS I.				
Bacon, shoulder, sugar-cured..... per pound.	\$0.13	\$0.13	\$0.13	\$0.15
Beans, string..... per bushel.	.08	.08	.08	.10
Beef, corned, Baltimore, extra family..... per pound.	.11	.11	.12	.15
Beef, roasting (exclusive of flank, neck, shoulder, or round pieces), per pound.	.13	.13	.13	.15
Beefsteak, primo cuts..... per pound.	.13	.13	.13	.15
Beef, round, clear, no shin or flank..... do.	.11	.11	.11	.15
Beef shins..... do.	.12	.12	.14	.10
Beets..... per lb.	.02	.02	.03	1.00
Cranberries..... per gallon.	.75	.75	.75	.75
Carrots..... per barrel.	.02	.02	.03	1.00
Cabbage, large heads..... per dozen.	1.10	1.00	1.25	2.00
Chickens, full-grown, killed and dressed..... per dozen.	9.60	9.00	9.00	9.00
Corn, sweet, ears..... per 100.	3.75	3.25	2.50	15.00
Fish, fresh..... per pound.	.14	.12	.13	.20
Fish, salt..... do.	.08	.08	.08	.10
Greens..... per bushel.	.03	.02	.02	.10
Hams, prime, sugar-cured..... per pound.	.16	.15	.17	.20
Lard, prime, in tubs..... do.	.12	.11	.13	.15
Liver, fresh..... do.	.12	.10	.11	.15

Proposals for supplying the Naval Hospital, Mare Island, Cal., etc.—Continued.

Articles.	Kelley and Mc-Innis.	J. F. Tobin.	James Brownlie.	Scott & Ford.
CLASS I—Continued.				
Mackerel, No. 1..... per ¼ barrel.	\$2.25	\$2.00	\$10.00	\$10.00
Mutton, prime, fore and hind quarters in equal number per pound.	.13½	.12½	.14	.15
Mutton-chops..... do.	.15½	.15	.15	.15
Onions..... per bushel.	.04	*.03	.03½	3.00
Oysters, fresh and large..... per solid quart.	1.15	†1.00	1.25
Paranips..... per bushel.	.12½	*.02	.13
Peas, green..... do.	.06½	.07	.08	2.50
Potatoes, Irish, early rose..... per barrel.	.02½	.02	.02½	6.50
Potatoes, sweet..... do.	.08	.03	.03½	10.00
Pork, salt..... per pound.	.13	.12½	.13	.25
Pork, fresh..... do.	.13	.12	.13	.15
Pork-sausage..... do.	.16	.15	.18	.20
Pork-steak..... do.	.15½	.15	.16	.15
Squash..... per 100 pounds.	2.65	.02½	2.75	1.50
Tomatoes, fresh..... per bushel.	.07½	.08	.08½	2.50
Turkey, killed and dressed..... per pound.	.25	.20	.23	.25
Turnips..... per barrel.	.02½	.02½	.03	2.90
CLASS II.				
Ale, Philadelphia..... per dozen.	2.25	2.50	2.25	2.25
Axle-grease..... per box.	.25	.20	.23	6.00
Apples..... per barrel.	2.00	1.50	1.75	.01½
Apples, dried..... per pound.	.11	.10	.11	.10
Beans, dried, medium, white..... per bushel.	.02½	*.02	.02½	2.50
Beer, lager..... per dozen.	2.20	2.00	2.15	3.00
Brooms, corn, No. 1, patent..... do.	5.25	5.00	5.50	5.00
Buckets, water, oak, 2-hoop..... do.	4.75	4.50	5.00	6.50
Bath-brick..... do.	.85	.75	1.00	1.25
Brushes, stove..... do.	5.00	4.50	4.75	5.50
Brushes, scrubbing..... do.	5.00	4.50	4.75	4.50
Brushes, dust, long-handled..... do.	8.00	7.50	7.75	15.00
Barley, pearl..... per pound.	5.25	5.00	5.50	10.00
Bluing, laundry, pint bottles..... per dozen.	2.25	2.50	2.50	5.00
Chocolate, Baker's..... per pound.	.31	.30	.35	.45
Corn-meal, yellow, bolted..... per 100 pounds.	3.25	3.00	3.50	2.50
Coffee, prime Rio, whole, roasted..... per pound.	.26	.24	.25	.28
Corn, canned, 2-pound tins..... per dozen.	1.85	1.75	2.00	1.50
Clothes-pins..... per gross.	.50	.50	.55	.25
Candles..... per pound.	.19	.13	.20	.16
Crackers, water..... do.	.11	.09	.10	.08
Farina..... do.	.10	.08	.09	.10
Flour, best quality..... per barrel.	5.15	5.00	5.50	5.60
Geatline, 3 ounce packages..... per dozen.	1.85	1.75	2.00	2.50
Hominy..... per pound.	.04½	.04	.04½	.08
Lemon essence, 4-ounce bottles..... per dozen.	2.55	2.50	2.60	3.00
Lemons..... do.	.40	.40	.40	.50
Lye, concentrated..... do.	1.40	1.25	1.50	1.25
Macaroni..... per pound.	.10½	.10	.11	.15
Mustard, Coleman's best..... do.	.57½	.80	.62½	.60
Molasses..... per gallon.	.55	.48	.50	.50
Matches, safety..... per gross.	1.95	1.75	2.00	3.00
Oatmeal..... per 100 pounds.	5.00	4.00	4.50	5.00
Oranges..... per dozen.	.50	.40	.45	.45
Oil, sperm..... per gallon.	2.15	2.00	2.10	2.50
Peaches, canned, 2-pound tins..... per dozen.	2.10	2.00	2.25	3.00
Pepper, black, ground..... per pound.	.25	.20	.22	.30
Peas, canned 2-pound tins..... per dozen.	1.65	1.60	1.75	2.50
Pickles, mixed..... per pound.	.0915	.09	.09	.10
Powder, baking, Royal..... do.	.48	.45	.50	.50
Powder, Peruvian insect..... do.	1.10	1.00	1.25	1.00
Prunes..... do.	.09	.08	.09	.15
Rice, choice..... do.	.06½	.08	.07	.10
Raisins, layer..... do.	.15½	.15	.16	.15
Salt, table..... do.	.01	.01	.01	.01
Salt, coarse..... per bushel.	.004	.004	.004	.06
Soap, laundry, Higgins's best..... per pound.	.08½	.08	.09	.04½
Soap, salt-water..... do.	.08½	.08	.09	.015
Soap, toilet..... per box.	1.60	1.50	1.75	2.50
Soap, soft..... per barrel.	4.25	4.00	4.50	2.50
Starch, corn..... per pound.	.09½	.09	.10	.10
Sepolio..... per dozen.	1.60	1.50	1.75	1.50

* Per pound.

† Per dozen.

Proposals for supplying the Naval Hospital, Mare Island, Cal., etc.—Continued.

Articles.	Kelley and Mc- Innis.	J. F. Tobin.	James Brownlie.	Scott & Ford.
CLASS II—Continued.				
Starch, laundry..... per pound..	\$0.09½	\$0.09	\$0.10	\$0.10
Spices, assorted..... do.....	.26	.25	.30	.50
Sugar, white, standard block..... do.....	.09½	.09	.09½	.10
Sugar, granulated, standard..... do.....	.08½	.08	.08½	.10
Sugar, yellow, light..... do.....	.07½	.07	.07½	.09
Soda, washing..... do.....	.02½	.01½	.02	.02
Tapioca..... do.....	.06	.05	.05½	.06
Tea, Oolong, best..... do.....	.35	.50	.60	1.00
Tomatoes 2-pound tins..... dozen..	1.55	1.50	1.60	1.50
Vermicelli..... per pound..	.12	.10	.10	.15
Vinegar, best cider..... per gallon..	.37½	.25	.30	.40
Vanilla, essence, 4-ounce bottles..... per dozen..	2.85	2.75	3.00	3.00
Wax tapers, lighting..... per box..	.28	.25	.30	.30
Yeast powder, 4-ounce bottles..... per dozen..	2.50	2.00	2.25	2.50
CLASS III.				
Butter, choice, new creamery..... per pound..	.38	.35	.42	.40
Cheese, prime..... do.....	.17	.15	.16	.20
Eggs, fresh and large..... per dozen..	.38	.35	.40	.40
CLASS IV.				
Ice..... per pound..	.03	.03	.03	.05
CLASS V.				
Milk, pure..... per quart..	.09		.10	.10
CLASS VI.				
Bread, fresh, 1-pound loaves..... per pound..	.05	.04½	.05	.10
CLASS VII.				
Bran..... per 100 pounds..	1.05	1.00	1.10	1.00
Corn (horse-feed)..... per pound..	.01½	.01½	.01½	.01½
Corn meal, unbolted, yellow..... per 100 pounds..	1.75	*.01½	1.55	*.01½
Feed, fine..... do.....	2.15	2.00	2.25	*.01½
Hay, loose, best timothy..... do.....	20.00	18.00	19.00	21.00
Hay, baled, best timothy..... per ton..	*.02	*.02	*.02½	.00
Oats, No. 1, white..... per 100 pounds..	*.12	†10.00	†11.00	.00
Straw, baled..... per bushel..	*.01½	*.01½	1.30	.75
Shorts..... do.....	*.01	*.00½	*.00½	§4.00
Screenings..... do.....				
CLASS VIII.				
Gas..... per 1,000 feet..		3.00		
CLASS IX.				
Water..... per 1,000 gallons..		.41½		

* Per pound.

† Per ton.

‡ Per bushel.

§ Per 100 pounds.

Classes I, II, III, IV, VI, VII, VIII, and IX were awarded to J. F. Tobin; Class V was awarded to Kelly & McInnis.

No. 15.—MARINE CORPS.

HEADQUARTERS UNITED STATES MARINE CORPS,
Washington, D. C., October 1, 1887.

SIR: I have the honor to submit my annual report of the condition of the U. S. Marine Corps.

On October 1, 1887, there were 1,893 enlisted men in the corps, 930 of whom were on board ships in commission, and 963 doing duty at the several shore stations.

During the past year there have been 701 enlistments, 147 re-enlistments, 6 enlistments from the Army, 10 deaths, 372 discharges, 415 desertions, and 6 enlisted men have been retired. There have been 2 officers and 21 enlisted men tried by courts-martial. One first lieutenant has been retired for physical disability, and 1 second lieutenant has died, 2 captains are under suspension by sentence of court-martial, and 1 captain and 1 second lieutenant are on sick leave on reports of boards of medical survey. There are but 78 officers on the active list, the present law requiring it to be reduced to 75.

In my report of 1885 I referred to the hardships resulting from a lack of promotion, and I again renew my recommendation that some increase in the higher grades be made, with a better distribution of officers. Twelve second lieutenants are totally inadequate for the duty required.

An increase of 500 privates is urgently demanded. With even the limited number of vessels now in the Navy and in commission, there are not enough men left on shore to properly garrison the different posts, and it constantly happens that it is necessary to send men to sea before they have been properly instructed in all their duties. A soldier should have at least one year's service in garrison before going to sea. Much of the desertion from ships is caused by this fact, the men not being familiar with the service become dissatisfied with ship life. The same reason, viz, paucity of numbers, is a powerful one for so many desertions on shore, the men being overworked. Nowhere in the Army are the men so constantly on guard duty and drill as in the Marine Corps.

I renew my recommendation for an appropriation to build barracks and quarters at the Norfolk navy-yard. The only building for the enlisted men now there is a wooden shed, not equal to the brick building in which the Government cattle are stabled near by. The officers have no quarters and live at long distances from the men. This matter has been brought forward year by year ever since the close of the war, but without result. Medical reports, calling attention to the limited space and the crowded and unhealthy condition of the troops, have also been submitted. It is earnestly hoped that the Department will urge upon Congress the necessity of an appropriation which has been submitted in the annual estimates.

The *Antietam*, at League Island, which has for several years been used as a barrack, has become so rotten as to fill with water and settle

in the mud. She has now some 10 feet of water in her hold. The men are still forced to remain on board of her at the risk of an epidemic of fever, because there is no building in the navy-yard which is available, except at a heavy cost for alterations, which there is no appropriation to pay for. Either this post should be broken up altogether and the men distributed to other stations, or the estimate submitted should be allowed to become an appropriation to build proper barracks for the use of the men at this station.

Frequent inspections of the different posts during the past year show them all to be in a creditable state of discipline and efficiency.

Recruiting has been carried on as usual at New York, Philadelphia, and San Francisco, and at the posts, but owing to the limited appropriation for this purpose, the results are not as satisfactory as they would be if recruiting offices could be opened in country towns, where, it is believed, a better class of recruits might be had. Advertising in country newspapers does not seem to produce the desired effect. The former appropriation for "Transportation and recruiting" was \$10,000. This was reduced by Congress for the present fiscal year to \$9,000, which makes it necessary to be very careful in its expenditure.

The annual estimates for the support of the corps were forwarded to the Department on September 26.

Very respectfully, your obedient servant,

C. G. MCCAWLEY,
Colonel Commandant.

Hon. W. C. WHITNEY,
Secretary of the Navy, Washington, D. C.

HEADQUARTERS U. S. MARINE CORPS,
Washington, D. C., September 26, 1887.

SIR: I inclose herewith for your approval the usual estimates for the support of the U. S. Marine Corps for the fiscal year ending June 30, 1889. The accompanying letter will explain the necessity of the several items of the quartermaster's estimates.

I have included in those of the paymaster an increase of pay for the chief clerks in his and the quartermaster's offices, also for the clerk of the assistant quartermaster in Philadelphia, and for pay of one civilian clerk in the office of the assistant quartermaster at San Francisco, Cal., he having none, all of which has heretofore been submitted to the Department in correspondence.

Very respectfully, your obedient servant,

C. G. MCCAWLEY,
Colonel Commandant.

Hon. W. C. WHITNEY,
Secretary of the Navy, Washington, D. C.

HEADQUARTERS U. S. MARINE CORPS,
PAYMASTER'S OFFICE,
Washington, D. C., September 24, 1887.

SIR: I respectfully submit herewith estimates for the pay of officers, non-commissioned officers, musicians, privates, and others of the U. S. Marine Corps, for the fiscal year ending June 30, 1889.

These estimates show an increase of \$1,005.30 over the estimates presented for the present fiscal year, as follows:

Pay of officers on retired list, increase	\$1,350.00
Pay of enlisted men, active list, increase	48.00
Pay of enlisted men, retired list, increase	1,688.12
Transportation of officers, increase	1,000.00
	4,086.12
Pay of officers, active list, decrease	\$3,080.00
Pay of civil force, decrease	82
	3,080.82
	1,005.30

Respectfully,

GREEN CLAY GOODLOE,
Major and Paymaster, Marine Corps.

The COLONEL COMMANDANT.

HEADQUARTERS U. S. MARINE CORPS,
Washington, D. C., September 26, 1887.

Respectfully referred to the honorable Secretary of the Navy.

C. G. MCCAWLEY,
Colonel Commandant, U. S. Marine Corps.

HEADQUARTERS U. S. MARINE CORPS,
QUARTERMASTER'S OFFICE,
Washington, D. C., September 23, 1887.

SIR: In transmitting the annual estimates for the support of the quartermaster's department, U. S. Marine Corps, fiscal year 1888-'89, I respectfully call your attention to the following variations in amounts estimated for as against those appropriated for same objects fiscal year 1887-'88, *i. e.*:

Provisions, increased	\$29.45
Clothing, decreased	10,200.00
Military stores, increased	*2,489.50
Transportation and recruiting increased	†1,000.00
Forage, decreased	500.00
Contingencies, increased	1,177.98
Repair of barracks, decreased	6,065.00

The erection of a medium-sized barracks for the use of the enlisted men at the navy-yard, League Island, Philadelphia, Pa., is rendered necessary, owing to the fact that the U. S. S. *Amittam*, which has been in use for several years, as a temporary barracks, has sunk so deep in the mud as to have about 10 feet of water in her hold, rendering her unsafe, in a sanitary point of view, for this use.

At the navy-yard, Norfolk, Va., there was erected in 1876 a small frame building, at an expense of \$3,373.46, for use as temporary barracks. At that date the question was in abeyance as to whether or not that navy-yard should be abandoned, and it was not deemed advisable to expend a large sum of money in erecting a barracks. Now, however, that this yard is assuming one of great importance, and also considering the fact that the building now in use is nearly half a mile from the main entrance to the yard and is erected on the site of the old "yellow fever burying ground," it is deemed advisable to erect a suitable barracks and also buildings for use as officers' quarters. At present \$2,016 is expended annually in "the hire of officers' quarters." This amount would be saved by the erection of the buildings heretofore mentioned.

Very respectfully, your obedient servant.

H. B. LOWRY,
Major and Quartermaster, U. S. Marine Corps.

The COLONEL COMMANDANT,
U. S. Marine Corps.

HEADQUARTERS U. S. MARINE CORPS,
Washington, D. C., September 26, 1887.

Respectfully referred to the honorable Secretary of the Navy.

C. G. MCCAWLEY,
Colonel Commandant, U. S. Marine Corps.

*This increase is caused by the necessity of purchasing new knapsacks.

†The opening of recruiting rendezvous at Philadelphia, Pa., accompanied, as it is, by an additional expense of rent, printing, and transportation, and the fact that this appropriation was \$1,000 less fiscal year 1887-'88 than it has been for any of the five years previous, makes this increase a necessity.

Schedule of proposals received for supply of wood and coal to the Marine Corps, under advertisement from Quartermaster's Office, dated March 8, 1887.

Names of bidders.	Where to be delivered.	Wood—per cord.				Coal—per ton.				
		Oak in stick.	Oak, sawed, and split.	Pine in stick.	Pine (kindling), sawed and split.	Red ash (egg).	Red ash (store).	Whitesash (egg).	White ash (store).	White ash (furnace).
T. B. Cross, jr	Offices and officers' quarters, Washington and Georgetown, D. C., and within 1 mile of limits of said cities.	\$5.98	\$7.50	\$5.37	\$6.83	\$6.55	\$6.78	\$6.37	\$6.43	\$6.27
Z. Williams & Son	do	*5.95	*7.45	*5.25	*6.75	*6.50	*6.75	*6.35	*6.40	*6.25
T. B. Cross, jr	Marine barracks and navy-yard, Washington, D. C.	5.98	7.50	5.37	6.83	6.55	6.78	6.37	6.43	6.27
Z. Williams & Son	do	*5.95	*7.45	*5.25	*6.75	*6.50	*6.75	*6.35	*6.40	*6.25
J. J. Convey	Offices and officers' quarters and rendezvous, Philadelphia, Pa.	*9.00	*10.00	*9.00	*10.00	*6.25	*6.25
John Kealy	Marine barracks, Annapolis, Md.	*4.40	*5.90	*3.40	*5.44	*6.25	*4.94	5.45
Jas. T. M. Basil	do	4.47	6.97	3.85	5.97	6.97	4.97	5.37
G. W. Taylor & Co.	Officers' quarters, Norfolk, Va.	4.90	6.40	4.90	6.40	5.90
Niemeyer & Co.	do	4.07	6.80	4.85	*5.38
W. G. Parker	do	*4.00	*6.00	*4.00	5.50
T. B. Cross, jr	Marine barracks, Norfolk, Va.	7.50	7.50	6.50	7.00	6.54
Niemeyer & Co.	do	4.00	4.35	*4.98	*5.43
W. G. Parker	do	*4.00	*4.00	5.50	6.00
C. E. Walker & Co.	Marine barracks, Portsmouth, N. H.	8.00	10.00	7.00	9.00	*5.70
S. G. French	do	7.74
E. C. Spinney	do	*7.90	*9.90	*6.90	*8.75
Sam'l G. French	Marine barracks, Charlestown, Mass.	7.74
Edmund Keys	do	*9.00	*11.50	*8.00	*10.00	*6.50
Sam'l G. French	Marine barracks, Brooklyn, N. Y.	*6.34	6.84	*6.34	6.84	*4.74
W. D. Bruns, jr	do	6.40	*6.40	6.40	*6.40	4.90	*4.90
Jno. T. White, jr.	Marine barracks, League Island, Pa.	*7.75	*7.00
J. J. Convey	do	12.50	12.00	*7.65
Jeremiah O'Neal	Marine barracks, Pensacola, Fla.	*14.00
Sam'l G. French	Marine barracks, Mare Island, Cal.	16.74
W. Walker	do	7.65	*8.50	*7.60	*9.50	15.74
J. McCudden	do	15.25
Aden Bros.	do	7.60	9.00	8.00	10.00	*13.95
S. G. French	Assistant quartermaster, Mare Island, Cal.	16.74
Wm. Walker	do	*8.50	*7.60	15.00
Aden Bros.	do	10.00	8.50	*13.95

*Accepted.

Offers for supplies under advertisement dated March 8, 1857.

Bidders.	Class.	Amount.
James Symington	Class 1*	\$8,925.00
Morrison & Turner	Class 1*	450.00
George L. Neville	Class 4*	1,297.00
John Sullivan	Class 4*†	411.80
Valentine Stortz	Class 3 and 4*†	860.86
John Welsh	Class 1 and 3*†	1,994.94
Lewis Brothers & Co.	Class 1*†	21,603.00
T. A. Ashburner	Class 1*	3,136.00
J. H. McKenney & Co.	Class 1 and 2*†	2,936.00
Augustus Thomas	Class 1*	9,408.00
B. Y. Pippet & Co.	Class 1*†	30,927.30
Thomas Kent	Class 1*	8,320.00
R. A. Robbins	Class 1, 3, and 4*†	32,022.05
R. Levicks' Son & Co.	Class 1*	868.00
William F. Brown	Class 1*	861.00
Frank C. Baxter	Class 4*†	521.30
J. Rodel, jr.	Class 1*†	9,960.00
Liberty Woolen Mills	Class 1*†	8,590.00
William P. West	Class 3*†	598.25
Young, Ewan & Co.	Class 4*	300.00
R. Wurlitzer & Brother	Class 2*†	477.40
J. M. Shaw & Co.	Class 4*	336.00
Frymier & Edwards	Class 4*†	280.00
Packard & Grover	Class 1*	10,400.00
John Early & Co.	Class 4*†	989.03
Paul J. Field	Class 2*†	1,215.99
Pioneer Woolen Company	Class 1*	11,842.00
William Hahn & Co.	Class 1*†	847.00
Thomas G. Hood	Class 1, 2, 3, and 4*†	9,458.43
Charles Lehman	Class 1 and 2*†	749.50
James R. Michael	Class 1 and 2*†	3,088.50
Horstman Brothers & Co.	Class 1, 2, 3, and 4*†	7,626.41
Lyon Brothers	Class 1*†	1,712.00
C. F. Bush	Class 1*	3,650.50
Edward Eicke	Class 1*	54.00

* Bids for part of class.

† Accepted for part of class.

Schedule of proposals received for supply of rations for the Marine Corps for the year 1857-58, under advertisement from the Quartermaster's Office, dated March 8, and May 20 and 24, 1857.

Names of contractors.	At Portsmouth, N. H.	At Charlestown, Mass.	At Brooklyn, N. Y.	At Philadelphia, Pa.	At Washington, D. C.	At Gosport, Va.	At Annapolis, Md.	At Pensacola, Fla.	At Mare Island, Cal.
P. J. Mooney								\$27.50	
McKenzie, Oerting & Co								\$24.69	
John Mullett		\$14.84							
Thomas J. Barlow						\$13.64			
J. T. Parker						14.74			
John Kealy							\$15.84		
J. C. Ergood & Co.	\$18.19	16.88	\$16.23	\$18.65	\$15.75	16.70	18.00		
John C. Gilbert			\$15.18						
Levi W. Norton	\$17.24								
James Scott									\$22.74
Frank Hume			16.04		\$15.64	15.99	16.99		
Samuel Kimberley			15.99	\$15.59	18.00	14.04			
J. F. Tobin									24.90
Michael J. Doran		\$13.43							
M. L. Kelly									\$17.49
James Brownlie									18.70
Hugh McHatton								28.23	
Jeremiah O'Neal								29.50	
Jacob Stuts									20.00
Albert Mass & Co.									17.74

* Accepted.

Estimates of appropriations required for the service of the fiscal year ending June 30, 1889, by the paymaster's department, U. S. Marine Corps.

Detailed objects of expenditure, and explanations.	Estimated amount which will be required for each detailed object of expenditure.	Total amount to be appropriated under each head of appropriation.	Amount appropriated for the current fiscal year ending June 30, 1888.
MARINE CORPS.			
Pay of the officers on the active list: For one colonel commandant, one colonel, two lieutenant-colonels, one adjutant and inspector, one paymaster, one quartermaster, four majors, two assistant quartermasters, one judge-advocate general, U. S. Navy, nineteen captains, thirty first lieutenants, and fifteen second lieutenants	\$181,530.00		
Pay of officers on the retired list: For one colonel, one quartermaster, three majors, two assistant quartermasters, six captains, two first lieutenants, and three second lieutenants	86,420.00		
Pay of non-commissioned officers, musicians, and privates: For one sergeant-major, one quartermaster-sergeant, one leader of the band, one drum-major, fifty first sergeants, one hundred and forty sergeants, one hundred and eighty corporals, thirty musicians, ninety-six drummers and fifers, and one thousand five hundred privates (R. S., p. 272, sec. 1, 508, 1,623; act June 30, 1834, vol. 4, p. 713, sec. 4, 5; March 2, 1847, vol. 9, p. 155, sec. 3; August 5, 1854, vol. 10, p. 586, sec. 1; February 21, 1857, vol. 11, p. 163, sec. 1; July 17, 1862, vol. 12, p. 594, sec. 2; June 30, 1864, vol. 13, p. 144, sec. 1; March 8, 1865, vol. 13, p. 487, sec. 1; July 28, 1866, vol. 14, p. 334, sec. 13; March 2, 1867, vol. 14, p. 422, sec. 1; July 15, 1870, vol. 14, p. 517, sec. 7.)	389,100.00		
Pay of retired enlisted men: For one sergeant-major, one drum-major, one first sergeant, four sergeants, one first-class musician, two drummers, one fifer, and five privates (act February 14, 1885, vol. 23, p. 305, sec. 1)	6,636.00		
Undrawn clothing: For payment of discharged soldiers for clothing undrawn	20,000.00		
Transportation: For transportation of officers traveling under orders without troops	8,000.00		
Commutation of quarters: For commutation of quarters for officers on duty without troops, where there are no public quarters	4,000.00		
PAY OF THE CIVIL FORCE.			
In the office of the colonel commandant (Navy Register, July 18, 1816): One chief clerk (act of March 3, 1883, vol. 22, pp. 479, 480, sec. 1)	\$1,540.80		
One messenger at \$80.94 per month (act July 7, 1884, vol. 23, pp. 243, 244, sec. 1)	971.28		
In the office of the adjutant and inspector (act July 7, 1884, vol. 23, pp. 262, 263, sec. 1): One chief clerk	1,540.80		
One clerk	1,498.52		
In the office of the paymaster: One chief clerk	1,800.00		
One clerk	1,498.52		
One clerk	1,257.12		
In the office of the quartermaster: One chief clerk	1,800.00		
One clerk	1,498.52		
One clerk	1,257.12		
In the office of the assistant quartermaster, Philadelphia: One clerk	1,400.00		
One messenger at \$1.75 per diem	638.75		
In the office of the assistant quartermaster, San Francisco: One clerk (submitted)	1,400.00		
	18,095.43	\$663,781.43	\$651,622.88

Estimates of appropriations required for the service of the fiscal year ending June 30, 1889, by the quartermaster's department, U. S. Marine Corps.

Detailed objects of expenditure, and explanations.	Estimated amount which will be required for each detailed object of expenditure.	Total amount to be appropriated under each head of appropriation.	Amount appropriated for the current fiscal year ending June 30, 1888.
RATIONS.			
For 1,000 non-commissioned officers, musicians, and privates, and for commutation of rations for enlisted men detailed as clerks and messengers.....	\$61,017.05		
(See note No. 1.)			
For amount required to be transferred to paymaster Marine Corps, on account of rations to retired men, \$38.40 per annum.....	1,168.00	\$62,185.05	\$62,155.00
(See note No. 2.)			
NOTE No. 1.—The commutation in lieu of rations in kind, at the rate of \$1.75 cents, and 50 cents, to the enlisted men, is authorized by orders of the Navy Department, dated June 28, 1880, and July 30, 1885.			
NOTE No. 2.—There are 20 retired men at this date.			
CLOTHING.			
For 2,000 non-commissioned officers, musicians, and privates.....		65,000.00	75,200.00
FUEL.			
For heating barracks and quarters, for ranges and stoves for cooking, fuel to enlisted men, and for sales to officers.....		18,000.00	18,000.00
MILITARY STORES.			
For pay of chief armorer at \$3.00 per day, \$939; three mechanics at \$2.50 per day each, \$2,347.50; in all.....	3,286.50		
For purchase of military equipments, such as cartridge-boxes, bayonet-scarbards, haversacks, blanket-bags, knapsacks, canteens, musket-slings, swords, drums, trumpets, flags, waist-belts, waist-plates, cartridge-belts, and spare parts for repairing muskets, etc.....	6,500.00		
For purchase of ammunition.....	1,000.00		
For purchase and repair of instruments for band, purchase of music, and musical accessories.....	500.00		
For purchase of tents and camp equipage.....	1,000.00	12,286.50	9,797.00
TRANSPORTATION AND RECRUITING.			
For transportation of troops and for the recruiting service.....		10,000.00	9,000.00
REPAIR OF BARRACKS.			
At Portsmouth, N. H., Boston, Mass., Brooklyn, N. Y., League Island, Pa., Annapolis, Md., Headquarters and navy yard, Washington, D. C., Norfolk, Va., Pensacola, Fla., and Mare Island, Cal., and per diem to enlisted men employed under the direction of the quartermaster's department, in the repair of barracks and other public buildings.....	10,000.00		
For alteration and enlargement of officers' quarters at Boston, Mass.....	4,000.00		
For repair of barracks at Annapolis, Md. (appropriation to be immediately available).....	2,000.00		
NOTE.—Recommended by Board of Visitors to Naval Academy, June 11, 1887.			
For alteration in marine barracks, Portsmouth, N. H.....	5,683.00		
NOTE.—Recommended by board of survey.			
For rent of buildings used for manufacture of clothing, storing supplies, and offices of assistant quartermasters, at Philadelphia, Pa., and San Francisco, Cal.....	1,780.00	23,463.00	29,580.00
ERECTION OF BARRACKS AND OFFICERS' QUARTERS.			
At Norfolk, Va (submitted).....	80,000.00		
ERECTION OF BARRACKS.			
At League Island, Pa (submitted).....	20,000.00	80,000.00	

Estimates of appropriations required for the service of the fiscal year, etc.—Continued.

Detailed objects of expenditure, and explanations.	Estimated amount which will be required for each detailed object of expenditure.	Total amount to be appropriated under each head of appropriation.	Amount appropriated for the current fiscal year ending June 30, 1898.
FORAGE.			
For forage in kind for 4 horses of the quartermaster's department and the authorized number of officers' horses		\$3,500.00	\$4,000.00
HIRE OF QUARTERS.			
For hire of quarters for officers serving with troops, where there are no public quarters belonging to the Government, and where there are not sufficient quarters possessed by the United States to accommodate them	\$4,500.00		
For hire of quarters for seven enlisted men employed as clerks and messengers in commandant's, adjutant and inspector's, paymaster's, and quartermaster's offices, Washington, D. C., and assistant quartermasters' offices, Philadelphia, Pa., and San Francisco, Cal., \$21 each per month.	1,764.00		
For hire of quarters for three enlisted men, employed as above, at \$10 each per month, \$360	360.00	6,624.00	6,624.00
CONTINGENCIES.			
For freight, ferrage, toll, cartage, funeral expenses of marines, stationery, telegraphing, rent of telephone, purchase and repair of type-writers, apprehension of deserters, per diem to enlisted men employed on constant labor as clerks and messengers for a period not less than ten days, repair of gas and water fixtures, office and barracks furniture, mess utensils for enlisted men, such as bowls, plates, spoons, knives, forks, packing-boxes, wrapping-paper, oil cloth, crash, rope, twine, camphor, and carbolized paper, carpenters' tools, tools for police purposes, iron safe, purchase and repair of public wagons, purchase and repair of harness, purchase of public horses, service of veterinary surgeons and medicine for public horses, purchase and repair of hose, repair of fire-extinguishers, purchase of fire hand grenades, purchase and repair of carts and wheelbarrows, purchase and repair of cooking-stoves, ranges, stoves where there are no grates, purchase of ice, towels, and soap for offices, postage stamps for foreign postage, purchase of newspapers and periodicals, improving parade grounds, repair of pumps and wharves, laying drain and water pipes, introducing gas, and for gas and oil for marine barracks maintained at the various navy-yards and stations, water at the marine barracks, Boston, Mass., Brooklyn, N. Y., Annapolis, Md., and Mare Island, Cal.; also straw for bedding for enlisted men at the various posts, furniture for Government houses and repair of same, and for all emergencies and extraordinary expenses arising at home and abroad, but impossible to anticipate or classify		27,500.00	26,322.02
Total		308,560.55	240,628.62

No. 16.—PAPERS RELATING TO CONTRACTS WITH THE BETHLEHEM IRON COMPANY, FOR SUPPLYING STEEL GUN-FORGINGS AND STEEL ARMOR-PLATES FOR THE NAVY.

[Circular, embodying information for those who intend to bid upon gun-steel and armor for the Navy pursuant to the following advertisement:]

TO THE STEEL MANUFACTURERS OF THE UNITED STATES OF AMERICA.

UNITED STATES NAVY DEPARTMENT,
Washington, D. C., August 21, 1886.

The attention of all steel manufacturers of the United States is hereby invited to the requirements of the Navy Department in the way of armor-plates and heavy gun-forgings, for the prosecution of work already authorized by Congress.

This advertisement invites all domestic manufacturers of steel to specify, in competition with each other, upon what terms they will engage to prepare for the production of and produce the forgings and armor-plate required for modern ordnance and armored ships; and no bids will be considered except such as engage to produce within the United States either all the gun-steel or all the armor-plate (or both) specified in this advertisement; nor will any bid be accepted unless accompanied by evidence satisfactory to the Department that the bidder is in possession of, or has made actual provision for, a plant adequate for its fulfillment.

Bids are hereby invited for supplying this Department with the under-mentioned material:

About 1,310 tons of steel gun-forgings, of which about 328 tons will be for guns of 6 inches caliber, 70 tons for guns of 8 inches caliber, and 912 tons for calibers between 10 inches and 12 inches (both inclusive).

These forgings are to be delivered rough-bored and turned, and when in that state the heaviest forging which enters into the construction of a gun of each of the desired calibers will be about as follows:

6-inch	3½ tons.
8-inch	5 tons.
10-inch	9½ tons.
10½-inch	9½ tons.
12-inch	12½ tons.

All these forgings must be delivered within the following times from the closing of a contract, viz:

For 6-inch guns, 28 within one year, and the remainder within eighteen months.

For 8-inch guns, within two years.

For 10-inch and larger guns, within two and one-half years.

Preference will be given for earlier deliveries.

Also, about 4,500 tons of steel armor-plates, to be of the best material and manufacture, shaped accurately after patterns to fit the form of each vessel for which intended, and of such sizes as may be required, varying somewhat as follows:

20 feet by 8 feet by 12 inches thick.

17½ feet by 6 feet by 17 inches thick.

11½ feet by 4½ feet by 6 inches thick.

There will also be thinner plates.

For information concerning shapes and weights of the gun-forgings and armor-plates, what parts must be manufactured in sets, time of delivery of each set, the chemical, physical, and ballistic tests which the metal must sustain in each case, and for all other particulars, apply to the Chief of Bureau of Ordnance, Navy Department, Washington, D. C.

Each bid upon armor-plate must specify the time within which the bidder will engage to make delivery; and preference will be given to earliest proposed deliveries.

Proposals must be in duplicate, sealed and addressed to the Secretary of the Navy, Navy Department, Washington, D. C., the envelopes indorsed "Proposal for steel gun-forgings and armor."

They will be received at the Navy Department until 12 o'clock M. on the 10th day of December, 1886, at which hour the opening of the bids will take place.

The right is reserved to waive defects in the form of, and to reject any or all bids.

Ten per cent. of the contract price will be retained from the payment for each article delivered, until the contract, as far as relates to articles of that class, shall have been completed.

Separate bids may be submitted for the gun-steel and for the armor, if any manufacturer so desires; but bids covering both will receive preference, other things being equal.

Bids will be compared in two classes.

First. Gun-forgings.

Second. Armor-plates.

And the total sum for which, and the time within which, the whole of the material covered by each class will be produced, and delivered, will be alone considered.

WILLIAM C. WHITNEY,
Secretary of the Navy.

NOTE.—The time for receiving proposals was subsequently extended to March 22, 1887.

Schedule of proposals received for gun steel and armor under above advertisement (opened March 22, 1887).

Name of bidder.	Proposed location of plant.	Gun steel, total price.	Armor, etc., total price.	Grand total.
Cambria Iron Company.....	Johnstown, Pa.....	\$851,513.90	\$851,513.90
Midvale Steel Company.....	Philadelphia, Pa.....	1,397,240.00	1,397,240.00
Bethlehem Iron Company.....	South Bethlehem, Pa.....	902,230.79	\$3,610,707.50	4,512,988.29
Cleveland Rolling Mill Company..	Cleveland, Ohio.....	4,021,560.00	4,021,560.00

Proposal of the Cambria Iron Company for steel gun-forgings.

To the SECRETARY OF THE NAVY,
Washington, D. C. :

Having carefully examined the advertisement of the Secretary of the Navy, dated August 21, 1886, inviting proposals for about 1,310 tons of steel gun forgings, and the printed circular of February 12, 1887, and addenda of March 11, 1887, furnished by the Navy Department for the information of those intending to bid upon gun steel and armor for the Navy, pursuant to said advertisement; also the general form of contract intended to be used in contracting for such gun steel; and having been furnished with all information in the premises essential to a full understanding of the obligations incurred, or to be incurred, under and by virtue of this proposal, we, the Cambria Iron Company, a corporation created under the laws of the State of Pennsylvania, and doing business at Philadelphia and Johnstown, Pa., do hereby propose and agree as follows:

First. To furnish, in the manner, within the time, and upon the terms and conditions stated in the advertisement, circular, and addenda aforesaid, copies of which are annexed to and form part of this proposal, all the steel gun forgings therein described or referred to, and as mentioned and described in the following table, at the prices per ton for the different exhibits, and for the total price shown in said table, as filled in by the undersigned, viz:

Table showing the prices at which the bidder agrees to furnish gun-forgings.

[The decimals in column 3 are thousandths of a ton.]

Exhibit.	Kind of forging.	Calculated number of tons in each exhibit.	Price per ton for each exhibit.	Price for each exhibit.
Col. 1.	Col. 2.	Col. 3.	Col. 4.	Col. 5=col. 3×col. 4.
A.	Tubes and jackets for 6-inch B. L. R.	146.418	\$800	\$117,134.40
B.	Tubes and jackets for 8-inch B. L. R.	31.804	700	22,262.80
C.	Tubes and jackets for 10-inch B. L. R.	428.888	650	277,477.20
D.	Tubes and jackets for 12-inch B. L. R.	59.470	750	44,602.50
E.	Hoops for 6-inch and 8-inch B. L. R.	140.474	800	112,379.20
F.	Hoops for 10-inch B. L. R.	390.024	650	214,515.60
G.	Hoops for 12-inch B. L. R.	49.796	750	37,347.00
H.	Trunnion-bands.	15.292	800	12,233.60
I.	Plugs and mushrooms for all calibers.	20.864	650	13,561.60
Total price (the sum of prices in column 5)				\$851,513.90

Secondly. That within two and a half years from and after the date of the contract to be executed under this proposal, the undersigned will provide at Johnstown, in the county of Cambria and State of Pennsylvania, a "plant," with all needful appliances and appurtenances, adequate to the manufacture of said forgings and to deliveries thereof within the prescribed periods.

Thirdly. That this proposal may be held by the Secretary of the Navy under advisement for a period of fifteen days after the opening of the bids, and if, within that period, evidence satisfactory to him, with reference to the ability of the undersigned to fulfill the conditions of this proposal, shall not have been supplied, the proposal may be rejected.

Fourthly. In case this proposal shall be accepted, we hereby agree to enter into contract for furnishing gun forgings in accordance with the advertisement, circular, and addenda aforesaid, and to give a bond, with sureties, to the satisfaction of the Secretary of the Navy, in a penal sum equal to 15 per cent. of the total amount of this bid, for the faithful performance of such contract.

Fifthly. This proposal is accompanied by a certified check for \$50,000, being over 5 per cent. of the amount of this bid, payable to the order of the Secretary of the Navy, which check, in case the undersigned shall fail to enter into a contract and furnish a bond as above proposed, shall become the property of the United States. In case the proposal is not excepted, the check is to be returned to the undersigned within twenty days after the opening of the bids. This proposal is made conditionally upon its acceptance only for the undivided whole (and not for any part) of the gun material herein bid for.

Witness our hands and seals at Philadelphia, Pa., the 21st day of March, 1887.

In presence of—

CAMBRIA IRON COMPANY, [L. S.]
By E. Y. TOWNSEND,
President.

Attest:

W. Y. ROBINSON, [L. S.]
Secretary.

Proposal of the Midvale Steel Company for steel gun-forgings.

To the SECRETARY OF THE NAVY,
Washington, D. C.:

Having carefully examined the advertisement of the Secretary of the Navy, dated August 21, 1886, inviting proposals for about 1,310 tons of steel gun-forgings, and the printed circular of February 12, 1887, and addenda of March 11, 1887, furnished by the Navy Department for the information of those intending to bid upon gun-steel and armor for the Navy, pursuant to said advertisement; also, the general form of contract intended to be used in contracting for such gun-steel; and having been furnished with all information in the premises essential to a full understanding of the obligations in-

curred, or to be incurred, under and by virtue of this proposal, we, the Midvale Steel Company, a corporation created under the laws of the State of Pennsylvania and doing business at Nicetown, Philadelphia, Pa., do hereby propose and agree as follows:

First. To furnish, in the manner, within the time, and upon the terms and conditions stated in the advertisement, circular, and addenda aforesaid, copies of which are annexed to and form part of this proposal, the steel gun-forgings therein described or referred to, and as mentioned and described in the following table, at the prices per ton for the different exhibits, and for the total price shown in said table, as filled in by the undersigned, viz:

Table showing the prices at which the bidder agrees to furnish gun-forgings.

[The decimals in column 3 are thousandths of a ton.]

Exhibit.	Kind of forging.	Calculated number of tons in each exhibit.	Price per ton for each exhibit.	Price for each exhibit.
Col. 1.	Col. 2.	Col. 3.	Col. 4.	Col. 5 = col. 3 × col. 4.
A.	Tubes and jackets for 6-inch B. L. R.	146.418	\$685.00	\$129,579.00
B.	Tubes and jackets for 8-inch B. L. R.	31.804	1,008.00	32,058.00
C.	Tubes and jackets for 10-inch B. L. R.	428.888	1,232.00	528,226.00
D.	Tubes and jackets for 12-inch B. L. R.	59.470	1,232.00	73,267.00
E.	Hoops for 6-inch and 8-inch B. L. R.	140.474	885.00	124,319.00
F.	Hoops for 10-inch B. L. R.	330.024	1,232.00	406,569.00
G.	Hoops for 12-inch B. L. R.	49.796	1,232.00	61,348.00
H.	Trunnion-bands.	15.292	1,680.00	25,690.00
I.	Plugs and mushrooms for all calibers.	20.864	885.00	18,464.00
Total price (the sum of prices in col. 5)				\$1,397,240.00

Secondly. That, within two and a half years from and after the date of the contract to be executed under this proposal, the undersigned will provide, at Philadelphia, in the county of Philadelphia and State of Pennsylvania, a "plant," with all needful appliances and appurtenances, adequate to the manufacture of said forgings and to deliveries thereof within the prescribed periods.

Thirdly. That this proposal may be held by the Secretary of the Navy under advertisement for a period of fifteen days after the opening of the bids, and if, within that period, evidence satisfactory to him, with reference to the ability of the undersigned to fulfill the conditions of this proposal, shall not have been supplied, the proposal may be rejected.

Fourthly. In case this proposal shall be accepted, we hereby agree to enter into contract for furnishing gun-forgings in accordance with the advertisement, circular, and addenda aforesaid, and to give a bond, with sureties, to the satisfaction of the Secretary of the Navy, in a penal sum equal to 15 per cent. of the total amount of this bid, for the faithful performance of such contract.

Fifthly. This proposal is accompanied by a certified check for \$70,000, being 5 per cent. of the amount of this bid, payable to the order of the Secretary of the Navy, which check, in case the undersigned shall fail to enter into a contract and furnish a bond as above proposed, shall become the property of the United States. In case the proposal is not accepted, the check is to be returned to the undersigned within twenty days after the opening of the bids.

Witness our hands and seals at Philadelphia, Pa., the 21st day of March, 1887.

In presence of—

MIDVALE STEEL CO., [L. S.]
By C. J. HARRAH, *President.*

Attest:

E. W. KIMBER,
Secretary pro tem.

Witnesses to signatures of C. J. Harrah and E. W. Kimber:
CLARENCE M. CLARK.
JOSEPH S. CLARK.

Proposal of the Bethlehem Iron Company for steel gun-forgings.

To the SECRETARY OF THE NAVY,
Washington, D. C. :

Having carefully examined the advertisement of the Secretary of the Navy, dated August 21, 1886, inviting proposals for about 1,310 tons of steel gun-forgings, and the printed circular of February 12, 1887, and addenda of March 11, 1887, furnished by the Navy Department for the information of those intending to bid upon gun-steel and armor for the Navy, pursuant to said advertisement; also, the general form of contract intended to be used in contracting for such gun-steel; and having been furnished with all information in the premises essential to a full understanding of the obligations incurred, or to be incurred, under and by virtue of this proposal, we, The Bethlehem Iron Company, a corporation created under the laws of the State of Pennsylvania and doing business at the borough of South Bethlehem, in the county of Northampton and State of Pennsylvania, do hereby propose and agree as follows:

First. To furnish, in the manner, within the time, and upon the terms and conditions stated in the advertisement, circular, and addenda aforesaid, copies of which are annexed to and form part of this proposal, the steel gun forgings therein described or referred to, and as mentioned and described in the following table, at the prices per ton for the different exhibits, and for the total price shown in said table, as filled in by the undersigned, viz:

Table showing the prices at which the bidder agrees to furnish gun forgings.

[The decimals in column 3 are thousandths of a ton.]

Exhibit	Kind of forging.	Calculated number of tons in each exhibit.	Price per ton for each exhibit.	Price for each exhibit.
Col. 1.	Col. 2.	Col. 3.	Col. 4.	Col. 5 = col. 3 × col. 4.
A.	Tubes and jackets for 6-inch B. L. R.	146.418	\$672.00	\$98,392.90
B.	Tubes and jackets for 8-inch B. L. R.	31.804	716.20	22,797.11
C.	Tubes and jackets for 10-inch B. L. R.	426.886	761.60	325,117.90
D.	Tubes and jackets for 12-inch B. L. R.	59.470	800.40	47,956.61
E.	Hoops for 6-inch and 8-inch B. L. R.	140.474	672.00	94,398.53
F.	Hoops for 10-inch B. L. R.	330.024	761.60	251,346.28
G.	Hoops for 12-inch B. L. R.	49.796	761.60	37,924.63
H.	Trunnion-bands	15.292	672.00	10,276.22
I.	Plugs and mushroom for all calibers	20.864	672.00	14,020.61
Total price (the sum of prices in col. 5)				\$902,230.79

Secondly. That within one and a quarter years from and after the date of the contract to be executed under this proposal, the undersigned will provide at South Bethlehem, in the county of Northampton, and State of Pennsylvania, a "plant," with all needful appliances and appurtenances, adequate to the manufacture of said forgings and to deliveries thereof immediately following said period.

Thirdly. That this proposal may be held by the Secretary of the Navy under advisement for a period of fifteen days after the opening of the bids, and if, within that period, evidence satisfactory to him with reference to the ability of the undersigned to fulfill the conditions of this proposal shall not have been supplied, the proposal may be rejected.

Fourthly. In case this proposal shall be accepted, we hereby agree to enter into contract for furnishing gun-forgings in accordance with the advertisement, circular, and addenda aforesaid, and to give a bond, with sureties, to the satisfaction of the Secretary of the Navy, in a penal sum equal to 15 per cent. of the total amount of this bid, for the faithful performance of such contract.

Fifthly. This proposal is accompanied by a certificate of deposit for \$50,000, payable to the order of the Secretary of the Navy, which certificate, in case the undersigned shall fail to enter into a contract and furnish a bond as above proposed, shall become the property of the United States. In case the proposal is not accepted, the certificate is to be returned to the undersigned within twenty days after the opening

of the bids. In case the proposal is accepted, the certificate of deposit to be returned in accordance with notice issued by the Secretary of the Navy, dated March 16, 1887.

Witness our hands and seals, at South Bethlehem, the 19th day of March, 1887.

In presence of—

THE BETHLEHEM IRON COMPANY, [L. S.]
Per ALFRED HUNT, *President*.

Attest:

ABRAHAM J. SCHROPP,
Secretary.

The prices named in this proposal are based upon the condition stated in the advertisement of August 21, 1886, that "bids covering both" (gun-forgings and armor-plates) "will receive preference, other things being equal," and are therefore to be considered in conjunction with our bid of this date for armor-plates.

THE BETHLEHEM IRON COMPANY,
Per ROBT. H. SAYRE, [SEAL.]
General Manager.

Proposal of the Bethlehem Iron Company for steel armor-plates.

To the SECRETARY OF THE NAVY,
Washington, D. C. :

Having carefully examined the advertisement of the Secretary of the Navy, dated August 21, 1886, inviting proposals for about 4,500 tons of steel armor-plates and appurtenances, and the printed circular of February 12, 1887, and addenda of March 11, 1887, furnished by the Navy Department for the information of those intending to bid upon gun steel and armor for the Navy, pursuant to said advertisement; also, the general form of contract intended to be used in contracting for such steel armor-plates and appurtenances; and having been furnished with all information in the premises essential to a full understanding of the obligations incurred, or to be incurred, under and by virtue of this proposal, we, the Bethlehem Iron Company, a corporation created under the laws of the State of Pennsylvania, and doing business at the borough of South Bethlehem, in the county of Northampton and State of Pennsylvania, do hereby propose and agree as follows:

First. To furnish, in the manner, within the time, and upon the terms and conditions stated in the advertisement, circular, and addenda aforesaid, copies of which are annexed to and form part of this proposal, the steel armor-plates and appurtenances therein described or referred to, and as mentioned and described in the following table, at the prices per ton for the different exhibits, and for the total price shown in said table, as filled in by the undersigned, viz:

Table showing the prices at which the bidder agrees to furnish armor-plates and appurtenances.

Exhibit.	Kind of material.	Estimated number of tons in each exhibit.	Price per ton for each exhibit.	Price for each exhibit.
Col. 1.	Col. 2.	Col. 3.	Col. 4.	Col. 5 = col. 3 × col. 4.
K.	Side armor for Puritan.....	734.7	\$510.00	\$374,097.00
L.	Side armor for Amphitrite and class.....	1060.8	510.00	544,068.00
M.	Turrets and pilot-houses for 4 monitors.....	835.8	575.00	480,585.00
N.	Smoke pipes and ventilators for 4 monitors.....	266.3	575.00	153,122.50
O.	Armor for breastworks for 2 armored vessels.....	080.0	575.00	391,000.00
P.	Armor for turrets, conning towers, and ammunition tubes for 2 armored vessels.....	485.0	575.00	278,875.00
Q.	Part of side armor for 2 armored vessels.....	354.0	500.00	182,000.00
R.	do.....	468.0	525.00	245,700.00
S.	do.....	272.0	600.00	163,200.00
T.	do.....	196.0	600.00	117,600.00
U.	Rolled plates, protective deck armor, and gun-shields.....	1135.0	490.00	558,150.00
V.	Turret and side armor bolts and steel accessories.....	181.0	650.00	117,650.00
W.	Small armor bolts, steel.....	6.0	650.00	3,900.00
X.	Tubing and washers, wrought iron.....	12.0	180.00	2,160.00
Total price (the sum of prices in col. 5).....				\$3,610,797.50

Secondly. That within two and a half years from and after the date of the contract to be executed under this proposal the undersigned will provide, at South Bethlehem, in the county of Northampton and State of Pennsylvania, a "plant," with all needful appliances and appurtenances, adequate to the manufacture of said armor-plates and appurtenances, and to deliveries thereof, within the prescribed period, and that such deliveries shall commence, and be continued at the rate of 300 tons per month, from the first day of October, 1889.

Thirdly. That this proposal may be held by the Secretary of the Navy under advertisement for a period of fifteen days after the opening of the bids, and if, within that period, evidence satisfactory to him with reference to the ability of the undersigned to fulfill the conditions of this proposal shall not have been supplied, the proposal may be rejected.

Fourthly. In case this proposal shall be accepted, we hereby agree to enter into contract for furnishing steel armor-plates and appurtenances in accordance with the advertisement, circular, and addenda aforesaid, and to give a bond, with sureties, to the satisfaction of the Secretary of the Navy, in a penal sum equal to 15 per cent. of the total amount of this bid, for the faithful performance of such contract.

Fifthly. This proposal is accompanied by certificate of deposit for \$50,000, payable to the order of the Secretary of the Navy, which certificate, in case the undersigned shall fail to enter into a contract and furnish a bond as above proposed, shall become the property of the United States. In case the proposal is not accepted, the certificate is to be returned to the undersigned within twenty days after the opening of the bids. In case the proposal is accepted, the certificate of deposit to be returned in accordance with notice issued by Secretary of the Navy, dated March 16, 1887.

Witness our hands and seals, at South Bethlehem, the 19th day of March, 1887.

In presence of—

THE BETHLEHEM IRON COMPANY, [L. S.]
Per ALFRED HUNT, *President.*

Attest:

ABRAHAM J. SCHROPP,
Secretary.

The prices named in this proposal are based upon the condition stated in the advertisement of August 21, 1886, that "bids covering both" (gun-forgings and armor-plates) "will receive preference, other things being equal," and are therefore to be considered in conjunction with our bid of this date for gun-forgings.

The wording of the advertisement, circular, and addenda calls for armor-plates at least equal to the highest grade forged steel armor-plates hitherto produced in Europe. Our bid proposes to supply such plates, and we are prepared to demonstrate our ability to produce and supply them. Should plates of somewhat lower quality be acceptable to the Department, we are prepared to make a lower bid for such, and we ask the opportunity of doing so.

THE BETHLEHEM IRON COMPANY, [L. S.]
Per ROBERT H. SAYRE,
General Manager.

Proposal of the Cleveland Rolling Mill Company for steel armor-plates.

To the SECRETARY OF THE NAVY,
Washington, D. C.:

Having carefully examined the advertisement of the Secretary of the Navy, dated August 21, 1886, inviting proposals for about 4,500 tons of steel armor-plates and appurtenances, and the printed circular of February 12, 1887, and addenda of March 11, 1887, furnished by the Navy Department for the information of those intending to bid upon gun-steel and armor for the Navy, pursuant to said advertisement; also the general form of contract intended to be used in contracting for such steel armor-plates and appurtenances; and having been furnished with all information in the premises essential to a full understanding of the obligations incurred, or to be incurred, under and by virtue of this proposal, we, the Cleveland Rolling Mill Company, a corporation created under the laws of the State of Ohio, and doing business at Cleveland, Ohio, do hereby propose and agree as follows:

First. To furnish, in the manner, within the time, and upon the terms and conditions stated in the advertisement, circular, and addenda aforesaid, copies of which are annexed to and form part of this proposal, the steel armor-plates and appurtenances therein described or referred to, and as mentioned and described in the following

table, at the prices per ton for the different exhibits, and for the total price shown in said table, as filled in by the undersigned, viz :

Table showing the prices at which the bidder agrees to furnish armor-plates and appurtenances.

Exhibit.	Kind of material.	Estimated number of tons in each exhibit.	Price per ton for each exhibit.	Price for each exhibit.
Col. 1.	Col. 2.	Col. 3.	Col. 4.	Col. 5 = col. 3 x col. 4.
K.	Side armor for Puritan	734.7	\$600	\$440,820
L.	Side armor for Amphitrite and class	1064.8	600	640,080
M.	Turrets and pilot-houses for 4 monitors	835.8	600	501,480
N.	Smoke-pipes and ventilators for 4 monitors	266.3	600	159,780
O.	Armor for breastworks for 2 armored vessels	680.0	600	408,000
P.	Armor for turrets, conning towers, and ammunition tubes for 2 armored vessels	485.0	600	291,000
Q.	Part of side armor for 2 armored vessels	364.0	600	218,400
R.	do	468.0	600	280,800
S.	do	272.0	600	163,200
T.	do	196.0	600	117,600
U.	Rolled plates, protective deck armor and gun-shields	1135.0	600	681,000
V.	Turret and side armor bolts and steel accessories	181.0	600	108,600
W.	Small armor bolts, steel	6.0	600	3,600
X.	Tubing and washers, wrought-iron	12.0	600	7,200
Total price (the sum of prices in col. 5)				\$4,021,560

Secondly. That, within two and a half years from and after the date of the contract to be executed under this proposal, the undersigned will provide, at Cleveland, in the county of Cuyahoga, and State of Ohio, a "plant," with all needful appliances and appurtenances, adequate to the manufacture of said armor-plates and appurtenances and to deliveries thereof within the prescribed period, and that such deliveries shall commence, and be continued at the rate of 300 tons per month from the 1st day of October, 1889.

Thirdly. That this proposal may be held by the Secretary of the Navy under advisement for a period of fifteen days after the opening of the bids, and if, within that period, evidence satisfactory to him, with reference to the ability of the undersigned to fulfill the conditions of this proposal, shall not have been supplied, the proposal may be rejected.

Fourthly. In case this proposal shall be accepted, we hereby agree to enter into contract for furnishing steel armor-plates and appurtenances in accordance with the advertisement, circular, and addenda aforesaid, and to give a bond, with sureties, to the satisfaction of the Secretary of the Navy, in a penal sum equal to 15 per cent. of the total amount of this bid, for the faithful performance of such contract.

Fifthly. This proposal is accompanied by a certified check for fifty thousand dollars (\$50,000), payable to the order of the Secretary of the Navy, which check, in case the undersigned shall fail to enter into a contract and furnish a bond as above proposed, shall become the property of the United States. In case the proposal is not accepted, the check is to be returned to the undersigned within twenty days after the opening of the bids.

Witness our hands and seals at Cleveland, Ohio, the 18th day of March, 1887.
In presence of—

THE CLEVELAND ROLLING MILL CO. [L. S.]
WM. CHISHOLM, President.

Attest:
ED. L. PAGE, Secretary.

Contract for steel gun-forgings.

This contract, of two parts, made and concluded this 1st day of May, A. D. 1887, by and between the Bethlehem Iron Company, a corporation created under the laws of the State of Pennsylvania, and doing business at South Bethlehem, in said State, represented by Alfred Hunt, president of said company, parties of the first part, and the United States, represented by William C. Whitney, Secretary of the Navy, party of the second part, witnesseth: That, for and in consideration of the payments hereinafter specified, the parties of the first part, for themselves and their successors, heirs, and assigns, and their and each of their personal and legal representatives, do hereby

jointly and severally covenant and agree to and with the United States as follows, that is to say :

First. That, within two and a half years from and after the date of this contract, the parties of the first part will, at their own risk and expense, provide and establish, at South Bethlehem, in the county of Northampton and State of Pennsylvania, a suitable "plant," with all necessary appliances and appurtenances, in all respects complete and adequate to the manufacture of the steel gun-forgings required under this contract, and to deliveries thereof within the periods herein prescribed; it being understood that the United States shall not, by reason of this contract or anything herein contained, acquire or possess any ownership or proprietary interest whatever of, in, or to such "plant," appliances, and appurtenances, or any part thereof; it being further expressly understood and agreed, by and between the parties to this contract, that the Secretary of the Navy may appoint suitable inspectors, who shall, at all times during the preparation of such "plant," be furnished by the contractors with full information respecting the character and progress of the work in the preparation of said "plant," and such access to the premises as shall enable the Department, from time to time, upon special order of the chief of the bureau of ordnance, to verify the correctness of such information.

Second. The parties of the first part will, at their own risk and expense, manufacture and deliver to the Navy Department, in the manner, within the periods prescribed, and according to the conditions stated in the advertisement of the Secretary of the Navy, dated August 21, 1886, inviting proposals for about 1,310 tons of steel gun-forgings; the proposal of the parties of the first part under said advertisement; the printed circular (including the drawings appended to and forming part thereof), approved by the Secretary of the Navy February 12, 1887; the addenda thereto, approved by the Secretary of the Navy March 11, 1887; and the notice by the Secretary of the Navy, dated March 16, 1887; which advertisement, proposal, circular, addenda, and notice, hereto annexed, shall be deemed and taken as forming part of this contract, with the like operation and effect as if the same were incorporated herein; the steel gun-forgings therein described or referred to, and at the prices per ton for the different exhibits, and for the total price, as follows :

Exhibit.	Kind of forging.	Calculated number of tons in each exhibit.	Price per ton for each exhibit.	Price for each exhibit.
Col. 1.	Col. 2.	Col. 3.	Col. 4.	Col. 5 = col. 3 x col. 4.
A.	Tubes and jackets for 6-inch B. L. R	146.418	\$634.23	\$92,862.69
B.	Tubes and jackets for 8-inch B. L. R	31.504	676.51	21,515.72
C.	Tubes and jackets for 10-inch B. L. R	426.888	718.79	306,842.83
D.	Tubes and jackets for 12-inch B. L. R	59.470	761.07	45,260.83
E.	Hoops for 6-inch and 8-inch B. L. R	140.474	634.23	89,092.83
F.	Hoops for 10-inch B. L. R	330.024	718.78	237,214.65
G.	Hoops for 12-inch B. L. R	49.796	718.79	35,792.87
H.	Trunnion-bands	15.292	634.22	9,698.49
I.	Flugs and mushrooms for all calibers	20.864	634.25	13,232.99
Total price				\$851,513.90

Subject, however, to such variations in said total price, and in the aggregate weight of said gun-forgings, as may result from changes which may be made under the provisions of the aforesaid circular and addenda relating to changes in said gun-forgings: *Provided, however,* That the aggregate weight of the gun-forgings to be delivered under this contract shall be not less than 1,221 tons, and that the several prices per ton above stated, for forgings of the various exhibits above specified, shall constitute the prices to be paid for forgings of such exhibits as may be called for beyond the weights above specified, such gun-forgings to be of domestic manufacture, and to conform to and with all the details, requirements, and stipulations relating to material, manufacture, tests, inspection, and delivery, and in all respects to the conditions stated in the aforesaid circular and in the addenda thereto.

Third. It is mutually understood, covenanted, and agreed, by and between the parties to this contract, that changes in the requirements of the circular and addenda hereinbefore referred to, and which form part of this contract, may be made by and with the mutual consent of the parties hereto; and if changes are thus made, the actual cost thereof and the damage, if any, caused thereby, and the amount of the increased or diminished compensation which the contractors shall be entitled to receive, if any, in consequence of such change or changes, shall be ascertained, estimated, and determined by a board of naval officers to be appointed by the Secretary of the Navy, and the determination of such board, or of a majority thereof, shall be binding upon the parties of the first part, who heroby expressly covenant and agree to accept and abide by such determination.

Fourth. The parties of the first part, in consideration of the provisions contained in the aforesaid circular and addenda for premiums to be paid to them for deliveries of gun-forgings in advance of the periods prescribed in paragraph 57 of said circular, do hereby further covenant and agree that, in case of delays in deliveries beyond the periods thus prescribed, a corresponding penalty of 1 per cent. per month on the contract price per ton of said forgings shall be imposed, and that all penalties incurred under this contract shall be off-set, from time to time, against any payment or payments falling due to the contractors; it being further understood and agreed between the parties hereto that every reasonable consideration shall be extended to the contractors in case of unavoidable delay in the preparation of the "plant" or in the manufacture and delivery of the gun-forgings aforesaid, provided it shall appear that they have assumed the obligations of this contract in good faith, and that they are prosecuting the work under the same with due diligence, in which case reasonable extensions of the periods prescribed, for the preparation of the "plant" or for deliveries of the forgings required under this contract, shall be granted. In case any delay shall arise in the prosecution of the work required under this contract or any part thereof, or in case any question shall arise under the provisions hereof concerning premiums or penalties, such questions, with all the facts relating thereto, shall be submitted to the Secretary of the Navy for consideration, and his decision thereon shall be conclusive and binding upon all the parties to this contract: *Provided, however,* That premiums shall be allowed only on deliveries of gun-forgings in advance of the periods fixed in paragraph 57 of said circular.

Fifth. It is further mutually understood, covenanted, and agreed, that if, at any stage of the work prior to final completion, the Secretary of the Navy shall find that the contractors are unable to go forward with the work necessary to provide and establish a "plant" as aforesaid, and to make satisfactory progress towards the completion of the same within the period prescribed as aforesaid, including such extension or extensions thereof, if any, as may have been granted under the fourth clause of this contract, then and in such case it shall be optional with the Secretary of the Navy to declare this contract forfeited on the part of the contractors.

Sixth. It is further mutually understood, covenanted, and agreed, that if, after the completion of the "plant" aforesaid, and at any stage of the work prior to the final completion of said gun-forgings, the Secretary of the Navy shall find that the contractors are unable to proceed with, and make satisfactory progress in, the manufacture and delivery of the gun-forgings required, and within the periods prescribed as aforesaid, including such extension or extensions thereof, if any, as may have been granted under the fourth clause of this contract, or if, at the end of sixty-six months from and after the date hereof, any of the gun-forgings required under this contract shall, through fault of the parties of the first part, remain undelivered, then and in such case it shall be optional with the Secretary of the Navy to declare this contract forfeited on the part of the contractors; and in case the Secretary of the Navy shall, under the provisions of this or of the next preceding clause, declare this contract forfeited, such forfeiture shall not affect the right of the United States to recover, for defaults which may have occurred under this contract, and as liquidated damages, a sum of money equal to the penalty of the bond accompanying the same.

Seventh. The parties of the first part, in consideration of the premises, hereby covenant and agree to hold and save the United States harmless from and against all and every demand or demands of any nature or kind for or on account of the adoption of any plan, model, design, or suggestion, or for or on account of the use of any patented invention, article or appliance, which has been or may be adopted or used in or about the manufacture or production of said gun-forgings, or any part thereof, under this contract, by the parties of the first part, and to protect and discharge the Government from all liability on account thereof by proper releases from patentees or otherwise, and to the satisfaction of the Secretary of the Navy, before final payment under this contract shall be made.

Eighth. It is mutually understood, covenanted, and agreed, by and between the respective parties, that this contract shall not, nor shall any interest therein, be transferred by the parties of the first part to any other person or persons, and that any such transfer shall cause the annulment of this contract so far as the United States are concerned; and that all rights of action to recover for any breach of this contract by the parties of the first part are reserved to the United States.

Ninth. It is hereby mutually and expressly covenanted and agreed, and this contract is upon the express condition, that no member of or delegate to Congress, officer of the Navy, or any person holding any office or appointment under the Navy Department, shall be admitted to any share or part of this contract, or to any benefit to arise therefrom; but this stipulation, so far as it relates to members of or delegates to Congress, is not to be construed to extend to this contract, it being made with an incorporated company.

Tenth. The parties of the first part hereby further covenant and agree to manufacture and deliver to the Navy Department such additional steel gun-forgings of any one or more or all of the several exhibits to be furnished under the second clause of

this contract as the party of the second part may require, not exceeding the aggregate weight of the gun-forgings required under said clause, subject to all the conditions, details, requirements, and stipulations relating to material, manufacture, tests, inspection, delivery, prices, and payments, and to all other requirements of the aforesaid circular, addenda, and notice, and of this contract, applicable to the gun-forgings to be delivered under the second clause hereof: *Provided*, That notice in writing, stating specifically the exhibit or exhibits and the quantity or quantities of each exhibit of such additional gun-forgings as may be thus required by the party of the second part, shall be given to the parties of the first part within one year from the date of this contract; it being, however, expressly understood and agreed, by and between the parties to this contract, that it shall be optional, until the expiration of one year from the date of this contract, with the party of the second part to require, or not to require, such additional gun-forgings, and that nothing herein contained shall be construed to create any obligation on the part of the United States either to receive or to pay for any quantity or quantities of gun-forgings in excess of those required in and by the second clause of this contract, unless such excess shall have been ordered or required as hereinbefore provided for.

Eleventh. The United States, in consideration of the premises, do hereby contract, promise, and engage, to and with the parties of the first part, as follows:

(1) The contract price to be paid by the United States to the said parties of the first part for the steel gun-forgings to be manufactured and delivered under this contract shall be the price per ton for each exhibit as stated in the second clause of this contract.

(2) Payments under this contract shall be regulated and made in accordance with the provisions relating to payments as contained in this contract and the circular and addenda aforesaid.

(3) There shall be a reservation of 10 per cent. on each payment made under this contract until the aggregate of such reservations shall reach the sum of fifty thousand dollars (\$50,000), when such reservations, so far as subsequent payments are concerned, shall cease, and the sum last mentioned shall be held as a special reserve under the conditions hereinafter stated.

(4) No payment shall be made except upon bills in triplicate, certified by the inspectors in such manner as shall be directed by the Secretary of the Navy, whose final approval of all bills thus certified shall be necessary before payment thereof.

(5) All warrants for payments under this contract shall be made payable to the contractors or their order.

(6) The special reserve aforesaid shall be retained until all the guns made by the Navy Department from the forgings furnished under this contract shall have successfully sustained five proof-rounds, as provided in paragraph 48 of the circular aforesaid; provided, that if such proof rounds are not fired before the expiration of fifteen months from the date of the final deliveries required under this contract, the said special reserve shall, at the expiration of that period, be paid to the contractors.

(7) When all the conditions, covenants, and provisions of this contract shall have been performed and fulfilled by and on the part of the contractors, they shall be entitled, within ten days after the filing and acceptance of their claim, to receive the said special reserve, or so much thereof as they may be entitled to, on the execution of a final release to the United States, in such form as shall be approved by the Secretary of the Navy, of all claims of any kind or description under or by virtue of this contract.

Twelfth. If any doubts or disputes arise as to the meaning of anything in the circular, addenda, or notice aforesaid, or if any discrepancy appear between the same and this contract, the matter shall be at once referred to the Secretary of the Navy for determination, and the parties of the first part hereby bind themselves, and their successors, heirs, and assigns, and their and each of their personal and legal representatives, to abide by his decision in the premises. If, however, the parties of the first part shall feel aggrieved at any decision of the Secretary of the Navy, they shall have the right to submit the same to the President of the United States, and his decision shall control.

In witness whereof the respective parties have hereunto set their hands and seals the day and year first above written.

[Seal of The Bethlehem Iron Co.]

THE BETHLEHEM IRON CO.
Per ALFRED HUNT,

President.

[Seal of the Navy Department.]

W. C. WHITNEY,

As Secretary of the Navy.

Attest:

ABRAHAM J. SCHROPP,
Secretary.

WM. B. REMEY,
Judge-Advocate-General,
as to Wm. C. Whitney, Secretary of the Navy.

Contract for steel armor-plates.

This contract, of two parts, made and concluded this 1st day of June, A. D. 1887, by and between the Bethlehem Iron Company, a corporation created under the laws of the State of Pennsylvania, and doing business at South Bethlehem in said State, represented by Alfred Hunt, president of said company, parties of the first part, and the United States, represented by William C. Whitney, Secretary of the Navy, party of the second part, witnesseth, that, for and in consideration of the payments hereinafter specified, the parties of the first part, for themselves and their successors, heirs, and assigns, and their and each of their personal and legal representatives, do hereby jointly and severally covenant and agree to and with the United States as follows—that is to say:

First. That within two and a half years from and after the date of this contract, the parties of the first part will, at their own risk and expense, provide and establish at South Bethlehem, in the county of Northampton and State of Pennsylvania, a suitable "plant," with all necessary appliances and appurtenances, in all respects complete and adequate to the production of the steel armor-plates and appurtenances required under this contract, and to deliveries thereof within the periods hereinafter prescribed; it being understood that the United States shall not, by reason of this contract or anything herein contained, acquire or possess any ownership or proprietary interest whatever of, in, or to such "plant," appliances, and appurtenances, or any part thereof; it being further expressly understood and agreed by and between the parties to this contract that the Secretary of the Navy may appoint suitable inspectors who shall at all times during the preparation of such "plant," be furnished by the contractors with full information respecting the character and progress of the work in the preparation of said "plant," and such access to the premises as shall enable the Department, from time to time, upon special order of the chief of the bureau of ordnance, to verify the correctness of such information.

Second. The parties of the first part will, at their own risk and expense, manufacture and deliver to the Navy Department, in the manner and within the periods prescribed—and according to the conditions stated in the advertisement of the Secretary of the Navy, dated August 21, 1886, inviting proposals for steel armor-plates; the proposal of the parties of the first part under said advertisement; the printed circular (including the drawings appended to and forming part thereof), approved by the Secretary of the Navy February 12, 1887; the addenda thereto approved by the Secretary of the Navy March 11, 1887, and the notice by the Secretary of the Navy dated March 16, 1887; which advertisement, proposal, circular, addenda, and notice, hereto annexed, shall be deemed and taken as forming part of this contract, with the like operation and effect as if the same were incorporated herein—the steel armor-plates and appurtenances therein described or referred to, and at the prices per ton for the different exhibits, and for the total price, as follows:

Exhibit.	Kind of material.	Estimated number of tons in each exhibit.	Price per ton for each exhibit.	Price for each exhibit.
Col. 1.	Col. 2.	Col. 3.	Col. 4.	Col. 5=col. 3x4.
K	Side armor for Puritan.....	784.7	\$510.00	\$374,897.00
L	Side armor for Amphitrite and class.....	1,066.8	510.00	544,088.00
M	Turrets and pilot-houses for four monitors.....	835.8	575.00	480,585.00
N	Smoke-pipes and ventilators for four monitors.....	266.3	575.00	153,122.50
O	Armor for breastworks for two armored vessels.....	690.0	575.00	399,000.00
P	Armor for turrets, conning-towers, and ammunition-tubes for two armored vessels.....	485.0	575.00	278,875.00
Q	Part of side armor for two armored vessels.....	384.0	500.00	192,000.00
R	Part of side armor for two armored vessels.....	468.0	525.00	245,700.00
S	Part of side armor for two armored vessels.....	272.0	600.00	163,200.00
T	Part of side armor for two armored vessels.....	194.0	600.00	117,600.00
U	Rolled plates, protective deck-armor, and gun-shields.....	1,135.0	490.00	556,150.00
V	Turret and side-armor bolts and steel accessories.....	181.0	650.00	117,650.00
W	Small armor bolts, steel.....	6.0	650.00	3,900.00
X	Tubing and washers, wrought-iron.....	12.0	180.00	2,160.00
	Total price.....			\$3,610,707.50

The quantities and weights named in column 3 constitute the estimated weights which will be required by the party of the second part under this contract.

Subject, however, to such variations in said total price, and in the weights, and in the aggregate weight, of said armor-plates and appurtenances as may result from

changes which may be made under provisions in the aforesaid circular, addenda, and notice, relating to changes, or from the operation of other conditions therein contained which may affect the total price or weights or aggregate weight aforesaid: *Provided, however*, That the aggregate weight of the armor-plates and appurtenances to be delivered under this contract shall be finally determined in accordance with the several provisions and conditions relating thereto contained in the aforesaid circular, addenda, and notice; such armor-plates and appurtenances to be of domestic manufacture, and to conform to and with all the details, requirements, and stipulations relating to material, manufacture, tests, inspection, and delivery, and in all respects to the conditions stated in the aforesaid circular, the addenda thereto, and notice; it being expressly understood, covenanted, and agreed, by and between the parties to this contract, that deliveries thereunder shall be commenced by the delivery of not less than (300) three hundred tons within two months from and after the expiration of the contract time for the completion of an adequate "plant," and shall be continued thereafter at the rate of not less than (300) three hundred tons per month, and shall be fully completed within two years from the date of such first delivery.

Third. It is mutually understood, covenanted, and agreed, by and between the parties to this contract, that changes in the conditions or requirements of the circular, addenda, and notice, hereinbefore referred to, and which form part of this contract, may be made by and with the mutual consent of the parties hereto; and, if changes are thus made, the actual cost thereof and the damage, if any, caused thereby, and the amount of the increased or diminished compensation which the contractors shall be entitled to receive, if any, in consequence of such change or changes, shall be ascertained, estimated, and determined by a board of naval officers to be appointed by the Secretary of the Navy, and the determination of such board, or of a majority thereof, shall be binding upon the parties of the first part, who hereby expressly covenant and agree to accept and abide by such determination.

Fourth. It is further mutually understood, covenanted, and agreed, by and between the parties to this contract, that every reasonable consideration shall be extended to the contractors in case of unavoidable delay in the preparation of the "plant" or in the manufacture and delivery of the armor-plates and appurtenances aforesaid, provided it shall appear that they have assumed the obligations of this contract in good faith, and that they are prosecuting the work under the same with due diligence, in which case reasonable extensions of the periods prescribed for the preparation of the "plant" or for deliveries of the armor-plates and appurtenances required under this contract shall be granted. In case any delay shall arise in the prosecution of the work required under this contract or any part thereof, or in case any question shall arise under the provisions hereof concerning premiums, such questions, with all the facts relating thereto, shall be submitted to the Secretary of the Navy for consideration, and his decision thereon shall be conclusive and binding upon all the parties to this contract.

Fifth. It is further mutually understood, covenanted, and agreed, that if, at any stage of the work prior to final completion, the Secretary of the Navy shall find that the contractors are unable to go forward with the work necessary to provide and establish a "plant" as aforesaid, and to make satisfactory progress towards the completion of the same within the period prescribed as aforesaid, including such extension or extensions thereof, if any, as may have been granted under the fourth clause of this contract, then and in such case it shall be optional with the Secretary of the Navy to declare this contract forfeited on the part of the contractors.

Sixth. It is further mutually understood, covenanted, and agreed, that if, after the completion of the "plant" aforesaid, and at any stage of the work prior to the final completion of said armor-plates and appurtenances, the Secretary of the Navy shall find that the contractors are unable to proceed with and make satisfactory progress in the manufacture and delivery of the armor-plates and appurtenances required, and within the periods prescribed, as aforesaid, including such extension or extensions thereof, if any, as may have been granted under the fourth clause of this contract, then and in such case it shall be optional with the Secretary of the Navy to declare this contract forfeited on the part of the contractors; and in case the Secretary of the Navy shall, under the provisions of this or of the next preceding clause, declare this contract forfeited, such forfeiture shall not affect the right of the United States to recover, for defaults which may have occurred under this contract, and as liquidated damages, a sum of money equal to the penalty of the bond accompanying the same.

Seventh. The parties of the first part, in consideration of the premises, hereby covenant and agree to hold and save the United States harmless from and against all and every demand or demands of any nature or kind for or on account of the adoption of any plan, model, design, or suggestion, or for or on account of the use of any patented invention, article, or appliance, which has been or may be adopted or used in or about the manufacture or production of said armor-plates and appurtenances, or any part thereof, under this contract, by the parties of the first part, and to protect

and discharge the Government from all liability on account thereof, by proper releases from patentees or otherwise, and to the satisfaction of the Secretary of the Navy, before final payment under this contract shall be made.

Eighth. It is mutually understood, covenanted, and agreed, by and between the respective parties, that this contract shall not, nor shall any interest therein, be transferred by the parties of the first part to any other person or persons, and that any such transfer shall cause the annulment of this contract so far as the United States are concerned; and that all rights of action to recover for any breach of this contract by the parties of the first part are reserved to the United States.

Ninth. It is hereby mutually and expressly covenanted and agreed, and this contract is upon the express condition, that no member of or delegate to Congress, officer of the Navy, or any person holding any office or appointment under the Navy Department, shall be admitted to any share or part of this contract, or to any benefit to arise therefrom; but this stipulation, so far as it relates to members of or delegates to Congress, is not to be construed to extend to this contract, it being made with an incorporated company.

Tenth. The United States, in consideration of the premises, do hereby contract, promise, and engage, to and with the parties of the first part, as follows:

(1) The contract price to be paid by the United States to the said parties of the first part for armor-plates and appurtenances manufactured and delivered under this contract shall be the price per ton for each exhibit as stated in the second clause of this contract.

(2) Payments under this contract shall be regulated and made in accordance with the provisions contained in this contract, and in the circular, addenda, and notice aforesaid.

(3) There shall be a reservation of 10 per cent. on each payment made under this contract until the aggregate of such reservations shall reach the sum of one hundred thousand dollars (\$100,000), when such reservations, so far as subsequent payments are concerned, shall cease, and the sum last mentioned shall be held as a special reserve under the conditions hereinafter stated.

(4) No payment shall be made except upon bills, in triplicate, certified by the inspectors in such manner as shall be directed by the Secretary of the Navy, whose final approval of all bills thus certified shall be necessary before payment thereof.

(5) All warrants for payments under this contract shall be made payable to the contractors or their order.

(6) The special reserve aforesaid shall be retained until all the armor-plates and appurtenances furnished under this contract shall have successfully met the requirements of paragraph 155 of the circular aforesaid; but for the purpose of such responsibility the party of the second part agrees that after eighteen months from the delivery of any plate, if notification of failure of such plate as referred to in said paragraph shall not have been served on the contractor, the responsibility of the contractor for defects shall cease as to such delivery, and no portion of said reserve shall thereafter be held for such delivery.

(7) When all the conditions, covenants, and provisions of this contract shall have been performed and fulfilled by and on the part of the contractors, they shall be entitled, within ten days after the filing and acceptance of their claim, to receive the said special reserve, or so much thereof as they may be entitled to, on the execution of a final release to the United States, in such form as shall be approved by the Secretary of the Navy, of all claims of any kind or description under or by virtue of this contract.

Eleventh. If any doubts or disputes arise as to the meaning of anything in the circular, addenda, or notice aforesaid, or if any discrepancy appear between the same and this contract, the matter shall be at once referred to the Secretary of the Navy for determination, and the parties of the first part hereby bind themselves and their successors, heirs, and assigns, and their and each of their personal and legal representatives, to abide by his decision in the premises. If, however, the parties of the first part shall feel aggrieved at any decision of the Secretary of the Navy, they shall have the right to submit the same to the President of the United States, and his decision shall control.

In witness whereof the respective parties have hereunto set their hands and seals the day and year first above written.

Attest:

ABRAHAM J. SCHROFF,
Secretary.

THE BETHLEHEM IRON CO.,
Per ALFRED HUNT, [SEAL.]
President.

W. C. WHITNEY, [SEAL.]
As Secretary of the Navy.

WM. B. REMEX,
Judge-Advocate-General,
as to Wm. C. Whitney, Secretary of the Navy.

Correspondence.

OFFICE CAMBRIA IRON COMPANY,
No. 218 South Fourth Street, Philadelphia, March 21, 1887.

To the SECRETARY OF THE NAVY,
Washington, D. C. :

SIR: We hand you herewith proposal for steel-gun forgings, under your advertisement of August 21, 1886, printed circulars of February 12, 1887, and March 11, 1887, accompanied by formal authority from our board of directors to make the bid, and our certified check, No. 9905, on Central National Bank, of Philadelphia, for \$50,000. The certificate of our incorporation has not been received from the secretary of Commonwealth at Harrisburg in time to accompany, but as our company is thirty-five years old, and have, entirely unincumbered, assets of some ten to twelve million dollars, this would seem unnecessary, but will be produced as soon as received.

Asking your favorable consideration, are yours, truly,

POWELL STACKHOUSE,
Vice-President.

P. S.—Certificate of incorporation since received and herewith inclosed.

OFFICE OF THE BETHLEHEM IRON COMPANY,
Bethlehem, Pa., March 22, 1887.

DEAR SIR: Referring to the circular issued by the Navy Department under date of August 26, 1886, I find this provision: "Nor will any bid be accepted unless accompanied by evidence satisfactory to the Department that the bidder is in possession of, or has made actual provision for, a plant adequate for its fulfillment." This seems to require the following summary statement to be made:

First. The Bethlehem Iron Company has been most diligently engaged for more than a year in constructing a complete plant of forging machinery and tools adapted to the fabrication of all the parts of the largest guns used in any part of the world, and of the shafts that may be required for vessels of any size that the United States Government may require, and in erecting the necessary buildings in which to do this work. The establishment, when completed, will be in every respect fully able to compete with any establishment in Europe.

Second. It has contracted with one of the largest and most successful concerns in Europe engaged in making steel armor-plates for the necessary aid, superintendence, use of patents, and guaranty of its work, and has arranged for a hammer of the largest class, if that be deemed necessary to the successful prosecution and completion of the work required for the Government.

Third. The company has up to this time expended in cash on the forging plant alone between \$300,000 and \$400,000, and is under contract obligations to the extent of \$500,000 additional for machinery and tools, to be delivered within the current year. The amount required to complete the plants for both guns and armor plate will be in all about \$1,500,000, and for this the financial arrangements are completed.

Fourth. The company has now in operation seven blast-furnaces. It owns or controls large deposits of ore peculiarly suitable for such iron as is needed for steel forgings, so that it is certain of obtaining the best and most uniform quality of metal, without being subject to the difficulty and uncertainty of purchasing in the market suitable material.

Fifth. In addition to what is being done in the way of special preparation for this heavy class of work the Bethlehem Iron Company now has in use in connection with its present work a large machine shop thoroughly equipped with the largest and most effective tools in this country, a foundry, smith-shop, and other necessary appendages, and is now turning out about 4,500 tons of steel per week.

Sixth. The Bethlehem Iron Company has, what is quite as essential as any other item to insure satisfactory results, a large corps of trained, skilled experts, mechanics, and workmen, commanded by a chief of well known and acknowledged ability, accustomed to accomplish what he undertakes. It has also made adequate arrangements for procuring all the needful assistance of men trained to the special work now called for by the Department.

Very respectfully,

ROB. H. SAYRE,
General Manager.

Hon. WM. C. WHITNEY,
Secretary of the Navy, Washington, D. C.

OFFICE OF THE BETHLEHEM IRON COMPANY,
(Written in Philadelphia, Pa.), March 22, 1887.

DEAR SIR: The result of to-day's bidding on armor-plates and gun-forgings must, to our view, inevitably be the awarding of both contracts to this company at our bids, for not only will that course give to the Government much earlier than any other possible course the gun-forgings which it urgently needs, and of more assured excellence, but it will effect a direct saving of over \$360,000 from the combination of the two separate lowest bids for the separate classes.

The terms of your advertisement, promising preference to a bidder for both classes over separate bidders for the two classes, when the comparison is otherwise equal, obviously insures to us the award of both, even though the combination of the other two showed a total cost as low as ours, which it does not. Nevertheless, we are willing to concede at once and cheerfully what you would doubtless be reluctant to ask, namely, in conjunction with the contract for armor-plates at our bid we will contract for the gun-forgings at the price named for them by the Cambria Iron Company, our lowest competitor for that class, viz, \$851,513.90, thus relieving the Department from any necessity of considering the question of right.

Furthermore, we will agree to allow you in conjunction as aforesaid to duplicate the quantity of gun-forgings named in your circular, thus enabling you to contract at this lowest price up to twice the weight you have proposed to purchase.

Very respectfully,

ROB. H. SAYRE,
General Manager.

Hon. WM. C. WHITNEY,
Secretary of the Navy, Washington, D. C.

Decision upon awards.

NAVY DEPARTMENT,
Washington, D. C., April 14, 1887.

Concerning the bids for armor and gun-steel, I have concluded, after full consideration, that the Bethlehem Iron Company is entitled to the award of the contracts for both.

To encourage bidding it was inserted in the advertisement that "bids covering both" (that is, armor and gun-steel) "will receive preference, other things being equal." The bid of the Bethlehem Iron Company for the gun-steel refers to their bid for the armor handed in at the same date, and has the following memorandum: "The prices named in this proposal are based upon the conditions stated in the advertisement of August 21, 1886, that 'bids covering both' (gun-forgings and armor-plates) 'will receive preference, other things being equal,' and are therefore to be considered in conjunction with our bid of this date for gun-forgings." A similar memorandum is contained in their bid for armor-plates.

The Bethlehem Iron Company is the only bidder for the whole contract. The theory of the advertisement was that the Government wanted the lowest price for the whole work (paying more or less for one or the other being immaterial, so long as the entire job is obtained at the lowest total price), the total sum for the whole job being the material thing. With this view the advertisement was framed so as to obtain the largest range of bidding, allowing a person to bid for either or for both; but the total sum which the whole should cost the Government being the matter alone to be considered.

The two lowest separate bids for the two classes being that of the Cambria Iron Company for the gun-steel, and the Cleveland Rolling Mill Company for the armor-plate, amounts to \$4,873,073.90. That of the Bethlehem Iron Company for the same classes amounts to \$4,512,933.29. They are the lowest bidders for the work by the sum of \$360,135.61.

Since the bidding has taken place the Bethlehem Company has offered to reduce their prices on the gun-steel, so as to make that company the lowest bidder for each of the separate classes. This may be done under the circumstances, although I should not permit it if I did not consider them, on other grounds, entitled to the award.

W. C. WHITNEY,
Secretary of the Navy.

NAVY DEPARTMENT,
Washington, April 15, 1887.

SIR: Referring to this Department's advertisement dated August 21, 1886, by which proposals were invited from "all steel manufacturers of the United States" to supply the Department with certain steel gun-forgings and steel armor-plates as therein in-

dictated or described; referring also to the condition expressed in said advertisement as follows: "Separate bids may be submitted for the gun-steel and for the armor, if any manufacturer so desires, but bids covering both will receive preference, other things being equal," I have to acknowledge the receipt, in due season, of the proposals hereinafter mentioned, accompanied by satisfactory evidence of the authority to make said proposals on behalf of "The Bethlehem Iron Company," and of the ability of the company to comply with all the conditions prescribed by the Department in the premises, which proposals, dated respectively March 19, 1887, and signed by you as president of said company, are, in substance as follows, viz:

(1) To furnish steel gun-forgings of the kinds and quantities, under the conditions and at the prices stated and set forth in the proposals, amounting in the aggregate to \$902,230.79.

(2) To furnish steel armor-plates and appurtenances of the kinds and quantities, under the conditions and at the prices stated and set forth in the proposals, amounting in the aggregate to \$3,610,707.50.

I have also to acknowledge the receipt of the company's letter, dated March 22, 1887, signed by Robert H. Sayre, general manager, in which, referring to the condition embraced in the aforesaid advertisement and above quoted, the company offers to reduce the aggregate amount of its bid for gun-forgings to the sum of \$851,513.90, being a reduction to the extent of \$50,716.89 from the bid contained in the company's above-mentioned proposal of March 19, 1887, relating to gun-forgings.

The proposals of the Bethlehem Iron Company above referred to, as modified by the Company in its letter of March 22, 1887, viz: to furnish steel gun-forgings amounting to \$851,513.90, and to furnish steel armor-plates and appurtenances amounting to \$3,610,707.50, the aggregate for gun-forgings and armor-plates being \$4,462,221.40, are hereby accepted, and suitable contracts for carrying the same into effect will be forwarded to you for execution.

A copy of the Department's decision, dated the 14th instant, relating to the award of contracts under the aforesaid advertisement is, for your further information, herewith inclosed.

The two checks for \$50,000 each which accompanied the said proposals of March 22, 1887, will be returned to the company on the execution of the contracts.

You are requested to acknowledge the receipt of this communication.

Very respectfully,

W. C. WHITNEY,
Secretary of the Navy.

Mr. ALFRED HUNT,
President of the Bethlehem Iron Company, South Bethlehem, Pa.

NAVY DEPARTMENT,
Washington, April 15, 1887.

SIR: Referring to this Department's advertisement, dated August 21, 1886, by which proposals were invited from "all steel manufacturers of the United States" to supply the Department with certain steel gun-forgings and steel armor-plates as therein indicated or described; referring also to the condition expressed in said advertisement, as follows:

"Separate bids may be submitted for the gun steel and for the armor, if any manufacturer so desires; but bids covering both will receive preference, other things being equal"—

I have to acknowledge the receipt, in due season, of the proposal, dated March 21, 1887, of the "Cambria Iron Company" to furnish the steel gun-forgings called for by said advertisement for an aggregate amount of \$851,513.90, which proposal is accompanied by evidence of the authority to make such proposal and of the ability of the company to carry the same into effect; also by a check in favor of the Secretary of the Navy, dated March 21, 1887, drawn by E. Y. Townsend, president, on the Central National Bank of Philadelphia, for the sum of \$50,000 and duly certified.

Contracts for said gun-forgings and armor-plates having, after due consideration, been awarded to "The Bethlehem Iron Company" of South Bethlehem, Pa., the above-described check is herewith returned, and I have to request that you will acknowledge the receipt thereof and of this communication.

A copy of the Department's decision, dated 14th instant, relating to the award of the contracts under the aforesaid advertisement, is, for your further information, here with inclosed.

Very respectfully,

W. C. WHITNEY,
Secretary of the Navy.

Mr. E. Y. TOWNSEND,
President Cambria Iron Company, Philadelphia, Pa.

**No. 17.—REPORT OF BOARD (CAPT. GEORGE BROWN, PRESIDENT)
ON CONCENTRATION OF STORES, ETC.**

NAVY DEPARTMENT,
Washington, D. C., September 5, 1887.

SIR: By your order of November 17, 1886, we were constituted a board for the purpose of formulating such regulations as would, so far as practicable, under existing laws, enable you to have concentrated under one general store-keeper at each navy-yard and station and on board of ships, the various public stores and material, also transferring to the Bureau of Provisions and Clothing the duty of providing, through contract and purchase, supplies for the Navy, together with the custody of all monetary and property accounts of the Navy Department and its several bureaus.

To us was subsequently assigned the duty of preparing schedules of condemned and unserviceable material at the several yards to be disposed of by public auction.

Our first duty was to confer with the chiefs of Bureaus and make known to them your views and wishes.

This we did and obtained from them the aid and co-operation which enabled us to proceed with the consideration of the radical changes contemplated in your order.

Under the existing organization of the Bureaus, each chief continued the system of conducting the details of business which had been followed by his predecessor, or adopted improved methods as suggested by his experience or required by changes in the laws.

We found a great want of uniformity in the several Bureaus in their requirements in the matter of making periodical returns from navy-yards and ships.

At the navy-yards there were store-houses under the charge of the representative of each Bureau, and each store-house necessarily had a force of store clerks, writers, and laborers to receive, care for, issue, and account for the stores and make out the required public bills, reports, and returns.

General Order No. 355, issued by you on December 4, 1886, fixed the date of January 1 following, when all stores and supplies, and the records of all property and plants at navy-yards and stations should be transferred to the Bureau of Provisions and Clothing, and directed that the charge of these, at the several yards, should be given to an officer of the Pay Corps, to be designated and known as the general store-keeper. This order required that the work of concentrating all stores in one or more store-houses should be then commenced, and that it should be completed by July 1 following.

On board ships the outfits and stores, and accounts of the same, were ordered transferred to the charge of the pay officers.

To the general store-keeper's department was assigned certain officers who were experts in their respective departments, and familiar with the character of the materials in the store-houses where their detail required them to perform duties.

Circular No. 36, addressed to commandants, commanding officers of vessels, and general store-keepers, issued by you on December 14, 1886, gave such detailed instructions as would insure a clear understanding of General Order No. 355.

In the store-houses at each yard there was an accumulation of serviceable stores, much of which had been purchased years ago, when prices were much higher than at present.

In order that the property accounts to be rendered should show the present values of all stores, the circular referred to directed that a statutory board should appraise and determine their true money values.

This appraisement was necessary when considering the question of transferring from a Bureau such stores and material as were found to be in excess of the immediate or prospective wants of that Bureau to another Bureau which was in need of them, and which, under other circumstances, would have to be purchased from current appropriations.

The chief of a Bureau could not consistently pay "war prices" to another Bureau, when a similar article could be obtained in the market for a much less sum.

With the values of the stores reduced so as to conform with current market values, the transfer became a convenient and satisfactory method by which one Bureau could obtain from another the required stores.

This also enabled some Bureaus to dispose of, by transfer, considerable serviceable material which was in excess, or which had been left for years in the store-houses, because of the changes in the character of stores or material, made necessary by the advancement and improvements in constructing and equipping naval vessels.

In other words, one department of a yard can now, with the approval of the commandant, obtain from another such material as may be urgently needed, and at market rates.

At stated times a balance sheet is prepared showing the character and value of stores or material transferred from one Bureau to another at the several yards, and the money involved by these transfers is settled at the Treasury Department by transfer of funds from one appropriation to another.

In the transfers at yards, the interests of each Bureau are carefully guarded by its representative, as he is required to certify that the article or articles can be spared by his department before the transfer requisition is submitted to the commandant for approval.

Circular No. 35 established at each yard a board of inspection, composed of three officers. Two members of this board to be designated by the commandant, to serve for three months, and the third member to be the representative of the Bureau for which the articles to be inspected are received.

Every article received from other yards, or by purchase, or which has been manufactured or repaired in the yard, must be inspected by this board for quality and quantity, and can not be received by the general store-keeper until it has been passed by the unanimous vote of the board, and so certified to by each member. By this system of inspection, the Bureaus are protected in the selection of their stores and material by having an expert representing them on the board; and if the article is not such as that representative has required for, or is not suitable for the purpose for which it was required, his vote causes re-

jection. The board also guaranties that the quantities paid for have actually been received.

Reports of inspection are made in duplicate to the commandant. He retains one copy for reference when public bills are presented to him for approval. The other copy is sent to the general store-keeper for his information and guidance in making the public bills and entering the articles on his books.

It is the general opinion at the yards that through this rigid inspection the Government is obtaining a better class of goods than were formerly received, and which were often inspected, received, and accounted for by a single individual, he being a civilian employé whose tenure of office was uncertain, and who, at times, was suspected of being in collusion with the professional contractor.

The concentration of the stores carried with it the concentration of business operations, so that now the general store-keeper is the business man of the yard.

The heads of other departments are relieved from the responsibility for the care of the stores and store-houses, as well as from the office work required in examining the numerous reports and returns, and he can consequently devote his whole time to professional work and exercise more personal supervision over the work being done in his department.

For the current work of the yard, the head of a department, when requiring stores or material, makes a slip requisition on the general store-keeper, stating to whom the article or articles are to be delivered and the specific purpose for which they are drawn. At the end of each month these slip requisitions are consolidated into one receipt, which becomes one of the expenditure vouchers of the general store-keeper.

If the article required by the head of a department is not in store to the credit of the Bureau which he represents, and is in store belonging to another Bureau, the general store-keeper can issue the same on a transfer requisition approved by the commandant.

If the article required is not in store to the credit of the department requiring it, or not available for transfer, the general store-keeper makes an open purchase requisition on the proper chief of Bureau, who decides as to the propriety of purchasing the article or transferring the same from some other station or of disapproving the requisition in part or in whole.

When the chief of a Bureau has approved an open-purchase requisition and certifies that an exigency exists which requires the immediate delivery of an article, the requisition goes to the chief of the Bureau of Provisions and Clothing for his action, and he directs the purchase to be made, after competition, by the pay officer, who is charged with the duties of making all purchases and agreements for services within the limits of his station. If no exigency exists which requires immediate delivery of the article, it is procured by contract after due advertisement.

Following this system, it will be seen that the chief of a Bureau exercises complete control over the appropriations for his Bureau, and is guided by the recommendations of his representatives at the navy-yards, who, as members of the boards of inspection, have the power to reject articles that are not up to the standard or are not what has been required.

The chiefs of Bureaus who are thus relieved from the trouble of making contracts, directing purchases to be made, and of the correspondence following such transactions where contractors are delinquent or

slow in making deliveries, together with many other annoyances connected with the responsibility of making purchases and payments, must realize that much of their valuable time has heretofore been taken from such technical work as they have had in hand and which could not receive the personal attention required.

Following this reorganization of the business methods and care of stores indicated above, came the necessity of providing a simple and uniform system of accounts, books, and returns.

Upon examination we found that no two Bureaus employed the same system. Though all of them had some admirable features, none of them were made in such form or were accompanied with such evidences of receipts and expenditures of stores as were necessary to a proper auditing of the accounts of the various yards and stations. Some of them were simply a list of articles supposed to be on hand by "book account," and which had not been verified by recent inventories.

The Board has recommended for use a uniform system of book-keeping for all the Bureaus, by means of which accurate records are kept of all receipts and expenditures of stores, the expenditures being grouped into two classes, those expended "by transfer" and therefore still available somewhere, and those expended "for use." Thus the Paymaster-General will be enabled to state, in answer to inquiries made by chiefs of Bureaus or other authorized persons, how much of any items of stores has been consumed during any quarter or year.

We have also provided an equally uniform system of quarterly returns, which are to be accompanied by all vouchers of receipts and expenditures necessary for their proper auditing in the Bureau of Provisions and Clothing. By this means a strict accountability on the part of the general store-keeper for all stores received and issued can be enforced.

We have further provided for a system of abstracting these returns in the Bureau of Provisions and Clothing, so that the Paymaster-General will be prepared, at any time, to give the amount and value of any one item of stores, with amount consumed by use during any quarter, or to give the absolute value of all stores under the cognizance of any Bureau, or the total amounts available in the Navy. This plan was submitted to the chiefs of Bureaus and met their approval. It is now in operation, and with such modifications as experience will suggest we believe will answer your requirements.

As appropriations are still made for supplies for the several Bureaus, necessitating separate systems of ledgers and returns for each, the system adopted is of necessity still cumbersome, and the full benefit in saving of clerical and other service can not be obtained.

It is to be hoped that Congress may hereafter make the appropriations for supplies general "for the Navy," thus obviating the present necessity of carrying items of stores common to all Bureaus, such as coal, paints, oils, stationery, etc., upon seven ledgers and returns.

While the Board has been unable, for reasons indicated above, to recommend such general reductions as your plan contemplated, the system has already effected a reduction in the personnel heretofore employed at the various yards and stations in the care and issue of stores of sixty-eight persons, whose pay aggregated \$55,000 per annum, at the same time exacting much more complete returns than were rendered before.

A general appropriation book is kept in the Bureau of Provisions and Clothing, showing the amount available under each head of appropriation by Bureaus. When a requisition has received the approval of the chief of a Bureau, the estimated cost of the article required is charged

against the proper appropriation and the balance remaining stated in pencil. When the purchase is made this estimate is permanently corrected and stated. Thus the exact amount available for expenditure can be ascertained, though the actual purchases may not be made for some time after the approval of the requisition.

In preparing schedules for annual supplies to be advertised and contracted for by the Paymaster-General, very many complications arose which delayed the work and necessitated a vast amount of labor which will be avoided in the future.

By your order of April 9, 1887, schedules of supplies required for each Bureau at the several yards and stations were, after receiving the approval of the chiefs of Bureaus, submitted to the Board by the Paymaster-General. The schedules for each yard and station were considered separately, and from the latest returns of stores on hand we were enabled to ascertain if any article required for one Bureau was in store to the credit of other Bureaus and in excess of prospective wants. By this means the schedules which had been prepared at the yards, without reference to the stock in store available for transfer, were materially changed so that in some cases articles were stricken from the schedules and in many others the quantities called for were reduced. In this way was determined the aggregate quantities of each article to be advertised for, to be delivered to the general store-keeper at each yard.

There was no uniformity in the classification of supplies; on the contrary, each Bureau had its own classification, and it frequently occurred that different names were used for the same articles and that commercial terms were ignored.

A provisional general uniform classification of stores was adopted, from which we prepared the specifications for bidders, showing the quantities of each article required at each yard, and, when practicable, the article was fully described.

The schedules for bidders were printed in pamphlet form and contained, besides the specifications, instructions to bidders, blank form for the bid, the guaranty, and the certificates, also blank forms for the contract, with the required bonds, and the certificate of solvency of the bondsmen.

We are informed by the Paymaster-General that the recent contracts for supplies, made in conformity with this system, were eminently satisfactory, there being a large and responsible class of bidders, while the prices offered were satisfactory.

A uniform general classification of all stores, supplies, and material usually purchased for the Navy is now being carefully prepared and will be so arranged that each class will be of such a character as is found in large establishments dealing in special articles; in other words, the articles usually purchased will be classified according to the business houses dealing in them.

The classification will also give the commercial name of the articles and the quantities contained in a commercial package. This will not only greatly simplify the labor of preparing schedules in the future, but will enable general store-keepers to accurately describe, in commercial terms, the articles required for by them.

It is evident from the knowledge gained by the Board of the practical operation of your most excellent plan for the reorganization of the business methods of the Navy, which have been reduced to a working basis, that great labor and expense, with additional safeguards to property, have been effected.

Experience will undoubtedly suggest modifications or additions, but we have the honor to report that the general system thus far is in successful operation.

We are, sir, respectfully, your obedient servants,

GEO. BROWN,
Captain, U. S. Navy.
 L. G. BILLINGS,
Pay Inspector, U. S. Navy.
 H. T. STANCLIFF,
Paymaster, U. S. Navy.

HON. WILLIAM C. WHITNEY,
Secretary of the Navy, Navy Department, Washington, D. C.

[First indorsement.]

NAVY DEPARTMENT, *September 27, 1887.*

Respectfully referred to Board, Captain Brown, senior member.
 By direction of the Secretary.

J. E. DOW,
Acting Chief Clerk.

[Second indorsement.]

NAVY DEPARTMENT, *September 29, 1887.*

Respectfully returned to the honorable Secretary of the Navy, with tabulated statement required.

GEO. BROWN,
Commodore, U. S. Navy, Senior Member of Board.

Comparative statement of the old and the new organization of store-keepers' forces.

Yard or station.		The old organization, to July 1, 1887.										
		From sheet.	Employés at inspections, Bureau Provisions and Clothing.						Employés in charge of stores transferred from other Bureaus.		Total.	
			Pay of Navy.		Civil establishment.		Provisions.		No.	Amount.	No.	Amount.
			No.	Amount.	No.	Amount.	No.	Amount.				
New York	A	1	\$1,600	23	\$22,181.31	20	\$14,359.88	10	\$10,817.25	54	\$48,968.44	
Norfolk	A	1	1,300	4	3,754.00	7	4,225.50	22	18,114.79	34	27,396.29	
Portsmouth	A	1	1,300	1	626.00	2	1,646.38	16	15,091.62	20	18,663.40	
Mare Island	A	1	1,300	1	1,017.25	4	3,004.80	11	11,218.50	17	16,538.55	
Washington	A	1	1,600	1	1,020.88	1	626.00	13	10,875.33	16	14,121.71	
Boston	A	1	1,600	4	3,602.63	4	3,130.00	12	10,670.51	21	19,003.14	
League Island	A	1	1,600	3	2,191.00	24	18,055.55	28	21,846.55	
Pensacola	A	1	1,400	1	282.00	1	626.00	5	3,841.62	8	6,149.62	
Annapolis	A	2	2,600	2	2,600.00	
New London	A	1	1,300	1	1,300.00	
Newport	A	1	1,300	1	720.00	2	2,020.00	
Key West	A	1	1,300	2	630.00	3	1,930.00	
		13	18,200	35	32,485.57	44	30,439.56	114	99,402.57	206	180,527.70	

Comparative statement of the old and the new organization of store-keepers' forces—Cont'd.

Yard or station.	The new organization.								
	From sheet.	Clerical force.						Total.	
		Pay of Navy.		Civil establish-ment.		Increased ap-propriation.			
		No.	Amount.	No.	Amount.	No.	Amount.	No.	Amount.
New York	B	1	\$1,600	4	\$4,867	13	\$12,760	18	\$19,227
Norfolk	B	1	1,600	1	942	7	6,874	9	9,416
Portsmouth	B	1	1,600	1	1,000	7	6,560	9	9,160
Mare Island	B	1	1,300	1	1,000	7	6,560	9	8,860
Washington	B	1	1,000	6	6,120	7	7,120
Boston	B	1	1,600	3	2,895	4	4,495
League Island	B	1	1,600	3	2,920	4	4,520
Pensacola	B	1	1,400	3	2,920	4	4,320
Annapolis	B	4	3,640	4	3,640
New London	B	1	1,300	1	1,200	2	2,500
Newport	B	1	1,800	1	1,200	2	2,500
Key West	B	1	1,300	1	1,200	2	2,500
		11	16,200	10	10,704	53	51,934	74	78,858

Yard or station.	The new organization.						
	From sheet.	Labor force, as rated under inspection.				Total.	
		Civil establish-ment.		Provisions.			
		No.	Amount.	No.	Amount.	No.	Amount.
New York	A	17	\$15,292.06	20	\$14,359.88	37	\$29,651.94
Norfolk	A	7	4,225.50	7	4,225.50
Portsmouth	A	1	626.00	2	1,646.38	3	2,272.38
Mare Island	A	4	3,004.80	4	3,004.80
Washington	A	1	626.00	1	626.00
Boston	A	1	707.38	4	3,130.00	5	3,837.38
League Island	A	3	2,191.00	3	2,191.00
Pensacola	A	2	282.00	2	282.00
Annapolis	A
New London	A
Newport	A
Key West	A	2	630.00	2	630.00
		19	16,625.44	45	30,095.56	64	46,721.00

Yard or station.	Gross total.		Difference between the old and the new organization.			
	No.	Amount.	Decrease.		Increase.	
			No.	Amount.	No.	Amount.
New York	55	\$48,878.37	1
Norfolk	16	13,641.50	18	13,754.79
Portsmouth	12	11,432.38	8	7,231.02
Mare Island	13	11,864.80	4	4,873.75
Washington	8	8,346.00	8	5,775.71
Boston	9	8,332.38	12	10,670.76
League Island	7	6,711.00	21	15,135.55
Pensacola	6	4,602.00	2	1,847.62
Annapolis	4	3,640.00	2	\$1,010.00
New London	2	2,500.00	1	1,200.00
Newport	2	2,500.00	480.00
Key West	4	3,130.00	1	1,200.00
Total	138	125,578.43	73	59,169.27	5	3,920.00

RECAPITULATION.

	No.	Amount.
Total decrease	73	\$59,169.27
Total increase	5	3,920.00
Net decrease	68	55,249.27

NO. 18.—REPORT OF BOARD ON TRIALS OF PNEUMATIC DYNAMITE GUN.

NEWPORT, R. I., November 14, 1887.

SIR: In obedience to your order of April 3, 1886, a copy of which marked A is appended, we have the honor to submit herewith a report on the pneumatic dynamite gun, which embraces the result of our labors and observations to date, including a report on the recent experiments with the schooner *Silliman*, in accordance with your order of August 12, 1887, a copy of which, marked B, is appended.

On the 5th of April, 1886, the Board communicated with the Pneumatic Dynamite Gun Company, announced that it was ready to proceed with the duty assigned, and requested to be informed as to the proposed tests.

To this the company replied, that as soon as the gun was ready the Board would be informed. The company desired to know what tests the Board wished.

The Board then suggested the following, reserving the right to make additions or changes.

- (1) Accuracy.
- (2) Range.
- (3) Power of projectile.
- (4) Reliability of action.
- (5) Simplicity and cost of the system.

The Board further suggested that the projectiles should be fired over a land range, so that they might be recovered and their behavior noted; also, that they ought to be exploded against iron plates at different velocities. The Board stated what instruments it desired to have during the tests, and that if the initial velocity could be ascertained it would be valuable.

In reply the company informed the Board that it would be practicable and agreeable to make tests Nos. 1, 2, 4, and 5 above mentioned, but that the power of the projectile could not well be shown nor could they be fired over a land range; that the company, in making the exhibition, was subject to the limitations attached to individuals.

FIRST TRIAL.

For various reasons the company was not ready to proceed with any tests until June 1, 1886. On that day the Board assembled at Fort Hamilton, New York Harbor. The Board at first proceeded to examine the gun, which is at Fort Lafayette, near Fort Hamilton. It is not the purpose of the Board at present to describe in detail the gun and its appurtenances, but the salient points of the system will be mentioned in order that what follows may be clearly understood. The gun is a smooth-bore breech-loader, 60 feet long, its interior diameter being $7\frac{1}{8}$ inches.

It is made up of four lengths of wrought-iron tubing $\frac{5}{8}$ inches thick, and lined with $\frac{1}{4}$ -inch seamless brass tubing; the iron tubing is flanged and bolted together. The gun is mounted on a carriage and provided with means for training, or giving it lateral motion; also for elevating or depressing, or giving the muzzle vertical motion, and for sighting or aiming. Compressed air is used for propelling the projectile; this is supplied and stored up by machinery and reservoirs placed in some safe place, in this instance the casemate of the fort; reservoirs are also placed upon the gun-carriage, which may be put in communication with the distant reservoirs by means of a pipe and valve; as the pressure in the latter is kept at a high standard, the pressure in the former can be quickly restored to any desired point after the gun has been fired. The carriage reservoirs can be placed in communication with the interior of the gun in rear of the projectile by means of a valve with a large port; this firing valve is operated by means of an auxiliary valve, opened by the gun captain or the person who aims and fires, and may be operated by pulling a lanyard much in the same manner as any gun is fired. The firing-valve generally remains open until the projectile about reaches the muzzle of the gun, when it automatically closes, but is capable of adjustment as regards the time of closing. The contents of the air reservoirs on the gun-carriage is large, compared with that of the bore of the gun, so that the projectile is followed up to the muzzle or point of cut-off by a pressure only slightly decreased from the initial pressure; for the same reason only a small per cent. of air in the carriage reservoirs is used at a single discharge. As an illustration, it may be said that when firing at a target 1 mile distant, using a pressure of 1,000 pounds per square inch in the carriage reservoirs, the pressure in the latter is usually about 950 pounds after discharging one projectile. The range of the projectile of this gun may be changed as follows:

- (1) By elevating or depressing the muzzle.
- (2) By increasing or decreasing the air pressure.
- (3) By changing the point of cut-off of the firing-valve.
- (4) By combinations of these three methods.

The sole object of the gun is to afford a safe, reliable, and effective means of throwing a projectile containing large masses of a high-power explosive.

It is claimed that the gentle and uniform action of air pressure permits this to be done with perfect safety. A twofold action is claimed for the projectiles of this gun, as follows:

(1) When the projectile hits a target in open air of sufficient resistance, an explosion follows which is equal in destructive effect to that due to the charge of the projectile placed at the point of impact and exploded by any ordinary means, such as a current of electricity, for instance, plus the tamping effect of the inertia of the projectile.

(2) That upon missing the target it enters the water, and after being submerged the proper amount, explodes, producing the same under-water effect upon any object near as would be produced by a torpedo similarly charged and exploded at the same spot.

The double action of the projectile is brought about in the following manner: Its charge is exploded by means of electric fuses. Two are employed, one for the above-water explosion and the other for the under-water explosion. Each has a separate battery; that for the former is all ready for action, but its circuit is interrupted until the moment of impact with some hard object, when it is closed and the fuse made active. The circuit of the under-water fuse is closed, but its battery requires to be wet to make it act. This is accomplished an appre-

cial time after the projectile has entered the water, when the fuse performs its functions and causes an explosion. Certain precautions are taken to render both fuses innocuous until after the projectile leaves the gun. When first presented to the Board the projectile essentially consisted of three parts: A cast iron head piece, a brass cylinder, and a wooden tail-piece. The three parts were lapped and secured together by screws. The wooden tail-piece was full size where it entered the brass cylinder and at the rear end. The intermediate part was considerably cut away. After the projectile was placed in the bore of the gun a gas check, consisting of layers of felt, wood, cotton flannel, and pasteboard, was inserted.

After an examination of the gun and its appurtenances, the company stated to the Board that all was in readiness to begin the tests for accuracy. The company had seven sand-loaded projectiles ready and the Board requested that five be fired and grouped together at the point of impact as near as possible. For this purpose the company had, previous to the arrival of the Board, placed a target 1,735 yards distant from the gun. The spot for the target was selected in this manner; a projectile was fired with a certain elevation and air pressure, and its point of impact with the water observed and marked. Here the target was moored with the idea that similar projectiles fired under similar circumstances would fall at the same place.

One member of the Board was stationed at the gun to observe with a theodolite the fall of the projectile relative to the line of fire. The others in a boat, at right angles to the line of fire and near the target, to note the range; the latter were assisted by buoys placed at known distances from the target. The following is a summary of the shots:

No. 1. 120 yards short, 9 yards right, wobbled.

No. 2. 35 yards short, 2 yards right, steady.

No. 3. 63 yards short, 1 yard left, wobbled.

No. 4. 30 yards short, 5 yards right, steady.

No. 5. 50 yards over, 4 yards right, steady.

It was observed that in shot No. 3 the wooden tail of the projectile broke off upon impact and went some distance ahead of the shell.

After shot No. 4 several miss-fires occurred, and the carriage reservoirs were blown down in order to place a new gasket under the firing valve. After an interval of about one hour and a half, shot No. 5 was fired. On attempting to fire other shots more miss-fires occurred and the officers of the company present requested the Board to postpone further trials.

It will be observed that the trials witnessed indicated that the gun was not reliable as to certainty of fire. It is proper to mention here, however, that subsequent trials indicated, without exception, a perfect control over the firing apparatus and a certainty of its action at the desired moment.

In discussing the fall of the shots it is proper to remember that it is the accuracy of the gun that is sought after rather than the skill of the gunner or the destruction of the target. So far as the lateral deviation is concerned the accuracy was good, although it is proper to observe that the day was quite calm. In regard to the accuracy of the range, the center of hits was 40 yards in front of the target. Comparing the point of impact of each shot with this, and allowing the complement of the angle of incidence to be 14° , which is probably about correct, we find the following:

No. 1. 80 yards short; would have done no damage unless ricocheting.

No. 2. 5 yards over ; would have hit a target 4 feet high.

No. 3. 23 yards short ; might possibly have inflicted some injury as a torpedo.

No. 4. 10 yards over ; would have hit a target 7 feet high.

No. 5. 90 yards over ; would have missed a target under 67 feet high.

The accuracy of these shots may be considered as fair. It is important, when considering the performance of this gun, to remember its high trajectory. On account of this fact it is more favorable to the gun to refer the impact of its projectiles to a horizontal target rather than a vertical one, although this quality of the gun militates against it as a mobile or naval weapon.

At the end of this trial the Board adjourned without date.

SECOND TRIAL.

The Board was again summoned to meet in New York on the 23d of June, 1886, to witness further experiments with the pneumatic dynamite gun. The 23d being stormy, the Board spent the day at the company's office examining plans and listening to the details of the system as explained by experts.

On the 24th instant the Board proceeded to Fort Lafayette, and during the day witnessed the firing of fifteen projectiles. The first, a sand-loaded shot, was fired in order to determine where to place the target, it being intended to use projectiles of a uniform weight and at a constant elevation and air pressure.

The target, and buoys at known intervals from it, were placed as during the trials on June 1.

The target was 1,600 yards distant. The air pressure used was 1,000 pounds, and the elevation 12 degrees. The second shot was a "plug" of the same weight as a service projectile, which was fired in order to determine the time required for the projectile to reach the muzzle of the gun after the command "fire." This was considered important, in order to test the working of the air valves and for other reasons. It was ascertained from this and nine other shots that the average time from the command "fire" until the projectile left the muzzle, at 12 degrees elevation and 100 pounds pressure, was 0.7 of a second. This is about five times longer than required for the same purpose with a modern high-power rifle gun. It was the intention of the company to fire five shots at one mile and five shots at one-half mile range, for accuracy ; they were all fired, however, at one mile range, with the following result :

No. 1. 35 yards over, 14 yards right, steady.

No. 2. 87 yards over, 3 yards left, wobbled.

No. 3. 57 yards over, 7 yards right, steady.

No. 4. 55 yards over, 6 yards left, steady.

No. 5. 93 yards over, 5 yards left, steady.

No. 6. 50 yards over, 3 yards left, steady.

No. 7. 23 yards over, 2 yards left, steady.

No. 8. A hit.

No. 9. 20 yards over line, right, steady.

No. 10. 72 yards short, 6 yards left, steady.

It will be observed that shot No. 2 was unsteady in its flight. It was thought that a portion of the wooden tail-piece came off soon after the projectile left the gun. The time of flight of these projectiles varied

from 8 to 9 seconds. They weighed from 151½ to 155 pounds, averaging 153.2 pounds.

Discussing the accuracy of these shots as before, we find that the center of hits was 35 yards beyond the target. Comparing this with the fall of each shot, we find the following :

- No. 1. A hit. A hit as regards range; lateral deviation, 14 yards.
- No. 2. 52 yards over. A miss.
- No. 3. 22 yards over. Would have hit a target 16½ feet high.
- No. 4. 20 yards over. Would have hit a target 15 feet high.
- No. 5. 58 yards over. A miss.
- No. 6. 15 yards over. Would have hit a target 11½ feet high.
- No. 7. 12 yards short. Good for torpedo effect.
- No. 8. 35 yards short. A miss.
- No. 9. 15 yards short. Good for torpedo effect.
- No. 10. 107 yards short. A miss.

Again, the accuracy of the range may be considered fair. Lateral deviation was also fair, except the first shot, which was poor. The day was fine and the wind light. It may be remarked that if it is desired to refer the impact of the shots to a horizontal target the above figures indicate half the width of one that would have been hit in each case. It is proper to state that the ten projectiles just discussed were of a new and experimental pattern, containing a shifting weight for the purpose of changing the center of gravity. The company claims that these were unsuccessful and that the shooting would have been much more accurate had the old form of projectile been used.

A projectile weighing 193½ pounds, and charged with 87½ pounds of explosives, consisting of 75 pounds of gelatine, and 12½ pounds of Atlas powder No. 1, fused both for above and under water service, was now discharged at the target, the gun being elevated 13° 40', and an air pressure of 1,000 pounds being used. It struck the water 100 yards beyond the target and did not explode.

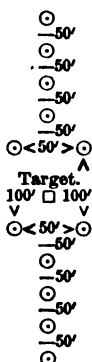
A projectile weighing 142½ pounds charged with 58½ pounds of explosives, consisting of the same mixture as before, was next discharged at the target with the same elevation and pressure. Being much lighter than the former projectile it fell, as might have been expected, about 360 yards beyond the target. This projectile contained two fuses for under-water service only, but it exploded practically at the time of its impact with the water. The explosion was rather a feeble one, and it is not probable that all of the charge was detonated.

The next and last shot of the day was fired to show the range of the gun with an elevation of 22° 7' and a pressure of 940 pounds. The projectile was sand loaded and weighed 150½ pounds. Its time of flight was from 20 to 22 seconds. The range, as marked by plane tables at Forts Hamilton and Wadsworth, was 3,100 yards. Generally speaking, the projectiles fired during the day could be plainly seen in the air and were fairly steady in their flight. The average velocity of the projectiles varied with the range and pressure from about 450 to 565 feet per second. The tests of loaded projectiles plainly indicated that either the fuzes or the explosive charge itself could not be depended upon to act as intended.

THIRD TRIAL.

On the following day, June 25, 1886, the Board again assembled at Fort La Fayette to witness further trials of the dynamite gun.

For the purpose of testing the accuracy of the shots a target and buoys were placed as follows:



The distance of the target from the gun was accurately determined to be 1,477 yards. Five shots were fired for accuracy; their weight averaged $131\frac{1}{2}$ pounds each; the pressure used was about 1,000 pounds, and there was a loss of 50 pounds at each discharge; the time of flight was about $8\frac{1}{2}$ seconds; the average velocity about 520 feet per second; the gun was elevated $10^{\circ} 40'$. The fall of the projectiles, determined as before, was as follows:

- No. 1. 139 yards over, 5 yards right, steady.
- No. 2. 146 yards over, 3 yards left, steady, ricocheted.
- No. 3. 139 yards over, 3 yards left, steady, ricocheted.
- No. 4. 139 yards over, 7 yards left, steady, ricocheted.
- No. 5. 139 yards over, 5 yards left, steady.

It will be observed that the grouping of the projectiles, so far as the accuracy of the range is concerned, was practically perfect. After the firing, three wooden tail pieces were picked up floating on the water. They were probably parts of the three projectiles that ricocheted, as it was plainly seen that they broke up upon impact. All broke where the diameter was reduced in rear of the joint with the brass cylinder; one side of the rear end was split off in each case, caused probably by the impact of this part with the water. It is important to observe that three out of five of these shots ricocheted with an elevation of $10^{\circ} 40'$. It is probable that the torpedo action of a projectile will be seriously interfered with if it strikes at a sufficiently small angle to ricochet.

A projectile weighing 133 pounds, containing 44 pounds of gelatine, 8 pounds of Atlas powder No. 1, and two fulminate of mercury fuses of 30 grains each, was next fired with an elevation of $10^{\circ} 10'$, and a pressure of 1,000 pounds. It was fitted for either above or under water service. It fell at about the same spot as the series of five previously fired and exploded upon impact before gaining any appreciable immersion.

At the request of the Board some shots were now fired with the intention of showing the torpedo action of the projectile only; also of placing them about 100 yards apart as in countermining. They were landed in comparatively shoal water and it was expected that they would explode on the bottom. The Board witnessed the firing of these projectiles from an elevated position near Fort Hamilton about abreast and not far from where they fell.

No. 1 contained 12 pounds of explosives; weighed 149 pounds; fired with a pressure of 448 pounds, and an elevation of 10° ; loss of press-

ure only 16 pounds; intended to have a range of about 1,000 yards. Its actual range was estimated to be 700 yards. Exploded shortly after impact, throwing a column of discolored water up at least 100 feet, and thus indicating but little immersion at the time of the explosion.

No. 2. Projectile the same as used during last experiment, fired with a pressure of 421 pounds, and an elevation of 10°; loss of pressure, 195 pounds. The range was estimated to be the same as last shot, 700 yards. Upon impact with the water the cast-iron head separated from the remainder of the projectile and ricocheted. No explosion occurred.

No. 3. Projectile contained the same amount of explosives as the preceding, and weighed 148½ pounds; fired with a pressure of 395 pounds, and an elevation of 10°; loss of pressure 395 pounds, or the total amount. The range was estimated to be somewhat greater than that of the last shot. Exploded upon impact, no water being thrown up and black smoke being visible. There was a prolonged sound of escaping air after the projectile left the gun.

No. 4. Projectile the same as in No. 1, except that it weighed 147¾ pounds; fired with a pressure of 379 pounds, and an elevation of 10°; loss of pressure 14 pounds only. Range much less than during the last experiment. Upon impact the cast-iron head of the projectile came off and ricocheted. No explosion.

These experiments point to the following results: The effort to place the projectiles about 100 yards apart with a decreasing range was unsuccessful. The effort to explode them on the bottom was unsuccessful; the fact that two did not explode at all was no doubt due to their breaking up upon impact; as they ought not to have exploded until reaching the bottom, this is rather in their favor. The projectile developed weakness by breaking up. The irregularity of the loss of air-pressure indicates that the firing valve did not act properly on account of the low pressure used or for some other reason.

On the conclusion of these experiments the company requested that further tests be postponed until an additional supply of projectiles could be obtained. The company appointed Thursday, July 1, 1886, as a day when it would be convenient to continue the tests.

The Board then suggested the following tests for that day:

(1) Five projectiles to be fired at a range of 1 mile for accuracy. Each projectile to be charged with gelatine and dynamite and fused both for above and under water water-action. In case the projectile strikes the water, the explosion to be delayed until the shot is submerged an appreciable amount.

(2) Five projectiles, charged as before, to be fired at the same range to explode on the bottom only, as in countermining.

The object of these suggestions was to clear up, if possible, questions upon which the Board was in doubt. The company assented to the propositions and the Board expected they would be carried out.

On the 28th of June, 1886, the members of the Board were informed by the president of the Dynamite Gun Company that the tests appointed for July 1st had been postponed, but it was expected they would occur on the 6th, 7th, or 8th of July. On July 2d he again informed the members of the Board that the tests had been postponed until July 13th. On the 10th of July, 1886, they were postponed indefinitely, and they have never taken place so far as the Board is aware.

On the 25th of June, 1886, the Board requested the Pneumatic Dynamite Gun Company to formally state what was claimed for the Pneumatic Dynamite gun as a destructive weapon suitable for modern warfare. A copy of the reply of the company, marked "E," is appended

DYNAMITE GUN CRUISER.

On December 1, 1886, the Board received from you an order relative to a dynamite gun cruiser, a copy of which, marked C, is appended. In obedience thereto the Board was convened and made a report, a copy of which, marked D, is appended. The subsequent action of the Board in regard to this cruiser in obedience to your verbal orders need not be repeated here.

DESTRUCTIVE EXPERIMENTS.

On the 15th of March, 1887, the Board received an order dated March 14, 1887, a copy of which, marked F, is appended, to arrange for a proper experiment to illustrate the "efficiency or inefficiency" of the dynamite gun.

Upon the receipt of this order the Board decided that the gun ought to be placed where it could be fired over both a land and sea range, the former to test the destructive qualities of the projectile when striking armor plates and the latter to test them when used as a torpedo. The Dynamite Gun Company pronounced it impracticable to move the 8-inch gun now at Fort Hamilton, and for a long time would come to no positive decision whether to use the gun above referred to or postpone these trials until another larger gun could be built. Eventually, under date of April 12, 1887, the company declined to make the tests as called for by your order of March 14, 1887, with the 8-inch gun. The company stated that it would probably conclude to make these experiments in the future when a 10½-inch or 12½-inch gun should be completed. This reply was communicated to you verbally by the president of the Board and then followed your order of April 20, 1887, a copy of which, marked G, is appended.

This order was communicated to the company, and the latter agreed to use the 8-inch gun at Fort Hamilton for any torpedo tests against a target, but expressed a preference for a larger gun. Upon being called upon to state what the 8-inch gun would do, as required by your order of April 20, 1887, the company addressed a letter dated April 22, 1887, to the president of the Board on that subject, a copy of which, marked H, is appended.

On April 28, 1887, the Board convened in New York for the purpose of discussing the necessary details connected with the proposed tests. The company then addressed another letter to the Board as to what the 8-inch gun could do, a copy of which, marked I, is appended.

The Board recommended that the hull of a good condemned navy ship, such as the *Powhatan*, *Ticonderoga*, or *Tennessee*, be used as a target, the machinery and such other articles of value as could be removed without weakening the hull to be taken out. Eventually the condemned Coast Survey schooner *Silliman* was, by your order, selected for a target. At the request of the Board she was surveyed at the New York navy-yard, and a copy of this survey, marked J, is appended. It shows her dimensions and general condition. It is proper to place on record the fact that the company expressed considerable disappointment that the target selected was not larger. The members of the Board were of the opinion that in fairness to the gun it should be larger, and that to test the destructive qualities of the projectile it should be stronger, heavier, and draw more water.

The experiments were first appointed to take place on the 10th of September, 1887, but by your order they were postponed, first to the 15th and then to the 20th. The Board convened in New York on the 19th of September for the purpose of discussing and arranging the details of the trial.

The Board found that several important changes had taken place in the arrangements of the projectile and fuses since the last experiments.

Plate I, appended, shows the latest model of projectile, and, except a slight change in the tail-piece, the kind used in all experiments witnessed by the Board from this date. The shell proper is made of brass and consists of three parts, the head, cylindrical body, and tail-piece; these pieces lap with shoulder joints and are firmly secured with screws. A gas check is placed between the joint of the cylinder and the tail-piece. Instead of the long wooden tail for steadying the projectile in its flight, formerly used, a metal arrow tail has been substituted, consisting of a brass tube screwing into the tail piece of the shell, on which are secured sheet-steel fins, shaped like the blades of a propeller. The object of these fins is to give the projectile rifle motion. The principle of the fuse remains the same; but it is the opinion of the Board that the details of the batteries, circuit-closers, circuit-breakers, and detonators, and their position and arrangement, have been much improved. At present there is a complete disruption between the fuses and batteries until after the projectile leaves the gun.

Plate II, appended, shows the arrangement of electrical circuits now employed.

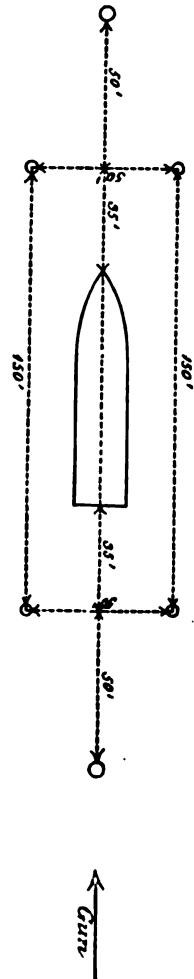
Plates III and IV show the progressive changes made in the arrangement of the projectile and fuses since the Board first examined them.

The schooner *Silliman* was placed in position on the morning of the 20th instant, by Lieut. C. H. Arnold, U. S. N., attached to the New York navy-yard. The exact spot where moored was designated by the representatives of the company, but the schooner was in charge of Lieutenant Arnold up to the time the experiments began. In placing the vessel, a rectangle with sides 150 feet by 50 feet was first laid off, the angles being marked by buoys. The schooner was then moored ahead and astern in about 24 feet of water at the center of the rectangle, the short side of the latter and the stern of the schooner being towards the gun. Each end of the schooner was 35 feet from the short side of the rectangle. Buoys were placed 50 feet in front of, and the same distance beyond, the rectangle, on a line passing through the center of the rectangle and schooner. The annexed diagram may make the matter more clear.

The *Silliman*, when moored, had her two lower masts and bowsprit standing. She was perfectly dry and tight. Everything had been taken out of her except the water tanks, which were tight for buoyant purposes. Chains were placed around her hull to aid in raising her if sunk. The distance of the stern of the schooner from the gun was 1,864 yards.

Six shots in all were fired on the 20th, one loaded with sand, and the remainder charged with explosives, each containing 50 pounds of gelatine, and 5 pounds of dynamite No. 1, and two fuses, each of the latter containing 30 grains of fulminate of mercury. All loaded projectiles were fused for both under water and above water service.

The time of flight for all projectiles was from 10.5 to 10.7 seconds. The sand projectile weighed 141 pounds; the loaded projectiles weighed from 136 to 137 pounds.



First shot.—Trial for range and projectile loaded with sand. Elevation $14^{\circ} 52'$. Aimed to the right so as not to hit the target. Firing pressure 590 pounds; final pressure 490 pounds. Struck 24 yards to the right and 27 yards short, the stern of the schooner being the point reckoned from.

Second shot.—Loaded and fused for service. Elevation $14^{\circ} 52'$. Aimed to hit target. Firing pressure 595 pounds; final pressure 485 pounds. Struck 8 yards to the left and 10 yards short. It entered the water properly for torpedo action but did not explode. No satisfactory reason for this failure to explode has been discovered by the Board. It is proper to add, however, that before the firing commenced the artillery expert of the company, Lieutenant Zalinski, U. S. A., explained to the Board that this form of projectile had never been fired when charged with explosives, and that the only defect feared was a weakness in the tail-piece, which might interfere with the proper action of the electric batteries. Plate I does not show the exact form of projectile used in these experiments, the tail-piece being somewhat different, designed to overcome the defect feared.

Third shot.—Loaded and fused for service. Elevation, $14^{\circ} 56'$. Aimed to hit target. Firing pressure, 605 pounds; final pressure, 200 pounds, the result of accidentally opening the firing valve a second time. It struck a little astern and on the starboard quarter, entering the water at once and exploding apparently at the proper depth for torpedo action. It may be here remarked that this depth can be pretty well estimated by the character and height of the water thrown up. Upon boarding the schooner after this shot, it was found that the mainmast had been broken off, just above the deck; it fell over the port side. The mast, where it broke off, was very rotten, there being only a slight shell of sound wood on the outside; it was also very slightly supported. Bulkheads were thrown down, and there were other evidences of the shattering effect of the projectile. There was about 2 feet of water in the schooner, and the planking under the starboard quarter appeared to be breached. The moorings of the schooner on the starboard quarter were disturbed by this shot so that the vessel drifted a few feet away from the gun and assumed a position slightly across the rectangle, with the stern to the left of the center line.

Attention is called to the small changes in pressure and elevation of the last three shots in order to slightly increase the range.

Fourth shot.—Loaded and fused for service. Elevation, $14^{\circ} 56'$. Aimed to hit target. Firing pressure, 610 pounds; final pressure, 505 pounds. This projectile struck the water a short distance from, and abreast of, the starboard quarter; entering the water, it exploded about abreast of the center of the schooner and very near, if not under, her. The torpedo action of the projectile was perfect, and it follows that the under-water fuse acted at the proper depth for this target, which was probably somewhere from 6 to 10 feet. The center of the schooner was raised well up, her back broken and penetrated by a column of water; the vessel fell back a complete disintegrated wreck. The appearance of this explosion bore a striking resemblance to the picture of the destruction of the *Dorothea* off Walmer Roads, England, in 1807, by one of Fulton's torpedoes. Upon examining the wreckage it was seen that it was not entirely caused by the shattering effect of the projectile, but that the explosion was near enough to show the peculiar cutting and twisting effect of high-power explosives on sound wood. The wreckage for the most part was still held together by the chains and moorings; it drifted, however, about 25 feet towards the farther and left-hand corner of the rectangle.

Fifth shot.—Loaded and fused for service. Elevation, $14^{\circ}52'$. Aimed at wreck of foremast. Firing pressure, 620 pounds; final pressure, 520 pounds. This projectile exploded in the open air, 3 or 4 feet above water, with a sharp detonation, immediately over the wreck and abaft the foremast. It is supposed that it struck some of the wreckage, causing the circuit of the above-water fuse to be closed.

Sixth shot.—Loaded and fused for service. Elevation, $14^{\circ}52'$. Aimed at wreck of foremast. Firing pressure, 612 pounds; final pressure, 520 pounds. It struck abreast of the wreckage, but about 10 yards to the right of it; entering the water it exploded, probably at a depth of 6 or 7 feet, throwing up a column of water of small diameter to a height of at least 100 feet.

This terminated the practice for the day. The first loaded projectile was fired at 3 hours 23 minutes p. m. and the last, 5 hours 8 minutes p. m. This is no indication of the time required to fire on service, as the target was examined between shots and projectiles were loaded and fused.

The weather was very fine, with no wind, presenting the most favorable circumstances for accuracy of fire.

The accuracy of the five loaded projectiles was very remarkable. At a distance of over a mile three certainly fell inside of a rectangle 50 feet by 150 feet, and the remaining two had the correct range, and if not actually inside, fell on the borders of the rectangle. All projectiles fired during this experiment were much steadier during their flight than any seen heretofore, due no doubt to their rifle motion.

It is very important to observe that in these experiments, undertaken by the company for destructive purposes, the air pressure was reduced from 1,000 pounds, the normal amount used in other experiments witnessed by the Board, to about 600 pounds, the elevation being increased a corresponding amount. This could have been for but one purpose, viz, to prevent ricochet and insure a proper entry into the water for torpedo action. This indicates the necessity for a high trajectory for a successful torpedo action of the projectile.

Lieutenant Zalinski stated that the angle of the fall of the projectile, or the complement of the angle of incidence, was 18° or 19° . While the accuracy of the gun is such that this high trajectory, with its accompanying narrow danger zone, may give satisfactory results when the gun is on a steady platform and the target stationary, it will be a very serious condition when both platform and target are moving.

EXPERIMENTING FOR RAPIDITY OF FIRE AND ACCURACY.

The Board convened in New York, in obedience to your order, on September 29, 1887, to witness some experiments conducted by the Dynamite Gun Company for the benefit of an English commission, consisting of Major Bainbridge, of the Royal Army, and Lieutenant Williams, of the Royal Navy. The object of these experiments was to group ten shots together as near as possible and in a short space of time.

Proceeded to Fort Lafayette, but the weather was too foggy for the trial to take place. Three "plug" shots were fired to determine the time required for the projectiles to reach the muzzle of the gun after the command "fire." This was found formerly to be .7 seconds, but the company claimed that it had been reduced. The means at hand for determining this time was not very accurate, and, therefore, the result can not be fully relied upon. The three shots indicated, however, that the time had been reduced to five-tenths (0.5) of a second,

tion 1
press
the ri
recko
Sec
to hit
Struc
prop
son fo
is pro
lery e
to the
charg
ess i
e el
us
ig
it

chette
chette
No.
No.
No.
No.
No.
No.
No.
No.
No.
No.
All t
unless
from ti
less.
be obs
to corr
to obs
is fara
cheate
Pm
tion, a
No. 1
No. 2
No. 3
No. 4
No. 5
No. 6
No. 7
No. 8
No. 9
No. 10

September 30, the experiments took place
of a single buoy with a boat attached, was placed
the gun. Ten shots were fired for accuracy and rapid
carefully selected and loaded with sand; seven weighed
pounds, two 140 pounds, and one 142 pounds; they repr
shells. The center of gravity only varied between
from the forward end. All were fired with a pressu
and an elevation of 14° 56'. About 90 pounds of fi
the carriage reservoir at each shot. The time of fl
about eleven seconds. In addition to there being no buo
in measuring the distance of the impact of the projec
the firing commenced before the members of
to note this distance got fully in position. Again, a
position their boat dragged, thus causing the record of
with a force of from 3 to 4 (nautical reckoning), and n
formed broad off the port bow while looking towards the target
sun. The water was a little lumpy. The following is a record of

- No. 1. 6 yards short, 22 yards right.
- No. 2. 8 yards over, 17 yards right.
- No. 3. 10 yards short, 11 yards right.
- No. 4. 50 yards short, 9 yards right. Broke up and piece
- No. 5. 6 yards short, 9 yards right. Broke up and the piec
- No. 6. 8 yards short, 10 yards right.
- No. 7. 8 yards short, 7 yards right.
- No. 8. 15 yards short, 17 yards right. Missed target.
- No. 9. 20 yards over, 10 yards right. Missed target.
- No. 10. 10 yards short, 10 yards right. Missed target.

casemate reservoirs was too small for such rapid fire and permit the air guage to settle properly. This difficulty, if the true one, could be easily remedied by using a larger connecting pipe.

A projectile weighing 140 pounds, sand loaded, was now fired for extreme range. The gun was elevated $32^{\circ} 42'$. The pressure used, 975 pounds; final pressure, 825 pounds. Time of flight, $24\frac{1}{2}$ seconds. Estimated range, about 4,000 yards.

Two projectiles, sand loaded, representing the 100-pound shells, were now fired. They weighed 203 and 204 pounds respectively. Elevation, 15° . Air pressure, 750 pounds; final pressure, 625 and 615 pounds. Time of flight, 10 seconds. Allowance was made in aiming for the effect of the wind. No boat was out to mark the fall of these shots, so that the point of impact could only be estimated. They seemed to fall about 100 yards short and a little to the left. At the time the projectiles were fired the water was quite lumpy and the wind blew with a force of 4 to 5 (nautical). Neither of these projectiles were as steady in the air as the 60-pound shells. Upon striking the water the tails of both projectiles broke off, and the shells proper ricocheted a long distance, the first about 20° to the left, and the second about 10° to the right, with a single very high ricochet trajectory. It is probable that the lumpy condition of the water had something to do with the several ricochet shots of the day. The 100-pound shells carry the center of gravity about 1 foot in rear of that of the 60-pound shells, while the steel fins have no greater surface than those of the 60-pound shells though placed on a longer tail.

These are all of the experiments or tests that have taken place before the Board.

DISCUSSION.

The Board does not consider that it has thoroughly tested the pneumatic dynamite gun. Only such experiments and trials as the company has seen fit to exhibit have been witnessed by the Board, and these may be characterized by the general term of mortar practice. The few experiments undertaken to show the value of the gun as an effective means for throwing large masses of a high power explosive given ranges with regular intervals between the points of impact, and exploding them on the bottom, as would be required in countermining, were not successful.

Most of the experiments have taken place during calm and fine weather. The Board is therefore unable to state what effect the wind will have upon the flight of the projectile.

But few projectiles charged with explosives have been fired in presence of the Board; chiefly, no doubt, due to the expense attending such an exhibition. Such as have been fired were uniformly charged with either explosive gelatine or dynamite, or both, and fulminate of mercury fuses. For naval purposes wet gun-cotton would probably be used. The Board was desirous of seeing this explosive tried, and it is proper to state that the company made some unsuccessful efforts to procure a supply for this purpose. The Board has no doubt that high-power explosives generally can be projected with safety from the 8-inch gun now used at a velocity such as employed during the trials witnessed.

The Board is not convinced of the soundness of the theory that the safe projection of large masses of high-power explosives, is entirely due to the gentle and uniform action of compressed air at time of the initial impulse of the shell, or that the limit of safety may not be passed

when using compressed air instead of powder gases, provided the velocity is sufficiently increased.

It is understood by the Board that the company intends to build guns with less length and greater proportional caliber, which it is expected will give the same range. It is the opinion of the Board that experiments in this direction ought to be encouraged.

The Board is of the opinion that a gun as modified above and installed on board ship in a manner somewhat similar to the present torpedo tubes or guns, may be valuable for the purpose of projecting large masses of explosives against hostile ships at short ranges, where a comparatively flat trajectory will be sufficient. Experiments in this direction should, in the opinion of the Board, be encouraged.

The Board is of the opinion that, on account of the high angle of fire and narrow danger zone, it will be very difficult to hit a moving target with this gun at the range, which ships will probably engage when mounted upon an unsteady platform.

The Board concedes that the projectiles of the pneumatic dynamite gun will be very destructive when exploded under water very close to a ship, as in the Silliman experiments, or on a ship's deck or anywhere inside of a ship, but their value when striking solid vertical armor is problematical.

The company has not experimented sufficiently with the present 8-inch gun to construct a range table for different pressures of air, elevation, or combinations of the two, and therefore was not prepared to throw projectiles at targets placed at unknown or irregular distances. In general the accuracy of the gun has been judged by its ability to duplicate its own shots.

The Board has observed that there is considerable moisture in the compressed air used which, upon the discharge of the gun, assumes somewhat the appearance of smoke. It would be an improvement if this moisture was extracted.

The Board has had no opportunity to observe what effect cold weather has upon the performance of a gun charged with compressed air.

FINDING.

After careful deliberation upon the experiments witnessed thus far with the 8-inch pneumatic dynamite gun, the Board finds:

(1) It is a new instrument of warfare which has its own peculiar functions in time of war. It can not replace any existing weapon, nor can its place be wholly taken by any other.

(2) The value of compressed air as a means of throwing projectiles from a gun is chiefly due to the ability of the gunner to exactly reproduce a shot, or to accurately increase or decrease the range at will and to the accuracy of fire with low velocities.

(3) The machinery employed by the company to control air at a great pressure has been brought to a high degree of efficiency.

(4) The accuracy of the gun is remarkable.

(5) The extreme range is probably about 2 miles. The effective range of projectiles in the trials witnessed by the Board has been from 1,477 to 1,868 yards.

(6) The power of the projectile has been determined only in a slight degree.

(7) The gun appears to be perfectly reliable in its action.

(8) The system is not a simple one. The gun does not require an expensive plant to manufacture and its cost should be moderate. Guns

of this pattern can be made in any of the large towns of the country where there are machine shops and foundries.

(9) It is an important weapon for harbor defense.

(10) It is adapted to naval warfare whenever mortar fire can be used to advantage.

(11) A modification of it may be valuable to project torpedoes from ships when at short range.

(12) It is not expedient to adopt it as a part of the battery of ships of war until after the efficiency of the guns on board of the dynamite cruiser now building has been ascertained and their performance afloat observed.

Very respectfully, your obedient servants,

J. A. HOWELL,
Captain, U. S. Navy.
C. F. GOODRICH,
Commander, U. S. Navy.
R. B. BRADFORD,
Lieutenant-Commander, U. S. Navy.

The SECRETARY OF THE NAVY,
Navy Department, Washington, D. C.

A.

NAVY DEPARTMENT,
Washington, April 3, 1886.

SIR: The president of the Pneumatic Dynamite Gun Company (office located at No. 44 Broadway, New York), has informed the Department that his company has perfected their weapon, and that it is now at Fort Hamilton, N. Y., ready for examination, and has requested that a Board of Naval Officers be ordered to make an examination and test of the same, the expense of which will be borne by the company. The Department desires to comply with this request. You are therefore appointed senior member of a Board to examine and report upon the weapon and upon any experiments or tests that may be made with it in your presence, and particularly as to its adaptability for naval warfare.

Commander C. F. Goodrich and Lieut. Commander R. B. Bradford will be associated with you on this duty as members of the Board. You will place yourself in communication with the president of the company, Mr. A. D. Schuyler, and will proceed to New York, and convene the Board at such a time as may be agreed upon by the president of the company and yourself.

Upon the completion of this duty you will return to Washington and resume regular duties.

Very respectfully,

W. C. WHITNEY,
Secretary of the Navy.

Capt. J. A. HOWELL, U. S. N.,
Navy Department, Washington, D. C.

B.

NAVY DEPARTMENT,
Washington, August 12, 1887.

SIR: Referring to your letter of the 27th ultimo, in reference to the proposed experiments with the pneumatic dynamite gun, I have to inform you that, at the suggestion of the Department, the time for said experiments has been changed from August 25 to September 10, 1887.

It is desired that yourself and the other members of the Dynamite Gun Board be present at the time the experiments are made, and that a report thereon be made by the Board to the Department. You will please notify the members of the Board accordingly.

Very respectfully,

W. C. WHITNEY,
Secretary of the Navy.

Capt. J. A. HOWELL, U. S. N.,
President of the Dynamite Gun Board, Chester, Pa.

7898 N—32

C.

NAVY DEPARTMENT,
Washington, December 1, 1886.

GENTLEMEN: You will report whether you approve the system of the Pneumatic Dynamite Gun Company, as specified in the act of Congress approved August 3, 1886, for naval purposes; the specification being that the gun be guaranteed to throw 200 pounds of dynamite, or other high explosive, at least one mile, each gun being capable of being discharged once in two minutes, three of these guns being carried in a vessel having a speed of 20 knots per hour.

Very respectfully,

W. C. WHITNEY,
Secretary of the Navy.

Capt. JOHN A. HOWELL,
Commander C. F. GOODRICH,
Lieut. Commander R. B. BRADFORD,
U. S. Navy, Washington, D. C.

D.

NAVY DEPARTMENT,
Washington, December 1, 1886.

SIR: In obedience to your order of this date, a copy of which is hereto appended and marked A, we respectfully report that we approve the system of the Pneumatic Dynamite Gun Company, as specified therein.

In addition, we venture to suggest that the specifications should contain certain details covering the performance of the cruiser, guns, and projectiles, not included in the act.

Very respectfully, your obedient servants,

J. A. HOWELL,
Captain, U. S. Navy.
C. F. GOODRICH,
Commander, U. S. Navy.
R. B. BRADFORD,
Lieutenant-Commander, U. S. Navy.

Hon. W. C. WHITNEY,
Secretary of the Navy,
Navy Department, Washington, D. C.

E.

NEW YORK, June 29, 1886.

DEAR SIR: Agreeably to the expressed wish of the Board, of which you are the senior member, I beg to submit a brief statement of the distinctive features of our pneumatic dynamite gun.

(1) In this gun we developed and have now in actual service an improved system for the use and control of air under high pressure for projecting missiles.

(2) We maintain a pressure of 1,000 pounds or more per square inch in reservoirs for such length of time as the exigencies of actual service may require, and this power is absolutely subject to control.

(3) We project explosive gelatine or other high explosives in large quantities and over a comparatively long range, and we do this with safety, rapidity of fire, and great accuracy.

(4) By electric fuses of proved uniformity of action we explode the shell containing the explosive either by impact or at will, after submersion in water to a desired depth.

(5) We are doing with success what neither Government nor individuals have been able heretofore or now to accomplish, although it has been the subject of extended trials for years.

(6) The gun and its appurtenances are of such character, that they can be manufactured in any of our large iron works and machine-shops.

(7) We claim that in this gun we have a now and valuable auxiliary arm for coast and harbor defense, and we submit with this a design for a vessel carrying three guns of large caliber, capable of projecting shells containing 200 pounds of explosive gelatine or other high explosive over a range of not less than one mile.

We are ready to undertake that the vessel shall have a speed of 20 knots per hour, and that the guns shall perform the service above mentioned, and that the rate of

firing shall not be less than one shell each two minutes, and that the cost of vessel and armament shall be reasonable, judged by the cost of vessels of similar power and ordinary armament.

(8) We claim that swift-moving vessels with the armanent mentioned would prove to be of incalculable value in resisting an attack of the most powerful of modern iron-clads.

Faithfully, yours,

Capt. J. A. HOWELL, U. S. N.,
Naval Advisory Board, Washington, D. C.

S. D. SCHUYLER,
President.

F.

NAVY DEPARTMENT,
Washington, March 14, 1887.

SIR: The recent appropriation act covers a sum for experimental purposes in such terms that I can now propose a thing which I have long desired.

The dynamite gun seems to be a most formidable weapon. I should like to see it destroy something a mile distant.

Will you quietly arrange for a proper experiment that will illustrate satisfactorily the efficiency or the inefficiency of this gun.

If it is as destructive as it ought to be, judging from the tables where the destructive qualities of torpedoes is given, it can show it practically.

It may fail in efficiency for some cause not apparent to the eye of reason, and in my experience an actual practical test is about the best judge.

Very respectfully,

W. C. WHITNEY,
Secretary of the Navy.

Capt. J. A. HOWELL, U. S. N.,
President Board, Washington, D. C.

G.

NAVY DEPARTMENT,
Washington, April 20, 1887.

SIR: Referring to my letter addressed to you on the 14th of March; I intended that the dynamite gun should have an opportunity of testing its efficiency by blowing up some object at a distance. It is claimed that the present gun has a certain destructive power. I desire that this power may be tested, not the ultimate extreme claim for the gun, unless the company wish it. The company should say what the present gun will certainly do. Will it destroy anything? If so, under what conditions? Then let it be tried on those conditions, and its ability tested to accomplish the object claimed.

Very respectfully,

W. C. WHITNEY,
Secretary of the Navy.

Capt. J. A. HOWELL,
Senior Member of the Pneumatic Dynamite Gun Board.

H.

PNEUMATIC DYNAMITE GUN COMPANY,
New York, April 22, 1887.

DEAR HOWELL: I have yours of the 20th, and shall be very glad to meet you and the other members of the Board on the 28th, as suggested. You ask me to say what our present gun will do. It will throw 100 pounds of No. 1 dynamite, explosive gelatine, or an amount of gun-cotton equal in bulk, or any other of the high explosives, and to a distance of at least 1 mile, with accuracy and safety. The charge can be immediately exploded on striking the target or on immersion at any desired depth under water.

What we have never had an opportunity of testing is the effect of the explosive of a large charge upon any particular object. If the Government will supply us with a tube for our present gun of sufficient size and other necessities to throw from 100 to 400 pounds of dynamite, explosive gelatine, or gun-cotton, and a target, say one of

the old monitors or any old vessel, or any target representing one, we will gladly undertake to drop and explode the charge on, in, or about it, where it will do the most good or the most bad as the case may be.

Hoping for such an opportunity, I am, very truly, yours,

S. D. SCHUYLER.

I.

PNEUMATIC DYNAMITE GUN COMPANY,

New York, April 28, 1887.

DEAR SIR: In further answer to yours of the 20th instant, and particularly to the questions, "Will it destroy anything;" and, if so, "Under what conditions," I will state that the 8-inch gun which we now have will, at a range of at least 1 mile, destroy any vessel now in the U. S. Navy, and with guns of a larger caliber, which we are prepared to construct, we will destroy any war vessel that is or can be built.

We claim further for this gun a two-fold field of action. (1) Against the over-water hull by direct impact; (2) against the under-water hull by torpedo action.

We would like as a target any war vessel of the U. S. Navy, preferably one of the monitors, but should it not be feasible to obtain a suitable naval vessel, any floating target having a size equivalent to that presented by an average-sized war vessel would be satisfactory to our company in making any trials which the Secretary of the Navy may desire to have made.

Very truly, yours,

S. D. SCHUYLER,

President.

Capt. J. A. HOWELL, U. S. N.

J.

NAVAL CONSTRUCTOR'S OFFICE,

Navy-Yard, New York, September 15, 1887.

SIR: In obedience to your order of the 12th instant, I would respectfully report that I have examined the *Silliman*, and find her in fair condition as to strength.

Her dimensions are as follows: Length, 79 feet; breadth, 22 feet; depth, 8 feet 6 inches. If filled with water she would sink. There is 12 or 13 tons of kentledge in her hold, which should be removed. Girt for chains, each 40 feet. Three fathoms of buoy rope is required for each chain.

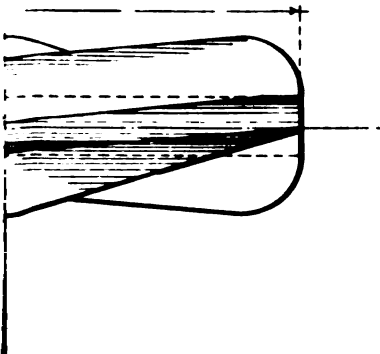
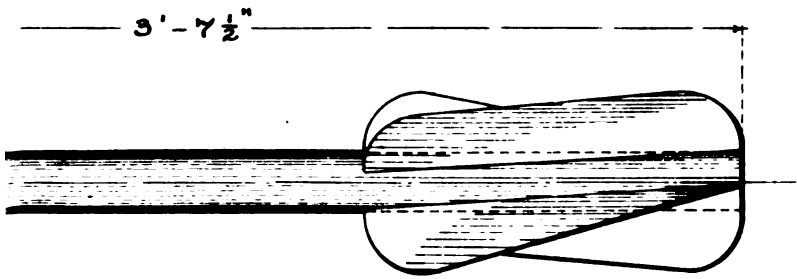
Very respectfully, your obedient servant,

JAS. R. MCGEE,

Master Shipwright in Charge.

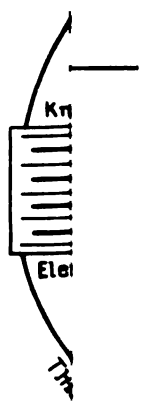
Rear-Admiral BANCROFT GHERARDI, U. S. N.,

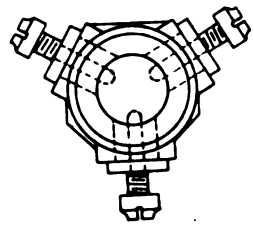
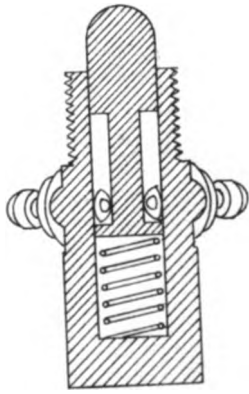
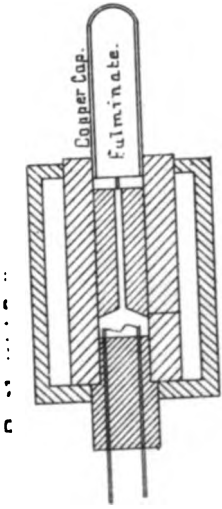
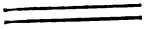
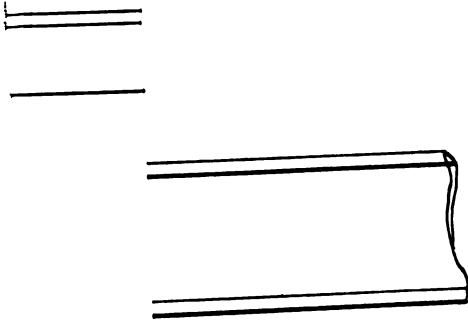
Commandant, Navy-Yard, New York.



PNI

ody

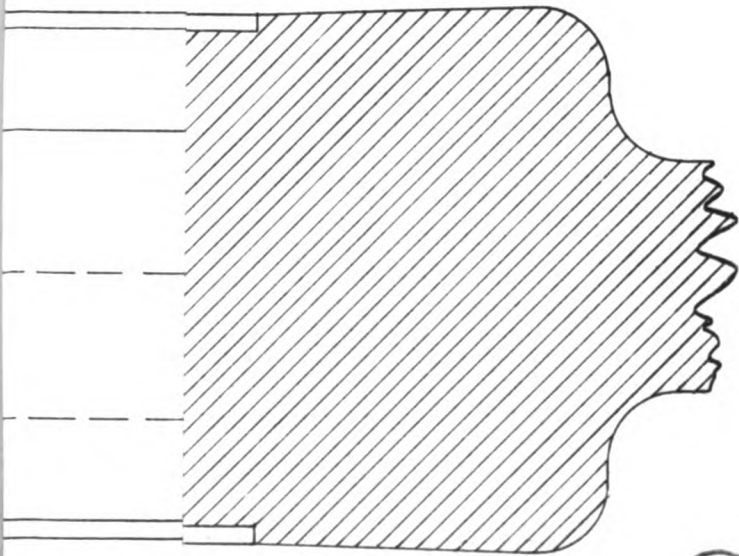
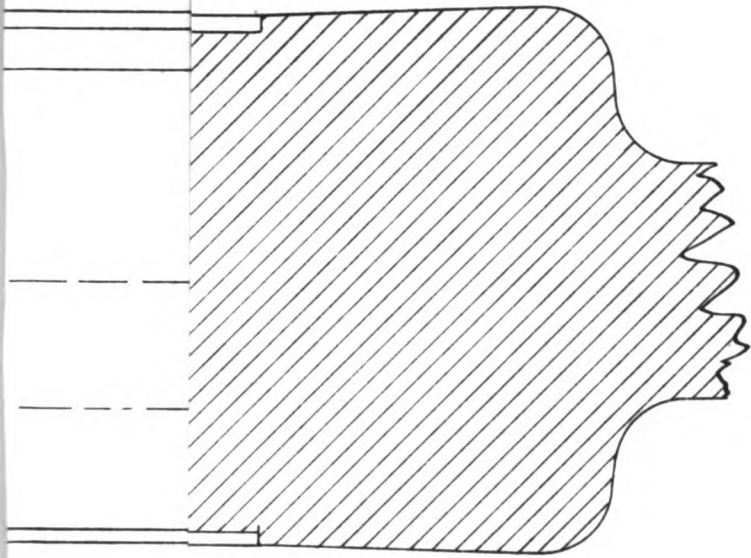




Circuit Breaker.







PAPERS ACCOMPANYING THE REPORT.

	Page.
Estimates submitted by the Secretary of the Navy	1
Sale of condemned vessels	8
Deposits from sales of condemned property	10
Detailed movements of vessels	16
Report of the Admiral of the Navy	27
Report of the Board of Visitors	71
Report of the Superintendent of the Academy	79
Bureau of Yards and Docks, report of	94
Bureau of Equipment and Recruiting, report of	128
Bureau of Navigation, report of	145
Bureau of Ordnance	230
Bureau of Construction and Repair, report of	286
Bureau of Steam Engineering, report of	340
Bureau of Provisions and Clothing, report of	397
Bureau of Medicine and Surgery, report of	416
Marine Corps	451
Steel-gun forgings and armor-plates	459
Concentration of stores, Captain Brown's report	476
Pneumatic dynamite-gun report	483

SUBJECT INDEX, SECRETARY'S REPORT.

	Page.
Armor and gun-steel, contracts entered into, for	IV, XXXI
manufactories required for, for iron-clads	III
Armor-clad vessel, design of Barrow Ship-building Company	IX
American ship-builders, ability of	VIII
Armored ships of the Navy, number and condition	XXXV
Appropriations and expenditures, 1886-'87	XIX
Armstrong guns, results of recent trials	XXIV
Admiral of the Navy, notice of the report of the	XXVII
Apprentice system, progress in	XXXI
new vessels needed for	XXXII
Armament of new ships, estimates for	XXI, XXIX
Bethlehem Iron Company, contracts made with	IV, XXIX
Barrow Ship-building Company, designs of the	IX, XXXVI
Bessemer steel castings, contracts for	XXVII
Belleville boilers, experiments with	XXXIII
Coast and harbor defense, subject considered	X
Condemned vessels, sale of and receipts from	XXI
property, sale of and receipts from	XXII
Construction and Repair, Bureau of, notice of report of Chief of	XXXIV
Double-turreted monitors, completion delayed	X
Dynamite projectiles, power of, recognized	XI
gun (pneumatic) development of	XIV, XXIV, XXXVII
Driggs-Schroeder rapid-fire gun, constructed	XXIV
Dupont gunpowder, good results from	XXIV
Expenditures, fiscal year 1886-'87	XIX
Estimates and appropriations, 1888-'89	XX
Equipment and Recruiting, notice of report of Chief of Bureau	XXXI
Forbes, J. M., courtesy of	XXXIII
Fortification board, reference to report of	IV
Fish Commission, men for the	XXXII
Gun-foundry board, investigations of	IV
Gun factory, Washington yard, progress in	XXX
Gulf Coast, improvement of naval facilities on	XXVIII
Hartford, appropriation for repairing, insufficient	XII, XXXV
Hotchkiss Company, arrangements with	V, XXIV, XXIX, XXX
Howell torpedo, remarks upon	XXVII
Hydraulic boiler-making outfit, necessity for	XXXIV
Hydrographic Office, notice of report of	XXXIX
Hall's torpedo, remarks upon	XXVII
Increase of the Navy, new vessels completed and under construction	V, VI, XLV
appropriations estimated for	XXI, XXIX
authority to construct three cruisers asked	XXII
Monitors, double-turreted, completion delayed	X
single-turreted, repair of, not recommended	XII
useless against modern iron-clads	XII
Midvale Steel Works, contracts with	XXXIX
Mare Island, repairing facilities needed at	XXXV
Medicine and Surgery, notice of report of Chief of Bureau of	XLIII
Marine Corps, notice of report of Colonel Commandant	XLIII
increase of, recommended	XLIII
New Navy, difficulties in creating	III
manufactories necessary for	III
vessels finished and under construction	V, XXXV

	Page.
New Navy, ability of American ship-builders to construct vessels.....	VIII
additional vessels recommended.....	XXII
Naval stores, consolidation and results.....	XI, XXXVII
Naval reserve, public feeling exists for creating a.....	XV
Department prepared to formulate plan.....	XVI, XXXIX
subsidies as an incident thereto.....	XVI
Nordenfelt's sub-marine torpedo-boat, trial of.....	XXVI
Navigation, Bureau of, notice of report of Chief.....	XXXVIII
Naval Ordnance Proving Ground, site not selected.....	XXIX
Naval Observatory, report of Superintendent, noticed.....	XLI
Naval War Records, publication of, urged.....	XLI
Naval Academy, notice of report of Superintendent.....	XLI
New cruisers. (See New Navy.)	
Old vessels and materials, sales of.....	XXI, XXII
Ordnance Bureau, notice of report of Chief of.....	XXVIII
Observatory, Naval, report of Superintendent noticed.....	XLI
Pneumatic dynamite gun, development of.....	XIV, XXIV, XXXVII
Gun Carriage Company, negotiations with.....	XXXI
Projectiles of steel, trials of.....	XXIV
Powder, Du Pont's, good results from.....	XXIV, XXX
Patrick torpedo, remarks upon.....	XXVII
Provisions and Clothing, notice of report of Chief of Bureau.....	XXXVII
Puget Sound, additional naval facilities needed at.....	XXVIII
Rapid-fire guns, development of.....	XXIV
revolving cannon, home manufacture of.....	XXIV
Secondary batteries, steps taken to provide.....	IV
arrangements with the Hotchkiss Company.....	V, XXX
Single-turreted monitors, repair of, not recommended.....	XII
Steel manufacturers, correspondence opened with.....	IV
Steel-wire nets, protection against torpedoes.....	XXVII
Steel manufactured on Pacific coast, fine quality of.....	V
Steam-Engineering Bureau, notice of report of Chief.....	XXXII
Steam tests, developments of the year.....	XXII
<i>Stiletto</i> , official trial of torpedo-boat.....	XXX
Steel forgings, manufactories required for.....	III
contracts made for.....	XXXI
Ship-builders, American, ability of.....	VIII
Ship-building, torpedo, in foreign countries.....	XXV
Squadrons, commanders and movements of.....	XVII
Torpedo boats, proposals to construct.....	X
views on subject of.....	X
constructed abroad.....	XXV
partial protection of machinery of.....	XXVI
transportation of, by rail.....	XXVI
experiments with submarine.....	XXVI
protection against.....	XXVII
Torpedoes, trials of, by order of Department.....	XXVII, XXX
<i>Tennessee</i> , expenditure of money on.....	XIII
Torpedo station, investigations and training at.....	XXX
Target practice, register of, by instantaneous photography.....	XXXI
Tugs, necessity for additional.....	XXXV, XXXVIII
Vessels of war in commission, statement of.....	XVII
condemned and sold.....	XXI
development in construction abroad.....	XXIII, XXV
wooden, deterioration of.....	XXXV
finished and under construction.....	VI, XXXV
authority asked to construct additional.....	XXII
War records, publication of, urged.....	XLI
Wire netting as protection against torpedoes.....	XXVII
Yates, Capt. A. R., training service carried on by.....	XXXI
Yards and Docks, notice of report of Chief of Bureau of.....	XXVII

INDEX TO APPENDIX.

	Page.
Abbott, General H. L., U. S. Army, lecture at War College.....	164
Advertising, limit as to extent of, suggested.....	400
sale of vessels, amount paid for.....	8
Admiral of the Navy, annual report of.....	27
Alcoholic stimulants, study of effects of.....	79
Aldrich, Hon. N. W., member of Board of Visitors.....	71
Allen, W. H., Lieutenant, transit work at Observatory.....	211, 213
Amsden, Lieut. C. H., duty in Nautical Almanac Office.....	229
Ammunition, tests and procurement of.....	231, 237
Anchor shop, Washington yard, work performed at.....	129
<i>Antieta</i> , unfit for quarters for marines.....	452
Apprentices, training of, at Coaster's Harbor Island.....	130
number and distribution of.....	130
clothing outfit for, recommended.....	134
promotion to grades of the line suggested.....	135
movements of vessels for training.....	26
Argentine Republic, subsidies granted by.....	66
Armament for <i>Chicago</i> and <i>Boston</i> delayed.....	234, 260
new cruisers, contract with Midvale Company.....	234, 235
for ships of war in service.....	236
Armington & Sims engines used for dynamos.....	159
Armored vessels of the Navy, description of.....	294, 312
battle-ship, description of.....	314
ships, comparison of English and American.....	35
guarding principal ports of Great Britain.....	33
heavy, needed to protect coast.....	34
Armor plates, requirements of, proposals for.....	459
proposals of Bethlehem Iron Company.....	464
Cleveland Rolling Mill Company.....	465
contracts with Bethlehem Iron Company.....	470, 473
decision upon awards.....	474
Armor-piercing projectiles, chrome steel for.....	232
<i>Atlanta</i> , movements of.....	16
compensating binnacles placed on.....	156
magnetic condition of.....	156
lighted by electricity.....	159, 160
description of.....	296, 337
search-lights used on.....	162
test of the guns of.....	231, 260
payments on machinery of.....	341
cost of work on, by Steam-Engineering Bureau.....	364
condition of.....	366
Atlantic harbors, defenseless condition of.....	32
Asiatic Station, movement of vessels on.....	24
Astronomical work at the Observatory.....	211
Congress at Paris, participation in.....	216
Auxiliary Navy, views of the Admiral.....	49
Chief of Bureau of Navigation.....	148
Baltimore, hydrographic branch office, report of Lieutenant Graham.....	204
<i>Baltimore</i> , new cruiser, description of.....	296, 325
progress of work on.....	306
Barge office, New York, transfer to Navy recommended.....	147

	Page.
Barometers, holosteric, examined at Observatory	223
Bartlett, Commander J. R., hydrographic report of	165
Bellevue boiler, remarks concerning	350
Bethlehem Iron Company, proposals for gun forgings	463
contract for gun forgings	466
correspondence with	473
proposals for armor plates	464
contract for armor plates	470
Binnacles, compensating, vessels in which used	145
Binoculars examined at the Observatory	223
Bliss, Lieut. T. H., U. S. Army, lectures at War College	164
Board of Visitors to the Naval Academy, report of	71
Boiler construction, remarks concerning	347
Bonds of disbursing officers, corporate sureties recommended	402
return of all, suggested	402
Book-keeping, approved methods adopted	399
Books and pamphlets, in division of issue, Hydrographic Office	184-186
Boston, Hydrographic Branch Office, report of Lieutenant Downes	190
<i>Boston</i> , steel cruiser, description of	296, 337
Bradford, Lieutenant-Commander R. B., report on electric lighting	157
Bradbury, Lieut. C. A., work on gun-carriages	233
Braine, D. L., rear admiral, commanding South American squadron	19
Brown, Capt. George, report on concentration of stores	476
Brown, Prof. S. J., work at the Observatory	211
Brown, William M., computer at the Observatory	211
Brown, Commander A. D., report on instruments	211
Brush system, electric lighting, use of	160
Buoys, uniform system, international congress recommended to establish	150
Cadet engineers, dropped and restored, promotion recommended	343
Cadets' clothing fund, appropriation should be legalized	401
Calkins, Lieut. C. C., lectures of, at War College	164
Campbell, Commander Charles R. N., notice of lecture by	146
Cambria Iron Company, proposals for gun forgings	460
correspondence with	473
Cannon for steel cruisers	230
Carriages, gun, for the steel cruisers	232
progress in manufacturing	233, 234
Cartridges, metallic, procured by Bureau of Ordnance	233, 261
<i>Charleston</i> , new cruiser, description of	296, 323
Chart construction, force on, and work performed	165
report of Lieut. Charles Laird	174
Chandler, Rear Admiral Ralph, commanding Asiatic station	23
Charts, inspection of outfit of, for merchant vessels	173
Chester, Commander C. M., soundings by	171
Charts, list of, prepared in Hydrographic Office	175, 176, 177, 178
Charts issued and received	182, 183
Chase, Ensign V. O., work at the Observatory	211
<i>Chicago</i> , steel cruiser, description of	296, 323
electric lights for	145, 160
search lights for	162
China, extension of trade with	60
Chronometers, authority wanted to destroy unserviceable	148
report of Lieut. S. C. Paine on	217
Civil establishment, estimates and expenditures for, Yards and Docks	106, 107, 114, 115
Equipment and Recruiting	136
Navigation	153, 155
Ordnance	244
Construction and Repair	291
Steam Engineering	371
Provisions and Clothing	413
Cleveland Rolling Mill Company, proposal for forgings	465
Clinometers, patent examined	223
Chrome steel for armor-piercing projectiles	232
Clark's deflection turret, preparations for test of	261
Clark, Past-Assistant Paymaster F. H., clerk at Torpedo Station	261
Clements, Ensign A. H., work at the Observatory	211

	Page.
Coffin, Commander G. W., information furnished by, to Hydrographic Office	172
<i>Constellation</i> , practice ship, cruise of	91
Construction and repair, report of chief of bureau	286
assistant to, recommended	286
chief draughtsman, increase of salary asked for	286
estimates for	291
expenditure of appropriations	272
proposals and contracts	273
Continuous-service men, special instruction for	238, 271
Contingent, deficiency estimate for ordnance	255
Contracts entered into by Secretary's office	7
yards and docks	117
navigation	154
equipment and recruiting	137
ordnance	244
provisions and clothing	410
construction and repair	293
medicine and surgery	432
steam engineering	372
Naval Academy	85
Marine Corps	454
Converse, Lieut. G. A., services under Bureau of Ordnance	240, 261
Conway, Lieut. W. P., report on branch Hydrographic Office, Philadelphia	202
Cornwell, Lieutenant, publication of his lecture	146
recommendation for binnacles	157
Cottman, Lieut. V. L., report on branch Hydrographic Office, New York	193
Couden, Lieut. A. R., services in Bureau of Ordnance	237
Cranes, traveling, for gun factory	235, 252
Clothing outfit for apprentices recommended	134
fund for cadets, appropriation for	401
suggestions to prevent depletion	400
condition of	403
Coasters Harbor Island, progress at training station	130
purchase of cottage at, recommended	135
estimates for	136, 153
Coal for steamers, purchased by Bureau of Equipment and Recruiting	129
Colts' Patent Fire-Arms Company, sample of pistol made by	234, 261
Color-blind, ratio in those examined	431
Compasses repaired and purchased	145
report of superintendent of	150
Compass houses, care of, by Observatory	223
Condemned vessels, sale of	8
property, sale of	10, 141, 251, 412
Cooper, Admiral Mason S., San Domingo navy, information furnished by	172
Dangers, "reported," vessels needed to examine	173, 180
Davenport, Lieut. H. G., report of book division, Hydrographic Office	184
Day, Commander B. F., information furnished Hydrographic Office by	172
Davis, Commander G. T., soundings made and information furnished by	171
Dean, Medical Director R. C., lectures at War College	164
Defenseless harbors, United States coast, list of	32
Defective turret, Clark's, preparation for trial of	261
Deep-sea surveys of Pacific suggested	173
soundings completed and being compiled	180
Denfield, Ensign G. W., services at torpedo station	264, 265
Derelicts, suitable vessels needed to destroy	148, 173
list of destroyed	189
Dewey, Capt. G. W., information furnished Hydrographic Office by	172
Distances computed by Hydrographic Office	180
Disbursing officers' bonds, corporate sureties advised,	402
return of old, suggested	402
Davis, Commander C. H., commanding training squadron	131
Davis, Rear Admiral John Lee, relieved from command Asiatic station	23
Diseases treated in the Navy, exhibit of	419
<i>Dolphin</i> , dispatch boat, description of	296, 338
Double-turreted monitors, appropriation for	
Downes, Lieut. John, report of branch Hydrographic Office, Boston	190

	Page.
Driggs, L. A. H., rapid-firing gun of	261
Dry-dock, Mare Island, progress of work on	98
Du Pont's powder, tests of, for 6 and 8 inch guns	231
Dyer, Lieut. G. E., assistant hydrographer, services mentioned	174
Dynamite gun, pneumatic, report of trials of	483
instructions as to trials of	497
Dynamite cruiser, progress of work on	307
description of	334
Dynamos, for electric lighting, location on ships	146, 159
selection of proper type	241
Eastman, Prof. J. R., work at the Observatory	211
East India trade, control of	58
Edison system electric lighting, use of	159, 160
Electricity, ships now lighted by	159
as a maneuvering power for guns	241
Electric lighting, report of superintendent in charge	145
at torpedo station	241
Electrical laboratory at Newport, progress at	263
Electric-light plant for the <i>Chicago</i>	145
schedule of bids for	154, 155
Electrotyping in the Hydrographic Office	178
Elliott, Lieut. Wm. P., work at the Observatory	211
Engineers' yeoman, assignment of duties to	30
Engineers, education of midshipmen and others, as	30
Engraving for the Hydrographic Office by contract, condemned	171
Enlisted men of the Navy, number and distribution	132
advanced course of instruction for	133
Engineer-in-Chief, report of G. W. Melville	340
Engineer Corps, remarks of the Admiral of the Navy, as to	28
increase of passed assistants, recommended	342
system of appointment, needs changing	343
rank of graduates, not equal to the line	343
duties of, on board ship, arrangement of	344
instruction of, abroad, should be continued	344
force (Engineer's) on ships inadequate	345
needs pointed out	345
communication with, on board ship	351
at stations	354
Enlisted men of the Navy, number and distribution of	132
advanced course of instruction for	133
temporary home for, re-enlisting	133
retirement of, recommended	134
administration of the oath to	134
promotion of, to the line	135
savings-bank system for, recommended	134
Estimates and expenditures, Secretary's Office	1
Naval Academy	53, 88
Yards and Docks	107-117
Equipment and Recruiting	136
Navigation	150
Naval Observatory	152
Nautical Almanac	152
Hydrographic Office	157
War Records and Library	150
Ordnance	230, 253
Steam Engineering	371
Provisions and Clothing	413
Medicine and Surgery	417
Marine Corps	453, 456
Equatorials, work performed with, at Observatory	213
Equipment and Recruiting, report of Chief of Bureau	128
estimates of the Bureau	128
schedules of offers and contracts	137
sale of old materials	141
European station, movements of vessels	20
Examinations for entry into naval service, number of	431

	Page.
Experimental Board at Torpedo Station	270
for Navy, revival recommended	351
Fillmore, Ensign J. H., organization of chart division, Hydrographic Office	166
Fish Commission, surveys and soundings by vessels of	172
supply of seamen to	133
Floating wrecks, vessels needed to destroy	148
Forbes, J. M., offered his yacht for experiments	350
Forge and anchor shop, Washington, work at	129
Forgings for cannon, contracts for	230, 252
France, subsidies granted by	64
Franklin, S. R., Rear-Admiral, detached from command European station	20
French Geographical Society, information furnished Hydrographic Office by	172
Frisbee, Edgar, Prof., work at Observatory	211
Froude, W. R., resistance of ships, publication of his papers	146
system recommended	287
Fuzes, improvements made in	234
Gardner, Wm. F., instrument-maker at Observatory	211
Gatewood, Naval Constructor, R., lectures at War College	164
General maintenance, estimates and expenditures	104, 109, 113
General storekeeper's department, organization of	481
Germany, subsidies granted by	64
Gilman, Hon. D. C., member of Board of Visitors	71
Gnomonic charts, progress of work on	180
Goff, Hon. Nathan, member of Board of Visitors	71
Goodloe, Maj. G. Clay, estimates submitted by	452
Goodrich, Commander C. F., report of Torpedo Station	242
Gove, Commander L. A., Chilean navy, information furnished by, to Hydrographic Office	172
Graham, Lieut. S. L., report of branch Hydrographic Office, Baltimore	204
Graham, Commander J. D., information furnished Hydrographic Office by	172
Gray, Hon. George, member of Board of Visitors	71
Great Britain, subsidies granted by	64
ship-building in	64
Green, Commander F. M., information furnished by, to Hydrographic Office	172
Greer, Rear-Admiral J. A., commanding European Station	20
Gun-boats 1, 2, 3, and 4, description of	330, 333
Gun-carriages, progress in constructing	233, 234
pneumatic, designs submitted	240
hydraulic, nearly completed	233
Gun-cotton, use of, as an explosive	241, 262
factory, larger, needed at Newport	235
Gun-factory, Washington yard, progress in constructing	235, 257
report of Civil Engineer Menocal	236
remarks of Chief Constructor Wilson upon	290
Gun-forgings, requirements of, for proposals	459
proposals for	460
contracts for, with Bethlehem Iron Company	466
correspondence regarding	473
decision upon awards	474
Gunnell, Surgeon-General F. M., annual report of	416
Hall, Prof. Asaph, work at the Observatory	211
Harbors, defenseless condition of, on United States coast	32
of Great Britain, iron-clads defending	33
Harkness, Prof. William, report on Transit of Venus	223
Harmony, Commodore D. B., member of Board of Visitors	71
report as Chief Bureau Yards and Docks	94
Harrington, Commander P. F., lectures at War College	166
Hartford, appropriation needed to complete repairs	287
Hawley, Lieut. J. M., information furnished Hydrographic Office by	172
Hayden, Ensign Everett, report on Marine Meteorology	187
Hazing, cases of, at Naval Academy	79
Heilner, Lieut. L. C., work at the Observatory	211
Hemp purchased by Bureau Equipment and Recruiting, quantity and cost	128
Herbert, Hon. H. A., member of Board of Visitors	71
Herrle, Gustave, charts designed by	166
Hodges, Lieut. B. W., work at the Observatory	211

	Page.
Hoff, Commander W. B., lectures at War College	164
Holman, Lieut. G. F. W., services at Torpedo Station	261, 264
Hospital at Annapolis, conversion into quarters	82
fund, condition of	417
Hospitals, increased appropriations needed for	418
Hotchkiss Ordnance Company, arrangements with	233, 261
Howison, Capt. H. L., information furnished to Hydrographic Office by	172
Howell Torpedo Company, finished torpedo of	238
Howell, Capt. J. C., report on pneumatic dynamite trials	497
Hunt, R. M., architect of new Observatory, preparing plans	148, 216
Huntington, Commander C. H., commandant of cadets, report	91
Hutchins, Lieut. Hamilton, work at Torpedo Station	261, 264
Hydraulic gun carriage, nearly completed	233
Hydrographic Office, report of Commander Bartlett	165
estimates for support of	151
additional room needed for	149, 172
additional branch offices required	174
former recommendations renewed	172
information furnished by merchant vessels	172
reports of officers in charge of branch offices	190, 193, 202, 204, 206, 207
Hydrographic information, officers and others who furnished	172
Ice for Navy Department, contract for	7
Increase of the Navy, estimates for construction and repair	292
description of new vessels	296, 352
Ingersoll, Lieut. R. R., member of Examining Board, Torpedo Station	273
Insane of the Navy, condition of	419
Inspection and survey, work of Board	67
Instrument Department, Steam Engineering, establishment of, recommended	351
Iron, English and American, comparison of	39
Iron cranes, Mare Island, completion of	98
Iron-clad vessels of the Navy, condition of	68-70
Iron and steel vessels of the world, list of	56
Iron ship building at home and abroad	61-65
Italy, subsidies granted by	65
Iverson, Lieutenant-Commander, leather board paper shield of	261
Jackson, C. W., secretary French Geographical Society, information furnished to Hydrographic Office by	172
Japan, extent of trade with	60
Jewell, Commander T. F., soundings made and information furnished by	171
Kefnpff, Commander L., information furnished Hydrographic Office by	172
Kennedy, Lieut. Duncan, lecture at War College	164
spiral pointed projectile of	261
Kimball, Lieut. W. W., services in Bureau of Ordnance	237
Kimberly, L. A., Rear-Admiral, commanding Pacific Station	21
Kirkland, Capt. W. A., commanding receiving-ship <i>Vermont</i>	132
Knight, Lieut. A. M., services at Proving Ground	237
Laird, Lieut. C. H., report on chart construction	174
Lefavor, Lieut. F. H., information furnished Hydrographic Office by	172
Letzke, Lieutenant, commended by Commander Huntington	93
Library Navy Department, purchase of books for	146
former recommendations renewed	149
estimates for	150, 151
of Observatory, volumes in	216
Hydrographic Office	184
Naval Academy, condition of	78, 80
at Torpedo Station	264
Libraries of cruising ships, books added to	146
Little, Lieut. McCarty, lecture at War College	164
Littlehales, W. G., work on magnetic variation, etc.	165, 179
Logan, Hon. Thomas L., member of Board of Visitors	71
Longitudes, work on, by W. G. Littlehales	179
Lower California, soundings off	146, 171
Lowry, Major H. B., estimates submitted by	453
Luce, Rear-Admiral S. B., commanding North Atlantic Station	16

	Page
Machinery (steam), instructions for care of, not observed	351, 352
suggestions as to inviting proposals for	352
surveys on, board should be engineers	349
should be in charge of engineers	348
more frequent inspections needed	348
more frequent trials required	349
of the monitors, condition of	347
Machinists on vessels, increase demanded	345
Machinists, better provision for, on berth deck	346
Machine guns and cannon, steps taken to procure	233
Magnetic variations, investigation by G. W. Littlehales	179
Mahan, Capt. A. T., report on, Superintendent of War College	163
lecture at War College	164
Marine Corps, report of colonel-commandant	451
number and disposition of enlisted men	451
of officers, active and retired	451
increase in higher grades recommended	451
force of second lieutenants inadequate	451
increase of 500 men necessary	451
new barracks at Norfolk and League Island needed	451
estimates for	453-456
proposals and contracts	454
Marine engines of high speed, experiments needed	350
Marine meteorology, report of Ensign Hayden on	187
work of division of	168
Mariners, notices to, issue of, etc	168, 187, 188, 190, 192
Mare Island yard, ship-building tools needed at	289
as a ship-building center	288-293
Mason, Lieut. N. E., work of, on gun-carriages	233
Mayer, Ensign A. N., work at the Observatory	211
McCaughey, Rear-Admiral E. Y., relieved from command Pacific stations	21
McCawley, C. G., colonel-commandant Marine Corps, report of	451
Medals and prizes for best target-practice suggested	239
Medicine and Surgery, report of Chief of Bureau of	416
estimates of Bureau	416
proposals and contracts	432
Medical Corps, condition and needs of	419
Medical statistics of the Navy, tabulated exhibits	419
Meigs, Lieut. J. F., lectures at War College	164
Menocal, Civil Engineer A. G., report on gun factory	257
Merchant marine, necessity for reviving	43-66
seaman, enrollment of, advocated	43-66
vessels, utilization of, for war purposes	31
Metallic cartridges, procured by Bureau of Ordnance	233
Mexican coast, publication of charts of	153
Miantonomoh, guns for the	235
Midvale Steel Company, contracts made with	230, 233, 234
proposals for forgings	465
Miller, Capt. J. N., commanding receiving-ship <i>Wabash</i>	132
Milton, Lieut. J. R., report of, branch hydrographic office, San Francisco	207
Mines for naval defense, design for	241
Monadnock's boilers, disposition by sale recommended	348
Monitors, suggestions of Bureau of Construction and Repair as to the	287
description of, in the Navy	294
Miantonomoh and class, description of	318
Puritan, description of	316
conditions of boilers of	347
changes for improvement suggested	348
proposals for armor-plate for	464, 466
contracts made	470
Morgan, Col. A. S., member of Board of Visitors	71
Munroe, Prof. C. E., chemist at Torpedo Station	261
Murdock, Lieut. J. B., services at Torpedo Station	261
Museum of Hygiene, investigations at	419
Nautical Almanac, estimates for office of	152
preparation and publication of	147
estimates for office of	150

	Page.
Nautical instruments, report of Commander A. D. Brown	222
Naval Academy, report of Board of Visitors	71
superintendent	79
commandant of cadets	91
additional ground needed for	82
cadet clothing fund	401
new practice-ship needed at	76, 81
Naval Asylum, suggestions for improvement of	102
estimates and expenditures	100, 101, 104, 107
Naval Asylum, beneficiaries on the rolls	101
administration of Captain Skerrett	101
Naval hospitals, increased appropriations needed for	418
Naval Hospital, Annapolis, conversion into quarters	75, 82, 84
Widows Island, completion	418
fund. condition of	417
Naval intelligence office, report of, demand for	198
Naval Observatory, estimates for	152
astronomical work performed at	148
plans for new, completed and approved	148, 216
report of Superintendent Phythian	211
Naval reserve, suggestions concerning	43, 148
Naval War College, building partially repaired	146
opening of third session	147
report of Superintendent Mahan	163
Naval War Records, preparation for publishing	146
former recommendations renewed	149
estimates for office of	150
Navesink Highlands, electric light at, needed	195
Navigation, Bureau of, report of Chief	145
estimates and expenditures	150
proposals and contracts	154
supplies, increased appropriations needed	149
Navy, auxiliary, importance of	47
Navy Regulations, new set needed	27
reorganization, necessity for	66
Navy-yards, general condition and needs of	95-100, 289, 353
Navy-yard reorganization, report of Captain Brown	476
Nelson, Commander T. A., information furnished Hydrographic Office by	172
<i>Newark</i> , description of new cruiser	296, 319
Newell, Lieutenant-commander, services at Torpedo Station	261
Newcomb, Professor Simon, report, of	226
New cruisers, description of	296, 352
progress of work on	306
New Orleans, branch hydrographic office, report of	206
New York branch Hydrographic Office, report of Lieutenant Cottman	193
Niles, Lieut. N. E., report of, supply division, Hydrographic Office	181
North Atlantic Station, movements of vessels on	46
Notices to Mariners, work performed in division	168, 187
Oath, administration of, to enlisted men	134
Observatory. (<i>See</i> Naval Observatory)	
Ocean surveys, estimates for	153
prosecution of	146
Octants, examined at Observatory	222
Official intercourse and communication, Engineer-in-Chief's remarks	348, 351, 354
Oil on waters, suggestions as to use of	169
Old materials, sale of, Auditor's statement	10
Bureau of Equipment and Recruiting	141
Provisions and Clothing	412
through proposals suggested	398
statutory boards on	398, 477
Ordnance, necessity of heavy, for coast defense	32
Ordnance, Bureau of, report of Chief	230
appropriations for	243
expenditures for labor	243
civil establishment	244
proposals, and contracts entered into	244

	Page.
Ordnance, Bureau of, estimates for	253
increased clerical force needed	242
deficiency estimate	255
Ordnance Proving Ground, work executed at	237, 260
suitable site not selected	237
Pacific coast, defenseless condition of	39
Station, movement of vessels on	21
Paine, Lieut. S. C., report on chronometers	217
engaged on time service and chronometers	211
Parker, Lieut. W. II., report of, Notices to Mariners	187
Patrick torpedo, furnished for trial	238
Paul, H. M., assistant astronomer at the Observatory	211
Pay Corps, ten additional assistants recommended	401
appointment of graduates from Academy suggested	401
assistants, to higher grades, should be detailed	401
Pay of the Navy, estimate for	2, 3
Pay miscellaneous, estimate for	2
Paymaster-General, annual report of	397
assistant to, recommended	397
Penobscot Bay, establishment of sanitarium at	418
Pensioners for long service, number of	132
Personnel of the Navy, reorganization needed	67
Pension cases disposed of by Bureau of Medicine and Surgery	418
Phelps, Gunner A. A., duty at Torpedo Station	261
Philadelphia, branch Hydrographic Office, report of Lieutenant Conway	202
Philip, Commander J. W., commanding receiving ship <i>Independence</i>	133
Photography in recording target practice	233, 239
Phythian, Capt. R. L., report of, Superintendent of Observatory	211
Pilot Chart and weekly supplement, issue of	169, 188, 190, 197, 201
Pneumatic gun-carriage, design submitted	240
dynamite gun, report on trials of	483
correspondence	487
Porter, Admiral D. D., annual report of	27
Navy Regulations, proper set needed	27
Engineer Corps, condition and reforms needed	28-31
Coast defenses, necessity for strengthening	31-43
Merchant seamen, enrollment of, suggested	43-45
Commercial marine, necessity for reviving	45-66
Auxiliary navy, importance of an	49
Subsidies, extent and necessity of	52-65
East Indian trade, control of	59
Encouragement of American ship-building	65
Reorganization of the Navy	66, 67
Board of Inspection, work of	67, 69
Iron-clad vessels of the Navy, condition of	69
Potter, Capt. E. E., information furnished Hydrographic Office by	172
Powell, W. F., chief draughtsman, increase of salary recommended	286
Powder, tests of, for 5 and 8 inch guns	231, 237
Practice ships, Academy, report of cruise	80, 91
new steam vessel recommended	81
Printing and binding, estimates for	2
Prizes for best target practice, appropriation asked	239
Projectiles, manufacture of, at Washington yard	232
by private parties	2, 32
Property, transfer of, from one Bureau to another	477
accountability for	399, 479
Proposals for ice and washing towels	7
Supplies, Naval Academy	85
Yards and Docks	117
Equipment and Recruiting	137
Navigation	154
Ordnance	244
Construction and Repair	273
Provisions and Clothing	402
Steam Engineering	374
Medicine and surgery	432
Marine Corps	452

	Page.
Provisions and Clothing, report of Chief of Bureau of.....	397
Provisions, statement of appropriations for.....	402
<i>Puritan</i> , description of.....	316
Rebellion Records, estimates for office.....	150
preparation for publishing.....	146
former recommendations renewed.....	149
Receiving ships, neat condition of.....	132
Regulations for the Navy, new set needed.....	27
Repairs and preservations at yards, estimates and expenditures.....	103, 105, 110, 112
Repeoid circle, at Annapolis, observations with.....	211
Revenue Marine, cadet graduates recommended for.....	79
Retirement of officers after thirty years service advocated.....	67
enlisted men of the Navy recommended.....	134
Resistance of ships, experimental models to determine.....	287
republishation of Froude's work on.....	146
Richardson, Ensign W. G., work at the Observatory.....	211
Rigging lofts, expenditures at.....	130
Rogers, Lieut. C. C., lecture at War College.....	164
Rohrer, Lieut. Karl, work at Torpedo Station.....	261, 262
Rolling mill, Washington yard, work performed at.....	129
Rolling Mill Machine Company, Simons projectiles.....	232
Rope walk, Boston, operations at.....	129
Sail lofts, work performed in.....	129
Sale of condemned vessels, receipts and expenditures.....	8
Sale of condemned property, receipts from, Auditor's statement.....	10
under Bureau Ordnance.....	251
Equipment and Recruiting.....	141
Provisions and Clothing.....	412
Sampson, Commander W. T., plan of work while at Torpedo Station.....	261
Superintendent Naval Academy, report of.....	82
Sanitarium, established at Penobscot Bay.....	418
San Francisco, branch Hydrographic Office, report of Lieutenant Milton.....	207
proposed force for defense of.....	41
Sayers, Hon. J. D., member of Board of Visitors.....	71
Sawyer, Lieut. G. E., report of, division of issue, Hydrographic Office.....	183
Schaefer, Lieut. H. W., work at the Observatory.....	211
Scheutze, Lieut. W. H., superintendent of compasses, report of.....	155
Schley, Commodore W. S., report of.....	128
Schroeder, Lieutenant, rapid-firing gun of.....	261
Seamanship, importance of, in the Navy.....	25
Seamen, in gun exercises (<i>see also</i> enlisted men).....	238, 271
Secretaries and clerks in the Navy, estimate for pay of.....	6
Search-light, vessel on which used.....	162
Seeley, Capt. H. B., commanding receiving ship <i>Saint Louis</i>	132
Sextants, unserviceable, authority to destroy, needed.....	148
examined at Observatory.....	222
Sharrer, Lieut. W. O., information furnished by, to Hydrographic Office.....	172
Shearman, Lieut. J. A., service at Torpedo Station.....	261
<i>Shenandoah</i> , description and sale of.....	287
Ship-building, preparations for, at Mare Island.....	288, 290
Ship-building, home and foreign, extent of.....	61, 65
Ship-yards, Government, necessity and importance of.....	38
private, importance of fostering.....	38
Sick of the Navy, tabulated exhibits of.....	432
Signal book, publication of, delayed.....	146
Sawyer-Man dynamo placed on the <i>Omaha</i>	159
Simonds Rolling Mill Machine Company, projectiles made by.....	232, 261
Skerrett, Capt. J. S., administration of, Naval Asylum.....	101
Skinner, A. N., assistant astronomer at Observatory.....	211
Small-arms, new designs for.....	234
Small-store fund, condition of.....	404
Snow, Lieut. Commander A. L., member of examining board, torpedo class.....	273
Solar eclipse, observations by Professor Todd.....	147
Soley, Prof. J. R., lectures at War College.....	164
Soundings, deep sea, in Pacific, recommended.....	173
South Boston Iron Works, progress in making guns for the Navy.....	230

	Page.
Spanish Main, errors in charts need correcting	146
Specifications, circulars, etc., for tests and trials	236
Spy-glasses, examined at Observatory	222
Stanton, Capt. A. F., member of examining board, torpedo class	273
Steam Engineering, report of Chief of Bureau	340
Steam laundries, for Torpedo Station, needed	353
Steam machinery. (See Machinery)	
Steam manufacturing plant in navy-yards, deficient	353
Steam trials of vessels, more frequent, necessary	351
Steam tugs, additional, needed	352
Steel armor plates. (See Armor plates)	
Steel plates, compound, presented for examination	261
Steel cast guns, bids for, received	240
Steel cruisers, armament for, progress in preparing	230, 231, 234
description of	296-313, 335, 337, 338
work required on <i>Chicago</i> and <i>Boston</i>	309
appropriations and expenditures for	341
Steel forgings, contracts for	233, 252
Steel manufacturers, circular to	459
<i>Stiletto</i> , torpedo boat, instructions for trial of	240
Stirling, Commander Yates, commanding receiving ship <i>Dale</i>	132
Stone, Lieut. C. A., services in Bureau Ordnance	237
Stores, reduction in stock of	397
accountability for	398
concentration of, at the yards	398
general appropriation to procure, recommended	399
list of, common to all of Bureau	400
consolidation of, estimates to procure	399
new system of purchasing introduced	399
statement of, in stock	402
Stromeyer, C. E., reprint of his paper, Working of Steel	146
Submarine diving-boat, steps to procure	240
Subsidies, remarks of the Admiral as to	52-65
Sumner, Prof. G. W., member of Board of Visitors	71
Supplies, proposals and contracts for—	
Naval Academy	85
Yards and Docks	117
Navigation	154
Ordnance	243
Steam Engineering	372
Medicine and Surgery	432
Provisions and Clothing	404
Marine Corps	454
(See also Stores.)	
Surgeon-General of the Navy, report of Medical Director Gunnell	416
Surveys on machinery, board should be engineers	34
Surveys and soundings by vessels of Navy and Fish Commission	172
Symonds, Lieut. F. M., information furnished Hydrographic Office by	172
Tanner, Lieutenant-Commander, Z. L., soundings made by	172
information furnished Hydrographic Office by	172
Target practice, medals and prizes for	239
record of, by photography	239
<i>Tennessee</i> , statement concerning the	288
Testing machine, needed at New York yard	354
Thermometers examined at Observatory	222
Time-ball service, extension of system recommended	150
at Torpedo Station	269
Tobacco, commercial classification of, recommended	401
Todd, Prof. D. P., observations on solar eclipse	147
Tools for ship-building, needed at Mare Island	288, 290
Tool-keeper, on ships, rate suggested	346
Torpedoes, designs and plans submitted	238
Torpedo outfit for ships	263
Torpedo boats and tugs, condition of	68
proposals for	240
sub-marine, requirements	273

	Page.
Torpedo Station, progress of work	241
examinations	272
course of instruction	242-264
report of Commander Goodrich	261
tugs needed	264
additional officers required	242
instructions to board	279
volunteer corps	271
Torpedo trials, instructions to board	238
Towels for Navy Department, contract for washing	7
Training service and station (see C. H. Island).	
Training-ships, necessity for steam	287
Transit circles, work and condition of	215
Transit of Venus Commission, report of Professor Harkness	223
Trials and tests, Bureau of Ordnance, circulars	236, 267, 277
Tugs, additional, needed for the Navy	288, 352
description of, in the Navy	304
Union Metallic Cartridge Company, cartridges furnished by	233
Van Eaton, Hon. H. S., member of Board of Visitors	71
Veeder, Lieut. T. E. D. W., electric light installation by	161, 162
Vessels, merchant, enrollment of, recommended	43
visited by Hydrographic officers	193, 201, 203, 205, 207, 210
information furnished by Hydrographic officers	193, 201, 203, 205, 207, 210
Vessels of the Navy, unfit for further service	68
condemned and sold	8
steel practice-vessels needed at Academy	76, 81
unarmored steel and iron, description of	296, 319, 313, 325, 331, 333, 335, 337, 338
wooden steam, description of	300, 306
wooden sailing, description of	304
tugs, description of	304
additional needed	288, 352
armored cruiser, description of	312
battle ship, description of	314
steam training-ship needed	287
resistance of, experiments to determine	287
repaired by Bureau Construction and Repair	292
work executed on machinery	355, 361
in ordinary, engines should be in charge of engineers	352
Vessels of war, steam, list of the world	56
of iron and steel, list of	56
Wall, Ensign F. R., report of branch hydrographic office, New Orleans	206
Walker, Commodore Jno. G., report of	145
Wallace, Hon. W. A., member of Board of Visitors	71
West Point Foundry, progress in making guns for Navy	230
Whaley, W. H., purchase of cottage from, recommended	135
Widow's Island, establishment of sanitarium at	418
Wilson, Chief Constructor T. D., report of	286
Winchester Repeating Rifle Company, cartridges procured from	233
Winterhalter, Lieut. A. G., range work at Observatory	211
astronomical congress, member of	216
Winlock, William C., assistant at Observatory	211
Wrecks, floating, vessel needed to destroy	148, 196
list of destroyed	189
reported	193
Wise, Surgeon Jno. C., instructor at Torpedo Station	261
Wiltze, G. C., captain commanding receiving-ship <i>Franklin</i>	133
Yards and Docks, report of Chief of Bureau	94-127
Yates, Capt. A. R., services at Training Station	130
Yarnall's catalogue, revision of, nearly completed	213
Yeoman, engineer's, should not be attached to Pay Department	346

