



This is a digital copy of a book that was preserved for generations on library shelves before it was carefully scanned by Google as part of a project to make the world's books discoverable online.

It has survived long enough for the copyright to expire and the book to enter the public domain. A public domain book is one that was never subject to copyright or whose legal copyright term has expired. Whether a book is in the public domain may vary country to country. Public domain books are our gateways to the past, representing a wealth of history, culture and knowledge that's often difficult to discover.

Marks, notations and other marginalia present in the original volume will appear in this file - a reminder of this book's long journey from the publisher to a library and finally to you.

Usage guidelines

Google is proud to partner with libraries to digitize public domain materials and make them widely accessible. Public domain books belong to the public and we are merely their custodians. Nevertheless, this work is expensive, so in order to keep providing this resource, we have taken steps to prevent abuse by commercial parties, including placing technical restrictions on automated querying.

We also ask that you:

- + *Make non-commercial use of the files* We designed Google Book Search for use by individuals, and we request that you use these files for personal, non-commercial purposes.
- + *Refrain from automated querying* Do not send automated queries of any sort to Google's system: If you are conducting research on machine translation, optical character recognition or other areas where access to a large amount of text is helpful, please contact us. We encourage the use of public domain materials for these purposes and may be able to help.
- + *Maintain attribution* The Google "watermark" you see on each file is essential for informing people about this project and helping them find additional materials through Google Book Search. Please do not remove it.
- + *Keep it legal* Whatever your use, remember that you are responsible for ensuring that what you are doing is legal. Do not assume that just because we believe a book is in the public domain for users in the United States, that the work is also in the public domain for users in other countries. Whether a book is still in copyright varies from country to country, and we can't offer guidance on whether any specific use of any specific book is allowed. Please do not assume that a book's appearance in Google Book Search means it can be used in any manner anywhere in the world. Copyright infringement liability can be quite severe.

About Google Book Search

Google's mission is to organize the world's information and to make it universally accessible and useful. Google Book Search helps readers discover the world's books while helping authors and publishers reach new audiences. You can search through the full text of this book on the web at <http://books.google.com/>



The Steam Navy of the United States

Frank Marion Bennett, Robert Weir

Mr. James L. Record

GIFT OF

MR. WILLIAM C. HOLCOMB

HARVARD COLLEGE LIBRARY



THE STEAM NAVY

OF THE

UNITED STATES.

A HISTORY OF THE GROWTH OF THE STEAM VESSEL OF WAR
IN THE U. S. NAVY, AND OF THE NAVAL
ENGINEER CORPS.

1

WITH NUMEROUS ILLUSTRATIONS.

BY FRANK M. BENNETT,

Passed Assistant Engineer, U. S. Navy.

SECOND EDITION.

1897:
WARREN & COMPANY, PUBLISHERS,
PITTSBURGH, PA.

W10-LC
VA
55
1349
1897
vol. 1
L

COPYRIGHTED 1896,
BY FRANK M. BENNETT.

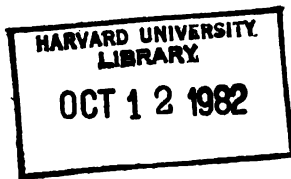

80*262

CONTENTS.

CHAPTER I.

	PAGE.
Introductory.....	I

CHAPTER II.

The DEMOLOGOS, or FULTON, the First Steam War Vessel ever Built—Robert Fulton—The SEA GULL—The FULTON, 2D—Mr. Chas. H. Haswell, the First Engineer in the United States Navy—Captain M. C. Perry's Recommendations Regarding Engineers' Force—Regulations Governing Appointment of Engineers—Performance of the FULTON Under Steam—Her Subsequent Career—Captain Perry's Interest in Engineers.....	8
---	---

CHAPTER III.

The ENGINEER—The MISSISSIPPI and MISSOURI—Establishment of the Engineer Corps by Act of Congress—Destruction of the MISSOURI—Career of the MISSISSIPPI—Steamers Transferred to the Navy from the War Department—The MICHIGAN.....	32
---	----

CHAPTER IV.

Experiments with the "Hunter Wheel"—The UNION—The WATER WITCH—The ALLEGHENY—The Stevens Battery.....	48
--	----

CHAPTER V.

Introduction of the Screw Propeller—John Ericsson—The PRINCETON and Her Remarkable Engine—Great-Gun Accident on the PRINCETON and Consequent Breach of Friendship Between Ericsson and Captain Stockton—Subsequent Career of the PRINCETON.....	61
---	----

CHAPTER VI.

Reorganization of the Engineer Corps—Case of Chief Engineer C. B. Moss—All Assistant Engineers Examined and Rearranged According to Proficiency—Laws and Regulations Affecting the Engineer Corps from 1845 to 1850—Resignation of Chief Engineer John Faron, Jr.....	75
---	----

CHAPTER VII.

The War With Mexico—Naval Operations in California—Important Service of Surgeon William Maxwell Wood—Blockade of the Gulf Coast—Commodore Perry and the MISSISSIPPI—valuable Professional Service of Engineer-in-Chief Haswell—Bombardment of Vera Cruz—"Alvarado Hunter"—Steamers Bought for Temporary Service—Naval Engineers Engaged in the Mexican War—Results of the War.....	88
--	----

CHAPTER VIII.

New Steamers Authorized for the Navy in 1847—The SUSQUEHANNA, POWHATAN, SARANAC, and SAN JACINTO—Mr. Haswell Succeeded as Engineer-in-Chief by Charles B. Stuart—Circumstances Connected with Mr. Haswell's Leaving the Navy—His Great Services to the Naval Engineer Corps—His Subsequent Career.....	102
--	-----

CONTENTS.

CHAPTER IX.

The Expedition to Japan and Treaty with that Country—Services of Engineers in the Expedition—Value of Steamers in Impressing the Japanese—Other Naval Affairs in the Far East..... 126

CHAPTER X.

End of the Experimental Period and Beginning of the Creatory Period of the American Steam Navy—The FRANKLIN—The MERRIMAC Class of Steam Frigates—The NIAGARA—Services of Chief Engineer Everett in Connection with the Atlantic Cable Laid by the NIAGARA—The HARTFORD Class of Large Screw Sloops—Mr. Archbold Succeeds Mr. Martin as Engineer-in-Chief—The MOHICAN Class—The PAWNEE—The Paraguay Expedition—Small Steamers Purchased for the Navy—Project to Convert Old Line-of-Battle-Ships into Steam Frigates..... 137

CHAPTER XI.

The Engineer Corps from 1850 to the Beginning of the Civil War—Congress Petitioned to Increase the corps—Pay Increased by United Effort of all Officers—Rank of Engineers defined—New Regulations Governing Appointment and Promotion Issued—Opinions of Chief Engineer Gay in Relation of Sails and Steam..... 177

CHAPTER XII.

The Civil War..... 193

CHAPTER XIII.

1861—The Civil War, Continued—Engineers and Steam Vessels in the Navy at the Outbreak of Hostilities—Resignation and Dismissal of Officers—Chief Engineer B. F. Isherwood Appointed Engineer-in-Chief of the Navy—Increase of the Engineer Corps—Qualifications of the Volunteer Engineers—Remarkable Career of Don Carlos Hasseltino—Vessels Added to the Fleet During the Year—The KEARSARGE and CANANDAIGUA Classes of Steam Sloops—The Ninety-Day Gunboats—The First Double-Enders..... 201

CHAPTER XIV.

1861—The Civil War, Continued—The Norfolk Navy Yard—Attempt to Save the Frigate MERRIMAC—Endeavors of Engineer-in-Chief Isherwood—Destruction of the Yard—Attack on Hatteras Inlet—Destruction of the Privateer JUDAH at Pensacola..... 230

CHAPTER XV.

1861—The Civil War, Continued—Expedition of Flag Officer DuPont to Port Royal—Loss of the GOVERNOR—Naval Battle at Port Royal—Killing of Assistant Engineer Whittemore on the MOHICAN—Affair of the TRENT.. 245

CHAPTER XVI.

1861—The Civil War, Continued—The First American Iron Clads—The Stevens Battery Condemned by a Board of Naval Officers—Authority to Build Armored Vessels Conferred by Act of Congress—Report of Board on Iron Clad Vessels—The GALENA, NEW IRONSIDES, and MONITOR—Armored Vessels on the Mississippi River..... 262

CONTENTS.

CHAPTER XVII.

- 1862—The Civil War, Continued—Capture of Roanoke Island and Elizabeth City—The MERRIMAC and Her Raid—Destruction of the CONGRESS and CUMBERLAND—The MONITOR Completed and Commissioned—Her Chief Engineer, Isaac Newton—Voyage of the MONITOR from New York and Her Arrival in Hampton Roads..... 286

CHAPTER XVIII.

- 1862—The Civil War, Continued—First Fight of Iron Clads—Effects of the Battle—Extraordinary Services Rendered by Chief Engineer Stimers—Attack on Drury's Bluff—The GALENA Badly Injured—Gallantry of Assistant Engineer J. W. Thompson..... 301

CHAPTER XIX.

- 1862—The Civil War, Continued—Naval Operations in the Mississippi River—Battles Below New Orleans—Catastrophe to the MOUND CITY—Attack on Vicksburg—Warfare on the Atlantic Coast—Wreck of the ADIRONDACK—Loss of the MONITOR—Peril of the PASSAIC—Heroism of Assistant Engineer H. W. Robie..... 318

CHAPTER XX.

- 1862—The Civil War, Continued—Increase of the Navy—Steamers Purchased. Mississippi Flotilla Transferred to the Navy Department—Steam Vessels of War Placed Under Construction—The PASSAIC Class of Monitors—The DICTATOR and PURITAN—The MIANTONOMOH Class—Other Monitors—The KROKUK—The DUNDERBERG—Legislation Regarding the Navy—Retired List Established—Creation of the Bureau of Steam Engineering—Pensions 337

CHAPTER XXI.

- 1863—The Civil War, Continued—Disasters at Galveston—Loss of the COLUMBIA—Raid of Rebel Rams off Charleston—Loss of the ISAAC SMITH—The FLORIDA, and Her Pursuit by the SONOMA—Investment of Washington, North Carolina—Assembling of Ironclads off Charleston—Remarkable Breakdown and Repairs to the Machinery of the WREHAWKEN—Attack on Fort McAllister—First attack on Fort Sumter—Destruction of the KROKUK—The ATLANTA-WREHAWKEN Duel—Protracted Investment of the Charleston Forts by the Monitors—Sinking of the WREHAWKEN..... 362

CHAPTER XXII.

- 1863—The Civil War, Continued—The War on the Western Waters—Passage of Port Hudson—Destruction of the Frigate MISSISSIPPI—Minor Operations in the West—New Vessels Placed Under Construction—The Light-Draft Monitors—Iron Double-Enders—Large Wooden Frigates and Sloops-of-War—The First Swift Cruisers—The KALAMAZOO Class of Monitors—Assimilated Rank of Staff Officers Raised—New Regulations Governing Promotion in the Engineer Corps Issued..... 384

CHAPTER XXIII.

- 1863—The Civil War, Continued—Controversy as to the Efficiency of Iron-Clads—Rear Admiral DuPont Reports Adversely to them—Chief Engineer Stimers Reports in Their Favor—Rear Admiral DuPont Prefers Charges Against Chief Engineer Stimers—The Case Investigated by a Court of Inquiry—Vindication of Mr. Stimers..... 403

CONTENTS.

CHAPTER XXIV.

- 1864—The Civil War, Continued—Confederate Success in the Use of Torpedoes—Blowing Up of the Sloop of War HOUSATONIC—Minor Naval Operations — Boiler Explosion on the CHERNANGO—The KEARSARGE-ALABAMA Fight—The Great Battle in Mobile Bay—Loss of the TECUMSEH—Capture of the Privateer FLORIDA by the WACHUSETT—The Gunboat OTSEGO Sunk by a Torpedo—First Attack on Fort Fisher..... 423

CHAPTER XXV.

- 1864—The Civil War, Continued—Naval Operations in the North Carolina Sounds—The Ram ALBEMARLE—Sinking of the SOUTHFIELD and defeat of the MIAMI—The Naval Battle of May Fifth—Disaster to the SASSACUS and Heroism of Her Chief Engineer—Daring Attempt of Enlisted Men to Destroy the Ram—Her Destruction by Lieutenant Wm. B. Cushing—Battle and Capture of Plymouth—Prize Money distributed on Account of the ALBEMARLE..... 447

CHAPTER XXVI.

- 1864—The Civil War, Continued—New Ships and Machinery Begun—The SERAPIS Class—The RESACA Class—Competitive Machinery of the QUINNEBAUG and SWATARA—The STROMBOLI, or SPUYTEN DUYVIL—The Light-Draft Monitors—Petition of the Engineer Corps Addressed to Congress and its Results..... 474

PREFACE.

HAVING completed this work, the author desires to express his thanks to many friends and acquaintances whose assistance, given in the form of books, letters, manuscripts, etc., has made the collection of much of the contained information possible. Especial thanks are due to Mr. Chas. H. Haswell of New York, a veteran engineer, and one of the few survivors of the earliest steam period of our navy; his clear mind has supplied a fund of information regarding the birth of our steam navy that could not have been obtained elsewhere, and which has made possible the rescue from oblivion of much of the subject-matter included in the first chapters. Chief Engineer B. F. Isherwood, U. S. Navy, has also kindly supplied much information and many references to documents from which valuable knowledge has been derived.

Chief Engineers James W. King, William H. Shock, Charles H. Loring, George W. Melville, David P. Jones, James Entwistle, F. G. McKean, Harrie Webster, and James H. Perry; Passed Assistant Engineers Robert S. Griffin, F. C. Bieg, Walter M. McFarland, H. P. Norton, F. C. Bowers, G. Kaemmerling, and Chief Naval Constructor Philip Hichborn, have all afforded so much aid in the way of papers, manuscripts, photographs, etc., that it is a pleasure to thank them by name. Mr. T. C. Brecht, formerly of the naval engineer corps, and Mr. A. O. Blaisdell of New York, have contributed valuable drawings of machinery of older ships, which might not have been found elsewhere, which are greatly appreciated. Mr. E. H. Hart, the well-known photographer of Brooklyn, has placed the author under many obligations by allowing the use of photographs upon which he holds copyrights. Besides those already named, nearly three hundred others—officers and ex-officers of the navy, ship and engine builders, and civilians interested in naval progress—have by letter or verbally given much assistance; all whom are now formally thanked.

In all matters of historical importance the aim has been to adhere strictly to official accounts written at the time by persons most directly concerned. With this idea in view, the annual reports of the Secretary of the Navy for more than fifty years, covering the

period since steam was introduced into the navy, have been carefully studied, as have also the reports of commanding officers of fleets, squadrons, and ships, especially those relating to the operations of the Civil War. The records of the naval Bureaus of Steam Engineering and Construction and Repair have been found mines of useful knowledge. Many reports made by committees of Congress on naval matters have also been used and much information gained from them, they being official and impartial to the same extent as departmental reports, and therefore equally suitable. From these official sources and from individuals of undoubted reliability the material for this book has been obtained.

In addition to official documents, many books have been used for reference. Some of these are mentioned in the text; among others, those found most useful have been, "The Atlantic and Gulf Coast," by Rear Admiral Daniel Ammen; C. B. Boynton, "History of the Navy During the Civil War;" Charles B. Stuart, "Naval and Merchant Steamers of the United States;" J. R. Soley, "The Blockade and the Cruisers;" Geo. F. Emmons, "Navy of the United States, 1775-1853;" Rear Admiral Preble, "History of Steam Navigation;" Dr. R. H. Thurston, "Growth of the Steam Engine;" Captain A. T. Mahan, "Gulf and Inland Waters;" T. H. S. Hamersly, "General Register of the U. S. Navy;" J. T. Scharf, "History of the Confederate States Navy;" Bennet Woodcroft, "Origin of Steam Navigation;" Wm. C. Church, "Life of John Ericsson;" H. O. Ladd, "The War With Mexico;" Chief Engineer B. F. Isherwood, "Engineering Precedents," and "Experimental Researches;" Chief Engineer George W. Melville, "In the Lena Delta;" Mrs. Emma De Long, "The Voyage of the Jeannette;" Chief Engineer James W. King, "European Ships of War," and Wm. Fairbairn, "History of Iron Ship-Building." The Journal of the American Society of Naval Engineers has furnished complete data regarding naval and commercial steamers of the United States and foreign countries for the past seven years, or ever since that journal was established.

Appendix A is known to be imperfect in not containing the names of that great body of patriotic Americans who served their country so well as volunteer engineers in the navy during the long war for the preservation of the Union: they numbered upwards of twenty-five hundred and their names and records when displayed in tabular form were found to fill so many pages as to exceed the limits

proposed for this volume, which obliged the author reluctantly to abandon his original intention of including them in the list of officers of the regular service.

Appendix B is also incomplete for lack of space. To properly present in tables all the important data relating to our naval steamers, their engines, boilers, builders, synopsis of service, etc., would require pages of folio, or at least quarto, size, the tables given being consequently limited by the size of these pages to a few columns of the most important items. Lack of space has also caused the omission from these tables of the names of a large number of steamers purchased or captured during the Civil War and used temporarily as war vessels. An excellent list of naval vessels, giving all useful information, was published in book form in 1853 by Lieutenant (afterwards rear admiral) George F. Emmons, but nothing of the kind has appeared recently. Some officer with a liking for statistics could not be better employed at present than in the preparation of similar tables brought up to date, using the Emmons book as a model, for it cannot be improved upon in form and arrangement. Unless this is done soon, much useful and interesting information will be lost, as the author, with all the records of the Navy Department to refer to, found great difficulty in collecting data pertaining to ships not more than thirty years old.

Appendix C, "Uncle Samuel's Whistle and What It Costs," is amusing rather than instructive. It is reprinted to gratify requests made by a number of present and former members of the engineer corps. It is hoped it will please the older officers of the navy to see it again in print, while it certainly will amuse the younger men of the service who have never seen it.

The author submits no apology for making this book. It is a custom in armies and navies for the histories of distinct corps, departments, regiments, and even ships, to be written, and, although the supply of books in the world is far too great, there is room for one more to tell the story of steam in the American Navy. The only regret felt by the writer in giving this volume to his friends and the public is because of its imperfections: the subject deserves better treatment, and with more time and better opportunities to bestow upon it could be made more valuable as a history and more attractive in literary form. As it is, it has cost much research and hard work in the intervals of busy employment afloat and ashore, and it is now open to criticism.

F. M. B.

New York, August, 1896.

THE STEAM NAVY
OF THE
UNITED STATES

THE STEAM NAVY
OF THE
UNITED STATES

THE STEAM NAVY OF THE UNITED STATES.

CHAPTER I.

"For we are to bothink us that the Epic verily is not *Arms and the Man*, but *Tools and the Man*—an infinitely wider kind of Epic."—THOMAS CARLYLE: *Past and Present*, Book IV., Chapter 1.

INTRODUCTORY.

A glorious epic of the olden world, with the first lines of which most modern men are familiar, sings in stately rythm of "The arms and the man who first from the shores of the Trojan into Italy came," and this association of man and his weapons has remained through all the ages as the symbol and corner stone of all human government, power, and progress. The events of the century now drawing to its end have to a considerable extent shaken this ideal, for other things than arms have come to be recognized in the story of man's development a change in sentiment expressed to perfection by that prince of modern philosophers in the words that appear at the head of this chapter. In undertaking the subject of this volume the author does not propose to sing, or try to sing, of tools and men alone, nor will he attempt to elevate either tools or arms to the disadvantage of the other; but rather, believing that the adoption of steam machinery for purposes of war furnishes the most perfect illustration in existence of the mutual dependence and co-operation of these two great factors in civilization, he will endeavor to treat them as equals, for the arm is a tool and the tool is an arm, and their uses and purposes are identical within the limits of the subject of this book.

The story of the application of steam power to navigation, especially to the navigation and operation of ships of war, is a long one, and one which must be imperfectly told in the following chapters for the reason that the slow acceptance and growth of the new element will be considered with reference to one country and one

navy only. Men who have made a study of the history of war, or who have given even a reasonable amount of reading to the subject are familiar with the reluctance with which the older weapons were laid aside for those which came in with the use of gunpowder. "Villainous saltpetre" was for a long era an object of dislike and distrust and those who used it were regarded with disfavor if not with contempt; they did not meet the enemy in hand-to-hand conflict with sword and spear; they begrimed their hands and clothing with burnt powder; they could not join in the rush and blood-stirring excitement of the charge, but stood off from friend and foe encumbered with their heavy weapons, creating an ill-smelling smoke and discordant noises, and their labors were very grudgingly admitted to be of any real advantage. So strong was the aversion to the new implement that in 1544, two hundred years after cannon are known to have been used by civilized nations in battle,¹ an historian dealing with the subject wrote that a monk was the inventor of cannon; adding that "the villian who brought into the world so mischievous a thing is not worthy that his name should remain in the memory of men."

As they did not take part in hand-to-hand conflict, gunners were looked upon as non-combatants, quite inferior to the warriors of the broad-sword and battle-axe variety, and as their weapon was very slow in its development they remained in an inferior military position for many centuries. It is an historical fact that it was not until just before the beginning of the American Revolution that the artillery branch of the British army, after a protracted but triumphant struggle with prejudice, "had vindicated its right to be, and was considered an important combatant arm."² So complete has been the change of sentiment with respect to cannon within about one hundred years that men belonging to military establishments now, especially navies, who make a point of priding themselves upon being essentially combatants, base their claim wholly upon the circumstance that their business is to handle cannon and gunpowder. The effect

¹ At Crècy in 1346. Traditions more or less authentic carry the use of "fire pipes" or other obscurely described weapons back almost to the beginning of the Christian era.

² Lieutenant W. E. Birkhimer: "Historical Sketch of the Artillery, U. S. Army."

of the prejudice of centuries against firearms is still visible in the lingering regiments of lancers, armed with the spear, occasionally met with in the great armies of the most progressive powers.

The introduction of steam into naval operations has revolutionized the fighting tactics of navies to fully as great an extent as gunpowder changed the methods of fighting on land, and in precisely the same manner has the development of steam been hindered by a prejudice born of older things and intolerant of change. Gunpowder has long since won its struggle, and steam on shore has been equally successful, but steam at sea is still in the very thickest of the fight for recognition upon its merit, and this in spite of the fact that the vehicle for its use—the marine engine—has advanced further toward perfection within the hundred years of its life than did the cannon during all the centuries from Crœcy to Sedan, and is now in a stage of development fully abreast, if not actually ahead of the most perfected pieces of ordnance. That steam will win an equal place and equal honor with gunpowder and the propelling and auxiliary engines of a ship of war will come to be recognized as arms fully as important in making up the ship's combative qualities, as the turret and machine guns is a matter of simple logic; it only remains to be seen how long it will be before preconceived notions will admit the value of a new weapon.

It is proposed to begin with the first steam war-vessel ever built, which happened to be in our own navy, and to trace from that clumsy beginning the slow development of the naval steamer, with such illustrations as have been obtainable, in such manner that the chapters of this book will be an orderly and progressive account of the growth of the war-steamer and the marine engine in the United States. Into this narrative, as a most essential part, will be woven the history of the engineer corps of the navy, whose members have, in the face of much that was discouraging, kept the standard of our steamers fully up to that of other nations and have made the new navy, with its swift steel ships and perfected machinery, an established fact. Naval histories, of which there are many, deal almost entirely with the deeds of those who fight in ships that they have received completed from the hands of the builders, and in a majority of cases have little or nothing to say of the ships themselves or of their makers, or of that other class of officials who not only design and build the vitals of all

modern war-ships but fight in the ships themselves as part of their naval duties. In making this work statistical to a considerable extent with regard to our naval steamers it is therefore proper that the lives and deeds of those who have been so intimately connected with them be also told, descriptively as well as statistically, and in so doing the author believes he will supply a lack that many beside himself have noticed in the older and more pretentious histories of our navy.

It has been written that it is difficult to become sentimental about the engineer. This idea is born of the belief that he deals only with material things and takes no part in the glorious possibilities of war or in the victories that are won from storms. This theory is absolutely false; his post of duty is as dangerous, as responsible, and as romantic, if you will, as any in a ship if people did but know it, and it is only because of a cultivated fondness for things that have been long celebrated in song and story that they do not know it. The life of the old-time sailor was in reality commonplace enough to satisfy even a ploughman, but an admiration for the sea and those who face its dangers on the part of those who never go to sea has made of the sailor's existence a picturesque ideal that has become an article of faith with all landsmen. And this faith excludes the new type of seaman—the man of the engine and boiler rooms—from any share in the romance of the sea because he faces dangers of another kind and performs his duty in another atmosphere, though equally exposed to the dangers that are peculiar to a life afloat. When some poet with a clearer vision and a willingness to enter an untrodden field shall appear and sing the song of steam it will be a revelation to the multitude; for there is music and romance and poetry as well as the embodiment of power about the mechanisms that drive the great ships of to-day.

From a habit of thought, then, rather than from any real state of affairs, the engine-room men of modern fleets are denied participation and honor in much of the life in which they take a leading part. With but little change, Napier's famous comparison of the conditions surrounding the British and French soldiers in the Peninsular War applies most aptly to the relation between the artificer and sailor classes in modern navies. The British soldier, though patiently fighting to conquer, could look forward to no honors to reward his

daring; no despatch gave his name to the plaudits of his countrymen; his life of danger and hardship was uncheered by hope, his death unnoticed. At the same time, "Napoleon's troops fought in bright fields, where every helmet caught some beams of glory." In just the same way the naval engineer and his men toil in darkness in the depths of the ship, knowing full well that much they do will be unknown and unnoticed, however important it may be; and they often meet emergencies so bravely that their ships are saved from destruction or disablement both in peace and war, as will be shown hereafter by a few notable instances of duty, well done, that have come to light out of the many that have been performed.

Few naval engineers of any length of service have not *once* at least, been suddenly brought face to face with death in its most fearful form by being called upon to act in an emergency resulting from a damaged boiler or steam pipe, and the instances are few where they have failed to prevent a calamity by sticking to their posts and encouraging their men to do the needful work, often so quietly that knowledge of the danger averted does not extend beyond the fire-room. If equal danger were faced from shot and shell in the smoke of battle, popular applause and military rewards would follow, but the engineer, encountering his peril in clouds of scalding steam and in the choke and wither of fierce fires suddenly hauled, does not appeal to the popular idea of heroism, though his acts are heroic and his performance of duty in navies is a military act just as much as nailing a flag to a mast, stopping a shot hole, or fishing a mast under fire, are military duties. Nor has he even the consoling thought when confronted with an emergency of meeting a death accounted heroic, for if he dies it must be like a rat in a hole, for which there is no glory, popular fancy regarding no death for one's country glorious, unless it is met not only beneath the flag but in full sight of it.

Popular ideas of naval administration are based upon a partial knowledge of an order of things that is no more, and not upon familiarity with conditions that really exist. Whatever notions the public may entertain, the fact remains that a much firmer and finer degree of courage is required in the officer who controls a division of men, either in peace or war, imprisoned beneath the battle-hatches of a war-steamer than in him whose men are in the open air and in sight of their danger. If the habit of command is ever needed in an

officer it is in the trying emergencies and conditions that beset the naval engineer, and he who possesses it to the degree that enables him in a critical moment to keep his men at their posts and free from panic, thereby making of them and the machinery they handle a fighting factor that can be relied upon, is aiding his commanding officer in carrying out a plan of battle to fully as great an extent as can any other officer who directs the handling of two or four guns; and the officer who does this is most thoroughly and essentially a combatant, performing duties directly contributory to the fighting capabilities of the ship. This proposition needs no proof to those familiar with modern naval conditions, but as one of the purposes of this book is to set the position of American naval engineers in a true light before the public a number of instances of gallantry and professional efficiency on their part will be recited to prove that they actually and by right, by virtue of the duties they perform, belong to the combatant class of naval officers, *of* the navy as well as *in* the navy.

As the Civil War furnishes the example of the most prolonged and arduous service that our navy has ever been called upon to perform, and is, moreover, the first and only instance of great naval operations being carried on by means of steam vessels, it will be taken as the proper field for illustrating the nature and importance of the duties that engineers have rendered this country in its naval service. Though nearly one-half of this volume will be devoted to the work of the navy during the Civil War, no idea has been entertained of giving even an outline of our naval history during that period. A sufficient number of naval engagements and undertakings will be narrated in chronological order to give an ordinarily good idea of the general services performed by the navy, and an effort will be made to trace with some care the changes in type of naval steam-ships and marine engines resulting from the experiences of the war. In all of this no undue or undeserved prominence will be given to the naval engineer corps or to any of its members, but where engineers have rendered conspicuous service, either in battle or in preparing ships and machinery for use in war, full credit will be accorded them. This being a history of engines and engineers, it is natural that engineers should be frequently mentioned, but that does not leave the inference that they were the only officers engaged in carrying on the war on the part of the navy; on the contrary, the

aim is simply to show that they did contribute much to the success of the Union arms and were much more than civilian adjuncts to the officers charged with the execution of general operations, whom they helped so well. The latter cannot at this late day regret that the story of the devotion of their engineer colleagues is to be told, especially as the story of their own deeds has been told often and well and has become a glorious part of our naval history.

CHAPTER II.

“Soon shall thy arm, unconquer'd Steam! afar
Drag the slow barge, or drive the rapid car;
Or on wide-waving wings expanded bear
The flying chariot through the fields of air.”

ERASMUS DARWIN.

The DEMOLOGOS,¹ or FULTON, the First Steam War-Vessel ever Built—Robert Fulton—The SEA GULL—The FULTON, 2D—Mr. Charles H. Haswell, the First Engineer in the United States Navy—Captain M. C. Perry's Recommendations Regarding Engineers' Force—Regulations Governing Appointment of Engineers—Performance of the FULTON Under Steam—Her Subsequent Career—Captain Perry's Interest in Engineers.

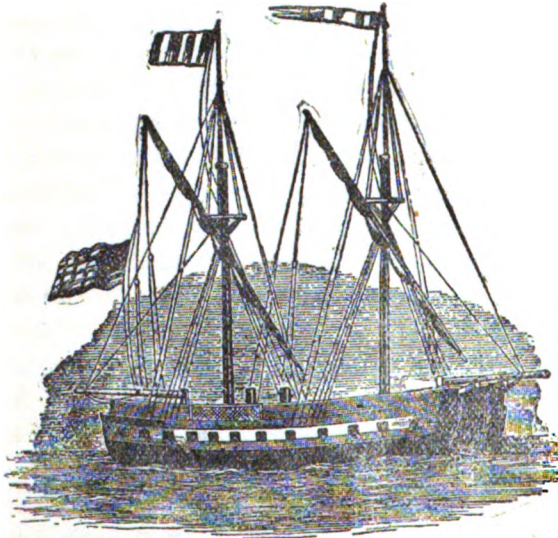

WAR STEAMER FULTON THE FIRST, OR, DEMOLOGOS.

THE first steam vessel for war purposes in the United States navy, or in any navy for that matter, was the *Demologos*, or *Fulton*, designed by Mr. Robert Fulton and built under his supervision in New York in 1814, while the war with Great Britain was going on. Owing to difficulties in obtaining

material and skilled labor, this vessel, or floating battery, was not completed in time to be used against the British fleet, then constantly hovering about the port of New York, an unfortunate circumstance that is to be regretted for more reasons than one. The subsequent performance of this peculiar craft under steam makes it

¹“Voice of the People.”

certain that with her powerful battery and independence of wind and tide she would have been entirely successful over the sailing-frigates she was built to assail, her advantage over them being not unlike that possessed by a savage, tireless wolf attacking a flock of sheep. Her earlier advent would have saved us the loss of the *President* frigate, and thus deprived the enemy of one of the very few causes for rejoicing over naval victories that the events of that war afforded.

Of much more importance would have been the incalculable impulse given to steam as a factor in naval warfare that would have followed the success of the *Demologos* in battle, and which would have set forward the development of the times in this regard almost half a century. The duel between the rudely-fashioned ironclads *Monitor* and *Merrimac* completely changed the naval architecture of the world, but who can tell of the absolute revolution, not only in naval architecture but in the methods of naval warfare, that would have resulted from the trial of Fulton's invention in actual war? Instead of being afterward obliged to fight its way inch by inch and foot by foot, compelled to struggle against every obstacle and every objection which jealousy, conservatism, and ignorance could bar against its progress, slowly and painfully forcing an unwilling and qualified recognition from the very element that should have championed its cause, steam-power would have appeared in the arena fully armed and equipped from the brain of its master, and would have been hailed not only as an auxiliary, but as an all-important arm in naval warfare.

The dimensions of the *Demologos* were: length, one hundred and fifty-six feet; breadth, fifty-six feet; depth, twenty feet; tonnage, two thousand four hundred and seventy-five; water-wheel, sixteen feet in diameter, fourteen feet wide, four feet dip; engine, cylinder forty-eight inches diameter, and five feet stroke; boiler, length, twenty-two feet; breadth, twelve feet; depth, eight feet.

The total cost of the vessel was \$320,000, or about the cost of a first-class frigate, the *Constitution*, built in 1797, having cost originally \$302,719.

A comparison of these dimensions with the views of this pioneer war-steamer given in this chapter shows that the drawings are somewhat out of proportion to the scale marked on them; they are, nevertheless, of great interest and value as being exact copies of the

"DEMOLOGOS"

Figure 1st Transverse section A her Boiler, B the steam Engine, C the water-wheel, E E her wooden walls, 5 feet thick, diminishing to below the waterline as at FF, draught of water 9 feet, DD her gun deck.

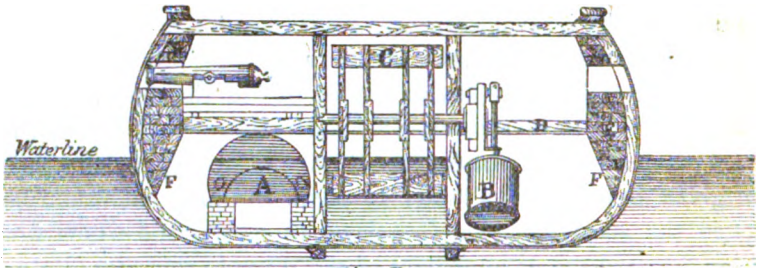

Fig. 1.

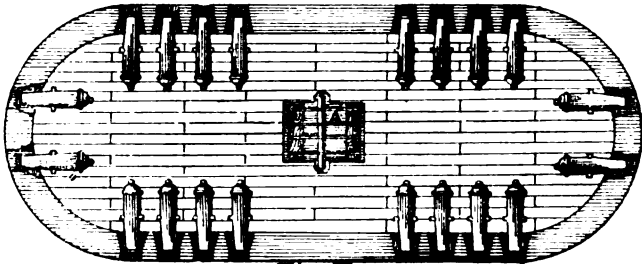

Fig. 2.

Figure 2nd This shows her gun deck 140 feet long 26 feet wide, mounting 20 guns A the Water wheel.

Side View

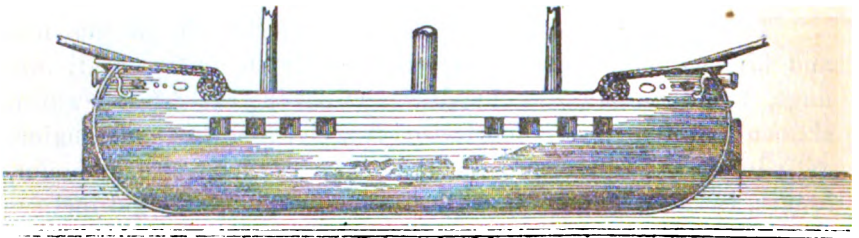

Fig. 3.

ROBERT FULTON
November 1813

FROM STUART'S NAVAL AND MAIL STEAMERS OF THE UNITED STATES.

originals made by Robert Fulton and exhibited by him to the President of the United States when advocating his plan of applying steam to naval warfare. Fulton had his interview with the Executive late in 1813 and his project was zealously accepted, Congress, in March, 1814, authorizing the President to have built and equipped one or more such floating batteries for the defense of the coast.

The Coast and Harbor Defense Association, having charge of the building of war vessels, committed the building of the *Demologos* to a sub-committee of five prominent gentlemen, and Robert Fulton was appointed the engineer in charge of the work. The complete vessel—hull, engines and boilers—was designed by Fulton and the engines and boilers were built by him at his machine works on the North River. The hull was built at the ship-yard of Adam and Noah Brown on the East River and was launched in the presence of a great multitude of spectators, October 29, 1814, a little more than four months after the keels were laid. The plural is used intentionally, as the structure, as may be seen from the drawings, consisted of two hulls with the paddle-wheel working in a channel or canal between them; this canal was not continuous from end to end of the vessel, but is described as occupying a space of about sixty feet adjacent to the wheel, with its approaches presumably sloped off to prevent the action of the wheel from being inutile.

In November the hull was moved from the ship-yard to Fulton's engine works and the machinery installed, that labor being completed by the end of May, 1815. Certain changes were made in the vessel about this time on the recommendation of Captain David Porter, who had just returned home from his unfortunate cruise with the *Essex* and had been assigned to the command of the war-steamer. The original plan was to rely upon steam alone for propulsion, but Porter regarded this with misgiving and caused two large masts to be stepped to support latteen sails, and bowsprits for jibs, with all the accompanying top-hamper; he also had the sides, originally stopped flush at the spar deck, carried up to form protecting bulwarks for the sailors who would be on deck attending to the sails and rigging that had been added. The boiler, or "caldron for preparing her steam," as the gentlemen having charge of the work called it in their report, was also changed, probably by Fulton's direction, and two boilers were installed instead of one. Owing to the rigor of the British

blockade about New York, guns for the vessel had to be hauled overland from Philadelphia, they having been taken from an armed British ship named *John of Lancaster*, captured by the *President* early in the war. In June, 1815, the *Demologos* steamed about New York Bay to try her machinery and found its performance to exceed every expectation; in the words of an early writer, "she exhibited a novel and sublime spectacle to an admiring people."

On the fourth of July of the same year, she made a passage to the ocean and back, steaming fifty-three miles in all, without any aid from her sails, in eight hours and twenty minutes; the wind and tide were partly in her favor and partly against her, the average rather in her favor. In September she made another trial trip to the sea, and having at this time the weight of her whole armament on board, she went at an average of five and a half miles an hour, with and against the tide. When stemming the tide, which ran at the rate of three miles an hour, she advanced at the rate of two and a half miles an hour. This performance was not more than equal to Robert Fulton's expectations, but it exceeded what he had promised to the government, which was that she should be propelled by steam at the rate of from three to four miles an hour.

The British were not uninformed as to the preparations which were making for them, nor inattentive to their progress. It is certain that the steam battery lost none of her terrors in the reports or imaginations of the enemy, as we find the following information in a treatise on steam vessels published in Scotland at that time, the author stating that he had taken great care to procure full and accurate accounts:

"Length on deck, *three hundred feet*; breadth, *two hundred feet*; thickness of her sides, *thirteen feet* of alternate oak plank and cork wood—carries forty-four guns, four of which are *hundred pounders*; quarter-deck and fore-castle guns, forty-four pounders; and further to annoy an enemy attempting to board, can discharge *one hundred gallons of boiling water in a minute*, and by mechanism brandishes *three hundred cutlasses* with the utmost regularity over her gunwales; works also an equal number of heavy iron pikes of great length, darting them from her sides with prodigious force, and withdrawing them every quarter of a minute!"

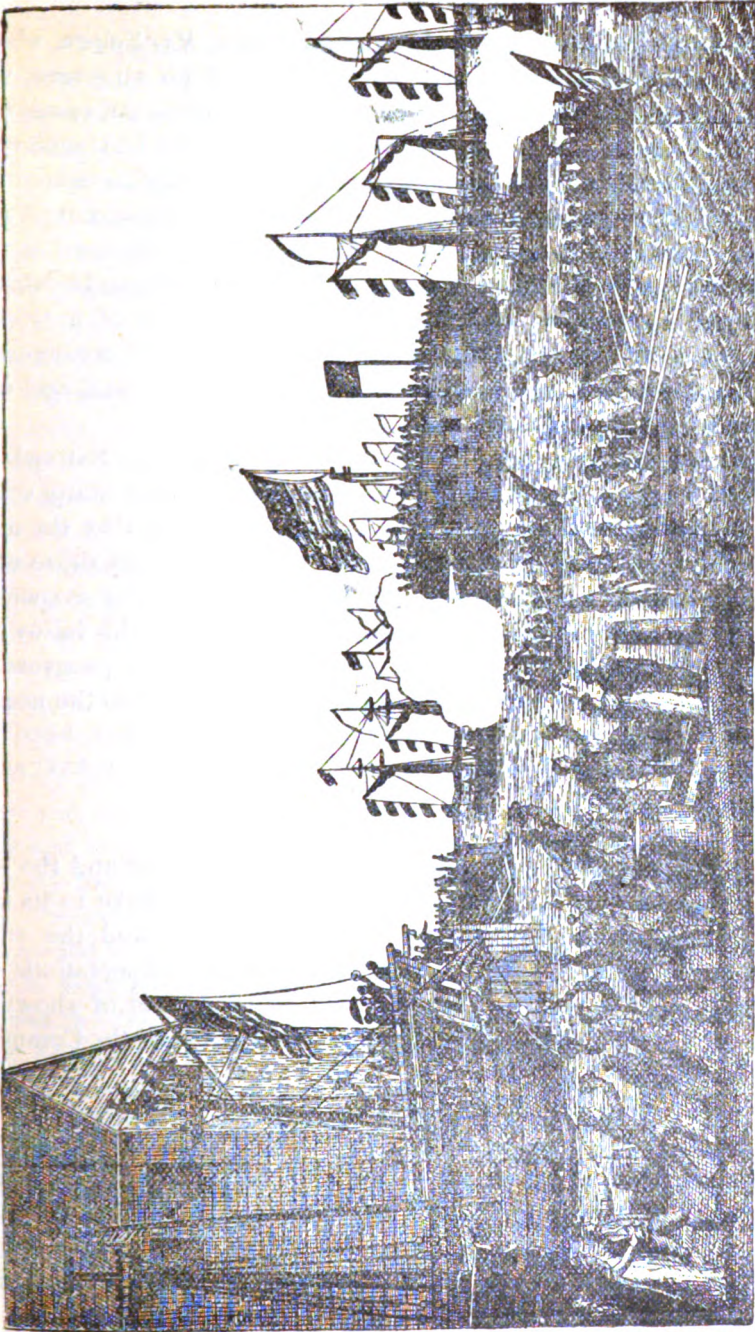

LAUNCHING OF FULTON THE FIRST, OR DEMOLOGOS.

By one of those inexplicable cruelties of fate, Mr. Fulton, whose heart and soul were absorbed in the progress of his structure, was taken ill and died suddenly in February, 1815, before the vessel was completed, so he never knew of the great success he had achieved. Referring to this sad event, the report of the construction committee says: "Their exertions were further retarded by the premature and unexpected death of the engineer. The world was deprived of his invaluable labors before he had completed his favorite undertaking. They will not inquire, wherefore, in the dispensations of a Divine Providence, he was not permitted to realize his grand conception. *His discoveries, however, survive for the benefit of mankind, and will extend to unborn generations.*"

The same committee report, signed by Messrs. Samuel L. Mitchell, Thomas Morris, and Henry Rutgers, contains many opinions and recommendations of great wisdom, indicating that the men of those days were more far-seeing and thoughtful than those of a later generation, and more disposed to appreciate the importance of new discoveries. Although written eighty years ago, the following paragraphs from the report sound not unlike the more progressive naval opinions of to-day, especially in that part relating to the necessity of training men for steam service, a subject that has been recommended and as regularly neglected from time to time ever since 1815:

"The Commissioners congratulate the Government and the nation on the event of this noble project. Honorable alike to its author and its patrons, it constitutes an era in warfare and the arts. The arrival of peace, indeed, has disappointed the expectations of conducting her to battle. That last and conclusive act of showing her superiority in combat, has not been in the power of the Commissioners to make.

"If a continuance of tranquility should be our lot, and this steam vessel of war be not required for the public defense, the nation may rejoice that the fact we have ascertained is of incalculably greater value than the expenditure—and that if the present structure should perish, we have the information never to perish, how, in a future emergency, others may be built. The requisite variations will be dictated by circumstances.

“Owing to the cessation of hostilities, it has been deemed inexpedient to finish and equip her as for immediate and active employ. In a few weeks everything that is incomplete could receive the proper adjustment.

“After so much has been done, and with such encouraging results, it becomes the Commissioners to recommend that the steam frigate be officered and manned for discipline and practice. A discreet commander, with a selected crew, could acquire experience in the mode of navigating this peculiar vessel. The supplies of fuel, the tending of the fires, the replenishing of the expended water, the management of the mechanism, the heating of shot, the exercise of the guns, and various matters, can only become familiar by use. It is highly important that a portion of the seamen and marines should be versed in the order and economy of the steam frigate. They will augment, diffuse, and perpetuate knowledge. When, in process of time, another war shall call for more structures of this kind, men, regularly trained to her tactics, may be dispatched to the several stations where they may be wanted.”

There being no active service in the navy against the enemy; the *Demologos*, or *Fulton*, as she was afterward named, was taken to the Brooklyn navy yard and used as a receiving ship for many years, until, on the fourth day of June, 1829, her magazine, containing two and one-half barrels of damaged powder used for firing the morning and evening gun, blew up, entirely destroying the vessel, killing twenty-four persons and wounding nineteen others. Lieutenant S. M. Breckenridge was among the killed, as was also a woman who happened to be on board at the time. The cause of the explosion has never been known, although there was a tale current at the time that it was the deliberate act of a gunner's mate who had been disgraced and flogged the morning of the day on which the catastrophe occurred. It is also said to have resulted from gross carelessness, survivors stating that the powder was kept in open kegs and that in the “bag-room” next the magazine, and separated from it only by a light bulkhead in which was a *sliding* door, the marine sergeant had a desk and was allowed to use an open light. Whatever the cause, the destruction was complete, and terminated the history of the *first steam vessel of war ever built*.

No engineers came into the navy because of the existence of the *Demologos*, men from Fulton's works having operated the machinery on the three occasions when she was under way with her own steam, and her engines were not moved after she was laid up in the navy yard. The next steamer to appear in the navy was the galliot *Sea Gull*, of one hundred tons, purchased in New York for \$16,000 in 1822 and used as a despatch boat in Porter's "Mosquito fleet," employed in the West Indies for the suppression of piracy in 1823-24. There is no record of the men who had charge of the machinery of this little craft and we can only surmise that they were probably the same who had run her before she was purchased, and that their connection with the service was merely temporary. The *Sea Gull* was laid up in 1825 at Philadelphia, where she remained until 1840 when she was sold for \$4,750.

For ten years after the *Sea Gull* was laid up, steamers do not appear in the official literature of the navy, though the same period witnessed a most wonderful development of the application of steam to navigation for commercial purposes, and steamers had visited India, China, the West Indies and other parts of the world, as well as having made the trans-Atlantic voyage no longer a marvellous one when performed under steam. That our navy was not the only one to remain in ignorance and indifference while this great change in marine affairs was going on all about it, is shown by the circumstance that in 1831 a steamer built in Quebec was, while on a peaceful voyage to London, fired on by a British frigate in the Gulf of St. Lawrence and compelled to heave-to until the officers of the frigate were satisfied that there was nothing diabolical in her construction. This same steamer, the *Royal William* by name, was sold after arriving in London to the Spanish government, and, under the name of *Isabella the Second*, became the first steam war-ship of that nation.

In 1835, under date of June 26, Mr. Mahlon Dickerson, then Secretary of the Navy, addressed a letter to the Board of Navy Commissioners, calling attention to an act of Congress dated April 29, 1816, which authorized the construction of a steam vessel, and requesting that the Board take immediate measures for commencing and completing such vessel; further directing that plans of the vessel and machinery be submitted to the Department for the approval of the President.

At that time there were about 700 steam vessels in use on the waters of the United States, the most of them being on the rivers and lakes, although some coastwise steamship lines had been established: with few exceptions these vessels were not larger than a modern steam tug, and their machinery was of the most crude design and workmanship, the chief object being to hammer together a boiler that would not leak too much to prevent the accumulation of some steam within it, and to hew out of heavy iron castings a cylinder with a roughly-fitted piston that could be forced to move back and forth under steam-pressure with reasonable regularity. There were at that time, of course, men of scientific attainments who were giving attention to the theory of the steam engine, and who had made considerable progress toward the solution of those thermo-dynamic problems, the knowledge of which in our own day has made the steam engine a comparatively economical machine.

To these experts, who were usually the managers or superintendents of the larger engine-building establishments then in existence, the Board of Navy Commissioners appealed for advice and help, but it does not appear from the records that any great amount of comfort was derived in this manner. One Wm. Kemble, who was the agent for the West Point Foundry Association, cheerfully supplied the Board with dissertations on the comparative merits of condensing and high-pressure engines and the theory of working steam expansively, giving copious opinions of Watt, Trevithick, Oliver Evans, and other authorities, all of which must have been highly interesting reading for the Board. One of these letters closes as follows: "I have given you our views candidly, but we are ready to execute any plan which the more extensive views and experience of the Board may decide on." Whether this was the irony of an expert who appreciated the humor of the situation, or was simply the homage demanded by the standing of the Board of Navy Commissioners, is open to doubt, but as no catastrophe to Mr. Kemble followed, we may conclude that the Board accepted this insinuation of its engineering wisdom as a proper and customary due.

Construction work on the hull of the vessel went forward rapidly at the New York navy yard, but the Navy Commissioners do not seem to have made corresponding progress in mastering the science of marine engineering, for we find them presently driven to the extremity of addressing the following letter to the Secretary of the Navy:

THE STEAM NAVY OF THE UNITED STATES.

“NAVY COMMISSIONERS’ OFFICE, December 30, 1835.

“**SIR:** The Commissioners of the Navy have, in conformity with the terms of your letter of the 26th instant, caused an advertisement to be published asking for proposals for furnishing the steam engines for the the steam vessel now building at New York. From their ignorance upon the subject of steam engines they are in doubt whether the advertisement gives the necessary information to enable persons to make proper offers. They are satisfied that they are incompetent themselves, and have no person under their direction who could furnish them with the necessary information to form a contract for steam engines that may secure the United States from imposition, disappointment, and loss, should the lowest offers happen to be made by persons whose general character and responsibility would not offer great security for their completing the engines in the best manner, according to the intentions and wishes of the board, in case the precise terms of the contract should leave them a legal opportunity of evading its spirit.

“The board beg leave, therefore, to request your authority for engaging some person who may be deemed competent to advise them upon this subject, and to superintend and inspect the engines during their progress, and until they shall be satisfactorily tested, and to designate the fund from which his compensation shall be paid.

“Respectfully, etc.,

“JOHN RODGERS.”

This request for the professional services of an engineer not meeting with any immediate response from the Secretary, the board renewed its call for help a month later by the following communication:

“**SIR:** The board would respectfully recall your attention to their letter of the 30th ultimo, in relation to the employment of an engineer; his services will be much wanted in superintending the construction and arrangement of the engines and boilers, and afterwards to work them in the vessel. As it will be desirable to obtain satisfactory testimonials of the qualifications of any person who may be thus employed, which may consume some time, an early decision may prove advantageous.

“Respectfully, etc.,

“JOHN RODGERS.”

Mr. Charles H. Haswell of New York became an applicant for the position of engineer which the Board of Navy Commissioners was so anxious to have filled, but his appointment was not made until the Board had taken occasion, while admitting the excellence of his professional knowledge as shown by his testimonials and conversation, to express grave doubts as to his *practical* familiarity with the manipulation of marine machinery, from which circumstance we of this day, who not infrequently encounter the same criticism, may see that the mistrust, inconsequential as it is, is by no means new. The Board qualified its doubt in Mr. Haswell's case with the following ingenuous confession: "How far such practical knowledge may be absolutely necessary, or can be supplied by superior information upon the construction of the engine itself, the Board has no means of determining, except such as are common to other persons." Mr. Haswell's appointment, made two days after the comments of the Board were submitted to the Department, reads as follows:

"NAVY DEPARTMENT, February 19, 1836.

"SIR: In your letter to the Commissioners of the Navy yesterday, you offer to furnish draughts of a high and low-pressure steam engine and boiler, on different elevations, suitable for the steam vessel now constructing by the Government of the United States, for the purposes stated.

"You are therefore appointed, for the term of two months, to make such draughts and report the same to the Board of Navy Commissioners, for which you will receive a compensation of two hundred and fifty dollars.

"MAHLON DICKERSON.

"To Mr. C. H. Haswell, *Washington.*"

In mid-summer following, under date of July 12th, 1836, Mr. Haswell was appointed chief engineer for the *Fulton*, as the steam-vessel then building was named; he thus becoming the first person to hold the position of engineer in the United States navy. Mr. Haswell was then an engineer of ability and established professional reputation, being earnestly engaged in the task, at that time a doubtful one, of proving the reliability of steam as a marine motor, independent of any aid from sails. To him has been granted a privilege that

comes to few men in any calling on this earth, for it has been his fortune to witness the emblem of his profession—the steamship—grow from its awkward infancy to its present gigantic and perfected form, a development in which he has had a prominent part during all these decades, and which in the completeness of the changes that have been wrought, far exceeds the magical transformations of a dream or the enchantments of a fairy-tale. In the great harbor where, as a young man, he saw the embryo steamer timidly and alone making its uncertain wake, an object so rare that curious crowds always flocked to watch it, he has been spared until now to see in his old age the crude and clumsy *Fulton* transformed into the *Columbia* or the *New York*, and the pioneer passenger steamers changed, as if by the magician's wand, into the *Umbria*, the *Majestic*, and the *Campania*.

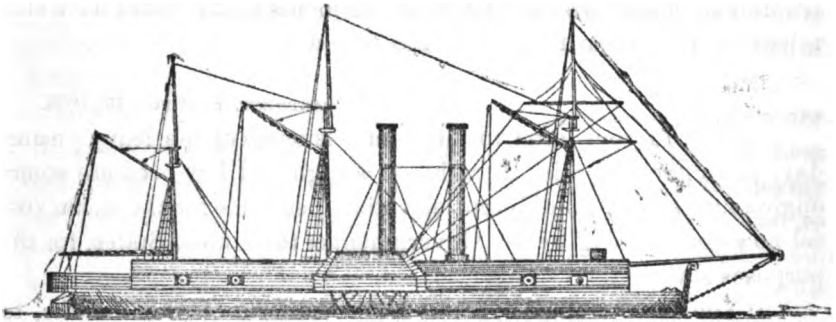

U. S. STEAMER FULTON (THE SECOND), 1837.

The following were the principal dimensions of the *Fulton*:

Length of vessel between perpendiculars ..	180 ft.
Beam on deck (extreme)	34 " 8 in.
Depth of hold.....	12 " 2 "
Mean draft.....	10 " 6 "
Immersed midship section at mean draft ..	308 square ft.
Weight of hull.....	470 tons.
Depth of keel	12 inches.
Displacement at mean draft (about)	1,200 tons.

The engines and boilers were built by the West Point Foundry Association of New York, under a contract dated January 23, 1837,

the engines in type and location being from the designs prepared for the Board of Navy Commissioners by Mr. Haswell, and the boilers from the designs of Mr. Charles W. Copeland, the engineer of the West Point company. There were two horizontal condensing engines located *on the spar deck*, the cylinders being of nine feet stroke and fifty inches in diameter, each engine turning a side-wheel twenty-two feet nine inches in diameter, and eleven feet six inches wide. The contract provided for a thwartship shaft to connect the two wheel shafts, at an additional cost of \$2,000, if required, but the requirement was not made and the vessel was completed without such connection. So undeveloped was the art of iron manufacture at that time that the cranks and shafts were made of cast iron. The contract price for the engines was \$40,000, to which was added \$198.57 for authorized changes. The wheels cost \$9,000. The boilers were built by the contractors at the New York navy yard for eight and one-half cents a pound, the Government furnishing the material, which consisted of copper plates and rivet rods provided in 1816 for another vessel like the *Demologos*, which was never built. The total cost of boilers, including the material and labor, was \$98,396.06. Originally there were four wagon-shaped boilers of the return-flue type, each sixteen feet long, ten feet six inches wide, and nine feet three inches high, but these were afterward changed to two boilers twenty-five feet nine inches long, the other dimensions remaining unchanged. These boilers were located in the hold under the engines, and were supplied with separate smoke pipes. The total cost of the vessel when completed—hull, equipments and machinery—was \$299,649.81.

The weight of engines was 81 tons; of boilers, including smoke pipes, steam pipes and connections, 119 tons, and water in the boilers, 41 tons. On a trial trip the following winter, Chief Engineer Haswell computed the horse-power developed to be 625, from which we observe that the weight of machinery per horse-power was about three times as much as under present practice.

The steamer was launched May 18, 1837, and the work of installing the machinery immediately undertaken; this work was much hindered by the action of the Board of Navy Commissioners in refusing to allow the hull to be taken to the engine builders' works on the North river, thus compelling the contractors to transport the en-

gines in pieces to the navy yard. The Commissioners, in refusing the application to have the hull moved, said that they did not "feel themselves justified in permitting the vessel to be moved from the navy yard to a place over which they have no control," although why they should have felt this way is not apparent, as they had previously confessed their incompetency to deal with matters relating to the vessel's machinery. This action forced the contractors to file a claim for "increased expense in the putting up of the work, together with an additional delay of not less than three weeks," just as contractors do now when their work is retarded by the interference of naval officers. Truly, there is no new thing under the sun.

About the first of September Captain Matthew C. Perry took general charge of the steamer, and immediately began investigating the subject of *personnel* required for her operation, the result of his researches being communicated to the Navy Commissioners by the following report:

"NEW YORK, September 11, 1837.

"GENTLEMEN:—I have sought to obtain the best information in reference to the number of engineers, firemen, &c., that will be required for the steam frigate *Fulton*, and the following is the result of the combined opinions of the various persons consulted:

"The lowest number for putting the engines in operation—

"2 1st-class assistant engineers, at \$800 per annum.

"2 2nd-class assistant engineers, at \$500 per annum.

"8 firemen, at from \$25 to \$30 per month. The firemen to be paid either of those amounts, at the discretion of the captain, as suitable persons can be obtained.

"4 or 6 coal heavers, at \$15 per month.

"Add to this when the vessel is in actual operation—

"1 chief engineer, 4 additional firemen and 4 coal heavers.

"The coal holes are at the ends of the boilers, opposite to the furnaces, and the coal must necessarily be transported some distance.

"These are the estimates of Mr. Haswell, Mr. Kimble, and several other competent persons with whom I have conferred on the subject.

"It is apparent that no less than four engineers will answer, as it requires *two* constantly at the levers, by which the engines are

stopped and put in motion, which are worked on the *spar deck*, and two at the engines and boilers *below deck*, to watch the machinery and attend the water in the boilers—a most important consideration, as by the least neglect in this particular some accident occurs or the boilers are burnt.

“It is necessary, also, that the firemen should be somewhat acquainted with the operation of the engines, the mode of supplying the boilers, &c., as also the mode of placing the coals to prevent the burning of the furnaces.

“The gentlemen all agree that the above is the least number that prudence and economy would authorize.

“The large North river and Rhode Island boats have three engineers each, and their firemen understand starting and stopping the engines, regulating the steam, &c. Their wages are—for the chief engineer, \$1,000 per annum; two assistants, at \$360 and \$600 per annum. Add to this their board, which, in the navy, would be defrayed by themselves all beyond the ration of 20 cents per day.

“Those denominated first-class assistants for the navy should correspond in qualifications with the chief engineers of private steamers, and their assistants with the second-class proposed for the navy, as it is supposed that the Government can hire persons on lower terms.

“It has been suggested, in which I fully concur, that there should be these several described rates among the engineers and firemen in our national steamers, the better to distribute authority and responsibility, and to produce a proper ambition with the inferior rates to rise to the higher classes.

“I enclose herewith a letter from Captain William Comstock, giving his views on the subject. And it may be remarked here, that all concur in the opinion of the necessity of separating the regular crew from any interference with the engineers.

“I would respectfully invite the attention of the Commissioners to the consideration of the *tenure* by which these assistant engineers are to hold their appointment, and by what authority they are to be granted. It seems to me the process of their discharge, at least, should be summary, and entirely divested of the legal forms of arrest, court-martial, &c. The slightest appearance of intemperance, neglect, carelessness, &c., should be sufficient cause for their certain

dismissal from the service. With whom is to rest the authority to judge of these delinquencies, and the necessity of the infliction of the penalty, will, of course, be determined on in time, and made known to the persons on receiving the appointment.

“I have the honor to be, gentlemen, your obedient servant,

“M. C. PERRY.

“To the Commissioners of the Navy, Washington, D. C.”

This letter is important in our history as a corps, being the earliest official document containing so much as a hint of the necessity of organizing a permanent corps of naval engineers.

The Board of Naval Commissioners agreed to Captain Perry's recommendations as to wages for engineers and firemen, although remarking that for the latter the pay appeared high in addition to the ration, and referred the matter to the Department with various recommendations. The Department let the matter rest for more than a month, until, about the end of October, Captain Perry reported the vessel ready for steam, and called attention to the fact that no authority existed for the employment of assistant engineers, adding that their services were much needed. The suggestions made by the Board of Navy Commissioners on September 15 were promulgated as the regulations of the Department governing the appointment of “these descriptions of persons for the steamer.” The recommendations of the Board, which became the Department's regulation, is another important document in the history of the engineer corps, and is here given:

“Upon the subject of *appointments* of the engineers, etc., the Board respectfully suggest the expediency of allowing, for the present, the commandant to nominate the assistant engineers, after collecting, as far as practicable, proofs or certificates of their character and qualifications, subject to the confirmation of the commander of the station, when time will allow of an immediate reference; in other cases, to be made by the commander of the vessel.

“That they receive a letter of appointment, revocable at any time by the commander of the station upon complaints of intemperance, incapacity, insubordination, negligence, or other misconduct, by the commander of the vessel, if proved to the satisfaction of such commanding officer of the station.

“The commander of the vessel, of course, to have the power of suspending them from duty, if he deems it necessary.

“The engineers to sign some proper instrument, which will legally render them liable to the laws for the government of the navy, but to be exempt from corporal punishment; which instrument is to be transmitted to the Secretary of the Navy, with the letter accepting their appointment.

“The firemen and coal-heavers to sign the shipping articles and be removable at the pleasure of the commander of the vessel, as authorized for the reduction and punishment of petty officers and seamen.”

This order was dated October 31, 1837, and was carried into effect by the appointment of John Faron, Jr., and Nelson Burt as first assistant engineers on November 15, and of J. C. Hines and Hiram Sanford as second assistants on November 21. These appointments were made by Captain Perry himself, as shown by the following extract from a report made December 16 on the steam trial of the *Fulton*:

“The assistant engineers appointed by me promise to be highly industrious and useful men. I have been much pleased with their conduct, and, so far as I am yet capable of judging, consider them well acquainted with their duty; of one thing I am certain, that if the vessel is to be employed at all, sixteen, instead of eight firemen will be indispensably necessary.”

On November 1 the engines of the *Fulton* were put in motion for the first time and the result was highly satisfactory; “twelve inches of steam was produced in less than an hour by chips from the yard,” to quote from Captain Perry’s report. During the ensuing winter the *Fulton* was thoroughly tried in free route and proved herself a success as a steamer, although certain peculiarities in construction precluded her use as a cruiser for general sea purposes: in fact she was not built for such service, the primary idea in her construction being to provide a harbor-defense vessel to take the place of the first *Fulton*, or *Demologos*.

Captain Perry reported in February that her usual speed at a medium pressure of steam and twenty revolutions per minute of the engines had been proved to be about twelve knots, and that her

maximum speed, at a forced pressure, might be extended to fifteen knots. He spoke highly of her efficiency as an armed vessel, in comparison with vessels of war not propelled by steam, and gave an opinion resulting from his observations that "there is not the least doubt that *sea steamers* of 1,400 or 1,500 tons can be constructed and equipped to cruise at sea, for limited periods (say twenty days,) as efficient vessels of war, to be as safe from the disasters of the sea as the finest frigate, and at an expense considerably less." Lieutenant Lynch, attached to the vessel, in a written report stated that "For harbor and coast defense, in *light winds and calms*, with a battery of long 64-pounders, the *Fulton*, with slight alterations, would be perfectly efficient, and more useful than any number of armed ships not propelled by steam," and the opinions of the other officers, all whom had to make reports to Captain Perry, generally agreed to this. In Chief Engineer Haswell's report we find the following carefully itemized statement of current expenses of running the engines, which is both curious and interesting at this date:

Engines, 3 quarts of oil, at 18½c.....	\$0.56
Engines and boilers, 5 pounds of tallow, at 10c.....	.50
Engines, 2½ pounds of hemp, at 12c.....	.30
2 pounds of spun yarn, at 12c.....	.24
½ pound of black lead, at 10c.....	.10
Paints and brushes.....	.75
Boilers, Indian meal.....	.24
Engines and boilers, white lead, 2 pounds at 12c.....	.24
Lamps and lanterns.....	.10
Shovels, brooms, and axes.....	.28
Tools.....	.50
	<hr/>
For twelve hours.....	\$3.66
Off one-sixth per diem of ten hours.....	.61
	<hr/>
	\$3.05

More light on the operation of the machinery is given by the synopsis of the engine-room log, here following in the form of the engineer's weekly report for one of the weeks that the vessel was under steam a considerable part of the time:

ENGINEER'S WEEKLY REPORT, (ENDING MONDAY, 22d, 1898), UNITED STATES STEAMER FULTON,

M. C. PERRY, Esq., COMMANDER.

Time of setting fire.	Time of raising steam.		Boilers used.		Engines used.		Average pressure.		Average vacuum.		Average revolutions.		Engines at rest.		Time of blowing off.		Engines in operation.		Time consuming fuel.		Cords of wood consumed.		Bu. of coal consumed.			
	H	M	H	M	H	M	H	M	H	M	H	M	H	M	H	M	H	M	H	M	H	M	H	M	H	M
17th, A. M.	10	30	11	40	4	2	10	11	17	0	15	P.M.	8	17	3	22	4	47	10	105	REMARKS.—Slip joints of starboard engine leaked some, but were screwed up after every trip. Lost five water-wheel arms and three buckets. Lengthened larboard piston rod one-fourth of an inch. Set grate bars in after larboard furnaces for burning coal. On 20th let fires in forward boilers go down after under way, and carried six inches steam, and engines made thirteenth revolutions with the two remaining boilers.					
18th, A. M.	9	5	10	0	4	2	7.5	10	14	0	40	P.M.	12	12	1	32	3	07	6	65						
20th, A. M.	8	40	9	30	4	2	11	12	18	0	20	P.M.	2	35	4	45	5	55	2†	205						
22d, A. M.	8	45	9	50	4	2	11	12	17.5	1	0	P.M.	3	30	4	40	6	45	5†	285						
														14	19	20	34	23†	660							

CHAS. H. HASWELL, ENGINEER.

APPROVED: M. C. PERRY, CAPTAIN.

NEW YORK, January 23, (S. A.), 1898.

When the *Fulton* was put in commission with a regular complement of officers and men on board, the question of what to do with the engineers as to their quarters and messing arrangements came up, and was a difficult one to settle, because there were no precedents to follow and no regulations regarding the new class of officials. Fortunately for Mr. Haswell, and for those who came after him as well, his social status was such, that his place among the officers was obviously in the ward room, and to that part of the ship he was assigned irrespective of the fact that he held no commission and no rank in the service. The precedent thus established of assigning the chief engineer to the ward-room operated to the benefit of other chief engineers in the following years, until, in 1842, the quarters for chief engineers on board ship were specified by law to be in the ward-room. The assistant engineers of the *Fulton* were berthed and messed with the warrant officers.

In April, 1838, the *Fulton* visited Norfolk and Washington and was an object of general attention, especially at the national capitol. In September of the same year, in consequence of a discussion that was related to the Secretary of the Navy, she was ordered back to

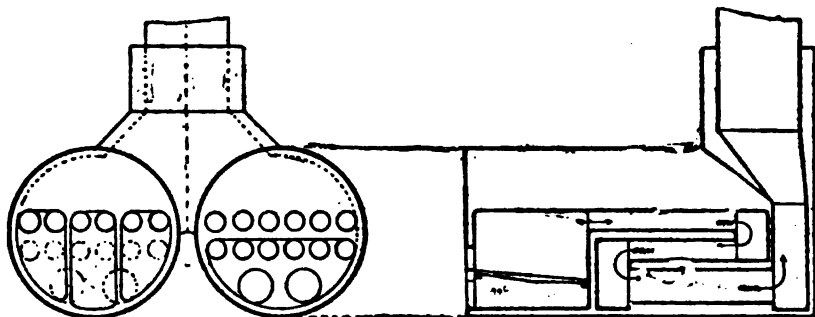

RETURN DROP-FLUE BOILERS, U. S. S. FULTON(3D), 1850.

Diameter of shells 10 feet, 6 inches. Length, 22 feet.
 Length of furnace, 7 feet. Height of furnace 6 feet, 3 inches.
 Diameter of flues, two upper rows, 16 inches. Lower row, 25 inches.
 Diameter of steam drum, 7 ft, 3 in. Diameter of smoke pipe, 5 ft. 3 in.

New York for the express purpose of testing her speed with that of the British steamer *Great Western*, running between New York and Liverpool. The *Fulton* followed the latter vessel to sea on the oc-

casian of her regular departure, ranged up alongside and passed her rapidly. After being employed in active service along the Atlantic coast of the United States until 1842, the *Fulton* was laid up in ordinary at the New York navy yard, where she remained a neglected and useless hulk until 1851. In the latter year the machinery was entirely replaced by a different type, designed under the direction of Mr. Charles B. Stuart, then engineer-in-chief of the navy. There was a single inclined engine mounted on a wooden frame, the cylinder being fifty inches in diameter and ten feet four inches stroke, provided with a Sickel's cut-off. The old copper boilers were replaced with two wrought iron ones of the double-return, drop-flue variety, ten feet six inches in diameter and twenty-two feet long. Feathering paddle wheels were substituted for the original radial wheels. The shaft of this engine was of wrought iron.

The hull was hauled on the ways and thoroughly repaired, the upper deck and high bulwarks being removed and the interior arrangements were completely changed because of the altered arrangement of the machinery, but the original lines of the ship were not disturbed. The rig was changed to a two-masted fore-topsail schooner. A trial trip was run January 1, 1852, in New York harbor, seventy-one and one-half miles being run under steam between various intervals of stopping, sailing, backing, etc., which interruptions completely destroy the results as a steam trial. The report of this trial gives the average steam pressure as twenty-five pounds; average vacuum, twenty six inches; average revolutions, twenty-one, and average speed, 13.34 *miles* per hour. For a period of twenty-one minutes at the end of the performance, with thirty pounds of steam and twenty-three revolutions, the distance run is given as seven miles, or at the rate of twenty miles per hour. Unfortunately the report does not state the condition of the wind and tide at that period, so we do not know whether the high speed was due entirely to the engines or not. It is a matter of record, however, that the vessel had a reputation in the service as a very fast steamer. She was employed on general cruising duty in the home squadron and West Indies for several years, was one of the vessels of the Paraguay expedition in 1858, and in 1861 was in ordinary at the Pensacola navy yard.

The Pensacola yard was surrendered to the Confederates Jan-

uary 10, 1861, and the *Fulton* thus fell into their hands ; she was then in very bad condition, having sometime previously been stranded and nearly wrecked near Pensacola, but her captors hauled her on the building-ways and began repairing her. May 9, 1862, military operations compelled the Confederates to abandon the yard, they burning everything behind them. An account of this destruction is given in Mr. J. T. Scharf's History of the Confederate States Navy, in which account appears the last historical reference to this famous old steamer—"The *Fulton*, that was on the stocks in the navy yard, was burned."

This story of the old *Fulton* would be incomplete without a special reference to the invaluable services rendered by Captain M. C. Perry to the steam navy which her example called into life, his able championship of engines and engineers in connection with her having properly given him a place in our naval history as the father of the American steam navy. Matthew C. Perry was a younger brother of that other Perry who overcame the British on Lake Erie in 1813, which event is so nearly synonymous in the public mind with the name of Perry that the deeds of the younger brother, some of which were of more lasting importance than the mere winning of a battle, have been dimmed by contrast. Captain Perry's services to the naval engineer corps in connection with his command of the *Fulton* were both important and lasting, and can best be told by quoting from his biography, written by a distinguished civilian, Reverend Wm. E. Griffis, another of whose books, "The Mikado's Empire," has been a source of instruction and pleasure to hundreds of our naval officers of the present time who have had the privilege of seeing the shores of beautiful Japan:

"Perry took command of the *Fulton* October 4th, 1837, when the smoke-pipes were up, and the engines ready for an early trial. His work meant more than to hasten forward the completion of the new steam battery. He was practically to organize an entirely new branch of naval economy. There were in the marine war service of the United States absolutely no precedents to guide him.

"Again he had to be 'an educator of the navy.' To show how far the work was left to him, and was his own creation, we may state that no authority had been given and no steps taken to secure firemen, assistant engineers, or coal heavers. The details, duties,

qualifications, wages, and status in the navy of the whole engineer corps fell upon Perry to settle. He wrote for authority to appoint first and second-class engineers. He proposed that \$25 to \$30 a month, and one ration, should be given as pay to firemen, and that they should be good mechanics familiar with machinery, the use of stops, cocks, gauges, and the paraphernalia of iron and brass so novel on a man-of-war.

“Knowing that failure in the initiative of the experimental steam service might prejudice the public, and especially the incredulous and sneering old salts who had no faith in the new fangled ideas, he requested that midshipmen for the *Fulton* should be first trained in seamanship prior to their steamer life. He was also especially particular about the moral and personal character of the ‘line’ officers who were first to live in contact with a new and strange kind of ‘staff.’ It is difficult in this age of war-steamers, when a sailing man-of-war or even a paddle-wheel steamer is a curiosity, to realize the jealousy felt by sailors of the old school towards the un-naval men of gauges and stop-cocks. They foresaw only too clearly that steam was to steal away the poetry of the sea, turn the sailor into a coal heaver, and the ship into a machine.

“Perry demanded in his line officers breadth of view sufficient to grasp the new order of things. They must see in the men of screws and levers equality of courage as well as of utility. They must be of the co-operative cast of mind and disposition. From the very first, he foresaw that jealousy amounting almost to animosity would spring up between the line and staff officers, between the deck and the hold, and he determined to reduce it to a minimum. The new middle term between courage and cannon was *caloric*. He would provide precedents to act as anti-friction buffers so as to secure a maximum of harmony.

“That was Matthew Perry—ever magnifying his office and profession. He believed that responsibility helped vastly to make the man. He suggested that engineers take the oath, and from first to last be held to those sanctions and to that discipline, which would create among them the *esprit* so excellent in the line officers.”

CHAPTER III.

"So shalt thou instant reach the realm assigned,
In wondrous ships, self-moved, instinct with mind;

Though clouds and darkness veiled the encumbered sky,
Fearless, through darkness and through clouds they fly."

ALEXANDER POPE, *translation of the Odyssey.*

The **ENGINEER**—The **MISSISSIPPI** and **MISSOURI**—Establishment of the Engineer Corps by Act of Congress—Destruction of the **MISSOURI**—Career of the **MISSISSIPPI**—Steamers Transferred to the Navy from the War Department—The **MICHIGAN**.

BEFORE the completion of the *Fulton*, a single steam vessel appeared in the navy in the form of a small paddle-wheel tug-boat of 142 tons, which was bought in Baltimore in 1836 for \$18,997, and was named the *Engineer*. This boat had a single beam engine of about one hundred horse-power, and one iron flue boiler: the vessel was used as a tug and dispatch boat about the Norfolk navy yard for a number of years, and also did some service on the southern coast as a surveying vessel. Although not a war vessel in any sense, this craft is here referred to because she was for a short time the only steamer in the navy, and was a familiar object to the early members of the engineer corps, many of whom were assigned to her for temporary service while getting broken in to the rules of the navy.

In 1839 two boards of officials were convened in Washington to consider the method of carrying out the provisions of an act of Congress authorizing the construction of two or more steam vessels of war. One of these boards was composed of commodores, and was directed to "consider and decide upon the qualities and power which it was desirable to secure in the vessels:" the other was composed of naval constructors and one engineer, Mr. Haswell being the latter, with instructions to scrutinize the report of the commodores, and determine whether the qualities and powers recommended by them could be combined practically, and if so, to prepare the details for carrying them out. The result of this labor set in process of construction two large side-wheel frigates named the *Mississippi* and

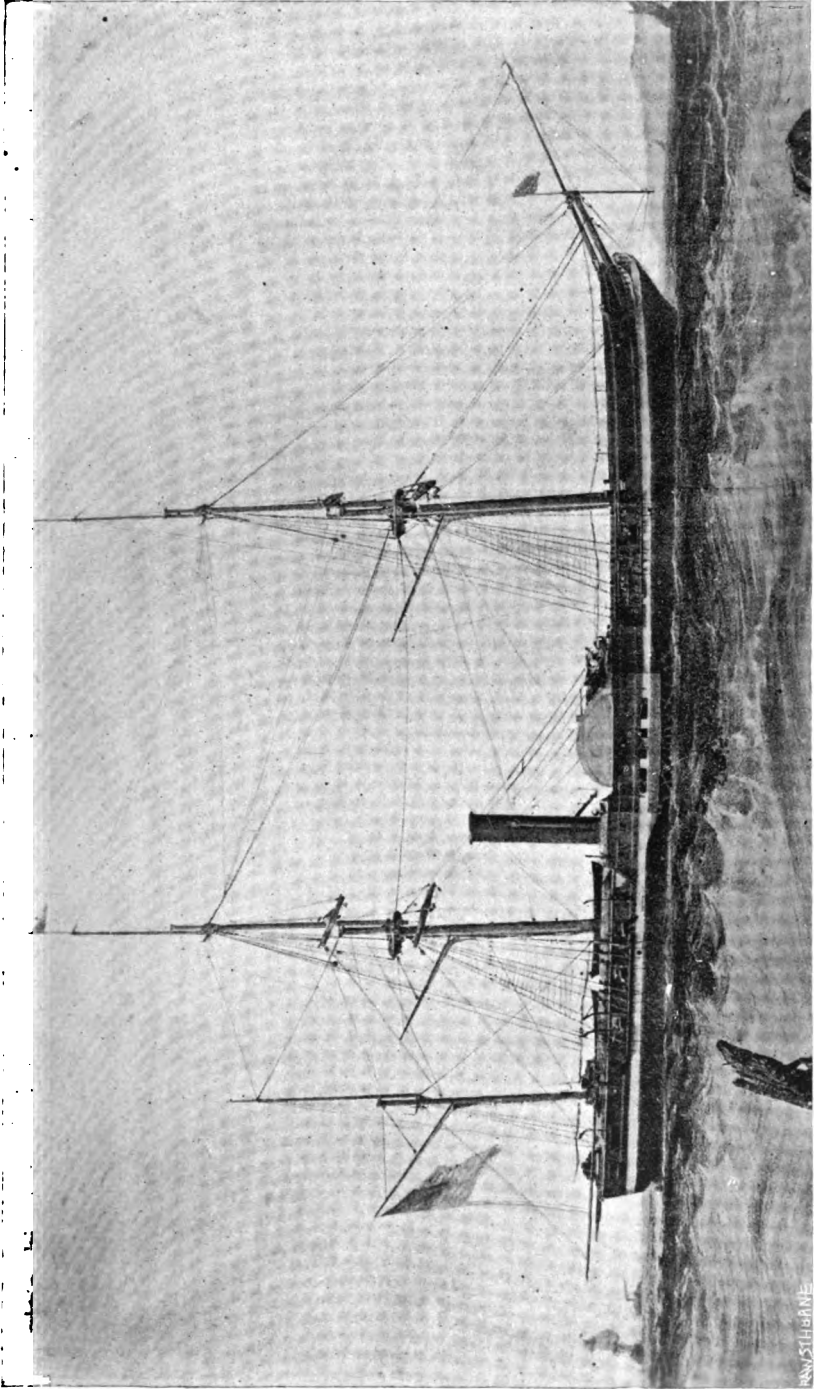

U. S. S. MISSISSIPPI (AND MISSOURI), 1842.

NEWSPHOTO

Missouri, precisely alike in all respects, except the type of engines. It is not to be supposed that the inauguration of the policy of building steam vessels for the navy was unattended with skepticism and opposition; like the application of all great scientific discoveries, the introduction of steam power was combatted and misunderstood, abroad as well as in our own country. The logic, if it may be so called, of the opposition is well indicated by the vehement utterance of Lord Napier in the British House of Commons in a speech fiercely antagonistic to the building of steamers of war: "Mr. Speaker, when we enter Her Majesty's naval service and face the chances of war, we go prepared to be hacked in pieces by cutlasses, to be riddled with bullets, or to be blown to bits by shot and shell; but, Mr. Speaker, we do not go prepared to be *boiled alive*."

The principal data common to both the *Mississippi* and *Missouri* were the following:

Length over all.....	229 feet.
Beam.....	40 feet.
Mean draft.....	19 feet.
Displacement at mean draft.....	3,220 tons.

The vessels were bark-rigged, spreading 19,000 square feet of canvas in plain sails to top-gallant sails inclusive. Each vessel had three copper boilers of the double return ascending flue variety, with three furnaces and eighty square feet of grate surface in each boiler; the heating surface of each boiler was 2,000 square feet, or exactly twenty-five times the grate surface. The paddle-wheels were twenty-eight feet in diameter and eleven feet broad. The battery of each vessel consisted of two X-inch and eight VIII-inch shell guns. The *Mississippi* had two side-lever engines with cylinders seventy-five inches in diameter and seven feet stroke, and the *Missouri* had two inclined direct-acting engines with cylinders sixty-two and one-half inches diameter and ten feet stroke: the cubical contents of the cylinders of the two vessels were practically the same, a difference being made in the length of the stroke to test the relative merits of long and short stroke engines.

The hulls were of wood, that of the *Mississippi* being constructed at the navy yard, Philadelphia, and that of the *Missouri* at the New York navy yard. The *Mississippi's* machinery was built

by Merrick and Towne in the city of Philadelphia, and that for the *Missouri* by the West Point Foundry Association at their works at Cold Spring, New York. The machinery for both vessels was designed by Mr. Charles W. Copeland, referred to in a previous chapter as the superintending engineer of the West Point Foundry Association at the time the engines for the *Fulton* were built. He had been employed as a consulting engineer for the Board of Navy Commissioners, and, with the title of Principal Engineer, held that position for several years, during which time he did much excellent work in designing machinery for the new steam navy, although he never was in the naval service in the sense of holding a commission as an officer or being amenable to military law and discipline.

In the fall of 1839, when the work of building these two vessels began, Mr. Haswell was detached from the *Fulton* and assigned to duty with Mr. Copeland in New York to prepare drawings of machinery for both vessels. It was in the course of this work that Mr. Haswell laid down the boilers of both the new vessels in full size, designed and determined the dimensions of each plate, and thus for the first time in the history of boiler manufacture were the plates rolled and trimmed to measure. In January, 1840, Mr. Faron, the senior engineer of the *Fulton*, was promoted to be a chief engineer, detached from the *Fulton* and detailed to superintend the building of the *Mississippi's* engines in Philadelphia, his place on the *Fulton* being filled by Mr. Andrew Hebard, who was appointed chief engineer from civil life. Shortly afterward Mr. Haswell was named as superintendent of the engines building for the *Missouri*.

The two frigates were completed early in 1842, and a number of engineers were appointed in the manner indicated by the Department's regulation on the subject, quoted in a former chapter. A remarkable fact in connection with the building of these two ships is the close parallelism of their cost, although they were built in different cities, and had engines radically different in details of construction: in 1853 the Navy Department, in obedience to a resolution of the House of Representatives, informed Congress that the actual cost of the *Mississippi* to the time of her first sailing, exclusive of ordnance, was \$569,670.70, and of the *Missouri*, \$568,806. Mr. Faron was the first chief engineer of the *Mississippi*, and Mr. Hebard of the

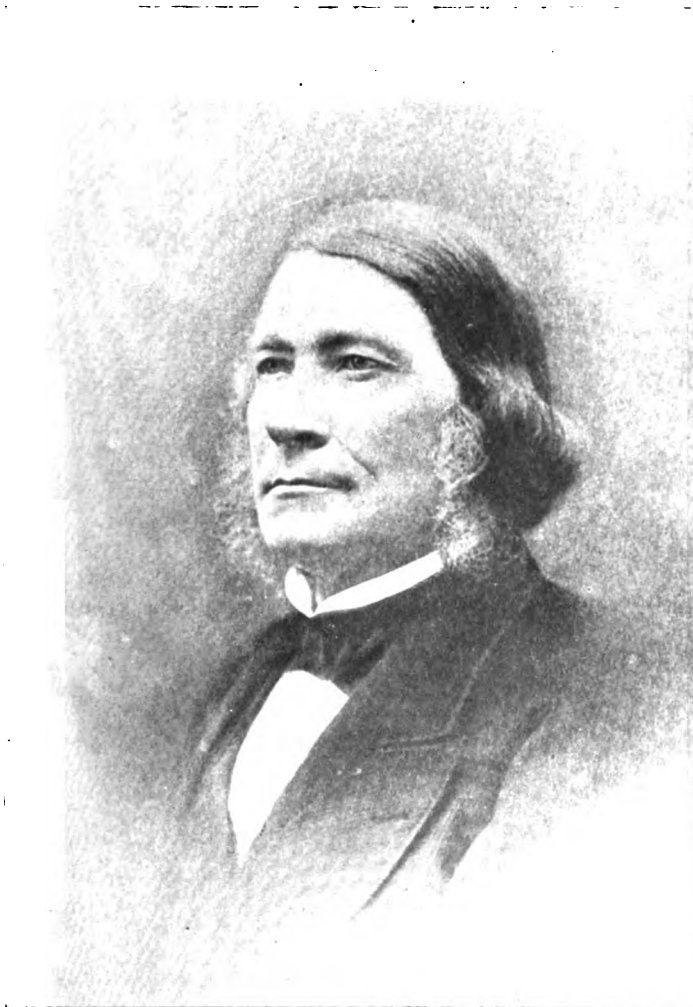

MR. CHARLES W. COPELAND,

**Principal Engineer, U. S. Navy. Designer of the machinery of the
*Mississippi, Missouri, etc.***

Missouri, he being temporarily assigned to that vessel while Mr. Haswell was engaged with Mr. Copeland on the designs of a new steamer—the *Michigan*. This latter work was completed in October, 1842, when Mr. Haswell returned to the *Missouri* as her chief engineer.

After the appointments for the two new frigates were made there were twenty engineers in the service, with prospects for the need of many more in the near future, as the policy of building war steamers was so well established that there was no longer any hope for success on the part of the conservative element which had struggled against the new order of things so stubbornly. The engineers were very much dissatisfied with various anomalies and evils incident to their connection with the navy, and began an agitation which speedily resulted in the legal establishment of the engineer corps as a permanent part of the naval organization. Their pay did not compare favorably with the wages of competent engineers in civil employment, and consequently was unsatisfactory to them; the irregular manner in which they were appointed, and their uncertain tenure of office, were also grievances, and early in the year with which we are now dealing an incident occurred which so provoked the engineers that they felt constrained to lay their troubles before Congress. This incident was the appointment as an engineer in the navy of a young man who made no pretense to knowledge of engineering, he being the *protege* of a powerful politician and simply wanted a salaried position under the Government, without bothering himself as to what the duties of that position might be. That the engineers then in the service resented this appointment is good proof that there already existed among them that pride in their calling and the *esprit de corps* that have for so long kept them united and made continuous progress possible in the midst of many discouragements.

Mr. Haswell, as the senior and most prominent of the engineers, took the matter in charge, and appealed to Congress for a redress of grievances. Mr. Gilbert L. Thompson, a prominent politician and man about town in Washington in those days, took up Mr. Haswell's cause and gave him much assistance, although his motives were not entirely philanthropic, as we shall presently see. The result of this effort was an act of Congress regulating the appointment and pay of

engineers in the navy, which act was approved August 31, 1842, and read in full as follows:

SECTION 1. *Be it enacted, etc.,* That the Secretary of the Navy shall appoint the requisite number of chief engineers and assistant engineers, not to exceed one chief engineer, two first assistant, two second assistant, and three third assistant engineers for each steamship of war, for the naval service of the United States, who shall be paid, when in actual service, as follows :

To the chief engineer, fifteen hundred dollars per annum and one ration per day ; to the first assistant engineer, nine hundred dollars per annum and one ration per day ; to the second assistant engineer, seven hundred dollars per annum and one ration per day ; to the third assistant engineer, five hundred dollars per annum and one ration per day. The chief engineer shall be entitled to mess in the wardroom of ships of war, and in all cases of prize-money he shall share as a Lieutenant ; the first assistant engineer shall share as a lieutenant of marines ; the second assistant engineer shall share as a midshipman ; the third assistant engineer shall share as the forward officers ; but neither the chief nor the assistant engineers shall hold any other rank than as engineers.

SEC. 2. *And be it further enacted,* That the Secretary of the Navy shall be authorized to enlist and employ the requisite number of firemen, who shall receive, each, thirty dollars per month and one ration per day ; and the requisite number of coal-heavers, who shall receive, each, eighteen dollars per month and one ration per day ; and the said firemen and coal-heavers shall in all cases of prize-money share as seamen.

SEC. 3. *And be it further enacted,* That the said chief engineer and the assistant engineers when waiting orders shall be paid as follows : to the chief engineer, twelve hundred dollars per annum ; to the first assistant engineer, seven hundred dollars per annum ; to the second assistant engineer, five hundred dollars per annum ; to the third assistant engineer, three hundred and fifty dollars per annum.

SEC. 4. *And be it further enacted,* That the Secretary of the Navy shall appoint a skillful and scientific engineer-in-chief, who shall receive for his services the sum of three thousand dollars per annum, and shall perform such duties as the Secretary of the Navy shall require of him touching that branch of the service.

SEC. 5. *And be it further enacted,* That the Secretary of the Navy shall be authorized to prescribe a uniform for the said chief engineers and assistant engineers, and to make all necessary rules and regulations for the proper arrangement and government of the corps of engineers and assistant engineers not inconsistent with the Constitution and laws of the United States. The said engineers and assistant engineers shall be in all respects subject to the laws, rules, and regulations of the naval service in like manner with other officers of the service.

SEC. 6. *And be it further enacted,* That the said chief engineers shall be appointed by commission, and the assistant engineers shall be appointed by warrant from the Secretary of the Navy, in such form as he may prescribe.

SEC. 7. *And be it further enacted,* That the Secretary of the Navy be and he is hereby authorized to establish, at such places as he may deem necessary, suitable depots of coal or other fuel for the supply of steam ships of war.

The day following the approval of this act Mr. Gilbert L. Thompson was appointed engineer-in-chief of the navy ; this to the

great amazement and disgust of Mr. Haswell, who had seen in him only a benevolent and influential gentleman disposed to devote his time to the support of the cause simply because it was right. Benevolent gentlemen with unlimited time and influence to expend in the righting of wrongs abound in the harmless works of fiction distributed by the tract societies, but in real life they are extremely rare. Of Mr. Gilbert L. Thompson one of his contemporaries has written the author: "Mr. Thompson was a lawyer, and knew absolutely nothing of engineering. He was a gentleman, a scholar, a diplomatist, and a son of a previous Secretary of the Navy; but his engineering was purely nominal, and confined to a very prompt and efficient drawing of his salary."

In the spring of 1843 the *Missouri*, after a prolonged cruise in the Gulf of Mexico, was ordered to Washington, where Mr. Thompson caused her smoke-pipe, seven feet in diameter, to be removed and replaced with two pipes, each *three feet six inches* in diameter. The two pipes diverged out towards the sides and connected with the wheel-houses with the idea that the centrifugal action of the wheels would induce a strong draught by forcing air up through the pipes. In this connection it must be known that the boiler room of the *Missouri* was abaft the engines and the wheels consequently were forward of the smoke-pipes, which arrangement would have seriously interfered with the operation of the forced draught scheme in a head wind, even if there had been any merit in it under other conditions. Mr. Haswell, the chief engineer of the *Missouri*, protested against the design and declared it impracticable, but his professional opinion was unheeded. Engineer-in-Chief Thompson was so confident of success that he had the members of the Cabinet invited on board to witness the trial of his discovery, but they attended a funeral feast, for the scheme failed most dismally in operation. A scapegoat being necessary, Mr. Haswell was selected and suspended from duty because he had "not used sufficiently inflammable material in lighting the fires," although it is not apparent at this late date just what the manner of lighting fires would have to do with any subsequent performance with steam raised. Mr. Haswell was later offered to be restored to duty and proceed with the ship to the **Mediterranean**, where she had been ordered, on condition that he

would apologize to the captain for his error (4), but this he declined to do, notwithstanding the requests of his messmates, saying that he would "rather suffer injustice from another than be unjust to himself." Whereupon he was detached from the vessel and Chief Engineer Faron ordered to take his place.

The experiment, above related, definitely established the fact that Mr. Thompson was not an engineer, whatever ability he might have in other directions, and his opinions were no longer sought in the councils of the Navy Department. After leaving the *Missouri*, Mr. Haswell was employed in designing machinery for four Revenue cutters, and in December was completely vindicated for his affair on the *Missouri* by being ordered to the Navy Department and assigned to the duties of engineer-in-chief; October 3 of the following year (1844) Mr. Thompson's name was dropped from the list and Mr. Haswell was regularly appointed engineer-in-chief of the navy.

The smoke-pipe of the *Missouri* was restored to its original form and the vessel proceeded to the Mediterranean, arriving at Gibraltar on the 25th of August after a voyage of nineteen days from the Capes of the Chesapeake. The next day, August 26, 1843, the engineer's yeoman broke a demijohn of spirits of turpentine in the store-room, which ignited and started a fire that spread so rapidly that all hope of saving the vessel had to be abandoned, and the crew barely escaped with their lives. In a few hours this splendid vessel was reduced to a blackened and sinking hulk. Her commander, Captain J. T. Newton, and Chief Engineer John Faron, Jr., were tried by court-martial upon their return home and were sentenced to suspension from duty, the former for a period of two years, and the latter for one year, which sentences were remitted after the captain had served four months and the chief engineer eight months. Congress appropriated sixty thousand dollars later to be expended in removing the sunken wreck from Gibraltar harbor. When chief engineer of the *Missouri* the year before she burned, Mr. Haswell had asked for a leaden tank in which to keep the spirits of turpentine, but the requisition was refused.

The *Mississippi* had a long and famous career, but eventually met a far more tragic fate than did her sister ship. She is said to have been a beautiful vessel, and from having had a succession of

able commanders and common-sense officers in full accord with each other, she won the enviable reputation of being a "happy ship," and with this reputation was the most popular and best known of all the steamers of the old navy. She was the flagship of Commodore M. C. Perry in the Mexican War, and also his flagship in the expedition to Japan; she carried the famous Hungarian exile, Kossuth, from Turkey to France, and brought a number of his fellow-exiles to the United States. As the flagship of Flag Officer Josiah Tatnall in 1859 she was present at the engagement in the Pei Ho river,

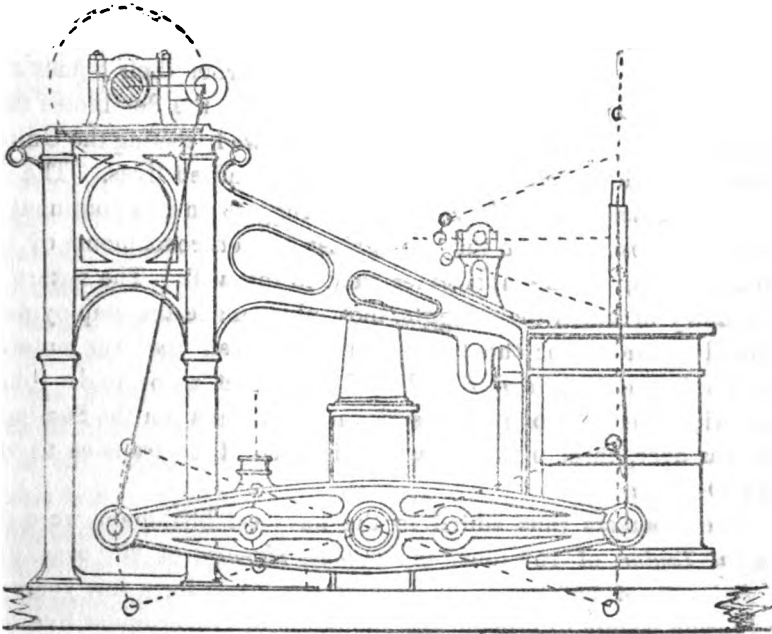

SIDE LEVER ENGINE, U. S. S. MISSISSIPPI.

where the "blood is thicker than water," sentiment is said to have originated, and at the outbreak of the Civil War was one of the first vessels to go to the front. She had twice circumnavigated the globe, and it was said of her, probably truly, that she had cruised more miles under steam than any war vessel of her time. Eventually a combination of circumstances, so strange that their suggestion during her palmy days would have been scouted as the climax of absurdity, brought this noble frigate with hostile intent into the great river

whose name she had so long and so worthily carried about the world, and there one dark night in a storm of shot and shell, in fire and smoke, she sank to her long rest, a coffin for many of her crew, on the bosom of her false god-mother.

While the *Mississippi* and *Missouri* were being built, the Government was bringing to an end a long and bloody war with the Seminole Indians of Florida. It had been decided to remove this tribe from its lands and deport it to the wilds beyond the western frontiers, but when efforts were made to carry the decision into effect the savages declined to be moved, they viewing the matter in the same light that we may imagine the present inhabitants of Florida would regard a similar project to eject them from their homes and belongings. Under their great chief, Osceola, the Seminoles took up arms and a long and devastating war followed, costing the United States ten million dollars and nearly fifteen hundred lives. The result was the same as of all other weary struggles on this continent of the original possessors of the soil against the encroachments of the dominant race, and the aborigines went to the wall. The nature of the country in which the struggle took place made the employment of small steamers for the transportation of men and war material absolutely necessary, and the War Department accordingly found itself with a number of such vessels on its hands when the Seminole War was over, three of which were disposed of by transfer to the Navy Department.

The steamers thus added to the navy establishment were the *General Taylor*, of 152 tons; the *Colonel Harney*, of 300 tons, and the *Poinsett*, of 250 tons. They were employed for a few years on the Florida waters to prevent the spoliation of Government live oak preserves, one or two naval engineers being usually attached to each. The *Poinsett* was sold in 1845 for \$5,000, and the *Harney* was returned to the War Department in 1846. The *General Taylor*, after being the tender at the Pensacola navy yard for several years, was sold in 1852 for \$3,000.

In 1841 and 1842 plans were prepared for the paddle-wheel steamer *Michigan*, the hull being designed by Naval Constructor Samuel Hartt, and the engines and boilers by Mr. C. W. Copeland. There were two inclined direct acting condensing engines, placed side by side, the cylinders being 36 inches in diameter and eight

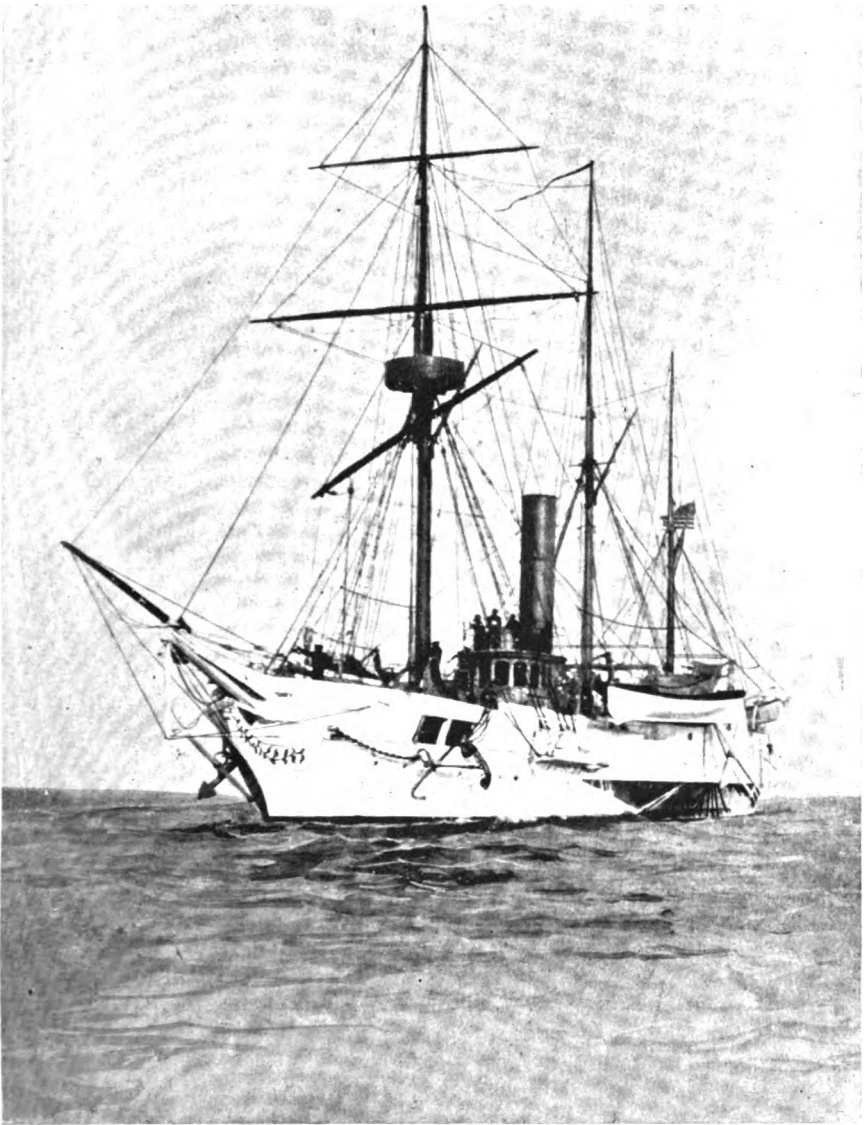

U. S. S. MICHIGAN.

feet stroke; these engines are now, more than fifty years after the *Michigan* was first commissioned, still in the vessel and in excellent working order. The two original return-flue iron boilers lasted nearly fifty years, they having been replaced as recently as the winter of 1892-93. The engines and boilers were built by Stackhouse & Tomlinson in Pittsburgh, Pa. The hull was built of iron, the plates, frames and other iron material being all prepared in Pittsburgh ready for assembling and then transported overland to Erie, Pa., where the vessel was put together and launched in 1843, making her first cruise on the Great Lakes in 1844. She was the first iron vessel afloat on those waters, and is still in active service, a striking illustration of the difference between fresh and salt water as agents for the deterioration of iron vessels. It should be mentioned, however, that the extraordinary longevity of the *Michigan* is partly due to the fact that she has to lie up in a winter harbor for about six months each year, and thus the chances for her untimely destruction by the usual perils of the sea have been reduced one-half. The first commander of the *Michigan* was William Inman, and her first chief engineer Andrew Hebard.

CHAPTER IV.

"A little learning is a dangerous thing."

ALEXANDER POPE.

Experiments with the "Hunter Wheel"—The UNION—The WATER WITCH—The ALLEGHANY—The Stevens Battery.

THE work of the engineers in designing and building machinery for the new naval steamers, while it excited suspicion and opposition from some who were well satisfied with the navy as it was, attracted a certain amount of admiration from others and it was not long before amateur imitators of their work sprung up in the service. Early in 1842, Lieutenant W. W. Hunter of the navy secured a patent for a submerged wheel, claiming a great improvement over the ordinary side wheels in propelling vessels. Experiments were made on the old canal in Washington with a small boat named the *Germ* fitted with Hunter's wheels, and the results obtained presented to the Navy Department in such a favorable light that it was determined to build a war-steamer to test the invention on a large scale.

The Hunter wheel consisted essentially of a drum with the paddles projecting from its surface like the teeth of a large gear wheel or pinion; the axis of the wheel was placed vertically and the wheel so located in the vessel, below the water line, that as it revolved the paddles, when at right angles to the keel, would project their whole width from the side of the ship through a suitable aperture. To keep the water from flowing into the ship through this opening the drum was cased inside the ship with a box or coffer-dam made to fit as closely as safety permitted, in practice a clearance of about two inches on all sides being allowed. A wheel was fitted on each side of the ship. In operation it will be observed that this wheel would act on the water on precisely the same principle as that governing the ordinary side wheel, but unlike the latter its idle side, instead of revolving through the air, had to do work all the time, by sweeping around the water inside the casing. It had an advantage in dispensing with the large wheel-houses which were exposed to shot and offered much resistance to the wind, beside blocking space belonging

to broadside guns, but this was practically offset by the disadvantage of having so much space in the hold occupied by the drum cases, while the enormous loss of work involved in constantly churning the water inside the cases, appeared at once to every engineer and mechanic to be a fatal defect in the device.

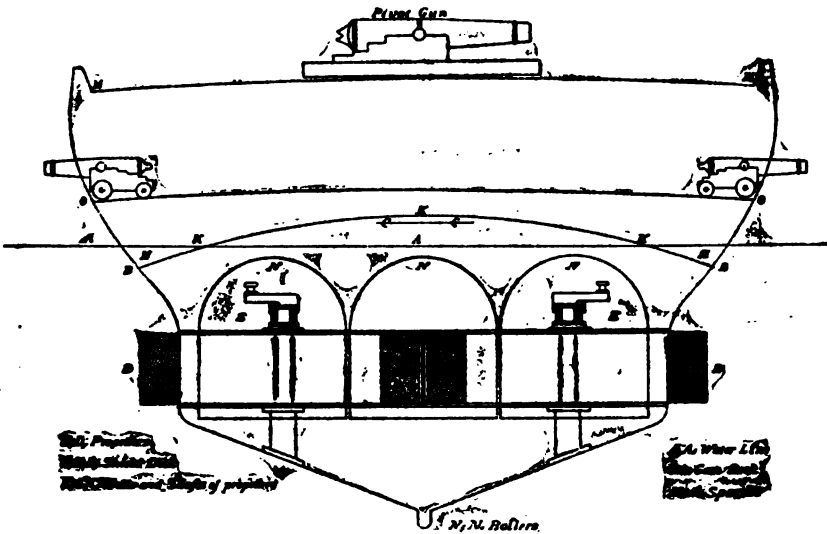

Sketch showing section of vessel and arrangement of Hunter's wheels. This is a reproduction of a drawing submitted by Lieut. Hunter to the Navy Department under date of Nov. 29, 1843, and is particularly interesting from the fact that it shows the principle of the protective or shield deck, believed by many to be a recent invention. None of Hunter's vessels had such a deck as built. This drawing was first published in the annual report of the secretary of the navy, about 1844.

However, the Navy Department ordered the building of a vessel on Mr. Hunter's plans and the work was carried out at the Norfolk navy yard in 1842. The vessel, named the *Union*, was 185 feet long, 33 feet beam, and displaced 900 tons on a draft of eleven feet. The rig was that of a three-masted topsail schooner, and the battery consisted of four 68-pounder guns. The engines were built at the Washington navy yard according to Mr. Hunter's ideas and consisted of a horizontal non-condensing engine for each wheel, the cylinders being twenty-eight inches in diameter and four feet stroke. There were three iron tubular boilers, eighteen feet long and six feet six inches in diameter, they being of the usual commercial pattern for

land service. The propelling wheels were fourteen feet in diameter, each fitted with twenty paddles four feet long and ten inches wide.

The *Union* was completed at the end of 1842 and Mr. William P. Williamson, who had assisted Mr. Hunter in his experiments with the *Germ*, was appointed a chief engineer in the navy and ordered to the new vessel. In 1843 she was engaged in experimental cruising about the coast, under command of Lieutenant Hunter, but was unable to develop a better average than five knots per hour, while the slip or lost work of the wheels in pumping water through the drum cases, was from fifty to seventy per cent. The boilers, carrying nearly one hundred pounds of steam for the high-pressure engines, rapidly accumulated scale causing an equally rapid deterioration, they being intended only for land service, were unprovided with means or accessibility for scaling, and in about a year new boilers fit for use at sea were supplied from designs of Chief Engineer Haswell, but the wheels continued to waste their energy by acting as centrifugal pumps instead of propelling the vessel. An average of five knots on a daily expenditure of eighteen tons of coal was the best that could be done with the ship. With a favorable wind she made on some occasions nine and ten knots for short periods, and Lieutenant Hunter reported one performance of about twelve knots sustained for five hours with a moderate breeze. In 1846 it was concluded the engines were not powerful enough, so they were removed and replaced with a pair of condensing engines, four feet stroke and forty inches diameter of cylinders; at the same time the boilers were thoroughly repaired and the wheels so altered that they had ten paddles each instead of twenty, the new paddles being four feet long and two feet wide; all this failed to increase the efficiency of the wheels and the *Union* was finally, in 1848, put to use as a receiving ship at the Philadelphia navy yard. The machinery was removed at this time and sold for \$3,840. The total cost of this experiment was:

Hull, to period of first sailing.....	\$107,065.07
Engines and dependencies, do.....	51,062.93
Repairs at various times	68,549.13
Total.....	\$226,677.13

While the troubles of the "Hunter wheel" in the *Union* were progressing, similar experience was being gained with a small iron steamer named the *Water Witch*. This vessel was built at the Washington navy yard in 1843 from Lieutenant Hunter's plans and was intended for a steam water tank to supply the vessels at the Norfolk station, but when completed it was discovered that she could not go through the locks of the Dismal Swamp canal, which had to be done in order to get at the water supply, so she was fitted for a harbor vessel and tug. Her length was 100 feet and beam 21 feet; the machinery consisted of two non-condensing engines with cylinders 22 inches in diameter and four feet stroke, driving two Hunter wheels 16 feet in diameter. The maximum speed of this contrivance was six and one-half knots per hour, which was so unsatisfactory considering her small size and great power, that the vessel was condemned and taken to Philadelphia to be rebuilt. The experiment with the Hunter wheel in this vessel stops at this point, but it will be interesting to trace the subsequent career of the *Water Witch* since she has been introduced.

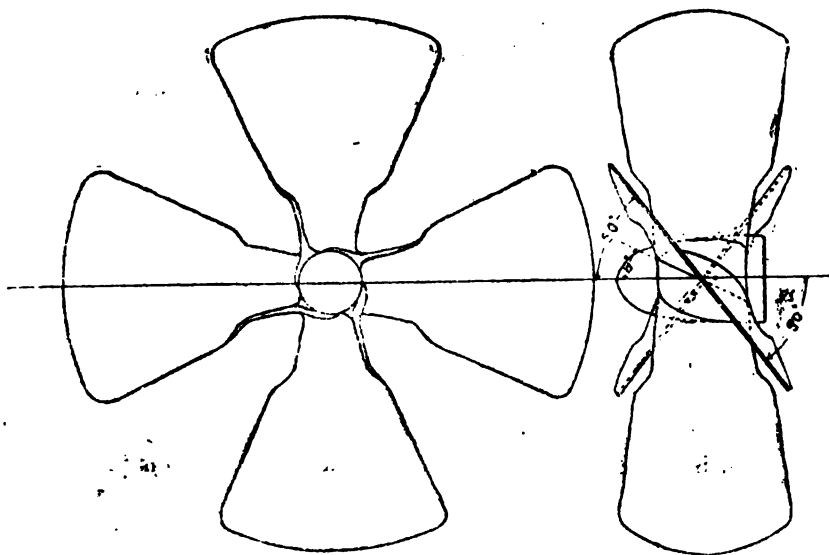

LOPER'S PROPPELLER.

A peculiarity claimed by the inventor for this instrument was that it was not a screw because "the propeller blades form an angle with the center line in the same."

At Philadelphia the vessel was lengthened thirty feet and the entire machinery removed, new machinery driving a "Loper" propeller as an experiment being substituted. This also was pronounced unsatisfactory, although when tried by a committee of the Franklin Institute in the Delaware river a speed of nearly nine knots was obtained, and in 1847 an inclined condensing engine driving side wheels, designed by Engineer-in-Chief Haswell, was substituted. With this alteration the *Water Witch* was actively employed in the Gulf during the Mexican War, but she had been the victim of so much patch-work on an originally faulty model that it required much labor to keep her in working order. In 1851 she sailed from Norfolk for a coastwise voyage and hopelessly broke down on the first day out, after which the machinery was removed and the hull put to good practical use as a target for gunnery practice at Washington. The machinery being perfectly good, a new hull of wood, somewhat larger than the old was built at the Washington yard in 1852 and a reasonably efficient little gunboat thus produced, still bearing the original name. This new steamer was employed for a number of years in the Rio de la Plata region of South America, and later saw some very active service during the first three years of the Civil War. June 3, 1864, she was captured in Ossabaw Sound by a large boarding party of the enemy after a most desperate struggle, in which her paymaster, Mr. Luther G. Billings, killed Lieutenant Pelot the Confederate commander in a hand-to-hand fight, and also saved the life of his own commanding officer by killing the man who had cut him down and was about to despatch him. The Union prisoners were taken to Savannah where they came under the control of the Confederate officer commanding that naval station, and who, singularly enough, was the same Hunter whose wheels had propelled the original *Water Witch*, he having resigned as a commander in 1861 and cast his fortunes with the Confederacy. The coincidence does not seem to have appealed to his magnanimity to any great extent, for it is a matter of official record that he treated his prisoners with considerable harshness.

To return to the experience of the Navy Department with the Hunter wheel. The experiments with the *Union* and *Water Witch* not being conclusive to Mr. Hunter and his supporters, the Department was prevailed upon to try the invention on a larger scale than

before. On the 11th of July, 1843, the Secretary of the Navy, Mr. A. P. Upshur, directed Captain Beverly Kennon, chief of the Bureau of Construction, "to take proper steps for building at Pittsburgh, Pennsylvania, an iron steamer on plans to be submitted by Lieutenant William W. Hunter," and a contract was accordingly made with Joseph Tomlinson for an iron steamer on Hunter's plan, together with engines, propellers, machinery, and all metal appurtenances, and Lieutenant Hunter was ordered by the Navy Department to superintend the construction of the whole. Work on this vessel, named the *Alleghany*, began in 1844 and was completed in April, 1847, when she descended the Ohio and Mississippi rivers to New Orleans, and thence steamed around to Norfolk, Va.

The *Alleghany* was 185 feet long, 33 feet beam, 13 feet 6 inches mean draft, at which her displacement was 1,020 tons. She was bark-rigged and mounted originally four 8-inch Paixham guns, weighing 10,000 pounds each, but this battery was reduced one-half before the vessel sailed for a foreign cruise. There were two horizontal condensing engines with cylinders of four feet stroke and 60 inches diameter, and two iron return-flue boilers containing 2,000 square feet of heating surface and 55 square feet of grate surface each. The boilers were designed by Mr. Haswell, but the engines and hull were Mr. Hunter's, modified by such suggestions as he collected from the engineers and constructors. The horizontal propelling wheels were 14 feet 8 inches outside diameter, fitted with eight paddles each, the paddles being 3 feet 6 inches long and 2 feet 2 inches wide.

On the trip from New Orleans to Norfolk the mean results of her best steaming performances in smooth sea and calms gave a speed of 4.9 knots on an expenditure of 2,000 pounds of coal per hour. At Norfolk it was concluded to cut out every other paddle, leaving only four in each wheel, and thus altered the *Alleghany* sailed for Brazil, on which station and in the Mediterranean she was employed until 1849, when she returned to the United States and went on duty in the Gulf of Mexico until October of that year. After the reduction of the paddles the average performance for eighty-eight hours' steaming at sea in calm weather was 5.9 knots per hour on an hourly consumption of 2,096 pounds of coal. The mean results of eleven hundred and ninety hours under steam and

sail in the Atlantic and Mediterranean during her cruise were as follows:

Mean pressure in boilers.....	11.77 pounds
Throttle.....	One-half open
Cut-off.....	28.100 of stroke
Coal consumption per hour.....	1,940 pounds
Average revolution of wheels.....	27.2 per minute
Vacuum.....	25 inches
Speed of vessel per log.....	5,883 knots

Upon the return of the *Alleghany* from the Gulf of Mexico in October, 1849, a survey was held on her by order of Commodore C. W. Skinner, chief of the Bureau of Construction, etc., the board of survey being composed of Commander J. B. Montgomery, Naval Constructor John Lenthal, Engineer-in-Chief C. H. Haswell, Chief Engineer Wm. P. Williamson, and Mr. Wm. Ellis, the supervising engineer of the Washington navy yard. Their report was a condemnation of the Hunter wheel, and a recommendation to substitute a common side wheel, but as the engines could be adapted to a screw propeller, and not to paddle wheels, a propeller was decided upon, as the cost of new engines would thereby be saved. This report definitely ended the career of Hunter's wheel and put a stop to needless expenditure of public money. The entire history of these experiments in the navy only confirms the correctness of an old adage a "shoemaker should stick to his last."

The actual cost of the *Alleghany* to the period of her departure from Pittsburg was:

Hull and fittings.....	\$118,635.27
Engines, boilers, fittings and connections.....	113,640.65
Patent right for Hunter's wheels.....	10,320.00
	Total.....
	\$242,595.92

In 1851-52 the *Alleghany* was rebuilt at the works of A. Me-haffy & Co., Portsmouth, Va., under the supervision of Chief Engineer Wm. P. Williamson, U. S. Navy. The iron hull, having been constructed by an establishment accustomed to building vessels

for river service, had been found too weak for rough cruising in the open sea, a number of frames having buckled inward, and an attempt to remedy this was made by putting in additional frames and braces. The openings in the side for the Hunter wheels were built in, and a new stern post, suitable for the passage of a propeller shaft, was substituted for the old one. The cylinders of the old engines, which worked fore and aft, were used in the new engine to work athwartship from the diagonally opposite corners of a new bed plate, the connecting rods reaching backward from cross-tails, and many of the minor parts of the old engines were likewise adapted in the new structure. The alterations in the engines were regarded by engineers at the time as very ingenious and were devised by Mr. B. F. Isherwood, a young chief engineer who had entered the service a few years previously. His arrangement of the cylinders with a back-acting motion, will be recognized as the fore-runner of the type so universally known some years later as the Isherwood engine.

Three new iron boilers, aggregating 5,500 square feet of heating surface and 200 square feet of grate surface were provided; these were of an English patent type known as "Lamb and Summer" boilers, hitherto unknown in the United States, although used successfully to some extent in England. They were installed in the *Alleghany* at the instance of Mr. Charles B. Stuart, the engineer-in-chief at the time, a royalty of forty-five cents per superficial foot of heating surface being paid to the patentees. Pirsson's patent double-vacuum condenser, to which was attached an evaporator for making up the waste of fresh water, was fitted in this steamer at this time, which was the first appearance in our naval service of that once popular type of condenser.

The cost of all these alterations and additions was about \$130,000, which, when added to the original cost of the vessel and about \$25,000 spent for repairs when she was in service, brings the total cost up to nearly \$400,000.

The screw propeller was made of cast iron, 13½ feet in diameter, with four blades 3½ feet wide, having an expanding pitch from 27 to 33 feet. So curious was this propeller in comparison with the modern pear-shaped development of the same instrument, that a reduced copy of the original drawing is shown on next page, the author feeling confident it will interest all his readers who ever had any connection with the profession of marine engineering.

The *Alleghany* was promised for the Perry expedition to Japan, which fitted out in the summer of 1852, but so many vexatious delays in her rebuilding occurred that she was not ready for a steam trial until nearly a year after Commodore Perry sailed for Japan in the *Mississippi*. On trial the *Alleghany* proved to be an absolute and unqualified failure; the hull was too weak to withstand the action of the engines and this resulted in the engine bed plates breaking in several places; the boilers were entirely inadequate for supplying the

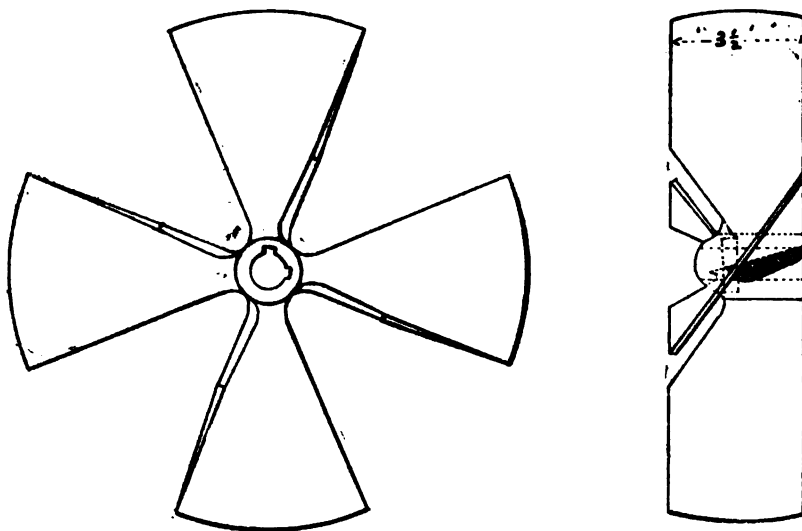

SCREW-PROPELLER, U. S. S. ALLEGHANY, 1852.

engines with steam, and things were at sixes and sevens generally. Misfortunes with other ships will be referred to in due time, which occurred during the same year and with the fiasco of the *Alleghany* caused public attention and much adverse criticism to be directed at the management of the Navy Department. Mr. Secretary Dobbin, in response to the popular clamor, organized a board of engineers with instructions to institute a searching investigation, not only as to the causes of the disasters, but also the officers or individuals who were responsible. This board consisted of Engineer-in-Chief D. B. Martin (Mr. Stuart had resigned in June of that year); Chief Engineer Henry Hunt, U. S. Navy, and Mr. C. W. Copeland. Mr. John Lenthal, the chief constructor of the navy, was ordered to act with the board and advise its members in matters relating to his speciality.

In the case of the *Alleghany*, the report of this board was not especially flattering to any who had been concerned in her building and repair, amounting to a general condemnation of the vessel as being totally unsuited for naval purposes. The hull, originally built for the reception of Hunter's wheels, was of a very peculiar form, the cross section being shaped like an inverted bell; a shape manifestly inconsistent with structural strength to withstand outside pressure, as well as a dangerous model for sailing, and it was found that the additional frames put in were so placed and fastened as not to add to the strength, while considerably increasing the weight. The English boilers, originally adopted as experimental, had been radically altered after another set of the same boilers had failed in another ship—the *Princeton*—and this fact was unfavorably dwelt upon by the board, although there was no reason for believing that this type would have been successful in the *Alleghany* after it had failed in another case. Chief Engineer Isherwood was scored for not providing, in the design and strength of the engine frames, for the weakness of the ship's bottom, and on his side he of course contended that it was his task to provide an engine only; not a hull to support it. With more experience, at a later period of his professional career, when it became his duty to provide power for a great number of war vessels with all sorts of hulls, his engine frames were made proof against any amount of racking they might receive, and then a hue and cry was raised again, not because the engines were too light, but because they were too heavy. Philosophers say that it is much easier to be critical than correct, and the belief that the most successful critics are those who have failed in other callings has long since passed into a proverb.

The great fault in this affair appears, from a careful study of the documents in the case, to have been the original attempt to make a serviceable war vessel out of a structure that in shape and scantling of material was utterly unfit for the reception of adequate power. After her lamentable failure the *Alleghany* was laid up in ordinary at Washington navy yard for a year or two and was then moved to Baltimore, where she remained for many years as a store ship, being eventually sold in 1869 for \$5,250.

During this same experimental period a project for constructing an iron-clad steam battery was submitted to the government by Mr. Robert L. Stevens of Hoboken, New Jersey, and was so well re-

ceived that Congress, by an act approved April 14, 1842, authorized the Secretary of the Navy to enter into contract with Mr. Stevens "for the construction of a war steamer, shot and shell proof, to be built principally of iron, upon the plan of the said Stevens," the act appropriating two hundred and fifty thousand dollars towards carrying the law into effect and providing that the whole cost of the steamer should not exceed the average cost of the *Mississippi* and *Missouri*. Although the steamer thus originated was never completed, and its history reached forward into a period far ahead of that with which we have yet begun to deal, it was such an object of interest to the early engineers that it is entitled to mention in this place, especially as the present chapter has been devoted to the recital of upset theories and blasted hopes.

Mr. Stevens was the son of the famous American inventor, John Stevens, who, as early as 1804, had successfully operated a small experimental steamer with twin screw propellers in place of paddle-wheels; who, in 1812, had prepared a complete set of plans for a circular iron-clad steam battery, and whose name was for many years intimately associated with the beginning of steam navigation and railway operations in this country. Robert L. Stevens inherited his father's inventive genius and his incomplete inventions, among them the idea of the armored steam battery. The original plan for this vessel was for a large iron steamer (about two hundred and fifty feet long) to be protected with plates of four and one-half inch iron armor plate, Mr. Stevens having proved to the satisfaction of the Coast Defense Board, composed of army and navy officers, that iron plates of this thickness could withstand the fire of any possible gun. Unfortunately for Stevens, another great genius, who will appear prominently in the next chapter, arrived on the scene about this time with a large wrought-iron gun of English manufacture, with which he proceeded to demonstrate by actual experiments that plates of iron four and one-half inches thick could be easily penetrated. This was a great discouragement to Mr. Stevens and occasioned so much official interference with his work that the project languished until 1854, when work on a modified battery was begun in earnest and carried almost to completion before it was brought to a stand still by the death of Mr. Stevens in 1856. The vessel thus constructed was much larger than the original design, being 420 feet long, 53 feet beam, and of about 6,000 tons displacement. The iron armor pro-

jected for this formidable craft was to be six and three quarter inches in thickness.

The machinery, which was completed in 1856, was designed for 8,600 horse-power, then an enormous engine power and equal to that of the famous *Great Eastern*. The vessel had twin screws, the shafts being eight feet apart at the engines and diverging towards the stern, at which point they were twenty-two feet apart; they also were designed to point down a little to get a better hold of the water, the screw ends being about a foot lower than the engine ends. The total length of each shaft was 184 feet, with a maximum diameter of seventeen inches. Each shaft was operated by a row of four vertical cylinders placed outboard of the shaft and connected to the cranks by means of overhead walking beams six feet long and the usual interposition of connecting rods, an arrangement that engineers familiar with our modern navy will recognize as remarkably like the beam engines adopted by the Advisory Board for the *Chicago*. The cylinders of these two sets of engines were all of the same dimensions, viz: forty-five inches in diameter and forty-two inches stroke. The four cranks of each shaft were placed ninety degrees apart, and the crank shafts, forged separately, were coupled together in a manner closely similar to modern practice. The engine frames were built up of iron plates. The fore-and-aft fire-room, seventy-six feet long, had five boilers on each side, aggregating 26,000 square feet of heating surface. Unlike the typical boilers of that time, these boilers were fitted with tubes two and a quarter inches in diameter instead of the large flues so generally used.

Up to this time the government had appropriated five hundred thousand dollars for this undertaking and the inventor had expended two hundred thousand dollars of his own money on it besides. At Robert Stevens' death, the unfinished structure became the property of his two brothers, Edwin A. and John C. Stevens, who, being very wealthy from having successfully followed out the railway and shipping enterprises of their father, offered in 1861 to complete the vessel at their own expense if the government would pay for it if it proved to be successful. This liberal offer was rejected by the Navy Department through the medium of a board of naval officers who reported adversely to the project, in spite of the fact that the country was sorely in need of armored vessels and at that very time another naval board was in daily session listening to the claims of every inventor

who came along with a scheme of any kind for an iron clad. In an effort to prove the practicability of their plan the Stevens brothers fitted out at their own expense a small steamer named the *Naugatuck*, with their arrangement of protective armor, and loaned her to the Navy Department; this craft was in action at Drury's Bluff on the James river in 1862 and had to fall out of battle owing to the bursting of her Parrott gun, so her armor did not receive the desired test, and she never figured as a national vessel on the official navy list.

In 1868 Mr. Edwin A. Stevens died, and by the terms of his will gave the unfinished battery to the State of New Jersey, bequeathing \$1,000,000 to be used in completing it. General George B. McClellan of Army of the Potomac fame, was appointed as the engineer to determine on the plans for completing the vessel, and Mr. Isaac Newton, who as an engineer in the navy during the war had won a high professional reputation, was appointed General McClellan's technical assistant. These officials determined to convert the structure into a ram, with a revolving turret similar to that of Ericsson's monitor type. The bow was strengthened accordingly, an inner skin, on the double bottom principal, and transverse water-tight bulkheads were introduced, and the old machinery was entirely replaced with ten large boilers and two sets of powerful engines of the "Maudsley & Field" vertical overhead-crosshead type, designed to propel the vessel at a speed of fifteen knots per hour.

In 1874 the million dollars left by Mr. Stevens was exhausted and the vessel not yet completed, although far enough along to justify the claim that she would be the most formidable war vessel in the world if completed. New Jersey was not disposed to spend the necessary money for her completion and opened negotiations for her sale to the United States, a bargain to that end being practically completed so far as the Navy Department was concerned, but Congress refused to appropriate the money to make the necessary payments, and the structure fell back upon the hands of the State of New Jersey. Proposals for her sale, either as a whole or in parts, were then advertised, and in 1874 and 1875 the most of the material and machinery was disposed of in that way, even the new engines being sold for old iron.

Although borne on the official navy list as a national vessel for several years, this troublous craft never had any other name than the designation of the "Stevens Battery."

CHAPTER V.

“Ericason’s career proved that the PENCIL, as well as the pen, is mightier than the sword. Napoleon did not effect greater changes in the face of Europe than has Ericason produced in naval warfare, and these latter are lasting, while the former have long since passed into other forms.”

J. VAUGHAN MERRICK IN CHURCH’S *Life of John Ericsson.*

Introduction of the Screw Propeller—John Ericsson.—The PRINCETON, and Her Remarkable Engine.—Great-gun Accident on the PRINCETON and Consequent Breach of Friendship Between Ericsson and Captain Stockton.—Subsequent Career of the PRINCETON.

THIS narrative of the early steam vessels and engineers of our navy has now progressed to the point where there appears on the scene the most remarkable marine engineer whose genius has ever impressed itself upon the engineering practice of the world, his advent into our naval history being due to the adoption of a war-steamer, the product of his brain, which in many particulars radically and successfully departed from the accepted dogmas of engineers of the time regarding the application of steam power to marine propulsion. Experiments with screw propellers of various types had been made in the United States, England, and, elsewhere and the practicability of the instrument had been visibly demonstrated by more than one inventor, notwithstanding which many engineers persisted in maintaining that its theoretical loss by oblique action, and other alleged defects, were fatal to its adoption in practice. Foremost among the experimenters in England was the Swedish engineer, John Ericsson, who, failing to gain recognition from the Admiralty although he had constructed entirely successful screw-propelled vessels, left that country in disgust and came to the United States, if not at the instance, certainly to the gratification of Captain Richard F. Stockton of the U. S. Navy.

Captain Stockton had been in England at the time the experiments with Ericsson’s propeller were attracting public attention and he became thoroughly converted to the importance and value of the invention. Becoming well acquainted with the great engineer, he had talked to him at length of his wish to have the United States

Government build a steamer on Ericsson's plan of propulsion, and had made many flattering promises of success to the latter should he ever take up the practice of his profession in America. The Act of Congress of 1839, under which the *Mississippi* and *Missouri* were built, had authorized the construction of three vessels, and at the urgent and repeated solicitations of Captain Stockton the Department, late in 1841, directed the construction of the third vessel from plans suggested by him. As soon as authority to build the ship was granted, Stockton summoned Ericsson to his aid and engaged him to make all the necessary designs for the hull and machinery, as well as to act as general superintendent of the construction of the same.

This vessel, named the *Princeton* after Captain Stockton's home town in New Jersey, was built in Philadelphia during the years 1842 and 1843, the hull at the navy yard and the machinery by the engineering firm of Merrick and Towne. She was 164 feet long, 30½ feet beam, and displaced 95½ tons at her mean draft of

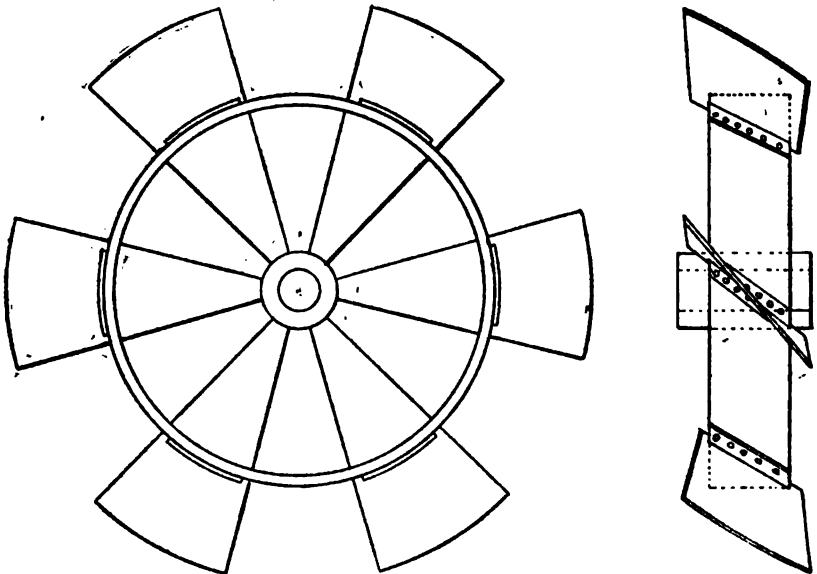

ERICSSON'S SCREW PROPELLER.

16½ feet. The peculiarity of model consisted in a very flat floor amidships, with great sharpness forward and excessive leanness aft,

the run being remarkably fine. She was ship-rigged, spreading fourteen thousand four hundred and thirteen square feet of canvas in plain sails. The screw propeller originally used was of the form known as "the Ericsson": it was composed of a cast brass hub with six arms, the latter being surrounded by a copper band or drum, on which six brass blades were riveted, the general appearance of the instrument being shown as in the annexed sketch. Both arms and blades were of true helicoidal twist. In Mr. Robert Macfarlane's *History of Steam Navigation*, published in 1851, this form of propeller is thus spoken of:—"The advantage of the Ericsson screw is in having a ring within the arms, whereby any number of blades can be fixed, and a large area of surface obtained." The *Princeton's* propeller was of the following dimensions:

Diameter, extreme.....	14 feet.
Diameter of drum.....	8 "
Diameter of hub.....	1 " 8 in.
Pitch of screw.....	35 "
Length of hub and arms in direction of axis.	2 "
Width of blades.....	4 " 1 in.
Weight of screw.....	12,000 pounds.

In 1845, about a year after the completion of the vessel, the original propeller was removed and a six-bladed screw without any supporting drum was substituted, the new screw being $14\frac{1}{2}$ feet in diameter, $32\frac{44}{100}$ feet pitch, with blades about $4\frac{1}{2}$ feet wide. Experiments made on the *Princeton* under similar conditions showed that the common screw was about 11 per cent. more efficient than Ericsson's. The *Princeton* had three iron boilers, designed by Ericsson to burn hard coal, aggregating 2,420 square feet of heating surface and 124 square feet of grate surface.

The *Princeton* was the *first screw steam war-vessel ever built*, although followed closely by *H. M. S. Rattler*, launched soon after she was. The *Rattler* was begun some time before the *Princeton* and was intended originally for side-wheels, but was changed while building owing to a change in sentiment regarding screw propellers. To this circumstance may be attributed the fact that the *Rattler* is frequently claimed to have been the first screw war-steamer. The *Princeton* was also the first vessel of war in which all the machinery

was placed entirely below the water line out of reach of shot. She was also the first war-vessel with boilers designed to burn anthracite coal, thus avoiding the volume of black smoke to betray her presence to an enemy: blowers were used for the first time in naval practice, and she was the first steamer provided with a telescopic smoke pipe. Ericsson was the first engineer to couple the engine direct to the screw shaft, other experimenters with screws using intermediate gearing in deference to the theories of the day.

The engine of the *Princeton* may be roughly described as a half-cylinder, in which a rectangular piston vibrated like a barn door on its hinges, and was beyond doubt the most remarkable modification of the steam engine ever carried into successful practice. The principle of a vibrating rectangular piston is an old mechanical device, so old, in fact, that it was embraced in Watt's patent as one of the modes of transmitting the power of steam to machinery, but, until Ericsson's time; engineers had failed to build successful engines on this plan. Ericsson's plan differed radically from previous attempts, from the fact, that he introduced, opposite the main semi-cylinder, a much smaller one with its piston a prolongation of of the large one on the opposite side of the shaft, both being acted on by the steam at the same time and the difference in their powers being the effective force transmitted to the crank levers.

In the *Princeton* this combined or double semi-cylinder was eight feet long and placed horizontal with the smaller semi-cylinder uppermost. The smaller, or re-acting, piston was ten inches wide and the lower, or working piston thirty-six inches wide. This difference leaves twenty-six inches of effective width of piston, with its center of pressure located $10+13=23$ inches from the center of the piston shaft. The effective piston area therefore was $26 \times 96 = 2,516$ square inches, moving back and forth through an arc of ninety degrees with an arm or radius of twenty-three inches, the distance of the center of pressure from the center of the piston shaft.

Before laughing at this contrivance as a crude effort of olden times it is well to investigate a little, and we will find that it possessed peculiar merits. The vibration of the working piston will be found to correspond closely to the beat of a pendulum; and therefore its swing during the first half of each vibration would be materially assisted by the force of gravity. The arrangement with the

steam ports underneath, facilitated the outflow of condensed water and prevented any dangerous accumulation in the cylinder. Centrifugal force aided the outward tendency of the packing, and in the case of the lower piston this was further assisted by the force of gravity. The crank levers were attached to the piston shafts in nearly the same plane with the pistons, which relieved the journals of that shaft from irregular strains. The small angular movement (ninety degrees) of the main piston was also an important feature. A greater motion would increase the power of any given sized engine but would also increase the strain on all the principal bear-

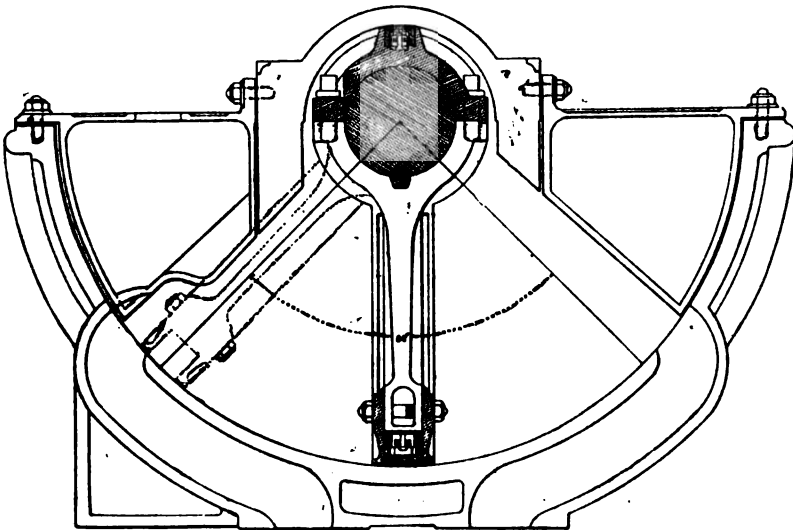

PISTON MOVEMENT U. S. S. PRINCETON (ERICSSON'S PATENT.)

ings, as the force of the piston obviously increases in the inverse ratio of the sines of the angles of the piston shaft cranks, with reference to the position of the connecting rods. A moderate increase of diameter would make up the loss of power due to the short arc through which the piston vibrates. Another advantage resulting from this short vibration was the possibility of fitting deep cylinder covers to resist the upward pressure of the steam. Finally it will be noticed that there are very few working parts, and the moving parts are fewer than in any other type of steam engine, except possibly the oscillating engine with the piston rod connected directly to the crank.

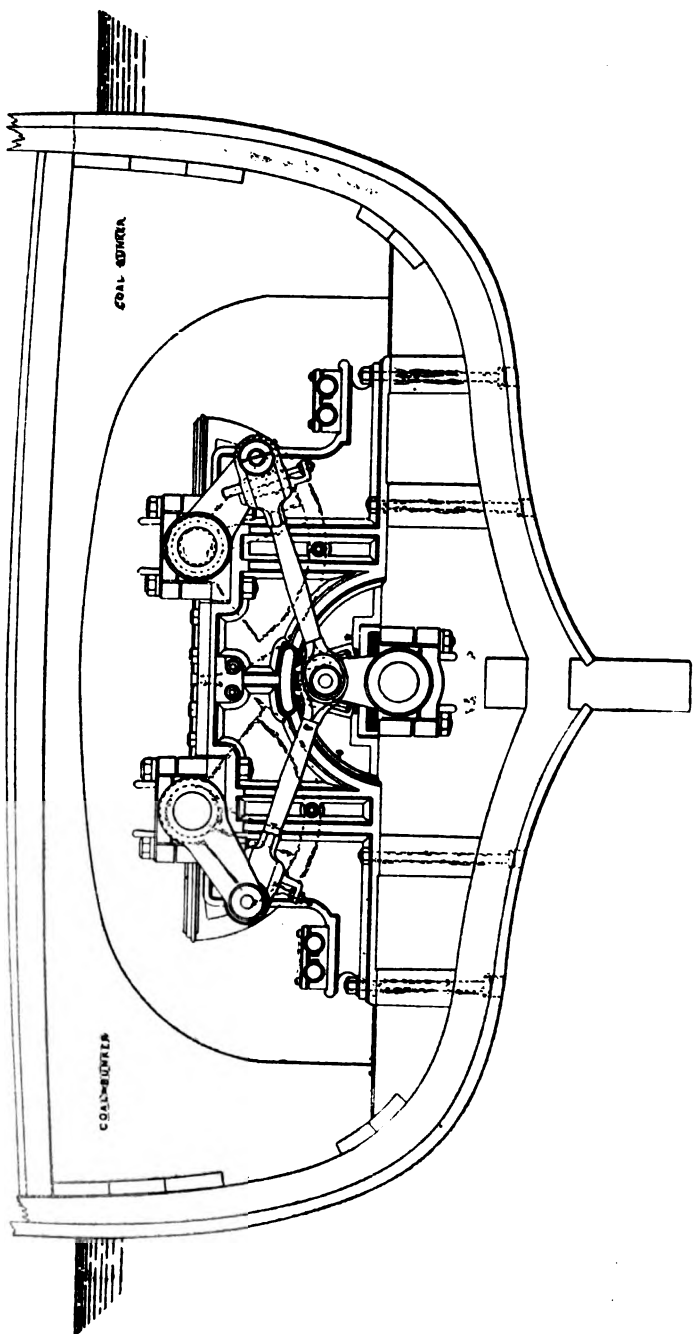

ARRANGEMENT OF ENGINES OF U. S. S. PRINCETON.

Ordinary slide valves of the locomotive type were fitted to this peculiar engine. Two of these engines were fitted in the *Princeton*, parallel to the crank-shaft and imparting motion by the connections shown in the outline sketch.

The ship was completed and ready for sea about the first of January, 1844, and was exhibited as a marine wonder at various places along the coast. Although this was some time after the enactment of the law regulating the appointment of engineers in the naval service. Captain Stockton appointed the first ones for this ship as though the ship belonged to him ; indeed it is not improbable he felt a certain right to ownership, he being a man of wealth had spent much of his own money on the vessel. When the vessel was completed he sent the following report to the Secretary of the Navy, which is very interesting and gives the best description of the *Princeton* in existence :

“ U. S. SHIP PRINCETON,
“ PHILADELPHIA, Feb. 5th, 1844.

“ SIR:

“ The United States Ship *Princeton* having received her armament on board, and being nearly ready for sea, I have the honor to transmit to you the following account of her equipment, etc. :

“ The *Princeton* is a full rigged ship of great speed and power, able to perform any service that can be expected from a ship of war. Constructed upon the most approved principles of naval architecture, she is believed to be at least equal to any ship of her class with her sail, and she has an auxiliary power of steam and can make greater speed than any sea going steamer or other vessel heretofore built. Her engines lie snug in the bottom of the vessel, out of reach of an enemy's shot, and do not at all interfere with the use of the sails, but can at any time be made auxiliary thereto. She shows no chimney, and makes no smoke, and there is nothing in her external appearance to indicate that she is propelled by steam.

“ The advantages of the *Princeton* over both sailing ships and steamers propelled in the usual way are great and obvious. She can go in and out of port at pleasure, without regard to the force or direction of the wind or tide, or the thickness of the ice. She can ride safely with her anchors in the most open roadstead, and may lie-to

in the severest gale of wind with safety. She can not only save herself, but will be able to tow a squadron from the dangers of a lee shore. Using ordinarily the power of the wind and reserving her fuel for emergencies, she can remain at sea the same length of time as other sailing ships. Making no noise, smoke, or agitation of the water (and if she chooses, showing no sail), she can surprise an enemy. She can take her own position and her own distance from an enemy. Her engines and water wheel being below the surface of the water, safe from an enemy's shot, she is in no danger of being disabled, even if her masts should be destroyed. She will not be at daily expense for fuel as other steamships are. The engines being seldom used, will probably outlast two such ships. These advantages make the *Princeton*, in my opinion, the cheapest, fastest, and most certain ship of war in the world.

“The equipments of this ship are of the plainest and most substantial kind, the furniture of the cabins being made of white pine boards, painted white, with mahogany chairs, table, and sideboard, and an American manufactured oil cloth on the floor.

“To economize room, and that the ship may be better ventilated, curtains of American manufactured linen are substituted for the usual and more customary and expensive wooden bulkheads, by which arrangement the apartments of the men and officers may in an instant be thrown into one, and a degree of spaciousness and comfort is attained unusual in a vessel of her class.

“The *Princeton* is armed with two long 225-pounder wrought iron guns, and twelve 42-pounder carronades, all of which may be used at once on either side of the ship. She can consequently throw a greater weight of metal at one broadside than most frigates. The big guns of the *Princeton* can be fired with an effect terrific and almost incredible, and with a certainty heretofore unknown. The extraordinary effects of the shot were proved by firing at a target, which was made to represent a section of the two sides and deck of a 74-gun ship, timbered, kneed, planked and bolted in the same manner. This target was 560 yards from the gun. With the smaller charges of powder, the shot passed through these immense masses of timber (being fifty-seven inches thick), tearing it away and splintering it for several feet on each side, and covering the whole surface of the ground for a hundred yards square with fragments of

wood and iron. The accuracy with which these guns throw their immense shot (which are *three feet* in circumference), may be judged by this: the six shots fired in succession at the same elevation struck the same horizontal plank more than half a mile distant. By the application of the various arts to the purposes of war on board the *Princeton*, it is believed that the art of gunnery for sea service has for the first time been reduced to something like mathematical certainty. The distances to which these guns can throw their shot at every necessary angle of elevation has been ascertained by a series of careful experiments. The distance from the ship to any object is readily ascertained with an instrument on board, contrived for that purpose by an observation which it requires but an instant to make, and by inspection without calculation. By self-acting locks, the guns can be fired accurately at the necessary elevation, no matter what the motion of the ship may be. It is confidently believed that this small ship will be able to battle with any vessel, however large, if she is not invincible against any foe. The improvements in the art of war adopted on board the *Princeton* may be productive of more important results than anything that has occurred since the invention of gunpowder. The numerical force of other navies, so long boasted, may be set at naught. The ocean may again become neutral ground, and the rights of the smallest as well as the greatest nations may once more be respected. All of which, for the honor and defense of every inch of our territory, is most respectfully submitted to the honorable Secretary of the Navy, for the information of the President and Congress of the United States.

“ By your obedient and faithful servant,

“ R. F. STOCKTON,

“ Captain, U. S. Navy.

On February 28, 1844, the *Princeton* sailed from Washington on a pleasure and trial trip down the Potomac river, having on board President Tyler and his Cabinet and a distinguished party of civil and military officials, invited by Captain Stockton to witness the performance of the vessel and her machinery. The trip was a great success professionally and convivially, and Captain Stockton was lionized as the greatest inventor of the times, it being the general impression that the ship and all that was in her had sprung from his

vigorous brain. On the return trip one of those irresponsible persons who are always doing something that ought not to be done and whose names are never known afterward, wanted to have the big gun known as "Peacemaker," fired again "just for fun," to which Captain Stockton dissented, as the guns had been thoroughly exercised earlier in the day; he yielded, however, upon the good-natured wish expressed by the Secretary of the Navy to let the guests have all the sport they wished, and the gun was fired. It burst, injuring many people, among them Stockton himself, and killing the Hon. Abel P. Upshur, Secretary of State; Hon. Thomas W. Gilmer, Secretary of the Navy; Captain Beverly Kennon, U. S. Navy; Hon. Virgil Maxey of Maryland; Mr. David Gardiner, and a colored servant. Mr. Gilmer had been Secretary of the Navy less than two weeks, and Mr. Upshur had been Secretary of the Navy at a period shortly before he received the portfolio of the Department of State. Mr. Gardiner was a descendant of the "lords of the manor" of Gardiner's Island, and his tragic death was the cause of an interesting romance; his body was taken to the White House by direction of the President, and in the resulting distress and sympathy President Tyler developed such an interest in Gardiner's beautiful daughter Julia that he afterward married her.

When Ericsson came to the United States he brought among many other inventions a large wrought iron gun, designed by himself and made in England. On trial this gun developed cracks which Ericsson remedied by an expedient now in general use in gun making, namely, by shrinking bands on it. Thus altered it was fired more than one hundred times with great success, its projectiles piercing a 4½-inch wrought iron target, and it was placed on board the *Princeton*, with the name of "Oregon," as one of the two heavy guns of that vessel; the name "Oregon" was adopted because that word was in everybody's mouth owing to an international controversy then in progress, the British Lion being engaged in an attempt to place his heavy paw upon our extreme north-western territories. The other great gun of the *Princeton*—the "Peacemaker"—was Captain Stockton's gun, and was simply an imitation of Ericsson's, being regarded as an improvement over the latter, as its breach was a foot greater in diameter and the gun was heavier throughout, the quality of its metal being overlooked in the effort to provide quan-

tity; it was of the same calibre, viz, twelve inches. Its weight was about ten tons and was claimed to be the largest forging then in the world and a great manufacturing triumph, as only a few years before the forges of the United States could not produce a wrought-iron shaft for the second *Fulton*.

It is a matter of simple history that Captain Stockton allowed the belief to become general that he was the originator of everything connected with the *Princeton* and tacitly, if not directly, withheld from Ericsson the credit which was his due. In the eulogistic account of the *Princeton* before quoted, the name of John Ericsson does not appear, although every detail mentioned with so much enthusiasm as great improvements was his invention. The hull of the *Princeton* was designed by Ericsson; the engines were of his patent, and so was the screw propeller; the telescopic smoke pipe and fire room blowers were his; the banded gun was his invention; the range finder was his; the automatic gun lock was his; the *Princeton* was essentially the child of Ericsson's brain. So long as the career of the *Princeton* amounted to a triumphal procession from one city to another, John Ericsson remained in the shadow of obscurity, but with the bursting of the "Peacemaker" he was remembered and summoned to Washington. "Captain Stockton," as Mr. Church very pointedly remarks, "bethought himself of Ericsson. If he was not disposed to share the credit of success with him he was quite ready to give him his full measure of responsibility for disaster." Ericsson declined to be held responsible for an imitation gun not of his making and his letter in reply to the summons to proceed to Washington is a veritable gem of irony and independence. Stockton never forgave him and greatly injured him afterward by preventing the payment by the Government of Ericsson's bill for his patents and his invaluable professional work for the two years that the ship was under construction. In denying Ericsson's claim for payment for his services Stockton referred to him as a "mechanic of some skill," and made the remarkable statement that he had allowed him, "as a particular act of favor and kindness," to superintend the construction of the *Princeton's* machinery. Not many months before, at a dinner in Princeton, celebrating the launching of the ship, Captain Stockton had introduced Ericsson as the man for whom he had searched all over the world, who was capable of inventing and carrying out all that was necessary to make a complete ship of

war. Ericsson experienced all the weary circumlocution of bills in Congress, suits in the court of claims, &c., and to the great shame of our country eventually died with the bills for his services on the *Princeton* still unpaid. The whole miserable story is told in Mr. Wm. C. Church's admirable history of the life of John Ericsson, a book that is well worth the study of all engineers.

The *Princeton* was employed in the home squadron during the years 1845, '46 and '47, and was actively engaged in the Mexican War, her performance under sail and steam at all times being highly satisfactory, and her reliability as a steamer remarkable. The mean results, when under steam alone during this period, were as follows:

Mean steam pressure in boilers.....	11.75	pounds.
Mean initial pressure in cylinders (throttle one-fifth open).....	6.3	“
Double vibrations of piston, per minute. . .	22.58	“
Consumption of anthracite coal per hour, fan blast.....	1,293	“
Mean effective pressure throughout stroke,	9	“
Horse-power developed by engines.....	191.893	
Speed of ship in knots, per hour.....	7.29	
Slip of the screw.	10.38	per cent.
Sea water evaporated per hour per pound of coal.....	6.64	pounds.

In 1847 the *Princeton* was supplied with new boilers of the same number and external dimensions as the old, but with about twenty per cent. more heating surface, thus improved she sailed for the Mediterranean station where she remained two years under the command of Commander Frederick Engle. Mr. Henry Hunt was her chief engineer the first part of this cruise, succeeded by Joshua Follansbee. On this cruise the performance under steam was much better than it had been with the original boilers and it was claimed that she was, considered in connection with the amount of fuel consumed, the most efficient steamer in existence. She was an object of interest and admiration to European engineers and her cruise in the Mediterranean did much to break down the prejudice of sailors against steamers, and of engineers against the screw and the practice

of coupling engines direct to the shaft. At sea she was readily handled, either with steam or sail, and had no bad quality except the fault of pitching violently owing to her great leanness forward and aft. Under sail, with the propeller uncoupled, she was claimed to be as fast and handy as most sailing vessels, and she is said to have beaten some sloops of war and frigates in clawing off a lee shore in a heavy gale, under sail and dragging her screw.

The old navy captains had strenuously asserted that steam could never be practically applied to naval warfare, and the defects in the first side wheel steamers and failure of Hunter's system of submerged propulsion added weight to their predictions. The appearance and successful performances of the *Princeton*, without any objectionable side-wheels and with the machinery entirely below the water line, left the objectors with no argument except their own sentimental predilections in favor of sails, and for this reason the *Princeton* may truly be credited with the honor of being the germ of our steam navy, for after her first service there was no longer any doubt in the minds of sensible men that the old order of things must yield to the new. Besides inaugurating the era of steam men of war, the *Princeton* may be credited with introducing another new factor into the problem of marine warfare. It has been previously mentioned that Ericsson's wrought-iron gun had been used to perforate an iron target, and, although that particular gun was removed from the ship after the disaster to its copy, this fact set people thinking about how to resist the fire of such guns. As Lieutenant Jacob W. Miller very aptly says in an essay read before the U. S. Naval Institute, "When the U. S. S. *Princeton*, propelled by Ericsson's screw and armed by Ericsson's wrought-iron gun, was launched the war between armor and projectiles began."

When the *Princeton* returned from the Mediterranean in 1849 she was condemned by a survey and immediately broken up at the Boston Navy Yard. It is asserted in Commodore Stockton's biography that the hasty condemnation and destruction of this ship was the work of certain naval captains who were jealous of the fame and popularity he had won in championing the cause of steam in the navy, and it is certain that much hard feeling was occasioned by the event, but this quarrel may well be passed over in silence, especially as its principals have long since ceased the contentions of this world. Two years later when Stockton was a member of the United States

Senate he prevailed upon the Navy Department to rebuild his ship, and a new hull was accordingly built at the Boston navy yard, such of the old timbers as were fit being worked into the new structure. The new *Princeton* was a clipper-built ship, 177 feet long, 33 feet 8 inches beam, and of 1370 tons displacement at mean draft, which dimensions it will be noticed correspond very closely with those of our present *Enterprise* class of corvettes. The old Ericsson semi-cylinder engines, being in good order, were not destroyed with the ship, and these were taken to Baltimore and thoroughly overhauled at the Vulcan Iron Works, under the supervision of Chief Engineer Wm. H. Shock, U. S. Navy. The only material change made in them was in the addition of Sickel's adjustable cut-off. Three iron boilers of the "Lamb and Summer" patent, previously referred to in connection with the *Alleghany*, were supplied by the Baltimore firm; also a four-bladed composition propeller, 16 feet in diameter, not unlike in general form the propellers in use fifteen years ago.

A long delay in completing the ship occurred on account of a controversy between the engine builders and the Navy Department as to whether the machinery was to be installed in Boston or Baltimore, but the Department, being anxious to get the ship for the Japan expedition, finally sent her to Baltimore and the machinery was put in place during the summer of 1852. Eventually completed, the *Princeton* sailed from Annapolis in November, 1852, in company with the *Mississippi*, but on the voyage down Chesapeake Bay the boilers gave so much trouble that she was detained at Norfolk and the *Mississippi* sailed without her. The Board of Engineers named in Chapter IV. as having been organized to investigate the failures of certain vessels, reported in the case of the *Princeton* that the addition of the Sickel's cut-off was injudicious and that the failure of the ship was attributable to the patent boilers; so far as any individual was to blame for the failure, the report stated that Mr. Stuart, the former engineer-in-chief, who had recommended the use of the Lamb and Summer boilers was the responsible person. Commodore Stockton felt that his pet ship had been terribly bungled in rebuilding, possibly maliciously so, and he denounced the whole affair by a vigorous speech in the Senate, referring to the new *Princeton* as "an abortion in the naval service." After lying idle in Norfolk for a year or two, the *Princeton* was taken to Philadelphia and used as a receiving ship until October 9, 1866, when she was sold.

CHAPTER VI.

"I hold every man a debtor to his profession; from the which as men of course do seek to receive countenance and profit, so ought they of duty to endeavour themselves by way of amends to be a help and ornament thereunto,"

FRANCIS BACON.

Reorganization of the Engineer Corps—Case of Chief Engineer C. B. Moss—All Assistant Engineers Examined and Re-arranged According to Proficiency—Laws and Regulations Affecting the Engineer Corps from 1845 to 1850—Resignation of Chief Engineer John Faron, Jr.

THE act of August 31, 1842, creating the engineer corps of the navy, authorized the Secretary of the Navy to appoint the engineer-in-chief and the chief engineers, as well as the assistant engineers. In the original draft of this bill it was provided that the engineer-in-chief and chief engineers should be commissioned officers, nominated by the President and confirmed by the Senate, which provision met with approval, but disappeared at the last moment when the bill assumed its final form. This omission was said to be due to the exertions of Mr. Gilbert L. Thompson, who had arranged to be appointed to the new office of engineer-in-chief, and, not being an engineer by profession, was fearful that the Senate would not confirm him when nominated; so he used his political influence to further his interests by making the way to the desired office as free from legislative and legal forms and ceremonies as possible.

After Mr. Thompson's short career as engineer-in-chief, his successor, Mr. Haswell, immediately undertook the task of remedying the defect in organization occasioned by the diplomacy of his predecessor, his efforts being so successful that the naval appropriation bill of the following year (approved March 3, 1845) contained the following:—

SEC. 7. *And be it further enacted,* That in lieu of the mode heretofore provided by law, the engineer-in-chief and chief engineers of the navy shall be appointed by the President, by and with the advice and consent of the Senate, and that the President, by and with the like advice and consent, may appoint six engineers, to be employed in the revenue service of the United States, and the Secretary of the Treasury may appoint six assistant engineers, to be employed in the like service, one engineer and one assistant to be assigned to each steamer in the said service, if the

same shall be deemed necessary by the Secretary of the Treasury, who shall prescribe the duties to be performed by said officers respectively; each of the said engineers shall be entitled to receive the same pay as now is, or hereafter may be, by law, allowed to first lieutenants in the revenue service; and that each assistant engineer shall be entitled to receive the same pay that now is, or hereafter may be, by law, allowed to third lieutenants in said service.

The enactment of this law made it necessary for the names of the chief engineers to be sent to the Senate for confirmation for commissions, and this furnished the engineer-in-chief with an opportunity to re-arrange them in what, according to his judgment, was their proper order of merit, his recommendation on the subject to the Secretary of the Navy, dated May 9, 1845, being approved and a re-arrangement accordingly made by numbering the commissions. There were then seven chief engineers ranking with each other according to date of appointment in the following order:

John Faron, Jr., appointed January 13, 1840.
 Andrew Hebard, appointed February 6, 1840.
 James Thompson, appointed April 14, 1842.
 Wm. P. Williamson, appointed October 20, 1842.
 Charles B. Moss, appointed May 29, 1844.
 Wm. Sewell, Jr., appointed February 11, 1845.
 W. W. W. Wood, appointed March 15, 1845.

By Mr. Haswell's recommendation, this order of precedence was changed to the following, in order of number of commission:

1. John Faron, Jr.
2. Andrew Hebard.
3. Wm. Sewell, Jr.
4. W. W. W. Wood.
5. James Thompson.
6. Wm. P. Williamson.
7. Charles B. Moss.

This new arrangement was of course not agreeable to those who were reduced in standing, Mr. Williamson especially feeling aggrieved at having Messrs. Sewell and Wood, who had just entered the corps as chief engineers direct from civil life, placed above him, and the case does appear to savor of hardship, but the judgment of the engineer-in-chief was allowed to stand as final, and Mr. Will-

iamson's protests to the Department availed him nothing. Chief Engineer Moss also came to grief at the hands of the Department at the same time. He was a close friend of President Tyler, and had been his private secretary prior to receiving an appointment as a chief engineer in the navy, and after that remained in Washington as a member of the President's household. President Tyler's term of office expired March 4, 1845, and the following day the Navy Department took possession of Mr. Moss by ordering him to Pittsburgh as inspector of machinery, building in that city for the *Alleghany*. Two months later, when Mr. Haswell recommended the re-arrangement of the chief engineers, he reported to the Department that "Mr. Moss, without the advantages of personal observation consequent upon the immediate management of the steam engine, has made himself well acquainted with its operation and possesses high attainments in physics and mathematics." *Proteges* of President Tyler were not popular with the new administration, however, and the Navy Department detached Mr. Moss from his duty in Pittsburgh, placed him on furlough, and ordered him to report at a future date to the engineer-in-chief for an examination as to his qualifications for sea duty, the letter of explanation accompanying the order stating:

"In consequence of the Department's want of confidence in your ability to assume the detailed direction and perform the practical duties of a chief engineer attached to a sea-going steamer, and at the same time, entertaining the disposition to concede to you all proper indulgence and facilities, it has decided that for the purpose of giving you an opportunity practically to acquire the knowledge which it conceives you to be in want of, you will be detached from your present duties and put on furlough until the 15th of December next."

About the middle of January following, Mr. Moss was ordered before an examining board composed of the engineer-in-chief and the two senior chief engineers of the navy, which resulted in his receiving the following notification from Secretary Bancroft:

"In consequence of the result of your examination, which has been communicated to you, I am authorized by the President to inform you that your commission as a chief engineer in the navy of the

United States is hereby revoked, and you are no longer a chief engineer.

“A warrant as a second assistant engineer in the navy, in accordance with the report of the Board of Engineers before which you were examined, will be given you upon your signifying your readiness to accept it.”

This letter was dated January 30, 1846, and as Mr. Moss did not signify his willingness to accept the proffered warrant, his connection with the service ceased on that date. The affair is narrated as an illustration of the danger of relying upon political influence for official position, and also as serving to show the uncertain tenure of a commission in the navy in olden times, which latter uncertainty was not confined to the young engineer corps, but menaced all commissioned officers alike.

Having disposed of the chief engineers, Mr. Haswell turned his attention to the assistants, and recommended that they all, irrespective of grade or length of service in the navy, be subjected to an examination to establish their fitness for the service and determine their relative merits, which recommendation was approved by Secretary Bancroft, and an examining board convened by his order in the city of Washington on the 9th of July, 1845. This board consisted of Engineer-in-Chief Haswell as president and Chief Engineers John Faron, Jr., and Wm. W. W. Wood as members, and before it all the assistant engineers who were within summoning distance were ordered to appear.

The proceedings of the examining board partook largely of “star chamber” methods, as may be seen from the following letter of instructions issued to the board by the chief of the Bureau of Construction, Equipment and Repairs, who represented the Secretary of the Navy for the time, and to which bureau the engineering branch was attached as a sub-department or bureau:

“ MESSRS. C. H. HASWELL, }
 JOHN FARON, } Engineers.
 W. W. W. WOOD. } ”

“ INSTRUCTIONS FOR A BOARD FOR EXAMINATION OF
 ASSISTANT ENGINEERS.

“ The board will take particular care to ascertain the qualifications of the candidates for all the duties that may be required of

them, as assistant engineers, and satisfy themselves of their moral, as well as professional fitness for the public service.

“ Having ascertained the merits of the candidates as above, the board will proceed to class them as first, second and third assistants—taking into view professional and moral fitness and other circumstances which may give claim to preference.

“ Having classed the candidates as above, the board will arrange them in their several classes according to merit.

“ The appointments now held by assistant engineers are to be considered as temporary, and not giving claim to precedence, except in cases when candidates may be thought to be equal in merit, then preference will be given to the senior appointment.

“ The board will admit but one candidate for examination at a time, the examination is to be considered private and confidential, and it will impress upon the mind of each candidate, and enjoin it on him, that he is not to disclose to any one the course of examination, the questions asked him, or anything that may occur in the session of the board.

“ The decisions at which the board may arrive are to be communicated to no one; but are, when the whole examination is completed, to be submitted to the Secretary of the Navy, for such action as he may deem proper.

“ By order of the Secretary of the Navy.

“ W. B. SHUBRIOK,

“ for Com. Morris,

“ Bureau of Construction, Equipment and Repairs, July 8, 1845.”

At that time the different grades of assistant engineers were composed of the following members, arranged in order of seniority according to length of service:

FIRST ASSISTANTS.	SECOND ASSISTANTS.	THIRD ASSISTANTS.
1. Hiram Sanford,	A. S. Palmer,	Smith Thompson,
2. William Scott,	J. S. Rutherford,	Joshua Follansbee,
3. James Cochrane,	J. K. Mathews,	Wm. F. Mercier,
4. Henry Hunt,	Gilbert Sherwood,	John Gallagher,
5. D. B. Martin,	N. C. Davis,	William Taggart,
6. John Alexander,	Daniel Murphy,	Samuel Archbold,
7. James Atkinson,	J. M. Middleton,	John Serro,
8. Thomas Copeland,	William Luce,	Thomas Dickson,
9. Levi Griffin,	Levi T. Spencer,	Theodore Zeller,
10. B. F. Isherwood,	J. F. Dryburgh.	M. M. Thompson,
11. Alexander Birkbeck.	James W. King,
12.	Robert Danby,
13.	William H. Shock,
14.	Charles Coleman.

After examining all the available assistant engineers the result of the examination was reported as follows:

"OFFICE OF ENGINEER CORPS, U. S. N.,
" July 28th, 1845.

" SIR:—

" In behalf of the Board for the examination of Assistant Engineers that was convened on the 9th instant, I have to report:

" That there were twenty-seven Assistants examined, one of whom was rejected.

" The accompanying paper contains a list of the names of those that were passed, arranged in the several grades and numbered in the order in which they are recommended to be placed.

" In consideration of this being the first occasion since the organization of the Engineer Corps that duty of this nature has been performed, and as many changes in the different grades are recommended to be made, I deem it proper to recur to the irregular manner in which the present tenure of appointments of those examined originated.

" Thus from 1837 to 1842 there did not exist the grade of Third Assistant, and not until 1842 was there an examination prior to admission into the corps, and even up to the present time there has not been an appointment under any defined regulations or restrictions.

" With these facts in view it is fair to infer that errors of

position could not have been avoided; added to which, observation, ambition, and a difference in capacity, have secured to some (since their appointments in the service) that advantage which is so readily obtained when their attendant results are contrasted with indifference and a less regard to the exactions of advancement.

“The want of a working model of a condensing engine for the purposes of illustration and reference was much felt, and in future examinations of candidates for admission into the corps much inconvenience will be experienced without the use of one. I recommend that one be constructed at the navy yard in Washington—the cost of which should not exceed \$300.

“Mr. Alexander Birkbeck, Jr., is recommended as worthy of an examination for promotion to a Chief Engineer whenever the Department may see fit to add to the number of that grade. First Assistant Thomas Copeland from physical infirmity, added to the want of professional experience as a marine engineer, is considered unfit to discharge the duties pertaining to an Assistant Engineer in the Naval Service.

‘ I am, very respectfully,

“ Your obedient servant,

“ CHAS. H. HASWELL.”

The paper referred to in the above report as giving the names of the assistant engineers, re-arranged in the order of merit recommended by the examining board, shows that the following order, which was officially approved, was recommended:

FIRST ASSISTANTS.	SECOND ASSISTANTS.	THIRD ASSISTANTS.
1. Alexander Birkbeck, Jr	Joshua Follansbee,	John M. Middleton,
2. Henry Hunt,	John Alexander,	Wm. F. Mercier,
3. Daniel B. Martin,	James Atkinson,	William Taggart,
4. Hiram Sanford,	Levi Griffin,	William Luce,
5. James Cochrane,	Levi T. Spencer,	James W. King,
6.	Albert S. Palmer,	James R. Dryburgh,
7.	Jesse S. Rutherford,	Theodore Zeller,
8.	Samuel Archbold,	Robert Danby,
9.	Naylor C. Davis,	William H. Shock,
10.	Daniel Murphy,	John Serro,
11.	M. M. Thompson.

Of the eight assistants not examined in July, two, Second Assistant Gilbert Sherwood and Third Assistant Smith Thompson, declined the examination and resigned. The other six, the vessels to which they were attached having returned to the United States, were ordered before the board in December and January following, and examined, Chief Engineer Andrew Hebard being then one of the examiners in place of Mr. Wood, who had been sent to New Orleans to superintend a general overhauling of the machinery of the *General Harney*. Those examined were first assistants Wm. Scott and B. F. Isherwood; second assistant John K. Mathews, and third assistants John Gallagher, Thomas Dickson, and Charles Coleman. The result of the examination was that Messrs. Scott and Isherwood were reduced to second assistants; Mr. Mathews advanced to the head of the second assistants list; Mr. Gallagher promoted to second assistant, and Messrs. Dickson and Coleman placed on the list of third assistants next after Wm. H. Shock and M. M. Thompson respectively.

This whole proceeding was most radical and arbitrary, and occasioned much heart-burning among those unfortunates who lost grade or numbers in the final arrangement; nevertheless, it was demanded by the lack of homogeneity in the corps which had resulted from the irregular manner in which the first engineers had been appointed, and the advantages of establishing professional competency as a requisite for membership in the corps, and of starting fair, even though a trifle late, with the engineering *personnel* graded according to merit, much more than offset any grievances of individuals resulting from the rearrangement. Of high professional ability and broad general education himself, Mr. Haswell felt that the requirement of similar ability from all the members of his corps was the only proper method of elevating its standard, and the imposition of this arbitrary examination upon the junior engineers was the first step in that direction. That the step was of great subsequent benefit to the corps is manifest, and its inception indicates a degree of corps pride and far-sightedness on the part of the engineer-in-chief to be admired and commended more than any other of his numerous acts which operated to the lasting benefit of his corps. Moral courage of a high order was necessary to the carrying out of this reform, for it could be of no possible personal benefit to its pro-

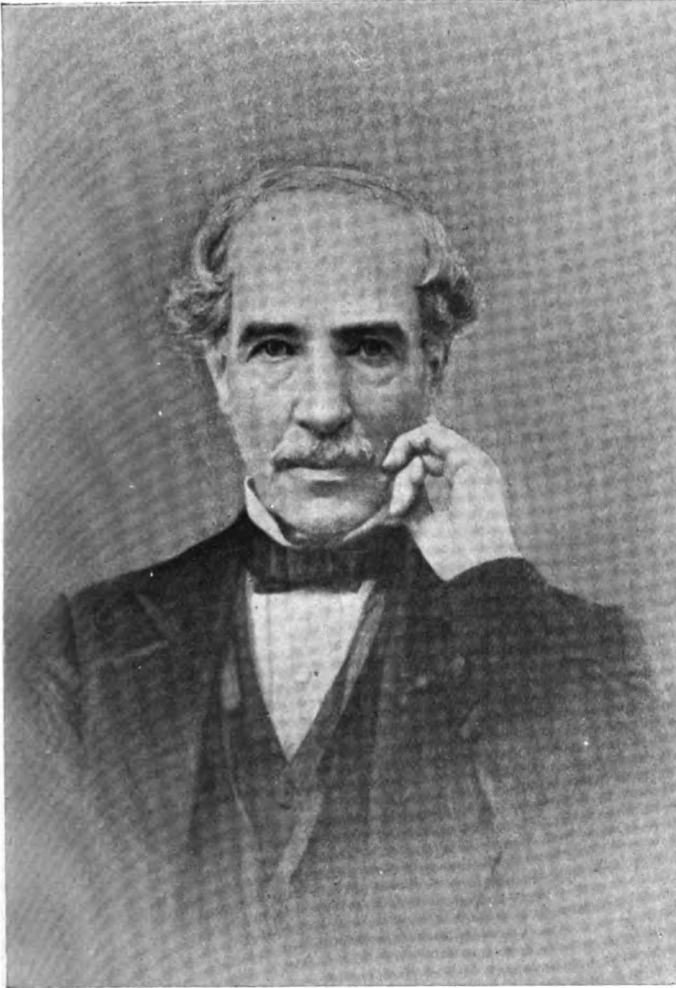

CHAS. H. HASWELL.

The first engineer in the United States Navy: appointed Chief Engineer July 12, 1836. Engineer-in-chief of the Navy from October 3, 1844, until December 1, 1850.

jector, and by its character was bound to make enemies for him within his own corps, where friends were most needed; enemies who treasured up their wrongs, real or imaginary, and patiently waited for the time, which eventually came, when they could safely combine to seek their revenge.

Mr. Haswell's scheme for the reformation and reorganization of his corps was further perfected this same year by the promulgation of a set of regulations governing the admission and promotion of members of the engineer corps. This order was dated July 8, 1845, and established limits of age for candidates, made the performance of a certain amount of sea service in each grade a requirement for promotion, and fixed a scale of mental requirements much in advance of what had been previously demanded. The initial examination for admission as a third assistant engineer was elementary compared with modern requirements, but the subsequent advances in grade were guarded by examinations that increased in difficulty in what may be termed geometrical progression, until the candidate for promotion to the list of chief engineers was required to pass a very exacting ordeal, calculated to establish the possession of much scientific and mechanical ability.

Chief engineers of excellent professional and general information were habitually selected for the duty of examiners, and it was an established rule that a failure to pass the required examination meant an end to the naval career of the delinquent. This furnished a strong incentive to the young engineers to fit themselves for advancement, and almost immediately after the reorganization of the corps a much keener incentive to study and self improvement appeared in the development of an intense spirit of corps pride which made the engineers quick to recognize their own short-comings and to strive to overcome them. Opposition from within the service to the new branch was the chief cause for the early inception of this *esprit de corps*, and, although disagreeable to those who had to resist it, should now be regarded as a blessing in disguise to the engineers, for it prompted all but the laggards not only to overcome the deficiencies charged against them, but to outstrip their competitors in the pursuit of knowledge.

The Naval Academy was opened the same year that the systematic reorganization of the engineer corps was effected, and as

soon as the two systems were well in operation the young men of the two branches of the service fell into an intellectual rivalry, which was good for both classes, and especially for the engineers. The result of this feeling was frankly confessed by a distinguished naval captain some years ago, who, in a discussion regarding naval education, remarked that under the old system a newly graduated midshipman was much better informed on general subjects than was a newly appointed third assistant engineer, but at the end of the first cruise the young engineer would generally be found to be much the better informed man of the two.

Immediately after being appointed engineer-in-chief, Mr. Haswell prepared a list of instructions for the government of the engineer department of vessels of war, which instructions were issued by the Secretary of the Navy in the form of a general order to commanding officers under date of February 26, 1845. This order defined in general, the duties and responsibilities of engineers afloat, precautions to be observed in the care and preservation of machinery, etc., and were so well considered and prepared that some of the sections still remain in the steam instructions without modification, except in matters of detail demanded by the changes in engineering practice.

August 1, 1847, the Navy Department issued a circular order regarding the enlistment of firemen and coal heavers, which directed that no fireman should be shipped in the future until he had passed a satisfactory examination before a board of engineers and demonstrated his ability to manage fires properly with different kinds of fuel, and to use skillfully smiths' tools in the repair of boilers and machinery. Two classes of firemen were established by the order, and a regular system of promotion from coal heaver to the two grades of firemen was directed. First class firemen were declared eligible for advancement to the warrant rank of third assistant engineer if they could qualify before the examining board.

The next year Congress, by an Act approved August 11, 1848, extended the benefits of existing laws, respecting naval pensions, to the engineer corps and to enlisted men of the engineers' force, the wording of the act being as follows:

“SEC. 2.—That engineers, firemen, and coal heavers in the navy shall be entitled to pensions in the same manner as officers, seamen, and marines, and the widows of engineers, firemen and coal heavers in the same manner as the

widows of officers, seamen, and marines: *Provided*, That the pension of a chief engineer shall be the same as that of a lieutenant in the navy, and the pension of the widow of a chief engineer shall be the same as that of the widow of a lieutenant in the navy; the pension of a first assistant engineer shall be the same as that of a lieutenant of marines, and the pension of the widow of a first assistant engineer shall be the same as that of the widow of a lieutenant of marines; the pension of a second or a third assistant engineer the same as that of a forward officer, and the pension of the widow of a second or third assistant engineer the same as that of the widow of a forward officer."

A new schedule of pay for engineer officers, by which an increase for all grades was effected, was created by the following section from the naval appropriation bill approved March 3, 1849:

SEC. 6. *And be it further enacted*, That the engineers in the navy shall hereafter receive the following pay, viz:

Chief engineers on duty first five years.....	\$1,500
Chief engineers on duty after five years.....	2,000
Chief engineers on leave first five years.....	1,200
Chief engineers on leave after five years.....	1,400
First assistant engineers on duty.....	1,000
First assistant engineers on leave.....	850
Second assistant engineers on duty.....	800
Second assistant engineers on leave.....	600
Third assistant engineers on duty.....	600
Third assistant engineers on leave.....	400

The engineer corps experienced a decided loss at this period by the resignation of the senior chief engineer in the service, Mr. John Faron, Jr., who tendered his resignation in April, 1848, in order to accept the position of Superintending Engineer of the newly established Collins line of transatlantic mail steamers. Mr. Faron, it will be remembered, was the first assistant engineer appointed to the *Fulton* in 1837, and became a chief engineer in January, 1840. He was a thoroughly capable and efficient marine engineer, and was prominently identified with the designing, building and management of the early naval steamers, as well as being a prominent factor as a member of the examining board, in the work of reorganizing the engineer corps. His name was continued on the navy list by the admission into the corps of a third assistant engineer named John Faron, a few months after his resignation.

CHAPTER VII.

“ I believe that if the question had been put to Congress before the march of the armies and their actual conflict, not ten votes could have been obtained in either house for the war with Mexico under the existing state of things.”—**WEBSTER.**

The War With Mexico—Naval Operations in California—Important Service of Surgeon Wm. Maxwell Wood—Blockade of the Gulf Coast—Commodore Perry and the *MISSISSIPPI*—Valuable Professional Service of Engineer-in-Chief Haswell—Bombardment of Vera Cruz—“*Alvarado Hunter*”—Steamers Bought for Temporary Service—Naval Engineers Engaged in the Mexican War—Results of the War.

THIS volume being devoted to the deeds of naval men, it is hardly within its province to deal with the causes, or pretexts, which brought about the war with Mexico. Without referring to the political and sectional interests involved, it will be sufficient to say in regard to the direct cause of the war that the Mexican State of Texas, after having achieved its independence after a short but exceptionally cruel war, and after having enjoyed the dignity of a sovereign republic for ten years, asked for admission into the North American Union, and was admitted late in 1845, bringing with her a bitter quarrel with her parent country as to the exact boundary line between them, and a vast assortment of fierce and bloody border feuds handed down from the days of the Alamo, Goliad and San Jacinto. The new administration, that of President Polk, resolved to defend by force if necessary the position taken by the Texans in regard to their boundary dispute, and within a few months collisions of troops in the disputed territory gave the American Congress the opportunity of declaring, May 11, 1846, that “By the acts of the Republic of Mexico, a state of war exists between the United States and that Republic.”

Mexico, being miserably poor, distracted, misgoverned, and revolutionary, had no national navy, and the navy of the United States therefore was restricted to a rather limited share in the operations of the war, being forced to unromantic blockading and transport duties along the coasts, and denied the glory of battles at sea

for lack of an enemy to meet on that element. Nevertheless, some of the acts of the naval force were productive of most important and lasting results in the prosecution of the war, while the maintenance of a blockade, imperfect as it was from being held by a fleet mainly composed of sailing ships on coasts famous for sudden storms, contributed greatly to hasten the end of hostilities: otherwise the war might have been prolonged by the sending of war material and supplies into Mexico by other nations had her ports been left unguarded.

One of the very first events of the war was of the greatest importance, and in all human probability its result was to give to the United States instead of Great Britain possession for all time of the vast region then composing the Mexican territory, or province, of California. The Mexican national debt was largely held by British capitalists, and fearing they would never realize on their investments because of the constant political turmoil of the feeble young republic, had appealed to their own government for assistance, which was readily attempted, as the foreign policy of England very properly includes the protection of the pockets of her subjects as well as their personal safety. Through the regular diplomatic channels propositions were made to Mexico to mortgage California and allow its occupation by England until the bonds were paid: a most astute scheme, and one that would have resulted in due time in the British government assuming the payment of the debt to its subjects and becoming the owner in fee simple of the territory held as security. While negotiations to this end were pending, the prospect of war between the United States and Mexico became threatening, and a subject of great interest to the British admiral in the Pacific, who is believed to have had instructions to seize upon California at the first news of hostilities, and thus insure his countrymen against financial loss.

In the spring of 1846 the American Pacific squadron, composed of sailing vessels, was lying at Mazatlan on the west coast of Mexico, Commodore John D. Sloat in the frigate *Savannah* being in command. The British admiral, Seymour, in the *Collingwood*, was also there, both watching each other and waiting eagerly for news, which came slowly in those days, without railways and telegraphs. It often happens that important events in the history of nations result

from the acts of individuals not prominently connected with them, or from obscure circumstances of which the public is not cognizant, and one these events was now to come about. Surgeon Wm. Maxwell Wood, of the *Savannah*, having been relieved by another surgeon, left Mazatlan April 30 on his way home, his plan being to cross Mexico and take a steamer for the United States before war began, if a war was really to result. He was commissioned by Commodore Sloat to convey important information verbally to the Secretary of the Navy, the condition of the country being such that it was not deemed safe to trust his despatches or letters to be carried across the country. Dr. Wood spoke Spanish fluently, and when well started on his journey, at Guadalajara, overheard a conversation not intended for his ears from which he learned that hostilities had actually occurred on the Rio Grande. He was a most phlegmatic man, and consequently was able to absorb the startling intelligence without any outward show of interest; furthermore, his manner and personal appearance were those of a prosperous Englishman, in which character he was traveling, so he was comparatively free from suspicion.

At the earliest possible moment Surgeon Wood wrote out a detailed account of what he had heard, and despatched it by messenger to Commodore Sloat at Mazatlan, this act involving great personal risk, for had the despatch been intercepted its author would certainly have been hunted down and treated as a spy. By good luck more than anything else the letter reached Commodore Sloat safely, and that officer was not slow to appreciate the importance of the news and the exigency of the occasion. He at once sent two of his vessels—the *Cyane* and *Levant*, names that had before been historically associated—to the northward, and followed soon after in the *Savannah*. Within a few days the British admiral learned of the beginning of the war, and, surmising the mission of the American squadron, sailed at once on the same errand; but he was too late. On the 7th of July the American vessels took possession of Monterey, the chief city of Upper California, and of San Francisco, the best harbor, and that territory has ever since remained a part of the American Republic, thanks in the first instance to Surgeon Wood for his quick perception of his duty in the emergency in which he was accidentally placed, and in the second to Commodore Sloat

for assuming the responsibility of seizing upon a vast territory without orders and without any assurance that his action would be upheld, or that a force sufficient to hold it would be supplied.

That Commodore Sloat acted wholly on his own judgment is proved by the fact that orders from Washington directing him to take possession of San Francisco Bay in the event of war were received by him long after the act had actually been performed. The importance of Surgeon Wood's part in the affair is testified to by Commodore Sloat, who, writing him some years later in relation to the event, said: "The information you furnished me at Mazatlan from Guadalajara (at the risk of your life) was the only reliable information I received of that event, and which induced me to proceed immediately to California, and upon my own responsibility to take possession of that country, which I did on the 7th of July, 1846." Had California become a British instead of American possession, the subsequent influence upon the progress of the United States, especially in the ultimate settlement of differences between the free and the slave states, is a subject quite beyond the bounds of any possible historical speculation.

Commodore Sloat was succeeded in command of the Pacific squadron by Commodore Stockton (of *Princeton* fame,) who, in cooperation with a small army under General Kearney, quelled an insurrection in the captured province and held it in hand until by the terms of the treaty of peace it became definitely a possession of the United States. His vessels also maintained as good a blockade of the ports on the western coast of Mexico as the nature of their motive power permitted. The action of Commodore Sloat in seizing upon the California coast was by all odds the most far-reaching move of the war, and the credit for it rests entirely with the navy.

An account of naval operations on the gulf coast of Mexico is largely a history of Captain M. C. Perry and his favorite war-vessel—the steamer *Mississippi*. Within a few weeks after the beginning of hostilities on the Rio Grande a reasonably efficient blockade of the Mexican ports was established, although the stormy character of that coast made blockading a rather difficult matter with the force at hand. This squadron, under the command of Commodore Connor, consisted of the steamers *Mississippi* and *Princeton*, the frigates *Raritan* and *Potomac*, several sloops-of-war, among which

were the ill-fated *Albany* and *Oumberland*, and a number of schooners, bomb-ketches and small steamers, the latter being mentioned more particularly hereafter. The principal military operation undertaken by Commodore Connor was an expedition against Alvarado in October, but owing to the grounding of a schooner on the bar and signs of an approaching "norther," signal was made to return to the station off Vera Cruz, the abandonment of the attack greatly displeasing the subordinate officers and eventually proving something of a reflection upon Commodore Connor.

In August, Captain Perry was ordered to take two small steamers to Mexico and upon his arrival to relieve Captain Fitzhugh in command of the *Mississippi*. The steamers were the *Vixen* and *Spitfire*, small side-wheel vessels of about 240 tons burden, fitted with horizontal half-beam engines. They were twin vessels and had been built by Brown & Bell of New York for the Mexican government, but being unfinished at the time the war began they were bought by the United States from the builders for about \$50,000 each. The *Spitfire* was sold at the close of the war and was lost on her first voyage as a commercial vessel; the *Vixen* was continued in the navy until 1855, when she was sold. Captain Perry arrived on the station with these steamers in September, after which there was a practical division of the squadron, Commodore Connor, who does not seem to have had much faith in steamers as war vessels, allowing Perry to control the steamers while he directed the operations of the sailing vessels, although he of course, as the senior, officially commanded the whole squadron.

At the time of Commodore Connor's demonstration against Alvarado, Perry with the *Mississippi*, *Vixen*, and some gun-schooners, reinforced by two hundred marines from the sailing ships, went to attack Tobasco up the river of the same name. Frontera, at the mouth of the river, was taken without resistance on October 23, a river steamer named *Petrita* which was afterward of great use being taken at this time. On the 26th Tobasco was captured after a smart fight, but the enemy, after having surrendered, attacked the naval force unexpectedly and this act obliged Perry to bombard the town, doing it a great deal of damage and completely subduing the war spirit of the Mexicans, the *Vixen* taking a prominent part in the cannonading. Not having a force with which to occupy the town,

Perry took away the small vessels he had captured and returned to rejoin the fleet. One of the vessels taken at Tobasco was a steamer named the *Champion*, formerly employed on the James River in Virginia, which as a despatch boat became afterward most useful to the American squadron. Although the captured city was not occupied, the expedition against it was not without value, for it infused new life into the men who were growing discontented under the monotony of looking at the enemy's shores from a distance.

About the middle of November both Connor and Perry went to attack Tampico, about two hundred miles north of Vera Cruz, and gained possession of that place without firing a shot, the appearance of the squadron off the bar being the signal for surrender. It being desirable for military reasons to retain this place, Perry with his ever-ready *Mississippi* was sent to Matamoros near the mouth of the Rio Grande to communicate with the army authorities and ask that troops be sent. After doing this he went on his own responsibility to New Orleans, where he obtained from the governor of Louisiana a battery of field guns and a quantity of shovels, picks, wheelbarrows, etc., much needed for entrenching purposes. Returning, he arrived at Tampico after just one week's absence, his quick trip amazing the old seamen in the fleet who were almost persuaded into the belief that a steamer might after all be good for something.

By the end of the year constant service under steam began to tell on the *Mississippi*, repairs being so urgently needed that early in January, 1847, Perry proceeded in her to Norfolk, where he turned her over to the navy yard authorities, going himself to Washington to consult with the Navy Department officials relative to the conduct of the war. A board of survey reported that it would require six weeks to fit the *Mississippi* for service, which was very discouraging news to Perry who felt that important events were impending in Mexico and who had his own reasons for wishing to be present during their occurrence. In this emergency he fell back on his old friend Haswell, the engineer-in-chief, knowing that if anyone could help him out Haswell was the man. The engineer-in-chief went to Norfolk and, after a critical examination of the ship, declared that she could be made ready in two weeks by working night and day, and this feat was actually accomplished under his personal direction. "We may safely add that, by his energy, and

ability in getting the *Mississippi* ready at this time, Mr. Haswell saved the government many thousands of dollars and contributed largely to the triumphs of a quick war which brought early peace.”¹

Commodore Perry's familiarity with steam vessels was utilized during his enforced stay in the United States at this time by putting him in charge of the fitting out of a flotilla of lightdraft vessels for service in Mexico. These were the steamers *Scourge* and *Scorpion*, and a number of bomb-ketches with imported volcanic names—*Vesuvius*, *Stromboli*, and the like—intended to be towed by the steamers. The *Scourge* was a small vessel of 230 tons burden, purchased in New York for \$44,825; she was fitted with two of the Loper flat-bladed propellers, and was sold at New Orleans at the close of the war. The *Scorpion* was a paddle-wheel steamer of 340 tons burden, bought in New York for \$80,505, and sold in 1848 for \$14,500. Although not a part of this flotilla, two other steamers added to the naval establishment for Mexican War service may properly be mentioned here. These were the *Iris*, a paddle-wheel vessel of 388 tons burden, fitted with a steep engine, bought in New York in 1847 for \$35,991 and sold in Norfolk in 1849 for about one-fourth that amount, and the *Polk*, a revenue cutter very similar to the *Scorpion*; the *Polk* was transferred to the Navy Department in 1846, but was found unseaworthy and defective in machinery, having broken down on an attempted voyage to the Gulf, in consequence of which she was returned to the Treasury Department.

Perry returned to Vera Cruz with the *Mississippi* early in March, carrying with him orders to relieve Commodore Connor and take command of the American fleet, which he did March 21, 1847, and immediately thereafter a vigorous and aggressive policy was inaugurated. General Winfield Scott's army had already landed and begun the siege of Vera Cruz, but found itself without ordnance heavy enough to make much impression upon the city walls. To General Scott's request for the loan of heavy guns from the fleet, Perry refused, unless his own men might go with their guns, a condition that Scott first declined, but when he fully realized that his

¹ William E. Griffis; "Biography of Matthew Calbraith Perry;" p. 211.

own batteries could not breach the walls he accepted it, and a heavy battery of six guns with ship's mounts and picked crews was at once landed and laboriously dragged through the sand in the night-time some three miles to the spot where it was to be located for most effective use. The earthwork defenses for this battery were laid out by an engineer of General Scott's staff—Captain Robert E. Lee. It may be interesting to mention that in the army before Vera Cruz at this time, gaining experience for a far greater war, were the following named young officers: First Lieutenants James Longstreet, P. G. T. Beauregard, John Sedgwick, and Earl Van Dorn, and Second Lieutenants U. S. Grant, George B. McClellan, Fitz John Porter, W. S. Hancock, and Thomas J. (Stonewall) Jackson.

After the installation of the naval battery the cannonading became more deadly and furious, resulting in the surrender four days later of the beleaguered city. The details of this exploit are not especially pleasant for the American historian to dwell upon. The Mexican general, Morales, had declined General Scott's summons to surrender and had not availed himself of the privilege offered to remove the inhabitants of the city before the bombardment began. The fire of the heavy naval guns was directed successfully to the breaching of the wall, but the army guns and mortars kept up an incessant storm of shot, shell and bombs, rained over the walls into the city. Ages ago Cicero established the maxim that "Laws are silent in war," and the truth of this was well illustrated by the tragedy of Vera Cruz. Whole families were destroyed in the ruins of their shattered homes; women and children praying in an agony of fear before the altars of their churches were torn and mangled by bombs and shells crushing through the roofs; even the sepulchres of the dead were torn to pieces and the corpses scattered about the streets. The damage done to combatants was small compared with the horrors inflicted upon the wretched populace.

An exhibition of bravado in the fleet was the only touch of comedy connected with the bombardment of Vera Cruz. The famous stone castle of San Juan d'Ulloa, built by the Spaniards in the 16th century at a cost of forty million dollars, stands in the harbor about a mile in front of the city, and its fire soon proved a serious annoyance to some of the investing batteries, the exact range of which had been ascertained by repeated firing. To divert this

fire, Perry ordered Commander Tatnall in the steamer *Spitfire* to approach and open fire on the castle. Tatnall, always disputations, asked for specific directions as to what point he should attack, to which "Ursa Major," as Perry was known behind his back, replied not too gently, "Where you can do the most execution, sir!" With this flea in his ear Tatnall proceeded with the *Spitfire*, in company with the *Vixen*, Commander Joshua B. Sands, to within a stone's throw of the castle and opened furiously against its massive walls. This close proximity probably saved the two little steamers, for they were untouched, although the men on board were thoroughly drenched with the water splashed over them by the storm of cannon balls. The spectacle was exciting to the crews of the on-looking ships, and ludicrous as well on account of its futility. Perry, both amused and provoked at the exhibition of temper on the part of his subordinate, made signal for the steamers to withdraw, but Tatnall failed to see any signals, assuring the officer who reported them that he was mistaken and was looking the wrong way. It finally became necessary to endanger a boat's crew by sending it to call him back. Mr. Wm. H. Shock, who was the engineer in charge of the machinery of the *Spitfire* on this occasion, has stated in a magazine article that when the vessels went out of action he heard Tatnall say in tones of regret, "Not a man wounded or killed."

After the fall of Vera Cruz, a combined army and naval expedition was planned against Alvarado, the place that had previously been proceeded against without results by Commodore Connor. The chief object in gaining this town was to supply Scott's army with animals for transportation in his projected invasion of Mexico, horses being abundant in the Alvarado neighborhood. General Quitman with a considerable force of artillery, cavalry and infantry, started overland, while Perry organized an expedition with small steamers manned by picked men from the fleet to proceed against the place by water. Lieutenant Charles G. Hunter in the *Scourge* was directed to blockade the threatened town and report the movements of the enemy to Captain Breese of the sloop-of-war *Albany*. This young officer, observing signs of the enemy abandoning the town, landed some men and took possession of it, a very presumptuous act when a general and a commodore had designs

upon the position and the honor of capturing it. Hunter was promptly arrested by order of Commodore Perry, tried by court-martial for disobedience of orders, and sent home in disgrace. In the United States he was given many dinners and receptions, and as "Alvarado Hunter" was the hero of the hour, while Perry was made the target for a multitude of newspaper attacks. All of which was natural enough on the part of the public, which saw nothing in the affair except the capture of a town without regard for the rank of the captor. As a matter of fact, by exceeding his authority Hunter completely defeated the real object of the expedition; his act forewarned the Mexicans and gave them ample time to remove with their horses and portable property before the army forces had hemmed them in.

The next naval operation of consequence in this war was Perry's capture in June of the city of Tobasco, after severe fighting. This is an important event in our naval history, as it is the first occasion on which a large force of blue-jackets was regularly organized into a naval brigade for prolonged military operations on shore, which was done under the personal direction and command of Commodore Perry. The necessity for this proceeding was brought about by the circumstance that the marines of the fleet had been formed into a regiment and sent with Scott's army on the march to the city of Mexico. The year before, Commodore Stockton had used his sailors to some extent for guard and garrison duty in California, but the credit for the first real naval brigade is given to Perry by the historians of our navy. The small steamers of the fleet were invaluable in the capture of Tobasco; in fact, without them the expedition would hardly have been practicable. Commodore Perry so fully appreciated the value of this type of vessel that he repeatedly asked for more light-draft steamers from home, and eventually so provoked the conservative old officers about the Navy Department that he got a stiff reprimand from the Secretary of the Navy for his persistence in this regard.

To First Assistant Engineer George Sewall is due credit for having repaired in a most ingenious manner without any convenient appliances the two steamers *Vixen* and *Spitfire*, which had become unseaworthy and unfit for use owing to leaky Kingston valve connections, thus giving to the Government two steamers for war operations.

Yellow fever broke out in July on the *Mississippi*, and that invaluable ship eventually had to be sent off the station, going to Pensacola with about two hundred invalids on board. A short time before the appearance of this pestilence a fire from spontaneous combustion had gained such headway in the *Mississippi's* coal bunkers that it was only extinguished by flooding the bunkers, and it was believed that the moisture remaining in the nooks and corners of the ship after this accident gave a foothold for the disease. Two of the *Mississippi's* engineers—First Assistant Charles A. Mapes, and Third Assistant Emerson G. Covel—died on board their ship of this epidemic and were buried in the soil of Mexico.

General Scott entered the city of Mexico on the 17th of September, 1847, and that practically ended the war, although the naval force continued the blockade of the coast until the treaty of peace was signed the following February. Then the vessels were gradually withdrawn, the larger ones to other stations and the small purchased steamers were sold for what they would bring. The most beneficial lesson to the navy derived from this war was that steamers were vastly superior to sailing vessels for war purposes, and the prejudice against the new motor were so broken down that naval opposition to the policy of building war steamers was materially diminished thereafter, although not wholly extinguished. The demonstrated value of the small steamers for river and harbor operations had quite as much to do with bringing about this change of sentiment as had the general utility exhibited by the *Princeton* and *Mississippi*.

With the return of peace, the steam navy was augmented by the transfer from the War Department of two steamers which had been used for troop-ships. The larger of these was the *Massachusetts*, a full-rigged ship of 750 tons burden with auxiliary steam power, which had been bought in 1847 for \$80,000. This ship had been the pioneer in a line of auxiliary steam packets employed in the New York and Liverpool trade, and was fitted with two small engines of Ericsson's design, driving an Ericsson screw only 9½ feet in diameter, the screw being attached to the shaft by a coupling that could be disengaged and the screw hoisted on deck in a few minutes. The propeller shaft passed out of the stern at the side of the stern post, to which was bolted the stern bearing of the shaft, the

latter projecting far enough to allow the screw to operate abaft the rudder. The rudder had a slot, or "shark's mouth" cut in it to prevent its striking the projecting shaft when put hard over. Both the stern bearing attached to the post and the cut in the rudder were features patented by John Ericsson. The *Massachusetts* was some years afterward converted into a bark-rigged sailing vessel, and under the name of *Farrallones* remained in the naval service until after the Civil War, when she was sold.

The other transferred transport was the auxiliary steam bark *Edith*, of 400 tons burden, which had Ericsson machinery of the same type as that described in the case of the *Massachusetts*. She had been in the East India trade and was on record as having made the quickest voyage then known between Calcutta and Canton. After being fitted for war purposes the *Edith* was sent on a cruise to the Pacific station, where, in 1850, she was run ashore and wrecked, but without loss of life.

The following list of engineers of the navy who served on vessels actively employed in the Mexican War is made up from a list given in General C. M. Wilcox's *History of the Mexican War*:

Chief Engineer John Faron, Jr.			
"	"	D. B. Martin.	
"	"	William Sewell.	
First Assistant Engineer Saml. Archbold.			
"	"	"	L. S. Bartholomew.
"	"	"	E. G. Covel.
"	"	"	T. H. Faron.
"	"	"	Jesse Gay.
"	"	"	J. K. Matthews.
"	"	"	Hiram Sanford.
"	"	"	George Sewell.
Second Assistant Engineer James Atkinson.			
"	"	"	N. C. Davis.
"	"	"	Joshua Follansbee.
"	"	"	John Gallagher.
"	"	"	A. P. How.
"	"	"	B. F. Isherwood.
"	"	"	R. M. Johnson.

Second Assistant Engineer, J. M. Middleton.		
“	“	“ A. S. Palmer.
“	“	“ Theodore Zeller.
Third Assistant Engineer J. M. Adams.		
“	“	“ Lafayette Caldwell.
“	“	“ John Carroll.
“	“	“ Charles Coleman.
“	“	“ Wm. E. Everett.
“	“	“ Edward Faron.
“	“	“ B. F. Garvin.
“	“	“ J. R. Hatcher.
“	“	“ J. W. King.
“	“	“ William Luce.
“	“	“ Charles A. Mapes.
“	“	“ J. W. Parks.
“	“	“ W. H. Shock.
“	“	“ William Taggart.
“	“	“ J. C. Tennent.
“	“	“ M. M. Thompson.
“	“	“ J. A. Van Zandt.
“	“	“ Wm. C. Wheeler.
“	“	“ Edward Whipple.

The material benefits to the United States resulting from the Mexican War were enormous, and entirely out of proportion to the outlay of life and treasure involved, notwithstanding it is difficult at this distance in time for one to grow enthusiastic over the events of that unequal struggle. Desperate battles were fought; many noteworthy deeds of valor were performed, and both army and navy achieved that peculiar distinction called *glory*, but to the American student of his country's history the fact that the military power of our great republic was ruthlessly used to overwhelm with woe and desolation a small sister republic struggling to maintain self-government on the democratic principles professed by the nation which inflicted upon her the horrors of war, must ever remain prominent. The cause of freedom had then enough to contend with, without the greatest nation governed by its own people tearing to pieces a feeble follower of its institutions.

The territory of the United States was increased one-third by the terms of the treaty which concluded the war, and a vast extent of sea coast on the Pacific Ocean was gained. The benefits to our country and to the world in general, resulting from this transfer of territory cannot be over-estimated, and this, as a manifestation of Providence forwarding the destiny of the Anglo-Saxon race, must be our chief apology for the manner in which that vast region changed hands. California under Mexican rule gave little promise for the future, but in the hands of the energetic and investigating American became almost in a day both famous and wealthy. It had long been known to the Mexicans of California that their rivers ran over golden sands, but the indolent and ease-loving people preferred the shade of their haciendas to the labor of exploring the mountains; *manana* or "the day after," would be ample time in which to investigate, and thus the great discovery bade fair to be neglected for an indefinite time.

The prying American lost no time in exploring his new possessions and within a year had proclaimed such wonderful discoveries that ships freighted with tools and men were converging upon the Golden Gate from every quarter of the globe; steamship lines before impossible, were established, and the transcontinental railways, which have hastened the development of the North American continent and the civilization of the Far East at least a century, were projected. It is a favorite statement of historians that the amount of gold produced by California since 1848 exceeds in value the enormous national debt incurred by the United States in the war for the preservation of the Union. Granting this to be true, and admitting that the mineral wealth of the territory acquired from Mexico is yet beyond computation, the greater truth remains that all this is actually secondary in value to the wonderful agricultural resources of the same region. But for the aggressive and perhaps undemocratic policy which led the United States to despoil a neighbor whose form of government should have been her defense, California, with sources of wealth far greater than those possessed by more than one empire which has ruled the world, might yet be the hunting ground of hungry savages, her fields untilled, her orchards unplanted, and the treasure of her streams and mountain ledges still undisturbed save by the hoof of the antelope and the paw of the bear.

CHAPTER VIII.

"The wheel of fortune turns incessantly round, and who can say within himself, 'I shall to-day be uppermost.'"—CONFUCIUS.

New steamers authorized for the navy in 1847—The SUSQUEHANNA, POWHATAN, SARANAC, and SAN JACINTO—Mr. Haswell Succeeded as Engineer-in-Chief by Charles B. Stuart—Circumstances Connected with Mr. Haswell Leaving the Navy—His Great Services to the Naval Engineer Corps—His Subsequent Career.

STEAM, as we have seen, did not play an important part in the naval operations of the Mexican war, but the numerous opportunities and advantages lost or not used simply for lack of motive power more reliable than the winds, served as excellent object lessons to direct naval and public attention to the necessity of having a fleet of steam war vessels if the navy were to be thereafter a useful military arm. In the report of the Secretary of the Navy for the year 1846 a policy of building war-steamers was urged, and in December of that year Mr. Fairfield, Chairman of the Senate Committee on Naval Affairs, asked the Department by letter for a statement as to the size, type, cost, &c., of the vessels desired. The reply was to the effect that at least four steamers, at an average cost of \$500,000 each should be immediately undertaken, and the authority asked for was conferred by the naval appropriation bill then under consideration, which was approved March 3, 1847. The same act directed the Secretary of the Navy to enter into contract with E. K. Collins and his associates for the transportation of the United States mails between New York and Liverpool; with A. G. Sloo for the transportation of the mails between New York and New Orleans, touching at Havana, and with some other agent, not named, for the transportation of the mails from Panama to Oregon Territory. In the first two cases, the steamers of the contractors were to be built under the supervision of a naval constructor and were to be adapted to use as war vessels, the contractors being also required by the terms of the act to receive on board each of their steamers four passed midshipmen of the navy to act as watch officers.

Mr. John Y. Mason, Secretary of the Navy, on March 22, 1847, ordered a board, consisting of Commodores Morris, Warrington and Smith, Engineer-in-Chief Haswell, Naval Constructors Grice, Lenthall and Hartt, and Mr. Charles W. Copeland, the eminent civilian engineer employed by the Navy Department, to assemble in Washington and determine upon the various features of the proposed vessels, the order stating in general terms some of the requirements to be observed, and directing that one of the vessels "should be propelled by some of the various screw propellers." Later, Commodore Skinner and Chief Engineer John Faron, Jr. were added to the board, which met at frequent dates from March 23 until July 3, 1847, on which latter date its final report and recommendations were submitted to the Department. So many interesting points arose later about the ships recommended by this board, and such a bitter controversy grew out of alleged defects in the design of at least one of them that the matter eventually became the subject of congressional inquiry, and its history in detail thus got into print in the form of a public document—Executive Document 65; House of Representatives, Thirty-third Congress; First Session: this document the author has been fortunate enough to discover in that vast mine of information almost inaccessibly buried in the crypt of the Capitol, and from it the principal facts presented in this chapter are derived.

The proceedings of the board indicate that the *Mississippi* was regarded as a model from which to copy as much as possible. Without going into all the differences of opinion, lengthy debates, and yea and nay votes indulged in by the commodores, constructors and engineers of the board, it is sufficient to say the resultant recommendations were the building of two large side-wheel steamers, similar to the *Mississippi*, but sufficiently large to carry coal, provisions, &c., for long voyages to foreign stations, and two smaller steamers, of about 2,100 tons displacement, one of the latter, to be fitted with a screw propeller. Wood was designated as the material from which these vessels were to be built, the vote of the Board showing that Mr. Haswell was the only member who favored iron as building material for even one of them. The board also decided that Naval Constructors Grice and Lenthall should each design the hull of one of the larger steamers and that Mr. Hartt should design

both of the smaller ones, Messrs. Haswell and Copeland each to design machinery for one large and one small vessel. All these recommendations were approved by the Navy Department, and on the 13th of July, 1847, the Secretary promulgated the President's order that the two large ships be built at Philadelphia and Norfolk respectively, and the smaller ones at Kittery and New York.

The large steamer designed by Mr. Lenthall was named *Susquehanna*, and was built in the navy yard at Philadelphia, where she was launched in April, 1850, and was entirely completed with machinery ready for service at the end of that year. She was bark-rigged, 250 feet long, 45 feet beam and displaced 3,824 tons at her load draft of 19½ feet. The engines, designed by Charles W. Copeland, were built by Murray & Hazelhurst of Baltimore, under the supervision of Chief Engineer Wm. P. Williamson, U. S. Navy, and consisted of two inclined direct-acting condensing engines, with cylinders 70 inches in diameter and 10 feet stroke, fitted with inclined air pumps. The paddle wheels were of the ordinary radial type, 31 feet in diameter. There were four copper boilers of the double return, ascending flue type, containing 342 square feet of grate surface and 8,652 square feet of heating surface.

In June, 1851, the *Susquehanna* sailed for the Asiatic station, then known as the East India Station, her first commander being Captain J. H. Aulick and her chief engineer Mr. Samuel Archbold. On the passage to Rio de Janeiro some defects or injuries to her engines and spars were discovered, resulting in a delay of some two months at the Brazilian capital, during which time repairs to the extent of about \$3,500 were made at the marine arsenal, mostly to the air pumps and paddle-wheels. Her performance thereafter was excellent, and most creditable to her engineers, as may be seen from the following report of the commanding officer, which report is of special interest in these days when we rather pride ourselves on our ability to cross wide seas under steam without an extravagant use of fuel, showing that the men of a previous generation were not wholly ignorant of the same desirable experience:

U. S. STEAM FRIGATE *SUSQUEHANNA*,
TABLE BAY, CAPE OF GOOD HOPE, October 17, 1851.

SIR: I have the honor to report our arrival here on the 15th instant, eighteen days from Rio de Janeiro.

This passage has thoroughly and severely tested the strength of our masts and engines. The weather for the greater part of the time was very stormy, and the sea higher than I have ever known it before, causing the ship to roll and plunge to such a degree that frequently one wheel was eight or ten feet entirely clear of the sea, when the other was full half its diameter buried in it; but nothing of any importance gave way, and the engines were never stopped from the time we weighed our anchor in "Rio;" until it was let go in this bay. I, however, did not neglect to use our sails and economize fuel; when the wind was fair, and the weather permitted, we used only two boilers, and with a daily expenditure of less than fourteen tons of coal, keeping up only sufficient steam to turn our wheels, we averaged for a number of days more than two hundred miles in the twenty-four hours. I adopted this course in preference to taking off the floats, for the reason that it is very difficult, if not impossible, to un-ship and re-ship them in a heavy seaway. We expended on the passage only about half the coal with which we left "Rio."

I am, &c.,

J. H. AULICK,

Commanding Squadron, East Indies and China.

HON. WILLIAM A. GRAHAM, Secretary of the Navy,
Washington, D. C.

The *Susquehanna* continued an efficient cruising steamer for many years, and was a prominent ship during the war of the rebellion; a few years after its close her machinery was entirely removed and the work of converting her into a screw steamer undertaken, but never completed, and she never went to sea again.

Constructor Grice's steamer was the *Powhatan*, launched at the Norfolk navy yard February 14, 1850. The principal dimensions of the hull were practically the same as those of the *Susquehanna*, but as her load draft when completed was about a foot less than that of the latter vessel, her displacement was also somewhat less; she was bark-rigged. The engines were designed by Engineer-in-Chief Haswell and were built by Mehaffy & Co., of Gosport, Va., under the inspection of Chief Engineer William Sewell, U. S. Navy. There were two inclined direct-acting condensing engines with the same cylinder dimensions as those of the *Susquehanna*, but

differing from that vessel in design, having vertical air pumps and a novelty in engine framing, the frames being of wrought iron, built up on the box-girder principle. There were four copper boilers of the same general dimensions as those of the sister ship, but differing from them considerably in details of arrangement, fittings, etc. The lower flues were made elliptical to increase the heating surface.

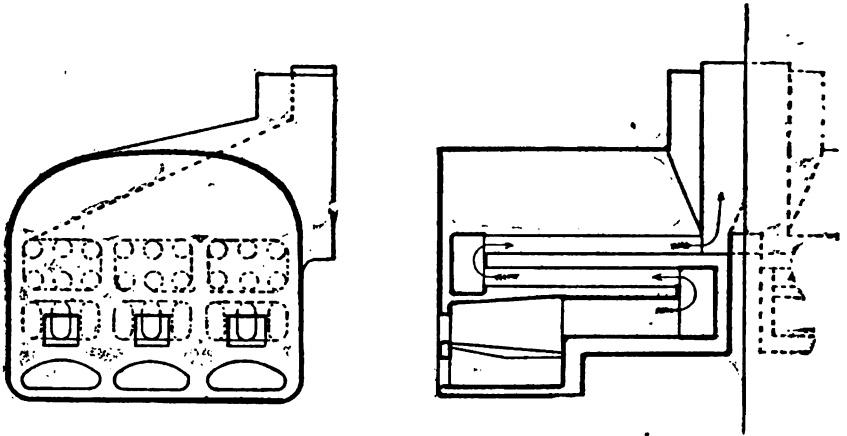

COPPER BOILER, U. S. S. POWHATAN; ASCENDING-FLUE RETURN TYPE.

Length, 16 feet; breadth, 15 feet 3 inches; height, 13 feet; grate surface, 88½ square feet; heating surface, 1,971 square feet.

A new feature in marine engineering practice appeared in this vessel in the introduction of a small one-furnace auxiliary boiler, intended primarily for supplying a hoisting engine to aid in coaling ship. The *Powhatan* also was fitted with two Worthington steam pumps, which is believed to be the first appearance in our navy of that now familiar auxiliary.

Owing to a lack of professional and clerical aid, Engineer-in-Chief Haswell personally designed every detail of the *Powhatan's* machinery and made the working drawings with his own hands in the intervals between attention to the necessary duties of his office. So pressed was he for time that he was unable to lay out a general design of the engines to work up to, but had to develop the various parts progressively. This feat is probably unprecedented in designing work of such magnitude, and, considered together with the remarkable success of the *Powhatan's* engines, furnishes a most valuable index to the rare professional accomplishments of Mr. Haswell.

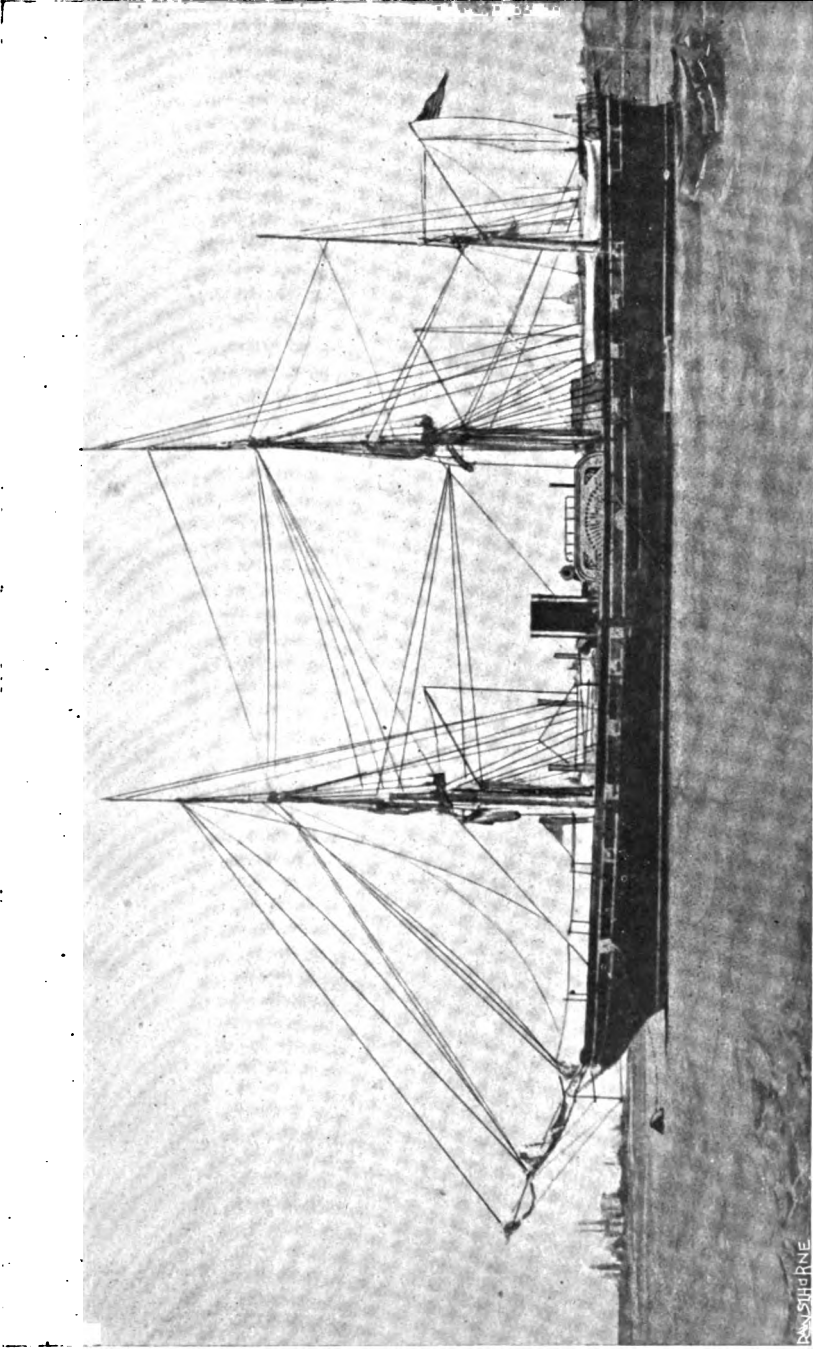

U. S. S. POWHATAN (AND SUSQUEHANNA), 1850.
(When first put in service the smoke pipes of these ships had flaring or bell mouthed tops).

The *Powhatan* was employed in service, almost continuously for a longer period than any steamer ever in the navy, with the sole exception of the *Michigan*, which latter vessel owes her longevity, as has been pointed out before, to the fact that her career has been confined to summer cruising on the fresh-water lakes of the Northwest. The copper boilers of the *Powhatan* of course had to be replaced in time, but her original engines remained thoroughly efficient and trustworthy to the end, a monument to the ability of their designer and the skill of the men who built them. When the *Powhatan* was attached to the Japan expedition squadron, her chief engineer, George Sewell, wrote home that in a trip of three thousand miles under steam a hammer had not been touched to her engines, which ran with such rhythmic regularity that they seemed set to music.

Even in her old age the *Powhatan* was a faster steamer than almost any other on the navy list and was decidedly the most comfortable and popular with both officers and men. With ten pounds of steam and her great wheels making ten revolutions per minute she was proverbially capable of making ten knots an hour, and that without much reference to the state of the weather. In 1878, after she had outlived almost every steamer of her date, she fought for her life off Hatteras, under the command of that splendid old seaman, Captain T. S. Fillebrown, through one of the most awful cyclones that any ship ever survived, and though terribly battered and strained, remained able to breast the sea for several years thereafter. In that storm it is reported by the indisputable evidence of many observers that her fore yard-arm dipped into the sea. In 1887, to the genuine regret of all in the navy, the *Powhatan* was condemned by a board of survey, being actually worn out in the service, and an unsentimental administration sold her poor old bones to the ghouls of the ocean—the ship-breakers.

One of the two smaller vessels was built at the navy yard at Kittery, Maine, and named *Saranac*. She was the first of the four steamers to be completed, being launched in November, 1848, and sailed for a cruise in the West Indies in April, 1850. She was 216 feet long, 38 feet beam, and of 2,200 tons displacement at the mean draft of 17 feet. The machinery, designed by Engineer Cope land, was built by Coney & Co. of Boston, under the inspec-

tion of Chief Engineers Wm. W. Wood and D. B. Martin, and consisted of a pair of inclined direct-acting condensing engines with cylinders 60 inches in diameter and 9 feet stroke, driving radial paddle-wheels 27 feet in diameter. The engines were fitted with Stevens' patent cut-offs. There were three copper double-return drop-flue boilers, designed to carry twelve pounds of steam pressure, aggregating 188 square feet of grate surface and 5,127 square feet of heating surface. At an ordinary engine speed of about twelve revolutions per minute about eight knots an hour could easily be maintained. The rig was that of a bark, and her lines were so graceful and the external finish so perfect that she was regarded as an ornament to the service. After a long career for a war vessel the *Saranac* came to a violent end in June, 1875, by running ashore and becoming a total wreck in Seymour Narrows, while on her way to Alaska.

The fourth one of these steamers—the *San Jacinto*—was, like the wrath of Achilles, “the direful spring of woes unnumbered,” to almost everyone ever prominently connected with her, her campaign of destruction beginning with blasting the naval career of Engineer-in-Chief Haswell. Designed by the same constructor, Mr. Hartt, who designed the *Saranac*, the hull was an exact counterpart of that vessel, and the rig was the same. She was built at the navy yard, New York, where she was launched in April, 1850. The engines were designed by Mr. Haswell and were built by Merrick and Towne of Philadelphia, under the inspection at different times of Chief Engineers Faron, Wood and Hunt, and finally Mr. Haswell himself. They consisted of two “square” engines, as they were termed, operating the shaft of a screw propeller; the cylinders were 62½ inches in diameter and 50 inches stroke, and were placed athwartship, inclined upward and outboard with the inner, or lower heads, in contact over the crank shaft. Long cross-heads carried two connecting rods for each engine, reaching backward and downward on each side of the cylinders to take hold of the cranks. There were three copper boilers of the same external dimensions as those of the *Saranac*, but somewhat better designed, as they displayed more grate and heating surface.

There were some strange things about this ship, one of which was the location of the propeller shaft twenty inches to one side of

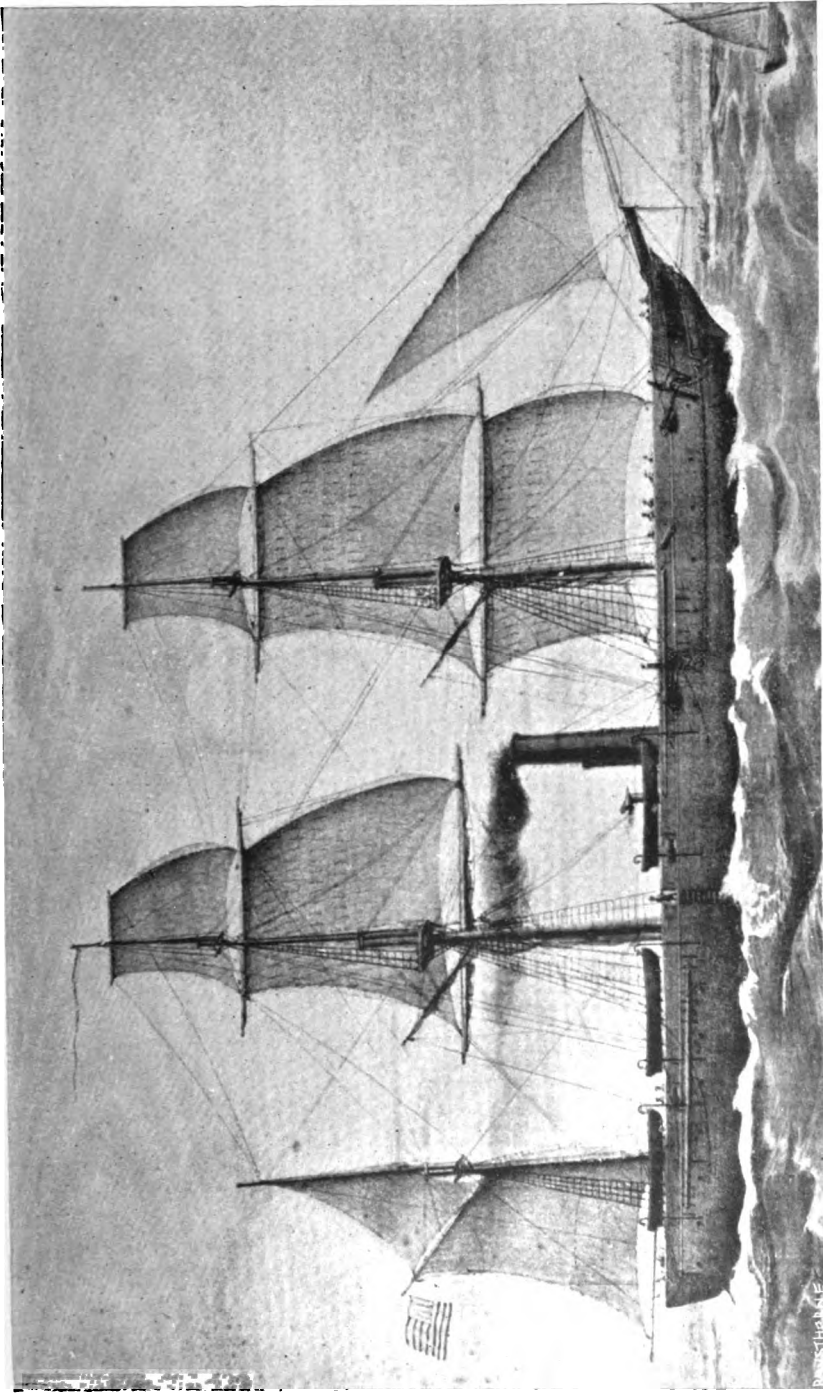

U. S. S. SAN JACINTO, 1850.

the center line of the keel, which was done at the instance of the three naval constructors, members of the board that settled upon the plans for the vessel. These gentlemen were eminent in the business of ship designing and building, but screw-propelled ships were new to them and they could not bring themselves to agree to any application of steam power that involved cutting a big hole for a shaft through the stern post. It transpired that Ericsson, who had patents on a multitude of marine appliances, useful and otherwise, had a patent on a precisely similar arrangement. This location entailed the projection of the propeller shaft far enough beyond the stern to allow the screw to work abaft the rudder, which plan Mr. Haswell had opposed in the Board, but made his designs in accordance when it was finally decided upon. The board also fixed the location of the engines so far aft and in such a cramped space that the engineer who had to design them was so handicapped that it was practically impossible for him to arrive at an arrangement of details that would allow proper room for examination, repairing and adjustment of the machinery when assembled in place. The screw itself as designed was a ponderous six bladed affair, five feet wide axially and weighing some seven tons, which weight, overhanging the stern five feet at least, was manifestly a menace to the safety of the ship. Mr. Haswell claimed, and with propriety as the records of the Board show, that he was forced to such a design by the board's exaction that no patents be infringed, and the lighter types of screws then in use, having thin supported blades, were covered by Ericsson's patents.

As the engines of the *San Jacinto* approached completion it began to be gossiped abroad among engineers that the engineer-in-chief had made a fearful botch of his designs, and the various naval engineers and machinery contractors who fancied they had been wronged by him in the fearless performance of his official duties, according to his conscientious judgment, gathered their forces for his overthrow, the movement being simply a manifestation of the natural tendency of mankind to assail and humble the eminent. In a primitive state of society, man kills his rival with a club and eats him, partly in revenge, partly to remove an obstacle to his ambition, and partly to provide subsistence for himself. As we become enlightened, the older and more natural code of ethics is abandoned in deference

to certain artificial prejudices which are adjuncts of civilization, and while less rude are equally effective methods of personal warfare. This seems to be a necessity, for the natural predilection of man is a love of hostility to his species, as exhibited in personal rivalries and jealousies when a state of war does not afford an outlet for his passions under the guise of patriotism.

Such a condition of society may be sad to contemplate in these closing years of the nineteenth century, and there are doubtless many who are thoughtlessly ready to controvert the proposition. A little reflection, however, will be convincing to the majority; for as we look about the world it appears that in spite of all the doctrines of peace and good-will to man, promulgated by the apostles of christianity and other great religions, there does not and never has existed, the nation large enough to permit of the harmonious existence within its borders at the same time, two great statesmen, soldiers, or others of the same calling; nor is there a village so small that two carpenters, shoemakers or blacksmiths within its limits fail to become rivals, each claiming his fellow craftsman to be incompetent and an imposter. Even the clergy, the anointed apostles of the doctrine of peace, take delight in bitter quarrels of creed, or, failing in opportunities for that, turn upon each other in the same denomination and institute heresy trials, and critical inquisitions regarding their profession of faith.

Unpalatable as it may be, it is nevertheless a plain, unvarnished truth that fondness for war and strife is an instinct inherent in the human breast. Without this instinct success in any undertaking is well-nigh impossible, as society is at present constituted. Nothing proves this more clearly than the history of nations, which, when analyzed, are simply tales of the contention of individuals striving for supremacy. He who becomes foremost in any walk in life must succeed at the expense of his fellows who are struggling for the same eminence, and it is literally "to him that overcometh," who, according to Revelation, "shall be given power over the nations."

Returning to the subject, after this digression, it must be admitted that there were some radically bad features connected with the design of the *San Jacinto's* machinery, but the assertions freely made at the time that the engines were an "object of ridicule to all



MR. CHARLES B. STUART,
Engineer-in-Chief of the Navy, December 1, 1850, to June 30, 1853.

engineers who have seen them," and a "standing monument of Mr. Haswell's incompetency and folly," were more ridiculous in view of Haswell's reputation and achievements as an engineer than any defect in these engines could possibly have been. Some of the faults of the *San Jacinto's* engines were forced upon the designer by conditions imposed by superior authority and were as well known to him as they could have been to any of his critics, while many of the other alleged defects existed chiefly in the minds of those who had decided the time had come to thrust him from the pedestal he occupied above all other scientific engineers of his time.

The hue and cry had its effect, and late in November, 1850, the President appointed Mr. Charles B. Stuart of New York to the office of engineer-in-chief of the Navy from December 1st, Mr. Haswell resuming his place at the head of the list of chief engineers. Mr. Stuart was a civil engineer of prominence, being the superintendent of the Erie Canal at the time of his appointment, and made no pretense to knowledge of marine engineering, though he acquired considerable knowledge by experience while engineer-in-chief. His was purely a political appointment as a reward for party service, and he never was an enrolled member of the naval engineer corps. Some serious engineering mistakes, which have been or will be noted in these pages, occurred in the navy during his administration, the result of which was that when he resigned, after an occupancy of his office for two years and a half, the custom was adopted of selecting the engineer-in-chief from the chief engineers of the navy, who were familiar with the service and the peculiarities of its steam vessels. While engineer-in-chief, Mr. Stuart performed good service for the engineering world by collecting the necessary data and publishing two remarkably valuable and reliable books on naval material—"The Naval Dry Docks of the United States," and "The Naval and Mail Steamers of the United States."

The day after Mr. Stuart's induction into office, Mr. Haswell was ordered to assume the duty of superintendent of the installation of the *San Jacinto's* machinery, and Chief Engineer B. F. Isherwood, who before entering the naval service had been associated with Mr. Stuart in the civil engineering work of the Erie canal, was detached from duty under the Light House Board and ordered as technical assistant to the engineer-in-chief. 2 Shortly thereafter, let-

ters expressing grave doubts about the *San Jacinto* were sent by the engineer-in-chief to the chief of the bureau of construction, and requests made that a survey be held before the work of completing the ship was allowed to go further. As a result, a board consisting of Chief engineers Wm. P. Williamson, Wm. Sewell and Henry Hunt, provided with a categorical list of fifteen questions, the answers to which, it was supposed would damn the machinery of the *San Jacinto*, was assembled at New York to examine the vessel and report discoveries, a report being made February 10, 1851. It

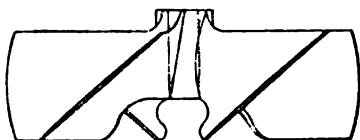
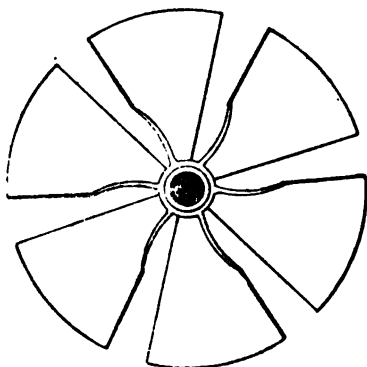

PROPOSED PROPELLER.

Diameter, $14\frac{1}{2}$ feet.
Pitch, 35 to 39 feet.

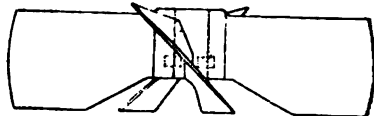
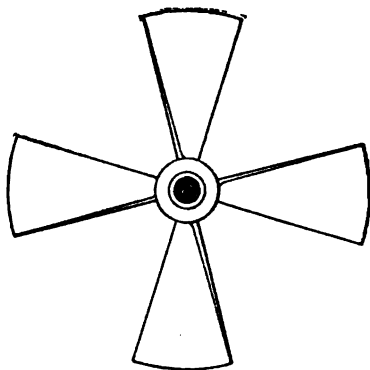

ADOPTED PROPELLER.

Diameter, $14\frac{1}{2}$ feet.
Pitch, 40 to 45 feet.

was decidedly unfavorable to the engines in general, and especially severe in regard to the heavy projecting propeller and the side location of the shaft, both of which objectionable features were recommended for alteration. The propeller was altered accordingly, it so happening that the one originally designed had not yet been cast, although its mold was completed; the modified screw, as recommended by the Board and designed by Mr. Isherwood, together with the one originally designed being represented by the outline sketches here inserted.

The shaft passage through the stern having been cut, the recommendation of the board of engineers regarding its modification was not carried out. It has been previously noted that Captain Ericsson had a patent on such an arrangement and he, through an attorney promptly made claim for infringement; the claim was referred to Engineer-in-Chief Stuart for an opinion, and that official made a most lengthy report, acknowledging in rather indirect terms that the shaft arrangement was practically the same as that described in the specification of Ericsson's patent and was therefore an infringement for which the patentee was entitled to damages. Besides this question, which was the only real point raised by Ericsson's claim, the engineer-in-chief dilated upon other features of the *San Jacinto's* machinery involved very indirectly, if at all, in the claim, and of course proved they were not infringements, the object of this digression being apparently to make an occasion to reflect upon the machinery designs of the ex-engineer-in-chief, which reflection was introduced into the report somewhat neatly by the following sentence: "I cannot discover that the construction of the 'engines' of the *San Jacinto* involves the infringement of Captain Ericsson's patent in any particular, nor do I think he would upon inspection of them, make any claim for the 'novelties' introduced in their construction."

The chief of the bureau of Construction was unable to extract any conclusions from the mass of verbiage with which the engineer-in-chief's opinions were clothed, and returned the report to him as being "too indefinite to authorize a settlement of the question." In replying to this, Mr. Stuart did himself no great credit by saying that if the report was indefinite it was "owing to the extreme illness under which I was suffering at the time of writing the report." This excuse, taken into consideration with the uncalled-for comments injected into the original report, has been conclusive proof to the author in his patient investigation of this case, that professional zeal was not the only motive that inspired the engineer-in-chief, and that in his effort to disparage his predecessor he rather stultified himself.

Chief Engineer Haswell, not giving satisfaction as an inspector of machinery to the new administration of the steam department, was eventually relieved from that duty and placed on waiting orders, the *San Jacinto* being completed and fitted for sea under

the supervision of Chief Engineer Henry Hunt. When the ship was ready for sea, Mr. Haswell was ordered to her, his orders being brought about by the following recommendation, which explains itself fully as to animus and motives :

OFFICE OF THE ENGINEER-IN-CHIEF, U. S. N.,
August 25, 1851.

SIR : I respectfully recommend that chief engineer Henry Hunt be detached from the United States steamer *San Jacinto*, and ordered to the United States steamer *Fulton* ; and that chief engineer Charles H. Haswell, now waiting orders at New York, be ordered to the United States steamer *San Jacinto*.

The propriety of the above recommendations will be obvious from the following considerations :

The machinery of the *San Jacinto* was designed by Mr. Haswell, and has been executed (with the exception of the propeller) in conformity with those designs. Upon my acceptance of the office of engineer-in-chief, the machinery of the *San Jacinto* was one of the first things that came under my notice, and struck me so entirely unfavorably, that I reported my opinion to the bureau, with the recommendation that a board of chief engineers be ordered to examine it, and report their opinion. The bureau acted on this recommendation, and the resulting report of the board completely sustained my own views ; their condemnation of the engines and propeller was full and unlimited, while, with a view to save the vessel from utter failure, the board proposed a new propeller of such proportions as the mal-design of the machinery had rendered necessary. This report was approved by the bureau, the new propeller was made in conformity with it, and is at present fitted to the vessel now about completed.

As the professional reputation of Mr. Haswell is involved in the performance of the machinery of this vessel, the propriety of sending him to sea in charge of it, instead of in charge of chief engineer Hunt, who was one of the board that condemned it, is too apparent for argument.

Furthermore, the *Fulton* has machinery designed by me, and

executed in conformity with my instructions ; and as it is necessary, owing to the limited number of chief engineers in the service, that Mr. Haswell be ordered either to the *San Jacinto* or *Fulton*, as he is the only chief engineer unemployed, the impropriety of putting him in charge of machinery designed by one who was compelled by his position and sense of duty to the disagreeable task of 'pointing out the defects of, and condemning Mr. Haswell's machinery, cannot fail to be properly appreciated.

Independently of the above considerations, the health of Mr. Hunt is such as to utterly incapacitate him for a long cruise, while he is sufficiently able to perform the short runs which will probably constitute the chief duty of the *Fulton*.

I have, therefore, in justice and delicacy to all parties, to conclude with the suggestion that the detachment of Mr. Hunt from the *San Jacinto* and ordering to the *Fulton*, and the ordering of Mr. Haswell to the *San Jacinto*, be made, to take effect on the 15th September next, which will give sufficient time for the performance of the trial trip of the *San Jacinto*, and the putting her in the hands of Mr. Haswell with her machinery in complete order.

I have the honor to be, sir, very respectfully your obedient servant.

CHAS. B. STUART,
Engineer-in-Chief.
Per B. F. ISHERWOOD,
Chief Engineer.

Com. CHAS. WM. SKINNER,
Chief of Bureau of Construction, &c.

At that time Mr. Haswell was a confirmed invalid from a torpid liver and chronic dyspepsia, which caused his subjection to a medical survey, two of the three members of the medical board reporting him unfit for sea service. When this report reached the Department the Secretary was absent and the Secretary of War was acting in his stead; that official, although he had said in private conversation that Mr. Haswell was unfit for service, inadvertently signed a dissent from the decision of the medical board, which the chief clerk, had laid before him with all the letters of the day. As soon as the *San Jacinto* was put in commission, the surgeon reported

Mr. Haswell as being unfit for sea duty, and not long afterward the surgeon and his assistant joined in a report to the same effect. No notice of these reports being taken, Mr. Haswell wrote to Commodore Morris, with whom he had been associated for several years, saying that he would be forced to resign on account of his health, but he was dissuaded from that by the commodore obtaining from the Secretary of the Navy a promise that in case the chief engineer's health did not improve by the time the vessel arrived at Gibraltar he would be invalided home, upon which assurance Mr. Haswell agreed to remain in the ship.

When the ship was about to sail, the surgeon and commanding officer both reported that Mr. Haswell was unable to proceed, and he, fearing that his friend, Commodore Morris, would think he had been instrumental in obtaining these reports, and thus had broken faith both with him and the agreement with the Secretary as to his remaining in the ship, telegraphed to Commodore Morris that the reports were not made at his instance. The commodore went to the Secretary, who was in the act of signing the order relieving Haswell from duty, and by exhibiting the telegram convinced him that the detachment was unnecessary. In this manner it happened that from an over sensitiveness regarding the estimate of his integrity he remained in the ship, and the misunderstanding of the telegram lost him his detachment, and in the end his commission as well. Three days after the vessel sailed he was put on the sick list and relieved from duty. Upon the arrival of the vessel at Cadiz he proceeded to Gibraltar to get the necessary orders for detachment from the commander-in-chief of the station, in accordance with the promise of the Secretary of the Navy, but that officer declined to take any action in the matter.

Sick, relieved from duty, denied the immunity of four reports of surgeons as to his physical unfitness, the promise of the Secretary of the Navy ignored, disgusted with his treatment, and mentally depressed, Chief Engineer Haswell left his ship on his own responsibility and returned to his own country, for which act, regardless of his past invaluable services for the steam navy, he was dropped from the rolls of the navy, the date of this action of the Department being May 14, 1852. Some years later (in 1859) the President at the close of a session of Congress sent his name to the

Senate for confirmation as a chief engineer in his former position, but Congress adjourned before the nomination was reached, and Mr. Haswell made no effort to have the matter revived, as he was very profitably employed at the time.

The engineer corps owes much to Mr. Haswell as its organizer and steady champion, and we of this day cannot but wonder at the great progress he made considering his limited official power and the intense prejudice he had to struggle against. Not only were many of the most influential of the old naval officers bitterly opposed to the invasion of steam into the domain they regarded as their own, but at least one Secretary of the Navy shared the same conservative sentiment. Mr. Secretary Paulding, who ruled the Navy Department when the steam navy was very young, set naval progress back a number of years by blocking the attempts to introduce the new power. In his diary he complained of being *steamed* to death, and wrote that he "never would consent to see our grand old ships supplanted by these new and ugly sea-monsters," the sea-monsters referred to especially being the beautiful steamers *Mississippi* and *Missouri*.

Mr. Haswell was master of the engineering science of his time and fully appreciated the magnitude of the change in naval methods meant by the introduction of steam, never missing an opportunity to teach and preach his belief. Without having any faith in Lieutenant Hunter's scheme of submerged propulsion, he nevertheless gave that officer much aid in his projects and furnished him with designs for machinery simply because Hunter needed steam, and his vessels, although fore-doomed to failure, were still additions to the steam navy. Captain Stockton, also, found in him a staunch supporter, always ready to supply professional facts and arguments in refutation of the many objections raised by the old conservatives against Stockton's scheme for a war-steamer.

Especially fortunate was Mr. Haswell in being associated with Captain M. C. Perry at the beginning of his naval career, for in him he found a friend of his profession and a supporter broad-minded enough to realize that a new era in naval construction had dawned, and that the interests of the naval service demanded its recognition to the subordination of all the prejudices of the past. To quote from Captain Perry's biographer, he, "first, last, and

always honored the engineer and believed in his equal possession, with the line officers, of all the soldierly virtues, notwithstanding that the man at the lever, out of sight of the enemy, must needs lack the thrilling excitement of the officers on deck. He felt that courage in the engine-room had even a finer moral strain than the more physically exciting passions of the deck.”

As this is probably the last appearance in this history of the eminent engineer who was the first leader and pioneer of the naval engineer corps, except by occasional reference to his works, it is fitting that this chapter should close with a brief review of his career and achievements.

Charles H. Haswell was born in the city of New York in the year 1809, and from earliest youth exhibited a decided talent for mechanical investigations and pursuits, having at the age of fifteen constructed a small fire-engine and later a steam engine of such excellence that both were readily disposed of to pecuniary advantage. After receiving a classical education, he entered upon the calling to which his natural bent directed by entering the employ of the engineering establishment of James P. Allaire of New York, where he developed into a thorough competent theoretical and practical mechanical engineer. In 1836, when twenty-seven years of age, and with the reputation of being one of the best scientific engineers in New York, he was appointed by the Navy Department as superintending engineer and later chief engineer of the steamer *Fulton*, his naval career in connection with that vessel and others having already been told. While connected with the *Fulton* at the New York navy yard Mr. Haswell (in 1837) lengthened the gig of the sloop-of-war *Ontario* and fitted in it a small engine and boiler with which the boat was run about the harbor; this was undoubtedly the first successful essay of a steam launch, notwithstanding the many claims that have been put forth regarding the origin of that useful application of steam.

In 1846, while engineer-in-chief of the navy, Mr. Haswell conceived the idea of placing zinc slabs in marine boilers to divert oxidation from their plates and had zinc placed in the boilers of the *Princeton* that year for the same purpose. He also had zinc placed in the hold of an iron steamer, the *Legare* of the Revenue Marine fleet, with the same object in view. This use of zinc was nearly thirty years before it was tried in England as a new invention.

Since leaving the naval service in 1852, Mr. Haswell has been actively engaged in the professions of civil and mechanical engineering in his native city. He has been a Member and President of the Common Council of the city of New York; a trustee of the New York and Brooklyn bridge; Surveyor of steamers for Lloyd's and the Underwriters of New York, Boston and Philadelphia; Consulting Engineer for the Health Department, Quarantine Commission, and Department of Public Charities and Correction of New York; etc., etc. He designed and superintended the construction of the long crib at Hart's Island, and the filling in of Hoffman's Island and the erection of buildings on same; designed and superintended many commercial steamers, foundations for some of the heaviest buildings in New York, tests of water works plants, etc. One of his greatest works is the volume of rules and formula pertaining to mathematics, mechanics and physics, compiled in the engineer's handbook that bears his name, a book so invaluable that it has reached its fifty-ninth edition and has won the name of the "Engineer's Bible." Mr. Haswell is an honorary life member of the American Society of Naval Engineers; a member of the American Society of Civil Engineers; the Institution of Civil Engineers, and the Institution of Naval Architects of England; the Engineer's Club of Philadelphia, the New York Academy of Sciences, the American Institute of Architects, the New York Microscopical Society, etc., etc.

CHAPTER IX.

“Into the city of Kambalu,
By the road that leadeth to Ispahan
At the head of his dusty caravan,
Laden with treasures from realms afar,
Baldacca and Kelat and Kandahar,
Rode the great captain Alan.”

—LONGFELLOW.

The Expedition to Japan and Treaty with That Country—Services of Engineers in the Expedition—Value of Steamers in Impressing the Japanese—Other Naval Affairs in the Far East.

THE opening of the ports of Japan to the world's commerce was one of the direct sequences of the settlement of California by citizens of the United States, for the latter event was accompanied with an immediate marine traffic in the Pacific and this in turn demanded the establishment of coaling ports, harbors of refuge, and other necessities to navigation on all the shores of that ocean. An extensive trade with China already existed, and the American whale fisheries in Asiatic waters gave employment to ten thousand men and represented an investment of seventeen million dollars. The march of commercial progress demanded that the veil of mystery and exclusiveness so long drawn over the Japanese islands be removed and the coasts of that country be opened and free to the world's shipping. The only port in Japan where foreigners were allowed to touch was Nagasaki in the southern part of the empire, where a Dutch trading station was permitted to exist under almost penal conditions, allowing annual visits from a single ship, bringing goods for exchange. To this place, any sailors who might be shipwrecked on the Japanese coast, and they were numerous, were conveyed and kept in close confinement until the time arrived for sending them out of the country by the Dutch merchantman.

In 1849, Commander James Glynn, U. S. Navy, in the brig *Preble* visited Nagasaki to demand the release of some American sailors known to be imprisoned there, and succeeded in his mission although not without much difficulty, as the authorities were very

loth to have anything to do with a foreigner, other than the lonely dutch trader. While there, Glynn made a careful study of Japanese affairs and when he returned to the United States early in 1851 he represented to the Navy Department that the time was ripe for either forcing or flattering Japan into the brotherhood of nations, urging furthermore that he be sent on a diplomatic mission with that object in view. The idea was well received, but when steps were taken to organize a squadron sufficiently large to lend force and dignity to the expedition, Glynn found himself speedily out-ranked, and had to step aside for his seniors who commanded larger ships; to him, however, belongs the credit for beginning the movement which ended in the great triumph of Matthew C. Perry. In June, 1851, Commodore Aulick, commissioned by Secretary of State, Daniel Webster to negotiate a treaty with Japan, sailed for the East India station in the new side-wheel steamer *Susquehanna*, some of the details of this first voyage having been related in a former chapter.

Soon after arriving on the station; late in the year, Commodore Aulick was abruptly recalled, being temporarily relieved by Commander Franklin Buchanan of the flagship and later by Commodore M. C. Perry. The direct cause for Aulick's detachment was alleged violation of naval orders in having taken his son to sea with him as a passenger, and for having stated that he had been obliged to defray the expense of carrying the Brazilian minister, Macedo, from the United States to his own country. Commodore Aulick's friends asserted that Perry had deliberately undermined him, and the subject became one of those factional controversies which have from time to time become notorious in our naval annals. The fact that Perry had for some time been making a study of matters relating to Japan and its people, gave strength to the charge that he had sacrificed a brother captain to his own ambition, but it is also a matter of official record that he was at the same time an applicant for the command of the Mediterranean squadron and felt himself aggrieved when ordered to the Far East. His biographer publishes a long letter addressed to the Secretary of the Navy, dated December 3, 1851, in which Perry speaks of the command of the Mediterranean squadron as his fondest ambition, and objects to the proposed detail to Japan on the ground that it would be a degradation

in rank for him to relieve Aulick who had served under him in a squadron some years before. This seems to clear Commodore Perry of any charge of double-dealing in the matter; at any rate the quarrel has no place in this book, and would not be referred to were it not necessary for the sake of thoroughness, to outline the steps leading up to, what may be fairly considered, the proudest achievement of the American navy.

On the 24th of January, 1852, Perry received orders to assume command of the East India squadron, and he at once began vigorously to make all necessary preparations for impressing the Japanese with the power and resources of the nation whose friendship they were asked to accept. His steam favorite the *Mississippi* was given for his flagship, and in compliance with his urgent request that he have more steamers, the *Princeton* and *Alleghany*, both then under extensive repairs, were promised. The mishaps to these vessels and their eventual failure to become part of the expedition are matters that have already been told. Perry had coal and ships' stores sent out in sailing vessels and by appealing to the mechanical industries of the country he made a vast collection of the implements of civilization with which to demonstrate to the Japanese the benefits they would derive from intercourse with foreign nations. Among other things he had a small locomotive and car, with rails to lay a circular track upon which to operate; agricultural machinery, telegraphic instruments, arms, sewing machines, printing presses, metal-working machinery, tools of various kinds, and all sorts of labor saving appliances. In a word, Perry drew upon the field of the engineer for his most potent arguments, and by that sign he conquered a peace that never could have been achieved by mere show of force or use of arms.

Wearied of delays, Perry finally sailed from Norfolk with only the *Mississippi* on the 24th of November, 1852, and proceeded to his station by way of Madeira and the Cape of Good Hope, arriving at Hong Kong on the 6th of April, 1853, and at Shanghai on May 4th. His flag was transferred to the *Susquehanna* on May 17, that vessel being the designated flagship of the squadron. Before going to the principal Japanese islands a visit was made to the Riu Kiu (also spelled Lew Chew and Loo Choo) and the Bonin islands. At Napa in Riu Kiu the telegraphic, photographic, and other appliances

were tested to make sure that no failures would occur later. The artist, Mr. Brown, who had charge of the daguerrotype outfit, not being a specialist in that particular art, had some trouble in his preliminary work and called to his aid Third Assistant Engineer Edward D. Robie of the *Mississippi*, who from a love for scientific matters had made himself an expert in this art. He succeeded at his first attempt with the apparatus, and took what is supposed to be the first daguerrotype ever made in the far east; it being a picture of Commodore Perry standing at the gateway of a native temple. Perry was delighted with Robie's work and remarked to him, "I believe that you engineers can do anything."

Finally the squadron, then consisting of the steamers *Mississippi* and *Susquehanna* and the sailing sloops of war *Saratoga* and *Plymouth*, proceeded northward and on the 7th of July entered Yeddo Bay and came to anchor off the village of Uruga. Foreign ships were no curiosity in those waters even then. Seven years before, Commodore Biddle with the ship-of-the-line *Columbus* and sloop-of-war *Vincennes* had visited the same spot, in the hope of securing permission for his countrymen to trade, but was turned away with a positive refusal. Many whalers and merchant vessels had been there, sometimes seeking in vain for commercial intercourse with the people; sometimes driven in by stress of weather to be refused a harbor of refuge, and sometimes on errands of mercy bringing home Japanese waifs picked up adrift at sea in their junks. In 1848 foreign shipping in the seas about Japan had so increased that the fact was noted as a remarkable phenomenon by the native chroniclers, and in 1850 it had been made a matter of grave report to the great officials of the empire that no less than eighty-six of the "black ships of the *i-jin*" had been counted passing Matsumaé within the space of a single year.

If foreign ships were familiar objects, steamers were not, for Perry's two steam frigates were the first craft of the kind to be seen in Japanese waters and their appearance excited the utmost consternation among the intelligent; for the Japanese are of an investigating and mechanical turn of mind, and all who were above ascribing the movements of the mysterious ships without sails to the spirits of evil, immediately reasoned that they must have some motive power, to themselves unknown, but about which, it would

be good to learn. The ignorant peasants supposed that the foreign barbarians had succeeded in imprisoning volcanoes in their ships, or, refusing to believe the evidence of their own eyes, comforted each other with the assurance that the uncanny spectacle was simply a mirage created by the breath of clams and would soon pass away.

Commodore Perry had thoroughly informed himself of the ceremonial customs of Japan, and used his knowledge of the extravagant etiquette observed by the people of that country to good and successful purpose. He secluded himself in his cabin and played Mikado and Sho-gun to perfection, first to the provocation, and finally to the amazement and awe, of the local officials of constantly increasing rank who visited the flagship, only to be snubbed by refusals to see the chief barbarian. Even the governor of the district learned to his mortification and dismay that he was not a personage important enough to be allowed to meet the mysterious power hidden behind the cabin doors. Orders to depart were met only by a movement of the ships further up the bay towards Yedo; offers to supply food and water in the hope that the unwelcome visitors would then leave were politely declined, and the natives were forced into accepting the proposal offered; namely, of designating an official of proper rank to meet the barbarian and listen to what he had to say. On the 14th of July, all arrangements having been completed, Perry first showed himself and went on shore with a large suite of officers and four hundred marines and sailors to meet the two commissioners appointed to deal with him. The whole affair was conducted studiously for theatrical effect to impress the natives with the grandeur and importance of the event, no detail of dress or ceremony likely to appeal to the sensibilities of the Japanese being omitted. A letter from the President of the United States to the "Emperor of Japan" asking that friendly relations between the two nations be established was delivered to the commissioners with all pomp and solemnity, but with few words, and the visitors withdrew, Perry saying that he would allow ample time for consideration and would return the following spring for an answer.

The vessels proceeded southward to Hong Kong, where the *Powhatan*, which had left the United States in March to join the squadron in place of the discarded *Princeton*, and some of the sail-

ing vessels belonging to the station were met. Headquarters for the Japanese expedition were established at Macao, where a house was rented and facilities furnished the members of the expedition for developing their sketches and writing reports of their observations. A number of specialists were attached to the different ships with appointments as master's mates in order that they would be subject to naval discipline, thereby avoiding the friction always resulting from joint naval and civil enterprises afloat. Principal among these were Messrs. Heine and Brown, the water-color artists whose beautiful pictures so embellish Commodore Perry's report, and Mr. Bayard Taylor, the "landscape painter in words." Besides the specialists a number of officers belonging regularly to the navy contributed much valuable material for the report of the expedition, notable among these being Surgeon Daniel S. Green and Chaplain George Jones. A number of the most accurate drawings relating to Japanese boat building and marine affairs published in the report, were made by Third Assistant Engineer Mortimer Kellogg of the *Powhatan*.

In January 1854 the squadron again moved northward, consisting of the steamers *Powhatan*, *Susquehanna* and *Mississippi*, and the sloops-of-war *Macedonian*, *Vandalia*, *Plymouth* and *Saratoga*; the store-ships *Supply*, *Lexington* and *Southampton*, with coal and provisions for the ships, and presents for the Japanese government, were also in company. On the 11th of February the greater part of this force had assembled off Yedo Bay, anchoring on the 13th off Yokosuke, where the great navy yard of New Japan is now located. The mystery play began again by Perry retiring from public view and holding the visiting officials at a respectful and chilly distance. While the Japanese were exhausting their efforts to induce the foreigners to go away and leave them in peace, boats were kept busy sounding and surveying the adjacent waters and giving intelligible names to the prominent features of the region; one name thus bestowed, Mississippi Bay, so well known to all visitors to Japan, will serve for all time to perpetuate in a far country the name of the historical old steamer whose keel was the first of foreign build to disturb its waters.

The following is a list of the officers of the engineer corps serving in this squadron on the expedition which is the principal subject of this chapter:

OFFICE.	NAME.	SHIP.
Chief Engineer.....	Jesse Gay.....	Mississippi.
“ “	Samuel Archbold.....	Susquehanna.
“ “	George Sewell.....	Powhatan.
First Assistant Engineer.....	John P. Whipple.....	Powhatan.
“ “ “	Robert Danby.....	Mississippi.
“ “ “	William Holland.....	Mississippi.
“ “ “	George F. Hebard.....	Susquehanna.
“ “ “	Henry H. Stewart.....	Susquehanna.
Second Assistant Engineer.....	John Faron.....	Powhatan.
“ “ “	George T. W. Logan..	Mississippi.
“ “ “	George Gideon, Jr....	Powhatan.
“ “ “	Edward Fithian.....	Susquehanna.
“ “ “	Eli Crosby.....	Susquehanna.
“ “ “	William Henry King..	Powhatan.
“ “ “	J. C. E. Lawrence....	Susquehanna.
“ “ “	Wm. H. Rutherford...	Mississippi.
“ “ “	George W. Alexander.	Mississippi.
Third Assistant Engineer.....	Thomas A Shock.....	Susquehanna.
“ “ “	William S. Stamm....	Powhatan.
“ “ “	Stephen D. Hibbert...	Susquehanna.
“ “ “	Mortimer Kellogg....	Powhatan.
“ “ “	Henry Fauth.....	Powhatan.
“ “ “	Edward D. Roble.....	Mississippi.
“ “ “	LeRoy Arnold.....	Powhatan.
“ “ “	John D. Mercer.....	Mississippi.

On the 24th of February, Perry, to convince the Japanese that he was in earnest and would not be put off, moved six of the ships up the Bay to within hearing of the temple bells of Yeddo and anchored not far above Kanagawa. This move had the desired effect, for the Sho-gun's government sent word in post haste, "If the American ships come to Yeddo it will be a national disgrace. Stop them, and make the treaty at Kanagawa." Yokohama, a small fishing village across an arm of the bay from Kanagawa, was finally fixed upon as the place for the negotiations and there the Japanese erected the necessary buildings for the ceremony, the enclosure about them embracing the present location of the Custom House and British Consulate in the cosmopolitan city that Yokohama has now become.

On the 8th of March Perry landed with five hundred armed men, and a glittering staff of officers in full uniform, the same ceremonial display and scrupulous etiquette being observed which had so impressed the natives on the occasion of his former visit. The first formalities having been performed with becoming splendor and,

dignity, the discussion of what was wanted was conducted more at leisure, the remainder of that month being thus consumed before a treaty was finally agreed to and signed. This treaty, which was signed on March 31st, conceded little to the Americans, but served as the thin end of the wedge for great possibilities thereafter. By its terms the Japanese agreed to treat kindly shipwrecked mariners; gave permission for ships to buy fuel, water, provisions, and other needed stores, and specified the ports of Simoda and Hakodate as places where foreign ships might anchor for repairs or to find refuge from storms. Trade in other than necessary ship supplies and permission to reside in the country were refused. These privileges, together with many others, and the opening of several treaty ports, followed in due time through the efforts of other diplomats.

While negotiations were going on at Yokohama the great collection of presents brought for the "Emperor," but by error given to the Sho-gun, was landed and displayed to the officials and people. The railway track, 369 feet in circumference, was laid by Chief Engineer Gay of the *Mississippi* and on it the little locomotive and car were daily operated, under the superintendence of Engineer Robert Danby of the same steamer, to the great interest and delight of the people. The telegraph line, a mile long, was another source of wonder and shrewd investigation on the part of the inquisitive and intelligent Japanese. This was in charge of two telegraphers named Draper and Williams, rated as master's mates, but was operated part of the time by engineers Alexander and Robie, whom Commodore Perry had sent ashore in New York in 1852 for a month, for the express purpose of learning telegraphy. A wealth of other useful articles—stoves, clocks, maps, books, and machinery of all kinds—were displayed, and their uses explained, this exhibition of mechanical appliances did more to win the people over to the fact that it would be beneficial to them to become neighbourly with other nations than all the arguments and bluster in the world. From the Japanese accounts of this most important event in their national history, it appears that the determining factors in Perry's success were his steamships and the machinery he brought with him. With a decided bent for the mechanic arts themselves, the Japanese were quick to see that the foreigners were far ahead of them in that respect, and they were willing to lay aside their ideas of exclusive-

ness for the opportunity of learning what the strangers had to teach.

The world at large knows of the wonderful results which sprang from the modest beginning above outlined, for the story of Japan is the most marvelous in all the histories of the nations. As Perry saw Japan, the people of that country were engulfed in the darkness and ignorance of a despotism fixed upon them by an unchanging and pitiless feudal domination of twenty centuries duration, a condition beside which the state of society existing along the banks of the Rhine in the middle of the Dark Ages would appear enlightened by contrast. From such a forbidding prospect the mind is dazed as it turns to look at New Japan with its railways, telegraph, post offices, factories, school-houses, and church-steeple, all as familiar objects to the people as they are to the dwellers in either Old or New England. The feudal system abolished; a parliamentary form of government established; the hundreds of thousands of idle and predatory knights deprived of their tyrannical prerogatives and transformed into industrious men, and the yoke of serfdom removed from the necks of four-fifths of the population of the empire are examples of the miracles that have been wrought in that wonderful land within the memory of men but little past middle age.

Having placed herself in the foremost rank of the civilized nations by making full use of the heritage of the ages conferred upon her, Japan has made herself the champion of modern enlightenment and assumed the task of breaking down Chinese conservatism and of introducing the methods of Western civilization by force into the greatest and most obstinate country that has ever been a barrier to the world's progress. By availing themselves of Western discipline, tactics and humane methods of warfare the brave little Japanese have been able to prevail against great numerical odds and by a series of victories, each more brilliant than its predecessor, have proceeded uninterruptedly on their mission of carrying enlightenment and civilization into the Dark East. Great as may be the victory to Japan as a nation, its moral and far-reaching effects will be much greater for the well-being of the world. When New Japan has celebrated her victories and duly honored her great captains who achieved them, she cannot pay a more appropriate tribute to the first cause that made her modern power possible, than by erecting on the strand at Yokohama a statue of Matthew C. Perry, looking outward upon the water over which his steamers brought Western methods

into Japanese history. And on the pedestal of that statue should be carved an image of a steamship, or some other symbol of the mechanic arts, as the true sign of the beginning of the greatness of New Japan; the sign by which she was conquered and by which she in turn has conquered.

Following the completion of negotiations in Japan, Perry's squadron began to disband, the Commodore himself proceeding home by way of Europe in a Peninsular and Oriental mail steamer—the *Handustan*. The *Mississippi* left Hong Kong on the 12th of September and after touching at Simoda in Japan began the long voyage homeward by way of Honolulu and Rio de Janeiro. She arrived at New York the 23d of April, 1855, having circumnavigated the globe during her absence and placed herself on record as the second steam vessel of the United States navy to do so. The *Susquahanna* also returned home by way of the Pacific and South America, her arrival in Philadelphia on the 10th of March giving her the honor of being the first American naval steamer to make a cruise around the world.

The home-coming ships brought with them many presents, now in the Smithsonian Institution at Washington, illustrative of the skill of artists and artisans of Japan, consisting of bronze, ivory, porcelain, and other work. More appropriate even were the blocks of carved and inscribed stone from different parts of Japan given for the Washington monument and which may now be seen in the walls of that structure. From Napa in Riu Kiu came as a gift the large bronze bell which for so many years has hung in its little temple in the grounds of the Naval Academy. The date of founding inscribed on this bell corresponds to the year 1456, A. D., and part of the inscription on it, as translated by Giro Kunitomo, a Japanese student at the academy, reads as follows:

“This beautiful bell has been founded, and hung in the tower of the temple. It will awaken dreams of superstition. If one will bear in mind to act rightly and truly, and the Lords and the Ministers will do justice in a body, the barbarians will never come to invade. The sound of the bell will convey the virtue of Fushi, and will echo like the song of Tsuirai; and the benevolence of the Lords will continue forever like those echoes.”

Regardless of the prediction thus written in brass, the barbarians not only came but carried the bell away with them.

The Tai-ping rebellion being in progress in China at the time now being dealt with, the United States vessels remaining in that region were kept actively employed in protecting the lives and property of American citizens. Piracy became rampant along the coasts and compelled much dangerous service in seeking out the piratical junks and capturing them in hand-to-hand conflicts, a chartered steamer of light draft, named the *Queen*, being especially active in this work. Referring to this disagreeable service, the Secretary of the Navy wrote in his annual report for 1855: "In these several encounters, the officers and men have conducted themselves gallantly, and honorable mention is made of Lieutenants Pegram, Preble, Rolando, E. Y. McCauley, and Sproston; Assistant Engineers Stamm and Kellogg; Acting Masters' Mates J. P. Williams and S. R. Craig; and Private Benjamin Adamson, of the Marine Corps, who was dangerously wounded. I deem this a proper occasion to suggest the purchase or building of one or two steamers of light draught, to be used in the Chinese rivers, as indispensable for the protection of the immense property belonging to citizens of the United States in China."

In July, 1855, while entering the harbor of Hong Kong, the *Powhatan* by accident had the starboard air-pump machinery so completely wrecked that the ship was seemingly disabled for an indefinite time. An international complication with Spain at the time made it probable that the next mail would bring news of a state of war, and the presence of a Spanish war vessel in Hong Kong harbor rendered the helpless condition of the *Powhatan* a source of most serious apprehension. In this emergency Mr. George Sewell, her chief engineer, rigged up a connection between the two engines, so that the port engine did the condensing of steam for the disabled starboard engine, the work being completed within forty-eight hours after the breakdown and the *Powhatan* made ready for any service, including battle if necessary. Officers of the British war-steamer *Batiler*, who attended a trial trip to test the success of Mr. Sewell's emergency makeshift, remarked that a chief engineer in their navy would be knighted for rendering service of such value in a similar emergency. An idea of the extent of the difficulty overcome by this ingenious engineer may be gained from the fact that ten weeks were consumed in permanently repairing the damages.

CHAPTER X.

"Our tall ships have souls, and plow with Reason up the deeps."

Ogilby, *Translation of the Odyssey.*

End of the Experimental, and Beginning of the Creative Period of the American Steam Navy—The FRANKLIN—The MERRIMAC class of Screw Frigates—The NIAGARA—Services of Chief Engineer Everett in connection with the Atlantic Cable Laid by the NIAGARA—The HARTFORD class of Large Screw Sloops—Mr. Archbold succeeds Mr. Martin as Engineer-in-Chief—The MOHICAN class—The PAWNEE—The Paraguay Expedition—Small Steamers Purchased for the Navy—Project to Convert Old Line-of-Battle Ships into Steam Frigates.

ALL the vessels of the early steam period of our navy have now been described with the exception of the *John Hancock*, a small screw-steamer of 208 tons, built at the Boston Navy Yard in 1850, intended to serve the double purpose of a steam tug and water-boat for that station. Her length was 113 feet; breadth of beam, 22 feet; mean draft, 8 feet. The machinery was designed by Mr. Charles W. Copeland and built at the Washington Navy Yard by Mr. William M. Ellis, the civilian chief engineer of the yard. There were two oscillating non-condensing cylinders, 20 inches in diameter and 21 inches stroke, suspended over the shaft, and one iron return-flue boiler 22 feet long, containing 28 square feet of grate surface and 755 square feet of heating surface. The cost of the vessel was \$20,550.72, of which sum \$5,622.59 was charged to the engine and propeller, and \$2,428.13 to the boiler and fittings. In 1851 the *Hancock* was used as a practice steamer for midshipmen at the Naval Academy, and later in the same year made a short cruise to the Gulf of Mexico.

In 1852 she was hauled into a ship-house at the Boston Navy Yard and remodeled, being cut in two and lengthened 38 feet, the change resulting in a trim bark-rigged steamer rated as of 382 tons burden. The engines were altered to low-pressure, with Pirsson's condenser, the stroke of pistons increased three inches, and the boiler replaced by two of the Martin vertical water-tube type, aggregating 70 square feet of grate surface and 2,280 square feet of

heating surface. The alterations in machinery were made by Harrison Loring, Boston, from plans supplied by Chief Engineer D. B. Martin, U. S. Navy. When completed, the new steamer proceeded to the Pacific Ocean and was employed for about three years on surveying duty in the North Pacific, Bering and China seas, under the command of Lieutenant John Rodgers, Messrs. Elbridge Lawton and David B. Macomb being the senior engineers. After making a survey of Bering Sea the *John Hancock* was put out of commission at San Francisco and remained there as a receiving ship or in ordinary until 1865, when she was sold.

Reference has already been made to the fact that advocates of steam power for naval purposes were compelled to face a most discouraging argument based upon the unprotected condition of machinery in paddle-wheel steamers. Ericsson had proved with the *Princeton* that a ship could be driven by a submerged propeller, but his application of power was new, at least to the navy, and it was many years before the lesson of the *Princeton* was accepted by naval officers as conclusive. The Secretary of the Navy, Mr. Dobbin, had become thoroughly impressed with the necessity for building up a steam navy, and in his annual report for 1853 made an urgent appeal to Congress for authority to begin the immediate construction of six "first-class steam frigate propellers," using the following argument in support of his request:

"Steam is unquestionably the great agent to be used on the ocean, as well for purposes of war as of commerce. The improved system of screw-propellers, instead of side-wheels, is one of the grand *desiderata* to render the use of steam effective in naval warfare—the one being exposed to the shot of the enemy, the other submerged and comparatively secure. When the bayonet was added to the musket the invention was applauded, for placing in the hands of the soldier, at one time, two engines of *destruction*; and the introduction of the screw-propeller has been similarly appreciated, as combining, without confusion, two elements of *progress*—the sail and the steam-engine. Side-wheel steamers are much impaired in their capacity for sailing, and consume too much coal for distant cruises. Those now on hand can be made to answer well for short cruises and for despatch vessels. The screw-propeller, being upon a principle not so much interfering with the sailing

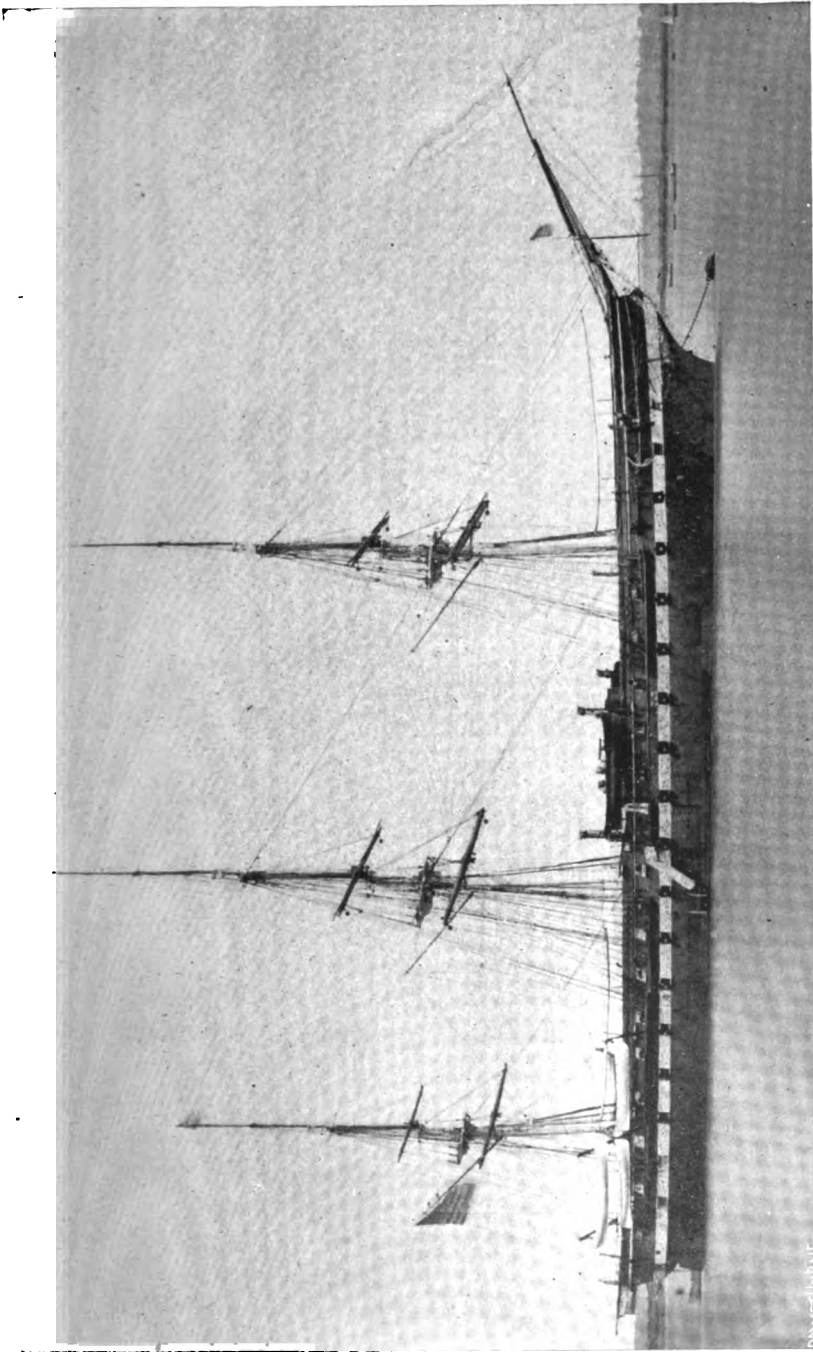

U. S. S. FRANKLIN.

Two telescopic smokepipes lowered below rail.

RSWATHORNE

capacity, with the improved models of the present day, can be so constructed as to sail as well as the best clipper ships, and reserve the use of steam for emergencies when the greatest speed is required, or when, in a calm, a desirable position can be more promptly and surely taken. The great necessary expense incident to the expedition to Japan could have been materially, indeed, one-half curtailed, had it been in the power of the department to have supplied the squadron with screw-propellers instead of the side-wheel steamers, now costing so much from the consumption of coal."

In the same year, 1853, Mr. Dobbin had already begun one screw frigate by using his authority to repair old vessels, the one selected being the old ship-of-the-line *Franklin*, lying at the Kittery Navy Yard. Orders were issued to repair this ship and make such changes in her model as would fit her for a first-class steam frigate. The old ship *Franklin* was built in 1815 at Philadelphia, and was 188 feet long and 50 feet beam. The new *Franklin*, as finished, was 265 feet long on the load water-line, and 53 feet 8 inches beam, dimensions so entirely different from those of the original ship that the process of repairing evidently amounted in reality to building an entirely new hull out of the old material. As the amount of money available each year for repairs was small, work on the *Franklin* progressed slowly, and it was ten years before the condition of the hull warranted a contract for machinery, which will be described later in proper chronological order.

The recommendation of the department regarding steam frigates was favorably received by Congress, and a few months later an act, approved April 6, 1854, authorized the Secretary of the Navy to have constructed "six first-class steam frigates to be provided with screw propellers." These ships were all built by the Government at navy yards as follows: The *Merrimac* at Boston; the *Wabash* at Philadelphia; the *Minnesota* at Washington; the *Roanoke* and *Colorado* at Norfolk, and the *Niagara* at New York. The three first named were launched in 1855 and the three others early in 1856, they being, when completed, the superiors of any war vessels then possessed by any nation in the world. When the first of them went abroad they became objects of admiration and envy to the naval architects of Europe, and their type was quickly

copied into other navies, notably that of England, which imitated their construction in the *Orlando*, *Mercy*, and others of that class.

Just at that period the American ship-building industry had reached its highest development; our architects had attained a skill in their profession which made their work famous throughout the world, and lent to the word American, when applied to ships, a peculiar significance, always an accepted guarantee of excellence. Some of the most eminent of the American ship-builders were members of the naval construction corps, which then included such men as Mr. Lenthal, the chief constructor of the navy; the two Delanos; Messrs. Pook and Hanscom, and several others, all famous in their line. To these gentlemen the navy was indebted for the designs which made our new ships the admiration of the world, and so elevated the standard and reputation of the American navy that every officer and man felt an accession of pride at being part of such an organization.

The first five of the ships named were frigate-built, with steam power that was merely auxiliary. They were full ship-rigged, the area of the ten principal sails being about thirty-two times the immersed midship section, which ratio is only slightly less than that observed in the practice of rigging sailing frigates. They were built of seasoned live-oak frames in stock in the navy yards and originally intended for use in old style sailing ships, an adaptation of material that exercised a controlling influence on the lines of the new ships from the necessity of so shaping them that the supply of frame timbers could be worked up without waste. The results, however, were entirely satisfactory as the ships proved to be fast and handy under sail alone, and their steam power was sufficient for the purpose intended—to steam in and out of port or across calm belts, and to lend additional manœuvring qualities in storms and battle.¹

¹Speaking of the building of these ships, the late Rear Admiral Edward Simpson, in an article published in Harper's Magazine, June, 1886, says: "There were those at that time who, wise beyond their generation, recognized the full meaning of the advent of steam, and saw that it must supplant sails altogether as a motive power for ships. These advocated that new constructions should be provided with full steam-power, with sails as an auxiliary; but the old pride in the sailing ship, with her taut and graceful spars, could not be made to yield at once to the innovation; old traditions pointing to the necessity of full sail-power could not be dispelled; it was considered a sufficient concession to admit steam on any terms, and thus the conservative and temporizing course was adopted of retaining full sail-power, and utilizing steam as an auxiliary."

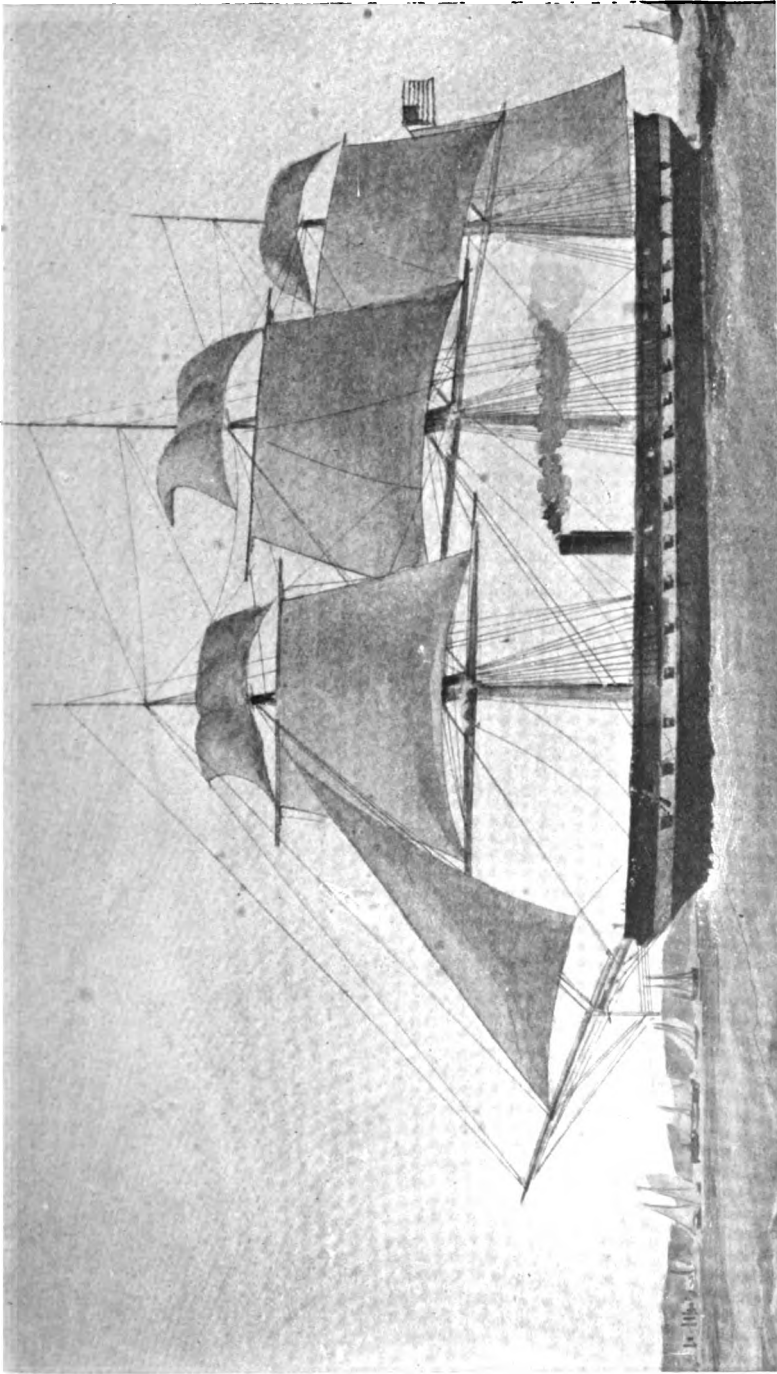

U. S. S. MERRIMAC, 1856,

From a Lithograph made in London on the occasion of the visit of the *Merrimac* to Southampton. Loaned by Mr. Charles Schroeder, of Portsmouth, Virginia, who was a third assistant engineer on the *Merrimac* during her European cruise in 1856.

Of these vessels the *Merrimack* (or *Merrimac*, as the name is usually spelled), was the type, the others being only slight modifications of the original. The *Wabash* and *Minnesota* differed only from the *Merrimac* in having a few feet more length inserted amidships to give additional space for machinery and fuel, while the *Roanoke* and *Colorado*, exact duplicates of each other, differed from the others mainly in having about one foot more beam. The following table shows the principal dimensions of these frigates as originally built, from which the points of difference may be readily traced:

	MERRIMAC.	WABASH.	MINNESOTA.	ROANOKE.	COLORADO.
Length on load water line, feet and inches.....	256.9	262.4	264.8½	263.8½	263.8½
Beam on same.....	51.4	51.4	51.4	52.6	52.6
Area of immersed midship section, square feet.....	868.1	868.1	868.1	902.9	902.9
Displacement at load water line, tons.....	4,635.6	4,774.3	4,833.4	4,772.2	4,772.2
Tonnage.....	3,200	3,200	3,200	3,400	3,400

The *Merrimac* had two horizontal back-acting engines, the cylinders being on opposite sides of the ship and located at diagonally opposite corners of a rectangle circumscribing the engines, the jet condenser, air pump and hot-well of one cylinder being by the side of the other cylinder, the two piston rods of each cylinder striding the crank shaft. The cylinders were 72 inches in diameter by 3 feet stroke of piston and were designed to make about 45 double strokes per minute. A three-ported slide valve placed horizontally on top of the cylinder and actuated by a rock-shaft was used, expansion being obtained by the use of an independent cut-off valve of the gridiron type. There were four 4-furnace Martin's vertical water-tube boilers of iron, except the tubes which were brass; the grate surface of all boilers was 333.5 square feet and total heating surface 12,537 square feet. The single smoke-pipe was 8 feet in diameter, telescopic to avoid spoiling the appearance of the ship while in port, and stood 65 feet above the grate bars. Each boiler had a system of brass tubes underneath for a feed-water heater, the feed water being pumped through the tubes which were kept hot by the supersalted

water being constantly blown off to keep down the saturation, according to the practice of those days. The propeller was a two-bladed Griffith's screw of bronze with spherical hub and blades, adjustable to different pitches, the mean pitch being 25 feet, and diameter of the screw 17 feet 4 inches. This machinery was designed by the contractor, Mr. Robert P. Parrot and built at his works at Cold Springs, New York, under the inspection of Chief Engineer Wm. H. Shock, U. S. Navy, who subsequently superintended its erection on board the vessel at Boston.

The maximum performance of the *Merrimac* in smooth water under steam alone is shown by the following figures:

Speed in knots per hour.....	8.87
Revolutions of screw per minute.....	46.7
Steam cut off in fraction of stroke.....	0.3
Steam pressure in boilers in pounds above atmosphere.....	13.5
Vacuum (mean) in inches of mercury.....	24.5
Total horse-power developed by engines.....	1,294.4
Pounds of coal per hour by square foot of grate..	12.74
Pounds of coal per hour per horse-power.....	3.28

An abstract of the log of the *Merrimac* when under steam alone and in all conditions of wind and weather shows an average speed of 5.25 knots; 36.5 revolutions per minute; 12.8 average steam pressure; 20.4 average vacuum, and a consumption of 3,400 pounds of anthracite coal per hour. A similar set of averages under steam and sail combined shows 7.67 knots; 39.3 revolutions; 12.5 steam pressure; 21 inches of vacuum, and 3,392 pounds of coal per hour.

The *Merrimac* was put in commission in December, 1855, under the command of Captain F. H. Gregory, Mr. Shock being the chief engineer, and for a few months was on special duty on the home coast, going later to Europe where she visited Southampton, Brest, Lisbon, Toulon, and other naval stations, exciting everywhere the admiration of naval experts, for she is said to have been the most beautiful of all the ships of her class. In 1857 she went to the Pacific as the flagship and remained on that station until

1860, her chief engineer being first Mr. R. H. Long and afterward Mr. Alban C. Stimers. In 1860 she returned home and was laid up at the Norfolk navy yard for extensive repairs to her machinery, which was very unsatisfactory. Mr. Charles H. Loring, engineer-in-chief of the navy a few years since, who was the first assistant engineer of the *Merrimac* during the whole period of her service, has written the author regarding her machinery, that the steam log books of the cruise, "contained a record of efforts to overcome inherent defects of design, and of experimental work in different directions, that would be interesting even now, despite its being very ancient history." The arrival of this ship at Norfolk concluded her active career in the United States navy; later chapters dealing with the Civil War will relate the circumstances of her loss to the government, and her career in the hands of her captors.

The *Wabash* had two horizontal condensing cylinders 72 inches in diameter by 3 feet stroke, motion being communicated from the piston rods to the crank by means of a yoke or harp, the once popular steeple-engine form of connection; the piston rods were secured to the large end of the harp, from the opposite, or small end of which the connecting rod reached backward, the crank revolving inside the larger part of the harp, the bottom of the large end of the harp was fitted with a shoe which rode back and forth on a guide-plate. A jet condenser was employed. The steam valves, operated by a Stevenson link from a rock shaft, were flat slide valves with independent cut-off valves on the back of each; these latter were operated by separate eccentrics and consisted in each case of two blocks or plates adjustable by right and left hand screws, being in short, the well-known Meyer expansion valve, which from this application of it came to be generally known in our navy as the "Wabash valve." The boilers were the same in number and type as those of the *Merrimac*, differing slightly in outside dimensions but containing five furnaces instead of four, the grate area of each furnace being proportionately smaller and the total grate area practically the same. The same type of feed-water heater was used. The propeller was a two-bladed true screw of brass, 17 feet 4 inches in diameter and 23 feet pitch, made to disconnect and hoist up in a well in the stern. This machinery was built by Merrick & Sons, Philadelphia, from their own designs and was superintended while under construction by Chief Engineer James W King, U. S. Navy.

The *Wabash* was first commissioned in August, 1856, and served as the flagship of Commodore Hiram Paulding on the home station for about two years, then going to the Mediterranean with the flag of Commodore Lavallette, Mr. King being the first chief engineer and Benjamin F. Garvin the second. She returned home in 1859 and remained in ordinary until the outbreak of the Civil War, when she was put in commission and saw much active service, as outlined in the appendix.

The *Minnesota's* engines were built at the Washington Navy Yard from designs prepared by Engineer-in-Chief D. B. Martin, and furnish a third example of the engine practice of that day. There were two horizontal cylinders of the Penn trunk type, 79½ inches in diameter and 3 feet stroke, the trunks being 33 inches in diameter. Unlike the usual Penn design, these engines had a separate slide valve for the cut-off valve, placed in advance of the main steam valve and working upon a fixed seat of its own. The steam valves were ordinary double-ported slides operated by link motion and located on the sides of the cylinders with faces vertical, while the cut-off valves were above them and horizontal, thus entailing the disadvantage of leaving a considerable space filled with steam after the cut-offs had closed. The boilers were in all respects duplicates of the Martin boilers described in the case of the *Merri-mac*, and the propeller was exactly the same as that of the *Wabash*. The first service of the *Minnesota* was on the East India station in 1857-58 and '59 under the command of Captain S. DuPont, the *Mississippi* being the flagship of that squadron at the time.

The engines, boilers and screws of the *Roanoke* and *Colorado* were in all respects the precise duplicates of those of the *Minnesota*, the machinery complete for both ships being built by Anderson, Dulany & Co., (Tredegar Iron Works), Richmond, Virginia, under the superintendence of Chief Engineer W. W. W. Wood, U. S. Navy. The *Colorado* was prepared for sea when completed in 1857, but did very little service besides steaming to Boston, where she was laid up, before the beginning of the war. The *Roanoke* was flagship of the home squadron in 1858, 1859, and the first months of 1860, then being put out of commission and laid up until the war made her services again necessary. A dearth of enlisted men, and the increased cost of maintaining the steam frigates in

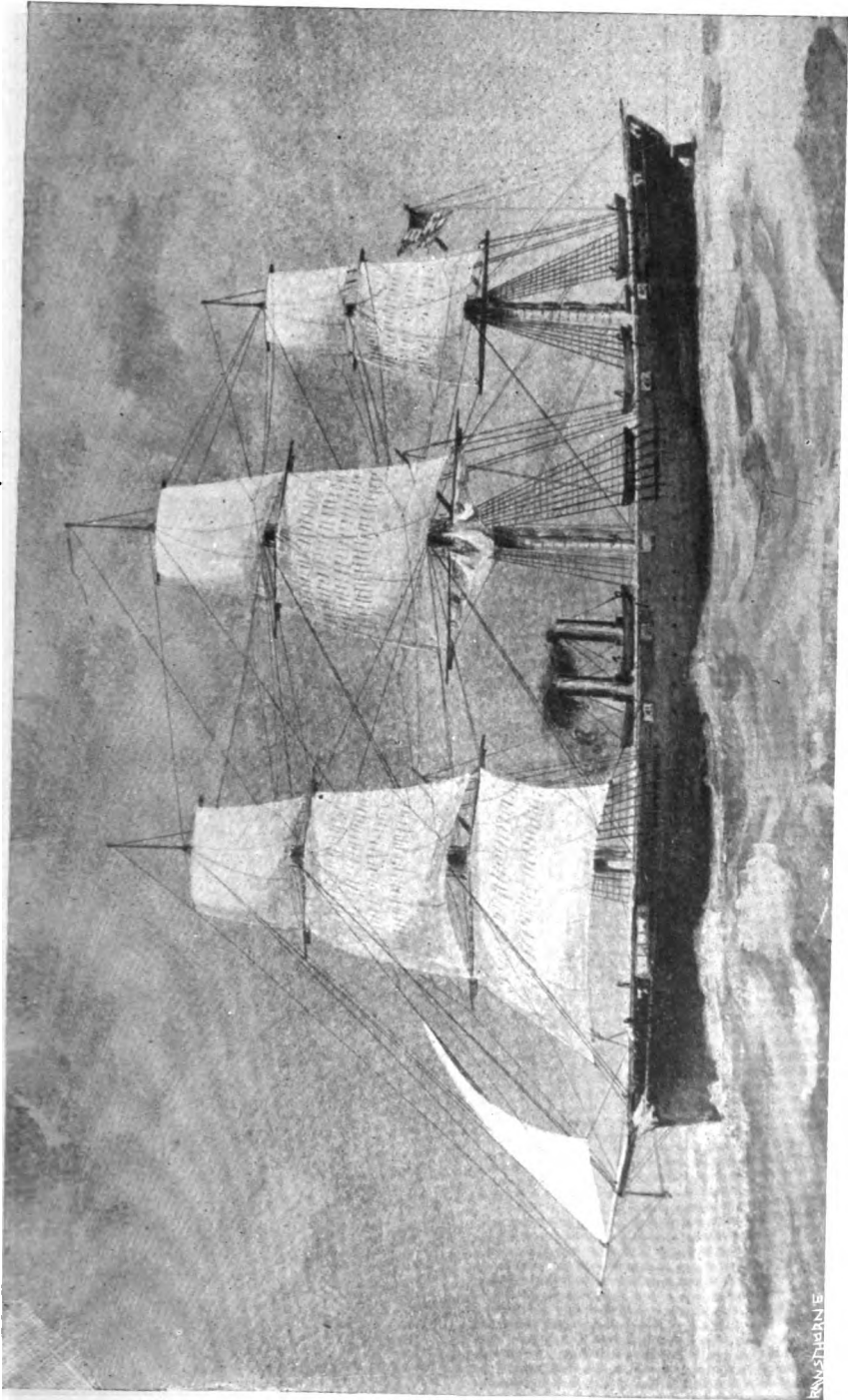

U. S. S. NIAGARA, 1857.
From a water-color by Clary Ray, Washington, D. C.

comparison with the cost of keeping sailing frigates in commission, were the reasons for the non-employment of these fine ships.

The *Niagara* is generally spoken of as a frigate, having been associated in building with the *Merrimac* class, but was in fact an exceedingly large sloop-of-war and not a frigate at all. The idea of speed was entertained in her case, and Mr. George Steers, an eminent ship-builder of New York, who had acquired fame as a designer of swift clipper-ships and yachts¹ was called upon for professional aid. Mr. Steers was given a temporary appointment as naval constructor, and during the two years he held that office he designed the *Niagara* and superintended her construction in the New York Navy Yard. The hull was designed with very sharp lines for speed, and her constructor was not restricted by any attempt to accommodate her model to the shape of frame timbers on hand; speed under sail was the primary quality sought, but speed under steam was not neglected, about fifty per cent. more power being provided than in the case of frigates. The dimensions of the vessel were unusually large for the time, length on the load water-line being 328 feet 10½ inches; breadth at same, 55 feet; displacement, 5,540 tons, and registered tonnage (old measurement), 4,580.

The *Niagara's* engines consisted of three horizontal direct-acting cylinders 72 inches in diameter and 3 feet stroke, fitted with independent gridiron slide cut-off valves and jet condensers. The boilers were of the Martin type, the same as used in the five frigates, but were considerably larger, having six furnaces each and about fifty per cent. more grate and heating surface. No heating apparatus for feed-water was supplied. There were two telescopic smoke-pipes, and the propeller was of the same hoisting type used on the frigates. The machinery was designed and built by Pease & Murphy (Fulton Iron Works), New York, its construction being under the direction of Chief Engineer William H. Everett, who also had charge of the work of installing it in the vessel. The maximum speed in smooth water under steam alone was found to be 10.9 knots, and the average sea speed under steam and sail with varying conditions of weather, was 8.5 knots.

¹ Mr. Steers designed and built the famous yacht *America*, which won the Queen's cup in the regatta at Cowes, England, in 1851.

The *Niagara* was put in commission in the spring of 1857 under command of Captain Hudson, Mr. Everett being her chief engineer, and proceeded to England in April to undertake the work of laying the first Atlantic cable. One-half the cable (about 1,250 miles) was put in the hold of the *Niagara* and the other half in H. M. S. *Agamemnon*, the two ships leaving Valencia, Ireland, August 7th, 1857, the *Niagara* paying out her part of the cable. The U. S. S. *Susquehanna* accompanied the expedition to lend assistance if needed. Four days after leaving Ireland the cable broke through defects in the paying-out machinery and the enterprise was abandoned for that year, the *Niagara* returning home. Chief Engineer Everett had detected the faults in the cable machinery and submitted plans to remedy them which were considered so excellent that at the request of the cable company he was detached from the *Niagara* and granted leave of absence with permission to go to England to direct the construction of the mechanism proposed by him. In March, 1858, the *Niagara* returned to England and with the *Agamemnon* proceeded to the middle of the ocean, from whence each vessel started homeward, each paying out her section of the cable, Mr. Everett in his capacity of superintendent for the cable company directing the work from the *Niagara*. After a delay of about a month occasioned by a break in the *Agamemnon's* section three days after the work was begun, the ships had no further trouble and landed their ends of the cable successfully, the *Niagara* at Trinity Bay, Newfoundland, and the *Agamemnon* at Valencia, Ireland.

The engineers of the *Niagara* on this noteworthy voyage were, Joshua Follansbee, chief; John Faron and Wm. S. Stamm, first assistants; George R. Johnson and Mortimer Kellogg, second assistants, and Jackson McElmell, George F. Kutz, and Wm. G. Buehler, third assistants. They all received gold medals from the Chamber of Commerce of the city of New York in commemoration of the event. Chief Engineer Wm. H. Everett, whose genius made the undertaking successful, is said to have received \$25,000 from the cable company for his services. After operating for two weeks and transmitting about four hundred messages, the cable ceased working on account of defective insulation, and was not replaced until 1866 when a much larger and better made cable was laid by

the *Great Eastern*, that vessel having failed in an attempt the year before. After laying the cable in 1858 the *Niagara* spent the remainder of that year in a task which was neither agreeable or glorious. To meet a demand of public sentiment she was freighted with nearly three hundred destitute and savage negroes, who had been taken from a slaver named the *Echo* off the coast of Cuba, and transported them to Liberia on the west coast of Africa. Many of the negroes died on the voyage and the whole experience with them was intensely distasteful, and disagreeable.

In 1860 the *Niagara* conveyed to Japan by way of the Cape of Good Hope the embassy which had been sent to the United States by the Sho-gun of that country. The Civil War brought her home the next year and after undergoing extensive repairs she was sent on special service to Europe, her great size rendering her unfit for hostile operations along the insurgent coasts. The capture of the Confederate privateer *Georgia* in August, 1864, and refusing battle with the iron-clad ram *Stonewall* off the port of Coruna in April, 1865, were the chief incidents of this cruise, which was the *Niagara's* last. At the close of the war she was laid up in Boston and remained there until condemned and sold in 1885. In 1871-'72 the work of remodeling and repairing her was prosecuted for a time, but eventually abandoned.

A resolution of Congress, approved February 3, 1855, authorized the Secretary of the Navy "to provide and despatch a suitable naval or other steamer, and, if necessary, a tender, to the Arctic seas for the purpose of rescuing or affording relief to Passed Assistant Surgeon E. K. Kane, of the United States Navy, and the officers and men under his command." This resolution added one small vessel to the steam navy, the *Arctic*, purchased in 1855 and which rendered most efficient service and made the relief expedition successful through her ability as a steamer to "bore" through the ice-pack of Baffin's Bay. Lieutenant H. J. Hartstene in the bark *Release* commanded the expedition and succeeded after many trials and hardships in finding Dr. Kane and brought him and his party safely home. The officers volunteered for this service from the navy, that that being a requirement imposed by the congressional resolution, the only one now believed to be living, being Rear Admiral Joseph Fyffe,¹ who was a passed midshipman in the *Release*. First Assist-

¹ Since deceased.

ant Engineer Harman Newell and Acting Third Assistant Engineer Wm. Johnson went in the *Arctic*. In 1859 the *Arctic's* machinery was removed and the hull transferred to the light house board for a light-ship.

In the year 1855 also a somewhat larger screw steamer, the *Despatch* was purchased and sent to the Pensacola navy yard as a tender for that station, her tonnage being 558 and cost \$139,088.17. In 1859 she was rebuilt at the Norfolk navy yard and enlarged to 694 tons, the name being at that time changed to *Pocahontas*, under which she performed much valuable service during the rebellion.

By an act of Congress approved March 3, 1857, authority was given for the immediate construction of five large screw sloops-of-war, the general size or class of the vessels being specified by the act. Four of them were at once placed under construction as follows: The *Pensacola* at Pensacola; the *Lancaster* at Philadelphia; the *Hartford* at Boston; and the *Richmond* at Norfolk. In order to incite a healthful rivalry between the naval constructors and civilian ship-builders it was decided to commit the building of the fifth sloop wholly to private enterprise, and advertisements were accordingly issued for competitive plans and specifications. Thirteen proposals were received in response, from which a board of officers selected the one submitted by Mr. Jacob Westervelt of New York, to whom a contract was awarded. The vessel thus brought into existence was the *Brooklyn*, the hull of which was built by Mr. Westervelt under the superintendence of Naval Constructor S. H. Pook, and the machinery by sub-contract by the Fulton Iron Works, superintended by Chief Engineer D. B. Martin, U. S. Navy.

Mr. Martin was the engineer-in-chief of the navy for a full term of four years beginning October 18, 1853, and was known as a thoroughly capable and painstaking engineer, familiar with the many branches of his calling so far as they were developed in his time. He was the inventor of the vertical water-tube boiler which for many years was the type of excellence in marine boiler work and was an improvement over the flue boilers that immediately preceded it. After being succeeded at the expiration of his term of office as engineer-in-chief by Chief Engineer Samuel Archbold, Mr. Martin performed duty as inspector of machinery for the *Brooklyn*, and as general inspector for some smaller sloops built



**CHIEF ENGINEER DANIEL B. MARTIN, U. S. NAVY;
Engineer-in-Chief of the Navy from October 18, 1853, to October 17, 1857.**

later, as well as serving on boards for the selection of types of new vessels authorized. He resigned from the service in 1859 and, like many other men who have occupied important public offices, expressed his weariness with the thankless world's work by returning to his native place and taking up the peaceful occupation of farmer.

The *Brooklyn* was 233 feet long on the load water line; 43 feet beam; 2,686 tons displacement, and of 2,070 tons burden. Her machinery consisted of two horizontal direct-acting cylinders 61 inches in diameter by 33 inches stroke. The steam valve was a three-ported slide fitted with the Meyer cut-off blocks on its back. A jet condenser was used. There were two Martin boilers with seven furnaces each, aggregating 250 square feet of grate surface and 7,788 square feet of heating surface, fitted with one telescopic smoke-pipe 7 feet in diameter and 50 feet high above the grate bars. The propeller was a two-bladed hoisting screw, $14\frac{1}{2}$ feet in diameter and 24.7 feet mean pitch. The total weight of machinery was 240 tons and of water in boilers, 64 tons. The vessel was completed in little more than a year after the date of contract and exhibited a speed of 9.2 knots under steam alone in smooth water, with 51 revolutions of the screw, 18 pounds steam pressure, 27 inches of vacuum, 878 developed horse-power, and 3.2 pounds of anthracite coal consumed per hour, per horse power. Her first service was in the home squadron in 1859-'60, '61.

The *Hartford*, built at the Boston Navy Yard, was slightly smaller than the *Brooklyn*, her principal factors being length, 225 feet; beam, 44 feet; tonnage (old) 1,900, and displacement, 2,550. Her machinery was built by Loring & Coney, Boston, under the supervision of Chief Engineer Jesse Gay, U. S. Navy, and consisted of a direct-acting two-cylinder jet condensing engine with cylinders 62 inches in diameter by 34 inches stroke, and two Martin boilers with 253 square feet of grate surface and 7,600 square feet of heating surface. The screw was of bronze, two-bladed, 14 feet diameter and 25 feet pitch. This was replaced in 1880 by a more efficient four-bladed screw and the original one diverted to a lasting and appropriate use by being melted and cast into the statue of Admiral Farragut, which stands in Farragut Square, Washington, D. C. The *Hartford* was launched early in 1859 and commissioned for sea the following summer, going to the East India station to re-

lieve the *Mississippi* as flagship. Her maximum speed under steam alone in smooth water was found to be 9.5 knots, an average sea performance with sail and steam, 7.3 knots. In 1880 the *Hartford* was fitted with new machinery, the engines put in being a pair of the 60"x36" Isherwood engines built by Harrison Loring during the war for a sloop that was never finished—the *Kewadin*.

The *Lancaster* was the largest of the ships of her class, being 235 feet 8 inches long, 46 feet beam, 3,290 tons displacement, and 2,362 registered tonnage. Her machinery was built by Reanie & Neafie, Philadelphia, under the inspection of Chief Engineer W. W. Wood, the engines and attachments being exactly like those for the *Brooklyn*. The boilers were of the same type, but about twelve per cent. larger in grate and heating surface than those of the *Brooklyn*. The contract price for the *Lancaster's* machinery complete, was \$137,500. Like the *Hartford*, she was eventually fitted with a pair of the 60"x36" Isherwood engines, built during the war. In 1879-80 the hull was thoroughly overhauled and remodeled with a ram-bow, making her a formidable appearing craft for our navy at that time. The *Lancaster* was launched in 1858 and went the following year to the Pacific station, where she remained as flagship until 1867, thus being deprived of an active part in the Civil War, in which her sister ships achieved so much glory.

The *Richmond* was built at the Norfolk Navy Yard and her machinery at the Washington Navy Yard, the latter being designed by Mr. Archbold, the engineer-in-chief. The principal dimensions of the vessel were: Length, 225 feet; beam, 42 feet; displacement, 2,604 tons, and registered tonnage 1,929. The machinery consisted of a two-cylinder direct-acting engine with cylinders 58 inches in diameter and 36 inches stroke of piston, fitted with single poppet valves and Sickles' cut-offs. The use of the poppet valves was forced upon the department by the political influence of two civilians who at that time had a contract for directing the construction of machinery for the *Pensacola*, and was found to be decidedly harmful to the efficiency of the ship. Much of the lighter engine work, pipe fittings, attachments, etc., was done at the Norfolk Navy Yard, but all the heavy work was done at Washington. In 1866, as soon as she could be spared from active service, the *Richmond* was fitted with a pair of the 60"x36" Isherwood engines built expressly for her

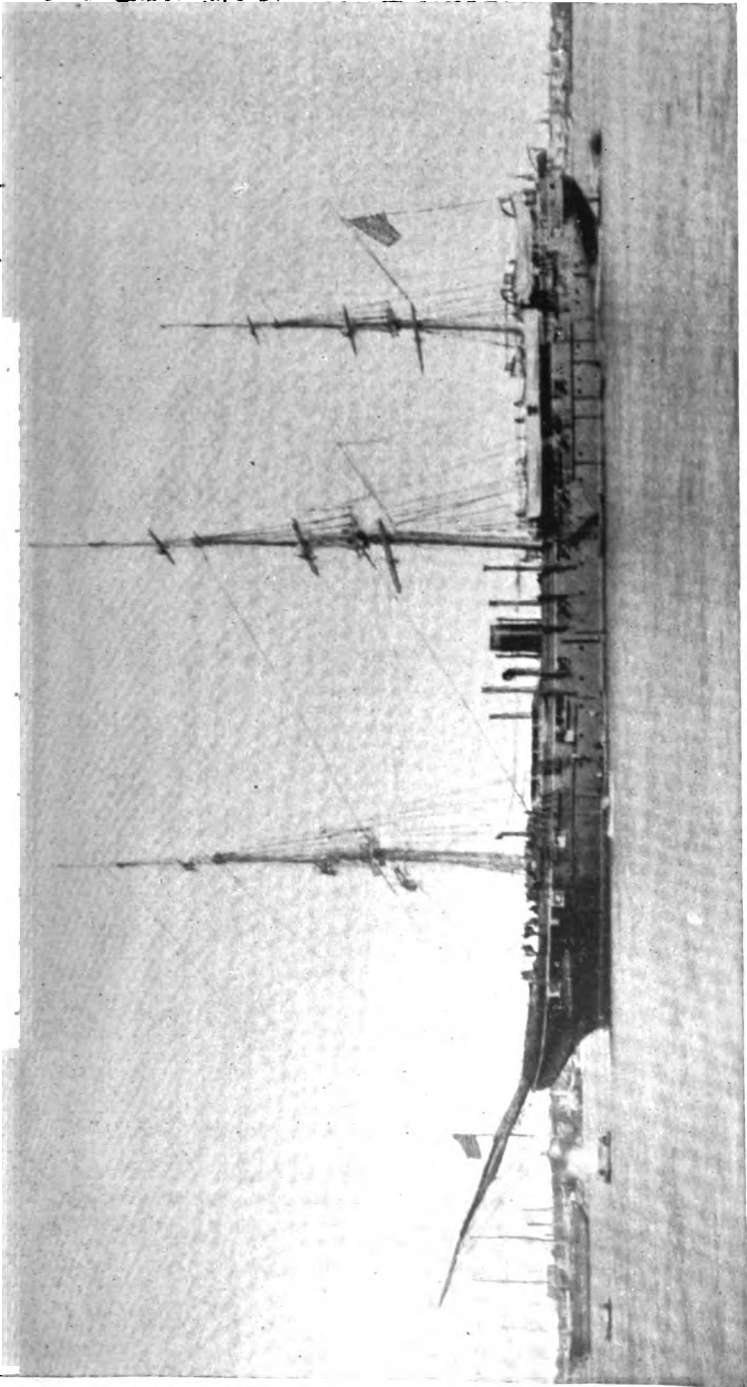

U. S. S. RICHMOND.
(Brooklyn, Hartford, Lancaster, Pensacola.)

at the Washington Navy Yard during the three preceding years. The *Richmond* was not launched until 1860, and in the latter part of that year went to the Mediterranean as flagship of the station; recalled by the outbreak of the rebellion the next year, she joined the West Gulf blockading squadron, and was a conspicuous factor in the varied operations which made Farragut famous.

The last of these five ships, the *Pensacola*, brought into the field of naval contention a new and unique character in the person of Mr. Edward N. Dickerson, who made the engineering life of the Navy Department exceedingly interesting for a number of years and enriched the annals of scientific experiment not a little, by injecting an element of novelty and humor into otherwise dry and technical matters. The *Pensacola* was built at the navy yard, Pensacola, Florida, and was 230 feet 8 inches in length; 44 feet 6 inches beam; 3,000 tons displacement, and 2,158 measured tonnage. Her greater displacement than the other ships of practically the same dimensions was due to the fact, that the machinery as originally installed weighed 540 tons, while that of the *Hartford* weighed only 200 tons, and of the larger *Lancaster* 246½ tons. This machinery was built at the Washington Navy Yard by the Government from the designs, and under the supervision of two civilians, Messrs. Sickles and Dickerson.

Mr. Frederick E. Sickles was an inventor and engineer of ability and experience; he was the inventor of a cut-off mechanism for poppet valves, and at this time was engaged in fitting his patent to the engines of the *Richmond*, as previously mentioned. Mr. Dickerson was a New York lawyer who had become acquainted with Sickles through patent suits and from gaining a smattering of mechanical matters had become an enthusiast on the subject, entering into the study of engineering with all the zeal and blindness of a new convert. He appears to have become enamored of Mariotte's law regarding the relationship of volumes, pressures, and temperatures of gases, and from his faith in the infallibility of that law under all conditions came to the conclusion that his mission upon earth was to reform the engineering practices of the time, in which, as now, owing to material difficulties, the law of Mariotte when applied to the steam engine did not display its theoretical perfection. Mr. Dickerson is described as a man of graceful manners

and appearance, and a most eloquent and persuasive speaker, capable of convincing almost anyone of the soundness of his theories.¹

Having entered into partnership with Sickels, the new firm proposed to the Navy Department to design machinery for one of the new ships which would "produce the highest possible effect from a given amount of fuel, and with the least possible weight." The plans suggested were regarded by all engineers as very faulty and Mr. Toucey, the Secretary of the Navy himself, saw their impracticability. Engineer-in-Chief Martin and his successor, Mr. Archbold, both strenuously opposed the proposition, as did also engineers generally in the Navy and in civil life. Mr. Dickerson, however, was intimately connected socially and politically with Mr. Mallory of Florida,, then Chairman of the Senate Committee on naval affairs, and with Senator Yulee of the same state and a prominent member of the same Committee, through whose political influence, exerted with great energy, Mr. Dickerson eventually obtained the sought for contract. The opposition of the Secretary was overcome and he most unwillingly signed it. The date of this contract was April 3, 1858; by its terms Sickels and Dickerson agreed to design and superintend the building of the *Pensacola's* machinery and allow the Government to use their patents.

The drawings furnished by them are still on file in the Bureau of Steam Engineering, Navy Department, and exhibit by their brilliant coloring and crudeness of execution their amateur origin. Mr. Sickels apparently had allowed his good engineering sense to lie dormant and permitted his enthusiastic partner to revel unchecked in mechanical movements and designs. Cams, ratchets, bell-cranks, combination levers, etc., appear in profusion for the performance of the simplest functions, seemingly introduced for the purpose of indicating knowledge of mechanical motions rather than from any necessity of using them. The peculiarities of the machinery thus designed may be generally stated as follows:

¹ As a patent lawyer Mr. Dickerson enjoyed a national reputation. In 1855 he was counsel for McCormick before the Supreme Court of the United States in the great suit involving the question of infringement of patents on harvesting machinery. Associated with him in this famous case were William H. Seward and Reverdy Johnson, while the opposing counsel were Abraham Lincoln, Edwin M. Stanton and George Harding.

1. The use of large cylinders to work steam with a large measure of expansion.
2. The use of a peculiar condensing apparatus.
3. The use of an air tight fire-room.
4. The use of small boilers in proportion to the cylinders.

Four steam cylinders 58 inches in diameter and 3 feet stroke of piston were arranged in pairs on opposite sides of the ship, the cylinders being jacketed with steam belts $4\frac{1}{2}$ inches in depth. The cylinders were directly opposite each other, but instead of two cranks, as was possible by the arrangement, the designer complicated matters by having *six*, in order to effect which, two of the connecting rods were made with forked ends to stride the crank of the opposite cylinder, each arm of the fork grasping a crank of its own. The intoxicating effect of this thing when in motion may be easily imagined. The four cylinders with their connections and gear made the engine plant of the *Pensacola* practically double in weight that of the other sloops, a fact that did not require an engineer to detect, and was fatal to the claim of the designers of minimizing weights. Two surface condensers with very small circulating pumps were supplied, the main dependence for effecting the circulation of water being scoops projecting from the ship's bottom, on the theory that the remarkable speed of the ship would drive water through the condensers, as is now done in practice on swift torpedo boats. The idea of the air-tight fire-room was not bad, but as the blowers were originally connected it was shown by experiment with a lamp that the air pressure obtained was actually negative, the flame of the lamp drawing inward from an open air-lock instead of being blown outward by the pressure within. Under this state of affairs the heat of the fire-room was so intolerable that men could not remain in it for any length of time. Two small 5-furnace horizontal fire-tube boilers and two 1-furnace auxiliary boilers of the same type were supplied, the total grate surface being 234 square feet and heating surface about 7000. Sickels' cut-off gear was of course used, the valves being set to cut off very early in the stroke, leaving Mariotte's law to do the rest. With this valve gear applied to steam and exhaust valves at each end of each cylinder, there was an array of lifting rods and dash-pots, decidedly bewildering.

The requirements of the department called for a 2-bladed hoist-

ing screw of the type then in favor, and the designers projected such a screw with very fine pitch based upon a calculated engine speed of eighty revolutions per minute, but as the work progressed they lost faith in their calculations for speed and altered the screw by increasing its pitch to conform to *forty* revolutions per minute. This confronted them with a new and unexpected problem, for a corresponding increase in the surface of the screw followed as a necessity, to effect which the diameter was increased about four feet and four blades substituted for two. This destroyed the hoisting feature of the screw and necessitated throwing away all the costly brass castings for the hoisting apparatus, as well as the two-bladed screw already made. The hull had to be docked to alter the stern and deepen the keel to accomodate the new screw, and the ship's draft accordingly increased. This one blunder cost about \$20,000, and is only one example of many, illustrative of what may be called the piece-meal manner in which the designing and fitting together of the different parts of the machinery was conducted. The result was, that when the machinery was at last pronounced ready for trial it had cost \$308,460, or more than twice as much as that of any other ship of the *Pensacola* class.

Progressing in this tentative manner the work was necessarily slow and sometimes came to a complete standstill for lack of knowledge as to what to do next. The other ships of the class were completed and in service, the Civil War began, and still the *Pensacola* was unfinished; so slow and uncertain did the work progress that the designers were finally suspected of disloyalty and Mr. Sickels, who had charge of installing the machinery, was actually put under guard and not allowed to leave the vessel or his work. Finally Mr. Edward Faron, who had once been an engineer in the navy, was employed and put in charge of the work, his energy resulting in its completion and a trial trip on the Potomac the 3d of January, 1862. On this trial a maximum speed of 8.8 geographical miles per hour was developed, this costing five pounds of coal per horse power, or about 25 per cent. more than the *Hartford* or *Lancaster*, while the speed was 0.7 miles less.

The *Pensacola* was sent at once to join Farragut's fleet off the mouth of the Mississippi and arrived there in the course of time, after having been ashore for ten days on one of the Florida Keys, her

machinery, and engineers as well, being in a condition of semi-collapse when she got in. She participated in the brilliant battle of the forts below New Orleans and the capture of that city in April, but was so uncertain under steam that she was thereafter used more as a floating battery than as a reliable cruising ship. In 1865 her entire machinery plant was taken out and replaced with new boilers and engines, the latter being a pair of the 60-inch Isherwood type built by Hazelhurst & Co., Baltimore, for a large sloop-of-war projected but never built, the name of which was *Wanalosett*,

Secession deprived Mr. Dickerson of his powerful Florida friends, but his persuasive eloquence about Washington had won him many more, with the support of whom he made himself a veritable thorn in the side of Engineer-in-Chief Isherwood, as well as a source of much trouble for the Secretary of the Navy. In spite of the object lesson furnished by the costly failure of the *Pensacola*, Mr. Dickerson was able to get other opportunities to experiment with his theories at public expense until his engineering career terminated with the complete failure of one of the finest ships ever built in this or any other country—the *Idaho*. The opportunity to make a grievance out of the *Pensacola* affair was not neglected by Dickerson, who had sufficient influence to have the matter made a subject for congressional investigation, the record of which (Report No. 8, 38th Congress, second session) is highly creditable to the engineering branch of the navy, and totally lacking in elements vindicating its instigator.

In 1864 Mr. Dickerson, as attorney in the case of Mattingly vs. the Washington and Alexandria Steamboat Company, had an opportunity to address a jury in the supreme court of the District of Columbia, on which occasion he launched forth upon a decidedly scholarly speech which he entitled "The Navy of the United States. An Exposure of its condition, and the Causes of its Failure." As an example of eloquent invective this speech is worthy of classification with the famous oration of Catiline, and its author was so proud of it, and so confident of its destroying the reputation of his arch-enemy, Isherwood, that he caused it to be published in pamphlet form and distributed broadcast. It turned out however to be a case of one's enemy writing a book and getting the worst of it. Mr. Isherwood was altogether too busy with a multitude of official cares

to give any heed to this furious attack upon him, and, indeed, it disturbed him very little, for he had been too long and too prominent in public life to be super-sensitive to criticism. There were other members of his corps who had more leisure and who were capable of detecting in the Mattingly speech an opportunity for amusement at the expense of the author, and there soon appeared an illustrated booklet entitled "Uncle Sam's Whistle, and What it Costs," dealing with Dickerson, the trial trip of the *Pensacola*, and the famous speech, in a most entertaining and amusing manner. In it Dickerson and his theories were ridiculed so perfectly that instead of appearing before the public as the purifier and reformer of the Navy Department, he found himself suddenly transformed into a laughing-stock for the entire engineering and naval element of the country. The authorship of the book referred to, is somewhat in doubt; the caricatures and sketches were made by Second Assistant Engineer Robert Weir, and the text is generally credited to him, as he was equally handy with pen and pencil. At any rate, the little book was the most exquisite satire ever produced within the navy, and was entirely successful in its purpose of turning the tables upon the assailant of the head of the engineering branch of the service.¹

In the annual report for 1857 the Secretary of the Navy reported progress on the five ships of the *Richmond* class and took occasion to say that they were too large for the performance of much of the service required of the navy on our own coasts, and especially in China. Ten steamers of "light draft, great speed and heavy guns" were recommended to meet the deficiency, to which Congress responded by an act approved June 12, 1858, authorizing the construction of seven screw-sloops and one side-wheel war steamer, the result of this legislation being the acquisition of a class of vessels whose names were familiar in the navy list for many years.

The side-wheel steamer, of only 453 tons, was built at the newly established navy yard at Mare Island near San Francisco and was named *Saginaro*. The machinery was designed and built by the Union Iron Works of San Francisco under the supervision of Chief Engineer George Sewell, and consisted of a 2-cylinder oscillating

¹ See Appendix C.

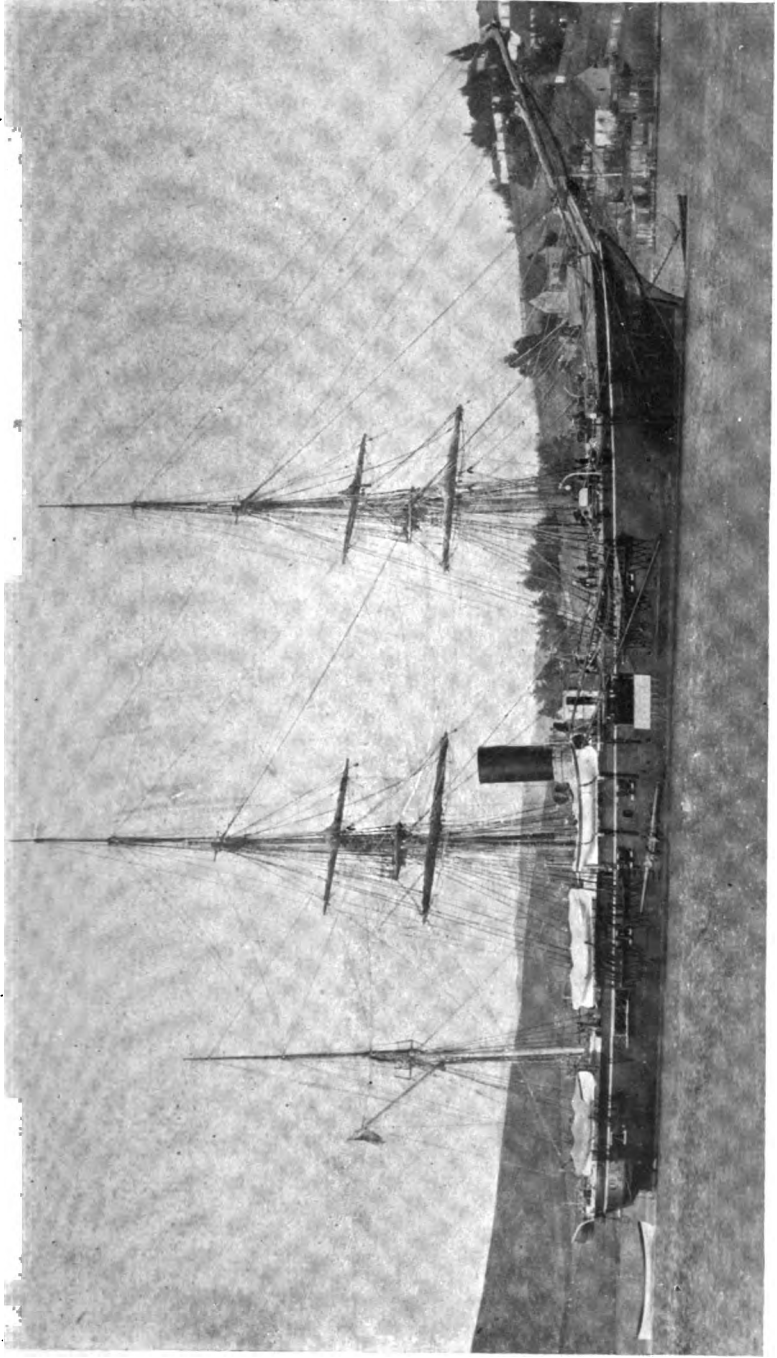

U. S. S. IROQUOIS, 1859.
(Dacotah, Mohican, Wyoming).

engine with cylinders 39 inches in diameter by 48 inches stroke, and two 3-furnace Martin boilers aggregating 81 square feet of grate and 2000 square feet of heating surface. The water wheels were 20 feet in diameter with flouts 6 feet in length. The *Saginaw* was completed in about a year, and in the latter part of 1859 went to the China Station for her first service, remaining on that station until 1862 when she returned to San Francisco. Thereafter she was constantly in commission attached to the Pacific Squadron until October, 1870, when she was wrecked on Ocean island.

Of the seven screw sloops, four were specified to be of 13 feet draft when ready for service, and the other three of 10 feet draft. The following table exhibits the size, etc., of the four larger sloops, as well as the navy yard where each was built:

Name.	Displacement.	Tonnage.	Length.	Beam.	Immersed midship section.	Where built.
Mohican.....	1,461	994	198'- 9''	33'	363 sq. ft.	Kittery, Maine.
Iroquois....	1,488	1,016	198'-11''	33'-10''	380 " "	New York.
Wyoming....	1,457	997	198'- 5''	33'- 2''	366 " "	Philadelphia.
Dacotah.....	1,369	996	198'- 5''	32'. 9''	365 " "	Norfolk, Va.

The *Mohican's* machinery was built by Woodruff and Beach, Hartford, Conn., under the supervision of Chief Engineer D. B. Martin, and consisted of a 2-cylinder back-acting engine with cylinders 54 inches in diameter by 30 inches stroke, supplied with a Pirsson's condenser, and two Martin boilers. Pease & Murphy of New York built the machinery for the *Iroquois*, which was of the same type as that of the *Mohican*, the boilers being slightly smaller and the stroke of pistons 28 instead of 30 inches. The machinery for the *Wyoming* was by Merrick & Sons, Philadelphia, inspected by Chief Engineer Edward Whipple. The engines were direct-acting with two cylinders 50 inches in diameter by 30 inches stroke, and had a close surface condenser of Mr. Merrick's design. The boilers were of the same type but considerably smaller than those of either the *Mohican* or *Iroquois*. Murray & Hazlehurst of Baltimore built the machinery of the *Dacotah*, which was radically different from that of the other sloops. Two large direct-acting en-

gines, 63 inches diameter by 36 inches stroke, drove a huge wooden-toothed gear wheel, which in turn drove a pinion keyed to the propeller shaft, the speed ratio being as 9 to 4. The engines were designed for a speed of 36 revolutions per minute, or 81 of the screw, which was about the same as the direct speed of the other vessels. The boilers of the *Dacotah*, two in number, were of the horizontal return fire-tube variety, instead of the Martin type then so generally used. Chief Engineer H. H. Stewart was the superintendent of construction of this machinery. The four vessels were all completed and in service by the end of 1859, the *Mohican* being on the coast of Africa, the *Iroquois* in the Mediterranean, the *Wyoming* in the Pacific, and the *Dacotah* on her way to join the Asiatic squadron. All of them showed a speed under steam alone in smooth water of about 11.5 knots per hour, and averaged 8 knots for general performance at sea.

The three smaller sloops were the *Narragansett*, *Seminole*, and *Pawnee*, all good and appropriate American names, like most of the names bestowed upon our war vessels in those days. The *Narragansett* was of 1,235 tons displacement and was built at the Boston navy yard, the machinery being built by the Boston Locomotive Works. She had a pair of direct-acting engines with cylinders 48 inches in diameter by 28 inches stroke of piston, driving a 4-bladed screw 12 feet in diameter. Pirsson's double-vacuum condenser was used. The boilers, two in number, were of the usual Martin type, containing 200 square feet of grate surface and about 6,150 square feet of heating surface. The *Narragansett* was completed and in commission by the end of 1859, sailing shortly thereafter for the Pacific station.

The *Seminole*, built at the navy yard, Pensacola, Florida, was a sister-ship of the *Narragansett* and similar to her in all principal dimensions. Her machinery was built by the Morgan Iron Works, New York, and consisted of a pair of back-acting horizontal engines with cylinders 50 inches diameter by 30 inches stroke, and two Martin boilers slightly smaller than those of the *Narragansett*. The *Seminole* went to the Brazil station in 1860 and was recalled in 1861 in time to take an active part in the battle of Port Royal in November of that year. Later she served in Farragut's West Gulf squadron and participated in the battle of Mobile Bay, going into action lashed alongside the *Lackawanna*.

The third of these sloops, the *Pawnee*, differed much from the other two in the form of her hull and in the feature of having twin screws. She was built by the government at the Philadelphia navy yard, but from the designs and under the supervision of a civilian ship-builder, Mr. John W. Griffiths of New York, who held a temporary appointment as a naval constructor while directing this work. It had been determined to arm the *Pawnee* with four XI-inch Dahlgren guns, and it was to demonstrate that this could be done without exceeding the specified draft of ten feet that Mr. Griffiths was employed. The resulting vessel was considerably longer and broader than the others of her class and of somewhat less than ten feet draft when armed and equipped for service, a fact that made her of great use with her heavy battery in the shallow rivers of the southern coast during the war. Besides having to carry the unusually large battery, the engines to drive the two screws

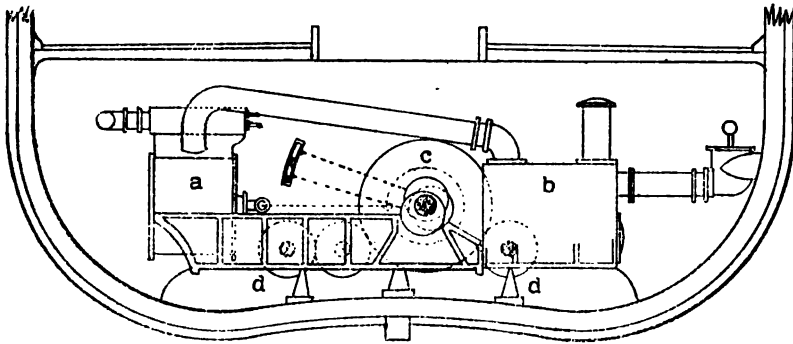

ELEVATION, LOOKING AFT, OF TWIN-SCREW GEARED ENGINES, U. S. S. PAWNEE.
a, cylinder. b, condenser. c, master-wheel. d-d, screw-shaft pinions.

were considerably heavier than in other vessels of the class, and this necessitated further calculation on the part of the constructor, who so modified the form of the hull that when the vessel was completed her bottom was actually concave.

The *Pawnee* was 221 feet 6 inches long; 47 feet beam; 1,533 tons displacement and rated at 1,289 tons burden. Chief engineers Wm. W. Wood and R. H. Long superintended the building of the machinery at the works of Reanie & Neafie, Philadelphia, there being two horizontal direct-acting cylinders 65 inches in

diameter by 36 inches stroke, driving a large gear wheel 7 feet 3 inches in diameter, this driving two smaller wheels keyed to the two shafts, the small wheels or pinions being 2 feet 11 inches diameter of pitch circle. The master wheel was somewhat to port of the center line of the ship, as shown by the outline sketch of this unusual type of engine. There were two 7-furnace horizontal return fire-tubular boilers containing 133 square feet of grate surface each. The propellers were four-bladed, nine feet in diameter, and instead of being supported by struts under the counters, the shafts were prolonged to the stern post where they were upheld by a cross-bar, the screws being at the ends of the shafts.

This vessel was launched in 1859 but was not completed for sea until the spring of 1861 when she at once became actively engaged in warlike operations along the Atlantic coast, her first important service being at the destruction of the Norfolk navy yard in April. During the same year she took part in the attack on Hatteras Inlet in August and in the battle of Port Royal in November. During the following years of the war she was attached to the South Atlantic blockading squadron and did much important service on the coast of Florida and elsewhere. After the war she made one cruise to the Brazil station and then became a hospital and store-ship at home, being finally sold out of the service at Port Royal in 1884.

In February, 1855, the *Water Witch*, which for years had been engaged in exploring La Plata River and its tributaries, was forcibly prevented from further prosecuting that work by being fired upon by a Paraguayan fort commanding the river, the man on duty at the wheel at the time being killed. Attempts to gain redress by diplomatic methods having been steadily repulsed by Lopez, the autocratic president of Paraguay, our government was finally forced to resort to a show of power, and late in the year 1858 a squadron of nineteen naval vessels carrying two hundred guns and twenty-five hundred men was assembled in the river under command of Flag Officer W. B. Shubrick. Nine of these vessels were sailing frigates, sloops-of-war and brigs, the other ten being small steamers capable of ascending the river. Two of the steamers, the *Fulton* and *Water Witch* belonged to the regular naval establishment; another was the revenue cutter *Harriet Lane*, named for the neice of

President Buchanan, and the others were merchant steamers chartered and armed for the occasion. Six of them were screw steamers varying from 220 to 550 tons burden and were named *Memphis*, *Atlanta*, *Caledonia*, *Southern Star*, *Westernport*, and *M. W. Chapin*, the seventh, the *Metacomet*, being a side-wheel steamer of 395 tons. Thirty-eight officers of the engineer corps were attached to these vessels.

All the steamers and such of the sailing vessels as were permitted by their draft of water were moved up the river to a point above Rosario, ready to act against Paraguay if necessary, and in January 1859 the Flag Officer and Mr. Bowlin, the special commissioner of the United States, proceeded in the *Fulton* and *Water Witch* to Assuncion, the capital of Paraguay. No difficulty was then experienced in gaining a respectful hearing and the object of the mission was fully and peacefully accomplished. A satisfactory apology was extended for firing on the *Water Witch*; an indemnity was paid on the spot for the benefit of the family of the seaman who had been killed, and the special envoy negotiated a new and advantageous commercial treaty with the Paraguayan government. Without the steamers the successful termination of this expedition would have been extremely difficult, if not impossible, Paraguay lying so far inland that natural obstacles would have prevented an approach by troops on land or by sailing vessels on the river except at an enormous outlay of life and money.

When the squadron returned to the United States the chartered steamers were purchased and added to the naval establishment, about one-half of their cost price being money already paid or due the owners for their charters. After purchase, the names were changed as follows: *Metacomet* to *Pulaski*; *Memphis* to *Mystic*; *Westernport* to *Wyandotte*; *Caledonia* to *Mohawk*; *Atlanta* to *Sumter*; *Southern Star* to *Crusader*; *M. W. Chapin* to *Anacostia*. The side-wheel vessel, the *Pulaski*, was kept on the Brazil station doing exploring and other river service until 1863, when she was sold at Montevideo. The smallest of the screw steamers, the *Anacostia*, became a navy yard tender and coastwise transport attached to the Washington navy yard, and the five other screw steamers were put on active cruising duty on the coasts of Cuba and Africa, in the suppression of the slave trade. All did good service during the

Civil War, and all were sold at its close with the exception of the *Sumter*, which had been sunk in 1863 by an accidental collision with the army transport *General Meigs*.

In the naval appropriation act approved June 22nd, 1860, a clause directed the Secretary of the Navy to have all the sailing vessels of the navy surveyed with a view to converting them into steamers. This duty was performed by a board composed of Captains George W. Storer and S. H. Stringham; Engineer-in-Chief Archbold and Chief Engineer Isherwood; Chief Constructor John Lenthal, and Naval Constructor B. F. Delano, the vessels which were abroad and therefore not accessible, were reported upon from their records and drawings in the department. The report of the board was, that it was not expedient to introduce steam into the brigs, sloops and frigates, but that it was desirable in the case of the ships of the line, which class was recommended to be razeed and converted into first-class steam frigates. The Secretary of the Navy transmitted this report to Congress with his annual report at the end of that year, and urged that the recommendation be carried out, on the ground that, "in the event of war no one of these line-of-battle ships, in the present state of steam navigation, could go to sea with a reasonable degree of safety." The work would undoubtedly have been authorized by Congress that winter had not events of startling magnitude intervened to split both Congress and the navy in twain, and made the problem of strengthening the steam navy one that could not be met by the make-shift of patching up old sailing ships.

CHAPTER XI.

“Ev’n now we hear with inward strife
A motion tolling in the gloom—
The spirit of the years to come
Yearning to mix himself with life.”

ALFRED TENNYSON.

The Engineer Corps from 1850 to the Beginning of the Civil War—Congress Petitioned to Increase the Corps—Pay Increased by United Efforts of All Officers—Rank of Engineers Defined—Issue of New Regulations Governing Appointment and Promotion—Opinions of Chief Engineer Gay in Relation to Sails and Steam.

The membership of the engineer corps provided by the act of Congress of 1842 was based upon the number of steamers in the navy at the time, and made no provision for the performance of shore duty, except by the engineer-in-chief, thus compelling him to obtain technical assistance either from civilian engineers employed as clerks or draftsmen, or naval engineers who might be unemployed because of a steam war vessel having been put out of commission. The inspection work required of the engineer corps by the building of the *Powhatan* and other steamers at the same time, had with great difficulty been provided for; but had imposed upon the engineer-in-chief a vast amount of care and professional labor, greater in fact than one man could perform. In this dilemma the engineers petitioned Congress for relief, this memorial having been preserved in official form as Senate Miscellaneous Document No. 45, 32d Congress, 1st session, is herewith presented.

MEMORIAL

OF

ENGINEERS OF THE NAVY,

PRAYING

A REORGANIZATION OF THE CORPS TO WHICH THEY BELONG.

February 24, 1852.

Referred to the Committee on Naval Affairs

February 25, 1852.

Ordered to be Printed.

To the Senate and House of Representatives of the United States of America in Congress assembled :

The undersigned respectfully represent to your honorable bodies the utter inadequacy of the present organization of the engineer corps of the United States navy, and most earnestly solicit your attention to the following brief statement of facts in proof of this assertion, and in support of the propositions herewith submitted.

The law of Congress authorizing the present organization of the engineer corps was established in the very infancy of our steam marine—at the time of constructing our first steam ship as an experiment. At that date neither a rapid increase of steamers nor an enlarged sphere of duties for the naval engineers, such as has since taken place, was contemplated; and the organization was accordingly made on a basis to meet the limited duties, both in extent and kind, which were intended to be performed by the corps.

Those limited duties were to be entirely performed afloat on the *Atlantic* coast of the United States, and their sphere of action was to be confined to the management of the machinery of a few second class vessels, for *home* service exclusively, to which it was proposed to restrict our steam marine. It is scarcely necessary here to state that these expectations were never, even from the first, realized, and the engineers of the naval corps at once entered upon a wide and very responsible range of duties combining all of theory and practice known in the extensively ramified arts and sciences; making up a thorough knowledge of the principles and practice of marine steam engineering and steam navigation—a knowledge which it is believed will not be contested by any qualified to judge, to demand quite as much natural ability, united with as deep study and long practice, as are required for any other profession; certainly for any of those composing the various corps in the government service.

Some of the duties of the engineer corps are briefly stated as follows: they decide upon and design the various complex machinery of the government war steamers; furnishing, first, the working drawings in the most complete detail, then superintending its manufacture at the various establishments where it is contracted to be built, and afterwards its erection on board the vessels; finally they operate this machinery at sea.

The machinery so designed and constructed is of the largest, most complicated and costly description, frequently amounting in a first-class steam-ship to hundreds of thousands of dollars. It is manufactured by contract at the various works where the Navy department may direct, and naval engineers are the sole guardians of the public interest, where the expenditures constitute a formidable fraction of the naval appropriations. They furnish the only barrier to speculation on the government, and the fraudulent performance of contracts, if such were attempted.

The amounts and kinds of labor done are determined by and paid for wholly on the certificates of the superintending engineer and the engineer-in-chief.

Having thus shown, as we trust, to the satisfaction of your honorable bodies, the importance of having at all times in the country, on shore duty, a sufficient number of engineers of the higher grades to discharge the above mentioned responsibilities, we proceed to show that in this very particular the present organization is defective. The act of 1842 only provides for the appointment of a sufficient number of engineers of all grades to supply our war steamers, leaving no margin for sickness or other disability, and making no provision whatever either for the supply of the many steamers attached to the coast survey, or for the designing and superintending the construction of such new machinery as the continually increasing wants of the service may require. It therefore follows, as the necessary consequence, either that the duty afloat must be performed by an insufficient number of engineers—and those, too, taken from the lower grades, not possessing the requisite experience and knowledge for its proper performance—or the more important, and indeed paramount, shore duties must be neglected.

The Department has therefore preferred the former, rather than incur the loss and inconvenience of the latter. From the very commencement of the steam navy there has scarcely ever been a steamship in commission with the full complement of engineers. Those Engineers, therefore, who are ordered on duty *afloat*—a duty which tasks arduously their physical qualities—have thrown upon them a much greater amount than can fairly be performed with justice, either to themselves or the government. And if the latter alternative were preferred, and the service afloat *filled* with the pre-

scribed number of Engineers, it would keep the whole corps at sea, continually absent from their families, and without the rotation of shore duty enjoyed by other officers of the navy.

The present organization allows one chief engineer, (commissioned by the President), two first assistant, two second assistant, and three third assistant engineers, for each *steamer-of-war*. All the assistant engineers hold their appointments by warrant of the Honorable Secretary of the Navy.

The present number of steamers-of-war actually in commission is *ten*, and in the course of four months *five* more will probably be added—making *fifteen*, in all, in commission by the first of June next.

The present organization authorizes the appointment of fifteen chief, thirty first assistant, thirty second assistant, and forty-five third assistant engineers. Now, by the first of June, next, twelve chief, twenty-seven first assistant, twenty-seven second assistant, and thirty-nine third assistant engineers will be required for service *afloat*, in naval steamers, leaving but *three* chief and *twelve* assistant engineers to perform the various shore duties, and engineer the *six* coast survey steamers. From this it will be seen how insufficient the present organization is, to provide for even a reasonable approximation of the requisite number.

Further : the original organization contemplating only a provision for the *management* of the machinery of the steam ships, provides merely for a chief engineer afloat as the highest grade ; but, as has been before shown, the construction of this machinery has been also superintended by the engineers of the navy. Now, it is well known that designing and constructing machinery requires a much higher order of ability than its after management ; and when the two duties are to be performed by the same Corps, those *distinct* offices should be performed by distinct grades—those of the highest talent being taken from the one to form the other.

The organization of 1842 is, therefore, insufficient, in not having this provision, and we suggest to your honorable bodies the propriety of adding another grade, formed from the present grade of chief engineers, (*without increase of pay*), to be called "*Inspectors of Machinery Ashore and Afloat*." In the British Navy, the necessities of their largest steam marine have already compelled the

organization here recommended, and from them the title of "Inspectors of Machinery" is borrowed.

Another reason for enlarging the engineer corps is furnished by the fact that a considerable extension of our steam marine must soon be made, and it is impossible to create good naval engineers as fast as it is possible to build steamships.

All other corps are sufficiently numerous to anticipate a considerable increase of the navy, while the engineers are too few even for the present service. Were a sudden enlargement of the steam marine now to be made, the Engineer Corps will have to be filled with such talent as could be immediately commanded—not such as would be desired—and the public interests would inevitably suffer as a consequence.

We would urge upon your honorable bodies the strong probability, which will scarcely be contested by any who have bestowed the proper reflection upon the subject, that in 20 years there will be no naval vessels unpropelled in whole or in part by steam. The introduction of steam for all marine war purposes will be compelled by necessity and the pressure of circumstances.

In conclusion, we, your memorialists, would state, that in our opinion the following additions to the present organization are necessary to render the engineer corps equal to the performance of the services required of it, viz :

The addition of the higher grade of Inspector of machinery ashore and afloat. An inspector of machinery ashore to be allowed for each of the *principal* navy yards, and a chief engineer for each of the other navy yards ; also, an assistant engineer of each grade for each navy-yard. An inspector of machinery afloat to be allowed for each squadron containing two or more steamers.

The inspector of machinery for the Washington Navy Yard to be attached to the office of engineer-in-chief of the Navy and to perform such duties as the engineer-in-chief may require of him.

The inspectors of machinery to receive the same pay and be entitled to the same privileges and immunities in all respects as chief engineers, and to be commissioned in the same manner as Chief Engineers.

The inspectors of machinery *now* required to be selected by the

Hon. Secretary of the Navy from the present grade of Chief Engineers, but that thereafter all promotions to that grade to be made by examination by a Board of Inspectors of machinery.

Believing the above facts to be truthfully stated and relying on the wisdom and justice of your honorable bodies, we respectfully solicit for them a favorable consideration.

CHARLES B. STUART,
Engineer-in-Chief, U. S. N. Navy.

B. F. ISHERWOOD,
Chief Engineer U. S. N. for the
grade of Chief Engineer.

J. W. KING,
First Assistant Engineer U. S. N.
For the grade of Asst. Engineer.

A bill providing for more engineers on the lines of the petition was favorably reported by the naval committees of Congress, but like the great majority of naval bills, failed to reach a vote through lack of interest in Congress and external opposition. Soon afterward work was begun on the large screw frigates described in the preceding chapter, and this provided the opportunity of appointing engineers for them before they were completed, nearly fifty new members being added to the corps in the next three years and thirty more in the year 1857.

In 1856 the engineers joined with all other branches of the service in an organized effort to obtain an increase of pay from Congress; this effort is noteworthy from the fact, that probably it is the only instance on record where all the corps of the navy laying aside their rivalries and jealousies honestly worked together for a common purpose, also for the more especial and important reason that their united effort was successful.

The writer has been fortunate enough to have been given a copy of a circular letter prepared by the officers' committee in Washington and sent to all officers of the service, directing the manner to be observed in furthering their endeavor, which letter is here reproduced as an instructive example of the method of going about the difficult task of securing legislation for the navy.

“ WASHINGTON, December, 8, 1856.

“**SIR** : At a meeting of Naval Officers, held in this city on the 6th instant, with the view of concert of action in advocating the necessity of a general increase of pay for the Navy, the following officers were unanimously appointed a committee, charged with the management of the memorial to which your signature is appended, viz :

W. W. Hunter, Commander.
 Charles Steedman, “
 Thomas B. Neille, Purser.
 Maxwell Woodhull, Lieutenant.
 Roger N. Stembel, “
 Henry A. Wise, “
 Joel S. Kennard, “
 William G. Temple, “
 John M. Brooke, “
 A. W. Johnson, “
 Robert Woodworth, Surgeon.
 Mordecai Yarnall, Professor of Mathematics.
 William Chauvenet, “ “ “
 Joseph S. Hubbard, “ “ “
 Montgomery Fletcher, First Assistant Engineer.
 James C. Warner, “ “ “

“ On the evening following, a sub-committee was appointed from this Body, under instructions to wait on the Hon. Secretary of the Navy, present the Memorial officially, make known the views of the memorialists, the action which had been already taken, and to consult with him as to the course most promissory of success.

“ The Secretary suggested the presentation of the Memorial to Congress through the Chairman of the Naval Committees, and that if any suggestions as to the mode of increase were elicited from the Committee, the most simple should be offered ; he has no objection to the exercise of whatever *personal* influence officers may possess with Members of Congress in furtherance of our object, but we will not approve indiscriminate approach to these gentlemen ; indeed such action would not comport with the dignity of our position as members of the Naval profession.

“The Secretary, although sensible of the necessity and propriety of our application for an increase of pay, and willing to heartily second our efforts in that direction, is not disposed to favor per centage on sea-service; he is of opinion that such a mode of increase would not be strictly just in its operation on the higher grades of the service.

“At a subsequent meeting of the General Committee it was unanimously resolved: ‘That, if our suggestions upon the subject were solicited by the Naval Committees, we should simply state, that, in our opinion, an addition of thirty per cent. to our present pay, all around, and *in each grade*, would not be taxing too much the liberality of Congress.’

“As a matter of course, the Naval Committees, should they require information upon this subject, will direct its enquiries to the Head of the Navy Department. So far as individual action of the officers is concerned, judicious management and unanimity of opinion is certainly necessary. It is with this view, and to prevent embarrassment, which might result in a defeat of the object contemplated, that we address to you this circular. This Committee, acting in the spirit of fairness and justice, would claim your confidence and earnest support.

“It is a well-known fact, that the expression of adverse views upon Naval matters before Congress tends to obstruct the action of that body, and we beg that in the exercise of whatever personal force you may be able to bring to the advancement and success of this measure, you will support the recommendation of your committee.”

A bill entitled “A bill to increase and regulate the pay of the navy,” was introduced and experienced the various vicissitudes of bills for two congresses, finally becoming a law on the 1st of June, 1860. By the terms of the act an increase of pay of about twenty-five per cent. in every grade and corps was provided for, and a longevity scale adopted, the majority of the grades being provided with four rates of pay increasing with length of service. The following rates were fixed for the engineer corps:

CHIEF ENGINEERS, (on duty).

For first five years after date of commission.....\$1,800

For second five years after date of commission..... 2,200

For third five years after date of commission \$2,450
 After fifteen years from date of commission 2,600

ON LEAVE, OR WAITING ORDERS.

For first five years after date of commission \$1,200
 For second five years after date of commission 1,300
 For third five years after date of commission 1,400
 After fifteen years from date of commission 1,500

FIRST ASSISTANT ENGINEERS.

On duty \$1,250
 On leave, or waiting orders 900

SECOND ASSISTANT ENGINEERS.

On duty \$1,000
 On leave, or waiting orders 750

THIRD ASSISTANT ENGINEERS.

On duty \$ 750
 On leave, or waiting orders 600

In January 1859 Mr. Toucey, the Secretary of the Navy, issued the following general order conferring naval rank upon the officers of the engineer corps:

“Chief engineers of more than twelve years will rank with commanders.

“Chief engineers of less than twelve years with lieutenants.

“First assistant engineers next after lieutenants.

“Second assistant engineers next after masters.

“Third assistant engineers with midshipmen.

“This order confers no authority to exercise military command, except in the discharge of their duties, and no additional right to quarters.”

This order was affirmed by Congress March 3, 1859, with the words “except in the discharge of their duties” stricken out, which omission merely served to emphasize the embarrassment of

the engineers in controlling their own men aboard ship, where their authority was necessarily military, or else no authority at all.

Orders defining the rank of surgeons and paymasters, similar to the above, had been in existence for some time and the status thus conferred was generally satisfactory to the staff officers. That it was not satisfactory to others is shown by the fact that the department had to re-affirm the staff officers' rank by the following order, issued February 25, 1861:

“Surgeons of the fleet, surgeons, paymasters, and chief engineers of more than twelve years, rank with commanders. Surgeons, paymasters, and chief engineers of less than twelve years, rank with lieutenants. Passed assistant surgeons and first assistant engineers rank next after lieutenants. Assistant surgeons and second assistant engineers next after masters, and third assistant engineers with midshipmen.

“This rank is now established by law, and neither the department nor any officer in command has authority to withhold it, or the honors which belong to it.

“Commanding and executive officers of whatever grade, while on duty, take precedence of surgeons, paymasters and engineers, and the effect of this precedence is to elevate the former, but not to depress the latter, or to detract from the rank or the honors of the rank already secured to them. Commanders, while on duty as commanding officers, will have a corporal's guard. Lieutenants, while on duty as executive officers, will wear on the cuffs a gold embroidered star, one inch and a quarter in diameter, to be placed one half of an inch above the stripe of gold lace, and these will indicate the precedence to which they are by law entitled.”

An entirely new schedule of requirements for admission and promotion of officers in the engineer corps was issued in 1859, the regulations in full are as follows:

REGULATIONS FOR ADMISSION AND PROMOTION IN THE ENGINEER CORPS.

Before persons can be appointed assistant engineers in the navy, they must have passed a satisfactory examination before a board of at least three engineers, designated at such times as the wants of

the service require. Application for permission to appear before such board must be made in writing to the Secretary of the Navy, accompanied by satisfactory testimonials as to good moral character, correct habits, and sound constitution. The application will be registered, and when a board next meets, permission will be sent to the applicant, stating the time and place of the meeting of the Board.

In the examination for a *third assistant engineer*, the candidate must be able to describe all the different parts of ordinary condensing and non-condensing engines, and explain their uses and their mechanical operation; to explain the manner of putting engines in operation, how to regulate and modify their action, and the manner of guarding against danger from the boilers, by the means usually applied to them for that purpose. He will be expected to write a fair, legible hand, and to be well acquainted with arithmetic and the mensuration of surfaces and solids of the regular forms; to have worked not less than one year in a marine engine manufactory, and present testimonials of his mechanical ability from the director of the establishment in which he may have served. He must not be less than twenty nor more than twenty-six years of age.

Candidates for promotion to the rank of *second assistant engineer* must have served at least two years as third assistants in the management of steam engines in the navy in actual service, must produce testimonials of good conduct from the commanders and senior engineers of the vessels in which they may have served, and must pass a satisfactory examination upon the subjects, and to the extent prescribed for third assistants; they must likewise be able to explain the peculiarities of the different kinds of valves, the construction of expansion valves, the manner of their operation, the remedies which are usually resorted to, to check foaming in boilers; must possess a knowledge of the usual causes of derangement in the operation of air pumps, force pumps, and feed pipes, the proper preventives and remedies, and the mode of cleaning boilers when required. They must have a general knowledge of the mensuration of surfaces and solids.

Before promotion to the rank of *first assistant engineer* candidates must have been employed at least three years as second assistant engineers in the management of steam engines in actual service,

and produce testimonials of character and good conduct from their former commanders and superior engineers; must pass a satisfactory examination upon the subjects prescribed for third and second assistants, the mechanical powers, the different kinds of deposits and incrustations to which boilers are exposed, and be able to furnish a working sketch or drawing of different parts of engines and boilers; to superintend their construction, and determine upon their accuracy and fitness for use.

Promotions to the grade of *chief engineer* are to be made after the candidate has served for two years as first assistant engineer in the management of steam engines in the navy in sea service, and has been examined upon any of the subjects specified for assistant, which the board may deem expedient, and after they shall have satisfied the board of their previous good conduct and character, of their sufficient knowledge of mechanics and natural philosophy, of the forms, arrangements, and principles of different kinds of steam engines, boilers, propellers, and their various dependencies, which have been successfully applied to steam vessels, and their alleged relative advantages, for sea or river service, and shall have attained 26 years of age.

Candidates for promotion who may fail to pass a satisfactory examination may be examined once again, and if they fail to pass at the second examination they shall be dropped from the list of engineers.

Candidates for admission or promotion will be required to furnish the board of examiners with evidence of their abilities in the execution of mechanical drawings, and their proficiency in penmanship.

The examining board will report the relative qualifications of the persons examined, and number them, giving the best qualified the lowest number.

When, in the opinion of the department, the wants of the service require the admission of engineers of any grade above that of third assistant, the same qualifications and restrictions as to times of service will be exacted as by the regulations required for promotion to the grade in question: *Provided*, that all appointments to the grade of second assistant shall be made between the ages of 21 and 28; and to that of first assistant, between 25 and 32; and to that of Chief engineer, between 28 and 35.

The assistants must employ all favorable opportunities for acquiring a practical knowledge of the fabrication of the different parts of steam engines and their dependencies, that they may be able to repair or replace such parts as the space and means for making and repairing can be furnished in steam vessels. When other qualifications are equal, candidates whose skill and abilities in these particulars are superior, will have precedence over others for admission or promotion, who may be considered equal in other particulars.

ISAAC TOUCEY,

Secretary of the Navy.

Navy Department, May 7, 1859.

During this decade immediately preceding the Civil War the supremacy of steam power over sails as a means of marine locomotion came to be very generally admitted in the naval service, even by the most conservative, and the work of creating an efficient steam fleet was begun in earnest. Of the many opinions and reports originating in the navy about this time and dealing with the subject of steam *versus* sails, one of the most interesting and valuable that has been preserved is a letter by Chief Engineer Jesse Gay of the *Mississippi* which exhibits so much good practical sense in looking at the question, that it is here copied for the benefit of a younger generation of naval officers, some of Mr. Gay's views even yet being pertinent to naval economy.

U. S. STEAMER MISSISSIPPI,

At Sea, November 8, 1851.

SIR: After long experience on board of this ship, a careful observation of the defects, with a wish to render her more efficient, I take the liberty to make the following observations, and suggest improvements, which, if adopted, will render the *Mississippi* more useful, efficient and safe.

The objects to be attained in a War Steamer are, first, weight of battery. Second, speed by steam, with an economical expenditure of coals. Third, to combine her steam and sails, so that one shall not be transported at the expense of the other. A ship of war, without guns, would be perfectly defenseless; a war steamer, with encumbrance on her steam power, is equally so. The sails of the

Mississippi are auxiliary to her steam; with her sails unaided by the engines, she is helpless; on the other hand her engines are sufficient to handle her without the assistance of sails. The conclusion is, therefore, that the less the engines are encumbered with the spars and sails, which are useless, the better for efficiency and safety. Again, if a ship is overburdened with sails, spars, steam engines, boilers, besides any useless weight, it deducts the same number of pounds from her battery, or immerses her to a dangerous depth in the water, obstructs her speed, and occasions a useless expenditure of coal, for which a small compensation is obtained.

The spars and sails of the *Mississippi* are too large; if they were reduced to the proper size, her speed would be augmented more than one knot per hour, allowing her to draw the same water. The engines not only have her vast hull to propel, but the great surface of spars, which are a great obstruction to the speed. It is supposed the larger the sails the more assistance they are capable of rendering. This is a mistaken idea, as experience abundantly has shown; a proper area of sails is unquestionably advantageous, but this area must not exceed a limit at which they would be an obstruction to speed by steam. When the winds are fair, a six knot breeze is required before the sails are of any use in propelling the ship conjointly with steam power; if the winds are strong a large spread of canvas is dangerous. In a storm, only a sufficient quantity is necessary to steady the ship, and this will of course be, fore and aft sails. With light fair winds, the power of the engines will bring light airs ahead; thus, a steamer will most of the time have light airs ahead, or occasionally aft, but not in sufficient force to make her sails effective; hence, it is clear that her great spars are an encumbrance to her speed under most of these circumstances; the mainsail cannot be carried—the main topsail has seldom been used—studding sails have been useless—fore topsail useful—top-gallant sails seldom—fore-topmast stay-sail and jib useful. The useful sails are fore and main trysails, fore topmast stay sail and jib, and occasionally the spanker with effect. With moderate or fresh breezes ahead, the top gallant sails are necessarily sent down; in strong head winds, lower yards and top masts are also sent down. In fine weather all these spars are again sent up to improve the appearance of the ship. All this has to be done at the expense of labor of the crew, while the very

spars which are so often sent up and down are seldom of any use in propelling the ship. The ship may be propelled by the aid of her sails, but in a very awkward manner; the first difficulty, the crew is far too small to handle her immense sails with sufficient promptitude; in the second place, the mainmast is so far abaft the centre of motion that all the sails upon it, (except with a wind directly aft), are of but little or no use; the foremast is also too far forward. All these difficulties it is impossible to obviate; with sails alone she is a clumsy ship, hardly capable of handling herself; she never can be an auxiliary steamer with her masts in their present position, the most important of which cannot be moved (the main). But these are not all the difficulties; the great length of spars produce another difficulty of equal damage to her efficiency, which must exist with her great spars, viz: spare sails, spars and rigging must be put into the ship to the amount of many tons; this weight only adds to her immersion and reduces her speed; or, in other words, it requires a portion of her steam power to transport this useless weight, which does nothing to efficiency, speed or safety. As I before remarked, all the unnecessary weight put into a War Steamer, deducts the same from her general efficiency and safety. On two occasions she has been fitted for a cruise with all the spare material on board, which rendered her dangerously deep and almost unfit for sea, and I believe a very small proportion of these sails and spare spars have ever been used, for the purpose for which they were put on board.

To remedy the difficulties I have enumerated, I suggest that the spars, including lower masts, be reduced to a proper dimension, which would not exceed in weight more than one half the present ones; this would be a reduction of many tons, beside the reduction of weight of spare spars, sails and rigging, the saving to convert to more useful purposes room which it now occupies, and with this reduction the sails, rigging, etc., would be useful, where now it is so unwieldy as not to be used at all. Again, if this reduction was made, the sails and spars would be proportioned to her crews, and could then be worked with ease, where now they cannot.

Besides the reduction of spars, she requires a reduction in the weight of her anchors (she now carries four, which weigh 63 cwt. each; she only requires two, or if four, of much less weight than the present) this would also reduce the weight of chain. At no time du-

ring this cruise has she required more than two anchors; late in the cruise a much smaller one was substituted for one of the above weight; this has been found sufficient and much less labor to work it.

I am of the opinion that a steamer is more secure with two anchors (and not extremely heavy ones) than a sailing ship is with four. The engines themselves are a greater security than two anchors; hence, a steamer does not require so great weight of anchor.

If the forgoing suggestions were followed out the *Mississippi* could then carry two or four more guns, and draw less water than she now does; her speed would be augmented with the same expenditure of coal. She would have more room to berth her crew, which she much needs; her expenses would be reduced, and she would be more formidable; but if her present spars are retained, all of these qualities, which are so important in a war steamer, will be lost.

In submitting these views, which I have gathered from experience on board the *Mississippi*, I have felt some delicacy, knowing that I have ventured opinions which do not accord with theory. What I have submitted is based upon practical observations alone, for the correctness and verity of which I appeal to every experienced officer who has sailed in her any length of time. I have also had opportunity of seeing many foreign war steamers, particularly those of England and France, the difference between them and the *Mississippi* is, they carry less spars and more guns. I have not seen a war steamer of any nation carrying so heavy spars as the *Mississippi*, but I have frequently met with those of much less tonnage and power, carrying a much greater weight of battery.

I am very respectfully,

Your obedient servant,

JESSE GAY,

Chief Engineer.

Capt. JOHN C. LONG,

Com. U. S. Steamer *Mississippi*.

CHAPTER XII.

“There’s a demon, and he dwelleth in the drum ;
See the volunteers as down the street they come.
Proudly the procession marches,
Under bunting, under arches,
To the rattle, rattle, rattle,
Like a volley belched in battle,
And he saith :
I am Cain come again ; on my forehead is the stain.
Come,
Come,
Come, come, come—
Unto Death.”—FRANCIS Z. STONE.

THE CIVIL WAR.

IN Captain Collum’s excellent history of the United States Marine Corps he prefaces his account of the services of the marines during the war of the rebellion with an extract from Lossing’s “Civil War in America,” which outlines most eloquently the services rendered by the navy to the nation during that gigantic struggle for life. So correctly is the arduous and baffling character of the naval operations indicated, and so gracefully is the praise due the navy accorded, that the author feels he cannot do better than introduce the same extract as a prelude to what he will have to say regarding the achievements of the naval engineers during that same trying period.

“In the spring of the year 1861 a civil war was kindled in the United States of America which has neither a pattern in character nor a precedent in causes recorded in the history of mankind. It appears in the annals of the race as a mighty phenomenon, but not an inexplicable one. Gazers upon it at this moment, when its awfully grand and mysterious proportions rather fill the mind with wonder than excite the reason, look for the half-hidden springs of its existence in different directions among the absurdities of theory. There is a general agreement, however, that the terrible war was clearly the fruit of a conspiracy against the nationality of the republic, and an attempt, in defiance of the laws of divine equity, to

establish an empire upon a basis of injustice and a denial of the dearest rights of man. . . . It was the rebellion of an oligarchy against the people, with whom the sovereign power is rightfully lodged.

“The services of the national Navy during the war, on account of their peculiarity, attracted less attention than those of the army, and were not appreciated by the people. They have an equal claim to the gratitude of the nation, so freely accorded to the other branch of the service. The Confederates having no navy, in a proper sense, and only flotillas here and there, and with some powerful ‘rams’ on rivers and in harbors, and not a ship on the ocean, excepting roving pirate vessels,—built, armed, furnished, and manned chiefly by the British, and cruising alone,—there were few occasions for purely naval battles. The whole force of the Navy Department was employed in the services of blockade, in assisting the attacks of the armies on fortifications along the rivers and on the borders of the Gulf and the ocean, or in chasing the pirates. In these fields of great usefulness the national vessels performed labors of incalculable value, and officers and men exhibited skill, valor, and fortitude unsurpassed.

“Never in the history of the world were there occasions for such exhausting labors and highest courage in service afloat as the American Navy was subjected to in its operations among the rivers and bayous of the southwestern regions of the Republic. Many a victory over which the people have shouted themselves hoarse in giving plaudits to the gallant army might never have been achieved but for the co-operation of the Navy. To the common observer it, in many instances, seemed to be only an auxiliary, or wholly a secondary force, when, in truth, *it was an equal, if not the chief, power in gaining a victory.* Without it, what might have been the result of military operations at Forts Henry and Donelson, Shiloh and all along the Mississippi River, especially at Vicksburg, Port Hudson, and New Orleans; what at Mobile, Pensacola, Key West, along the Florida seaboard, the sea-coast islands, Charleston and the borders of North Carolina, and even in holding Fortress Monroe and Norfolk?

“Notwithstanding the weak condition of the naval service, the decree went forth, in the spring of 1861, that all the ports of the

States wherein rebellion existed must be closed against commerce by a strict blockade. Foreign nations protested and menaced, *but the work was done*. There were no dock-yards or workmen adequate to construct the vessels needed for the service, yet such was the energy of the Department that an unrelaxing blockade was maintained for four years, from the Capes of the Chesapeake to the Rio Grande, while a flotilla of gunboats, protecting and aiding the army in its movements, penetrated and patrolled our rivers, through an internal navigation almost continental, from the Potomac to the Mississippi. Ingenuity and mechanical skill developed amazing inventions. That marine monster, the *Monitor*, was created and began a new era in naval warfare; and the world was suddenly enriched by new discoveries in naval service. Vessels of the merchant service were purchased and converted into strong warriors; and men from that service were invited to man them. Schools were established for nautical instruction; dock-yards were enlarged and filled with workmen; and very soon a large number of vessels were afloat, watching the harbors under the ban. No less than two hundred and eight war vessels were constructed, and most of them fitted out during the four years; and four hundred and eighteen vessels were purchased and converted into war ships.

“The blockading service was performed with great vigor and efficiency under the triple stimulus of patriotism, duty, and personal emolument. The British government professed to be neutral, but British merchants and adventurers were allowed to send swarms of swift-winged steamers, laden with arms, ammunition, clothing, and everything needed by the insurgents, to run the blockade. The profits of such operations were enormous, but the risks were equally so; and it is believed that a true balance-sheet would show no profits left, in the aggregate, with the foreign violators of the law. The number of such vessels captured and destroyed during the rebellion by the national Navy was fifteen hundred and four. The gross proceeds of property captured and condemned as lawful prize before the first of November following the close of the war amounted to nearly twenty-two millions of dollars, which sum was subsequently enlarged by new decisions. The value of the vessels captured and destroyed (eleven hundred and forty-nine captured and three hundred and fifty-five destroyed) was not less than seven mil-

lion of dollars, making a total loss, chiefly to British owners, of at least thirty million of dollars.”

It is not believed that the distinguished historian from whose work the above is quoted has in the least overstated the value of the services rendered the nation by the navy during the Civil War. As the length of time increases since the conclusion of that struggle, we are getting to study its events more carefully and to be more critical in analyzing the exact relationship between causes and effects. An analysis that was quite impracticable in the years immediately succeeding the close of the war because at that time men's minds were filled with the magnitude and brilliancy of the achievements of an army numerically so enormous as to eclipse entirely the naval force, and in which a personal interest was compelled from the very circumstance of its greatness, which necessitated representation in its ranks of every family within the borders of the nation. The blockade of the sea coast alone, of the revolted territory, cannot appear now in any other light than a deciding factor in the ultimate conquest of the Confederacy. Had the Southern states been free to ship their cotton to Europe and exchange it for provisions and munitions of war, who is wise enough to say when the end would have come? Could the invasion of the South been possible had not the naval force, hovering over the coasts with ceaseless vigilance for more than three years, practically disarmed the Confederacy and starved its people into submission by depriving them of the benefits of commerce?

In telling the story of the maintenance of the blockade it is impossible to give too much credit for results to the naval engineers serving in the blockading squadrons. A great object in view was to keep the vessels in condition to remain on their stations, for the removal of even one steamer at a time meant the weakening of the line of watchers and might involve a breaking of the blockade, and this duty to a great extent fell upon the engineers, for without steam power—always ready—the ships were worthless. In hastily constructed gunboats, or commercial vessels as hastily equipped for war purposes, without an adequate supply of engineering stores and without proper tools or facilities for effecting repairs, the duties of the engineers were the most difficult and fretting that can be imagined; notwithstanding which, they, as a rule were found equal

to the emergencies that confronted them and succeeded in keeping their ships and the blockade efficient, and this in spite of the fact that the engineering talent of every sea-port of Great Britain was arrayed against them in the effort to produce marine machinery that could over-endure that of the Federal vessels.

The author has been favored with a large number of letters from men who as regular or volunteer engineers performed their share in the labor of making a rigorous blockade possible, and from the recital of trials and hardships thus presented he cannot but marvel at the faithfulness, loyalty, and thoroughness of the services rendered. The engineers shared with other officers the dangers of battle, pestilence, and storm, as well as the hardships due to improper food and insufficient clothing, and in addition, they had to struggle constantly with the discouraging task of keeping old and worn-out, or new and badly adjusted, machinery in working order; a task that permitted no rest for either body or mind. A record of the make-shifts, alterations, inventions and substitutes to which these devoted men were compelled to resort from sheer lack of proper mechanical appliances to aid them in their labors, would prove a most interesting chapter in the history of man's ingenuity, and would be valuable to the engineers of to-day, even though our smallest gun-vessels now carry excellently equipped repair shops, and are supplied with a veritable mine of tools, fittings and spare parts.

Had the service been less arduous and afforded some opportunities for rest, the possibility of securing it was often wanting. Although absolutely essential to the well-being of the ship, in a degree scarcely approximated by any other class of officers, the engineer was too often precluded by the nebulous nature of his relative rank from occupying any, but the merest leavings of the quarters in which he was supposed to have a share. One former member of the corps writes of an instance where an engineer attached to a small armed steamer was completely left out in the distribution of living space and for upwards of two years had no home on board whatever, except a piece of canvas in form of a tent under which he was allowed to sleep, summer and winter, on top of the deck house. Numerous other instances have been related to the writer of engineers unprovided with quarters being obliged to sleep in the

hot drum-rooms over the boilers, or who constructed for themselves rough bunks in the engine rooms or shaft alleys. These cases of individual neglect and hardship fortunately do not stand as representative of the experience of all, for in many vessels there was room even for the engineers, but they serve to show what discouragements were encountered by a considerable number of an invaluable class of officers who inherited an official position vastly inferior to the value of their services or their real merits.

Under such circumstances it is remarkable that the engineers maintained their patriotism and devotion to duty as well as they did, the records of the war showing, however, that instances of defection or faint-heartedness among them were rare indeed. Soon after the war closed, Rear Admiral David D. Porter, writing to Chief Engineer W. W. Wood, thus referred to his experience with the naval engineers: "I have had more than two thousand engineers under my command during the Rebellion and I have never known them to shrink from any service." There were of course occasional instances of discouragement after prolonged and arduous duty where the engineer gave up in despair and declared his inability to keep his department longer in service, and there were also a very few cases where the engineer allowed a wearied and disgusted commanding officer to influence him into making such a report against his judgment. In either case the effort to get off the blockade and enjoy a respite from its toils at some Northern navy yard generally came to naught.

After the capture of Port Royal, early in the war, a naval supply and repairing station was maintained at that place, and there the broken-down ships from the blockade were usually sent for examination before being allowed to proceed North. The mechanical department of this station was presided over by veteran chief engineers of the old navy, who had long before lost all the nonsense of youth and were incapable of sympathy for their juniors who had tales to tell of what they *could not do*. To their minds, an engineer in charge of a steamer in the presence of the enemy ought to be able to do anything, and be resourceful enough to meet any emergency. If, upon examination, they decided that the reported defects in a vessel could have been repaired at sea the offending engineer whose report had taken the vessel off her station received very little

mercy. A report to the commander-in-chief of the squadron meant a court-martial, and that in turn meant reduction in grade or summary dismissal from the service. This may seem harsh and uncharitable treatment of those whose duties at best were trying, but individuals have little right to consideration in great national operations, and their chief engineers, whose reports would have appeared cruel and savored of persecution in time of peace, were merely performing their proper part in the prosecution of the war. The service rendered by them in this manner, and in directing repairs to disabled ships, was of incalculable benefit to commanders of squadrons in carrying out the operations entrusted to them, a fact appreciated and very properly referred to by Rear Admiral Dahlgren, who wrote to the Department on the occasion of relinquishing command of the South Atlantic Blockading Squadron at the close of the war: "Fleet Engineer Danby has been for the last two years in charge of the mechanical steam department at Bay Point, where his industry and thorough knowledge of his business has alone enabled me to keep in active operation so many steamers; the first time, perhaps, that this power has been submitted to such a test."

To those who study the social and industrial conditions existing within the United States prior to the Civil War, conditions which contributed fully as much to the causes which made that war possible, as did the political questions generally supposed to have been its provocation, the fact that the mechanical element of the North, represented by the engineers of the navy, had such an important part in accomplishing the conquest of the Confederacy must appear as a most appropriate manifestation of retributive justice. An artificial state of society at the South, founded upon the institution of human slavery, had inculcated a genuine contempt for labor and the industrial arts, and resulted in the utter neglect of the vast mineral resources of that region, now one of its most important sources of wealth, simply because no one was so low in the social scale as to burden his mind with a knowledge of metallurgy, which involved practical experience. Had the South possessed the educated scientists, the skilled mechanics, and the innumerable mills and workshops that a higher order of progress has now given her, there is no telling when, or how the war might have ended.

As it was, when the war broke out there was but one establish-

ment—the Tredegar Iron Works, of Richmond—within the limits of the Confederacy capable of making the very modest armor plates used on the *Merrimac* and *Albemarle*, while the total number of skilled artisans was probably exceeded by the number employed in any one of a score or more of Northern workshops busily engaged in making ships, engines and guns for the national navy. When the first supply of arms and tools had been exhausted, the South was unable to make others, nor could she receive them from abroad on account of the vigilance of the blockading ships, kept up to their work by the skill of the Northern engineers. As tersely expressed by Engineer-in-Chief Isherwood, in one of his official reports regarding the conduct of the war, “our antagonists had neither engineering skill nor resources in themselves, nor could they, owing to the efficiency of our navy, obtain them from others, and the want was fatal ; they had despised the mechanical arts and sciences, and by those arts and sciences they fell.”

CHAPTER XIII.

" Mine eyes have seen the glory of the coming of the Lord;
He is trampling out the vintage where the grapes of wrath are stored;
He hath loosed the fateful lightnings of his terrible swift sword;
His truth is marching on.

JULIA WARD HOWE—*Battle-Hymn of the Republic.*

1861. The Civil War, continued—Engineers and Steam Vessels in the Navy at the Outbreak of Hostilities—Resignation and Dismissal of Officers—B. F. Isherwood Appointed Engineer-in-Chief of the Navy—Increase of the Engineer Corps—Qualifications of the Volunteer Engineers—Remarkable Career of Don Carlos Hasseltino—Vessels Added to the Fleet during the Year—The KEARSARGE and CANANDAIGUA Class of Steam Sloops—The Ninety Day Gunboats—The First Double-Enders.

AT the beginning of the eventful year 1861 the engineer corps of the navy consisted of twenty-eight chief engineers, forty-three first assistant engineers, twenty-nine second assistant engineers, and ninety-two third assistants, a total of one hundred and ninety-two. This number was established by adhering as closely as practicable to the provisions of the act of Congress of 1842, which authorized the appointment of one chief engineer, two first assistants, two second assistants, and three third assistants for each steam-vessel of war. The steam navy at the beginning of 1861 consisted of six great ships, of which the *Niagara* and *Colorado* were types, and which in their size, battery and beauty were the marvels of the maritime world at that day; six first-class screw sloops, every one of which was destined to become famous in the annals of the navy, and one of which—the *Hartford*—was to become a name synonymous with naval glory; four large side-wheel steamers, one of which was the *Powhatan*; eight second-class steam-sloops, represented in the modern navy by the *Iroquois*; five purchased screw steamers of about five hundred tons each, and five small side wheel gunboats, the *Michigan* of this class being still with us.

Twenty-seven of the members of the engineer corps were Virginians, and seven others belonged to the Carolinas, Alabama, and Florida, but the majority came from the New England and Middle States, Maryland and the District of Columbia being especially well

represented. The Northwestern States, which now furnish so many naval engineers through the medium of the Naval Academy, then had but five representatives—two each from Ohio and Wisconsin and one from Illinois. Mr. Samuel Archbold was the engineer-in-chief of the navy at the beginning of the year, but in March he resigned that position and his commission as a chief engineer in the navy as well, going out of the service without any suspicion of disloyalty, as his motives for resigning were personal and not connected in any way with the political unrest of the times. He was succeeded by Mr. Benjamin F. Isherwood, who was selected by the President and appointed engineer-in-chief on the 26th day of March, 1861. Mr. Isherwood's name was the fifth in order on the list of chief engineers at the time, and he was recognized as the foremost man of his corps in professional ability and zeal, while his indefatigable energy and intense patriotism brought to the head of one of the most important executive branches of the Navy Department a man well fitted for the Herculean task that the next few years had in store.

In the spring of this year the political storm that had been gathering for so many years finally burst, and the officers and men of the navy were confronted with the desperate issue of choosing between two flags. Of the engineers from the Southern States five resigned and had their resignations accepted by the Department, but by that time resignations of officers of the army and navy had become epidemic, and President Lincoln directed that all such in the future be treated as proof of disloyalty sufficient to warrant summary dismissal from the service of the United States, which treatment was administered to seventeen of the naval engineers who sent in their resignations after it was too late. One of these, William P. Williamson, whose name had stood at the head of the list of chief engineers, became the engineer-in-chief of the Confederate navy; a few others continued their profession in the same service, while others went into the insurgent army, where some achieved considerable military distinction, and others were killed or crippled fighting against the flag under which they had acquired their first military ideas, and to which they would have remained loyal had they been inspired by that thoughtful good judgment supposed to be an attribute of all engineers by the virtue of philosophic nature of their calling.

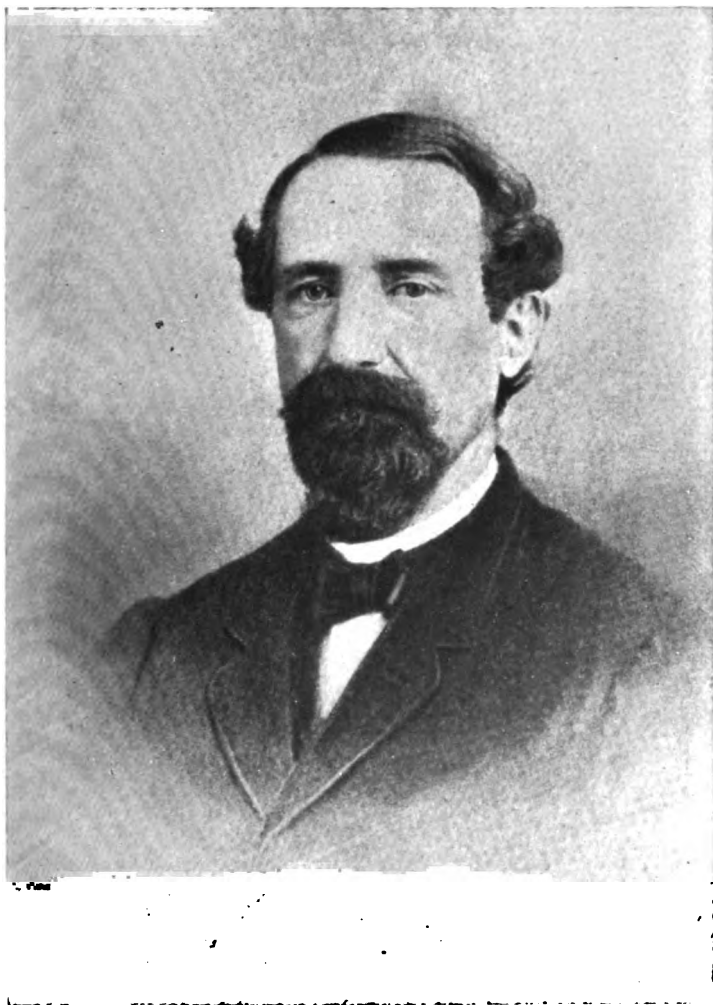

CHIEF ENGINEER SAMUEL ARCHBOLD, U. S. N.
Engineer-in-Chief of the Navy from October 16, 1857, to March 25, 1861.

In July, 1861, Congress provided for a temporary increase of the navy "for and during the present insurrection," which act authorized the Secretary of the Navy to hire, purchase, or contract for such vessels as might be found necessary, to arm and equip them, and to appoint acting or volunteer officers for them. Under the operation of this law the navy grew rapidly both in ships and in *personnel*: such vessels as were bought outright or built on the order of the Navy Department became, of course, government war-vessels, and as such served to authorize a great increase in the regular engineer corps, a considerable increase being effected during the first year of the war, but not at all in proportion to the increase in the number of war steamers, as the officials of the Navy Department were wise enough to know that the rebellion would eventually be put down, and it was only a question of time before the navy would have to be re-established on a peace basis. Accordingly the majority of the new engineers held only acting appointments. At the end of the year 1861 the regular engineer establishment had increased to four hundred and four, of whom forty-eight were chief engineers; at the same time there were three hundred and sixty-four acting engineers distributed through the grades of first, second and third assistants. The increase in numbers went steadily on until, in January, 1865, there were four hundred and seventy-four regulars and eighteen hundred and three volunteers, of which numbers fifty-nine regulars and fifty-five volunteers were chief engineers.

In spite of all the hurry, excitement, and anxiety incident to the existence of a state of war, it is greatly to the credit of the officials at the head of the engineer corps that the careful system of examinations for admission to the regular service was rigidly adhered to throughout the war, thus preventing the acquisition to the permanent corps of any who were not professionally and morally fit for the service. In the case of acting appointments in the volunteer service little or no examination was required, the need for engineers being so great that almost any one who could show a letter of recommendation from a commander or chief engineer of a war-vessel, or from a civilian of prominence, could get an acting appointment. The majority of the acting engineers were men who were really engineers, many of them being of recognized ability and reputation in their line, who entered the service from motives of patriotism, and natur-

ally chose the engineering branch of the navy in preference to wading through the mud, either with or without a sword, in the army.

Numbers of the volunteer engineers were men who belonged to the profession of civil engineering and were attracted to the engineer corps of the navy by the similarity of names, when they made up their minds to enter the military service of the government. These gentlemen, with possibly a few exceptions, began with no practical knowledge of marine machinery, but with their excellent training in matters relating to civil engineering they were quick to learn and in a short time became among the best acting engineers. Several of them entered the regular service by taking the prescribed examinations and, both during the war and since, have been professionally prominent in the corps. As was often the case in the army, many men of education and ability served in subordinate positions in the navy solely because they wished to serve their country in its day of need, and such men were generally appreciated and promoted to official positions after short periods of faithful service as subordinates. A case in point is that of Mr. P. J. McMahon, a civil engineer employed on the Boston and Worcester Railway, who was a personal friend of the chief engineer of the *San Jacinto*, and was very desirous of going to sea with him as an acting engineer. The plan was prevented by the *San Jacinto* hurriedly going to sea at a time when her complement was filled, with the exception of one coal heaver, but Mr. McMahon was determined to go, and accordingly took the vacant billet. He cheerfully did duty as a fireman, oiler and yeoman until, in about a year, he received the coveted warrant as an acting third assistant engineer; promotion to second assistant came not long afterward, and the close of the war found him a first assistant in charge of the machinery of the *Mahaska*.

Mr. McMahon's predecessor as engineer in charge of the *Mahaska* furnishes a curious example of motive, in seeking service in the volunteer engineer corps. The Atlantic Works of Boston did a tremendous business from the very beginning of the war in building ships and machinery for the navy, and when the owners found themselves getting rich by staying at home they came to the very proper conclusion that some one having a proprietary interest in the business must represent the patriotism of the firm by going to the

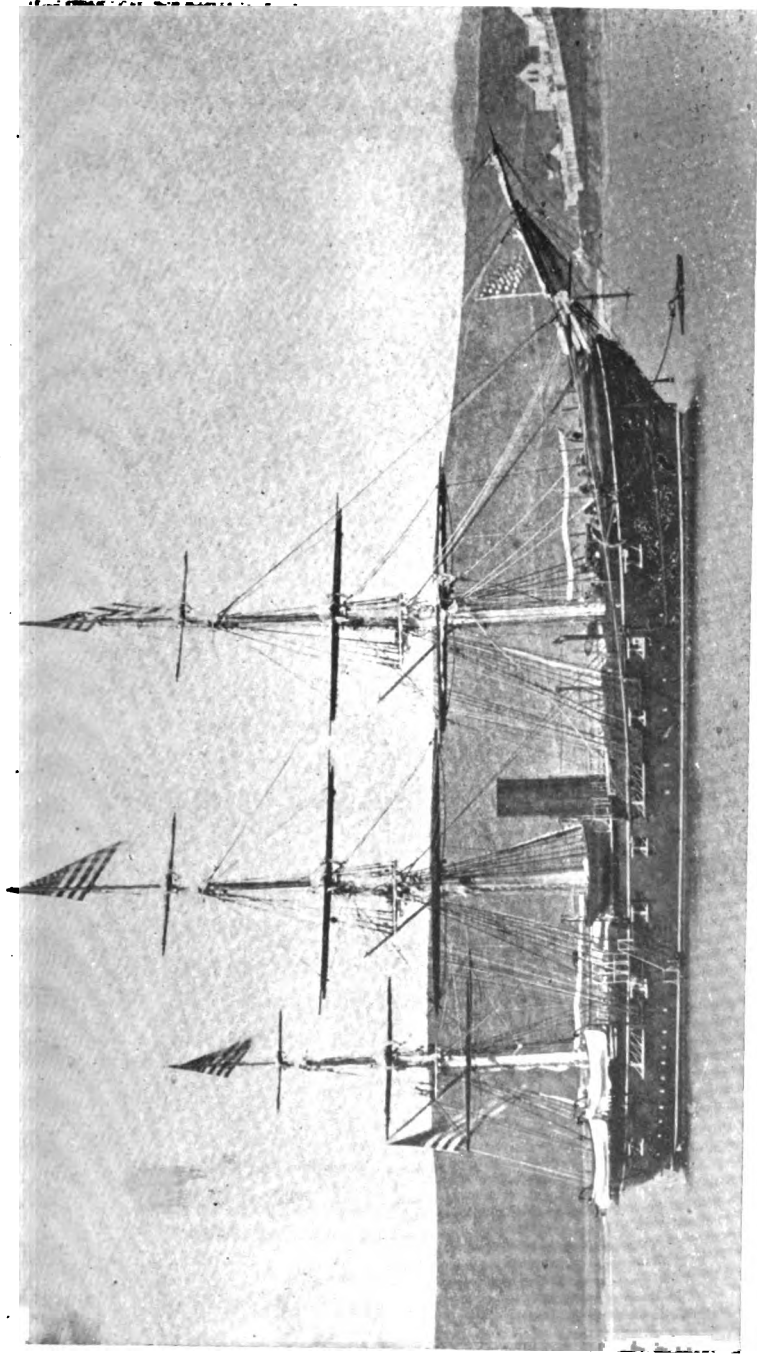

U. S. S. TUSCARORA.

Length, 198' 6"; beam, 33' 2"; disp., 1,457 tons. (*Kearsarge*, *Oneta* and *Wachusett* same class.)

war. Accordingly, the proprietors cast lots and Mr. Philander S. Brown was elected to go to the front. He chose the engineer corps of the navy for his field of usefulness, asked for, and received a warrant as acting first assistant engineer, and served as chief engineer of the *Mahaska* until the war was over, when he resigned and returned to his home and business interests.

As might be expected, and as often occurred in the other branches of the navy, some acting appointments were given to men who were unqualified for the duties they were expected to perform on board a war steamer. Adventurers who saw in the seven hundred and fifty dollars per annum of the "Acting Third" in the navy more attraction than was offered by thirteen dollars per month and found in the ranks of the Army of the Potomac; firemen recommended by their captains for some gallant or meritorious act; sons or friends of prominent military and civil officials; subalterns disgusted with the Chickahominy swamps, and many other classes too numerous to mention, all had their representatives in the volunteer engineer corps. As there were from four to ten engineers on each war steamer in those days, the presence of one of these inexperienced persons was not dangerous, as he was always under the eye of some one who was able to prevent disaster by interfering in case of necessity. When a number of them happened to get shuffled together, as sometimes occurred, and thus obliged to try to do something without being told how to do it, they generally came to grief, as is attested by innumerable tales in the service.

One of these stories relates to the wearing away of the valve faces and seats of the engine of one of the new sloops-of-war on one of her first sea trips. The acting engineer in charge of the machinery had been in the regular service and was a competent engineer, but, unfortunately for the vessel, he was confined to his room by illness on the voyage referred to. Of the four acting assistant engineers, one only had any experience with machinery and that was limited to fire-room work, he having been a fireman promoted as a reward for some act of bravery in an emergency; his scholastic attainments were extremely limited and stopped short at the problem of subtracting the hourly records of the engine-room counter and dividing the remainder by sixty to find the average revolutions of the engines per minute, a problem that he never

mastered, and which finally drove him back into the fire-room, where he found more familiar tools to handle than pencils and paper. This case had numerous parallels in the line as well as in the engineer corps during the war, and is a good illustration of the folly of making officers of enlisted men simply as a reward for gallantry in battle, without any regard for the fitness of the person to perform the duties of the office to which he is advanced.

Another of the acting engineers was a village schoolmaster from the up-country of New Hampshire, whose knowledge of marine engines had been obtained from a picture of a condensing engine in Olmstead's "Principles of Natural Philosophy," at that time a favorite text book in the country schools of New England. The third one was a youth of about seventeen, who had been the schoolmaster's favorite pupil in the New Hampshire village, and who had joined him in the enterprise of suppressing the rebellion through the medium of the naval engineer corps. The fourth acting engineer had gained such engineering knowledge as he possessed by having been the captain of a tug boat. Although well meaning and inspired with a desire to do their best, these amateur engineers in some way managed to overlook in turn the necessity of having the steam chests oiled, and, as a result, the valves and seats at the end of the trip were found to be reduced to little more than a heap of iron filings, and the ship was kept from active service many weeks in consequence while damages were being repaired.

Another incident which occurred about the same time was not the source of any great amount of delight to the acting engineers directly concerned. A war steamer left New York for the seat of war one fine day, the commander and all hands indulging in high hopes of glory and prize money. After a few hours at sea the engine suddenly stopped, and then began running backward at a furious rate; do what they would, the engineers could not coerce the engine into going ahead again, and finally the captain had to ignominiously abandon his cruise and take his ship, tail first, back to New York, an object of surprise and derision to the watermen of that busy seaport. The navy yard was reached in the course of time, where a few vigorous remarks from the chief engineer of the yard and about two minutes work put everything to rights. The eccentric had slipped.

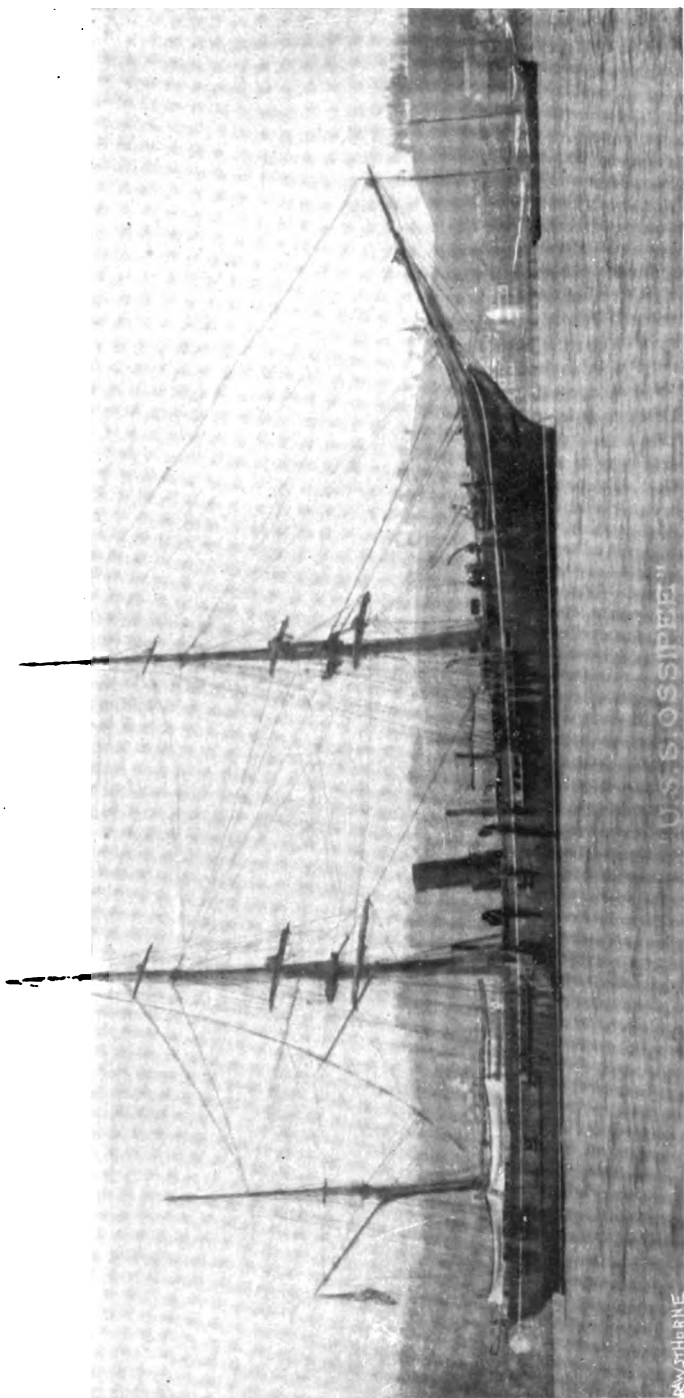

U. S. S. OSSIPEE.

Length, 205'; beam, 38'; disp., 1,934 tons (Adirondack, Housatonic and Juniata in same class.)

The volunteer engineer who was not an engineer did not always get into trouble, as is shown by the successful experience of one Don Carlos Hasseltino, whose remarkable naval career is worthy of a little space in the history of the naval engineering of the rebellion. This gentleman was a native of the West Indies, but had graduated at a college in Ohio, and at the time of the outbreak of the war was reading law in Hamilton, Ohio. His sympathies being with the South, he went to Montgomery, Alabama, and entered the Confederate army, rising to the rank of lieutenant-colonel in about two years, when he fell into the hands of the enemy in the vicinity of Fort Donelson. Pretending to be a civilian and a foreigner, which he could easily do by his ability to speak French, he succeeded in getting a pass from the Union officer in command at Memphis, and went to St. Louis, not knowing just why he was going there or what he would do next.

In the streets of St. Louis he chanced to meet a former college mate who was an assistant engineer on one of the gunboats in the Mississippi River. This friend urged him to give up the Confederate cause and enter the navy as an engineer, to which proposal he demurred, as he said he "did not know a steam engine from a horse power," but his friend assured him that did not make any difference. Accordingly, and knowing that he would probably be hanged as a spy if his connection with the South were discovered, he studied some of the assistant engineer's books for a few weeks and then presented himself to the authorities as a candidate for the engineer corps. He made such a good impression that he was given an acting appointment as a first assistant engineer, and was ordered to duty on board the *Essex*, then the flag-ship of Rear-Admiral D. D. Porter.

According to Mr. Hasseltino's account of himself, his great fear at this time was that the *Essex* would be ordered to get under way to go somewhere, and he would consequently be called upon to do something with the machinery, which he knew he could not do, his mechanical knowledge being yet so imperfect that he thought the feed-pump was a contrivance for making the vessel go sidewise. But luck was on his side, for he had opportunities to talk with Admiral Porter, and so impressed that distinguished officer with his professional worth that he was put upon the Admiral's staff and as-

signed to important special duty in connection with the building and inspection of ironclads at various points on the Mississippi River. A report made by him to the admiral respecting the value of certain types of ironclads for river service was considered so meritorious that the admiral embodied it in his report to the Secretary of the Navy, and that official in turn transmitted it to Congress in his annual report.

In May, 1864, after less than a year's service, Mr. Hasseltino was made an acting chief engineer, in which capacity he continued on duty with the Mississippi flotilla; two years later, in May, 1866, he was honorably mustered out of the service. Subsequently he acquired the title of general and considerable wealth by engaging in various wars in Chile, Peru, and Cuba, but with this we need not deal here. Acting Assistant Surgeon J. M. Batten has written an interesting little volume of reminiscences of his service in the navy during the war, in which book occurs the following account of the person whose versatile career has just been described:

"Don Carlos Hasseltino was chief engineer of the United States monitor *Oatanoba*, but spent most of his time on board the United States monitor *Onesota*, and was one of the messmates of that vessel. I associated with him constantly from October 6, 1865, to January 16, 1866. He was a jolly, kind, sympathetic and intelligent associate. In height he was about six feet, and had a large, wiry frame. His hair and eyes were black; he wore a black mustache. He never gave offense to any one, but would not suffer himself to be insulted. He carried two Derringers in leather pockets buttoned to his pantaloons above the hips. He was very polite and chivalrous; woe to the person that gave offense or offered insult."

The progress made in increasing the fleet during the year 1861 was phenomenal. Mr. George D. Morgan of New York was appointed a special agent of the Navy Department with orders to buy every American merchant vessel found at all suitable for war purposes, in the selection of which he was aided by a board of officers of the navy—a constructor, a chief engineer, and an ordnance officer. This board had a small steamer in New York harbor and made a business of boarding and examining every American vessel within

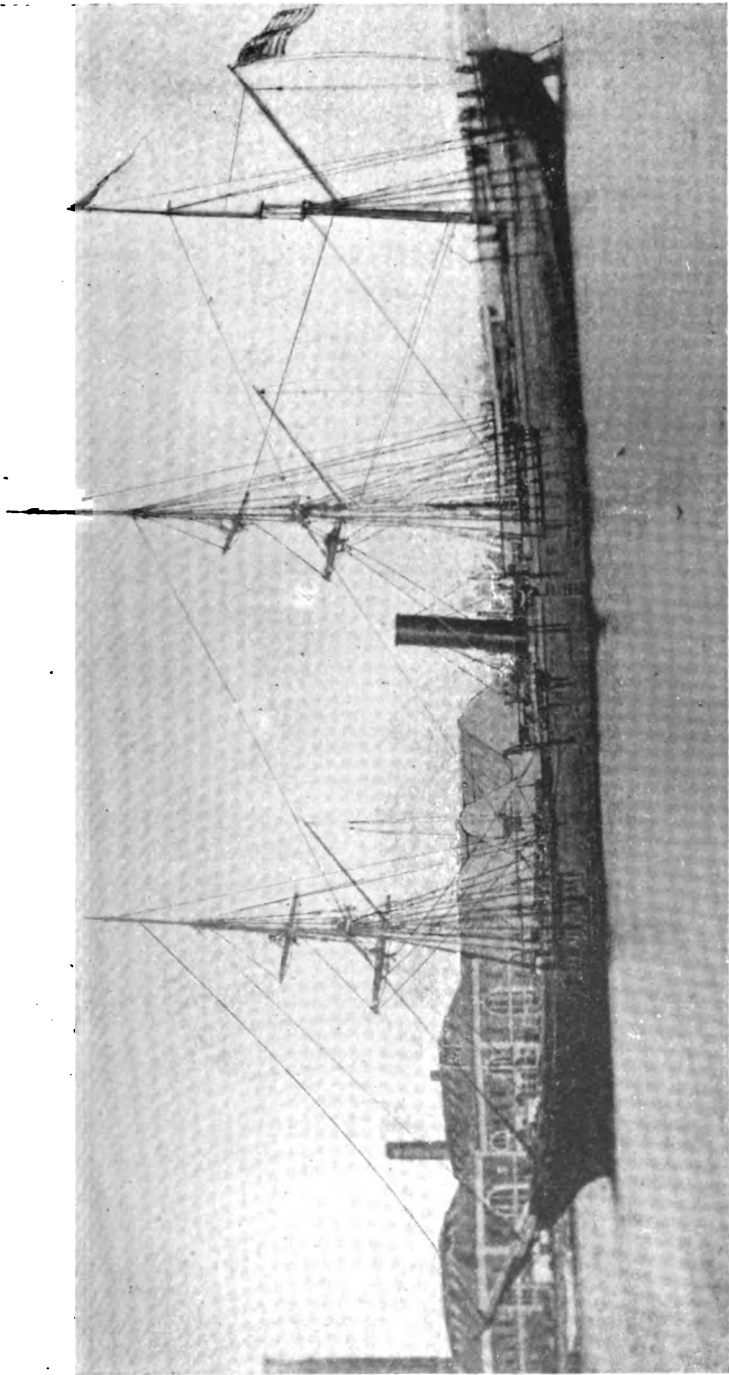

U. S. S. CANANDAIGUA.

Length, 225'; beam, 38' 4"; disp., 2,030 tons. (Lackawanna, Monongahela, Sacramento, Shenandoah and Ticonderoga in same class.)

reach, a favorable report on any vessel making it obligatory on Mr. Morgan's part to buy the vessel at the best bargain he could make with the owners. As Mr. Morgan received a commission of two and one-half per cent. on his purchases this obligation to buy, was for him, a decidedly good thing. From the middle of July until the first of December there were purchased in this manner thirty-six side-wheel steamers aggregating 26,680 tons and costing \$2,418,103; forty-three screw steamers aggregating 20,403 tons and costing \$2,215,037, and one hundred and eighteen sailing vessels—ships, barks and schooners—at a cost of \$1,071,898. Sixty of these latter were loaded with stone and sunk for the purpose of closing some of the southern ports; the others, and all of the steamers, were converted into war vessels and put into active service.

At the same time that merchant vessels were being pressed into service, the navy yards and private ship and engine building establishments were worked to their utmost capacity in building war vessels. By the end of the year, fifty-two such vessels were entirely completed and in service or were well along in construction. None of the navy yards were then equipped for the building of engines on a large scale, which work therefore had to be let out by contract to marine engine builders, the machinery specifications in the majority of cases being furnished by the Navy Department from designs of Engineer-in-Chief Isherwood. Excellent plants for building wooden ships existed at the navy yards and many of the hulls of these rapidly constructed vessels were built by the Government at the different yards while their machinery was under construction at neighboring machine shops.

The ship and engine building work of the Navy Department now assumes such magnitude that space forbids the practice previously observed in these pages of giving detailed information as to the designers and builders of the various vessels, their machinery, armament, cost, and subsequent naval careers, although it is hoped that the value of this work will be enhanced by its appendix, in which much of the information referred to is given in tabular form. Henceforth it will be necessary to refer to new vessels in general terms only, except in certain special cases where peculiarities of design or remarkable engine performance occasion so much interest from an engineering point of view that a more detailed history of their origin is desirable.

In February, 1861, Congress authorized the construction of seven sloops-of-war, and the Navy Department, to take advantage of the plans already in its possession of the sloops built in 1858, duplicated the *Iroquois* in the *Oneida*, the *Wyoming* in the *Tuscarora*, the *Mohican* in the *Kearsarge*, and the engines of the *Seminole* in the *Wachusett*. These vessels were of about 1,560 tons displacement. By subsequent action of Congress, at the special session, authority was granted to build other sloops of war, similar to those previously ordered, making fourteen in all, and work on them was begun in the early fall of the year. These sloops-of-war, besides those already named, were the *Juniata*, *Ossipee*, *Adirondack*, *Housatonic*, *Sacramento*, *Canandaigua*, *Lackawanna*, *Ticonderoga*, *Shenandoah*, and *Monongahela*. The first four named were of 1,934 tons displacement, and the other six, differing somewhat in size from each other, were of about 2,200 tons. The hulls of all fourteen were built by the Government at the navy yards, three each at Portsmouth, N. H., and Boston, and four each at New York and Philadelphia, the machinery being built by contract at various places in New England, New York and Philadelphia.

These fourteen steam sloops were large, handsome vessels and did much excellent service during the war and afterward. The only one still remaining in the service is the *Monongahela*, which, with her machinery removed, is used as a training ship in which naval cadets and apprentice boys acquire those arboreal habits supposed to be essential in the training of modern men-of-war's men. With the disappearance of this class of vessels we have suffered what the author regards as a most serious loss in the removal from the navy list of those sonorous and distinctively American names, like *Canandaigua*, *Oneida*, *Lackawanna*, *Tuscarora*, *Shenandoah*, and the like, which were sufficient in themselves to proclaim the nationality of the vessel bearing them, and at the same time precluded by their derivation from adoption by foreign navies, except inappropriately. Our *Ajax*, *Dolphin*, *Petrel*, *Vesuvius*, and others, always have their namesakes in other navies, and imply a poverty of resource on our part wholly undeserved in view of the great multitude of beautiful and euphonious words that have become part of our American language in the names the vanished tribes of aborigines gave to their hills and forests, rivers and lakes.

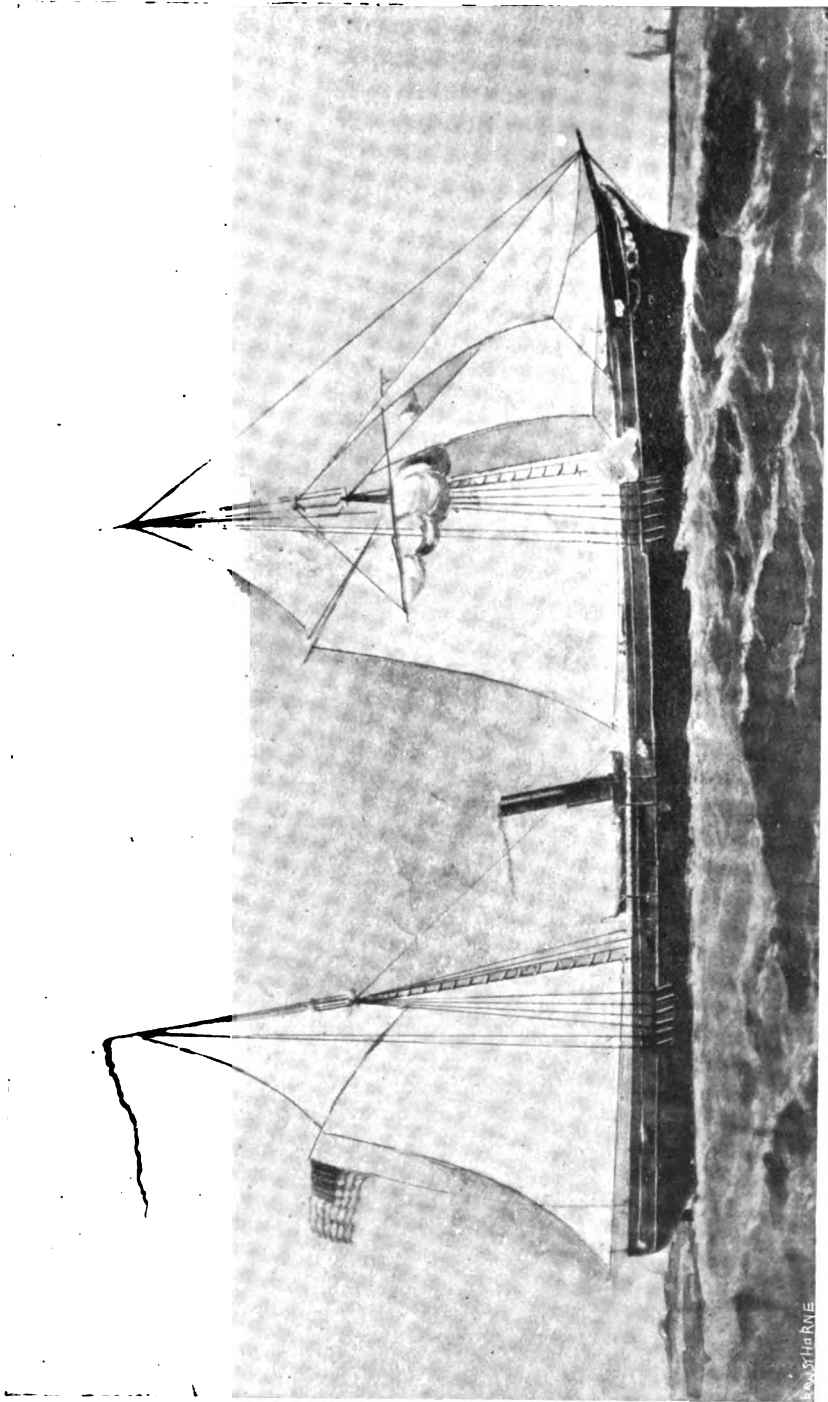

U. S. S. KATAHDIN, 1861.
Type of the Ninety-Day Gunboats. Length, 158' 4"; beam, 28'; disp., 691 tons.

Before work on the fourteen sloops heretofore named had been undertaken, the Navy Department, acting on its own responsibility in the emergency, without waiting for the sanction of Congress, issued proposals and entered into contracts with different builders for the construction of twenty-three small, heavily-armed screw gunboats, of about 500 tons burden, which, from the rapidity of their construction came to be known in the service as "ninety-day gunboats." The contracts were nearly all made during the first two weeks in July, and work was pushed to such an extent that four of them were in the battle of Port Royal on the seventh of November, and seventeen of them were in active service before the end of the year. Their names were: *Huron, Sagamore, Itasca, Sciota, Kennebec, Kineo, Aroostook, Chippewa, Cayuga, Chocura, Kamaroha, Katahdin, Marblehead, Ottawa, Owasco, Pembina, Penobscot, Pinola, Seneca, Tahoma, Unadilla, Wissahickon, and Winona.*

The machinery of the first four named was constructed by the Novelty Iron Works, New York, which establishment duplicated in them the machinery it had previously put into two gunboats built for the Russian government. The machinery for the other nineteen was built by various contractors from designs and specifications furnished by Engineer-in-Chief Isherwood, and was somewhat similar to that of the first four, but with about sixty per cent. more boiler power. The hulls of all these gunboats were built by contract.

For service in shallow and narrow rivers a new and peculiar type of gunboat was developed in the "double-enders," twelve of which were begun during the summer and fall of 1861. These were pointed at both ends and had a rudder at each end, being thus freed from the necessity of turning around by being able to steam at equal advantage in either direction. Paddle wheels had become practically obsolete for war vessels, but the imperative demand for very light draft in these gunboats made it necessary to adopt side wheels for their propulsion. They were the *Maratanza, Mahaska, Sebago, Octorora, Sonoma, Conemaugh, Tioga, Genessee, Miami, Paul Jones, Port Royal, and Cimмерone.* They were of 850 tons burden. The engines were built by contract from Mr. Isherwood's plans, and were of the direct-acting inclined type. All had Bartol's vertical water tube boilers, except the *Paul Jones*, which had Mar-

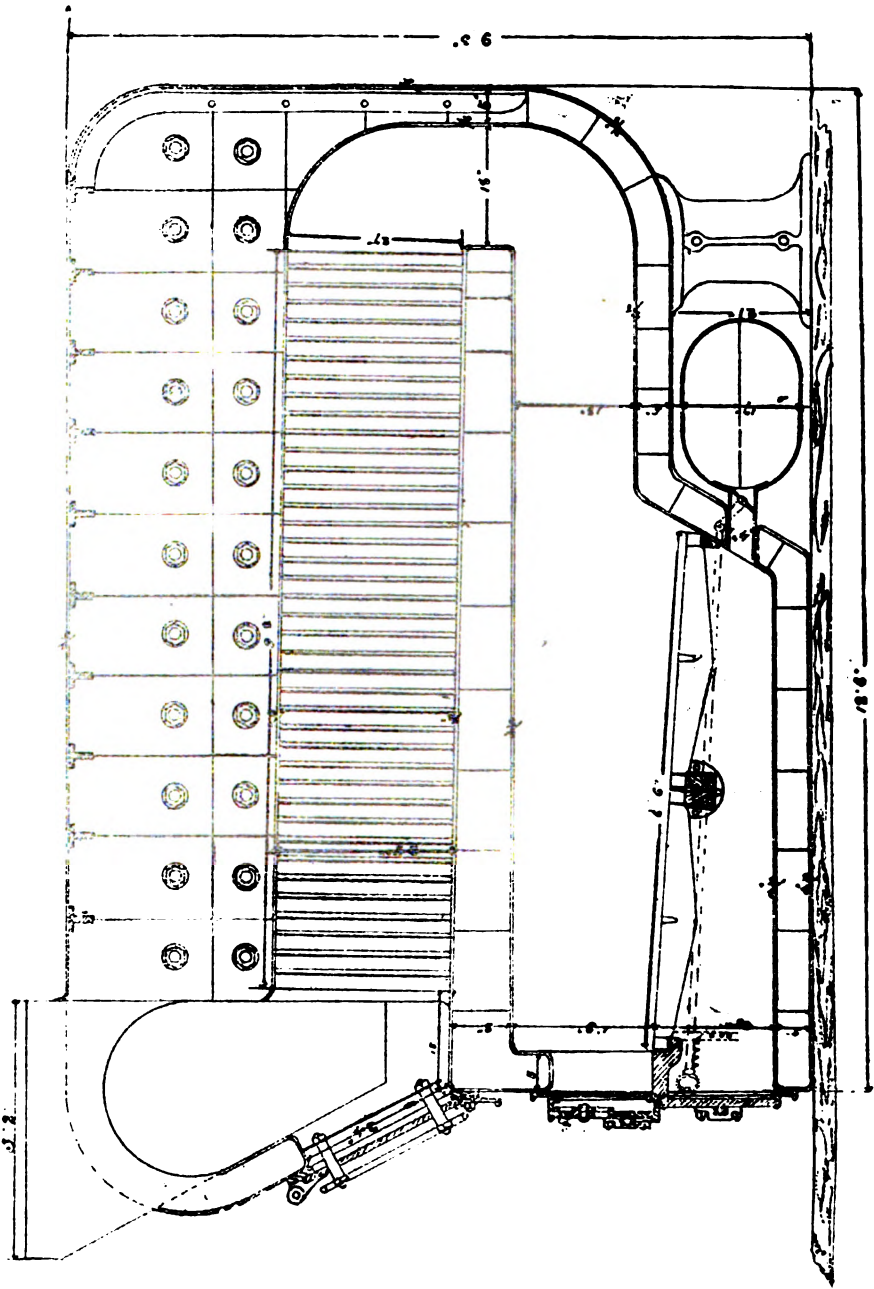

MANUFACTURED BY THE WESTINGHOUSE ENGINEERING AND MACHINE COMPANY

CLAR

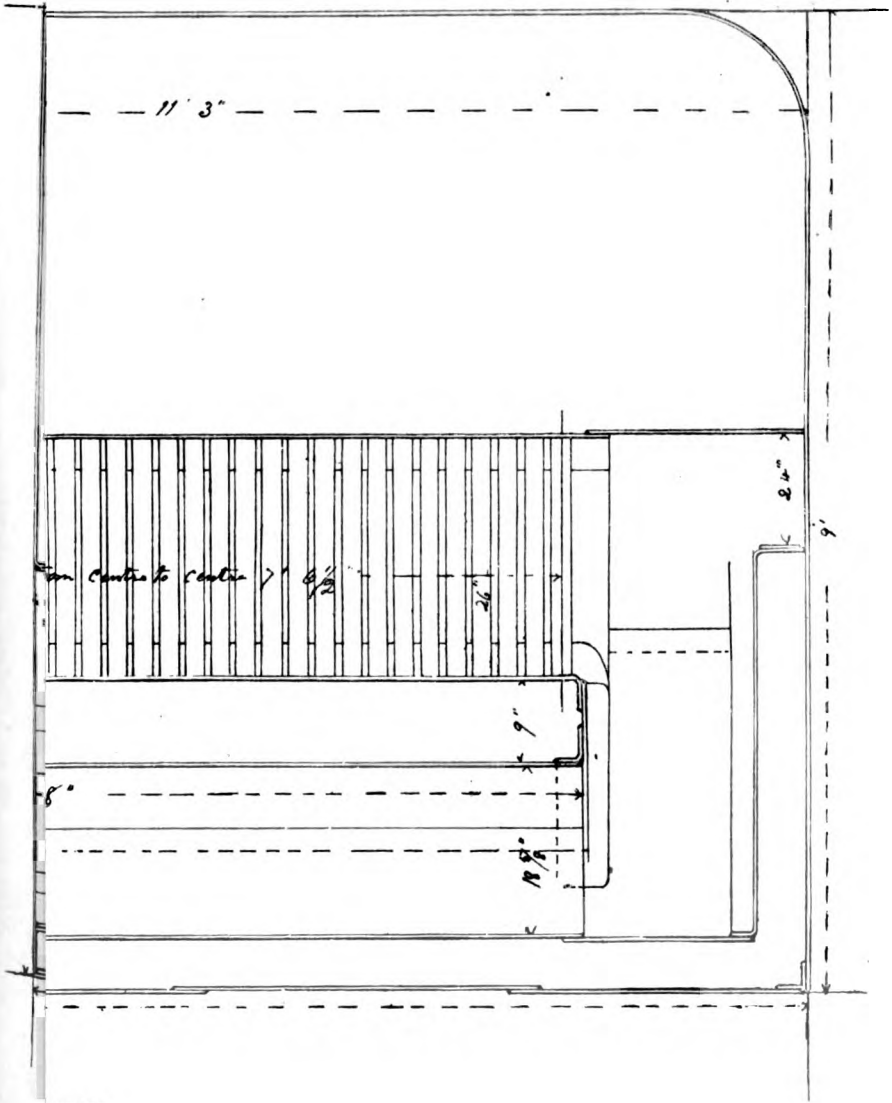

CLASS.

tin's boilers. All had blowers for forcing the draft. The hulls of the last three-named were built by contract, and the other nine in the navy yards.

Besides the forty-nine steamers already referred to, three iron-clad war vessels were undertaken during this same busy year. These, being a new departure in naval construction and marking a development in that direction exactly in line with the naval engineer's profession, will be described in a separate chapter. To quote from the report of the Secretary of the Navy regarding the war-ship building of the year, "No sailing vessels have been ordered to be built, for steam as well as heavy ordnance, has become an indispensable element of the most efficient naval power."

CHAPTER XIV.

"I have seen him in the watch-fires of a hundred circling camps;
They have builded him an altar in the evening dews and damps;
I have read his righteous sentence by the dim and flaring lamps;
His day is marching on."

JULIA WARD HOWE—*Battle-Hymn of the Republic.*

1861. The Civil War, Continued—The Norfolk Navy Yard—Attempt to Save the Frigate *MERRIMAC*—Endeavors of Engineer-in-Chief Isherwood—Destruction of the Yard—Attack on Hatteras Inlet—Destruction of the Privateer *JUDAH* at Pensacola.

WITH the exception of two events in the career of the frigate *Chesapeake* early in the present century, there are few incidents in our naval history more humiliating than the loss of several of our national vessels at the Norfolk navy yard at the beginning of the rebellion. So utterly lacking is this affair in redeeming features that it would be gladly passed over without comment were it not for the fact that the principal efforts to save the nation's honor and property on that occasion were the outcome of the zeal and patriotism of two naval engineers, and for that reason the story must be told as a necessary part of this history.

The navy yard at Norfolk, Virginia, at the beginning of 1861 was the largest and most important of the government navy yards. It was one of the oldest in date of establishment and the most completely equipped with wharves, docks, ship-houses, workshops, and store-houses. Great quantities of naval material and stores had been assembled there prior to the outbreak of the rebellion, among other war material there being about twelve hundred cannon of various types, mostly serviceable, although some of the guns were of very ancient patterns; fifty-two, according to the inventory made by the Confederates immediately after they took possession of the yard, were new nine-inch Dahlgren guns, at that time formidable pieces of ordnance.

At the beginning of April, 1861, the following named vessels were lying at the Norfolk Yard: the new steam frigate *Merrimac*, of

forty guns; the sloop-of-war *Germantown* and *Plymouth*, of twenty-two guns each; the brig *Dolphin*, of four guns; the old ships-of-the-line *Pennsylvania*, *Delaware* and *Columbus*; the frigates *United States*, *Raritan* and *Columbia*; and the sloop-of-war *Cumberland*. An unfinished ship-of-the-line named the *New York* was on the stocks in one of the ship houses. The *Merrimac* was one of those large and beautiful steam frigates of which the Navy was then so justly proud. She had made one cruise, as flagship of the Pacific Station, and had been laid up in the Norfolk yard for an extensive overhauling of her machinery. The sloops *Germantown* and *Plymouth* were completely equipped for sea, but had no crews on board, and the *Dolphin* could have been made ready for sea in a few hours. The frigate *United States* was the same vessel, rebuilt, that had defeated and captured the British frigate *Macedonian* in 1812. The *Pennsylvania* was in commission as the receiving ship and was famous as being the largest ship-of-the-line ever built for our navy, mounting one hundred and twenty guns and being rated as of 3,241 tons, old measurement, which is little more than one-half the present rating by tons displacement. The other large battle ships of that time—the *North Carolina*, *Vermont* and others—carried eighty-four guns and were of about 2,600 tons. The *Cumberland* was the flagship of the home squadron and had just arrived at the yard after the usual winter cruise in Southern waters. She was saved from the destruction that followed, but less than a year later was destroyed by the *Merrimac*, which vessel by all rights should have been the one to have towed her and the other sailing vessels to a place of safety.

The navy yard was commanded by Captain Charles S. McCauley, a native of Pennsylvania, who, according to the custom then prevailing, was addressed as Commodore. The twelve other line officers associated with him were natives of southern states, seven of them being Virginians; three of the four medical officers were Virginians, and a majority of the other staff and warrant officers was likewise of southern nativity. These officers had been assigned to this station by the previous administration and the fact that the preponderance of southerners among them was so great makes it reasonably certain that there was more method than chance in their selection. The Chief Engineer of the yard, Mr. Robert Danby, was a native of Delaware and could be depended upon to stand by his

colors, for the inhabitants of that little State have been distinguished for loyalty and patriotism ever since the "Blue Hen's Chickens," as the Delaware Regiment was called, made such an enviable record in the Continental Army.

One of the first acts of the new engineer-in-chief was to call the attention of the Secretary of the Navy to the possibility of getting the *Merrimac* away from Norfolk, and it is certain that had it not been for him no effort to that end would have been made. The Secretary's mind was engrossed with too many other important matters to give any thought to this particular subject unless it had been urged upon him and, indeed, it is more than probable, as he had been in office less than one month, and that month a most harassing one, that he did not even know that the *Merrimac* was at Norfolk. Mr. Isherwood was familiar with the Norfolk yard and as the work on the *Merrimac's* machinery was an important detail of his office, the subject of saving the ship naturally suggested itself to his mind. By corresponding with chief engineer Danby, Mr. Isherwood had learned of the exact state of affairs, including the information that the Confederates counted surely on having the *Merrimac* as a nucleus for their future navy, which intention Mr. Isherwood determined to defeat if possible. With this knowledge he repeatedly urged Secretary Welles to order the removal of the ship and finally, on the 11th of April, orders were issued looking towards removing the *Merrimac* to Philadelphia, but about this time discouraging news came from Norfolk in the form of an official report saying that it would take a month to get her machinery in condition to move. This estimate of time was so different from the private information received from the chief of the yard that misrepresentation was evident and Mr. Isherwood at his own urgent request was ordered to go to Norfolk in person, take full charge of the *Merrimac*, and get her ready as soon as possible. He carried a peremptory order to Commodore McCauley to place the ship entirely in his hands, which order contained among other directions these words:

"The Department desires to have the *Merrimac* removed from the Norfolk to the Philadelphia Navy Yard with the utmost despatch. The Engineer-in-Chief, Mr. B. F. Isherwood, has been ordered to report to you for the purpose of expediting the duty,



CHIEF ENGINEER ROBERT DANBY, U. S. NAVY.

and you will have his suggestions for that end promptly carried into effect."

Mr. Isherwood arrived at the yard on Sunday morning, April 14th, and immediately, in company with Mr. Danby, made a most thorough examination of the *Merimac's* condition; the machinery was completely dismembered and many parts of it scattered about the shops, but nothing of importance was in such bad condition as to forbid its temporary use. The Navy yard employes had previously abandoned their places, but as many of the machinists and other mechanics were known to Mr. Isherwood and as Mr. Danby had been popular with them, those two officers succeeded that Sunday afternoon and evening in inducing a considerable number of them to resume work for a time. The force thus obtained began work Monday morning and worked night and day, being divided into three eight-hour gangs. Messrs. Isherwood and Danby relieving each other every twelve hours and exercising the most minute supervision over every detail, for they did not wish any mistakes to be made. On Wednesday afternoon Mr. Isherwood had the satisfaction of reporting to the Commandant that he was ready to get up steam. Commodore McCauley was seemingly startled by the suddenness of the preparation, after he had reported that a month's time would be necessary for the work that now appeared to have been done in three days, and when asked for authority to start fires hesitated and finally said; that the next morning would be soon enough, which order the engineers took the utmost advantage of by lighting the fires the very moment that midnight had passed. The following, from Boynton's history of the navy, gives an account of what followed with as much detail as is presented in any of the various historical accounts of this affair:

"About 9 o'clock on Thursday morning the report was made to Commodore McCauley that the vessel was ready to proceed, when he replied that he had not yet decided to send the steamer out. It was in vain that he was reminded of the peremptory nature of the order which Mr. Isherwood brought from the Secretary of the Navy, to get the Frigate out at the earliest possible moment and send her to Philadelphia; he only replied that in the course of the day he would let his decision be known. He seemed to fear that

obstructions had been placed in the channel. He was told by those who were well informed that the obstructions already there would be easily passed by the *Merrimac*, but that every night's delay would increase the danger. All this produced no effect. Early in the afternoon Mr. Isherwood again called upon Commodore McCauley, who then said that he had decided to retain the frigate, and ordered the fires to be drawn. He was again reminded of the peremptory nature of the orders from the Navy Department, but it seemed to produce no impression; he had determined to retain her, and thus the noble frigate was lost."

The writer has been at great pains to get at the real truth of this event and with that object in view has made a careful study of the various official reports and documents relating to the case, as well as making use of numerous histories which treat of naval operations during the Civil War. More recently he has been favored with a thorough and most carefully written account of the affair from the pen of the chief actor—Chief Engineer Isherwood—which throws light upon some of the dark places found in the usual accounts, and which will be made use of as this narrative progresses. The principal officers concerned in the event were called upon to testify before the Senate Committee which investigated the Conduct of the War, and, while they told the truth so far as they went, they told no more than was necessary, for at that time it would not have been either patriotic or politic, to have made some of the details public; and this restriction applies to a considerable extent even yet.

Commodore McCauley's conduct appears highly inconsistent with the theory that he was loyal to the Government and anxious to defend his country's honor, notwithstanding which all the evidence shows that he was both loyal and patriotic. At the time of this trouble he had been *fifty-two* years in the Navy, having lived all through that long and uneventful period following the war of 1812, which may well be called the Dark Age of our naval history, during which midshipmen grew to middle age before becoming lieutenants, and then remained in that grade until old age was actually upon them, before they rose to a position of individual responsibility. He was surrounded by younger officers who, as we have already

seen, were southerners and who systematically deceived him by false rumors and imaginary difficulties, but, upon whom the Commodore depended entirely, never doubting their loyalty to him, until they actually deserted their posts of duty.

In addition to the perplexities of the actual situation at the navy yard, the Commodore was hampered with political instructions from Washington which simply added to his bewilderment. There was a false hope that Virginia would not secede, and President Lincoln was led to believe by arguments and influences that probably no one but himself ever knew, that an attitude of confidence and trust towards Virginia, on the part of the Federal Government would so conciliate the people that they would remain true to the Union. This in spite of the fact that Norfolk was full of armed men openly avowing their intention to seize upon the Navy yard, and that the Virginia authorities had begun obstructing the channels and placing guns to oppose the egress of any of the national vessels. So commodore McCauley was repeatedly cautioned not to do anything that might appear hostile, or provoking to the Virginians, and at the same time he was ordered to save the public property under his command by any means in his power.

All these contradictions and perplexities were too much for the Commodore to unravel, having spent the greater part of his life in a sphere where he only did what some one else told him to do, it is no wonder therefore, that the poor old man was unable to rise to the occasion. To his mind, long before narrowed to follow the one straight line of naval customs and precedents, the situation was most irregular and wholly inexplicable. His common sense told him that the information that his subordinates gave him could not be true, and yet he accepted it as truth because he himself had always been true to his superiors, and naval laws explicitly required such loyalty. Never before had he heard people talk of taking possession of a navy yard, a place sacred by every tradition of the service to the imperial sway of the commandant; never before had navy yard workmen been known to leave their employment and refuse to return except as hostiles; never before had the majesty of a navy yard been outraged by officers walking out of the gates without leave, and without written orders properly endorsed by the commandant as required by regulation. And then, as if to prove that all signs

had failed, the infallible regulations themselves contained not a word of instruction as to what to do in case of insurrection and threatened seizure of a navy yard. The fault was not with Commodore McCauley, but with the system that had trained him.

Mr. Isherwood thus graphically describes the pitiful situation of the Commodore at this trying time:

“The Commodore was in a state of complete prostration. He sat in his office immovable, not knowing what to do. He was weak, vacillating, hesitating, and overwhelmed by the responsibilities of his position. He listened blandly, or seemed to listen, to what was said to him, but could not be made to give any order or take any action. I kept reporting to him what I was doing and what I intended to do. He looked vaguely at me, nodded his head, but said nothing. He behaved as though he were stupefied. He was a very good man, personally brave and loyal, perplexed in the extreme, deserted by his officers, and utterly unequal to the occasion. As a subordinate he would have done well; as a principal he was a wretched failure. I endeavored to advise him, to explain the object of the Department, and to make him understand the necessity of getting the *Merrimac* out at once, and I told him we could tow out at the same time several other vessels. I knew the Navy Yard would be in our possession but a few days longer, and wanted to save all the public property I could, as well as to diminish the force of the enemy by preventing it from falling into their hands. All was in vain. I could not get him to do anything. He never came near the vessel.”

After getting up steam Thursday morning Mr. Isherwood kept the engines running at the dock all day as a visible sign that the Frigate was ready to go; he had got enough coal and stores on board by his own exertions (for no official of the Yard except Mr. Danby aided him by word or deed during all this time) to take the vessel as far as Newport News where she would be safe. Knowing that Commander Alden, who had been ordered to take command of the vessel after her machinery had been put in working order, was meeting with every obstacle that red-tapeism could suggest to prevent his getting men, Mr. Isherwood had inquired among his mechanics and found some who had been to sea, and these he de-

tailed as wheelmen to steer the vessel. By lavish promises of pay he secured a sufficient number of the others to act as firemen, oilers, etc. and these men faithfully agreed to work the ship as far as Newport News, which promise they undoubtedly would have kept, as they needed the large sums offered them, and they were under many obligations to Chief Engineer Danby for liberal treatment when employed under him in the yard. Mr. Isherwood also on his own authority had the chain cables that secured the ship to the dock removed and replaced with rope hawsers and he had provided axes and stationed men with them to cut the hawsers when the word to go was given. Many other details of preparation were attended to by him and throughout the day the vessel was entirely ready to go out, which she could easily have done without a pilot as she was so light without coal, guns, or stores that she would easily have passed over the obstructions already in the channel. But the commandant would not say the word which would have authorized them to start.

It is pertinent to say just here, that the orders to Mr. Isherwood gave him full and absolute authority over the ship until the engines were in condition to drive her; then Commander Alden was by his orders to assume command and take the ship to sea. Had this authority been vested in Mr. Isherwood the *Merrimac* would have been saved and the carnage that Hampton Roads saw the following March would never have been heard of. As it was, Mr. Isherwood had to resist a very strong temptation to take charge of the ship himself, but he had been in the service too many years not to understand the full significance of the laws and regulations that declared staff officers not eligible to exercise command, and he felt that no meritorious result of such an assumption on his part, even if it were the saving of one of the finest ships in the Navy, would serve to excuse his encroachment upon the prerogatives held as belonging only to another class of officers. Mr. Isherwood himself writes as follows relative to this perplexing crisis:

“As I witnessed the gradual dying out of the revolutions of the *Merrimac's* engines at the dock I was greatly tempted to cut the ropes that held her, and to bring her out on my own responsibility. This would have been my destruction, for then, the disasters which

followed her detention, and which are my justification for the desire to take the matter into my own hands, would not have happened."

The last act in this miserable affair, when the commandant finally refused to allow the ship to leave and directed her fires to be hauled, is told by Chief Engineer Isherwood in a letter to the writer, as follows:

"Although I could not get the Commodore to take any decisive action I kept the engines working at the dock all day in hopes that he might be persuaded to carry out the plain intentions of the Department. Late in the afternoon, at our last interview, he told me to draw the fires and stop the engines as he had decided to retain the vessel and meant to defend the yard. I looked at him with amazement, went over the case again, urged the orders and the desire of the Department, told him the inevitable consequences of his decision, tried to show him the utter absurdity of attempting to defend an unfortified navy yard without men or any military means at command, for by this time he was absolutely alone. But he was brave, had a high sense of honor and duty and considered himself bound to struggle to the last. If he had had the smallest force on which he could have depended he would have died gallantly, and I believe gladly, at its head, sword in hand against any odds.

"Finding that I could not move him and that he was growing impatient at my reiterated appeals I drew from my pocket the order of the Department to me, wrote upon it the usual indorsement that having completed the duty assigned me to return to Washington, and laid it before him. He understood the significance of the act, but signed the indorsement without a word. With great sorrow and chagrin I dismissed my men, waited until the engines made their last revolution, when I left the navy yard, and have never seen it since."

On Wednesday, the 17th of April, the State Convention of Virginia had passed the Ordinance of Secession, so there was no excuse whatever on Thursday, for maintaining a pacific attitude at the yard for fear of provoking the disloyal sentiment among the inhabitants into open rebellion; the rebellion was already declared

and the time for temporizing had passed. Why the *Merrimac*, with her engines working and a sufficient number of men on board to handle her, did not that day tow out to safety the other vessels is one of those speculative questions that cannot be satisfactorily answered. Like many other controversies over sins of omission in the past, this question is important chiefly on account of the disasters that followed in the footsteps of the first error, the knowledge of which was of course hidden at the time that its possession would have incited action on the part of those whose failure it is now easy to criticise.

Mr. Isherwood's work on the *Merrimac* was known to all in Norfolk, and naturally, was greatly resented by the populace, as it was a menace to the prospects of possessing the ship. In fact, only a week before, the *Merrimac* had been moved under the shears of the ordnance wharf to have her guns placed on board, and this act had raised such a howl of protest that the commandant had stopped the work and moved her back, so we can readily understand the feeling when it was known that her machinery was being fitted for use. A plot to capture Mr. Isherwood and hold him as a prisoner of war was hatched, and it was only by chance that he escaped falling into the hands of his country's enemies. Fortunately for him, a civilian in the town, who knew of the plot, was his warm personal friend and this gentleman warned him of his danger. The friend engaged a room on the Baltimore steamer in the morning, in his own name, and took possession of it with Mr. Isherwood's trunk, going later with a closed carriage to the hotel and conveying the unwelcome guest to the steamer, where he remained locked in the room until the boat was well out in Chesapeake Bay. A party of Confederates waited for hours on the wharf for him to arrive, and only knew by going to the hotel after the steamer had left, that their enemy had outwitted them and escaped. After his return to the Department Mr. Isherwood made a short written report of his connection with the *Merrimac*, and the Secretary and himself never exchanged a word about it. It was tacitly understood that the subject was to be ignored, as one not politic for the public to know in the existing state of high feeling and excitement, and it was ignored.

Following closely upon the events before narrated, came the order to abandon the navy yard. Captain Hiram Paulding, in the

steam sloop-of-war, *Paonoe* with one hundred marines and a raw regiment of Massachusetts volunteers went up to the yard on April 20 and found the *Germantown*, *Plymouth*, and *Dolphin* scuttled and rapidly sinking, which prevented him from carrying out his intention to use those vessels to defend the channel. Feeling that the yard was hopelessly lost, and not wishing to let anything of value fall into the hands of the enemy, he ordered the destruction by fire of everything inflammable, and the work-shops, ship-houses, many of the ships, and numerous other buildings went up in smoke that night. The guns were spiked and many of them permanently ruined by knocking off the trunnions, but all efforts in this direction failed with the Dahlgren guns and they afterward became dreaded weapons in the hands of the enemy. The wild scene of destruction was of unearthly awfulness and sublimity utterly indescribable. The upper works of the *Merrimac* were burned away, but the submerged portion of the hull remained intact and was subsequently used with terrible effect.

As the morning of Sunday, the 21st, approached, the *Paonoe* took the *Cumberland* in tow and departed, leaving behind no vestige of the sovereignty of the United States. The Confederates rushed in as the Union forces left, extinguished the train that was to blow up the granite dry dock, saved the officers' houses and some other buildings, and thus provided themselves with the nucleus for a great naval station. Thus was public property to the value of ten millions of dollars destroyed or lost to the Government. One of the vessels which escaped destruction that dreadful night was the historical old frigate *United States*, but her respite was brief, for, in May of the following year, when the Confederates in turn had to abandon Norfolk, she, too, notwithstanding the glorious memories that clustered about her, was burned to ashes.

In the latter part of August, 1861, an expedition planned by the Navy Department, and commanded by Flag Officer Stringham, proceeded from Hampton Roads to attack Hatteras Inlet, which place had been fortified and armed with guns taken from the Norfolk navy yard. Two transport steamers, carrying about nine hundred troops under the command of Major General Benjamin F. Butler, accompanied this expedition as a part of the combined attacking force. The naval vessels composing the squadron were the

steamers *Minnesota*, *Wabash*, *Susquehanna*, *Monticello*, *Pawnee*, and *Harriet Lane*, and the sailing frigate *Cumberland*. About thirty engineers of the navy were attached to these vessels and in their appointed stations performed their duties thoroughly and well, keeping the motive power of their vessels in a constant condition of readiness and efficiency to meet any demand that the exigencies of the expedition might require.

The squadron arrived off Hatteras on August 28, and immediately landed the soldiers and marines to attack the fortifications from the land, in conjunction with the bombardment from the ships, which was maintained all the afternoon and resumed the morning of the 29th, ceasing only with the surrender of the enemy about 11 A. M. that day. The most exciting event connected with this affair was a bad quarter of an hour experienced by the *Monticello*, during which she narrowly escaped destruction. This small steamer, after assisting in landing the marines and soldiers, was supplied with a local coast pilot by the flag-ship and ordered to go in through the inlet to see what was going on inside. The pilot, either by design or through ignorance, took her into the wrong channel and she began to strike bottom when in dangerous proximity to the forts, the shoalness of the water finally obliging her to abandon her undertaking and to try to work out to sea again. Seeing the *Monticello* in this distress the large fort of fifteen guns, which had not molested her up to that time, opened on her with a furious cannonade, which was returned with the fire of such guns as could be brought to bear. By working the engines rapidly back and forth, to take advantage of the swell and eddying currents, the ship was finally turned around and worked out of her dangerous predicament, not, however, until she had suffered seriously from the merciless storm of shot and shell poured upon her. Her escape from destruction was due in large measure to the skill and ability of the engineers under whose alert charge the machinery responded instantly to every movement required. Commander John P. Gillis, who commanded the *Monticello* at the time, in reporting this experience expressed his indebtedness to the acting chief engineer of the ship—Mr. George M. Waite—“for his care and promptness in the management of the engine.” The assistant engineers of the *Monticello* at this time were Messrs. Jonathan Thomas and Columbus L. Griffin.

On the night of September 13, the U. S. S. *Colorado*, lying off Fort Pickens, Florida, sent out an expedition in four boats against the navy yard at Pensacola then in possession of the Confederates; the objects of the expedition being the destruction of the schooner *Judah* fitting out at one of the docks for a privateer, and the spiking of a gun in battery at the southeast end of the yard. The party consisted of exactly one hundred officers, seamen and marines, the officers being Lieutenants Russell, Sproston, and Blake, Captain Reynolds of the marine corps; Assistant Surgeon Kennedy, Assistant Engineer George H. White, Gunner Boretton and Midshipmen Steece, Forrest and Higginson.

The attack was made on the morning of the 14th at half past three o'clock. Instead of surprising the enemy, the crew of the *Judah* was found awake and ready to receive the expedition, doing great damage with musketry fire as the boats approached, and not giving up their vessel until after a most desperate hand-to-hand combat on the deck. The schooner being captured and set on fire, and the gun spiked, the naval expedition withdrew, for by that time the yard was as busy as a hornet's nest and fully one thousand Confederates were swarming for an attack. The Union party had three men killed and twelve wounded, among the latter being Captain Reynolds of the marines and Midshipman F. J. Higginson, who had the end of his thumb shot off.

Assistant Engineer White's part in the exploits of the night is indicated by the following extracts from the official report of the affair:

"In the meantime the vessel was set on fire in several places. That which finally consumed her was lighted in the cabin by Assistant Engineer White and a coal-heaver Patrick Driscoll, who went as a volunteer."

"Assistant Engineer White brought down from the cross-trees of the schooner a man who had been seen to fire upon the boats, killing him instantly."

CHAPTER XV.

"I have read a fiery gospel writ in burnished rows of steel;
'As ye deal with my contemners so with you my grace shall deal';
Let the Hero, born of woman, crush the serpent with his heel;
Since God is marching on."

JULIA WARD HOWE—*Battle Hymn of the Republic*

1861. The Civil War, Continued.—Expedition of Flag Officer Du Pont to Port Royal.—Loss of the *Governor*.—Naval Battle at Port Royal.—Killing of Assistant Engineer Whittemore on the *Mohican*.—The Affair of the *Trent*.

IN dividing the coast for convenience in maintaining the blockade proclaimed along the entire sea line of the insurgent states the limits of the South Atlantic blockading squadron were fixed at the boundary line between the Carolinas on the north and Cape Florida on the south. This region being far from any of the Union ports it became necessary to establish somewhere within its limits a harbor of refuge in heavy weather where a repair station and depot could be maintained. In order to seize such a place and hold it with a strong garrison a large combined army and naval expedition, commanded by Flag Officer Samuel F. DuPont and Brigadier General T. W. Sherman (not Wm. T. Sherman), was fitted out and sailed from Hampton Roads on the 29th of October. The frigate *Wabash*, Commander C. R. P. Rodgers, was the flagship, and the fleet, numbering forty-eight vessels including the troop ships, was the largest ever before assembled under our flag. A fleet of twenty-five schooners laden with coal was despatched the previous day under convoy of the sailing sloop of war *Vandalia* with orders to rendezvous at sea off Savannah.

On November 1st the fleet was scattered by a furious gale from the southeast, approaching a hurricane in violence, and some of the vessels fared very badly, especially the transports which had been hurriedly purchased or chartered and in some cases were actually unseaworthy. The steamer *Governor*, in which was embarked the fine battalion of marines, foundered, and the marines with seven exceptions were rescued by the frigate *Sabine* and the steamer

Isaac Smith, the latter vessel having been obliged to throw over-board her battery to save herself. The transport *Peerless* also went down and her people were taken off in boats under the most perilous circumstances by the crew of the *Mohican*.

The selection of the point to be captured was left entirely to the judgment of Flag Officer DuPont, who decided that Port Royal, South Carolina, was the best located and most suitable for a station for the blockading squadron. Accordingly as the vessels began to reassemble after the gale, the *Wabash* led them to the vicinity of that place and anchored off the bar during the day of November 4. All buoys and other aids to navigation had been removed by the enemy, which made it necessary to find, sound, and buoy the channel before any of the vessels could venture further, the bar being several miles off shore. This work was done under the direction of Mr. Bontelle the Assistant Chief of the Coast Survey, who was very familiar with the coast in this region and who was fortunately with the expedition in charge of a small steamer named the *Viam*. Late in the afternoon the transports drawing less than eighteen feet of water and all the gun-vessels were sent to the anchorage in Port Royal roadstead, the gunboats having a brush with two or three Confederate steamers under command of Commodore Tatnall, of "blood is thicker than water" fame, and drove them under the shelter of the batteries on Bay Point and Hilton Head (Forts Beauregard and Walker).

The next morning, November 5, the grave responsibility of hazarding the noble frigate *Wabash* in crossing the bar was assumed by DuPont and that vessel, thanks to the careful work of Mr. Bontelle, was safely taken inside, followed by the side-wheel frigate *Susquehanna* and the deep-draught transports. Immediate preparation for action was made but various delays, among them the grounding of the *Wabash* after getting into the roadstead, occurred and night came on before the fleet was ready, while a south-westerly gale the following day again postponed the assault.

On the morning of November 7 the fleet got under way to attack the forts, the order of battle comprising a main squadron ranged in line ahead, and a flanking squadron to engage the enemy's vessels and prevent them from cutting off any of the vessels that might be disabled and fall out of action. The main squadron was

made up of the *Wabash*, *Susquahanna*, *Mohican*, *Seminole*, *Parnee*, *Unadilla*, *Ottawa*, *Pembina*, and the sailing-sloop *Vandalia* towed by the *Isaac Smith*; the flanking squadron was composed of the *Bienville*, *Seneca*, *Curlow*, *Penguin*, and *Augusta*. The battle was opened by a gun from Fort Walker at 9:26 A. M. and ended about 2 P. M.; the enemy abandoning his works with great zeal and precipitation. Commander O. R. P. Rodgers with a force of marines and blue jackets went ashore from the *Wabash* and took possession of Fort Walker and by nightfall a brigade of troops was landed and in possession. At sunrise the next morning Lieutenant commanding Daniel Ammen of the *Seneca* landed and hoisted the American flag on Fort Beauregard. The forts were badly damaged by the furious cannonading to which they had been subjected, the terrific nature of which can be understood from the fact that the *Wabash* alone fired nearly nine hundred shells, besides grape and shrapnel.

The foregoing briefly outlines the circumstances attending the taking possession of the forts by the Union forces, and is given in the usual form in which the event is recorded in history. The following extracts from Flag Officer DuPont's detailed report of the engagement furnish the foundation for the bestowal upon the distinguished Rodgers brothers of the honor of landing first and personally taking possession of Fort Walker:

"I sent Commander John Rodgers on shore with a flag of truce. The hasty flight of the enemy was visible, and was reported from the tops. At twenty minutes after two Captain Rodgers hoisted the flag of the Union over the deserted post. At forty-five minutes after two I anchored and sent Commander O. R. P. Rodgers on shore with the marines and a party of seamen to take possession, and prevent, if necessary, the destruction of public property."

"Commander John Rodgers, a passenger in this ship, going to take command of the steamer *Flag*, volunteered to act upon my staff. It would be difficult for me to enumerate the duties he performed, they were so numerous and various, and he brought to them all an invincible energy and the highest order of professional knowledge and merit. I was glad to show my appreciation of his

great services by allowing him the honor to hoist the first American flag on the rebellious soil of South Carolina.”

In large operations of this nature it is customary, and perhaps proper, to give credit for worthy deeds to the officer who commands, the acts of his subordinates being assumed to be his own. The actual details attending the landing at Fort Walker differ somewhat from the usual historical accounts, and have been learned by the author from some documents loaned him by Mr. Hillary Messimer, Superintendent of Motive Power of the Calumet and Hecla Mining Company, one of the most important papers being a letter written in 1883 by Rear Admiral C. R. P. Rodgers, then on the retired list.

It appears from these records that Third Assistant Engineer Hillary Messimer of the *Wabash*, hereafter referred to as having excited the admiration of his superior officers by his coolness and attention to duty during the action while stationed at the engine-room signal on the bridge, was selected by Flag Officer DuPont to take charge of an armed party of marines to land and spike the guns in the fort should the enemy show any signs of returning. Mr. Messimer's party took, besides the necessary tools, an American flag with which he landed and was inside the works with men stationed at the guns ready to spike them before Commander John Rodgers set his foot on the shore. The latter officer shoved off from the *Wabash* when Messimer's boat was almost on shore and his men about to jump overboard to land, in doing which a few moments later Messimer took care to be first, although followed closely by his men, and to him belongs the credit of being the first person from the Union force to land in this stronghold of the enemy. With his own hands, assisted by a marine corporal, Mr. Messimer hauled down the Confederate flags from the general and regimental headquarters, after which, leaving a sergeant in command of the spiking party, he went down to the beach to meet Commander C. R. P. Rodgers then landing with a force of men from the *Wabash*.

After receiving and approving Messimer's report of what he had done, Commander Rodgers ordered him to go off to the flagship and deliver to Flag Officer DuPont the captured flags and five Confederate prisoners whom he had taken, and then to return to the fort with the chaplain of the ship to bury the dead; all which

was done. A sword carried on board the *Wabash* with the Confederate flags was afterward given to Mr. Messimer by Flag Officer Dupont with the complimentary remark, "You have earned it."

This engagement furnishes one of the many striking instances illustrative of the division of families over the issues which caused the Civil War. The Confederate commander of the works at Port Royal was General Drayton brother of Commander Percival Drayton of the Federal navy, whose vessel, the *Pocahontas*, was so disabled in the gale on the voyage down that he did not arrive in time to be assigned a position in the order of battle, but he succeeded in reaching the scene of action about noon and rendered gallant service by engaging the batteries on both sides in succession, and aided materially in driving his brother and his men out of the works.

Several of the vessels engaged were badly cut up by the fire from the forts and it was a matter of surprise, expressed at the time in the official reports, that the casualties under the circumstances were not greater than they were. These amounted to eight killed and twenty-three wounded, seven of the latter severely. The only officer killed was Third Assistant Engineer John W. Whittemore, of the *Mohican*, who was stationed on deck at the engine room telegraph where he was instantly killed by a solid shot coming through the hammock rail and driving before it a piece of an iron bolt or screw from the rigging which passed through his head. Mr. Whittemore was the son of a celebrated Universalist minister of Boston, and was a highly cultured and accomplished young gentleman, whose New England spirit of patriotism had impelled him to enter the naval service in a capacity where he felt he could serve his country most usefully. He had been in the service less than three months at the time of his death, but in that short time his many admirable qualities had greatly endeared him to all who were associated with him.

On the same vessel another assistant engineer, Mr. Mayland Cuthbert, narrowly escaped being killed while at his post of duty in the starboard gangway in charge of the fire division. A shot struck the main yard and cut the jack stay into pieces, one of which took an oblique direction downward, striking Cuthbert in the thigh and inflicting a frightful wound, in which the femoral artery was laid bare, but fortunately not cut. The vacancy on the *Mohican* caused

by the killing of Whittemore was filled by transferring Assistant Engineer Absalom Kirby from the *Pocahontas*, which fact is mentioned because, by a curious coincidence, Mr. Kirby had narrowly escaped being killed in the action under the same circumstances leading to the death of Mr. Whittemore. He, also, was stationed at the engine-room bell, which on the *Pocahontas* was attached to the main mast, and while standing at his station a solid shot passed through the mast within a few inches of his head, showering him with splinters but doing him no serious harm.

Attached to the various steamers of the assaulting squadron were about seventy-five officers of the Engineer Corps, regulars and volunteers, all of whom acquitted themselves with great credit and by their skilful performance of duty, contributed very materially to the success of the undertaking. The chief or senior engineers of the different vessels engaged were the following: *Wabash*, J. W. King; *Susquehanna*, Geo. Sewell; *Mohican*, E. D. Robie, *Seminole*, R. L. Harris; *Pawnee*, W. H. Rutherford; *Unadilla*, Edw. Marsland; *Ottawa*, W. W. Dungan; *Pembina*, Jefferson Young; *Isaac Smith*, J. Tucker; *Bienville*, W. H. Wright; *Seneca*, J. W. de Krafft; *Ourlow*, George R. Emory; *Penguin*, M. P. Randall; *Augusta*, George V. Sloat. Mr. J. M. Hobby, who at a later period in the war signally distinguished himself as chief engineer of the *Sasacus* in battle with the ram *Albemarle*, was, on this occasion, the first assistant of the *Susquehanna*.

That one at least of the vessels was kept in action by the ability of her engineers is shown by the following extract from the report of the commanding officer of the *Ourlow*:

“Messrs Emory, Swasey, McConnell, and Loyds engineers of the vessel, with great difficulties to contend against, in the general unfitness of engine, boilers and condensing apparatus, for such rough service, managed to carry us through the action, for which I was thankful.

Commander C. R. P. Rodgers of the flag ship reported as follows regarding the work of the engineers of that vessel.

“The engine and steam, during the whole action, were managed with consummate skill, which did great credit to Chief Engineer King and his assistants. Third Assistant Engineer Messimer, who

stood upon the bridge by my side during the action, impressed me very favorably by his cool intelligence and promptness."

Flag officer DuPont also mentioned Mr. Messimer's excellence in his report of the battle, and in other reports of commanding officers occur references from which one concludes that the engineers were very necessary officials and a part of the combatant element of the fleet.

The affair of the *Trent*, on account of its international aspect, attracted probably more attention and wide-spread interest than any other single event connected with the operations of the Navy during the Civil War, and, as two officers of the engineer corps were prominently concerned, it is proper that a brief account be given in this work. The U. S. Steamer, *San Jacinto*, commanded by Captain Charles Wilkes, was employed the latter part of this year in cruising about the West Indies seeking for the Confederate privateer *Sumter*, which had committed numerous depredations in those waters; the last day of October the *San Jacinto* went into the port of Havana, where Wilkes learned that Messrs Mason and Slidell, commissioners from the insurgent states to England and France, were about to sail from that port for St. Thomas on their way to Europe in the British mail steamer *Trent*. These gentlemen with their families and secretaries had escaped from the blockade about Charleston in a famous swift blockade-runner, the *Theodora*, which had landed them at Cardenas in Cuba. Captain Wilkes was a grim, taciturn seaman of the old school, which had for its chief article of faith the celebrated sentiment of Stephen Decatur—"Our country! In her intercourse with foreign nations may she always be in the right; but our country, right or wrong,"—so when he learned of the proposed expedition of the Confederate emissaries to preach disruption of the Union abroad, there was, according to his lights, but one course of action to pursue, and that was, to intercept them, "right or wrong."

With this determination in his mind Captain Wilkes went to sea on the 2nd of November, after having coaled ship in Havana, and for a day or two cruised along the northern coast of Cuba looking for the *Sumter*; then he went over to Key West hoping to find the *Powhatan* to accompany him on his intended enterprise, but that ship had gone to sea the day before, thus making it necessary

for the *San Jacinto* to watch for the *Trent* alone. The *Trent* was scheduled to sail from Havana on the 7th of November, and to make sure of her, Wilkes went down the coast some two hundred and forty miles to a place on the sea route to St. Thomas where the old Bahama Channel narrows to a width of fifteen miles; here the *San Jacinto* arrived on November 4 and laid in wait for her prey, with all the patience of a red Mohawk lurking sleeplessly on the trail over which his enemy might pass. About noon of November 8 the *Trent* ran into this fatal snare and was hove to by a shell thrown across her bows, after a shot had been disregarded.

The interesting details of what happened when the *Trent* was boarded are given hereafter in the copies of official reports of the boarding officers. For the present it is sufficient to say that Messrs. Mason and Slidell, after refusing to leave the mail steamer, were man-handled and put into the boats of the *San Jacinto*, taken aboard that vessel as prisoners, and ultimately incarcerated in Fort Warren, Boston Harbor. The *Trent* was allowed to resume her voyage after the commissioners had been taken. After a few weeks imprisonment Mason and Slidell were delivered to the British government in response to a demand not over gracious made by Earl Russel. Captain Wilkes made a mistake in allowing the *Trent* to escape, for the weight of precedent, established by decisions of the British admiralty courts, was largely on the side of the theory that neutral vessels knowingly carrying officials or despatches of the enemy were liable to capture and condemnation. No accepted principle of international law justified the act of taking the commissioners out of the vessel, and no nation but England had ever insisted upon such a right; indeed, in 1812, the United States had gone to war with the mother-country in opposition to the very doctrine involved in Wilkes' act.

It is not probable, however, that Wilkes' technical breach of international law in failing to take the *Trent* into port as a prize had any real effect upon subsequent events in the case; such a procedure would have been entirely in accord with the established rules of war, but the wave of popular indignation and rage which swept over England when the passengers of the *Trent* came home with their tale, is sufficient proof that considerations of abstract right would not have a determining part in the action taken by the

British Government. The United States, being fully employed in the task of suppressing the most gigantic rebellion that ever threatened a nation's life, could not engage in war with powerful neighbors disposed to seek it, and the demands made had to be acceded to whether agreeable or not. A few years later, when the rebellion was crushed, and the United States had a million armed men, hardened by years of campaigning both ready and willing for any service, and our navy, with five hundred vessels in commission, possessed the heaviest iron-clads and the swiftest cruisers in the world, another controversy between England and our country ended in the former swallowing her pride, and accepting the decidedly humiliating terms imposed by an arbitration commission. The two events, considered singly or together, are an excellent illustration of the truth of the principle, that might more frequently than right determines the actions of nations as well as of men.

The officers of the *San Jacinto* who boarded the *Trent*, although performing a duty in which they had no personal concern, were treated with great contempt and indignity on board that vessel, and exhibited in return a spirit of forbearance and dignity highly creditable to them, and the service which they represented. The details of their experience on board the *Trent* are usually eclipsed by the more important complications growing out of the event; they are, however, most interesting as showing what naval officers sometimes have to do in the line of their varied duties, and are here presented in the form of the reports made by the boarding officers.

UNITED STATES STEAMER SAN JACINTO,
At Sea, November 12, 1861.

SIR: At 1:20 p. m., on the 8th instant, I repaired alongside of the British mail packet in an armed cutter, accompanied by Mr. Houston, second assistant engineer, and Mr. Grace, the boatswain.

I went on board the *Trent* alone, leaving the two officers in the boat with orders to await until it became necessary to show some force.

I was shown up by the first officer to the quarter-deck, where I met the Captain and informed him who I was, asking to see the passenger list. He declined letting me see it. I then told him that I had information of Mr. Mason, Mr. Slidell, Mr. Eustis, and Mr.

McFarland having taken their passage at Havana in the packet to St. Thomas, and would satisfy myself whether they were on board before allowing the steamer to proceed. Mr. Slidell, evidently hearing his name mentioned, came up to me and asked if I wanted to see him. Mr. Mason soon joined us, and then Mr. Eustis and Mr. McFarland, when I made known the object of my visit. The captain of the *Trent* opposed anything like the search of his vessel, nor would he consent to show papers or passenger list. The four gentlemen above mentioned protested also against my arresting and sending them to the United States steamer near by. There was considerable noise among the passengers just about this time, and that led Mr. Houston and Mr. Grace to repair on board with some six or eight men, all armed. After several unsuccessful efforts to persuade Mr. Mason and Mr. Slidell, to go with me peaceably, I called to Mr. Houston and ordered him to return to the ship with the information that the four gentlemen named in your order of the 8th instant were on board, and force must be applied to take them out of the packet.

About three minutes after there was still greater excitement on the quarter deck, which brought Mr. Grace with his armed party. I however deemed the presence of any armed men unnecessary, and only calculated to alarm the ladies present, and directed Mr. Grace to return to the lower deck, where he had been since first coming on board. It must have been less than half an hour after I boarded the *Trent* when the second armed cutter, under Lieutenant Greer, came alongside, (only two armed boats being used). He brought in the third cutter eight marines and four machinists, in addition to a crew of some twelve men. When the marines and some armed men had been formed just out side of the main deck cabin, where these four gentlemen had gone to pack up their baggage, I renewed my efforts to induce them to accompany me on board—still refusing to accompany me unless force was applied. I called in to my assistance four or five officers, and first taking hold of Mr. Mason's shoulder, with another officer on the opposite side, I went as far as the gangway of the steamer, and delivered him over to Lieutenant Greer, to be placed in the boat. I then returned for Mr. Slidell, who insisted that I must apply considerable force to get him to go with me; calling in at last three officers, he also was taken in charge and handed over

to Mr. Greer. Mr. McFarland and Mr. Eustis, after protesting, went quietly into the boat. They had been permitted to collect their baggage, but were sent in advance of it under charge of Lieutenant Greer. I gave my personal attention to the luggage, saw it put in a boat and sent in charge of an officer to the *San Jacinto*.

When Mr. Slidell was taken prisoner a great deal of noise was made by some of the passengers, which caused Lieutenant Greer to send the marines into the cabin. They were immediately ordered to return to their former position outside. I carried out my purpose without using any force beyond what appears in this report. The mail agent, who is a retired commander in the British navy, seemed to have a great deal to say as to the propriety of my course, but I purposely avoided all official intercourse with him. When I finally was leaving the steamer he made some apology for his rude conduct, and expressed personally his approval of the manner in which I had carried out my orders. We parted company from the *Trent* at 2:30 p. m.

Very respectfully, your obedient servant,

D. M. FAIRFAX,

Lieutenant and Executive Officer.

CAPTAIN CHARLES WILKES, U. S. N.,
Commanding *San Jacinto*.

UNITED STATES STEAMER SAN JACINTO,
At Sea, November 12, 1861.

SIR: In accordance with your instructions I submit the following: On November 8th, between 1 and 2 p. m., I was ordered by Lieutenant Breese, acting executive officer, to shove off with the third cutter and go alongside the English mail steamer, which was then lying-to under our guns. In the boat with me were Third Assistant Engineer Hall, Paymaster's Clerk Simpson, Master's Mate Dahlgren, one sergeant, one corporal, and six privates, of marines; four machinists and the crew, consisting of thirteen men, the whole party being well armed. When I arrived on the steamer, I was met on the guard by Mr. Grace, with a message from Lieutenant Fairfax (who had preceded me on board) to bring the marines on board and station them outside of the cabin, which I did; also to

keep the spare men on the guard, and to have the boat's crew in readiness to jump on board if needed. As soon as the marines were stationed, I had the space outside and forward of the cabin kept clear of passengers, and assumed a position where I could see Lieutenant Fairfax, who was then engaged in conversation with persons in the cabin. He shortly came out and told me to remain as I was. He then went back into the cabin, and in a few minutes returned with Mr. Mason. He had his hand on his shoulder, and I think Mr. Hall had his on the other one. He transferred Mr. Mason to me, and I had the third cutter hauled up, into which he got. Shortly after Mr. McFarland came out and got into the boat; I think he was unaccompanied by any of the officers. About this time I heard a good deal of loud talking in the cabin, and above all I heard a woman's voice. I could not hear what she said. Mr. Fairfax appeared to be having an altercation with some one. There was much confusion created by the passengers and ship's officers, who were making all kinds of disagreeable and contemptuous noises and remarks.

Just then Mr. Houston came to me and said he thought there would be trouble. I told him to ask Mr. Fairfax if I should bring in the marines. He returned with an answer to bring them in. At that time I heard some one call out "shoot him." I ordered the marines to come into the cabin, which they did at quick time. As they advanced the passengers fell back. Mr. Fairfax then ordered the marines to go out of the cabin, which they did, Mr. Slidell at the same time jumping out of a window of a state-room into the cabin, where he was arrested by Mr. Fairfax, and was then brought by Mr. Hall and Mr. Grace to the boat, into which he got. Soon after Mr. Eustis came to the boat, accompanied by Mr. Fairfax. I then, by his order, took charge of the boat and conveyed the gentlemen arrested, viz: Messrs. Slidell, Mason, McFarland, and Eustis to the *San Jacinto*, where I delivered them over to Captain Wilkes. This was about 2 o'clock. I then returned to the steamer; when I reached her the baggage of the gentlemen was being brought up and sent to the *San Jacinto*. Soon after Mr. Fairfax told me to send the marines and spare hands on board, which I did. He then left me in charge of our party and went on board the *San Jacinto*. About 3 o'clock she ran under the *Trent's* stern; I was hailed and directed to come on board, which I did with all except-

ing Mr. Grace, Mr. Dahlgren and Mr. Hall, who came in another boat.

Very respectfully, your obedient servant,

JAMES A. GREEB,

Lieutenant.

CAPTAIN C. WILKES,

Commanding *San Jacinto*.

P. S. I desire to add that it was about 1.35 p. m. when I went alongside the *Trent*. There were but two armed boats used during the day; a third boat, the crew of which were unarmed, went alongside during the detention. When I first went on board with the marines, and at intervals during my stay, the officers of the steamer made a great many irritating remarks to each other and to the passengers, which were evidently intended for our benefit. Among other things said were: "Did you ever hear of such an outrage?" "Marines on board! Why, this looks devilish like mutiny." "These Yankees will have to pay well for this." "This is the best thing in the world for the South; England will open the blockade." "We will have a good chance at them now." "Did you ever hear of such a piratical act?" "Why, this is a perfect Bull's Run!" "They would not have dared to have done it if an English man-of-war had been in sight." The mail agent, (a man in the uniform of a commander in the royal navy, I think) was very indignant and talkative, and tried several times to get me into a discussion of the matter. I told him I was not there for that purpose. He was very bitter; He told me that the English squadron would raise the blockade in twenty days after his report of this outrage (I think he said outrage) got home; that the Northerners might as well give up now, etc., etc." Most all the officers of the vessel showed an undisguised hatred for the Northern people and a sympathy for the Confederates. I will do the captain of the vessel the justice to say that he acted differently from the rest, being, when I saw him, very reserved and dignified. The officers and men of our party took no apparent notice of the remarks that were made, and acted with the greatest forbearance.

Respectfully,

JAS. A. GREEB.

UNITED STATES STEAMER SAN JACINTO,

At sea, November 13, 1861.

SIR: In obedience to your order of the 11th instant, I respectfully report: That upon going alongside of the English steamer *Trent*, on the 8th of this month, Lieutenant Fairfax went on board, ordering the boatswain and myself to remain in the boat. A few minutes after this my attention was attracted by persons speaking in a loud and excited manner upon the steamer's upper deck. While considering its meaning the noise was repeated, which decided me to join Lieutenant Fairfax immediately on board, and found him surrounded by the officers of the ship and passengers, among whom I recognized Messrs. Mason, Slidell, and Eustis. The confusion at this time passes description. So soon, however, as he could be heard, the mail agent (who was a retired lieutenant or commander in the British navy) protested against the act of removing passengers from an English steamer. Lieutenant Fairfax requested Mr. Mason to go quietly to the *San Jacinto*, but that gentleman replied that he would "yield only to force;" whereupon I was ordered to our ship to report the presence of the above-named gentlemen, together with Mr. McFarland, and ask that the remainder of our force be sent to the *Trent*, after which I returned to her, and entering the cabin, saw Mr. Fairfax endeavoring to enter Mr. Slidell's room, which was then prevented in a measure by the excitement which prevailed in and around that gentleman's quarters. The passengers (not including Mr. Mason, Slidell, Eustis or McFarland) were disposed to give trouble; some of them went so far as to threaten, and upon Lieutenant Greer being informed by me of this fact, he ordered the marines to clear the passage-way of the cabin, but as Mr. Slidell had now come out of his state room through the window, where we could get to him, the order to the marines was countermanded by Lieutenant Fairfax. Mr. Slidell was removed to the boat by Mr. Grace and myself, and no more force was used than would show what would be done in case of necessity. Mr. Mason was taken in charge by Lieutenant Fairfax and Third Assistant Engineer Hall. The two secretaries walked into the boat by themselves.

While we were on board of the *Trent* many remarks were made reflecting discreditably upon us and the government of the United

States. No one was more abusive than the mail agent, who took pains at the same time to inform us that he was the only person on board officially connected with her Britannic majesty's government, who he said would, in consequence of this act, break the blockade of the southern United States ports. Another person, supposed to be a passenger, was so violent that the captain ordered him to be locked up. A short time before leaving the steamer I was informed by one of her crew that the mail agent was advising the captain to arm the crew and passengers of his ship, which I immediately communicated to Lieutenant Greer. About 3:30 p. m. we returned to the *San Jacinto*.

I am, respectfully, your obedient servant,

J. B. HOUSTON,

Second Assistant Engineer,

U. S. Steamer *San Jacinto*.

CAPTAIN CHARLES WILKES,
Commanding.

UNITED STATES STEAMER SAN JACINTO,
At sea, November 13, 1861.

SIR:—In obedience to your order of the 11th instant, I respectfully make the following report of what came under my observation on board the mail steamer *Trent* whilst hove-to under our guns on the 8th instant:

I boarded the steamer in the third cutter, under the command of Lieutenant Greer. Immediately on reaching the steamer's deck I stationed four men (an oiler, assistant oiler and two firemen) who accompanied me, in the port gang-way. I then went into the cabin, where I saw Lieutenant Fairfax, surrounded by a large number of passengers and the officers of the ship. He was conversing with Mr. Mason, and endeavoring to get him to come peaceably on board this ship. Mr. Mason refused to comply unless by force, and taking hold of Mr. Mason's coat collar, gave an order, "Gentlemen, lay hands on him." I then laid hold of him by the coat collar, when Mr. Mason said he would yield under protest. I accompanied him as far as the boat, which was at the port gang-way.

Returning to the cabin, Lieutenant Fairfax was at Mr. Slidell's room. After a short time Mr. Slidell came from his room through

a side window. He also refused Lieutenant Fairfax's order to come on board this ship, unless by force. I, with several of the officers, then caught hold, and used sufficient power to remove him from the cabin. He was accompanied to the boat by Second Assistant Engineer Houston and Boatswain Grace. I then received an order from both Lieutenants Fairfax and Greer to retain the boat until Messrs. Eustis and McFarland were found. I remained in the gangway till Messrs. Mason, Slidell, Eustis and McFarland shoved off, Lieutenant Greer having charge of the gentlemen.

There was a great deal of excitement and talking during the whole time, the officers of the steamer endeavoring particularly to thwart Lieutenant Fairfax in carrying out his orders. They also used very harsh expressions toward us, calling us pirates, piratical expedition, etc., and threatened to open our blockade in a few weeks. At one time the officers and passengers made a demonstration, at the moment the marine guard came hastily in the cabin, but were immediately ordered back by Lieutenant Fairfax.

As far as I am able to judge, everything was conducted on our part in a peaceable, quiet and gentlemanly manner, and most remarkably so by Lieutenant Fairfax, who certainly had sufficient cause to resort to arms. I remained aboard the *Trent* till after the baggage belonging to the gentlemen had been sent, and finally returned to this ship with Lieutenant Greer.

Most respectfully, your obedient servant,

GEO. W. HALL,

Third Assistant Engineer, U. S. N.

CAPTAIN CHARLES WILKES,

Commanding U. S. Steamer *San Jacinto*.

Lieutenants Fairfax and Greer, who had such a conspicuous part in this affair, have both since made enviable records for distinguished services in the navy, and have both risen to the rank of rear admiral; the former was retired in 1881 and died in January, 1894. Rear Admiral Greer is also on the retired list now, having had the distinguished honor of being the senior officer of the navy for some months before his retirement. Second Assistant Engineer Houston served his country faithfully throughout the war and resigned from the naval service in July, 1865, to engage in business. He

has been eminently successful, having been a director, vice-president and president of the Pacific Mail Steamship Company for a long period of years, and only recently gave up active business to enter into the quiet enjoyment of a fortune which his talents have enabled him to amass during his busy life. Third Assistant Engineer Hall served faithfully throughout the rebellion and resigned from the service not long after the close of the war.

The chief engineer of the *San Jacinto* was Mr. John Faron, who three years later was killed on board the *Tecumseh* with all five of his assistant engineers in the battle of Mobile Bay.

CHAPTER XVI.

“The man who goes into action in a wooden vessel is a fool, and the man who sends him there is a villain.”—ADMIRAL SIR JOHN HAY.

1861. The Civil War, continued—The First American Iron Clads—The Stevens Battery Condemned by a Board of Naval Officers—Authority to Build Armored Vessels Conferred by Act of Congress—Report of Board on Iron-Clad Vessels—The *GALENA*, *NEW IRONSIDES*, and *MONITOR*—Armored Vessels in the Mississippi River.

AT the outbreak of the Civil War the United States had no armored war vessels, although the example of the unfinished Stevens' battery and the presentation of plans for an armored floating battery by the Swedish-American inventor John Ericsson to the Emperor Napoleon III. had resulted in the adoption of iron armor abroad to a limited extent. Three iron-plated floating batteries had been used by the French in the Crimean War, and at the beginning of the year 1861 that nation had *La Gloire* and three other large wooden steam frigates in commission, all sheathed with light iron armor, and fourteen others in process of construction. England also had entered the field and had at sea the *Warrior*, *Black Prince*, *Defense*, *Resistance* and *Royal Oak*, large armored steam-ships similar to *La Gloire*, with sixteen other armor-clads in various stages of construction. These British and French vessels were large full-rigged ships with auxiliary steam power, dependent upon the wind fully as much as upon steam for locomotion; their iron sides constituted the only feature wherein they resembled the Stevens' battery or the vessel suggested by Ericsson to Napoleon in 1854.

A joint resolution of Congress approved June 24, 1861, directed the Secretary of the Navy to appoint a board to examine the Stevens' battery and ascertain the cost and time necessary for its completion, and the expediency thereof. The board consisted of Commodores Silas H. Stringham and William Inman, Captain T. A. Dornin, Chief Engineer A. C. Stimers, and Joseph Henry, Esq., Secretary of the Smithsonian Institution. The report of this board, not made until the end of the year, was adverse to the completion of the iron

battery, and the project was then dropped, so far as the government was concerned.

An extra session of Congress was assembled by presidential proclamation July 4, 1861, to which, the Secretary of the Navy made a report on the condition of the navy at that time. In this report the Secretary referred to the attention given by England and France to iron-clad war-steamers, and asked for authority to construct such vessels if an investigation by a competent board should show such construction to be advisable. Congress responded with liberality and promptness by an act, approved August 3, 1861, entitled "An Act to provide for the construction of one or more armored ships and floating batteries, and for other purposes," it being brief and to the point, as follows:

Be it enacted by the Senate and House of Representatives of the United States of America in Congress assembled, That the Secretary of the Navy be, and is hereby authorized and directed to appoint a board of three skilful naval officers to investigate the plans and specifications that may be submitted for the construction or completing of iron or steel-clad steamships or steam batteries, and, on their report, should it be favorable, the Secretary of the Navy will cause one or more armored or iron or steel-clad steamships or floating steam batteries to be built; and there is hereby appropriated, out of any money in the treasury not otherwise appropriated, the sum of one million five hundred thousand dollars.

Sec. 2. And be it further enacted, That in case of a vacancy in the office of engineer-in-chief of the navy the appointment thereto shall be made from the list of chief engineers.

August 7, the Navy Department issued an advertisement asking for bids from responsible persons for the construction of one or more iron-clad steam-vessels of war, either of iron or of wood and iron combined, for sea or river service, the advertisement giving in general terms the principal requirements. These were, that vessels proposed must be of not less than ten, nor more than sixteen feet draft; must carry an armament of from eighty to one hundred and twenty tons weight, with provisions and stores for from one hundred and sixty-five to three hundred persons, according to armament, for

sixty days, with coal for eight days; must have two masts, with wire rope standing rigging for navigating the sea. The lighter draft of water, compatible with other requisites, was preferred. General descriptions and drawings of vessel, armor and machinery were required, as well as estimates of cost and time for completion of the whole. Twenty-five days from date of advertisement were allowed for the presentation of plans.

A naval board, composed of Commodore Joseph Smith, Commodore Hiram Paulding, and Commander Charles H. Davis, was appointed on the eighth of August to examine carefully all plans submitted and report upon the same. The report of this board, dated September 16, 1861, is both interesting and instructive from many points of view, showing as it does the opinions entertained by the naval men of that period regarding armor, and its probable utility; it also unfolds some of the rare schemes of inventors and patriots, who rushed to their country's succor. It follows in full:

REPORT ON IRON CLAD VESSELS.

NAVY DEPARTMENT,

Bureau of Yards and Docks, September 16, 1861.

SIR: The undersigned, constituting a board appointed by your order of the 8th ultimo, proceeded to the duty assigned to them, in accordance with the first section of an act of Congress, approved 3d of August 1861, directing the Secretary of the Navy "to appoint a board of three skilful naval officers to investigate the plans and specifications that may be submitted for the construction or completing of iron-clad steam-ships or steam batteries, and on their report, should it be favorable, the Secretary of the Navy will cause one or more armored or iron-clad or steel clad steamships or floating steam batteries to be built; and there is hereby appropriated, out of any money in the treasury not otherwise appropriated, the sum of one million five hundred thousand dollars."

Distrustful of our ability to discharge this duty, which the law requires should be performed by three skilful naval officers, we approach the subject with diffidence, having no experience and but scanty knowledge in this branch of naval architecture.

The plans submitted are so various, and in many respects so entirely dissimilar, that without a more thorough knowledge of this

mode of construction and the resisting properties of iron than we possess, it is very likely that some of our conclusions may prove erroneous.

Application was made to the Department for a naval constructor, to be placed under our orders, with whom we might consult; but it appears that they are all so employed on important service that none could be assigned to this duty.

The construction of iron clad steamships of war is now zealously claiming the attention of foreign naval powers. France led; England followed, and is now somewhat extensively engaged in the system; and other powers seem to emulate their example, though on a smaller scale.

Opinions differ amongst naval and scientific men as to the policy of adopting the iron armature for ships-of-war. For coast and harbor defence they are undoubtedly formidable adjuncts to fortifications on land. As cruising vessels, however, we are skeptical as to their advantage and ultimate adoption. But whilst other nations are endeavoring to perfect them, we must not remain idle.

The enormous load of iron, as so much additional weight to the vessel; the great breadth of beam necessary to give her stability; the short supply of coal she will be able to stow in bunkers; the greater power required to propel her; and the largely increased cost of construction, are objections to this class of vessels as cruisers, which we believe it is difficult successfully to overcome. For river and harbor service we consider iron-clad vessels of light draught, or floating batteries thus shielded, as very important; and we feel at this moment the necessity of them on some of our rivers and inlets to enforce obedience to the laws. We however do not hesitate to express the opinion, notwithstanding all we have heard or seen written on the subject, that no ship or floating battery, however heavily she may be plated, can cope successfully with a properly constructed fortification of masonry. The one is fixed and immovable and though constructed of a material which may be shattered by shot, can be covered if need be, by the same or much heavier armor than a floating vessel can bear, whilst the other is subject to disturbances by winds and waves, and to the powerful effects of tides and currents.

Armored ships or batteries may be employed advantageously to pass fortifications on land for ulterior objects of attack, to run a

blockade, or to reduce temporary batteries on the shores of rivers and the approaches to our harbors.

From what we know of the comparative advantages and disadvantages of ships constructed of wood over those of iron, we are clearly of opinion that no iron-clad vessel of equal displacement can be made to obtain the same speed as one not thus encumbered, because her form would be better adapted to speed. Her form and dimensions, the unyielding nature of the shield, detract materially in a heavy sea from the life, buoyancy and spring which a ship built of wood possesses.

Wooden ships may be said to be but coffins for their crews when brought in conflict with iron-clad vessels; but the speed of the former, we take for granted, being greater than that of the latter, they can readily choose their position and keep out of harm's way entirely.

Recent improvements in the form and preparations of projectiles, and their increased capacity for destruction, have elicited a large amount of ingenuity and skill to devise means for resisting them in the construction of ships-of-war. As yet we know of nothing superior to the large and heavy spherical shot in its destructive effects on vessels, whether plated or not.

Rifled guns have greater range, but the conical shot does not produce the crushing effect of spherical shot.

It is assumed that $4\frac{1}{2}$ inch plates are the heaviest armor a sea going vessel can safely carry. These plates should be of tough iron, and rolled in large, long pieces. This thickness of armor, it is believed, will resist all projectiles now in use at a distance of 500 yards, especially if the ship's sides are angular.

Plates hammered in large masses are less fibrous and tough than when rolled. The question whether wooden backing, or any elastic substance behind the iron plating, will tend to relieve at all the frame of the ships from the crushing effect of a heavy projectile, is not yet decided. Major Barnard says: "to put an elastic material behind the iron is to insure its destruction." With all deference to such creditable authority, we may suggest that it is possible a backing of some elastic substance (soft wood, perhaps, is the best) might relieve the frame of the ship somewhat from the terrible shock of a heavy projectile, though the plate should not be fractured.

With respect to a comparison between ships of iron and those of wood, without plating, high authorities in England differ as to which is the best. The tops of ships built of iron, we are told, wear out three bottoms, whilst the bottoms of those built of wood will outwear three tops. In deciding on the relative merits of iron and wooden-framed vessels, for each of which we have offers, the board is of opinion that it would be well to try a specimen of each, as both have distinguished advocates. One strong objection to iron vessels, which, so far as we know, has not yet been overcome, is the oxidation or rust in salt water, and their liability of becoming foul under water by the attachment of sea grass and animalcules to their bottoms. The best preventive we know of is a coating of pure zinc paint, which so long as it lasts, is believed to be an antidote to this cause of evil.

After these brief remarks on the subject generally, we proceed to notice the plans and offers referred to us for the construction of plated vessels and floating batteries.

It has been suggested that the most ready mode of obtaining an iron-clad ship of war would be to contract with responsible parties in England for its complete construction; and we are assured that parties there are ready to engage in such an enterprise on terms more reasonable, perhaps, than such vessels could be built in this country, having much greater experience and facilities than we possess. Indeed, we are informed there are no mills and machinery in this country capable of rolling iron $4\frac{1}{2}$ inches thick, though plates might be hammered to that thickness in many of our work-shops. As before observed, rolled iron is considered much the best, and the difficulty of rolling it increases rapidly with the increase of thickness. It has, however, occurred to us that a difficulty might arise with the British government in case we should undertake to construct ships-of-war in that country, which might complicate their delivery; and, moreover, we are of opinion that every people or nation who can maintain a navy should be capable of constructing it themselves.

Our immediate demands seem to require, first, so far as practicable, vessels invulnerable to shot, of light draught of water, to penetrate our shoal harbors, rivers and bayous. We therefore favor the construction of this class of vessels before going into a more perfect system of large iron-clad sea-going vessels of war. We

are here met with the difficulty of encumbering small vessels with armor, which, from their size, they are unable to bear. We nevertheless recommend that contracts be made with responsible parties for the construction of one or more iron-clad vessels or batteries of as light a draught of water as practicable, consistent with their weight of armor. Meanwhile, availing ourselves of the experience thus obtained, and the improvements which we believe are yet to be made by other naval powers in building iron-clad ships, we would advise the construction, in our own navy yards, of one or more of these vessels, upon a large and more perfect scale, when Congress shall see fit to authorize it. The amount now appropriated is not sufficient to build both classes of vessels to any great extent.

We have made a synopsis of the propositions and specifications submitted, which we annex, and now proceed to state, in brief, the result of our decisions upon the offers presented to us.

J. ERISSON, New York, page 19.—This plan of a floating battery is novel, but seems to be based upon a plan which will render the battery shot and shell proof. We are somewhat apprehensive that her properties for sea are not such as a sea-going vessel should possess. But she may be moved from one place to another on the coast in smooth water. We recommend that an experiment be made with one battery of this description on the terms proposed, with a guarantee and forfeiture in case of failure in any of the properties and points of the vessel as proposed.

Price, \$275,000; length of vessel, 172 feet; breadth of beam, 41 feet; depth of hold, $11\frac{1}{2}$ feet; time, 100 days; draught of water 10 feet; displacement, 1,255 tons; speed per hour, 9 statute miles.

JOHN W. NYSTROM, Philadelphia, 1216 Chestnut St, page 1.—The plan of (quadruple) guns is not known and cannot be considered. The dimensions would not float the vessel without the guards, which we are not satisfied would repel shot. We do not recommend the plan.

Price, about \$175,000; length of vessel, 175 feet; breadth of beam, 27 feet; depth of hold, 13 feet; time, four months; draught of water, 10 feet; displacement, 875 tons; speed per hour, 12 knots.—

WILLIAM PERINE, New York, 2777 post office box, presents three plans. The specifications and drawings are not full. The

last proposal (No. 3, page 2) for the heavy plating is the only one we have considered; but there is neither drawing nor model, and the capacity of the vessel, we think, will not bear the armor and armament proposed.

Price, \$621,000; length of vessel, 225 feet; breadth of beam, 45½ feet; depth of hold, 15½ feet; time, 9 months; draught of water 13 feet; displacement, 2,454 tons; speed per hour, 10 knots.

JOHN C. LE FÈVRE, Boston, page 9.—Description deficient. Not recommended. Sent a model, but neither price, time, nor dimensions stated.

E. S. RENWICK, New York, 335 Broadway, presents drawings, specifications and model of an iron-clad vessel of large capacity and powerful engines, with great speed, capable of carrying a heavy battery, and stated to be shot-proof and a good sea boat. The form and manner of construction and proportions of the vessel are novel, and will attract the attention of scientific and practical men. She is of very light draft of water, and on the question whether she will prove to be a safe and comfortable sea-boat we do not express a decided opinion. Vessels of somewhat similar form, in the part of the vessel which is emersed, of light draught of water on our western lakes, have, we believe, proved entirely satisfactory in all weathers. To counteract the effect of the waves, when disturbed by the winds, by producing a jerk, or sudden rolling motion of flat shoal vessels, it is proposed to carry a sufficient weight above the center of gravity to counterpoise the heavy weight below, which is done in this ship by the immense iron armor. If, after a full discussion and examination by experts on this plan, it should be decided that she is a safe vessel for sea service, we would recommend the construction upon it of one ship at one of our dock yards.

The estimate cost of this ship, \$1,500,000, precludes action upon the plan until further appropriations shall be made by Congress for such objects.

Time not stated; length of vessel 400 feet; breadth of beam, 60 feet; depth of hold, 33 feet; draught of water, 16 feet; displacement, 6,520 tons; speed per hour, at least 18 miles.

WHITNEY & ROWLAND, Brooklyn, Greenpoint, page 13; propose an iron gunboat, armor of bars of iron and thin plate over it. No price stated. Dimensions of vessel, we think, will not bear the weight and possess stability. Time, 5 months. Not recommended.

Length of vessel, 140 feet; breadth of beam, 28 feet; depth of hold, $13\frac{1}{2}$ feet; draught of water, 8 feet.

DONALD MCKAY, Boston, page 6.—Vessel, in general dimensions and armor, approved. The speed estimated slow. The cost precludes the consideration of construction by the board.

Price, \$1,000,000; length of vessel, 227 feet; breadth of beam, 50 feet; depth of hold, $26\frac{1}{2}$ feet; time, 9 to 10 months; draught of water, 14 feet; displacement, 3,100 tons; speed per hour, 6 to 7 knots.

WILLIAM H. WOOD, Jersey City, N. J., page 14.—Dimensions will not float the guns high enough; not recommended.

Price, \$255,000; length of vessel, 160 feet; breadth of beam, 34 feet; depth of hold, 22 feet; time, 4 months; draught of water, 13 feet; displacement, 1,215 tons; speed, not stated.

MERRICK & SONS, Philadelphia, pages 7 and 8—Vessel of wood and iron combined. This proposition we consider the most practical one for heavy armor. We recommend that a contract be made with that party, under a guarantee, with forfeiture in case of failure to comply with the specifications; and that the contract require the plates to be 15 feet long and 36 inches wide, with a reservation of some modifications which may occur as the work progresses, not to affect the cost.

Price, \$780,000; length of vessel, 220 feet; breadth of beam, 60 feet; depth of hold, 23 feet; time, 9 months; draught of water, 13 feet; displacement, 3,296 tons; speed per hour, $9\frac{1}{2}$ knots.

BENJAMIN RATHBURN, —, page 20.—We do not recommend the plan for adoption.

Price not stated; length of vessel not stated; breadth of beam, 80 feet; depth of hold, 74 feet; time not stated; draught of water, 25 feet; displacement, 15,000 tons; speed not stated; specifications incomplete.

HENRY R. DUNHAM, New York, page 11.—Vessel too costly for the appropriation; no drawings or specifications; not recommended.

Price, \$1,200,000; length of vessel, 325 feet; breadth of beam, 60 feet; depth of hold not stated; time, 15 to 18 months; draught of water, 16 feet; displacement not stated; speed per hour, 12 miles.

C. S. BUSHNELL & Co., New Haven, Conn., page 121.—Pro-

pose a vessel to be iron-clad, on the rail and plate principle, and to obtain high speed. The objection to this vessel is the fear that she will not float her armor and load sufficiently high, and have stability enough for a sea vessel. With a guarantee that she shall do these, we recommend on that basis a contract.

Price, \$235,250; length of vessel, 180 feet; breadth of beam, — feet; depth of hold, $12\frac{3}{4}$ feet; time, 4 months; draught of water, 10 feet; displacement, — tons; speed per hour, 12 knots.

JOHN WESTWOOD, Cincinnati, Ohio, page 17.—Vessel of wood, with iron armor; plan good enough, but the breadth not enough to bear the armor. No detailed specification; no price or time stated; only a general drawing. Not recommended.

NEAFIE & LEVY, Philadelphia, page 5.—No plans or drawings, therefore not considered. Neither price nor time stated.

Length of vessel, 200 feet; breadth of beam, 40 feet; depth of hold, 15 feet; draught of water, 13 feet; displacement, 1,748 tons; speed per hour, 10 knots.

WM. NORRIS, New York, 26 Cedar street, page 6.—Iron boat without armor—too small and not recommended.

Price, \$32,000; length of vessel 83 feet; breadth of beam 25 feet; depth of hold 14 feet; time 60 to 75 days; draught of water. 3 feet; displacement 90 tons; speed not stated.

WM. KINGSLEY, Washington, D. C., page 10, proposes a *rubber-clad* vessel, which we cannot recommend. No price or dimensions stated.

A. BEEBE, New York, 82 Broadway, page 18.—Specification and sketch defective. Plan not approved.

Price, \$50,000; length of vessel, 120 feet; breadth of beam, 55 feet; depth not stated; time 100 days; draught of water, 6 ft. displacement, 1,000 tons; speed per hour, 8 knots.

These three propositions recommended, viz: Bushnell & Co., New Haven, Connecticut; Merrick & Sons, Philadelphia, and J. Ericsson, New York, will absorb \$1,290,050 of the appropriation of \$1,500,000, leaving \$209,750 yet unexpended.

The board recommends that armor with heavy guns be placed on one of our river craft, or, if none will bear it, to construct a scow, which will answer, to plate and shield the guns, for the river service on the Potomac, to be constructed or prepared by the government at the navy yard here for immediate use.

We would further recommend that the Department ask of Congress at the next session, an appropriation, for experimenting on iron plates of different kinds, of \$10,000.

All of which is respectfully submitted,

JOSEPH SMITH,
H. PAULDING,
C. H. DAVIS.

HON. GIDEON WELLES,
Secretary of the Navy.

The first of the three plans accepted resulted in a contract dated September 27, 1861, with C. S. Bushnell & Co., of New Haven, Conn., for the armored gunboat that was named *Galena*. She was built at Mystic Bridge, Conn., from designs prepared by Mr. S. H. Pook, afterward a constructor in the navy, for \$235,250, and was completed in April, 1862, being almost immediately thereafter in action and badly damaged at Drury's Bluff, on James' river. In form the *Galena* was similar to an ordinary gun-vessel, with the important difference that her sides tumbled home at an angle of nearly forty-five degrees and were covered with iron bars and plates, protecting a gun deck in which six large guns were mounted. She was rated as of 738 tons burden, and was rigged as a two-masted foretopsail schooner. There were two Ericsson vibrating lever engines, with horizontal cylinders forty-eight inches in diameter and three feet stroke, driving a four-bladed screw propeller, twelve feet in diameter and twenty feet pitch. Steam was supplied by two horizontal tubular boilers with three furnaces in each, two blower engines for fan blast being provided. The *Galena's* armor was about four inches in thickness and was so badly shattered at Drury's Bluff that she was not considered a success as an armor clad, although she continued in active service throughout the war, and, lashed to the unfortunate *Oneida*, was in Farragut's fleet in Mobile Bay. In the early '70's, under the guise of "repairing" her, the Department built the 1,900 ton sloop of war *Galena*, that was for many years a prominent figure in our wooden fleet.

The contract with Merrick & Sons of Philadelphia gave the United States navy the *New Ironsides*, beyond question the finest and most formidable example of a battle-ship in existence at the time she

first took the sea. The hull was built of white oak at Cramp's ship-yard in Philadelphia, Merrick & Sons building the machinery at their own works. The engines were of only about seven hundred horse power and could drive the ship scarcely six knots an hour, but that was regarded as fast enough for the service required of her, as it was not apprehended that she would be obliged to run away from anything then afloat. The contract price was \$780,000. She was of 4,120 tons displacement; 232 feet long; 57½ feet beam, and mounted a very heavy battery, consisting of sixteen XI-inch Dahlgren guns, two 200-pounder Parrott rifles, and four 24-pounder howitzers.

The *New Ironsides* was large and decidedly ship-shape in appearance, with a projecting ram bow, the sides for the length of the main battery being sheathed with four inches of iron plate armor, the bow and stern sections being unarmored. The main battery was also protected with athwart-ship bulkheads, or walls, of the same thickness of armor as the sides, so she was really a case-mated ship. She was originally bark-rigged, but when sent to the seat of war she was stripped for fighting, the masts being taken out at Port Royal and replaced with light clothes-poles, with which rig her appearance was remarkably like that of a modern war-vessel. In 1863 the masts were replaced previous to a trip north for repairs, but were again removed, this time at Norfolk, before she again went into action.

Completed late in 1862, she proceeded at once to the front and was actively employed during the remainder of the rebellion, it being said of her that she was in action more days than any other vessel of our navy during the war. Mr. William S. Wells of New Haven, Connecticut, recently the Rear Admiral of the National Association of Naval Veterans, was attached to the *New Ironsides* as an assistant engineer during her entire period of war service, beginning with her first commission, and was the only officer who remained in her that length of time. To him Admiral Porter wrote long after the war that the *New Ironsides* had a record for having been hammered more thoroughly than any vessel that ever floated, and gave, with other interesting facts about the ship, the statement that in a series of engagements from July 18 to September 8, 1863, she had fired *four thousand four hundred and thirty-nine* eleven-

inch projectiles. In one engagement with the batteries on Sullivan's Island she was struck seventy times within three hours, but aside from some temporary damage to the port-shutters, which the engineers quickly repaired, was in perfect fighting condition at the end of the action. On another occasion she very narrowly escaped being blown up by a torpedo. At the close of the war she was laid up at the League Island navy yard, where, on the night of December 15-16, 1866, she was burned to the water's edge, having taken fire in some unknown manner late at night and not discovered until the flames were beyond control.

The picture of this famous ship which appears in the text is a reproduction of a drawing made by Second Assistant Engineer William S. Wells, before referred to as having served in her throughout her war career, and represents the *New Ironsides* exactly as she looked in the battles in Charleston harbor in 1863.

The third proposal accepted resulted in the construction of John Ericsson's *Monitor*, probably the most famous and epoch-making craft that ever floated, unless we revert to very ancient history and except Noah's Ark. The contract for this novel iron-clad was made October 4, 1861, between John Ericsson and his sureties on one part, and Gideon Welles, as Secretary of the Navy, on the other. It provided that the parties of the first part should construct an iron-clad, shot-proof steam battery, of iron and wood combined, on Ericsson's plan; the length to be 179 feet; extreme breadth, 41 feet, and depth 5 feet, or larger if found necessary, to carry the required armament and stores. A sea speed of eight knots an hour, maintained for twelve consecutive hours was stipulated. The contract price was \$275,000, to be paid in five instalments of \$50,000 each and one of \$25,000, payments to be made upon certificates of the naval superintendent of construction when in his judgment work had progressed sufficiently to warrant them. A reservation of twenty-five per cent. was withheld from each payment to be retained until after the completion and satisfactory trial of the vessel, not to exceed ninety days after she was ready for sea.

A clause of the contract provided that in case the vessel did not develop the stipulated speed or failed in other stated requirements, the contractors should refund to the United States the full amount of money paid them. This clause is the basis of the oft-

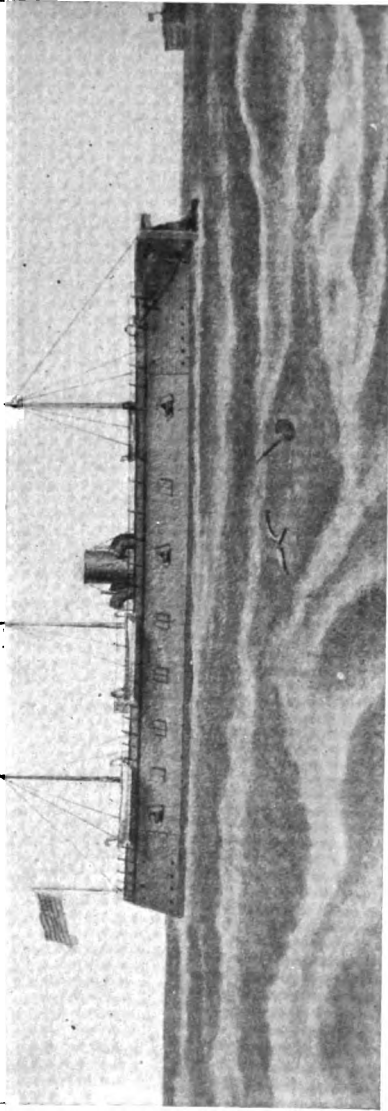

THE NEW IRONSIDES; 1862.

repeated statement that Ericsson and his sureties paid for the building of the vessel themselves; this was not the case, as all the payments, excepting the twenty-five per cent. reservation, were made before the *Monitor* left New York, although the contract would have required the contractors to pay for her had it not been for her fortunate encounter with the *Merrimac*, as her speed and some other qualities could not have been regarded as satisfactory. Her performance in Hampton Roads was regarded as a satisfactory test and the Navy Department paid the reservations within a week thereafter without insisting upon the full letter of the contract being carried out in minor particulars. A curious clause in the contract, which Ericsson ignored and the Department did not insist upon, indicates how reluctant the naval advisers of the Secretary were to authorise an entire departure from the method of marine propulsion which they had grown up to believe was the only reliable one. The clause referred to required the contractors to "furnish masts, spars, sails, and rigging of sufficient dimensions to drive the vessel at the rate of six knots per hour in a fair breeze of wind."

The adoption of the plan proposed by Ericsson was due to a train of accidental circumstances far more than to any percipience on the part of the board to which it was submitted. After being promised the contract for the *Galena*, Mr. C. S. Bushnell called upon Ericsson in New York for professional advice regarding some of the details of his plans, and during the interview Ericsson resurrected from a rubbish heap in the corner of his office the model that he had made for the French naval officials in 1854, and exhibited it as *his* idea of what an iron-clad should be. Bushnell instantly perceived the possibilities of the design, but could not induce Ericsson to submit it to the naval board, the inventor having already had a surfeit of experiences with the Navy Department in years gone by. He did succeed, however, in getting Ericsson's permission to take the model and submit it himself. Knowing that Secretary Welles, who was his personal friend, was then in Connecticut, Mr. Bushnell hastened thither and laid the plan before him, the Secretary being so impressed with its merits that he urged Bushnell to take it to Washington immediately, promising that he would, if necessary, order the board to extend the limit of time prescribed for the submission of plans.

Through influential friends Mr. Bushnell obtained a personal interview with President Lincoln and so enlisted his support by exhibiting the model and explaining the simplicity of operation of the ship it represented that the President voluntarily offered to accompany him to the Navy Department the next day. At the appointed time Mr. Bushnell and the President called on Assistant Secretary Fox and exhibited the model to him and a number of naval officers, including members of the iron-clad board. All were surprised with the simplicity and novelty of the plan, and some favored giving it a trial; others ridiculed it. The following day Commodore Smith convened his board and gave Mr. Bushnell an official hearing, that gentleman quitting the session with a hope that he had successfully presented his case; he was doomed to disappointment, however, for the next morning he found the interest of the previous day entirely gone, and the members of the board indifferent and skeptical. The two commodores told him that they would vote for a trial of the design if he could get Commander Davis to vote for it, Davis as the junior member of the board being evidently used as the executioner to administer the *coup de grace* to suspected "cranks." The latter officer, when appealed to by Bushnell, grew merry over what he regarded as the absurdities of the project and told Bushnell that he might "take the little thing home and worship it, as it would not be idolatry, because it was in the image of nothing in the heaven above or on the earth beneath or in the waters under the earth."¹

Almost in despair, Mr. Bushnell resolved to play his last card by calling in the eloquent voice of Ericsson to explain his own invention, a difficult thing to do, for Ericsson had been so shamefully treated by the Navy Department in regard to the *Princeton* that he had often announced his determination never to set foot in Washington again. Bushnell proceeded to New York and by representing the state of affairs in much brighter colors than the actual facts warranted, induced Ericsson to go to Washington and appear before the board. Arriving there, he was coldly received and informed that his plan had already been rejected; mortified and indignant, he was about to leave, but a remark dropped by Commodore

¹ Letter from Mr. Bushnell to Hon. Gideon Welles; published in W. C. Church's *Life of John Ericsson*, Vol. I., page 250.

Smith to the effect that the cause for rejection was *lack of stability* excited his professional pride and he launched forth into a most masterful and eloquent defense of his model, convincing the members of the board in short order that he knew more of stability and ships in general than had ever been dreamed of in their philosophy. The impression he made gained him another audience with the board, the Secretary of the Navy, who had fortunately returned to Washington, being present on the second occasion; after Ericsson had charmed everyone in the room with his glowing description of what his vessel could do, Mr. Welles asked each member of the board in turn if he approved of a contract being made with Ericsson, and each in turn gently answered, "Yes, by all means." No more time was lost; the Secretary told Ericsson that he would be awarded a contract, and urged him to begin work at once without waiting for formalities, which he did with such vim that in the few days that elapsed before the contract was drawn up the keel plates of the *Monitor* were put through the rolling mill. Thus by the precarious train of happenings above related did Ericsson's model narrowly escape remaining for an indefinite time in the dusty oblivion of his workshop.

The name *Monitor* was given by Ericsson himself to his iron-clad, his reasons for the selection being thus stated in a letter of his to Assistant Secretary Fox, dated January 20, 1862:

"SIR: In accordance with your request, I now submit for your approbation a name for the floating battery at Greenpoint. The impregnable and aggressive character of this structure will admonish the leaders of the Southern Rebellion that the batteries on the banks of their rivers will no longer present barriers to the entrance of the Union forces. The iron-clad intruder will thus prove a severe monitor to those leaders. But there are other leaders who will also be startled and admonished by the booming of the guns from the impregnable iron turret. 'Downing Street' will hardly view with indifference this last 'Yankee notion', this monitor. To the Lords of the Admiralty the new craft will be a monitor, suggesting doubts as to the propriety of completing those four steel-clad ships at three and a half millions apiece. On these and many similar grounds, I propose to name the new battery *Monitor*."

Every part of this wonderful vessel was designed by John Ericsson, and she was purely and wholly an engineers' ship, entirely free from the trappings and adjuncts pertaining to the seamanship of the period in which she was built. Hull, machinery, turrets, gun carriages, anchor hoists, everything, all were built from working drawings made by Ericsson's own hands. In order to hasten the work it was given out by sub-contracts to different establishments: the hull was built by Thomas F. Rowland at the Continental Iron Works, Greenpoint; the propelling engines and all auxiliary machinery by Delamater & Co., and the turret, built up of eight layers of one-inch iron plates bolted together, by the Novelty Iron Works. Chief Engineer Alban C. Stimers, U. S. Navy, represented the Government as the inspector of construction of the whole fabric. Within one hundred working days from the laying of the keel the *Monitor* was practically completed and her engines had been operated under steam. As built, her extreme length was 172

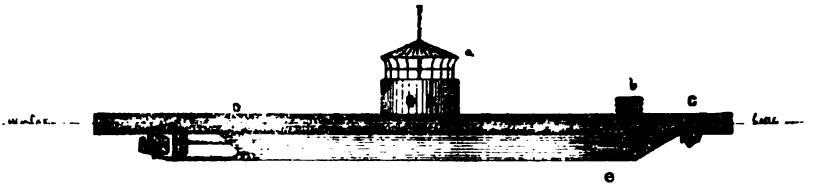

THE ORIGINAL ERICSSON MONITOR.

a. awning. b. pilot house of iron "logs." c. anchor well. d. wooden upper body or raft, armored on sides and deck. e. iron hull or under-body.

feet; breadth, $41\frac{1}{2}$ feet; depth of hold, $11\frac{1}{2}$ feet; draft of water, $10\frac{1}{2}$ feet; inside diameter of turret, 20 feet; height of turret, 9 feet. The deck was plated with iron an inch thick, and the sides of the upper body, or wooden cover of the iron hull as it may be called, were protected with five inches of iron armor. Two XI-inch Dahlgren guns were mounted in the turret. The engines were of Ericsson's vibrating-lever type, with cylinders three feet in diameter and twenty-six inches stroke, driving a propeller nine feet in diameter.

While the *Monitor* was being built, the Navy Department and Captain Ericsson were liberally ridiculed and abused by the public press for what was regarded as a fatuitous waste of public money, and Ericsson himself, in the midst of his overwhelming labors, had

constantly to calm the doubts of Commodore Smith, who appears from his many letters full of foreboding to Ericsson, to have repented of his approval of this revolutionary design in naval architecture. In the midst of all this hostility and opposition, Mr. Secretary Welles, Captain Ericsson, the three gentlemen who became his sureties (Messrs. C. S. Bushnell, John A. Griswold, and John F. Winslow), and Chief Engineer Stimers remained steadfast in their faith in the new departure, and seem to have been about the only persons interested who did not regard the scheme as a crazy dream, doomed to utter failure. The performance of the *Monitor* in battle immediately after her completion caused a sudden change in sentiment, naval and civil, and many who had been loudest in jeering became

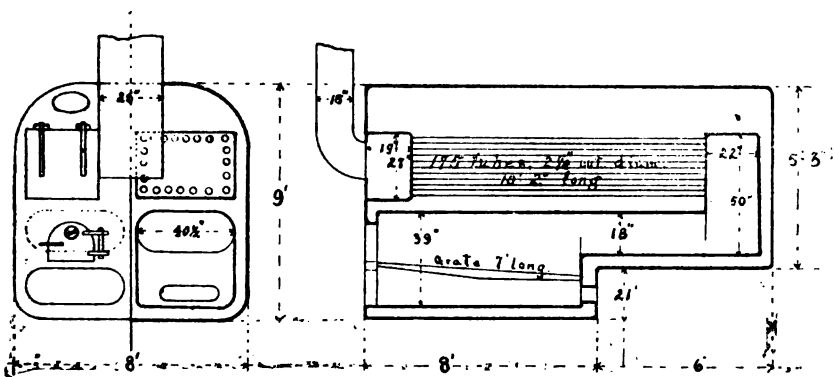

BOILER (2) OF THE MONITOR, 1861.

equally loud in praise, announcing their own presence. Credit for the creation of the *Monitor* belongs largely to Mr. Secretary Welles for appreciating its possibilities and for his action in influencing the armor-clad board to approve the original plans; after him, the credit is probably fairly distributed in his own words as follows:

“To the distinguished inventor of this new-class vessel, to his sureties, to the board of naval officers who reported in her favor, to the vigilant and very able naval officer who superintended her construction, the Secretary has, on repeated occasions, tendered his obligations and his thanks for their patriotic services in coming to the assistance of the department and the government in a great emergency. Great praise and commendation are due to them re-

spectively, but no one can be justified in attempting to arrogate to himself undue merit at the expense of others. The Navy Department, under great embarrassments, was compelled to enter upon a new field in naval warfare, and in this experiment it had the services and active and efficient co-operation of Captain John Ericsson, with that of the wealthy and deserving gentlemen who aided in the development of this new class of vessels, which have entered into the navy of the United States, and been elsewhere incorporated into the service of other governments." ¹

The year 1861 also saw the appearance of iron-clad steamers in the Mississippi River, built by the War Department for use in connection with the army. Seven of these iron-clads were built by the distinguished engineer of St. Louis, Mr. James B. Edes, under a contract dated August 7, 1861, and were mostly completed by the end of the year. They were 175 feet long, 50 feet beam, and were propelled by a huge paddle-wheel amidships near the stern, working in an opening 18 feet wide and 60 feet long fore and aft, the two parts of the after body of the vessel thus formed being joined abaft the wheel by a flying deck, known in river parlance as the "fantail." The wheel was 22 feet in diameter. Almost the entire deck was covered with a casemate, or superstructure, with sides sloping inward and upward at an angle of forty-five degrees, enclosing the battery, machinery and paddle-wheel. The expectation being to fight bows on as a rule, the front end of the casemate was plated with $2\frac{1}{2}$ inches of iron, backed with twenty inches of oak. The sides abreast the engines and boilers had the same thickness of iron without any oak backing, and the remainder of the surface was unprotected. The engines were of the usual high-pressure river type, and, with the boilers, were in constant danger from shot in action, the light draft of the boats making it impossible for the machinery to be placed below the water line. These Edes gun-boats were named *Cairo*, *Carondelet*, *Cincinnati*, *Louisville*, *Mound City*, *Pittsburgh*, and *St. Louis*, after towns in the Mississippi valley. They had two horizontal high-pressure steam cylinders, 22 inches in diameter and 6 feet stroke, and five cylindrical flue boilers, 3 feet in diameter and 24 feet long.

¹ Senate Ex. Doc., No. 86; 40th Congress, 2d Session.

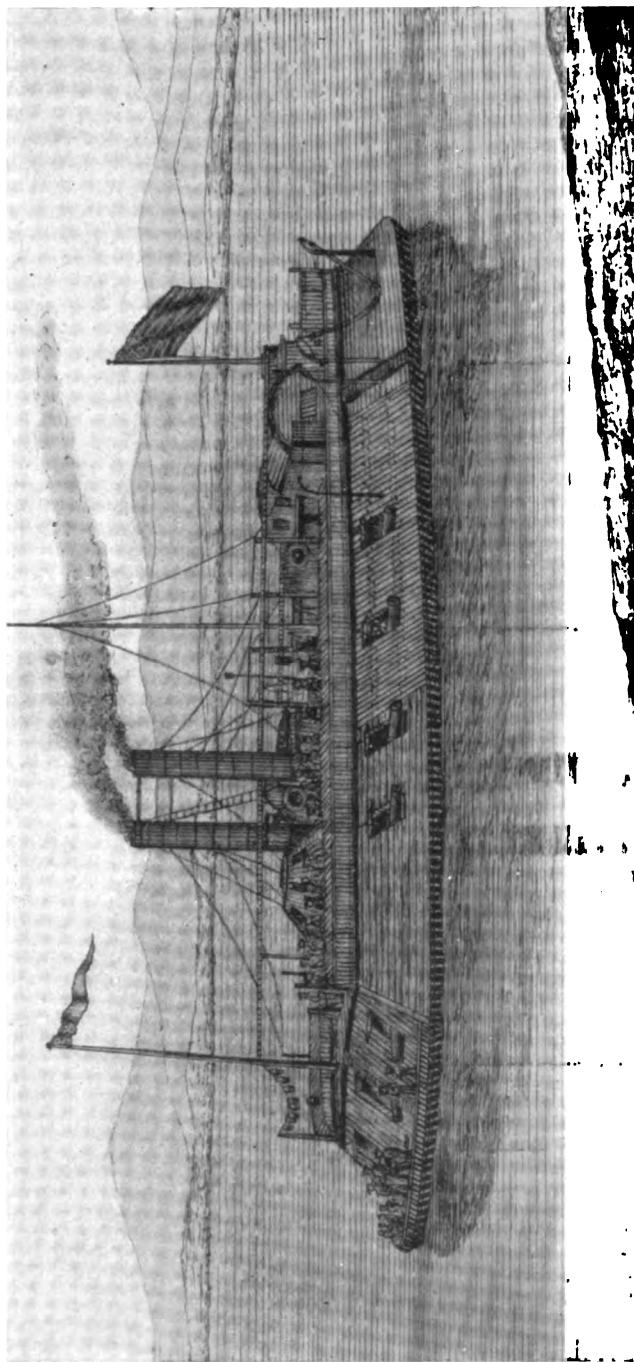

U. S. S. CAIRO.

Type of Western River Armored Gunboat.

Two other steamers—the *Essex* and *Benton*—nearly twice as large as the Edes' boats, were bought and converted into gunboats, the armor both iron and wood backing, being heavier than that of the seven contract vessels. A naval officer (Commander John Rodgers first, and Captain A. H. Foote a few months later) had general command of this flotilla under the army authorities, and officers of the regular navy were assigned to the command of the different steamers: the subordinate officers were volunteers, recruited chiefly from the captains, engineers, mates and pilots of the river, and the crews were decidedly mixed—soldiers, rivermen, men-of-war's-men from the East, and sailors from the Great Lakes. The naval commanders were of necessity junior by relative rank to the numerous generals and colonels doing duty about them, and this produced more or less friction, as the army officers had authority to give orders to the gunboats, or “interfere” with them, as Captain Foote expressed it. In July, 1862 this unpleasant state of affairs was done away with by the transferring of the entire river flotilla to the Navy Department.

CHAPTER XVII.

“ Then, like a kraken huge and black.
She crushed our ribs in her iron grasp !
Down went the Cumberland all a wrack,
With a sudden shudder of death,
And the cannon's breath
For her dying gasp.”—LONGFELLOW.

1862. The Civil War, Continued. Capture of Roanoke Island and Elizabeth City. The MERRIMAC and her Raid. Destruction of the CONGRESS and CUMBERLAND. The MONITOR Completed and Commissioned. Her Chief Engineer, Isaac Newton. Voyage of the MONITOR from New York and her arrival in Hampton Roads.

AT the beginning of 1862 a large combined military and naval force under the command of Flag Officer L. M. Goldsborough and Brigadier General A. E. Burnside was fitted out at Annapolis for the purpose of entering the Sounds of North Carolina through Hatteras Inlet, and capturing the fortified positions of the enemy on Roanoke Island, the possession of which would give to the Union forces the military command of those waters. This expedition has passed into history as the “Burnside Expedition,” but it might with much propriety be designated by Goldsborough's name, inasmuch as its character was essentially naval. Owing to the shoalness of water on the bulkhead at Hatteras Inlet and at many places in the Sounds, vessels of light draft were necessarily used, several of them being armed ferry-boats, and others were purchased tugs, river steamers, freight-boats, etc., not one of them having been built for war purposes. It should be remarked in regard to the ferry-boats that in spite of their uncouth appearance they were found remarkably useful for coast and river service, combining light draft with handiness in narrow places, being able to steam and steer equally well in either direction, while the broad overhanging deck furnished an excellent gun platform on which heavy batteries were habitually mounted.

Proceeding down Chesapeake Bay, the flotilla assembled in Hampton Roads and sailed thence the 11th of January, being then

composed of one hundred and twenty-five vessels, about twenty of which belonged to the navy and the remainder were purchased or chartered army transports, carrying some twelve thousand soldiers, with horses, ammunition, provisions, and all the paraphernalia of war. With much tooting of whistles, waving of flags, and cheering of soldiers, the expedition moved out towards the Capes of the Chesapeake, being probably the most motley and piebald aggregation of craft ever afloat with warlike intent. The enthusiasm of the soldiers speedily subsided when the Atlantic was reached and the voyage down the coast was so devoid of pleasure that men who subsequently became hardened veterans of the Army of the Potomac now refer to that sea experience with more abhorrence than they exhibit in recalling the dreadful scenes of Chancellorsville and Gettysburg.

The fleet arrived off Hatteras January 13, and spent some two weeks in the very difficult task of working over the shoals inside the Sounds, the army transports not all getting inside until the 5th of February. Three of the transports were wrecked and a considerable number of horses, rifles, and ordnance stores were lost. One of the naval steamers, the *Whitehall*, was so injured in trying to get in that she had to return to Hampton Roads for repairs. As finally collected inside, the naval force consisted of nineteen vessels arranged in three divisions, commanded respectively by Lieutenant Reed Werden in the *Stars and Stripes*, Lieutenant A. Murray in the *Louisiana*, and Lieutenant H. K. Davenport in the *Hetzel*. A number of the army vessels were armed with one or more guns and were intended for fighting as well as transport purposes; these, bearing such names as *Picket*, *Lancer*, *Huzzar*, &c., were formed into a division under the command of Commander S. F. Hazard, of the navy. Mr. Chas. H. Haswell, who has figured so prominently in the earlier chapters of this work, was attached to General Burnside's staff as fleet engineer, and Lieutenant D. W. Flagler, now brigadier general and Chief of the Ordnance Department of the army, was Burnside's chief ordnance officer. Flag Officer Goldsborough's flagship, the *Philadelphia*, not being suited for safe handling over the lumpy and uncertain bottom about Roanoke Island, did not participate in the ensuing engagement, Goldsborough temporarily transferring his flag and going, with his fleet captain, Commander A. L. Case, into action in the armed ferry-boat *Southfield*.

February 7th the fleet moved up and engaged the shore batteries and a small squadron of gunboats of the enemy with such good effect that by midnight Burnside had been able to land over ten thousand troops. The next day the attack was begun at daybreak and continued until the middle of the afternoon, when a bold charge of the military forces gained possession of the enemy's strongest positions and compelled his surrender. About three thousand Confederates were made prisoners, the remainder escaping in their gunboats to Elizabeth City near the Albemarle end of the Dismal Swamp canal.

The casualties in the fleet were small considering the character of the vessels and the severe bombardment they underwent, the total loss amounting to seven killed and sixteen wounded. Two of the killed were officers—Charles Harris, Master's Mate of the *Hetzal*, and Acting Second Assistant Engineer Stephen Mealius, senior engineer of the *Seymour*. Mr Mealius was struck in the hip by a 32-pound shot and so injured that he died about a week later, the same shot killing a coal-heaver at his side. These two were the only casualties on the *Seymour*. The unsuitability of the vessels for war service was shown by the fact that several of them were temporarily disabled during the attack by injuries to their machinery. The cross-head and one of the slides of the engine of the *Hunchback* were shot away, and the *Commodore Perry* was partly crippled by a shot which passed between the engine and boiler and destroyed the feed-water tank. A shell struck the upper deck of the *Ceres* and glancing downward from a beam in very curious flight passed through the lower deck and rolled into one of the ash pits where it exploded, hurling fire and grate-bars in all directions.

One episode of the fight brought Chief Engineer Haswell into enviable prominence for gallantry, the affair being thus related in Frank Leslie's Pictorial History of the War: "During her efforts to get near the fort, the *Ranger* got aground, and for a few moments was in great danger, being a stationary target for the rebel guns. Mr. Charles Haswell, Engineer-in-chief of the fleet, who was in command of the steamer *Tempest*, at this critical juncture went to the rescue, and taking her hawser, towed the *Ranger* out of danger into deep water again. The act was greatly applauded."

Immediately after the capture of Roanoke Island, Flag Officer Goldsborough despatched his second in command, Commander S.

C. Rowan, with fourteen of the steamers to Elizabeth City to attack the Confederate gunboats, all of which had taken refuge there with the exception of the *Curlew* which had been so badly damaged in the fight of the 7th that she had been set on fire and destroyed. February 10th Rowan's squadron attacked the enemy and destroyed all his vessels except one, the *Ellis*, which was captured in good condition and converted into a Federal gunboat, performing good service as such in the waters of the Sounds until her loss by stranding near the end of the year. At the time of her loss she was under the command of Lieutenant Wm. B. Cushing, then rising into prominence by virtue of a courage at once heroic and reckless. For exceptional excellence in the action at Elizabeth City Mr. John Cahill, second assistant engineer and acting chief of the *Underwriter*, was highly commended in the report of his commanding officer, Lieutenant William N. Jeffers, who praised Mr. Cahill's management of the engineer department and also his services in working the after gun during the fight. The same engagement furnished an instance of remarkable courage and presence of mind on the part of John Davis, gunner's mate of the *Valley City*, who, when the magazine was set on fire by a shell, deliberately sat down in an open barrel of powder and prevented its ignition until the fire division came to the rescue.

After the affair at Elizabeth City an expedition consisting of the *Shawsheen*, *Lockwood*, and two or three smaller vessels, all under the command of Lieutenant Jeffers, was sent to drive the enemy away from the mouth of the Chesapeake and Albemarle canal and to block up that water-way. On February 13, after shelling the position and driving the enemy back half a mile or more, a force of sailors and engine-room men under Acting Master Graves and Second Assistant Engineer John L. Lay, acting chief of the *Louisiana*, was landed and destroyed the machinery of a large dredging machine, afterward sinking it and some schooners in the canal, completely obstructing it. Mr. Lay, who afterward became prominent in the navy in connection with the torpedo service, was highly commended in the commanding officer's report for the thorough manner in which the work had been done.

The story of how the fine frigate *Merrimac* was lost to the Union has been told in a former chapter. After gaining possession of the

Norfolk navy yard the Confederates lost no time in making repairs and reaping the benefit of their enormous prize. Their most valuable booty consisted of the great number of guns, mostly uninjured, and the vast quantities of ordnance and equipment supplies that fell into their hands, but they gave attention also to the ships that had been scuttled. The *Germantown*, *Plymouth* and *Merrimac* were raised and the first two easily restored to a serviceable condition, but were not equipped for sea. The failure to attempt to make use of these two ships may be attributed to the fact that some of the most able and progressive officers of the old navy had joined the Confederacy and these gentlemen, from having studiously observed the tendencies of war-ship development, were ready to accept the inevitable and admit that the day of the sailing ship of war was over. They had discerned the growing shadow of coming events and in this regard were far ahead of their naval brethren at the North, who did not awake from the spell of old beliefs until the Southerners gave them a rude and terrible object lesson.

The upper works of the *Merrimac* had been burned as she sank but all the lower hull, as well as the machinery, was found in as good condition as could be expected after a month's submersion. A board, consisting of Engineer-in-Chief William P. Williamson, Lieutenant John M. Brooke, and Chief Constructor John L. Porter was assembled early in June to determine upon a plan for converting the *Merrimac* into an iron-clad battery, and a plan was adopted without any great delay. Lieutenant Brooke was given credit at the time in the newspaper and official reports for having originated the design adopted, and the question has been a matter of dispute and controversy ever since. Constructor Porter claimed the honor and he undoubtedly made the drawings from which the vessel was reconstructed, as that was a duty pertaining to his office, but he might have made them without originating them. In Scharf's History of the Confederate States' Navy the matter is gone over at length and Mr. Porter's claim very fully supported. Chief Engineer Thom Williamson, U. S. Navy, who is a son of the Confederate Engineer-in-Chief, has informed the author that years before the war, when interest in the Stevens battery had directed the minds of naval men to the possibilities of iron armor, his father had made drawings of an iron-clad war vessel, and that the reconstructed *Merrimac* was in

general design an exact reproduction of those plans. Williamson beyond doubt submitted his design and Porter developed it, the two men as representative ship engineers of the South being jointly entitled to the credit of having created the vessel which became the type and embodied the ideas of the engineers of the South of what an armored war-ship should be.

The damaged hull of the *Merrimac* was rebuilt up to the level of the berth deck and a huge cast iron spur was fitted on the bow about two feet below the water-line and projecting eighteen inches beyond the cutwater. When equipped for service, with coal and stores on board, it was designed that the vessel should float with her deck slightly submerged. On the central part of the deck extending one hundred and seventy feet fore and aft and the full width of the vessel athwartship was erected a citadel or casemate, with rounded ends, the sides sloping at an angle of forty-five degrees and extending some two feet below the water line along the sides, or *caves*, as the lower edges have appropriately been called. This casemate was seven feet high in the clear, its flat top being covered with a wooden grating to let light and air inside, and forming the promenade or spar deck of the ship. The structure was built of pine, twenty inches in thickness, sheathed with four inches of oak planking and this in turn with two layers of 2-inch iron bars or plates, these being eight inches wide and about ten feet long. The first layer of these armor bars was put on horizontally like a ship's planking, the other, or outer course being up and down. Through-bolts, one and three-eighths inches in diameter secured inside fastened the armor to the wooden superstructure. The battery mounted in this floating stronghold consisted of a VII-inch Brooke rifle pivoted in each of the rounded ends and eight guns in broadside, four on each side, six of the latter being IX-inch Dahlgrens and two 32-pounder Brooke rifles.

The iron-clad approached completion early in March and was christened *Virginia*, but the name she had borne in the old navy stuck to her, probably on account of its alliterative affinity with *Monitor*, and as the *Merrimac* she will ever be known. On the 8th of March she got under way from the Norfolk navy yard and proceeded down the Elizabeth River accompanied by the gunboats *Beaufort* and *Raleigh*, mounting one gun each. Her crew of about three hundred men was composed mostly of volunteers from the

troops about Richmond, and because of the crowds of workmen on board until the last minute had not been exercised at their stations. The engines, which had been a nightmare to the engineers of the old navy, had been thoroughly overhauled under the direction of Chief Engineer Williamson, but, with a raw force to manage them, were an object of apprehension rather than a reliable source of power. The Union force in and about Hampton Roads consisted of the large 40-gun frigates *Roanoke* and *Minnesota*, sister ships of the original *Merrimac*, some small armed tugs, the 50-gun sailing frigates *Congress* and *St. Lawrence*, and the 24-gun sloop-of-war *Cumberland*. The two steam frigates have been described in a former chapter, and were regarded as the climax of all excellence in war-ship construction, "yet," as remarked by Professor Soley, "it required but the experience of a single afternoon in Hampton Roads, in the month of March, 1862, to show that they were antiquated, displaced, superseded, and that a new era had opened in naval warfare."

"The *Congress* and *Cumberland* had been lying off Newport News for several months. Their ostensible duty was to blockade the James River; but it is not very clear how a sailing-vessel at anchor could be of any use for this purpose. Most of the old sailing vessels of the navy had by this time been relegated to their proper place as school-ships, store-ships, and receiving-ships, or had been sent to foreign stations where their only duty was to display the flag. Nothing shows more clearly the persistence of old traditions than the presence of these helpless vessels in so dangerous a neighborhood. Although the ships themselves were of no value for modern warfare, their armament could ill be spared; and they carried between them over eight hundred officers and men, whose lives were exposed to fruitless sacrifice."¹

The *Merrimac* emerged from the river about 1 p. m and turned down towards Newport News where the *Congress* and *Cumberland* lay at anchor, already cleared for action. Three Confederate gun-boats, the *Jamestown*, *Teazer* and *Patrick Henry* (or *Yorktown*), soon afterwards came out of the James River past the Federal batteries at Newport News and took part in the ensuing engagement, rendering much aid to the *Merrimac*. The story of what happened that

¹ Professor J. R. Soley: *The Blockade and the Cruisers*, page 61, chapter iii.

afternoon has been told so often that no detailed account of it will be repeated here. As the ram approached the sailing vessels she was furiously pounded by their broadside fire, but her sloping armor glanced the shot off like peas; passing the *Congress*, she deliberately rammed the *Cumberland* in the wake of the starboard forechains, tearing a great hole in her side, in which the cast-iron beak remained, it having been wrenched off in impact, Before reaching the *Cumberland* a broadside from that vessel put one or two shells into the forward gun port of the *Merrimac*, killing two and wounding five men,¹ but doing no serious damage to the ship itself. The first lieutenant of the *Cumberland*, Lieutenant George Upham Morris, who was in command in the absence of his captain, gallantly refused to surrender and fought his ship with a heroism not excelled in naval history, but in vain, for she sank in three-quarters of an hour, carrying down the wounded and many of the crew. The *Congress*, next assailed, was run on shore in hope of saving her, but the enemy got into easy range astern and tore her through and through with shot and shell, butchering her people without mercy. Unable to make any resistance, she surrendered, but the army force on shore, not understanding the situation, fired on the Confederate gunboats that had gone alongside to remove the prisoners, and drove them off. The *Merrimac* then set her on fire with incendiary shot, the survivors of the crew escaping to the shore in their boats or by swimming. The *Congress* burned until far into the night, when she blew up.

Meanwhile the *Minnesota* had got under way from Hampton Roads and approached the scene of action, but ran aground when still more than a mile distant; she was fortunately in such a position with regard to the deep-water channel that the *Merrimac* could not get within effective range of her, but the gunboats *Yorktown* and *Teazer* took comparatively safe positions off her bow and stern and did her much damage, besides killing three and wounding sixteen of her men. The *Roanoke* was unable to move under steam, having broken her shaft some months previously, and consequently had no more business in the presence of the enemy than had the sailing frigates. However, her gallant captain, John Marsden, as well as

¹ William Norris, a member of the *Merrimac's* crew; in *Southern Magazine* November, 1874.

Captain Purviance of the *St. Lawrence*, felt it to be duty to be in action, even in a forlorn hope, and they made desperate efforts to move their vessels from Hampton Roads with the aid of armed tugs, called gunboats, to the scene of action. The approach of night and the falling of the tide defeated the brave endeavors of these two captains, and their ships consequently did not become a prey to the invulnerable monster they hoped to destroy.

About 7 P. M. the *Merrimac* withdrew from action and anchored off Sewall's Point, intending to complete her work of destruction in the morning. Her captain, Franklin Buchanan, had been wounded by a rifle ball from shore; the muzzles of two of her guns had been knocked off, and her steaming ability, bad at best, had been considerably weakened by the loss of the smoke pipe above the casemate: otherwise she was entirely fit for action. Her people were jubilant over their success, and well they might be, for besides winning a sea-fight against great numerical odds they had proved their vessel to be absolutely in control of the situation with no apparent limit to the range of her conquests. Her performance that afternoon had been exactly what we have a right to believe would have resulted had the *Demologos*, nearly fifty years before, been completed in time to encounter a fleet of British frigates. The sound of the *Merrimac's* guns had rung the curtain down forever upon the most picturesque and romantic mode of sea fighting that the world has ever known: thenceforth the march of iron and the engineer would have to be recognized as all-important in naval warfare, and the picturesque must yield before a homely materialism.

Besides the loss of the *Congress* and *Cumberland*, the Federal navy suffered severely in men. The official reports show that the *Congress* lost in killed, wounded and missing one hundred and thirty-six men, or nearly one-third of her entire crew. Among her dead was her gallant commanding officer, Lieutenant Joseph B. Smith. The *Cumberland* lost one hundred and twenty-one, also about one-third of her crew, which numbered three hundred and seventy-six officers and men when the action began. The *Minnesota's* casualties, previously mentioned, were nineteen. On the gunboat *Whitehall* Third Assistant Engineer Andrew Nesbitt was instantly killed by a fragment of shell from the *Merrimac*, and another assistant engineer was wounded in the face in the same manner. Two of her men were

killed. The *Whitehall* was a small New York ferryboat of 323 tons, purchased and armed in 1861, and has been mentioned before in this chapter as having been disabled in the Burnside Expedition. Her career ended the following night, March 9, by destruction by fire while lying at the wharf at Fortress Munroe, the chief loss involved being the breeching, tackles, and other gun gear of the *Minnesota*, together with a quantity of small arms and equipment, put on board her for safe keeping the night of the 8th when the destruction of the *Minnesota* seemed imminent. All the casualties due to the raid of the *Merrimac*, as above enumerated, amount to a total of two hundred and eighty. The Confederate loss, including casualties on their gunboats, was not more than one tenth of this figure.

Ericsson's *Monitor* was launched January 30, 1862, and by the middle of February was practically completed, going on a trial trip the 19th of that month. On this occasion the main engines, the steering gear, the turret turning mechanism, almost everything in fact, went wrong or refused to work; natural results of the lack of adjustment due to hasty construction, and needing only this trial to show what remedies were required. The newspapers that had indulged in endless jeremiads over "Ericsson's Folly" now redoubled their attacks and added greatly to the public mistrust of the vessel, but Ericsson himself and Chief Engineer Stimers maintained their faith unmoved and, ignoring the opportunities for controversy, patiently set to work to remedy the defects. February 25, the *Monitor* was put in commission under the command of Lieutenant John L. Worden, U. S. Navy, and on the 4th of March a final and successful trial trip was run, the guns being satisfactorily tried at this time and a favorable report regarding the vessel was made by a board of naval officers. On these trials and while adjusting the machinery Mr. Stimers made it his business to operate personally every piece of mechanism in the ship and to become thoroughly familiar with and master of every detail of every department, thus gaining knowledge without which the performance of the *Monitor* immediately thereafter would have been impossible and the events of the Civil War materially changed.

Escaping finally from the onslaughts of the press, the *Monitor* faced a new foe by putting to sea on the 6th of March, being conveyed by the gunboats *Sachem* and *Currituck* and in tow of the steamer

Seth Low, although she used her own steam as well. Two hours after her departure a telegraphic order arrived for her to proceed direct to Washington and this order was repeated to Captain Marsden at Hampton Roads. The failure of Worden to receive this order before leaving New York is referred to by naval historians as little less than providential, and so it seems in view of the ensuing events; at any rate the circumstance adds one more to the list of almost miraculous chances that united in making the *Monitor* possible and in shaping her career. The officers who went in her as volunteers for the more than hazardous experiment of taking her to sea were, besides Worden the commander, Lieutenant Samuel Dana Greene; Acting Masters John J. N. Webber and Louis N. Stodder; Acting Assistant Paymaster W. F. Keeler; Acting Assistant Surgeon Daniel C. Logue; First Assistant Engineer Isaac Newton; Second Assistant Engineer Albert B. Campbell, and Third Assistant Engineers R. W. Hands and M. T. Sundstrum. The commander, executive officer, and all the engineers were of the regular service and the other officers volunteers. The crew consisted of forty-three men who had volunteered from the receiving-ship *North Carolina* and the sailing frigate *Sabine*. Chief Engineer Stimers voluntarily went as a passenger to observe the working of the novel craft and to give her officers the benefit of his knowledge, he being, as stated by W. C. Church in his *Life of John Ericsson*, "The only man on board who thoroughly understood the characteristics of the vessel."

Mr. Isaac Newton, the acting chief engineer of the *Monitor*, was a genius in his way who deserves more than passing mention. His father, also named Isaac Newton, was a prominent North River steamboat builder and owner, and young Newton, besides getting an excellent education in the New York city schools, had grown up in his father's steamers and shops, so that by the time he reached manhood he was a thorough steamboat captain, pilot, engineer, boat builder, machinist, and all-around mechanic. In June, 1861, he volunteered for the war and selected the engineer corps of the navy for his place of best service, coming into the navy with letters of commendation from a number of the most prominent men in New York. His education enabled him to overstep the nominal requirements for the volunteer service, and by passing the required examinations he obtained an appointment as a first assistant engineer in the

regular service. If his experience could have been augmented with the four or five years of military training so essential to service in the regular navy he would have been an ideal naval officer for a war-steamer: as it was, he won a fine reputation for ability as an engineer and for general usefulness. He resigned at the close of the war and associated himself with John Ericsson in his disastrous *Madawaska-Wampanoag* controversy with Engineer-in-Chief Isherwood; was later General McClellan's associate in the work of rebuilding the Stevens battery, and again, having embarked in politics, held the very important position of chief engineer of the Croton Aqueduct in the Public Works Department of the City of New York.

The first twenty-four hours of the voyage of the *Monitor* from Sandy Hook were uneventful, light winds and smooth water being encountered. The wind and sea then rose and the vessel was soon in great peril. Great quantities of water came in through the hawse pipes, due to "gross carelessness in going to sea without stopping them up," as claimed by Ericsson in a paper on the "Building of the *Monitor*," in *Battles and Leaders of the Civil War*. The turret was designed to slide on a bronze ring let into the deck at its base, this joint not being water tight nor intended to be, pumps being provided to remove the small quantity of water that would come in through this necessary crack. Before leaving New York, however, some "expert" at the navy yard, accustomed to the manifold uses of rope on shipboard, had caused the turret to be wedged up and had driven into the wide opening thus formed a plaited hemp gasket, the result being that when the sea began to break violently over the deck this gasket was washed out and water poured in cascades down the whole annular space sixty-three feet in circumference. The smoke pipes and blower supply pipes, were simply temporary trunks intended to be removed in action, projecting only about six feet above the deck, over which the seas broke and interrupted the action of the furnaces very seriously.

From getting wet, the belts of the blowers would not cling and the engine and fire-rooms soon became charged with poisonous gases to such an extent that life below became almost impossible. Messrs. Newton and Stimers, with the help of their assistants, struggled bravely to get the blowers in operation and kept at this task until they succumbed to the gas and were carried to the top of the turret,

where they revived, though they were thought dead when dragged out of the engine room. Lieutenant Greene, the executive officer, a few days latter gave an account of the *Monitor's* experience in a letter written to his mother, which is regarded as the most graphic narrative of the event in existence, and which has been twice published in the *United Service Magazine* (In April, 1885 and October, 1893), in which he speaks of this incident as follows: "Our engineers behaved like heroes, every one of them. They fought with the gas, endeavoring to get the blowers to work, until they dropped apparently dead." In the meantime the fires had become so low from water and loss of air that the pumps stopped and loss by foundering became imminent. The tug was directed to steer shoreward and after four or five hours of constant peril smoother water was reached, the machinery started again, water pumped out, and danger for the time averted. It was then evening of the 7th, and for a time safe progress was made, but soon after midnight danger once more appeared as thus described by Lieutenant Greene in the letter to his mother:

"We were just passing a shoal, and the sea suddenly became rough and right ahead. It came up with tremendous force through our anchor-well, and forced the air through our hawse-pipe where the chain comes, and then the water would rush through in a perfect stream, clear to our berth deck, over the wardroom table. The noise resembled the death-groans of twenty men, and was the most dismal, awful sound I have ever heard. Of course the captain and myself were on our feet in a moment, and endeavored to stop the hawse-pipe. We succeeded partially, but now the water began to come down our blowers again, and we feared the same accident that happened in the afternoon. We tried to hail the tug-boat, but the wind being dead ahead they could not hear us, and we had no way of signaling them, as the steam-whistle which father had recommended had not been put on.

"We began then to think the 'Monitor' would never see daylight. We watched carefully every drop of water that went down the blowers, and sent continually to ask the fireman how they were going. His only answer was 'Slowly,' but could not be kept going much longer unless the water could be kept from coming down. The sea was washing completely over the decks, and it was danger-

ous for a man to go on them, so we could do nothing to the blowers. In the midst of all this our wheel-ropes jumped off the steering wheel (owing to the pitching of the ship), and became jammed. She now began to sheer about at an awful rate, and we thought our hawser would certainly part. Fortunately it was new, and held on well. In the course of half an hour we freed our wheel-ropes, and now the blowers were the only difficulty. About three o'clock Saturday A. M. the sea became a little smoother, though still rough, and going down our blowers somewhat."

By 8 o'clock the next morning smooth water was again found and the *Monitor* slowly and wearily pursued her voyage, entering the Capes of the Chesapeake about 4 P. M. Here they heard the sound of shotted guns, for the *Merrimac* was at that moment in the midst of her carnival of destruction, and the worn-out crew infused with new life cleared their novel and untried craft for action. A pilot-boat coming out told them of what was going on at Newport News but the tale of big frigates being helpless in the presence of any known form of enemy was so improbable that it was not believed until night came on and the pitiful spectacle of the doomed *Congress* loomed up in lines of fire against the dark sky. About 9 P. M. the *Monitor* anchored in Hampton Roads and Worden reported in person to Captain Marsden on the *Roanoke*.

In view of the events of the day it was decided without hesitation to disregard the order of the Department to send the *Monitor* direct to Washington, the occasion for which she was built being nearer at hand. The programme of the enemy for the morning so obviously would begin with an attack upon the grounded *Minnesota* that Worden was ordered to go up to Newport News to protect that vessel if he could, so the *Monitor* got under way again and about 2 A. M. came to anchor near the distressed frigate, her wearied crew spending the rest of the night in repairing damages wrought by the sea and in making ready for the struggle that they knew would come with the morning.

The stage settings were now complete; the curtain had fallen just before upon the last of a long series of glorious deeds performed under a slowly-fading system of seamanship that had many years before reached its culmination, and a new order of seamanship with a new type of sea warrior was about to appear upon the stage. The

engineer's machine of John Ericsson was to face the fabric that represented the engineering ingenuity of the South, and the telegraphic tidings of their encounter would inflict an inconsolable fright upon the old romance of the sea, and in an hour reduce the masted navies of the world to mere collections of picturesque and useless relics.

CHAPTER XVIII.

“The old must fall, and time itself must change,
And thus new life shall blossom from the ruins.”

SCHILLER.

1862—The Civil War, Continued—First Fight of Iron-Clads—Effects of the Battle—Extraordinary Services Rendered by Chief Engineer Stimers—Attack on Drury’s Bluff—The *GALENA* Badly Injured—Gallantry of Assistant Engineer J. W. Thomson.

THE morning of Sunday, March 9, dawned upon a peaceful scene in Hampton Roads. The *Roanoke* and *St. Lawrence* were lying at anchor near Fortress Monroe; the *Minnesota*, still aground off Newport News, overshadowed with her great hull the *Monitor* lying beside her, and off Sewall’s Point, black and ominously still, was the *Merrimac*. The topmasts of the *Cumberland* sticking out of the water and blackened wreckage about the spot where the *Congress* burned were the only signs that anything unusual had happened or was likely to happen. Soon after daylight, volumes of black smoke appeared over the *Merrimac*, rising and spreading in the quiet morning air into a cloud that must have seemed a veritable embodiment of the Shadow of Death to the men in the Federal ships.

About 8 A. M. the *Merrimac* got under way and proceeded slowly up towards the Rip Raps in order to swing into the channel whence she could assail the *Minnesota*. Captain Buchanan’s wound of the day before had proved so serious that he had been obliged to give up his command to the first lieutenant, Catesby Ap R. Jones, who was now taking the ship into action. Lieutenant Jones, upon whom the responsibility for the day’s work rested, was about forty years of age and was a thoroughly trained naval officer, having seen twenty-five years’ service in the old navy in the grades from midshipman to lieutenant. One cannot resist the temptation to pause a moment and speculate upon the possibilities that must have arisen before the mental vision of this young and ambitious officer as he moved his destroying machine slowly up to the place for action. The events of the day before left no doubt as to the outcome of the combat he was about to

precipitate, and looking beyond his actual surroundings his mind's eye saw the cities of the North laid under ransom by his guns; the national capitol abandoned; the sovereignty of the South acknowledged; the war ended, and himself its central naval figure: he would be the admiral of the Southern navy; perhaps the president of the new nation of the South. It was indeed an hour of vast possibilities for him.

Turning leisurely down the main ship-channel the *Merrimac* headed for the *Minnesota* and opened fire when still a mile distant, the first shot striking the counter near the water line but doing no serious damage. Whatever dreams of conquest Lieutenant Jones may have indulged in earlier in the morning he was now giving all his attention to the material scene about him, and as he looked away to where the *Minnesota* lay stranded to see the effect of his shot, his eye fell on an unfamiliar object. The *Monitor* had moved out from behind the big frigate and was coming unflinchingly across the stretch of water to meet him. This movement of the *Monitor* excited the admiration of Captain Van Brunt of the *Minnesota*, who said in his official report that she ran "right within range of the *Merrimac* completely covering my ship as far as was possible with her diminutive dimensions, and much to my astonishment laid herself right alongside of the *Merrimac*, and the contrast was that of a pigmy to a giant."

On board the *Monitor* every preparation for battle had been made, but the officers and men were kept up by nervous excitement rather than by physical strength; almost without exception they had been without sleep for more than forty-eight hours, and on account of lack of facilities for cooking had had no proper food to sustain them. Worden had left a sick bed to go on board at New York and had suffered much on the voyage down. Newton, who had been at the point of death when dragged out of the engine-room on the occasion of the stoppage of the blowers, was confined to his bed and reported as being unable to do duty for at least a week; when the call to arms sounded, however, he got up and performed his part in the fight courageously and well. There was scarcely a man in the ship who would not have been in a condition of physical prostration had it not been for the excitement due to the presence of the enemy.

Worden took his station in the pilot house, Greene with sixteen men in charge of the guns in the turret, Stodder at the turret turning gear

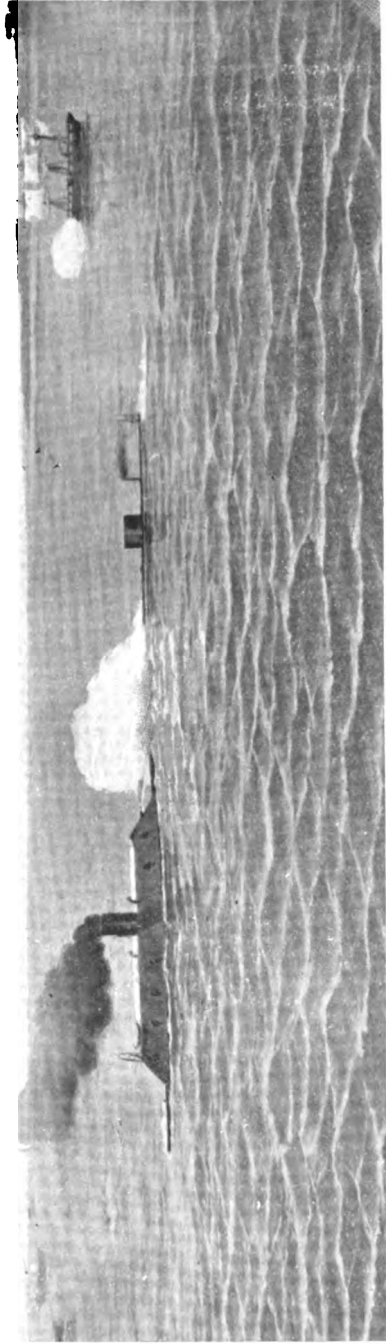

THE MONITOR-MERRIMAC DUEL.

From a copyrighted photograph of a painting by Mr. B. A. Richardson of Norfolk, Va., the use of which is kindly allowed by him.

and Webber had the small powder division on the berth deck. Stodder was disabled early in the action by the concussion of a shot striking the turret when he was touching it and Stimers took his place, he having volunteered at the beginning of the fight to go in the turret and show the people how to operate it. The pilot house, built log cabin fashion of iron beams or billets, 9 inches by 12 inches, with the corners dovetailed and bolted together, was far forward on deck with no means of communicating with the turret except by a speaking tube; this became disconnected soon after the fight began and communication between Worden and Greene then had to be maintained by passing the word along the berth deck, Paymaster Keeler and the captain's clerk doing this important service. The great error of separating the captain from the battery was remedied in the later monitors by simply placing the pilot-house on top of the turret, engineer Isaac Newton having suggested this arrangement immediately after the fight. As an offset to the wearied condition of the *Monitor's* men, the *Merrimac* was far from being in perfect fighting trim. Two of her guns were disabled by the loss of their muzzles, her ram had been wrenched off, and the upper part of the smoke-pipe was shot away. This last was her greatest injury for it so impaired the furnace draft that steam could not be maintained at anything like a proper working pressure, and her motions were consequently extremely sluggish. Speed is a word hardly applicable to either the *Monitor* or *Merrimac*, but by reason of the damage to the latter the great advantage of quicker movement rested with the *Monitor*.

The first shot fired at the *Monitor* missed her and the Confederates realized that they no longer had the big hull of a frigate for a target. Further enlightenment regarding the altered status of their antagonists came quickly in the furious impact of the heavy XI-inch solid shot of the *Monitor* against their casemate, knocking men down and leaving them dazed and bleeding at the nose, ears and mouth. It will be needless to repeat the circumstantial account of the combat, which has been told so carefully by so many writers. Neither vessel could penetrate the armor of the other, which prevented the question of their supremacy being definitely settled and left it open to dispute ever since. Each at different stages of the fight tried ramming, the *Monitor* with the most success as she struck her enemy fairly enough near the stern, having aimed to injure the propeller,

but on account of the smoke and other obstacles to exact steering missed the vital spot by about three feet only. The *Merrimac's* attempt resulted in a harmless glancing blow, the superior speed of the *Monitor* making it an easy matter to elude her antagonist.

After about an hour of fighting, the *Merrimac* tried to give the *Monitor* up as a bad task and turned her attention again to the *Minnesota*, the first shell fired at the frigate passing "through the chief engineer's state-room, through the engineers' mess-room, amidships, and burst in the boatswain's room, tearing four rooms into one in its passage, and exploding two charges of powder, which set the ship on fire."¹ The second shell exploded the boiler of tug-boat *Dragon* lying alongside the *Minnesota*, and by the time the third shell was thrown the *Monitor*, not disposed to be ignored, had again interposed between the *Minnesota* and her assailant and thereafter she engrossed the entire attention of the enemy. Shortly after this diversion the ammunition in the *Monitor's* turret became exhausted and she had to go out of action to replenish it, the scuttle by which it was passed being impossible to use except when the turret was stationary and in a certain position. This circumstance greatly encouraged the Confederates who believed their opponent to be disabled from their fire, but in a quarter of an hour their hopes were dispelled by the *Monitor* resuming the fight more vigorously than ever.

Soon after 11 A. M. Lieutenant Worden, while looking through a sight-hole in the pilot-house, was disabled by a shell striking and exploding immediately in front of his eyes, he being temporarily blinded and his face terribly burned and cut by the flying grains of powder and bits of iron. The steersman was stunned for a few minutes by the concussion also and in that short space of time the *Monitor* without anyone in control of her ran off aimlessly towards shoal water away from the fight, for no one had signalled the engine-room to stop. This gave such an appearance of defeat that on the *Minnesota* all hope was abandoned and every preparation made for setting the ship on fire and abandoning her. In a short time, however, Lieutenant Greene learned of the casualty in the pilot-house and, leaving Stimers in charge of the guns, took command of the ship and turned upon his foe again. Then to the

¹ Official report of Captain Van Brunt of the *Minnesota*.

amazement of all the *Merrimac* suddenly gave up the fight and steamed away toward Norfolk. Catesby Jones reported afterward as a reason for withdrawing at this time that he believed the *Monitor* disabled and he was very desirous of crossing the Elizabeth River bar before ebb tide. There was no reason for believing the *Monitor* out of action and every reason for believing the contrary, for when she returned under the command of Greene, Stimers fired two or three shots against the *Merrimac*, which were the last guns of the encounter. Had the Confederates believed in their success to the extent of demanding the surrender of the *Monitor*, Greene could and very probably would have replied in the words used long before by John Paul Jones under similar circumstances—"We have not yet begun to fight."

Lieutenant Greene did not follow the retreating enemy, the orders under which the *Monitor* fought limiting her action to a defense of the Federal ships, the *Minnesota* especially. Greene was very young at the time and inexperienced in judging of the amount of discretion allowed a commanding officer in obeying orders in battle, so it was with many misgivings that he allowed the *Merrimac* to go unmolested while he returned to the side of the *Minnesota*, but the superior officers of both army and navy present sustained his action and assured him that he had done exactly the right thing. Curious as it appears, many able writers have indulged in much argument to prove which of the two iron-clads won the fight. The *Merrimac* won a most decided victory in her attack upon the wooden sailing vessels the first day of her appearance, but when all argument regarding the second day's fight is exhausted a few very pertinent facts remain undisturbed. When the *Merrimac* got up steam in the morning it was obviously for no other purpose than to destroy the Federal vessels in Hampton Roads, and she did not destroy anything. When the day was done she was not even in Hampton Roads herself. The *Monitor* was ordered to protect the wooden ships, and she protected them. When night came she was still on guard over them, grim, ugly, and ready to fight.

The *Monitor* was struck twenty-one times in the action and fired forty-one XI-inch solid shot. The most damaging blow she received was from the shell which disabled Worden, this having

cracked one of the heavy iron logs of the pilot-house entirely through and forced the fractured ends inboard an inch and a half, besides knocking the loose cover of the pilot-house half off. The deepest indentation in her turret was two inches and the deepest score on her deck was only one-half inch. Two people in the turret were disabled by concussion and Chief Engineer Stimers was hurt in the same way, but his injuries were slight and he pluckily continued in the fight to the end. The *Merrimac* was struck ninety-seven times in the two days' fight, twenty of her shot marks being from the guns of the *Monitor*. Six plates of her outer layer of iron were penetrated but the inner layer was not broken. The XI-inch guns of the *Monitor* were new and large for their time and the Bureau of Ordnance was suspicious of them, having issued orders not to use more than fifteen pounds of powder for their charge; otherwise their shot would probably have broken into the casemate of the *Merrimac*. At a later period greater confidence regarding these guns was entertained and thirty, and even fifty pounds of powder were safely used in charging them. Engineer Isaac Newton, who was very level-headed about such matters, testified before the Congressional Committee on the Conduct of the War that he believed the failure of the *Monitor* to destroy her antagonist was due entirely to the low powder charges prescribed. He also testified to his belief that, "But for the injury received by Lieutenant Worden, that vigorous officer would very likely have badgered the *Merrimac* to a surrender." The *Merrimac* having been hastily equipped and not expecting to meet any but wooden ships had nothing but shell on board; had she been provided with solid shot the effect upon the *Monitor* might have been different.

The success of the *Monitor* completely changed the aspect of the opening military operations of the year and raised the North from a depth of apprehension to a pinnacle of hope and jubilation. No single event of the Civil War so thoroughly aroused the enthusiastic admiration of the loyal North as did this Sunday duel in Hampton Roads, and the *Monitor* and her crew became the great and almost only subject for public discussion and applause. The world is prone to sing the praises of the warrior who destroys, and to neglect the honors due to him who makes the soldier's success possible by providing him with his armor and his weapons, but in

this case the patient toiler reaped the greater glory, and the name and fame of John Ericsson went to the uttermost parts of the earth. Worden, Greene, Stimers and Newton were all heroes in the public estimation and saw their pictures and the story of their deeds in the public prints for many a day, but all the applause showered upon them was little compared to the perfect avalanche of honors heaped upon Ericsson the Engineer. The reason for this unusual sentiment is easily found. Ericsson had been for several months held up to ridicule and abuse to such an extent by the press that he and his work were known to all men, and when his hour of triumph came, that innate sense of sympathy for the "under dog" in a fight manifested itself joyously at seeing him suddenly and unexpectedly come uppermost. Ericsson's enemies had so overdone the matter of persecution that in the end he owed much of his fame to their acts.

Abroad, the news of the battle created a profound sensation and more than one naval power whose commercial interests or thirst for foreign conquest had led to the point of seriously preparing to assail the American Republic in the day of its distress, now paused to take a sober second thought and ultimately concluded to check their designs. "Probably no naval conflict in the history of the world ever attracted as much attention as did the battle in Hampton Roads, between the *Monitor* and the *Merrimac*. It revolutionized the navies of the world, and showed that the wooden ships, which had long held control of the ocean, were of no further use for fighting purposes. Commenting upon the news of that event, the *London Times* said: 'Whereas we had available for immediate purposes one hundred and forty-nine first-class war-ships, we have now two, these two being the *Warrior* and her sister *Ironsides*. There is not now a ship in the English navy, apart from these two, that it would not be madness to trust to an engagement with that little *Monitor*.' England and all other maritime powers immediately proceeded to reconstruct their navies, and the old fashioned three and four-decker line-of-battle ships were condemned as useless. Not only in ships, but in their armament, there was rapid progress, and so great has been the advance in marine artillery that the *Monitors* of 1862, and the subsequent years of the American war, would be unable to resist the shot from the guns of 1880-'87."¹

¹ Thomas W. Knox;—Decisive Battles since Waterloo.

On March 28, by joint resolution, Congress passed a vote of thanks to Ericsson for his "enterprise, skill, energy, and forecast" in the design and construction of the *Monitor*, and he was the recipient of similar honors from the Legislature of the State of New York and from innumerable civil organizations and societies. Lieutenant Worden was tendered the thanks of Congress by a resolution approved July 11, 1862, and in the following February was given more substantial recognition for his great service by a second resolution authorizing his advancement one grade, that is, to the rank of captain, he having been promoted to commander in the meantime. Ericsson steadily maintained that Stimers and not Worden was the real hero of the *Monitor*, because he alone of all on board knew how to operate the various mechanisms of the vessel, without which knowledge she would have been utterly useless in the face of the enemy. At a banquet given him by the New York Chamber of Commerce Ericsson made a point of asserting in his speech that he regarded the success of the *Monitor* as "entirely owing to the presence of a master-mind (Mr. Stimers)," a belief which he defended at length and with an indisputable array of facts.

This public laudation of Stimers, not confined by any means to Ericsson, greatly disturbed Lieutenant Worden and his friends, and Worden, as late as two years after the fight, waited upon Mr. Griswold, a Member of Congress and a friend of Ericsson, having been one of his sureties in the enterprise of building the *Monitor*, to complain of the fancied injustice done him by Ericsson. Of this interview Mr. Griswold wrote to Ericsson: "I have just had a call from Captain Worden. He thinks you did him injustice in your Chamber of Commerce remarks for the sake of complimenting Stimers, and says the 'master-spirit' had nothing at all to do with the affairs of the *Merrimac*, was not consulted, and was in no special way tributary to the result of that combat."¹ In spite of this assertion, the great weight of testimony goes to show that Stimers was consulted and was in a special way "tributary" to the result of the action. Assistant Secretary of the Navy Fox, who saw the fight, telegraphed the Navy Department as soon as he

¹ W. C. Church;—Life of John Ericsson, Vol. I, p. 298.



CHIEF ENGINEER ALBAN C. STIMERS, U. S. NAVY.

could learn particulars that "Lieutenant Worden, who commanded the *Monitor*, handled her with great skill, and was assisted by Chief Engineer Stimers." He could have had no other object in mentioning Stimers' name, to the exclusion of the other officers, in this message except the wish to have the Department understand who, next to Worden, deserved credit for the victory of the *Monitor*.

Lieutenant Greene in the letter to his mother before quoted from in these pages, and which for obvious reasons is more apt to reveal unvarnished facts than a formal official report that would become a public document, says in regard to the officers' stations for battle: "Acting Master Stodder was at the wheel which turns the tower, *but as he could not manage it*, he was relieved by Stimers." The italics are the author's.

Mr. W. C. Church, who cannot be accused of partiality for Mr. Stimers, says in his *Life of John Ericsson*: "During the passage from New York, the working gear of the turret was permitted to rust for want of proper cleaning and oiling, and it worked with so much difficulty during the engagement with the *Merrimac* that, but for the energy and determination of Engineer Stimers, it might not have revolved at all."

Proofs like the above may be multiplied, but these are sufficient for every logical purpose. The writer has no desire to magnify the services of Mr. Stimers, especially as it will become a duty as this history progresses to narrate certain mistakes of that officer whereby the naval engineer corps suffered the most serious reflection upon its professional competence that it has ever experienced, but from an impartial review of all the facts connected with the *Monitor-Merrimac* battle the conclusion is plain that Chief Engineer Alban C. Stimers was the one person on board the *Monitor* who thoroughly knew how to use that vessel and her weapons, and but for his presence the result of the combat would in all probability have been very different, and most disastrous to the *Monitor*, to the reputation of Lieutenant Worden, and to the cause of the Union.

The day after the fight of the iron-clads, the *Minnesota* was floated and soon restored to serviceable condition. Immediately thereafter the Union fleet in Hampton Roads began receiving addi-

tions almost daily, for the naval occupation of this position was an important element in the grand campaign against Richmond then in movement by the Army of the Potomac. The *Merrimac* retired to Norfolk where she was docked by Constructor Porter, her plating repaired and strengthened, and a new spur fitted to her bow. The rough-and-ready old commodore, Josiah Tatnall, was placed in command and great things were expected. On two occasions—April 11 and May 8—she went into Hampton Roads and looked at the *Monitor* and the Federal fleet, but no fight occurred at either time. From the reports of the Federal commander-in-chief, Goldsborough, and of Tatnall it appears that each party earnestly desired a conflict and that the other was afraid, or at least avoided hostilities.

Military operations compelled the surrender of Norfolk to the Union forces on the 10th of May, and Tatnall endeavored to save the *Merrimac* by taking her up the James river, but finding her to draw several feet too much water for the river he reluctantly set her on fire and abandoned her. Early on the morning of May 11 the fire reached her magazine and she blew up. This event occasioned such a wild outburst of public grief in Richmond that for a time it was feared the governmental departments of the Confederacy would be attacked by a mob. The *Merrimac* had been proudly called the "iron diadem of the South," and had been so confidently relied upon for the defense of the James River that after her destruction serious thoughts of surrendering Richmond were entertained. The men of the *Merrimac* were utilized to man a battery up the river at Drury's Bluff, where a few days later they again encountered their old foes of the *Monitor*.

Immediately after the destruction of the *Merrimac*, Flag Officer Goldsborough took possession of the lower part of James River with his flagship, the *Susquehanna*, and a number of smaller vessels, sending Commander John Rodgers with the *Galena*, *Monitor*, *Aroostook* and *Port Royal* on an expedition up the river. The *Galena* had just come from the builders' works at Mystic, Conn., and will be recalled as the iron-clad gunboat built in accordance with the report of the board on armored vessels of the previous year. The *Monitor* was now commanded by Lieutenant William N. Jeffers. The *Aroostook* was one of the ninety-day gunboats and the *Port Royal* was one of the first lot of double-enders. Accompanying

them was the vessel fitted out by the Stevens brothers to demonstrate the excellence of their system of protective armor, this vessel being referred to indiscriminately in the official reports as the *Naugatuck* and the "U. S. revenue steamer *E. A. Stevens*;" she was commanded by a revenue marine lieutenant named D. C. Constable.

The morning of May 15 this squadron came up to Ward's, or Drury's Bluff, eight miles below Richmond, where the river was found obstructed with piles and sunken vessels and defended by a heavy battery mounted about two hundred feet above the water. The *Galena* and *Monitor* anchored about six hundred yards from the battery and the unarmored vessels about twice that distance, all opening fire upon the enemy's works. The *Monitor* soon had to remove to a greater distance on account of being unable to elevate her guns sufficiently. She was struck only three times during the attack and had no casualties. The 100-pounder Parrott gun of the *Naugatuck* burst early in the action and disabled that vessel as it was the only gun she had, the accident resulting eventually in the discouragement of the efforts of the Stevens brothers to induce the government to accept their unfinished battery.

The *Galena*, at anchor and with her broadside sprung towards the enemy's battery, proved a fine target and was very roughly used by the plunging shot from the bluff, which struck her sloping side armor almost at right angles. In the plain words of her commander, John Rodgers, "We demonstrated that she is not shot proof." Thirteen shot penetrated the side armor, several coming clear through and doing great damage to the crew by scattering splinters and fragments of the iron plating, while others stuck in the wooden backing after passing through the plating. One shell made a clean passage through the side and exploded in the steerage, setting the ship on fire. The spar deck was badly splintered and broken through in some places. All along the port side, which was the one exposed, knees, planks, bulkheads, and beams were splintered and started out of place. Although exposed to this terrible riddling, Commander Rodgers kept his ship in action for more than three hours and only withdrew when his ammunition was nearly expended. The *Galena* had thirteen men killed and eleven wounded; the *Naugatuck*, two wounded, and the *Port Royal* had her commander, George Morris, wounded.

The following extracts from the official report of Commander Rodgers of the *Galena* refer to meritorious services performed by members of the engineer department of that vessel:

“ Mr. J. W. Thomson, first assistant engineer, coolly repaired some of the valve gear which broke down, under fire, and under his direction a fire in the steerage, caused by an exploding shell, was extinguished before the regular firemen reached the place.”

“ Mr. T. T. Millholland, third assistant engineer, in charge of the steam fire department, was active and efficient; as a sharp-shooter he did good service.”

“ Charles Kenyon, fireman, was conspicuous for persistent courage in extracting a priming wire, which had become bent and fixed in the bow gun, and in returning to work the piece after his hand, severely burnt, had been roughly dressed by himself with cotton waste and oil.”

The *Wachusett* being at City Point in the James River the 19th of May, it was represented to her captain that there were no physicians in the town and that some of the people, mostly women and children, were in great need of medical attendance. The enemy's lines were believed to be about eight miles from the town, so there was apparently no danger in answering this appeal. Assistant Surgeon G. D. Slocum volunteered to go on shore and minister to the distressed people if some of his shipmates would go with him, he not caring to be entirely alone in an enemy's town, and Assistant Paymaster L. S. Stockwell, Chief Engineer Charles H. Baker, and Lieutenant DeFord of the army signal corps agreed to accompany him. On shore, while visiting the sick, a detachment of Confederate cavalry suddenly appeared and made prisoners of the officers and two of the boat's crew with them, carrying them off to Petersburg. At that place the commander of the district, General Huger, apologized to them for the stupidity of his men and said he would have them released, as they had been captured while rendering humane aid to citizens of Virginia, and, furthermore, were unarmed with the exception of side arms when taken.

The Richmond authorities refused to release the prisoners on General Huger's recommendation and they were accordingly taken

to a military prison at Salisbury, North Carolina, and confined in that place. The peculiar action of the Richmond government in this case was due to the fact that there was talk at the North of treating some Confederate officers captured on privateers as pirates, and the Southerners wished to hold some Federal naval officers as hostages to insure their own officers being treated as prisoners of war. After a detention of twelve weeks in Salisbury, Mr. Baker and some of the others were transferred to Libby prison in Richmond, and about a week later were allowed to enter the Union lines on parole. On the 24th of September Chief Engineer Baker was exchanged for a Confederate army captain and resumed duty under his own flag.

CHAPTER XIX.

“ He has sounded forth the trumpet that shall never call retreat ;
He is sifting out the hearts of men before his judgement-seat ;
Oh! be swift, my soul, to answer Him ; be jubilant, my feet ;
Our God is marching on.”

JULIA WARD HOWE—*Battle-Hymn of the Republic.*

1862—The Civil War, Continued—Naval Operations in the Mississippi River—Battles Below New Orleans—Catastrophe to the MOUND CITY—Attack on Vicksburg—Warfare on the Atlantic Coast—Wreck of the ADIRONDACK—Loss of the MONITOR—Peril of the PASSAIC—Heroism of Assistant Engineer H. W. Robie.

AS soon as a sufficient number of iron-clad steamers in the Mississippi were completed, Commodore Foote hastened to make use of them, the first hostile movement being an attack upon Fort Henry, which was captured February 6th after a closely contested action of little more than one hour. The attacking force consisted of the iron-clads *Benton*, (Foote's flagship); *Essex*, *Carondelet*, and *St. Louis*, and the wooden gunboats *Conestoga*, *Tyler*, and *Lexington*. The attack was planned as a joint army and navy enterprise by General U. S. Grant and Commodore Foote, but owing to the wretched condition of the roads the army was delayed and consequently did not share in the honor of the capture, the fort having surrendered to the naval force. From Fort Henry, Foote moved with his flotilla to Fort Donelson, which place he attacked February 14th. Here he met with much more vigorous opposition than had been experienced at Fort Henry, and in the course of an hour and a half two of his vessels were temporarily disabled, and the attack was discontinued for the night. The next morning, upon resuming the bombardment, the enemy was found considerably demoralized and after a feeble resistance surrendered.

A naval movement on a far greater scale was already on foot, having for its object the opening of the Mississippi River from its mouth. Captain David G. Farragut was selected for the command of this expedition and in his flagship, the *Hartford*, arrived on the 20th of February off the mouth of the great river where he was to

make his name famous. The vessels ordered to this station assembled one by one at the Southwest Pass and the entire month of March was consumed in the task of getting the heavier ships into the deep water of the river inside, which labor was finally accomplished with the exception of the *Colorado*, which vessel could not be lightened enough to make her entrance possible. Her commander and a large number of her officers and men went as volunteers in other ships of the fleet. As finally assembled in the river at Pilot Town the fleet proper consisted of seventeen vessels of the classes and armament exhibited in the table following. The *Varuna* was a merchant steamer purchased in 1861 for \$135,000, but all the others will be recognized as being regularly built war-vessels and all, with the exception of the *Mississippi*, of a type then modern.

NAME.	TONS.	GUNS.	COMMANDING OFFICER.	CHIEF ENGINEER.
<i>Screw Sloops</i>				
Hartford	1990	24	Capt. D. G. Farragut. ¹ Capt. H. H. Bell. ²	Chief Engr. J. B. Kimball.
Pensacola.....	2158	23	Capt. H. W. Morris. ³	Chief Eng. S. D. Hibbert.
Brooklyn.....	2070	22	Capt. T. T. Craven.	Chief Eng. Wm. B. Brooks.
Richmond.....	1929	24	Com. James Alden.	Chief Eng. John W. Moore.
Oneida.....	1032	9	Com. S. P. Lee.	Chief Eng. F. C. Dade.
Varuna.....	1300	10	Com. Chas. S. Boggs.	Act. 1st. A. Eng. R. Henry.
Iroquois.....	1016	7	Com. John DeCamp.	1st Asst. Eng. John H. Long.
<i>Side Wheel.</i>				
Mississippi ..	1692	17	Com. M. Smith.	Chief Eng. E. Lawton.
<i>Ninety-day gunboats</i>				
Cayuga.....	507	2	Lieut. N. B. Harrison.	2d. Asst. Eng. G. W. Rodgers.
Itaska.....	507	2	Lieut. C. H. B. Caldwell.	2d. Asst. Eng. J. H. Morrison.
Katahdin....	507	2	Lieut. Geo. H. Preble.	2d. As. Eng. T. M. Dukehart.
Kennebec.....	507	2	Lieut. J. H. Russell.	2d. As. Eng. Henry W. Fitch.
Kineo.....	507	2	Lieut. G. M. Ransom.	2d. As. Eng. S. W. Cragg.
Pinola.....	507	2	Lieut. Pierce Crosby.	1st As. Eng. John Johnson.
Sciota.....	507	2	Lieut. E. Donaldson.	2d. A. Eng. Chas. E. Devalin.
Winona.....	507	2	Lieut. E. T. Nichols.	2d. A. Eng. Jas. P. Sprague.
Wissahickon	507	2	Lieut. A. N. Smith.	2d. A. Eng. T. S. Cunningham.

¹ Flag Officer, commanding fleet.

² Fleet-Captain. Commander Richard Wainwright actually commanded the *Hartford* during the ensuing operations.

³ Owing to Captain Morris' defective eyesight, the executive officer, Lieutenant F. A. Roe, was in practical charge of this ship.

In addition to this force there was also a flotilla of twenty schooners under the command of Commander David D. Porter, each schooner mounting one XIII-inch mortar. These vessels were mostly commanded by their former captains, who had entered the naval service as acting masters and were excellent examples of that large and courageous class of practical seamen who contributed so largely to the success of the naval arms during the rebellion. Their character and services were well understood by Porter, who thus refers to them in a report written by him in July, 1862:

“Again, sir, I have to mention favorably the divisional officers, and the acting masters commanding mortar vessels. Anchored at all times in a position selected by myself, more with regard to the object to be accomplished than to any one’s comfort or safety; knowing that they will have to stay there without a chance of getting away till I think proper to remove them, (no matter how thick the shot and shell may fly) there has always existed a rivalry as to who shall have the post of honor (the leading vessel) almost certain to be struck, if not destroyed.

“They know no weariness, and they really seem to take delight in mortar firing, which is painful even to those accustomed to it. It requires more than ordinary zeal to stand the ordeal. Though I may have at times been exacting and fault-finding with them for not conforming with the rules of the service (which requires the education of a life-time to learn) yet I cannot withhold my applause when I see these men working with such earnest and untiring devotion to their duties while under fire.”

Six steamers accompanied the mortar fleet to move the schooners about and to protect them in a measure from attacks that their peculiar armament could not oppose, these steamers being the *Owasco*, *Miami*, *Harriet Lane*, *Westfield*, *Clifton*, and *J. P. Jackson*. The *Owasco* was a ninety-day gunboat; the *Miami* one of the first lot of double-enders; the *Harriet Lane* a side-wheel revenue cutter transferred from the Treasury Department, and the other three were large and heavily-armed side-wheel ferry-boats.

After the fleet had stripped for action and left at Pilot Town all spars, sails, rigging and unnecessary boats, it moved up to the

desperate undertaking of attacking and passing the two forts, Jackson and St. Phillip, most advantageously located at a bend on opposite banks of the river. A short distance below the forts the river was barred with a combination of large log rafts and schooners at anchor, supporting heavy chains reaching from bank to bank. Auxiliary to the forts and above them in the river was a flotilla of Confederate vessels, consisting of four naval steamers, six gunboats of the local River Defense Fleet, and two armed steamers belonging to the State of Louisiana. The most formidable of the Confederate naval vessels was the ram *Manassas*, which the previous October had been in action with the *Richmond* in the Southwest Pass and had somewhat damaged that vessel. She was originally a large sea-going tug-boat named *Enoch Train* and had been converted into a ram by being arched over with timber and plated with old-fashioned railroad strap iron, about an inch thick. She had twin screws and carried one 32-pounder gun pointing right ahead. Another of the naval vessels was the *Louisiana*, a large armored river steamer similar to the Federal iron-clad *Benton* described in a previous chapter; she had sixteen heavy guns, nine of them being VI and VII-inch rifles, and would have been a formidable antagonist had it not been for the fact that Farragut made his attack before her machinery was quite finished. The other naval vessels and the River Defense boats were river steamers mounting from two to seven guns each, lightly armored forward, and the two State vessels were small sea-going steamers, also armored on their bows, and mounting two guns each.

The mortar flotilla was moved up to within about three thousand yards of Fort Jackson and rendered almost indistinguishable by dressing the masts with bushes and foliage, the vessels lying close to the bank with a background of trees. On the 18th of April they opened fire upon Jackson and for nearly six days maintained an almost uninterrupted bombardment, doing the enemy's works much damage and receiving some in return, one of the schooners being sunk at her anchors by a shell dropping completely through her. To divert the fire of the forts from the mortar fleet, a sloop of war and two or three gunboats were each day advanced into the zone of fire and effected the object satisfactorily by moving about near the head of the line of schooners and firing on the forts at the same

time. The *Oneida*, just out of the shipyard where she was built, was the first of the sloops to go into this fire and she demonstrated that in spite of her pretty name of the beautiful lake of the Iroquois she was to be ruled by an evil star, for her baptism of fire cost her many ugly hits and nine men badly wounded. Thenceforth her career was one of misfortune, until finally in a far-distant sea she went to the bottom with the greater part of her crew.

While the mortars were thus furiously engaged, Farragut was making all ready for the attempt to run past the forts. One interesting expedient adopted by him was the shifting of weights on board all the vessels so that they were down by the head about one foot, the object being to prevent the swift current from swinging them head down stream in case of taking the bottom, as would have resulted had they grounded with the usual trim of the greatest draft aft. All unnecessary top-hamper had been previously dispensed with, and now five of the gunboats removed even their lower masts. Chain cables were stopped up and down the ships' sides to protect the machinery, and the vessels were rendered difficult to see on the muddy water by daubing them over with the yellow mud of the river. These last two expedients were due to the ingenuity of engineers on board the *Richmond*. The use of chain cable for armor is said by several officers who were attached to the *Richmond* at the time to have been suggested by First Assistant Engineer Eben Hoyt of that vessel and was proposed to the commanding officer by the chief engineer, Mr. John W. Moore. From Farragut's detailed report of the battles below New Orleans the following relating to this point is quoted:

“Every vessel was as well prepared as the ingenuity of her commander and officers could suggest, both for the preservation of life and of the vessel, and, perhaps, there is not on record such a display of ingenuity as has been evinced in this little squadron. The first was by the engineer of the *Richmond*, Mr. Moore, by suggesting that the sheet cables be stopped up and down on the sides in the line of the engines, which was immediately adopted by all the vessels.”

Under the date of October 16, 1862, Chief Engineer Moore,

writing from the *Richmond*, then at Pensacola, addressed the Navy Department in regard to a change which had been made to his disadvantage in the arrangement of the list of chief engineers. On the original of this letter, now on file in the Department, in Admiral Farragut's own handwriting is the following endorsement:

“Respectfully forwarded. Mr. Moore is the gentleman whom I mentioned in my official letter as the originator of cladding the ships with their chain cables and has always been spoken of by his Commander as a man of great merit both in and out of his profession.

“Very respectfully,
D. G. FARRAGUT.”

The commanding officer of the *Richmond* in forwarding Mr. Moore's protest took occasion to write the following letter, which certainly is conclusive as to whether or not the expedients referred to originated with members of the engineer corps:

“SIR:—I have the honor to enclose herewith a remonstrance of Chief Engineer Moore of this vessel against the action of a Board of Examiners which has evidently done him great injustice. Being more or less interested in the welfare of all those serving under my command and feeling it a duty to come to their aid when they require it, I trust that I shall be excused for thus trespassing on your valuable time and will proceed at once to the point. *Imprimis* then, Mr. Moore's professional standing has been fixed at the highest point by the several Boards before which he has appeared, and to my mind he is justly entitled to that distinction; but I wish now to show the Department that he has besides that other claims to consideration. They are as follows: About this time last year I arrived at the Southwest Pass in the *South Carolina* pretty nearly broken down in machinery. Our main shaft was all adrift and neither the *Niagara* and *Colorado* could do anything for us. Mr. Moore, who was on board this ship at the time at the head of the passes, hearing of our trouble came down and very soon decided that he could make us all right again, and in less than three days we were, by his individual exertions, fully and efficiently repaired

and off for our station. Again, the idea of mailing our vessels' sides, which was adopted by all the ships of the squadron, with chain cables, is his. We know that it saved this ship's as well as the *Hartford's* machinery from serious injury and consequently the vessels from destruction, the armor on both having been struck by solid shot in that vital locality. After the passage of the forts two-thirds of a 32-pounder shot, which had broken its way through parts of the chain, was found embedded in our side. The Captain of the *Brooklyn* says in his official report, in speaking of the ram *Manassas*: "His efforts to damage me were completely frustrated, our chain armor proving a perfect protection to our sides." Subsequent examination showed, however, that the ship had received serious damage and that *nothing but the armor saved her from destruction.*

"The idea of painting the ships with the mud of the Mississippi on that memorable occasion so as to screen them as much as possible from observation, a color now adopted by the Department as national, is also Mr. Moore's.

"Regretting my inability to state this case properly in fewer words, I am, Respectfully, Your obedient servant,

"JAMES ALDEN, Commander.

"HON. GIDEON WELLES, Secretary U. S. Navy, Washington, D. C."

The night of the 20th of April, Lieutenant Caldwell in the *Itaska* most gallantly boarded one of the schooners supporting the barrier chain and, finding its ends bitted on board, slipped them and thus created a gap in the line of obstructions. The night of the 23rd Farragut made all final preparations for passing through the gap and running the batteries of the forts. A detailed account of the event that followed would fill a book the size of this if properly dealt with, and is, moreover, a story of our navy to which sufficient justice has never yet been done by historians, it being one of the greatest and most desperate engagements in our naval annals. Briefly, at 2 A. M. the 24th, the signal—two blood-red lights at the peak of the *Hartford*—was made for the movement to begin and the leading division, after some delay on account of difficulty in

managing the anchors in the strong current, moved up through the opening and into furious action with the forts. This division was led by Captain Theodorus Bailey in the gunboat *Cayuga*, followed by the *Pensacola*, *Mississippi*, *Oneida*, *Varuna*, *Katahdin*, *Keneo*, and *Wissahickon*, in the order named, and was under orders to proceed along the left, or east, bank of the river, engaging Fort St. Phillip with the starboard batteries. Captain Bailey belonged to the *Colorado* and had hoisted his division flag on the *Cayuga* through the kindness of Lieutenant Napoleon B. Harrison commanding that vessel, the commander of the *Oneida* having previously objected to being overshadowed by the presence of a divisional officer on board his vessel, which objection cost him the honor of having his ship lead the first column.

Behind Bailey's division came Farragut with the *Hartford*, *Brooklyn* and *Richmond*, forming what was called the center division, and this was followed by Fleet Captain Bell, leading the third division of six vessels, in the gunboat *Sciota*. The second and third divisions were to follow up the western bank and engage Fort Jackson with the port batteries.¹ The steamers attached to the mortar flotilla moved up near the forts as the fleet got under way and in conjunction with the mortar schooners opened a terrific cannonading against the works, greatly augmented by the firing from the passing ships. In the heavy smoke that soon settled over the river it became impossible for signals to be read and much confusion resulted, each vessel being obliged to fight out its own destiny. With the air filled with bursting shells and obscured by smoke, the roar of heavy guns, the shouts of command, the screams of mangled men, and the river covered with fire rafts and burning wreckage, the scene was most awful and unearthly, and justified the brief comment made by Farragut in his official report: "Such a fire, I imagine, the world has rarely seen."

The vessels suffered severely from damages and casualties, but within an hour and a quarter after the *Cayuga* had passed the gap in the barrier the fleet with the exception of three gunboats of the last

¹ The order of battle herein described is derived from the supplemental report published in the annual report of the Secretary of the Navy for 1869, which was intended as an official correction of numerous inaccuracies that had appeared in several naval histories.

division—the *Kennebec*, *Itasca* and *Winona*—had passed above the forts and appeared in the Confederate flotilla, “like dogs among a flock of sheep,” as Captain Mahan expresses it in his account of the battle in “The Gulf and Inland Waters.” The three last gunboats had to bear the brunt of the fire from the forts after the other vessels had passed out of range and were very roughly used; the *Itasca* was wholly disabled by a shot through her boiler, two firemen being severely scalded as a result, and the other gunboats suffered so severely that the attempt to run the batteries appeared not only foolhardy but impossible. They rejoined the fleet a few days later.

The first vessels to break into the enemy’s fleet were the *Cayuga* and *Varuna*, both of which fared badly until more vessels came up. The *Varuna* was rammed by two of the Confederate boats and so damaged that her commander ran her ashore, where she sank, the crew escaping previous to the disaster with the exception of three men killed and nine wounded. The *Cayuga* was badly cut up, being struck forty-two times, but she remained in action and individually received the surrender of three of the enemy’s vessels. The ram *Manassas* struck the *Richmond* on the starboard side and so crushed in her planking that she must have been destroyed had the blow been slightly heavier; as it was, the chain armor saved her. The *Manassas* also rammed the old side-wheel frigate *Mississippi* and nearly stove in her side, but the blow being a glancing one the break did not extend entirely through the side. These acts of the *Manassas* were committed while the vessels were in action with the forts. When the Federal fleet had passed up, the *Manassas* was seen quietly following, and Captain Melancthon Smith of the *Mississippi*—a good fighter and a good Christian—asked and obtained permission by signal to go back and attack her. The ram seemed unwilling to try conclusions with the heavy old ship coming straight down upon her with the swift current, and just before the impending collision she shied high up into the river bank, where her crew made hurried preparations for her destruction and abandonment, and then took to the shore. As soon as possible a boat was sent from the *Mississippi* to see what could be done with her late antagonist, First Assistant Engineer William H. Hunt being in the boarding party to take charge of the machinery. The

boat soon returned, reporting that it was impracticable to save the *Manassas*, which had been set on fire and disabled, and Mr. Hunt on his part reported that the piping through the hull had been cut, the water run out of sight in the boiler, the fires kept raging in the furnaces, the safety valves shored down, and the steam gauge showing 136 pounds (a frightful pressure in those days),—"with a tendency hellward." The *Mississippi* therefore returned up the river to rejoin the fleet. Later, the water coming in through the cut pipes, depressed the stern of the *Manassas*, floated her bow off the bank, and the current carried her down to Porter's mortar fleet, where her appearance created considerable consternation, but she soon faintly exploded and sank.

According to Flag Officer Farragut's report eleven of the enemy's steamers were destroyed during this morning fight, which practically annihilated their fleet. The Federal fleet remained at anchor one day to rest the men and repair damages and on the morning of the 25th, Captain Bailey in the *Cayuga* still leading, proceeded up the river, had a sharp skirmish with the Chalmette batteries, and at noon anchored off the City of New Orleans. The city was taken possession of and held by the naval force under very strained and trying circumstances until May 1, when General B. F. Butler arrived with a large force and assumed military control of the place, the fleet soon after proceeding on its mission of conquest up the river. Commander Porter continued the bombardment of the lower forts with his flotilla until the 28th of April, when they surrendered to him. The casualties in the fleet during the battle of the 24th, as reported by the fleet surgeon, amounted to thirty-seven killed and one hundred and forty-seven wounded, a record that makes this one of the bloodiest naval battles of the rebellion. Two officers, both midshipmen, were killed and eleven were wounded; three of the latter—Second Assistant Engineer S. Wilkins Cragg, acting chief of the *Keneo*; Third Assistant J. C. Hartley of the *Pensacola*, and Acting Third Assistant Frank R. Hain of the *Colorado*, serving as a volunteer on the *Iroquois*—were of the engineer corps, all injured by gunshot wounds.

The reports of many of the commanding officers of vessels engaged in this battle referred in terms of praise to the zeal and ability displayed by the engineers and their men in keeping the machin-

ery in efficient operation under trying conditions. Captain Bailey, in describing the battle afterward, on the occasion of a banquet given him at the Astor House in New York, is credited with having made the modest statement that, "the engineers ran the ships and all we had to do was to blaze away when we got up to the forts." Assistant Engineer Hartley of the *Pensacola* was most highly referred to in the official reports for the courage he exhibited; he was stationed at the engine-room bell and was wounded in the head by a piece of shell, and, although urged to go below for treatment, refused to leave his station, remaining there all through the action.

On the 28th of May Chief Engineer James B. Kimball of the *Hartford*, while ashore in Baton Rouge with a boat's crew on duty was suddenly fired upon by the enemy and himself and two of the men badly wounded. Mr. Kimball was struck in the head, face and neck with slugs and most painfully hurt, although he recovered.

A frightful disaster befell a squadron of the Mississippi flotilla in June of this year. The gunboats *Mound City*, *St. Louis*, *Lexington*, and *Conestoga*, under Commander Augustus H. Kilty of the *Mound City*, were sent into White River to convoy some troop transports and assist in an attack upon some Confederate batteries at St. Charles, Arkansas. The attack was made June 17 and resulted in the capture of the enemy's fortifications, but during its progress a shot penetrated the casemate of the *Mound City* just above a gun port, killed three men in its flight, and exploded her steam drum. The immediate result was horrible; nearly eighty men were scalded to death by the steam which filled the casemate, and forty-three others were drowned or shot by the enemy after leaping overboard. Of one hundred and seventy-five officers and men only twenty-five escaped uninjured, the number killed or who subsequently died being one hundred and thirty-five. Commander Kilty was so scalded that his left hand had to be amputated. Among the killed were Chief Engineer John Cox; Second Assistant Engineer John C. McAfee, and Third Assistant G. W. Hollingsworth.

Early in the morning of June 28th, Admiral Farragut with the *Hartford*, *Richmond*, *Iroquois*, *Oneida*, *Wissahickon*, *Sciota*, *Winona*, and *Pinola* ran the batteries at Vicksburg, assisted by

Commander Porter with his mortar flotilla. The military importance of this move is not apparent, as the batteries were not destroyed, and in the nature of things could not be materially harmed by ships, located as they were on bluffs high above the water. From Farragut's report it seems that the move was largely experimental, for he says:

“In obedience to the orders of the department and the command of the President, I proceeded back to Vicksburg with the *Brooklyn*, *Richmond*, and *Hartford*, with the determination to carry out my instructions to the best of my ability.”

And again:

“The department will perceive from this (my) report that the forts can be *passed*, and *we have done it*, and *can do it again as often as may be required of us*. It will not, however, be an easy matter for us to do more than silence the batteries for a time, as long as the enemy has a large force behind the hills to prevent our landing and holding the place.”

One of Porter's steamers, the *Clifton*, was disabled in this affair by a shot through her boiler which killed six men by scalding. The total casualties of the morning were fifteen men killed and thirty wounded, about one-third of the number being on the flagship. Farragut himself and Captain Broome of the Marine corps appear on the surgeon's report of casualties as having suffered from contusions on the *Hartford*. The report of Commander S. P. Lee of the *Oneida* says: “One 6-inch rifle shell came through the starboard after pivot port, killing S. H. Randall, a seaman, at the after pivot gun, severely wounding Richard Hodgson, third assistant engineer, at the engine bell, and, passing through the coamings of the engine-room hatch, picked up three loaded muskets, (each lying flat on the deck, on the port side of that hatch) and burst into the bulwarks, over the first cutter, which was lowered to near the water's edge, drove the muskets through the open port there, and severely wounded William Cowell, seaman, who was in the boat sounding, and slightly wounding Henry Clark, chief boatswain's mate A second 8-inch compound solid shot carried

away, amidships, the keel of the launch, (which was partly lowered) and, entering on the starboard side, struck the steam drum, and, glancing, fell into the fire-room.”

On the 5th of July when the iron-clad *Lexington* was proceeding along the White River, Arkansas, her chief engineer, Mr. Joseph Huber, was shot dead by guerillas lurking along the banks.

On the Atlantic coast after the remarkable fight of the iron-clads in Hampton Roads there were no very important naval engagements during the year. The unromantic and wearying work of maintaining the blockade along that coast employed the greater number of the sea-going vessels and kept them extremely active, while in the rivers, bays and sounds the smaller steamers were engaged in a ceaseless border warfare with the armed vessels and shore batteries of the enemy. This latter employment furnished a fine field for adventure and, although on a small scale, gave opportunity for the development of a class of intrepid and self-reliant young officers, of which class Lieutenant-commander C. W. Flusser and Lieutenant Wm. B. Cushing were brilliant examples. Two or three incidents will suffice to indicate the dangerous nature of this litteral warfare.

On the 14th of August Lieutenant George B. Balch in the *Pocahontas* proceeded up Black River, South Carolina, some twenty-five miles looking for a Confederate steamer said to be in hiding there. Meeting with more resistance than expected from the enemy along the banks he finally turned back and as the neighborhood had become aroused the *Pocahontas* had to run the gauntlet for over twenty miles of riflemen concealed in the thickets on both banks, she replying all the distance with grape and cannister and smallarm fire. By keeping the men behind breastworks of hammocks and lumber she escaped with only one casualty, that being reported by Lieutenant Balch as follows: “At 3:40 P. M., whilst under a very sharp fire of the enemy, Acting Third Assistant Engineer John A. Hill was wounded by a Minie ball, and I regret to report that his wound is very dangerous; as yet, however, I am rejoiced to state that his symptoms are all favorable; it is a penetrating wound of the abdomen, the ball having passed entirely through his body. I need not say that he is receiving the most assiduous care of Dr.

Rhoades, and he has been removed to the open deck under the poop, that he may have the benefit of the cooler atmosphere; and I am satisfied that if skill and attention can avail his life will be saved.”

Mr. Hill furnished an example of remarkable recovery, for he survived his wound, served faithfully throughout the war and, as a first assistant engineer, was honorably mustered out in December, 1865.

September 9th, the *Shawsheen* had a similar experience, she being ambushed off Cross' Landing in the Chowan River, North Carolina, and escaped with one casualty, also an assistant engineer; this officer, John Wall by name, was shot in the thigh and wrist and dangerously wounded, but ultimately recovered.

The morning of October 3d, Lieutenant Commander Flusser with the *Commodore Perry*, *Hunchback*, and *Whitehead* went up the Blackwater River to co-operate with Major General Dix in an attack on Franklin, Virginia. When near the town the vessels were suddenly attacked by a large force lying in ambush in the woods and on high bluffs, and suffered severely, not being able to use their ordnance to advantage in reply. After fighting for three hours under these conditions and getting no support from the army, which did not appear, the steamers returned down the river, being obliged to force their way with a heavy head of steam through obstructions made by the enemy felling trees into the narrow stream. The affair cost four men killed and fifteen wounded, twelve of the casualties being on Flusser's steamer, the *Commodore Perry*. One of the killed was an officer—Master's Mate John Lynch. The following instances of gallantry are mentioned in Flusser's report:

“I desire to mention as worthy of praise for great gallantry, Lieutenant William B. Cushing, who ran the field-piece out amid a storm of bullets, took a sure and deliberate aim at the rebels, and sent a charge of cannister among them, that completely silenced their fire at that point. Mr. Lynch assisted Mr. Cushing, and here met his death like a brave fellow, as he was.

“Mr. Richards, third assistant engineer, who had charge of the powder division, also assisted with the howitzer, and showed

great courage. Mr. Anderson, the paymaster, was of great assistance in bringing in the wounded from under the fire."

Upon the receipt of this report Acting Rear Admiral Lee, commanding the squadron, directed that Acting Third Assistant Engineer George W. Richards be examined for promotion on account of his conduct in the fight, and he was shortly afterward advanced to the grade of acting second assistant engineer.

The fine screw-sloop *Adirondack*, fresh from the New York navy yard where she was built, while proceeding to the Gulf of Mexico struck on a reef near Little Abaco Island the morning of August 23rd, and became a total wreck, the engineer of the watch stating that when she struck he saw the jagged points of the reef sticking up through her bottom into the fire-room. At daylight the commanding officer, Captain Guert Gansevoort, ordered all hands to go to the island, about five miles distant, and said that he would remain on board. The boatswain, Mr. William Green, and Second Assistant Engineer Henry W. Robie elected to stay with him and soon had to defend the ship with hatchets and revolvers against a boat load of villainous-looking black wreckers who came off to board her, but were successfully driven off. The two officers named finally prevailed upon the almost distracted captain to abandon the ship, her salvage being hopeless, and with him went ashore to join the rest of the crew. All hands lost everything they owned except the clothing they had on at the time of stranding, as the ship filled with water immediately and settled down on the reef until her spar deck was almost awash. The shipwrecked men remained on Little Abaco about two weeks, when they were taken off by the U. S. *Canandaigua*. The members of the corps who shared in this misfortune were Chief Engineer Alexander Henderson, First Assistant Engineer George J. Barry, Second Assistants Louis J. Allen and Henry W. Robie, and Third Assistants T. M. Mitchell, J. G. Greene and Thomas Crummey.

Mr. Robie was a brother of Chief Engineer E. D. Robie, a prominent member of the corps until his recent retirement, and from his unfortunate adventure in the *Adirondack* went to the new monitor *Passaic*, where a more dangerous experience was in store for him. The *Passaic* and the *Monitor* left Hampton Roads the

afternoon of December 29th, 1862, to join the blockading fleet off Charleston, the former being towed by the *State of Georgia* and the latter by the *Rhode Island*, but both using their own steam as well. Captain Percival Drayton commanded the *Passaic* and Commander J. P. Bankhead the *Monitor*, the senior engineers of the vessels respectively being First Assistant Engineer George Bright and Second Assistant Joseph Watters. The evening of December 30 the sea became rough, and the *Monitor* began making heavy weather of it, taking in quantities of water through the hawse pipes and under the turret, and generally renewing the experience of her first voyage from New York. The water gained steadily and soon impaired the fires by rising into the ash pits and swashing against the grate bars, until the falling steam pressure showed too plainly that the engines and pumps must soon stop. At 10:30 p. m. signals of distress were made to the *Rhode Island* and that vessel undertook the extremely dangerous and difficult task of removing the *Monitor's* people in the heavy sea by means of boats, but before the work was completed the *Monitor* sank. This happened shortly after midnight of the morning of December 31, about twenty miles S. S.-W. of Cape Hatteras. With her perished acting ensigns Norman Atwater and George Frederickson; third assistant engineers R. W. Hands and Samuel A. Lewis, and twelve enlisted men. In Commander Bankhead's report of the disaster he asserted his conviction that a serious leak had been sprung by the pounding of the sea separating the iron hull from the wooden upper body, and this seems very probable.

In the meantime the *Passaic* was having a similar experience, water gaining in her bilges steadily on account of lack of strainers on the suction pipes of the pumps which resulted in the pump valves soon choking with dirt and ashes. This absence of a very essential fitting was caused by the vessel having been hurried away from the contractors' works by the naval authorities before the engine-room details were completed. About midnight the last pump gave out and as the water threatened to reach the fires and extinguish them, the fire-room was abandoned and the crew assembled on top of the turret. The chief engineer was confined to his room by illness before the vessel left Hampton Roads, leaving Mr. Robie in charge, and he now proved himself equal to the emergency. With a second

class fireman named Richards, who volunteered to stay below with him, he put on the bilge injection and for two or three hours stood over it, almost submerged in water, keeping the mouth of the pipe clear and opening or closing the valves as required, while the fireman attended to the fires. Captain Drayton waded into the fire-room during this time and gave the not very cheering information that the *Monitor* had just gone down. Eventually the pump gained on the water and confidence was restored. The story of Mr. Robie's heroism is more fully set forth in the following affidavit made by the surgeon of the vessel:

“Newark, N. J., May 1st., 1890.

“To whom in the interest of patriotism and justice it may concern, be it known that I, Edgar Holden, formerly Surgeon of the monitor *Passaic*, actuated by a desire to see atonement made by a great government for the unmerited neglect of a brave fellow-officer, to whose heroism and fortitude were due the safety of the monitor *Passaic*, and through this the consummation of the plan for placing the monitor ironclads in southern waters during the late war, do certify to the following facts; said facts being not matters of memory but drawn from notes made at the time in my private journal and in large part published in the year 1863 in *Harpers Monthly Magazine*, October, 1863.

“To-wit: That when in that awful night in which the original *Monitor* was lost, officers and men had toiled for hours at the seemingly hopeless task of throwing overboard shot and shell and bailing the sinking ironclad with buckets passed from hand to hand, and when from exhaustion and despair we fell at times to rise again to the futile task, and when from the engine-room came the report that one after another the pumps had given out, and that the water was knee deep in the fire-room, swashing against the fire bars with every lurch of the ship, and when finally the report came ‘the last pump has failed’ and we threw down our buckets to die, that Assistant Engineer H. W. Robie stood alone at his post and succeeded in starting the pumps known as the bilge injections, and frequently submerged to the neck in water, worked the valves with his hands, his head held by myself or his fireman, while the task seemed puerile to the despairing men on deck. That he stood for

hours under the platform around the engines to prevent the entrance of chips and floating debris from entering and clogging the valves which were without the usual strainers. That these pumps were the only ones that could be so cleared, the others having suction pipes passing in some way that I have forgotten through an iron bulkhead and making it impossible to free them. That Mr. Robie thus stood at his post after all but one fireman had left the engine rooms. That further it was my conviction, as well as that of all who knew at the time of his heroism, that to his fidelity alone was due the safety of the *Passaic*.

“And I would further certify that only of late have I been made aware that this unsurpassed devotion to duty has never been acknowledged by the Navy Department or the Government, and that the facts were not made known at the time, probably through a patriotic desire to conceal the bad sea-going qualities of the monitors, and were certainly omitted from my published journal solely on this account.

“I would further state that this gallant officer is, as I am credibly informed, ill and in straitened circumstances, and that any action tending to show a just appreciation of his invaluable services should be taken promptly.

(Signed,)

“EDGAR HOLDEN, M. D., PH. D.

“Medical Director Mutual Benefit Life Insurance Co., Fellow and Vice President American Laryngological Society, Member American Medical Association, etc., etc.; formerly Assistant Surgeon U. S. N.”

“Personally appeared before me this 2d day of May, 1890, Dr. Edgar Holden, of the city of Newark and county of Essex, known to me to be a physician and surgeon in good standing, formerly an officer of the United States Navy, who certifies that the above statements are just and true.

(Signed,)

“F. K. HOWELL, Notary Public, N. J.”

Heroism and devotion to duty of the order described have won promotion and reward in innumerable instances where the degree was less than in this case, but there is no record of Mr. Robie hav-

ing received either for his signal services. One considerable recognition which he did receive, and which he said well repaid him for his experience, occurred shortly before the battle in Mobile Bay, when Captain Drayton introduced him to Admiral Farragut with the remark, "Mr. Robie saved the *Passaic* the night the *Monitor* was lost."

CHAPTER XX.

“ When the temple at Jerusalem was completed, King Solomon gave a feast to the artificers employed in its construction. On unveiling the throne it was found that a blacksmith had usurped the seat of honor on the right of the king’s place, not yet awarded. Whereupon the people clamored and the guard rushed to cut him down. ‘ Let him speak ! ’ commanded Solomon. ‘ Thou hast, O King, invited all craftsmen but me, yet how could these builders have raised the temple without the tools I fashioned ? ’ ‘ True, ’ decreed Solomon, ‘ the seat is his of right. All honor to the iron-worker. ’ ”—*Jewish Legend*.

1862—The Civil War, Continued—Increase of the Navy—Steamers Purchased—Mississippi Flotilla Transferred to the Navy Department—Steam Vessels of War Placed Under Construction—The PASSAIC Class of Monitors—The DICTATOR and PURITAN—The MANTONOMOH Class—Other Monitors—The KEOKUK—The DUNDERBERG—Legislation Regarding the Navy—Retired List Established—Creation of the Bureau of Steam Engineering—Pensions.

DURING 1862 the naval force both in ships and men was largely increased. About fifty steamers from the merchant service were bought during the year and converted into armed vessels, and a similar number of vessels was added to the naval establishment by the transfer of the Mississippi flotilla in July from the army and by the transfer of some revenue cutters from the Treasury Department. Several vessels captured from the enemy in action, or while attempting to run the blockade, were found suitable for use as war steamers, prominent among these being the powerful iron-clad ram *Tennessee* captured at New Orleans while still unfinished, and the steamer *Eastport* taken by Lieutenant Phelps in the Tennessee River.

This year witnessed a remarkable awakening of public interest in naval ship construction; an interest that took the form of practically dictating to the Navy Department the types of war ships the country needed, and was so powerful that it entirely overcame and consigned to the background the practices and prejudices which had long been fundamental in the naval service relative to the same subject. As a result all the old theories based upon the supposed unreliability of steam, the alleged necessity for sail-power on war-

vessels, and the doubted utility of iron as a material for ship construction, were cast aside, and with the prestige resulting from the performance of the *Monitor* and the failure of the old type of ships in Hampton Roads the engineer was allowed free scope to develop his ideas and build ships embodying them. It was, in fact, one of those occasions which recur from time to time when society is forced by unusual circumstances to admit its dependence upon the iron-worker, and in its distress to fall before him humbly begging for succor. The result of all this was that the greater part of the constructive activity of the year was devoted to the building of engineers' war-ships,—mastless vessels dependent entirely upon steam and mailed with iron.

If public opinion sustained and demanded this revolution in naval architecture, the same cannot be said of naval opinion. With the exception of engineers, who saw in the change a development of their own speciality, the general sentiment of the navy, as exhibited by a multitude of letters, reports and opinions, all items of public knowledge through the medium of Navy Department and Congressional publications, appears to have been one of mistrust, if not positive opposition to the new development. Thus it was that the engineer corps, with a few prominent exceptions in other branches of the service, had to bear the brunt of incessant attacks upon the probable utility of the new class of vessels; a strife that was well maintained against great odds at first and finally terminated in an historical controversy between a prominent representative of each naval faction, from which controversy the engineer and the principles championed by him emerged signally victorious.

It is unnecessary to introduce any of the opinions of the old school naval officers, breathing hostility to the engineers' ships, for a proper respect for the intelligence and patriotism of the officers of our navy as a class is sufficient warrant that such of those opinions as have been preserved are not indicative of the belief of the whole service. That belief, however, while not actually hostile, was far from being favorable, and cannot be more truthfully presented than by quoting from an opinion respecting iron-clads submitted to the Navy Department in February, 1864, by Rear Admiral L. M. Goldsborough, an officer of more than fifty years service, of great

prominence and recognized professional ability, and as progressive and liberal-minded a representative of this class as could well be found.

“Their absolute worth, however, in these particulars, (offensive and defensive properties), I cannot regard as entitled to the extravagant merit claimed for it, induced, I apprehend, in a great measure by conclusions drawn from the encounters of the first *Monitor* and *Weehawken* with the *Merrimack* and *Atlanta*, without a sufficient knowledge of the facts attending them, and without any (or more than an unwilling) reference to the cases of opposite results, as, for instance, the *Ogeechee*, and the repeated displays before Charleston. That the charm of novelty in construction, or quaintness in appearance, had anything to do with the matter, I will not undertake to assert, although I may, perhaps, be allowed to indulge suspicion as to probable effect. Popular opinion is not always right on such subjects, nor do I know that it is apt to be when it runs counter to popular naval opinion. At any rate, I do know that the latter is not likely to be very wrong in relation to professional matters of the kind.”

Before the original *Monitor* was launched, Secretary Welles had become convinced of the extraordinary merits of that type of fighting ship, and in his annual report, in December, 1861, he recommended the immediate construction of twenty iron-clad steamers. The House of Representatives acted quickly on this recommendation and passed a bill authorizing the Secretary of the Navy to cause to be constructed not exceeding twenty-one iron-clad steam gunboats. The Senate, more conservative, delayed action on the bill until February, when the Secretary of the Navy, foreseeing that the country would suffer from longer inaction, addressed the chairman of the Senate naval committee on the subject, with the result that the bill was soon passed. In its final form it authorized the Navy Department to expend \$10,000,000 for armored vessels, and this appropriation was greatly augmented by subsequent legislation.

Under date of March 31, the Department entered into contract with John Ericsson for the construction, hull and machinery complete, of six single-turreted monitors, slightly larger than his first vessel and possessing improvements that experience had shown to

be desirable. Chief among the changes was the locating of the pilot house on top of the turret, and the installation of a permanent smoke-pipe. Chief Engineer Alban C. Stimers was detailed as general superintendent of the building of these vessels. Encouraged by his happy selection of the name of the *Monitor*, Ericsson proceeded to name these six, *Impenetrable*, *Penetrator*, *Paradox*, *Gauntlet*, *Palladium*, and *Agitator*, but the Department very properly disapproved of these polysyllables and gave the vessels good American names—*Passaic*, *Montauk*, *Catskill*, *Patapsco*, *Lehigh*, and *Sangamon*,—under which they did the state good service and with which four of them are still on the navy list, and a fifth, the *Sangamon* with her name changed to *Jason*, also remains with us. The *Patapsco* was lost in January, 1865. Besides these six, there were four others of the *Passaic* class, built by other contractors from Ericsson's general designs, these being the *Nantucket*, built by the Atlantic Works, Boston; the *Nahant*, by Harrison Loring, Boston; the *Weehawken*, by Z. and F. Secor, New York, and the *Camanche*. The contract for this last vessel was given to Donahue, Ryan & Secor of San Francisco, Cal. and the actual work of building the ship was done at the ship yard of the Secor brothers in Jersey City: when the different parts were all completed a sailing ship, the *Aquila*, was freighted with them and proceeded to San Francisco by way of Cape Horn, having the misfortune to sink at the dock soon after arriving at her destination. After these delays, the *Camanche* did not appear as a completed monitor until 1865. There is perhaps no more eloquent tribute to the genius of John Ericsson than the fact that of the thirteen single turreted monitors that remain in our navy as the survivors of the many vessels of that type built during the war, eight are members of the original ten of the *Passaic* class.

On the 28th of July a contract was made with Ericsson for two large and high-powered monitors, which he named *Puritan* and *Protector*, the first name being accepted by the Department and the second changed to *Dictator*. The following table exhibits the main features of the Ericsson monitors of 1862 compared with the original *Monitor*, the data given being with reference to the vessels as actually built and not according to their dimensions as altered by subsequent rebuilding or repairs. The table is from Church's Life of John Ericsson.

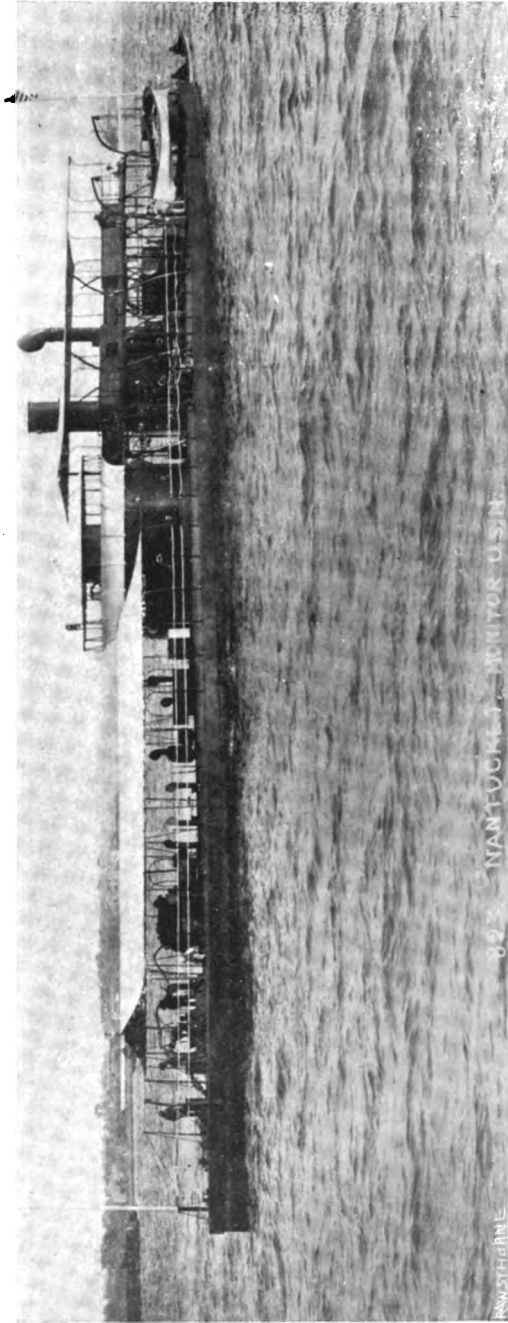

U. S. MONITOR, NANTUCKET, 1862.

Typical of the *Passate* class; length, 200 feet; beam, 46 feet; displacement, 1,875 tons.

The flying-bridge, with hammock-boxes, etc. Shown abaft the turret is a peace-time convenience that was not built upon the monitors during the war.

	Monitor.	Passaic & class 6.	Dictator and Puritan.
Contract price, each.....	\$275,000	\$400,000	\$1,150,000
Extreme length, feet.....	172	200	312 and 340
Extreme breadth, feet.....	41½	46	50
Depth of hold, feet.....	11½	...	21½
Draft of water, feet.....	10½	10½	20
Diam. of turret, inside, feet.....	20	21	24
Thickness of armor, inches.....	8	10½	15
Diameter of propellers, feet.....	9	12	21½
Diam. steam cylinders, inches.....	36	40	100
Length of stroke, inches.....	24	22	48
Side armor, inches.....	4½	5	6
Weight of guns, pounds.....	44,000	84,000	84,000 and 220,000
Coal capacity, tons.....	100	150	300 and 1,000
Displacement, tons.....	987	1,335	4,438 and 4,912
Tonnage.....	776	844	3,083 and 3,265
Midship section, square feet.....	321	392	777

The story of the troubles and delays experienced in the building of the two large monitors is too long to go into. Ericsson was much hampered and annoyed by the numerous changes in his designs forced upon him by the Department acting on the advice of naval officers with and without experience in monitors. One considerable modification in the *Dictator* was in dispensing with the forward overhang of the upper hull, which Ericsson regarded as an essential as it afforded a perfect protection to the anchors when under fire. Officers in command of the smaller monitors while the *Dictator* was building generally condemned that feature and believed it had been the cause of the loss of the *Monitor*, their opinions ultimately leading to the modification referred to. When the *Dictator* went into service at the end of 1864 her commander, Captain John Rodgers, complained of the absence of the forward overhang, which complaint angered Ericsson on account of the source of the influence that had forced him to make the change. Writing to the Secretary of the Navy regarding the criticisms to which the monitors were subjected by the commander of one of them, he said: "I trust that neither he nor the officers of the turret vessels, all of whom are admitted to be as skilful in their profession as they are brave, will take offense at my remarks. I have only the single object in view—the triumph of the service which their skill

and valor has raised so high in the public estimation. I beg, earnestly, however, to call their attention to the fact that they have entered on a new era, and that they are handling not ships, but floating machines, and that, however eminent their seamanship, they cannot afford to disregard the advice of the engineer."

With all his engineering ability, Ericsson made some mistakes himself right in the line of his own profession, and as he was so stubborn by nature and so confident of his own powers his errors were seldom corrected until too late, for he would take advice of no man. Chief Engineer E. D. Robie, U. S. Navy, was the naval superintendent of the construction of the *Dictator*, and, without claiming to be a genius or a remarkable inventor, he was a better marine engineer than Ericsson, for he had the invaluable knowledge gained by long experience with engines at sea which Ericsson lacked, and without which no engineer, no matter how accomplished, can intelligently design marine engines. Several faults in design were pointed out by Mr. Robie, who knew to a certainty that they would result in trouble at sea, but Ericsson would listen to nothing, his favorite reply to these suggestions, which was both egotistical and incorrect, being that he had built successful engines before Robie was born.

One fault alone which Ericsson scorned to recognize resulted in defeating the hopes of the Department regarding the first operations of the *Dictator*. Her main shaft was nineteen inches in diameter, an enormous size even for this day, and the main bearings as designed were disproportionately short for the size of the shaft they were to support. This was strenuously objected to by Robie, but without avail, and the result was that when the *Dictator* started to join the fleet for the first assault on Fort Fisher, her first employment, the bearings wore down three-eighths of an inch in going twenty miles and the shaft became so loose as to endanger the ship. Upon Chief Engineer Robie's report, she was turned back to port, and for many weeks she had to lie idle under Robie's charge while he had longer brasses made and brackets fitted to support them. This was a most lamentable failure when the Department was expecting so much of the ship, and Ericsson afterward admitted in conversation with Mr. Robie that for once he had made a mistake in not listening to the opinions of another engineer.

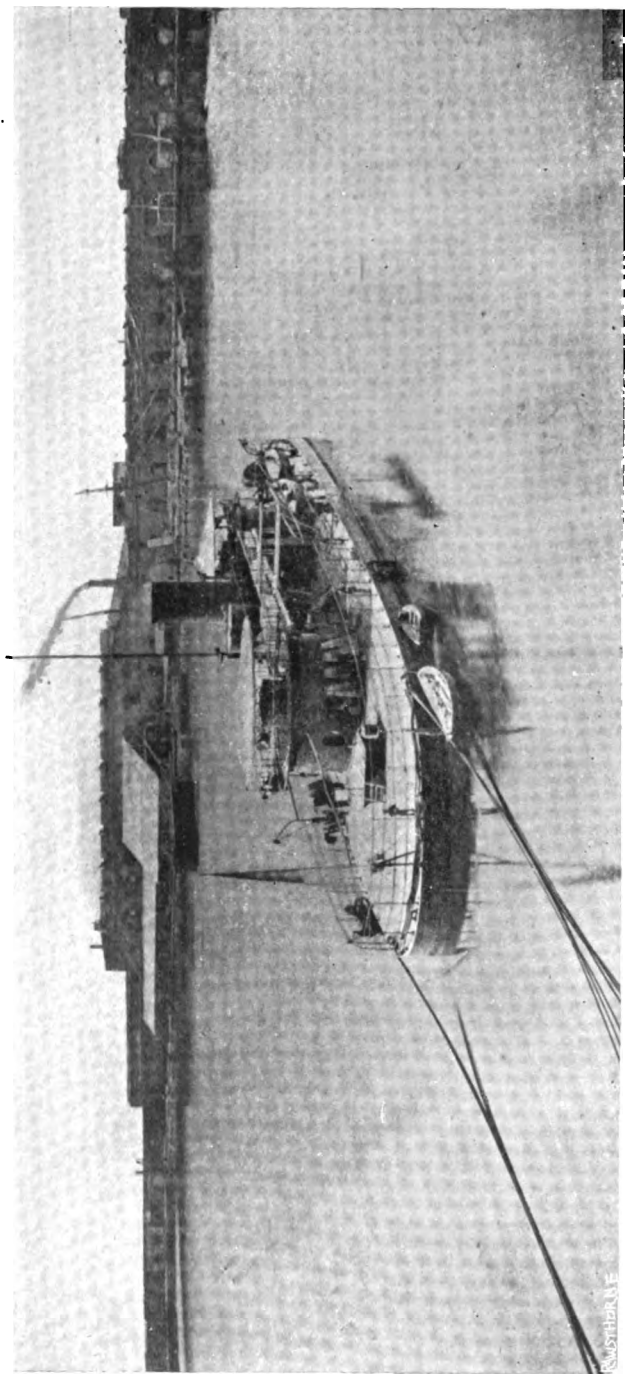

U. S. S. MIANTONOMOH;

Photographed in Europe in 1866. Length, 257 feet; beam, 52 feet 10 inches; disp., 3,401 tons.
(*Argumenticus, Monardnock, Tonawanda*, in class.)

Against Ericsson's wishes the *Puritan* was provided with twin screws, and it was also directed that she be fitted with two turrets; to this latter modification of his plan Ericsson vehemently objected, and finally arranged a compromise of one huge turret to mount two twenty-inch guns, but these changes and counter changes amounted to nothing, for the end of the war found the *Puritan* still unfinished. The *Virginus* excitement in 1874 induced the Navy Department to take steps towards her completion, but she cannot be said to be finished yet, for now (1896) the work of converting her into a coast defense battle-ship is still going forward. Very little of Ericsson's ship remains in the new *Puritan*. The *Dictator* was put in service and sent to Key West at the time of the *Virginus* affair and proved to be an excellent sea boat, but very expensive to operate. In 1883 she was sold to A. Purves & Son of Philadelphia for \$40,250, the government having expended up to that time about \$260,000 for her preservation and repair, in addition to her original cost.

Besides the twelve Ericsson monitors already referred to, twenty-eight other armored vessels, the majority of which were of the monitor type, were placed under construction during the year. Four of these were large double-turreted vessels designed to carry four XV-inch guns each and were undertaken by the government at the navy yards as follows: *Miantonomah* at New York; *Tonawanda* (afterward *Amphitrite*) at Philadelphia; *Monadnock* at Boston, and *Agamenticus* (*Terror*) at Kittery, Maine. Machinery for these vessels was contracted for with various builders in New York and Philadelphia, that for the first two named being designed by Engineer-in-Chief Isherwood and that for the other two by John Ericsson. The turrets, side armor, deck plating, stringers, etc. were obtained by contract with different iron manufacturers. The *Onondaga*, also two-turreted, was contracted for, hull and machinery complete, with George Quintard of New York and was built for him by T. F. Rowland at the Continental Iron Works, Greenpoint. Four other two-turreted monitors were placed under construction in the Mississippi Valley, the contracts for them, dated May 27th, being with the following builders: Thomas G. Gaylord, Cincinnati, Ohio, for the *Chickasaw*; G. B. Allen & Co., St. Louis, for the *Kickapoo*; James B. Edes, St. Louis, for the *Milwaukee* and *Winnebago*. These western craft were modifications of Ericsson's monitor, their decks in-

stead of being flat were so much crowned that they were known as "turtle-backs," and the guns were mounted in turrets built from Edes' designs on the disappearing principle.

In September, nine single-turret monitors, somewhat larger than the *Passaic* class were contracted for as follows: With Harrison Loring, Boston, for the *Canonius*; Swift, Evans & Co., Cincinnati, for the *Catawba* and *Oneota*; Z. & F. Secor, New York, for the *Mahopac*, *Manhattan* and *Tecumseh*; Albert G. Mann, Pittsburgh, for the *Manayunk*; Harlan & Hollingsworth, Wilmington, Delaware, for the *Saugus*, and Miles Greenwood, Cincinnati, for the *Tippecanoe*. Two very small single-turret vessels, the *Marietta* and *Sandusky*, were contracted for May 16th with Hartupee & Co., Pittsburgh, and during the same month contracts were signed with James B. Edes, St. Louis, for the *Neosho* and *Osage*, having one turret and recessed stern wheels, and with George C. Bestor, Peoria, Ill., for a similar vessel, the *Ozark*. Joseph Brown of St. Louis by contracts signed May 30th, built three small iron-plated casemate vessels named *Chillicothe*, *Tuscumbia* and *Indianola*. These vessels had side wheels far aft working independently to facilitate turning in close quarters, and had also twin screw propellers.

One or two novel plans for armored war-vessels were accepted during the year as the aftermath of the crop of designs submitted to the iron-clad board of 1861. One remarkable vessel originating in this manner was the *Keokuk*, built according to the terms of the contract made with Charles W. Whitney of New York on the 25th of March. This contract called for an iron-plated, shot-proof steam battery, 159 feet long, 36 feet beam, 13 feet 6 inches depth of hold, to carry two XI-inch guns mounted in towers. Low-pressure condensing engines capable of driving the vessel ten knots per hour for twelve consecutive hours were specified. The contract price was \$220,000. The peculiar feature of the *Keokuk* was in the disposition of armor, the sides being built of alternate horizontal strata of wooden timbers and iron bars, each layer being about five inches wide. Like the *Galena*, this conception came to grief when subjected to the fire of the enemy, and in worse degree, for she sank from the effects of the puncturing she received, as will be related in a subsequent chapter regarding naval operations off Charleston.

Another iron-clad of quite different type was the *Dunderberg*,

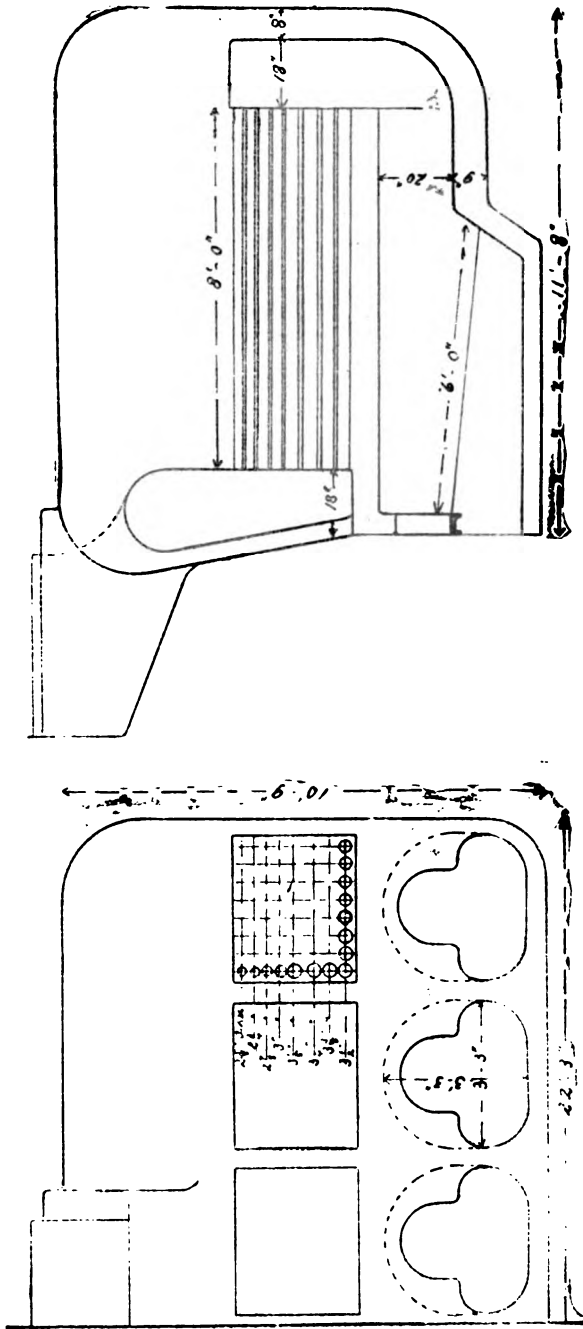

STIMER'S PATENT DIFFERENTIAL FIRE-TUBULAR BOILER USED IN CANONICUS CLASS.

Six furnaces in each boiler; 117 square feet grate surface in each boiler.

contracted for with W. H. Webb of New York city, July 3rd, 1862. This vessel, described as an "ocean-going iron-clad frigate ram," was a remarkable step in advance of the war-ship construction of the time, but was not put to the test of battle as her great size and huge pieces of iron work to be made so delayed her building that she was not launched until July 22, 1865. The tendency in armored ship construction after the affair of the *Monitor* and *Merrimac* was to accept Ericsson's circular turret as the proper protection for guns, and this plan, modified and improved by changing conditions and better appliances for perfecting mechanical work, still remains and may be seen in one form or another in almost every armored vessel of the present day. The *Dunderberg*, however, departed most radically from the favorite practice of her year, and instead of the features of the *Monitor* her construction presented an almost faithful reproduction, in a greatly improved form, of the general characteristics of the *Merrimac*. That is, she consisted essentially of a low hull surmounted with a sloping-sided armored casemate protecting a very heavy battery. Great engine power, calculated to give a sea speed of fifteen knots an hour, and an enormous ram fifty feet long were important factors in her war-like make up. The hull, of unusually heavy timbers, was built in Mr. Webb's shipyard, foot of Sixth Street, East River, and the machinery was built by John Roach & Son at the Etna Iron Works near by. Chief Engineer Wm. W. Wood, U. S. Navy, was the general Superintendent of construction and Second Assistant Engineer Wilson K. Purse was the resident inspector at the Etna Iron Works. The contract price for the vessel complete was \$1,250,000.

The following table exhibits the general dimensions of the ship and machinery, and shows her to have been an unusually huge craft for her day:

Extreme length.....	380 feet 4 inches.
Extreme beam.....	72 " 10 "
Depth of main hold.....	22 " 7 "
Height of casemate.....	7 " 9 "
Length of ram.....	50 "
Draft when fully equipped for sea.....	21 "
Displacement.....	7,000 tons.
Tonnage.....	5,090 "
Weight of iron armor.....	1,000 "

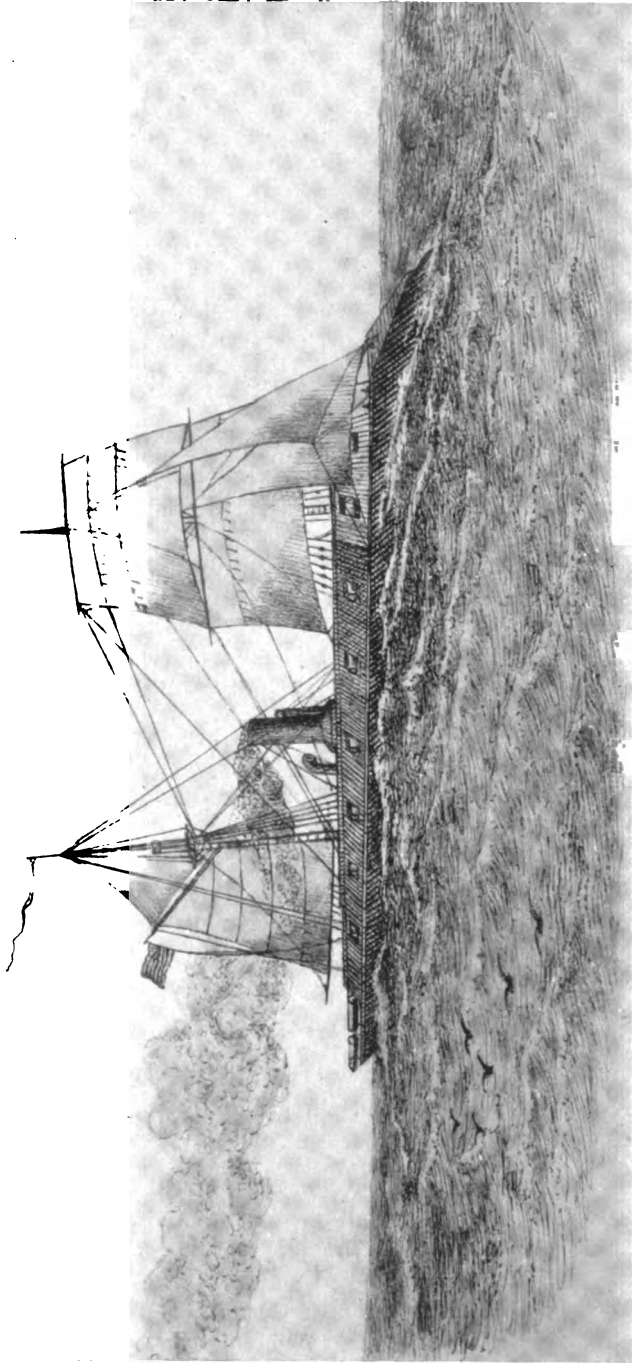

U. S. S. DUNDERBERG.

Diameter of steam cylinders (two)	100 inches.
Stroke of pistons.....	45 "
Bollers—Six main and two auxiliary.	
Depth of bollers.....	13 feet.
Height of bollers.....	17 feet 6 inches.
Front width of bollers, each.....	21 " 5 "
Weight of bollers.....	450 tons.
Total heating surface.....	30,000 square feet.
Grate surface.....	1,200 " "
Cooling surface in condensers.....	12,000 " "
Diameter of screw propeller.....	21 feet.
Pitch of propeller.....	27 to 30 "
Weight of propeller.....	34,580 pounds.
Capacity of coal bunkers.....	1,000 tons.
Horse-power of main engines.....	5,000

This "Thundering Mountain" of the navy, as her size and armament as well as the translation of her name caused her to be called, embraced a number of features in construction now regarded as essential but which in 1862-3 were thought unimportant or were almost unheard of. She had a double bottom, collision bulkheads, and a system of transverse longitudinal and water-tight bulkheads extending up to the spar deck. The engine and boiler spaces were entirely enclosed with water-tight bulkheads. Her air and circulating pumps were independent of the main engines and she had also a pair of independent wrecking pumps. The smoke-pipe, thirteen feet in diameter, had armor gratings fitted inside it, as is now universally practiced, to prevent injury to the boilers by grenades or heavy debris. The engines were horizontal back-acting in arrangement, designed to run at an ordinary speed of sixty revolutions per minute, with intention to work up to eighty revolutions for full power. The main shaft was 118 feet long and 18 inches in diameter, and was supported by bearings 40 inches long cored for water circulation. The air and circulating pumps each had two steam cylinders 36"x36", which in themselves were engines nearly as large as the propelling engines of the *Canandaigua* class of sloops of war.

Not being completed until after the Civil War was over, the naval authorities had no desire to receive this splendid specimen of war-ship into the service, the policy then being to get rid of as many vessels as possible instead of adding to the number. At Mr.

Webb's request the vessel was released to him under the terms of a special act of Congress approved March 2, 1867, he refunding to the government the sum of \$1,092,887.73, which had been paid to him on account. He immediately sold her to the French government, and under the name of *Rochambeau* she was for many years regarded as one of the most formidable vessels in the navy of that country. The effect of the presence in the French navy of the *Dunderberg* is still visible in the exaggerated ram bows and home-sloping top sides so generally designed by French naval architects. Mr. Edward Marsland, who had been a first assistant engineer in the navy during the war, went across the Atlantic in the *Dunderberg* as her chief engineer and found the sea-behaviour of both ship and machinery admirable. The same day that Congress authorized the release of the *Dunderberg* to Mr. Webb another private act was passed releasing the *Onondaga* to Mr. Quintard, who refunded the money he had been paid and received the vessel, although she had

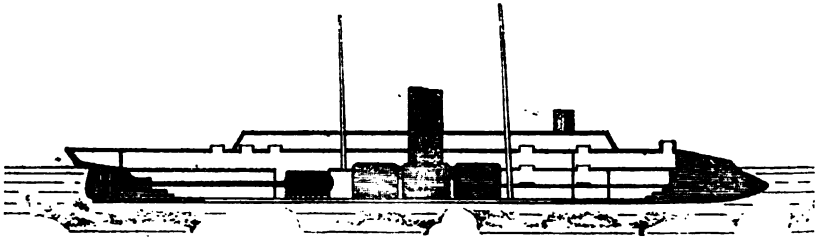

Longitudinal section of the *Dunderberg*, showing backing of ram, arrangement of machinery, disposition of armor, etc.

been completed and in active service the last eighteen months of the war. She also was sold to the French and still appears on the navy list of that country as an armored coast-defense turret ship.

From the lesson of Hampton Roads the Navy Department attempted one modification of a war vessel that was not especially successful. In 1862 work was begun on the frigate *Roanoke* of cutting her down as the *Merrimac* had been, and on the low deck resulting three Ericsson turrets were fitted by the Novelty Iron Works, New York. Although employed about a year in the North Atlantic squadron, the modified *Roanoke* was not found satisfactory. The

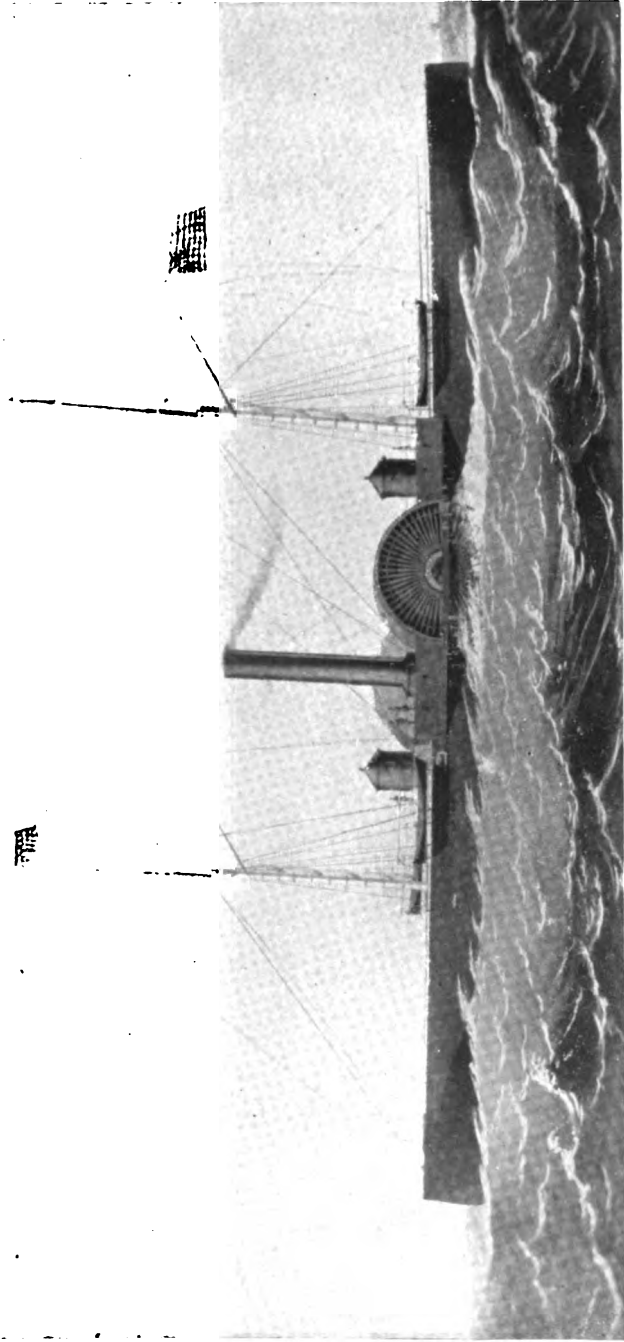

U. S. S. ROSCO, 1862.

Type of the *Sasacus* class; length, 240 feet; beam, 35 feet; disp., 1,173 tons.

In general appearance, without regard to dimensions, this vessel well represents the *Octorora* class of 1861 and the *Mohorago* class of 1863, as well as its own class of double-enders.

great weight of the three turrets made her rolling dangerous and the hull was not found to be strong enough to properly carry them, the thrust of the turret spindles on the keel when the turrets were being keyed up for action always threatening to force out the bottom.

The twelve double-ended gunboats begun in 1861 proved so useful that in the autumn of 1862 contracts were made for twenty-seven others, considerably larger than the first lot. From the name of one of these that became especially famous they came to be known as the *Sassacus* class, their names being as follows: *Agawam*, *Ascutney*, *Chenango*, *Chicopee*, *Eutaw*, *Iosco*, *Lenapee*, *Mackinaw*, *Massasoit*, *Mattabessett*, *Mendota*, *Metacomet*, *Mingoe*, *Osceola*, *Otsego*, *Parrotuset*, *Peoria*, *Pontiac*, *Pontoosuc*, *Sassacus*, *Shamrock*, *Tacony*, *Tallahoma*, *Tallapoosa*, *Wateree*, *Winooski*, and *Wyalusing*. All were built of wood with the exception of the *Wateree*, which was of iron. They were all rated as of 974 tons burden. One other wooden vessel of this class—the *Algonquin*—was delayed on account of controversy as to the machinery to be fitted in her and was not put under construction until March, 1863. A few of the hulls were built at navy yards, but the majority of them and the machinery for all were built by contract, the engineer-in-chief furnishing the machinery designs except for the *Algonquin*. The *Sassacus* was built at the navy yard, Portsmouth, New Hampshire, by Naval Constructor Isaiah Hanscom, and her machinery by the Atlantic Works, Boston. Near the close of the year a class of small screw sloops, about 100 tons larger than the ninety-day gunboats, was begun at navy yards and contracts let for their machinery. These were the *Kansas*, *Manumee*, *Nipsia*, *Nyack*, *Pequot*, *Saco*, *Shawmut*, and *Yantic*. With the exception of the *Kansas* all were under construction by the 1st of January, 1863.

Important changes in naval organization and administration were brought about by Congressional action during the early part of of the Civil War. During the special session of the 37th Congress in the summer of 1861, to go a little back of the year with which this chapter is dealing, an act, approved August 3, 1861, created a naval retired list by providing that any officer of the navy who had been forty years in the service of the United States might be retired upon his own application; the same act provided that officers of the navy found incapacitated for active service by reason of wounds or

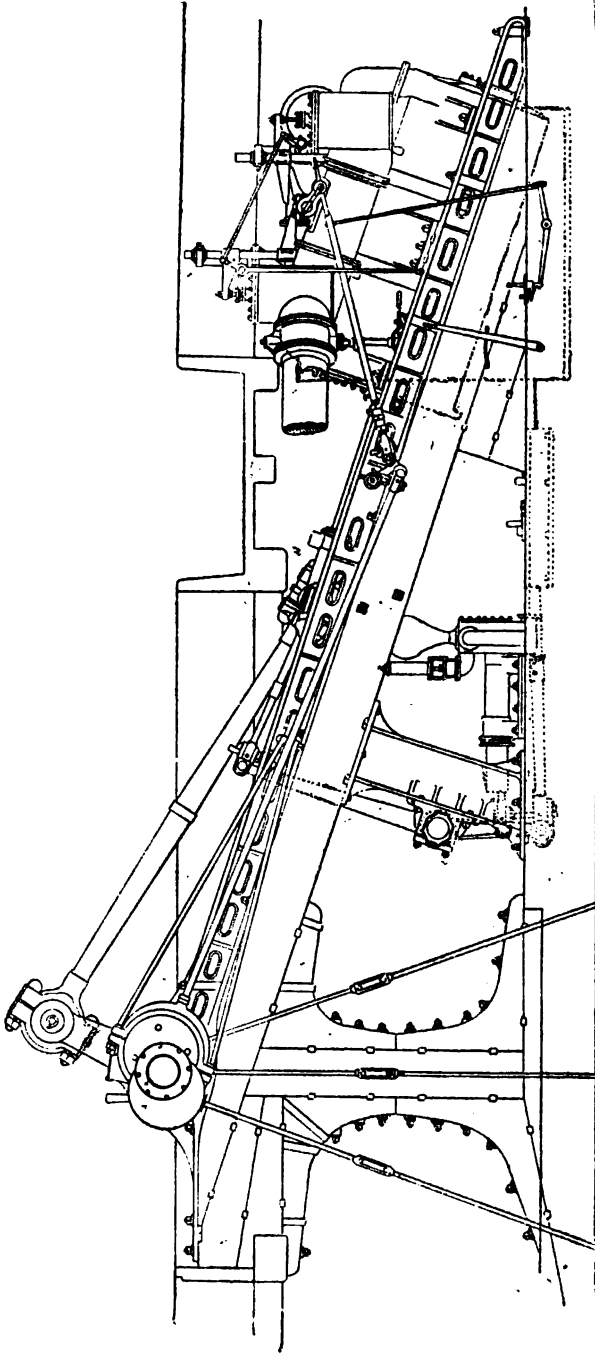

Inclined single-cylinder direct-acting engine of the *Agaveorn* and class. The same arrangement obtained in the other classes of double-enders and in numerous other vessels that have been described in this book.

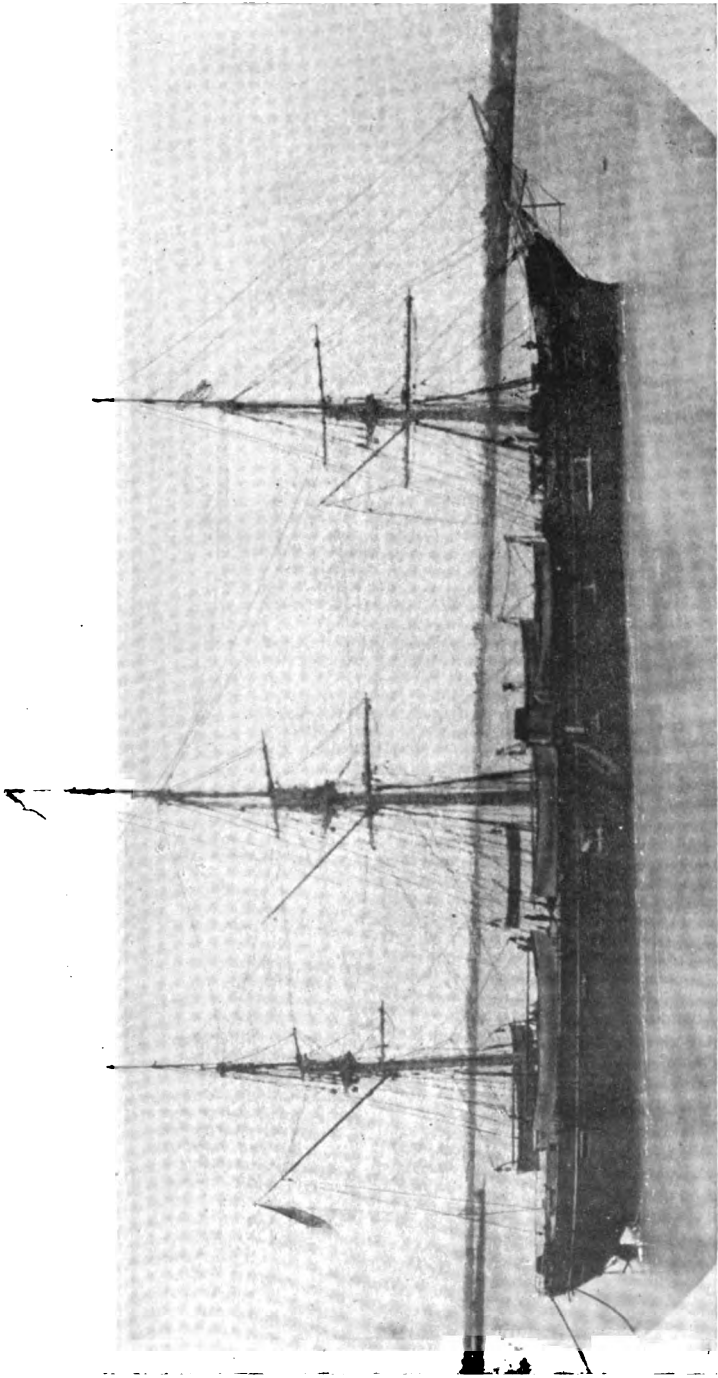

U. S. S. SHAWMUT, 1863.

Type of the *Kansas* class; length, 179 feet 6 inches; beam 30 feet; disp., 836 tons.

other disability incurred in the line of duty should be placed on the retired list, and the officer next in rank promoted to the place of the retired officer according to the established rules of the service. Early in the first regular session of the same Congress, an act, approved December 21, 1861, made the retirement of naval officers compulsory after forty-five years' service, or upon arriving at the age of sixty-two. A number of old officers of the line and medical corps were immediately retired in accordance with this legislation, and it was due only to the presence on the active list of these superannuated officers, unable to perform their duties in time of war, and at the same time deserving of all consideration for past services, that the navy received the inestimable, though deserved, gift of the retired list.

An act to reorganize the Navy Department was approved July 5th, 1862, which created the Bureau of Steam Engineering as a separate executive branch of the department and provided that the chief of that bureau should be a skillful engineer selected from the list of chief engineers of the navy. The same act created the present bureaus of Navigation, Equipment, and Construction, the two last named and the bureau of steam engineering being obtained by dividing up the old bureau of Construction, Equipment and Repair, the business of which under the demands of war having grown to the extent of making its division a business necessity.

The present schedule of pensions for disability incurred in the naval service was established by an act of Congress approved July 16th, 1862. Other acts approved the same day directed the transfer of the western gunboat fleet built by the War Department to the Navy Department, and reorganized the grades of line officers of the navy; the last act referred to added the grades of commodore and rear admiral to the line establishment and created within it the additional grades of lieutenant-commander and ensign. A new pay table was also established.

CHAPTER XXI.

“ When sorrows come, they come not single spies,
But in battalions.”

—*Hamlet; Act IV. sc. 5.*

1863—The Civil War Continued—Disasters at Galveston—Loss of the *Columbia*—Raid of Rebel Rams off Charleston—Loss of the *Isaac Smith*—The *Florida*, and Her Pursuit by the *Sonoma*—Investment of Washington, North Carolina—Assembling of Ironclads off Charleston—Remarkable Breakdown and Repairs to the Machinery of the *Weehawken*—Attack on Fort McAllister—First Attack on Fort Sumter—Destruction of the *Keokuk*—The *Atlanta-Weehawken* Duel—Protracted Investment of the Charleston Forts by the Monitors—Sinking of the *Weehawken*.

NAVAL operations during the year 1863 were conducted on a greater scale than before and were in the main successful, the enemy's coasts being more rigorously invested and the lines of the blockade made more and more impassable. A number of misfortunes to vessels engaged in more or less important undertakings which occurred with considerable regularity from month to month served, however, in connection with the first unfortunate demonstration of the ironclads at Charleston, to distract public attention from the real service being done by the navy and to give the general impression that the operations of that arm for the year were largely unsuccessful.

The series of disasters to the navy began the first day of the new year with an extremely humiliating affair at Galveston, Texas. That place was in partial possession of the Union forces and was occupied by 260 men of the 42d regiment, Massachusetts volunteer infantry, camped on a wharf, a blockade of the approaches to the harbor being maintained to seaward by the steamers *Westfield*, *Clifton*, *Harriet Lane*, *Owasco*, and *Sachem*, and the schooner *Corypheus*. About 3 A. M. the morning of January first a large force of Confederates appeared in the town and made an attack upon the soldiers on the wharf, the latter being supported by the fire from some of the vessels lying nearest to them. At dawn two large river steamers crowded with troops and well protected by

barricades of cotton bales attacked the *Harriet Lane*, or rather were attacked by her, she being under way at the time and moving up into range of the fight going on ashore, and effected her capture by boarding in overwhelming numbers. Her captain, Commander J. M. Wainwright, and Lieutenant Commander Edward Lee, were both killed, as were also three enlisted men, and fifteen people were wounded, the survivors of the ship's company, amounting to about one hundred, being made prisoners of war. The officers of the engineer corps who fell into the hands of the enemy on this occasion were M. H. Plunkett, second assistant engineer; C. H. Stone, second assistant engineer; and John E. Cooper, R. N. Ellis and A. T. E. Mullen, third assistant engineers.

An interesting incident illustrative of considerate forethought under trying conditions is related of Assistant Engineer Mullen on this occasion. After Commander Wainwright had been killed and the loss of the ship appeared inevitable, Mr. Mullen threw away his own sword and put on that of the captain with the hope of preserving it for Wainwright's relatives; a most generous undertaking which is said to have been successful, as it was a custom on both sides to return side-arms to captured officers after their surrender was complete.

The gunboat *Owasco* went to the relief of the *Harriet Lane* but was driven off by an incessant musketry fire to which she could make scarcely any reply, the narrowness of the channel preventing her from getting into a position to use her guns. She had fifteen men killed and wounded. Her experience deterred the *Clifton* from making the same attempt and that vessel's fire was accordingly directed against the shore batteries. The *Westfield*, lying a considerable distance out, had got underway and gone hard and fast aground early in the morning when the first movement of the enemy's steamers had been observed. About 7:30 A. M. a Confederate officer bearing a flag of truce boarded the *Clifton* and informed her commander that the Massachusetts troops and the *Harriet Lane* had surrendered and that the steamers, three more of which had appeared, were about to move upon and overwhelm the Federal vessels in detail. As an alternative he proposed the surrender of all the Federal vessels but one, which would be allowed to leave the harbor with the crews of all.

Lieutenant Commander Law of the *Clifton* did not favor this proposal, but agreed to carry it to Commander Renshaw of the *Westfield*, the senior officer present, it being promised that the flags of truce should fly for three hours to give him time to go and return. Commander Renshaw of course refused to accept the terms and ordered Law back to his ship with instructions to get the vessels under way and take them out of the harbor at all hazards, saying also that as the *Westfield* could not be floated he would blow her up and escape with her crew in the army transport *Saxon* lying near him. Finding upon his return to the *Clifton*, that the enemy had made many changes to their advantage in the position of their steamers and batteries, Law felt under no obligation to observe the truce and immediately got under way with all the vessels and went out of the harbor under a heavy fire, abandoning the blockade for the time being by going to New Orleans. Two barks laden with coal for the steamers were left behind and fell into the enemy's possession with the *Harriet Lane*.

Through some terrible blunder in firing the *Westfield* her magazine blew up before the people were out of her with the result that fourteen persons were killed and sixteen wounded, among the killed being commander William B. Renshaw; Lieutenant C. W. Zimmerman, and Acting Second Assistant Engineer William R. Greene, the senior engineer of the ship. Mr. Greene had acquired an excellent reputation for professional and personal worth and his untimely taking off was a source of much regret in the corps. In July of the previous year when the *Westfield* was employed in the operations about Vicksburg, Commander Renshaw had reported to the Department in the following highly favorable terms regarding him: "The engineer in charge, Mr. William R. Greene, with his assistants, Messrs. George S. Baker and Charles Smith, have been untiring in their exertions to keep the engine in repair, and have exercised so much judgment and care that since leaving the United States there has never been a day that the machinery has not been in perfect working order."

The Confederates recovered the large main shaft of the *Westfield* from the wreck and manufactured from it a 60-pounder rifled gun. This in due course of time found its way to the Annapolis Naval Academy and has rested in the grass of the gun-park there for many years as a trophy of war.

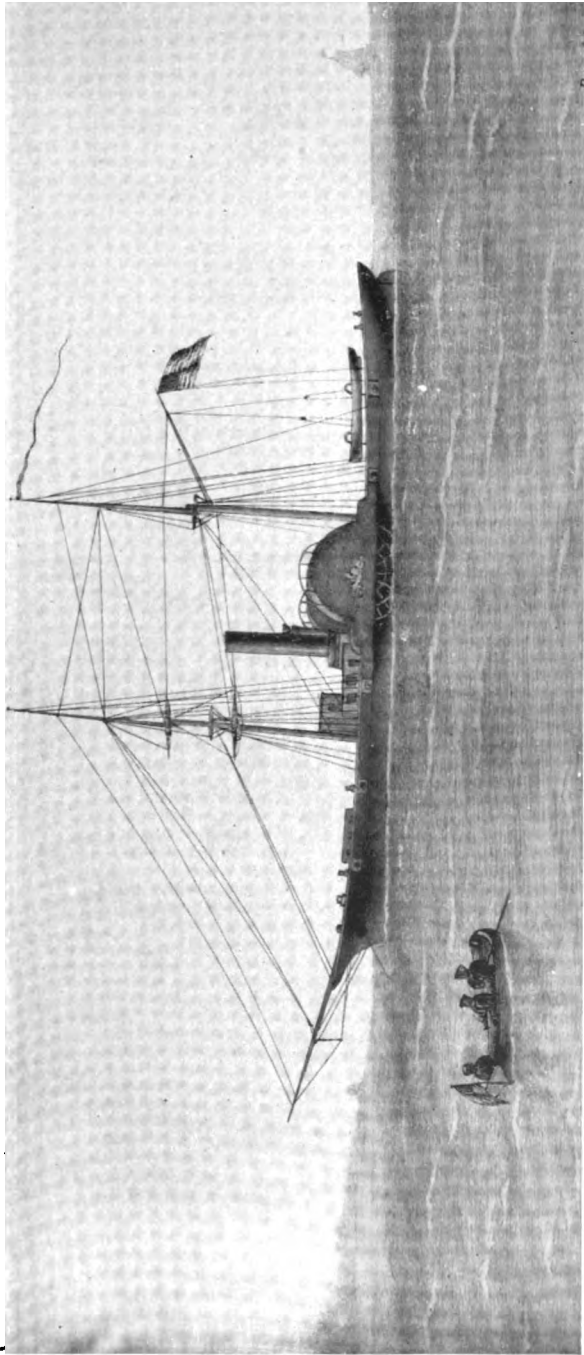

THE HARRIET LANE.

Immediately after the arrival of the *Clifton* at New Orleans with the news of the disaster at Galveston, Admiral Farragut sent Commodore Bell with the *Brooklyn* and six gunboats to re-establish the blockade off that port. The afternoon of January 11th a strange sail was seen off Galveston and the iron steamer *Hatteras*, Lieutenant Commander H. O. Blake, was sent in pursuit. After running from the *Hatteras* until dark, the stranger ceased steaming and allowed her pursuer to approach close alongside, replying to the hail that she was "Her Britannic Majesty's ship *Vixen*." The *Hatteras* lowered a boat to board her, when she suddenly fired a broadside at point blank range, accompanying it with the announcement that she was the Confederate steamer *Alabama*. The *Hatteras* returned the fire at once and for several minutes a sharp fight ensued, in which the Federal vessel was speedily disabled. She was a commercial steamer originally named *St. Mary*, purchased in Philadelphia in 1861 for \$110,000, and was wholly unfit for a contest with a regularly built vessel of war. Her overhead walking beam was shot away immediately and another shot struck and destroyed the main engine cylinder, either of which blows was sufficient to deprive the ship of her motive power and prevented her commander from carrying out his intention of closing with the *Alabama* and boarding her. Shells striking the *Hatteras* near the water line tore off whole sheets of iron and caused her to fill as rapidly as a perforated tin pan. In this fatal predicament she surrendered and her crew was taken off by the victors, who had barely time to save them before the *Hatteras* sank. The boat's crew that had been called away to board the stranger escaped and carried the news of the disaster to Galveston.

In this engagement the *Hatteras* had two men, both firemen, killed and five wounded. The prisoners were taken to Kingston, Jamaica, all except the officers being kept in irons on the voyage of nine days to that place. At Kingston they were put on the beach in a most pitiable condition without money or adequate clothing, having lost everything they owned in the *Hatteras*. In spite of their unfortunate condition the treatment accorded them by the British residents of Kingston was such as to cause the following comment to appear in the report of Lieutenant Commander Blake: "Landed on an unfriendly shore, in a state of abject destitution,

that should have commanded the sympathy of avowed enemies, we felt keenly the unkind criticisms of those who profess to have no dislike for our government or its people." The engineers of the *Hatteras* who shared in the resulting hardships were Acting First Assistant A. M. Covert, and acting third assistants Jos. C. Cree, Jacob Colp and Benjamin C. Bourne.

On the evening of the 14th of January, the steamer *Columbia*, a purchased vessel attached to the North Atlantic Blockading Squadron, while on duty off Marlboro Inlet, North Carolina, got ashore on an unknown bar. The gunboat *Penobscot* went to her aid the following day and succeeded in taking off about thirty of her crew by means of a surf-line, but night coming on and the sea increasing compelled the abandonment of the effort at rescue. The second day the enemy mounted some guns on the shore and opened a heavy fire on the distressed vessel, then practically a wreck, which forced her to surrender; the commander, Acting Lieutenant J. P. Couthouy, with his remaining officers and men going on shore and delivering themselves up as prisoners of war after having spiked and thrown overboard the battery. The wreck was burned by the captors. The officers all belonged to the volunteer service and included George M. Bennett, first assistant engineer; W. W. Shipman and Samuel Lemon, second assistants, and J. H. Pelton and W. H. Crawford, third assistants. They were confined first at Salisbury, North Carolina, and later in Libby prison until May 5th, when they were sent north for exchange. The surgeon, by some curious mental operation on the part of the Confederates, was declared a "non-combatant" and was released on parole, but it did not occur to anyone that the paymaster and engineers were entitled to like consideration. Perhaps in an actual state of war there was no doubt about their military status.

Early in the morning of January 29th, the British steamer *Princess Royal*, from Halifax by way of Bermuda, attempted to run the blockade off Charleston and nearly succeeded, being headed off at the last moment by the gunboat *Unadilla*, whose shots forced the captain of the blockade runner to run his ship ashore. Acting Master Van Sice and Third assistant Engineer R. H. Thurston with two armed boat-crews took possession of the prize and labored all day of the 29th in lightening her preparatory to hauling her off,

which was accomplished about dark by the combined efforts of her own engines and those of the light-draft vessels of the squadron. When afloat, the prize was anchored close to the *Housatonic*, acting as flagship in the absence of the *Powhatan* and *Canandaigua* gone to Port Royal for coal, and preparations were carried forward for sending her north with a prize crew. The *Princess Royal* had a very valuable cargo of rifled guns and marine engines for some Confederate rams building at Charleston; a great quantity of shoes for the army, small arms, armor plates, medicines, canned provisions, hospital stores, etc., all worth many times their money value to the Confederacy. When adjudicated in the prize court at Philadelphia the sum of \$342,005.31 was declared available for distribution, shares of which made some of the officers of the *Unadilla* almost wealthy. The vessel had powerful engines with two cylinders 49 inches diameter and 39 inches stroke, geared to the screw shaft in the ratio of five to two. She was converted into a gun vessel and performed excellent duty on the blockade during the remainder of the war.

While the people of the *Unadilla* and the fleet were exerting themselves to get the *Princess Royal* afloat, the Confederates were making equally strenuous efforts to prevent it, horses and men in large numbers being engaged throughout the day in dragging siege guns from Fort Moultrie through the sands of Sullivan's Island into a position to fire upon the stranded steamer, but about the time their battery opened fire she was floated and taken out of range. Baffled in this attempt, they made on the morning of the 31st, the *Princess Royal* still lying by the *Housatonic*, a most desperate effort to wrest her from her captors. At 4 A. M. two rams—the *Chicora* and *Palmetto State*—came down from Charleston and about daylight assailed the blockading squadron, superior to them in numbers in about the proportion of four to one. Without any desire to detract from the gallantry of this attack, it should be stated that with the exception of the *Housatonic* and *Unadilla* the blockaders in the vicinity were all purchased merchant vessels wholly unfit for fighting at close quarters, their unsuitability being fully demonstrated by the event.

The Federal vessels were lying at wide intervals apart, a circumstance that further reduced the seeming disparity in force, and owing to the morning mist that lay over the water did not discover

the approach of the enemy until he was close aboard. The first vessel attacked was the *Mercedita*, a purchased screw-steamer of about 800 tons that had cost \$100,000 in 1861. She was struck a glancing blow on the starboard quarter by one of the rams and at the same time was disabled by a heavy rifle shell which passed diagonally through her, penetrating the steam drum of the port boiler in its passage and filling the ship with hot steam. The ram lay so low in the water that the guns of the *Mercedita* could not be depressed to bear upon her and the latter vessel, being thus both helpless and defenseless, accepted the summons to surrender, the executive officer going on board the ram and pledging his word of honor for the parole of the crew. Nothing was said regarding the vessel and as she was not taken possession of by the enemy she was retained in the squadron after the fight was over. Her gunner, who was in his room at the time, was killed by the shell, and she had three men killed and three wounded by scalding; with the exception of one ordinary seaman slightly scalded at the engine-room hatch these unfortunate men all belonged to the watch on duty in the engine-room.

Leaving the *Mercedita* to her fate, to sink or not, the ram next joined her consort in an attack upon the *Keystone State*, a large side-wheel merchant steamer of nearly 1,400 tons that had cost \$125,000 in 1861, and did her great damage with shells, one of which set her on fire in the fore-hold and another exploded the steam chimneys or drums of both boilers. About one-fourth of her crew was instantly prostrated by the escaping steam, among them Assistant Surgeon Gotwold who was scalded to death while in the act of rendering aid to the wounded; several men had been killed or wounded by the shells and of the latter a number met death from the steam. The total number of casualties was forty, of which twenty-six were due to scalding. In this critical condition of the *Keystone State* her captain, Commander (afterward Rear Admiral) William E. LeRoy, ordered her flag hauled down in response to a summons to surrender, resistance or flight being apparently impossible. The chief engineer, Acting First Assistant Archibald K. Eddowes, did not stop the engines at this juncture but hastened on deck and informed Commander LeRoy that they would run for fifteen or twenty minutes on their vacuum and that that time should suffice to get out of the enemy's reach or obtain assistance from other vessels already be-

ginning to engage the rams. Upon this representation the captain ordered the colors hoisted and the ship moved away from her assailants, being soon taken in tow by the *Memphis* and in that manner was saved to the United States government through the fidelity and knowledge of her chief engineer.

Mr. Eddowes was subsequently promoted to be an acting chief engineer and had the honor of serving for a time as chief engineer of the big frigate *Minnesota*. Being in the volunteer service, he was honorably discharged at the close of the war and disappeared from naval cognizance for many years. In the summer of 1894 the hard times compelled him to write to the Navy Department asking to be admitted to the Naval Home in Philadelphia, his letter stating that he was old, broken in health, out of employment, and homeless. Although not eligible for admission to the institution mentioned under a strict interpretation of the law, it is a gratifying fact that his case was considered in a liberal manner and his prayer was granted. Although now cared for in that manner, there remains in the story an undercurrent painfully suggestive of the concluding lines of Mr. Kipling's reproachful verses concerning the survivors of the charge of the Light Brigade:

“O thirty million English that babble of England's might,
Behold, there are twenty heroes who lack their food to-night;
Our children's children are lisping 'to honor the charge they made,'
And we leave to the streets and the workhouse the charge of the Light Brigade.”

Besides the two vessels so badly used by the rams, the *Quaker City* was considerably damaged by a shell exploding in her engine-room, which fortunately did not kill anyone, and the *Augusta* also received a shell through her side without loss of life. While the fight was in progress Mr. Thurston on the *Princess Royal* by almost superhuman exertions got up steam from cold water and the vessel was taken out seaward for safety. About 7.30 A. M. the *Housatonic* and other vessels having reached the scene and attacked the rams, they gave up the fight and retreated up the channel to the vicinity of Fort Moultrie; late in the afternoon they got under way and returned to Charleston.

“It was this incident which led to the famous dispute in which it was asserted by General Beauregard and Commodore Ingraham,

on the one side, that the blockade had been broken, and that, under the accepted interpretation of international law, it could not be re-established until after three months' notice, that time at least being thus permitted to free trade, by foreign nations, with the Southern Confederacy; while, on the other hand, it was unanimously certified, by the officers of the National fleet, that, on the contrary, the blockade had not been broken, the fleet had not been driven off, and that it had only been the more closely drawn in around the harbor of Charleston by the action with the iron-clads. This, which was the finally accepted version of the affair, was certainly correct, as those of us who were in the action well know. The whole affair was over before breakfast, and at 9:30 A. M., our prize was on her way to report to Admiral DuPont, at Port Royal, convoyed by the injured vessels, which were sent there for repair."¹

On January 30th the purchased screw steamer *Isaac Smith* was sent up the Stono River, South Carolina, to make a reconnoissance. When near Legareville she was suddenly attacked by three batteries of heavy guns concealed on the banks, and was soon compelled to surrender, having been entirely disabled by getting a shot through her steam drum. Before surrendering she had nine people killed and sixteen wounded, the only officer killed being Acting Second Assistant Engineer James S. Turner, who was struck in the breast and thigh by pieces of shell. Acting Third Assistant Engineer Erastus Barry was wounded, as was also Acting Lieutenant Conover, who was in command, and the paymaster, Mr. F. C. Hills, the latter being in command of the powder division. The survivors, including First Assistant Engineer Jacob Tucker and Third Assistant William Ross, became prisoners of war.

On the 15th of January the commerce-destroyer *Florida* ran out from Mobile through the blockading fleet and entered upon a devastating career in the waters of the West Indies, adding to the terror already inspired by the known presence of the *Alabama* in those waters. In September of the preceding year the *Florida* had run into the port of Mobile past the blockade under circumstances that made the exploit one of the most daring of any performed

¹Dr. R. H. Thurston, in *Cornell Magazine*, March, 1890.

afloat during the war. Built in Liverpool as a copy of a class of gun-vessels in the British navy designed for swift despatch boats, this vessel had proceeded out to the West Indies late in the spring of 1862 and had spent the summer of that year with a small and disheartened crew wandering about from place to place trying to procure men and equipments sufficient to allow her to enter upon her intended mission of destruction against American commerce. Eventually her commander, Maffitt, with only about twenty men on board fit for duty on account of the ravages of yellow fever, was driven to the extremity of seeking a port in the Confederacy where he could procure a crew and also acquire nationality for his vessel.

The *Florida* being exactly like some of the British gun-boats cruising about the Gulf coast, Maffitt resolved to put on a bold front and take the chances of a deliberate rush into the line of blockaders in broad daylight, which desperate resolve was carried out the afternoon of September 4th. The blockading squadron off Mobile consisted of the *Susquehanna*, *Oneida* and about half a dozen gun-boats, but it happened by mere chance that on the day of the *Florida's* appearance all the steamers but the *Oneida* and *Winona* were away from the immediate vicinity, having gone for coal or on other errands in the neighborhood. The approach of the *Florida* was not regarded with much suspicion, as her appearance and the white English ensign she displayed made it reasonably certain that she was a British gun-vessel that would stop and communicate according to custom before proceeding through the lines. As she came on with no slacking of speed, however, the *Oneida* already cleared for action as required by regulation under the circumstances fired three shots across her bow in rapid succession, and as these produced no sign of her stopping a broadside was fired into her, followed by a general cannonading from the *Oneida* and from the *Winona* and gun-schooner *Rachel Seamen* some distance away. But the ruse was successful; the *Florida* had advanced so far and was running at such speed that she passed on and was soon under the protection of the guns of Fort Morgan, having received a "frightful mauling," to use Maffitt's own words, and lost twelve men in killed and wounded. When thoroughly repaired, manned and equipped, she came out in January, 1863; ran the blockade successfully, and began her career as before mentioned.

A flying squadron commanded by Captain Wilkes of *San Jacinto* fame was kept busy scouring the West Indies in search of the commerce-destroyers. On the first day of February the double-ender *Sonoma* of this squadron, while near the southern end of that body of water lying between Andros Island and Nassau known to sailors as the Tongue of the Ocean, discovered a strange sail about six miles to the northward and gave chase, the stranger being identified when examined with the marine glasses as the much-sought-for *Florida*. The pursuit was kept up with varying prospects of success for thirty-four hours, during which time no one on the *Sonoma* slept nor ate a regular meal; after traversing the length of the Tongue of the Ocean and the Providence Channel the pursued vessel stood out on a northeast course into the open sea, where her superior sea qualities enabled her to draw away from the *Sonoma* and escape. The episode is not especially important except for an engineering question involved, which is the reason for its introduction.

The chief engineer of the *Sonoma* was Acting First Assistant Engineer Henry E. Rhoades who demonstrated his capability and zeal as an engineer by remaining on duty continuously during the chase and urging the boilers to their utmost capacity under forced draft, even going to the extent of burning hams and bacon to add to the fierceness of the fires. That he was able to keep a vessel like the *Sonoma* for more than thirty hours close astern of the *Florida*, built with special reference to speed, is sufficient proof of his ability as an engineer, although in doing it he well knew that he was inflicting fatal injury upon his own machinery. The commanding officer of the *Sonoma*, Commander T. H. Stevens, published in the *Cosmopolitan Magazine* for December, 1890, a very interesting account of this chase, from which narrative the following extracts are made: "Orders were at once given to the engineer to make all possible steam, the sails were cast loose, and the *Sonoma* sprung ahead in pursuit." . . . "Renewed orders were given to the engineer to crowd all steam and use every possible effort to increase the steam by the use of blowers or through any other means." . . . "Two or three times the engineer reported that the extreme pressure upon the boilers if kept up would cause an explosion, to which reply was finally made, 'Your duty is to obey orders, mine to capture or destroy the *Florida* at any risk.'"

This latter sentiment is an eminently proper one from a military standpoint, for more than one commander or final judge of expedients in a camp or on board an armed vessel can only result in confusion and failure through crossing of authority, but the principle should in all cases be double-acting to the extent of holding the determining authority alone responsible for the results of his judgment, both in success and failure. The last reference to the *Sonoma* in the magazine article from which quotations have been made says : " Shortly afterward, upon receiving orders to take the *Sonoma* to New York, we proceeded thither and immediately after our arrival there the vessel was put out of commission. The long chase of the *Florida* made extensive repairs essential." The vessel arrived at New York about the middle of June and a survey showed that her cylinder had been damaged by overwork and that her boiler tubes were so nearly burned out that they would have to be entirely renewed. The story is concluded by the following letter sent to Mr. Rhoades under date of July 25th : " Sir : A report of the examination of the machinery of the gunboat *Sonoma* shows that it has been seriously injured in consequence of your neglect of duty. You are therefore dismissed the service, and will, from this date, cease to be regarded as an Acting First Assistant Engineer in the navy.

Very respectfully,
GIDEON WELLES, Secretary of the Navy."

The town of Washington some distance up the Pamlico River from Pamlico Sound had been taken and occupied by the Federal naval force in the North Carolina Sounds since early in 1862. During the first two weeks of April, 1863, the enemy cut off water communication by occupying some works below the town and made a determined though unsuccessful attempt to recapture it, the two or three naval vessels thus cut off being forced to severe and prolonged exertions to retain possession of the place and preserve themselves. The following extracts from official reports regarding the investment refer to valuable services performed by members of the engineer corps.

From the report of Acting Rear Admiral S. P. Lee :

"The *Louisiana*, *Commodore Hull*, and an armed transport

called the *Eagle*, under charge of Second Assistant Engineer Lay and Paymaster W. W. Williams, of the *Louisiana*, as volunteers, were almost constantly engaged with the enemy's batteries opposite Washington."

" . . . Acting Second Assistant Engineer H. Rafferty, Acting Third Assistant Engineer John E. Harper, . . . are recommended to especial notice for their good conduct and bravery in battle."

From the report of Commander R. T. Renshaw of the *Louisiana*:

"Second Assistant Engineer John L. Lay and Assistant Paymaster W. W. Williams volunteering to take charge of the guns on board transport *Eagle*, I directed them to do so; they have done good service, and acted to my entire satisfaction."

"Acting Third Assistant Engineer Thomas Mallahan, of the *Ceres*, while attempting to land in one of her boats, was killed by a musket ball."

From the report of Acting Lieutenant Graves of the *Lockwood*:

"Late in the afternoon my boiler commenced leaking to such an extent as to put out the fires. I ordered the engineers to blow out the water and repair it temporarily with all possible despatch, and my thanks are due to Acting Second Assistant Engineer J. T. Newton and Acting Third Assistant John I. Miller for the energy and promptness they displayed in complying with my orders. At 9 P. M. had steam again."

As early as May, 1862, the Navy Department had informed Flag Officer DuPont confidentially of its intention to attempt the capture of Charleston, and in January, 1863, orders were sent to him to carry the plan into execution, the iron-clads as fast as completed being ordered to report to him for the undertaking. One of the first to arrive, the *Montauk*, Captain John L. Worden, distinguished herself the 28th of February by going under the guns of Fort McAllister in the Ogeechee River and destroying with her

shells the Confederate steamer *Nashville* which had been discovered aground about 1,200 yards up the river, the *Montauk* receiving a severe fire from the fort without material damage while shelling the *Nashville*. On the third of March, DuPont, to test the mechanical appliances of the monitors and give the men practice in firing the guns, sent the *Passaic*, *Patapsco* and *Nahant* to attack Fort McAllister. The monitors stood the test well and received no serious damage beyond dents in the turrets and side armor, while the few defects in turret turning mechanism, gun mounts and machinery that existed were discovered and remedied. The *Weehawken* while on her way to join the fleet broke down February 7th off Port Royal and was completely disabled. The trunk of one of her engines broke short off at the piston, canting the latter to the extent of cracking the cylinder beyond repair. It happened that the cylinders of the *Comanche* were completed in Jersey City and were made from the same patterns and in the same shop where the *Weehawken* was built, so by use of the telegraph and the chartering of a vessel the cylinders of the latter with all their attachments were hastened to Port Royal and installed in the disabled vessel in a remarkably short space of time.

On the 7th of April DuPont made an unsuccessful attack upon Fort Sumter with the *New Ironsides*, *Montauk*, *Weehawken*, *Cat-kill*, *Passaic*, *Nahant*, *Patapsco*, *Nantucket* and *Keokuk*. The iron-clads were in action less than two hours and were then withdrawn by signal from the flagship. A quartermaster was killed in the pilot house of the *Nahant* by a flying piece of bolt from the armor and Commander Downes and five others were injured in the same manner on that vessel. The *Keokuk* with her curious striped armor fared badly, being struck ninety times in thirty minutes and pierced through at and about the water-line nineteen times, while her turret was penetrated and the ship generally riddled. Fifteen of her crew were wounded, some of them seriously. She was kept afloat during the ensuing night, but when the water became rough in the morning she sank, her people being taken off just in time to save their lives. Rear Admiral DuPont made a discouraging report to the Navy Department respecting the monitors, and Chief Engineer Stimers, who had been sent down from New York with a company of machinists and ship-smiths to repair injuries to the iron-clads,

●

reported very favorably regarding them, the two reports being the beginning of a famous controversy that will be dealt with in a separate chapter.

The iron-clads did not again engage the Charleston forts while under DuPont's command, but in June an event took place that did much to redeem the reputation of the monitors. In November, 1861, an English iron steamer named *Fingal* ran the blockade into Savannah and after discharging her cargo was sold to the Confederate government and converted into an armored vessel of war by alterations practically the same as those adopted in the case of the *Merrimac*, with the addition of a heavy armor belt of timber about the water-line and a torpedo spar fitted on the bow. She was armed with two 6 $\frac{1}{2}$ inch and two 7 inch Brooke rifles, the latter pivoted for bow and stern as well as broadside fire, and had a crew of one hundred and forty-five officers and men. These preparations consumed much time and it was not until 1863 that she was ready for service, the blockaders in the meanwhile having maintained a vigilant watch over all channels whereby she might get to sea. In June it became definitely known that the *Atlanta*, as the *Fingal* had been re-named, had crossed over into Wassaw Sound south of Savannah and might be expected to make a raid on the blockaders thereabouts. The double-ender *Cimmerone* being the only vessel just then off Wassaw Sound, Admiral DuPont immediately despatched thither the monitors *Weehawken* and *Nahant*, the senior officer being sturdy John Rodgers in the *Weehawken*.

Early in the morning of June 17th, the anniversary of Bunker Hill, the *Atlanta* came down to give battle to the monitors, being accompanied by two steamers said to have been filled with excursionists expecting to witness an easy victory. Owing to the narrowness of the channel the *Nahant*, having no pilot, had to follow the *Weehawken* and was unable to fire a gun in the action which ensued. At 4.55 A. M. the *Atlanta* opened fire without effect, which was not returned until twenty minutes later when Rodgers with deliberate precision began using the *Weehawken's* guns, one of which was a XI-inch like those of the original *Monitor*, and the other a XV-inch. In fifteen minutes the *Atlanta*, then aground and badly damaged, hauled down her colors and surrendered. Four of the five shots fired from the *Weehawken* had struck her, one of the XV-inch, the first fired, having

broken through the armor and wood backing, strewed the gun-deck with splinters and prostrated forty men by the concussion, one of whom died; the other XV-inch shot knocked off the top of the pilot-house and disabled both pilots and the man at the wheel, which accounts for the vessel going aground. One of the XI-inch shots did no damage beyond breaking a plate or two at the knuckle, but the other one carried away a port-shutter and scattered its fragments about the gun-deck. Lieutenant Commander D. B. Harmony of the *Nahant* was put in charge with a prize crew, Acting First Assistant Engineer J. G. Young of the *Weehawken* taking charge of the engines. The prize was found fully equipped with ammunition and stores for a cruise and was appraised as follows by a board of naval officers:

Hull.....	\$250,000.00
Machinery.....	80,000.00
Ordnance, ordnance stores &c	14,022.91
Medical stores.....	20.00
Provisions, clothing and small stores.....	1,012.85
Equipments and stores in the master's, boatswain's, sailmaker's, and carpenter's departments.....	5,773.50
	\$350,829.26
Total valuation.....	\$350,829.26

The above amount, less \$789.30 costs of trial, was subsequently declared by the prize court as available for distribution.

Three hours after the surrender the engine of the *Atlanta* was reversed by engineer Young and the vessel backed off into deep water, proceeding later under her own steam without convoy to Port Royal where she was repaired and enrolled in the naval service of the United States. Captain Rodgers' report of the engagement contains the following: "The engine, under the direction of First Assistant Engineer James G. Young, always in beautiful order, was well worked. Mr. Young has, I hope, by his participation in this action, won the promotion for which, on account of his skill and valuable services, I have already recommended him." On the 5th of July Mr. Young received his promotion to the grade of acting chief engineer.

The outline sketches of the *Atlanta* here following are reproduced from drawings made at the time of her capture by Second

Assistant Engineer P. R. Voorhees of the *Wabash*, and were forwarded as part of the official report of the capture. In a general way they serve to illustrate the type of armored vessels which lack of iron building material forced the constructors and engineers of the South to resort to.

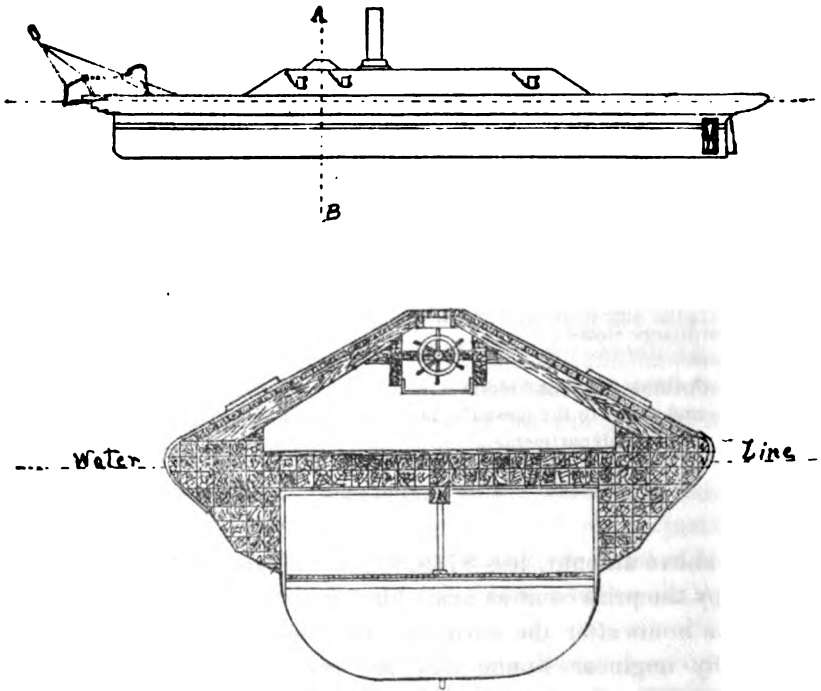

CONFEDERATE IRON-CLAD *Atlanta*, CAPTURED BY THE *Weehawken*.
Enlarged section on A-B showing framing, wooden armor, etc.

Rear Admiral John A. Dahlgren relieved Rear Admiral Dupont on the 6th of July and immediately began a determined and prolonged struggle, in conjunction with the army, for the possession of Charleston Harbor, partial success being achieved by the capture of Morris Island and its formidable fort, Wagner, on the 6th of September. Fort Sumter was steadily assailed for months and by the end of the year was little more than a heap of ruins, though the enemy retained possession of it. A noteworthy casualty of the siege

occurred on the *Catskill* while engaged with Fort Wagner on the 17th of August. A shot from the fort struck the top of the pilot-house and shattered the inner lining of it, pieces of which killed Commander George W. Rodgers and Assistant Paymaster J. G. Woodbury, and wounded a pilot and a master's mate, all of whom were in the pilot-house. It is claimed by the friends of the monitor type of ships that these two unfortunate officers and the quartermaster killed on the *Nahant* were the only persons who were killed on the monitors by cannon fire during the whole course of the war. The constant employment of the monitors during these months of siege entailed much hard work and suffering upon the engine-room force, the reports of commanding officers containing frequent reference to a prostration of engineers and firemen from the intense heat of their stations.

Immediately after the evacuation of Morris Island by the enemy an unsuccessful attempt was made to take Sumter by assault, a landing party of about four hundred men from the fleet being sent on shore the night of September 8th for that purpose. While landing from the boats a number of casualties occurred from the enemy's fire and the party was driven off after a sharp fight with the loss of about one hundred and twenty officers and men made prisoners, Third Assistant Engineer J. H. Harmony of the *Housatonic* being one of the latter. The night of October 5th a most daring attempt to blow up the *New Ironsides* was made by Lieutenant Glassell, Assistant Engineer Toombs, and a pilot, who went out to her in a small and almost submerged cigar-shaped craft and exploded a torpedo close alongside the big iron-clad. The explosion started some beams and knees in the side of the iron-clad but did no serious injury. A mass of water fell upon the deck and also extinguished the fires of her assailant. Lieutenant Glassell took to the water and was captured; the engineer and pilot stuck to their disabled boat and afterward got up steam and returned to Charleston the same night. For this Mr. Toombs was made a chief engineer.

In the operations of this protracted siege the resisting and aggressive qualities of the monitors were well tested and demonstrated. An idea of the hard knocks they gave and took during the summer may be gained from the following tabular statement of their services, as reported to the department by Admiral Dahlgren:

	NUMBER SHOTS FIRED JULY 10-SEPT 7, 1863.		HITS.	HITS, APRIL 7; FIRST ATTACK ON SUMMER.	HITS AT FT. MCALLISTER.
	xv in.	xi in.			
Catekill.....	138	425	86	20
Montauk.....	301	478	154	14	46
Lehigh.....	41	28	36
Passaic.....	119	107	90	35	9
Nahant.....	170	276	69	36
Patapsco.....	178	30	96	47	1
Weehawken.....	264	633	134	53
Nantucket.....	44	155	53	51
New Ironsides.....	4,439	164
Totals.....	1,255	6,771	882	256	56

The limited operations of the *Lehigh* were due to the fact that she did not arrive at Charleston until August 30, and consequently was engaged only about a week of the period dealt with.

About the middle of the afternoon of Sunday, December 6, the *Weehawken* sank at her anchorage off Morris Island. The cause of this disaster as determined by a court of inquiry appears to have been altering her trim by stowing an unusual quantity of shot and shell in the bow compartments and leaving the forward hatch open when water was breaking on board. Ordinarily all water ran aft and was thrown out by the pumps in the engine-room, but with the changed trim this did not occur until a large quantity of water had accumulated forward, bringing her more and more down by the head, and rapidly increasing through new leaks started by the unusually heavy load forward. This condition was not discovered until ten or fifteen minutes before she sank, and the desperate attempts then made to relieve her were unavailing; her limit of buoyancy, which was only 125 tons, was reached before the pumps began gaining on the water, and she went down. Four officers and twenty-six men perished in her, the entire watch on duty in the engine and fire-rooms being lost. The four officers drowned were all third assistant engineers—Messrs. Henry W. Merian; Augustus Mitchell; George W. McGowan, and Charles Spangberg. Two of these were on duty and the other two heroically went to the engine-room to try to render assistance instead of saving themselves, as

they might have done. The engineer in charge, Mr. J. B. A. Allen, acting second assistant, whose duties obliged him to go on deck at intervals to report to the executive officer, was saved.

CHAPTER XXII.

“For Southern prisons will sometimes yawn,
And yield their dead unto life again;
And the day that comes with a cloudy dawn
In golden glory at last may wane.”

KATE PUTNAM OSGOOD.

1863—The Civil War, Continued—The War on the Western Waters—Passage of Port Hudson—Destruction of the Frigate *MISSISSIPPI*—Minor Operations in the West—New Vessels Placed Under Construction—The Light-Draft Monitors—Iron Double-Enders—Large Wooden Frigates and Sloops-of-War—The First Swift Cruisers—The *KALAMAZOO* Class of Monitors—Assimilated Rank of Staff Officers Raised—New Regulations Governing Promotion in the Engineer Corps Issued.

THE naval force in 1863 on the western rivers was engaged in a ceaseless and baffling warfare under conditions that were very difficult and often disheartening. Great annoyance was experienced from the development by the Confederates of the torpedo, and another danger, equally unassailable, existed in the guerrillas or “bush-whackers” who infested the swamps and forests along the river banks in such unseen numbers that no man’s life was safe on a passing steamer. David D. Porter, still a commander, but holding an acting appointment as rear admiral, was now in general command of the Mississippi fleet, which had been increased by a number of regularly built war vessels in addition to the mortar boats and make-shifts previously spoken of. On the 4th of July Porter was commissioned a rear admiral in recognition of his services before Vicksburg, which place succumbed to the combined army and naval forces on that date. Besides Porter’s fleet, vessels of Farragut’s West Gulf blockading squadron also operated in the river, the most noteworthy battle of the year in this region being fought by a division of that squadron.

The night of March 14-15 Farragut attempted to run past the formidable batteries at Port Hudson, Louisiana, his object in wishing to get above them being to cut off the enemy’s supplies from the Red River region and also to recover if possible the iron-clad

casemated gunboat *Indianola*, which had been captured by four Confederate steamers on February 24th. Farragut's fleet consisted of his flagship *Hartford*, three large ships and three gunboats. To provide for keeping the large vessels going ahead in case of injury to their machinery they were each ordered to lash a gunboat alongside on their port sides, that being away from Port Hudson which is located on the east side of the river. The *Mississippi* had no consort; not from any sentiment that the old sea-veteran could fight her battles better alone, but because there was no gunboat for her and her overhanging paddle-boxes would have made the arrangement difficult if not impossible had there been another gunboat available. The iron-clad *Essex* and some mortar boats of Porter's fleet were also present and did good service bombarding the forts, as they had done before at the forts below New Orleans.

Shortly before midnight the squadron moved up the river and received a terrible fire from the batteries on shore, the ships being brought into bold relief by the light of burning buildings and bonfires on the banks. Farragut in the *Hartford*, with the *Albatross* lashed alongside, succeeded in running the batteries and gained a position in the river above, but all the other vessels failed in the attempt. The *Monongahela* grounded on a spit in front of the principal battery and for half an hour was a stationary target for a most severe fire which killed six and wounded twenty-one of her crew, Captain McKinstry being among the wounded. Her escape from this almost fatal predicament was due largely to the exertions and courage of her chief engineer, Mr. George F. Kutz, and his assistants, the senior one of whom was Mr. Joseph Trilley, now a chief engineer in the navy. To work the engines to their utmost in the endeavor to back off, these officers took the desperate risk of doubling the steam pressure in the boilers and with the added power thus obtained and the assistance of the consort *Kineo* the ship was finally floated. This extraordinary power worked through the engines resulted in heating the forward crank pin, the brasses of which were slacked off during a momentary stop, and the engines thereafter kept running at full speed by playing a stream of water from the fire hose on the hot pin until the ship was off the bottom. By that time the pin was so burned and cut that the engines were disabled and the *Monongahela* and *Kineo* had to drop down the

river out of action. While the engineers were struggling with the crank-pin adjustment an 80-pounder rifle shot came into the engine-room and broke into pieces by striking the end of the reversing shaft.

The reports made by the commanding and executive officers ascribed the failure of the *Monongahela* to get past the batteries to the failure of the engines, but Chief Engineer Kutz was able to prove to the satisfaction of Admiral Farragut that the casualty to the engines occurred while unusual exertions were being made to back off the spit, and not after the vessel was again afloat, as had been charged.

The *Mississippi* following astern of the *Monongahela* also went aground and for thirty-five minutes made heroic endeavors to get off and escape from the galling cross fire of three batteries concentrated upon her. The chief engineer, Mr. Wm. H. Rutherford, increased the steam pressure from thirteen to twenty-five pounds and backed the engines with all their power without avail. The fire of the enemy finally became so accurate and deadly that Captain Melancthon Smith deemed it "most judicious and humane," as he expressed it in his report, to abandon the vessel, and then followed a task that must have been most repugnant to those who loved the old ship and respected her historical associations. Her battery was spiked; the small arms thrown overboard; the engineers and their men broke and destroyed the vital parts of the machinery; fires were kindled in several places between decks, and after the sick and wounded were brought up the ship was left to her fate. Sixty-four of her crew were reported killed and missing and two hundred and thirty-three as saved, a number of the latter being wounded from the enemy's fire, among them Mr. J. E. Fallon, third assistant engineer. In this disaster and its sequence Third Assistant Engineer Jefferson Brown was the subject of one of those incidents of resurrection from supposed death which occurred a number of times during the Civil War and turned mourning into rejoicing for a number of families both North and South. Mr. Brown was reported drowned when the *Mississippi* was lost, and in collecting material for this book the writer found his name still inscribed in the list of the dead in the casualty-book of the rebellion kept by the bureau of Medicine and Surgery, Navy Department. Some months after the disaster, when an exchange of prisoners was

effected, Mr. Brown appeared among the captives given up, and has lived to be at present a chief engineer on the retired list of the navy.

The following spirited description of the final scene in the career of the *Mississippi* is taken from a paper read before the District of Columbia Commandery of the Military Order of the Loyal Legion by Chief Engineer Harrie Webster, U. S. Navy, who as an assistant engineer on board the *Genesee* witnessed the tragedy.

“As the smoke slowly drifted to leeward we caught sight of the old frigate *Mississippi*, hard and fast aground, apparently abandoned, and on fire.

“When we first discovered her the fire was already crawling up the rigging.

“From every hatch the flames were surging heavenward, and it seemed but a question of minutes when the good old ship must blow up.

“Every mast, spar, and rope was outlined against the dark background of forest and sky, and it was a sad, and at the same time, a beautiful spectacle.

“While all hands were speculating on the causes of the disaster the staunch old craft, which had braved the gales of every clime, slowly floated free from the bank, and, turned by an eddy in the current, swept out into the river and headed for the fleet as though under helmsman’s control.

“As the burning ship neared the ships at anchor in her path, her guns, heated by the flames, opened fire, one after another in orderly sequence, and as their breechings had been burned away the recoil carried them amidships, where, crashing through the weakened deck, they fell into the fiery depths, showers of sparks and fresh flames following the plunge.

“Fortunately for us, her guns had been trained on the bluffs, so her shots flew wide of the fleet and sped crashing into the forest below the batteries of Port Hudson.

“Majestically, as though inspired with victory, the ship, which by this time was a mass of fire from stem to stern, from truck to water-line, floated past the fleet, down past Profit’s Island, down into the darkness of the night.

“Suddenly, as if by magic, her masts shot into the air all ablaze, a tremendous tongue of flame pierced the sky for an instant, and amid the muffled thunder of her exploded magazine the *Mississippi* disappeared in the stream whose name she had borne so bravely and so long.”

The *Richmond*, with the *Genesee* alongside, was the second in line following the flagship, and was disabled at the turning point in the river opposite the batteries by a shot carrying away both her safety valves and letting off the steam, which obliged her to drop down stream, the *Genesee* being unable to carry her up against the strong current. She had three men killed and twelve wounded, the majority of the casualties occurring among the marines, a gun's crew of whom were nearly all swept away by a single shot. Commander James Alden of the *Richmond* in his report of the battle said, “To Mr. Moore, our chief engineer, great credit is due for his management throughout the fight, and particularly after the accident to the safety-valve chest.” The *Genesee* was considerably damaged by shot and had three wounded; her commander reported, “I also bring to special notice the efficient manner in which Mr. John Cahill, senior engineer, and the assistant engineers, Charles H. Harreb, Michael McLaughlin, Christopher Milton and Harrie Webster, with the firemen and coal heavers attached to this department, worked the engine and supplied the furnaces during the action.”

The state of affairs in the engine department of the *Richmond* was most critical after the destruction of the safety valves, the engine and fire-rooms being filled with steam, which obliged the most heroic devotion to duty in order to save the boilers by hauling the fires. Mr. Eben Hoyt, the first assistant engineer, was conspicuous in this work, as described by the following from the official report of Chief Engineer John W. Moore :

“I consider it my duty to bring to your notice the valuable assistance rendered me by First Assistant Engineer E. Hoyt, who, during the whole engagement, was actively employed wherever most required, until after having penetrated the steam several times, while superintending the hauling of the fires, trying to ascertain the

extent of injury, &c., he was finally led away completely exhausted and fainting."

In forwarding this report to the Secretary of the Navy, Commander Alden sent the following letter:

"SIR: I have the honor to enclose herewith the report of the chief engineer of this vessel setting forth the injuries done to our machinery on the night of the 14th instant. It would have been sent with the others, but Mr. Moore's attention has been so entirely engrossed in the personal superintendence of the repairs that it was found impracticable.

"In my general report of our proceedings, at the time referred to, I had occasion to speak of Mr. Moore's services, and would again call the attention of the department to his merits as an officer. All that he says of his assistants I can endorse most fully, and would beg leave to mention here what I regret was from some oversight omitted in my first report, namely, that Third Assistant Engineer Weir, who was stationed at the bell-pull on the bridge, was of the greatest assistance to me in pointing out the location of the different batteries, and although knocked down and injured by splinters, recovered himself immediately and continued unflinchingly at his post."

In order to communicate with the admiral above Port Hudson, Commander Alden directed the commander of the *Genesee* to fit out an expedition from his vessel for that purpose. As the undertaking was one of great peril, volunteers were called for from among the officers, and three or four responded: from these Commander Macomb selected Acting Third Assistant Engineer Harrie Webster, although he was the only staff officer who had volunteered; put him in command of a boat's crew, and started him off on his dangerous mission. Mr. Webster successfully took his boat through the six or eight miles of intervening swamps and lagoons, delivered his despatches to Admiral Farragut, received others from him to Commander Alden, and returned to the *Genesee* the same night. On the way back he landed and examined a signal station of the enemy, and, finding about it the fresh trail of a horseman, he took his party

in pursuit, eventually overhauling and capturing at the point of his revolver a Confederate lieutenant with his horse, accoutrements, and important despatches. The exploit was one of remarkable nerve and daring, performed as it was in the gloomy fastnesses of the enemy's country.

On the 22nd of March while Rear Admiral Porter with some mortar-boats and small steamers was trying to work through the thickets of Steele's Bayou and thus get into the Yazoo River, he was attacked by a large force of the enemy concealed in the woods; two of his men were severely wounded and Acting Third Assistant Engineer Henry Sullivan of the *Dahlia* was struck by a rifle ball and killed.

On March 28th the purchased gun-vessel *Diana*, Acting Master T. L. Peterson commanding, was sent into Grand Lake from the Atchafalaya River to make a reconnoissance. When on her return she was attacked near Berwick Bay from shore by field pieces and sharp-shooters, and was forced to surrender after a fiercely fought contest lasting nearly three hours. The commanding officer and two master's mates next to him in rank were killed before the surrender, and Acting Assistant Engineer James McNally was also killed, the latter's death being instantaneous from a Minie ball in the head.

About the middle of July while a detachment of vessels of the Mississippi flotilla was up the Yazoo River destroying Confederate steamers that had taken refuge there, the armored gunboat *Baron de Kalb* ran upon two torpedoes and was sunk in twenty feet of water. Her hull was so damaged that no effort was made to raise her, but her guns, stores, and parts of the machinery were removed, and her armor plates were taken off to prevent them from becoming of use to the enemy. The *Baron de Kalb* was originally the *St. Louis*, the name having been changed about the time she was transferred to the Navy Department, and she was the third of the seven original Edes iron-clads to be destroyed by the enemy. The *Cairo* was sunk by a torpedo in the Yazoo River in December, 1862, and the *Cincinnati* was sunk by the Vicksburg batteries, May 27th, 1863. These disasters were unattended with loss of life except in the case of the *Cincinnati*, which had nineteen people killed or drowned and fourteen wounded, First Engineer Simon Shultice being one of the latter.

An unfortunate and unsuccessful attack was made September 8th by a combined army and navy force upon a fortified position at Sabine Pass, Texas. The force consisted of 1,200 troops in transports, convoyed by the naval steamers *Granite City*, *Arizona*, *Sachem*, and *Clifton*, all purchased vessels of inferior resisting powers. In the engagement the two last named were both disabled by shots exploding their boilers, and were compelled to surrender. The *Sachem* had two engineers and seven men killed and a considerable number wounded, the two unfortunate engineers being John Frazer, acting second assistant engineer, and John Munroe, acting third assistant. The executive officer, Acting Master Rhoades, and seven men of the *Clifton* were killed and a number, mostly soldiers, wounded; her chief engineer, Mr. Bradley, was wounded and was afterward reported by the Confederate captors of the survivors as having died of his injuries.

In October the commander of the ironclad *Osage*, of the Mississippi squadron, having received information that a Confederate steamer was tied up to the bank in the Red River, sent out an expedition under command of Acting Chief Engineer Thomas Doughty, with Assistant Engineer Hobbs as his lieutenant, which expedition captured and destroyed the steamer and another one, took a number of prisoners, and returned without loss to the *Osage*. Mr. Doughty's report of the affair, dated October 7, 1863, follows:

“SIR: In obedience to your order, I, with a party of twenty men, with the assistance of Mr. Hobbs, started for Red River this morning. Arriving at Red River, I could see no signs of a steamboat. I divided the party, sending eight men down the river to look into the bend below, and with twelve started up the river. When we had traveled about half a mile I saw the chimneys of a steamer. The woods were found so dense that we could not penetrate them, and the only alternative was to advance in sight. The steamer was on the opposite side of the river, and I feared those on board might see us in time to escape before we were near enough to use our rifles. No one saw us, and I chose a spit opposite her, where we could see any one who attempted to escape. I hailed her; two men were seen to run forward and disappear; I directed three files on the right to fire. The fire brought the men out, and at my command they brought to my side of the river two skiffs which belonged to the boat. I was

about to embark a party to burn her, when I heard a steamboat descending the river. I ordered the men out of sight behind a large log and some bushes, and in two minutes I saw a steamer round the point above. I waited until she was within four hundred yards, and showed myself, and ordered her to stop. She did so, and I found myself in possession of nine prisoners and two steamboats. I knew I could not get them out of the river, and I ordered the destruction of the first one captured, the *Argus*, and embarked on board the second, the *Robert Fulton*, and steamed down to the landing where I first struck the river, where I ordered her to be set on fire, and in a few minutes she was one mass of flame. She was the better vessel of the two, and was valued by her owner at seventy-five thousand dollars. Neither of them had any cargo on board. I captured all the officers of the boats, one first lieutenant in the Confederate army, and three negroes."

Admiral Porter in reporting this affair to the Department said, "This is a great loss to the rebels at this moment, as it cuts off their means of operating across that part of Atchafalaya where they lately came over to attack Morganzia. This capture will deter others from coming down Red River. The affair was well managed, and the officers and men composing the expedition deserve great credit for the share they took in it."

During 1863 the navy was increased by about one hundred and thirty vessels of all kinds acquired by purchase or capture, and lost thirty-two in battle or by accidental destruction. Fifty-eight vessels of war were placed under construction during the same period. The first of these were twenty light-draft single-turreted monitors, contracts for the construction of which were distributed among a dozen different cities from Portland, Maine, to St. Louis, Missouri, during the spring months of the year. The general plans for these monitors were furnished by John Ericsson and the entire control and supervision of their building was entrusted to Chief Engineer A. C. Stimers. They were designed to draw six feet of water and were intended to operate in shallow rivers and other inland waters where guerrillas had made the service of other types of light-draft boats extremely perilous and of doubtful success. For causes that will be referred to later, these monitors failed to fulfill

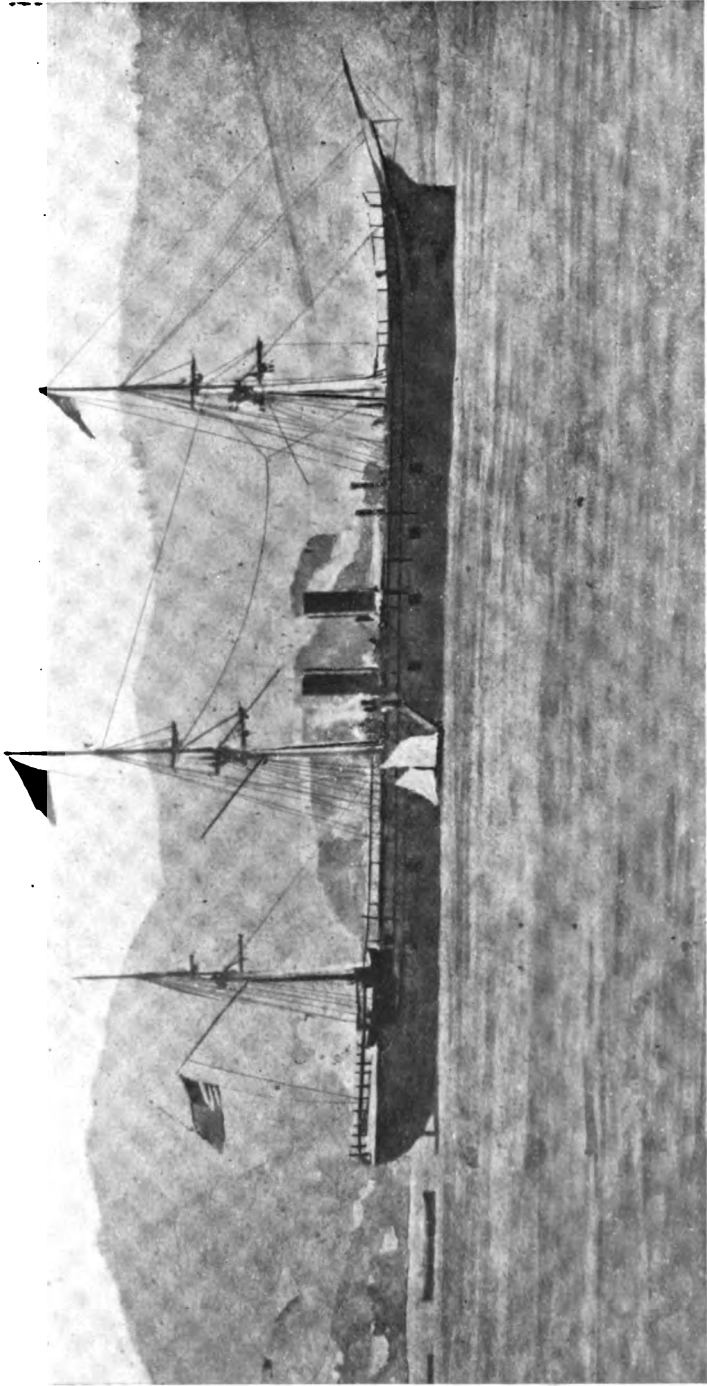

U. S. STEAM FRIGATE GUERRIERE.

Length, 312 feet 6 inches; beam, 46 feet; disp., 3,953 tons.

(From a photograph taken in Rio de Janeiro, loaned by Chief Engineer John L. Hannum, U. S. Navy.)

their mission and never rendered any service of value to the government. Their names were, *Casco*, *Chimo*, *Cohoes*, *Etlah*, *Klamath*, *Koka*, *Modoc*, *Napa*, *Naubuc*, *Naussett*, *Sharonee*, *Shiloh*, *Squando-Suncook*, *Tunwis*, *Umpqua*, *Wassuc*, *Wassaw*, *Yazoo*, and *Yuma*.

In June and July contracts were made with various ship-builders for seven iron double-enders, somewhat larger than those of the two classes previously built; each had a single inclined low-pressure engine from designs furnished by the engineer-in-chief. They were of 1,370 tons displacement and were named *Ashuelot*, *Mohongo*, *Monocacy*, *Muscoota*, *Shamoken*, *Surwancee*, and *Winnipeg*.

In order to provide for a fleet that would be useful for general cruising purposes when peace should be restored, the Department had plans prepared by the Bureau of Construction during the summer for a number of large wooden frigates and sloops-of-war, and began the construction of a number of them at the different navy yards. Unfortunately the supply of seasoned timber had been so drawn upon by the unusual amount of ship-building of the preceding years that much green material had to be used in these vessels and as a consequence those that were eventually finished were very short-lived. Being long and narrow, they were strengthened with diagonal iron bracing amounting almost to an enormous iron basket woven over the hull, and this held them together long after the decay of the timbers and would have caused them to fall in pieces.

Eight of these ships were gun-deck frigates of 4,000 tons displacement and full ship-rigged. They were about 310 feet long between perpendiculars and forty-six feet extreme beam. Their names were, *Antietam*, *Guerriere*, *Illinois*, *Java*, *Kewadin*, *Minnetonka*, *Ontario*, and *Piscataqua*. Two other gun-deck frigates, the *Hassalo* and *Wautaga*, somewhat larger than these eight, were projected at the same time, but their hulls were never built. In addition to the frigates, ten large sloops-of-war of what was known as the *Contoocook* class were ordered. They were of about 3,050 tons displacement and were named *Arapahoe*, *Contoocook*, *Keosauqua*, *Manitou*, *Mondamin*, *Mosholu*, *Pushmataha*, *Tahganyuta*, *Wanalosett*, and *Willamette*. Of these only four—the *Contoocook*, *Manitou*, *Mosholu* and *Pushmataha*—were ever built, and they, with the new names of *Albany*, *Worcester*, *Severn*, and *Congress*

respectively, fell into decay after not many years' service. All twenty of the ships above named were to have two-cylinder back-acting engines of the Isherwood type, the cylinders being sixty inches in diameter and three feet stroke of piston; boilers for each vessel were specified to have not less than 546 square feet of grate service. Late in the fall Mr. Isherwood, acting for the Department, entered into contracts with eleven different machinery firms for the engines and boilers of these ships, the contract price for machinery for each ship being \$400,000, except the *Ontario* which contract was awarded to John Roach of the Etna Iron Works for \$385,000. Owing to the non-completion of the hulls of many of the ships, the matter of making settlements and compromises with the machinery contractors became a vexed problem for the bureau of steam engineering to struggle with after the war.

The swift cruiser came into existence this year also by the beginning of work on seven vessels in which speed was to be the most important element. The Secretary of the Navy in explaining the need of having such vessels said in his annual report for that year, "Besides the turreted vessels for coast defense and large armored ships for naval conflict we need and should have steamers of high speed constructed of wood, with which to sweep the ocean, and chase and hunt down the vessels of an enemy." One of these cruisers, the *Idaho*, was the child of Mr. E. N. Dickerson, who had secured sufficient influence to obtain this opportunity of experimenting on a large scale with his theory of perfect expansion of gases when applied to the steam engine. With the *Idaho* the Bureau of Steam Engineering had nothing to do, the contract for hull and machinery complete being made by the Bureau of Construction in May, 1863, with Paul L. Forbes and E. N. Dickerson, the contract price being \$600,000. The hull was built by the famous ship-builder, Steers, of New York, and the machinery by the Morgan Iron Works from designs prepared by Mr. Dickerson; there were two pairs of engines driving twin screws, the cylinders having the very remarkable dimensions for marine engines of eight feet stroke and thirty inches diameter. The *Idaho* was 298 feet long, 44½ feet beam, and of 3,240 tons displacement.

John Ericsson also availed himself of this opportunity to try engineering conclusions with Engineer-in-Chief Isherwood. It was

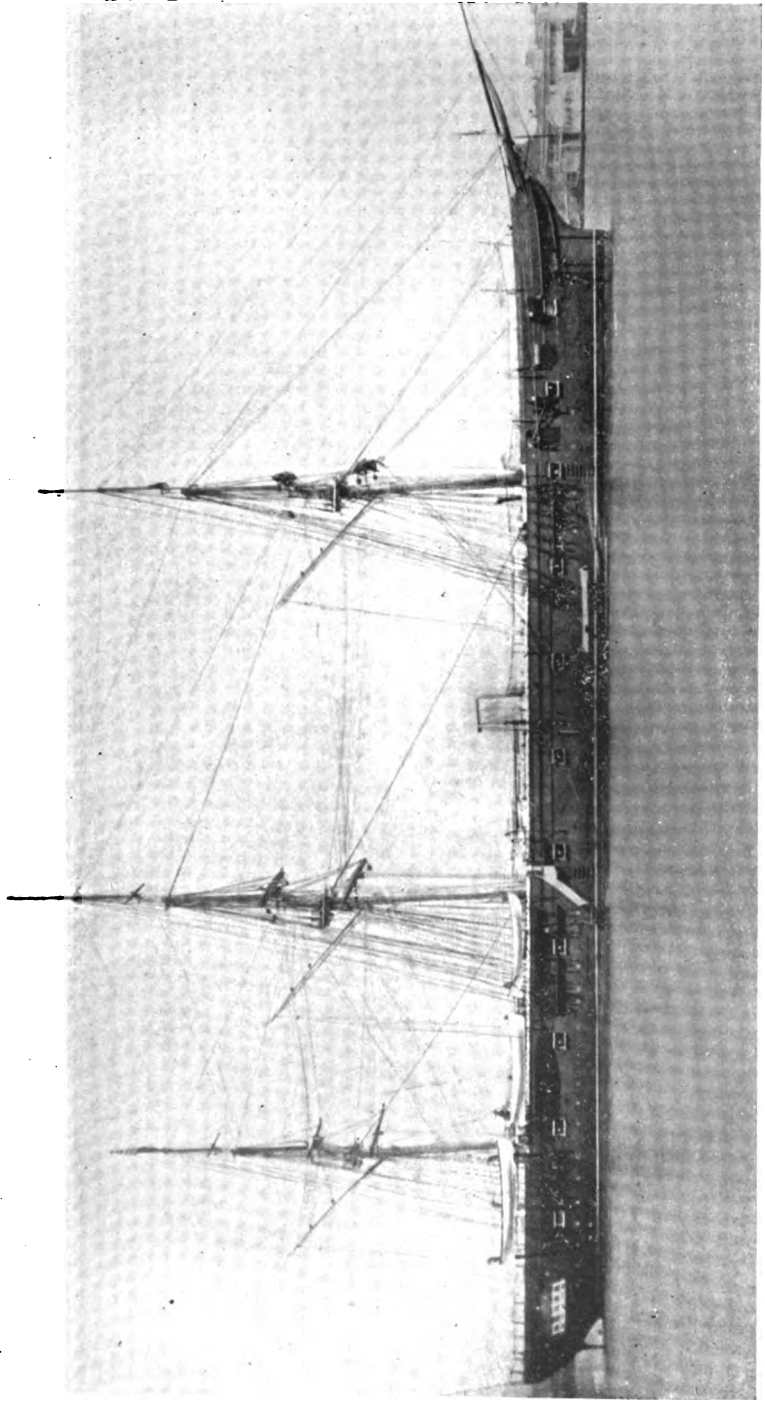

U. S. S. WORCESTER, ORIGINALLY MANITOU.
Typical of the *Cumtcook* class of screw sloops.

arranged that two ships exactly alike should be built, one to be fitted with Isherwood's engines and the other with Ericsson's. The ships were the *Madawaska* and *Wampanoag*, built side by side in the Brooklyn navy yard by that master-builder, Naval Constructor B. F. Delano; they were 335 feet long, 45.2 feet beam, 4,200 tons displacement, and rated at 3,281 tons burden. Their boilers and all auxiliaries were the same. Isherwood's engines consisted of a pair of cylinders 100 inches in diameter and four feet stroke, arranged by means of huge wood-toothed gear wheels to make one double stroke of the piston for every 2.04 revolutions of the propeller shaft. Ericsson's cylinders were the same in number and dimensions as Isherwood's, but their arrangement was according to his patented vibrating lever type, connecting directly with the shaft. Ericsson's engines for the *Madawaska* were built at the Allaire Iron Works, New York, and Isherwood's for the *Wampanoag* at the Novelty Iron Works in the same city, the contract price in each case being \$700,000.

Still another ship entered into this competition for speed was the *Chattanooga* by the Cramp & Sons Ship Building Co. of Philadelphia, which firm built the hull at their own yard and obtained the machinery by sub-contract from Merrick & Sons. The *Chattanooga* had a pair of back-acting engines, 84 inches diameter by 42 inch stroke, and 980 square feet of grate surface; her length was 315 feet; breadth 46 feet, and displacement 3,040 tons. The contract price for the vessel complete was \$600,000. The three other cruisers not yet mentioned were the *Pomponoosuc*, *Ammonoosuc*, and *Neshaminy*, all of which had Isherwood engines precisely like those of the *Wampanoag*, and which cost \$700,000 for each of the first two named and \$680,000 for the *Neshaminy*. The machinery for the *Pomponoosuc* was built by the Corliss Steam Engine Co. of Providence, Rhode Island; that for the *Ammonoosuc* by George Quintard at the Morgan Iron Works, New York, and that for the *Neshaminy* by John Roach, New York. The *Ammonoosuc* was built at the Boston Navy Yard and the *Neshaminy* at the Philadelphia navy yard, these two being sister ships, and of about 4,000 tons displacement each. The *Pomponoosuc* was somewhat larger than the other two, but was never completed: under the name of *Connecticut* she stood in frame on the stocks at the Boston navy yard for many years and was finally broken

up. The completion and speed trials of these cruisers did not occur until some time after the close of the war; the trials of some of them demonstrated a new possibility in war-ship building and were the occasion for one of the most remarkable professional triumphs ever achieved by an engineer, for which reasons the subject will be taken up in detail hereafter.

Towards the end of the year it was decided to build four double-turreted monitors to be heavily armed and armored and adapted to ocean cruising; battle-ships, in fact. These were big vessels (5,660 tons displacement) with big names—*Quinsigamond*, *Passaconaway*, *Kalamazoo*, and *Shackamaxon*. The hulls were put under construction at four different navy yards, wood being used, and all deck-plating, side armor, turrets, etc., obtained by contract with iron masters. In December the Bureau of Steam Engineering made contracts for their machinery, the contract price for that for the *Quinsigamond* and *Kalamazoo* being \$580,000 each, and \$590,000 each for the other two. The contracts called for twin screws, each screw shaft to be actuated by a pair of direct-acting horizontal engines with cylinders $46\frac{1}{2}$ inches in diameter and 50 inches stroke; horizontal tubular boilers of not less than 900 square feet of grate surface for each vessel were specified. Designs for this machinery were furnished the contractors by Mr. John Baird, engineer, of New York city. None of the hulls were ever completed, but under changed names they stood on the stocks for a number of years and were eventually broken up. The following table shows the place of building of the ships and machinery:

OLD AND NEW NAME.	WHERE BUILT.	
	HULL.	MACHINERY.
<i>Quinsigamond</i> , (Oregon)..	Boston Navy Yard.	Atlantic Works. Boston.
<i>Passaconaway</i> , (Mass.).....	Kittery Navy Yard.	Delamater Iron Works, N. Y.
<i>Kalamazoo</i> , (Colossus).....	New York Navy Yard.	“ “ “ “
<i>Shackamaxon</i> , (Nebraska)	Philadelphia Navy Yard.	Pusey, Jones & Co. Wil'n Del.

In November of this year Mr. Isherwood entered into a contract with the Atlantic Works of Boston for a complete outfit of machinery for the big frigate *Franklin*, still unfinished at the Kittery navy yard. The contract called for a pair of back-acting

engines with cylinders 68 inches in diameter and 42 inches stroke; four vertical water-tube boilers; two superheating boilers; a Sewell's surface condenser, and a detachable hoisting screw. The contract price was \$440,000.

Under the old naval organization the ranks of line officers as established by law were, midshipman, master, lieutenant, commander, and captain. Staff officers held assimilated rank with these up to the rank of commander, as directed by Secretary Toucey's order of January 13, 1859. In 1862, as has been noted, the line ranks were increased by adding commodore and rear admiral at the top and inserting the intermediate ranks of ensign and lieutenant-commander, no change in the assimilated rank of the staff being made at that time. To remedy the practical reduction in rank of the staff thus occasioned the Secretary of the Navy issued an order, dated March 13, 1863, re-grading the relative rank of the staff corps, that part of the order especially interesting to engineers reading as follows:

“*Third Assistant Engineers* to rank with Midshipmen.

“*Second Assistant Engineers* to rank with Ensigns.

“*First Assistant Engineers* to rank with Masters.

“*Chief Engineers* to rank with Lieutenant Commanders for the first five years after promotion; after the first five years, with Commanders; and after fifteen years date of commission, to rank with Captains.

“*Fleet Engineer* to rank with the Captain.

“The *Fleet Captain* to be called the ‘Chief of Staff,’ and to take precedence of the Staff Officers of every grade.

“*Chiefs of Bureaus* of the Staff Corps to rank with Commodores, and to take precedence of each other according to their dates of commission as Surgeons, Paymasters, Naval Constructors, and Engineers, and not according to the date of appointment as Fleet Officer, or Chief of Bureau.

“*Fleet Staff Officers* to take precedence of Executive Officers.”

August 11th, 1863, the Navy Department issued a circular directing that thereafter no more appointments of engineers for acting or volunteer service should be made until the applicant had passed satisfactory examinations before the chief engineer and

surgeon of the navy yard where application for appointment was made.

The following is an extract from a general order issued by the department under date of September 16, 1863:

“Engineers will hereafter understand that the condition of the machinery under their charge on the arrival of the vessel from a cruise will be considered as a test of their efficiency and fidelity in the discharge of their duties; and that the result of the examination then made will determine whether they have discharged their duties in such manner as to deserve commendation, or have been so grossly negligent or incompetent as to render their expulsion from the service an act of justice to the public.”

On the 22nd of December a new schedule of examinations for promotion of engineers in the regular service was promulgated by circular order, the standard being raised considerably above the requirements of the regulation on the subject issued in 1859. This order was specified to apply temporarily only, during the war, and to the examination of engineers in the squadrons.

CHAPTER XXIII.

"Be aware
Of entrance to a quarrel ; but being in,
Bear't that the opposed may be aware of thee."
Hamlet; Act I, Sc. 3.

1863—The Civil War, Continued—Controversy as to the Efficiency of Iron-Clads—Rear Admiral DuPont Reports Adversely to Them—Chief Engineer Stimers Reports in Their Favor—Rear Admiral DuPont Prefers Charges Against Chief Engineer Stimers—The Case Investigated by a Court of Inquiry.—Vindication of Mr. Stimers.

THIS history of the steam ships and engineers of the American navy would be incomplete without some reference to an internal strife in the service in the year 1863, growing out of the introduction of mastless war-vessels; a controversy that produced much ill feeling at the time, and one that would gladly be passed over in silence were it not for the fact that it was a matter of national interest and importance while it lasted and reduced itself to a clean-cut issue between the old and the new. It was in fact a struggle for existence almost on the part of the engineers and their machinery, opposed by the older, more picturesque, and more conservative sentiments that had formed the traditions and institutions of the old navy and sought to preserve them unchanged, regardless of the progress in all other things being effected through the agency of the steam engine.

The attack made upon Fort Sumter April 7th by Rear Admiral DuPont with a squadron of iron-clads has been described in a former chapter, and the fact that the Navy Department expected unqualified success from these vessels has been mentioned. Great, therefore, was the disappointment in Washington when DuPont's report of the engagement arrived with his announcement that he had determined not to renew the attack, as in his judgment it would convert a failure into a disaster. In a later report he enlarged upon what he considered the bad qualities of the monitors and said they could not be depended upon for protection against the armored

vessels the Confederates were known to be fitting out at Charleston. It is possible that an element of distrust entered into the disappointment felt in Washington, for immediately after the receipt of the news from Charleston President Lincoln telegraphed DuPont to hold his position inside the bar near Charleston, or to return to it if he had left it and hold it until further orders. Beginning in this way a correspondence was opened between Rear Admiral DuPont and the Navy Department, gradually increasing in acerbity, and terminating in the admiral being relieved of his command and deprived of any further participation in the war.

The whole story of this affair was given to the public more than thirty years ago by the publication in book form, by virtue of a joint resolution of Congress, of five thousand copies of the documents in the case together with other interesting letters and reports relating to armored vessels. In the present chapter the author will confine himself almost entirely to the records as preserved in the public form referred to, not being disposed to enter upon any expression of his own views as to the motives and interests involved.

Chief Engineer Alban C. Stimers, as the general inspector of all iron-clad vessels of the Ericsson type built or building for the government, made frequent visits to the fleet off Charleston for purposes of examination and to direct repairs in case of damage. He was present at the first attack on Fort Sumter and made a visit of inspection to each of the monitors immediately after they came out of action. Returning to his office in New York a few days later he made, on the 14th of April, a detailed and critical report to the Secretary of the Navy of the result of his observations, his views as to the offensive and defensive properties of the monitors being very favorable to them and quite at variance with the opinions expressed in Rear Admiral DuPont's despatches. For this he was thereafter involved in the growing controversy and appeared in it to excellent advantage as the defender of the new type of war ship. Besides exercising an oversight upon the iron-clads, he had attempted while at Charleston on this occasion to induce the authorities to use an "obstruction remover" invented by Ericsson and with which Stimers had made some satisfactory experiments in the still waters of New York harbor. This was a huge raft, called by the

sailors a "boot-jack" on the account of its form, intended to be pushed by a monitor and carrying an enormous elongated shell or torpedo at its forward edge designed to destroy by explosion any piling or other obstacles that might be encountered. Mr. Stimers referred with much regret in his report to the lack of success he had had in trying to convince the naval captains of the utility of this invention. It received a fair enough trial from Captain John Rodgers of the *Weehawken* soon afterward and was found so unmanageable in the rough water in which it had to operate that it may be put down as one of Ericsson's inventions that was more successful on a sheet of drawing paper than it was in actual practice afloat. Chief Engineer E. D. Robie, one of the most ingenious and capable engineers of the war period, was diverted from his regular duty as resident inspector of the building of the *Dictator* to go to Charleston to try to make this torpedo raft a success, and his failure to do so is good proof that it was impracticable.

On the 22nd of April Rear Admiral DuPont sent a long letter to the Navy Department complaining most bitterly of an account of the battle of April 7th which had been published in a Baltimore newspaper and in which it was stated that the weapons at DuPont's disposal were not used to advantage through disinclination induced by a dislike to Ericsson and his naval innovations. The complaint closed with the statement that the newspaper mentioned "seems to have had its own hostile proclivities heightened by an association with an officer of the service whose name appears frequently and prominently in its report in connexion with the repairs upon the iron-clads and in relation to the torpedoes and the rafts; I mean Mr. A. C. Stimers, a chief engineer in the naval service of the United States." The reply of Secretary Welles to this letter reminded the rear admiral that the press of the country had been generally lenient and indulgent toward him, and the censures, under a great disappointment, had been comparatively few. It told him that his suspicions regarding Mr. Stimers did that officer much injustice, and concluded with the comment:

"It has not appeared to me necessary to your justification that the powers of assault or resistance of our iron-clad vessels should be deprecated, and I regret that there should have been any labored effort for that purpose."

Rear Admiral DuPont replied at much length to this letter, making an especial point of objecting to the use of the word "lenient" as applicable to the opinions entertained by the public toward him; and so the matter went on; every letter written by each of the distinguished gentlemen tending more and more to estrange them. On the 22nd of May the Department sent the rear admiral an item cut from a Charleston newspaper in which it was stated that the guns of the *Keokuk* had been removed by the Confederates and taken to Charleston, and requested information regarding it. DuPont replied curtly that he knew nothing of it other than the statement of the newspaper; that he had little doubt of its truth; that the work must have been done in the night, and that he had offered Chief Engineer Robie every facility to blow up the *Keokuk*, with Mr. Ericsson's raft, but that officer found it too dangerous to use. This called forth an equally curt retort from Secretary Welles, who wrote, "The duty of destroying the *Keokuk*, and preventing her guns from falling into the hands of the rebels, devolved upon the commander-in-chief rather than on Engineer Robie. I do not understand that the operations were necessarily limited to Mr. Ericsson's raft, of which such apprehensions appear to have been entertained. The wreck and its important armament ought not to have been abandoned to the rebels, whose sleepless labors appear to have secured them a valuable prize."

In the latter part of June Rear Admiral Andrew H. Foote, who had achieved such success while commanding the Mississippi flotilla, was ordered to relieve DuPont, but being seized with a fatal illness the orders were transferred to Rear Admiral John A. Dahlgren, who took over the command of the South Atlantic blockading squadron on the 6th of July from DuPont, who was placed on waiting orders. The protracted siege of the Charleston forts at once inaugurated by Dahlgren has already been described.

Previous to this, on the 12th of May, Rear Admiral DuPont had requested the Navy Department to arrest Chief Engineer Stimers and send him to Charleston to be tried on the following charges :

Charges and Specifications of Charges Preferred by Rear Admiral Samuel F. DuPont, Commanding South Atlantic Blockading

Squadron, against Chief Engineer Alban C. Stimers, United States Navy.

CHARGE FIRST: Falsehood.

“*Specification.*—In this: that between the eleventh and fifteenth days of April, eighteen hundred and sixty-three, the said Alban C. Stimers, a chief engineer in the United States navy, being then on board the steamship *Arago*, by the authority and direction of Rear Admiral Samuel F. DuPont, commanding the South Atlantic blockading squadron—the said *Arago* being on her passage from Port Royal, South Carolina, to New York City, via Charleston bar—did, at the table of said steamer, in the presence of officers of said steamer and other persons, a number of whom were correspondents of the public press, and at divers other times during the passage of said steamer, falsely assert, knowing the same to be untrue, that he was told by one or more of the commanders of the iron-clad vessels engaged in the attack upon the forts and batteries in Charleston harbor, on the seventh day of April, eighteen hundred and sixty-three, that the attack of that day ought to have been renewed; and that they did further state to him that the said iron-clad vessels were in fit condition to renew it; and the said Alban C. Stimers did further falsely assert, knowing the same to be untrue, that several of the commanders of the said iron-clad vessels had said to him in his presence and hearing that they, the said commanders, were, after the attack aforesaid, ‘hot for renewing the engagement,’ or words to that effect.

CHARGE SECOND: Conduct unbecoming an officer of the navy.

“*Specification.*—In this: that between the eleventh and fifteenth days of April eighteen hundred and sixty-three, the said Alban C. Stimers, a chief engineer in the United States navy, being then on board the steamship *Arago*, by the authority and direction of Rear Admiral S. F. DuPont, commanding South Atlantic blockading squadron—the said *Arago* being on her passage from Port Royal, South Carolina, to New York City via Charleston bar—did, at the table of said steamer, in the presence of officers of the said steamer and other persons, a number of whom were correspondents

of the public press, and at divers other times during the passage of the said steamer, with the intent to disparage and injure the professional reputation of his superior officer, Rear Admiral S. F. DuPont, criticise and condemn, in terms unbecoming the circumstances and his position as an officer of the navy, the professional conduct of his superior officer, Rear Admiral S. F. DuPont, in the attack upon the forts and batteries in Charleston harbor on the seventh day of April, eighteen hundred and sixty-three, and did, with the like intent, knowingly make false statements, using, among other improper and unfounded expressions, words in substance as follows: 'That the monitors were in as good condition on Wednesday, the eighth day of April, eighteen hundred and sixty-three, after they had undergone some slight repairs, to renew the attack, as they had been to commence it the day before; that they could go into Charleston in spite of guns, torpedoes, and obstructions, and that Rear Admiral DuPont was too much prejudiced against the monitors to give them a fair trial.'

Instead of sending the accused officer to DuPont for trial by court-martial the department convened a court of inquiry at the Brooklyn navy yard to investigate the truth of the charges and report regarding them. This court was composed of Rear Admiral Francis H. Gregory, Rear Admiral Silas H. Stringham, and Commodore William C. Nicholson, all old and distinguished officers, but by training and professional associations more apt to lean towards DuPont's side of the issue than to feel any sympathy for Stimers and the mechanical innovations represented by him. Mr. Edwin M. Stoughton was named as judge advocate, but that gentleman refused to act, and appeared in the case as counsel for Stimers. Judge Edward Pierrepont of New York was next appointed judge advocate, and he too refused to accept the office, which was then conferred upon Mr. Hiram L. Sleeper. The list of witnesses named by the prosecution included the officers and a number of passengers of the *Arago* and the commanders and some other officers of the iron-clads off Charleston.

The court met at the Marine Barracks, Brooklyn, June 5th, and continued in session for more than four months, with some lengthy adjournments to allow of the taking of testimony of wit-

nesses on duty with the fleet at Charleston, which was done by means of written interrogatories and cross-interrogatories according to the terms of a formal stipulation between the judge advocate and the counsel for the accused which was spread on the pages of the record. The testimony presented by the prosecution was generally favorable to Mr. Stimers and failed to substantiate the charges and specifications made against him. As printed in the public document before referred to as the source of information for the facts presented in this chapter it is too long to admit of an analytical review in this place, which review is therefore omitted in favor of the careful one made by Chief Engineer Stimers in his written defense; a most manly and straightforward argument which was submitted to the court on the 19th of October and is here reproduced in full:

“May it please this honorable court:

“The testimony introduced by the Judge Advocate to sustain the charges made against me by Rear Admiral DuPont is now closed. Acting in view of the proof thus placed before the court I deem it wholly unnecessary to offer evidence in reply. The very foundation on which these charges must rest is wanting, and hardly an attempt has been made to supply it. They were carelessly, if not recklessly, made by a high officer of the Government, willing to give them the sanction of his name, apparently without inquiring whether they were capable of proof, or founded upon worthless rumor. Much time has been uselessly spent in apparent efforts to prove them; but anyone attentively reading the evidence discovers that the real purpose has been not to establish the charges in question, but to justify their author in failing effectively to use the formidable means for destroying the defences of Charleston, which our Government in its confidence and hope had lavished upon him. That I am not unjust or uncharitable in making this suggestion will be manifest from an examination of the charges and proof which I will now proceed to make.”

“1st. The first specification charges me with having, whilst on board the steamer *Arago*, on her voyage from Charleston to New York, at table, in presence of her officers and other persons, a

number of whom were correspondents of the public press, falsely asserted, knowing the same to be untrue, that I was told by one or more of the commanders of the iron-clads engaged in the attack on Charleston that it ought to have been renewed; that the vessels were in a fit condition to renew it; and that several of the commanders had said to me that they were hot for renewing the engagement.

“A person observant of Christian precepts, considerate of his duty towards a fellow man, or actuated by self respect, would, before deliberately framing a charge calculated to consign a brother officer to disgrace and infamy, have inquired carefully into its truth, and the means of establishing it. Indeed, he would hardly have been content to make it before conversing personally with those capable of proving it; and then a just man would have withheld the accusation, so painful for a gentleman to bear, until satisfied that his witnesses were entitled to full credit. The course which my accuser has seen fit to pursue presents a wide departure from the path thus indicated. The names of persons who were on board the *Arago* during the voyage were appended as witnesses to the charges made, and most of them have been examined. It appears that I sat at the public table of the steamer in the immediate neighborhood of several other persons, all no doubt accessible to my accuser, or to those seeking to support the charges. If, therefore, I, during the voyage, used the language imputed to me, it was susceptible to easy proof. Not a particle of testimony to that effect has, however, been furnished. No one pretends I ever said that any commander of the iron-clads had stated to me either that the attack on Charleston ought to have been renewed, or that the iron-clads were in a fit condition to do so, or that their commanders were hot for renewing the engagement. No language bearing the least resemblance to that charged is proven to have been uttered by me at any time; and I am bound to assume that neither of the witnesses named ever stated otherwise than they have sworn here. If not, then upon what information could the charges in question have been framed? Was it believed that they could be proven? And if not, were they wantonly made, so that upon pretense of sustaining them, the naval inactivity, painful to a whole nation, might be justified by proof

quite irrelevant to the charges being tried, and therefore quite likely to pass uncontradicted by me ?

“ 2d. The second charge made against me is for conduct unbecoming an officer of the navy, and specifies, in substance, that at the table of said steamer, and elsewhere on board of her, during the passage, I criticised and condemned, in terms unbecoming the circumstances, the professional conduct of Rear Admiral DuPont, by stating that the monitors were in as good condition on the 8th day of April, 1863, after they had undergone some slight repairs, to renew the attack, as they had been to commence it the day before. That they could go into Charleston in spite of guns, torpedoes and obstructions; but that Admiral DuPont was too much prejudiced against the monitors to give them a fair trial.

“ Now if, under the circumstances, I had stated all that is charged, it would, in my judgment, have been no more than I was authorized to say. I had been charged by the government with the important duty of inspecting the construction and armament of the vessels whilst they were being made. They were new in the history of the world; but in the contest between the *Monitor* and *Merrimac* although the latter on the day previous had defied a fleet of our largest frigates, carrying an armament fifty times greater than the *Monitor*, destroying some and threatening all with the same fate, yet the *Monitor*, working her two eleven inch guns behind an invulnerable shield, tested her powers, offensive and defensive, by so terrible an ordeal that intelligent and unprejudiced men here and in Europe from that hour saw that naval supremacy must be maintained, if at all, by abandoning wooden ships and adopting those which the genius, engineering skill, and ripe, practical knowledge of their author had taught the world how to construct. My knowledge of this class of war vessels had been acquired not only by watching and inspecting their construction step by step, but under the orders of the government I had enjoyed the good fortune of participating in the contest to which I have referred, and which had developed the capacity of the *Monitor* system to sustain unharmed the fire of heavy guns at short range, and at the same time to inflict deadly injuries upon an adversary's ship of great power heavily

sheathed in iron. With an experience thus gained I might, as I think, have justly claimed the right to express an opinion as to the value and capacities of the monitors, even had this differed from the views entertained by Rear Admiral DuPont, whose knowledge concerning them was probably derived from casual inspection and the reports of others. Moreover, I was charged by the Government with the duty of proceeding to Charleston to watch and report the performance of these vessels in action, to assist in maintaining them in readiness for battle, and afford to the officers having them in charge such information as might be needful.

“In addition to all this it may here be proper to say that at a great expense shells had been devised by Captain Ericsson, the author of the Monitor system, which, in connexion with rafts to be attached to the bows of vessels, were to be used for removing by means of explosive force, obstructions within the harbor, and by firing torpedoes supposed to be sunk by the enemy in the track of our advancing fleet. The effectiveness of these shells had been so tested by me, before they were sent to Admiral DuPont, as to make it clear to my mind and to that of the government that they would be practically safe and capable of clearing the track of battle. I strongly urged Admiral DuPont to use these shells, and requested permission to participate in the action of the 7th, on board a monitor which should be thus armed. The privilege was denied to me, and although in view of supposed obstructions, I had expressed to Admiral DuPont and to his officers the opinion that the monitors could successfully pass them, my confidence in expressing it was greatly strengthened by, and somewhat founded upon, the assumption that these shells were to be employed, and this the Admiral knew. He nevertheless declined to order their employment and thus was lost to the government and nation a powerful means of penetrating to the cradle of this great rebellion.

“Under these circumstances, and well aware that the government had expected much from the attack upon Charleston with the abundant means furnished to the rear admiral commanding, I was greatly disappointed that the important instruments I have mentioned were not used by him, especially as I believed (an as an earnest of my conviction had offered to hazard my life and limb) that with

shells attached to the monitors they could pass all obstructions and hold the city of Charleston at their mercy.

“All this was certainly calculated to awaken in my mind criticism upon the conduct of Rear Admiral Dupont, which, as the evidence shows, I refrained from expressing, maintaining a reserve, not merely respectful to him, but calculated to defend him from the censures freely and openly cast upon him for failing to renew the attack of the 7th of April.

“I will now briefly examine the proof introduced to maintain the second charge, the mere reading of which will show that even if I had said all that is charged against me, it was but the statement of views which, if honest, I had a right in common with all other persons to express. Entertaining the opinion, and officially reporting it as I did to Rear Admiral DuPont, that the monitors were on the 8th substantially, for practical purposes, as fit to renew the attack as they had been to make it on the day previous. I was bound neither by courtesy nor by any rule of the service with which I am acquainted, to withhold or conceal it; and believing, as I certainly did, that the monitors, with the rafts and shells attached, could have gone into Charleston in spite of guns, torpedoes and obstructions, I was equally entitled to state, in respectful language, that opinion also; and, moreover, I think the disrespect, if there be any, in imputing to Rear Admiral DuPont prejudice against the monitors, was so slight that his self-respect can hardly have been increased by noticing it. Indeed, whilst there is no proof in the case that I ever charged him with entertaining this prejudice, and whilst by asserting that I did, he, by implication at least, denies the existence of the prejudice so imputed, the evidence introduced on his behalf very clearly established that he was prepossessed against them, for Captain Drayton in substance declares *he don't think Admiral DuPont had a high opinion of the monitors, and that he could not have had after reading his (Drayton's) reports concerning them, made before the fight.*

“What these reports were does not appear, but that the witness believed he had succeeded in instilling into the admiral's mind his own unfavorable opinion is quite clear.

“The proof, however, fails to show that I made the statement charged against me. The evidence on this subject consists of the

testimony of Captain Gadsden, of the *Arago*, and of several other persons who were on board of that steamer during her voyage from Charleston to New York. He says in substance that I stated that the monitors had received no serious injury; that they could be repaired in a few hours; that the trial ought not to condemn them; that they had not had a fair trial; that with the shells attached to them they could go in. He further swore that I said the *officers* of the navy were prejudiced against the monitors, but that I mentioned no one in particular, and did not reflect upon Admiral DuPont.

“The purser of the *Arago* testified that I said the officers of the navy were rather prejudiced against them, but that I spoke of Admiral DuPont personally in the highest terms. Mr. Colwell swore that those on board the *Arago* were much excited about the fight at Charleston, and condemned the admiral for his failure; but he did not intimate that I took part in such conversation, stating only that I said the monitors were very little injured, and were repaired in about five hours; that I was respectful in my remarks concerning Admiral DuPont; and although this witness said he at one time was under the impression that I had said the admiral was prejudiced against the monitors, he afterwards stated that I might not have said so, but that as the passengers generally united in condemning him, the witness may have confounded their statements with mine.

“Mr. Fulton, in his testimony, states that my conversations with him on the subject of the attack were private, and in an undertone, and that I said I had sometimes retired to my stateroom to avoid being questioned; that I said the attack was not an earnest one, and expressed disappointment that the shells were not employed, but did not say the monitors could have entered the harbor without them, nor that the admiral was prejudiced against the monitors, but that I did say he would have renewed the attack but for the influence of some of those who were.

“Mr. Mars, a passenger, testified that I appeared not to wish to speak on the subject of the attack, and that although he sat opposite to me at the table, he did not hear me say that the admiral was prejudiced.

“Having thus failed to prove that I had uttered any of the language as charged, and it appearing upon the evidence that I had spoken of Rear Admiral DuPont in high terms, studiously refraining

from talking upon the subject of the attack, it appeared to me remarkable that the prosecution, instead of acknowledging the injustice of these charges, should persist in calling witnesses to prove that the monitors were seriously injured in their attack upon the forts, and could not have renewed it without probable disaster.

“Whilst this attempt has signally failed, it has nevertheless disclosed the real purpose of this prosecution to have been, not an inquiry into any language or conduct of mine, but, under that pretext, an effort to justify the failure by Rear Admiral DuPont, which had attracted the observation of the world, by condemning as inadequate the instruments which a liberal government had placed in his hands.

“His desire to justify himself was natural, but that he should have been willing to achieve even his own vindication by making and persisting in prosecuting unfounded charges against a brother officer, is extraordinary. How utterly he has failed to accomplish this a brief examination of the proofs will show.

“It appears from these that before the attack was made it was supposed by Admiral DuPont that torpedoes had been placed in the channel along which his fleet must pass. That network had been suspended from buoys designed to entangle the propellers and thus prevent their action, and that for some purpose piles had been placed across the middle ground to obstruct the entrance of monitors from that direction. It moreover appears, especially from a careful reading of the deposition of Commander C. R. P. Rodgers, the admiral's fleet captain, that no additional information upon either of these subjects was obtained by means of the attack. After that was over, the existence of torpedoes, of network and the purpose of the piles were shrouded in the same mystery as before. It was ascertained, however, that if torpedoes lurked in the channel, they were probably harmless, for none had been exploded; and that they were incapable of being fired is shown by the letter referred to by this witness, written by a rebel officer in Fort Sumter, stating that the effort to explode a torpedo whilst directly under the hull of the *Ironsides* had failed.

“We must therefore accept it as established, that as no information was obtained during the conflict which could be used to strengthen the surmises before existing as to the character of these

obstructions, their supposed existence could not have afforded ground for declining to renew the engagement which was not equally good as an objection against having made it at all; and this being so, we must look for some other reason for the failure of the admiral to offer battle on the 8th, in pursuance of his declared intention, when he gave the signal for the monitors to haul off on the previous day.

“It is true that some of this testimony conveys the impression that the fear of encountering these supposed obstructions was a controlling element in the admiral’s mind in forming the determination not to renew the attack; but in this there is evident mistake, for a brave and intelligent commander would hardly be so fearful of obstructions which might or might not be real, as to abandon a great enterprise without practical effort to learn whether obstacles to its achievement existed or not. Against such a suspicion I feel disposed to defend Admiral DuPont, and hence am constrained to look elsewhere for some reason why he failed to renew an attack which, if persisted in, might have succeeded. His witnesses on this subject next point to the injuries sustained by the monitors, and to their alleged inability to withstand a repetition of the terrible fire to which they were subjected on the 7th. A glance at the testimony will show how utterly unfounded is this effort at an excuse, whilst it will also establish to the satisfaction of intelligent and unprejudiced men that the capacity of the monitors to resist unharmed the most terrible fire from guns and rifles of the heaviest calibre, has never been overstated. It appears from the testimony of the fleet captain that the fire to which they were exposed was by far more terrific than that which he or anyone connected with the fleet had ever before seen. From fifty to one hundred rebel guns, of heavier calibre than were ever before employed against ships-of-war, were brought to bear upon the monitors at the same time, and probably many more. The *Patapsco* was struck by fifty-one shots, twenty-one of which hit the turret, and fifteen or more of these—all heavy ball—struck it within the period of five minutes, and yet at 8:30 o’clock on the evening of the 7th she was in a fit condition to renew the engagement.

The *Nantucket* was struck fifty-three times; and although the mechanism which worked her XV-inch gun was disordered, this was repaired on the 8th. Captain Drayton states that the top of the pilot house of the *Passaic* was raised up by a shot, but it is quite evi-

dent, from his account of it, that this in no manner disabled the vessel, whilst it hardly increased the chances of danger to those within. It sufficiently appears that the *Weeharoken* was fit to have renewed the engagement on the following day, although she was struck several times on her side armor in nearly the same place.

“ Without following this subject further in detail, it is sufficient to state, what appears from the proof, that each and all of the monitors were in fighting condition within twenty-four hours after they came out of battle, whilst the injuries received by them were so trifling, when the terrible means employed for inflicting them were considered, that they may be pronounced substantially invulnerable to the strongest artillery. But one life was lost on board of them during the conflict; and whilst one or two of the turrets were by the impact of shot partially prevented from turning until repaired, it should be remembered that, turning by their rudders, each could at all times present her guns to the enemy at pleasure. Indeed, it was partly by this means that the guns of the *Monitor* were brought to bear on the *Merrimac* in that first engagement of ironclads to which I have before referred. One of the witnesses has suggested that if other shots had struck in the same place as previous ones, the armor might have been endangered. Entertaining, as I do, the opposite opinion, I would suggest that even if the witness was correct, he anticipates a hazard too remote to be much apprehended: for it is well known that the chances that one shot will strike exactly where a previous one had hit, are very slight.

“ The *Keokuk*, an ironclad vessel, but not built upon the plan of the monitors, was almost immediately disabled, having fired but three guns at the enemy; and the *Ironsides*, a much stronger and better armed ship, although she escaped serious injury, no doubt owed this to the temporary means employed to strengthen her before going into action, and to the care exercised in keeping her at a great distance from the enemy's guns.

“ That this distance was maintained is apparent from the testimony of the fleet captain, who stated in substance, that when the order was signalled for the monitors to retire from the conflict they *all passed the Ironsides in moving out*. This shows that they were inside of her and much closer to the enemy's batteries; and how much nearer may be inferred from his cross-examination, in which he

states that twenty minutes may have elapsed before the last of the monitors passed by. They engaged the batteries within six hundred yards, and it need hardly be suggested, that no ship not constructed upon their plan could have lived under the heavy fire to which, at that distance, they were subjected.

I here close what I have thought it well to say concerning this attempt by Rear-Admiral DuPont to justify his inaction and failure by attacking that system of war vessels which has already, in my opinion, given us a more effective fleet than is possessed by any other nation. A judicious use of these vessels might have transmitted his name with honor far into the future. An assault upon the system can but recoil upon the assailant. From me it needs no defense. Time and battle will but confirm the opinions I have expressed concerning it, whilst its adoption by the nations of the world will bear unfailing testimony to the great skill and foresight of its contriver.

“With these remarks I submit my case to the just consideration of this honorable Court.

“Very respectfully,

(Signed) “ALBAN C. STIMERS;

“Chief Engineer, United States Navy.

“Naval Lyceum, New York, October 19, 1863.”

The next day, October 20, the court met for its last session and added the following finding to its record :

“The court having diligently and fully inquired into the matters embraced in the specifications of charges in this case, hereby report that, in their opinion, there is no necessity or propriety for further proceedings in the case.”

Rear Admiral DuPont was an eminent and capable naval officer of the old school, but of too long service and of too fixed ideas to yield before a development that entirely upset all the naval methods of his lifetime, and by standing in the way of the march of progress, instead of gracefully stepping aside and admitting the competence of a mechanical generation, he was run over and humiliated by a power more potent than he had imagined. In a time of peace when the public is indifferent to the navy and its advancement the con-

servative opinions of its veteran officers usually prevail and prevent changes in methods or *material* that involve any great departure from what has existed so long as to become custom, but in time of war sentiment and dogma must yield to practical utility, and the irresistible power of public opinion will always force this submission. Assistant Secretary of the Navy, Fox, was from his own training probably the most competent official connected with the Navy Department during the war to judge of the characteristics of the officers of the navy. In a letter written by him to John Ericsson in 1864 he summed up in the following manner the actual attitude of Rear Admiral DuPont towards the new iron-clad war-vessels :

“He is of a wooden age, eminent in that, but in an engineering age behind the time. You were always opposed to attacking forts, but DuPont despised the vessels and the brain that conceived them.”

The “old school” of navalism means a great deal unknown to the officers of the present generation if all the testimony of the past may be depended upon. A very curious condition of affairs was allowed to grow up in our navy during that long period of comparative inactivity, interrupted only by the Mexican War, which intervened between the end of the last war with Great Britain and the outbreak of the rebellion. “The commodore of the period was an august personage who went to sea in a great flag-ship, surrounded by a conventional grandeur which was calculated to inspire a becoming respect and awe. As the years of peace rolled on, this figure became more and more august, more and more conventional. The fatal defects of the system were not noticed until 1861, when the crisis came, and the service was unprepared to meet it.”¹ Surrounded thus with much of the pomp and dignity of a court and invested with what some of the admirers of that old *regimé* have been pleased to call “kingly power,” it is no wonder that the average commodore lost sight of his true relation to the civil head of the navy and, unconsciously perhaps, came to regard him as merely a secretary, in fact as well as in title, interposed somewhat unneces-

¹ Professor J. R. Soley, in *Battles and Leaders of the Civil War*: Vol. I, p. 623.

sarily between himself and the chief executive. Instances are not lacking of commanders-in-chief of squadrons abroad ignoring or mis-interpreting orders sent them from the department, and there is at least one case on record of a commodore issuing an order, upon taking command of a squadron in a remote part of the world, abolishing all regulations of the Navy Department except such as had been approved by the President.

Under these influences and surroundings Samuel F. DuPont had acquired step by step his naval education and beliefs through all the monotonous years from a midshipman in 1815 to within two numbers of being the senior rear admiral in 1863. The sentiments expressed by him in his correspondence with the Secretary of the Navy are therefore not surprising, although they would be actually startling if attempted at the present day. When the court of inquiry had finally disposed of the *Stimers* case, DuPont, under date of October 22nd, broke the silence that he had observed since being detached from his command and sent a letter to the department that is one of the most instructive documents ever made public, its expressions providing us with a perfect mirror of the mind of the old navy. A few of them are repeated as illustrative examples.

“It is with profound regret that I perceive in your despatch of the 26th of June a reiteration of the charges and reproaches of previous despatches and in your silence since, during a period of three months, a resolution not to recall them. My last hope of justice at the hands of the department is therefore extinguished.

“If I have failed in my duty I am liable to trial, but insulting imputations in official despatches are grave wrongs, perpetrated on the public records to my permanent injury.

“The remedy which the law would afford me against a superior officer indulging in the language of your despatches does not exist against the civil head of the department.

“I was aware of the visit of the Assistant Secretary to Charleston, but I learn with surprise from your despatch that, without a commission in the navy, he *commanded* the expedition which witnessed the bombardment of Sumter without relieving it.

“I have no desire to question the power of the department to relieve me at its discretion, but its order of the 3d of June assigns

causes which do not exist, and ascribed to me opinions which I had neither expressed nor entertained."

Secretary Welles, after a delay of about two weeks, replied to this letter without resentment, reviewing the whole subject at great length and giving reasons in justification of the course pursued by the department that were considerate, even if not necessary. The general tone of the communication impresses one as conveying fatherly sorrow rather than the expression of offended authority, the only passage in it that may fairly be considered harsh being the following review of DuPont's operations at Charleston :

"You disapproved of the occupancy of the harbor, yet I am not aware that you ever caused or attempted to have a reconnoissance of the obstructions or any examination of the harbor made before the attack, nor am I aware that you have ever offered an excuse for this omission. After the attack was made you were dissatisfied with the *Ironsides*—dissatisfied with the monitors—dissatisfied with Chief Engineer Stimers, against whom you prepared charges and desired that he might be arrested and sent to you for trial, he having expressed his surprise that you should abandon the assault on so brief an effort—dissatisfied with Surgeon Kershner, whom you court-martialed for a similar offense—dissatisfied with Mr. Fulton, the special agent of the Post Office Department, for his criticisms on your movements and acts—dissatisfied with the President for his telegram, and dissatisfied with the department for not more promptly and formally acknowledging and publishing your reports.

"If these complaints and reports, wherein the admiral of the squadron devoted so large a portion of his time to his personal matters and so little towards marshalling his force for the occupation of the harbor of Charleston and the capture of the city, were not received with the patience to which they were entitled, it was my misfortune. I do not deny that it would have been more acceptable to the department to have witnessed the zeal manifested in hunting down newspaper editors, engineers, and surgeons, directed against rebel enemies and to the destruction of their works."

This correspondence terminated the controversy and also con-

cluded Rear Admiral DuPont's active participation in the executive administration of the operations of the Navy Department, for he remained unemployed, on waiting orders, until his death, which occurred in June, 1865, soon after the close of the war. It was the fault of the system under whose influence his life had been passed rather than from any personal short-coming of his own that the last years of his life were embittered. "There was no more accomplished officer in our naval service than Admiral DuPont, no man of nobler personality, but he was the very incarnation of naval exclusiveness and prejudice against innovation, and the introduction of the monitors into our navy gave a shock to his sensibilities from which they never recovered. It may be that he was expected to accomplish with them more than was possible in his attack upon Charleston, but he was disposed to exaggerate their deficiencies and to criticise them in a spirit of unfriendliness that arrayed against him the active hostility of their champions."¹

¹W. C. Church, *Life of John Ericsson*; Vol. II., p. 64-65.

CHAPTER XXIV.

“ In the beauties of the lilies Christ was born beyond the sea,
With a glory in his bosom that transfigures you and me ;
As he died to make men holy, let us die to make men free ;
While God is marching on.”

JULIA WARD HOWE; *Battle-hymn of the Republic.*

1864.—The Civil War, Continued—Confederate Successes in the Use of Torpedoes—Blowing up of the Sloop-of-War *HEUSATONIC*—Minor Naval Operations—Boiler Explosion on the *CHENANGO*—The *KEARSARGE*—*ALABAMA* Fight—The Great Battle in Mobile Bay—Loss of the *TECUMSEH*—Capture of the Privateer *FLORIDA* by the *WACHUSETT*—The Gunboat *OTSEGO* sunk by a Torpedo—First Attack on Fort Fisher.

NAVAL operations during 1864 were marked by a number of minor disasters and by several decisive victories, the general results of the year being most favorable to the reputation of the service. The first mishap of the year occurred to the small side-wheel steamer *Underwriter*, prominently identified with the service of holding possession of the North Carolina Sounds during the two preceding years. About 2 A. M. February 2nd this vessel, while lying at anchor in the Neuse River near Newburn, was boarded in the dark by a force of over one hundred men in boats and overpowered after a resistance of fifteen minutes in which her commander, Acting Master Westervelt, was killed, and the crew, numbering only forty people all told, became prisoners of war. After taking off the prisoners and plundering the vessel she was set on fire and destroyed. Acting Third Assistant Engineer George E. Allen and twenty-two of the men escaped in a peculiar manner due to the haste of the enemy and the courage and presence of mind of Mr. Allen. They were all driven into one boat, the last to shove off from the *Underwriter*, and were soon surprised to hear the guard in charge of it hailing the boat ahead for assistance, it appearing that in their hurry to get away from the ship the Confederates had all embarked in the first boats, leaving only two to go in the last one, in which were over twenty prisoners. Quickly realizing

the situation, Mr. Allen snatched the cutlass from the belt of the guard near him and thus made himself master of the boat, the other guard jumping overboard and swimming for another boat which had turned back. By hard pulling on the part of the men, Mr. Allen safely conducted his captured boat to the Federal fortifications at Newbern and at daylight reported with his party on board the *Lockwood*, lying at that place. The other officers and the remainder of the crew became prisoners of war.

About 9 o'clock the evening of February 17th a Confederate "david," as the nearly immersed cigar-shaped torpedo boats of the enemy came to be called from the name of one of the first of them, just as monitor became a generic term, approached the sloop-of-war

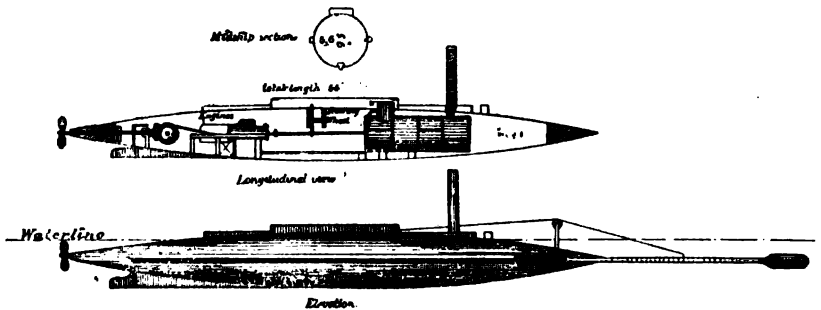

Confederate "david," or torpedo boat. From a drawing by Second Assistant Engineer W. S. Smith for a report of Rear Admiral Dahlgren.

Housatonic, lying on the outer blockade off Charleston, and was not discovered until so close as to explode a torpedo under the *Housatonic*, sinking her. Ensign Hazeltine, Captain's Clerk Muzzy, and three men were drowned, all others of the ship's company saving themselves by taking to the rigging, which remained above water, the boats of the *Canandaigua* rescuing them soon afterward. The torpedo boat itself also went to the bottom. This disaster was due to the excellence in the use of torpedoes which had been arrived at by the Confederates, they, in the absence of ships to carry on naval operations, being forced to wage war with these weapons then novel and unusual. The use of torpedoes was by no means a new thing, but it was a practice rather abhorrent to the minds of trained fighting men, and owed its development by the naval officers of the South to necessity rather than desire.

One of the first successful uses of the torpedo in the Civil War was the blowing up of the iron-clad gun-boat *Cairo* in the Mississippi River in 1862, by a Confederate naval officer who had been taught less furtive methods of warfare in the old navy, and who was so doubtful of the propriety of the mode of attack directed by him that he described his feelings, when he saw that the *Cairo* was actually going to sink, as much the same as those of a schoolboy at seeing serious results follow from something begun in sport. The sentiment in the navy regarding torpedoes at that time is well shown by some comments of Rear Admiral Farragut, who, reporting to the department in May, 1864, that he intended to make use of them to be on an equality with his enemy, felt it necessary to excuse himself by explaining:

“Torpedoes are not so agreeable when used on both sides; therefore I have reluctantly brought myself to it.

“I have always deemed it unworthy of a chivalrous nation, but it does not do to give your enemy such a decided superiority over you.”

In the hands of the Confederates torpedo warfare was considerably advanced and torpedoes became the most formidable weapon against which our naval vessels had to contend, as well as the cause of the greater part of the disasters suffered by the Federal navy during the rebellion. The present high development of torpedoes as a weapon for naval warfare may be directly traced to the impetus gained by its successes during the Civil War, which not only illustrated its great possibilities but also overcame any chivalric objections to its use which may have been formerly entertained by naval officers.

The evening of April 18th another “david” passed through the iron-clad blockade line off Charleston and made for the big frigate *Wabash* lying in the outer line. In this case, however, it was discovered in time for the *Wabash* to get under way and man the battery, her fire either destroying or driving off the small but much-feared adversary. On the sixth of May the ferry gunboat *Commodore Jones* while near Four Mile Creek in the James River ran upon a moored torpedo and met with utter destruction, about one-half of her crew being either killed or wounded. The next day the gunboat

Shawsheen while searching for torpedoes near Turkey Bend in the same locality fell a victim to exposed machinery and was destroyed by a battery suddenly unmasked in the woods, the first shots from which disabled her by exploding the steam drum and breaking the walking-beam of the engine. The officers and crew became prisoners and the vessel was burned by her captors.

A daring expedition, although on a small scale, was conducted in March by Acting Master Champion of the *Pawnee*, who, with the tug gunboat *Columbine* commanded by Acting Ensign Sanborn, and a party of volunteers from the *Pawnee*, proceeded up the St. Johns River in Florida, captured two steamers, a large quantity of cotton, provisions, and army supplies, and returned safely to the ship after having been for two weeks in the enemy's country and penetrated the river over two hundred miles. The volunteer party from the *Pawnee* consisted of Second Assistant Engineer Alfred Adamson, Third Assistant Engineer Arthur Price, an acting master's mate, and twelve men, all embarked at first in a launch towed by the *Columbine*, but transferred the second day to a steamer, the *General Sumter*, they had captured in Great Lake George. Two days later the *Sumter* encountered and captured the steamer *Hattie* in Deep Creek and converted her into a transport for carrying cotton, machinery, and other contraband of war seized at the river stations visited. When taken, the *Hattie* was found disabled by the Confederates, who in abandoning her had carried off all the valves of the feed and other pumps about the engines and boilers, but the ingenuity of Messrs. Adamson and Price overcame this defect and soon restored the steamer to a useful condition. Without any means of doing better, they hastily made valves of wood which were found to answer the purpose and enabled the vessel to do service until time permitted more permanent repairs.

Two months' later in the same river the *Columbine* met the fate that had overtaken so many of the purchased steamers with exposed machinery and fell into the hands of the enemy. She was attacked by a battery hidden in the underbrush along the bank and almost at the first fire rendered helpless by a shot cutting the main steam pipe, her surrender following as the natural result of her inability to move into a position to use her guns or get out of the range of fire. Her people were taken prisoners and the enemy burned their prize with-

out taking time to remove anything of value. The senior engineer of the *Columbine* was referred to in the following complimentary manner in the commanding officer's report of the disaster: "I take great pleasure in recommending to your favorable notice the conduct of Acting Third Assistant Engineer Henry J. Johnson, who coolly performed his duty until the engine became disabled, when he rendered me the most valuable assistance on deck." Mr. Johnson and his assistant, Mr. George Whitney, acting third assistant engineer, had a most miserable time for several months after capture, being moved about to various prison pens, jails and workhouses, and forced to mix with felons imprisoned for all sorts of crimes.

A frightful disaster occurred on board the new double-ender *Chenango* when she first sailed from the city where she was built. This vessel, on the 15th of April, left New York, under the command of Lieutenant Commander T. S. Fillebrown, bound for Hampton Roads; while passing between Forts Hamilton and Lafayette her port boiler suddenly exploded blowing up the deck, killing twenty-five of the crew and wounding ten others, all four of her engineers being among the killed. A court of inquiry held at the Brooklyn navy yard found that the disaster was caused by a defective vein in the iron in the boiler, and that no blame or want of vigilance could be ascribed to any officer of the vessel. The chief engineer, Mr. Joseph N. Cahill, first assistant engineer, U. S. Navy, was particularly exonerated, he being known as one of the most careful and cautious officers in the service. The *Shenango* belonged to the *Sasacus* class of double-enders and was built by J. Simonson, Greenpoint, Long Island, the engines and boilers being supplied by the Morgan Iron Works, New York. The boilers were of the Martin vertical water-tube type and may have been defective in bracing as well as material, as another of them had exploded with fatal results on the *Lenapee* of the same class when steam was raised in it at the contractor's works.

Besides the naval court of inquiry as to the accident, it was also investigated by a coroner's jury which found the cause to be defective material and fixed the blame upon the person or persons responsible for the construction of the boilers. The responsibility narrowed down to Second Assistant Engineer S. Wilkins Cragg, who as an assistant to a general engineer superintendent had been stationed at

the Morgan Works in special charge of the *Chenango's* machinery, and he was dismissed the service by the Secretary of the Navy, who cited the finding of the coroner's jury as the reason for his action. Owing to the haste with which vessels were built in those days and the constant pressure always bearing upon the contractors to hurry their work along, Mr. Cragg proved that he was unable to control the nature of the work under his inspection and that his dismissal was unjust. About two years later he was restored to the navy, and a few years afterward resigned. In after years he was a prominent figure in Paris in connection with the street improvements of that city.

On the morning of June 2nd the U. S. Steamer *Victoria* chased ashore, captured and set on fire a large British steamer named *Georgianna McCaw* trying to run the blockade into Wilmington, on which occasion an engineer officer of the *Victoria* greatly distinguished himself, as shown by the following extracts from the report of the commanding officer:

“I immediately ordered the first and second cutters to board and fire her—the former under command of Acting Master's Mate William Moody, the latter under charge of Acting Third Assistant Engineer Thomas W. Hinline.

“On their arrival on board they found that two boats with their crews had escaped to the shore. They, however, succeeded in capturing twenty-nine of the crew, including the captain and most of the officers, together with three passengers. They fired her in several places, and she continued to burn until 10 a. m., when she was boarded from the shore.

“At daylight Fort Caswell and the adjacent batteries opened fire upon our boats with shot and shell, which compelled them to return without accomplishing her destruction.

“I would add, sir, that too much credit cannot be awarded to Acting Master's Mate William Moody and Acting Third Assistant Engineer Thomas W. Hinline for their perseverance and energy displayed, and their cool and gallant conduct while under fire of the enemy.”

For this exploit the acting master's mate was made an acting

ensign, and Mr. Hineline advanced to the grade of second assistant engineer, the following letter being sent him by the department on the 22nd of July, 1864:

“SIR: For your cool and gallant conduct under fire of the enemy as mentioned by Acting Master Everson commanding U. S. S. *Victoria* in his report of the attempt to destroy the blockade-runner *Georgianna McCaw*, you are hereby promoted to the grade of acting Second Assistant Engineer in the navy of the United States, on temporary service.

“Very respectfully,

“GIDEON WELLES.”

The capture of the *Water Witch* in Ossabaw Sound on the 3rd of June, 1864, has been referred to in an earlier chapter, but is worthy of further comment on account of a peculiar question regarding the conduct of her chief engineer in the affair. The *Water Witch* was boarded while lying at anchor by a large force of the enemy, who, in the extreme darkness of the night, got close aboard before being discovered and gained the deck before the crew could be assembled to repel them. The commander of the vessel, Lieutenant Commander Austin Pendergrast, reported afterward that his crew showed no disposition to defend the ship and gave as a reason for this very remarkable behavior that the men were dissatisfied because the most of them were kept on board after their time of enlistment had expired. Such defense as was made was against great numerical odds by a few of the men and some of the officers, the hero of the occasion and most formidable combatant being Acting Assistant Paymaster Luther Billings, who was subsequently recognized by promotion for his gallantry.

With the hope of swamping the enemy's barges alongside, the ship's engines (side-wheels) were started, but soon stopped at the demand of a Confederate officer who enforced his order with a revolver. Lieutenant Commander Pendergrast referred to this in his report as an exhibition of cowardice on the part of the engineers and charged the loss of the ship against them in the following words: “Had they obeyed my orders to work the engine, the enemy would have been unable to board us; but, so far from fight-

ing the rebels, they surrendered at the first summons, and thereby lost the ship." The engineers on their part called attention to the fact that they were unarmed and claimed that the appearance of the enemy in the engine-room led them to believe that the deck had been already carried. Just how an unarmed man, engineer or not, is to resist an order given by an armed enemy in battle is not at all apparent. Instead of charging the disaster to the cowardice of the engineers it seems that a more liberal and logical view of the matter would place the blame upon an organization that compelled them to go into action unarmed, when the nature of their duties were such that they might at any moment be called upon to fight and when their inability to do so might result in the loss of the ship, as the commanding officer reported was the case in this instance.

Besides the misbehavior charged against him at the time of the capture, the senior engineer of the *Water Witch*, Samuel Genter, acting first assistant engineer, was reported by his commanding officer for "disgraceful conduct" while held as a prisoner of war, in that he asked to be released from confinement on the ground that he did not fight and as a non-combatant should not be made to suffer the consequences of war. Mr. Genter was a volunteer officer of less than two years' service, the greater part of which had been passed on the *Water Witch*, and it may be that he had been led to believe that he, as a staff officer, was simply a civil employe and a non-combatant, and he may have been sincere in asserting his claim to release from captivity. It was unfortunate for him, however, that he could not have had a time of peace in which to pronounce himself a non-combatant, for it availed him nothing under the living conditions of war: the enemy refused to liberate him, and the Navy Department, as soon as he was exchanged, summarily dismissed him from the service for his part in the surrender of the *Water Witch* and for "un-officer-like conduct" while held as a prisoner of war.

The duel between the U. S. sloop-of-war *Kearsarge* and the Confederate war-steamer *Alabama* on Sunday the 19th of June, 1864, was one of the most gratifying events of the Civil War, not alone from the fact that it resulted in removing from the surface of the ocean the scourge and terror of American commerce, but because circumstances made it practically a competitive test to destruction of the systems of ship, engine and gun building and

management in the American and British navies. The two ships were as evenly matched in size, armament and crew as could possibly be expected of vessels built and armed in different countries, their relative proportions being as follows:

	ALABAMA.	KEARSARGE.
Length over all.....	220 feet	214 feet 3 inches.
Length on water-line.....	210 "	198 " 6 "
Beam.....	32 "	33 " 10 "
Depth of hold.....	17 "	16 "
Tonnage.....	1,150	1,031

The *Alabama* was full bark-rigged with very lofty spars, her main especially being so tall that it had come to be recognized as a sign of danger to American skippers in all seas, and this gave her the appearance of being a much larger vessel than the *Kearsarge*, which at that time was fitted with disproportionately low and small masts and carried no spars above the topsail yards. The armament of the *Alabama* consisted of one VII-inch Blakely rifle; one VIII-inch shell-gun, and six long 32-pounders; all British guns. That of the *Kearsarge* was two XI-inch smooth-bore guns; one 30-pounder rifle, and four short 32-pounders; all American guns. The *Alabama* went into action with 149 officers and men in her crew, a majority of her men being British subjects, and the *Kearsarge* had 163 all told. With the exception of eleven persons of inferior ratings this ship's company was composed of native-born citizens of the United States, the most of them being seamen and mechanics from the coast and workshops of New England.

The magnificent discipline and courage displayed by the *Kearsarge's* men; the question of the chain armor; the conduct of the British yacht *Deerhound*; the wild firing of the *Alabama* and the deadly precision of that of the *Kearsarge*, with other familiar and often-told incidents of the fight need not be gone over here, but instead a few comments will be made upon some other features of the combat not usually brought into prominence in the historical accounts. One of these points is the assumed superiority of the gunners of the *Alabama*, her commander, Semmes, being quoted in the *London Times* a few days after the fight as saying that he expected his trained British gun-captains to make short work of the volunteers of the *Kearsarge*. It is true that the gun's-crews of the

Federal ship, divisional officers as well as men, were volunteers, but they were anything but recruits as the term usually signifies. The *Kearsarge* had been in commission for more than two years under a well organized and liberally administered system of naval discipline, that length of time being more than sufficient to convert almost any class of recruits into thorough men-of-war's-men. The material in this case happened to be of intelligence to start with, and after thirty months of constant training aboard ship had arrived at a state of competence and familiarity with their duties that left absolutely nothing to dread from the products of British or any other system of naval training. Just such volunteers as these manned our ships in the war of 1812, and will man them in the next naval war.

The circling tactics observed by the two ships during the fight were forced by Captain Winslow of the *Kearsarge* to prevent his antagonist from approaching the neutral three-mile limit off shore. His ability to thus determine the order of battle was due to the superiority of his engineer's department, and to that alone, for had the *Alabama* possessed the greater speed she could have compelled the fight to be maintained on parallel courses leading shoreward, as pointed out in Winslow's report of the battle. The *Alabama* was built with special reference to speed both as a steamer and as a sailer and was supposed to be much the superior of the *Kearsarge* in both capacities, Captain Semmes, again, being authority for the statement that he expected to have a decided advantage in the matter of speed when he went into action. With the weaker motive power, the *Kearsarge* owed her superior performance to her engine-room force which was made up of intelligent and capable young American mechanics, who had been trusted to carry out the details of their duties without captious interference, and who consequently had arrived at a point so near perfection that when the hour of battle came the performance of the machinery exceeded all previous records and made the *Kearsarge* the better ship.

The *Kearsarge's* machinery was built by the well-known firm of Woodruff & Beach, Hartford, Connecticut, the contract price for it being \$104,000. The ship itself was built at the navy yard, Kittery, Maine. The machinery was well made and excellent for its kind, although not designed with any special reference to speed,

and its fine condition after thirty months of service is the best possible proof of the zeal and capability of the engineers who had charge of it. An Englishman, Mr. Frederick Milnes Edge, who published a pamphlet account of the battle soon after it occurred, was so impressed with the evident care exhibited by the condition of the machinery of the *Kearsarge* that he wrote:

“ I have not seen engines more compact in form, nor apparently in finer condition—looking in every part as though they were fresh from the workshop, instead of being, as they are, half through the third year of the cruise.”

Mr. Cushman, the chief engineer of the ship, was a veteran of the old navy well qualified to train the new hands which the war had brought into the service; the four assistant engineers belonged to the regular service but had entered on account of the existence of war and consequently had no more naval experience than the volunteer deck officers of their ship, but that, as the event showed, was quite sufficient for both classes. The *Kearsarge* went into action with her fires raked perfectly clean and bright, the furnace draft forced by artificial means, and the safety valves lashed down, under which conditions she fought at her utmost speed throughout the engagement, her decks trembling under the feet of the crew from the vibration of the engines and the roar of the fires. The senior assistant engineer, Mr. Badlam, was stationed in charge of the engines; Mr. Miller, the next engineer in rank, had charge of the boilers; Third Assistant Engineer Sidney L. Smith was on the spar deck with the fire-hose company, and the junior, Mr. McConnell, was stationed at the engine-room signal-bell. In the report of the chief engineer the conduct of these four officers and of the men of the engine-room force was especially referred to as being cool, self-possessed and efficient. The same was true of the whole ship's company, for the action was fought with the same deliberation and lack of excitement that had characterized the daily drills.

The detailed report of the conduct of officers and men contains the following relative to the engineer's department :

“The engineer's division was admirably and efficiently con

ducted, under the command of Chief Engineer W. H. Cushman. Sidney L. Smith and Henry McConnell, third assistant engineers, were stationed on deck, and their conduct came immediately under my observation. It was distinguished by coolness and vigilance. The other assistants, Mr. W. H. Badlam and Mr. F. L. Miller, were on duty in the engine and fire-rooms, and, judging from the prompt manner in which the orders from the deck were executed, I know that their duties were creditably performed.”

The *Alabama* fired about three hundred and seventy times but only twenty-eight of her shots struck the *Kearsarge*, and they did her no serious harm ; only three of her men were wounded, one of whom, William Gowin, subsequently died. The *Kearsarge* fired one hundred and seventy-three times, the most of her projectiles finding the mark : about forty men were killed and wounded on the *Alabama*, and the ship was dreadfully cut to pieces before she sank. Her engines were disabled by a shell which exploded in a coal bunker, completely blocking the engine-room with coal and wreckage and wounding two assistant engineers. Another shell alone was reported by prisoners to have killed and wounded eighteen men and disabled a gun. Ten of the shots fired from the *Kearsarge* were from a 12-pounder howitzer and performed no part in the sinking of the *Alabama*.

“Two quartermasters were put in charge of this gun with instructions to fire when they were ordered ; but the old salts, little relishing having nothing to do when their shipmates were all so busy commenced peppering away with their pea-shooter of a piece, alternating its discharges with vituperation of each other. This low-comedy by-play amused the ship’s company, and the officer of the division good-humoredly allowed the farce to continue until the single box of ammunition was exhausted.”¹

One other incident of the fight cannot be told too often to correct a popular error regarding the supposed narrow escape the *Kear-*

¹ From a popular account of the battle by Mr. Henry McConnell, cashier of the Kensington National Bank of Philadelphia ; Mr. McConnell was the assistant engineer of the *Kearsarge* stationed at the engine-room signal bell.

sarge had from destruction. A 100-pounder shell was found lodged in her stern-post after the battle and has been exhibited at one of the navy yards ever since with a section of the stern-post, where it has been regarded with awe by a whole generation of visitors. At the World's Columbian Exposition this same piece of the stern-post with the shell still lodged in it was one of the most attractive exhibits on the model battle-ship and was seen by upwards of three million people. It is currently believed that if this shell had exploded, the *Kearsarge* and not the *Alabama* would have gone to the bottom of the English Channel, and people, according to their degree of piety, ascribe the miraculous escape to luck, Providence, or the direct intervention of the Almighty. The truth is, however, that this shell struck the counter of the *Kearsarge* at least twenty feet from the stern-post and would have exploded then, where the damage would have been slight, had it possessed any explosive power, for it was a percussion shell. After striking, it glanced, scoring the planking for about ten feet, then passed through the air some ten feet more and finally embedded itself in the stern-post, its final impact doing some damage by starting the transom frame and binding the rudder so that four men were required thereafter to work the wheel.

The most sanguinary and important naval battle of the Civil War was the battle in Mobile Bay the morning of August 5, 1864. The fleet under command of Rear Admiral Farragut stripped for action much the same as was done more than two years before preparatory to passing the forts below New Orleans. Superfluous boats, spars, etc., were taken out of the ships and anchored off shore or left at Pensacola, some of the ships thus disposing even of their lower yards and topmasts. The plan of lashing a small vessel to the unexposed side of a larger one to carry her past the fort in case of serious damage was again adopted, and at daylight the morning of the 5th the vessels designated for the attack moved up the bay to their work, the pairing and order of advance, together with the names of commanding officers and chief engineers being as follows:

{	<i>Brooklyn</i> , Captain James Alden; Chief Engineer Mortimer Kellogg.
	<i>Octorora</i> , Lieutenant Commander C. H. Greene; Acting First Assistant Engineer W. W. Shipman.

- { *Hartford* (flag), Captain Percival Drayton ; Chief Engineer Thomas Williamson.
Metacombet, Lieutenant Commander Jas. E. Jouett ; First Assistant Engineer James Atkins.
- { *Richmond*, Captain Thornton A. Jenkins ; Chief Engineer Jackson McElmell.
Port Royal, Lieutenant Commander B. Gherardi ; First Assistant Engineer Fletcher A. Wilson.
- { *Lackawanna*, Captain J. B. Marchand ; First Assistant Engineer Jas. W. Whittaker.
Seminole, Commander Edward Donaldson ; Acting First Assistant Engineer Claude Babcock.
- { *Monongahela*, Commander J. H. Strong ; Chief Engineer George F. Kutz.
Kennebec, Lieutenant Commander Wm. P. McCann ; Second Assistant Engineer L. W. Robinson.
- { *Ossipee*, Commander Wm. E. LeRoy ; Acting Chief Engineer James M. Adams.
Itaska, Lieutenant Commander George Brown ; Second Assistant Engineer John L. D. Borthwick.
- { *Oneida*, Commander J. R. M. Mullany ; Chief Engineer William H. Hunt.
Galena, Lieutenant Commander Clark H. Wells ; First Assistant Engineer William G. Buehler.

Four monitors, two of the Ericsson type and two of the Edes Mississippi "turtle-back" type, were already inside the bar and near Fort Morgan with orders to move along with the head of the column between the leading ships and the fort, in the following order :

- Tecumseh*, Commander T. A. M. Craven ; Chief Engineer John Faron.
- Manhattan*, Commander J. W. A. Nicholson ; Acting Chief Engineer C. L. Carty.
- Winnebago*, Commander T. H. Stevens ; Acting Chief Engineer Simon Shultice.
- Chickasaw*, Lieutenant Commander Geo. H. Perkins ; Acting Chief Engineer Wm. Rodgers.

Six small gunboats, the *Pembina*, *Pinola*, *Sebago*, *Tennessee*, *Bienville*, and *Genesee*, were advanced into the shoal water off Mobile Point somewhat to the rear of Fort Morgan for the purpose of disconcerting by their fire the batteries of that fortification, but owing to some confusion of orders or misunderstanding they anchored so far away that their fire was ineffective and they are not usually credited with having participated in the battle.

About 6.30 A. M. the line was well up towards the fort, the four monitors being close into the shore, and the formation for battle was being perfected, the first shots at the fort being fired at that time by the *Tecumseh*. A few minutes past seven the fort opened on the leading ship, the *Brooklyn*, and immediately thereafter the action became general between the fort, the leading ships and the monitors. In this firing the *Tecumseh* did not take part, for after having fired the first two shots to scale her guns she had loaded with steel bolts and the heaviest charges of powder allowed, to be in readiness to engage the iron-clad ram *Tennessee* then emerging from behind Fort Morgan. At 7.30 A. M. the *Tecumseh* was the foremost vessel in the line, being off the starboard bow of the *Brooklyn*, and was steadily advancing, intent only upon getting into action with the *Tennessee*, when her destruction came with awful suddenness by the explosion of a torpedo underneath her, from the effects of which she went to the bottom with her gallant commander and the greater part of her crew within less than half a minute. The swiftness of her destruction may be comprehended from the following extract from a lecture by an eye-witness, Chief Engineer Harrie Webster, U. S. Navy who as an assistant engineer was in the turret of the *Manhattan* in charge of its turning gear, only two hundred yards distant from the *Tecumseh*.

“A tiny white comber of froth curled around her bow, a tremendous shock ran through our ship as though we had struck a rock, and as rapidly as these words flow from my lips the *Tecumseh* reeled a little to starboard, her bows settled beneath the surface, and while we looked, her stern lifted high in the air with the propeller still revolving, and the ship pitched out of sight, like an arrow twanged from her bow.”

The *Tecumseh* went into action with seven line officers, includ-

ing the commander, six engineers, one surgeon, one paymaster, a pilot, and ninety-eight enlisted men. Of these, three line officers, the pilot, and seventeen men were saved, all others losing their lives by drowning or concussion. With the exception of one coal-heaver the entire engine-room force of six officers and thirty-seven men was annihilated, the majority probably by shock, as the survivors reported that the torpedo exploded under the middle of the ship and blew the bottom about the machinery spaces to pieces. The chief engineer, Mr. John Faron, had left a sick bed in the hospital at Pensacola at his own urgent request to go on board his vessel to take part in the battle. He had been in the regular navy since 1848 and was a popular and capable officer whose death, resulting from his own devotion to duty, was greatly deplored. The engineers who perished with him were F. S. Barlow, Elisha Harsen, and H. S. Leonard, all second assistants in the regular service, and Thomas Ustick and Henry Ritter, acting third assistants.

The tragedy of the *Tecumseh* occasioned some confusion in the fleet, during which the *Brooklyn* faltered and *Farragut* went ahead of her with the *Hartford* and led the fleet successfully past the fort, but not without great loss, the fire from the fort and from the Confederate gunboats lying above doing great injury to several of the ships. The broadside fire of the larger vessels was so terrific that it eventually practically silenced the fort and the column was able to pass almost unmolested after the first vessels had gone by. Last in the line came the evil-starred *Oneida*, and by the time she arrived abreast of *Morgan* the gunners had returned to their batteries and opened upon her with great fury. Able naval critics say it was a mistake to put a small vessel last in line, for had one of the large broadside ships like the *Richmond* or *Brooklyn* brought up the rear she could have successfully protected herself by her own fire and forced the enemy to again abandon his guns. As it was, the *Oneida* was roughly handled.

“A rifled shell passed through her chain armor, and entering the starboard boiler exploded in it, causing sad havoc among the firemen and coal-heavers of the watch below, all of whom were either killed outright or fearfully scalded by the escaping steam. Another shell, exploding in the cabin, cut both wheel-ropes, while

a third set fire to the deck above the forward magazine; yet, encouraged by the chivalric bearing of their commander, and the fine example set them by the executive officer and the chief engineer of the ship, the crew of the *Oneida* behaved splendidly. The relieving tackles were instantly manned, the fire put out, and connection between the starboard and port boiler cut off; and the *Oneida*, assisted by the *Galena*, went on as if nothing unusual had happened on board of her, her guns never for a moment ceasing to respond to the really terrific fire of the enemy."¹

The chief engineer of the *Oneida*, Mr. Wm. H. Hunt, was badly scalded in both arms but remained at his post and succeeded in restoring order from the frightful scene following the explosion of the shell in the boiler, his gallantry being so conspicuous that it was made a subject of special reference in the report of the commanding officer. Mr. Fitch, the senior assistant engineer of the ship, was severely scalded and likewise distinguished himself by his gallant behavior, the chief engineer reporting of him in the following terms: "Too much praise cannot be accorded to First Assistant Engineer R. A. Fitch, who, at the time of the injury to the boiler, displayed the utmost courage and coolness, remaining at his station in the execution of his duties until he was so badly scalded by the escaping steam as to be rendered almost helpless." Acting Third Assistant Engineer Nicholas Dillon was also commended in the official reports for extraordinary services, he having undertaken the duties of Mr. Fitch when that officer succumbed to his injuries.

After getting past the fort with the assistance of the *Galena*, the *Oneida* came up to the scene of a fierce combat between the *Monongahela* and some of the other Union vessels and the *Tennessee* just in time to be assailed by the latter, which, by chance rather than design, got under the *Oneida*'s stern and raked her fore and aft with a broadside, destroying boats and rigging, dismounting a gun, crippling the mainmast, and injuring some of her people, among them Commander Mullany, who lost an arm. At this stage of the

¹ Commodore Foxhall A. Parker, U. S. Navy—The Battle of Mobile Bay; page 31.

fight the Confederate gunboats had become so annoying that Farragut signaled his own small vessels to cast loose from their consorts and attack them; to which order the *Metacomet*, *Port Royal*, *Kennebec* and *Itaska* at once responded. The first named, under Lieutenant Commander (now Rear Admiral) James A. Jouett, got off first and captured the *Selma* which she singled out and pursued. One of the enemy's gunboats, the *Morgan*, escaped to Mobile; the other, the *Gaines*, was run on shore in a sinking condition near the fort, set on fire by her own people and abandoned. The *Tennessee* withdrew from the fight and anchored under the guns of the fort, still practically uninjured and without a man in her crew disabled. The Federal vessels proceeded about four miles up the bay and anchored, piping to breakfast after hastily clearing away the wreckage and other more dreadful evidences of the conflict.

Scarcely had the men gathered about their mess-cloths when the *Tennessee* was observed to be under way, standing up the bay for another fight. The struggle that ensued between her and the whole Federal fleet was a desperate one and lasted more than an hour before the *Tennessee* was literally worried into a surrender. She was pelted with the broadsides of the large ships, which, however, did her little damage, and was rammed in succession by the *Monongahela*, *Lackawanna* and *Hartford*. The three monitors, especially the *Chickasaw*, hung close aboard her and with their heavy projectiles succeeded in crushing her casemate armor, jamming her port-shutters, and finally reduced her to the necessity of surrendering. Her admiral, Franklin Buchanan, lost a leg; two of her men were killed; two assistant engineers, the pilot, and five men were wounded. The *Selma* in her fight with the *Metacomet* had eight men killed and seven wounded before she surrendered. The Confederate loss in Fort Morgan was not known.

The last shot fired by the *Tennessee* entered the berth deck of the *Hartford*, exploded and killed five men and wounded eight, one of the latter being Third Assistant Engineer William G. McEwan, stationed there in charge of the fire-hose company, who lost his right arm. The sword which he wore was torn from him and hurled across the deck, the sword-belt being driven under a mess-chest where it was found several days later. Mr. McEwan was a volunteer officer, and as he had distinguished himself in the earlier part of the engagement,

Admiral Farragut made a special report of his case, recommending that he be rewarded by transfer to the regular service, which was done and a comfortable pension assured him for life by his being placed on the retired list.

The *Tennessee* was the largest and most formidable war vessel built within the limits of the Confederacy during the war, her length being 209 feet; extreme beam 48 feet, and average draft of water 14 feet: her general design was like the *Atlanta*, of which a sketch has appeared in a former chapter, except that her hull was built wholly of wood. The casemate was of the same form but heavier, the wooden backing of yellow pine and oak being 22½ inches thick, sheathed with 5 inches of iron plating on the sides and after end and 6 inches forward. This iron plating, it is worthy of remark, was made from the ore at the iron furnaces in Atlanta, the Southerners having begun when too late to pay attention to the mechanic arts so necessary for prosperity in peace and absolutely vital in war. The *Tennessee* was built at Selma, Alabama, from timber that was standing at the time the work was begun in 1863, and was gotten down the Alabama river and into Mobile bay only by overcoming many difficulties. Her battery of six Brooke rifles was also of southern manufacture. Her weak point was the machinery, which was not built for her and was wholly unfit for a war vessel: it was taken out of a river steamer named *Alonzo Child*, and consisted of two high-pressure engines with cylinders 24 inches in diameter by 7 feet stroke placed fore and aft in the vessel and driving an idler shaft by means of spur gearing; this shaft in turn driving the screw-shaft through the medium of cast iron bevel-gears. Steam was supplied by four horizontal return-flue boilers 24 feet long, placed side by side with one furnace under the whole of them. The vessel was found by a board of survey immediately after capture to be fit for service, and was taken into the navy at the appraised value of \$595,000. Admiral Farragut's original report of his prize was accompanied with some excellent drawings and sketches of her, made by second assistant engineers Isaac DeGraff of the *Hartford* and Robert Weir of the *Richmond*, from whose sketches and the accompanying description the data of this paragraph have been obtained.

Fort Morgan surrendered to the combined army and naval

forces about two weeks after the battle, the other fortifications in Mobile Bay having surrendered or been abandoned within a day or two after the Federal fleet forced its way in.

The casualties in the fleet during the morning battle were as follows:

	KILLED.	WOUNDED.
Hartford	25	28
Brooklyn.....	11	43
Lackawanna	4	35
Onelda	8	30
Monongahela.....	0	6
Metacomet.....	1	2
Ossipee	1	7
Richmond.....	0	2
Galena	0	1
Octorora.....	1	10
Kennebec	1	6
Tecumseh.....	92	0
Total.....	144	170

The above list of casualties does not include two men killed and two wounded immediately after the battle on the small armed steamer *Phillippi* which rashly attempted to follow the fleet in and was destroyed by the guns of the fort.

The loss in the British fleet at the battle of Copenhagen, somewhat similar in character to that of Mobile, was 253 killed and 688 wounded.

Early in October the U. S. sloop-of-war *Wachusett*, Commander Napoleon Collins, was in the harbor of Bahia, Brazil, in company with the Confederate privateer *Florida*, which vessel the *Wachusett* was seeking. Determined to seize or destroy her, even if the neutrality of the port had to be violated, Collins assembled some of his officers and announced he was going to get under way with the apparent intention of going to sea and when near the *Florida* to suddenly change the course, run into and sink her, or carry her by boarding. To this plan the chief engineer objected on the ground that the shock of the collision might start the boilers from their seatings and create ruin by rupturing the steam pipes and boiler connections; an objection that appeared so reasonable in the absence of anyone with experience in ramming that the intention

would probably have been abandoned had not one of the assistant engineers announced that he would voluntarily take charge of the machinery, allow everyone else to leave the engine and fire-rooms just before the collision and remain there alone himself to take the consequences of an accident and to reverse the engines if required after the shock. The *Florida* was run down according to the plan of the commander but owing to some error in handling the *Wachusett* the blow struck was a glancing one and did no great damage to the privateer beyond carrying away her mizzen mast and main yard; a few volleys of small arms were exchanged, and upon the discharge of two of the *Wachusett's* broadside guns the *Florida* surrendered and was towed out of the harbor by her captor, the Brazilian forts firing upon the *Wachusett* as she went out. A serious complication grew out of the affair, ending in an apology made by our government to Brazil and an agreement to return the *Florida* to the port where she had been captured. While preparing at Hampton Roads for the voyage to Brazil the *Florida* sank, apparently by accident, and the return was never made.

The assistant engineer who courageously volunteered to risk his life in the engine-room of the *Wachusett* when ramming was first proposed was George Wallace Melville, who was destined to make his name famous at a later period by the exhibition of heroism and fortitude of such superior quality as to extend far beyond his own individuality and reflect world-wide honor upon the naval service and the nation to which he belonged. Previous to the capture of the *Florida*, Mr. Melville, knowing that his commander was desirous of gaining information as to the battery of the enemy's ship, attempted to get on board of her in civilian's clothing in the guise of a visitor, but was suspected and driven off when he went alongside; this act in itself was far from commonplace, for the penalty for being in the enemy's country or on board an enemy's ship in plain clothes in time of war was well known by him.

The evening of December 9th the double-ender *Otsego*, of the *Sassaous* class, ran upon two torpedoes near Jamesville in the Roanoke river and was sunk, no lives being lost, she being at the time a member of a flotilla sent up the river to attack a battery at Rainbow Bluff. Lieutenant Commander H. N. T. Arnold, the commanding officer, in his report of the disaster expressed his indebtedness to

the senior engineer, Mr. Samuel C. Midlam, who had advised and rigged a torpedo net over the bow which had saved the *Otsego* on two occasions by picking up torpedoes, but was unavailing against those that finally destroyed the vessel, they being struck when she had rounded to preparatory to anchoring and were not under the bow.

Towards the close of the year a great fleet was assembled under commander Rear Admiral Porter to co-operate with General B. F. Butler in an attack upon the immense fortification known as Fort Fisher on Federal Point at the mouth of Cape Fear River, North Carolina. An unusual method of making war was attempted on this occasion, the result of which exposed both Porter and Butler to considerable ridicule, although General Butler is said to have been the instigator of the plan. An accidental explosion of a powder magazine in England not long before had done so much damage to the neighborhood that the idea was conceived of adopting the same means to "paralyze" the enemy or destroy his works by concussion. Accordingly the purchased screw gun-vessel *Louisiana*, which had cost only \$35,000 in 1861 and which was pretty well worn out by constant service in the North Carolina Sounds, was converted into a torpedo on a huge scale by being loaded with an enormous quantity of powder arranged in cells to facilitate its simultaneous explosion. The crew of this dangerous floating mine consisted of Commander A. C. Rhind, Lieutenant S. W. Preston, Second Assistant Engineer Anthony T. E. Mullen, Master's Mate Paul Boyton, and eleven enlisted men, all volunteers from Rhind's vessel—the *Agawam*. Admiral Porter referred to the mission in his report of the attack as "the most perilous adventure that was, perhaps, ever undertaken," and recommended that the officers be promoted, adding that no one in the squadron expected them to survive their expedition.

The night of December 23rd the powder vessel was towed by the *Wilderness* to a position close to Fort Fisher where she was cast off, and, though literally a powder-magazine from stem to stern, proceeded under her own steam to within three hundred yards of the beach under the walls of the fort, trusting to her disguise as a blockade runner to escape being fired into. Having anchored unmolested, the fuzes and fires for causing the explosion were lighted,

these having been arranged, as stated in Commander Rhind's report, by Engineer Mullen. The crew then left her by boat and boarded the *Wilderness*, that vessel going at full speed to join the fleet lying twelve miles off shore to be beyond reach of the catastrophe that was supposed would occur. The explosion took place about 1.30 A. M. and resulted in nothing; the men in Fort Fisher were disturbed in their sleep, but no one was paralyzed and no earthworks were jarred down, while the sound was scarcely heard by the people in the fleet intently listening for it. The reward extended to Mr. Mullen for his share in this perilous enterprise was very considerable, he receiving a week later the following letter from the Secretary of the Navy:

“**SIR:** As a recognition of your gallant conduct while attached to the *Louisiana* you have permission to present yourself to Chief Engineer Newell, at the navy yard, Philadelphia, for examination for promotion.”

Mr. Mullen at the time was number ninety-two on the list of second assistant engineers and his advancement to the foot of the list of first assistants, which occurred immediately after his examination, is belived to be the most substantial reward for distinguished service conferred upon any staff officer during the war.

On the 24th of December Admiral Porter gave the fort a terrific battering and silenced its fire for the time being, but no important results followed, as General Butler with the troop-ships was not present to follow up the advantage. Porter's attacking force consisted of thirty-seven war-vessels, ranging in size from the *New Ironsides*, *Wabash*, *Colorado* and *Powhatan* down to the double-enders *Sassaous* and *Mackinaw* and the ninety-day gunboats *Undilla* and *Chippewa*, lying in semi-circular formation about one mile distant from the fort. The monitors *Monadnock*, *Mahopac*, *Saugus* and *Canonicus* were in this line of battle and did great execution with their heavy guns, they and the *New Ironsides* lying a considerable distance inside the one-mile circle. Besides the fighting line, a reserve division of nineteen vessels, all purchased merchant steamers, laid further out and did not take part in the attack.

The army transports came the next day (Christmas) and the

attack was renewed, General Butler landing some of his troops under cover and with the assistance of about twenty of the gun-vessels. He, however, gave up the plan of attack and began re-embarking his men after a few thousands had landed, an act that was the beginning of a bitter controversy between him and Admiral Porter, prosecuted by both as long as they lived. During the two days the vessels suffered slightly from the fire of the fort, their chief losses resulting from the bursting of their own guns, about forty-five officers and men being killed or wounded by the bursting of 100-pounder Parrott rifles. On the *Juniata* Lieutenant Wemple and four men were killed and Paymaster Caspar Schenck and seven men wounded in this manner; the *Ticonderoga* had eight killed and eleven wounded in the same way, and similar casualties, but with less loss of life, occurred to the *Mackinaw*, *Yantic* and *Quaker City*. An idea of the magnitude of the bombardment may be gained from the fact that the *Colorado* alone fired 1,569 heavy shot and shell the first day, and 1,226 the second day.

CHAPTER XXV.

“And in this faith all went to their posts, prepared to obey the regulations and ‘fight courageously’; for in a fleet where a single shell, exploding in the boiler of a vessel, might subject the engineers and firemen to the fate of *Marsyas*, or a torpedo or infernal, exploding under her bottom, send all hands journeying *ad astra*, no one could properly be considered a non-combatant.

“Commodore FOXHALL A. PARKER—*Battle of Mobile Bay.*”

1864. The Civil War, Continued—Naval Operations in the North Carolina Sounds—The Ram ALBEMARLE—Sinking of the SOUTHFIELD and defeat of the MIAMI—The Naval Battle of May Fifth—Disaster to the SASSACUS and Heroism of Her Chief Engineer—Daring Attempt of Enlisted Men to Destroy the Ram—Her Destruction by Lieutenant Wm. B. Cushing—Battle and Capture of Plymouth—Prize Money Distributed on Account of the ALBEMARLE.

MENTION has been made in former chapters of the capture of the fortified posts of the enemy on the large sounds lying along the coast of North Carolina, and of the constant warfare waged thereafter by the national war-vessels to keep possession of what had been gained. This region, remote as it was from the battle-grounds of the war, was not of direct importance to the Federals as its occupation could have little influence upon the strategical combinations being attempted by the armies in distant fields, but from the Confederate point of view the situation was very different: to them possession of these waters and ports meant a source of supply from Europe, through the medium of blockade-runners, of clothing, medicines, arms, and other war supplies, and an almost perfect facility for the distribution of such articles by the many rivers and water-ways flowing into the sounds. Thus it was that Federal policy required the seizure and retention of the entire region, while Confederate necessity dictated a ceaseless struggle for the recovery of what had been lost early in the war.

The theatre of operations for the naval force assigned to this region was geographically small compared with the vast extent of coasts and rivers on which the navy had to operate, but it was large enough to afford very active employment, and to require the most

untiring vigilance on the part of the small force there charged with the task of maintaining Federal supremacy. The vessels sent into these waters were called gunboats by courtesy, but as a rule they were a sorry lot, being generally purchased steamers, tugs, or ferry-boats, armed and protected as well as the nature of their construction would allow; owing to the shallowness of the waters in which they had to operate they were necessarily small, until the naval authorities had had time to build light-draft gunboats, when some side-wheel vessels of considerable size, built expressly for war purposes, found their way into the Sounds. The officers and men aboard these vessels were a fair average of the naval *personnel* of the period; mostly volunteers, with a sufficient sprinkling of the "old navy" both before and abaft the mast to keep alive the traditions and maintain the rigid rules of the service. Volunteer officers commanded some of the smaller vessels, and the subordinate officers, almost without exception, were of this class; the larger vessels were generally commanded by regular officers, usually lieutenants and lieutenant-commanders. Chief among these C. W. Flusser and W. B. Cushing, whose exploits read like romance as well as history. They were young: Flusser, who at times was the ranking officer in the Sounds, was about thirty, while Cushing was barely of age, yet these young men accepted responsibilities and dealt with questions of policy, the gravity of which in these days would be regarded great enough to warrant consideration by a board of admirals.

The conditions of service were vastly different from the ideal naval life of the period; the lofty frigate shortening sail and clearing for action under the blue sky far out in the open sea was then the symbol of naval glory, but no such spectacle cheered the eyes and exalted the patriotism of the seamen in the Carolina Sounds. The vessels were small and smoky, redolent of engine oil and innocent of snowy canvass and glistening spars; instead of the bright blue sea of nautical romance, one saw the muddy, shallow flood of the far-reaching inland waters, stained and poisoned by the ooze and vegetable decay swept down by numberless rivers and creeks from the surrounding swamps. The great peninsula between Pamlico and Albemarle Sounds was a vast miasmatic swamp; stretching northward from Albemarle Sound lay the deadly and forbidding morass

known as the Dismal Swamp, the character of which was the type of all the region lying adjacent to the Sounds. Thomas Moore, who visited this country early in the present century, described the physical characteristics of more than one locality in verse that will live as long as our language lasts, and in his beautiful ballad called "The Lake of the Dismal Swamp," narrating the legend of the youth who sought the firefly lamp and white canoe of his dead sweetheart in the depths of the Dismal Swamp, occurs the two following verses that describe the nature of the region far better than can any prose description:

" Away to the Dismal Swamp he speeds,—
His path was rugged and sore;
Through tangled juniper, beds of reeds,
Through many a fen where the serpent feeds,
And man never trod before!

" And when on earth he sank to sleep,
If slumber his eyelids knew,
He lay where the deadly vine doth weep
Its venomous tear, and nightly steep
The flesh with blistering dew!"

Such, then, were the surroundings of the Federal naval force and the material with which it had to operate; both doubtless very different from what the officers would have wished. But the country was at war, and whatever came to each man's hand that was he expected to do with all his might; so these gentlemen abandoned the dreams of romantic adventures at sea acquired by reading Cooper and the "Naval Monument," took off their white gloves, folded away their finely starched linen, and went to work.

Frequent attempts by the Confederate land forces to recapture the sea-ports of the Sounds came to naught, principally on account of the persistent presence of the little gunboats and their wicked habit of throwing large quantities of shells into the woods where the attacking forces were making their approaches; while boat attacks and guerilla warfare from the shore directed at the gunboats simply served to provoke Flusser and the other commanders to more vigorous hostility, and to teach the enemy that the gunboats would have to be assailed with some more powerful weapon than had yet been

used against them if they were to be defeated. The fruit of this lesson was the *Albemarle*. She was built in the woods at Edward's Ferry on the Roanoke River, some forty miles above Plymouth, by Mr. Gilbert Elliot, from designs prepared by John L. Porter, who was the chief constructor of the Confederate navy, and who had been a naval constructor in the United States navy before the war. The hull was shallow, or "flat," built of eight-inch by ten-inch frame timbers sheathed with four-inch planking; near the water-line the sides were protected by a belt of several courses of squared logs bolted on longitudinally, and corresponding in some degree to the armor belt worn by modern battle-ships; the bow was developed forward into a solid oaken beak plated with two-inch iron and tapered to an edge. On the water-line the craft was one hundred and twenty-two feet long (which is sixteen feet less than the length of our modern torpedo boat *Cushing*), and the breadth of beam was forty-five feet. On the central part of the deck the full width of the boat and sixty feet in length fore and aft stood the superstructure or casemate; this was of heavy squared timbers inclined at an angle of almost sixty degrees to the vertical, sheathed with heavy planking and two layers of two-inch iron plates; the timbers at the forward part of the casemate were carried up above the flat top high enough to form the framing of a conning-tower of truncated pyramidal form. The corners of the main central structure were cut off, making its deck plan an oblong octagon. Inside the casemate at each end was mounted a 100-pounder rifled gun, one a Brooke, the other a Whitworth; each gun was pivoted to fire out of its end port and out of a port on each broadside. The vessel had twin-screws, each screw driven by an engine of only two hundred horse-power. The draft of water when ready for service was eight feet. From this description the *Albemarle* will be recognized as a typical Confederate war-vessel, differing from the *Merrimac*, *Atlanta* or *Tennessee* in no important particular except that of size.

In the spring of 1864 the *Albemarle* was ready for service, and on April 18 she dropped down the Roanoke River to within about three miles of Plymouth; her engine-power was so feeble and her steering qualities so bad that it was found impossible to keep her in the channel when going ahead with the current, so she came down the river backward dragging chains from her bows. The command-

ing officer was Captain J. W. Cooke, of the Confederate navy, whose name stood at the head of the list of lieutenants of the old navy when the war broke out in 1861. After anchoring, a lieutenant was sent out to explore the river in the vicinity of Plymouth, he returning in about two hours with the report that the river was so obstructed with piles, sunken vessels, and torpedoes that it would be impossible to pass down. Fires were then banked and port watches set. Mr. Elliott, the builder of the vessel, was on board as a volunteer aide to the captain, and he seems to have been more anxious to see his fabric get into a fight than was anyone else connected with her; he took the pilot, two seamen, and a small boat and proceeded to examine the obstructions with a long pole, finding to his great delight that there was a place near the middle of the river, wide enough for the ram to pass through, where there was ten feet of water; this was due to a remarkable freshet, the water being higher in the river that night than it had been known to be for many years. He returned to the *Albemarle* about one o'clock in the morning and reported his discovery to the captain, who immediately resolved to go out. All hands were quietly called, fires spread, and when all was ready she proceeded slowly down the river, being fired on in the darkness by the Union batteries about Plymouth as she passed.

Meantime, Flusser, in command of the *Miami*, with the *Southfield*, *Ceres*, and *Whitehead* in company, had been in action all day of April 18, aiding the garrison of Plymouth in resisting the attack of a large body of Confederates. The *Miami* was a paddle-wheel gunboat of about seven hundred and thirty tons, carrying six IX-inch guns, one 100-pounder Parrott rifle, and one 24-pounder howitzer; the *Southfield* was a ferry-boat, but had a very respectable battery (five IX-inch guns, one 100-pounder rifle, and one 12-pounder howitzer); the *Ceres* and *Whitehead* were merely armed tug-boats of less than one hundred and fifty tons each. The *Miami* and *Southfield* anchored for the night below Plymouth, the two smaller vessels lying higher up to watch for the ram, which was known to be abroad. In reporting the result of the day's fighting, Flusser wrote that night that he expected the ram down at any moment, and that he thought he could whip her. This was his last letter: he had already come within the range of vision of the

Fates, and she of the open shears was about to close them and sever the thread of his life.

With the dawn came the *Albemarle*. During the night the *Miami* and *Southfield* had been lashed together, and with the first warning of the coming of the foe, which was given by the *Ceres* at 3:45 A. M., they got under way and steamed up the river at full speed with the intention of ramming. The advantage of this combination is not manifest, although the majority of naval writers who have described this affair pass over it without comment, apparently accepting it as a proper arrangement. Admiral Ammen, in his book regarding the naval operations on the Atlantic coast, says that he is at a loss to understand the *rationale* of lashing two vessels together and using them as a ram. The *Albemarle* avoided the attack by running close in to the southern shore, and then, turning towards mid-stream, taking advantage of the swift current, and using all the steam power she had, she rushed at her antagonists, striking the *Miami* a glancing blow on the port bow and crushing into the starboard side of the *Southfield* so far that her beak appeared in the fire-room. The *Southfield* immediately sank, dragging the bow of the *Albemarle* which was tangled in her side, down so far that the forward deck of the ram was deeply submerged, and water poured in torrents through the port-holes in the forward part of the casement. When the *Southfield* touched bottom she rolled over away from the ram, and this disentangled the vessels and allowed the latter to resume an even keel. While this was taking place the *Albemarle*, being partially between the two Union vessels, was fiercely assailed by the great gun and small-arm fire of both, but she did no firing herself except with small arms. The projectiles fired at point-blank range struck fire on the sloping sides of the *Albemarle*, and flew harmlessly off high up into the air, or were broken in pieces to fly back on the decks of the vessels whence they came. From the engagement of the previous day the guns of the *Miami* were loaded with shell, and this circumstance proved fatal to her commanding officer. With his usual zeal and courage this officer had personally taken charge of his battery and fired the guns himself, being instantly killed and badly mangled by pieces of the third shell he fired, it having rebounded from the enemy's side and exploded.

The pressure of the ram between the two Federal vessels had parted the forward lashings, and as the *Southfield* was sinking the after lashings were cut or cast adrift, leaving the *Miami* unencumbered. After getting clear of the wreck of the *Southfield* the *Albemarle* backed off preparatory to striking the *Miami*, which vessel, at the same time, having swung around to starboard, began backing her engines to straighten herself in the current and keep off the bank.

Acting Volunteer Lieutenant C. A. French, who had been in command of the *Southfield*, and who with six officers and about thirty men had come aboard the *Miami* over the stern as his own vessel sank, had now assumed command of the *Miami*, and knowing that it would be folly to further resist the ram when the fire of his guns had no effect upon her armor, and where there was not room to avoid her terrible beak, he withdrew to the open water at the mouth of the river, the *Albemarle* doggedly following for some distance and receiving the fire of the *Miami* with unconcern.

Besides the people of the *Southfield* who got on board the *Miami*, a few others escaped by boat and were picked up by the *Ceres* and *Whitehead*; the remainder got ashore, where some fell into the hands of the enemy, and some ultimately escaped by hiding in the swamps. Flusser was the only person killed on the *Miami*; but that vessel had one ensign, two assistant engineers, and nine enlisted men wounded, mostly by pieces of her own shells. In the engagements of the two previous days the *Ceres* had one fireman killed and three assistant engineers, one master's mate, and four men wounded.

The *Albemarle* having thus obtained command of the river, preparations were at once made by General Hoke for assaulting the Federal fortifications about Plymouth, which assault was successfully made the next day (April 20), but not without severe loss, Ransom's brigade alone leaving five hundred killed and wounded men on the field in front of the breastworks east of the town. All day long the *Albemarle* held the river front and poured shell into the Federal intrenchments. Thus far the *Albemarle* was a success. She had accomplished the first act of her mission to wrest the waters of North Carolina from the invader, and within the limits of her intended field of operations she was the symbol of what men call the

dominion of the seas. Of the places remaining liable to her attack, Newbern was by far the most important, as the Union forces had recently been making it an important depot and supply station, and even as early as the time with which we are dealing stores were being assembled there in anticipation of the last stages of the grand movement of Sherman's army through Georgia, and then northward through the Carolinas. So the capture of Newbern was a move of vast importance to the Confederacy, and one to be prevented by the Federals at any cost.

News of the disaster at Plymouth traveled quickly, and the Navy Department made all haste to get a sufficient force into the Sounds to resist the progress of the *Albemarle* towards Newbern. One of the vessels hurriedly ordered to the scene of hostilities was the *Sassacus*, whose movements we will now follow. Lieutenant-Commander (now Rear Admiral) F. A. Roe was in command. The *Sassacus* left Hampton Roads just before midnight of Friday, April 22, and anchored at Hatteras Inlet at 6 the following evening; on Monday, the 25th, she crossed Hatteras bar, and soon after went aground on a sand-bar a mile inside known as the "Bulkhead," where she was delayed about twelve hours, and was disabled for a time by the condenser being filled with sand. Once inside the Sounds, she first visited Newbern, then the post on Roanoke Island, and finally, on May 3, went with other vessels up to the vicinity of Plymouth in the western end of Albemarle Sound.

Captain Melancthon Smith had been selected by the Navy Department to assume command of the naval forces in the Sounds, with special orders to devote his energies to the destruction of the *Albemarle*. The force he now had with him in Albemarle Sound consisted of the double-enders *Mattabessett*, Commander Febiger; *Sassacus*, Lieutenant-Commander Roe; *Wyahusing*, Lieutenant-Commander Queen, and *Miami*, Acting Volunteer Lieutenant French; the armed ferry-boat *Commodore Hull*, Acting Master Josselyn, and the little gunboats *Ceres* and *Whitehead*, commanded by Acting Master Foster and Acting Ensign Barrett respectively. The *Mattabessett* was the flag-ship. In Captain Smith's order of battle, issued on May 2, the *Mattabessett*, *Sassacus*, *Wyahusing*, and *Whitehead*, in the order named, were constituted the first or right line of steamers, the *Miami* being the leader of the second column. A council had been

held on board the flag-ship when the vessels were in the vicinity of Roanoke Island and the methods of attacking the ram discussed; the Department and Rear-Admiral S. P. Lee, who was in command of the North Atlantic blockading squadron, seem to have favored ramming, but Captain Smith was doubtful of this mode of attack, chiefly because of the peculiar construction of the "double-enders," they having an enclosed rudder in the bow as well as one at the stern. Captain Smith was hopeful of disabling the ram by paying out seines about her, to be caught and wound up in her propellers. In the order of battle it was directed that the vessels should pass alongside the ram as close as possible and pound her with their broadsides, then round to for a second discharge. The *Miami*, which had a torpedo fitted to her bow, was to seek every opportunity to use it. All vessels were to be ready to throw powder and shell down the ram's smoke-pipe, and also to have the fire-hose ready for throwing water into the smoke-pipe should it be found so capped as to prevent the introduction of powder and shell. Ramming was doubtfully referred to, and was left to the discretion of the commanding officers. Rear-Admiral Roe told the writer recently that he took the *Sassacus* into the action that ensued with the firm intention of ramming, saying that under the circumstances he believed it would be a good trade if he could disable the enemy by "expending his vessel, his crew, and himself."

At "turn to" after the men's dinner hour on May 5 the *Miami*, *Commodore Hull*, *Ceres*, and army transport *Trumpeter* got under way from their station in Edenton Bay, and steamed across the end of the Sound with the intention of planting torpedoes in the mouth of Roanoke River. When within a short distance of the buoy at the mouth of the river the *Albemarle* was discovered coming down, accompanied by the steamer *Cotton Plant* laden with troops, and the captured army gunboat *Bombshell* with coal and stores. The *Trumpeter* was dispatched as a herald in haste to give warning to the squadron lying about ten miles down the Sound, and the *Miami* and consorts, in accordance with previous instructions, slowly retired before the foe to take their places in the plan of battle as the second line as before described.

It was a beautiful day, clear and still, and as the *Albemarle* emerged from the river and moved slowly down the bay she pre-

sented a spectacle of concentrated, deliberate power that was viewed by the anxious watchers in the fleet with anxiety and and misgiving, but not with fear. Her iron plates had been covered with grease, and shone and glistened in the sun like the scales of a dragon. Formidable as the *Albemarle* seemed, it appears that the *Boombshell* was at first regarded with even more apprehension. She was a steam canal-boat, long and flat, formerly in use on the Dismal Swamp Canal, but had been converted into a river gunboat by the army authorities, and had fallen into the hands of the Confederates at the time they captured Plymouth. Her sides were notched or indented for the reception of a large number of small field pieces, and in the refraction caused by the slanting rays of the hot afternoon sun on the shimmering water this novel craft appeared magnified, distorted, and unreal to the Union naval officers, few of whom had ever seen her before.

As soon as the ram appeared in the Sound the vessels of the squadron began getting under way to form order of battle to meet her, and in this a delay of about half an hour occurred on account of the unreadiness of the flagship. The chief engineers of all vessels in the squadron had received orders to keep their fires in readiness for steaming at a moment's notice, which order had been supplemented later by another enjoining economy in the use of coal, schooners with a supply of the latter having failed to appear when due. The two orders were successfully reconciled by all the chief engineers, upon whom their execution devolved, except in the case of the *Mattabessett*, on which vessel an allowance of coal had been fixed by authority superior to the engineer and, as it proved, so small as to prevent the maintenance of the fires in a condition for use. The result was that when the enemy did appear, the *Mattabessett* was found wanting, and was indebted only to the slow speed of the enemy for being able to get into her position at the head of the first column before the ram was upon them. After the engagement the chief engineer of the *Mattabessett*, Mr. John T. Hawkins, was suspended from duty for the delay that had occurred, but as he had written a letter to his commanding officer informing him of the insufficiency of the coal allowance, he had reason to believe himself unjustly treated, and his view was supported by a court of inquiry which acquitted him of all blame in the matter.

At 4.40 P. M. the *Albemarle* opened the battle by firing a Brooke shell, which tore the launch of the *Mattabessett* into splinters and wounded several men, following it quickly by a second, which did considerable damage to the rigging. The *Albemarle* being headed directly for the *Mattabessett* with the intention of ramming, that vessel starboarded her helm and circled around the ram to port, giving her a broadside at very close range as she passed, afterward putting her helm to port to come on around the enemy's stern. As she crossed the wake of the *Albemarle* she came close up to the *Bombshell*, fired into that vessel and received her surrender, according to the official reports. Failing to strike the *Mattabessett*, the ram turned on the *Sassacus*, and that vessel narrowly escaped being rammed as she followed the lead of the flag-ship, she pouring in her fire against the iron sides of the enemy as she passed; then, with a port helm, she rounded the stern of the *Albemarle*, and fired a broadside into the *Bombshell* still lying there, which vessel in answer to a hail said she surrendered, at the same time hauling down the Confederate flag. The *Wyalusing* coming on next in line made a move to ram the *Bombshell*, learning only just in time to avoid striking that luckless craft that she had surrendered.

There was a controversy afterward as to whether the *Bombshell* had surrendered to the *Mattabessett* or the *Sassacus*, but the weight of evidence from the official reports, viewed at this distance by one who has no interest in the dispute beyond a desire to get at the facts, points to the conclusion that the *Sassacus* was the captor. When the battle was over, the crew of the *Bombshell* was on board the *Sassacus*. The engine-room log-book of the *Sassacus* records the fact that in the eight to twelve watch that evening an assisant engineer and some engine-room men went on board the prize to take charge of the machinery. Lieutenant Hudgins, who had commanded the *Bombshell*, when asked about the matter and not knowing that there was any dispute about it, replied readily that he had surrendered to the *second* in line, which was the *Sassacus*.

As the first column of vessels passed around the starboard side of the *Albemarle* that vessel kept turning towards them with her helm apart until by the time the *Mattabessett* and *Sassacus* had gotten well across her wake she had turned almost around and was headed in the opposite direction, that is, towards the mouth of the river

whence she came. This turn brought the *Mattabessett*, which vessel had continued on in her circling course, constantly firing, almost astern, while the *Sassaous*, thrown considerably out of line by her affair with the *Bombshell*, was almost abeam of the ram, and at a distance given at from three hundred to five hundred yards in the various reports. Roe saw the chance for which he hoped, and shouted to his navigator, "Can you strike her?" "Yes," answered Boutelle. "Then go for her!" As before stated, Commander Roe intended to ram if he got a chance, and this intention he had communicated to his officers. Mr. Boutelle, as the navigator or sailing-master, had entered into an understanding with Mr. Hobby, the chief engineer, to inform him should the attempt be made. Accordingly, after ringing the signal for full speed and laying the course for the enemy, he went to the engine-room skylight and shouted down to Hobby that the time had come.

There was then a pressure of thirty pounds in the boilers, which was ten pounds, or about fifty per cent., more than usually carried; the steam valves were set to cut off at about half stroke. In order to utilize the full force of the steam, the chief engineer resorted to an expedient known as "gagging" the engine, the hand working-gear being called into play to hold the steam valves open after their automatic closing had been effected by the toes on the rock-shaft. This was a task requiring a quick eye, good judgment and a high order of courage and self-reliance, for an error in working the valves of a fraction of a second at either end of the stroke would have defeated the object and destroyed the power of the engine by opposing pressure on both sides of the piston, while the danger of disaster in thus driving a heavy engine at an abnormal pressure was great. Mr. Hobby, however, had sufficient self-confidence and nerve to assume all risks involved, and imposed upon himself this dangerous post in order to get the greatest power from his machine and consequently the greatest speed from the ship. He thus became the active agent in driving the ship onward, just as an oarsman urges forward a racing boat, except that in his case the power of eight hundred horses followed up each motion of the lever that he controlled, and instead of moving a small boat he was giving momentum to a projectile weighing nearly twelve hundred tons with which to strike the enemy.

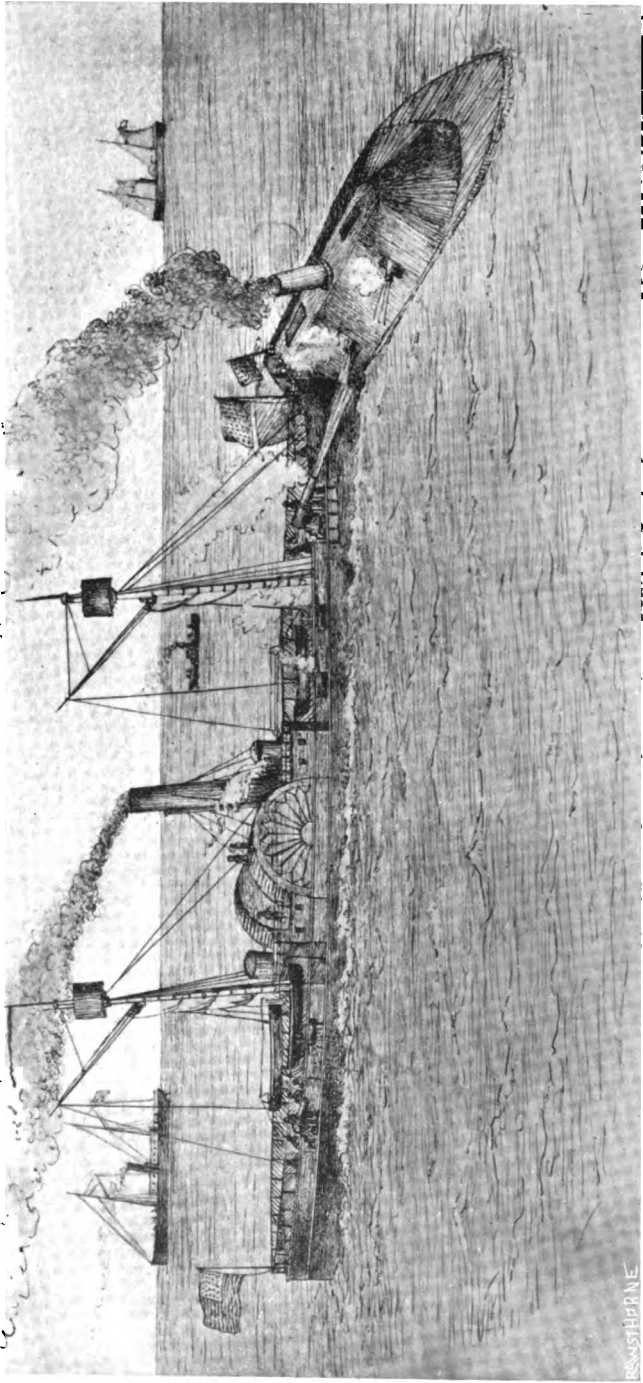

ACTION BETWEEN THE SASSACUS AND ALBEMARLE.
May 5th, 1864.

The *Sassacus* struck the *Albemarle* squarely abaft her starboard beam, and in line with the after end of the casemate, with a speed of nine or ten knots, the engines making twenty-two revolutions with thirty pounds of steam. The force of the blow drove the bronze stem of the *Sassacus* several feet into the timber belt of her antagonist and in all probability started her to leaking. The ram heeled considerably over towards the side on which she had been struck, so much so in fact that a quantity of large stones lying on her after-deck, probably to weigh her down to bring her knuckle into the water, fell overboard, making a great racket as they tumbled and slid across the deck. Hoping to ride her enemy down, the *Sassacus* kept her engines running ahead at full speed while in contact (about thirteen minutes), a furious fire of small-arms being maintained during that period. The constant pressure against the ram considerably abaft her centre of gravity tended to swing her around, which tendency was overcome to some extent by her own motion in going ahead, but eventually the resultant of these two forces so changed the angle between the ships that the starboard battery of each could be used, which advantage was quickly availed of by both; as soon as the *Sassacus* came under the range of the *Albemarle's* guns the after one was fired, its shot passing diagonally through the berth-deck, but doing no material damage; this shot was immediately followed by a similar one from the forward gun, which shot, entering the *Sassacus* abreast of the foremast four feet above the water on the starboard side, crushed obliquely through the side, cutting through the back of a hanging-knee and leaving the inside of the ceiling about seven and one-half feet abaft where it first struck on the outside. From thence it passed through the throat of the next hanging-knee, through the dispensary and bulk-head, starboard coal-bunker, passing on through the starboard boiler, and, keeping on through the engine-room, cut in two a three-inch stanchion, thence through steerage and wardroom bulk-heads, smashing doors and sideboard, cutting through magazine-screen, when, striking an oak stanchion,—which it splintered,—it glanced at right angles and lodged in one of the starboard state-rooms.

The havoc wrought in the engine-room by this shot is best told by the engine-room log for the first dog-watch of that eventful day:

“About 6 p. m. she succeeded in getting clear of us and fired a solid shot, which passed through the berth-deck and forward coal-bunker, then entering forward end of starboard boiler seven feet from front and fourteen inches from top, passing out the after end three feet from front and fourteen inches from top, cutting away in its passage stays, T-irons, and dry-pipe and steam and exhaust-pipes for Woodward pump; then passed the length of engine-room between cylinder and condenser, cutting away a three-inch stanchion and discharge-water thermometer, and badly bending exhaust unhooking gear; thence through after bulkhead. The rush of steam was instantaneous, driving all hands out of the engine and fire-room, killing Thomas Johnson, coal-heaver, instantly and severely scalding First Assistant Engineer J. M. Hobby and the following men.” Then follow the names of fourteen firemen and coal-heavers, and some other information, including the statement that the engines continued to run on a vacuum until 6.35 p. m.

Pandemonium then reigned. The howl of the escaping steam from the overcharged boilers completely drowned all other sounds, even the discharge of the guns, while the steam gathered in a dense cloud over the ship, shutting off her vision so completely that the enemy close alongside could not be seen. The men on deck were bewildered by the sudden calamity and demoralized at the horrible spectacle of their scalded comrades rushing up from below frantic and screaming in agony. Order was finally restored by the officers leading the men to repel boarders on the starboard bow, although there is no record that any attempt was made by the enemy to board. The men being thus reorganized were returned to their guns, and began firing again as soon as the ram could be seen, the first proof to the on-lookers in the surrounding ships that the *Sassacus* was not destroyed being the bright flash of her guns bursting out of the cloud that hung over her. The annals of naval warfare contain few instances of persistence and dauntless courage in adversity that can match this exhibition made by the *Sassacus*. The interval during which the engines continued to run was availed of to get the ship clear of the enemy and out of the way of the other gunboats so they would be free to attack: in getting clear the starboard paddle-wheel rode over the stern guard of the *Albemarle* and was “tangled up

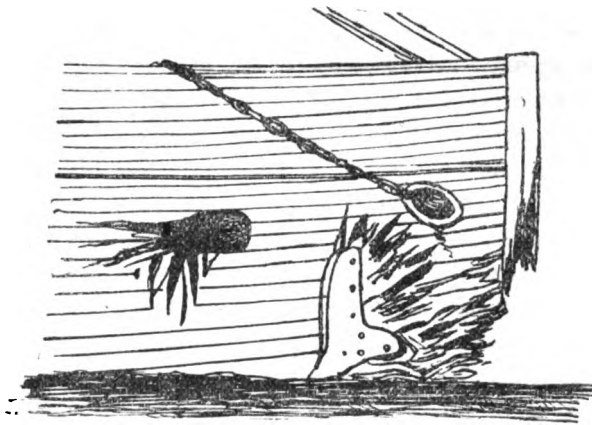

APPEARANCE OF BOW OF "SASSACUS" AFTER THE BATTLE.

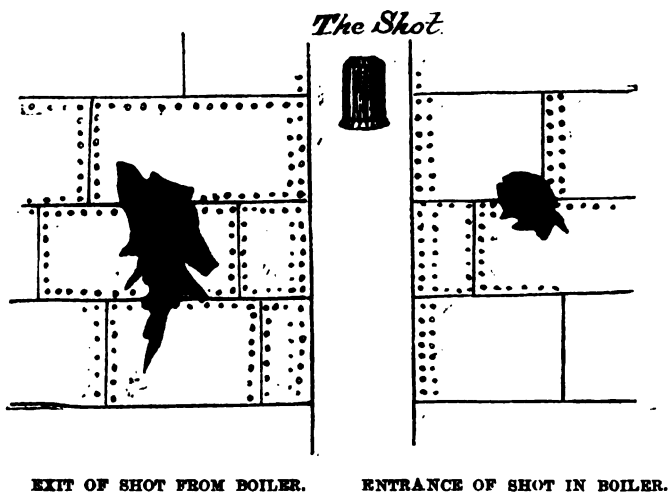

EXIT OF SHOT FROM BOILER.

ENTRANCE OF SHOT IN BOILER.

like a cobweb," as Admiral Roe expressed it to the writer. The false stem of the *Sassacus* was so bent out of line that she steered very badly, and on her subsequent voyage to Hampton Roads she was obliged to steam backward in consequence.

In the midst of all the horrors before described, the chief engineer, although badly scalded, stood with heroism at his post; nor did he leave it until after the action was over, when he was brought up helpless to the deck. For some reason, which is not clearly stated in any of the reports, it was impossible to cut off the connection between the two boilers, so that steam from the port boiler, rapidly generated by the fierce fires in its furnaces, continued to pour out of the holes in the other boiler, thus maintaining the cloud that hung over the ship and embarrassing her movements; in this emergency Mr. Hobby saw that the fires must be hauled, not only to stop the out-rush of steam, but also to prevent the complete disabling of the ship by burning the sound boiler, not to mention the danger from its possible explosion. By his voice and example, injured as he was, he rallied some of his men and led them into the fire-room, where the necessary work was done, he doing a good part of it personally with his scalded hands. So modest was this brave man that in his official report of the engagement he dismisses this incident with the following words: "The steam so filled the engine and fire-rooms that it was with the greatest exertions on the part of the engineers that the fires were hauled." In those days of war, when all on board a ship were equally exposed to danger, and when all contributed to the fighting qualities of the ship as a unit, it was customary to accord credit for duty well done to all deserving it, irrespective of corps: accordingly we find in the reports of the commander of the *Sassacus* that praise for the conduct of Mr. Hobby which is always accorded by one brave man to another who has shared the danger and assisted to his utmost in an endeavor common to both. In the hurried report made at midnight after the battle occurs the following: "The chief engineer, Mr. Hobby, is badly scalded, but most nobly and heroically remained at his post, and saved us from a worse disaster, of explosion to the other boiler and of being helpless."

In the fuller and more complete report made by Lieutenant-

Commander Roe the following day, he speaks highly of all his officers, and of the chief engineer in the following terms :

“To the heroism and devotion of First Assistant Engineer J. M. Hobby the government is probably indebted for the preservation of the *Sassacus* from a worse disaster. While every one who could was forced to seek safety by flight from the scalding clouds of steam, Mr. Hobby stood at his post by the machinery, and though fearfully scalded himself, he cared for his machinery until the engine finally stopped. If it were possible to promote this officer, I earnestly and devoutly beg it may be done, for I consider that it has been amply and professionally won.”

The medical journal of the *Sassacus* shows that Mr. Hobby was on the sick list for his injuries about three weeks, and that four of the scalded firemen subsequently died. The surgeon attributes the comparatively quick recovery of Mr. Hobby from injuries that were almost as serious as those of any of the men to the rare presence of mind shown by him in covering his burns with oil the moment he received them. A very simple remedy, and one that is well worth remembering.

As soon as the *Sassacus* was well clear of her antagonist the engagement again became general, and the ram was furiously assailed, especially after the order of battle had been restored and the vessels thus enabled to operate without danger of injuring each other. Shot and shell were poured upon the sloping sides of the enemy; seines were paid out almost encompassing him, but without success, and the *Miami* tried in vain to use her torpedo, being thwarted in this endeavor by her own slow speed and bad steering qualities. Finally, as twilight approached, the *Albemarle* headed up the Sound and proceeded slowly to the mouth of the Roanoke River, which she entered never again to emerge from. The extent of her damages has never been satisfactorily known, but it is certain that she was so much injured as to be glad to withdraw from the fight, and unwilling to renew it on another day. That the blow from the *Sassacus* did her considerable damage cannot be doubted; the muzzle of one of her guns was knocked off, although she pluckily continued to use it; several shot and shell were believed to have entered her ports, and

her plaiting was observed to be much injured. An idea of the terrible pounding she received can be gained from the fact that over four hundred and sixty shot and shell were hurled against her at close range, this number not including the expenditures of the *Sassacus*, which are not given in the official reports.

The casualties on the *Albemarle*, if any, have never been known. Those of the Federals were confined to the three largest double-enders, and were: *Mattabessett*, two killed, six wounded; *Sassacus*, one killed, nineteen wounded; *Wyalusing*, one killed. Included in the number of wounded here given are the four firemen of the *Sassacus* and one man of the *Mattabessett* who subsequently died of their injuries.

The *Albemarle* returned unmolested to her fastness in the river at Plymouth, and, although she was not conquered, the result of the engagement may be regarded as a Federal victory, inasmuch as the object of the *Albemarle* was defeated: she had failed to win the supremacy of the Sounds, and Newbern remained safe from her attack. That all of the vessels in Captain Smith's command that were in the engagement performed their share in effecting this result is evident from the official reports; but as the details of this struggle become dim with the lapse of years since the roar of hostile cannon has been heard in Albemarle Sound, there is one point that rises above all others and becomes more and more prominent, and that is that the *Sassacus* was the ship that issued boldly forth from the line of battle and threw down the gage of single combat to her powerful antagonist. If praise is due to one ship more than to another we cannot help awarding it to the brave little *Sassacus*.

As soon as possible after the *Sassacus* had dropped out of the fight her engineers set to work to repair damages as far as circumstances would permit. Her engine-room log-book shows that the necessary alterations in the steam connections were completed, water run up in the port boiler, and fires started again in that boiler at 10.45 the same evening, and that at 3.30 the next morning, only about nine hours after the shot had passed through her boiler, the engines were reported ready for service. With the repairs effected by her engineers' force the ship remained in the Sounds on active service for more than a month, always steaming with one boiler, and finally steamed north and went on duty in James River without any more extensive repairs.

When the reports of this engagement had been received and considered in Washington, many of the officers of the *Sassacus* were commended by the Navy Department and promoted for gallantry in battle. Acting Masters Muldaur and Boutelle were appointed acting lieutenants; Acting Ensign Mayer, who had personally fought the forward pivot rifle, and whose shot was supposed to have been the one that knocked the muzzle off one of the enemy's guns, was made an acting master, and Acting Assistant Paymaster Barton, who had served as signal-officer and aid to the commander during the engagement, was appointed an assistant paymaster in the regular service. Lieutenant-Commander Roe was advanced *five* numbers in his grade. After reading of the advancement of a number of officers of a whole grade, one naturally wonders that their commanding officer who had led them in the fight, and whose bravery had made their promotion possible, received no greater reward than this; but on this matter the records contain nothing beyond the mere statement of fact.

The chief engineer, who had been freely voted the hero of the occasion by his associates, was overlooked in the distribution of awards and it was not until a year and a half after the battle, the war then being many months ended, that he received the recognition that was his due and was advanced in his grade in accordance with the following notification sent him by the Secretary of the Navy :

“SIR : By and with the advice and consent of the Senate you are hereby advanced thirty numbers in your grade, to take rank next after First Assistant Engineer Finney, for distinguished conduct in battle, and extraordinary heroism as mentioned in the report of Lieutenant Commander Francis A. Roe, commanding the U. S. steamer *Sassacus* in her action with the rebel ram *Albemarle* on the 5th of May, 1864. I have the pleasure to transmit herewith your warrant, the receipt of which you will acknowledge to the department.

“Very respectfully,

“GIDEON WELLES,

“*Secretary of the Navy.*”

The *Albemarle* remained at Plymouth, inactive but a constant

menace to the Federals and making necessary the maintenance of a large naval force in Albemarle Sound in anticipation of her again attempting to dispute the supremacy of those waters. A daring attempt to destroy her was made the night of May 25th by some of the enlisted men of the *Wyabusing*, who conceived an excellent plan of attacking her with torpedoes, and were allowed to try the experiment without any official oversight or direction. The plan, briefly stated, was to get in the river above the ram and float down upon her two large torpedoes joined by a line or bridle, these after getting across her bows—one on either side—to be exploded by means of a hauling line in the hands of a man hidden on shore. The torpedoes, containing 100 pounds of powder each, were carried by the men on a stretcher through the swamps until a proper position was reached, when they were connected and one of the men, Charles Baldwin, coal-heaver, assumed the really heroic task of swimming down the river with them to guide them upon the *Albemarle*. The programme was accidentally interrupted by fouling a schooner, and when Baldwin finally got within a few yards of the ram he was discovered and fired upon, this thwarting the attempt and obliging the men to hide in the depths of the neighboring swamps to avoid capture. Three of them got off to their ships the second day and the other two, two days later, all having suffered much from exposure and hunger. The names of these gallant men were John W. Lloyd, coxswain; Allen Crawford and John Laverty, firemen, and Charles Baldwin and Benjamin Lloyd, coal-heavers. All received the medal of honor prescribed by Congress for bravery.

Late in October Lieutenant William B. Cushing arrived in Albemarle Sound with a large steam launch fitted with a spar torpedo, he having some time before been selected on account of his reputation for intrepidity for the perilous undertaking of assailing the ram with this instrument of destruction. The launch with the torpedo and all attached gear had been carefully fitted out at the New York navy yard by Chief Engineer William W. Wood and First Assistant Engineer John L. Lay, the torpedo being known in the service by the name of the latter, although it is well known that the perfection of its details was the work of Mr. Wood. The crew of the picket launch, besides Lieutenant Cushing, consisted of W. L.

Howarth, acting master's mate; William Stotesbury, acting third assistant engineer; Samuel Higgins, first class fireman, and Lorenzo Dening, Henry Wilkes and Robert H. King, landsmen. When ready for the attack this crew was increased by volunteers from the ships of the squadron as follows: Francis H. Swan, acting assistant paymaster; Charles L. Steever, acting third assistant engineer, and Thomas S. Gay, acting master's mate, from the *Otsego*; William Smith, Bernard Hartley and E. J. Houghton, ordinary seamen, from the *Chicopee*; Richard Hamilton, coal-heaver, from the *Shamrock*; and John Woodman, acting master's mate, from the *Commodore Hull*. With these additions the crew numbered fifteen all told.

The night of October 27th Cushing set out on his mission, having the second cutter of the *Shamrock* with a crew of eleven men and two officers in tow, this boat being taken along with the ambitious design of capturing the ram by boarding and bringing her out of the river uninjured. When near the ram this part of the programme was frustrated by discovery and the cutter was cast off and sent back, her crew boarding the wreck of the *Southfield* on the way down the river and taking as prisoners therefrom four Confederate pickets whose neglect of duty had permitted the boats to pass up close by them without discovery. Without answering the repeated hails from the *Albemarle* and ignoring the fire of musketry opened upon him and by which Paymaster Swan was wounded, Cushing steamed up the river past the ram, swept around in a circle, and rushed at her bows on, the impact being sufficient to breast in a boom of logs about the vessel and reach near enough to use the torpedo, which was trained into position and the firing line pulled by Cushing, standing on the bow of his boat, just as one of the *Albemarle's* guns directly overhead was depressed and fired. A large hole was blown in the side of the ram and she sank at her moorings in a short time.

Refusing the summons to surrender, Cushing told his men to look out for themselves and with them took to the water as their launch swamped from the effects of the explosion. Acting Master's Mate Woodman and Fireman Higgins were drowned; Cushing and Houghton, after much suffering and hardship, regained the squadron, and the others were made prisoners. In Lieutenant Cushing's report he made special reference to the coolness and gallantry of

Master's Mate Howarth and Engineer Stotesbury. This daring achievement led to the capture of Plymouth a few days later, removed all apprehension as to the safety of government supplies at Newbern, and released for service elsewhere the large squadron of vessels that had been kept so long in Albemarle Sound to guard against another raid of the ram. Cushing himself received the thanks of Congress and was promoted to be a lieutenant commander, he being at that time only twenty-one years of age, and all the officers who shared the expedition with him were advanced one grade for conspicuous gallantry; the enlisted men were advanced in ratings and all received the medal of honor for distinguished service and bravery.

Immediately after Cushing's return with the tidings of the sinking of the *Albemarle*, Commander Macomb, in command of the squadron known as the Naval Division of the Sounds of North Carolina, moved against Plymouth, but because of sunken vessels in the Roanoke River could not approach close enough to deliver the attack successfully. He then took his vessels by way of a branch outlet into the river above Plymouth and on the 31st of October descended upon that place and captured the enemy's batteries after a severe and well-fought engagement. Besides Macomb's vessel, the *Shamrock*, the attacking force consisted of the *Otsego*, Lieutenant Commander Arnold; *Wyalusing*, Lieutenant Commander Earl English; *Tacony*, Lieutenant Commander W. T. Truxton, all double-enders, and the armed ferry-boat *Commodore Hull*, Acting Master Josselyn. The tugs *Whitehead*, *Bazley*, and *Belle* were lashed to the unengaged sides of the three first named double-enders in accordance with the tactics established by Farragut at Port Hudson and Mobile. To guard against the distressing casualties and disablement of ships that had occurred in other engagements from boilers being struck by shot, steam was blown off the boilers on the engaged sides of the double-enders and fires in those boilers kept low banked to keep the water warm so that steam could be quickly raised when wanted. All these vessels, and others generally throughout the navy, were fitted by their engineers with appliances for closing the boiler stop-valves from deck, the affair of the *Sassacus* having demonstrated the necessity for such precaution.

The battle at Plymouth took place early in the morning of

October 31st, and, as before stated, resulted in the capture of the enemy's batteries, the town of Plymouth, and the partly submerged ram *Albemarle*. The latter was eventually raised and taken to Norfolk, where the material of which the vessel was built was sold for the benefit of the Navy Department. In this battle Commander Macomb's squadron suffered a loss of six men killed and nine wounded, the senior engineer of the *Shamrock*, Mr. W. H. Harrison, being one of the latter. The control of the ships while under way and in action in the narrow and intricate river put a difficult and responsible duty upon the engineers, which was performed with credit, as shown by the following complimentary references in the reports of commanding officers:

Shamrock: "The engineers' department, under Second Assistant Engineer W. H. Harrison, was very efficient."

Otsego: "The precaution taken by Acting First Assistant Engineer Samuel C. Midlam (in charge of this vessel's engines) to meet any mishap that might have occurred to her boilers or engine merits my approbation, and the prompt manner in which the whole engine corps performed its duty during the engagement was most satisfactory and creditable to it."

Wyalusing: "In conclusion, I cannot refrain from mentioning the handsome manner in which the engine was worked, under the supervision of Chief Engineer H. H. Stewart, through the whole engagement, and likewise on the day previous, while passing the narrow bends in Middle river."

Tacony: "The engineer's department, under its very efficient chief, First Assistant Engineer Thomas M. Dukehart, performed its duties in the most satisfactory manner."

The reward received by Cushing and his crew in the form of prize money was very considerable, as the prize law directed that when the captured vessel was of superior force to the one making the capture, as was the case in this instance, the whole of the prize money should be distributed among the captors. In 1865 the Navy

Department fixed the value of the *Albemarle* at a little less than \$80,000, probably very near her true value, which amount was distributed to the crew of the picket boat or their heirs, but it afterward transpiring that property, acquired as a result of Cushing's exploit, of the net value of \$282,856.80 had been applied to public use, the case was re-opened by direction of a special act of Congress and by virtue of the reappraisal Congress appropriated \$202,912.80, the difference between the former award and the new appraisal, which was distributed in 1873.

The case became very much involved, Cushing being paid on the basis of his salary instead of being awarded one-tenth of the whole as commander of the capturing vessel, and he and some of the other officers had their shares computed upon the rates of pay of the higher grades into which they were promoted after the event, while others received only the share to which their rate of pay entitled them, this latter being the proper apportionment as provided by law. As a result of the illegal method followed, some of the beneficiaries were very much overpaid, while others suffered in consequence and received less than their true shares. The matter finally got before Congress in the form of a bill which was favorably reported by the Naval committee, but never became a law, and as the original appropriation had been distributed those who were wronged got no redress. An interesting item connected with the last Congressional investigation of the matter was the testimony of Admiral Porter before the naval committee, he stating that the *Albemarle* had cost the Confederates \$1,500,000, and could not have been built and equipped as she was, in Northern shipyards, for less than \$800,000, which opinion shows that a man may become eminent in a profession without being familiar with the practical business details upon which it is founded. The following table, taken from the report of the naval committee (Report No. 97; 45th Congress, 2d Session) exhibits the actual distribution of this prize money, with the amount received by each officer and man, or their heirs, and the amount that each was over or underpaid.

Rate of Pay Adopted.	True Rate.	DISTRIBUTION MADE.	True Shares.	Overpaid.	Underpaid.
\$1,875	to	Admiral Porter	\$3,864.98	\$9,791.82	\$13,656.75
2,342	to	Commander Breese	772.98	1,968.37	2,731.35
	to	Commander Maccomb.....		5,462.70	5,462.70
	to	Lieutenant Cushing.....	15,112.50		
		Same afterwards as Com-		38,103.69	56,056.27
		mander	2,840.08		
1,200	\$ 480	Master's Mate Howarth.....	9,194.66	24,394.17	35,887.50
1,500	480	Same afterwards as Master	3,898.81	24,841.19	16,745.48
1,200	1,300	Master's Mate Gay	10,477.97	20,624.53	45,352.32
	1,000	Paymaster Swan	8,060.00	15,865.00	23,925.00
	1,000	3rd Asst. Engr. Stokesbury	8,060.00	15,865.00	23,925.00
	1,000	" " Steever	3,888.81	7,615.19	11,484.00
	480	Master's Mate Woodman.....	2,901.50	5,711.51	8,613.01
	360	Fireman Higgins	1,934.41	3,807.60	5,742.01
	240	Coal-heaver Hamilton.....	1,547.53	3,046.07	4,593.60
192	192	Ordinary seaman Houghton	1,547.53	3,046.07	4,593.60
192	192	" " Harley	1,547.53	3,046.07	4,593.60
188	188	" " Smith	1,354.09	2,665.31	4,019.40
168	168	Landsman King.....	1,354.09	2,665.31	4,019.40
	168	" Wilkes	1,354.09	2,665.31	4,019.40
	168	" Denning	1,354.09	2,665.31	4,019.40
		Amount for distribution	81,960.18	191,174.91	273,135.09
			77,298.70	196,896.89	
		Difference	4,661.48		
				59,849.80	59,849.80
				11,964.52	\$14,249.82
					10,961.40
					10,961.40
					5,261.48
					3,946.09
					2,630.72
					2,104.60
					2,104.60
					1,941.53
					1,841.53
					1,841.53

CHAPTER XXVI.

“ An examination of facts is the foundation of science.”

CHAS. H. HASWELL.

1864. The Civil War, Continued—New Ships and Machinery Begun—The *SERAPIS* Class—The *RESACA* Class—Competitive Machinery of the *QUINNEBAUG* and *SWATARA*—The *STROMBOLI*, or *SPUYTEN DUYVIL*—The Light-Draft Monitors—Petition of the Engineer Corps Addressed to Congress and its Results.

THE work of building a great steam navy, so vigorously prosecuted during the three preceding years, went forward in 1864, but with a less number of new vessels projected, and of these still fewer ever reached completion. One more of the large swift cruisers of the *Wampanoag* class was ordered and the machinery at once begun at the Washington navy yard, the keel of this vessel, which was given the name of *Bon Homme Richard*, was never laid, and the ship, therefore, never existed except on paper; but the engines, of the 100-inch geared type, like those of the *Wampanoag*, were carried to completion in the course of about four years, and remained in store at the Washington yard for many years, being finally broken up and the material used for various purposes.

Eight screw-sloops of 2,400 tons displacement, slightly larger than the *Shenandoah* class, were projected in 1864, and named *Algoma*, *Confiance*, *Detroit*, *Meredosia*, *Peacock*, *Serapis*, *Taghkanic*, and *Talledaga*. Of these only one, the *Algoma*, built at the Kittery navy yard, was ever constructed, she being launched in 1868, and continued in the service, the name being changed in 1869 to *Benicia*, until 1884, when she was sold at Mare Island for \$17,000. The Bureau of Steam Engineering, carrying out its instructions, undertook the work of building engines for these ships at the navy yards, several of the yards being by this time supplied with suitable tools, and four sets of the engines required were commenced at each of the yards at Boston and New York. They were of the usual Isherwood back-acting type, the cylinders being 50 inches diameter by 42 inches stroke. One pair of these was erected in the *Benicia*, and three pairs went into some vessels built in 1868—the *Alaska*,

Omaha and *Plymouth* (originally named *Kenosha*); the other four sets were converted into compound engines for vessels built or re-engined in 1872-1880.

Six smaller screw-sloops, of what was known as the *Resaca* class, were also projected this year, and four of them were launched eventually at navy yards as follows: The *Swatara* at Philadelphia, May, 1865; the *Resaca* at Kittery, November, 1865; the *Quinnebaug* at New York, March, 1866; and the *Nantasket* at Boston, August, 1867. The other two, named *Alert* and *Epervier*, were never built. The four completed were each 216 feet long and about 12 feet mean draft, the *Nantasket* and *Resaca* being 31 feet beam and 1,129 tons displacement, and the other two 30 feet beam and 1,113 tons displacement. The engines of the *Swatara*, *Resaca* and *Nantasket* were of the Isherwood design, with cylinders 36"x36", and were built at navy yards, the two former at Washington and the latter at Kittery. By direction of Assistant Secretary Fox the engines for the *Quinnebaug* were contracted for in England, with Jackson & Watkins, of London, the object of this unusual proceeding being to subject the machinery designed by the Bureau of Steam Engineering to a competitive test with that produced by the best English practice. The *Quinnebaug's* model was altered for the reception of twin screws to suit the English machinery, which consisted of two pairs of two-cylinder engines with cylinders 38 inches in diameter by 21 inches stroke of piston. The grate surface of the boilers was 114 square feet, while that of the other sloops of the class was 210 each. The English engines were designed on the high expansion principle, the valves cutting off at one-fourth stroke, while Isherwood's engines cut off at six-tenths of the stroke.

The machinery for the *Swatara*, the sister-ship of the *Quinnebaug*, was nearly completed when the contract for the machinery of the latter was made, and the contractors were informed of the exact dimensions and arrangement of the machinery against which they were to compete. They believed, however, that with twin screws and the high rate of expansion adopted, their area of grate surface would give better results in speed and economy than the Bureau's design. The result was greatly to the disadvantage of the English engines. The *Swatara* on her steam trial near Hampton Roads made twelve geographical miles per hour, while the *Quinnebaug's*

best effort in New York harbor was seven geographical miles, both vessels burning the same kind of coal and having the same conditions of trial as nearly as possible. The *Quinnebaug* made one cruise of about three years' duration on the Brazil station and was then laid up; she subsequently was rebuilt and received a pair of the 50"x42" Isherwood engines, converted into compound engines.

The *Alert* and *Epervier* were never built, but the Bureau of Steam Engineering carried out the Department's order and constructed machinery for them, that for the *Alert*, built at Kittery, being exactly like the machinery of Bureau design put into the other ships of the class. The *Epervier's* engines were of the same back-acting type but the proportional dimensions of the cylinders were changed, they being 36 inches in diameter and 48 inches stroke; they were built at the Washington navy yard and were of remarkably excellent workmanship and quality, the forged parts of them being of steel, which was the first use of that material for such purpose in our navy or in the engine practice of the country. In 1870 these engines were prepared for erection in the *Quinnebaug* in place of the defective English engines, but before the work of altering the vessel to receive them was completed it was determined to fit her with compound engines, and the *Epervier's* engines were soon after shipped to the Norfolk navy yard for stowage. In 1876 they were exhibited at the Centennial Exposition in Philadelphia as an example of excellence in navy yard work, and were thereafter stowed at the Norfolk yard until as late as 1894, when an order was reluctantly given by the engineer-in-chief to break them up and make use of the material, the changes in marine engine practice having precluded the possibility of their ever being made use of.

At the time Mr. Fox ordered a contract made for the engines of the *Quinnebaug* in England, a pair of 36" x 36" Isherwood engines for that vessel were practically completed at the Washington navy yard; there being thus no ship for this pair of engines they were sent to the Naval Academy in 1866 and erected in the new department of steam engineering at that institution, where they have remained ever since, a valuable object lesson originally to the cadet engineers of much that was excellent in marine engineering, but eventually transformed by the changing years into relics of what has been and is no more.

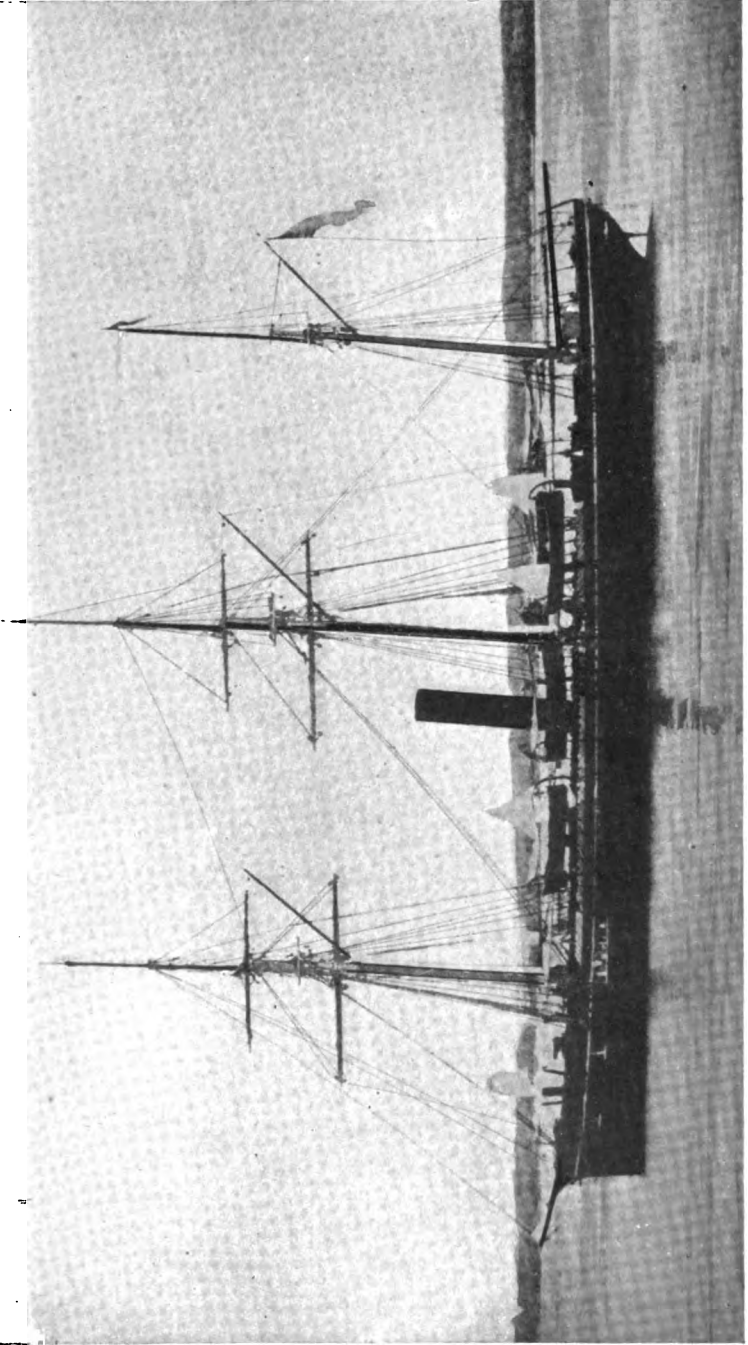

U. S. S. RESACA. 1867.

Contracts were made this same year for the *Pinta* class of large iron sea-going tugs, designed to carry two guns and to be of general usefulness in the operations of war. The class embraced nine vessels in all, six being built by James Tetlow, Boston; two by Reany & Archbold, Chester, Pa., and one, the *Triana*, by Wm. Perrine, New York. Their cost complete varied from \$84,640 to \$128,000 each. The principal dimensions were, length, 137 feet; beam, 26 feet; displacement, 420 tons, and registered tonnage 350. Three of these steamers—the *Fortune*, *Mayflower*, and *Standish*—in after years became familiar and not especially beloved objects to the youth of the engineer corps as practice vessels for summer cruising from the Naval Academy. Two smaller tugs, the *Pilgrim* and *Maria*, of 170 tons each, were also built in 1864 by contract, and several other smaller ones were undertaken at navy yards, the events of the war having shown the value of such vessels in carrying on warlike operations.

Continued Confederate successes with torpedoes finally forced the Navy Department to give attention to that weapon, on the principal of fighting the devil with fire, and proposals were issued inviting inventors to submit plans for boats and torpedoes to use with them. Many designs were submitted, from which those of Chief Engineer W. W. Wood and First Assistant John L. Lay were accepted and the work of constructing the boats and torpedoes begun under the direction of these engineers in the spring of 1864. Wood and Lay's plans embraced two projects; one of fitting large steam launches with a torpedo on a spar, and the other of building a regular armored torpedo boat like a small monitor and equipping it with a torpedo on the end of a long bar operated by steam, both of which plans were accepted. A number of steam launches were fitted out and supplied with torpedoes by Wood and Lay during the the summer of 1864 and one of these was the boat placed at the disposal of Lieutenant Cushing and with which he sank the *Albatross*.

The spar was carried in suitable supports or crutches alongside the boat and could be run forward and the end submerged to the desired depth by attached ropes. The torpedo consisted of a cylindrical copper case held in a scoop at the end of the spar and so overlooped by a line that it could be thrown out of the scoop when

desired. It was only partly filled with powder, the remainder of the case being an air chamber separated from the powder by a partition, the two parts being so proportioned that the specific gravity of the whole was slightly less than that of water. Running down from the air-chamber end was a tube with a fulminate cap in its lower end near the bottom of the powder space and provided with a grape-shot held in the upper end by a pin working through a stuffing box, and to which a hauling line was attached. When used, the spar and torpedo were lowered under or near the object to be attacked and the torpedo thrown forward from the scoop by means of the first line. Its construction then caused it to float with the air end uppermost and with a tendency to rise to the surface or against the bottom of the attacked vessel. By pulling the second line the pin could then be withdrawn, causing the grapeshot to fall upon the cap and explode the charge of powder. Besides the torpedo these picket boats were armed with one 12-pounder boat howitzer mounted on the bow.

The other plan resulted in the building of a torpedo boat by contract with Samuel H. Pook of New Haven, Conn., which was first named *Stromboli* but soon afterward changed to *Spruten Dnyvil*. To this vessel Lieutenant Commander Barnes, writing a treatise on submarine warfare, in 1868, referred to as "the most formidable engine of destruction for naval warfare now afloat of which the public have any knowledge." The contract for this boat, dated June 1, 1864, required that "for the consideration hereinafter mentioned, he will construct upon the plan of Mr. Wm. W. W. Wood, Chief Engineer, U. S. Navy, a torpedo vessel in accordance with specifications herewith attached, of the following dimensions, viz: length of keel, 75 feet; breadth of hull, 19½ feet; depth of hold 9 feet more or less." As actually built the boat was 84 feet 2 inches long; 20 feet 8 inches extra beam; 7 feet 5 inches draft, and of 207 tons displacement. The total cost was \$45,036.29.

When going into action the draft was increased to about nine feet by admitting water into sinking tanks, thereby lessening the exposure above water. The deck was covered with three inches of iron; the sides with five inches, and the pilot-house with five inches. The torpedo was the same in principle as the one fitted to the picket boats, but was so much larger that it was worked by machinery

which ran the torpedo-bar out through a water-tight box and gate-valve in the bow, the detachment and firing of the torpedo being automatic when the extreme reach of the bar was attained, and at the same time the return motion of the bar was begun. When the bar had returned to its inboard position the gate-valve was closed, the water-box pumped out, which could be done in a few seconds, and everything was then ready for attaching another torpedo. The weight of the torpedo handling machinery was ten tons while that of the motive engine was only two and one-half tons.

The *Spytten Duyvil* was in service in the James River during the last months of the war and had the honor of taking President Lincoln to Richmond when he visited that city after its abandonment by the enemy. She subsequently made extensive use of her torpedoes by blowing up the obstructions that had been placed in the river by both Union and Confederate combatants. After the war she remained for many years at the New York navy yard and was subjected to many improvements by her inventors, as well as serving for a series of experiments in torpedo warfare upon which much of our modern torpedo practice and knowledge is founded.

The twenty light-draft monitors undertaken in 1863 began arriving at completion in 1864 and immediately revealed defects so serious as to destroy their usefulness. The history of these vessels is as unfortunate a chapter of errors as the annals of our navy during the war afford, involving as it does an account of much public money expended for which the nation received no benefit. So little attention had been given to the displacement of the vessels that it was found they would float with only three inches of freeboard instead of fifteen, as intended, a difference that practically ruined their efficiency. Various causes contributed to this result and none of the officials connected with their construction was entirely blameless, but the principal responsibility fell upon Chief Engineer A. C. Stimers, the general inspector of iron-clads, who had been given free scope by the Department to have the monitors built according to his own ideas.

The matter was so serious that it became the subject of an investigation by a committee of the House of Representatives and also by the joint Congressional Commission on the Conduct of the War: the latter investigation occupies 124 pages in volume III of the 1865

series of that committee's report, and is a useful document to the historian and biographer, because by judiciously selecting extracts from it, as some writers have already done, it is easy to prove credit or culpability indifferently in the case of any individual concerned. As the object of this book is to call spades by their right names within the bounds of propriety and to tell the truth so far as it can be ascertained, the following outline of this unhappy story is given as the most probable version deducible from the mass of conflicting and in some cases decidedly spiteful testimony. In arriving at conclusions the author has given especial weight to the testimony of Assistant Secretary of the Navy Gustavus V. Fox, who was an official superior to the contractors and officers connected with the building of the vessels, was less apt to have any personal grudges or rivalries to ventilate.

The need for light-draft armored vessels, especially for service on the Mississippi River and its tributaries, impressed itself upon the Navy Department during the summer of 1862. Mr. John Ericsson was appealed to for designs and he decided that the proposed draft of water (four feet) was incompatible with impregnability. He afterward furnished the Department with general plans for monitors of the required type, but of six feet draft, which he pronounced the least possible for vessels of the desired size, armor and battery. Ericsson being engrossed with the *Puritan* and *Dictator* and the *Pas-saic* class, as well as with the *Canonicus* class then being built from his designs, had little time for new work and his plans were turned over to Chief Engineer Stimers to be developed. Mr. Stimers was directed to establish an office in New York adjacent to that of Ericsson for convenience in consultation, and was given practically unlimited power in the matter of designs, inspection, authority to make changes, etc., the Secretary of the Navy ordering him verbally not to trouble the Department with letters on technical matters but to judge and act for himself.

Mr. Stimers proceeded on the line of his instructions so literally as to lose the benefit of advice from the heads of the two mechanical bureaus of the Department—construction and steam engineering—neither of whom he consulted except informally when visiting Washington at intervals, and both of whom naturally felt aggrieved that a subordinate officer should be permitted to direct

extensive work pertaining to them without being in any way under their control. Stimers in fact ruled a combined construction and engineering bureau of his own with a staff of assistants, draftsmen and clerks that was, as testified before the Congressional committee, almost as numerous as the total office force of all the bureaus of the Navy Department, and he was subject to no authority less than that of the Department. Rear Admiral F. H. Gregory, who was on the retired list, was on duty in New York as general superintendent of all ship and engine work being done by contract along the Atlantic coast for the navy and all correspondence had to be forwarded through his office, but as his naval service dated from 1809 it is not probable that he exercised any technical direction over steam vessels or steam engines. In fact, when the contracts for the light-draft monitors were made Admiral Gregory received an order from the Department informing him "very laconically," to quote from his testimony, that Mr. Stimers would have entire charge of all vessels building on the Ericsson plan. The admiral succeeded after a number of months in getting this order so modified that Stimers had to forward all communications through him and obtain his approval, but, to depend upon the admiral's testimony again, Stimers went right on ordering changes and writing letters over his head. Mr. Stimers probably thought that in busy times action was more important than red tape, and there is no doubt whatever that he had the tacit consent of the Department to hasten matters along by communicating directly with the contractors in all technical matters.

To add to the difficulty arising from Stimers' relations with the construction and engineering bureaus he fell out with his friend Ericsson about this time and this so nearly concluded their intercourse that Ericsson's opinions were thereafter seldom sought and never volunteered. The occasion of the estrangement was the unsympathetic manner in which Stimers had tested Ericsson's friction gear on the *Canonicus*; a trifling matter for middle-aged men to quarrel about, but sufficient to cause Ericsson, proud, stubborn, and imperious as he was, to avoid his former friend and protégé and leave him to his own resources.

Many changes were made in Ericsson's original plans and many of these changes were of a nature to increase the weight and draft of the vessels. Instead of the boilers proposed by Ericsson a dif-

ferent type with differential tubes, designed by Stimers himself,¹ were adopted, and these, in the opinion of Ericsson, were twice as large and heavy as the size of the engines required, although Stimers claimed that they were designed to furnish steam for all the main and auxiliary machinery in the ship should the unlikely occasion of using it all at the same time arise. The engines were considerably reduced in size, being finally made with cylinders 22 inches in diameter and 30 inches stroke of piston, one engine being placed on each side of the ship, inclined upwards, and driving a screw-shaft on the opposite side, the vessels all having twin-screws. After the first fight of the iron-clads with Fort Sumter it was decided to fit all the monitors then building with heavy base rings around the turrets, and this, in the case of the light-drafts, increased their weight about eighteen tons each, and also added much to the cost, the most of them being under contract before the change was ordered. The pilot-houses were also made thicker and heavier as a result of the experience gained in the Fort Sumter fight.

The most important change was in fitting large tanks along the sides inside the vessels for carrying water to increase the draft purposely; this was ordered by the Department on the urgent recommendation of Rear Admiral Joseph Smith, chief of the Bureau of Yards and Docks, the idea being that when the vessel grounded in shallow and little-known rivers, as would necessarily occur sometimes, she could be quickly floated by pumping out these tanks. The intention was excellent, but the application of the idea to vessels of only 15 inches freeboard was of doubtful propriety as it involved much extra weight for the tanks, piping, valves, and pumping engines, not to mention the weight of water to be carried.

A serious mistake involving additional weight was made in Stimers' office in calculating the weight of the oak deck and side timbers, of which latter especially there was an enormous mass. It appears from the testimony that the weight of seasoned white oak timber formed the basis for the estimates, no allowance being made

¹ These boilers had the same differential sizing of tubes as those of the *Canonicus* class illustrated in a former chapter, but the structural design was different. To make the boilers low enough to go into the shallow hulls, the tube boxes were placed between the furnaces, two of the latter being at each end of the boiler.

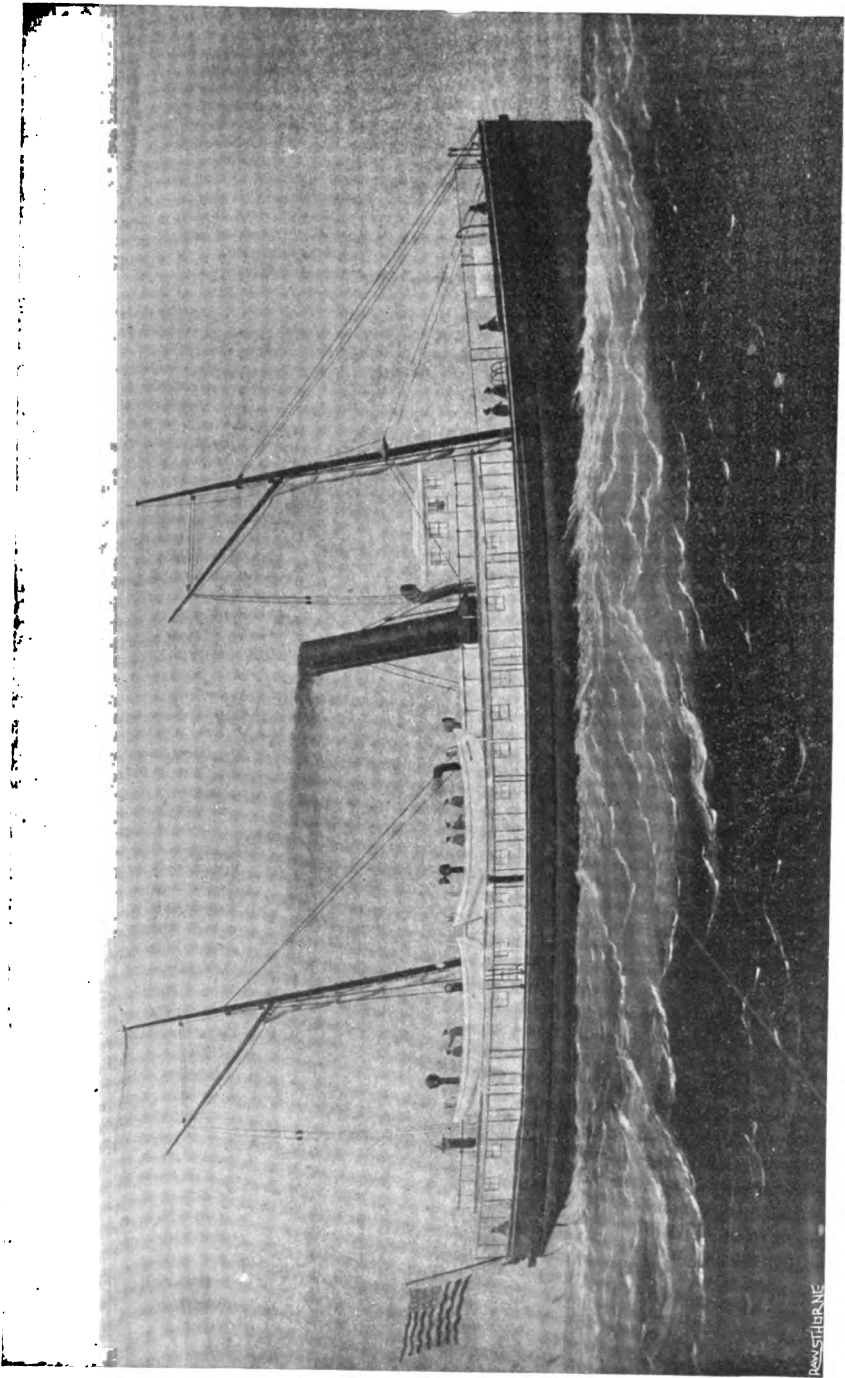

U. S. S. MAYFLOWER.
Fitted as a Practice Steamer for Cadet Engineers.

REYNOLDS & BIRNIE

for the fact, then well enough known, that green timber would have to be used on account of the supply of seasoned oak ship timbers at the North being completely exhausted. The result of all the changes and errors was that when the first of the light-draft monitors—the *Chimo*—was launched she was found to draw about a foot more water than was intended, leaving her deck almost awash. The certainty that others of the class would possess the same fatal defect was a startling discovery to the Department and a cause of chagrin to Mr. Fox who had selected Chief Engineer Stimers for their superintendence and who was chiefly responsible for the conferring upon him of power superior to the bureaus under whose cognizance their building properly belonged. The crying need for light-draft armored vessels in the Western rivers and the great things that had been promised from these monitors were well known to the public, and this made the failure more notorious and disappointing.

Mr. Fox went immediately to New York and held a consultation with Mr. Ericsson and Chief Engineers King and Wood as to what should be done, his desire being to remedy the defects if possible and get monitors with which to make war, rather than to waste time in speculating as how the mistake had been made or who was to blame for it. It was decided that the only remedy was to build the vessels up about twenty-two inches, thereby still further increasing their draft with the added weight and lessening their usefulness for service in shallow waters, but which would give the country monitors that could be made of some use. This was done with fifteen of them at an additional cost of from \$55,000 to \$115,000 each, varying with the degree of completion when the change was ordered. The water-tanks with their pipes and pumps were taken out of nearly all of them. This work of raising the sides of the vessels so delayed their completion that they were not finished in time to be of any service before the war came to an end, and their cost was therefore practically thrown away.

The officer in command of the North Atlantic blockading squadron having asked for light-draft armored vessels to be used as torpedo boats in the North Carolina Sounds and James River, it was decided to equip five of these monitors for that purpose without their turrets and without building their decks up, which was done with those nearest completion when the fault in displacement was dis-

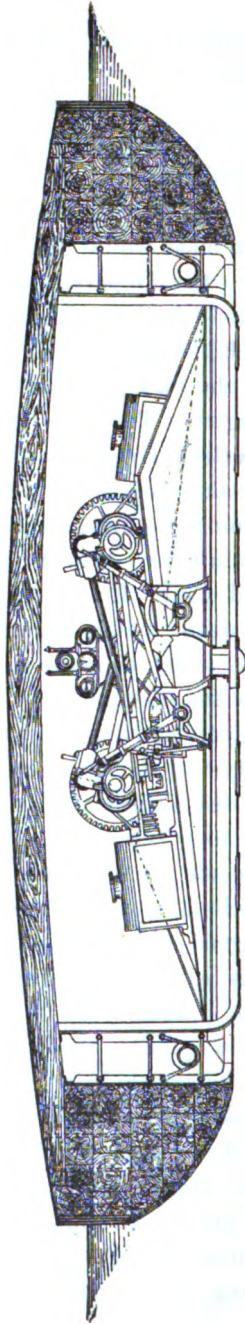

LIGHT DRAFT MONITOR. SECTION THROUGH ENGINE ROOM.

covered, they being fitted with spar-torpedo gear of the Wood-Lay invention. They had a gun mounted on deck forward without any protection for the men who would work it, a serious objection for service in narrow rivers within easy gunshot of the banks, and their speed was barely five miles an hour, which made their use as torpedo boats almost ludicrous. These five were in active service for several months before the end of the war, but their employment was of little use to the government. The others after being built up became reasonably good monitors for coast service and were seaworthy, as appears from a report made by Acting Lieutenant Commander H. A. Gorringe, an excellent sea-officer, relative to a voyage of the *Warsaw* from Hampton Roads to Philadelphia in January, 1866, although it was asserted by the opponents of Mr. Stimers that they would be worthless even after modification.

Mr. Gorringe says: "We experienced during the whole passage fresh northerly winds, and a heavy swell from the southeast, which gave us an opportunity of testing the sea-worthiness of this class of monitor. I beg leave to add that the behavior of this vessel during the passage has increased the confidence I already had in the ability of this class of monitor to ride out safely a gale of wind."

The responsibility for this deplorable failure and waste of public money rests largely upon Chief Engineer Stimers, though not by any means so completely as the enemies of that officer charged. The added weights due to the heavy base-rings around the turrets, the water-ballast equipment, and increased armor on the pilot-houses, were not by his direction. The testimony before the joint Committee on the Conduct of the War developed the fact that the error in computing the weight of timber was committed by a draftsman in Stimers' office and that Stimers had not personally verified the calculations. In this he was of course to blame as the responsible official, in precisely the same manner that the commander of a ship is responsible for disasters due to the mistakes of the navigator or other subordinate officer. Although officially culpable, there is no evidence to show that the blunder resulted from personal incompetence on the part of Mr. Stimers, and there is much to prove that physical impossibility and not negligence was the cause of his failure to critically examine the work of his subordinates.

Besides the twenty light-draft monitors, Mr. Stimers had under his general direction the building of a number of other iron vessels, the *Canonicus* class especially, and he was required to be absent from his office in New York much of the time visiting ship and engine works in many cities where these vessels were under construction. In the spring of 1863, just at the time when the plans for the light-drafts were being completed and the contracts being awarded, he was sent as superintending engineer to the iron-clad fleet off Charleston and was absent on that duty for two months. For four months during the summer of 1863 when his whole time should have been given to the new monitors his attention was largely occupied with the court of inquiry investigating the charges preferred against him by Rear Admiral DuPont, which in itself was sufficient to distract his mind from his legitimate duties, as his reputation and commission in the navy were at stake. The report made by Senator Wade, the chairman of the Committee on the Conduct of the War, states the difficulties under which Mr. Stimers labored, and that report does not specifically fix the responsibility for the failure upon him.

The Department detached Mr. Stimers from his duty as general inspector and put the work of completing the monitors in other hands; but beyond this nothing was done to punish him for his part in the affair. Assistant Secretary Fox wrote: "I cannot be too hard upon Stimers, who helped us in the first *Monitor* with so much zeal and courage." The shortcomings of Mr. Stimers in connection with these vessels may properly be charged to an excess of ambition. His connection with the *Monitor* had made his name well known throughout the country, and his subsequent responsible connection with the building of armored vessels had still further extended his fame and associated his name with that of Ericsson as an exponent and champion of the new order of war ships. When, therefore, he was trusted by the Department with almost absolute power in the construction of the light-drafts, from which so much was expected that the whole country knew of them, he sought to achieve all the honor for their success by refusing advice from older and wiser men than himself, and in attempting too much came to disaster. His professional reputation was so well established, however, that it was not overthrown by this failure, and at the close of

the war he received such inducements as to resign his commission and enter upon practice as a consulting engineer in New York under the most favorable and prosperous circumstances. Not long thereafter he fell a victim to an epidemic of small-pox and lost his life.

As John Ericsson stood before the country as the inventor and sponsor of the monitor type of war-ship, and as his name was linked with the light-drafts and all other monitors, he received much public censure for their failure; a censure that was almost entirely undeserved. When asked by the joint committee in what relation he stood to the twenty light-draft monitors, he replied: "I have nothing whatever to do with those twenty monitors, directly or indirectly." He did, however, furnish the original plans and some of his details were carried out; in his own testimony further on he said that the turrets were arranged very nearly according to his principle and instructions, and from his testimony and that of others it is proved that although he ceased intercourse with Stimers the draftsmen from the latter's office frequently consulted him as to different details. It is true that he disapproved of almost everything shown him, but the fact admitted by himself that he was consulted is proof enough that he had some connection with the work, for no one who has any conception of his devotion to work and intolerance of interruption can believe that he would have given a moment of his time to anything that did not concern him. There is no doubt whatever that he knew that Stimers was supposed to be working under his direction, and the fact that a quarrel between them should have prevented the one from seeking advice and the other from insisting upon giving it, is not at all creditable to either.

Although busily employed with the duties compelled by war, the naval engineers found time at the beginning of 1864 to prepare and submit to Congress a memorial asking for legislation in their interests in certain directions. This document was neatly gotten up in pamphlet form with a decorative cover embellished with engravings of the *Monitor* and *Wampanoag* and a wreath made up of weapons of war and engineer's instruments—the *arms* and the *tools* symbolical of the naval and military engineer's calling. The memorial asked for an increase of pay commensurate with that received by other officers of the navy and dwelt at length upon the

desirability of establishing some regular system of education and training for the future engineers of the navy. Both objects were attained. Congress passed a bill, which received Presidential approval July 4, 1864, establishing the course of instruction for cadet engineers at the Naval Academy and fixing a new rate of pay for engineer officers, amounting to an increase for all grades of about twenty-two per cent., the new rate being shown by the following extract from the act:

“*SEC. 6. And be it further enacted, That the number of chief engineers shall not exceed one for each first and second rate vessel in the navy, with such first, second, and third assistant engineers, or those acting as such, as the wants of the service actually require. And that from and after the passage of this act the annual pay of the engineer officers of the navy, on the active list, shall be as follows: Every chief engineer on duty, for the first five years after the date of his commission, two thousand two hundred dollars. For the second five years after the date of his commission, two thousand five hundred dollars. For the third five years after the date of his commission, two thousand eight hundred dollars. After fifteen years after the date of his commission, three thousand dollars. Every chief engineer on leave or waiting orders, for the first five years after the date of his commission, one thousand five hundred dollars. For the second five years after the date of his commission, one thousand six hundred dollars. For the third five years after the date of his commission, one thousand seven hundred dollars. After fifteen years after the date of his commission, one thousand eight hundred dollars. Every first assistant engineer on duty, one thousand five hundred dollars. While on leave or waiting orders, one thousand one hundred dollars. Every second assistant engineer on duty, one thousand two hundred dollars. While on leave or waiting orders, nine hundred dollars. Every third assistant engineer on duty, one thousand dollars. While on leave or waiting orders, eight hundred dollars.*”

INDEX.

A
ADAMSON, A., 426
Adirondack, 218, wrecked, 338
Agamenticus, 847
Agawam, 357, 444
Alabama, 367; sunk, 430 et seq
Alaska, 474
Albany, sloop-of-war, 92, 96
Albany, 396
Albemarle, ram, 450 et seq., sunk, 469
Alden, James, 288, 319, 324, 338, 435
Alert, 1st, 477
Aligona class, names of, 474
Algonquin, 357
Allegheny, 53 et seq
"Alvarado Hunter," 97
America, yacht, 151
Ammen, Daniel, 247, 452
Ammonocoac, 399
Amphitrite, 1st, 347
Arctiam class, names of, 365
Archbold, Sam'l, engr-in-chief, 704, 154 158, 162, 176, 202
Arctic, 153
"Arms and the Man," 1
Aroostook, 221, 314
Ashuelot, 395
Atlanta, Confed. strmr., captured, 378
Atlantic cable, laid by *Niagara*, 152
Atlantic Works, 206, 340, 357, 400
Augusta, 247, 250, 371
Aullock, J. H., 104, 127, 128

B
BAILEY, THEODORUS, 325, 327
Baker, C. H., 316
Balch, George E., 330
Bancroft, Geo., secy. navy, 77
Baron de Kalb, sunk, 390
Barton, paym'r 467
Batten, J. M., surgeon, 214
Bell, H. H. 319, 325, 367
Bentola, 474
Benton, 285, 318
Bienville, 247, 250, 437
Billings, L., paym'r, 53, 439
Blake, H. C., 367
Blockade runners, captured or destroyed, 195
"Blood is thicker than water," 43
Boller, drop-flue, 28; ascending flue, 106; Martin's, 223; Bartol's 223; of *Monitor*, 281; Stimer's, 349
Bombshell, 455; captured, 457
Bonne Homme Richard, 474
Boutelle, C. A., 458, 467
Brook, John M., 290
Brooklyn, 1st, 157; 319 et seq.; 367, 435 et seq
Brown, Jefferson, 396
Buchanan, Franklin, 127, 294, 301
Buehler, Wm. G., 152, 496
Rureau of Steam Engineering, created, 361
Bushnell, C. S., 270, 272, 277, 291
Butler, Gen'l B. F., 243, 327, 444, 446

C
CAHILL, JOS. N., killed, 427
Caïro, 232; sunk, 300, 426
Comanche, 340
Canandagua, 218, 332, 369, 424
Canoncus, 348 445, 464
Carondelet, 282, 318
Casualties at Fort Jackson, 327; at Mobile, 442
Catawba, 348
Catskill, 340, 377, 381
Cayuga, 221, 319 et seq
Ceres, 288, 451 et seq
Chain armor, by whom devised, 322, 324.

Chattanooga, 399
Chenango, 357; explosion on, 427
Chickasaw, 347, 436 et seq
Chicopee, 357, 469
Chillicothe, 348
Chimo, 395, 489
Chippewa, 231, 445
Church, W. C. — "Life of John Ericsson," quoted, 71, 73, 296, 310, 313, 340, 422
Cimmarone, 221, 378
Cincinnati, 1st, 282, sunk, 390
Clifton, 320, 329 362, 391
Colorado, 145, 244, 319, 325, 445
Columbia, wrecked, 368
Columbine, captured, 426
Commodore Hull, 375, 454, 455, 470
Commodore Jones, blown up, 425
Commodore Perry, 288, 331
Conestoga, 318, 323
Congress, 395
Connor, Com., 91 et seq
Contocook, 395
Contocook class, names of, 395
Copeland, Charles W., 21, 36, 56, 108, 104, 137
Cragg, S. W., 319, 327, 427, 428
Cramp Shipbuilding Co., 273, 399
Craven, T. A. M., 436
Crosby, Pierce, 319
Cumberland, sloop-of-war, 92, 231, 243, 492, et seq
Cushing, William B., 289, 330, 331, 448, 468 et seq
Cushman, W. H., 433, 434

D
DACOTAH, 169
Dahlgren, rear ad., 199, 390, 406
Danby, Robt., 132, 133, 199, 231 et seq
"David," 424
Delano, B. F., 142, 176, 399
Demologos, 9 et seq
Despatch, 1st, 154
Detroit, 1st, 474
Diana, captured, 390
Dickerson, E. N., 161 et seq.; 396
Dickerson, M., sec. navy, 16, 19
Dictator, 340, 344, 347
Dobbin, sec. navy, 56, 138
'Double-enders,' names of, 221, 357, 395
Doughty, Th., chief engineer, 391
Drayton, Percival, 249, 333, 336, 436
Dukehart, T. M., 319, 471
Dunderberg, 345 et seq
Dungan, W. W., 250
DuPont, S. F., 148, 545 et seq., 576 et seq., 463 et seq., 418 et seq

E
EDDOWES, A. K., 370, 371
Edee, James B., 282, 347, 348
Edith, 99
Ellis, William, 54, 137
Engine, side lever, 43; half-cylinder, 65; in-lined, 360
Engineer, 33
Engineer-in-Chief, office created, 40
Engineer Corps, U. S. Navy, established, 40; increased in 1861, 205
Engineers, naval, first in service, how appointed, 24; how berthed and messed, 18; declared to be officers, 40; names of, 25, 76, 80; arranged in order of merit, 76 et seq.; receive commission, 75
Engineers, naval in Mexican War, 99; in Japan expedition, 132; at Port Royal battle, on *Monitor*, at Fort Jackson, 319; at Mobile, 436; lost in *Mound City*, 328; in *Weehawken*, 332; in *Tecumseh*, 438; volunteer qualifications of, 305 et seq

INDEX.

Engineers for Revenue cutters, appointed, 75
Epervier, 477
 Ericsson, John, 61 et seq.; his gun, 70, 71, 99, 262, 268; builds *Monitor*, 274 et seq.; 306, 330, 303, 306, 309, 419, 484 et seq

Essex, 1st, 225, 819, 365
 Everett, William H., 151, 153

FAIRFAX, D. M., 255 et seq
 Faron, John, Jr., 25, 36, 43, 76, 78, 87, 106
 Faron, John, 152; killed, 433
 Farragut, D. G., 318 et seq.; wounded, 329, 336, 335, 425, 428 et seq.; his statue made from screw of *Hartford*, 157

Fillebrown, T. B., 109, 427
 Firemen classified in 1847, 86
Florida, confed. cr., 872 et seq.; captured 443
 Flusser, C. W., 330, 448, 451; killed, 452
 Follansbee, Joshua, 73, 152
 Foote, A. H., 285, 318, 406
 Fort Donelson, captured, 318
 Fort Fisher, first attack, 444
 Fort Jackson, battle at, 321 et seq
 Fox, G. V., asst. secy. navy, 278, 310, 419, 477, 478, 494, 499, 492

Franklin, 141, 400
Fulton, 1st, see *Demologos*
Fulton, 2d, 19 et seq
Fulton, 3d, 29, 30, 174

GALENA, 1st, 272, 277, 815, 436
 Gay, Jesse, 132, 133, 157, 169
 Gearing for engines discarded, 64
Genessee, 221, 387, 389, 437
Germ, 48, 50
Germantown, sloop-of-war, 231, 242, 360
 Gilmer, T. W., sec. navy, killed, 70
 Gotwood, surgeon, killed, 370
Goldsborough, L. M., 286, 314, 339
 Grant, U. S., 95, 318
 Greene, S. Dana, 296, 302, 318
 Greene, Wm. R., killed, 364
 Greer, J. A., 254, 260
 Gregory, F. H., 408, 485,
 Grice, Francis, 103, 105
 Griffis, W. E., 30, 94
 Griffiths, J. W., 173
 Griswold, John A., 281, 310
Guerriere, 395
 Gunners, originally non-combatants, 2.

HALL GEO. W., 255, 260, 261
 Hands, R. W., 296, 333
 Hanscom, Isaiah, 357
Harriet Lane, 174, 320, 362, captured, 363
Hartford, 157, 818 et seq., 385 et seq., 428 et seq
 Hartt, Saml., 44, 108, 110
 Hasseltino, D. C., 213 et seq
 Haswell, Chas. H., first engr. in navy, engr.-in-chief, etc., 19, 21, 36, 41, 42, 75, 86, 93, 105, 110, 120 et seq., 287, 293

Hatteras, sunk, 367
 Hawkins, J. T., 456
 Hebard, A., 36, 47, 76, 82
 Henderson, Alex., 332
 Hobby, J. M., 250, 458, 462, 464, 467
 Holden, Dr. Edgar, 334, 335
Housatonic, 218, 369, sunk 424
 Houston, J. B., 253 et seq., 259
 Hoyt, Eben, 322, 388
 Huber, Jos., chief engr., killed, 330
 Hunt, Henry, 56, 72, 118, 120
 Hunt, Wm. H., 323, 327, 436, 439
 Hunt, Lieut. W. W., his wheel, 48 et seq
Huron, 1st, 221

IDAHO, 165, 396
Indanacia, 343, 394
 Inman, Wm., 47, 263
Iris, 94
 Iron-clads, first, 262, river type, 233
Iroquois, 169, 319 et seq
Isaac Smith, 246, 247, captured, 373

Isherwood, B. F., engr.-in-chief, 55, 57, 80, 82, 99, 117, 121, 165, 176, 182, 200, 308, 317, 321, 233 et seq., 364, 399, 400
Itaska, 221, 319, et seq., 434, 440

JAPAN, expedition to, 126 et seq
 Japanese bell at Naval Academy, 136
 Jeffers, Wm. N., 289, 314
John Hancock, 1st, 187; 2d, 137
 Jones, Cateby, 301, et seq., 307
 Jonett, Jas. E., 436, 440
Judah, schooner, 244
Juntata, 218, 446

KALAMAZOO, class, names of, 400
 Kane, E. K., arctic explorer, 153
Kansas, 357
Katahdin, 1st, 221, 319
Kearsarge, 218; fights *Alabama*, 430 et seq
 Kellogg, Mortimer, 131, 138, 153, 425
Kennebec, 221, 319, 436, 440
 Kennon, Beverly, 63, killed, 70
Keokuk, 248, sunk, 377
Keystone State, 370
Kickapoo, 347
 Kimball, J. B., 319, 336
Kineo, 221, 319, et seq., 395
 King, J. W., engr.-in-chief, 147, 183, 250, 487
 King, Wm. H., 132
 Kipling, Rudyard, quoted, 311
 Kutz, Geo. F., 152, 365, 336, 426

LACKAWANNA, 218, 436 et seq
Lancaster, 158
 Lawton, Elbridge, 138, 319
 Lay, J. L., 289, 376, 448, 451
 Lee, S. P., 319, 329, 332, 375, 455
Lehigh, 340, 382
Lenape, 367, 427
 Lenthall, John, 54, 56, 103, 142, 176
 Le Roy, Wm. E., 370, 436
Lexington, 318, 323, 330
 Light-draft monitors, names of, 395; failure of, 433 et seq
 Lincoln, Abraham, 162, 203, 237, 278, 404, 463
Lockwood, 289, 424
 Long, R. H., 147, 173
 Loring O. H., engineer-in-chief, 147
 Loring, Harrison, 188, 158, 340, 348
Louisiana, 287, 289, 375; used as powder magazine, 444
Louisiana, Confed., 331

MCOAULEY, Captain Charles S., 231 et seq
 McClellan, George B., 60, 95, 297
 McElmell, J., 152, 436
 McEwan, William G., 440
 McKay, Donald, 270
Mackinaw, 367, 445
Madawaska, 399
Mahopac, 348, 445
 Mallahan, Thos., killed, 376
Manassas, Confed. ram, 321 et seq
Manhattan, 348, 436
Marblehead, 1st, 231
Marietta, 348
 Masrden, Captain J., 233, 296, 299
 Martin, D. B., engineer-in-chief, 56, 99, 110, 128, 148, 164, 162, 169
Massachusetts, 1st, 93; 2d, 400
Mattabesett, 357, 454, 456, 466
Maumee, 357
 Maxey, Hon. Virgil, killed on *Princeton*, 70
 Melville Geo. W., engineer-in-chief, 443
Mercedita, surrender of, 370
 Merrick & Towne, 36, 62, 110
 Merrick & Sons, 147, 169, 270, 272, 399
Merrimac, 141, 145, 146, 230, et seq.; 290; raid of, 291 et seq.; fights *Monitor*, 301 et seq., destroyed, 314
 Messier, H., 243, 250
Metacomb, 357, 436, 440
 Mexican War, 88 et seq
Miami, 231, 320, 451 et seq

INDEX.

Antonomoh, 1st, 347
Michigan, 44
Milwaukee, 347
Minnesota, 145, 148, 243, 292, 313
Mississippi, 32 et seq.; 36, 42, 91 et seq.; 128 et seq.; 189, 319 et seq.; destroyed, 886 et seq
Missouri, 35, 36; burned, 43
Mobile Bay, battle, 436 et seq
Mohawk, 175
Mohican, 1st, 169; 247 et seq
Mohongo, 395
Monadnock, 1st, 347, 445
Monitor, 274 et seq.; 295 et seq.; 301 et seq.; 314; foundered, 333
Monongahela, 218, 385, 436 et seq
Montauk, 340, 376, 383
Monterey, 376, 382
Monticello, 243
Moore, J. W., 319; 322 et seq.; 388, 399
Morgan Iron Works, 170, 396, 427
Moshohu, 295
Moss, Chas., case of, 76 et seq
Mound City, 232, 328
Muldaur, A. W., 467
Mullen, A. T. E., 363, 444, 445
Muscoota, 395

NAHANT, 340, 377, 378, 382
Nantasket, 477
Nantucket, 340, 377, 383
Narragansett, 170
Nashville, Confed. Steamer, 363
Naugatuck, 60, 315
Naval Constructors, 143
Neshaminy, 399
Newell, H., 154, 445
New Ironides, 272 et seq.; 377, 382, 445
Newton, Isaac, 60, 296, 305, 307
Niagara, 141, 151, 162
Nicholson, J. W. A., 436
"Ninety-day" gunboats, names of, 221
Nipic, 1st, 357
Norfolk navy yard, loss of, 230 et seq
Novelty Iron Works, 221, 280, 399
Nyack, 357

NOTORORA, 221, 435
Omaha, 477
Onetida, 218, 272, 319 et seq.; 373, 436 et seq
Oneota, 348
Onondago, 347, 354
Oregon, 1st, 400
Osage, 348, 391
Ossipee, 218, 436 et seq
Ottawa, 221, 247, 250
Ostego, 357; sunk, 443, 469 et seq
Owaeco, 221, 320, 362
Ozark, 348

PALOS, 481
Paraguay expedition, 174; steamers chartered for, 175
Passtac, 333 et seq.; 340, 377, 383
Patapaco, 340, 377, 382
Paulding, Captain Hiram, 148, 241, 264
Pawnee, 173, 243, 247 et seq.; 426
Pay of naval engineers in 1837, 22; in 1842, 40; in 1849, 87; in 1860, 184; in 1864, 494
Pembina, 221, 247 et seq.; 437
Penobscot, 221, 365
Pensacola, 161 et seq.; 319 et seq
Pensions extended to engineer corps, 86
Pequot, 357
Perry, Captain M. C., 22, 26, 30, 91 et seq.; 123, 127 et seq
Philadelphia, 1st, 287
Pinola, 221, 319 et seq.; 437
Pinta class, names of, 481
Pirsson's condenser, 55
Piscataqua, 395
Pittsburgh, 232
Plymouth, N. C., battle, 471
Plymouth, sloop-of-war, 129, 131, 231; sunk, 242, 290

Plymouth, 477
Pocahontas, 154, 249, 330
Potomsett, 44
Polk, 94
Pomponooc, 399
Pook, S. H., 272, 432
Port Hudson, battle, 284 et seq
Port Royal, battle, 245 et seq
Port Royal, 221, 314, 430, 440
Porter, Capt. David, 11, 16
Porter, Adm'l. D. D., 213, 327, 329, 384, 390, 392, 444, 446, 472; his opinion of engineers, 196; of acting masters, 320
Porter, J. L., 299, 314, 450
Powhatan, 105, 109, 130, 136, 445
Princess Royal, 368 et seq
Princeton, 1st, 62 et seq.; gun explosion on, 70, 72, 91, 98
Princeton, 2d 74
Propeller, Loper's, 51; of *Allegheny*, 56; Ericsson's, 62; of *San Jacinto*, 118
Puritan, 1st, 340

QUAKER CITY, 371, 446
Quinnedaug, 1st, 477
Quinetgamond, 400
Quintard Iron Works, 399

RANK conferred upon naval engineers in 1859, 185; reaffirmed in 1861, 186; raised in 1863, 401
Rattler, H. M. S., 63, 136
Resaca, 477
Retired list created, 357
Rhoades, H. E., 374, 375
Richmond, 158; 319 et seq.; 388; 436 et seq
Roach, John 350, 396, 399
Roanoke, 145, 292 et seq.; 301, 354
Roanoke Island, battle, 286 et seq
Robie, E. D., 129, 132, 250, 344, 405, 406
Robie, H. W., 332 et seq
Robinson, L. W., 498
Rodgers, O. R. P., 245 et seq
Rodgers, Geo. W., killed, 351
Rodgers, John, 138; 247 et seq.; 285, 314, 343, 378, 405
Roe, F. A., 819, 454, 458, 464, 467

SACHEM, 295, 362; captured, 391
Saco, 357
Sacramento, 218
Saginaw, 166
San Jacinto 110, 114; 251 et seq
Saranac, 109; wrecked, 110
Sassaacus, 357, 445, 454, 461, 466
Saugus, 348, 445
Setota, 221, 319
Scott, Winfield, 94, 96
Sea Gull, 16
Seminole war, 44
Seminole, 170, 247, 250, 436
Seneca, 221, 247
Sewell, Geo., 97, 109, 136, 166, 250
Sewell, Wm., 70, 105, 118
Shamrock, 357, 469
Shawmut, 357
Shawsheen, 239, 331; captured, 426
Shenandoah, 218
Shock, W. H., engr.-in-chief, 74, 80, 82, 96, 146
Sloat, J. D., 89 et seq
Smith, Jos., 264, 278, 281, 486
Smith, Melancthon, 319, 326, 386, 454, 455
Soley, J. R., quoted, 232, 419
Sonoma, 221, 374
Southfield, 287, 451; sunk, 452
Spitfire, 92, 96, 97
Spuytgen Duynd, 482 et seq
St. Louis, 232, 318, 323
Stamm, W. S., 136, 152
Steam launch, 1st, 124
Steers, Geo., 151
Stevens Battery, 57 et seq; 263
Stewart, H. H., 170, 471

INDEX.

Stimers, A. C., 147, 262, 290, 291, 295, 296, 306 et seq., 313, 340, 349, 377, 392, 404, et seq.; 409, 484 et seq
 Stockton, Capt. R. F., 61 et seq, 70, 74, 91, 97
 Stodder, L. N., 296, 302, 313
 Stotesbury, Wm., 469, 470, 473
 Stringham, S. H., 176, 242, 262, 408
 Stuart, Chas. B., engineer-in-chief, 29, 55, 74, 117, 119, 163
 Susquehanna, 104, 128, 185, 152, 242, 260, 314, 373
 Swanes, 385
 Swatara, 1st, 477

TACONY, 357, 470, 471
Tallapoosa, 357
 Tatnall, Josiah, 43, 96, 246, 314
 Taylor, Bayard, master's mate in navy, 131
Tecumseh, 348; sunk, 437
Tennessee, confed. stmr., 337
Tennessee, confed. ram, 437 et seq
 Thompson, G. L., engr-in-chief, 39, 41, 42
 Thurston, E. H., 268 et seq.; 372
Ticonderoga, 218, 446
Tonawanda, 347
 Torpedo, unchivalrous, 425; Lay, described, 451
 Toucey, secy. navy, 163, 185, 189
 Trent, affair of, 251 et seq
Tuscarora, 316
Tusculum, 348
 Tyler, John, President, 69, 70, 77
 Tyler, 318

UNADILLA, 221, 247, 368, 369, 445
Underwriter, 289 captured, 423
 Unton, 49 et seq
 Union Iron Works, 166
United States, frigate, 281; burned, 242
 Upshur, A. P., secy. navy, 53; killed, 70

VAN BRUNT, Capt., 302, 306
Varuna, 819; destroyed, 326
 Vera Cruz, bombarded, 94, 95
 Vizen, 92, 96
 Voorhees, P. R., 380

WABASH, 141, 145, 147, 245 et seq.; 226, 245
Wachusett, 218, 316, 442
Wampanoag, 399
Waterloo, 357
Water Witch, 1st, 51; 2d, 52; 3d, 53, 174, 439
Wazawa, 395, 491
 Webber, J. J. N., 296, 305
 Webster, Harrie, 387, 389, 437
Weehawken, 340, 377, 378; foundered, 363
 Weir, Robt., 166, 389, 441
 Welles, Gideon, secy. navy, 272, 274, 277, 279, 281, 339, 375, 405, 421
 Wells, Wm. S., 273, 274
Westfield, 320, 362; sunk; 364
 West Point Foundry, 17, 20, 36
 White, Geo. H., 244
Whitehall, 287, 294; destroyed, 295
Whitehead, 331, 451, 453, 470
 Whittemore, J. W., killed, 249
 Wilkes, Chas., 251 et seq.; 374
 Williamson, Thomas, 290, 436
 Williamson, Wm. P., 50, 54, 76, 104, 118, 202, 290, 292

Winnebago, 347, 436 et seq
Winona, 221, 319, 378
Winooski, 357
 Winslow, Capt. J. H., 432
Wissaticton, 221, 319
 Wood, Wm. Maxwell, 90
 Wood, Wm. W. W., engr-in-chief, 76, 78, 110, 148, 158, 173, 198, 250, 468, 481, 489
 Woodbury, J. G., paymr., killed, 381
 Woodruff & Beach, 169, 432
Worcester, 395
 Worden, J. L., 295, 296, 302 et seq.; 310, 313, 376
Wyandung, 357, 454, 457, 463, 468, 470, 471
Wyoming, 169

YANTIC, 357, 446
 Young, Jas. G., 379

ZELLER, Theo., 80, 81, 100
 Zinc first used in boilers, 124

† 8.12.21 21/12/21
10/12/21 11/21

