

Cornell University Library
Ithaca, New York

THE LIBRARY OF

EMIL KUICHLING, C. E.
ROCHESTER, NEW YORK

THE GIFT OF
SARAH L. KUICHLING
1919

Cornell University Library
VA 40.K53

Report of Chief Engineer J. W. King, Uni



3 1924 005 009 638 enfr, anr

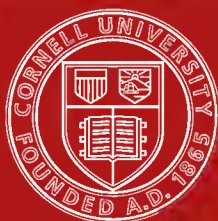

Cornell University
Library

The original of this book is in
the Cornell University Library.

There are no known copyright restrictions in
the United States on the use of the text.

<http://www.archive.org/details/cu31924005009638>

REPORT

OF

CHIEF ENGINEER J. W. KING,
UNITED STATES NAVY,

ON

EUROPEAN SHIPS OF WAR AND THEIR ARMAMENT, NAVAL
ADMINISTRATION AND ECONOMY, MARINE CONSTRUCTION
AND APPLIANCES, DOCK-YARDS, ETC., ETC.



WASHINGTON:
GOVERNMENT PRINTING OFFICE.
1877.

LETTER

FROM

THE SECRETARY OF THE NAVY,

TRANSMITTING,

In compliance with a Senate resolution of January 26, 1877, the report of Chief Engineer J. W. King, United States Navy, on European ships of war, &c.

JANUARY 30, 1877.—Referred to the Committee on Naval Affairs and ordered to be printed.

NAVY DEPARTMENT,
Washington, January 27, 1877.

SIR: In compliance with a resolution of the Senate, passed on the 26th instant, I have the honor to transmit herewith the report of Chief Engineer J. W. King, of the United States Navy, on European ships of war, &c.

Very respectfully, &c.,

GEO. M. ROBESON,
Secretary of the Navy.

Hon. THOS. W. FERRY,
President pro tem. of the United States Senate.

CONTENTS.

PART I.

	Page.
Letter	11
Introduction	13
The British navy	15

PART II.

The <i>Inflexible</i> .—Mastless, armored sea-going ships. Hull and appendages. Defense. Turrets. Armament. Trials of the 31-ton gun. Motive machinery. Boilers. Rig. Weights. Cost. Conclusions.....	19
---	----

PART III.

The <i>Devastation</i> .—Design. Alterations. Dimensions and weights. Consumption of coal. Motive machinery. Official trials of machinery, guns, and sea-going qualities	35
--	----

PART IV.

The <i>Thunderer</i> .—Design. Machinery. Armament. Hydraulic-machinery for working guns.....	47
The <i>Dreadnought</i> .—Design. Details of turret. Hull. Armament. Motive and other machinery	53

PART V.

Broadside-armored ships.....	59
The <i>Audacious</i> class.— <i>Audacious, Iron Duke, Vanguard, Invincible, Triumph,</i> and <i>Swiftsure</i>	62
The <i>Alexandra</i> .—Design. Description of hull. Motive power. Boilers. Observations	64

PART VI.

The <i>Téméraire</i> .—Design. Armament. Dimensions. Motive power	69
The <i>Shannon</i> .—Peculiarities of design. Armor-belt. Construction of hull. Armament. Motive power. Boilers. Weights. Belted cruisers.....	74

PART VII.

The <i>Nelson</i> and <i>Northampton</i> .—Design. Description of hull. Armament. Ram. Rig. Remarks. Motive power	77
The <i>Warrior</i> .—Old, but still efficient. Repairs. Late performances.....	82
The <i>Waterwitch</i> .—Peculiar features. Hydraulic propulsion an old idea. Poor performance. Waste of power. Coast-defense vessels. Description of the <i>Glatton</i>	83

PART VIII.

Cost of British armored ships.—Addition of percentage for maintenance of plant, for materials, &c., in dock-yards. Cost of repairs.....	87
Table of dimensions of vessel; armament, machinery, cost, &c., of the armored ships of Great Britain.....	94

PART IX.

	Page.
Unarmored ships of Great Britain.— <i>Inconstant</i> , <i>Raleigh</i> , <i>Boadicea</i> , <i>Rover</i> , and <i>Euryalus</i> . Positions of cranks in compound engines. Sloops. Corvettes. Gun-vessels.....	99

PART X.

The sloop <i>Pelican</i> to be engined on Perkins's high-pressure compound system.—Description of vessel. Description of engines. Pressure of steam to be carried. Condenser. Boilers to be tested to 2,500 pounds per square inch. Distilled sea-water not to be used. Other vessels on Perkins's system.....	117
Cruisers of the rapid type, the <i>Iris</i> and <i>Mercury</i> .—Built of steel and designed for exceptionally high speed. Hull. Motive machinery. Boilers. Tests of materials. Preparations against the privateers of the United States.....	122
Corvettes of steel and iron.—Names. Principal dimensions. To be cruisers.....	127
Trials at the measured mile.—Subsequent examination by shipwright and engineers. Regulations for trial at the measured mile. Semi-annual trial at full power. Objections to the system and deceptiveness of the speed, as subsequently claimed. Testimony before court-martial in relation to real speed of <i>Iron Duke</i> and <i>Vanguard</i>	128

PART XI.

The French navy.—Composed chiefly of broadside vessels. Uniformity of classification carried to an extreme. Tests of iron and steel for the French navy...	131
Table of dimensions, &c., of the armored ships of France.....	137
The <i>Duquesne</i> and <i>Tourville</i> , cruisers of the rapid type.—Dimensions. Weights. Armament. Motive machinery.....	139
The <i>Duguay-Trouin</i> and <i>Rigault de Genouilly</i> and class.....	140
Table of vessels building and proposed for the French navy in 1876.....	141

PART XII.

The German navy.—Of late origin. Vessels chiefly built abroad.....	143
The <i>Deutschland</i> .—Dimensions. Hull. Armament. Armor. Machinery and boilers.....	145
The <i>Borussia</i> or <i>Preussen</i> .—Dimensions. Hull. Armor. Turrets. Armament. Rig. Weights. Materials of exceptional strength and quality.....	147
Other German vessels, armored and unarmored.....	150
Table of dimensions, &c., of the armored ships of Germany.....	152

PART XIII.

The Italian navy.—Great advances made in the past quarter of a century.....	153
The <i>Duilio</i> .—Dimensions. Hull. Position of turrets. Armor. Armament. The hundred-ton gun. Construction of gun. Weight of projectile. Trials of the gun. The targets. Revolution in guns, ships, and armor. Ram. Motive power. A most formidable ship.....	155
The <i>Dandolo</i> .—Differs only in motive machinery from the <i>Duilio</i> . Engines and boilers.....	161
The <i>Christoforo Colombo</i> .—Cruiser of the rapid type. Dimensions. Battery. Motive machinery. Estimated speed 17 knots. Wooden hulls are not strong enough to sustain the power necessary for the speed.....	162
Italian dock-yards of Venice, Castellamare, and Spezia.....	162
Table of dimensions, &c., of the armored ships of Italy.....	164

PART XIV.

The Russian navy.—General description of vessels.....	165
Circular armored ships.—The <i>Novgorod</i> and <i>Admiral Popoff</i> . Description by Mr. E. J. Reed. Dimensions. Advantages of the system. Objectionable features.	169
Table of dimensions, &c., of the armored ships of Russia.....	172

PART XV.

The Austrian navy.—Mistake of building wooden armored ships.....	173
The <i>Tegethoff</i> .—Dimensions of hull and machinery, weights, cost, armament, &c. Detailed description of peculiar features of construction and armor.....	175
Table of dimensions, &c., of the armored ships of Austria.....	178

PART XVI.

	Page.
Armored ships.—Total estimated tonnage and cost. Number of vessels belonging to various nations. Not tested yet except at Lissa, and that battle not decisive for or against armored ships.....	179
Table of dimensions, &c., of the armored ships of Turkey.....	183
Table of dimensions, &c., of the armored ships of Holland.....	185
Table of dimensions, &c., of the armored ships of Spain.....	186

PART XVII.

Compound engines.—Extracts from former report on this subject. In Europe simple engines are almost obsolete. Rapidity in substituting the compound for the simple engines. Lloyd's inspectors state the saving in fuel to be from 30 to 40 per centum.....	187
Naval compound engines.—Begun in England in 1871. Report to Parliament. Number of vessels ordered on this recommendation. Introduced soon after into France, Italy, and Germany. Certain objections to the system untenable.....	192
Comparative merits of the simple and compound engine.—Experiments on the <i>Swinger</i> and <i>Goshawk</i> . The <i>Mallard</i> and <i>Moorhen</i> . Experiments of the Allen Line on the <i>Polynesia</i> and <i>Circassian</i>	194

PART XVIII.

Corrosion of marine boilers.—Generally called galvanic action. Doubtless caused by the action of redistilled sea-water. The use of pure rain-water seems to be a preventive. Experience of Messrs. Perkins and Milan. Admiralty circular. Precautions in the merchant service.....	199
Preservation of boilers in Her Britannic Majesty's vessels not in commission.—Two systems, the wet and dry.....	201
Water-tube boilers.—Difficult to carry high steam and yet make the boilers tight and safe. Extracts from paper of Mr. Flannery. Boilers of the <i>Montana</i> , <i>Propontis</i> , <i>Birkenhead</i> , <i>Malta</i> , <i>Gertrude</i> , &c.....	201
Boiler explosions.—Report of the chief engineer surveyor to Lloyd's on the explosion of the <i>Thunderer's</i> boiler.....	209
Boilers of the mercantile marine.—Either cylindrical or elliptical. Composition tubes used instead of iron ones. Spring safety-valves used instead of those with levers. Adams's spring safety-valve. Extracts from Lloyd's Rules and Formulæ for boilers.....	214

PART XIX.

Sea-valves and cocks.—Should be always accessible and visible. Serious accidents have occurred when otherwise placed. The <i>Knight Templar</i> , <i>Europe</i> , <i>Greece</i> , <i>Amérique</i> , <i>Ormesby</i> , and other examples. Water-tight bulkheads should extend above the water-line.....	217
Steering-gear.—Essentials. Reasons for using steam or other power. The ordinary arrangement. McFarlane Gray's gear. Unimportant objection to steam-gear. Hydraulic gear. Description of Brown's gear. Unimportant objection to hydraulic system. Other uses for the gear than steering. Brotherhood's system.....	220

PART XX.

Manufacture of steam machinery for the British navy.—Policy of fostering engineering works. These establishments build, the dock-yards only repair, naval machinery. Drawing up specifications and awarding contracts. Designs accepted are not invariably in accordance with specifications.....	225
---	-----

PART XXI.

Offensive torpedo warfare.—The <i>Ziethen</i> . Motive machinery. Arrangement for ejecting the Whitehead or fish torpedo. Preparing and discharging the torpedo. Weak point of the instrument. Nations which have purchased the right to use it. Reported price paid. Experiments for its improvement and development. In England, the <i>Vesuvius</i> and other vessels fitted for the purpose. The <i>Uhlan</i>	229
Spar torpedo-boats.—Swift vessels of small size. Torpedo-boat for Holland.....	234
The <i>Oberon</i> experiments.—Description of vessel. Damage sustained. The torpedo more destructive than a projectile from the heaviest gun. Small vessels a necessity. Experiments needed in stopping leaks.....	236

PART XXII.

	Page.
British naval dock-yards.—Portsmouth. Chatham. Devonport and Keyham. Sheerness. Pembroke	239
Administration of dock-yards.—The superintendent. Master attendant. Chief constructor. Chief engineer. Store-keeper. Accountaut. Cashier. Civil engineer. Workmen and boys. Political. Pay. Police. Pensions. Remarks.	246

PART XXIII.

Conclusious.—Distinguishing features of modern line-of-battle ships, coast-defense vessels, cruising vessels, dispatch-vessels, and torpedo-boats. Compound engines. Very heavy guns and those not of cast iron. Our Navy is not commensurate with the dignity of the country. European naval powers have outstripped us in developing American ideas and improvements in fast-sailing vessels, screw propulsion, shell-fire, heavy guns, and torpedoes. The <i>Miantonomoh</i> and <i>Wampanoag</i> originated mastless sea-going armored ships and the rapid type of cruisers. In war the mercantile marine can furnish numerous large and fast vessels for light guns and torpedoes. We should take advantage of the very expensive and exhaustive experiments made by foreign powers in reconstrucing our Navy. Commerce and trade look to Congress for the encouragement afforded by naval protection	251
--	-----

PART XXIV.

SUPPLEMENT.

The Royal Naval College at Greenwich.—Regulations for admission of engineer students. Observations	257
Rank, pay, etc., of royal naval engineers	263
Naval models at Greenwich	264
Scientific apparatus at the South Kensington Museum.—Watt's models. Froude's method of ascertaining the resistance of ships. Whitworth's measuring instruments. Joule's apparatus for discovering the mechanical equivalent of heat. Howe's link-motion. Brunel's block-making machinery, &c.	266
<i>Conservatoire des Arts et Métiers</i>	272

LIST OF ILLUSTRATIONS.

Number 1. The <i>Inflexible</i> , longitudinal view and plan of hull.
Number 2. The <i>Inflexible</i> , section of side.
Number 3. The <i>Inflexible</i> and her armament.
Number 4. Target at which the eighty-ton gun was fired.
Number 5. The <i>Thunderer</i> , longitudinal view, plan, and section of hull.
Number 6. The <i>Thunderer</i> , hydraulic gear for working the guns.
Number 7. The <i>Dreadnought</i> , longitudinal view and plan of hull.
Number 8. The <i>Alexandra</i> , longitudinal view and plan of hull.
Number 9. The <i>Téméraire</i> , longitudinal view and plan of hull.
Number 10. The <i>Shannon</i> , longitudinal view and plan of hull.
Number 11. The <i>Nelson</i> and <i>Northampton</i> , longitudinal view and plan of hull.
Number 12. Compound engines of the <i>Rover</i> .
Number 13. Arrangements of cranks in compound engines.
Number 14. Perkins's surface-condenser tubes.
Number 15. The <i>Duquesne</i> , longitudinal view and plan of hull.
Number 16. Plan of Wilhelmshafen dock-yard.
Number 17. The hundred-ton gun.
Number 18. Targets at which the hundred-ton gun was fired.
Number 19. The <i>Dandolo</i> , longitudinal view and plan of hull.
Number 20. Plan of the naval arsenal, Spezia.
Number 21. The circular monitors <i>Admiral Popoff</i> and <i>Novgorod</i> .
Number 22. The <i>Tegethoff</i> , longitudinal view and plan of hull.
Number 23. Sections of sides of armor-clads <i>Kaiser</i> , <i>Deutschland</i> , &c.
Number 24. Boilers of the steamship <i>Montana</i> .
Number 25. Boiler of the <i>Gertrude</i> .
Number 26. Detail of Watt's boiler.
Number 27. Adams's spring safety-valve.
Number 28. Plan of Portsmouth dock-yard extension.
Number 29. Plan of Chatham dock-yard extension.

PART I.

LETTER; INTRODUCTION; THE BRITISH NAVY.

LETTER.

WASHINGTON, D. C., *January 16, 1877.*

SIR: In obedience to your order, dated July 29, 1875, received at Bethlehem, N. H., August 6, directing me to proceed to Europe for the purpose of personally observing and reporting upon recent constructions and mechanical appliances for ships of war, with the view of utilizing the information to the advantage of the naval service, the accompanying is respectfully submitted.

I sailed from New York August 14, 1875, and returned to the United States July 30, 1876.

While in Europe I was steadily employed, and no time was unnecessarily lost in the discharge of the duties assigned, as may be seen from the information collected and contained in the report.

All the navies of Europe have been recently undergoing reconstruction, and there has never been a time, during peace, when such large expenditures for naval purposes were made as at present, and such radical changes effected in the construction of ships of war, in steam-machinery, in machinery for working guns, and for various other purposes on board ship, and in offensive torpedo warfare. It is, therefore, expedient for the Department to be correctly informed of the extent and character of improvements in European naval warfare and economy in order that it may take advantage of the results.

I am indebted for kind attentions to the dock-yard naval officers and proprietors of iron-ship yards and engine-factories visited in Great Britain and on the continent of Europe.

I have the honor to be, sir, respectfully, your obedient servant,
J. W. KING,

*Chief Engineer United States Navy,
Late Chief of Bureau of Steam-Engineering.*

Hon. GEO. M. ROBESON,
Secretary of the Navy.

INTRODUCTION.

For the study of naval construction and marine engineering, the most important field of observation is Great Britain. England is in the fore-front as the leader and model to all European naval powers. In addition to their magnificently equipped public dock-yards, the patronage of the government has sufficed to keep in existence and to increase the supplemental resources which relieve and aid the national establishments, in time of peace, and which in time of war would be to them of priceless value. It is owing to this patronage, and to foreign orders for ships of war, in no small measure, that on the Thames, the Mersey, the Clyde, and the Tyne are found unrivaled establishments fully equipped, with expanded and developed resources, requisite for modern war-ship construction. Besides the numerous ships designed and built yearly for the British flag, English ship-yards have produced, and are still producing, war-ships for other nations. Nearly every considerable naval power, except the United States and France, has employed English designers, English ship-builders, engineers, and gun-manufacturers. It was here that the *König Wilhelm, Kaiser, Deutschland*, and other ships for the German navy were built. Turkey obtained from the Clyde and the Thames a large proportion of her armored fleet, including all the most powerful vessels. Russia, Spain, Holland, Italy, Denmark, Greece, Portugal, Brazil, Chili, Peru, and Japan all come to England to have armored ships of war constructed. The Sheffield works not only supply armor-plates for these ships, but also plates and materials for war-vessels built in continental countries. The Elswick works and Whitworth manufacture guns solely for foreign orders. Besides this, all the nations above named are customers of the English ship-yards and engineering works to supply vessels for their mercantile marine. In London may be found naval *attachés* of nearly all important nations, observing the progress and changes in naval construction. In consequence of these facts, and for the additional reason that comparatively little of value, new or novel, originating with continental naval architects or engineers, was found on the continent, the larger portion of my time abroad was employed in Great Britain.

THE BRITISH NAVY.

In contemplating the power of England the navy is always regarded as her bulwark. On her navy England depends for security at home and respect abroad. Everything concerning it excites eager interest, and it never fails to receive support, whatever party may be in power. No censure is ever passed upon the large expenditures for maintenance and additions to the fleets; but the criticisms of the press and the people are constantly directed at the administration of the admiralty, and the types of vessels constructed. If any condition proposed in a design be not realized in the completed ship, the fact is certain to be exposed by the press, and severely commented upon. This influence, together with the watchfulness over the progress made elsewhere, has not been without effect. In the House of Commons, at the last session of Parliament, the first lord of the admiralty said, "It is our policy to keep pace with the inventions of the day, and ahead of all maritime powers." The most able constructive ability and engineering talent in the kingdom is employed in producing designs for new types of vessels, for machinery, and for appliances of offense and defense. It may be confidently asserted that never since the application of steam propulsion to ships of war, has the British navy been relatively so strong as at the present time, and yet the complaints are that it is not more powerful.

The fleets of former beautiful wooden screw-ships, like their predecessors of the old sailing line-of-battle ship period, and the subsequent paddle-wheel steamers, are fast disappearing from the navy-list for either fighting or cruising purposes. Numbers of wooden line-of-battle ships and frigates provided with auxiliary steam-power, but whose days were passed mainly under canvas; and others that never made a cruise—indeed, antiquated before completed—vessels in whose outlines the beauty of naval architecture may be said to have culminated, are in the same category. In fact, whole squadrons may be seen in the harbors of Portsmouth, Devonport, and other dock-yards, some bearing famous names, and "pierced for" from fifty to one hundred and one guns, but now as useless for purposes of modern warfare as the old paddle-wheel frigates or the fifty-nine sailing-vessels borne on the British navy-list.

The effective force of the British navy may now be divided into ships for great naval battles, ships for coast-defense, and unarmored cruising vessels. There are so many different types that it is quite impossible to classify them according to any former standard. The present collective fleet as presented in the navy-list consists of nearly four hundred vessels of all kinds. This includes those building; but does not include one hundred and thirty-four laid up or employed in permanent harbor-service, and not ever likely to be sent to sea. The total tonnage of these four hundred vessels is about 900,000.

From published returns it appears that during the eight years from 1866 to 1874, ten and a half millions of pounds sterling was expended in the construction of new ships, six millions of which was for armored

ships, and four and a half millions for unarmored vessels. During the same period, one and one-third million pounds were expended on the repairs of armored ships, and nearly four millions on the repairs of vessels of all other kinds, and it is now estimated that about a million pounds sterling is expended annually on new armored ships, and three-quarters of a million on all other new vessels.

ARMORED SHIPS.

It is to the production of the most powerful sea-going fighting-ships that the resources of the navy are first directed; ships sufficiently armored to resist projectiles of any ordinary kind, sufficiently armed to silence forts or to meet the enemy under any conditions proffered; sufficiently fast to choose the time and place to fight, and sufficiently buoyant to carry coal and stores into any ocean. Of this class, according to official statement in the House of Commons, there will be, when those now under construction shall have been completed, eighteen, placed in the order following, according to their power, the *Inflexible* ranking first.*

TURRET SHIPS.

Inflexible, building at Portsmouth, to be completed April, 1878.
Dreadnought, building at Pembroke, nearly completed.
Thunderer, just completed and in commission.
Devastation, in commission, in Mediterranean.
Agamemnon, building at Chatham, date of completion uncertain.
Ajax, building at Pembroke, date of completion uncertain.
Monarch, in commission, Channel squadron.

BROADSIDE SHIPS.

Alexandra, completed at Chatham, but not tried at sea.
Téméraire, building at Chatham, to be completed January, 1878.
Sultan, in commission in the Mediterranean.
Hercules, flag-ship, Mediterranean.
Bellerophon, flag-ship, West Indies.
Swiftsure, in commission in the Mediterranean.
Triumph, in commission, Channel squadron.
Audacious, flag-ship, China squadron.
Invincible, in commission in the Mediterranean.
Iron Duke, coast-guard service, Kingstown.
Penelope, coast-guard service, Harwich.

OCEAN-CRUISE SHIPS OF THE ARMOR-BELTED TYPE.

Shannon, built at Pembroke, not yet commissioned.
Nelson, building at Glasgow, to be completed September, 1877.
Northampton, building at Glasgow, to be completed September, 1877.

VESSELS FOR COAST DEFENSE.

These are for the most part turret vessels, built on the breastwork system, and are named *Glatton*, *Hotspur*, (a ram,) *Rupert*, (a ram,) *Prince*

* When wooden vessels were first plated with armor, they were known as "iron-clads;" now that all hulls are built of iron and plated with heavy armor upon a wooden backing, the term "armored ships" is used, as being more proper than "iron-clads."

Albert, Cyclops, Gorgon, Hecate, Hydra, Scorpion, Wivern; also the broadside gunboats *Viper* and *Vixen*. Besides these, for home defense, there are the *Abyssinia* and *Magdala*, stationed at Bombay, and the *Cerberus*, in one of the Australian harbors. Any of these monitors are capable of going to sea, but they are unfit for cruising; all are low free-board vessels, each provided with a single revolving turret rising above the breastwork, the *Hotspur* and *Rupert* excepted. The former of these was built to be used as a powerful ram solely, and the latter has a fixed turret in which the gun revolves on a platform. This vessel is also fitted especially for ramming.

SHIPS OF THE ORIGINAL ARMORED TYPE.

These vessels are built of iron, and are of the broadside variety. They have become antiquated, and are not now regarded as competent to meet in line of battle the armored ships of the present period. They consist of the *Agincourt, Northumberland, Achilles, Black Prince, Warrior, Hector, Valiant, Resistance, and Defence*.

WOODEN ARMORED SHIPS.

Most of these ships were under construction as line-of-battle ships or frigates at the time of the battle between the little *Monitor* and *Merrimac* in Hampton Roads; they were subsequently altered and converted into sea-going iron-clads. Many of them are decayed and relegated to harbor service, and it is not probable that any of them will be much longer continued as cruisers, or extensively repaired. They are as follows: *Prince Consort, Royal Oak, Caledonia*, (which has an iron upper deck,) *Research, Zealous*, (which has an iron upper deck,) *Lord Clyde*, (which has had her machinery removed, and is fitted for a drill-ship,) *Royal Alfred*, (which has an iron deck,) *Royal Sovereign*, (a turret-ship with an iron upper deck,) *Favorite, Enterprise*, (with iron top-sides,) *Lord Warden*, (with iron inner skin,) *Pallas*, and *Repulse*. The *Pallas* was built for an iron-clad in 1865, and the *Repulse* in 1868; they were the last armored wood-built ships for the royal navy, and are still cruising, the former in the Mediterranean and the latter in the Pacific.

PART II.

THE INFLEXIBLE

MASTLESS ARMORED SEA-GOING SHIPS.

The *Devastation*, the *Thunderer*, and the *Dreadnought* come under the above heading, and take rank first as the most powerful fighting ships armed and now afloat in the world. The *Inflexible*, now building, designed as a still more powerful ship, is intended to be mastless only during time of peace, as also the *Agamemnon* and *Ajax*, ships of the same type but of smaller dimensions.

The following descriptions and dimensions of these highly important ships will be found accurate, and a careful reading will convey as correct knowledge of them as can be obtained without working-drawings in detail.

NOTE.—While in Europe, engaged collecting the information contained in this report, various scientific publications were consulted, and none were found more reliable than *Engineering*, published at 37 Bedford street, London. From this excellent periodical extracts have been taken; also from some others when they were found correct.

THE INFLEXIBLE

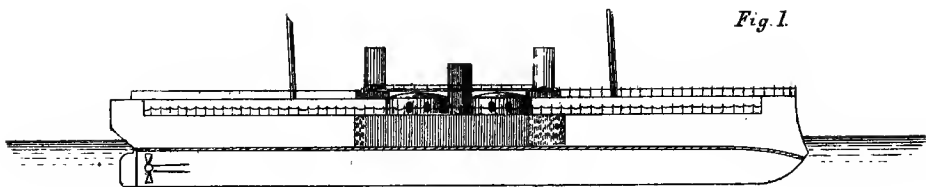

Fig. 1.

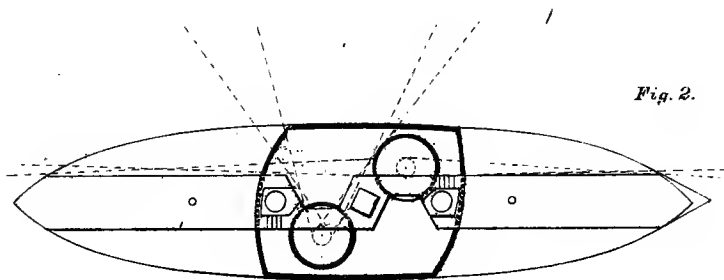

Fig. 2.

THE INFLEXIBLE.

The modern man-of-war is much more than an armored steamer; she is a great engine of destruction, clad in heavy armor, provided with huge guns which are operated by machinery, driven by powerful engines, and fitted with machinery for purposes of all kinds. Year by year the thickness of armor and weight of naval artillery go on increasing together. Mechanical appliances have more and more replaced manual labor, and at the same time the forms of ships have been adapted to the work they have to do and to the conditions under which they must act. No war vessel yet designed has departed so widely from pre-existing types, and in none has so enormous a stride been made, in offensive and defensive power, as in the one about to be described.

The *Inflexible*, which was commenced at Portsmouth dock-yard in February, 1874, and launched April, 1876, is a twin-screw, double-turret ship, with a central armed citadel. She was designed by Mr. Barnaby, the director of naval construction at the Admiralty, and at a meeting of the Institution of Naval Architects in London he describes the vessel in the following language: "Imagine a floating castle 110 feet long and 75 feet wide, rising 10 feet out of water and having above that again two round turrets, planted diagonally at its opposite corners. Imagine this castle and its turrets to be heavily plated with armor, and that each turret has two guns of about eighty tons each. Conceive these guns to be capable of firing, all four together, at an enemy ahead, astern, or on either beam, and in pairs toward every point of the compass. Attached to this rectangular armored castle, but completely submerged, every part being 6 to 7 feet under water, there is a hull of ordinary form with a powerful ram bow, with twin screws and a submerged rudder and helm. This compound structure is the fighting part of the ship. Sea-worthiness, speed, and shapeliness would be wanting in such a structure if it had no addition to it; there is therefore an unarmored structure lying above the submerged ship and connected with it, both before and aft the armored castle, and as this structure rises 20 feet out of water from stem to stern without depriving the guns of that command of the horizon already described, and as it moreover renders a flying deck unnecessary, it gets over the objections which have been raised against the low free-board and other features in the *Devastation*, *Thunderer*, and *Dreadnought*. These structures furnish also most luxurious accommodations for officers and seamen. The step in advance has therefore been from 14 inches of armor to 24 inches; from 35-ton guns to 80 tons; from two guns ahead to four guns ahead; and from a height of 10 feet for working the anchors to 20 feet. And this is done without an increase in cost, and with a reduction of nearly 3 feet in draught of water. My belief is that in the *Inflexible* we have reached the extreme limit in thickness of armor for sea-going vessels."

The length of the vessel between perpendiculars is 320 feet, and she has the extraordinary breadth of 75 feet at the water-line; depth of hold, 23 feet $3\frac{1}{2}$ inches; free-board, 10 feet; mean draught of water, 24 feet 5 inches, (23 feet 5 inches forward and 25 feet 5 inches aft;) area of midship section, 1,658 square feet; and displacement when all

the weights are on board, 11,407 tons, being the largest of any man-of-war hitherto constructed. She is, as before described, a rectangular-armed castle; the whole of the other parts of the vessel which are unprotected by armor have been given their great dimensions for the simple purpose of floating and moving this invulnerable citadel and the turrets by which it is surmounted. Her immense bulk, unprecedented armament, powerful machinery, and the provision for ramming, and for resisting the impact of rams as well as of shot and shell, have made it necessary that strength and solidity should enter into every part of the structure.

HULL AND APPENDAGES.

While the cellular compartments of the double bottom have a little less depth than in the *Devastation* class, they are built up of heavier angle-irons and plating, and steel has been very largely employed for the purpose of securing great strength with comparative lightness of material. The hull is composed of flat and vertical keels, transverse and longitudinal frames, inner and outer bottom-plating. The vertical keel is formed of steel plates $\frac{3}{4}$ -inch thick by 40 inches deep, and the flat keel-plates are of iron in two thicknesses of $\frac{1}{16}$ inch and $\frac{3}{4}$ inch, the two being connected by angle-irons 5 by 5 inches by $\frac{3}{4}$ inch. On the upper edge of the vertical keel the angle-irons by which it is fastened to the inner bottom-plates are 3 inches by $3\frac{1}{2}$ by $\frac{1}{2}$ inch. The framework of the vessel below the armor is composed of longitudinal and transverse frames. The former, eight in number, are formed of steel plates $\frac{7}{16}$ inch in thickness, the shelf-plate being of iron $\frac{1}{2}$ inch thick. These frames extend as far forward and aft as is deemed practicable. Within the double bottom, which extends through 212 feet of the ship's length, the transverse frames are solid, and are made water-tight at intervals of 20 feet. There are also intermediate bracket-frames placed 4 feet apart. Throughout the double bottom the transverse frames, which are likewise 4 feet apart, are of the thickness of $\frac{3}{8}$ inch, but are considerably lightened by having holes cut through them, the upper parts at the same time being much narrowed. Additional intermediate frames are worked in the engine-room in order to secure greater strength. The angle-irons forming the frames vary from $5\frac{1}{2}$ inches by 3 inches by $\frac{1}{2}$ inch to 3 inches by $3\frac{1}{2}$ by $\frac{1}{2}$ inch. The outer skin plating of the bottom varies from $\frac{1}{16}$ inch in the garboard strakes to $\frac{5}{8}$ inch, with the exception of the ends, where the thickness is increased to $\frac{7}{8}$ inch, and behind the anchors, where the plating is doubled. The plating of the inner bottom, which extends through the length of the double bottom, and which, like the outer bottom, is made perfectly water-tight, is of the uniform thickness of $\frac{3}{8}$ inch, except under the engines, where it is $\frac{7}{16}$ inch. As is usual in iron vessels, the stern of the *Inflexible* consists of a solid iron forging scarfed at its lower end to the keel-plates. The stern-post and after pieces of keel, which are formed of the best angle-iron, were also made in a single forging. The rudder is a solid iron frame filled in with wood and covered with iron plates. In consequence of its immense weight—some 9 tons—it is made to work upon double pintles in combination with the ordinary pintles and braces. It is moved by a tiller 4 feet 6 inches below the water. Indeed, the whole of the steam steering-gear will be placed below the water-line and armored deck, so that it will be impossible for the rudder-head to be injured by shot or shell during an engagement. To receive the propeller-shafts two iron tubes are constructed, one under each quarter. The fore parts of these tubes, where they leave the run of the ship, are supported by the frame-

work of the hull, which is bossed out in a suitable form for the purpose, the after parts being supported by struts from the ship's bottom. There are four decks—the lower, middle, upper, and superstructure decks—the last being a middle-line erection placed forward and aft above the upper deck for working the ship, carrying and lowering the boats, &c. Outside the citadel the lower-deck beams are covered with iron 3 inches thick. This deck is depressed at the fore end so as to meet that part of the bow which is intended for ramming, thus conferring upon it greatly increased strength and resistance when engaged in butting an enemy's ship. It may be here stated that the ram of the *Inflexible* is of the spur kind, and though it is fixed at the present time, it will eventually be made to unship during ordinary cruises. The middle-deck flat consists of $\frac{1}{2}$ -inch plating covered with 3-inch deal planks; while the upper-deck beams in the vicinity of the citadel are covered with 3-inch plating, and in other places with $\frac{1}{2}$ -inch plating. The beams, pillars, and bulk-heads for supporting the various decks and platforms, and forming the different compartments and rooms, are arranged and fitted so as to give the greatest possible strength to the sides of the vessel. The largest beams are on the main deck. They are 14 inches deep, while those on the upper deck are 10 inches, and those on the lower deck are 12 inches deep. Every beam is either supported by wrought-iron tube-pillars or is trussed where pillars cannot be erected, the strongest being under the turrets. The two superstructures themselves in no wise add to the power of the ship, either for attack or defense. Their purpose in the economy of the ship is to afford accommodation for the officers and crew; and as the structures are erected on the upper deck, this will be of the best kind, with abundance of air and natural light. Their dimensions are: fore superstructure, extreme length, 104 feet 4 inches; breadth, 21 feet 4 inches; after superstructure, extreme length, 105 feet 4 inches; breadth, 30 feet. The frames are formed of angle-iron, 7 inches by 3 inches, placed 4 feet apart, and between them are intermediate frames made of angle-iron 4 inches by 3 inches. The ends are covered with $\frac{3}{8}$ -inch plates, and the whole surface with 3-inch deals. The cabin-walls are all coated with Welch's wood-faced cement, as a protection against the results of atmospheric condensation. The officers and men together will number 350. As a protection against the casualties of war and the sea, the hull is divided by means of the transverse and longitudinal bulk-heads into no fewer than 135 water-tight compartments, and arrangements will be made for quickly removing therefrom any water that may collect within them through collision or other cause. Powerful steam-pumps, among which may be mentioned two of Friedman's patent ejectors, capable of discharging 300 tons of water each per hour, will be fitted. All the bulk-heads are provided with water-tight doors of an improved pattern, sluice-valves, man-holes, and water-tight scuttles. Water-tight doors can also be fitted, when necessary, to the bulk-heads passing through the coal-bunkers. Each of the water-tight compartments has been tested by hydraulic pressure. Great attention has been bestowed upon the question of ventilation, which in ships of the *Devastation* class and, indeed, in all monitors of low free board, has been a source of considerable discomfort and embarrassment. In the *Inflexible* the fresh air will be drawn into the midship part of the vessel through a series of downcast shafts, by means of eight powerful fans, worked by four of Messrs. Brotherhood & Hardingham's patent three-cylinder engines. The air is then conducted into main pipes, which run around the sides of the hull to the extremities, and from these, subsidiary or branch pipes discharge the air in ample quantities to every part of the ship.

DEFENSE.

The protected portion of the ship is confined to the citadel or battery, within whose walls are inclosed the engines and boilers, the turrets, the hydraulic loading-gear, the magazines, and in fact all the vital parts of the vessel. It measures 110 feet in length, 75 feet in breadth, and is armored to the depth of 6 feet 5 inches below the water-line, and 9 feet 7 inches above it. The sides of the citadel consist of an outer thickness of 12-inch armor-plating, strengthened by vertical angle-iron guides 11 inches wide and 3 feet apart, the space between them being filled in with teak backing. Behind these girders, in the wake of the water-line, is another thickness of 12-inch armor, backed by horizontal girders 6 inches wide, and supported by a second thickness of teak backing. Inside this are two thicknesses of 1-inch plating, to which the horizontal girders are secured; the whole of the armor-backing and plating being supported by and bolted to transverse frames 2 feet apart, and composed of plates and angle-irons. It will thus be seen that the total thickness of armor at the water-line strake is not less than 24 inches. The armor-belt, however, is not of uniform strength throughout, but varies in accordance with the importance of the protection required and the exposure to attack. Consequently, while the armor at the water-level is 24 inches in two thicknesses of 12 inches each, above the water-line it is 20 inches in two thicknesses of 12 inches and 8 inches, and below the water-line it is reduced to 16 inches in two thicknesses of 12 inches and 4 inches. The teak-backing with which it is supported also varies inversely as the thickness of the armor, being, respectively, 17 inches, 21 inches, and 25 inches in thickness, and forming with the armor, with which it is associated, a uniform wall 41 inches thick. The depth of armor below the load water-line is 6 feet 5 inches, but as the vessel will be sunk a foot on going into action by letting water into its double bottom, the sides will thus have armor protection to the depth of 7 feet 5 inches below the fighting-line. The outside armor is fastened by bolts 4 inches in diameter, secured with nuts and elastic washers on the inside. The shelf-plate on which the armor rests is formed of $\frac{1}{2}$ -inch steel plates, with angle-iron on the outer edge 5 inches by $3\frac{1}{2}$ inches by $\frac{9}{16}$ inch. The armor on the fore bulk-head of the citadel is exactly the same in every respect as that on the sides, but the armor of the rear bulk-head is somewhat thinner, being of the respective gradations of 22, 18, and 14 inches, and forming with the teak backing, which is 16, 20, and 24 inches, a uniform thickness of 38 inches. It may also be useful to mention that before and abaft the citadel the frames are formed of 7-inch and 4-inch angle-irons, covered with $\frac{9}{16}$ -inch plates. The total weight of the armor, exclusive of deck, is 2,250 tons, and the total weight of armor, inclusive of deck, is 3,155 tons.

TURRETS.

But the most singular feature in the design of the ship is the situation of the turrets. In the *Devastation* and *Thunderer*, and, in fact, all monitors afloat, the turrets are placed on the middle line, an arrangement which, though advantageous in some respects, possesses this signal disadvantage, that in double-turreted monitors only one-half of the guns can be brought to bear on the enemy either right ahead or directly astern. In the *Inflexible*, however, the turrets rise up on either side of the ship *en échelon* within the walls of the citadel, the forward turret being on the port side and the after turret on the starboard side, while the superstructures are built up along a fore-and-aft line of the deck. By these means the whole of the four guns can be discharged simultaneously at a ship right ahead or right astern, or on either beam, or in

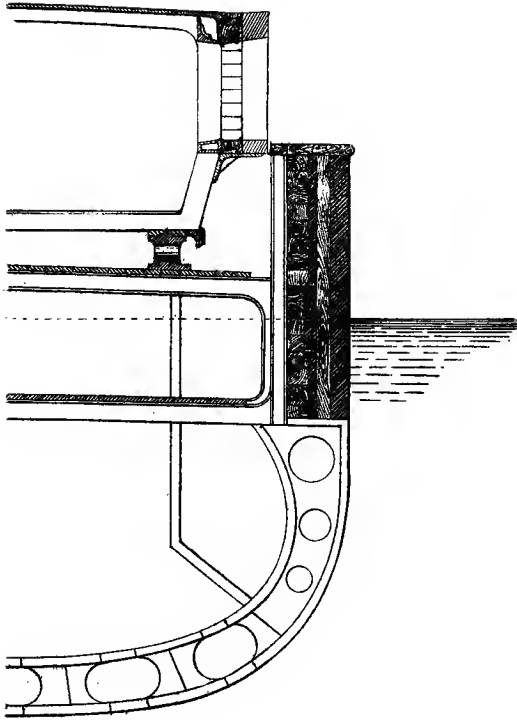

INFLEXIBLE.

pairs toward any point of the compass. Besides these important advantages, the guns of each turret can be projected clear of the ship's side—in the case of the one turret to port, and in the case of the other turret to starboard. They can then be depressed enough not only to strike a vessel at close quarters, below the line of her armor, but even to fire down upon her deck, should the enemy be ranged alongside. The walls of the turrets, which last have an internal diameter of 28 feet and an external diameter of about 33 feet 10 inches, are formed of armor of a single thickness of 18 inches, (the thickest ever manufactured, with the exception of the 22-inch experimental plate which was rolled at Messrs. Cammel & Co.'s works, at Sheffield, for the turrets of the Italian frigates,) with backing of the same thickness, and an inner plating of 1 inch in two equal thicknesses. All experience has proved that, for many reasons, this arrangement is the best. The wood backing distributes the blow when struck, deadens the vibrations, protects the fastenings, and stops the splinters, while the inner iron is also of advantage, since it renders the backing more compact, and also assists in arresting the passage of *débris*. The height of the turret-ports from the load-line is 12 feet, and a foot less from the fighting-line, and all the plating in the wake of the guns is considerably strengthened.

OFFENSE.

A very special interest attaches to the armament of the *Inflexible*, not only because it consists of guns vastly more powerful than any yet mounted afloat, but because these guns are carried and worked on the new and remarkable hydraulic system which has hitherto only been tried in the fore turret of the *Thunderer*. Each turret weighs no less than 750 tons, (including the guns,) and having to deal with a moving mass of such enormous weight, and with the superadded difficulty of a floating, and therefore unstable, platform on which to revolve, it was determined to commence at this point with the adoption of the hydraulic system of Sir William Armstrong, as developed for gunnery purposes by his partner, Mr. George Rendel. The revolution of the turrets accordingly will be accomplished by hydraulic machinery, in a manner similar to that employed by the Elswick firm for turning swing-bridges and great cranes. In such cases the weights dealt with have already exceeded that of the turrets of the *Inflexible*; and so complete is the control afforded by hydraulic machinery in the movements of heavy masses in these analogous cases, that it is believed the turrets, will, by this machinery, be rotated at any speed, from a complete revolution in one minute, down to a rate as slow and as uniform as desired. The advantage of the high speed is plain; that of the slow but regular rotation will be apparent when it is remembered how much delicacy of adjustment is necessary for following with the aim an object moving rapidly and at a distance. Although the 81-ton guns will be worked on a system similar to that adopted in the case of the 38-ton guns of the *Thunderer*, yet as the design of the *Inflexible* had not been completed before the decision to work the guns by hydraulic power was formed, a much more complete hydraulic gunnery arrangement has become possible. The sponging and loading apparatus is still, as in the *Thunderer*, to be placed at duplicate fixed stations outside the turrets, and under the protection of the armored deck of the vessel. The muzzles of the guns are brought to the loading mechanism by revolving the turret and slightly depressing the guns. But there is no special loading-port as in the *Thunderer*. All that is necessary is to depress the guns to the small angle required for bringing the muzzles below the level of the deck, which, still further to reduce this angle, is raised and inclined upward

at the base of the turrets so as to form a sort of glacis, and to give cover to the muzzles without involving any considerable depression of the gun. By this means the objection brought against the greater depression of the guns of the *Thunderer* is avoided. A more important novelty is the manner of mounting the 81-ton guns in the turrets. Hitherto it has been the practice to place all heavy guns upon an iron structure, called the carriage, on which they rest by means of the trunnions. This carriage bears, besides the gun, the mechanism for elevating and depressing the gun, and for "tripping," and also in part the mechanism for checking recoil. Besides the carriage, again, there is the slide upon which the carriage runs. Now in the system adopted for the *Inflexible*, Mr. G. Rendel has taken the bold step of dispensing altogether with a carriage, properly so called.

The leading features of the arrangement are shown in figure 3. Two guns will be mounted side by side in each turret. Each gun will be mounted so as to be supported on three points. The trunnions will rest on blocks sliding on fixed beams bolted down to the floor of the turret, while the breech will rest on a third block, sliding like the others between guides upon a beam or table. Behind each of the trunnion-blocks, in the line of recoil, are two hydraulic cylinders, connected with them by piston-rods. The cylinders communicate by a pipe, on which there is a valve, which, on the recoil of the gun, opens and allows the pistons to run back slowly, checking the recoil. By reversing the apparatus, the gun can be run out again. The beam on which the breech rests is supported by a third hydraulic cylinder, fixed vertically beneath it in the turret. By this means, the breech can be easily raised or lowered, thus elevating or depressing the muzzle of the gun, which pivots on its trunnions with a large preponderance toward the breech. In order to load, the muzzle is depressed until it comes opposite to an opening made in the upper deck before the turret. A hydraulic rammer works in guides through this hole, and the rammer-head is hollow, and is so constructed that when it is driven into the recently-fired gun, and comes in contact with the sides of the powder-chamber, a valve opens, and it discharges through a number of holes small jets of water, thus acting as a sponge, and extinguishing any remnants of the charge or of the products of the explosion which may have remained smoldering in the bore. It is then withdrawn, and a hydraulic shot-lift raises up to the muzzle of the gun the charge, the projectile, and a retaining wad, and then a single stroke of the rammer drives them into the gun and home to the base of the bore. Again the rammer is withdrawn, the hydraulic piston under the breech of the gun elevates the muzzle, the turret swings around, and the shot is fired. A 9-inch gun, mounted experimentally in a turret at Elswick, and loaded on this system, was brought to the loading position, sponged, loaded, and brought back to the firing-point in forty seconds. Comparatively equally rapid loading was effected with the 38-ton gun during the experimental trial of the hydraulic gear on board the *Thunderer*. Thus, the first advantage of the system is rapidity of fire; the second is economy of labor. One man only for each gun is stationed in the turret, another works the hydraulic rammer on the main deck, six or eight others are employed in bringing up the ammunition to the shot-lift by means of a small tram-way. There are two sets of loading-gear for each turret; but even if both were put out of order, the gun could still be loaded with an ordinary rammer and sponge by a number of men stationed on the main deck. The adoption of the system enables very heavy guns to be carried in comparatively small turrets. Those of the *Inflexible* are very little larger than those of the *Devastation*, so that with the old plan of having a numer-

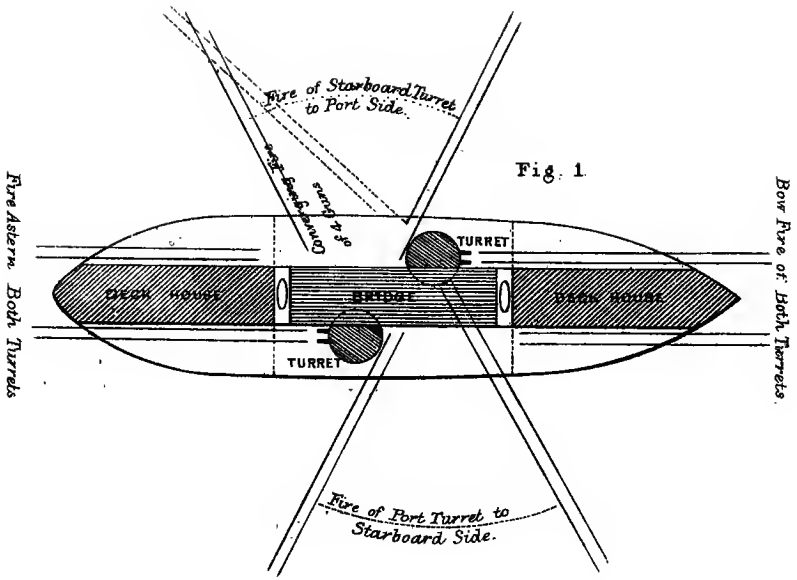

Fig. 1

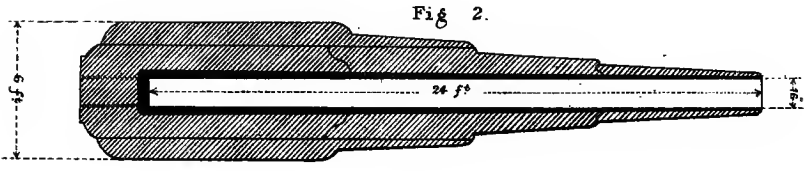

Fig. 2.

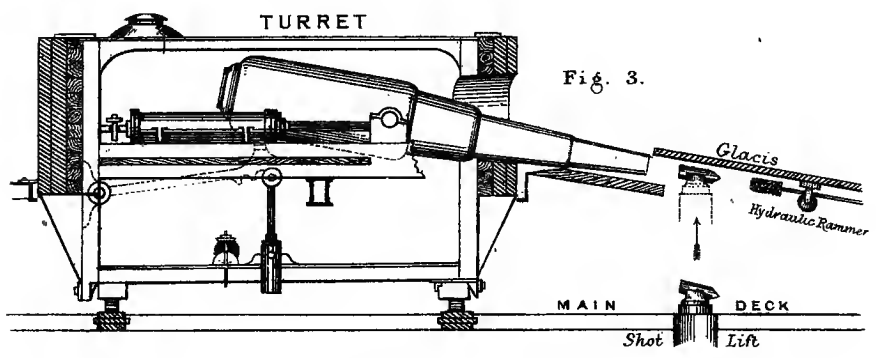

Fig. 3.

The Inflexible and her Armament.

ous crew in the turret and running in the gun in order to load it by hand, only the 38-ton gun could be carried. As it is quite possible that the *Inflexible* will be armed with even more tremendous weapons than the 81-ton guns, this has been held in view in designing the ship; and, by a slight modification, it will be possible to mount in each of her turrets a pair of 160-ton guns, with a length of 30 feet and a caliber of 20 inches. The armament of the *Inflexible* will be composed of four of the heaviest guns (except those making for the Italian vessels) ever constructed, of which the experimental 81-ton gun completed at Woolwich and tested is the type.* Figure 2 is a sectional sketch of the gun, showing the arrangement of the wrought-iron coils welded around the massive central steel tube. This tube, which forms the core of the gun, is bored out of a solid ingot, which cost £1,700. The bore is 24 feet long, and rifled from the muzzle to within a short distance of the base of the tube, where the unrifled portion forms the powder-chamber. The greatest external diameter of the gun is 6 feet, and at the muzzle it is 2 feet in diameter. The full caliber of the piece is 16 inches. The experimental gun was first bored out to 14½ inches and tested; for a second series of experiments it was given a caliber of 15 inches, and then bored to the full caliber of 16 inches and finally tested.

The gun is rifled with 13 grooves, each having an increasing pitch from 0 to 1 in 35 calibers. The service powder-charge is 370 pounds of 1.5 inch powder. The weight of the projectile for the service-shell is 1,700 pounds, and the bursting charge about 100 pounds of powder. The details of the series of proof-trials at Woolwich, also the tests at Shoeburyness, have been widely published. Still, for reference, it is believed advisable to give here the results of the trials last made with the caliber of 16 inches, that at which the gun is to be used in actual warfare:

Number of rounds.	Size of powder.	Weight of charge.	Weight of projectile.	Muzzle velocity per second.	Mean pressure in gun.	Total energy developed.
	<i>Cubic inches.</i>	<i>Pounds.</i>	<i>Pounds.</i>	<i>Feet.</i>	<i>Tons per square inch.</i>	<i>Foot-tons.</i>
1.....	1.5	340	1,700	1,486	20.1	26,030
2.....	1.5	350	1,700	1,505	20.4	26,740
3.....	1.5	350	1,700	1,502	20.3	26,630
4.....	1.5	350	1,700	1,467	19.6	25,406
5.....	1.5	350	1,700	1,475	18.4	25,683
6.....	1.5	350	1,700	1,493	21	26,314
7.....	1.5	360	1,700	1,487	18.8	26,103
8.....	1.5	370	1,700	1,495	19.9	26,385
9.....	1.5	350	1,700	1,518	20.5	27,203
10.....	1.5	370	1,700	1,523	20.3	27,363
11.....	1.5	360	1,700	1,519	21.3	27,239
12.....	1.5	360	1,700	1,518	20.0	27,203
13.....	1.5	370	1,700	1,519	19.6	27,239
14.....	1.5	370	1,700	1,517	20.7	27,168

* The largest rifled piece previously manufactured is the Krupp gun, exhibited at the Vienna Exposition, and subsequently exhibited at the Centennial Exhibition. It was mounted on a wrought-iron sea-coast carriage, having steel hydraulic recoil-cylinders.

This gun is a breech-loader, and is built up with steel hoops over a steel tube. Its weight, including the breech-loading apparatus, is 56½ tons. The length of the tube is 26 feet 3 inches. The length of the bore is 22 feet 6½ inches, and the caliber 14 inches. The twist is uniform.

The projectiles consist of both steel and chilled shells, and long fuse shells 2.8 calibers. The heaviest projectiles, when charged, weigh, the steel, 1,124.5 pounds; the chilled, 1,157.5 pounds; and the powder-charge of the gun is 242.5 pounds for steel and chilled shells, and 275 pounds for long fuse shells.

The experiments for range and accuracy were conducted at Shoeburyness, and are reported to have met the unqualified approval of the authorities. When the last experiments were concluded, viz, October 4, 1876, the 81-ton gun had fired 140 rounds, and it may be interesting to summarize the amount of ammunition that has been thus expended. "With its normal caliber of 14.5 inches it fired 4,660 pounds of powder and 27,052 pounds of iron in 21 rounds. With a caliber of 15 inches it fired in 32 rounds 8,223 pounds of powder and 45,712 pounds of iron. With the same caliber, but with a powder-chamber of 16 inches, in 21 rounds it disposed of 6,020 pounds of powder and 30,810 pounds of shot. With its present uniform bore of 16 inches, and while at Woolwich, it fired 8,870 pounds of powder and 45,981 pounds of iron in 27 rounds. This gives 27,773 pounds of powder and 149,555 pounds of iron expended at Woolwich in 101 rounds. At Shoeburyness the gun has fired 39 rounds with 14,430 pounds of powder and 66,300 pounds of iron. This gives a total number of 140 rounds, 42,203 pounds of powder, and 215,855 pounds of iron."

During the experiments for range, shells were reported to have been recovered from a minimum distance of six miles; others were traced still farther, until deep water arrested the progress of the explorers.

What the 81-ton gun can do against an armored target has yet to be practically demonstrated, a target now being in course of construction for this purpose, and it is expected the tests will be made during December. As, however, some important results have been achieved with the gun, which comes next below it in magnitude, viz, the 38-ton of the pattern mounted in the fore turret of the *Thunderer*, and manufactured for the *Dreadnought*, also designed for the *Agamemnon* and *Ajax*, it may be interesting for reference to state as a matter of fact that the 38-ton gun has sent its projectile nearly through an armored target of the following combination: A 12-inch plate, an 8-inch plate, 6 inches of teak, and a 5-inch plate, into which last it penetrated 2 inches, or altogether 22 inches of iron and 6 inches of teak. In another instance, the projectile was sent through a target built up in the following manner: A 4-inch plate, an 8-inch plate, 6 inches of teak, a 5-inch plate, 6 inches of teak, and an inner 1-inch skin, supported by angle-irons, making altogether 18 inches of iron and 12 inches of teak. This was done at close quarters. Besides, in October last, at a range of 70 yards, the projectile was sent nearly through a target composed as follows: Three plates each 10 feet wide, 8 feet high, and $6\frac{1}{2}$ inches thick; between the plates were 5 inches of teak-backing, making the total thickness of the target $29\frac{1}{2}$ inches. The shot, which had a striking velocity of 1,421 feet per second, punched a clean hole 13 inches by $12\frac{1}{2}$ inches in the two front plates, and penetrated into the rear plate, where it broke up. The charge was 130 pounds of 1-inch pebble-powder, and the projectile weighed 812 pounds. The target was an exact sample of the armor of some of the English coast forts; therefore, as a prelude to experiments on a larger scale, this experiment opens up the question of coast-defense.

Some idea of the amount of ammunition required for the 81-ton gun may be formed when it is estimated that in an action, if the *Inflexible* would fire only ten shots from each of the four guns, she would use up 14,800 pounds of pebble-powder, and hurl upward of 30 tons of projectiles, at a cost of about \$6,320.

The cost of the gun, exclusive of carriage and the machinery for working it, was estimated at £15,000, and the factory-plant and experimental trials at £10,000. The actual cost of each of the eight guns will be best known when all are manufactured.

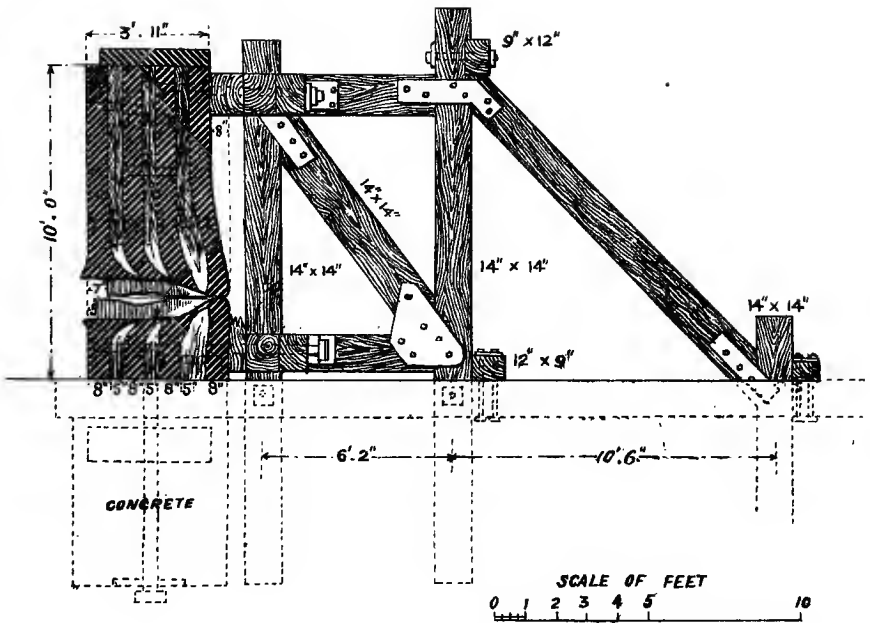

TARGET No. 41 AFTER IMPACT OF SHOT.

Owing to the delay in putting this report in press, after being submitted, consequent upon the large amount of congressional proceedings taking precedence of it at the Government Printing Office, I am enabled to add the results of the first firing of the 81-ton gun at the target at Shoeburyness.

The target against which this gun has been proving its powers is the most formidable of any hitherto fired at. It is gigantic, even in comparison with those fired at by the 100-ton gun at Spezia, hereafter to be noticed.

Its construction is beautifully and plainly shown by illustrations giving front elevation, horizontal and vertical sections, with accompanying figures and explanations, in the *Engineer* of February 2 and 9, and from which the accompanying figure has been taken.

The target is altogether different from the Spezia targets, as may be seen by referring to the sketch. It is composed of four iron armor-plates, each 8 inches thick, sandwiched between three layers of teak each 5 inches thick, amounting in all to 32 inches of iron and 15 inches of teak. The plates are 16 feet in breadth by 10 feet in height. Each plate weighs 23 tons, the collective weight of iron being thus 92 tons. The plates are secured together in pairs by bolts; that is to say, the front plate is bolted to the second one, the second to the third, the third to the fourth, and the fourth to the horizontal beams in the rear. The bolts employed are 3 inches in diameter. The shank of the bolt has the Palliser projecting screw-thread on it, while the head is made on the ball-and-socket principle, with the hole in the plate allowing play round the neck of the shank, so that one plate may move slightly on the next without shearing the bolt.

The target is supported by a heavy frame-work of beams, mostly 14 inches square, and very firmly secured to the ground by strutted piles at the ends, and weighted with an old armor-plate on the top to keep the teak filling from escaping under the force of the blow of impact.

The cost of the armor-plates and bolts was about \$24,300 in gold, and the cost of the timber and labor about \$1,000 more.

The first shot was fired February 1. "The gun was charged with 370 pounds of powder, cubes of 1.5 inch, and a Palliser projectile filled with sand to 1,700 pounds' weight, including gas-check, and plugged. This projectile was of service-form, having an ogival head of $1\frac{1}{2}$ caliber radius.

By reference to the cut, it will be seen that the projectile buried itself into the target, having penetrated through the first three plates and the three layers of wood, also about one inch into the rear plate; that is, it penetrated through 24 inches of iron, 15 inches of teak-wood, and was arrested with the point one inch into the fourth plate, thus leaving 7 inches of iron in front of it unperforated, which iron, being cracked and bent, would offer greatly-diminished resistance to further penetration—the projectile itself being split.

The horizontal beam at the base of the back of the target was crushed and split into ribbons, and the whole target-structure sprung and shaken.

On the same day, a blind common shell was fired from the 81-ton gun at an old 8-inch unbacked armor-plate, which was completely demolished, being split and broken across and thrown out of its position, and the shell broken up and scattered.

Doubtless the common shell from this gun would be terrible against any weak-armored ship."

MOTIVE MACHINERY.

The machinery was constructed by Messrs. John Elder & Co., of Glas-

gow. Each screw will be driven by an independent set of compound engines with three vertical inverted cylinders of the collective power of 4,000 horses, giving an aggregate power of 8,000 horses (indicated) for both sets of engines. The diameter of the high-pressure cylinder is 70 inches, and the diameter of each low-pressure cylinder is 90 inches; the former is placed between the two latter. They are steam-jacketed and are connected together by stay-bolts continued to bulkheads, so as to serve as ramming-chocks. The pistons have a stroke of 4 feet, and the number of revolutions expected is 65 per minute. The piston-rods are double, and are connected by crank cross-heads. They are each 7 inches in diameter, the connecting-rods having a diameter of 9 inches and a length of 7 feet 6 inches. The valves are of the piston kind. They are worked by link-motions and levers, and are reversed by an ingenious combination of steam and hydraulic power. The engines at starting are assisted by auxiliary steam-gear, the valves of which are fitted to the receiver. The steam from the low-pressure cylinders is exhausted into independent surface-condensers, having a total cooling surface of 16,000 square feet. The steam is condensed in the interior of a series of tubes of $\frac{3}{4}$ -inch external diameter, of which each condenser has no less than 6,650. The condensers are constructed to be worked as common condensers. The circulating-pumps are actuated by separate engines, each having its own feed, bilge, and air-pumps, worked by levers from the cross-heads. The air-pumps are made of gun-metal, with a diameter of 34 inches and stroke of 2 feet 3 inches, the water being discharged below the armor-deck. With respect to the centrifugal pumps, it may be mentioned that they are judiciously placed at so high a level in the vessel that in the case of leakage occurring, by which the ship's bottom may be flooded to as great a depth as 12 feet, they can be worked with perfect freedom. There are also double-acting hand-pumps, each two coupled; feed donkey-engines, each with double-acting pumps 4 inches in diameter; bilge-donkeys, each with double-acting pumps 6 inches in diameter, and fire-engines, with double-acting pumps $8\frac{1}{2}$ inches in diameter. It may be mentioned that the engines which work the circulating-pumps are also made to pump out the bilge, in the event of the ship springing a leak or sustaining damage from being rammed; that the centrifugal pumps are to be sufficiently powerful to perform the same work in case of emergency; and that a Kingston valve is fitted through the bottom, in connection with each fire-pump.

Each cylinder is fitted with an expansion-valve, having a variable cut-off, with an extreme range of from one-sixth to one-half stroke. These valves are cylindrical gridiron-valves, of phosphor-bronze,* 3 feet in diameter, working on cast-iron gridiron seats, and giving a minimum of clearance between the expansion-valve and main slide. They are worked by an eccentric on the crank-shaft and a slotted lever, and are all connected to a shaft in front of the engines, so that they may be

* This alloy is now gaining favor for cylinder valve-faces where high-pressure steam is used, and for bearings where heavy pressures are applied. Its component parts consist of copper, tin, and phosphorus, and it is capable of being made tough and malleable, or hard, according to the proportions of the several ingredients. It is rendered so liquid in the molten state by the addition of the phosphorus that it forms very clean castings.

Messrs. Levi & Kingel, of the Val Benoit nickel works, near Liege, Belgium, have, for a number of years past, been engaged in making experiments for the purpose of improving bronzes of this kind. The results of their experiments are thus summed up by M. Dumas:

"The color, when the proportion of phosphorus exceeds $\frac{1}{2}$ per cent., becomes warm and like that of gold largely mixed with copper. The grain and fracture approximate to those of steel, the elasticity is considerably increased, the absolute resistance under

thrown out by a single handle. Each engine is also fitted with a common injection apparatus. The crank-shaft is formed of three pieces, the diameter of the bearings being $17\frac{1}{2}$ inches. The propellers will be about 20 feet in diameter, and will be worked outwards, the thrust being at the after end. The shaft tubes are of wrought iron, supported by struts, while the shafting will be made of Whitworth fluid-compressed steel, with solid couplings. It will be hollow, the inner diameter being 10 inches and the outer 16 inches. The faces of the high-pressure cylinders are formed of phosphor-bronze 2 inches thick; the liners of the cylinders are also constructed of the Whitworth compressed steel, which possesses properties rendering it not only extremely light, but at the same time much more trustworthy than the ordinary metal used for this and shafting purposes. Each engine will be fitted with a governor, to prevent racing in stormy weather; and in addition to the hand-gear, small auxiliary engines will be erected for turning the main engines.

BOILERS.

The steam is to be furnished by twelve boilers, eight single-ended and four double-ended. They are constructed of the best Lowmoor plates, tested to 21 tons lengthwise and 18 tons crosswise, and the pressure of steam will be 60 pounds per square inch. The four double-ended boilers are 17 feet long, 9 feet 3 inches wide, and 14 feet 3 inches high, with four furnaces in each. Four of the single-ended boilers are 9 feet long, 13 feet 7 inches wide, and 15 feet 6 inches high, with three furnaces each, and the four remaining single-ended boilers are 9 feet long, 11 feet wide, and 13 feet 4 inches high, with two furnaces, each having a separate fire-box. All the boilers are to be clothed with four thicknesses of boiler-felt, and covered with galvanized sheet-iron, and are stayed to prevent their moving by concussion when the ship is engaged in ramming. They are to be supplied with water by four feed-pumps, which are attached to each engine, the pumps being $7\frac{1}{2}$ inches in diameter, and having a stroke of 2 feet 8 inches. In the event of the feed-pumps receiving injury, the boilers are provided with four small auxiliary engines, (one in each boiler-room,) and having separate connections with the boilers. The two auxiliary engines which are used for washing the decks are also arranged to work the fire-engines in the engine-room. The safety-valves are fitted with springs upon an improved plan. The smoke-pipes, of which there will be two, are 65 feet high from the dead-plate of the lower furnaces. The bunkers, which are placed at the water-line along the unarmored sides of the ship, where the entrance of shot or water cannot injure them, are built to store 1,200 tons of coal, and are so disposed that their contents can be approached from the upper and lower compartments independently of each other.

a fixed strain becomes more than doubled, the density is equally increased, and to such a degree that some alloys are with difficulty touched by the file. The metal when cast has great fluidity, and fills the mold perfectly. By varying the dose of phosphorus the particular characteristic of the alloy which is most desired can be varied at will."

In a series of experiments at the Royal Academy of Industry at Berlin, a bar of phosphor-bronze, (proportions of components not stated,) under a strain of ten tons resisted 862,980 bends, while the best gun-metal broke after 102,650 bends.

In Austria the following comparative results have been obtained :

	Pounds per square inch.
Phosphor-bronze	81,798
Krupp cast steel.....	72,258
Ordnance bronze	31,792

RIG.

The *Inflexible* is also to possess sail-power, with respect to the advantages of which, however, considerable diversity of opinion exists. She will be brig-rigged, having two iron masts, but no bowsprit or stay gear. The fore-mast will be 36 inches in diameter, and will measure 83 feet 6 inches from the deck to the head, while the main-mast will have a diameter of 37 inches, and a height of 96 feet. Each will have a top-mast and top-gallant mast, with lower yard, top-sail yard, and top-gallant yard. The total area of sails will be 18,470 square feet.

In time of war it is intended that the ship will carry no masts, except for signal purposes.

The anchors, of which there are to be four, will be of Martiu's self-canting pattern.

WEIGHTS.

The estimated weight of the hull is 7,300 tons. The engines will weigh 614 tons. The propellers, shafts, and stern-fittings weigh 151 tons each; the boilers, smoke-pipes, casings, &c., 522 tons, and the water in the boilers when ready for steaming is estimated at 190 tons.

COST.

The cost is estimated as follows:

Materials	£269,000
Engines and appendages.....	100,150
Boilers.....	20,600
Labor.....	132,000

The date named in the navy estimates for the completion of this ship is March, 1878.

As a new type of a man-of-war, the leading features of the *Inflexible* may be summed up as follows: The armor is confined to the central fighting portion and to the main substructure which floats the ship. An armored deck 7 feet under water divides the vessel into two separate portions. The unarmored ends are so constructed that the vessel will float even when they are penetrated by shot. The ship has a wide beam and a comparatively light draught of water. The deck-houses give a high bow and stern, and the turrets are so arranged as to enable all four guns to be fired both ahead and astern, or on either beam.

The *Inflexible* has been accepted as the type of the British future line-of-battle ships, and the Admiralty have determined on building others, two of which are already under process of construction, viz, the *Agamemnon* at Chatham, and the *Ajax* at Pembroke. These sister vessels are to be of reduced dimensions. They will be 280 feet long, 66 feet wide, and will have a displacement of 3,500 tons, with a mean draught of water of 25 feet. They are to carry armor 18 inches thick, and an armament of two 38-ton guns in each of the two turrets. The indicated horse-power is to be 6,000.

In perusing the foregoing description of the *Inflexible* it has been seen that her double bottom is divided and subdivided into an unusual number of spaces, and that the water-tight bulkheads have been introduced to an extent not before attempted, and in fact almost every conceivable precaution has been taken to make her secure against the ram and the torpedo. If, however, she should be fairly struck by several powerful fish-torpedoes it is quite probable she would be crippled, water-logged, or possibly sunk. The question therefore presented is, whether two vessels of smaller dimensions, each carrying two 81-ton guns instead of four, would not have been a safer and in some respects a better investment.

PART III.

—

THE DEVASTATION.

THE DEVASTATION.

The *Devastation*, as designed in 1869, was a low free-board, sea-going turret-ship. She was the first of this character which it was determined to build from plans prepared at the admiralty. The great question of that day in England, "Turret *versus* Broadside," for mounting heavy guns in sea-going armored ships, will still be remembered by all persons read-up in the progress of naval construction. So strong were the supporters of certain views with regard to the former system that, notwithstanding the continued opposition of the chief constructor of the navy, the order had been given for the *Captain*, a vessel embodying these views, to be designed and built by a private firm. The *Devastation* may be regarded as designed to compete with the *Captain*. She represented Mr. Reed's views of what a sea-going monitor should be. Low sides were adopted, but not in combination with rigging and sails, as was the case in the ill-fated *Captain*. As originally designed, the *Devastation* was 285 feet long between the perpendiculars, had 62 feet 3 inches beam, and 26 feet $1\frac{1}{2}$ inches mean draught. Her sides, which, except right forward, arose only to a height of 4 feet 6 inches above the surface of the water, were protected by armor 12 inches thick. Her armament consisted of four 25-ton guns, mounted in pairs in two turrets, one at each end of a raised breastwork or platform, which extended about 150 feet along the middle of the upper deck. The guns were thus elevated to a height of some 14 feet above the surface of the water. The turrets were protected by armor 12 inches and 14 inches thick, and the breastwork by armor 10 inches and 12 inches thick. A fore-castle extended forward from the fore-end of the breastwork, at a height of 9 feet 3 inches above the water-line, but in wake of this fore-castle the armor on the sides dropped to a height of only 6 inches above the surface of the water, this corresponding to the level of an armored deck. All the necessary hatchway openings, &c., into the ship were led up by iron trunks to a light flying deck, which extended between the two turrets, somewhat overlapping each.

The vessel was to be propelled by two screws, one under each counter, and each screw was to be worked by separate pairs of engines, so that the ship might be driven by their conjoint action or by either of them working singly. The total power of the engines was to be 5,600 horses, indicated, and the estimated speed was 12.5 knots. She was designed with a spur bow, the point of the ram advancing some 10 or 12 feet under water. The strength of the hull was arranged so as to give great support to the bow when ramming. She had a double bottom, the space between the two skins, some 3 feet deep, being divided, as is usual, into a number of separate water-tight cells, so that injury to the outer bottom could only result in the filling of one or more of these. The hold of the vessel, also, was divided into a number of compartments by watertight bulkheads across the ship; so that even in the event of a clean breach being made through both bottoms, such as might be effected by a torpedo, for instance, she might still have a considerable chance for escape, from being able to confine the water to the compartment or compartments into which the breach was made.

This was the *Devastation* as first designed, and the work of building was being rapidly pushed forward at Portsmouth dock-yard. The *Cap-*

tain in the mean time was winning a high reputation. She had been launched in March, 1869, and had toward the close of 1870 made one or two successful cruises. True, when completed, it was found that a very important element in connection with the design, the weight of the ship, and consequently the draught of water and height of free-board, had been loosely calculated; but the error arising therefrom, though by no means small, was not regarded as serious; and as it did not apparently much influence her sea-going qualities, no special notice was taken of it. Her stability was never doubted by her designers; nor, indeed, was her critical state ever properly realized by any one; any doubt that may have existed was smothered by the confidence of her advocates. The chorus of praise which she elicited on all sides continued to increase, and the question, what the type of British war-ship for the future should be, was supposed to be settled in her beyond dispute. Then came the dreadful news that she had gone down during the night between the 6th and 7th of September, off Cape Finisterre. The wind had not been unusually violent; the sea had not been exceptionally heavy; there were no extenuating circumstances; she had not bravely battled with ordinarily rough weather; she was proceeding confidently under steam and sails when, in an ordinary squall, she displayed once and for all her subtle and treacherous character by slowly turning over and becoming the coffin of nearly the whole of her crew, some five hundred men, including a large number of accomplished officers. The people of England were almost panic-stricken at this terrible news. How it could have occurred with the comparatively wide-spread knowledge relating to the subject and the actual facts and figures of her special case before them, it was difficult to conceive. To remove the doubt which immediately arose as to the safety of the other armored ships, and particularly as to that of the *Devastation*, a special committee was appointed to examine into the designs of these vessels. This committee, which consisted of many of the highest professional and scientific authorities in England, met in January, 1871, and made their report concerning the *Devastation* class early in the following March. After numerous calculations and investigations they came to the conclusion that the stability of the *Devastation* was everything that could be desired, and reported that "ships of this class have stability amply sufficient to make them safe against the rolling and heaving action of the sea." The committee, however, agreed in recommending a plan which the constructors of the Admiralty had proposed with the view of making safety doubly safe.

By this plan, which was afterward adopted, the stability of the ship has been very considerably increased; and besides this, the accommodation of the officers and men has been very largely augmented. The plan consisted in the addition of the side superstructures. They were formed by continuing the ship's sides upward with light framing, as high as the level of the top of the breastwork, and continuing the breastwork deck over to the sides. The structures were extended aft on each side a considerable distance beyond the end of the breastwork, providing two spacious wings, which add largely to the cabin accommodation. Some other alterations in the design which were suggested by the committee were carried out; among them may be mentioned the introduction of athwartship armor-plated bulkheads, so as to afford additional protection to the magazines and engines. An alteration of considerable importance had been made some time before, consisting in the substitution of 35 ton guns for 25-ton guns, as originally arranged. With these and some other slight alterations the vessel was completed. Her mean draught of water is now 26 feet 8 inches. Her height of side above water-line is 10 feet 9 inches, except right forward in wake of the

forecastle, where it is 8 feet 6 inches, and right aft abaft the superstructure, where it is only 4 feet.

The following tables give all the dimensions and data necessary to be known of this powerful vessel :

Statement of dimensions, weights, and other particulars of Her Majesty's ship Devastation.

Dimensions, &c.	Estimate of April, 1869.	Estimate of November, 1869.	Estimate of January, 1871.	Actual dimensions, &c., as completed in April, 1873.				
Length between the perpendiculars	285 feet 0 in.	285 feet 0 in.	285 feet 0 in.	285 feet 0 in.				
Length of the keel for tonnage	246 feet 3 $\frac{3}{4}$ in.	246 feet 3 $\frac{3}{4}$ in.	246 feet 3 $\frac{3}{4}$ in.	246 feet 3 $\frac{3}{4}$ in.				
Breadth, extreme	62 feet 3 in.	62 feet 3 in.	62 feet 3 in.	62 feet 3 in.				
Breadth, for tonnage	58 feet 0 in.	58 feet 0 in.	58 feet 0 in.	58 feet 0 in.				
Depth in hold	18 feet 0 in.	18 feet 0 in.	18 feet 0 in.	18 feet 0 in.				
Burden, in tons	4, 406 57-94	4, 406 57-94	4, 406 57-94	4, 406 57-94				
Draught of water:								
Forward	25 feet 9 in.	25 feet 9 in.	25 feet 9 in.	26 feet 3 in.				
Aft	26 feet 6 in.	26 feet 6 in.	26 feet 6 in.	27 feet 1 in.				
Mean	26 feet 1 $\frac{1}{2}$ in.	26 feet 1 $\frac{1}{2}$ in.	26 feet 1 $\frac{1}{2}$ in.	26 feet 8 in.				
Displacement, in tons	9, 062	9, 062	9, 090	9, 298				
Area of midship section, in square feet	1, 449	1, 449	1, 454	1, 487				
Height of portells from load water-line:								
Fore turret	13 feet 6 in.	13 feet 6 in.	13 feet 6 in.	12 feet 11 in.				
After turret	13 feet 2 in.	13 feet 2 in.	13 feet 2 in.	12 feet 7 in.				
Height of upper deck at side water-line:								
Forward	9 feet 3 in.	9 feet 3 in.	9 feet 3 in.	8 feet 6 in.				
Amidships	4 feet 6 in.	4 feet 6 in.	4 feet 6 in.	10 feet 9 in.				
Engines:								
Nominal horse-power	800	800	800	800				
Indicated horse-power	5, 600	5, 600	5, 600	6, 633				
Speed, per hour, in knots	12.5	12.5	12.5	13.84				
	(Estimated.)	(Estimated.)	(Estimated.)	(Actual)				
Coals, number of tons	1, 700	1, 600	1, 600	1, 350				
Water:								
Number of tons	16	16	16	30				
Number of weeks' consumption	2	2	2	3				
Provisions:								
Number of tons	9.5	9.5	9.5	19				
Number of weeks' consumption	4	4	4	6				
Complement of men and officers								
Armament	250	250	250	329				
Total weight of armor, in tons, (including fastening)	4 25-ton guns.	4 30-ton gnns.	4 35-ton guns.	4 35 ton guns.				
Total weight of backing, in tons, (including fastening)	2, 307 306	2, 329 306	2, 482 306	2, 581 314				
Depth of armor below water-line, amidships	5 feet 0 in.	5 feet 0 in.	5 feet 0 in.	5 feet 6 $\frac{1}{2}$ in.				
Height of armor above water-line:								
On sides	4 feet 2 in.	4 feet 2 in.	4 feet 2 in.	3 feet 7 $\frac{1}{2}$ in.				
{ Amidships								
{ Forward	0 feet 6 in.	0 feet 6 in.	0 feet 6 in.	nil.				
On breastwork	11 feet 5 in.	11 feet 5 in.	11 feet 5 in.	10 feet 10 $\frac{1}{2}$ in.				
{ Amidships								
{ At fore end	11 feet 9 in.	11 feet 9 in.	11 feet 9 in.	11 feet 2 $\frac{1}{2}$ in.				
	Armor.	Back- ing.	Armor.	Back- ing.	Armor.	Back- ing.	Armor.	Back- ing.
	Inches.	Inches.	Inches.	Inches.	Inches.	Inches.	Inches.	Inches.
Thickness of armor and backing:								
On sides	12 & 10	18	12 & 10	18	12 & 10	18	12 & 10	18
On bulkheads at break of deck forward	12	16	12	16	12	16	12	16
On bulkheads in hold							4, 5 & 6	10
On breastwork	12 & 10	18 & 16	12 & 10	18 & 16	12 & 10	18 & 16	12 & 10	18 & 16
On turrets	14 & 12	15 & 17	14 & 12	15 & 17	14 & 12	15 & 17	14 & 12	15 & 17
Thickness of skin-plating behind armor:								
On sides	1 $\frac{1}{2}$ & 1 $\frac{1}{2}$		1 $\frac{1}{2}$ & 1 $\frac{1}{2}$		1 $\frac{1}{2}$ & 1 $\frac{1}{2}$		1 $\frac{1}{2}$ & 1 $\frac{1}{2}$	
On bulkheads at break of deck forward	1 $\frac{1}{2}$		1 $\frac{1}{2}$		1 $\frac{1}{2}$		1 $\frac{1}{2}$	
On breastwork	1 $\frac{1}{2}$		1 $\frac{1}{2}$		1 $\frac{1}{2}$		1 $\frac{1}{2}$	
On turrets	1 $\frac{1}{2}$		1 $\frac{1}{2}$		1 $\frac{1}{2}$		1 $\frac{1}{2}$	
Thickness of deck-plating:								
On upper deck	2		2		3		3	
{ Amidships								
{ Aft	1 $\frac{1}{2}$		1 $\frac{1}{2}$		2		2	
On belt-deck	3 & 2 $\frac{1}{2}$		3 & 2 $\frac{1}{2}$		3		3	
On deck over breastwork	1		1		1		2	

Statement of dimensions, weights, and other particulars of Her Majesty's ship Devastation, as completed for sea, and as estimated at various dates.

Weights, &c.	Estimate of	Estimate of	Estimate of	Actual
	Apr., 1869.	Nov., 1869.	Jan., 1871.	weights, &c., as completed in Apr., 1873.
	Tons.	Tons.	Tons.	Tons.
Water for two weeks	18.8	18.8	18.8	40.0
Tare of tanks				
Provisions, spirits, &c., for four weeks	12.5	12.5	12.5	24.0
Tare of casks				
Officers' slops and stores	12.0	12.0	12.0	12.0
Tare of casks, boxes, cases, &c.				
Officers, men, and effects	32.0	32.0	32.0	42.0
Maat and derrick for hoisting boats			20.0	20.0
Cables	87.5	87.5	87.5	70.0
Anchor	25.0	25.0	25.0	23.5
Boats	12.0	12.0	12.0	12.0
Warrant-officers' stores	34.0	34.0	34.0	50.0
Armament	355.0 (425-ton guns)	422.2 (430-ton guns)	512.2 (435-ton guns)	514.5 (435-ton guns)
Total weight of rigging, guns, and ship's stores	588.8	656.0	766.0	808.0
Engines, and boilers with water in, including engines for turrets, ventilating and fire-service, spare gear, &c.	970.0	952.0	982.0	1,064.0
Engineers' stores	15.0	15.0	15.0	23.0
Coals	1,700.0	1,600.0	1,600.0	1,350.0
Total weight of equipment to be received on board	3,273.8	3,223.0	3,363.0	3,245.0
Weight of hull	2,874.0	2,894.0	2,487.0	*2,882.0
Weight of protective deck-plating, including glaci-plates and armored skylights	413.0	413.0	522.0	556.0
Weight of armor, exclusive of turret and pilot-tower armor	1,604.0	1,626.0	1,542.0	1,629.0
Weight of backing, exclusive of turret and pilot-tower backing	266.0	256.0	256.0	254.0
Weight of turrets	590.0	581.0	592.0	622.0
Weight of pilot-tower			110.0	110.0
Weight of conning-hood	15.0	15.0		
Total displacement required	9,035.8	9,005.0	8,872.0	9,298.0
Total displacement per drawing	9,062.0	9,062.0	9,090.0	9,292.0
Difference	26.2	54.0	218.0	Nil.

* This includes the superstructure added in January, 1871, and the additions recommended by the committee on designs.

Estimated consumption of coal in the Devastation, at speeds of ten and twelve knots.

	Speed of ten knots an hour.		Speed of twelve knots an hour.	
	Total distance steaming.	Number of days' consumption.	Total distance steaming.	Number of days' consumption.
	Knots.	Days.	Knots.	Days.
Coal carried, 1,600 to 1,700 tons: Statement in Mr. Reed's memorandum on new designs for iron-clad ships, dated 2d March, 1869, page 311, report of committee on designs of ships, (printed for Parliament)	4,320	18	2,880	10
Coal carried, 1,400 tons: Calculations based on results of measured-mile trial, 31st October, 1872	4,580	19	2,890	10
Coal carried, 1,600 tons: Calculations based on results of measured-mile trial, 31st October, 1872	5,236	21.8	3,300	11.5
Coal carried, 1,400 tons: Calculations based on six hours' trial, 15th April, 1873	4,876	20.31	3,109	10.79
Coal carried, 1,600 tons: Calculations based on six hours' trial, 15th April, 1873	5,572	23.21	3,553	12.33

MOTIVE MACHINERY.

The *Devastation* is propelled by twin screws, each driven by an independent pair of engines. These engines, which have been constructed by Messrs. John Penn and Sons, of Greenwich, are of that firm's direct-acting trunk type, contracted for prior to the adoption of compound engines, and they have cylinders 88 inches in diameter, and trunks $36\frac{1}{2}$ inches in diameter; the trunks reducing the effective area of the pistons to that due to a diameter of 80 inches. The cylinders are steam-jacketed, both at sides and ends, and the stroke of pistons is 3 feet 3 inches. The engines are fitted with expansion gear, which enables the steam to be cut off at any required part of the stroke. The main slide-valves are double-ported, and fitted with an equilibrium ring. The expansion-valves are of the gridiron form, with a variable stroke and cut-off. The admission of steam to the engines is regulated by equilibrium valves, which are worked by screws and suitable gearing, led away to the starting platform. To insure ready handling of the engines, small auxiliary slide-valves are fitted to each cylinder. Each pair of engines is fitted with a surface-condenser containing 5,432 $\frac{3}{4}$ -inch tubes, 6 feet $3\frac{1}{2}$ inches long; the condensing surface for each pair of engines being thus 6,710 square feet. The tubes are packed with screwed glands and tape packing. The air-pumps and the circulating-pumps are double-acting, and are worked direct from the pistons. The condensing water is drawn through the tubes and the steam admitted to the outside. The crank-shafts are in two pieces, with solid couplings forged on. The turning-gear consists of a worm-wheel and worm, worked by hand by means of a long ratchet lever. The disconnecting coupling is fitted with four steel pins, which can be drawn out of gear by means of screws and ratchet spanners. The thrust of the propellers is taken by a bearing fitted with ten movable collars. The screw propellers are 17 feet 6 inches in diameter, and have 19 feet 6 inches pitch, and are so fitted that the pitch can be varied from 17 feet to 22 feet. The number of blades to each is four, and the propellers are formed on the Griffiths principle. The boilers are eight in number, of the old kind, containing thirty-two furnaces, the four boilers in the forward fire-room having four furnaces each, while of the four boilers in the after fire-room two have three and two have five furnaces each. The length of bars is 6 feet 6 inches, and the width of furnaces 3 feet 2 inches, the total fire-grate area being thus 742 square feet. The boilers contain in all 2,592 tubes $3\frac{1}{2}$ inches in diameter and 6 feet long. The working pressure of steam is 30 pounds per square inch. The total heating surface is 17,806 square feet. A superheater is fixed in each chimney, of which there are two, the total superheating surface exposed being 1,866 square feet. The chimneys are telescopic, and are fitted with hoisting-gear and shell-proof gratings at the bottom. The length in the ship occupied by the engines is 32 feet, and that by the boilers 80 feet, this latter length being divided into two equal compartments, separated from the engines and each other by water-tight bulkheads. Telegraphs are fitted between the engine-rooms and the bridge, and, in addition to the ordinary means of ventilation, fans are fitted, driven by independent engines. A powerful fire-engine is provided with pipes leading to all parts of the ship. Engines are also fixed for moving the capstans and hoisting the ashes. The weight of engines and boilers complete, with water in boilers and condensers, and including spare gear and all the fittings above enumerated, is 985 tons, or but 2.96 cwt. per indicated horse-power developed

when working at full power on the official trial. The following results were obtained on the official trial, September 2, 1872:

	Feet.	Inches.
Draught of water forward	26	4
Draught of water aft.....	26	6
Immersion of upper edge of screw.....	7	2
Pressure of steam in engine-room, 27 pounds.		
	Full power.	Half power.
Revolutions	76.76	63
Mean pressure in cylinders, starboard.....	22.066	12.88
Mean pressure in cylinders, port.....	21.53	14.41
Indicated horse-power, starboard.....	3,359.21	1,566.03
Indicated horse-power, port.....	3,278.5	1,838.89
	Knots.	Knots.
Speed of vessel	13.839	11.909

Immersed midship section, 1,460 square feet at 26 feet 5 inches draught.

Co-efficient, 582.

During the full-power trial the total power developed by the two pairs of engines was thus 6,637.71 horse-power, and the areas of grate surface and condensing surface, per indicated horse-power, were as follows:

Area per indicated horse-power developed on full power trial:

	Square feet.
Fire-grate	0.112
Heating surface.....	2.68
Heating surface, including superheating surface	2.96
Condensing surface.....	2.02

The trial-cruises of the *Devastation*, to ascertain the degree of success attained in the design as an engine of war, as well as her sea-going qualities, were made in the summer of 1873; and it may be said with confidence that never before did the proceedings of any single vessel elicit so large an amount of public interest as did those of this ship. The novelty of her design as an ocean-cruising man-of-war, her odd appearance, and her fighting power, formed continued topics of discussion in the scientific and other papers, but the real source of interest to the English people was doubtless to be found in the fact that the vessel was looked upon by the general public as belonging to the same type as the unfortunate *Captain*. Hence, notwithstanding the vital points of difference between the two vessels, to which attention had been repeatedly drawn, her trials were watched with an interest amounting almost to anxiety.

The preliminary trials had reference principally to the performance of the engines, boilers, turrets, and other machinery. The great importance of the first of these will be evident, since the vessel is an ocean-going cruiser, without masts and sails—*i. e.*, she is entirely dependent on her engines for propulsion. As has been seen, at the full-speed measured-mile trial a speed of 13.8 knots per hour was obtained, the engines indicating 6,637 horse-power; and from a series of continuous steaming trials at various speeds, it was shown, with her full supply of coal, what distances could be run, the results of which are recorded above.

The gunnery trials were made subsequently at the usual testing-ground off the Isle of Wight. The guns are capable of being raised and lowered by hydraulic pressure through a height of 20 inches, and may be thus placed for firing so as to obtain any desirable degree of elevation or depression in combination with small port-holes. The projectiles used in the trials were 700-pound Palliser cored shot, with a battering charge of 110 pounds of pebble-powder. At the trial the guns were fired first with extreme elevation, and then with extreme depression in all directions around the ship. During two or three trials made by the vessel off Portland and Queenstown, the difficulty of judging of her behavior, with reference to the seas inducing that behavior, as compared with the behavior of ships of ordinary form under similar circumstances, suggested the desirability of prosecuting the ocean trials in company with some ship or ships of about the same dimensions but of less unusual type. Carrying out this idea, the vessel was placed in company with the *Agincourt* and *Sultan*, and thus made to form part of a division of the channel squadron. The *Agincourt* is one of the early iron-clads, having been built in 1862-'65. She is 400 feet long, and is somewhat heavily rigged with five masts. She is completely protected by armor $5\frac{1}{2}$ inches thick. Her armament consists of twenty-eight guns in a long row, after the old style of frigates; but although the thickness of her armor and the weight of her guns are now out of date, she is claimed to be one of the best sea-boats in the whole fleet. The *Sultan*, on the other hand, is one of the more modern iron-clads. She is short, not much longer than the *Devastation*, and is rigged with three masts as a ship. Her armament, consisting of twelve guns, is mounted in a central two-storied battery and protected by thick armor. The water-line also is protected by a belt of thick armor.

A scientific gentleman who was on board the *Devastation* during these sea-trials wrote a highly interesting and valuable account of the proceedings, and, as a matter of interest in relation to the behavior of this class of vessels at sea, the notable points of this letter are extracted as follows:

The squadron, consisting of these three vessels, put to sea from Plymouth Sound at the end of August, 1873; the programme laid down being to proceed to Bear Haven, on the southwest coast of Ireland, and from this point make occasional cruises into the open Atlantic, as suitable weather should occur. This programme was pretty strictly adhered to in all respects. The vessels arrived and anchored off Bear Haven on the 2d of September, after a cruise of four days, during which many points of interest came out, although no very heavy weather was met with. For purposes of comparison in pitching and lifting, &c., the *Sultan* had the height of the *Devastation's* upper deck at side painted on her in a broad white stripe, so that the behavior of the two ships might be quickly appreciated apart from the records of instruments. The lowness of the extremities of the *Devastation* gives a great deal of interest to the pitching and lifting (really the longitudinal rolling) of the vessel. Two trials were made, one on the 9th and the other on the 15th of September. On the first of these occasions, she was accompanied by the *Sultan* only, and on the second she was accompanied by the *Agincourt* only. The seas met with on the 9th of September were lumpy and irregular, the wind having shifted somewhat suddenly during the previous night. Having got well out to sea, about 40 miles off land, the wind was found to be blowing rather north of west with the force of a moderate gale, its speed varying from 40 to 45 miles per hour; and the largest of the waves were found to vary from 300 to 350 feet in length from crest to crest, occasionally reaching 400 feet—the greatest heights from hollow to crest being 15 and 16 feet. Going head to sea, at from six to seven knots, both vessels pitched considerably; the *Devastation*, however, had the best of it, pitching through smaller angles than the *Sultan*. The latter vessel was remarkably lively; at one moment she was to be seen with her fore-foot completely out of water, and the next with her bow dipped down to so great an extent that it was difficult to see from the flying deck of the *Devastation*—although the ships were pretty close together—whether the sea did not really break inboard; and this notwithstanding that the bow of the *Sultan* rises forward some 30 feet above the surface of the water. On the other hand, the

forecastle-deck of the *Devastation* was repeatedly swept by the seas, to each of which she rose with surprising readiness; indeed, it invariably happened that the seas broke upon her during the upward journey of the bow, and there is no doubt it is to this fact that her moderate pitching was mainly due, as the weight of the water on the forecastle-deck during the short period it remained there acted as a retarding force, preventing the bow from lifting as high as it otherwise would, and this of course limited the succeeding pitch, and so on. The maximum angle pitched through on this occasion, *i. e.*, the angle between the extreme elevation and depression of the bow, was $7\frac{1}{2}^{\circ}$. Each vessel behaved extremely well when placed broadside onto the sea, rolling very little. The trial of the ship on the 15th of September, in company with the *Agincourt*, was by far the most severe of any. Early in the morning the vessel got under weigh and steamed out to sea, accompanied by the *Agincourt*. The wind was blowing with considerable force from the northwest, while the sea was at times very regular, long, and undulating; just the sort to test the rolling propensities of a ship, but scarcely long enough to be most effective in doing so, either in case of the *Devastation* or *Agincourt*. The largest waves ranged from 400 to 650 feet long, and from 20 to 26 feet high. The ships were tried in almost every position with regard to the direction of the sea, and at various speeds, the result in point of comparison being extremely interesting, and, so far as the *Devastation* was concerned, very satisfactory. With the sea dead ahead, and proceeding at about seven knots, the *Devastation* pitched rather more than the *Agincourt*, although the great length of the latter compared with that of the former caused her bow to rise and fall through a much greater height, giving her the appearance of pitching through a greater angle. The usual angles pitched through by the *Devastation*, measuring the whole arc from out to out, were from 5° to 5° ; the maximum angle pitched through was, however, $11\frac{1}{2}^{\circ}$. The scene from the fore end of the flying deck when the vessel was thus going head to sea, was very imposing. There was repeatedly a rush of water over the forecastle, the various fittings, riding-bitts, capstan, anchors, &c., churning it up into a beautiful cataract of foam; while occasionally a wall of water would appear to rise up in front of the vessel, and dashing on board in the most threatening style, as though it would carry all before it, rushed aft against the fore turret with great violence, and, after throwing a cloud of heavy spray off the turret into the air, dividing into two, pass overboard on either side. All the hatchways leading below from the upper deck were closed; it was not, however, thought necessary to close the doors in the sides of the trunks leading up from the main hatchways to the flying deck, most of the men on deck preferring to remain here under the overhang of the flying deck. It was quite the exception for the water coming over the bow to get much abaft the fore turret; but this, however, occurred occasionally. The foremost turret makes a most perfect breakwater; it receives with impunity the force of the water, which, after spending itself against it, glances off overboard, leaving two-thirds of the deck seldom wetted. There was one sea which came on board, while thus proceeding head to sea, which was much heavier than any other; it rose in front of the vessel some ten or twelve feet above the forecastle, and broke on the deck with great force, for the moment completely swamping the fore end of the vessel. A mass of broken water swept up over the top of the fore turret, and heavy volumes of spray extended the whole length of the flying deck, some small portion of it even finding its way down the funnel-hatchway—which had been left uncovered—into the fore stoke-hole. It should be borne in mind that the angles pitched through, given above, do not measure the inclination of the ship to the surface of the water, but only her inclination to the true vertical. Pitching and lifting are produced by the vessel endeavoring to follow the slope of the waves, or, roughly speaking, to keep her displacement the same as in still water, both as to volume and to longitudinal distribution.

As to the depressing effect of the water on the bow, a layer of water one foot deep over the entire forecastle exerts a pressure of 65 tons; this will produce a change of trim of 11 inches, together with an increase in the mean draught of $1\frac{1}{2}$ inches; *i. e.*, the draught of water forward will be increased by $7\frac{1}{2}$ inches, while that aft will be diminished by $3\frac{1}{2}$ inches. A layer two feet thick will have double this effect; one three feet thick will have treble the effect, and so on up to a considerable angle. This follows from the fact that the front slope of the longitudinal curve of stability, up to a considerable angle, is very nearly straight. Hence the effect, even of a large body of water passing over the forecastle, tending to make the vessel dive down head foremost, is small and of no importance. It modifies, however, the transverse stability. When proceeding head to sea there was no appreciable rolling motion. With the wind and sea on the bow she pitched considerably less than when going head to sea, but rolled through 5° or 6° . With the wind and sea abeam, lying passively in the trough of the waves, the maximum angle rolled through was 14° from port to starboard, $6\frac{1}{2}^{\circ}$ to the windward, and $7\frac{1}{2}^{\circ}$ to leeward, and this without perceptible pitching. When, however, proceeding at about $7\frac{1}{2}$ knots, with the wind and sea on her quarter, she rolled through $27\frac{1}{2}^{\circ}$ from port to starboard, 13° off the perpendicular to windward, and $14\frac{1}{2}^{\circ}$ off the perpendicular to leeward, beside also pitching through some 4° or 5° . This is by far the greatest angle she has ever rolled

through. It is the apparent period of the waves, *i. e.*, their period relatively to the ship, which operates in making a vessel roll. The motions of the vessel, both as to pitching and lifting and to rolling, were extremely easy. She indeed claims to have behaved better than her companion, the *Agincourt*. Certainly, her rolling motion was somewhat slower, and she rolled less deeply; when the *Agincourt* was rolling 17° from port to starboard the *Devastation* was only rolling 14° . As to pitching, the *Devastation* may fairly claim to have had the advantage, for, as we have seen, although the *Agincourt* pitched rather less, her bow moved vertically through a greater distance, so much so that while going head to sea at 7 knots she shipped a sea over her high fore-castle, showing that she could not be driven under the circumstances at a much higher speed with at least anything like comfort. The behavior of the vessel generally accorded, with considerable approximation, with what was to be expected under the circumstances from the theoretical knowledge possessed on the subject; and although on no occasion during the trials were the waves quite so long as was wished for, the data obtained have been most valuable in testing and correcting the theory, so that the behavior of this ship, or of any similar ship, in any weather, may now be foretold with considerable accuracy. The instruments measuring and recording the behavior of the vessel were most perfect in their action. They were personally attended throughout the trials by their inventor, Mr. Froude.

The *Devastation* has lately been cruising in the Mediterranean. Last winter at a public meeting in London, Admiral Inglefield thus spoke of her: "I have just returned from Malta and I saw the *Devastation*, having come into port from a long cruise. The captain spoke of the ship as being perfectly seaworthy, wholesome, and comfortable for the men and officers, and everything he could wish."

PART IV.

THE THUNDERER; THE DREADNOUGHT.

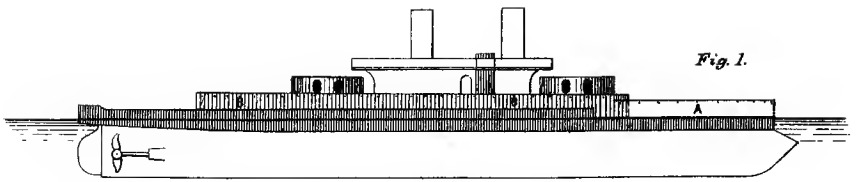

Fig. 1.

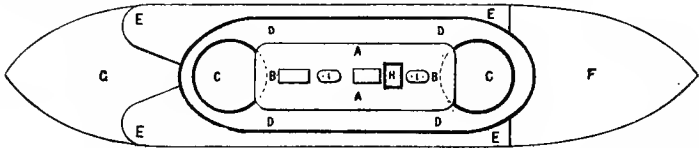

Fig. 2.

THE THUNDERER.

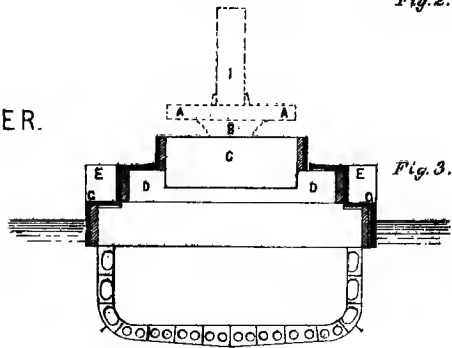

Fig. 3.

THE THUNDERER.

The *Thunderer* is a sister ship to the *Devastation*, launched March 12, 1872, nearly one year after the *Devastation*, but was only being prepared for the first commission at the time of my visit, early last summer. The principal dimensions of the two vessels are alike; they differ only in detail of construction, in the type of motive-machinery, and in armament.

The *Thunderer*, like her sister ship, was designed to be thoroughly sea-going, and to be capable of performing every service which can be required from a first-class modern line-of-battle ship.

At the date of construction they were admitted to be the most powerful fighting-ships then laid down. The committee on designs of the ships of the royal navy gave their judgment upon them in these words: "They represent in their broad features the first-class fighting-ships of the immediate future."

A clear understanding of the general arrangement of the vessel will best be seen by the drawings annexed, figures 1, 2, and 3. The fore-castle is shown at A, in figure 1, where the height of the side-armor above and below water is also shown. The position of the armored deck is indicated by the black line along the upper edge of the side-armor. In Fig. 1 the armored portions are shaded, the unarmored left plain. Where the armor is visible from the outside, as on the turrets and sides, it is shaded dark; where concealed by any unarmored structure it is lighter. The breastwork, except at one corner where it is not screened, is shaded light in Fig. 1, being concealed by a structure to be noticed hereafter.

An end view of the deck-house, and the hurricane-deck which it supports, is seen in Fig. 3, a section through the fore turret. The broadside superstructure, as it is usually called, is shown at B B in Fig. 1, and at E E in section 3. The superstructures and other parts are clearly shown in the plan, Fig. 2, where, commencing with the highest points, I I are the smoke-pipes, H is the conning-tower, A A the hurricane-deck, B the elevated deck-house which supports it, C C are the turrets, D the breastwork, E E the broadside superstructure level with the breastwork, F the fore-castle, 3 feet lower than the breastwork, and G the armored deck, about 7 feet lower than the breastwork in the only part where it comes in sight, though it extends, of course, under E and F, and, indeed, throughout the ship except inside the breastwork. The same letters apply to Fig. 3. The conning-tower will be noticed in Fig. 1. It is sufficiently high to give a view over the hurricane-deck bulwarks, and wide enough to command a view forward and aft past the smoke-pipes, which are oval.

MACHINERY.

The *Thunderer*, in common with all modern fighting-ships, is operated in every essential particular by the power of steam. The motive-power of the ship is solely steam, and there are in all twenty-eight steam-en-

gines and nine boilers. Thirteen of these engines are in pairs, having two cylinders, and the remaining fifteen are single engines, having one cylinder only. Two of the pairs are employed for driving the twin screws, and are termed the motive-engines. The others are small engines, employed for subsidiary purposes, such as revolving the turrets, working the hydraulic gun-machinery, hoisting shot and shell, working the capstans, hoisting anchors and boats, working the steering-apparatus, working pumps for circulating cold water through the surface-condensers, starting the motive-engines, pumping water from the spaces between the double bottoms, feeding the boilers, hoisting ashes, and driving fans for ventilating the ship. In addition to this great responsibility, the engineer department is charged with all the water-tight doors in the ship, and all valves and pipes. In short, the interior of the ship is a vast engineering workshop, requiring skill and energy successfully to manage it.

The motive-machinery of this vessel, as well as that of the *Devastation*, was contracted for previous to the introduction of the compound engine into the royal navy. It was constructed by Messrs. Humphrys Tenant & Co., and the engines are of the horizontal, direct-acting type adopted by that firm, and built for several other ships of the navy. There is one pair to each of the two screw-propellers; the cylinders are 77 inches in diameter, and the stroke is 3 feet 6 inches. The boilers are of the old box variety, and a description of them follows, under the head of "boiler-explosions." In consequence of the explosion of one of the boilers in July last, the final official trials at the measured mile have just been made; and the following data of the performance are believed to be correct.

Two days after the measured-mile trials on the 4th of January, 1877, a crucial test of the working of the machinery by a six hours' continuous full-power run was made up and down the Solent in boisterous weather, the force of the wind being between seven and nine, and the sea rough; the following results were obtained as the means of the twelve half hours:

Pressure in boilers.....	27. 80	pounds.
Vacuum, starboard forward engine.....	27. 3	inches.
Vacuum, starboard after engine.....	25. 79	inches.
Vacuum, port forward engine.....	27. 99	inches.
Vacuum, port after engine.....	25. 52	inches.
Revolutions per minute, starboard.....	75. 20	
Revolutions per minute, port.....	75. 03	
Pressure in cylinders per square inch, starboard.....	19. 491	pounds.
Pressure in cylinders per square inch, port.....	19. 25	pounds.
Indicated horse-power, 5,748.97, or 149 horse-power beyond the contract.		

The best quality of Nixon's steam-navigation coal was used, and the expenditure was 3.14 pounds per indicated horse-power per hour.

. ARMAMENT.

The *Thunderer* was originally fitted, like the *Devastation*, with two 35-ton, 12 inch Woolwich rifled guns in each of the two turrets, mounted on carriages similar to those of the *Glatton*, and known as Captain Scott's design; but after Mr. Rendel brought out his system for working heavy guns by hydraulic pressure, it was decided to introduce the principle for the first time into the forward turret of this vessel. Accordingly the two 35-ton guns were removed, and guns thirty-eight tons in

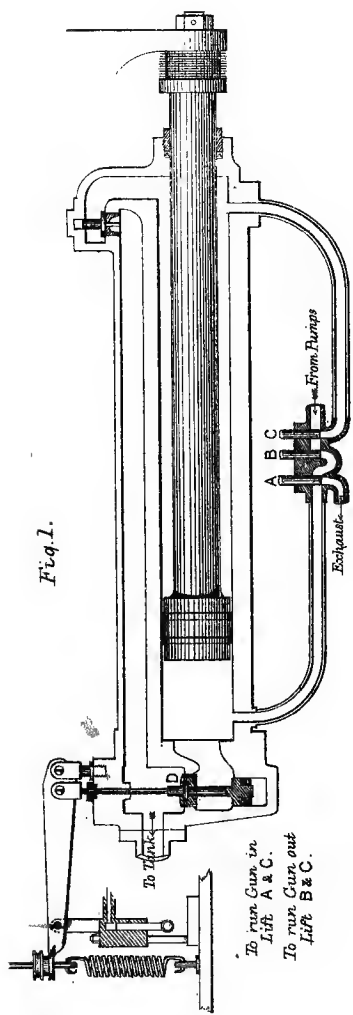
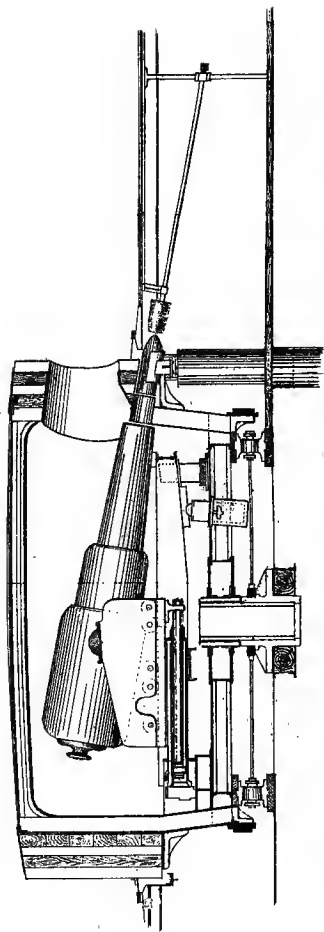

Fig. 1.

HYDRAULIC RECOIL PRESS.

Fig. 2.



TURRET WITH TWO 38 TON GUNS, SHOWING LOADING FROM BELOW & HYDRAULIC BUFFER.

weight, having a bore of $12\frac{1}{2}$ inches, were substituted. The same carriages were retained. At the time of my visit all the machinery for working these guns had been fitted on board and subjected to the first tests; as, however, deficiencies usually experienced in new and untried machinery were expected to be developed, no reports were permitted to be made. Yet it was confidently stated by reliable authority that the result of this first trial on board ship was satisfactory, the proof of which may be found in the fact that the system has been adopted and ordered for the *Dreadnought*, *Inflexible*, and other vessels. All British service gun-carriages are at present mounted on their slides in such a manner as to recoil on a dead bearing, but to run out on wheels thrown into action by eccentrics. By placing the carriage permanently on wheels and trusting more to the compressor to arrest recoil, the operation of "tripping" the carriage, *i. e.*, of throwing the wheels into action for running out, is avoided. In 1867 and 1868 a partial muzzle-pivoting carriage was made at the Elswick works for an 18-ton gun on the plan of raising and lowering the trunnion-bearings of the gun in vertical grooves formed in the carriage. Captain Scott modified the arrangement by the substitution of hydraulic jacks, in combination with chocks, for the screw-lifting gear, and by the application of the jacks to act from fixed positions in the slide or turret-floor on a bow-piece carrying the trunnions. In this form the system has been applied for heavy turret-guns in the British royal navy. It makes the carriage, however, high and top-heavy, a disadvantage for naval service which would become more serious with every increase in the weight of guns. The object of muzzle-pivoting is the reduction of the size of the ports. The size of ordnance, however, continues to increase with rapid strides, while the number of men employed to work the guns cannot be much further added to, and the train of mechanism required to apply the constant and limited power of men to the forces to be exerted in loading and working heavy guns becomes larger and more complicated as the weight of the guns is increased. Hence, the adoption of some inanimate power in the place of mere hand-labor for loading and working heavy ordnance has become an absolute necessity for existing guns, and for those of the immediate future. Adopting the steam-engine as the most ready and convenient source of power, it has been found that that power can be best applied through the medium of water under pressure. The simplicity and compactness of hydraulic machinery, and the perfect control it gives over the motion of heavy weights, especially adapt it for the purpose. Power sufficient for the heaviest guns may be transmitted by water through a very small pipe for long distances and by intricate ways, so that a steam-pumping engine may supply power by this means for working many guns.

Hydraulic machinery for working the guns in the fore turret of the Thunderer.

In the turret-arrangement of the *Thunderer*, (which differs from that of the *Inflexible*,) shown by Figs. 1 and 2, the carriage is placed upon rollers. In this carriage the gun is made partially muzzle-pivoting by hinging the slide at the rear horizontally, and raising and lowering the front end upon a press to three or more positions, in which it can be chocked by turning under it the bracketed supports.

The cylinder, Fig. 1, performs the double office of checking recoil and moving the gun in or out along the slide. The gun or recoil drives back the piston, and is arrested by the resistance which the valve D offers to

the escape of the water from the cylinder. The valve is loaded with a spring, which may be adjusted to give any required resistance, and so meet the variations of the force of recoil. It is also partly balanced, to lessen the load required upon it. The area of the piston-rod is one-half that of the piston, and the gun is run out by admitting the water-pressure to both sides at once. For running the gun in, the pressure is admitted to the front of the piston only, the exhaust being at the same time opened to the rear. Clack-valves, in connection with a waste-water tank, are used to insure the cylinder being always full, and there is a relief-valve on the front for preventing any excessive strain. On the rear the recoil-valve acts as a relief-valve upon occasion. It will happen in some cases that the pressure required on the valve D to arrest recoil falls short of that necessary for running the gun in or out, in which case the water admitted to the cylinder for the purpose would lift the valve and escape to waste. This is provided for by making the act of opening the cylinder inlet-valve A place an additional load on the recoil-valve D, retaining it there so long as the inlet-valve remains open. Fig. 1 shows one method of placing the extra load on the recoil-valve, viz, by a small inverted press, having in its normal condition an open communication with the waste-water tank, which communication is closed and the press charged with water under pressure by the first movement of the lever employed to open the inlet-valve A of the recoil-cylinder. It was stated that the recoil could be regulated with precision, and that excellent control could be exercised over the movement of the gun on its slide. By the arrangements described the following advantages are claimed: The loading operation is transferred from a confined space in the port of the turret to a roomy and convenient place on the main deck. The dimensions of the turret can be reduced; one man in the turret and one outside may direct and control all the movements of a pair of the heaviest guns, and may load and fire them without other help than that involved in bringing up the ammunition, and, finally, far greater rapidity of fire is attainable than would be possible by manual labor.

An objection raised to this system is the alleged liability to premature explosions in loading, and, as a consequence, to risk of self-destruction, to which it is said the ship is thus exposed. This objection is, however, it is said, obviated by not depressing the gun for loading to such an extent as to aim a shot below the water-line, and furthermore provided for by a special arrangement for drenching the bore of the gun with water in sponging, and it is entirely removed by the arrangement that will be applied to the *Inflexible*, in which the loading-gear is placed so that the gun is little depressed when in the loading position.

THE RECENT BOILER EXPLOSION.

It was after my visits on board the *Thunderer* and immediately after the foregoing account of that vessel had been written that the awful disaster occurred, occasioned by the explosion of the forward starboard boiler, which produced results more terrible than any accident on board a ship of war from the effects of steam, hitherto recorded. The report on the subject will be found under the head of "Boiler explosions."

THE DREADNOUGHT.

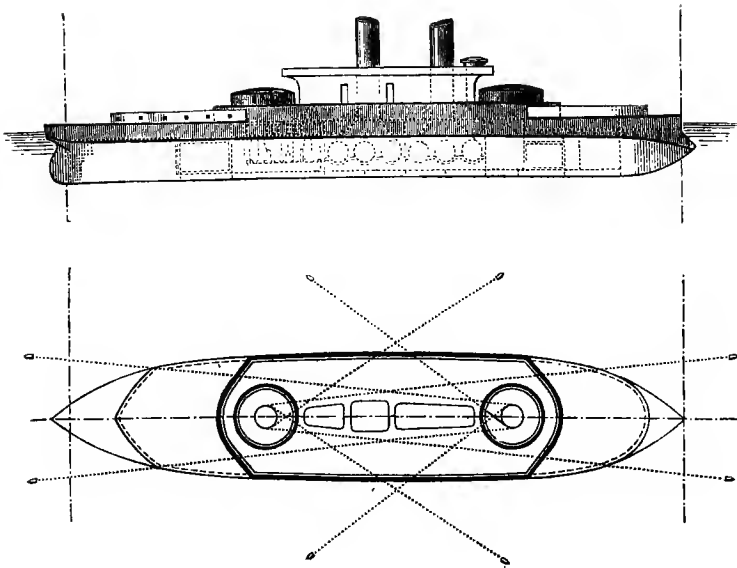

THE DREADNOUGHT.

This ship, recently completed at the Pembroke dock-yard, South Wales, is spoken of as a modified and improved *Devastation*, on a larger scale; but the modifications, resulting from the experience of the trials of the former vessel, are such as to change the type. The *Dreadnought* cannot be called a low free-board ship, or a breastwork monitor, for the height from the load water-line to the turret-deck is nearly 12 feet, and the superstructure is more properly an armored oval citadel or tower, of which the sides are those of the vessel carried up from the broadside surface; or, in other words, instead of building a breastwork on the deck of the armored hull some 185 feet long amidships, with a passage of, say, 10 feet between it and the sides of the vessel, as was done in the *Thunderer* and other low free-board ships, the sides of the *Dreadnought* are built up flush to the top of the upper or turret deck. This armored side rises nearly 12 feet above water, and is extended in length amidships 184 feet. The design, as will be seen, requires considerably more armor than would be used if the vessel had been built on the breastwork system, but the advantages derived from having the whole width of the vessel below the upper deck unobstructed, affording light, with facilities for loading the guns on the hydraulic system, and working the turrets, is of importance; besides which, it increases the room and allows comfortable quarters for officers and crew above water.

The citadel, as before stated, is 184 feet in length, and the height between decks is 7 feet 6 inches. It is armored with solid plates, 11 inches thick except at the ends and abreast the bases of the turrets, where the thickness is increased to 13 and 14 inches. The increased thickness at the ends is to protect more thoroughly the bases of the turrets, the machinery for working them, and for loading the guns; in short, all the working apparatus inclosed therein. The armor-belt, which is carried entirely around the vessel, is 11 inches thick on the water-line, tapering to 8 inches at 5 feet below water, where it stops. It also tapers above water, fore and aft of the citadel, as well as toward the ends. This armor-belt, fore and aft the fighting part of the ship, rises only 4 feet above water, and is intended solely to protect the vital portion of the hull; all parts above it are destructible, and may be riddled with shot without detriment to the fighting or sea-going qualities of the vessel. The turret-deck, or deck over the citadel, is plated with two courses of $1\frac{1}{2}$ and 1 inch iron respectively, and the main berth-deck below is also plated with the same thickness of metal fore and aft of the citadel; of course, no armor on this deck inside of the citadel is needed.

The turrets rise through the citadel-deck to a height of 12 feet from the base or revolving deck-platform inclosed by the citadel. The diameter of each turret inside of framing is 27 feet 4 inches, the depth of the framing being 10 inches. They are built up with two courses of plates and two courses of teak, in the following manner: first, the shell

or wall consists of two $\frac{3}{4}$ -inch plates, bolted together and riveted to the framing; on the exterior of this shell is a teak backing 6 inches thick; on this backing, armor-plates 7 inches thick are secured; next, teak backing 9 inches thick is fastened on; finally, armor-plates outside of all, 7 inches thick; all securely bolted together. The plates were rolled at Sheffield, and curved to templates drilled and prepared for their places. The following are the dimensions of the plates for one turret:

Inside course.

- No. 1, 15 feet $2\frac{1}{2}$ inches by 8 feet by $3\frac{1}{2}$ inches thick.
- No. 2, 15 feet 2 inches by 8 feet by $3\frac{1}{2}$ inches thick.
- No. 3, 14 feet $8\frac{1}{4}$ inches by 8 feet by $3\frac{1}{2}$ inches thick.
- No. 4, 15 feet $2\frac{1}{2}$ inches by 8 feet by $3\frac{1}{2}$ inches thick.
- No. 5, 19 feet $6\frac{3}{4}$ inches by 8 feet by $3\frac{1}{2}$ inches thick.
- No. 6, 13 feet $\frac{1}{2}$ inch by 8 feet by $3\frac{1}{2}$ inches thick.

Outside course.

- No. 1, 16 feet $10\frac{5}{8}$ inches by 8 feet $2\frac{1}{2}$ inches, by 7 inches thick.
- No. 2, 18 feet $3\frac{7}{8}$ inches by 8 feet $2\frac{1}{2}$ inches, by 7 inches thick.
- No. 3, 13 feet $\frac{1}{2}$ inch by 8 feet $2\frac{1}{2}$ inches, by 7 inches thick.
- No. 4, 14 feet $8\frac{1}{2}$ inches by 8 feet $2\frac{1}{2}$ inches, by 7 inches thick.
- No. 5, 21 feet $8\frac{1}{2}$ inches by 8 feet $2\frac{1}{2}$ inches, by 7 inches thick.
- No. 6, 16 feet $7\frac{5}{8}$ inches by 8 feet $2\frac{1}{2}$ inches, by 7 inches thick.

The displacement of the *Dreadnought* when loaded will be 10,950* tons, or 1,650 more than that of the *Devastation* and *Thunderer*. The length between perpendiculars is 320 feet; breadth, extreme, 63 feet 10 inches; mean draught of water, loaded, 27 feet. The hull is constructed with the usual double bottom, and, including the spaces in it there are sixty-one water-tight compartments in the vessel. The same general system of divisions and water-tight doors is adhered to, including the longitudinal bulkhead, which commences about 40 feet from the stem and extends to nearly the same distance of the stern, thus giving backbone and dividing the vessel in the center.

The flying deck and conning tower are quite similar to those on the *Thunderer*, before described, and there is also one mast only, to be used for signal purposes and hoisting boats. The bottom of the vessel is not sheathed with wood.

The armament will consist of two 38-ton Woolwich guns in each of the two turrets, all of them to be worked on the hydraulic system of Rendel.

MOTIVE-MACHINERY.

The *Dreadnought* has been engined by Messrs. Humphrys and Tennant. The engines are of the compound type, very similar to those in the *Alexandra*, constructed by the same firm, and to be described hereafter.

There is an independent set of vertical inverted engines to each of the twin-screws. Each set consists of three cylinders, the high-pressure exhausting into the two low-pressure cylinders. The diameter of the former is 6 inches; the diameter of each of the latter is 90 inches, and the stroke of pistons 4 feet 6 inches. All the cylinders are steam-jacketed.

*The Navy-list of November, 1876, gives the displacement of the *Dreadnought* as 10,886 tons, instead of 10,950 tons, as in former Navy-lists.

The high-pressure jacket is adjusted to the working boiler-pressure of 60 pounds, and those of the low pressure to 30 pounds. The air-pumps are of composition, and placed fore and aft, immediately under the low-pressure cylinders, from which they are worked. The arrangement is compact and accessible, the condensers forming the midship framing, while the wing framing consists of two wrought-iron columns to each cylinder.

The surface-condensers are of the usual variety employed in the British service. They contain upward of 16,500 square feet of cooling surface, and are fitted to be worked as common jet-condensers in the event of necessity. The condensing water is supplied by two powerful centrifugal pumps, and an extra bilge-suction is provided, so that the air-pumps can receive directly from the bilge in case of an accident by which large quantities of water would enter the ship.

The engine crank-shaft is composed of three pieces, interchangeable; each piece has a length of 10 feet $7\frac{3}{4}$ inches, and a diameter of $17\frac{3}{4}$ inches. The diameter of the propelling-shafts is 16 inches, except the lengths in the stern-tubes, which are 18 inches.

The engines are started and reversed by an auxiliary engine having cylinders 6 by 8 inches. The ship is provided with six ventilating-engines, two auxiliary fire-engines, four main fire-engine pumps, steering-engines, turret-turning engines, capstan and ash-hoist engines, besides the engine and hydraulic apparatus for working the guns; in all, there are twenty-nine steam-engines on board, and there are one hundred and eighty valves connected with the ventilating-pipes.

The screw-propellers are of Griffith's recent pattern, the diameter of each being 20 feet, with pitches adjustable from 21 to 26 feet.

Boilers.—The steam for the motive and other engines is supplied by twelve main boilers and one auxiliary boiler. Instead of being arranged in the vessel face to face, as are those in former ships, so that the firemen have fires behind as well as in front of them, they are placed back to back against the middle-line bulkhead of the ship; the firing is thus done at the sides, convenient to the coal-bunkers. The boiler-rooms are further divided by athwart-ship bulkheads, whereby four rooms are formed, the forward ones being 42 feet and the after ones 40 feet in length. The length of the engine-room aft of this is also 40 feet.

The shells of the main boilers are elliptical in shape, 12 feet 2 inches by 11 feet 10 inches, and 14 feet in length, with three furnaces in each boiler; the shells and tube-plates are $\frac{3}{4}$ inch thick, and the furnace and back-plates $\frac{1}{2}$ inch. The shells are double-riveted, and butt-straps are placed inside and outside the longitudinal seams; the tubes are of composition, and 3 inches in diameter; each furnace is 6 feet 10 inches long, and fitted with 66 wrought-iron grate-bars, $3\frac{1}{2}$ inches deep by $1\frac{1}{4}$ inch broad, and 2 feet 3 inches long.

In addition to the ordinary safety-valve chamber, containing a couple of spring safety-valves, each boiler is fitted with a supplementary test-valve placed on the front of the boiler. The stop-valves and safety-valves can be worked from the fire-room floors.

The total heating surface, including that of the auxiliary boiler, is 22,025.5 square feet.

The engines and boilers are entirely surrounded by the coal-bunkers; the bunker immediately forward of the boilers is 22 feet in length, fore and aft, and the one immediately aft of the engines is 8 feet in length; there are consequently 152 feet in the length of the ship by the extreme breadth occupied by the motive machinery and coal. The bunkers contain 1,200 tons of coal only.

The ventilation of the fire-rooms is supplied by fans, supplemented by eight cowls on the hurricane-deck and four others at the side, and which are also utilized as ash-hoists.

As the ship is mastless, steam-power is to be used solely.

The total weight of the steam-machinery is given as 1,430 tons; hull and accessories, 7,350 tons; all other weights, including coal and stores, 2,170 tons.

The improvements of the *Dreadnought* over the other two mastless sea-going ships, the *Devastation* and *Thunderer*, or the difference between them, may be summed up briefly as follows: The displacement is 1,650 tons more; the length between perpendiculars is 35 feet greater, with an increase of beam of 1 foot 7 inches, and an increased depth of hold of 1 foot 2 inches.

The structural improvements consist in carrying out the breastwork entirely to the sides of the vessel, and in bringing the fore-castle and after-deck up to near the level of the breastwork, or, rather, armored citadel; by this arrangement the facilities for working the guns and ship have been greatly increased and better accommodations provided, besides which the objectionable *cul de sac* that exists in the other two ships has been removed, and a high free-board all around is obtained, which must make her both a drier ship and a more comfortable cruiser than either of the others.

Another important structural arrangement first introduced here, and since adopted in other ships, is the longitudinal water-tight bulkhead between the respective sets of engines and boilers; so that in the event of one set being disabled by rams, torpedoes, or other causes, it can be effectually shut off, the ship being propelled by the other set.

The side armor of the *Dreadnought* varies in thickness from 8 to 14 inches, while in the other two ships it varies from 10 to 12 inches, besides which it extends $7\frac{1}{2}$ inches deeper under water than in the former-named vessel. The external diameter of the turrets is 32 feet 3 inches, and the thickness of its armor is uniformly 14 inches, while the other turrets are 31 feet 3 inches in diameter, and the thickness ranges from 12 to 14 inches.

The armament is also more formidable. It consists of four 38-ton guns, all worked on the hydraulic system, while the *Devastation* carries four 35-ton guns worked by hand-power, and the *Thunderer* two 38-ton guns worked by hydraulic-power, and two 35-ton guns worked by hand.

Again, the *Dreadnought* is engined on the compound system, by which greatly increased power is obtained with reduced consumption of fuel.

The six-hour trial of the motive machinery was made early this month. The London *Times* reports the results as follows:

Hour.	Vacuum.	Revolutions.	Horse-power.
1	27 ins. and 27.43	67.3 and 67.4	8,201.52
2	27 ins. and 27.18	67.6 and 67.4	8,233.78
3	27 ins. and 27.25	67.4 and 67.3	8,179.94
4	27 ins. and 27.37	66.9 and 67.0	8,177.77
5	27.5 ins. and 27.43	67.1 and 66.9	8,155.93
6	27 ins. and 27.37	66.0 and 66.8	8,207.39

The mean power developed by the engines during the six hours was 8,216.28, or 216.28 horse-power beyond the contract. * * * The blasts were not used from first to last. * * * The mean boiler-pressure was 60.3 pounds. The mean pressure of steam on the pistons was, high, 31.6 pounds; low, 9 pounds. * * * The coal consumed on the trial amounted to 50 tons 122 pounds, being equal to 2.27 pounds per indicated horse-power per hour. The consumption on the six-hour trial of the *Thunderer* was 3.14 pounds. In order to show the superiority of the *Dreadnought's* compound engines from an economic point of view, it may be mentioned that had she been fitted

with engines of the common type, as those of the *Thunderer*, she would have to burn 80 tons* a day more fuel to develop the same power as on the day of trial.

The engines were stopped from full speed in 18 seconds, and from going astern were started full speed ahead in 15 seconds.

The speed of the ship is not given, but the pitch of the screw-propellers was $23\frac{1}{2}$ feet, which, with $12\frac{1}{2}$ per cent. slip, would give 13.8 knots per hour.

The *Dreadnought* is now the most formidable fighting ship on the ocean, and next after the *Inflexible* will be the most powerful ship of war ever floated in British waters.

* The *Times* is in error; the correct figures are 76 tons; and this may be instructive, in view of our very limited naval appropriations, to the officers who have been raising objections to the use of compound engines in our Navy.

PART V.

BROADSIDE ARMORED SHIPS.

THE AUDACIOUS CLASS; THE ALEXANDRA.

BROADSIDE ARMORED SHIPS.

France is credited with having produced the first ship clad in armor. The *Gloire** was commenced in 1858; two others of the same type immediately followed; all of them wooden ships plated with iron. The first great English armored ship, the *Warrior*, was begun in 1859, and was followed by the *Black Prince*. These ships were ordinary single-screw war-steamers, with iron hulls 380 feet long, incompletely protected by plates $4\frac{1}{2}$ inches thick. After the *Black Prince* followed the *Minotaur* and *Northumberland*, each 400 feet in length; but it was soon found that these long ships were not well adapted for manœuvering in line of battle, and hence the later armored ships were made gradually broader in the beam and shorter in length.

At the same time various improvements were introduced into the build, one of which was the change of the old oblique projecting bow into the reverse-curved swan-breasted shape, which is substantially the same as that of the present running-down bow or ram. The armor was no longer restricted to the amidship portion of the vessels; it was extended fore and aft, until they were completely covered above water, and for a short distance below it. The weight of the guns steadily increased, and with it the thickness of armor. Leaving out of account the converted ships, we come to the *Bellerophon*, put afloat in 1865. This ship was Mr. Reed's first production. She was considered to be a long step in advance; still the central battery delivered no end-on fire. That was sought to be obtained by the contrivance of a bow-battery on the main deck. Thus, though the *Bellerophon* was known as carrying ten 12-ton guns, the bow fire was intrusted to two $6\frac{1}{2}$ -ton guns. The next first-class ship, the *Hercules*, gained an improved fire from the central battery (18-ton guns) by the expedient of recesses in the ship's sides forward and aft of the battery; advantage was taken of the

* The first account we have of an armored ship is in 1530. The largest ship then known, one of the fleet of the Knights of Saint John, was sheathed entirely with lead, and is said to have successfully resisted all the shot of that day.

At the siege of Gibraltar, in 1782, the French and Spaniards employed floating batteries, made by covering the sides of the vessels with junk, rawhide, and timber, to the thickness of 7 feet, and bomb-proofing the decks.

Iron armor was suggested in the United States in 1812. In March, 1814, a bomb-proof vessel was patented by Thomas Gregg, of Pennsylvania.

In 1842 R. L. Stevens, of New York, commenced the construction of an iron-armored ship of war.

The first practical use of wrought-iron plates as a defense for the sides of vessels was made by the French during the Crimean war. The vessels used were of light draught, exposed little surface above water, and were termed floating batteries. They rendered very efficient service, especially at the bombardment of Kinburn, in 1855, and their success doubtless led to the adoption, by the French government, of armor-plating to ships of war.

The English built armored boats at about the same time, which were also used in the Crimean war.

recesses to make four ports in the ends, or rather corners, of the battery, from which four of the guns were able to fire within a few degrees of the line of the keel. If required to fight upon the broadside, these guns, which were mounted on turn-tables, were revolved to other ports. The armament of this ship, when put on board in 1870, was considered very powerful. It consisted of fourteen Woolwich rifled guns, of which eight were of 10-inches, two of 9-inches, and four of 7-inches caliber. Her water-line is defended by a belt of 9-inch armor, believed at the time it was put on to be impenetrable at the thickest part by any of the guns at that time afloat in European waters. This armor-belt extends for upward of 3 feet above and $3\frac{1}{2}$ feet below the water-line, from stem to stern of the ship. This defensive strength is, however, confined to the belt. The battery from which the largest guns are worked is only protected with 6 inches thickness of armor, and experiment has shown that armor of that thickness with the ordinary backing can be penetrated at a distance of 1,000 yards and at an inclination of impact of 30° by the 9-inch rifled gun, and at close quarters by the 7-inch rifled gun, such as is carried by many armored ships. But the *Hercules* has other excellencies; she is, for an armored ship, a fair sailer, though represented to be awkward in tacking or wearing. She had a speed under steam on the measured mile, of 14 knots, and can probably make 12 knots steadily for a few hours at sea. She is said to be a very steady ship, and can, therefore, use her offensive powers under conditions of sea in which a less steady ship would be almost *hors de combat*.

In the *Sultan*, built subsequently, of the same general dimensions and much resembling the *Hercules*, a step in advance was made by adding an upper-deck battery. This ship carries eight 18-ton guns on the lower gun-deck, two of less weight in the upper-deck casement, and two on this same deck forward, but they do not command an all-round fire. In most essential points the ships are the same, though the *Sultan* is reported to have the defect of excessive top weight, to counterbalance which considerable extra ballast has been put into her. Both vessels are built with bows having projecting rams, and they are counted with the formidable sea-going fighting-ships.

THE AUDACIOUS CLASS.

The loss of the *Vanguard*, by sinking, off the coast of Ireland, in September, 1875, from the effects of an accidental blow of the ram of a sister vessel—the *Iron Duke*—drew public attention for a time to the easy manner in which one of these powerful and costly ships could be disposed of, as well as to this particular class of vessels. In order that the Department may be correctly informed on the subject, I have submitted a complete set of drawings showing the construction of the vessel, the entire internal arrangements, and the point penetrated by the ram of the *Iron Duke*.

The class consisted of six broadside vessels of similar design, viz, the *Audacious*, *Iron Duke*, *Vanguard*, *Invincible*, *Triumph*, and *Swiftsure*. The loss of the *Vanguard* leaves five. They were all built for sea-going cruising-ships, but the *Triumph* and *Swiftsure* only were sheathed in wood and coppered. A brief outline of their history may serve to show how designs for ships of war have sometimes been decided on by the Admiralty.

It was in the year 1867, in the midst of the controversy between the advocates of broadside and turret systems, that the Board of Admiralty resolved to invite the principal private ship-builders of the kingdom to

compete in designs for either a turret or a broadside ship, at the option of the designer. Certain conditions were imposed in either case: the displacement was fixed, the draught of the water was to be $22\frac{1}{2}$ feet, and the speed $13\frac{1}{2}$ knots.

The armor-plating was to be at least 8 inches in thickness at the water-line, and 6 inches in other parts, except at the bow and stern, and it was essential that an all-round fire should be practical, or at least that some one gun behind armor-plates should command every point of the horizon.

A prize was to be awarded to the successful competitor. Seven ship-building firms responded to the invitation, and sent in designs of various degrees of merit. The London Engineering Company proposed to build a broadside ship of 3,800 tons; the Millwall Company, a compound of broadside and turret of nearly the same tonnage; Messrs. Palmer & Co., a broadside ship with a movable upper-deck battery; and the Thames Company, a broadside ship, while the firms of Messrs. Napier & Son, Messrs. Samuda, and Messrs. Laird each designed a turret-ship, fulfilling the proposed conditions.

To the surprise of the competitors, all the designs were referred to Mr. Reed, then chief constructor of the navy, and he, though selecting the designs of Messrs. Laird as the best offered, referred to a turret-ship of his own, of the same dimensions, previously submitted, and the controller of the navy in reporting on the designs, which was the entire subject-matter referred to him, decided in favor of Mr. Reed's ship over all the private designs, and that the admiralty designs of the *Audacious* class of broadside-ships was superior to either.

This view was adopted, and the result of all this competition among the naval architects of Great Britain was that six of the *Audacious* class were ordered to be built, four of them being given out to be built in the yards of the disappointed shipbuilders. These ships have all been thoroughly tested at sea, and the results have not been entirely satisfactory. It is reported, in the first place, that the calculations were so defective that the ships have turned out lighter than was intended, and it has been necessary to fill in the bottoms with concrete and ballast to give moderate stability, and that it became necessary to alter the rig and largely reduce the masts and sails. The *Audacious*, when broadside on, presents an area of 6,670 square feet, and of these only 3,207 square feet, or less than one-half, are plated. Amidships for 100 feet by 3 feet, at the water-line, the armor is 8 inches in thickness, tapering to $4\frac{1}{2}$ inches at the bow and stern, and at the other portions the armor is 6 inches thick, except that the ends of the main-deck battery have only 4 and 5 inch armor, while the ends of the upper-deck battery are unprotected against a raking fire, and more than half the ship's side is in the same unprotected state.

It seems, however, that some officers entertain high opinions of the sea-going qualities of this class of ship, as will be seen from the following:

The *Audacious* is now the flag-ship of the China station. Admiral Ryder, in command, writes to the controller of the navy of this ship as follows: "Whatever objections may have been raised to ships of the *Audacious* class, the longer experience I have of them the more I am struck with their wonderful steadiness. I have just lately made a passage running before a heavy sea and strong wind, all my stern ports barred in, and to our great surprise the ship did not roll more than 2° to 1° each way. I half made up my mind to broach her to, to see what she would do in such a sea, but the helmsman did it for me. In giving the

ship a yaw he brought her to the wind, and positively to our surprise she declined to take any notice of the sea at all. An iron-clad flag-ship of a first-class naval power accompanied me. We were both proceeding before the same sea, my flag-ship rolling 2° to 1° , the flag-ship of the other power rolling 20° ."

After the above brief outline of vessels of former types we now come to the more recent and important designs of broadside armored ships. Taking up first—

THE ALEXANDRA.

The broadside system has proved tenacious of life. For masted vessels it fairly holds its own against the turrets. The hitherto unknown perfection to which it has been brought in the *Alexandra* appears likely to give it a new lease of life, especially in combination with all-round fire from fixed turrets on the upper deck, as will be applied in the *Téméraire*. This vessel, the largest masted iron-clad heretofore designed, and now well advanced toward completion at the Chatham dock-yard, is a central-battery ship in the best sense—that is, she needs no bow or stern batteries to give her end-on fire. For the first time a broadside armored masted ship is built with satisfactory all-round fire, for, out of twelve guns, four of them, including the heaviest, can fire straight ahead and two straight astern. On each broadside from four to six guns can be fought, according to the bearing of the enemy. In other words, she has almost as perfect an all-round fire as is attainable in a broadside armored vessel, and this forms her chief claim to consideration. So far as the fighting portion of the vessel is concerned, she is a two-decker, unlike the six armored vessels of the *Audacious* class referred to above, and she may be considered a perfect example of a war-ship shadowed forth in those vessels. The battery consists of two Woolwich rifled muzzle-loading guns of 25 tons each, and ten of the same kind but of 18 tons each, the former being a size not previously attempted to be carried on a broadside ship. In Fig. 2, shown above, the numbers denote the weight of the guns in tons. It will be observed that the only two 25-ton guns she possesses are located in the upper battery forward. These can be trained from 2° or 3° across the fore-and-aft line forward, to several degrees abaft the beam, as shown at A. BB are 18-ton guns with much the same training aft that the others possess forward. These four guns comprise the armament of the upper battery. To localize the effects of shells exploding between decks, the main-deck battery is divided into two by an armored bulkhead which forms a continuation downward of the forward bulkhead of the upper battery. In the portion which lies under and corresponds with the upper battery are six 18-ton guns, three on each side, for broadside fire only. These are shown at D D, in Fig. 2. In the forward and detached portion of the main battery are two other 18-ton guns for end-on fire, which they attain by means analogous to those employed to give similar fire to the upper-battery guns. Forward of the main-deck battery the whole side of the ship is set back from the level of the main deck (at the top of the armor-belt) upward. In other words, the ship forward of the battery is narrower above the main deck than below it; the two guns, C as well as A, can therefore fire right ahead past the sides. Their arc of training is about the same as that of A, or nearly 100° . The sills of the main-deck ports are 9 feet, and those of the upper-deck ports more than 17 feet above the water. The water-line is protected by a belt having a maximum thickness of 12 inches, and it will be seen by Fig. 1 that the armor forward is carried down over the ram, both to

THE ALEXANDRA.

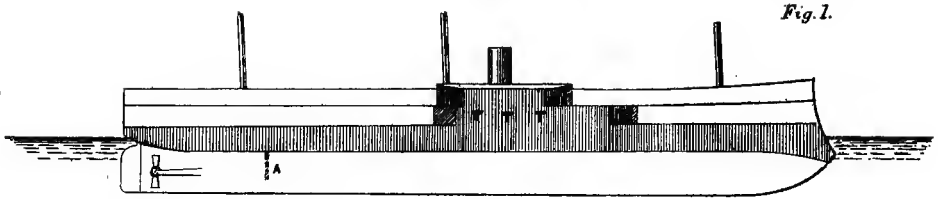

Fig. 1.

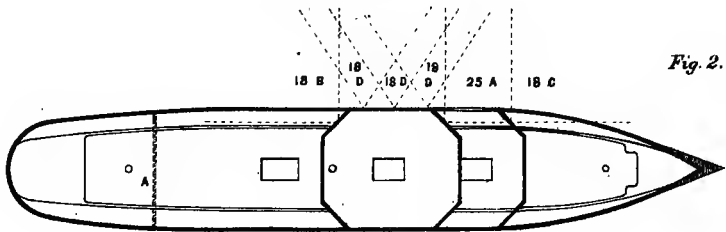

Fig. 2.

strengthen the latter and to guard the vital parts of the ship from injury by a raking fire from ahead, at times when waves or pitching action might expose the bow. The machinery, magazines, &c., are similarly protected against a raking fire from abaft by an armed bulkhead, 5 inches thick, shown at A, Figs. 1 and 2. The batteries are protected by armor only 8 inches thick below and 6 inches above, which is a deficiency of protection against guns now in common use on board armed vessels in European navies.

The total weight of armor and backing is 2,350 tons.

The principal dimensions of the vessel are :

Length between perpendiculars	325 feet.
Breadth extreme	63 feet 8 inches.
Depth of hold	18 feet 7½ inches.
Tonnage	6, 050.
Displacement	9, 492.
Draught forward	26 feet.
Draught aft	26 feet 6 inches.

The system of framing adopted in former armored vessels has been preserved in its main features. The great weight of armor and machinery, together with the immense power to be developed, necessitates arrangements which shall give extraordinary strength to the hull. The chief characteristics of the system, as in other vessels, consists in the adoption of an inner bottom and short angle-irons connected by bracket-plates. Increased strength longitudinally is gained by the use of much deeper longitudinal frames than employed in many former vessels; an advantage in this feature is that the space between the two bottoms (4 feet amidships) is roomy and easy of access for cleaning and painting, operations essential to the preservation of an iron structure. Facilities are also afforded by these arrangements for letting in water between the bottoms to regulate the trim of the vessel. Provision is made to pump out any compartment required, the space being in several divisions. In addition to the strength and safety proceeding from these numerous water-tight cells between the two bottoms, great increased strength is gained by the employment of a heavy longitudinal bulkhead through the center of the ship, commencing at 40 feet aft of the stem and extending to within 40 feet of the stern. Besides the wing passages, bulkheads on either side form longitudinal divisions of the hold, while advantage is taken of transverse bulkheads to form subdivisions for the magazines, shell rooms, chain-lockers, shaft-passages, and passages between the engines and boilers. By the bulkheads the twelve boilers are subdivided into four separate sets of three each, and the engines of the twin screws into two sets. In other words, the center longitudinal bulkhead divides the engines of each screw; it also divides the boilers, six being on either side of it, besides which there is a transverse bulkhead aft of the boilers, one immediately forward of them, and one in the center of the six. These several water-tight bulkheads are so arranged that any one or more sets of boilers can be worked independently of the others. All communication can also be shut off from either set of engines, so that if one side of the ship be damaged the engines on the opposite side can be worked independently. In the event of damage to the bottom, or accident by fire or other causes, any one of the compartments can be shut off or flooded. All the bulkheads are butted at the joints, beautifully fitted, and strongly secured as one rigid bridge. The water-tight doors on the lowermost deck are fitted

with hinges having loose pins, and are secured when shut by levers placed at short intervals all around the edges of the doors, which may be worked from either side of the bulkhead. The doors in the hold are made to slide up and down, being raised or lowered by screws worked from the main deck. Flooding arrangements are fitted to the magazines, shell-rooms, and torpedo-rooms, proper stop-cocks with locks being fitted in each case to prevent the possibility of water being let in by mistake. Excellent facilities for pumping have been applied, to be worked by steam, also by hand, from the decks. Drain-pipes are placed between the two bottoms, giving control over the water in every compartment, so as to fill or empty them; the former when they are used for carrying water-ballast, the latter when they are pumped out in case of accident.

The frame spaces and the hollow masts constitute excellent ventilating tubes, the masts especially being good uptakes. To prevent the liability of the inhabited decks from becoming contaminated, attention has been given to the necessity of conveying the foul air away to the upper deck by distinct pipes from the hold and from the berth-decks. This point has not, however, been carried to the extent it deserves. The last consideration of atmospheric influence consists in providing means for closing all ventilators in event of fire. This seems the more important in the case of hollow masts used as ventilating tubes, for if a fire should occur in the hold, the masts at once become tall chimneys creating enormous draughts to fan the flames. One case of this kind is known to have occurred in the mercantile vessel *River Boyne* within a year, and it is probable other unrecorded cases have happened.

MOTIVE-POWER.

The *Alexandra* is the first cruising armored broadside ship of the royal navy engine on the compound system. The machinery was designed and constructed by Messrs. Humphrys & Tenant, at their works, Deptford-on-the-Thames.

As in all late armored ships of the royal navy, twin screws are applied to the *Alexandra*. Each screw is driven by an independent set of engines with three vertical inverted cylinders of the collective power of 4,000 horses, giving an aggregate indicated horse-power of 8,000 for both sets of engines. The diameter of the high-pressure cylinder is 70 inches, and the diameter of the low-pressure cylinders each 90 inches. The high-pressure cylinder is in the center; its faces are made separately, of hard, close-grained iron, 2 inches thick, and secured to the cylinder with brass countersunk screws. The linings or working-barrels of all the cylinders are made separately, and bolted to the cylinders at one end, and fitted with an expansion joint at the other, with a width of steam space of 1 inch between. The intermediate spaces between the high and low pressure cylinders are also steam-jacketed. The slide-valves are double-ported and fitted with packing-rings on the back, to relieve them of part of the steam pressure. Chocks are fitted to the cylinders to stay them in the event of the ship being used for ramming. The crank-shafts are made in three pieces, which are interchangeable. The diameter of the bearings of the crank-pin is $17\frac{1}{2}$ inches, and their lengths equal to the diameters. The crank-shaft brasses are lined with white-metal and so fitted that they can be removed without necessitating the removal of the shaft, and each top brass and cap has a hole large enough to admit a man's hand for the purpose of ascertaining its temperature. The diameter of the propeller shafting is 16 inches, ex-

cept the stern-shaft through the tube, which is 18 inches exclusive of the brass casing. The tubes through the stern are of one length, and of gun-metal, and the driving-shafts within them are also cased with gun-metal cast on. The lengths of the lignum-vitæ bearings in the tubes are at the after end 4 feet 6 inches, at the forward end 2 feet 3 inches.

The engines are raised considerably above the inner bottom of the ship, with the view to prevent damage to them in case of accident to the ship's bottom. The propeller-shafts are in consequence inclined toward the stern. The surface-condensers, one to each set of engines, are so fitted as to be worked as common jet-condensers if necessary. They contain an aggregate of 16,500 square feet of cooling surface. The tubes are of solid drawn brass, $\frac{5}{8}$ inch in diameter, and fitted to be packed at each end in the usual manner practiced at present in Great Britain. The water is supplied by means of centrifugal pumps, worked by independent engines. The air-pumps, two to each low-pressure cylinder, are worked directly from the main pistons.

Each set of engines is fitted with two feed-pumps and corresponding bilge-pumps; and an auxiliary engine is fitted to each boiler-compartment, capable of working another feed-pump having a set of feed-pipes, feed-cocks, and overflow-valves, separate and distinct from the pipes and apparatus belonging to the main feed-pumps. Two additional auxiliary engines (one to each engine-room) are fitted as fire engines. A double hand-pump to each set of engines is also provided; also a hand-pump to each screw-tunnel, with all necessary attachments, for the purpose of drawing water from the lowest point in the ship. The screw propellers are of the Mangin type, 21 feet in diameter, and work outward.

The boilers are twelve in number, divided by bulkheads into four several sets. They are placed in the ship back to back against the longitudinal bulkhead. The fronts face the sides of the ship; consequently they are fired from fire-rooms convenient to the coal-bunkers. An additional advantage in this arrangement consists in keeping the sides of the ship clear of boilers, and accessible in the event of torpedoes or rams punching holes through the sides of the ship. The four sets of boilers are arranged to be used separately, in sets, or singly. Each boiler contains three furnaces 40 inches in diameter and 6 feet 6 inches long. The total heating surface is 21,900 square feet, and the pressure of steam to the square inch will be 60 pounds. The smoke and gases are all carried into one chimney. Each boiler is fitted with an internal steam-pipe to obviate the effects of priming. This pipe is of brass, $\frac{1}{2}$ inch thick; it extends the whole length of the boiler, and has narrow transverse slits through which the steam must pass. "So as to prevent any catastrophe through the safety-valves getting out of order, each boiler, in addition to the ordinary safety-valve box, containing two spring safety-valves, has a supplementary test-valve loaded with a lever and weight and placed on the front of the boilers. There are also two pressure-gauges to each boiler, one being intended to act as a check to the other, the working gauge being graduated to 80 pounds and the other to 120 pounds. The stop-valves and safety-valves are all worked from the stoke-hole floors, and the main engine stop-valves are so arranged that they can be either worked from the engine-room or from the main deck. The whole of the boiler mountings, including the safety-valves and their boxes, are made of gun-metal."

Two cwt. of zinc, in blocks of 12 by 6 by 2 inches, are suspended in each boiler with the view of preventing corrosion. The furnaces are made in short lengths, riveted together with flanges, having short distance

pieces between them. The furnaces, the tube-plates, and fire-boxes are of Lowmoor iron, all other parts of B B Staffordshire iron. The thickness of the plates is as follows: tube-plates $\frac{3}{4}$ inch; shells $\frac{7}{8}$ inch; back $\frac{5}{8}$ inch; front, above and below the tube-plates, $\frac{5}{8}$ inch; all other parts $\frac{1}{2}$ inch. The shells of the boilers are double-riveted, and longitudinal seams have butt-plates inside and outside. The grate-bars are of wrought-iron, $3\frac{1}{2}$ inches deep by $1\frac{1}{4}$ inch wide, and made in three lengths. The fire-rooms are ventilated by means of circular faus, located well up, and driven by small engines.

The complement of engineer-officers is one chief and ten assistants, and the complement of stokers, eighty. In addition to the care and management of the enormous machinery to propel the ship, the engineer-officers have charge of the machinery for steering the ship, for hoisting the anchors, for ventilation, and all the water-tight doors, valves, and cocks in the ship. There are also two pairs of auxiliary engines, immediately aft of the main engines, for revolving the screws when disconnected from the main engine with the ship under sail. These engines work the screws through the intervention of brass bevel-wheels, working into wood cog-wheels on the couplings of the disconnected shafts. The ship has three masts, is bark-rigged, and is designed as a cruiser. Ventilators are abundantly provided, carrying fresh air throughout the ship; water-pipes are also extended along the decks, with attachments to the steam and hand fire-engines. The estimated speed of the ship is 14 knots as the maximum, and it is believed that $12\frac{1}{2}$ knots under sail may be attained under favorable circumstances.

The mind of an officer who has passed his sea-life on board the old type of wooden ships of war, and become accustomed to their low, dark "between-decks," small and badly-arranged air-ports, wretched ventilation, and horrid bilge-water odor, together with the familiar cast-iron smooth-bore guns, mounted on wooden carriages, must be impressed to a degree of astonishment when, for the first time, he enters the batteries of the *Alexandra*, and sees the great rifled-guns mounted on Scott's system of wrought-iron carriage; the unusual height between decks, 10 feet 4 inches in the upper battery, and 9 feet 6 inches in the lower. But lofty and spacious as these battery-decks are, his surprise would be still greater upon entering the berth or living deck. Here will be seen the extraordinary height between the berth-deck planks and the gun-deck beams of 11 feet 6 inches, equal to the lofty ceiling of a modern dwelling-house. He would also be impressed with the large air-ports; pleasant, light, commodious state-rooms for the officers; and a ward-room centrally located, with a passage between it and the state-rooms on either side; an arrangement for convenience and comfort unknown to ancient officers. The admiral's cabin is of small dimensions and aft of the ward-room, and the captain is quartered on the upper deck, directly over the admiral.

Since writing the foregoing description of the *Alexandra*, the official trial on the measured mile has been made, when a speed at the rate of $15\frac{1}{2}$ knots per hour was attained, with entirely satisfactory working of the machinery.

The revolutions made by the screws on this trial were 67 per minute, and 8,600 indicated horse-power was developed, which was 600 horse-power above the contract.

It is proper, however, to remark that these heavy engines can never be worked at such high speeds for more than a few minutes at a time.

PART VI.

THE TÉMÉRAIRE; THE SHANNON.

THE TÉMÉRAIRE.

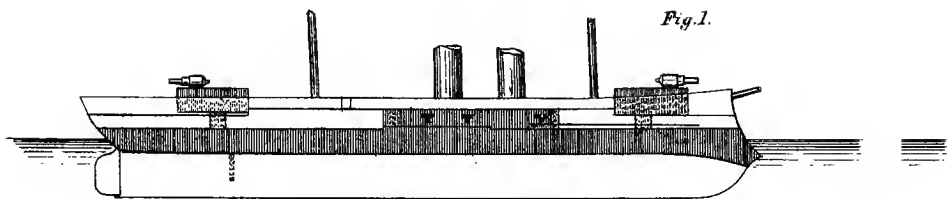

Fig. 1.

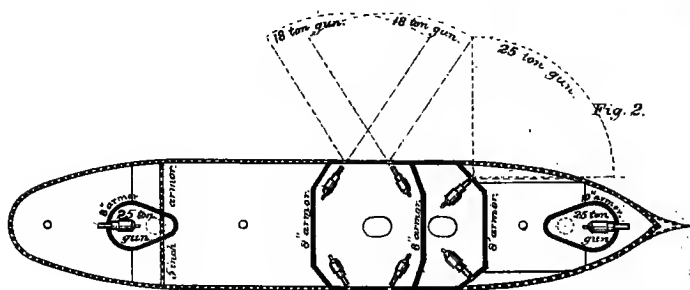

Fig. 2.

11" armor at water line.

THE TÉMÉRAIRE.

The *Téméraire*, building at the Chatham dock-yard, is designed for a sea-going ship. Her most important feature—the feature, in fact, which distinguishes her fundamentally from all other armored ships of the British navy—is that she carries the upper-deck armament in two fixed open-topped turrets instead of a central battery. At each end of the upper deck is a pear-shaped tower or battery, standing about 6 feet above the deck, and measuring about 33 feet on its longest axis by 21 feet 6 inches across. This contains a turn-table, on which is to be mounted a 25-ton gun, worked by hydraulic machinery, on Mr. Rendel's disappearing principle; that is, the gun is raised to be fired over the edge of the tower, and immediately after firing sinks under cover to be reloaded. As the sides of the vessel from the level of the upper deck to that of the main deck are, of course, not armored at the extremities, connection is maintained between the tower and the lower part of the ship by an armored trunk or tube, so placed that on the gun being revolved after firing, into the fore and-aft line, with its muzzle toward the middle of the ship, the muzzle comes just over the opening, ready for the fresh charge from below. It must, of course, always be brought to one position for loading. The French engineers have, from the first introduction of armored ships, entertained a noted antipathy to revolving turrets. Their objections were to protecting the guns by a weight equal to that of those guns and their ammunition; to a system which prevented an enemy from being clearly seen, and to the impossibility of getting an all-round fire with two turrets on a line; while the advantages they claimed for the barbette system were that an enemy could be clearly seen, and that the freedom and *morale* of the gunners were better assured in a barbette than in a turret battery.

The French naturally defend their own system against the opinions of all other European naval authorities. In the usual sense of words, the guns in the open battery of the *Téméraire* are not barbette guns at all. They are fired *en barbette*, just as guns in Moncrieff gun-pits are, but they are not *en barbette* at any other time, which is an important distinction. They and their crews are not exposed to one-half of the risks which attend guns mounted permanently above the parapet of the battery, as is the case in all the French open-top turrets. The upper-deck guns of the *Téméraire* have much more in common with the Moncrieff system of mounting, or even with guns in ordinary turrets, than with the old and objectionable system of barbette firing. But it remains to be seen whether this disappearing system of Rendel's, to be tested in the *Téméraire*, will be successful.

The foremost turret is protected with 10-inch armor, the after one with 8-inch. The guns have a clear sweep around the respective ends of the ship to some distance abaft or forward of the beam, as the case may be. In order not to obstruct the fire the bulwarks are kept low, about 4 feet above the deck, an arrangement hardly to be avoided, but likely to be objected to by sailors. The high bulwarks of ordinary men-of-war are

liked by the men for the protection they give against wind and wet; on the other hand, the *Téméraire* gains an upper deck, with no break in it except the poop and forecastle, (and the fixed turrets, which are partly inclosed in them.) All recent cruising iron clads had an upper deck here, interfering more or less with the working of ropes; this is got rid of in the *Téméraire*.

ARMAMENT.

The *Téméraire*, from the upper deck, fires right ahead one 25-ton gun right astern, the same; and through a large arc on the beam, two. On the main deck, protecting also the smoke pipe, is the *Téméraire's* double or divided battery, shown in plan in Fig. 2, and resembling, except in being shorter, the main deck battery of the *Alexandra*. The forward part contains two 25-ton guns, whose arc of training extends from slightly abaft the beam on each side to slightly across the fore-and-aft line, so as to secure a converging fire at some distance ahead of the vessel, as already described in the case of the *Alexandra*. These guns, of course, fire from corner ports, and the sides of the ship above the main deck or top of the belt forward are set back several feet; this is shown in Fig. 2. The after part of the battery contains four 18-ton guns, for broadside fire only. On the whole, the *Téméraire* fires three 25-ton guns right ahead; on either bow, two 25-ton; right aft, one 25-ton; on either quarter, one 25-ton; on either beam, (if engaged on one side at a time,) two 25-ton and two 18-ton, (with a third 25-ton available through only half the usual arc.)

The guns of the *Téméraire* are better defended than those of any other broadside ship, and this fact, coupled with a water-line defense nearly equal to that of the *Alexandra*, an armament which many will prefer to hers, and a much less size and cost, should give her the character of being the most successful masted ship, provided the system of working the 25-ton guns prove successful. She is at least immeasurably superior to everything, however large, which preceded the *Alexandra*.

Like all belted ships, the *Téméraire* has weak places in her water-line; but amidships, over the most vital parts, she has 11-inch armor, (against 12-inch in the *Alexandra*,) reduced very slightly above and below.

At the bow, to guard against exposure to raking fire in pitching, the armor is carried down over the point of the ram, and similar protection is gained for the magazines, &c., against raking fire from aft, by an armored bulkhead across the hold, (shown in the sketches;) this is plated with 5-inch armor. The deck at the level of the top of the belt outside the main-deck battery is $1\frac{1}{2}$ inches thick. The hull, which has the usual double bottom, and is divided into very numerous water-tight compartments, is built on the well-known bracket-frame system, and it is sheathed externally with wood covered with zinc. As in other recent twin-screw ships, the engine and boiler rooms are divided into two, longitudinally, by a bulkhead, to limit the entry of water, and its ill consequences to the engines in case of injury from rams or torpedoes. The weight of the armor and backing is about 2,300 tons, or nearly the same as in the *Alexandra*; the bunkers contain only 600 tons of coal; and the guns, ordnance stores, engines, boilers, and all other equipments weigh about 2,200 tons. These weights, amounting in all to 5,100 tons, are carried by a hull weighing 3,300 tons. The spread of canvas is considerable, but it is carried brig fashion, on two masts only, to avoid obstructing the end-on fire of the upper-deck guns.

The following are the principal dimensions, with like information added for the *Alexandra* for the sake of comparison :

	<i>Téméraire.</i>	<i>Alexandra.</i>
Length between perpendiculars.....	285 feet.	325 feet.
Breadth, extreme	62 feet.	63 feet 8 inches.
Drault aft	27 feet.	26 feet 6 inches.
Drault forward	26 feet 6 inches.	26 feet.
Displacement	8,412 tons.	9,492 tons.
Indicated horse-power, (intended) ...	7,000	8,000
Speed, (intended)	14 knots.	14 knots.
Armor :		
Maximum thickness on belt.....	11 inches.	12 inches.
Thickness on batteries	10-inch, 8-inch.	8-inch, 6-inch.
Guns of 25 tons	4	2
Guns of 18 tons	4	10
Weight of broadside fire	2,600 pounds.	2,600 pounds.
Weight of bow fire	1,800 pounds.	2,000 pounds.
Weight of stern fire	600 pounds.	800 pounds.
Cost, estimated	£374,000	£521,000

The *Téméraire*, in like manner with all recently-constructed armored ships, is to be fitted for discharging Whitehead torpedoes beneath the water, through a hole on the broadside, having a projecting shield.

MOTIVE-POWER.

Each screw is to be operated by an independent set of compound engines, with two vertical inverted cylinders of the same dimensions as to diameter and stroke as the high and low pressure cylinders of the *Alexandra*; that is, a diameter of 69 inches for the high pressure, and 90 inches for each low pressure, with a stroke of 4 feet; the maximum number of revolutions on the trial, 65. They are the first examples of engines in the British navy in which all the stationary parts, (cylinders, valves, and their covers excepted,) as well as the working parts, are made of wrought iron, steel, and composition—no cast iron being used in the construction, except as before mentioned; as a consequence, the same strength is attained with increased lightness, added to beautiful appearance, standing, as I observed them in the works, ready for erection on board ship. The bed-plates are built up of wrought-iron plates, into which the forged main pillow-blocks are riveted. The condensers are of composition, cast in four plates each, and bolted together. The condenser-tubes are tinned on both sides, and each one secured in its place by a stuffing-box tapped into the plate, with a canvas washer behind it. The air and other pumps are also of composition. The valve-face of the high-pressure cylinder is of phosphor bronze, screwed on by composition screws. The boilers are twelve in number, of elliptical shape, containing three furnaces in each. They are placed in the ship back to back, against the longitudinal bulkhead, with the fronts facing the coal-bunkers next to the sides of the vessel. They are divided by bulkheads into four several sets, in the same manner as those in the *Alexandra*, any one set or any one boiler of which can be worked independently of the others.

THE SHANNON.

The *Shannon*, just completed at Pembroke, is a new design of special type, of broadside armor-belted cruising-ship. The length between perpendiculars is 260 feet; breadth, extreme, is 54 feet; depth of hold, 21 feet 7½ inches; draught of water forward, 20 feet; aft, 22 feet 6 inches; displacement, 5,100 tons. She has a full ship-rig, is designed to carry a large spread of canvas, and the single screw-propeller is of the lifting kind; sail-power is to be used under all ordinary conditions of cruising. There are several interesting peculiarities in the construction of this vessel. The guns which are to fight upon the broadside are on an open deck, and all without protection of armor. The armor is limited to a belt extending around the vessel at the water-line; this belt is not tapered toward the bow, as is usual, but ends abruptly 60 feet short of it, at an armored bulkhead 9 inches thick, which extends across the vessel at this point, and descends 5 feet under water. Forward of this bulkhead the armor takes the form of a submerged deck 5 feet below water, running forward and sloping to 10 feet at the stem. The plating of this deck is 3 inches thick. The deck aft of this armor-bulkhead is of iron, 1½ inch thick, covered by wood; the hatchways passing through it are protected by shell-proof gratings. The armor-bulkhead already referred to—that across the bow of the vessel 60 feet from the stem—rises to a height of 20 feet above the water-level to the top of the forecastle; and it here turns at the sides, extending aft and embracing the forecastle with arms 26 feet long on both sides. It thus guards both decks against raking fires from ahead, and creates an armored forecastle, open at the rear, and carrying two 18-ton bow-guns. Within this armored forecastle are the instruments for communicating with the engine-room, the helm, and the battery. In other respects the ship is unarmored, *i. e.*, when engaged upon the beam her broadside-guns are unprotected by armor, excepting the two under the forecastle; and, against an enemy astern, the battery is as unprotected as it would be in any ordinary unarmored ship. It is, of course, intended that the *Shannon* shall, when possible, present her bow to the enemy, as the men can be withdrawn under the cover of armor, and the guns, being laid on the broadside, can be discharged by electricity when passing an enemy, after an attempt on either side to ram. Compared with the powerful, fast, unarmored ships, and engaged with them, the *Shannon* will have, if properly handled, many of the advantages of a first-class armored ship. She would be much more formidable than such an adversary as the *Minotaur*, which has twice her bulk and double her power of engines, and cost nearly twice as much money; or more formidable than any of the formerly-constructed armored ships of continental countries.

The armor-belt referred to is 9 feet deep, 5 feet of which are under water and 4 feet above water. It is put on in 12-foot lengths, and extends from 4 inches under the counter to 60 feet from the stem. The thickness at the water-line is 9 inches, tapering below as well as above

THE SHANNON.

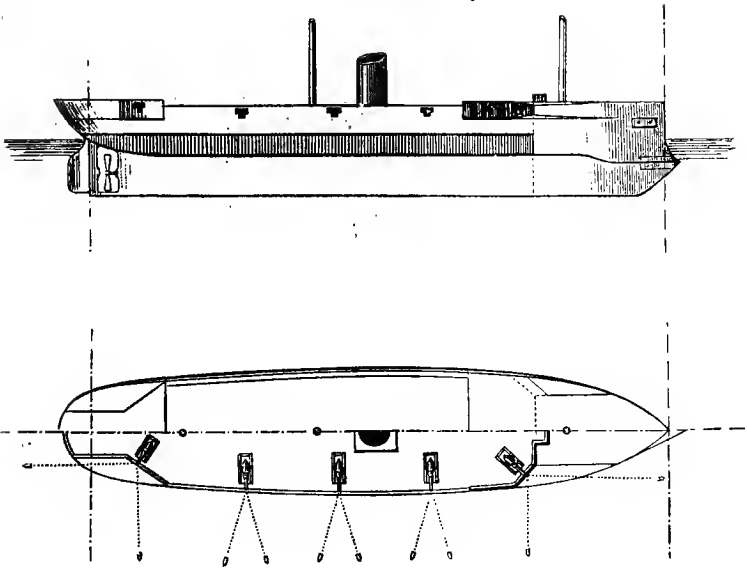

the water. The hull of the vessel is constructed on the usual system, but the double bottom is only 168 feet in length; it is divided into twenty separate water-tight spaces. There are nine principal athwartship water-tight bulkheads, and fifteen water-tight coal-bunkers; but there is no longitudinal bulkhead extending through the vessel, as in all recently-constructed armored ships having twin screws. This backbone of strength and safety becomes impracticable in single-screw vessels.

The stem of the ship has fitted to it a shifting-ram, the snout of which is 8 feet 3 inches above the keel, and extends 8 feet ahead of the stem. This ram is at present stowed on board the vessel, the idea being that as so many accidents have occurred in time of peace from the ram, and especially in view of the loss of the *Vanguard* from the blow by the ram of the *Iron Duke*, it has been thought best to make the ram portable and to fit it in place only in time of war. In favor of this plan much can be urged, but it seems to suggest the questions: first, whether ships on foreign stations will be able in emergencies of war times to go into docks to have their rams secured in place; secondly, whether, if they should succeed in this, the officers who up to that time will be deprived of all experience in guarding against accidents from it, will be able to avoid multiplying those accidents which have hitherto occasionally happened under the most ordinary circumstances, notwithstanding the experience they have acquired.

The outer hull of the *Shannon*, in common with that of all recently-constructed cruising-vessels of the royal navy, is sheathed with wood. The material is teak, put on in the usual way, in a single course, with the seams left uncalked, except above the water-line, for the purpose of admitting sea-water freely between the iron hull and the zinc with which the planking is covered.

ARMAMENT.

The armament is placed on an open deck not unlike the uncovered decks of corvettes. It consists of nine Woolwich guns, two of which are 18-ton guns, under protection of armor at the bow from raking fire ahead; six 12-ton guns (three on either broadside unprotected by armor) and one 12-ton stern gun, which is carried on a platform amidships aft, and is intended to be fought at a port on either side of the deck. It is also unprotected by armor. The two 18-ton bow-guns can be trained to fire on a line with the keel or to any point around at right angles with it.

One of the features noticed in the design of this belted ship is the protection by horizontal armor at the top of the belt; an important feature, since the side armor extends only 4 feet above water.

The plated decks protect the magazines, machinery, steering-gear, &c., from plunging fire of any guns that might be carried on an enemy's upper deck, and could easily send projectiles through the unarmored side above the belt.

A second feature is the system of coal-tanks introduced for the first time at the bow of the vessel.

Another noticeable arrangement is the adoption of two ventilating cowls upon the outside of the vessel—one for carrying air directly to the fire-rooms, and the other for ventilating the coal-bunkers.

MOTIVE POWER.

The ship is to be propelled by a single screw. The machinery was constructed by Messrs. Laird Bros., of *Alabama* fame. The engines are

of the compound, horizontal, return connecting-rod type, with four cylinders—two high and two low pressure—bolted together similarly to the *White Star* type, if laid horizontally. The diameter of the high-pressure cylinders is 44 inches; the diameter of the low-pressure cylinders is 85 inches, and the stroke of pistons is 4 feet. The condensers are of the ordinary surface variety used in the British navy. The diameter of the air-pumps is 22½ inches, and the stroke 4 feet. The diameter of the crankshaft is 17½ inches. The screw propeller is of the common Griffith type, two-bladed, and lifting; its diameter is 19 feet 6 inches, and its pitch varies from 18 to 22 feet, according to the position in which the blades may be set. The boilers, cylindrical in form, are eight in number, each 12 feet in diameter by 12 feet long, and each boiler contains two furnaces 3 feet 8 inches in diameter by 6 feet in length. They are placed in the vessel back to back, against a longitudinal bulkhead, and as a consequence are divided into two sets, with the fire-rooms facing the side coal-bunkers; in this position they are conveniently fired. A transverse bulkhead separates the boilers from the engines; also, a transverse bulkhead forward separates them from the hold; hence the central position of the boilers in the vessel, the division into two fire-rooms, and protection by water-tight bulkheads, gives all the security to them possible in the event of damage to the hull by rams or torpedoes. The entire length of the boiler-space in the vessel is 56 feet, and the width, including the two fire-rooms, is about 40 feet. The space occupied by the engines in the length of the vessel is 36 feet. The pressure of steam to be carried in the boilers is 70 pounds per square inch. The maximum number of revolutions of the engines is to be 70 per minute. At this speed of pistons, 560 feet, the indicated horse-power is estimated at 3,500 and the speed of the ship at 13 knots per hour. The engines are designed to work the steam expansively, from 12 to 20 times, as desired. The coal-bunker capacity is only 500 tons; it is therefore evident that steaming will be the exception and sailing the rule in the *Shannon*.

WEIGHTS OF MACHINERY.

Engines, appendages, and spare gear, with water in condensers	266 tons.
Boilers, including everything between boiler-room bulkheads; also, water in boilers	310 tons.
Propeller, shafts, &c	61 tons.
Total	637 tons.
Total cost of machinery, \$245,430.	

It is to the Russian admiralty that the credit is due for the introduction of the first belted cruiser. It has been four or five years since they built the first vessel in which the vital part, *i. e.*, the water-line only, was protected by armor, leaving the guns and crew unprotected. The *Shannon* is, however, a notable improvement on the Russian idea, and yet it has been authoritatively stated that, while she is capable of taking part in general engagements if required, she was primarily designed for distant cruising service, the rig and sail-power being above the average for armored broadside ships.

PART VII.

THE NELSON AND NORTHAMPTON; THE WARRIOR; THE
WATERWITCH; THE GLATTON.

THE NELSON AND NORTHAMPTON.

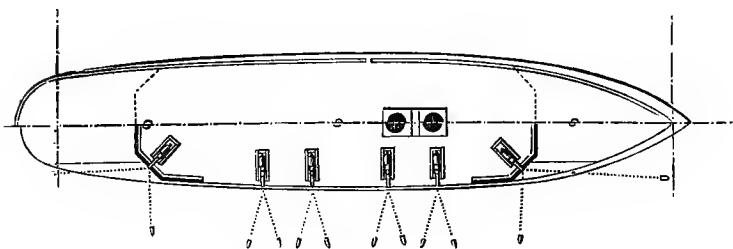
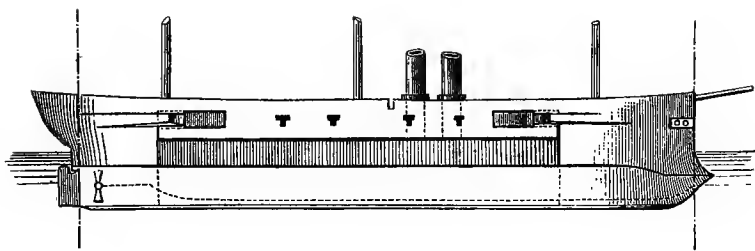

THE NELSON AND NORTHAMPTON.

These two sister ships, the former under construction by Messrs. Elder & Co., and the latter by Messrs. Napier & Sons, near Glasgow on the Clyde, constitute a new type of ocean-cruising broadside armored ships. They are the last productions of armored vessels by the chief naval architect, and before an audience last summer at the loan exhibition, South Kensington, he pronounced them to be his "ideal of cruising fighting-ships." A glance at the longitudinal section and plan of gun-deck given above, will convey an idea of the general design.

The length between perpendiculars is 280 feet; breadth, extreme, 60 feet; and the mean draught of water, loaded, is to be 24 feet 2 inches.

The framing is on the usual longitudinal system adopted in the construction of Her Britannic Majesty's ships of war, and in this instance the longitudinal frames are made of steel, so as to combine lightness with strength. The double-bottom extends for about 150 feet amidships, and the space between the inner and outer skins is divided into many water-tight compartments. According to the system recently adopted for armored ships, there is a central longitudinal bulkhead; besides numerous transverse bulkheads underneath the lower deck; also, wing-passage bulkheads. Altogether, including the spaces between the two skins, there are 90 water-tight compartments; all the doors leading to these compartments are likewise water-tight and are to be worked by machinery, and every conceivable precaution has been taken to provide against destruction by rains and torpedoes.

There are three principal decks: the lower, main, and upper.

The protecting armor consists of a belt on the water-line of about 181 feet in length amidships; this belt is 9 feet deep, 4 feet above water, and 5 feet under water. It is put on in two strakes; the upper plates are 9 inches thick on a 10-inch backing of teak, and the lower plates are tapered to 6 inches thick, supported by a teak backing 13 inches thick. Extending across the ship at each end of this armor-belt there is an armor bulkhead; it starts at the bottom of the armor-belt 5 feet under water and extends to the upper deck, having in all a depth of 22 feet. Its thickness is 9 inches above water, tapering to 6 inches at the bottom. Between the main and upper decks these bulkheads are shaped to form corner ports at the fore and after ends of the battery. Between the armor bulkheads, and at the upper level of the armor-belt, the lower deck is formed throughout of 2-inch plates, by means of which protection is afforded to the machinery, boilers, magazines, &c. A peculiar feature is the horizontal armor as here applied. For about 57 feet at the fore end there is an armor-deck. This deck is 2 inches thick and it is 5 feet under water at the junction with the armor-bulkhead, but inclines deeper toward the stem and terminates forward in the ram. There is likewise a horizontal armor-deck of the same thickness and same depth under water, extending from the after armored bulkhead to the stern. These submerged armor-decks are intended to protect the lower part of the ship fore and aft of the armored bulkheads, especially the steering-gear provided for emergencies. From the

above outline and reference to the annexed drawing, it will be seen that the central part of the vessel for 181 feet in length, in which all the motive machinery is contained, may be regarded as completely protected from ordinary shots of the enemy. The ends of the vessel above the submerged decks are entirely unprotected by armor, and may, it is supposed, be riddled with shot without serious injury to the flotation of the vessel.

The armament will consist of four 18-ton guns and eight 12-ton guns on the main deck, also six small guns on the upper or spar deck; the latter are designed to be used as torpedo-boat destroyers. Two of the 18-ton guns, one on either side forward and one on either side aft, are situated behind the oblique portion of the armor-bulkheads, and the ports are so cut that these guns can command a fire across the line of bow and stern. The eight 12-ton guns, four disposed equally on either side, are termed intermediate, and have in front of them the thin sides of the ship only. They are separated by a transverse bulkhead or splinter-screen 1 inch thick, intended to cut off each gun's crew from the others. This broadside of guns is designed to be loaded and laid in close engagement under the shelter of the bow or stern armor, and may be fired by electricity without exposing the crew.

The rai is a heavy plate, triangular in shape, set vertically, and terminating in a sharp point about 11 feet in advance of the stem; it is supported by two side plates 3 inches thick, which may be regarded as a continuation of the armor-deck. The rudder, which is massive, is 18 feet deep by 11 feet in breadth, and is formed by two thicknesses of teak planking set in a strong iron frame. The vessel has fitted to it bilge keels 33 inches deep, formed of two plates riveted together and extending amidships about 100 feet; and the outer bottom of the hull below the water-line is sheathed with one course of teak planks 3 inches thick, while over that there is also a sheathing of zinc. The seams between the sheathing-planks are left uncalked, with the view of admitting free communication between the iron hull and zinc. There are to be three masts fitted, as for a full-rigged ship, and the coal-bunker accommodation is sufficient for a long voyage and cruising in distant seas. In time of war it is intended that only the lower masts shall stand.

The novelty of design worked out in the *Nelson* and *Northampton* consists in the system of armoring, and, as may be readily seen, the object contemplated is to give thicker plates to vessels of this class over the vital parts of the ship, at the expense of the exposed parts, and to increase the offensive power by carrying a heavier weight of ordnance.

MOTIVE-POWER.

The machinery of the *Nelson* was designed and constructed under the direction of Mr. Kirk, the manager of the engineering works of Messrs. Elder & Co. The ships are fitted with twin screws, each to be driven by an independent pair of compound engines, with vertical inverted cylinders, of the collective power of 3,000 horses, giving an aggregate power of 6,000 indicated horse-power for both pairs of engines. The diameter of the high-pressure cylinder is 60 inches, and the diameter of the low-pressure cylinder is 104 inches. The length of the stroke is 3 feet 6 inches, and the number of revolutions to be obtained on the trial is 75 per minute. These engines are constructed entirely of wrought-iron and brass, except the cylinders, cylinder covers, steam and expansion valves. The two pairs of engines are tied together by wrought-

iron braces, and are to be fixed in the ship directly opposite each other. The central longitudinal bulkhead of the ship, however, divides the two pairs, and all the pipes are arranged so that, in the event of collision or other casualty to the bottom of the vessel, either pair can be worked separately. The crank-shafts are in two parts, interchangeable, 16½ inches in diameter in the bearings, with an aggregate length of bearing of 9 feet 6 inches. The propeller-shafts are hollow, made of Whitworth's compressed steel. The screw-propellers are to be 18 feet in diameter, to work outward, and to be of the Mangin type, *i. e.*, two 2-bladed screws on each hub, separated from each other.*

The boilers are ten in number, with three furnaces in each, set back to back against the longitudinal bulkhead, with the fronts toward the sides of the ship. They are oval in shape, 12 feet 6 inches wide by 14 feet 6 inches high, and 9 feet 6 inches long, and are divided by transverse water-tight bulkheads into four separate fire or boiler rooms. The furnaces are made in short lengths, riveted together with flanges having distance-pieces between them. The pressure of steam is to be 60 pounds per square inch. All the necessary pumps and equipments described for other vessels are here provided.

The machinery for the *Northampton* was designed and constructed by Messrs. John Penn & Son, of Greenwich. The engines of this ship are of Penn's new type, three-cylinder vertical inverted, the first design of which was made in 1875 for the Italian frigate *Cristoforo Colombo*, built at Venice. The three cylinders are of equal diameter, 54 inches, with a stroke of 39 inches. The cranks are set at equal angles, and the shafts are interchangeable. When the ship is to be driven at full speed, the engines are to be worked as simple expansive engines, cutting off the steam long or short, as desired; but under all ordinary conditions of steaming they are intended to be worked on the compound system, taking the steam first in the center cylinder and expanding it in the two outside cylinders, valves and connections being provided to effect the change from one system to the other when desired. The only difference between the general design of these engines and the set built for the Italian government is, that in the former the cylinders are separate from each other and tied together by wrought-iron braces, while in the latter they are united by castings. The power to be developed by the engines of the *Northampton* is to be the same as provided for the *Nelson*, and the boilers are almost identical, ten in number, of the elliptical type, with three furnaces in each, and to carry a pressure of 60 pounds per square inch.

The ends of the ship are provided for coal-tanks.

*The Mangin screws have given satisfaction as applied to several twin-screw vessels in England and France where the space permitted sufficient separation of the screws on the shafts; but as applied to one of our single-screw second-rates, in a short well, it proved, as might have been expected, unsuccessful.

THE WARRIOR.

This fine old ship, the first iron-armored ship built in England, was lying at Portsmouth during my visit to that place. It is worthy of note that while the first productions of all nations, of wooden ships clad in armor, have gone to decay, the iron hull of the Warrior, now sixteen years old, presents no sign of deterioration, being to all appearances as sound and as durable as when set afloat in 1860; and although large expenditures for repairs have been made on the vessel and her machinery, the hull proper has required no expenditure beyond that for its preservation by cleaning and painting. The description, dimensions, and performance of this ship have appeared in various publications many years ago. In consequence of her great length, (380 feet,) unhandiness, and thin armor ($4\frac{1}{2}$ inches) she is no longer regarded as suitable for action in great naval battles, but her success as to speed at so early a day in the race for naval supremacy seems to deserve attention still. In 1874, a new set of boilers, made at the Portsmouth dock-yard, were fitted on board. They are of the old box type, having superheaters, with the usual appliances of this variety. The cylinders were rebored, the slide-faces and ports strengthened and braced, and the expansion-valves altered to give an earlier cut-off.

The grate-area of the boilers is 780 square feet, and the heating surface 19,906 square feet.

After these repairs the ship was put on trial on the measured mile, to test the machinery and speed against the runs made over the same ground thirteen years previously.

The following is a comparison of the trials at full power on three several occasions:

	October, 1861.	April, 1868.	May, 1874.
Pressure of steam in boilers.....	22.00	21.6	21.5
Revolutions.....	54.25	53.14	56.0
Indicated horse-power.....	5,471	5,270	4,811
Speed, in knots.....	14.354	14.079	14.158
Pitch of screw.....	30 feet.	30 feet.	27 feet $8\frac{1}{2}$ inches.
Immersion of screw.....	11 inches.	27 inches.	13 inches
Ship by the stern.....	11 inches.	23 inches.	5 inches.

One curious result noted is the same speed on the last trial with 459 less horse-power than on the former trials many years previously.

THE WATERWITCH.

The *Waterwitch* was built as an experimental vessel, to test the Ruthven system of propulsion by a turbine wheel, or what is known as the water-jet engine. The vessel is built of iron; is 162 feet long, 32 feet broad, 13 feet 9 inches deep; has a load-displacement of 1,279 tons, and the indicated horse-power on the measured mile was 777. She has an excessively flat floor, is double ended, and fitted with a rudder at each extremity. An armor-belt $4\frac{1}{2}$ inches thick at the water-line extends around the hull, which rises at the middle of her length into a casemate rendered complete by athwartship bulkheads. The propelling instrument consists of a turbine wheel, or centrifugal pump, 14 feet 6 inches in diameter, made of wrought and cast iron. This wheel revolves in a chamber 19 feet in diameter, in the center of the hull, below the water-line, and the chamber is bored to a smooth surface inside, in order to reduce hydraulic friction to a minimum. The turbine has 12 radial blades or vanes, and weighs about 8 tons; it is put in motion by a set of three engines, arranged at angles of 120 degrees, the connecting-rods taking hold directly of a single crank rising vertically above the wheel-casing, an application similar to the manner in which the engines of the old *Union* and the *Alleghany* were connected to the once well-known Hunter wheels.* The engine-cylinders are $38\frac{1}{2}$ inches in diameter and the stroke of pistons 3 feet 6 inches, and are supplied by steam from two ordinary box-boilers having 6 furnaces.

The wheel receives the water from a rectangular box, or tank, resting on the keelsons of the ship, and placed in free communication with the sea by means of a large number of rectangular orifices in the bottom. From the wheel-casing perimeter at opposite sides, two copper pipes about 27 inches by 25 inches internally, lead to the discharge-nozzles at the ship's side. These are 24 inches by 18 inches, and extend about 8 feet along the side of the hull just above the water-line, so that the engines have to raise the water through a very small height. A sluice-valve is arranged at each side in such a manner that the current from the turbine may be directed ahead or astern at pleasure by simply moving a lever, the engines revolving always in one direction. The water taken in through the bottom of the ship is expelled at both sides in the line of the keel, and the reaction of the fluid issuing at high speed imparts forward motion to the hull. The movement of the vessel ahead or astern is regulated by the direction of the escape of the water. If the water escapes aft, the movement will be ahead; if it escapes toward the bow, it will be astern.

* As early as 1782, James Rumsey made a public experiment on the Potomac with a boat 80 feet long, propelled by a steam-engine working a vertical pump in the middle of the vessel, by which the water was drawn in at the bow and expelled through a horizontal tube at the stern; she went at the rate of 4 miles per hour. Benjamin Franklin and Oliver Evans suggested substantially the same mode of propulsion. Subsequently various applications of the principle were tried in the United States without success.

The idea is exceedingly simple and very old. As far back as 1661, Togood received a patent for propelling vessels by expelling water from their sterns. In 1730, Allen secured a patent for nearly the same thing; and the proposal was also made by Bernouilli eight years subsequently. Indeed, the extreme simplicity of the system seems to have attracted many inventors, for down to the year 1857 it appears that upward of fifty persons have either proposed or patented the scheme in Europe, and many experiments were tried from time to time, but none of them received much encouragement until Mr. Ruthven entered the field, and the success, such as it has been, which attended his exertions, seems to have been mainly due to the adoption of the centrifugal pump, with equable and enormous delivery, instead of the ordinary piston-pump commonly adopted by other inventors.

Ruthven's first patent is dated in 1839. Under this, two small boats were built and exhibited on a canal at Edinburgh, Scotland. In 1849, another boat was built and exhibited on the Thames. In 1853, the *Albert* was built on this principle in Prussia by Mr. Sydel, the engines and pump being furnished by the patentee. In 1865, the *Nautilus* was built in England, embodying all of Mr. Ruthven's improvements up to that date. With this little vessel, several experiments were made in the presence of the admiralty authorities, the results of which betrayed them into the construction of the *Waterwitch*.

In consequence of the convenience of directing a vessel ahead or astern by the simple movement of a lever from the deck, this system of propulsion has been very fascinating to many officers; but unfortunately for this instrument of propulsion, in common with the Hunter wheel, the Fowler wheel,* and all such submerged water-wheels as applied to steam-vessels, an extraordinary power must be developed by the engines to obtain a small result; or, in other words, only a small amount of the power developed is utilized.

In the trial of the *Waterwitch*, a vessel of only 1,279 tons displacement, of light draught and good lines, a power of 775 horses was developed to obtain an average speed of 6½ knots per hour.

Additional alterations and experiments were made last summer with the view of endeavoring to obtain better results. These alterations consist in superseding the 140 small apertures through which the water is admitted, by one large aperture under the wheel, and in the bottom of the ship; also in lengthening the nozzles at the sides through which the water makes its escape. The results of the trials after these alterations will, of course, be nearly the same as in previous trials. The speed of the vessel at sea has never exceeded 5 or 6 knots, and although ten years old, she has never been trusted out of sight of land, and as she is neither fit for coast-defense nor harbor-service, it is believed that the next move will be to break her up; and thus ends the experiment of propelling vessels by means of turbine wheels.

* Fowler's steering-propeller is a submerged wheel revolving on a vertical shaft, with paddles which are feathered by an eccentric cam in such a manner that the paddles shall have a pushing and drawing action on the water while passing through the propelling arc, and present only their edges to the water while passing the dead points. By turning the cam-wheel, which is done at the wheel on deck by a simple connection, the feathering is done at different points, and the vessel may be backed or turned on her center without reversing the engines.

A propeller-wheel of this kind was applied to a revenue-cutter on Lake Erie in 1872, but after the first trial it was condemned, and was removed from the vessel with the machinery to work it.

Hunter's steering-propeller, patented in 1874, is similar to the Fowler wheel in some respects. It has two wheels on opposite sides of the stern-post, revolving in opposite directions. The blades are feathered so as to have but one dead point.

COAST-DEFENSE VESSELS.

Of the twelve coast-defense vessels named at pages 16 and 17, the *Glatton* is the most powerful. She is an iron double-screw turret-ship of 4,912 tons displacement. Her length is 245 feet, breadth, 54 feet, and draught of water, 19 feet.

The maximum horse-power is 2,868, and the maximum speed 12 knots. The hull is double-bottomed, and divided into water-tight compartments in the usual manner.

The armor of the hull proper consists of two strakes, the upper (above water) being 12 inches thick, and the lower (below water) 10 inches in thickness. The former has a teak backing of 18 inches, and the latter a backing of 20 inches.

The breastwork, which rises 6 feet 3 inches above the upper deck, is armored with plates 12 inches thick, having behind it a teak backing of 18 inches. The deck extending on either side of the breastwork consists of 1-inch plates covered by 2-inch plates, and over this, 6 inches of oak planking. The turret, which rises out of the center, above the breastwork chamber, is 30 feet 6 inches in external diameter, and there is a space of 6 inches between it and the surrounding glacis-belt, which is 3 feet in breadth.

The general thickness of the turret-armor is 12 inches, with 15 inches teak backing.

All of these coast-defense vessels are engined on the old system, the *Cyclops* and *Hydra* excepted, the engines of which were the first examples of Elder's compounds introduced into armored ships. Each vessel has a pair of vertical inverted cylinders to each of the two screws.

The boilers are cylindrical, and the pressure of steam 60 pounds per square inch.

PART VIII.

COST OF BRITISH ARMORED SHIPS; TABLE OF DIMENSIONS,
ETC., OF THE ARMORED SHIPS OF GREAT BRITAIN.

COST OF BRITISH ARMORED SHIPS.

The account rendered of the cost of the construction or repair of a vessel or its machinery in one of our navy-yards is that of the actual labor and material entering into such construction or repair, no account being taken of the cost of plant, tools, appliances, fuel, &c., used in connection therewith.

In the British navy a different system prevails. A nominal percentage is added to the actual cost of labor, materials, and stores entering into the construction of the vessel, to cover what is believed to be the ship's share of the value of maintenance of the plant, appliances, materials, &c., necessarily employed in the dock-yards as ship-building establishments. This nominal percentage has differed materially in the years prior to 1866, but since that time a bulky volume has annually been presented to Parliament, containing upwards of 700 pages of figures, which gives in great detail, information of a definite character as to the cost of building and repairing every vessel in the British navy. These volumes were, to some extent, in existence before 1866, but prior to that time they could not, for purposes of comparison, be regarded as trustworthy, consequent upon the results of individual judgments obtained by taking the actual cost of maintaining the dock-yards and of their plant and distributing it ratably over the dock-yard construction and repairs of ships at the dock-yards. Thus, in comparing the cost of the *Achilles* with that of the *Bellerophon*, as the former was built when the percentage was low and the latter when it was high, it is found that these accounts make the former-named vessel apparently cost considerably less than the latter, though she really cost considerably more. Since 1866 this fluctuating percentage has been excluded from the accounts, and the details relating to the cost of ships have been limited to the actual prime cost of production; or, in other words, to the cost of the labor, materials, &c., expended on them. At the same time, the necessary information is given, enabling a percentage to be added. The following extract from a carefully-prepared paper in the *London Times* will be found interesting, showing, as it does in detail, the cost of construction and maintenance of the British navy for eighteen years:

While it was difficult to assess beyond the reach of dispute the proper charge ships should bear as their share of the cost of keeping up the dock-yards and machinery necessary for construction and repair, it was not so difficult, though the difficulty must, necessarily, have been great at first, so to limit the items of charge on account of ship-building as to enable an effective comparison to be made between the estimate voted by Parliament and the actual expenditure incurred on our fleets for construction and repair; to be able, in fact, to prepare an account which should show on one side the actual votes for labor and stores as given in the navy estimates, and on the other side the actual fruit of those votes in dock-yard work of all kinds. The difficulty, which for years existed, of establishing anything like a satisfactory and direct relation between the money voted for ships by Parliament and the money actually paid for ships and expended upon ships by the admiralty was seriously felt, and was acknowledged to be a blot on naval finance; but the course taken by Mr. Childers guaranteed this important result, and on this principle these accounts since 1866 have been framed. To make

this comparison more effectual, the navy estimates are now always accompanied by an analysis of the ship-building votes, or "retabulation," as it is called, which forms the basis of the dock-yard accounts. This, however, is not the only result which these accounts give. In addition to the comparatively simple process of setting off actual against estimated expenditure, an exhaustive balance-sheet, which prefaces these accounts, shows the value of land, stock, buildings, and other elements of property representing the value of our dock-yards at the commencement of each year, with the receipts from various sources on one side; on the other, the expenditure of stores and labor during the year; and, finally, the balance at the end of the year of stores in hand, and of the appreciated or depreciated value of dock-yard property. Regarded simply for the purposes they are intended to serve, these are, perhaps, the most complete government accounts to which the public have access.

In endeavoring, therefore, to ascertain what iron-clad ship-building has cost the country, it is possible to refer for eight successive years to accounts which give, readily and uniformly, this information. While it is only since 1866 we are able to accept the figures in these accounts as useful for this purpose, we are, fortunately, previously to that date, not left without trustworthy information. Mr. Reed, in his book on "Our Iron-clad Ships," gives in detail the cost of iron-clads from the earliest date, and his figures are no doubt derived from official sources.

Before the date of these accounts, then, we have Mr. Reed's figures; and since the 31st of March, 1874, the date of the last published account, an official return gives the estimated cost of each iron-clad which was then incomplete, or has been since commenced. Mr. Reed's figures give the sum of £7,338,687 as the cost of construction before 1866; the admiralty accounts, the sum of £5,961,203 as the cost between 1866 and 1874; and the estimated cost from 1874 to the present time gives the sum of £3,439,035, of iron-clads incomplete but still under construction. The result is that the cost of our iron-clad fleet which has been both completed and commenced may be calculated at the sum of £16,738,935. During the past 18 years, then, while the navy estimates have amounted to £197,000,000, the sum of £16,500,000 has been spent on the construction of iron-clads; and, if the cost of wear and tear, repair and maintenance, be added, we may raise this sum to £18,000,000. Mr. Reed's statement that our iron-clad fleet had, since it was first commenced, cost the country about £1,000,000 a year, was founded on a liberal calculation, and is beyond a doubt, correct.

The two divisions of expenditure on iron-clads into construction and repair will be dealt with separately.

In turning, then, to the cost of construction, it will be found that, including four floating batteries, sixty iron-clads of all kinds have been built either by contract or at the Royal dock-yards.

The following table exhibits the total amount spent each year on iron-clad construction, and the amounts paid to contractors and spent at the Royal dock-yards for this purpose:

Year.	Cost of construction.		Total.
	At the dock-yards.	By contract.	
1866-'67	£436, 301	£154, 840	£591, 141
1867-'68	440, 143	348, 474	788, 617
1868-'69	394, 146	725, 914	1, 110, 060
1869-'70	536, 293	540, 055	1, 076, 348
1870-'71	558, 800	455, 415	1, 014, 215
1871-'72	345, 750	349, 288	695, 038
1872-'73	237, 956	61, 869	299, 825
1873-'74	377, 715	8, 244	385, 959
Before 1866	3, 326, 104	2, 644, 099	5, 961, 203
	3, 481, 843	3, 856, 844	7, 338, 687
Total	6, 807, 947	6, 530, 943	13, 299, 890

The following table gives the expenditure for construction and wear and tear (including repairs and maintenance) of vessels of all kinds in the effective navy :

Year.	Cost of building.		Cost of wear and tear, &c.		Total.
	Iron-clad.	Not iron-clad.	Iron-clad.	Not iron-clad.	
1866-'67	£591, 141	£423, 265	£109, 145	£782, 728	£1, 006, 279
1867-'68	783, 617	1, 103, 132	159, 552	568, 489	2, 519, 790
1868-'69	1, 110, 060	584, 302	187, 699	426, 084	2, 308, 150
1869-'70	1, 076, 348	310, 699	130, 743	468, 623	1, 966, 413
1870-'71	1, 014, 215	316, 599	182, 065	451, 880	1, 964, 759
1871-'72	695, 038	439, 134	87, 595	358, 388	1, 630, 155
1872-'73	299, 825	509, 262	158, 933	336, 259	1, 204, 279
1873-'74	385, 959	904, 069	291, 381	464, 911	2, 046, 320
Total	5, 961, 203	4, 540, 462	1, 307, 113	3, 857, 362	15, 666, 145

This table throws a fuller and more accurate light than the previous one on the ship-building policy and expenditure of these eight years.

But to give these figures their full value and to test them, as it were, independently, it is desirable to compare them with the amounts voted by Parliament for ship-building and for all naval services, and to compare them further with the number of artisans employed and the tonnage of shipping annually built. The result should present a complete chart of the ship-building work and a guide to the ship-building policy of these eight years, which cannot fail to be interesting. The following table gives this information :

Year.	Expenditure on building and repairs.	Estimates for ship-building, (votes 6 and 10.)	Total naval estimates.	Number of workmen.	Tonnage built.	
					Iron-clad.	Total (iron-clad and un-armored.)
1866-'67	£1, 906, 279	£2, 718, 000	£10, 031, 000	18, 607	7, 013	15, 384
1867-'68	2, 519, 790	3, 091, 000	10, 976, 000	18, 309	12, 448	33, 701
1868-'69	2, 308, 145	3, 219, 000	11, 157, 000	15, 464	15, 045	26, 291
1869-'70	1, 966, 413	2, 655, 000	9, 996, 000	14, 124	18, 769	24, 230
1870-'71	1, 964, 759	2, 124, 000	9, 370, 000	11, 223	12, 567	19, 925
1871-'72	1, 630, 155	2, 557, 000	9, 756, 000	12, 831	10, 678	21, 137
1872-'73	1, 304, 279	2, 384, 000	9, 532, 000	12, 626	4, 798	16, 092
1873-'74	2, 046, 320	2, 797, 000	9, 872, 000	13, 485	4, 050	17, 329
Total	15, 666, 145	21, 545, 000	80, 690, 000	85, 368	174, 089

To return, however, to the cost of construction. The sum of sixteen and one-half millions sterling represents, as has been shown, the total cost of iron-clad construction, past and prospective, so far as naval accounts and estimates are concerned. To the 31st of March, 1874, the sum of £13,299,890 had been actually spent of this sum. What have we got for it? Forty-nine finished and seven unfinished iron-clads. These last consist of the *Alexandra*, *Téméraire*, *Dreadnought*, and *Inflexible*, whose partial cost had amounted in March, 1874, to £1,084,887. The remaining 49 vessels, whose total cost had been brought to account in March, 1874, had cost £12,215,000. Judging by the standard suggested by Mr. Reed, we may consider seven only of these 49 vessels effective; or, we may say that, of the above sum, two millions sterling represents the cost of our effective iron-clads, and ten millions of those which are obsolete or ineffective. To go still further into detail, it may be interesting to compare the cost of these two classes. In the obsolete class of broadside vessels the *Warrior*, for instance, one of the oldest, was built at a cost of £379,154, and her sister ship, the *Black Prince*, at a cost of £378,310, each having a burden of 6,109 tons. Then the *Achilles*, with 6,121 tons, cost no less than £470,230, and the *Northumberland*, with 6,621 tons, cost £490,681. Of modern iron-clads the *Hercules* and *Sultan* are smaller, having a tonnage of 5,226 tons only, but they may each be regarded as four times as strong as the *Warrior*, while their cost in construction was respectively £377,007 and £374,777. A

smaller class of vessel, which the loss of the *Vanguard* has drawn attention to, namely, the *Audacious* class, consists now of five vessels, each having a tonnage of 3,774 tons. The *Audacious* cost £256,295, the *Iron Duke* £208,763, and the *Vanguard* £272,100. In the construction of the *Bellerophon*, an attempt was first made to economize the cost of construction, and at the same time increase the strength. The vessel cost to build £364,327, or more than £100,000 less than the *Achilles*, with which it may be compared. Of turret vessels, two, the *Monarch* and *Glutton*, are included in the class of the seven effective iron-clads already referred to. The *Monarch* cost £371,415, and the *Glutton* £223,105, to build. The unfortunate *Captain* cost £355,764. The most expensive of the four small coast-defense vessels, built in 1870, is the *Cyclops*, which cost to build £149,465; and the two rams, the *Hotspur* and *Rupert*, cost respectively £175,995 and £235,032. So far, then, as these 49 vessels are concerned, it seems clear that, as time advanced, the cost of construction diminished; it may, indeed, be said that recent invention has had the tendency to increase power with diminished size and cost. The satisfaction, however, this statement may cause must, we fear, be short-lived; for, while up to 1874 or 1875, this is true enough, since then iron-clads have become much more expensive than ever. Increased prices and more costly appliances have had an unmistakable effect on the iron-clads now under construction. The *Inflexible* is estimated to cost £521,750, the *Dreadnought* £508,395, and the *Alexandra* £521,500. Then the *Téméraire* is to cost £374,000, the *Nelson* £333,800, and the *Northampton* £349,000. These vessels, not yet finished, show a startling advance in cost as compared with some of the vessels we have noticed, or even with vessels like the *Thunderer* and *Shannon*, which are not yet complete, but are of earlier construction, and are estimated to cost £334,000 and £268,500 respectively. These points are worth noting, as they are essential to any effective criticism or comparison of past and present naval expenditure, and will help to correct many erroneous impressions on the subject. But a more serious element of disturbance in naval finance has been caused by the sudden if not entirely unsuspected demands made for the repair of iron-clads.

The repair of iron-clads is a difficulty which has only made itself felt seriously in the past three years. Mr. Goschen, in bringing forward the naval estimates in 1873, alluded to the necessity which existed for making special provision for this work by employing additional hands at the dock-yards. But Mr. Hunt, following in the same line, explained last year that extensive repairs of a costly character were inevitable. When iron-clads were first built it was considered satisfactory that, although the cost of construction was great, the ships would last longer than unarmored vessels. This, however, seems doubtful, now that we have the experience of fifteen years as a guide; and, even were iron-clads exceptionally durable, it is quite certain their repair is exceptionally costly. For the first ten years the charges for repair were, comparatively speaking, light; but during the last three years the necessity of entering upon an expensive course of repair has made itself felt. The following table shows the actual cost during the eight years from 1866 to 1874 of providing for the wear and tear of iron-clads and unarmored vessels, and of keeping them in repair, in commission, and reserve:

Year.	Iron-clads.	Unarmored vessels.	Total.
1866-'67.....	£109, 145	£782, 728	£891, 873
1867-'68.....	159, 552	568, 489	728, 041
1868-'69.....	187, 699	426, 084	613, 783
1869-'70.....	130, 743	468, 623	599, 366
1870-'71.....	182, 065	451, 860	633, 945
1871-'72.....	87, 595	358, 388	445, 983
1872-'73.....	158, 933	336, 259	495, 192
1873-'74.....	291, 381	464, 911	756, 292
Total.....	1, 307, 113	3, 857, 362	5, 164, 475

Here it will be seen that in 1873-'74, the largest expense was incurred for the repair of iron-clads. It is also worthy of remark that a small number of vessels only was dealt with, as a reference to the accounts would prove. Thus, in that year alone the *Achilles* cost £24,907, the *Bellerophon*, which had cost nearly £30,000 in 1870, was again in 1873 charged with an expense of £40,395; the *Minotaur* cost in this year £16,681; the *Northumberland*, £10,255; the *Resistance*, £31,647; and the *Warrior* the large sum of £50,000. From these instances it will be seen that the maintenance and repair of iron-clads have introduced a new and serious element of expense into the navy which for some years is likely to make itself severely felt. A reference to the above table will show that the cost of the maintenance and repair of the entire fleet

for the eight years which have been analyzed, amounts to more than five millions sterling, of which £1,307,113 is applicable to iron-clads; and that of this sum, no less than a third was incurred during the last ten years. * * * * Coming now to the consideration of what has been the cost of repairing individual vessels during this period, it appears that those which have already been classed as obsolete or old-fashioned, including serviceable and unserviceable ships, have cost during this period £870,000. Of these the *Warrior* is the most remarkable; for her cost has amounted, for maintenance and repair, to £124,245. She was built in 1860, cost £379,154 to build and fit out for sea, and has now, in the eight years since 1866, cost no less than a third of this sum to keep in good order. The *Defence* and *Resistance*, which were built at the same time as the *Warrior*, but are much smaller, have cost during the same period no less than £82,450 and £91,965, which, when compared with the cost of their construction, are large sums. The *Black Prince*, sister ship to the *Warrior*, and built at the same time, has for the same period cost only £59,193. But this difference would, in all probability, vanish if we knew what her cost had been during the past two years. The *Minotaur* has cost for the same period £55,627, and the *Achilles* £61,209, against a cost of construction of £478,885 and £470,230 respectively; the *Hector*, the cost of whose construction was about half that of either of those vessels, has cost for repair and maintenance £56,490. These, however, are all old-fashioned broadside vessels. The turret-ships are most of them too recently built to enable an opinion to be formed of what they will cost to repair; it will be seen that the whole cost amounts to £139,845. Of this sum the *Monarch* absorbs a large share, which amounts to £53,018. Of effective and powerful sea-going broadside vessels, the *Bellerophon*, *Hercules*, and *Sultan* may be taken as good examples. The *Bellerophon* was launched in 1865, and the cost of her maintenance and repair, from 1866 to 1874, is £87,256, or about one-fourth of the cost of her construction, which was £364,327. The *Hercules* was launched in 1866, and has, similarly, cost £37,537, against a cost of construction of £377,007; and the *Sultan*, which is, comparatively speaking, a new vessel, has only cost £15,666. The *Vanguard* shows a cost, since 1869, of £12,891; the *Iron Duke*, since 1870, of £17,022; and the *Invincible*, since 1870, of £18,271. These instances prove sufficiently that the cost of the maintenance and repair of iron-clads is a growing item of naval expenditure, and an item which requires as much consideration, from a financial point of view, as building. When a million a year represents the full normal average amount available for iron-clad construction out of naval estimates amounting to ten millions sterling, it is alarming to find £300,000 is required in one year alone for their repair and maintenance.

* * * * *

Armored ships of Great Britain. (The principal data are from Parliamentary returns.)

Name and class of ship.	Vessel.							Armament.		
	Length between perpendiculars, in feet and inches.	Extreme breadth, in feet and inches.	Depth of hold, in feet and inches.	Immersed midship section, in square feet.	Displacement, in tons.	Draught forward, in feet and inches.	Draught aft, in feet and inches.	Number of guns and description.	Height of battery above water, in feet and inches.	Thickness of armor at water-line, in inches.
<i>Turret ships of the first class. (a)</i>										
Inflexible (b).....	320 0	75 0	23 3½	1,658	11,165	23 0	25 0	4 81-ton guns.....	11 0	24 to 16
Dreadnought (c).....	320 0	63 10	18 0	1,510	10,866	26 6	27 0	4 38-ton guns.....	13 0	14
Thunderer.....	285 0	62 3	18 0	1,454	9,190	26 2	26 3	do.....	13 4	14 and 12
Devastation.....	285 0	62 3	18 0	1,463	9,157	26 2	26 3	4 35-ton guns.....	13 0	14 and 12
Agamemnon.....	260 0	66 0	8,500	8,500	25 0	4 38-ton guns.....	18
Ajax.....	260 0	66 0	8,500	8,500	25 0	do.....	18
Monarch (d).....	330 0	57 6	21 1	1,328	8,322	22 7	26 0	4 25-ton and 2 6½-ton guns.....	16 0	10 and 8
<i>Broadside ships of the first class.</i>										
Alexandra (e).....	325 0	63 8	18 7½	1,413	9,492	26 0	26 6	2 25-ton and 10 18-ton guns.....	12 and 8
Téméraire.....	285 0	62 2	18 8	1,442	9,412	26 6	27 0	4 25-ton and 4 18-ton guns.....	9 0	12 and 8
Sultan.....	325 0	59 0	21 1	1,401	9,266	24 10	27 6	8 18-ton and 4 12-ton guns.....	11 7	9 to 6
Hercules.....	325 0	59 0	21 1	1,318	9,700	23 0	26 5	8 18-ton and 2 12-ton and 4 6½-ton guns.....	12 2	9 to 3
Bellerophon.....	300 0	56 0	17 3.5	1,218	7,540	21 0	26 0	10 12-ton and 4 6½-ton guns.....	7 11	6
Swiftsure.....	280 0	55 0	25 10.6	1,156	6,660	24 2	26 2	do.....	7 2	8 to 6
Trinmph.....	280 0	55 0	25 10	1,156	6,660	24 2	26 2	do.....	7 2	8 to 6
Audacious.....	280 0	54 0	24 8.8	1,063	6,034	22 0	23 0	do.....	7 8	8 to 6
Invincible.....	280 0	54 0	24 9	1,063	6,034	22 0	23 0	do.....	7 8	8 to 6
Iron Duke.....	280 0	54 0	24 9	1,063	6,034	22 0	23 0	do.....	7 8	8 to 6
Penelope.....	260 0	50 0	4,394	15 9	17 4	do.....	6 and 5
<i>Armor-belted. (f)</i>										
Shannon.....	260 0	54 0	21 7½	1,006	5,103	20 0	22 6	2 18-ton and 7 12-ton guns.....	9
Nelson.....	280 0	60 0	1,162	7,323	24 2	24 2	4 18-ton 8 12-ton, and 6 Gasing guns.....	9
Northampton.....	280 0	60 0	1,162	7,323	24 2	24 2	do.....	9
<i>Breastwork monitors. (g)</i>										
Glatton.....	245 0	54 0	19 4	913	4,912	19 0	19 0	2 25-ton gun.....	10 5	14 to 12
Hotspur, (ram).....	235 0	50 0	20 1	840.5	4,012	19 0	20 8	1 25-ton gun.....	10 6.5	11 to 8

Rupert, (ram).....	250 0	53 0	20 0.5	1, 067	5, 358	21 6	23 6	2 18-ton guns.	10 10	14 to 9
Prince Albert.....	240 0	48 1	25 3	787	3, 900	17 9	19 8	4 18-ton guns.	9 3	4 1/2
Cyclons.....	225 0	45 0	16 7	666	3, 430	16 5	16 5	do	10 7	10 to 6
Gorgon.....	225 0	45 0	16 7	666	3, 430	16 5	16 5	do	10 to 6	10 to 6
Hecla.....	225 0	45 0	16 7	666	3, 430	16 5	16 5	do	10 to 6	10 to 6
Hydra.....	225 0	45 0	16 7	666	3, 430	16 5	16 5	do	10 to 6	10 to 6
Scorpion.....	224 6	42 4.5	16 7	634	2, 777	16 11 1/2	16 9 1/2	4 9-inch guns.	4 9	4.5 and 5
Wive n.....	224 6	42 4	14 6 1/2	14 6 1/2	15 8	do	5 11	4 1/2
Viper.....	160 0	32 0	13 3	339	1, 220	10 8	11 7 1/2	2 7-inch guns.	5 11	4 1/2
Vixen.....	160 0	32 0	13 3	339	1, 220	10 8	11 7 1/2	do	5 11	4 1/2
Abyssinia.....	225 0	45 0	12 3	557	2, 901	14 0 1/2	14 0 1/2	4 10-inch guns.	7 6	7
Magdala.....	225 0	42 0	16 6	557	3, 344	13 0	14 8	do	9 0	8
Carberus.....	225 0	45 0	16 6	557	3, 344	15 3	15 3	do	9 0	8
<i>Iron broadside-ships of the old type.</i>										
Agincourt.....	400 0	59 5	21 0	1, 356	10, 395	26 0	27 0	17 12-ton guns.	9 0	5 1/2
Minotaur.....	400 0	59 5	21 0	1, 356	10, 395	26 0	27 0	do	9 0	5 1/2
Northumberland.....	400 0	59 5	21 0	1, 356	10, 395	26 0	27 0	10 12-ton and 7 6 1/2-ton guns.	9 0	5 1/2
Achilles.....	383 0	58 0	21 0	1, 326	9, 681	26 3	27 4	14 12-ton guns.	9 0	4 1/2
Black Prince.....	380 0	58 0	21 0	1, 326	9, 681	26 0	27 0	10 12-ton and 16 6 1/2-ton guns.	9 0	4 1/2
Warrior.....	380 0	58 0	21 0	1, 326	9, 681	25 6	26 5	do	9 0	4 1/2
Hector.....	280 2	56 5	21 0	6, 960	24 0	25 7	18 6 1/2-ton guns.	4 1/2	4 1/2
Valiant.....	280 2	56 5	21 0	6, 420	25 10	26 10	do	4 1/2	4 1/2
Resistance.....	280 0	54 0	21 0	1, 094	6, 074	23 9	26 0	16 6 1/2-ton guns.	6 11	4 1/2
Defence.....	280 0	54 0	21 0	1, 094	6, 074	24 3	25 6	do	6 11	4 1/2
<i>Wooden broadside-ships of the old type.</i>										
Lord Warden.....	280 0	58 9	28 0	7, 675	34 6	36 0	18 6 1/2-ton guns.	5 1/2
Royal Alfred.....	273 0	58 5	27 0	6, 416	24 0	25 6	do	6
Royal Oak (h).....	273 0	58 5	27 0	6, 416	23 8	25 8	34 6 1/2-ton guns.	4 1/2
Prince Consort (h).....	273 0	58 5	27 0	9, 430	23 8	25 8	do	4 1/2
Caledonia (h).....	273 0	59 0	27 0	5, 800	23 6	26 0	do	4 1/2
Zetland (h).....	252 0	58 7	26 0	6, 927	24 6	26 0	20 6 1/2-ton guns.	7 6	4 1/2
Ocean (h).....	273 0	56 6	26 0	1, 908	24 10	27 0	24 6 1/2-ton guns.	4 1/2
Royal Sovereign.....	240 7	62 0	21 0	983.5	21 6	24 11	5 9-inch guns.	5 1/2
Pallas.....	225 0	50 0	16 6	821	3, 797	18 3	24 3	4 8-inch guns.	8 6	4 1/2
Favourite.....	225 0	46 9	20 0	771	3, 232	19 7	22 7	8 6 1/2-ton guns.	8 6	4 1/2
Research.....	195 0	38 6	1, 780	13 2	15 5	do	8 6	4 1/2
Replise.....	252 0	59 0	25 4	26 2	10 9-ton guns.	4 1/2
Enterprise (c).....	180 0	36 0	16 6	399	1, 350	12 2	15 6	4 7-inch guns.	6 11	4 1/2
Waterwitch (c).....	162 0	32 1	13 3	339	1, 279	11 9	11 9	2 7-inch guns.	5 0	5

Armored ships of Great Britain, &c.—Continued.

Name and class of ship.	Machinery.							Cost.		
	Kind of engines.	Number of cylinders.	Diameter of cylinders, in inches.	Stroke of pistons, in feet and inches.	Number of screws.	Indicated horse-power on trial.	Maximum speed, in knots, per hour.	Makers of engines.	Machinery, in dollars, (gold).	Total cost of hull and rigging, outfit, &c.
<i>Turret ships of the first class. (a)</i>										
Inflexible (b).....	Inverted vertical compound.....	6	70, 90, & 90	4 0	2	8, 000	14	John Elder & Co.....	\$586, 845	\$2, 287, 845
Dreadnought (c).....	do.....	6	69, 90, & 90	4 6	2	8, 000	14	Humphrys & Tenant.....	520, 020	2, 470, 800
Thunder.....	Horizontal.....	4	77	3 6	2	5, 600	13.5	Humphrys & Co.....	225, 990	1, 416, 690
Devastation.....	Horizontal trunk, surface-condenser, &c.....	2	88	3 3	2	6, 638	13.8	J. Penn & Son.....	295, 960	1, 717, 038
Agrammonon.....	Inverted vertical compound.....	2			2	*6, 000				1, 701, 000
Ajax.....	do.....	2			2	*6, 000				1, 701, 000
Monarch (d).....	Horizontal, 4 piston-rods.....	2	120	4 6	1	7, 842	14.9	Humphrys & Co.....	323, 400	1, 723, 235
<i>Broadside ships of the first class.</i>										
Alexandra (e).....	Inverted vertical compound.....	6	69, 90, & 90	4 0	2	8, 000	14	Humphrys & Tenant.....	594, 880	2, 539, 253
Téméraire.....	do.....	4	69, 90, & 90	4 0	2	7, 000	14	do.....	1, 817, 640	1, 817, 640
Sultan.....	Horizontal trunk, superheater, surface-condenser.....	2	117.9	4 6	1	8, 629	14.13	J. Penn & Son.....	362, 600	1, 737, 037
Heroules.....	Horizontal trunk, superheater, surface-condenser, &c.....	2	118	4 6	1	8, 529	14.69	do.....	396, 900	1, 755, 111
Bellerophon.....	Horizontal trunk, surface-condenser, &c.....	2	104.2	4 0	1	6, 312	14.05	do.....	425, 320	1, 605, 527
Swiftsure.....	Horizontal, double piston-rod.....	2	98	4 0	1	4, 913	13.75	Maudslay & Co.....	239, 150	1, 249, 414
Triumph.....	do.....	2	98	4 0	1	4, 892	14.07	do.....	1, 255, 450	1, 255, 450
Audacious.....	Two pairs, horizontal direct.....	4	77	3 0	2	4, 021	12.8	Ravenhill & Co.....	238, 140	1, 197, 902
Invincible.....	do.....	4	72	3 0	2	4, 832	14.09	Napier & Son.....	252, 730	1, 163, 683
Iron Duke.....	Two pairs, horizontal direct.....	4	77	3 0	2	4, 368	13.6	Ravenhill & Co.....	252, 730	954, 888
Penelope.....	Two sets, horizontal, three cylinders.....	6	55½	2 6	2	4, 703	12.76	Maudslay & Co.....	199, 260	908, 081
<i>Armor-belted. (f)</i>										
Shannon.....	Horizontal, back-acting.....	4	44 and 85	4 0	1	3, 500	13	Leard Brothers.....	245, 430	1, 304, 910
Nelson.....	Inverted vertical compound.....	4	60 and 104	3 6	2	6, 000	14	John Elder & Co.....	1, 692, 268	1, 692, 268
Northampton.....	do.....	6	54	3 3	2	6, 000	14	John Penn & Son.....		1, 696, 140
<i>Breastwork monitors. (g)</i>										
Glattton.....	Two pairs, horizontal.....	4	60	2 3	2	2, 868	12.1	Leard & Co.....	145, 040	1, 066, 911
Holspur, (ram).....	Two pairs, horizontal direct.....	4	64	2 9	2	3, 497	12.65	Napier & Son.....	176, 400	853, 686

Rupert, (ram)	Two pairs, horizontal	3	4	72	3 0	2	4, 200	13.6	do	187, 110	1, 130, 811
Prince Albert	Horizontal	3	1	31 and 57	2 3	2	2, 128	11.65	Humphrys & Co.	117, 600	984, 957
Cyclops	Compound, tilt-hammer	4	1	57	2 3	2	1, 660	11.03	John Elder & Co.	78, 400	673, 168
Gorgon	do	4	1	57	2 3	2	1, 670	11.14	Ravenhill & Co.	77, 760	659, 512
Hecate	do	4	1	57	2 3	2	1, 755	10.9	do	77, 760	630, 483
Hydra	do	4	1	57	2 3	2	1, 472	11.2	John Elder & Co.	77, 760	645, 393
Scorpion	Horizontal, double piston-rod	2	1	56	3 0	1	1, 455	10.52	Laird Brothers	537, 385	537, 385
Wivern	do	2	1	56	3 0	1	1, 476.1	10	do	566, 258	566, 258
Albatross	Two pairs, horizontal	4	2	32	1 6	2	636	9.5	Maudslay & Co.	37, 240	248, 477
Viper	do	4	2	32	1 6	2	696	9.5	do	37, 240	248, 477
Vixen	Two pairs, inclined, direct-acting	4	2	34	1 9	2	960	9.6	Dudgeon	37, 240	263, 778
Abysinia	Horizontal, direct-acting	4	4	48	1 9	2	1, 369	10.6	Ravenhill & Co.
Magdala	do	4	4	48	1 9	2	1, 369	10.6	do
Cerberus	Two pairs, horizontal	4	4	43	2 3	2	1, 369	9.7	Maudslay & Co.	630, 857
<i>Iron broadside-ships of the old type.</i>											
Aigoucré	Horizontal, double-piston-rod	2	2	101	4 6	1	6, 621	15.4	do	404, 726	2, 262, 218
Minotaur	Horizontal, trunk	2	1	104	4 4	1	6, 949	14.4	J. Penn & Son	390, 040	2, 239, 194
Northumberland	do	2	1	104	4 4	1	6, 558	14.1	do	353, 278	2, 290, 771
Achilles	do	2	1	104	4 0	1	5, 732	14.3	do	375, 473	2, 160, 494
Black Prince	do	2	1	104	4 0	1	5, 773	13.6	do	361, 963	1, 738, 111
Warrior	do	2	1	104	4 0	1	5, 092	13.9	do	361, 628	1, 733, 528
Hector	Horizontal	2	1	82	4 0	1	3, 256	12.3	R. Napier & Son	222, 286	1, 376, 362
Valiant	Horizontal, double piston-rod	2	2	82	4 0	1	3, 560	12.6	Maudslay & Co.	434, 850	1, 556, 560
Resistance	Horizontal, trunk	2	1	70½	3 6	1	2, 428	11.8	J. Penn & Son	168, 560	1, 176, 193
Defence	do	2	1	70½	3 6	1	2, 537	11.8	do	168, 560	1, 123, 667
<i>Wooden broadside-ships of the old type.</i>											
Lord Warden	Horizontal	3	3	91	4 6	1	6, 706	13.5	Maudslay & Co.	331, 836	1, 533, 772
Royal Alfred	Horizontal, double piston-rod	2	2	82	4 0	1	3, 434	12.3	do	230, 908	1, 295, 977
Royal Oak (h)	do	2	1	82	4 0	1	3, 704	12.3	do	220, 207	1, 141, 629
Prince Consort (h)	do	2	1	82	4 0	1	3, 953	12.7	do	1, 083, 493	1, 261, 194
Calcutta (h)	do	2	1	82	4 0	1	4, 538	13	do	1, 261, 194	1, 261, 194
Zealonia (h)	do	2	1	82	4 0	1	3, 623	11.7	do	363, 091	1, 063, 564
Ocean (h)	do	2	1	82	4 0	1	4, 244	12.8	do	362, 640	1, 213, 435
Royal Sovereign	do	2	1	82	4 0	1	2, 463	11	do	1, 204, 648	1, 204, 648
Pallas	Horizontal, Wolf's principle, single trunk in large cylinder	4	4	2 51 & 2 91½	3 3	3	3, 581	13	Humphrys & Co.	193, 477	889, 234
Favorite	Horizontal	2	2	64	2 8	1	1, 773	11.8	do	117, 600	704, 355
Research	Horizontal, surface-condenser	2	2	50	2 0	1	1, 042	10.3	Jas. Watt & Co.	49, 308	317, 091
Repulse	Horizontal, trunk	2	1	82	4 0	1	710	9.7	J. Penn & Son	42, 532	892, 490
Enterprise	Horizontal, surface-condenser	2	2	45	1 6	1	777	6.5	Ravenhill & Co.	66, 300	926, 832
Waterwitch (c)	Horizontal	3	3	38.5	3 6	3	777	6.5	Dudgeon	66, 300	275, 061

* Estimated. a Mastless, turret, modern line-of-battle ships. b Estimated cost of guns and incidentals, \$600,000. c Late Fury. d Masted, turret line-of-battle ship. e Late Superb. f Cruising ships with lifting-screws. g Coast-defense vessels. h These converted vessels, built about 1863, are not likely to be sent to sea again, as they are fast de-caying, but are employed in harbor service. i Hydraulic gunboat, Ruthven's water-jet.

PART IX.

UNARMORED SHIPS OF GREAT BRITAIN.

UNARMORED SHIPS.

It has been seen on page 15 of this report that all the *old types* of British naval vessels are gradually disappearing from the navy-list for fighting or cruising purposes; sailing-craft, paddle-wheel vessels, and auxiliary or low-speed screw-vessels are alike obsolete. Besides which, wooden vessels of all classes are doomed, and at no distant day will be counted out or relegated to harbor-service. The modern cruising-fleet consists of full-powered screw-ships, having iron hulls cased in wood, and vessels of the smaller class called composite, in which the materials are either iron or steel, except the outside planking, put on in two courses, as is hereafter described.

The corvettes *Sapphire* and *Diamond*, built in 1874, were the last wooden war-vessels that will probably ever be added to the British navy, for it has been authoritatively made public that no more wooden ship-frames, knees, or beams will be required at the dock-yards.

The British modern unarmored cruising-fleet may be divided into seven or eight classes or types. The frigates and corvettes of this new fleet, constructed and in process of building, are as follows:

	Length between perpendiculars.	Extreme breadth.	Mean draught of water.	Load-displacement, in tons.	Maximum horse-power.	Speed, measured mile, in knots.	Number of guns.	Cost of hull and machinery in dollars, (gold.)	Remarks.
IRON FRIGATES.									
<i>Inconstant</i>	<i>Fleet.</i> 333	<i>Ft. in.</i> 50 1	<i>Ft. in.</i> 23 7	5,782	7,361	16	16	\$1,036,756	Has made two cruises.
<i>Shah</i> , (late the <i>Blonde</i>)	334.8	52	23	5,700	7,500	16.3	26	1,119,861	Recently commissioned.
<i>Raleigh</i>	298	49	22	5,200	5,639	22	939,856	Has made one cruise.
IRON CORVETTES.									
<i>Boadicea</i>	280	45	22	4,027	5,320	14.8	*16	1,040,040	Ready for sea.
<i>Bacchante</i>	280	45	21 7	3,932	5,250	(†)	*16	1,020,600	Building.
<i>Enryslus</i>	280	45	21 7	3,932	5,250	(†)	*16	1,015,740	Do.
<i>Rover</i>	280	43 6	20 2	3,439	4,750	14.5	18.	782,460	On first cruise.
<i>Volage</i>	270	42	3,078	4,015	13	8	617,706	Built in 1870.
<i>Active</i>	270	42	3,078	4,532	13	8	613,104	Do.
COMPOSITE CORVETTES.									
Six of <i>Opal</i> class.....	220	40	16 3	1,864	2,100	14	‡420,390	Begun in 1875, and some yet uncompleted.
Six steel and iron vessels of the <i>Cleopatra</i> class.	225	40	20	2,377	2,300	14	400,000	Building.
STEEL VESSELS.									
Two steel dispatch-vessels.	300	46	20	3,693	7,000	§17	10	Do.

* Under covered deck.

† Trial trips not made.

‡ Estimated cost of each.

§ Estimated

Several other unarmored corvettes are projected. It is intended to construct them with an armored deck three feet below water, with a ram, and to fit them to use the Whitehead torpedo. The speed is to be 13 knots per hour.

The first essential element of power for an unarmored cruising man-of-war of the present day is speed; a speed sufficiently high to overtake any vessel on the ocean desirable to capture, and to escape from any powerful fighting-ship desirable to evade.

The above-named vessels constitute the present fleet of fast unarmored cruising-ships of the British navy. The hulls of these vessels, larger than the *Opal*, are of iron and steel, and they are built with improved structural arrangements for securing great strength to withstand the immense engine-power put into them and to endure it for any desirable length of time. The bottoms are sheathed with wood, and coppered or zinced to prevent fouling. They carry a large spread of canvas, are provided with lifting screw-propellers, and are in all respects fitted to keep the sea. They have not the speed aimed at by the naval authorities, *i. e.*, such speed as will be attained in the class of vessels now building called rapid cruisers, and in which vessels requirements for keeping the sea for lengthened periods must be sacrificed; but they have speed superior to that of the cruising-ships of any other navy, besides which they are reputed to be excellent sea-boats, fast under sail, and are armed with rifled guns, some of which are of heavy caliber.

The *Inconstant* is the only one of the number to my knowledge, that has as yet been driven under full steam-power alone for upward of twenty-four consecutive hours. This was in the emergency when carrying the news of the loss of the unfortunate *Captain* from Cape Finisterre to England, on the 7th of September, 1870. On this occasion a speed of very nearly 14 knots per hour was averaged for the whole distance. The speed of each of these cruising-vessels on the measured mile has been shown in the column above, and it is fair to conclude that the maximum performance of any one of them at sea, in smooth water, for a period of, say, twenty-four hours, would be one and a half knots less than was recorded on the measured-mile trials.

THE INCONSTANT.

Every officer familiar with the progress and advancement in naval science of late years is acquainted with the fact that when the *Wampanoag* and that class of vessels were under construction at New York and Boston, reports went abroad of the extraordinary speed and terrible power they were designed to possess, and of the fearful destruction which would follow their path. These reports, published in American journals, and copied and commented on in the London papers, alarmed the British government; and as a consequence the chief constructor of the admiralty was directed as early as 1866, before the *Wampanoag* was completed, or her defects known in Europe, to prepare the plans for competing vessels. Thus originated the *Inconstant*. She was designed for full-sail power, and provided with a lifting-screw, and to give sufficient scope for the combination of high speed with what was then a heavy armament, good sea-going qualities, a large carrying capacity, and provision for all requirements, she was made to have a displacement of 5,782 tons, was 333 feet long, had 50 feet beam and 23 feet mean draught of water. Iron sheathed with wood, and coppered, was the material chosen to stand the immense strain of the power to be devel-

oped by the engines.* She was launched November 12, 1868, and the trial cruises were made upward of a year afterward. Subsequently a sister-ship, the *Shah*, was constructed, and was launched in 1873. These two ships represent the largest class of unarmored frigates, and are in all essential features of construction the same. The latter has, however, an increased length of 20 inches over the former, and, in order to give greater stability than in the *Inconstant*, an increase of beam to 52 feet was given.

The armament of the *Inconstant* and *Shah* is as follows :

	Main deck.	Upper deck.	
		Pivot-guns.	Broadside.
<i>Inconstant</i>	10 12½-ton.	2 6½-ton.	4 6½-ton.
<i>Shah</i>	{ 16 6½-ton. 2 64-pdrs. }	2 18-ton.	6 64-pdrs.

The particulars of the *Shah's* guns are taken from a paper published by the committee on designs. Several alterations, tending to greater efficiency, have been made, and one—the substitution of 18 for 12 ton pivot-guns—is embodied above.

The bow-guns fire on a line with the keel. The 18-ton 10-inch guns mounted on the *Shah* are similar to the broadside guns of the *Sultan* and the *Hercules*.

THE RALEIGH,

also launched in 1873, is a ship of the same general design and construction, but of reduced dimensions. The cost of her construction was £37,038 less than the cost of the *Shah*, and £19,948 less than that of the

* In a paper by Mr. John Vernon, on the construction of iron ships, *Trans. I. M. E.*, it is stated: "The main points of superiority of iron ships over those built of wood consist in the superior strength, greater durability, and consequently less cost of iron ships, together with their larger carrying capability and greater facility of construction."

The greater strength of iron ships is shown in daily practice in numerous ways, and it is also shown by the fact that in many modern wooden ships it has been found necessary to introduce diagonal iron straps inside the framing, and in many cases the use of iron bulk-heads, knees, beams, and stringers, and even the frame-work itself for the whole structure; but this arrangement, it is admitted, falls far short in point of strength of a vessel built entirely of iron. Again, the introduction of iron affords great facility for obtaining the necessary strength in keels, stem and stern posts, screw-port frames, and other parts, by the application of large forgings.

The greater comparative durability of iron arises mainly from its freedom from the decay to which wood is always liable, in consequence of being unavoidably subject to constant and extreme variations of temperature and moisture. Another important source of this greater durability is to be found in the firm and substantial union of the several parts of an iron ship by means of riveting, which effectually prevents that *working* under heavy strains to which all wood ships are more or less liable, and which is a source of great difficulty with the engines, caused by the screw-shafts being forced out of alignment, and thereby strained.

Abundant proof of these facts may be found in the records of the Navy Department, showing the enormous cost of repairs to the wooden vessels of the Navy and their machinery; also in the yearly sale or breaking up of vessels consequent upon decayed timber. Some vessels have been found so decayed after the first cruise as to condemn them for further service, and the repairs to others have in some cases after one cruise exceeded for the hull of a single ship \$80,000, while many having been several years on the stocks have rotted before being launched.

It is fair to assume that the difference between the cost of the repairs of our entire fleet and one of the same number and dimensions of vessels all having iron hulls cased in wood, would be a sufficient sum to add to the Navy yearly at least one good-sized cruising-vessel.

Inconstant. Although the *Raleigh* is not possessed of as powerful a battery as the larger ships, she is by far more serviceable, more easily handled, and less costly to maintain. The comparison between the *Raleigh* and the *Inconstant* stands thus:

	Raleigh.	Inconstant.	
		As designed.	As completed.
Tonnage	3,210	3,978	4,066
Displacement	5,200	5,495	5,782
Length between perpendiculars.....	298 feet.	333 feet.	
Breadth, extreme.....	49 feet.	50 feet 1 inch.	
Draught { forward.....	20 feet.	22 feet.	
{ aft.....	23 feet.	24 feet.	
Horse-power { nominal.....	800	1,000	
{ indicated.....	5,639	7,361	
Guns { upper deck.....	{ 2 12½-ton. }	4 6½-ton.	
{ main deck.....	{ 4 64-pdrs. }		
	{ 14 90-cwt. }	10 12½-ton.	
	{ 2 64-pdrs. }		

These ships, as previously stated, are built of iron; externally they are entirely sheathed with wood, the chief object of which is to admit of copper being applied to the bottom. There are two thicknesses of sheathing, except over parts of the top-sides, where there is one thickness only; the first is secured to the skin of the ship by galvanized-iron screw-bolts, which are tapped into the skin, but also bear lock-nuts on the inside. The bolts are of course screwed in through holes prepared in the wood, for the holes become unduly enlarged if there is the slightest want of concentricity between the threaded and the plain parts of the bolt, thus occasioning leakage through the wood to the skin. The second layer of planking is secured to the first by metal wood-screws, which stop short, of course, of the iron skin, and avoid contact with the galvanized bolts. The two courses of planks break joint, and are carefully put on the iron skin, the planks being properly painted and their joints made tight by calking. The wood is teak, and the thickness as a rule is, for the first course 3 inches, and for the second 2½ inches, tapering as the top is approached. This system has been tested for some years on the *Inconstant*, and has proved to be so successful that its adoption for all naval iron cruising-vessels, both of English and Continental build, has become general. It may be well to mention that the courses of planks are both applied horizontally, except in the *Shah*, where one course is vertical and the other over it horizontal.

The motive steam-machinery of all these ships was designed and contracted for prior to the date of the adoption of the compound engine by the admiralty. They are, therefore, of obsolete types, and the consumption of fuel in each of them is upward of 30 per cent. greater than in the ships of recent construction. Moreover, the anticipated speeds have not been realized.

A brief description of the machinery of the *Raleigh* and of the trials may not be out of place. The engines, constructed by Humphrys, Tenant & Co., are of the horizontal, direct-acting, return-connecting-rod type, and intended to indicate 6,000 horse-power. A few of their dimensions are as follows:

Number of cylinders.....	2
Diameter of cylinders.....	8 feet 4 inches.
Stroke.....	4 feet 6 inches.
Diameter of piston-rods, 4 to each piston.....	7 inches.
Diameter of back trunk, 1 to each piston.....	1 foot 6 inches.
Travel of slide-valves, (vertical, double-ported).....	10½ inches.
Depth of valve.....	5 feet 10 inches.
Width of valve.....	5 feet 1½ inches.
Depth of ports.....	5 feet 2 7-16 inches.
Depth of bars in extreme ports, 2 in each.....	2 inches.
Depth of bars in other ports, 2 in each.....	1 inch.

The expansion-valves are horizontal and of the gridiron type, placed above the slide-casing, and worked from rocking-shafts by means of eccentrics on the main shaft. The cut-off ranges from 3½ inches of the stroke onward, and is varied by moving the end of the eccentric-rod along a quadrant arm on the rocking-shaft. There is one surface-condenser to each cylinder. The air-pumps are 25½ inches in diameter, double-acting, and worked direct from the pistons. The circulating-pumps are centrifugal, and driven by separate engines with 12-inch cylinders having 12 inches stroke, exhausting into the condensers; the water is forced through the condensers outside the tubes. The condenser-tubes are vertical, and there are 6,740 in each condenser; their dimensions are as follows :

Diameter inside.....	¾ inch.
Diameter outside.....	⅝ inch.
Length between tube-plates.....	6 feet 6½ inches.
Cooling surface.....	12,000 square feet.

The starting-gear can be worked by hand or steam. A Silver's governor is fitted. The propeller is by Hirsch, two-bladed, has 26 feet 8 inches pitch, and is fitted for being raised when the ship is under sail alone.* The number of boilers is nine; but two of them are small and intended for auxiliary purposes; these are together equal to one of the large ones. The chief data relative to the boilers are as follows :

Number of chimneys.....	2
Number of furnaces.....	32
Length of fire-grate.....	6 feet 10 inches.
Breadth.....	3 feet 3½ inches.
Area of fire-grate.....	720 square feet.
Number of tubes.....	2,880
Length between tube-plates.....	6 feet 4 inches.
Diameter of tubes outside.....	3 inches.
Tube-heating surface.....	14,300 square feet.
Number of superheaters, (steam passing through the tubes).....	2
Number of tubes.....	248
Diameter of tubes, inside.....	2 inches.
Length of tubes.....	9 feet.
Superheating-tube surface.....	1,170 square feet.

* The screw-propeller invented by Hermann Hirsch, of Paris, patented in France December 16, 1865, and in the United States April 26, 1870, has been successfully applied to many ships in Europe. The claims set forth in his letters-patent are, 1st. "Constructing screw-propellers with blades the faces of which are formed of concave lines in cross-section, in combination with an increasing pitch or helicoidal inclination from the axis to the circumference. 2d. In combination with said transverse curvature and graduated helical form, the recession of the forward terminal edges of the blades."

A two-bladed screw, made from the drawings of Mr. Hirsch, was applied to one of our second-rates in 1872, but after a trial at sea in rough weather it was reported on unfavorably, and removed from the vessel.

The boilers are of the ordinary box kind, and carry 30 pounds pressure on the square inch. The dimensions quoted above give the following relative areas per indicated horse-power :

	Square feet.
Grate surface.....	. 117
Tube-heating surface	2. 32
Superheating-tube surface 19
Condenser-tube cooling surface.....	1. 95

Trials of Her Britannic Majesty's ship Raleigh.

Date of trial.....	April 1, 1874.....	September 2.....	September 2.
Kind of trial.....	Measured mile.....	6 hours.....	Measured mile.
Where tried.....	Maplin Sands.....	Off Portsmouth.....	Stokes Bay.
Draught:			
Forward.....	19 feet 6 inches.....	21 feet 10 inches.....	21 feet 11 inches.
Aft.....	23 feet 6 inches.....	25 feet 2 inches.....	24 feet 10 inches.
Mean.....	21 feet 6 inches.....	23 feet 6 inches.....	23 feet 4½ inches.
Ship by the stern.....	4 feet.....	3 feet 4 inches.....	2 feet 11 inches.
Screw:			
Diameter.....	21 feet.....	21 feet 1 inch.....	21 feet 1 inch.
Length, greatest.....	3 feet 2½ inches.....	3 feet 3½ inches.....	3 feet 3½ inches.
Upper edge, immersed.....	2 feet 10 inches.....	2 feet 5½ inches.....	2 feet 1½ inches.
Force of wind.....	4 to 5.....	4 to 5.....	3.
State of sea.....	Smooth.....	Moderate.....	Smooth.
Steam-pressure and temperature:			
Boilers.....	32.7 pounds.	29.1 pounds.....	27.4 pounds.....
Superheaters.....	Mean, 310°.....	370°.....	Mean, 325°.....
Engines.....	31.2 pounds, 274°.....	27.6 pounds, 282°.....	25.9 pounds, 289°.....
Vacuum:			
Forward.....	27.6 inches.....	27.4 inches.....	27.0 inches.....
Aft.....	26.9 inches.....	26.4 inches.....	26.5 inches.....
Revolutions per minute.....	73.9.....	58.5.....	68.8.....
Indicated mean pressure.....	19.8.....	13.8.....	19.1.....
Indicated horse-power.....	6157.....	3413.....	5541.....
Speed of vessel.....	15.503.....	13.455.....	15.139, calculated.....
Revolutions per knot.....	286.0.....	260.8.....	272.5, calculated.....
Slip, per cent.....	20.28.....	12.6.....	16.35, calculated.....
Temperatures:			
Deck.....	56 degrees.....	65°.....	64°.....
Engine-room.....	77 degrees.....	87°.....	83°.....
Stoke-hole, aft.....	105 degrees.....	118°.....	108°.....
Stoke-hole, fore.....	118 degrees.....	110°.....	92°.....
Kind of coal used on trial.....	Nixon's Navigation.....	Nixon's Navigation.....	Nixon's Navigation.

The *Inconstant* has had considerable service; the *Raleigh* made a cruise to India and returned; but the *Shah* was just put on the last measured-mile trials at the time of my visit on board that vessel in April last.

It is now freely admitted by the authorities that both the *Inconstant* and the *Shah* are undesirable property. They were too costly to build, are too costly to maintain, and too unwieldy to handle. It is said by Mr. Brassey, M. P., that "The designers of these vessels were betrayed into an exaggeration of size from over-anxiety to combine in a single ship every quality with which an unarmored vessel can possibly be endowed. They were to possess unrivaled speed, both under steam and under sail, and to be armed with such batteries of armor-piercing guns that it was hoped engagements might be fought even against armored ships with some prospect of success. The attempt was ambitious and not altogether unsuccessful, but they are now found to be too expensive for mere protection of commerce, and their guns would be useless against armored ships of the present day." "A perfect ship of war," as it was very prudently observed by the admiralty committee on designs, "is a desideratum which has never yet been obtained; any near approach to perfection in one direction inevitably brings with it disadvantages in the other."

We now come to recent productions, vessels set afloat last year, and

COMPOUND ENGINES OF H.M.S. ROVER.

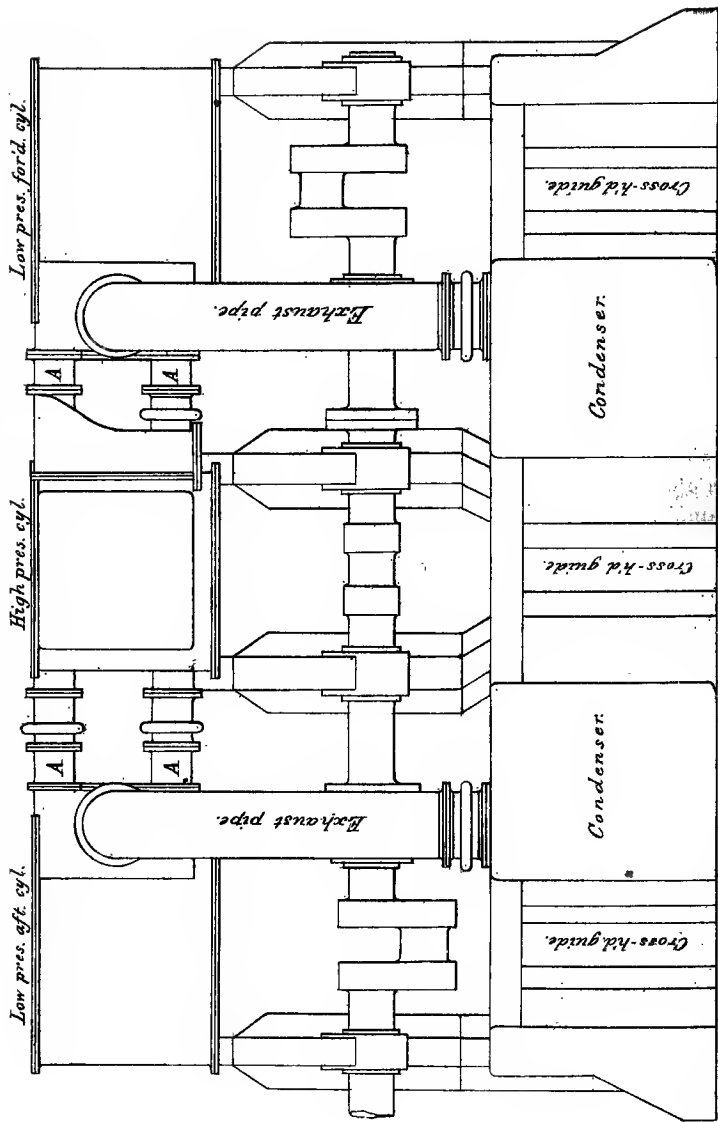

vessels not yet completed. They are the *Boadicea*, *Bacchante*, *Euryalus*, and *Rover*. These vessels are of smaller dimensions than the *Raleigh*; they are engine on the new system with three-cylinder compound engines, and promise, with modifications which experience may prove advantages, to have permanence as types. They are all rated as corvettes, although the main batteries of the first three named are carried under covered decks.

THE BOADICEA

has 95 tons more displacement than the other two; she has a brass stem and the bottom is sheathed with two courses of planks and coppered, while the other two ships are built to utilize the power of the ram; and with this object in view, they are formed with upright bows, have iron stems, and are sheathed with only one course of planks, which is covered with zinc instead of copper.

When such vessels are fitted for ramming, it not only becomes necessary to make the stems of iron or steel, but also to build them of additional strength, and to avoid coppered bottoms, for the reason that any damage to the bow in ramming which should expose the iron skin to the action of the copper sheathing would cause serious galvanic action.

The *Boadicea* has been completed and equipped for sea. Her engines were tested at the measured mile in October last, and in December a special run of six hours' duration was made, when the following results were attained, the draught of ship forward being 20 feet 6 inches, and aft, 22 feet 4 inches:

Pressure of steam in boilers, 70 pounds; horse-power in the first hour, 4,893, with 73 revolutions; in the second hour, 5,406 horse-power and 74.6 revolutions; in the third hour, 5,414 horse-power and 75.3 revolutions; in the fourth hour, 5,227 horse-power and 74.5 revolutions; in the fifth hour, 5,523 horse-power and 75 revolutions; in the sixth hour, 5,320 horse-power and 74.4 revolutions; the mean being 5,300 horse-power, 74.5 revolutions, and speed 14.5 knots.

The engines are reported to have worked satisfactorily, and one feature of the trial was in working them with a pressure of only 10.5 pounds in the boilers.

The *Bacchante*, building at the Portsmouth dock-yard, is to be completed in October, 1877, and the date of the completion of the *Euryalus*, building at Chatham, is uncertain.

THE ROVER.

This vessel was built by contract; she has 493 tons less displacement than the *Bacchante* and *Euryalus*. She was launched August 12, 1874, put on the trial-trips in November, 1875, and sent to the West India squadron immediately thereafter. She approaches the size and type of a class of vessels very greatly needed in our own Navy. The length between perpendiculars is 280 feet; breadth, extreme, 43 feet 6 inches; draught of water forward, 17 feet 2 inches; aft, 23 feet 2 inches; displacement, 3,494 tons.

The contract-price for hull and machinery was \$782,460. She was made large enough to be sea-going, to act as a ram, and to be fast; and no ship having structural strength to withstand the engine-power necessary to drive her 15 knots per hour, to act as a ram, to have all the requirements necessary for a war-ship, and to keep the sea as a cruiser, is likely to be made very much smaller until some further advancement is made in engineering.

The engines are the first of their kind completed and used in the British navy, and special interest has been taken in their performance. They are compound and surface-condensing, and belong to the type known as the horizontal-return connecting-rod, and have their cross-heads working in slipper guides. According to the contract, they were to indicate 4,750 indicated horse-power at the measured-mile trial.

The above diagram shows the main parts of the engines in plan. The diameter of the high-pressure cylinder is 72 inches, equivalent to an area of 4,071.51 square inches of piston. The diameter of each low-pressure cylinder is 88 inches, and the area of piston 6,082.13 square inches. The two low-pressure pistons combined giving an aggregate area of 12,164.26 square inches, the high and low pressure pistons bear the ratio to each other of 1 to 2.98 in effective area. The high-pressure cylinder, which is fitted with a working barrel made of Sir Joseph Whitworth's patent compressed steel,* is placed between the two low-pressure ones, and each cylinder stands separately and distinctly by itself, securely attached to its own two main frames—these latter, six in all, carrying the crank-shaft. The slide-valve of the high-pressure cylinder is placed on the upper side of it, and lies on its face; the valve-face of the cylinder is cast separately, and bolted to its place, with a view to its ready repair or removal in case of need. The slide-valves of the low-pressure cylinders are placed on the sides of the latter, the valve-faces of these cylinders being also bolted on; and all the slide-valves are fitted with the usual metallic packing-rings on their backs to relieve the pressure. Steam starting-gear, in addition to the ordinary hand-gear, is fitted for facility of handling them, and the easy way in which these large engines can be hauled is best told by describing the results obtained. While running full speed ahead, they were stopped in nine seconds, went astern at full speed in six seconds more, and were reversed from that position to full speed ahead again in eight seconds. The casing of the high-pressure slide-valve, to which the expansion-valve casing is attached, is connected with the low-pressure slide-valve casings by four copper pipes, A, A, A, A, which are fitted as shown, and through which the steam passes after leaving the high-pressure cylinder. These pipes and the passages connected with them form the only steam reservoirs between the cylinders. The surface-condensers are on Hall's system, the steam passing through the tubes; they stand on the side of the connecting-shaft opposite to the cylinders, and each condenser is connected with its own low-pressure cylinder by an eduction-pipe, through which the steam passes on leaving the latter. The condensers have a total

* This metal, first introduced by Sir Joseph Whitworth, about twenty years ago, and since used for his ordnance, is now gradually gaining favor for such constructions as demand a material of exceptional strength and toughness, or where a combination of strength and lightness is essential, as in many parts of marine steam-engines, especially in cylinder linings and valve-faces, where hardness is also necessary to resist abrasion.

Steels, as ordinarily cast by pouring into ingot-molds, are found to be porous and comparatively heterogeneous in texture, and brittle in consequence of gas and air-boles. Whitworth adopted the simple but effective expedient of subjecting the ingot or casting, while still molten, to the tremendous pressure of a heavy hydraulic press while solidifying; by this means the pores and bubble-holes are effectually closed, and the compressed steel is given a strength and homogeneity unequalled by any other known metal. Although a simple expedient, it has required a considerable amount of experiment, ingenuity, and cost to produce this compressed steel with uniform success; this was, however, accomplished, and the material is now used in the British navy, in France, and in Austria.

The inventor has stated that by a careful selection and treatment of metals, a steel can be produced capable of resisting a tensile stress of 45 tons per square inch of section, and of elongating 25 per cent. before breaking.

First cost is the only objection raised against its general use.

number of 7,224 brass tubes, tinned inside and outside, with a total cooling-surface of 9,500 square feet. The tubes are fitted in the tube-plates with screwed glands and stuffing-boxes, and the condensers are so arranged that they may be worked as common condensers, if required. The air-pumps, double-acting, are two in number, 23 inches in diameter, with a stroke of 4 feet, and the circulating water is driven through the condensers by two centrifugal pumps worked by an independent pair of small engines, and the main receiving-pipes to these pumps are fitted with branches leading into the bilges of the vessel, so that the pumps may become large bilge-pumps in the event of any leak arising in the vessel. There is the usual arrangement of feed and bilge pumps fitted on the main engines, two of each; they are of gun-metal, and are 5 inches in diameter, with a stroke of 4 feet. In addition to these pumps there are two feed auxiliaries, a bilge auxiliary, hand-pump, and fire-engine, all fitted in accordance with the admiralty specification.

The length of the stroke of the main engines is 4 feet, and the length of the connecting-rod is twice the length of the stroke. The diameter of the connecting-shafts is 18 inches, and of the crank-pins 20 inches. The shaft is made in three pieces, having couplings forged on the ends, by which they are bolted securely together. The diameter of the line-shafting is $16\frac{1}{2}$ inches, and that of the stern-shaft is $18\frac{1}{2}$ inches, the latter running in the usual *lignum-vitæ* bearings fitted in the stern-tube. The screw-propeller is of gun-metal, is on the Hirsch principle, has a diameter of 21 feet, and is driven by an ordinary cheese-coupling keyed on the stern-shaft, and is fitted to lift in a banjo-frame by means of sheer legs and tackles on deck.

BOILERS.

The boilers, which are ten in number, stand athwartships in two groups. Each group of four and six, respectively, has its own separate chimney, fitted on the telescopic principle, and the boilers carry a working pressure of 70 pounds to the square inch. They are about 11 feet 10 inches in diameter, 9 feet 6 inches long, fitted with brass tubes 3 inches in outside diameter, and with wrought-iron stay-tubes. Each boiler has two furnaces 3 feet 10 inches in diameter and 6 feet 8 inches long. The total heating-surface of the boilers is 12,700 square feet, and the grate-bar surface is 510 square feet.

Among other fittings of the engines it may be mentioned that both low-pressure cylinders have separate starting-valves; a double-beat regulator-valve is placed in the main steam-pipe close to the expansion-valve, and beside this a steam-separator. There is also a throttle-valve to be used with a Silver's governor. The high-pressure piston is provided with a 20-inch trunk at the back, which is inclosed in a casing bolted upon the cylinder-cover, and works always upon an adjustable composition block; the latter thus takes the principal weight of the piston, by which means it is hoped that excessive wear of the cylinder may be prevented. This adjustable block is regulated by set-screws, and although at the time when made it was thought to be an improvement, it has since been found to be a disadvantage, because there is no means of ascertaining just how much to raise or lower the piston. The starting and reversing gear referred to is simply a vertical steam-cylinder with the necessary valve-gear; the lower end of its piston-rod is connected by a link with the reversing-gear, the upper end of the same rod is formed as a very coarsely-pitched screw; this is so proportioned that it does not move of itself when steam is turned on, but is then

so far balanced that scarcely an effort is required at the hand-wheels, (of which two are provided and connected with the piston-rod by bevel-gearing), in order to move the reversing-links in either direction.

The following results were obtained in November on the measured-mile trial: The mean speed on the six full-power runs was then 14.533 knots, the mean revolutions being 68.51; steam, 68 pounds to 70 pounds; vacuum, $27\frac{1}{2}$ inches. The mean indicated horse-power on these runs was 2,476.6 in the high-pressure cylinder, 1,343.2 in the forward low-pressure cylinder, and 1,143.7 in the after low-pressure cylinder; the total being thus 4,963.5 indicated horse-power. The mean speed on the four half-power runs was 11.714 knots with 54.26 revolutions, 66 pounds of steam, and 28 inches of vacuum. The indicated horse-power was 1,240 in the high-pressure cylinder, 580.6 in the forward low-pressure cylinder, and 501.7 in the after low-pressure cylinder, the total being 2,322.3. The propeller was set at a mean pitch of 24 feet 11 inches.

As previously stated, the engines of the *Rover* are the first of the kind put on trial in the royal navy. The most marked feature about them is the use of two low-pressure cylinders instead of one. The diameter of one cylinder, equal in area to the two low-pressure cylinders of the *Rover*, would be nearly $124\frac{1}{2}$ inches. Cylinders of about this size have been used in Her Britannic Majesty's navy, working with pressures greater than those at which the low-pressure cylinder of a compound engine works, and they have been used in the merchant-service in compound engines; but the experience with these large cylinders has been very unsatisfactory, consequent upon the number that have been cracked by unequal expansion and contraction in these large castings, besides which the inconveniences of handling and working with such large and heavy parts in the confined space of an engine-room are very great. For these reasons the low-pressure cylinders have been kept within reasonable limits in all recently-designed engines for the naval service.

THE EURYALUS.

The engines and boilers of this ship are similar to those of the *Rover* except that the high-pressure cylinder has a diameter 2 inches greater than that of the *Rover*, the low-pressures are correspondingly increased in diameter, and also the working parts. The power of the boilers is also increased by an addition of one furnace in each, thus making 30 furnaces in the ten boilers, each having a diameter of $3\frac{1}{2}$ feet and a 6-foot length of grate.

During the time these and the several other sets of three-cylinder engines have been building, the subject of the position in which the cranks should be set relatively to each other has received considerable attention and discussion. At the fifteenth session of the Institution of Naval Architects, Mr. G. B. Rennie, a distinguished mechanical engineer and marine-engine builder, read a paper on the subject, (to be noticed directly,) and at the last session of the same institution Mr. John R. Ravenhill, also well known as a mechanical engineer, made the following statement:

In the month of March, 1874, a paper was read by Mr. G. B. Rennie, on engines at that time under course of construction by his firm for Her Majesty's steamships *Boadicea* and *Bacchante*, in which he brought under our notice a series of diagrams showing the theoretical force exerted by the three cylinders at all parts of the path of the crank-pin's centers, in four different ways of setting the relative angles of the cranks, which he described as follows: No. 1. With equal angles of 120° with each other. No. 2. The two low-pressure cranks with 90° between them, and 135° between

To illustrate M. G. B. Rennie's Paper on Three-throw Crank Engines of the Compound System, H.M.S. Boadicea and Baccharite.

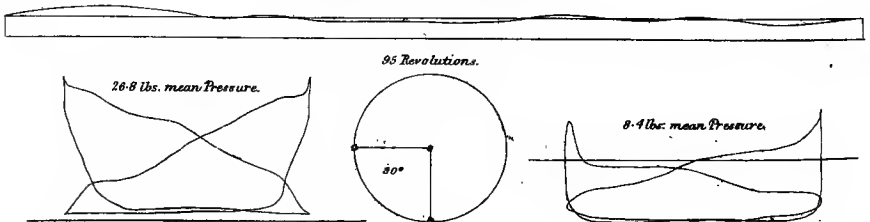
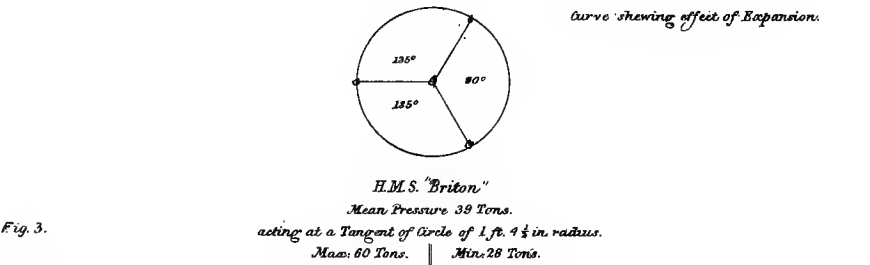
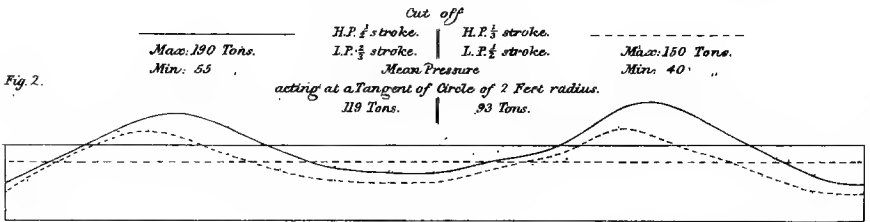
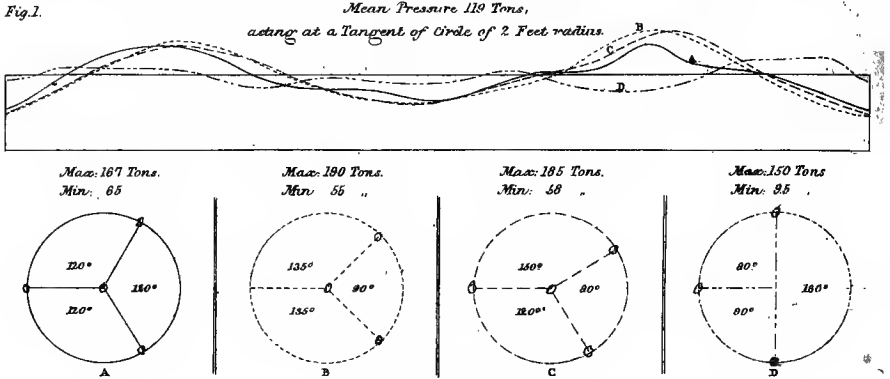

these and the high-pressure crank. No. 3. The low-pressure cranks with the same angle between them, but at angles of 150° and 120° with the other one. No. 4. The low-pressure cranks placed opposite to each other, and at right angles to the high-pressure crank. And he proceeded to give his reasons for concluding to adopt the position described in No. 4, for the angles of the cranks of the two above-named ships. (See Figs. 1 to 4.) In the discussion that followed, I stated that in the three-cylinder compound engines then making by my late firm for the *Rover*, I had adopted the plan of placing the cranks at equal angles of 120° with each other, (see Fig. 1,) and promised to furnish the institution with the practical result obtained. Recent experience has demonstrated most clearly that we have closely approached, if we have not actually reached, the point at which the crank-pins of large high-speed engines will work satisfactorily in consequence of the very limited amount of bearing surface that of necessity can be allotted to them; and unless phosphor bronze should come to the assistance of the marine engineers, as white-metal and *lignum-vitæ* did in days gone by, it may be necessary to reduce the load on the high-pressure crank-pins. Rather than depart from the angle of 120° for my cranks I would alter the multiple of my cylinders, for with the three cranks set at equal angles to each other you possess the great practical advantage of being able to work on with any two cylinders out of the three, under many circumstances, in the event of temporary derangement with the third, an advantage that might prove to be the salvation of a ship and her crew on a lee shore or in the time of war.

It will be seen that the cranks of the engines of the *Rover* are set as represented by the position at Figure No. 1. The cranks of the engines of the *Boadicea* and the *Bacchante* are set according to the positions represented at No. 4. In the armored ships *Alexandra* and *Dreadnought*, the position adopted for the engine-crank is that of No. 2.

The following is the paper by Mr. Rennie, and the above are the diagrams produced by him :

ON THREE-THROW CRANK ENGINES OF THE COMPOUND SYSTEM—HER MAJESTY'S SHIPS BOADICEA AND BACCHANTE.*

By G. B. RENNIE, Esq., *Member of Council.*

[Read at the fifteenth session of the Institution of Naval Architects, 27th March, 1874; the Right Hon Lord Hampton, G. C. B., D. C. L., president, in the chair.]

Since I had the honor of reading a paper before you on the subject of compound engines of Her Majesty's ship *Briton*, in 1871, the system of engine adopted in the navy has been almost entirely compound, even to the largest size. The engines for the ships *Thetis*, *Encounter*, and *Amethyst* closely followed those of the *Briton*, of similar size and construction, besides others of the same size and many smaller. All of these were made with one high-pressure and one low-pressure cylinder; but when a much larger power than that developed in the *Briton* was required, it was considered advisable by Mr. Wright, chief engineer of the admiralty, to have two low-pressure cylinders and one high-pressure cylinder, on account of the risk involved in making good castings of the size of cylinders that would be required if made with one low-pressure cylinder, especially as casualties had taken place in some of the larger cylinders in Her Majesty's ships.

Last year my firm entered into a contract for two sets of compound engines, each 5,250 horse-power, to be fitted on board Her Majesty's ships *Boadicea* and *Bacchante*; each set of engines has three cylinders, one high-pressure of 73 inches diameter, and two low-pressure of 93 inches diameter, the stroke being 4 feet.

Wishing to ascertain the most advantageous angles to place the cranks in relation to each other, so as to develop the required power with the greatest regularity of motion, with the least strain on the shaft, I had some carefully-made diagrams constructed, taking into account the cut-off to which the valves were made to, [work,] as well as making allowance for the capacity of the ports, passages, &c., between one cylinder and the other at each successive point of the travel of the pistons. The steam being cut off at *half stroke* in the high-pressure cylinder by a separate expansion-valve, and at three-fifths of the stroke in the two low-pressure cylinders; the initial pressure being 82 pounds, and the back pressure, from imperfect vacuum, at 4 pounds. It was impossible to make allowance for the "wire drawing" of the steam through the ports, pipes, &c., with any degree of accuracy; this, therefore, was not taken into account, so that the total horse-power indicated on the diagrams is in excess of that which would be actually realized in practice; but as each case is relatively the same in this respect, it would not affect the general comparison.

* Received 19th March, 1874.

The diagrams are made for four different positions of cranks :

No. 1. With equal angles of 120° with each other.

No. 2. The two low-pressure cranks, with 90° between them, and 135° between these and the high-pressure crank.

No. 3. The low-pressure cranks, with the same angle between them, but at angles of 150° and 120° with the other one.

No. 4. The low-pressure cranks placed opposite to each other, and at right angles to the high-pressure crank.

Having thus ascertained the pressures at different points, in each case, when the cranks were placed at the above-named angles, the diagrams of the tangential forces were constructed, taking into account the length of the connecting-rod, to be four times that of the crank.

These diagrams show the force exerted by the three cylinders at all parts of the path of the crank-piu center ; and the greater regularity of the curve, and the nearest approach to a straight line, the more uniform the rotation of the shaft and screw-propeller.

It is seen clearly by the diagrams that the most uniform motion is derived by placing the cranks at right angles, as in No. 4 ; and the next best position is where the angles are equal, (No. 1.)

The more uniform motion also gives the least maximum strain on the shaft, and thus allowing for the same margin of safety in each case. And, supposing in one case the diameter of the shaft to be 18 inches, in the other it would have to be $19\frac{1}{2}$ inches diameter.

As regards the better propelling-machine, I can fancy there can be little doubt among naval engineers that a steady, continuous pressure will be a far better propelling-machine than one subject to a series of jumps and variation of strain during the rotation of the propeller.

In order to ascertain the effect of an earlier cut-off than half-stroke, I had a further diagram (No. 5) made, supposing the steam cut off at one-third in the small, and one-half in the large cylinders, but this does not appear to affect the irregularity of the motion, but merely shows a gradual depression throughout the circle. How far a greater cut-off in the low-pressure cylinders affects the curves I have not yet gone into, the engines in question not being fitted with separate expansion-valves on the low-pressure cylinders.

The sixth set of diagrams are those of the *Briton*, with two cylinders, taken on her trial-trip, and reduced to a curve, showing the tangential force to turn the shaft round.

From these examples, it seems to me that in compound engines—whether with two or three cylinders—the best position to place the cranks, both for uniformity of motion as well as strain on the shaft, is where the low-pressure cylinder cranks are placed at right angles to the crank of the high-pressure cylinder.

SMALLER VESSELS.

There is yet a smaller class of modern corvettes of different build, known formerly as the *Magicienne*, now as the *Opal* class, that promises permanence. It consists of the *Opal*, *Turquoise*, *Tourmaline*, *Garnet*, *Ruby*, and *Emerald*.* The first named have been completed and two of them are in commission ; the other three are to be completed this year.

These vessels are all of the composite build. The length is 220 feet ; breadth, 40 feet ; draught of water forward, 15 feet 6 inches ; aft, 17 feet ; and the displacement is 1,864 tons. They are fully rigged as sailing-vessels and fitted with lifting screw-propellers. The motive engines, as well as those of all other lately-designed cruisers, are of the compound type. Though the engines are not all from the same patterns, it may be sufficient to give the general dimensions of one of them as specified by the admiralty. There is to be one pair of horizontal engines. The diameter of the high-pressure cylinder is 57 inches and of the low-pressure 90 inches. The length of the stroke is 2 feet 9 inches and the maximum revolutions per minute about 90.

The high-pressure cylinder face is made separately of phosphor bronze, secured to the cylinder with brass screws. The diameter of the crank-

* Names given to vessels when ordered to be built are sometimes changed when they are launched.

shaft and crank-pin bearings is 13 inches; the aggregate length of the former bearings is 7 feet 6 inches, and that of each crank-pin 13 inches. The diameter of the propeller-shaft is 12 inches, and the section which passes through the tube is $13\frac{1}{2}$ inches in diameter. The screw-propeller is 15 feet in diameter. The boilers are cylindrical, with horizontal tubes, and the pressure of steam 60 pounds per square inch. The indicated horse-power on the measured mile is to be 2,100, and the maximum speed with this power is to be $11\frac{1}{2}$ knots.

The armament consists of fourteen 64-pounder rifled guns, one of which is a bow-chaser, working under cover of a fore-castle, and another is a stern-chaser, under a poop; the remainder of the guns are uncovered.

Sloops of modern date are also of composite build; they are rated next after corvettes, and may be divided into three classes. Those of the first class consist of the *Wild Swan* and *Penguin*, completed in 1876, and the *Cormorant*, *Osprey*, and *Pelican*, to be completed this year. These vessels have a displacement of 1,124 tons. The length between perpendiculars is 170 feet, the breadth extreme is 36 feet, and the draught of water forward is 13 feet, and aft, 16 feet. They carry four guns on the broadside and two bow or stern chasers. The estimated cost of the hull, &c., is \$169,891, and of the machinery \$50,787, in gold. The second class are all completed and in commission, and consist of the *Daring*, *Albatross*, *Flying Fish*, *Egeria*, *Fantôme*, and *Sappho*. These have a displacement of 894 tons; the length between perpendiculars is 160 feet; breadth, extreme, 31 feet 4 inches; draught of water forward, 12 feet; aft, 14 feet; the average indicated horse-power being 900 and the number of guns four, two of which are chasers. Total cost of hull and machinery, \$171,558 in gold.

The third class, rated by parliamentary returns as sloops and in the navy-list as gun-vessels, consist of the *Arab* and *Lily* in commission, each of 700 tons displacement, with the length of 150 feet; breadth, $28\frac{1}{2}$ feet, and draught of water forward 10 feet, and aft, 12 feet; the indicated horse-power being respectively 656 and 829. Also of the *Flamingo*, *Condor*, *Griffon*, and *Falcon*, building and to be completed this year. These last named have a displacement of 774 tons; length, 150 feet; breadth, 29 feet; draught forward, 11 feet; aft, 13 feet; and the indicated horse-power is to be 750. Total cost of hull and machinery, \$160,380 in gold.

All of these vessels, as well as all other classes of recent construction, are engine on the compound system. The largest of these sloops, *i. e.*, those having a displacement of 1,124 tons, are fitted with engines capable of developing an indicated horse-power of 900 on the measured-mile trials. The diameter of the high-pressure cylinder is 38 inches, of the low-pressure cylinder 66 inches, and the stroke of piston 2 feet. The maximum revolutions are to be 100 per minute, and the speed under steam in smooth water between 9 and 10 knots per hour. The steam is supplied by cylindrical boilers, and the pressure is to be 60 pounds per square inch. The screw-propeller is 13 feet in diameter, and like those of other cruising vessels it is two-bladed and lifting. The vessels are to be fully rigged as cruisers, and intended to keep the sea under sails.

The *Arab* class are also three-masted; they are square-rigged on the main-mast as well as on the fore-mast.

There are also a large number of what is known as composite gun-vessels fitted as cruisers, of which the *Coquette* class are the smallest sea-going vessels in the British navy. The displacement of this class is 430 tons; the length is 125 feet; breadth, extreme, 23 feet 6 inches;

draught forward, 8 feet; aft, 10 feet. They also have lifting-screws, are three-masted, and square-rigged on the fore-mast only. The armament consists of two 64 and two 20-pounder rifles. The speed under steam is only about 8 knots in smooth water at the best, but under favorable conditions of wind and weather a run of twenty-four hours can be made with 3 tons of coal.

In addition to the composite gunvessels and gunboats, there is a large number of iron double-screw gunboats, ten of which were building by the Palmer Ship-building Company at Jarrow-on-Tyne, at the time of my visit to that place last summer. These vessels have a displacement of 363 tons; the indicated horse-power is to be 310, and the number of guns three. Quite a number are of still smaller size, and some of them are fitted to carry a single gun mounted on a rising and lowering platform forward, so arranged that the gun can be lowered into the hold when the vessel goes to sea.

This peculiar type of vessel was invented by Mr. Rendel; the *Staunch*, built in 1867, being the original. She cost \$64,481 in gold. Since then about thirty have been added to the navy.

Recently, Sir W. Armstrong & Co. have been constructing four gunboats for the Chinese government, in which several important improvements over the *Staunch* type have been introduced. Two of these boats, each mounting a 26½-ton gun, have already been delivered at Tientsin, and two others, each mounting a 38-ton gun, are probably by this time completed and ready to sail for China.

These two last little vessels, built of iron, measure 126 feet over all, their extreme breadth is 30 feet, draught of water 8 feet, and displacement 430 tons. They are schooner-rigged, with tripod-masts, carry 50 tons of coal, 50 rounds of ammunition, and, in addition to the heavy gun, they carry two 12-pounders and a Gatling gun. They are propelled by twin-screws, and are intended to have a speed of 9 knots.

The main peculiarities consist in the great gun mounted on so small a vessel, and the system of working it; the piece being much heavier than those used in the English boats, and the little vessel is herself made to act as the gun carriage. The gun is worked by hydraulic power, and the entire arrangement of the mechanism is similar to that employed in working the 100-ton gun at Spezia, to be noticed hereafter. Two heavy iron beams in the fore part of the vessel are placed side by side on a level with the deck and parallel with the keel; on these beams are bolted frames analogous to the cross-head guides of a horizontal engine, and the trunnions of the gun are fitted in slide-blocks, these last taking the place of the cross-head. Thus arranged, the gun can slide back and forth through a range of about 3 feet. The preponderance at the breech-end is supported by two secondary parallel bars inside the main gun-beams. These are hinged at the rear end, while at the forward end they are carried on the cross-head of a vertical hydraulic ram fixed beneath the deck. The breech-end of the gun is supplied with a hoop and lugs; the lugs rest on the two secondary bars near their hinged ends, and thus, by causing the hydraulic ram to rise or fall, the gun can be elevated or depressed at will. No turning-gear is provided, the lateral training of the gun being effected by turning the whole boat through the required arc by the use of the rudder and twin-screws. To run the gun in and out, two hydraulic cylinders are used, one of which is fixed horizontally on each side-beam, the cross-heads of the rams taking hold of the trunnion slide-blocks. The recoil is taken up by these rams, or more properly pistons, delivering water under a weighted valve.

The gun is loaded by a hydraulic rammer, the shot being brought to the muzzle by a trolley or carriage, off which it is pushed into the bore.

During the trials of the *Gamma*, one of the vessels just tested, the 38-ton gun was fired with charges consisting of 130 pounds of powder behind an 800-pound projectile, the elevation being $3\frac{1}{2}$ degrees.

These boats are regarded as the nucleus of a Chinese hornet fleet, which fleet, if properly manned, will no doubt give a deal of trouble to Japan or any other country which may dare to invade the sanctity of Celestial waters. Extravagant estimates of their merits have, however, been formed, and some of the English papers have been urging the adoption of the type into the British navy. They are a great improvement on the English boats, but not free from objections, one of which is the want of lateral movement of the gun without moving the vessel, and in order that they may operate with maximum efficiency the water must be tolerably smooth; and at such a time it would not be difficult to hit one of them by a shot from the small rifled guns carried by armored ships and send her to the bottom. Therefore, except under peculiar circumstances, they are useful for defensive purposes only, and service on board of them must in many cases during war be attended with extreme risk.

COMPOSITE SYSTEM.

All the modern cruising vessels of the British navy (unarmored) below the rate of the *Active* are now built on the composite system. In this method of construction the frame-work inside of the skin, including frames, beams, keelsons, stringers, shelf-pieces, water-ways, transoms, bulkheads, &c., are of iron, and arranged nearly as they would be in an ordinary iron-built ship, the frames and beams being of the same kind and dimensions and spaced the same distances apart, with bulkheads of the usual number and construction. The keel, stem, outside planking, and decks are of wood. The planks are put on in two courses laid fore and aft. The first course is secured to the iron frames by $\frac{5}{8}$ -inch Muntz's-metal bolts tapped into the iron, having also lock-nuts on the points inside. The bolts have screw-driver heads, and are screwed home against a shoulder so as to leave the head below the surface of the plank, the cavity over the head of the bolt being filled with white and red lead so as to prevent leakage. The planks on both sides, as well as the iron, are carefully painted; after the first course of planks have been carefully calked between the joints with oakum, the second course is laid on it, breaking joints with the planks of the first course. The planks of this second course are fastened to those of the first course by copper bolts driven through both thicknesses, and riveted inside the vessel. The joints between the planks of the last course are then likewise calked, and the surface below water coppered over. The kind of wood used is teak; the thickness of the first course of planks is about $3\frac{1}{2}$ inches, and of the second course about 3 inches; the width is about 12 inches, and there are two bolts to every frame through each plank of the first course. The work is required to be carefully done, and special attention is directed to see that the iron is completely insulated or cut off from electrical communication with the copper sheathing and bolts used in the structure.

In this system of ship-construction the same strength of hull is not expected to be attained as when the hull is composed entirely of iron, having each skin-plate riveted to the next, also to the frames and the bottom, and decks tied together by bulkheads; the constructors employed in building them, however, estimate the strength of one of these well-built composite vessels to be from 40 to 50 per cent. greater than the strength of a wood-built vessel of the same dimensions, besides which the durability is infinitely greater, for there is no wear-out of the interior parts, and the skins are of teak, which possesses durability equal to our live-oak.

PART X.

THE SLOOP PELICAN, TO BE ENGINED ON PERKINS'S HIGH-PRESSURE COMPOUND SYSTEM; CRUISERS OF THE RAPID TYPE, THE IRIS AND MERCURY; CORVETTES OF STEEL AND IRON; TRIALS AT THE MEASURED MILE.

HER BRITANNIC MAJESTY'S SLOOP PELICAN

(ENGINED ON THE PERKINS HIGH-PRESSURE COMPOUND SYSTEM.)

The British Admiralty have long been noted for the careful investigation given untried plans of any kind proposed for ships of the royal navy. As a rule, they adopt useful inventions only after such have been successfully established in the mercantile marine; a case in point was the caution exercised in the introduction of the compound engine. It must therefore have been unusually strong proof which decided that august board to make the test, on a considerable scale, of a system so far in advance of the present day, and to pass from 70 pounds pressure per square inch as the highest used in boilers of the navy to 300 pounds pressure per square inch; it was a step beyond anything previously attempted.

The *Pelican* is a composite sloop, of 1,124 tons displacement, building at Devonport. The steam-machinery for this vessel was designed by the Yorkshire Engine Company, under letters-patent granted Mr. Loftus Perkins, an enterprising American, long established as a manufacturer in London. The novelty of the design and the principles involved are so unlike those which have influenced the construction heretofore of machinery for marine purposes, that the subject has excited no small degree of attention among parties interested in naval and mercantile vessels. The contract provides that the vessel shall on the trials at the measured mile, and on the six-hour runs, develop 900 indicated horse-power and consume not more than $1\frac{1}{2}$ pounds of coal per indicated horse-power per hour. The engines have five cylinders of three different diameters, two high-pressure of 16 inches diameter, two medium-pressure of 32 inches diameter, and one low-pressure of 56 inches diameter. One high and one medium pressure are bolted together, end to end; their pistons are on one casting, and their common piston-rods work through a stuffing-box in the end of the medium-pressure cylinder. These cylinders are single-acting, the steam being admitted first to the high-pressure, thence on a return stroke to the opposite end of the medium-pressure cylinder, and thence it escapes into a receiver. The other high and medium pressure cylinders are bolted together in the same manner and are acted upon by the steam in the same way. The low-pressure cylinder is double-acting, and draws its supply of steam from the receiver into which the medium-pressure cylinders exhaust, and itself exhausts into the condenser. As arranged in the vessel, the cylinders are inclined upward in a small degree toward the ship's sides, but are all on the same side of the ship. There are three cranks, placed 120° apart, and these are coupled, the after crank to the common piston-rod of one pair of cylinders of high and medium pressure; the mid-crank to the piston-rod of the low-pressure cylinder, and the forward crank to that of the other pair of high and medium pressure cylinders. The stroke is two feet, and the revolutions per minute are intended to be about 100. The valves employed throughout

are of the piston variety; the advantages claimed for the method of construction in these valves is the almost entire absence of friction, wear, or leakage, combined with a balanced valve. The surface-condenser, also patented by Mr. Perkins, is constructed in such a way as to prevent the possibility of leakage of the tubes when they are correctly fitted.

The tubes are galvanized, and arranged as illustrated by the annexed sketch.* The cooling-tubes, which are surrounded by steam, and of which one, C D, is shown, are closed by welding up one end, D, and are accurately and permanently screwed into a strong plate at the other end, C. Each has within it a circulating-tube, B, secured to a tube-plate placed at a little distance from the former. The circulating water passes from the sea into and through the internal tube and returns by the annular space between the two tubes, passing out to the pumps.

The pistons of the steam-cylinders will be made tight by having several rings, or sets of rings, say six, of hard metal; each being separated from the others by what the inventor terms intermediate junk-rings. These rings, of Mr. Perkins's patent metal, are composed of five parts of tin and sixteen parts of copper.

All hot surfaces of the cylinders and pipes are surrounded with a jacket of sheet-iron, packed with vegetable black. Independent air, circulating, and feed pumps are to be provided, driven by a separate pair of engines. The boilers contain a nest of built-up tubes, placed horizontally, close to each other, and having the flame and gases passing around and among them. These tubes are 3 inches in diameter and $\frac{3}{8}$ of an inch thick; when put together in the boilers, they are to be proved to 2,500 pounds hydrostatic pressure to the square inch, and to be worked at a pressure of 300 pounds per square inch. There is consequently an enormous margin of safety, and every precaution is to be taken in building the tubes together to insure tightness, and their connections are to be beyond doubt of danger or waste. So also with the engines; they are to be made of the best materials, and to involve the best workmanship. The water-gauges to be employed are made of mica, and to secure a tight joint between the two plates of mica and the two opposite faces of the body of the gauges there is formed a narrow raised edge, against which the mica is firmly pressed by a metal plate applied to its front face.

The first peculiarity of the Perkins system is the extremely high pressure at which he works the steam—in this case from 250 to 300 pounds per square inch; and he claims to have quite overcome all the difficulties hitherto experienced in using steam at sea above ordinary working pressures. A second peculiarity of the system is the absence of internal lubrication with either oil or tallow, thereby avoiding the possibility of corrosion by fatty acids; while, to prevent the wear of cylinders and slides which is experienced under ordinary circumstances, he uses a metal of his own, whose composition and working are reported as most exceptional. Another peculiarity and important feature of the Perkins system consists in the use, over and over again, of soft fresh water or

* From *Engineering*.

rain-water. The continually recurrent use of pure water, *not distilled sea-water*, is claimed as the only remedy against the internal corrosion of marine-boilers supplied with water from surface-condensers. So much importance is attached to this point, that the committee appointed by the Admiralty to investigate the subject of boiler-corrosion were urgent in their recommendation to test the system, without loss of time, on a scale sufficiently large to arrive at correct conclusions on the subject. Of course this involves the necessity of carrying at sea a supply of fresh water sufficient to make up for all waste accruing during a voyage, and objection has been urged to the system on this account; but, on the other hand, it is alleged that all joints are to be made mathematically correct and tight, as shown by the boilers and engines now in operation on the system, hence the leakage will be reduced to a minimum. This will be the first attempt to use steam of 300 pounds pressure at sea; and while an expression of opinion would be premature, it is proper to state that Mr. Perkins has been entirely successful in his land-engines built on the same system, one of which has been continuously employed at his works for fourteen years, using steam at 500 pounds pressure per square inch. The tubes of this boiler, cut out after thirteen years' service, as inspected by me, were found to be in a remarkable state of preservation, as were also the piston-packing and valve-rings, which had been at work eighteen months without lubrication since the previous examination.

Besides the land-engines manufactured by Mr. Perkins, he has built and kept employed during the last few years, for his own use, a small yacht, the *Emily*, engined on his own system. By invitation of the generous owner I passed a part of two days on board this pretty boat steaming on the river Thames from Westminster Bridge to its mouth and again to the upper locks, the greater portion of the time running under a boiler-pressure of 500 pounds per square inch. The number of cylinders in this boat is six; two high-pressure, two intermediate, and two low-pressure. The high and intermediate pressure cylinders are single-acting, the latter exhausting into a chamber from which the low-pressure cylinder is supplied. The steam is expanded 24 times, and the expenditure of fuel is a little above 1 pound of coal per horse-power per hour.

Mr. Perkins has also engined one of the Thames tug-boats on his high-pressure double-compound system. This boat has a length of 69 feet, with a beam of 14 feet 6 inches, and a draught of water of 12 feet. There is in this case a pair of engines working a screw 8 feet 6 inches in diameter, and of 11 feet 6 inches pitch. The cylinders are four in number, with diameters of 15 and 30 inches, and the working-pressure is 250 pounds per square inch. It was after the inspection of this boat, the yacht *Emily*, and Mr. Perkins's land-engines that the committee appointed by the Admiralty was induced to recommend the system to be tested on a considerable scale in one of Her Britannic Majesty's vessels.

In consideration of the high indorsement the system of Mr. Perkins has received, and the test to be made by the Admiralty, the sea trials of the *Pelican* will attract unusual interest.*

*Since writing the foregoing account of the machinery designed for the *Pelican*, I learn that as it could not be completed in time for her, it will be placed in another vessel of the same class, and that the *Pelican* will be engined with the ordinary compound type of machinery.

SHIPS OF THE RAPID TYPE OR SPECIAL CRUISERS.—THE IRIS AND MERCURY.

These two sister ships, under construction at the Pembroke dock yard, to be completed early in 1878, are being built of steel, and are termed armed steel dispatch-vessels. They are the first of a new type designed for high speed as the pre-eminant requisite; all other requirements are to be subordinated to this important element.

The model from which they are being built presents a beautiful sharp bow, a long, exceptionally clean run, and altogether an admirable specimen of a design for a swift and lightly-sparred vessel. The general dimensions are to be as follows: length between perpendiculars, 300 feet; breadth, extreme, 46 feet; mean load-draught, 20 feet; and displacement at this draught, 3,693 tons. The bottoms are double for the distance occupied by the engines and boilers; the space between the outer and inner skins is nearly 4 feet at the middle of its length, with a reduced depth toward either end. There will be the usual transverse water-tight bulkheads, by which the bottoms and decks are tied together, thereby adding strength and stiffness to the structure; but the limited beam—46 feet—prohibits the introduction of the longitudinal bulkhead extending from stem to stern, a backbone of strength so desirable for a vessel built comparatively lightly, and intended to endure the immense strain of the extraordinary engine-power that is to be put into it.

Viewing the *Iris* with the frames in place, and the bottoms plated, the scantlings appear exceedingly light. I am not aware of the amount of reduction allowed on account of the material being steel of superior quality instead of iron, but it cannot be far from 25 per cent. The excess of tensile strength of the steel being used, over the kind of iron used generally, is considerably more than this, yet in rigidity the thicker iron plates would have some advantage. The plating below the water-line is $\frac{1}{2}$ -inch thick, garboard-strakes excepted, which are $\frac{5}{8}$ -inch thick. Above the water-line the thickness of plates is a little reduced.

The motive machinery of the *Iris* is under construction by Messrs. Maudslay, Field & Son, of London. It will consist of two pairs of four-cylinder compound-engines to each of the two screw-propellers. The engines are to be of a similar type to those made by this firm for the White Star Line of steamers, except that they are to be placed in a horizontal position, and the detailed arrangements made accordingly. The diameter of the high-pressure cylinders is 41 inches, the diameter of the low-pressure cylinders is 75 inches, and the stroke 2 feet 9 inches. The diameter of the crank-shafts at the bearings is to be $16\frac{1}{2}$ inches. The propeller-shafts, excepting the aftermost lengths, are to be made hollow, of Whitworth's fluid compressed steel, the couplings solid. The diameter of these shafts is to be $11\frac{1}{2}$ inches inside and 17 inches outside, exclusive of the brass casings. The length of these twin-screw shafts, partly outside the vessel, is in the neighborhood of 50 feet. They will be of wrought iron, solid, and $16\frac{1}{2}$ inches in diameter.

The tubes through the stern, as well as outside, will be of composition, and the casing of the shafts of the same material. Lignum-vitæ will be used at both ends of the stern-tubes, as well as in the tubes through the outer brackets. There will also be annular thrust-rings with lignum-vitæ facings fitted at the after ends of the stern-tubes, to assist in taking the thrust of the screws. The screw-propellers had not

been designed, but it was intended to give them a diameter of 18 feet 6 inches, and, in common with other twin screws, they will revolve outward.

BOILERS.

These are to be twelve in number, eight of which will be elliptical in shape and four cylindrical. Six are to be 12 feet 6 inches by 13 feet 6 inches, and 9 feet 7 inches long; two will be 12 feet 6 inches by 13 feet 3 inches, and 7 feet 6 inches long; and four will be 11 feet 2 inches in diameter by 9 feet 6 inches long.

The grate-surface will be 700 square feet, and the heating-surface 15,960 square feet. The pressure of steam is to be 60 pounds per square inch. The space to be occupied by the machinery and coal is the whole width of the vessel and 150 feet in its length—just one-half the length of the vessel, in the most important part.

The coal-carrying capacity is intended to be sufficient to enable the vessel to steam 6,200 miles at the rate of 10 knots per hour, or 8,600 miles at 8 miles per hour.

The engines for each propeller are to develop a maximum indicated horse-power of 3,500, giving an aggregate indicated power of 7,000 horses for both sets of engines; and the speed is to be 17 knots per hour for twenty-four hours consecutively at sea. The contract for the steam-machinery for the *Mercury* had not been decided upon; it will probably be of an entirely different type from that of the *Iris*. The same power and same general conditions are, however, to be adhered to. These ships are to have three masts, to be lightly sparred; and the armament of each is to be ten guns of calibers not decided upon. The power to be applied to the propellers of these ships is considerably more than was ever before put in hulls of their dimensions, and, while no doubts exist as to securing the estimated speed, it remains to be seen whether the hulls have the strength to endure for any length of time the immense strain of 7,000 horse-power.

The *Iris* and *Mercury* will be the first armed war-vessels constructed of steel. The keels are of iron, but every part of the hulls proper, frames, beams, and plating will be of steel, also the masts. In consideration of the uncertainty in regard to steel, hitherto employed in large quantities for ship construction, unusual care was exercised in the selection of the works to manufacture it. Some months were devoted to testing specimens of steel supplied by the most eminent firms of the kingdom before the decision was arrived at, which resulted in giving the contract to the Landore Steel Company, of South Wales, some forty or fifty miles distant from the dock-yard. This company has the contract for the whole supply, under very rigid requirements. The steel is made according to the Siemens process. Its chief characteristics, and those which give it its special value for ship-building purposes, are its extreme ductility when cold, its ability to stand punching without appreciable loss of strength between the rivet-holes, its not requiring to be annealed after shearing or punching, its having a smoother surface than iron, its capability of being easily forged and worked hot, its uniformity of quality being absolutely insured, and its strength along the grain. The most remarkable point about this steel is the fact that punching produces scarcely any injury to the material in the neighborhood of the hole, and that annealing the plates and angles after punching and shearing is not necessary; without this quality, which has not been hitherto obtained, steel cannot possibly make headway with ship-builders, for annealing cannot be intrusted to an ordinary ship-building

yard. Therefore, where the problem is to combine the greatest speed of vessel with the smallest dimensions, this Landore steel is a material admirably suited for the purpose—it is stronger than iron by from 25 to 30 per cent., and equal in ductility to iron of the best quality. The requirements of the Admiralty as to the materials supplied under their contract with the Landore Steel Company are as follows:

“From every plate made a strip is to be cut, which, after being heated to a ‘cherry red’ color, shall be plunged into water having a temperature of 82° Fahrenheit. After being thus cooled, the strip is to be bent, without fracture, until the radius of the inner curve equals not more than 1½ times the thickness of the strip. This is known as the ‘tempering test.’ Further, from each lot of 50 plates or angles a piece is to be taken, and the edges having been planed parallel, its tensile strength is to be proved. To be satisfactory, this must not exceed 30 tons nor be less than 26 tons on the square inch, and before fracture takes place there must be an elongation of not less than 20 per cent. on 8 inches of its original length. These tests are applied in the presence of a resident representative of the government. * * * *

“Up to [April last,] 101 samples, representing over 5,000 plates or angles, have been subjected to the tensile test, with the following results:

Number of test pieces.	Breaking strain in tons, per square inch.	Average elongation in 8 inches.
		<i>Inches.</i>
1	25 to 26	2.00
20	26 to 27	2.00
24	27 to 28	2.03
28	28 to 29	1.93
24	29 to 30	1.89
2	30 to 31	1.96
2	31	1.78
101	Mean, 28.16 tons.	1.94 inches, or 24.25 per cent.

“* * * The tensile strength of best best iron is 22 tons when tested with the grain, and 18 tons when tested crosswise. In certain experiments by Mr. Kirkaldy on two very fine plates manufactured at Borsig’s Works, Berlin, and, I believe, stated to be homogeneous, the tensile strength was found to be lengthwise 23.84 tons, and crosswise 22.6 tons. When similarly tested the Landore steel gave lengthwise 28.85 tons, crosswise 28.2 tons; the comparison, therefore, stands thus:

	B. B. iron.	Borsig’s plates.	Landore plates.
	<i>Tons.</i>	<i>Tons.</i>	<i>Tons.</i>
Lengthwise	22	23.84	28.85
Crosswise	18	22.60	28.20
Difference .. {	4 tons, or 18.18 per cent.	1.24 tons, or 5.20 per cent.	.65 tons, or 2.59 per cent.

"Therefore, taking the lowest tensile strength of best iron and of Landore steel, there is a difference in favor of the latter of 10.20 tons, or the Landore steel is 56.6 per cent. stronger than the best iron."

I was granted the privilege of inspecting the tested specimens at the Pembroke dock-yard. For convenience they are divided into cold tests and hot-forge tests, as follows:

COLD TESTS.

(1) "A piece of 6-inch by 3-inch by $\frac{7}{16}$ -inch angle, with the corner bent over and flattened close by blows from a 40-cwt. steam-hammer. No fracture.

(2) A piece of 3-inch by 3-inch by $\frac{3}{8}$ -inch angle, 1 foot long, flattened out by two blows of steam-hammer. No fracture.

(3) A piece of 3-inch by 3-inch by $\frac{3}{8}$ -inch angle, 1 foot long, closed by two blows of steam-hammer. No fracture.

(4) A piece of 3-inch by 3-inch by $\frac{3}{8}$ -inch angle, 1 foot long, flattened out same as No. 2, after which the wings were turned back over the outside angle. Slight fracture at the ends only.

(5) A piece of 3-inch by 3-inch by $\frac{3}{8}$ -inch angle, 18 inches long. After being flattened out, as in the previous cases, the two ends were turned over in opposite directions; the piece was then doubled up in the middle, and closed by hard blows from a steam-hammer. There is no fracture, but there are cuts from the hammer-tool in one place, and from its own angle in another.

(6) A piece of 3-inch by 3-inch by $\frac{3}{8}$ -inch angle, 18 inches long, dealt with as in the specimen last mentioned, except that before bending one end over, the wings were bent back as in No. 4. There is a slight fracture, as shown, caused by its own angle.

(7) A piece of $\frac{5}{8}$ -inch square bar, formed into a knot, occupying only $4\frac{1}{2}$ inches by 3 inches space. No fracture.

(8) A piece of $\frac{3}{4}$ -inch round bar, formed into a knot, occupying only 3 inches by 2 inches space.

(9) A piece of $\frac{1}{2}$ -inch round bar, formed into a knot, occupying $2\frac{1}{2}$ inches by $1\frac{1}{2}$ inches. This is a very fine specimen.

(10) A ring 5 inches in diameter, made from two pieces of plate welded together, and closed by blows from a sledge-hammer. No fracture.

(11) A similar ring made from Low Moor iron, closed by one blow from a 60-cwt. steam-hammer. There are slight fractures where bent, as shown.

(12) A similar ring, made from Landore steel, and closed in the same manner. Fractured in the weld, as shown.

(13) A piece of $\frac{1}{2}$ -inch steel plate, 12 inches diameter, dished to $3\frac{1}{2}$ inches deep by five blows from a 60-cwt. steam-hammer. Without fracture.

A piece of steel from an eminent firm, similarly treated, broke into three pieces at the fifth blow.

(14) A piece of 6-inch by 3-inch by $\frac{7}{16}$ -inch angle, had the wings closed in, as shown; it was then placed edgewise, on bearings 5 feet apart, and bent by hydraulic pressure to a deflection of $12\frac{1}{2}$ inches. A piece of best angle-iron, similarly treated, broke at deflection of 6 inches.

(15) A piece of plate, 3 feet by 3 feet by $\frac{1}{2}$ inch, had an iron block placed under each corner, 9 inches from the edge, and an iron ball weighing 1,291 pounds was dropped on the center from a height of 30 feet. Bent, as shown, without a sign of fracture.

(16) A piece of steel, from an eminent firm, similarly treated, was bent and fractured as shown.

(17) A piece of best best iron, similarly treated, was bent and fractured as shown.

(18) A beam piece, 4 feet 6 inches long, made of $\frac{5}{16}$ -inch plate, 5 inches deep, with double angles $2\frac{1}{2}$ inches by $2\frac{1}{2}$ inches by $\frac{5}{16}$ inch on upper and lower edges, riveted together with $\frac{5}{8}$ -inch rivets, ($3\frac{1}{2}$ diameters apart,) was bent under hydraulic pressure to the form shown, without fracture, when the fixings failed. It was removed before the test could be completed.

(19) A piece of $\frac{3}{4}$ -inch plate, 12 inches diameter, forced by hydraulic pressure through a ring 10 inches diameter, and dished to the form shown, that is, $3\frac{1}{2}$ inches deep, by a pressure of $145\frac{1}{2}$ tons, without fracture.

(20) A piece of $\frac{3}{8}$ -inch plate rested during experiment upon a perfectly horizontal surface of an annular iron anvil; a central circular portion of the plate, 12 inches in diameter, being unsupported. The anvil was firmly imbedded in the ground. A charge of 18 ounces of compressed gun-cotton was suspended over the center of the plate, an air space of 3 inches intervening between the upper surface of the plate and the base of the charge. The charge was exploded by detonation.

The result is that the plate is dished down to the extent of $1\frac{1}{2}$ inches, but there is no sign of fracture.

(20a) A piece of $\frac{3}{8}$ -inch best best iron, similarly tested, is almost shattered to pieces.

(21) A piece of plate $\frac{1}{16}$ inch thick, supported on anvil as above. Charge of gun-cotton 10 ounces, and 3 inches in diameter, placed upon the upper surface of the plate in a central position, and exploded by detonation.

The result is that a hole $1\frac{1}{2}$ inches diameter is made in the center of the plate, and that for $\frac{3}{4}$ inch all around this hole the plate is beautifully cupped or countersunk, as if it had been done by a cutting tool. There are no lateral fractures in the plate.

(21a) A piece of best best iron plate $\frac{1}{16}$ inch thick, similarly treated, was fractured as shown.

(22) A piece of plate doubled close up, four-fold, as shown, without fracture.

* * * * *

HOT-FORGE TESTS.

(1) A piece of $\frac{1}{2}$ -inch plate subjected to the ram's-horn test, the low end being doubled close while cold, without fracture.

(2) Shearings of $\frac{1}{2}$ -inch plate about $1\frac{1}{2}$ inches wide, welded together and bent in the weld to a radius of $\frac{3}{4}$ inch, without fracture.

(3) Two pieces of plate welded together and bent in the parts welded, one to an angle of 90° , and the other to an angle of 105° , without fracture.

(4) A box end made from $\frac{1}{2}$ -inch plate to form angle steel, 3 inches by $3\frac{1}{2}$ inches by $\frac{1}{2}$ inch. It is soundly welded, and is in every respect as sound as one made from angle-iron.

(5) An intercostal, made from $\frac{1}{2}$ -inch plate, to form angle steel, $3\frac{1}{2}$ inches by 3 inches by $\frac{1}{2}$ inch, soundly welded, and considered a good job.

(6) An outside corner, made from $\frac{1}{2}$ -inch plate, to angle steel. This is a fair average weld, these corners being much more difficult to make than inside corners, as the gusset piece has to be welded in after being fitted.

(7) Two pieces of plate, $2\frac{1}{2}$ inches by $\frac{1}{2}$ inch, welded together straight, then turned [upon] its edge to form a circle 6 inches in the clear. It is a sound weld, and there is no fracture in the turning.

(8) Two pieces of plate, 3 inches by $\frac{1}{2}$ inch, welded together and bent off at right angles. It is soundly welded, and bent to the form shown without fracture.

(10) A piece of plate 21 inches by 10 inches by $\frac{1}{2}$ -inch, turned to the form of a tube, (not welded,) then placed in a flanged socket, and a flange-pin forced into it by blows from a 60-cwt. steam-hammer. It assumed the form shown after eight blows. Stood well.

(11) A piece of $\frac{1}{2}$ -inch plate, 12 inches diameter, forced into a socket by blows from a steam-hammer, to the form shown. Stood well.

(12) A piece of $\frac{1}{2}$ -inch plate dished to form shown No. 11, then flattened back nearly to its original form. Stood well.

(13) A piece of $\frac{1}{2}$ inch plate, 12 inches in diameter, forced into a tube, then flanged back on the anvil to form shown. Stood well.

(14) An outside and inside corner, made from angle steel, 6 inches by $3\frac{1}{2}$ inches by $\frac{7}{16}$ inch, welded sound, but with more difficulty than in welding iron." * * * * *

The above tests establish the fact that the material can be easily manipulated, and I was informed by the officers in charge that welding was successfully accomplished.* In addition to the qualities claimed for this steel, it is represented that a series of experiments extending over about three years, carefully conducted at the Terre Noir works, had established the fact that when exposed to the action of sea-water this soft steel suffered by corrosion only in the proportion of 60 to 140, when compared with the effect of similar treatment upon iron plates. I do not know of any boilers made from this steel; it would seem, however, in consideration of the rapid decay of the plates of iron boilers consequent upon the use of redistilled sea-water, that a liberal expenditure in this direction would be wise.

DESIGN OF THE IRIS AND MERCURY.

At a date soon after these two ships were ordered, a distinguished English writer in a London magazine enunciated the following:

It is forgotten that by the declaration of Paris the field of operations is much restricted as regards either the necessity for protecting our own commercial marine or the possibility of injuring an enemy's commerce. This declaration, to which most European maritime powers adhered, but which the United States did not join in, is a contract to respect private property, not being contraband of war, if carried in ships bearing a neutral flag. * * * Many advantages to this country result from the declaration, although serious disadvantages press upon ship-owners, and our position as the chief maritime carriers must suffer. On the other hand, it must be noted that the United States and England are under no such mutual obligations; and with the rankling recollection of the mischief done by the *Alabama* and her consorts to their own mercantile marine, Americans never miss an opportunity of expressing their intention to make similar attacks on British commerce in case of war, so that *England is bound always to maintain an unarmored fleet more powerful than that of the United States, and not to allow individual unarmored ships in her navy to be surpassed in speed or power by vessels of the American Navy.*

STEEL AND IRON CORVETTES.

The following-named vessels recently ordered to be built are also to be constructed of steel, and to have the outside hulls sheathed with

* The account of Landore steel is chiefly from a paper by Mr. Reilly, the manager of the works.

wood in the usual manner, viz: *Carysfort, Cleopatra, Conquest, Champion, Comus, Curaçoa.*

The length between perpendiculars is 225 feet; beam, extreme, 40 feet; depth of hold, 21 feet 6 inches; and displacement, 2,300 tons.

The material entering into the construction of the hulls will in the main be steel. The principal water-tight bulkheads will be four in number. There will be two decks, and, for the purpose of protecting the machinery, the lower deck, for the distance extending over the engines and boilers, will be armored with 1½-inch steel plates.

The vessels are to be fully rigged as cruisers and to be fitted with single screw-propellers arranged for lifting.

The steam-machinery has not been ordered at this date, but the fact has been announced that the engines would be of the compound type, having as great power as the dimensions of the vessel would admit.

TRIALS OF BRITISH NAVAL VESSELS AT THE MEASURED MILE.

The speed of all steam-vessels belonging to the British navy is tested by running them over a measured mile in Stokes Bay, near Portsmouth. The indicated horse-power of new engines, as stipulated by contract, is also determined on the runs over this course. The noteworthy points in the regulations for these trials are as follows :

Her Majesty's ships are to be tried on the measured mile on the following occasions :

1st. After having new engines erected.

2d. After every extensive repair of engines.

3d. On being commissioned when all their weights are on board.

4th. When trials may be ordered on special occasions. * * *

Ships in the first division of the reserve are to be tried under way once every year during summer for not less than six hours; but it is not required that they be taken to the measured mile for the purpose, and their trial at full speed need not be of longer duration than four hours. * * *

The trials of ships at the measured mile are to be conducted under the charge of the captain or commander of the reserve, who is to be accompanied by the constructor, an engineer officer from the yard, and the chief inspector of machinery afloat. * * *

As a rule the trials should not take place when the force of wind exceeds 3. * * * No other coal is to be used while running the mile than the coals specially ordered by the Admiralty. * * *

The best trained stokers that can be selected from the reserve are to be employed. On the full-power trials of ships at the measured mile, the engines and boilers are to be worked to the utmost extent of their capabilities, not only when running the mile, but the whole of the intervals between the several runs.

In the intervals between the runs, ships are to be run well away from the marks, so as to insure the attainment of full speed on their return to them.

Steam must not be partially shut off when the ship is not on the mile in order to obtain a higher result when she is on the mile. * * *

Indicator-diagrams are to be taken, as nearly as possible, at equal intervals of time during each run, in order to obtain the real mean pressure in the cylinders. * * *

The revolutions of the engines during each run are to be taken by the counter. If, during the trial, any defects should occur to the machinery or the ship, the trial is to cease; * * * a new series of trials being commenced when the defects shall have been made good.

If the boilers should prime so that they cannot be worked at full power, even at the close of the trial, it is to be considered as unsatisfactory and the trial is to be repeated.

Whenever irregularities occur in running the measured mile, either at full or half power, the officers are to repeat the runs until the results agree one with the other so nearly as to leave no reasonable doubt of their substantial accuracy.

When ships which have new engines not yet received from the contractor are under trial at the measured mile, the engines and boilers during the trial are to be under the charge of the contractor or his agent, who is to have the whole responsibility and management; * * * but the trial is to be conducted in strict accordance with the regulations laid down for all trials at the measured mile, and the engineer officers will be responsible that the regulations are never deviated from. * * *

Full and detailed reports of the results of the trial of each ship at the measured mile are to be made in the prescribed forms and forwarded to the Admiralty. A tracing of

the screw-propeller is to be annexed thereto, also a set of original indicator-diagrams for one mile only. * * * In all reports of trials it is to be stated whether the engines and boilers did or did not work in a satisfactory manner, and are or are not in all respects fit for service at sea. If the trial should not have been satisfactory, the reason is to be stated and the time it will take to render the machinery fit for service at sea.

When the ship tried is in commission, the reports are to be signed by the captain and chief engineer of the ship, as well as by the officers of the reserve and the dock-yard.

After every trial of a ship in commission, and before proceeding to sea, the ship is to run into the harbor for at least 24 hours, and be carefully examined by a shipwright and engineer officers of the yard, to ascertain that there are no defects, and a report made. These reports are to be signed by the dock-yard officers who made the examination, the chief constructor, and the chief engineer of the dock-yard; also by the officer in command of the ship and the chief engineer of the ship, and are to be accompanied by any remarks which the superintendent may think proper to offer.

* * * Besides the above trials, it is directed that the engines of all ships in commission for service at sea are to be worked at full power twice during each year by their own complement. The first full-power trial is to be made when the ship is commissioned ready for sea, after the dock-yard trials to test the machinery have been made, and it is to be of six hours' duration. * * *

In reviewing the above and considering the subject, it may be questioned whether the system thus prescribed for testing the strength and power of motive machinery and the speed of a vessel be not seriously objectionable; also, whether any practical purpose is thereby served.

It has been seen that the coal used on the trials is of the very best quality; that the firemen employed are the best trained and most expert in the service; that the machinery is placed in the most complete order, and that under these conditions the engines and boilers are forced to the utmost extent of their capabilities, the time engaged in running the measured mile being only a few minutes. Now, it may reasonably be asked whether the excessive strain to which the machinery is subjected while undergoing this severe test does not leave weakness in some hidden parts, and is not the cause of defects subsequently exposed. Furthermore, as the engines can never under any possible conditions be worked at sea for any extended time up to the measured-mile speed, it may be asked what practical purpose is served by it, except that of recording a speed never afterward attainable under any other conditions. It may, moreover, be instructive as regards the speed of the armored ships, to refer to the proceedings of the court-martial held at Devonport in September, 1875, to inquire into the loss of Her Majesty's ship *Vanguard* by collision with a sister ship, the *Iron Duke*, off the coast of Ireland, September 1 of that year.

The commanding officer of the *Iron Duke*, Captain Hickley, being sworn and examined, testified as follows to questions:

768. It is stated in the steam-register that at 12.30 *Iron Duke* was going fifty-four revolutions; what speed would that produce?—Answer. Eight knots.

769. And at 12.40, sixty revolutions; what speed would that produce?—Answer. Eight and one-half knots, or under. And I may refer to the log of the 23d of August, that on leaving Loch Swilly under full speed, to pick the squadron up, she was going eight and one-half knots at sixty revolutions.

770. What was the state of the weather on that occasion?—Answer. Very fine.

816. How many revolutions do *Iron Duke's* engines go at their utmost speed—all boilers?—Answer. The only opportunity I had of judging was on the 23d of August, and on a short trial we had to test the engines; sixty-three revolutions was the utmost we could get, with most indifferent stokers.

J. D. CHARTER, engineer in Her Majesty's ship *Iron Duke*, being sworn and examined, testified as follows to questions:

1076. What is the pitch of your screws?—Answer. Twenty-one feet.

1077. What is the slip percentage in calm weather?—Answer. The slip varies according to the number of revolutions we are making.

1078. Fixing your revolutions at sixty, what is the slip?—Answer. About 15 per cent.

1079. Going at sixty revolutions with a screw of 21 feet pitch, what speed would that give?—Answer. About ten and one-half knots.

Taking the pitch of the screws and the revolutions as above given, it appears from the testimony of the captain of the ship that about 8.92 knots was the maximum speed that could be obtained by the *Iron Duke*, while from the testimony of Engineer Charter it would appear that a speed of about 11.02 knots was possible when working the engines to the utmost.

Now, by referring to the tables of armored ships in this report it will be seen that the speed of the *Iron Duke* on the measured mile was 13.6 knots. This great discrepancy could not be owing even in a small degree to foulness of the iron bottom, (the bottom is not sheathed with wood,) for, if so, the slip of the screw would have very largely exceeded 15 per cent.

It appears also, from the testimony given before the same court by the commanding officer of Her Majesty's ship *Vanguard*, Captain Dawkins, that the maximum speed of that ship was nine knots, or thereabouts.

It may probably not be fair to make an abatement for the speed of all British armored ships in accordance with those sworn to for the *Iron Duke* and the *Vanguard*; but from the testimony in these two cases, we may reasonably conclude that a wide margin exists between the speeds of the ships at the measured-mile trials, and the maximum speed that can be obtained when cruising at sea.

The real speed of a ship is that recorded under full power at sea in ordinary weather during 12 to 24 hours consecutively, and of this we have but little from any ships of the British navy.*

In considering this subject it may be well to remember that the "indifferent stokers" referred to as being on board the *Iron Duke*, although inferior to those employed on the measured-mile trials, are far superior to the firemen that have been employed in our naval vessels within seven or eight years.

* Have no record of the *Sultan-Bellerophon* relative-speed trial of 24 hours in 1873.

PART XI.

THE FRENCH NAVY.

TABLE OF ARMORED SHIPS OF FRANCE; TABLE OF VESSELS BUILDING
AND PROPOSED FOR THE FRENCH NAVY IN 1876.

THE FRENCH NAVY.

Frenchmen have of late been compelled to assume the attitude of critical observers, if not of careful imitators of other naval powers, and particularly of England.

Driven by stress of circumstances and by force of competition from the proud position so long occupied and so eagerly contended for, of pioneers in armored-ship construction, they have had the wisdom and courage fairly to face their position, and to endeavor to make the best of the condition in which they are placed. With their earlier armored ships growing obsolete, and rapidly becoming worn out or unserviceable, and with very limited means at command, the naval authorities in France had no easy problem to solve when they endeavored to give the best direction to their expenditure in the new programme of the fleets, which was published with their estimates soon after the worst pressure of the Franco-German war had passed away. In arranging this new building-programme, English types, more or less modified, but in the main reproduced, have been taken as models, and English systems of construction have been adopted in lieu of the discarded wood-ship building which previously was almost exclusively in use. Breastwork monitors for coast defense, central-battery armored ships with iron hulls, (with added barbette batteries,) fast unarmored ships with iron hulls, sheathed in wood and coppered, constitute the latest additions to the French navy.

In reviewing their fleets, it is seen that they have perpetuated not merely the forms and approximate dimensions of their unarmored steam-fleet in their armored ships, but have also clung pertinaciously to the old broadside system of armament. Not a sea-going turret-ship has been built.

Their coast-defense vessels (*garde-côtes*) include six turret-vessels, each with a single turret; but all the other vessels in the armored fleet are on the broadside principle, and all sea-going ships are rigged. There are no representatives of the mastless sea-going type to match the English *Dreadnought*, *Devastation*, *Thunderer*, and *Inflexible*, or the Russian *Peter the Great*, or the Italian *Duilio* or *Dandolo*, or analogous vessels of other nations. The revolving turret has found no favor with the French for sea-going ships, although they have adopted, in many cases in association with a broadside armament, the plan of mounting the gun on a revolving platform, and allowing it to fire *en barbette* over a fixed armor-wall or turret. There are in the large ships two of these open-topped turrets on either side of the vessel, and, true to their national instinct of systematic classification, they laid down simultaneously many ships of one design, or differing but in minor details. First of all, in 1858 three of the *Gloire* class were begun, corresponding to the English converted ship *Prince Consort* class, begun three years later; then, after the iron ship *Couronne*, no less than ten vessels of the *Flandre* class, modified from the *Gloire* and not much better, were commenced; while some slight variety was introduced by building a few coast-defense vessels.

In the design of their smaller vessels (*corvettes cuirassées*) for foreign service, the similar uniformity was maintained. After building the first, the *Belliqueuse*, some few changes were made, and then on the amended

design (of which the *Alma* is the type) no less than seven vessels were built.

The *Océan* class of frigates again, contains no less than five, which may be fairly termed sister ships. So, taking the three classes represented by the *Flandre*, *Alma*, and *Océan*, more than twenty ships, or nearly one-half the entire French fleet, will be found grouped therein.

The English Admiralty have pursued a different and a wiser course. Instead of spending their great resources on the construction of ships which were mere *fac-similes* of each other, they have, with rare exceptions in successive designs, made onward steps in offensive and defensive power; from the very first the English designers struck out an independent course.

The *Warrior* was designed in 1858, with an iron hull one-half as long again and 2,000 tons heavier than the largest screw three-decker that had been built before her; and she was considerably faster than any war-ship previously built.

In some respects this venture proved a success, for the *Warrior* is still, after sixteen years' service, sound and serviceable; while all wooden armored vessels, both of previous and subsequent date, are counted out or relegated to harbor service. The precedent established in the design of the *Warrior* has been followed; novelties being daringly introduced and new designs constantly brought forward, until it is difficult to place more than three or four vessels in any one class, by far the greater number of designs having been given shape in not more than one vessel.

Prior to 1873 the only French naval sea-going armored ships in service, built of other materials than wood, were three in number, viz, the *Friedland*, *Héroïne*, and *Couronne*. Neither iron nor steel had hitherto been used in the navy for ship-construction to any considerable extent; the use of steel was limited to masts, boats, and very small vessels; but recently both iron and steel as materials for ship-construction have rapidly gained favor. In the large new armored ship *Redoutable* built at L'Orient, steel has been employed for the frames, beams, deck-plating, bulkheads, the plating behind the armor, and the inner bottom; consequently only the outer bottom and the rivets throughout the ship are of iron. Two other large armored ships, viz, the *Tempête* and *Tonnerre*, are building at Brest and L'Orient with the same distribution of material. The steel has been produced mainly at Creuzot and Terre Noir. All the steel employed in France for naval vessels is made under government inspection at the various manufactories, and it is not tested in the dock-yards upon receipt. The quality is defined by the conditions of official regulations lately issued by the minister of marine, as follows:

Steel plates.—Steel plates are classified under five heads. For plates of the first class the lowest ruling rates will be accepted; for those in the four other classes 2, 4, 6, and 8 francs per hundred kilogrammes (.8l., 1.6l., 2.4l., and 3.2l. per ton) are allowed. The thicknesses of the plates thus classified range from .059 inch to 1.18 inches, and the dimensions from 12 feet 4 inches by 3 feet 11½ inches to 19 feet 8½ inches by 4 feet 7½ inches.

Testing.—The following tests will be required to ascertain the extension of the metal, and its ultimate strength, both longitudinally and transversely, the recorded results in all cases being the mean of at least five independent tests. Test pieces are to be cut from a certain percentage of plates taken at random, which are to be subjected alike to each class of test.

These sample bars are to have in each case a width of 1.3½ inches, excepting those taken from plates less than .197 inch thick, in which cases the width will be reduced to .787 inch, and for plates .708 inch and under, the width will be reduced to the thickness of the plate. The length of the portion submitted to test will be in all cases 7.875 inches, and the test bars will always be annealed. The initial-test load will be such as to produce a strain equal to four-fifths of the load required to rupture the plate. This initial load will be kept on the test piece for a time of five minutes. Additional

weights will then be added at equal intervals of time, probably half-minute periods. The corresponding extension for each increment of load will be carefully noted, and measured on the original length of 7.875 inches. The ultimate extension will be that produced at the moment of rupture.

These test bars to be passed should not break under the initial load, nor give an ultimate extension less than eight-tenths of the maximum final extension mentioned above.

The minimum loads in tons per square inch of the original section and the minimum percentages of extension are given in the following tables. For plates the mean results which should be compared with the table are those which have been obtained in the direction of least resistance.

TABLE I.—Steel plates.

Thickness of plate in inches.	For constructive purposes.		For boilers.	
	Average maximum load.	Average final extension.	Average maximum load.	Average final extension.
	<i>Tons per sq. in.</i>	<i>Per cent.</i>	<i>Tons per sq. in.</i>	<i>Per cent.</i>
.019	30.3	10		
.07 to .118	30.3	12		
.118 to .157	30.3	14		
.157 to .197	29.5	16		
.197 to .236	29.5	18		
.236 to .315	29.0	20	27.0	25
.315 to .787	29.0	20	27.0	26
.787 to 1.181	28.4	20	25.8	25

TABLE II.—Strips and cover-plates.

Thickness of plate in inches.	Longitudinal.		Transverse.	
	Maximum load.	Maximum extension.	Maximum load.	Maximum extension.
	<i>Tons per sq. in.</i>	<i>Per cent.</i>	<i>Tons per sq. in.</i>	<i>Per cent.</i>
.157 to .236	31	18	28.4	16
.236 to .630	31	22	28.4	18
.630 to 1.181	31	22	27.0	17

Hot tests.—These tests will be made with sample plates of suitable dimensions, and consist in stamping a dished cavity, the side of the plates preserving its original plane. The diameter of this cavity is to be equal to forty times the thickness of the plate, and the depth will be ten times this thickness; the flat edge to be joined to the cavity by a curve the radius of which is not to be greater than the thickness of the plate. Moreover, plates more than .197 inch thick will be stamped with a flat-bottomed depression with square angles and straight sides, the diameter of the bottom to be thirty times the thickness of the plate, and the depth ten times the same thickness. The bottom of this cavity will be pierced with a round hole with the metal forced perpendicularly beyond the bottom of the recess. The diameter of the hole to be twenty times the thickness of the plate, and the height of the sides five times the same thickness. All of the corners will be rounded with a curve not of greater radius than the thickness of the plate. The pieces thus tested with every precaution which the working of steel requires, must show no signs of yielding or cracking even when cooled in a brisk current of air.

Tempering tests.—For these tests bars 10.24 inches long by 1.58 inches wide will be cut from the plate longitudinally as well as transversely. These strips will be heated uniformly to a slightly dull cherry-red, and then tempered in water at a temperature of 82°. Thus treated they must be bent in the testing-machine to a curve of which the minimum radius is not greater than the thickness of the bars. These same bars, when the corresponding plates are to be used for boilers, will be bent double in the press

without showing any traces of fracture, and in such a way that the halves of the plate may be in contact. The sides of the bars thus tested, if rounded, can be squared up with a soft file. Plates not coming up to these tests will be rejected.

Angle, Profile, T and I-Irons.—To ascertain the qualities of different classes of profile bars three series of tests will be imposed: 1, cold tests; 2, tempering; and 3, hot tests.

1. *Cold tests.*—These have for their object to ascertain the ultimate strength and properties of extension of the metal. A certain number of pieces will be cut from the webs of bars taken at random, and care will be taken that the cross-sections are almost rectangular, the thickness being that of the web and the width 1.18 inches, except for sections less than .197 inch thick, in which cases the width will be reduced to .787 inch, and for those more than .71 inch thick, while the width will be reduced to the thickness of the plate. The length of the samples tested to be 7.87 inches. The bars will be subjected to tensile strains either by direct weights or by levers, the load increasing up to the point of rupture. The initial load will be such as to produce a strain equal to eight-tenths the breaking strain calculated upon the basis in the following table. The first load will be kept on during five minutes, and the additional loads will be added at half-minute intervals. The ultimate extension is that produced at the moment of rupture, and no samples will be passed which show an extension less than the required amount.

The lowest average loads per square inch of original section under which the bars should break when tested, and the minimum corresponding extensions, are as follows:

Thickness of web in inches.	Angle and profile sections.		T-sections.		I-sections.	
	Average minimum load.	Average ultimate extension.	Average minimum load.	Average ultimate extension.	Average minimum load.	Average ultimate extension.
	<i>Tons per sq. in.</i>	<i>Per cent.</i>	<i>Tons per sq. in.</i>	<i>Per cent.</i>	<i>Tons per sq. in.</i>	<i>Per cent.</i>
.118 to .157	31	18	29.23	18	29.5	16
.157 to .236	31	20	29.23	20	29.5	16
.236 to .63	31	22	29.23	20	29.5	18
.63 to .984	31	20	29.23	20	29.5	18

2. *Temper tests.*—For these tests bars will be cut from the webs of the various sections 10.24 inches long and 1.575 inches wide. The sides of these pieces must not be rounded, but they may be squared up with a soft file. The bar will be heated uniformly to a dull cherry-red, and then cooled in water at 82°. Thus tempered they ought to take under the action of the press a permanent curvature, the inner radius of which must not be greater than one and a half times the thickness of the plate.

3. *Hot tests.*—The angle-bars will be subjected to the following tests: With one piece cut from the end of a bar taken at random from each parcel, a ring shall be made, so that while one web preserves its original plane, the other shall be bent into a circle the inner diameter of which shall not be more than three times the width of the flat web. A piece cut from another bar shall be opened until the inner faces of the webs shall be practically in the same plane, and a third piece shall be closed until the webs come into contact. The samples thus treated shall show no cracks or other imperfections. Plain T-bars shall be subjected to the following tests: A piece cut from the end of a bar taken at random from a parcel, shall be bent into a semicircle, while the vertical web preserves its original plane. The interior diameter of this curve shall not exceed four times the height of the bar. In a piece cut from another bar taken from the same parcel, a horizontal slot will be cut in the middle of the web, of a length equal to the depth of the bar; a hole will be drilled at each end of the slot, in order to prevent the plate from tearing under the test, and that part of the web beneath the slot will then be bent until it forms an angle of 45° with the remainder. Care will be taken to keep the bent portion in the same line with the rest of the web, to which it will be connected by a bend of small radius. No cracks or other imperfections must be developed under this test. Bulb and double T-bars will be tested as follows: At the end of a bar taken at random from the parcel, a horizontal slot will be cut in the center of the web, equal in length to three times the depth of the bar, holes being drilled at the ends as before; then the bar will be bent at one or several heats, until one part thus opened forms an angle of 45° with the other, the portion thus bent being kept in the same plane. In bulb-sections the portion bent will be that carrying the bulb. In all cases the angles must be connected with the straight parts by curves of small radius. All samples failing under these tests will lead to the rejection of the parcel from which they were selected.

Armored ships of France.

Name and class of ship.	Vessel.				Armament.			Machinery.				Cost.				
	Length between perpendiculars, in feet and inches.	Extreme breadth, in feet and inches.	Depth of hold, in feet and inches.	Immersed mid-ship section, in square feet.	Displacement, in tons.	Draught forward, in feet and inches.	Draught aft, in feet and inches.	Number of guns and description.	Height of battery above water, in feet and inches.	Thickness of armor at water-line, in inches.	Number of screws.	Indicated horse-power on trial.	Maximum speed, in knots per hour.	Makers of engines.	Machinery, in dollars.	Ship, completely equipped, in dollars, gold.
Line-of-battle cruisers:																
Redoutable (a).....	311 8	64 6	43 2	1,353	8,658	22 3 7	24 11	4 10.63-inch; 2 12.6-inch; 4 12.6-inch; 2 10.6-inch; 8 5.5-inch.	13 7	1	6,000
Fondroyant (a).....	371 7	66 5	9,630	23 0	24 8	2	14
Dévastation (a).....	371 7	66 5	1,249	9,630	23 0	27 10.6	8 18-ton; 2 12-ton; also, 1 8 18-ton; 2 12-ton; 2 9.45-inch howz-gun.	2 11	14.9	2	6,000	Creuzot.....
Richelieu (b).....	314 0	57 3	28 1	1,249	8,269	24 7	27 10.6	13 4	8.66	2
Colbert.....	314 1	57 3	28 1	1,259	8,167	24 7	27 10.6	8 10.63-inch; 2 9.45-inch howz-gun.	13 4	8.66	1
Trident (a).....	314 1	57 3	28 1	1,259	8,164	24 7	27 10.6	13 4	8.5	1
Friedland.....	314 1	57 3	28 1	1,259	8,164	24 7	27 10.6	13 4	8.5	1
Marogo (c).....	282 10	57 7	34 8	1,267	7,360	24 10	29 14	8 18-ton; 2 12-ton	11 9	7.75	1	3,673	Forges et Chantiers	260,680	1,369,000	
Océan (e).....	282 10	57 7	34 8	1,267	7,360	24 10	29 14	4 18-ton; 4 7-ton	11 9	7.75	1	3,673	260,680	1,362,000	
Suffren (e).....	282 10	57 7	34 8	1,267	7,360	24 10	29 14	11 9	7.75	1	3,673	260,680	1,362,000	
Solférino (d).....	284 0	57 3	27 3	1,225	6,786	24 1	28 0	52 6.3-inch	6 3	4.72	1	4,019	278,320	1,162,280	
Flandre (e).....	258 0	55 9	27 10	1,058	5,703	23 6	26 10	8 12-ton; 4 7-ton	7 3	5.9	1	3,500	269,880	1,066,240	
Gauloise (e).....	258 0	55 9	27 10	1,058	5,703	23 6	26 10	7 3	5.9	1	3,500	269,880	1,066,240	
Guyenne (e).....	258 0	55 9	27 10	1,058	5,703	23 6	26 10	7 3	5.9	1	3,500	269,880	1,066,240	
Magnanime (e).....	258 0	55 9	27 10	1,058	5,703	23 6	26 10	7 3	5.9	1	3,500	269,880	1,066,240	
Provence (e).....	258 0	55 9	27 10	1,058	5,703	23 6	26 10	7 3	5.9	1	3,500	269,880	1,066,240	
Revanche (e).....	258 0	55 9	27 10	1,058	5,703	23 6	26 10	7 3	5.9	1	3,500	269,880	1,066,240	
Savoie (e).....	258 0	55 9	27 10	1,058	5,703	23 6	26 10	7 3	5.9	1	3,500	269,880	1,066,240	
Surveillante (e).....	258 0	55 9	27 10	1,058	5,703	23 6	26 10	7 3	5.9	1	3,500	269,880	1,066,240	
Valenrose (e).....	258 0	55 9	27 10	1,058	5,703	23 6	26 10	7 3	5.9	1	3,500	269,880	1,066,240	
Héroïne (e).....	258 0	55 9	27 10	1,058	5,703	23 6	26 10	7 3	5.9	1	3,500	269,880	1,066,240	
Gloire (d).....	252 3	55 9	26 9	1,068	5,530	23 1	27 10	36 6.3-inch	6 2	4.72	1	2,537	246,960	919,240	
Couronne.....	260 0	54 3	23 0	25 0	10 7-ton; 2 12-ton
For ordinary station-service: (f)																
La Galissonnière.....	230 0	45 9	3,445	17 5	21 0	4 7 1/2-inch; 4 6 1/2-inch	6	1	3,963	Mazeline	274,912	
Triomphante (d).....	230 0	45 9	3,445	17 5	21 0	6	1	3,963	274,912	
Victorieuse.....	230 0	45 9	3,445	17 5	21 0	6	1	3,963	274,912	
Alma.....	230 0	46 3	22 10	781	3,675	18 19	23 9	6 7-ton	6 3	6	1	1,887	127,776	495,860	

Note.—The Rochambeau is no longer borne on the list. a Central battery and four fixed turrets, with guns en barbette; ram bow. b A central battery and two fixed turrets, with guns en barbette; ram bow. c Central battery and four fixed turrets, with guns en barbette; ram bow. d Broadside battery; ram bow. e A central battery and four fixed turrets, with guns en barbette. f Central battery and two open-top fixed turrets; four cylinders to each screw.

Armored ships of France—Continued.

Name and class of ship.	Vessel.				Armament.			Machinery.				Cost.				
	Length between perpendiculars, in feet.	Extreme breadth, in feet and inches.	Depth of hold, in feet and inches.	Turned mid-ship section, in square feet.	Displacement, in tons.	Draught forward, in feet and inches.	Draught aft, in feet and inches.	Number of guns and description.	Height of battery above water, in feet and inches.	Thickness of armor at water-line, in inches.	Number of screws.	Indicated horse-power on trial.	Maximum speed, in knots per hour.	Makers of engines.	Machinery, in dollars.	Ship, completely equipped, in dollars, gold.
For ordinary station-services—Cont'd. (f)																
Armide.....	230 0	45 3	22 10	781	3,675	18 10	23 9	6 3	6	1	1,897	11.8	Mazeline.....	127,776	495,880	
Atalante.....	230 0	46 3	22 10	781	3,675	18 10	23 9	6 3	6	1	1,897	11.8	do.....	127,776	495,880	
Bellepueuse.....	230 0	46 3	22 10	781	3,675	18 10	23 9	6 3	6	1	1,897	11.8	do.....	127,776	495,880	
Jeune d'Arc.....	230 0	46 3	22 10	781	3,675	18 10	23 9	6 3	6	1	1,897	11.8	do.....	127,776	495,880	
Moncaen.....	230 0	46 3	22 10	781	3,675	18 10	23 9	6 3	6	1	1,897	11.8	do.....	127,776	495,880	
Reine Blanche.....	230 0	46 3	22 10	781	3,675	18 10	23 9	6 3	6	1	1,897	11.8	do.....	127,776	495,880	
Thétis.....	230 0	46 3	22 10	781	3,675	18 10	23 9	6 3	6	1	1,897	11.8	do.....	127,776	495,880	
Const-defenders:																
Tonnerre (g) (h).....	241 6	57 9	23 7	1,098	5,495	20 8	21 4	13 5 ¹ / ₂	11 ¹ / ₂	1						
Falmioant (h).....	241 6	57 9	23 7	1,098	5,495	20 8	21 4	13 5 ¹ / ₂	11 ¹ / ₂	1						
Furieux (h).....	241 6	57 9	23 7	1,098	5,495	20 8	21 4	13 5 ¹ / ₂	11 ¹ / ₂	1						
Tempête (h).....	241 6	57 9	19 2	966	4,452	16 9	16 9	13 1 ¹ / ₂	11 ¹ / ₂	1						
Vengeur (h).....	241 6	57 9	19 2	966	4,452	16 9	16 9	13 1 ¹ / ₂	11 ¹ / ₂	1						
Tonnant (h).....	241 6	57 9	19 2	966	4,452	16 9	16 9	13 1 ¹ / ₂	11 ¹ / ₂	1						
Bellier (t).....	216 6	52 6	17 7	831	3,313	17 0	17 0	17 5 8	8	2	1,508	12.5	Creuzot.....	121,968		
Bouledogue (t).....	216 6	52 6	17 7	831	3,313	17 0	17 0	17 5 8	8	2	1,508	12.5	do.....	121,968		
Cerbère (t).....	216 6	53 1	17 7	831	3,702	18 7 ¹ / ₂	19 7 ¹ / ₂	17 5 9	9	2	1,508	11.3	do.....	121,968	668,736	
Tigre (t).....	216 6	53 1	17 7	831	3,702	18 7 ¹ / ₂	19 7 ¹ / ₂	17 5 9	9	2	1,508	11.3	do.....	121,968	668,736	
Taureau.....	216 6	53 1	17 7	831	3,702	18 7 ¹ / ₂	19 7 ¹ / ₂	17 5 9	9	2	1,508	11.3	do.....	121,968	668,736	
Onondaga (j).....	228 7 ¹ / ₂	51 2	13 2	549	2,551	12 3 ¹ / ₂	12 7 ¹ / ₂	1 2 ¹ / ₂	5 ¹ / ₂	2	613	7.07	Quintard, N. Y.	124,369	978,040	
Arrogant.....	144 4	48 5	10 3	385	1,338	8 8	8 8	4 9	4 ¹ / ₂	2	484	6.75	Creuzot.....	39,690	225,400	
Impiscable.....	144 4	48 5	10 3	385	1,338	8 8	8 8	4 9	4 ¹ / ₂	2	484	6.75	do.....	39,690	225,400	
Opuscule.....	144 4	48 5	10 3	385	1,338	8 8	8 8	4 9	4 ¹ / ₂	2	484	6.75	do.....	39,690	225,400	
Enbasade.....	129 7	31 10	13 0	513	1,422	10 2	10 10	3 1	5 ¹ / ₂	2	433	8.5	do.....	39,104	330,280	
Imprenable.....	129 7	31 10	13 0	513	1,422	10 2	10 10	3 1	5 ¹ / ₂	2	433	8.5	do.....	39,104	330,280	
Protectrice.....	129 7	31 10	13 0	513	1,422	10 2	10 10	3 1	5 ¹ / ₂	2	433	8.5	do.....	39,104	330,280	
Refuge.....	129 7	31 10	13 0	513	1,422	10 2	10 10	3 1	5 ¹ / ₂	2	433	8.5	do.....	39,104	330,280	
Floating battery No. 5.	72 0	25 3	5 7	177	1,140	3 3 ¹ / ₂	3 3 ¹ / ₂	2 6	1 ¹ / ₂	2	94	4.21	Forges et Chantiers.	8,131	93,160	
Batteries Nos. 8, 9, 10.	88 7	29 6	5 7	156	280	5 7	5 7	2 5 ¹ / ₂	3	2	99	5.37	do.....	11,228	52,488	

f Central battery and two fixed turrets, with guns en barbette; ram bow. g Turret-ship; ram bow. h In process of construction; turret-ships. i Single turret-ships, ram bow. j Turret-ship.

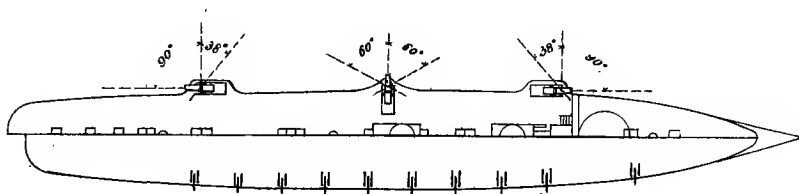
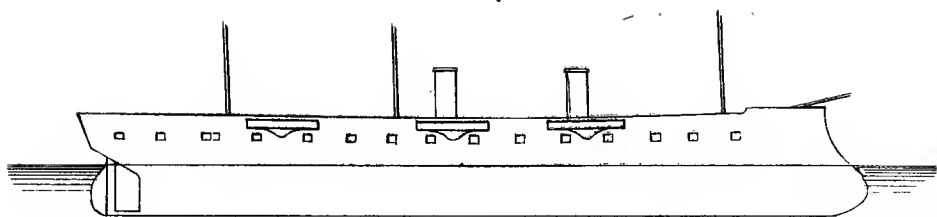

THE DUQUESNE.

THE DUQUESNE AND TOURVILLE.

The above outlines represent the modern French frigate *Duquesne*, recently set afloat at the Rochefort dock-yard. A sister ship, the *Tourville*, is fast approaching completion, under contract, at a yard near Toulon. Both ships are termed cruisers of the rapid type, and are designed for seventeen knots per hour at sea. The frames, bulk-heads, beams, and all interior parts, also masts, are composed of steel; but the outside plating of the hulls is entirely of iron, and the bottoms are sheathed with two layers of teak planks, in all 7 inches thick, and coppered; put on in a similar manner to the system of the English, except that, to insulate the iron from the copper, thick layers of marine glue have been placed between the iron hulls and the teak planks, also between the teak and copper.

The dimensions are as follows:

Length between perpendiculars.....	309 feet.
Length total.....	354 feet.
Breadth at load water-line.....	50 feet.
Draught of water forward.....	20 feet 3 inches.
Draught of water aft.....	25 feet 2 inches.
Displacement, loaded.....	5,340 tons.
Area of sail-surface.....	21,000 square feet.

WEIGHTS.

Weight of hull.....	2,650 tons
Weight of guns and ammunition.....	260 tons.
Weight of engines and boilers.....	1,280 tons.
Coal.....	655 tons.

ARMAMENT.

This consists of twenty-seven guns; twenty of these have a caliber of 14 centimeters, and seven of 24 centimeters, about $5\frac{1}{2}$ and $9\frac{1}{4}$ inches, respectively.

MOTIVE MACHINERY.

The engines and boilers for the *Tourville* were both designed and constructed at the extensive *Forges et Chantiers de la Méditerranée*, at Marseilles. The engines are of a horizontal compound type, and consist of two sets, of four cylinders to the set, making, in all, eight cylinders, having four piston-rods connected to one crank-shaft, to work a single screw; *i. e.*, the four low-pressure cylinders are laid horizontally on one side of the shaft, each having its high-pressure cylinder bolted to the outboard end, the steam being admitted directly from the high to the low pressure cylinders without passing through a receiver. The boilers are of the old box type, braced to carry a pressure of 45 pounds per square inch, and built after the systematic style of the French.

The grate-surface is 950 square feet, and the heating-surface 24,500 square feet. The diameter of the screw-propeller is 20 feet 3 inches. The estimated number of revolutions per minute is 76. The estimated indicated horse-power is 7,500, and the speed at these figures 17 knots per hour. The space occupied by these engines is greater than that occupied by the engines of any single-screw ship I have knowledge of, and the numerous parts and multitudinous connections make the com-

plication great, and will cause serious difficulty with the operation of the machinery, if it does not result in other evils; besides which, the boilers are of the discarded type, and cannot be worked to the pressure necessary to obtain the economy resulting from the compound system; and as the *Tourville* has been built for high speed as the first requirement, it may be regretted that a more simple type of machinery has not been adopted. The French naval authorities, in building this, their first rapid cruiser, have, in many features of the hull, followed the system of the English, and have accepted the errors admitted by the British authorities to exist in their modern frigate the *Shah*.

Besides the original great cost, large cost for maintenance, and unwieldy bulk to handle, the motive power is decidedly objectionable, and the coal supply is only 655 tons.

The motive machinery for the *Duquesne* is from a different design. It is being manufactured at the *Usine d'Indret*.

SMALLER VESSELS.

The corvette *Duguay-Trouin*, building at Cherbourg, is also designed as a rapid cruiser. She is to have 3,180 tons displacement, to make 16 knots per hour on the measured mile, and is intended to compete with the English *Rover* class.

There is also a third class building, of which the *Rigault de Genouilly* is the type. They are to compete with the English *Opal* class. These vessels are 240 feet long, have 44 feet extreme beam, 14 feet 7 inches mean draught, and a displacement of 1,640 tons.

The list appended below contains the names of the vessels building and proposed January 1, 1876. It will give a very good idea of the progress made at that time in reconstructing the French navy.

List of vessels for the French navy building and proposed January 1, 1876.

Name of vessels.	Class.	Kind.	Where built.	Hulls.			Machinery.				Total appropriation for machinery year 1876, in dollars, gold.
				Percentage of work on the hulls, completed on June 1, 1876.	Percentage of work to be done during 1876.	Amount appropriated for each class for 1876, in dollars, gold.	Percentage of work done on machinery Jan. 1, 1876.	Percentage of work to be done during 1876.	Amount appropriated for work on machinery during year 1876, each class, in dollars, gold.		
Redoutable	First class	Iron-clad	L'Orient	73	27	45	33	33	33	218,777	218,777
Foudroyant	do	do	Toulon	12	20	0	33	33	33		
Dévastation	do	do	L'Orient	0	6	0	33	33	33	236,068	236,068
Colbert	do	do	Brest	0	25	0	33	33	33		
Trident	do	do	Toulon	0	21	0	33	33	33	128,038	128,038
N	do	do	Brest	75	22	100	33	33	33		
N	do	do	Industrie	77	23	85	15	15	15	85,653	85,653
Triomphante	Second class	do	Rochefort	62	15	100	15	15	15		
Victorieuse	do	do	Toulon	77	23	100	15	15	15	11,290	11,290
Turenne	do	do	Cherbourg	0	4	0	15	15	15		
N	do	do	do	20	0	0	15	15	15	38,200	38,200
N	do	do	Industrie	0	9	0	15	15	15		
Fulmigeant	First class	do	Cherbourg	92	95	94	56	56	56	218,777	218,777
Tonnerre	do	do	L'Orient	80	20	190,161	6	6	6		
Fortieux	do	do	Cherbourg	6	14	0	0	0	0	4,312	4,312
N	do	do	Toulon	0	15	0	0	0	0		
N	do	do	Industrie	0	24	0	0	0	0	85,653	85,653
Tempête	Second class	do	Brest	63	28	81,341	0	50	50		
Vengeur	do	do	do	10	10	0	0	50	50	11,290	11,290
Tonnant	do	do	do	15	15	0	0	50	50		
Lutin	First class	Iron gunboat	Rochefort	55	40	12,505	25	75	75	23,795	23,795
N	do	do	Cherbourg	55	40	0	25	75	75		
Lyon	do	do	do	90	24	0	92	24	24	100,353	100,353
Milan	do	do	do	14	14	0	25	25	25		
Vautour	do	do	Rochefort	53	20	61,153	10	40	40	38,200	38,200
Duquesne	do	do	do	53	20	0	10	40	40		
Tourville	do	do	La Seyne	80	20	0	75	25	25		

List of vessels for the French navy building and proposed January 1, 1876—Continued.

Names of vessels.	Class.	Kind.	Where built.	Hulls.			Machinery.			Total appropriation for machinery and hulls for the year 1876, in dollars, gold.
				Percentage of work on the hulls completed on June 1, 1876.	Percentage of work to be done during 1876.	Amount appropriated for each class for 1876, in dollars, gold.	Percentage of work done on machinery Jan. 1, 1876.	Percentage of work to be done during 1876.	Amount appropriated for work on machinery during year 1876, each class, in dollars, gold.	
La Pérouse	Second class	Cruising-ship	Cherbourg	92	90	\$39,984	0	0	\$10,973	\$50,957
Duguay-Trouin	do	do	do	59	26					
Duport-Thouars	do	do	Brest	100	0	21,991	0	0	25,480	47,471
Villars	do	do	do	19	15					
Rigault de Genonilly	Third class	do	do	38	35	68,561	0	0	29,361	97,922
Eclaireur	do	do	Toulon	55	40					
Four transports	do	do	Cherbourg	79	15	0	0	0	0	0
	do	do	do	48	20					
	do	do	do	0	26					
	do	do	do	0	20					

PART XII.

THE GERMAN NAVY.

THE DEUTSCHLAND; THE BORUSSIA OR PREUSSEN; TABLE OF DIMENSIONS, &c., OF ARMORED SHIPS OF GERMANY.

THE GERMAN NAVY.

The public mind in Europe has for some time been directed to the growing power of Germany at sea, and friendly people have looked, not without some degree of admiration, upon the earnest and business-like efforts of that practical-minded nation to attain a position at sea somewhat commensurate with her position on land.

The German navy commenced only about twenty-seven years ago with one sailing-corvette and two gunboats. Two years afterward it was increased by two steamers and forty gunboats, consequent upon the Danish war and the subsequent blockade of the Baltic ports; and, in the two succeeding years the addition was made to it of four more vessels, viz, a brig, two dispatch-boats, and a corvette. From this time up to the year 1860, the German navy was steadily increased by the addition of wooden vessels, until the total of 31 steamers, 8 sailing-ships, and 42 gunboats had been reached. But it was not until after the year 1860, when the building of armored ships was first commenced, that the German navy began to take rank among the navies of Europe. About this time it was determined by the authorities at Berlin to increase the navy by the addition of several armored ships. Two, viz, the *König Wilhelm* and *Arminius*, were built in England. Some were built in France at the Forges et Chantiers, on the Mediterranean, and others in Prussia. But after the close of the Franco-Prussian war, when Germany became united, the imperial German government deemed it necessary to increase and build up a navy commensurate with the wants and interests of a powerful empire. Accordingly, a number of ships were about that time ordered, including in the list 5 armored frigates. Two, viz, the *Kaiser* and *Deutschland*, from the designs of Mr. E. J. Reed, late chief constructor of the British navy, were contracted to be built by Messrs. Samuda Brothers, of London; two, viz, the *Grosser Kurfürst* and the *Friedrich der Grosse*, were ordered to be built at the imperial dockyards of Wilhelmshafen and Kiel; another, the *Borussia*, was contracted for by the Vulcan Engineering Company, at Brėdów, near Stettin. The drawings and specifications for the three last-named ships were prepared at the Admiralty in Berlin. The two frigates built in England are designed as cruisers. They have a central battery, and are in general feature and arrangement similar to the British frigate *Hercules*, but differing in numerous points of detail. The last one was just completed on my arrival in England.

THE DEUTSCHLAND

is about 285 feet long, with a breadth extreme of 62 feet, load draught 24 feet 6 inches, and a displacement of 7,600 tons. The system of framing is unique; both the outer and inner frames are of continuous angle-iron, between which the longitudinal plates and angle-irons are worked. She is built on the bracket-plate system, like the *Invincible* class of ships; and has a depth of 40 inches in the vertical keel, while her longitudinals diminish to 33 inches in breadth, and then increase to 45 inches at the armor-shelf. There are no wing passages, but she is divided into compartments by transverse water-tight bulkheads; and

the double-bottom is in 32 water-tight compartments, so that in striking a rock it is expected that not more than four could be filled with water at once, the cubic capacity of the four being about 40 tons.

She has one central battery on the main-deck, carrying four guns on each side; of which the forward ones fire 3° within the fore-and-aft line, and thus afford a converging fire ahead; while the embrasures are so arranged that the fire of all the guns on one side may converge at a point 276 feet or about one ship's length distant. This battery overhangs the side about 3 feet 6 inches at the forward end and 1 foot 6 inches at the after end, but it is within the extreme breadth of the ship, and the ports are fitted with heavy forgings on a new plan, so as to protect the gunners as much as possible. The guns are Krupp's 26-centimeter steel breech-loading cannon, having a bore of about $9\frac{3}{4}$ inches, and weighing about 22 tons each. To complete the all-round fire, a Krupp 22-centimeter gun of $8\frac{1}{2}$ -inch bore, weighing about 18 tons, is placed on the main deck aft, and is capable of being trained to an angle of 15° on each side of the middle line, and protected with armor-plates. The height of the port-sills above the load water-line is 11 feet. The armor at the water-line, in the wake of the engines, boilers, and magazines, is 10 inches thick, and elsewhere on the belt it is 8 inches amidships, tapering to 5 inches forward and aft. In the central battery it is 10 inches at the port-sills, 8 inches on the sides, and 7 inches on the bulkheads. The wood-backing is of teak, 10 inches thick, placed upon two thicknesses of $\frac{5}{8}$ -inch plate, which are supported by 10-inch frames, spaced 2 feet apart. The armor on the belt abaft the battery extends 5 feet 6 inches below the water-line and 6 feet 6 inches above it, while in front of the battery it extends to 2 feet 6 inches above the water-line, up to the lower deck, which is covered with protective plating in two thicknesses, 2 inches thick for 10 feet in front of the battery bulkhead, and $1\frac{1}{2}$ inch thick from this forward. There is an armored bulkhead at each end of the battery, the forward one extending down to the lower deck in order to protect the engines and boilers against a plunging fire. The upper and main decks and part of the lower deck are also protected with plates.

The portion of the upper deck over the battery is covered with $\frac{3}{8}$ -inch steel plates, and $\frac{1}{4}$ -inch plates before and abaft it; while the entire surface of the main deck is covered with steel plating $\frac{1}{2}$ -inch thick abaft the battery, and $\frac{1}{4}$ -inch thick in the battery and forward of it. The lower deck is not plated abaft the forward armor bulkhead. The ship is supplied with a very efficient system of arrangements for pumping out or flooding the compartments, &c. The capstan and fire-engine are worked by an auxiliary steam-engine, which can be supplied with steam either from the main boilers, or, in case steam is not up in them, from a small separate boiler attached to the engine. The hawse-pipes are placed in the upper deck, and therefore special arrangements have been made for the bits. The steering-wheel, engine-rooms, and battery can be communicated with by means of a telegraph placed on the upper deck, and protected by armor-plates, and close to them a small armor-shield is fitted, behind which two officers could, if necessary, hold a consultation. Deviating from the usual custom, the sick-berth is in this ship placed on the main deck, instead of on the lower deck. The bottom of the vessel has been coated with Redman's anti-fouling composition, which proved so successful in the trials in the Medway, and of which mercury is the chief ingredient used to resist fouling.

The machinery was designed and constructed by Messrs. Penn & Son. The engines are of the old type, horizontal, direct-acting, with

trunks; they are of the collective power of 8,000 indicated horses. The diameter of the cylinders is 122 inches, length of stroke 4 feet, and the maximum speed of pistons is 75 revolutions per minute. A speed of 13 knots per hour was attained at sea. The boilers are of the box type, and are eight in number. The *Deutschland* is ship-rigged, has an area of 3,900 square feet of canvas with all sail set, and an area of plain sail of 2,800 square feet. The screw is fixed, and made to revolve when the ship is under sail. It will be seen from the above that the *Deutschland* and sister vessel are powerful armored frigates.

THE BORUSSIA OR PREUSSEN.

For the following particulars of this vessel I am indebted to the *Zeitschrift des Vereines deutscher Ingenieure*:

This vessel is an armored-turret sea-going ship, similar to the British ship *Monarch*. The length between perpendiculars is 308 feet 6 inches; extreme length, 318 feet; extreme breadth, 53 feet 6 inches; depth from the upper deck to the keel, 34 feet 10 inches; displacement, loaded, 6,748 tons; load-draught of water, mean, 23 feet 8 inches.

THE HULL.

The keel consists of two horizontal plates riveted together, upon which are fastened at the middle, by means of two angle-irons, a vertical plate 3 feet 10 inches high, extending to the two posts, to which all the plates forming the keel are connected by bolts and rivets. Four longitudinal frames stand almost vertically upon the outer skin, and their depth, which up to the fourth longitudinal frame is 31 inches, decreases gradually from the keel, running in the same direction as the latter, but approaching it fore and aft as required by the shape of the vessel. These longitudinal frames are made of plates and angle-irons, and are lightened at intervals by large oval holes. The cross-frames from the keel to the fourth longitudinal frame, and placed at distances apart of 4 feet, are made of short angle-irons extending only from one longitudinal to the other, to which they are connected by full plates, brackets, or angle-irons. The plates have the height of the corresponding longitudinal frames, and those belonging to one cross-frame are connected at the top by means of an angle-iron extending from side to side, through all the longitudinal frames and the keel. The outer skin is riveted to the longitudinal and cross framing, and to the inner side of the latter is secured the second skin, over a length of 180 feet; the end cross-frames and nine intermediate ones have full plates, so as to form longitudinal water-tight compartments, which are again divided by the vertical keel, and are thus inclosed fore and aft by a complete water-tight cross-frame, at the top of the inner bottom plates, at the bottom of the outer skin, and at the sides, by the vertical keel-plate and the fourth longitudinal frame.

Similar water-tight compartments are formed by the frames fore and aft of the double bottom, so that the extreme ends are as far as possible protected against casualty. Above the fourth longitudinal frame the distance between the cross-frames is 2 feet, and the latter extend from this longitudinal frame to the armor-framing, which runs from the front to the back, and which is constructed, like the longitudinal frame, of plates and angle-irons. The cross-framings above the armor-framing are thrown back as much as the thickness of the armor, inclusive of the teak backing, and consists of heavy angle-irons $9\frac{3}{4}$ by $3\frac{1}{2}$ inches by $\frac{1}{2}$ inch, which are fastened to the inner edge of the plates of the cross-frames above the fourth longitudinal, and which are provided at the outside

with two angle-irons for the fastening of the outer skin behind the armor. These frames behind the armor extend in the central part of the vessel, that is to say, within the limits of the armored casemate, to the upper deck, but fore and aft of the casemate to the battery-deck only, or the height of the armored belt for the two ends of the vessel. The extension of the frames at both sides of the casemate to the upper deck is formed of light angle-iron; the parts of the vessel above the battery-deck being altogether constructed of light material. A water-tight partition of plates strengthened by angle-irons is erected almost parallel with the outer skin of the vessel at each side, over the length of the double bottom, and extends from the latter to the battery-deck, at a distance from the outer wall of the vessel of about 3 feet; these partitions connected with the double bottom and battery-deck form the bulkheads of the gangway, and they will serve to prevent the entrance of water during action into the other parts of the vessel. The space formed by these partitions and the outer skin is further divided longitudinally, by water-tight cross-frames, so that even here only small spaces can be filled with water, which can easily be removed by pumps. The gangway will serve besides, during action, as a free passage to effect provisional repairs of damage done by shells. The outer skin of the vessel in the bottom has the almost uniform thickness of .6 inch, but is doubled at the two extreme ends. The skin behind the armor consists of two .62-inch plates, while that above it at the two ends of the armored casemate has a thickness of .4 inch. Much care was used in riveting up the hull, and rivets with a conical enlargement under the head corresponding with the cone of the holes are used throughout. The decks are carried on girders of T and I irons. The upper deck is covered to a great extent, the battery-deck entirely, and the between-deck at several places with iron plates from $\frac{1}{4}$ to $\frac{3}{8}$ inch thick, upon which are fastened the deck-planks; the places for the capstan, hawse-holes, timber-heads, &c., are especially strengthened, and the deck-beams are supported by wrought-iron tubes which have under the turrets a diameter of $7\frac{1}{2}$ inches and a thickness of metal of $\frac{3}{8}$ inch. The vessel is divided below the battery-deck by eleven water-tight cross-partitions into twelve compartments, which are connected with each other by water-tight doors. Two of these partitions, one at the front and the other at the rear of the casemate, extend to the upper deck, and serve between the latter and the battery-deck for the reception of armor-plates which are to protect the casemate against shells that may penetrate through the two ends of the vessel.

Special care is taken to maintain effective communication between the pumps and the whole of the water-tight compartments. For this purpose an iron pipe $12\frac{1}{2}$ inches in diameter is placed close to and parallel with the vertical keel-plate over the length of the double bottom; from this pipe, branches extend to the various compartments; the main pipe carries the accumulated water into a reservoir placed under the engine-room, whence it is pumped away by a $12\frac{1}{2}$ -inch Downton pump, as well as by all the pumps in connection with the machinery. Four $9\frac{1}{4}$ -inch pumps are besides placed upon the battery-deck, each of which can draw the water from a certain number of compartments; one can also be used for filling the tanks with drinking-water.

ARMOR.

An armored casemate surrounds the two turrets, which project 6 feet 2 inches above the upper deck. This casemate is separated from the fore and aft parts of the vessel by armored transverse bulkheads, while

those parts are protected only between wind and water by an armored belt reaching from about 6 feet 2 inches below water to the battery-deck. The armored casemate is 90 feet 6 inches long; rising through it from the battery-deck are the turrets; also a second steering-wheel, to be used during action. The armor-plates at the water-line are $9\frac{1}{4}$ inches thick, below the water $7\frac{1}{4}$ inches, and above water $8\frac{1}{4}$ inches; these thicknesses decrease toward the ends to 4 inches; behind these plates there is a backing of teak about $10\frac{1}{2}$ inches thick, but varying with the thickness of plates. Angle-irons are used for fastening this layer of teak to the outer skin. The armor-plates are secured by means of bolts $2\frac{1}{2}$ inches in diameter, with conical heads fitting exactly in corresponding holes in the plates. The nuts of the bolts for the armor-plates are provided with double washers, between which a thickness of rubber is placed, in order to prevent as far as possible the tearing off of the bolt-heads when the armor-plates are struck by shot. The armored cross-walls have plates 5 inches thick, with a teak backing $8\frac{1}{4}$ inches thick.

TURRETS, ETC.

The two turrets are each 26 feet 9 inches in diameter; the shells are made in the usual way. They extend, as already stated, from the battery-deck to 6 feet 2 inches above the upper deck, and are covered with armor only at the parts exposed above the upper deck. The plates of these turrets are $8\frac{1}{4}$ inches thick, with the exception of those through which the port-holes for the guns are cut, and which have a thickness of $10\frac{1}{4}$ inches. The teak backing between the shells and armor-plates is $8\frac{1}{4}$ inches in thickness. These turrets revolve around strong cast-iron center-pins secured vertically upon the battery-deck, and the outer circumferences of the turrets take their weights, and revolve on conical rollers, running upon rails laid on the deck. Each turret is operated by a high-pressure engine with two cylinders $10\frac{1}{4}$ by $10\frac{1}{4}$ inches, besides which, hand-gear for working by manual labor is provided. The ammunition is brought from the battery-deck into the turrets through openings the tops of which are covered by plates 1 inch thick. The port-sills of the turrets are 13 feet $5\frac{1}{2}$ inches above the water-line.

The *armament* in the turrets consists of four Krupp rifled guns, about $10\frac{1}{2}$ inches in bore and 22 tons in weight, besides a lighter gun forward and one aft.

The upper deck is provided only in the middle above the turrets with a light platform for the reception of the chart-house, and there is a raised fore-castle. A light screen for the protection of the crew is arranged so that it may be laid down, in order to be out of the way of the guns of the turrets, which lie close to the upper deck.

The *Borussia* has three masts, made to be used as ventilating-tubes, and she is a full-rigged frigate. The motive engines are of the three-cylinder type, and the boilers of the box variety. The screw is fixed, and fitted to revolve when the ship is under sail.

MATERIALS.

The following are the weights of materials used for the hull of the vessel, the masts, and the turrets: Plates, 1,375 tons; angle-irons, 600 tons; bar iron and large forgings, 33 tons; iron for rivets, 115 tons; cast iron, 100 tons.

Exceptional strength of material was required. For the plates two qualities were specified, the first to be used for all main parts, such as

the keel, longitudinal frames, outer skin, deck-plates, &c., while the other quality was used for the cross-frames, gangways, coal-bunker and transverse bulkheads, &c. The tests were made as follows: Out of each five tons of plate one sample plate was selected; of which, again, sample pieces were taken, which had to be tested for absolute and relative strengths, with and across the fibers, both cold and hot. In order to test the absolute strength, the sample-pieces were torn asunder by means of a testing-machine; the pressure required for plates of the first quality was, for longitudinal strain, 49,677 pounds per square inch, with 7 per cent. extension; for cross-strain, 40,447 pounds per square inch, with 5 per cent. extension; for plates of second quality, in the longitudinal direction, 44,705 pounds per square inch, with 5 per cent. extension, and for cross-strain, 39,000 pounds per square inch, with 3 per cent. extension. The relative strength of the plates was tested by bending them over the rounded corner of a test-plate up to a certain angle, both cold and hot, by means of slight blows with a hammer. The angles differ for the various thicknesses and qualities of plates, and the iron must show no fracture or cracks. For angle-iron and special sections one quality only is allowed, which must sustain in tension a strain of 49,677 pounds per square inch, and must give an extension of 7 per cent. Great care was also taken in the forging tests. All the materials were furnished by German manufacturers, except the stern-post and the armor-plates.

OTHER VESSELS.

Germany has now thirteen armored ships afloat, three of which are turret-ships, viz: the *Preussen*, the *Friedrich der Grosse*, and the *Grosser Kurfürst*. The first of these was built at the private dock-yard of the Vulcan Company at Stettin, and was launched in 1873; the second was built at Ellerbeck, near Kiel, and launched in 1874, and is being completed at the Kiel dock-yard; the third was constructed at the Wilhelmshafen dock-yard, launched in 1875, and at the date of my visit was sufficiently advanced toward completion to receive the armor-plates and turrets. These vessels are full-rigged ships, constructed after the model of the British ship *Monarch*, and engined by a Berlin factory. The boilers of the *Grosser Kurfürst* are of the old box type, and the engines are intended to be worked either compound or non-compound, as desired—an arrangement, in view of the low pressure of steam, not to be commended.

The Germans have also three broadside frigates, viz: the *König Wilhelm*, built at the Thames Iron Works, London, and at the time of her construction reckoned to be a powerful vessel; the *Kron-Prinz*, built by Samuda on the Thames; and the *Friedrich Karl*, built in France, near Toulon. There are two citadel frigates, the *Kaiser* and the *Deutschland*, above described. There are also two armored corvettes, the *Leipzig* or *Arcona* and the *Hansa*, both built by the Vulcan Company, near Stettin; the monitor *Arminius* and the little armored vessel *Prinz Adalbert*; the former built in France, and the latter by Samuda at Poplar, on the Thames. There is the corvette *Elisabeth*, repaired and fitted at Dantzig in June for a cruise to America. Besides the above-mentioned vessels actually afloat, they have three new unarmored corvettes: the *Ariadne*, the *Freya*, and the *Louise*, of 1,258 tons; also a larger vessel, the *Thusnelda*, of 1,846 tons. The old wooden frigates, such as the *Hertha* and *Medusa*, and other vessels with auxiliary steam-power are obsolete, and may be considered useless as fighting-vessels.

The ships of the German navy are armed with Krupp's steel breech-loading guns. In these weapons the German officers have great confidence. No originality has yet been exhibited in naval architecture by the German constructors or engineers. It has been thought sufficient to repeat the types which the English have tried and found successful, and as a consequence of this, considering the long period of time it has taken them to build an armored ship, and the advancement recently made in naval construction in England, they are now completing types far inferior to the late English designs, and they will have nothing to match the *Thunderer*, *Devastation*, or *Dreadnought*, nor the Russian *Peter the Great*, nor the Italian *Dandolo* and *Duilio*, to say nothing of the *Inflexible*.

The German naval authorities, however, have not overlooked the progress being made elsewhere in the construction of rapid unarmored ships, and with the view of keeping pace in this respect with other continental powers, they have designed and placed on the stocks two vessels of the rapid type, the speed of which is to be $15\frac{1}{2}$ knots per hour; they have also completed one fine specimen of a torpedo-boat—the *Ziethen*, hereafter to be described—which made $16\frac{1}{2}$ knots per hour on the trial at the measured mile, besides one which is building; and some other types are to be put in hand, all of which, when finished, will raise the German fleet to a very respectable degree of strength.

DOCK-YARDS.

The two principal naval dock-yards of Imperial Germany are located at Kiel, on the Baltic, and Wilhelmshafen, on the North Sea. The latter invited special attention and examination, not only because of its greater importance as a construction-yard, but also in consequence of its being the most-modern of all the European dock-yards. It was laid out on clear ground as late as 1871, and the works were commenced with an appropriation for them of about \$10,000,000. The engineer selected by the Admiralty at Berlin to make the designs and plans, previous to beginning his work made visits of observation and study to the leading European yards. The plans subsequently produced by him for this important naval establishment, and from which the works and buildings up to this time have been constructed, are most excellent in their general arrangement as well as in the design of the buildings themselves. Those already completed present an outward uniform appearance not found in dock-yards elsewhere. They are built one story high, of stone, brick, iron, and glass; and such of them as are to be used for mechanical operations are grouped in three spans to each building, and well lighted from the sides as well as from the roofs. These are supplied with the best kind of machinery and appliances. Several buildings are yet to be erected on sites properly located on the general plan, and one novel arrangement in the design, but not yet commenced, is a canal to convey fresh water from a distance into the basin in the yard.

The plan of the dock-yard following shows, as will be seen, the design and location of all the works and buildings, and any other drawings desired can doubtless be secured from the liberal naval authorities of Germany.

In the annexed table will be found the principal dimensions of the ships of the German armored fleet.

Armored ships of Germany.

Name of ship.	Class.	Vessel.						Armament.				Machinery.		
		Length between perpendiculars, in feet and inches.	Extreme breadth, in feet and inches.	Depth of hold in feet and inches.	Immersed mid-ship section, in square feet.	Displacement, in tons.	Draught forward, in feet and inches.	Draught aft, in feet and inches.	Number of guns and description.	Height of battery above water, in feet and inches.	Thickness of armor at water-line, in inches.	Number of screws.	Maximum speed, in knots per hour.	Makers of engines.
Kaiser	Casemate frigates.	280	62 4	1,336	7,560	24 2	24 8	8 10-inch Krupp; 1 8-inch Krupp.	13 7½	10	1	14.56	Seimda Bros.
Deutschland *	do	280	62 4	7,560	24 2	24 8	do	11 0	10	1	14.47	John Penn & Son.
Preussen	Turret-ship	308 6	53 6	34 10	9,643	23	24 8	4 10.24-inch Krupp; 2 6.7-inch Krupp.	13 5½	9½ & 1¼	1	Vulcan Engineering Company, Stettin.
Grosser Kurfürst	do	298 3	52	23 11½	1,143	9,663	22	22 11½	4 10-inch Krupp; 2 6¼-inch Krupp.	8 5	8 & 1¼	1	Egells.
Friedrich der Grosse.	do	307	2,678	6,663	23	24 8	do	9	1	Do.
König Wilhelm I.	Broadside frigate	352 8	60	25 8	1,269	9,425	24 3	26 6	26 Krupp guns of 8.27 inches.	9 11½	8 & 1¼	1	14.71	Mandalay.
Kron-Prinz	do	286	5,480	5,480	22 8	24 6	16 Krupp guns of 8.27 inches.	7 6	5	1	14.25	Penn.
Prinz Friedrich Karl I.	do	290	54 6	1,047	5,934	22 0	23 11½	2 11-inch; 6 7¼-inch	5	1	13.58	Forges et Chantiers.
Hansa	Corvette	235 2	45	3,553	17 6	21 7	2 11-inch; 6 7¼-inch	6	1	Vulcan Company.
Arcona §	do	Do.
Arminius 	Monitor	197 4	36	1,583	12 5	13 7	4 bronze 8.3-inch guns.	4.61&60.7	1	11
Prinz Adalbert	do	159 9	1,479	13 2	15 9	1 8½-inch; 2 6¼-inch	4½	1	10.24
1 corvette, (no data)

* Indicated horse-power, 8,000. † Indicated horse-power, 8,345. Total cost, \$2,442,160.
 ‡ Indicated horse-power, 3,363. Total cost, \$1,562,120. § In process of construction. || Total cost, \$456,680.

DOCK YARD of WILHELMSHAVEN

1875
Scale = 1:5000

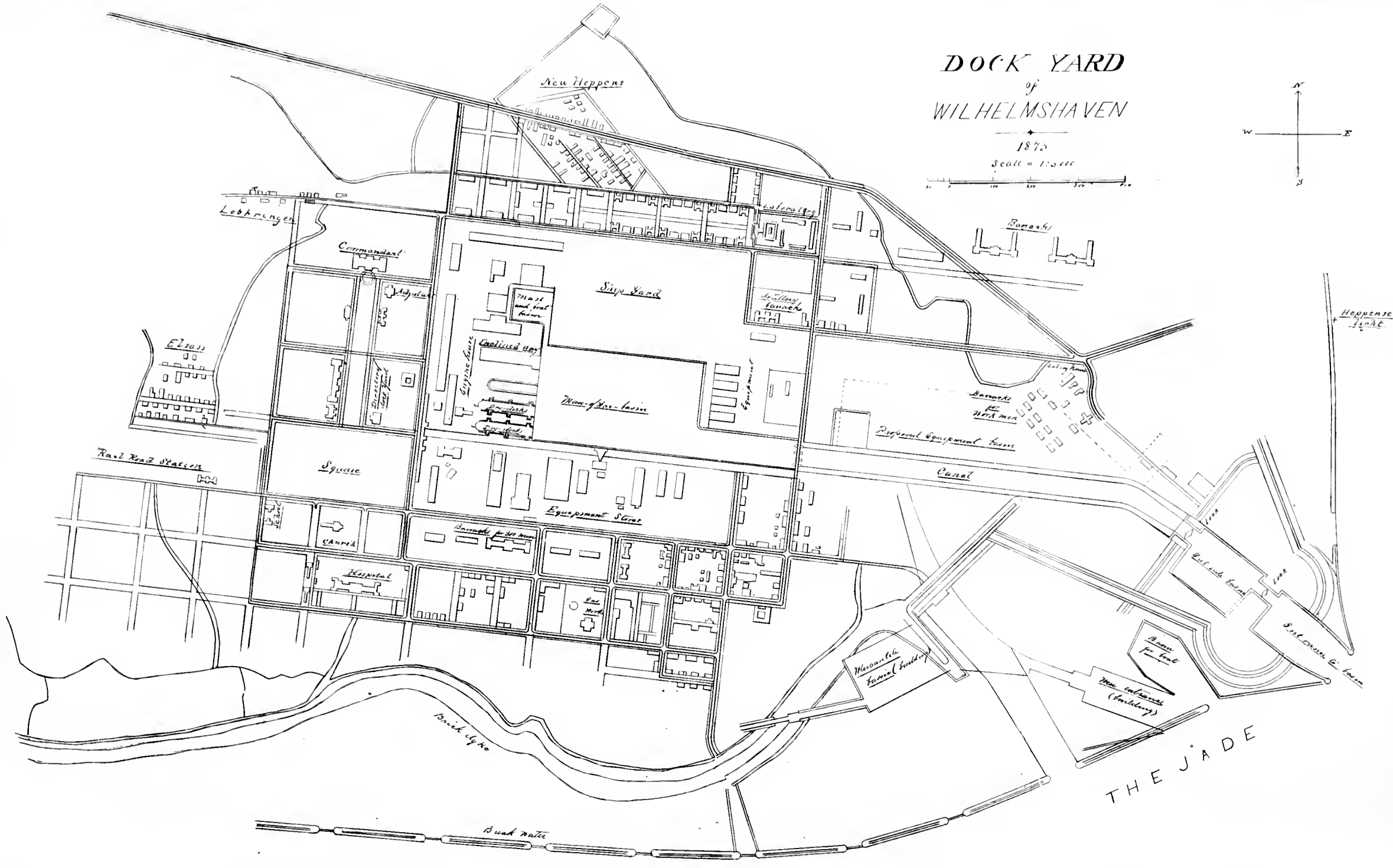
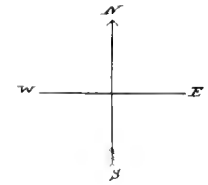

THE JADE

PART XIII.

THE ITALIAN NAVY.

THE DUILIO; THE HUNDRED-TON GUN; THE DANDOLO; THE CRISTOFORO COLOMBO; TABLE OF DIMENSIONS, &c., OF ARMORED SHIPS OF ITALY.

THE ITALIAN NAVY.

The fleet of which Italy could actually dispose at the beginning of last year was composed as follows: Fourteen armored ships, of which six were already armed and constituted the permanent squadron of the Mediterranean, four were ready to be armed at short notice, and four required considerable repairs before they could be sent to sea; seven gunboats, of which three were outside the Mediterranean, two armed and in the Mediterranean, and two ready to be armed; nine wooden frigates or corvettes, of which two were beyond the Mediterranean, three armed and in Italian ports, two capable of being armed in a few days, and two others requiring repairs; six dispatch-boats, of which three were armed, one of which could be ready for sea at short notice and two after a few weeks; six transports, of which the three largest were armed; and eighteen smaller vessels, of which one was on foreign service, three armed, and fourteen ready to be armed. These ships carry a total of 490 guns, of which thirty of those on the armored ships are of heavy caliber.

The changes and improvements in all branches of administration and industry during the past quarter of a century, and especially in mechanics, force themselves on the observation of one acquainted with Italian ports and cities in years past. The spirit of advancement and progress is seen to advantage in the reconstruction of the navy. So far has it been pushed here that the late minister of marine at Rome, when he took office, is said to have condemned as obsolete, and recommended the sale of no less than seven armored ships out of the total of fifteen, although some of these condemned vessels were quite new, because they did not reach the standard set up for modern fighting-vessels. I believe the plan has not as yet been carried out in its entirety, and probably will not be until after the more formidable ships now under construction shall have been completed.

THE DUILIO AND THE DANDOLO.

These two powerful armored sister-ships, the former building at Castellamare, and the latter at Spezia, in the Mediterranean, have been designed to outdo the British *Inflexible* and every other fighting-ship afloat.

The *Duilio* was commenced at Castellamare in 1873, and launched in May of last year.

The general design as to the location of turrets is similar to that of the *Inflexible*, and although this vessel was commenced before the *Inflexible*, it is claimed by Mr. Reed, late chief constructor of the British navy, that the original conception belongs to him.

The length of the <i>Duilio</i> between perpendiculars is ..	339 feet	7 inches.
Beam, extreme	64 feet	7 inches.
Draught of water, average.....	25 feet	11 inches.
Height of main deck above water.....	11 feet	6 inches.
Height of battery.....	15 feet	9 inches.
Displacement in tons, English, at load-draught.....		10,650

The hull is built of iron and steel, on the cellular system. The double bottom extends for upward of 230 feet in length, and is divided both

longitudinally and transversely into a great number of water-tight compartments. Each compartment is provided with a branch-tube which is connected with one principal tube in communication with powerful steam-pumps. The tubes are, of course, fitted with the necessary valves, so that in the event of damage to the bottom of the vessel, or for any desirable purpose, any one or more of the compartments may be drained or filled with water. There is a central armored citadel or compartment, 107 feet in length and 58 feet in breadth, which descends to 5 feet 11 inches below the load water-line. It protects the machinery and boilers, the magazines and shell-rooms, and a portion of the machinery for working the turrets and guns. Forward and aft of this citadel, the decks, which are 4 feet 9 inches under water, are defended by horizontal armor. Over this citadel is built a second central armored compartment which incloses the bases of the turrets and the remaining portion of the mechanism employed in loading and working the guns. Lastly, above this second compartment rise the two turrets. The position of the turrets in the *Duilio* was made the subject of a novel arrangement, and one which was tried for the first time in that vessel. They are placed at each end of the central armored citadel—not in an even line with each other, but diagonally at opposite corners of it, with the centers at the distance of 7 feet 8 inches from the longitudinal center-line of the vessel, so that one turret is on the starboard side and the other on the port side. The effect of this arrangement is to render possible the discharge of three guns simultaneously in a direction parallel with the keel. Only the central portion of the ship and the two turrets will be protected by vertical armor.

As regards the armor of the central portion of the vessel, the thickness of which at the water-line is to be 22 inches, it had not been decided whether the plates should be made in one or two thicknesses; that was to depend on the results of comparative experiments made at Spezia by shots discharged by the 100-ton gun, and guns of 10 and 11-inch calibers, against targets constructed on four different systems of steel and iron from three manufacturers. The decks are protected by horizontal armor of iron and steel, the former being under the latter. The armor of the turrets will be composed of solid plates 19 inches in thickness, resting upon teak backing.

ARMAMENT.

The original intention was that the armament should be composed of two 60-ton guns in each turret; subsequently it was decided to employ 100-ton guns, and the opinion prevails that this decision was reached after the fact became known that the *Inflexible* would be armed with 81-ton guns. These 100-ton guns, four for each ship, are being manufactured by Sir William Armstrong, at the Elswick Works, Newcastle-on-Tyne, England; the first one of the number having just been completed ready for shipment to Italy, to undergo the necessary experimental firing-tests, at the time of my visit to Elswick.

The accompanying drawing illustrates the construction of the gun—the heaviest and most powerful piece of ordnance in the world. It is built up according to the well-known Armstrong system, the inner barrel or tube being of steel, rifled with twenty-seven grooves, the spaces between which are nearly equal to the width of the grooves themselves. The rifling has an increasing pitch, commencing at the chamber with 1 in 150 calibers, and increased to 1 in 50 calibers. The depth of the grooves is $\frac{1}{8}$ inch throughout. The steel barrel is 31 feet 3 inches long, 6 inches

Targets fired at by the 100-ton gun.

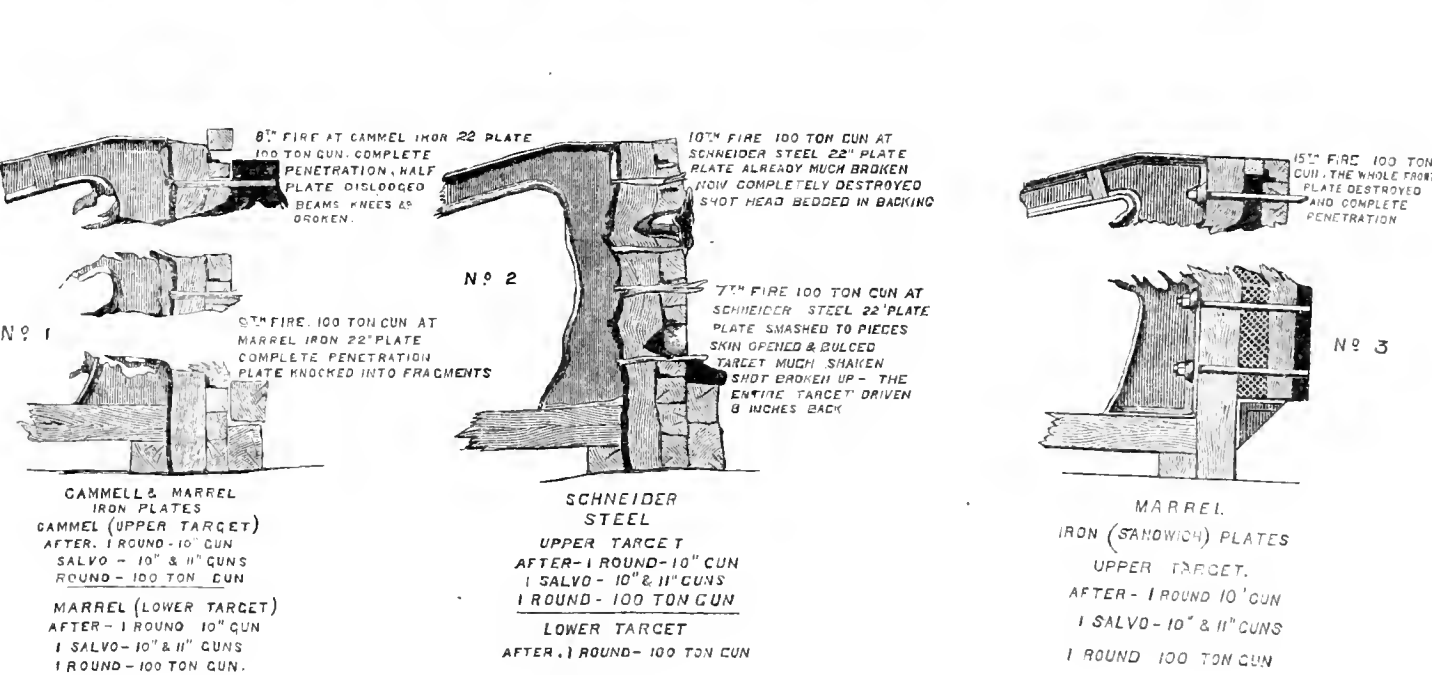
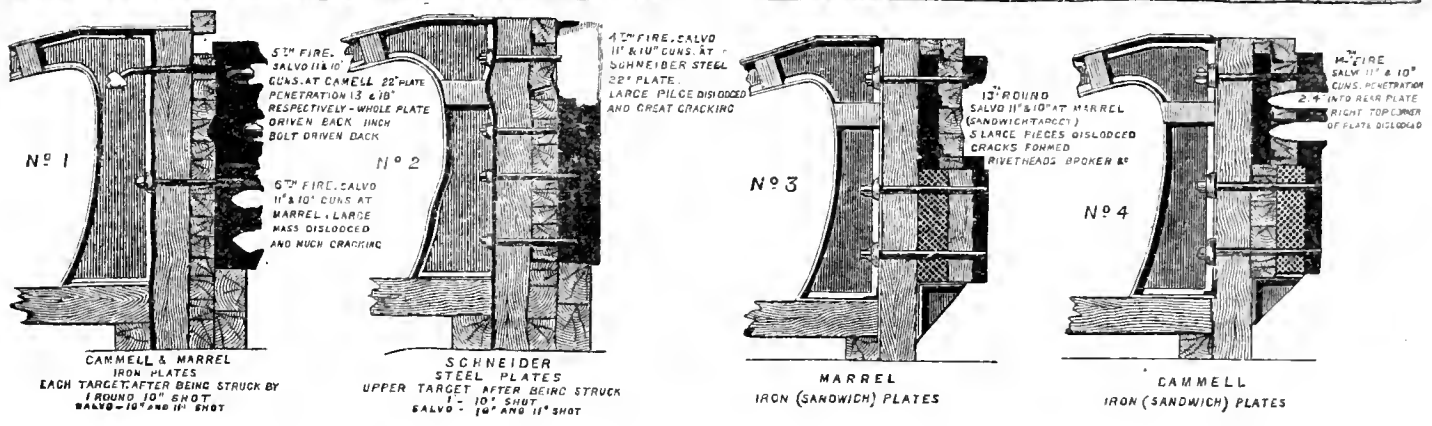
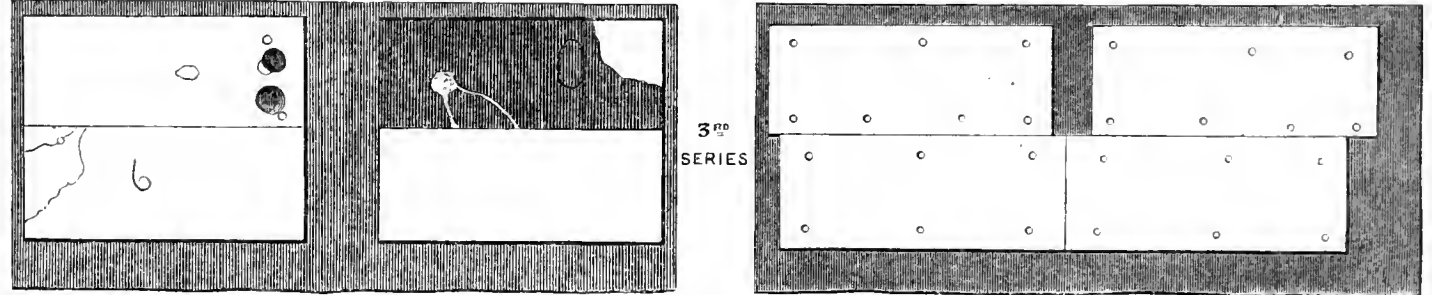
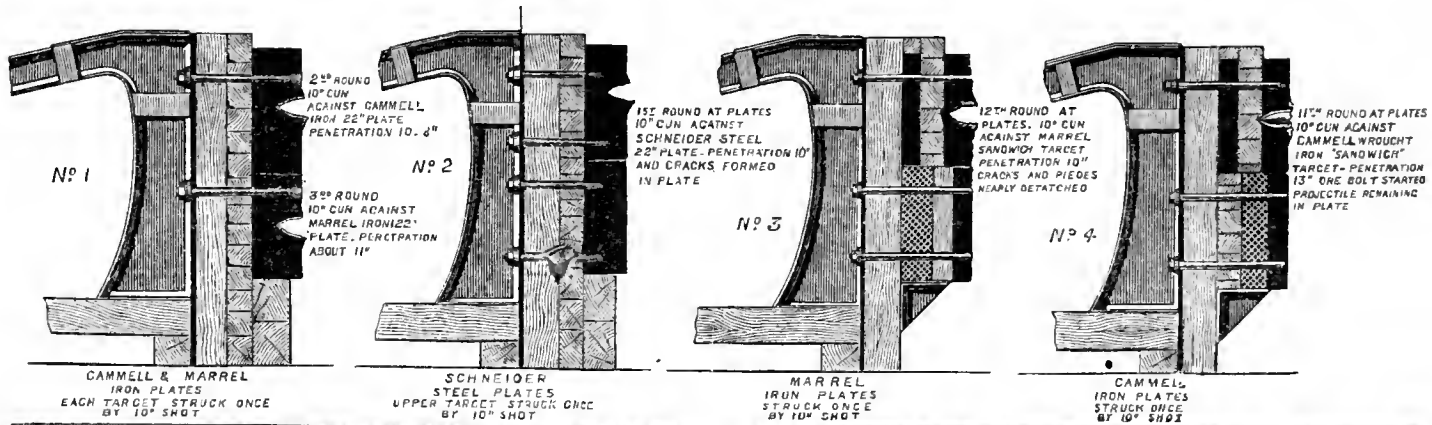

THE HUNDRED-TON GUN.

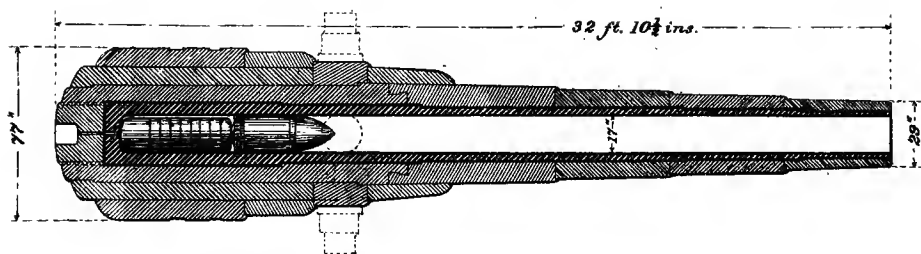

thick at the powder-chamber, diminishing to $3\frac{1}{2}$ inches at the muzzle. It is bound by successive layers of wrought-iron coiled cylinders. There are ten of these coils, and they are so arranged as to interlock with and overlap each other at their junctions; six of them are on the rear half of the gun, the remaining four being placed singly end to end around the tube. The first coil at the rear is 13 feet long by 7 inches thick; over this is a coil 8 inches thick and 9 feet 6 inches in length; then the trunnion-coil, which is 11 inches thick and 2 feet long; forward of this is a tapered coil, having an average thickness of $6\frac{1}{2}$ inches and a length of 3 feet 3 inches. Outside of the second long coil is another to the rear, 9 inches thick and 5 feet 6 inches long. Thus the breech portion is bound by three coils, the trunnion portion by two, and the forward portion by one. The trunnions, it may be observed, are not placed on the largest diameter of the gun, but further forward, where the diameter is considerably reduced. There is consequently a preponderance of weight at the breech-end of about 4 tons, which gives stability in working, inasmuch as the weight is always tending in one direction. The exact weight of the gun is $101\frac{1}{2}$ tons, its extreme length is 32 feet $10\frac{1}{2}$ inches, the length of the bore is 30 feet 6 inches, and its diameter is 17 inches. The outside diameter of the gun at the muzzle is 29 inches, and at the breech it is 77 inches.

The weight of the projectile is 2,000 pounds, and that of the proof-shot 2,500 pounds. Rotation is given to the projectile, not by the usual studs fixed in the projectiles to fit the grooves, but by a copper gas-check fixed into the rear end of the shell, and which has projections upon it corresponding with the rifling-grooves of the gun; the shell is so formed that the check on being crushed against it by the pressure of the explosion of the charge, presses firmly about it; and the gas-check being caused to rotate by the rifling-grooves, causes the projectile to turn and to take the same rotation. The cartridge measures 52 inches in length by $15\frac{1}{2}$ inches in diameter.

TRIALS OF THE GUN.

The trials decided upon were to settle two points: the one being the test of the gun and machinery for working it under the stipulations of the contract, and the other was the determination of the system of vertical armor to be used on the ships in which the guns are to be mounted. With these objects in view the gun has been placed on a pontoon constructed for the purpose, and moored in a firing position in the bay of Spezia. It is mounted on its trunnion-blocks, left free to move on the slides, and all the hydraulic apparatus for loading, for regulating the elevation, for running out and for taking the recoil, is fitted as it will be used when in its place on board ship. As descriptions of similar apparatus for working the guns of the *Inflexible* and *Thunderer* have already been given in this report, it is only necessary to record here the results of the trials, which, with the drawings of the targets shown above, have been taken from that excellent paper, *The Engineer*.

If correctly reported, the contract provides that the gun shall discharge 2,000-pound shots with a muzzle velocity of 1,350 feet; that 50 rounds of service-charges shall be fired, and 5 of them with projectiles weighing each 2,500 pounds. The experimental firing was commenced October 20, (since my return home,) and up to the date of the last advices had not been completed. The series of rounds fired by the 100-ton gun is given by *The Engineer* of December 29, in the following table:

No. of rounds.	Date.	Charge, weight, and nature, in pounds.	Projectile, weight in pounds.	Velocity, feet per second.	Mean pressure in bore, tons.	Stored up work, foot-tons.	Recoil valves set to pounds.	Recoil in inches.	Remarks.
1	Oct. 20	200 W.A. 1½ inch.	2,000	(*)	1,050	
2	Oct. 21	300 W.A. 1½ inch.	2,000	(*)	16.6	
3	Oct. 21	300 W.A. 1½ inch.	2,000	1,375	15.9	1,150	
4	Oct. 23	300 W.A. 1½ inch.	2,000	
5	Oct. 23	300 W.A. 1½ inch.	2,000	16.0	35.5	
6	Oct. 23	300 W.A. 1½ inch.	2,000	1,374	16.0	37.5	
7	Oct. 23	330 W.A. 1½ inch.	2,000	1,456	20.8	29,400	
8	Oct. 23	319 W.A. 1½ inch.	2,000	1,424	18.0	28,120	42.5	
9	Oct. 25	319 W.A. 1½ inch.	2,000	(*)	44.75	
10	Oct. 25	336.6 W.A. 1½ inch.	2,000	19.4	46.3	
11	Oct. 26	319 W.A. 1½ inch.	2,000	1,437	28,625	42.6	At earth.
12	Oct. 26	341 W.A. 1½ inch.	2,000	1,475	19.75	30,150	47.1	At Schneider steel plate.
13	Oct. 27	341 W.A. 1½ inch.	2,000	1,478	19.75	30,300	46.0	At Cammell's iron plate.
14	Oct. 27	341.6 W.A. 1½ inch.	2,000	Shot broken up in bore.
15	Oct. 27	341.6 W.A. 1½ inch.	2,000	1,500	20.6	31,200	At Marrel's iron plates.
16	Oct. 28	341.6 W.A. 1½ inch.	2,000	1,493	20.1	30,920	2,180	48.2	At Schneider steel.
17	Oct. 28	341.6 W.A. 1½ inch.	1,492	19.2	30,880	46.0	At Marrel's and w'ich t'rg't.
18	Nov. 2	319 W.A. 1½ inch.	2,000	Fired against earth.
19	Nov. 2	319 W.A. 1½ inch.	2,500	1,294	19.0	29,027	44.75	
20	Nov. 2	319 W.A. 1½ inch.	2,500	1,293	19.0	29,000	44.5	
21	Nov. 2	319 W.A. 1½ inch.	2,500	1,293	18.8	29,000	2,000	44.25	
22	Nov. 3	319 W.A. 1½ inch.	2,500	42.5	Not taken.
23	Nov. 3	319 W.A. 1½ inch.	2,500	18.6	40.5	
24	Nov. 3	276 Fossano	2,000	1,165	1,850	23.5	
25	Nov. 3	300 Fossano	2,000	863	(†)	17.0	
26	Nov. 3	319 W.A. 1½ inch.	2,000	
27	Nov. 4	319 W.A. 1½ inch.	2,000	36.0	
28	Nov. 4	319 W.A. 1½ inch.	2,000	
29	Nov. 4	319 W.A. 1½ inch.	2,000	35.25	
30	2,000	
31	2,000	
32	2,000	
33	Nov. 7	353 W.A. 1½ inch.	2,000	1,512	31,700	42.5	
34	Nov. 7	364 W.A. 1½ inch.	2,000	1,514	19.8	31,750	42.8	
35	Nov. 7	375 W.A. 1½ inch.	2,000	1,542.8	21.4	33,000	At earth.
36	Nov. 8	319 W.A. 1½ inch.	2,000	1,348	25,200	
37	Nov. 8	341 Fossano	2,000	1,415	27,760	
38	Nov. 8	363 Fossano	2,000	1,408	27,500	
39	Nov. 8	363 Fossano	2,000	1,444	13	28,900	

(*) Not observed.

(†) Under 10.

The four targets above represented are faced with three several kinds of plates, viz: wrought-iron plates by Cammell & Co., of Sheffield, steel plates by Messrs. Schneider & Co., of Creuzot, and wrought-iron plates by M. Marrel, another French maker. The plates are each 11 feet 6 inches long by 4 feet 7 inches deep and 22 inches thick, mounted on framing representing that of the *Duilio* and *Dandolo*. Referring to the engravings, the second series shows each target after receiving one blow from a 10-inch projectile. The third series shows each after receiving, in addition to the single round above mentioned, a salvo consisting of one 10-inch and 11-inch shot. The fourth series deals with the effect produced by the 100-ton gun, either on uninjured or injured targets. The nature of the target and the rounds hitherto fired at it are entered beneath each section.

The targets were built facing the sea. Opposite them was a battery consisting of one 11-inch gun, with two 10-inch guns, one on either side of the 11-inch. Farther to the rear, that is, farther to sea, was the raft on which the 100-ton gun was placed. As this gun is mounted for working in a turret, it has no provision for lateral adjustment or training; the raft, therefore, acted as a turret, the gun was "lined" as to direction by moving the raft, and the latter could be readily turned right round so as to enable the gun to fire for range out to sea. This was the part of the programme that was first carried out, the rounds from No. 1 to No. 10 being fired to test the performance of the gun as to the velocity it imparted to the shot and the pressure in the bore of the gun, and as to its strength and general behavior on firing, and also to test the action of the

carriage. The most important matter in this firing is the velocity that can be obtained with such a pressure as may be deemed allowable for the gun. The highest pressure recorded is 20.8 tons per square inch, and this appears to be rather exceptionally high and irregular. The velocity corresponding to it was 1,456 feet per second. The highest pressure occurring in the 80-ton gun, during the first ten rounds with the full 16-inch bore, was 22 tons, the corresponding velocity being 1,452 feet. This, it is fair to say, was also rather unduly high, being the highest registered at any time with this caliber.

The Italian arrangements as to taking velocities, &c., were not in good working at first; but every portion of the Elswick gear performed its part well, the recoil being checked and the gun working easily.

The plate-experiments began on October 25. The construction of the targets is shown in No. 1 series of sections and in Fig. 1.*

No. 1 target consists of wrought-iron plates * * 22 inches thick, on teak backing, with angle-iron and 1½-inch skin. The plate on the upper half of the target is supplied by Messrs. Cammell, that on the lower by Messrs. Marrel.

No. 2 is a similar target, except that 22-inch steel plates supplied by M. Schneider take the place of the wrought-iron plates both in the upper and lower portions of the target.

Nos. 3 and 4 are targets with what has been termed sandwich-plating in the upper halves, that is to say, alternate layers of iron and teak, the front plate in each case being 12 inches thick and the inner plate 10 inches, as shown in Nos. 3 and 4, the only difference between the two being that, in No. 3, Marrel, and in No. 4, Cammell plates, were employed. The lower portions of the two targets had wrought-iron front plates 8 inches thick, No. 3 having a layer of teak next and then chilled cast iron 14 inches thick, and No. 4 having a similar thickness of chilled iron next to the front plates, the teak being all behind. The bolts of all the targets pass through the entire structure except in the case of the Schneider steel plates, into which the bolts were screwed to a depth of not quite half the thickness of the plate. The total thickness of wood in every target was the same, namely, 29 inches; and the iron, exclusive of skin, was 22 inches, the skin being 1½ inches. The sections are given on the plan of the Italian government sketch.

The object of the programme was as follows: The effect of the lighter guns to be first ascertained; a single round from the 10-inch gun being first fired at each, and then a salvo of the 10-inch and 11-inch guns. The whole three guns were intended to be fired simultaneously, but one 10-inch missing the first round, two only were fired in the subsequent salvos. One steel Schneider half-target was to be reserved untouched for the 100-ton gun; the remainder were to be brought under its fire after the lighter guns had done their worst on them. It was considered that the targets ought to be more than a match for 10-inch and 11-inch guns, and consequently that, after being struck, a very fairly strong target of each kind would thus be fired at by the 100-ton gun. The firing was as follows:

No. 1 round: 10-inch shot against No. 2 upper half, Schneider steel 22-inch plate. Shot penetrated about 10 inches near the center of the plate—*vide* target No. 2, No. 2 series of sections—the plate at the edges of the hole being burred up about 4.4 inches. At first the plate appeared to be but little damaged, but a singing noise was heard in the metal, which shortly after split in two cracks, one running from the hole to the proper right edge of the target, and the other in a downward direction, extending some distance, but not to the plate edge.

No. 2 round: 10-inch gun against upper half of No. 1 target, Cammell wrought-iron 22-inch plate; penetration about 10.8 inches in depth. Two cracks were developed, extending from a left bolt-hole to target edge.

No. 3 round: 10-inch gun at lower half of No. 2 target, Marrel, 22-inch, front plate. Penetration about equal to that in Cammell plate; crack opened from lower left bolt-hole.

No. 4 fire: Salvo from 11-inch and both 10-inch guns at Schneider upper target No. 2. One 10-inch gun missed fire, so that one 11-inch and one 10-inch shot were actually fired at the plates. Both struck from 2 feet to 3 feet of right of target—*vide* third series of sections. A large piece of the plate was dislodged from the right-hand top corner. The cracks already made were opened much wider, and fresh cracks were visible, especially in the shot-hole. The entire plate, in fact, had suffered very severely, and was far on the way to destruction. The 100-ton gun was then fired two rounds, Nos. 9 and 10 on table, which we keep distinct from the plate-firing.

On October 26.—No. 5 fire at plates—a salvo of one 10-inch and one 11-inch shot was fired at Cammell's 22-inch iron plate—target on third series—the plate was struck rather near to the edge. The 11-inch shot lodged and broke up; the 10-inch drove one bolt some distance inward. The top layer of that was lifted above the target edge. The entire plate was driven back 1 inch, and a crack was made from a bolt-hole to the edge of the plate.

* The engravings of the first series are omitted as being unnecessary.

No. 6 fire at plates: Salvo of one 10-inch and one 11-inch shot at Marrel iron 22-inch plate, No. 1 target, lower portion, third series. A huge mass of iron was dislodged, and a crack was formed from bolt-hole to toward top edge of plate; penetration not quite so much as in Cammell's plate. The iron of the plate was heard to sing. The general quality of it appeared decidedly more steely than that of Cammell's plate. The 100-ton gun was now fired at an earth-butt 52 feet thick and 27 feet high, with results given in table, No. 11 round.

No. 7 fire at plates: The 100-ton gun was next fired with 340-pound charge at the Schneider steel plate, which had hitherto been left untouched. The effects are shown generally in lower portion of No. 2 target, fourth series. The plate was smashed to pieces, but the shot had broken up, and had not penetrated through the backing. The whole target had been driven 8 inches back, the inner skin was bulged and opened, and the angle-iron torn and twisted. For units of work and pressure, &c., see table No. 12.

On the 27th—No. 8 fire at plates: The 100-ton gun was fired at the Cammell iron plate, with results indicated generally in the upper half No. 1 section of No. 4 series. For charges, see No. 13 in table. Half the plate was struck away, leaving the wood bare. A part of the shot passed completely through the target, having a velocity measured at 600 feet on the far side. A hole was made nearly 4 feet in diameter, showing *débris* of broken iron and wood in interior. The following round was fired at the steel target, but the shot broke up in the bore of the gun.

No. 9 effective fire at plates: The 100-ton gun was next fired at Marrel's target, on the lower half of the same structure as Cammell's. (See No. 1, series 4.) The whole knocked into ruins. The shot passed completely through, leaving a large hole in the center, as in the case of Cammell's, showing the same heap of *débris*. For charge, velocity, &c., see No. 15 on table. No. 2 engraving shows the state of the targets at this stage of the proceedings.

No. 10 effective fire at plates was from the 100-ton gun at the upper half of Schneider's steel target. For effects, see No. 2 in No. 4 series. Although this plate had suffered severely from the fire of the smaller guns, complete penetration was not obtained. The plate was shivered into fragments. The head of the projectile remained buried in the backing. A considerable part of the body of the shot had been projected outward and bent forward without entirely separating from the head, (*vide* figure) a most unusual circumstance with chilled shot.

On October 28—effective fire No. 11 at plate: 10-inch gun at Cammell's sandwich target. Effects, see No. 4 and No. 2 series. Shot-head penetrated 13 inches, the metal remaining in the hole. One bolt started in the rear.

No. 12: 10-inch gun at Marrel's sandwich target. Effects, see No. 3, second series. Shot penetrated 10 inches only, but the plate was split in several directions, some pieces being nearly detached. Cracks through upper bolt-holes.

No. 13: Salvo of one 10-inch and one 11-inch gun at Marrel's sandwich target. Effects, wide fissures opened in plate 5; large pieces of plate and some small ones dislodged altogether and thrown on the ground.

No. 14: Salvo of one 10-inch and one 11-inch at Cammell's. Both shots pierced front plate, and penetrated 2.4 inches into rear plate; right-hand corner of plate dislodged; backing moved; one bolt sheared and broken, and one bolt-head forced into interior. (See section 3 in No. 4 series.)

No. 15: The 100-ton gun at Marrel's sandwich plates as injured above. Effects the main part of the target carried away, and complete penetration obtained. (See 3 in No. 4 series.)

The remainder of the rounds detailed in the table were then fired from the 100-ton gun.

In reviewing the plate-firing, the principal features to notice are the following:

Series Nos. 2 and 3 show that steel is more liable to be destroyed by the fire of guns not capable of penetrating it than wrought iron,* which under these circumstances suffers but little.

Series No. 4 shows that steel, by transmitting the blow of impact through the plate, is less liable to let the shot through the backing, while more liable to be stripped off and destroyed itself.

It also appears obvious that the *Duilio's* power of offense will be greatly in excess of her powers of defense.

Engineering says that in comparing the results of the thirty-fifth round with those afforded by the 81-ton gun, firing 370 pounds of the same powder and a 1,700-pound projectile, it will be seen that there is a preponderance of energy greatly in favor of the 100-ton gun. The 81-ton gun gave a velocity of 1,520 feet to its 1,700-pound shot, with an energy of 27,200 foot-tons, or 540 foot-tons per inch of circumference of the shot. The 100-ton gun gave a velocity of 1,543 feet to a 2,000-pound shot, with an energy of 33,000 foot-tons, or 623 foot-tons per inch of circumference.

* The steel used was evidently not the best adapted to the purpose.—J. W. K.

THE DANDOLO.

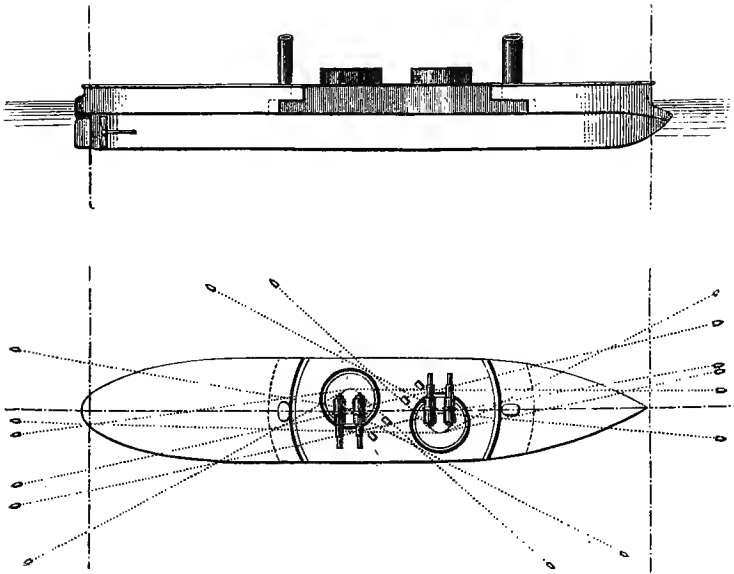

These artillery experiments conducted at Spezia by the Italian government are by far the most important ever undertaken. Not only is the greatest gun ever made being tested for velocity and penetration, but armor-plates of different kinds and of almost unparalleled magnitude are tried for resistance and durability. The interest felt in the experiments by all naval authorities is not due alone to the performance of a single gun, but to the undisputed fact that the Spezia trials must exercise a powerful influence on the warfare of the future. Guns, ships, and armor will all undergo modifications.

The *Duilio* is to be armed with a heavy projecting ram, and she is also to be provided with apparatus for discharging the Whitehead fish-torpedoes. Besides these powerful means of offense, there is to be novel and original arrangement of carrying a rapid torpedo-boat; this boat is to be inclosed at the stern in a tunnel closed by a grated door, and when necessary can be launched and started on its course against an enemy's vessel.

The ship is to be driven by twin-screws. The motive machinery is furnished by Messrs. John Penn & Son, of Greenwich, England, and consists of his old type, a pair of trunk-engines to each screw. The steam will be supplied by the ordinary box-boilers. The two sets of engines are designed to develop the aggregate power of 7,500 horses, and the estimated speed of the vessel on the measured mile is 14 knots per hour. The heavy forgings for the ship were made in Italy. The frames, beams, and plates for the hull, in fact all the iron and steel entering into the construction of the vessel, were being made in France. All the armor-plates were ordered from Cammell & Co., of Sheffield, England, and the guns and machinery for working them were also to be of English manufacture, thus leaving only the construction and labor entering therein to be performed by the Italian engineers. The *Duilio* will be armed with four of the heaviest and most powerful guns ever mounted on any ship, and if completed and successful in all respects, she will be the most formidable fighting-machine, both for offense and defense, ever set afloat in the waters of continental Europe. When launched, the draught of water was found to be just what the designer estimated it would be, and it remains to be seen whether the prediction of the eminent ex-chief constructor of the British navy will be fulfilled, viz, that she will capsize in the first engagement, if seriously injured by shot in the unprotected parts.*

THE DANDOLO.

This sister-ship to the *Duilio* is under construction at Spezia, but is very far from being in the advanced condition of that vessel, and will not probably be completed in several years, as the financial resources of the Italian admiralty will doubtless be taxed to the utmost during the coming two years to complete the first of the great ships. The *Dandolo* is to be, in essential features of construction, the same as her sister, but an important distinction is in the motive machinery. This has been designed and finished by Messrs. Maudslay, Field & Son, of London, and consists of a pair of their inverted vertical compound engines to each of the two screw-propellers. The engines are to be supplied with steam from eight boilers fired from both ends, having in all thirty-two furnaces, four of the boilers being located forward and four aft of the engines.

* For the drawings of the *Dandolo*, *Tegethoff*, *Shannon* and *Nelson*, I am indebted to Monsieur P. Dislere, of the naval department, Paris.

The pressure of steam is to be sixty pounds per square inch, and the maximum indicated horse-power the same as is intended to be developed in the *Duilio*.

THE CRISTOFORO COLOMBO.

This vessel, of the rapid type, building at Venice, is a wooden corvette, but having iron beams and iron knees. The exact data were not obtainable, but they are nearly as follows:

Length.....	270
Breadth.....	36
Draught of water aft.....	17
Draught of water forward.....	13

The hull is composed of Italian seasoned oak, put together in the strongest and very best manner. The air-ports are much larger than are found in any of our own vessels; the quarters exceedingly comfortable, and the interior well arranged in all respects. The battery consists of two rifled guns on each broadside and one bow-chaser. The motive machinery was constructed by Messrs. Penn & Son, of England, and consists of one pair of their patent inverted vertical three-cylinder engines, applied to a single screw, and so arranged as to be worked either on the compound or on the non-compound system, as desired. They were designed to develop a maximum indicated horse-power of 4,000, and the maximum speed of the vessel on the measured mile was estimated at 17 knots. But neither the constructors of the machinery nor the naval architects with whom I conferred believed that the hull had sufficient strength to sustain for any lengthened period the power necessary to produce 17 knots per hour.

DOCK-YARDS

The naval dock-yards of the kingdom of Italy are at Venice, on the Adriatic; Castellamare, on the Bay of Naples; and Spezia, between Leghorn and Genoa, on the Mediterranean.

VENICE.

The dock-yard at Venice was in ancient times, as at present, known as the arsenal. There is no spot in Venice more intimately connected with the times of her powerful grandeur. It was considered one of the most important elements of the power of the republic. Here were constructed the galleys so celebrated for their strength and lightness. Not only were all the stores required in war preserved here, but everything warlike was manufactured within its walls. Before the principal gate, as if to guard it, stand four marble lions, spoils taken from conquered nations. The ancient walls still remain; also many of the former buildings; but they have been internally reconstructed, to suit the many varied and wonderful changes in naval architecture since the days of the Doges. The estimated area within the walls is about one hundred acres. The basin area is very considerable, and one superior stone dry-dock is completed, and a second is under construction. The appliances and machinery are as yet rather primitive. The few tools and machinery of value in the buildings of the engineering department are of English manufacture. In fact, none of the buildings contain appliances worth noting.

Plan of Upper Deck Breastwork &c

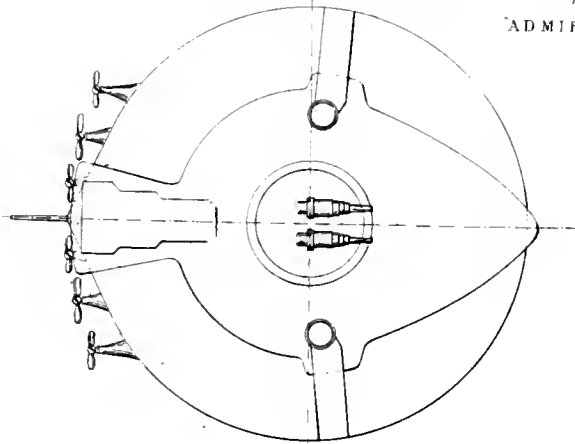

Fig 2
ADMIRAL POPOFF

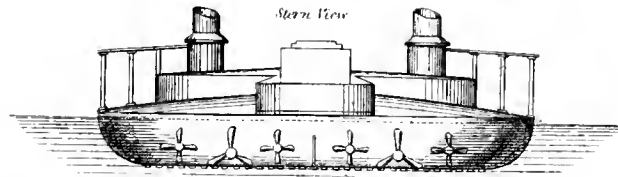
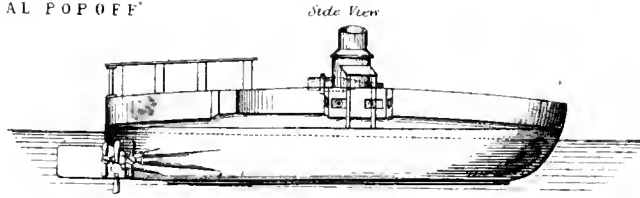
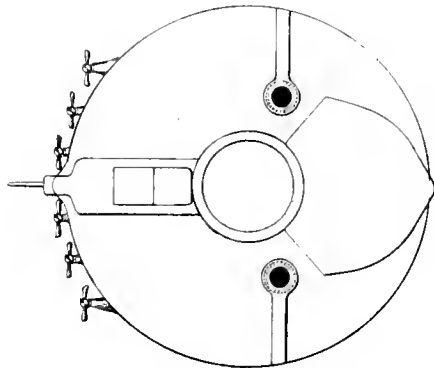
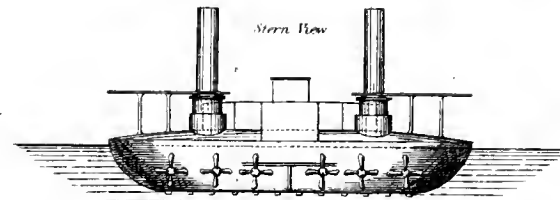
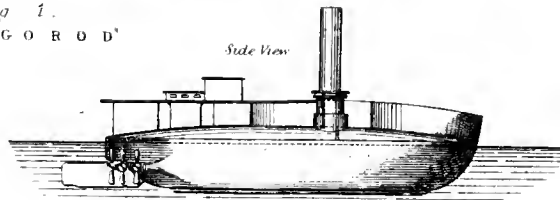

Fig 1.
NOVGOROD



Plan of Upper Deck Breastwork



Journal R.F.S. Institution
VOL. 20.

ADMIRAL POPOFF
Plan showing watertight divisions

Fig 6.

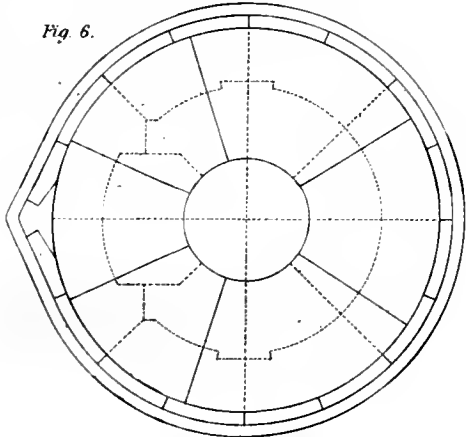
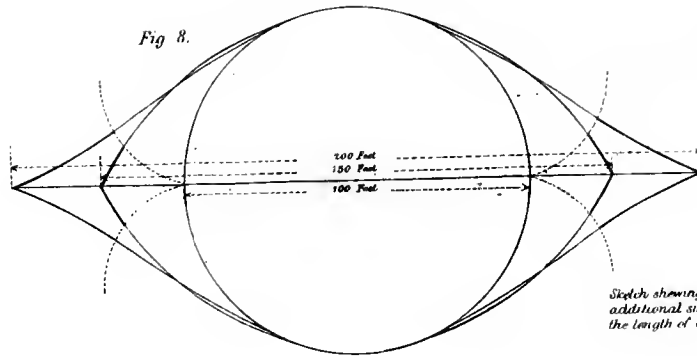
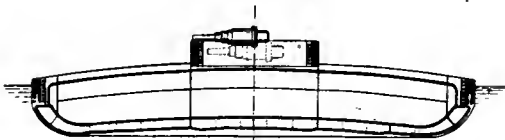

Fig 8.



Sketch showing the small amount of additional side armour required if the length of Ships is increased somewhat



Section.

Naval Arsenal "Spezzia"

1 Chief entrance	9 Wood store for cabinet-makers
11 Surrounding canal	10 Paints shop
12 Wall enclosing arsenal	11 Sinks store
B Felling-out basin	12 Hand saw-mill
C Basin for construction and repairs	13 Ironwork shop
DD Artillery basin	14 Store
EA Provisioning docks	15 Shanty shops
EP Repairing docks	16 Ironed planks
GO Building slips	17 General store
H Artillery depot	18 Pumps
11 Anchor and chain depot	19 Rope store
X Coal depot	20 Forge
1 Mill	21 Steam hammer
2A Battery	22 Panshop
N Casemates	23 General shops
O Prison	24 Foundry
1 Main entrance and office	25 Bistron
2 Copprasanti and Construction office	26 Sails and fittings
3 Boiler shops	27 Gasation bureau
4 Machine shops	28 Ammunition store
5 Framing and Carthage shops	29 Salt d'Arnie
6 Coal store	30 Artillery repairing shops
7 Carpenter and pattern shops	31 Shop de garde
8 Steam saw-mills	32 Food store

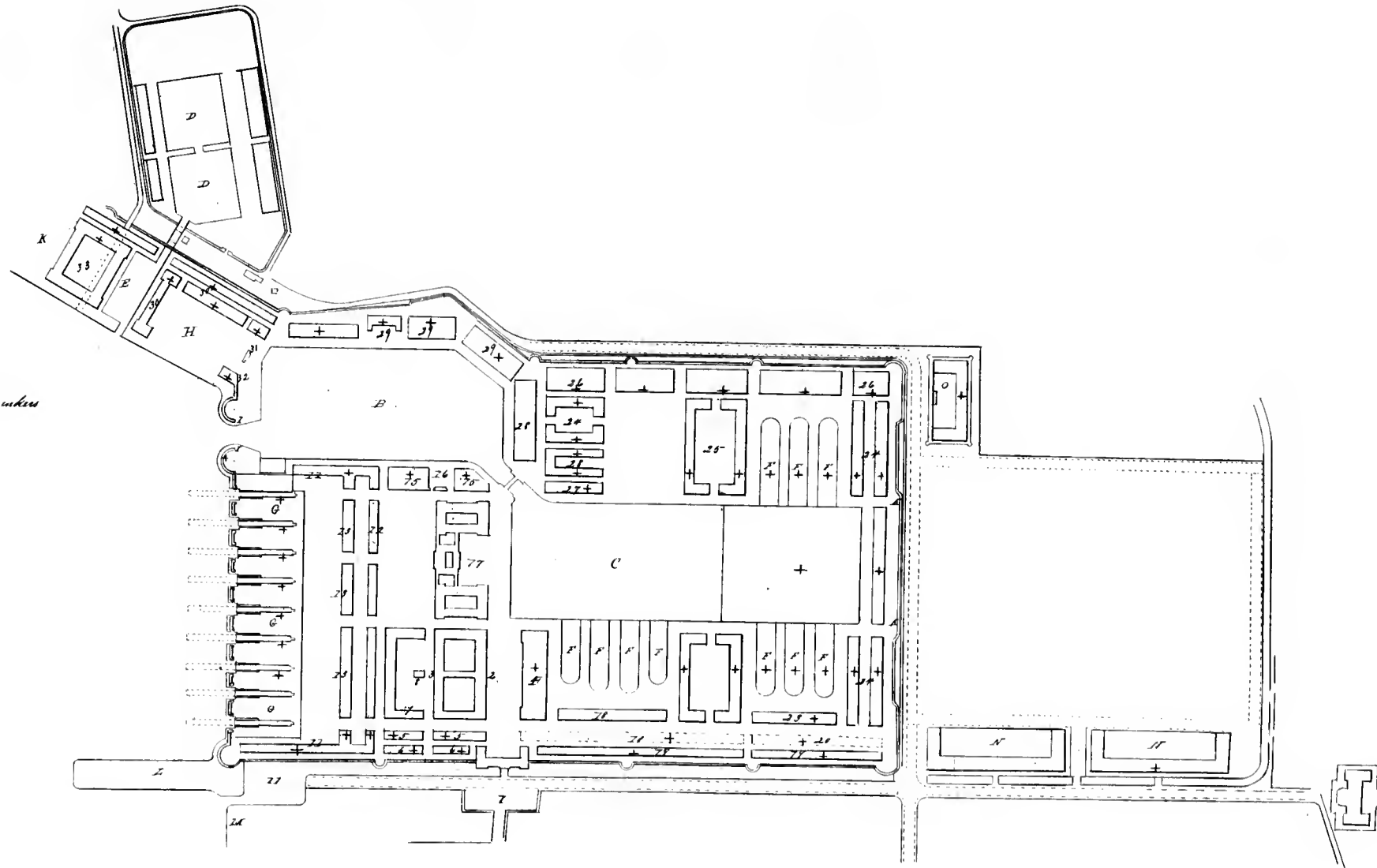

The uncompleted picture is marked +

CASTELLAMARE

is an old ordinary ship-building yard, furnished with improvised sheds, containing the necessary machinery, tools, and appliances for iron ship-building, all purchased in order to be used in the construction of the *Duilio*.

SPEZIA.

The dock-yard at Spezia, on the Bay of this name, is, in common with other Italian naval-yards, known as the arsenal. It has been laid out on a scale of great magnitude, and is intended as the principal naval port. Already about \$10,000,000 have been expended on the works, and it may now be ranked among the most important of the maritime establishments of Europe. The accompanying drawing shows the plan as originally designed. It is intended that there should be nine building-slips and ten dry-docks; but only two of the slips and four of the docks have been completed. The large basin for construction and repairs was designed to be 443 feet long and 80 feet wide at the top, and 56 feet 8 inches at the invert. This basin has only been completed for half of its length. The adjoining fitting-out basin is 360 feet 9 inches long and 72 feet 9 inches and 55 feet 9 inches wide. In addition to this completed basin there are two smaller ones. The basins and docks are emptied by means of two turbines driven by two 150-horsepower engines. A small pump is also kept constantly at work to remove infiltrating water. The buildings completed are of one story, excepting the one containing the offices and mold-lofts. These buildings are as follows: machine, boiler, and smith shops, foundery, forges, steam-hammer-buildings, temporary iron ship-building shop and framing-shop, gun-carriage shops, artillery-shops, store-houses, sail-stores, torpedo-stores, and special stores. The machinery and tools and system of cranes and appliances are as yet incomplete.

The following table contains the principal dimensions of the Italian armored fleet now afloat and in process of building:

Armored ships of Italy.

Name of ship.	Class.	Vessel.						Armament.		Thickness of armor at water-line.	Maximum speed, in knots,	Machinery.	Remarks.
		Length between perpendiculars, in feet and inches.	Extreme breadth, in feet and inches.	Displacement, in tons.	Draught forward, in feet and inches.	Draught aft, in feet and inches.	Number of guns and description.	Height of battery above water, in feet and inches.					
Principe Amedeo.....	Line-of-battle cruisers.	265	57 10	5,780	24 8	24 8	1 12-inch Armstrong; 6 10-inch Armstrong.	6	6
Palestro.....	do	265	57 10	5,780	24 8	24 8	do	6	6	10	Mandslay	Makers of engines.	
Roma.....	do	250	57 5	5,697	23 6	25 6	6 18-ton Armstrong; 2 9-inch Armstrong.	6	6
Venezia.....	do	250	57 5	5,697	23 6	25 6	do	6	6
Castelfidardo.....	do	256 5	50	4,194	19 7	22	11 guns	6 4	4 $\frac{1}{2}$	12 9	Forges et Chantiers	Immersed midship sec'n 771 square feet. Single screws. Horse-power, 3,000. The total cost of each ship of this class is stated at \$842,800 gold. Total weight of each, 3,789.5 tons.	
Messina.....	do	256 5	50	4,194	19 7	22	14 guns	6 4	4 $\frac{1}{2}$	12 9	Forges et Chantiers		
San Martino.....	Ordinary station-service.	256 5	50	4,194	19 7	22	11 guns	6 4	4 $\frac{1}{2}$	12 9	do		
Maria Pia.....	do	256 5	50	4,194	19 7	22	do	6 4	4 $\frac{1}{2}$	12 9	do		
Auonia.....	do	256 5	50	4,194	19 7	22	do	6 4	4 $\frac{1}{2}$	12 9	do		
Conte Verde.....	do	198 3	49 4	3,932	13	13	7 guns	5 $\frac{1}{2}$	10	Forges et Chantiers	Broadside battery; ram.	
Verona.....	do	198 3	45	2,700	17 8	17 8	30 6 $\frac{1}{2}$ -ton guns.	4 $\frac{1}{2}$	10	do		
Terribile.....	do	198 3	45	2,700	17 8	17 8	do	4 $\frac{1}{2}$	10	do	D. double turret; ram. Twin-screws. Horse-power, 7,500.	
Formidabile.....	do	198 3	45	2,700	17 8	17 8	do	4 $\frac{1}{2}$	10	do		
Costa defender.....	do	339 8	64	10,650	Mean 25 11	Mean 25 11	2 9-inch Armstrong guns.	15 9	21 $\frac{1}{2}$	14	Millwall Iron Works John Penn & Son.		
Afonador.....	do	339 8	64	10,650	Mean 25 11	Mean 25 11	2 100-ton Armstrong guns.	15 9	21 $\frac{1}{2}$	14	Mandslay, Field & Son		
Dandolo.....	Mastless turret-ship.	339 8	64 7	10,650	Mean 25 11	Mean 25 11	do	15 9	21 $\frac{1}{2}$	14	Mandslay, Field & Son	

* At Castellamare, Naples.

† At Spezia.

PART XIV.

THE RUSSIAN NAVY.

CIRCULAR ARMORED SHIPS; TABLE OF DIMENSIONS, &c., OF ARMORED
SHIPS OF RUSSIA.

THE RUSSIAN NAVY.

The Russian navy is now composed of 29 armored ships and 196 other vessels of all classes, carrying altogether 521 guns. Of the 29 armored ships, 27 were in the Baltic and 2 were in the Black Sea last summer.

The *personnel* of the navy consists of 81 flag-officers of all ranks, 1,224 other officers, 513 mates, 210 artillery officers, 145 engineer officers, 545 mechanics, 56 constructors, 260 medical officers. Employed at the admiralty dock-yards, &c., there are 297 officers and 480 civil officials, and the total number of enlisted men is 24,500.

The naval armament of Russia has been for some few years past undergoing the changes necessary to keep up with the progress of the times. Cast-iron smooth-bore guns are gradually being replaced by steel breech-loading rifles. The first of these were supplied by Krupp; now they are manufactured in Russia, some at Perm, and others at Oboukoff, about nine miles from St. Petersburg, on the left bank of the Neva. The Broadwell system of breech-loading mechanism is employed, and the calibers of the guns are 6, 8, 9, and 11 inches. One gun, of 12-inch caliber, was manufactured for the Vienna Exposition, but it is not known that any others of this size have been made. The broadside ships have not hitherto been armed with guns heavier than 8 inches, with 9 inches for stern or chase guns, but it is intended to substitute 11-inch pieces for these.

Except for coast-defense, the Russian fleet is rather numerous than powerful. The *Peter the Great* and the *Minin* are the only two vessels on the list of sea-going armored ships which approach the modern standard of fighting efficiency. The first named was designed after the British ship *Devastation*, and commenced before the sea-trials of this vessel; subsequently modifications were made, and, as completed in 1875, she somewhat resembles the *Dreadnought*; and, as may be seen by consulting the list of armored ships, the dimensions are nearly the same as those of the *Devastation*, and the displacement 316 tons more. The indicated horse-power and speed are represented to be equal, and armor and battery superior to those of the *Devastation*. The armor is 14 inches in thickness, with iron hollow stringers in the backing besides, which are alleged to give an additional resistance equivalent to 2 inches of iron. The four guns, two in each of the turrets, are of 12-inch caliber, and the weight of each 40 tons. In respect, therefore, to speed, armor, and guns she is the match of any ship *now in commission* belonging to other nations. But she is not fitted with a spur to utilize the power of the ram.

The *Minin* was constructed as a rigged turret-ship on the Coles system, has a length of 298 feet 3 inches and breadth of 49 feet 1 inch, with a displacement of 5,650 tons. The armament consisted of 4 guns of 28 tons each, and armor of 12-inch plates on 24-inch backing, and the free-board was very low. In consequence of the catastrophe to the British vessel *Captain*, alterations to the *Minin* were decided upon. As altered she will have a central battery 98 feet long, rising 10 feet above the water-line. The guns will be mounted in pairs on two turntables, on the main deck, and will fire *en barbette* over the top of the battery. In this form she is expected to be a formidable ship.

The next ships of the sea-going fleet to be noticed are the broadside belted vessels *Duke of Edinburgh*, originally called the *Alexander Nevsky*, and the *General Admiral*. These ships are of recent construction and were designed to compete with the fast British unarmored ships *Raleigh* and *Boadicea*. They are built of iron sheathed with wood and coppered. The length between perpendiculars is 285 feet 9 inches; breadth 48 feet 2 inches; draught, mean, 21 feet; displacement, 4,438 tons. In weight and dimensions they are therefore between the two British ships just named. These vessels embody the original conception of the armor-belt on the water-line to protect the vital parts; it is 6 inches thick and 7 feet wide. The battery-deck is similar to that of the British *Invincible* class; open-topped, and arranged so as to give both broadside and right-ahead and astern fire from corner ports. It contains four 8-inch rifled guns and two 6-inch chase-guns. An article in the *Revue Maritime et Coloniale*, from which extracts have been taken, represents the lines of these vessels to be fine, the engine-power large, and the speed 13 knots per hour. They are not provided with spurs to be used as rams, and have neither the speed nor the power of battery possessed by the British ships referred to.

Next in the sea-going fleet are the four ships named after admirals, viz, the *Admiral Lazareff* and *Admiral Greig*, carrying each six guns in three turrets, and the *Admiral Tchitchagoff* and *Admiral Spiridoff*, carrying each four guns in two turrets. These vessels are of the Coles type of turret-ships, and differ from each other but little, except in number of turrets. The two first-named have a free-board of 4 feet, and the other two of 5 feet. The displacement is about 3,500 tons, and the speed from 9 to 10 knots. The thickness of armor on hulls and turrets is 6 inches, and the caliber of the guns only 9 inches. The sea-going qualities of these four ships, unless it be near home, may be doubted; as coast-defenders, however, they are important additions.

Last among the sea-going fleet are noticed two wooden armored frigates, the *Sevastopol* and *Petropaulovski*, built in 1863 and armored with plates only $4\frac{1}{2}$ inches thick. They have large crews, numbering 609 and 682 men. They displace 6,000 tons, have steamed 11 knots, and carry batteries respectively of ten and twenty 8-inch breech-loading guns, and of eight and four 80-pounders. These ships may be regarded as obsolete.

For coast-defense Russia has a considerable fleet. The two circular vessels hereafter to be described are the most formidable of the number.

The next in power are ten monitors of early date on Ericsson's plans, similar to our harbor and river monitors; drawing 12 feet of water, and armored on the sides with 5-inch plates on a backing of nearly 3 feet. The one turret of each vessel is built up of eleven 1-inch plates without backing. The two guns in the single turret are 9-inch rifles or 15-inch smooth-bores of old pattern.

The *Smertch*, a double-turret vessel, built in England in 1864, is armored both on the sides and turrets with plates only $4\frac{1}{2}$ inches thick, and carries only two 8-inch guns. There are, however, two other monitors of later date and somewhat greater power, built in Russia in 1868.

These are the *Tcharodeika* and *Rousalka*. The side-armor is 5 inches thick, and that on the turrets 6 inches. They carry four 9-inch rifles in two turrets.

The speed of all of these monitors is given at from 6 to $8\frac{1}{2}$ knots, and they are not provided with spurs for ramming, and must therefore be considered as weak vessels, fit only for operations in shallow water.

RUSSIAN CIRCULAR ARMORED SHIPS NOVGOROD AND ADMIRAL POPOFF.

During the autumn of 1875, Mr. E. J. Reed, C. B., M. P., ex-chief constructor of the British navy, made a visit to Russia for the purpose, as stated by him, of inspecting two circular armored vessels, one of them completed and in commission, and the other under construction. While in Russia he wrote several letters to the London *Times* on the subject of these vessels, in which he eulogized them and attached so much importance to the advantage of the circular form over that of existing types of armored ships, that nearly all the newspapers of London and some scientific papers also contained articles discussing their merits. Subsequently Mr. Gouleaff, a Russian officer, read a paper before the Institution of Naval Architects on the many advantages possessed by vessels constructed on the circular principle. Finally, Mr. Reed was invited to deliver a lecture at the United Service Institution in London, and did so February 4, 1876, upon "Circular Iron-clads."

The following drawings will give a good idea of the outward form and design of these much talked-of Russian vessels. The noteworthy points in Mr. Reed's lecture are that—

In the first place they are circular only in one sense, *i. e.*, their horizontal sections only are circular, or, in other words, they have circular water-lines. The departure from a circle is a small extension or protuberance at the stern for the purpose of facilitating the arrangement and working of the rudder and steering apparatus. It follows as a consequence from the circular form of water-line, that all the radial sections are alike; * * * * the bottom of the vessel is an extended, plane surface, which is connected with the edge of the deck by a quadrant of a small circle. With this form of section great displacement is obtained on moderate draught of water. The deck of the circular ship is formed in section with such curvature as to give in a ship of 100 feet in diameter a round-up of about 4 feet. There are two Popoffkas already built, named respectively the *Novgorod*, Fig. 1, and the *Admiral Popoff*, Fig. 2, of which the following are the dimensions and other particulars:

	Novgorod.		Admiral Popoff.	
	<i>Ft.</i>	<i>In.</i>	<i>Ft.</i>	<i>In.</i>
Extreme diameter	101	0	121	0
Diameter of flat bottom.....	76	0	96	0
Depth in hold at center, from under side of beam to top of the frames of the double bottom	13	9	14	0
Draught of water forward	13	2	12	0
Draught of water aft.....	13	2	14	0
Draught of water, mean	13	2	13	0
Height of barbette tower from load water-line	12	0	13	3
Diameter of barbette tower, outside.....	30	0	34	0
Height of upper deck at side, from load water-line amidships	1	6	1	6
Displacement, in tons.....	2,490		3,550	
Area of midship section, in square feet	1,170		1,416	
Engine, nominal horse-power.....	480		640	
Coal supply, in tons.....	200		250	
Propellers, screw, in number	6		6	
Complement of officers and men	110		120	
Armament, breech-loading guns:				
Two in number, each weighing, in tons.....	28		40	
Smaller guns in unarmored breastwork			4	
Height of armor on side above water.....	1	6	1	6
Depth of armor below load water-line amidships	4	6	4	6
Thickness of armor on sides, (including equivalent thickness for the hollow iron girders behind armor).....	11		1	6
Thickness of armor on lower strake	9		1	4
Thickness of armor on barbette tower	11		1	6
Thickness of deck plating	2½		2½	

It is but fair to the distinguished designer of these vessels, carefully to bear in mind that in so far as the *Novgorod* and *Admiral Popoff* are concerned, they have been designed and built purely for service in shallow waters and near the land. * * *

The *Novgorod* and *Admiral Popoff* have extensive unarmored houses erected above the armored decks. The chief of these is a spacious forecastle, which, of course, adds greatly to the buoyancy forward when the sea rises there upon the vessel. I do not think even circular vessels, of very low free-board, could be steamed against a heavy head sea without such a forecastle, more especially when driven at high speed. * * *

The chief characteristic of these circular iron-clads is that they are purely and simply sea-citadels propelled by steam, and without any attempt to make them conform to the shape of an ordinary ship. The question to be determined hereafter is, is this form of vessel thus originated for coast-defense purposes, and proved eminently successful for that purpose, available under proper modifications for sea-going citadels?

I think we may fairly say, that for a sea-going citadel, viewed as a citadel only, apart from other features, the circular form is best, because it requires a minimum amount of armor to protect a given area or volume, or in other words, a given amount of armor secures the greatest amount of buoyancy. For special purposes some modified form might be preferable; but speaking generally, the circular form is the best for floating armor to protect an included space, and also for giving that equal all-round cannonade with guns which is so desirable at sea. Starting, then, with this circular armored citadel, and wishing to propel it at a given speed at sea, there are several ways in which we can deal with it:

First. We can put engine-power in it just as it stands without modification; or,

Second. We can build ends to it like those of an ordinary ship, protecting those ends by a belt of armor, as in many other ships; or,

Third. We can build such ends to it and protect the lower parts of them by an under-water deck of armor, as in the *Inflexible*; or,

Fourth. We can build around it an outer circle of thin iron, with a mere narrow belt of armor analogous to the belt of ordinary iron-clads; or,

Fifth. We can build around it such an outer circle of thin iron, with an under-water deck of armor analogous to that of the *Inflexible*; or,

Sixth. We can build short ends to it with either above or under water armored decks, but of greatly reduced length as compared with the ends of ordinary ships of large beam.

The *Novgorod* is the only actual example of the first of these cases that has yet been tried, and we may state roughly that in her, 750 tons of armor and 56 tons of guns are carried on a displacement of 2,500 tons, and driven at $8\frac{1}{2}$ knots, with 2,270 indicated horse-power. This confirms what we already know, viz, that such ships will require great power in proportion to displacement. But taking, not the false standard of displacement, but the better (although not perfect) standard of weight of armor and guns as our guide, we shall find nothing very extraordinary in the power required.

Such are the chief points in Mr. Reed's lecture. I did not see these Russian circular vessels, but I did see a completely-equipped model of one of them in London; from the examination of which and the drawings, I arrived at the conclusion that, as floating forts designed for shallow water, they do possess some of the merits stated; but even for this purpose, as at present constructed, there are serious objectionable features, some of the most prominent of which are given below:

1st. As the *Novgorod* is built, there is in the center an open-top fixed turret, or an iron martello tower, having inside it a revolving platform, on which the guns are *en barbette*. This is the system employed in the upper-deck batteries of the French armored ships; but in the French ships the towers are located near the sides of the vessels, and high above water, while in the Russian vessels they are located in the center and on hulls having a free-board of only 18 inches. The barbette principle affords very considerable lateral range, but the disadvantages are, as here applied, that it leaves the guns and men working them fully exposed to the fire of the enemy. On shore, artillery officers rarely, if ever, contemplate mounting guns *en barbette* near the level of the water where serious and close action is expected. They seek for a high and somewhat distant position, where the advantages of an all-round lateral and plunging fire are available, and where the exposure of the men and the guns is reduced to a minimum. With a view to remedy this serious disadvantage in a degree, the tower of the second vessel is constructed so as to work the guns on the disappearing principle of Rendel, in which the gun is loaded in the low position seen at Fig. 6, and as previously

described for the British ship *Téméraire*. This change is only a partial remedy; the disadvantage of the open-top tower slightly above the level of the water still remains.

2d. The second objection is that the side armor-plates do not extend deeper below the water-line than in ordinary vessels, and as the *Admiral Popoff* is 121 feet in diameter, there is this large target at all times presented for under-water attack by locomotive-torpedoes, instead of the bow or stern alone, as would often happen in the attacks on other vessels. The extra defense against torpedoes gained from the cellular construction by means of the circular system would avail nothing.

3d. The third objection consists in the complication of the motive machinery. There are six screw-propellers, operated by three sets of engines. Two of the propellers have diameters greater than the draught of the vessel, the periphery of the blades extending below the keel. These two screws are three-bladed, and are not worked in shallow water.

I had considerable experience, during our civil war, on the Mississippi River, in building and operating the machinery of the four large wide flat-bottomed gun-vessels of the *Milwaukee* class, provided with four screw-propellers. I, therefore, think I know what the complication of the machinery for six must be. Moreover, I do not see that the six screw-propellers are protected from attacks of any kind.

4th. The fourth and most serious objection to the circular form of vessels consists in the extraordinary steam-power necessary to drive a vessel, say, of 121 feet diameter, through the water at a speed equal to that of the ordinary vessel of the same carrying capacity. The weight and space occupied by the machinery would be so great as to leave but little room for all the other requirements.

Mr. Reed says that the *Novgorod* made a speed on the measured mile of $8\frac{1}{2}$ knots; that she has steamed a considerable distance at $7\frac{1}{2}$ knots; and when he made a trip in her the speed averaged $6\frac{1}{2}$ knots. This last is probably the real speed when steaming in ordinary weather for a period of twenty-four or more hours. If the weights of the steam-machinery had been given, and other necessary data, the weights, &c., for higher speeds could be readily estimated.

The first objection raised to the circular vessel, viz, the open-top tower, could be remedied in future constructions by substituting the Ericsson revolving turret, and the second objection could be removed by extending the vertical side-armor down to the keel. This would entirely protect the vessel from the attacks of moving torpedoes.

The third objection may be obviated, but the fourth is insurmountable. Therefore for sea-going vessels, although the form may be changed by adding ends, as shown at figure 8, the principle of construction will not be likely to meet with favor from naval architects, much less from naval officers.

The list of Russian armed ships with the principal dimensions is given herewith.

Armored ships of Russia.

Name of ship.	Class.	Vessel.						Armament.			Thickness of armor at water-line, in inches.	Number of screws.	Maximum speed, in knots per hour.	Machinery.
		Length between perpendiculars, in feet and inches.	Extreme breadth, in feet and inches.	Depth of hold, in feet	Displacement, in tons.	Draught forward, in feet and inches.	Draught aft, in feet and inches.	Number of guns, and description.	Height of battery above water, in feet and inches.					
Peter the Great*	Two-turret.	321	64	9,510	23	9	4 12-inch guns	13	14	2	13	Baird, St. Petersburg.	
Minin	do	238 3	49 1	5,650	19 8	8	4 11-inch guns	10	12	McPherson.	
Duke of Edinburgh †	Corvette	285 9	48 2	4,438	19	23	4 8-inch; 2 6-inch guns	23	6	Seminokoff & Politica.	
General Admiral †	do	285 9	48 2	4,438	19	23	4 8-inch; 2 6-inch guns	23	6	Colpino.	
Sevastopol	Frigate	304 9	52 2	6,048	23 11	11	20 8-inch; 4 80-pounders	44 & 34	4 & 3	Baird, St. Petersburg.	
Petrovopolovski	do	294 3	56	5,291	22 7	21	10 8-inch guns; 4 80-pounders	44 & 34	4 & 4	Baird.	
Prince Pojarski	Casemate	270	49	4,291	17	21	10 8-inch guns	4	2	McPherson.	
Admiral Lazareff	Three-turret	260	43 6	3,450	19	19	6 25-ton, rifled	4	2	Do.	
Admiral Greig	do	260	43 6	3,450	19	19	6 25-ton guns	4	2	Do.	
Admiral Tchibchagoff	Two-turret	260	43 6	3,396	19 2	19 2	4 35-ton guns	5	2	Seminokoff & Politica.	
Admiral Spiridoff	do	260	43 6	3,396	19 2	19 2	4 35-ton guns	5	2	Do.	
Pervencic	Battery	220	53	3,260	15	17	96 32-pounders	44	4	9 1/2	
Ne-iron-ne-nis	do	220	53	3,260	15	17	16 8-inch; 1 80-pounder	44	4	7	
Krenl	do	218 6	53	3,358	16	18	6 8-inch; 2 6-inch; 13 80-pdrs	5 1/2 & 4 1/2	8	
Novgorod †	Circular	101	101	14	2,490	13 2	13 2	2 11-inch, 28-ton guns	11	6	5-6	
Vice-Admiral Popoff	do	121	121	14	3,550	12	14	2 40-ton guns	18	2	Baird.	
Ouragan	Sigs-turret.	200	46	12 3	1,555	10 6	11 6	2 15-inch guns §	6 4	4 1/2	Do.	
Tiphon	do	200	46	12 3	1,555	10 6	11 6	do	6 4	4 1/2	Do.	
Latalik	do	200	46	12 3	1,555	10 6	11 6	do	6 4	4 1/2	Do.	
Lava	do	200	46	12 3	1,555	10 6	11 6	do	6 4	4 1/2	Do.	
Vetobonn	do	200	46	12 3	1,555	10 6	11 6	do	6 4	4 1/2	Do.	
Koldonn	do	200	46	12 3	1,555	10 6	11 6	do	6 4	4 1/2	Do.	
Sershtz	do	200	46	12 3	1,555	10 11	11	2 10-inch guns	6 4	4 1/2	Built at St. Petersburg.	
Edunorog	do	200	46	12 3	1,555	10 11	11	do	6 4	4 1/2	Do.	
Bromenotch	do	200	46	12 3	1,555	10 11	11	do	6 4	4 1/2	Do.	
Perrn	do	200	46	12 3	1,555	10 11	11	do	6 4	4 1/2	Do.	
Smerch †	Two-turret	172 10	38	14 3 1/2	1,380	10 6	10 6	2 8-inch guns	4	4 1/2	Mandslay.	
Tchardalaka	do	210	42	1,835	11 9	11 9	4 9-inch guns	4	5	Built in England.	
Rousalka	do	210	42	1,835	11 9	11 9	do	5	Baird.	

* Cost of machinery, \$780,080; indicated horse-power, 10,000.

† Armor-belted ships; † indicated horse-power, 5,400.

‡ Cost of machinery, \$215,000; indicated horse-

power, 3,000; immersed midship section, 1,170 and 1,416.

§ The 15-inch guns are smooth-bore.

|| The 10-inch guns are rifled.

¶ Total cost, \$395,920.

PART XV.

AUSTRIAN ARMORED SHIPS.

THE TEGETHOFF; TABLE OF DIMENSIONS, &c., OF THE ARMORED SHIPS
OF AUSTRIA.

THE TEGETHOFF.

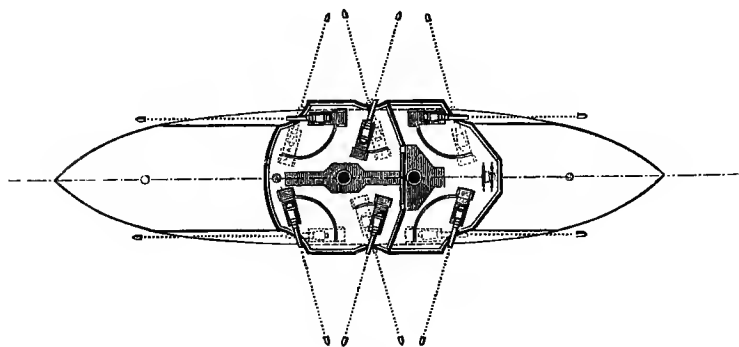
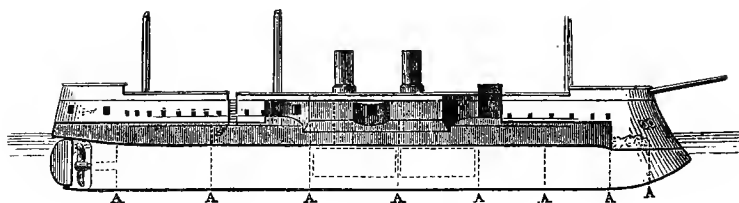

AUSTRIAN ARMORED SHIPS.

The naval authorities of Austria, in common with those of other European countries, have paid dearly for the error of building wooden armored ships. The *Kaiser Max*, the *Prinz Eugen*, and the *Don Juan d'Austria* constituted the early iron-clad fleet of Austria. The decay of the wooden hulls, insufficient strength, and the advancement made in defense as well as offense of the modern fighting-ships, sometime since rendered these vessels useless. As a matter of economy, however, it was decided to reconstruct them, with the view of utilizing as far as practicable the machinery and materials. They were accordingly taken to pieces, and the replacing of the wooden hulls with hulls of iron proceeded with, advantage being taken of the superior lightness of the iron hull by providing for a considerable increase of armor-strength in vital places. The original engines and most of the fittings of the wooden ships are being used in the iron ones; and this object is being carried into effect, it is said, with economy. The constructor says:

It is true that the engines of the three old ships cannot give a higher speed to the new ships than 12 knots per hour, but instead of building only one new ship we will possess three rams.

It remains to be seen, after these ships have been completed, what success has attended the making of modern fighting-vessels from the materials of obsolete vessels, engined with the old types of machinery.

The latest design and the most important fighting-ship of the Austrian navy will be the armored ship *Tegethoff*, now under construction at the works of the *Stabilimento Technico* at Trieste.

THE TEGETHOFF.

The *Tegethoff* will be a broadside central-battery ship, in which the batteries project over the sides of the vessel, as first introduced in the upper batteries of the British *Audacious* class. The following figures give her dimensions, calculated elements, &c.:

Length between perpendiculars.....	286 feet 11 $\frac{1}{2}$ inches.
Length, total.....	303 feet 1 $\frac{1}{2}$ inches.
Breadth on water-line.....	62 feet 9 inches.
Extreme breadth to the outside of armor.....	71 feet 1 $\frac{1}{2}$ inches.
Depth of hold.....	34 feet 9 inches.
Draught of water aft.....	26 feet 7 $\frac{1}{2}$ inches.
Draught of water forward.....	23 feet 1 inch.
Displacement with the half of provisions.....	7,390 tons.
Area of the midship section.....	1, 301 square feet.
Area at the load water-line.....	14, 308 square feet.
Height of metacenter above center of gravity of displacement.....	14.623 feet.
Height of metacenter above water.....	4.770 feet.
Distance of the center of gravity of displacement forward of the midship section.....	3.356 feet.
Depth of the center of gravity of displacement below water.....	9.853 feet.
Co-efficient of displacement.....	0. 582
Co-efficient of water-line.....	0. 782
Co-efficient of midship section.....	0. 82
Displacement of an inch immersion at the load water-line.....	34. 47 tons.
Weight of armor and backing.....	2, 160 tons.

The armament consists of six 11-inch Krupp guns.

Area of sails.....	12, 165 square feet.
Cost of hull, estimated.....	\$839, 759
Cost of engines and boilers, estimated.....	\$397, 135
Nominal horse-power.....	1, 200
Number of cylinders.....	2
Diameter of cylinder, effective.....	125 inches.
Length of stroke.....	4 feet 3 inches.
Griffith's propeller, diameter.....	23 feet 6 inches.
Pitch.....	24 feet.
Number of blades.....	2
Revolutions per minute.....	70
Number of boilers.....	4
Area of fire-grate.....	850 square feet.
Heating surface.....	25, 500 square feet.
Superheating surface.....	1, 800 square feet.
Pressure of steam.....	30 pounds.
Number of furnaces.....	36
Mean indicated horse-power.....	8, 000
Speed, estimated.....	14 knots.

Mr. E. J. Reed, C. B., M. P., before the Institution of Naval Architects in London, in April last, spoke as follows of this ship :

From these figures it will be seen that although we are not dealing with a ship of the *Inflexible* type, in which armor of excessive thickness is placed over a central citadel of extremely limited extent, we nevertheless have a very powerful ship indeed, with armor of apparently about 13 to 14 inches thick, and with a concentrated battery of six 11-inch Krupp guns, each weighing, I presume, about 27 tons. The ship has a belt of armor extending from the stern to within about 30 feet of the foremost perpendicular, where it terminates in a transverse armored bulkhead, and a stout iron deck going forward to the stem at about 7 feet below water. It would appear from this that the Austrian authorities consider that a strong iron stem, supported by a stout deck near the point of the ram, is sufficient for ramming purposes, whereas in our navy we have thought it better, beginning, if I remember rightly, with the *Rupert* and *Hotspur*, to keep the bow armor and carry it down at the stem to considerably below the ram point. We take it for granted that the latter, or English, arrangement would at least have the advantage of protecting the ram bow from much local damage in ramming iron vessels, and this is no doubt very desirable where a ship is designed primarily as a ram, as were the *Rupert* and *Hotspur*; while, on the other hand, where the ram is a subordinate feature, as in the *Tegethoff*, it may be unnecessary to burden the bow with so much armor protection.

It is worth while to observe in this connection that the Austrians, who have had practical experience of the effects of ramming in actual warfare, have in this, their largest and most powerful ship, preserved a very great length of under-running or sheer-projection. * * * The projection is 9 feet from the stern at the load water-line and 19 feet from the stem-head.

I observe next in this ship, the Austrian Admiralty have adopted an improvement in armor to which I have for a long time past attached great importance. I refer to the getting rid for the most part of great curvature. Of course armor-plates, if carried round the ends of a ship, must be bent to the curvature of the water-lines; and when imbedded, so to speak, in the sides of a ship of ordinary form and curvature, as has been usual in sea-going ships, they must also be bent crosswise. Now, this double curvature of the plates is not only an expensive process, but it is also injurious to the armor-plates in some degree.

By so designing the ships that the armor-plates have only to be curved in one direction, all these disadvantages and difficulties are practically got rid of. The next feature to be remarked in this ship is that the battery is of the projecting type, which so greatly facilitates the obtainment of direct fire ahead and astern from a midship-battery without excessive recession of the unarmored parts of the ship before and abaft the battery.

The Admiralty constructors and myself introduced this arrangement in many cases of upper-deck batteries in ships designed while I was at the Admiralty, (most notably in the case of the *Audacious* class,) but I do not think the same thing has been done at the Admiralty in the case of the main-deck battery. I have, however, done it myself in several ships for foreign governments since I left the Admiralty, and I give examples in Figs. 1 and 2, which represent outline sections of the *Kaiser* and *Deutschland*, (German,) and the *Amirante*, *Cochrane*, and *Valparaiso*, (Chilian,) armor-clad ships.

In the *Tegethoff*, the overhang is very low and considerable in amount, the battery

FIG. 2

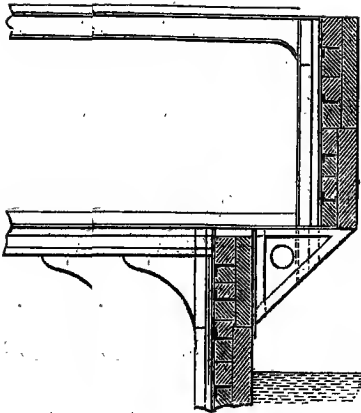
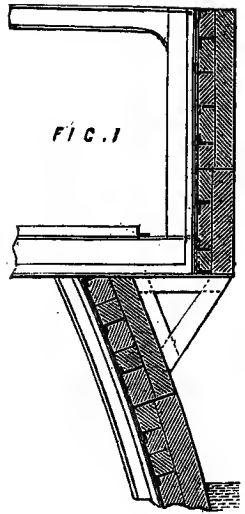

FIG. 1



projecting between 4 feet and 5 feet, the spread commencing at 18 inches above the water, and terminating at a height of 6 feet.

The armored citadel of the *Tegethoff* is to be furnished with a transverse armored bulkhead abaft the two foremost guns, an arrangement which will prevent the battery from being raked in chasing. This improvement exists in the *Alexandra*, where it was, I believe, introduced for the first time by the present Admiralty constructors. The foremost bulkhead of the battery is inclined forward at a considerable angle to within about 4 feet of the middle line, where it becomes transverse, as shown. Immediately over this foremost portion of the battery, at the middle, is a very strong pilot-tower, standing well above both the gunwale and the forecastle. This shows that the Austrian officers who have been in an action with iron-clads do not consider such towers unnecessary. The above appear to me to be the principal features of the *Tegethoff*. It may be interesting to add that, while the outer skin and angle-irons of the hull are of iron, all the remainder is of Bessemer steel, varying in tensile strength from 30 to 33 tons per square inch of section, and possessing this, as I am informed, in combination with 25 per cent. of ductility. This Bessemer steel is produced very successfully in Styria and Carinthia, from which districts of Austria the chief supplies of the *Tegethoff* are derived. I may further add that, in designing this ship, much consideration has been given to securing both strength and subdivision by means of water-tight bulkheads between the coal-spaces and the boilers and elsewhere.

S. Ex. 27—12

Armored ships of Austria.

Name of ship.	Vessel.								Armament.			Thickness of armor at water-line, in inches.	Machinery.			Cost.	
	Length between perpendiculars, in feet and inches.	Extreme breadth, in feet and inches.	Depth of hold, in feet and inches.	Immersed midship section, in square feet.	Displacement, in tons.	Draught forward, in feet	Draught aft, in feet and inches.	Number of guns and description.	Height of battery above water, in feet and inches.	Number of screws.	Indicated horse-power on trial.		Maximum speed, in knots per hour.	Machinery.	Ship completely equipped, in gold.		
LINE-OF-BATTLE CRUISERS.																	
Costozza*	302 3	57 10	37 1	1,082	6,750	21 7	25 10	8 10-inch Krupp guns; 4 howitzers.	9 9	1	6,000	\$387,100	\$2,030,560		
Erzherzog Albrecht*	275 7	54 4.8	35	969	5,365	18 9½	23 3¼	8 10-inch Krupp guns.....	10 2	1	4,300	362,600	1,752,240		
Kaiser*	263 8	59 5	30 3	860	5,800	24 1	25 8	10 9-inch Armstrong guns.....	8	1	282,240	1,652,280		
Ferdinand Max†	253 2	50 9.8	20 3	831	4,558	20 24 1	24 10	14 8.27-inch Krupp guns.....	6 11	1	2,962	10.3	239,120	1,403,360		
Habsburg†	253 2	50 9.8	20 3	831	4,558	20 24 1	24 10	do.....	6 11	1	239,120	1,403,360		
Lissa.....	274 6	55	22 3	1,047	6,406	24	28 2	12 9.45-inch Krupp guns.....	6 6	1	3,550	13	323,419	2,022,780		
Kaiser Max†	222	44 2	706	3,464	18 4	22 6	do.....	6 4½	1	1,710	8.5	204,441	1,028,376		
Don Juan d'Austria†	222	44 2	706	3,464	18 4	22 6	do.....	6 4½	1	1,710	8.5	204,441	1,028,376		
Prioz Engen†	222	44 2	706	3,464	18 4	22 6	do.....	6 4½	1	1,710	8.5	204,441	1,028,376		
Tegethoff.....	287	71 1	34 7	1,301	7,390	23 1	26 7¼	6 11-inch Krupp guns.....	1	8,000	14	397,135	1,236,894		
ORDINARY STATION SERVICE.																	
Drache*	186 6	43 7	693	2,932	18 7	21 3	10 7-inch Armstrongs, rifled.....	6 3	1	1,418	7	174,240	800,928		
Salamander*	186 6	43 7	693	2,932	18 7	21 3	do.....	6 3	1	1,418	7	174,240	800,928		
COAST DEFENDERS.																	
Maros	160 1	26 8	95	300	3 6	3 6	2 5.9-inch Krupp guns.....	3 9	1	314	5.6	19,600	98,000		
Leitha	160 1	26 8	95	300	3 6	3 6	do.....	3 9	1	5.6	19,600	98,000		

* Central battery.

† Broadside battery.

‡ In process of reconstruction.

§ In process of construction.

|| Single turrets.

PART XVI.

ARMORED SHIPS.

TABLES OF DIMENSIONS, &c., OF THE ARMORED SHIPS OF TURKEY, HOLLAND, AND SPAIN.

ARMORED SHIPS.

The sheets following contain the lists and principal dimensions of the armored ships of other important European naval powers; and although necessarily far from complete, the tables will be found more accurate and fuller to recent date than any previously published, and may be useful as accessible, trustworthy information.

As the *résumé* of interesting facts relating to armored fleets, it may be stated that the grand total of all the European armored ships built from the commencement amounts in the aggregate to 1,014,500 tons; that the grand total of all the armored ships built and building for the British navy up to January, 1876, amounts in the aggregate to 317,000 tons, and the cost thereof, in round numbers, is given at eighteen million pounds sterling, or eighty-seven millions four hundred thousand dollars in gold.

According to numbers, and excluding the small craft, such as the *batteries démontables* of the French and the few floating batteries still remaining on the English and French lists from the Crimean war period, it appears, by reckoning in all the other classes, rigged and mastless, sea-going and coast-defenders, that eighteen years' continuous effort and the expenditure of enormous sums of money have produced the following results: England heads the list with 59 vessels. France comes next with 53 vessels, having an aggregate tonnage of 184,000, including those now building. Russia is possessed of 29 ships, with a tonnage of 89,000, among which are four sea-going ships. Italy can muster 16 vessels of the aggregate tonnage of 55,000, and when the *Duilio* and *Dandolo* are completed, will possess the two most powerful fighting-ships in the continental waters of Europe. Turkey, if possessed of little else, can show a fleet of 24 fighting-ships, with an aggregate tonnage of 65,000. The German Empire has 13 vessels, eight of them sea-going, and the aggregate tonnage of all is 60,000. Holland possesses 17, of the tonnage of 23,000. Austria 14, and Spain 7.

No European power claiming to have a navy is entirely without armored ships, and of those not contained in the following tables nor heretofore given, Denmark possesses 6, Sweden and Norway 8, (half belonging to each,) Portugal 1, and Greece 2. The grand total of European armored ships, including those building, may, at the present time, therefore, be taken as 249; of which England possesses about one-fourth, France about one-fifth, Russia about one-eighth, and the remaining powers still smaller proportions. Crossing the ocean, it is found that Brazil has 17 armored vessels, Peru 6, Chili and the Argentine Confederation each 2; while in Asia, Japan boasts of 2 armored vessels, (one of them the *Stonewall Jackson* of well-known fame,) and, lastly, the Chinese have entered the field with armored gunboats.

It is proper to add that neither the number of vessels, the number of guns carried, nor the total tonnage will convey correct ideas of the power and efficiency of the fleets.

With a single exception, leaving out of account the skirmishes on the coast of Spain during the late civil war, none of the numerous European

armored ships have ever been engaged in mutual warfare. The exception is the short and ill-contested fight of one hour's duration at Lissa, between the Austrians and Italians. The account of this battle published by Admiral Persano has shown that the Austrian fleet consisted of seven armored vessels and fifteen wooden frigates, and that the Italian fleet consisted of twelve armored vessels and eight wooden vessels; that the Italian flag-ship *Re d'Italia*, a wooden iron-clad, was sunk by the ram of the Austrian flag-ship *Ferdinand Max*; that the Italian corvette *Palestro* was struck abaft in the unarmored part by a shell, which set the vessel on fire and she blew up, all hands on board being lost. The sea was somewhat rough, and the Italians managed their ships and guns so unskillfully that but little damage was done to the Austrian ships; and although one of the Italian ships delivered two concentrated broadsides at one of the enemy's ships as she passed within 40 yards, not one shot struck. All, on both sides, were broadside ships. This battle cannot be quoted as decisive testimony of the value or weakness of armored ships, nor does it prove that future naval engagements will be mainly decided by ramming, for if any one will carefully read the account of the *Fatti di Lissa* he will perceive the extreme difficulty which was experienced by both Austrian and Italian captains in delivering against a ship in motion the fatal and decisive blow. It was not until the rudder of the *Re d'Italia* was disabled, that the Austrian iron-clad was able to ram her. No lesson of value can therefore be drawn from this contest. It remains for future great naval battles to furnish naval architects and officers with practical illustrations.

Armored ships of Turkey.

Name of ship.	Vessel.				Armament.		Height of battery above water, in feet and inches.	Thickness of armor at water-line, in inches.	Number of sorews.	Maximum speed, in knots per hour.	Remarks.
	Class.	Length between perpendiculars, in feet and inches.	Extreme breadth, in feet and inches.	Draught forward, in feet and inches.	Draught aft, in feet and inches.	Number of guns and description.					
Mesoudiyeh.....	Line-of-battle ship.....	332	59	23	25	12 18-ton guns, 3 6½-ton guns, and 6 small guns..	10	12	1	13.8	{ Midship section, 1,281 square feet. Displacement, 9,120 tons. Indicated horse-power, 7,300.
Memoobiye.....	do.....	332	59	23	25	do.....	10	12	1	13.8	
Azizieh.....	do.....	293	56	24	25	15 6½-ton guns; 1 12-ton gun.....	10	1	12	Displacement, 6,635 tons.
Orkaneh.....	do.....	293	56	24	25	do.....	10	1	12	
Osmanieh.....	do.....	293	56	24	25	do.....	10	1	12	
Mahmondieh.....	do.....	293	56	24	25	do.....	10	1	12	
Ahar Tevkek.....	do.....	275	50	19	21	8 12-ton guns.....	4½	4½	
Noosretieh.....	do.....	292	3	10 12-ton guns; 2 6½-ton guns, and 6 small guns	9	9	
Feth i Bonlend.....	Ordinary station-serv-ice ship.....	235	43	17	18	4 12-ton guns.....	9	9	1	14	
Mukademe Kies.....	do.....	235	43	17	18	do.....	9	1	14	
Arni Ullah.....	do.....	230	35	15	17	do.....	7	1	12	
Moyhi Zaffir.....	do.....	230	36	15	17	do.....	7	1	12	
Ahar-Sheffet.....	do.....	210	40	15	17	5 150-pounder guns; 1 12-ton gun	4½	4½	
Neghin Shekkel.....	do.....	210	40	15	17	do.....	4	4	
Idjia Lieh.....	do.....	219	41	15	17	do.....	4	4	
Latif Gellit.....	Coast-defense vessel.....	204	43	9	9	4 150-pounder guns.....	4½	4½	
Hafiz Rahman.....	do.....	204	43	9	9	do.....	4½	4½	
Two corvettes.....	do.....	} Monitors. No data.
Feth il Islam.....	Armored gunboat.....	100	24	6	6	2 12-ton guns.....	2	3	2	9.05	
Baskor Selim.....	do.....	100	24	6	6	do.....	2	3	2	9.05	{ Immersed midship section, 124 square feet. Displacement, 328 tons. Engines built at the Forges et Chantiers Each vessel to cost about \$57,130. Indicated horse-power, 411. Height of battery, 2 feet 3 inches.
Semendrieh.....	do.....	100	24	6	6	do.....	2	3	2	9.05	
Iskodra.....	do.....	100	24	6	6	do.....	2	3	2	9.05	
Podgoritza.....	do.....	100	24	6	6	do.....	2	3	2	9.05	

The last additions to the Turkish armored fleet are the sister-ships *Mesoodiyeh* and the *Memdoohiyeh*, both designed by Ahmed Pasha, the chief constructor of the Turkish navy, built by the Thames Iron-Works Company, London, and supervised by Admiralty officers. Favorable opportunities were seized to inspect these ships, the former being afloat and well advanced toward completion, and the latter on the blocks, and subsequently launched during my visits to the Thames building yards.

The *Mesoodiyeh* was delivered to the Sultan of Turkey last year, and the *Memdoohiyeh* had her official trial-trip over the measured mile on the Maplin Sands only this month of January, 1877.

The displacement of these ships is 9,000 tons each, and the principal dimensions may be seen by referring to the foregoing table of armored ships of the Turkish navy. They are full-rigged frigates of the broad-side central-battery type, with hulls of the usual cellular construction—there being in all 82 water-tight compartments. The battery is 153 feet in length, and the armor-plating on the sides is 12 inches thick, backed by the same thickness of East India teak.

The armaments were furnished by Sir W. G. Armstrong & Co., and consist of twelve 18-ton guns on the gun-deck, two 6½-ton guns on the upper deck forward, and one of the same caliber aft.

The steam-machinery of the *Memdoohiyeh* was constructed by Messrs. Maudslay Sons and Field. The engines are of that firm's well-known old type, with two piston-rods to each cylinder, connected by an inclined cross-head, one rod passing over and the other below the crank-shaft. The two steam-cylinders are each 116 inches in diameter, and the stroke of pistons 4 feet. The surface-condensers contain 8,800 composition tubes, each 8½ feet in length by ¾ inch diameter inside, giving a total condensing-surface of 16,500 square feet. The condensing-water is circulated by two 3-foot centrifugal-pumps, each pump being capable of circulating 5,000 gallons of water per minute. The diameter of the screw-propeller is 23 feet, and the pitch, as set on the trial-trip, 19½ feet. It is arranged to be disconnected from the screw-shaft, and to revolve when the ship is under sail.

The boilers are eight in number, and of the rectangular type, each containing five furnaces 7½ by 3 feet. The total grate-surface is 900 square feet, and total heating-surface, 22,500 square feet.

The results of the trials on the measured mile are given by The Engineer. Six runs were made, every alternate one being against the tide—the means of all being, revolutions per minute, 66.3; vacuum, 26½; boiler-pressure, 28½ pounds; speed in knots, 13.74.

Armored ships of Holland.

Vessel.		Vessel.				Vessel.		Vessel.		Vessel.		Vessel.		Vessel.		Vessel.		Vessel.		Vessel.	
Name of ship.	Class.	Length between perpen- diculars, in feet and inches.	Extreme breadth, in feet and inches.	Draught forward, in feet and inches.	Draught aft, in feet and inches.	Number of guns and de- scription.	Thickness of armor at water-line, in inches.	Maximum speed, in knots per hour	Engines, where built.	Remarks.											
Prinz Hendrik der Nederlanden.	Double-turret	230 2	44	17 10	18 10	4 9-inch Armstrong guns	5.75	12	Birkenhead	Height of battery above water, 7' 2", depth of hold, 26' 6", indicated horse-pow- er, 2,426.											
De Ruyter	Central-battery			21 4	21 4	14 60-pounders	4½	11	Flushing	Indicated horse-power, 2,232. Total cost of each, \$448,840. Midsbip section, 542 sq. ft. Displacement, 2,113 tons. Height of battery above water, 7' 3". Displacement, 2,100 tons. Depth of hold, 24' 0".											
Schorpioen	Single-turret with ram bow	193 6	36 0	15 6	15 6	2 9-inch guns	6	12.82	Forges et Chantiers	} Twin-screws. Do. Do. Do. Do. Do. Do. Do. Do. Do.											
Stier	do	193 6	36 0	15 6	15 6	do		12.82	do												
Buffel	do	205 0	40 0	15 6	15 6	2 12-ton guns, 4 32-pounders	8½	13													
Guinea	do	205 0	40 0	15 6	15 6			7													
König der Neder- landen.	Single-turret	187	44	8 6	8 6	2 12-ton guns	5½	7	Amsterdam												
Bloedhond	do	187	44	8 6	8 6	do	5½	7	do												
Cerberus	do	187	44	8 6	8 6	do	5½	7	Birkenhead												
Heiliger lee	do	187	44	8 6	8 6	do	5½	7	do												
Krokodill	do	187	44	8 6	8 6	do	5½	7	do												
Tijger	do	187	44	8 6	8 6	do	5½	7	Glasgow												
Alder	do	187	44	8 6	8 6	do	5½	7	do												
Haak	do	187	44	8 6	8 6	do	5½	7	Amsterdam												
Hyena	do	187	44	8 6	8 6	do	5½	7	do												
Panther	do	187	44	8 6	8 6	do	5½	7	do												
Wesp.	do	187	44	8 6	8 6	do	5½	7	do												
Unfinished	do					18 60-pounders			do												
Two gunboats				No data.	11 2	2 4½-inch guns			do												

Armored ships of Spain.

Name of ship.	Class.	Vessel.							Armament.	Thickness of armor at water-line, in inches.	Remarks.
		Length between perpendiculars, in feet and inches.	Extreme breadth, in feet and inches.	Depth of hold, in feet and inches.	Midship section, in square feet.	Displacement, in tons.	Draught forward, in feet and inches.	Draught aft, in feet and inches.			
Numancia	Line-of-battle ship	313 7	56 11	23 11	1, 151	7, 053	23 4½	26 8	6 18-ton Armstrongs; 3 9-ton Armstrongs; 16 7-ton	5	Broadside battery; ram bow. Built at the Forges et Chantiers. Indicated horse-power, 3,708. Speed, 13 knots. Single screw. Total cost, \$1,546,440. Height of battery above water, 7 feet 6½ inches.
Vittoria	do	316	57	23 11	1, 151	7, 053	23 4½	27	4 12-ton Armstrongs; 3 9-ton Armstrongs; 12 7-ton	5½	
Saragossa	do								4 11-inch; 2 8½-inch; 14 7½-inch	4½	
Arapiles	do								2 18-ton; 5 9-ton; 10 7-ton	4½	
Mendez Nunez	Ordinary station-service ship.								4 9-inch Armstrongs; 2 8-inch		Late the Resolucion.
Sagunto	do								2 18-ton; 5 9-ton; 10 7-ton	4½	
Aragon	do			No data.					3 guns		In course of construction.
Castilla	do								do		Do.
Navarra	do								do		Do.
Duque de Tetuan	Light draught battery								do		
Puigcerda	do								do		

PART XVII.

COMPOUND ENGINES.

NAVAL COMPOUND ENGINES; COMPARATIVE MERITS OF THE SIMPLE
AND THE COMPOUND ENGINE.

COMPOUND ENGINES.

The efforts of the engineering profession have long been directed to the reduction of the cost of the production of power, and for a lengthened period the question of the relative merits of the simple and compound engines occupied the attention of the engineering world. Many experiments have been made and much ability and ingenuity displayed, to prove that the compound system possessed no advantages over the ordinary simple engine working high-pressure steam; the most important of these experiments will be noticed presently.

My annual report to the Department, as Chief of the Bureau of Steam-Engineering, dated October 30, 1871, just after returning from a short tour of investigation of the subject, gives the facts at that time; and as they hold good to-day, I cannot do better than copy that part of the report which bears on the subject. It is as follows:

The tour proved very instructive and interesting in many respects, especially in Great Britain, where immense fleets of iron ships are constructed and put afloat yearly, where ships are built for nearly all European nations, and where the British navy is systematically improved and strengthened by additions of nearly twenty thousand tons of iron-clads annually, besides transports and unarmored vessels.

The vast and varied experience of their constructing engineers and the sharp competition between rival building-firms have given rise to rapid improvements, and compelled the abandonment of many designs only a few years ago regarded as the best productions of engineering skill.

The pressure of steam carried in marine boilers has gradually risen with corresponding increase in the extent to which expansion is carried, until boilers have been introduced, and are coming into universal use on board ship, in which the steam is kept from sixty to seventy-five pounds per square inch, and expanded in the cylinders from ten to fourteen times.

The form of boiler used for generating the steam differs from the variety so long employed in all European steamers. It is built with a cylindrical shell of from 9 to 15 feet diameter, and of thickness from $\frac{3}{4}$ -inch to $1\frac{1}{4}$ inches, according to the pressure to be carried. It is sometimes from 9 to 10 feet long, and is placed in the vessel athwartships, with fire-rooms fore and aft in the ordinary way, and sometimes about 18 feet long, placed fore and aft and fired from either end. There are two or three cylindrical flues, according to diameter, in which are the grates, and above them a set of horizontal fire-tubes, through which the gases return to the front, thence to the funnel. This boiler is strong, of moderate cost, and generates steam freely and economically.

The type of engine employed for working the steam is known as double-expansion or compound, the steam being admitted from the boilers first into a small high-pressure cylinder, there expanded to a third or fourth of its original pressure, then passed through a receiver into a large or low-pressure cylinder, where, after propelling the piston to the end of the stroke, it is exhausted into the condenser. This system of working steam expansively was introduced by Woolf seventy years ago; but at that date steam was used at a very low pressure, and the project met with no success. For many succeeding years the subject was discussed and experimented upon by engineers, but no advantages over the ordinary method of working steam expansively in a single cylinder were reached until a talented engineer of Scotland, Mr. John Elder, proprietor of the Fairfield Works, near Glasgow, several years ago took up the subject, and, in the face of immense opposition, zealously pursued it, designing and constructing every year several sets, each being more and more improved in design and detail, until they have been brought to the present state of perfection.

Of the thirty-seven engineering works and iron-ship building-yards on the Clyde, the Fairfield Works is now the most extensive and important. At the time of my visit this firm had already completed one hundred and thirty pairs of marine compound engines, and accompanying boilers, and had then twenty-two pairs under construction—all for ocean-steamers; besides, in their ship-yard, ten large iron vessels were on

the blocks, four at the wharf being engined and completed, and orders were on hand for others as soon as room could be made for them. This firm is justly regarded as the pioneer of the compound system, and their productions are accepted as the best types.

The largest establishment on the river Tyne, "and, as a combination of engineering and manufacturing," the most extensive in Great Britain, the Palmer Company, had under construction about the same number of compound engines, two iron-clads for the British navy, and several other vessels. In short, all engineering-works in Great Britain are now building their marine steam-machinery on the new system. These engines are also manufactured by Messrs. Schneider & Co., at Creuzot, and M. Mazeline, at Havre, France. They are also built in Germany and in Belgium. Indeed, the success of the system is so certainly established that no European owner will now contract for an ocean-steamer unless it is stipulated that she shall be propelled by compound machinery.

Many commercial vessels containing very good machinery of the ordinary kind have been laid up, the machinery removed, and other machinery, on the new system, substituted. An example of this came under my notice in the case of one of the West India mail screw-steamers—the *Tasmania*. This vessel, twelve years old, had the best machinery, with jet-condenser, at the date of construction; with it fifty round trips had been made. All the machinery was then removed, and compound machinery substituted. At the date of my visit one round trip had been made with it, and an inspection of the logs showed the average consumption of coal for the round trip with the old machinery to be three thousand tons, while the round trip with new machinery had been made with fourteen hundred and forty-five tons, the speed of vessel remaining the same. In some cases, such as that of the *Ville de Paris* and *Periere*, of the French Atlantic line, both comparatively new ships and having excellent machinery, orders have been issued for its conversion by the addition of a third steam-cylinder, to be used for the admission of the high-pressure steam, the removal of the present boilers, and in lieu thereof high-pressure ones placed on board.

The Cunard Company, the most conservative of all steamship owners, who were the last of the companies to substitute iron vessels for wooden vessels, who were the last to give up the paddle-wheels for the screw, are now the last to accept the compound engine and high-pressure steam in the vessels of their line in lieu of the old system. But in this, as in former cases, sharp competition of several lines has caused this company to convert the machinery of one of their vessels, and to place the new type in two small vessels, the *Batavia* and *Parthia*; besides, at the time of my visit, the models were being prepared for two vessels of dimensions larger than any now on the line, to be constructed and supplied with the compound type of machinery.*

The British Admiralty, charged with the administration of by far the largest and most powerful navy in the world, always cautious in the application of new inventions, rarely adopting any untried plans, but surely accepting the most successful in practical operation, have in this particular made the test of the new system by its application to two ordinary wooden vessels, the *Tenedos* and the *Briton*, of 1,331 and 1,261 tons register, respectively. The success attending the trials of these two vessels justified them in ordering the third set for the *Thetis*; also two other sets for the twin-screw iron-clads *Hydra* and *Cyclops*, all now under construction; and although several iron-clads and unarmored vessels are being completed with the ordinary type of screw-machinery, ordered two or more years ago, all future ships constructed for the British navy will doubtless be engined on the new system. It is not probable, however, that any of their six hundred registered vessels will be ordered to undergo the process of alteration, because their cruising steamers are intended to be essentially sailing-vessels, and their steam-power is only used when the sails cannot be depended upon to accomplish the purpose required; the cost, therefore, of the alteration from the old to the new machinery would be too great for the results desired to be obtained.

The original cost of steam-machinery on the compound system, its total weight, and the space occupied by it in a vessel, does not materially differ from that of the ordinary type. The advantages are chiefly in the reduced consumption of fuel, less space for it on board, and smaller number of men required to handle it. These advantages have been found very great in commercial vessels making long passages, so great that the new type of machinery is as surely displacing the old on the ocean as the screw displaced the paddle, and surface-condensation displaced the old jet-condenser. In the two steamers of the British royal navy to which the compound engines have been applied and tested, and in the Atlantic steamers plying between New York and Liverpool, having this kind of machinery on board, the power developed is obtained with less than two pounds of good English coal per horse-power per hour, or half the fuel for the same power developed under the system of non-expansion and jet-condensation. In other words, a steamer is propelled the same distance and at the same speed by compound machinery with five hundred tons of coal, that required one thousand tons with the old type, and from thirty to forty per centum less than with the latest and best kind, having surface-condensation and superheaters.

* These two ships, since completed, are the *Bothnia* and *Scythia*.

The progress made in this direction, of economy in fuel, may be briefly noted in the following facts: The paddle-wheel steamer *Scotia*, of the Cunard line, put afloat in 1862, and at that date regarded as the best and latest type of engineering skill, a vessel having a midship section of 841 square feet, consumed 160 tons of coal per day, or 1,600 tons on the ten days' passage between New York and Liverpool. The *City of Brussels*, a screw-steamer of the Inman line, put afloat in 1869, and having a midship section of 709 square feet, consumed 95 tons per day, or 950 tons on the ten days' passage. The *Spain*, a screw-steamer of the National line, put afloat in 1871 with compound machinery, and the largest ship on the Atlantic, having a length of 425 feet 6 inches on the load-line, beam molded 43 feet, draught, loaded, 24 feet 9 inches, made the passage in September with 53 tons of coal per day, or 530 tons on the ten days' run; all three vessels having the same average speed; a small percentage only of the gain being due to the finer lines and proportions of the last-constructed vessels.

The field of observations in this direction has been thoroughly gone over, the subject carefully investigated, and the Bureau is informed of the extent of European operations and results, of which a brief outline has been given. The information is positive, and there can be no hesitation in recommending that all cruising steamers for the Navy hereafter put afloat be engined on the compound system, and that all the steam-machinery stored in the navy-yards that cannot be used to advantage in the old vessels, or converted into compound, be disposed of by public sale, or broken up and used as old material; and in view of the necessity of timely preparation, the Bureau has taken steps for the execution of complete sets of working-drawings for machinery of vessels on the stocks, and that will suit classes of vessels that may be designed as cruisers. It is not, however, recommended to remove the machinery from any of the old vessels for the purpose of replacing it by the new, except in cases where the repairs to the old shall be found so costly as to condemn it altogether; for the appropriations are desired to be as small as compatible with the public interest, and the cost of alteration would be too great, considering the advantages desired to be gained under the regulations, of using sails as the motive-power, except in cases of emergencies.

Subsequent experience has still more firmly established the compound system. In European nations simple-expansion engines for all commercial and naval vessels are now as obsolete as the paddle-wheel on the ocean. The records of the surveyor's office in London show that of the several hundred commercial sea-going vessels built in the kingdom since 1871, including one hundred and twenty-three under construction when the report of this last year was received, all, excepting a very few for special purposes, have been engined on the compound system. Besides this, a large number of steamers set afloat previous to the successful application of the compound engine on the ocean, have, since my last report, been docked, the engines and boilers removed to the scrap-heap, and in lieu thereof compound machinery erected on board; a number of the vessels having the machinery so altered not being more than eight years old, and some only five years old. The steamers of the commercial fleet of Great Britain still retaining the old types of engines and boilers, retain them because the vessels cannot be spared from employment sufficiently long to remove the old machinery and substitute the new, or because the vessels are not worth the expense of the change. So far has this system of compounding the machinery of old vessels been carried, or, more properly, of substituting the compound for the simple type, that for vessels of 1,000 tons and under the proprietors of several engineering works have built in anticipation, and retained on hand to a considerable extent, compound engines and accompanying boilers suitable for vessels probably requiring them, and in many cases they have contracted for and accomplished the feat of removing the old machinery and erecting on board the new in ten days' time. Many of the old channel, coast, and river steamers of England still retain their old machinery, for the reasons above stated. Some, however, have been altered; one of them a paddle-steamer, the *Wolf*, in which I chanced to make a passage from Havre to Southampton. This vessel has a length of 250 feet, breadth 27 feet, and draws 9 feet of water. She was furnished originally with the old type of in-

clined engines, jet-condensers and box-boilers, carrying 30 pounds pressure of steam. For eight years she made the passage regularly between Havre and Southampton, of eighteen hours, on 48 tons of coal for the round trip. Two years ago these engines were compounded, and cylindrical boilers, carrying 60 pounds pressure of steam, substituted for the old ones. The results of this change were increased speed and an average consumption of coal for each round trip of 28 tons. Many other cases could be cited, but it is believed to be sufficient to state that Lloyd's inspecting-engineer's books show the saving of fuel resulting from compounding engines of British steamers to be from 30 to 40 per cent.

One of the steamship companies visited, having steamers that make long passages, was the Royal Mail. This company owns twenty-four steamers, eighteen of which are engined on the compound system, three still retain the old type of engines, and three have been altered from the old to the new system, with an average gain in fuel of 40 per cent. The *Moselle*, a vessel of this line, to which my attention was called as one economical in fuel, has a length of 376 feet, breadth of 40 feet, and a draught of water of 21 feet. She was built by Elder & Co. in 1873. The engines are of the inverted vertical compound type, with a high-pressure cylinder of 60½ inches and low-pressure of 112 inches in diameter, having a stroke of 4 feet. The boilers are cylindrical, and the pressure of steam 60 pounds to the square inch. This vessel is on the West India line; the distance steamed for each round voyage is 10,000 miles, the average speed 12 knots, and the average consumption of coal 40 tons per day of 24 hours.

NAVAL COMPOUND ENGINES.

It has been seen that as early as 1871 the British Admiralty, though always cautious in the application of new inventions, had set afloat two corvettes engined on the compound system, and that the same type of engines were under construction for three other vessels. About this time a special committee on the designs of ships of war, consisting of sixteen of the most distinguished naval officers, naval architects, and engineers in the kingdom, were holding their sessions in London. In 1872 their voluminous report was presented to both houses of Parliament, and the following is an extract from all that part of the report relating to compound engines:

* * * The carrying-power of ships may certainly be to some extent increased by the adoption of compound engines into Her Majesty's service. We are aware that this modification of the ordinary marine engine has not escaped the notice of the constructive department of the navy, and that some few of Her Majesty's ships have been so fitted; but its use has recently become very general in the mercantile marine, and the weight of evidence in favor of the large economy of fuel thereby gained is, to our minds, overwhelming and conclusive. It is unnecessary for us to say that in designing a ship, economy of fuel may mean either thicker armor, greater speed, a smaller and cheaper ship, or the power of moving under steam alone for an increased period, according to the service which the ship is intended to perform. We beg leave, therefore, earnestly to recommend that the use of compound engines may be generally adopted in ships of war hereafter to be constructed; and applied, whenever it can be done with due regard to economy and to the convenience of the service, to those already built.

Since the date of this recommendation, viz, 1872, there have been designed and ordered to be constructed nine armored ships of large size; twenty-three unarmored corvettes; twelve unarmored sloops; two armed dispatch-vessels; one troop-ship, and twenty-eight gunboats, besides several vessels designed but not ordered to be built. All of these vessels, excepting a very few of the gunboats and one sloop, have been or are being engined on the compound system. The excepted

gunboats referred to have been supplied with simple expansive engines, carrying the same pressures of steam on the boilers, viz, from 60 to 70 pounds per square inch; and the sloop is to be engined on the Perkins system, in which the steam is to be carried at from 250 to 300 pounds per square inch.

The British Admiralty have not converted the engines of any war-vessels for the reason stated at page 190, but some of the troop-ships employed in making long passages to India, and as a consequence using coal in large quantities, have been converted—one, the *Euphrates*, built and engined by Laird Brothers nine years ago, at a cost for the machinery of \$364,500. Though the machinery was in all respects in good order, it was last year removed to the scrap-heap, and compound engines and accompanying boilers substituted by the same firm at a cost of \$267,300 and the old machinery. The *Euphrates* is of 6,211 tons displacement and 5,000 indicated horse-power.

The compound system was introduced and adopted in the national navy of France after its success was established in the British navy; and I was informed at the engineering department of the *Ministre de la Marine* in Paris that no ships are now built or ordered to be built for the French navy with other than compound machinery.

In the Italian navy one ship, the *Duilio*, building at Castellamare, is being engined with Penn's old type of machinery. This machinery was ordered before the Italian naval authorities felt sure of the success of the compound system, but all other new vessels are being fitted with compound engines; and it is quite certain that all vessels for this navy hereafter ordered to be built will be engined on the new system.

In the German imperial navy the compound system is in use, and, as far as I was able to learn, it is also in use in all other continental navies, as well as in the vessels of the commercial marine of every country.

If our naval vessels, built since the successful introduction of the compound engine in foreign navies, had been engined with the old types of machinery, we should have been regarded, both at home and abroad, as being far behind the times in steam-engineering; and the very officers who have raised objections to the compound engine for naval vessels, would doubtless have been the first to denounce the Engineering Department as being uninformed and incompetent for the responsible duties of construction.

If objection to the compound system is based on the necessarily higher pressure of steam used than formerly, it may be stated in reply that the working-pressure of steam has gradually risen from about five pounds per square inch, as at first introduced on board ship, to 80 pounds per square inch. Also, that in all the gunboats employed on the western rivers during the civil war, about 140 pounds pressure per square inch was used. Again, that the British Admiralty are now building the machinery for a sloop, in the boilers of which pressures of from 250 to 300 pounds per square inch are to be carried.

The objection to high-pressure steam on board fighting-ships is said to be the increased danger to life in the event of a projectile piercing a boiler during an engagement. Now, all experience in boiler explosions, that of the *Thunderer* included, has proved that no persons can breathe steam at whatever pressure it may escape from the boiler in which it was contained, and live. If, therefore, a boiler having a pressure of 80 pounds per square inch should be penetrated, the result would be the same as if the pressure had been only 20 pounds, viz, probable death to the engineers and men employed in and near the fire-rooms, but to none others necessarily.

COMPARATIVE MERITS OF THE SIMPLE AND COMPOUND ENGINE.

I have previously stated that many experiments had been made to test the relative merits of the compound engine, and the simple engine working high-pressure steam. It is quite unnecessary to go into any lengthened statement or detail of these experiments. Many of them have been published in full and are familiar to the engineering profession. I shall therefore refer only to those made by the British Admiralty, and to the more important and expensive experiment of the Allen line of steamers.

In 1874 two gunboats for the Royal navy were built. One, the *Swinger*, was supplied with simple engines, and the other, the *Goshawk*, with compound engines. The same kind of boilers and the same pressure of steam was used in each case, and the indicated horse-power was to be the same in both, viz, 360. The limited trials made with these boats were at the time published, and as different opinions existed as to the merits of the two systems for small vessels with low power, it was decided to supply three others ordered to be built, after the same fashion. Accordingly the *Sheldrake* and the *Moorhen* were fitted with simple expansion engines, and the *Mallard* with compound engines. These vessels are composite gunboats. The two former were engined by Messrs. Napier and Sons, and the latter by Earl's Engineering Company at Hull. The boilers in all are practically identical. They are cylindrical, each containing two cylindrical furnaces 2 feet 6 inches in diameter and 4 feet 6 inches long. These two furnaces terminate in a common combustion-chamber 3 feet 2 inches deep. The tubes do not return over the furnaces, but are continued from the combustion-chamber to the smoke-box at the forward end of the boiler, the boilers being placed in a fore-and-aft direction. On the top of the combustion-chamber, between the ends of the furnaces and the tubes, is suspended a bridge, which deflects the flame and heated gases before they enter the tubes, and the use of which has been attended with satisfactory results. The engines of the *Sheldrake* and *Moorhen* are simple expansion engines, direct-acting, the connecting-rods working between the cylinders and the cranks; expansion-valves, capable of cutting off the steam as early as one-fifteenth of the stroke, are fitted on the backs of the main slide.

The experiments above named were with small vessels, in which either system of working the steam will answer the purpose. I am not aware of any large sea-going vessel with screw-propeller, and as a consequence short-stroke engines, in which the simple engine using high-pressure steam has been successful. The most expensive and notable attempt to realize the benefits of the compound system by the simple engine at sea was made two years ago by the proprietors of the Allen line of steamers. This company made the comparative test on a large scale. Two ships were built, the one fitted with compound engines and the other with simple expansive engines. The boilers were identically alike, made from the same drawings, having the same grate and heating surface, and the same pressure of steam was used in each vessel.

I have not at command all of the details of these ships, nor all of the results of the performances at sea, but I received from the designer of the machinery the following particulars:

Name of ship, *Polynesia*.
 Length, 400 feet.
 Breadth, 42 feet.
 Draught of water, 25 feet, 6 inches.
 Kind of engines, compound.
 Number of cylinders, 4, (two high and two low pressure.)
 Diameter, high-pressure, 43 inches.
 Diameter, low-pressure, 80½ inches.
 Stroke, 4 feet.
 Number of boilers, 10.
 Number of furnaces, 20.
 Pressure of steam, 60 pounds.

Name of ship, *Circassian*.
 Length, 360 feet.
 Breadth, 40 feet.
 Draught of water, mean, 23 feet.
 Kind of engines, non-compound.
 Number of cylinders, 2.
 Diameter of cylinders, 62 inches.
 Stroke, 4 feet.
 Number of boilers, 10.
 Number of furnaces, 20.
 Pressure of steam, 60 pounds.

The expansion valves were fitted in the simple engines to work the steam, when desired, to the same degree of expansion as in the compound engines. The workmanship and materials were equally good, and the parts equally strong, in each set of engines. The two ships were put on the line between Liverpool and Quebec, Canada, and, as was anticipated, the results as to economy of fuel were not materially different, about two pounds of good Welsh coal per indicated horse-power per hour being expended in each ship. This satisfactory result, however, soon found an offset in the shape of unexpected difficulties with the simple engine, consequent upon the serious shocks resulting from the rapidly-varying pressures on the crank-pins. So serious were these, that not only the crank-shaft, but also the stationary parts of the engines, began at an early day to show signs of weakness, and in a short time gave out altogether. The superintending engineer of the company was the designer of the machinery, and it was only after his skill and efforts failed to keep the ship running that he reluctantly decided to remove the engines and to substitute compound engines in their stead. The engines substituted had a pair of vertical inverted cylinders, with a diameter for the high pressure of 55 inches, and for the low pressure of 92 inches.

The performance of the *Polynesia* was satisfactory from the first, the voyages never having been interrupted; and the performance of the *Circassian* has also been satisfactory since the substitution in her of the compound engines for the simple ones.

In so far as simple expansion is concerned, it is not of consequence whether it takes place in one cylinder or in several; or, as Professor Rankine says:

The energy exerted by a given portion of a fluid during a given series of changes of pressure and volume depends on that series of changes, and not on the number and arrangement of the cylinders in which those changes are undergone. The advantages of employing the compound engine are connected with those causes which make the actual indicated work of the steam fall short of its theoretical amount, and also with the strength of the engine and its framing, the steadiness of action, and the friction of its mechanism.

The economy of working steam many times expanded may be readily seen when it is stated that a decrease of one-half pound of coal per horse-power per hour may give, on a large trans-Atlantic steamer, a saving of about four hundred tons of coal for a single round voyage.

This economy is obtainable only by using steam of high pressures, whether it be worked in a compound engine with its divided expansion, or in a single-cylinder engine with its irregular strains. As yet, by no satisfactory device except compounding have great expansion and consequent economy of fuel been obtained at sea.

In the face of these facts, further discussion on the subject of adopting the compound engine for the vessels of our own Navy is as useless as would be a discussion of the relative merits of the screw-propeller and paddle-wheel for ships of war.

PART XVIII.

MARINE BOILERS.

CORROSION OF MARINE BOILERS; PRESERVATION OF BOILERS IN HER
BRITANNIC MAJESTY'S VESSELS NOT IN COMMISSION; WATER-TUBE
BOILERS; EXPLOSION OF THE BOILER OF THE THUNDERER; BOILERS
OF THE MERCANTILE MARINE; HIGH PRESSURE SAFETY-VALVE;
LLOYD'S RULES AND FORMULÆ FOR BOILERS.

CORROSION OF MARINE BOILERS.

This subject has attracted the attention of engineers, ship-owners, and chemists in England from the time of the introduction of the surface-condenser up to the present day. Much diversity of opinion has always existed as to the exact nature of the action which, accompanying surface-condensation, destroys the boiler-plates so rapidly and so curiously. Most of the various explanations which have been given attribute the process of deterioration to galvanic action arising from passing the repeatedly distilled water over large surfaces of copper or brass tubes, but the tinning of condenser-tubes and the substitution of iron boiler-tubes and pipes in place of brass or copper has not arrested it. It has been attributed to the corrosive action of certain acids arising from the decomposition of the lubricants; but such action is too limited to do the mischief, and even where little, if any, lubricant has been used in the cylinders, the results have been the same. Many panaceas have been proposed, from time to time, to cure the malady, such as the injection of solutions of soap and soda, of muriatic acid, &c. Much was at one time expected as the result of the simple plan of placing plates of zinc at different points in each boiler. The corrosion was, it was stated, confined to the zinc, while the iron of the boilers escaped. The zinc-cure was reported in some cases to have been an advantage, while in other cases it appears to have been entirely inoperative. The use of strainers or filters, by which grease was taken out of the feed-water, was also held to be a remedy, but this scheme, like many others, died a natural death. In fact, many cases are known where boilers working with engines into the cylinders of which no lubricant whatever was admitted, decayed just as rapidly as though oil or tallow had been admitted, and others in which all the remedies referred to were applied have also met the same fate. The profession now seem inclined to account for the corrosion by the action of the redistilled sea-water itself; and this view seems to be substantially confirmed by the Perkins system, where it is seen that a boiler thirteen years in constant daily working, using pure rain-water over and over again, without change for all of that time, is found to be in a good state of preservation. This case, with many other well-authenticated instances which came under my notice, seems to establish the fact that the evil must be attributed to the use over and over again of distilled sea-water, and that no remedy, except that of changing the water in the boilers at frequent intervals, has been found effective. It has been believed by marine engineers that the formation of scale on the surfaces of the iron protects it from corrosion, but more recent evidence has been produced that the protection is not due to the scale, but to the condition of the water. The circumstance that scale is found on the iron is simply evidence that the water has been kept in such a condition that it would not cause corrosion, and that is all the scale has to do with the matter. Very many illustrations of the proof as to changing the water being the sure remedy were found; among them were noted, as a comparison, two ships of the same size in the royal navy serving on the same station at the same

time. They were paid off and recommissioned at the same period. In one ship the water had been used in the boilers over and over again; in the other the feed-water had been mixed largely with sea-water. The boilers of the former had been found free from scale, but so completely deteriorated as to be useless. Those of the latter had a scale formed on the plates, but the boilers were found in excellent preservation. The experience of many intelligent engineers has been presented on the subject, among the most important of which is that of Mr. Milan, read before the Cleveland Iron-Trade Association. The following is an extract:

I may begin this paper by stating that what data I shall have the pleasure of laying before you, as to the corrosion of boiler-plates when generating steam from distilled or redistilled water, will be generally such as has resulted from my personal observation. Much of it will doubtless be familiar enough to those whose professional experience has included the management of boilers while working in conjunction with surface-condensers. In the earlier days of the practical application of these condensers, (I refer to fifteen or sixteen years ago,) you must be aware that engineers were often driven to their "wit's end" in striving to account for or to arrest the extraordinary and insidious decay which was steadily and rapidly consuming their boilers before their eyes, while yet there was no recognized means of preventing it. And, indeed, up to the present time, although we have, by a primitive and withal a make-shift expedient, been able in great measure to mitigate the evil, I am not aware that the light of scientific research has yet been brought to bear upon the subject with a view to determine the nature or cause of the action itself, or to devise any means of counteracting it.

Fully a decade of years has passed since the writer first endeavored to ventilate this question, by introducing it to the notice of gentlemen whose social and professional positions and interests warranted him in assuming that they would have influenced scientific inquiry in respect to the question. More recently I have tried to set forth the necessity for immediate and decisive action in the matter.

The decay of boilers in Her Majesty's ships has been so extraordinary since the introduction of surface-condensers that the officers have been greatly exercised in regard to it. In spite of all their care the decay has gone on silently and certainly; boilers have become disabled after a few years' service, and it became evident that the causes baffled discovery and remedy in the ordinary course of duty. So impressed were the Admiralty with the vital importance of the subject, and with the futility of trusting to experience alone to find a way out of the difficulty, that about two years ago they appointed a committee to inquire into the boiler management of ships in commission and in the reserve, the nature and extent of the decay of boilers, and to ascertain, if possible, what are the causes and what the remedies. This committee consists of two executive officers, two engineers, and one chemist. Their labors have been directed to the examination of boilers in ships arriving from different seas of the world and in different stages of condition or decay; also in experimenting at the dock-yards.

The report of this committee is looked for by the naval and commercial services with unusual interest; up to the last accounts not one word of the results had been made public.

The following is an extract from an order issued by the Admiralty for the care and management of the boilers in the vessels of the royal navy; the entire circular has been furnished the Bureau of Steam-Engineering:

In order to protect the plates and stays from corrosion it is essential that the surfaces should be coated with some impervious substance. A thin layer of hard scale, deposited by working the boilers with sea-water, has been found to be the most effectual preservative, and, therefore, all boilers when new, or at any time when any of the plates or stays are bare, are to be worked for a short time with the water at a density of about three times that of sea-water, until a slight protective scale has been deposited.

* * * After this, in the ordinary working of the boilers, the engineer officers in charge of machinery are to use their discretion as to the most suitable density at which the water in the boilers should be kept for the service on which the ship is employed. This density, which is in no case to exceed three times or to be less than one and a half times that of sea-water, will probably vary to some extent on different stations and under different conditions of working.

No tallow or oil of animal or vegetable origin is to be put into the boilers to prevent priming, nor for any purpose. Boilers should, if possible, be kept empty and dry when they are not at work. * * * The engineer officer must bear in mind that unless the boilers can be made thoroughly dry, it will be better to keep them entirely full of water, as a simply damp state of the boilers and stays is a most fruitful cause of decay.

Boilers are not to be used as tanks to contain fresh water for the use of the ship's company, and they are to be used as little as possible for the purpose of trimming the ship when under sail, as these practices tend to keep the boilers in a damp state, and conduce to their decay. When boilers are used for distilling water, care is to be taken that the stop-valves be quite tight, so that no steam can leak into the boilers not in use.

Particular directions are also given as to regular inspection of the interior of the boilers, and if signs of decay are detected, to reports of the facts with sketches showing the parts attacked, &c.

In the mercantile marine also, the system of protecting the interior surfaces of iron boilers by a thin coating of scale is practiced. Much importance is also attached to the care and management of the boilers, and greater care taken than was formerly the case in the selection of competent engineers to operate the machinery. In some lines of steamers the plan has been adopted of *not* discharging (blowing off) any water from the boilers at sea, but steaming from port to port with the water taken in before starting, and making up the deficiencies caused by leaks, &c., with sea-water, even though the density should reach $\frac{4}{32}$. The average life of usefulness of boilers in the commercial vessels of England is nine years.

PRESERVATION OF BOILERS IN HER BRITANNIC MAJESTY'S VESSELS NOT IN COMMISSION.

To preserve the boilers in vessels laid up at the dock-yards from deterioration, two different systems have been tested, in both of which dry caustic lime, lime newly burned, is the material used. The one is known as the wet and the other as the dry system. The former consists in keeping the boilers filled completely with sea-water mixed with unslaked lime, removing the same at stated periods only to repeat the operation. The latter consists in removing all water from the boilers, to dryness, after which depositing pans of unslaked lime in the bottoms, over the furnaces and above the tubes; then closing all openings and connections air-tight, the lime to be removed periodically and the operation repeated. In addition to this, when the atmospheric dampness is extreme, light fires in the ash-pits are sometimes found to be necessary. The wet system, although successful to a considerable degree, has the objectionable feature of keeping the boilers and surroundings damp and disagreeable, and as a consequence it has not met with favor among the engineer officers, while the treatment as applied by the dry system has received universal favor, and has been so successful as to be now generally adopted. New boilers stored in the dock-yards waiting to be placed on board vessels are, except in two locations, left out in the open weather, but care is taken to preserve them by paint, and to keep all openings and doors closed.

WATER-TUBE BOILERS.

Ever since the successful introduction of the compound engine on the Atlantic Ocean, the desire has been to extend the expansion of steam beyond the limits at which it is now worked; and in order to meet this demand, the attention of many engineers has been directed toward producing a safe and reliable steam-generator, capable of carrying steam of 100 pounds and upward per square inch. Many plans have been projected and quite a number of them tested practically at sea, some of which have been on a scale of magnitude involving large expenditures of money. Every one of these new types of boilers, practically tested,

has, up to this time, proved a total failure. In England considerable professional as well as public interest has been drawn to these failures, and many discussions took place and numerous papers appeared on the subject during my stay abroad. Perhaps the most able of the papers referred to, and one which gives a clear and full account of the noted failures at sea, was produced last April by J. F. Flannery. This paper so completely covers the ground, that I reproduce it here. It is as follows:

* The almost universal adoption of high-pressure steam at sea has brought with it much inconvenience, notwithstanding its great economy of fuel. The anxiety attending upon the construction and the working of the marine boiler is much greater now than formerly, its first cost is largely increased, the expense of repair is much more, and the duration of its life is much less. I think I will have the concurrence of the members in saying that one of the gravest, if not the very gravest and most important, of the questions now arising in connection with the machinery of steamships is the improvement of the marine boiler. And not only does the present practice leave much to be desired, but the feeling in favor of still higher pressures is checked chiefly by the difficulty of designing a boiler which will sustain them safely and efficiently. It is an axiom laid down by theory, and confirmed by practice, that the higher the boiler-pressure and the greater the ratio of expansion, the greater is the economy of fuel. Theoretically this axiom is sustained by the fact that to generate steam of the pressure of 30 pounds per square inch about 1,190° of heat are required, while to generate steam of 120 pounds per square inch about 1,218° of heat are required; that is to say, to produce steam of four times the boiler-pressure, less than $1\frac{1}{100}$ times the heat is required. Again, a boiler-pressure of 240 pounds per square inch requires about 1,235° of heat, or $1\frac{1}{100}$ times the heat of steam at 30 pounds, and contains eight times the initial force. Practically these differences are so small, that the same consumption of coal may be taken to evaporate the same quantity of water, whatever the pressure. Theoretically, therefore, we have only to increase our boiler-pressure to reduce our consumption of fuel, were it not that two well-ascertained considerations intervene. First, we have not hitherto been practically able to construct a boiler which, under usual conditions of steamship requirements, will stand a pressure greater than is now in use; and, second, the heat of very highly pressed steam burns up the lubricant in the engine cylinder, quickly destroying the working parts. With the second consideration, however, we have not now to deal; and if we could overcome the difficulty of making a boiler to bear even 120 pounds with safety, much improvement would be effected.

To start from the beginning, let us remember that the thickness of the shell of a cylindrical vessel containing high-pressed steam must, in order to maintain the necessary strength, be increased directly in proportion to increase of pressure and diameter, and that the thickness of the shell may, consistently with the strength necessary for any given pressure, be reduced, if its diameter be also reduced. A very usual size for modern high-pressure cylindrical boilers is, say, 12 feet in diameter, and the thickness of the shell of a boiler this diameter, double rivetted, to bear a pressure of 120 pounds per square inch, would be fully $1\frac{1}{2}$ inches. I am not aware of any examples of boiler-construction where the thickness of the shell-plates has exceeded $1\frac{1}{2}$ inches or $1\frac{3}{4}$ inches, and it is almost doubtful if, considering the practical difficulties of manufacture, a perfectly good job is made with shell-plates of this thickness; at all events, it is generally accepted that to make sound workmanship with a thickness greater than this is practically impossible. On the other hand, a cylindrical vessel or tube, say 12 inches in diameter, may, for this same pressure of 120 pounds per square inch, be made, if welded, only $\frac{3}{8}$ inch thick, and still possess the same proportionate strength, or, for a pressure of 150 pounds per square inch, it would be made practically about $\frac{1}{2}$ inch thick, and this would give a factor of safety nearly three-fourths times greater than that possessed by the cylindrical boiler-shell 12 feet in diameter, $1\frac{1}{2}$ inches thick, and pressure of 120 pounds. It is practically certain, therefore, that the limit of pressure with the present type of boiler has been reached; and when we consider how much economy of fuel has been effected by increasing the pressure to its present height, and how much more economy may be effected by still further increasing the pressure, it is seen that the adaptation of an efficient high-pressure marine boiler would meet a great and increasing want.

Many look for the solution of this problem to the type known as the water-tube or tubulous boiler; that is, the system by which the cylindrical portions of the boiler subject to internal pressure are reduced in diameter and increased in number, the result being that for a given weight of material a much higher pressure of steam is carried, and, indeed, by the reduction of the necessary thickness of the shells a higher pressure of steam is carried, and more economy of coal insured than is possible with any

* Paper read before the Institution of Naval Architects.

other type of boiler. The other advantages claimed for boilers of this type are, that the thinness of the metal interposed between the fire and the water enables the heat to be conveyed more efficiently and with less waste, and also enables the steam to be raised more rapidly; that the danger of explosion is limited; that a damaged tube can be easily replaced; that greater strength proportionate to the pressure being possible in first manufacture, the wear of the metal in the boilers need not, at a later date, enforce reduced pressure, and therefore reduced speed of ship, as in the case with existing types of boilers. It is pointed out also that where boilers of the ordinary type require renewal the decks must be broken away, whereas the separate portions of the tubulous boiler may be passed down the hatchway; and, further, that a war-ship on a foreign station must either return home or to the nearest dock-yard in the event of any serious wear upon ordinary boilers, but so many spare tubes of the water-tube system might be carried as to greatly extend the period of service upon a foreign station.

The direction of the flame in the ordinary boiler is always along the faces of the heating-surfaces, whereas in the water-tube boiler it is in a direction at right angles to them; the heating efficiency of flame striking the plate directly, as in this latter case, must be much greater than when sliding along the surface, and we see, therefore, that this system not only enables thinner plates conveying the heat more perfectly to the water to be used, but also directly increases the action of the flame itself. Again, the escape of the steam-bubbles from the metal surface upon which they are generated is more rapid and direct when that surface is disposed horizontally. The condition most essential to safety is beyond doubt good circulation. The heat to which a tube immediately over a fire is exposed amounts to upward of 2,000°; the specific heat of water, or its power to absorb heat, is twice that of steam, and, in addition, the evaporating water absorbs the latent heat of steam, making its receptive power many times that of steam; there is, therefore, no difficulty in arriving at the conclusion that a tube of, say, $\frac{3}{8}$ inch thickness, which is not relieved by freely-circulated water, will become hot and dangerous in a very few seconds, and it may be shown that the absence of provision for this good circulation has been the primary cause of the difficulties the water-tube boiler has yet encountered. It is noticed, on reference to the diagrams, how large a body of water is contained by the ordinary boiler, as compared with the volume of water held by the water-tube boiler in proportion to their heating and grate surfaces. The effect of this is that the ordinary boiler has a large reserve of water at nearly boiling-point, and is not therefore exposed to such sudden fluctuations of pressure, with their attendant evils, as the water-tube boiler. If the strength of the fires be suddenly increased in a water-tube boiler, a spasmodic rise of pressure, leading to accumulation of steam in the water-chambers, priming, loss of water, and overheated tubes, takes place, and this defect is quite absent from the ordinary boilers; and not only so, but the large reserve of water in the ordinary boiler, the whole of which above the fire-bar level must be heated to nearly boiling-point, is the cause of a much more gradual, and, therefore, more easily-effected circulation of the water; indeed, the small volume of water is still further reduced by the isolated subdivision of the parts, each tube having to supply, circulate, and evaporate in a very independent manner, and with little reference to the volume of water contained by its neighbors. Clearly the smallness of the contents of a tubulous boiler is in some respects a serious drawback, although it is in other respects an advantage. The difficulty of obtaining a good circulation is from the nature of the case greater in the tubulous boiler, and the increased friction of the water due to high pressure adds to this difficulty, while at the same time it increases the necessity, and it is a matter for the earnest consideration of inventors whether artificial circulation, produced by subdivided feed-inlets or otherwise, may not after all be resorted to. This idea has been expressed to me by one of our most eminent marine engineers, and it does seem that the certainty of good circulation thus obtained would compensate for the complication of working parts. One element of danger absolutely possessed by the water-tube boiler, and not shared by the ordinary boiler, lies in the fact that the metal exposed to the direct action of the fire is at the same time subjected to the tensile strain of internal pressure. In the ordinary boiler the parts subjected to tensile strain are not acted upon by the fire, and those parts acted upon by the fire have the water surrounding them with a compressing strain. Although the crushing strain of wrought-iron is less than its tensile strain, the case in point of the fire playing upon iron under tension is more dangerous, because any flaws will be stretched out, the flame will penetrate them, and promote their increase to bursting-point.

The water-tube boiler has, under several designs differing in their details, been extensively used for the generation of steam in factories, and for other stationary purposes, both in England and America; and, although some important defects exist and some unfortunate failures have occurred, still it cannot be denied that, as a rule, its results have been fairly satisfactory. Why then, has it not come into more extensive use at sea? It may be answered, generally, that the conditions to be fulfilled on board ship are more stringent, the space allotted is more circumscribed, and the boiler must

conform to its limits. A less leisurely and methodical action is necessary than in a machine used for stationary purposes, and defects of little importance on land develop into serious evils at sea. We may best elucidate this question, however, by considering some of the cases in which the water-tube boiler has been tested for marine purposes, and by analyzing the cause of failure in these cases. Several practical trials at sea have been made, and the enterprising and truly admirable spirit displayed by two steamship owners especially cannot be too highly commended. The gentlemen alluded to are Mr. S. B. Guion, of Liverpool, the managing owner of the steamship *Montana*, and Mr. W. H. Dixon, of Liverpool, the owner of the steamship *Propontis*. The examples in these vessels being the most recent and by far the most important trials of the water-tube system, I propose to ask your attention to them first.

The *Montana* is a steamship of more than 4,000 tons, and was built for service on the Gt. Britain line between Liverpool and New York. Among other innovations, she was fitted by Messrs. Palmer, of Jarrow-on-Tyne, with boilers intended to work at 100 pounds pressure, and it was anticipated that the economy of fuel would be very great. Figs. 1 and 2 * * * will convey a good idea of the nature of the design. Each boiler was composed of tubes 15 inches in diameter and 15 feet long, sealed at the ends, but communicating with each other by vertical necks about 6½ inches in diameter. There were five horizontal, or nearly horizontal, rows of these tubes in each boiler, and each row contained seven tubes. Noticing the profile, it will be seen that to carry off the steam generated and to promote the circulation of the water each horizontal tube was supplied with two necks. As the steam must all rise to the top, the necks between the bottom tube and the one immediately above must take up the steam generated in the bottom tube; the neck between the second row from the bottom and the one immediately above it must take not only the steam generated in the second, but also that in the first row, and so on, the neck nearest the top having to convey the steam generated in the whole of the tiers of tubes below it. In addition to these tubes, there are in the uptake three steam reservoirs or superheaters 3 feet in diameter. In designing the boiler, the two vertical rows of tubes nearest the fire-door were set apart for the purpose of heating the feed-water, and the six other vertical rows of tubes farthest from the fire-door were set apart to generate steam from the feed-water so heated. In accordance with the duty thus assigned to them, the two rows of tubes vertically nearest the fire-door had the feed-pipes connected to them at the top and had small pipes only ½ inch in diameter fitted also at the top, to carry away any steam which might happen to be generated. It was, of course, expected that the current of the feed-water passing through these two feed-heating sections would be so rapid and that the fire under them would be so much less vivid nearest to the dead-plate that the water could not, while in them, absorb sufficient heat to evaporate. The water was delivered from these feed-heating sections into a large feed-water chamber, which supplied the other sections. The two sections designed as feed-heaters are so called, though as a matter of fact they were not feed-heaters only, but calculated to generate steam nearly as much as any of the other tubes in the boiler, and the steam had really no outlet, because the ½-inch pipe provided for the purpose was so small as to be practically useless. The natural action of the steam generated in these sections was, therefore, to rise to the top tubes, to accumulate there, and to depress the level of the water, driving it out through the bottom pipes from all that vertical section of tubes, and finally exposing to the direct action of the fire a bottom tube filled only with steam, or steam and a small quantity of water. This is exactly what did take place, and on the first trial-passage of the vessel from the Tyne toward the Mersey, five of the tubes burst. These tubes were all situated in corresponding places in the different boilers; that is, the lowest tube in the inner feed-heating section. After this experience, the connections were altered so as to join this inner feed section to the rest of the steam-generating part of the boiler, leaving the outer vertical row only to act as a feed-heater. For some few hours this arrangement gave promise of better success; but, after a day and a half's working, two more tubes, one of them the fourth from the front in the bottom row, gave way; and the owners, completely discouraged by these failures, and taking into consideration also the fact that the boilers were heavier and more bulky than boilers of the same power of the ordinary kind, decided to condemn them and replace them by ordinary cylindrical boilers. The cause of the failure of the sections devoted to feed-water heating appears sufficiently obvious, and as the separation of these sections was a special feature in this example, and is not likely to be repeated in other water-tube boilers, we may dismiss it from further consideration. But the bursting of the other tubes is more serious, and appears to more closely affect the general principle of water-tube boilers. A very able article, from which some of the particulars given above have been drawn, appeared in the *Nautical Magazine* on the subject of the *Montana's* boilers, and it is there suggested that the cause of the explosion of the inner tube on the bottom row was the absence of a sufficiently large steam connection between the top or steam-holding chambers to counteract the inequality of pressure in them. It will be noted that the feed-pipes for all the sections are common to one feed-water chamber, and, supposing any inequality of steam-press-

WATER-TUBE MARINE BOILERS.

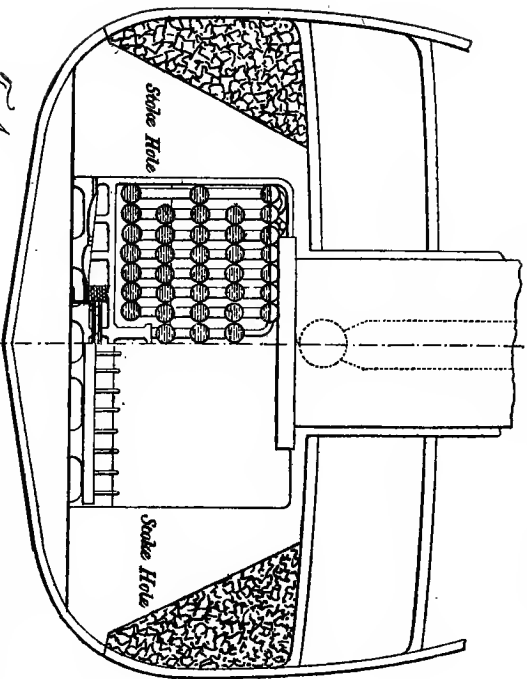

Fig. 1.

BOILERS OF THE S.S. "MONTANA."

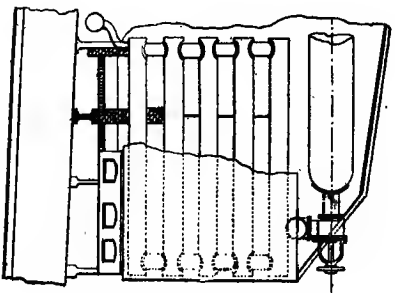

Fig. 2.

ure to exist, the water would, of course, be forced from the chamber containing the highest pressure to those containing a lower pressure. The steam-pipes connecting the upper chambers were 2 inches in diameter, and the area of the fire-grate under each section was about $7\frac{1}{2}$ square feet. A very simple calculation shows that these 2-inch pipes were very small, if any large difference in pressure was to be equalized. Another explanation, and one which appears quite reasonable, was advanced by Mr. John Watt; he calculates that the grate-surface, 7.75 feet, acting upon the water in each bottom tube, is equal to the evaporation of 12.83 pounds of water, or 78 cubic feet of steam at 50 pounds pressure per minute. Now, the only orifices through which this quantity of steam may escape are the before-mentioned pair of $6\frac{1}{2}$ -inch vertical necks, which have each an area of 33.18 square inches; one of these would probably be a downcast for the water, and the other, at the higher level, being an upcast for the steam, the steam would therefore rush through this neck at the rate of nearly 340 feet per minute, a speed so great that the assumption that the steam would drag the water upward from the bottom tubes, leaving them exposed to the fire, does not seem exaggerated. Whichever of these explanations be correct, it is evident, in the light of the experience now gained, that the failure of these tubes in the *Montana's* boilers proceeded from easily-preventible causes, because in a future design the feed-water arrangement could be omitted, and the steam connections to equalize the pressures in the different sections could be enlarged, the vertical necks for the escape of the steam could be much increased in area, and it is possible that if these alterations had been effected upon the *Montana*, a result very nearly approaching success would have been obtained. Indeed, it was most unfortunate, in the interests of science, that no further experiments were made with this vessel; she was condemned after a series of trials extending altogether over not more than five or six days.

The *Propontis* is a steamer of about 2,000 tons, belonging to Mr. W. H. Dixon, of Liverpool. In 1874 she was fitted by Messrs. John Elder & Co. with boilers on the water-tube principle, under Rowan & Horton's patent. * * * They are four in number, having one chimney, and each boiler consists of seven horizontal cylindrical vessels, connected together by vertical tubes 12 inches in diameter, supplemented by numerous pipes $2\frac{1}{2}$ inches in diameter; the space for steam in the upper vessels being increased by four diagonal domes. To further guard against priming, tubes are carried directly from the steam-doms down to the lowest vessels, so that any water carried up by the steam will be broken from it in the upper chamber and fall down again to the lowest level; the feed is also delivered at the bottom chambers. Baffle-plates are fitted to circulate the flame among the tubes. * * * The lower or water chambers were connected, but no connection was made between the upper or steam chambers; the importance of this omission is obvious, and was discovered in the working of the boilers, as will be seen further on. The working-pressure intended was 150 pounds. While the defects in the boilers of the *Montana* exhibited themselves after a very few hours' work, the boilers of the *Propontis* continued their promise of success for a much longer period, and, indeed, were exhaustively tested at sea for a time extending over several months. The first voyage of the *Propontis* was from Liverpool to the Black Sea and back, and very careful observations of the working of the boilers were made. The consumption of coal, taken during a run of 10 hours, was 1.54 pounds per indicated horse-power per hour; the pressure of steam being easily maintained at 130 pounds to 140 pounds. It is by no means certain that the full advantage of the *Propontis's* boilers in point of economy is represented by the above figures, because the baffle-plates for the deflection of the flame were not arranged just in the way that experience afterward showed they should be arranged, and consequently much unconsumed gas escaped up the chimney. So far the career of the tubulous boiler in this ship was fairly satisfactory and sufficiently promising; but before long, evils, which had been gradually accumulating, developed themselves in an unpleasantly conspicuous manner. * * * Some of the smaller-sized vertical tubes terminate in S-bends at the points where they join the horizontal vessels. The peculiarity of this bend rendered it impossible to clean the tubes from scale, so that salt water could not be used; indeed, precautions of an unusually perfect character were taken to admit pure distilled water only to the boiler, and the action of this distilled water, unmixed with any salt, was just what might have been expected: a corrosive action was set up in the tubes; some parts of the internal surface were quite untouched, while other parts close to them were perforated by circular blotches of corrosion of $\frac{1}{2}$ inch to $1\frac{1}{2}$ inches diameter. These were continually giving out, allowing the steam and water to escape upon the fires. The defects were temporarily remedied by drawing the fires and binding a ligature round the injured tube over the hole; and these little explosions were of such frequent occurrence that one of the four boilers was almost constantly disconnected.

In the early part of 1875 the boilers underwent a thorough repair, being supplied with some 300 new tubes, and were tested by water pressure to 275 pounds. After this a small quantity of sea-water was allowed to enter the boilers to make up the waste, and after completing another voyage to and from the Levant, her boilers were opened up

and found to be coated with a slight scale. In September of last year she commenced another voyage, but on the third or fourth day the wing-chamber of the forward starboard boiler burst, injuring two men, the pressure at the time being 150 pounds. The rent was nearly 2 feet long, and was in the solid plate near the lower side of the tube, and about its middle length. At Lisbon this was repaired by riveting a patch $\frac{3}{4}$ inch thick. Leaving Lisbon, she had been but a very few days out before another explosion took place, the pressure at the time being only 105 pounds. The fracture was in the wing-chamber of the starboard after boiler, and was again in the solid plate, at the lower side of the chamber; the rent measured 12 inches by 7 inches. The diameters of the tubes which gave way were 21 inches, the plate $\frac{3}{4}$ inch thick, and the bursting pressure of this would be 1,200 pounds, provided the plate were cool and uninjured. Putting into Algiers, the boilers underwent an inspection by French engineers, and in accordance with their advice the furnaces were partially bricked up and the pressure reduced to 60 pounds. It may be here remarked that the opinion of the French engineers that a reduction of pressure meant, in the case of these boilers, greater safety, was very questionable. It may be a paradox to say that the lower the pressure the greater the danger, but in the case of water-tube boilers, under certain conditions, that is the fact. Let us remember that a cubic inch of water will make a cubic foot of steam of the same tension as the atmosphere, and that the greater the pressure the less is the bulk of any given quantity, say a pound weight of steam. Now, as the power of a boiler may be measured by the number of pounds weight of steam that it evaporates, the *Proponitis* boiler would evaporate no really greater quantity of steam at 60 pounds pressure than it could evaporate at 150 pounds pressure; but whatever steam it did evaporate would at 60 pounds pressure occupy more than twice the space it would occupy if at 150 pounds pressure. Again, evaporation cannot take place without circulation, and circulation is the mutual changing places of the steam as it is generated and the water about to be evaporated; if, therefore, the steam occupies twice the volume, then there will be twice the space for it to travel through to circulate or change places with the new water; and as one dangerous defect in the *Proponitis* was insufficient circulation, it is seen that by lowering the pressure the French consulting engineers may not at all have increased the safety of the boiler. It is a most interesting investigation, but one which I fear can only be conducted practically to learn how far the increased friction, varying directly as the pressure, compensates for the decreased volume of the evaporating steam. The vessel was towed from Algiers to Gibraltar, and then the extra fire-bricks were taken out, a baffle-plate between the chambers and the fires was fitted, and test-cocks were placed on each water-chamber. Under the protection of the baffle-plates, and the careful watching of the water-level made possible by the test-cocks, the vessel steamed home with three boilers.

Upon final examination it was found that the vertical tubes were bulged and distorted in several places, and all the horizontal tubes exposed to the direct action of the fire were more or less bulged upon their lower sides, thus affording clear evidence that in most of the water-chambers of the boiler steam was sometimes collected. These bulgings or partial injuries to the boiler evidently arose from defective circulation, and the bursting or more serious injuries were the result of the unequal pressure of steam in different sections. There was no pipe connecting the steam-chambers of the two boilers, and although the steam-chambers were not connected, the water-chambers were, so that any increase of steam-pressure in one boiler simply had the effect of driving the water out of its own chamber into the other boiler. Not only was the unprotected plate exposed to the fire, but the abnormal increase in the water-level of one chamber held out every inducement to priming. This serious structural omission explains the bursting due to overheating, and at the same time the priming which occurred. It is very remarkable that the partial absence of a similar pipe contributed to the failure of the boilers of the *Montana*. It has been suggested that the bursting of the tubes in the *Proponitis* arose not so much from defective circulation of the water as from corrosion and consequent weakening of the plates; this is the fact as regards the small circular perforations, but the same explanation does not apply to the longitudinal rents, and is not borne out by an examination into the character of the larger fractures. The longitudinal rents which caused the loss of life occurred in portions of the tubes practically uninjured by corrosion, and it was found that the fracture showed only a slightly reduced thickness of metal, and that at a distance of about 1 inch from the lip of the rent the plates resumed their original thickness. The bursting-pressure of the rent tube was, as already stated, 1,200 pounds per square inch, and the uncorroded appearance of the fractured portions points to the conclusion that defective circulation and overheating caused the explosion. The plates, if hot, would stretch a little before giving way, and the confined space over which the thinness extends seems to show that it should be traced to stretching only.

The *Birkenhead* is one of the large passenger ferry-steamers running between Liverpool and Birkenhead. She was built in 1872, and fitted by the Patent Steam-Boiler Company, Birmingham, with tubulous boilers on Root's patent. The boilers * * * were each divided into fifteen sections, each section consisting of eight horizontally-

inclined tubes 11 feet long by 6 inches in diameter; these tubes were at the ends connected to small cellular vessels. Communication between these vessels in their respective horizontal tiers was effected by bent pipes bolted to them.

The working-pressure was 40 pounds, although in designing the boiler the pressure was intended to be 60 pounds. It is only fair to the manufacturers to say that they labored under the difficulty of very confined head-room; these vessels are of limited draught, and as a flush deck is necessary for the passenger-traffic, the vertical space at the disposal of the designer was quite insufficient to give boilers of this type a fair chance of success. The boilers were for the first few months of their existence worked with impure water, and considerable trouble from overheated tubes was the consequence. A fresh-water tank was afterward fitted, and with an improved result, but still it was found that the tubes in the bottom row were continually bulging and giving out from overheating, and the vessel was frequently off duty for repair. The exit of the steam was no doubt retarded by the turnings and counter-turnings it underwent before reaching the surface. The greater vertical distance through which the steam rises from the surface of the water before rushing to the engine, the less is the tendency to carry water away with it, not only because there is more time given for the water to fall back from the ascending steam, but because the pull caused by each stroke of the engine is less severely felt at the bottom tubes if they are some distance below the steam outlet.

In this design a very small height was between the stop-valve and the bottom tubes, and the engines being paddle-engines with large cylinders and slow stroke, there is no doubt that the tendency of the water to forsake the bottom tubes was greatly enhanced from this cause, although primarily due to imperfect circulation. This defect would also be increased by the stoppages and the lying-to of the vessel in her work as a ferry-steamer allowing accumulations of the steam-pressure. Not only so, but the deficient room rendered it impossible to get in so much boiler-power as was afterward thought necessary, and the manufacturers allege that consequent forcing of the fire contributed in no small degree to the failure of the tubes. The sister ships to the *Birkenhead*, working on the same station and with very similar engines, but boilers of the ordinary type, offered an excellent standard of the average consumption of coal, and the saving in the *Birkenhead* by comparison with one of the boats amounted to 17 per cent., and by comparison with the other to 25 per cent. This result is the more remarkable when it is remembered that the pressure was only 40 pounds, and that the expansion in the engines of the *Birkenhead* could not be greater than in the sister ships; the comparative economy was therefore entirely due to the more effective arrangement of the parts, the thinness of the metal in the tubes, and the direct action of the flame upon them favoring the evaporation; had the pressure been higher and the expansion greater, the economy would no doubt have been largely increased. Notwithstanding the excellent result in point of economy, the ferry management condemned the boilers after nearly three years' work, on account of the continual breakdowns, and the vessel is now fitted with boilers of the ordinary type made by Messrs. James Taylor & Co. The cause of the comparative failure of these boilers has already been indicated; the twisted passages for the exit of the steam and the low vertical height, added to heavy firing, caused the bottom tubes to be occasionally full of steam, and being exposed to the full action of the fire they were quickly destroyed.

Another vessel fitted with boilers on a Root's patent, and of very similar design, but still more contracted passages for circulation, was the steamship *Malta*, of 2,000 tons, belonging to the Merchants' Trading Company, Liverpool. They were in this case found to give off steam with great rapidity, and steam could be raised in them in about half the time necessary in boilers of the ordinary type. The working-pressure was 50 pounds. The boilers went on about twelve months, during which time the vessel visited the Mediterranean and the Baltic. Very little priming took place, but the same defect as in the other cases developed itself, the circulation of the water was insufficient, some of the bottom tubes nearest the fire hulled and gave out, and the boilers were finally taken out to convert the vessel into a sailing-ship. The engines were very old before the Root boiler was fitted, and their worn-out condition contributed to the owners' decision to alter the vessel. I am informed that many of these Root boilers, of the same manufacture, are working successfully on land, and where large space may be given and leisurely delivery of the steam is possible, they have been found highly successful.

Boilers were fitted to the steamships *Amalia* and *Palm* under Ramsden's patent. These boilers worked very satisfactorily for about four years, but at the end of that time it was found that the construction of the boilers not fully providing means for the removal of the incrustation, the plates had seriously deteriorated, and the boilers were consequently removed.

Trials were made of the Howard patent safety boiler in the steamships *Fairy Dell*, *Meredith*, and *Marc Antony*. These boilers were all constructed about the same date, 1870. Their working on board ship in all these cases was quite unsatisfactory; the

lower tubes burst, others leaked, and very great priming took place. These results were traced to the same general causes that led to the difficulties experienced with the *Birkenhead* and *Malta*, and it is unnecessary to discuss them in detail.

After discussing so many failures of the water-tube system, I cannot close this paper without describing the most recent working example of the tubulous boiler for marine purposes. One of the earliest advocates of the tubulous boiler is Mr. John Watt, of Birkenhead, and his system is shown on the diagrams. The diagram represents the boiler of the steam-flat *Gertrude*. "The boiler consists of a series of inclined tubes connected at their ends to rectangular water-chambers. To the top of the chamber is connected a steam-receiver, from whence the steam is taken to the engines. The rectangular chambers are stayed like the ordinary locomotive fire-box, by means of stays through the door and tube-plates, one end of each stay being left sufficiently long to enable the tube-doors to be secured. The tubes are in diagonal rows, and the course of the flame is in zigzag direction among them." A very brief consideration of the natural action of the steam and water in this boiler will show that it possesses features superior to some of the boilers already described. As the steam is generated in the tubes, the angle at which they are inclined will facilitate its ascent to the upper rectangular water-space B, and once there, its ascent to the steam-receiver is easy and certain, its upper passage being unobstructed; at the same time the water to take the place of the steam generated contained in the lower rectangular chamber A will, by a natural action, ascend from it, and so a good circulation is secured. The necessary feature in a boiler of this arrangement is a separate outlet for the steam and a separate inlet for the circulating water; any contention between the ascending steam and the descending water must be fatal.

The shorter and wider the tubes are made the greater will be their safety, because the amount of evaporation will vary as the heating surface of the tube. Now the surface of the tube increases directly as the diameter, but the volume contained increases as the square of the diameter, and this fact goes far to explain the danger of long narrow tubes, the length still further increasing the difficulty of the exit of the steam. In the case of the *Propontis*, some of the smaller vertical pipes were so far attenuated as to be 8 feet long and $2\frac{1}{2}$ inches in diameter. I am informed that the *Gertrude's* boiler has worked for some months, and with so perfect a circulation that no deposit or scale has been formed, although partially salt water is used, and the engine is not fitted with a surface-condenser. Another design, strongly advocated by the inventor, is that of Mr. Wigzell. * * * This is a compromise between the tubulous boiler and the boiler of ordinary type; the flame will surround the inclined cylinders, and the other cylinders being perforated with tubes, it will pass through these on its way to the chimney, its exit through them being made compulsory by blocking up the outer spaces between the cylinders by diaphragm plates. No boilers of this design have yet been tried at sea, though the inventor assures me that most satisfactory results are obtained by its use for land purposes.

We set out with the statement that, so far as present lights enable us to judge greater economy in the use of coal at sea can only be obtained by increased boiler-pressure; that cylindrical vessels of small diameter are the only practical generators of high-pressure steam; that up to the present time no water-tube boiler on a large scale has given perfectly satisfactory results at sea; and that the practical trials already made are in themselves sufficient to teach useful lessons, and perhaps to indicate to some extent the practice of the future. If there is some specific feature in the design of the boilers of the above-mentioned ships which is common to them all, and has contributed to their failure, then a valuable lesson will have been drawn from them. Insufficient circulation of the water has been more or less a characteristic of the above cases, and to get at the root of the matter it is necessary to discover why the circulation has been insufficient. In the ordinary boiler the reservoir for steam is vertically above the surface upon which it is generated, and no obstruction to its ascent is offered except the friction through the superincumbent water. Looking at the diagrams, it will be seen that the steam generated at certain portions of the boiler surface, in all the examples of water-tube boilers, must travel a greater or less distance horizontally, or nearly horizontally, before it can make its movement in a vertical direction, and in some of the cases the steam encounters repeated obstructions to the horizontal deviations from its continued ascent through the water. No difficulty of this kind is to be found in the ordinary marine boiler; the steam as it is generated ascends by a free and natural action through an unobstructed body of water, and it is only when steam can move in a vertical or nearly vertical direction that it has any tendency to circulation at all. To design a boiler in such a manner that the steam shall move in a horizontal direction for ever so short a distance, is to lay down a wrong principle, because the horizontal movement can only be borrowed from the force developed in those particles of steam which are ascending, and which jostle, so to speak, their neighbors along the horizontal portion of their journey. Now, the greatest obstruction to circulation at high pressures, apart from the arrangement of the tubes, is the great friction. An arrangement which at a lower pressure would give fairly good results will quite refuse

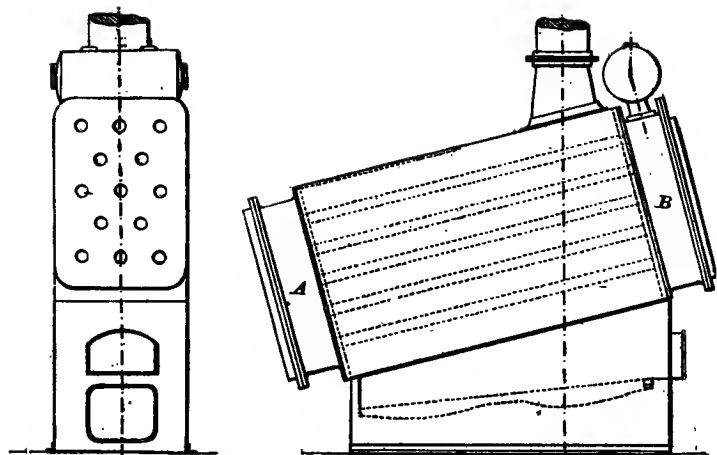

FIGS. 12 AND 13. BOILER OF THE "GERTRUDE."

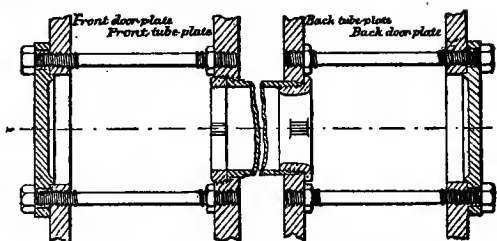

FIG. 14. DETAIL OF WATT'S BOILER.

to produce proper circulation when the friction is seriously increased by high pressure, and it is evident that a high-pressure water-tube boiler must, if it does not depend on artificial circulation, have no portion of its interior so arranged that a horizontal flow of the steam through the water is necessary. The features which the successful marine high-pressure boiler must possess are, a clear vertical lead for the steam as it is generated, separate downcasts for the water and upcasts for the steam, and accessibility for the removal of incrustation. Whether the designs introduced, but not yet fully tested, may be found to give better results than some of those we have named is a problem yet to be solved.

I have to express my thanks to the various manufacturers and other gentlemen who have assisted in the preparation of this paper; and having briefly reviewed some of the principal experiments already made at sea with the tubular boiler, it remains to say that the Admiralty is now engaged in a trial of the high-pressure boiler on Perkins's system; and no doubt the results will in due time become generally known.

So far as we may now judge, it does appear that the water-tube boiler, designed scientifically and in accordance with the experience the past failures have taught, holds out prospect of much more satisfactory and profitable work than has yet been obtained by its use at sea.

The most extensive and costly of the boiler experiments represented in the foregoing paper was the one made by the Guion line of steamers. In addition to the boilers fitted on board the steamship *Montana* and tested at sea, the *Dakota*, a sister ship, was also fitted with the same kind of boilers, and although the boilers in this ship were not quite completed when those in the *Montana* were condemned, they too were at the same time removed to the scrap-heap. The cost of the boilers for each of these ships was \$175,000, and it is believed that the total cost to the company for this experiment has been not less than \$486,000. It has been estimated that during the last seven years the total cost in Great Britain resulting from the failures of boilers designed to be worked at sea with pressures of upward of 100 pounds per square inch, has nearly reached the enormous sum of \$1,000,000.*

BOILER EXPLOSIONS.

“At the annual meeting of the Manchester Steam-Users Association, held at the Manchester town-hall, (last year,) there were exhibited some large boiler-plates showing the rents that had been formed by hydraulic pressure in a full-sized mill-boiler of the *Lancashire* type, constructed entirely for experimental purposes. The plates shown contain the fractures developed. The experiments on this boiler, which have just been brought to a conclusion, have extended over about eighteen months. The boiler has been burst eleven times, being substantially repaired after each bursting, the entire outer shell at one time being remade. These experiments have led to interesting and important results, of which the following is an official summary. They have shown the weakening effect that steam-domes have upon cylindrical boilers, and the importance at high pressures of having man-hole mouth-pieces, as well as all the fitting blocks, of wrought iron instead of cast. They have also proved that the furnace-tubes when strengthened at the ring-seams of rivets with encircling hoops or flanged joints, and the flat ends, when suitably stayed, are stronger than the cylindrical portion of the shell, which rends at the longitudinal seams of rivets. In the recent fatal explosion at Rochester on board the steam-tug *Prince of Wales*, the flat end failed before the cylindrical portion of the shell, showing that the boiler was malconstructed. The experimental boiler, which was 7 feet in diameter, and made of plates 7-16ths of an inch in thickness, rent in

* For description of sectional boilers used in Europe, see report, volume III, on International Exposition held at Vienna, 1873, by Prof. R. H. Thurston, A. M., C. E., late engineer officer United States Navy.

the outer casing at a cast-iron man-hole mouth-piece at a pressure of 200 pounds on the inch; at a machine-made, single-riveted longitudinal seam of rivets, at a pressure of 275 pounds on the inch; at a double-riveted longitudinal seam of rivets at a pressure of 300 pounds on the inch when hand-made, and at a pressure of 310 pounds on the inch when machine-made. The experiments showed the superior tightness as well as strength of double-riveted to single-riveted seams, and of machine-work to hand-work. The factor of safety adopted by the association, and which they find efficient, is 4 to 1. It had been calculated that the bursting-pressure of the boiler would be 300 pounds, which has been verified by the experiments. Boilers of the dimensions just given are guaranteed by the association at a working-pressure of 75 pounds on the square inch. The plates of which the boiler has been made are about to be tested in an accurate machine as regards cohesion and elasticity, so as to check the results obtained by water-pressure. When these are completed the entire results will be given to the public.

"The labors of the association have conclusively shown that steam-boiler explosions are not accidental nor mysterious, but that they arise in the great majority of cases from the use of boilers unfit for work."

REPORT ON EXPLODED BOILER OF THE THUNDERER BY THE CHIEF ENGINEER SURVEYOR TO LLOYD'S.

In consequence of a request made by Messrs. Humphrys, Teuant & Co. to the committee of Lloyd's Register, that I should form one of the committee of experts to investigate the cause of the explosion of one of the boilers of this vessel, I received instructions from the secretary to accompany the various gentlemen deputed by the coroner, the Admiralty, and the manufacturers, to inquire into the cause of this accident.

The investigation commenced on the 26th July, and has since been carried on from day to day.

The *Thunderer* is an armor-clad turret-ship, built at Pembroke about 1870. The engines, which are constructed to indicate between 5,000 and 6,000 horse-power, were made about the same time. They receive their steam from nine rectangular wet-bottom boilers, of the form at that time adopted in Her Majesty's navy, the boilers having 33 furnaces in all. They are arranged in a fore-and-aft direction on each side of the vessel, and are situated in two stoke-holes, there being four boilers in the after stoke-hole and five in the forward one. The boilers are all connected to the main steam-pipes by screw-down stop-valves, situated on the tops of the boilers, and so arranged that each can be shut off from the others at will. Each boiler is also fitted with a smaller stop-valve connecting it to a system of steam-pipes, so that each or any of them can be used for supplying steam to the numerous auxiliary engines fitted for various services in all parts of the vessel.

Properly-constructed steam and water gauges, feed-cocks, blow-off cocks, and other necessary appliances are fitted to each boiler, together with a sufficient number of safety-valves. These safety-valves are inclosed in cast-iron chests bolted on the fronts of the boilers, and have internal pipes or pockets fitted so that the steam is taken from the highest part of the boiler.

The valves themselves are made on the ordinary direct-weighted principle, with solid spindles, and are guided at the bottom by three leathers working in the valve-seats. Each valve is loaded to a working-pressure of 30 pounds per square inch. They are such as are gen-

erally fitted in Her Majesty's navy, and have nothing novel about their construction.

The steam-gauges are on the ordinary Bourdon principle, graduated to 35 pounds per square inch, and are fixed in conspicuous places on the fronts of the boilers.

It appears the vessel was tried under steam several times at Pembroke, afterward was steamed around to Portsmouth in charge of the Admiralty officials, and has subsequently been under steam on several occasions.

On the 14th July it was arranged to make the official trial. The vessel lay at Spithead, fires were lighted at 10 o'clock, steam was slowly raised in all the boilers, and about 1 o'clock the engines were started for a preparatory run before going on the measured-mile full-power trial.

In about eight or ten minutes afterward the foremost starboard boiler in the after stoke-hole exploded. The vessel was towed into Portsmouth Harbor and the stoke-holes were strictly guarded until the official inspection took place. I was present at the first inspection and have been present at all subsequent examinations.

On examining the exploded boiler, it was found that almost the whole of the front plates above the smoke-box doors had been forced away, and lay, together with the smoke-box doors and other *débris*, in a distorted mass on the stoke-hole floors. The plates themselves were torn through the first seam of rivets above the smoke-boxes for almost the whole length of the boiler, rending in a diagonal direction through the solid plate at the man-hole, and again tearing through the seams of rivets connecting them with the crown and other parts of the shell. The front of the uptake was bulged, torn, and driven back against the back plates. The plates were drawn over the stays supporting these flat surfaces. The T-iron fastenings to the stays above the uptake-plates were sheared through the pinholes. The top of the boiler immediately over the uptake was bulged upward. The sides of the smoke-boxes below the ruptured parts, together with the flat surfaces in the combustion-chambers, and two of the furnace-crowns were bulged between the stays. Altogether the boiler showed decided symptoms of having been subjected to excessive pressure.

There were no signs of shortness of water.

The workmanship appeared to be of the best description, and from the proof-mark on the front of the boiler, it had been tested in November, 1870, by hydraulic pressure to 60 pounds per square inch.

Both stop-valves on this boiler were found to be shut, and the steam-gauge was entirely destroyed.

The safety-valve chest lay on the stoke-hole plates in exactly the position it had fallen. It contained two valves, each $5\frac{1}{2}$ inches in diameter, one of which could be lifted by means of a screw beneath it, while the other is inclosed and entirely out of the control of the engineer. The cap over the spindle of the hand-lifting valve was carried away, and the top of the spindle broken off.

The stop-valves being closed, it was evident that none of the steam generated in this boiler, from the time the fires were lighted to the time of the explosion, could have gone to the engines. It must therefore have been accumulating pressure in the boiler all that time, or escaping by the safety-valves. The safety-valves were stated to have been loaded to 30 pounds per square inch, and the pressure-gauge was said to have been observed out of order more than an hour before the explosion occurred.

It was considered very important to make a minute examination of the remainis of the safety-valves, to see if there was any evidence of their being jammed or otherwise not in working order. The chest was opened in the presence of all the inspectors, and there were no such things as wedges, stops, or other means for jamming the valves found. Both valve-spindles were found broken and bent, the valves were perfectly free in their seats, but the feathers of these valves were battered and distorted in such a manner as to destroy all evidence of their condition at the time of the explosion.

If the safety-valves were not jammed or set fast, the boiler must have exploded owing to structural weakness; and in order to ascertain as far as possible whether it could have arisen from this cause, the whole of the other boilers, with the exception of one small boiler in the forward stoke-hole, were tested by hydraulic pressure to from 60 pounds to 65 pounds per square inch. They were quite tight, and after being carefully gauged before, during, and after the test, they showed no signs of weakness.

Strips of plate were cut from the ruptured parts, and tested by the testing-machine in the dock-yard. The iron was found to be above the average strength of iron used in boiler-making, the mean results of these experiments showing that it would stand a tensile stress of 21 tons per square inch of section.

As a guide to the pressure which this boiler was capable of bearing, a chamber was constructed to represent to some extent the part of the boiler which gave way. From its form it did not, in my opinion, give exact information on that point, seeing that the side plates of the uptake, which very materially add to the strength, were omitted, and consequently the whole strength of the structure was reduced. It was burst at various pressures under four or five different conditions, and although it did not exactly represent the exploded part of the boiler, the results of these experiments show almost with certainty that the pressure within the boiler at the moment of rupture could not have been less than 100 pounds per square inch.

The whole question of the cause of this explosion therefore centers itself upon the condition of the safety-valves at the time of the explosion, and as they were so destroyed by the accident as to make it impossible from their appearance to speak of their condition at that time, it was deemed advisable to make an examination of all the safety-valves of the other boilers. This examination was made, and they were all found to be loaded to about 30 pounds per square inch. They were free to move, and to all appearance were in a workable condition.

The feathers of safety-valves made on this principle require to be an easy fit in their seats; if too slack, the rolling of the vessel shifts them on their faces and causes them to leak. In this case they appeared to be a good working fit, and it was suggested to try them under steam. One of the valve-chests containing two valves was accordingly attached a land-boiler in the dock-yard. It was found that when steam was raised, one of the valves, although loaded to only 30 pounds per square inch and quite free when cold, did not lift until the pressure reached 52 pounds per square inch, but after blowing a short time and uniformly heating the cast-iron chest, it rose and fell at about the working-pressure.

This conclusively proved that the expansion of the feathers of the brass valve was sufficient to make them grip or set fast, when fitted so close as this valve was fitted.

Although this single valve did stick under this trial, the whole of the

others were tried afterward under similar conditions and were perfectly free; the experiment therefore affords no certain evidence of the exact condition of the safety-valves on the exploded boiler at the time of the explosion. But as there can be little doubt of their inoperativeness, it can be inferred that had they been a little tighter than the valve that was tried and found to stick, or if they had been neglected and scale or dirt allowed to get between the working surfaces, the expansion of the valve would have caused them to jam or set fast, and allow the pressure to accumulate until it overcame the strength of the boiler.

The facts of the case may be summarized as follows :

1. The stop-valves were shut, so that the steam generated in the boiler could not escape to the engines.

2. The steam-gauge was discarded as being out of order, and therefore it did not make known any abnormal pressure in the boiler.

3. The fires were burning briskly, and therefore the pressure must have been rapidly increasing in the boiler.

4. The boiler presents unmistakable symptoms that it burst from excessive pressure, and not from faulty construction.

Under these circumstances, I am of opinion that the safety-valves of the boiler in question at the time of the explosion were set fast in their seats, and that the cause of the explosion was excessive pressure, owing to the stop-valves being shut and there being no outlet for the steam which the fires were generating.

Having, therefore, arrived at this conclusion, I think it my duty to urge the necessity of the greatest care being taken (1) in the designing of safety-valves, and (2) in the absolute necessity of their being frequently examined. There ought to be a certain means of preventing any increase of pressure beyond the stipulated amount.

Since this explosion I have carefully considered this subject, and, with a view to reducing the chances of safety-valves sticking or otherwise being inoperative, I would suggest :

1. That the valve with a central guiding-spindle is less liable to set fast by unequal expansion than a feather-guided valve.

2. That the spindles which support the weights of these valves should be detached from the valves themselves, or that a guide should be fitted between the valve and the weights, so that any inclination of the weights caused by the motion of the vessel should not tend to cant the valves and make them grip in their seats.

3. Easing-gear should be fitted to all the valves, and arranged to lift the valves themselves.

4. That all safety-valve spindles should extend through the covers, and be fitted with sockets and cross-handles, so arranged that it would be impossible to add any extra weight or to control their action, but at the same time allowing them to be lifted and turned round on their seats, and their efficiency tested by the engineer at any time, whether the steam is up or not.

I would, in conclusion, add that loading safety-valves for marine purposes by means of dead-weights is now in the merchant service almost entirely superseded by springs.

WILLIAM PARKER,

Chief Engineer-Surveyor to Lloyd's Register of Shipping.

(Lloyd's Register of British and Foreign Shipping, 2 White Lion Court, Cornhill, London, August 16, 1876.)

Of the four several official reports on this explosion the above is given as the most practical.

BOILERS OF THE MERCANTILE MARINE.

Through the kind attention of the general inspecting engineer of Lloyd's, I had the privilege of observing the practice and inspection as applied to the boilers and machinery of the commercial marine of Great Britain. Steamers were visited after long voyages; some vessels in which the machinery and boilers were comparatively new, others having boilers in different stages of deterioration, and still others in which the machinery was undergoing construction. All that relates to the corrosion of boilers will be found under that head at page 199 *et sequitur*. As to the kind of boilers now employed, no material changes have taken place in the last five years, but the old type of box or wagon-shaped boiler, so familiar to the marine engineer of former days, is no longer seen. It is obsolete, reckoned among the inventions of the past, and years hence will probably be shown in the South Kensington Patent Museum by the side of the marine side-lever engine and numerous other obsolete curiosities stored in that interesting institution.

The pressure of steam carried at the present day on marine boilers varies from 60 to 70 pounds per square inch, and the boilers used to generate it have shells either cylindrical or elliptical. More care is exercised than was formerly considered necessary in the details of construction, and better workmanship in fitting and riveting the parts together.

Composition tubes are being used to a considerable extent where iron tubes were formerly employed. Safety-valves, having levers with loaded weights attached, have, in consequence of the higher pressures used than formerly, and of the difficulty with them, arising from the pitching and rolling of the vessel in rough weather, been abandoned, and spring safety-valves substituted in all steamers. The valve adopted generally for boilers, both of commercial and naval vessels, is known as Adams's. The following cut is a representation of it.

In this connection, it may be interesting to quote from Lloyd's Register a section relating to the designing, building, testing, and fittings of boilers; also their formulæ for the strength of cylindrical shells of boilers and of circular flues or furnaces.

Lloyd's Register of British and foreign shipping.

[Extract from the rules of the society.]

MACHINERY AND BOILERS OF STEAMSHIPS.

SECTION 73. With respect to the boilers and machinery, the owners are required to submit them to the inspection of the society's engineer-surveyors, who will furnish a report to the committee describing their state and condition, in the manner and form (No. 8) annexed. The committee will thereupon grant a certificate, and insert in the registry-book the notification "Lloyd's MC." (*in red*), indicating that the boilers and machinery have been inspected by the engineer-surveyors, and certified to be in good order and safe working condition. (See section 81.)

The society's engineer-surveyors are to examine the plans of the boilers, and approve of the strengths for the intended working-pressure.

Any great novelty in the construction of the machinery or boilers to be reported to the committee.

The boilers, together with the machinery, to be inspected at different stages of construction.

The boilers to be tested by hydraulic pressure in the presence of the surveyor to twice the intended working-pressure.

Two safety-valves to be fitted to each boiler; if common valves are used, their combined areas to be half a square inch to each square foot of fire-grate surface; if improved valves are used, their efficiency to be tested under steam in the presence of the surveyor, and in all cases set to the working-pressure.

A stop-valve to be fitted, so that each boiler can be worked separately.

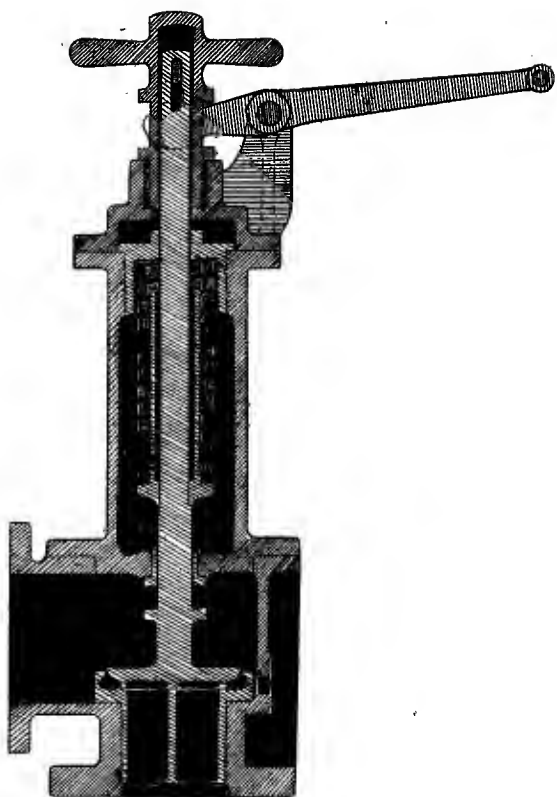

Each boiler to be fitted with a separate steam-gauge, to accurately indicate the pressure.

With a view to insuring better control over all cocks, valves, and pipes connecting the engines and boilers with the sea, they are to be fixed as follows, viz: All cocks fitted on the plating of steam-vessels to be raised above the level of the stoke-hole plates *on the turn of the bilge*, or attached to Kingston valves of sufficient height to lift them up to the level of the stoke-hole plates, so that they can at all times be seen and attended to. All discharge-pipes to be, if possible, carried above the deep load-line, with discharge-valves fitted on the plating of the vessel. No pipes to be carried through the bunkers without properly-constructed wrought-iron casings around them. The bilge suction-pipes to be fitted to pump from each hold, and suction-pipes and roses to be fitted in the bilges and amidships in the engine-room; these roses to be fitted in a convenient place, where they can at all times be accessible; the cocks and valves connecting these pipes to be fixed above the stoke-hole plates. All blow-off cocks to be constructed so that the spanner or key can only be fixed or taken off when the cock is shut.

The arrangement of bilge-pumps, bilge-injections, suction and delivery pipes, also the non-return valves, to be inspected and approved by the surveyors; any defective arrangement to be reported to the committee.

Lloyd's formulæ for cylindrical shells of boilers.

$$\frac{51520 \times 2 T \times C}{D \times 6.5 \times 100} = \text{working-pressure in pounds.}$$

$$\frac{(P-d) \times 100}{P} = \text{percentage of strength of plate at joint compared with solid plate.}$$

$$\frac{(a \times N) \times 100}{P \times T} = \text{percentage of strength of rivets compared with solid plate.}$$

51520 = tensile strength of iron in pounds per square inch of section.

T = thickness of plate, in inches.

D = diameter of inside of shell, in inches.

6.5 = factor of safety.

C = less of the two above percentages.

d = diameter of rivets.

P = pitch of rivets.

a = area of section of rivets.

N = number of rows of rivets in shear.

Formula for collapsing of circular flues.

$$\frac{89600 \times T^2}{L \times D} = \text{working-pressure in pounds.}$$

89600 = constant.

T = thickness of plate, in inches.

L = length of flue or furnace, in feet.

D = inside diameter of flue or furnace, in inches.

The stays in the flat surfaces to take up the whole strain, and not to be subjected to a greater strain than 5,000 pounds per square inch, calculated from the weakest part of the stay or fastening.

PART XIX.

SEA VALVES AND COCKS; STEERING GEAR.

SEA VALVES AND COCKS

It is well known that all the water from the sea required for the purpose of working the engines and boilers of the vessel is admitted through several holes cut through the bottom or bilge, and that these holes are covered by what is known as sea valves or cocks, made either of cast iron or brass; and that they are secured to the skin of the vessel by bolts, and connected to the engines and boilers by pipes of copper, brass, or iron. Heretofore, these valves or cocks have generally been placed low down on the floor, so as to be out of the way; the engine-room as well as the fire-room floor-plates being above them, they are out of sight and very difficult of access, so that if a leak or accident occurs, it is not always discovered until the water rises to the floor, when it may be too late, for the engineer cannot ascertain the cause in consequence of the valves and pipes being covered with a considerable depth of water. Many serious accidents have happened in consequence of this arrangement. Among them may be mentioned the loss of the *Knight Templar*; also, the case of the French trans-Atlantic steamer *Europe*, of 4,000 tons, abandoned in the Atlantic April 2, 1874; the crew and passengers, in all about four hundred, being taken off the sinking vessel by the English steamer *Greece*. When abandoned there were only about 6 feet of water in the engine and fire rooms, and 1 foot in the adjoining holds. It is evident that the leak was in the engine department from sea-connections, as was proved by a very singular coincidence, for only a few days afterward her sister ship, the *Amérique*, of 4,000 tons, belonging to the same owners, was abandoned in the English Channel; afterward picked up by an English steamer and towed into Plymouth Harbor, with the engine and boiler rooms full of water. When it was pumped out, nothing was found wrong with the ship, and the difficulty with the sea-connections was never made public. These two ships were valued at nearly \$3,888,000, exclusive of cargoes, and their abandonment at sea, under such circumstances, was altogether owing to the want of practical engineering skill and courage, added to the captains' lack of presence of mind in emergencies. The *Ormesby*, of 930 tons, was abandoned in the Bay of Biscay in January, 1874. After having encountered a heavy gale, water was suddenly discovered coming into the engine and fire rooms, which in a short time put out the fires; as no leaks could be discovered in any other parts of the vessel, it was supposed to have come from the exposed and dangerous condition of the sea-cocks. There are many known cases of narrow escape, and, among naval vessels, notably that of the *Iron Duke*, besides which it is believed that unreported losses have occurred from the same causes. In consequence of these accidents, Lloyds now require the sea valves and cocks of all descriptions to be placed above the bilge in all ships constructed or remodeled. There is, however, no British law regulating the number of bulkheads in iron vessels or the height to which they should extend. Neither Lloyds nor the Board of Trade make other provision than that there must be a collision-bulkhead at

each end of a steamer and at one end of a sailing-vessel. A vessel may be 500 feet long, and have 400 feet of that length in the center practically in one compartment. In some ships the bulkheads are sufficiently numerous, but do not extend above a deck which is nearly level with the load water-line. In that case, if one compartment fills, the vessel sinks enough to bring the tops of all bulkheads under water. In other ships where there are proper bulkheads, doors are cut in them, which destroy their integrity. The pumps afford but feeble refuge against the dangers thus incurred. That greater precautions are consistent with commercial success is proved by the recent practice of some English owners.

STEERING-GEAR.

The most essential features in any arrangement of steering-gear are simplicity, certainty of action, immunity from derangement, and general efficiency. Several varieties of gear have been patented to accomplish these objects. It may be profitable to consider those most successfully employed, of which there are three systems of recent date, viz, the screw-gear, the steam-gear, and the hydraulic gear.

The introduction of steam-power and screw-propellers brought into greater prominence the demand for an increase of power in the steering-gear, owing to the increased speed, and different conditions under which the rudder acts in a steam and sailing vessel, beside which it became important to relieve the steersman from the shocks given by the rudder when the vessel is being driven through heavy seas. To meet these demands the screw-gear (the well-known right and left handed screw) was introduced, which in some form or other is now generally employed in steamers either as a primary gear or as a stand-by in heavy weather. A large number of steamers of the mercantile marine are fitted with two sets, one placed aft, immediately in connection with the rudder, and the other in such a position that the steersman who works it commands a view ahead and is immediately under the eye of the officer on watch. That placed aft is as a rule a screw-gear, and the forward one is of the old-fashioned variety, either a combination of tiller with blocks, with wire-rope or chains carried along the deck to the steering-wheel, or else a quadrant is keyed on to the rudder-head, to each extremity of which are attached chains which pass through snatch-blocks on either quarter, and the communication is carried along the decks by rods or rope as before to the hand-gear. But in order to obtain sufficient power by the hand-wheels, geared wheels are used, and a pitch-chain which connects the rods or wire-rope on either passes over a sprocket-wheel or chain-pulley, which is keyed on to the same shaft as the spur-wheel. By the arrangement of the screw-gear the danger consequent on the rudder taking charge is partially avoided, but the whole of the gearing and rudder-stock require to be of increased strength to meet the additional strain. These appliances or modifications of them for ships of moderate dimensions answer the purpose, and do not require under ordinary circumstances a very great amount of manual power, but in the largest steamers the best devised of any of these hand-gears meet their wants inadequately, and for heavy ships of war the efficiency of the steering apparatus becomes a most important question. Here, again, mechanical skill has enabled the problem to be dealt with, for both steam and hydraulic power have been successfully applied, and one or the other is now generally employed in such vessels, so that they can be readily handled in narrow channels or crowded harbors and manœvered in action.

The steam-gear which up to the present time has met with the largest measure of success, and has been adopted in many ships of the British navy, also in a large number of commercial ocean steamers, is that designed by Mr. McFarlane Gray, and now made by Messrs. Forrester, of Liverpool.

As generally applied, it consists of a pair of engines with barrel and pitch-wheel, which are placed aft, so as to be in close communication with the tiller or quadrant. The valve which controls and reverses the engines is in connection with a light steering-wheel placed forward in the ship in some convenient position, the connection being made by means of shafting. The rudder is also placed in communication with this valve, in order that when the position of the rudder required by the steersman is reached the engines may come to rest, and on further motion being given to the steering-wheel the rudder can be moved either to port or starboard. The engines can be fitted amidships, as is sometimes the case, and various modifications made. This steering-apparatus possesses simplicity, is rapid in its action, the engines are not liable to disarrangement, it is as efficient as a simple steam-winch, and the rudder can be easily controlled by *one man in the heaviest weather*. The first cost of this system of working the rudder is considerably more than that of the old plan worked by manual power, but the saving in the number of men at the wheel is a large item; added to which (and of more importance) is the greater security of the vessel by steering more easily in narrow or crowded places, and the less risk of collision owing to rapid handling.

The other steam-steering gears patented, and in some cases fitted, vary from the above principally in the manner in which the engines are brought to rest whenever the desired movement of the rudder has been effected, and in the arrangement of the slide-valves.

The only objection raised to steam as the power to move the rudder is the condensation in the long pipes when the engines are placed aft; but with a proper adjustment of the valves this need not interfere with the quick and sensitive action of the engines.

The system of steering-gear that has for some time been competing with steam as an agency, is the hydraulic. Several types of this have been patented. The most successful is that designed by Mr. Brown, of Edinburgh, Scotland. It is by far the most complete of its kind, possessing many of the essentials required for a steering apparatus. The large ferry-steamers running between Liverpool and Birkenhead, double-enders—vessels which can be steered from either end—are successfully handled by this gear. It has also been applied to some large passenger-steamers nearly 400 feet in length, and is reported on favorably. In these vessels a small hand-tiller is used for steering, which requires but a comparatively small amount of pressure to move from amidships to port or starboard, and the rudder quickly follows the movement of the hand-tiller, remaining in a similar position until this is again moved,

A clear description of the apparatus, by Mr. W. J. Pratten, I. N. A., is here given:

In this plan the tiller is acted upon by rams placed athwartships, or in any other convenient position; the water being conveyed to them by small pipes from an accumulator in the engine-room. This accumulator is kept filled with water by a pair of small pumping-engines; it consists of a long cylinder fitted with piston and ram. The space on the top side of the piston is in communication with the boiler, thereby having the same pressure per square inch as the boiler, the space under the ram being, as usual, filled with water. It is so arranged that the pumping-engines take their steam from the top of the cylinder, so that when the piston rises to the top, owing to the

water-chamber being filled, the steam is shut off and the engines come to rest. As the water is used and the piston falls, the engines at once start, and fresh water is pumped into the accumulator. The relative areas of piston and ram are such that the water is under a pressure of about 700 pounds per square inch at the full boiler-pressure of steam. Iron pipes of one inch bore convey the water from the accumulator to a small slide-valve, which is in close proximity to the hand-wheel or tiller, for the use of steersman, and other pipes lead from this valve to the driving-rams placed aft. This valve, which resembles a small locomotive one, has a double connection, viz, with the tiller used by the steersman, by means of a vertical shaft and levers, and with the rudder by wire-ropes. The action is very simple. On moving the hand-tiller far enough to port or starboard, as may be required, water passes from the accumulator through the open valve-port to one of the driving-rams aft; the water at the same time escaping from the other ram through the exhaust-port of slide to a tank in the engine-room, from which the engines take their supply of water. The rudder is also connected to this valve, which is closed by the former getting into the position indicated by the hand-tiller. The valve is thus entirely self-acting in closing, after any movement of the hand-tiller. The device by which this valve is worked is very ingenious, and other contrivances in the design are well worthy of notice.

As the water is continually returned from the rams to the accumulator, there is only the loss by leakage to be made good. This leakage will be principally from the driving-rams, and, when these are packed, is reduced to a very small quantity. One great advantage arising from always using the same water, is in case of frosty weather, when it is necessary to add some non-freezing mixture to protect the pipes from injury. The patentee of this design advocates in such cases the use of about 20 per cent. of methylated spirits, as a cheap and most effective preventive against frost.

The liability of water to freeze in the pipes has been urged as a main objection to the use of water-power in any form for a steering apparatus; but, except in cases of extreme frost, there is little risk of injury if even a smaller proportion of spirits than the above be used. The pipes can be carried along the main or lower deck, and the driving-rams can also be placed below instead of on the exposed upper deck.

It is highly necessary that the rams should have sufficient power to place the rudder hard over when the ship is running full speed; in fixing the diameter of the rams and leverage on tiller, it must be borne in mind that the boiler-pressure of steam is not always constant. If the rams have only been designed to force the rudder hard over when using the highest steam-pressure, it is obvious that it will partially fail to work effectually when the pressure of steam falls to one-half or two-thirds; but this is a minor point.

In order to relieve the pipes from a sudden increase of pressure, such as would take place when a sea struck the rudder, spring escape-valves are fitted on the barrels of the rams, allowing the water to pass from behind one ram to the other, thus preventing any loss of water and giving relief to the pipes.

Of the other hydraulic gears patented, the one by Mr. Esplin has been fitted to several ships; also one by Admiral Inglefield has been fitted to a vessel, but it was not free from objections, and after trial was removed. When hydraulic gear of this nature is fitted, the water in the accumulator may be usefully employed for other purposes, such as working independent engines for the starting-gear or anchor-hoisters.

In war-ships or large merchant-ships entire trust is not placed in the steam or hydraulic gears, where they are fitted; for they are supplemented by a screw-gear or other suitable arrangement. In some cases the engines are so fitted that they can be readily disconnected from the remaining gearing, which can then be worked by hand in the ordinary manner.

Besides the steering-gear successfully applied as above described, there has been recently produced by Messrs. P. Brotherhood & Hardingham,* engineers, of London, a new system of steam steering-gear by means of which the rudder of a ship can be laid over at any desired

* A set of Brotherhood engines was exhibited at the Vienna Exposition, and has been described by Professor Thurston as follows: "The cylinders are arranged with their axes making angles with each other of 120°. They are single-acting, and the pistons are coupled to a single crank. The valve is a revolving one, its axis is coincident with that of the crank-shaft and it is turned by a prolongation of the crank-pin. The central chamber is the steam-chest, and the valve permits steam to pass to the rear of the pistons successively, thus disturbing the existing equilibrium and producing rotation."

angle, and when released, always returns to its normal position. The power is transmitted through the Brotherhood three-cylinder type of engines. The apparatus is illustrated in the *Revue Industrielle*, and described fully in *Engineering* of October 13, 1876. It has been approved by the British Admiralty, and is being fitted on board the armored ship *Téméraire*.

The advantages to be derived from the application of power other than manual for steering, as well as for hoisting anchors, and for receiving and discharging weighty articles on board vessels, are so well known that enumeration of them is unnecessary.



MANUFACTURE OF STEAM-MACHINERY FOR THE BRITISH NAVY.

The policy of England has been steadily to encourage the responsible engineering-works of the kingdom with orders, which have in no small degree tended to expand and develop their special resources for marine-engine construction, and, besides, to obtain through these establishments the best constructive and mechanical engineering ability. No steam-machinery for ships of war has at any time been manufactured in the excellent works of the dock-yards. These works are employed solely on the repairs of the steam fleet. All new machinery is built by contract from the designs of responsible bidders, and the establishment to which the contract is awarded guarantees the entire work and the indicated horse-power on the measured mile. It is also held responsible for the efficiency of the machinery for a period of one year after it has been accepted by the Admiralty, and any parts which during that period may be found defective, or may show symptoms of weakness owing to faulty design, materials, or workmanship, must be removed and others substituted for them by the contractors at their own expense. When the machinery for a new ship or class of vessels is to be furnished, the specifications are drawn up by the engineer-in-chief and printed. They are headed "Specifications of certain particulars to be strictly observed in the construction of ——— engines, with ——— screws, for the ship ———, of ——— indicated horse-power." These specifications give all the principal dimensions and many of the details of the engines, boilers, and appendages. They also limit the weight and space to be occupied. They are then sent out to the following-named firms: Messrs. John Penn & Son, Greenwich; Messrs. Maudslay, Field & Son, London; Messrs. Humphrys & Tenant, Deptford; Messrs. Rennie & Bros., London; Messrs. Napier & Son, Glasgow; Messrs. John Elder & Co., Glasgow; Messrs. Laird Bros., Birkenhead; Messrs. Easton & Anderson, Leith, and sometimes to other works.

In tendering for the supply of the machinery, the contractors are requested to forward a design in accordance with the specifications and tracings of the ship, &c., supplied. They are also requested to furnish a design and tender for any other plan of engines and boilers not based on the specifications, adhering to the total weight and space to be occupied by the machinery. The tender accepted by the Admiralty is in most cases in accordance with the specifications, but not always so, as may be seen in the case of the sister ships *Nelson* and *Northampton*. The specifications for the motive machinery of these two ships were printed as for a class, and while the contract for the former is based on them, the latter has engines of an entirely different design, as has been seen in the brief description of these vessels elsewhere. There are other similar cases of contracts where tenders have been received on the specifications of a class, but it is unnecessary to refer to them here, as it is believed that sufficient has been said to show the system pursued in obtaining machinery for the British navy.

PART XXI.

OFFENSIVE TORPEDO-WARFARE.

THE ZIETHEN; THE UHLAN; SPAR TORPEDO-BOATS; THE OBERON
EXPERIMENTS.

OFFENSIVE TORPEDO-WARFARE.

THE TORPEDO-VESSEL ZIETHEN.

The *Ziethen* is an unarmored German iron-built vessel, 226 feet long, 28 feet broad, 18 feet 6 inches deep, and has a load-draught of 11 feet 8 inches. This vessel was built and completed in June last by the Thames Iron Works at Blackwall, London, for the torpedo-service of the German imperial government, and she is intended to carry out a series of experiments at sea with the Whitehead or fish torpedo. She has twin-screws and two pairs of non-compound engines, by Messrs. John Penn & Son, designed to indicate 2,500 horse-power. There are six cylindrical boilers, each containing two furnaces, set in the vessel back to back, occupying the whole width and about 30 feet fore and aft of the vessel, besides the fire-rooms, one of which is forward and the other aft, next to the engines. The maximum speed is 16 knots per hour at sea, and as the vessel is not to be used as a cruiser, economy of fuel was not a consideration in the design.

The *Ziethen* is built with two tubes, not much unlike screw-propeller-shaft tubes, placed in a line with the keel, one forward and the other aft, having valves at either end. They are 6 feet below the water-line; the after tube projects just over and beyond the rudder, the outlet of the forward tube is about 16 feet back in the forebody of the vessel, and a triangular portion of the hull is made to hinge in the stem and lift into a water-tight well, so that there is no projection to interfere with the speed of the vessel. From these tubes the torpedoes are to be expelled by means of compressed air forced in by pumps worked by a steam-engine. A small pipe connects the tube with a Kingston valve in the bilge of the ship. The torpedo used in this vessel is represented to be an improvement over the weapon for which the patent was purchased by the British government. It is cigar-shaped, is about 17 feet 6 inches long, by 15 inches in diameter at the center, and the pressure of air contained in its chamber, when launched from the tube, is stated to be 1,000 pounds per square inch. To use the torpedo it is first charged with air to the desired pressure by means of an air-compressing pump, and then set to the depth and distance intended to be run, after which the fore end containing the explosive charge is secured, and the percussion arrangement properly adjusted. The torpedo being then ready for action it is pushed into the launching-tube, the valve behind is closed, and the water from the Kingston valve admitted into the tube. A pump in the engine-room supplies air to a reservoir under a high pressure, and when it is wished to discharge the torpedo, the exit-valve of the tube being open, communication is opened between the reservoir and an apparatus in the rear end of the launching-tube, which forces the torpedo out with great velocity, at the same instant tripping its air-valve, which sets in motion the engine that works the screw-propeller by the self-

contained power accumulated in the air-chamber. The speed at which the torpedo leaves the ship is represented to be 18 miles per hour, and that it will maintain this speed for a short distance with a given immersion, after which the speed, consequent upon lessened pressure in the air-chamber as the engine works it off, will gradually diminish until the distance of about 2,500 feet from the starting-point is reached, when it will have run its course. The slower the velocity at which it is started the greater the distance it will run, depending on the capacity of the air-chamber and the pressure of air contained therein. The line of horizontal travel is preserved by regulating-mechanism with which the weapon is provided.

The principal features of construction of the Whitehead-Luppis fish-torpedo are unknown to the public, for its mechanism has been successfully kept a secret since its first introduction to notice. Each of the several European governments which purchased the secret appointed a small number of officers to be put in possession of a complete set of drawings furnished with the weapons, and they are bound on honor not to reveal their workings. Many attempts have been made to describe the invention, but none of them were of any value until Lieut. F. M. Barber, U. S. N., entered the field and wrote his exceedingly clear and comprehensive paper, delivered as a lecture at Newport, R. I., November 20, 1874. This paper not only gives a clear understanding of the supposed construction in all its essential features, but also points out to ingenious mechanical minds ideas for producing similar projectile torpedoes.

It may not be out of place here to say what is known to naval officers, but not to the public, viz, that, as before represented, it is cigar-shaped, or more properly approaching in form a spindle of revolution. It is made of thin metal, either iron or steel; the fore end, containing the explosive material, is made separately and secured to the main body when desired. The air-reservoir next adjoining the fore end constitutes about one-half of the torpedo-vessel, and its strength must be very great to withstand the pressure. Aft of this reservoir is a set of three-cylinder engines actuated by air received through a pipe from the reservoir. The screw-propeller operated by the engines is connected by a shaft passing through a tube. There is a rudder or external mechanism capable of regulating the depth under water at which the torpedo shall advance, and also of keeping it straight or sending it on any curve which may be desired, taking into account currents and eddies. It has been announced that the torpedo can be set to run a straight course under water of from 600 to 6,000 feet, according to its speed from 18 knots per hour to 9 knots; that at a starting speed of 5 knots a range of 12,000 feet may be reached, and that the charge is sure of exploding on striking its object; that it can be arranged so as to half-cock or full-cock its trigger when approaching the object at which it is directed, and to rise near the water-line, or sink to the keel of the enemy's ship, as may be desired. If it misses its aim, a safety-pin is released, and the torpedo goes harmlessly away, to be recovered at any future time.

The weak point of the instrument is that, being propelled by an air-engine, the speed naturally decreases with the decreased pressure in the air-chamber, and although a very high rate of speed is insured throughout the journey, the velocity is the least at the termination of the course, when speed for the purpose of breaking through guards or netting around a ship is most desired.

England, France, Germany, Austria, and Italy have purchased the

right to use this torpedo, and Spain and Russia will probably soon follow in securing the secret. The first-named governments have paid, it is reported, about \$72,300 for the privilege of its use, with examples and drawings. The improvement and development of the instrument and system of working it is an object of continued study and experiment by the English, at the royal arsenal, Woolwich, and in the river Medway; by the Italians at Venice; by the French at the mouth of the Charente; by Austria at Fiume, where the inventor has his factory; and by the Germans in the North Sea. The German government intends to determine, by careful experiment at sea, whether it can be delivered with certainty from a ship more or less in motion riding on waves, against another vessel similarly circumstanced, and perhaps moving under sails; in fact, under all conditions likely to happen in war. For this purpose, together with the cost of the *Ziethen*, the patent-fees and torpedoes, about \$350,000 have been appropriated, and it is intended to expend \$150,000 additional if the experiments justify it.*

The first torpedo-boat constructed by the English for ejecting the Whitehead fish-torpedo through a launching-tube was the *Vesuvius*, an iron vessel of 241 tons, built in 1874. This vessel has one tube in the fore end, and she has been used in Portchester Lake, near Portsmouth, as a school of instruction in the use of the Whitehead torpedo for both executive and engineer officers. The naval authorities of England, Germany, and other European countries take advantage of the mechanical knowledge of their naval engineers, and employ them in their torpedo-service as well as in all naval-machinery work.

Several other vessels for torpedo-service exclusively, have been projected by the British Admiralty, besides which it has been determined to apply the apparatus for working the Whitehead torpedo to all vessels, both armored and unarmored, fitted out for service.† The first ship to which the necessary machinery for working it has been adapted was the powerful coast-defense vessel *Glatton*. In this vessel, fitted for the purpose last summer, the tube is on the broadside below the armor, and a similar arrangement will probably be made in other vessels fitted for sea.

GERMAN TORPEDO-BOAT UHLAN.

This boat was built in Germany by the Stettin Engine Company, and launched early in the summer of 1876. I did not see her, but the Ger-

* The most successful automatic or self-propelling torpedo tested in the United States is the one invented by Mr. John L. Lay, late an engineer officer United States Navy. A specimen of this torpedo was shown at the Centennial Exhibition. It was made of boiler-iron; was shaped like a spindle, 28 feet 3 inches in length, and was divided into four compartments. The front end, technically called the nose, contains the explosive material, viz, about 300 pounds of powder and 75 pounds of dynamite. The motive power, which consists of carbonic-acid gas generated in the usual way, is conducted from the generating apparatus, through iron tubes, to the engine, which is in the fourth section, and which operates the screw-propeller. The initial pressure is about forty atmospheres. The third, or middle, section contains a roll of two or more miles of insulated wire which is paid out from the torpedo itself, and serves to keep up electrical connection with the firing station. The torpedo is submerged to about four-fifths of its volume. Its maximum speed claimed is 10½ knots, but it seems from the Newport experiment that 7 knots only were attained. The instrument is entirely under the control of the electrician, who, by means of a series of contacts, opens or closes the communicating valves, and thus increases or diminishes the speed, and stops or starts the torpedo as required. It may be fired either by contact or by closing the electric circuit. Its position is always kept in view by a rod projecting from its upper surface.

† The British Admiralty have recently ordered 200 Whitehead fish-torpedoes from the inventor, also a large number to be manufactured at the Woolwich arsenal.

man papers announced the leading features of the boat, and, as they are peculiar and unusual, I copy the description:

This vessel will receive a torpedo charged with dynamite, to be carried on a 10-foot ram, lying deeply under the water-line; which torpedo is to explode on contact with the hostile ship. To protect the torpedo-boat from the results of the discharge of its own torpedo, the vessel is built with two complete fore parts, sliding one within the other, and having a considerable extent of intermediate space between them. This space is filled with a tough and elastic material, (cork and marine glue,) and thus if even the bows were carried off, there would be a second line of resistance. The object of the filling is to act like a buffer, deadening the blow and protecting the stem.

Another striking feature is the great power of the engines. The *Uhlán* carries an engine of 1,000 indicated horse-power. The steam is supplied by Belleville's tubular generator. The vessel, in fact, is all engine, only a very small space being left for coal and crew. The great power of the engines is necessitated by two circumstances. In the first place, the steamer has to be propelled at a high speed, and it has a very great draught, so as to offer but little scope to projectiles. In the next place, the greatest facility of steering or manoeuvring had to be attained; hence the proportion of width to length, 25 to 70 feet. In order to save the crew at the worst, a raft has been constructed, which is filled with the above mixture of cork and marine glue, and is placed near the helm. When the *Uhlán* enters into action the dynamite cartridge is to be fixed by divers at the point of the ram. The rudder is then to be fixed; and the crew are to open a wide port on the ship's side, and with their raft jump into the water. The steamer is then allowed to rush forward and burst its cartridge on the enemy's armor. The crew, however, are to hold on to the torpedo-boat by a line while they are awaiting the result of the explosion; and in case their boat is not hurt they are to board it again, in order, if necessary, to repeat the manoeuvre. The price of this torpedo-boat is about 200,000 thalers.

The above description is given for what it may be worth.

SPAR-TORPEDO BOATS.

Spar-torpedo launches for marine warfare are now being generally adopted into the service of all foreign navies. They may be divided into two classes, viz, those intended for river service and those designed for ocean purposes; both classes are built either of iron or steel. The first are usually about 45 feet long and 7 feet 6 inches broad, with a draught of water of about 3 feet 6 inches, and have 2 feet free-board. The frames are made of 1-inch angle-iron with $\frac{3}{4}$ -inch reverse irons, the plates being $\frac{1}{2}$ inch thick at the keel and $\frac{3}{4}$ inch at the gunwale. There is a steel turtle-back shield $\frac{1}{2}$ inch thick forward, to afford protection to the men and steering-wheel, and to throw off the water which might come on board from the explosion of the torpedo. The engine and boiler hatches are also provided with steel sliding covers. For boats of this size the engines are in one pair and operate a single screw; they are vertical, direct-acting, and non-condensing, with a maximum indicated power of about sixty horses.

The diameter of each cylinder is 7 inches, and the stroke $7\frac{1}{2}$ inches. The boiler is of the locomotive type, made of the best Lowmoor iron, and capable of being worked to 140 pounds pressure per square inch, and the maximum speed of the boat is from 13 to 14 knots per hour. The boats intended for ocean-work are designed to be navigated in any weather short of a storm, and are made on the same principle but with larger scantling, greater draught of water, and more height of free-board.

During my visits to Mr. Thorneycroft's celebrated steam-yacht-building yard at Chiswick, on the Thames, my notice was called to a torpedo-boat just then completed for the Swedish government. She is 58 feet long, has 7 feet 6 inches beam, and 3 feet draught of water, and is built entirely of steel, as light as will possibly hold together, the bottom plating being only $\frac{3}{32}$ of an inch thick; the top of this boat is completely covered with a very thin steel deck over the central portion. The engines are surface-condensing, and all the working parts are of steel. At the measured-mile run, the engines made upward of 500

revolutions per minute, and the boat obtained a mean speed of 17 miles per hour. This kind of trial is, however, no evidence of the speed when the boat is run for several hours consecutively.*

As I was an invited guest on one occasion of the trial of a boat of extraordinary speed on the measured mile, I had the opportunity of witnessing the *modus operandi*, and can bear evidence to the worthlessness of such trials for any practical purpose. The machinery is put in the very best order for the race, all weights are left out of the boat except fuel and water for the occasion and the few men necessary to operate the machinery and steer, also a very limited number of observers. The coal is hand-picked and of the best quality, carried in bags; the men are experienced hands, the fires are put in the best order, the steam is bottled up to the extreme pressure until the boat approaches the stake-marks, when the valves are opened wide, and the fires driven by a fan-blast sufficient to keep up the pressure for the three or four minutes required to run the single mile.

During 1875 a torpedo-boat for ocean purposes was built by Messrs. Yarrow and Hedley, on the Thames, for the navy of Holland. It is 66 feet long, 10 broad, and 5½ feet deep, and is driven by a pair of inverted, inches direct-acting engines, of 11 inches diameter of cylinders and 14 stroke of pistons. The boiler is of the locomotive type, with a total heating-surface of 450 square feet, and a working-pressure of 140 pounds per square inch; the estimated maximum horse-power is 200. This firm has now in course of construction one of their fast torpedo-steamers for the Russian service in the Black Sea. It is 85 feet in length, and the guaranteed speed on the measured mile is 20 knots per hour.

In the boats provided with non-condensing engines there is a chamber to which the exhaust-steam is conducted, and in which the condensation is effected against a portion of the skin of the boat, the plates there being increased in thickness; the object being simply to condense the steam in order to avoid the noise, and not to obtain a vacuum.

One of the primary conditions required for these boats is high speed; the more quickly one can dart out from the shelter of a bank or ambush, and approach her adversary, the more likely is she to escape observation. Another condition is that the machinery shall be noiseless. This condition is now obtained by means of the exhaust-chamber referred to.

The English government have not as yet done much in the direction of special torpedo-launches, but ordinary launches and cutters have been fitted for this service. The method of fitting these boats hitherto used has been to cover the forepart of the boat with a canopy of canvas, to work the torpedo-spar on outriggers placed on either side of the boat, and to rig it out and in by means of a rope worked from the stern-sheets, another rope being attached to the heel of the spar to ease it out and rig it in again.

They have also adopted the electric method of firing at will and not by contact. The system of torpedoes employed and the method of working the spars are so well known, that remarks thereon would be superfluous. It may be mentioned however, that in the Dutch boat referred to there is an auxiliary steam-engine to facilitate the working of the spars.

* The boats built by Mr. Thornycroft are driven by screw-propellers of his own invention. They are generally three-bladed, with the driving-faces of the blades slightly concave and the opposite faces convex. In his letters-patent granted in the United States, 24th of August, 1875, he says: "I claim as my invention: 1st. A propeller, the blades of which are projected rearward from the hub, said rearward projection being most prominent nearest the hub and decreasing toward the tips of the blades; 2d. A propeller, the blades of which have an increasing pitch and are projected rearward from the hub, said rearward projection being most prominent nearest the hub and decreasing toward the tips of the blades."

THE OBERON TORPEDO EXPERIMENTS.

The *Oberon* is an iron vessel, of 649 tons B. M., which has for several years past been used for carrying into effect a series of extensive and costly experiments, by exploding torpedoes near to and against her bottom, the chief object in view being to ascertain the effect of torpedo explosions on the double bottoms of armored ships, under different forms of construction and various conditions of attack. For this purpose the vessel has had an outer bottom built to the inner skin, which is intended to represent, as nearly as possible, the bottom of the broadside-armored ship *Hercules*, and to be of about the same strength.

The *Oberon* has an original $\frac{1}{2}$ -inch plate bottom, single-riveted, with support afforded by angle-iron transverse frames 21 inches apart. These frames consist of two pieces of angle-iron riveted together. The second or outer bottom, $\frac{3}{4}$ inch thick, is fixed at a distance of 3 feet 6 inches from the inner one at the keel, and 2 feet 3 inches above the water-line. This bottom has every alternate plate with both its edges double-riveted outside those of the adjacent plates. Along the center of each of these alternate or outside plates, which are those that first come in contact with any external object, runs a longitudinal frame attached also to the inner bottom. Transverse frames run around at intervals of 4 feet, and are riveted to both bottoms by means of an angle-iron. Thus the space between the two bottoms of the ship is divided up by the longitudinal and transverse frames into spaces something like cubes or boxes, the top and bottom of such boxes being furnished by the inner and outer bottoms of the ship, and the four sides by the frames crossing one another. To lessen the weight of the metal, circular holes are cut in the middle of these box-sides in most cases. Every fourth transverse frame, however, is thoroughly closed and made a water-tight bulkhead. It will be seen, therefore, that this is an exceedingly strong bottom.

The several experiments made with this vessel have been published in detail. The only one carried out during my sojourn in England was in June last, and as it was considered the most important of all, I reproduce here, from *Engineering*, the results for the benefit of those interested in this special branch of naval warfare :

The *Oberon* torpedo-hulk was placed in No. 10 dock at Portsmouth on Wednesday afternoon, and the water having been let out, on Thursday morning it was possible for the first time to observe clearly the injuries she sustained from the torpedo experiments of Monday. The ship is divided into seven water-tight compartments, of which the two in the immediate neighborhood of the discharges were destroyed and filled with water. The bulkheads of four of the others remained intact, but permitted the water to leak through, but not beyond the capacities of the ordinary ship's pumps to keep down. The center compartment amidships remained perfectly dry; and as this was the largest in the vessel, it sufficed, with the artificial flotation which was afforded by upward of 300 casks which were packed away in the fore and aft compartments, to float the *Oberon* at high-tide, and enable her to be taken in tow with little difficulty. In consequence of the buoyancy thus imparted to her, she settled with great deliberation, and it was the general impression at the time that she had not been severely hit, and least of all by the Harvey torpedo, which had been suspended from the starboard bow. This impression was effectually dispelled by the melancholy spectacle which presented itself on Thursday morning when the ship was fully exposed in dock. Notwithstanding the lightness with which she lay in the water—she only drew 11 feet, and consequently bore only a distant comparison with an iron-clad with its machinery and weights on board—every charge seems to have told with terrible effect, any one of the holes being sufficient of itself to have sunk the best of iron-clads, in spite of the Makaroff mat or any other leak-stopping devices that could have been applied. The Harvey torpedo, which contained 66 pounds of gunpowder, has split and bulged in an area of plating of the outer bottom about 16 feet square, extending downward through two longitudinals to the garboard plates, and laterally to the water-tight frame on each side of No. 4, utterly destroying the intermediate brackets. The injury

here is very clearly defined, the longitudinals and frames having apparently acted as knives, so cleanly have the plates forced in upon them been cut through in the direction of the fiber of the iron. Had the longitudinal girders been placed closer together, the resistance would have been greater, and the damage to the inner bottom would at least have been less. The bracket-frames, which are only kept in position by angle-irons, seem to have been snapped and doubled up with alarming ease by the force of the concussion. The inner bottom has been extensively damaged and bulged in, but not so much as might have been supposed from the appearance of the outer skin, the straightness of the bows having allowed much of the explosion to spend itself vertically. As might have been expected, the greatest damage is exhibited under the bilge on each side of No. 30½ frame, against which two charges, respectively of 33 pounds of slab gun-cotton and 33 pounds of granulated gun-cotton, were fired. Here frightful wounds were visible—wounds which are plainly past redemption. The holes are about 18 feet square each, and extend from the third strake below the armor-shelf well-nigh to the keel-plating. The greatest force appears to have been exerted on the starboard side by the granulated preparation. The iron skin has been torn from the rivets, the girders and bracket-frames shot away, and the upper plating wrenched completely off from their supports and blown away. The port side of the same frame presents a similarly ruinous aspect. The only difference is—and practically it is one without a distinction—that the plates, instead of being broken off, are lacerated in all directions and forced upon the inner bottom, which here as also on the opposite side is torn and forced inward. With the exception that the taffrail is blown away and the galley dismantled, the explosive forces seem to have been confined for the most part within well-defined limits. The wounds left by the previous experiments have not been re-opened, and though the ship must have been lifted fore and aft, the fissures amidships do not appear to have extended. It is probable that, after a careful survey has been made, the *Oberon* will be filled with coal and submitted to a series of shell experiments. She can be of no further use for torpedo purposes.

It is impossible not to be struck by the suggestiveness of the above-mentioned experiments with reference to the future not only of naval warfare, but, in a still more impressive degree, of naval architecture. The terrible injury which the *Oberon* has sustained proves beyond all caviling that no iron-clad can withstand the bursting of a torpedo in contact; a torpedo would prove destructive almost wherever it struck, and a ship could hardly be saved by any turn of the helm. A projectile from the 81-ton gun would probably not prove utterly destructive, unless it hit at right angles with the keel; but a torpedo, so long as it hits, no matter where, would dislocate the integrity of the ship within an area large enough to prove fatal. The larger the vessel the more likely it is to fall a prey to the torpedo or the water-rocket. Its size would render it more susceptible to attack, and its slower speed would make it more difficult to get out of the way of an active enemy. Smaller ships, therefore, would seem a necessity of the time, leaving details of construction for further consideration. The question of stopping leaks from the outside, which was raised in the case of the *Vanguard*, again suggests itself here. It would appear that this was the most hopeful way of dealing with a leak of this character, where there is so much bent plate, which, while it is very difficult to repair, affords support to the sail or other material let down over it from the outside. Some experiments as to the possibility of closing such leaks would be valuable.

Contact charges and the action of the movable torpedo lead naturally to the contemplation of the probable effect of the Whitehead fish-torpedo. On every ground this has become a grave question for the British, especially since it has been found that it can be dispatched from the deck of armor-clad or other ships. As long as a special and subordinate class of vessels was devoted entirely to this species of attack, and had to carry tubes below the water-line, it was argued that approach would be excessively difficult; but when the heaviest armor-clads can, without sacrificing anything, avail themselves of this additional weapon, the question wears a different aspect.

TORPEDO EXPERIMENTS AT SEA.

The Paris correspondent of the London Times sends to that paper the following notes on some recent interesting torpedo experiments with one of Messrs. Thornycroft's spar torpedo-boats :

"Some very interesting experiments were made a few days ago at Cherbourg, with the little torpedo-vessel called the Thornycroft. It was the first occasion of testing, in French water, whether a torpedo could be launched against a ship in full sail. Accordingly, Admiral Jaurez, who commands the squadron, ordered a disabled ship, the Bayonnaise, during a rather rough sea, to be towed out by a steamer belonging to the navy. A second lieutenant, M. Lemoine, was sent for, and informed that he had been selected to make the experiment of launching the Thornycroft against the Bayonnaise while both were in full sail. He accepted the mission without hesitation, picked out two enginemen and a pilot, and went down with them into the interior of the Thornycroft, of which only a small part was above water, this visible portion being painted of a grayish color so as to be easily confused with the sea. The torpedo was placed so as to project from the bow of the vessel, at the extremity of which were two lateen-sail yards about three meters in length. The towing-steamer then took up its position in front of the squadron, and the Thornycroft also assumed the position assigned for it, an interval of three or four marine miles separating the torpedo and the Bayonnaise. On a signal being given both were set in motion, the steamer advancing in a straight line and the Thornycroft obliquely, so as to take the Bayonnaise in flank. The steam-tug went at 14 knots an hour, going at full speed in order to escape the Thornycroft. The latter went 19 knots an hour, a rate not attained by any vessel in the squadron. The chase lasted about an hour, the squadron keeping in the rear, so as to witness the operations. At the end of that time the distance between the Thornycroft and the Bayonnaise had sensibly diminished, and at a given moment the former, in order to come up with the latter at the requisite distance, had to slacken speed to eight knots an hour. The whole squadron watched this last phase of the struggle with breathless interest, and the people asked themselves whether the shock of the torpedo would not infallibly destroy the little vessel which bore it. It was feared that the lives of second-lieutenant Lemoine and his two companions were absolutely sacrificed. However, the two vessels got visibly nearer. All at once the Thornycroft put on a last spurt, and struck the Bayonnaise with its whole force on the starboard-bow. The sea was terribly agitated, a deafening report was heard, and the Bayonnaise, with a rent as big as a house, sank with wonderful rapidity. As for the Thornycroft, rebounding by the shock about 15 meters off, even before the explosion occurred, it went round and round for a few moments, and then quietly resumed the direction of the squadron. No trace remained of the Bayonnaise; it was literally swallowed up by the sea. Unanimous plaudits greeted the courageous sailors as they joined the admiral's squadron to report on the mission they had accomplished. The experiment was repeated two days later, under the same conditions, with another disabled ship, and with the same success; and, in the opinion of competent men, this is one of the most decisive torpedo experiments which have yet been made. The little torpedo-boat, with its lateen-sail yards, resembles a small, gray lizard, and is scarcely discernible in the water. It is evident that a single boat of this kind would be unable to approach an enemy's ship unless at dusk, or when it would be impossible to distinguish it at a distance, for had such an attack been attempted in broad daylight, the Thornycroft would manifestly have been knocked to pieces by the guns of the threatened ship before it could have carried out its project. On the other hand, it would be quite impossible for one or even several ships to defend themselves against a simultaneous attack, say by twenty or twenty-five Thornycrofts; and as these cost only a fiftieth part of the expense of a man-of-war, this experiment presents a formidable problem to state navies. What is certain is that those who witnessed the affair were greatly impressed by it, and are persuaded that it is the starting-point of an inevitable transformation in naval tactics."

It appears from the British navy estimates, recently submitted to Parliament, that the British Admiralty intend to build, during the ensuing financial year, fifteen torpedo-vessels for harbor defense; also one gunless vessel, to be known as the "torpedo ram."

PART XXII.

BRITISH NAVAL DOCK-YARDS.

PORTSMOUTH; CHATHAM; DEVONPORT AND KEYHAM; SHEERNESS;
PEMBROKE.

ADMINISTRATION OF DOCK-YARDS.

THE SUPERINTENDENT; MASTER ATTENDANT; CHIEF CONSTRUCTOR;
CHIEF ENGINEER; STORE-KEEPER; ACCOUNTANT; CASHIER; CIVIL
ENGINEER; WORKMEN AND BOYS; POLITICAL; PAY; POLICE; PEN-
SIONS; REMARKS.

PLAN OF PORTSMOUTH DOCKYARD EXTENSION.

SHEWING THE STATE OF THE WORKS IN JANUARY, 1875.

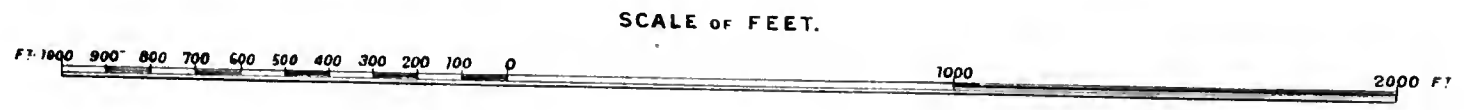

Note. — Boundary of Admiralty Property shown thus
 Boundary Stones shown thus B.S.18

P O R T S M O U T H
 H A R B O U R
 U N T A I N

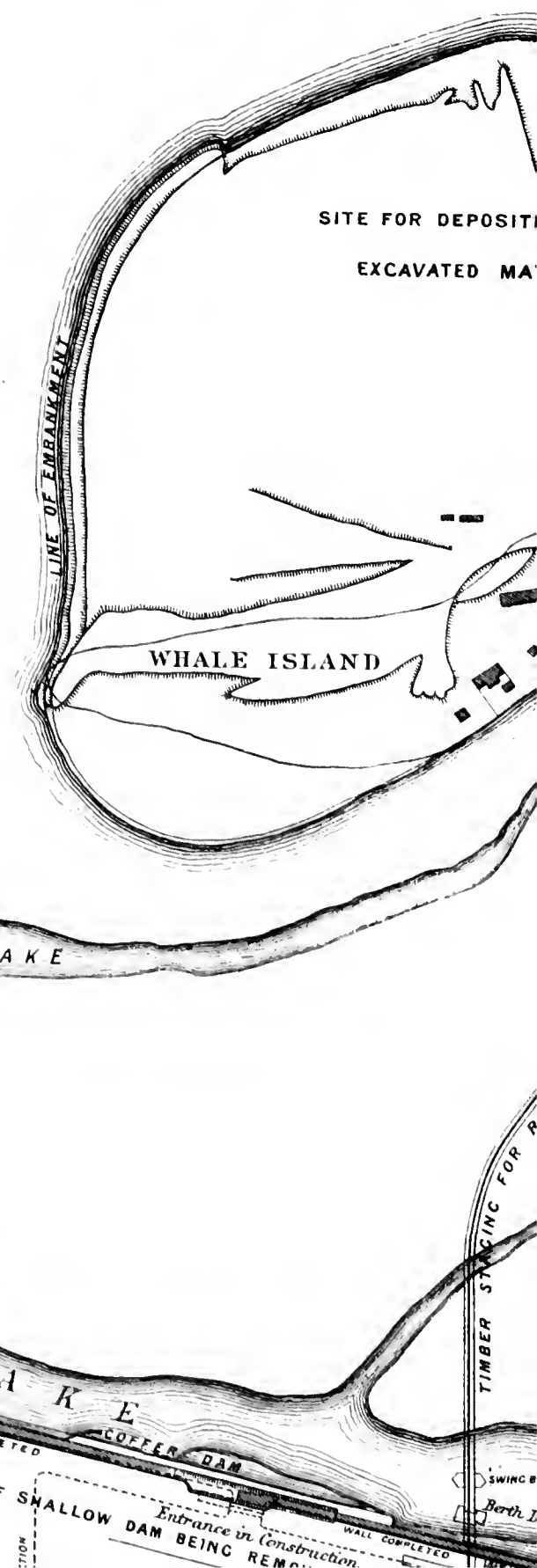

F RD EXTENSION.

S IN JANUARY, 1875.

1000 2000 FT

shown thus
S B.S.18.

H A R B O U R

U N T A I N

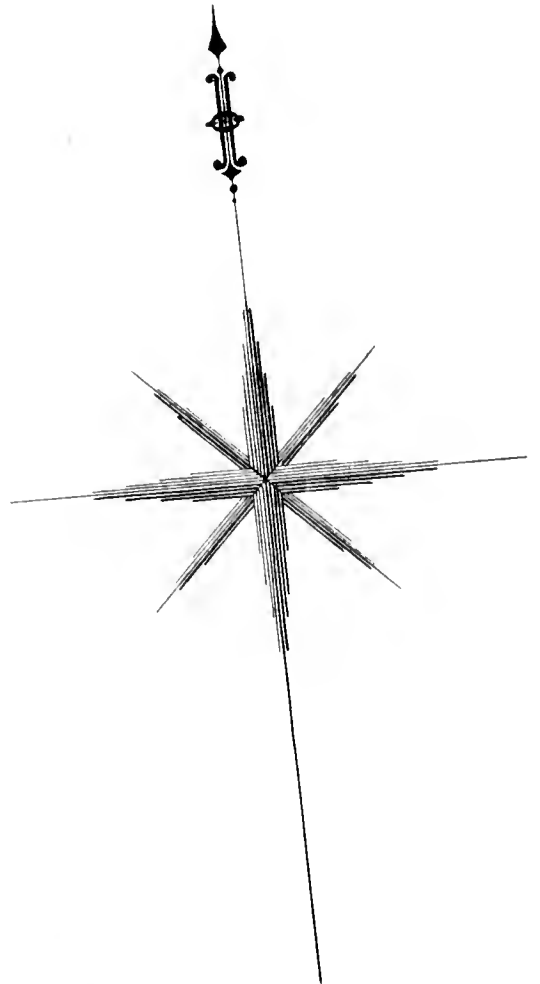
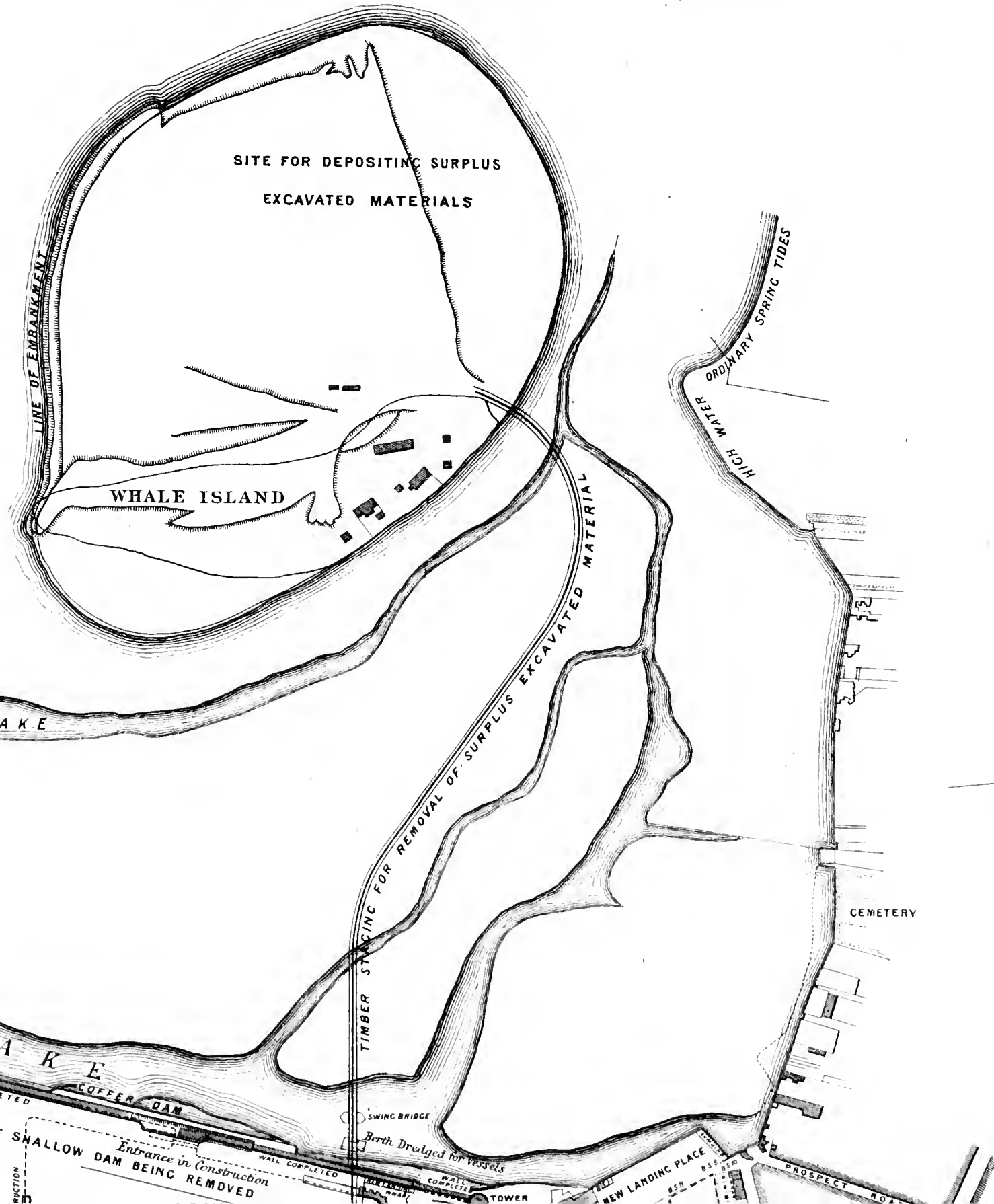

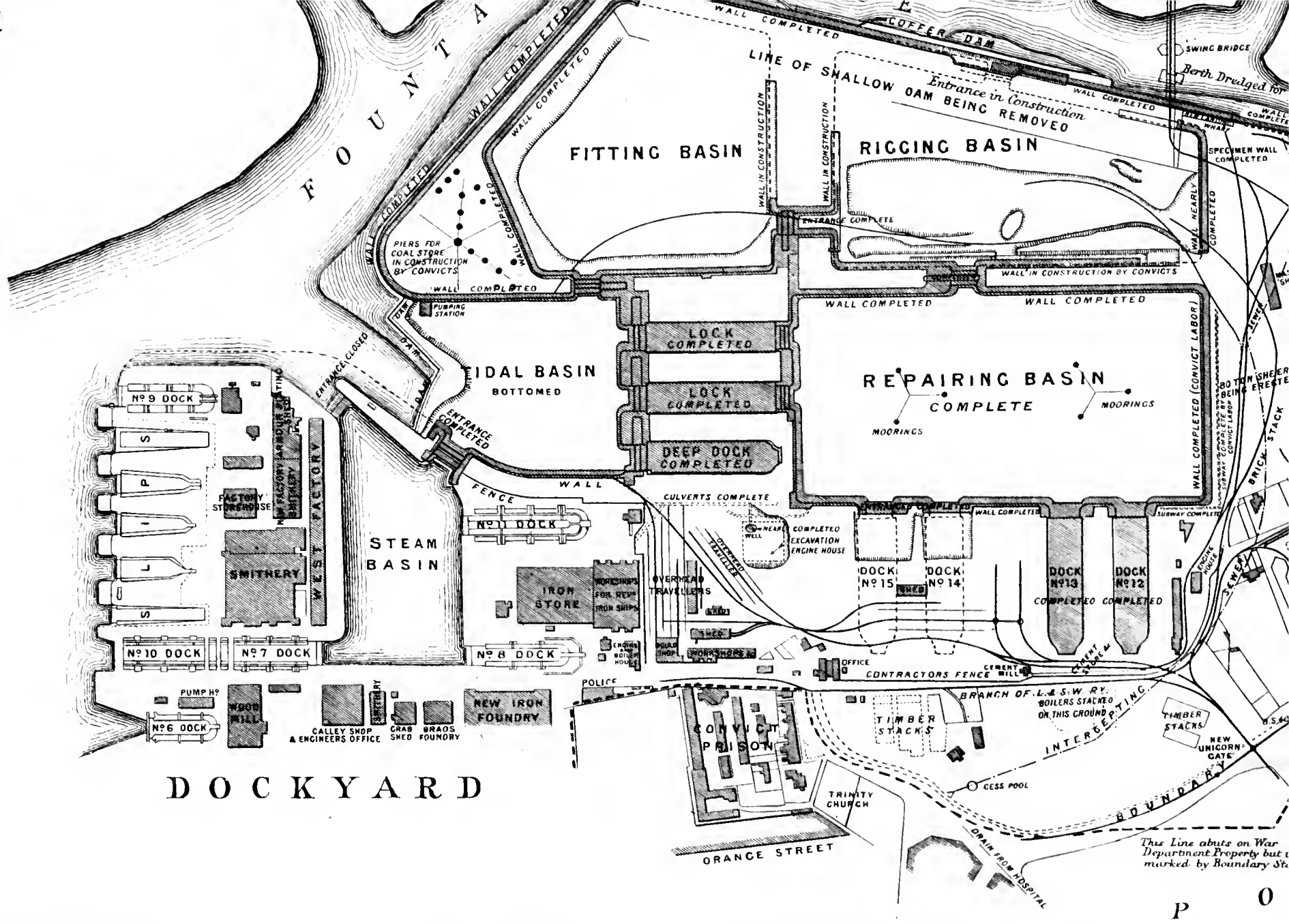

DOCKYARD

This Line abuts on War Department Property but is marked by Boundary St

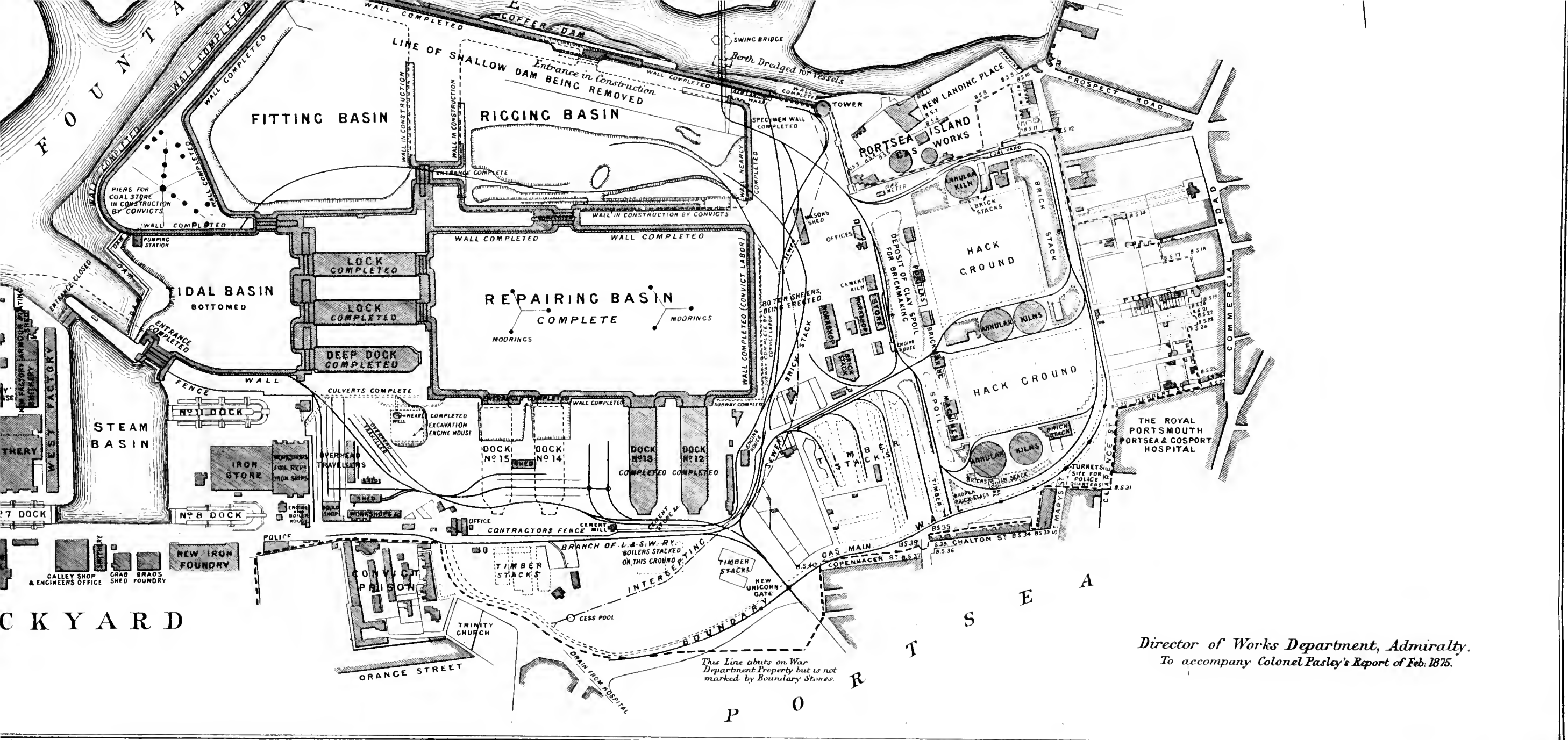

Director of Works Department, Admiralty.
 To accompany Colonel Pasley's Report of Feb. 1875.

BRITISH NAVAL DOCK-YARDS.

The naval dock-yards of Great Britain are five in number, viz : Portsmouth, near the Channel ; Chatham, on the river Medway ; Devonport and Keyham, on the southwest coast ; Sheerness, at the junction of the Thames and Medway ; and Pembroke, on the coast of South Wales. These yards have been described in a former report, printed by order of Congress ; but since that time the Woolwich yard has been abandoned for naval purposes, the yard at Deptford has been turned over to the victualing department, and Portsmouth and Chatham yards have been largely extended and the facilities greatly increased. A brief description, therefore, of the five first named will be given.

PORTSMOUTH.

The Portsmouth dock-yard is located near the English Channel. It is fortified, and the approaches to it are well covered. It possesses a capacious natural harbor, and, in respect to position, extent of ground covered, and number and capacity of basins, docks, buildings, and appliances of all kinds for building, repairing, and equipping ships of war, has occupied the foremost place among English dock-yards. In 1864 the first appropriation was made by Parliament for its extension and improvement, and, with the aid of liberal votes since that time, the work has been steadily progressing. The accompanying plan will show the extent and character of the new works since their commencement in 1865 ; also, a portion of the old dock-yard is shown. That portion of the old yard not shown on the plan, but containing buildings lies south of the steam-basin ; and south of dock No. 6 is the ship-basin with its four stone docks. There is also another stone dock south of the ship-basin, with its inlet from the harbor. The old yard contains two basins and eleven stone dry-docks, and, as it has been one of the chief seats of manufactures for the royal navy, a brief description of its principal workshops may be found instructive.

On the northeast side of the old yard is the steam-basin, the basin in which steam-machinery is put into or taken out of vessels, or where general machinery repairs are carried on. The entrance to the steam-basin is from the harbor, through the camber, or dry-dock No. 7, hereafter to be mentioned. On the eastern end of the basin is located a pair of box wrought-iron steam-operating shears, 145 feet high, designed chiefly for hoisting and lowering boilers out of or into vessels. The shears have two main purchases and one crab, with engines to each ; these, together with the boiler, are located at a convenient distance from the basin. On the same side of the basin there is, in addition, one large Fairbairn steam-crane, having the boiler and engines attached. Besides these appliances for raising and lowering weights, there are on the borders of the basin five Fairbairn cranes, operated by manual labor. On the east side of the basin are the dry-docks, No. 8 and No. 11 on the plan ; the first, 300 feet, and the second nearly 400 feet long, measured on the bottoms. On the west side of the basin, and parallel with its

greatest length, are the machine, boiler, erecting, and copper shops, in one building, under one roof. The building, like others in Portsmouth dock-yard, is of brick. It is 720 feet long by 40 feet wide, measured inside, and two stories high. Entering the first or lower story, the height of which is 28 feet, it is found to be divided by cross-walls into five equal compartments. The boiler-shop and boiler-making machines occupy three of the north divisions. The divisions are conveniently arranged and well stocked with a variety of superior machinery, tools, and appliances of the present day. The division adjoining the boiler-shops is occupied exclusively as a machine-erecting shop. It has but one traveling crane, a few heavy machines, and the usual mechanical appliances. The next or north division, on the ground floor, is the machine-shop for heavy work. It is provided with traveling cranes, and stocked with heavy machinery and tools. Ascending to the second floor of the building the machine-shop is first reached, which is provided with the usual machinery and tools for fitting and finishing light work; and afterward the coppersmith-shop, the chemical and store rooms. It may be added that the building containing the various shops just named was built originally for a store-house, and is therefore not altogether such a building as would have been designed for the various purposes.

On the south side of the basin are the iron and brass founderies, the pattern-shops, offices, and drawing-rooms. The iron foundery is 200 feet long by 45 feet wide, with 30 feet height from the floor to the bottom of the overhead cranes. The building is of brick, with an iron-frame roof, slated. It is well lighted, and the internal arrangements and appliances are complete. It contains overhead travelers; also wall cranes. The cupolas are conveniently placed, and there are hydraulic lifts for raising stock to the platforms. At right angles with this building is another, of equal dimensions, two stories high. On the lower floor of this building are the foundery cleaning rooms and foundery store-rooms. On the upper floor are the pattern-shop and pattern store-room in separate divisions. The pattern-shop proper occupies the larger portion of the floor, and is excellent in its detail of arrangement. A complete number of wood-working machines are ranged on one side of the room, and the work-benches on the opposite side. The pattern-shop storage-room has a complete distribution of patterns. They are contained in cases with iron frames and supports, each case having its special patterns so marked, and each pattern its special mark in plain letters. The brass-foundery is also excellent. It is one story high, 105 feet long by 85 feet wide, divided longitudinally by a wall with a center opening, in which are located the cupolas and air-furnaces, arranged to discharge the metal into the division prepared for making the heaviest castings. In the opposite division are the crucible furnaces. This foundery is the largest and most complete of its kind in any of the dock-yards, and in it are made heavy brass castings for other yards. Drawings of both founderies have been submitted to the Department.

On the west side of the machine and boiler shops are the smithery and forge. These occupy a large brick building, with a metal roof, and well lighted from the sides. It contains about 120 smithy fires, ranged in a quadrangle, with separate pipes from each pair of fires to carry off the smoke and gases. The forge is amply supplied with steam-hammers, furnaces, cranes, and appliances for ordinary work. Heavy shafts are not made in dock-yards. Besides this smithery, there is a smaller one on the south side of the basin.

This concludes notice of the works denominated steam factories, and no more need be said of them beyond the fact that they are of insufficient capacity, and the location of some of the buildings is objectionable. An

additional building is, however, being erected next adjoining the machine and boiler shops as an extension, and a new factory is projected to be built in the not distant future.

The next building that claims attention is the one containing the block-making machinery invented by the celebrated engineer, I. K. Brunel. This machinery is the most complete in detail of the several machines for making different parts of blocks; it is perfect in combination, and up to the present day has not been superseded or surpassed; by it the wooden blocks for all vessels of the royal navy have been made for more than forty years. The only other building for mechanical purposes to be noticed is the saw-mill, which is two stories high, the lower floors containing all the usual sawing-machines, while the upper floors are provided with machines for light work.

Returning to the notice of the dry-docks, it is observed that leading from the steam-basin to the harbor, in a southwesterly direction, is the camber, the large dry-dock spoken of before. It is 644 feet long on the bottom, and has three gates: one at the harbor entrance, one in the center, and one at the basin outlet. This arrangement admits of the dock being used as two or one, as may be desired. The other basin, beside the one shown on the plan, is the ship-basin, south of the camber, with an outlet directly from the harbor. It is used chiefly for placing vessels in to be fitted out for sea or to be docked. Attached to it are four dry-docks, namely, Nos. 2', 3', 4', and 5'. These docks were constructed in the days when ships of war were of short dimension. They are of the following lengths, all measured on the bottoms: No. 2 is 220 feet 1 inch; No. 3', 270 feet 8 inches; No. 4', 235 feet 4 inches; and No. 5', 208 feet 9 inches. South of the basin is dry-dock No. 1', with inlet from the harbor; its length on the bottom is 229 feet 4 inches. North of the basin is dry-dock No. 6', also with inlet from the harbor; its length on the bottom is 192 feet 8 inches. Dry-dock No. 9' is in the northwest corner of the dock-yard; its length is 253 feet 4 inches, measured on the bottom. All the docks, building-slips, and basins are formed of granite blocks, and are constructed in the most substantial manner.

Between dry-dock No. 9' and the camber are the building-slips, which are five in number. They are in a group, covered with substantial and well-lighted ship-houses; between some of them, in a line with the vessel building, are overhead traveling cranes and steam-hoisting appliances for raising materials to the vessels under construction.

Having now briefly described the buildings and appliances in which the principal mechanical operations are carried on, it will only be necessary to name the other buildings, and to add that all of them have heavy walls and are capacious and sufficiently substantial. These buildings may be best mentioned in the arbitrary order of the plan. No. 1, boiler-house; and No. 3, office; No. 7, engine-house, containing engines and boilers for pumping out the docks; No. 10, guard and store houses; and No. 12, police-station; Nos. 13 and 14, store-houses; and Nos. 15, 16, and 17, timber-sheds and wood-work shops; No. 18, officers' houses, in which reside all the principal officers of the yard; and No. 19, admiral-superintendent's house; Nos. 20 and 21, store-houses; and No. 22, building for officers; No. 23, tar-making house; No. 24, water-tank; and No. 25, rope-making house; No. 26, mast-making house; No. 27, boat-pond, or water-area, in which ships' boats are floated; No. 28, store-houses; No. 29, rigging and sail loft; No. 30, chain and cable store; No. 33, gate entrance to the dock-yard.

Such is a brief description of the Portsmouth dock-yard of the present day. What its future is to be will be best seen from the plan showing the proposed extension and works completed thereon.†

CHATHAM.

This dock-yard is situated on the river Medway, about twelve miles from the mouth of the Thames. It has now grown in importance to be second only to Portsmouth among the naval dock-yards of the world. The position is advantageous, because, not being on the coast, but far up the river, to be reached by a hostile fleet the defenses of Sheerness must first be passed; secondly, the Medway, from Sheerness to Chatham, has the natural protection of high land on both sides, readily convertible into positions of defense.

The old dock-yard proper has a considerable river frontage, and the several docks, ship-houses, buildings, and necessary avenues cover an area of 89 acres. By a vote of Parliament, in 1863, St. Mary's Island, adjoining the yard, was appropriated, and in the following year the works of extension on it were commenced. This island contains about 300 acres, and the place having been somewhat analogous to League Island before the work of extension was commenced, lessons may be drawn from a study of its hydrographical features.

The work of extension was commenced in 1864, and the accompanying plan will show the progress made up to January, 1875. The estimated total cost of the work was £1,750,000 sterling, but it is now seen by the memoranda of the director of works of 1875-'76, that the total ultimate cost of the whole works will be not less than £1,950,000, or \$9,477,000 gold. A very large part of the work has been executed by contract and a small portion by convict labor. The above does not include any sum for the erection of buildings. The director gives as reasons for the ultimate cost exceeding the estimates, the extremely treacherous character of the soil, a large portion of the work having been executed in mud, water, and alluvial deposits of very varying tenacity, at a great depth below the surface. The plan accompanying does not show docks or buildings of the old dock-yard. In describing them, therefore, as at present existing, it may be premised that there are no basins or works denominated steam factories, but for the construction of vessels there is ample provision. Fronting the river are four dry-docks and seven building-slips. The first and largest is of sufficient capacity to take in a vessel 390 feet long, and the second, one of 295 feet. The third and fourth are comparatively small. The dry-docks and slips are excavated from soft ground, but piled, and then built throughout with granite blocks, in a similar manner to those in the other British dock-yards.

The building-slips are all covered with substantial ship-houses, four of which are grouped side by side, having the appearance of one building roofed in four spans. They are constructed solely of iron and glass, afford ample light, and will endure, there being no danger of their destruction by fire.

In the intermediate spaces from slip to slip is a sufficient area to prepare materials for vessels building, the whole of which is neatly paved or laid with wooden blocks, making a dry, hard, and comfortable floor, both to work on and travel over.

The ship-houses are provided with overhead traveling carriages, sufficiently elevated to be above the largest vessel constructed. These carriages travel from end to end of the building, and are adapted to pick up material from the ground, and carry it to and place it in any part of the vessel. There is also a traveling carriage between two of the slips adjoining that last mentioned, used for the purpose of moving timber which has been or is to be prepared. There are, in addition,

RIVER MEDWAY
CHATHAM REACH

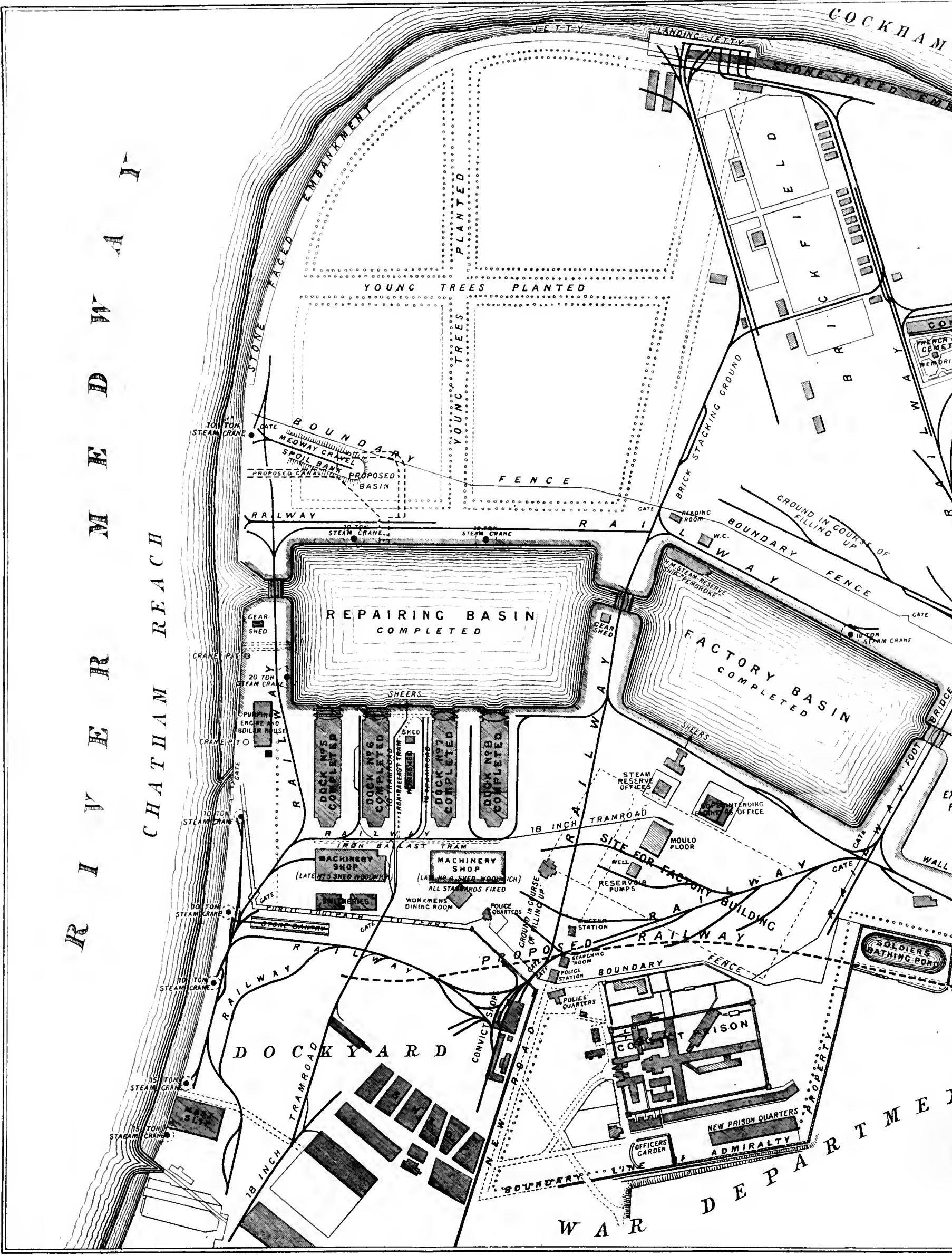

COCKHAM

WAR DEPARTMENT

REPAIRING BASIN
COMPLETED

FACTORY BASIN
COMPLETED

DOCKYARD

COAST GUARD STATION

ADMIRALTY

SOLDIERS BATHING POND

YOUNG TREES PLANTED

YOUNG TREES PLANTED

FIELD

BRICK STACKING GROUND

GROUND IN COURSE OF FILLING UP

18 INCH TRAMROAD

18 INCH TRAMROAD

PROPOSED

BOUNDARY

BOUNDARY

BOUNDARY

STONE FACED EMBANKMENT

BOUNDARY

FENCE

BOUNDARY

FENCE

RAILWAY

RAILWAY

RAILWAY

RAILWAY

DOCK NO 5 COMPLETED

DOCK NO 6 COMPLETED

DOCK NO 7 COMPLETED

DOCK NO 8 COMPLETED

TON TON STEAM CRANE

GATE

MEDWAY CRANES

PROPOSED CANAL

PROPOSED BASIN

RAILWAY

STEAM CRANE

STEAM CRANE

READING ROOM

GATE

W.C.

STEAM CRANE

STEAM CRANE

CRANE PIT

20 TON STEAM CRANE

PUMPING ENGINE AND BOILER HOUSE

CRANE PIT

TO TON STEAM CRANE

GATE

STEAM CRANE

STEAM CRANE

STEAM CRANE

STEAM CRANE

STEAM CRANE

STEAM CRANE

STEAM CRANE

TO TON STEAM CRANE

GATE

TO TON STEAM CRANE

GATE

TO TON STEAM CRANE

GATE

TO TON STEAM CRANE

GATE

TO TON STEAM CRANE

GATE

TO TON STEAM CRANE

GATE

TO TON STEAM CRANE

TO TON STEAM CRANE

GATE

TO TON STEAM CRANE

GATE

TO TON STEAM CRANE

GATE

TO TON STEAM CRANE

GATE

TO TON STEAM CRANE

GATE

TO TON STEAM CRANE

GATE

TO TON STEAM CRANE

PLAN OF CHATHAM DOCKYARD EXTENSION.

SHEWING THE STATE OF THE WORKS IN JANUARY, 1875.

SCALE OF FEET.

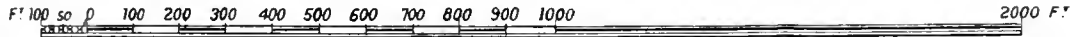

Director of Works Department, Admiralty.
To accompany Colonel Pasley's Report of Feb. 1875.

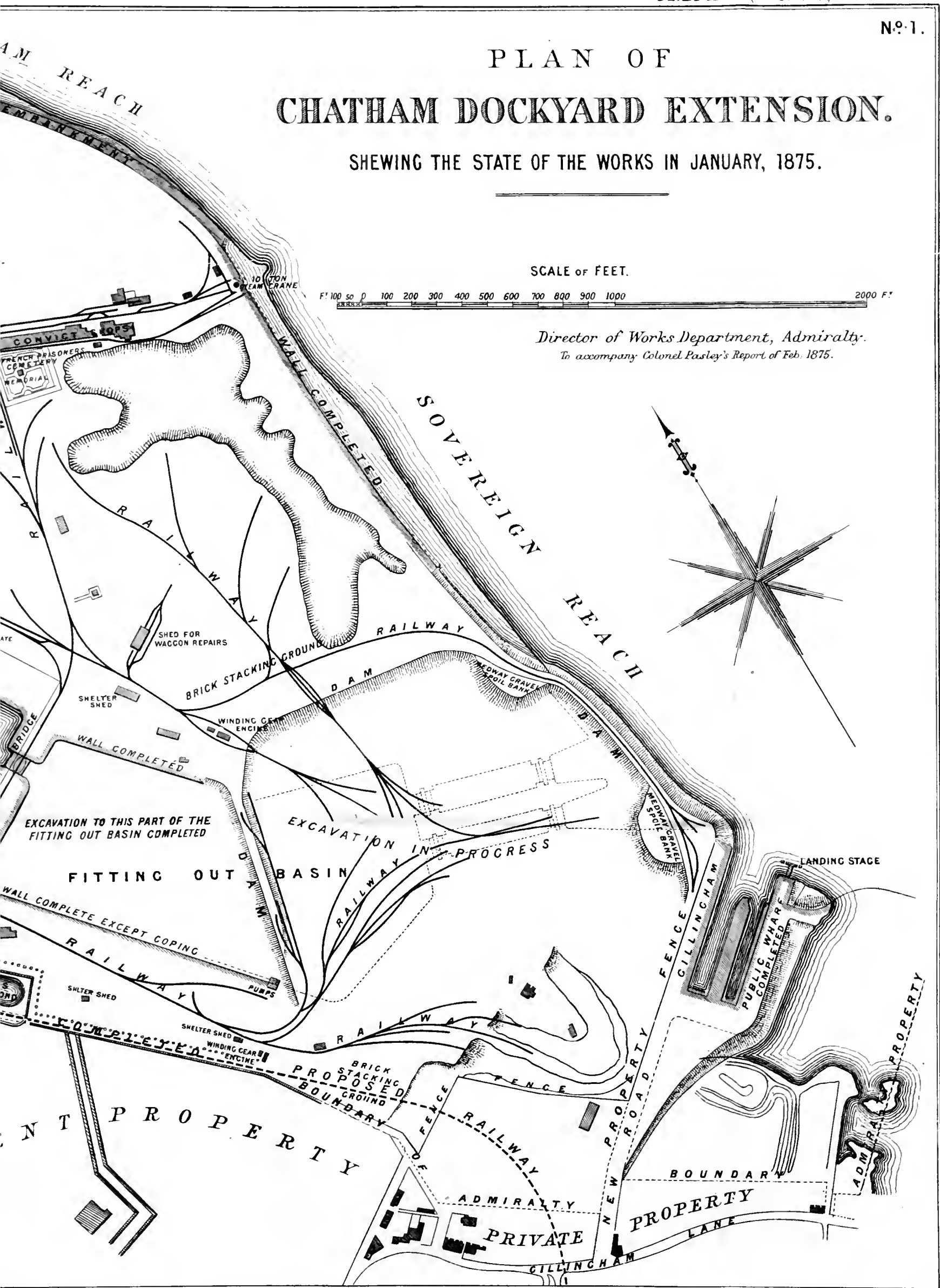

minor facilities for the purpose of carrying materials to or from the vessels under construction. The want of basins in the Chatham dock-yard has always been a great inconvenience, the fitting and repairing of vessels taking place in the river where the rise and fall of the tides is considerable and the room insufficient. This want is now supplied at the new yard. As before stated, there are, as yet, no steam factories in the yard, but there is an old ordinary machine-shop, two stories high; there is also a small ordinary iron-foundry, containing two medium-sized and one small cupola, a small brass foundry, pattern-shop, and boiler-repairing shop. All these shops are used merely for jobbing purposes. The ship-smithery, constructed many years ago, is a brick building, in the form of a quadrangle, with an open middle court, each of its sides being about 250 feet in length; the plan of the building is good, and if properly lighted and ventilated, with a simple plan of carrying off the smoke and gas, the shop would be unexceptionable. The various other buildings and workshops in this dock-yard are, with two exceptions, nearly identical with those named or described as existing in the other royal dock-yards, the exceptions being a copper-rolling mill and saw mill; attached to the latter is an oar-making machine, which turns out all the oars for the vessels of the British navy. The copper-rolling mill contains the furnaces, machinery, and appliances for the manufacture of sheathing and bolts; it has turned out all the sheathing for the bottoms of the vessels of the navy. In addition to the copper-rolling machinery, &c., there are rolls and facilities for the manufacture of small-sized angle and bar irons.

DEVONPORT AND KEYHAM.

The dock-yards of Devonport and Keyham are situated on the southwest coast of England, and are employed principally as repair-yards.

Devonport dock-yard has existed for more than a century, and it was supposed to answer all the requirements of the line-of-battle sailing-ship period. But after the introduction of steam, it was thought desirable to create an entirely new dock-yard, namely, Keyham, which is three-quarters of a mile distant from Devonport. Both dock-yards are connected under ground by tunnel, and one general superintendence controls the two. Devonport has been chiefly the department of wooden-ship building, storage, &c., while Keyham is the department of steam-machinery repairs and manufactures; the latter alone invites attention. Besides, as Keyham is a modern dock-yard, established not more than twenty years, its factories are greater in extent and more complete in detail than those of any other dock-yard in England or France.

Keyham dock-yard contains two basins and four dry-docks. The north basin is of sufficient depth to take in vessels of any size afloat. Around the basin are all the needful mechanical appliances for raising weights to or from vessels. The south basin is entered from the harbor and also from the north basin. It possesses three attached dry-docks, one of which is 600 feet in length. As a matter of convenience, to facilitate the movement of weights to and from the vessels in dock, rail-tracks extend parallel with either side of the dock, while traveling steam-cranes, with boilers and engines attached, pass up and down the tracks and perform the work of carrying material to or from the vessels under repair or fitting out. One of the rails of this either-side track is laid directly on the edge of the top surface of the dock, and the other on beams projecting over the edge and supported by uprights; the

cranes are thus brought within reaching distance of the vessels. The other two dry-docks differ only in length and in the absence of mechanical facilities for raising weights.

The machine-works, founderies, smitheries, boiler-making and pattern shops, copper-making and tin shops (which in Great Britain are denominated steam factories) are the chief features of Keyham dock-yard. They are grouped together in a quadrangle 890 feet long by 580 feet wide. The center area of the group is a space substantially covered with a slate roof, supported on cast-iron columns, and lighted from the top. The covered center area is formed into divisions by seven longitudinal rows of columns. Rail-tracks extend through two of the divisions of the buildings, and provision exists for steam traveling cranes. The whole of the covered center area admits of being appropriated for workshops, and some of it has been partitioned off and so appropriated. Within these appropriations are the smithery and forge, the copper-smiths' shop and the boiler-making smiths' shop, the smithery and forge occupying a division at the south end.

SHEERNESS.

This dock-yard is rated as second-class, and is employed as a repairing and fitting-out yard. There are not any extensive steam factories in it, and it contains only one building-slip for the construction of small vessels. There are, however, three basins and five dry-docks, and all necessary facilities for repairing and equipping vessels for sea.

PEMBROKE.

This dock-yard, located on the coast of South Wales, is employed exclusively as a building-yard for hulls and accessories of hulls. Some of the heaviest armored ships have been built here.

Briefly described, such are the dock-yards of the British navy. Any one of them is worthy of an inspection, and in some the *tout ensemble* is imposing. The number of stone dry-docks at present completed in the five yards is thirty-seven. The number of building-slips having ship-houses over them is thirty-one, and the several basins have an aggregate water-area of about 130 acres.

Neither ordnance nor provisions are supplied from the dock-yards. The armaments for all vessels of the navy, as well as for fortifications and the army, are manufactured and supplied from the great arsenal at Woolwich. Provisions for the ships at home are supplied from the victualing-yards at Deptford, Gosport, Plymouth, and Haulbowline.

In addition to the large naval dock-yard facilities, the British government can in emergencies command any of the private iron-ship-building yards on the Clyde, the Tyne, the Mersey, the Thames, and other rivers, numbering in the aggregate about fifty; also as many engine-factories in the kingdom as may be desired, besides any number of stone dry-docks belonging to private companies.

ADMINISTRATION OF BRITISH NAVAL DOCK-YARDS.

The administration of the dock-yards is conducted under the system of civil employment. The officer in charge of each yard is called the superintendent. The term "command" or "commanding officer" is on

no occasion used, and there is no "aid or executive officer" to the superintendent.

After the superintendent, the principal officers of the yard are named in the order of precedence as follows:

The master attendant.

The chief constructor.

The chief engineer.

The assistant master attendant.

The store-keeper.

The accountant.

The cashier.

The superintending civil engineer.

The chaplain.

The surgeon.

THE SUPERINTENDENT

in the largest yards is a rear-admiral, and in the small yards he is a captain. He has full and complete authority over all officers and other persons whomsoever employed in the dock-yard, and control over every part of the business carried on therein. In his absence the captain of the reserve is charged with the duties, and in the absence of both these officers, "the other officers are authorized to take charge of the yard, according to precedence on the list above named." The duties of every officer, foreman, and other person having authority are defined in great detail in the Admiralty dock-yard instructions.

The superintendent is required to hold at his office every working day, at 9½ o'clock a. m., a meeting of the officers above named, (chaplain and surgeon excepted,) and to have read to them all orders and dispatches, except such as may be marked confidential. At this meeting the captain of the steam-reserve is also to be present.

Besides this method of promptly making all the principal officers daily acquainted with the business to be done, each one is furnished when necessary with copies, or extracts therefrom, of the orders pertaining to his respective department.

MASTER ATTENDANT.

The duties of the master attendant are defined. He is to attend to the docking, grounding, and graving of all ships, by day or night. He has charge of the moorings at the port, of all the yard craft, consisting of tugs and vessels of all kinds, including coal-hulks. He attends to the loading of stores, he superintends the sail-loft, rigging-house, and all persons employed therein, besides having other duties connected with vessels; but he has nothing whatever to do with any mechanical department, or persons employed in them. His rank is staff-captain, and in the largest yards he has one and sometimes two assistants.

CHIEF CONSTRUCTOR.

He is to cause all ships and vessels to be built, and all work to be executed in strict accordance with the approved drawings and specifications. He has charge of the shipwrights and other workmen belonging to the ship-building branch. He has the direction of the boatswain and laborers under him. He has charge of the ship-smithy, mast-house, boat-house, joiners' shop, and all other workshops appertaining to the

ship-building branch, and all foremen and workmen employed therein. His assistant is a constructor; but in the absence of the chief constructor, the chief engineer is charged with his duties.

THE CHIEF ENGINEER

has the superintendence of all the engines and boilers, cranes, sheers, capstans, leading-blocks, turn-tables, weigh-bridges, and pumps in the dock-yard, also the machinery at the smitheries and saw-mills, and all other machinery in the yard. He is charged with the superintendence of the ropery, and all persons employed therein, and is responsible for the steam fire-engines used for supplying water in case of fire.

The foremen of the engineering workshops have, under their directions and those of their assistants, charge of the men and all the work carried on therein and on board vessels under repairs. These foremen are answerable for the conduct of the leading men and workmen employed under them, and responsible for all work intrusted to their supervision.

In the absence of the chief engineer, his first assistant is charged with the duties.

STORE-KEEPER.

There is but one store-keeping officer to a dock-yard. He has charge of all store-houses, receiving-rooms, plank-sheds, and other inclosures used for the storage of timber or goods. He gives receipts for all stores received, and takes receipts for all stores delivered, and is responsible for all articles in store, and that the accounts in relation thereto be correctly kept.

ACCOUNTANT.

He is to audit the amount paid for wages to the workmen and all other employés, such audit to comprise a verification of the accuracy of the authorities for the entry of each person on the muster and pay books, the rates of pay, the amounts cast up as due, and a comparison of the casualties of attendance recorded in the muster and pay books with those in the weekly returns of lost and extra time.

CASHIER.

Under his directions all workmen and laborers employed in the dock-yard are mustered by persons attached to his department, and the several time-keepers are placed in charge of the muster-galleries according to his assignment. Besides which, all other responsible duties necessarily belonging to such an office are discharged by him.

CIVIL ENGINEER.

The dry-docks, basins, and other important public works are constructed from plans prepared at Whitehall by the director, who is a colonel of the royal engineers. The civil engineer attached to the yard has charge of the architectural works, buildings, and houses, alterations and repairs of existing buildings and works, also the supply of water and gas, and the maintenance and management of the lines of railways in the dock-yard to which he is attached.

WORKMEN AND BOYS.

Two classes of workmen are employed, distinct from the various classes and grades in such establishments. One of these is termed

“established men,” and the other “hired men.” The former are permanent, are not discharged except in cases of great emergency, and are pensioned after long and faithful service.

Great care is exercised in the selection of all workmen and boys. “The superintendent is strictly enjoined to give his active personal attention to the subject of the entry of men when wanted, with a view to prevent any abuse or irregularity; he is to use his best endeavors to check and prevent any attempts being made to support applications for employment in the yard by aid of interest either political or personal.” The best men are to be taken, and they are entered on probation for a fortnight, with the understanding that they will be retained if at the end of the prescribed period they shall have proved themselves competent, but if otherwise, they are discharged.

Established men are received between the ages of twenty-one and thirty-five only. They must be passed by the medical officers, and thoroughly tested as to their qualifications as workmen before their appointments are confirmed. These men are eligible to promotion as leading men, foremen, &c.

Boys are selected by competitive examination, and thoroughly tested before being made permanent. Hired men are also selected with much care, but they are liable to discharge in the event of the reduction of force.

POLITICAL.

Under the heading of “Rules for workmen,” (dock-yard instructions,) is the following paragraph:

No interference, direct or indirect, is to be exerted over any person, whatever be his rank or station, in the matter of the elective franchise; and in the event of elections for members of Parliament, the men who may be qualified to vote are to be left to the exercise of their unbiased judgment, free from all influence, inquiry, let or hinderance; and no canvassing by or on the part of any candidate is to be permitted within the dock-yard upon any pretense whatever.

The pay of all employés is regulated by the Admiralty; it is the same for each class or grade of men in every dock-yard, and it is not changed to suit varied conditions. The working hours are regulated by Greenwich time, and are also the same in every yard. The muster of men is by ticket, both when entering and leaving the yard.

POLICE.

No marines or watchmen are employed in any dock-yard. The commissioner of the metropolitan police of London details a force of intelligent and well-trained men, sufficient for each yard. These men are under the orders of the superintendent, and are stationed at the gate and at such other judiciously-chosen places in the yard as the superintendent may direct. They perform all the duties of watching the public property in the dock-yard, and on board vessels building, and at the wharves, both by day and night. They wear the uniform of the London police, perform their duties thoroughly, and are highly respected.

PENSIONS.

All officers, clerks, foremen, leading men, established workmen, and crews of the yard-craft are granted pensions, retiring allowances, or gratuities, according to pay and length of service. Ten years' service will entitle a man to a pension or superannuation for injuries received, and after forty years' service he is allowed to retire with forty-sixtieths of

his full pay, intermediate rates being graduated between these accordingly.

¶ All the principal officers and clerks must be superannuated on attaining the age of seventy years, and all inferior officers and workmen are superannuated on attaining the age of sixty years.

All the principal officers of each yard are provided with most comfortable houses inside the walls, taking precedence therefor as they are named on the foregoing list.

The superintendent wears the uniform of his rank, but no professional officer wears a uniform on any occasion whatever.

The number of persons employed in each of the principal dock-yards averages from 7,000 to 8,000; about 1,500 of whom are under the supervision of the engineer department.

No foreigner is permitted to enter any of Her Britannic Majesty's dock-yards without authority given by the Admiralty through application of the ambassador or minister of the country to which the person belongs, made to the secretary of state for foreign affairs; naval attachés of the foreign embassies in London excepted. Foreigners, including officers, whether singly or in parties, are always accompanied throughout the periods of their visits by an officer detailed for the purpose, and while all necessary attention is given, and every proper facility is afforded for viewing the works and ships under construction, sketches or written notes are not allowed to be taken except by special permission.

The system of dock-yard administration very briefly sketched in the foregoing paragraphs is the best in existence.

The superintendent and principal officers are selected especially for their fitness, and not because they may have claims for shore-duty or otherwise. The inferior officers and workmen are employed solely on their merits, and are mainly well trained, efficient, and faithful; besides which, the permanence of employment adds stability and gives character to the whole staff of employés.

One familiar and experienced as I am with dock-yard duties and with workshops generally, at home and abroad, cannot but feel impressed on observing the prompt and business-like way in which the duties are carried on in these great British naval establishments. No idle officers or loitering persons are to be seen in any place within one of these yards at any time during working hours.

The contrast between these admirably-conducted establishments and those of France and other continental countries, Germany excepted, is noticeable soon after entering the gates; there, and especially in France, numerous idle officers in uniform and loitering workmen may be seen in every department entered.

PART XXIII.

CONCLUSIONS.

invention, and the revolving turret for vessels of war originated on this continent. It remained for European naval powers, having large appropriations at command, to develop and expand American ideas. The ideas for the present powerful mastless sea-going armored ships of the English grew out of the visits of our turret-vessel *Miantonomoh* to British ports; and the unarmored fleet of fast ships, of which the *Inconstant* was the first, owe their development to the building of the *Wampanoag*.

To the European view it is strange that the nation which first devised and attempted to construct a squadron of powerful, fast, unarmored cruisers, has now nothing to match the British *Raleigh*, *Boadicea*, and *Euryalus*, or fast cruisers of other countries; and stranger still, that the naval force to which American commerce is obliged to look for protection, is composed of a small number of corvettes and sloops of very moderate speed and power, mainly of the types and armed with the weapons (torpedoes excepted) of the period before our civil war.

During the time of inactivity and comparative non-progress in American naval construction, the work of reconstructing the navy of Great Britain has been vigorously pushed forward, and in the effort to make it efficient from the modern point of view, there has been no hesitation in weeding out vessels of obsolete types; thus, in the five years ending April 1, 1875, no less than eighty-four vessels of obsolete types had been disposed of by sale, viz: Twelve screw line-of-battle ships; eight screw frigates; three screw corvettes; seven screw sloops; twenty-three gun-vessels; twenty-two sailing-vessels, and nine paddle-wheel steamers; besides which there have been condemned as no longer fit for active service, eight frigates, eight corvettes, nine sloops, and ten gunboats, all wooden screw-vessels.

It has already been seen what kinds of vessels are being added to the navy in lieu of the obsolete wooden types, and it is well to remember that the new fleet given under the head of unarmored ships do not represent the total available force of fast cruisers. The British mercantile marine is possessed of 419 steamers above 1,200 tons and under 5,000 tons register, very many of which ships have high speeds, and some of which can be relied upon for 14 and 15 knots per hour in good weather at sea, for seven or eight days consecutively, and they have sufficient coal-carrying capacity. In the event of war any of these ships are at the command of the government, and in view of utilizing this source of great naval strength, the Admiralty have carefully considered the subject of arming with light rifled guns, and more especially with Whitehead torpedoes, such vessels as may be suitable, and in order to act understandingly, they have required the builders or owners to furnish necessary drawings of their vessels.

While lamenting the want of superiority in our individual ships, a careful review of the situation brings home the inevitable conclusion that the interregnum with us will in the end result signally to our advantage. If, after our civil war, we had gone on building armored ships designed for sea-going purposes, each succeeding vessel would have been superseded in offensive and defensive powers by productions on the other side of the Atlantic. The result would have been an antiquated armored fleet, for it has been seen that the power of the gun and the weight and thickness of armor have continued to increase; which, together with additional mechanical appliances, has made each succeeding ship built, an improvement over preceding types, and even yet no law of finality seems to be reached either in regard to the weight and power of the gun or the thickness and weight of the armor. With the Sheffield Works promising armor-plates of still greater thickness,

and Herr Krupp and Sir William Armstrong proposing guns of 150 tons each, it would be unsafe to regard the limit as having been reached, and unwise to accept even the last productions as the future types. In view of the value given to small fast vessels by the invention of the self-moving torpedo and the risks to be encountered from this terrible weapon, as well as the ram, it is not probable that hereafter any war-vessel will be built larger or as large as the *Inflexible*; but it is reasonable to anticipate heavier guns in less numbers mounted on vessels of smaller dimensions. Considering these facts and conclusions, the enormous cost and length of time necessary to build an armored sea-going ship in this country, and the further fact that in Europe the advocates for abandoning armor altogether are increasing, any administration may well pause before it sanctions the expenditure for such a vessel, of three or four millions of dollars.

Turning now to the policy of maintaining an efficient cruising-fleet for the police of the seas, for the training of men, for the purpose of exhibiting the American flag in foreign ports, and especially in harbors of semi-barbarous countries where they can scarcely realize the existence of a force unless it be visibly present to their gaze, for the repression of piracy and slavery, and for the punishment of offending savage tribes, the ship is the distant representative of our national power, and it should have no superior of its type belonging to any other country. With the view, therefore, of reconstructing and adding to our unarmored fleets, the time is near at hand, if not already present, for reaching judicious conclusions as to the immediate future types of vessels. We are now at liberty to take advantage of the results of the most expensive and exhaustive experiments made by foreign powers in the construction of ships, of machinery of various kinds for naval purposes, and in the manufacture of weapons.

As there is a hopeless want of unanimity among our officers as to the types that should be built, and as the prerogative of deciding questions so important, as well as the province of giving shape in detail to designs, belong to the controlling powers, it is not out of place to suggest that, in considering the subject, it will be wise, as before said, to go carefully over the experience of possible enemies and to take advantage of the results.

Under the head of British unarmored ships, it may be seen that the costly experiment of building the first fast cruisers proved, to say the least, unsatisfactory. They were too costly to build, are too unwieldy to handle, and are too costly to maintain.

It may also be seen that the *Rover* is perhaps as small a ship as with our present knowledge can be built, to have the speed of fifteen knots per hour, to have sufficient structural strength to endure the engine-power necessary for this speed, to utilize the power of the ram, to carry sufficient battery, to have sail-power, to be provided with machinery for ejecting torpedoes, and to possess all necessary requirements for keeping the sea.

Again, it may be seen that the French in their endeavor to outdo the English in the element of speed have fallen into the same general faults in building their first two cruisers of the rapid type, the *Duquesne* and *Tourville*. Lessons can therefore be drawn from these practical illustrations.

By trade and commerce we grow to be a rich and powerful people, and by their decay we would grow poor and impotent; and as trade and commerce enrich, so they fortify our country. And to the American Congress they must look for the encouragement afforded by naval protection.

PART XXIV.

SUPPLEMENT.

ROYAL NAVAL COLLEGE AT GREENWICH.

REGULATIONS FOR ADMISSION OF ENGINEER STUDENTS; OBSERVATIONS.

RANK, PAY, ETC.

NAVAL MODELS AT GREENWICH.

SCIENTIFIC APPARATUS AT THE SOUTH KENSINGTON MUSEUM.

CONSERVATOIRE DES ARTS ET MÉTIERS.

navigation; two naval instructors, corresponding to our professors of mathematics; and four engineer officers, instructors in steam, in marine engineering, and applied mechanics. The remaining members of the staff of instructors, twenty in number, are civilians, and most of them are distinguished scientific professors. Beside the above-named, there is one medical officer and one store-keeper, who also acts as cashier. The president, his assistant, and secretary reside in the buildings; all instructors reside outside the walls.

All officers known in our service as line-officers, are in the British navy denominated executive officers. They are appointed at an early age and placed on board training-ships as naval cadets. It is not intended to provide at Greenwich for the education of these cadets. The naval college is fitted in every respect for the education of officers of all ranks above that of midshipman, in all branches of theoretical and scientific study bearing upon their profession; and it is stated that while every possible advantage in respect to scientific education will be given, no arrangement will be allowed in any manner prejudicing the all-important practical training in the active duties of the profession. It is after the cadets have been passed to acting sub-lieutenants and acting navigating sub-lieutenants, that they enter the college for final instruction and graduation. The college is also open, under limitations, to all executive officers below flag-rank, to improve or prepare for promotion. It is at this college that all the officers of the engineering branch of the royal navy are now and are hereafter to be graduated. To this corps of officers my attention was especially invited, and I propose to give particulars relating to this branch only.

The college was opened February 1, 1873, to sub-lieutenants and gunnery lieutenants, and on the 1st of October following it was opened to officers of the engineering branch. The institution is therefore in its infancy. Its foundation is, however, laid, looking to a great future, as the fountain from which are to emanate the officers who are to construct and to control all the ships, all the dock-yards, and all the naval operations of the most powerful navy in the world. It was as early as 1811 that the British government commenced to encourage the instruction of naval architects in a primary school at the Portsmouth dock-yard; but this school had a brief existence. A second school was by order of the Admiralty opened in the same dock-yard in 1848; and as a result of the instruction given here, a number of able scientists were turned out, among them Mr. Isaac Watts and Mr. E. J. Reed, both of whom became chief constructors of the navy.

Subsequently four schools were established for the purpose of preparing students as assistant engineers for the navy. These schools are still in existence at the dock-yards of Chatham, Portsmouth, Sheerness, and Devonport. Finally, the South Kensington School of Naval Architecture was opened to the most meritorious graduates of the students from the dock-yard schools. But it was only when the Royal Naval College at Greenwich was opened, that the Admiralty decided systematically to strengthen and improve the engineering branch, by raising the standard of education to a degree previously unknown to that class of officers. It was accordingly determined, January 30, 1873, and announced by regulation, that thereafter all engineer students who successfully passed through the six years' course at the dock-yards, would be sent to the Greenwich College for a period of study, and none are now appointed to vessels until passed by the director of studies at Greenwich.

The following regulations will give a clear understanding of the system of entrance and instruction at the dock-yards. The system of

instruction and examination at the naval college was submitted to the Department by me for our Naval Academy at the beginning of 1876:

REGULATIONS FOR ADMISSION OF ENGINEER STUDENTS.

1. Vacancies for appointments as engineer students in the factories at Chatham, Sheerness, Portsmouth, and Devonport are open to public competition.

2. The lists of candidates for these situations will be kept by the civil-service commissioners in London and the superintendents of the dock-yards, to whom all applications must be addressed before the 1st of May in each year.

3. Candidates must not be less than fourteen nor more than fifteen years of age on the first day of examination. Proof of age will be required by the production of a certificate of birth, an extract from a baptismal register, or by declaration before a magistrate. Evidence of respectability and good character must also be produced on a form which will be furnished by the civil-service commissioners or by the superintendents of the dock-yards.

4. Candidates will not be admitted for examination until they have been pronounced fit for Her Majesty's service by the medical officers.

5. The examinations will commence on the first Tuesday in June in each year, and will be held by the civil-service commissioners in London as well as at the dock-yards.

7. The following will be the subjects of examination, and the maximum number of marks for each subject:

Arithmetic, including vulgar and decimal fractions, and square and cube roots.	250
Orthography.....	100
Handwriting.....	100
Grammar.....	100
English composition.....	100
Geography.....	100
Translation of French into English.....	150
Euclid—first six books.....	300
Algebra, including quadratic equations.....	300
Total.....	1,500

8. Candidates will be subjected to a preliminary examination in the first three subjects, and should they fail in any of the three they will be at once rejected. Those who pass the preliminary test will then undergo a competitive examination in the remaining subjects, and the candidates who display a competent knowledge of all the above subjects, and who obtain not less than 750 marks in the aggregate, will be classed in one general list in order of merit, according to the number of marks gained, and will be eligible for appointment as engineer students in the dock-yards in existing vacancies.

9. Engineer students will remain for six years at the dock-yards for practical training in the factory workshops, and to receive instruction in iron-ship building. They will also attend the dock-yard schools for such periods and to pursue such studies as may from time to time be determined on; they will also pass a portion of their time in the drawing office. Means will be afforded them of acquiring the groundwork of the knowledge required by a naval engineer respecting the working of marine engines and boilers, including those repairs which can be carried out afloat, the practical use of the various instruments used in the engine-room, including the indicator, and of becoming generally acquainted with the duties of a naval engineer.

10. Engineer students will be examined once a year under the director of education and the engineer officers of the Admiralty. The examination of the sixth-year students will include tests of their skill as workmen, and those found qualified will, on the completion of their term of service at the dock-yards, proceed to the Royal Naval College, at Greenwich, as acting second-class assistant engineers, on the 1st October succeeding the examination, where they will pass through a course of higher instruction during one term.

11. Those engineer students who fail to pass the examination at the end of their six years' service will be allowed to remain one year longer at the dock-yards, and will then be re-examined, when, if they are unable to pass, they will cease to be eligible for the rank of naval engineer.

Admission into the college.

12. Engineer students will not be entered as acting second-class assistant engineers until they have been pronounced fit for Her Majesty's service by the medical officers, and have learned to swim.

13. The term for study at Greenwich will be from the 1st October to the 30th June

following. All will be examined under the director of education on the completion of their term at Greenwich, and will receive certificates according to their merit in three classes. Those taking the first-class certificate will be granted twelve months; the second-class six months' additional time to count for promotion; those taking the third-class certificate will only count the time since they passed out of the dock-yards.

14. Acting second-class assistant engineers will receive 3s. 6d. a day, and 1s. 6d. a day toward the mess during their first term of study at Greenwich. If selected for further study during one or more terms they will receive their full pay of 6s. a day, and 1s. 6d. a day toward the mess.

15. Four acting second-class assistant engineers will be selected from those who take the highest place at the examination on the completion of their term at Greenwich, to pass through a further course of scientific instruction if they desire it. These four will be examined at the end of the second term, and one or more will, at the discretion of the Admiralty, be allowed to remain a third term at Greenwich, on the completion of which they will be sent to sea as assistant-engineers, and after one year's service at sea they will be considered eligible to fill positions in the dock-yards and at the Admiralty.

16. Those passing the second and third terms at Greenwich will be attached during the vacations between the 30th June and 1st October, to the dock-yards or steam-reserves, where they will attend trials of new and repaired engines, and obtain experience respecting the duties they will have to perform at sea.

17. No assistant engineer who has passed three terms at Greenwich will be allowed to leave Her Majesty's service within seven years of the completion of his term at Greenwich, unless he shall pay the sum of £250 to defray the charges of his education.

18. All time at Greenwich will count as sea-time.

19. The weekly pay of engineer students while employed in the dock-yards will be 8s. during the first year of their training, and if they are reported on favorably by the officers, it will be increased 2s. a week each year until the sixth, and then increased 8s., making their wages 24s. a week for the last year.

The acting assistant engineers, during their term of study at Greenwich, will be lodged, and will receive 1s. 6d. a day toward their mess expenses, and in addition they will receive pay at the rate of 3s. 6d. a day. Those selected for further study during one or more terms will receive pay at the rate of 6s. a day and 1s. 6d. toward their mess expenses.

The number of students for the mechanical branch, entered at the Greenwich Royal College in the first three years, was 137, including those—24 in number—transferred from the South Kensington school; this institution having ceased to exist when Greenwich opened.

Of the foreign students permitted to enjoy the benefits of this excellent college, there are three Russians, two Italians, two Danes, one Spaniard, one Norwegian, and one Brazilian; all studying engineering and naval architecture, under the rules and laws of the institution.

It will be observed from the foregoing regulations that the system of education provided for the British royal naval engineers is as follows:

1st. They are received into the dock-yards between the ages of fourteen and fifteen, by public competition, after evidence is produced of respectability and good character.

2d. They are required to serve six years in these yards, during which time they are employed for stated periods in the several branches of the engineering factories, on board ships, on the hulls of ships, and in the draughting-rooms. While occupied in this practical training, they are superintended by competent leading men, under the directions of the factory officers. They are also required to attend the dock-yard schools on appointed afternoons and in the evenings for theoretical instruction. They are examined regularly, and those who do not make satisfactory progress are dismissed. At the end of the fourth, fifth, and sixth years they are examined by the engineer officers at the Admiralty, as well as by the dock-yard officers and instructors, and all those who pass satisfactory examinations at the end of six years, and found qualified, are appointed assistant engineers and entered at Greenwich College on the 1st of October succeeding the examination.

3d. All assistant engineers are required to serve one collegiate term at

Greenwich, on the completion of which they are examined and receive certificates in three classes. But *four* out of the whole class of each year who take the highest honors may optionally pass through a second collegiate course; and at the end of this second year one or more who take the highest number out of the four thus selected is granted a third collegiate term. It will thus be seen that the greatest number of assistant engineers receive seven years' government instruction before entering on the duties for which they have been educated; that three each year are turned out after eight years' instruction, and that one each year is graduated after nine years' instruction. These long-term graduates are required to go to sea for one year only, after which they are eligible for positions at the Admiralty and in the dock-yards. The training and education are most thorough and complete, and it is believed that from the number graduated some constructing-engineers of marked ability will be developed. The college is also open to engineer officers in the service who have not had the advantage of study at Greenwich or South Kensington, but, as with executive officers, the number that can be annually admitted is limited. These officers remain one term, and a small number may elect by permission to remain a second term for study. Their pay while at the college is the same as when at sea, with 1s. 6d. each toward the mess. If this advantage could be granted the passed and assistant engineers of our Navy, of a term of study at the Naval Academy before examination for promotion, it would result in much good to the service.

All the students reside in the college except the higher grades, who are permitted to reside in the town.

France, Germany, and other continental countries have also government schools for the education of cadet engineers, but there is no system of instruction for this class of officers so thoroughly practical and scientific as that of the English.

RANK, PAY, ETC., OF ROYAL NAVAL ENGINEERS.

Last year the lords commissioners of the Admiralty appointed a committee or board, consisting of Vice-Admiral Sir A. Cooper Key, K. C. B., F. R. S., Captain Sir John E. Commerell, K. C. B., Captain W. M. Dowell, R. N., C. B., the engineer-in-chief of the navy, and two chief inspectors of machinery, royal navy, to investigate the claims of the royal naval engineers for increased rank, pay, &c. This committee was in session in London for several months, carefully taking testimony, all of which was printed in like manner with the proceedings of a military court. The result of their investigations may be found in the report submitted to the Admiralty in March last. The first recommendation reads as follows:

"Engineer officers for the future to be *executive officers*, [*i. e.*, line-officers,] but not to command." Increased rank and pay were recommended; also increased encouragement to retire.

The pay and position of the engineers of the royal navy, have recently been attracting considerable attention in England. The well-known author, Hon. E. J. Reed, ex-chief constructor of the British navy, and now member of Parliament, in articles to the press suggests radical changes. He says:

It is at least a plausible view that we must look to those upon whom the management of the navy, as a fighting machine, most nearly depends for the most valuable assistance. A ship of war is now a machine of the greatest intricacy, set to work mainly, if not exclusively, by the power of steam; it is a steam being, and the man who understands it, can work it with safety, can control it efficiently, can use it, preserve it, repair it, renew it, is the engineer.

The London *Times*, in a leader commenting on Mr. Reed's letters, says:

Every one who wants to be informed of the condition of the navy, and to obtain an opinion on the value of any proposed changes in the design and arrangement of our ships, takes counsel of the engineers among the foremost; and if the Admiralty and Parliament would get from the service itself the most trustworthy views of naval policy, they must consent to make the fullest recognition of the value and importance of the functions of the engineers.

And adds:

Mr. Reed is altogether right in insisting that it is a matter of prime interest for England that the class [corps] of naval engineers should be raised to a level corresponding to the greatness of their present trust, and to the weight of their enlarged responsibilities.

NAVAL MODELS AT GREENWICH.

The models of the vessels of the British navy for many years were not open to the general public. They were kept in a room at the Admiralty, Somerset House, and afterward removed to the South Kensington Museum. On the establishment of the naval college at Greenwich, in 1873, it was determined that they should be sent there for the purpose of being easily accessible to the students. At Greenwich they are exhibited to great advantage and admirably arranged in a building which for generations has been associated with the British navy, and they are within easy reach of the classes most interested in the objects of the exhibition. The subject of study here presented is exceedingly interesting to persons desiring to be informed of the history of naval construction, for here can be seen the models of the vessels of the British navy from its earliest time, step by step, down to the present period. Here is seen the successive development of wooden sailing-vessels from the earliest war-period to the date of the introduction of steam; the first paddle-wheel steamer and the subsequent changes in form of this kind of vessel; the first screw-vessel, with the changes that followed the introduction of motive-power in that form; the first iron vessel; the first iron-clad or armored ship, and the still later type of fast iron vessel sheathed in wood.

It is believed that the first ship in the royal navy was built in the reign of Henry VII., but the first man-of-war of respectable size, as shown by the models, was the *Great Harry*, or, as she was at first called, the *Henri Grâce à Dieu*, laid down by Henry VII. in 1512, and launched June, 1514. It was under this sovereign that the British navy was founded. He not only built the first man-of-war, but also established the three royal dock-yards at Portsmouth, Woolwich, and Deptford; and at the close of his reign there were fifty-eight ships in the navy, of an aggregate tonnage of 12,000. The tonnage of the *Great Harry* is stated at 1,000, but the dimensions are not precisely known. She had much top-hamper, and history says that, notwithstanding her crankiness, she performed good service, and was ultimately burned accidentally at Woolwich in 1553. In the same case with the *Great Harry* is a model of another remarkable ship, *The Sovereign of the Seas*. She was built in 1637. Upon comparing the models of the two ships, one is impressed with the improvement effected in a hundred years. The *Royal William*, of which there are two models, one full-rigged, representing her as originally built in 1670, the other, showing her as altered in 1692, is a better exemplification of the ships of the seventeenth century than is the *Royal Sovereign*.

The *Royal Sovereign* was the first ship in the British navy with three decks. She was afterward cut down, and, it is said, did good service. She was destroyed by accidental fire at Chatham in 1695. The next model is that of the notable *Britannia*, of 100 guns and 1,700 tons,

built in 1682. These ships of the seventeenth century furnished the type for line-of-battle ships for nearly a century and a half, and the earliest designs are noticeable as having considerable sheer, the effect of which was further increased by the fact of there being in the after part of the ship two decks more than amidships. The first step toward a flush upper deck was not taken until the beginning of the present century, when bridges called "gang-boards" were thrown across the waist close in to the side, in order to save the descent from the quarter-deck and the ascent to the fore-castle; and at last the interval was bridged over completely. The upper-deck of a line-of-battle ship was then spoken of as the fore-castle, gangways, and quarter-deck, and at last as the spar-deck; and hence we have the origin of the terms. There are models of two foreign ships in this room, the *Commerce de Marseilles*, a French vessel of 120 guns, captured at Toulon in 1793; and the *Salvador del Mundi*, captured from the Spaniards in 1797. They are both models of ships superior to those of the English of the same date. The second room contains the models of a few famous ships. The first *Victory*, built in 1737, and lost seven years after in the English Channel, with her admiral, officers, and crew of 1,000 men. There is also the *Royal George*, famous as having capsized in dock, "with all her crew complete," in 1782. Her guns and stores were recovered fifty-seven years afterward. On the walls there are large numbers of half-models of frigates captured from the French and Spaniards.

Among the later vessels noticed, whose class will soon only be represented by the models in the Royal Museum, are the screw line-of-battle ships *Royal Albert* and *Howe*; the former launched at Woolwich in 1854, and the latter at Pembroke in 1860. The armament of the *Howe* consisted of 121 guns, and her complement of crew was intended to be 1,130 men, but she never made a cruise, and it is not probable she will ever be sent out of the harbor of Devonport, where she now lies.

Going back a little, to the introduction of steam, the first steamer built in the British navy is represented by a model of a paddle-wheeler called the *Gulnare*, a name afterward changed to *Gleaner*. She was launched at Chatham in 1833, was 120 feet long, 23 feet 3 inches broad, and drew 13 feet of water. Two years previous to this, however, a small purchased steamer, the *Black Eagle*, carrying one gun, was employed in the navy. The first screw-vessel was the *Dwarf*, the next was the *Rattler*, both small vessels, built immediately after the successful adaptation of the screw-propeller to the *Princeton* in our own Navy. The first war screw-ship is represented by a model of the *Sans Pareil*, of 80 guns, ordered in 1848 as a sailing-vessel, altered and launched in 1851 as a screw-ship, eight years after our screw-sloop *Princeton* was built, and four or five years after the French Admiralty had sent out the *Napoléon*.

The first iron vessels are represented by the *Jackal* and the *Simoom*, both still in commission; the former built in 1844, and the latter, as a war steam-frigate, in 1849. Here may be found reason for comment on the wisdom of naval authorities. It was only about as late as the year 1840 that wise and distinguished old admirals were invited to witness the performance of a little screw-vessel on the Thames, with the view of the introduction of the screw into the navy. They inspected its performance, and reported the screw-propeller unsuitable for war-vessels. Again, the *Simoom*, the first iron war-ship built, was pronounced by the Board of Admiralty to be unfit for war purposes in consequence of the material of which the hull was composed, and as a result they altered her into a troop-ship. Thirty years after this short-sighted decision the *Simoom* is still sound and doing good service; all the first-rates are built

of iron, and all naval vessels are propelled by the same instrument—the screw—pronounced unsuited for war-vessels by the officers of the sailing-period. While citing the *Simoom* as proof of the durability of iron vessels, it is not out of place to mention the troop-ship *Himalaya*, of 3,453 tons, B. M. This iron vessel, built about 1850, and purchased by the Admiralty in July, 1854, at a cost of \$631,800, has seen about twenty-five years' work, and is still sound in hull and serviceable.

We come next to the collection of models of iron-clad ships. The Russian war brought into existence the use of armor on the seas. Three floating batteries, built by the French, silenced the forts at Kinburn. They were named the *Lave*, *Tonnante*, and the *Dévastation*. There are no models of these in the museum, but there is one of the English batteries subsequently built and used against the Russian forts.

The model of the *Warrior*, the first armored ship, is to be seen, and the various types that followed her are represented.

In the upper rooms are seen illustrations of the old and new systems of construction of men-of-war, materials and equipments of various kinds, and a full-rigged model of Nelson's *Victory*, the original being still preserved and doing duty as a guard-ship at Portsmouth. In a separate room there is also a large model showing the stations of the ships at the battle of Trafalgar.

The above brief outline of models has been mentioned simply as being of historic interest, and on account of the lessons for students to be drawn therefrom.

Several visits were also made to the collection of models of naval vessels, &c., at the Louvre in Paris. There is here seen a succinct history of naval construction in the French service from its earliest period to the present time, but no useful purpose would be served by entering into details of them.

THE EXHIBITION OF SCIENTIFIC APPARATUS AT THE SOUTH KENSINGTON MUSEUM, LONDON.

England does not possess a patent-office furnished with models like ours in Washington. Patentees have only to deposit complete drawings and descriptions of their inventions. These are to be found at the Free Library, Chancery Lane. There is, however, an interesting permanent collection of original machines, instruments, &c., at the South Kensington Museum, where besides, of late years, an annual international exhibition took place, of inventions, productions, manufactures, &c., of more interest to the curious public at large than to mechanics and scientific men. In the beginning of last year, however, it was determined to step out of the beaten track and to do something of a really scientific nature. Consequently, it was resolved to form a loan collection of scientific apparatus, which was to include not only apparatus of all kinds for investigation, but also such as possessed historic interest on account of the persons by whom, or the researches in which, they had been employed. It was at first intended to devote only a small space in the museum to this collection, which was not expected to be a large one. The idea, however, found such favor with scientific men, both in England and other countries, that it was soon apparent that some building much larger must be provided. Consequently, the galleries of the horticultural gardens of the international buildings were obtained. A general committee was formed in January, 1875, consisting of more than one hundred of the leading men of science in England, and including

the presidents of all the learned and scientific bodies. At their first meeting it was decided to divide the whole exhibition into the five following sections, viz: Mechanics, including pure and applied mathematics; physics; chemistry, including metallurgy, geology and mineralogy; geography, and biology. As soon as the programme had been definitely settled, steps were taken to interest foreign countries in the matter, and men of science in nearly all European countries were invited to join the general committee, and also to form special subcommittees to further the due representation of science of their respective countries; all of which was promptly responded to.

The exhibition was opened in May, 1876, and is known as the "Loan Collection of Scientific Apparatus." It is doubtless the most extensive and best collection of the kind ever seen. By mechanics, professional and scientific men, food for study and thought could be found here for all spare time.

Entering at the door nearest the Kensington Museum for a general survey in methodical order, the educational collection is the first reached. Here Germany and Russia divide the palm, England being completely distanced. The most general collection is that contributed by the committee of the Pedagogical Museum of Russia, which indicates most clearly that in no country is the value of scientific instruction more appreciated than in Russia. The most complete in the field of chemistry and physics are those of E. Leybold's successors at Cologne—Rohrbech, Luhme & Co., and Warmbrunn and Qualitz, both of Berlin; the former showing general sets for superior educational institutes and national schools, and special apparatus for teaching chemistry.

On leaving the educational collections, the most notable objects on the right and left respectively are Stephenson's "Rocket" and "Puffing Billy," lent by the commissioners of patents. The next objects on the left and right are now exhibited for the first time in England. They are a steam-cylinder by Papin, bearing the date 1699, sent over from the Royal Museum of Cassel; and a collection of Watt's original models of various parts of steam-engines, contributed by Mr. Hamilton. The steam-cylinder, which was made at Cassel, is almost the only remaining witness of the works of Papin, from which a series of inventions has sprung, which have completely changed in a few decades our modes of life. How exactly Papin knew the importance of his idea of employing steam as a motive-power is clearly demonstrated by his writings. They contain the invention of the piston steam-engine and its application to steam-vessels. The cylinder exhibited, undoubtedly the first ever made, was to be employed for a steam-engine of peculiar construction, with which a canal connecting Karlshafen with Cassel, on the summit of Hofgeismar, was to be supplied with water. The model of the pumping-machine was completed, and some parts of the machinery cast at Veckerhagen, when a machine, by means of which he was making experiments on throwing bomb-shells by steam, exploded in Papin's laboratory, and he was obliged to take to flight.

Newcomen's engine and Captain Savery's engine also find places here, as does Bramah's first hydraulic-press. Mr. Bennett Woodcroft contributes a large number of models, and the Royal Mining Academy at Berlin and the School of Mines vie with each other in their collections of instruments to aid in teaching. In the series of rooms devoted to naval architecture and marine engineering, the first object, on the left, is a model of the *Faraday*, and, after a long line of other models, we come, in the next room, to Mr. Froude's apparatus,

(2,149,) illustrating his method of ascertaining the resistance of ships by measuring the resistance of their models. This method is now used for British naval vessels, and experiments have shown that the results obtained with the models accord very closely with those obtained from the ship itself; so that the Admiralty is no longer obliged to make experiments with the ships themselves. It has never before been exhibited, except to those who have been privileged to see Mr. Froude's laboratory at Torquay. The London *Times* thus describes the manner of making the experiments:

We may state that the models, from 6 feet to 16 feet in length, are made of hard paraffine; the experimental apparatus employed in working the model includes appliances for designing, molding, and casting the models, shaping them by automatic machinery, moving them through the water at the required speeds, and automatically recording the leading phenomena of the trial—namely, the speed, the resistance, and the change of level induced by the speed at each end of the model. When the model exactly represents the lines of the ship the form of which has to be studied, it is put into a tank and connected with a dynamometric truck, which runs on a railway about 200 feet in length, suspended over a waterway 36 feet wide and 10 feet deep. The model floating in the water is, as it were, "harnessed" to the truck and travels with it. The towing strain—i. e., the force necessary to make the model accompany the truck in its longitudinal progress—is taken during the experiment by a spiral spring, the extension of which, measuring the towing force, is indicated on a large scale by a pen on a recording cylinder. The recording cylinder is driven by the truck-wheels, and thus its circumferential travel indicates distance run; at the same time another pen, jerked at half-second intervals by a clock, records time. Other pens actuated by strings led over pulleys record the change of level of the ends of the model. Thus the diagrams made furnish an exact measure of the speed and a continuous record of the resistances and of the change of level of the model throughout the experimental run at steady speed. The truck is connected by a wire-rope, with a winding drum, driven by a small stationary double-cylinder steam-engine.

After the avenue of marine models, we pass through another of light-houses. Among these, mention must be made of the magnificent series representing the earliest attempts of Fresnel, sent by the light-house service of France.

* The first room in the western galleries is devoted to sections 9 and 10, embracing magnetism and electricity. These include a most remarkable and interesting collection of original apparatus connected with terrestrial magnetism, the development of magnetic and voltaic electricity, and the application of the electric current on the progressive development of the telegraph. This, perhaps, is the most bewildering room of all; it is certainly the most crowded; and steam-engines in an annex are used for driving some machines not necessarily electrical, but for which some power is necessary. The non-electrical objects driven are M. Pelet's new ice-machine, and two machines, the counterparts of each other, in the process of type-setting by mechanism, instead of by hand as heretofore. Leaving this gallery where are exhibited the electrical and magnetic instruments, we come into that containing the geometrical models and instruments. In the next gallery is another collection of instruments, illustrating the laws of statics and dynamics, and noteworthy for its historical interest; it contains the apparatus employed by the celebrated Dutch physicist, Gravesande, in demonstrating the oscillations of the pendulum, and the parabolic flight of a projectile. The next section contains, among other things, Mr. Babbage's calculating-machine, or difference engine, and tide-calculating machines.

The contributions of two other men, famous, the one in mechanical arts, the other in science, have been described elsewhere as follows:

Sir Joseph Whitworth has contributed a collection (210,217) of measuring-instruments of the most perfect accuracy of workmanship. Among them is a machine for measuring thicknesses up to one ten-thousandth of an inch; and, wonder greater still, also a machine on the same principle by means of which a distance of one millionth of an inch can be made perceptible. The latter has never previously been shown anywhere. The collection also includes specimens of the true plane surface which, as Sir J. Whitworth insists, is the only means of obtaining perfect power of accurate measurement.

* From the London *Standard*.

To the scientific man, if not to the general public, the most interesting objects in an exhibition of this kind are the actual instruments by which celebrated investigators have discovered the truths with which their name is associated. Of this nature is the apparatus we have here, by which Dr. Joule ascertained the mechanical equivalent of heat, or, in other words, the actual work which a given quantity of heat would accomplish. The two forms of apparatus exhibited are vastly like vertical churns, and the process employed by Joule consisted in churning water till its temperature was thereby raised, and carefully noting the exact rise of temperature and the amount of work performed.

To the eyes of mechanical engineers, the exhibition acquires a new value in the exceedingly interesting collection of original steam-engines, commencing with the production of Papin, the very first of which we have knowledge, (and referred to elsewhere in this description,) passing through various stages of progression, and culminating in the last type of compound engines introduced into the ships of the British royal navy. This collection of historic machines is placed mainly in the room set apart for applied mechanics. Many of them have been moved from their usual dingy resting-places in the patent museum, and are historically, at least, familiar to American engineers who visit South Kensington. They represent the brain-work of the men who laid the very foundation of our profession—quaint old constructions, but which, in semblance or reality, have been the friends of all our generation of engineers since their boyhood.

Papin's cylinder is a really notable memorial of that genius to whom we owe so much, (for the piston was also introduced by him,) and who died at last penniless and unfortunate in England. Not far from Papin's cylinder stands a model of the engine of his more fortunate successor, Newcomen; it is dated 1705, and is said to have been made by the inventor, and by him presented to King George III. It is now the property of King's College, London, is beautifully made, and is in admirable preservation. Being in all probability the only authenticated example of Newcomen's own handiwork in existence, it must be looked upon as possessing much interest. At the back of the case which contains this model hangs a print which represents the steam-engine near Dudley Castle, invented by Captain Savery and Newcomen, executed by the latter in 1712. Here is seen the engine of Savery, made in 1718, and used to raise water in the garden of Peter the Great, Emperor of Russia; also the little engine used in the University of Glasgow in 1765, which James Watt was employed to repair, and from which he conceived the idea of the separate condenser that subsequently identified his name with the steam-engine all over the civilized world.

Passing across the street to the patent museum, we find the original old Cornish pumping-engine made by Newcomen and Cawley, which was in operation at Mr. Boulton's Works, Soho, near Birmingham, and to which Watt in 1777 applied for the first time his separate condenser and air-pump; also his first sun and planet engine, erected at Soho in 1788. Returning to the loan exhibition, we find models to illustrate mechanism proposed by Watt; notable among these are a Bell pumping-engine, and an engine with a T-ended beam, having two separate connecting-rods, and intended for driving the shafting of two separate mills. There are a number of modifications of the sun and planet gear, including one in which the connecting-rod carries an elliptical annular wheel. There is also a model representing the improvements carried out by James Watt in the steam-engine; they are as follows:

- 1st. Making the engine double-acting.
- 2d. Steam-jacketing the cylinder.
- 3d. The separate air-pump and condenser.

4th. The parallel-motion.

5th. The D slide-valve.

6th. The governor.

A machine which will no doubt excite very considerable interest is the little engine made by William Symington, for driving the now historic pleasure-boat of Mr. Miller on his lake at Dalswinton. It has two vertical single-acting cylinders, (of brass,) standing side by side, their piston-rods attached to the two ends of a long chain carried around a central pulley, (above and between the cylinders,) around two more pulleys which were upon the shafts of the two paddle-wheels, and further, by means of guide-pulleys, along the whole length of the engine, in one piece. The pistons, which are about 4 inches in diameter and 15 inches in stroke, are single-acting, and work alternately, the whole chain being pulled first in one direction and then in the other. By means of a clutch arrangement the paddle-shafts receive motion from it in one direction only. The valves are worked by a plug-rod driven by a chain from the central pulley. This queer contrivance, the "parent of modern steam-navigation," was finished in 1788, and drove the little pleasure-boat, (25 feet long and 7 feet broad,) on which it was placed, at the rate of five miles an hour.

Among the other exhibits of historic interest in this section may be mentioned two models of Stirling's air-engine, made by the inventor, and belonging to the universities of Edinburgh and Glasgow respectively; the original model of Trevithick's locomotive, lent by Mr. Woodcroft; a very old model of Savery's engine, lent by the council of King's College; a sketch made in 1842, by Mr. William Howe, of the link-motion, together with a little rough wooden model of it made soon after; a set of light models of Brunel's celebrated block-making machinery, lent from the Royal Naval Museum, Greenwich; a "steel-mill" such as was used for producing light in coal-mines before the introduction of the safety-lamp, sent by the North of England Institution of Mechanical and Mining Engineers; and a model of Cugnot's steam-carriage, (1769,) which succeeded a century ago in carrying four passengers at the rate of $2\frac{1}{2}$ miles an hour, in stages of from 12 to 15 minutes, lent by the *Conservatoire des Arts et M \acute{e} tiers*.

We come next to the engine of the *Comet*, made by Henry Bell, and remarkable as being the first steamboat in Europe advertised for the conveyance of passengers. It was completed in January, 1812, and on the 5th of August of the same year, Bell issued a circular announcing that his vessel would run on the Clyde between Glasgow and Greenock. The *Comet* was of 30 tons burden, 42 feet long and 14 feet wide. The engine was estimated at four horse-power. It is compactly arranged, but, as a matter of fact, it is not so well suited to the propulsion of a boat as Symington's engine in the *Charlotte Dundas*, which was built in 1803. Bell's engine has undergone various vicissitudes, having been once at the bottom of the sea; it was eventually used for blowing a smith's fire in Glasgow, where it was discovered by Mr. Napier, who purchased it and presented it to the commissioners of patents. In the department of the exhibition devoted to naval architecture there is a small model of the *Comet*, said to be correct. The original vessel was wrecked off the West Highland coast, and the second *Comet* met a similar fate by collision with the steamer *Ayr*.

Americans will remember that the first application of steam to navigation which showed evidences of success, was made on the Delaware River in 1788, by John Fitch. The boat was 60 feet long, 8 feet wide,

and 4 feet deep. The project was not successful, and it was left to Fulton to carry out the idea.*

We now reach historical locomotives, beginning with Trevithick's model. Trevithick's claim to be considered the inventor or originator of the locomotive is based upon his patent taken out in conjunction with Vivian in 1802. The model in question has been contributed for exhibition by Mr. Woodcroft, and has been for some years in the South Kensington Museum. Although this machine was not adapted to run on rails, it is obvious that only the substitution of a pair of wheels for a single one is necessary to enable it to do so. It is a matter of history that Trevithick made a locomotive which, in February, 1804, drew a train of five trucks, carrying ten tons of iron and seventy men, nine miles in five hours. This was at Penydaran, South Wales, over an iron tram-way with inclines of 1 in 50; and the exploit indubitably proved that the friction between ordinary smooth rails and similar driving-wheels was sufficient to effect propulsion. This engine continued to work for five months.

We come now to the Wylam engine, which has been removed for exhibition from the Patent-Office Museum. It appears to far greater advantage in its present temporary position than it did in its permanent home, where it was so crowded that it was impossible to get a fair view of it. It was built at Wylam in 1813, or thereabout, from the designs of William Hedley, and it forms a most interesting link in the history of the locomotive. Under the name of "Puffing Billy," or, as some have it, "Puffing Dilly," it was at work on a colliery line almost uninterruptedly from the above date until June, 1862. The word "dilly," we may mention, is well known in the north of England in the sense of a carriage, and is said by Hallowell, in his dictionary of archaic words, to be derived from the French *diligence*.

The next is the "Sans Pareil," constructed by Timothy Hackworth of Darlington, in 1829, to compete in the trials on the Liverpool and Manchester Railway. This is followed by Stephenson's first locomotive, the "Rocket," also made in 1829 to compete on the Liverpool and Manchester Railway. This locomotive, unlike all which preceded it, has outside inclined cylinders, the connecting-rods being connected directly to the driving-wheels. The boiler is horizontal. In fact, the system originated by Stephenson is that employed at the present day, though, it is needless to say, vastly improved upon. This original locomotive took the prize and laid the foundation for the fame and fortune of the Stephenson family. Among the many old machines and instruments of peculiar interest in the patent museum, is the first screw-propeller that was applied

* The first patents granted by the United States for the propulsion of boats by steam were issued to John Fitch, of Philadelphia, and to James Rumsey, of Pennsylvania, August 26, 1791.

In 1804 and 1805 John Stevens, of Hoboken, N. J., built a boat and steam-engine with a single-screw propeller, and a second with twin-screws, and worked them successfully. Subsequently he built the paddle-wheel boat *Phoenix*, and sent her from New York to Philadelphia by sea. She was the first steamer on the ocean, and was for some years employed on the Delaware.

Fulton's first experiments were made on the Seine at Paris, in 1803, with a paddle boat 60 feet long. It was unsuccessful. In 1807 he launched the *Clermont* on the East River, New York. This vessel was about 132 feet long and 18 feet wide, fitted with a Boulton & Watt engine, and propelled by paddles. She made regular trips between New York and Albany. He built several other steamers, and in 1811 he constructed at Pittsburgh the first steamer that navigated the western waters. To him more than to any other one man is due the credit of the introduction of steam navigation.

The first voyage made across the ocean by a steam-vessel was that of the *Savannah*, of 300 tons burden, in 1819. She sailed from New York to Liverpool, thence to St. Petersburg, and returned in safety. This voyage created a great sensation. In 1838 the steamer *Sirius* crossed the Atlantic, and the *Great Western* began to make regular trips

to a vessel of war in Europe. It is made of gun-metal; is a two-bladed true-screw, 10 feet 1 inch in diameter, with 11 feet pitch; has a length on the shaft of 18 inches, and is correctly proportioned. This screw was made for and was used to propel the British war-steamer *Rattler*, from the time that vessel was built, in 1843, until she was broken up. So perfect is the construction of this simple true-screw, that in the thousands made since then, in the numerous patents that have been granted for screw-propellers, and in the volumes that have been written on the subject, scarcely any improvement has been effected.*

Leaving these curious and interesting specimens of historic engines and instruments, we come to models in steel and iron of engines of modern date. Here are found, in glass cases, models of a number of the engines of the ships of the British royal navy. They consist of those in the *Monarch* and *Prince Albert*, by Messrs. Humphrys, Tenant & Co.; of the *Nelson*, *Conqueror*, and *Tamar*, by Messrs. Ravenhill & Co.; and a fine collection by Messrs. Maudslay, Sons & Field, consisting of those in the *Agincourt*, *Prince Consort*, *Caledonia*, and *Ocean*; and last, the model, beautifully executed, of the compound engines of the *Boadicea* and *Bacchante*, by Messrs. J. & E. Rennie. All of these several types of engines are so well known that descriptions are needless.

The next interesting subject for inspection is the collection of models of war and mercantile vessels of various types, among which are noticed not only models of ships built for the British navy and merchant marine, but also of ships built for the navies of Germany, Russia, Spain, Turkey, Holland, Brazil, and other nations.

The brief outline of the machines, mechanical appliances, &c., above noted, seemed desirable to be given as a matter of historical interest, principally to the engineering profession.

Professor Edward S. Holden, U. S. N., who was detailed by the Department to inspect and study the astronomical instruments, &c., of the exhibition, has in his able and instructive report on the subject, printed with the report of the honorable Secretary of the Navy and accompanying documents, given much valuable information that may be used to the advantage of our Government.

CONSERVATOIRE DES ARTS ET MÉTIERS.

To the engineer this is one of the most interesting institutions of Paris or, indeed, of France. Several visits of observation and study were made to its wonderful collection of models, which has been gathered from all directions, and which represents every department of industry. Among them are many specimens of early engineering; the original looms of Vaucanson and Jacquard are preserved here in the *Salle des Filatures*, and in other departments are almost equally interesting relics.

M. Tresca, the subdirector, has a mechanical laboratory in which are many of the larger objects belonging to the institution, but it is mainly occupied by apparatus for testing the efficiency of machinery and with illustrative models driven by power.

* Captain Ericsson instituted experiments with his screw-propeller vessel *Francis B. Ogden*, on the Thames, in 1836. His second screw-vessel, the *Robert F. Stockton*, was launched on the Mersey in 1838 and crossed to the United States in 1839. He afterward built the *Enterprise*, and designed the machinery for the first screw-propeller ship of war floated on the ocean. This was the *Princeton*, built in Philadelphia in 1842. She was in continuous commission from 1843 until 1849. In 1847 she crossed the Atlantic, being the first screw war-steamer that made the passage. She cruised for two years in the Mediterranean, and was visited by thousands of persons curious to see the propelling-power. She returned to Boston in 1849, the author being one of the officers on board.

This great school has been liberally aided by the government and its growth has been gradual, but now its collection is unexampled in extent and completeness.

Professor E. H. Thurston, A. M., C. E., late an engineer officer, United States Navy, made several visits to it, and in his able and instructive report, as a member of the scientific commission of the United States to the International Exposition held at Vienna, 1873, gives the following account of its history:

Descartes, the distinguished philosopher, is claimed to have been the earliest to propose public instruction for working-people.* He proposed to build a large lecture-hall for each trade, annexing to each a cabinet containing the apparatus appropriate to that department, and to place each of these lecture-rooms in charge of a professor familiar with the subject there to be taught, who should present to the students the principles of his art in proper form, and who should be capable of answering the questions addressed him by his pupils in relation to all details of practice.

It was a century later, however, that this project of Descartes took shape, and the actual commencement of the work is attributed to the great mechanic, Vaucanson.

This distinguished man, previous to 1775, had gathered together, at *l'Hotel de Montagne*, the first collection of machinery and apparatus which was ever devoted to public use in the manner proposed by Descartes. At his death, Vaucanson bequeathed this collection to the state, and it thus became the germ of this splendid institution which is now so famous.

M. de Vandermonde, the first director, added five hundred machines to the collection between 1785 and 1792.

In 1793 a "*commission temporaire des arts*" was formed, by decree of the *Convention Nationale*, consisting of MM. Vandermonde, J. P. Leroy, Conte, Beuvelot, Molard, l'Abbe Gregoire, and the celebrated physician, Charles. This commission did a noble work in collecting valuable apparatus and models, and in preserving them from injury during the riots and the turmoil of that sad period in French history.

By a decree of the convention it was soon after ordered that a "*conservatoire des arts et metiers, un depot public de machines modeles, outils, dessins*," &c., should be established, and that three "*demonstrateurs*" and a designer should be employed. After some delays the new institution was established in the old priory of *Saint-Martin-des-Champs*.

The school has experienced the vicissitudes always to be anticipated in such cases; but its collections have never ceased growing, and its field has been extended by the addition of new departments and the establishment of new professorships, until it now has a faculty of fifteen members.

Many of the most noted French savants have been members of its councils or of its faculty. Thenard, Charles, Darcet, Dupin, Say, Clement, Berthollet, Chaptal, Gay-Lussac, Arago, Pouillet, Poncelet, Morin, Tresca, Ollivier, Becquerel, Payen, Peligot, Moll, Alcan, and others have all been, or are at present, on the list.

* The Marquis of Worcester, the distinguished inventor of one of the earlier forms of steam-engine, two hundred years ago, earnestly urged the establishment of a definitely-arranged system of technical education, which should combine instruction in science and in its useful application in the arts.

NOTE.—For valuable assistance in preparing the foregoing report, I am indebted to Passed Assistant Engineer Frederick G. McKean, United States Navy, attached to the Bureau of Steam-Engineering; and for prompt attention at the Government Printing Office, credit is due to the intelligent foreman, H. T. Brian.

