



3 1761 06895458 5

THE EYES OF THE ARMY AND NAVY



PRACTICAL AVIATION

Ex Libris



PROFESSOR J. S. WILL

INTERNET ARCHIVE

, Digitized for Microsoft Corporation
by the Internet Archive in 2007.

From University of Toronto.

May be used for non-commercial, personal, research,
or educational purposes, or any fair use.

May not be indexed in a commercial service.

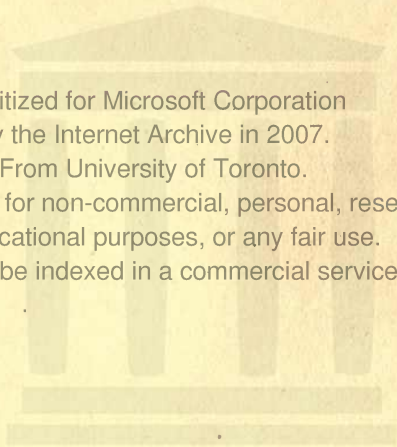

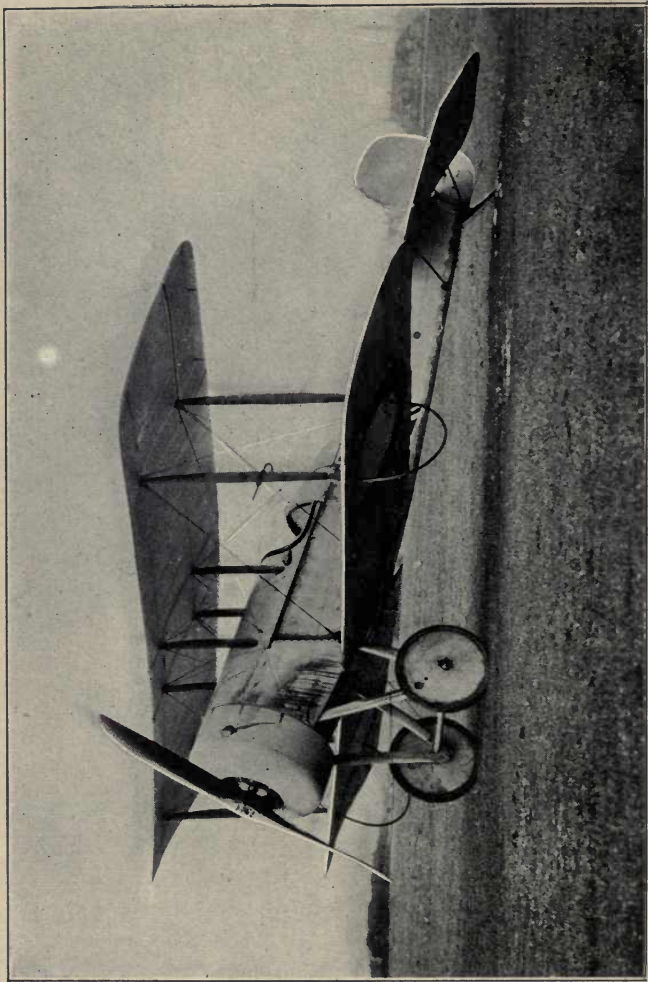

BRISTOL SCOUT (BULLET)

An English machine equipped with 80-h.p. Gnome engine used against Zeppelins

THE EYES OF
THE ARMY AND NAVY
Practical Aviation

BY
ALBERT H. MUNDAY
FLIGHT LIEUTENANT, R. N.

ILLUSTRATED

THE MUSSON BOOK CO., LIMITED
TORONTO

Digitized by Microsoft®

UG
630
M85



769036

THE EYES OF THE ARMY AND NAVY

Copyright, 1917, by Harper & Brothers
Published October, 1917

K-R

Digitized by Microsoft®

CONTENTS

	PAGE
FOREWORD	xi
CHAPTER I. AERIAL NAVIGATION	I
Importance of Aerial Navigation—The Compass—Variation—Deviation—To Lay Off a Course by Compass—The True Course and True Bearing—The Magnetic Course and the Magnetic Bearing—The Compass Course and the Compass Bearing—To Lay Off a Course Allowing for Drift—To Ascertain a Position of an Aeroplane—Consideration of Wind—Veering of the Wind—Increase in Velocity of Wind as Height Is Attained—Beaufort Wind Scale—How to Ascertain the "Radius of Action" of an Aeroplane—"Radius of Action" Returning to Different Position—"Radius of Action" Returning to a Seaplane Carrier—To Intercept an Enemy Machine.	
CHAPTER II. THEORY OF FLIGHT	23
Pressure—The Action of Pressure on a Flat Plate—Lift Over Drift Ratio—Aspect Ratio—Center of Pressure—The Advantages of Curved and Flat Planes—Stream-line Effect—The Dynamics of an Aeroplane—Lift and Drift on a Wing Section in Motion—Loading—Weight, Lift—The Gliding Angle—How to Ascertain Visibility of Horizon—Miscellaneous Formulæ—Lift and Drift Co-efficient, and Aerodynamical Efficiency Curves.	
CHAPTER III. MAP-READING	37
The Scale of a Map—Definitions: Basin, Crest, Contour, Dune, Escarpment, Gorge, Hachures, Knoll, Meridian or North Line, Magnetic Meridian, Pass, Plateau, Plotting, Salient or Spur, Setting or Orienting a Map, Underfeature, Undulating Ground, Watercourse, Watershed—Conventional Signs Adopted.	

CONTENTS

	PAGE
CHAPTER IV. CROSS-COUNTRY FLYING	43
Importance of Knowledge—General Hints.	
CHAPTER V. CHARTS	51
Starboard-hand Buoys—Port-hand Buoys—Middle-ground Buoys—Telegraph Buoys—Spoilt-ground Buoys—Abbreviations—Lights.	
CHAPTER VI. METEOROLOGY	57
Importance of Knowledge—Aeroplane Weather—Atmosphere—Composition of Atmosphere—Atmospheric Pressure—Measure of Pressure—Approximate Relation between Inches and Millibars of Pressure—High and Low Pressure Regions—Cyclone or Low-pressure Area—Line Squalls—Anticyclone—Wind—Beaufort Scale—Veering of Wind—Increase of Velocity of Wind Relative to Height—The Gradient Wind—Wind Eddies—Upward Currents—Descending Currents—Wind Layers—Clouds: The Upper Layer, The Middle Layer, Heap Clouds—Airship and Balloon Weather—Buys Ballot's Law—Conversion of Temperature—Change of Temperature Relative to Height.	
CHAPTER VII. CONSTRUCTION	78
Materials: Ash, Spruce, Hickory, Canadian Elm, Basswood, Walnut, Mahogany, Three-ply Wood—Metals: Aluminium, Duralumin, Manganese, Phosphor-bronze, Steel—Fabric: Securing and Repairing Fabric; To Repair a Tear in the Fabric when Away from an Aerodrome; Repairing a Tear in the Fabric at an Aerodrome—Dope: Its Uses—Wires: Flexible Cable, Attaching Flexible Cable, Solid-drawn Wire, Method of Attaching Solid-drawn Wire, Strength of Wire and Flexible Cable, Construction of Principal Parts of an Aeroplane—Wings: Ribs, Struts, Attachment of Struts, Wiring, Flying-wires, Landing-wires, Drift Wires, Incidence Wires, Method of Attaching Wire—The Body: Fuselage and Nacelle Covering—The Tail: The Landing-chassis, or Undercarriage; The Control of a Machine, Control Wires, Lateral Control, Truing-up an Aeroplane.	

CONTENTS

	PAGE
CHAPTER VIII. THE CARE AND MAINTENANCE OF AEROPLANES	104
Importance—The Handling and Transport of a Machine—Filling up Machines—Priming or “Doping” an Engine—Preparations for Swinging the Propeller—Swinging the Propeller—Cleaning the Machine—Storage of Aeroplane—Care of Material: Fabric, Wood, Propellers, Bracing Wires, Tires, Field Repairs.	
CHAPTER IX. AERO ENGINES	116
Requirements—Rotary Engines—Stationary Engines, Air-cooled and Water-cooled—Magnetos: Action of the Magneto, Platinum Points of Magnetos, High-tension Terminal, Low-tension Terminal, To Strip a Magneto—Care and Maintenance of Aero Engines: Causes of Defects of Engines, Backfiring, Failure to Start, Pre-ignition, Continuation of Firing when Switch Is “Off,” Misfiring, Causes of Loss of Power—Lubricants: System of Oiling on Rotary Engines—Carburetors.	
CHAPTER X. AEROPLANE AND AIRSHIP INSTRUMENTS	127
Importance—Altimeter—Anemometer—Aneroid Barometer—Inclinimeter—Laterometer—Pressure Gauge—Manometer—Revolution-counter—Speed-indicator—Statoscope.	
CHAPTER XI. WIRELESS TELEGRAPHY AND SEMAPHORE	133
Symbols Used in Diagrams of Wireless-telegraphy Circuits: Importance, Elementary Principles of Wireless Telegraphy, The Morse Code, Units of Electricity, The Coulomb, The Ampere, The Watt, The Joule, The Farad, The Henry, The Ohm, The Volt, Magnetism, Electromagnetism, Mutual Inductance, The Condenser, The Circuit, Accumulators, Electric Waves, The Aerial—Alphabet and Numeral Signs—Points to be Observed.	
CHAPTER XII. AERIAL PHOTOGRAPHY	152
Importance—Camera—Focus Lens—Ultra-violet Rays—Wratten Screen—Body of Camera—The Shutter—The View-finder—Exposures—Plate Slides—Actinometer—Plate Recommended—Printing-papers Recommended—Developing—Printing.	

CONTENTS

	PAGE
CHAPTER XIII. BOMBS AND BOMB-DROPPING	162
Types of Bombs—Method of Arming Bombs—Method of Carrying and Releasing Bombs—How to Ascertain Direction of Wind—Theory of Bomb-dropping—Square Root.	
CHAPTER XIV. NIGHT FLYING	172
Importance—Landing at Night—Methods of Placing Landing-flares.	
CHAPTER XV. ARTILLERY OBSERVATIONS FROM AIRCRAFT .	175
Shells Used by the Artillery—Signaling from an Aeroplane—Location of Targets and Ranging—Ranging—Hints for Artillery Observers.	
CHAPTER XVI. AERIAL FIGHTING	181
Formation Flying—The Flight Leader—The Flying Officer—Crossing Enemy Lines—Signals Between Machines—Attacking Hostile Aircraft—Delivering an Attack—On Being Attacked—Taking Aim in the Air.	
CHAPTER XVII. LIGHTER THAN AIR	197
Different Types—Hydrogen and Coal-gas—Balloons—The Equipment of a Balloon—Doping and Varnishing Envelopes—Handling Envelopes—Storage of Envelopes—Airship Planes and Rudders—Ballonets—Size of Ballonets—Rigging—The Mooring of an Airship—Landing Skids and Wheels—The Training of an Airship Pilot—Piloting an Airship—The Maintenance of Gas Pressure—Leaving the Ground—In the Air—Descending—Landing—Loss and Gain of Buoyancy.	
CHAPTER XVIII. MEDICAL SUPERVISION OF AVIATORS . . .	213
APPENDIX	219
Definitions and Metric System.	

ILLUSTRATIONS

BRISTOL SCOUT (BULLET)

Frontispiece

An English machine equipped with 80-h.p. Gnome engine used against Zeppelins.

"BABY" NIEUPORT (FRENCH), EQUIPPED WITH 130-H.P.

CLERGETT ROTARY ENGINE *Facing p.* 20

GERMAN AEROPLANE EQUIPPED WITH PONTOONS . . . " 58

The biplane shown is a German machine convertible for either land or sea work that has been developed since the beginning of the war. It is being brought to the water's edge by a crane.

GIANT ITALIAN TRIPLANE " 176

This Caproni triplane can carry three tons in addition to its own weight and can easily accommodate twenty-five persons. It has a 700-h.p. engine and travels ninety miles an hour. Nine guns can be mounted on the plane, and in addition a multitude of bomb-throwing, position-finding and other devices of great utility in battle and bombarding have been perfected.

FOREWORD

I HAVE read and studied most of the many hand-books on aeronautical subjects published since the outbreak of the Great War, but, although I have burned much midnight oil, the book dealing with those points and principles of aviation which many of my colleagues especially wished to have was not to be obtained. The majority of the text-books delved into unnecessary technicalities and formulæ, which many of my aeronautical friends could not fathom without much study.

It was after spending considerable time in construction-sheds, aero-engine shops, and repair plants, after graduating as an aeroplane pilot in the Royal Naval Air Service, and after many months on the French, Belgian, and British battle-fronts, with a mobile fighting squadron, that I was requested by pilot friends to compile a handbook that would meet the requirements of the layman with a moderate education who wished to obtain a practical knowledge of flying and the fundamental principles of construc-

FOREWORD

tion, aero-engines, and various other aeronautical subjects.

For the most valuable assistance and corroboration I wish to thank the many contractors, flight lieutenants, naval, army, and flight instructors, flight commanders, and others of the Royal Flying Corps and the Royal Naval Air Service. In this connection, I shall always remember with deep gratitude Lieut. J. W. Langmuir of the Royal Flying Corps for his timely and pointed suggestions.

To those who wish to become efficient in only one or two departments of aerial practice I would refer them to books dealing with special subjects, but to those who wish a general knowledge of aeronautical matters I submit this handbook with the hope that it will be not only beneficial while training, but also a help and reference in the days following graduation.

A. H. M.

"IN THE FIELD," 1917.

THE EYES OF
THE ARMY AND NAVY

THE EYES OF THE ARMY AND NAVY

I

AERIAL NAVIGATION

THE mastery of aerial navigation is, of course, the objective of every student-pilot. War conditions have emphasized the vital importance to an aviator of a thorough and intimate knowledge of flying, combined with practical experience in the use of map, compass, and other instruments used in aerial navigation. Many tragic occurrences in oversea flights have illustrated how priceless an aid to the airman is an efficient compass and a knowledge of its practical use.

The Compass

It will be well to bear in mind that the compass can give a pilot only his direction through the air; it

THE EYES OF THE ARMY AND NAVY

is very inaccurate in regard to the actual course that he is making over the ground. This inaccuracy is due to side drift.

In learning to use the aeroplane compass the practical meaning of the terms "variation," "deviation," and "drift" must be understood by the student.

Variation

The working part of a compass, which comprises the system of magnets and card, will, if undisturbed, take up a position with the north-seeking ends of its magnets pointing to the north magnetic pole. This is shown to the pilot by the card-reading, and any direction with reference to this magnetic meridian can be ascertained by the angular markings around the card, measured to the right from north, through east, south, and west. This card is graduated to 360° and in the aeroplane compass the last cipher is generally omitted to avoid crowding.

The angle between the true and magnetic meridians is *the variation*, and is termed east or west variation, according as the magnetic meridian is to the right or left of the true north. No satisfactory method of giving a "true" reading of a compass is possible; and as all maps used for land work are based on the

AERIAL NAVIGATION

true meridian (or circle joining the geographical poles of the earth), the correction known as variation must always be determined.

It is clear that the application of any correction is a

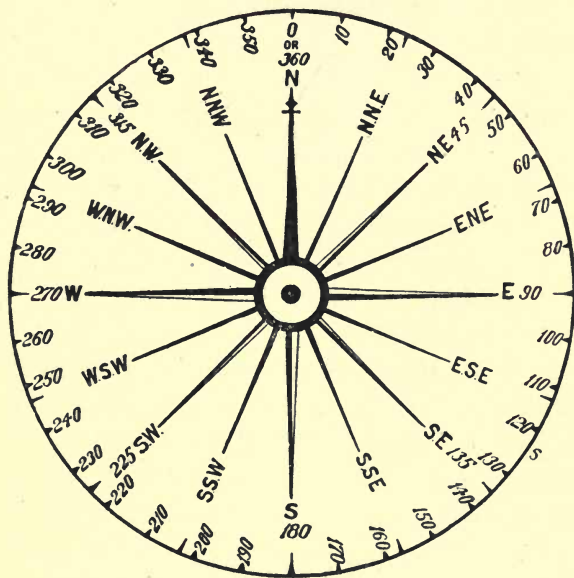

Fig. 1

troublesome matter under flying conditions, and the omission or wrong application of the variation is probably the cause of many bad "landfalls."

THE EYES OF THE ARMY AND NAVY

Deviation

Deviation is the error caused in a compass by the effect of local magnetic material used in the construction of an aeroplane. This may be to the right or left of the magnetic meridian, according to the

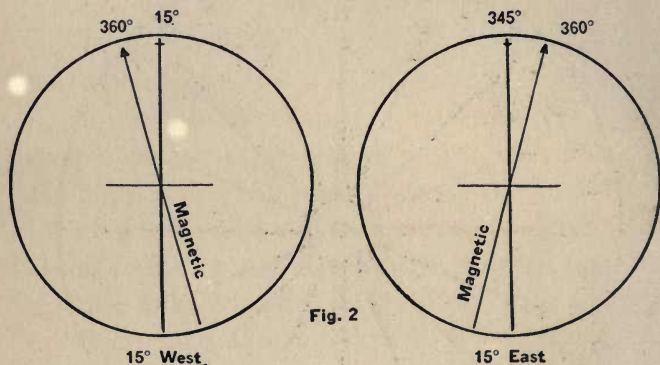

amount of disturbing influences. This error is frequently very large, and as it varies with the direction in which the machine is headed, the importance of eliminating it altogether, or at least reducing it to moderate proportions, is obvious. This may be done by properly placing and adjusting the compass. Nevertheless, even after the best correction results are obtained a deviation card is generally made out and placed near the instrument:

AERIAL NAVIGATION

Example:

For Magnetic Course

North.....	4°
Northeast	49°
East.....	92°
Southeast	137°
South.....	182°
Southwest.....	223°
West	268°
Northwest.....	312°
North	4°

For example, a pilot wishes to steer to a point in a northeasterly direction; instead of steering 45°, he must steer 49°. In this case the deviation is westerly and would be termed 4° westerly deviation. It will be noticed in the above table that on the northeast, east, southeast, and south, *westerly deviation* is noticed. A very good method of ascertaining whether the error is east or west is to memorize the following lines:

Compass best deviation west,
Compass least deviation east.

For instance, if the compass was 49° instead of 45°, the reading would be termed best or greater and the deviation would be west; but in the case of the reading being least, the deviation would be east.

The first rule for an air pilot should be to familiarize himself with the use of the compass by employing

THE EYES OF THE ARMY AND NAVY

it constantly to keep his direction. The majority of aviators are without experience in the use of the rudder for keeping a steady course or direction, and often the compass is blamed quite unjustly for unsteadiness which is simply due to bad steering. However, if long flights by compass are to be made with any certainty the pilot must be capable of steering a steady course by the instrument, and considerable experimenting is necessary under all conditions.

To Lay Off a Course by Compass

The courses and bearings may be placed in three distinct classes: the true course and the true bearing, the magnetic course and the magnetic bearing, and the compass course and the compass bearing. If the student-pilot masters the principles of mapping out a true course and thoroughly understands the meanings of the associate terms, he will experience few difficulties.

A. The true course is the angle between the true meridian and the meridian on which a point lies.

B. The magnetic course is the angle between the magnetic meridian and the meridian on which a point lies.

C. The compass course is the angle between the

AERIAL NAVIGATION

direction in which the compass points approximately north, or the compass north, and the meridian on which a point lies.

Consider the aeroplane heading in direction D, then:

A = Magnetic course.

B = Compass course.

C = True course.

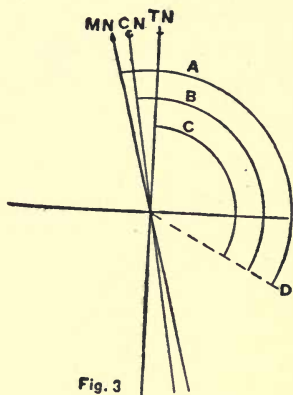

Fig. 3

Suppose it is desired to steer a course from a place A to a place B, on a map of sufficiently small scale to contain both places. Join A and B with a light pencil line and make a note of all prominent places or objects that the line passes over. Lakes, railways, villages, and large forests are excellent landmarks. Lay a pair of parallel rulers along the line and then transfer the line to one of the uprights of the edge of the map, which are drawn true north and south, and read off the angle the rulers make with the perpendicular. This angle will give the true course. To obtain the magnetic course, the *mean* of the variations between the two points must

THE EYES OF THE ARMY AND NAVY

be applied and added or subtracted accordingly, whichever side of true north the variation may be. Should there be any deviation, it should be applied also.

The drawing of a rough figure will always be found helpful, as the pilot can tell at a glance in which direction the error should be applied. In laying off bearings on the map they should be corrected for variation and brought up to the true in the reverse way.

Thus, if your compass has a variation of 15° and the magnetic bearing is 65° , then obviously the true bearing of the place must be $65^{\circ} - 15^{\circ} = 50^{\circ}$.

To Lay Off a Course, Allowing for Drift

Suppose a pilot wishes to travel from A to B and the magnetic course is 65° , the speed of the machine is 60 knots an hour and the wind direction is southeast (which is 135° true).

Lay off a line A-B in the direction required (65° magnetic bearing). From A set off a line in the direction of the wind (135° true), and mark off on the line a point equal to an hour's wind speed upon the line A-C. This should be applied from a scale already decided upon.

Set the dividers at an hour's speed of the aircraft,

AERIAL NAVIGATION

applying the same scale, and from the point C cut the line A-B with an arc and mark this point D. Join the two points C-D. Next draw the true north-and-south line through the point C, and by placing a protractor on the north-and-south line, central, at the point C, the angle the line C-D makes is the true course. By

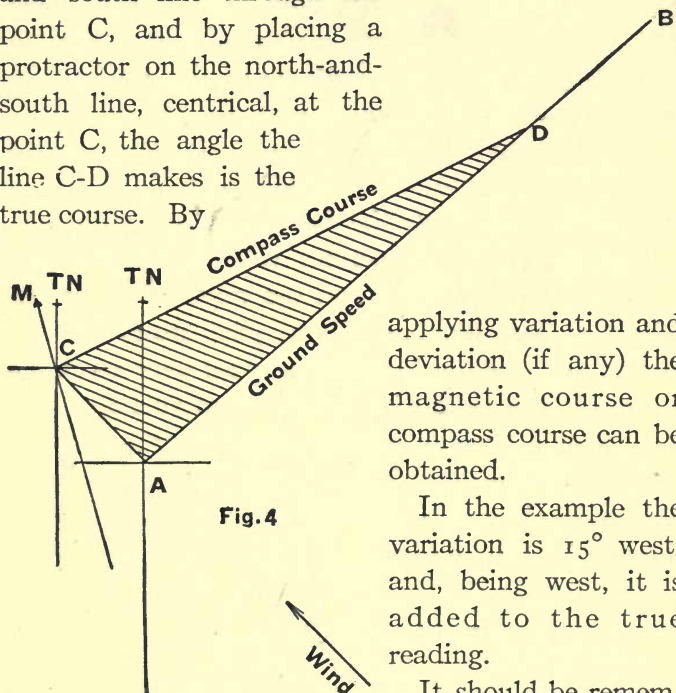

Fig. 4

applying variation and deviation (if any) the magnetic course or compass course can be obtained.

In the example the variation is 15° west, and, being west, it is added to the true reading.

It should be remembered that in the first course the wind was not considered, and to get from A to B it was necessary to steer 65° magnetic or 50° true. But when the wind is to be taken into account

THE EYES OF THE ARMY AND NAVY

it will be readily observed that it is necessary to steer 79° magnetic or 64° true if the pilot wishes to fly straight on the course A-B. The horizontal and vertical lines through the point A are only guide-lines to insure the correct placing of the protractor when mapping out the direction of the wind. The line A-D is the ground speed for one hour of flight. By ascertaining the length of the line D-B and applying it to the ground speed, the time it would require to cover the distance A-B is obtained.

Assuming that the correct calculation regarding the velocity of the wind and the velocity of the machine has been obtained, if the pilot steers the correct course, the machine should pass over the landmarks already selected. A very good rule to follow is to take bearings of certain objects in the range of vision from the map before a pilot starts out, and as the journey is undertaken the course may be checked from time to time.

To Ascertain Position

A position of an aircraft can be obtained by taking bearings of an object ahead and slightly to one side of another object abeam or a little abaft the beam, and where these two lines cross is the position of the aeroplane.

AERIAL NAVIGATION

The bearing of point X is 70° true and the bearing of point Z is 150° true. Place the protractor, central, at the point X and mark off the true bearing. Produce the line through the point. Carry out this same procedure on the point Z and by ascertaining the latitude and longitude of the point where the lines cross, the exact position is obtained.

Parallels of latitude are obtained from the north and south edges of the chart or map, and longitude from the meridians given at the top and bottom of the chart or map.

Consideration of Wind

In calculating courses where wind is to be considered it is absolutely necessary to have a knowledge of the increase in velocity of the wind and the veering and backing as height is attained.

Veering of the Wind

When a wind is said to "veer," one means that it is moving around in a clockwise direction, and to "back" indicates that the motion is in an anti-clockwise direction; however, in the northern hemisphere the wind seldom "backs," and in all calculations it is

THE EYES OF THE ARMY AND NAVY

advisable to allow for veering at the following average:

At 1,000 feet the wind veers 10°

At 2,000 feet the wind veers 15°

At 3,000 feet the wind veers 20°

Above this height the wind remains practically constant.

At 1,000 feet the velocity of the wind increases to one and a half times its own velocity.

At 2,000 feet the velocity of the wind increases to twice its own velocity.

Above 2,000 feet there is practically no increase. In the aeronautical school the speed of the wind is always given in force numbers as indicated by the Beaufort Scale.

BEAUFORT WIND SCALE

<i>Force</i>	<i>Velocity in Nautical Miles per Hour</i>
1.....	1-3
2.....	4-6
3.....	7-10
4.....	11-16
5.....	17-21
6.....	22-27
7.....	28-33
8.....	34-40
9.....	41-47
10.....	48-55

AERIAL NAVIGATION

How to Ascertain the Radius of Action of an Aeroplane

If a pilot is ordered to scout in a certain direction and the machine has petrol-supply for a given time, with a little calculation a pilot can ascertain the correct time to commence the return journey and the position reached. If the expedition is undertaken on a comparatively calm day, the pilot can ordinarily fly in the direction ordered for half the time of petrol-supply and then return; but when the wind is to be taken into account a calculation is necessary.

EXAMPLE.—A pilot is ordered to scout in a north-easterly direction, the machine has petrol-supply for five hours, and the wind is south. The order is given to a pilot and it is for him to work out the problem. First it is necessary for him to ascertain the speed of the wind and decide the height at which he will carry out the scouting patrol. Suppose the wind is 9 knots an hour and the pilot decides to fly at 3,000 feet. The upper wind, or the wind at the height mentioned, will be twice the velocity, which will be 18 knots and will veer 20° . Therefore, instead of the wind being in a direction southeast (135° true) it will be 155° true.

Now that the direction and speed of the upper wind has been obtained and the pilot knows the

THE EYES OF THE ARMY AND NAVY

speed of his machine (say 60 knots an hour), he can work out the problem.

Draw a line A-B in a northeasterly direction; select a point E, approximately half-way along the line. From this point E draw the wind line E-C to a scale decided upon. The E-C line should indicate an hour's speed of the wind—18 knots. Set the dividers at 60 knots, the speed of the machine for one hour, according to scale, and set

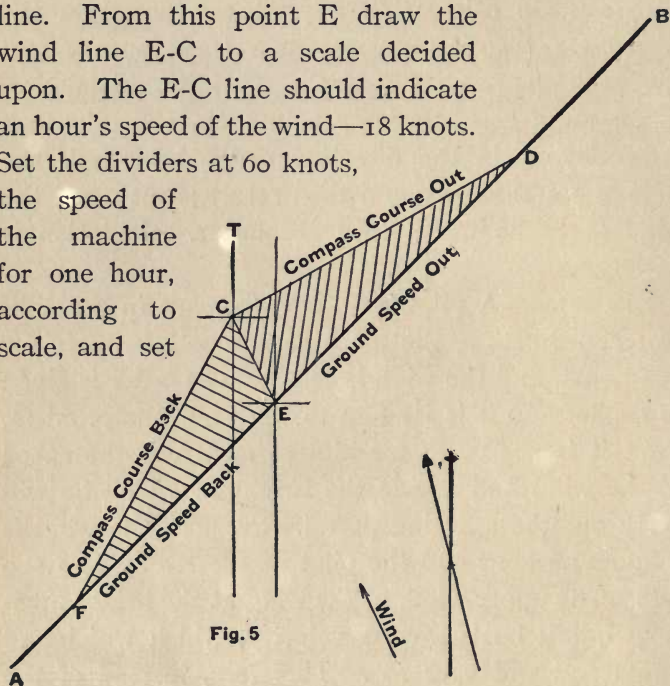

Fig. 5

one point of the dividers at the point C and cut the line E-B. Mark the point obtained D. From the point C, mark off a similar distance to cut the line E-A, and mark the point where the E-A line is cut F. Connect the

AERIAL NAVIGATION

points C-D and C-F. Draw the north line through C, and the angle the line C-D makes is the course out, and the angle the line C-F makes is the course returning. E-D is the ground speed out, and E-F the ground speed on the return journey. These two speeds should be termed G.1 and G.2, respectively, and by applying the following formula the radius of action is obtained:

$$\begin{aligned} \text{Radius of action} &= \text{Time} \times G.1 \times G.2 \\ \text{Time to turn} &= \frac{\text{Radius}}{G.1} \end{aligned}$$

In the example the time is five hours, G.1 is 62 miles and G.2 is 52 miles, therefore:

$$R = \frac{5 \times 62 \times 52}{62 + 52} = 141.4$$

$$\text{Time to turn} = \frac{141}{62} = 2 \text{ hours } 17 \text{ minutes} \\ \text{(approximately)}$$

If a pilot desires to ascertain the position reached, all that is necessary is to apply the time out and locate the position. For instance, if the time to turn is two hours, measure twice the ground speed out on the E-B line produced, and the point reached is the point of turning or should be if the pilot has calculated correctly.

THE EYES OF THE ARMY AND NAVY

Radius of Action and Returning to a Different Position

To scout in a given direction and return to another point, or to a seaplane carrier steaming in a given direction, is an order that often appears when on seaplane duty, and quite occasionally land-machine pilots are ordered to patrol an area in a certain direction and return to an aerodrome many miles from the home station.

EXAMPLE.—Scout in a direction northeast and return to a point eighty miles north.

The pilot ascertains the direction of the wind and the force. He decides to fly at 4,000 feet. Suppose the surface wind is Force 3, at the height mentioned it would be approximately 18 knots and would veer 20° . Suppose the wind is from the south and it veers the 20° , it would be 20 west of south. The speed of the machine is 60 knots an hour and has petrol-supply for four hours.

Draw a line A-B in the direction named and then the wind line A-C. From C set off an hour's speed of the machine and mark the point where the A-B is cut D.

From A draw a line north (true) and measure off (to scale) 80 miles. Mark the point F. The machine has petrol-supply for four hours, therefore, as one hour is being considered in the problem, mark off a point

THE EYES OF THE ARMY AND NAVY

viation (if any) the magnetic, or compass, course can be obtained.

The line A-D is the ground speed out for one hour.

The line C-D is the magnetic course, assuming that the magnetic course is desired and the correct applications have been made.

The line C-H is, likewise, the course to steer for the return journey.

The line H-A is the ground speed for one hour on the return trip. The transferred line F-J is the actual track returning.

This problem, as also the preceding radius of action problem, can be proved by applying the ground speed along the track line. If the figure has been worked out correctly, the ground speed should correspond with the number of hours of petrol-supply; but care should be taken, when proving figures, that the correct lines are applied. In the last example the line A-D should only be applied along the line A-J, and then the line A-H should be applied along the line J-F.

Thirty minutes instead of an hour may be taken in all the above problems, as long as the pilot bears in mind that only thirty minutes is being considered throughout and applies the scale accordingly. In my experience of mapping out courses I have found

AERIAL NAVIGATION

that one hour is the most advisable to use, as much calculation is thereby eliminated.

Radius of Action Returning to a Seaplane Carrier Steaming in a Given Direction

A pilot is ordered to scout in a northeasterly direction and to return to a carrier which is steaming south at 15 knots an hour. Wind is from the northwest and the machine has petrol-supply for four hours. Suppose the expedition is carried out at 4,000 feet and the surface wind is 10 miles an hour. At the height mentioned it would veer over 20° and be twice its surface velocity; therefore it would be from a direction 335° and the strength would be 20 miles an hour.

Draw a line A-B in the direction named and from A draw a line south, and produce this line a short distance north of A. On this line produced mark off a distance equal to an hour's speed of the carrier; mark this point C. From C mark off the wind C-D. From D set the dividers at the speed of the aircraft for one hour, take 60 knots, and cut the line A-B. Mark the point obtained F. Join C and F, and D-F. From A measure the distance that the carrier would cover in four hours and mark off this distance on the south line from A. Indicate the po-

"BABY" NIEUPORT (FRENCH), EQUIPPED WITH 130-H.P. CLERGETT ROTARY ENGINE



AERIAL NAVIGATION

line F-C and from the point D cut this line with an hour's speed of the aircraft. Mark this point P. Join the points D-P and A-P. The line D-P is the return course line, and the line A-P the ground speed for one hour on the return journey. In all problems where a ship steaming in a given direction has to be considered, it is necessary to reverse the ship's speed (the line A-C in the example) in order to bring the ship at rest to allow for calculation of wind. (Fig. 7.)

To Intercept an Enemy Machine

This order is a very common one on active service and when on coastal patrol. An enemy machine is reported to be flying over a position 100 miles southeast of your location and steering in a northeasterly direction. You are ordered to intercept the machine. (Fig. 8.)

Mark your location A and draw a line southeast (true, unless otherwise stated). To a scale mark the position 100 miles southeast B. Draw a line of indefinite length in a northeasterly direction and mark the farthest point C. From B set the distance equal to an hour's speed of the enemy aircraft. In this case we will take 60 knots. Mark the point obtained D. Set the dividers at one hour's speed of your own machine, take 75 knots, and set one point

THE EYES OF THE ARMY AND NAVY

of the dividers at the point D and cut the line A-B. Mark the position obtained H. Join D to H. From the point A draw a line parallel to the line H-D, and where this line cuts the B-C line is the point of inter-

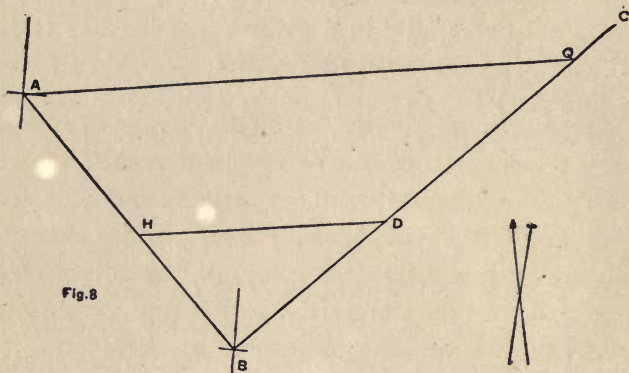

ceptance. Mark the point Q. A-Q is the course, and as the wind is not taken into account it is also the track. H-D is the ground speed for one hour; therefore H-D into A-Q will give the time to intercept. In problems of this nature the wind is seldom taken into account, as the enemy machine is also affected.

II

THEORY OF FLIGHT

IN the study of theory of flight many formulæ are necessary to gain a comprehensive knowledge of the various lift and drift coefficients and to learn how to apply the coefficient curves. This chapter deals only with a brief description of the action of a stream of air on different-sized planes and gives only a general outline of the dynamics of an aeroplane.

Pressure

The pressure of the atmosphere is due to the weight of the atmosphere; it is usually measured by the height of a column of mercury. At mean sea-level, at a temperature of 32° Fahrenheit, the normal pressure is 29.9 inches of mercury; under the same circumstances, at sea-level, the weight of a cubic foot of air is .08 pound. The pressure of the atmosphere is affected, to a moderate extent, by both temperature and humidity. When the atmosphere is in motion there is a large mass of air under weight, and in this

THE EYES OF THE ARMY AND NAVY

condition it possesses considerable energy and is capable of exerting force. By the use of aero-engines the air is put into motion and similar energy is obtained.

The Action of Pressure on a Flat Plate

If a flat plate is towed at right angles to a stream of air the stream will be deflected and will flow over the edges of the plate and will unite again a considerable distance to the rear. To the immediate rear of the plate, eddies will be formed, and on the front part of the plate a pressure will be exerted. This pressure and the eddies formed will cause a drop in the general pressure; therefore the force necessary to keep up a steady forward motion of the plate will depend on

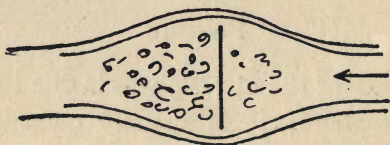

Fig. 9

the difference of the absolute pressure between the two sides of the plate. The total pressure will also be influenced by the length of the edge of the plate, the point of greatest pressure being near the center of the plate. (Fig. 9.)

The resistance to forward motion varies as the ve-

THEORY OF FLIGHT

locity squared; generally written V^2 . If a plate of one square metre is towed at the rate of one metre a second a resistance of .08 kilo will be set up; therefore for calculation of the power wasted by the detrimental surface of an aeroplane the following formula is used:

$$R = .08 \times A \times V^2 \text{ and}$$

R = Resistance.

.08 = Unit of resistance.

A = Area of supporting or lifting surface.

V^2 = Velocity squared.

The term "detrimental surface" includes the fuselage, landing-chassis, struts, wires, pilot, and in fact all those parts which do not help in the lift, but on the contrary retard the progress of the machine.

Lift Over Drift Ratio

On a flat plate the "lift over drift" ratio may reach a fairly high value, but its value is small, while the lift coefficient is sufficiently large for ordinary purposes. The negative pressure, or suction, upon the upper surface of a wing section provides not less than 75 per cent. of the total lift. There is a critical angle above which the negative pressure on the upper surface becomes uniform, while the pressure on the lower surface falls off. The effect is to cause a sudden

THE EYES OF THE ARMY AND NAVY

decrease in the total lift, coupled with a sudden increase in the drift. At an angle of incidence less than 2° the pressure upon the lower surface vanishes and becomes negative.

Aspect Ratio

Aspect ratio is the porportion that the length of the plate or plane bears to the width. A stream of air naturally follows the path of least resistance;

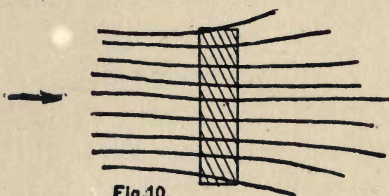

Fig.10

GOOD ASPECT RATIO

therefore it will not only attempt to escape over the forward and rear edges of the plate, but also over the

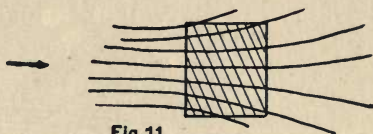

Fig.11

POOR ASPECT RATIO

sides. This leakage means loss of power. In the Fig. 10 it will be readily observed that the plate suffers very

THEORY OF FLIGHT

little from the leakage on account of the good aspect ratio, but in the Fig. 11 the leakage is very pronounced.

In the above paragraphs a flat plate towed at *right angles* with the stream of air has been considered throughout. If a flat plate is *inclined*, the stream lines

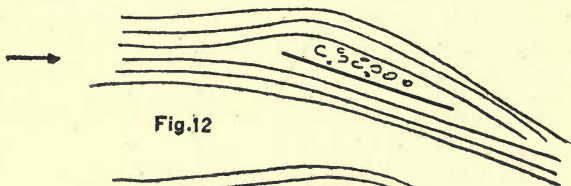

Fig.12



Fig.13

will follow the underneath part of the plate closely, but will be deflected to a considerable degree at the top surface, and an eddy field will result. A suction or negative pressure is set up by the eddies, which increase the total resistance to a large extent. In order to overcome this eddy field, curved planes are used for all aeroplane work. (Figs. 12 and 13.)

Center of Pressure

It will be observed that in a flat plane the center of pressure is in the middle of the plane at approxi-

THE EYES OF THE ARMY AND NAVY

mately ninety degrees, and moves nearer to the leading edge as the angle of incidence decreases; however, in a curved plane the center of pressure follows a more complex law. In a curved plane the center of pressure is also at the middle of the plane at the same angle as the flat plane, but it gradually approaches the leading edge until the angle of thirty degrees is reached; it then moves abruptly until the angle of incidence is slightly above fifteen degrees, when it approaches the trailing edge rapidly. Therefore it should be borne in mind, in considering ordinary angles of incidence used in aviation, that when the angle of incidence decreases in a flat plane the center of pressure moves toward the leading edge, and in a curved plane the center of pressure moves toward the trailing edge.

The Advantages of Curved and Flat Planes

The lift or pressure which the wind exerts on any plane is due to, and is a measure of, the downward momentum of the mass of air dealt with by the plane.

In the curved plane the air is not only given a more downward trend, but it is given this downward trend with far less eddying.

The effect is that a bigger vertical momentum is produced with actually less resistance; thus the effi-

THEORY OF FLIGHT

ciency of a properly designed curved plane is immensely greater than that of a simple flat plane.

It is of great importance to notice that, whether in the flat plane or the curved plane, the lower and the upper surfaces each contribute to drive the air downward; when the plane is set at an angle to the air, the under surface by directly forcing the air to take a downward path and the upper surface by the force of suction or negative pressure, of the total lift thus derived at ordinary small angles of incidence about 70 per cent. is due to this suction on the top surface.

When the top surface is divided from the bottom surface, as is practically always the case in modern aeroplanes, the lifts due to each surface are practically independent of one another; that is to say, we can have a flat or convex or concave under surface without altering the characteristics of the upper surface appreciably; conversely, we could alter the camber of the upper surface considerably without affecting the lift due to the under surface appreciably.

Stream Line

In aeroplanes, as in airships, the object is to present as little resistance to forward motion as possible; therefore all the materials are made smooth, projections eliminated, and the various parts which go to

THE EYES OF THE ARMY AND NAVY

make up a complete aeroplane stream-lined. By stream-lined is meant that a body must be so shaped that when it strikes or is struck by a current of air very few eddies are caused. It has been proved conclusively that for low speeds the shape of the rear part of the body is more important than the front. The reason of this is that the air is easily split asunder with little eddying, but if it is to be united again evenly, without eddies in the rear, the sides of the body must be carefully shaped to lead the air to unite.

If the trailing edges of the body are not stream-lined, the air streams do not unite until some distance



Fig.14

NON-STREAM LINE



Fig.15

STREAM LINE

behind the body. In this space, namely, between the body and where the currents unite, eddies are formed; to form these needs an expenditure of energy. For this reason it will be seen, on looking at an aeroplane, that all spars and struts are placed blunt-edged forward and stream-lined in rear. (Figs. 14 and 15.)

The Dynamics of an Aeroplane

If a wing section or aerofoil is towed through air, disturbances are set up. These disturbances are of a

THEORY OF FLIGHT

very complex character and the nature of them depends upon the shape of the wing section, its presentation to the air current, and a few minor factors.

The general trend of the air is in a downward direction. When matter has velocity imparted to it, it is said to possess momentum. This momentum is measured by the product of the mass of the matter and its velocity. The force necessary to impart this momentum is equal to the amount of momentum imparted to the matter in unit time. For instance, if a wing section deals with a mass of air A pounds in one second and gives to the mass of air a vertical downward velocity of B feet a second, then it is obvious that the force necessary to create this air disturbance is A pounds $\times B$ feet and it will be readily observed that the upward reaction on the wing must also be equal to AB .

In addition to the downward velocity imparted to a mass of air by the moving plane, which produces lift, there is also a certain amount of relative forward motion given to the air, due to the angle of incidence and the skin friction. This reaction is called resistance, or the drift of a plane. Therefore the most efficient lifting surface is one in which the upward force per unit area of surface is large, while the resistance or drift is comparatively small. In order to maintain flight the power supplied to an aeroplane has to be

THE EYES OF THE ARMY AND NAVY

great enough to overcome the resistance set up by the wings, and to provide sufficient extra thrust for the body and all other non-lifting surfaces.

Lift and Drift on a Wing Section in Motion

In Fig. 16 a wing section, whose chord is inclined at an angle S to the direction of motion, is represented. S is the angle of incidence. V indicates the speed of the air relative to the machine or the actual speed

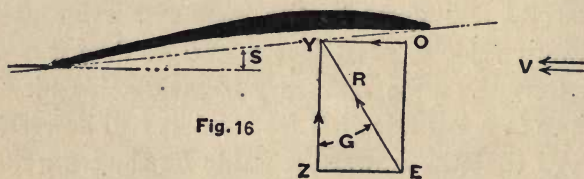

Fig. 16

of the aeroplane when flying in still air. $Z-Y$ represents the lift on the plane, while $O-Y$ indicates the drift or resistance to motion. $E-Y$ is the resultant force on the wing section and is inclined to the direction of the lift at the angle $E-Y-Z$, which is equal to G , the gliding angle; for the particular wing section and angle of incidence. Y , the point at which the resultant force cuts the chord, is the point of the center of pressure. This point varies with the angle of incidence, and is described under "center of pressure."

THEORY OF FLIGHT

Loading

The loading of an aeroplane is the weight carried per unit area of supporting surface; therefore if W equals the total weight of a machine and A is the area of supporting surface,

$$\text{Loading} = \frac{W}{A}$$

Example:

Weight of machine is 2,000 pounds
Area.....500 square feet
= Loading = 4 lbs. per sq. foot

The loading is always constant for a given machine.

Weight = Lift

In horizontal flight the lift on the wing of an aeroplane must be exactly equal to the weight of the machine; therefore, $W = L$.

The Gliding Angle

A machine gliding at its correct gliding angle is under the same conditions as when flying level. In Fig. 17 a machine gliding is represented.

L-K is the gliding path. J-M represents the total weight which replaces the thrust of the engine; there-

THE EYES OF THE ARMY AND NAVY

fore it is equal to the total resistance of the machine at the particular angle of incidence at which the machine is flying. J-X is the component of the weight

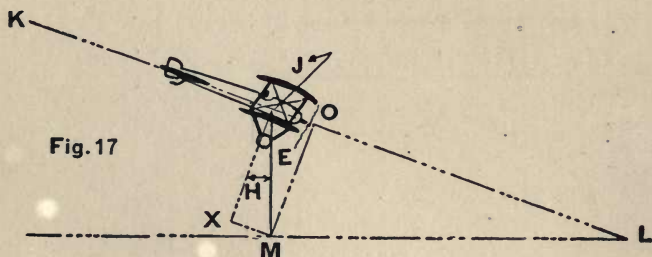

Fig. 17

perpendicular to the flight path and practically equal to the weight. Therefore,

$$\text{Gliding angle} = \frac{\text{Total Resistance}}{\text{Weight}}$$

The point of minimum total resistance gives the flattest gliding angle.

How to Ascertain Visibility of Horizon

$$\text{Visibility of height} = 1.15\sqrt{H}$$

Note: (For explanation of square root " $\sqrt{\quad}$ " see "The Application of Square Root" under chapter dealing with bombs and bomb-dropping.)

THEORY OF FLIGHT

LIFT AND DRIFT CO-EFFICIENT, AND AERO-DYNAMICAL EFFICIENCY CURVES

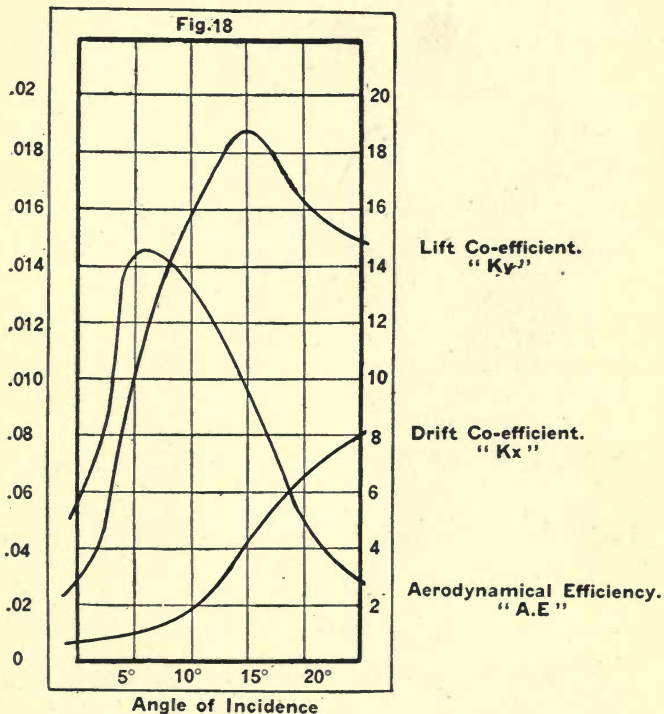

The maximum value of Lift Co-efficient is from .018 to .02, and occurs at 15 degrees angle of incidence.

The maximum Aerodynamical Efficiency is just over 14, and occurs at 4 degrees to 6 degrees angle of incidence.

THE EYES OF THE ARMY AND NAVY

Example: An aeroplane is flying at a height of 8,100 feet; find visibility of horizon.

$$\text{Visibility of horizon} = 1.15 \sqrt{8100}$$

Square root of height is 90, therefore visibility of height, =
 $1.15 \times 90 = 103.5$ miles

Miscellaneous Formulæ

To ascertain the weight of a machine:

$$W = K_y \rho A V^2$$

W = Weight.

K_y = Lift co-efficient.

ρ = Density of air (usually .08 lbs. per cubic ft.)

A = Area of wing surface.

V^2 = Velocity squared.

$$\text{Area of wings} = A = \frac{W}{K_y \rho A V^2}$$

$$\text{Resistance} = \frac{\text{drift}}{\text{weight}} = \frac{K_x}{K_y}$$

$$\text{Velocity} = \sqrt{\frac{\text{weight}}{K_y \rho A}}$$

Thrust = (approximately) $\frac{1}{6}$ of weight.

$$\text{Stalling speed} = \sqrt{\frac{\text{loading}}{K_y \rho}}$$

III

MAP-READING

IT is not necessary for a pilot to have an extensive knowledge of this subject, but the meanings of the various conventional signs that are used on service maps and nautical charts, and a knowledge of how to apply a scale of a map, are absolutely essential. The scale of a map, sketch, or plan is used to denote the proportion that a distance between any two points on a map bears to the distance between the same two points on the ground. For instance, if the distance between two towns on a map is one inch and the distance on the ground is two miles the scale may be said to be one inch to two miles. The scale of a plan is dependent upon the amount of detail which has to be shown. In the case of plans of houses, fortifications, and earthworks the scale would be a large one, whereas in sketches of roads, routes, and positions the scale would be small.

There are various methods of showing the scale. On a plan it may be stated that the scale is "so many

THE EYES OF THE ARMY AND NAVY

inches to the mile," or "so many miles to the inch." What is known as a representative fraction (R. F.) may be used. In this case the numerator is always one unit and the denominator is expressed in similar units. The latter shows the length of a line on the ground which is represented by the former on the plan. The unit may be an inch, a foot, a yard or a metre.

For instance, if the R. F. is $\frac{1}{50}$ it means that one inch on the map represents 50 inches on the ground; 1 foot represents 50 feet; 1 yard, 50 yards; and, in fact, 1 unit represents 50 units. It is immaterial what the unit may be. It is well to remember that the majority of maps are based on the inches to the mile scale, and if a pilot once trains his eye to readily recognize the length of an inch on paper he will readily estimate the distance between any two points on a map with considerable accuracy. Maps of a foreign and colonial origin are, however, generally constructed so that the denominator is a multiple of ten. For an example the scale adopted for military maps of South Africa is $\frac{1}{250,000}$, and the scales used for the German maps are:

$\frac{1}{25,000}$ for roads and rivers. This scale is rather more than two and a half inches to a mile.

$\frac{1}{12,500}$. This scale is used for positions, and is somewhat more than five inches to a mile, but for

MAP-READING

tracts of country 1:100,000, less than one inch to a mile, is used.

Map-reading Definitions

BASIN. This term is used to describe a small area of level ground surrounded, or nearly surrounded, by hills, and also to describe a district drained by a river and its tributaries, as the "Basin of the Thames."

CREST. The top of a hill or mountain.

CONTOUR. An imaginary line along the surface of the ground at the same height above mean sea-level throughout its length.

DUNE. A hill or ridge of sand formed by the wind.

ESCARPMENT. An extended line of cliffs or bluffs.

GORGE. A rugged and deep ravine.

HACHURES. Hachuring of a vertical nature is the conventional method of representing hill features by shading in short disconnected lines drawn directly down slopes in the direction of the flow of water on the slopes.

KNOLL. A low detached hill.

MERIDIAN OR NORTH LINE. A true north-and-south line.

MAGNETIC MERIDIAN. A magnetic north-and-south line.

THE EYES OF THE ARMY AND NAVY

PASS. A track over a mountain range. Usually a depression in the range.

PLATEAU. An elevated plain.

PLOTTING. The process of taking notes and sketches of observations and measurements.

SALIENT or SPUR. A projection from the side of a hill or mountain running out of the main feature.

SETTING or ORIENTING. A person is said to set a map when placing a map or plan so that the north-and-south line points north and south.

UNDERFEATURE. A minor feature; an offspring of a main feature.

UNDULATING GROUND. Ground which alternately rises and falls gradually.

WATERCOURSE. The line defining the course of water. The lowest part of a valley, whether occupied by water or not.

WATERSHED. A ridge of land separating two drainage basins. A summit of land from which water divides or flows in two directions. This term does not necessarily include the highest point of a range of mountains or hills.

There are many other terms, such as **hill**, river, mountain, island, cliff, and ravine, which I do not think it necessary to define.

MAP-READING

Church or Chapel

with Tower



with Spire



without Tower
or Spire



Windmill



Road enclosed by hedge, fence, ditch
or obstacle of any kind.



Villages
under 4" to 1 Mile



Wood



Scale 4" to 1 Mile

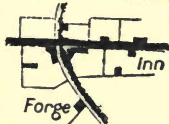

Lake



Telegraph



ABBREVIATIONS

P.----- Post Office

T.----- Telegraph

S.P.----- Sign Post

Entrenchments



Footpath

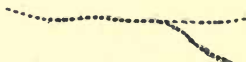

CONVENTIONAL SIGNS ADOPTED ON SERVICE MAPS AND FIELD SKETCHES

THE EYES OF THE ARMY AND NAVY

Conventional Signs Adopted on Service Maps and Field Sketches

Railways are indicated by a heavy line and roads by a double line. On all maps and field sketches the north line and magnetic north line are almost invariably indicated, and in making field sketches and notes on observations the point should be observed and marked on the sketch.

IV

CROSS-COUNTRY FLYING

ON most naval and military aeronautical services special rules and regulations are laid down and must be carried out before a pilot is allowed to undertake a cross-country flight, but from experience I advise the student-pilot to use common sense and to memorize a few common-sense rules. Before starting on a cross-country flight always assure yourself that your machine is in perfect condition. Have the engine tested and personally examine the controls, control wires, landing-wires, chassis, and the machine in general. Insure that the tires are sufficiently inflated and that the dust-caps are screwed on. Tank-caps should also be securely screwed down. Until you know your mechanics are reliable always make certain yourself that you have a petrol and oil supply for the journey. A careless mechanic may be the cause of a forced landing, and a landing of this nature may cause damage to the machine. Map out your course and always take a map or sketch of the

THE EYES OF THE ARMY AND NAVY

country that you intend passing over. Make notes of prominent landmarks. The most difficult country over which to navigate is where the ground is covered with a network of small roads and dotted with hamlets and small villages. Roads do not make good landmarks, as at a height they all look alike.

A good way to identify a small village is by the position of the church with reference to the roads. On large maps streams are usually much more conspicuous on the map than on the ground.

Railways are always very good landmarks, and as a rule are very conspicuous. Towers, windmills, church spires, and the like are as a rule not very conspicuous unless flying low.

Woods are usually very accurately marked on service maps and are seen very easily from above.

When traveling directly into the eye of the sun a slight haze is liable to obliterate many landmarks, but on such occasions water can usually be detected many miles away.

If the journey is to be a long one it is advisable to obtain a weather report from the place of destination; otherwise a pilot may run into a mist or fog when nearing his destination and disastrous results may follow.

Always "take off" and land head to wind, and while flying keep a sharp lookout for other aircraft. If a

CROSS-COUNTRY FLYING

pilot should encounter other aircraft he should not leave it to the pilot of the other machine to keep clear of his own machine, no matter how well he is acquainted with the good qualities of the other pilot; on the contrary, he should assume that the other pilot is a "blockhead" and doing his best to collide. If pilots follow this principle collisions in the air will be greatly eliminated.

The direction of the wind can be ascertained by the direction of the smoke from factory smokestacks or house-chimneys, but never under any circumstances consider the direction of smoke from a moving train or steamboat. As you fly along, frequently consider how the present wind will affect your return journey.

If a pilot makes a forced landing, the care of his machine and the immediate resumption of his journey should be his first thoughts. If repairs are likely to take considerable time it is advisable to get the machine under cover and well guarded, as inquisitive onlookers, while not intending to damage a machine, have frequently been the cause of further delay by petty meddling. If a pilot is unable to obtain shelter for the machine it is advisable to lash the machine down and cover the engine.

It is advisable after every flight to report the condition of the engine and the machine in general

THE EYES OF THE ARMY AND NAVY

to the engineer rating and the carpenter rating in charge of the respective machine.

In cross-country flying the chief danger is that the engine will fail when the aeroplane is over ground on which it is impossible to land. When the engine "gives up the ghost" the machine must come down somewhere inside a circle whose radius is about equal to five times the height of the aeroplane above the ground. If an aeroplane is flying at a height of one mile the pilot will have an area of about 60 square miles in which to choose a landing-ground, while at a height of 2,000 feet on a calm day the machine has less than 10 square miles to choose from. In England it is almost always possible to choose a favorable landing-place in a circle containing 60 square miles, but it is frequently impossible to do so in an area of 10 square miles. For this reason cross-country trips should never be undertaken when clouds are at a low altitude.

War Flight

If a pilot is about to leave on a bomb-dropping expedition he should personally examine all bombs. The wind-vanes should work freely and the safety pins should be removed. The dropping-gear should be tested by having a man stand under the bomb-

CROSS-COUNTRY FLYING

frame and catch the bomb when the bomb is released by movement of the releasing-lever. The machine-gun should be tested by firing from twenty to thirty rounds a few degrees from the vertical. If the machine is equipped with a wireless outfit, see that the instruments are in working order.

Hints for Beginners

Always examine machine and test controls before every flight. Have the engine running to *your* satisfaction before going up. Do not be satisfied with another person's opinion. *You* are to pilot the machine; *be satisfied* with the condition of the engine and the machine in general. *Strap yourself in*. See that no other machines are preparing to land, and be sure that your control lever, or control wheel, is at the neutral position before "taking off," and always "take off" *head to wind*.

Do not attempt to turn before sufficient height has been reached. A beginner should never turn unless at a height of 500 feet.

Always put "nose down" slightly before turning and put on the correct amount of bank.

Do not fly by the instruments. Learn to fly by "feel," and only refer to the instruments for confirmation.

THE EYES OF THE ARMY AND NAVY

At all times keep a sharp lookout for other aircraft, and conform to the "Rules of the Air" posted up at all air stations.

If side-slipping occurs, always turn in the direction in which the machine is slipping and put "nose down" slightly until perfect control is regained. A good method to adopt to ascertain whether machine is slipping is to tie a piece of string from the center forward struts, and if placed correctly the piece of string should blow straight back. If it blows in a direction to the right of a pilot, it indicates that from the left side of the machine there is a greater pressure; and if the string blows to the left of the pilot, it indicates a greater pressure from the right side of the machine. (Figs. 19, 20, and 21.)

A beginner should never attempt to "stunt" under an altitude of 5,000 feet. If any difficulty with engine or control is experienced while in the air, *come down*.

If volplaning from a great height, switch on your engine for a few seconds every 1,000 feet. This will clear the cylinders of surplus petrol and oil; if this practice is carried out, possibility of the engine "choking" will be practically eliminated.

Before attempting to land, make sure that the landing-field is clear, and land *head to wind*. It is better to get into the habit of "undershooting" the

CROSS-COUNTRY FLYING

landing-field than "overshooting." In the first case a pilot can always switch off for a few seconds (provided the engine is in perfect order); whereas, if he

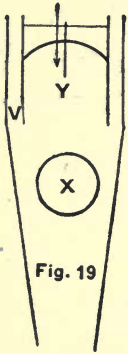

Fig. 19

STRING BLOWING
STRAIGHT BACK, NO
SIDE-SLIPPING

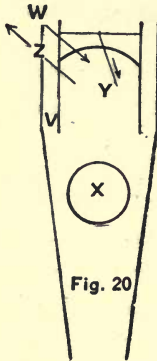

Fig. 20

STRING BLOWING
TO RIGHT OF PILOT,
GREATER PRESSURE
FROM LEFT INDICAT-
ING SIDE-SLIPPING
TO LEFT

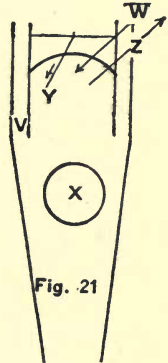

Fig. 21

STRING BLOWING
TO LEFT OF PILOT,
GREATER PRESSURE
FROM RIGHT INDI-
CATING SIDE-SLIP-
PING TO RIGHT

- (W) Indicates greater pressure.
- (Z) Direction of side-slipping.
- (Y) Direction of string.
- (X) Pilot's seat.
- (V) Forward center struts.

"overshoots" the landing-field, he is obliged to make another circuit.

A "flying" log-book should be kept by all pilots, and columns should be correctly filled in. Under a column headed "Wind" the direction and velocity of the wind should be stated. Under a column headed

THE EYES OF THE ARMY AND NAVY

“Remarks” against each flight a small diary of the record of the flight should be given.

Method of Marking Landing-grounds

The majority of landing-grounds have a T for indicating the direction of the wind. This T consists of

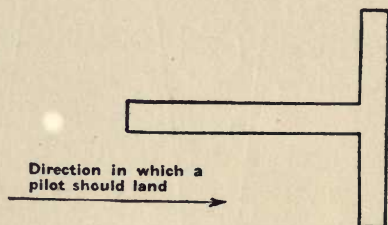

Fig. 22

strips of linen tacked on to a framework of wood and is generally placed in the center of the landing-field with the head of the T facing directly to the direction of the wind. The position of the T should be changed with any slight change of the wind. (Fig. 22.)

V

CHARTS

ALTHOUGH it is not imperative that a pilot should know the difference of buoys, their meanings, the abbreviations used in the Admiralty list of lights, and the definitions of the characteristic phrases, it is advisable to describe the most important. In some examinations queries on the subject crop up, and to seaplane pilots the information may prove beneficial in the days of the sea patrol.

Starboard-hand Buoys

By the term starboard hand is meant that side which will be on the right hand when going with the main stream or flood tide, or when entering a harbor, river, or estuary from seaward.

The term port hand indicates that side which will be on the left hand under the same circumstances. (Fig. 23.)

Starboard-hand buoys mark the starboard side of

THE EYES OF THE ARMY AND NAVY

a channel as defined above. They are conical in shape and are painted one color; in England, red or black; in Scotland and Ireland, red only. Quite often starboard-hand buoys are surmounted by a top mark in order that they may be distinguished readily. This top mark consists of a staff and globe, as shown in Fig. 23.

Port-hand Buoys

Port-hand buoys, buoys that indicate the port side of a channel as defined above, show a flat surface above the water and are termed can buoys. In England they are painted red and white or black and white, showing cheques or vertical stripes. (Figs. 24 and 25.)

In Scotland and Ireland they are painted black. The distinguishing top mark for this type of buoy consists of a staff and cage.

Middle-ground Buoys

What is known as middle ground, which is a shoal with a channel on either side of it, has its ends marked by buoys which show a domed top above water and are known as spherical buoys and are colored with horizontal stripes. A buoy of this type,

CHARTS

surmounted with a staff and diamond (see Fig. 26), indicates the outer end of the middle ground; and a spherical buoy surmounted with a staff and triangle marks the inner end.

Telegraph Buoys

A telegraph buoy is generally placed over a telegraph cable. It is conical in shape and usually has

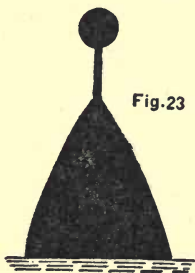

Fig. 23

BLACK

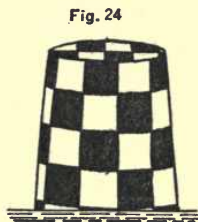

Fig. 24

RED AND WHITE
CHEQUERS

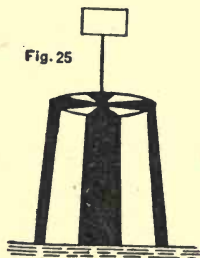

Fig. 25

BLACK AND WHITE
VERTICAL STRIPES

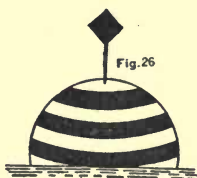

Fig. 26

BLACK AND WHITE
HORIZONTAL STRIPES

THE EYES OF THE ARMY AND NAVY

the word "Telegraph" painted on. This buoy is painted green. What is known as a wreck buoy is similar to a telegraph buoy and has the word "Wreck" painted on. This buoy is also painted green.

Spoilt-ground Buoys

A spoilt-ground buoy, used to indicate ground used by dredges, is usually conical in shape and painted yellow and green vertical stripes.

Abbreviations

The following abbreviations generally shown below buoys on a chart indicate the characteristics:

R.....	Red
B., Blk.....	Black
G.....	Green
Cheque.....	Chequered
H. S	Horizontal
W	White
Y.....	Yellow
V. S	Vertical stripes

Lights

Lights may be divided into two classes, namely:
Lights whose colors do not alter throughout the

CHARTS

whole system of changes, and lights which alter in color.

The following abbreviations and characteristic phases should be committed to memory:

Lights Whose Colors Do Not Change	Characteristic Phases	Lights Which Alter in Color
F. Fixed	A continuous, steady light	Alt. Alternating
Fl. Flashing	(A) Showing a single flash at regular intervals, the duration of light being always less than that of darkness (B) A steady light with a total eclipse at regular intervals; the duration of light being always less than that of darkness	Alt. Fl. Alternating flashing
Gp. Fl. Group flashing	Showing a group of two or more flashes at regular intervals	Alt. Gp. Fl. Alternating group flashing
Occ. Occulting	A steady light with a sudden and total eclipse at regular intervals; the duration of darkness being always less than, or equal to, that of light	Alt. Occ. Alternating occulting
Gp. Occ. Group occulting	A steady light with a group of two or more sudden eclipses at regular intervals	Alt. Gp. Occ. Alternating group occulting

THE EYES OF THE ARMY AND NAVY

Lights Whose Colors No Not Change	Characteristic Phases	Lights Which Alter in Color
<p>F. Fl. Fixed and flashing</p>	<p>A fixed light varied by a single flash of relatively greater brilliancy at regular intervals. The flash may, or may not, be preceded and followed by an eclipse</p>	<p>Alt. F. Fl. Alternating fixed and flashing</p>
<p>F. Gp. Fl. Fixed and group flashing</p>	<p>A fixed light, varied at regular intervals by a group of two or more flashes of relatively greater brilliancy. The group may, or may not, be preceded and followed by an eclipse</p>	<p>Alt. F. Gp. Fl. Alternating fixed and group flashing .</p>
<p>Rev. Revolving</p>	<p>A light gradually increasing to full brilliancy, then decreasing to eclipse</p>	<p>Alt. Rev. Alternating revolving</p>

VI

METEOROLOGY

IT cannot be too strongly impressed upon pilots of aircraft that the impending weather conditions are of the greatest importance and a pilot should know how to study a weather chart and have a knowledge of forecasting weather.

Aeroplane Weather

Calm, clear weather with little or no wind is the most suitable for aeroplanes. The only conditions which make it impossible for a good pilot to fly a modern aeroplane are a strong gale or fog. Such conditions prevent useful work from being carried out by aeroplanes. Military and civilian flying is affected by the weather in quite different ways. When a machine is tested with a view to finding the rate of climb, the maximum speed when flying level, the best landing speed, and the other aerodynamical qualities, it is usually necessary to wait for a calm

THE EYES OF THE ARMY AND NAVY

day, when eddies, or large ascending or descending currents, or other conditions prejudicial to accurate testing, are unlikely to occur.

When flying under war necessities eddied and vertical currents are almost immaterial, provided they are not so violent as to impede observations. Low clouds make observations over the enemy's lines almost impossible, owing to the accuracy of modern anti-aircraft guns. Detached clouds often impede but do not put a stop to reconnaissance.

A ground haze, very evident on calm days, frequently makes it impossible to carry out useful reconnaissance, and on these occasions the direction of the sun is an important factor. At a time of day when the sun is behind the enemy's lines it is impossible to observe enemy operations except from behind their own lines, where the sun need not be faced.

In England easterly and northeasterly winds are uncomfortable for flying because the "bumps" are more violent and extend to a greater height in winds from the above directions than in winds from the west. In North America winds from the east and southeast are the most favorable. Early morning and evening are the best times for school and civilian flying. At these periods of the day the air is much calmer than at other times.

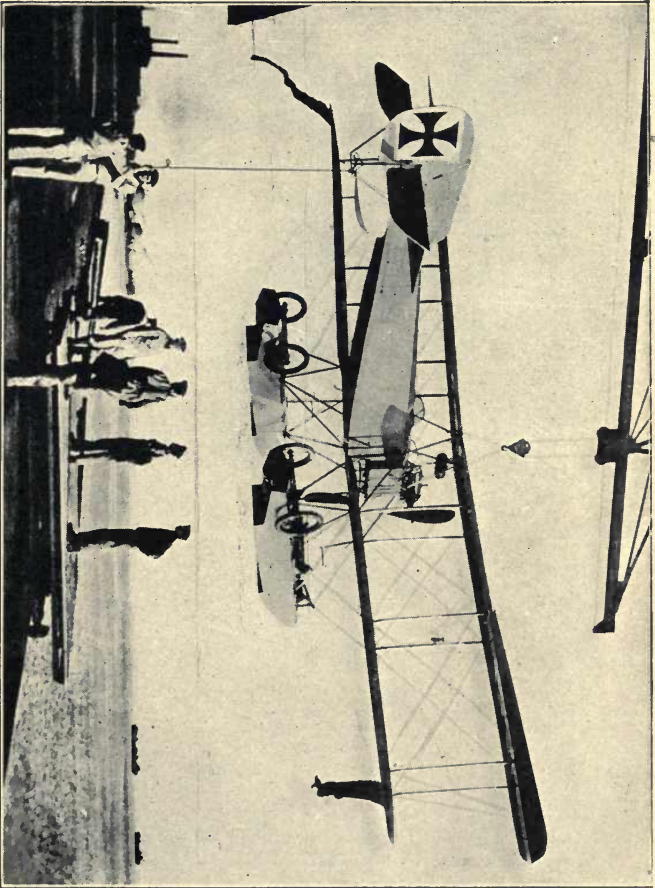

GERMAN AEROPLANE EQUIPPED WITH PONTOONS

Photograph by Underwood & Underwood

The biplane shown is a German machine convertible for either land or sea work that has been developed since the beginning of the war. It is being brought to the waters edge by a crane

METEOROLOGY

The Atmosphere

The atmosphere is a gaseous body which surrounds the earth. It is elastic, very sensitive to the action of heat, and is necessarily much denser in the vicinity of the earth's surface than above. From observations it has been discovered that at a height of six miles the atmosphere is so rarefied that great difficulty is found in breathing.

Composition of Atmosphere

The composition of the atmosphere, for all practical aeronautical purposes, may be considered as follows:

Nitrogen.....	79 per cent.
Hydrogen.....	20 per cent.
Argon.....	1 per cent.

These constituents diminish as height is attained and other gases take their places.

Atmospheric Pressure

Pressure of the atmosphere is the weight of the air pressing down just as the weight of water in a pond exerts a certain pressure on the bottom. The atmospheric pressure at the surface of the earth is

THE EYES OF THE ARMY AND NAVY

not constant, but varies from day to day. This pressure is measured by means of an instrument called a barometer, by which the pressure is measured by the height, in inches, of a column of mercury necessary to balance it. The average pressure of the atmosphere at the surface of the earth is 29.8 inches. In the British Isles, at a certain time each day the atmospheric pressures are taken at a number of places and flashed to a head meteorological office, and later what is known as a synoptic chart or weather chart is made out. The places which register the same barometric pressure are joined by a line, and this line is known as an isobar. (These isobars may be likened to contour lines on an ordinary map. Certain areas will have high pressure, while other areas will have low pressures.

In addition to the atmospheric pressures the direction and force of the wind and the Fahrenheit temperature will be registered at each observation station and marked on the synoptic chart. (In the lowest strata the height of the mercury column decreases approximately one-tenth of an inch for every ninety feet above sea-level.)

Measure of Pressure

Barometric pressure is now measured in pressure units as well as in inches of mercury. Since the

METEOROLOGY

study of meteorology in connection with aircraft, this method has been adopted, as the measuring of pressure by inches of mercury only was very unsatisfactory for accuracy. The centimetre gram second system, better known as the "C. G. S." system, is used. The absolute unit of pressure on this system is the dyne per square centimetre. As this unit is an exceedingly small one, it was suggested by the meteorological authorities that a practical unit one million times greater be used. This unit, the megadyne per square centimetre, is called a "bar." In daily weather reports the centibar and the millibar, respectively the hundredth and the thousandth part of a bar, have been adopted as working units.

Approximate Relation

The approximate relation between the millibars and inches of mercury is given below, and the list covers all that is required to be known by the pilot for practical purposes.

AT 32° F. AND LATITUDE 45°:

Ins.	Milli- bars.	Ins.	Milli- bars.	Ins.	Milli- bars.	Ins.	Milli- bars.	Ins.	Milli- bars.	Ins.	Milli- bars.
28.00	948.2	28.50	965.1	29.00	982.0	29.50	999.0	30.00	1,015.9	30.50	1,032.8
28.10	951.6	28.60	968.5	29.10	985.4	29.60	1,002.4	30.10	1,019.3	30.60	1,036.2
28.20	954.9	28.70	971.9	29.20	988.8	29.70	1,005.7	30.20	1,022.7	30.70	1,039.6
28.30	958.3	28.80	975.3	29.30	992.2	29.80	1,009.1	30.30	1,026.1	30.80	1,043.0
28.40	961.7	28.90	978.6	29.40	995.6	29.90	1,012.5	30.40	1,029.4	30.90	1,046.4

THE EYES OF THE ARMY AND NAVY

High and Low Pressure Regions

A pressure under 29.8 inches of mercury or approximately 1,010 millibars represents a low-pressure region, and above that reading an area is known as a high-pressure region. The former is known as a cyclone or cyclonic depression and the latter an anti-cyclone or anti-cyclonic region. From experience it has been proved that anti-cyclonic conditions are, in general, more favorable for flying than conditions of a cyclonic nature. The distribution of pressure governs the winds. In a region where the pressure is changing rapidly the wind will be strong, and in a region where the pressure is more or less uniform the wind will be light.

Cyclone or Low-pressure Region

The weather to be expected in a cyclone or low-pressure region is shown in Fig. 27, and the small arrows indicate the direction of the wind. The large arrow passing through the center of the figure indicates the direction of the depression. As the cyclone approaches an observer the barometer falls, and this continues until the center of the region has passed and then the barometer begins to rise. A line through the center of the cyclone and perpendicular to its path is known as the "trough" of the

METEOROLOGY

cyclone and is associated with a squall or heavy shower. This is known as the clearing shower, as it generally indicates the approach of fine weather. As a rule, cyclones move in a direction from south-

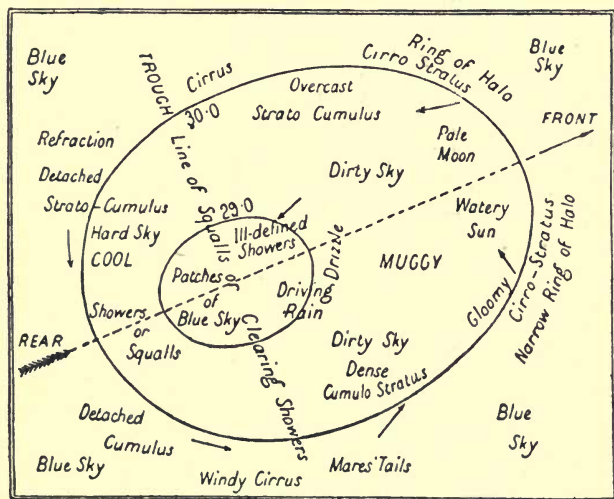

Fig. 27

southwest to east-northeast. The usual path lies rather to the north of Scotland, so that the British Isles generally come in for the weather expected in the southern part of the cyclone. When the influence of a cyclone is evident the direction of the wind is south or southeast; the barometer begins to fall and light wisps of cirrus clouds appear. As the cyclone

THE EYES OF THE ARMY AND NAVY

approaches the clouds thicken, the wind changes to the southwest, and rain begins to fall. This continues until the "trough" passes. The barometer then begins to rise; frequently in a sudden squall, the wind changes to the west or northwest. The weather then clears and after a few showers becomes fine and a northwest wind usually prevails.

Line Squalls

It has been stated that when a trough of a cyclone passes there is usually a heavy squall and a change in

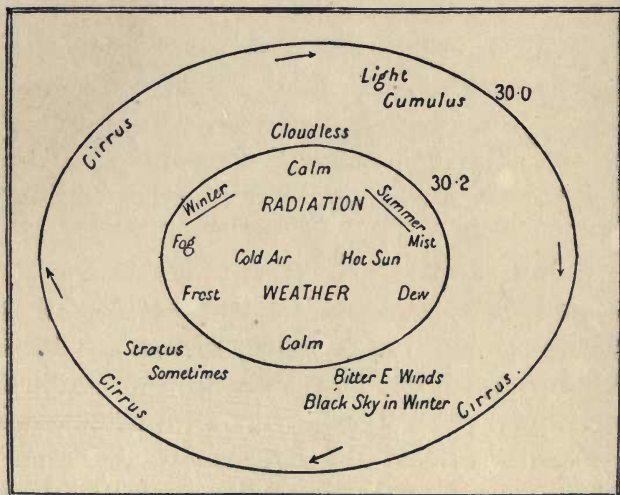

Fig. 28

METEOROLOGY

the direction of the wind. Squalls of this kind are known as line squalls and are generally very sudden and violent. This sudden change in the direction and velocity of the wind makes these squalls very dangerous to aircraft. When a trough of a cyclone passes they are to be expected and also when an irregularity in the isobars on the edge of a cyclone known as a "secondary depression" passes. They sometimes occur when there is no such warning of their approach. (Fig. 28.)

Anti-cyclone

The weather to be expected in an anti-cyclone or high-pressure region is shown in Fig. 27, and it will be observed that the conditions are almost the reverse to those in a cyclonic depression. The winds are usually light and blow round the center in a clockwise direction. Although the sky may in some cases be cloudy, the weather is generally fine. In a region of this nature mist or fog very frequently occurs in the early morning. An anti-cyclone has no general direction of motion and may move in any direction and is frequently stationary for days.

Wind

Wind is air in motion. It is not necessary for the pilot to study the cause of the winds and the reason of

THE EYES OF THE ARMY AND NAVY

their distribution. In most cases the air flows from an area of relatively high pressure to a region of relatively low pressure. The velocity of the wind is governed by the relative pressure in the adjoining areas and is determined by the barometer gradient. A scale known as Beaufort's Scale is used for the purposes of reference and classifies the various velocities of the wind.

BEAUFORT SCALE

Beaufort Force Number	Nautical Miles per Hour	Description of Wind
0	$\left. \begin{array}{l} \text{Less} \\ \text{than 1} \end{array} \right\}$	Calm
1	1-3	Light air
2	4-6	Slight breezes
3	7-10	Gentle breezes
4	11-16	Moderate breezes
5	17-21	Fresh breezes
6	22-27	Strong breezes
7	28-33	High wind
8	34-40	Gales
9	41-47	Strong gales
10	48-55	Whole gale
11	56-65	Storm
12	Above 65	Hurricane

Veering of Wind

As height is attained the velocity of the wind increases in strength, and in the northern hemisphere

METEOROLOGY

it is usually said to "veer," which indicates that it goes round in a clockwise direction. This increase in velocity continues to a height of from 2,000 to 3,000

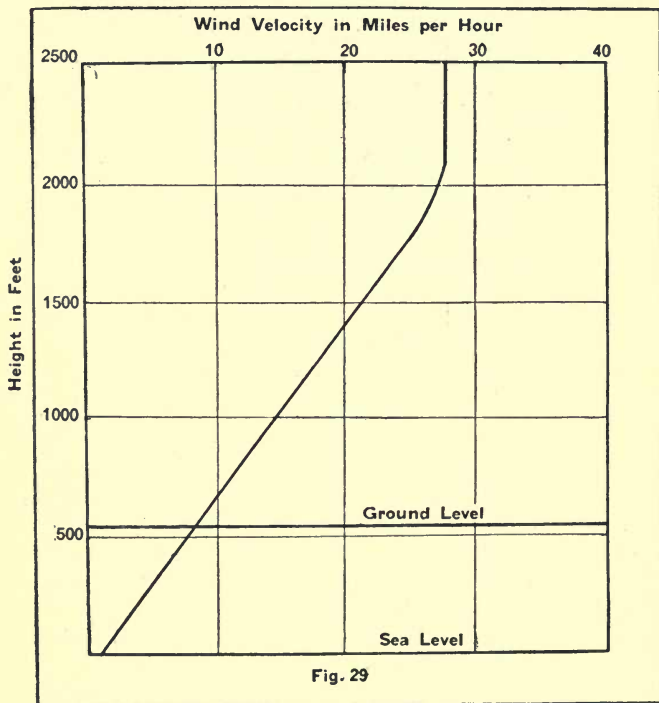

Fig. 29

RELATION OF WIND VELOCITY TO HEIGHT

feet, after which it sometimes increases and sometimes decreases, but on the average remains nearly constant. The following scales are used when work-

THE EYES OF THE ARMY AND NAVY

ing out problems in which the upper wind is to be considered:

At 1,000 feet the wind veers 10 degrees.

At 2,000 feet the wind veers 15 degrees.

At 3,000 feet the wind veers 20 degrees.

Above this height the wind remains practically constant.

Increase in Velocity Relative to Height

At 1,000 feet the velocity of the wind increases to one and a half times its own velocity.

At 2,000 feet the velocity of the wind increases to twice its own velocity.

Above 2,000 feet there is practically no increase.

The Gradient Wind

The gradient wind is a theoretical wind calculated from the pressure gradient and the deflecting force due to the earth's rotation. If V is speed of gradient wind in knots and D the distance between the isobars on either side of a place considered, then $V = \frac{2500}{D}$

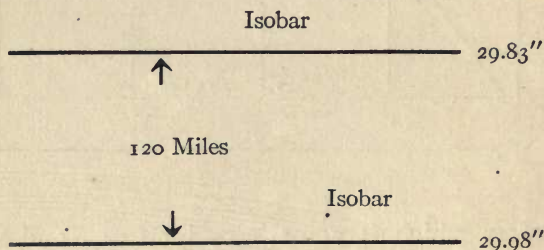

Fig. 30

$$\text{Velocity} = \frac{2500}{120} = 29 \text{ knots per hour (approximately).}$$

METEOROLOGY

Gusts or "Bumps"

Gusts, better known as "bumps," is an expression used to denote a turbulent motion of the air. These bumps are most conspicuous near the surface and may be attributed to the effect of obstacles in the path of moving air, which transform the uniform motion of steady current into pulsating motion with eddies. Bumps are sometimes felt at a height of 5,000 feet and occasionally at a height of 10,000 feet. In the former case they are sometimes due to the presence of clouds. In the latter they are mostly due to one current of air meeting with another current moving in a different direction.

Wind Eddies

Eddies are very conspicuous in a strong wind and always greater on the lee side of hills and cliffs. On

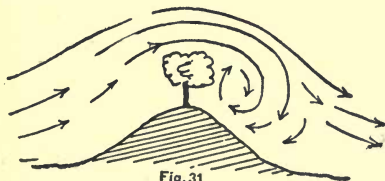

account of these wind eddies it is not advisable to land an aeroplane in the lee of hills, cliffs, and large

THE EYES OF THE ARMY AND NAVY

buildings in a strong breeze. If a pilot experiences engine trouble and a forced landing is inevitable, he should endeavor to land on the windward side; however, if unable to make the windward side, he should endeavor to land well away on the lee side. (Fig. 31.)

Upward Currents

Of these wind eddies the most important to aircraft are rising currents and descending currents. A mass of air rises or falls as its density decreases or increases. Warm and expanded air ascends when the surrounding air at the same level is colder. As the atmosphere is heated mainly through contact with the earth's surface, which in turn has been heated by the rays of the sun, these upward currents are very conspicuous during warm, clear weather. Over water, currents of this nature carry large quantities of aqueous vapor resulting from the evaporation of the water. As these masses of air and aqueous vapor arise they expand, owing to the rarefied state of the upper atmosphere. These columns of air and vapor lose heat as height is attained, and the loss, together with a lower temperature over the upper region, causes the vapor to be condensed. This condensed vapor, combined with the multitudes of small dust particles floating in the atmosphere,

METEOROLOGY

presents the appearance known as clouds. From observation it has been discovered that the rate of ascent of these columns may be very great. A velocity of 25 feet per second has been known to occur, and therefore it may be readily seen that these vertical velocities are a source of danger to aircraft. If an aeroplane plunges squarely into a column of this nature it will cause the machine to rise; emerging from a similar column, the machine will drop. Grazing a column with one wing will tilt the machine, and in the case of an airship or a balloon these columns will cause the airship or balloon to rise or fall.

These rising columns are encountered over flat, barren country on clear summer days, and above isolated hills on calm, warm days; in the former case on account of the heat being quickly radiated, and in the latter case on account of the sunny side of the hills being warmer than the surrounding atmosphere. In the early part of the forenoon, and especially over water and green vegetation, these rising currents are less frequent than during the hotter part of the day. Before sunrise and when the sky is overcast these disturbances are practically absent.

Descending Currents

Descending currents are mainly due to two causes. In the upper regions they are caused by cold air

THE EYES OF THE ARMY AND NAVY

descending to take the place of rising hot-air currents; however, they are usually not rapid and do not

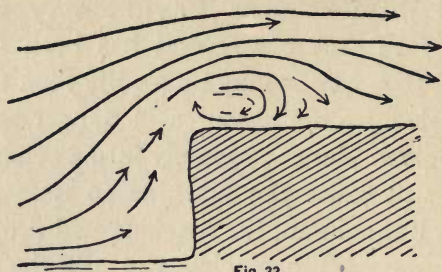

Fig. 32

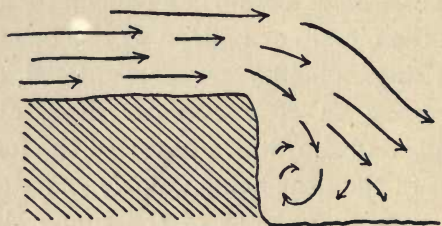

Fig. 33

cause much inconvenience to pilots. Near the surface they are caused by air flowing up to or over a precipice. (Figs. 32 and 33.)

Wind Layers

Very often a pilot will experience wind blowing in different directions at different heights; thus clouds are frequently seen moving in different directions at different heights. Helmholtz explained that layers

METEOROLOGY

of air differing in density are the cause, and that they glide with little or no intermingling one over the other, very much as air flows over water and with the same wave-producing effect.

From an aeronautical point of view this is important, as the passage from one layer to another of different speed and different direction will cause the rise or fall of a machine; however, these wind layers generally flow somewhat across one another, so that a machine passing from one layer to another will only experience a turbulent motion and a few bumps.

Clouds

Under the heading "Upward Currents" the formation of clouds by condensation by cooling was explained. Condensation by mixing will also form clouds. In this case it occurs when a mass of moist air encounters, in its ascent, another mass of moist air which is at a different temperature. Certain types of clouds and the direction in which they are moving indicate the weather to be expected, and a few notes in that respect are given in the list of the different types of clouds on the following page. Clouds may be classified in two typical forms, cloud sheets and cloud heaps. The former may be divided up into three classes which differ in appearance and height.

THE EYES OF THE ARMY AND NAVY

THE UPPER LAYER. The upper layer is chiefly composed of the cirrus clouds and is generally at a height of from 25,000 to 30,000 feet.

THE MIDDLE LAYER. The middle layer consists chiefly of the alto clouds and is to be expected at a height of from 10,000 to 25,000 feet; the lower-layer clouds are below 9,000 feet.

HEAP CLOUDS. Clouds of this form have considerable vertical structure and their height is variable. The mean height of the base is from 4,000 to 5,000 feet and the height of the top varies from 6,000 to 25,000 feet.

Cloud Sheets

CIRRUS. Mare's-tails; wisps or lines of pure white clouds with no shadows. At 27,000 to 50,000 feet. Predict wind and a cyclonic depression.

CIRRO-STRATUS. A thin sheet of tangled web structure, sometimes covering the whole sky; watery sun or moon. At an average of 29,500 feet. Predicts bad weather.

CIRRO-CUMULUS. Small speckles and flocks of white clouds; fine ripple clouds; mackerel sky. At 10,000 to 23,000 feet. Denotes fine weather.

ALTO-CUMULUS. Somewhat similar to cirro-cumulus, but the cloud masses are larger and show some shadow. At 10,000 to 23,000 feet.

METEOROLOGY

CIRRO-NEBULA. Similar to last, but a veil of cloud with no visible structure. At 10,000 to 23,000 feet.

ALTO-CUMULUS CASTELLATUS. Turret cloud; alto-cumulus with upper margins of the cloud masses developed upward into miniature cumulus, with hard upper edges. At 10,000 to 23,000 feet.

ALTO-STRATUS. Very like cirro-stratus and cirro-nebula, but a thicker and darker cloud. At 10,000 to 23,000 feet.

STRATO-CUMULUS. Cloud masses with some vertical structure; rolls or waves sometimes covering the whole sky. At 6,500 feet. Predicts a change in the weather.

STRATUS. A uniform layer of cloud resembling a fog but not resting on the ground. One hundred to 3,500 feet.

NIMBUS. Shapeless cloud without structure, from which falls continuous rain or snow. At 3,000 to 6,500 feet. Usually a rain cloud.

SCUD. Small shapeless clouds with ragged edges; sometimes seen without other cloud, especially in hilly country; but more commonly seen below other clouds, such as cumulus and nimbus. At 1,000 to 4,000 feet. Predicts unsettled weather.

THE EYES OF THE ARMY AND NAVY

Heap Clouds

CUMULUS. (Woolpack clouds); clouds with flat base and considerable vertical height. Cauliflower-shaped top. At 4,500 to 6,000 feet. These clouds are caps of ascension currents and a pilot will experience violent disturbances when passing through them or just above or below them.

CUMULO-NIMBUS. (Anvil-, thunder-, or shower-cloud). Towering cumulus with the top brushed out in soft wisps or larger masses (false cirrus) and rain cloud at base. At 4,500 to 24,000 feet. From clouds of this type rain usually falls.

Airship and Balloon Weather

The most favorable weather for airships and balloons is in calm or light winds, when visibility is good, extends over a large area, over the whole of the area to be traversed, and when the conditions existing are liable to persist for a period of many hours. The characteristic conditions associated with the central part of an area of high barometric pressure, or anti-cyclone, are the most favorable. In a region of this nature the pressure is, as a rule, above the normal, good weather may be expected; bad weather does not usually begin until the barometer has been falling for several hours.

METEOROLOGY

Buys Ballot's Law

This law is a necessary consequence of the rotation of the earth and may be enunciated thus:

In the northern hemisphere stand with your face to the wind and the barometric pressure will be lower on your right hand than on your left. In the southern hemisphere it is the reverse.

Conversion of Temperature

From Centigrade to Fahrenheit.

$$\frac{C}{5} = \frac{F - 32}{9}$$

How to ascertain density of atmosphere if given temperature and pressure.

$$P = 1.36 \times \rho \times T$$

Therefore: $\rho = \frac{P}{1.36 \times T}$

P = Pressure in inches of mercury
 ρ = Density in pounds per cubic foot
T = Absolute temperature

Change in Temperature (Fahrenheit) Relative to the Height

The decrease in the temperature relative to the height is one degree in every 273 feet. For all practical purposes it may be considered as one degree in every 300 feet.

VII

CONSTRUCTION

Materials

THE choosing of materials for the construction of aircraft has been and is at present a study in itself. To obtain the maximum strength and reliability out of the minimum weight is our problem. This problem has been solved sufficiently to permit successful flying, although there is still room for vast improvement.

First it is advisable for the student-pilot to have a knowledge of the materials used in the construction of aeroplanes and the reasons for their respective use.

Woods

ASH is used for main spars, chassis struts, skids, flanges of ribs, the longerons of the fuselage, and for engine-bearers. It is a straight-grained wood and very tough, but rather heavy. It is not obtainable

CONSTRUCTION

in great lengths, and in the construction of fuselages splicing is often necessary. This wood has the advantage of being easily bent, if carefully steamed, without splitting.

SPRUCE is used for main spars, also struts and ribs. This is also a straight-grained wood and is obtainable in great lengths. It is not as strong as ash, but considerably lighter. In compression its strength for weight is very great. Silver spruce is preferable and always used when obtainable.

HICKORY is frequently used for landing-chassis struts, especially in the construction of heavy machines, on account of its capability of resisting great shocks. It is a very heavy wood, and therefore not used in the construction of scouts and light machines.

CANADIAN ELM. This is a very tough wood, though easily twisted or warped, and is frequently used instead of ash for engine-bearers and longerons. Its one great advantage is that it will not snap.

BASSWOOD. Used in the webs of ribs. It is a very tough wood and has considerable resiliency.

WALNUT. Used in the construction of propellers. A hard, close-grained wood and not apt to bend or split.

MAHOGANY. Also used in propeller construction and has the same advantages as walnut.

THREE-PLY WOOD. What is known as three-ply

THE EYES OF THE ARMY AND NAVY

wood is used in the construction of fuselages and nacelles and frequently used for covering those parts of the planes which serve as a footboard when getting in and out of a machine. It is also largely used in the construction of floats for seaplanes. The material consists of three very thin layers of wood, placed in such a way that the grains of the wood do not lie in the same direction. This method gives the material considerable strength for weight and equal strength in all directions.

Metals

ALUMINIUM. Used for engine-cowls, supports for wind-screens and control wheels. It is a very light material, but very unsuitable for resisting shock or tension, and is apt to crack if subject to friction. This metal suffers extensively under the influence of moisture, and especially where salt is present. It is very unsuitable for seaplanes, and if used in their construction requires careful watching and constant cleaning.

DURALUMIN. This metal is seldom used, and occasionally instead of aluminium. It is a very light metal and approaches the tenacity of mild steel. Its one great advantage is that it can stand excessive distorting without loss of usefulness.

CONSTRUCTION

MANGANESE. A very tough metal, and on account of its properties of resisting corrosion it is very advantageous in the construction of seaplanes. Used for wood-screws and bearing for rotary parts.

PHOSPHOR-BRONZE. Very similar to manganese and used for similar purposes.

STEEL. Used for struts, sockets, junction of spars, control leads, wire attachments, and in fact for almost all the fittings of a machine. A few constructors have made use of steel for the whole framework of a machine and have been very successful; however, the disadvantage is the increased difficulty of repair. Steel tubes are now used for the interior of struts, and in some cases the tubes have been stream-lined with steel sheeting. In experiments of this kind one great advantage has been discovered. When a machine receives a shock something has to take the shock effect. It was found that a steel tube in a strut or a steel strut would bend and crumple up, thus absorbing the shock gradually, while in the case of a wooden strut it would usually split or snap and the broken ends cause further damage to the machine.

Fabric

Ordinary linen and Egyptian cotton are the principal materials used for covering of aeroplane wings,

THE EYES OF THE ARMY AND NAVY

fuselages, and nacelles. The warp and weft threads should be of a uniform thickness throughout and a good length, as joints in the threads cause weak spots in the fabric. Some fabrics have what is known as guide-threads. These are extra-stout threads and woven at intervals both in the warp and in the weft, and are for the purpose of localizing a split or flaw.

SECURING AND REPAIRING FABRIC. On no account should glue be used or be allowed to come in contact with the fabric, as glue, when hard, has sharp edges and may cut the material. Before securing the fabric it is important that all sharp edges of ribs and spars be rounded; to insure that the fabric is well laid on, warp and weft to the fore-and-aft line of the wing section. This method equalizes the strength in the warp and weft. The fabric should be either sewn or tacked on to the ribs. If the latter method is adopted a strip of rough tape should be placed along the line of tacks in order to take the wear of the tacks. A washer should be placed under the head of each tack. Brass or copper tacks, with shanks of the same material, should be used. Steel tacks are frequently used, but owing to their liability to rust and therefore destroy the fabric they should be avoided.

TO REPAIR A TEAR IN THE FABRIC WHEN AWAY FROM AN AERODROME. On having a forced landing

CONSTRUCTION

a pilot may often discover a slight tear in the fabric, and, to use the appropriate term, "A stitch in time saves a thousand." This slight tear, however slight, should be attended to before a pilot continues on his flight. I have found the following a very good method:

Obtain needle and thread (one can usually obtain the required articles from any farm-house) and stitch the edges of the fabric together with a "figure-eight" stitch. This will serve the purpose of the pilot until he reaches an aerodrome, assuming that the tear is not a large one, in which case it would be advisable to wait and have the fabric properly attended to.

REPAIRING A TEAR IN THE FABRIC AT AN AERODROME. This is somewhat different to the above procedure. First, it is imperative that the fabric in the vicinity of the tear be thoroughly cleaned, then the two edges drawn together with a figure-eight stitch. A patch of fabric, overlapping the tear by about two inches, should be placed over the rent, and after fraying the edges the patch should be well doped. When the dope is dry a larger patch, frayed at the edges, should be placed over the first patch and doped thoroughly.

DOPE. Dope is used for stretching the fabric taut after it has been secured. It also preserves the fabric from deterioration caused by water, oil, heat, and

THE EYES OF THE ARMY AND NAVY

general weather conditions. Experiments have shown that good dope increases the tensile strength of fabric, but makes it more liable to tear than the undoped material. In order to render the dope fluid enough to work into the fabric it is necessary to add spirit. As the dope is applied to the fabric the spirit evaporates. Some spirits, used for dissolving the dope, are very detrimental to the fabric. These are generally the cheaper kind; only the best should be used. Spirit of any description is detrimental to metal and generally causes rust; therefore, too much precaution in protecting the parts of metal which come in contact with the dope with paint or grease cannot be taken. Several constructors have adopted the method of applying a coat of varnish over the dope. This affords an excellent protection against water and oil, but is highly inflammable. At the present time experiments are being carried out in an effort to obtain a fluid that will protect against moisture, oil, general weather conditions, and also be fireproof.

Wires

Two types of wire are used, the solid-drawn and the flexible cable. Control wires, flying- and landing-wires are always of the latter material. The solid-drawn type is used for all bracing purposes where the

CONSTRUCTION

safety of the machine in the air does not depend directly on the wiring.

FLEXIBLE CABLE This type has many advantages over the solid-drawn type. It shows chafe at once, the outer strands chafing through first, and the broken ends can be plainly seen. It also has a slight resiliency.

ATTACHING FLEXIBLE CABLE. The method usually employed, when an attachment or join has to be made, is to make a small loop in the end of the wire and attach by means of a steel fitting or pin. When making the loop the end of the pin should be spliced and the splice either bound by a single-strand flexible wire or by soldering.

SOLID-DRAWN WIRE. This wire is much stronger for its diameter than cable and much easier to attach. Its disadvantages are that it does not show wear, is liable to snap suddenly, and has very little or no elasticity.

METHOD OF ATTACHING SOLID-DRAWN WIRE. The usual method, and the most simple and most practical, is by means of a steel ferrule.

The ferrule should be made of metal, solid-drawn; and the material slightly thicker than the diameter of the wire. The hole through the ferrule should be of



Fig. 34

METHOD OF ATTACHMENT
FOR SOLID-DRAWN WIRE

a diameter to allow two wires to pass through. The ferrule is slipped over the end of the wire and the end

THE EYES OF THE ARMY AND NAVY

of the wire then placed on to the steel attachment, by the means of a small loop, and the end of the wire then placed through the ferrule. The ferrule should then be forced as close as possible to the point of attachment and the end of the wire bent over the outside of the ferrule. (Fig. 34.)

Strength of Wires and Flexible Cables

The following lists have been obtained from experiments and practical tests and are sufficient for all practical purposes:

SOLID-DRAWN WIRE

Gauge Number	Breaking Load in Pounds
8.....	2,750
10.....	2,280
12.....	1,720
14A.....	1,170
14B.....	825
16A.....	520
16B.....	450

FLEXIBLE CABLE

Circumference in Inches	Breaking Load in Pounds
$\frac{1}{2}$	4,500
$\frac{3}{8}$	3,600
$\frac{5}{16}$	1,650
$\frac{1}{4}$	1,350
$\frac{3}{16}$	650

CONSTRUCTION

Construction of Principal Parts of an Aeroplane

For all practical purposes an aeroplane may be divided into four principal parts: wings, body (fuselage or nacelle), tail, and landing-chassis.

WINGS. Wings consist of main spars, ribs, interplane struts, fabric, and wiring. The main spars, two in each plane, the front and the rear, are usually of wood and may be either solid or built up. If solid, they are generally made of silver spruce or ash, and if built up a combination of spruce and ash is used. Frequently constructors are unable to get materials for solid spars in the required length, and it is necessary to make the spars out of two or more pieces of material. This is done by means of a long glued scarf securely bound with whipcord or glued canvas. The sections of solid spars vary in shape, depending upon the bending strain in the particular type of machine for which the spar is designed. For the sake of lightness spars are generally hollowed out, and in section they somewhat resemble the letter I. The majority of built-up spars are also of this shape in section. In the construction of built-up spars the webs and flanges of the I are sometimes of different materials; often the I is solid and has a different material attached to the indentation on each side, so as to form a square spar.

THE EYES OF THE ARMY AND NAVY

RIBS. The ribs give the wings their shape and they complete the framework to which the fabric is attached. They also take the compression between the front and rear main spars. In many types of planes there are both compression ribs and former ribs, and they may be "made up" or solid. The compression ribs take up the whole of the compression between the spars and will always be found at the point of attachment of struts, of flying-wires, landing-wires, and drift wires. Former ribs are lighter in construction and are used for maintaining the shape of the wing.

STRUTS. All interplane struts of a biplane are in compression. They may be either solid or "built up." When solid, spruce is generally used, and when built up, ash and spruce. Steel struts are now used considerably and in most practical experiments have given excellent results. They are constructed in the form of a tube and are usually plugged with spruce in part or the whole of their length. In section they are either oval, for stream-line effect, or circular. The latter type has, so far, given the best results, and the struts are always stream-lined by a shaped wood backing.

ATTACHMENT OF STRUTS. The strut attachments most used and which give the best results are the metal-socket type; these are secured to the main

CONSTRUCTION

spars in some cases by bolts passed through the spar or by means of a metal strap, or a bolt in the shape of a U passing round the spar. The latter method is the most preferable.

Wiring

This is one of the most important factors in the construction of aeroplanes. For all practical purposes wiring can be divided into four principal kinds: flying, landing, drift, and incidence wires. Flying-wires are generally of flexible cable and in duplicate; each wire of sufficient strength to support the plane or bay that it is designed to support. Flying-wires are those which transmit the loading from bay to bay, in a biplane, and lead from the upper attachment of the interplane struts to the bottom attachment of the next strut inward, and in the inner bay the wires are attached to the bottom of one of the vertical members of the fuselage. In the case of a pusher-type machine, the inner-bay flying-wires are secured to the bottom of the struts that are placed vertically alongside of the nacelle.

FLYING-WIRES. It should be borne in mind that when a machine is in the air the wings are supporting, practically, the whole weight of the machine by their lift. It will be readily seen that, if no flying-wires were attached, the lift on the wings, being so great,

THE EYES OF THE ARMY AND NAVY

would cause the wings to fold up under the weight of the fuselage and the dead weights of the machine, such as engine, tanks, pilot, and passenger. Several cases have been known where pilots have met disaster

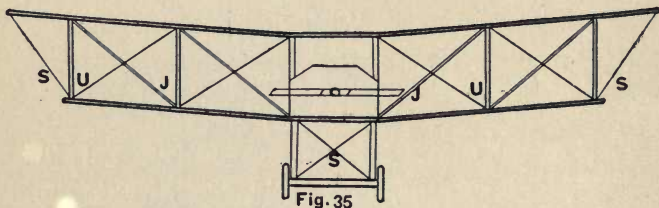

U—Landing-wires.
J—Flying-wires.
S—Bracing-wires.

when the flying-wires, not being of a strength sufficient to overcome the lift, have broken and the wings have folded up.

Flying-wires are best known by pilots by the expression "down and in," on account of their leading in that direction when seated in the machine. Landing-wires are known as "down-and-out" wires. (Fig. 35.)

LANDING-WIRES. Landing-wires, in a biplane, lead from the top of each strut to the bottom of the next strut outward. These wires are usually single and generally made of flexible cable. The safety of the machine, when in the air, does not in any way depend on these wires.

As the flying-wires support the weight of a machine

CONSTRUCTION

when in the air, in a similar manner the landing-wires support practically the whole weight of the planes when on the ground. If no landing-wires were attached to an aeroplane the wings would be liable to collapse. Frequently, when a machine "pancakes" the strain overcomes the landing-wires and the wings break down.

DRIFT WIRES. When a machine is flying, the forward motion of the machine creates much resistance of the air and this resistance has a tendency to sweep back the planes. To counteract this sweep-back, drift wires are used and are usually attached to the front of the engine-bearers in a tractor, and extend to the front outer struts. In a pusher-type machine they are generally attached to the front of the outriggers or to the nacelle, and extend to the outer struts. These wires are known as flying drift wires and are frequently in duplicate; however, many of the latest types of scouts are not fitted with these drift wires. Landing drift wires are not so important as the flying drift wires. These are attached to the rear outer strut and lead back to a position just in front of the tail plane in a tractor; in a pusher type they extend to the tail booms. But in nearly all of the latest types these landing-wires have been abandoned.

The horizontal cross-bracing wires, inclosed in the fabric inclosure and considered part of the construc-

THE EYES OF THE ARMY AND NAVY

tion of the plane, are also drift wires, although they serve to prevent the ribs from flattening out and losing their curvature. These wires are attached to the main spars at positions where the flying- and landing-wires and the struts meet. They are also known as flying drift wires and landing drift wires. The former lead to the rear of the plane and out, from a person seated in the machine, and the latter to the front of the plane and out.

INCIDENCE WIRES. Incidence wires are used in rigid wings to adjust and maintain the angle of a wing in relation to the body of the machine and take the form of vertical cross-bracing between the front and rear struts of each bay. These wires are usually of the solid-drawn type.

METHOD OF ADJUSTING WIRE. "Turnbuckles" are generally used when wire attachments are made. These turnbuckles allow the wire to be slackened or tightened and should have sufficient threads engaged to insure their safety, and should be properly locked to avoid any possibility of their unscrewing through vibration.

The Body

The body of a tractor-type machine is termed the fuselage, and in the pusher type the body is termed the nacelle. The body of an aeroplane generally carries

CONSTRUCTION

the dead weights, consisting of engine, tanks, pilot, passenger, and freight; it also carries the forward motion from an engine to the machine; therefore it should be rigidly attached to the planes. In biplanes of the former type the main spars of the lower planes are usually passed through the sides of the body and connected together by means of a steel box fitting, half-way between the two sides and in the center line of the fuselage.

In types of machines such as the Caudron, which has a short body, the lower planes are usually continuous right across, forming one plane throughout; it is attached to the main spars by means of bolts and to the upper plane by means of struts and bracing-wires.

The main foundation and engine-bearers of all bodies are strong longitudinals, usually of ash. These longitudinal members are connected by vertical and horizontal members of spruce and ash, and are cross-braced with wires between each, both horizontally and vertically. The vertical members on each side are also cross-braced diagonally across the body. These longitudinals are usually made up of two or more lengths of material. The splices are always aft of the pilot's seat and are enforced by long steel box fittings. Immediately behind and to the front of the pilot's seat the longitudinals are, as a rule, much thicker than

THE EYES OF THE ARMY AND NAVY

the portions that extend to the tail of the machine. The vertical and horizontal members are also stouter and placed closer together in the fore part of the fuselage than in the rear portion. In several types of aeroplanes a portion of the longitudinals serve as engine-bearers and are protected from deterioration, due to oil, by a steel casing.

Fuselage and Nacelle Covering

Fabric is the chief material used for covering fuselages and nacelles, but aluminium and three-ply wood are sometimes used. The latter is always used in types where perfect stream-line effect is desired. The use of this material adds greatly to the strength of the machine. In short bodies the floor, and frequently the end of the body, which is either pointed or rounded off, is constructed of three-ply.

The Tail

The construction of the tail plane is very similar to the construction of the main planes. There are two distinct types of tails, the non-lifting and the lifting tail, the only difference being that the latter is designed to carry a portion of the weight of the machine. A lifting tail has a tail plane with cambered upper

CONSTRUCTION

surface, similar to an ordinary plane, and a non-lifting tail has a tail plane that is flat; this may be defined as a horizontal fin to give steadiness in a fore-and-aft direction. There are also non-lifting tails which have both upper and lower surfaces of the tail plane cambered. Some types of machines have the leading edge of the tail plane curved; in these types a steel tube usually forms the leading edge and main spar combined. The trailing edge of tail planes is usually constructed of metal and thus forms the rear spar. To this trailing edge is attached the elevator plane in the case of a "hinge" tail. There are various methods of attaching this flap to the tail plane. Pintals and gudgeons, similar to the method employed to attach a rudder to a ship, are used frequently; but when a steel tube forms the rear spar and trailing edge, the method of steel straps passing round the tube and free to revolve round it is advised; this is the method usually adopted.

In the case of the "warp" tail the rear portion and trailing edge of the tail plane, being flexible and capable of being moved up and down, performs the elevator functions of the machine. Aeroplanes with inclosed fuselages usually have the tail plane attached to the longitudinals by means of U-bolts. In machines of this type the rudder post is rigidly connected to the ends of the longitudinal members.

THE EYES OF THE ARMY AND NAVY

Machines with nacelles such as a Farman, or very short open bodies, as a Caudron, are equipped with open or box tails. In such machines the tail plane, elevator, and rudder are attached to the outriggers; these consist of four horizontal members, connected together by struts and cross-bracing. These outriggers are attached to the rear spars of the upper and lower planes on either side of the body. Wires extending from the rear outer interplane struts to the rear ends of the outriggers hold the outriggers in their respective positions. A tail cell is attached to the end of these outriggers and usually consists of upper and lower tail plane, upper and lower elevator plane, and one, two, or more rudders. This tail cell is connected together by means of small struts and wire bracing.

The Landing-chassis or Undercarriage

The landing-chassis, usually termed the undercarriage, has two forces to resist: the vertical shock of landing and the horizontal force tending to sweep the undercarriage backward when the machine is running along the ground. These forces vary greatly. The former is great when a machine is "pancaked," and the second strain is greatest in a fast landing on rough or soft ground. These two forces are best

CONSTRUCTION

resisted by placing the principal landing-chassis struts in the direction of the resultant force of the two strains. For instance: if the principal struts are placed sloping forward, from the fuselage to the skid, or axle, of the machine, the vertical force of landing will have a tendency to thrust the undercarriage forward, and by doing so will counteract the horizontal force which is created when the wheels are checked by the ground. In the majority of fast scouts, where weight and resistance are important factors, the undercarriage is comparatively narrow and usually consists of two struts on each side joined together at the bottom in the form of a V. These struts are very stout and may be made of steel, ash, or spruce. The V is attached to a continuous axle by means of rubber shock-absorbers. In the slower and heavier type of machines ash skids are usually fitted and are connected to the struts by steel fittings.

All undercarriages are cross-braced, generally by means of strong flexible cable, and in types where long skids are used transverse struts or transverse wires are used.

In machines that have short bodies, such as the Caudron type, the two sides of the undercarriage are attached to the lower planes under the interplane struts. In such machines the undercarriage is much

THE EYES OF THE ARMY AND NAVY

wider and is equipped with a short axle and a wheel at each end on each side of the landing-chassis.

Undercarriages are usually placed so that the wheels are at the point of center of gravity; but in many types of machines this rule has been somewhat disregarded in order to allow for peculiarities in the design. However, if the wheels are placed too far behind the center of gravity the machine will have a tendency to pitch forward on landing, and if the wheels are placed too far in front the machine on landing will be inclined to bounce and slew round quickly on the ground if traveling fast or the direction of motion is altered. This will be observed when landing or taxi-ing a machine of the Nieuport type; however, the tendency to bounce can be avoided if the following method is adopted. When the machine touches the ground, instead of pulling back the "joy-stick" or control lever, as in the case when landing the majority of machines, push the control lever forward slightly. This movement will keep the tail off the ground until the forward speed of the machine has slackened somewhat and the tail drops of its own accord.

The Controls of a Machine

The standard method of control adopted is rudder control by means of a foot-bar or pedals, and a control

CONSTRUCTION

lever, commonly termed a "joy-stick" or, in the case of a Curtiss machine, a control wheel. The elevator is controlled by the fore-and-aft movement of the lever or wheel, and the lateral or aileron control by a lateral movement of the "joy-stick" or rotation of the wheel. Rotation or movement of the control lever in a direction to the plane on which less lift is desired.

CONTROL WIRES. All control wires should be of the flexible-cable type and should be in duplicate; as also their attachments. When control wires lead round angles some type of belt or semicircular crank is advisable. Sheaves and copper fairleads are usually used. The elevator and rudder control wires are usually attached to a V piece or a king post. In the construction of rudders this king post should be bolted on to the rudder post. In some types it is bolted on to the central rib, but the former method is preferable. A light steel tube, bent into the required shape, cross-connected by horizontal wood ribs and covered with fabric, usually forms the rudder. The rudder post passes through these wood ribs and is secured to the steel tube at the top and bottom, usually by welding.

The elevator control and construction is similar to the rudder. In many types of machines, owing to the length of the elevator flap, it is necessary to fit two king posts, one toward either end, and this necessitates a double set of control wires. A light

THE EYES OF THE ARMY AND NAVY

steel tube usually forms the main spar to which ribs are fitted. They should be rigidly attached by means of metal flanges. Some types have the steel tube bent to form the outline of the elevator. Frequently wood is used for the sides and a light wood or metal strip to maintain the shape of the leading edge. Quite often the elevator is divided into two portions, the rudder passing between them.

LATERAL CONTROL. There are two methods of lateral control in general use, the *warp* control and the *aileron* control; the latter may be either double- or single-acting. In machines fitted with the former (the warp) the control wires pass from the control lever or wheel through fairleads, low down in the body, to the rear outer struts of the warping bay. There are various methods of attaching these warping wires. One method is to pass the wires through fairleads fitted at the bottom of the rear outer struts to different points along the warping section of the top plane. Only the top plane is warped, and may be warped along the entire length of the plane or only the outer bay. Warp-controlled machines are fitted with a compensating wire which is usually placed along the top of the upper plane leading from one warp section to the warp section on the opposite plane. By this means, when one warp section is pulled down, by movement of the control lever or wheel,

CONSTRUCTION

the opposite warp section is pulled up by the compensating wire.

Ailerons are hinged flaps attached to the rear extremities of the planes. They are always fitted to the upper planes of aileron-controlled machines and frequently attached to the lower planes also. There are two methods of operation of single-acting ailerons: by wires leading from the under side of the aileron through a fairlead on the rear spar of the lower plane, or by means of a vertical king post on the under side and leading across the plane to the leading edge and thence to the control lever.

The operation of double-acting aileron control is very similar to single-acting; but from a king post on the upper side of the aileron a compensating wire is fitted. This wire is led across the upper surface of the top plane to a fairlead on the front spar, along the front spar and through another fairlead and across the plane to a similar king post on the opposite aileron. The difference in action of single- and double-acting ailerons is: in the latter the compensating wire performs the same function as the warp-control machines, as described above, and in single-acting aileron control each aileron is independent.

Both single- and double-acting controls have their advantages and disadvantages. In nearly all of the latest types the double-acting ailerons are fitted.

THE EYES OF THE ARMY AND NAVY

The warp control is not used except on old-type machines manufactured for school work.

Truing Up an Aeroplane

A machine is said to be "trued up" when all controls and control wires have been thoroughly inspected and put in perfect order and when the angle of incidence and the dihedral angle have been adjusted to the correct angles and the aeroplane, in general, thoroughly inspected. No set rule or method of "truing up" can be laid down, as different constructions and different riggers have slightly different methods; but in the majority of machines the procedure is the same. First it is necessary to place the machine in a flying position—that is, in a position similar to when the machine is flying level. This is done by placing a stand under the tail and stands under the wings to take the weight of the body and wings off the undercarriage. It is usual to place a stand each side of the fuselage and one at each wing tip. Care should be taken that these stands are placed under the interplane struts. The fuselage should then be leveled. This can be done by placing a spirit-level on the engine-bearers and adjusting the tail stand until the body is level both fore and aft and laterally. The fuselage should then be corrected

CONSTRUCTION

in the fore-and-aft position. A very common method is to mark a position half-way down one of the vertical members of the fuselage, close to the pilot's seat, and also on the rear vertical member of the fuselage. Stretch a string between the two points and this line should cut all the vertical members at a point half-way between the top and bottom of the fuselage. Next trammel the bags of the fuselage both vertically and horizontally. The undercarriage should then be corrected and the stands supporting the weight of the machine removed. If the machine is a type with a center section it should be trued up and adjustments made if necessary. Landing-wires should then be trammed; flying-wires trammed; incidence wires trammed. Flying-wires should be slightly slacker than the landing-wires. While trammeling these wires the dihedral angle should be considered and adjustments made if necessary. The angle of incidence should then be tested, and lastly the control wires and drift wires, and adjusted if necessary.

VIII

THE CARE AND MAINTENANCE OF AEROPLANES

Importance

AS an Arab's first and last thoughts are for his faithful steed, so should a pilot care for his machine. Air-worthiness, reliability, and endurance of a machine depend largely upon the care spent upon it. Machines should not be exposed to extremes of weather. Wood, no matter how well seasoned, if not protected by a coat of varnish, will absorb moisture, and will deteriorate quickly. Aeroplane sheds and hangars should be kept dry and, as far as possible, at an even temperature.

When a machine returns from a flight it should be thoroughly cleaned, as soon as possible; rust, sand, mud, and oil, if left to dry, will cause considerable deterioration and an increased amount of labor in removing. The machine should be thoroughly examined and the least sign of wear and tear be attended to promptly. Special attention should be paid to control, aileron, flying- and landing-wires and the

THE CARE OF AN AEROPLANE

points where they pass round pulleys or through fair-leads. Quite often a pilot, when running over the control wires with his thumb and forefinger, will discover a single strand gone; this should be attended to before the machine is flown again. Periodically a machine should be thoroughly examined and every part of the aeroplane inspected. Aeroplane engines should always be tested and should run to the satisfaction of the pilot before a flight is undertaken.

The Handling and Transport of an Aeroplane

The following rules should be observed when moving a machine in or out of a shed or, in fact, every time the machine is moved.

Always place the propeller in a horizontal position before moving a machine. Quite often the tail of a machine is lifted too high and if the propeller is not thus protected it is liable to be damaged by touching the ground. The tail of a machine should be lifted and care should be taken that sufficient men are told off for this work so as to avoid risk of the tail being dropped through a man slipping or dropping through fatigue. In the case of a tractor-type machine the tail should be lifted on the bottom longerons of the fuselage at the base of the bay struts. In most

THE EYES OF THE ARMY AND NAVY

machines of the latest types an arrow, painted on the outside of the fuselage, indicates the point at which to lift. However, if there are no indications of the vertical members of the body they can be easily found by passing the hand along the side of the fuselage. In the pusher type of machine the lift should be exerted on the lower tail-booms, close to and on either side of the inter-tail boom struts. Always tell off a hand to watch each wing-tip and to give warning of any obstruction to the person in charge.

The wheels and tires of a machine are designed to go forward, and a machine should not be turned without moving it backward and forward; however, a machine should only be moved backward when absolutely necessary. At all times pay great attention to the wheels.

When pushing or pulling an aeroplane the force should always be exerted at the base of the strut, and never on any occasion should men be allowed to grasp the middle of the strut. If when getting into and out of a machine it is necessary for a pilot to hold on to a strut he should always endeavor to grasp it as near the upper end as possible.

The trailing edge of a plane is one of the weakest points and also one of the most important; therefore it should never be touched, except when necessary, and should be well protected at all times. The

THE CARE OF AN AEROPLANE

leading edge is another important part of a machine and should be carefully watched. Never lift on the tail plane, elevators, rudder, or any wires. If, on any occasion, it is necessary to move the elevator and rudder, when stowing a machine away, always move them by their proper controls.

Filling Up Machines

“Fill the oil tank first.” Many machines have a petrol gauge and no oil gauge, and if the above method is adopted it is less likely that the oil will be forgotten. Petrol should always be strained through a chamois skin. This will check all particles of sand and dirt and will absorb any water that may be in the petrol. Tank caps should always be screwed down securely. Too much importance cannot be paid to this matter, especially when machines are equipped with pressure tanks. It is never advisable to alter the position of any petrol or oil cock or tap in a machine unless ordered to do so. Care should be taken that the outside of petrol and oil cans be kept clean. They should not be left standing on the ground, as sand and dirt thus gathered may find their way into the tanks and cause considerable trouble.

Petrol and oil tins should not be damaged, as these

THE EYES OF THE ARMY AND NAVY

cans are usually on charge and have to be returned for refilling.

Priming or "Doping" an Engine

To enable an engine to start easily it is primed. A small amount of petrol is forced into each cylinder by means of a small squirt gun. Care should be taken to avoid spilling petrol over the exterior of the engine and not to "over-dope," as both faults are liable to cause trouble. While priming it is advisable to rotate the propeller in order to circulate the petrol in the cylinders.

Preparations for Swinging the Propeller

"Chocks" should be placed under the wheels before an engine is tested. These chocks are generally provided with a long lanyard to enable them to be pulled away readily by men stationed at the wing-tips. When testing engines in tractor machines the men (except those required for holding the lanyards of the chocks and a hand for the swinging of the propeller) should be in rear of the machine. Two men should be told off to hold down the tail, at a position just in front of the tail plane, as under the action of the slip stream from the propeller the tail has a great

THE CARE OF AN AEROPLANE

tendency to lift. Men told off to hold struts should grasp and pull on the rear interplane struts at the bottom.

In engine testing on the pusher-type machine the strut hands should push on the bottom of the front interplane struts. Two hands should be stationed to hold down the tail. This is best accomplished by holding down on the inter-tail boom struts. Men should never be allowed to put their weight on the tail booms.

Swinging a Propeller

First make sure that the ignition switch is at "off." This not only applies when actually swinging a propeller, but also when cleaning machines in their sheds. In short, never touch a propeller until you have satisfied yourself that the switch is off.

In tractors most rotary engines are fitted with two-bladed propellers and rotate in an anti-clockwise direction, *i.e.*, when facing the engine. The majority of stationary engines are fitted with two- or four-bladed propellers which revolve in a clockwise direction. In order to become a good "prop" hand a great deal of practice is required. There is a knack in this work which can only come by actual swinging. Strength is an important factor, but not nearly so important as a knowledge of using the weight of the

THE EYES OF THE ARMY AND NAVY

body properly and efficiently. Although there are many methods of swinging a propeller, the main principle, in all of them, is the same. The following method has been found to be a very good one and applies to a 130 H. P. Clerget engine in a Sopwith scout, although it can be applied to all rotary engines, whatever the direction of their rotation may be, the only difference being a change in the position of the feet.

Place the propeller in a horizontal position just past compression in one of the cylinders. Grasp the blade with both hands as close together as possible and a little to the center of the propeller, half-way between the boss and the tip of the blade. Arms and wrists should be slightly bent. The left foot carries all the weight of the body and should be placed about a foot in rear of the hands. The right foot should be clear of the ground. The weight of the body should be suddenly transferred to the propeller, the left foot giving the body a swing to the right across the plane of the propeller. The grasp of the blade should not be released until the blade passes the horizontal on the opposite side. The right foot comes down to the right of the boss and takes up the whole weight of the body. A part of a circle is described by the left foot and comes down about a pace in rear of the right foot. (Fig. 36.)

THE CARE OF AN AEROPLANE

The first position of the feet is shown by L.1. and R.1. R.1. is off the ground. L.2. and R.2. shows the position of the feet at the completion of the swing. The lines joining L.1. and L.2., R.1. and R.2. show the approximate paths of the feet.

The four-bladed propellers, fitted on machines

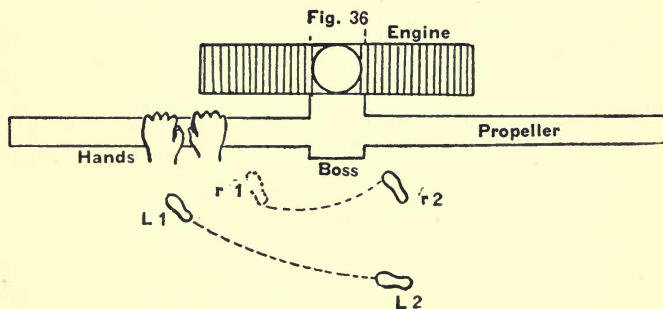

such as the 80 H. P. Renault engine B. E., require different handling on account of the blades being very thin. Propellers on machines of this type generally rotate in a clockwise direction when facing the propeller. The "one-handed" swing is recommended for these machines, and the following is usually the method employed:

Place one of the blades at, approximately, the "two o'clock" position and with the right hand grasp the blade as near as possible to the boss; swing the propeller by running across the front of the machine.

THE EYES OF THE ARMY AND NAVY

Cleaning the Machines

As soon as possible after a flight a machine should be cleaned. All mud, dirt, sand, and oil should be removed. Attention should also be paid to the inside of the fuselage or nacelle and it should receive a thorough cleaning periodically. When doing this care should be taken that no instruments, switches, or taps are meddled with. Plenty of soap and warm water is the best for all cleaning purposes. Petrol damages varnish and paint and is susceptible to fire, therefore it should be avoided. It will be observed that when the fabric is washed with soap and water it is inclined to slacken somewhat, but will regain its tautness when thoroughly dry.

If a machine gets wet the water should be dried off the planes as soon as possible, by means of clean waste, and the wires should be greased.

Storage of Aeroplanes

Immediately a machine is housed a tray should be placed under the engine. This will prevent oil from dropping on the floors and therefore save tires and greatly assist in maintaining the general cleanliness of the sheds. The weight of the machine should be relieved from the wheels or floats by placing supports

THE CARE OF AN AEROPLANE

under the axle. Care should be taken that the supports are placed in such a position that the main weight of the machine is evenly distributed. It is advisable to take the weight off the tail skid or tail float, as, if much weight is carried, the main longerons or the tail booms are liable to be thrown out of true shape by the constant bending.

Care of Materials

Fabric. It has been stated that the fabric is protected from damp, oil, and the general weather conditions by the application of dope; however, the fabric should be cleaned as soon as possible after a flight; if moisture, oil, or mud is allowed to remain on the fabric it will greatly deteriorate the material. Frequently it is found that portions of the fabric become saturated with oil. These portions should be cleaned and redoped thoroughly.

Wood. All wood should be protected with a coat of varnish.

Propellers. Propellers should always be stored in a dry place and kept as dry as possible. Exposure to damp renders them liable to warp. They should be examined frequently in order to see that the laminations are not beginning to separate.

Bracing Wires. The external bracing wires should

THE EYES OF THE ARMY AND NAVY

be protected by grease or a coat of paint. It should be remembered that wires and fittings when painted deteriorate quicker than wires and fittings protected with grease. Also, on account of the paint, it is less easy to detect deterioration. All internal bracing wires should be painted, but before a coat of paint is applied it is imperative that the wires be perfectly dry and free from rust and grease.

Turnbuckles, bolts, nuts, and wire-strainers should be protected from rust by a light film of oil or grease. The turnbuckles should have sufficient threads engaged to insure their safety and should be locked to prevent any possibility of their unscrewing. Bolts and nuts should be properly tightened and locked by means of split pins or locknuts.

Tires. Grease and oil are very detrimental to tires, therefore they should be kept free from such substances and should be kept pumped up.

Field Repairs. If a pilot has a forced landing and his machine is only slightly damaged he should first ascertain the new parts required to continue his journey and communicate with his respective aerodrome for the parts required. But it should be borne in mind that an absolutely correct report of parts necessary will save considerable time and trouble. For instance, if a leading edge of a plane is only slightly damaged a pilot could manage to fly

THE CARE OF AN AEROPLANE

back to his aerodrome without having a new plane attached; whereas, if a tail plane or rudder has suffered only slightly, it would be necessary to have new parts fitted before attempting to continue the journey. If a machine is damaged to such an extent that the trip has to be abandoned, the following points in dismantling and transporting a machine should be observed:

The wings should be taken down and taken apart. They should be placed on their leading edge after having it protected; if the planes are placed in pairs, all four planes (in the case of a biplane) can easily be placed on one large lorry or trailer. If the machine is a small type, the fuselage or nacelle can also be placed on the lorry between the two sets of planes; however, if the undercarriage is undamaged a good method is to trail the fuselage or nacelle and center section.

IX

AERO ENGINES

THE main requirements of aeroplane engines are: reliability, small weight per horse power, small oil and petrol consumption per horse power, a minimum head resistance, and absence of vibration. There are two distinct types of aero engines, the rotary and the stationary. The former is always air cooled; the latter may be either air or water cooled.

Types of Rotary Engines

Gnome, Clerget, Verdet, Le Rhone, and Isaacson.

Types of Stationary Air-cooled Engines

Renault, Anzani, and De Dion.

Types of Stationary Water-cooled Engines

Curtiss, Green, Austro-Daimler, Chenu, Argyll, Sunbeam, Canton Unné, Rolls Royce, Hispano-Suize, Hall-Scott, Mercedes, Isolta.

AERO ENGINES

Stationary engines have their cylinders placed vertically, V-shaped, radially, or horizontally.

Magnetos

The Bosch magneto is the most widely used in the air services. It is driven either by means of spur wheels or chains. If the former method, which is usually adopted, is employed, the spur wheels should be made alternately of hardened steel and phosphor-bronze.

Action of the Magneto

The armature core, a soft laminated "H" section, is wound with primary and secondary windings; the secondary is a continuation of the primary and is wound round it. The primary is always in series with the secondary, and a contact-breaker is connected in series with the primary and rotates bodily with the armature. This armature rotates between soft iron pole shoes which are magnetized by permanent steel magnets of a horseshoe shape. Across the contact-breaker a condenser is fitted in order to eliminate sparking at the platinum points and to insure a quick breaking of the primary current. By means of the armature being rotated and the rotary circuit being broken at the correct moment by the

THE EYES OF THE ARMY AND NAVY

contact-breaker, a spark jumps across the plug points.

Platinum Points of Magnetos

These should be adjusted so that they should not break more than 0.5 mm., and not less than 0.3 mm., when the fiber block strikes the steel segment on the timing lever. These platinum points should be carefully and frequently examined and, if found uneven, should be adjusted or replaced by new points.

High-tension Terminal

The end of the secondary winding is led out of the opposite end of the armature to the end which carries the contact-breaker to a slip ring. Above the ring, and in contact with it, is a carbon brush which is held in an ebonite holder. From this carbon brush a connection leads to the distributing wheel and thence to the spark plugs.

Low-tension Terminal

From the low-tension terminal a wire is led to the switch and through this switch to "earth." When a pilot desires to switch "on" the contact between this terminal and the earth is broken, and when it is

AERO ENGINES

desired to switch "off" contact between the terminal and earth is made.

To Strip a Magneto

First remove high-tension carbon brush. Remove brass end cap by turning spring round. Remove brass sleeve to which is attached the switch terminal. Remove set screw which secures the make and break. This can be done by the means of a screw-driver being placed beneath the brass disk and prizing. The make-and-break mechanism will slide off the spindle quite readily. Remove the four screws in the end plate adjacent to the timing wheel. Remove the armature and end plate. These should come away together by prizing against the magnet poles with a screw-driver.

Care and Maintenance of Aeroplane Engines

All aero engines should run smoothly, and the slightest difference in running, especially the presence of metallic sounds, should be investigated immediately. True records of all running time and a statement of all adjustments of engines should be logged. All rotary engines should be thoroughly overhauled after twenty to thirty hours' running, and stationary

THE EYES OF THE ARMY AND NAVY

engines should be thoroughly overhauled after every fifty hours' running. In the latter type the piston heads and plugs should be examined and cleaned after every five hours' running and the oil pump cleaned out after every five to six hours' running. When an engine is overhauled a thorough examination for cracked pistons, valves, valve seatings, piston rings, and for flaws in the crankcase and connecting rods should be made. Great care should be taken that the cylinder walls, valve seatings, and all working surfaces are protected from being scratched when cleaning is in progress. Adjustable bearings of engines should be examined regularly in order to ascertain any signs of wear. In the stationary water-cooled types rain or distilled water should be used to fill the radiators, and in frosty weather, unless the sheds are heated, the radiators should be emptied when the engine is not in use.

Many types of rotary engines are fitted with piston rings. These rings should be removed with care when dismantling an engine, and they should be replaced on the piston from which they were removed.

When "doping" or priming an engine care should be taken that the engine is not over-doped. A very good rule is to inject paraffin into the cylinders after an engine has been run for some time; but the engine should be cool before the paraffin is injected. Rotary

AERO ENGINES

engines should be rotated a few times daily when not in use, and if the exhaust valve of the bottom cylinder is choked open the excess oil will drain off.

All electrical connections should be kept securely fastened and all wire free from oil, moisture, and rust. Continuous backfiring is detrimental to the engine and should not be permitted.

The "mixture" should contain, approximately, one part of petrol to seventeen parts of air. In cold weather less air should be used. An engine of any description should never be allowed to run at the maximum speed. If the maximum revolutions of an engine are 1,800 revolutions per minute, 1,200 to 1,300 revolutions per minute would be the speed at which the best results would be obtained. Use the switch as little as possible, thereby reducing the strains on the engine, engine-bearers, and the machine in general. All engines deserve great care and attention. See that they get it and the best results and a long life of the machine are assured.

Causes for Defects of Engines

BACKFIRING. Spark too far advanced. Valve timing incorrect. Broken inlet valve springs. Sticky inlet valve stems. If self-starting device is fitted, backfiring is often caused by improper manipulation.

THE EYES OF THE ARMY AND NAVY

FAILURE TO START. The main cause of an engine failing to start is excessive doping. To remedy this fault, turn propeller back a few turns, cut off petrol, then swing the propeller again. If the engine still refuses to start, ascertain whether the magneto or switch is out of order. A good test is by switching on and placing a finger on one of the plugs of a cylinder just previous to the firing-point, and by moving the propeller backward and forward a few times a shock should be felt.

PRE-IGNITION. This is mainly caused by overheating, excessive carbon deposit, and by having the spark too far advanced.

CONTINUATION OF FIRING WHEN SWITCH IS OFF. Overheated cylinders, especially if heavily carbonized. Defective switch, earth wire broken or detached from the magneto terminal.

MISFIRING. This trouble is mostly caused by the following magneto and switch troubles: Magneto points need adjusting. Moisture on the high-tension terminal and wires. Excess of oil on the connecting wires. Carbon brush not bearing correctly, owing to weak spring or not being in proper position with respect to the distributor ring. Short circuit, caused by dirty, carbonized, or defective plugs, or by the high-tension wire coming into contact with metal engine-bearers. Defective switch.

AERO ENGINES

Other causes of misfiring are: Insufficient petrol supply. Excessive petrol supply. Needle valve not correctly adjusted. Freezing of induction pipe. Incorrect valve opening and closing. Valve spring broken. Incorrect mixture. Excessive lack of compression.

CAUSES OF LOSS OF POWER. Loss of power will frequently be experienced after an engine has been overhauled, owing to piston rings, valves, and valve seatings not having properly run themselves to running adjustment; however, this remedies itself after a short run. Insufficient petrol supply or excessive petrol supply. Improper mixture. Incorrect valve or ignition timing. Defective valves or valve seatings. Cracked piston or seatings. Overheating and lack or excess of lubrication. Excessive carbon deposit. Misfiring. Obstructed inlet or exhaust pipes. Worn, sticky, or cracked piston rings. Incorrect placing of engine in the aeroplane. Improper adjustment of bearings. Worn valve guides, cams, rollers, or valve-rod pins. Defective inlet or broken exhaust valve springs. Excessive vibrations, due either to unbalanced engine or unbalanced propeller, unequal tension in inlet-valve springs, or weak engine-bearers will cause great loss of power.

THE EYES OF THE ARMY AND NAVY

Lubricants

In all lubricants for aero engines the flash point should be high. Lubricants containing mineral properties are used for the majority of stationary engines and castor-oil for all rotary engines. The evaporation of petrol causes a distinct lowering of temperature, and all lubricating oils should have qualities in order to withstand the low temperature without liability to congeal. They should also contain such properties that high temperatures will not decrease their viscosity. When exposed to heat no acids or corrosive fluids should be formed. Oils that have properties that make them liable to gum or to set up excessive carbon should be avoided.

System of Oiling on Rotary Engines

Castor-oil is used for all rotary engines because it does not mix with petrol. In all the gnome types, except the double-cylinder ones, only one oil pump is fitted. All high-powered rotaries are fitted with two oil pumps. The oil flows to the pump by gravity and a pinion wheel operates the pump. This consists of two plungers and two piston valves. The oil is forced along two copper tubes to the hollow crankshaft, where two internal copper pipes lead part of

AERO ENGINES

the supply to the thrust bearings and the other part to the crank pin. From the pin it travels along the connecting rods to the gudgeon pins and then through small holes in the top angle of the piston, and so lubricates the cylinders. The oil pump should be cleaned regularly and special attention paid to the suction holes.

Carburetor

The carburetor is that part of an engine which is responsible for the regular supply of "mixture." There are many types of carburetors and many methods of carburation, but the main principle in all of them is similar. The petrol is led from the petrol tank, either by means of gravity or pressure, to the "float chamber." This chamber keeps the petrol at a constant level and prevents the carburetor from overflowing when the engine is throttled down or when the engine is not running. Inside this float chamber is a brass float and through this float a needle valve passes. When the float has risen to a certain position the top of the float comes into contact with two balance weights, which are pivoted about the needle, and when these weights are forced up the needle is forced down and the bottom of the needle valve falls down into the supply jet, and by doing so cuts off the supply of petrol. When the

THE EYES OF THE ARMY AND NAVY

level of the petrol falls the float falls, the weights are released and drop, and the needle valve is forced up, allowing a fresh supply of petrol to pass into the chamber. By means of lifting the needle valve the carburetor can be flooded in order to start the engine. A small pipe leads the petrol from the float chamber into the jet chamber. A vertical jet or nozzle is attached to the end of this pipe. Around this jet a partial vacuum, due to the suction effect of the engine, is set up and the petrol is emitted in a fine spray. This spray is evaporized easily and consequently mixed with the air, being sucked past the jet. Some types of carburetors are fitted with an arrangement for warming the supply of air to the carburetor and thereby assisting evaporation. From the jet chamber the mixture passes along the induction pipe to the cylinder.

X

AEROPLANE AND AIRSHIP INSTRUMENTS

ALL aeroplane and airship instruments are very delicate; they are easily damaged and are costly to repair. Great care should be taken in handling them and at all times they should be protected from oil, dirt, and dust.

Altimeter

It has been stated that as height is attained the pressure of the atmosphere decreases. The approximate decrease, relative to the height, is 1° in every 275 feet; therefore an instrument which is affected by the pressure of the atmosphere will give a rough indication of the height. The altimeter is an aneroid barometer, graduated in hundreds of feet, and is designed to show height instead of pressure. Altimeters are made in all sizes, from the size of a watch to a dial ten inches in diameter. This instrument is operated by means of a corrugated metal vacuum drum. As the pressure of the air decreases or increases the metal drum rises or

THE EYES OF THE ARMY AND NAVY

falls, respectively, and these movements are communicated to a pointer moving over a graduated scale. Care should be taken that the altimeter is set at the "zero" mark on the ground, before a flight is undertaken; the pressure of the atmosphere varies daily and it frequently acts upon the instrument at the earth's surface.

Anemometer

This is an instrument for measuring the force or velocity of the wind at the earth's surface. There are many types of anemometers, but the one favored in the air services is the "cup operated." By means of four or more out-facing cups mounted on a revolving spindle the velocity of the wind is ascertained by a count of the revolutions applied to a scale.

Aneroid Barometer

This is an instrument for determining the pressure of the atmosphere. The operation of this instrument is very similar to the operation of the altimeter. It registers the pressure of the atmosphere instead of a rough estimation of the height.

Inclinometer

This instrument is of the same principle as the ordinary spirit-level, but is placed vertically in the ma-

AEROPLANE INSTRUMENTS

chine so as to indicate, in degrees, any slight change in angle of the fore-and-aft line of the aeroplane or airship. Zero, or level, is the flying-level position of the aircraft. This instrument, as also the laterometer, should be rigidly attached to the machine, and if placed correctly should never require adjusting.

Laterometer

This instrument is also similar to the ordinary spirit-level. It is set in the machine horizontally to indicate any change of angle in the lateral position of the aircraft. This instrument is so constructed that when a turn is being made, zero will be registered; that is, if there is no "side slip." But if a turn without "bank" is attempted, the side slip, which would occur, would be registered immediately by this instrument.

Pressure-gauge

This instrument is used for registering the difference between the pressure of the gas or air in the envelope of an airship and the pressure of the outside atmosphere. The favorite type is the "U" tube. The tube is made of glass and is half filled with colored liquid. A scale is graduated on either side of the tube and divided into millimetres. The tube that leads to the

THE EYES OF THE ARMY AND NAVY

envelope has the scale reading from zero to zenith down the tube; the connected tube exposed to the atmosphere has the scale reading from zero to zenith up the tube. When the pressure in the envelope of the airship and that of the atmosphere are equal, both scales should read zero. If the liquid in the tube, connected to the gas-bag, is lower, or reads lower than the atmospheric-pressure scale, it is readily observed that the pressure of the gas or air is greater, and *vice versa*. In many of the latest types of pressure-gauges one arm of the "U" tube is somewhat thicker than the other, in order to insure a quicker and more accurate reading.

Manometer

This is another type of pressure-gauge. Its principle is similar to that of the aneroid, but far more delicate, and records the pressure of the gas in millimetres of water.

Revolution-counter

This instrument is for ascertaining the revolutions of the engine. It is operated by means of a governor. A cable is led from a worm wheel on the engine to the revolution-counter box; increase of the revolutions of the cable forces the balls of the governor to swing out; this in turn forces the pivot of the governor down. In a similar manner, if there is a decrease of revolutions

AEROPLANE INSTRUMENTS

of the cable, the balls of the governor, owing to their weight, will drop and force the pivot up. These movements are communicated to a pointer which registers the reading.

Speed-indicator

The function of this instrument is to register the speed of a machine through the air, not the speed of the machine in relation to the ground. Ground speed is estimated by adding the wind velocity to or subtracting it from the air speed. The speed-indicator is operated by means of a leather diaphragm. Two tubes, the pitôt and the static tube, are placed at the leading edge of the machine, openings facing toward the direction of motion, and are connected to the instrument. The pitôt tube is left full open at the end, and allows the wind to pass down the tube to the instrument. The static tube has a small cone attached to its end, and this cone overlaps part of the tube. The wind passing over the cone causes a negative pressure or suction to be set up at the overlapping point. Through small holes in the tube at this point the suction force continues along the tube to the instrument. The box of the instrument is divided into two distinct chambers by means of a leather diaphragm. On one side of this diaphragm the pitôt tube enters, and on the other side of the diaphragm

THE EYES OF THE ARMY AND NAVY

the static tube enters the box of the revolution-counter. The increase of pressure in the one chamber, caused by the wind blowing down the pitôt tube, and the decrease of pressure in the other chamber, caused by the suction in the static tube, cause the diaphragm to move accordingly. To the center of the diaphragm a needle is attached, and this needle is free to move backward or forward, according to the movements of the diaphragm. This needle communicates all movements to a small lever, and in conjunction with a fine spring gives movement to a pointer on a graduated scale and so registers the air speed of the aircraft. The two tubes are always placed together and should be placed in a position of least disturbance from the revolutions of the propeller and from the eddies set up at the wing-tip. About half-way along the wing, and on the leading edge of the upper plane, is the usual and the best position. In an airship they should be placed on the framework, well forward and away from all disturbing influences.

Statoscope

An instrument designed to register the difference of atmospheric pressure at heights varying by only a few feet and so to detect whether an aircraft is rising or falling.

XI

WIRELESS TELEGRAPHY AND SEMAPHORE

Importance

EVERY pilot should have a knowledge of the elementary principles of wireless telegraphy; he should be able to read Morse, to send at least ten words a minute, and should know how to semaphore. It may seem absurd to many pilots to study these subjects, but some day, sooner or later, if a person continues flying, the need and usefulness of these subjects will be realized. For instance, a pilot on sea-plane duty has a forced landing. A passing vessel signals, asking him if he requires help. If he has a knowledge of semaphore he will be able to communicate with the vessel, whereas if he is unable to read or send semaphore he might be ignored by the passing vessel and be at the mercy of the elements for many days before another vessel is sighted. When on active service it often happens that observers are scarce and a pilot may be ordered to act as an ob-

THE EYES OF THE ARMY AND NAVY

server on an expedition over the enemy's lines. On such an occasion a knowledge of wireless would be invaluable.

In graduating as a pilot in the air services there is always an examination on elementary wireless, and a pilot is required to read ten words a minute and to send eight words a minute in wireless and semaphore.

Elementary Principles of Wireless

To describe fully the elementary principles of wireless telegraphy would require from one hundred to one hundred and fifty of these pages, and would be out of place in a work of this description. In this article a short description of the fundamental principles, the symbols used, and the Morse and Phillips codes are given. This covers all that is required to be known by the pilot, for all practical purposes.

Careful methodical study and drill on the practical application of the various symbols on the instruments is required to master the art of good sending and receiving. In the actual study the first step is to memorize the alphabet numerals and practical punctuation code.

The Morse Code

A	B	C	D	E	F	G	H
I	J	K	L	M	N	O	P
Q	R	S	T	U	V	W	X
Y	Z						
1	2	3	4	5	6		
7	8	9	0				

Comma, - - - - - Period, - - - - -

Practical Symbols of the Phillips Code (American)

A	B	C	D	E	F	G	H	I
J	K	L	M	N	O	P	Q	
R	S	T	U	V	W	X	Y	
Z	&							
1	2	3	4	5	6			
7	8	9	0					

Period . - - - - - Comma , - - - - - Interrogation mark ?
- - - - -

THE EYES OF THE ARMY AND NAVY

Units of Electricity

In order to define and measure the various electrical factors of a circuit certain practical standards, or units, have been adopted.

The unit of quality	is one coulomb
“ “ “ current	“ “ ampere
“ “ “ power	“ “ watt
“ “ “ energy	“ “ joule
“ “ “ capacity	“ “ farad
“ “ “ inductance	“ “ henry
“ “ “ resistance	“ “ ohm
“ “ “ pressure or electromotive force	is one volt

The Coulomb

The coulomb can be compared with the “gallon” or the mechanical unit of an engine—namely, “one revolution.”

The Ampere

This unit can be compared with the number of “gallons per second” that are flowing in a water-main, or the number of “revolutions per minute” of an engine.

The Watt

The rate of doing work. One watt is the power required to do one joule of work per second.

$$\text{Watt} = \text{volts} \times \text{amperes}$$

WIRELESS AND SEMAPHORE

For convenience, the kilowatt is often used as the unit of electrical power instead of the watt. One kilowatt is equal to 1,000 watts.

The Joule

In order to cause a current of electricity to flow in a circuit, energy or work must be expended, and the joule is the unit of electrical energy or work.

The Farad

The farad is the unit of capacity. This unit is a large one, and for convenience the microfarad, a millionth part of a farad, is usually adopted.

The Henry

This is the unit of inductance. This term inductance should not be confused with the term resistance. Resistance opposes a flow of electricity. Inductance is best described as "inertia." It is well known that when an engine with a heavy fly-wheel is started a short time elapses before the engine has attained full speed, owing to the "inertia" of the heavy fly-wheel. In a similar manner inductance is the quality in a current which tends to oppose any change in the flow of

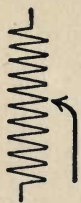

VARIABLE
RESISTANCE

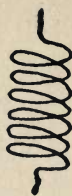

INDUCTIVE
WINDING

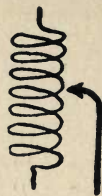

VARIABLE
INDUCTANCE

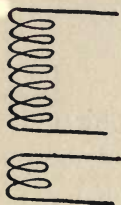

TWO COILS HAVING
MUTUAL INDUCTANCE



RESISTANCE
COIL

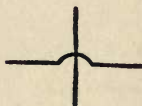

CONDUCTORS
CROSSING

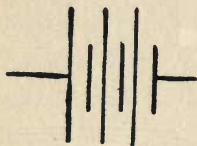

BATTERY

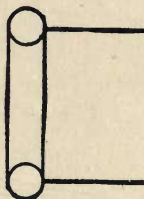

SWITCH



POSITIVE



NEGATIVE

SYMBOLS USED IN DIAGRAMS OF WIRELESS-TELEGRAPHY CIRCUITS



CONDUCTOR



CONDUCTORS
CONNECTED



DIRECT-CURRENT
DYNAMO

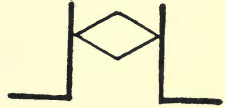

CRYSTAL
DETECTOR

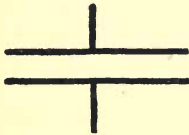

CONDENSER

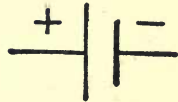

CELLS

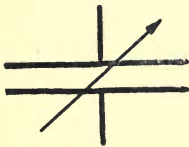

VARIABLE
CONDENSER



ALTERNATING
CURRENT

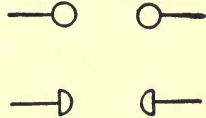

SPARK GAPS

SYMBOLS USED IN DIAGRAMS OF WIRELESS-TELEGRAPHY CIRCUITS

THE EYES OF THE ARMY AND NAVY

capacity. The microhenry is frequently used as a unit. One microhenry is equal to one millionth part of a henry.

The Ohm

The ohm is the unit of resistance. Just as friction opposes the flow of water through a pipe, so does resistance oppose the flow of electricity through a conductor.

The Volt

The volt is the unit of electrical pressure. It can be compared with the practical unit of mechanical force—namely, the pound. For instance, a flow of water—that is, the number of gallons per hour that will flow through a pipe of given length, size, and shape—will depend upon the number of pounds of pressure applied behind the water.

Magnetism

The power which a magnet has of attracting iron or any other magnetic substance is termed magnetism. When a piece of steel is magnetized it is called a permanent magnet. One end of this magnet would be termed the north pole, and the opposite end the south pole. The range of any space over which the magnet will attract other magnetic substances is called the

WIRELESS AND SEMAPHORE

magnetic field. Like poles repel, and unlike poles attract one another. For instance, if the north pole of one magnet is brought near the south pole of another magnet the two will attract each other, and if the two north poles or two south poles are brought together they will repel each other. The "lines of force" pass out from the north pole of a magnet, round a circuit, and return into the south pole. Any magnetic substance which is brought into the magnetic field of a magnet becomes magnetized. This effect is termed "magnetic inductance."

It should be borne in mind that magnetism is not electricity. The study of the relation between the two forces is called "electromagnetism."

Electromagnetism

A magnetic field is produced around a conductor when an electric current is passed through the conductor. A field of this description consists of a number of lines of force in concentric circles traveling around the conductor. The direction of these lines of force is influenced by the direction of the current. If a conductor is bent so as to form a coil, it will be readily observed that the lines of force will act upward on the inside of the coil and in a downward direction on the outside of the coil; but instead of the lines of

THE EYES OF THE ARMY AND NAVY

force acting right round one turn of the wire, they combine with those produced by the next turn and form complete lines of force, as shown in Fig. 37.

In this way a bobbin or coil of wire is very similar to a magnet. If a steel rod is placed in the center of

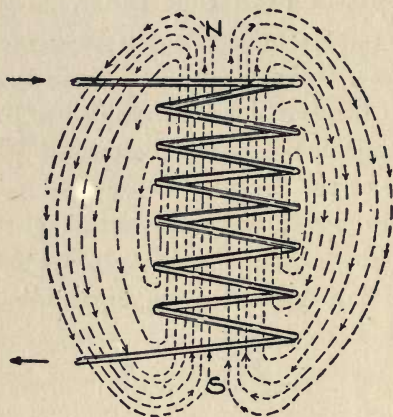

Fig. 37

the bobbin or coil it will become a permanent magnet; if a rod of soft iron is inserted into the coil it becomes a magnet, but not a permanent magnet, because the magnetism only lasts as long as the current lasts. A magnet of this latter description is called an electro-magnet. If the two ends of the wire around the coil are joined a current of electricity will flow through the coil. This effect is known as electromagnet induction. The strength of the current induced will depend upon

WIRELESS AND SEMAPHORE

the rate of change in the number of magnetic lines of force passing through the coil.

Mutual Induction

It has already been stated that if an electric current is passed through a coil of wire, a magnetic field, similar to that produced by a permanent magnet, would result. Now instead of placing a steel rod or soft iron rod inside a coil, a smaller coil of wire may take the place of the rod of steel or iron, and if a current of electricity is kept flowing through the smaller coil it is termed "mutual induction." In this method the smaller coil is termed the primary coil and the larger coil the secondary coil. It will be readily observed that if a core of iron is passed through the primary coil the voltage of the secondary coil will be greatly increased. In the case of mutual induction it is not necessary to move the primary coil in and out of the secondary coil in order to change the number of lines of force. This is done by the switch connecting the circuit at the ends of the primary coil.

The Condenser

The function of the condenser is holding an electrical charge and exerting an opposite force. One simple

THE EYES OF THE ARMY AND NAVY

type of condenser consists of a plate of glass covered with tin-foil, or any other thin conductor, on both sides. This conductor merely acts as a means of dis-

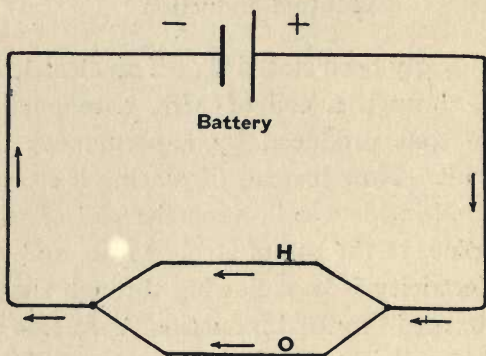

Fig. 38

tributing any applied electrical pressure uniformly over the surface of the dielectric, or non-conductor.

The Circuit

A circuit is a path composed of a conductor, or conductors, through which an electric current flows from one point in it, around the conducting path and back to the point from which it started. Various parts of the circuit may be connected, either in series or in parallel. (Figs. 38 and 39.) For instance, when two conductors, H and O, are joined

WIRELESS AND SEMAPHORE

together as illustrated in Fig. 38 they are said to be joined in parallel, and if joined as shown in Fig. 39 they are said to be joined in series. In the former method only a portion of the total current passes

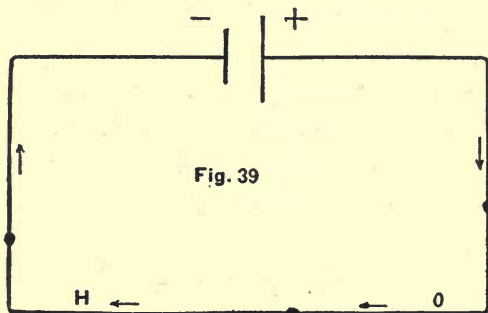

through each conductor, and in the latter method the whole current passes through each conductor successively.

Cells

Cells are a source of electrical pressure obtained from chemical action. Cells may also be connected in parallel or series, and the same principle, regarding the flow of current, applies as described above.

Accumulators

An accumulator is a cell in which, if a current of electricity is passed through, chemical action is set

THE EYES OF THE ARMY AND NAVY

up between two plates in the cell and the electrolyte surrounding them. This is known as charging the cells, and the current is known as the charging current. When this current is discontinued and the two plates are joined together, the cell will act the same way as a primary cell and a current of electricity will pass from the cell through the conductor in a direction opposite to that of the charging current. When two or more accumulators are joined together they are termed an accumulator battery.

Electric Waves

In order to communicate between one point and another point by wireless telegraphy it is necessary to have an apparatus for producing and emitting electric waves at the one point, and an apparatus for detecting them at the other point. The aerial wire performs both functions at each point. A charge of electricity is sent into the aerial wire by a movement of the key. The current will be large at first and will gradually diminish as the aerial becomes charged. When the aerial becomes fully charged the current will cease to flow in the direction in which the current traveled and will flow in the opposite direction. By movements of the key the current is despatched backward and forward and is termed an oscillating current.

WIRELESS AND SEMAPHORE

Wave lengths, usually employed in wireless, vary in length from 100 metres to over 15,000 metres. The larger the power of a station the longer the wave length employed. However, if the length of an aerial is increased, the capacity and induction of the aerial is increased, and thereby the fundamental wave length is also increased.

The Aerial

It is often necessary to adjust the aerial to obtain the desired electric wave length, and in aerial—that is, aeroplane—wireless this is frequently done by letting out or taking in the aerial wire, although most of the latest types of wireless outfits are fitted with a special apparatus for increasing or decreasing the wave length without altering the aerial wire.

It is obvious that the aerial circuit has to be “in tune” for despatching a signal, and must also be in tune for receiving a signal. The buzzer must also be adjusted and in tune for the two circuits, the oscillatory circuit and the generating circuit by which the oscillatory is excited.

When at semaphore drill or actually sending messages, the following points are important:

The signaller should stand exactly facing the opposite person or station.

The flags must not be thrown to the rear, and should

THE EYES OF THE ARMY AND NAVY

be held at the full extent of the arms and in exact prolongation of them.

Care should be taken that the arms are placed at the exact position to indicate the letters and signs.

When making the letters T, O, W, and the numeral sign, the flags should be distinctly separated, not crossing each other.

The signaler should turn slightly on the hips when making letters such as J, X, O, Z, but the eyes of the signaler should continue to look straight to the front.

When double letters occur, the flags should be brought in to the body after the first letter is made.

The flags should be kept unfurled and moved quickly from one letter or sign to the next. A pause should be made on the letter or sign, according to the rate of sending.

The simplest method of learning the semaphore alphabet and signs is by circles, thus:

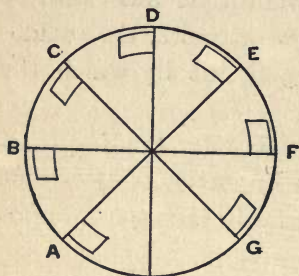

Fig. 40

First circle, A to G

Second circle, H to N (omitting J)

Third circle, O to S

Fourth circle, T, U, Y, and
"Erase"

Fifth circle, Numerical sign, J (or
Alphabetical sign), and V

Sixth circle, W and X

Seventh circle, Z

WIRELESS AND SEMAPHORE

In the first circle, the letters A to D should be made with the right arm, and E to G with the left arm.

When semaphoring without the use of flags the arms should be placed in a correct position, and in making letters where only one arm is used, that arm should not be brought across the body.

When letters follow one another, as in a word or group, the flags should not be brought back to the "ready" position after each letter, but if an arm is already in position to form or to assist to form the next, it should be kept steady.

When sending words and groups, the arms must be moved from letter to letter and both arms brought in to the non-signaling position on completion of the word or group.

The caller and writer should stand immediately in rear of the sender and reader, respectively, so that they may be clear of the flags and yet close enough to be heard and to hear the latter distinctly.

The same signs are used for the numerals 1 to 0 as for the letters A to K (omitting J), but are distinguished from the latter by being preceded by the "numerical sign" and followed by the "alphabetical sign." They are checked by being repeated back.

The "Stop" signal is "PP."

The "General Answer" will be made by the letter A or T, and "Flag up" by the letter E.

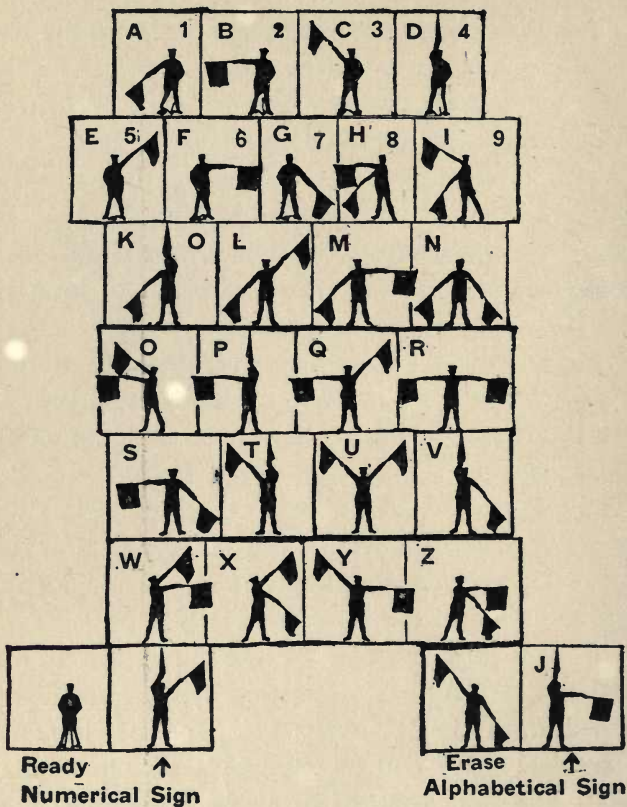

SEMAPHORE ALPHABET AND NUMERAL SIGNS

WIRELESS AND SEMAPHORE

The "Preparative" is J and waving the flags, and is answered by the "General Answer."

Known stations are called up and answer by their station calls; unknown stations by the "Preparative" and answer by the "General Answer."

The "Erase" (opposite to L) is used (a) to erase a word or group sent incorrectly, or (b) to erase a word or group incorrectly checked.

Go on, or spell out, is signaled G.

The "Repeat" signal is I M I.

"Word after" is signaled W A.

"Word before" is signaled W B.

"End of message" is signaled V E.

"Message correct" is signaled R D.

The "Obliterator" sign is W W.

The "numerical" sign (opposite to T) will be used to indicate numerals about to be sent, and the "alphabetical" sign to indicate numerals finished, letters being resumed.

XII

AERIAL PHOTOGRAPHY

AERIAL photography is a very important branch of duty carried out by the air services. It differs greatly from photography on the ground. It is put to a variety of uses. Where objects are easy to observe and count, it is not of much assistance, but a photographic record of defended harbors, arsenals, coast-works and dockyards, giving their relative position with objects visible from the sea, is of valuable importance to attacking ships. Aeroplanes operating with the land forces have a much wider scope for their activities, and an extensive list of the uses of aerial photography may be found in military manuals.

It requires much study combined with actual experience and practical experiments to become an expert photographer. To go into the subject thoroughly, in this handbook, would be out of place. This chapter is intended for those who wish to acquire sufficient knowledge of the subject to enable them to

AERIAL PHOTOGRAPHY

take successful photographs, from an amateur's point of view; however, a few notes have been added that may be found useful for reference purposes by aerial photographers detailed for official work.

Camera

Any good camera may be used for aeronautical work, but to obtain the best results the following points should be observed: The lens should be of the very best quality, and a large aperture lens is essential. The largest possible aperture enables the fastest possible exposure. A large aperture is advised for all exposures and at all times. The majority of service photographers set their lenses at the maximum aperture and never, on any occasion, reduce them. If the light is bright the time of exposure is reduced, instead of the size of the aperture. Most aeronautical photographs are taken at a medium height, but on active service some are occasionally taken at a great elevation. The height at which a photograph is taken depends, largely, on the size of the field and the amount of detail required. The usual elevation at which service pictures are taken is from 6,500 to 9,000 feet.

Focus Lens

As a wide field is generally required when taking pictures from a height, a short focus lens is advisable.

THE EYES OF THE ARMY AND NAVY

If details are wanted, an enlargement can be made. When taking photographs for official information it is not wise to use a shorter focus than a 6-inch, or the detail becomes altogether too small. With a half-plate camera a 6-inch lens is very satisfactory.

Ultra-violet Rays

There is ever present between the aircraft and the ground a mass of air carrying dust particles and moisture, which have the properties of reflecting the blue light in the atmosphere. These dust particles cause a bluish-violet haze to appear above the ground whenever the sky is clear. This haze varies in density. When the sky is partly overcast the haze will not be so pronounced as on a clear day. At times, when the sky is completely overcast, the haze will be practically at a minimum. This is on account of the rays that cause the haze being absorbed by the clouds.

Wratten Screen

Photographic plates and films are more active to rays of blue and purple colors than to yellow, red, or green rays. Therefore it is obvious that if a plate or film is exposed to the ground from above the bluish haze, the light in the haze will act on the plate or

AERIAL PHOTOGRAPHY

film more rapidly than the rays actually coming from the ground. This will "fog" the plate or film, and the exposure will, in nine cases out of ten, be a failure. However, this difficulty has been met and methods of counteracting the haze and somewhat eliminating the bluish-violet rays have been discovered. The best method to employ for this purpose is the use of a wratten screen or light filter. This is an attachment to be placed on the lens of a camera and is fitted with a screen of light-yellow color. This attachment allows the red, yellow, and green light rays to pass through the lens, and stops the greater proportion of the bluish-violet rays, according to the density of the screen color. These screens are manufactured in light, medium, heavy and extra heavy; for all practical purposes the light shade is recommended for use in winter and dull days, and the medium at all other times. A longer exposure is necessary with these screens. With the extra-heavy screen, ten times the period of normal exposure is required; the reason for the light and medium screens is therefore obvious.

These screens are of great assistance on occasions when fog or light clouds intervene between the object and the camera. The red, yellow, and green rays, being of longer wave length than the blue, violet, and purple rays, they penetrate the fog or mist much

THE EYES OF THE ARMY AND NAVY

better; and therefore diminish the possibility of the plate or film being fogged by the bluish-violet rays.

In the British Isles there are very few days when a wratten screen is not beneficial. For official use heavy screens are often used, as the object is to get clear detail rather than true representation of colors.

Special plates, made relatively more sensitive to red, yellow, and green rays, are now manufactured and used largely in conjunction with the screens for aeronautical photography.

Body of Camera

Cameras of the non-collapsible type are recommended for aerial work, but on account of lack of room in aeroplanes they cannot always be carried. With folding cameras care should be taken that the camera is correctly opened out and adjusted. If the folding portion is of flexible material, the side exposed to the direction of the aeroplane should be protected against the force of the air; otherwise the rushing wind will bear against the side and may obscure part of the plate from the lens.

The Shutter

The special aeronautical cameras are fitted with focal shutters. These have a distinct advantage over

AERIAL PHOTOGRAPHY

any other type, as they permit more light to pass. Shutters of this type require delicate handling and offer great difficulties in repairing. They should be carefully calibrated and occasionally checked.

The View-finder

The view-finder should be of the "direct view" pattern; the wire grid type is recommended. The finder should be first adjusted correctly; with a little practice an operator can locate the exact lines of the photograph. The most common fault is to show too little ground, and, although this is an error on the right side, it often causes needless waste of plates when large areas are being photographed to be mounted together.

Exposures

It is a common belief that as an aeroplane is usually traveling at a great speed a very quick exposure is required in order to get the best results; but this is not the case. The higher a machine is flying the longer a plate or film may be exposed with safety. Recent experiments have proved that exposures of $\frac{1}{25}$ of a second duration, taken at a height of 5,000 feet from a fast aeroplane, were very successful. For all official aeroplane photography, an exposure of

THE EYES OF THE ARMY AND NAVY

$\frac{1}{8}$ of a second is usually recommended; and from an airship or balloon an exposure of $\frac{1}{16}$ of a second is required; but as the atmospheric conditions vary greatly, no exact table can be laid down.

Plate Slides

Plate slides for aerial work should be made of wood, preferably teak. The much-used vulcanite slides soon become brittle and crack and are liable to accumulate dust, which, in time, gets transferred to the plates and spotty photographs are the result. Boxes holding from 12 to 18 plates are now used considerably, taking the place of plate slides. They save much time and are more convenient to operate than slides, although the disadvantage is that if any mishap occurs all the plates may be spoiled.

Actinometer

An actinometer is a very useful instrument and should be included with every aerial photographer's outfit. This instrument is shaped like a watch and enables a person to test the quality of the light, without reference to tables or to his own sense of light value. It is also possible, by its means, to ascertain, with some degree of certainty, before leaving the

AERIAL PHOTOGRAPHY

ground, whether successful photography can be carried on; it is often of assistance in preliminary preparations such as choice of shutter, aperture, or shade of screen likely to be required. When the actinometer is supplied, full instructions of how to use it should be given with the instrument.

Plates Recommended

Paget Orthochromatic, extra special rapid, specially hardened.

Norris Isochromatic, rapid exposure. (American production.)

Wellington extra speedy.

Imperial special rapid.

Printing Papers Recommended

Kodak, Platino Matto, rapid, smooth.

Wellington gaslight, S. C. P. medium, is best for very thin plates or film exposures.

Developing

Time methods of development give the best and quickest results and are the only methods applicable to orthochromatic plates. The best developer to

THE EYES OF THE ARMY AND NAVY

use is pyrometol. This can be obtained in tabloid form, or can be made up in fresh solution, but the former is advised.

To make up the fresh solutions:

A	B
Metabisulphite soda 240 grains	Carbonate soda..... 8 oz.
Pyrog. acid100 "	Sulphite soda..... 2½ "
Metol 90 "	Water.....40 "
Potass. brom..... 40 "	
Water..... 40 oz.	

Equal parts of A and B.

If the fresh solutions are used, the following points should be observed: A solution should not be kept made up for more than a few days. The two solutions mixed should not be used after two days. When developing by the time method, a pint of solution will be sufficient to develop one dozen plates; it is advisable to commence with less than the required amount and add a little fresh solution as each plate is developed. The developing pans should be heated before the fluid is poured in and should be kept hot during the process of development. This can be done by placing the developing dish in a pan of hot water. The specially hardened plates, used when quick results are required, can be safely developed in a solution with a temperature of about 150°-200° Fahrenheit. The following table indicates the time

AERIAL PHOTOGRAPHY

necessary to develop fully exposed negatives in order to obtain the best results.

Temperature of developing solution in degrees Fahrenheit.....

	45° Mins.	50° Mins.	55° Mins.	60° Mins.	65° Mins.	70° Mins.	75° Mins.
Paget Orthochromatic.....	8	7	4½	4	3	2¾	2¼
Norris Isochromatic.....	8	7	5	4½	3¾	3	2½
Imperial and Wellington.....	7	5½	4¾	3¾	3½	2¾	2¼

In cases where plates have been known to be under-exposed it is advisable to have the solution at a slightly higher temperature. In cases of known over-exposure the best results are obtained by developing the plates for one-half the time, then fix, and intensify after washing.

Fixing solution should be kept as strong, and of the same temperature, as the developing solution.

Printing

The method of printing aerial photographs does not vary much from the methods usually employed in ground photography, and for all practical purposes the same methods are advised.

XIII

BOMBS AND BOMB-DROPPING

Types of Bombs

BOMBS weighing from 10 to 25 pounds are known as light bombs. The case is usually sheet-metal case and is filled with amatol or trotyl. Object: To drop a trail of bombs across a building to make sure of a hit.

There are two types of heavy bombs, the light case (sheet-steel) and the heavy case (cast). Heavy bombs are also filled with amatol or trotyl. Object: *For submarine destruction.* If a submarine is on the surface, bombs fitted with direct-action fuse should be used. If submerged, delay-action fuse would give the best results. *For attacking buildings:* If dropped from a height above three thousand feet direct-action fuse should be used, and if dropped from an altitude under three thousand feet delay-action fuse would be desirable. *For attacking earth-works:* Delay-action fuse would give the best results.

BOMBS AND BOMB-DROPPING

Petrol, incendiary and carcass bombs are filled with petrol and secret composition and are used for the destruction of hostile materials and inflammable goods. Parachute flares are used to show up enemy positions by night and for night-landing purposes. Signal flares are used for signaling purposes and may be made so as to give a white or colored light.

Method of Arming Bombs

In a work of this kind, descriptions of the various methods of arming bombs would be out of place and would also be a contravention of the "Defense of the Realm Regulations," but it may be taken as practically general that small bombs, bombs weighing up to 25 pounds, are armed before they are placed on the bomb-dropping frame and bombs weighing more than 25 pounds are usually armed after being placed on the frame.

Method of Carrying and Releasing Bombs

Bomb-carrying frames are usually attached under the lower planes and near the fuselage or nacelle, and in some types of machines under the fuselage to the rear of the undercarriage. Small bombs are generally carried in series of fours and eights and the larger bombs in couples. The releasing lever is placed, either inside the fuselage or nacelle or on the

THE EYES OF THE ARMY AND NAVY

outside within easy reach of the pilot or observer, and the gear is arranged so as to drop the projectiles alternatively, first from the one side and then from the other side; this insures the lateral stability of the machine not being interfered with by the weight of the bombs.

Bomb-dropping

Best results in bomb-dropping are obtained by dropping head to wind, or, as termed in the services, "up wind"; however, if conditions do not permit of this method a pilot should endeavor to drop his bombs tail to wind or "down wind." Many types of bomb-dropping frames and sights are used in the service and a pilot will be instructed in their proper use. When attacking an object with a number of small bombs the best results are obtained by "straddling" the target; that is, by dropping the first bomb just previous to the target appearing on the bomb sight and dropping the last bomb just after the sight has passed over the object. If this method is adopted a sure hit by one or more of the bombs is probable.

How to Ascertain Direction of Wind when Flying

There are many methods of ascertaining the direction of the wind when ready to drop bombs. Smoke drift from factory chimneys or dwellings is an excellent guide. Bomb-dropping over enemy

BOMBS AND BOMB-DROPPING

country is generally carried out from a height of between 10,000 and 15,000 feet, however; unless the visibility is very good these smoke signs would be very indistinct. The best method to adopt under such conditions is to ascertain the drift of the machine. When preparing to drop bombs the pilot should head his machine in the direction from which he assumes the wind to be blowing, and then take a line of two objects ahead, along the side of the fuselage or nacelle. Suppose he chooses a village far ahead, and a forest is between the village and the machine, on the left or port side of the machine. He should endeavor to steer straight along the line of the two objects. If, however, the forest disappears under the fuselage or nacelle, he knows that he is drifting to port, or to the left of the machine; therefore the wind is slightly to his right. If in the other case the forest appears to be moving toward the port wing-tip, the machine is drifting to his right, or starboard, and indicates that the direction of the wind is slightly to his left. By carrying out this procedure a few times the true direction of the wind can be ascertained

The Theory of Bomb-dropping.

A bomb has two forces to resist. The force of gravity and the force of forward velocity. The differ-

THE EYES OF THE ARMY AND NAVY

ence between the time of the fall of a bomb in vacuum and the fall of a bomb under ordinary conditions is termed the "time lag," and the difference of the distance traveled forward on the ground between the two is termed the "ground lag." (Fig. 41.)

An endeavor has been made to dispense with all formulæ in this work, but there are two simple for-

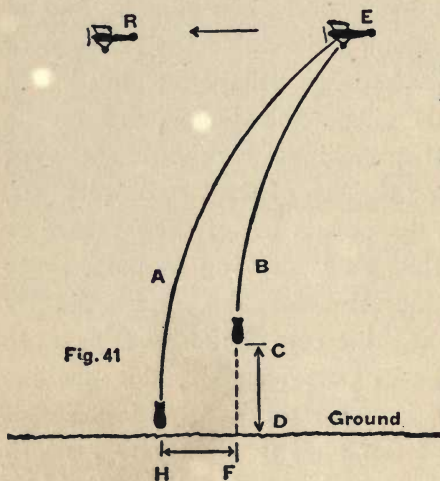

Fig. 41

Line A indicates trajectory of bomb dropped in a vacuum.

B—trajectory of bomb dropped under normal conditions.

CD—time lag.

HF—ground lag.

E—position of machine when bomb is dropped.

R—position of machine when bomb in vacuum strikes the ground.

mulæ in the theory of bomb-dropping which every pilot should master; these can be easily worked out if the application of "square root" is understood. At the end of this chapter a few lines, explaining how to ascertain the square root of a number and how to apply it, are given.

BOMBS AND BOMB-DROPPING

To ascertain the time of fall of a bomb, if given the height at which it is dropped:

$$\sqrt{\frac{H}{4}} + \frac{H}{9000} = \text{Time of fall} =$$

$$\sqrt{\frac{\text{Height in feet}}{4}} + \frac{\text{Height}}{9000} \left(\frac{H}{9000} \text{ is time lag} \right)$$

Example: Machine is flying at 6,400 feet; therefore the time of fall is

$$\sqrt{\frac{6400}{4}} + \frac{6400}{9000}$$

The square root of 6,400 is 80, therefore:

$$\frac{80}{4} + \frac{6400}{9000} = 20.7 \text{ seconds (approximately)}$$

To ascertain the distance a bomb travels forward from a point on the ground vertically beneath the machine, at the time of release, to a point where the bomb strikes the ground:

$$\left[\left(\sqrt{\frac{H}{4}} + \frac{H}{9000} \right) \times \text{Speed of machine in feet per second} - \frac{H}{40} \text{ (ground lag)} \right]$$

Example: Machine is at 8,100 feet, speed of machine is 100 feet per second. Find distance bomb travels forward, from the moment of release to the time of striking the ground:

44 1/2
44 1/2
9 12000
176
26
176
4

Digitized by Microsoft®

THE EYES OF THE ARMY AND NAVY

The square root of 8,100 is 90, therefore:

$$\frac{90}{4} + \frac{8100}{9000} \times 100 - \frac{8100}{40} = 2138 \text{ feet (approximately)}$$

It should be borne in mind that in the majority of problems of this nature the speed is either given in feet per second or knots per hour. If the latter is given, to bring knots per hour to feet per second:

Multiply the number of knots per hour by 1.69. This will give the approximate number of feet per second, and will be sufficient for all problems of this nature.

Square Root

If a number be multiplied by itself, the product is called the square, or second power, of the number. Thus the square of 8 is 8×8 , which is 64. The square of a number is symbolized by placing a small figure at the right of the upper part of the number; for example, in the above, the square of 8 is 8×8 , and is represented by 8^2 .

The square root of a given number is that number which multiplied by itself will produce the given number. For example, the square root of 64 is 8 because 8 times 8 is 64. The square root of a number is denoted by the sign $\sqrt{\quad}$ placed before the number; thus, the square root of 64 is denoted by $\sqrt{64}$.

BOMBS AND BOMB-DROPPING

Since $\sqrt{100} = 10$, and $\sqrt{10,000} = 100$, and $\sqrt{1,000,000} = 1,000$, it follows that the square root of any number between 100 and 10,000 lies between 10 and 100, and consists of two digits; that the square root of any number between 10,000 and 1,000,000 lies between 100 and 10,000, and consists of three digits, and so on. Hence it will be observed that for two additional digits of a number in periods of two, beginning at the right hand, the number of these periods will be the same as the number of digits in the square root. The left-hand period will sometimes contain only one digit. Consider the number 1,444, obtained by multiplying 38 by 38. Its square root is 38.

In ascertaining this square root first determine the number of *tens*, and then the number of *units*.

Write 38 in the form $30 + 8$, and multiply it by $30 + 8$, thus,

$$\begin{array}{r}
 30 + 8 \\
 \hline
 30 + 8 \\
 \hline
 30 \times 8 + 8^2 \\
 30^2 + 30 \times 8 \\
 \hline
 30^2 + 2 \times 30 \times 8 + 8^2 \\
 = 1444 = 30^2 + (2 \times 30 + 8) \times 8.
 \end{array}$$

The number of *tens* in the square root can be found by ascertaining what multiple of 10 has its square next less than 1,444; this is clearly 30, for $40^2 = 1,600$ and is too great.

THE EYES OF THE ARMY AND NAVY

Having found the *tens*, next find the *units*.

Subtracting 30^2 , or 900, from 1,444, the remainder is 544; hence 544 must be equal to $(2 \times 30 + 8) \times 8$.

If 544 could be divided by $2 \times 30 + 8$ the number of units 8 would be obtained. But since the divisor itself involves this unascertained number 8, the plan adopted is to use the part 2×30 as a *trial* divisor, to find by means of it a *trial* quotient, and then to see whether $(2 \times 30 + \text{trial quotient}) \times \text{trial quotient} = 544$.

The first trial quotient may not prove correct; if it proves to be too great, try the number next less, and so on.

In this particular case, divide 544 by 2×30 , *i.e.*, by 60, and the trial quotient 9 is obtained. But $(60 + 9) \times 9 = 621$, and is too great; therefore try 8, and $(60 + 8) \times 8 = 544$ is the result.

The digits of the square root 38 are thus found in succession.

The above operations may be stated concisely thus:

$$\begin{array}{r}
 \begin{array}{r}
 \hline
 14,44 \overline{) 30 + 8,} \\
 \underline{900} \\
 60 + 8 \overline{) 544} \\
 \underline{544} \\
 \hline
 \end{array}
 \qquad
 \text{or thus, }
 \begin{array}{r}
 \hline
 14,44 \overline{) 38} \\
 \underline{9} \\
 68 \overline{) 544} \\
 \underline{544} \\
 \hline
 \end{array}
 \end{array}$$

In the latter form, which is the practical one, the process is briefly stated as follows:

BOMBS AND BOMB-DROPPING

Mark off the digits in twos, beginning at the right hand.

The greatest square in 14 is 9, and its square root is 3. Place 3 in the root place. Multiply 3 by 3, and subtract the product from 14. The remainder is 5.

To this remainder annex the period 44, and the dividend becomes 544. Twice the root digit 3 is 6, so put 6 in the divisor.

Instead of 60 take 6 as a *trial divisor*, and take 54 as a *trial dividend*. Proceeding as explained above, it will be readily observed that 8 is the true quotient. Annex 8 to the 3 in the root place, and also to the divisor. Multiply 68 by 8, and, subtracting the product from 544, there will be no remainder, and the operation is completed.

The square root is thus 38.

In this way a square root can be obtained, however many digits the number may have.

Example: Find the square root of 56,644.

1st. Mark off the digits in periods of *two*, beginning at the right hand.

2d. The root nearest to that of the first period 5 is 2. The square of 2 is 4. Subtracting 4 from 5, the remainder is 1. Bringing down the second period, 166 is the next dividend.

3d. The *trial divisor* is 2×2 , or 4, and the *trial dividend* is 16. The true quotient is 3. Place 3 as the second digit in the root, and also annex 3 to the trial divisor.

4th. The next *trial divisor* is 46, obtained by doubling the 23 in the root; and the *trial dividend* is 374.

$$\begin{array}{r}
 2 \overline{)56,644} \quad | \quad \underline{238} \\
 \underline{4} \\
 43 \overline{)166} \\
 \underline{129} \\
 468 \overline{)3744} \\
 \underline{3744}
 \end{array}$$

XIV

NIGHT FLYING

NIGHT flying is a comparatively new and special branch of the aerial services, and duties in this connection are usually carried out by bombing squadrons and by defensive squadrons engaged in intercepting hostile aircraft. A pilot recommended for such duties receives special instruction and is practically obliged to fly by means of the instruments. The preliminary instruction consists of flying during the evening and staying up later every night until proficient.

In "taking off" and landing it is imperative that a pilot should get *head to wind* and maintain perfect lateral stability. Machines for night flying are usually equipped with wing-tip and tail lights and the instruments have illuminated ciphers as well as a pilot light in the cockpit. In "taking off" and preparing for formation flying the wing-tip and tail lights are used, but on approaching enemy territory

NIGHT FLYING

they are extinguished and are not used again until over friendly country.

Landing at Night

Landing at night is most difficult, especially in a small aerodrome. Each aerodrome should have prearranged signals so that a pilot passing over an air station would know whether he had arrived at his own station. For instance, a pilot from X station would fire a prearranged colored light when over an air station, and if the correct prearranged colored signal was fired from the ground in answer he would know that he had arrived at his own aerodrome; but if a different colored light was fired, it would signify that he was at an air station other than where he was stationed. When a pilot is ready to land he gives the landing signal and the landing flares or searchlights are lit.

Methods of Placing Landing Flares

There are many methods of placing landing flares; the most commonly adopted is to place a number of flares in the field so as to form the letter L in accordance with the direction of the wind. (Fig. 42.)

A pilot landing would be required to touch the ground at the end of the long arm of the L and land in the direction of the short arm of the L.

THE EYES OF THE ARMY AND NAVY

All other lights within a radius of one mile of the landing-ground should be extinguished and parts of

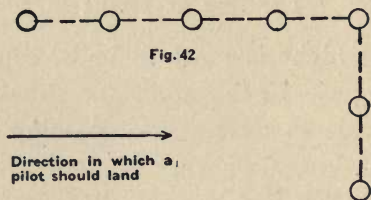

the landing-ground likely to cause damage should be marked with red lights.

On a bright moonlight night flares and searchlights may be dispensed with and the same signal used as for day flying.

It is a common practice to fire rockets or signal lights from the aerodrome to attract an aeroplane when in the vicinity.

Parachute flares are usually carried on machines on night-flying duties, and these flares are useful on occasions when a pilot has a forced landing. It consists of a flare attached to a parachute and is launched from an electric launching tube. It burns for a short period and gives a pilot an idea of the country he is over. When this parachute has been fired it is necessary for the pilot to pilot his machine between the flare and the ground, otherwise his vision of the ground would be obliterated by the glare.

XV

ARTILLERY OBSERVATIONS FROM AIRCRAFT

Shells Used by the Artillery

THE following notes on "spotting" are given as a guide to pilots and observers working with the artillery.

The shell used by the artillery consists of shrapnel, high explosive, and common shell.

Shrapnel may burst either with a time or percussion fuse. When a time fuse is used effective shell should burst above the ground and from twenty-five to seventy-five yards short of the target; the bullets from the shell then carry on into the target.

Shrapnel has a great effect on personnel, but very little effect on material. When shrapnel shells burst in the air they are easy to see, but difficult to observe when they burst on striking the ground.

High-explosive shells are sometimes very difficult to see when they detonate, particularly on striking soft ground. Shells of the high-explosive type that detonate produce a black smoke, and shells that do

THE EYES OF THE ARMY AND NAVY

not detonate produce a whitish-green smoke. High-explosive shells have great material but extremely local effect; a burst about five yards from a trench may do little or no damage.

Signaling from an Aeroplane

When a battery is "ranging" one gun only is generally used.

There are three methods of signaling from an aeroplane to the ground: wireless, lamps, and signal lights; but for artillery work the wireless is the most common.

Before going up an observer should find out exactly what is required. The fire may be for effect, or merely to register certain definite points. Again, a battery commander may want to correct the line and range of all the guns of his battery and so require observation of fire for each one, or may only want observation for the particular one selected to carry out the ranging.

Location of Targets and Ranging

The direction and range are taken from a square of the map as reported by the observer, who then proceeds to correct the fire by the usual methods.

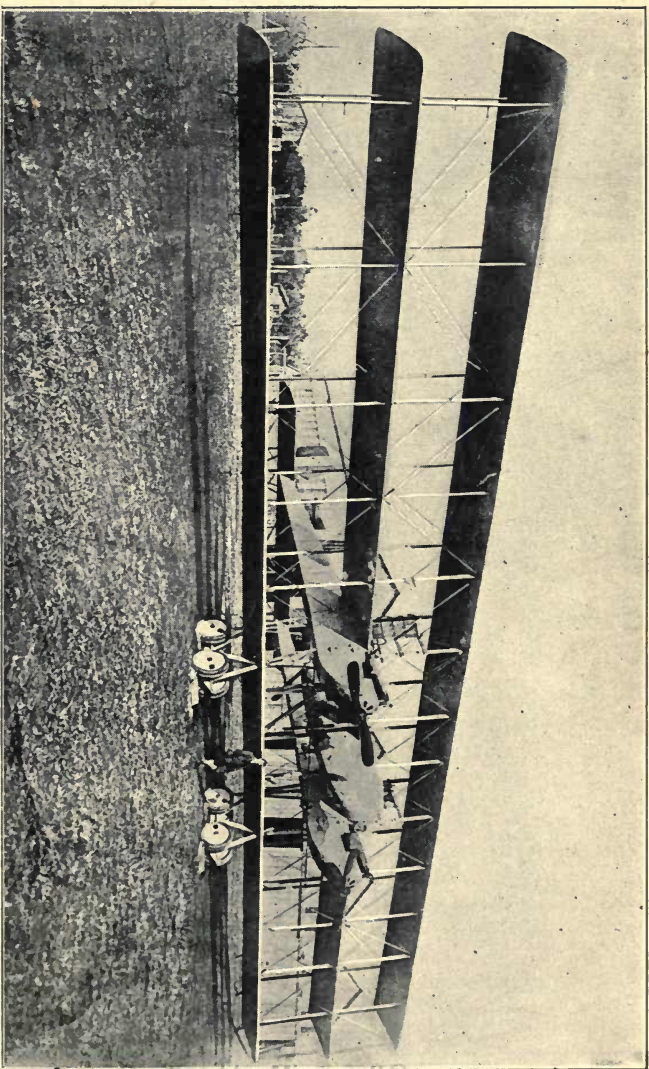

GIANT ITALIAN TRIPLANE

Photograph by Underwood & Underwood

This Caproni triplane can carry three tons in addition to its own weight and can easily accommodate twenty-five persons. It has a 700-h.p. engine and travels ninety miles an hour. Nine guns can be mounted on the plane, and in addition a multitude of bomb-throwing, position-finding and other devices of great utility in battle and bombarding have been perfected.

ARTILLERY OBSERVATIONS

When signal lights or smoke puffs as signals are used the position of the target can be shown by the aeroplane flying to a position vertically over the target and then giving a signal. The range may be obtained by the angle of sight of the aeroplane. When this method is adopted the aeroplane flies at a prearranged height and the angle of sight is taken at the moment when the aeroplane signals that it is vertically over the target.

When "spotting" with machines equipped with wireless, prearranged symbols are used. The station or stations answer the signals, either by lamp or by placing strips of linen on the ground. When the battery is ready to fire the ground station puts out a signal, and the observer acknowledges it and then sends a symbol for "stand by," followed by the symbol for the target for which he is going to "range." He then flies to a convenient position for observing the fall of shell and, when ready, gives the signal to open fire. The battery repeats each signal sent by the observer and the aeroplane sends a general answer in acknowledgment. This practice eliminates the likelihood of any mistakes. When the commander of the battery decides that he has obtained sufficient results he gives the signal for the observer to range for the next target.

When an observer desires to give the commander

THE EYES OF THE ARMY AND NAVY

of a battery more information than can be conveyed by signals it is necessary for him to fly over the station and drop a message bag. There are many methods of giving range adopted, but for reasons that must be obvious they cannot be disclosed in this work.

Ranging

When a round is fired the observer notes it fall with reference to imaginary squares or circles on the ground, the target being calculated as the middle square or center of the circle. These squares or circles are numbered, and by signaling the number or symbol of the square or circle where the shell falls the battery commander can refer to the adopted method and make corrections.

This procedure is carried on until the shells hit the target, then the "battery fire" signal is given and firing is carried on until the "cease firing" order.

Observers should always, when possible, watch the battery to see if the gun fires when the signal is given, as then there is less chance of the burst being missed if it is reasonably near the target. It is not a good practice to stare at the target; the observer should watch as wide an area as possible which has the target for its center, otherwise a burst far from the target will almost certainly be missed. When an actual battle

ARTILLERY OBSERVATIONS

is in progress the number of targets will be large, and in order to produce the best results both pilot and observer should do the maximum amount of work possible. If the observer does the ranging, the pilot should, to a certain extent, watch him to see where he wishes to go, when endeavoring to locate new targets; therefore, pilots as well as observers should receive training in observation of artillery fire.

Hints for Artillery Observers

(1) Do not send wireless messages while the machine is turning, and avoid sending when directly over ground stations.

(2) If the ground station is experiencing difficulty in receiving your signals, send only when flying toward it from the target. This may be found laborious, but will often save a shot from being an entire failure.

(3) Before commencing work with a ground station always give the operator a chance of tuning his instrument into you. It is impossible to do this when you are very low and near the ground station. Fly toward the station, calling it; when over it turn and fly away, and commence to call again when not directly over it.

(4) Limit your signals to as few as possible.

THE EYES OF THE ARMY AND NAVY

(5) Send your Morse characters with precision.

(6) Do not send too quickly, but avoid wasting time between signals.

(7) During the first few rounds on a new target allow time to elapse between the observation and the next "Go ahead" signal, especially if the battery has started rather wide of the mark. From two to two and a half minutes should be ample for any battery.

(8) Slow shots are often due to slow observing. In order to observe quickly it is necessary to manoeuvre for a good position.

(9) In a shot for effect inform the battery when to change—that is, when the first target is sufficiently dealt with.

(10) When you see that another battery than the one you are assisting is dropping shells near your target, make up your mind at once if you are going to be able to range your battery on it or not. If you decide that it is impossible, change to another target.

XVI

AERIAL FIGHTING

ALL pilot-students hope to become "star" aviators. In reality, only those possessing very special qualities ever succeed in attaining such extraordinary superiority.

The "star" pilot must be fearless and at the same time cautious. He must first of all possess "flying sense" that enables him to throw his machine about in apparent abandon, while, in fact, it is at all times under perfect control. To acquire this proficiency the pilot must have experimented extensively with all the tricks and "stunts" in the aeronautical category, including looping, tail sliding, and tail spinning, side slipping, rolling, and nose diving. These evolutions must be practised in a suitable machine and never at a lower elevation than 5,000 feet. The limit of your machine's capacity in structural strain must be always kept in mind.

A cool head and quick wits are essential to the

THE EYES OF THE ARMY AND NAVY

successful air fighter. You have successful fighters among your enemies; they must be surpassed.

One must have perfect eyesight; above all, one must keep himself at all times absolutely fit, physically.

Following are a few suggestions regarding the ordinary day's work of the fighting pilot:

Formation Flying

Type of machine considered, Sopwith Scout. Number of machines, five. 130-H.P. Clerget motor.

On leaving the ground the flight leader must choose suitable pilots to fly together, and having chosen them must let them always fly together and in the same positions in the formation as far as possible. He must endeavor never to let the pilot fly any machine but his own over the lines.

He is responsible for his flight leaving the ground punctually, and to make certain of this must insure that all pilots are dressed and comfortably settled in their machines five minutes before the flight is due to start.

All engines, having previously been tested by the mechanic in charge, must be seen to be running "throttled down." Then, on a signal from the ground officer that all engines are satisfactory, the flight leader leaves the ground. The remaining four

AERIAL FIGHTING

machines, if head to wind, should be off the ground in thirty seconds, the order of getting away corresponding to each machine's position in the formation thus:

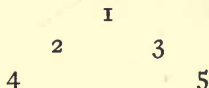

The leader must fly full out to about 700 feet and in an absolutely straight direction. He then "throttles down and flies his machine as slowly as possible," meantime watching his pilots pick up formation (this should not take more than one or two minutes). This done, he gives the "attention" signal by rocking his machine laterally, or by firing a red Very's light; he turns and heads to the lines and opens up his engine when the turn is absolutely completed. The squadron then begins to climb and the leader must adjust his engine to the worst climbing machine as quickly as possible, and having done that thereafter alter his throttle, speed, and direction as little as possible. He must look round at his formation at least every minute. Do not use a diamond formation, as this leaves three rear machines open to attack instead of two.

The Flying Officer

It is of paramount importance for a flying officer to be able to use his throttle to the full and to be able

THE EYES OF THE ARMY AND NAVY

to alter the angle of climb of his machine. This sounds extraordinarily easy, but it is the root of all bad formation.

Having left the ground, each pilot picks up his allotted station in order; *i. e.*, as close as possible and slightly above his next ahead. When flying in "V" formation, pilots should fly as close as possible together, and the angle subtended by the formation must not be too acute; otherwise the leader will have difficulty in watching his flight.

There is no excuse for a pilot being astern of station if he is above his next ahead; he must put the nose of the machine down and catch up. Having once picked up formation, it leads to endless trouble if a flying officer loses position and starts doing independent circles of his own. The slightest mistake in position must be instantly corrected; do not wait till the error is a big one. An exact parallel is found in steering a boat or a car. A good helmsman keeps on his course by employing none but the smallest motions of the tiller.

The evolution of altering course is more difficult. The flight leader should always turn in the same direction (assume this to be the left), thus giving each pilot a chance to learn his own particular turn.

The flight leader rocks his machine repeatedly, and pauses; then he does a minute turn to the left, at

AERIAL FIGHTING

the same time throttling down and putting the nose of his machine down a little. The two pilots on his left do a slight right-hand turn, throttling down a little more. The two pilots on his right commence a left-hand turn, keeping their engines full on. Then the pilots on his left both steer a left-hand turn, the leader turns to the left, and the two right-hand pilots carry on with their left-hand turn. Then the leader straightens out and the formation picks up its dressing, and the leader opens his engine and carries on as before. This is the most successful method of turning a formation.

No further manœuver should present great difficulty on this side of the lines.

Pilots must remember to fire their guns as continuously as possible to prevent freezing, keeping in mind the bullet's ultimate destination. Also remember to look behind and toward your formation, thus helping to prevent a surprise attack on the other "arms" of the formation.

Crossing Enemy Lines

In enemy territory hostile aircraft and anti-aircraft fire make an accurate formation a matter of some difficulty; in practice, machines fly more in a group than in a formation. But the more accurate the for-

THE EYES OF THE ARMY AND NAVY

mation the easier is the task for the already over-worked leader. The leader has to keep his formation together, to decide when to attack hostile aircraft, to watch for hostile aircraft about to attack, to see that his formation does not lose its way, and to attend to many other small points.

The flying officer's main duty is to keep formation and watch out for attacks, especially on the two rear pilots.

Signals Between Machines

These are in practice mostly given by the leader.

Rocking the machine laterally to attract attention. If accompanied by waving the arm, it calls attention to hostile aircraft in whichever direction the arm is waved. If followed by rocking the machine in a fore-and-aft direction, it means a gun jam.

Never wave except to indicate hostile aircraft.

If a pilot wishes to communicate with the leader he must get in front of him and give the signal; if unable to do this, he must communicate somehow with another pilot, and he will warn the leader. The leader must on no account allow a returning pilot to cross the lines unescorted.

A green light means an escort to the lines for engine failure or any other reason.

If a machine gets out of touch with the formation

AERIAL FIGHTING

the squadron should go to a previously arranged spot for reforming.

Attacking Hostile Aircraft

The following "ten commandments" in aerial fighting are considered of vital importance. They may appear cowardly, but they are compiled from the experiences of the pilots that I have come into contact with on active service.

(1) Do not lose formation.

(2) Do not press an attack on a two-seater that fires at you before you are in perfect position. Break away and attack it or another hostile aircraft later with a chance of surprise.

(3) Do not stay to manœuvre with a two-seater.

(4) Do not dive to break off a combat unless you are confident that your machine is a better "diver" than that of the enemy.

(5) Do not unnecessarily attack a superior formation; you will get a better chance if you wait five minutes.

(6) Do not attack without looking for the machine above you; he will almost certainly come on your tail unawares while you are attacking if you are not watching him. Look behind continually while on a dive.

THE EYES OF THE ARMY AND NAVY

(7) Do not come down too low on the other side or you will have all the enemy on to you.

(8) Do not go to sleep in the air for one instant of your patrol. Watch your tail.

(9) Do not deliver a surprise attack at over 90 knots unless you wish to scare hostile aircraft off friendly machines' tails. Most machines are not easily enough controlled at that speed, and the firing period passes too rapidly.

(10) Do not deliver a surprise attack at over 100 yards' range at the very most.

These rules only apply to an offensive patrol. If the hostile machines must be moved, they must be moved at all costs.

Delivering an Attack

In delivering an attack remember that your most important asset is surprise. The commonest way to effect this is to wait till the enemy machine is going away from the sun; then come in on his tail; also you may attack while he is obviously otherwise engaged. Thus it is often not wise to attack immediately. Sometimes it pays to find out what is the object of the enemy's flight and attack him while carrying out this object and least likely to be on the lookout (as in the case of photography).

AERIAL FIGHTING

While he is attacking or waiting to attack a machine an enemy presents little or no defensive.

When shadowing hostile aircraft keep as far away as possible and keep to sunward of him.

Do not forget that a single enemy machine at low altitude is probably a bait, and a counter-attack must be expected and anticipated.

With regard to the method of attack, it is usually best and easiest to attack from behind. A right-angle attack through the wing is not usually successful.

Attacking from in front is not to be recommended. In practice the method of attacking from behind is the one most used. But it is very easy to make a failure of an easy chance.

Try and discover if you have the speed of the hostile aircraft flying level (always assuming you are above him). If you have *not*, glide straight down to him and attack him on the steep glide, withholding fire until within a hundred yards of him. If you *have*, dive well behind him and come up to him, very slightly lower, on the throttle. If the attack is a surprise, place yourself about twenty-five yards behind him, very slightly below, and throttle down to his exact speed, then fire. Have one hand on the throttle the whole time, and of course the lanyard on the trigger should always be on the control level.

THE EYES OF THE ARMY AND NAVY

It is very easy to lose speed too far astern and be so long in catching up that you are observed, or to have too much speed and shoot by the enemy machine before firing. The most difficult test is to withhold fire till the correct moment.

Pilots learn their own methods of attack from experience; the following will be found a good one to try, especially in a Sopwith Scout. If, before you are in a position to fire, you see the observer produce his gun, make off at once. Do not stay to manoeuvre with a two-seater. A scout is designed for offensive and has absolutely no defensive except its ability to escape.

When the leader attacks it is usual for Nos. 2 and 3 to accompany him down. No. 2 is supposed to attack the same machine as the leader, but in practice things arrange themselves. If two machines attack an enemy simultaneously, it more than doubles the chance of success. Nos. 4 and 5 should remain aloft for a short period to guard the tails of machines 1, 2, and 3, and then join in if 1, 2, and 3 are not attacked. It will be readily understood that, in the case of one formation attacking the other, no rules of combat can be laid down.

On Being Attacked

If you see a hostile machine above you, try and climb above him. If this fails, try and get into his

AERIAL FIGHTING

blind spot below the lower plane and then turn and try and lose him. You can always shake him off by going back to the lines or joining a friendly formation. If you are already in a formation he will probably not attack. If you see that he has got to

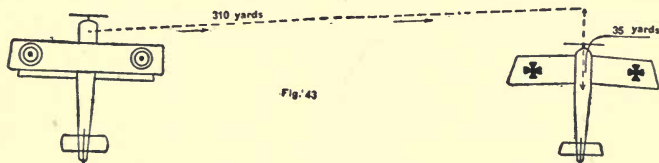

attack, steer a straight course for the lines, unless that course is away from the sun, and wait for him to dive. It is not advisable to turn and twist the moment he starts to dive or he will stop and you will have to go through it again. Wait till he is nearly within decisive range, then put the nose of your machine down slightly and do a turn. That is quite sufficient to make him miss, and he will probably carry on his dive. Should you be left at his level in a Sopwith Scout, it is always best to climb away. If you suddenly hear a machine spin on your tail, do a side loop at once. In all fighting in the air keep your head, put yourself in the enemy's position, and do not unnecessarily tackle any chance less than an even one.

The aviator who "bags" the most enemy machines

THE EYES OF THE ARMY AND NAVY

is the aviator who uses his powers of observation and fights with his head. The others either get killed or get nerves in a very short time, and their respective countries do not get the full benefit of having trained

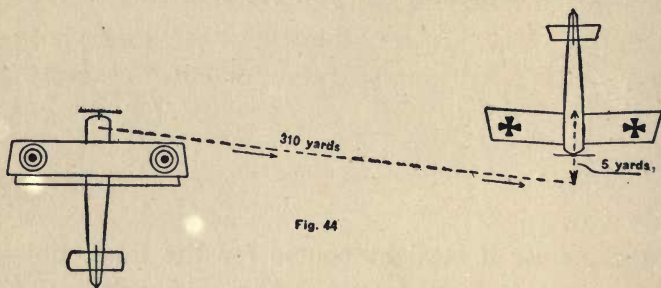

Fig. 44

them. In time of trouble it is a very pleasant help to put yourself in the enemy's place and view the situation from his point of view. If you feel frightened before an attack, *just think how frightened he must be.*

Taking Aim in the Air

When sighting a gun to fire at a hostile machine in the air the following points have to be considered:

- (1) The speed of your own machine.
- (2) The speed of the hostile machine.
- (3) The angle at which your gun is aimed with reference to the path of flight.

AERIAL FIGHTING

(4) The path of flight of the hostile machine.

There are only two cases in which the target is in line with the sights for effective fire: *i. e.*, when the target is directly behind or in front and is at the same height relative to your line of flight and traveling along that line. At all other times the above points have to be taken into account for effective fire. A

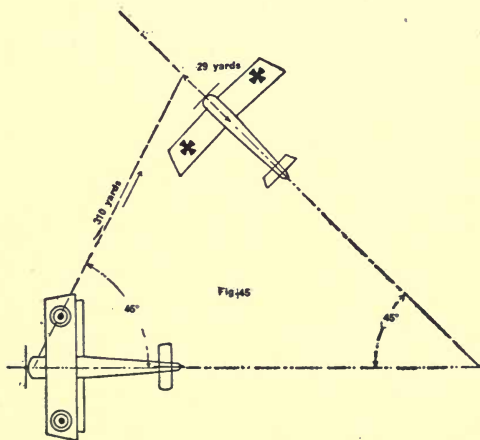

rough idea as to the distance to aim in front or behind the target is as follows:

(1) *The speed of your own machine.* When aiming the gun (Lewis machine-gun) at right angles to the line of flight, with your machine traveling at the rate of 78 miles per hour, aim 15 yards in front of the target at a range of 310 yards, or 30 yards in front

THE EYES OF THE ARMY AND NAVY

at a range of 620 yards. This only corrects for the speed of your own machine.

(2) *The speed of the hostile machine.* If the hostile machine is traveling at the same speed as your own machine (78 miles per hour), and in the same direction

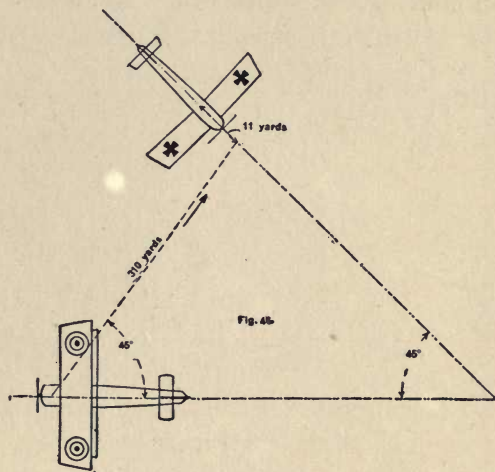

and parallel to your line of flight, aim the 15 yards in front to allow for your own speed and another 20 yards in front to allow for the speed of the hostile aircraft, a total of 35 yards at a range of 310 yards. These corrections vary in direct proportion to the range. (Fig. 43.)

If the target is traveling in the opposite direction, aim 5 yards in front. (Fig. 44.)

AERIAL FIGHTING

(3) *The angle at which your gun is aimed with reference to the path of flight.* When aiming at a machine at an angle of 45° , either to the front or rear of your line of flight, the correction for the speed of your own machine would be 9 yards in front or behind the target, according to its direction. To correct for the

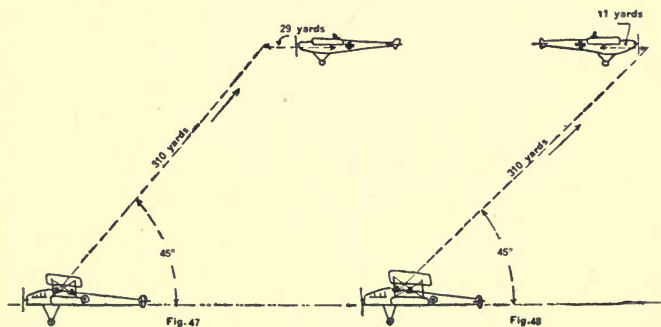

speed and the direction of the target, if it is traveling at right angles to the barrel of your gun, aim 20 yards in front, making a total of 29 yards, or 11 yards in front, as the case may be. (Figs. 45 and 46.)

(4) *The line of flight of the hostile machine.* If the target is directly in front or behind and traveling along your line of flight, but above it, with the barrel of your gun at about an angle of 45° , make the same corrections as in case (3). (Figs. 47 and 48.)

To make corrections for a ground target, the speed of the machine and direction and velocity of the

XVII

LIGHTER THAN AIR

LIGHTER-THAN-AIR cruisers are of three types: The rigid is the most efficient type and is illustrated by the Zeppelin. The semi-rigid is less useful, but correspondingly less expensive. It is suitable for shorter cruises and for lighter loads. The French Lébandy may be taken as an example of this class. The third type is the non-rigid, which is the most popular, the least costly, and the least efficient class. To this third class belong the British Blimp, the French Bayard-Clement, and the German Parseval. This German product is said to be the first representative of its class. Germany has specialized in the airship line and leads the world in this department of aeronautics.

The free balloon and the captive balloon are also of the non-rigid type, but these are distinct from all other aircraft in that they have no means of self-propulsion. The free balloon is practically useless as an instrument of war, since its movements cannot be controlled nor guided. The captive balloon, on the other hand, is a

THE EYES OF THE ARMY AND NAVY

very important means of reconnaissance over enemy lines.

The principal lighter-than-air machines are the German Zeppelin, Schütte-Lanz, Gross, and Parseval; the French Bayard-Clement, Zodiac, Astra, and Lébandy; the British Astra-Torres and late Government designs popularly known as Blimps.

Hydrogen and Coal-gas

Balloons and airship envelopes may be filled with hydrogen or coal-gas. Hydrogen, in a pure state, will lift approximately 70 pounds per 1,000 cubic feet; although the majority of balloon and airship designers only allow for a lift of 67 pounds per 1,000 cubic feet of hydrogen. The lift to be expected for coal-gas varies. According to quality the lift varies from 41 to 33 pounds per 1,000 cubic feet. This gas is much cheaper than hydrogen and is easier to obtain.

The lift of both these gases is subject to variation, due to the temperature, humidity of the atmosphere, and the height of the barometer.

Balloons

The balloon envelope is usually constructed of varnished silk, rubber-proofed silk, cotton, or oiled silk. It is spherical in shape and the lower portion is usually

LIGHTER THAN AIR

tapered off so as to form the neck, and at the upper end a circular opening is formed into which a valve seating is secured.

There are many types of valves used in the air services, and the majority are arranged to be kept closed by means of springs or rubber cords. These valves are so arranged that they are easily opened by means of the valve line. This line is usually passed through the balloon, out at the neck, and thence into the car.

The car is generally constructed of basket-work and suspended from netting, which covers the entire balloon. The upper part of the netting terminates at a circular grummet which slips around, and is secured to the valve seating.

The majority of modern balloons and many airships are fitted with a "ripping panel," the object of which is to deflate the balloon envelope quickly. This panel usually consists of a strip of fabric sewn over an opening in the upper part of the balloon or airship envelope. Attached to the upper portion of this panel a line is attached and passed into the car of the aircraft. The line is invariably painted red and a certain amount of slack rope has always to be gathered in before the panel can be thrown away. This device acts as a means of safety; a small accidental pull will not start the "rip."

THE EYES OF THE ARMY AND NAVY

The Equipment of a Balloon

The equipment of a balloon should consist of anchor, anchor rope, balloon cloth for incasing gas bag, ballast (preferably in the form of dry sand), knife in leather sheath, maps or charts, statoscope, thermometer, two aneroid barometers (graduated in feet), trail ropes, valve case, watch, and a rough log-book and pencil.

Doping and Varnishing Envelopes

Boiled linseed varnish is a dope which is used considerably in the lighter-than-air services. It is important that the varnish be of the best quality. On rubber-fabric envelopes the varnish is generally used as a foundation on which to apply aluminium paint. This kind of paint is used to avoid the effect of the sun heat. The paint reflects the rays of the sun, instead of allowing them to penetrate the envelope and expand the gas.

Handling Envelopes

All balloon and airship envelopes should be handled with the greatest care, if their gas tightness is to be maintained. For the inflation and deflation process,

LIGHTER THAN AIR

ground cloths should be spread out, and on no account should any person wearing street boots or shoes be allowed to walk on these cloths. Rubber-soled shoes should be worn by all men working around airship and balloon envelopes.

Storage of Envelopes

Envelopes should always be stored in a place free from the sun's rays and out of reach of mice and rats. They should never be stored in a building where they may be subject to extremes of weather. Between 40° and 60° Fahrenheit is the most favorable temperature. A rack, similar to a large clothes-horse, has been found to be very useful when folding and packing up an envelope.

Airship Planes and Rudders

Movable planes are used to alter the angle of flight of an airship, and fixed vertical and horizontal planes to stabilize the airship in flight. Without the horizontal planes the airship would be continually pitching up and down, and without the vertical fixed planes a pilot would be unable to steer a straight course. All fixed planes are placed toward the aft end of the airship and the movable planes are usually attached to the rear of the horizontal fixed planes. These planes,

THE EYES OF THE ARMY AND NAVY

both fixed and movable, are usually made up of steel tubing, braced with wiring and king post, and covered with fabric. The fabric is doped and stretched taut. Special care should be taken that the control wires are kept taut and well protected from moisture and not allowed to fray.

Ballonets

Ballonets are internal balloons fitted inside the main envelope; arrangements are made in the car of the airship, so that they can be inflated with air from a blower driven by the engines or an auxiliary motor. For instance, an airship ascending from the ground full to 1,000 feet: at the outset the ballonets are lying empty at the bottom of the envelope, and they remain so throughout the ascent; by the time the airship has risen to 1,000 feet it will have lost $\frac{1}{80}$ of its volume of gas, which will have escaped through the valves. If, therefore, the airship has 300,000 cubic feet capacity, it will have lost 10,000 cubic feet of gas. The airship now commences to descend; as it descends, the gas within contracts, and it is necessary to commence to blow air into the ballonets; by the time the craft reaches the ground 10,000 cubic feet of air will have been blown into the ballonets and the airship will have retained its shape and not be flabby.

If a second ascent is necessary, as the airship ascends

LIGHTER THAN AIR

the air must be let out from the ballonets instead of gas from the envelope; and, to insure that this is always done the ballonet valves are set to work at a lower pressure than the gas valve; and so by the time an altitude of 1,000 feet has been reached the ballonets will be empty.

It will be readily observed that in this case, provided an ascent is not made to over 1,000 feet, it will not be necessary to lose gas during flight.

Size of Ballonets

The size of ballonets govern the height to which an airship can ascend; therefore the size of them must be determined by the amount of spare buoyancy which the aircraft is designed to possess. For instance, suppose that the volume of the ballonets, when fully inflated, amounts to one-quarter of the total volume, if the airship descends from 7,500 feet, then at sea-level the ballonets will be loaded to capacity; however, if the craft has risen to 8,600 feet, then on descending to 600 feet the ballonets will be full, and below this height it would be impossible to preserve the internal pressure or the shape of the envelope. The usual size of the envelope is, for small airships, one-fifth of the volume; for medium-size airships, one-quarter; and for craft specially designed to attain

THE EYES OF THE ARMY AND NAVY

height, one-third of the total volume. These sizes can ascend, roughly, to the maximum heights of 6,000, 7,000, and 10,000 feet, respectively; but it should be borne in mind that, owing to the contraction of the gas, when descending in bright sunlight or unfavorable weather, 500 to 1,000 feet may easily be lost.

On active service it frequently happens that an airship is obliged to descend from a greater height than that which her ballonets can cope with, and on such occasions an extemporized safeguard is fitted.

Rigging

The main object of rigging is to distribute the weight of the car evenly over the balloon. Rigging cables are attached to the car either by eye-bolts or toggles. At the head of the lower cable there is an eye through which runs the next section of rigging. This method enables the single cable to be branched into a double cable and further up the double cable is again branched off, each single cable into a double cable, and so on until the point of attachment is reached. The three main methods of attachment of the car to the envelope are by means of the toggle flap, by a "goosefoot," or by means of a rigging band.

The rigging is usually made either of flexible steel cable or hemp rope. The eyes are generally of alumin-

LIGHTER THAN AIR

ium, but in the smaller type of aircraft they are made of boxwood. All rigging is necessarily exposed to the meteorological elements and should therefore be protected.

The Mooring of an Airship

Two methods of mooring an airship are adapted in the air services: by the nose of the craft being secured to a specially designed mooring mast, and by the bridle to a holdfast in the ground. The former of the two methods is the most satisfactory and is accomplished by passing a steel cable over a block in the cone of the mooring mast. One end of the cable is attached to the nose of the airship and the other end is shackled to a cable passing down the center of the mast to a windlass at the foot of the mast. The windlass is revolved and the airship is hauled in until the nose of the envelope is tight in the cone. The cone should be well padded to prevent injury to the envelope. This operation should never be attempted while the car is resting on the ground; it should float clear of the ground and should be ballasted so that the car hangs roughly horizontal. When it is desired to release the airship a trip catch is operated which allows the aircraft to be almost instantly released.

The bridle method cannot be carried out successfully unless the car is equipped with swiveling landing-

THE EYES OF THE ARMY AND NAVY

wheels. The center part of the bridle is secured to a holdfast in the ground and tightened up, until the tail of the craft points perceptibly upward. The car should then be ballasted down, to prevent liability of lifting in a gust.

Landing Skids and Wheels

Landing skids and wheels are provided on airship cars to protect the bottom of the car from scraping along the ground and thus damaging and straining the craft in general. They also protect the main framework from damage in a heavy landing.

The Training of an Airship Pilot

Several balloon flights are a necessary preliminary training for an airship pilot. If at any time the power plant of an airship becomes useless, an airship at once becomes a free balloon, and on such occasions a knowledge of the effect of ballast and the effect of change of temperature will be very useful. It also affords an excellent opportunity for map-reading practice, the use of the various instruments, and in making landings.

In the air services the course laid down for officers and men qualifying as airship pilots includes four ascents

LIGHTER THAN AIR

as passenger; in the last of these the pupil takes complete charge under the supervision of an officer-instructor. Then one "solo" run of at least an hour's duration and one night ascent of not less than two hours' duration must be taken.

Piloting an Airship

The first fault found with inexperienced airship pilots is the lack of maintaining elevation; the second fault is that of inability to maintain the correct pressure. There are many ways to get alterations of elevation, and the pilot should bear in mind the relative value of each and under what circumstances each should be adopted. The trimming planes, or elevators, are always used to correct small alterations of elevation, but in order to obtain a greater inclined path the filling of one ballonnet with more gas than the others is the best method. By distributing the lift in this way a diminution of lift is obtained at the point where the fullest ballonnet is situated. The result is that there will be an increase of lift at the opposite end and the airship will tilt downward or upward according to the distribution, and will follow an inclined path through the air.

Swiveling propellers are sometimes used, and this is the most powerful and most direct method of

THE EYES OF THE ARMY AND NAVY

tilting, but it has a great disadvantage—that of impediment to the forward motion of the craft.

The Maintenance of Gas Pressure

If the pressure in an envelope of an airship becomes too great there is danger of the envelope bursting, and if the pressure is allowed to become too little the craft may become unmanageable; therefore it is obvious that this point is an important one. If the pressure falls too low in an envelope of an airship, the nose of the craft is liable to be blown in and in many cases the tail curls up. This causes extra strain on parts of the rigging and frequently the craft will not answer to the controls.

Leaving the Ground

In piloting an airship having landing-wheels or an efficient skid gear, it is possible to leave the ground like an aeroplane, providing the field is large enough and there are no obstructions. To assist in a quick rise the craft should be ballasted a little light. The forward ballonnet should be light and the aft ballonnet heavy. As soon as the ship is released by the landing party it will ascend, and will move off at an increasing angle as it gathers speed. In an airship fitted with swiveling propellers, the method of leaving the ground

LIGHTER THAN AIR

is somewhat different. The propellers are adjusted for a direct lift, and if the buoyancy of the craft is correct the airship will rise almost vertically. When clear of all obstacles, forward motion by the motor power is maintained.

In the Air

When the airship rises the pressure will rise also, and it is usual to let air out of the aft ballonnet in order to adjust the trim of the craft. The approximate loss of lift with height is one-thirtieth of the craft's gross lift for every thousand feet rise. Suppose a pilot decides to fly at a thousand feet: When the height is attained the trimming planes are set at the horizontal position and the craft should fly on even keel. However, if the path of flight is not maintained the trim should be adjusted by blowing air into whichever ballonnet is higher, and letting out air in the lower one. Rising currents, change of temperature, and passing over water will affect the elevation of the craft; but all slight corrections can be made with the trimming planes.

Descending

It is important that a descent be not made so rapidly that the blowers cannot cope with the de-

THE EYES OF THE ARMY AND NAVY

mand for air; therefore the speed of descent must be modified to suit the capacity of the blowers.

Landing

The landing of an airship, that is, to bring the craft to rest, both vertically and horizontally, about fifty feet above the landing party, is the most difficult task in the piloting of an airship. The momentum of an airship must be absorbed during the process of gliding to the landing party; this momentum is two-fold—the falling motion and the speed forward. The former can only be absorbed by the resistance of the air or by throwing out ballast, and the latter by the resistance of the air, although some types of ships are equipped with engines whose propellers can be reversed. A pilot should ascertain before landing if a craft is lighter than air or heavier than air, and exactly how much ballast will adjust it. Before the craft is landed the engine should be stopped or throttled down to idling speed. All aircraft should be landed head to wind. The trail rope should be dropped when over the landing party, and guy hands below should be in readiness to seize the guys as soon as they are within reach. The landing party should be in front of the craft and not underneath or on one

LIGHTER THAN AIR

side. The men should haul in hand over hand and should stand their ground.

When landing craft that are equipped with the swiveling propellers, it is possible to land easily, although you may be considerably lighter or heavier than air; but, as stated previously, it is necessary for the pilot to know beforehand the buoyancy of the craft. If the swiveling propellers are tilted beyond 45° up or down, the steersman loses almost all control, owing to the craft losing way. The best method of landing a craft equipped with swiveling propellers is to descend to between 200 and 250 feet from the landing party by use of the planes. The swiveling propellers should then be started, and if manipulated skilfully the craft can be landed perfectly without discharging ballast or dropping the trail rope. If the craft has a negative buoyancy, very little downward thrust will be required; but a considerable upward thrust will be required near the ground; otherwise the craft will bump.

The qualities of a pilot are generally judged by the quality of landings which he makes. Sudden outpourings of ballast at the last moment indicate faulty judgment. A poor pilot is also indicated by dropping the trail rope too soon or too late, overshooting or undershooting the landing party and thus causing the landing party to have a run for the trail rope.

THE EYES OF THE ARMY AND NAVY

Loss of Buoyancy

Loss of buoyancy may be due to: rise of temperature, snow, rain, falling of barometer, and loss of gas, caused by continuing to rise after the ballonets are empty.

Gain of Buoyancy

Gain of buoyancy may be due to: discharge of ballast, fall of temperature, rise of barometer, petrol and oil consumption and therefore less loading; frequently an increase in buoyancy will be experienced when a wet envelope is drying.

XVIII

MEDICAL SUPERVISION OF AVIATORS

AS the height at which aviators carry out their respective duties and the speed of aircraft increase almost daily, a course of medical training for aviators has been universally adopted. Fitness is tested more thoroughly after the pupil has made his first few "solo" flights, and an invaluable insight into his temperament under stress is given in this way.

Experience alone can teach that a man is fit to fly, and medical men must watch the results throughout with sympathy and understanding and also with logic and a close, detective instinct.

To fly, a man must be temperamentally and physically fit; although this is obvious, it remains somewhat difficult to discover the flaws of temperament likely to unfit the pupil for his work, as some of the flaws are so fine that no medical test can reveal them. The would-be aviator is advised to avoid any concealment under the mistaken notion that he might be doing himself an injustice if he tells

THE EYES OF THE ARMY AND NAVY

the whole truth. If a pupil feels unfit, either temperamentally or physically, he should inform the proper authorities. It sometimes happens that pupils remain silent and do not confess a disinclination to fly, fearing that the surgeon or instructor or their brother pupils will saddle them with the odium of having "cold feet."

An aviator's disinclination to fly must have its basis upon some temporary defect of mind or body; such defects are often curable by proper treatment. Pupils should not be unduly timid or sensitive in confessing their fears; therefore a candid confession should be made rather than tempt Providence by running the risk of overtaxing their powers. It is a mistaken idea that flying is wholly a question of nerves. Some of the most nervous of civilians have turned out "stunt" airmen. Flying is a question of an active, well-balanced mind, prompt decision, and a series of sound and quick reflex actions; these are defined as the response to external sensations. An aviator observes that the right wing of his machine is tilted up; the impression is transmitted through the eyes to the brain, where it is recorded and a decision is made, which is transmitted to the muscles of the hands, and the control lever is pushed over to the right.

These impressions and actions constitute what is

MEDICAL SUPERVISION

known in the medical realm as the visual reflex. Twenty-hundredths of a second is the normal time of the circuit. This visual reflex is the most important. To this accurate sense of sight and reflex the best aviators owe their greatest feats and success. The sense of sight is essential. The other senses, hearing, touch, muscular, and the sense of equilibration and their reflexes, must be normal.

The rush of cold air during flight often causes temporary deafness, and an unsuspected defect of this kind may be fatal to a beginner. While flying the perception of such a thing as diminished acuteness of hearing is a difficult matter. An instructor should test his pupil's hearing often, and occasionally while flying.

The cultivation of the sense of touch and the muscular sense should come in the third and fourth places in the medical training. A man must feel very quickly when his machine bumps, and cultivation of these senses will enable him to keep his machine from tossing or rolling too much in a heavy wind.

Anent the equilibration reflex: It has been proved that a man who smokes too much doesn't balance as quickly as a non-smoker, and an excess of intoxicants has a bad effect on co-ordination of nerves and muscles. An aviator should have plenty of sleep; at least eight

THE EYES OF THE ARMY AND NAVY

out of every twenty-four hours. Airmen should avoid flying when hungry. Vertigo and dizziness in the air are caused by hunger or by bad or indigestible food. Nutritious and not rich food is essential.

Goggles, made of non-splintering glass, should always be worn when flying. Large leather gloves, lined with wool, are recommended. Tight-fitting gloves should be avoided. Boots should be of leather, lined with lamb's wool; rubber boots are harmful.

The possibilities of heat and frost-bite are practically eliminated if the hands and face are smeared with vaseline. There are two forms of air-sickness; one similar to seasickness, and the other fatigue and sometimes torpor, due to height effects. The former is sometimes seen in amateurs who are invited to fly with experienced pilots. Symptoms of the latter begin to appear at an altitude of 10,000 feet. The pulse and breathing become quicker and fatigue and, in some cases, torpor occur. Experience does much to overcome these air effects.

The best type of aviator is much of a piece with other good fighting men, but requires a special training under medical supervision.

APPENDIX

APPENDIX

DEFINITIONS AND METRIC SYSTEM

AEROFOIL. A structure, analogous to the wing or tail of a bird, designed to obtain a reaction from the air at right angles to the direction of its motion.

AILERON. An apparatus for maintaining the lateral stability of an aeroplane.

AIRSCREW. Includes both pusher and a tractor screw.

ANEMOMETER. An instrument for ascertaining the velocity of the wind at the earth's surface.

ANGLE OF DIHEDRAL. The angle between two wings.

ANGLE OF INCIDENCE. The angle a wing makes with the direction of motion relative to the air. This angle is usually measured between the chord of the wing and the direction of motion.

BACKING. Wing is said to be "backing" when changing direction in an anti-clockwise direction.

BALANCING FLAPS. Aerofoils used for balancing an aeroplane on its longitudinal axis.

BALLONET. Adopted from the French word meaning "a small balloon." An envelope of an airship generally contains several ballonets.

BANKING. A machine is said to bank when one wing is lowered and the opposite wing is raised, as in the case when a machine is turning.

THE EYES OF THE ARMY AND NAVY

BAROGRAPH. A recording barometer, the charts of which can be calibrated for showing either atmospheric pressure or a rough estimation of the height.

BAROMETER. An instrument for ascertaining the pressure of the atmosphere.

BASIN. A small area of level ground surrounded or nearly surrounded by hills, and also to describe a district drained by a river and its tributaries.

BLOWER. A fan of the rotary type, used for blowing air into balloons or ballonets, and by doing so maintaining the pressure in non-rigid airships.

BODY. That part of the aeroplane containing the engine and passenger, and to which the wings are attached.

BRIDLE. A loop of rope attached at each end to the sides of the envelope of an airship.

CABANE. A French word denoting the mast structure projecting above the body, to which the top load wires of a monoplane are attached.

CABRE. Tail-down.

CAMBER (of a wing section). The convexity of a wing section.

CANT, To. To tilt.

CARRIAGE. That part of the aircraft beneath the body, intended for its support on land or water.

CHASSIS. See **CARRIAGE.**

CHORD. The straight line touching the under surface of an aerofoil near the leading and trailing edges.

CONDUCTION is the transference of heat by contact.

CONTOUR. An imaginary line along the surface of the ground at the same height above mean sea-level throughout its length.

CONTROL LEVER. A lever by means of which pitching and rolling of the aeroplane are controlled.

APPENDIX

CONVECTION in a fluid is the transference of heat by motion.

CREST. The top of a hill or mountain.

DIFFUSION. The tendency of two different gases to mix when separated by a porous partition.

DOPING. Doping fabric is to paint it with a fluid, usually containing a varnish of cellulose base, which tends to tighten and protect the material. The fabric of balloons and airships is also doped.

DRAG. Head resistance or drift.

DRIFT. A machine is said to drift when it is carried out of its course by a current of air.

DRIFT BRACING. The system of bracing used to transfer the drag or head resistance of the wings to the body of an aeroplane.

DRIP FLAP. A flap of fabric stitched the whole way round an airship, or balloon envelope, to deflect the rain and prevent it falling into the car.

DUNE. A hill or ridge of sand formed by the wind.

ELEVATOR. An aerofoil set in a more or less horizontal plane, used for controlling the angle of incidence.

ESCARPMENT. An extended line of cliffs or bluffs.

EYE. A small ring, usually of boxwood or aluminium, having an annular groove on its outer edge, round which a rope can be spliced.

FAIRING. A piece added to any structure to reduce its head resistance.

FINS. Thin and flat or slightly curved organs, attached parallel to the normal direction of motion of an aircraft. In an aeroplane or seaplane they are always set vertically.

FUSELAGE. The body of a tractor aeroplane.

GAP. The distance between the upper and lower planes of a biplane.

THE EYES OF THE ARMY AND NAVY

GLIDING ANGLE. The angle, relative to a horizontal line in the air, at which a machine descends with the engine cut off.

GOOSEFOOT. Method of attaching the rigging on to the envelope of an airship.

GORGE. A rugged and deep ravine.

HACHURES. Hachuring of a vertical nature is the conventional method of representing hill features by shading, in short disconnected lines. These lines are drawn in the direction of the flow of water on the slopes.

HANDLING ROPE. A rope hanging from the envelope of an airship and used when manœuvering it on the ground.

INCLINOMETER. An instrument for measuring the angle or slope of an aircraft away from the horizontal.

KNOLL. A low detached hill.

LEADING EDGE. The forward edge of a plane.

LEAK DETECTOR. An instrument which is used for the purpose of detecting the presence of hydrogen and other light gases in the air. This instrument can also be adapted to find leaks in an envelope when inflated with gas.

LEE, LEEWAY, or LEEWARD. Away from the direction of the wind. The lateral drift of an aeroplane to leeward.

LIFT. In aircraft the upward force in the direction perpendicular to the direction of motion relative to the air. "Net lift" is a term frequently applied to an airship, and denotes the lifting capacity in fuel, crew, and ballast. "Gross lift" is used to denote the gross displacement of an airship.

LOADING. The weight carried per unit area of sustaining surface.

LONGERON. See **LONGITUDINAL.**

LONGITUDINALS. The long fore-and-aft spars.

MAGNETIC MERIDIAN. A magnetic north-and-south line.

APPENDIX

MERIDIAN or NORTH LINE. A true north-and-south line.

MOORING-CAP. A cap, usually made of fabric, on the nose of an airship and used to prevent rubbing between the envelope and the cone of the mooring-mast.

MOORING-MAST. A mast, usually of steel, having a cone mounted on the universal joint at its top.

MOORING-ROPE. A cable used for attaching an airship to a mooring-mast.

PANCAKE, To. To drop like a parachute, with wings at a very large angle of incidence.

PASS. A track over a mountain range. Usually a depression in the range.

PITCH. The distance forward that a screw propeller would travel in one revolution, plus the slip of the propeller.

PITÔT TUBE. A tube with open end exposed to the direction of an aeroplane, and which forms part of the speed indicator.

PLATEAU. An elevated plain.

PLOTTING. The process of taking notes and sketches of observations and measurements.

PROPELLER. An airscrew in a pusher machine.

PUSHER. A type of aircraft with the propeller behind the wings.

PYLON. A mast or post.

RADIATION is the transference of heat by ether waves.

RIB, COMPRESSION. A rib designed to act as a strut between the front and rear spars of a wing.

RIPPING PANEL. A strip of fabric on the envelope of a balloon or airship especially arranged so that it can be torn away by means of a rope and thus allow the gas to escape rapidly.

ROLL, To. To turn about the fore-and-aft axis.

THE EYES OF THE ARMY AND NAVY

RUDDER. A subsidiary aerofoil by means of which an aircraft is turned to right or left.

RUDDER-BAR. The foot-bar, by means of which the rudder of an aeroplane is worked.

SALIENT or SPUR. A projection from the side of a hill or mountain running out of the main feature.

SETTING or ORIENTING. A person is said to set a map when placing a map or plan so that the north-and-south line points north and south.

SIDE DRIFT. See **DRIFT.**

SIDE SLIP. When a machine slips from the path of flight, either inward or outward, it is said to sideslip.

SKID. The part of the landing gear of an aircraft designed to support the tail of the machine.

SLIP. The difference between the actual progress of a propeller in one revolution and its pitch.

SPAN. The distance from wing-tip to wing-tip.

SPAR. A long piece of timber or beam which runs transversely to the aircraft.

STABILITY, DIRECTIONAL. Exists when the aeroplane tends to travel along its fore-and-aft axis.

STABILITY, LATERAL. Exists when the tranverse axis of the aeroplane tends to return to the horizontal.

STABILITY, LONGITUDINAL. Exists when the longitudinal axis of the aeroplane tends to return to the horizontal.

STABILITY, NATURAL. Exists when the aeroplane tends to return to its normal attitude of flight and when oscillations about that position tend to decrease without the application of the controls. Sometimes described as inherent stability.

STABILIZING PLANES. Planes fixed vertically and horizontally on

APPENDIX

the aft end of an airship's envelope to prevent pitching and to aid in maintaining a course.

STAGGER. The wings of a biplane are said to be staggered when the wings are set with the upper plane slightly ahead of, or in rear of, the lower plane. The stagger is generally measured by the angle made with the normal vertical by a line joining the leading edges.

STATOSCOPE. An instrument to detect a small rate of ascent or descent.

STREAMLINE. This term is used when a machine is so constructed that there is an absence, or minimum amount, of eddy motion.

TAIL. The after part of an aircraft.

THIMBLE. A metal "eye" with a grooved outer surface round which a cable or rope is spliced.

TIE. A structural member intended to resist tension.

TOGGLE FLAP. A toggle flap is a piece of material sewn to the envelope of an airship.

TORQUE OF PROPELLER. The tendency of a propeller to turn an aircraft about its longitudinal axis in a direction opposite to that in which the propeller or tractor is revolving.

TRACTOR. The type of aeroplane with propeller in front of the wings.

TRAILING EDGE. The after edge.

TRAIL-ROPE. A rope carried in an airship or balloon and thrown out when about to land to enable the aircraft to be pulled to the ground.

TRAJECTORY BANDS. A device used in some types of airships for distributing the weight of the car evenly over the envelope.

TURNBUCKLE. A form of wire-tightener.

UNDER-CARRIAGE. See CARRIAGE.

THE EYES OF THE ARMY AND NAVY

UNDERFEATURE. A minor feature; an offspring of a main feature.

UNDULATING GROUND. Ground which alternately rises and falls gradually.

VEER, OF THE WIND. To change direction clockwise.

VELOCITY OF SIDESLIP. The speed with which the craft moves broadside with respect to the air. Distinguish from "Drift."

WARP, To. To bend a wing so that the outer end of the back spar moves up or down. It is convenient to call the warp positive when the movement is downward.

WATERCOURSE. The line defining the course of water. The lowest part of a valley, whether occupied by water or not.

WATERSHED. A ridge of land separating two drainage basins. A summit of land from which water divides or flows in two directions. This term does not necessarily include the highest point of a range of mountains or hills.

WING FLAPS. See **BALANCING FLAPS.**

WINGS. The main supporting organs of an aeroplane. A monoplane has two and a biplane four.

WIRES, DRAG. Wires the principal function of which is to transfer the drag of the wings to the body or other part of the aeroplane structure. Wires intended mainly to resist forces in the opposite direction are called "anti-drag wires."

WIRES, LIFT. Wires the principal function of which is to transfer the lift of the wings to the body of the aeroplane.

WIRES, TOP LOAD. Wires intended mainly to resist forces in the opposite direction of the lift.

WIRES, WARP. Lift wires connected to the back spar and controlled so as to move its outer end down in warping the wing.

YAW, To. An aircraft is said to yaw when its fore-and-aft axis turns to the right or left down the line of flight.

APPENDIX

Metric System

10 mm.	= 1 cm.
100 cm.	= 1 m.
1,000 m.	= 1 km.
1,000 grms.	= 1 kg.
1,000 kg.	= 1 metric ton
	1 cm ³ . of water weighs 1 grm.
	1,000 cm ³ . water = 1 litre and weighs 1 kg

Conversion Tables

	<u>British</u>		<u>Metric</u>
1 in.	= 25.4 mm.	1 mm.	= .04 in.
1 ft.	= .3 metre	1 cm.	= .39 in.
1 yd.	= .9 metre	1 m.	= 3.3 ft.
1 mile	= 1.6 kiloms.	1 km.	= .62 mile.

Squared

1 sq. in.	= 6.45 cm ² .	1 mm ² .	= .0015 sq. in.
1 sq. ft.	= .093 m ² .	1 cm ² .	= .15 sq. in.
1 sq. yd.	= .84 m ² .	1 m ² .	= 10.76 sq. ft.

Cubed

1 cu. in.	= 16.4 cm ³ .	1 cm ³ .	= .06 cu. in.
1 cu. ft.	= .028 m ³ .	1 m ³ .	= 35.3 cu. ft.

THE END

PLEASE DO NOT REMOVE
CARDS OR SLIPS FROM THIS POCKET

UNIVERSITY OF TORONTO LIBRARY

UG
630
M85

Munday, Albert H
The eyes of the army
and navy

UTL AT DOWNSVIEW

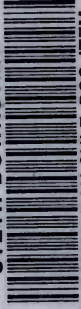

D RANGE BAY SHLF POS ITEM C

39 10 01 08 02 004 4