

THE APOLLO  
SPACECRAFT

A CHRONOLOGY

VOLUME I

NATIONAL AERONAUTICS AND SPACE ADMINISTRATION

NASA SP-4009

THE  
APOLLO SPACECRAFT

A CHRONOLOGY

VOLUME I

Through November 7, 1962

*by*

Ivan D. Ertel and Mary Louise Morse

THE NASA HISTORICAL SERIES



*Scientific and Technical Information Division*  
OFFICE OF TECHNOLOGY UTILIZATION  
NATIONAL AERONAUTICS AND SPACE ADMINISTRATION  
1969  
*Washington, D.C.*



---

For sale by the Superintendent of Documents

U.S. Government Printing Office, Washington, D.C. 20402

Price \$2.50 (Paper Cover)

*Library of Congress Catalog Card Number 69-60008*

## FOREWORD

The chronology of the development of the Apollo spacecraft and the lunar mission provides specific documented information covering a wide range of happenings both directly and indirectly related to the program. This wealth of material should be of value to historians and others interested in the events of the great adventure. The foreword presents a synopsis of the first several years of the program as seen from the vantage point of the first Apollo Project Office Manager. It is hoped that it will aid the user of the chronology by providing context for some of the material presented.

A discussion of the Apollo Spacecraft Program must include reference to the Mercury and Gemini Programs, not because they are manned space programs but because of the interrelationship between the programs in time, in people, and in organizations, and the differences and similarities in the requirements of the programs. The Mercury Program had a very specific objective, namely to place a man in orbit and return him to earth. The Gemini Program was somewhat different. It was operating in the same earth orbital environment as Mercury but had as its goal a number of objectives which were intended to explore and develop our capabilities to work in this environment. In doing this, the Gemini Program had more resources than Mercury, in terms of increased payload weight in orbit. Apollo is more like Mercury. It has a well-defined objective that involves moving into a new environment—deep space—and resources that offer little if any payload capability beyond that required to achieve the objective. Perhaps the Apollo Applications Program will be to Apollo what Gemini has been to Mercury, establishing an operational capability in an environment which has been first explored in a prior program.

The Mercury project was formally initiated in October 1958 and at that time the Space Task Group was formed to manage the project. This group and others had been studying the specifics of the program for over a year at Langley and other NACA Centers. During 1959, the requirements of the Mercury Program left no time for advanced program study by the Space Task Group. In 1960, the first organized activity related to advanced mission study began. Committee studies, such as that carried out by the Goett Committee, had indicated that the lunar mission should be the next major manned objective. With this in mind, a series of technical guidelines was developed to guide the spacecraft studies. These guidelines were based on assumptions that launch vehicles then planned were capable only of circumlunar flight rather than lunar landing and that there were enough unknowns related to the lunar mission that the hardware should be equally capable of advanced earth orbital missions as an alternative.

Based on the technical guidelines, three efforts were undertaken. A formal liaison activity was set up with other NASA Centers to stimulate and encourage their



research and studies toward the lunar mission, using the guidelines as a general reference. Three system study contracts were let to industry and a preliminary design study was conducted by Space Task Group personnel. This total effort took approximately one year and culminated in a conference held in Washington in June 1961. These studies were primarily based on a circumlunar mission with the intent that the hardware elements developed would have application to a later lunar mission.

Concurrent with the completion of this year of study effort in the Spring of 1961, two events of utmost significance to the program took place. The first U.S. manned suborbital flight, of Lt. Cdr. Alan B. Shepard, Jr., was successful. Shortly thereafter, President John F. Kennedy announced the national objective of a manned lunar landing mission within the decade.

As a follow-on to the study effort of the previous year, specifications were being prepared for the command and service modules so a contract could be let to industry. These specifications were changed to acknowledge the requirement for a lunar landing rather than a circumlunar mission. Since the lunar-mission launch vehicle had not been determined, it was assumed that a single launch vehicle would insert a spacecraft into the lunar trajectory and that the command and service modules would land on the lunar surface with the aid of a third module which would decelerate the total spacecraft as it approached the surface. The launch vehicle required for this approach was never fully defined but was of the class referred to as the Nova.

During the Spring and Summer of 1961, work statements and specifications were completed and issued to industry for the command and service modules. During the Fall, proposals were evaluated and a contractor was selected in November 1961. Throughout this period, practically all Space Task Group activity had been directed toward the command and service modules; launch vehicle studies by Marshall Space Flight Center and others had led to a selection of the Saturn C-5 as the lunar launch vehicle in the Fall of 1961.

This decision eliminated the lunar mission approach previously described, involving the Nova class vehicle, and offered two alternatives. The first involved the use of two Saturn C-5's and an earth orbit rendezvous to mate the spacecraft module, plus an earth-to-moon rocket stage. This would allow a landing of the entire spacecraft, employing a third module to decelerate the command and service modules to the lunar surface; then a launch from the lunar surface would use the service-module propulsion. The other alternative was to use a single Saturn C-5 launch vehicle carrying the entire spacecraft, consisting of three modules. The third module, instead of being an unmanned module whose purpose was to decelerate the other two modules to the lunar surface, would be a manned module which would go to the lunar surface from lunar orbit and return, while the command and service modules waited in lunar orbit to rendezvous with the third module.

This latter approach had been studied by the Langley Research Center and others during 1960 and 1961. At first it was not received enthusiastically by the Space Task Group in comparison with the Nova direct approach previously described.

## FOREWORD

In late 1961, the Space Task Group (redesignated Manned Spacecraft Center, November 1, 1961) personnel moved to Houston and initiated studies of the two remaining approaches offered by the C-5 vehicle. Studies were also being conducted by Marshall, Headquarters, and other groups. The Manned Spacecraft Center study concentrated on the feasibility of the lunar orbit rendezvous method and the definition of the lunar module, then known as the LEM (Lunar Excursion Module). In the Spring of 1962, the Manned Spacecraft Center studies indicated the desirability of the lunar orbit rendezvous approach as opposed to the earth orbit rendezvous approach. Discussions were held with Headquarters and Marshall. It was decided to complete preparation of the work statement and specifications for the LEM and to issue them to industry. This was done in the Summer and contractors' proposals were evaluated. In early November, the final decision was made to go the lunar orbit rendezvous approach. A contractor was selected and negotiations were completed by the end of 1962.

Parallel to the effort related to mission selection, specifications preparation, and contractor selection for the major modules, additional work was being done on the navigation and guidance system. During this 1960 study phase previously described, Massachusetts Institute of Technology (MIT) was conducting a study of concepts for the Apollo system. It was subsequently decided that MIT would be given the navigation and guidance system task, with support from appropriate industrial contractors. The contract with MIT was signed in August 1961, the support contractor work statements and specifications were prepared and issued in early 1962, and three contractors were selected in the Spring of that year.

In summary, the period through 1962 was one of mission definition and major contractor selection. With the selection of the lunar orbit rendezvous mission mode and the LEM contractor, the program was in a position to move into specific design efforts.

Robert O. Piland  
*Science and Applications Directorate*  
*Manned Spacecraft Center*



Page Intentionally Left Blank

# CONTENTS

	PAGE
FOREWORD -----	iii
LIST OF ILLUSTRATIONS -----	viii
THE KEY EVENTS -----	xi
PREFACE -----	xiii
PART I: CONCEPT TO APOLLO; BEGINNINGS THROUGH JULY 1960 ---	1
PART II: DESIGN—DECISION—CONTRACT; AUGUST 1960 THROUGH NOVEMBER 1961 -----	49
PART III: LUNAR ORBIT RENDEZVOUS: MODE AND MODULE; DECEM- BER 1961 THROUGH NOVEMBER 7, 1962 -----	129
APPENDIXES	
1. Glossary of Abbreviations -----	205
2. Committees -----	207
3. Major Spacecraft Contractors -----	223
4. Flight Summary -----	224
5. Funding -----	228
6. Organization Charts -----	230
7. Apollo Launch Vehicle Family -----	234
INDEX -----	237



# LIST OF ILLUSTRATIONS

All photographs and illustrations are U.S. Government ones except as credited. Persons in the photographs are identified in the captions and included in the index.

	PAGE
PART I	
Egress after lunar landing.....	30
Lunar liftoff.....	30
Reentry concept.....	30
Lunar-Earth Return Vehicle.....	37
Saturn C-1 static-fired.....	39
Planned space flight program.....	48
PART II	
Apollo seating arrangement.....	58
Reentry module geometry.....	70
Configuration sketches.....	72
Reentry vehicle sketches.....	72
Early LEM model.....	83
C-2 mission possibilities.....	86
Suggested spacecraft concepts.....	88
Lunar mission.....	89
Spacecraft nearing moon.....	89
Cutaway of proposed D-2 spacecraft.....	90
A mission sequence.....	90
C-1 mission possibilities.....	91
Lunar lander comparison.....	92
Lunar landing techniques.....	96
C-3 mission possibilities.....	97
MSC (architect's impression).....	111
SA-1 launch.....	116
A lunar lander.....	117
Simplified lunar rendezvous.....	117
A team and a goal.....	127

PART III

Circumlunar spacecraft configuration.....	136
RASPO established.....	141
Lunar landing techniques.....	145
Apollo spacecraft configurations, mission oriented.....	145
Saturn launch vehicle family.....	146
Lunar landing sequence (artist's concepts).....	148-149
Command module mockup.....	151
Little Joe II (artist's concept).....	153
SA-2 launch.....	156
Spacecraft diagrams.....	158
Control system design work.....	162
Proposed lunar vehicle comparison.....	169-170
Mission Control Center (architect's impression).....	171
Spacecraft configuration evolution.....	179
Service module engine, prototype.....	184
LEM model at Houston.....	189
Three-man moon vehicle.....	196
GAEC LEM model.....	201



Page Intentionally Left Blank

## THE KEY EVENTS

### 1957

*October 4:* *Sputnik I*, the first man-made satellite, successfully launched by the Soviet Union.

### 1958

*October 1:* NASA officially constituted and charged with responsibility for the U.S. civilian space program.

### 1959

*April–December:* Detailed study of advanced manned space flight missions by NASA's Research Steering Committee on Manned Space Flight (Goett Committee).

### 1960

*April–May:* Preparation of the guidelines for the three-man advanced spacecraft by NASA's Space Task Group (STG).

*July 28–29:* The announcement of the Apollo program to representatives of American industry.

*October 25:* Selection of the General Electric Company, Convair/Astronautics Division of General Dynamics Corporation, and The Martin Company to prepare Apollo spacecraft feasibility studies.

### 1961

*April 12:* First successful manned orbital flight, by Cosmonaut Yuri A. Gagarin of the Soviet Union.

*May 5:* First successful American manned suborbital flight, by Astronaut Alan B. Shepard, Jr.

*May 15:* Completion of the Apollo spacecraft feasibility studies.

*May 25:* President John F. Kennedy's proposal to Congress and the nation of an accelerated space program including a manned lunar landing within the decade.

*August 9:* Selection of the Massachusetts Institute of Technology Instrumentation Laboratory to develop under STG direction the Apollo spacecraft navigation and guidance system—first major Apollo contract.

*October 27:* First successful flight (SA-1) of the Saturn C-1 booster.

*November 28:* Selection of North American Aviation, Inc., as prime contractor for the Apollo spacecraft under Manned Spacecraft Center (MSC) direction.

*December:* Selection of the Saturn C-5 as the Apollo launch vehicle for lunar landing.

### 1962

*February 20:* First successful American manned orbital flight, by Astronaut John H. Glenn, Jr.

*July 11:* Selection by NASA of the lunar orbit rendezvous mode for the manned lunar landing mission.

*November 7:* Selection of the Grumman Aircraft Engineering Corporation to develop the lunar excursion module under MSC direction.

Page Intentionally Left Blank

## PREFACE

Project Apollo, conceived as a successor to the Mercury program in this nation's manned exploration of space and originally planned as a circumlunar flight, now has as its primary objective a manned lunar landing and return within the decade. As a bridge between Mercury and Apollo, the Gemini program has provided essential experience in space rendezvous and demonstrated the feasibility of long-duration space flight. Like Mercury and Gemini, Apollo is a program of complex and interrelated elements: launch vehicles; spacecraft; and launch, tracking, and recovery facilities. This is the first volume of a chronology dealing with the spacecraft.

It is planned to publish *The Apollo Spacecraft: A Chronology* in several volumes. The intent of the authors is to concentrate on the important events that have affected the concept, design, and development of the Apollo spacecraft rather than to cover in detail the entire Apollo program. In keeping with this intent, the authors have tried to give a balanced overview of the Apollo spacecraft program, not limiting the chronology to the activities of a single NASA Center.

Part I, "Concept to Apollo," reviews the earliest years up to the official announcement of the Apollo program. Part II, "Design—Decision—Contract," continues through the selection of the principal contractor for the command and service modules. Part III, "Lunar Orbit Rendezvous: Mode and Module," completes Volume I, ending with the naming of the contractor for the lunar module.

As far as possible, primary sources were consulted. These included congressional documents, Apollo program status reports, Manned Spacecraft Center and Apollo Spacecraft Project Office weekly activity reports, contractors' progress reports, Apollo working papers, letters, memoranda, NASA and industry staff reports, minutes of meetings, and interviews with persons directly involved in the early years of the Apollo program. In addition, books, newspaper accounts, press releases, chronologies, and magazine articles were researched for material. The present volume was extensively revised several times as new sources of information came to light.

This and succeeding volumes are meant not only to provide a useful and accurate reference work for the scientist, historian, and general reader, but also to serve as a foundation for a narrative history of the Apollo program as part of the NASA Historical Series.

The materials used in this chronology were accumulated from a wide variety of sources and so the authors are indebted to a number of individuals and organizations for outstanding cooperation and assistance. Some have assisted to such a degree that special recognition seems warranted. This group includes: Rose Sidick, Redstone Scientific Information Center, and Lois Robertson, Marshall Space Flight Center, for their invaluable assistance in research and documentation retrieval;



THE APOLLO SPACECRAFT: A CHRONOLOGY

Jack C. Heberlig, MSC Office of Engineering and Development, and J. Thomas Markley, MSC Apollo Spacecraft Program Office, who proffered many early Apollo documents; Charles F. Allyn, MSC Technical Information Preparation Branch, for development of a technical documentation retrieval system; the staff of the NASA Historical Office in Washington, D.C., and especially William D. Putnam, Assistant NASA Historian for Manned Space Flight, who performed yeoman research and documentation service and offered many cogent suggestions concerning the content and format of this publication; Jean K. Bays, Contract Historian on the Apollo chronology project from the University of Houston, who helped materially in the preparation of the appendixes and in the final revision of the comment draft; and MSC Historian James M. Grimwood for his thorough review and constructive criticism of the draft version. Catherine A. De Leon and Phyllis R. Hagan typed the comment draft edition and Sally D. Gates was responsible for preparation of the final product. Especial thanks is given to Billie D. Rowell, MSC Historical Office archivist, for her outstanding service in setting up and maintaining the research files.

This volume of the chronology was written under the sponsorship of NASA at its Manned Spacecraft Center, with principal reliance on a contract with the University of Houston.

I. D. E.  
M. L. M.

August 1968

# **PART I**

**Concept to Apollo**

**Beginnings through July 1960**

# PART I

## The Key Events

### 1955

*March:* The feasibility of a million-pound-thrust liquid-fueled rocket engine established by the Rocketdyne Division of North American Aviation, Inc.

### 1957

*April:* Studies of a large clustered-engine booster to generate 1.5 million pounds of thrust begun by the Army Ballistic Missile Agency (ABMA).

*October 4:* *Sputnik I*, the first man-made satellite, successfully launched by the Soviet Union.

### 1958

*January 31:* *Explorer I*, the first U.S. satellite, launched successfully.

*June 23:* Preliminary design begun by Rocketdyne Division on a single-chamber liquid-fueled rocket engine (the F-1) of 1.5 million pounds of thrust.

*July 29:* The National Aeronautics and Space Act signed, authorizing the establishment of the National Aeronautics and Space Administration (NASA).

*August 15:* Development begun of the Juno V (later named Saturn) booster under Advanced Research Projects Agency Order 14.

*October 1:* NASA officially constituted and charged with responsibility for the U.S. civilian space program.

*October 11:* Letter contract signed by NASA with Rocketdyne Division for development of the H-1 engine designed for use in the clustered-engine booster.

*November 5:* Space Task Group (STG) officially organized to implement the manned satellite project.

### 1959

*January 19:* Contract signed by NASA with Rocketdyne Division for design and development of the F-1 engine.

*April 9:* First group of astronauts selected for the manned space flight program.

*April-December:* Detailed study of advanced manned space flight missions by the Research Steering Committee on Manned Space Flight (Goett Committee).

*August-September:* Meetings of the STG New Projects Panel to discuss an advanced manned space flight program.

*September 12:* Launching by the Soviet Union of *Lunik II*, which crash-landed on the moon about 35 hours later.

*October 4:* Launching by the Soviet Union of *Lunik III*, which photographed the far side of the moon three days later.

*December 31:* NASA approval of the Saturn C-1 configuration and the long-range Saturn development program.

### 1960

*January 28:* NASA's Ten-Year Plan presented to Congress during testimony before the House Committee on Science and Astronautics.

## THE KEY EVENTS

- March 15:* ABMA's Development Operations Division and the Saturn program transferred to NASA cognizance.
- April-May:* Presentation by STG members of the guidelines for an advanced manned spacecraft program to NASA Centers.
- April 26:* NASA selection of the Douglas Aircraft Company to build the second stage (S-IV) of the Saturn C-1.
- April 29:* All eight H-1 engines of the Saturn C-1 first stage ground-tested simultaneously for the first time.
- May 25:* STG Advanced Vehicle Team formed to conduct research and make preliminary design studies leading to the definition of requirements for an advanced multiman spacecraft.
- May 31:* Selection of Rocketdyne Division by NASA to develop the 200,000-pound-thrust J-2 rocket engine.
- July 28-29:* The announcement of the Apollo program to representatives of American industry.



Page Intentionally Left Blank

# PART I

## Concept to Apollo

### Beginnings through July 1960

In a discussion of the uses of an interplanetary rocket, Hermann Oberth proposed circumlunar flight to explore the hidden face of the moon and discussed the possibility of storing cryogenic fuels in space. A spacecraft could rendezvous and dock in earth orbit with a fuel capsule. When the spacecraft reached the vicinity of a planet, it would detach itself from the capsule and descend to the surface. On departure, the spacecraft would ascend and reconnect to its fuel supply for the return trip.

Hermann Oberth, *Die Rakete zu den Planetenräumen (The Rocket in Interplanetary Space)* (1923), pp. 94, 96–97.

**1923**  
During  
the  
Year

Hermann Noordung (pseudonym for Capt. Potočnik of the Austrian Imperial Army) expanded the ideas of Hermann Oberth on space flight in a detailed description of an orbiting space observatory. The problems of weightlessness, space communications, maintaining a livable environment for the crew, and extravehicular activity were considered. Among the uses of such an observatory were chemical and physical experiments in a vacuum, telescopes of great size and efficiency, detailed mapping of the earth's surface, weather observation, surveillance of shipping routes, and military reconnaissance.

Hermann Noordung, "The Problems of Space Flying," translated from the German, *Science Wonder Stories*, July–September, 1929; Wernher von Braun and Frederick I. Ordway III, *History of Rocketry and Space Travel* (1966), p. 202.

**1929**  
July–  
September

As part of a summary of his work on rockets during World War II, Wernher von Braun speculated on future uses of rocket power. These included an observatory in space, the construction of space stations in earth orbit, a space mirror, and interplanetary travel, beginning with trips to the moon.

Wernher von Braun, "Survey of the Development of Liquid Rockets in Germany and Their Future Prospects," in F. Zwicky, *Report on Certain Phases of War Research in Germany*, Summary Report No. F-SU-3-RE (Headquarters Air Materiel Command, January 1947), pp. 38–42.

**1945**  
During  
the  
Year

1948

November

13

A paper read to the British Interplanetary Society by H. E. Ross described a manned lunar landing mission which would require a combination of the earth orbit and lunar orbit rendezvous techniques. Three spacecraft would be launched simultaneously into earth orbit, each carrying a pilot. After rendezvous, the crew would transfer to ship A, which would refuel from ships B and C. Ship C would be discarded completely, but ship B would be fueled with the surplus not needed by A. The spacecraft would then be fired into a translunar trajectory. Upon reaching the vicinity of the moon, the spacecraft would go into lunar orbit, detach fuel tanks, and descend to the lunar surface. To return to earth, the spacecraft would rendezvous with the fuel tanks, refuel, and fire into a transearth trajectory. On approaching the earth, the spacecraft would rendezvous with ship B, the crew would transfer to ship B, and descend to earth. The ability to rendezvous in space was seen to be the essential element of such a project. The total payload weight at launch would be 1326 tons equally divided among the three ships as compared to 2.6 times this weight required for a direct ascent and return from the moon.

H. E. Ross, "Orbital Bases," *Journal of the British Interplanetary Society*, 8 (1949), pp. 1-7.

1949-1952

The awakening public interest in the scientific exploration of space was shown by the publication in September 1949 of *The Conquest of Space* by Willy Ley, illustrations by Chesley Bonestell. Featured in this book was a detailed description of a manned lunar landing and return, using the direct ascent technique. In the same year the Technicolor film "Destination Moon" went into production. Again the direct ascent mode was used in a four-man lunar landing mission. The movie premiered in New York City in 1950. On October 12, 1951, the First Symposium on Space Flight was held at the Hayden Planetarium in New York City, *Collier's* published papers from this Symposium on March 22, 1952, under the title "Man Will Conquer Space Soon." Contributors were Wernher von Braun, Joseph Kaplan, Heinz Haber, Willy Ley, Oscar Schachter, and Fred L. Whipple. Among the topics discussed were an orbiting astronomical observatory, problems of survival in space, circumlunar flight, a manned orbiting space station, and the question of sovereignty in outer space. In 1952, Arthur C. Clarke's *The Exploration of Space* became a Book of the Month Club selection. First published in England in 1951, the book included an alternative to the direct ascent technique: assembling or refueling the space vehicle in earth orbit before injection into translunar trajectory, to be followed, possibly, by rendezvous in lunar orbit with fuel tanker rockets launched from the earth.

Willy Ley, "Target for Tonight: Luna!," *The Conquest of Space* (1949), pp. 41-88; "Destination Moon" (1950), produced by George Pal; *Collier's* (March 22, 1952), pp. 22-36, 65-67, 70-72, 74; Arthur C. Clarke, *The Exploration of Space* (1952), pp. 62-82.

1951

September

7

The uses of rendezvous techniques in space were discussed in a paper read to the Second International Congress on Astronautics in London, England. The problems involved in refueling in space might be simplified considerably if astronauts could



maneuver freely, perhaps using a gas-jet pistol and a lifeline. The construction of a space station might then be possible. Mechanical linkage of objects in space was described as the most difficult task of all. While computing the position of an object in orbit might be comparatively easy, linking up with the object without damage by impact would require human intelligence to anticipate error in the attitude of approach.

R. A. Smith, "Establishing Contact Between Orbiting Vehicles," *Journal of the British Interplanetary Society*, 10 (1951), pp. 295-297.

1951  
September

The first symposium on space medicine was held under U.S. Air Force and Lovelace Foundation sponsorship at Randolph Air Force Base, San Antonio, Tex.

Lloyd S. Swenson, Jr., James M. Grimwood, and Charles C. Alexander, *This New Ocean: A History of Project Mercury* (NASA SP-4201, 1966), p. 34.

November  
During  
the  
Month

Robert J. Woods of the Bell Aircraft Company recommended to the Committee on Aerodynamics of the National Advisory Committee for Aeronautics (NACA) that a small study group be formed to investigate the problems of space flight. On June 24, the NACA Committee adopted a resolution (1) that NACA research effort on problems of manned and unmanned flight in the upper stratosphere at altitudes between 12 and 50 miles and at Mach numbers between 4 and 10 be increased, and (2) that NACA devote a modest effort to problems associated with manned and unmanned flight at altitudes from 50 miles to infinity and at speeds from Mach 10 to the velocity of escape from earth's gravity. On July 14, the NACA Executive Committee approved an almost identical resolution and a month later authorized Langley Aeronautical Laboratory to set up a preliminary study group. Other NACA laboratories were requested to submit comments and recommendations. Formal authorization for the research study was forwarded to Langley on September 8.

1952  
January  
30

Minutes of meeting, NACA Committee on Aerodynamics, June 24, 1952, pp. 19, 21; letters, Milton B. Ames, Jr., Acting Assistant Director for Research, to Langley Aeronautical Laboratory, July 10, 1952; John W. Crowley, Associate Director for Research, to Langley Aeronautical Laboratory, August 14, 1952; Research Authorization A73L95, NACA, September 8, 1952.

Rocketdyne Division of North American Aviation, Inc. (NAA), established the feasibility of a million-pound-thrust liquid-fueled rocket engine for the U.S. Air Force.

Rocketdyne *Skywriter*, May 20, 1960, p. 1.

1955  
March  
During  
the  
Month

The RAND Corporation issued the first of a series of reports on the feasibility of a lunar instrument carrier, based on the use of an Atlas booster. A braking rocket would decelerate the vehicle before lunar landing, and a penetration spike on the

1956  
May  
28



1956

May

forward point of the instrument package would help to absorb the 500 feet per second impact velocity. Instruments would then transmit information on the lunar surface to earth.

Historical Division, Office of Information, Space Systems Division, Air Force Systems Command, U.S. Air Force, "Chronology of Early Air Force Man-in-Space Activity, 1955-1960" (1964), unpublished, p. 5; H. A. Lang, *Lunar Instrument Carrier: Landing Factors*, RM-1725 (The RAND Corporation, June 4, 1956), pp. 1-3, 29, 31, 33-34.

1957

April

During  
the  
Month

The U.S. Army Ballistic Missile Agency, Redstone Arsenal, Ala., began studies of a large clustered-engine booster to generate 1.5 million pounds of thrust, as one of a related group of space vehicles. During 1957-1958, approximately 50,000 man-hours were expended in this effort.

H. H. Koelle, F. L. Williams, W. G. Huber, and R. C. Callaway, Jr., *Juno Space Vehicle Development Program; (Phase I): Booster Feasibility Demonstration* (Army Ballistic Missile Agency, October 13, 1958), p. 1.

October

4

*Sputnik I*, the first man-made earth satellite, was launched by the Soviet Union and remained in orbit until January 4, 1958.

Henry L. Richter, Jr., Editor, *Instruments and Spacecraft: Space Measurements Survey, October 1957-March 1965* (NASA SP-3028, 1966), p. 2.

14

The Rocket and Satellite Research Panel, established in 1946 as the V-2 Upper Atmosphere Research Panel and renamed the Upper Atmosphere Rocket Research Panel in 1948, together with the American Rocket Society proposed a national space flight program and a unified National Space Establishment. The mission of such an Establishment would be nonmilitary in nature, specifically excluding space weapons development and military operations in space. By 1959, this Establishment should have achieved an unmanned instrumented hard lunar landing and, by 1960, an unmanned instrumented lunar satellite and soft lunar landing. Manned circumnavigation of the moon with return to earth should have been accomplished by 1965 with a manned lunar landing mission taking place by 1968. Beginning in 1970, a permanent lunar base should be possible.

U.S. Congress, Senate, Special Committee on Space and Astronautics, *Compilation of Materials on Space and Astronautics No. 1*, 85th Congress, 2nd Session (1958), pp. 17-19.

November

14

The General Assembly of the United Nations adopted Resolution 1148 (XII), calling, in part, for "the joint study of an inspection system designed to ensure that the sending of objects through outer space shall be exclusively for peaceful and scientific purposes."

John Michael Kemp, *Evolution Toward a Space Treaty: An Historical Analysis* (NASA HHN-64, 1967), pp. 8-9.

December

9

The Air Force Scientific Advisory Board Ad Hoc Committee on Space Technology recommended acceleration of specific military projects and a vigorous

space program with the immediate goal of landings on the moon because "Sputnik and the Russian ICBM (intercontinental ballistic missile) capability have created a national emergency."

1957  
December

Thomas A. Sturm, *The USAF Scientific Advisory Board: Its First Twenty Years, 1944-1964* (1967), pp. 82-83.

The Army Ballistic Missile Agency completed and forwarded to higher authority the first edition of *A National Integrated Missile and Space Vehicle Development Program*, which had been in preparation since April 1957. Included was a "short-cut development program" for large payload capabilities, covering the clustered-engine booster of 1.5 million pounds of thrust to be operational in 1963. The total development cost of \$850 million during the years 1958-1963 covered 30 research and development flights, some carrying manned and unmanned space payloads. One of six conclusions given in the document was that "Development of the large (1520 K-pounds thrust) booster is considered the key to space exploration and warfare." Later vehicles with greater thrust were also described.

10

*A National Integrated Missile and Space Vehicle Development Program* (Army Ballistic Missile Agency, 1957), pp. 3, 6, Table XV.

The Martin Company proposed to the Department of Defense (DOD) that a stage of the Titan intercontinental ballistic missile be combined with the Vanguard rocket to provide a launch vehicle capable of placing an instrument package into lunar orbit and, ultimately, on the lunar surface.

During  
the  
Month

The Martin Company, *Lunar Vehicle* (1957), p. 2.

NACA established a Special Committee on Space Technology to study the problems of space flight. H. Guyford Stever of the Massachusetts Institute of Technology (MIT) was named Chairman. On November 21, 1957, NACA had authorized formation of the Committee.

1958  
January  
12

NACA News Release, "Space Technology Committee Established by NACA," January 13, 1958.

NACA adopted a resolution recommending that the national space program be a cooperative effort by DOD, NACA, the National Academy of Sciences, and the National Science Foundation, together with the universities, research institutions, and industrial companies. NACA viewed the development and operation of military space vehicles as the responsibility of DOD, while NACA's primary interest lay in the scientific exploration of space.

16

"National Advisory Committee for Aeronautics, Resolution on the Subject of Space Flight, Adopted January 16, 1958."

*Explorer I*, the first U.S. earth satellite, was launched by a modified Army Ballistic Missile Agency Jupiter-C. *Explorer I*, developed by the Jet Propulsion Laboratory, carried the U.S.-IGY (International Geophysical Year) experiment

31



1958

January

of James A. Van Allen and resulted in the discovery of the radiation belt around the earth.

U.S. Congress, Senate, Special Committee on Space and Astronautics, *Compilation of Materials on Space and Astronautics No. 2*, 85th Congress, 2nd Session (1958), p. 365; Fletcher G. Watson, *Between the Planets* (1962), pp. 210-211.

February

7

To further the national space effort pending a decision as to permanent organization, the Secretary of Defense created the Advanced Research Projects Agency (ARPA). ARPA was authorized to direct or perform advanced projects in the field of research and development. It was also empowered to deal directly with operational elements on all aspects of ARPA projects; for example, to bypass the Army Staff and the Chief of Ordnance in dealing with the Army Ballistic Missile Agency on what was to be the Saturn project. Roy W. Johnson was named ARPA Director.

U.S. Congress, Senate, Committee on Aeronautical and Space Sciences, *Manned Space Flight Program of the National Aeronautics and Space Administration: Projects Mercury, Gemini, and Apollo*, Staff Report, 87th Congress, 2nd Session (1962), p. 156.

10

A greatly expanded NACA program of space flight research was proposed in a paper, "A Program for Expansion of NACA Research in Space Flight Technology," written principally by senior engineers of the Lewis Aeronautical Laboratory under the leadership of Abe Silverstein. The goal of the program would be "to provide basic research in support of the development of manned satellites and the travel of man to the moon and nearby planets." The cost of the program was estimated at \$241 million per year above the current NACA budget.

NACA Staff, "A Program for Expansion of NACA Research in Space Flight Technology," February 10, 1958, pp. 1-2, 29; Swenson *et al.*, *This New Ocean*, pp. 76-77.

March

5

President Dwight D. Eisenhower approved the recommendations of his Advisory Committee on Government Organization that the "leadership of the civil space effort be lodged in a strengthened and redesignated National Advisory Committee for Aeronautics," and that legislation be enacted to "give NACA the authority and flexibility" to carry out its expanded responsibilities.

Robert L. Rosholt, *An Administrative History of NASA, 1958-1963* (NASA SP-4101, 1966), p. 8.

April

1

A \$61,000 contract was signed by the Yerkes Observatory, University of Chicago, and the Air Force. Gerard P. Kuiper, principal investigator, was to produce a new lunar photographic atlas. The moon's visible surface would be divided into 44 areas, and each would be represented by at least four photographs taken under varying lighting conditions. The photographs would be assembled from the following observatories: Yerkes, Williams Bay, Wisc.; Lick, Mount Hamilton, Calif.; Mount Wilson-Palomar, Mount Wilson, Calif.; Pic-du-Midi, France; and McDonald, Fort Davis, Tex. The contract was to run from April 1, 1958, to March 31, 1959. It was extended on February 25, 1959, to September 3, 1959, with increase in

funds of \$52,500, and again on November 18, 1959, to April 30, 1960, with no increase in funds.

1958

April

U.S. Congress, House, Committee on Science and Astronautics, *Army Lunar Construction and Mapping Program*, Committee Report, 86th Congress, 2nd Session (1960), Appendix.

President Dwight D. Eisenhower, in a message to Congress, proposed the establishment of a National Aeronautics and Space Agency into which the National Advisory Committee for Aeronautics would be absorbed. The new agency would conduct the civilian space program through research in its own facilities or by contract and would also perform military research required by DOD. Projects primarily military in character would remain the responsibility of DOD. A National Aeronautics and Space Board, appointed by the President and composed of eminent persons outside the government and representatives of interested government agencies (with at least one member from DOD), was to assist the President and the Director of the National Aeronautics and Space Agency.

2

Senate Committee Print, *Compilation of Materials on Space and Astronautics No. 2*, pp. 79-83.

The Air Force Ballistic Missile Division published the first development plan for an Air Force manned military space systems program. The objective was to "achieve an early capability to land a man on the moon and return him safely to earth." The program called for the start of a high priority effort (similar to that enjoyed by ballistic missiles), characterized by "concurrency" and single Air Force agency management. The complete program would be carried out in four phases: first, "Man-in-Space Soonest"; second, "Man-in-Space Sophisticated"; third, "Lunar Reconnaissance," exploring the moon by television camera and by a soft landing of an instrumented package on the moon's surface; and finally, "Manned Lunar Landing and Return," which would first test equipment by circumlunar flights returning to earth with instrumented capsules containing animals. At this stage of project development, the payload capacity would be increased to 9000 pounds. The spacecraft would then undertake a full-scale flight to the moon and safe return with an animal passenger. The climax would be a manned lunar landing, brief surface exploration, and return. This would be followed by other flights to explore the lunar surface thoroughly and gather additional data. The program was scheduled for completion in December 1965 at a cost of \$1.5 billion.

25

Space Systems Division, Air Force Systems Command, and the USAF Historical Division Liaison Office, "Chronology of Early USAF Man-in-Space Activity, 1945-1958" (U.S. Air Force, 1965), unpublished, pp. 21-22.

The U.S. Air Force contracted with NAA, Rocketdyne Division, for preliminary design of a single-chamber, kerosene and liquid-oxygen rocket engine capable of 1 to 1.5 million pounds of thrust. During the last week in July, Rocketdyne was awarded the contract to develop this engine, designated the F-1.

June

23

Senate Staff Report, *Manned Space Flight Program*, p. 158; *Rocketdyne Valley Skywriter*, August 1, 1958, p. 1.



- 1958**  
**July**  
 29 President Dwight D. Eisenhower signed the National Aeronautics and Space Act of 1958, Public Law 85-568, which established the National Aeronautics and Space Administration (NASA).  
*Senate Staff Report, Manned Space Flight Program*, p. 159; Eugene M. Emme, *Aeronautics and Astronautics: An American Chronology of Science and Technology in the Exploration of Space, 1915-1960* (NASA, 1961), p. 100.
- August**  
 8 T. Keith Glennan, President of Case Institute of Technology, and Hugh L. Dryden, Director of the National Advisory Committee for Aeronautics, were nominated by President Dwight D. Eisenhower to be Administrator and Deputy Administrator of NASA. The Senate confirmed their nominations one week later.  
*Rosholt, An Administrative History of NASA, 1958-1963*, pp. 40-42.
- 15 The Advanced Research Projects Agency (ARPA) provided the Army Ordnance Missile Command (AOMC) with authority and initial funding to develop the Juno V (later named Saturn) launch vehicle. ARPA Order 14 described the project: "Initiate a development program to provide a large space vehicle booster of approximately 1.5 million pounds of thrust based on a cluster of available rocket engines. The immediate goal of this program is to demonstrate a full-scale captive dynamic firing by the end of calendar year 1959." Within AOMC, the Juno V project was assigned to the Army Ballistic Missile Agency at Redstone Arsenal Huntsville, Ala.  
*Koelle et al., Juno Space Vehicle Demonstration; (Phase I)*, p. 2.
- 17 The first Air Force lunar probe was launched, using a Thor-Able booster. An explosion ripped it apart 77 seconds after launch.  
*Instruments and Spacecraft*, p. 27.
- September**  
 11 A letter contract was signed by NASA with NAA's Rocketdyne Division for the development of the H-1 rocket engine, designed for use in a clustered-engine booster.  
 MSFC Saturn Systems Office and MSFC Historical Office, *Saturn Illustrated Chronology* (George C. Marshall Space Flight Center, MHR-3, 1964), pp. 2-3.
- 23 Following a Memorandum of Agreement between Maj. Gen. John B. Medaris of Army Ordnance Missile Command (AOMC) and Advanced Research Projects Agency (ARPA) Director Roy W. Johnson on this date and a meeting on November 4, ARPA and AOMC representatives agreed to extend the Juno V project. The objective of ARPA Order 14 was changed from booster feasibility demonstration to "the development of a reliable high performance booster to serve as the first stage of a multistage carrier vehicle capable of performing advanced missions."  
 H. H. Koelle, F. L. Williams, W. G. Huber, and R. C. Callaway, Jr., *Juno V Space Vehicle Development Program (Status Report—15 November 1958)* (Army Ballistic Missile Agency, November 15, 1958), p. 2.

NASA was organized and NACA was abolished, at the close of business on September 30, with all personnel and facilities transferred to the new agency. At the same time, several space projects were transferred to NASA from DOD. Among these were two Air Force and two Army lunar probes; the services kept the actual work of construction and launching.

Rosholt, *An Administrative History of NASA, 1958-1963*, pp. 44-48; Swenson *et al.*, *This New Ocean*, p. 538.

*Pioneer I*, intended as a lunar probe, was launched by a Thor-Able rocket from the Atlantic Missile Range, with the Air Force acting as executive agent to NASA. The 39-pound instrumented payload did not reach escape velocity.

*Instruments and Spacecraft*, pp. 30-32.

The Stever Committee, which had been set up on January 12, submitted its report on the civilian space program to NASA. Among the recommendations:

- A vigorous, coordinated attack should be made upon the problems of maintaining the performance capabilities of man in the space environment as a prerequisite to sophisticated space exploration.
- Sustained support should be given to a comprehensive instrumentation development program, establishment of versatile dynamic flight simulators, and provision of a coordinated series of vehicles for testing components and subsystems.
  - Serious study should be made of an equatorial launch capability.
  - Lifting reentry vehicles should be developed.
  - Both the clustered- and single-engine boosters of million-pound thrust should be developed.
  - Research on high-energy propellant systems for launch vehicle upper stages should receive full support.
  - The performance capabilities of various combinations of existing boosters and upper stages should be evaluated, and intensive development concentrated on those promising greatest usefulness in different categories of payload.

NASA Special Committee on Space Technology, "Recommendations Regarding a National Civil Space Program," October 28, 1958, pp. 1-2.

A contract was signed by the University of Manchester, Manchester, England, and the Air Force [AF 61(052)-168] for \$21,509. Z. Kopal, principal investigator, was to provide topographical information on the lunar surface for production of accurate lunar maps. Kopal would work at the Pic-du-Midi Observatory in France, and the data would be transmitted to the Air Force Aeronautical Chart and Information Center for reduction. The lunar charts produced would be used for intelligence purposes and for the national space effort led by NASA. The contract was extended on August 4, 1959, to April 30, 1960, and was to include exploratory spectroscopic observations of the moon.

House Committee Report, *Army Lunar Construction and Mapping Program*, Appendix.

1958

October

1

11

28

November

1



- 1958**
- November**
- 5 The Space Task Group (STG) was officially organized at Langley Field, Va., to implement the manned satellite project (later Project Mercury). NASA Administrator T. Keith Glennan had approved the formation of the Group, which had been working together for some months, on October 7. Its members were designated on November 3 by Robert R. Gilruth, Project Manager, and authorization was given by Floyd L. Thompson, Acting Director of Langley Research Center. STG would report directly to NASA Headquarters.
- Memorandum, Gilruth, Project Manager, to Associate Director, "Space Task Group," November 3, 1958; Swenson *et al.*, *This New Ocean*, p. 114.
- 8 *Pioneer II* was launched from the Atlantic Missile Range, using a Thor-Able booster, the Air Force acting as executive agent to NASA. The 86.3-pound instrumented payload, intended as a lunar probe, failed to reach escape velocity.
- Instruments and Spacecraft*, p. 34.
- December**
- 3 By Executive Order, President Dwight D. Eisenhower transferred the Jet Propulsion Laboratory (JPL), a government-owned facility staffed and operated by the California Institute of Technology, from Army to NASA jurisdiction. The new JPL radio telescope at Camp Irwin, Calif., called the Goldstone Tracking Facility, was capable of maintaining radio contact at distances of up to 400,000 miles and was the first of NASA's deep-space tracking stations.
- First Semiannual Report to Congress of the National Aeronautics and Space Administration*, October 1, 1958–March 31, 1959 (1959), pp. 24, 36, 42–43; U.S. Congress, House, Committee on Science and Astronautics, *A Chronology of Missile and Astronautic Events*, 87th Congress, 1st Session (1961), p. 61.
- 3 Secretary of the Army Wilber M. Brucker and NASA Administrator T. Keith Glennan signed cooperative agreements concerning NASA, Jet Propulsion Laboratory, Army Ordnance Missile Command (AOMC), and Department of the Army relationships. The agreement covering NASA utilization of the von Braun team made "the AOMC and its subordinate organizations immediately, directly, and continuously responsive to NASA requirements."
- First NASA Semiannual Report*, pp. 81–87.
- 6 *Pioneer III*, the third U.S.–IGY intended lunar probe under the direction of NASA with the Army acting as executive agent, was launched from the Atlantic Missile Range by a Juno II rocket. The primary objective, to place the 12.95-pound scientific payload in the vicinity of the moon, failed. *Pioneer III* reached an altitude of approximately 70,000 miles and revealed that the earth's radiation belt comprised at least two distinct bands.
- Instruments and Spacecraft*, p. 35; *New York Times*, December 7, 1958.
- 17 NASA Administrator T. Keith Glennan announced that the manned satellite program would be called "Project Mercury."
- Swenson *et al.*, *This New Ocean*, p. 132.

PART I: CONCEPT TO APOLLO

Representatives of Advanced Research Projects Agency, the military services, and NASA met to consider the development of future launch vehicle systems. Agreement was reached on the principle of developing a small number of versatile launch vehicle systems of different thrust capabilities, the reliability of which could be expected to be improved through use by both the military services and NASA.

1958  
December  
17

*NASA-Industry Program Plans Conference, July 28-29, 1960* (1960), p. 2.

The H-1 engine successfully completed its first full-power firing at NAA's Rocket-dyne facility in Canoga Park, Calif.

17

*Saturn Illustrated Chronology*, p. 4.

The U.S. Army Map Service studied methods of mapping the moon. This effort evolved into Project LAMP (Lunar Analysis and Mapping Program) in cooperation with the U.S. Geological Survey. By spring 1960, the first maps were in preparation. Four stages were incorporated in the project:

During  
the  
Year

Stage I: Moon map on scale of 1:500,000 and feasibility studies, through 1960 (\$200,000)

Stage II: Expansion and acceleration of Stage I, including balloon photographic reconnaissance and radar investigation, through 1961 (\$800,000)

Stage III: System design per requirements of the lunar mission, through 1962 (\$2 million)

Stage IV: Operational program assembling all system components for lunar mission, through 1963 (\$5 million)

U.S. Congress, House, Committee on Science and Astronautics, *Lunar Mapping and Construction in Support of Space Programs*, Hearings, 86th Congress, 2nd Session (1960), p. 4.

The Soviet Union announced the successful launching of *Mechta* ("Dream"), popularly called *Lunik I*, toward the moon. Carrying nearly 800 pounds of instruments, *Lunik I* missed the moon and became the first man-made solar satellite.

1959  
January  
2

*Instruments and Spacecraft*, p. 38.

In a staff report of the House Select Committee on Astronautics and Space Exploration, Wernher von Braun of the Army Ballistic Missile Agency predicted manned circumlunar flight within the next eight to ten years and a manned lunar landing and return mission a few years thereafter. Administrator T. Keith Glennan, Deputy Administrator Hugh L. Dryden, Abe Silverstein, John P. Hagen, and Homer E. Newell, all of NASA, also foresaw manned circumlunar flight within the decade as well as instrumented probes soft-landed on the moon. Roy K. Knutson, Chairman of the Corporate Space Committee, NAA, projected a manned lunar landing expedition for the early 1970's with extensive unmanned instrumented soft lunar landings during the last half of the 1960's.

2

U.S. Congress, House, Select Committee on Astronautics and Space Exploration, *The Next Ten Years in Space, 1959-1969*, Staff Report, 86th Congress, 1st Session (1959), pp. 96, 122, 211.



- 1959**
- January**
- 6 The Army Ordnance Missile Command (AOMC), the Air Force, and missile contractors presented to the ARPA–NASA Large Booster Review Committee their views on the quickest and surest way for the United States to attain large booster capability. The Committee decided that the Juno V approach advocated by AOMC was best and NASA started plans to utilize the Juno V booster.
- Senate Staff Report, *Manned Space Flight Program*, p. 165.
- 19 NASA signed a definitive contract with Rocketdyne Division, NAA, for \$102 million covering the design and development of a single-chamber, liquid-propellant rocket engine in the 1- to 1.5-million-pound-thrust class (the F–1, to be used in the Nova superbooster concept). NASA had announced the selection of Rocketdyne on December 12.
- First NASA Semiannual Report, p. 27.
- 27 After consultation and discussion with DOD, NASA formulated a national space vehicle program. The central idea of the program was that a single launch vehicle should be developed for use in each series of future space missions. The launch vehicle would thus achieve a high degree of reliability, while the guidance and payload could be varied according to purpose of the mission. Four general-purpose launch vehicles were described: Vega, Centaur, Saturn, and Nova. The Nova booster stage would be powered by a cluster of four F–1 engines, the second stage by a single F–1, and the third stage would be the size of an intercontinental ballistic missile but would use liquid hydrogen as a fuel. This launch vehicle would be the first in a series that could transport a man to the lunar surface and return him safely to earth in a direct ascent mission. Four additional stages would be required in such a mission.
- “A National Space Vehicle Program,” NASA report to the President, January 27, 1959.
- February**
- 2 The Army proposed that the name of the large clustered-engine booster be changed from Juno V to Saturn, since Saturn was the next planet after Jupiter. Roy W. Johnson, Director of the Advanced Research Projects Agency, approved the name on February 3.
- Senate Staff Report, *Manned Space Flight Program*, p. 165; *Saturn Illustrated Chronology*, p. 5.
- 4 Maj. Gen. John B. Medaris of the Army Ordnance Missile Command (AOMC) and Roy W. Johnson of the Advanced Research Projects Agency (ARPA) discussed the urgency of early agreement between ARPA and NASA on the configuration of the Saturn upper stages. Several discussions between ARPA and NASA had been held on this subject. Johnson expected to reach agreement with NASA the following week. He agreed that AOMC would participate in the overall upper stage planning to ensure compatibility of the booster and upper stages.
- Senate Staff Report, *Manned Space Flight Program*, p. 166.

A Working Group on Lunar Exploration was established by NASA at a meeting at Jet Propulsion Laboratory (JPL). Members of NASA, JPL, Army Ballistic Missile Agency, California Institute of Technology, and the University of California participated in the meeting. The Working Group was assigned the responsibility of preparing a lunar exploration program, which was outlined: circum-lunar vehicles, unmanned and manned; hard lunar impact; close lunar satellites; soft lunar landings (instrumented). Preliminary studies showed that the Saturn booster with an intercontinental ballistic missile as a second stage and a Centaur as a third stage, would be capable of launching manned lunar circumnavigation spacecraft and instrumented packages of about one ton to a soft landing on the moon.

1959

February

5

U.S. Army Ordnance Missile Command, *A Lunar Exploration Program Based Upon Saturn-Boosted Systems*, DV-TR-2-60 (February 1, 1960), p. i.

Roy W. Johnson, Director of the Advanced Research Projects Agency (ARPA), testified before the House Committee on Science and Astronautics that DOD and ARPA had no lunar landing program. Herbert F. York, DOD Director of Defense Research and Engineering, testified that exploration of the moon was a NASA responsibility.

17

U.S. Congress, House, Committee on Science and Astronautics, *Missile Development and Space Sciences*, Hearings, 86th Congress, 1st Session (1959), pp. 346, 359.

In testimony before the Senate Committee on Aeronautical and Space Sciences, Deputy Administrator Hugh L. Dryden and DeMarquis D. Wyatt described the long-range objectives of the NASA space program: an orbiting space station with several men, operating for several days; a permanent manned orbiting laboratory; unmanned hard-landing and soft-landing lunar probes; manned circum-lunar flight; manned lunar landing and return; and, ultimately, interplanetary flight.

20

U.S. Congress, Senate, Committee on Aeronautical and Space Sciences, *NASA Supplemental Authorization for Fiscal Year 1959*, Hearings, 86th Congress, 1st Session (1959), pp. 46, 81.

The fourth U.S.-IGY lunar probe effort, *Pioneer IV*, a joint project of the Army Ballistic Missile Agency and Jet Propulsion Laboratory under the direction of NASA, was launched by a Juno II rocket from the Atlantic Missile Range. Intended to impact on the lunar surface, *Pioneer IV* achieved earth-moon trajectory, passing within 37,300 miles of the moon before going into permanent orbit around the sun.

March

3

*Instruments and Spacecraft*, pp. 45-46.

The thrust chamber of the F-1 engine was successfully static-fired at the Santa Susana Air Force-Rocketdyne Propulsion Laboratory in California. More than one million pounds of thrust were produced, the greatest amount attained to that time in the United States.

6

*Washington Evening Star*, April 1, 1959.



1959

March

13

The Army Ordnance Missile Command (AOMC) submitted the "Saturn System Study" which had been requested by the Advanced Research Projects Agency (ARPA) on December 18, 1958. From the 1375 possible configurations screened, and the 14 most promising given detailed study, the Atlas and Titan families were selected as the most attractive for upper staging. Either the 120-inch or the 160-inch diameter was acceptable. The study included the statement: "An immediate decision by ARPA as to choice of upper stages on the first generation vehicle is mandatory if flight hardware is to be available to meet the proposed Saturn schedule." On March 17, AOMC presented the study to NASA, DOD, and ARPA reiterating the urgent need for an early decision on upper staging. Roy W. Johnson, ARPA Director, formed a Saturn ad hoc committee of NASA and DOD personnel to recommend upper stages and payload missions.

Senate Staff Report, *Manned Space Flight Program*, p. 167; *Saturn Illustrated Chronology*, p. 5.

20

An Army task force was formed to develop a plan for establishing a manned lunar outpost by the quickest practical means. The effort was called Project Horizon. The first phase of the project was to make a limited feasibility study, with estimated time and costs. The task force worked under the direction of Maj. Gen. John B. Medaris of the Army Ordnance Missile Command and in full collaboration with the von Braun team. The report was completed on June 8.

Senate Staff Report, *Manned Space Flight Program*, p. 167.

During  
the  
Month

H. Kurt Strass and Leo T. Chauvin of STG proposed a heatshield test of a full-scale Mercury spacecraft at lunar reentry speeds. This test, in which the capsule would penetrate the earth's radiation belt, was called Project Boomerang. An advanced version of the Titan missile was to be the launch vehicle. The project was postponed and ultimately dropped because of cost.

Interview with Strass, Manned Spacecraft Center, November 30, 1966; Memorandum, Strass to Chief, Flight Systems Division, "Second Meeting of the New Projects Panel," August 26, 1959.

April

1-8

John W. Crowley, Jr., NASA Director of Aeronautical and Space Research, notified the Ames, Lewis, and Langley Research Centers, the High Speed Flight Station (later Flight Research Center), the Jet Propulsion Laboratory, and the Office of Space Flight Development that a Research Steering Committee on Manned Space Flight would be formed. Harry J. Goett of Ames was to be Chairman of the Committee, which would assist NASA Headquarters in carrying out its responsibilities in long-range planning and basic research on manned space flight.

Memoranda, NASA Headquarters to Ames, Lewis, and Langley Research Centers and High Speed Flight Station, "Steering Committee on Manned Space Flight," April 1, 1959; Director of Aeronautical and Space Research to Director of Space Flight Development, "Research Steering Committee on Manned Space Flight," April 2, 1959; NASA Headquarters to Jet Propulsion Laboratory, "Research Steering Committee on Manned Space Flight," April 8, 1959.

The advanced manned space program to follow Project Mercury was discussed at a NASA Staff Conference held in Williamsburg, Va. Three reasons for such a program were suggested:

(1) Preliminary step to development of spacecraft for manned interplanetary exploration

(2) Extended duration work in the space environment

(3) Support of the military space mission.

Among areas requiring study were the cost of an equatorial launch site, adequacy of tracking stations and DOD-NASA coordination of tracking systems, and the need for NASA's own propulsion test stands and facilities.

"NASA Staff Conference, Williamsburg, Va., April 2-5, 1959," pp. 2-3.

NASA Administrator T. Keith Glennan requested \$3 million for research into rendezvous techniques as part of the NASA budget for Fiscal Year 1960. In subsequent hearings, DeMarquis D. Wyatt, Assistant to the NASA Director of Space Flight Development, explained that these funds would be used to resolve certain key problems in making space rendezvous practical. Among these were the establishment of referencing methods for fixing the relative positions of two vehicles in space; the development of accurate, lightweight target-acquisition equipment to enable the supply craft to locate the space station; the development of very accurate guidance and control systems to permit precisely determined flight paths; and the development of sources of controlled power.

7

U.S. Congress, Senate, NASA Authorization Subcommittee of the Committee on Aeronautical and Space Sciences, *NASA Authorization for Fiscal Year 1960*, Hearings on S. 1582, 86th Congress, 1st Session (1959), p. 7; U.S. Congress, House, Committee on Science and Astronautics, *1960 NASA Authorization*, Hearings on H.R. 6512, 86th Congress, 1st Session (1959), pp. 97, 170, 267-268.

Testifying before the House Committee on Science and Astronautics, Francis B. Smith, Chief of Tracking Programs for NASA, described the network of stations necessary for tracking a deep-space probe on a 24-hour basis. The stations should be located about 120° apart in longitude. In addition to the Goldstone, Calif., site, two other locations had been selected: South Africa and Woomera, Australia.

8

*1960 NASA Authorization*, Hearings on H.R. 6512, p. 295.

At a press conference in Washington, D.C., NASA Administrator T. Keith Glennan announced that seven pilots had been selected for the Mercury program. They were Lt. Cdr. Alan B. Shepard, Jr., Navy; Capt. Virgil I. Grissom, Air Force; Lt. Col. John H. Glenn, Jr., Marines; Lt. Malcolm Scott Carpenter, Navy; Lt. Cdr. Walter M. Schirra, Jr., Navy; Capt. Donald K. Slayton, Air Force; and Capt. Leroy Gordon Cooper, Jr., Air Force.

9

U.S. Congress, House, Committee on Science and Astronautics, *Meeting with the Astronauts, Project Mercury, Man-in-Space Program*, Hearings, 86th Congress, 1st Session (1959).



1959

April

9-28

Members of the new Research Steering Committee on Manned Space Flight were nominated by the Ames, Lewis, and Langley Research Centers, the High Speed Flight Station (HSFS) (later Flight Research Center), the Jet Propulsion Laboratory (JPL), the Office of Space Flight Development (OSFD), and the Office of Aeronautical and Space Research (OASR). They were: Alfred J. Eggers, Jr. (Ames); Bruce T. Lundin (Lewis); Laurence K. Loftin, Jr. (Langley); De E. Beeler (HSFS); Harris M. Schurmeier (JPL); Maxime A. Faget (STG); George M. Low of NASA Headquarters (OSFD); and Milton B. Ames, Jr. (part-time) (OASR).

Memoranda, Ames, Lewis, and Langley Research Centers to NASA Headquarters, "Research Steering Committee on Manned Space Flight," April 9 and 17, 1959; High Speed Flight Station to NASA Headquarters, "Research Steering Committee on Manned Space Flight," April 28, 1959; letter, W. H. Pickering, Director of the Jet Propulsion Laboratory, to Dr. J. W. Crowley, Director of Aeronautical and Space Research, NASA, April 13, 1959; memorandum, Abe Silverstein, Director of Space Flight Development, to Director of Aeronautical and Space Research, "Research Steering Committee on Manned Space Flight," April 13, 1959.

15

In response to a request by the (DOD-NASA) Saturn Ad Hoc Committee, the Army Ordnance Missile Command (AOMC) sent a supplement to the "Saturn System Study" to the Advanced Research Projects Agency (ARPA) describing the use of Titan for Saturn upper stages. On May 19, Roy W. Johnson, ARPA Director, notified AOMC that the Saturn second stage would be the first stage of the Titan. After discussions by ARPA, AOMC, Air Force, and Martin Company personnel, ARPA authorized AOMC to enter into direct contracts for modification and procurement of Titan hardware, and on July 24 the appropriate government offices were told by Army Ballistic Missile Agency (ABMA) to conclude letter contracts with Aerojet-General Corporation and The Martin Company. Five days later, ARPA ordered all AOMC Saturn second-stage effort suspended. Johnson later testified that Herbert F. York, DOD Director of Defense Research and Engineering, had informed him: "I have decided to cancel the Saturn program on the grounds that there is no military justification therefore, on the grounds that any military requirement can be accommodated by Titan-C as proposed by the Air Force [Titan-C was a booster, not yet developed, of lower thrust than the Saturn and intended for use in the Dyna-Soar program], and on the ground that by the cancellation the Defense Department will be in a position to terminate the costly operation being conducted at ABMA." Johnson testified that he had been ready to concur in the cancellation of the Saturn program if it were established that the Titan-C could be developed for about 75 percent of the cost of Saturn and if the Titan-C could accomplish the military missions projected for the next ten years. York then appointed a Booster Evaluation Committee which convened on September 16.

U.S. Congress, House, Committee on Science and Astronautics, *To Amend the National Aeronautics and Space Act of 1958*, Hearings, 86th Congress, 2nd Session (1960), pp. 408, 412, 413; Senate Staff Report, *Manned Space Flight Program*, pp. 171, 172, 173.

Testifying before the Senate Committee on Aeronautical and Space Sciences, Maj. Gen. Bernard A. Schriever, Commander of the Air Force Ballistic Missile Division, stated that all three military services should be studying the possibility of a base on the moon. Up to that point, he felt, all such studies had been "in the blue thinking."

U.S. Congress, Senate, Committee on Aeronautical and Space Sciences, *Investigation of Governmental Organization for Space Activities*, Hearings, 86th Congress, 1st Session (1959), p. 483.

The Army Ordnance Missile Command submitted to NASA a report entitled "Preliminary Study of an Unmanned Lunar Soft Landing Vehicle," recommending the use of the Saturn booster.

Senate Staff Report, *Manned Space Flight Program*, p. 168.

STG was transferred to the authority of the newly formed Goddard Space Flight Center but remained based at Langley Field, Va.

Memorandum, T. E. Jenkins to Assistant Directors and Division Chiefs, Goddard Space Flight Center, "Organization and Functions of the Goddard Space Flight Center," May 1, 1959, with attachment: Abe Silverstein, Director of Space Flight Development, "Organization of Activities of Goddard Space Flight Center," May 1, 1959.

The first Rocketdyne H-1 engine for the Saturn arrived at the Army Ballistic Missile Agency (ABMA). The H-1 engine was installed in the ABMA test stand on May 7, first test-fired on May 21, and fired for 80 seconds on May 29. The first long-duration firing—151.03 seconds—was on June 2.

Senate Staff Report, *Manned Space Flight Program*, p. 168.

Milton W. Rosen of NASA Headquarters proposed a plan for obtaining high-resolution photographs of the moon. A three-stage Vega would place the payload within a 500-mile diameter circle on the lunar surface. A stabilized retrorocket fired at 500 miles above the moon would slow the instrument package sufficiently to permit 20 photographs to be transmitted at a rate of one picture per minute. A radio altimeter could be used to index the height at which each picture was taken. The camera system, developed by the Eastman Kodak Company for the Air Force, would be available within the year. The alternative approach of using direct television appeared less attractive because the resolution of the television system was at least an order of magnitude lower than the comparable photographic system. Because of the difficulty in placing an instrument package in a close lunar orbit, photographs taken by a vehicle orbiting the moon, including those taken of the far side and recorded on magnetic tape for later transmission, would probably have low resolution owing to the distance from the lunar surface. On June 12, Rosen described a new television system which could be used for early attempts at lunar photography. The system, which would be available within a year, would relay pictures comparable to that of the Eastman Kodak camera system.

Memoranda, Rosen to A. Silverstein, "Lunar Photography," May 9, 1959; Rosen to Silverstein, "Lunar Photography, Revisions to Memorandum of May 9, 1959," June 12, 1959.

1959

April

24

May

1

1

3

9



**1959****May****25-26**

The first meeting of the Research Steering Committee on Manned Space Flight was held at NASA Headquarters. Members of the Committee attending were: Harry J. Goett, Chairman; Milton B. Ames, Jr. (part-time); De E. Beeler; Alfred J. Eggers, Jr.; Maxime A. Faget; Laurence K. Loftin, Jr.; George M. Low; Bruce T. Lundin; and Harris M. Schurmeier. Observers were John H. Disher, Robert M. Crane, Warren J. North, Milton W. Rosen (part-time), and H. Kurt Strass.

The purpose of the Committee was to take a long-term look at man-in-space problems, leading eventually to recommendations on future missions and on broad aspects of Center research programs to ensure that the Centers were providing proper information. Committee investigations would range beyond Mercury and Dyna-Soar but would not be overly concerned with specific vehicular configurations. The Committee would report directly to the Office of Aeronautical and Space Research.

Minutes, Research Steering Committee on Manned Space Flight, May 25-26, 1959, pp. 1-2.

**25-26**

The national booster program, Dyna-Soar, and Project Mercury were discussed by the Research Steering Committee. Members also presented reviews of Center programs related to manned space flight. Maxime A. Faget of STG endorsed lunar exploration as the present goal of the Committee although recognizing the end objective as manned interplanetary travel. George M. Low of NASA Headquarters recommended that the Committee:

- Adopt the lunar landing mission as its long-range objective
- Investigate vehicle staging so that Saturn could be used for manned lunar landings without complete reliance on Nova
- Make a study of whether parachute or airport landing techniques should be emphasized
- Consider nuclear rocket propulsion possibilities for space flight
- Attach importance to research on auxiliary power plants such as hydrogen-oxygen systems.

Minutes, Research Steering Committee on Manned Space Flight, May 25-26, 1959, pp. 3-10.

**25-26**

Tentative manned space flight priorities were established by the Research Steering Committee: Project Mercury, ballistic probes, environmental satellite, maneuverable manned satellite, manned space flight laboratory, lunar reconnaissance satellite, lunar landing, Mars-Venus reconnaissance, and Mars-Venus landing. The Committee agreed that each NASA Center should study a manned lunar landing and return mission, the study to include the type of propulsion, vehicle configuration, structure, and guidance requirements. Such a mission was an end objective; it did not have to be supported on the basis that it would lead to a more useful end. It would also focus attention at the Centers on the problems of true space flight.

Minutes, Research Steering Committee on Manned Space Flight, May 25-26, 1959, pp. 10, 11; memorandum, Harry J. Goett to Ira H. Abbott, Director of Aeronautical and Space Research, "Interim Report on Operations of 'Research Steering Committee on Manned Space Flight,'" July 17, 1959.

PART I: CONCEPT TO APOLLO

Director Robert R. Gilruth met with members of his STG staff (Paul E. Purser, Charles J. Donlan, James A. Chamberlin, Raymond L. Zavasky, W. Kemble Johnson, Charles W. Mathews, Maxime A. Faget, and Charles H. Zimmerman) and George M. Low from NASA Headquarters to discuss the possibility of an advanced manned spacecraft.

1959

May

27

Memorandum, Purser to Gilruth, "Log for the Week of May 25, 1959," p. 2.

Construction of the first Saturn launch area, Complex 34, began at Cape Canaveral, Fla.

June

3

Senate Staff Report, *Manned Space Flight Program*, p. 169.

At an STG staff meeting, Director Robert R. Gilruth suggested that study should be made of a post-Mercury program in which maneuverable Mercury spacecraft would make land landings in limited areas.

4

Memorandum, Paul E. Purser to Gilruth, "Log for the Week of June 1, 1959," p. 4.

The Project Horizon Phase I report was completed. In it, a U.S. manned landing on the moon in 1965 was proposed, to be followed in 1966 by an operational lunar outpost. Expenditures would average \$667 million a year from Fiscal Year 1960 through Fiscal Year 1968. The guiding philosophy of the report was one of "enlightened conservatism of technical approach." On July 28 the report was presented to the Secretary of the Army and the Chief of Staff. In discussion following the presentations, several conclusions emerged:

8

- The earliest possible U.S. manned lunar outpost was vital to American interests.

- Project Horizon was the earliest feasible means by which the United States could achieve that objective.

- The extensive and in many cases exclusive Army capabilities in this field should be used in the nation's service, regardless of who would have the responsibility for the lunar outpost.

- The general reception accorded U.S. Army proposals of space operations had not been uniformly enthusiastic.

- The source of the proposal should not be allowed to prejudice the reception of the proposal.

For these reasons, it was decided that the report should be recast to eliminate any U.S. Army organization to manage the lunar operation, at the same time deleting all possible military implications and inferences and emphasizing the scientific and inherently peaceful intent of the United States in its space operations. The report was accordingly revised, leaving the time frame intact, and on September 4 was submitted to the Secretary of the Army. It was later forwarded to the Secretary of Defense and (after the transfer of the von Braun team to NASA) to the NASA Administrator.

Senate Staff Report, *Manned Space Flight Program*, pp. 169, 172.



1959

June

18

NASA authorized \$150,000 for Army Ordnance Missile Command studies of a lunar exploration program based on Saturn-boosted systems. To be included were circumlunar vehicles, unmanned and manned; close lunar orbiters; hard lunar impacts; and soft lunar landings with stationary or roving payloads.

Senate Staff Report, *Manned Space Flight Program*, p. 170.

25-26

At the second meeting of the Research Steering Committee on Manned Space Flight, held at the Ames Research Center, members presented reports on intermediate steps toward a manned lunar landing and return.

Bruce T. Lundin of the Lewis Research Center reported to members on propulsion requirements for various modes of manned lunar landing missions, assuming a 10,000-pound spacecraft to be returned to earth. Lewis mission studies had shown that a launch into lunar orbit would require less energy than a direct approach and would be more desirable for guidance, landing reliability, etc. From a 500,000-foot orbit around the moon, the spacecraft would descend in free fall, applying a constant-thrust decelerating impulse at the last moment before landing. Research would be needed to develop the variable-thrust rocket engine to be used in the descent. With the use of liquid hydrogen, the launch weight of the lunar rocket and spacecraft would be 10 to 11 million pounds.

If the earth orbit rendezvous concept were adopted, using Saturns to launch Centaurs for the lunar landing mission, nine Saturns would be needed to boost nine Centaurs into earth orbit for assembly to attain escape from earth orbit; three more Centaurs would have to be launched into earth orbit for assembly to accomplish the lunar orbit and landing; two additional Centaurs would be needed to provide for return and for the payload. The total of 14 Saturn/Centaur launches would be a formidable problem, not even considering the numerous complex rendezvous and assembly operations in space. The entire operation would have to be accomplished within two to three weeks because of the limitations on storing cryogenics in space.

Research would be needed on propulsion problems; on reliable, precisely controlled, variable-thrust engines for lunar landing; on a high-performance, storable-propellant, moon-takeoff engine; on auxiliary power systems; and on ground operations. Reduction of the ultimate payload weight was extremely vital, and more accurate information was needed on power and weight requirements for life support, capsule weight and size, and the exact scientific payload.

Lundin felt that a decision on whether to use the Saturn or Nova approach should be made as soon as possible since it would affect research and intermediate steps to be taken.

Minutes, Research Steering Committee on Manned Space Flight, June 25-26, 1959, pp. 2-5.

During the Research Steering Committee meeting, John H. Disher of NASA Headquarters discussed the lunar mission studies under way at the Army Ballistic Missile Agency (ABMA):

- ABMA had a large and competent group concentrating primarily on the lunar mission.
- Velocity and thrust requirements agreed well with those determined by the Lewis Research Center.
- ABMA was recommending a Saturn C-2 launch vehicle having a 2-million-pound-thrust first stage, a 1-million-pound-thrust second stage, and a 200,000-pound-thrust third stage. Another launch vehicle six times larger than the Saturn C-2 was also being studied for direct ascent.
- ABMA was interested in obtaining a NASA contract to study the Saturn C-2 vehicle.
- Two approaches were being studied for the manned lunar landing, one refueling in earth orbit and the other assembling separately landed parcels on the moon for the return flight (lunar surface rendezvous).
- The ABMA schedule dates were unrealistic considering present funding and problem complexities.
- Orbit control and landing point control experiments were urgently needed, possibly with Mercury-type capsules.
- Large-scale controlled reentry experiments at lunar reentry velocity should begin as soon as possible.

The Committee agreed that studies should continue on the direct ascent versus earth orbital assembly and that Lewis should become more familiar with ABMA studies, while concentrating on the Nova approach. It was also suggested that the High Speed Flight Station look into the operational problems of assembly in orbit.

Minutes, Research Steering Committee on Manned Space Flight, June 25-26, 1959, pp. 5-6.

A report on a projected manned space station was made to the Research Steering Committee by Laurence K. Loftin, Jr., of the Langley Research Center. In discussion, Chairman Harry J. Goett expressed his opinion that consideration of a space laboratory ought to be an integral and coordinated part of the planning for the lunar landing mission. George M. Low of NASA Headquarters warned that care should be exercised to assure that each step taken toward the goal of a lunar landing was significant, since the number of steps that could be funded was extremely limited.

Minutes, Research Steering Committee on Manned Space Flight, June 25-26, 1959, p. 6.

Alfred J. Eggers, Jr., of the Ames Research Center told the members of the Research Steering Committee of studies on radiation belts, graze and orbit maneuvers on reentry, heat transfer, structural concepts and requirements, lift over drag considerations, and guidance systems which affected various aspects of the manned lunar mission. Eggers said that Ames had concentrated on a landing maneuver

1959

June

25-26

25-26

25-26



1959

June

involving a reentry approach over one of the poles to lessen radiation exposure, a graze through the outer edge of the atmosphere to begin an earth orbit, and finally reentry and landing.

Manned steps beyond Mercury, he said, should be:

- The use of the Vega or Centaur boosters to put a manned satellite into an orbit with a 50,000-mile apogee, carrying two men for two weeks to gain experience beyond Mercury with reentry techniques and extended manned space flight applicable to the lunar mission.

- The use of the Saturn booster in manned flight to the vicinity of the moon and return, putting two men in a highly elliptical orbit, with an apogee of up to 250,000 miles or even one pass around the moon before heading back to earth. The flight time would be about one week, providing experience similar to that of the manned lunar mission, including hyperbolic reentry to earth. A close, direct view of the lunar surface by man would support lunar landing.

- The use of the Nova or clustered-engine Saturn booster for a lunar landing and return. Two men would carry out this one-week to one-month expedition.

Eggers recommended that the same type of return capsule be used in all these missions to build up reliability and experience with the spacecraft before the lunar landing mission. Unmanned space probes should also be used to investigate certain factors related to the success of the lunar mission: polar radiation, lunar radiation, grazing reentry, lunar surface characteristics, and micrometeoroids.

The Committee unanimously agreed that investigation of a grazing reentry was necessary and would require an unmanned space probe. NASA Centers would look into experiments that might be launched by a Scout or Thor-Delta booster. Committee members would check to be sure that the basic programs in the Office of Space Flight Development space sciences programs covered the requirements for investigation of the other factors of special interest to the manned lunar mission.

Minutes, Research Steering Committee on Manned Space Flight, June 25-26, 1959, pp. 6-7.

25-26

Members of the Research Steering Committee determined the study and research areas which would require emphasis for manned flight to and from the moon and for intermediate flight steps:

Lunar mission studies: More work would be required on determining "end" vehicle weight, life-support requirements, scientific payload requirements and objectives, exploring the possibility of using the "end" vehicle configuration in intermediate flight steps, booster requirement analysis, and Mercury stretch-out capabilities.

Direct ascent versus assembly in earth orbit: Lewis to continue Nova studies and become familiar with Army Ballistic Missile Agency (ABMA) work on the rendezvous approach, High Speed Flight Station (HSFS) to study operational requirements for assembly in earth orbit, and recommended for ABMA study of assembly in earth orbit.

1959

June

A reliable, precisely controlled, variable-thrust engine for lunar landing.

A storable propellant lunar takeoff rocket.

Storage of cryogenics in space (emissivity, absorptivity, etc.).

Structural work: a study of molybdenum coating life at higher temperatures, a contract for test specimens to expedite NASA research, emphasis on research on ablating materials suitable for low heating rates, and study of combination radiation and ablation techniques.

Life support (short term up to one month): contract study proposed.

Space suit development: HSFS to study desired specifications.

Guidance system studies focused on the lunar mission: development of light but sophisticated onboard computers, data-smoothing techniques and effects on midcourse guidance accuracies, effects of gravity anomalies on initial instrumentation, terminal guidance system including retrothrust programming, and error analysis and energy requirements for the entry corridor on return to earth.

Minutes, Research Steering Committee on Manned Space Flight, June 25–26, 1959, attached summary pages 1–2.

A report entitled “Recoverable Interplanetary Space Probe” was issued at the direction of C. Stark Draper, Director of the Instrumentation Laboratory, MIT. Several organizations had participated in this study, which began in 1957.

During  
the  
Month

Interview with Milton B. Trageser, Instrumentation Laboratory, MIT, April 27, 1966.

Members of STG—including H. Kurt Strass, Robert L. O’Neal, Lawrence W. Enderson, Jr., and David C. Grana—and Thomas E. Dolan of Chance Vought Corporation worked on advanced design concepts of earth orbital and lunar missions. The goal was a manned lunar landing within ten years, rather than an advanced Mercury program.

Summer

Interview with H. Kurt Strass, November 30, 1966.

Advanced Research Projects Agency representatives visited Army Ordnance Missile Command to discuss studies of a Maneuverable Recoverable Space Vehicle (MRS. V). The general purpose was to identify U.S. space needs before 1970 which might require vehicles of this type.

July  
23

Senate Staff Report, *Manned Space Flight Program*, p. 171.

The Advanced Research Projects Agency (ARPA) directed the Army Ordnance Missile Command to proceed with the static firing of the first Saturn vehicle, the test booster SA–T, in early calendar year 1960 in accordance with the \$70 million program and not to accelerate for a January 1960 firing. ARPA asked to be informed of the scheduled firing date.

August

1

David S. Akens, Paul K. Freiwirth, and Helen T. Wells, *History of the George C. Marshall Space Flight Center from July 1 to December 31, 1960* (MHM–2, 1961), Vol. 1, Appendix D, p. 23.



1959

August

12

The STG New Projects Panel (proposed by H. Kurt Strass in June) held its first meeting to discuss NASA's future manned space program. Present were Strass, Chairman, Alan B. Kehlet, William S. Augerson, Jack Funk, and other STG members. Strass summarized the philosophy behind NASA's proposed objective of a manned lunar landing: maximum utilization of existing technology in a series of carefully chosen projects, each of which would provide a firm basis for the next step and be a significant advance in its own right. Each project would be an intermediate practical goal to focus attention on the problems and guide new technological developments. The Panel considered the following projects essential to the goal of lunar landing and return: a detailed investigation of the earth's radiation belts, recovery of radiation belt probes carrying biological specimens, an environmental satellite (three men for two weeks), lunar probes, lunar reconnaissance (both manned and automatic), and lunar landing beacons and stores. The Panel recommended that work start immediately on an advanced recovery capsule that would incorporate the following features: reentry at near lunar return velocity, maneuverability both in space and in the atmosphere, and a parachute recovery for an earth landing. Kehlet was assigned to begin a program leading to a "second-generation" space capsule with a three-man capacity, space and atmospheric maneuverability, advanced abort devices, potential for near lunar return velocity, and advanced recovery techniques.

Memorandum, Strass to Chief, Flight Systems Division, "First Meeting of New Projects Panel," August 17, 1959.

18

At its second meeting, STG's New Projects Panel decided that the first major project to be investigated would be the second-generation reentry capsule. The Panel was presented a chart outlining the proposed sequence of events for manned lunar mission system analysis. The target date for a manned lunar landing was 1970.

Memorandum, H. Kurt Strass to Chief, Flight Systems Division, "Second Meeting of the New Projects Panel," August 26, 1959.

31

A House Committee Staff Report stated that lunar flights would originate from space platforms in earth orbit according to current planning. The final decision on the method to be used, "which must be made soon," would take into consideration the difficulty of space rendezvous between a space platform and space vehicles as compared with the difficulty of developing single vehicles large enough to proceed directly from the earth to the moon.

U.S. Congress, House, Committee on Science and Astronautics, *Space Propulsion*, Staff Report, 86th Congress, 1st Session (1959), p. 2.

31

In a paper presented to the Tenth International Astronautical Congress in London, England, Milton W. Rosen and F. Carl Schwenk described a five-stage launch vehicle for manned lunar exploration. The direct ascent technique would be used in landing an 8000-pound spacecraft on the moon and returning it to earth. The F-1 engine would power both the booster and second stage of the launch vehicle. The concepts presented in the paper had been developed between February and April.

Milton W. Rosen and F. Carl Schwenk, "A Rocket for Manned Lunar Exploration," *Proceedings of the Tenth International Astronautical Congress, London, 1959* (1960).

McDonnell Aircraft Corporation reported to NASA the results of several company-funded studies of follow-on experiments using Mercury spacecraft with heat-shields modified to withstand lunar reentry conditions. In one experiment, a Centaur booster would accelerate a Mercury spacecraft plus a third stage into an eccentric earth orbit with an apogee of about 1200 miles, so that the capsule would reenter at an angle similar to that required for reentry from lunar orbit. The third stage would then fire, boosting the spacecraft to a speed of 36,000 feet per second as it reentered the atmosphere.

McDonnell Aircraft Corporation, *Project Mercury Capsules, Follow On Experiments*, Engineering Report 6919 (September 1, 1959), p. 6.0-1.

The Soviet Union launched *Lunik II*, total payload weight 858.4 pounds. After a flight of about 35 hours, covering a distance of 236,875 miles, *Lunik II* became the first man-made object to impact on the moon. Three radio transmitters sent back signals until the crash landing.

*Instruments and Spacecraft*, p. 63.

The ARPA-NASA Booster Evaluation Committee appointed by Herbert F. York, DOD Director of Defense Research and Engineering, April 15, 1959, convened to review plans for advanced launch vehicles. A comparison of the Saturn (C-1) and the Titan-C boosters showed that the Saturn, with its substantially greater payload capacity, would be ready at least one year sooner than the Titan-C. In addition, the cost estimates on the Titan-C proved to be unrealistic. On the basis of the Advanced Research Projects Agency presentation, York agreed to continue the Saturn program but, following the meeting, began negotiations with NASA Administrator T. Keith Glennan to transfer the Army Ballistic Missile Agency (and, therefore, Saturn) to NASA.

*To Amend the National Aeronautics and Space Act of 1958*, Hearings, p. 410; Senate Staff Report, *Manned Space Flight Program*, p. 175.

At the third meeting of STG's New Projects Panel, Alan B. Kehlet presented suggestions for the multimanned reentry capsule. A lenticular-shaped vehicle was proposed, to ferry three occupants safely to earth from a lunar mission at a velocity of about 36,000 feet per second.

Memorandum, H. Kurt Strass to Chief, Flight Systems Division, "Third Meeting of New Projects Panel," October 1, 1959.

A study of the guidance and control design for a variety of space missions began at the MIT Instrumentation Laboratory under a NASA contract.

Interview with Milton B. Trageser, Instrumentation Laboratory, MIT, April 27, 1966.

The Soviet Union launched *Lunik III* toward the moon on the second anniversary of *Sputnik I*. The spacecraft, called an "Automatic Interplanetary Station," carried 345 pounds of instruments including cameras. On October 7, a signal from earth activated the cameras, which photographed about 70 percent of the hidden side of the moon in 40 minutes. The photographs were transmitted to Soviet stations

1959  
September  
1

12

16-18

28

During  
the  
Month

October  
4



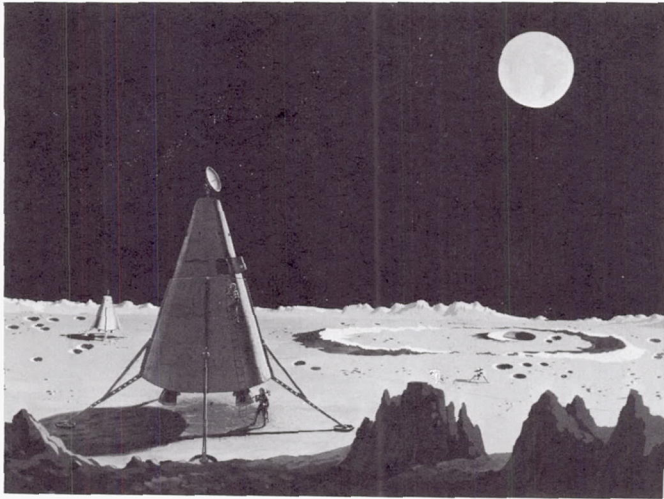

The artist's concepts on this page were used in a presentation by M. W. Rosen and F. C. Schwenk at the Tenth International Astronautical Congress in London, England, August 31, 1959. Above, astronauts egress from the spacecraft and prepare to investigate the lunar surface; at right, the takeoff from the moon; and, below, the reentry vehicle starts to enter the atmosphere while the jettisoned propulsion unit, shown more clearly in the lunar takeoff concept, is at left.

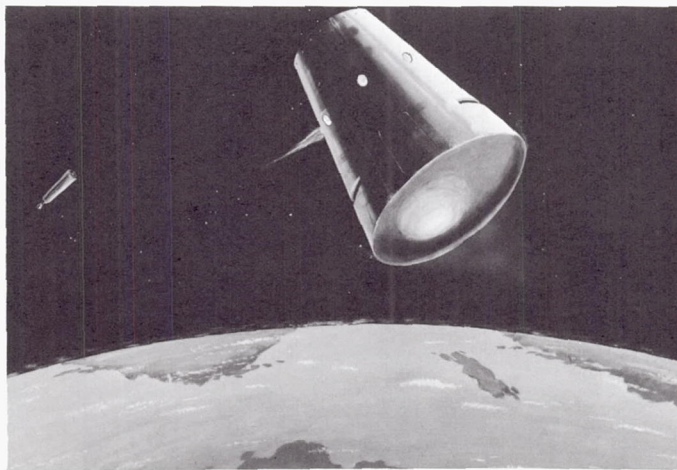
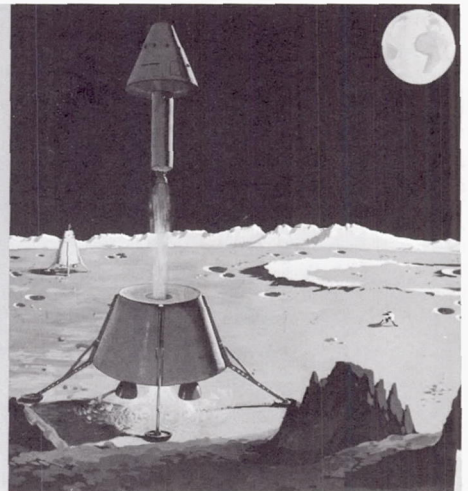
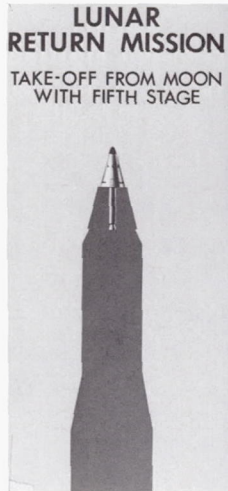



on October 18 and released to the world press on October 27. First analyses of the photographs by Soviet astronomers seemed to indicate that the hidden side of the lunar surface had fewer craters than its visible face.

*New York Times*, October 27, 1959; *Instruments and Spacecraft*, pp. 69-71.

After a meeting with officials concerned with the missile and space program, President Dwight D. Eisenhower announced that he intended to transfer to NASA control the Army Ballistic Missile Agency's Development Operations Division personnel and facilities. The transfer, subject to congressional approval, would include the Saturn development program.

*New York Times*, October 22, 1959; Emme, *Aeronautics and Astronautics*, p. 114.

At an STG meeting, it was decided to begin planning of advanced spacecraft systems. Participants in the meeting were Director Robert R. Gilruth, Paul E. Purser, Charles J. Donlan, Maxime A. Faget, Robert O. Piland, H. Kurt Strass, Charles W. Mathews, John D. Hodge, James A. Chamberlin, and Caldwell C. Johnson. Three primary assignments were made: (1) The preliminary design of a multi-man (probably three-man) capsule for a circumlunar mission, with particular attention to the use of the capsule as a temporary space laboratory, lunar landing cabin, and deep-space probe; (2) mission analysis studies to establish exit and reentry corridors, weights, and propulsion requirements; (3) test program planning to decide on the number and purpose of launches. A panel composed of Piland, Strass, Hodge, and Johnson was appointed to carry out these assignments. The ground rules given to the panel, which was responsible to the Director's office, were: (1) use personnel necessary to accomplish the work, but do not slow down Mercury; (2) as many as 30 persons (10 percent of the STG staff) might possibly be used in the future.

Memorandum, Purser to Gilruth, "Log for the Week of November 2, 1959."

In a memorandum to the members of the Research Steering Committee on Manned Space Flight, Chairman Harry J. Goett discussed the increased importance of the weight of the "end vehicle" in the lunar landing mission. This was to be an item on the agenda of the third meeting of the Committee, to be held in early December. Abe Silverstein, Director of the NASA Office of Space Flight Development, had recently mentioned to Goett that a decision would be made within the next few weeks on the configuration of successive generations of Saturn, primarily the upper stages. Silverstein and Goett had discussed the Committee's views on a lunar spacecraft. Goett expressed the hope in the memorandum that members of the Committee would have some specific ideas at their forthcoming meeting about the probable weight of the spacecraft.

In addition, Goett informed the Committee that the Vega had been eliminated as a possible booster for use in one of the intermediate steps leading to the lunar mission. The primary possibility for the earth satellite mission was now the first-generation Saturn and for the lunar flight the second-generation Saturn.

Memorandum, Goett, Chairman, to the Research Steering Committee on Manned Space Flight, "Estimate of Weight of 'End Vehicle' for Lunar Soft Landing and Return Mission To Aid in Choice of Booster Configuration," November 19, 1959.

1959  
October

21

November

2

19

- 1959**
- November**
- 26 An intended lunar probe launched from the Atlantic Missile Range by an Atlas-Able booster disintegrated about 45 seconds later when the protective sheath covering the payload detached prematurely. The probe was sponsored by NASA, developed by the Jet Propulsion Laboratory, and launched by the Air Force Ballistic Missile Division.
- Instruments and Spacecraft*, p. 81; *New York Times*, November 28, 1959.
- 27 While awaiting the formal transfer of the Saturn program, NASA formed a study group to recommend upper-stage configurations. Membership was to include the DOD Director of Defense Research and Engineering and personnel from NASA, Advanced Research Projects Agency, Army Ballistic Missile Agency, and the Air Force. This group was later known both as the Saturn Vehicle Team and the Silverstein Committee (for Abe Silverstein, Chairman).
- Senate Staff Report, *Manned Space Flight Program*, p. 179.
- December**
- 1 Twelve nations signed a treaty making the Antarctic continent a preserve for scientific research, immune from political and military strife. Signatories were Argentina, Australia, Great Britain, Chile, France, New Zealand, Norway, Belgium, Japan, South Africa, the Soviet Union, and the United States. Legal experts have suggested that the Antarctic Treaty provided a precedent for similar agreements demilitarizing the moon and other bodies in space.
- U.S. Congress, Senate, Committee on Aeronautical and Space Sciences, *Legal Problems of Space Exploration: A Symposium*, 87th Congress, 1st Session (1961), pp. 1297-1303.
- 6 The initial plan for transferring the Army Ballistic Missile Agency and Saturn to NASA was drafted. It was submitted to President Dwight D. Eisenhower on December 11 and was signed by Secretary of the Army Wilber M. Brucker and Secretary of the Air Force James H. Douglas on December 16 and by NASA Administrator T. Keith Glennan on December 17.
- David S. Akens, *Historical Origins of the George C. Marshall Space Flight Center* (MSFC Historical Monograph No. 1, 1960), p. 73, Appendix C, approval page.
- 7 The Advanced Research Projects Agency (ARPA) and NASA requested the Army Ordnance Missile Command (AOMC) to prepare an engineering and cost study for a new Saturn configuration with a second stage of four 20,000-pound-thrust liquid-hydrogen and liquid-oxygen engines (later called the S-IV stage) and a modified Centaur third stage using two of these engines (later designated the S-V stage). AOMC was also asked to indicate what significant program improvements or acceleration could be achieved with an increase in Fiscal Year 1960 funding if provided late in the fiscal year. The study was sent to ARPA and NASA by AOMC on December 10 and formally submitted on December 28.
- Senate Staff Report, *Manned Space Flight Program*, p. 180.
- 8-9 At the third meeting of the Research Steering Committee on Manned Space Flight held at Langley Research Center, H. Kurt Strass reported on STG's thinking on steps leading to manned lunar flight and on a particular capsule-laboratory space-



1959  
December

craft. The project steps beyond Mercury were: radiation experiments, minimum space and reentry vehicle (manned), temporary space laboratory (manned), lunar data acquisition (unmanned), lunar circumnavigation or lunar orbiter (unmanned), lunar base supply (unmanned), and manned lunar landing. STG felt that the lunar mission should have a three-man crew. A configuration was described in which a cylindrical laboratory was attached to the reentry capsule. This laboratory would provide working space for the astronauts until it was jettisoned before reentry. Preliminary estimates put the capsule weight at about 6600 pounds and the capsule plus laboratory at about 10,000 pounds.

Minutes, Research Steering Committee on Manned Space Flight, December 8-9, 1959, p. 3.

H. H. Koelle told members of the Research Steering Committee of mission possibilities being considered at the Army Ballistic Missile Agency. These included an engineering satellite, an orbital return capsule, a space crew training vehicle, a manned orbital laboratory, a manned circumlunar vehicle, and a manned lunar landing and return vehicle. He described the current Saturn configurations, including the "C" launch vehicle to be operational in 1967. The Saturn C (larger than the C-1) would be able to boost 85,000 pounds into earth orbit and 25,000 pounds into an escape trajectory.

8-9

Minutes, Research Steering Committee on Manned Space Flight, December 8-9, 1959, p. 4.

Several possible configurations for a manned lunar landing by direct ascent being studied at the Lewis Research Center were described to the Research Steering Committee by Seymour C. Himmel. A six-stage launch vehicle would be required, the first three stages to boost the spacecraft to orbital speed, the fourth to attain escape speed, the fifth for lunar landing, and the sixth for lunar escape with a 10,000-pound return vehicle. One representative configuration had an overall height of 320 feet. H. H. Koelle of the Army Ballistic Missile Agency argued that orbital assembly or refueling in orbit [earth orbit rendezvous] was more flexible, more straightforward, and easier than the direct ascent approach. Bruce T. Lundin of the Lewis Research Center felt that refueling in orbit presented formidable problems since handling liquid hydrogen on the ground was still not satisfactory. Lewis was working on handling cryogenic fuels in space.

8-9

Minutes, Research Steering Committee on Manned Space Flight, December 8-9, 1959, pp. 4-5.

The General Assembly of the United Nations unanimously approved Resolution 1472 (XIV), establishing the Committee on the Peaceful Uses of Outer Space to replace the Ad Hoc Committee. There were no meetings of the Committee until November 27, 1961, because of failure to agree on the composition of the Committee.

12

Senate Committee Symposium, *Legal Problems of Space Exploration*, pp. 1274-1275.



**1959**  
**December**  
**21**

A guideline letter was sent to William H. Pickering, Director of the Jet Propulsion Laboratory (JPL), from Abe Silverstein, Director of NASA's Office of Space Flight Development, outlining a program of five lunar spacecraft flights, intended primarily to obtain information on the lunar surface. JPL was requested to conduct tradeoff studies on spacecraft design and mission. The scientific objective would be to "acquire and transmit a number of images of the lunar surface." In addition, JPL was asked to "evaluate the probability of useful data return from a survivable package incorporating . . . a lunar seismometer of the type . . . being developed for NASA." This letter provided the formal basis for what was subsequently the Ranger program.

U.S. Congress, House, Subcommittee on NASA Oversight of the Committee on Science and Astronautics, *Investigation of Project Ranger*, Hearings, 88th Congress, 2nd Session (1964), p. 56.

**29**

In a memorandum to Don R. Ostrander, Director of Office of Launch Vehicle Programs, and Abe Silverstein, Director of Office of Space Flight Programs, NASA Associate Administrator Richard E. Horner described the proposed Space Exploration Program Council, which would be concerned primarily with program development and implementation. The Council would be made up of the Directors of the Jet Propulsion Laboratory, the Goddard Space Flight Center, the Army Ballistic Missile Agency, the Office of Space Flight Programs, and the Office of Launch Vehicle Programs. Horner would be Chairman of the Council which would have its first meeting on January 28–29, 1960 [later changed to February 10–11, 1960].

Memorandum, Horner to Ostrander and Silverstein, December 29, 1959.

**31**

NASA accepted the recommendations of the Saturn Vehicle Evaluation Committee (Silverstein Committee) on the Saturn C-1 configuration and on a long-range Saturn program. A research and development plan of ten vehicles was approved. The C-1 configuration would include the S-I stage (eight H-1 engines clustered, producing 1.5 million pounds of thrust), the S-IV stage (four engines producing 80,000 pounds of thrust), and the S-V stage (two engines producing 40,000 pounds of thrust).

Akens *et al.*, *History of the George C. Marshall Space Flight Center from July 1 to December 31, 1960*, Vol. 1, Appendix D, p. 33; *Saturn Illustrated Chronology*, pp. 8–10.

**1959–1960**

For the first time, attention was focused on the lunar orbit rendezvous scheme at Langley Research Center during studies in support of the Langley Research Center Lunar Mission Steering Group. This committee was active in 1959 and 1960. In 1960, the lunar trajectory group of the Theoretical Mechanics Division prepared information for presentation to the Lunar Mission Steering Group and for circulation throughout the laboratory to stimulate interest in problems related to the lunar mission.

John D. Bird, "Short History of the Development of the Lunar Orbit Rendezvous Plan at the Langley Research Center," September 6, 1963, unpublished, pp. 1–2.

President Dwight D. Eisenhower directed NASA Administrator T. Keith Glennan "to make a study, to be completed at the earliest date practicable, of the possible need for additional funds for the balance of FY 1960 and for FY 1961 to accelerate the super booster program for which your agency recently was given technical and management responsibility."

1960  
January  
14

Letter, President Dwight D. Eisenhower to Dr. T. Keith Glennan, January 14, 1960.

In testimony before the House Committee on Science and Astronautics, Richard E. Horner, Associate Administrator of NASA, presented NASA's ten-year plan for 1960-1970. The essential elements had been recommended by the Research Steering Committee on Manned Space Flight. NASA's Office of Program Planning and Evaluation, headed by Homer J. Stewart, formalized the ten-year plan.

28

- 1960: First launching of a meteorological satellite
- First launching of a passive reflector communications satellite
- First launching of the Scout vehicle
- First launching of the Thor-Delta vehicle
- First launching of the Atlas-Agena B (DOD)
- First suborbital flight by an astronaut
- 1961: First launching of a lunar impact vehicle
- First launching of an Atlas-Centaur vehicle
- Attainment of orbital manned space flight, Project Mercury
- 1962: First launching of a probe to the vicinity of Venus or Mars
- 1963: First launching of a two-stage Saturn
- 1963-1964: First launching of an unmanned vehicle for controlled landing on the moon
- First launching of an orbiting astronomical and radio astronomical laboratory
- 1964: First launching of an unmanned circumlunar vehicle and return to earth
- First reconnaissance of Mars or Venus, or both, by an unmanned vehicle
- 1965-1967: First launching in a program leading to manned circumlunar flight and to a permanent near-earth space station
- Beyond 1970: Manned lunar landing and return

On February 19, NASA officials again presented the ten-year timetable to the House Committee. A lunar soft landing with a mobile vehicle had been added for 1965. On March 28, NASA Administrator T. Keith Glennan described the plan to the Senate Committee on Aeronautical and Space Sciences. He estimated the cost of the program to be more than \$1 billion in Fiscal Year 1962 and at least \$1.5 billion annually over the next five years, for a total cost of \$12 to \$15 billion.

U.S. Congress, House, Committee on Science and Astronautics, *Review of the Space Program, Part I, Hearings, 86th Congress, 2nd Session (1960)*, p. 189; U.S. Congress, House, Committee on Science and Astronautics, *1961 NASA Authorization, Hearings on H.R. 10246, 86th Congress, 2nd Session (1960)*, p. 176; U.S. Congress, Senate, NASA Authorization Subcommittee of the Committee on Aeronautical and Space Sci-



- 1960**  
**January**  
**During the Month**
- ences, *Hearings on H.R. 10809*, 86th Congress, 2nd Session (1960), pp. 21-22; "Highlights of GSFC Program—Mr. Goett," NASA Staff Conference, Monterey, Calif., March 3-5, 1960; Rosholt, *An Administrative History of NASA, 1958-1963*, pp. 130-131.
- The Chance Vought Corporation completed a company-funded, independent, classified study on manned lunar landing and return (MALLAR), under the supervision of Thomas E. Dolan. Booster limitations indicated that earth orbit rendezvous would be necessary. A variety of lunar missions were described, including a two-man, 14-day lunar landing and return. This mission called for an entry vehicle of 6600 pounds, a mission module of 9000 pounds, and a lunar landing module of 27,000 pounds. It incorporated the idea of lunar orbit rendezvous though not specifically by name.
- Interview with John D. Bird, Langley Research Center, June 20, 1966.
- During the Month**
- At a luncheon in Washington, Abe Silverstein, Director of the Office of Space Flight Programs, suggested the name "Apollo" for the manned space flight program that was to follow Mercury. Others at the luncheon were Don R. Ostrander from NASA Headquarters and Robert R. Gilruth, Maxime A. Faget, and Charles J. Donlan from STG.
- Interview with Charles J. Donlan, Langley Research Center, June 20, 1966.
- February**  
**1**
- The Army Ballistic Missile Agency submitted to NASA the study entitled "A Lunar Exploration Program Based Upon Saturn-Boosted Systems." In addition to the subjects specified in the preliminary report of October 1, 1959, it included manned lunar landings.
- U.S. Army Ordnance Missile Command, *A Lunar Exploration Program Based Upon Saturn-Boosted Systems*, DV-TR-2-60 (February 1, 1960).
- 10-11**
- The first meeting of the NASA Space Exploration Council was held at NASA Headquarters. The objective of the Council was "to provide a mechanism for the timely and direct resolution of technical and managerial problems . . . common to all [NASA] Centers engaged in the space flight program." Present at the meeting were Richard E. Horner, Chairman, Don R. Ostrander, Abe Silverstein, Nicholas E. Golovin, Abraham Hyatt, and Robert L. King (Executive Secretary) of NASA Headquarters; Wernher von Braun of the Army Ballistic Missile Agency; Harry J. Goett of Goddard Space Flight Center; and William H. Pickering of the Jet Propulsion Laboratory. Among the agreements were:
- Membership of the Council would be expanded to include the Director of Advanced Research Programs.
  - Meetings would be quarterly.
  - A Senior Steering Group would be appointed by Horner to resolve policy issues concerning the proposed NASA Headquarters reliability staff. This staff was to develop policies and methods for ensuring the functional reliability of space systems from initial design stage through final launch.
  - The Council would decide whether to move up the firing date of the first Atlas-Agena B lunar mission from May to February 1961.
- Minutes, Space Exploration Program Council Meeting, February 10-11, 1960, pp. 1, 3-5.



## LUNAR-EARTH RETURN VEHICLE

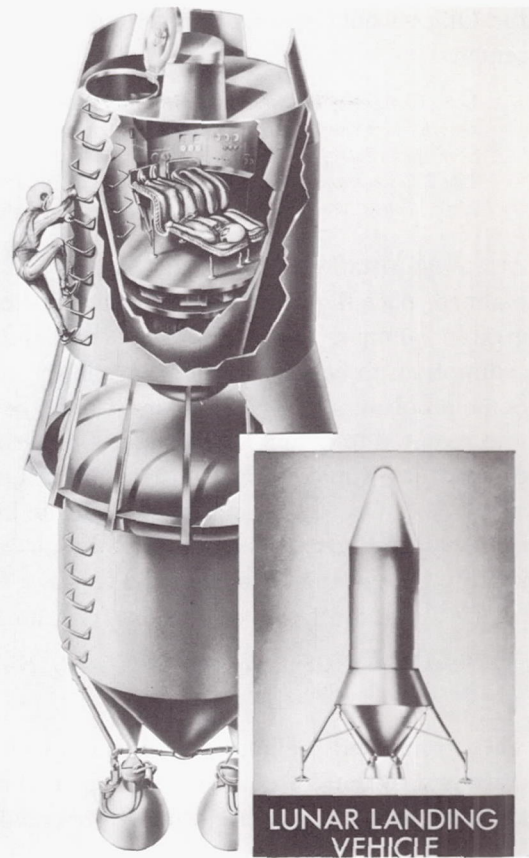

A concept of a Lunar-Earth Return Vehicle as envisioned at the Army Ballistic Missile Agency (ABMA) in early 1960. This illustration was prepared for use of Wernher von Braun in connection with an ABMA study, "A Lunar Exploration Program Based Upon Saturn-Boosted Systems."

Eleven companies submitted contract proposals for the Saturn second stage (S-IV): Bell Aircraft Corporation; The Boeing Airplane Company; Chrysler Corporation; General Dynamics Corporation, Convair/Aeronautics Division; Douglas Aircraft Company, Inc.; Grumman Aircraft Engineering Corporation; Lockheed Aircraft Corporation; The Martin Company; McDonnell Aircraft Corporation; North American Aviation, Inc.; and United Aircraft Corporation.

*Akens et al., History of the George C. Marshall Space Flight Center from July 1 to December 31, 1960, Vol. 1, Appendix D, p. 41.*

NASA established the Office of Life Sciences Programs with Clark T. Randt as Director. The Office would assist in the fields of biotechnology and basic medical and behavioral sciences. Proposed biological investigations would include work on the effects of space and planetary environments on living organisms, on evidence of extraterrestrial life forms, and on contamination problems. In addition,

1960  
February  
29

March  
1

- 1960**  
**March** the Office would arrange grants and contracts and plan a life sciences research center.
- U.S. Congress, House, Committee on Science and Astronautics, *Space Medicine Research*, Hearings before the Special Investigating Subcommittee, 86th Congress, 2nd Session (1960), p. 3; U.S. Congress, House, Committee on Science and Astronautics, *Life Sciences and Space*, Hearings, 86th Congress, 2nd Session (1960), p. 13; Mae Mills Link, *Space Medicine in Project Mercury* (NASA SP-4003, 1965), p. 38.
- 3-5** At a NASA staff conference at Monterey, Calif., officials discussed the advanced manned space flight program, the elements of which had been presented to Congress in January. The Goddard Space Flight Center was asked to define the basic assumptions to be used by all groups in the continuing study of the lunar mission. Some problems already raised were: the type of heatshield needed for reentry and tests required to qualify it, the kind of research and development firings, and conditions that would be encountered in cislunar flight. Members of STG would visit NASA Centers during April to define the tasks and request assistance. STG representatives were directed to maintain contact with the Centers and try to identify gaps in the technology. STG was also assigned the responsibility for preparing a first draft of specifications for a lunar spacecraft.
- "Highlights of GSFC Program—Mr. Goett," NASA Staff Conference, Monterey, Calif., March 3-5, 1960.
- 8** STG formulated preliminary guidelines by which an "advanced manned spacecraft and system" would be developed. These guidelines were further refined and elaborated; they were formally presented to NASA Centers during April and May.
- STG, "Ground Rules for Manned Lunar Reconnaissance," March 8, 1960.
- 15** The Army Ballistic Missile Agency's Development Operations Division and the Saturn program were transferred to NASA after the expiration of the 60-day limit for congressional action on the President's proposal of January 14. [The President's decision had been made on October 21, 1959.] By Executive Order, the President named the facilities the "George C. Marshall Space Flight Center." Formal transfer took place on July 1.
- Akens, *Historical Origins of the George C. Marshall Space Flight Center*, pp. 76-7.
- 28** Two of the eight H-1 engines of the Saturn C-1 first stage were successfully static-fired for approximately eight seconds. The test, conducted at Redstone Arsenal, was designated SAT-01—the first live firing of the Saturn test booster (SA-T).
- Saturn Illustrated Chronology*, p. 11.
- April 1-May 3** Members of STG presented guidelines for an advanced manned spacecraft program to NASA Centers to enlist research assistance in formulating spacecraft and mission design.



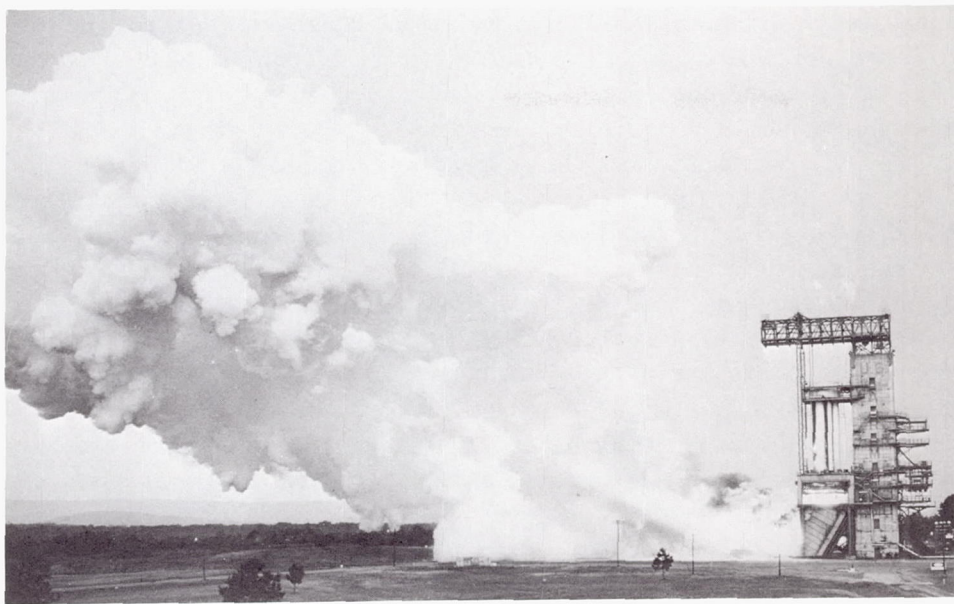

A cloud of smoke mushroomed from the base of the static-firing facility at Redstone Arsenal, Ala., when two of the eight H-1 engines of the Saturn C-1 launch vehicle's first stage were tested for the first time.

To open these discussions, Director Robert R. Gilruth summarized the guidelines: manned lunar reconnaissance with a lunar mission module, corollary earth orbital missions with a lunar mission module and with a space laboratory, compatibility with the Saturn C-1 or C-2 boosters (weight not to exceed 15,000 pounds for a complete lunar spacecraft and 25,000 pounds for an earth orbiting spacecraft), 14-day flight time, safe recovery from aborts, ground and water landing and avoidance of local hazards, point (ten-square-mile) landing, 72-hour postlanding survival period, auxiliary propulsion for maneuvering in space, a "shirtsleeve" environment, a three-man crew, radiation protection, primary command of mission on board, and expanded communications and tracking facilities. In addition, a tentative time schedule was included, projecting multiman earth orbit qualification flights beginning near the end of the first quarter of calendar year 1966.

STG, "Guidelines for Advanced Manned Space Vehicle Program," June 1960, pp. ii, 1-5.

STG's Robert O. Piland, during briefings at NASA Centers, presented a detailed description of the guidelines for missions, propulsion, and flight time in the advanced manned spacecraft program:

(1) The spacecraft should be capable ultimately of manned circumlunar reconnaissance. As a logical intermediate step toward future goals of lunar and planetary landing many of the problems associated with manned circumlunar flight would need to be solved.

(2) The lunar spacecraft should be capable of earth orbit missions for initial evaluation and training. The reentry component of this spacecraft should

1960

April 1-May 3

April 1-May 3



1960

April 1–May 3

be capable of missions in conjunction with space laboratories or space stations. To accomplish lunar reconnaissance before a manned landing, it would be desirable to approach the moon closer than several thousand miles. Fifty miles appeared to be a reasonable first target for study purposes.

(3) The spacecraft should be designed to be compatible with the Saturn C-1 or C-2 boosters for the lunar mission. The multiman advanced spacecraft should not weigh more than 15,000 pounds including auxiliary propulsion and attaching structure.

(4) A flight-time capability of the spacecraft for 14 days without resupply should be possible. Considerable study of storage batteries, fuel cells, auxiliary power units, and solar batteries would be necessary. Items considered included the percentage of the power units to be placed in the "caboose" (space laboratory), preference for the use of storage batteries for both power and radiation shielding, and redundancy for reliability by using two different types of systems versus two of the same system.

STG, "Guidelines for Advanced Manned Space Vehicle Program," June 1960, pp. 6-14.

April 1–May 3

In discussing the advanced manned spacecraft program at NASA Centers, Maxime A. Faget of STG detailed the guidelines for aborted missions and landing:

(1) The spacecraft must have a capability of safe crew recovery from aborted missions at any speed up to the maximum velocity, this capability to be independent of the launch propulsion system.

(2) A satisfactory landing by the spacecraft on both water and land, avoiding local hazards in the recovery area, was necessary. This requirement was predicated on two considerations: emergency conditions or navigation errors could force a landing on either water or land; and accessibility for recovery and the relative superiority of land versus water landing would depend on local conditions and other factors. The spacecraft should be able to land in a 30-knot wind, be watertight, and be seaworthy under conditions of 10- to 12-foot waves.

(3) Planned landing capability by the spacecraft at one of several previously designated ground surface locations, each approximately 10 square miles in area, would be necessary. Studies were needed to assess the value of impulse maneuvers, guidance quality, and aerodynamic lift over drag during the return from the lunar mission. Faget pointed out that this requirement was far less severe for the earth orbit mission than for the lunar return.

(4) The spacecraft design should provide for crew survival for at least 72 hours after landing. Because of the unpredictability of possible emergency maneuvers, it would be impossible to provide sufficient recovery forces to cover all possible landing locations. The 72-hour requirement would permit mobilization of normally existing facilities and enough time for safe recovery. Locating devices on the spacecraft should perform adequately anywhere in the world.

(5) Auxiliary propulsion should be provided for guidance maneuvers needed to effect a safe return in a launch emergency. Accuracy and capability of the guidance system should be studied to determine auxiliary propulsion requirements. Sufficient reserve propulsion should be included to accommodate correc-

tions for maximum guidance errors. The single system could serve for either guidance maneuvers or escape propulsion requirements.

STG, "Guidelines for Advanced Manned Space Vehicle Program," June 1960, pp. 15-23.

Stanley C. White of STG outlined at NASA Centers the guidelines for human factors in the advanced manned spacecraft program:

(1) A "shirtsleeve" spacecraft environment would be necessary because of the long duration of the lunar flight. This would call for a highly reliable pressurized cabin and some means of protection against rapid decompression. Such protection might be provided by a quick-donning pressure suit. Problems of supplying oxygen to the spacecraft; removing carbon dioxide, water vapor, toxic gases, and microorganisms from the capsule atmosphere; basic monitoring instrumentation; and restraint and couch design were all under study. In addition, research would be required on noise and vibration in the spacecraft, nutrition, waste disposal, interior arrangement and displays, and bioinstrumentation.

(2) A minimum crew of three men was specified. Studies had indicated that, for a long-duration mission, multiman crews were necessary and that three was the minimum number required.

(3) The crew should not be subjected to more than a safe radiation dose. Studies had shown that it was not yet possible to shield the crew against a solar flare. Research was indicated on structural materials and equipment for radiation protection, solar-flare prediction, minimum radiation trajectories, and the radiation environment in cislunar space.

STG, "Guidelines for Advanced Manned Space Vehicle Program," June 1960, pp. 24-38.

Command and communications guidelines for the advanced manned spacecraft program were listed by STG's Robert G. Chilton at NASA Centers:

(1) Primary command of the mission should be on board. Since a manned spacecraft would necessarily be much more complex and its cost much greater than an unmanned spacecraft, maximum use should be made of the command decision and operational capabilities of the crew. Studies would be needed to determine the extent of these capabilities under routine, urgent, and extreme emergency conditions. Onboard guidance and navigation hardware would include inertial platforms for monitoring insertion guidance, for abort command, and for abort-reentry navigation; optical devices; computers; and displays. Attitude control would require a multimode system.

(2) Communications and ground tracking should be provided throughout the mission except when the spacecraft was behind the moon. Voice contact once per orbit was considered sufficient for orbital missions. For the lunar mission, telemetry would be required only for backup data since the crew would relay periodic voice reports. Television might be desirable for the lunar mission. For ground tracking, a study of the Mercury system would determine whether the network could be modified and relocated to satisfy the close-in requirements of a lunar mission. The midcourse and circumlunar tracking requirements might be met by the deep-space network facilities at Goldstone, Calif., Australia, and South Africa. Both existing and proposed facilities should be studied to ensure that frequencies for all systems

1960

April 1-May 3

April 1-May 3

April 1-May 3



1960

April 1–May 3

could be made compatible to permit use of a single beacon for midcourse and reentry tracking.

STG, "Guidelines for Advanced Manned Space Vehicle Program," June 1960, pp. 39–46.

April

5

John C. Houbolt of the Langley Research Center presented a paper at the National Aeronautical Meeting of the Society of Automotive Engineers in New York City in which the problems of rendezvous in space with the minimum expenditure of fuel were considered. To resupply a space station, for example, the best solution appeared to be to launch the ferry rocket into an adjacent orbit. A minimum amount of fuel would then be needed to inject the ferry rocket into the same orbital plane as the space station. Attention was also focused on the wait time before a rendezvous launch.

If launch were made into the correct orbital plane, with subsequent lead or lag correction, wait periods of many days would be necessary, but if launch were made into an incorrect orbital plane with a later plane correction, wait periods of only a day or two would be feasible.

John C. Houbolt, "Considerations of the Rendezvous Problems for Space Vehicles," paper presented at the Society of Automotive Engineers, National Aeronautical Meeting, April 5–8, 1960.

6

Four of the eight H–1 engines of the Saturn C–1 first-stage booster were successfully static-fired at Redstone Arsenal for seven seconds.

*Saturn Illustrated Chronology*, p. 11.

9–16

Detailed lunar charts, consisting of 230 photographic sheets, were published by the Air Force and the University of Chicago Press. The atlas, in preparation under Air Force contract since April 1958, was assembled by Gerard P. Kuiper of the Yerkes Observatory.

*New York Herald Tribune*, April 10, 1960.

15

Briefings on the guidelines for the advanced manned spacecraft program were presented by STG representatives at NASA Headquarters.

Memorandum, John H. Disher to Abe Silverstein, May 10, 1960.

18

In a memorandum to NASA Administrator T. Keith Glennan, Robert L. King, Executive Secretary of the Space Exploration Program Council (SEPC), reported on the status of certain actions taken up at the first meeting of the Council:

- Rather than appoint a separate Senior Steering Group to resolve policy problems connected with the reliability program, SEPC itself tentatively would be used. A working committee would be appointed for each major system and would rely on the SEPC for broad policy guidance.
- Proposed rescheduling of the first Atlas-Agena B lunar mission for an earlier flight date was abandoned as impractical.

Memorandum, King to Glennan via Richard E. Horner, "SEPC Meeting of February 10–11, 1960—Status of Actions," April 18, 1960.



STG members, visiting Moffett Field, Calif., briefed representatives of the Jet Propulsion Laboratory, Flight Research Center, and Ames Research Center on the advanced manned spacecraft program. Ames representatives then described work at their Center which would be applicable to the program: preliminary design studies of several aerodynamic configurations for reentry from a lunar trajectory, guidance and control requirements studies, potential reentry heating experiments at near-escape velocity, flight simulation, and pilot display and navigation studies. STG asked Ames to investigate heating and aerodynamics on possible lifting capsule configurations. In addition, Ames offered to tailor a payload applicable to the advanced program for a forthcoming Wallops Station launch.

Memoranda, John H. Disher to Abe Silverstein, May 10, 1960; Paul E. Purser to Robert R. Gilruth, "Log for the Week of April 18, 1960."

1960

April

18

Members of STG visited the Flight Research Center to be briefed on current effort and planned activities there. Of special interest were possibilities of the Flight Research Center's conducting research on large parachutes in cooperation with Ames Research Center, analytical and simulator studies of pilot control of launch vehicles, and full-scale tests of landing capabilities of low lift over drag configurations.

Memoranda, John H. Disher to Abe Silverstein, May 10, 1960; Paul E. Purser to Robert R. Gilruth, "Log for the Week of April 18, 1960."

21

NASA announced the selection of the Douglas Aircraft Company to build the second stage (S-IV) of the Saturn C-1 launch vehicle.

*Wall Street Journal*, April 27, 1960; Emme, *Aeronautics and Astronautics*, p. 122.

26

NASA announced that Aeronutronic Division of the Ford Motor Company had been selected from 13 bidders for a \$3.5 million contract to design and build a 300-pound instrumented capsule which would be crash-landed on the surface of the moon. The capsule would be launched by an Atlas-Agena B and would be attached to a larger payload currently under development at the Jet Propulsion Laboratory. The larger payload was intended to carry television cameras. When the spacecraft (later named "Ranger") had reached a point 25 miles above the lunar surface, the smaller capsule would detach itself and crash-land. The instruments, including a seismometer and a temperature recorder, would then transmit data back to earth.

*New York Times*, April 27, 1960.

26

At Redstone Arsenal, all eight H-1 engines of the first stage of the Saturn C-1 launch vehicle were static-fired simultaneously for the first time and achieved 1.3 million pounds of thrust.

*New York Times*, April 30, 1960.

29

A study report was issued by the MIT Instrumentation Laboratory on guidance and control design for a variety of space missions. This report, approved by C. Stark Draper, Director of the Laboratory, showed that a vehicle, manned or unmanned, could have significant onboard navigation and guidance capability.

Interview with Milton B. Trageser, Instrumentation Laboratory, MIT, April 27, 1966.

During  
the  
Month

1960

Spring

Thomas E. Dolan of the Chance Vought Corporation prepared a company-funded design study of the lunar orbit rendezvous method for accomplishing the lunar landing mission.

Interview with H. Kurt Strass, MSC, November 30, 1966.

May

1

An additional contract for \$10,000 was signed by the University of Manchester, Manchester, England, and the Air Force. Z. Kopal, principal investigator, would continue to work at the Pic-du-Midi Observatory in France, providing topographical information on the lunar surface for the production of accurate lunar maps. The contract [AF 61(052)380] was a continuation of one signed on November 1, 1958, and was to run from May 1, 1960, to October 31, 1960. In addition, the Air Force provided \$40,000 for a 40-inch reflector telescope at the Observatory, tremendously increasing its capability for lunar topographical research. By June 1960, information on one-fourth of the visible area of the moon had been produced.

House Committee Report, *Army Lunar Construction and Mapping Program*, Appendix.

2

Members of STG presented the proposed advanced manned spacecraft program to Wernher von Braun and 25 of his staff at Marshall Space Flight Center. During the ensuing discussion, the merits of a completely automatic circumlunar mission were compared with those of a manually operated mission. Further discussions were scheduled.

Memoranda, John H. Disher to Abe Silverstein, May 10, 1960; Paul E. Purser to Robert R. Gilruth, "Log for the Week of May 2, 1960."

3

STG members presented the proposed advanced manned spacecraft program to the Lewis Research Center staff. Work at the Center applicable to the program included: analysis and preliminary development of the onboard propulsion system, trajectory analysis, and development of small rockets for midcourse and attitude control propulsion.

Memorandum, John H. Disher to Abe Silverstein, May 10, 1960.

4

Clifford I. Cummings, Jet Propulsion Laboratory spacecraft program director, announced at a meeting of the Aviation Writers Association in Los Angeles, Calif., that the spacecraft which would carry television and a detachable instrumented capsule to be crash-landed on the moon would be called "Ranger."

Baltimore *Sun*, May 5, 1960.

5

Robert R. Gilruth, Paul E. Purser, James A. Chamberlin, Maxime A. Faget, and H. Kurt Strass of STG met with a group from the Grumman Aircraft Engineering Corporation to discuss advanced spacecraft programs. Grumman had been working on guidance requirements for circumlunar flights under the sponsorship of the Navy and presented Strass with a report of this work.

Memorandum, Purser to Gilruth, "Log for the Week of May 2, 1960."

9

The first production Mercury spacecraft, using its launch escape rocket as propulsion, was launched from Wallops Island in a successful "beach abort" test.

Swenson *et al.*, *This New Ocean*, p. 262.



A discussion on the advanced manned spacecraft program was held at the Langley Research Center with members of STG and Langley Research Center, together with George M. Low and Ernest O. Pearson, Jr., of NASA Headquarters and Harry J. Goett of Goddard Space Flight Center. Floyd L. Thompson, Langley Director, said that Langley would be studying the radiation problem, making configuration tests (including a lifting Mercury), and studying aerodynamics, heating, materials, and structures.

1960

May

.12

Memorandum, Paul E. Purser to Robert R. Gilruth, "Log for the Week of May 9, 1960."

.15

The Soviet Union launched an unmanned spacecraft into near-earth orbit. Designated *Korabl Sputnik I* by the Russians and called *Sputnik IV* by the Western press, the spacecraft weighed approximately 10,000 pounds and contained a pressurized space cabin with a dummy astronaut. On May 19, the attempt to bring the spacecraft back to earth failed when a flaw in the guidance system deflected the ship into a higher orbit. Soviet scientists said that conditions in the cabin, which had separated from the remainder of the spacecraft, were normal.

*Wall Street Journal*, May 16, 1960; *Baltimore Sun*, May 21, 1960; *Instruments and Spacecraft*, p. 105.

16-17

A meeting on space rendezvous was held at the Langley Research Center and attended by representatives from NASA Headquarters, Flight Research Center, Goddard Space Flight Center, Space Task Group, Langley Research Center, Jet Propulsion Laboratory, Lewis Research Center, and Marshall Space Flight Center. Bernard Maggin of NASA Headquarters was chairman. Current NASA Center programs on rendezvous were reviewed and ideas were exchanged on future projects. Many of the studies in progress involved the concept of a space ferry rendezvousing with a station in cislunar space. The consensus of the meeting was that the rendezvous technique would be essential in the foreseeable future and that experiments should be made to establish feasibility and develop the technique. There was as yet no funding for any rendezvous flight test program.

Inter-NASA Research and Development Centers Discussion on Space Rendezvous, Langley Research Center, May 16-17, 1960.

25

STG formed the Advanced Vehicle Team, reporting directly to Robert R. Gilruth, Director of the Mercury program. The Team would conduct research and make preliminary design studies for an advanced multiman spacecraft. In addition, the Team would maintain contacts and information flow between STG and the Langley, Lewis, Ames, and Flight Research Centers and the Jet Propulsion Laboratory and would effect necessary liaison with the Marshall Space Flight Center on the development and planned use of boosters. Contacts with industrial groups and government agencies on advanced systems studies would be focused in this group. Robert O. Piland was appointed Head of the Advanced Vehicle Team; other members assigned full-time were H. Kurt Strass, Robert G. Chilton, Jack Funk, Alan B. Kehlet, Jr., R. Bryan Erb, Owen E. Maynard, Richard B. Ferguson, and Alfred B. Eickmeier. Team members would retain their current permanent organizational



1960

May

status and receive technical direction and guidance in their particular areas from their supervisors, as well as support from other specialists.

Memorandum, Gilruth to Staff, STG, "Advanced Vehicle Team," May 25, 1960.

Assembly of the first Saturn flight booster, SA-1, began at Marshall Space Flight Center.

26

Senate Staff Report, *Manned Space Flight Program*, p. 187.

26

Eight H-1 engines of the first stage of the Saturn C-1 launch vehicle were static-fired for 35.16 seconds, producing 1.3 million pounds of thrust. This first public demonstration of the H-1 took place at Marshall Space Flight Center.

Rocketdyne *Skywriter*, June 3, 1960, p. 1.

31

NASA selected Rocketdyne Division of NAA to develop the J-2, a 200,000-pound-thrust rocket engine, burning liquid hydrogen and liquid oxygen. [A decision was later made to use the J-2 in the upper stages of the Saturn C-5.]

*Saturn Illustrated Chronology*, pp. 13-14; Rocketdyne *Skywriter*, June 3, 1960.

June

15

The Saturn C-1 first stage successfully completed its first series of static tests at the Marshall Space Flight Center with a 122-second firing of all eight H-1 engines.

Rocketdyne *Skywriter*, June 24, 1960, p. 4.

21

Robert O. Piland, Head of the STG Advanced Vehicle Team, and Stanley C. White of STG attended a meeting in Washington, D. C., sponsored by the NASA Office of Life Sciences Programs, to discuss radiation and its effect on manned space flight. Three consultants presented their views: John R. Winckler of the University of Minnesota, a cosmic-ray physicist; Cornelius A. Tobias of the University of California, a radiologist specializing in radiation effects on cells and other human subsystems; and Col. John E. Pickering, Director of Research at the Air Force School of Aviation Medicine. Their research showed that it would be impracticable to shield against the inner Van Allen belt radiation but possible to shield against the outer belt with a moderate amount of protection.

Memorandum, Piland, Head, Advanced Vehicle Team, to Project Director, "Radiation and Its Effects on Manned Space Vehicles—June 21 Meeting, Washington, D.C.," June 24, 1960.

Summer

H. Kurt Strass of STG and John H. Disher of NASA Headquarters proposed that boilerplate Apollo spacecraft be used in some of the forthcoming Saturn C-1 launches. [Boilerplates are research and development vehicles which simulate production spacecraft in size, shape, structure, mass, and center of gravity.] These flight tests would provide needed experience with Apollo systems and utilize the Saturn boosters effectively. Four or five such tests were projected. On October 5, agreement was reached between members of Marshall Space Flight Center and STG on tentative Saturn vehicle assignments and flight plans.

Interview with Strass, MSC, November 30, 1966.

The House Committee on Science and Astronautics declared: "A high priority program should be undertaken to place a manned expedition on the moon in this decade. A firm plan with this goal in view should be drawn up and submitted to the Congress by NASA. Such a plan, however, should be completely integrated with other goals, to minimize total costs. The modular concept deserves close study. Particular attention should be paid immediately to long lead-time phases of such a program." The Committee also recommended that development of the F-1 engine be expedited in expectation of the Nova launch vehicle, that there be more research on nuclear engines and less conventional engines before freezing the Nova concept, and that the Orion project be turned over to NASA. It was the view of the Committee that "NASA's 10-year program is a good program, as far as it goes, but it does not go far enough. Furthermore the space program is not being pushed with sufficient energy."

U.S. Congress, House, Committee on Science and Astronautics, *Space, Missiles, and the Nation*, 86th Congress, 2nd Session (1960), pp. 55-56.

After reviewing proposals by 37 companies, NASA awarded contracts to the Hughes Aircraft Company, McDonnell Aircraft Corporation, North American Aviation, Inc., and Space Technology Laboratories, Inc., for preliminary competitive design studies of an instrumented soft-landing lunar spacecraft, the Surveyor. The companies were scheduled to submit their reports in December.

*Fourth Semiannual Report of the National Aeronautics and Space Administration*, April 1, 1960, through September 30, 1960 (1961), pp. 60-61; *Fifth Semiannual Report to Congress of the National Aeronautics and Space Administration*, October 1, 1960, through June 30, 1961 (1961), p. 49; *Los Angeles Times*, July 10, 1960.

The third meeting of the Space Exploration Program Council was held at NASA Headquarters. The question of a speedup of Saturn C-2 production and the possibility of using nuclear upper stages with the Saturn booster were discussed. The Office of Launch Vehicle Programs would plan a study on the merits of using nuclear propulsion for some of NASA's more sophisticated missions. If the study substantiated such a need, the amount of in-house basic research could then be determined.

Minutes, Space Exploration Program Council Meeting, July 14-15, 1960, pp. 1, 4-5.

NASA Director of Space Flight Programs Abe Silverstein notified Harry J. Goett, Director of the Goddard Space Flight Center, that NASA Administrator T. Keith Glennan had approved the name "Apollo" for the advanced manned space flight program. The program would be so designated at the forthcoming NASA-Industry Program Plans Conference.

Memorandum, NASA Headquarters to Goddard Space Flight Center, Attn: Dr. H. J. Goett, "Official Name for the Advanced Manned Space Flight Program," July 25, 1960.

The first NASA-Industry Program Plans Conference was held in Washington, D.C. The purpose was to give industrial management an overall picture of the NASA program and to establish a basis for subsequent conferences to be held at various NASA Centers. The current status of NASA programs was outlined, in-

1960

July

5

9

14-15

25

28-29

1960  
July

cluding long-range planning, launch vehicles, structures and materials research, manned space flight, and life sciences.

NASA Deputy Administrator Hugh L. Dryden announced that the advanced manned space flight program had been named "Apollo." George M. Low, NASA Chief of Manned Space Flight, stated that circumlunar flight and earth orbit missions would be carried out before 1970. This program would lead eventually to a manned lunar landing and a permanent manned space station.

Three follow-up conferences were planned: Goddard Space Flight Center in August (held in Washington, D.C.), the Marshall Space Flight Center in September, and Jet Propulsion Laboratory in October. Industry representatives would receive more detailed briefings on specific phases of the NASA program.

*NASA-Industry Program Plans Conference, July 28-29, 1960 (1960).*

29

*Mercury-Atlas 1 (MA-1)* was launched from the Atlantic Missile Range in a test of spacecraft structural integrity under maximum heating conditions. After 58.5 seconds of flight, MA-1 exploded and the spacecraft was destroyed upon impact off-shore. None of the primary capsule test objectives were met.

*Swenson et al., This New Ocean, pp. 275-278.*

This chart was used by George M. Low July 29, 1960, as he described the plans for Project Apollo during the NASA-Industry Program Plans Conference.

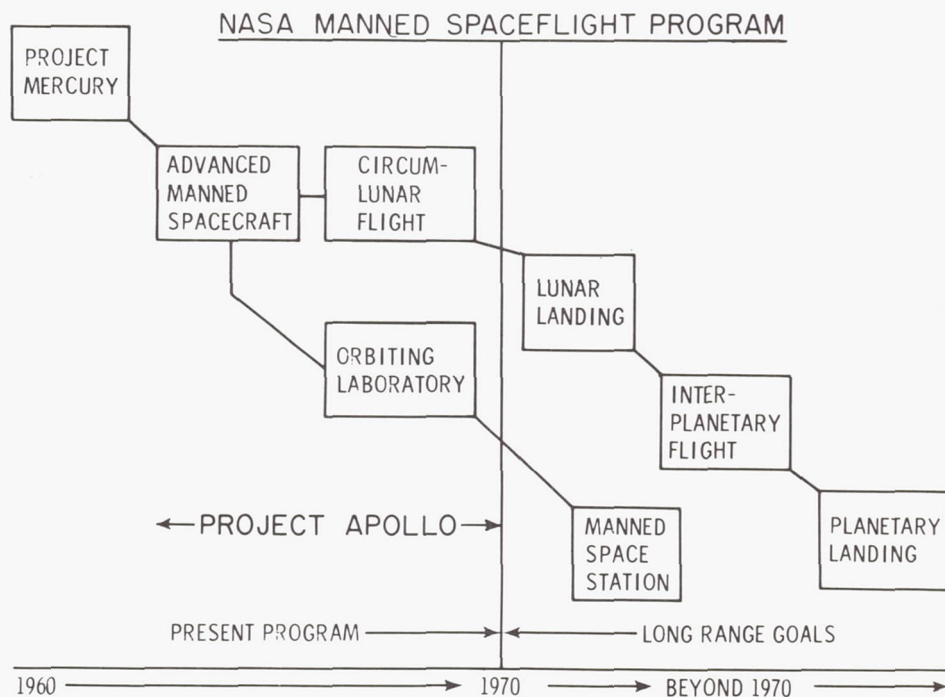



## **PART II**

**Design—Decision—Contract**

**August 1960 through November 1961**

## PART II

### The Key Events

#### 1960

- August 30:* Industry briefing by Goddard Space Flight Center on feasibility studies for the Apollo spacecraft.
- September 1:* The Apollo Project Office formed under the Space Task Group (STG) Flight Systems Division.
- September 13:* STG briefing for prospective bidders on the feasibility studies for the Apollo spacecraft.
- October 21:* STG selection of the Apollo command module design.
- October 25:* Selection by NASA of Convair/Astronautics Division of General Dynamics Corporation, the General Electric Company, and The Martin Company to prepare feasibility studies for the Apollo spacecraft.

#### 1961

- January 6-12:* First meetings of the Apollo Technical Liaison Groups, formed to coordinate NASA inter-Center information exchange.
- February 7:* Six-month study contract for Apollo guidance and navigation support signed by NASA with the Massachusetts Institute of Technology (MIT) Instrumentation Laboratory.
- February 7:* Final report of the Low Committee outlining a manned lunar landing within the decade using either the earth orbit rendezvous or direct ascent technique.
- April 12:* First successful manned orbital flight, by Cosmonaut Yuri A. Gagarin of the Soviet Union.
- May 5:* First successful American suborbital flight, by Astronaut Alan B. Shepard, Jr.
- May 5:* Completion of the first draft of the Apollo spacecraft specifications by STG.
- May 15-17:* Submission of final reports by contractors on the feasibility studies on the Apollo spacecraft.
- May 22:* Completion of the second draft of the Apollo spacecraft specifications by STG.
- May 25:* President John F. Kennedy's proposal to Congress and the nation of an accelerated space program including a manned lunar landing within the decade.
- June 10:* Report of the Lundin Committee recommending a low-altitude earth orbit rendezvous mode using the Saturn C-3 to accomplish the manned lunar landing mission.
- June 16:* Report of the Fleming Committee identifying the chief pacing items of a manned lunar landing mission within the decade as the development of and facilities for the launch vehicle.
- July 28:* NASA invitation to 12 companies to submit bids on the prime Apollo spacecraft contract.

PART II: DESIGN—DECISION—CONTRACT

- August 9:* Selection of the MIT Instrumentation Laboratory to develop under STG direction the Apollo navigation and guidance system—first major Apollo contract.
- August:* Report of the Heaton Committee recommending the earth orbit rendezvous technique and use of the Saturn C-4 for the manned lunar landing mission.
- October 11:* Presentations to NASA representatives by five industrial teams bidding on the Apollo spacecraft contract.
- October 27:* Successful flight of the first Saturn C-1 (SA-1) booster.
- November 1:* Formal redesignation of the Space Task Group as the Manned Spacecraft Center (MSC).
- November 8:* First meeting of the MSC-MSFC Coordination Panels, formed to find solutions to the interrelated problems of the Apollo launch vehicle and spacecraft.
- November 20:* Report of the Rosen working group to the NASA Office of Manned Space Flight, recommending direct ascent as the primary lunar landing mission mode with a backup rendezvous capability development.
- November 28:* Selection of North American Aviation, Inc., as principal contractor for the Apollo spacecraft under MSC direction.



Page Intentionally Left Blank

## PART II

### Design—Decision—Contract

August 1960 through November 1961

In a memorandum to Abe Silverstein, Director of NASA's Office of Space Flight Programs, Harry J. Goett, Director of Goddard Space Flight Center, outlined the tentative program of the Goddard industry conference to be held on August 30. At this conference, more details of proposed study contracts for an advanced manned spacecraft would be presented. The requirements would follow the guidelines set down by STG and presented to NASA Headquarters during April and May. Three six-month study contracts at \$250,000 each would be awarded.

1960  
August  
8

Draft Memorandum, Goett to Director, Office of Space Flight Programs, August 8, 1960.

Secretary of the Interior Fred A. Seaton and Secretary of the Army Wilber M. Brucker announced that the U.S. Geological Survey had completed the first known photogeological survey of the surface of the moon. The study, part of a program to select lunar landing sites for manned and unmanned spacecraft, consisted of three diagrams, all showing the visible face of the moon at 36 inches diameter. These diagrams depicted, respectively, the physiographic lunar regions, naming features on the moon's surface; a generalized photogeologic map giving the age of craters and structural features; and the prominent lunar rays.

13

*Palo Alto Times*, August 18, 1960.

The Soviet Union launched its second spaceship satellite, the *Korabl Sputnik II*, or *Sputnik V*. The spacecraft was similar to the one launched on May 15 and carried two dogs, Strelka and Belka, in addition to a gray rabbit, rats, mice, flies, plants, fungi, microscopic water plants, and seeds. Electrodes attached to the dogs and linked with the spacecraft communications system, which included a television camera, enabled Soviet scientists to check the animals' hearts, blood pressure, breathing, and actions during the trip. After the spacecraft reentered and landed safely the next day, the animals and biological specimens were reported to be in good condition.

19

*Baltimore Sun*, August 20, 1960; *New York Herald Tribune*, August 22, 1960; *Instruments and Spacecraft*, pp. 120-121.

The Goddard Space Flight Center (GSFC) conducted its industry conference in Washington, D.C., presenting details of GSFC projects, current and future. The

30

1960

August

objectives of the proposed six-month feasibility contracts for an advanced manned spacecraft were announced:

- To define a manned spacecraft system fulfilling STG guidelines
- To formulate a program plan for implementation
- To identify areas requiring long lead-time research and development effort
- To analyze the cost of providing the system.

Fixed-fee contracts were to be let to prime contractors only; several contracts would be let concurrently. The timetable was announced: (1) August 30, 1960, industry familiarization; (2) August 31–September 6, expression of interest to NASA; (3) September 7, invitation to bidders' conference; (4) September 12, bidders' conference at STG; (5) October 10, proposals received; (6) November 14, contracts awarded; (7) May 15, 1961, contracts completed.

Presentations for the Industry Conference to be conducted by the Goddard Space Flight Center, Greenbelt, Md., August 30, 1960.

September

1

In an organizational change within STG, Maxime A. Faget was appointed Chief of the Flight Systems Division and Robert O. Piland was named Assistant Chief for Advanced Projects. The Apollo Project Office was formed with Piland as Head of the Office; members included John B. Lee, J. Thomas Markley, William W. Petynia, and H. Kurt Strass.

Memorandum, Robert R. Gilruth to Staff, STG, "Change in Organization of the Space Task Group," September 1, 1960.

2

NASA Administrator T. Keith Glennan directed that an accelerated joint planning effort be made by persons at NASA Headquarters who were most familiar with the Saturn, Apollo, manned orbital laboratory, and unmanned lunar and planetary programs. They were to determine whether the Saturn and Saturn-use programs were effectively integrated and whether sufficient design study and program development work had been done to support decisions on projected Saturn configurations. The group responsible for the study consisted of Lloyd Wood, Richard B. Canright, Alfred M. Nelson, John L. Sloop, Oran W. Nicks, Fred D. Kochendorfer, and George M. Low.

Memorandum, Donald H. Heaton to Director, Launch Vehicle Programs, and Director, Space Flight Programs, "Integration of the Saturn and Saturn Applications Programs," September 2, 1960.

10

A NASA contract for approximately \$44 million was signed by Rocketdyne Division of NAA for the development of the J-2 engine.

Rocketdyne *Skywriter*, September 16, 1960, p. 1.

13

An STG briefing was held at Langley Field, Va., for prospective bidders on three six-month feasibility studies of an advanced manned spacecraft as part of the Apollo program. A formal Request for Proposal was issued at the conference.

Ralph B. Oakley, *Historical Summary, S&ID Apollo Program* (NAA, Space and Information Systems Division, January 20, 1966), p. 3; "Agenda for Bidders' Briefing for a Feasibility Study, Project Apollo," September 13, 1960.



A formal agreement was signed by the United States and South Africa providing for the construction of a new deep-space tracking facility at Krugersdorp, near Johannesburg. It would be one of three stations equipped to maintain constant contact with lunar and planetary spacecraft.

1960  
September  
13

*Fourth NASA Semiannual Report*, p. 111.

A staff meeting of the Flight Systems Division of STG was held to discuss design constraints for an in-house design study of the Apollo spacecraft. [See October 21, 1960.]

20

Memorandum, H. Kurt Strass to Apollo Design Team, "Design Restraints for FSD Apollo Design Study (Information and Action)," October 25, 1960.

An attempt to launch a Pioneer satellite into lunar orbit failed when one of the upper stages of the Atlas-Able rocket malfunctioned.

25

*Washington Post*, September 26, 1960.

In a memorandum to NASA Associate Administrator Robert C. Seamans, Jr., Robert L. King, Executive Secretary, described the action taken on certain items discussed at the July 14–15 meeting of the Space Exploration Program Council. Among these actions was the awarding of a contract to The RAND Corporation to evaluate missions for which nuclear propulsion would be desirable. Included in the study would be the determination of availability dates, cost of development, operational costs, the safety aspects of the missions, and an evaluation of research requirements.

29

Memorandum, King to Seamans, "Actions Since SEPC Meeting of 14–15 July 1960," September 29, 1960.

The fourth meeting of the Space Exploration Program Council was held at NASA Headquarters. The results of a study on Saturn development and utilization was presented by the Ad Hoc Saturn Study Committee. Objectives of the study were to determine (1) if and when the Saturn C-2 launch vehicle should be developed and (2) if mission and spacecraft planning was consistent with the Saturn vehicle development schedule. No change in the NASA Fiscal Year 1962 budget was contemplated. The Committee recommended that the Saturn C-2 development should proceed on schedule (S-II stage contract in Fiscal Year 1962, first flight in 1965). The C-2 would be essential, the study reported, for Apollo manned circumlunar missions, lunar unmanned exploration, Mars and Venus orbiters and capsule landers, probes to other planets and out-of-ecliptic, and for orbital starting of nuclear upper stages.

30

During a discussion on the Saturn program, several major problems were brought up:

- The adequacy of the Saturn C-1 launch vehicle for orbital qualification of the complete Apollo spacecraft was in question. Although the C-1 could be used to launch a command module of 5100 pounds, it was probable that the command

1960

September

module weight would increase to as much as 8000 pounds. George M. Low of NASA Headquarters, in a critical review of the Apollo program, pointed out that a spacecraft for a circumlunar mission could be constructed within the payload limitation of the C-2 launch vehicle. Both the developmental and production spacecraft could be available to meet the Saturn schedules.

- Much basic research would be needed before the first Apollo flight. In particular, the problem of reentry heating was of great concern. Low noted that a prediction criterion for proton beam events had been developed, making possible safe manned circumlunar flights insofar as the radiation problem was concerned.

- Concern was also expressed as to the possible need and availability of additional personnel to support the Apollo program.

Minutes, Space Exploration Program Council Meeting, September 30, 1960, pp. 1, 4-5; Low, "Saturn Requirements for Project Apollo," presentation to Space Exploration Program Council, September 30, 1960; "Presentation of Results of Saturn Study by Ad Hoc Study Committee to Space Exploration Program Council," September 30, 1960.

September 30-  
October 3

Charles J. Donlan of STG, Chairman of the Evaluation Board which would consider contractors' proposals on feasibility studies for an advanced manned spacecraft, invited the Directors of Ames Research Center, Jet Propulsion Laboratory, Flight Research Center, Lewis Research Center, Langley Research Center, and Marshall Space Flight Center to name representatives to the Evaluation Board. The first meeting was to be held on October 10 at Langley Field, Va.

Letters, Donlan to Smith J. DeFrance, Brian O. Sparks, Paul F. Bikle, Eugene J. Manganiello, Floyd L. Thompson, Wernher von Braun, September 30-October 3, 1960.

October

4

Members were appointed to the Technical Assessment Panels and the Evaluation Board to consider industry proposals for Apollo spacecraft feasibility studies. Members of the Evaluation Board were: Charles J. Donlan (STG), Chairman; Maxime A. Faget (STG); Robert O. Piland (STG), Secretary; John H. Disher (NASA Headquarters Office of Space Flight Programs); Alvin Seiff (Ames); John V. Becker (Langley); H. H. Koelle (Marshall); Harry J. Goett (Goddard), ex officio; and Robert R. Gilruth (STG), ex officio.

Memorandum, Donlan to Members, Technical Assessment Panels, "Instruction for Members of Technical Assessment Panels for Evaluation of Contractors' Proposals for a Feasibility Study of an Advanced Manned Spacecraft, RFP-302 (Project Apollo)," October 4, 1960; NASA, Goddard Space Flight Center, and STG, "Project Apollo: Plan for the Evaluation of Contractors' Proposals for a Feasibility Study of an Advanced Manned Spacecraft and System," October 6, 1960.

5

Members of STG visited the Marshall Space Flight Center to discuss possible Saturn and Apollo guidance integration and potential utilization of Apollo onboard propulsion to provide a reserve capability. Agreement was reached on tentative Saturn vehicle assignments on abort study and lunar entry simulation; on the use of the Saturn guidance system; and on future preparations of tentative flight plans for Saturns SA-6, 8, 9, and 10.

Memorandum, H. Kurt Strass to Chief, Flight Systems Division, "Report on Visit to MSFC, October 5, 1960, by STG Personnel," October 5, 1960.



1960

October

9

Contractors' proposals on feasibility studies for an advanced manned spacecraft were received by STG. Sixty-four companies expressed interest in the Apollo program, and of these 14 actually submitted proposals: The Boeing Airplane Company; Chance Vought Corporation; Convair/Astronautics Division of General Dynamics Corporation; Cornell Aeronautical Laboratory, Inc.; Douglas Aircraft Company; General Electric Company; Goodyear Aircraft Corporation; Grumman Aircraft Engineering Corporation; Guardite Division of American Marietta Company; Lockheed Aircraft Corporation; The Martin Company; North American Aviation, Inc.; and Republic Aviation Corporation. These 14 companies, later reduced to 12 when Cornell and Guardite withdrew, were subsequently invited to submit prime contractor proposals for the Apollo spacecraft development in 1961. The Technical Assessment Panels began evaluation of contractors' proposals on October 10.

"Participating Companies or Company Teams," partial set of material for Evaluation Board use; "Apollo Spacecraft Chronology," unpublished, annotated by Robert O. Piland, p. 4.

In a memorandum to Abe Silverstein, Director of NASA's Office of Space Flight Programs, George M. Low, Chief of Manned Space Flight, described the formation of a working group on the manned lunar landing program: "It has become increasingly apparent that a preliminary program for manned lunar landings should be formulated. This is necessary in order to provide a proper justification for Apollo, and to place Apollo schedules and technical plans on a firmer foundation.

17

"In order to prepare such a program, I have formed a small working group, consisting of Eldon Hall, Oran Nicks, John Disher, and myself. This group will endeavor to establish ground rules for manned lunar landing missions; to determine reasonable spacecraft weights; to specify launch vehicle requirements; and to prepare an integrated development plan, including the spacecraft, lunar landing and takeoff system, and launch vehicles. This plan should include a time-phasing and funding picture, and should identify areas requiring early studies by field organizations."

Memorandum, Low to Director of Space Flight Programs, "Manned Lunar Landing Programs," October 17, 1960.

A staff meeting of STG's Flight Systems Division was held to fix additional design constraints for the in-house design study of the Apollo spacecraft.

21

Fundamental decisions were made as a result of this and a previous meeting on September 20:

- The entry vehicle should have a Mercury-type configuration, a lift over drag ratio of 0.35, and an overall heatshield and should follow the modular concept, in which a module containing redundant equipment could be jettisoned before reentry.
- Solid propellant systems should be used throughout for onboard propulsion.
- The nominal design load should be 8 g, with an emergency ultimate of 20 g.



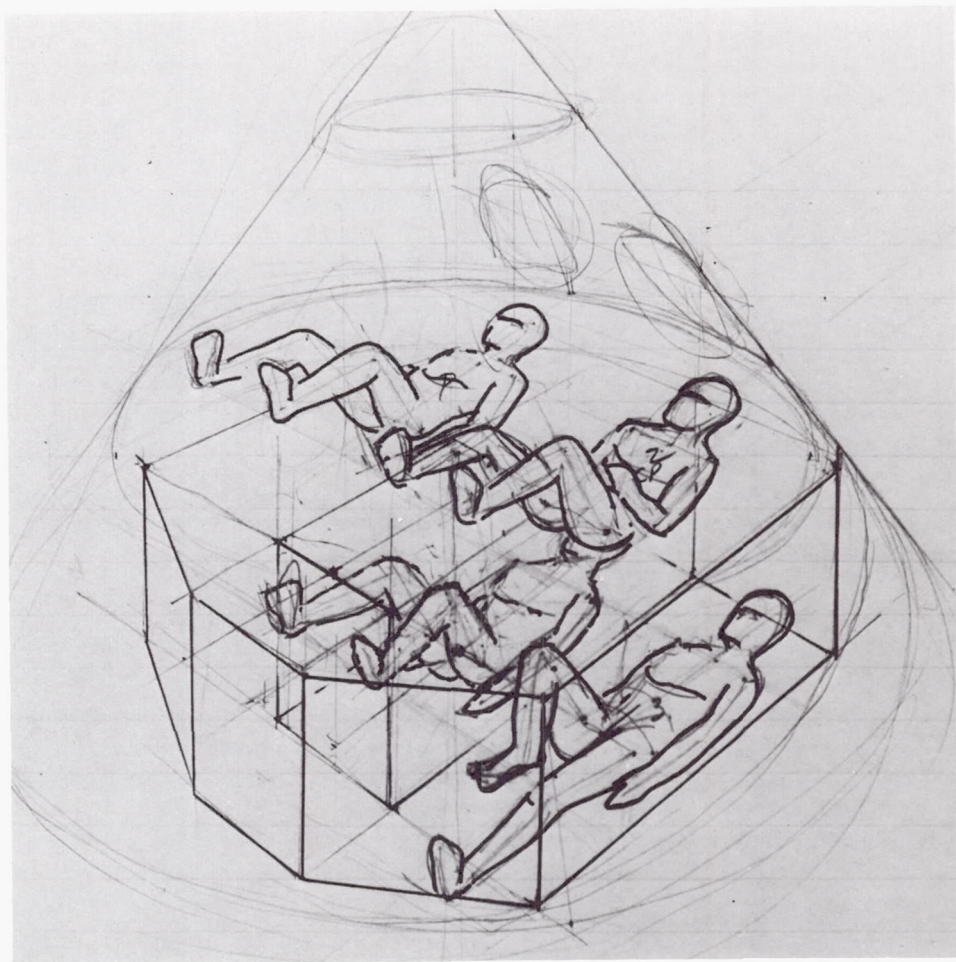

The sketch above, drawn by Caldwell C. Johnson in October 1960, proposed and led to the development of the seating arrangement which was adopted for the Apollo command module.

**1960**  
**October**

- For flight path control in atmospheric flight, with lift over drag ratio of 0.35 constant, roll control only would be used; for space flight, midcourse corrections should be made by fixed-impulse solid-propellant units.
- Attitude control should be maintained during powered flight by thrust vector, during space flight by control jets, and during atmospheric flight by control jets for damping.
- The onboard guidance system should utilize special purpose computers and inertial reference based on the use of fundamentally manual star-sight systems with provision for automatic use.
- Both parachutes and rotors should be studied for the touchdown mode.
- Further research on the spacecraft atmosphere would be necessary.

Memorandum, H. Kurt Strass to Apollo Design Team, "Design Restraints for FSD Apollo Design Study (Information and Action)," October 25, 1960.

The Technical Assessment Panels presented to the Evaluation Board their findings on the contractors' proposals for feasibility studies of an advanced manned spacecraft. On October 24, the Evaluation Board findings and recommendations were presented to the STG Director.

1960  
October  
21

"Apollo Spacecraft Chronology," pp. 4, 5.

Included in the current Saturn flight schedule were: mid-1961, begin first-stage flights with dummy upper stages; early 1963, begin two-stage flights; late 1963, begin three-stage flights; early 1964, conclude ten-vehicle research and development flight test program.

25

Senate Staff Report, *Manned Space Flight Program*, p. 193.

NASA selected three contractors to prepare individual feasibility studies of an advanced manned spacecraft as part of Project Apollo. The contractors were Convair/Astronautics Division of General Dynamics Corporation, General Electric Company, and The Martin Company.

25

TWXs, Goddard Space Flight Center to John A. Powers; NASA Headquarters to STG, Langley; STG Public Affairs Office, Langley Field, Va., Powers to Convair/Astronautics of General Dynamics Corporation, General Electric Company, and The Martin Company, October 25, 1960; Oakley, *Historical Summary, S&ID Apollo Program*, p. 3.

Representatives of the General Electric Company, The Martin Company, and Convair/Astronautics Division of General Dynamics Corporation visited STG to conduct negotiations on the Apollo systems study contracts announced on October 25. The discussions clarified or identified areas not completely covered in company proposals. Contracts were awarded on November 15.

October 27–  
November 2

Minutes of Technical Negotiation Meetings with the General Electric Company, The Martin Company, and Convair/Astronautics Division of General Dynamics Corporation for Apollo Systems Study (RFP-302), October 27, November 1, and November 2, 1960; "Apollo Spacecraft Chronology," p. 5.

Key staff members of NASA Headquarters and the Commander, U.S. Air Force Research and Development Command, met at the Air Force Ballistic Missile Division, Los Angeles, Calif., to attend briefings and discuss matters of mutual concern.

October  
28

At an executive session, Air Force and NASA programs of orbital rendezvous, refueling, and descent from orbit were discussed. Long-range Air Force studies on a lunar base were in progress as well as research on more immediate missions, such as rendezvous by an unmanned satellite interceptor for inspection purposes, manned maintenance satellites, and reentry methods. NASA plans for the manned lunar landing mission included the possible use of the Saturn booster in an orbital staging operation employing orbital refueling. Reentry studies beyond Mercury were concentrated on reentry at escape speeds and on a spacecraft configuration capable of aerodynamic maneuvering during reentry.

Memorandum, Donald H. Heaton, Assistant Administrator for Resources, for the Record, "Minutes of the Executive Meeting at AFBMD on October 28, 1960," November 2, 1960.



1960  
November  
3

The Department of the Interior announced that the U.S. Geological Survey would undertake detailed studies of lunar geology as part of a new \$205,000 program in astrogeology financed by NASA. The program would include geological analysis of photographs of selected areas on the moon, terrestrial crater studies, and investigations into the origin of tektites, meteorites, and related material of possible extraterrestrial origin. Certain lunar features would be studied more closely and larger scale diagrams would be made of specific areas in the vicinity of sites selected by NASA for unmanned spacecraft landings.

*New York Times*, November 9, 1960.

4

At a meeting, Charles J. Donlan of STG and George M. Low, John H. Disher, Milton W. Rosen, and Elliott Mitchell, all of NASA Headquarters, discussed a plan to set up informal technical liaison groups to broaden the base for inter-Center information exchange on the Apollo program with particular reference to onboard propulsion.

Memorandum, Abe Silverstein to Director, Launch Vehicle Programs, "Apollo Technical Liaison Groups," November 29, 1960.

8

*Little Joe 5* with a Mercury production spacecraft was launched from Wallops Island to test the spacecraft in an abort simulating the most severe launch conditions. At 15.4 seconds after liftoff, the escape rocket motor and tower jettison motor ignited prematurely. Booster, capsule, and tower remained mated through ballistic trajectory until destroyed on impact.

James M. Grimwood, *Project Mercury: A Chronology* (NASA SP-4001, 1963), p. 117; Swenson *et al.*, *This New Ocean*, p. 291.

12

*Discoverer XVII* was launched into polar orbit from Vandenberg Air Force Base and the payload was recovered on November 14. On December 2, the Air Force revealed that exceedingly valuable information had been obtained from human tissues carried by *Discoverer XVII*. The tissues had been exposed to an unexpectedly heavy dose of radiation for more than 50 hours in flight.

*Baltimore Sun*, November 14, 1960; *Los Angeles Times*, December 3, 1960.

16

STG formulated a plan for the proposed Apollo Technical Liaison Groups. These Groups were to effect systematic liaison in technical areas related to the Apollo project. The objectives and scope of the plan were as follows:

- Provide an up-to-date summary of progress on the Apollo project in specific technical areas at the Centers
- Give a regular summary of Apollo research and study investigations to ensure their use in the project
  - Report Apollo contractor activities to Group members
  - Bring expert consideration to the technical problems as they arose
  - Point out research activity needed in support of Apollo for its assignment to the Centers
- Assist in monitoring contractor studies through participation of individual panel members



- Develop requirements for flight tests resulting from research and study activity
- Provide assessments of progress in the technical areas.

To carry out these objectives, Technical Liaison Groups would be formed:

- Trajectory Analysis: studies related to the manned circumlunar mission including atmospheric and nonatmospheric phases of normal and emergency maneuvers
  - Configurations and Aerodynamics: theoretical and experimental studies of the aerodynamic characteristics and performance of vehicles proposed for the manned circumlunar mission
  - Guidance and Control: studies and developments in the guidance, navigation, and control areas related to all phases of the manned circumlunar mission
  - Heating: convective, conductive, and radiative heat-transfer studies during launch, abort, and reentry for various configurations; investigations of heat transfer through turbulent boundary layers; ablation rates for materials at different heating conditions; and pressure distribution for various configurations
  - Structures and Materials: studies of design concepts for proposed circumlunar vehicle structures including the optimum payload distribution, protection against radiation and meteoroids, and possible shapes and types of structures suitable for circumlunar missions
  - Instrumentation and Communications: studies and developments of instruments required for the mission; studies on voice, telemetry, and tracking communications
  - Human Factors: studies on human tolerance levels, life-support requirements, and the assessment of the biological effects of radiation
  - Mechanical Systems: studies and developments of systems required for the manned circumlunar mission
  - Onboard Propulsion: studies and developments in propulsion systems and components required to meet the abort and midcourse performance requirements
- Representatives in a given Group would be limited to a single member from each Center. STG would be responsible for meeting arrangements.

STG, "Apollo Technical Liaison Plan," November 16, 1960.

An attempt was made to launch Mercury-Redstone 1 (MR-1) from the Atlantic Missile Range. After a four- or five-inch liftoff, MR-1 launched its escape tower but not the capsule. The undamaged spacecraft was recovered for reuse.

21

Swenson *et al.*, *This New Ocean*, pp. 293-297.

STG held a meeting at Goddard Space Flight Center to discuss a proposed contract with MIT Instrumentation Laboratory for navigation and guidance support for Project Apollo. The proposed six-month contract for \$100,000 might fund studies through the preliminary design stage but not actual hardware. Milton B. Trageser of the Instrumentation Laboratory presented a draft work statement which divided the effort into three parts: midcourse guidance, reentry guidance, and a satellite experiment feasibility study using the Orbiting Geophysical Observa-

22

1960  
November

tory. STG decided that the Instrumentation Laboratory should submit a more detailed draft of a work statement to form the basis of a contract. In a discussion the next day, Robert G. Chilton of STG and Trageser clarified three points:

(1) The current philosophy was that an onboard computer program for a normal mission sequence would be provided and would be periodically updated by the crew. If the crew were disabled, the spacecraft would continue on the programmed flight for a normal return. No capability would exist for emergency procedures.

(2) Chilton emphasized that consideration of the reentry systems design should include all the guideline requirements for insertion monitoring by the crew, navigation for aborted missions, and, in brief, the whole design philosophy for manned flight.

(3) The long-term objective of a lunar landing mission should be kept in mind although design simplicity was of great importance.

Chilton and Trageser agreed that the purpose of the Apollo program was the development of manned space flight system capability, not simply circumnavigation of the moon with an encapsulated man.

Memorandum, Chilton to Associate Director, "Meeting with MIT Instrumentation Laboratory to Discuss Navigation and Guidance Support for Project Apollo," November 28, 1960.

- 22 Charles J. Donlan, Associate Director of STG, invited Langley, Ames, Lewis, and Flight Research Centers, Marshall Space Flight Center, and Jet Propulsion Laboratory to participate in Technical Liaison Groups in accordance with the plan drawn up on November 16.

Letters, Donlan to Langley, Ames, Lewis, and Flight Research Centers, Marshall Space Flight Center, and Jet Propulsion Laboratory, November 22, 1960; memorandum, Abe Silverstein to Director, Launch Vehicle Programs, "Apollo Technical Liaison Groups," November 29, 1960.

- 29 A joint briefing on the Apollo and Saturn programs was held at Marshall Space Flight Center (MSFC), attended by representatives of STG and MSFC. Maxime A. Faget of STG and MSFC Director Wernher von Braun agreed that a joint STG-MSFC program would be developed to accomplish a manned lunar landing. Areas of responsibility were: MSFC—launch vehicle and landing on the moon; STG—lunar orbit, landing, and return to earth.

Memorandum, J. Thomas Markley, Apollo Project Office, to Associate Director, STG, "Meeting between MSFC and STG on Mission for Saturn C1 R and D Program and Summary of MSFC Trips by J. T. Markley," December 8, 1960.

- 30 Smith J. DeFrance, Director of the Ames Research Center, designated Ames working members on six of the nine Apollo Technical Liaison Groups. They were Stanley F. Schmidt (Trajectory Analysis), Clarence A. Syvertson (Configurations and Aerodynamics), G. Allen Smith (Guidance and Control), Glen Goodwin (Heating), Charles A. Hermach (Structures and Materials), and Harald S. Smedal (Human Factors).

Letter, DeFrance to STG, Attn: Mr. C. J. Donlan, "Apollo Technical Liaison Groups," November 30, 1960.



- The Soviet Union launched its third spaceship satellite, *Korabl Sputnik III*, or *Sputnik VI*. The spacecraft, similar to those launched on May 15 and August 19, carried two dogs in addition to other animals, insects, and plants. The next day, during reentry, the spacecraft disintegrated and burned. 1960  
December  
1
- Washington Post, December 2 and 3, 1960; *Instruments and Spacecraft*, p. 143.
- Eugene J. Manganiello, Associate Director of the Lewis Research Center, appointed Lewis members to six of the Apollo Technical Liaison Groups. They were Seymour C. Himmel (Trajectory Analysis), Jack B. Esgar (Structures and Materials), Robert E. Tozier (Instrumentation and Communications), Robert F. Seldon (Human Factors), Robert R. Goodman (Mechanical Systems), and Edmund R. Jonash (Onboard Propulsion). 1
- Letter, Manganiello to STG, Attn: Charles J. Donlan, "Apollo Technical Liaison Groups," December 1, 1960.
- A meeting was held by representatives of STG and the MIT Lincoln Laboratory to discuss the scope of the studies to be performed by the Lincoln Laboratory on the ground instrumentation system for the Apollo program. The discussion centered about the draft work statement prepared by STG. In general, those at the meeting agreed that Lincoln Laboratory should conduct an overall analysis of the requirements for the ground system, leading to the formulation of a general systems concept. The study should be completed by the end of December 1961, with interim results available in the middle of 1961. 2
- Memorandum, Jack Cohen, Operations Representative, Apollo Office, to Associate Director, "Meeting with Lincoln Laboratory Personnel to Discuss Apollo Study Contract," December 5, 1960.
- Milton B. Trageser of MIT Instrumentation Laboratory transmitted to Charles J. Donlan of STG the outline of a study program on the guidance aspects of Project Apollo. He outlined what might be covered by a formal proposal on the Apollo spacecraft guidance and navigation contract discussed by STG and Instrumentation Laboratory representatives on November 22. 2
- Letter, Trageser, Assistant Director, MIT Instrumentation Laboratory, to Donlan, Associate Director of STG, December 2, 1960.
- The Director of the Flight Research Center, Paul F. Bikle, nominated Flight Research Center members to eight of the nine Apollo Technical Liaison Groups. They were Donald R. Bellman (Trajectory Analysis), Hubert M. Drake (Configurations and Aerodynamics), Euclid C. Holleman (Guidance and Control), Thomas V. Cooney (Heating), Kenneth C. Sanderson (Instrumentation and Communications), Milton O. Thompson (Human Factors), Perry V. Row (Mechanical Systems), and Norman E. DeMar (Onboard Propulsion). 2
- Letter, Bikle to STG, Attn: Mr. C. J. Donlan, "Apollo Technical Liaison Groups," December 2, 1960.
- Representatives of Marshall Space Flight Center (MSFC) were assigned to eight of the nine Apollo Technical Liaison Groups by H. H. Koelle, Director, Future 2



1960  
December

Projects Office, MSFC. They were Rudolph F. Hoelker (Trajectory Analysis), Edward L. Linsley (Configurations and Aerodynamics), Werner K. Dahm and Harvey A. Connell (Heating), Erich E. Goerner (Structures and Materials), David M. Hammock and Alexander A. McCool (Onboard Propulsion), Heinz Kampmeier (Instrumentation and Communications), Wilbur G. Thornton (Guidance and Control), and Herman F. Beduerftig (Mechanical Systems). Dual representation on two of the Groups would be necessary because of the division of technical responsibilities within MSFC.

Memorandum, Koelle to STG, Attn: Charles J. Donlan, Assistant Director, Project Mercury, "Apollo Technical Liaison Groups," December 2, 1960.

- 6-8 The first technical review of the General Electric Company Apollo feasibility study was held at the contractor's Missile and Space Vehicle Department. Company representatives presented reports on the study so that STG representatives might review progress, provide General Electric with pertinent information from NASA or other sources, and discuss and advise as to the course of the study.

Minutes of General Electric Missile and Space Vehicle Department Meeting No. 1, December 6-8, 1960.

- 7 Floyd L. Thompson, Director of the Langley Research Center, assigned Langley members to eight of the Apollo Technical Liaison Groups. They were William H. Michael, Jr. (Trajectory Analysis), Eugene S. Love (Configurations and Aerodynamics), John M. Eggleston (Guidance and Control), Robert L. Trimpi (Heating), Roger A. Anderson (Structures and Materials), Wilford E. Sivertson, Jr. (Instrumentation and Communications), David Adamson (Human Factors), and Joseph G. Thibodaux, Jr. (Onboard Propulsion).

Letter, Thompson to STG, "Langley Appointments to Apollo Technical Liaison Groups," December 7, 1960.

- 7-9 The Martin Company presented the first technical review of its Apollo feasibility study to STG officials in Baltimore, Md. At the suggestion of STG, Martin agreed to reorient the study in several areas: putting more emphasis on lunar orbits, putting man in the system, and considering landing and recovery in the initial design of the spacecraft.

Minutes of The Martin Company Apollo Technical Review No. 1, December 7-9, 1960.

- 9 Brian O. Sparks, Deputy Director of the Jet Propulsion Laboratory (JPL), designated JPL members to serve on six of the nine Apollo Technical Liaison Groups. They were Victor C. Clarke, Jr. (Trajectory Analysis), Edwin Pounder (Configurations and Aerodynamics), James D. Acord (Guidance and Control), John W. Lucas (Heating), William J. Carley (Structures and Materials), and Duane F. Dipprey (Onboard Propulsion).

Letter, Sparks to Charles J. Donlan, Associate Director of Project Mercury, December 9, 1960.

- Representatives of the Langley Research Center briefed members of STG on the lunar orbit method of accomplishing the lunar landing mission. 1960  
December  
10
- Langley Research Center, *Manned Lunar-Landing through use of Lunar-Orbit Rendezvous* (Langley Research Center, 1961), p. 5.
- Convair/Aeronautics Division of the General Dynamics Corporation held its first technical review of the Apollo feasibility study in San Diego, Calif. Brief presentations were made by contractor and subcontractor technical specialists to STG representatives. Convair/Aeronautics' first approach was oriented toward the modular concept, but STG suggested that the integral spacecraft concept should be investigated. 14-15
- Minutes of Meeting of Convair Aeronautics Technical Review No. 1, December 14-15, 1960.
- Associate Administrator of NASA Robert C. Seamans, Jr., and his staff were briefed by Langley Research Center personnel on the rendezvous method as it related to the national space program. Clinton E. Brown presented an analysis made by himself and Ralph W. Stone, Jr., describing the general operational concept of lunar orbit rendezvous for the manned lunar landing. The advantages of this plan in contrast with the earth orbit rendezvous method, especially in reducing launch vehicle requirements, were illustrated. Others discussing the rendezvous were John C. Houbolt, John D. Bird, and Max C. Kurbjun. 14
- Bird, "Short History of the Development of the Lunar Orbit Rendezvous Plan at the Langley Research Center," p. 2.
- The final launch in the Pioneer lunar probe program was unsuccessful; the Atlas-Able booster rocket went out of control and exploded at an altitude of 40,000 feet off Cape Canaveral. 15
- New York Times*, December 16, 1960.
- Mercury-Redstone 1A* (unmanned) was launched successfully from the Atlantic Missile Range. The objective was to qualify the spacecraft for a primate flight scheduled shortly thereafter. Apart from the launch vehicle cutoff velocity being slightly higher than normal, all flight sequences were satisfactory. 19
- Grimwood, *Project Mercury: A Chronology*, pp. 119-120.
- The MIT Instrumentation Laboratory submitted a formal proposal to NASA for a study of a navigation and guidance system for the Apollo spacecraft. 22
- Memorandum, Robert G. Chilton to Associate Director, "Massachusetts Institute of Technology Guidance System Study for Apollo," January 16, 1961.
- The Grumman Aircraft Engineering Corporation began work on a company-funded lunar orbit rendezvous feasibility study. 29
- Interview with Saul Ferdman, Grumman Aircraft Engineering Corporation, Bethpage, N.Y., May 2, 1966.



1961

January

3

STG, which was responsible for Project Mercury and other NASA manned space flight programs, became a separate field element reporting to the Director of Space Flight Programs at NASA Headquarters.

*Fifth NASA Semiannual Report*, p. 2.

5-6

During a meeting of the Space Exploration Program Council at NASA Headquarters, the subject of a manned lunar landing was discussed. Following presentations on earth orbit rendezvous (Wernher von Braun, Director of Marshall Space Flight Center), lunar orbit rendezvous (John C. Houbolt of Langley Research Center), and direct ascent (Melvyn Savage of NASA Headquarters), the Council decided that NASA should not follow any one of these specific approaches, but should proceed on a broad base to afford flexibility. Another outcome of the discussion was an agreement that NASA should have an orbital rendezvous program which could stand alone as well as being a part of the manned lunar program. A task group was named to define the elements of the program insofar as possible. Members of the group were George M. Low, Chairman, Eldon W. Hall, A. M. Mayo, Ernest O. Pearson, Jr., and Oran W. Nicks, all of NASA Headquarters; Maxime A. Faget of STG; and H. H. Koelle of Marshall Space Flight Center. This group became known as the Low Committee.

Minutes, Space Exploration Program Council Meeting, January 5-6, 1961; Bird, "Short History of the Development of the Lunar Orbit Rendezvous Plan at the Langley Research Center," p. 2.

6

Three of the Apollo Technical Liaison Groups held their first meetings at STG (Instrumentation and Communications, Mechanical Systems, and Onboard Propulsion).

The Group for Instrumentation and Communications discussed a set of working guidelines on spacecraft instrumentation and communications, tracking considerations, and deep-space communication requirements. Progress of the three Apollo feasibility study contracts was reviewed and the proposed MIT Lincoln Laboratory study on a systems concept for the ground instrumentation and tracking required for the Apollo mission was discussed. Reports of studies were given by members from the NASA Centers. The Group recommendations were:

- All Group members should be supplied with copies of the Apollo contractors' proposals.
- Existing ground facilities should be used as much as possible.
- Jet Propulsion Laboratory (JPL) should be asked to participate in future panel activities.
- All Group members should be supplied with copies of the STG-Lincoln Laboratory Work Statement.

Members of the Group for Mechanical Systems considered studies being done at NASA Centers. Some specific points of interest in these studies were:

- Lewis and Langley work on reaction controls, Langley research on auxiliary power systems, Marshall Space Flight Center (MSFC) investigations on mechanical elements



1961

January

- A call for more detailed definitions of the environmental control system requirements, further investigation of chemical auxiliary power systems, consideration of artificial gravity configuration effects on mechanical systems, and development of reliable materials for use in the space environment.

The Group for Onboard Propulsion reviewed the three contractors' work on the Apollo feasibility studies. Among studies being undertaken by the NASA Centers and reported on at this meeting were: an STG consideration of an all-solid fuel propulsion system for a circumlunar flight, determination of midcourse and abort propulsion system requirements based on Saturn trajectories (MSFC), experimental evaluation at zero gravity of expulsion bag techniques for cryogenic propellants (Lewis), analysis and experiments on solid propellant rocket motors of very high mass fraction (Langley), methods of achieving thrust vector control by secondary injection of gases and the design of a highly reliable and versatile bipropellant spacecraft propellant system using hydrogen tetroxide and hydrazine or hydrazine derivatives (JPL), and a contract to examine hardware requirements for space missions and lunar landings (NASA Headquarters).

Minutes of meetings of Technical Liaison Groups on Instrumentation and Communications, Mechanical Systems, and Onboard Propulsion, January 6, 1961.

The Manned Lunar Landing Task Group (Low Committee) set up by the Space Exploration Program Council was instructed to prepare a position paper for the NASA Fiscal Year 1962 budget presentation to Congress. The paper was to be a concise statement of NASA's lunar program for Fiscal Year 1962 and was to present the lunar mission in terms of both direct ascent and rendezvous. The rendezvous program would be designed to develop a manned spacecraft capability in near space, regardless of whether such a technique would be needed for manned lunar landing. In addition to answering such questions as the reason for not eliminating one of the two mission approaches, the Group was to estimate the cost of the lunar mission and the date of its accomplishment, though not in specific terms. Although the decision to land a man on the moon had not been approved, it was to be stressed that the development of the scientific and technical capability for a manned lunar landing was a prime NASA goal, though not the only one. The first meeting of the Group was to be held on January 9.

"Instructions to Manned Lunar Landing Task Group," January 6 and 9, 1961.

At the first meeting of the Manned Lunar Landing Task Group, Associate Administrator Robert C. Seamans, Jr., Director of the Office of Space Flight Programs Abe Silverstein, and Director of the Office of Advanced Research Programs Ira H. Abbott outlined the purpose of the Group to the members. After a discussion of the instructions, the Group considered first the objectives of the total NASA program: (1) the exploration of the solar system for knowledge to benefit mankind; and (2) the development of technology to permit exploitation of space flight for scientific, military, and commercial uses. NASA's lunar program was a logical step toward these objectives. In current lunar program planning, three steps were projected: (1) a manned landing on the moon with return to earth,

1961

January

(2) limited manned lunar exploration, and (3) a scientific lunar base. To accomplish the first step, a great increase in launch vehicle capability would be needed beyond that provided by current funding. A comparison of a three-million-pound-thrust and a six-million-pound-thrust Nova launch vehicle was made. It was estimated that a 60,000- to 80,000-pound payload to escape velocity would be needed for a manned lunar landing mission.

Manned Lunar Exploration Working Group [Manned Lunar Landing Task Group] Minutes, January 9, 1961.

10

Representatives of STG visited Convair/Astronautics Division of the General Dynamics Corporation to monitor the Apollo feasibility study contract. The meeting consisted of several individual informal discussions between the STG and Convair specialists on configurations and aerodynamics, heating, structures and materials, human factors, trajectory analysis, guidance and control, and operation implementation.

Memorandum, William W. Petynia, Convair Liaison Engineer, to Associate Director, STG, "Visit to Convair Astronautics on January 10 Regarding Apollo Study," February 3, 1961.

10

A conference was held at the Langley Research Center between representatives of STG and Langley to discuss the feasibility of incorporating a lunar orbit rendezvous phase into the Apollo program. Attending the meeting for STG were Robert L. O'Neal, Owen E. Maynard, and H. Kurt Strass, and for the Langley Research Center, John C. Houbolt, Clinton E. Brown, Manuel J. Queijo, and Ralph W. Stone, Jr. The presentation by Houbolt centered on a performance analysis which showed the weight saving to be gained by the lunar rendezvous technique as opposed to the direct ascent mode. According to the analysis, a saving in weight of from 20 to 40 percent could be realized with the lunar orbit rendezvous technique.

Memorandum, O'Neal, Systems Integration Section, to Associate Director, STG, "Discussion with Dr. Houbolt, LRC, Concerning the Possible Incorporation of a Lunar Orbital Rendezvous Phase as a Prelude to Manned Lunar Landing," January 30, 1961.

11

Three of the Apollo Technical Liaison Groups (Trajectory Analysis, Heating, and Human Factors) held their first meetings at the Ames Research Center.

After reviewing the status of the contractors' Apollo feasibility studies, the Group on Trajectory Analysis discussed studies being made at NASA Centers. An urgent requirement was identified for a standard model of the Van Allen radiation belt which could be used in all trajectory analyses related to the Apollo program.

The Group on Heating, after consideration of NASA and contractor studies currently in progress, recommended experimental investigation of control surface heating and determination of the relative importance of the unknowns in the heating area by relating estimated "ignorance" factors to resulting weight penalties in the spacecraft. The next day, three members of this Group met for further discussions and two areas were identified for more study: radiant heat inputs and their



effect on the ablation heatshield, and methods of predicting heating on control surfaces, possibly by wind tunnel tests at high Mach numbers.

The Group on Human Factors considered contractors' studies and investigations being done at NASA Centers. In particular, the Group discussed the STG document, "Project Apollo Life Support Programs," which proposed 41 research projects. These projects were to be carried out by various organizations, including NASA, DOD, industry, and universities. Medical support experience which might be applicable to Apollo was also reviewed.

Minutes of meetings of Technical Liaison Groups on Trajectory Analysis, on Heating, and on Human Factors, January 11, 1961.

J. Thomas Markley of the Apollo Spacecraft Project Office reported to Associate Director of STG Charles J. Donlan that an informal briefing had been given to the Saturn Guidance Committee on the Apollo program. The Committee had been formed by Don R. Ostrander, NASA Director of the Office of Launch Vehicle Programs, to survey the broad guidance and control requirements for Saturn. The Committee was to review Marshall Space Flight Center guidance plans, review plans of mission groups who intended to use Saturn, recommend an adequate guidance system for Saturn, and prepare a report of the evaluation and results during January. Members of STG, including Robert O. Piland, Markley, and Robert G. Chilton, presented summaries of the overall Apollo program and guidance requirements for Apollo.

11

Memorandum, Markley to Associate Director, STG, "Briefing for Saturn Guidance Committee," January 11, 1961.

President-elect John F. Kennedy released a report made to him by his Ad Hoc Committee on Space named to review the U.S. space and missile programs and identify personnel, technical, or administrative problems which would require the prompt attention of the Kennedy Administration. The Committee, whose chairman was Jerome B. Wiesner of MIT, concluded that the national space program required a redefinition of objectives, that the National Aeronautics and Space Council should be made an effective agency for managing the space program, that there should be a single responsible agency within the military establishment to manage the military part of the space program, that NASA management should be reorganized with stronger emphasis on technical direction, and that organizational machinery should be set up within the government to administer an industry-government civilian space program.

11

Report to the President-Elect of the Ad Hoc Committee on Space, January 11, 1961, pp. 1, 4-5; *New York Times*, January 12, 1961.

John Blake of the Air Force Aeronautical Chart and Information Center (ACIC) described to STG representatives the progress made by ACIC in mapping the moon. Lunar maps to the scale of 1:5,000,000 and 1:10,000,000 were later requested and received by STG. In addition, the first two sheets of a projected 144-

11



1961

January

sheet map coverage of the lunar surface on a 1: 1,000,000 scale were forwarded to STG by the Center.

Letter, Charles J. Donlan to Commander, ACIC, January 17, 1961; Lt. Col. Ross J. Foster, ACIC, to Donlan, STG, January 31, 1961.

12

Three of the Apollo Technical Liason Groups (Structures and Materials, Configurations and Aerodynamics, and Guidance and Control) held their first meetings at the Ames Research Center.

The Group on Structures and Materials, after reviewing contractors' progress on the Apollo feasibility studies, considered reports on Apollo-related activities at NASA Centers. Among these activities were work on the radiative properties of material suitable for temperature control of spacecraft (Ames), investigation of low-level cooling systems in the reentry module (Langley), experiments on the landing impact of proposed reentry module shapes (Langley), meteoroid damage studies (Lewis), and the definition of suitable design criteria and safety factors to ensure the structural integrity of the spacecraft (STG).

Three prime reentry vehicles under consideration during late 1960 and early 1961 are shown in the engineering sketch.

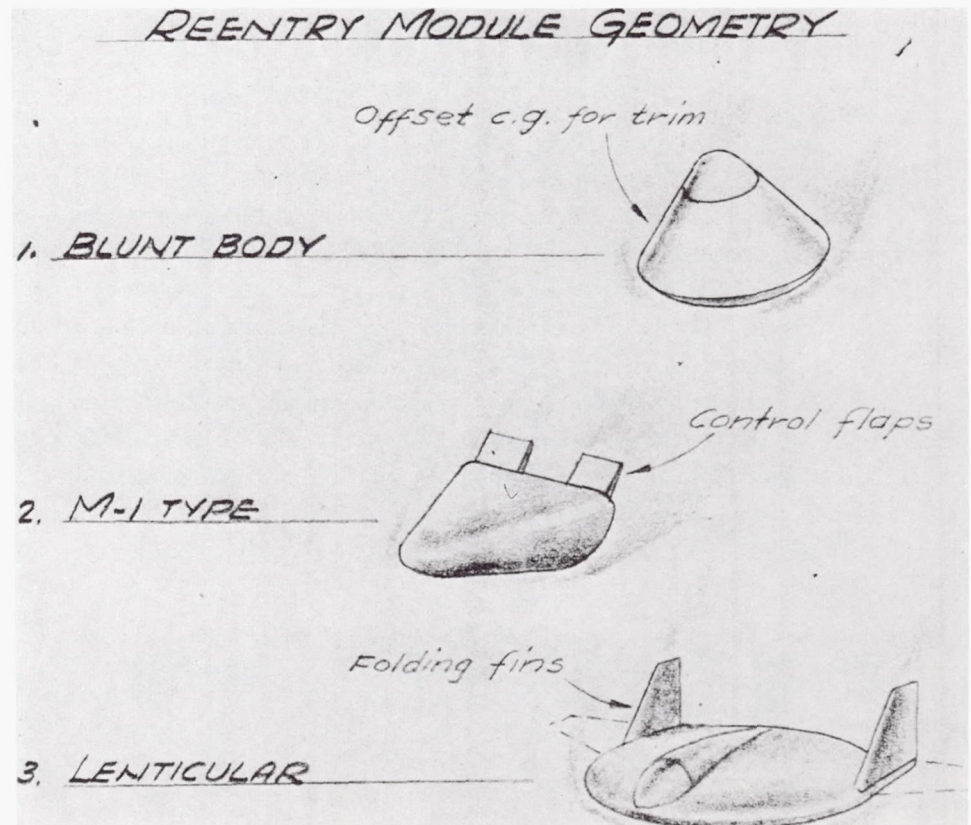

The Group on Configurations and Aerodynamics recommended:

- Investigations to determine the effects of aerodynamic heating on control surfaces
- Studies of the roll control maneuvers with center of gravity offset for range control
- Tests of packaging and deployment of paraglider and multiple parachute landing systems
- Studies to determine the effects of jet impingement upon the static and dynamic stability of the spacecraft.

The various spacecraft configurations under consideration by the Apollo feasibility study contractors were reviewed: (1) The General Electric Company effort was being concentrated on the Mark-II, NERV, RVX (9° blunted cone), elliptical cone, half-cone, and Bell Aerospace Corporation Dyna-Soar types. (2) The Martin Company was studying the M-1 and M-2 lifting bodies, the Mercury with control flap, the Hydrag (Avco Corporation), and a winged vehicle similar to Dyna-Soar. In addition, Martin was proposing to investigate the M-1-1, a lifting body halfway between the M-1 and the M-2; a flat-bottomed lifting vehicle similar to the M-1-1; a lenticular shape; and modified flapped Mercury (the Langley L-2C). (3) Convair/Aeronautics Division of the General Dynamics Corporation had subcontracted the major effort on reentry to Avco, which was looking into five configurations: a Mercury-type capsule, the lenticular shape, the M-1, the flat-face cone, and half-cone.

The Group for Guidance and Control drew up a list of suggestions for research and development programs:

- An “absolute emergency” navigation system in which the crew would use only a Land camera and a slide rule
- The possible applications of the equipment and test programs to be used on Surveyor
- The question whether Apollo lunar landing trajectories should be based on minimum fuel expenditure—if so, doubts were raised that the current STG concept would accomplish this goal
- The question whether radio ranging could be used to reduce the accuracy requirements for celestial observations and whether such a composite system would fall within the limits set by the Apollo guidelines
- The effects of lunar impact on the return spacecraft navigation equipment
- Studies of hardware drift-error in the guidance and navigation systems and components
- A study of the effect of rotating machinery aboard the spacecraft on attitude alignment and control requirements
- Problems of planet tracking when the planetary disk was only partially illuminated
- A study of the transient effects of guidance updating by external information
- One adequate guidance and control concept to be mechanized and errors analyzed and evaluated

COMPLETE CONFIGURATION		
CONVAIR	MARTIN	GENERAL ELECTRIC
<p><u>M-1</u> WT=18,615</p> <p>556</p>	<p><u>L-2C</u> WT=14,577</p> <p>492</p>	<p><u>D-2</u> WT=16,476</p> <p>401</p>
<p><u>LENTICULAR</u> WT=19,357</p> <p>384</p>	<p><u>W-1</u> WT=14,724</p> <p>460</p>	<p><u>R-3</u> WT=18,543</p> <p>365</p>

REENTRY VEHICLES		
CONVAIR	MARTIN	GENERAL ELECTRIC
<p><u>M-1</u> WT=5,604</p> <p>125 144 L/D = .52</p>	<p><u>L-2C</u> WT=5,711</p> <p>154 105 L/D = .75</p>	<p><u>D-2</u> WT=4,815</p> <p>113.2 94.6 L/D = .62</p>
<p><u>LENTICULAR</u> WT=6,322</p> <p>192 68 L/D = 4.4</p>	<p><u>W-1</u> WT=5,847</p> <p>136 142 L/D = .8</p>	<p><u>R-3</u> WT=6,473</p> <p>130 180 L/D = .7</p>

Some of the configurations studied by the three companies doing the feasibility studies on Apollo for NASA are shown on this page. As indicated, Convair emphasized M-1 and lenticular configurations; Martin Company, the modified, flapped Mercury (L-2C) and the flat-bottomed lifting vehicle similar to the M-1-1 (W-1); and General Electric, the nine-degree blunted cone (D-2) and the Bell Dyna-Soar type (R-3).



- The effects of artificial g configurations on observation and guidance.
- The development of a ground display mission progress evaluation for an entire mission
- An abort guidance sequence including an abort decision computer and pilot display
- An earth orbit evaluation of the position computer input in a highly eccentric orbit (500- to 1000-mile perigee, 60,000-mile apogee).

1961

January

Minutes of meetings of Apollo Technical Liaison Groups on Structures and Materials, Configurations and Aerodynamics, and Guidance and Control, January 12, 1961.

Representatives of STG visited The Martin Company in Baltimore, Md., to review the progress of the Apollo feasibility study contract. Discussions on preliminary design of the spacecraft, human factors, propulsion, power supplies, guidance and control, structures, and landing and recovery were held with members of the Martin staff.

12-13

Memorandum, John B. Lee, Apollo Liaison Engineer, to Associate Director, STG, "Visit to The Martin Company, Baltimore, Md., on January 12-13, 1961, Regarding the Monitoring of the Apollo Study Contract," February 6, 1961.

At the second meeting of the Manned Lunar Landing Task Group (Low Committee), a draft position paper was presented by George M. Low, Chairman. A series of reports on launch vehicle capabilities, spacecraft, and lunar program support were presented and considered for possible inclusion in the position paper.

16-17

Minutes of Manned Lunar Landing Working Group [Manned Lunar Landing Task Group], January 16 and 17, 1961.

The Marshall Space Flight Center awarded contracts to the Douglas Aircraft Company and Chance Vought Corporation to study the launching of manned exploratory expeditions into lunar and interplanetary space from earth orbits.

19

U.S. Congress, House, Committee on Science and Astronautics, *Aeronautical and Astronautical Events of 1961*, Report of the National Aeronautics and Space Administration, 87th Congress, 2nd Session (1962), p. 3.

After evaluating preliminary design studies, NASA selected the Hughes Aircraft Company to build seven Surveyor spacecraft. This 750-pound, three-legged, unmanned spacecraft would carry 200 pounds of instruments, including zoom television cameras, a drill to sample the lunar soil, chemical analysis equipment, and a seismometer. The first Surveyor was scheduled to be launched in 1963.

19

*Fifth NASA Semiannual Report*, p. 49; *Los Angeles Examiner*, January 20, 1961.

The Manned Lunar Landing Task Group (Low Committee) submitted its first draft report to NASA Associate Administrator Robert C. Seamans, Jr. A section on detailed costs and schedules still was in preparation and a detailed itemized backup report was expected to be available in mid-February.

24

Memorandum, George M. Low, Program Chief, Manned Space Flight, to Associate Administrator, "A Plan for Manned Lunar Landing," January 24, 1961.

- 1961**
- January**
- 25 NASA announced that the Lockheed Aircraft Corporation had been awarded a contract by the Marshall Space Flight Center to study the feasibility of refueling a spacecraft in orbit.  
*Baltimore Sun*, January 26, 1961.
- 26 Wernher von Braun, Director of Marshall Space Flight Center, proposed that the Saturn C-1 launch vehicle be changed from a three-stage to a two-stage configuration to meet Apollo program schedules. The planned third stage (S-V) would be dropped.  
*Saturn Illustrated Chronology*, p. 17.
- 30 President John F. Kennedy announced that he was nominating James E. Webb as Administrator of the National Aeronautics and Space Administration and Hugh L. Dryden as Deputy Administrator. Senate confirmation followed on February 9 and they were sworn in on February 14.  
*Washington Post*, January 31, 1961; *Fifth NASA Semiannual Report*, p. 2.
- 31 *Mercury-Redstone 2* was launched successfully from the Atlantic Missile Range, with Ham, a chimpanzee, aboard. Despite the over-acceleration of the launch vehicle, which caused the spacecraft to reach a higher altitude than planned, the capsule was recovered safely with Ham in good condition.  
 Grimwood, *Project Mercury: A Chronology*, p. 121.
- January 31–  
February 1**
- Members of STG met with representatives of the Convair/Astronautics Division of the General Dynamics Corporation and Avco Corporation to monitor the progress of the Apollo feasibility study. Configurations and aerodynamics and Apollo heating studies were discussed. Current plans indicated that final selection of their proposed spacecraft configuration would be made by Convair/Astronautics within a week. The status of the spacecraft reentry studies was described by Avco specialists.  
 Memorandum, William W. Petynia, Convair Liaison Engineer, to Associate Director, STG, "Visit to Avco, Wilmington, Mass., on January 31 and February 1, 1961, Regarding Monitoring of Apollo Study Contract," February 13, 1961.
- During  
the  
Month**
- Marshall Space Flight Center awarded contracts to NAA and Ryan Aeronautical Corporation to investigate the feasibility of recovering the first stage (S-I) of the Saturn launch vehicle by using a Rogallo wing (paraglider).  
*Saturn Illustrated Chronology*, pp. 17–18.
- February**
- 7 The Manned Lunar Landing Task Group (Low Committee) transmitted its final report to NASA Associate Administrator Robert C. Seamans, Jr. The Group found that the manned lunar landing mission could be accomplished during the decade, using either the earth orbit rendezvous or direct ascent technique. Multiple launchings of Saturn C-2 launch vehicles would be necessary in the earth orbital mode, while the direct ascent technique would require the development of a Nova-class



1961  
February

vehicle. Information to be obtained through supporting unmanned lunar exploration programs, such as Ranger and Surveyor, was felt to be essential in carrying out the manned lunar mission. Total funding for the program was estimated at just under \$7 billion through Fiscal Year 1968.

Memorandum, George M. Low, Program Chief, Manned Space Flight, to Associate Administrator, "Transmittal of Report Prepared by Manned Lunar Working Group [Manned Lunar Landing Task Group]," February 7, 1961.

NASA selected the Instrumentation Laboratory of MIT for a six-month study of a navigation and guidance system for the Apollo spacecraft. 7

Information from the Apollo Procurement Branch, Procurement and Contracts Division, Manned Spacecraft Center, Houston, Tex., October 2, 1967.

A voice message was sent from Washington, D.C., to Woomera, Australia, by way of the moon. NASA Deputy Administrator Hugh L. Dryden spoke by telephone to Goldstone, Calif., which "bounced" it to the deep-space instrumentation station at Woomera. The operation was conducted as part of the official opening ceremony of the Australian facility. 10

*Aeronautical and Astronautical Events of 1961*, p. 6.

Rocketdyne Division's first static test of a prototype thrust chamber for the F-1 engine achieved a thrust of 1.550 million pounds in a few seconds at Edwards Air Force Base, Calif. 10

Rocketdyne *Skywriter*, February 17, 1961; *Washington Post*, February 11, 1961.

At the first meeting of the House Committee on Science and Astronautics, during the first session of the 87th Congress, Charles F. Ducander, Executive Director and Chief Counsel of the Committee staff, outlined a number of proposed subjects for study. One subject was the Air Force's interest in a three-man spacecraft similar to the Apollo spacecraft planned by NASA. A Committee staff member had been assigned to investigate this duplication of effort. On February 22, testifying before the Committee, Air Force Undersecretary Joseph V. Charyk stated that the Dyna-Soar program was a direct approach to manned military space applications. The Air Force interest in an Apollo-type spacecraft was part of the post-Dyna-Soar program, Charyk said. 10

U.S. Congress, House, Committee on Science and Astronautics, *Miscellaneous Committee Business*, 87th Congress, 1st Session (1961), p. 6; U.S. Congress, House, Committee on Science and Astronautics, *Research and Development for Defense*, 87th Congress, 1st Session (1961), p. 161.

*Mercury-Atlas 2* (unmanned) was launched successfully from the Atlantic Missile Range in a test of maximum heating and its effects during the worst reentry design conditions. All test objectives were met. 21

Grimwood, *Project Mercury: A Chronology*, p. 124.

A NASA inter-Center meeting on space rendezvous was held in Washington, D.C. Air Force and NASA programs were discussed and the status of current studies was 27-28



1961  
February

presented by NASA Centers. Members of the Langley Research Center outlined the basic concepts of the lunar orbit rendezvous method of accomplishing the lunar landing mission.

"Apollo Spacecraft Chronology," p. 6; Bird, "Short History of the Development of the Lunar Orbit Rendezvous Plan at the Langley Research Center," p. 3; *Manned Lunar-Landing through use of Lunar-Orbit Rendezvous*, p. 5.

March  
1

The current Saturn launch vehicle configurations were announced:

C-1: S-I stage (eight H-1 engines, 1.5 million pounds of thrust); S-IV stage (four LR-119 engines, 70,000 pounds of thrust); and S-V stage (two LR-119 engines, 35,000 pounds of thrust)

C-2 (four-stage version): S-I stage (same as first stage of the C-1); S-II (not determined); S-IV (same as second stage of the C-1); S-V (same as third stage of C-1)

C-2 (three-stage version): S-I (same as first stage of C-1); S-II (not determined); and S-IV (same as third stage of C-1).

Senate Staff Report, *Manned Space Flight Program*, p. 196.

1-3

The midterm review of the Apollo feasibility studies was held at STG. Oral status reports were made by officials of Convair/Astronautics Division of the General Dynamics Corporation on March 1, The Martin Company on March 2, and the General Electric Company on March 3. The reports described the work accomplished, problems unsolved, and future plans. Representatives of all NASA Centers attended the meetings, including a majority of the members of the Apollo Technical Liaison Groups. Members of these Groups formed the nucleus of the mid-term review groups which met during the three-day period and compiled lists of comments on the presentations for later discussions with the contractors.

Project Apollo, A Feasibility Study of an Advanced Manned Spacecraft and System, Comments on the Convair-Astronautics Company Midterm Presentation, March 1, 1961; Comments on The Martin Company Midterm Presentation, March 2, 1961; and Comments on the General Electric (Missile and Space Vehicle Division) Company Midterm Presentation, March 3, 1961.

7

The first flight model of the Saturn C-1 booster (SA-1) was installed on the static test stand for preflight checkout at the Marshall Space Flight Center.

*Saturn Illustrated Chronology*, p. 21.

9

The Soviet Union launched and recovered on the same day *Korabl Sputnik VI*, or *Sputnik IX*, in a test of spacecraft construction and systems and the influence of cosmic rays on living beings. The spacecraft carried a dog, guinea pigs, mice, and insects.

*New York Times*, March 10, 1961; *Baltimore Sun*, March 13, 1961; *Instruments and Spacecraft*, pp. 162-163.

20

Management personnel from NASA Headquarters and STG met to plan general requirements for a proposal for advanced manned spacecraft development.

"Apollo Spacecraft Chronology," p. 7.

Representatives of Marshall Space Flight Center recommended configuration changes for the Saturn C-1 launch vehicles to NASA Headquarters. These included:

- Elimination of third-stage development, since two stages could put more than ten tons into earth orbit
- Use of six LR-115 (15,000-pound) Centaur engines (second-stage thrust thus increased from 70,000 to 90,000 pounds)
- Redesign of the first stage (S-I) to offer more safety for manned missions.

Plans were also presented to accelerate the development of the Saturn C-2, and a recommendation was made that a prime contractor be selected to work on the second stage (S-II) of the C-2. NASA Headquarters approved the C-2 plans on March 31.

*Saturn Illustrated Chronology*, pp. 21-22; Senate Staff Report, *Manned Space Flight Program*, p. 196.

In an apparent duplication of the March 9 launch, the Soviet Union orbited and recovered *Korabl Sputnik VII*, or *Sputnik X*. The spacecraft, the third of its kind to be recovered safely by the Russians, carried a dog and other animals.

Baltimore *Sun*, March 26, 1961; *Instruments and Spacecraft*, p. 164.

President John F. Kennedy submitted to Congress an amended budget request for NASA which totaled \$1,235,300,000. This total was \$125,670,000 greater than the Eisenhower Administration's request. The increase included \$56 million for Saturn research and development and \$11 million for the extension of Cape Canaveral facilities.

Senate Staff Report, *Manned Space Flight Program*, p. 197.

William W. Petynia of STG visited the Convair/Astronautics Division of General Dynamics Corporation to monitor the Apollo feasibility study contract. A selection of the M-1 in preference to the lenticular configuration had been made by Convair. May 17 was set as the date for the final Convair presentation to NASA.

Memorandum, Petynia, Convair Liaison Engineer, to Associate Director, STG, "Visit to Convair Astronautics on March 29-30, 1961, Regarding Monitoring of the Apollo Study Contract," April 5, 1961.

The Space Science Board of the National Academy of Sciences submitted to President John F. Kennedy its recommendation that "scientific exploration of the moon and planets should be clearly stated as the ultimate objective of the U.S. space program for the foreseeable future." While stressing the importance of the scientific goals of the program, the Board also emphasized other factors such as "the sense of national leadership emergent from bold and imaginative U.S. space activity." The recommendations of the Board had been adopted at a meeting on February 10-11 and were made public on August 7.

Space Science Board, "Man's Role in the National Space Program," August 7, 1961.

1961  
March  
23

25

28

29-30

31



- 1961** The Marshall Space Flight Center announced that 1.640 million pounds of thrust was achieved in a static-firing of the F-1 engine thrust chamber at Edwards Air Force Base, Calif. This was a record thrust for a single chamber.
- April 6** Baltimore *Sun*, April 12, 1961; Rocketdyne *Skywriter*, April 14, 1961.
- 10** A joint meeting of the Apollo Technical Liaison Groups was held at STG. NASA Headquarters and STG representatives briefed members of the Groups on the status of the Apollo program. The individual Liaison Groups were asked to re-examine the Apollo guidelines in the light of NASA and contractor studies conducted during the past year and to help gather detailed technical information for use as background material in the preparation of the Apollo spacecraft specification.
- Minutes of meeting of Apollo Technical Liaison Group, Configurations and Aerodynamics, April 10-12, 1961.
- 10-12** At the second meeting of the Apollo Technical Liaison Group for Configurations and Aerodynamics at STG, presentations were made on Apollo-related activities at the NASA Centers: heatshield tests (Ames Research Center); reentry configurations (Marshall Space Flight Center); reentry configurations, especially lenticular (modified) and spherically blunted, paraglider soft-landing system, dynamic stability tests, and heat transfer tests (Langley Research Center); tumbling entries in planetary atmospheres (Mars and Venus) (Jet Propulsion Laboratory); air launch technique for Dyna-Soar (Flight Research Center); and steerable parachute system and reentry spacecraft configuration (STG). Work began on the background material for the Apollo spacecraft specification.
- Minutes of meeting of Apollo Technical Liaison Group, Configurations and Aerodynamics, April 10-12, 1961.
- 10-12** The Apollo Technical Liaison Group for Heating heard reports at STG by Group members on current studies at the NASA Centers. Recommendations concerning the spacecraft specification included:
- The contractor should present the design philosophy and criteria to be used for the heat protection system and discuss the interplay of thermal and structural design criteria.
  - The details of the analysis should be presented: for example, the methods used in calculating the various modes of the heating load; the listing of the material properties and ablation effectiveness of heatshields; and the listing, in terms of temperature or extra heat protection weight, of the safety factors that had been used.
- Minutes of meeting of Apollo Technical Liaison Group, Heating, April 10-12, 1961.
- 10-12** At STG the Apollo Technical Liaison Group for Human Factors discussed the proposed outline for the spacecraft specification. Its recommendations included:
- NASA Headquarters Offices should contact appropriate committees and other representatives of the scientific community to elicit recommendations for scientific experiments aboard the orbiting laboratory to be designed as a mission module for use with the Apollo spacecraft.



- NASA should sponsor a conference of recognized scientists to suggest a realistic radiation dosage design limit for Apollo crews.

1961

April

Minutes of meeting of Apollo Technical Liaison Group, Human Factors, April 10, 11, and 12, 1961.

The Apollo Technical Liaison Group for Instrumentation and Communications met at STG and drafted an informal set of guidelines and sent them to the other Technical Liaison Groups:

10-12

- Instrumentation requirements: all Groups should submit their requests for measurements to be made on the Apollo missions, including orbital, circumlunar, and lunar landing operations.

- Television: since full-rate, high-quality television for the missions would add a communications load that could swamp all others and add power and bandwidth requirements not otherwise needed, other Groups should restate their justification for television requirements.

- Temperature environment: heat normally pumped overboard might be made available for temperature control systems without excessive cost and complexity.

- Reentry communications: continuous reentry communications were not yet feasible and could not be guaranteed. It was suggested that all Groups plan their systems as though no communications would exist at altitudes between about 250,000 feet and 90,000 feet.

- Vehicle reentry and recovery: if tracking during reentry were desired, it would be far more economical to use a water landing site along the Atlantic Missile Range or another East Coast site.

- Digital computer: the onboard digital computer, if it were flexible enough, would permit the examination of telemetry data for bandwidth reduction before transmission.

- Antenna-pointing information: the spacecraft should have information relative to its orientation so that any high-gain directive antenna could be positioned toward the desired location on earth.

The Group then discussed the preparation of material for the Apollo spacecraft specification.

Minutes of meeting of Apollo Technical Liaison Group, Instrumentation and Communications, April 10, 11, and 12, 1961.

The Apollo Technical Liaison Group for Onboard Propulsion met at STG and considered preparation of background material for the Apollo spacecraft specification. It agreed that there were several problem areas for study before onboard propulsion final specifications could be drafted: cryogenic propellant storage problems, booster explosion hazards and assessment thereof, spacecraft system abort modes, propulsion system temperature control, propellant leakage, ignition in a confined space, zero suction pump proposals for cryogenic liquid bipropellant main engine systems, and propellant utilization and measurement system.

10-12

Minutes of meeting of Apollo Technical Liaison Group, Onboard Propulsion, April 10-12, 1961.

- 1961**  
**April**  
**10-12**
- The Apollo Technical Liaison Group for Structures and Materials discussed at STG the preparation of material for the Apollo spacecraft specification. It decided that most of the items proposed for its study could not be specified at that time and also that many of the items did not fall within the structures and materials area. A number of general areas of concern were added to the work plan: heat protection, meteoroid protection, radiation effects, and vibration and acoustics.
- Minutes of meeting of Apollo Technical Liaison Group, Structures and Materials, April 10-12, 1961.
- 10-12**
- The Apollo Technical Liaison Group for Trajectory Analysis met at STG and began preparing material for the Apollo spacecraft specification. It recommended:
- STG should take the initiative with NASA Headquarters in delegating responsibility for setting up and updating a uniform model of astronomical constants.
  - The name of the Group should be changed to Mission Analysis to help clarify its purpose.
  - A panel should be set up to determine the scientific experiments which could be done on board, or in conjunction with the orbiting laboratory, so that equipment, weight, volumes, laboratory characteristics, etc., might be specified.
- Minutes of meeting of Apollo Technical Liaison Group, Trajectory Analysis, April 10-12, 1961.
- 10-13**
- In preparing background material for the Apollo spacecraft specification at STG, the Apollo Technical Liaison Group for Mechanical Systems worked on environmental control systems, reaction control systems, auxiliary power supplies, landing and recovery systems, and space cabin sealing.
- Minutes of meeting of Apollo Technical Liaison Group, Trajectory Analysis, April 10-13, 1961.
- 10-14**
- Meeting at STG, the Guidance and Control Group changed its name to the "Apollo Technical Liaison Group for Navigation, Guidance, and Control." Definitions were established for "navigation" (the determination of position and velocity), "guidance" (velocity vector control), and "control" (control of rotational orientation about the center of gravity—i.e., attitude control). Work was started on the preparation of the navigation, guidance, and control specifications for the Apollo spacecraft.
- Minutes of meeting of Apollo Technical Liaison Group, Navigation, Guidance, and Control, April 10-14, 1961.
- 12**
- NASA Associate Administrator Robert C. Seamans, Jr., established the permanent Saturn Program Requirements Committee. Members were William A. Fleming, Chairman; John L. Sloop, Deputy Chairman; Richard B. Canright; John H. Disher; Eldon W. Hall; A. M. Mayo; and Addison M. Rothrock, all of NASA Headquarters. The Committee would review on a continuing basis the mission



planning for the utilization of the Saturn and correlate such planning with the Saturn development and procurement plans.

1961

April

Memorandum, Seamans to Program Directors, "Establishment of Saturn Program Requirements Committee," April 12, 1961.

The Soviet Union launched into orbit the five-ton *Vostok I*, with Yuri A. Gagarin as pilot, the first man to make a successful orbital space flight. The payload included life-support equipment and radio and television to relay information on the condition of the pilot. The spacecraft apogee was 187.8 miles, the perigee was 109.5 miles, inclination 65.07°, and the orbital period 89.1 minutes. After a 108-minute, one-orbit flight, the capsule and pilot reentered and landed safely in the Soviet Union.

12

*New York Times*, April 13, 1961; *Instruments and Spacecraft*, p. 170.

President John F. Kennedy, in his regular press conference, stated that "no one is more tired than I am" of seeing the United States second to Russia in space. "They secured large boosters which have led to their being first in Sputnik, and led to their first putting their man in space. We are, I hope, going to be able to carry out our efforts, with due regard to the problem of the life of the men involved, this year. But we are behind . . . the news will be worse before it is better, and it will be some time before we catch up . . ."

12

*Washington Post*, April 13, 1961.

Under questioning by the House Committee on Science and Astronautics, NASA Associate Administrator Robert C. Seamans, Jr., stated that a landing on the moon in 1967 might be possible through an all-out crash program at a cost of \$4 to \$5 billion a year instead of the current budget of \$1.236 billion.

14

*Washington Post*, April 15, 1961.

A circular, "Manned Lunar Landing via Rendezvous," was prepared by John C. Houbolt from material supplied by himself, John D. Bird, Max C. Kurbjun, and Arthur W. Vogeley, who were members of the Langley Research Center space station subcommittee on rendezvous. Other members of the subcommittee at various times included W. Hewitt Phillips, John M. Eggleston, John A. Dodgen, and William D. Mace.

19

Bird, "Short History of the Development of the Lunar Orbit Rendezvous Plan at Langley Research Center," p. 3.

John C. Houbolt and members of the Langley Research Center subcommittee on rendezvous outlined the objectives of a rendezvous program that would lead ultimately to a manned lunar landing: (1) establish manned and unmanned orbital operations, (2) establish techniques for accomplishing space missions through the orbital assembly of units. Three key projects were described which would accomplish these objectives. The first was MORAD (Manned Orbital Rendezvous and Docking), which would require the use of the Mercury-Atlas and

19



1961

April

Scout in the 1961–1963 period. Rendezvous in space between the Mercury spacecraft and Scout payload would establish confidence in manned rendezvous techniques and lead to simplification of equipment and increased reliability. The second key project was ARP (Apollo Rendezvous Phases), in which the Atlas, Agena, and Saturn boosters would be used in the 1962–1965 period. This program would accomplish rendezvous with space stations, personnel transfer, resupply of space laboratory, execution of space maneuvers after coupling (steps toward lunar landing), and development of specifications for subsequent orbital and moon missions. The third project was called MALLIR (Manned Lunar Landing Involving Rendezvous), in which Saturn and Apollo components would be used during the 1961–1967 period. After qualification of the Saturn components for rendezvous operations, an early manned lunar landing would take place.

Langley Research Center, "Manned Lunar Landing via Rendezvous," April 19, 1961.

19

The booster requirements for Project MALLIR (Manned Lunar Landing Involving Rendezvous) would be satisfied by use of the Saturn C-2 as the basic launch vehicle. The number of boosters needed to achieve a lunar landing would be substantially reduced by using a combination of earth orbit and lunar orbit rendezvous. In a Project MALLIR configuration, two Saturn C-2's would be required. The first would launch the command module, lunar lander, and propulsion unit for lunar braking. The second would launch a booster which would rendezvous in earth orbit with the spacecraft. This booster would be jettisoned after launching the configuration into a lunar trajectory. After reaching lunar orbit, the lunar lander would separate from the command module and descend to the lunar surface. One man would remain behind in the command module orbiting the moon. After a brief lunar stay, the two men would ascend in the lunar lander and rendezvous with the command module. The command module would then boost to return trajectory, leaving behind the lunar lander, and reenter after jettisoning the propulsion unit. The command module was estimated to weigh 11,000 pounds, and the lunar lander 11,000 pounds.

"Manned Lunar Landing via Rendezvous."

19

Recommendations on immediate steps to be taken so that the three key projects—MORAD (Manned Orbital Rendezvous and Docking), ARP (Apollo Rendezvous Phases), and MALLIR (Manned Lunar Landing Involving Rendezvous)—could get under way were:

- Approve the MORAD project and let a study contract to consider general aspects of the Scout rendezvous vehicle design, definite planning and schedules, and tie down cost estimates more exactly.
- Delegate responsibility to STG to give accelerated consideration to rendezvous aspects of Apollo, tailoring developments to fit directly into the MALLIR project.
- Let a study contract to establish preliminary design, scheduling, and cost figures for the three projects.

"Manned Lunar Landing via Rendezvous."

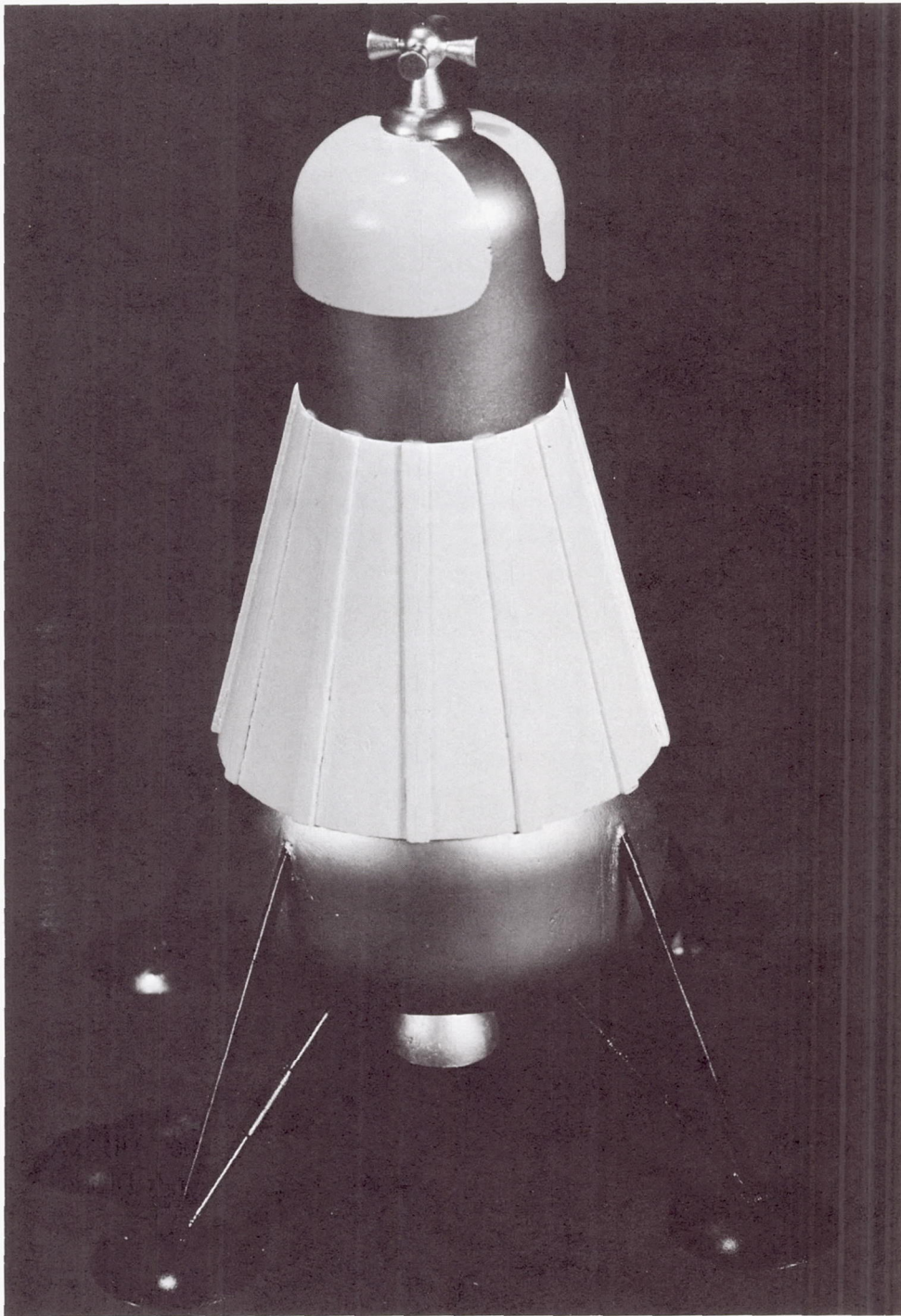

An early lunar excursion model was proposed by personnel of Langley Research Center as the lunar lander for the suggested Project MALLIR.



1961

April

20

A conference was held at NASA Headquarters on the relationship between the Prospector and Apollo programs. Representatives of the Jet Propulsion Laboratory (JPL) and STG discussed the possible redirection of Prospector planning to support more directly the manned space program. The Prospector spacecraft was intended to soft-land about 2500 pounds on the lunar surface with an accuracy of  $\pm 1$  kilometer anywhere on the visible side of the moon. An essential feature of Prospector was the development of an automatic roving vehicle weighing about 1500 pounds which would permit detailed reconnaissance of the lunar surface over a wide area. STG representatives felt that the most useful feature of the Prospector program lay in its planned ability to soft-land cargo in close proximity to a desired site. Many applications could be foreseen, such as the deposit of landing aids and essential material in support of a manned lunar landing or in continuing support for a manned lunar expedition. However, the Prospector roving vehicle seemed to be a much more complicated and heavier piece of hardware than a manned lunar transport and, for that reason, STG did not support its development. The planning for Prospector involved JPL in-house studies concerning closer integration with manned space flight requirements, definitive decisions on the program within several months, a contractor's study in Fiscal Year 1962, engineering design in Fiscal Year 1963, and a hardware contract at a future date. Future Prospector planning would emphasize its cargo-carrying ability as a prime requirement, JPL representatives stated.

Memorandum, H. Kurt Strass, Apollo Project Office, to Associate Director, STG, "Conference at NASA Headquarters Concerning Relationship Between the Prospector and Apollo Programs, April 20, 1961," May 1, 1961.

25

Mercury-Atlas 3 (MA-3) was launched from the Atlantic Missile Range, carrying a "mechanical astronaut" in an intended unmanned orbital flight. Forty seconds after liftoff, MA-3 was destroyed by the range safety officer because the inertial guidance system had failed to pitch the vehicle over toward the horizon. The spacecraft successfully aborted and was recovered a short distance off shore.

Swenson *et al.*, *This New Ocean*, pp. 335-337.

25

A conference was held at Lewis Research Center between STG and Lewis representatives to discuss the research and development contract for the liquid-hydrogen—liquid-oxygen fuel cell as the primary spacecraft electrical power source. Lewis had been provided funds (approximately \$300,000) by NASA Headquarters to negotiate a contract with Pratt & Whitney Aircraft Division of United Aircraft Corporation for the development of a fuel cell for the Apollo spacecraft. STG and Lewis representatives agreed that the research and development should be directed toward the liquid-hydrogen—liquid-oxygen fuel cell. Guidelines were provided by STG:

- Power output requirement for the Apollo spacecraft was estimated at two to three kilowatts.
- Nominal output voltage should be about 27.5 volts.
- Regulation should be within  $\pm 10$  percent of nominal output voltage.



- The fuel cell should be capable of sustained operation at reduced output (10 percent of rated capacity, if possible).
- The fuel cell and associated system should be capable of operation in a space environment.

Lewis planned to request a pilot model of the fuel cell of about 250 watts capacity, capable of unattended operation. Contract negotiations were expected to be completed by May 2 and the model delivered within 12 months of the contract award.

Memorandum, Preston T. Maxwell, Aeronautical Research Engineer, to Associate Director (Research and Development), STG, "Conference with Lewis Research Center Personnel to Discuss R and D Contract for H<sub>2</sub>-O<sub>2</sub> Fuel Cell," April 27, 1961.

*Little Joe 5B* was launched from Wallops Island, carrying a production Mercury spacecraft. In spite of an erroneous trajectory which subjected the capsule to much greater dynamic pressures than planned, the spacecraft and escape system performed successfully.

Swenson *et al.*, *This New Ocean*, pp. 337-338.

The first successful flight qualification test of the Saturn SA-1 booster took place in an eight-engine test lasting 30 seconds.

*Saturn Illustrated Chronology*, p. 24.

The Douglas Aircraft Company reported that air transport of the Saturn C-1 second stage (S-IV) was feasible.

*Saturn Illustrated Chronology*, p. 22.

Anticipating the expanded scope of manned space flight programs, STG proposed a manned spacecraft development center. The nucleus for a center existed in STG, which was handling the Mercury project. A program of much greater magnitude would require a substantial expansion of staff and facilities and of organization and management controls.

STG Study, "Manned Spacecraft Development Center, Organizational Concepts and Staffing Requirements," May 1, 1961.

NASA Associate Administrator Robert C. Seamans, Jr., established the Ad Hoc Task Group for a Manned Lunar Landing Study, to be chaired by William A. Fleming of NASA Headquarters. The study was expected to produce the following information:

- All tasks associated with the mission
- Interdependent time-phasing of the tasks
- Areas requiring considerable technological advancements from the current state of the art
- Tasks for which multiple approach solutions were advisable
- Important action and decision points in the mission plan
- A refined estimate by task and by fiscal year of the dollar resources required for the mission

1961

April

28

29

During  
the  
Month

May

1

2



- Nuclear-powered launch vehicles should not be considered for use in the first manned lunar landing mission.

1961

May

- The flight test program should be laid out with enough launchings to meet the needs of the program considering the reliability requirements.

- Alternative approaches should be provided in critical areas—e.g., upper stages and mission modes.

Memorandum, Seamans to Directors, Office of Space Flight Programs, Office of Launch Vehicle Programs, Office of Advanced Research Programs, and Office of Life Sciences Programs, "Establishment of Ad Hoc Task Group for Manned Lunar Landing Study," May 2, 1961.

STG completed the first draft of "Project Apollo, Phase A, General Requirements for a Proposal for a Manned Space Vehicle and System" [Statement of Work], an early step toward the spacecraft specification. A circumlunar mission was the basis for planning.

5

"Apollo Spacecraft Chronology," p. 8.

In the first American manned space flight, *Freedom 7*, piloted by Astronaut Alan B. Shepard, Jr., was launched successfully from the Atlantic Missile Range. The Redstone rocket boosted the Mercury capsule to 116.5 miles and a maximum speed of 5180 miles per hour. After a flight of 15 minutes and 22 seconds, the landing was made 302 miles downrange from the launch site. Recovery operations were perfect; there was no damage to the spacecraft; and Astronaut Shepard was in excellent condition.

5

Grimwood, *Project Mercury: A Chronology*, p. 137.

Albert C. Hall of The Martin Company proposed to Robert C. Seamans, Jr., NASA's Associate Administrator, that the Titan II be considered as a launch vehicle in the lunar landing program. Although skeptical, Seamans arranged for a more formal presentation the next day. Abe Silverstein, NASA's Director of Space Flight Programs, was sufficiently impressed to ask Director Robert R. Gilruth and STG to study the possible uses of Titan II. Silverstein shortly informed Seamans of the possibility of using the Titan II to launch a scaled-up Mercury spacecraft.

7

Interview with Seamans, Washington, D.C., May 26, 1966.

After study and discussion by STG and Marshall Space Flight Center officials, STG concluded that the current 154-inch diameter of the second stage (S-IV) adapter for the Apollo spacecraft would be satisfactory for the Apollo missions on Saturn flights SA-7, SA-8, SA-9, and SA-10.

8

Letter, Robert R. Gilruth, Director, STG, to Marshall Space Flight Center, Attn: W. M. von Braun, Director, "S-IV Adapter and C-1 Two-Stage Report," May 8, 1961.

The final reports on the feasibility study contracts for the advanced manned spacecraft were submitted to STG at Langley Field, Va., by the General Electric

15-17



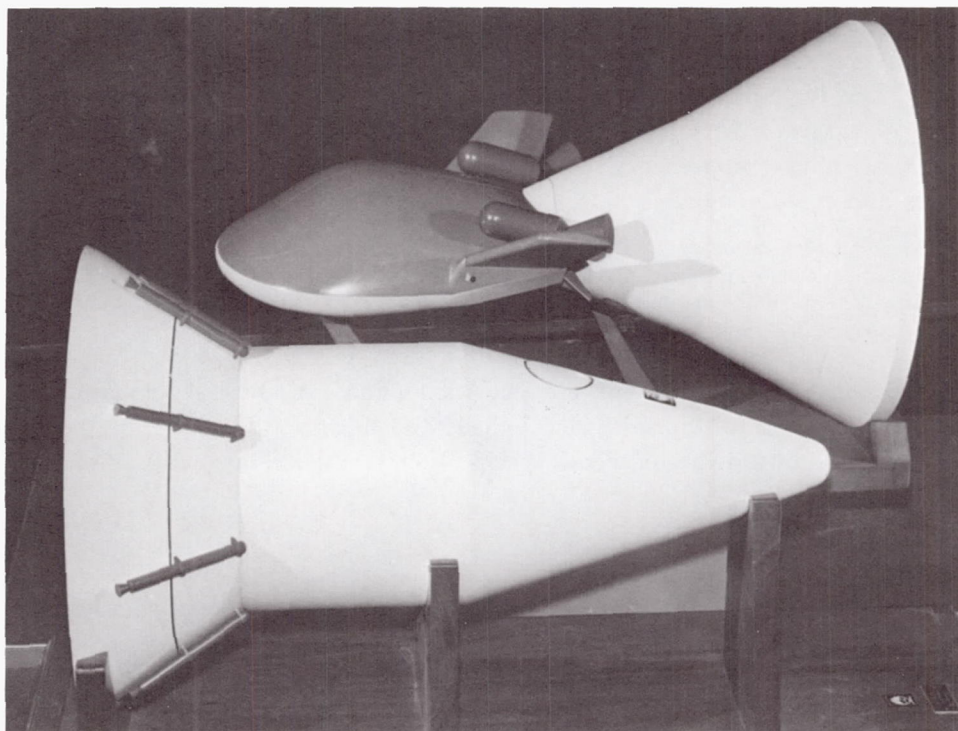

Models of two spacecraft concepts for Apollo. The designs, a semiballistic reentry vehicle and a winged glide-type spacecraft, resulted from the Project Apollo G.E. feasibility study in late 1960 and early 1961. (G.E. photo)

**1961**  
**May**

Company, Convair/Astronautics Division of General Dynamics Corporation, and The Martin Company. These studies had begun in November 1960.

*Aeronautical and Astronautical Events of 1961*, pp. 20, 23; "Apollo Spacecraft Chronology," p. 9.

**22**

The second draft of a Statement of Work for the development of an advanced manned spacecraft was completed, incorporating results from NASA in-house and contractor feasibility studies.

"Apollo Spacecraft Chronology," p. 9.

**25**

In a special message to Congress on urgent national needs, President John F. Kennedy called for new, long-range goals for the space program: "Now it is time to take longer strides—time for a great new American enterprise—time for this nation to take a clearly leading role in space achievement, which in many ways may hold the key to our future on earth. . . . I believe that this nation should commit itself to achieving the goal, before this decade is out, of landing a man on the moon and returning him safely to the earth. No single space project in this period will be more impressive to mankind, or more important for the long-range exploration of space; and none will be so difficult or expensive to accomplish . . .

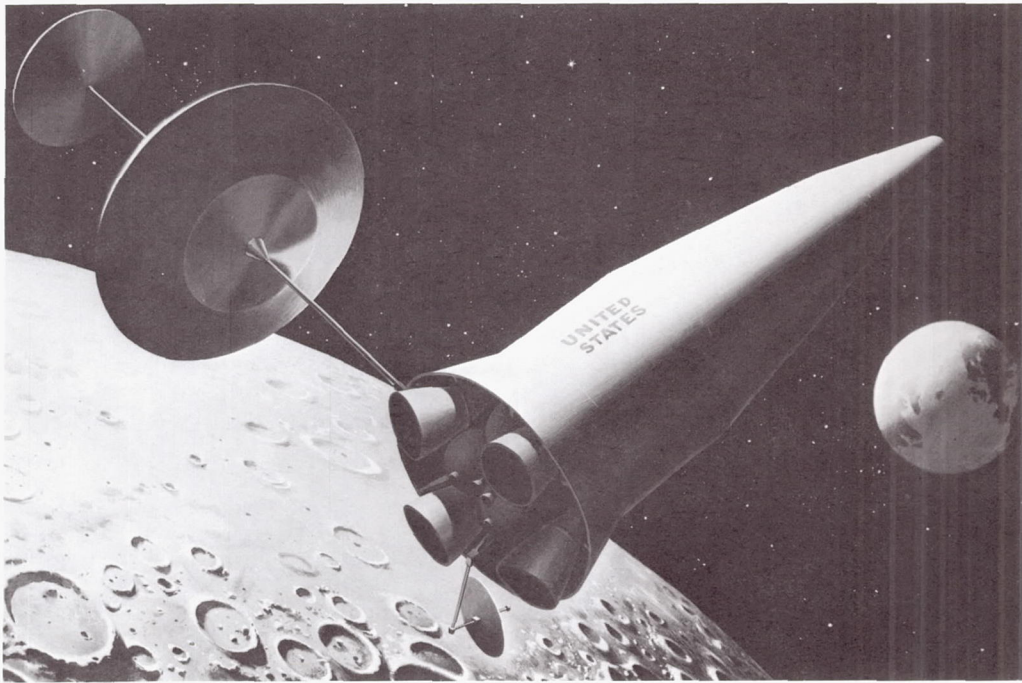
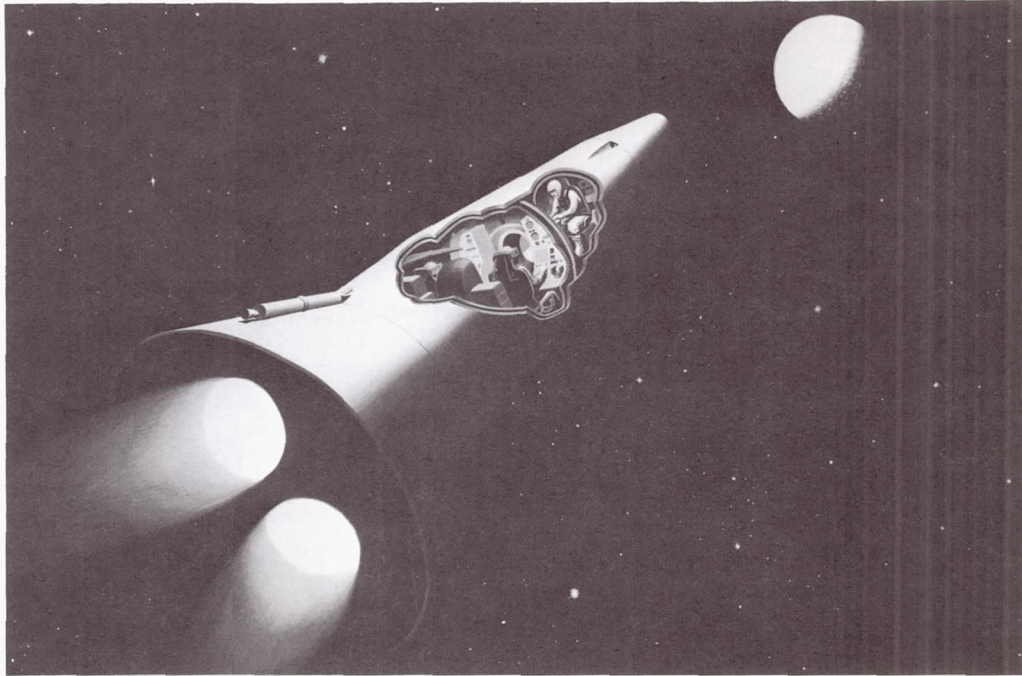

An artist's concepts of a spacecraft on a Project Apollo lunar mission. The spacecraft design was the concept of G.E.'s Missile and Space Vehicle Department, which conducted a feasibility study for NASA during late 1960 and early 1961. (G.E. photo)

## D-2 CONFIGURATION

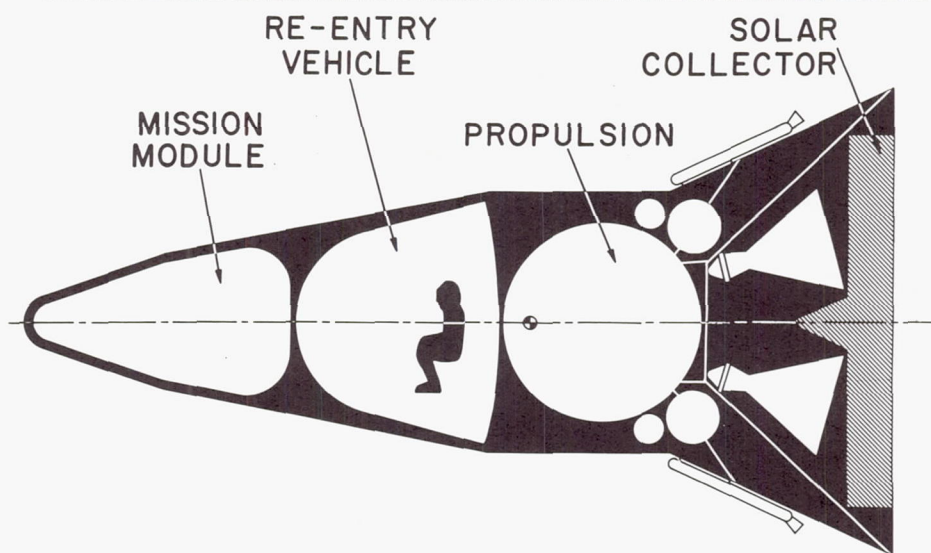

A cross-section drawing of the vehicle (D-2) recommended by General Electric's Missile and Space Vehicle Department for the Apollo program during the Apollo feasibility study, completed in May 1961. (G.E. illustration)

## MISSION SEQUENCE TO EARTH

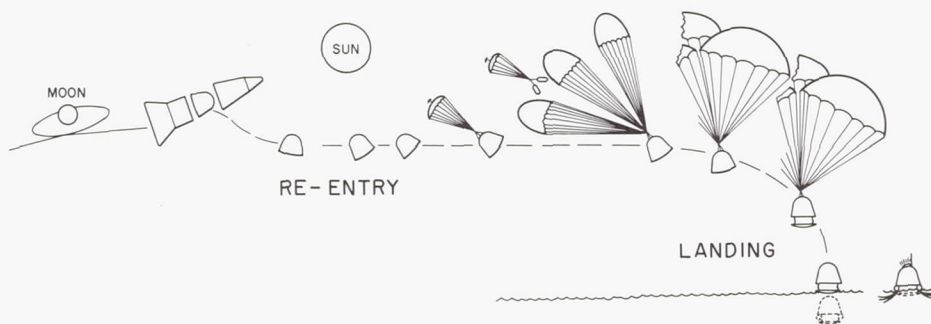

A mission sequence to earth landing, developed by G.E. during its Project Apollo feasibility study, including the planned configuration through the lunar-earth trajectory, reentry, and landing. (G.E. illustration)



TO THE MOON WITH C-1's OR BUST

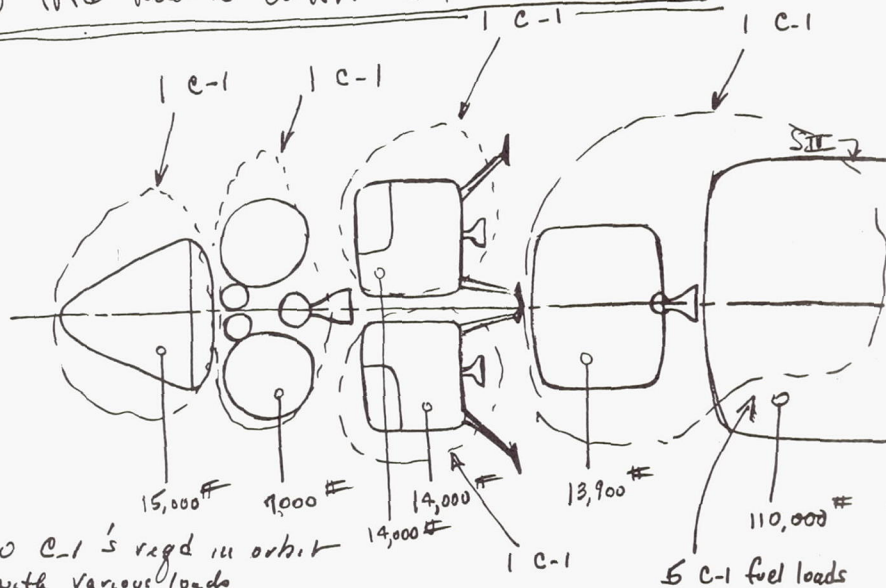

10 C-1's req'd in orbit  
with various loads

4 Modular connections  
5 refueling operations

5/22/61

“TO THE MOON WITH C-1’s OR BUST” was the theme of the day at Langley Research Center May 22, 1961. The sketch by John D. Bird on that day portrays the means of completing the lunar mission by launching ten C-1’s.

in a very real sense, it will not be one man going to the moon—if we make this judgment affirmatively, it will be an entire nation. For all of us must work to put him there.” The President also called for the early development of the Rover nuclear rocket, the acceleration of the use of space satellites for worldwide communications, and the development of a weather satellite system. For these and associated projects in space technology, the President requested additional appropriations totaling \$611 million for NASA and DOD for Fiscal Year 1962.

U.S. Congress, Senate, Committee on Aeronautical and Space Sciences, *Documents on International Aspects of the Exploration and Use of Outer Space, 1954-1962*, Staff Report, 88th Congress, 1st Session (1963), pp. 202, 203.

Robert C. Seamans, Jr., NASA’s Associate Administrator, requested the Directors of the Office of Launch Vehicle Programs and the Office of Advanced Research Programs to bring together members of their staffs with other persons from NASA Headquarters to assess a wide variety of possible ways of accomplishing the lunar landing mission. This study was to supplement the one being done by the Ad Hoc Task Group for Manned Lunar Landing Study (Fleming Committee) but was to

1961  
May

25

1961  
May

be separate from it. Bruce T. Lundin was appointed Chairman of the study group (Lundin Committee). The following guidelines were suggested:

- All possible approaches for accomplishing the manned lunar landing mission in the 1967–1970 period should be considered.
- Primary emphasis should be placed on the launch vehicle portion of the system: vehicle size and type, the use of rendezvous, etc.
- Nuclear-powered launch vehicles should not be considered for use in the early manned lunar landing missions.
- Advantages, disadvantages, and problems associated with each technique should be indicated and, based on these, a relative rating of the various methods should be established.
- The time phasing and a rough order of magnitude cost should be indicated for each method considered.
- The study should be completed at about the same time as the one under way by the Ad Hoc Task Group on Manned Lunar Landing Study.

Lunar lander sizes under study in May 1962 as various groups were making determinations on the best way to achieve the lunar landing goal.

## COMPARISON OF LANDER SIZES

### DIRECT LANDING

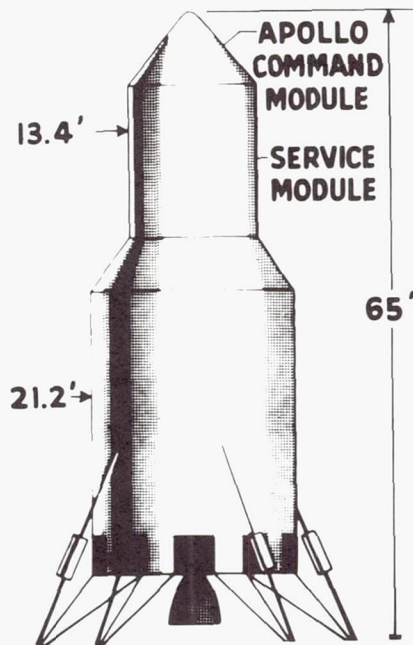

### LUNAR FERRY OF LUNAR RENDEZVOUS

### LUNAR EXCURSION VEHICLE

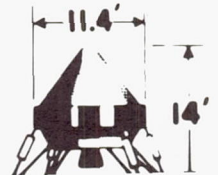

The Lundin Committee report was submitted June 10.

1961

Memorandum, Associate Administrator to Directors, Launch Vehicle Programs and Advanced Research Programs, "Broad Study of Feasible Ways for Accomplishing Manned Lunar Landing Mission," May 25, 1961; Rosholt, *An Administrative History of NASA, 1958-1963*, p. 213.

May

STG submitted to NASA Headquarters recommendations on crew selection and training:

31

- There would be no need to select crews within the next 12 months. Pilots could be chosen as required from the astronaut group, permitting the prospective crewmen to be active in test flying until assigned to Apollo missions.

- Based on extrapolations from the Mercury program, STG expected that 12 months would be ample time for specialized training before a flight.

- A maximum of 18 astronauts in 1965 would be needed to fulfill the requirements of the flight schedule.

- All crew members would be experienced flight personnel; special engineering or scientific capabilities would be provided through crew indoctrination.

Letter, Robert R. Gilruth, Director, STG, to NASA Headquarters, Attn: Abe Silverstein, "Apollo Crew Selection and Training," May 31, 1961.

The Marshall Space Flight Center began reevaluation of the Saturn C-2 configuration capability to support circumlunar missions. Results showed that a Saturn vehicle of even greater performance would be desirable.

During  
the  
Month

*Saturn Illustrated Chronology*, p. 26.

Basic concepts of the lunar orbit rendezvous plan were presented to the Lundin Committee by John C. Houbolt of Langley Research Center.

During  
the  
Month

Bird, "Short History of the Development of the Lunar Orbit Rendezvous Plan at the Langley Research Center," p. 3.

NASA announced a change in the Saturn C-1 vehicle configuration. The first ten research and development flights would have two stages, instead of three, because of the changed second stage (S-IV) and, starting with the seventh flight vehicle, increased propellant capacity in the first stage (S-I) booster.

June  
1

Senate Staff Report, *Manned Space Flight Program*, p. 199.

A meeting to discuss Project Apollo plans and programs was held at NASA Headquarters. Abe Silverstein, Warren J. North, John H. Disher, and George M. Low of NASA Headquarters and Robert R. Gilruth, Walter C. Williams, Maxime A. Faget, James A. Chamberlin, and Robert O. Piland of STG participated in the discussions. Six prime contract areas were defined: spacecraft (command center), onboard propulsion, lunar landing propulsion, launch vehicle (probably several prime contracts), tracking and communications network, and launch facilities and equipment. The prime contractor for the spacecraft would be responsible for the design, engineering, and fabrication of the spacecraft; for the integration of the onboard and lunar landing propulsion systems; and for the integration of the entire

2



1961

June

spacecraft system with the launch vehicle. In connection with the prime contract, STG would:

- Define details for specifications and justify choices
- Prepare a "scope of work" statement for release to industry by July 1
- Prepare spacecraft specifications for release by August 1
- Set up a contract evaluation team, qualified to evaluate the technical, management, design, engineering, and fabrication capabilities of the bidders.

In connection with other projects directly relating to the Apollo program, STG was to:

- Forward to Marshall Space Flight Center, via the Office of Space Flight Programs, the spacecraft systems part of a preliminary development plan for Saturn reentry tests
  - Make recommendations on an advanced version of the Mercury capsule
  - Designate a liaison member for the Lunar Sciences Subcommittee of the Space Sciences Steering Committee.

The Office of Space Flight Programs would arrange a meeting with the Office of Advanced Research Programs, STG, and Langley Research Center on the Atlas-Agena reentry tests and with the Office of Advanced Research Programs, Office of Life Sciences Programs, STG, and Ames Research Center on the biomedical flight program.

Memorandum, Low, Assistant Director for Manned Space Flight Programs, to Director of Space Flight Programs, "Report of Meeting with Space Task Group on June 2, 1961," June 6, 1961.

- 5 The Flight Vehicles Integration Branch was organized within STG. Members included H. Kurt Strass, Robert L. O'Neal, and Charles H. Wilson. Maxime A. Faget, Chief, Flight Systems Division, also served as temporary Branch Chief. The Branch was to provide technical aid to STG in solving compatibility requirements for spacecraft and launch vehicles for manned flight missions.

Memorandum, Faget to Staff, STG, "Change in Organization of Flight Systems Division," June 5, 1961.

- 5 Saturn Launch Complex 34 at Cape Canaveral, Fla., was dedicated in a brief ceremony by NASA. The giant gantry, 310 feet high and weighing 2800 tons, was the largest movable land structure in North America.

*Aeronautical and Astronautical Events of 1961*, p. 25.

- 7 A preliminary study of a fin-stabilized solid-fuel rocket booster, the Little Joe Senior, was completed by members of STG. The booster would be capable of propelling a full-size Apollo reentry spacecraft to velocities sufficient to match critical portions of the Saturn trajectory. The purpose was to provide a simple and fairly inexpensive means of determining, from flight tests, full-scale configuration concepts, systems hardware performance, and vehicle structural integrity. Of particular importance would be the flight testing of the Apollo spacecraft

escape system under simulated maximum conditions. (On April 6, 1962, NASA submitted a Request for Proposal to bidders on the Little Joe Senior, by that time renamed Little Joe II.)

1961

June

NASA Project Apollo Working Paper No. 1020, "A Preliminary Study of a Fin-Stabilized Solid-Fuel Rocket Booster for Use with the Apollo Spacecraft," June 7, 1961.

The Lundin Committee completed its study of various vehicle systems for the manned lunar landing mission, as requested on May 25 by NASA Associate Administrator Robert C. Seamans, Jr. The Committee had considered alternative methods of rendezvous: earth orbit, lunar orbit, a combination of earth and lunar orbit, and lunar surface. Launch vehicles studied were the Saturn C-2 and C-3. The concept of a low-altitude earth orbit rendezvous using two or three C-3's was clearly preferred by the Committee. Reasons for this preference were the small number of launches and orbital operations required and the fact that the Saturn C-3 was considered to be an efficient launch vehicle of great utility and future growth.

10

Lundin Committee, "A Survey of Various Vehicle Systems for the Manned Lunar Landing Mission," June 10, 1961.

The Fleming Committee, which had been appointed on May 2, submitted its report to NASA Associate Administrator Robert C. Seamans, Jr., on the feasibility of a manned lunar landing program. The Committee concluded that the lunar mission could be accomplished within the decade. Chief pacing items were the first stage of the launch vehicle and the facilities for testing and launching the booster. It also concluded that information on solar flare radiation and lunar surface characteristics should be obtained as soon as possible, since these factors would influence spacecraft design. Special mention was made of the need for a strong management organization.

16

Ad Hoc Task Group, *A Feasible Approach for an Early Manned Lunar Landing*, Part I, "Summary Report of Ad Hoc Task Group Study," June 16, 1961, pp. 95-96.

Robert C. Seamans, Jr., NASA Associate Administrator, notified the Directors of Launch Vehicle Programs, Space Flight Programs, Advanced Research Programs, and Life Sciences Programs that Donald H. Heaton had been appointed Chairman of an Ad Hoc Task Group. It would establish program plans and supporting resources necessary to accomplish the manned lunar landing mission by the use of rendezvous techniques, using the Saturn C-3 launch vehicle, with a target date of 1967. Guidelines and operating methods were similar to those of the Fleming Committee. Members of the Task Group would be appointed from the Offices of Launch Vehicle Programs, Space Flight Programs, Advanced Research Programs, and Life Sciences Programs. The work of the Group (Heaton Committee) would be reviewed weekly. The study was completed during August.

20

Memorandum, Seamans to Director, Launch Vehicle Programs, Director, Space Flight Programs, Director, Advanced Research Programs, and Acting Director, Life Sciences Programs, "Establishment of Ad Hoc Task Group for Manned Lunar Landing by Rendezvous Technique," June 20, 1961.



# LUNAR-LANDING MODULE LANDING TECHNIQUES

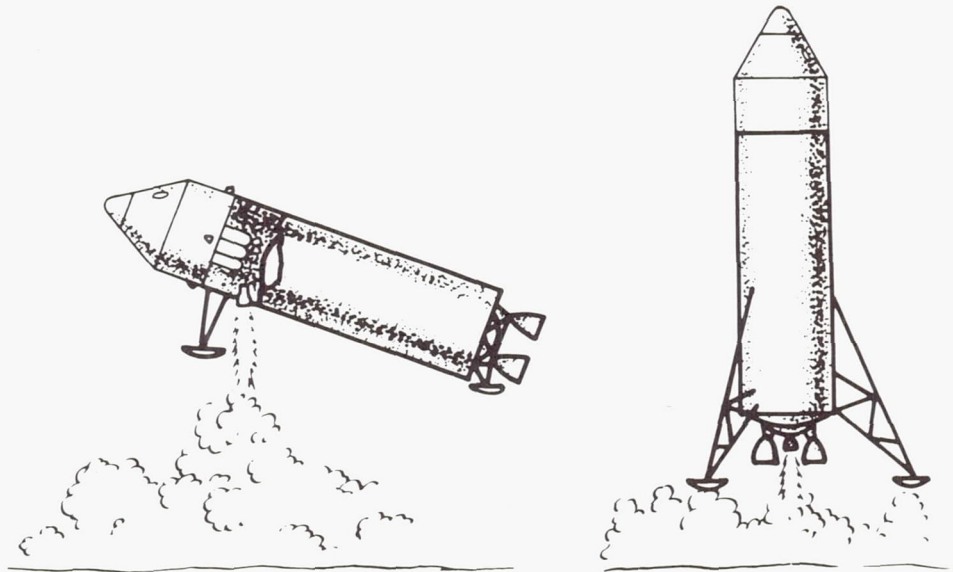

Two methods of landing techniques proposed for the direct ascent mode for the lunar landing mission.

1961

June

23

NASA Associate Administrator Robert C. Seamans, Jr., requested Kurt H. Debus, Director of the NASA Launch Operations Directorate, and Maj. Gen. Leighton I. Davis, Commander of the Air Force Missile Test Center, to make a joint analysis of all major factors regarding the launch requirements, methods, and procedures needed in support of an early manned lunar landing. The schedules and early requirements were to be considered in two phases: (1) in line with the Fleming Report, a direct flight to the moon would be assumed, using the Saturn C-1 and C-3 launch vehicles in early support phases and liquid- or solid-fueled Nova launch vehicles for the lunar landing; (2) as a possible alternative or parallel program, orbital rendezvous operations using Saturn C-3 and liquid-fueled Nova. The analysis should include recommendations on mutual NASA-DOD range responsibilities, authority, management structures, and other allied subjects. On June 30, Seamans notified Debus and Davis that the evaluation of tracking and command stations should not be included in the study. He stressed that the factors of immediate concern with regard to launch operations were those of launch site locations, land acquisition requirements, spacecraft and launch vehicle preparation



# (C-3 LUNAR MISSION)

LUNAR MISSION - ONE VEHICLE FROM EARTH  
 LAUNCHED OUT OF COASTING ORBIT - THREE  
 MEN - RENDEZVOUS AT MOON - 79,500# TOTAL WT.

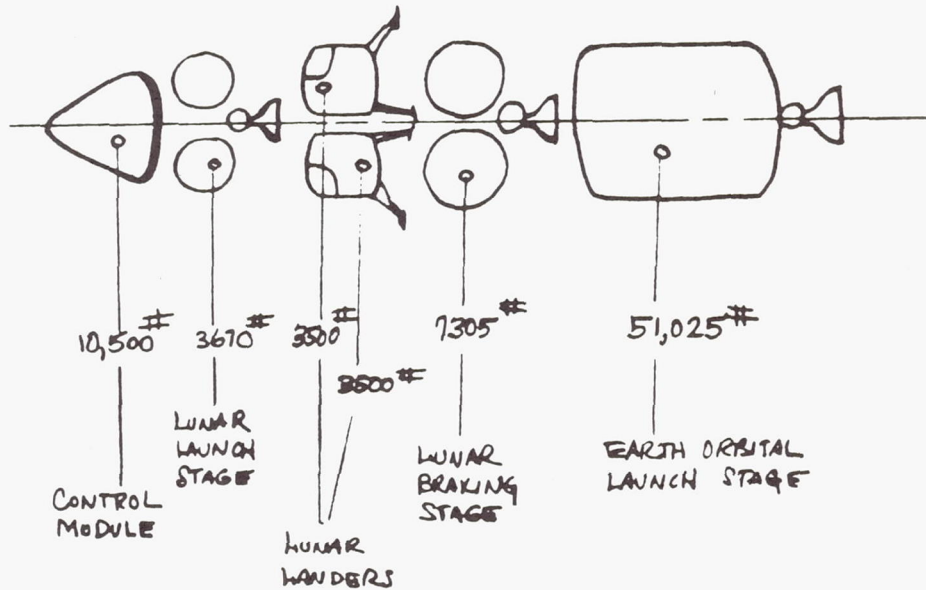

## NASA-LANGLEY

Another John D. Bird engineering sketch shows the potential of the Saturn C-3 for a lunar mission as visualized in June 1961.

facilities, vehicle launch facilities, and other facilities and requirements at the launch site. (Phase I of the Report was submitted on July 31.)

1961  
 June

Memorandum, Seamans to Commander, AFMTC, and Director, LOD, MSFC, "National Space Program Range Facilities and Resources Planning," June 23, 1961; letter, Seamans to Gen. Davis and Dr. Debus, "National Space Program Range Facilities and Resources Planning," June 30, 1961.

NASA announced that the Saturn C-1 launch vehicle, which could place ten-ton payloads in earth orbit, would be operational in 1964.

23

Senate Staff Report, *Manned Space Flight Program*, p. 200.

NASA announced that further engineering design work on the Saturn C-2 configuration would be discontinued and that effort instead would be redirected toward

23

- 1961**  
**June**  
 clarification of the Saturn C-3 and Nova concepts. Investigations were specifically directed toward determining capabilities of the proposed C-3 configuration in supporting the Apollo mission.  
*Saturn Illustrated Chronology*, pp. 31-32.
- 26**  
 Maxime A. Faget, Paul E. Purser, and Charles J. Donlan of STG met with Arthur W. Vogeley, Clinton E. Brown, and Laurence K. Loftin, Jr., of Langley Research Center on a "lunar landing" paper. Faget's outline was to be used, with part of the information to be worked up by Vogeley.  
 Memorandum, Purser to Robert R. Gilruth, "Log for the Week of June 26, 1961."
- During the Month**  
 STG completed a detailed assessment of the results of the Project Apollo feasibility studies submitted by the three study contractors: the General Electric Company, Convair/Astronautics Division of the General Dynamics Corporation, and The Martin Company. (Their findings were reflected in the Statement of Work sent to prospective bidders on the spacecraft contract on July 28.)  
 "Apollo Spacecraft Chronology," p. 9.
- During the Month**  
 Members of Langley Research Center briefed the Heaton Committee on the lunar orbit rendezvous method of accomplishing the manned lunar landing mission.  
*Manned Lunar-Landing through use of Lunar-Orbit Rendezvous*, p. 5.
- Summer**  
 Construction began at Langley Research Center of facilities specifically oriented toward the Apollo program, including a lunar landing simulator.  
 Interview with Charles J. Donlan, Langley Research Center, June 20, 1966.
- July**  
**6**  
 At NASA Headquarters, the first meeting was held of the Manned Lunar Landing Coordination Group, attended by NASA Associate Administrator Robert C. Seamans, Jr., Ira H. Abbott, Don R. Ostrander, Charles H. Roadman, William A. Fleming, DeMarquis D. Wyatt (part-time), and George M. Low (in place of Abe Silverstein). This Headquarters Group, appointed by Seamans, was to coordinate problems that jointly affected several NASA Offices, during the interim period while the manned space flight organization was being formed. Members of the steering group included NASA program directors, with participation by Wernher von Braun of Marshall Space Flight Center, Robert R. Gilruth of STG, and Wyatt and Abraham Hyatt of NASA Headquarters, as required. Fleming acted as Secretary of the Group. A list of decisions and actions required to implement an accelerated lunar landing program was drawn up as a tentative agenda for the next meeting:
- Begin Nova systems integration studies and develop the general arrangement of second and third stages. The studies should include spacecraft propulsion stages and spacecraft.
  - Begin Saturn C-3 systems integration studies.

1961

July

- Begin developing Nova and C-3 first-stage specifications in preparation to letting contracts.
- Continue Launch Operations Directorate-Air Force Missile Test Center studies of Nova and C-3 launch sites at Atlantic Missile Range (AMR).
- Take steps to bring the contractor aboard as soon as possible for Nova and C-3 launch facility and test stand designs.
- Accelerate F-1 engine funding to provide adequate production engines for the Nova and C-3.
- Examine the Marshall Space Flight Center (MSFC) proposal for static test facilities for large vehicle stages with a view toward beginning detailed site examination.
- Accelerate funding of the J-2 engine to provide acceptance test stands.
- Determine the necessity for a one-million-pound-thrust liquid-hydrogen—liquid-oxygen engine.
- Begin design studies on spacecraft propulsion systems and develop specifications. Define management responsibilities.
- Begin preparations for letting the contract for a spacecraft operations facility at AMR.
- Determine the relationships and responsibilities of MSFC and STG on guidance and control.

Memoranda, Low, Assistant Director for Manned Space Flight Programs, to Director of Space Flight Programs, "Meeting of Manned Lunar Landing Coordination Group," July 8, 1961; Ostrander, Director, Launch Vehicle Programs, to Staff, "Manned Lunar Landing Program," July 10, 1961.

The NASA Administrator and the Secretary of Defense concluded an agreement to study development of large launch vehicles for the national space program. For this purpose, the DOD-NASA Large Launch Vehicle Planning Group was created, reporting to the Associate Administrator of NASA and to the Assistant Secretary of Defense (Deputy Director of Defense Research and Engineering).

7

Memorandum, Associate Administrator to the Administrator, "Planning of a DOD-NASA Program for Development of Large Launch Vehicles," July 7, 1961; letters, James E. Webb to Robert S. McNamara, July 7, 1961; McNamara to Webb, July 7, 1961.

Jet Propulsion Laboratory announced that construction was under way on the first large space simulator in the United States capable of testing full-scale spacecraft of the Ranger and Mariner classes. Three primary space effects could be simulated: solar radiation, cold space heat sink, and a high vacuum equivalent to about one part in a billion of the atmospheric pressure at sea level.

12

*Aeronautical and Astronautical Events of 1961*, p. 32.

A NASA-Industry Apollo Technical Conference was held in Washington, D.C., for representatives of about 300 potential Project Apollo contractors. Scientists from NASA, the General Electric Company, The Martin Company, and General Dynamics/Astronautics presented the results of studies on Apollo requirements.

18-20



1961

July

Within the next four to six weeks NASA was expected to draw up the final details and specifications for the Apollo spacecraft.

*Wall Street Journal*, July 18, 1961; *Aeronautical and Astronautical Events of 1961*, p. 33; "Apollo Spacecraft Chronology," p. 10.

20

The Large Launch Vehicle Planning Group, established on July 7, 1961, began its formal existence with seven DOD and seven NASA members and alternates. The members of the Group included: Nicholas E. Golovin, Director of the Group, Technical Assistant to the Associate Administrator of NASA; Lawrence L. Kavanau, Deputy Director of the Group, Special Assistant (Space) in the Office of the Director of Defense Research and Engineering; Warren Amster and Edward J. Barlow, Aerospace Corporation; Aleck C. Bond, STG; Lt. Col. David L. Carter and Col. Otto J. Glasser, Air Force Systems Command; Col. Matthew R. Collins, Jr., U.S. Army, Office of Chief of Ordnance; Eldon W. Hall, Harvey Hall, and Milton W. Rosen, NASA Office of Launch Vehicle Programs; Wilson B. Schramm and Francis L. Williams, Marshall Space Flight Center; Rear Adm. Levering Smith, U.S. Navy, Special Projects Office; Capt. Lewis J. Stecher, Jr., U.S. Navy, Office of the Chief of Naval Operations; H. J. Weigand, Headquarters, U.S. Air Force; Kurt R. Stehling, NASA Office of Program Planning and Evaluation; and William W. Wolman, NASA Office of Programs.

The Group, frequently called the Golovin Committee, was to concern itself only with large launch vehicle systems, including propulsion elements, guidance and control, and instrumentation. It was to suggest launch vehicle configurations and operational procedures, taking into consideration not only the manned lunar landing program but other anticipated needs of DOD and NASA.

Report of DOD-NASA Large Launch Vehicle Planning Group, Vol. 1, 1961.

21

*Liberty Bell 7*, manned by Astronaut Virgil I. Grissom, was launched successfully from the Atlantic Missile Range. The Mercury capsule, boosted by a Redstone rocket, reached a peak altitude of 118.26 miles and a speed of 5168 miles per hour. After a flight of 15 minutes and 37 seconds, the landing was made 302 miles downrange from the launch site. The spacecraft was lost during recovery operations, but Astronaut Grissom was rescued and was reported in excellent condition.

Swenson *et al.*, *This New Ocean*, pp. 370-377, 640-641.

24

Changes in Saturn launch vehicle configurations were announced:

C-1: stages S-I (1.5 million pounds of thrust) and S-IV

C-2: stages S-I, S-II, and S-IV

C-3: stages S-IB (3 million pounds of thrust), S-II, and S-IV.

Senate Staff Report, *Manned Space Flight Program*, p. 200.

24

NASA issued a letter contract to the Astro-Electronic Division of Radio Corporation of America to develop and fabricate the high-resolution television system (including associated communication and electronic equipment) for the Ranger program.

*Sixth Semiannual Report of the National Aeronautics and Space Administration*, July 1, 1961, through December 31, 1961 (1962), p. 66.

NASA invited 12 companies to submit prime contractor proposals for the Apollo spacecraft by October 9: The Boeing Airplane Company, Chance Vought Corporation, Douglas Aircraft Company, General Dynamics/Convair, the General Electric Company, Goodyear Aircraft Corporation, Grumman Aircraft Engineering Corporation, Lockheed Aircraft Corporation, McDonnell Aircraft Corporation, The Martin Company, North American Aviation, Inc., and Republic Aviation Corporation.

In the Statement of Work sent to each prospective bidder, three phases of the Apollo program were described:

Phase A: Manned low-altitude earth orbital flights of up to two weeks' duration and unmanned reentry flights from superorbital velocities. The spacecraft designed for these missions should be capable of development for the lunar landing and return. The objectives of Phase A were to qualify the spacecraft systems and features for the lunar landing mission within the constraints of the earth orbital environment, to qualify the heat protection and other systems for the lunar mission through reentry tests from superorbital velocities, to study the physiological and psychological reactions and capabilities of human beings under extended periods in the space environment, to develop flight and ground operational techniques and equipment for space flights of extended duration, and to conduct experimental investigations to acquire information for the lunar mission. The Saturn C-1 would be used for Phase A missions.

Phase B: Circumlunar, lunar orbital, and parabolic reentry test flights employing the Saturn C-3 launch vehicle for furthering the development of the spacecraft and operational techniques and for lunar reconnaissance.

Phase C: Manned lunar landing and return missions using either the Nova class or Saturn C-3 launch vehicles and using rendezvous techniques for the purpose of lunar observation and exploration.

The contractor was to design and manufacture the command module, service module, and spacecraft adapter with associated ground support equipment, excluding the navigation and guidance system, research and development instrumentation, and scientific instrumentation; to design and manufacture the "test" spacecraft for use with Saturn C-1 research and development launch vehicles; to integrate the spacecraft modules and to integrate these modules with their ground support equipment and ensure compatibility of spacecraft with launch vehicle and with the ground operational support system; and to design and manufacture spacecraft mockups.

The contractor was to prepare the spacecraft for flight, man the systems monitoring positions in the ground operational support system, and support the operation of the overall space vehicle.

STG had prepared the Statement of Work, using both contractor and in-house studies. Included in the Statement of Work was a description of the major command and service module systems.



1961

July

Guidance and control system

Navigation and guidance subsystem components:

- Stable platform
- Space sextant
- Radar altimeter
- Secondary inertial elements
- Computer
- Periscope
- Sun trackers
- Associated electronics
- Displays and controls
- Cabling

Stabilization and control subsystem to provide:

Flight-path control during the thrusting period of atmospheric abort and stability augmentation after launch escape system separation

Orientation, attitude control, and reentry stabilization and control during extra-atmospheric abort

Stabilization of the spacecraft plus the final stage of the launch vehicle while in a parking orbit

Stabilization and control during translunar and transearth midcourse flight Rendezvous and docking with the space laboratory module

Attitude control for accomplishing landings and takeoffs from the moon and for entering and departing from lunar orbits

Control requirements for reentry guidance

Stabilization and control of the command module flight direction in the landing configuration, as well as the landing system suspension members

Vernier propulsion system

The system would be included in the service module to provide longitudinal velocity control not supplied by the reaction control system, mission propulsion system, or lunar landing module; and to furnish effective thrust-vector control during operation of the mission propulsion system. It would be pressure-fed, using storable hypergolic bipropellants.

Mission propulsion system

Representing the major portion of propulsion for translunar abort, lunar orbit injection and rejection, and velocity increment for lunar launch, the system would comprise a number of identical solid-propellant rocket motors and would be included in the service module.

Reaction control system

The system would provide attitude control, stabilization, ullage for the vernier propulsion system, and minor velocity corrections. For both the command and service modules, the system would be pulse-modulated, pressure-fed, and would use storable hypergolic fuel identical with that in the vernier propulsion system. The fuel tanks would be the positive expulsion type.



### Launch escape system

During failure or imminent failure of the launch vehicle during all atmospheric mission phases, the system would separate the command module from the launch vehicle. The basic propulsion system would be a solid-fuel rocket motor with "step" or regressive burning characteristics.

### Earth landing system

The system would consist of a ribbon drogue parachute and a cluster of three simultaneously deployed landing parachutes, sized so that satisfactory operation of any two of the three would satisfy the vertical velocity requirement. The command module would hang in a canted position from the parachute risers and be oriented through roll control to favor impact attenuation.

### Structural system

In addition to fundamental load-carrying structures, the command and service modules would carry meteoroid protection, radiation protection inherent in the structure, and passive heat protection systems.

### Crew systems

Included were:

- Three couches, the center one stowable
- Support and restraint systems at each duty station
- Shock mitigation devices for individual crew support and restraint systems
- Pressure suits for each crewman
- Sleeping area
- Sanitation area

### Environmental control system

To provide a shirtsleeve environment in the command module, the system would consist of:

- Cabin atmosphere—an oxygen-nitrogen mixture stabilized at 7.0 psia
- Removal of carbon dioxide by lithium hydroxide
- Removal of noxious gases by activated charcoal and a catalytic burner
- Heat-exchanger water-separation system for control of temperature and humidity
- Potable water from the fuel cells
- Controls for pressure, humidity, and temperature

### Electrical power system

The system would be composed of nonregenerative hydrogen-oxygen Bacon-type fuel-cell batteries carried, with their fuel supply, in the service module; silver-zinc primary batteries required during reentry and postlanding carried, with their associated fuel, distribution, and control equipment, in the command module.

### Communication and instrumentation system

Communication subsystems:

- Deep-space communication
- Telemetry
- VHF transmitter and receiver
- Intercommunication system

1961

July

- Near-field transceiver
- Television
- C-band transponder
- Altimeter and rendezvous radar
- Minitrack beacon
- HF/VHF recovery subsystem
- Antennas
- Instrumentation subsystem:
  - Sensors
  - Data disposition (telemetry and onboard recorders)
  - Subsystem calibration
  - Auxiliary instrumentation (clock, cameras, telescope)
- Scientific equipment
  - The equipment was unspecified but would be fitted into ten cubic feet and weigh 250 pounds.

In addition to the description of the major command and service module systems, the Statement of Work outlined the general concepts of the lunar landing module and space laboratory module.

#### Lunar landing module

The basic systems comprised:

- Lunar touchdown system to arrest impact, support the spacecraft during its period on the moon, and provide a launching base

- Guidance and control, provided by the command and service modules

- Main propulsion system, for translunar velocity control and the gross velocity decrement required for lunar landing, using liquid-hydrogen—liquid-oxygen propellant

- Terminal propulsion system, to provide propulsion and attitude reaction control to perform the terminal descent maneuver, including hovering and translation

- Structural system, to meet the same requirements as specified for the command and service modules

#### Space laboratory module

The module would be used in earth orbital flights for special experiments. It would provide its own power supply, environmental control system, etc., without demand on the command and service module systems and could support two of the three Apollo crewmen except for their food and water.

NASA, *Project Apollo Spacecraft Development Statement of Work, Phase A* (STG, July 28, 1961), pp. 1-1 to 1-3, A-2 to A-21; *New York Times*, July 29, 1961.

28

NASA Associate Administrator Robert C. Seamans, Jr., appointed members to the Source Evaluation Board to evaluate contractors' proposals for the Apollo spacecraft. Walter C. Williams of STG served as Chairman, and members included Robert O. Piland, Wesley L. Hjernevik, Maxime A. Faget, James A. Chamberlin, Charles W. Mathews, and Dave W. Lang, all of STG; George M. Low, Brooks C. Preacher, and James T. Koppenhaver (nonvoting member) from NASA

Headquarters; and Oswald H. Lange from Marshall Space Flight Center. On November 2, Faget became the Chairman, Kenneth S. Kleinknecht was added as a member, and Williams was relieved from his assignment.

1961

July

Memoranda, Robert R. Gilruth to Member, Source Evaluation Board, "Instructions for Members of the Source Evaluation Board for Evaluation of Proposals for Project Apollo Spacecraft, RFP No. 9-150," September 1, 1961; Seamans to STG, "Redesignation of Source Evaluation Board Members," November 2, 1961.

Phase I of a joint NASA-DOD report on facilities and resources required at launch sites to support the manned lunar landing program was submitted to Associate Administrator Robert C. Seamans, Jr., by Kurt H. Debus, Director, Launch Operations Directorate, and Maj. Gen. Leighton I. Davis, Commander of the Air Force Missile Test Center. The report, requested by Seamans on June 23, was based on the use of Nova-class launch vehicles for the manned lunar landing in a direct ascent mode, with the Saturn C-3 in supporting missions. Eight launch sites were considered: Cape Canaveral (on-shore); Cape Canaveral (off-shore); Mayaguana Island (Atlantic Missile Range downrange); Cumberland Island, Ga.; Brownsville, Tex.; White Sands Missile Range, N. Mex.; Christmas Island, Pacific Ocean; and South Point, Hawaii. On the basis of minimum cost and use of existing national resources, and taking into consideration the stringent time schedule, White Sands Missile Range and Cape Canaveral (on-shore) were favored. White Sands presented serious limitations on launch azimuths because of first-stage impact hazards on populated areas.

31

NASA-DOD, *Phase I Report: Joint Report on Facilities and Resources Required at Launch Site to Support NASA Manned Lunar Landing*, July 31, 1961.

Langley Research Center simulated spacecraft flights at speeds of 8200 to 8700 feet per second in approaching the moon's surface. With instruments preset to miss the moon's surface by 40 to 80 miles, pilots with control of thrust and torques about all three axes of the craft learned to establish orbits 10 to 90 miles above the surface, using a graph of vehicle rate of descent and circumferential velocity, an altimeter, and vehicle attitude and rate meters, as reported by Manuel J. Queijo and Donald R. Riley of Langley.

During  
the  
Month

*Aeronautical and Astronautical Events of 1961*, p. 36.

James A. Chamberlin and James T. Rose of STG proposed adapting the improved Mercury spacecraft to a 35,000-pound payload, including a 5000-pound "lunar lander." This payload would be launched by a Saturn C-3 in the lunar orbit rendezvous mode. The proposal was in direct competition with the Apollo proposals that favored direct landing on the moon and involved a 150,000-pound payload launched by a Nova-class vehicle with approximately 12 million pounds of thrust.

During  
the  
Month

Interviews with Chamberlin, Houston, Tex., June 9, 1966; Rose, St. Louis, Mo., April 13, 1966.

Ralph Ragan of the MIT Instrumentation Laboratory, former director of the Polaris guidance and navigation program, in cooperation with Milton B. Trageser of the Laboratory and with Robert O. Piland, Robert C. Seamans, Jr., and Robert

During  
the  
Month



1961

July

G. Chilton, all of NASA, had completed a study of what had been done on the Polaris program in concept and design of a guidance and navigation system and the documentation necessary for putting such a system into production on an extremely tight schedule. Using this study, the group worked out a rough schedule for a similar program on Apollo.

Interview with Ralph Ragan, Instrumentation Laboratory, MIT, April 27, 1966.

July–September

The MIT Instrumentation Laboratory and NASA completed the work statements for the Laboratory's program on the Apollo guidance and navigation system and the request for quotation for industrial support was prepared.

Interview with Ralph Ragan, Instrumentation Laboratory, MIT, April 27, 1966.

August

2

NASA Headquarters announced that it was making a worldwide study of possible launching sites for lunar spacecraft. The size, power, noise, and possible hazards of Saturn or Nova rockets would require greater isolation for public safety than currently available at NASA launch sites.

*Washington Post*, August 3, 1961.

6

The Soviet Union successfully launched *Vostok II* into orbit with Gherman S. Titov as pilot. The spacecraft, which weighed 10,430 pounds, carried life-support equipment, radio and television for monitoring the condition of the cosmonaut, tape recorder, telemetry system, biological experiments, and automatic and manual control equipment. After 17.5 orbits, the spacecraft reentered on August 7 and landed safely. Titov made a separate parachute landing in an ejector couch.

*New York Times*, August 7 and 8, 1961; *Instruments and Spacecraft*, p. 194.

7

STG appointed members to the Technical Subcommittee and to the Technical Assessment Panels for evaluation of industry proposals for the development of the Apollo spacecraft.

Memoranda, Wesley L. Hjernevik for Walter C. Williams to Member, Technical Subcommittee, "Instruction for Members of the Technical Subcommittee for the Evaluation of Contractors' Proposals for Project Apollo Spacecraft RFP-9-150," August 7, 1961; Hjernevik for Williams to Member, Technical Assessment Panel, "Instruction for Members of the Technical Assessment Panels for the Evaluation of Contractors Proposals for Project Apollo Spacecraft RFP-9-150," August 7, 1961.

9

NASA selected the Instrumentation Laboratory of MIT to develop the guidance and navigation system for the Apollo spacecraft. This first major Apollo contract had a long lead-time, was basic to the overall Apollo mission, and would be directed by STG.

Memorandum, William W. Petynia to Associate Director, STG, "Visit to MIT Instrumentation Laboratory on September 12-13, 1961, regarding Apollo Navigation and Guidance Contract," September 21, 1961.

14

STG requested that a program be undertaken by the U.S. Navy Air Crew Equipment Laboratory, Philadelphia, Penna., to validate the atmospheric composition requirement for the Apollo spacecraft. On November 7, the original experimental

design was altered by the Manned Spacecraft Center (MSC). The new objectives were:

- Establish the required preoxygenation time for a rapid decompression (80 seconds) from sea level to 35,000 feet
- Discover the time needed for equilibrium (partial denitrogenation) at the proposed cabin atmosphere for protection in case of rapid decompression to 35,000 feet
- Investigate the potential hazard associated with an early mission decompression—i.e., before the equilibrium time was reached, preceded by the determined preoxygenation period
- Conduct any additional tests suggested by the results of the foregoing experiments.

Letter, Robert R. Gilruth, Director, MSC, to Director, Air Crew Equipment Laboratory, November 7, 1961.

STG held a pre-proposal briefing at Langley Field, Va., to answer bidders' questions pertaining to the Request for Proposal for the development of the Apollo spacecraft.

14-15

"Apollo Spacecraft Chronology," p. 11.

STG appointed members to the Business Subcommittee and to the Business Assessment Panels for evaluation of industry proposals for the development of the Apollo spacecraft.

16

Memoranda, Walter C. Williams to Member, Business Subcommittee, "Instructions for Members of the Business Subcommittee for Evaluation of Proposals for Project Apollo Spacecraft, RFP No. 9-150," August 16, 1961; Williams to Member, Business Assessment Panels, "Instructions for Members of the Business Assessment Panels for Evaluation of Proposals for the Project Apollo Spacecraft, RFP No. 9-150," undated.

*Ranger I*, a test version of the spacecraft which would attempt an unmanned crash landing on the moon, was launched from the Atlantic Missile Range by an Atlas-Agena B booster. The 675-pound spacecraft did not attain the scheduled extremely elongated orbit because of the misfiring of the Agena B rocket. Although the spacecraft systems were tested successfully, only part of the eight project experiments could be carried out. *Ranger I* reentered on August 29 after 111 orbits.

23

*New York Times*, August 24, 1961; *Aeronautical and Astronautical Events of 1961*, pp. 41, 42, 84.

The Large Launch Vehicle Planning Group (Golovin Committee) notified the Marshall Space Flight Center (MSFC), Langley Research Center, and the Jet Propulsion Laboratory (JPL) that the Group was planning to undertake a comparative evaluation of three types of rendezvous operations and direct flight for manned lunar landing. Rendezvous methods were earth orbit, lunar orbit, and lunar surface. MSFC was requested to study earth orbit rendezvous, Langley to study lunar orbit rendezvous, and JPL to study lunar surface rendezvous. The NASA Office of Launch Vehicle Programs would provide similar information

23



1961

August

on direct ascent. Emphasis was to be placed on developmental problems, exclusive of vehicle design which would be handled separately.

In each case, environmental conditions peculiar to the particular mode of rendezvous, and their effects on equipment design, were to be considered so that the problems characteristic of the different rendezvous modes could be separated and compared as quantitatively as possible. Examples of problem areas were automatic versus manual operation, mission profile, and lunar surface conditions. All rendezvous modes would assume that the reentry capsule(s) should be capable of supporting three men and weigh within the range specified by STG (about 8500 pounds).

The preliminary results of the study were to be ready in 30 days.

TWX from Harvey Hall, NASA Coordinator, NASA-DOD Large Launch Vehicle Planning Group, to MSFC, Langley Research Center, and JPL, August 23, 1961.

- 24 Expanded facilities in the Cape Canaveral area would be the site for the launch of manned lunar flights and other missions requiring the use of Saturn and Nova vehicles, NASA announced. The site of the new facilities, north and west of the Air Force Missile Test Center, had been chosen after months of NASA-DOD surveys of proposed launch areas.

*Washington Post*, August 25, 1961.

- 29 NASA announced that planned Ranger launchings would be increased from five to nine. These additional spacecraft would be equipped with six high-resolution television cameras. They would be programmed to begin operating at about 800 miles above the lunar surface and continue until moments before the spacecraft crash-landed. The final pictures would record features no more than eight inches across. About 1600 photographs were expected from each spacecraft, which would no longer carry previously planned instrumented capsules. The objective of these spacecraft now was to provide information on the lunar surface in support of the manned lunar landing mission.

*Sixth NASA Semiannual Report*, p. 67.

- 31 C. Stark Draper, Director of the MIT Instrumentation Laboratory, at a meeting with NASA Administrator James E. Webb, Deputy Administrator Hugh L. Dryden, and Associate Administrator Robert C. Seamans, Jr., at NASA Headquarters proposed that at least one of the Apollo astronauts should be a scientifically trained individual since it would be easier to train a scientist to perform a pilot's function than vice versa. (In a letter to Seamans on November 7, Draper further proposed that he be that individual.)

Ralph Ragan and David G. Hoag, personal notes of meeting, August 31, 1961; letter, Draper to Seamans, November 7, 1961.

During  
the  
Month

The Ad Hoc Task Group for Study of Manned Lunar Landing by Rendezvous Techniques, Donald H. Heaton, Chairman, reported its conclusions: rendezvous offered the earliest possibility for a successful lunar landing, the proposed Saturn



C-4 configuration should offer a higher probability of an earlier successful manned lunar landing than the C-3, the rendezvous technique recommended involved rendezvous and docking in earth orbit of a propulsion unit and a manned spacecraft, the cost of the total program through first lunar landing by rendezvous was significantly less than by direct ascent.

1961

August

Summary report of Ad Hoc Task Group Study, "Earth Orbital Rendezvous for an Early Manned Lunar Landing," Part I, August 1961.

John C. Houbolt of Langley Research Center made a presentation to STG on rendezvous and the lunar orbit rendezvous plan. At this time James A. Chamberlin of STG requested copies of all of Houbolt's material because of the pertinence of this work to the Mercury Mark II program and other programs then under consideration.

During  
the  
Month

Bird, "Short History of the Development of the Lunar Orbit Rendezvous Plan at the Langley Research Center," p. 3.

The deep-space tracking station at Hartebeesthoek, South Africa, was completed. Dedication took place on September 8. NASA thus gained the capacity for continuous line-of-sight communication with lunar and interplanetary probes despite the earth's rotation. The other deep-space tracking stations were at Goldstone, Calif., and Woomera, Australia.

During  
the  
Month

*Sixth NASA Semiannual Report*, p. 76; *Aeronautical and Astronautical Events of 1961*, p. 45.

The Jet Propulsion Laboratory selected the Blaw Knox Company of Pittsburgh, Penna., for second-phase feasibility and design studies of an antenna in the 200- to 250-foot diameter class. The first of these antennas, which were to be used in acquiring data from advanced lunar and planetary exploration programs, would be operational at Goldstone, Calif., by early 1965.

During  
the  
Month

*Sixth NASA Semiannual Report*, p. 76.

NASA announced that the government-owned Michoud Ordnance Plant near New Orleans, La., would be the site for fabrication and assembly of the Saturn C-3 first stage as well as larger vehicles.

September

7

*St. Louis Post-Dispatch*, September 7, 1961.

NASA selected NAA to develop the second stage (S-II) for the advanced Saturn launch vehicle. The cost, including development of at least ten vehicles, would total about \$140 million. The S-II configuration provided for four J-2 liquid-oxygen—liquid-hydrogen engines, each delivering 200,000 pounds of thrust.

11

*Wall Street Journal*, September 12, 1961.

Representatives of STG and NASA Headquarters visited the Instrumentation Laboratory of MIT to discuss the contract awarded to the Laboratory on August 9 and progress in the design and development of the Apollo spacecraft navigation and guidance system. They mutually decided that a draft of the final contract

12-13

1961

September

should be completed for review at Instrumentation Laboratory by October 2 and the contract resolved by October 9. Revisions were to be made in the Statement of Work to define more clearly details of the contract. Milton B. Trageser of the Laboratory, in the first month's technical progress report, gave a brief description of the first approach to the navigation and guidance equipment and the arrangement of the equipment within the spacecraft. He also presented the phases of the lunar flight and the navigation and guidance functions or tasks to be performed. Other matters discussed were a space sextant and making visual observations of landmarks through cloud cover.

Memorandum, William W. Petynia to Associate Director, STG, September 21, 1961.

13

*Mercury-Atlas 4*, carrying an astronaut simulator, was launched from the Atlantic Missile Range in the first earth orbital test of the Mercury spacecraft. After one orbit, the spacecraft reentered and was recovered safely. With minor deviations, the flight was highly successful.

Grimwood, *Project Mercury: A Chronology*, pp. 148-149.

14

In a memorandum to the Large Launch Vehicle Planning Group (LLVPG) staff, Harvey Hall of NASA described the studies being done by the Centers on rendezvous modes for accomplishing a manned lunar landing. These studies had been requested from Langley Research Center, Marshall Space Flight Center, and the Jet Propulsion Laboratory on August 23. STG was preparing separate documentation on the lunar orbit rendezvous mode. An LLVPG team to undertake a comparative evaluation of rendezvous and direct ascent techniques had been set up. Members of the team included Hall and Norman Rafel of NASA and H. Braham and L. M. Weeks of Aerospace Corporation.

The evaluation would consider:

- Effect of total flight time on specifications and reliability of equipment and on personnel
- Effect of vehicle system reliability in each case, including the number of engine starts and restarts
- Dependence on data, data-rate, and distance from ground station for control of assembly and refueling operations
- Launch and injection windows
- Effect of differences in the total weight propelled to earth escape velocity
- Relative merits of lunar gravity and of a lunar base in general versus an orbital station for rendezvous and assembly purposes.

Reliability estimates on vehicles would be based on LLVPG data; estimates on equipment would rely on experience with similar types in known applications.

Memorandum, Hall to Large Launch Vehicle Planning Group Staff, "Comparison of Mission Alternatives (Rendezvous versus Direct Flight)," September 14, 1961.

17

NASA invited 36 companies to bid on a contract to produce the first stage of the advanced Saturn launch vehicle. Representatives of interested companies would attend a pre-proposal conference in New Orleans, La., on September 26. Bids



were to be submitted by October 16 and NASA would then select the contractor, probably in November.

*Wall Street Journal*, September 18, 1961.

NASA announced that a site near Houston, Tex., had been selected for the manned space flight research center which would design, develop, evaluate, and test Apollo spacecraft in addition to training the astronauts for lunar flights and other space missions. The laboratory would be the command center for the manned lunar landing mission and subsequent space flight missions. Selection had followed a nationwide study by NASA of prospective sites.

*Washington Post*, September 20, 1961.

A major reorganization of NASA Headquarters was announced by Administrator James E. Webb. Four new program offices were to be formed, effective November 1: the Office of Advanced Research and Technology, Ira H. Abbott, Director; the Office of Space Sciences, Homer E. Newell, Director; the Office of Manned Space Flight, D. Brainerd Holmes, Director; and the Office of Applications, directorship vacant. Holmes' appointment had been announced on September 20. He had been General Manager of the Major Defense Systems Division of the Radio Corporation of America. The new Directors would report to Robert C. Seamans, Jr., NASA's Associate Administrator.

At the same time, Robert R. Gilruth was named Director of the Manned Spacecraft Center to be located in Houston, Tex. The Directors of NASA's nine field centers would, like the newly appointed program Directors, report to Seamans.

*Washington Post*, September 24, 1961; *Washington Daily News*, September 21, 1961.

An architect's impression of how the Manned Spacecraft Center at Houston, Tex., would look when completed.



1961

September

19

24



1961  
September  
During  
the  
Month

Richard H. Battin published MIT Instrumentation Laboratory Report R-341, "A Statistical Optimizing Navigation Procedure for Space Flight," describing the concepts by which Apollo navigation equipment could make accurate computations of position and velocity with an onboard computer of reasonable size.

Battin, *Astronautical Guidance* (1964).

October  
3

The Charter of the MSFC-STG Space Vehicle Board, prepared jointly by Marshall Space Flight Center (MSFC) and STG, was approved at the first meeting of the Board at NASA Headquarters. The purpose of the Space Vehicle Board was to assure complete coordination and cooperation between all levels of the MSFC and STG management for the NASA manned space flight programs in which both Centers had responsibilities. Members of the Board were the Directors of MSFC and STG (Wernher von Braun and Robert R. Gilruth), the Deputy Director for Research and Development, MSFC (Eberhard F. M. Rees), and the STG Associate Director (Walter C. Williams). The Board was responsible for:

- Management of the SFC-STG Apollo-Saturn program
- Resolution of all space vehicle problems, such as design systems, research and development tests, planning, schedules, and operations
- Approval of mission objectives
- Direction of the respective organizational elements in the conduct of the MSFC-STG Apollo-Saturn program, including approval of the Sub-Board and of the Coordination Panels
- Formation of the Advanced Program Coordination Board consisting of top personnel from MSFC and STG. This Board would consider policy and program guidelines.

A Sub-Board would comprise the Director, Saturn Systems Office, MSFC (H. H. Koelle), the Apollo Project Manager, STG (Robert O. Piland), the Board Secretary, and alternate Board Secretary.

The Sub-Board would:

- Resolve space-vehicle coordination and integration problems and assign these to the Coordination Panels, if required
- Prepare briefs in problem areas not resolved by the Board or Sub-Board
- Act as a technical advisory group to the Board
- Channel the decisions of the Board through the respective organizational elements of MSFC or STG for proper action
- Ensure that the Saturn-Apollo Coordination Panels were working adequately and within the scope of their charters
- Recommend to the Board modifications of the Panels
- Define or resolve systems or integration problems of the Saturn launch vehicle and the Apollo spacecraft
- Define mission objectives of the Saturn-Apollo space vehicle
- Analyze and report progress of the Saturn-Apollo space vehicle
- Initiate and guide studies for the selection of optimum Saturn-Apollo space vehicle systems

- Define and establish reliability criteria
- Establish and document flight safety philosophy.

1961

October

The Secretariat set up under the Charter was to be responsible for the orderly conduct of business and meetings.

Four Saturn-Apollo Coordination Panels were established to make available the technical competence of MSFC and STG for the solution of interrelated problems of the launch vehicle and the spacecraft. The four included the Launch Operations, Mechanical Design, Electrical and Electronics Design, and Flight Mechanics, Dynamics, and Control Coordination Panels. Although these Panels were designated as new Panels, the members selected by STG and MSFC represented key technical personnel who had been included in the Mercury-Redstone Panels, the Mercury-Atlas Program Panels, the Apollo Technical Liaison Groups, and the Saturn working groups. The Charter was signed by von Braun and Gilruth.

Charter of the MSFC-STG Space Vehicle Board, October 3, 1961.

The MSFC-STG Space Vehicle Board at NASA Headquarters discussed the S-IVB stage, which would be modified by the Douglas Aircraft Company to replace the six LR-115 engines with a single J-2 engine. Funds of \$500,000 were allocated for this study to be completed in March 1962. The status of orbital launch operations studies at Marshall Space Flight Center (MSFC) were reviewed and the Board agreed that an ad hoc study group should be formed to consider such operations and the S-IVB as the orbital launch vehicle. Other matters discussed were the mission plans for SA-5 through SA-10, a review of the Apollo flight program schedule, planned MSFC participation in the Dyna-Soar program, the agenda for the first meeting of the Advanced Program Coordination Board, and joint MSFC-STG study of post-Apollo programs.

3

Minutes, Marshall Space Flight Center-Manned Spacecraft Center Space Vehicle Board Meeting No. 1, November 7, 1961; Senate Staff Report, *Manned Space Flight Program*, p. 202.

Representatives of STG visited the Instrumentation Laboratory of MIT for the second monthly progress report meeting on the Apollo spacecraft guidance and navigation contract. A number of technical topics were presented by Laboratory speakers: space sextant visibility and geometry problems, gear train analysis, vacuum environmental approach, midcourse guidance theory, inertial measurement unit, and gyro. The organization of the Apollo effort at the Laboratory was also discussed. A preliminary estimate of the cost for both Laboratory and industrial support for the Apollo navigation and guidance system was presented: \$158.4 million through Fiscal Year 1966.

4

Memorandum, William W. Petynia, Apollo Project Office, to Associate Director, "Second Apollo Monthly Meeting at MIT, Instrumentation Laboratory, on October 4, 1961," October 10, 1961.

Officials of STG heard oral reports from representatives of five industrial teams bidding on the contract for the Apollo spacecraft: General Dynamics/Astronautics

11



1961

October

in conjunction with the Avco Corporation; General Electric Company, Missile and Space Vehicle Department, in conjunction with Douglas Aircraft Company, Grumman Aircraft Engineering Corporation, and Space Technology Laboratories, Inc.; McDonnell Aircraft Corporation in conjunction with Lockheed Aircraft Corporation, Hughes Aircraft Company, and Chance Vought Corporation of Ling-Temco-Vought, Inc.; The Martin Company; and North American Aviation, Inc. Written proposals had been received from the contractors on October 9. The presentations were made in the Virginia Room of the Chamberlain Hotel at Old Point Comfort, Va. Following the reports, 11 panels, under the direction of the Business and Technical Subcommittees, began studying the proposals. The Panels established were: Systems Integration; Propulsion; Flight Mechanics; Structures, Materials, and Heating; Human Factors; Instrumentation and Communications; Onboard Systems; Ground Operational Support Systems and Operations; Technical Development Plan; Reliability; and Manufacturing. The Technical Assessment Panels completed their evaluation October 20 and made their final report to the Technical Subcommittee on October 25. The Technical Subcommittee made its final report to the Source Evaluation Board on November 1.

MSC *Space News Roundup*, November 1, 1961, p. 8; December 13, 1961, p. 7; "Apollo Spacecraft Chronology," p. 12.

20

The MSFC-STG Advanced Program Coordination Board met at STG and discussed the question of the development of an automatic checkout system which would include the entire launch vehicle program from the Saturn C-1 through the Nova. It agreed that the Apollo contractor should be instructed to make the spacecraft electrical subsystems compatible with the Saturn complex.

In further discussion, Paul J. DeFries of Marshall Space Flight Center (MSFC) presented a list of proposed guidelines for use in studying early manned lunar landing missions:

- The crew should draw on its own resources only when absolutely necessary. Equipment and service personnel external to the spacecraft should be used as much as possible.
- Early lunar expeditions would receive active external support only up to the time of the launch from earth orbit.
- The crew would board the spacecraft only after it was checked out and ready for final countdown and launch.
- The first Apollo crews should have an emergency shelter available on the moon which could afford several months of life support and protection.
- The capability for docking an orbital launch vehicle with a propulsion stage—the "connecting mode"—should be possible.
- The capability of fueling an orbital launch vehicle should be made available—"fueling mode."
- The capability of making repairs, replacements, or adjustments in orbit should be developed.
- For repairs, replacements, and adjustments on the orbital launch vehicle in earth orbit, two support vehicles would be necessary. These would be a Saturn



C-1 launch vehicle manned by Apollo technicians and an unmanned Atlas-Centaur launch vehicle carrying repair kits.

- Development of docking, testing of components, and techniques for docking and training of man in orbital operations could be carried out by a space ferry loaded with a Mercury capsule.

Some of the points discussed in connection with these suggestions were:

- Orbital launch operations were just as complex, if not more complex, than earth-launched operations.

- A question existed as to how complex the orbital launch facility could be and what its function should be.

- There was a possibility that the crew could do most of the checkout and launch operations. Studies should be made to define the role of the crew versus the role of a proposed MSFC auxiliary checkout and maintenance crew.

After the discussion on orbital launch operations, the Board agreed that contemporary technology was inadequate to support such operations. Both STG and MSFC would need to study and develop both refueling and connector techniques.

Memorandum, J. Thomas Markley, Acting Secretary, to Distribution Members of the MSFC-STG Space Vehicle Board, "Minutes of MSFC-MSFC Advanced Program Coordination Board," December 11, 1961.

NASA selected the Pearl River site in southwestern Mississippi, about 35 miles from the Michoud plant near New Orleans, La., as a static-test facility for Saturn- and Nova-class launch vehicles. The completed facility would operate under the direction of the Marshall Space Flight Center.

25

Washington *Daily News*, October 26, 1961; *Aeronautical and Astronautical Events of 1961*, p. 58.

The Saturn SA-1 first-stage booster was launched successfully from Cape Canaveral. The 925,000-pound launch vehicle, the largest known to be tested up to that time, carried water-filled dummy upper stages to an altitude of 84.8 miles and 214.7 miles down the Atlantic Missile Range. The booster's eight clustered H-1 engines developed 1.3 million pounds of thrust.

27

Washington *Evening Star*, October 28, 1961; *Aeronautical and Astronautical Events of 1961*, p. 58.

Under the direction of John C. Houbolt of Langley Research Center, a two-volume work entitled "Manned Lunar-Landing through use of Lunar-Orbit Rendezvous" was presented to the Golovin Committee (organized on July 20). The study had been prepared by Houbolt, John D. Bird, Arthur W. Vogeley, Ralph W. Stone, Jr., Manuel J. Queijo, William H. Michael, Jr., Max C. Kurbjun, Roy F. Brissenden, John A. Dodgen, William D. Mace, and others of Langley. The Golovin Committee had requested a mission plan using the lunar orbit rendezvous concept. Bird, Michael, and Robert H. Tolson appeared before the Committee in Washing-

31

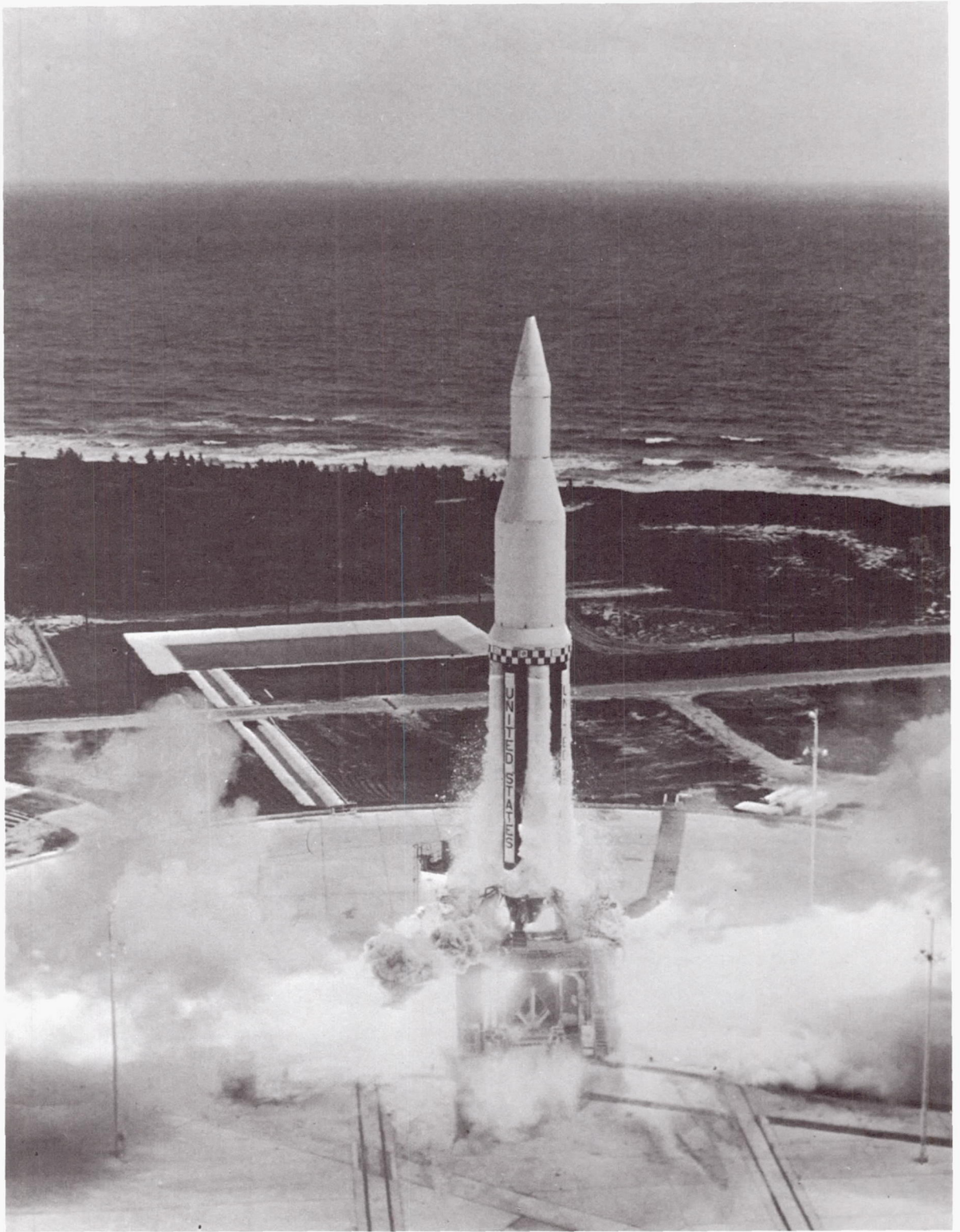

Launch of the Saturn SA-1 from Cape Canaveral, Fla., October 27, 1961.



## LUNAR LANDER-ONE MAN

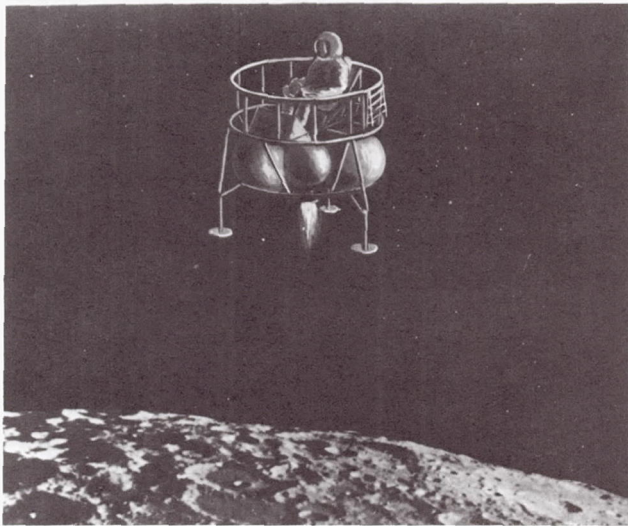

	<u>LB</u>
1 MAN AND LIFE SUPPORT	220
CONTROLS	50
STRUCTURE	230
ENGINE AND TANKAGE	220
FUEL AND OXIDIZER	2500
TOTAL	<u>3220</u>

Above is an artist's concept of a small lunar lander during descent to the lunar surface, as proposed by personnel of Langley Research Center in October 1961. Diagrammed below are actions required for the lander to rendezvous in orbit with the mother craft as it progresses along a path indicated by the broken line.

### SIMPLIFIED LUNAR RENDEZVOUS (100,000 FT ORBIT)

- 1-2 VERTICAL THRUST (33.3 SEC)
- 2-3 VERTICAL COAST (109 SEC)
- 3-4 HORIZONTAL THRUST (117 SEC)
- 4 RENDEZVOUS

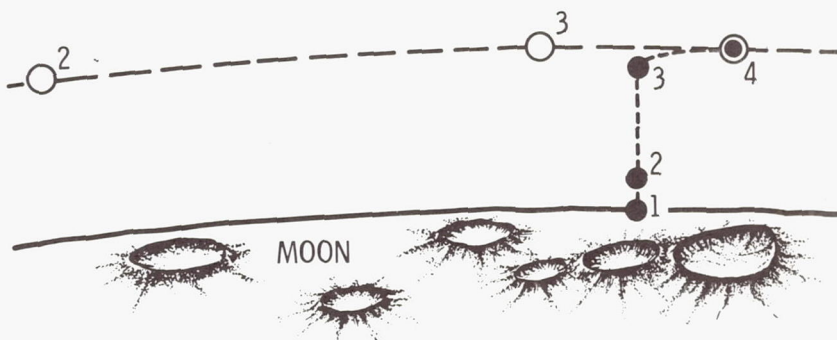



1961  
October

ton to explain certain matters of trajectory and lunar stay time not covered in the document.

Bird, "Short History of the Development of the Lunar Orbit Rendezvous Plan at the Langley Research Center," p. 3.

31

Robert G. Chilton of STG gave the MIT Instrumentation Laboratory new information based on NASA in-house studies on the Apollo spacecraft roll inertia, pitch and yaw inertia, and attitude jets.

David G. Hoag, MIT, personal notes, October 1961.

November

1

The Space Task Group was formally redesignated the Manned Spacecraft Center, Robert R. Gilruth, Director.

Grimwood, *Project Mercury: A Chronology*, p. 152.

6

Marshall Space Flight Center directed NAA to redesign the advanced Saturn second stage (S-II) to incorporate five rather than four J-2 engines, to provide a million pounds of thrust.

*Saturn Illustrated Chronology*, p. 46.

6

An Apollo Egress Working Group, consisting of personnel from Marshall Space Flight Center, Launch Operations Directorate, and Atlantic Missile Range, was formed on November 2. Meetings on that date and on November 6 resulted in publication of a seven-page document, "Apollo Egress Criteria." The Group established ground rules, operations and control procedures criteria, and space vehicle design criteria and provided requirements for implementation of emergency egress systems.

Memorandum, Walter C. Williams, Associate Director, MSC, to Apollo Office, Attn: Bob Piland; Chief, Flight Operations Division; and Chief, Preflight Operations Division, "Apollo Emergency Egress Requirements," December 11, 1961.

6

In a memorandum to D. Brainerd Holmes, Director, Office of Manned Space Flight (OMSF), Milton W. Rosen, Director of Launch Vehicles and Propulsion, OMSF, described the organization of a working group to recommend to the Director a large launch vehicle program which would meet the requirements of manned space flight and which would have broad and continuing national utility for other NASA and DOD programs. The group would include members from the NASA Office of Launch Vehicles and Propulsion (Rosen, Chairman, Richard B. Canright, Eldon W. Hall, Elliott Mitchell, Norman Rafel, Melvyn Savage, and Adelbert O. Tischler); from the Marshall Space Flight Center (William A. Mrazek, Hans H. Maus, and James B. Bramlet); and from the NASA Office of Spacecraft and Flight Missions (John H. Disher). (David M. Hammock of MSC was later added to the group.) The principal background material to be used by the group would consist of reports of the Large Launch Vehicle Planning Group (Golovin Committee), the Fleming Committee, the Lundin Committee, the Heaton Committee, and the Debus-Davis Committee. Some of the subjects the

group would be considering were: (1) an assessment of the problems involved in orbital rendezvous, (2) an evaluation of intermediate vehicles (Saturn C-3, C-4, and C-5), (3) an evaluation of Nova-class vehicles, (4) an assessment of the future course of large solid-fuel rocket motor development, (5) an evaluation of the utility of the Titan III for NASA missions, and (6) an evaluation of the realism of the spacecraft development program (schedules, weights, performances). Rosen set November 20 as a target date for a recommended program.

Memoranda, Rosen to Holmes, "Large Launch Vehicle Program," November 6, 1961; Rosen to Holmes, "Recommendations for NASA Manned Space Flight Vehicle Program," November 20, 1961.

Representatives of MSC and NASA Headquarters visited the MIT Instrumentation Laboratory to discuss clauses in the contract for the Apollo navigation and guidance system, technical questions proposed by MSC, and work in progress. Topics discussed included the trajectories for the SA-7 and SA-8 flights and the estimated propellant requirements for guidance attitude maneuvers and velocity changes for the lunar landing mission. Presentations were made on the following subjects by members of the Laboratory staff: the spacecraft gyro, Apollo guidance computer logic design, computer displays and interfaces, guidance computer programming, horizon sensor experiments, and reentry guidance.

Memoranda, Jack Barnard, Apollo Project Office, to Associate Director, MSC, "Visit to MIT Instrumentation Laboratory Concerning the Apollo Navigation and Guidance System," November 15, 1961; William W. Petynia, Apollo Project Office, to Associate Director, MSC, "Third Apollo Monthly Meeting at MIT Instrumentation Laboratory on November 8-9," November 15, 1961.

The four MSC-MSFC Coordination Panels held their first meeting at Marshall Space Flight Center (MSFC). A significant event was the decision to modify the Electrical and Electronics Design Panel by creating two new Panels: the Electrical Systems Integration Panel and the Instrumentation and Communications Panel. In succeeding months, the Panels met at regular intervals.

MSF Management Council Minutes, June 25, 1963, Agenda Item 6.

In a letter to NASA Associate Administrator Robert C. Seamans, Jr., John C. Houbolt of Langley Research Center presented the lunar orbit rendezvous (LOR) plan and outlined certain deficiencies in the national booster and manned rendezvous programs. This letter protested exclusion of the LOR plan from serious consideration by committees responsible for the definition of the national program for lunar exploration.

Letter, Houbolt to Seamans, November 15, 1961.

NASA announced that the Chrysler Corporation had been chosen to build 20 Saturn first-stage (S-I) boosters similar to the one tested successfully on October 27. They would be constructed at the Michoud facility near New Orleans, La. The contract, worth about \$200 million, would run through 1966, with delivery of the first booster scheduled for early 1964.

Washington *Post*, November 18, 1961.



1961  
November  
18

*Ranger II* was launched into near-earth orbit from the Atlantic Missile Range by an Atlas-Agena B booster. The scheduled deep-space trajectory of the spacecraft was not achieved when the Agena engine failed to restart in orbit.

Washington *Evening Star*, November 18, 1961.

20

Milton W. Rosen, Director of Launch Vehicles and Propulsion, NASA Office of Manned Space Flight (OMSF), submitted to D. Brainerd Holmes, Director, OMSF, the report of the working group which had been set up on November 6. The recommendations of the group were:

- The United States should undertake a program to develop rendezvous capability on an urgent basis.

- To exploit the possibilities of accomplishing the first manned lunar landing by rendezvous, an intermediate vehicle with five F-1 engines in the first stage, four or five J-2 engines in the second stage, and one J-2 engine in the third stage should be developed (Saturn C-5). The vehicle should be so designed that it could be modified to use a three-engine first stage. The three-engine vehicle provided a better match with a large number of NASA and DOD requirements and earlier flights in support of the manned lunar program.

- The United States should place primary emphasis on the direct flight mode for achieving the first manned lunar landing. This mode gave greater assurance of accomplishment during this decade. To implement the direct flight mode, a Nova vehicle consisting of an eight F-1 engine first stage, a four M-1 engine second stage, and a one J-2 engine third stage should be developed on a top priority basis.

- Large solid-fuel rockets should not be considered as a requirement for manned lunar landing. If these rockets were developed for other purposes, the manned space flight program should support a solid-fuel first-stage development to provide a backup capability for Nova.

- Development of the S-IVB stage (one J-2) engine should be started, aiming toward flight tests on a Saturn C-1 in late 1964. It should be used as the third stage of both Saturn C-5 and Nova and also as the escape stage in the single earth orbit rendezvous mode.

- NASA had no present requirement for the Titan III vehicle. If the Titan III were developed by DOD, NASA should maintain continuous liaison with DOD development to ascertain if the vehicle could be used for future NASA needs.

Memorandum, Rosen to Holmes, "Recommendations for NASA Manned Space Flight Vehicle Program," November 20, 1961.

27

The original Apollo spacecraft Statement of Work of July 28 had been substantially expanded.

The requirements for the spacecraft navigation and guidance system were defined:

Control of translunar injection of the spacecraft and monitoring capability of injection guidance to the crew both for direct ascent and for injection from an earth parking orbit



Data and computation for mission abort capability en route to the moon and for guidance to a point from which a safe lunar landing could be attempted

Guidance of the command module to a preselected earth landing site after safe reentry

Guidance for establishing lunar orbit and making lunar landings; mission abort capability from the lunar landing maneuver

Control of launch from the lunar surface into transearth trajectory by both direct ascent and from lunar parking orbit

Rendezvous in earth orbit between the spacecraft and space laboratory module or other space vehicle

Components of the navigation and guidance system now clearly identified were:

Inertial platform

Space sextant

Computer

Controls and displays

Electronics assembly

Chart and star catalog

Range or velocity measuring equipment for terminal control in rendezvous and lunar landing

Backup inertial components for emergency operation

The stabilization and control system requirements were revised:

Roll control as well as flight path control during the thrusting period of atmospheric abort and stability augmentation after launch escape system separation

Stabilization of the spacecraft and the lunar injection configuration while in earth parking orbit

Rendezvous and docking with the space laboratory module or other space vehicle

Attitude control and hovering for lunar landings and launchings and for entering and leaving lunar orbit

Basic components of the stabilization and control system were defined:

Attitude reference

Rate sensors

Control electronics assembly

Manual controls

Attitude and rate displays

Power supplies

A single-engine service module propulsion system would replace the earlier vernier and mission propulsion systems. The new system would be capable of:

Abort propulsion after jettison of the launch escape system

All major velocity increments and midcourse velocity corrections for missions prior to the lunar landing attempt

Lunar launch propulsion and transearth midcourse velocity correction.

Earth-storable, hypergolic propellants would be used by the new system, which would include single- or multiple-thrust chambers with a thrust-to-weight ratio

1961  
November

of at least 0.4 for all chambers operating (based on the lunar launch configuration) and would have a pressurized propellant feed system.

The reaction control systems for the command and service modules would now each consist of two independent systems, both capable of meeting the total torque and propellant requirements. The fuel would be monomethylhydrazine and the oxidizer would be a mixture of nitrogen tetroxide and nitrous oxide.

The parachute system for the earth landing configuration was revised to include two FIST-type drogue parachutes deployed by mortars.

The command module structure was specified: a ring-reinforced, single-thickness aluminum shell pressure vessel separated from the outer support structure of relatively rigid brazed or welded sandwich construction. The ablative heatshield would be bonded to this outer structure.

Service module structure was also detailed: an aluminum honeycomb sandwich shell compatible with noise and buffet and with meteoroid requirements. The structural continuity would have to be maintained with adjoining modules and be compatible with the overall bending stiffness requirements of the launch vehicle.

The duties of the three Apollo crewmen were delineated:

Commander

Control of the spacecraft in manual or automatic mode in all phases of the mission

Selection, implementation, and monitoring of the navigation and guidance modes

Monitoring and control of key areas of all systems during time-critical periods  
Station in the left or center couch

Co-Pilot

Second in command of the spacecraft

Support of the pilot as alternative pilot or navigator

Monitoring of certain key parameters of the spacecraft and propulsion systems during critical mission phases

Station in the left or center couch

Systems Engineer

Responsibility for all systems and their operation

Primary monitor of propulsion systems during critical mission phases

Responsibility for systems placed on board primarily for evaluation for later

Apollo spacecraft

Station in the right-hand couch

During launch, reentry, or similar critical mission phases, the crew would be seated side by side. At other times, at least one couch would be stowed.

One crew member would stand watch during noncritical mission phases at either of the two primary duty stations. Areas for taking navigation fixes, performing maintenance, food preparation, and certain scientific observations could be sepa-

rate from primary duty stations. Arrangements of displays and controls would reflect the duties of each crewman. They would be so arranged that one crewman could return the spacecraft safely to earth. All crewmen would be cross-trained so that each could assume the others' duties.

Radiation shielding for the crew would be provided by the mass of the spacecraft modules.

A description of crew equipment was added:

The couch for each crewman would give full body and head support during all normal and emergency acceleration conditions. It would be adjustable to permit changes in body and leg angles and would be so constructed as to allow crewmen to interchange positions and to accommodate a crewman wearing a back or seat parachute. A restraint system would be provided with each couch for adequate restraint during all flight phases. Each support and restraint system would furnish vibration attenuation beyond that needed to maintain general spacecraft integrity. This system would keep crew vibration loads within tolerance limits and also enable the crew to exercise necessary control and monitoring functions.

Pressure suits would be carried for extravehicular activity and for use in the event of cabin decompression.

The spacecraft would be equipped with toilet facilities which would include means for disinfecting the human waste sufficiently to render it harmless and unobjectionable to the crew. Personal hygiene needs, such as shaving, the handling of non-human waste, and the control of infectious germs would be provided for.

Food would be dehydrated, freeze-dried, or of a similar type that could be reconstituted with water if necessary. Heating and chilling of the foods would be required. The primary source of potable water would be the fuel cells. In addition, sufficient water would have to be on board at launch for use during the 72-hour landing requirement in case of early abort. Urine would not have to be recycled for potable water.

Emergency equipment would include:

Personal parachutes

Post-landing survival equipment: one three-man liferaft, food, location aids, first aid supplies, and accessories to support the crew outside the spacecraft for three days in any emergency landing area. In addition, a three-day water supply would be removed from the spacecraft after landing; provision for purifying a three-day supply of sea water would be included.

The crew would be furnished "shirtsleeve" garments, lightweight cap, and exercise and recreation equipment.

Medical instrumentation would be used to monitor the crew during all flights, especially during stressful periods of early flights, and for special experiments to be performed in the space laboratory module and during extravehicular activity and lunar exploration. Each crewman would carry a radiation dosimeter.



1961

November

The environmental control system would comprise two air loops, a gas supply system, and a thermal control system.

One air loop would supply the conditioned atmosphere to the cabin or pressure suits. The other would remove sensible heat and provide cabin ventilation during all phases of the mission including postlanding.

The primary gas supply would be stored in the service module as supercritical cryogenics. The supply would be 50 percent excess capacity over that required for normal metabolic needs, two complete cabin repressurizations, a minimum of 18 airlock operations, and leakage. Recharging of self-contained extravehicular suit support systems would be possible.

Thermal control would be achieved by absorbing heat with a circulating coolant and rejecting this heat from a space radiator. During certain mission modes, other cooling systems would supplement or relieve the primary system.

Water collected from the separator and the fuel cells would be stored separately in positive expulsion tanks. Manual closures, filters, and relief valves would be used where needed as safety devices.

Metabolic requirements for the environmental control system were:

Total cabin pressure (oxygen and nitrogen mixture):  $7 \pm 0.2$  psia

Relative humidity: 40 to 70 percent

Partial pressure carbon dioxide—maximum 7.6 mm Hg

Temperature:  $75^\circ \pm 5^\circ$  F

The major components of the electrical power system were described more fully:

Three nonregenerative hydrogen-oxygen fuel cell modules characterized by low pressure, intermediate temperature, Bacon-type, utilizing porous nickel, unactivated electrodes, and aqueous potassium as the electrolyte

Mechanical accessories, including control components, reactant tankage, piping, etc.

Three silver-zinc primary batteries, each having a normal 28-volt output and a minimum capacity of 3000 watt-hours (per battery) when discharged at the ten-hour rate at  $80^\circ$  F

A display and control panel, sufficient to monitor the operation and status of the system and for distribution of generated power to electrical loads as required

The fuel cell modules and control, tanks (empty), radiators, heat exchangers, piping, valves, total reactants plus reserves would be located in the service module. The silver-zinc batteries and electrical power distribution and controls would be placed in the command module.

Under normal operation, the entire electrical power requirements would be supplied by the three fuel cell modules operating in parallel. The primary storage batteries would be maintained fully charged under this condition of operation.

If one fuel cell module failed, the unit involved would automatically be electrically and mechanically isolated from the system and the entire electrical load assumed by the two remaining fuel cells. The primary batteries would remain fully charged.

If two fuel cell modules failed, they would be isolated from the system and the spacecraft electrical loads would immediately be reduced by the crew and manually programmed to hold within the generating capacities of the remaining fuel cell.

At reentry, the fuel cell modules and accessories would be jettisoned. All subsequent electrical power requirements would be provided by the primary storage batteries.

Each fuel cell module would have a normal capacity of 1200 watts at an output voltage of 28 volts and a current density conservatively assigned so that 50 percent overloads could be continuously supplied. The normal fuel cell operating pressure and temperature would be about 60 psia and 425° to 500° F respectively. Under normal conditions of operation, the specific fuel (hydrogen and oxygen) consumption should not exceed a total of 0.9 lb/kw-hr.

Self-sustaining operation within the fuel cell module should begin at a temperature of about 275° F. A detection system would be provided with each fuel cell module to prevent contamination of the collected potable water supply.

The degree of redundancy provided for mechanical and electrical accessory equipment would be 100 percent.

The distribution portion of the electrical power system would contain all necessary buses, wiring protective devices, and switching and regulating equipment.

Sufficient tankage would be supplied to store all reactants required by the fuel cell modules and environmental controls for a 14-day mission. The reactants would be stored supercritically at cryogenic temperatures and the tankage would consist of two equal volume storage vessels for each reactant. The main oxygen and nitrogen storage would supply both the environmental control system and the fuel cells.

The communication and instrumentation system was further detailed:

The equipment was to be constructed to facilitate maintenance by ground personnel and by the crew and to be as nearly self-contained as possible to facilitate removal from the spacecraft. Flexibility for incorporation of future additions or modifications would be stressed throughout the design. A patch and programming panel would be included which would permit the routing of signal inputs from sensors to any selected signal conditioner and from this to any desired commutator channel. Panel design would provide the capability of "repatching" during a mission. The equipment and system should be

1961  
November

capable of sustained undegraded operation with supply voltage variation of + 15 percent to - 20 percent of the normal bus voltage.

A circuit quality analysis for each radiating electrical system would be required to show exactly how ranging, telemetry, voice, and television data modulated all transmitters with which they were used.

The equipment and associated documentation would be engineered for comprehensive and logical fault tracing.

Components of the communication subsystem would include :

- Voice communication
- Telemetry
- Tracking transponders
- Television
- Radio recovery aids
- Antenna subsystems
- Radar altimeter (if required by the guidance system)

The instrumentation system would be required to detect, measure, and display all parameters needed by the crew for monitoring and evaluating the integrity and environment of the spacecraft and performance of the spacecraft systems.

Data would be transmitted to ground stations for assessment of spacecraft performance and for failure analysis. Information needed for abort decisions and aid in the selection of lunar landing sites would also be provided. The mission would be documented through photography and recording.

Included in the components of the instrumentation system were :

- Sensors
- Data disposition
- Tape recorders
- Panel display indicators
- Calibration
- Clock
- Telescope
- Cameras

In addition to the description of the major command and service module systems, the Statement of Work also included sections on the lunar landing module, space laboratory module, mission control center and ground operational support system, and the engineering and development test plan.

The propulsion system for the lunar landing module would now comprise a composite propulsion system: multiple lunar retrograde engines for the gross velocity increments required for lunar orbiting and lunar landing; and a lunar landing engine for velocity vector control, midcourse velocity control, and the lunar hover and touchdown maneuver. The lunar retrograde engines would



use liquid-oxygen and liquid-hydrogen propellants. The single lunar landing engine would require the same type of propellant, would be throttleable over a ratio of  $\pm 50$  percent about the normal value, and would be capable of multiple starts within the design operating life of the engine.

No additions or changes had been made in the space laboratory module systems description.

Overall control of all Apollo support elements throughout all phases of a mission would be exercised by the Mission Control Center. Up to the time of liftoff, mission launch activities would be conducted from the launch control center at Cape Canaveral. Remote stations would be used to support near-earth and lunar flights and track the command module during reentry.

Five major phases of a development and test plan were identified:

- (1) Design information and development tests
- (2) Qualification, reliability, and integration tests
- (3) Major ground tests
- (4) Major development flight tests
- (5) Flight missions.

NASA, *Project Apollo Spacecraft Development Statement of Work* (STG, November 27, 1961), Part 3, Technical Approach, pp. 35–96.

A team and a goal—officials of North American Aviation, Inc., study a replica of the moon shortly after the announcement that the firm had been selected by NASA as the prime contractor for the Apollo command and service modules. From left to right are Harrison A. Storms, president of North American's Space and Information Systems Division; John W. Paup, program manager of Apollo; and Charles H. Feltz, Apollo program engineer. (NAA photo)



1961  
November  
28

NASA announced that the Space and Information Systems Division of North American Aviation, Inc., had been selected to design and build the Apollo spacecraft. The decision by NASA Administrator James E. Webb followed a comprehensive evaluation of five industry proposals by nearly 200 scientists and engineers representing both NASA and DOD. Webb had received the Source Evaluation Board findings on November 24. Although technical evaluations were very close, NAA had been selected on the basis of experience, technical competence, and cost. NAA would be responsible for the design and development of the command module and service module. NASA expected that a separate contract for the lunar landing system would be awarded within the next six months. The MIT Instrumentation Laboratory had previously been assigned the development of the Apollo spacecraft guidance and navigation system. Both the NAA and MIT contracts would be under the direction of MSC.

NAA Space and Information Systems Division, News Release SP3-0610, November 28, 1961; *Wall Street Journal*, November 29, 1961; U.S. Congress, Senate, Committee on Aeronautical and Space Sciences, *Apollo Accident*, Hearings, 90th Congress, 1st Session (1967), Part 6, p. 513; TWX, NASA Headquarters to Ames, Langley, Lewis, and Flight Research Centers, Goddard and Marshall Space Flight Centers, Jet Propulsion Laboratory, Launch Operations Center, Space Task Group, Wallops Station, and Western Operations Office, November 28, 1961.

29

The *Mercury-Atlas 5* launch from the Atlantic Missile Range placed a Mercury spacecraft carrying chimpanzee Enos into orbit. After a two-orbit flight of 3 hours and 21 minutes, the capsule reentered and was recovered 1 hour and 25 minutes later. Enos was reported in excellent condition. No additional unmanned or primate flights were considered necessary before attempting the manned orbital mission scheduled for early 1962.

MSC *Space News Roundup*, December 13, 1961, p. 1; Swenson *et al.*, *This New Ocean*, pp. 402-407.

29-30

On a visit to Marshall Space Flight Center by MIT Instrumentation Laboratory representatives, the possibility was discussed of emergency switchover from Saturn to Apollo guidance systems as backup for launch vehicle guidance.

David G. Hoag, personal notes, November 29-30, 1961.

## **PART III**

**Lunar Orbit Rendezvous: Mode and Module**

**December 1961 through November 7, 1962**



## PART III

### The Key Events

#### 1961

- December 15:* Selection of The Boeing Company for negotiations as the prime contractor for the first stage (S-IC) of the Saturn C-5, under the direction of Marshall Space Flight Center (MSFC).
- December 20:* Selection of the Douglas Aircraft Company to develop the S-IVB stage of the Saturn C-5, under the direction of MSFC.
- December 21:* Letter contract No. NAS 9-150 signed by NASA and North American Aviation, Inc. (NAA), authorizing work to begin on the Apollo spacecraft development program.
- December 21:* Decision by the Manned Space Flight Management Council on the Saturn C-5 configuration.
- December 21:* Four major subcontractors on the Apollo spacecraft systems chosen by NAA.

#### 1962

- January 15:* Apollo Spacecraft Project Office established at the Manned Spacecraft Center (MSC).
- February 20:* First successful American orbital flight, by Astronaut John H. Glenn, Jr.
- March 12:* Primary activities for the Apollo program relocated at MSC, Houston, Tex.
- April 11:* Assignment by the President of DX (highest) priority to the Apollo program.
- May 8:* Three major associate contractors on the Apollo spacecraft guidance and navigation system selected by the Massachusetts Institute of Technology Instrumentation Laboratory.
- May 11:* General Dynamics/Convair awarded contract by NASA to design and manufacture the Little Joe II test launch vehicle.
- July 11:* Announcement by NASA that the Saturn C-IB launch vehicle would be developed to test the Apollo spacecraft in earth orbit missions.
- July 11:* Selection by NASA of the lunar orbit rendezvous mode for the manned lunar landing mission.
- July 20:* Announcement by NASA that the Mission Control Center would be located at MSC.
- July 25:* Invitations by NASA to 11 companies to bid on the lunar excursion module contract.
- July:* Hamilton Standard Division of United Aircraft Corporation selected by NASA to develop the Apollo space suit.
- September 5:* Nine industry proposals for the lunar excursion module contract received by NASA.
- October 30:* Contract signed by NASA with NAA for the development and production of the S-II (second) stage of the Saturn C-5, directed by MSFC.
- November 7:* Selection of the Grumman Aircraft Engineering Corporation by NASA to design and develop the lunar excursion module under MSC direction.

# PART III

## Lunar Orbit Rendezvous: Mode and Module

December 1961 through November 7, 1962

The Project Apollo Statement of Work for development of the Apollo spacecraft was completed. A draft letter based on this Statement of Work was presented to NAA for review. A prenegotiation conference on the development of the Apollo spacecraft was held at Langley Field, Va.

1961  
December  
4

"Apollo Spacecraft Chronology," p. 13.

NASA Associate Administrator Robert C. Seamans, Jr., commented to D. Brainerd Holmes, Director, Office of Manned Space Flight, on the report of the (Rosen) working group on launch vehicles, which had been submitted on November 20. Seamans expressed himself as essentially in accord with the group's recommendations.

4

Memorandum, Seamans to Holmes, "Recommendations for NASA Manned Space Flight Vehicle Program," December 4, 1961.

NASA negotiations with NAA on the Apollo spacecraft contract were held at Williamsburg, Va. Nine Technical Panels met on December 11 and 12 to review Part 3, Technical Approach, of the Statement of Work. These Panels reported their recommended changes and unresolved questions to the Technical Subcommittee for action. Later in the negotiations, NASA and NAA representatives agreed on changes intended to clarify the original Statement of Work. Among these was the addition of the boilerplate program. Two distinct types of boilerplates were to be fabricated: those of a simple cold-rolled steel construction for drop impact tests and the more complex models to be used with the Little Joe II and Saturn launch vehicles. The Little Joe II, originally conceived in June 1961, was a solid-fuel rocket booster which would be used to man-rate the launch escape system for the command module.

5-20

In addition, the Apollo Project Office, which had been part of the MSC Flight Systems Division, would now report directly to the MSC Director and would be responsible for planning and directing all activities associated with the completion of the Apollo spacecraft project. Primary functions to be performed by the Office would include:

- Monitor the work of the Apollo Principal Contractor (NAA) and Associate Contractors
- Resolve technical problems arising between the Principal Contractor and Associate Contractors which were not directly resolved between the parties involved

1961

December

- Maintain close liaison with all Apollo contractors to keep fully and currently informed on the status of contract work, potential schedule delays, or technical problems which might impede progress.

[On January 15, 1962, the Apollo Spacecraft Project Office was established at MSC.]

Letter contract No. NAS 9-150, authorizing work on the Apollo development program to begin on January 1, 1962, was signed by NASA and NAA on December 21. Under this contract, NAA was assigned the design and development of the command and service modules, the spacecraft adapter, associated ground support equipment, and spacecraft integration. Formal signing of the contract followed on December 31.

Project Apollo, "Minutes of Technical Panel Meetings for Negotiation of Spacecraft Development," December 12-15, 1961; Oakley, *Historical Summary, S&ID Apollo Program*, pp. 4, 27; *Project Apollo Quarterly Status Report No. 1 for Period Ending September 30, 1962*, p. 9; MSC, *Project Apollo Spacecraft Development Statement of Work* (December 18, 1961), Part 4, pp. 1-2.

6 D. Brainerd Holmes, NASA Director of Manned Space Flight, outlined the preliminary project development plan for the Mercury Mark II program in a memorandum to NASA Associate Administrator Robert C. Seamans, Jr. The primary objective of the program was to develop rendezvous techniques; important secondary objectives were long-duration flights, controlled land recovery, and astronaut training. The development of rendezvous capability, Holmes stated, was essential:

- It offered the possibility of accomplishing a manned lunar landing earlier than by direct ascent.
- The lunar landing maneuver would require the development of rendezvous techniques regardless of the operational mode selected for the lunar mission.
- Rendezvous and docking would be necessary to the Apollo orbiting laboratory missions planned for the 1965-1970 period.

The plan was approved by Seamans on December 7. [The Mercury Mark II program was renamed "Gemini" on January 3, 1962.]

Memorandum, Holmes to Associate Administrator, "Mercury Mark II Preliminary Project Development Plan," December 6, 1961.

7 Plans for the development of a two-man Mercury spacecraft were announced by Robert R. Gilruth, MSC Director. The two-man spacecraft, to be built by McDonnell Aircraft Corporation, would be similar in shape to the Mercury spacecraft but slightly larger and two to three times heavier. Its booster rocket would be a modified Air Force Titan II, scheduled for flight test in early 1962. One of the major objectives in the program would be a test of orbital rendezvous, in which the two-man spacecraft would be launched into orbit by the Titan II and attempt to rendezvous with an Agena stage launched by an Atlas rocket. The total cost



for a dozen two-man spacecraft plus boosters and other equipment was estimated at \$500 million.

*Aeronautical and Astronautical Events of 1961*, p. 71.

NASA Associate Administrator Robert C. Seamans, Jr., and DOD Deputy Director of Defense Research and Engineering John H. Rubel recommended to Secretary of Defense Robert S. McNamara and NASA Administrator James E. Webb that detailed arrangements for support of the Mercury Mark II spacecraft and the Atlas-Agena vehicle used in rendezvous experiments be planned directly between NASA's Office of Manned Space Flight and the Air Force and other DOD organizations. NASA's primary responsibilities would be the overall management and direction for the Mercury Mark II/Agena rendezvous development and experiments. The Air Force responsibilities would include acting as NASA contractor for the Titan II launch vehicle and for the Atlas-Agena vehicle to be used in rendezvous experiments. DOD's responsibilities would include assistance in the provision and selection of astronauts and the provision of launch, range, and recovery support, as required by NASA.

7

Memorandum, Deputy Director of Defense Research and Engineering, DOD, and Associate Administrator, NASA, to The Secretary of Defense and the Administrator, NASA, "Recommendation Relative to the Division of Effort between the NASA and DOD in the Development of Space Rendezvous and Capabilities," December 7, 1961.

NASA announced that The Boeing Company had been selected for negotiations as a possible prime contractor for the first stage (S-IC) of the advanced Saturn launch vehicle. The S-IC stage, powered by five F-1 engines, would be 35 feet in diameter and about 140 feet high. The \$300-million contract, to run through 1966, called for the development, construction, and testing of 24 flight stages and one ground test stage. The booster would be assembled at the NASA Michoud Operations Plant near New Orleans, La., under the direction of the Marshall Space Flight Center.

15

*Saturn Illustrated Chronology*, pp. 49-50.

Fred T. Pearce, Jr., of MSC visited the MIT Instrumentation Laboratory to discuss the first design-study space sextant produced at the Laboratory. The instrument was intended to be used with the guidance computer. The working mockup was demonstrated and the problem of the effect of the vehicle motion on the sextant was discussed.

18-19

Memorandum, Pearce to Associate Director, STG, "Visits to Instrument Laboratory and Ames Research Center to Discuss the Apollo Navigational Instrument," December 22, 1961.

The General Assembly of the United Nations unanimously adopted Resolution 1721 (XIV) on international cooperation in the peaceful uses of outer space.

20

Kemp, *Evolution Toward a Space Treaty: An Historical Analysis*, p. 55.

The Douglas Aircraft Company was selected by NASA for negotiation of a contract to modify the Saturn S-IV stage by installing a single J-2 Rocketdyne engine of

20

1961  
December

200,000 pounds of thrust. The contract would be under the direction of the Marshall Space Flight Center.

*Saturn Illustrated Chronology*, p. 50.

- 21 D. Brainerd Holmes, Director of the NASA Office of Manned Space Flight, announced the formation of the Manned Space Flight Management Council. The Council, which was to meet at least once a month, was to identify and resolve difficulties and to coordinate the interface problems in the manned space flight program. Members of the Council, in addition to Holmes, were: from MSC, Robert R. Gilruth and Walter C. Williams, Director and Associate Director; from Marshall Space Flight Center, Wernher von Braun, Director, and Eberhard F. M. Rees, Deputy Director for Research and Development; from NASA Headquarters, George M. Low, Director of Spacecraft and Flight Missions; Milton W. Rosen, Director of Launch Vehicles and Propulsion; Charles H. Roadman, Director of Aerospace Medicine; William E. Lilly, Director of Program Review and Resources Management; and Joseph F. Shea, Deputy Director for Systems Engineering. Shea, formerly Space Programs Director for Space Technology Laboratories, Inc., Los Angeles, Calif., had recently joined NASA.

MSC *Space News Roundup*, January 10, 1962, p. 1; Senate Staff Report, *Manned Space Flight Program*, p. 205.

- 21 The Manned Space Flight Management Council decided at its first meeting that the Saturn C-5 launch vehicle would have a first stage configuration of five F-1 engines and a second stage configuration of five J-2 engines. The third stage would be the S-IVB with one J-2 engine. It recommended that the contractor for stage integration of the Saturn C-1 be Chrysler Corporation and that the contractor for stage integration of the Saturn C-5 be The Boeing Company. Contractor work on the Saturn C-5 should proceed immediately to provide a complete design study and a detailed development plan before letting final contracts and assigning large numbers of contractor personnel to Marshall Space Flight Center or Michoud.

MSF Management Council Minutes, December 21, 1961, pp. 1-2.

- 21 NAA's Space and Information Systems Division selected four companies as subcontractors to design and build four of the major Apollo spacecraft systems. The Collins Radio Company, Cedar Rapids, Iowa, received the telecommunications systems contract, worth more than \$40 million; Minneapolis-Honeywell Regulator Company, Minneapolis, Minn., received the stabilization and control systems contract, \$30 million; AiResearch Manufacturing Company, division of The Garrett Corporation, Los Angeles, Calif., was awarded the environmental control system contract, \$10 million; and Radioplane Division of Northrop Corporation, Van Nuys, Calif., was selected for the parachute landing system contract, worth more than \$1 million. The total cost for the initial phase of the NAA contract was expected to exceed \$400 million.

MSC *Space News Roundup*, December 27, 1961.



NASA made public the drawings of the three-man Apollo spacecraft to be used in the lunar landing development program. On January 9, NASA announced its decision that the Saturn C-5 would be the lunar launch vehicle.

1962

January

5

Washington *Evening Star*, January 5, 1962; *Washington Post*, January 10, 1962.

In his State of the Union message to the Congress, President John F. Kennedy said: "With the approval of this Congress, we have undertaken in the past year a great new effort in outer space. Our aim is not simply to be first on the moon, any more than Charles Lindbergh's real aim was to be first to Paris. His aim was to develop the techniques and the authority of this country and other countries in the field of the air and the atmosphere, and our objective in making this effort, which we hope will place one of our citizens on the moon, is to develop in a new frontier of science, commerce and cooperation, the position of the United States and the free world. This nation belongs among the first to explore it. And among the first—if not the first—we shall be."

11

Senate Staff Report, *Documents on International Aspects of the Exploration and Use of Outer Space, 1954-1962*, p. 228.

The Apollo Spacecraft Project Office (ASPO) was established at MSC. Charles W. Frick was selected as Manager of the new Office, to assume his duties in February. Frick had been Chief of Technical Staff for General Dynamics/Convair. Robert O. Piland was appointed Deputy Manager of ASPO and would serve as Acting Manager until Frick's arrival. ASPO would be responsible for the technical direction of NAA and other industrial contractors assigned to work on the Apollo spacecraft. All technical coordination with NAA or with other contractors on the Apollo project would be coordinated through this Office. The Manager of ASPO would be responsible for keeping the Director and Associate Director of MSC fully advised on the status of the program.

15

MSC Announcement No. 10, *Establishment of the Apollo Spacecraft Project Office*, January 15, 1962.

The first Apollo engineering order was issued to fabricate mockups of the Apollo command and service modules.

22

Oakley, *Historical Summary, S&ID Apollo Program*, p. 5.

*Ranger III* was launched toward the moon from the Atlantic Missile Range by an Atlas-Agena B booster. Because of a malfunction in the Agena guidance system, the spacecraft missed its target by 22,862 miles and eventually went into solar orbit. Of four scientific experiments only one was partially completed: gamma-ray readings of the lunar surface. Attempts to relay television pictures of the moon and to bounce radar signals off the moon at close range were unsuccessful.

26

*New York Times*, January 29, 1962.

NAA engineers began preliminary layouts to define the elements of the command module (CM) configuration. Additional requirements and limitations imposed

During  
the  
Month



## APOLLO SPACECRAFT CIRCUMLUNAR CONFIGURATION

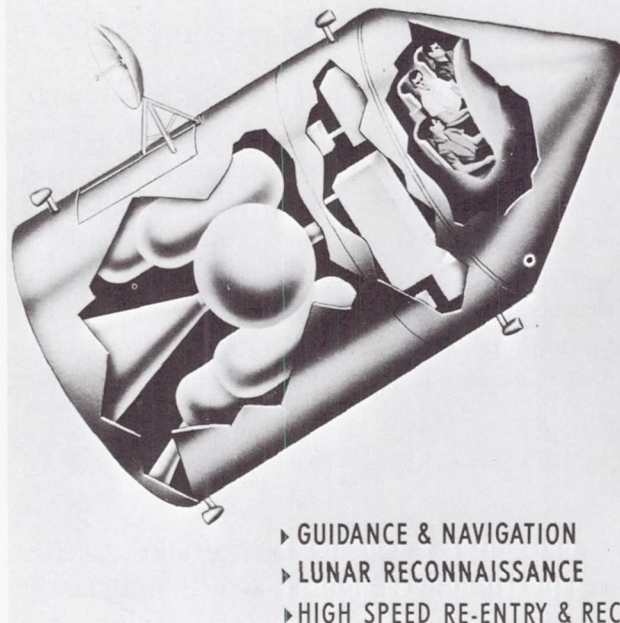

### COMMAND MODULE:

- MISSION CONTROL
- CREW QUARTERS
- LIFE SUPPORT
- RE-ENTRY

### SERVICE MODULE:

- MIDCOURSE CORRECTIONS
- ABORT PROPULSION
- ELECTRIC POWER
- EXPENDABLE SUPPLIES

- ▶ GUIDANCE & NAVIGATION
- ▶ LUNAR RECONNAISSANCE
- ▶ HIGH SPEED RE-ENTRY & RECOVERY

The early 1962 concept of the configuration of the Apollo spacecraft for a circumlunar mission. The artist took seriously the requirement for a shirtsleeve atmosphere.

**1962**

**January**

on the CM included reduction in diameter, paraglider compatibility, 250 pounds of radiation protection water, redundant propellant tankage for the attitude control system, and an increase in system weight and volume.

Layouts were also being prepared to identify equipment requirements in the CM aft compartment, while layouts depicting the position and orientation of the three crewmen during various phases of the lunar flight were complete.

Basic load paths for the CM inner structure, an access door through the outer structure, and the three side wall hatches for crew entrance and exit had been tentatively defined. The CM inner structure was currently of bonded aluminum honeycomb, the outer structure of high-temperature, brazed steel honeycomb.

NAA, *Apollo Monthly Progress Report*, SID 62-300-1, January 31, 1962, pp. 15-16.

**During  
the  
Month**

Command module heatshield requirements, including heating versus time curves, were established by NAA for several design trajectories. A computer program method of analyzing the charring ablation process had been developed. By this means, it was possible to calculate the mass loss, surface char layer temperature, amount of heat conducted through the uncharred ablation material and insulation

into the cabin, and temperature profile through the ablator and insulation layers. In February, NAA determined that a new and more refined computer program would be needed.

1962  
January

*Apollo Monthly Progress Report*, SID 62-300-1, p. 1.

The solid propellant called for in the original NAA proposal on the service module propulsion system was replaced by a storable, hypergolic propellant. Multitank configurations under study appeared to present offloading capabilities for alternative missions.

During  
the  
Month

*Apollo Monthly Progress Report*, SID 62-300-1, p. 18.

The Requests for Quotation on production contracts for major components of the Apollo spacecraft guidance and navigation system, comprising seven separate items, were released to industry by the MIT Instrumentation Laboratory. (The Source Evaluation Board, appointed on January 31, began its work during the week of March 5 and contractors were selected on May 8.)

January-February

Interview with Ralph Ragan, Instrumentation Laboratory, MIT, April 27, 1966; Apollo Spacecraft Project Office, MSC, Weekly Activity Report, March 5-10, 1962; memorandum, Robert C. Seamans, Jr., to MSC, Attn: Robert R. Gilruth, "Appointment of Source Evaluation Board," January 31, 1962.

The Grumman Aircraft Engineering Corporation developed a detailed, company-funded study on the lunar orbit rendezvous technique: characteristics of the system (relative cost of direct ascent, earth orbit rendezvous, and lunar orbit rendezvous); developmental problems (communications, propulsion); and elements of the system (tracking facilities, etc.). Joseph M. Gavin was appointed in the spring to head the effort, and Robert E. Mullaney was designated program manager.

January-June

Interview with Saul Ferdman, Director of Space Vehicle Development, Grumman Aircraft Engineering Corporation, May 2, 1966.

John C. Houbolt of Langley Research Center and Charles W. Mathews of MSC made a presentation of lunar orbit rendezvous versus earth orbit rendezvous to the Manned Space Flight Management Council.

February

6

MSF Management Council Minutes, February 6, 1962, p. 1.

At his regular press conference, President John F. Kennedy was asked for his "evaluation of our progress in space at this time" and whether the United States had changed its "timetable for landing a man on the moon." He replied: "As I said from the beginning, we have been behind . . . and we are running into the difficulties which came from starting late. We, however, are going to proceed by making a maximum effort. As you know, the expenditures in our space program are enormous . . . the time schedule, at least our hope, has not been changed by the recent setbacks [Ranger failures]."

7

*Washington Post*, February 8, 1962.



1962

February

7

On the basis of a study by NAA, a single-engine configuration was chosen as the optimum approach for the service module propulsion subsystem. The results of the study were presented to MSC representatives and NAA was authorized to issue a work statement to begin procurement of an engine for this configuration. Agreement was also reached at this meeting on a vacuum thrust level of 20,000 pounds for the engine. This would maintain a thrust-to-weight ratio of 0.4 and allow a considerable increase in the lunar liftoff weight of the spacecraft.

NAA, *Apollo Monthly Progress Report*, SID 62-300-2, February 28, 1962, p. 46.

9

Robert R. Gilruth, MSC Director, in a letter to NASA Headquarters, described the Ad Hoc Lunar Landing Module Working Group which was to be under the direction of the Apollo Spacecraft Project Office. The Group would determine what constraints on the design of the lunar landing module were applicable to the effort of the Lewis Research Center. Gilruth asked that Eldon W. Hall represent NASA Headquarters in this Working Group. [At this time, the lunar landing module was conceived as being that part of the spacecraft which would actually land on the moon and which would contain the propulsion system necessary for launch from the lunar surface and injection into transearth trajectory. Pending a decision on the lunar mission mode, the actual configuration of the module was not yet clearly defined.]

Letter, Gilruth, MSC, to NASA Headquarters, Attn: Mr. Rosen, "Formation of Lunar Landing Module Ad Hoc Working Group," February 9, 1962.

9

NASA announced that the General Electric Company had been selected for a major supporting role in the Apollo project, to provide integration analysis of the total space vehicle (including booster-spacecraft interface), ensure reliability of the entire space vehicle, and develop and operate a checkout system.

U.S. Congress, House, Committee on Science and Astronautics, *Astronautical and Aeronautical Events of 1962*, Report of the National Aeronautics and Space Administration, 88th Congress, 1st Session (1963), p. 15.

13

A contract for the escape rocket of the Apollo spacecraft launch escape system was awarded to the Lockheed Propulsion Company by NAA. The initial requirements were for a 200,000-pound-thrust solid-propellant rocket motor with an active thrust-vector-control subsystem. After extensive study, Lockheed was directed to remove the control subsystem. A letter contract change was subsequently made with Lockheed to develop and manufacture a pitch-control motor to replace the thrust-vector-control subsystem. In conjunction with the use of the pitch-control motor, the escape-motor thrust was reduced to 155,000 pounds.

*Apollo Quarterly Status Report No. 1*, p. 10; Oakley, *Historical Summary, S&ID Apollo Program*, p. 6; TWX, NAA to MSC, February 12, 1962.

13-15

A meeting on the technical aspects of earth orbit rendezvous was held at NASA Headquarters. Representatives from various NASA offices attended: Arthur L. Rudolph, Paul J. DeFries, Fred L. Digesu, Ludie G. Richard, John W. Hardin, Jr., Ernst D. Geissler, and Wilson B. Schramm of Marshall Space Flight Center (MSFC); James T. Rose of MSC; Friedrich O. Vonbun, Joseph W. Siry, and



James J. Donegan of Goddard Space Flight Center (GSFC); Douglas R. Lord, James E. O'Neill, Richard J. Hayes, Warren J. North, and Daniel D. McKee of the NASA Office of Manned Space Flight (OMSF). Joseph F. Shea, Deputy Director for Systems, OMSF, who had called the meeting, defined in general terms the goal of the meeting: to achieve agreement on the approach to be used in developing the earth orbit rendezvous technique. After two days of discussions and presentations, the Group approved conclusions and recommendations:

- Gemini rendezvous operations could and must provide substantial experience with rendezvous techniques pertinent to Apollo.
- Incorporation of the Saturn guidance equipment in a scaled-down docking module for the Agenas in the Gemini program was not required.
- Complete development of the technique and equipment for Apollo rendezvous and docking should be required before the availability of the Saturn C-5 launch vehicle.
- Full-scale docking equipment could profitably be developed by three-dimensional ground simulations. MSFC would prepare an outline of such a program.
- The Apollo rendezvous technique and actual hardware could be flight-tested with the Saturn C-1 launch vehicle. MSFC would prepare a proposed flight test program.
- The choice of connecting or tanking modes must be made in the near future. The MSFC Orbital Operations Study program should be used to provide data to make this decision.
- The rendezvous technique which evolved from this meeting would place heavy requirements on the ground tracking network. GSFC should provide data relating the impact of detailed trajectory considerations to ground tracking station requirements.

[This meeting was part of a continuing effort to select the lunar mission mode.]

Minutes, Earth Orbital Rendezvous Meeting, February 13-15, 1962, pp. 2-4.

NASA signed a contract with The Boeing Company for indoctrination, familiarization, and planning, expected to lead to a follow-on contract for design, development, manufacture, test, and launch operations of the first stage (S-IC) of the Saturn C-5 launch vehicle.

14

Senate Staff Report, *Manned Space Flight Program*, p. 205.

NASA announced Project Fire, a high-speed reentry heat research program to obtain data on materials, heating rates, and radio signal attenuation on spacecraft reentering the atmosphere at speeds of about 24,500 miles per hour. Information from the program would support technology for manned and unmanned reentry from lunar missions. Under the management of the Langley Research Center, Project Fire would use Atlas D boosters and the reentry package would be powered by an Antares solid-fuel motor (third stage of the Scout).

18

*Astronautical and Aeronautical Events of 1962*, p. 17.

1962

February

20

The Mercury spacecraft *Friendship 7*, with Astronaut John H. Glenn, Jr., as pilot, was launched into orbit from the Atlantic Missile Range by an Atlas booster. After a three-orbit flight of 4 hours, 55 minutes, and 23 seconds, *Friendship 7* splashed down in the Atlantic Ocean about 800 miles southeast of Bermuda. The spacecraft was recovered within minutes, and Astronaut Glenn was reported to be in excellent condition. With this flight, the basic objectives of Project Mercury had been achieved.

Grimwood, *Project Mercury: A Chronology*, pp. 159–160.

27

The preparation of schedules based on the NASA Fiscal Year 1962 budget (including the proposed supplemental appropriation), the Fiscal Year 1963 budget as submitted to Congress, and Fiscal Year 1964 and subsequent funding was discussed at the Manned Space Flight Management Council meeting. Program assumptions as presented by Wernher von Braun, Director, Marshall Space Flight Center (MSFC), were approved for use in preparation of the schedules:

- The Saturn C-5 launch vehicle and earth orbital rendezvous were considered the primary mode for the lunar landing.
- Full-scale orbit operations development, including ground testing, would be accomplished, using S-I boosters and orbital upper stages. This development would be planned so that upper stages and rendezvous techniques would be developed by the time the C-5 was operational. Planning would consider both connecting and fueling modes.
- The development of a two-stage Nova with liquid-propellant engines in both stages would be activated as early as realistically feasible. This would provide an alternative, direct flight mode carrying the same orbital launch vehicle as developed for the C-5.
- There would be no solid-propellant vehicle development.

Charles W. Frick of MSC and Hans H. Maus of MSFC would coordinate schedule assumptions between the Centers.

MSF Management Council Minutes, February 27, 1962, Erratum Sheet, Agenda Item 3.

During  
the  
Month

A NASA Apollo Office was established at NAA's Space and Information Systems Division, under the direction of J. Thomas Markley of MSC. The Office would serve primarily as liaison between the prime contractor and the Apollo Spacecraft Project Office at MSC.

MSC *Space News Roundup*, February 21, 1962, p. 8.

During  
the  
Month

The command module crew couch was repositioned and redesigned because of numerous problems. In the new design, an adjustable hand controller, similar to that used on the X-15, would be attached to an adjustable arm rest. The head rest could be regulated for an approximate four-inch movement, while the side head support was limited in movement for couch-module clearance. The adjustable leg support included a foot controller which could be folded up.



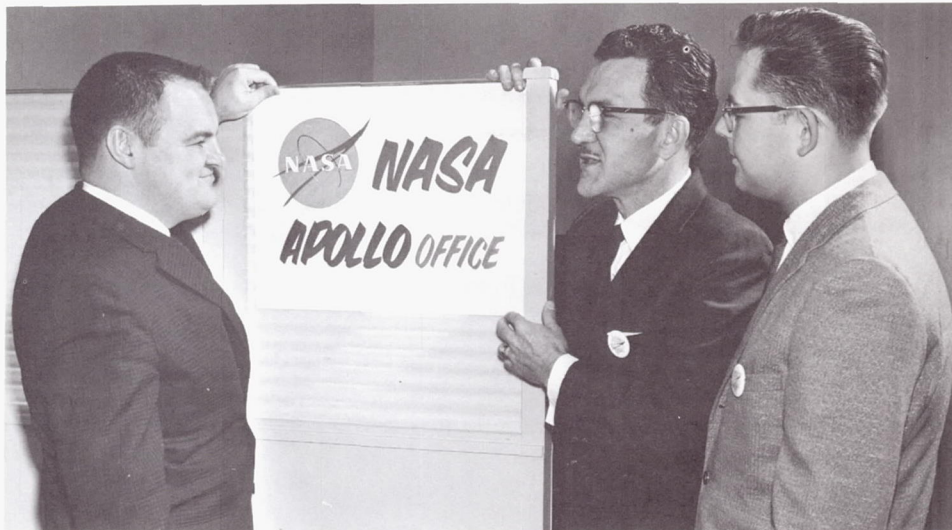

The first resident Apollo Spacecraft Program Office (RASPO) manager, J. Thomas Markley, at the left, the day the office was opened at the North American plant in Downey, Calif. Others in the photo are MSC employees Henry P. Yschek, center, and Raymond R. Clemence.

The center couch, including the crewman parachute and survival kit, could be folded out to a sleep position and stowed under either remaining couch. Allowance was made for the crewman to turn over.

Principal problems remaining were the difficulty of removing the center couch and providing the clearances needed for the couch positions specified for various phases of the lunar mission.

*Apollo Monthly Progress Report*, SID 62-300-2, p. 43.

NASA wind tunnel data on the adaptation of the Project Mercury Little Joe booster to the Apollo launch escape system were analyzed. The booster fins were ineffective in maintaining the stability of the configuration and the project was canceled. The later Little Joe II depended on the inherent stability of the total vehicle to attain a successful ballistic trajectory to test altitude.

*Apollo Monthly Progress Report*, SID 62-300-2, p. 1; Convair Division of General Dynamics, *Little Joe II Test Launch Vehicle, NASA Project Apollo: Final Report* (May 1966), Vol. 1, p. 117.

NASA Headquarters selected the Chance Vought Corporation of Ling-Temco-Vought, Inc., as a contractor to study spacecraft rendezvous. A primary part of the contract would be a flight simulation study exploring the capability of an astronaut to control an Apollo-type spacecraft.

*Astronautical and Aeronautical Events of 1962*, p. 27.

**1962**

**February**

**During  
the  
Month**

**March**

**1**



1962

March

2

The Marquardt Corporation was selected by NAA's Space and Information Systems Division to design and build the reaction control rocket engines for the Apollo spacecraft. The contract was signed during April.

Oakley, *Historical Summary, S&ID Apollo Program*, p. 6; *Apollo Quarterly Status Report No. 1*, p. 17; Apollo Spacecraft Project Office, MSC, Weekly Activity Report, February 25–March 3, 1962.

3

The Aerojet-General Corporation was named by NAA as a subcontractor for the Apollo service module propulsion system.

Oakley, *Historical Summary, S&ID Apollo Program*, p. 6.

6

The organizational elements and staffing for the MSC Apollo Spacecraft Project Office was announced:

Office of Project Manager

Charles W. Frick, Project Manager

Robert O. Piland, Deputy Project Manager

Command and Service Module

Caldwell C. Johnson, Chief

William F. Rector, Special Assistant

Calvin H. Perrine, Flight Technology

Lee N. McMillion, Crew Systems

David L. Winterhalter, Sr., Power Systems

Wallace D. Graves, Mechanical Systems

Milton C. Kingsley, Electrical Systems

(Vacant), Ground Support Equipment

Lunar Landing Module

Robert O. Piland, Acting Chief

Guidance and Control Development

David W. Gilbert, Chief

Jack Barnard, Apollo Office at MIT

Systems Integration

Paul F. Weyers, Chief

(Vacant), Reliability and Quality Control

Emory F. Harris, Operations Requirements

Robert P. Smith, Launch Vehicle Integration

Owen G. Morris, Mission Engineering

Marion R. Franklin, Ground Operational Support Systems

Apollo Office at NAA

Herbert R. Ash, Acting Manager

Alan B. Kehlet, Engineering

Alan B. Kehlet, Acting Manager, Quality Control and Engineering

Herbert R. Ash, Acting Manager, Business Administration

Planning and Resources

Thomas F. Baker, Chief

MSC Announcement No. 30, Personnel Assignments for Apollo Spacecraft Project Office, March 6, 1962.

- NAA awarded a development contract for the Apollo spacecraft fuel cell to Pratt & Whitney Aircraft Division of United Aircraft Corporation. 1962
- Oakley, *Historical Summary, S&ID Apollo Program*, p. 5. March
- Primary MSC activities for the Apollo program were relocated from Langley Field, Va., to the Manned Spacecraft Center, Houston, Tex. 8
- MSC Announcement No. 21, Relocation of MSC Headquarters, February 26, 1962. 12
- A NASA Headquarters-MSc management meeting was held to discuss the general status of the Apollo project, Apollo Spacecraft Project Office organization, mission and engineering studies, and budgets and schedules. Participants at the meeting agreed that a staged lunar landing propulsion module would be studied. 12-13
- Apollo Spacecraft Project Office, MSC, Weekly Activity Report, March 11-17, 1962.
- James E. Webb, NASA Administrator, recommended to President John F. Kennedy that the Apollo program be given DX priority [highest priority in the procurement of critical materials]. He also sent a memorandum to Vice President Lyndon B. Johnson, Chairman of the National Aeronautics and Space Council, requesting that the Council consider advising the President to add the Apollo program to the DX priority list. 13
- Letter, Webb to The President, March 13, 1962; memorandum, Webb to Chairman, National Aeronautics and Space Council, "Request for Highest National Priority for the Apollo Program," March 13, 1962.
- NASA and the Jet Propulsion Laboratory announced the selection of the Military Electronics Division of Motorola, Inc., as the contractor to manufacture and test radio equipment in the first two phases of a program to augment the Deep Space Instrumentation Facility (DSIF) by providing "S" band capability for stations at Goldstone, Calif., Woomera, Australia, and near Johannesburg, South Africa. With these stations located some 120° apart around the earth, DSIF would have a high-gain, narrow-beam-width, high-frequency system, with very little interference from cosmic noise and would provide much improved telemetering and tracking of satellites as far out as the moon and nearby planets. 14
- Astronautical and Aeronautical Events of 1962*, p. 35.
- Charles W. Frick, Manager of the MSC Apollo Spacecraft Project Office, together with Maxime A. Faget, Charles W. Mathews, Christopher C. Kraft, Jr., John B. Lee, Owen E. Maynard, and Alan B. Kehlet of MSC and George M. Low of the NASA Office of Manned Space Flight, visited NAA at Downey, Calif. This was the first monthly meeting of the Apollo design and review team to survey NAA's progress in various areas, including the Apollo spacecraft heatshield, fuel cells, and service module. 15-16
- MSF Management Council Minutes, March 27, 1962, Agenda Item 4.

- 1962**  
**March**  
**18**
- Marshall Space Flight Center's latest schedule on the Saturn C-5 called for the first launch in the last quarter of 1965 and the first manned launch in the last quarter of 1967. If the C-5 could be man-rated on the eighth research and development flight in the second quarter of 1967, the spacecraft lead time would be substantially reduced.
- MSFC Consolidated Program Schedules and Funding, M-CP-R2, March 18, 1962.
- 23**
- The Avco Corporation was selected by NAA to design and install the ablative material on the Apollo spacecraft outer surface.
- Oakley, *Historical Summary, S&ID Apollo Program*, p. 6; Apollo Spacecraft Project Office, MSC, Weekly Activity Report, March 18-24, 1962.
- 23**
- Wind tunnel tests were completed at the Jet Propulsion Laboratory and at Langley Research Center on two early configurations of Apollo spacecraft models.
- Oakley, *Historical Summary, S&ID Apollo Program*, p. 6.
- 25-31**
- NASA Headquarters approved plans for the development of the Little Joe II test launch vehicle. Prospective bidders were notified of a briefing to be held at MSC on April 6, at which time Requests for Proposals would be distributed.
- Apollo Spacecraft Project Office, MSC, Weekly Activity Report, March 25-31, 1962.
- 29**
- Members of Langley Research Center briefed representatives of the Chance Vought Corporation of Ling-Temco-Vought, Inc., on the lunar orbit rendezvous method of accomplishing the lunar landing mission. The briefing was made in connection with the study contract on spacecraft rendezvous awarded by NASA Headquarters to Chance Vought on March 1.
- John D. Bird, "Short History of the Development of the Lunar Orbit Rendezvous Plan at the Langley Research Center," p. 4.
- 29**
- NASA announced that a \$5 million contract would be awarded to Republic Aviation Corporation for the construction of two experimental reentry spacecraft. Republic was selected from eight companies that submitted bids on March 12. The contract was part of Project Fire, to develop a spacecraft capable of withstanding reentry into the earth's atmosphere from a lunar mission. Plans called for the spacecraft to be tested during the second half of 1963.
- New York Times*, March 30, 1962.
- During the Month**
- A small group within the MSC Apollo Spacecraft Project Office developed a preliminary program schedule for three approaches to the lunar landing mission: earth orbit rendezvous, direct ascent, and lunar orbit rendezvous. The exercise established a number of ground rules:
- Establish realistic schedules that would "second guess" failures but provide for exploitation of early success.
  - Schedule circumlunar, lunar orbit, and lunar landing missions at the earliest realistic dates.



# PROJECT APOLLO LUNAR LANDING FLIGHT TECHNIQUES

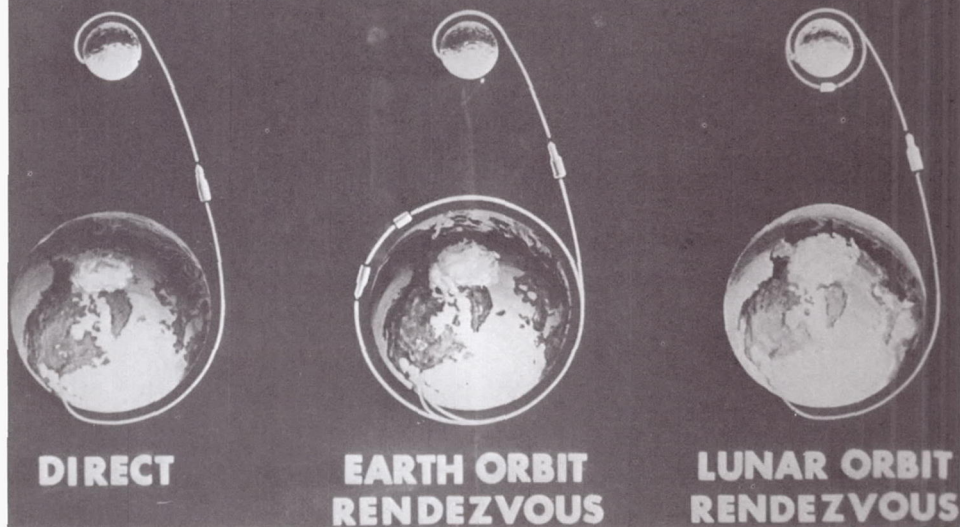

These illustrations were used by D. Brainerd Holmes, Director, Manned Space Flight, NASA, in testimony before the House of Representatives Committee on Science and Astronautics, Subcommittee on Manned Space Flight, March 26, 1962.

## APOLLO SPACECRAFT THREE CONFIGURATIONS

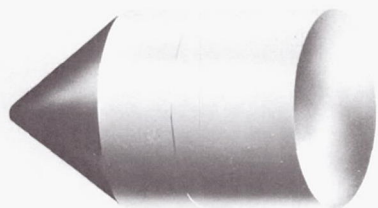

EARTH ORBIT



CIRCUMLUNAR

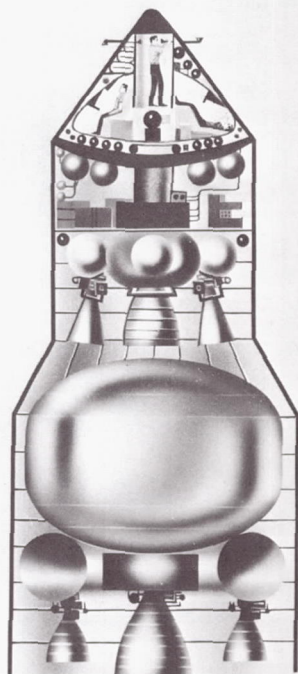

LUNAR LANDING

M62-175

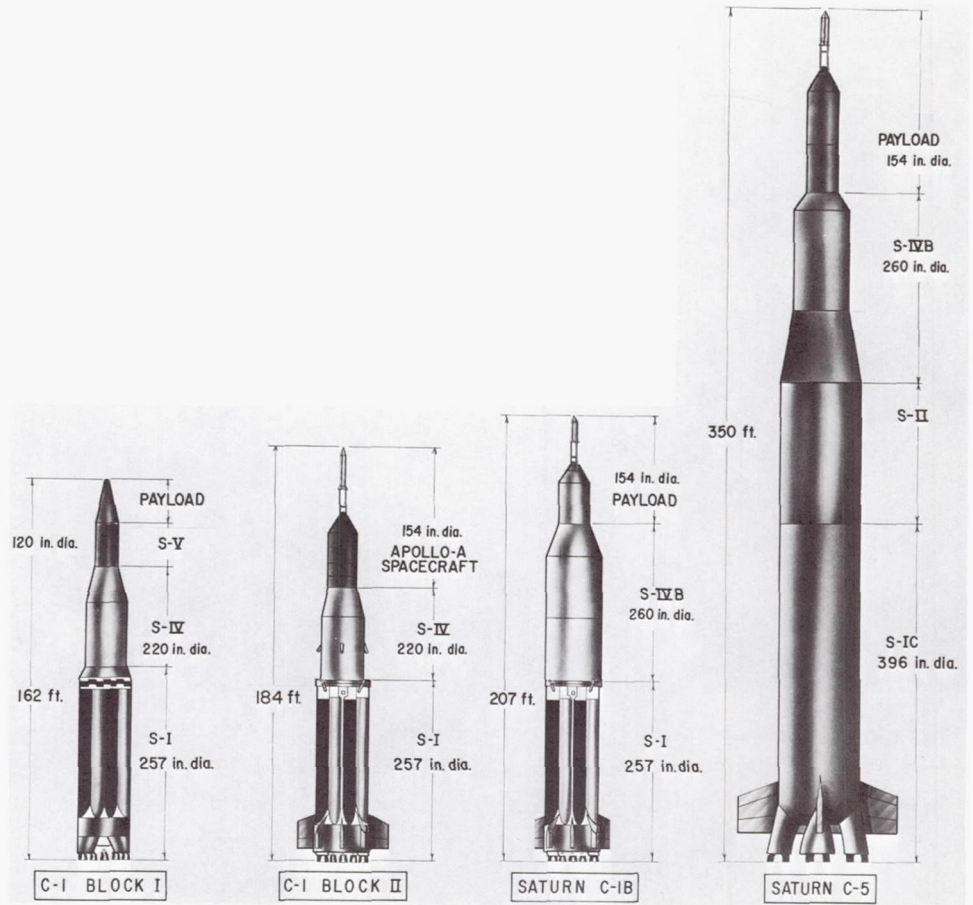

Saturn launch vehicles that were under development or in planning stages during early 1962.

1962

March

- Complete the flight development of spacecraft modules and operational techniques, using the Saturn C-1 and C-1B launch vehicles, prior to the time at which a “man-rated” C-5 launch vehicle would become available.

- Develop the spacecraft operational techniques in “buildup” missions that would progress generally from the simple to the complex.

- Use the spacecraft crew at the earliest time and to the maximum extent, commensurate with safety considerations, in the development of the spacecraft and its subsystems.

The exercise also provided a basis for proceeding with the development of definitive schedules and a program plan.

Memorandum, Thomas F. Baker, Chief, Planning and Resources, to Manager, Apollo Spacecraft Project Office, March 23, 1962.

March–November

The Apollo guidance and navigation system was defined in more detail as more information from NASA–MIT studies was received on new requirements for the

system. As a result, the scope of the component development tasks given to all the guidance and navigation subcontractors was substantially increased.

1962

March

Interview with Ralph Ragan, MIT Instrumentation Laboratory, April 27, 1966.

NAA was directed by the MSC Apollo Spacecraft Project Office to begin a study to define the configuration and design criteria of the service module which would make the lunar landing maneuver and touchdown.

April

1-7

Apollo Spacecraft Project Office, MSC, Weekly Activity Report, April 1-7, 1962.

A meeting to review the lunar orbit rendezvous (LOR) technique as a possible mission mode for Project Apollo was held at NASA Headquarters. Representatives from various NASA offices attended: Joseph F. Shea, Eldon W. Hall, William A. Lee, Douglas R. Lord, James E. O'Neill, James Turnock, Richard J. Hayes, Richard C. Henry, and Melvyn Savage of NASA Headquarters; Friedrich O. Vonbun of Goddard Space Flight Center (GSFC); Harris M. Schurmeier of Jet Propulsion Laboratory; Arthur V. Zimmerman of Lewis Research Center; Jack Funk, Charles W. Mathews, Owen E. Maynard, and William F. Rector of MSC; Paul J. DeFries, Ernst D. Geissler, and Helmut J. Horn of Marshall Space Flight Center (MSFC); Clinton E. Brown, John C. Houbolt, and William H. Michael, Jr., of Langley Research Center; and Merrill H. Mead of Ames Research Center. Each phase of the LOR mission was discussed separately.

2-3

The launch vehicle required was a single Saturn C-5, consisting of the S-IC, S-II, and S-IVB stages. To provide a maximum launch window, a low earth parking orbit was recommended. For greater reliability, the two-stage-to-orbit technique was recommended rather than requiring reignition of the S-IVB to escape from parking orbit.

The current concepts of the Apollo command and service modules would not be altered. The lunar excursion vehicle (LEV), under intensive study in 1961, would be aft of the service module and in front of the S-IVB stage. For crew safety, an escape tower would be used during launch. Access to the LEV would be provided while the entire vehicle was on the launch pad.

Both Apollo and Saturn guidance and control systems would be operating during the launch phase. The Saturn guidance and control system in the S-IVB would be "primary" for injection into the earth parking orbit and from earth orbit to escape. Provisions for takeover of the Saturn guidance and control system should be provided in the command module. Ground tracking was necessary during launch and establishment of the parking orbit. MSFC and GSFC would study the altitude and type of low earth orbit.

The LEV would be moved in front of the command module "early" in the translunar trajectory. After the S-IVB was staged off the spacecraft following injection into the translunar trajectory, the service module would be used for midcourse corrections. Current plans were for five such corrections. If possible, a symmetric configuration along the vertical center line of the vehicle would be considered for the



Four artist's concepts, prepared by artist David A. Willment at Langley Research Center in 1962, show the basic mission flight plan and three major phases of activity—separation of lander, takeoff from the moon, and rendezvous—proposed for accomplishing the lunar landing mission with lunar orbit rendezvous.

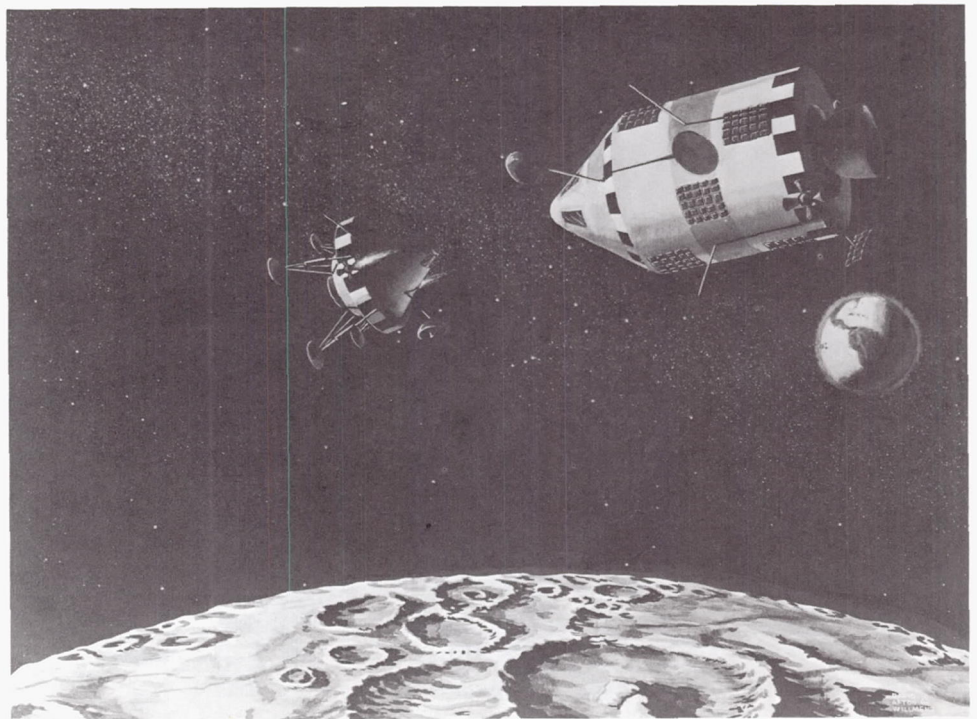
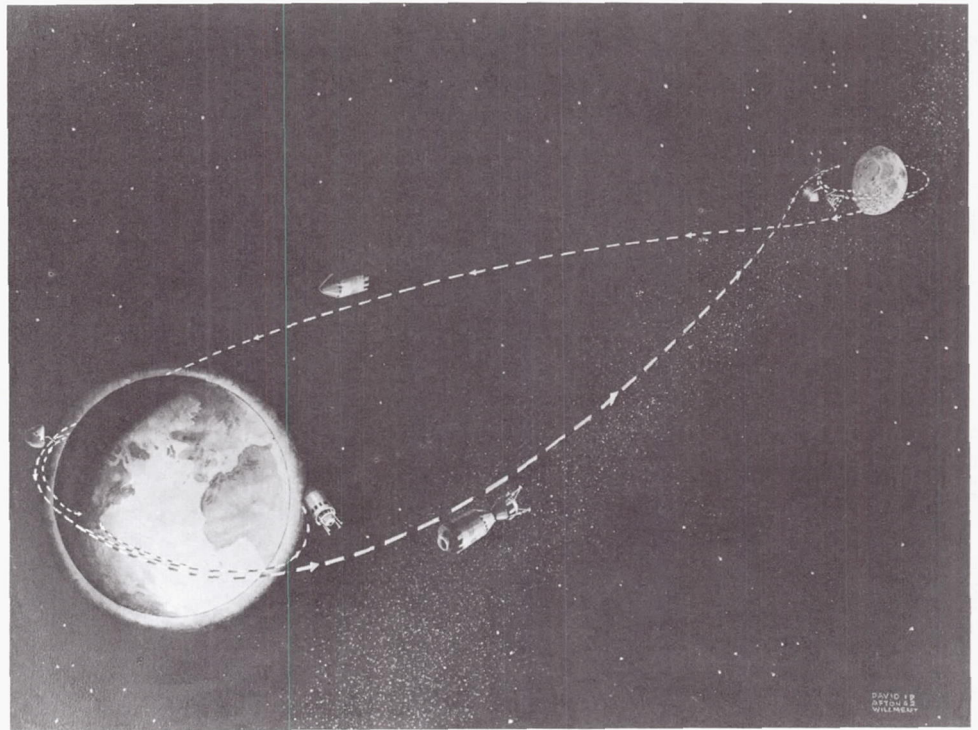

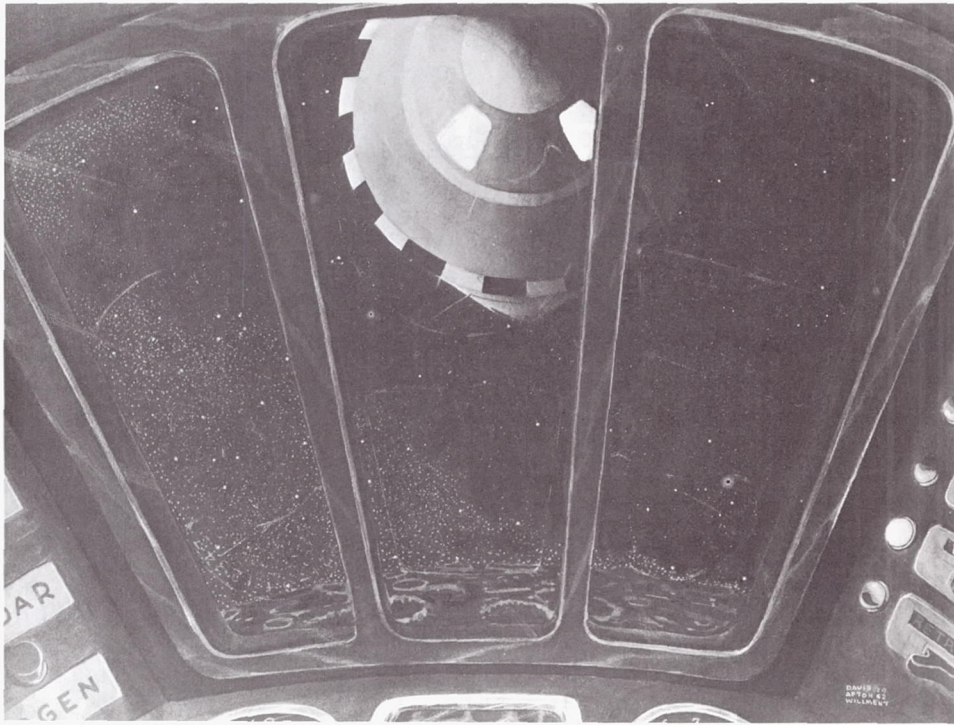
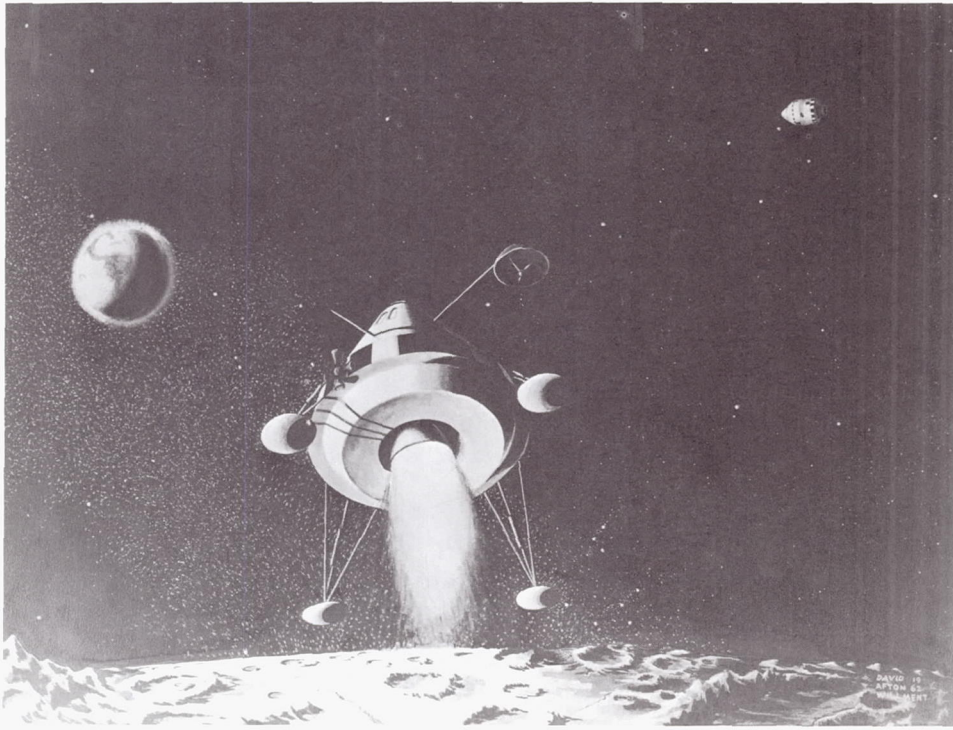



1962

April

LEV. Ingress to the LEV from the command module should be possible during the translunar phase. The LEV would have a pressurized cabin capability during the translunar phase. A "hard dock" mechanism was considered, possibly using the support structure needed for the launch escape tower. The mechanism for relocation of the LEV to the top of the command module required further study. Two possibilities were discussed: mechanical linkage and rotating the command module by use of the attitude control system. The S-IVB could be used to stabilize the LEV during this maneuver.

The service module propulsion would be used to decelerate the spacecraft into a lunar orbit. Selection of the altitude and type of lunar orbit needed more study, although a 100-nautical-mile orbit seemed desirable for abort considerations.

The LEV would have a "point" landing ( $\pm 1/2$  mile) capability. The landing site, selected before liftoff, would previously have been examined by unmanned instrumented spacecraft. It was agreed that the LEV would have redundant guidance and control capability for each phase of the lunar maneuvers. Two types of LEV guidance and control systems were recommended for further analysis. These were an automatic system employing an inertial platform plus radio aids and a manually controlled system which could be used if the automatic system failed or as a primary system.

The service module would provide the prime propulsion for establishing the entire spacecraft in lunar orbit and for escape from the lunar orbit to earth trajectory. The LEV propulsion system was discussed and the general consensus was that this area would require further study. It was agreed that the propulsion system should have a hover capability near the lunar surface but that this requirement also needed more study.

It was recommended that two men be in the LEV, which would descend to the lunar surface, and that both men should be able to leave the LEV at the same time. It was agreed that the LEV should have a pressurized cabin which would have the capability for one week's operation, even though a normal LOR mission would be 24 hours. The question of lunar stay time was discussed and it was agreed that Langley should continue to analyze the situation. Requirements for sterilization procedures were discussed and referred for further study. The time for lunar landing was not resolved.

In the discussion of rendezvous requirements, it was agreed that two systems be studied, one automatic and one providing for a degree of manual capability. A line of sight between the LEV and the orbiting spacecraft should exist before lunar takeoff. A question about hard-docking or soft-docking technique brought up the possibility of keeping the LEV attached to the spacecraft during the transearth phase. This procedure would provide some command module subsystem redundancy.



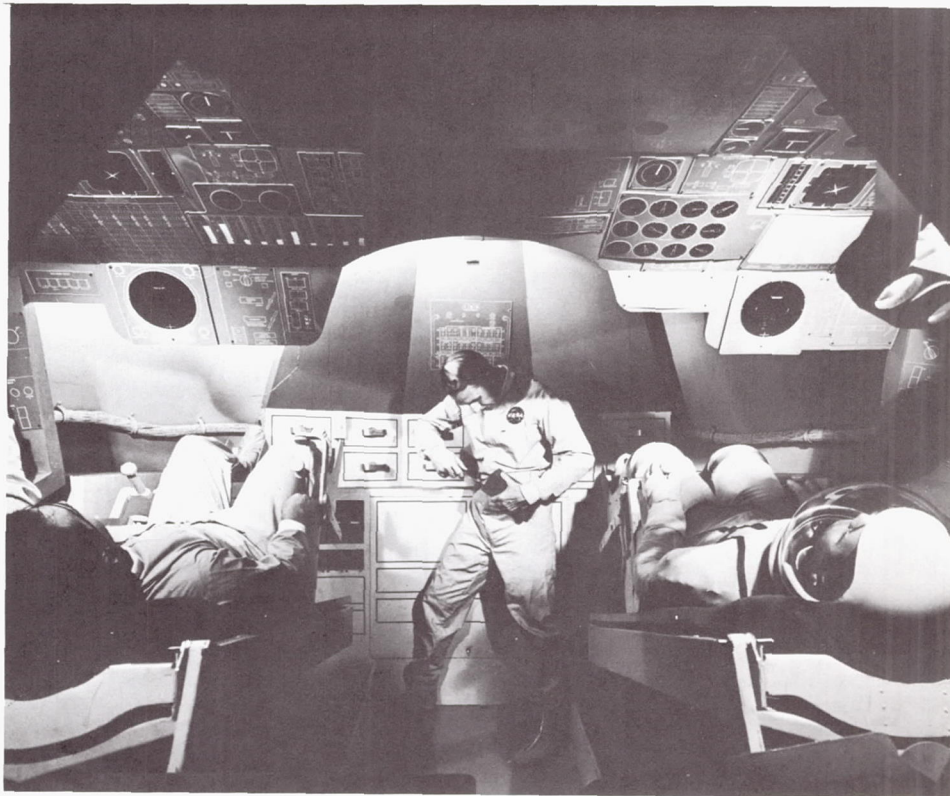
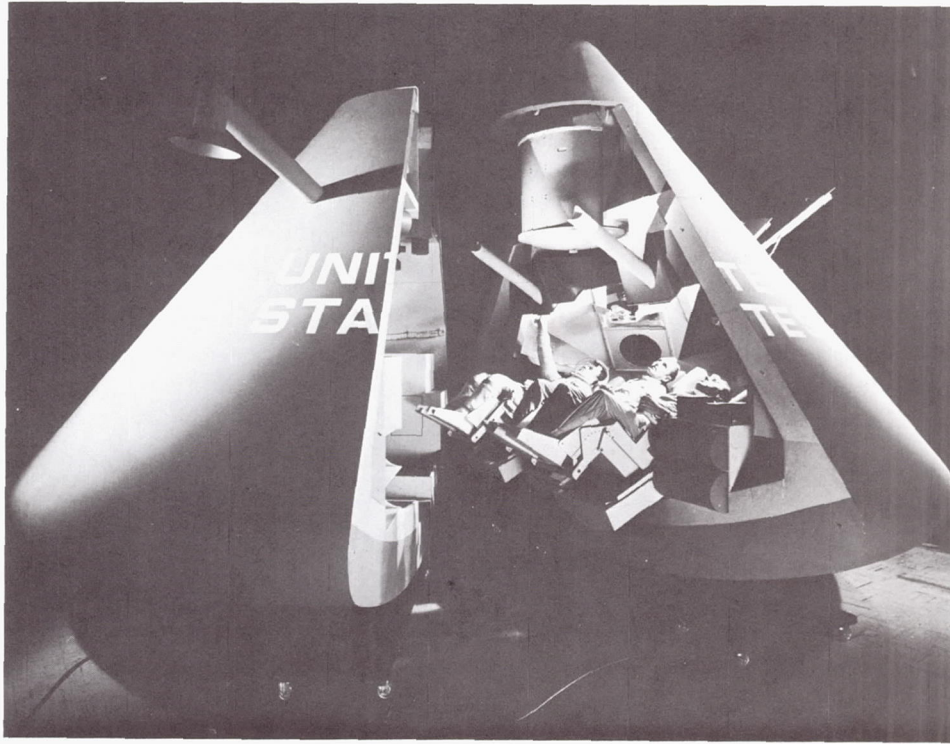

Two views of a preliminary mockup command module built by North American's Space and Information Systems Division.

1962

April

Direct link communications from earth to the LEV and from earth to the spacecraft, except when it was in the shadow of the moon, was recommended. Voice communications should be provided from the earth to the lunar surface and the possibility of television coverage would be considered.

A number of problems associated with the proposed mission plan were outlined for NASA Center investigation. Work on most of the problems was already under way and the needed information was expected to be compiled in about one month.

[This meeting, like the one held February 13–15, was part of a continuing effort to select the lunar mission mode.]

Minutes, Lunar Orbit Rendezvous Meeting, April 2–3, 1962.

- 4 A mockup of the Apollo command module, built by the Space and Information Systems Division of NAA, was made public for the first time during a visit to NAA by news media representatives.

Oakley, *Historical Summary, S&ID Apollo Program*, p. 6.

- 5 The X-15 was flown to a speed of 2830 miles per hour and to an altitude of 179,000 feet in a test of a new automatic control system to be used in the Dyna-Soar and Apollo spacecraft. NASA's Neil A. Armstrong was the pilot. The previous electronic control system had been automatic only while the X-15 was in the atmosphere; the new system was automatic in space as well.

Baltimore *Sun*, April 6, 1962.

- 6 The Thiokol Chemical Corporation was selected by NAA to build the solid-fuel rocket motor to be used to jettison the Apollo launch escape tower following a launch abort or during a normal mission.

Oakley, *Historical Summary, S&ID Apollo Program*, p. 6.

- 6 The request for a proposal on the Little Joe II test launch vehicle was submitted to bidders by a letter from MSC, together with a Work Statement. Five launches, which were to test boilerplate models of the Apollo spacecraft command module in abort situations, were called for: three in 1963 and two in 1964. The first two launches in 1963 were to be max  $q$  abort tests and the third was to be a high-altitude atmospheric abort. The first launch in 1964 was to be a very-high-altitude abort and the final launch a confirming max  $q$  abort [max  $q$ —the point in the exit trajectory at which the launch vehicle and spacecraft are subjected to the severest aerodynamic load]. (Evaluation of the proposals took place from April 23 to 27, and the contractor was selected on May 11.)

Apollo Spacecraft Project Office, MSC, Monthly Activity Report, April 1–30, 1962, p. 3; *Little Joe II Test Launch Vehicle, NASA Project Apollo: Final Report*, Vol. I, pp. 1–2, 4–1.

- 11 President John F. Kennedy designated the Apollo program (including essential spacecraft, launch vehicles, and facilities) as being in the highest national priority



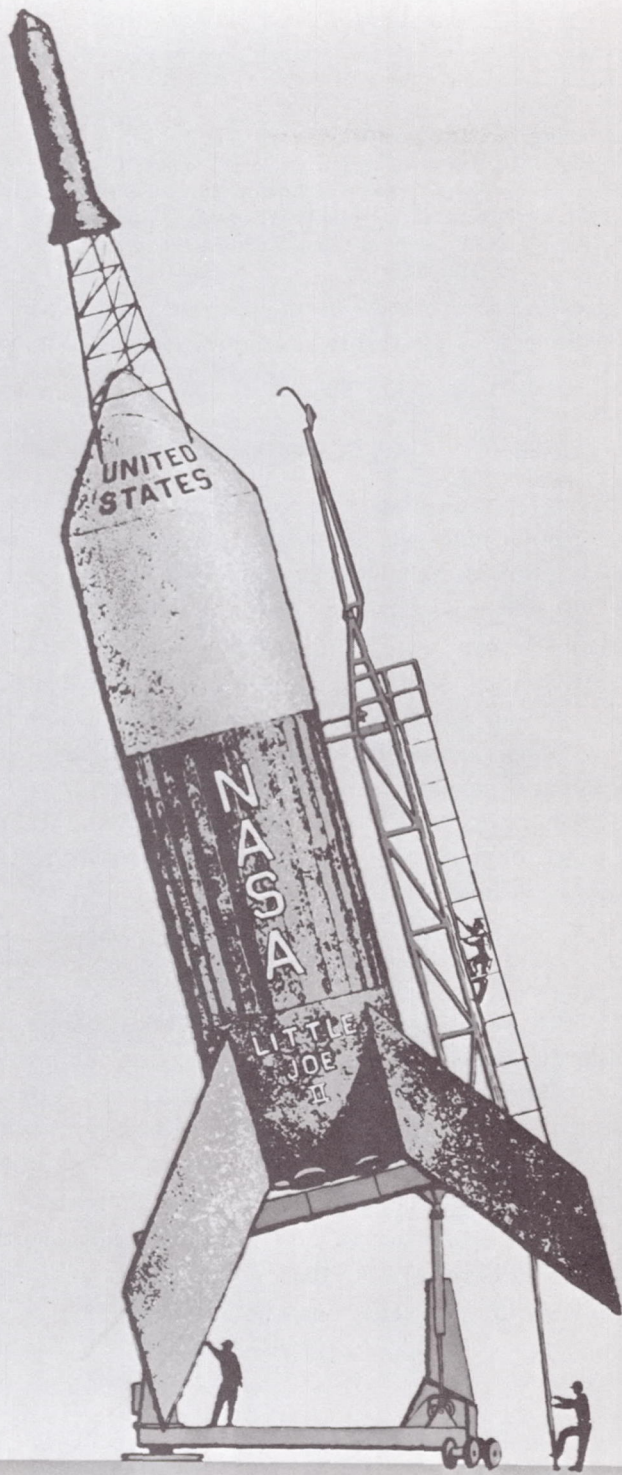

The first artist's conception of the Little Joe II solid-fuel launch vehicle, selected by Manned Spacecraft Center for testing Apollo spacecraft on unmanned sub-orbital flights. These flights were designed to test the launch escape system and the earth landing system. (General Dynamics/Convair photo)



- 1962**  
**April**
- category (DX) for research and development and for achieving operational capability.
- National Security Action Memorandum No. 144, McGeorge Bundy to the Vice President (as Chairman, National Aeronautics and Space Council); The Secretary of Defense; the Secretary of Commerce; Administrator, NASA; Director, Bureau of the Budget; Director, Office of Emergency Planning, "Assignment of Highest National Priority to the APOLLO Manned Lunar Landing Program," April 11, 1962.
- 16** Representatives of MSC made a formal presentation at Marshall Space Flight Center on the lunar orbit rendezvous technique for accomplishing the lunar mission.
- Apollo Spacecraft Project Office, MSC, Weekly Activity Report, April 15–21, 1962.
- 19–20** Discussions at the monthly NAA–NASA Apollo spacecraft design review included:
- Results of an NAA study on environmental control system (ECS) heating capabilities for lunar night operations were presented. The study showed that the system could not provide enough heating and that the integration of ECS and the fuel cell coolant system was the most promising source for supplemental heating.
  - The launch escape system configuration was approved. It embodied a 120-inch tower, symmetrical nose cone, jettison motor located forward of the launch escape motor, and an aerodynamic skirt covering the escape motor nozzles. This configuration change in the escape rocket nozzle cant angle was intended to prevent impingement of hot gases on the command module.
  - MSC senior personnel directed NAA to study the technical penalties and scheduling effects of spacecraft design capabilities with direct lunar landing and lunar rendezvous techniques.
- NAA, *Apollo Monthly Progress Report*, SID 62–300–3, April 30, 1962, pp. 19, 59; Apollo Spacecraft Project Office, MSC, Weekly Activity Report, April 15–21, 1962.
- 23** *Ranger IV* was launched by an Atlas-Agena B booster from the Atlantic Missile Range, attained a parking orbit, and was fired into the proper lunar trajectory by the restart of the Agena B engine. Failure of a timer in the spacecraft payload caused loss of both internal and ground control over the vehicle. The Goldstone Tracking Station maintained contact with the spacecraft until it passed behind the left edge of the moon on April 26. It impacted at a speed of 5963 miles per hour, the first American spacecraft to land on the lunar surface. The Agena B second stage passed to the right of the moon and later went into orbit around the sun. Lunar photography objectives were not achieved.
- Astronautical and Aeronautical Events of 1962*, pp. 59, 61; *New York Times*, April 24, 1962; *Washington Post*, April 26, 1962.
- 24** Milton W. Rosen, NASA Office of Manned Space Flight Director of Launch Vehicles and Propulsion, recommended that the S–IVB stage be designed specifically as the third stage of the Saturn C–5 and that the C–5 be designed specifically for the manned lunar landing using the lunar orbit rendezvous technique. The S–IVB stage would inject the spacecraft into a parking orbit and would be restarted in space to place the lunar mission payload into a translunar trajectory. Rosen also

1962

April

recommended that the S-IVB stage be used as a flight test vehicle to exercise the command module (CM), service module (SM), and lunar excursion module (LEM) [previously referred to as the lunar excursion vehicle (LEV)] in earth orbit missions. The Saturn C-1 vehicle, in combination with the CM, SM, LEM, and S-IVB stage, would be used on the most realistic mission simulation possible. This combination would also permit the most nearly complete operational mating of the CM, SM, LEM, and S-IVB prior to actual mission flight.

MSF Management Council Minutes, April 24, 1962, Agenda Item 1.

MSC Associate Director Walter C. Williams reported to the Manned Space Flight Management Council that the lack of a decision on the lunar mission mode was causing delays in various areas of the Apollo spacecraft program, especially the requirements for the portions of the spacecraft being furnished by NAA.

24

MSF Management Council Minutes, April 24, 1962, Agenda Item 2.

The Manned Space Flight Management Council decided to delay the awarding of a Nova launch vehicle study contract until July 1 at the earliest to allow time for an in-house study of bids submitted and for further examination of the schedule for a manned lunar landing using the direct ascent technique.

24

MSF Management Council Minutes, April 24, 1962, Agenda Item 4.

The Saturn SA-2 first stage booster was launched successfully from Cape Canaveral. The rocket was blown up intentionally and on schedule about 2.5 minutes after liftoff at an altitude of 65 miles, dumping the water ballast from the dummy second and third stages into the upper atmosphere. The experiment, Project Highwater, produced a massive ice cloud and lightning-like effects. The eight clustered H-1 engines in the first stage produced 1.3 million pounds of thrust and the maximum speed attained by the booster was 3750 miles per hour. Modifications to decrease the slight fuel sloshing encountered near the end of the previous flight test were successful.

25

*New York Times*, April 26, 1962; *Astronautical and Aeronautical Events of 1962*, p. 61.

The contract for the Apollo service module propulsion engine was awarded by NAA to Aerojet-General Corporation. The estimated cost of the contract was \$12 million. NAA had given Aerojet-General authority April 9 to begin work.

30

*Apollo Quarterly Status Report No. 1*, p. 19; *MSC Space News Roundup*, May 2, 1962, p. 8; Aerojet-General Corporation, *Apollo Service Module Rocket Engine Monthly Progress Report*, October 1962, p. 1.

John C. Houbolt of Langley Research Center, writing in the April issue of *Astronautics*, outlined the advantages of lunar orbit rendezvous for a manned lunar landing as opposed to direct flight from earth or earth orbit rendezvous. Under this concept, an Apollo-type spacecraft would fly directly to the moon, go into lunar orbit, detach a small landing craft which would land on the moon and then return to the mother craft, which would then return to earth. The advantages would be the much smaller craft performing the difficult lunar landing and takeoff,

During  
the  
Month



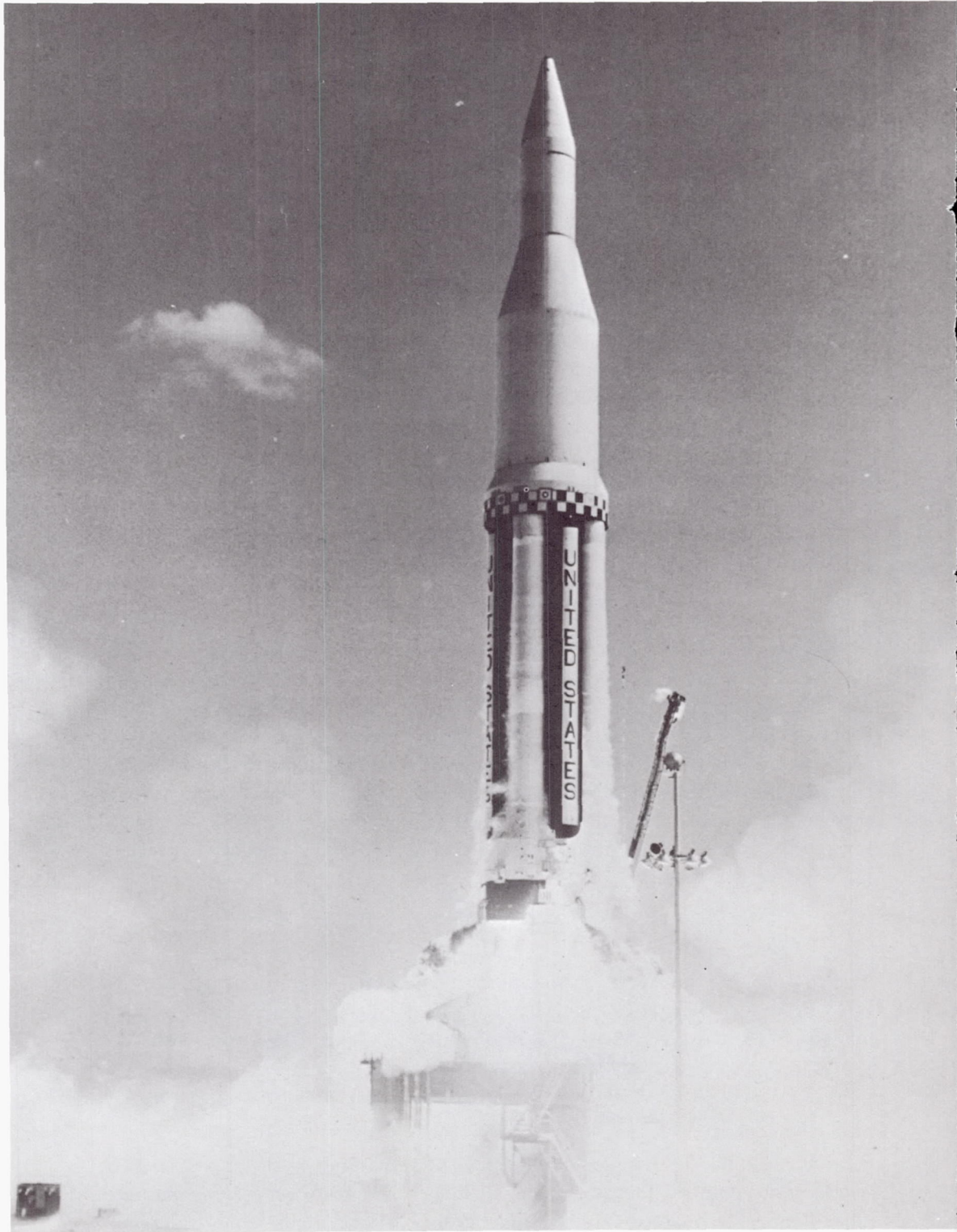

The second Saturn launch at Cape Canaveral, April 25, 1962.



the possibility of optimizing the smaller craft for this one function, the safe return of the mother craft in event of a landing accident, and even the possibility of using two of the small craft to provide a rescue capability.

Houbolt, "Lunar-Orbit Rendezvous and Manned Lunar Landing," *Astronautics*, 7 (April 1962), pp. 26-29, 70, 72.

1962

April

The basic design configuration of the command module forward compartment was changed by the relocation of two attitude control engines from the lower to the upper compartment area, where less heat flux would be experienced during reentry.

During  
the  
Month

*Apollo Monthly Progress Report*, SID 62-300-3, p. 79.

Three major changes were made by NAA in the Apollo space-suit circuit:

During  
the  
Month

(1) The demand oxygen regulator was moved downstream of the crew to prevent a sudden drop of pressure when a crewman opened his face plate.

(2) The suit manifold would now have a pressure-controlled bypass to prevent variable flow to other crew members, if one crewman increased or decreased oxygen flow. The manifold would also include a venturi in each suit-inlet connection to prevent a loss of oxygen flow to other crew members if the suit of one crewman should rupture. In this situation, the venturi would prevent the damaged suit flow out from exceeding the maximum flow of demand regulators.

(3) The circuit water evaporator and coolant loop heat exchanger of the suit were integrated into one by fluid exchange to make it smaller. A coolant-temperature control was also provided for sunlight operation on the moon.

In addition, a suit inlet-outlet was added to the command module sleeping quarters, and the cabin fan was shifted so that it would operate as an intake fan during the post-landing phase.

*Apollo Monthly Progress Report*, SID 62-300-3, pp. 17-18, 65.

NAA developed a concept for shock attenuation along the command module Y-Y axis (see diagrams, p. 158) by the use of aluminum honeycomb material. Cylinders mounted on the outboard edge of the left and right couches would extend mechanically to bear against the side compartment walls.

During  
the  
Month

*Apollo Monthly Progress Report*, SID 62-300-3, p. 68.

NAA studies resulted in significant changes in the command module environmental control system (ECS).

During  
the  
Month

(1) Among modifications in the ECS schematic were included:

- (a) Reduction in the cooling water capacity
- (b) Combining into one command module tank the potable water and cooling water needed during boost
- (c) Elimination of the water blanket for radiation protection.

(2) More water would be generated by the fuel cells than necessary and could be dumped to decrease lunar landing and lunar takeoff weight.

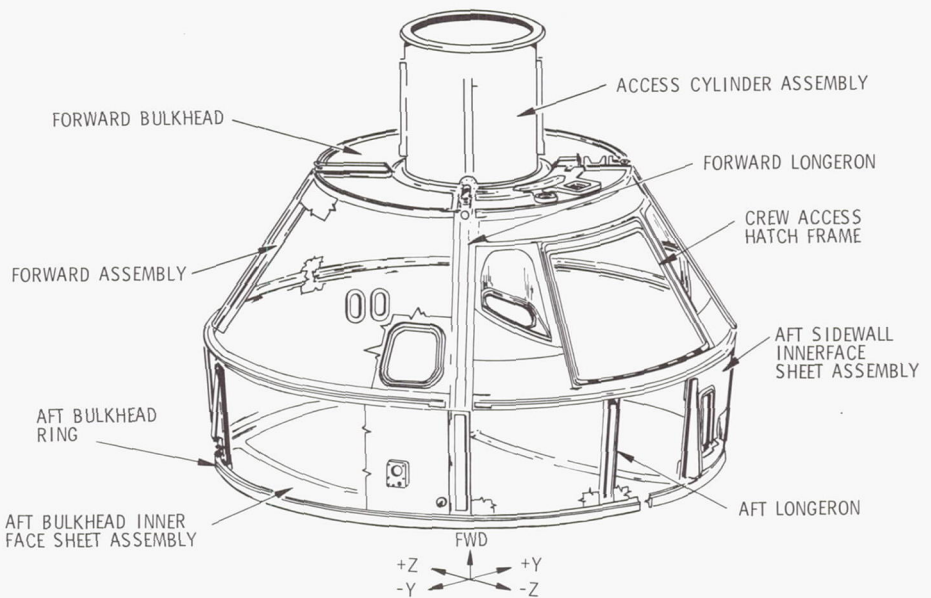
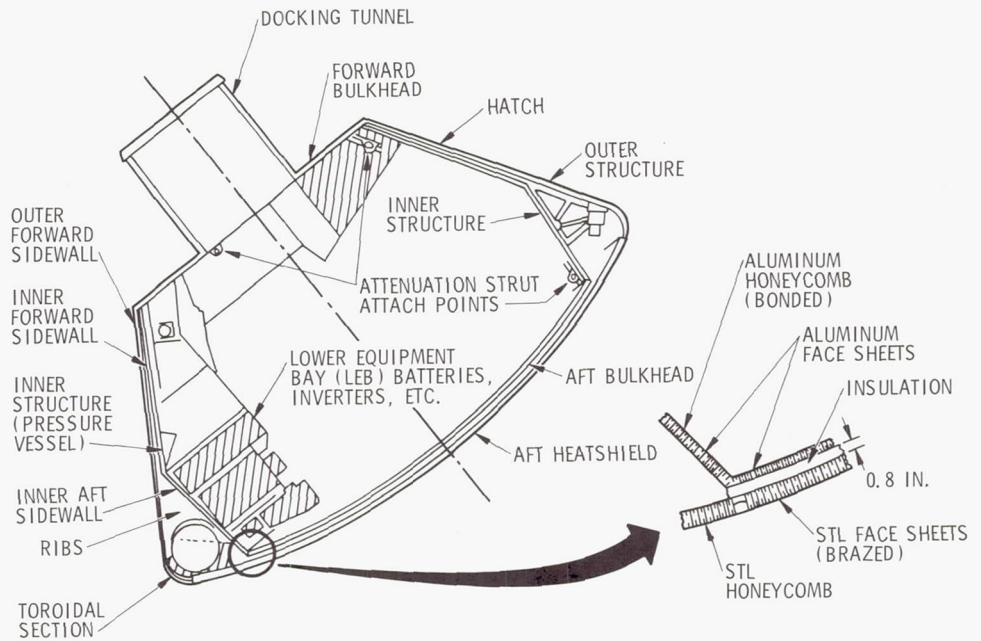

1962

April

(3) Airlock valving requirements would permit two or more crewmen to perform extravehicular operation simultaneously. Area control of the space radiator to prevent coolant freezing was specified.

(4) A new concept to integrate heat rejection from the spacecraft power system and the ECS into one space radiator subsystem was developed. This subsystem would provide full versatility for both lunar night and lunar day conditions and would decrease weight and complexity.

(5) Because of the elimination of the lunar supplemental refrigeration system and deployable radiators, the water-glycol coolant system was modified:

- (a) Removal from the service module of the coolant loop regenerative heat exchanger
- (b) Replacement by a liquid valving arrangement of the gas-leak check provision at the radiator panels
- (c) Changeover to a completely cascaded system involving the suit-circuit heat exchanger, cabin heat exchanger, and electronic component coldplate.

In addition, a small, regenerative heat exchanger was added in the command module to preheat the water-glycol. A separate coolant branch to the inertial measurement unit section of the electronic system provided for the more critical cooling task required in that area.

*Apollo Monthly Progress Report*, SID 62-300-3, pp. 15, 17, 21, 64-65.

NAA determined that preliminary inflight nuclear radiation instrumentation would consist of an onboard system to detect solar x-ray or ultraviolet radiation and a ground visual system for telemetering solar flare warning signals to the command module. The crew would have eight to ten minutes warning to take protective action before the arrival of solar flare proton radiation.

*Apollo Monthly Progress Report*, SID 62-300-3, p. 22.

A presentation on the lunar orbit rendezvous technique was made to D. Brainerd Holmes, Director, NASA Office of Manned Space Flight, by representatives of the Apollo Spacecraft Project Office. A similar presentation to NASA Associate Administrator Robert C. Seamans, Jr., followed on May 31.

Apollo Spacecraft Project Office, MSC, Monthly Activity Report, May 1-31, 1962.

The Source Evaluation Board for selecting Apollo navigation and guidance components subcontractors completed its evaluation of bids and technical proposals and submitted its findings to NASA Headquarters. Preliminary presentation of the Board's findings had been made to NASA Administrator James E. Webb on April 5.

Apollo Spacecraft Project Office, MSC, Weekly Activity Report, April 1-7, 1962; MSC, Weekly Activity Report for the Office of the Director, Manned Space Flight, April 29-May 5, 1962, p. 12.

At the monthly Apollo spacecraft design review meeting at NAA, MSC representatives recommended that NAA and Avco Corporation prepare a comprehensive test plan for verifying the overall integrity of the heatshield including flight tests deemed necessary, without regard for anticipated launch vehicle availability.

Apollo Spacecraft Project Office, MSC, Weekly Activity Report, June 3-9, 1962.

A preliminary Statement of Work for a proposed lunar excursion module was completed, although the mission mode had not yet been selected.

MSC, Weekly Activity Report for the Office of the Director, Manned Space Flight, April 29-May 5, 1962, p. 12.

1962

April

During  
the  
MonthMay  
3

4

4-5

5



1962

May

5

A purchase request was being prepared by NASA for wind tunnel support services from the Air Force's Arnold Engineering Development Center in the amount of approximately \$222,000. These wind tunnel tests were to provide design parameter data on static stability, dynamic stability, pressure stability, and heat transfer for the Apollo program. The funds were to cover tests during June and July 1962. Approximately \$632,000 would be required in Fiscal Year 1963 to fund the tests scheduled to December 1962.

MSC, Weekly Activity Report for the Office of the Director, Manned Space Flight, April 29–May 5, 1962, p. 13.

5

MSC processed a purchase request to increase NAA's spacecraft letter contract from \$32 million to \$55 million to cover NAA's costs to June 30, 1962. [Pending the execution of a definitive contract (signed August 14, 1963), actions of this type were necessary.]

MSC, Weekly Activity Report for the Office of the Director, Manned Space Flight, April 29–May 5, 1962, p. 13; Oakley, *Historical Summary, S&ID Apollo Program*, p. 9.

8

NASA announced the selection of three companies for the negotiation of production contracts for major components of the Apollo spacecraft guidance and navigation system under development by the MIT Instrumentation Laboratory. The largest of the contracts, for \$16 million, would be negotiated with AC Spark Plug Division of General Motors Corporation for fabrication of the inertial, gyroscope-stabilized platform of the Apollo spacecraft; for development and construction of ground support and checkout equipment; and for assembling and testing all parts of the system. The second contract, for \$2 million, would be negotiated with the Raytheon Company to manufacture the digital computer aboard the spacecraft. Under the third contract, for about \$2 million, Kollsman Instrument Corporation would build the optical subsystems, including a space sextant, sunfinders, and navigation display equipment.

Apollo Spacecraft Project Office, MSC, Weekly Activity Report, May 5–11, 1962; Washington *Evening Star*, May 9, 1962.

11

NASA awarded a letter contract to General Dynamics/Convair to design and manufacture the Little Joe II test launch vehicle which would be used to boost the Apollo spacecraft on unmanned suborbital test flights. The Little Joe II would be powered by clustered solid-fuel engines. At the same time, a separate 30-day contract was awarded to Convair to study the control system requirements. White Sands Missile Range, N. Mex., had been selected for the Little Joe II max  $q$  abort and high-altitude abort missions.

Apollo Spacecraft Project Office, MSC, Weekly Activity Report, May 13–19, 1962; *Little Joe II Test Launch Vehicle, NASA Project Apollo: Final Report*, Vol. I, pp. 1–2, 4–1; *Astronautical and Aeronautical Events of 1962*, p. 82.

24

The *Aurora 7* spacecraft, with Astronaut M. Scott Carpenter as pilot, was launched successfully by an Atlas booster from Atlantic Missile Range. After a three-orbit flight, the spacecraft reentered the atmosphere. Yaw error and late retrofire caused the landing impact point to be over 200 miles beyond the intended

area and beyond radio range of the recovery forces. Landing occurred 4 hours and 56 minutes after liftoff. Astronaut Carpenter was later picked up safely by a helicopter.

1962

May

Grimwood, *Project Mercury: A Chronology*, pp. 164-165.

D. Brainerd Holmes, NASA's Director of Manned Space Flight, requested the Directors of Launch Operations Center, Manned Spacecraft Center, and Marshall Space Flight Center (MSFC) to prepare supporting component schedules and cost breakdowns through Fiscal Year 1967 for each of the proposed lunar landing modes: earth orbit rendezvous, lunar orbit rendezvous, and direct ascent. For direct ascent, a Saturn C-8 launch vehicle was planned, using a configuration of eight F-1 engines, eight J-2 engines, and one J-2 engine. MSFC was also requested to submit a proposed schedule and summary of costs for the Nova launch vehicle, using the configuration of eight F-1 engines, two M-1 engines, and one J-2 engine. Each Center was asked to make an evaluation of the schedules as to possibilities of achievement, major problem areas, and recommendations for deviations.

25

Memorandum, Holmes to Director, Launch Operations Center; Director, Manned Spacecraft Center; and Director, Marshall Space Flight Center, "The Manned Lunar Landing Program," May 25, 1962.

The F-1 engine was first fired at full power (more than 1.5 million pounds of thrust) for 2.5 minutes at Edwards Rocket Site, Calif.

26

Rocketdyne *Skywriter*, June 1, 1962, p. 1.

A schedule for the letting of a contract for the development of a lunar excursion module was presented to the Manned Space Flight Management Council by MSC Director Robert R. Gilruth in anticipation of a possible decision to employ the lunar rendezvous technique in the lunar landing mission.

29

MSF Management Council Minutes, May 29, 1962, Agenda Item 12.

The Manned Space Flight Management Council approved the mobile launcher concept for the Saturn C-5 at Launch Complex 39, Merritt Island, Fla.

29

MSF Management Council Minutes, May 29, 1962, Agenda Item 9.

NAA completed a preliminary requirement outline for spacecraft docking. The outline specified that the two spacecraft be navigated to within a few feet of each other and held to a relative velocity of less than six inches per second and that they be steered to within a few inches of axial alignment and parallelism. The crewman in the airlock was assumed to be adequately protected against radiation and meteoric bombardment and to be able to grasp the docking spacecraft and maneuver it to the sealing faces for final clamp.

During  
the  
Month

NAA, *Apollo Monthly Progress Report*, SID 62-300-4, May 31, 1962, p. 66.

A feasibility study was completed by NAA on the ballistic (zero-lift) maneuver as a possible emergency flight mode for lunar mission reentry. Based upon single-

During  
the  
Month



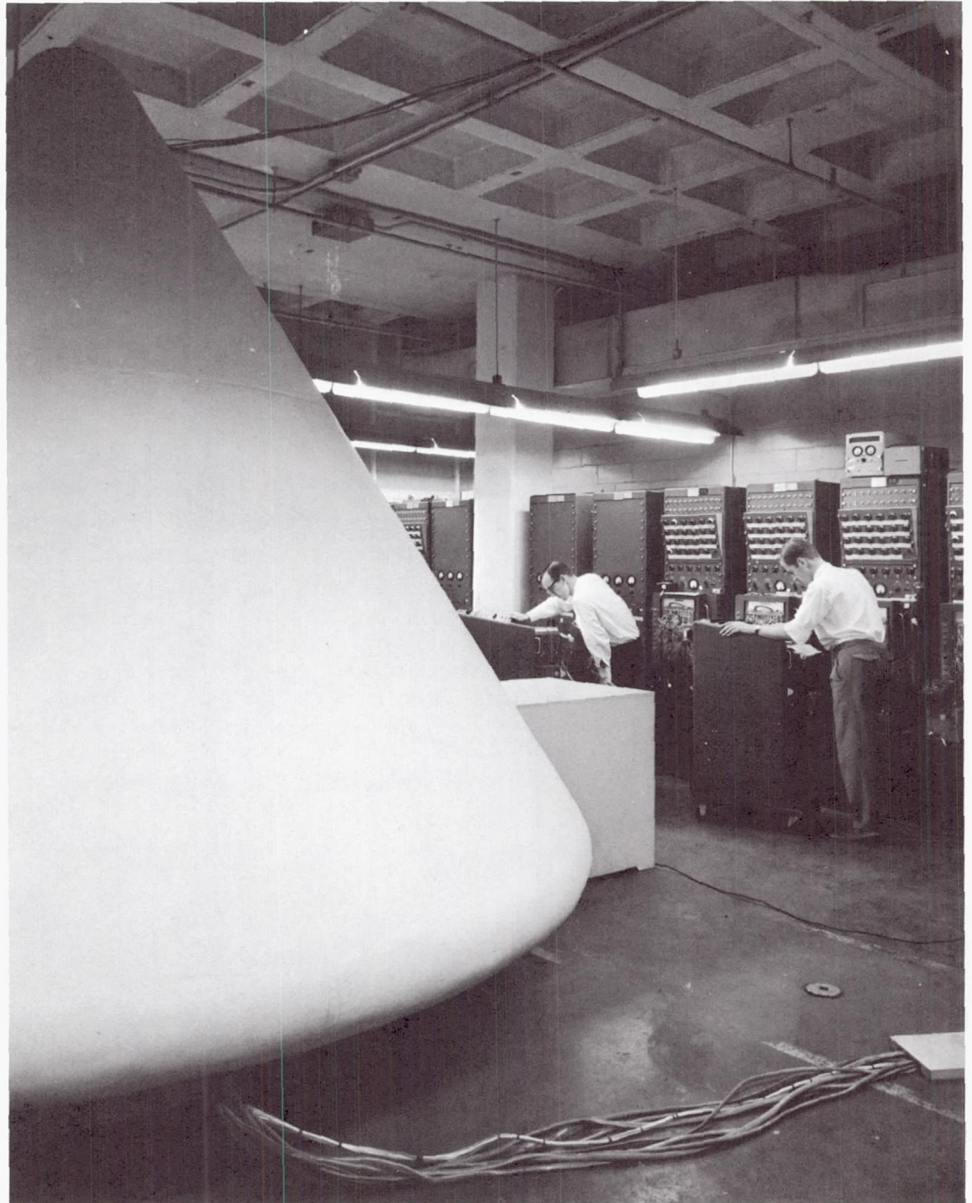

In May 1962, NASA's Apollo spacecraft in mockup form was instrumented and computerized at Honeywell's Aeronautical Division for use in designing equipment to stabilize and control the vehicle in flight. The mockup, at the left, is electronically linked to the bank of analog computers on the right. Honeywell disclosed that ten weeks after agreement with the prime contractor, North American Aviation, Inc., on the job to be done, a breadboard Apollo manual control and display system was in design operation. The company was selected for the assignment in December 1961. (Honeywell photo)

**1962**  
**May**

pass and 12 g maximum load-factor criteria, the guidance corridor would be nine nautical miles. When atmospheric density deviations were considered ( $\pm 50$  percent from standard), the allowable corridor would be reduced to four nautical



miles. Touchdown dispersions within the defined corridor exceeded 2500 nautical miles.

*Apollo Monthly Progress Report*, SID 62-300-4, p. 17.

1962

May

Telescope requirements for the spacecraft were modified after two study programs had been completed by NAA.

During  
the  
Month

A study on the direct vision requirement for lunar landing showed that, to have a simultaneous direct view of the lunar landing point and the landing feet without changing the spacecraft configuration, a periscope with a large field of view integrated with a side window would be needed. A similar requirement on the general-purpose telescope could thus be eliminated, reducing the complexity of the telescope design.

Another study showed that, with an additional weight penalty of from five to ten pounds, an optical drift indicator for use after parachute deployment could easily be incorporated into the general-purpose telescope.

*Apollo Monthly Progress Report*, SID 62-300-4, pp. 29-30.

The first reliability prediction study for the Apollo spacecraft was completed by NAA. Assuming all systems as series elements and excluding consideration of alternative modes, redundancies, or inflight maintenance provisions, the study gave a reliability estimate of 0.731. This analysis provided a basis from which means of improving reliability would be evaluated and formulated.

During  
the  
Month

*Apollo Monthly Progress Report*, SID 62-300-4, p. 26.

Layouts of three command module observation window configurations were made by NAA. A study disclosed that sufficient direct vision for lunar landing was not feasible and that windows could not be uncovered during reentry.

During  
the  
Month

*Apollo Monthly Progress Report*, SID 62-300-4, p. 66.

NAA began compiling a list of command module materials to be classified selectively for potentially toxic properties. These materials would be investigated to determine location (related to possible venting of gases), fire resistance, exposure to excessive temperatures, gases resulting from thermal decomposition, and toxicity of gases released under normal and material-failure conditions. Although a complete examination of every material was not feasible, materials could be grouped according to chemical constituency and quantity of gases released.

During  
the  
Month

*Apollo Monthly Progress Report*, SID 62-300-4, p. 10.

The basic spacecraft adapter structure was defined as consisting of six aluminum honeycomb panels, six longerons, and forward and aft bulkheads. The design of the honeycomb panels for the test requirements program was complete.

During  
the  
Month

*Apollo Monthly Progress Report*, SID 62-300-4, p. 89.

- 1962**  
**May**  
NAA decided to retain the inward-opening pull-down concept for the spacecraft crew hatch, which would use plain through bolts for lower sill attachment and a manual jack-screw device to supply the force necessary to seat and unseat the hatch.
- During the Month**  
Concurrently, a number of NAA latching concepts were in preparation for presentation to NASA, including that of an outward-opening, quick-opening crew door without an outer emergency panel. This design, however, had weight and complexity disadvantages, as well as requiring explosive charges.  
*Apollo Monthly Progress Report, SID 62-300-4, p. 68.*
- During the Month**  
The command module reaction control system (RCS) selected by NAA was a dual system without interconnections. Either would be sufficient for the entire mission.  
For the service module RCS, a quadruple arrangement was chosen which was basically similar to the command module RCS except that squib valves and burst discs were eliminated.  
*Apollo Monthly Progress Report, SID 62-300-4, p. 84.*
- During the Month**  
NAA evaluated the possibility of integrating the fuel cell and environmental control system heat rejection into one system. The integrated system proved to be unsatisfactory, being 300 pounds heavier and considerably more complex than the two separate systems. A preliminary design of separate fuel cell radiators, possibly located on the service module, was started by NAA.  
*Apollo Monthly Progress Report, SID 62-300-4, p. 82.*
- During the Month**  
NAA studies on the prototype crew couch included one on the use of the center couch for supporting a crewman at the astro sextant during lunar approach and another on the displacement of outboard couches for access to equipment areas.  
*Apollo Monthly Progress Report, SID 62-300-4, p. 65.*
- During the Month**  
Two NAA analyses showed that the urine management system would prevent a rise in the command module humidity load and atmospheric contamination and that freeze-up of the line used for daily evacuation of urine to the vacuum of space could be prevented by proper orificing of the line.  
*Apollo Monthly Progress Report, SID 62-300-4, pp. 10-11.*
- June**  
**7**  
Wernher von Braun, Director, Marshall Space Flight Center, recommended to the NASA Office of Manned Space Flight that the lunar orbit rendezvous mode be adopted for the lunar landing mission. He also recommended the development of an unmanned, fully automatic, one-way Saturn C-5 logistics vehicle in support of the lunar expedition; the acceleration of the Saturn C-1B program; the development of high-energy propulsion systems as a backup for the service module and possibly the lunar excursion module; and further development of the F-1 and J-2 engines to increase thrust or specific impulse.  
"Concluding Remarks by Dr. Wernher von Braun about Mode Selection for the Lunar Landing Program Given to Dr. Joseph F. Shea, Deputy Director (Systems), Office of Manned Space Flight, June 7, 1962," undated.



- NAA was directed by the Apollo Spacecraft Project Office at the monthly design review meeting to design an earth landing system for a passive touchdown mode to include the command module cant angle limited to about five degrees and favoring offset center of gravity, no roll orientation control, no deployable heatshield, and depressurization of the reaction control system propellant prior to impact. At the same meeting, NAA was requested to use a single "kicker" rocket and a passive thrust-vector-control system for the spacecraft launch escape system. 1962  
June  
10-11
- Apollo Spacecraft Project Office, MSC, Weekly Activity Report, June 8-14, 1962.
- NASA announced that the Apollo service module propulsion system would be tested at a new facility at White Sands Missile Range, N. Mex. 16
- Oakley, *Historical Summary, S&ID Apollo Program*, p. 7.
- Results of a preliminary investigation by NAA showed that a 100 percent oxygen atmosphere for the command module would save about 30 pounds in weight and reduce control complexity. 16-22
- NASA-Resident Apollo Spacecraft Project Office, NAA, Weekly Activity Report for Week Ending June 22, 1962, p. 3.
- As the result of considerable joint engineering effort and discussion by NAA and MIT Instrumentation Laboratory, the location of the onboard space sextant in the command module was changed from the main instrument panel to the wall of the lower equipment bay. The instrument would penetrate the hull on the hot side during reentry and the navigator would have to leave his couch to make navigation sightings and to align the inertial measurement unit. 18
- David G. Hoag, personal notes, June 18, 1962.
- MSC Director Robert R. Gilruth reported to the Manned Space Flight Management Council that the selection of the ablative material for the Apollo spacecraft heatshield would be made by September 1. The leading contender for the forebody ablative material was an epoxy resin with silica fibers for improving char strength and phenolic microballoons for reducing density. 22
- In addition, Gilruth noted that a reevaluation of the Saturn C-1 and C-1B launch capabilities appeared to indicate that neither vehicle would be able to test the complete Apollo spacecraft configuration, including the lunar excursion module. Complete spacecraft qualification would require the use of the Saturn C-5.
- MSF Management Council Minutes, June 22, 1962, Agenda Item 2.
- Joseph F. Shea, NASA Deputy Director of Manned Space Flight (Systems), presented to the Manned Space Flight Management Council the results of the study on lunar mission mode selection. The study included work by personnel in Shea's office, MSC, and Marshall Space Flight Center. The criteria used in evaluating the direct ascent technique, earth orbit rendezvous connecting and fueling modes, and lunar orbit rendezvous were: the mission itself, weight margins, guidance accuracy, communications and tracking requirements, reliability (abort prob-



- 1962** lems), development complexity, schedules, costs, flexibility, growth potential, and military implications.
- June**
- MSF Management Council Minutes, June 22, 1962, Agenda Item 12.
- 22** After an extended discussion, the Manned Space Flight Management Council unanimously decided:
- Lunar orbit rendezvous, using the Saturn C-5 launch vehicle, should be the mission mode for lunar exploration.
  - The development of a lunar logistics vehicle, using the Saturn C-1B or the C-5 launch vehicle, should be started and a six-month study of this development should begin immediately.
  - Time was too short and the expense too great to develop a parallel backup mode.
  - Study of the Nova vehicle should continue with the expectation that its development would follow the C-5 by two or three years.
  - The C-1B launch vehicle should be started immediately, looking toward the first two-stage flight in mid-1965.
  - Development of a lunar excursion module should begin at once.
- These decisions were to be presented to NASA Associate Administrator Robert C. Seamans, Jr., NASA Deputy Administrator Hugh L. Dryden, and NASA Administrator James E. Webb for approval.
- MSF Management Council Minutes, June 22, 1962, Agenda Item 12.
- 30** A thermal coverall for use in extravehicular space suit design was completed in-house and would be shipped to Vought Astronautics for use in the MSC evaluation contract.
- MSC, Weekly Activity Report for the Office of the Director, Manned Space Flight, June 24-30, 1962.
- During the Month**
- Five NASA scientists, dressed in pressure suits, completed an exploratory study at Rocketdyne Division of the feasibility of repairing, replacing, maintaining, and adjusting components of the J-2 rocket while in space. The scientific team also investigated the design of special maintenance tools and the effectiveness of different pressure suits in performing maintenance work in space.
- Rocketdyne *Skywriter*, July 13, 1962.
- Summer-Fall**
- NASA and MIT agreed that the Instrumentation Laboratory would use the microcircuit for the prototype Apollo onboard computer. The Fairchild Controls Corporation microcircuit was the only one available in the United States.
- Interview with Ralph Ragan, Instrumentation Laboratory, MIT, April 27, 1966.
- July 1-7**
- The delta V (rate of incremental change in velocity) requirements for the lunar landing mission were established and coordinated with NAA by the Apollo Spacecraft Project Office.
- Apollo Spacecraft Project Office, MSC, Weekly Activity Report, July 1-7, 1962.

NASA awarded three contracts totaling an estimated \$289 million to NAA's Rocketdyne Division for the further development and production of the F-1 and J-2 rocket engines. 1962  
July  
2

*Wall Street Journal*, July 3, 1962.

The document entitled "Charter of the MSFC-STG Space Vehicle Board," adopted on October 3, 1961, was revised to read "Spacecraft Launch Vehicle Coordination Charter for the Apollo Program MSFC-MS." The reasons for the revision were: to include the recently formed Management Council, to include the Electrical Systems Integration Panel and Instrumentation and Communications Panel responsibilities, and to establish Integration Offices within MSC and Marshall Space Flight Center (MSFC) to manage the Panels. 6

MSF Management Council Minutes, June 25, 1963, Agenda Item 6.

Employment at NAA's Space and Information Systems Division reached 14,119, an increase of 7000 in seven months. 6

Oakley, *Historical Summary, S&ID Apollo Program*, p. 7.

The first Apollo spacecraft mockup inspection was held at NAA's Space and Information Systems Division. In attendance were Robert R. Gilruth, Director, MSC; Charles W. Frick, Apollo Program Manager, MSC; and Astronaut Virgil I. Grissom. 10

Oakley, *Historical Summary, S&ID Apollo Program*, p. 7.

At the monthly Apollo spacecraft design review meeting with NAA, MSC officials directed NAA to design the spacecraft atmospheric system for 5 psia pure oxygen. From an engineering standpoint, the single-gas atmosphere offered advantages in minimizing weight and leakage, in system simplicity and reliability, and in the extravehicular suit interface. From the standpoint of physiological considerations, the mixed-gas atmosphere (3.5 psia oxygen, 3.5 psia nitrogen) had the advantages of offering protection against dysbarism and atelectasis, whereas the single-gas atmosphere afforded greater decompression protection. The atmosphere validation program demonstrated the known fire hazard of a pure oxygen atmosphere. Two fires occurred, one at the Air Force School of Aerospace Medicine, Brooks Air Force Base, Tex., on September 10 and the other at the U.S. Naval Air Engineering Center, Philadelphia, Penna., on November 17. The answer to this problem appeared to be one of diligent effort on the part of spacecraft designers to be aware of the fire hazard and to exercise strict control of potential ignition sources and material selection. The official authorization was issued to NAA by NASA on August 28. 10-11

Apollo Spacecraft Project Office, MSC, Weekly Activity Report, July 8-14, 1962; *Apollo Quarterly Status Report No. 1*, p. 13; Edward L. Michel, George B. Smith, Jr., and Richard S. Johnston, *Gaseous Environment Considerations and Evaluation Programs Leading to Spacecraft Atmosphere Selection*, NASA Technical Note TN D-2506 (1965), pp. 1-6; letter, C. D. Sword, MSC, to NAA, Space and Information Systems Division, "Contract Change Authorization No. 1," August 28, 1962.



1962  
July  
10-11

Charles W. Frick, MSC Apollo Project Office Manager, assigned MIT Instrumentation Laboratory to report on a simulated lunar landing trainer using guidance and navigation equipment and other displays as necessary or proposed.

Ralph Ragan, notes, 4th Apollo Design Review Meeting, NAA, S&ID, Downey, Calif., July 10 and 11, 1962.

11

NASA officials announced at a Washington, D.C., press conference that the lunar orbit rendezvous (LOR) technique had been selected as the primary method of accomplishing the lunar landing mission. The launch vehicle would be the Saturn C-5, with the smaller two-stage Saturn C-1B (S-IVB as second stage) used in early earth orbital spacecraft qualification flights. Requests for industrial proposals would be issued immediately on the lunar excursion module. The reasons for the decision on lunar orbit rendezvous were explained:

- A higher probability of mission success with essentially equal mission safety was provided by this technique.
- The method promised mission success some months earlier than other modes.
- LOR costs would be ten to 15 percent less than other techniques.
- LOR would require the least amount of technical development beyond existing commitments while advancing significantly the national technology.

In addition, it was announced that:

- Studies would continue on the feasibility of using the Saturn C-5 to launch a two-man spacecraft in a direct ascent approach to the moon or in an earth orbit rendezvous mode.
- An in-depth study would be made on a lunar logistics vehicle.
- Investigations would continue on the development of the Nova launch vehicle.

NASA, "Lunar Orbit Rendezvous: News Conference on Apollo Plans at NASA Headquarters on July 11, 1962," pp. 1, 3, 4.

16

Beech Aircraft Corporation was selected by NASA to build the spherical pressure vessels that would be used to store in the supercritical state the hydrogen-oxygen reactants for the spacecraft fuel cell power supply.

*Apollo Quarterly Status Report No. 1*, p. 23; Oakley, *Historical Summary, S&ID Apollo Program*, p. 6.

17

Joseph F. Shea, NASA Deputy Director of Manned Space Flight (Systems), told an American Rocket Society meeting in Cleveland, Ohio, that the first American astronauts to land on the moon would come down in an area within ten degrees on either side of the lunar equator and between longitudes 270 and 260 degrees. Shea said that the actual site would be chosen for its apparent scientific potential and that the Ranger and Surveyor programs would provide badly needed information on the lunar surface. Maps on the scale of two fifths of a mile to the inch would be required, based on photographs which would show lunar features down



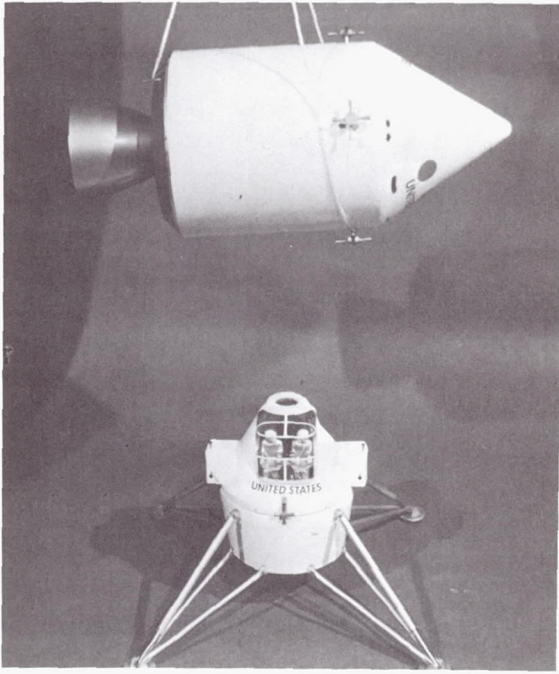

1

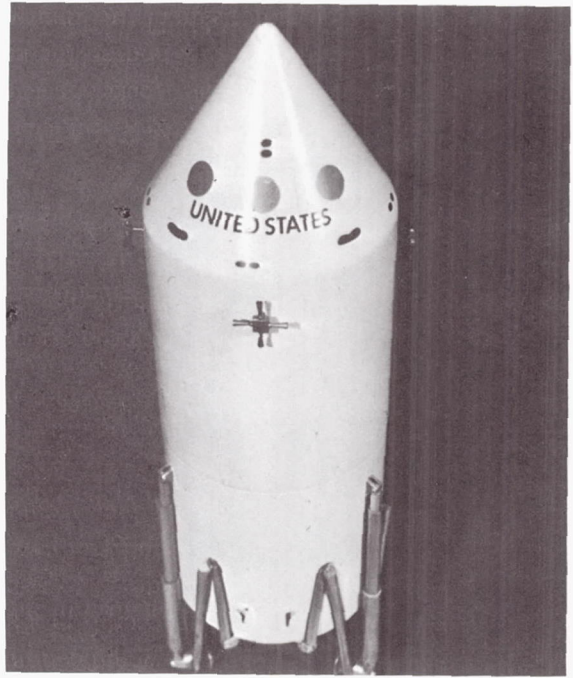

2

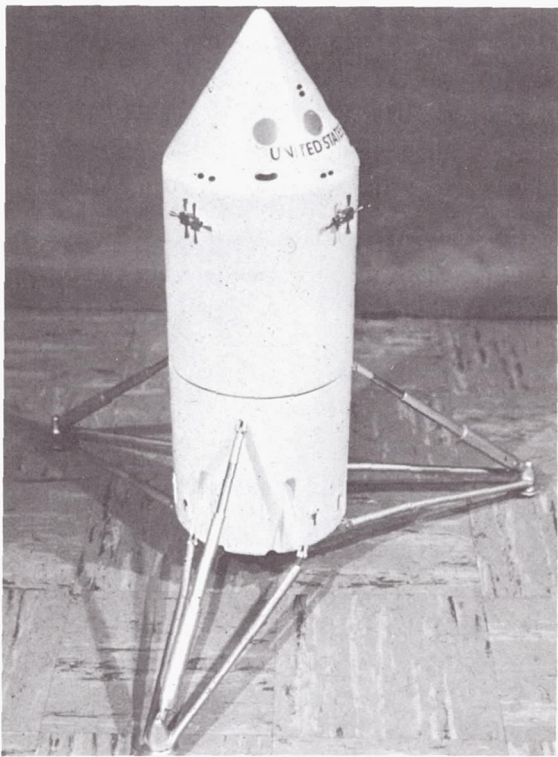

3

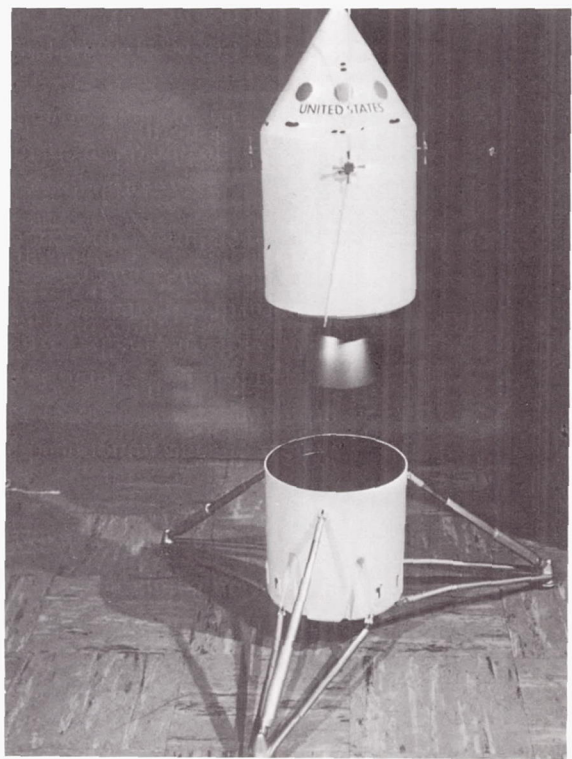

4



5

NASA officials James E. Webb, Administrator; Dr. Robert C. Seamans, Jr., Associate Administrator; D. Brainerd Holmes, Director, Office of Manned Space Flight; and Joseph F. Shea, Deputy Director of Systems, Office of Manned Space Flight, used models extensively as they announced that the lunar orbit rendezvous mode had been selected and compared this mode with earth orbit rendezvous and direct ascent. Shown on preceding page and above are: (1) lunar landing of the lunar excursion module, with the command and service modules overhead in lunar orbit; (2) the lunar descent phase after braking, with the command, service, and lunar landing modules combined in the earth orbit rendezvous approach; (3) the lunar landing module landing gear extended following a lunar landing (direct ascent); (4) lunar takeoff and transearth flight configuration of the command and service modules (direct ascent); and (5) the reentry command module, virtually the same for any of the three modes.

1962

July

to five or six feet in size. The smallest objects on the lunar surface yet identified by telescope were about the size of a football field.

*MSC Space News Roundup*, August 22, 1962, p. 8.

17

In an address to the American Rocket Society lunar missions meeting in Cleveland, Ohio, James A. Van Allen, Chairman of the Department of Physics and Astronomy, State University of Iowa, said that protons of the inner radiation belt could be a serious hazard for extended manned space flight and that nuclear detonations might be able to clean out these inner belt protons, perhaps for a prolonged period, making possible manned orbits about 300 miles above the earth.

*New York Times*, July 18, 1962.



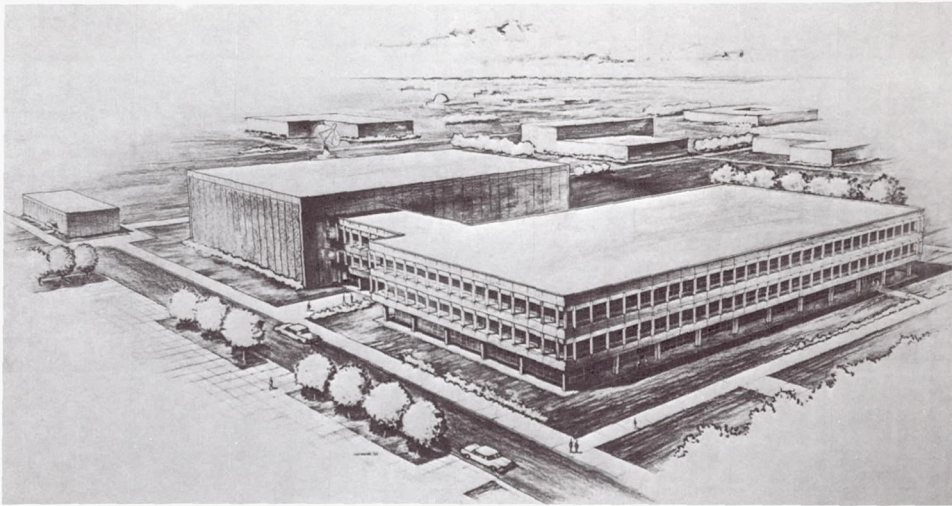

An architect's conception of the Mission Control Center to be constructed at Manned Spacecraft Center.

NASA Administrator James E. Webb announced that the Mission Control Center for future manned space flights would be located at MSC. The Center would be operational in time for Gemini rendezvous flights in 1964 and later Apollo lunar missions. The overriding factor in the choice of MSC was the existing location of the Apollo Spacecraft Project Office, the astronauts, and Flight Operations Division at Houston.

**1962**  
**July**  
**20**

*New York Times*, July 22, 1962; NASA News Release, 62-172, July 20, 1962; memorandum, Robert C. Seamans, Jr., to Administrator, "Location of Mission Control Center," July 10, 1962.

NASA announced plans for an advanced Saturn launch complex to be built on 80,000 acres northwest of Cape Canaveral. The new facility, Launch Complex 39, would include a building large enough for the vertical assembly of a complete Saturn launch vehicle and Apollo spacecraft.

**21**

*Washington Sunday Star*, July 22, 1962.

MSC invited 11 firms to submit research and development proposals for the lunar excursion module (LEM) for the manned lunar landing mission. The firms were Lockheed Aircraft Corporation, The Boeing Airplane Company, Northrop Corporation, Ling-Temco-Vought, Inc., Grumman Aircraft Engineering Corporation, Douglas Aircraft Company, General Dynamics Corporation, Republic Aviation Corporation, Martin-Marietta Company, North American Aviation, Inc., and McDonnell Aircraft Corporation.

**25**

The Statement of Work distributed to the prospective bidders described the contractor's responsibilities:

Detail design and manufacture of the LEM and related test articles, mockups, and other hardware with the exception of certain government-furnished equip-



1962

July

ment [navigation and guidance system (excepting the rendezvous radar and radar altimeter), flight research and development instrumentation system, scientific instrumentation system, and certain components of the crew equipment system (space suits, portable life support systems, and personal radiation dosimeters)]

Integration of government-furnished equipment into the LEM; development of specifications for equipment performance, interfaces, and design environment; and maintenance of interface control documentation in a state of validity and concurrence

Detailed trajectory analysis from lunar orbit separation until lunar orbit rendezvous directly related to the contractor's area of responsibility

Specification of the mission environment on the lunar surface and assessment of the effects of the spacecraft adapter environment on the LEM

Detail design of the LEM-mounted equipment for repositioning and mating the LEM to the command module (CM)

Design of the LEM-mounted equipment within the overall specification of the Principal Contractor (NAA)

Determination of the desirability of checkout or operation of the LEM during the translunar period of the flight

Identification of crew tasks related to the LEM before and during separation, whether actually performed in the LEM or CM

Design and manufacture of the ground support equipment directly associated with the hardware for which the contractor was responsible and ensurance of compatibility of all ground support equipment involved with the LEM

Design and manufacture of certain LEM training equipment for flight or ground personnel as required by NASA

Prelaunch preparation and checkout of the LEM, working with the other contractors in the same manner as during systems testing

Coordination of all LEM activities with the overall spacecraft prelaunch requirements

Planning and implementation of a reliability and quality assurance program

Provision of adequate logistic support for the equipment furnished by the contractor

The mockups to be delivered by the contractor would include but not be limited to:

- Complete LEM
- Cabin interior arrangement
- Cabin exterior equipment
- Docking system
- Environmental control system

Crew support system  
Antenna radiation pattern  
Handling and transportation  
Module interface

Before the first translunar midcourse correction, the LEM would be transferred from its stowed position in the spacecraft adapter to a docked configuration with the command and service modules (CSM). At a later point in the mission, the two-man LEM crew would enter the LEM from the CSM by means of a hatch without being exposed to the environment of space. Another hatch would allow access to the LEM during countdown and egress into space while docked with the CSM.

The LEM systems were to operate at their normal design performance level for a mission of two days without resupply. Equipment normally operated in the pressurized LEM cabin environment would be designed to function for a minimum of two days in vacuum without failure. The LEM pressurization system would be capable of six complete cabin repressurizations and a continuous leak rate as high as 0.2 pound per hour. Provision would be made for a total of six recharges of the portable life support system which had a normal operating time without resupply of four hours. Under usual conditions in the LEM cabin, the crew would wear unpressurized space suits. Either crewman would be able, alone, to return the LEM to the CSM and successfully perform the rendezvous and docking maneuver. Of the overall crew safety goal of 0.999, the goal apportioned to the LEM was 0.995.

The LEM would be capable of independently performing the separation from the CSM, lunar descent, landing, ascent, rendezvous, and docking with the CSM. It would allow for crew exploration in the vicinity of lunar touchdown but would not be required to have lunar surface mobility.

Lunar landing would be attempted from a lunar orbit of 100 nautical miles. After separation, the LEM would transfer from the circular orbit to an equal-period elliptical orbit which would not intersect the lunar surface. The hovering, final touchdown maneuvers, and landing would be performed by the LEM from the elliptical orbit.

Normally there would not be a requirement to reposition the LEM attitude before lunar launch. To rendezvous and dock with the CSM, the LEM would transfer from an elliptical to a circular orbit after lunar launch.

The LEM would not be recoverable.

Included in the Statement of Work was a description of the major LEM systems:

#### Guidance and control system

The navigation and guidance system would provide steering and thrust control signals for the stabilization and control system, reaction control system, and the lunar excursion propulsion system. Its basic components were:

Inertial measurement unit  
Optical measurement unit

1962

July

Range-drift measurement unit (reticle)

Computer

Power and servo assembly

Control and display unit

Displays and controls

Cabling and junction box

Chart book and star catalog

Rendezvous radar and radar altimeter

The stabilization and control system would meet the attitude stabilization and maneuver control requirements and would include:

Attitude reference

Rate sensors

Control electronics assembly

Manual controls

Displays

Power supplies

#### Lunar excursion propulsion system

The system would use storable hypergolic bipropellants and a pressurized propellant feed system. Variable thrust would be required from a propulsion system to be designed.

#### Propellants

The fuel would be monomethylhydrazine or a mixture of 50 percent hydrazine and 50 percent unsymmetrical dimethylhydrazine. Nitrogen tetroxide with nitrous oxide, added to depress the freezing point if necessary, would be used as oxidizer.

#### Reaction control system

The system comprised two independent, interconnectable, pulse-modulated subsystems, each capable of meeting the total torque and impulse requirements and providing two-directional control about all axes. The same propellant combination would be used as for the LEM propulsion system.

#### Lunar touchdown system

Attached to the LEM by hard points which would accommodate variations of landing gear geometries, the system would have load distribution capabilities compatible with anticipated landing gear loads and would include meteoroid protection and radiation protection inherent in its structure. Normally, the system would be deployed from within the spacecraft but could be operated manually by the crew in space suits outside the spacecraft.

#### Crew systems

The flight crew would consist of the Commander and Systems Engineer.

The crew equipment system would include an adjustable seat for each crewman, restraint system for each seat, food and water, first aid equipment, space



suits, portable life support systems for each crewman, and personal radiation dosimeters.

1962

July

#### Environmental control system

The following conditions would be provided:

Total cabin pressure: Oxygen,  $5 \pm 0.2$  psia

Relative humidity: 40 to 70 percent

Carbon dioxide partial pressure (maximum): 7.6 mm Hg

Temperature:  $75^\circ \pm 5^\circ$  F

#### Electrical power system

Selection of the source was still to be made and would depend largely on the time contingency allowed for various mission events, especially during rendezvous maneuvers.

#### Instrumentation system

The operational instrumentation system would consist of a clock, tape recorder system, display and control system, sensors, calibration system, cameras, and telescope.

The flight research and development instrumentation system would be made up of telemetry systems (including transmitters), clock and tape recorder system, sensors and signal conditioning, calibration system, power supply, radar transponder, and antennas.

The scientific instrumentation system would comprise a lunar atmosphere analyzer, gravitometer, magnetometer, radiation spectrometer, specimen return container, rock and soil analysis equipment, seismographic equipment, and soil temperature instrument.

NASA, *Project Apollo Lunar Excursion Module Development Statement of Work* (MSC, July 24, 1962), pp. 2-5, A-89 to A-108; *Astronautical and Aeronautical Events of 1962*, p. 130.

Wesley F. Messing was designated as Acting Resident MSC Manager at White Sands Missile Range, N. Mex., to coordinate MSC test programs at that site.

25

MSC Announcement No. 67, Establishment of Resident MSC Manager at White Sands Missile Range, July 25, 1962.

As a result of an MSC in-house technical review, NAA was directed to investigate the adaptation of the Gemini-type heatshield to the Apollo spacecraft.

29-August 4

Apollo Spacecraft Project Office, MSC, Weekly Activity Report.

The Office of Systems under NASA's Office of Manned Space Flight summarized its conclusions on the selection of a lunar mission mode based on NASA and industry studies conducted in 1961 and 1962:

30

- There were no significant technical problems which would preclude the acceptance of any of the modes, if sufficient time and money were available. [The

1962

July

modes considered were the C-5 direct ascent, C-5 earth orbit rendezvous (EOR), C-5 lunar orbit rendezvous (LOR), Nova direct ascent, and solid-fuel Nova direct ascent.]

- The C-5 direct ascent technique was characterized by high development risk and the least flexibility for further development.

- The C-5 EOR mode had the lowest probability of mission success and the greatest development complexity.

- The Nova direct ascent method would require the development of larger launch vehicles than the C-5. However, it would be the least complex from an operational and subsystem standpoint and had greater crew safety and initial mission capabilities than did LOR.

- The solid-fuel Nova direct flight mode would necessitate a launch vehicle development parallel to the C-5. Such a development could not be financed under current budget allotments.

- Only the LOR and EOR modes would make full use of the development of the C-5 launch vehicle and the command and service modules. Based on technical considerations, the LOR mode was distinctly preferable.

- The Directors of MSC and Marshall Space Flight Center had both expressed strong preference for the LOR mode.

On the basis of these conclusions, the LOR mode was recommended as most suitable for the manned lunar landing mission. [The studies summarized in this document were used by the Manned Space Flight Management Council in their mission mode decision on June 22.]

Office of Systems, Office of Manned Space Flight, "Manned Lunar Landing Program Comparison," July 30, 1962, pp. 145-146.

31

The Manned Space Flight Management Council decided that the Apollo spacecraft design criteria should be worked out under the guidance of the Office of Manned Space Flight (OMSF) Office of Systems. These criteria should be included in the systems specifications to be developed. A monthly exchange of information on spacecraft weight status should take place among the Centers and OMSF. Eldon W. Hall of the Office of Space Systems would be responsible for control of the detailed systems weights.

MSF Management Council Minutes, July 31, 1962, Agenda Item 16.

During  
the  
Month

The Hamilton Standard Division of United Aircraft Corporation was selected by NASA as the prime contractor for the Apollo space suit assembly. Hamilton's principal subcontractor was International Latex Corporation, which would fabricate the pressure garment. The contract was signed on October 5.

*Apollo Quarterly Status Report No. 1*, p. 29.

During  
the  
Month

The control layout of the command module aft compartment was released by NAA. This revised drawing incorporated the new umbilical locations in the lower heat-shield, relocated the pitch-and-yaw engines symmetrically, eliminated the ground

support equipment tower umbilical, and showed the resulting repositioning of tanks and equipment.

1962

July

NAA, *Apollo Monthly Progress Report*, SID 62-300-5, July 31, 1962, p. 96.

NAA completed control layouts for all three command module windows, including heatshield windows and sightlines. Structural penalties were investigated, window panes sized, and a weight-comparison chart prepared.

During  
the  
Month

*Apollo Monthly Progress Report*, SID 62-300-5, p. 98.

NAA's evaluation of the emergency blow-out hatch study showed that the linear-shaped explosive charge should be installed on the outside of the command module, with a backup structure and an epoxy-foam-filled annulus on the inside of the module to trap fragmentation and gases. Detail drawings of the crew hatch were prepared for fabrication of actual test sections.

During  
the  
Month

*Apollo Monthly Progress Report*, SID 62-300-5, pp. 97-98.

After the determination of the basic design of the spacecraft sequencer schematic, the effect of the deployment of the forward heatshield before tower jettison was studied by NAA. The sequence of events of both the launch escape system and earth landing system would be affected, making necessary the selection of different sequences for normal flights and abort conditions. A schematic was prepared to provide for these sequencing alternatives.

During  
the  
Month

*Apollo Monthly Progress Report*, SID 62-300-5, p. 123.

NAA completed the analysis and design of the Fiberglas heatshield. It duplicated the stiffness of the aluminum heatshield and would be used on all boilerplate spacecraft.

During  
the  
Month

*Apollo Monthly Progress Report*, SID 62-300-5, p. 93.

Final design of the command module forward heatshield release mechanism was completed by NAA.

During  
the  
Month

*Apollo Monthly Progress Report*, SID 62-300-5, p. 79.

Air recirculation system components of the command module were rearranged to accommodate a disconnect fitting and lines for the center crewman's suit. To relieve an obstruction, the cabin pressure regulator was relocated and a design study drawing was completed.

During  
the  
Month

*Apollo Monthly Progress Report*, SID 62-300-5, p. 73.

A study was made by NAA to determine optimum location and configuration of the spacecraft transponder equipment. The study showed that, if a single deep space instrumentation facility transponder and power amplifier were carried in the command module instead of two complete systems in the service module, spacecraft weight would be reduced, the system would be simplified, and command and

During  
the  
Month



**1962****July**

service module interface problems would be minimized. Spares in excess of normal would be provided to ensure reliability.

*Apollo Monthly Progress Report*, SID 62-300-5, p. 84.

**During  
the  
Month**

A modified method of cooling crew and equipment before launch and during boost was tentatively selected by NAA. Chilled, ground-support-equipment-supplied water-glycol would be pumped through the spacecraft coolant system until 30 seconds before launch, when these lines would be disconnected. After umbilical separation the glycol, as it evaporated at the water boiler, would be chilled by Freon stored in the water tanks.

*Apollo Monthly Progress Report*, SID 62-300-5, p. 75.

**During  
the  
Month**

NAA selected the lunar landing radar and completed the block diagram for the spacecraft rendezvous radar. Preliminary design was in progress on both types of radar.

*Apollo Monthly Progress Report*, SID 62-300-5, p. 57.

**During  
the  
Month**

A 70-mm pulse camera was selected by NAA for mission photodocumentation. The camera was to be carried in the upper parachute compartment. Because of the lack of space and the need for a constant power supply for a 35-watt heating element, NAA was considering placing the camera behind the main display panel. The advantages of this arrangement were that the camera would require less power, be available for changing magazines, and could be removed for use outside the spacecraft.

One 16-mm camera was also planned for the spacecraft. This camera would be positioned level with the commander's head and directed at the main display panel. It could be secured to the telescope for recording motion events in real time—such as rendezvous, docking, launch and recovery of a lunar excursion module, and earth landing; it could be hand-held for extravehicular activity.

*Apollo Monthly Progress Report*, SID 62-300-5, p. 81.

**During  
the  
Month**

NAA investigated several docking methods. These included extendable probes to draw the modules together; shock-strut arms on the lunar excursion module with ball locators to position the modules until the spring latch caught, fastening them together; and inflatable Mylar and polyethylene plastic tubing. Also considered was a system in which a crewman, secured by a lanyard, would transfer into the open lunar excursion module. Another crewman in the open command module airlock would then reel in the lanyard to bring the modules together.

*Apollo Monthly Progress Report*, SID 62-300-5, p. 99.

**During  
the  
Month**

Command module (CM) flotation studies were made by NAA, in which the heatshield was assumed to be upright with no flooding having occurred between the CM inner and outer walls. The spacecraft was found to have two stable attitudes: the desired upright position and an unacceptable on-the-side position 128 degrees from the vertical. Further studies were scheduled to determine how much lower

the CM center of gravity would have to be to eliminate the unacceptable stable condition and to measure the overall flotation stability when the CM heatshield was extended.

*Apollo Monthly Progress Report, SID 62-300-5, p. 27.*

A recent Russian article discussed various methods which the Soviet Union had been studying for sending a man to the moon during the decade. The earth orbital rendezvous method was reported the most reliable, but consideration also had been given to the direct ascent method, using the "Mastodon" rocket.

*Astronautical and Aeronautical Events of 1962, p. 136.*

At MSC, J. Thomas Markley was appointed Project Officer for the Apollo spacecraft command and service modules contract, and William F. Rector was named Project Officer for the lunar excursion module contract.

*MSC Space News Roundup, August 22, 1962, p. 1.*

NASA's Office of Manned Space Flight issued Requests for Proposals for a study of the lunar "bus" and studies for payloads which could be handled by the C-1B and C-5 launch vehicles. Contract awards were expected by September 1 and completion of the studies by December 1.

*MSF Management Council Minutes, July 31, 1962, Agenda Item 7.*

The Apollo spacecraft configuration changed radically from May 1960 to July 1962. These are the major configuration changes during that period. The inset reentry bodies indicate the shapes which received the greatest amount of study.

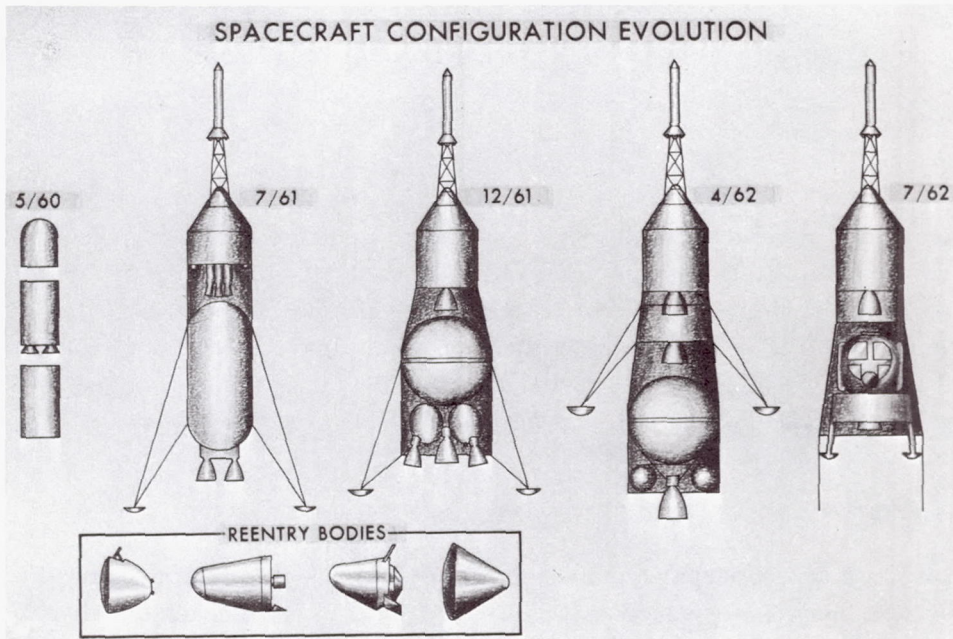

1962

July

August

1

1

2



- 1962**  
**August**
- 2                   The heatshield for Apollo command module boilerplate model 1 was completed five days ahead of schedule.  
                       Oakley, *Historical Summary, S&ID Apollo Program*, p. 8.
- 6                   The MIT Instrumentation Laboratory ordered a Honeywell 1800 electronic computer from the Minneapolis-Honeywell Regulator Company's Electronic Data Processing Division for work on the Apollo spacecraft navigation system. After installation in 1963, the computer would aid in circuitry design of the Apollo spacecraft computer and would also simulate full operation of a spaceborne computer during ground tests.  
                       *Astronautical and Aeronautical Events of 1962*, p. 141.
- 7                   The first completed boilerplate model of the Apollo command module, BP-25, was subjected to a one-fourth-scale impact test in the Pacific Ocean near the entrance to Los Angeles Harbor. Three additional tests were conducted on August 9.  
                       Oakley, *Historical Summary, S&ID Apollo Program*, p. 8; MSC, Weekly Activity Report for the Office of the Director, Manned Space Flight, August 5-11, 1962.
- 8                   NASA awarded a \$141.1 million contract to the Douglas Aircraft Company for design, development, fabrication, and testing of the S-IVB stage, the third stage of the Saturn C-5 launch vehicle. The contract called for 11 S-IVB units, including three for ground tests, two for inert flight, and six for powered flight.  
                       *Astronautical and Aeronautical Events of 1962*, p. 144.
- 8                   Representatives of the MSC Gemini Project Office and Facilities Division inspected the proposed hangar and office facilities to be refurbished at El Centro Naval Air Facility, Calif., for joint use in the Apollo and Gemini drop-test programs.  
                       MSC, *Project Gemini Quarterly Status Report No. 2 for Period Ending August 31, 1962*, p. 14.
- 8                   At a bidders' conference held at NASA Headquarters, proposals were requested from Centers and industry for two lunar logistic studies: a spacecraft "bus" concept that could be adapted for use first on the Saturn C-1B and later on the Saturn C-5 launch vehicles and a variety of payloads which could be soft-landed near manned Apollo missions. The latter study would determine how a crew's stay on the moon might be extended, how human capability for scientific investigation of the moon might be increased, and how man's mobility on the moon might be facilitated.  
                       *Astronautical and Aeronautical Events of 1962*, p. 144.
- 10                  MSC requested the reprogramming of \$100,000 of Fiscal Year 1963 funds for advance design on construction facilities. The funds would be transferred from Launch Operations Center to MSC for use on the Little Joe II program at White



Sands Missile Range, N. Mex., and would cover Army Corps of Engineers design work on the launch facility.

1962  
August

MSC, Weekly Activity Report for the Office of the Director, Manned Space Flight, August 5-11, 1962.

NASA selected the Aerojet-General Algol solid-propellant motor to power the Little Joe II booster, which would be used to flight-test the command and service modules of the Apollo spacecraft.

10

*Astronautical and Aeronautical Events of 1962*, p. 146.

A NASA program schedule for the Apollo spacecraft command and service modules through calendar year 1965 was established for financial planning purposes and distributed to the NASA Office of Manned Space Flight, Marshall Space Flight Center, and MSC. The key dates were: complete service module drawing release, May 1, 1963; complete command module drawing release, June 15, 1963; manufacture complete on the first spacecraft, February 1, 1964; first manned orbital flight, May 15, 1965. This tentative schedule depended on budget appropriations.

11

MSC, Weekly Activity Report for the Office of the Director, Manned Space Flight, August 5-11, 1962, pp. 4, 5.

Of the 11 companies invited to bid on the lunar excursion module on July 25, eight planned to respond. NAA had notified MSC that it would not bid on the contract. No information had been received from the McDonnell Aircraft Corporation and it was questionable whether the Northrop Corporation would respond.

11

MSC, Weekly Activity Report for the Office of the Director, Manned Space Flight, August 5-11, 1962, p. 4.

The Soviet Union launched *Vostok III* into orbit at 11:30 a.m. Moscow time, the spacecraft piloted by Andrian G. Nikolayev. At 11:02 a.m. Moscow time the next day, the Soviet Union launched the *Vostok IV* spacecraft into orbit with Pavel R. Popovich as pilot. Within about an hour, Cosmonaut Popovich, traveling in nearly the same orbit as *Vostok III*, made radio contact with Cosmonaut Nikolayev. Nikolayev reported shortly thereafter that he had sighted *Vostok IV*. In their official report, Nikolayev and Popovich said their spacecraft had been within a little over three miles of each other at their closest approach. This was the first launching of two manned spacecraft within a 24-hour period. Popovich and Nikolayev landed safely in Kazakhstan, U.S.S.R., on August 15.

11-12

*New York Times*, August 14 and 22, 1962.

Ten Air Force pilots emerged from a simulated space cabin in which they had spent the previous month participating in a psychological test to determine how long a team of astronauts could work efficiently on a prolonged mission in space. Project

13

- 1962**  
**August** Director Earl Alluisi said the experiment had "far exceeded our expectations" and that the men could have stayed in the cabin for 40 days with no difficulty.  
*New York Herald Tribune*, August 14, 1962.
- 13-14** NAA suggested that the pitch, roll, and yaw rates required for the Apollo guidance and navigation system would permit reduction in the reaction control thrust.  
MSC-NAA Apollo Spacecraft Design Review No. 5, August 13-14, 1962, Downey, Calif., Item 5-6.
- 14** The NAA spacecraft Statement of Work was revised to include the requirements for the lunar excursion module (LEM) as well as other modifications. The LEM requirements were identical with those given in the LEM Development Statement of Work of July 24.  
The command module (CM) would now be required to provide the crew with a one-day habitable environment and a survival environment for one week after touching down on land or water. In case of a landing at sea, the CM should be able to recover from any attitude and float upright with egress hatches free of water.  
The service propulsion system would now provide all major velocity increments required for translunar midcourse velocity corrections, for placing the spacecraft into a lunar orbit, for rendezvous of the command and service modules (CSM) with the LEM on a backup mode, for transfer of the CSM from lunar orbit into the transearth trajectory, and for transearth midcourse velocity corrections for lunar missions.  
Three FIST-type drogue parachutes would replace the original two called for in the earth landing system.  
The CM camera system was revised to require one for monitoring the crew, displays, and spacecraft interior; the other for lunar photography and stellar studies. The latter camera could be used in conjunction with the telescope or independently at the crew's discretion.  
A new communication concept was described in which all voice, telemetry, television, and ranging information for near-earth and lunar distances would be transmitted over a unified frequency system.  
All references to the lunar landing module and space laboratory module were dropped. Among other deletions from the previous Statement of Work were:  
Parawing and other earth landing systems instead of parachutes  
The "skip" reentry technique  
HF beacon as recovery aid  
Radar altimeter from CSM communication system  
Crew recreational equipment  
Engineering and Development Test Plan  
NASA, *Project Apollo Spacecraft Development Statement of Work* (MSC, December 18, 1961, Revised August 14, 1962), Part 3, Technical Approach, pp. 3, 7, 12, 61, 84, and 88.



The first Apollo boilerplate command module, BP-25, was delivered to MSC for water recovery and handling tests. Flotation, water stability, and towing tests were conducted with good results. J. Thomas Markley of MSC described all spacecraft structural tests thus far as "successful."

1962

Mid-August

*Apollo Quarterly Status Report No. 1*, p. 41; *Astronautical and Aeronautical Events of 1962*, p. 167; Apollo Spacecraft Project Office, Weekly Activity Report, Period Ending August 18, 1962.

The second stage (S-IV) of the Saturn C-1 launch vehicle was successfully static-fired for the first time in a ten-second test at the Sacramento, Calif., facility by the Douglas Aircraft Company.

16

*Astronautical and Aeronautical Events of 1962*, p. 156.

Carl Sagan, University of California astronomer, warned scientists at a lunar exploration conference, Blacksburg, Va., of the need for sterilization of lunar spacecraft and decontamination of Apollo crewmen, pointing out that *Lunik II* and *Ranger IV* probably had deposited terrestrial microorganisms on the moon. Even more serious, he said, was the possibility that lunar microorganisms might be brought to earth where they could multiply explosively.

17

*Washington Post*, August 18, 1962.

Responsibility for the design and manufacture of the reaction controls for the Apollo command module was shifted from The Marquardt Corporation to the Rocketdyne Division of NAA, with NASA concurrence.

22

Oakley, *Historical Summary, S&ID Apollo Program*, p. 7.

The length of the Apollo service module was increased from 11 feet 8 inches to 12 feet 11 inches to provide space for additional fuel.

22

Oakley, *Historical Summary, S&ID Apollo Program*, p. 7.

Robert R. Gilruth, Director of MSC, presented details of the Apollo spacecraft at the Institute of the Aerospace Sciences meeting in Seattle, Wash. During launch and reentry, the three-man crew would be seated in adjacent couches; during other phases of flight, the center couch would be stowed to permit more freedom of movement. The Apollo command module cabin would have 365 cubic feet of volume, with 22 cubic feet of free area available to the crew: "The small end of the command module may contain an airlock; when the lunar excursion module is not attached, the airlock would permit a pressure-suited crewman to exit to free space without decompressing the cabin. Crew ingress and egress while on earth will be through a hatch in the side of the command module."

During  
the  
Month

*Astronautical and Aeronautical Events of 1962*, p. 167.

The first tests incorporating data acquisition in the Apollo test program were conducted at El Centro, Calif. They consisted of monitoring data returned by telemetry during a parachute dummy-load test.

During  
the  
Month

Oakley, *Historical Summary, S&ID Apollo Program*, p. 7.



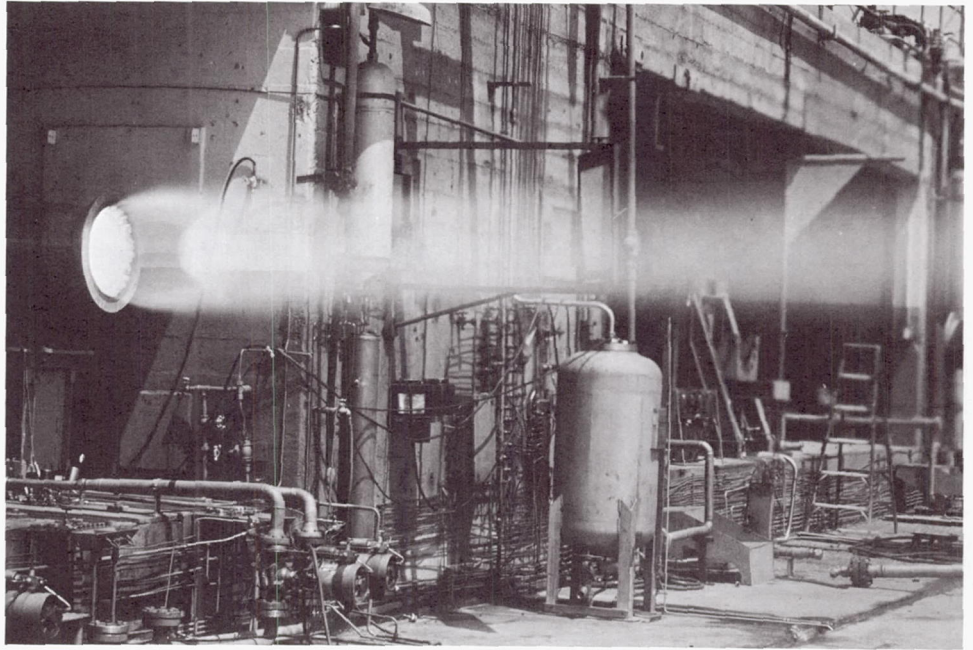

A prototype of the main engine of the Apollo service module test-fired at Aerojet-General Corporation's Azusa, Calif., plant in August 1962. The engine used storable liquid propellants and had an ablative thrust chamber assembly. (Aerojet-General photo)

**1962**  
**August**  
**During**  
**the**  
**Month**

The revised NAA Summary Definitions and Objectives Document was released. This revision incorporated the lunar orbit rendezvous concept, without lunar excursion module integration, and a revised master phasing schedule, reflecting the deletion of the second-stage service module. The NAA Apollo Mission Requirements and Apollo Requirements Specifications were also similarly reoriented and released.

*NAA, Apollo Monthly Progress Report, SID 62-300-6, August 31, 1962, p. 24.*

**During**  
**the**  
**Month**

The establishment of a basic command module (CM) airlock and docking design criteria were discussed by NAA and NASA representatives. While NASA preferred a closed-hatch, one-man airlock system, NAA had based its design on an open-hatch, two-man airlock operation.

Another closed-hatch configuration under consideration would entirely eliminate the CM airlock. Astronauts transferring to and from the lunar excursion module would be in a pressurized environment constantly.

*Apollo Monthly Progress Report, SID 62-300-6, p. 97.*

**During**  
**the**  
**Month**

The launch escape thrust-vector-control system was replaced by a passive system using a "kicker" rocket as directed by NASA at the June 10-11 design review meeting. The rocket would be mounted at the top of the launch escape system tower and fired tangentially to impart the necessary pitchover motion during the initial phase

of abort. The main motor thrust was revised downward from 180,000 to 155,000 pounds and aligned 2.8 degrees off the center line. A downrange abort direction was selected; during abort the spacecraft and astronauts would rotate in a heels over head movement.

**1962**  
**August**

*Apollo Monthly Progress Report*, SID 62-300-6, p. 4.

A preliminary NAA report was completed on a literature search concerning fire hazards in 100 percent oxygen and oxygen-enriched atmospheres. This report showed that limited testing would be warranted.

**During  
the  
Month**

*Apollo Monthly Progress Report*, SID 62-300-6, p. 12.

A final decision was made by NAA to redesign the command module fuel cell radiator and associated tubing to accommodate a 30-psi maximum pressure drop. Pratt & Whitney Aircraft Division agreed to redesign their pump for this level.

**During  
the  
Month**

*Apollo Monthly Progress Report*, SID 62-300-6, p. 109.

Layouts of a command module (CM) telescope installation in the unpressurized upper parachute compartment were completed by NAA. The concept was for the telescope to extend ten inches from the left side of the spacecraft. The light path would enter the upper bulkhead through the main display panel to an eyepiece presentation on the commander's side of the spacecraft. A static seal (one-half-inch-thick window) would be used to prevent leakage in the pressurized compartment. The installation was suitable for use in the lunar orbit rendezvous mission and would allow one man in the CM to accomplish docking with full visual control.

**During  
the  
Month**

*Apollo Monthly Progress Report*, SID 62-300-5, pp. 81, 83; *Apollo Monthly Progress Report*, SID 62-300-6, pp. 72-73.

NAA established design criteria for materials and processes used in food reconstitution bags. An order was placed for polypropylene material with a contoured mouthpiece. This material would be machined and then heat-fused to a thermoplastic bag.

**During  
the  
Month**

*Apollo Monthly Progress Report*, SID 62-300-6, p. 56.

Preliminary studies were made by NAA to determine radiation instrument location, feasibility of shadow-shielding, and methods of determining direction of incidence of radiation. Preliminary requirements were established for the number and location of detectors and for information display.

**During  
the  
Month**

*Apollo Monthly Progress Report*, SID 62-300-6, p. 72.

An NAA study indicated that the effects of crew motions on spacecraft attitude control would be negligible.

**During  
the  
Month**

*Apollo Monthly Progress Report*, SID 62-300-6, p. 53.

The command module waste management system analysis, including a new selection valve, revised tubing lengths, odor removal filter, and three check valves,

**During  
the  
Month**



1962

August

was completed by NAA for a 5 psia pressure. There was only a small change in the flow rates through the separate branches as a result of the change to 5 psia.

*Apollo Monthly Progress Report*, SID 62-300-6, p. 12.

During  
the  
Month

NAA completed attitude orientation studies, including one on the control of a tumbling command module (CM) following high-altitude abort above 125,000 feet. The studies indicated that the CM stabilization and control system would be adequate during the reentry phase with the CM in either of the two possible trim configurations.

*Apollo Monthly Progress Report*, SID 62-300-6, p. 5.

During  
the  
Month

NAA finished structural requirements for a lunar excursion module adapter mating the 154-inch diameter service module to the 260-inch diameter S-IVB stage.

*Apollo Monthly Progress Report*, SID 62-300-6, p. 107.

September

4

An interim Apollo flight operation plan for Fiscal Year 1963, dated August 28, calling for funding of \$489.9 million, was transmitted to NASA Headquarters from MSC. System requirements were under study to determine the feasibility of cost reduction to avoid schedule slippage.

MSC, Weekly Activity Report for the Office of the Director, Manned Space Flight, September 2-8, 1962, p. 4.

4

Nine industry proposals for the lunar excursion module were received from The Boeing Company, Douglas Aircraft Company, General Dynamics Corporation, Grumman Aircraft Engineering Corporation, Ling-Temco-Vought, Inc., Lockheed Aircraft Corporation, Martin-Marietta Corporation, Northrop Corporation, and Republic Aviation Corporation. NASA evaluation began the next day. Industry presentations would be held on September 13 and 14 at Ellington Air Force Base, Tex. One-day visits to company sites by evaluation teams would be made September 17-19. After evaluation of the proposals, NASA planned to award the contract within six to eight weeks.

Apollo Spacecraft Project Office, MSC, Weekly Activity Report, September 2-8, 1962; *Wall Street Journal*, September 6, 1962.

5

Two three-month studies of an unmanned logistic system to aid astronauts on a lunar landing mission would be negotiated with three companies, NASA announced. Under a \$150,000 contract, Space Technology Laboratories, Inc., would look into the feasibility of developing a general-purpose spacecraft into which varieties of payloads could be fitted. Under two \$75,000 contracts, Northrop Space Laboratories and Grumman Aircraft Engineering Corporation would study the possible cargoes that such a spacecraft might carry. NASA Centers simultaneously would study lunar logistic trajectories, launch vehicle adaptation, lunar landing touchdown dynamics, scheduling, and use of roving vehicles on the lunar surface.

*Wall Street Journal*, September 6, 1962; *Astronautical and Aeronautical Events of 1962*, pp. 173-174.



Apollo Spacecraft Project Office requested NAA to perform a study of command module-lunar excursion module (CM-LEM) docking and crew transfer operations and recommend a preferred mode, establish docking design criteria, and define the CM-LEM interface. Both translunar and lunar orbital docking maneuvers were to be considered. The docking concept finally selected would satisfy the requirements of minimum weight, design and functional simplicity, maximum docking reliability, minimum docking time, and maximum visibility.

The mission constraints to be used for this study were:

- The first docking maneuver would take place as soon after S-IVB burnout as possible and hard docking would be within 30 minutes after burnout.
- The docking methods to be investigated would include but not be limited to free fly-around, tethered fly-around, and mechanical repositioning.
- The S-IVB would be stabilized for four hours after injection.
- There would be no CM airlock. Extravehicular access techniques through the LEM would be evaluated to determine the usefulness of a LEM airlock.
- A crewman would not be stationed in the tunnel during docking unless it could be shown that his field of vision, maneuverability, and communication capability would substantially contribute to the ease and reliability of the docking maneuver.
- An open-hatch, unpressurized CM docking approach would not be considered.
- The relative merit of using the CM environmental control system to provide initial pressurization of the LEM instead of the LEM environmental control system would be investigated.

Apollo Spacecraft Project Office, MSC, Weekly Activity Report, September 2-8, 1962; letter, C. D. Sword, MSC, to NAA, "Contract Change Authorization No. 4," September 22, 1962.

NASA deleted five Apollo mockups, three boilerplate spacecraft, and several ground support equipment items from the NAA contract because of funding limitations.

Oakley, *Historical Summary, S&ID Apollo Program*, p. 7.

Apollo command module boilerplate model BP-1 was accepted by NASA and delivered to the NAA Engineering Development Laboratory for land and water impact tests. On September 25, BP-1 was drop-tested with good results. Earth-impact attenuation and crew shock absorption data were obtained.

Oakley, *Historical Summary, S&ID Apollo Program*, p. 7; *Apollo Quarterly Status Report No. 1*, p. 41.

Apollo command module boilerplate model BP-3, showing the arrangement of the cabin interior, was shipped to MSC.

Oakley, *Historical Summary, S&ID Apollo Program*, p. 7.

1962  
September  
10

Fire broke out in a simulated space cabin at the Air Force School of Aerospace Medicine, Brooks Air Force Base, Tex., on the 13th day of a 14-day experiment to determine the effects of breathing pure oxygen in a long-duration space flight. One of the two Air Force officers was seriously injured. The cause of the fire was not immediately determined. The experiment was part of a NASA program to validate the use of a 5 psia pure oxygen atmosphere for the Gemini and Apollo spacecraft.

Washington *Evening Star*, September 10, 1962; Michel *et al.*, *Gaseous Environment Considerations and Evaluation Programs Leading to Spacecraft Atmosphere Selection*, pp. 5-6.

Early  
September

MSC reported that it had received a completed wooden mockup of the interior arrangement of the Apollo command module (CM). An identical mockup was retained at NAA for design control. Seven additional CM and service module (SM) mockups were planned: a partial SM and partial adapter interface, CM for exterior cabin equipment, complete SM, spacecraft for handling and transportation (two), crew support system, and complete CSM's. A mockup of the navigation and guidance equipment had been completed. A wooden mockup of the lunar excursion module exterior configuration was fabricated by NAA as part of an early study of spacecraft compatibility requirements.

*Apollo Quarterly Status Report No. 1*, p. 41.

11

J. Thomas Markley, command and service module Project Officer at MSC, announced details of the space facility to be established by NASA at White Sands Missile Range (WSMR). To be used in testing the Apollo spacecraft's propulsion and abort systems, the WSMR site facilities would include two static-test-firing stands, a control center blockhouse, various storage and other utility buildings, and an administrative services area.

MSC Fact Sheet No. 97, Apollo at White Sands, September 11, 1962.

12

President John F. Kennedy spoke at Rice University, Houston, Tex., where he said:

"Man, in his quest for knowledge and progress, is determined and cannot be deterred. The exploration of space will go ahead, whether we join in it or not, and it is one of the great adventures of all time, and no nation which expects to be the leader of other nations can expect to stay behind in this race for space . . . ."

"We choose to go to the moon in this decade and do the other things, not because they are easy, but because they are hard, because that goal will serve to organize and measure the best of our energies and skills, because that challenge is one that we are willing to accept, one we are unwilling to postpone, and one which we intend to win, and the others, too.

"It is for these reasons that I regard the decision last year to shift our efforts in space from low to high gear as among the most important decisions that will be made during my incumbency in the office of the Presidency . . . ."

Senate Staff Report, *Documents on International Aspects of the Exploration and Use of Outer Space, 1954-1962*, pp. 328-330.



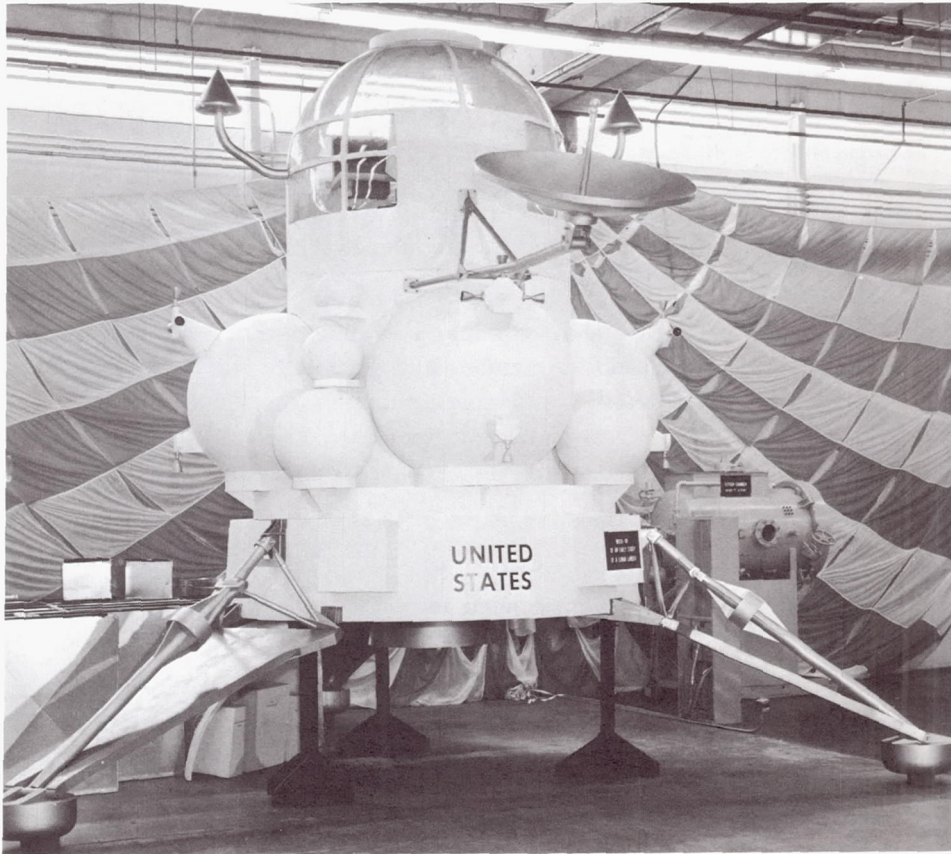

The above model of the Apollo lunar landing module was on display at Manned Spacecraft Center and was seen by President John F. Kennedy during his trip to Houston, Tex., September 12, 1962. The model was constructed by NAA.

NASA's nine new astronauts were named in Houston, Tex., by Robert R. Gilruth, MSC Director. Chosen from 253 applicants, the former test pilots who would join the original seven Mercury astronauts in training for Projects Gemini and Apollo were: Neil A. Armstrong, NASA civilian test pilot; Maj. Frank Borman, Air Force; Lt. Charles Conrad, Jr., Navy; Lt. Cdr. James A. Lovell, Jr., Navy; Capt. James A. McDivitt, Air Force; Elliot M. See, Jr., civilian test pilot for the General Electric Company; Capt. Thomas P. Stafford, Air Force; Capt. Edward H. White II, Air Force; and Lt. Cdr. John W. Young, Navy.

*Washington Daily News*, September 18, 1962.

NASA contracted with the Armour Research Foundation for an investigation of conditions likely to be found on the lunar surface. Research would concentrate first on evaluating the effects of landing velocity, size of the landing area, and shape of the landing object with regard to properties of the lunar soils. Earlier studies by

1962  
September  
17

21



1962  
September

Armour had indicated that the lunar surface might be composed of very strong material. Armour reported its findings during the first week of November.

*Astronautical and Aeronautical Events of 1962*, p. 196.

September 23–  
October 6

Deletion of non-critical equipment and improvement of existing systems reduced the weight of the command and service modules by 1239 pounds, with a target reduction of 1500 pounds.

Among the items deleted from the command module (CM) were exercise and recreation equipment, personal parachutes and parachute containers located in the couches, individual survival kits, solar radiation garments, and eight-ball displays. A telescope, cameras and magazines considered scientific equipment, and a television monitor were deleted from the CM instrumentation system.

Apollo Spacecraft Project Office, MSC, Activity Report for the Period September 23–October 6, 1962.

24

General Dynamics/Convair recommended and obtained NASA's concurrence that the first Little Joe II launch vehicle be used for qualification, employing a dummy payload.

*Little Joe II Test Launch Vehicle, NASA Project Apollo: Final Report*, Vol. I, p. 1–4.

26

NASA announced that it had completed preliminary plans for the development of the \$500-million Mississippi Test Facility. The first phase of a three-phase construction program would begin in 1962 and would include four test stands for static-firing the Saturn C-5 S-IC and S-II stages; about 20 support and service buildings would be built in the first phase. A water transportation system had been selected, calling for improvement of about 15 miles of river channel and construction of about 15 miles of canals at the facility. Sverdrup and Parcel Company of St. Louis, Mo., was preparing design criteria; the Army Corps of Engineers was acquiring land for NASA in cooperation with the Lands Division of the Justice Department. The 13,500-acre facility in southwestern Mississippi was 35 miles from NASA Michoud Operations, where Saturn stages were fabricated.

*Astronautical and Aeronautical Events of 1962*, pp. 200–201.

During  
the  
Month

MSC reported that the reliability goal for design purposes in the spacecraft Statement of Work for the Apollo mission was 0.9. The probability that the crew would not be subjected to conditions in excess of the stated limits was 0.9, and the probability that the crew would not be subjected to emergency limits was 0.999. The initial Work Statement apportionment for the lunar excursion module was 0.984 for mission success and 0.9995 for crew safety. Other major system elements would require reapportionment to reflect the lunar orbit mission.

*Apollo Quarterly Status Report No. 1*, p. 37.

During  
the  
Month

Release of the structural design of the Apollo command module was 65 percent complete; 100 percent release was scheduled for January 1963.

*Apollo Quarterly Status Report No. 1*, p. 11.

PART III: LUNAR ORBIT RENDEZVOUS

The lunar excursion module was defined as consisting of 12 principal systems: guidance and navigation, stabilization and control, propulsion, reaction control, lunar touchdown, structure including landing and docking systems, crew, environmental control, electrical power, communications, instrumentation, and experimental instrumentation. A consideration of prime importance to practically all systems was the possibility of using components from Project Mercury or those under development for Project Gemini.

*Apollo Quarterly Status Report No. 1, p. 26.*

MSC reported that renovation of available buildings at the El Centro Joint Service Parachute Facility was required to support the Apollo earth recovery tests. The Air Force's commitment of a C-133A aircraft to support the qualification tests had been obtained.

*Apollo Quarterly Status Report No. 1, p. 52.*

MSC reported that Arnold Engineering Development Center facilities at Tullahoma, Tenn., were being scheduled for use in the development of the Apollo reaction control and propulsion systems. The use of the Mark I altitude chamber for environmental tests of the command and service modules was also planned.

*Apollo Quarterly Status Report No. 1, p. 52.*

MIT's Lincoln Laboratory began a study program to define Apollo data processing requirements and to examine the problems associated with the unified telecommunications system. The system would permit the use of the lunar mission transponder during near-earth operations and eliminate the general transmitters required by the current spacecraft concept, thus reducing weight, complexity, and cost of the spacecraft system.

*Apollo Quarterly Status Report No. 1, p. 47.*

MSC reported that Apollo training requirements planning was 40 percent complete. The preparation of specific materials would begin during the first quarter of 1964. The crew training equipment included earth launch and reentry, orbital and rendezvous, and navigation and trajectory control part-task trainers, which were special-purpose simulators. An early delivery would allow extensive practice for the crew in those mission functions where crew activity was time-critical and required development of particular skills. The mission simulators had complete mission capability, providing visual as well as instrument environments. Mission simulators would be located at MSC and at Cape Canaveral.

*Apollo Quarterly Status Report No. 1, p. 45.*

The Apollo wind tunnel program was in its eighth month. To date, 2800 hours of time had been used in 30 government and private facilities.

*Apollo Quarterly Status Report No. 1, p. 35.*

1962

September

During  
the  
Month

During  
the  
Month

During  
the  
Month

During  
the  
Month

During  
the  
Month

During  
the  
Month



- 1962**  
September
- During the Month
- The external natural environment of the Apollo spacecraft as defined in the December 18, 1961, Statement of Work had been used in the early Apollo design work. The micrometeoroid, solar proton radiation, and lunar surface characteristics were found to be most critical to the spacecraft design.
- Apollo Quarterly Status Report No. 1, p. 32.*
- During the Month
- The freeze-dried food that would be used in the Gemini program would also be provided for the Apollo program. Forty-two pounds of food would be necessary for a 14-day lunar landing mission. Potable water would be supplied by the fuel cells and processed by the environmental control system. A one-day water supply of six pounds per man would be provided at launch as an emergency ration if needed before the fuel cells were fully operative.
- Apollo Quarterly Status Report No. 1, p. 13.*
- During the Month
- The Apollo spacecraft weights had been apportioned within an assumed 90,000-pound limit. This weight was termed a "design allowable." A lower target weight for each module had been assigned. Achievement of the target weight would allow for increased fuel loading and therefore greater operational flexibility and mission reliability. The design allowable for the command module was 9500 pounds; the target weight was 8500 pounds. The service module design allowable was 11,500 pounds; the target weight was 11,000 pounds. The S-IVB adapter design allowable and target weight was 3200 pounds. The amount of service module useful propellant was 40,300 pounds design allowable; the target weight was 37,120 pounds. The lunar excursion module design allowable was 25,500 pounds; the target weight was 24,500 pounds.
- Apollo Quarterly Status Report No. 1, p. 31.*
- During the Month
- MSC reported that the lunar excursion module guidance system was expected to use as many components as possible identical to those in the command and service modules. Studies at the MIT Instrumentation Laboratory indicated that the changes required would simplify the computer and continue the use of the same inertial measurement unit and scanning telescope.
- Apollo Quarterly Status Report No. 1, p. 27.*
- During the Month
- MSC reported that the three liquid-hydrogen—liquid-oxygen fuel cells would supply the main and emergency power through the Apollo mission except for the earth reentry phase. Two of the fuel cells would carry normal electrical loads and one would supply emergency power. Performance predictions had been met and exceeded in single-cell tests. Complete module tests would begin during the next quarter. The liquid-hydrogen—liquid-oxygen reactants for the fuel cell power supply were stored in the supercritical state in spherical pressure vessels. A recent decision had been made to provide heat input to the storage vessels with electrical heaters rather than the water-glycol loop. Three zinc-silver oxide batteries would supply power for all the electrical loads during reentry and during the brief periods of peak loads. One of the batteries was reserved exclusively for the postlanding



phase. Eagle Picher Company, Joplin, Mo., had been selected in August as subcontractor for the batteries.

*Apollo Quarterly Status Report No. 1, p. 23.*

MSC reported that meteoroid tests and ballistic ranges had been established at the Ames Research Center, Langley Research Center, and NAA. These facilities could achieve only about one half of the expected velocity of 75,000 feet per second for the critical-sized meteoroid. A measured improvement in the capability to predict penetration would come from a test program being negotiated by NAA with General Motors Corporation, whose facility was capable of achieving particle velocities of 75,000 feet per second.

*Apollo Quarterly Status Report No. 1, p. 32.*

MSC outlined a tentative Apollo flight plan:

(1) Pad abort: Two tests to simulate an abort on the pad. The purpose of these tests was to qualify the launch escape system and its associated sequencing.

(2) Suborbital (Little Joe II test launch vehicle): Three suborbital tests with the objective of development and qualification of the launch escape system and qualification of the command module structure. Test conditions would include maximum dynamic pressure for the launch escape system and module structure testing and high atmospheric altitudes for launch escape system testing. The latter test requirement was being reviewed.

(3) Saturn C-1: Current Apollo requirements for the Saturn developmental flights were to determine launch exit environment on SA-6 with SA-8 as backup. Requirements on launch vehicles SA-7, SA-9, and SA-10 were to flight-test components of or the complete emergency detection system.

(4) Saturn C-1B: Four launch vehicle development flights prior to the manned flight. Flight test objectives for the unmanned flights were one launch environment flight with a spare and two launch vehicle emergency detection system flights.

(5) Saturn C-5: Six unmanned Saturn C-5 launch vehicle development flights. Flight test objectives were two launch vehicle emergency detection system flights, one spacecraft launch environment flight, and three reentry qualification flights. Preliminary objectives of manned flights were completion of the lunar excursion module qualification, lunar reconnaissance, and lunar exploration. Although the first C-5 manned flight was scheduled as the seventh C-5, a spacecraft suitable for manned flight would be available for use on the sixth C-5 to take advantage of possible earlier development success.

*Apollo Quarterly Status Report No. 1, p. 48.*

The pad abort boilerplate command module, BP-6, to qualify the launch escape system, was scheduled for delivery to White Sands Missile Range by mid-April 1963. A pad abort test of BP-6 was scheduled for May 15, 1963.

*Apollo Quarterly Status Report No. 1, p. 42.*

1962

September

During  
the  
MonthDuring  
the  
Month

October

1

- 1962**  
**October**  
 3 The *Sigma 7* spacecraft with Astronaut Walter M. Schirra, Jr., as pilot was launched into orbit by a Mercury-Atlas vehicle from Atlantic Missile Range. In the most successful American manned space flight to date, Schirra traveled nearly six orbits, returning to earth at a predetermined point in the Pacific Ocean 9 hours, 13 minutes after liftoff. Within 40 minutes after landing, he and his spacecraft were safely aboard the aircraft carrier U.S.S. *Kearsarge*.
- Grimwood, *Project Mercury: A Chronology*, pp. 174–175; *Astronautical and Aeronautical Events of 1962*, pp. 208–209.
- 4 Rocketdyne Division successfully completed the first full-duration (250-seconds) static firing of the J–2 engine.
- Rocketdyne *Skywriter*, October 12, 1962.
- 5 NASA signed a \$1.55-million contract with Hamilton Standard Division of United Aircraft Corporation and International Latex Corporation for the development of a space suit for the Apollo crewmen. As the prime contractor, Hamilton Standard would have management responsibility for the overall program and would develop a life-support, backpack system to be worn by crewmen during lunar expeditions. International Latex Corporation as subcontractor would fabricate the suit, with Republic Aviation Corporation furnishing human factors information and environmental testing. The suit would allow a crewman greater mobility than previous space suits, enabling him to walk, climb, and bend with relative ease.
- Astronautical and Aeronautical Events of 1962*, p. 211; MSC, *Project Apollo Quarterly Status Report No. 2 for Period Ending December 31, 1962*, p. 22.
- 10 The Minneapolis-Honeywell Regulator Company letter subcontract for the Apollo stabilization and control system was suspended by NAA and amended in accordance with the current design concepts.
- Apollo Quarterly Status Report No. 2*, p. 16.
- 15 The analysis of scientific measurements made by the *Ranger III* lunar probe showed that gamma-ray intensity in interplanetary space was ten times greater than expected, NASA reported. Measurements were taken by gamma-ray spectrometers on *Ranger III* after it was launched on January 26. NASA scientists, however, did not believe that gamma-ray intensity was “great enough to require any changes in the design of radiation shielding for manned spacecraft.”
- New York Times*, October 16, 1962.
- 15 NASA announced that five additional Ranger spacecraft would be added to the lunar exploration program, raising the total to 14 to be launched through 1964.
- New York Times*, October 15, 1962.



NASA announced the selection of the International Business Machines Corporation to provide a ground-based computer system for Projects Gemini and Apollo. The computer complex would be part of the mission control center at MSC.

1962  
October  
16

*Astronautical and Aeronautical Events of 1962*, p. 216.

The *Ranger V* lunar probe was launched from Atlantic Missile Range by an Atlas-Agena B launch vehicle. The Agena B stage attained parking orbit and 25 minutes later reignited to send *Ranger V* toward the moon. The spacecraft's solar cells did not provide power, making reception of the flight-path correction signal impossible and rendering its television cameras useless. *Ranger V* was to have relayed television pictures of the lunar surface and rough-landed an instrumented capsule containing a seismometer. The spacecraft was tracked for 8 hours, 44 minutes, before its small reserve battery went dead.

18

On October 29, Homer E. Newell, NASA Director of the Office of Space Sciences, established a Board of Inquiry to review the entire Ranger program. The Board, headed by Albert J. Kelley of NASA Headquarters, submitted its report on December 4 and found that, while the Ranger design concept was basically sound, improvements could be made to increase flight reliability.

*Washington Post*, October 19 and 22, 1962; U.S. Congress, House, Subcommittee on Space Sciences and Advanced Research and Technology of the Committee on Science and Astronautics, *1964 NASA Authorization*, Hearings on H.R. 5466, 88th Congress, 1st Session (1963), pp. 1597-1598.

The Lunar and Planetary Laboratory of the University of Arizona, directed by Gerard P. Kuiper, reported that its analysis of lunar photographs taken by *Lunik III* differed from that announced by Soviet scientists. The most extensive feature of the moon's far side, photographed in 1959, had been named "The Soviet Mountains"; this feature was identified by the Arizona laboratory as an elongated area of bright patches and rays, possibly flat. Another feature, named the "Joliot-Curie Crater" by Soviet scientists, was re-identified by the Arizona laboratory as Mare Novum (New Sea), first identified by German astronomer Julius Franz near the turn of the century.

22

*New York Times*, October 22, 1962.

At the request of NASA, about 300 pieces of Gemini ground support equipment were examined by NAA engineers. It appeared that about 190 items would be usable on the Apollo program.

23

Oakley, *Historical Summary, S&ID Apollo Program*, p. 7.

The Office of Systems under NASA's Office of Manned Space Flight completed a manned lunar landing mode comparison embodying the most recent studies by contractors and NASA Centers. The report was the outgrowth of the decision announced by NASA on July 11 to continue studies on lunar landing modes while basing planning and procurement primarily on the lunar orbit rendezvous (LOR) technique. The results of the comparison between the LOR technique, a

24



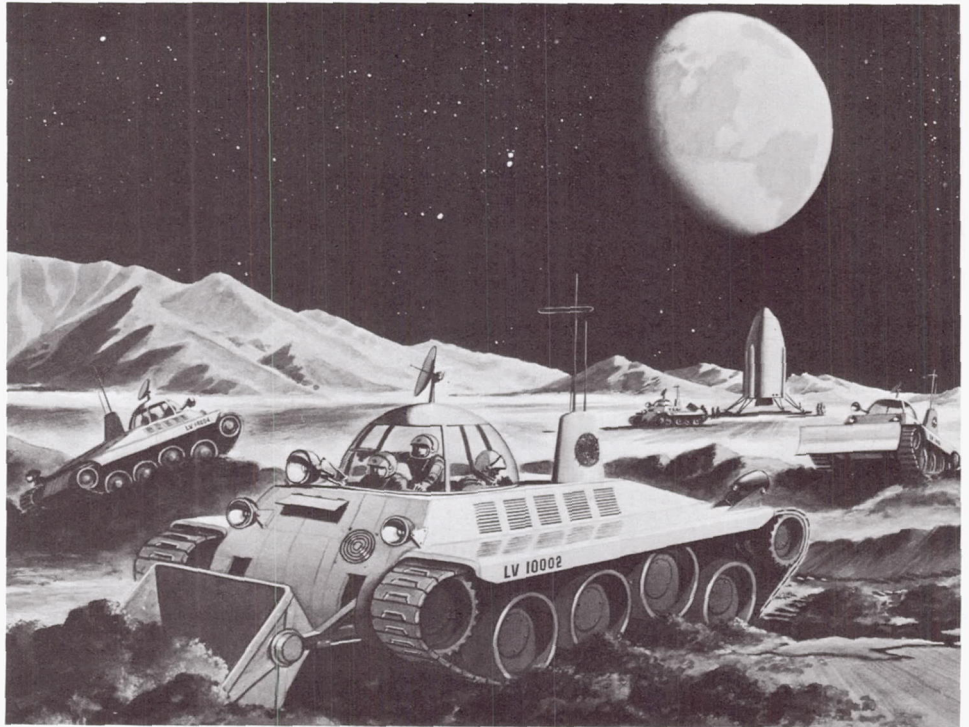

A three-man moon vehicle, which could be driven by a new power system designed at Martin Company's Space Systems Division in Baltimore, prepares ground for a lunar base in this artist's concept. The new system would provide electrical power for motors to drive the vehicle's tracks. Exhausts of the system would be regenerated by a nuclear reactor and reused by the vehicle. The primary source of power would be a turbine-generator driven by hydrogen gas under pressure. This photo was released October 18, 1962. (Martin Company photo)

**1962**

**October**

two-man C-5 direct flight, and a two-man earth orbit rendezvous (EOR) mode were:

- The C-5 direct flight mode required cryogenic fuels and was marginal, even with a two-man spacecraft.
- Both the LOR and EOR modes were feasible.
- The reliability differences between LOR and EOR could not be demonstrated conclusively by analysis at this time. LOR appeared to have a higher probability of mission success at less risk to the astronauts.
- Designing the lunar excursion module specifically for the lunar landing and performing the mission with a single C-5 launch vehicle were important advantages of the LOR mode, offsetting the problems connected with LOR rendezvous.
- Human factors considerations were not significant in the mode selections; the addition of rendezvous to the requirement for lunar landing and reentry did

not add appreciably to crew stress or fatigue or to the overall hazards of the mission.

- Both LOR and EOR provided the basis for projected national space requirements before the development of Nova-class launch vehicles. The C-5 launch vehicle capability met estimated payload requirements. LOR provided experience in personnel transfer between spacecraft as contrasted with fuel transfer in EOR.

- The lunar landing mission could be accomplished at least one year and probably 18 months sooner by using LOR rather than EOR.

- The LOR mode was 10 to 15 percent less expensive than EOR.

- The LOR mode provided the cleanest management structure within the NASA organization.

In conclusion, the LOR mode offered the best opportunity of meeting the goal of an American manned lunar landing within the decade of the sixties.

Office of Systems, Office of Manned Space Flight, "Manned Lunar Landing Comparison," October 24, 1962, pp. 1, 5-6.

Republic Aviation Corporation selected the Radio Corporation of America to design and build the data acquisition and communications subsystem for Project Fire.

*Astronautical and Aeronautical Events of 1962*, p. 222.

Flight missions of the Apollo spacecraft were to be numerically identified in the future according to the following scheme:

Pad aborts: PA-1, PA-2, etc.

Missions using Little Joe II launch vehicles: A-001, A-002, etc.

Missions using Saturn C-1 launch vehicles: A-101, A-102, etc.

Missions using Saturn C-1B launch vehicles: A-201, A-202, etc.

Missions using Saturn C-5 launch vehicles: A-501, A-502, etc.

The A denoted Apollo, the first digit stood for launch vehicle type or series, and the last two digits designated the order of Apollo spacecraft flights within a vehicle series.

Memorandum, Charles W. Frick, Manager, Apollo Spacecraft Project Office, to Distribution, "Designations for Apollo Missions," October 26, 1962.

NASA announced the realignment of functions under Associate Administrator Robert C. Seamans, Jr. D. Brainerd Holmes assumed new duties as a Deputy Associate Administrator while retaining his responsibilities as Director of the Office of Manned Space Flight. NASA field installations engaged principally in manned space flight projects (Marshall Space Flight Center, Manned Spacecraft Center, and Launch Operations Center) would report to Holmes; installations engaged principally in other projects (Ames, Langley, Lewis, and Flight Research Centers, Goddard Space Flight Center, Jet Propulsion Laboratory, and Wallops Station) would report to Thomas F. Dixon, Deputy Associate Administrator for

1962

October

25

26

30



- 1962**  
**October**
- the past year. Previously most field center directors had reported directly to Seamans on institutional matters beyond program and contractual administration.
- Rosholt, *An Administrative History of NASA, 1958-1963*, pp. 256-257; Washington *Evening Star*, October 31, 1962.
- 30 MSC Director Robert R. Gilruth reported to the Manned Space Flight Management Council that the Apollo drogue parachutes would be tested in the Langley Research Center wind tunnels.
- MSF Management Council Minutes, October 30, 1962, Agenda Item 1.
- 30 NASA announced the signing of a contract with the Space and Information Systems Division of NAA for the development and production of the second stage (S-II) of the Saturn C-5 launch vehicle. The \$319.9-million contract, under the direction of Marshall Space Flight Center, covered the production of nine live flight stages, one inert flight stage, and several ground-test units for the advanced Saturn launch vehicle. NAA had been selected on September 11, 1961, to develop the S-II.
- Wall Street Journal*, October 31, 1962.
- 31 NAA completed the firm-cost proposal for the definitive Apollo program and submitted it to NASA. MSC had reviewed the contract package and negotiated a program plan position with NAA.
- Oakley, *Historical Summary, S&ID Apollo Program*, p. 7; *Apollo Quarterly Status Report No. 2*, pp. 5, 6.
- 31 NASA announced that the Douglas Aircraft Company had been awarded a \$2.25-million contract to modify the S-IVB stage for use in the Saturn C-1B program.
- NASA News Release, 62-232, October 31, 1962.
- During the Month**
- Proposed designs for view port covers on the crew-hatch window, docking ports, and earth landing windows were prepared by NAA. Design planning called for these port covers to be removed solely in the space environment. [Crew members would not use such windows during launch and reentry phases.]
- NAA, *Apollo Monthly Progress Report*, SID 62-300-7, October 31, 1962, p. 71.
- During the Month**
- Elimination of the requirement for personal parachutes nullified consideration of a command module (CM) blowout emergency escape hatch. A set of quick-acting latches for the inward-opening crew hatch would be needed, however, to provide a means of egress following a forced landing. The latches would be operable from outside as well as inside the pressure vessel. Outside hardware for securing the ablative panel over the crew door would be required as well as a method of releasing the panel from inside the CM.
- Apollo Monthly Progress Report*, SID 62-300-7, p. 70.
- During the Month**
- An NAA study on the shift of the command module center of gravity during reentry proposed moving the crew and couches about ten inches toward the aft equipment bay and then repositioning them for landing impact.



A review of body angles used for the current couch geometry disclosed that the thigh-to-torso angle could be closed sufficiently for a brief period during reentry to shorten the overall couch length by the required travel along the Z-Z axis. [See diagrams on page 158.] The more acute angle was desirable for high g conditions. This change in the couch adjustment range, as well as a revision in the lower leg angle to gain structure clearance, would necessitate considerable couch redesign.

1962

October

During  
the  
Month

*Apollo Monthly Progress Report*, SID 62-300-7, p. 68.

Incandescent lamps would be used for floodlighting the command module because they weighed less than fluorescent lamps and took up less space while increasing reliability and reducing system complexity. A 28-volt lamp was most desirable because of its compatibility with the spacecraft 28-volt dc power system. Laboratory tests with a 28-volt incandescent lamp showed that heat dissipation would not be a problem in the vacuum environment but that a filament or shock mount would have to be developed to withstand vibration. An incandescent quartz lamp was studied because of its small size and high concentration of light.

During  
the  
Month

*Apollo Monthly Progress Report*, SID 62-300-7, p. 89.

The feasibility of using the Gemini fuel cell for the lunar excursion module was studied by NAA. However, because of modifications to meet Apollo control and auxiliary requirements, the much lighter Gemini system would ultimately weigh about as much as the Apollo fuel cell. In addition, the Gemini fuel cell schedule would slip if the system had to be adapted to the Apollo mission.

During  
the  
Month

*Apollo Monthly Progress Report*, SID 62-300-7, pp. 91-92.

The valves of the command module (CM) environmental control system were modified to meet the 5.0 psia oxygen operating requirements. All oxygen partial pressure controls were deleted from the system and the relief pressure setting of  $7 \pm 0.2$  psia was changed to  $6 \pm 0.2$  psia. The CM now could be repressurized from 0 to 5.0 psia in one hour.

During  
the  
Month

*Apollo Monthly Progress Report*, SID 62-300-7, p. 48.

The revised NAA recommendation for a personal communications system consisted of a duplex capability with a simplex backup. Simultaneous transmission of voice and biomedical data with a break-in capability would be possible. Two changes in spacecraft VHF equipment would be needed: a dual-channel in place of a single-channel receiver, and a diplexer for use during duplex operation.

During  
the  
Month

*Apollo Monthly Progress Report*, SID 62-300-7, p. 57.

NAA completed a preliminary design for the deployment of the spacecraft deep space instrumentation facility antenna to the Y axis [see diagrams on page 158]. The antenna would be shifted into the deployed position by actuation of a spring-loaded swing-out arm.

During  
the  
Month

*Apollo Monthly Progress Report*, SID 62-300-7, p. 82.

1962

October

During  
the  
Month

An NAA digital computer program for calculating command module heatshield and couch system loads and landing stability was successful. Results showed that a five-degree negative-pitch attitude was preferable for land landings.

*Apollo Monthly Progress Report*, SID 62-300-7, p. 14.

During  
the  
Month

NAA completed a study of reentry temperatures. Without additional cooling, space suit inlet temperatures were expected to increase from 50° F at 100,000 feet to 90° F at spacecraft parachute deployment. The average heat of the command module inner wall was predicted not to exceed 75° F at parachute deployment and 95° F on landing, but then to rise to nearly 150° F.

*Apollo Monthly Progress Report*, SID 62-300-7, p. 26.

During  
the  
Month

A new launch escape tower configuration with an internal structure that would clear the launch escape motor exhaust plume at 30,000 feet was designed and analyzed by NAA. Exhaust impingement was avoided by slanting the diagonal members in the upper bay toward the interior of the tower and attaching them to a ring.

*Apollo Monthly Progress Report*, SID 62-300-7, p. 26.

During  
the  
Month

The technique tentatively selected by NAA for separating the command and service modules from lower stages during an abort consisted of firing four 2000-pound-thrust posigrade rockets mounted on the service module adapter. With this technique, no retrorockets would be needed on the S-IV or S-IVB stages. Normal separation from the S-IVB would be accomplished with the service module reaction control system.

*Apollo Monthly Progress Report*, SID 62-300-7, p. 17.

November

2

NAA completed the release of the layout and preliminary design of command module crew accessories and survival equipment.

NAA, *Apollo Monthly Progress Report*, SID 62-300-8, November 1962, p. 34.

First Week

The Armour Research Foundation reported to NASA that the surface of the moon might not be covered with layers of dust. The first Armour studies showed that dust particles become harder and denser in a higher vacuum environment such as that of the moon, but the studies had not proved that particles eventually become bonded together in a rocket substance as the vacuum increases.

*Astronautical and Aeronautical Events of 1962*, p. 234.

3

Four "hot spots" on the moon were reported to have been discovered by Bruce C. Murray and Robert L. Wildey of California Institute of Technology, using a new telescope with a heat-sensitive, gold-plated mirror to detect infrared radiation. The two space scientists speculated that hot spots could indicate large areas of bare rock exposed on the lunar surface. The spots were discovered during a survey of the moon which also revealed that the lunar surface became colder at night than previously believed, -270° F compared to -243° F recorded by earlier heat-



measuring devices. Murray said the new evidence could mean that there were prominences of heat-retaining rock protruding through a thick dust layer on the lunar surface.

*Washington Post*, November 4, 1962.

William L. Gill, Chief of Crew Systems Division's Radiation Branch, MSC, said that the walls of the Apollo spacecraft would provide most of the radiation shielding required for the crew. Astronauts would have special shielding devices only for their eyes.

*Astronautical and Aeronautical Events of 1962*, p. 233.

NASA announced that the Grumman Aircraft Engineering Corporation had been selected to build the lunar excursion module of the three-man Apollo spacecraft under the direction of MSC. The contract, still to be negotiated, was expected to be worth about \$350 million, with estimates as high as \$1 billion by the time the project would be completed. NASA Administrator James E. Webb, in announcing the selection, remarked: "We are affirming our tentative decision of last July" [in

A model of the lunar excursion module proposed by Grumman Aircraft Engineering Corporation. The figure at the left demonstrates the relative size of an astronaut. Grumman was selected by NASA to build the module November 7, 1962.

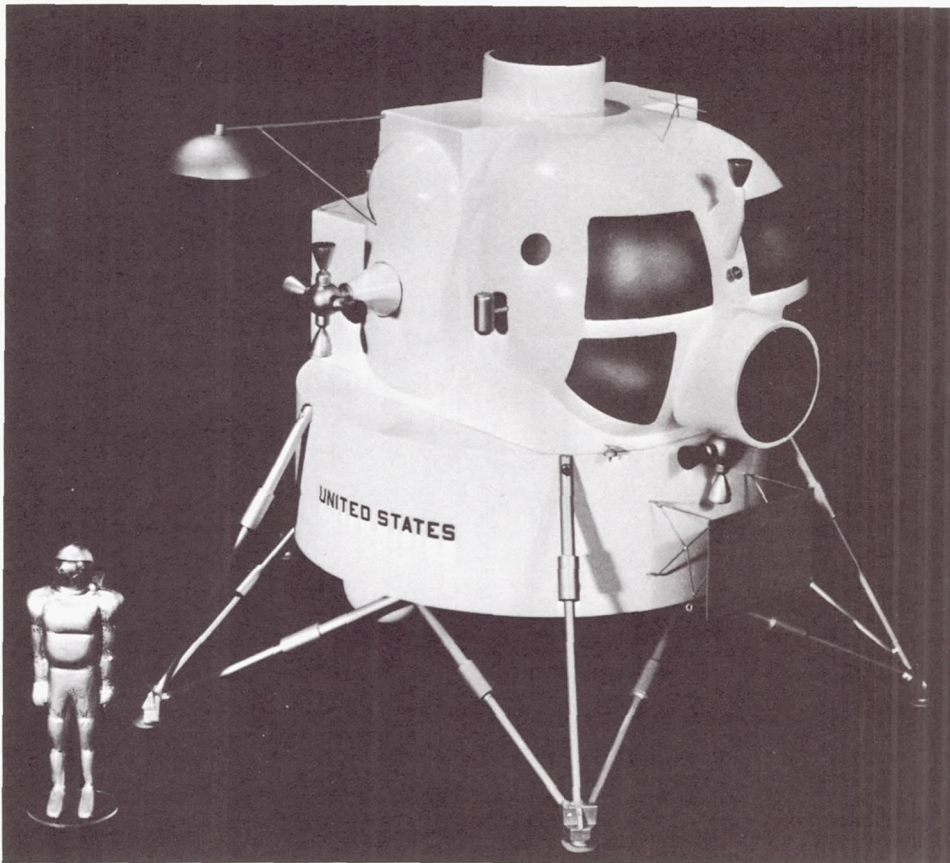

1962  
November

5

7



**1962****November**

favor of the lunar orbit rendezvous approach]. D. Brainerd Holmes, NASA Director of the Office of Manned Space Flight, noted that more than one million man-hours of some 700 outstanding scientists, engineers, and researchers had gone into studies of the Apollo mission during the past year. "The results of these studies," he said, "added up to the conclusion that lunar orbit rendezvous is the preferable mode to take." With this award, the last major part of the Apollo program had been placed under contract.

*New York Times*, November 8, 1962; TWX, NASA Headquarters to MSC; Marshall Space Flight Center; Launch Operations Center; Ames, Langley, Lewis, and Flight Research Centers; Goddard Space Flight Center; Jet Propulsion Laboratory; Wallops Station; and Western Operations Office, November 7, 1962.

## APPENDIXES

APPENDIX A. [Illegible]

Page Intentionally Left Blank



## APPENDIX 1—GLOSSARY OF ABBREVIATIONS

DOD	Department of Defense
MIT	Massachusetts Institute of Technology
MSC	Manned Spacecraft Center
NAA	North American Aviation, Inc.
NACA	National Advisory Committee for Aeronautics
NASA	National Aeronautics and Space Administration
STG	Space Task Group
U.S.	United States of America
U.S.S.R.	Union of Soviet Socialist Republics

Page Intentionally Left Blank

## APPENDIX 2-COMMITTEES

### Special Committee on Space Technology (Stever Committee)

Date of organization: January 12, 1958

Date of first meeting: February 13, 1958

Recommendations submitted to NASA: October 28, 1958

H. Guyford Stever, Chairman	Milton U. Clauser
Norman C. Appold	Dale R. Corson
Abraham Hyatt	James R. Dempsey
Wernher von Braun	Samuel K. Hoffman
Hugh L. Dryden	W. Randolph Lovelace II
Robert R. Gilruth	William H. Pickering
H. Julian Allen	Louis N. Ridenour
Abe Silverstein	James A. Van Allen
H. W. Bode	Carl B. Palmer, Secretary

### *Working Group on Space Research Objectives*

James A. Van Allen, Chairman	Robert P. Haviland
Dale R. Corson	John R. Pierce
Norman C. Appold	Lyman Spitzer, Jr.
Robert Cornag	Ernest O. Pearson, Jr., Secretary

### *Working Group on Vehicular Program*

Wernher von Braun, Chairman	Krafft A. Ehricke
Samuel K. Hoffman	M. W. Hunter
Norman C. Appold	C. C. Ross
Abraham Hyatt	Homer J. Stewart
Louis N. Ridenour	George S. Trimble, Jr.
Abe Silverstein	William H. Woodward, Secretary

### *Working Group on Reentry*

Milton U. Clauser, Chairman	Harlowe J. Longfelder
H. Julian Allen	J. C. McDonald
Mac C. Adams	S. A. Schaaf
Alfred J. Eggers, Jr.	John P. Stapp
Maxime A. Faget	R. Fabian Gornason, Secretary
Alexander H. Flax	Harvey H. Brown, Secretary
Lester Lees	



*Working Group on Range, Launch, and Tracking Facilities*

James R. Dempsey, Chairman	Robert F. Freitag
Robert R. Gilruth	J. Allen Hynek
Paul T. Cooper	John T. Mengel
L. G. deBey	Grayson Merrill
Carl E. Duckett	Carl B. Palmer, Secretary

*Working Group on Instrumentation*

William H. Pickering, Chairman	Albert C. Hall
Louis N. Ridenour	Eberhardt Rechten
H. W. Bode	William T. Russell
Robert W. Buchheim	Robert C. Seamans, Jr.
Harry J. Goett	Bernard Maggin, Secretary

*Working Group on Space Surveillance*

H. W. Bode, Chairman	K. G. Macleish
William H. Pickering	William B. McLean
Wilbur B. Davenport, Jr.	Alan H. Shapley
W. B. Hebenstreit	Fred L. Whipple
Richard D. Leghorn	Carl B. Palmer, Secretary

*Working Group on Human Factors and Training*

W. Randolph Lovelace II, Chairman	James D. Hardy
A. Scott Crossfield	Wright Haskell Langham
Hubert M. Drake	Ulrich C. Luft
Don D. Flickinger	Boyd C. Myers II, Secretary
Edward B. Giller	

---

*Working Group on Lunar Exploration*

Date of formation: February 5, 1959

First meeting attended by representatives of NASA, Jet Propulsion Laboratory, California Institute of Technology, and the University of California (names of representatives are currently unavailable).

---

*DOD-NASA Saturn Ad Hoc Committee*

Date of formation: March 17, 1959

---

*Research Steering Committee on Manned Space Flight (Goett Committee)*

Date of formation: April 1-8, 1959

Date of first meeting: May 25-26, 1959

Date of last meeting: December 8-9, 1959

Harry J. Goett, Chairman	Harris M. Schurmeier
Alfred J. Eggers, Jr.	Maxime A. Faget
Bruce T. Lundin	George M. Low
Laurence K. Loftin, Jr.	Milton B. Ames, Jr. (part time)
De E. Beeler	

## Booster Evaluation Committee

Date of organization: April 15, 1959

Dates of first meetings: September 16-18, 1959

Herbert F. York and Hugh L. Dryden, Co-  
chairmen

Abe Silverstein

Richard E. Horner

Joseph V. Charyk

And a representative of the United States Army

## New Projects Panel of the Space Task Group

Date of organization: Early July, 1959

Date of first meeting: July 12, 1959

H. Kurt Strass, Chairman

Alan B. Kehlet

William S. Augerson

Jack Funk

Caldwell C. Johnson

Harry H. Ricker, Jr.

Robert G. Chilton

Stanley C. White

## Saturn Vehicle Team (Silverstein Committee)

Date of formation: November 27, 1959

Recommendations submitted to NASA: December 15, 1959

Abe Silverstein, Chairman

(Names of committee members are unavailable.)

## Space Exploration Program Council

Date of organization: January 1960

Date of first meeting: February 10-11, 1960

Date of fifth meeting: January 5-6, 1961

Harry J. Goett

Wernher von Braun

William H. Pickering

Ira H. Abbott

Abe Silverstein

Don R. Ostrander

Albert F. Siefert

Richard E. Horner, Chairman

Robert L. King, Secretary (succeeded by John I.

Cumberland)

Other officials, including T. Keith Glennan, Hugh L. Dryden, Abraham Hyatt, Robert C. Seamans, Jr., Aaron Rosenthal, and Donald H. Heaton, attended from time to time.

## Advanced Vehicle Team (of Space Task Group)

Date of formation: May 25, 1960

Robert O. Piland, Head

H. Kurt Strass

Robert G. Chilton

Jack Funk

Alan B. Kehlet

R. Bryan Erb

Owen E. Maynard

Richard B. Ferguson

Alfred B. Eickmeier

Integration of the Saturn and Saturn Application Programs Study Group

Date of formation: September 2, 1960

Lloyd Wood  
Richard B. Canright  
Alfred M. Nelson  
John L. Sloop

Oran W. Nicks  
Fred D. Kochendorfer  
George M. Low

---

Evaluation Board (to consider industry proposals for Apollo spacecraft feasibility studies)

Date of appointment: October 4, 1960

Recommendations submitted to Robert R. Gilruth, Director, STG: October 24, 1960

Charles J. Donlan, Chairman  
Maxime A. Faget  
Robert O. Piland  
John H. Disher  
Alvin Seiff

John V. Becker  
H. H. Koelle  
Harry J. Goett, ex officio  
Robert R. Gilruth, ex officio

---

Working Group on the Manned Lunar Landing Program

Date of organization: October 17, 1960

George M. Low  
Eldon W. Hall

Oran W. Nicks  
John H. Disher

---

Apollo Technical Liaison Groups

Date of organization: November 22, 1960

First meetings of the groups: January 6, 11, and 12, 1961

Joint meeting of the groups: April 10, 1961

Second meetings of the groups: April 10-14, 1961

*Group for Configurations and Aerodynamics*

Alan B. Kehlet, Chairman, STG  
Hubert M. Drake, Flight Research Center  
(FRC)  
Edward L. Linsley, Marshall Space Flight  
Center (MSFC)  
Eugene S. Love, Langley Research Center  
(LaRC)

Edwin Pounder, Jet Propulsion Laboratory  
(JPL)  
Clarence A. Syvertson, Ames Research Center  
(ARC)  
William W. Petynia, Secretary, STG

*Group for Guidance and Control*

Richard R. Carley, Chairman, STG  
James D. Acord, JPL  
John M. Eggleston, LaRC  
Edmund J. Habib, Goddard Space Flight Center  
(GSFC)

Euclid C. Holleman, FRC  
Helmut A. Kuehnel, STG  
G. Allen Smith, ARC  
Wilbur G. Thornton, MSFC  
James P. Nolan, Jr., Secretary, STG



*Group on Heating*

Kenneth C. Weston, Chairman, STG	Glen Goodwin, ARC
Harvey A. Connell, MSFC	John W. Lucas, JPL
Thomas V. Cooney, FRC	Robert L. Trimpi, LaRC
Werner K. Dahm, MSFC	Leo T. Chauvin, Secretary, STG

*Group on Human Factors*

Richard S. Johnston, Chairman, STG	Harald A. Smedel, ARC
David Adamson, LaRC	G. Dale Smith, NASA Hq.
Bruce A. Aikenhead, STG	Milton O. Thompson, FRC
C. Patrick Laughlin, STG	Lee N. McMillion, Secretary, STG
Robert F. Seldon, Lewis Research Center (LRC)	

*Group for Instrumentation and Communications*

Ralph S. Sawyer, Chairman, STG	Wilford E. Sivertson, LaRC
Dennis E. Fielder, STG	Robert E. Tozier, LRC
Heinz W. Kampmeier, MSFC	Friedrich O. Vonbun, GSFC
Eberhardt Rechtin, JPL	J. Thomas Markley, Secretary, STG
Kenneth C. Sanderson, FRC	

*Group for Mechanical Systems*

Richard B. Ferguson, Chairman, STG	Joseph M. Hallissy, Jr., LaRC
Peter J. Armitage, STG	Perry V. Row, FRC
Herman F. Beduerftig, MSFC	John B. Lee, Secretary, STG
Robert R. Godman, LRC	

*Group for Onboard Propulsion*

Maxime A. Faget, Chairman, STG	David M. Hammock, MSFC
Henry Burlage, Jr., NASA Hq.	Edmund R. Jonash, LRC
William Cohen, NASA Hq.	Alexander A. McCool, MSFC
Norman E. DeMar, FRC	Joseph G. Thibodaux, Jr., LaRC
Duane F. Dipprey, JPL	Robert H. Rollins, Secretary, STG

*Group on Structures and Materials*

Robert O. Piland, Chairman, STG	Erich E. Goerner, MSFC
Roger A. Anderson, LaRC	Charles A. Hermach, ARC
William J. Carley, JPL	Robert E. Vale, STG
Jack B. Esgar, LRC	Herbert G. Patterson, Secretary, STG

*Group on Trajectory Analysis*

Jack Funk, Chairman, STG	Rudolph F. Hoelker, MSFC
Donald R. Bellman, FRC	William H. Michael, Jr., LaRC
Victor C. Clarke, Jr., JPL	Stanley F. Schmidt, ARC
James F. Dalby, STG	Kenneth R. Squires, GSFC
Seymour C. Himmel, LRC	Donald C. Cheatham, Secretary, STG

Manned Lunar Landing Task Group (Low Committee)

Date of organization: January 5–6, 1961

Date of first meeting: January 9, 1961

Date of second meeting: January 16, 1961

Report submitted to Robert C. Seamans, Jr., NASA Associate Administrator: February 7, 1961

George M. Low, Chairman

Oran W. Nicks

Eldon W. Hall

Maxime A. Faget

A. M. Mayo

H. H. Koelle

Ernest O. Pearson, Jr.

---

Ad Hoc Committee on Space (Wiesner Committee)

Report submitted to President-elect John F. Kennedy: January 10, 1961

Jerome B. Wiesner, Chairman

Max Lehrer

Kenneth BeLieu

Edward H. Purcell

Trevor Gardner

Bruno B. Rossi

Donald F. Hornig

Harry J. Watters

Edwin H. Land

---

Ad Hoc Task Group for a Manned Lunar Landing Study (Fleming Committee)

Date of formation: May 2, 1961

Report submitted to Robert C. Seamans, Jr., NASA Associate Administrator: June 16, 1961

William A. Fleming, Chairman

Berg Paraghamian

Addison M. Rothrock, Deputy Chairman

Walter W. Haase

Albert J. Kelley

*Spacecraft*

John H. Disher

Kenneth S. Kleinknecht

Merle G. Waugh

Alan B. Kehlet

*Launch Vehicles*

Eldon W. Hall

Norman Rafel

Melvyn Savage

Alfred M. Nelson

H. H. Koelle

*Facilities*

Samuel Snyder

Robert D. Briskman

Secrest L. Berry

*Life Sciences*

James P. Nolan, Jr.

A. H. Schwichtenberg

*Advanced Technology*

Ernest O. Pearson, Jr.

*Space Sciences*

William Shipley

Robert Fellows

Lundin Committee

Date of formation: May 25, 1961

Study completed and submitted to Robert C. Seamans, Jr., NASA Associate Administrator: June 10, 1961

Bruce T. Lundin, Chairman	Laurence K. Loftin, Jr.
Walter J. Downhower	Harry O. Ruppe
Alfred J. Eggers, Jr.	William J. D. Escher, Secretary
George W. S. Johnson	Ralph W. May, Jr., Secretary

Ad Hoc Task Group for Study of Manned Lunar Landing by Rendezvous Techniques  
(Heaton Committee)

Date of organization: June 1961

Report submitted to Robert C. Seamans, Jr., NASA Associate Administrator: August 1961

Donald H. Heaton, Chairman	Norman Rafel
Richard B. Canright	Joseph E. McGolrick
L. E. Baird	

*Launch Vehicle Performance and Logistics*

Wilson B. Schramm	John L. Hammersmith
L. H. Glassman	R. Voss

*Guidance and Control*

Paul J. DeFries	William H. Phillips
Robert D. Briskman	J. Yolles

*Orbital Launch Operations*

John C. Houbolt	James P. Nolan, Jr.
Hubert M. Drake	Warren J. North
H. H. Koelle	Harry O. Ruppe

*Advanced Technology*

William H. Woodward

Manned Lunar Landing Coordination Group

Date of first meeting: July 6, 1961

Robert C. Seamans, Jr.	DeMarquis D. Wyatt (part time)
Ira H. Abbott	George M. Low (attended first meeting in place of Silverstein)
Don R. Ostrander	Abe Silverstein
Charles H. Roadman	
William A. Fleming	



DOD-NASA Large Launch Vehicle Planning Group (Golovin Committee)

Date of organization: July 20, 1961

Nicholas E. Golovin, Director  
Lawrence L. Kavanau  
Warren Amster  
Edward J. Barlow  
Aleck C. Bond  
David L. Carter  
Matthew R. Collins, Jr.  
Otto J. Glasser  
Eldon W. Hall  
Harvey Hall

Milton W. Rosen (served until August 18, 1961)  
Wilson B. Schramm  
Levering Smith  
Lewis J. Stecher, Jr. (appointed August 29,  
1961)  
Kurt R. Stehling  
H. J. Weigand  
Francis L. Williams  
William W. Wolman

---

Source Evaluation Board (for evaluation of contractors' proposals for the Apollo spacecraft)

Date of appointment: July 28, 1961

Report submitted to James E. Webb, NASA Administrator: November 24, 1961

Walter C. Williams, Chairman  
Robert O. Piland  
Wesley L. Hjernevik  
Maxime A. Faget

James A. Chamberlin  
Charles W. Mathews  
Dave W. Lang  
Oswald H. Lange

Nonvoting members: George M. Low, James T. Koppenhaver, Brooks C. Preacher

Technical Subcommittee

Date of appointment: August 7, 1961

Evaluation of proposals began: October 9, 1961

Report submitted to Source Evaluation Board: November 1, 1961

Robert O. Piland, Chairman, STG  
Robert G. Chilton, STG  
Caldwell C. Johnson, STG  
Kenneth S. Kleinknecht, STG  
Christopher C. Kraft, Jr., STG

Andre J. Meyer, Jr., STG  
Stanley C. White, STG  
Alvin Seiff, ARC  
John V. Becker, LaRC  
William A. Mrazek, MSFC

Technical Subpanels

Report submitted to Technical Subcommittee: October 25, 1961

*Systems Integration*

Caldwell C. Johnson, Chairman, STG  
William M. Bland, STG  
John D. Hodge, STG  
Alan B. Kehlet, STG  
Owen E. Maynard, STG

Alan B. Shepard, Jr., STG  
Hubert M. Drake, FRC  
Stanley R. Reinartz, MSFC  
John J. Williams, STG

*Propulsion*

David M. Hammock, Chairman, STG  
 Arthur M. Busch, STG  
 Robert H. Rollins, STG  
 Robert R. Brashears, JPL

Joseph G. Thibodaux, Jr., LaRC  
 Edmund R. Jonash, LRC  
 John W. Conlon, STG

*Flight Mechanics*

Robert G. Chilton, Chairman, STG

*(Aerodynamics)*

Alan B. Kehlet, Group Leader, STG  
 Clarence A. Syvertson, ARC  
 Edward L. Linsley, MSFC

Eugene S. Love, LaRC  
 Bruce G. Jackson, STG  
 Warren J. North, NASA Hq.

*(Trajectory Analysis)*

Jack Funk, Group Leader, STG  
 John P. Mayer, STG  
 Luigi Cicolani, ARC

Kenneth R. Squires, GSFC  
 Tecwyn Roberts, STG

*(Guidance and Control)*

Robert G. Chilton, Group Leader, STG  
 Morris V. Jenkins, STG  
 Richard R. Carley, STG  
 John M. Eggleston, LaRC

Euclid C. Holleman, FRC  
 Thomas V. Chambers, STG  
 Welby T. Risler, STG

*Structures, Materials, and Heating*

Robert E. Vale, Chairman, STG  
 Kenneth C. Weston, STG  
 Glen Goodwin, ARC  
 Roger A. Anderson, LaRC

Harry L. Runyan, Jr., LaRC  
 Richard H. Kemp, LRC  
 George J. Vetko, MSFC

*Human Factors*

Richard S. Johnston, Chairman, STG

*(Crew Considerations)*

Richard S. Johnston, Group Leader, STG  
 C. Patrick Laughlin, STG  
 Gerard J. Pesman, STG

Walter M. Schirra, Jr., STG  
 Harald A. Smedal, ARC  
 Lee N. McMillion, STG

*(Training and Crew Participation)*

Robert B. Voas, Group Leader, STG  
 Virgil I. Grissom, STG  
 Harold I. Johnson, STG

Richard F. Day, FRC  
 Milton O. Thompson, FRC

*(Radiation)*

David Adamson, Group Leader, LaRC  
Francis W. Casey, Jr., STG

C. Patrick Laughlin, STG  
William L. Gill, STG

*Instrumentation and Communications*

Ralph S. Sawyer, Chairman, STG

*(Instrumentation)*

Alfred B. Eickmeier, Group Leader, STG  
Jacob C. Moser, STG  
Kenneth C. Sanderson, FRC

Harvey Golden, MSFC  
Marion R. Franklin, Jr., STG  
John A. Dodgen, LaRC

*(Communications)*

Ralph S. Sawyer, Group Leader, STG  
Dennis E. Fielder, STG  
Richard Z. Toukdarian, JPL

Robert E. Tozier, LRC  
William R. Stelges, STG

*Onboard Systems*

Richard B. Ferguson, Chairman, STG

*(Auxiliary Power Supplies)*

Richard B. Ferguson, Group Leader, STG  
Preston T. Maxwell, STG  
Robert N. Parker, STG

Joseph M. Hallissy, Jr., LaRC  
Thomas Williams, STG

*(Environmental Control Systems)*

Richard B. Ferguson, Group Leader, STG  
James R. Hiers, STG  
Frank H. Samonski, Jr., STG

Walter M. Schirra, Jr., STG  
Edward L. Hays, STG  
James F. Saunders, STG

*(Landing and Recovery Systems)*

John W. Kiker, Group Leader, STG  
Peter J. Armitage, STG  
M. Scott Carpenter, STG

James K. Hinson, STG  
Rodney G. Rose, STG  
Samuel T. Beddingfield, STG

*(Mechanical Systems)*

Richard F. Smith, STG  
John Janokaitis, STG  
Perry V. Row, FRC

Herman F. Beduerftig, MSFC  
Walter J. Kapryan, STG



*Ground Operational Support Systems and Operations*

Christopher C. Kraft, Jr., Chairman, STG

*(Ground Operational Support Systems)*

Robert D. Harrington, Group Leader, STG  
Howard C. Kyle, STG  
John W. Small, Jr., STG

Friedrich O. Vonbun, GSFC  
Gerald W. Brewer, STG  
Robert B. Voas, STG

*(Operations)*

Christopher C. Kraft, Jr., STG  
Sigurd A. Sjoberg, STG  
B. Porter Brown, STG  
L. Gordon Cooper, STG

Philip R. Maloney, STG  
Robert F. Thompson, STG  
Paul C. Donnelly, STG  
Emil P. Bertram, MSFC

*Technical Development Plan*

Kenneth S. Kleinknecht, Chairman, STG  
Alan B. Kehlet, STG  
Donald C. Cheatham, STG

Donald K. Slayton, STG  
H. Kurt Strass, STG  
John H. Disher, NASA Hq.

*Reliability*

F. John Bailey, STG  
John C. French, STG  
Edward H. Olling, STG

Harold D. Toy, STG  
K. Fred Okano, NASA Hq.

*Manufacturing*

Joseph V. Piland, Chairman, STG  
Jack Kinzler, STG  
William J. Nesbitt, STG  
T. Schaus, Air Force Systems Command

Clyde Thiele, LaRC  
Norman Levine, MSFC  
Frank M. Crichton, STG  
Archibald E. Morse, Jr., STG

*Business Subcommittee*

Date of organization: August 16, 1961

Evaluation of proposals began: October 9, 1961

Report submitted to the Source Evaluation Board: November 3, 1961

Glenn F. Bailey, Chairman, STG  
Phillip H. Whitbeck, STG  
John D. Young, NASA Hq.  
Douglas E. Hendrickson, STG  
George F. MacDougall, Jr., STG

John M. Curran, NASA Hq.  
Wilbur H. Gray, STG  
John H. Glenn, Jr., STG  
Thomas F. Baker, STG

Business Assessment Panels

*Organization and Management*

Thomas W. Briggs, Chairman, STG	Nickolas Jevas, STG
J. B. Trenholm, Jr., Air Force Systems Command	J. Thomas Markley, STG
Henry P. Yscheck, STG	Dugald O. Black, STG
Pinkney McGathy, STG	Walter W. Haase, NASA Hq.
Allen L. Granfield, STG	Ralph E. Cushman, NASA Hq.
James A. Bennett, STG	Earl E. McGinty, NASA Hq.
Bryant L. Johnson, STG	Don Hardin, MSFC
	Peter F. Korycinski, LaRC

*Logistics*

Lawrence Jacobson, Chairman, NASA Hq.	Walter D. Wolhart, STG
Paul H. Kloetzer, STG	A. Martin Eiband, STG
Richard F. Baillie, STG	

*Subcontract Administration*

Harry L. Watkins, STG	James S. Evans, Western Operations Office
Wayne W. Corbett, STG	Eldon W. Kaser, ARC
John B. Lee, STG	

*Cost*

Charles J. Finegan, Chairman, NASA Hq.	James H. Sumpter, Jr., Army Audit Agency
A. E. Hyatt, STG	Irving J. Sandler, AF Auditor General's Office
J. Howard Allison, STG	Adaron B. Jordan, AF Systems Command
Lester A. Stewart, STG	

---

MSFC–MSC–LOC Coordination Panels (originally designated MSFC–MSC Coordination Panels);  
also called Apollo-Saturn Coordination Panels

Date of establishment: October 3, 1961

Date of first meeting: November 8, 1961

Panels reported to: Space Vehicle Review Board (MSFC–MSC–LOC Space Vehicle Review Board), which consisted of the Directors of the three Centers (Wernher von Braun, Robert R. Gilruth, and Kurt H. Debus); division directors and other key technical personnel; NASA Headquarters representatives; observers; specialists; panel representatives invited to attend by the Directors of MSFC, MSC, and LOC.

*Electrical Systems Integration Panel*

## MSC

Milton G. Kingsley, Co-chairman  
 Lyndon Robinson  
 R. C. Irvin, Co-secretary  
 Robert E. Munford  
 W. E. Williams

## MSFC

Hans J. Fichtner, Co-chairman  
 Richard G. Smith  
 Robert M. Aden  
 David B. Gardiner, Jr., Co-secretary  
 James Vann

## LOC

Daniel D. Collins

*Instrumentation and Communication Panel*

## MSC

Alfred B. Eickmeier, Co-chairman  
 Clyde Whittaker, Co-secretary  
 Robert F. Thompson  
 James L. Strickland  
 Howard C. Kyle  
 Gordon Woosley  
 William R. Stelges

## MSFC

Otto A. Hoberg, Co-chairman  
 Harvey Golden, Co-secretary  
 Heinz W. Kampmeier  
 Herman F. Kurtz  
 James Vann

## LOC

Daniel D. Collins

*Mechanical Integration Panel*

## MSC

Lyle M. Jenkins, Co-chairman  
 Robert P. Smith, Co-secretary  
 Percy Hurt  
 Robert E. Vale  
 Samuel T. Beddingfield

## MSFC

Hans R. Palaoro, Co-chairman  
 Robert O. Barraza, Co-secretary  
 Jack H. Furman  
 Tom Isbell  
 Earl M. Butler  
 Wallace Kistler  
 Desmond Beck  
 Fred G. Edwards

## LOC

Andrew J. Pickett  
 Robert Moore



*Flight Mechanics, Dynamics, Guidance, and Control Panel*

MSC

Calvin H. Perrine, Jr., Co-chairman  
Robert J. Ward, Co-secretary  
Robert G. Chilton  
Aaron Cohen  
John P. Mayer

MSFC

R. F. Hoelker, Co-chairman  
Lewis L. McNair, Co-secretary  
Thomas G. Reed  
Hans H. Hosenthien  
F. Brooks Moore  
John W. Massey

LOC

A. H. Knothe

*Launch Operations Panel*

MSC

John J. Williams  
Melvin Dell  
Philip R. Maloney  
Paul C. Donnelly

MSFC

Robert E. Moser  
Joachim P. Kuettner

LOC

Rocco A. Petrone, Chairman  
Emil P. Bertram, Secretary  
Robert E. Gorman

*Mission Control Operations Panel*

MSC

John D. Hodge, Co-chairman  
Dennis E. Fielder, Co-secretary  
Howard C. Kyle  
Tecwyn Roberts  
Gordon Wosley  
Eugene F. Kranz

MSFC

Fridjof A. Speer, Co-chairman  
Ernest B. Nathan, Co-secretary  
James T. Felder  
Wallace Kistler  
E. W. King  
Ludie G. Richard  
Grady Williams

LOC

Rudolf H. Bruns  
Emil P. Bertram  
Walter W. Kavanaugh

*Crew Safety Panel*

## MSC

Alfred Mardel, Co-chairman  
 Art White, Co-secretary  
 Donald K. Slayton  
 Sigurd A. Sjoberg  
 Warren J. North  
 C. K. Anderson

## MSFC

Joachim P. Kuettner, Co-chairman  
 E. W. King, Co-secretary  
 James Powell  
 Friedrich W. Brandner  
 Jerry L. Mack  
 George Butler, Jr.  
 Wallace Kistler  
 Robert M. Hunt  
 James P. Lindberg, Jr.  
 Frank Bryan

## LOC

Emil P. Bertram

---

 MSFC–MSC Advanced Program Coordination Board

Date of first meeting: October 20, 1961

Attended first meeting:

## MSC

Robert R. Gilruth  
 Walter C. Williams  
 Aleck C. Bond  
 Maxime A. Faget  
 Kenneth S. Kleinknecht  
 J. Thomas Markley  
 Charles W. Mathews  
 Robert O. Piland  
 G. Merritt Preston  
 Paul E. Purser  
 James A. Chamberlin  
 Alan B. Shepard, Jr.

## MSFC

Wernher von Braun  
 Paul J. DeFries  
 Fred E. Digesu  
 Ernst D. Geissler  
 Joachim P. Kuettner  
 Charles A. Lundquist  
 Jerry C. McCall  
 William A. Mrazek  
 J. Unger  
 H. H. Koelle

---

 Rosen Working Group

Date of organization: November 6, 1961

Recommendations submitted to D. Brainerd Holmes, Director, Office of Manned Space Flight:  
 November 20, 1961

Milton W. Rosen, Chairman  
 Richard B. Canright  
 Eldon W. Hall  
 Elliott Mitchell  
 Norman Rafel  
 Melvyn Savage

Adelbert O. Tischler  
 William A. Mrazek  
 Hans H. Maus  
 James B. Bramlet  
 John H. Disher  
 David M. Hammock

---

Manned Space Flight Management Council

Date of formation and first meeting: December 21, 1961

D. Brainerd Holmes  
Robert R. Gilruth  
Walter C. Williams  
Wernher von Braun  
Eberhard F. M. Rees

George M. Low  
Milton W. Rosen  
Charles H. Roadman  
William E. Lilly  
Joseph F. Shea

---



# APPENDIX 3—MAJOR SPACECRAFT CONTRACTORS

August 9, 1961, through November 7, 1962

Company	System	Potential Value of Contract (in millions)
<i>Principal Contractor—Spacecraft</i> North American Aviation, Inc., Space and Information Systems Division	Command and service modules	\$900
<i>Subcontractors</i>		
Aerojet-General Corp.	Service module propulsion motor	\$ 28.423
Avco Corp.	Ablative heatshield	\$ 22.462
Beech Aircraft Corp.	Supercritical gas storage system	\$ 4
Collins Radio Co.	Communications and data	\$ 96.996
Garrett Corp., AiResearch Mfg. Co.	Environmental control system	\$ 44.735
Lockheed Propulsion Co.	Launch escape and pitch control motors	\$ 9.702
Marquardt Corp.	Reaction control motors (service module)	\$ 19.593
Minneapolis-Honeywell Regulator Co.	Stabilization and flight control	\$104.064
Northrop Corp., Ventura Division	Earth landing system	\$ 10.486
Thiokol Chemical Corp., Hunter-Bristol Division	Escape system jettison motors	\$ 2.629
United Aircraft Corp., Hamilton Standard Division	Space suit	\$ 1.550
United Aircraft Corp., Pratt & Whitney Aircraft Division	Fuel cell	\$ 43.531
<i>Guidance and Navigation</i>		
Massachusetts Institute of Tech- nology, Instrumentation Laboratory	Management of guidance and navigation development	\$ 71
General Motors Corp., AC Spark Plug Division	Inertial platform and associated ground support equipment	\$ 44.545
Kollsman Instrument Co.	Optical subsystems	\$ 10
Raytheon Co.	Onboard guidance computer	\$ 15
Sperry Rand Corp., Sperry Gyroscope Division	Accelerometers	\$ 0.747
<i>Lunar Excursion Module</i>		
Grumman Aircraft Engineering Corp.	Lunar excursion module	Undetermined

## APPENDIX 4—FLIGHT SUMMARY\*

[August 17, 1958, through November 7, 1962]

Date	Name	General Mission	Launch Vehicle (site)	Performance‡		
				Vehicle	Payload	Mission Results
<i>1958</i>						
Aug 17	<i>Pioneer</i>	Scientific lunar probe	Thor-Able (AMR) †	U	Unknown	U
Oct 11	<i>Pioneer I</i>	Scientific lunar probe	Thor-Able (AMR)	U	Unknown	U
Nov 8	<i>Pioneer II</i>	Scientific lunar probe	Thor-Able (AMR)	U	Unknown	U
Dec 6	<i>Pioneer III</i>	Scientific lunar probe	Juno II (AMR)	P	P	P
<i>1959</i>						
Jan 2	<i>Lunik I</i>	Scientific lunar probe	Unknown (U.S.S.R.)	P	P	P
March 3	<i>Pioneer IV</i>	Scientific lunar probe	Juno II (AMR)	P	P	P
Sept 12	<i>Lunik II</i>	Scientific lunar lander	Unknown (U.S.S.R.)	S	S	S
Oct 4	<i>Lunik III</i>	Lunar photography	Unknown	S	S	S
Nov 26	<i>Pioneer</i>	Scientific lunar probe	Atlas-Able (AMR)	U	Unknown	U

1960						
May 9	Mercury abort test	Capsule escape rocket test, unmanned	Launch escape rocket (Wallops Isl.)	S	S	S
May 15	<i>Korabl Sputnik I</i>	Unmanned orbital spacecraft flight	Unknown (U.S.S.R.)	P	S	P
July 29	Mercury-Atlas 1 (MA-1)	Unmanned suborbital spacecraft flight	Atlas (AMR)	U	Unknown	U
Aug 19	<i>Korabl Sputnik II</i>	Unmanned orbital spacecraft flight	Unknown (U.S.S.R.)	S	S	S
Sept 25	Pioneer	Lunar orbiter	Atlas-Able (AMR)	U	Unknown	U
Nov 8	<i>Little Joe 5 (LJ-5)</i>	Unmanned max q Mercury spacecraft abort test	Little Joe (Wallops Isl.)	U	Unknown	U
Nov 21	Mercury-Redstone 1 (MR-1)	Unmanned suborbital spacecraft flight	Redstone (AMR)	U	Unknown	U
Dec 1	<i>Korabl Sputnik III</i>	Unmanned orbital spacecraft flight	Unknown (U.S.S.R.)	P	S	P
Dec 15	Pioneer	Scientific lunar probe	Atlas-Able (AMR)	U	Unknown	U
Dec 19	<i>Mercury-Redstone 1A (MR-1A)</i>	Unmanned suborbital spacecraft flight	Redstone (AMR)	S	S	S
1961						
Jan 31	<i>Mercury-Redstone 2 (MR-2)</i>	Unmanned suborbital spacecraft flight	Redstone (AMR)	S	S	S
Feb 21	<i>Mercury-Atlas 2 (MA-2)</i>	Unmanned suborbital spacecraft flight	Atlas (AMR)	S	S	S
March 9	<i>Korabl Sputnik IV</i>	Unmanned orbital spacecraft flight	Unknown (U.S.S.R.)	S	S	S



## APPENDIX 4—FLIGHT SUMMARY\*—Continued

[August 17, 1958, through November 7, 1962]

Date	Name	General Mission	Launch Vehicle (site)	Performance‡		
				Vehicle	Payload	Mission Results
<i>1961</i>						
March 18	<i>Little Joe 5A (LJ-5A)</i>	Unmanned max q Mercury spacecraft abort test	Little Joe (Wallops Isl.)	P	P	P
March 25	<i>Korabl Sputnik V</i>	Unmanned orbital spacecraft flight	Unknown (U.S.S.R.)	S	S	S
April 12	<i>Vostok I</i>	Manned orbital spacecraft flight	Unknown (U.S.S.R.)	S	S	S
April 25	<i>Mercury-Atlas 3 (MA-3)</i>	Unmanned orbital spacecraft flight	Atlas (AMR)	U	Unknown	U
April 28	<i>Little Joe 5B (LJ-5B)</i>	Unmanned max q Mercury spacecraft abort test	Little Joe (Wallops Isl.)	P	S	S
May 5	<i>Freedom 7 (MR-3)</i>	Suborbital manned spacecraft flight	Redstone (AMR)	S	S	S
July 21	<i>Liberty Bell 7 (MR-4)</i>	Suborbital manned spacecraft flight	Redstone (AMR)	S	S	S
Aug 6	<i>Vostok II</i>	Manned orbital spacecraft flight	Unknown (U.S.S.R.)	S	S	S
Aug 23	<i>Ranger I</i>	Scientific lunar probe	Atlas-Agena B (AMR)	U	Unknown	U
Sept 13	<i>Mercury-Atlas 4 (MA-4)</i>	Unmanned orbital spacecraft flight	Atlas (AMR)	S	S	S
Oct 27	Saturn (SA-1)	Launch vehicle development test	Saturn C-1 (AMR)	S		S

Nov 18	<i>Ranger II</i>	Scientific lunar probe	Atlas-Agena B (AMR)	U	Unknown	U
Nov 29	<i>Mercury-Atlas 5 (MA-5)</i>	Unmanned orbital spacecraft flight	Atlas (AMR)	S	S	S
1962						
Jan 26	<i>Ranger III</i>	Scientific lunar lander	Atlas-Agena B (AMR)	U	Unknown	U
Feb 20	<i>Friendship 7 (MA-6)</i>	Manned orbital spacecraft flight	Atlas (AMR)	S	S	S
April 23	<i>Ranger IV</i>	Scientific lunar lander	Atlas-Agena B (AMR)	S	U	P
April 25	Saturn (SA-2)	Launch vehicle development test	Saturn C-1 (AMR)	S	S	S
May 24	<i>Aurora 7 (MA-7)</i>	Manned orbital spacecraft flight	Atlas (AMR)	S	S	S
Aug 11-12	<i>Vostok III-Vostok IV</i>	Manned orbital spacecraft flights	Unknown (U.S.S.R.)	S	S	S
Oct 3	<i>Sigma 7 (MA-8)</i>	Manned orbital spacecraft flight	Atlas (AMR)	S	S	S
Oct 18	<i>Ranger V</i>	Scientific lunar lander	Atlas-Agena B (AMR)	S	U	U

\*The launches described in this table include only those related to the exploration of the moon: unmanned lunar probes, unmanned tests of spacecraft designed for later manned missions, and manned spacecraft flights. The table is not intended as a comprehensive summary of all American and Soviet space flights.

†AMR—Atlantic Missile Range.

‡S—Successful.

P—Partially successful.

U—Unsuccessful.

Unknown—Launch vehicle malfunctions did not give the payload a chance to exercise its main experiments.

## APPENDIX 5—FUNDING

Fiscal Year	Funding
1960	NASA: \$523, 575, 000 Advanced technical development studies: \$100,000
1961	NASA: \$964, 000, 000 Advanced technical development studies: \$1,000,000
1962 (Original budget request)	NASA: \$1, 109, 630, 000 Apollo: \$29, 500, 000
1962 (Revised budget request, March 17, 1961)	NASA: \$1, 417, 821, 000 Apollo: \$72, 100, 000
1962 (Bureau-of-the-Budget—approved request)	NASA: \$1, 235, 300, 000 Apollo: \$29, 500, 000



1962 (H.R. 6874, May 24, 1961)	NASA: \$1,361,900,000 Apollo: \$72,100,000		
1962 (Final budget appropriation)	NASA: \$1,671,750,000 Apollo: \$160,000,000	Apollo funding break- down	Orbital flight tests: \$63,900,000 Biomedical flight tests: 16,550,000 High-speed reentry tests: 27,550,000 Spacecraft development: 52,000,000
1963 (Original budget request including Fiscal Year 1962 supplemental)	NASA: \$3,787,276,000 Apollo: \$617,164,000		Command and service modules: \$345,000,000 Lunar excursion module: 123,100,000 Guidance and navigation system: 32,400,000
1963 (Final budget appropriation with Fiscal Year 1962 supplemental)	NASA: \$3,674,115,000 Apollo: \$617,164,000	Apollo funding break- down	Instrumentation and scientific equipment: 11,500,000 Operational support: 2,500,000 Supporting development: 3,000,000 Little Joe II development: 8,800,000 Saturn C-1 launch vehicles (10): 90,864,000

# APPENDIX 6—ORGANIZATION CHARTS

## SPACE TASK GROUP

[September 26, 1960]

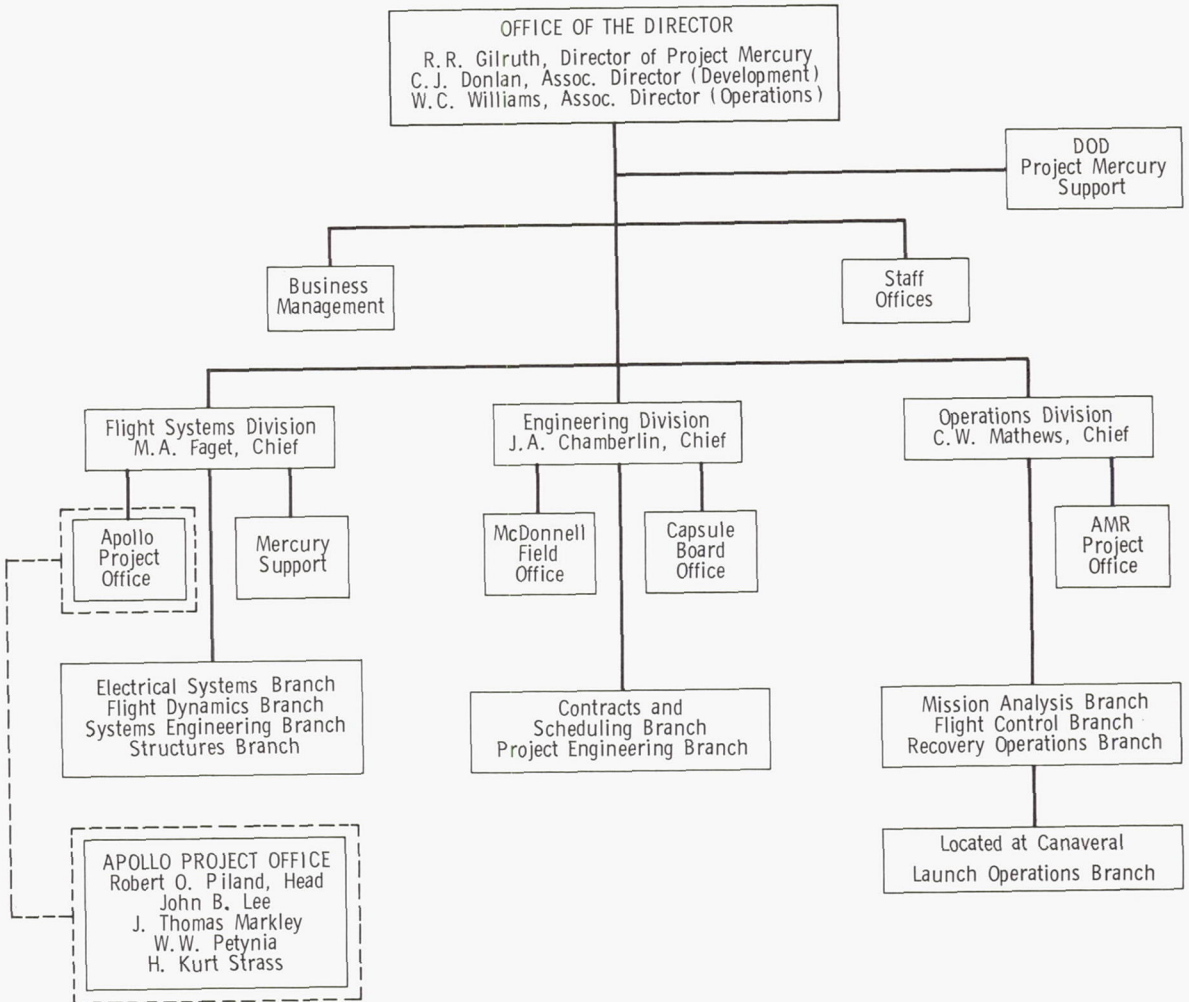

FLIGHT SYSTEMS DIVISION

[May 23, 1961]

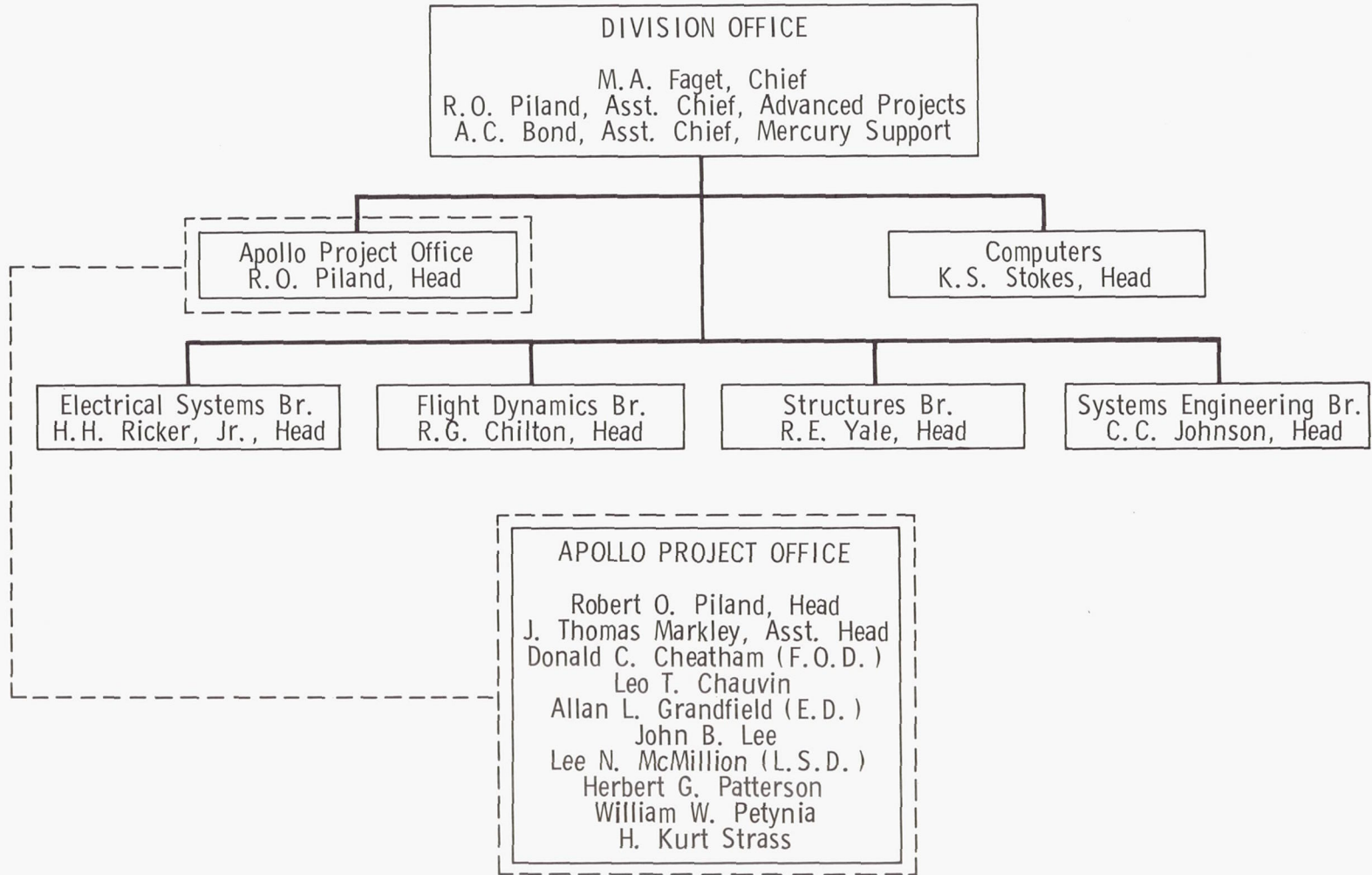



# APOLLO SPACECRAFT PROJECT OFFICE

[March 6, 1962]

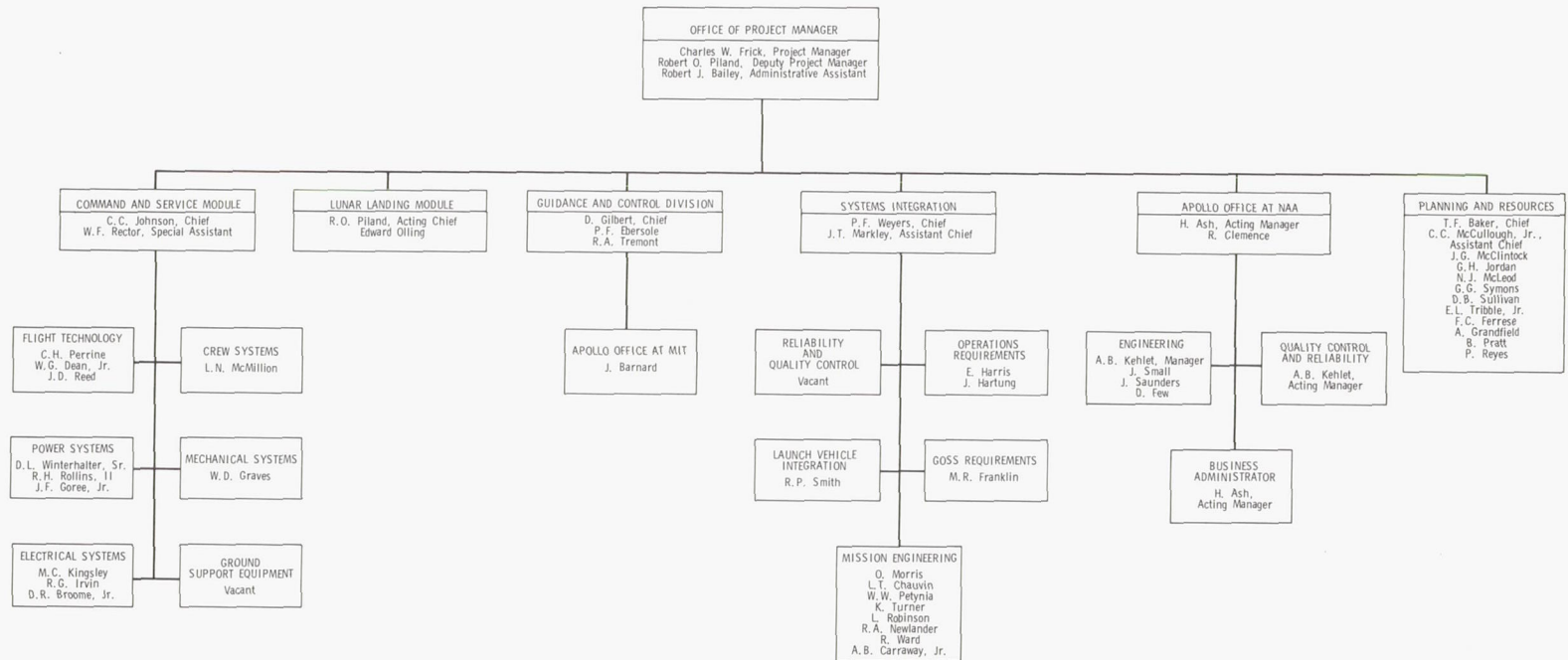

232

# MANNED SPACECRAFT CENTER

[September 1962]

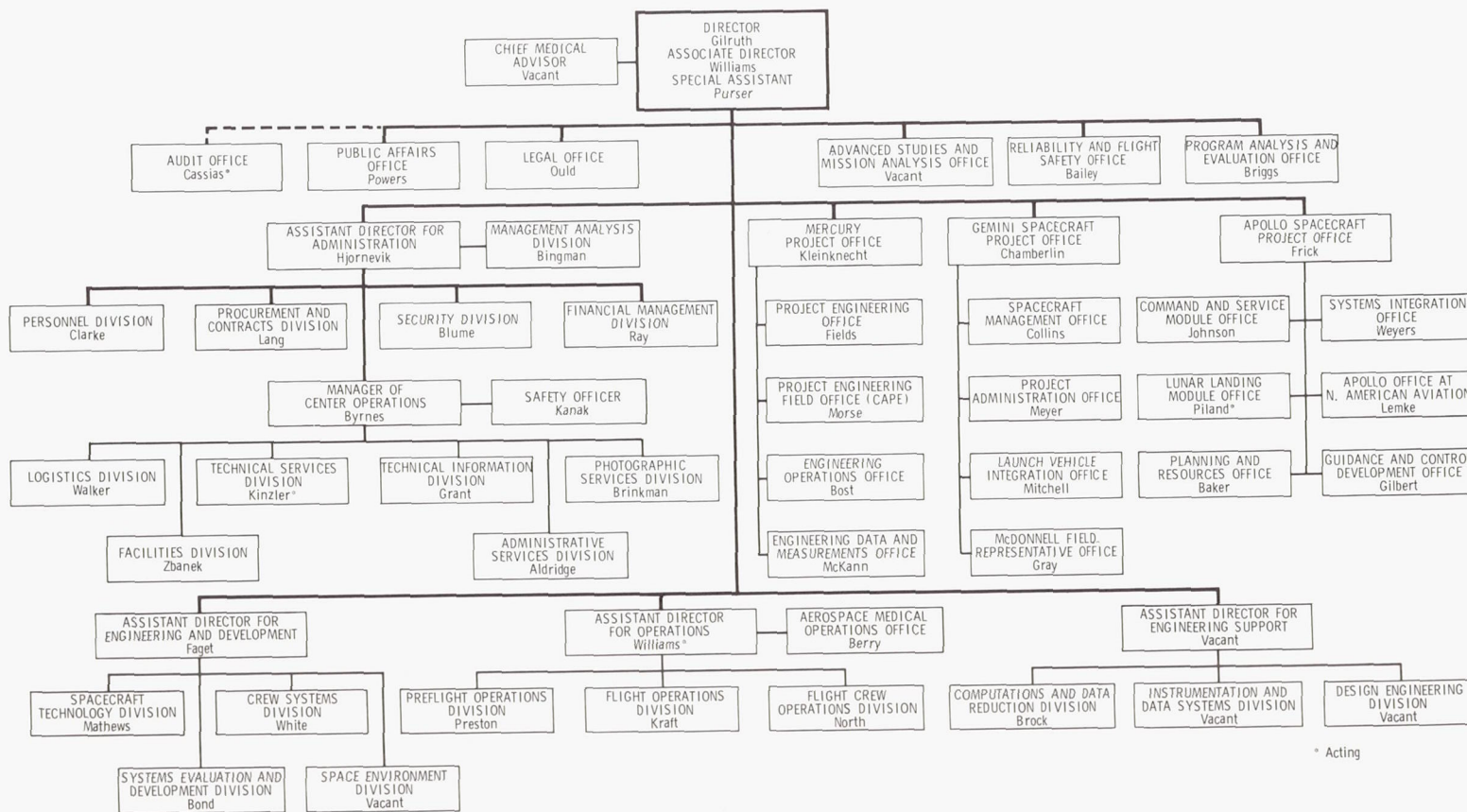

\* Acting

## APPENDIX 7—APOLLO LAUNCH VEHICLE FAMILY

### Little Joe II

#### Configuration:

Single stage test vehicle powered by Algol solid-propellant motors. Recruit rocket motors were used as booster motors, to supplement liftoff thrust.

#### Mission:

The Little Joe II test launch vehicle, under construction during the period of this volume, was to be used to man-rate the launch escape system for the command module.

### Saturn C-1 (renamed Saturn I)

#### Configuration:

S-I booster (eight H-1 engines, clustered, producing 1.5 million pounds of thrust); S-IV second stage (four engines using liquid-hydrogen and liquid-oxygen propellants and producing 80,000 pounds of thrust); and S-V third stage (two engines of the type used in the S-IV stage, producing 40,000 pounds of thrust). The LR-119 engine (17,500 pounds of thrust), an uprated version of the LR-115 engine (15,000 pounds of thrust), was selected to be used in the S-IV and S-V stages. On March 29, 1961, NASA approved a change to six LR-115 engines on the S-IV stage. On June 1, 1961, NASA announced that the S-V had been dropped from the configuration.

#### Mission:

Two successful launches of the Saturn C-1 took place during the period covered by this volume. Later launches would test boilerplate Apollo command and service modules under flight conditions.

### Saturn C-1B (renamed Saturn IB or Uprated Saturn I)

#### Configuration:

S-IB booster (eight uprated H-1 engines, clustered, producing 1.6 million pounds of thrust); and S-IVB second stage (one J-2 engine, producing 200,000 pounds of thrust).

#### Mission:

On July 11, 1962, NASA announced that the Saturn C-1B would be used to launch unmanned and manned Apollo spacecraft into earth orbit.

### Saturn C-2

#### Four-stage configuration:

S-I booster (same as booster stage of the Saturn C-1); S-II second stage (not defined); S-IV third stage (same as Saturn C-1 second stage); and S-V fourth stage (same as Saturn C-1 third stage).

#### Three-stage configuration:

S-I booster (same as booster stage of the Saturn C-1); S-II second stage (not defined); and S-IV third stage (same as Saturn C-1 second stage).

#### History:

Plans for the Saturn C-2 were canceled in June 1961 in favor of the proposed Saturn C-3.



## Saturn C-3

## Configuration:

Booster stage (two F-1 engines, producing 3 million pounds of thrust); second stage (four J-2 engines, producing 800,000 pounds of thrust); and S-IV third stage (same as Saturn C-1 second stage).

## History:

Plans for the Saturn C-3 were canceled in favor of a more powerful launch vehicle.

## Saturn C-4

## Configuration:

Booster stage (four F-1 engines, clustered, producing 6 million pounds of thrust); second stage (four J-2 engines, producing 800,000 pounds of thrust).

## History:

The Saturn C-4 was briefly considered in planning for the advanced Saturn launch vehicle but was rejected in favor of the Saturn C-5.

## Saturn C-5 (renamed Saturn V)

## Configuration:

S-IC booster (five F-1 engines, clustered, producing 7.5 million pounds of thrust); S-II second stage (five J-2 engines, producing 1 million pounds of thrust); and the S-IVB third stage (one J-2 engine, producing 200,000 pounds of thrust).

## Mission:

The Saturn C-5 was selected by NASA in December 1961 as the launch vehicle to be used in accomplishing the lunar landing mission.

## Saturn C-8

## Configuration:

First stage (eight F-1 engines, clustered, producing 12 million pounds of thrust); second stage (eight J-2 engines, producing 1.6 million pounds of thrust); and third stage (one J-2 engine, producing 200,000 pounds of thrust).

## History:

The Saturn C-8 was briefly considered for the direct ascent lunar landing mission during the selection of the lunar landing mode. It was rejected in favor of the Saturn C-5 which would be used in the lunar orbit rendezvous mission.

## Nova

## Configuration:

Several configurations were proposed during the period of this volume. All were based on the use of the F-1 engine in the first stage. One typical configuration was: first stage (eight F-1 engines, clustered, producing 12 million pounds of thrust); second stage (four liquid-hydrogen M-1 engines, producing 4.8 million pounds of thrust); third stage (one J-2 engine, producing 200,000 pounds of thrust). Nuclear upper stages were also proposed.

## Mission:

The Nova was intended for use in a direct ascent lunar landing mission.

Page Intentionally Left Blank

## INDEX

### A

- Abbott, Ira H., 22, 67, 98, 111, 209, 213
- Ablating materials, 165
- Avco Corp. named by NAA to design and install on spacecraft surface, 144
  - research, 27
- Ablation techniques, 27
- charring, 27
  - surface char layer temperature, 136
- ABMA. *See* Army Ballistic Missile Agency.
- Abort, 188
- high-altitude, 152, 160, 186
  - launch, 152
  - max-q, 152, 160, 192
  - study, 56
- Acord, James D., 64, 210
- Acoustics, 80
- AC Spark Plug Division, 160
- contract for guidance and navigation system components, 160
- Adams, Mac C., 207
- Adamson, David, 64, 211, 216
- Aden, Robert M., 219
- Ad Hoc Committee on Space (Wiesner Committee), 69, 212
- report to John F. Kennedy, 69
- Ad Hoc Committee on Space Technology. *See* Air Force Scientific Advisory Board.
- Ad Hoc Lunar Landing Module Working Group, 138
- to determine design constraints, 138
  - under direction of ASPO, 138
- Ad Hoc Saturn Study Committee, 20, 55
- Ad Hoc Task Group for Manned Lunar Landing Study (Fleming Committee), 91, 212
- established, 85
  - guidelines, 86
    - alternative approaches, 87
    - flight test program, 87
    - manned lunar landing target date—1967, 86, 95
    - mission plan, 86
    - reliability requirements, 95
- pacing items, 50, 95
- facilities for launching and testing, 95
  - first stage of launch vehicle, 95
- report submitted, 95
- See also* Fleming Committee.
- Ad Hoc Task Group for Study of Manned Lunar Landing by Rendezvous Techniques (Heaton Committee), 213
- established, 95
  - guidelines, 95
  - operating methods, 95
  - report submitted, 108
- See also* Heaton Committee.
- Advanced design concepts
- earth orbital missions, 27
  - lunar missions, 27
- Advanced manned space flight missions, 2
- Advanced manned space flight program, 2, 38, 47, 48
- Advanced manned space program, 19
- Advanced manned spacecraft program, 2, 23, 31, 38, 39, 40-45, 53, 54, 87
- guidelines, 38-42
    - 14-day flight time, 39, 40
    - auxiliary propulsion, 39, 40
    - compatibility with C-1 or C-2 boosters, 39, 40
    - earth orbital missions, 39
    - expanded communications facilities, 39, 41, 42
    - expanded tracking facilities, 39
    - flight time, 39
    - ground and water landing, 39, 40
    - manned lunar reconnaissance, 39, 40
    - missions, 39, 40, 101
    - onboard command, 41
    - point landing, 39
    - propulsion, 39, 44
    - radiation protection, 39, 41
    - safe recovery from abort, 39-40
    - "shirtsleeve" environment, 39, 41
    - three-man crew, 31, 39, 41
    - weight constraints, 31, 39, 40
- presented to NASA organizations, 39, 40
- spacecraft development proposal, 76
- study contracts, 53
- Statement of Work, 87, 88
- incorporated in-house and contractor feasibility study results, 88
- "Advanced manned spacecraft and system," 38
- preliminary guidelines, 38
- Advanced mission study, iii
- Advanced multiman spacecraft, 3, 40, 45
- preliminary design studies, 3, 45
- Advanced Program Coordination Board, 112, 113
- Sub-Board, 112
    - members, 112
    - responsibilities, 112
- Advanced recovery capsule, 28
- Advanced Research Projects Agency (ARPA), 2, 10, 12, 15, 18, 20, 27, 29, 32
- Advanced Saturn launch vehicle, 109, 110, 133
- invitations to bid, 110
- Advanced spacecraft
- mission analysis studies, 31
  - exit corridor, 31
  - reentry corridor, 31
- planning, 31
  - programs, 44
  - systems, 31
- Advanced Vehicle Team, 45, 46, 209
- formed, 45
- See also* Space Task Group.
- Advisory Committee on Government Organization, 10
- Aerodynamics, 45, 68, 74



## INDEX

- Aerojet-General Corporation, 20, 181, 184  
 Algol motor selected to power Little Joe II, 181  
 contract for Apollo service module propulsion engine, 155  
 named by NAA as subcontractor for service module propulsion system, 142
- Aeronautical Division, 162  
 designed stabilization and control system, 162  
*See also* Minneapolis-Honeywell Regulator Company.
- Aeronutronic Division  
 named to build instrumented lunar-landing capsule ("Ranger"), 43
- Aerospace Corporation, 100, 110
- Aikenhead, Bruce A., 211
- Air Force, 32  
 programs, 7, 10, 13, 14, 20  
 descent from orbit, 59  
 lunar base studies, 59  
 orbital rendezvous, 59  
 reentry methods, 59  
 refueling, 59  
 rendezvous by satellite interceptor, 59
- Air Force Aeronautical Chart and Information Center, 13, 69
- Air Force Missile Test Center, 96, 99, 105, 108
- Air Force School of Aerospace Medicine, 167, 188  
 simulated space cabin, 167, 188  
 fire, 167, 188
- Air Force School of Aviation Medicine, 46
- Air Force Scientific Advisory Board, 8  
 Ad Hoc Committee on Space Technology, 8
- Aircraft  
 C-133A, 191  
 X-15, 140, 152
- AiResearch Manufacturing Company  
 selected by NAA to design and build environmental control system, 134
- Airlock, 161, 187  
 and docking (command module) design criteria, 161, 184, 187  
 configurations, 183, 187
- Airport landing technique, 22
- Akens, David S., 27
- Alexander, Charles C., 7
- Algol  
 selected to power Little Joe II booster, 181  
 solid-propellant, 181
- Allen, H. Julian, 187
- Allison, J. Howard, 218
- Alluisi, Earl, 182
- Allyn, Charles F., xiv
- American Marietta Corporation, Guardite Division, 57
- American Rocket Society, 8, 168, 170
- Ames, Milton B., Jr., 7, 20, 22, 208
- Ames Research Center, 18, 20, 24, 25, 43, 56, 62, 68, 70, 78, 94, 147, 197  
 ballistic range established, 193  
 flight simulation, 43  
 heating and aerodynamic investigations on lifting capsule configurations, 43  
 meteoroid tests established, 193  
 potential reentry heating experiments at near escape velocity, 43  
 studies  
 aerodynamic configuration for reentry from lunar trajectory, 43  
 guidance and control requirements, 43  
 pilot display and navigation, 43
- AMR. *See* Atlantic Missile Range.
- Amster, Warren, 100, 214
- Anderson, C. K., 221
- Anderson, Roger A., 64, 211, 215
- Antarctic Treaty, 32
- Antares  
 solid-fuel, 139
- Antenna, 109
- AOMC. *See* Army Ordnance Missile Command.
- Apollo, 48, 54  
 program name approved, 47  
 program name suggested, 36
- Apollo Applications Program, iii  
 "Apollo Egress Criteria," 118  
 ground rules, 118  
 operations and control procedures criteria, 118  
 requirements for implementation of emergency egress systems, 118  
 space vehicle design criteria, 118
- Apollo Egress Working Group, 118  
 formed, 118  
 prepared "Apollo Egress Criteria," 118
- Apollo engineering order, first issued, 135  
 to fabricate command module mockup, 135  
 to fabricate service module mockup, 135
- Apollo launch vehicle (Saturn), 50  
*See also* Boosters; Appendix 4, 224-227; and Appendix 7, 234-235.
- Apollo program, xi, 3, 54, 62, 66, 78, 84  
 DX priority assigned, 130, 152, 154  
 flight operation plan for Fiscal Year 1963, 186  
 flight plan outline, 193  
 mission objectives, 112  
 primary responsibilities relocated at Houston, 130, 143  
 schedule established by NASA Hq, 113, 186  
 STG responsibilities, 113
- Apollo Project Office, 131, 132  
 formed, 50  
 responsible to MSC Director, 131  
 functions  
 maintain liaison with contractors, 132  
 monitor contractor work, 131  
 resolve technical problems, 131
- Apollo Project Office Manager, iii
- Apollo Rendezvous Phases (ARP), 82
- Apollo-Saturn Coordination Panels, 218  
*See also* MSFC-MSFC-Coordination Panels and MSFC-MSFC-LOC Coordination Panels.
- Apollo space suit, 123, 194  
 circuit, 157  
 Hamilton Standard Division of United Aircraft Corporation selected to develop, 130, 194  
 International Latex Corporation to fabricate pressure garment, 194
- Apollo spacecraft, iii, 50, 152, 154, 160  
 adapter, 101  
 attitude jets, 118  
 boilerplates proposed, 46, 131  
 concept, xiii, 65  
 configuration, 74, 136, 147, 165, 179  
 contractor selected, 51, 106, 128  
 design, xiii, 73, 136, 176  
 development program, xiii, 57, 130, 131, 132  
 DX priority, 152, 154  
 feasibility studies, xi, 50, 54, 56, 64, 66, 68, 73, 89, 98  
 ground support equipment, 101  
 guidance and navigation system study, v, 50, 65, 160  
 in-house design study, 55  
 invitation to bid, 50, 101  
 mockup, 162, 167, 188  
 computerized, 162  
 instrumented, 162  
 pitch and yaw inertia, 118  
 prenegotiation conference, 131  
 proposals submitted, 50, 113

- reliability, 113  
 estimate, 163  
 prediction study, 163
- Request for Proposal, 107
- roll inertia, 118
- Source Evaluation Board, 104
- specifications, 50, 79, 80, 87, 100, 163
- Statement of Work, 87, 98, 101, 104, 122, 123, 124, 125, 126, 137, 190, 192  
 completed, 131  
 engineering and development test plan, 126  
 deleted, 182  
 expanded, 120  
 ground operational support system, 101, 126  
 mission control center, 126  
 lunar landing module, 104, 126  
 deleted, 182  
 Phase A, 101  
 Phase B, 101  
 Phase C, 101  
 revised to include LEM requirements, 182  
 space laboratory module, 104, 126  
 deleted, 182
- subcontractors selected, 130, 134, 138, 142, 143, 144, 152, 160
- systems, 59  
 communication and instrumentation, 66, 103, 125, 126, 190  
 crew, 103, 140, 141, 164  
 earth landing, 103, 165, 177  
 electrical power, 103, 124, 125, 192  
 environmental control, 103, 124, 157, 164, 167  
 guidance and control, 102  
 launch escape, 103, 138, 141, 165, 177  
 mission propulsion, 121, 142, 165  
 reaction control, 102, 142, 164, 176  
 structural, 103, 163  
 vernier propulsion, 102, 121
- See also* Spacecraft, Command module, Service module, Lunar excursion module, Lunar excursion vehicle, and Spacecraft adapter.
- Apollo spacecraft contract  
 negotiations with NAA, 130, 131  
 changes to original Statement of Work, 131  
 Technical Panels, 131  
 Technical Subcommittees, 131
- Apollo Spacecraft Program, iii, 154
- Apollo Spacecraft Project Office (ASPO), xiii, xiv, 69, 135, 140, 147, 159, 166, 171, 187  
 budgets and schedules, 143, 181  
 developed preliminary program schedule for three approaches to lunar landing mission, 144  
 direct ascent, 144  
 earth orbit rendezvous, 144  
 lunar orbit rendezvous, 144
- directed Ad Hoc Lunar Landing Module Working Group, 138
- directed NAA to design earth landing system, 165  
 command module cant angle, 165  
 depressurization of reaction control system propellants, 165  
 no deployable heatshield, 165  
 no roll orientation control, 165  
 offset center of gravity, 165
- directed NAA to design spacecraft atmosphere for 5 psia pure oxygen, 167
- established at MSC, 130, 132, 135
- mission and engineering studies, 143
- monthly design review meeting, 143, 159, 165, 167
- organization, 142, 143, 232
- Apollo Technical Liaison Groups, 62, 63, 64, 66, 68, 70, 71, 73, 76-80, 113, 210  
 Group for Configurations and Aerodynamics, 61-64, 70, 71, 78, 210  
 Group for Guidance and Control, 61-64, 71, 73, 80, 210  
 Group on Heating, 61-64, 68, 69, 78, 211  
 Group on Human Factors, 61-64, 68, 69, 78, 79, 211  
 Group for Instrumentation and Communications, 61, 63, 64, 66, 79, 211  
 Group for Mechanical Systems, 61, 63, 64, 66, 80, 211  
 Group for Navigation, Guidance and Control, 70, 71, 80  
 Group for Onboard Propulsion, 60, 61, 63, 64, 66, 79, 211  
 Group for Structures and Materials, 61-64, 70, 80, 211  
 Group on Trajectory Analysis, 61-64, 68, 80, 211  
 plan formulated by MSC, 60  
 objectives and scope, 60-61  
 to coordinate NASA inter-Center information exchange, 50
- Apollo test program, 183, 193  
 boilerplate, 131  
 data acquisition, 183
- Appold, Norman C., 207
- Argentina, 32
- Armitage, Peter J., 211, 216
- Armour Research Foundation, 190, 200  
 contract for lunar surface conditions investigation, 189
- Armstrong, Neil A., 152, 189
- Army Ballistic Missile Agency (ABMA), 2, 8, 9, 12, 15, 17, 20, 21, 25, 26, 29, 31-34, 36, 37  
 Development Operations Division, 31, 38  
*See also* United States Army.
- Army Corps of Engineers, 181, 190
- Army Ordnance Missile Command (AOMC), 12, 14, 16, 20, 21, 24, 27, 32
- Arnold Engineering Development Center, 160, 191  
 Mark I altitude chamber, 191  
 environmental tests, 191  
 propulsion system development tests, 191  
 reaction control development tests, 191  
 wind tunnel tests for Apollo data, 160  
 dynamic stability, 160  
 heat transfer, 160  
 pressure stability, 160  
 static stability, 160  
*See also* United States Air Force.
- ARP. *See* Apollo Rendezvous Phases.
- ARPA. *See* Advanced Research Projects Agency.
- ARPA-NASA Large Booster Review Committee, 16
- Ash, Herbert R., 142
- ASPO. *See* Apollo Spacecraft Project Office.
- Assembly operations  
 in earth orbit, 24, 25
- Astro-Electronics Division, 100  
 contract for television system, Ranger program, 100  
*See also* Radio Corporation of America.
- Astronaut simulator, 110  
 Mercury-Atlas 4, 110
- Astronaut training. *See* Crew training.
- Astronautics*, 155
- Astronauts, 6  
 selected, first group, 2  
 selected, second group, 189
- Astronomers  
 Soviet Union, 31  
 University of California, 183
- Astronomical constants, 80
- Astro sextant, 164



- Atlantic Missile Range (AMR), 14, 17, 32, 48, 61, 65,  
 74, 75, 79, 84, 87, 99, 100, 105, 107, 110, 118, 120,  
 128, 135, 140, 154, 160, 194  
 Atlantic Ocean, 140  
 Atlas, 7, 18, 132, 140, 160  
 Atlas-Able, 32, 55, 65  
 Atlas-Agena, 132, 133  
   reentry tests, 94  
 Atlas-Agena B, 35, 36, 42, 43  
   launched Ranger spacecraft, 107, 120, 135, 154  
   lunar mission, 36, 42, 135, 154  
 Atlas-Centaur, 35, 115  
 Atlas D, use in Project Fire, 139  
 Atmosphere, 41  
   100 percent oxygen in spacecraft, 165, 188  
   30-pound weight saving, 165  
   advantages, 167  
   fire hazard, 167  
   reduced control complexity, 165  
   validation program, 106, 167, 188  
   earth's, 30  
   spacecraft, 41, 58, 167  
 Attitude control, 41, 58, 102, 136, 185  
   by control jets, 58  
   by thrust vector, 58  
   crew motion effects negligible, 185  
   engines relocated, 157  
   propulsion, 44  
 Attitude orientation studies, 178, 186  
   completed by NAA, 186  
 Augerson, William S., 28, 209  
*Aurora 7*  
   launch, 160  
   recovery, 161  
   *See also* Spacecraft, U.S.  
 Australia, 32, 41  
 Austrian Imperial Army, 5  
 Automatic checkout system for launch vehicle programs,  
   114  
   Saturn C-1 through Nova, 114  
 "Automatic Interplanetary Station," 29  
 Auxiliary power, 40  
   system, 22  
 Auxiliary propulsion, 40  
   for guidance maneuvers, 40  
 Avco Corporation, 71, 74, 159  
   participated in Apollo spacecraft bid, 114  
   selected by NAA to design and install ablative  
   material on spacecraft surface, 144  
 Aviation Writers Association, 44  
 Azusa, Calif., 184
- B**
- Bailey, F. John, 217  
 Bailey, Glenn F., 217  
 Baillie, Richard F., 218  
 Baird, L. E., 213  
 Baker, Thomas F., 142, 146, 217  
 Ballistic Missile Division, 11, 21, 32, 59  
 Ballistic probes, 22  
 Ballistic trajectory, 60  
 Baltimore, Md., 64, 73  
 Barlow, Edward J., 100, 214  
 Barnard, Jack, 119, 142  
 Barraza, Robert O., 219  
 Batteries, 192, 193  
 Battin, Richard H., 112  
 Bays, Jean K., xiv  
   "Beach abort" test, 44  
   Mercury spacecraft, 44  
 Beck, Desmond, 219  
 Becker, John V., 56, 210, 214  
 Beddingfield, Samuel T., 216, 219  
 Beduerftig, Herman F., 64, 211, 216  
 Beech Aircraft Corporation, selected to build hydrogen-  
   oxygen storage tanks, 168  
 Beeler, De E., 20, 22, 208  
 Behavioral sciences, 37  
 Belgium, 32  
 Be Lieu, Kenneth, 212  
 Belka, 53  
   *See also* Dogs.  
 Bell Aircraft Company, 7  
 Bell Aircraft Corporation, 37  
 Bell Dyna-Soar. *See* Spacecraft configurations.  
 Bellman, Donald R., 63, 211  
 Bennett, James A., 218  
 Bermuda, 140  
 Berry, Secrest L., 212  
 Bertram, Emil P., 217, 220, 221  
 Bickle, Paul F., 56, 63  
 Bioinstrumentation, 41, 53  
   blood pressure, 53  
   breathing, 53  
   heart, 53  
 Biological investigations, 37  
   specimens, 53  
 Biomedical flight program, 94  
 Biotechnology, 94  
 Bird, John D., 34, 36, 65, 81, 86, 91, 115, 144  
 Black, Dugald O., 218  
 Blacksburg, Va., 183  
   lunar exploration conference, 183  
 Blake, John, 69  
 Bland, William M., 214  
 Blaw Knox Company, 109  
   antenna feasibility and design studies, 109  
 Blunted cone (RVX). *See* Spacecraft configurations.  
 Bode, H. W., 207, 208  
 Boeing Airplane Company, The, 37, 101  
   bid on feasibility study, 57  
   bid on LEM, 186  
   invited to bid on LEM, 171  
 Boeing Company, The, 134  
   contract from NASA for S-1C stage, 130, 133, 139  
   familiarization, 139  
   indoctrination, 139  
   planning, 139  
   selection as prime contractor, 139  
   follow-on contract  
   design, 139  
   development, 139  
   launch operations, 139  
   manufacture, 139  
   test, 139  
   contractor for stage integration of Saturn C-5, 134  
 Boilerplate (BP) 1  
   accepted by NASA, 187  
   delivered to NAA Engineering Development Lab-  
   oratory for land and water impact tests, 187  
   heatshield, 180  
 Boilerplate (BP) 3  
   cabin interior arrangement, 187  
   shipped to MSC, 187  
 Boilerplate (BP) 6, 193  
   pad abort test scheduled, 193  
 Boilerplate (BP) 25  
   one-fourth-scale impact test, 180  
   delivered to MSC for tests, 183  
   flotation, 183  
   handling, 183  
   towing, 183  
   water recovery, 183  
   water stability, 183  
 Boilerplate program, 131, 152, 177  
 Bond, Aleck C., 100, 214, 221  
 Bonestell, Chesley, 6  
 Booster Evaluation Committee, 20, 29, 209



## Boosters

- Atlas, 7, 132, 140, 160
  - Atlas-Able, 65
  - Atlas-Agena B, 35, 135, 154
  - Atlas-Centaur, 35
  - Atlas D, 139
  - clustered engine, 2, 8, 12, 13
    - 1.5 million pounds of thrust, 2, 8, 9
  - Juno V, 2, 12, 16
  - Jupiter-C, 9
  - Little Joe, 141
  - Little Joe II, 131, 141
  - Little Joe Senior, 94
  - Nova, 14, 22, 25, 47, 96, 98, 99, 105, 106, 155, 176
  - Redstone, 87, 100
  - Saturn, 10, 12, 16, 22, 24, 26, 46, 47, 54
    - development, 31
  - Scout, 35, 139
  - single-engine, 13
  - Thor-Able, 12, 13, 14
  - Thor-Delta, 35
  - Titan, 20
  - Titan II (modified), 132
  - Titan-C, 20, 29
  - See also* names of each; Appendix 4, 224-227; and Appendix 7, 234-235.
  - Borman, Frank, 189
  - Braham, H., 110
  - Bramlet, James B., 118, 221
  - Brandner, Friedrich W., 221
  - Brashears, Robert R., 215
  - Brewer, Gerald W., 217
  - Briggs, Thomas W., 218
  - Briskman, Robert D., 212, 213
  - Brissenden, Roy F., 115
  - British Interplanetary Society, 6
  - Brooks Air Force Base, Tex., 167
  - Brown, B. Porter, 217
  - Brown, Clinton E., 65, 68, 98, 147
  - Brown, Harvey H., 207
  - Brownsville, Tex., 105
  - Brucker, Wilber M., 14, 32, 53
  - Bruns, Rudolph H., 220
  - Bryan, Frank, 221
  - Buckheim, Robert W., 208
  - Bundy, McGeorge, 154
  - Burlage, Henry, Jr., 211
  - Busch, Arthur M., 215
  - Business Assessment Panels, 218
    - for evaluation of proposals for Apollo spacecraft, 107
    - members appointed, 107
  - Business Subcommittee, 217
    - for evaluation of proposals for Apollo spacecraft, 107, 114
    - members appointed, 107
  - Butler, Earl M., 219
  - Butler, George, Jr., 221
- C**
- C-133A, 191
  - Cabin, 173
    - atmosphere, 107, 178
    - decompression, 107, 123
    - pressure regulator, 177
  - "Caboose" (space laboratory), 40
  - California Institute of Technology, 14, 17, 200
  - Callaway, R. C., Jr., 8, 12
  - Cameras, 29, 108, 178, 182, 190
    - 16-mm, 178
    - 70-mm pulse, 178
    - by Eastman Kodak Company, 21
    - location, 178
  - Camp Irwin, Calif., 14
  - Canoga Park, Calif., 15
  - Canright, Richard B., 54, 80, 118, 210, 213, 221
  - Cape Canaveral, Fla., 94, 115, 116, 155, 156, 171, 191
    - Cape Canaveral, off-shore, 65, 105
    - Cape Canaveral, on-shore, 105
    - facilities extended, 23, 77, 108
    - possible direct ascent launch site, 105
  - Capsule, 32
    - size, 24
    - weight, 24, 32
  - Capsule-laboratory spacecraft, 32, 33
    - weight, 33
  - Carbon dioxide, 41
  - Carley, Richard R., 210, 215
  - Carley, William J., 64
  - Carpenter, M. Scott, 19, 160, 161, 216
  - Carter, David L., 100, 214
  - Case Institute of Technology, 12
  - Casey, Francis W., Jr., 216
  - Cedar Rapids, Ia., 134
  - Centaur, 16, 26, 29
    - assembly in earth orbit, 24
    - modified, 32
  - Chamberlain Hotel, 114
  - Chamberlin, James A., 23, 31, 44, 93, 104, 105, 109, 214, 221
  - Chambers, Thomas V., 215
  - Chance Vought Corporation, 27, 38, 73
    - awarded contract by MSFC to study launching of manned exploratory expedition from earth orbit, 73
    - bid on feasibility study, 57
    - company-funded study (MALLAR), 36, 44
    - participated in Apollo spacecraft bid, 101, 114
    - selected by NASA Hq to study spacecraft rendezvous, 141, 144
      - briefed by Langley Research Center personnel on lunar orbit rendezvous, 144
    - See also* Ling-Temco-Vought, Inc.
  - Charyk, Joseph V., 75, 209
  - Chauvin, Leo T., 18, 211
  - Cheatham, Donald C., 211, 217
  - Chemical analysis equipment, 73
  - Chile, 32
  - Chilton, Robert G., 41, 45, 62, 65, 69, 105, 118, 209, 214, 215, 220
  - Christmas Island, Pacific Ocean, 105
  - Chrysler Corporation, 37
    - contractor for stage integration of Saturn C-1, 134
    - selected to build 20 first stage boosters, 119
  - Cicolani, Luigi, 215
  - Circumlunar flight, xiii, 5, 6, 11, 44, 48, 56, 67, 87, 93, 101, 144
    - manned, 15, 17, 35
  - Circumlunar mission, iv, 24, 31, 35, 44
  - Circumnavigation, lunar, 62
  - Cislunar flight, 38
  - Cislunar space, 41, 45
  - Clarke, Arthur C., 6
  - Clarke, Victor C., Jr., 64, 211
  - Clauser, Milton U., 207
  - Clemence, Raymond R., 141
  - Cleveland, O., 168, 170
  - CM. *See* Command module.
  - Cohen, Aaron, 220
  - Cohen, Jack, 63
  - Cohen, William, 211
  - Collins, Daniel D., 219
  - Collins, Matthew R., Jr., 100, 214
  - Collins Radio Company, selected by NAA for Apollo spacecraft telecommunications system, 134

- Command module (CM), 93, 101, 102, 103, 128, 147, 152, 170, 179, 183, 184, 185, 199  
 aft compartment, 176, 198  
 camera system, 182  
 center of gravity, 179, 198  
 configuration design work, 135, 157  
 crew couches, 41, 122, 140, 164, 198, 200  
 design configuration change, 157, 179  
   forward compartment, 157  
 design selected, 50  
 earth landing system, 103, 122  
 environmental control system, 157, 187  
   changes, 157, 199  
 flotation studies, 178  
 hatches, side wall, 136, 164, 183, 198  
 heat exchanger, 103, 159  
 heatshield, 136, 176-179, 200  
   requirements, 136, 177  
 humidity, 103, 164  
 increase in system weight and volume, 136, 183  
 interface problems, 177, 178  
 launch escape system, 103  
 mockup, 152, 162  
   first public showing, 152  
   ordered, 135  
   received by MSC (interior arrangement), 188  
 paraglider compatibility, 136  
 preliminary mockup, 151  
 radiation protection (water), 103, 136, 157  
 reaction controls, 183  
 reduction in diameter, 136  
 redundant propellant tankage, 136  
 reentry, 179  
 seating arrangement, 58, 164  
 shirtsleeve atmosphere, 136  
 specifications, iv  
 structure, 103, 122, 136, 161, 190  
 survival environment, 182  
 weight, 55, 56, 82, 157, 165, 176, 177, 190, 192  
*See also* Apollo spacecraft and Spacecraft.
- Command module-lunar excursion module (CM-LEM), 172  
 docking and crew transfer operations study, 187
- Committee on Aerodynamics, 7  
*See also* National Advisory Committee for Aeronautics.
- Committee on the Peaceful Uses of Outer Space, 33, 133
- Committees. *See* Appendix 2, 207-222.
- Communications, 5, 41  
 deep-space network, 41  
 direct link, 152  
   earth to lunar excursion vehicle, 152  
   earth to spacecraft, 152  
 ground tracking network, 41  
 telemetry, 41, 182  
 television, 41, 152, 182  
 voice, 41, 152, 182
- Communications and instrumentation system, 66, 103, 125, 126  
 communications subsystems, 103, 126, 199  
   altimeter and rendezvous radar, 104, 126  
   deleted, 182  
   antennas, 104, 126  
   C-band transponder, 104  
   deep-space communications, 103  
   HF/VHF recovery subsystem, 104  
   intercommunication system, 103  
   minitrack beacon, 104  
   near-field transceiver, 104  
   radio recovery aid, 126, 182  
   telemetry, 103, 126  
   television, 104, 126  
   tracking transponder, 126  
   VHF transmitter and receiver, 103, 199  
   voice communications, 126  
 instrumentation subsystems, 104, 126  
 auxiliary instrumentation  
   calibration, 126  
   cameras, 104, 126  
   clock, 104, 126  
   telescope, 104, 126  
 data disposition, 104, 126  
   onboard recorders, 104, 126  
   telemetry, 104  
 panel display indicators, 126  
 sensors, 104, 126
- Communications satellite, 35  
 worldwide, 91
- Complex 34, 23, 94
- Complex 39, 161, 171
- Computers, 58, 119, 195  
 digital, 79, 160, 200  
 displays and interfaces, 119  
 guidance, 41, 119, 133, 180 192  
   logic design, 119  
   programming, 119
- Honeywell 1800 electronic, 180
- onboard, 79, 166, 180  
 microcircuit, 166
- Configurations, 45, 68, 74
- Congress, xi, 2, 11, 38, 47, 50, 67, 77, 88, 135
- Conlon, John W., 215
- Connell, Harvey A., 64, 211
- Conrad, Charles, Jr., 189
- Control, 58, 68, 73, 152
- Controlled land recovery, Mercury Mark II objective, 132
- Controls and displays, 162
- Convair/Aeronautics Division, 37, 68, 71, 72, 74, 76, 77, 98, 99  
 bid on feasibility study, xi, 57  
 final report submitted, 77, 88  
 first technical review, 65  
 selected for Apollo spacecraft feasibility study, 50, 59  
*See also* General Dynamics Corporation.
- Cooney, Thomas V., 63, 211
- Cooper, L. Gordon, Jr., 19, 217
- Cooper, Paul T., 208
- Corbett, Wayne W., 218
- Cornag, Robert, 207
- Cornell Aeronautical Laboratory, Inc., bid on feasibility study, 57
- Corson, Dale R., 207
- Cosmic noise, 143
- Cosmic rays, 46  
 influence on living beings, 46, 76
- Couch, 123, 140, 164  
 design, 41, 140  
 position, 140, 164
- Crane, Robert M., 22
- Crew environment, 167
- Crew systems  
 couches, 103, 140, 157, 164  
 emergency equipment, 123  
   personal parachutes, 123, 141, 190, 198  
   postlanding, 123  
     first aid supplies, 123  
     food, 123  
     location aids, 123  
     three-day water supply, 123  
     three-man liferaft, 123  
 exercise equipment, 123, 190  
 lightweight cap, 123  
 medical instrumentation, 123  
 sanitation area, 103  
 "shirtsleeve" garments, 123



- shock mitigation devices, 103
  - support and restraint systems, 103
  - Crew Systems Division, 201
  - Radiation Branch, 201
  - See also* Manned Spacecraft Center.
  - Crew training, 93
  - equipment, 191
    - mission simulators, 191
    - part-task trainers, 191
    - special purpose simulators, 191
  - Mercury Mark II objective, 132
  - Crichton, Frank M., 217
  - Crossfield, A. Scott, 208
  - Crowley, John W., Jr., 7, 18, 20
  - Cryogenic fuels, 67
    - storage in space, 5, 24, 27, 33, 79
    - absorptivity, 27
    - emissivity, 27
  - Cumberland, John I., 209
  - Cumberland Island, Ga., 105
  - Cummings, Clifford I., 44
  - Curran, John M., 217
  - Cushman, Ralph E., 218
  - Cylindrical laboratory, 33
- D**
- D-2. *See* Spacecraft configurations.
  - Dahm, Werner K., 64, 211
  - Dalby, James F., 211
  - Data and computation, 191, 197
  - Davenport, Wilbur B., Jr., 208
  - Davis, Leighton I., 96, 105
  - Day, Richard F., 215
  - de Bey, L. G., 208
  - Debus, Kurt H., 96, 105, 218
  - Debus-Davis Committee, 118
  - Decompression, 41, 107, 167
  - Deep space, iii
    - probes, 19
  - Deep Space Instrumentation Facility, 75, 143, 177, 199
    - power amplifier, 177
    - "S" band capability added, 143
    - transponder, 177
  - Deep space tracking stations, 14, 41
    - Goldstone, Calif., 14, 19, 109, 143
    - Hartebeesthoek, South Africa, 109
    - Krugersdorp, South Africa, 55
    - Woomera, Australia, 19, 109, 143
  - DeFrance, Smith J., 62, 65
  - DeFries, Paul J., 114, 138, 147, 213, 221
  - DeLeon, Catherine A., xiv
  - Dell, Melvin, 220
  - Delta V (rate of incremental change in velocity), 166
    - requirements established by ASPO, 166
  - DeMar, Norman E., 63, 211
  - Dempsey, James R., 207, 208
  - Denitrogenation, 107
  - Department of Defense (DOD), 9, 13, 16, 17, 91, 120
    - Director of Defense Research and Engineering, 32, 100
    - Deputy, 99, 100, 133
    - Mercury Mark II responsibilities, 133
  - Development and test plan, 127
    - design information and development tests, 127, 192
    - flight missions, 127, 192
    - major development flight tests, 127, 192
    - major ground tests, 127
    - quality, reliability, and integration tests, 127
  - Development Operations Division, 31, 38
    - transferred to NASA, 38
    - See also* Army Ballistic Missile Agency.
  - Digesu, Fred E., 138, 221
  - Dipprey, Duane F., 64, 211
  - Direct ascent, iv, 6, 16, 25, 26, 28, 33, 50, 51, 66, 67, 68, 74, 76, 107-110, 120, 132, 144, 168, 170, 176
    - launch vehicles, 105, 155, 168, 176, 196
    - Nova configurations, 105, 120, 155
    - Saturn C-8 proposal, 161
  - Discoverer XVII*, 60
    - launched into polar orbit, 60
  - Disher, John H., 22, 25, 42-44, 46, 56, 57, 60, 80, 93, 118, 210, 212, 217, 221
  - Displays, 41
  - Dixon, Thomas F., 197
  - Docking, 198
    - methods, 150, 187
      - lunar orbital, 187
      - translunar, 187
    - requirements, 161, 187
    - design and functional simplicity, 187
    - maximum docking reliability, 187
    - maximum visibility, 187
    - minimum docking time, 187
    - minimum weight, 187
  - DOD. *See* Department of Defense.
  - DOD-NASA Large Launch Vehicle Planning Group. *See* Golovin Committee.
  - DOD-NASA Saturn Ad Hoc Committee, 208
  - Dodgen, John A., 81, 115, 216
  - Dogs, 76, 77
    - Belka, 53,
    - Strelka, 53
  - Dolan, Thomas E., 27, 36, 44
  - Donegan, James J., 139
  - Donlan, Charles J., 23, 31, 36, 56, 60, 62, 63, 64, 69, 70, 98, 210
  - Donnelly, Paul C., 217, 220
  - Douglas Aircraft Company, Inc., 37, 73, 133, 183
    - awarded contract by MSFC on manned exploratory expedition launched from earth orbit, 73
    - bid on Apollo spacecraft feasibility study, 57
    - bid on lunar excursion module, 186
    - contract to modify S-IVB stage for Saturn C-1B program, 113
    - invited to bid on lunar excursion module, 171
    - participated in Apollo spacecraft bid, 101, 114
    - reported air transport of S-IV stage feasible, 85
    - selected to build Saturn C-1 S-IV stage, 43
    - selected to develop S-IVB stage of Saturn C-5, 130, 180
  - Douglas, James H., 32
  - Downey, Calif., 141, 143
  - Downhower, Walter J., 213
  - Drake, Hubert M., 63, 208, 210, 213, 214
  - Draper, C. Stark, 27, 43, 108
  - Drill, to sample lunar soil, 73
  - Dryden, Hugh L., 12, 15, 17, 48, 74, 75, 108, 166, 207, 209
  - Ducander, Charles F., 75
  - Duckett, Carl E., 208
  - Dynamic pressure, Little Joe 5B, 85
  - Dyna-Soar program, 20, 22, 75, 152
    - planned MSFC participation, 113
    - post-Dyna-Soar program, 75
- E**
- Eagle Picher Company, 193
    - selected as subcontractor for zinc-silver oxide batteries, 193
  - Earth landing system, 103, 153
    - 3 landing parachutes, 103
    - FIST-type drogue parachutes, 122, 182
    - parachute risers, 103
    - ribbon drogue parachute, 103, 198
  - Earth-moon trajectory, 17



- Earth orbit, 5, 24, 33, 48, 147  
 qualification flights, 39, 168  
 schedule, 39
- Earth orbit rendezvous, iv, v, 6, 24, 33, 36, 50, 65, 66, 74, 82, 86, 120, 137, 140, 144, 168, 170, 176, 179, 196, 197  
 Lundin Committee preference, 95  
 meeting at NASA Hq, 138, 139  
 MSFC to study, 107  
 multiple launchings of Saturn C-2 required, 74, 82
- Earth orbital assembly, 25, 33  
 operational problems, 96
- Earth orbital missions, 39  
 low-altitude, unmanned reentry flights from super-orbital velocities, 101, 147  
 spacecraft weight, 39  
 to test Apollo spacecraft, 130
- Earth parking orbit, 120, 147
- Earth satellite mission, 31
- Eastman Kodak Company, 21
- Eccentric earth orbit, 29, 73
- Edwards Air Force Base, Calif., 75, 78
- Edwards, Fred G., 219
- Edwards Rocket Site, Calif., 161  
 F-1 engine firing, 161
- Eggers, Alfred J., Jr., 20, 22, 25, 26, 207, 208, 213
- Eggleston, John M., 64, 81, 210, 215
- Egress, crew, 30, 182, 183  
*See also* Hatches.
- Ehricke, Krafft A., 207
- Eiband, A. Martin, 218
- Eickmeier, Alfred B., 45, 209, 216, 219
- Eisenhower Administration, 77
- Eisenhower, President Dwight D., 11, 12, 14, 31, 32, 35
- El Centro Naval Air Facility, Calif., 180, 183, 191  
 Apollo drop-test program, 180  
 Gemini drop-test program, 180
- Electrical power, 192  
 primary source, 84, 192
- Electrical power system, 103, 124, 125  
 display and control panel, 103, 124  
 fuel-cell modules, 103, 124, 125, 192  
 fuel equipment  
 control, 103, 124  
 distribution, 124  
 heat exchangers, 124  
 radiators, 124  
 silver-zinc batteries, 103, 124, 125, 192, 193  
 requirements, 103, 124
- Electronic Data Processing Division, 180  
 furnished Honeywell 1800 electronic computer to MIT Instrumentation Laboratory, 180  
*See also* Minneapolis-Honeywell Regulator Company.
- Ellington Air Force Base, Tex., 186
- Elliptical cone vehicle, 71
- Emergency detection system, 192
- Enderson, Lawrence W., Jr., 27
- Engineering satellite, 33
- Engines  
 F-1, 2, 75, 120, 161, 164  
 H-1, 46, 76, 155  
 J-2, 46, 109, 113, 120, 161, 164  
 LR-115 (Centaur), 77, 113  
 LR-119, 76  
 liquid-hydrogen and liquid-oxygen, 32, 46, 99, 109, 127  
 lunar takeoff, 24  
 M-1, 120, 161  
 main, service module, 184  
 rocket, liquid-fueled, 2  
 variable thrust (descent), 27  
*See also* names of each.
- England, 6
- Entry corridor, 27
- Entry vehicle, 57
- Environmental control system, 103, 124, 125, 154, 164, 199  
 AiResearch Manufacturing Company named to design and build, 134  
 to provide shirtsleeve environment, 103  
 cabin atmosphere, 103, 167  
 carbon dioxide removal, 41, 103, 124  
 heat rejection, 158, 168  
 humidity control, 103, 124  
 pressure control, 103, 124  
 temperature control, 103, 124  
 toxic gas removal, 41
- Environmental satellite, 22, 28
- Erb, R. Bryan, 45, 209
- Escape rocket motor  
 200,000-pound-thrust, 138  
 contract to Lockheed Propulsion Company, 138  
 solid-propellant motor, 138
- Escape system, 94, 95  
 Little Joe 5B, 85
- Escape velocity, 13, 14, 68
- Escher, William J. D., 213
- Esgar, Jack B., 63, 211
- Evaluation Board (spacecraft feasibility studies), 56, 210  
 findings, 59  
 members, 56  
 recommendations, 59
- Evans, James S., 218
- Executive Committee. *See* National Advisory Committee for Aeronautics.
- Experiments, 123  
 chemical, 5  
 Mercury follow-on, 29  
 physical, 5  
 scientific, 80
- Exploration of solar system, 67
- Exploration of space, 88, 188
- Explorer I*, launched, 2, 9
- Extraterrestrial life forms, 37
- Extravehicular activity, 5, 123
- Extravehicular space suit design, 166  
 shipped to Vought Astronautics, 166  
 thermal coverall, 166

## F

- F-1 engine, 28, 120, 133, 134, 161  
 accelerated funding proposed, 99  
 contract awarded to Rocketdyne, 2, 167  
 design, 2  
 development, 2, 47, 164  
 fired at full power, 17, 161  
 thrust chamber  
 static test at Edwards, 75, 78, 161
- Facilities Division, 180  
*See also* Manned Spacecraft Center.
- Faget, Maxime A., 20, 22, 23, 31, 36, 40, 44, 54, 56, 62, 66, 93, 94, 98, 104, 105, 143, 207, 208, 210, 211, 212, 214, 221
- Fairchild Controls Corporation, 166  
 microcircuit manufacturer, 166
- Feasibility study (spacecraft), 56, 59, 64, 65, 66, 68, 70-74, 77, 89, 90  
 bidders briefing, 54  
 contractor proposals, 57  
 contractors selected, 59  
 final reports submitted, 87  
 midterm review, 76  
 objectives announced, 54  
 Request for Proposal, 54  
 timetable, 54
- Felder, James T., 220

INDEX

- Fellows, Robert, 212  
 Feltz, Charles H., 127  
 Ferdman, Saul, 65, 137  
 Ferguson, Richard B., 45, 209, 211, 216  
 Ferry rocket, 42  
 Fichtner, Hans J., 219  
 Fielder, Dennis E., 211, 216, 220  
 Finegan, Charles J., 218  
 Fire hazards, 185  
 First Symposium on Space Flight, 6  
 Fiscal Year 1960, 19, 23, 32, 35  
 Fiscal Year 1961, 35  
 Fiscal Year 1962, 35, 55, 67, 84, 140  
     budget presentation to Congress, 91  
     lunar program, 35, 67  
 Fiscal Year 1963, 84, 140, 160, 180, 186  
 Fiscal Year 1964, 140, 161  
 Fiscal Year 1965, 161  
 Fiscal Year 1966, 113, 161  
 Fiscal Year 1967, 161  
 Fiscal Year 1968, 23, 75  
 Flat-bottomed lifting vehicle, 71, 72  
 Flat-face cone, 71  
 Flax, Alexander H., 207  
 Fleming Committee, 50, 85, 91, 118, 212  
     report submitted, 95  
     facilities, 50  
     launch vehicles, 50, 96  
     *See also* Ad Hoc Task Group for a Manned Lunar Landing Study.  
 Fleming, William A., 80, 85, 98, 212, 213  
 Flickinger, Don D., 208  
 Flight Mechanics Panel. *See* Technical Assessment Panels.  
 Flight path control, 102, 121  
 Flight research and development instrumentation system, 172  
     lunar excursion module, 172  
 Flight Research Center, 18, 20, 43, 45, 56, 62, 63, 78, 197  
 Flight simulators, 13  
 Flight summary. *See* Appendix 4, 224-227.  
 Flight Systems Division  
     Apollo Project Office formed, 50  
     fix design constraints for Apollo spacecraft, 55, 57  
     in-house design study, 57  
     Flight Vehicles Integration Branch, 94  
     Organization chart, 231  
     *See also* Space Task Group.  
 Flight tests, 159  
     Little Joe II, 153, 160  
     program, 181  
         suborbital, 153, 160  
     SA-1, 46  
     SA-2, 155, 156  
 Flight Vehicles Integration Branch. *See* Flight Systems Division.  
 Food, 123  
     dehydrated, 123  
     freeze-dried, 123, 192  
     reconstitution bags, 185  
         design criteria, 185  
 Ford Motor Company, 43  
     Aeronutronic Division, 43  
 Fort Davis, Tex., 10  
 Foster, Ross J., 70  
 France, 10, 32  
 Franklin, Marion R., Jr., 142, 216  
 Franz, Julius, 195  
 Freedom 7, 87,  
     first U.S. manned space flight, 87  
     launched, 87  
     recovery, 87  
     *See also* Spacecraft, U.S.  
 Freitag, Robert F., 208  
 Freiwirth, Paul K., 27  
 French, John C., 217  
 Freon, 178  
 Frick, Charles W., 135, 140, 142, 167, 168, 197  
 Friendship 7, 140  
     first U.S. manned orbital flight, 140  
     launch, 140  
     recovery, 140  
     *See also* Spacecraft, U.S.  
 Fuel cell, 40, 85, 103, 125, 143, 154, 168, 185, 192, 199  
     contract for development to Pratt & Whitney, 84, 143  
 Gemini, 199  
     heat rejection, 164  
     liquid-hydrogen, liquid-oxygen, 84, 168, 192  
     potable water, 192  
     progress reviewed, 143  
     radiators, 164, 185  
 Funding. *See* Appendix 5, 228-229.  
 Funk, Jack, 28, 45, 147, 209, 211, 215  
 Furman, Jack H., 219
- G**
- Gagarin, Yuri A. (cosmonaut, *Vostok I*), xi, 50, 81  
 Gantry, 94  
 Gardiner, David B., Jr., 219  
 Gardner, Trevor, 212  
 Garrett Corporation, AiResearch Manufacturing Company, 134  
 Gas-jet pistol, 7  
 Gates, Sally D., xiv  
 Gavin, Joseph M., 137  
 Geissler, Ernst D., 138, 147, 221  
 Gemini Program, iii, xiii, 192  
     rendezvous operations, 139, 171  
     to provide Apollo related experience, 139  
 Gemini Project Office, 180  
     *See also* Manned Spacecraft Center.  
 General Dynamics/Astronautics, participated in Apollo spacecraft bid, 113  
 General Dynamics/Convair, 101, 135, 160, 190  
     awarded contract to design and manufacture Little Joe II, 130, 160  
 General Dynamics Corporation, 57  
     bid on lunar excursion module, 186  
     Convair/Astronautics Division, 71, 76, 99  
     invited to bid on lunar excursion module, 171  
 General Electric Company, 64, 71, 72, 76, 98, 99  
     bid on spacecraft feasibility study, xi, 57, 89, 90  
     final report submitted, 87, 88  
     Missile and Space Vehicle Department, 64, 89, 90, 114  
     participated in Apollo spacecraft bid, 101, 114  
     selected for Apollo spacecraft feasibility study, 50, 59  
     selected  
         to develop and operate a checkout system, 138  
         to ensure reliability of the total space vehicle, 138  
         to provide integration analysis of total space vehicle, 138  
 General Motors Corporation, AC Spark Plug Division, 160  
 Gilbert, David W., 142  
 Gill, William L., 201, 216  
 Giller, Edward B., 208  
 Gilruth, Robert R., 14, 23, 31, 36, 39, 43, 44, 45, 54, 56, 87, 93, 98, 105, 107, 111, 112, 113, 118, 132, 134, 138, 161, 165, 167, 183, 189, 198, 207, 208, 210, 218, 221, 222  
 Glasser, Otto J., 100, 214  
 Glassman, L. H., 213



- Glenn, John H., Jr., xi, 19, 130, 140, 217  
 Glennan, T. Keith, 12, 14, 15, 19, 29, 32, 35, 42, 47, 54, 209  
 Glossary of Abbreviations. *See* Appendix 1, 205.  
 Goddard Space Flight Center, 21, 34, 36, 45, 47, 48, 53, 61, 139, 147, 197  
   industry briefing, 48, 50, 53  
 Godman, Robert R., 211  
 Goerner, Erich E., 64, 211  
 Goett Committee, iii, xi, 2, 208  
   *See also* Research Steering Committee on Manned Space Flight.  
 Goett, Harry J., 18, 22, 25, 31, 36, 45, 47, 53, 56, 208, 209, 210  
 Golden, Harvey, 216, 219  
 Goldstone, Calif., 109  
 Goldstone Tracking Facility, 14, 41, 109, 143  
   contact with *Ranger IV*  
 Golovin Committee (DOD-NASA Large Launch Vehicle Planning Group), 100, 107-108, 110, 115, 118, 214  
   established, 99, 100  
   responsibilities  
     guidance and control, 100  
     instrumentation, 100  
     large launch vehicle systems, 100  
     launch vehicle configurations, 100  
     propulsion elements, 100  
 Golovin, Nicholas E., 36, 100, 214  
 Goodman, Robert R., 63  
 Goodwin, Glen, 62, 211, 215  
 Goodyear Aircraft Corporation, 101  
   bid on spacecraft feasibility study, 57  
 Gorman, Robert E., 220  
 Gornason, R. Fabian, 207  
 Government-furnished equipment, 171, 172  
 Grana, David C., 27  
 Granfield, Allen L., 218  
 Graves, Wallace D., 142  
 Gray, Wilbur H., 217  
 Great Britain, 32  
 Grimwood, James M., xiv, 7, 60  
 Grissom, Virgil I., 19, 100, 167, 215  
 Ground operational support system, 101  
 Ground Operational Support Systems and Operations Panel. *See* Technical Assessment Panels.  
 Ground support equipment, 176, 177  
 Ground tracking network, 139  
 Ground tracking station, 139  
 Group for Configurations and Aerodynamics, 71, 78  
   Center activities presentations, 78  
   configurations under study reviewed, 71  
   recommendations, 71  
   *See also* Apollo Technical Liaison Groups.  
 Group for Guidance and Control, 71, 73  
   changed name to Group for Navigation, Guidance and Control, 80  
   suggestions for research and development  
     abort guidance sequence, 73  
     "absolute emergency" navigation system, 71  
       Land camera, 71  
       slide rule, 71  
     adequate guidance and control concept, 71  
     application of Surveyor equipment, 71  
     development of ground display mission progress evaluation, 73  
     effects of artificial g configuration on observation and guidance, 73  
     effects of lunar impact on return navigation equipment, 71  
     problems of planet tracking, 71  
     radio ranging to reduce accuracy requirements, 71  
     study of effect of onboard machinery on attitude alignment and control requirement, 71  
     study of guidance and navigation system hardware drift-error, 71  
   *See also* Apollo Technical Liaison Groups.  
 Group on Heating, 68, 78  
   heat protection system, 78  
   investigation of radiant heat inputs and effects on heatshield, 68  
   *See also* Apollo Technical Liaison Groups.  
 Group on Human Factors, 69, 78, 79  
   recommended  
     experiment suggestions from scientific community, 69, 78  
     radiation dosage design limit, 79  
   reviewed investigations at NASA Centers, 69  
   *See also* Apollo Technical Liaison Groups.  
 Group for Instrumentation and Communications, 79  
   discussed material for Apollo spacecraft specifications, 79  
   discussed working guidelines  
     antenna pointing information, 79  
     deep-space communications requirements, 66  
     digital computer, 79  
     instrumentation requirements, 79  
     reentry communications, 79  
     spacecraft instrumentation and communications, 66  
     television, 79  
     temperature environment, 79  
     tracking considerations, 79  
     vehicle reentry and recovery, 79  
   *See also* Apollo Technical Liaison Groups.  
 Group for Mechanical Systems, 80  
   considered NASA Center studies, 66  
     auxiliary power systems, 66, 80  
     chemical, 67  
     environmental control system, 67, 80  
     landing and recovery systems, 80  
     mechanical elements, 66  
     reaction control systems, 66, 80  
   *See also* Apollo Technical Liaison Groups.  
 Group for Navigation, Guidance and Control  
   definitions established  
     control, 80  
     guidance, 80  
     navigation, 80  
   *See also* Apollo Technical Liaison Groups.  
 Group for Onboard Propulsion, 67, 79  
   considered preparation of Apollo spacecraft specification, 79  
   reviewed feasibility study work on  
     bipropellant spacecraft propellant system, 67  
     consideration of all-solid fuel propulsion for circumlunar flight, 67  
     determination of abort propulsion system, 67  
     determination of midcourse propulsion system, 67  
     solid-propellant rocket motors, 67  
     thrust vector control, 67  
   *See also* Apollo Technical Liaison Groups.  
 Group on Structures and Materials, 70, 80  
   considered reports on activities of NASA Centers  
     acoustics, 80  
     heat protection, 80  
     low-level cooling system in reentry module, 70  
     meteoroid damage studies, 70  
     meteoroid protection, 70, 80  
     radiation effects, 80  
     reentry module shapes, 70  
     temperature control of spacecraft, 70  
     vibration, 80  
   reviewed contractors' progress, 70  
   *See also* Apollo Technical Liaison Groups.



INDEX

Group for Trajectory Analysis, 68, 80  
 changed name to Mission Analysis, 80  
 recommendations, 80  
 Van Allen radiation belt model required, 68  
*See also* Apollo Technical Liaison Groups.

Grumman Aircraft Engineering Corporation, 37, 44, 137, 201  
 began company-funded lunar orbit rendezvous feasibility study, 65  
 bid on Apollo spacecraft feasibility study, 57  
 bid on lunar excursion module, 186  
 developed company-funded study on lunar orbit rendezvous technique, 137  
 invited to bid on lunar excursion module, 171  
 participated in Apollo spacecraft bid, 101, 114  
 selected to build lunar excursion module, xi, 130, 201  
 to study unmanned logistic system study, 186

Guardite Division, 57  
 bid on Apollo spacecraft feasibility study, 57

Guidance, 68, 73, 119

Guidance and control system, 19, 68, 102, 147, 159  
 design study, 43  
 MSFC-STG relationships and responsibilities, 69, 99

Guidance and navigation system, 65, 130, 137, 159, 160  
 development, 109  
 further defined, 146, 147  
 MIT selected to develop, 106  
     work statements completed, 106  
 NAA suggested pitch, yaw, and roll rates would permit reduction in reaction control thrust, 182  
 onboard hardware, 41  
 Requests for Quotation, 137  
     released to industry by MIT Instrumentation Laboratory, 137  
     Source Evaluation Board appointed by NASA Hq, 137

Guidance corridor, 27, 161, 162  
 lunar mission reentry, 161  
     zero-lift maneuver, 161

Guidance system studies, 25, 27, 128  
 Apollo guidance requirements, 69  
 retrothrust programming, 27  
 terminal guidance system, 27

Gyro, 113

H

H-1 engine, 115, 155  
 arrived at ABMA, 21  
 long-duration firing, 21  
 static-fired, 38, 39, 42, 43, 46  
 test-fired, 3, 15, 21  
*See also* Engines.

Haase, Walter W., 212, 218

Haber, Heinz, 6

Habib, Edmund J., 210

Hagan, Phyllis R., xiv

Hagen, John P., 15

Half-cone configuration, 71

Hall, Albert C., 87, 208

Hall, Eldon W., 57, 66, 80, 100, 118, 138, 147, 176, 210, 212, 214, 221

Hall, Harvey, 100, 108, 110, 214

Hallissy, Joseph M., Jr., 211, 216

Ham (chimpanzee), passenger on *Mercury-Redstone 2*, 74

Hamilton Standard Division, 130  
 selected as prime contractor for Apollo space suit assembly, 176, 194  
     International Latex Corporation to fabricate pressure garment, 176, 194  
*See also* United Aircraft Corporation.

Hammersmith, John L., 213

Hammock, David M., 118, 211, 215, 221

Hardin, Don, 218

Hardin, John W., Jr., 138

Hardy, James D., 208

Harrington, Robert D., 217

Harris, Emory F., 142

Hartebeesthoek, South Africa, 109  
     deep-space tracking station, 109  
         completed, 109  
         dedicated, 109

Hatches, 173, 187  
     detail drawings prepared, 176  
     egress, 164, 182, 183  
     ingress, 164  
     emergency, study results, 164, 177, 198  
     inward-opening, pull-down concept, 164  
     outward-opening, quick-opening, 164  
     disadvantages  
         complexity, 164  
         required explosive charges, 164, 176  
         weight, 164  
     side wall, 136

Haviland, Robert P., 207

Hayden Planetarium, 6

Hayes, Richard J., 139, 147

Hays, Edward L., 216

Heat, 160, 164  
     exchanger, 103  
     protection, 80, 101

Heating, 45, 58, 68, 74

Heaton Committee, 50, 95, 98, 108, 118, 213  
     established, 95  
     report submitted, 50, 108  
     *See also* Ad Hoc Task Group for Study of Manned Lunar Landing by Rendezvous Techniques.

Heaton, Donald H., 54, 59, 95, 108, 209, 213

Heatshield, 38, 143, 159, 165, 175, 177, 178, 179  
     ablative material, 69, 122, 144, 165  
     aluminum, 177  
     Fiberglas, 177  
     forward, 177  
     overall, 57  
     progress reviewed, 143, 165

Heatshield test, 159  
     at Ames Research Center, 178  
     full-scale Mercury spacecraft, 18  
     lunar reentry speeds, 18  
     modified for experiments, 29

Heat sink, cold space, 99

Heat transfer, 25  
     tests at Langley Research Center, 78

Heberlig, Jack C., xiv

Hebenstreit, W. B., 208

Helicopter, 161  
     recovery of MA-7, 161

Hendrickson, Douglas R., 217

Henry, Richard C., 147

Hermach, Charles A., 62, 211

Hiers, James R., 216

High Speed Flight Station (HSFS), 18, 20, 25, 26, 27

Himmell, Seymour C., 63, 211

Hinson, James K., 216

Hjornevik, Wesley L., 104, 106, 214

Hoag, David G., 108, 118, 128

Hoberg, Otto A., 219

Hodge, John D., 31, 214, 220

Hoelker, Rudolph F., 64, 211, 220

Hoffman, Samuel K., 207

Holleman, Euclid C., 63, 210, 215

Holmes, D. Brainerd, 111, 118-120, 131, 132, 134, 145, 159, 161, 170, 197, 202, 221, 222

INDEX

Horizon sensor, 119  
 experiments, 119  
 Horn, Helmut J., 147  
 Horner, Richard E., 34, 35, 36, 42, 209  
 Hornig, Donald F., 212  
 Hosenthien, Hans H., 220  
 Houbolt, John C., 42, 65, 66, 68, 81, 93, 109, 115, 119,  
 137, 147, 155, 213  
 House of Representatives  
 Committee on Science and Astronautics, 2, 17, 19,  
 35, 47, 75, 81, 145  
   asked manned lunar expedition, 47  
   Subcommittee on Manned Space Flight, 145  
 Select Committee on Astronautics and Space Ex-  
 ploration, 15  
 Houston, Tex., 111, 130, 143, 171, 188, 189  
   selected as site for MSC, 111  
   selected as site for MCC, 171  
 HSFS. *See* High Speed Flight Station.  
 Huber, W. G., 8  
 Hughes Aircraft Company  
   participated in Apollo spacecraft bid, 114  
   selected to build Surveyor spacecraft, 73  
 Human factors, 41, 68, 73, 194, 196  
   guidelines, 41, 196  
   safe radiation dose, 41  
   "shirtsleeve" environment, 41  
   three-man crew, 41  
 Human Factors Panel. *See* Technical Assessment Panels.  
 Hunt, Robert M., 221  
 Hunter, M. W., 207  
 Huntsville, Ala., 12  
 Hurt, Percy, 219  
 Hyatt, A. E., 218  
 Hyatt, Abraham, 36, 98, 207, 209  
 Hydrogen-oxygen systems, 22, 168  
 Hydrag configuration (Avco Corporation), 71  
 Hynek, J. Allen, 208

**I**

IGY. *See* International Geophysical Year.  
 Impact attenuation, 103  
 Inertial guidance system, 84  
 Inertial measurement unit, 113, 159, 165, 192  
 Inertial platform, 41, 160  
 Ingress, crew, 183  
 Institute of Aerospace Sciences, 183  
 Instrument package, 8, 21  
   soft landing on moon, 11  
   with penetration spike, 7  
 Instrumentation, 41  
   monitoring, 41  
   research and development, 27, 101  
   scientific, 101  
 Instrumentation and Communications Panel. *See* Techni-  
 cal Assessment Panels.  
 Instrumentation Laboratory, 27, 62  
   selected for six-month study of navigation and  
   guidance system for Apollo spacecraft, 50, 61  
   selected to develop guidance and navigation system  
   for Apollo spacecraft, 61, 106  
   *See also* Massachusetts Institute of Technology.  
 Instrumented capsule, 44  
   to crash-land on moon, 44  
   with animals, 11  
 Integration of the Saturn and Saturn Application Pro-  
 grams Study Group, 210  
 Intercontinental ballistic missile  
   Titan, 9  
 Interface control documentation, 172  
 International Business Machines Corporation, 195  
   selected to provide ground-based computer sys-  
   tem, 195  
 International Geophysical Year (IGY), 9, 14, 17

International Latex Corporation  
 principal subcontractor to Hamilton Standard Di-  
 vision for Apollo space suit, 176, 194  
 Interplanetary flight, 17  
 Interplanetary rocket, 5  
 Interplanetary travel, 5  
 Irvin, R. C., 219  
 Isbell, Tom, 219

**J**

J-2 engine, 109, 113, 118, 161, 164, 166, 194  
 200,000-pound-thrust, 3, 46, 109, 133  
 accelerated funding proposed, 99  
 C-5 upper stage use, 46, 120, 134  
 Rocketdyne selected to develop, 3, 46, 54, 167  
*See also* Engines.  
 Jackson, Bruce G., 215  
 Jacobson, Lawrence, 218  
 Janokaitis, John 216  
 Japan, 32  
 Jenkins, Lyle M., 219  
 Jenkins, Morris V., 215  
 Jenkins, T. E., 21  
 Jet Propulsion Laboratory (JPL), 9, 17, 18, 20, 32, 34,  
 36, 43-45, 48, 56, 62, 64, 66, 67, 78, 84, 107, 109, 110,  
 143, 147, 197  
   announced construction of first large space simu-  
   lator, 99  
   transferred to NASA jurisdiction, 14  
   wind tunnel tests, 144  
 Jevas, Nickolas, 218  
 Johannesburg, South Africa, 55, 143  
 Johnson, Bryant L., 218  
 Johnson, Caldwell C., 31, 58, 142, 209, 214  
 Johnson, George W. S., 213  
 Johnson, Harold I., 215  
 Johnson, Vice President Lyndon B., 143  
 Johnson, Roy W., 10, 12, 16, 17, 18, 20  
 Johnson, W. Kemble, 23  
 Johnston, Richard S., 167, 211, 215  
 "Joliot-Curie Crater," 195  
 Jonash, Edmund R., 63, 211, 215  
 Joplin, Mo., 192  
 Jordan, Adaron B., 218  
 JPL. *See* Jet Propulsion Laboratory.  
 Juno II, 17  
   launched *Pioneer III*, 141  
 Juno V, 2, 12, 16  
   authority, 12  
   initial funding, 12  
   renamed Saturn, 12  
 Jupiter-C, 9  
 Justice Department, 190  
   Lands Division, 190

**K**

Kampmeier, Heinz W., 64, 211, 219  
 Kaplan, Joseph, 6  
 Kapryan, Walter J., 216  
 Kaser, Eldon W., 218  
 Kavanau, Lawrence L., 100, 214  
 Kavanaugh, Walter W., 220  
 Kazakhstan, U.S.S.R., 118  
 Kehlet, Alan B., 28, 29, 45, 142, 143, 209, 210, 212,  
 214, 215, 217  
 Kelley, Albert J., 195, 212  
 Kemp, John M., 8  
 Kemp, Richard H., 215  
 Kennedy Administration, 69  
 Kennedy, President John F., iv, 69, 74, 77, 81, 88, 137,  
 143, 188, 189, 212  
   assigned DX priority to Apollo program, 130, 152,  
   154



INDEX

proposal to Congress, iv, xi, 50  
 State of the Union message, 135  
 Kiker, John W., 216  
 King, E. W., 220, 221  
 King, Robert L., 36, 42, 55, 209  
 Kingsley, Milton G., 142, 219  
 Kinzler, Jack, 217  
 Kistler, Wallace, 219, 220, 221  
 Kleinknecht, Kenneth S., 105, 212, 214, 217, 221  
 Kloetzer, Paul H., 218  
 Knothe, A. H., 220  
 Knutson, Roy K., 15  
 Kochendorfer, Fred D., 54, 210  
 Koelle, H. H., 8, 33, 56, 63, 112, 210, 212, 213, 221  
 Kollsman Instrument Corporation, 160  
     contract to build optical subsystems, 160  
     navigation display equipment, 160  
     space sextant, 160  
     sunfinders, 160  
 Kopal, Z., 44  
 Koppenhaver, James T., 104  
*Korabl Sputnik I (Sputnik IV)*, 45  
     dummy astronaut, 45  
     guidance system flaw, 45  
     launched, 45  
     pressurized space cabin, 45  
     weight, 45  
     See also Spacecraft, U.S.S.R.  
*Korabl Sputnik II (Sputnik V)*, 53  
     animals, 53  
     communications system, 53  
     launched, 53  
     recovery, 53  
     reentry, 53  
     television camera, 53  
     See also Spacecraft, U.S.S.R.  
*Korabl Sputnik III (Sputnik VI)*, 63  
     animals, 63  
     disintegrated and burned, 63  
     dogs, 63  
     See also Spacecraft, U.S.S.R.  
*Korabl Sputnik VI (Sputnik IX)*, 76  
     launched, 76  
     recovered, 76  
     See also Spacecraft, U.S.S.R.  
*Korabl Sputnik VII (Sputnik X)*, 77  
     launched, 77  
     recovered, 77  
     See also Spacecraft, U.S.S.R.  
 Korycinski, Peter F., 218  
 Kraft, Christopher C., Jr., 143, 214, 217  
 Kranz, Eugene F., 220  
 Krugersdorp, South Africa, 55  
     deep-space tracking facility, 55  
 Kuehnel, Helmut A., 210  
 Kuettner, Joachim P., 220, 221, 222  
 Kuiper, Gerard P., 10, 42, 195  
 Kurbjun, Max C., 65, 81, 115  
 Kurtz, Herman F., 219  
 Kyle, Howard C., 217, 219, 220

L

L-2C. See Spacecraft configurations.  
 Lamps  
     for command module, 199  
     incandescent, 199  
     quartz, 199  
     fluorescent, 199  
 Land acquisition requirements, 190  
 Land, Edwin H., 212  
 Landing  
     and recovery systems, 73

maneuver  
     earth orbit, 25  
     graze and orbit, 25-26  
     reentry approach over pole to lessen radiation exposure, 26  
 point  
     control experiments, 25  
     techniques, 96  
 Lang, Dave W., 104, 214  
 Lang, H. A., 8  
 Lange, Oswald H., 104, 214  
 Langham, Wright H., 208  
 Langley Aeronautical Laboratory, 7  
 Langley Research Center (LaRC), iii, iv, 14, 18, 20, 25, 32, 34, 42, 45, 56, 62, 64-68, 70, 76, 78, 81, 83, 86, 91, 93, 94, 98, 107, 109, 110, 115, 117, 119, 137, 139, 144, 147, 148, 155, 197  
     ballistic range established, 192  
     Lunar Mission Steering Group, 34  
     meteoroid test established, 192  
     simulated spacecraft flight, 105  
     space station subcommittee on rendezvous, 81  
     Theoretical Mechanics Division, 34  
     wind tunnel tests, 144, 198  
 Large Launch Vehicle Planning Group. See Golovin Committee.  
 Large launch vehicle program, 99, 118  
 Laughlin, C. Patrick, 211, 215, 216  
 Launch Complex 34, 23, 94  
 Launch Complex 39, 161, 171  
 Launch escape rocket, 44, 138  
 Launch escape system, 102, 103, 121, 141, 177, 184, 185, 192  
     ASPO requested, 165  
     passive thrust-vector-control system, 165, 184  
     single "kicker" rocket, 165, 184  
     configuration approved, 154  
     120-inch tower, 154  
     aerodynamic skirt, 154  
     escape rocket nozzle, 154  
     jettison motor, 154  
     launch escape motor, 154, 185  
     symmetrical nose cone, 154  
     escape rocket, 44, 138  
     contract to Lockheed Propulsion Company, 138  
     flight tests, 153, 192  
     propulsion system, 103  
     solid-fuel rocket motor, 103  
     motors, 138, 200  
     tower, 152, 177, 184, 200  
     jettison motor, 152  
 Launch facilities, 108, 180  
 Launch Operations Center (LOC), 161, 180, 197  
 Launch Operations Directorate, 99, 118  
 Launch sites, 105  
     considered for direct ascent missions, 105  
     Brownsville, Tex., 105  
     Cape Canaveral (off-shore), 105  
     Cape Canaveral (on-shore), 105  
     Christmas Island, Pacific Ocean, 105  
     Cumberland Island, Ga., 105  
     Mayaguana Island (AMR downrange), 105  
     South Point, Hawaii, 105  
     White Sands Missile Range, N. Mex., 105  
 Launch vehicle studies, 15, 93  
     capability, 68  
     3-million-pound-thrust Nova, 68  
     6-million-pound-thrust Nova, 68  
     pilot control studies  
         analytical, 43  
         simulator, 43  
     requirements, 33



- Launch vehicle systems  
 guidance system, 128  
 emergency switchover from Saturn to Apollo, 128
- Launch vehicles  
 Atlas, 18  
 Atlas-Agena B, 135  
 Atlas-Centaur, 35, 115  
 Centaur, 16  
 Juno V, 16  
 Little Joe, 141  
 Little Joe II, 130, 131, 141, 144, 152, 160  
 Little Joe Senior, 94  
 Nova, 16, 47, 74-75, 96, 119  
 Redstone, 87  
 Saturn, 16, 131  
 Saturn C-1, 96, 193  
 Saturn C-1B, 193  
 Saturn C-2, 74, 95  
 Saturn C-3, 95, 96, 119  
 Saturn C-4, 119  
 Saturn C-5, 119, 135, 193  
 six-stage, 33  
 Titan, 18  
 Titan II, 87, 133  
 Titan III, 119  
 Vega, 16  
*See also* names of each; Appendix 4, 224-227; Appendix 7, 234-235.
- Lee, John B., 50, 73, 143, 211, 218  
 Lee, William A., 147  
 Lees, Lester, 207  
 Leghorn, Richard D., 208  
 Lehrer, Max, 212  
 LEM. *See* Lunar excursion module.  
 Lenticular configuration, 29, 71, 72, 77, 78  
 LEV. *See* Lunar excursion vehicle.  
 Levine, Norman, 217  
 Lewis Aeronautical Laboratory, 10  
 Lewis Research Center (LRC), 18, 20, 24, 25, 26, 33, 44, 45, 56, 62, 63, 66, 67, 70, 84, 85, 138, 147, 197  
 Ley, Willy, 6  
 Liberty Bell 7, 100  
 astronaut recovery, 100  
 launched, 100  
 spacecraft lost, 100  
*See also* Spacecraft, U.S.
- Lick Observatory, 10  
 Lifeline, 7  
 Life sciences, 38  
 research center, 38  
 Life support, 81  
 Lift over drag, 40, 58  
 considerations, 25, 57  
 low lift over drag configurations, 40, 43  
 landing capability studies, 40, 43
- Lifting Mercury, 45  
 Lilly, William E., 134, 222  
 Lincoln Laboratory. *See* Massachusetts Institute of Technology.  
 Lindberg, James P., Jr., 221  
 Lindbergh, Charles A., 135  
 Ling-Temco-Vought, Inc., 114, 141  
 bid on lunar excursion module, 186  
 Chance Vought Corporation, 144  
 invited to bid on lunar excursion module, 171
- Linsley, Edward L., 64, 210, 215  
 Liquid-hydrogen, liquid-oxygen engine, 32, 46, 99, 109, 127  
*See also* Engines.  
 Liquid-hydrogen, liquid-oxygen fuel cell, 16, 24  
 Lithium hydroxide, 103  
 Little Joe 5, 60  
 launched, 60
- Little Joe 5B, 85  
 launched, 85  
 payload, 85
- Little Joe II, 95, 141, 152, 180  
 first vehicle used for qualification, 131, 190  
 General Dynamics/Convair awarded contract, 130, 160  
 NASA Hq approved development plan, 144  
 solid-fuel launch vehicle, 131, 153, 160  
*See also* Boosters and Launch Vehicles.
- Little Joe Senior, 94  
 fin-stabilized solid-fuel rocket booster, 94  
 for flight tests of Apollo reentry vehicle and launch escape system, 94  
 later named Little Joe II, 95  
*See also* Boosters and Launch Vehicles.
- Living organisms  
 effects of planetary environment, 37  
 effects of space environment, 37
- Lockheed Aircraft Corporation, 74  
 awarded contract by MSFC to study feasibility of refueling spacecraft in orbit, 74  
 bid on Apollo spacecraft feasibility study, 57  
 bid on lunar excursion module, 186  
 invited to bid on lunar excursion module, 171  
 participated in Apollo spacecraft bid, 101, 114
- Lockheed Propulsion Company, awarded contract for launch escape system escape rocket, 138
- Loftin, Laurence K., Jr., 20, 22, 25, 98, 208, 213  
 London, England, 28, 30  
 Long duration, xiii, 132, 188  
 mission, 41
- Longfelder, Harlowe J., 207  
 Long-range planning, 18  
 Lord, Douglas R., 139, 147  
 LOR. *See* Lunar orbit rendezvous.  
 Los Angeles, Calif., 44, 59, 134  
 Los Angeles Harbor, 180  
 Love, Eugene S., 64, 210, 215  
 Lovelace Foundation, space medicine symposium, 7  
 Lovelace, W. Randolph, II, 207, 208  
 Lovell, James A., Jr., 189  
 Low Committee, 66, 73, 74, 212  
 final report, 50, 74  
 NASA position paper, 67  
*See also* Manned Lunar Landing Task Group.
- Low, George M., 20, 22, 23, 25, 45, 48, 54, 56, 57, 60, 66, 73, 75, 93, 98, 104, 134, 143, 208, 210, 212, 213, 222
- LR-115 engine, 113  
 15,000-pound-thrust, 113  
 replaced in S-IVB stage, 113  
*See also* Engines.
- LR-119, 77, 113  
*See also* Engines.
- Lucas, John W., 64, 211  
 Luft, Ulrich C., 208
- Lunar and Planetary Laboratory, 195  
 analysis of *Lunik III* photos, 195
- Lunar  
 approach, 164  
 base, 110, 196  
 permanent, 8  
 base supply, 33  
 unmanned, 33  
 "bus," 179, 180  
 charts, 13, 42  
 published by Air Force, 42  
 circumnavigation, 33  
 manned, 17
- Lunar Analysis and Mapping Program (Project LAMP), 15  
 Lunar-Earth Return Vehicle, 37

INDEX

- Lunar excursion module (LEM), 154, 161, 163, 165, 168, 172, 179, 181, 184, 196
    - cabin environment, 173
    - crew exploration in vicinity of touchdown, 173
    - flight configuration, 163, 173, 184
      - docked, 173
      - stowed in adapter, 173
    - Grumman selected to design and develop, 130
    - industry proposals received, 130, 186
    - invitations to bid issued, 130, 171
    - maneuver capabilities
      - ascent, 172, 173
      - docking, 172, 173, 187
      - landing, 172, 173
      - lunar descent, 172, 173
      - rendezvous, 172, 173
      - separation from command and service modules, 172, 173
    - mockups, 172-173, 188
      - antenna radiation pattern, 173
      - cabin exterior equipment, 172
      - cabin interior arrangement, 172
      - complete lunar excursion module, 83, 172
      - crew support system, 173
      - docking system, 172
      - environmental control system, 172
      - handling and transportation, 173
      - module interfaces, 173
    - model, Grumman proposal, 201
    - portable life support system, 173
    - preliminary Statement of Work completed, 159
    - pressurization system, 173
    - research and development proposal invitations, 171
    - Statement of Work, 171, 173
      - contractor responsibilities, 171
    - See also* Apollo spacecraft, Spacecraft, and Lunar excursion vehicle.
  - Lunar excursion module systems, v, 191
    - communications systems, 191
    - crew systems, 174, 175, 191
      - crew equipment system, 174, 175
        - adjustable seats, 174
        - food, 174
        - personal radiation dosimeters, 175
        - portable life support systems, 173, 175
        - restraint systems, 174
        - space suits, 174, 175
        - water, 174
      - flight crew, 174
        - commander, 174
        - systems engineer, 174
    - electrical power system, 175, 191, 199
    - environmental control system, 175, 186, 191
      - cabin pressure, 175
      - humidity, 175
      - temperature, 175
    - experimental instrumentation system, 191
    - guidance and control, 173, 174, 191, 192
      - navigation and guidance system, 172, 173, 174, 191
        - cabling and junction box, 174
        - chart book and star catalog, 174
        - computer, 174, 192
        - control and display unit, 174
        - displays and controls, 174
        - inertial measurement unit, 173, 192
        - optical measurement unit, 173
        - power and servo assembly, 174
        - rendezvous radar and radar altimeter, 172, 174
        - reticle, 174
      - stabilization and control system, 173, 174, 191
        - attitude reference, 174
        - control electronics assembly, 174
        - display, 174
        - manual controls, 174
        - power supplies, 174
        - rate sensors, 174
    - instrumentation system, 175, 191
      - flight research and development instrumentation system, 175
        - antennas, 175
        - calibration system, 175
        - clock and tape record system, 175
        - power supply, 175
        - radar transponder, 175, 191
        - sensors and signal conditioning, 175
        - telemetry system (including transmitters), 175
      - operational instrumentation system, 175
        - calibration system, 175
        - cameras, 175
        - clock, 175
        - display and control system, 175
        - sensors, 175
        - tape recorder system, 175
        - telescope, 163, 175, 192
      - scientific instrumentation system, 175
        - gravitometer, 175
        - lunar atmosphere analyzer, 175
        - magnetometer, 175
        - radiation spectrometer, 175
        - rock and soil analysis equipment, 175
        - seismographic equipment, 175
        - soil temperature instrument, 175
        - specimen return container, 175
  - lunar touchdown system, 174, 191
    - load distribution capabilities, 174
    - meteoroid protection, 174
    - radiation protection, 174
- propellants
  - fuel, 174
  - oxidizer, 174
- propulsion system, 164, 173, 174, 191
  - storable hypergolic bipropellants, 174
  - variable thrust, 174
- reaction control system, 164, 173, 191
- structural system, 191
- Lunar excursion vehicle (LEV), 147, 150
  - direct link communications, 152
  - guidance and control systems, 147, 150
    - automatic, 150
    - manual, 150
  - landing site, 150
  - location in configuration, 147
  - lunar stay time, 150
  - "point" landing, 150, 163
  - pressurized cabin, 150
    - two-man, 150
  - propulsion system, 150
  - redesignated lunar excursion module, 155
  - See also* Lunar excursion module.
- Lunar expedition, 164
  - supported by Saturn C-5 logistics vehicle, 164
- Lunar exploration conference, 183
  - Blacksburg, Va., 183
- Lunar exploration program, 101, 119, 123, 194
  - unmanned, 75
    - Ranger, 75, 194
    - Surveyor, 75
- Lunar flights, 31, 41
- Lunar geology, 60
- Lunar gravity, 110
- Lunar impact vehicle, 24, 35



- Lunar instrument carrier, 7
- Lunar lander, 82, 83, 92, 105, 117
  - 5000-pound, 105
  - competed with direct ascent approach, 105
  - launch by Saturn C-3, 105
  - lunar orbit rendezvous mode, 105
- Lunar
  - landing, iii, iv, 22, 39, 102, 132, 140, 163, 173
  - beacons, 28
  - development program, 8, 9, 22, 25, 135
  - goal, 27
  - maneuver, 147
  - mission, 25, 31, 44, 51, 62, 65, 76, 91, 96, 101, 119, 144, 149, 161, 164, 168, 186, 195, 197
    - delta V requirements, 166
    - hard-landing, 17
    - long-term objective, 22
    - soft-landing, 8, 15, 17, 35, 180
    - unmanned, instrumented, 8, 15, 17, 186
    - weight, 31
  - module, 31, 36, 104, 126, 127, 170
    - 27,000 pounds (MALLAR), 36
    - design constraints, 138
    - from 100-nautical-mile lunar orbit, 100, 173
      - circular orbit to elliptical orbit, 173
      - hovering, 126, 173
      - touchdown maneuver, 126, 173
    - guidance and control system, 104, 119
    - landing gear, 170
    - lunar touchdown system, 104, 186
    - main propulsion system, 104, 126
    - model, 82, 189
    - propulsion system, 126, 138
      - lunar landing engine, 126
      - throttleable, 127
      - lunar retrograde engine, 126
    - structural system, 104
    - terminal propulsion system, 104
  - program, 98
  - simulator, 98, 168
    - construction started at Langley Research Center, 98
  - site selection, 53
  - soft, 180
  - touchdown, 126, 147
  - trajectories, 126, 138, 172, 186
  - unmanned, instrumented, 186
- Lunar launch, 173
  - vehicle, 135
    - Saturn C-5 selected, iv, 135
- Lunar logistics, 168, 180, 186
  - studies, 168, 180, 186
  - trajectories, 186
  - vehicle, 168, 186
- Lunar maps, 13, 44, 69, 70
- Lunar mission, iii, iv, 33, 38, 40, 67, 139, 141, 144
  - 14-day lunar landing and return, 36, 39
  - communications, 41
  - cost, 67, 81
  - date, 81
  - ground tracking, 41
  - launch vehicle, iv
  - mode, 138, 139, 152, 155, 175, 176
  - module, 39
  - payload, 154, 180
  - scientific payload, 26
  - studies, 26, 34
    - life support requirements, 26
    - Mercury stretchout capabilities, 26, 33
    - vehicle weight, 26
- Lunar Mission Steering Group, 34
  - See also Langley Research Center.
- Lunar observation, 101
- Lunar orbit, iv, 55, 82, 101, 102, 173
  - close, 24
- Lunar orbit rendezvous (LOR), v, 6, 36, 44, 64, 66, 68, 82, 95, 98, 109, 110, 119, 137, 144, 149, 154, 155, 159, 164, 170, 176, 185, 196, 197
  - advantages, 155, 168, 176, 196, 197
  - general operational concept, 65, 68, 76, 184
  - Langley Research Center to study, 107
  - NASA Hq meeting, 75, 76, 115, 118, 147
  - reasons for choice, 68, 168, 176, 202
    - cost, 168
    - mission success probability, 168
    - schedule, 168
    - technical development required, 168
  - selected as lunar landing mode, 130, 168, 202
- Lunar orbiter (unmanned), 33
- Lunar photographic atlas, 10
- Lunar photography, 53, 154, 168, 182, 195
- Lunar probes, 28, 32, 195
  - Air Force, 12, 13, 14
  - Army, 13
  - Pioneer, 55, 65
    - Pioneer I*, 13
    - Pioneer II*, 14
    - Pioneer III*, 14
    - Pioneer IV*, 17
  - unmanned, hard-landing, 54
  - unmanned, soft-landing, 54
- Lunar reconnaissance, 22, 28, 40
  - before manned landing, 11, 26, 40, 101
- Lunar rendezvous, 86, 161
  - technique, 161
- Lunar soft-landing, 47, 180
- Lunar spacecraft, 31, 34, 39, 43, 47
  - capable of earth orbit missions, 39
  - specifications, 38
  - weight, 31, 39
- Lunar spacecraft flights
  - JPL to study tradeoffs on design and mission, 34
  - program, 34
    - later designated Ranger Program, 34
- Lunar surface, iv, 6, 30, 31, 34, 43, 44, 53, 148, 168, 170, 172, 186, 189, 190, 196, 200, 201
  - characteristics, 26, 95, 168, 192, 200
  - exploration, 180
  - mobility, crew, 173, 180, 194
  - topographical information, 13, 44, 70, 108
  - use of roving vehicles, 186
- Lunar surface rendezvous, 95
  - JPL to study, 107
- Lunar takeoff, 30, 57, 102
  - engine, 24
- Lunar trajectory, iv, 82, 172
- Lundin, Bruce T., 20, 22, 24, 33, 92, 208, 213
- Lundin Committee, 50, 92, 118, 213
  - completed study, 95
  - guidelines, 92
  - lunar orbit rendezvous presentation, 93
  - mode preference stated, 50, 95
  - recommendations, 95
- Lundquist, Charles A., 221
- Lunik I*, 15
  - Lunik II*, 183
    - impacted on moon, 2, 29
    - launched, 2, 29
    - payload, 29
    - radio transmitters, 29
  - Lunik III*, 195
    - launched, 2, 29
    - photographed dark side of moon, 2, 195



## M

- M-1 lifting body configuration, 71, 77  
M-1 engine, 120, 161  
*See also* Engines.  
M-1-1 lifting body configuration, 71, 72  
McCall, Jerry C., 221  
McCool, Alexander A., 64, 211  
McDivitt, James A., 189  
McDonald, J. C., 207  
McDonald Observatory, 10  
McDonnell Aircraft Corporation, 29, 37, 132, 181  
awarded Surveyor design study, 47  
invited to bid on lunar excursion module, 171  
participated in Apollo spacecraft bid, 101, 114  
McGathy, Pinkney, 218  
McGinty, Earl E., 218  
McGolrick, Joseph E., 213  
McKee, Daniel D., 139  
McLean, William B., 208  
McMillion, Lee N., 142, 211, 215  
McNair, Lewis L., 220  
McNamara, Robert S., 99, 133  
MacDougall, George F., Jr., 217  
Mace, William D., 81, 115  
Mack, Jerry L., 221  
MacLeish, K. G., 208  
Maggin, Bernard, 45, 208  
Magnetic tape, 21  
Main engine, service module, 184  
ablative thrust chamber assembly, 184  
storable liquid propellants, 184  
*See also* Engines.  
Major spacecraft contractors. *See* Appendix 3, 223.  
MALLAR (manned lunar landing and return), 36  
14-day lunar landing and return, 36  
entry vehicle, 6600 pounds, 36  
lunar landing module, 27,000 pounds, 36  
mission module, 9000 pounds, 36  
MALLIR (Manned Lunar Landing Involving Rendezvous), 82, 83  
booster requirements, 82, 83  
Maloney, Philip R., 217, 220  
Manchester, England, 13, 44  
Maneuverable manned satellite, 22, 28  
Maneuverable Recoverable Space Vehicle (MRS. V), 27  
Manganiello, Eugene J., 56, 63  
Man-in-space problems, 22  
"Man-in-Space Soonest," proposed Air Force program, 11  
"Man-in-Space Sophisticated," proposed Air Force program, 11  
Manned circumlunar flight, 39, 55, 86  
reconnaissance, 39  
vehicle, 33  
Manned exploration of space, xiii  
Manned interplanetary exploration, 19, 22  
Manned lunar exploration, 68  
Manned lunar landing, ii, 36, 48, 50, 62, 66, 67, 81  
by direct ascent, 33  
by rendezvous, 65, 109, 120, 155  
launch vehicle requirements, 96, 120, 155  
launch requirements, 86, 155  
methods, 25, 33, 67, 96, 120, 132, 161, 195, 196  
procedures, 96, 155  
target date, xi, 23, 27, 50, 86  
"Manned Lunar Landing and Return," proposed Air Force program, 11  
Manned lunar landing and return, xiii, 11, 15, 35, 67, 101  
intermediate steps, 24, 35  
mission study by NASA Centers, 22  
guidance, 22  
propulsion, 22  
structure, 22  
vehicle configuration, 22  
Manned Lunar Landing Coordination Group, 98, 213  
Manned lunar landing mission, iv, 6, 50, 57, 59, 74, 95, 98, 108, 111, 171  
early, 92, 96  
guidelines proposed, 92, 114  
modes, xi, 6, 120, 130, 155, 161, 176  
propulsion requirement, 92, 161  
national objective, iv  
pacing items, 95  
within 10 years, 27, 28, 74  
Manned Lunar Landing Task Group (Low Committee), 66, 67, 73, 75, 212  
submitted draft report, 73  
submitted final report, 74  
*See also* Low Committee.  
"Manned Lunar Landing through use of Lunar-Orbit Rendezvous," 115  
Manned lunar outpost, 18, 23  
Manned lunar reconnaissance, 39  
Manned lunar transport, 84  
Manned military space systems program, 75  
Manned orbital flight, xi, 130  
first successful, xi, 50, 81  
Manned orbital laboratory, 33, 54  
Manned orbiting space station, 6  
Manned satellite project, 2, 14  
Manned space flight, 18, 22  
Manned space flight laboratory, 22  
Manned Space Flight Management Council, 140, 154, 161, 165, 166, 167, 176, 198, 222  
Apollo spacecraft design criteria, 176  
decision for lunar orbit rendezvous as mission mode, 166  
development of LEM, 166  
lunar logistics vehicle study, 166  
Nova study, 166  
Saturn C-1B, 166  
Saturn C-5, 166  
decision on Saturn C-5 configuration, 130, 134  
delayed awarding Nova study contract, 155  
formed, 134  
members, 134  
purposes, 134  
results of studies on lunar mission mode selection, 165, 166, 195, 196  
criteria, 165-166  
communications and tracking requirements, 165  
costs, 166, 196  
development complexity, 166  
flexibility, 166  
growth potential, 166  
guidance accuracy, 165  
military implication, 166  
mission, 165  
reliability, 165  
schedules, 166, 196  
weight margins, 165  
modes  
direct ascent, 165, 196  
earth orbit rendezvous, 137, 165, 196  
connecting mode, 165  
fueling mode, 165  
lunar orbit rendezvous, 137, 165, 196

- Manned space flight priorities  
 ballistic probes, 22  
 environmental satellite, 22  
 lunar landing, 22  
 lunar reconnaissance satellite, 22  
 maneuverable manned satellite, 22  
 manned space flight laboratory, 22  
 Mars-Venus landing, 22  
 Mars-Venus reconnaissance, 22  
 Project Mercury, 22  
*See also* names of each.
- Manned space flight program, 2, 66, 112, 120  
 extended scope anticipated, 85
- Manned space flight research center (later designated Manned Spacecraft Center), 111
- Manned space station, 48
- Manned spacecraft, 59, 109
- Manned Spacecraft Center (MSC), v, xiii, 107, 111, 130, 137, 138, 140, 147, 152, 153, 161, 181, 189, 191, 197  
 Apollo Spacecraft Project Office established, 130, 132  
 Crew Systems Division, 201  
 designation, 50, 118  
 Facilities Division, 180  
 Flight Operations Division, 171  
 Gemini Project Office, 180  
 Integration Office established, 167  
 Mission Control Center, 171  
 location announced, 130, 171  
 move to Houston, v, 143  
 Office of Engineering and Development, xiv  
 organization chart, 233  
 responsibilities, 111  
 site selection announced, 111  
 Technical Information Preparation Branch, xiv
- Manned spacecraft development center, 85  
 proposed by STG, 85
- Manned suborbital flight, iv, xi, 87
- Manufacturing Panel. *See* Technical Assessment Panels.
- Mardel, Alfred, 221
- Mare Novum (New Sea), 195
- Mariner spacecraft, 99
- Mark II configuration, 71
- Markley, J. Thomas, 54, 62, 69, 115, 140, 141, 179, 183, 188, 211, 218, 221
- Marquardt Corporation, The, 183  
 selected to design and build reaction control rocket engine, 142
- Mars (planet), 78  
 probe, 35  
 unmanned reconnaissance, 35, 55
- Marshall (George C.) Space Flight Center (MSFC), iv, v, xiii, 38, 44-46, 48, 52, 62, 63, 66, 67, 69, 73, 74, 76-78, 87, 93, 94, 98, 104, 107, 110, 112-114, 118, 119, 128, 130, 133, 134, 138, 144, 147, 154, 161, 164, 181, 197, 198  
 awarded contract to study feasibility of refueling spacecraft in orbit, 74  
 awarded contracts for study of exploratory expeditions launched from earth orbit, 73  
 Integration Office established, 167  
 named, 38  
 static test facility for large vehicle stages, 99, 115
- Mars-Venus landing, 22
- Mars-Venus reconnaissance, 22
- Martin Company, The, 20, 37, 71, 72, 76, 87, 98, 99, 196  
 bid on Apollo spacecraft, 101, 114  
 bid on Apollo spacecraft feasibility study, 57  
 final report submitted, 88  
 selected for Apollo spacecraft feasibility study, xi, 50, 59  
 Space Systems Division, 196  
 study progress reviewed, 9, 64, 73
- Martin-Marietta Company  
 bid on LEM, 186  
 invited to bid on LEM, 171
- Massachusetts Institute of Technology (MIT), v, 9, 65, 69, 75  
 Instrumentation Laboratory, 29, 43, 63, 105, 106, 108-110, 113, 118, 119, 130, 133, 137, 160, 165, 168, 180, 191, 192  
 selected to develop guidance and navigation system, xi, 50, 106, 128  
 study contract for Apollo guidance and navigation support, 50, 61  
 Lincoln Laboratory, 63, 66  
 studies on ground instrumentation system for Apollo, 63, 66
- Massey, John W., 220
- "Mastodon" 179
- Materials, 45
- Mathews, Charles W., 23, 31, 104, 131, 143, 147, 214, 221
- Maus, Hans H., 118, 140, 221
- Maxwell, Preston T., 85, 216
- May, Ralph W., Jr., 213
- Mayaguana Island (AMR downrange), 105
- Mayer, John P., 215, 220
- Maynard, Owen E., 68, 143, 147, 209, 214
- Mayo, A. M., 66, 80, 212
- Mead, Merrill H., 147
- "Mechanical astronaut," on *Mercury-Atlas 3*, 84
- Mechta ("Dream"), 15
- Medaris, John B., 12, 16, 18
- Medical sciences, 37
- Mengel, John T., 208
- Mercury-Atlas, 81, 194
- Mercury-Atlas 1* (MA-1)  
 exploded, 48  
 launched, 48  
 spacecraft destroyed on impact, 48
- Mercury-Atlas 2* (MA-2)  
 launched, 75  
 maximum heating test, 75
- Mercury-Atlas 3* (MA-3)  
 destroyed, 84  
 launched, 84  
 "mechanical astronaut," 84
- Mercury-Atlas 4* (MA-4)  
 astronaut simulator, 110  
 launched, 110  
 recovered, 110
- Mercury-Atlas 5* (MA-5)  
 chimpanzee, Enos, passenger, 128  
 recovery, 128  
 reentry, 128  
 two orbits, 128
- Mercury-Atlas Program Panels, 113
- Mercury Mark II program, 109, 132, 133  
 project development plan, 132  
 astronaut training, 132  
 controlled land recovery, 132  
 rendezvous techniques development, 132  
 long-duration flight, 132  
 renamed "Gemini," 132  
 spacecraft, 133
- Mercury Mark II/Agena, 133  
 experiments, 133  
 rendezvous development, 133
- Mercury Program, iii, xiii, 22, 85  
 astronauts selected, 19  
 follow-on experiments, 29  
 post-Mercury program, 23, 26, 32, 33
- Mercury-Redstone 1* (MR-1)  
 launched escape tower, 61



INDEX

- Mercury-Redstone 1A* (MR-1A)  
launched from AMR, 65
- Mercury-Redstone 2* (MR-2)  
chimpanzee, Ham, passenger, 74  
launched, 74  
recovered, 74
- Mercury-Redstone Panels, 113
- Mercury spacecraft, 44, 45, 115, 140  
advanced version recommendations, 23, 94  
first earth orbital test, 110  
first production spacecraft in test, 44  
improved, 105  
proposed for lunar mission, 105  
scaled-up, 87  
two-man, 132  
booster, 132  
plans announced, 132  
shape, 132  
to be built by McDonnell, 132
- Merrill, Grayson, 208
- Merritt Island, Fla.  
Launch Complex 39, 161, 171
- Messing, Wesley F., 175
- Meteorites, 60
- Meteoroid  
damage studies, 70  
protection, 80
- Meteorological satellite, 35
- Meyer, Andre J., Jr., 214
- Michael, William H., Jr., 64, 115, 147, 211
- Michel, Edward L., 167
- Michoud Ordnance Plant, 109, 115  
named for fabrication and assembly of C-3 first stage, 109
- Micrometeoroids, 26, 192
- Microorganisms, 41
- Midcourse  
guidance theory, 61  
propulsion, 44, 182  
velocity corrections, 182
- Military Electronics Division  
selected to manufacture and test radio equipment, 143
- Military reconnaissance, 5
- Military space mission, 19
- Minimum space and reentry vehicle (manned), 33
- Minneapolis-Honeywell Regulator Company, 180, 194  
Aeronautical Division, 162  
Electronic Data Processing Division, 180  
named to design and build Apollo stabilization and control system, 134
- Minneapolis, Minn., 134
- Missile and Space Vehicle Department  
*See* General Electric Company.
- Mission Control Center, 127, 171, 195  
overall control of Apollo support elements, 127  
site selection announced by NASA, 130, 171  
*See also* Manned Spacecraft Center.
- Mission flight plan, 149
- Mission mode, 107, 159, 175, 176  
C-5 direct ascent, 176, 196  
C-5 earth orbit rendezvous, 176, 196  
C-5 lunar orbit rendezvous, 176, 196  
direct ascent, 108, 161, 170, 176  
earth orbit rendezvous, 107, 161, 170, 176  
lunar orbit rendezvous, 107, 161, 170, 176, 195  
Nova direct ascent, 161, 176  
solid-fuel Nova direct ascent, 176
- Mission propulsion system  
lunar launch velocity increment, 102  
lunar orbit injection, 102  
lunar orbit rejection, 102  
translunar abort, 102
- Mississippi Test Facility, 190  
plans, 190  
test stands, 190  
water transportation system, 190
- MIT. *See* Massachusetts Institute of Technology.
- Mitchell, Elliott, 60, 118, 221
- Mockups  
command module, 161, 188  
lunar excursion module, 83, 171, 172-173, 188  
service module, 188
- Modified flapped Mercury configuration, 71, 72
- Modular concept, 47, 57, 65
- Moffett Field, Calif., 43
- Molybdenum coating, 27
- Monterey, Calif., 38
- Moore, F. Brooks, 220
- Moore, Robert, 219
- MORAD (Manned Orbital Rendezvous and Docking), 81, 82  
*See also* Scout.
- Morris, Owen G., 142
- Morse, Archibald E., Jr., 217
- Moser, Jacob C., 216
- Moser, Robert E., 220
- Motorola, Inc., 143  
Military Electronics Division, 143
- Motors  
Algol, 181  
Antares, 139  
*See also* names of each.
- Mount Hamilton, Calif., 10
- Mount Wilson, Calif., 10
- Mount Wilson-Palomar Observatory, 10
- Mrazek, William A., 118, 214, 221
- MRS. V. *See* Maneuverable Recoverable Space Vehicle.
- MSC. *See* Manned Spacecraft Center.
- MSC-MSFC Coordination Panels, 50, 119  
Electrical and Electronics Design Panel, 119  
modified, 119  
Electrical Systems Integration Panel created, 119, 167  
Instrumentation and Communications Panel created, 119, 167
- MSFC. *See* Marshall Space Flight Center.
- MSFC-MSFC Advanced Program Coordination Board, 113, 114, 221
- MSFC-MSFC Coordination Panels, 218  
*See also* MSFC-MSFC-LOC Coordination Panels and Apollo-Saturn Coordination Panels.
- MSFC-MSFC-LOC Coordination Panels, 218, 219, 220, 221  
Crew Safety Panel, 221  
Electrical Systems Integration Panel, 219  
Flight Mechanics, Dynamics, Guidance, and Control Panel, 220  
Instrumentation and Communication Panel, 219  
Launch Operations Panel, 220  
Mechanical Integration Panel, 219  
Mission Control Operations Panel, 220  
*See also* MSFC-MSFC Coordination Panels and Apollo-Saturn Coordination Panels.
- MSFC Orbital Operations Study, 139
- MSFC-STG Apollo-Saturn program, 112
- MSFC-STG Space Vehicle Board, 112, 113, 167  
Charter, 112, 167  
purpose, 112  
responsibilities, 112  
Sub-Board, 112, 113  
membership, 112  
responsibilities, 112, 113  
*See also* Saturn-Apollo Coordination Panels.
- Mullaney, Robert E., 137
- Multiman crews, 41
- Multiman orbital satellites, 86



INDEX

Multimanned reentry capsule, 31, 40  
 Munford, Robert E., 219  
 Murray, Bruce C., 200  
 Myers, Boyd C., II, 208

N

NAA. *See* North American Aviation, Inc.  
 NAA-NASA Apollo spacecraft design review, 154  
     environmental control system, 154  
     fuel cell, 154  
     launch escape system configuration approved, 154  
     monthly, 154  
 NACA. *See* National Advisory Committee for Aeronautics.  
 NASA. *See* National Aeronautics and Space Administration.  
 NASA-DOD Facilities Report, 105  
 NASA-DOD range responsibility, 96  
 NASA Headquarters, v, 14, 18, 20, 22, 23, 25, 36, 42, 46,  
     53-56, 59, 66, 76-78, 80, 84, 91, 93, 98, 104, 106, 112,  
     138, 141, 147, 159, 179, 180, 195  
     announced launch site study, 106  
     major reorganization, 111, 197  
     program offices  
         Office of Advanced Research and Tech-  
             nology, 111  
         Office of Advanced Research Programs, 67,  
             91, 94, 95  
         Office of Aeronautical and Space Research,  
             18, 20, 22, 67, 91, 94, 95  
         Office of Applications, 111  
         Office of Launch Vehicle Programs, 34, 47,  
             69, 91, 95, 107  
         Office of Launch Vehicles and Propulsion,  
             118, 120  
         Office of Life Sciences Programs, 37, 46,  
             94, 95  
         Office of Manned Space Flight, 51, 111,  
             118, 120, 131-134, 139, 143, 145, 154,  
             159, 164, 170, 175, 176, 179, 181, 195,  
             197, 202  
         Office of Program Planning and Evaluation,  
             35  
         Office of Space Flight Development, 18, 19,  
             20, 26, 31, 34  
         Office of Space Flight Programs, 36, 53, 57,  
             66, 67, 87, 94, 95  
         Office of Space Sciences, 111, 195  
         Office of Spacecraft and Flight Missions, 118  
 NASA Historical Office, xiv  
 NASA-Industry Apollo Technical Conference, 99, 100  
     results of Apollo feasibility studies, 99  
     Washington, D.C., 99  
 NASA-Industry Program Plans Conference, 47, 48  
     launch vehicles, 48  
     life sciences, 48  
     long-range planning, 48  
     manned space flight, 48  
     structure and materials research, 48  
 NASA Launch Operations Directorate, 96, 105  
 NASA Michoud Operations Plant, 119, 134, 190  
     S-1C stage assembly area, 133  
 NASA Staff Conference, 38  
     Monterey, Calif., 38  
     Williamsburg, Va., 19  
 NASA ten-year plan, 2, 35, 47  
     presented to Congress, 35  
 Nathan, Ernest B., 220  
 National Academy of Sciences, 9, 77  
     Space Science Board, 77  
 National Advisory Committee for Aeronautics (NACA),  
     10, 12  
     abolished, 11, 13  
     Committee on Aerodynamics, 7

Executive Committee, 7  
 Special Committee on Space Technology (Stever  
     Committee), 9, 13, 207  
 National Aeronautics and Space Act of 1958, 2, 12  
     Public Law 85-568, 12  
     signed, 12  
 National Aeronautics and Space Administration (NASA),  
     2, 3, 16, 17, 24, 32, 47, 50, 59, 73, 91, 99, 115, 130,  
     132, 133, 180, 181, 189  
     Administrator, 14, 19, 23, 29, 32, 35, 42, 47, 54,  
         74, 99, 108, 111, 128, 133, 143, 159, 166, 170,  
         171, 201  
     announced C-1B to be developed, 168  
     announced MSC as location for Mission Control  
         Center, 130  
     announced selection of Saturn C-5 as lunar launch  
         vehicle, 135, 168  
     announced selection of spacecraft contractor, 128  
     Associate Administrator, 34, 35, 55, 65, 67, 73, 74,  
         80, 81, 85, 87, 91, 95, 96, 98, 99, 104, 105, 108,  
         111, 119, 131, 132, 133, 166, 170, 197  
     bidders' conference for two lunar logistic studies,  
         180  
     constituted, xi, 2  
     Deputy Administrator, 48, 74, 75, 108, 166  
     established, 2, 11, 12  
     long-range objectives, 59  
     manned lunar landing  
         philosophy, 28  
     organized, 13  
     selected Hamilton Standard Division to develop  
         Apollo space suit, 130, 176, 194  
     selected lunar orbit rendezvous for manned lunar  
         landing mission, 130, 168  
     *See also* NASA Headquarters.  
 National Aeronautics and Space Agency, proposed, 11  
 National Aeronautics and Space Board, 11  
 National Aeronautics and Space Council, 69, 143  
 National booster program, 22, 119  
     deficiencies outlined, 119  
 National Science Foundation, 9  
 National Space Establishment, 8  
 National space program, 13, 65, 69  
     development of large launch vehicles, 99  
 National space vehicle program formulated by NASA, 16  
 Navigation, sightings, 165  
 Navigation and guidance system, v, 43, 101, 102, 119  
     components, 159  
         associated electronics, 102, 121  
         cabling, 102  
         computer, 102, 121, 180  
         displays and controls, 102, 121, 190  
         inertial platform, 121  
         periscope, 102  
         radar altimeter, 102  
         range or velocity measuring equipment, 121  
         secondary inertial elements, 102  
         space sextant, 102, 113, 121, 165  
         stable platform, 102  
         star and chart catalog, 121  
         sun trackers, 102  
 draft work statement  
     midcourse guidance, 113  
 equipment, 110  
 formal proposal, 65  
 MIT selected, 50  
 Statement of Work expanded, 110, 120, 121  
     control of launch from lunar surface, 121  
     control of translunar injection, 120  
     data and computation for abort capability,  
         121  
     guidance for establishing lunar orbit, 121  
     rendezvous in earth orbit, 121  
 study, 75

INDEX

- Navigation equipment, 168  
 concepts, 112  
   onboard computer, 180
- Nelson, Alfred M., 54, 210, 212
- NERV configurations, 71
- Nesbitt, William J., 217
- New Orleans, La., 109, 110, 115, 119, 133
- New Projects Panel, 2, 28, 29, 209  
*See also* Space Task Group.
- New York City, 6
- New Zealand, 32
- Newell, Homer E., 15, 111, 195
- Nicks, Oran W., 54, 57, 66, 210, 212
- Nikolayev, Andrian G., 181  
 cosmonaut, *Vostok III*, 181
- Noise, in spacecraft, 41
- Nolan, James P., Jr., 210, 212, 213
- Noordung, Hermann, 5
- North American Aviation, Inc. (NAA), 2, 37, 127, 128, 131, 143, 147, 152, 155, 159, 162, 165, 175, 181, 189  
 assigned design and development  
   associated ground support equipment, 132  
   command module, 132  
   service module, 132  
   spacecraft adapter, 132  
   spacecraft integration, 132
- ballistic range, 192
- bid on Apollo spacecraft, 101, 114
- bid on Apollo spacecraft feasibility study, 57
- contract signed for development and production of S-II stage of C-5, 198
- Corporate Space Committee, 15
- directed to redesign S-II stage, 118
- design study for Surveyor spacecraft, 47
- directed to study penalties and scheduling effects of spacecraft design capabilities with direct ascent and LOR, 154
- invited to bid on LEM, 171
- letter contract for spacecraft development signed, 130, 132
- meteoroid test established, 192
- RASPO established, 140, 141
- revised Apollo Mission Requirements, 184
- revised Apollo Requirements Specifications, 184
- revised Summary Definitions and Objectives Document, 184
- Rocketdyne Division, 7, 11, 54
- selected as principal contractor for Apollo spacecraft, xi, 51, 128
- selected to develop S-II stage, 130, 198
- Space and Information Systems Division, 127, 128, 134, 140, 141, 142
- subcontractors, 134
- North, Warren J., 22, 93, 139, 213, 215, 221
- Northrop Corporation, 181  
 bid on lunar excursion module, 186  
 invited to bid on lunar excursion module, 171  
 Radioplane Division, 134
- Northrop Space Laboratories  
 unmanned logistic system study, 186
- Norway, 32
- Nova, 14, 16, 22, 25, 47, 74-75, 96, 98, 99, 105, 106, 119, 155, 176  
 3-million-pound-thrust, 68  
 6-million-pound-thrust, 68  
 configurations, 86, 120, 161  
 design and development, 74, 75, 168  
 first-stage specifications, 99, 120  
 launch facility and test stand designs, 99, 108  
 lunar landing mission plan, 86, 161  
 systems integration studies, 98  
 two-stage Nova planned, 140  
   alternative direct flight mode, 140, 176  
   liquid-propellant engines, 140
- Nuclear rocket propulsion, 22, 47, 55
- Nutrition, 41
- Oakley, Ralph B., 54
- Oberth, Hermann, 5
- Observatory in space, 5
- Office of Advanced Research and Technology (NASA), 111  
 formed, 111
- Office of Aeronautical and Space Research (NASA), 18, 20, 22, 67, 91, 94, 95
- Office of Applications (NASA), 111  
 formed, 111
- Office of Engineering and Development. *See* Manned Spacecraft Center.
- Office of Launch Vehicle Programs (NASA), 34, 47, 69, 91, 95, 107
- Office of Launch Vehicles and Propulsion (NASA), 118, 120
- Office of Life Sciences Programs (NASA), 37, 46, 94, 95  
 established, 37
- Office of Manned Space Flight (OMSF, NASA), 51, 118, 120, 131-134, 139, 143, 145, 154, 159, 164, 170, 176, 179, 181, 195, 197, 202  
 formed, 111  
 Office of Systems, 175  
   lunar mission mode conclusions, 175
- Office of Program Planning and Evaluation (NASA), 35
- Office of Space Flight Development (NASA), 18, 20, 26, 31, 34
- Office of Space Flight Programs (NASA), 36, 47, 53, 57, 66, 67, 87, 94, 95
- Office of Space Sciences (NASA), 111, 195  
 formed, 111
- Office of Spacecraft and Flight Missions, 118
- Office of Systems (in Office of Manned Space Flight, NASA), 175  
 Office of Space Systems, 176  
   Apollo spacecraft design criteria, 176  
   control of detailed system weights, 176  
*See also* Office of Manned Space Flight.
- Okano, K. Fred, 217
- Old Point Comfort, Va., 114
- Olling, Edward H., 217
- OMSF. *See* Office of Manned Space Flight.
- Onboard guidance computer, 62, 112, 166
- Onboard guidance system, 43, 58  
 computer, 27, 58  
 inertial reference, 58  
 star sight system, 58
- Onboard propulsion system, 44, 56  
 analysis and preliminary development, 44, 60  
 solid propellant system, 57
- Onboard Systems Panel. *See* Technical Assessment Panels.
- O'Neal, Robert L., 27, 68, 94
- O'Neill, James E., 139, 147
- Operational techniques  
 flight, 101  
 ground, 101
- Optical devices, 41, 163
- Optical subsystems, 160
- Orbital launch operations, 115  
 complexity, 115  
 connector technique, 115  
 refueling technique, 115  
 studies, 115
- Orbital manned space flight, 35
- Orbital rendezvous, 59, 119  
 in Mercury Mark II, 59
- Orbital return capsule, 33
- Orbital station, 110
- Orbiting astronomical laboratory, 35, 80
- Orbiting astronomical observatory, 6
- Orbiting Geophysical Observatory, 61, 62



Orbiting space observatory, 5  
 Ordway, Frederick I., III, 5  
 Organization Charts. *See* Appendix 6, 230-233.  
 Ostrander, Don R., 34, 36, 69, 98, 209, 213  
 Oxygen, 167, 188

## P

- Pacific Ocean, 180, 194  
 Pad abort, 193  
 Pal, George, 6  
 Palaoro, Hans R., 219  
 Palmer, Carl B., 207, 208  
 Parachute, 43, 58, 198  
   deployment, 163, 200  
   dummy-load test, 183  
   earth landing configuration, 122  
   landing systems, 78  
     Radioplane Division selected as contractor,  
     134  
   recovery for an earth landing, 28  
   steerable system, 78  
   studied for touchdown mode, 22  
 Paragharian, Berg, 212  
 Paraglider  
   Rogallo wing, 74  
 Paris, France, 135  
 Parker, Robert N., 216  
 Parking orbit, 102  
   earth, 147  
 Patterson, Herbert G., 211  
 Paup, John W., 127  
 Payload, 32, 43, 68, 81, 105, 180  
   instrumented, 13  
   scientific, 14, 180  
   weight, 24  
 Peaceful uses of outer space, 23, 133  
 Pearce, Fred T., Jr., 133  
 Pearl River site (southwestern Mississippi), 115  
   static-test facility for Saturn and Nova-class launch  
   vehicles, 115  
 Pearson, Ernest O., Jr., 45, 66, 207, 212  
 Periscope, 163  
 Perrine, Calvin H., Jr., 142, 220  
 Pesman, Gerard J., 215  
 Petrone, Rocco A., 220  
 Petynia, William W., 54, 68, 74, 77, 106, 113, 119, 210  
 Philadelphia, Penna., 106, 167  
 Phillips, W. Hewitt, 81  
 Phillips, William H., 213  
 Photographs, 60  
   by vehicle orbiting moon, 21, 29  
 Physiographic lunar regions, 52  
 Pic-du-Midi Observatory, France, 10, 13, 44  
   40-inch reflector telescope, 44  
 Pickering, John E., 44  
 Pickering, William H., 20, 34, 36, 207, 208, 209  
 Pickett, Andrew J., 219  
 Pierce, John R., 207  
 Piland, Joseph V., 217  
 Piland, Robert O., v, 31, 39, 45, 46, 54, 56, 69, 93, 104,  
   105, 112, 118, 135, 142, 209, 210, 211, 214, 221  
 Pioneer, launch attempt failed, 55, 65  
*Pioneer I*, 13  
*Pioneer II*, 14  
*Pioneer III*, 14  
*Pioneer IV*, 17  
 Pitch rates, 182  
 Pittsburgh, Penna., 109  
 Planetary  
   atmospheres, 78  
   exploration program, 109  
   landing, 39  
   probes, 54  
 Polaris guidance and navigation program, 105, 106  
 Popovich, Pavel R. (cosmonaut, *Vostok IV*), 181  
 Portable life support systems, 172  
 Potočnik, Capt., 5  
 Pounder, Edwin, 64, 210  
 Powell, James, 221  
 Power sources, 192  
   auxiliary, 24, 40  
   hydrogen-oxygen systems, 84, 168, 192  
   requirements, 84  
   turbine-generator, 196  
 Power supplies, 73, 192  
 Powers, John A., 59  
 Pratt & Whitney Aircraft Division, 185  
   contract for fuel cell development, 84, 143  
   *See also* United Aircraft Corporation.  
 Preacher, Brooks C., 104  
 Preoxygenation, 107  
 Pressure suit, 41, 103, 123, 166, 176, 183, 194  
   quick donning, 41  
   *See also* space suit.  
 Pressurized cabin, 41  
 Preston, G. Merritt, 221  
 Project Apollo, xiii, 48, 63, 93, 99, 147, 195  
   feasibility study, 59, 88  
   named, 48  
   Statement of Work, 131  
   *See also* Apollo Program.  
 Project Boomerang, 18  
 Project Fire, 139, 197  
   experimental reentry spacecraft contract to Re-  
   public Aviation Corporation, 144  
   high-speed reentry heat research program, 139, 144  
     heating rates, 139  
     materials, 139  
     radio signal attenuation, 139  
   reentry package powered by Antares solid-fuel mo-  
   tor, 139  
 Project Gemini, 191, 195  
 Project Highwater, 155  
 Project Horizon, 18  
   Phase I report, 23  
 Project LAMP (Lunar Analysis and Mapping Program),  
   15  
 Project MALLIR, 82, 83  
 Project Mercury, 14, 19, 22, 35, 66, 140, 191  
   Little Joe booster, 141  
 Propellants, 127  
   earth-storable, hypergolic, 121, 137  
   high-energy system, 13  
   high-performance, storable, 24  
   leakage, 79  
   storable, liquid, 27  
   utilization and measurement system, 79  
 Propulsion, 30, 31, 40, 73, 79, 121, 164, 188, 191  
   abort, 121  
   auxiliary for guidance maneuvers, 121  
   lunar landing system, 24, 93  
   nuclear rocket, 47, 55  
   onboard system, 57, 93  
   service module, 121, 137, 138, 142, 165, 182  
   system temperature control, 79  
 Propulsion Panel. *See* Technical Assessment Panels.  
 Prospector program, 84  
   automatic roving vehicle, 84  
   cargo-carrying ability, 84  
   schedule, 84  
   soft-landing on lunar surface, 84  
   spacecraft, 84  
 Public Law 85-568, 2, 12  
 Purcell, Edward H., 212  
 Purser, Paul E., 23, 31, 43, 44, 45, 98, 221  
 Putnam, William D., xiv

## Q

Quality assurance program, 172  
 Queijo, Manuel J., 68, 105, 115



## R

- R-3 (Bell Dyna-Soar) configuration, 72
- Radar  
lunar landing, 178  
spacecraft rendezvous, 178
- Radiation, 46, 159, 170  
dosage on *Discoverer XVII*, 60  
dosimeter, 123, 172  
effects, 46, 80  
environment, 41  
experiments, 33  
lunar, 26  
polar, 26  
problems, 45, 56  
protection, 39, 161  
safe dose, 41  
shielding, 40, 122, 201  
trajectories, 41
- Radiation belt, 10, 14, 25, 170  
probes carrying biological specimens, 28
- Radio altimeter, 21
- Radio astronomical laboratory, 35
- Radio Corporation of America, 111  
Astro-Electronics Division, 100  
Ranger contract, 100  
Major Defense Systems Division, 111  
selected to design and build Project Fire data acquisition and communication subsystem, 197
- Radioplane Division  
selected to design and build Apollo spacecraft parachute landing system, 134  
*See also* Northrop Corporation.
- Rafel, Norman, 110, 118, 212, 213, 221
- Ragan, Ralph, 105, 106, 108, 137, 147, 166, 168
- RAND Corporation, The, 7, 55  
awarded contract to evaluate missions with nuclear propulsion desirable, 55
- Randolph Air Force Base, Tex., 7
- Randt, Clark T., 37
- Range safety officer  
destroyed *Mercury-Atlas 3*, 84
- Ranger I*, 107  
675-pound spacecraft, 107  
Agena B misfired, 107  
launched by Atlas-Agena B, 107  
reentered, 107
- Ranger II*, 120  
Agena engine failed, 120  
launched, 120
- Ranger III*  
launched, 135  
scientific experiments  
analysis of results, 135, 194  
gamma-ray spectrometer, 135, 194
- Ranger IV*  
attained parking orbit, 154  
contamination of moon, 183  
impacted on moon, 154  
launched, 154  
payload, 154  
timer failure, 154
- Ranger V*  
failed, 195  
launched, 195  
lunar probe, 195  
mission, 195
- Ranger program, 43, 75, 100, 168  
basis, 34, 168  
failures, 137, 195  
named, 44  
program expanded, 108, 194  
spacecraft, 43, 44, 99, 108, 194  
launchings increased from 5 to 9, 108  
television system, 44, 100, 108  
spacecraft contractor, 43
- RASPO. *See* Resident Apollo Spacecraft Program Office.
- Raytheon Company, contract to manufacture digital computer for spacecraft, 160
- Reaction control system, 122, 191  
command module, 102, 122, 164  
fuel, 102, 122  
oxidizer, 122  
rocket engines, 122  
The Marquardt Corporation to design and build, 122  
design and manufacture of rocket engines shifted from The Marquardt Corporation to Rocketdyne Division, 183  
service module, 102, 164  
thrust reduction suggested, 182  
attitude control, 102  
minor velocity corrections, 102  
stabilization, 102  
ullage for vernier propulsion system, 102
- Rechtin, Eberhardt, 208, 211  
"Recoverable Interplanetary Space Probe," 27
- Recovery tests, 191
- Rector, William F., III, 142, 147, 179
- Redstone, 87, 100
- Redstone Arsenal, Ala., 8, 12, 38, 39, 42, 43
- Redstone Scientific Information Center, xiii
- Reed, Thomas G., 220
- Reentry, 74  
at near lunar return velocity, 25, 28, 144  
capsule, 33, 108  
second generation, 28  
weight, 108  
configuration, 78  
from lunar missions, 29, 33  
manned, 29  
guidance, 61, 102, 119  
heating, 56, 144  
hyperbolic, 26  
parabolic, 101  
systems design, 62  
techniques  
"skip," 182  
deleted from Statement of Work, 182  
temperatures, 200
- Reentry vehicle, 30  
configuration, 59, 70, 78  
lifting, 13  
*See also* Entry vehicle.
- Rees, Eberhard F. M., 112, 134, 222
- Refueling in earth orbit, 6, 33, 110
- Reinartz, Stanley R., 214
- Reliability, 36, 40, 113, 163, 190  
lunar excursion module, 172  
vehicle system, 36, 40, 87, 110
- Reliability Panel. *See* Technical Assessment Panels.
- Rendezvous, iv, 26, 45, 65, 67, 109  
and docking, 5, 109, 132, 139, 173  
technique and equipment, 139  
capability, 132  
earth orbit, 24, 95, 107  
experiments, 133  
flight test program, 45  
in orbit, 6, 117  
in space, 6, 19, 42, 45  
lunar excursion vehicle requirements, 173  
lunar orbit, 95, 107, 109, 110  
lunar surface, 95, 107  
techniques, 6, 45, 95, 109, 132, 139, 140  
Mercury Mark II objective, 132

- Republic Aviation Corporation, 101, 194, 197  
 awarded contract for Project Fire spacecraft, 144  
 bid on Apollo spacecraft feasibility study, 57  
 bid on lunar excursion module, 186  
 invited to bid on lunar excursion module, 171
- Research and Development Command. *See* United States Air Force.
- Research Steering Committee on Manned Space Flight, xi, 2, 18, 20, 22, 24, 25, 26, 27, 32, 33, 35, 208  
*See also* Goett Committee.
- Resident Apollo Spacecraft Program Office (RASPO), 140, 141
- Resolution XII (United Nations), 8
- Resolution XIV (United Nations), established Committee on the Peaceful Uses of Outer Space, 33, 133
- Rice University, 188
- Richard, Ludie G., 138, 220
- Richter, Henry L., Jr., 8
- Ricker, Harry H., Jr., 209
- Ridenour, Louis N., 207, 208
- Riley, Donald R., 105
- Risler, Welby T., 215
- Roadman, Charles H., 98, 134, 213, 222
- Roberts, Tecwyn, 215, 220
- Robertson, Lois, xiii
- Robinson, Lyndon, 219
- Rocket and Satellite Research Panel, established, 8
- Rocket engines  
 liquid-fueled, 2  
 variable thrust (descent), 27
- Rocketdyne Division, 2, 7, 15, 21, 75, 166, 194  
 additional contracts, 167  
 assigned responsibility for reaction control system, 183  
 contract for F-1 engine, 11, 16, 167  
 contract for H-1 engine, 12  
 contract for J-2 engine, 3, 46, 54, 167  
*See also* North American Aviation, Inc.
- Rockets  
 Juno II, 17, 141  
 Juno V, 16  
 "Mastodon," 179  
 posigrade, 2000-pound-thrust, 200  
 Rover (nuclear), 91  
 solid-fuel, 120  
 Vanguard, 9  
*See also* names of each.
- Rogallo wing (paraglider), 74  
 use in recovery of Saturn S-I stage, 74
- Roll  
 control, 103, 121  
 rates, 182
- Rollins, Robert H., 211, 215
- Rose, James T., 105, 138
- Rose, Rodney G., 216
- Rosen, Milton W., 21, 22, 28, 30, 60, 100, 118, 119, 120, 134, 154, 214, 221, 222
- Rosen Working Group, 118, 119, 120, 221  
 report, 51, 120, 131
- Rosenthal, Aaron, 209
- Rosholt, Robert L., 10
- Ross, C. C., 207
- Ross, H. E., 6
- Rossi, Bruno B., 212
- Rothrock, Addison M., 80, 212
- Rotors, 58
- Rover (nuclear rocket), 91
- Row, Perry V., 63, 211, 216
- Rowell, Billie D., xiv
- Rubel, John H., 133
- Rudolph, Arthur L., 138
- Runyan, Harry L., Jr., 215
- Ruppe, Harry O., 213
- Russell, William T., 208
- RVX (blunted cone) configuration, 71
- Ryan Aeronautical Corporation, study on feasibility of S-I stage recovery, 74
- ## S
- Sacramento, Calif., 183
- Sagan, Carl, 183
- Samonski, Frank H., Jr., 216
- San Antonio, Tex., 7
- Sanderson, Kenneth C., 63, 211, 216
- San Diego, Calif., 65
- Sandler, Irving J., 218
- Santa Susana Air Force-Rocketdyne Propulsion Laboratory, 17
- Satellites  
*Discoverer XVII*, 60  
*Explorer I*, 2, 9  
*Lunik I*, 15  
*Lunik II*, 2, 29, 183  
 Pioneer, 55, 65  
*Sputnik I*, xi, 2, 8  
*See also* names of each.
- Saturn (booster), 10, 12, 16, 22, 24, 26, 46, 47, 54  
 first-generation, 31  
 nuclear upper stages, 47  
 second-generation, 31  
*See also* Boosters and Launch vehicles.
- Saturn (launch vehicle), 32, 106, 108, 146, 171  
 abort study, 192  
 development schedule, 55, 74  
 guidance system, 56, 69, 139  
 new configuration, 18, 31, 32, 74, 100, 147  
 study of S-I stage recovery, 74  
 two-stage, 35, 74, 147  
 upper-stage configuration, 16, 18, 20, 31, 32  
 vehicle assignments, 46, 56, 192  
*See also* Boosters and Launch vehicles.
- Saturn-Apollo Coordination Panels, 112  
 established, 113  
 Electrical and Electronics Design, 113  
 Flight Mechanics, Dynamics, and Control, 113  
 Launch Operations, 113  
 Mechanical Design, 113
- Saturn C  
 payload, 33  
 85,000 pounds in earth orbit, 33
- Saturn C-1, 29, 33, 39, 43, 76, 91, 96, 101, 114, 115, 134, 146, 193  
 adequacy to qualify spacecraft questioned, 55  
 Apollo boilerplates proposed, 46  
 configuration, 34, 76  
 configuration approved, 2  
 configuration change announced, 93, 100  
 configuration change proposed, 74, 77  
 first flight, xi, 50  
 first stage, 3, 43, 46  
 engines static-fired, 3, 38, 39, 42, 43, 46  
 H-1 engines, 38, 42, 43, 46, 120  
 S-IV stage air transport feasible, 85  
 S-IV stage static-fired, 183  
 second stage, 3, 93, 120, 183  
 to test Apollo rendezvous technique and hardware, 139, 165
- Saturn C-1B, 146, 179, 180, 193, 198  
 acceleration recommended, 164  
 to test Apollo spacecraft in earth orbit, 130, 165, 168
- Saturn C-2, 39, 74, 77, 82, 86, 95  
 1-million-pound-thrust second stage, 25  
 2-million-pound-thrust first stage, 25  
 200,000-pound-thrust third stage, 25  
 configuration, 76, 100  
 configuration reevaluated, 55, 93



INDEX

- development accelerated, 47, 77
- development schedule, 55
- engineering design work discontinued, 97
- payload limitation, 56
- schedule, 56
- Saturn C-3, 96, 109, 119
  - Apollo support capability studied, 105
  - configuration, 98, 100
  - first-stage specifications, 99
  - first stage to be built and assembled at Michoud, 109
  - launch facility and test stand design, 99
  - production engines, 99
  - recommended for manned lunar landing mission, 50, 95, 101
  - systems integration studies, 98
- Saturn C-4, 119
  - recommended for manned lunar landing mission, 50, 104, 105
- Saturn C-5, iv, v, 46, 119, 130, 140, 164, 168, 176, 179, 190, 193, 196, 198
  - announced as lunar launch vehicle, 135
  - availability, 139, 146
  - configuration approved, 130, 134
  - configuration proposed, 120, 147
  - launch schedule, 147
  - recommended launch vehicle for manned lunar landing by LOR, 154, 168
  - required for qualification of complete spacecraft, 165
  - S-IVB stage to be third stage, 154, 180
- Saturn C-8
  - configuration, 161
  - planned for direct ascent, 161
- Saturn/Centaur launches, 24, 32
- Saturn development program, 2, 31, 55, 81
  - approved by NASA Hq, 2
- Saturn flight schedule, 59
- Saturn Guidance Committee, 69
  - formed, 69
  - objectives, 69
- Saturn guidance equipment, 139, 147
- Saturn launch area
  - Complex 34, 23, 94
  - Complex 39, 161, 171
- Saturn program, 32, 38, 54, 62
  - research and development, 77
  - transferred to NASA, 38
  - transferred to NASA cognizance, 2
- Saturn Program Requirements Committee, 80
  - established, 80
- Saturn reentry tests, 94
  - preliminary development plan, 94
  - spacecraft systems, 94
- Saturn S-I stage, 34, 76, 93, 140
  - 1.5-million-pound thrust, 34
  - Chrysler Corporation selected to build, 119
  - eight H-1 engines, 34
  - feasibility study for stage recovery, 74
  - redesign proposed, 77
- Saturn S-IB stage
  - 3-million-pound thrust, 100
- Saturn S-IC stage, 190
  - configuration, 133
  - first stage of Saturn C-5, 130, 133, 147
  - The Boeing Company selected as contractor, 130, 133
- Saturn S-II stage, 55, 77, 109, 118, 190
  - configuration, 76, 100, 109, 147
  - five J-2 engines, 118
  - four J-2 engines, 109, 118
  - NAA selected to develop and produce, 130, 198
- Saturn S-IV stage, 32, 33, 34, 37, 76, 100, 200
  - 154-inch-diameter adapter, 87
  - 80,000-pound thrust, 32, 34
  - air transport feasible, 85
  - Douglas Aircraft Company to build, 3, 43
  - four engines, 34
  - Saturn second stage, 37, 93, 168, 183
  - static-fired, 183
- Saturn S-IVB stage, 113, 147, 200
  - adapter, 186
  - development plan, 120
  - Douglas Aircraft Company selected for development, 130, 180
  - modification by Douglas Aircraft Company, 113, 198
  - recommended as flight test vehicle, 113, 134, 154
  - six LR-115 engines, 113
    - replaced by single J-2 engine, 113, 134
- Saturn S-V stage, 32, 34, 74, 76
  - 40,000-pound thrust, 32, 34
  - two engines, 32, 34
- Saturn SA-1, 46
  - assembly, 46
  - flight qualification test, 85
  - installed on static test stand, 76
  - launch, xi, 50, 115, 116
- Saturn SA-2, 155
  - launch, 155, 156
  - Project Highwater, 155
- Saturn SA-5, 113
- Saturn SA-6, 56, 113, 193
  - tentative flight plan, 56, 193
- Saturn SA-7, 113, 193
  - S-IV adapter approved for Apollo missions, 87
  - trajectories, 119
- Saturn SA-8, 56, 87, 113, 193
  - tentative flight plan, 56
  - trajectories, 119
- Saturn SA-9, 56, 87, 113, 193
- Saturn SA-10, 56, 87, 113, 193
- Saturn SA-T (test booster), 38
  - SAT-01 test, 38
  - static firing, 27
- "Saturn System Study," 18, 20
  - 1375 possible configurations, 18, 20
- Saturn Vehicle Team (Silverstein Committee), 32, 34, 209
- Saunders, James F., 216
- Savage, Melvyn, 66, 118, 147, 212, 221
- Sawyer, Ralph S., 211, 216
- Schaaf, S. A., 207
- Schachter, Oscar, 6
- Schaus, T., 217
- Schirra, Walter M., Jr., 19, 215, 216
- Schmidt, Stanley F., 62, 211
- Schramm, Wilson B., 100, 138, 213, 214
- Schriever, Bernard A., 21
- Schurmeier, Harris M., 20, 22, 147, 208
- Schwenk, F. Carl, 28, 30
- Schwichtenberg, A. H., 212
- Scientific
  - equipment, 104
  - experiments, 194
  - exploration of space, 9, 77
  - lunar base, 68
- Scout, 26, 35, 82, 139
  - MORAD, 81, 82
    - payload, 82
- Seamans, Robert C., Jr., 55, 65, 67, 73, 74, 80, 81, 85, 87, 91, 95, 96, 98, 104, 105, 108, 119, 131, 132, 159, 166, 170, 171, 197, 198, 208, 209, 213
- Seattle, Wash., 183



- Seaton, Fred A., 53  
 "Second-generation" space capsule, 28  
   advanced abort devices, 28  
   advanced recovery techniques, 28  
   potential for near lunar return velocity, 28  
   space and atmospheric maneuverability, 28  
   three-man capacity, 28  
 Second International Congress on Astronautics, 6  
 Secretary of Defense, 12, 23, 99, 133  
 Secretary of the Air Force, 32  
 Secretary of the Army, 23, 32, 53  
 Secretary of the Interior, 53  
 See, Elliot M., Jr., 189  
 Seiff, Alvin, 56, 210, 214  
 Seismometer, 43, 195  
   lunar, 34, 43, 73, 195  
 Seldon, Robert F., 63, 211  
 Senate, 12, 74  
   Committee on Aeronautical and Space Sciences,  
     17, 21, 35  
 Senior Steering Group, 36, 42  
   *See also* Space Exploration Program Council.  
 Service module (SM), 101, 124, 128, 147, 150, 170, 179,  
 190  
   adapter, 186, 200  
   fuel cell radiators, 164  
   interface problems, 178  
   length increased, 183  
   mockup ordered, 135  
   progress reviewed, 143  
   propulsion system, 102, 137, 150, 155, 164, 165,  
     182, 200  
     ground tests, 165  
   reaction control system, 164  
   specifications, iv  
   structure, 103, 122  
 Shapley, Alan H., 208  
 Shea, Joseph F., 134, 139, 147, 165, 168, 170, 222  
 Shepard, Alan B., Jr., iv, xi, 19, 50, 87, 214, 221  
 Shipley, William, 212  
 Shock attenuation, 157  
   NAA concept, 157  
 Sidick, Rose, xiii  
 Siepert, Albert F., 209  
*Sigma 7*  
   launch, 194  
   manned, 194  
   mission, 194  
   recovered, 194  
 Silverstein, Abe, 10, 15, 20, 31, 32, 34, 36, 42, 43, 44, 47,  
 53, 57, 60, 62, 67, 87, 93, 98, 207, 209, 213  
 Silverstein Committee, 32, 209  
   Saturn Vehicle Team, 32, 34, 209  
 Simulators, mission, 191  
   complete mission capability, 191  
   instrument environment, 191  
   visual environment, 191  
 Siry, Joseph W., 138  
 Sivertson, Wilford E., Jr., 64, 211  
 Sjoberg, Sigurd A., 217, 221  
 Slayton, Donald K., 19, 217, 221  
 Sloop, John L., 54, 80, 210  
 SM. *See* Service module.  
 Small, John W., Jr., 217  
 Smedal, Harald A., 62, 211, 215  
 Smith, Francis B., 19  
 Smith, G. Allen, 62, 210  
 Smith, G. Dale, 211  
 Smith, George B., Jr., 167  
 Smith, Levering, 100, 214  
 Smith, R. A., 7  
 Smith, Richard F., 216  
 Smith, Richard G., 219  
 Smith, Robert P., 142, 219  
 Snyder, Samuel, 212  
 Society of Automotive Engineers, 42  
   National Aeronautical Meeting, 42  
 Solar batteries, 40  
 Solar cells, 195  
 Solar flares, 41, 95, 159  
 Solar satellite, 15  
 Source Evaluation Board, 104, 114, 128, 159, 214  
 South Africa, 19, 32, 41, 55  
 South Point, Hawaii, 105  
 Sovereignty of outer space, 6  
 Soviet Union, xi, 2, 8, 15, 29, 32, 45, 53, 62, 76, 77, 81,  
 106, 179, 181  
 Space and Information Systems Division, 128, 151, 152,  
 198  
   employment increase, 167  
   first spacecraft mockup inspection, 167  
   named subcontractors, 130, 134, 138, 142, 143  
   NASA Apollo Office established, 140  
   selected to design and build Apollo spacecraft, 128  
   *See also* North American Aviation, Inc.  
 Space  
   cabin, 80, 167, 181, 188  
     fire, 188  
     sealing, 80  
     simulated, 181, 188  
   environment, 13, 19, 67, 85, 101, 173  
     physical reactions to, 101  
     psychological reactions to, 101, 167, 181  
   exploration, 9  
   ferry, 45, 115  
   flight, 5  
   flight research, cost, 10  
   goal, 10, 77, 88  
   laboratory, 25, 31, 40, 102  
     module, 102, 104, 123, 127  
     temporary (manned), 33  
   medicine, first symposium, 7  
   mirror, 5  
   platforms, 28  
   probes, unmanned, 26  
   radiator, 159  
   sextant, 110, 160, 165  
     first design study, 133  
     visibility problem, 110  
   station, 5, 7, 17, 19, 35, 42, 45  
     in earth orbit, 39, 40  
   suit, 157, 172, 176, 194, 200  
     development, 27, 130, 166, 176, 194  
     *See also* Apollo space suit.  
   vehicle, problems, 112  
     design studies, 112  
     operations, 112  
     planning, 112  
     refueling in earth orbit, 112  
     research and development tests, 112  
     schedules, 112  
     weight, 112  
 Space Exploration Program Council, 34, 36, 42, 47, 55,  
 66, 67, 209  
   Senior Steering Group, 36, 42  
 Space rendezvous, xiii, 45  
   NASA inter-Center meeting, 45  
 Space Science Board (National Academy of Sciences), 77  
 Space Sciences Steering Committee, 94  
   Lunar Sciences Subcommittee, 94  
 Space Task Group (STG), iii, iv, v, xi, 21, 32, 39, 40, 41-  
 45, 56, 60, 61, 66, 68-70, 73, 74, 76, 78, 84, 87, 93, 98,  
 104, 105, 107, 110, 112, 113  
   Advanced Vehicle Team, 3, 35, 209  
   Apollo Project Office formed, 54  
   Flight Systems Division, 50, 54, 55, 94  
   formulated guidelines for advanced manned  
     spacecraft, 38  
   New Projects Panel, 2, 209

- Organization chart, 230
- organized, 14
- proposed a manned spacecraft development center, 85
- redesignated, v, 50, 118
- responsibilities with prime contract, 93, 94
- responsibility for lunar spacecraft specifications, 94
- transferred to Goddard Space Flight Center, 21
- Space Technology Laboratories, Inc., 134
  - Apollo spacecraft bid, 114
  - design study for Surveyor spacecraft, 47
  - unmanned logistic system study, 186
- Space Vehicle Review Board, 218
- Spacecraft, 6, 197, 200
  - 14-day flight-time capability, 39
  - compatibility with Saturn boosters, 39, 40
  - coolant system, 70, 154, 178
  - lunar liftoff weight, 138
  - propulsion systems, 24, 40, 99, 164
  - specifications, 176
    - Statement of Work, 131
  - stability, 200
  - temperature control, 70
  - transponder equipment, 177
  - weight, 24, 40, 55, 56, 57, 165, 176, 177, 190, 192
  - See also* Apollo spacecraft, Command module, Lunar excursion module, and Lunar excursion vehicle.
- Spacecraft adapter, 186
  - structure defined, 186
- Spacecraft "bus," 180
  - lunar logistic study, 180
- Spacecraft configurations, 59
  - Bell Dyna-Soar, 71, 72
  - D-2, 72, 90
  - elliptical cone, 71
  - flat-bottomed lifting vehicle, 71, 72
  - flat-face cone, 71
  - half-cone, 71
  - Hydrag (Avco Corporation), 71
  - L-2C (Langley), 71, 72
  - lenticular, 29, 71, 72, 77, 78
  - lifting Mercury, 45
  - M-1, 71, 77
  - M-1-1, 71, 72
  - M-2, 71
  - Mark II, 71
  - Mercury-type, 57, 71
  - Mercury with control flap, 71
  - modified flapped Mercury, 71, 72
  - NERV, 71
  - R-3, 72
  - RVX (blunted cone), 71
  - W-1, 72
  - winged glide, 88
- Spacecraft contractors. *See* Appendix 3, 223.
- Spacecraft design, 40
  - crew survival for 72 hours, 72
- Spacecraft development program, 119
  - performances, 119
  - schedules, 119
  - weights, 119
- Spacecraft, U.S.
  - Aurora 7*, 160, 161
  - Freedom 7*, 87
  - Friendship 7*, 140
  - Liberty Bell 7*, 100
  - Mariner, 99
  - Ranger I*, 107
  - Ranger II*, 120
  - Ranger III*, 135, 194
  - Ranger IV*, 154, 183
  - Ranger V*, 195
  - Sigma 7*, 194
  - See also* names of each.
- Spacecraft, U.S.S.R.
  - Korabl Sputnik I (Sputnik IV)*, 29, 45
  - Korabl Sputnik II (Sputnik V)*, 53
  - Korabl Sputnik III (Sputnik VI)*, 63
  - Korabl Sputnik VI (Sputnik IX)*, 76
  - Korabl Sputnik VII (Sputnik X)*, 77
  - Lunik I*, 15
  - Lunik II*, 2, 29, 183
  - Lunik III*, 2, 29, 195
  - Sputnik IV*, 45
  - Sputnik V*, 53
  - Sputnik VI*, 63
  - Sputnik IX*, 76
  - Sputnik X*, 77
  - Vostok I*, 81
  - Vostok II*, 106
  - Vostok III*, 181
  - Vostok IV*, 181
  - See also* names of each.
- Sparks, Brian O., 56, 64
- Special Committee on Space Technology (Stever Committee), 9, 13, 207-208
- Speer, Fridjof A., 220
- Spitzer, Lyman, Jr., 207
- Sputnik I*, xi, 2, 8
- Sputnik IV*, 29, 45
- Sputnik V*, 53
- Sputnik VI*, 63
- Sputnik IX*, 76
- Sputnik X*, 77
- Squires, Kenneth R., 211, 215
- Stabilization and control subsystem, 102, 121, 186, 194
  - attitude and rate displays, 121
  - attitude reference, 121
  - contract to Minneapolis-Honeywell Regulator Company to design and build, 134
  - control electronics assembly, 121
  - manual controls, 121
  - power supplies, 121
  - rate sensors, 121
  - requirements, 102
- Stafford, Thomas P., 189
- Stapp, John P., 207
- State University of Iowa, 170
- Stecker, Lewis J., Jr., 100, 214
- Stehling, Kurt R., 100, 214
- Stelges, William R., 216, 219
- Stever Committee, 9, 13, 207
- Stever, H. Guyford, 9, 207
- Stewart, Homer J., 35, 207
- Stewart, Lester A., 219
- STG. *See* Space Task Group.
- STG-Lincoln Laboratory Work Statement, 66
- St. Louis, Mo., 190
- Stone, Ralph W., Jr., 65, 68, 115
- Storage batteries, 40, 125
- Storms, Harrison A., 127
- Strass, H. Kurt, 18, 22, 27, 28, 31, 32, 33, 44, 45, 46, 54, 55, 56, 58, 68, 94, 209, 217
- Strelka, 53
  - See also* Dogs.
- Strickland, James L., 219
- Structural system, 25, 48, 103
  - protection, 103
    - meteoroid, 103
    - passive heat, 103
    - radiation, 103
- Structures, 45, 73
  - command module, 190
- Structures, Materials and Heating Panel. *See* Technical Assessment Panels.
- Structures and materials, 68



- Sturm, Thomas A., 9  
 Suborbital flight, 35, 192  
   manned, 35, 50  
 Sumpster, James H., Jr., 218  
 Sun, 154  
 Super booster program, 35  
 Surveyor, 73, 75  
   contract award, 47  
   instrumentation, 73  
   program, 168  
   schedule, 73  
   soft-lunar landing, 47  
   spacecraft, 47, 73  
 Survival kit, 141, 190  
 Sverdrup & Parcel Company, 190  
 Swenson, Loyd S., Jr., 7  
 Sword, C. D., 167  
 Systems Integration Panel. *See* Technical Assessment Panels.  
 Syvertson, Clarence A., 62, 210, 215
- ### T
- Technical Assessment Panels, 56, 57, 106, 114  
   findings, 59  
   Panels, 214, 215, 216, 217  
     Flight Mechanics, 114, 215  
     Ground Operational Support Systems and Operations, 114, 217  
     Human Factors, 114, 215  
     Instrumentation and Communications, 114, 216  
     Manufacturing, 114, 217  
     Onboard Systems, 114, 216  
     Propulsion, 114, 215  
     Reliability, 114, 217  
     Structures, Materials and Heating, 114, 214  
     Systems Integration, 114, 214  
     Technical Development Plan, 114, 217  
       proposal evaluation, 57, 114  
 Technical Development Plan Panel. *See* Technical Assessment Panels.  
 Technical Information Preparation Branch, xiv  
   *See also* Manned Spacecraft Center.  
 Technical Subcommittee, 106, 114, 131, 214  
 Technology development, 67  
 Tektites, 60  
 Telecommunications system, Collins Radio Company  
   selected to build, 134  
 Telemetry, 143, 182  
   data, 79, 183  
 Telescope, 5, 170, 182, 185, 190, 200  
   requirements for spacecraft, 163, 185  
   scanning, 192  
 Television, 81, 182, 195  
   camera, 11, 44, 73, 108  
   direct, 21  
   monitor, 190  
   system, 21, 44  
 Temperature recorder, 43  
   lunar, 43  
 Tenth International Astronautical Congress, 28, 30  
 Terrestrial crater, 60  
   studies, 60  
 Theoretical Mechanics Division, 34  
   lunar trajectory group, 34  
   *See also* Langley Research Center.  
 Thibodaux, Joseph G., Jr., 64, 211, 215  
 Thiele, Clyde, 217  
 Thiokol Chemical Corporation, selected to build launch  
   escape tower jettison motor, 152  
 Thompson, Floyd L., 14, 45, 56, 64  
 Thompson, Milton O., 63, 211, 215  
 Thompson, Robert F., 217, 219  
 Thor-Able, 12, 13, 14  
 Thor-Delta, 26, 35  
 Thornton, Wilbur G., 64, 210  
 Three-man advanced spacecraft, xi, 135  
 Thrust requirements, 25  
 Thrust chamber assembly, ablative, 184  
 Tischler, Adelbert O., 118, 221  
 Titan, 18, 20  
   first stage, 20  
   hardware procurement, 20  
   second stage of Saturn, 20  
 Titan II, 9, 132, 133  
   proposed for lunar landing program, 87  
 Titan III, 119  
   NASA had no requirement, 120  
 Titan-C, 20, 29  
 Titov, Gherman S. (pilot, *Vostok II*), 106  
 Tobius, Cornelius A., 46  
 Tolson, Robert H., 115  
 Topographical research, 13  
 Toukdarian, Richard Z., 216  
 Toxic gases, 41  
 Toy, Harold D., 217  
 Tozier, Robert E., 63, 211, 216  
 Tracking requirements, 41, 42, 66  
   circumlunar, 41  
   midcourse, 41, 42  
   reentry, 42  
 Tracking stations  
   deep-space stations, 14, 66  
 Tracking systems  
   DOD-NASA coordination, 19  
 Trageser, Milton B., 43, 61, 62, 63, 105, 110  
 Trainers  
   part-task, 191  
   simulated lunar landing, 168  
 Trajectory analysis, 44, 68, 172  
   lunar excursion module, 172  
 Transearth trajectory, 6, 102, 182  
 Translunar injection, 147  
 Translunar trajectory, 6, 102, 147, 150, 154, 182  
 Transponder, 177  
 Trenholm, J. B., Jr., 218  
 Trimble, George S., Jr., 207  
 Trimpi, Robert L., 64, 211  
 Tullahoma, Tenn., 191  
 Turnock, James, 147
- ### U
- Unger, J., 221  
 United Aircraft Corporation, 37, 84, 143  
   Hamilton Standard Division, 130, 176, 194  
   Pratt & Whitney Aircraft Division, 84, 143  
 United Nations, General Assembly  
   adopted Resolution XII, 8  
   adopted Resolution XIV, 33, 133  
 United States, 32, 55  
 United States Air Force  
   Arnold Engineering Development Center, 160, 191  
   Ballistic Missile Division, 11, 21, 32, 59  
   Research and Development Command, 59  
   Scientific Advisory Board, 8  
   sponsored space medicine symposium, 7  
 United States Army  
   Ballistic Missile Agency, 2, 8, 9, 12, 15, 17, 20, 21,  
     25, 26, 29, 31-34, 36, 37  
   Chief of Ordnance, 10  
   Chief of Staff, 23  
 United States Navy, 44  
   Air Crew Equipment Laboratory, 106  
   Naval Air Engineering Center, 167  
 University of Arizona, 195  
   Lunar and Planetary Laboratory, 195  
 University of California, 17, 46



INDEX

University of Chicago, 10, 42  
 University of Houston, xiv  
 University of Manchester, 13, 44  
 University of Minnesota, 46  
 Unmanned logistic system studies, feasibility of developing  
     general-purpose spacecraft, 8  
 Upper Atmosphere Rocket Research Panel, 8  
 Urine management system, 164  
 U.S. Army Map Service, 15  
 U.S. Geological Survey, 15, 53, 60  
 U.S.S. *Kearsarge*, 194

V

V-2 Upper Atmosphere Research Panel, 8  
 Vacuum, environmental approach, 99  
 Vale, Robert E., 211, 215, 219  
 Van Allen, James A., 10, 170, 207  
 Van Allen radiation belts, 46, 68  
     inner belt, 46  
     outer belt, 46  
 Vandenberg Air Force Base, Calif., 60  
 Vanguard, 9  
 Vann, James, 219  
 Van Nuys, Calif., 134  
 Variable-thrust engines for lunar landing, 24  
 Vega, 16, 21, 26, 31  
 Velocity requirements, 25, 102  
 Venus (planet), 78  
     orbiter, 55  
     probe, 35  
     unmanned reconnaissance, 35  
 Vernier propulsion system, 102  
 Vetko, George J., 215  
 Vibration, 41, 80, 123  
     attenuation, 123  
     crew loads, 123  
     in spacecraft, 41, 123  
 Voas, Robert B., 215, 217  
 Vogeley, Arthur W., 81, 98, 115  
 von Braun team, 23  
 von Braun, Wernher, 5, 6, 14, 15, 36, 38, 44, 56, 62, 66,  
     74, 87, 98, 112, 113, 134, 140, 164, 207, 209, 218, 221,  
     222  
 Vonbun, Friedrich O., 138, 147, 211, 217  
 Voss, R., 213  
*Vostok I*  
     launch, 81  
     payload, 81  
     reentry, 81  
*Vostok II*  
     launch, 106  
     manned, 106  
     payload, 106  
     reentry, 106  
     weight, 106  
*Vostok III*  
     launch, 181  
     manned, 181  
     recovery, 181  
     rendezvous with *Vostok IV*, 181  
*Vostok IV*  
     launch, 181  
     manned, 181  
     recovery, 181  
     rendezvous with *Vostok III*, 181  
 Vought Astronautics  
     MSC space suit evaluation contract, 166

W

W-1 configuration, 72  
 Wallops Island, Va., 44, 60, 85  
 Wallops Station, Va., 43, 197  
 Ward, Robert J., 219

Washington, D.C., iv, xiv, 19, 36, 46, 47, 53, 55, 99, 115,  
 118, 168  
 Waste disposal, 41  
 Water boiler, 178  
 Water tanks, 178  
 Water vapor, 41  
 Water-glycol, 159, 178, 192  
 Watkins, Harry L., 218  
 Watson, Fletcher G., 10  
 Watters, Harry J., 212  
 Waugh, Merle G., 212  
 Weather observation, 5  
 Weather satellite system, 91  
 Webb, James E., 74, 99, 108, 128, 133, 143, 159, 166, 170,  
 171, 201  
 Weeks, L. M., 110  
 Weigand, H. J., 100, 214  
 Weight, 31, 68, 165, 176, 190  
 Weightlessness, 5  
 Wells, Helen T., 27  
 Weston, Kenneth C., 211, 215  
 Weyers, Paul F., 142  
 Whipple, Fred L., 6, 208  
 Whitbeck, Philip H., 217  
 White, Art, 221  
 White, Edward H., II, 189  
 White, Stanley C., 41, 46, 209, 214  
 White Sands Missile Range (WSMR), N. Mex., 105,  
 165, 175, 188, 193  
     facilities, 165, 180, 181, 188  
     MSC test programs, 165, 175  
     potential direct ascent launch site, 105  
     selected as Little Joe II launch site, 160  
 Whittaker, Clyde, 219  
 Wiesner Committee (Ad Hoc Committee on Space), 69,  
 212  
 Wiesner, Jerome B., 69, 212  
 Wildey, Robert L., 200  
 Williams Bay, Wisc., 10  
 Williams, Francis L., 8, 100, 214  
 Williams, Grady, 221  
 Williams, John J., 214, 220  
 Williams, Thomas, 216  
 Williams, Walter C., 93, 104-107, 112, 118, 134, 155,  
 214, 221, 222  
 Williams, W. E., 219  
 Williamsburg, Va., 131  
 Willment, David A., 149  
 Wilson, Charles H., 94  
 Winckler, John R., 46  
 Wind tunnel  
     program, 141, 191  
     tests, 69, 144  
 Windows, 163  
     spacecraft, 163, 177, 198  
 Winged-glide configuration, 88  
 Winterhalter, David L., Sr., 142  
 Wolhart, Walter D., 218  
 Wolman, William W., 100, 214  
 Wood, Lloyd, 210  
 Woods, Robert J., 7  
 Woodward, William H., 207, 213  
 Woomera, Australia, 19, 75, 109, 143  
 Wosley, Gordon, 219, 220  
 Working Group on Human Factors and Training (Stever  
     Committee), 208  
 Working Group on Instrumentation (Stever Committee),  
 208  
 Working Group on Lunar Exploration, 17, 208  
 Working Group on Manned Lunar Landing Program,  
 57, 210  
     formed by George Low, 57  
     purposes, 57

INDEX

Working Group on Range, Launch and Tracking Facilities (Stever Committee), 208  
 Working Group on Reentry (Stever Committee), 207  
 Working Group on Space Research Objectives (Stever Committee), 207  
 Working Group on Space Surveillance (Stever Committee), 208  
 Working Group on Vehicle Program (Stever Committee), 207  
 World War II, 5  
 WSMR. *See* White Sands Missile Range.  
 Wyatt, DeMarquis D., 17, 19, 98, 213

**X**

X-15, 140, 152

**Y**

Yaw rates, 182  
 Yerkes Observatory, 10, 42  
 Yolles, J., 213  
 York, Herbert F., 17, 20, 29, 209  
 Young, John D., 217  
 Young, John W., 189  
 Yscek, Henry P., 141, 218

**Z**

Zavasky, Raymond L., 23  
 Zimmerman, Arthur V., 147  
 Zimmerman, Charles H., 23  
 Zwicky, F., 5

## THE AUTHORS

Ivan D. Ertel has been the Assistant Historian of the Manned Spacecraft Center since September 1964. Born in Marion, New York (1914) he received his B.B.A. degree from Georgia State College, Atlanta, Georgia (1958). He was news editor of *Atlanta's Suburban Reporter*, East Point, Georgia, and the *Decatur-DeKalb News, Decatur, Georgia* (1954–1957). Before coming to NASA in 1961 he was Press Officer at Headquarters, Third Army. Ertel established the MSC official news organ, *Space News Roundup*, and authored brochures and fact sheets about each Mercury and Gemini manned flight. He is married and has three daughters.

Mary Louise Morse has been a Research Associate with the Department of History of the University of Houston since the fall of 1966. Born in Beverly, Massachusetts, she received her B.S. in Education from Salem State College, Salem, Massachusetts (1947), and her M.A. in History from Columbia University (1950). She was a senior editor with the MIT Press, Cambridge, Massachusetts, before moving to Houston.



Page Intentionally Left Blank

# NASA HISTORICAL PUBLICATIONS

## HISTORIES

### MANAGEMENT HISTORY SERIES

- Robert L. Rosholt, *An Administrative History of NASA, 1958-1963*, NASA SP-4101, 1966, \$4.00.\*

### PROGRAM HISTORY SERIES

- Loyd S. Swenson, Jr., James M. Grimwood, and Charles C. Alexander, *This New Ocean: A History of Project Mercury*, NASA SP-4201, 1966, \$5.50.
- Constance McL. Green and Milton Lomask, *Vanguard: A History* (1969).

### CENTER HISTORY SERIES

- Alfred Rosenthal, *Venture into Space: Early Years of Goddard Space Flight Center*, NASA SP-4301, 1968, \$2.50.

## HISTORICAL STUDIES

- Eugene M. Emme (ed.), *History of Rocket Technology*, special issue of *Technology and Culture* (Fall 1963); augmented and published by Society for the History of Technology (Detroit: Wayne State University Press, 1964).
- Mae Mills Link, *Space Medicine in Project Mercury*, NASA SP-4003, 1965, \$1.00.
- *Historical Sketch of NASA*, NASA EP-29, 1965 (Out of Print).

## CHRONOLOGIES

- *Aeronautics and Astronautics: An American Chronology of Science and Technology in the Exploration of Space, 1915-1960*, compiled by Eugene M. Emme, Washington: NASA, 1961 (Out of Print).
- *Aeronautical and Astronautical Events of 1961*, published by the House Committee on Science and Astronautics, 1962 (Out of Print).
- *Astronautical and Aeronautical Events of 1962*, published by the House Committee on Science and Astronautics, 1963, \$1.00.
- *Astronautics and Aeronautics, 1963*, NASA SP-4004, 1964, \$1.75.
- *Astronautics and Aeronautics, 1964*, NASA SP-4005, 1965, \$1.75.
- *Astronautics and Aeronautics, 1965*, NASA SP-4006, 1966, \$2.25.
- *Astronautics and Aeronautics, 1966*, NASA SP-4007, 1967, \$1.50.
- *Astronautics and Aeronautics, 1967*, NASA SP-4008 (1968), \$2.25.
- *Project Mercury: A Chronology*, by James M. Grimwood, NASA SP-4001, 1963.
- *Project Gemini Technology and Operations: A Chronology*, by James M. Grimwood and Barton C. Hacker, with Peter J. Vorzimmer, NASA SP-4002 (1969).

---

\*All titles with prices can be ordered from the Superintendent of Documents, Government Printing Office, Washington, D.C. 20402.