

SATURN S-IVB-505N STAGE FLIGHT EVALUATION REPORT

MDC G0008
MSFC-DRL-021
LINE ITEM 130
AUGUST 1969

PREPARED BY:
SATURN S-IVB TEST PLANNING AND
EVALUATION COMMITTEE AND
COORDINATED BY: H. L. WILLIAMS
PROJECT OFFICE - TEST
HUNTINGTON BEACH DEVELOPMENT ENGINEERING

PREPARED FOR:
NATIONAL AERONAUTICS AND
SPACE ADMINISTRATION
UNDER NASA CONTRACT NAS7-101



APPROVED BY: A. P. O'NEAL
HUNTINGTON BEACH DEVELOPMENT ENGINEERING DIRECTOR
SATURN/APOLLO & APOLLO APPLICATIONS PROGRAMS

MCDONNELL DOUGLAS ASTRONAUTICS COMPANY
WESTERN DIVISION

5301 Bolsa Avenue, Huntington Beach, California 92647 (714) 897-0311

ABSTRACT

This report presents the evaluation results of the prelaunch countdown, powered flight, and orbital phases of the S-IVB-505N stage which was launched 18 May 1969 as the third stage of the Saturn AS-505 vehicle.

The report is a contractual document as outlined in NASA Report MSFC-DRL-021, Contract Data Requirements, Saturn S-IVB Stage and GSE, dated 1 August 1968, Revision B. It was prepared by the Saturn S-IVB Test Planning and Evaluation Committee and coordinated by the Saturn S-IVB Project Office of the McDonnell Douglas Astronautics Company - Western Division.

DESCRIPTORS

Data Evaluation	S-IVB-505N
Flight Test	Saturn AS-505 Vehicle
Saturn V	Countdown

REQUIRING R. C. ...

PREFACE

The purpose of this report is to present the evaluation results of the prelaunch countdown, powered flight, and orbital phases of the S-IVB-505N stage which was launched on 18 May 1969 as the third stage of the Saturn AS-505 vehicle.

This report was prepared in compliance with the National Aeronautics and Space Administration Contract NAS7-101. It is published in accordance with NASA Report MSFC-DRL-021, Contract Data Requirements, Saturn S-IVB Stage and GSE, dated 1 August 1968, Revision B, which delineates the data required from the McDonnell Douglas Astronautics Company.

This document was prepared by the Saturn S-IVB Test Planning and Evaluation Committee and coordinated by the Saturn S-IVB Project Office of the McDonnell Douglas Astronautics Company - Western Division.

PRECEDING PAGE BLANK NOT FILLED.

TABLE OF CONTENTS

<u>Section</u>		<u>Page</u>
1.	INTRODUCTION	1-1
	1.1 General	1-1
	1.2 History	1-1
2.	SUMMARY	2-1
	2.1 Flight Description	2-1
	2.2 Mission Objectives	2-4
	2.3 Test Operations	2-5
	2.4 Cost Plus Incentive Fee	2-5
	2.5 Trajectory	2-5
	2.6 Mass Characteristics	2-6
	2.7 Engine System	2-6
	2.8 Solid Rockets	2-6
	2.9 Oxygen-Hydrogen Burner System	2-6
	2.10 Oxidizer System	2-6
	2.11 Fuel System	2-7
	2.12 Auxiliary Propulsion System (APS)	2-7
	2.13 Pneumatic Control and Purge System	2-7
	2.14 Propellant Utilization	2-7
	2.15 S-II/S-IVB Separation	2-8
	2.16 Data Acquisition System	2-8
	2.17 Electrical System	2-8
	2.18 Range Safety System	2-9
	2.19 Flight Control	2-9
	2.20 Hydraulic System	2-9
	2.21 Stage Structure and Environment	2-9
	2.22 Forward Skirt Thermoconditioning	2-10
	2.23 Acoustic and Vibration Environment	2-10
3.	TEST CONFIGURATION	3-1
	3.1 General	3-1
4.	SEQUENCE OF EVENTS	4-1
	4.1 Predicted Times	4-1
	4.2 Monitored Times	4-2
	4.3 Time Bases	4-2
	4.4 Data Omissions	4-3
	4.5 Comments	4-3
	4.6 Ground Initiated Commands	4-3

TABLE OF CONTENTS (Continued)

<u>Section</u>		<u>Page</u>
5.	TEST OPERATIONS	5-1
	5.1 Launch Vehicle Tests	5-1
	5.2 AS-505 Launch Countdown	5-2
	5.3 Redline Limits	5-5
	5.4 Countdown Problems	5-5
	5.5 Environmental Control System	5-5
	5.6 Atmospheric Conditions	5-6
6.	COST PLUS INCENTIVE FEE	6-1
	6.1 Flight Mission Accomplishment	6-1
	6.2 Telemetry Performance	6-1
7.	TRAJECTORY	7-1
	7.1 Comparison Between Actual and Preflight Prediction Trajectories	7-1
	7.2 Powered Flight Simulated Trajectory Evaluation	7-2
	7.3 Translunar Orbit Analysis	7-4
8.	MASS CHARACTERISTICS	8-1
	8.1 Mass Property Uncertainty Analysis	8-1
	8.2 Best Estimate Ignition and Cutoff Masses	8-1
9.	ENGINE SYSTEM	9-1
	9.1 Modifications	9-1
	9.2 Sequence of Events	9-2
	9.3 Engine Chillumdown and Conditioning	9-2
	9.4 Start System Performance	9-4
	9.5 Engine Pneumatic System Performance	9-5
	9.6 Engine Performance	9-8
	9.7 Trajectory Simulation Analysis	9-12
	9.8 Component Operation	9-13
	9.9 Propellant Lead Experiment	9-15
	9.10 Reported Vibration	9-30
10.	SOLID ROCKETS	10-1
	10.1 Retrorockets	10-1
	10.2 Ullage Rockets	10-1
11.	OXIDIZER SYSTEM	11-1
	11.1 LOX Tank Pressurization Control	11-1
	11.2 Pressurization System Conditions During Coast	11-5
	11.3 LOX Pump Chillumdown	11-6
	11.4 Engine LOX Supply	11-7

TABLE OF CONTENTS (Continued)

<u>Section</u>		<u>Page</u>
12.	FUEL SYSTEM	12-1
	12.1 LH2 Tank Pressurization Control	12-1
	12.2 Pressurization System Conditions During Coast	12-3
	12.3 LH2 Pump Chilloverdown	12-5
	12.4 Engine LH2 Supply	12-5
13.	OXYGEN-HYDROGEN BURN SYSTEM	13-1
	13.1 Burner Performance	13-1
	13.2 LH2 Tank Re-pressurization	13-2
	13.3 Cold Helium Supply	13-2
14.	AUXILIARY PROPULSION SYSTEM	14-1
	14.1 APS Flight Operation	14-1
	14.2 APS System Operation	14-3
	14.3 Engine Performance	14-6
15.	PNEUMATIC CONTROL AND PURGE SYSTEM	15-1
	15.1 Pneumatic Control	15-1
	15.2 Ambient Helium Purges	15-1
16.	PROPELLANT UTILIZATION	16-1
	16.1 PU Mass Sensor Calibration	16-1
	16.2 Propellant Mass History	16-2
	16.3 PU System Response	16-5
	16.4 Anomalies	16-5
17.	S-II/S-IVB STAGE SEPARATION	17-1
	S-II/S-IVB Separation Dynamics	17-1
18.	DATA ACQUISITION SYSTEM	18-1
	18.1 Data Acquisition System Objective	18-1
	18.2 Summary of Performance	18-1
	18.3 Instrumentation System Performance	18-2
	18.4 Telemetry System Performance	18-2
19.	ELECTRICAL POWER AND CONTROL SYSTEM	19-1
	19.1 Power System	19-1
	19.2 Electrical Control System	19-4
20.	RANGE SAFETY SYSTEM PERFORMANCE	20-1
	20.1 Controllers	20-1
	20.2 Firing Unit Monitors	20-1
	20.3 Receivers Signal Strength	20-1

TABLE OF CONTENTS (Continued)

<u>Section</u>		<u>Page</u>
21.	FLIGHT CONTROL	21-1
	21.1 S-IVB Powered Flight Control System Evaluation	21-1
	21.2 Attitude Control-Orbit	21-4
22.	HYDRAULIC SYSTEM	22-1
	22.1 Hydraulic System Operation	22-1
23.	STAGE STRUCTURE AND ENVIRONMENT	23-1
	23.1 Flight Load Conditions and Structural Integrity	23-1
24.	FORWARD SKIRT THERMOCONDITIONING SYSTEM	24-1
	24.1 Temperature	24-1
	24.2 Pressure	24-1
	24.3 Flow	24-1
25.	ACOUSTIC AND VIBRATION ENVIRONMENT	25-1
	25.1 Data Acquisition and Reduction	25-1
	25.2 Vibration Environment	25-2
	25.3 Acoustic Environment	25-4
	25.4 Low Frequency Measurements	25-4
	25.5 Dynamic Strain Measurements	25-6
26.	AERO/THERMODYNAMIC ENVIRONMENT	26-1
	26.1 Compartment Venting	26-1
	26.2 Thermodynamic Environment	26-1
27.	PROPELLANT DUMP	27-1
	27.1 LOX DUMP	27-1
	27.2 High-Pressure Sphere Passivation	27-1

APPENDICES

Appendix

1.	GLOSSARY AND ABBREVIATIONS	AP 1-1
	DISTRIBUTION LIST	

LIST OF TABLES

Table

3-1	S-IVB-505N Stage and GSE Flight Orifices	3-4
3-2	S-IVB-505N Stage Pressure Switch Data	3-7

LIST OF TABLES (Continued)

<u>Table</u>		<u>Page</u>
4-1	AS-505 Mission F Post Flight Sequence of Events as of June 13, 1969	4-4
4-2	Post Flight Sequence for Ground Initiated Commands as of June 13, 1969 . .	4-50
5-1	Launch Vehicle Tests	5-7
5-2	S-IVB-505N Stage Propellant Loading Data	5-8
5-3	APS Loading Data	5-9
5-4	Sphere Pressurization Data	5-10
5-5	AS-505N Terminal Countdown Sequence	5-11
6-1	S-IVB-505 Preconditions of Flight (PCF) (S-II/S-IVB Separation Command)	6-2
6-2	S-IVB-505 End Conditions of Flight (ECF) Translunar Injection	6-3
6-3	Flight Telemetry Performance Summary	6-5
7-1	Conditions at Maximum Dynamic Pressure	7-6
7-2	Conditions at S-IC/S-II Separation Command	7-7
7-3	Conditions at S-II/S-IVB Separation Command	7-8
7-4	Conditions at S-IVB First Guidance Cutoff Command	7-9
7-5	Conditions at Parking Orbit Insertion	7-10
7-6	AS-504 Condition at SC/LV Final Separation	7-11
7-6	Conditions at Time Base 6	7-11
7-7	Conditions at S-IVB Second Engine Start Command	7-12
7-8	Conditions at S-IVB Second Cutoff Command	7-13
7-9	Conditions at Translunar Orbit Insertion	7-14
7-10	AS-504 Conditions at CSM Separation	7-15
8-1	AS-505 Third Flight Stage Final Evaluation Mass Summary	8-3
9-1	Engine Sequence (505-First Burn)	9-32
9-2	Engine Sequence (505-Second Burn)	9-37
9-3	Fuel Lead Conditions	9-42
9-4	Engine Start Sphere Data	9-43
9-5	Control Sphere Data	9-44
9-6	Start Bottle Refill Performance	9-45
9-7	J-2 Engine Steady Performance Compared to Predicted (STDV +2.5 SEC to ECO)	9-46
9-8	Data Inputs to Computer Programs	9-47
9-9	J-2 Engine Start Transients	9-49
9-10	S-IVB Total J-2 Propulsion Performance	9-50
9-11	S-IVB Steady State Performance (Performance at Standard Altitude Conditions)	9-51
9-12	J-2 Engine Cutoff Transients	9-52
9-13	AS-505 S-IVB Cutoff Impulse	9-53

LIST OF TABLES (Continued)

<u>Table</u>		<u>Page</u>
11-1	LOX Tank Prepressurization Data	11-8
11-2	LOX Tank Pressurization Data	11-9
11-3	Cold Helium Supply Data	11-10
11-4	J-2 Heat Exchanger Performance Data	11-11
11-5	LOX Chillover System Performance Data	11-12
11-6	LOX Pump Inlet Condition Data	11-15
12-1	LH2 Tank Prepressurization Data	12-7
12-2	LH2 Tank Pressurization Data	12-8
12-3	LH2 Tank Repressurization Data	12-9
12-4	LH2 Chillover System Performance Data	12-10
12-5	LH2 Pump Inlet Condition Data	12-13
13-1	O2-H2 Burner Performance Data	13-2
14-1	Helium Bottle Conditions	14-8
14-2	APS Module Performance Span	14-9
14-3	S-IVB APS Propellant Consumption	14-10
15-1	Pneumatic Control and Purge System Data	15-2
16-1	Mass History Table	16-6
16-2	Propellant Residual Summary	16-7
17-1	AS-505 Separation Events	17-2
18-1	Measurement Status	18-6
18-2	Measurement Failures Not Affecting CPIF	18-8
18-3	Measurement Failures	18-9
18-4	Measurement Anomalies	18-11
18-5	RF System Performance	18-13
21-1	Maximum Values of Critical Flight Control Parameters, AS-505 First Burn.	21-8
21-2	Maximum Values of Critical Flight Control Parameters, AS-505 Second Burn	21-9
21-3	Maneuver Requirements for "F" Mission	21-10
21-4	APS Impulse Requirements for Attitude Control (lb-sec)	21-11
23-1	Maximum Local Stringer Bending Moments and Axial Loads, Aft and Forward Skirts	23-6
23-2	Axial Load Factors During Powered Flight	23-7
25-1	Composite Levels	25-7
25-2	S-IVB Stage Low Frequency Vibration Summary	25-9
27-1	High Pressure Sphere Passivation	27-3
AP 1-1	Glossary and Abbreviations	

LIST OF ILLUSTRATIONS

<u>Figure</u>		<u>Page</u>
1-1	S-IVB-505 Stage Checkout and Test History	1-2
3-1	Schematic, S-IVB/V Propulsion System Complete	3-9
7-1	S-IC/S-II Stage Altitude History	7-16
7-2	S-IC/S-II Stage Ground Range History	7-17
7-3	S-IC/S-II Stage Crossrange Position History	7-18
7-4	S-IC/S-II Stage Crossrange Velocity History	7-19
7-5	S-IC/S-II Stage Inertial Velocity History	7-20
7-6	S-IC/S-II Stage Axial Acceleration History	7-21
7-7	S-IC/S-II Stage Inertial Flight Path Elevation Angle History	7-22
7-8	S-IC/S-II Stage Inertial Flight Path Azimuth Angle History	7-23
7-9	S-IC/S-II Stage Mach Number History	7-24
7-10	S-IC Stage Dynamic Pressure History	7-25
7-11	S-IC Stage Pitch Angle of Attach History	7-26
7-12	Boost Phase Pitch Attitude Angle History	7-27
7-13	Boost Phase Yaw Attitude Angle History	7-28
7-14	Boost Phase Roll Attitude Angle History	7-29
7-15	S-IVB Stage First Burn Altitude History	7-30
7-16	S-IVB Stage First Burn Ground Range History	7-31
7-17	S-IVB Stage First Burn Crossrange Position History	7-32
7-18	S-IVB Stage First Burn Crossrange Velocity History	7-33
7-19	S-IVB Stage First Burn Inertial Velocity history	7-34
7-20	S-IVB Stage First Burn Axial Acceleration History	7-35
7-21	S-IVB Stage First Burn Inertial Flight Path Elevation Angle History	7-36
7-22	S-IVB Stage First Burn Inertial Flight Path Azimuth Angle History	7-37
7-23	S-IVB Stage Second Burn Altitude History	7-38
7-24	S-IVB Stage Second Burn Ground Range History	7-39
7-25	S-IVB Stage Second Burn Crossrange Position History	7-40
7-26	S-IVB Stage Second Burn Inertial Velocity History	7-41
7-27	S-IVB Stage Second Burn Axial Acceleration History	7-42
7-28	S-IVB Stage Second Burn Inertial Flight Path Elevation Angle History	7-43
7-29	S-IVB Stage Second Burn Inertial Flight Path Azimuth Angle History	7-44
7-30	S-IVB Stage Second Burn Pitch Attitude Angle History	7-45
7-31	S-IVB Second Burn Yaw Attitude Angle History	7-46
7-32	S-IVB Stage Second Burn Roll Attitude Angle History	7-47
7-33	Trajectory Simulation Deviations from Observed Trajectory - First Burn	7-48
7-34	Comparison of Reshaped and Observed Thrust	7-49
7-35	Comparison of Actual and Reconstructed Thrust	7-50
7-36	Deviations from Observed Trajectory	7-51
7-37	Velocity Increment Due to Slingshot Activity	7-52

LIST OF ILLUSTRATIONS (Continued)

<u>Figure</u>		<u>Page</u>
8-1	Third Flight Stage Vehicle Mass (First Burn)	8-6
8-2	Third Flight Stage Vehicle Mass (Second Burn)	8-7
8-3	Third Flight Stage Vehicle Horizontal Center of Gravity (First Burn)	8-8
8-4	Third Flight Stage Vehicle Horizontal Center of Gravity (Second Burn)	8-9
8-5	Third Flight Stage Vehicle Roll Moment of Inertia (First Burn)	8-10
8-6	Third Flight Stage Vehicle Roll Moment of Inertia (Second Burn)	8-11
8-7	Third Flight Stage Vehicle Pitch Moment of Inertia (First Burn)	8-12
8-8	Third Flight Stage Vehicle Pitch Moment of Inertia (Second Burn)	8-13
8-9	AS-505 Third Flight Stage Best Estimate Masses - First Burn	8-14
8-10	AS-505 Third Flight Stage Best Estimate Masses - Second Burn	8-15
9-1	J-2 Engine System and Instrumentation	9-54
9-2	First Burn Tag Values	9-55
9-3	Second Burn Tag Values	9-57
9-4	Engine Start Sequence - First Burn	9-59
9-5	Engine Start Sequence - Second Burn	9-60
9-6	Oxidizer Pump Discharge Pressure Versus Temperature	9-61
9-7	Thrust Chamber Chillover - First Burn	9-62
9-8	Fuel Lead - First Burn	9-63
9-9	Fuel Lead - Second Burn	9-64
9-10	GH2 Start Sphere Critical Limits at Liftoff	9-65
9-11	Engine Start Sphere Performance - First Burn	9-66
9-12	Engine Control Sphere Performance - First Burn	9-68
9-13	Start Sphere Refill Performance	9-69
9-14	Start Sphere Conditions - Earth Orbit	9-71
9-15	Start Sphere Refill	9-72
9-16	Start Tank Safing	9-74
9-17	Control Sphere Performance	9-75
9-18	Control Sphere Conditions	9-77
9-19	Engine Regulator Outlet Pressure	9-79
9-20	Control Sphere Performance During Coast	9-81
9-21	Engine Control Sphere Performance During Fuel Lead Experiment	9-82
9-22	Control Sphere Pressure - Passivation	9-84
9-23	Fuel Lead Characteristics - First Burn	9-85
9-24	Fuel Lead Characteristics - Second Burn	9-87
9-25	Engine Start Transient Characteristics	9-89
9-26	LOX-LH2 Consumption During Burn Start Transient	9-91
9-27	LOX and LH2 Pump Performance	9-93
9-28	Engine Chamber Pressure	9-95
9-29	PU Valve Operation	9-97

LIST OF ILLUSTRATIONS (Continued)

<u>Figure</u>		<u>Page</u>
9-30	J-2 Engine Flowrates	9-99
9-31	J-2 Engine Pump Operating Characteristics	9-101
9-32	J-2 Engine Injector Supply Conditions	9-103
9-33	Turbine Operating Conditions	9-105
9-34	Engine Steady-State Performance - First Burn	9-107
9-35	Engine Steady-State Performance - Second Burn	9-110
9-36	Engine Cutoff Transient Characteristics	9-113
9-37	LH2 Pump Performance during Engine Start	9-115
9-38	Gas Generator Performance	9-117
9-39	ASI Temperatures - First Burn	9-119
9-40	ASI Temperatures - Second Burn	9-120
9-41	LOR Mission Operational Contingency Restart Characteristics	9-121
9-42	Propellant Lead Experiment Chillover Characteristics	9-125
9-43	LOX Tank Conditions	9-126
9-44	LOX Mass In Tank	9-127
9-45	Temperature Measurement Location	9-128
9-46	Fuel Tank Conditions	9-129
9-47	LH2 Mass in Tank	9-130
9-48	S-IVB Propellant Lead Experiment and Orbital Safing Experiment	9-131
9-49	LOX Pump Inlet Conditions for Propellant Lead Experiment	9-132
9-50	LOX Lead Subcooling	9-133
9-51	LOX Pump Outlet Conditions for Propellant Lead Experiment	9-134
9-52	LOX Pump Inlet Conditioning for Propellant Lead Experiment	9-135
9-53	LOX Pump Outlet Conditioning for Propellant Lead Experiment	9-136
9-54	Fuel Pump Inlet Conditions for Propellant Lead Experiment	9-137
9-55	Fuel Lead Subcooling	9-138
9-56	Fuel Lead Subcooling	9-139
9-57	Fuel Pump Outlet Conditions for Propellant Lead Experiment	9-140
9-58	Fuel Pump Inlet Conditioning for Propellant Lead Experiment	9-141
9-59	Hardware Conditions for Propellant Lead Experiment	9-142
9-60	LOX Lead Time vs Delay Time vs LOX Inlet NPSH for Experiment	9-143
9-61	LOX Lead Time vs Delay Time vs LOX Inlet NPSH - Contingency Propellant Lead Prediction	9-144
9-62	LOX Lead Flowrate and Masses Overboard	9-145
9-63	LOX Lead Thrust and Total Impulse	9-146
9-64	Fuel Lead Quality	9-147
9-65	Fuel Lead Performance (Temperature Entropy Diagram)	9-148
9-66	Fuel Lead Flowrate and Mass Overboard	9-149
9-67	Fuel Lead Thrust and Total Impulse	9-150

LIST OF ILLUSTRATIONS (Continued)

<u>Figure</u>		<u>Page</u>
9-68	LOX Feed System Stability	9-151
11-1	Schematic, LOX Tank Pressurization and Repressurization System	11-17
11-2	LOX Tank Conditions during Prepressurization and Boost	11-18
11-3	LOX Tank Pressurization System Performance - First Burn	11-20
11-4	Cold Helium Supply - Boost and First Burn	11-22
11-5	J-2 Heat Exchanger Performance - First Burn	11-24
11-6	LOX Tank Pressurization System Performance - Second Burn	11-25
11-7	Cold Helium Supply - Second Burn	11-27
11-8	J-2 Heat Exchanger Performance - Second Burn	11-28
11-9	LOX Tank Pressurization System Performance	11-30
11-10	LOX Tank Conditions During Orbit and Translunar Coast	11-31
11-11	LOX Tank Ullage Pressure During Orbit and Translunar Coast	11-33
11-12	LOX Nonpropulsive Vent System Performance - Translunar Coast	11-35
11-13	Cold Helium Sphere Conditions - Earth Orbit	11-36
11-14	Cold Helium Conditions - Translunar Coast and Dump	11-38
11-15	LOX Pump Chillover System Operation - Boost and First Burn	11-40
11-16	LOX Pump Chillover System Performance - Boost and First Burn	11-42
11-17	LOX Pump Chillover System Operation - Second Burn	11-44
11-18	LOX Pump Chillover System Performance - Second Burn	11-46
11-19	Schematic, LOX Fill and Feed System	11-48
11-20	LOX Pump Inlet Conditions - First Burn	11-49
11-21	LOX Pump Inlet Conditions during Firing - First Burn	11-51
11-22	Effect of LOX Mass Level on LOX Pump Inlet Temperature	11-52
11-23	LOX Pump Inlet Conditions - Second Burn	11-53
12-1	Schematic, LH2 Tank Pressurization and Repress System	12-15
12-2	LH2 Tank Prepressurization System Performance	12-16
12-3	LH2 Tank Pressurization System Performance - First Burn	12-17
12-4	LH2 Tank Pressurization System Performance - Second Burn	12-19
12-5	LH2 Tank Ambient Helium Repressurization System Performance	12-21
12-6	Nonpropulsive Vent System Operation - Translunar Coast	12-22
12-7	LH2 Tank Continuous Vent System Operation - Earth Orbit	12-23
12-8	LH2 Tank Continuous Vent System Performance - Earth Orbit	12-24
12-9	LH2 Tank Continuous Vent System Operation - Translunar Coast	12-26
12-10	LH2 Tank Continuous Vent System Performance - Translunar Coast	12-27
12-11	LH2 Tank Continuous Vent System Operation During LH2 Tank Passivation	12-28
12-12	LH2 Tank Continuous Vent System Performance During LH2 Tank Passivation	12-29
12-13	NPV Operation During LH2 Tank Passivation	12-30
12-14	LH2 Pump Chillover Performance - First Burn	12-31

LIST OF ILLUSTRATIONS (Continued)

<u>Figure</u>		<u>Page</u>
12-15	LH2 Pump Chillover - First Burn	12-33
12-16	LH2 Pump Chillover System Performance - Second Burn	12-35
12-17	LH2 Pump Chillover - Second Burn	12-37
12-18	Schematic, LH2 Fill and Feed System	12-38
12-19	LH2 Pump Inlet Conditions - First Burn	12-39
12-20	LH2 Pump Inlet Conditions during Firing - First Burn	12-40
12-21	Effect of LH2 Mass Level on LH2 Pump Inlet Temperature	12-42
12-22	LH2 Pump Inlet Conditions - Second Burn	12-43
12-23	LH2 Pump Inlet Conditions during Firing - Second Burn	12-45
12-24	LH2 Pump Inlet Conditions during Firing - Second Burn	12-46
13-1	Schematic, Oxygen Hydrogen Burner	13-3
13-2	O ₂ -H ₂ Burner Operation	13-4
13-3	LH2 Tank Burner Re-pressurization	13-6
13-4	Cold Helium Sphere Conditions during O ₂ -H ₂ Burner Operation	13-7
14-1	Schematic, Auxiliary Propulsion Bladder System	14-11
14-2	APS Module 1 Helium Leakage	14-12
14-3	APS Module 1 Helium Bottle Temperature	14-13
14-4	APS Module 1 Helium Bottle Pressure	14-14
14-5	APS Module 2 Helium Bottle Temperature	14-15
14-6	APS Module 2 Helium Bottle Pressure	14-16
14-7	APS Helium Mass	14-17
14-8	APS Module No. 1 Propellant Temperatures	14-18
14-9	APS Module 1 Propellant Masses	14-19
14-10	APS Module 2 Propellant Temperatures	14-20
14-11	APS Module 2 Propellant Masses	14-21
14-12	APS Total Impulse Per Pulse (Module 1)	14-22
14-13	APS Total Impulse Per Pulse (Module 2)	14-23
14-14	APS Thrust (Module 1)	14-24
14-15	APS Thrust (Module 2)	14-25
14-16	APS Total Impulse (Module 1 Attitude Control Engines)	14-26
14-17	APS Total Impulse (Module 2 Attitude Control Engines)	14-27
15-1	Schematic, SV Pneumatic Control System	15-3
15-2	Pneumatic Control and Purge System Performance - Boost and First Burn	15-4
15-3	Pneumatic Control and Purge System Performance - Earth Orbit	15-5
15-4	Pneumatic Control and Purge System Performance - Second Burn	15-6
15-5	Pneumatic Control and Purge System Performance - Translunar Coast	15-7
15-6	Pneumatic Control and Purge System Performance - Translunar Coast and Dump	15-8
15-7	LOX Chillover Pump Motor Container Purge Performance - First Burn	15-9

LIST OF ILLUSTRATIONS (Continued)

<u>Figure</u>		<u>Page</u>
15-8	LOX Chilldown Pump Motor Container Purge Performance - Second Burn	15-10
16-1	LOX S-IVB-505N Stage Total Volumetric Flight PU Mass Correction	16-8
16-2	LH2 S-IVB-505N Stage Total Volumetric Flight PU Mass Correction	16-9
16-3	PU Valve Response History	16-10
17-1	Longitudinal Acceleration	17-3
17-2	Angular Velocity	17-4
18-1	AS-505 Flight - TEL Ground Station	18-14
18-2	AS-505 Flight - Bermuda Ground Station	18-15
18-3	AS-505 Flight - Vanguard Ship Station	18-16
18-4	AS-505 Flight - Mercury Ship Station	18-17
18-5	AS-505 Flight - Mercury Ship Station	18-18
19-1	Forward Battery No. 1	19-7
19-2	Forward Battery No. 2	19-10
19-3	Aft Battery No. 1	19-13
19-4	Aft Battery No. 2	19-16
21-1	Pitch Attitude Control during S-IVB First Burn	21-12
21-2	Yaw Attitude Control during S-IVB First Burn	21-13
21-3	Roll Attitude Control during S-IVB First Burn	21-14
21-4	LOX Slosh Frequency and Height during S-IVB Stage First Burn	21-15
21-5	Pitch Attitude Control during S-IVB Second Burn	21-16
21-6	Yaw Attitude Control during S-IVB Second Burn	21-17
21-7	Roll Attitude Control during S-IVB Second Burn	21-18
21-8	LOX Slosh Frequency and Height during S-IVB Stage Second Burn	21-19
21-9	LH2 Slosh Frequency and Height during S-IVB Stage Second Burn	21-20
21-10	Pitch Attitude Control during the Maneuver to Local Horizontal after S-IVB First Burn	21-21
21-11	Yaw Attitude Control during the Maneuver to Local Horizontal after S-IVB First Burn	21-22
21-12	Roll Attitude Control during the Maneuver to Local Horizontal after S-IVB First Burn	21-23
21-13	Pitch Attitude Control during Orientation to TD&E Attitude	21-24
21-14	Yaw Attitude Control during Orientation to TD&E Attitude	21-25
21-15	Roll Attitude Control during Orientation to TD&E Attitude	21-26
21-16	Pitch Attitude Control during S-IVB/CSM Separation	21-27
21-17	Yaw Attitude Control during S-IVB/CSM Separation	21-28
21-18	Roll Attitude Control during S-IVB/CSM Separation	21-29
21-19	Pitch Attitude Control during Hard Docking	21-30
21-20	Yaw Attitude Control during Hard Docking	21-31
21-21	Roll Attitude Control during Hard Docking	21-32
21-22	Pitch Attitude Control during LM Extraction	21-33

LIST OF ILLUSTRATIONS (Continued)

<u>Figure</u>		<u>Page</u>
21-23	Yaw Attitude Control during LM Extraction	21-34
21-24	Roll Attitude Control during LM Extraction	21-35
21-25	Pitch Attitude Control During Orientation to Slingshot Attitude, Propellant Lead Experiment and LOX Dump	21-36
21-26	Yaw Attitude Control During Orientation to Slingshot Attitude, Propellant Lead Experiment and LOX Dump	21-37
21-27	Roll Attitude Control During Orientation to Slingshot Attitude, Propellant Lead Experiment and LOX Dump	21-38
22-1	Hydraulic System Functional Sequence	22-3
22-2	Hydraulic System Pressures - Boost & 1st Burn	22-4
22-3	Reservoir Oil Press - Boost & 1st Burn	22-5
22-4	Aft Battery No. 2 Current Boost & 1st Burn	22-6
22-5	Hydraulic Actuator Positions Boost & 1st Burn	22-7
22-6	Hydraulic System Temperatures - Orbital Coast	22-8
22-7	Hydraulic System Line Temps - Orbital Coast	22-9
22-8	Hydraulic System Pressures - Second Burn	22-10
22-9	Reservoir Oil Pressure - Second Burn	22-11
22-10	Aft Battery No. 2 Current - Second Burn	22-12
22-11	Hydraulic Actuator Positions - Second Burn	22-13
22-12	Hydraulic System Temps - 2nd Burn & TLI	22-14
22-13	Hydraulic Line Temps - 2nd Burn & TLI	22-15
22-14	Aft Battery No Current - Propellant Dump	22-16
22-15	Hydraulic Actuator Positions - Propellant Dump	22-17
22-16	Hydraulic System Temps - Propellant Dump	22-18
22-17	Hydraulic System Temps - Translunar Coast	22-19
22-18	Hydraulic System Line Temp - Propellant Dump	22-20
22-19	Hydraulic System Line Temps - Translunar Coast	22-21
23-1	Stringer Strain Gage Locations	23-8
23-2	Flight Axial Strain vs Flight Time, Forward Skirt Station 3145	23-9
23-3	Flight Axial Strain vs Flight Time, Forward Skirt Station 3145	23-10
23-4	Flight Axial Strain vs Flight Time, Forward Skirt Station 3145	23-11
23-5	Flight Axial Strain vs Flight Time, Forward Skirt Station 3145	23-12
23-6	Flight Axial Strain vs Flight Time, Aft Skirt Station 2821	23-13
23-7	Flight Axial Strain vs Flight Time, Aft Skirt Station 2821	23-14
23-8	Flight Axial Strain vs Flight Time, Aft Skirt Station 2821	23-15
23-9	Flight Axial Strain vs Flight Time, Aft Skirt Station 2821	23-16
23-10	Flight Axial Load vs Time, Forward Skirt Station 3145	23-17
23-11	Flight Axial Load vs Time, Aft Skirt Station 2821	23-18
23-12	Flight Stage Bending Moment vs Time, Forward Skirt Station 3145	23-19
23-13	Flight Stage Bending Moment vs Time, Aft Skirt Station 2821	23-20

LIST OF ILLUSTRATIONS (Continued)

<u>Figure</u>		<u>Page</u>
25-1	Measurement Locations	25-10
25-2	Vibration Measured on Combustion Chamber Dome, Thrust Direction - E0209-401	25-11
25-3	Vibration Measured at LH2 Turbopump, Radial Direction - E0210-401	25-12
25-4	Vibration Measured at LOX Turbopump, Radial Direction - E0211-401	25-13
25-5	Vibration Measured on Main Fuel Valve, Tangential Direction - E0236-401.	25-14
25-6	Vibration Measured on Main Fuel Valve, Radial Direction - E0237-401	25-15
25-7	Vibration Measured on Main Fuel Valve, Thrust Direction - E0238-401	25-16
25-8	Vibration Measured on LOX Turbine Bypass Valve, Tangential Direction - E0239-401	25-17
25-9	Vibration Measured on LOX Turbine Bypass Valve, Radial Direction - E0240-401	25-18
25-10	Vibration Measured on LCX Turbine Bypass Valve, Thrust Direction - E0241-401	25-19
25-11	Vibration Measured on Fuel ASI Block, Radial Direction - E0242-401	25-20
25-12	Vibration Measured on ASI LOX Valve, Radial Direction - E0243-401	25-21
25-13	Vibration Measured on ASI LOX Valve, Thrust Direction - E0245-401	25-22
25-14	Vibration Measured at Input to Helium Bottle, Pitch Direction - E0042-403	25-23
25-15	Vibration Measured at LOX Chillover Pump, Normal to Done - E0233-424	25-24
25-16	Vibration Measured on LH2 Feedline at Tank, Thrust Direction - E0222-404	25-25
25-17	Vibration Measured on LH2 Feedline at Tank, Radial Direction - E0223-404	25-26
25-18	Vibration Measured at LH2 Prevalve, Thrust Direction - E0226-404	25-27
25-19	Vibration Measured at LH2 Prevalve, Radial Direction - E0227-404	25-28
25-20	Vibration Measured at Forward Support of Retrorocket No. 4, Radial Direction - E0235-423	25-29
25-21	Vibration Measured on APS No. 1 Propellant Control Module, Radial Direction - E0230-414	25-30
25-22	Vibration Measured on APS No. 1 Propellant Control Module, Tangential Direction - E0231-414	25-31
25-23	Vibration Measured at APS No. 1 Helium Regulator, Tangential Direction - E0234-414	25-32
25-24	Vibration Measured at Chillover Inverter, Thrust Direction - E0224-404	25-33
25-25	Vibration Measured at Chillover Inverter, Radial Direction - E0225-404	25-34
25-26	Vibration Measured at LH2 Vent Disconnect, Thrust Direction - E0228-411.	25-35
25-27	Vibration Measured at LH2 Vent Disconnect, Radial Direction - E0229-411	25-36
25-28	Vibration Measured on Continuous Vent Module, Radial Direction - E0232-411	25-37
25-29	External Sound Pressure Levels Measured on Aft Skirt - B0019-427	25-38
25-30	Internal Sound Pressure Levels Measured on Aft Skirt - B0022-404	25-39
25-31	External Sound Pressure Levels Measured on Forward Skirt - B0025-426	25-40

LIST OF ILLUSTRATIONS (Continued)

<u>Figure</u>		<u>Page</u>
25-32	Internal Sound Pressure Levels Measured on Forward Skirt - B0016-411	25-41
25-33	Vibration Measured on Field Splice Position I, Thrust Direction - E0091-411	25-42
25-34	Vibration Measured on Separation Plane Position II, Thrust Direction - E0092-404	25-43
25-35	Forward Skirt Body Bending, Pitch Direction - E0099-411	25-44
25-36	Forward Skirt Body Bending, Yaw Direction - E0100-411	25-45
25-37	Vibration Measured on Combustion Chamber Dome, Thrust Direction - E0251-401	25-46
25-38	Acceleration Measured on Gimbal Block, Pitch Direction - A0010-403	25-47
25-39	Acceleration Measured on Gimbal Block, Yaw Direction - A0011-403	25-48
25-40	Acceleration Measured on Gimbal Block, Thrust Direction - A0012-403	25-49
25-41	Acceleration Measured on J-2 Engine Skirt, Pitch Direction - A0013-401	25-50
25-42	Acceleration Measured on J-2 Engine Skirt, Yaw Direction - A0014-401	25-51
26-1	Forward Compartment Internal Pressure Minus Ambient Pressure	26-3
26-2	Aft Compartment Internal Pressure Minus Ambient Pressure	26-4
26-3	Forward Compartment Internal Pressure Minus Ambient Pressure	26-5
26-4	Aft Compartment Internal Pressure Minus Ambient Pressure	26-6
26-5	Saturn V Flight Trajectories Comparison	26-7
27-1	LOX Tank Dump	27-4
27-2	Ambient Repressurization Helium Dump	27-5

1. INTRODUCTION

1.1 General

This report presents the results of analyses performed of the S-IVB-505N stage operation in the AS-505 mission.

McDonnell Douglas Astronautics Company - Western Division personnel performed an analysis of the prelaunch countdown, launch, and flight operations of the S-IVB-505N stage through completion of the propellant lead and passivation activities.

This report is authorized by NASA Contract NAS7-101 and is the final report on the S-IVB-505N stage by the MDAC-WD S-IVB Test Planning and Evaluation Committee, Huntington Beach, California.

1.2 History

The S-IVB-505N stage was assembled at MDAC-WD, Huntington Beach, California. A checkout was performed in the vehicle checkout laboratory (VCL) prior to shipping the stage to Sacramento Test Center (STC). The stage was delivered to STC on 18 August 1967 and installed at Complex Beta on test stand I on 1 September 1967. The S-IVB-505N stage was acceptance fired on 12 October 1967. No confidence firings of the two auxiliary propulsion system modules were scheduled. Evaluation and analysis of the acceptance firing is presented in MDAC-WD Report SM-47008, Saturn S-IVB-505N Stage Acceptance Firing Report.

The stage was then shipped to Kennedy Space Center, installed in the low bay of the vehicle assembly building and subjected to post transportation receiving inspections. After installation of the aft interstage the stage was installed in the high bay. The S-IVB-505N stage was then mated to AS-505. The AS-505 was launched from launch complex 39B on 18 May 1969 at 16:49:00.56 GMT. Figure 1-1 presents significant checkout and test history dates.

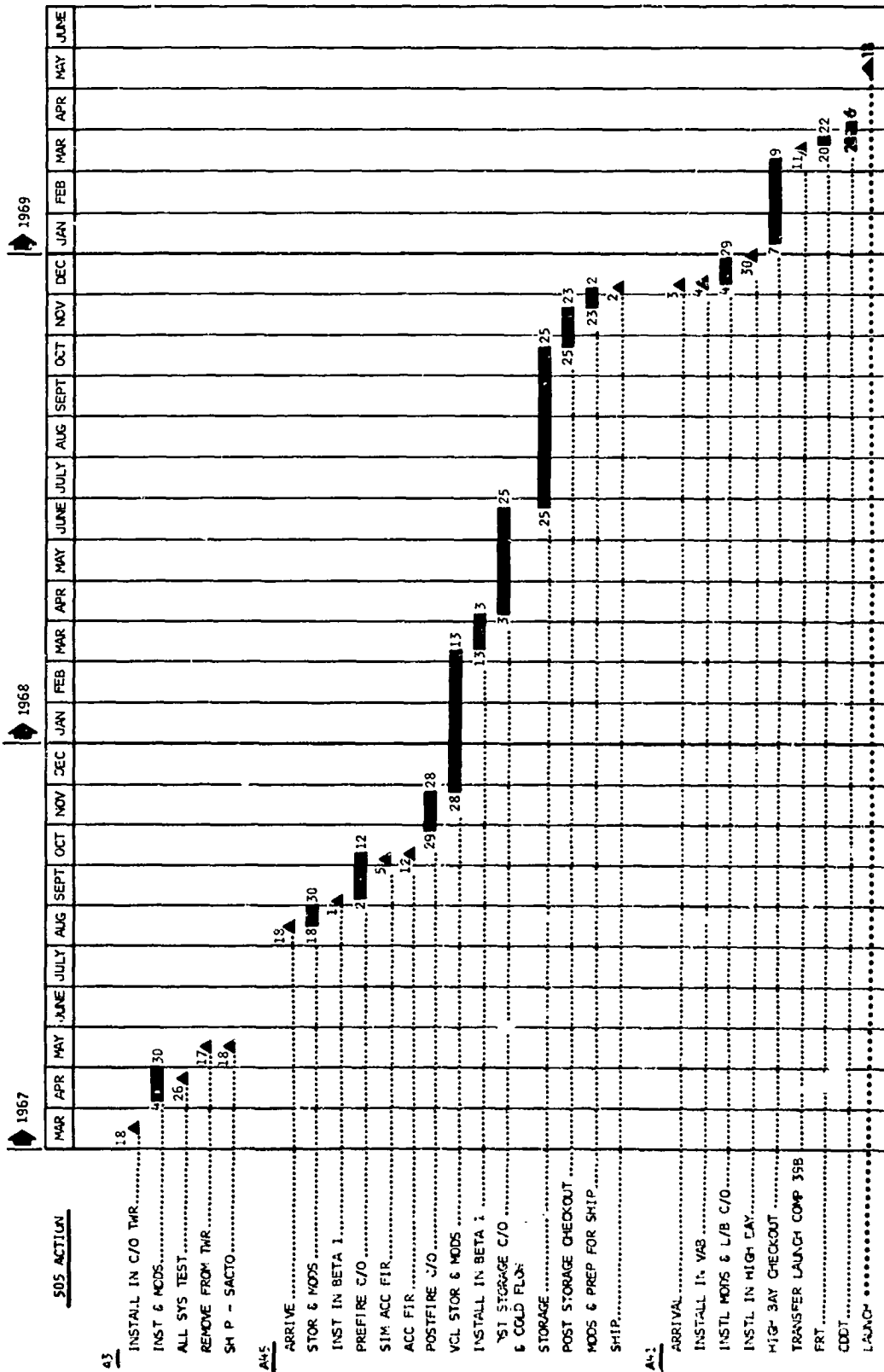

Figure 1-1. S-IVB-505 Stage Checkout and Test History

2. SUMMARY

2.1 Flight Description

2.1.1 Launch Phase

2.1.1.1 S-IC Flight

The AS-505 (Apollo 10) vehicle was launched from Kennedy Space Center (KSC), complex 39B, from a launch azimuth of 90 deg on May 18, 1969, at 16:49:00.56 GMT. Guidance Reference Release (GRR) occurred 16.981 sec before range zero. Umbilical disconnect and the corresponding establishment of time base one (TB1) occurred 0.58 sec after range zero. After tower clearance a tilt and roll maneuver was initiated to achieve the flight attitude and proper orientation for the 72 deg flight azimuth. At 82.6 sec after range zero, the vehicle encountered the maximum dynamic pressure of 617.9 lbf/ft². At 135.29 sec after range zero, center engine cutoff occurred, and time base 2 (TB2) was established. The center engine cutoff was timed so that the vehicle acceleration did not exceed 4 g's. S-IC outboard engine cutoff occurred at 161.66 sec after range zero, establishing time base 3 (TB3). S-IC/S-II separation was commanded 0.652 sec after TB3.

2.1.1.2 S-II Flight

S-II stage engine start command occurred 1.425 sec after TB3. The burn was absent of the low frequency oscillations encountered on AS-503 and AS-504 due to the early center engine cutoff command (CECO) which occurred at TB3 + 298.95 sec. S-II outboard engine cutoff which established time base 4 (TB4) occurred 552.645 sec after range zero (Ro). S-II/S-IVB separation was commanded at TB4 + 0.852 sec.

2.1.1.3 S-IVB First Burn Operation

S-IVB first engine start command occurred at 553.595 sec after range zero. First burn stage performance was nominal except for a gradual buildup and

decay of 17 to 19 hertz low amplitude oscillations over a 53 second period starting approximately 35 seconds after ignition. S-IVB engine cutoff was commanded by guidance at TB5 + 0.215 sec (RO + 703.761 sec) with a total burntime of 149.951 sec. The stage was inserted into a 99.98 nmi circular parking orbit.

2.1.2.1 Orbit and Second Burn Operations

At TB5 + 20.074 sec a maneuver was initiated to align the S-IVB/spacecraft along the local horizontal. After this maneuver, the flight vehicle maintained an orbital rate. LH2 continuous venting operation was initiated at TB5 + 58.976 sec. Vehicle subsystem verification was performed during parking orbit coast. At 8629.212 sec from Ro, restart preparations (TB6) were initiated. The LH2 continuous vent was closed at TB6 + 36.287 sec. LH2 tank repressurization was accomplished by the O2-H2 burner (LOX tank repressurization was not required). Second engine start command was received at TB6 + 569.991 sec initiating an 8 sec fuel lead. Following the fuel lead, S-IVB restart occurred at an EMR of 4.5:1.0. The PU valve was commanded to the null position at ESC2 + 135.114 sec providing an EMR of 5.0:1.0 for the duration of S-IVB second burn.

S-IVB stage performance was nominal during second burn. There was a minor 45 hertz oscillation observed in the forward skirt area following LH2 tank step pressurization. There was also a slight buildup of low amplitude 15 hertz oscillations throughout the second burn operations. Following second engine start the auxiliary hydraulic pump compensator apparently failed. This was not degrading to the mission during second burn since the engine driven pump was carrying the hydraulic load.

The flight vehicle attitude was maintained in the orbit plane and parallel to the local horizontal throughout parking orbit coast until second burn IGM initiation. From this time the IGM steered the vehicle along a near-optimum flight profile into a translunar conic. S-IVB guidance cutoff signal occurred at RO + 9550.57 sec. Time base 7 (TB7) was established at RO + 9550.781 sec. Translunar injection occurred at RO + 9,560.53 sec.

2.1.6 Coast in Translunar Orbit

Immediately following S-IVB second burn cutoff, venting of both LOX and LH2 tanks was programmed to guarantee no tank relief venting during the time in which launch vehicle spacecraft (LV/SC) separation occurred (RO +10,971.0 sec). The vent sequence following second cutoff was as follows:

- a. A 150-sec nonpropulsive vent (NPV) of the LOX tank
- b. A 900-sec LH2 tank NPV
- c. A 900-sec continuous vent of the LH2 tank.

The LV/SC separation sequence was initiated by crew command after the maneuver to separation attitude at TB7 +899.219 sec. An LH2 tank NPV was commanded Open to ensure no relief venting prior to the start of the propellant dump sequence.

At TB7 + 7384.969 sec Time base 8 (TBE) was entered with a maneuver initiated to align the S-IVB/IU in a retrograde, near horizontal attitude for the ensuing propellant dump. The Auxiliary Hydraulic Pump was energized at TB8 + 690.793 sec to provide hydraulic power to center the engine for the LOX dump. Although the pump outlet was below the telemetry measurement lower limit the actuators did successfully center the engine. A 300.2 sec LOX dump through the J-2 engine was initiated at Ro +17,665.792 sec. An NPV of both LOX and LH2 tanks was initiated and both the continuous vent valves and NPV valves remained open for the remainder of S-IVB flight. Sufficient stage slingshot velocity correction was supplied by the LOX dump so as to allow a ground commanded cutoff of the APS ullage engines after an average of only 8.12 seconds of operation.

The change in S-IVB velocity (ΔV) due to the impulse imparted by the LOX dump significantly perturbed the S-IVB translunar trajectory. Since the impulse was imparted in a retrograde direction along the local horizontal, the resulting trajectory was characterized by a lower orbital energy. The small decrease in orbital energy caused an appreciable increase in the earth-moon transit time, thus causing the S-IVB to pass

into the vicinity of the moon's orbit somewhat later than it would have had it been allowed to continue unperturbed. Slowed down by the LOX dump the stage passed behind the moon's trailing edge, 2620 nmi from the surface. The nearness of the passage and the direction of approach of the stage relative to the moon permitted the moon's gravitational field to accelerate or slingshot the stage--in effect, "dragging" the S-IVB along. By imparting a portion of its kinetic energy, the moon induced a resultant acceleration which caused, in turn, an increase in velocity sufficient for the stage to escape into solar orbit. The S-IVB is now orbiting the sun with a period of 344 days.

2.2 Mission Objectives

MDAC-WD considers the MSFC Document I-V-8010.3, Revision A "Saturn Mission Implementation Plan, AS-505 Mission F/Apollo 10," dated April 4, 1969, as the official document for providing identification and control of launch vehicle mission requirements. The S-IVB-505N stage mission objectives are summarized and discussed as follows:

<u>Principle DTO's</u>	<u>Objective Accomplishment</u>
Demonstrate launch vehicle capability to inject the spacecraft onto the specified translunar trajectory	Objective Achieved
Demonstrate launch vehicle capability to maintain a specified attitude for TD&E operations after translunar injection.	Objective Achieved
<u>Secondary DTO's</u>	
Perform launch vehicle dumping and safing after launch vehicle/spacecraft separation to prevent: S-IVB/IU recontact with spacecraft, S-IVB/IU earth impact, and S-IVB/IU lunar impact.	Objective Achieved
Verify J-2 engine modifications	Objective Achieved
Confirm J-2 engine environment in S-II Stage and S-IVB stages	Objective Achieved
Confirm launch vehicle longitudinal oscillation environment during S-IC stage burn period	Objective Achieved
Confirm launch vehicle longitudinal oscillation environment during S-II stage burn period	Objective Achieved

2.3 Test Operations

The AS-505 space vehicle was launched at 1649:00.56 GMT from Launch Complex 39B on 18 May 1969. The overall performance of the S-IVB-505N stage was satisfactory during all phases of the countdown. No significant S-IVB stage or equipment problems occurred during the launch countdown, and the MDAC supplied ground support equipment sustained no significant damage during liftoff.

2.4 CPIF

2.4.1 Flight Mission Accomplishment

Performance of the S-IC and S-II stages provided PCF at S-II/S-IVB Separation Command that were within allowable tolerances. Trajectory ECF, as defined in the MDAC-WD position and the MSFC position, were within allowable tolerances. Also, maximum flight values of attitude errors and rates for all phases of S-IVB operation (i.e., burn phase, parking orbit phase, and waiting orbit phase) did not exceed the respective allowable tolerances. It was concluded for purposes of incentive achievement, therefore, that all ECF were achieved.

2.4.2 Telemetry Performance

Evaluation of the telemetry performance indicated that the telemetry system operated at 98.9 percent efficiency during the telemetry performance evaluation period (TPEP) phase I (liftoff to first S-IVB engine cutoff +10 sec) and performed at 98.1 percent efficiency during the TPEP phase II (Liftoff to planned LV/SC separation).

2.5 Trajectory

The AS-505 trajectory showed 100 percent performance during the S-IC/S-II stage burn V phase. S-IVB stage first and second burns were close to predicted. Detailed comparison of actual and predicted trajectory parameters at key event times may be found in tables 7-1 through 7-10.

2.6 Mass Characteristics

At S-IVB-505N first burn Engine Start Command the mass of the AS-505 vehicle was $365,070 \pm 566$ lbm. At S-IVB-505N first burn Engine Cutoff Command, the mass was $295,025 \pm 527$ lbm. At second burn Engine Start Command, the mass of the vehicle was $292,204 \pm 478$ lbm. At second burn engine cutoff, the mass of the vehicle was $137,540 \pm 242$ lbm. All total vehicle mass characteristics parameters were within tolerance throughout the flight.

2.7 Engine System

The J-2 engine operated nominally during both mainstage operations and start and cutoff transients. A delayed second burn PU cutback (from EMR = 4.5 to 5.0) was used for the first time and was satisfactory. The only other unusual aspects of the flight were a propellant lead engine chilldown experiment and reported excessive vibration.

2.8 Solid Rocket Performance

The solid rocket motors on the AS-505 launch vehicle performed satisfactorily and accomplished their intended purpose. The S-II stage was separated from the S-IVB stage by the retrorockets, and the S-IVB propellants were settled prior to engine start by the ullage rockets.

2.9 Oxygen-Hydrogen Burner System

The oxygen-hydrogen burner satisfactorily accomplished LH2 tank repressurization prior to second burn; LOX tank repressurization was not required for second burn.

2.10 Oxidizer System

The oxidizer system performed adequately during both periods of J-2 engine operation. The LOX tank was repressurized with ambient helium in preparation for the propellant lead experiment and LOX dump. Propellant dump occurred as predicted, and the LOX tank was adequately safed by latching open the LOX NPV valves.

2.11 Fuel System

The fuel system supplied LH2 to the engine as expected, and the NPSP exceeded minimum requirements at all times. Ambient repressurization of the LH2 tank was satisfactorily accomplished in preparation for the fuel lead experiment, which was successfully performed. Fuel dump was not required; passivation was adequately performed after the fuel lead test.

2.12 Auxiliary Propulsion System

The auxiliary propulsion system operated nominally throughout its design life, although module 1 developed a leak in the repressurization system. This leak, however, started after the system had exceeded its design life. The attitude control, maneuvering, and ullaging requirements of the mission were all fulfilled.

2.13 Pneumatic Control and Purge System

The pneumatic control and purge system performed satisfactorily throughout the flight. The system employed on S-IVB-505N differed from those on previous flight stages in that the pneumatic control sphere was supplemented by the LOX tank repressurization spheres. The helium supply was therefore more than adequate to meet all mission requirements and to accomplish all purges. No helium leakage was evident during orbital periods.

2.14 Propellant Utilization

The PU system successfully accomplished the requirements associated with propellant loading and management during burn. The best estimate propellant mass values at liftoff were 192,055 lbm LOX and 43,382 lbm LH2. These values are well within the required ± 1.12 percent stage loading accuracy.

2.15 S-II/S-IVB Separation

The AS-505 separation analysis was done by a comparison with the AS-501 and AS-503 separation data. The majority of the data compared closely for all three vehicles. The S-II stage longitudinal acceleration showed the effect of the lighter S-II stage weight.

2.16 Data Acquisition System

Data acquisition system performance during the mission was excellent, and there were no system malfunctions.

System performance is summarized as follows:

Measurements assigned	388
Measurements inoperative due to stage configuration	1
Checkout measurements	7
Landline measurements	2
Measurements deleted prior to flight	2
Measurements active for flight	376
Phase I measurement failures	4
Phase I measurement efficiency	98.9%
Phase II measurement failures (includes phase I)	7
Phase II measurement efficiency	98.1%

The RF System blackout period data loss during S-IC/S-II separation was observed at Ro + 162.5 for approximately 1 second. Flame attenuation was not observed during S-II/S-IVB separation.

2.17 Electrical System

The electrical control system and the electrical power system performed satisfactorily. All responses to switch selector commands were satisfactory and all event measurements verified that they occurred in the proper sequential order. The APS electrical control system performed

within prescribed limitations. All batteries performed satisfactorily throughout the mission. All three 5V excitation modules performed satisfactorily and the PU Static Inverter-Converter operated with its design limits.

2.18 Range Safety System

The range safety system was not required for propellant dispersion during the flight. All indications were that the system was operating properly and would have properly executed its function had it been called upon to do so.

2.19 Flight Control

The attitude control system performance was adequate during the entire AS-505 mission. Although there was an anomaly associated with the Auxiliary Hydraulic Pump system, sufficient pressure was available to operate the thrust vector control to center the engine for propellant dump.

2.20 Hydraulic System

The hydraulic system performance was within predicted limits and the system operated successfully up to second burn. During second burn an anomalous condition exhibited itself in the auxiliary hydraulic pump performance. This condition persisted for the remainder of the mission as a pump performance degradation. Details of the anomaly are found in Section 22.

2.21 Stage Structure and Environment

An evaluation of strain, acceleration, and pressure data from the S-IVB stage for the AS-505 trajectory indicated adequate structural strength existed in the stage for the conditions encountered.

Body bending moments were less than the maximum predicted values due to comparatively moderate wind shears and gusts. A maximum vehicle axial acceleration of 3.92 g was obtained compared to the mission restricted nominal acceleration of 4.0 g.

The LH2 tank and LOX tank ullage pressures did not exceed the vent and relief pressure values. The differential tankage pressures acting on the Common Bulkhead were as expected. The Common Bulkhead internal pressure remained substantially constant at less than the 1 psia predicted.

2.22 Forward Skirt Thermoconditioning

The thermocondition system operated normally during boost and flight. All parameters were within their design limits with respect to temperature, pressure and flow.

2.23 Acoustic and Vibration Environment

The acoustic and vibration environments were comparable to those measured on the AS-503 flight. The low frequency measurements showed several variations from those on the AS-503 flight. The three most significant differences were the increase in amplitude of the 19 HZ oscillations during first burn, the occurrence of 45 HZ oscillations during second burn, and the intermittent buildup of 15 HZ oscillations at the end of second burn. The low frequency vibration levels were well within the stage design criteria. The dynamic strains measured on both ASI lines were in good agreement with those from the AS-503 flight.

3. TEST CONFIGURATION

3.1 General

The S-IVB-505N stage was equipped with a Rocketdyne 250,000 lbf thrust engine, serial number J-2091; additional stage information is presented in the following documents:

- a. MDAC-WD Report No. SM-47461, Saturn S-IVB-505N Stage Acceptance Firing Report, dated December 1967.
- b. MDAC-WD Drawing 1B66684, "P" Advance, S-IVB-V End Item Test Plan, dated March 14, 1969.

Table 3-1 presents the S-IVB-505N stage and GSE orifice data and table 3-2 presents the pressure switch checkout data.

Figure 3-1 is a schematic of the S-IVB-505N propulsion system.

3.1.1 Electrical Configuration

The following paragraphs delineate significant electrical configuration differences between S-IVB-504N and S-IVB-505N:

3.1.1.1 Data Acquisition System Changes

- a. The following Telemetry Systems were added to the S-IVB-505 stage:
 1. One FM/FM System
 2. One SSB/FM System

The S-IVB-505N stage was equipped with a PCM/FM System, an FM/FM System and an SSB/FM System.

- b. As indicated above the S-IVB-505N stage had a modified operational telemetry system. Active measurements on the S-IVB-505N totaled 388. S-IVB-504N had 299 active measurements. All of the

measurements on the S-IVB-504N were on the S-IVB-505N except for the following:

- C2015 - Temp - Crossover Duct Ext. Wall - 1
- C2016 - Temp - Crossover Duct Ext. Wall - 2
- D248 - Pressure - Cold Helium Spheres
- D545 - Pressure - Common Bulkhead Int - H/W

The following measurement types which were on the S-IVB-505N were not installed on the S-IVB-504:

1. Acceleration
2. Acoustic
3. Vibration
4. Strain

In addition, the number of pressure, temperature, event and miscellaneous types of measurements were increased on the S-IVB-505.

- c. On this stage, in order to facilitate increased measurement recovery capability, a data switching device was used at the data input to the single sideband translator. Two groups of measurements (24 total) with primary interest in different periods of the launch sequence were switched from one to the other. The switch was in position "A" during the SIC boost period then in position "B" thereafter. The transfer was accomplished by IU command.
- d. The IU was also used to convey stage information to ground stations. The IU VHF POM (DP-1) link was paralleled to the IU S-Band PCM (DP-1A) link. The IU and S-IVB VHF links were the primary flight control data links from liftoff to shortly after the S-IVB second burn. The S-Band link served as a backup for the VHF links during this period. After the S-IVB second burn the VHF links were primary unless the VHF range was exceeded at supporting sites. The S-Band link was primary during all periods that the VHF range was exceeded. The transmitting frequencies were:

IU DP-1	245.3 MHz
IU DP-1A (S-Band)	2277.5 MHz

The capability to parallel the S-IVB VHF PCM CP-1 link with the IU Command Communications System (CCS) existed on the S-IVB-505 stage and was used on the S-IVB-504 stage. No IU CCS DP-1B link existed on this stage and therefore this capability was not utilized.

TABLE 3-1 (Sheet 1 of 4)
S-IVB-505N STAGE AND GSE FLIGHT ORIFICES

Description	Orifice Size or Nominal Flowrate	Coefficient of Discharge	Effective Area (in ²)
<u>S-IVB-505N Stage</u>			
LH2 chilldown valve purge	14 scfm with 3,000 psia	--	Sintered
Continuous vent bypass valve bellows purge	300 scfm with 3,200 psia	--	Sintered
Continuous vent bypass valve switch cavity purge	15 scfm with 3,200 psia	--	Sintered
Continuous vent No. 1	1.0881 in. dia	0.9016	--
Continuous vent No. 2	1.0885 in. dia	0.9048	--
Continuous vent purge	1 scfm with 3,200 psia	--	Sintered
LH2 fill and drain valve purge	15 scfm with 3,200 psia	--	Sintered
LOX fill and drain valve purge	15 scfm with 3,200 psia	--	Sintered
LOX tank pressurization module, heat exchanger	0.2181 in. dia	--	0.0324
LOX tank pressurization module, heat exchanger bypass	0.185 in. dia	--	0.0240
LH2 tank pressurization module (Overcontrol - second burn)	0.200 in. dia*	--	0.1121**
LH2 tank pressurization module (Undercontrol)	0.3557 in. dia	--	0.0852**
LH2 tank pressurization module control (Overcontrol-first burn)	0.2005 in. dia*	--	0.1109**
LH2 tank repressurization module outlet	0.3125 in. dia	--	0.0647

* Indicates diameter of overcontrol or step orifice only.

** Discharge coefficient and effective area are calculated for overcontrol or step orifices in combination with the undercontrol orifice.

TABLE 3-1 (Sheet 2 of 4)

Description	Orifice Size or Nominal Flowrate	Coefficient of Discharge	Effective Area (in ²)
LH2 tank nonpropulsive vent purge	1 scfm with 3,200 psia	--	Sintered
LH2 tank nonpropulsive vent No. 1	2.1761 in. dia	--	3.1360
LH2 tank nonpropulsive vent No. 2	2.1793 in. dia	--	3.1356
LOX chilldown pump purge supply	200 scfm with 445 psia	--	--
LOX chilldown pump purge vent	200 scfm with 445 psia	--	--
LOX sensing line purge	1,728 scfm with 3,200 psia	--	Sintered
Burner LH2 tank press. coil outlet	0.221 in. dia	--	0.03368
LOX tank vent and relief valve	65 scfm with 3,200 psia	--	Sintered
Burner LH2 tank press. coil helium inlet balance	0.1200 in. dia	--	0.00975
Burner LOX tank press. coil outlet	0.089 in. dia	--	0.00563
LOX tank ambient repressurization		--	0.00855
Engine purge control module	0.0180 in. dia	--	--
<u>Pneumatic Console 432A</u>			
Stage 1 regulator dome vent	0.018 in. dia	--	--
Stage 1 regulator 3,100 psig dome loading	0.018 in. dia	--	--
APS helium supply and purge	0.027 in. dia	--	--
Console 432A GN2 inerting supply	0.031 in. dia	--	--
Mainstage OK pressure switch checkout, coarse (used with A12054)	0.025 in. dia	--	--
Mainstage OK pressure switch checkout, fine	0.025 in. dia	--	--

TABLE 3-1 (Sheet 3 of 4)

Description	Orifice Size or Nominal Flowrate	Coefficient of Discharge	Effective Area (in ²)
LH2 system checkout supply, fine	0.016 in. dia	--	--
LH2 system checkout supply, coarse (used with A11824)	0.016 in. dia	--	--
3200 Dome supply orifice	0.013 in. dia	--	--
LOX system checkout supply, fine	0.016 in. dia	--	--
LOX system checkout supply, coarse (used with A11837)	0.016 in. dia	--	--
Console 432A stage 1 bleed	--	--	Variable
Stage 4 regulator vent	--	--	Variable
Pressure switch checkout, low pressure, fine	0.025 in. dia	--	--
Pressure switch checkout, low pressure, coarse (used with A11793)	0.015 in. dia	--	--
Stage 2 regulator vent	--	--	Variable
750 psia helium purge supply	0.062 in. dia	--	--
<u>Pneumatic Console 433A</u>			
2000 psig cold purge valve supply	--	--	Variable
750 psig cold purge valve supply	--	--	Variable
Thrust chamber jacket purge and chilldown supply	0.072 in. dia	--	0.00347
Engine control helium sphere supply	0.125 in. dia	--	--
LOX tank prepressurization supply (located in model 315 aft umbilical kit)	0.0114 in. dia	--	--
Cold helium sphere pressurization supply (same orifice as above)	0.0114 in. dia	--	--
LOX umbilical purge supply	0.305 in. dia	--	--

TABLE 3-1 (Sheet 4 of 4)

Description	Orifice Size or Nominal Flowrate	Coefficient of Discharge	Effective Area (in ²)
Umbilical purge supply vent	--	--	Variable
Stage regulator inlet	0.018 in. dia	--	--
LOX umbilical purge dome regulator inlet	0.180 in. dia	--	--
Stage 3 regulator outlet bleed	0.0022 lbm/min	--	Sintered
<u>Heat Exchanger 438A</u>			
Circuit No. 1 upstream vent (primary)	0.081 in. dia	--	--
Circuit No. 1 downstream vent (secondary)	0.055 in. dia	--	--
LH2 fill valve closing control	0.013 in. dia	--	--
LH2 tank prepressurization supply	0.113 in. dia	--	0.00853
GH2 regulator dome bleed	3 scim at 750 psid	--	Sintered

TABLE 3-2

S-IVB-505N STAGE PRESSURE SWITCH DATA

Name	Part No. and Serial No.	Specification (psia)		Preflight Calibration* (psia)			
		Pickup	Dropout	Dropout	Pickup	Dropout	Dropout
LOX tank ullage	1B52624-515 S/N 026	41 max	37.5 min	0.5 min	40.57	38.82	1.75
LOX tank repressurization backup	1B52624-519 S/N 051	467.5 +23.5	362.5 +33.5	--	470.00	368.33	101.67
LOX tank regulator backup	1B52624-519 S/N 044	467.5 +23.5	362.5 +33.5	--	466.67	379.00	87.67
Engine pump purge	1B52623-515 S/N 008	136 max	99 min	3 min	132.33	114.00	18.33
Control helium regulator backup	1B52624-517 S/N 011	600 +21	490 +31	58	610.67	490.67	120
LH2 tank repressurization control	1B52624-511 S/N 025	31.5 max	27.8 min	0.5 min	30.88	28.18	2.7
LH2 tank ullage-first burn	1B52624-511 S/N 035	31.5 max	27.8 min	0.5 min	30.31	28.24	2.07
LH2 tank repressurization backup	1B52624-519 S/N 052	467.5 +23.5	362.5 +33.5	--	480.00	373.33	103.33
Mainstage OK No. 1	308390 S/N	515 +36	Pickup minus 75 +61, -36	--	518.00	443.33	74.67
Mainstage OK No. 2	308390 S/N	515 +36	Pickup minus 75 +61, -36	--	500.00	430.00	70

* These values are the average of three actuations.

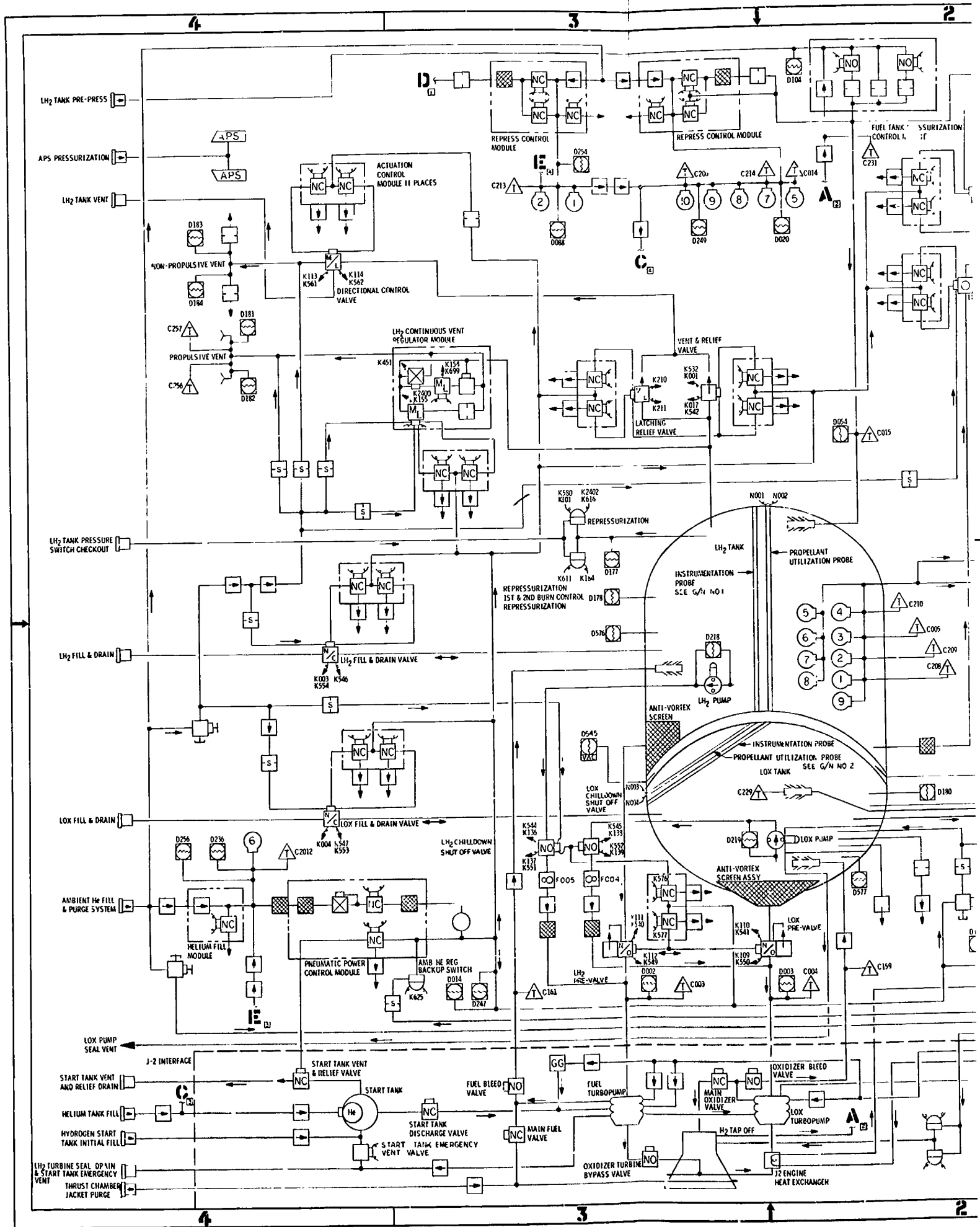

FOLDOUT FRAME

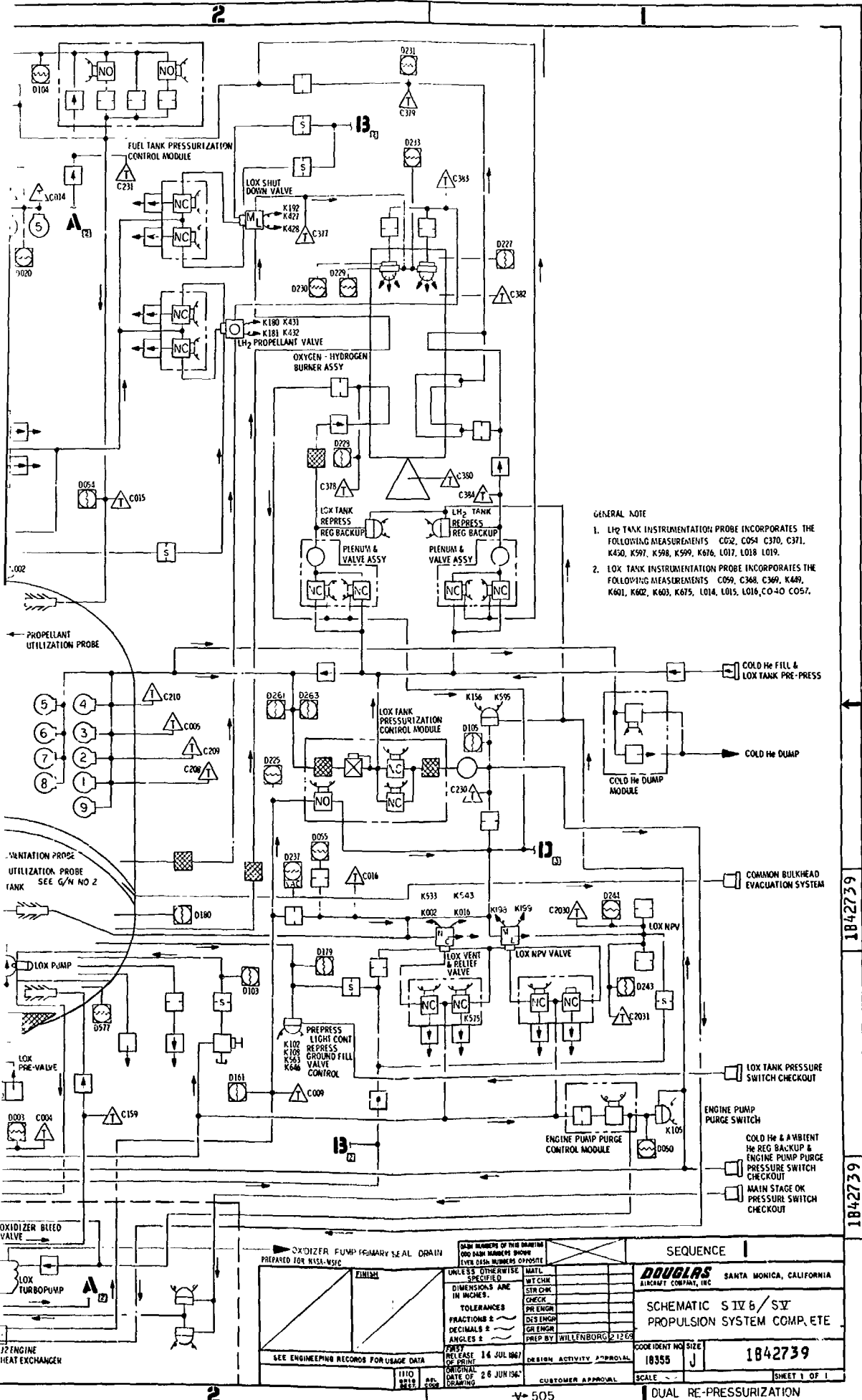

FOLDDOUT FRAME 2 Figure 3-1. Schematic, S-IVB/SV Propulsion - Complete

4. SEQUENCE OF EVENTS

The AS-505 flight sequence of events is presented in tables 4-1 and 4-2. Table 4-2 provides the sequence for ground initiated commands and Table 4-1 the remainder of the flight sequence. Four types of items are included in the sequence:

a. LVDC Commands

These items originate from the Launch Vehicle Digital Computer (LVDC) in the Instrument Unit (IU) and direct vehicle system actions.

b. Responses

These items are responses to commands that are issued from the IU and are monitored in the S-IVB.

c. Events

These items are monitored occurrences resulting from vehicle performance, e.g., the time of maximum dynamic pressure.

d. Ground Commands

These items are ground initiated changes, i.e., additions or modifications to the flight sequence of events.

In the sequence, all commands and events are preceded by an item number. Sequential series of related commands and responses are listed under the same event number with lower case letters distinguishing separate items.

4.1 Predicted Times

Predicted times for preprogrammed commands were obtained from the AS-505 flight sequence program; Interface Control Document - Definition of Saturn SA-505 Flight Sequence Program, ICD 40M33625B, dated January 15, 1969. Predicted times for major flight events up to time base four were obtained from MSFC's predicted operational trajectory, AS-505 Launch Vehicle Operational Flight Trajectory, dated February 17, 1969. The remainder of predicted flight event times were obtained from MDAC-WD predicted trajectory simulations.

Predicted times for S-IVB command responses are not estimated and, therefore, are not shown. Predicted times for TB5 and TB7 were derived

by adding 0.20 seconds to the S-IVB cutoff times obtained from the MDAC-WD predicted trajectory simulation. Command times were not predicted for non-programmed telemetry calibrations made when passing over ground stations or for unscheduled ground commands.

4.2 Monitored Times

Commands issued from the LVDC to the S-IC, S-II, S-IVB, and IU were monitored at the LVDC. Times for these items were obtained from IBM document, Saturn Instrument Unit S-IU-505 Intermediate Flight Evaluation Report for Apollo 10 Mission, dated June 9, 1969. Commands issued from the LVDC to the S-IVB were also monitored at the S-IVB switch selector. Times for these items were obtained from the MDAC-WD Electronics Department Postflight Sequence of Events. Monitored times for guidance parameters, S-IVB attitude maneuvers, pre-launch events, ground commands, and other special events were obtained from IBM document, Saturn Instrument Unit S-IU-505 Intermediate Flight Evaluation Report for Apollo 10 Mission, dated June 9, 1969.

The time from range zero is provided for all items. Range zero, which is by definition the even second prior to liftoff, occurred at 16:49:00.0 GMT.

A time-from-base is given for all preprogrammed LVDC commands and for the monitored S-IVB command responses. A time-from-base is not applicable (N/A) for events which are not preprogrammed, such as maximum dynamic pressure.

4.3 Time Bases

Eight sequential series of preprogrammed commands were issued from the LVDC. Each sequential series was initiated by the establishment of its time base in the LVDC. Listed below are the eight time bases with their respective originating events:

- a. Time Base One, TB1 - IU umbilical disconnect
- b. Time Base Two, TB2 - S-IC inboard engine cutoff
- c. Time Base Three, TB3 - S-IC outboard engines cutoff

- d. Time Base Four, TB4 - S-II outboard engines cutoff
- e. Time Base Five, TB5 - First S-IVB engine cutoff
- f. Time Base Six, TB6 - Begin restart preparations for second burn (LVDC solves an equation)
- g. Time Base Seven, TB7 - Second S-IVB engine cutoff
- h. Time Base Eight, TB8 - Ground Command

4.4 Data Omissions

Data omissions are indicated in the sequence with the words "no data". A dashed line is inserted for predicted times of S-IVB command responses since these times are not predicted. The times for command issuance from the LVDC are supplied to MDAC-WD by IBM and MSFC, and no explanation is available for data omissions. Loss of monitored times for S-IVB command responses can be mainly attributed to loss of ground station coverage.

4.5 Comments

The accuracies of S-IC, S-II, and IU monitored times are not included in the sequence. The accuracy of IU signals is not available. The accuracy of S-IVB command response times is plus zero, minus nine milliseconds.

4.6 Ground Initiated Commands

The list of ground initiated commands in sequential order is provided in Table 4-2. Most of the ground commands were part of a planned Propellant Lead Experiment. Also, time base eight was initiated by ground command.

TABLE 4-1 (Sheet 1 of 46)
 AS - 505 MISSION F
 POST FLIGHT SEQUENCE OF EVENTS
 AS OF JUNE 13, 1969

ITEM NO.	EVENT	PREDICTED TIME		SIGNAL MONITORED AT	MONITORED TIME		DATA SOURCE	ACCURACY (MS)
		TIME FROM RANGE ZERO (HR:MIN:SEC) (SEC)	TIME FROM BASE (SEC)		TIME FROM RANGE ZERO (HR:MIN:SEC) (SEC)	TIME FROM BASE (SEC)		
1	GUIDANCE REFERENCE RELEASE	00:00:17.003 (-17.003)	N/A		00:00:16.968 (-16.968)	N/A	MSFC	---
2	RANGE ZERO	00:00:00.000 (0.000)	N/A		00:00:00.000 (0.000)	N/A	MSFC	---
3	FIRST MOTION	00:00:00.247 (0.247)	N/A		00:00:00.247 (0.247)	N/A	MSFC	---
4	HOLDOWN ARMS RELEASE	00:00:00.247 (0.247)	N/A		00:00:00.247 (0.247)	N/A	MSFC	---
5	TIME BASE 1 LIFTOFF IJ JMRICAL DISCONNECT	00:00:00.646 (0.646)	TB 1+ 0.000		00:00:00.583 (0.583)	TB 1+ 0.000	MSFC	---
6	BEGIN YAW MANEUVER	00:00:01.646 (1.646)	N/A		00:00:01.630 (1.630)	N/A	MSFC	---
7	SIGNAL FROM LVDC FOR: SENSOR BIAS ON	00:00:05.646 (5.646)	TB 1+ 5.000	IU	00:00:05.537 (5.537)	TB 1+ 4.954	MSFC	---
8A	SIGNAL FROM LVDC FOR: LOX TANK PRESSURIZATION SHUTOFF VALVES CLOSE ON	00:00:06.646 (6.646)	TB 1+ 6.000	IU	00:00:06.534 (6.534)	TB 1+ 5.951	MSFC	---
8B	SIGNAL RECEIVED IN S-IVB FOR: LOX TANK PRESSURIZATION SHUTOFF VALVES CLOSE ON	-----	-----	S-IVB	00:00:06.531 (6.531)	TB 1+ 5.948	MDAC	---
9	END YAW MANEUVER	00:00:09.646 (9.646)	N/A		00:00:09.990 (9.990)	N/A	MSFC	---
10	BEGIN PITCH MANEUVER	00:00:12.497 (12.497)	N/A		00:00:13.050 (13.050)	N/A	MSFC	---
11	BEGIN ROLL MANEUVER	00:00:12.497 (12.497)	N/A		00:00:13.050 (13.050)	N/A	MSFC	---
12								
13	SIGNAL FROM LVDC FOR: MULTIPLE ENGINE CUTOFF ENABLE	00:00:14.646 (14.646)	TB 1+ 14.000	IU	00:00:14.535 (14.535)	TB 1+ 13.952	MSFC	---

TABLE 4-1 (Sheet 2 of 46)
 AS - 505 MISSION F
 POST FLIGHT SEQUENCE OF EVENTS
 AS OF JUNE 13, 1969

ITEM NO.	EVENT	PREDICTED TIME		SIGNAL MONITORED AT	MONITORED TIME		DATA SOURCE	ACCURACY (MS)
		TIME FROM RANGE ZERO (HR:MIN:SEC) (SEC)	TIME FROM BASE (SEC)		TIME FROM RANGE ZERO (HR:MIN:SEC) (SEC)	TIME FROM BASE (SEC)		
14	SIGNAL FROM LVDC FOR: S-1C OUTBOARD ENGINES CANT ON 'A'	00:00:20.446 (20.446)	TB 1+ 19.800	IU	00:00:20.338 (20.338)	TB 1+ 19.755	MSFC	---
15	SIGNAL FROM LVDC FOR: S-1C OUTBOARD ENGINES CANT ON 'B'	00:00:20.646 (20.646)	TB 1+ 20.000	IU	00:00:20.553 (20.553)	TB 1+ 19.970	MSFC	---
16	SIGNAL FROM LVDC FOR: S-1C OUTBOARD ENGINES CANT ON 'C'	00:00:20.646 (20.646)	TB 1+ 20.200	IU	00:00:20.735 (20.735)	TB 1+ 20.152	MSFC	---
17	SIGNAL FROM LVDC FOR: TELEMETRY CALIBRATE ON	00:00:24.646 (24.646)	TB 1+ 24.000	IU	00:00:24.554 (24.554)	TB 1+ 23.971	MSFC	---
18	SIGNAL FROM LVDC FOR: TELEMETRY CALIBRATOR IN-FLIGHT CALIBRATE ON	00:00:27.646 (27.646)	TB 1+ 27.000	IU	00:00:27.558 (27.558)	TB 1+ 26.975	MSFC	---
19	SIGNAL FROM LVDC FOR: TELEMETRY CALIBRATE OFF	00:00:29.646 (29.646)	TB 1+ 29.000	IU	00:00:29.539 (29.539)	TB 1+ 28.956	MSFC	---
20	SIGNAL FROM LVDC FOR: LAUNCH VEHICLE ENGINES EDS CUTOFF ENABLE	00:00:30.646 (30.646)	TB 1+ 30.000	IU	00:00:30.537 (30.537)	TB 1+ 29.954	MSFC	---
21	END ROLL MANEUVER	00:00:30.497 (30.497)	N/A		00:00:32.280 (32.280)	N/A	MSFC	---
22	SIGNAL FROM LVDC FOR: TELEMETRY CALIBRATOR IN-FLIGHT CALIBRATE OFF	00:00:32.646 (32.646)	TB 1+ 32.000	IU	00:00:32.555 (32.555)	TB 1+ 31.972	MSFC	---
23	SIGNAL FROM LVDC FOR: FUEL PRESSURIZING VALVE NO. 2 OPEN	00:00:50.146 (50.146)	TB 1+ 49.500	IU	00:00:50.036 (50.036)	TB 1+ 49.453	MSFC	---
24	MACH 1 ACHIEVED	00:01:05.672 (65.672)	N/A		00:01:06.800 (66.800)	N/A	MSFC	---
25	SIGNAL FROM LVDC FOR: START DATA RECORDERS	00:01:14.646 (74.646)	TB 1+ 74.000	IU	00:01:14.542 (74.542)	TB 1+ 73.959	MSFC	---
26	SIGNAL FROM LVDC FOR: COOLING SYSTEM ELECTRONIC ASSEMBLY POWER OFF	00:01:15.646 (75.646)	TB 1+ 75.000	IU	00:01:15.539 (75.539)	TB 1+ 74.956	MSFC	---

TABLE 4-1 (Sheet 3 of 46)
 AS - 505 MISSION F
 POST FLIGHT SEQUENCE OF EVENTS
 AS OF JUNE 13 1969

ITEM NO.	EVENT	PREDICTED TIME		SIGNAL MONITORED AT	MONITORED TIME		DATA SOURCE	ACCURACY (MS)
		TIME FROM RANGE ZERO (HR:MIN:SEC) (SEC)	TIME FROM RISE (SEC)		TIME FROM RANGE ZERO (HR:MIN:SEC) (SEC)	TIME FROM BASE (SEC)		
27	MAXIMUM DYNAMIC PRESSURE	00:01:21.122 (41.122)	N/A		00:01:22.600 (82.600)	N/A	MSFC	---
28	SIGNAL FROM LVDC FOR: TELEMETRY CALIBRATOR IN-FLIGHT CALIBRATE ON	00:01:30.646 (90.646)	TB 1+ 90.000	IJ	00:01:30.534 (90.534)	TB 1+ 89.951	MSFC	---
29	SIGNAL FROM LVDC FOR: TELEMETRY CALIBRATOR IN-FLIGHT CALIBRATE OFF	00:01:35.646 (95.646)	TB 1+ 95.000	IJ	00:01:35.546 (95.546)	TB 1+ 94.963	MSFC	---
30	SIGNAL FROM LVDC FOR: FUEL PRESSURIZING VALVE NO. 3 OPEN	00:01:35.946 (95.946)	TB 1+ 95.300	IJ	00:01:35.843 (95.843)	TB 1+ 95.260	MSFC	---
31	SIGNAL FROM LVDC FOR: FLIGHT CONTROL COMPUTER SWITCH POINT NO. 1	00:01:45.646 (105.646)	TB 1+ 105.000	IJ	00:01:45.535 (105.535)	TB 1+ 104.952	MSFC	---
32	SIGNAL FROM LVDC FOR: TELEMETRY CALIBRATE ON	00:01:55.746 (115.746)	TB 1+ 115.100	IJ	00:01:55.646 (115.646)	TB 1+ 115.063	MSFC	---
33	SIGNAL FROM LVDC FOR: TELEMETRY CALIBRATE OFF	00:02:05.746 (120.746)	TB 1+ 120.100	IJ	00:02:00.635 (120.635)	TB 1+ 120.052	MSFC	---
34	SIGNAL FROM LVDC FOR: FLIGHT CONTROL COMPUTER SWITCH POINT NO. 2	00:02:10.646 (130.646)	TB 1+ 130.000	IJ	00:02:10.541 (130.541)	TB 1+ 129.958	MSFC	---
35	SIGNAL FROM LVDC FOR: FUEL PRESSURIZING VALVE NO. 4 OPEN	00:02:13.046 (133.046)	TB 1+ 132.400	IJ	00:02:12.953 (132.953)	TB 1+ 132.370	MSFC	---
36	SIGNAL FROM LVDC FOR: S-1C TWO ENGINES OUT AUTO-ABORT INHIBIT ENABLE	00:02:14.246 (134.246)	TB 1+ 133.600	IJ	00:02:14.160 (134.160)	TB 1+ 133.577	MSFC	---
37	SIGNAL FROM LVDC FOR: S-1C TWO ENGINES OUT AUTO-ABORT INHIBIT	00:02:14.446 (134.446)	TB 1+ 133.800	IJ	00:02:14.335 (134.335)	TB 1+ 133.752	MSFC	---
38	SIGNAL FROM LVDC FOR: EXCESS RATE (P,Y,H) AUTO-ABORT INHIBIT ENABLE	00:02:14.646 (134.646)	TB 1+ 134.000	IJ	00:02:14.550 (134.550)	TB 1+ 133.967	MSFC	---

TABLE 4-1 (Sheet 4 of 46)

AS - 505 MISSION F
POST FLIGHT SEQUENCE OF EVENTS
AS OF JUNE 13, 1969

ITEM NO.	EVENT	PREDICT:		ME	SIGNAL MONITORED AT	MONITORED TIME		DATA SOURCE	ACCURACY (MS)
		TIME FROM RANGE ZERO (HR:MIN:SEC) (SEC)	TIME FROM BASE (SEC)			TIME FROM RANGE ZERO (HR:MIN:SEC) (SEC)	TIME FROM BASE (SEC)		
39	SIGNAL FROM LVDC FOR: EXCESS RATE (P,Y,R) AUTO-ABORT INHIBIT AND SWITCH RATE GYRO SC INDICATION 'A'	00:02:14.846 (154.446)	TB 1+ 134.200	TB 1+ 134.200	IU	00:02:14.733 (134.733)	TB 1+ 134.150	MSFC	---
40	SIGNAL FROM LVDC FOR: TWO ADJACENT OUTBOARD ENGINES OUT CUTOFF ENABLE	00:02:15.046 (135.046)	TB 1+ 134.400	TB 1+ 134.400	IU	00:02:14.934 (134.934)	TB 1+ 134.351	MSFC	---
41	SIGNAL FROM LVDC FOR: INBOARD ENGINE CUTOFF + TAPE RECORDER RECORD	00:02:15.246 (135.246)	TB 1+ 134.600	TB 1+ 134.600	IU	00:02:15.148 (135.148)	TB 1+ 134.565	MSFC	---
42	TIME BASE 2 S-IC INBOARD ENGINE CUTOFF	00:02:15.247 (135.247)	TB 2+ 0.000	TB 2+ 0.000	IU	00:02:15.291 (135.291)	TB 2+ 0.000	MSFC	---
43	SIGNAL FROM LVDC FOR: INBOARD ENGINE CUTOFF BACKUP ENABLE	00:02:15.447 (135.447)	TB 2+ 0.200	TB 2+ 0.200	IU	00:02:15.461 (135.461)	TB 2+ 0.170	MSFC	---
44	SIGNAL FROM LVDC FOR: START PAM-FM/FH CALIBRATION	00:02:15.647 (135.647)	TB 2+ 0.400	TB 2+ 0.400	IU	00:02:15.644 (135.644)	TB 2+ 0.353	MSFC	---
45	SIGNAL FROM LVDC FOR: AUTO-ABORT ENABLE RELAYS RESET	00:02:15.847 (135.847)	TB 2+ 0.600	TB 2+ 0.600	IU	00:02:15.853 (135.853)	TB 2+ 0.562	MSFC	---
46	SIGNAL FROM LVDC FOR: EXCESS RATE (ROLL) AUTO-ABORT INHIBIT ENABLE	00:02:16.047 (136.047)	TB 2+ 0.800	TB 2+ 0.800	IU	00:02:16.043 (136.043)	TB 2+ 0.752	MSFC	---
47	SIGNAL FROM LVDC FOR: EXCESS RATE (ROLL) AUTO-ABORT INHIBIT AND SWITCH RATE GYRO SC INDICATION 'B'	00:02:16.247 (136.247)	TB 2+ 1.000	TB 2+ 1.000	IU	00:02:16.253 (136.253)	TB 2+ 0.962	MSFC	---
48	SIGNAL FROM LVDC FOR: STOP PAM-FM/FH CALIBRATION	00:02:20.647 (140.647)	TB 2+ 5.400	TB 2+ 5.400	IU	00:02:20.666 (140.666)	TB 2+ 5.375	MSFC	---
49	SIGNAL FROM LVDC FOR: S-II ORDNANCE ARM	00:02:29.747 (149.747)	TB 2+ 14.500	TB 2+ 14.500	IU	00:02:29.755 (149.755)	TB 2+ 14.464	MSFC	---
50	SIGNAL FROM LVDC FOR: SEPARATION AND RETRO NO. 1 EBW FIRING UNITS ARM	00:02:29.947 (149.947)	TB 2+ 14.700	TB 2+ 14.700	IU	00:02:29.943 (149.943)	TB 2+ 14.652	MSFC	---

TABLE 4-1 (Sheet 5 of 46)

AS - 505 MISSION F
POST FLIGHT SEQUENCE OF EVENTS
AS OF JUNE 13, 1969

ITEM NO.	EVENT	PREDICTED TIME		SIGNAL MONITORED AT	MONITORED TIME		DATA SOURCE	ACCURACY (MS)
		TIME FROM RANGE ZERO (HR:MIN:SEC)	TIME FROM BASE (SEC)		TIME FROM RANGE ZERO (HR:MIN:SEC)	TIME FROM BASE (SEC)		
51	SIGNAL FROM LVDC FOR: SEPARATION AND RETRO NO. 2 EBW FIRING UNITS ARM	00:02:30.147 (150.147)	TB 2+ 14.900	IU	00:02:30.154 (150.154)	TB 2+ 14.863	MSFC	---
52	SIGNAL FROM LVDC FOR: TELEMETRY MEASUREMENT SWITCHOVER	00:02:32.047 (152.047)	TB 2+ 16.800	IU	00:02:32.046 (152.046)	TB 2+ 16.755	MSFC	---
53	SIGNAL FROM LVDC FOR: G-BALL POWER OFF	00:02:32.247 (152.247)	TB 2+ 17.000	IU	00:02:32.260 (152.260)	TB 2+ 16.969	MSFC	---
54	SIGNAL FROM LVDC FOR: OUTBOARD ENGINES CUTOFF ENABLE	00:02:32.447 (152.447)	TB 2+ 17.200	IU	00:02:32.444 (152.444)	TB 2+ 17.153	MSFC	---
55	SIGNAL FROM LVDC FOR: OUTBOARD ENGINES CUTOFF BACKUP ENABLE	00:02:32.647 (152.647)	TB 2+ 17.400	IU	00:02:32.645 (152.645)	TB 2+ 17.354	MSFC	---
56	END PITCH MANEUVER	00:02:36.747 (156.747)	N/A		00:02:38.670 (158.670)	N/A	MSFC	---
57	MAXIMUM ACCELERATION	NO DATA 00:02:40.2	NO DATA N/A		00:02:41.620 (161.620)	N/A	MSFC	---
58	TIME BASE 3 S-1C OUTBOARD ENGINES CUTOFF	00:02:40.205 (160.205)	TB 3+ 0.000		00:02:41.656 (161.656)	TB 3+ 0.000	MSFC	---
59	SIGNAL FROM LVDC FOR: LHP TANK HIGH PRESSURE VENT MODE	00:02:40.305 (160.305)	TB 3+ 0.100	IU	00:02:41.739 (161.739)	TB 3+ 0.083	MSFC	---
60	SIGNAL FROM LVDC FOR: S-II LH2 RECIRCULATION PUMPS OFF	00:02:40.405 (160.405)	TB 3+ 0.200	IU	00:02:41.831 (161.831)	TB 3+ 0.175	MSFC	---
61	SIGNAL FROM LVDC FOR: S-II ULLAGE TRIGGER	00:02:40.705 (160.705)	TB 3+ 0.500	IU	00:02:42.130 (162.130)	TB 3+ 0.474	MSFC	---
62	SIGNAL FROM LVDC FOR: S-1C/S-II SEPARATION (NO.1)	00:02:40.905 (160.905)	TB 3+ 0.700	IU	00:02:42.308 (162.308)	TB 3+ 0.652	MSFC	---

TABLE 4-1 (Sheet 6 of 46)

AS - 505 MISSION F
POST FLIGHT SEQUENCE OF EVENTS
AS OF JUNE 13, 1969

ITEM NO.	EVENT	PREDICTED TIME		SIGNAL MONITORED AT	MONITORED TIME		DATA SOURCE	ACCURACY (MS)
		TIME FROM RANGE ZERO (HR:MIN:SEC)	TIME FROM PHASE (SEC)		TIME FROM RANGE ZERO (HR:MIN:SEC)	TIME FROM BASE (SEC)		
63	SIGNAL FROM LVDC FOR: S-1C/S-II SEPARATION (NO.2)	00:02:41.005 (161.005)	TB 3+ 0.800	IU	00:02:42.409 (162.409)	TB 3+ 0.753	MSFC	---
64	SIGNAL FROM LVDC FOR: S-II ENGINES CUTOFF RESET	00:02:41.105 (161.105)	TB 3+ 0.900	IU	NO DATA	NO DATA	MSFC	---
65	SIGNAL FROM LVDC FOR: ENGINES READY BYPASS	00:02:41.205 (161.205)	TB 3+ 1.000	IU	NO DATA	NO DATA	MSFC	---
66	SIGNAL FROM LVDC FOR: PREVALVES LOCKOUT RESET	00:02:41.305 (161.305)	TB 3+ 1.100	IU	NO DATA	NO DATA	MSFC	---
67	SIGNAL FROM LVDC FOR: SWITCH ENGINE CONTROL TO S-II AND S-1C OUTBOARD ENGINE CANT OFF 'A'	00:02:41.405 (161.405)	TB 3+ 1.200	IU	NO DATA	NO DATA	MSFC	---
68	SIGNAL FROM LVDC FOR: S-1C OUTBOARD ENGINES CANT OFF 'B'	00:02:41.505 (161.505)	TB 3+ 1.300	IU	NO DATA	NO DATA	MSFC	---
69	SIGNAL FROM LVDC FOR: S-II ENGINE START	00:02:41.605 (161.605)	TB 3+ 1.400	IU	00:02:43.080 (163.080)	TB 3+ 1.424	MSFC	---
70	SIGNAL FROM LVDC FOR: S-II ENGINE OUT INDICATION 'A' ENABLE, S-II AFT INTER-STAGE SEPARATION INDICATION 'A' ENABLE	00:02:41.705 (161.705)	TB 3+ 1.500	IU	NO DATA	NO DATA	MSFC	---
71	SIGNAL FROM LVDC FOR: S-II ENGINE OUT INDICATION 'B' ENABLE, S-II AFT INTER-STAGE SEPARATION INDICATION 'B' ENABLE	00:02:41.905 (161.905)	TB 3+ 1.700	IU	NO DATA	NO DATA	MSFC	---
72	SIGNAL FROM LVDC FOR: ENGINES READY BYPASS RESET	00:02:42.105 (162.105)	TB 3+ 1.900	IU	NO DATA	NO DATA	MSFC	---
73A	SIGNAL FROM LVDC FOR: MEASUREMENT TRANSFER MODE POSITION 'B'	00:02:42.205 (162.205)	TB 3+ 2.000	IU	NO DATA	NO DATA	MSFC	---

TABLE 4-1 (Sheet 7 of 46)

AS - 505 MISSION F
POST FLIGHT SEQUENCE OF EVENTS
AS OF JUNE 13, 1969

ITEM NO.	EVENT	PREDICTED TIME		SIGNAL MONITORED AT	MONITORED TIME		DATA SOURCE	ACCURACY (MS)
		TIME FROM RANGE ZERO (HR:MIN:SEC) (SEC)	TIME FROM BASE (SEC)		TIME FROM RANGE ZERO (HR:MIN:SEC) (SEC)	TIME FROM BASE (SEC)		
73B	SIGNAL RECEIVED IN S-1VB FOR: MEASUREMENT TRANSFER MODE POSITION 'B'			S-1VB	NO DATA	NO DATA	MDAC	---
74	SIGNAL FROM LVDC FOR: S-II HYDRAULIC ACCUMULATORS UNLOCK	00:02:43.205 (163.205)	TB 3+ 3.000	IU	00:02:44.615 (164.615)	TB 3+ 2.959	MSFC	---
75	SIGNAL FROM LVDC FOR: CHILLDOWN VALVES CLOSE	00:02:46.605 (166.605)	TB 3+ 6.400	IU	00:02:48.025 (168.025)	TB 3+ 6.369	MSFC	---
76	SIGNAL FROM LVDC FOR: S-II START PHASE LIMITER CUTOFF ARM	00:02:46.905 (166.905)	TB 3+ 6.700	IU	00:02:48.325 (168.325)	TB 3+ 6.669	MSFC	---
77	SIGNAL FROM LVDC FOR: HIGH (5.5) ENGINE MIXTURE RATIO ON	00:02:47.105 (167.105)	TB 3+ 6.900	IU	00:02:48.508 (168.508)	TB 3+ 6.852	MSFC	---
78	SIGNAL FROM LVDC FOR: S-II START PHASE LIMITER CUTOFF ARM RESET	00:02:47.905 (167.905)	TB 3+ 7.700	IU	00:02:49.307 (169.307)	TB 3+ 7.651	MSFC	---
79	SIGNAL FROM LVDC FOR: PREVALVES CLOSE ARM	00:02:48.005 (168.005)	TB 3+ 7.800	IU	00:02:49.410 (169.410)	TB 3+ 7.754	MSFC	---
80	SIGNAL FROM LVDC FOR: STOP DATA RECORDERS	00:02:52.105 (172.105)	TB 3+ 11.900	IU	00:02:53.520 (173.520)	TB 3+ 11.864	MSFC	---
81	SIGNAL FROM LVDC FOR: WATER COOLANT VALVE OPEN	00:02:59.405 (179.405)	TB 3+ 19.200	IU	00:03:00.813 (180.813)	TB 3+ 19.157	MSFC	---
82	SIGNAL FROM LVDC FOR: S-II AFT INTERSTAGE SEPARATION	00:03:10.905 (190.905)	TB 3+ 30.700	IU	00:03:12.325 (192.325)	TB 3+ 30.669	MSFC	---
83	LAUNCH ESCAPE TOWER JETTISON	00:03:16.405 (196.405)	N/A		00:03:17.800 (197.800)	N/A	MSFC	---
84	START FIRST PHASE IGM	00:03:21.497 (201.497)	N/A		00:03:22.832 (202.832)	N/A	MSFC	---
85	SIGNAL FROM LVDC FOR: FLIGHT CONTROL COMPUTER SWITCH POINT NO. 3	00:03:41.605 (221.605)	TB 3+ 61.400	IU	00:03:43.009 (223.009)	TB 3+ 61.353	MSFC	---

TABLE 4-1 (Sheet 8 of 46)
AS - 505 MISSION F
POST FLIGHT SEQUENCE OF EVENTS
AS OF JUNE 13, 1969

ITEM NO.	EVENT	PREDICTED TIME		SIGNAL MONITORED AT	MONITORED TIME		DATA SOURCE	ACCURACY (MS)
		TIME FROM RANGE ZERO (HR:MIN:SEC)	TIME FROM BASE (SEC)		TIME FROM RANGE ZERO (HR:MIN:SEC)	TIME FROM BASE (SEC)		
86	SIGNAL FROM LVDC FOR: S-II LOX STEP PRESSURIZATION	00:04:20.205 (260.205)	TB 3+ 100.000	IU	00:04:21.622 (261.622)	TB 3+ 99.966	MSFC	---
87	SIGNAL FROM LVDC FOR: START PAM-FM/F4 CALIBRATION	00:04:45.205 (285.205)	TB 3+ 125.000	IU	00:04:46.611 (286.611)	TB 3+ 124.955	MSFC	---
88	SIGNAL FROM LVDC FOR: STOP PAM-FM/F4 CALIBRATION	00:04:50.205 (290.205)	TB 3+ 130.000	IU	00:04:51.610 (291.610)	TB 3+ 129.954	MSFC	---
89	SIGNAL FROM LVDC FOR: FLIGHT CONTROL COMPUTER SWITCH POINT NO. 4	00:05:51.605 (351.605)	TB 3+ 191.400	IU	00:05:53.008 (353.008)	TB 3+ 191.352	MSFC	---
90	SIGNAL FROM LVDC FOR: TELEMETRY CALIBRATOR IN-FLIGHT CALIBRATE ON	00:06:02.905 (362.905)	TB 3+ 202.700	IU	00:06:04.110 (364.310)	TB 3+ 202.654	MSFC	---
91	SIGNAL FROM LVDC FOR: TELEMETRY CALIBRATOR IN-FLIGHT CALIBRATE OFF	00:06:07.905 (367.905)	TB 3+ 207.700	IU	00:06:09.309 (369.309)	TB 3+ 207.653	MSFC	---
92	SIGNAL FROM LVDC FOR: START PAM-FM/F4 CALIBRATION	00:06:25.205 (385.205)	TB 3+ 225.000	IU	00:06:26.616 (386.616)	TB 3+ 224.960	MSFC	---
93	SIGNAL FROM LVDC FOR: STOP PAM-FM/F4 CALIBRATION	00:06:30.205 (390.205)	TB 3+ 230.000	IU	00:06:31.609 (391.609)	TB 3+ 229.953	MSFC	---
94	SIGNAL FROM LVDC FOR: TELEMETRY CALIBRATOR IN-FLIGHT CALIBRATE ON	00:07:31.105 (451.105)	TB 3+ 290.900	IU	00:07:32.532 (452.532)	TB 3+ 290.876	MSFC	---
95	SIGNAL FROM LVDC FOR: TELEMETRY CALIBRATOR IN-FLIGHT CALIBRATE OFF	00:07:36.105 (456.105)	TB 3+ 295.900	IU	00:07:37.509 (457.509)	TB 3+ 295.853	MSFC	---
96	SIGNAL FROM LVDC FOR: S-II INBOARD ENGINE CUTOFF	00:07:39.205 (459.205)	TB 3+ 299.000	IU	00:07:40.609 (460.609)	TB 3+ 298.953	MSFC	---
97	SIGNAL FROM LVDC FOR: S-II LH2 STEP PRESSURIZATION	00:07:40.205 (460.205)	TB 3+ 300.000	IU	00:07:41.609 (461.609)	TB 3+ 299.953	MSFC	---
98	BEGIN ARTIFICIAL TAU MODE	00:08:03.247 (483.247)	N/A		00:08:04.732 (484.732)	N/A	MSFC	---

TABLE 4-1 (Sheet 9 of 46)

AS - 505 MISSION F
POST FLIGHT SEQUENCE OF EVENTS
AS OF JUNE 13, 1969

ITEM NO.	EVENT	PREDICTED TIME		SIGNAL MONITORED AT	MONITORED TIME		DATA SOURCE	ACCURACY (MS)
		TIME FROM RANGE ZERO (HR:MIN:SEC) (SEC)	TIME FROM RASE (SEC)		TIME FROM ZERO (HR:MIN:SEC) (SEC)	TIME FROM BASE (SEC)		
99	STOP FIRST PHASE IG1	00:08:03.247 (483.247)	N/A		00:08:04.732 (484.732)	N/A	MSFC	---
100	STANT SECOND PHASE IG1	00:08:03.247 (483.247)	N/A		00:08:04.732 (484.732)	N/A	MSFC	---
101	SIGNAL FROM LVDC FOR: HIGH (5.5) ENGINE MIXTURE RATIO OFF	00:08:04.805 (484.805)	TB 3+ 324.600	IU	00:08:06.337 (486.337)	TB 3+ 324.681	MSFC	---
102	SIGNAL FROM LVDC FOR: LOW (4.5) ENGINE MIXTURE RATIO ON	00:08:05.005 (485.005)	TB 3+ 324.800	IU	00:08:06.545 (486.545)	TB 3+ 324.889	MSFC	---
103	END ARTIFICIAL TAU MODE	00:08:03.497 (483.497)	N/A		00:08:10.232 (490.232)	N/A	MSFC	---
104A	SIGNAL FROM LVDC FOR: CHARGE ULLAGE IGNITION ON	00:08:11.405 (491.405)	TB 3+ 331.200	IU	00:08:12.809 (492.809)	TB 3+ 331.153	MSFC	---
104B	SIGNAL RECEIVED IN S-IVB FOR: CHARGE ULLAGE IGNITION ON	-----	-----	S-IVB	00:08:12.806 (492.806)	TB 3+ 331.150	MDAC	---
105	SIGNAL FROM LVDC FOR: S-II/S-IVB ORDNANCE ARM	00:08:11.605 (491.605)	TB 3+ 331.400	IU	00:08:13.020 (493.020)	TB 3+ 331.364	MSFC	---
106A	SIGNAL FROM LVDC FOR: LOX TANK PRESSURIZATION SHUTOFF VALVES OPEN ON	00:08:12.205 (492.205)	TB 3+ 332.000	IU	00:08:13.611 (493.611)	TB 3+ 331.955	MSFC	---
106B	SIGNAL RECEIVED IN S-IVB FOR: LOX TANK PRESSURIZATION SHUTOFF VALVES OPEN ON	-----	-----	S-IVB	00:08:13.614 (493.614)	TB 3+ 331.958	MDAC	---
107	SIGNAL FROM LVDC FOR: START DATA RECORDERS	00:08:12.705 (492.705)	TB 3+ 332.500	IU	00:08:14.109 (494.109)	TB 3+ 332.453	MSFC	---
108	SIGNAL FROM LVDC FOR: S-II LOX DEPLETION SENSORS CUTOFF ARM	00:08:14.405 (494.405)	TB 3+ 334.200	IU	00:08:15.809 (495.809)	TB 3+ 334.153	MSFC	---
109	SIGNAL FROM LVDC FOR: S-II LH2 DEPLETION SENSORS CUTOFF ARM	00:08:14.605 (494.605)	TB 3+ 334.400	IU	00:08:16.019 (496.019)	TB 3+ 334.363	MSFC	---

TABLE 4-1 (Sheet 10 of 46)

AS - 505 MISSION F
POST FLIGHT SEQUENCE OF EVENTS
AS OF JUNE 13, 1969

ITEM NO.	EVENT	PREDICTED TIME		SIGNAL MONITORED AT	MONITORED TIME		DATA SOURCE	ACCURACY (MS)
		TIME FROM RANGE ZERO (HR:MIN:SEC) (SEC)	TIME FROM BASE (SEC)		TIME FROM RANGE ZERO (HR:MIN:SEC) (SEC)	TIME FROM BASE (SEC)		
110	STOP SECOND PHASE IGM	00:09:14.137 (554.137)	N/A		00:09:12.648 (552.648)	N/A	MSFC	---
111	TIME BASE 4 S-II ENGINES CUTOFF	00:09:14.137 (554.137)	TB 4+ 0.000		00:09:12.648 (552.648)	TB 4+ 0.000	MSFC	---
112	BEGIN CHI FREEZE PERIOD-	00:09:14.137 (554.137)	N/A		00:09:12.648 (552.648)	N/A	MSFC	---
113	START THIRD PHASE IGM	00:09:14.137 (554.137)	N/A		00:09:12.648 (552.648)	N/A	MSFC	---
114	SIGNAL FROM LVDC FOR: S-II ENGINES CUTOFF ON	00:09:14.237 (554.237)	TB 4+ 0.100	IU	00:09:12.733 (552.733)	TB 4+ 0.085	MSFC	---
115	SIGNAL FROM LVDC FOR: START RECORDER TIMERS	00:09:14.337 (554.337)	TB 4+ 0.200	IU	00:09:12.825 (552.825)	TB 4+ 0.177	MSFC	---
116A	SIGNAL FROM LVDC FOR: PREVALVES CLOSE OFF	00:09:14.437 (554.437)	TB 4+ 0.300	IU	00:09:12.919 (552.919)	TB 4+ 0.271	MSFC	---
116B	SIGNAL RECEIVED IN S-1VB FOR: PREVALVES CLOSE OFF	-----	-----	S-1VB	00:09:12.922 (552.922)	TB 4+ 0.274	MDAC	---
117A	SIGNAL FROM LVDC FOR: S-1VB ENGINE CUTOFF OFF	00:09:14.537 (554.537)	TB 4+ 0.400	IU	00:09:13.011 (553.011)	TB 4+ 0.353	MSFC	---
117B	SIGNAL RECEIVED IN S-1VB FOR: S-1VB ENGINE CUTOFF OFF	-----	-----	S-1VB	00:09:13.013 (553.013)	TB 4+ 0.365	MDAC	---
118A	SIGNAL FROM LVDC FOR: LOX TANK FLIGHT PRESSURE SYSTEM ON	00:09:14.637 (554.637)	TB 4+ 0.500	IU	00:09:13.117 (553.117)	TB 4+ 0.469	MSFC	---
118B	SIGNAL RECEIVED IN S-1VB FOR: LOX TANK FLIGHT PRESSURE SYSTEM ON	-----	-----	S-1VB	00:09:13.105 (553.105)	TB 4+ 0.457	MDAC	---
119A	SIGNAL FROM LVDC FOR: ENGINE READY BYPASS	00:09:14.737 (554.737)	TB 4+ 0.600	IU	00:09:13.203 (553.203)	TB 4+ 0.555	MSFC	---
119B	SIGNAL RECEIVED IN S-1VB FOR: ENGINE READY BYPASS	-----	-----	S-1VB	00:09:13.204 (553.204)	TB 4+ 0.556	MDAC	---

TABLE 4-1 (Sheet 11 of 46)
 AS - 505 MISSION F
 POST FLIGHT SEQUENCE OF EVENTS
 AS OF JUNE 13, 1969

ITEM NO.	EVENT	PREDICTED TIME		SIGNAL MONITORED AT	MONITORED TIME		DATA SOURCE	ACCURACY (MS)
		TIME FROM RANGE ZERO (HR:MIN:SEC)	TIME FROM BASE (SEC)		TIME FROM RANGE ZERO (HR:MIN:SEC)	TIME FROM BASE (SEC)		
120A	SIGNAL FROM LVDC FOR: LOX CHILLDOWN PUMP OFF	00:09:14.837 (524.837)	TB 4+ 0.700	IU	00:09:13.300 (553.300)	TB 4+ 0.652	MSFC	---
120B	SIGNAL RECEIVED IN S-IVB FOR: LOX CHILLDOWN PUMP OFF	-----	-----	S-IVB	00:09:13.304 (553.304)	TB 4+ 0.656	MDAC	---
121A	SIGNAL FROM LVDC FOR: FIRE ULLAGE IGNITION ON	00:09:14.937 (524.937)	TB 4+ 0.800	IU	00:09:13.399 (553.399)	TB 4+ 0.751	MSFC	---
121B	SIGNAL RECEIVED IN S-IVB FOR: FIRE ULLAGE IGNITION ON	-----	-----	S-IVB	00:09:13.404 (553.404)	TB 4+ 0.756	MDAC	---
122	SIGNAL FROM LVDC FOR: S-II/S-IVB SEPARATION	00:09:15.037 (525.037)	TB 4+ 0.900	IU	00:09:13.500 (553.500)	TB 4+ 0.852	MSFC	---
123A	SIGNAL FROM LVDC FOR: S-IVB ENGINE START ON	00:09:15.137 (525.137)	TB 4+ 1.000	IU	00:09:13.599 (553.599)	TB 4+ 0.951	MSFC	---
123B	SIGNAL RECEIVED IN S-IVB FOR: S-IVB ENGINE START ON	-----	-----	S-IVB	00:09:13.595 (553.595)	TB 4+ 0.947	MDAC	---
124	SIGNAL FROM LVDC FOR: FLIGHT CONTROL COMPUTER S-IVB BURN MODE ON 'A'	00:09:15.337 (525.337)	TB 4+ 1.200	IU	00:09:13.812 (553.812)	TB 4+ 1.164	MSFC	---
125	SIGNAL FROM LVDC FOR: FLIGHT CONTROL COMPUTER S-IVB BURN MODE ON 'B'	00:09:15.437 (525.437)	TB 4+ 1.300	IU	00:09:13.909 (553.909)	TB 4+ 1.261	MSFC	---
126A	SIGNAL FROM LVDC FOR: FUEL CHILLDOWN PUMP OFF	00:09:16.337 (526.337)	TB 4+ 2.200	IU	00:09:14.801 (554.801)	TB 4+ 2.153	MSFC	---
126B	SIGNAL RECEIVED IN S-IVB FOR: FUEL CHILLDOWN PUMP OFF	-----	-----	S-IVB	00:09:14.804 (554.804)	TB 4+ 2.156	MDAC	---
127	SIGNAL FROM LVDC FOR: S-IVB ENGINE OUT INDICATION 'A' ENABLE	00:09:16.637 (526.637)	TB 4+ 2.500	IU	00:09:15.101 (555.101)	TB 4+ 2.453	MSFC	---
128	SIGNAL FROM LVDC FOR: S-IVB ENGINE OUT INDICATION 'B' ENABLE	00:09:16.837 (526.837)	TB 4+ 2.700	IU	00:09:15.306 (555.306)	TB 4+ 2.658	MSFC	---
129A	SIGNAL FROM LVDC FOR: FUEL INJECTION TEMPERATURE OK BYPASS	00:09:18.137 (528.137)	TB 4+ 4.000	IU	00:09:16.601 (556.601)	TB 4+ 3.953	MSFC	---

TABLE 4-1 (Sheet 12 of 46)
 AS - 505 MISSION F
 POST FLIGHT SEQUENCE OF EVENTS
 AS OF JUNE 13, 1969

ITEM NO.	EVENT	PREDICTED TIME		SIGNAL MONITORED AT	MONITORED TIME		DATA SOURCE	ACCURACY (MS)
		TIME FROM RANGE ZERO (HR:MIN:SEC)	TIME FROM BASE (SEC)		TIME FROM RANGE ZERO (HR:MIN:SEC)	TIME FROM BASE (SEC)		
1298	SIGNAL RECEIVED IN S-1VB FOR: FUEL INJECTION TEMPERATURE OK BYPASS	-----	-----	S-1VB	00:09:16.604 (556.604)	TB 4+ 3.956	MDAC	---
1304	SIGNAL FROM LVDC FOR: S-1VB ENGINE START OFF	00:09:18.337 (558.337)	TB 4+ 4.200	IU	00:09:16.798 (556.798)	TB 4+ 4.150	MSFC	---
1308	SIGNAL RECEIVED IN S-1VB FOR: S-1VB ENGINE START OFF	-----	-----	S-1VB	00:09:16.795 (556.795)	TB 4+ 4.147	MDAC	---
1314	SIGNAL FROM LVDC FOR: FIRST BURN RELAY ON	00:09:19.937 (559.937)	TB 4+ 5.800	IU	00:09:18.406 (558.406)	TB 4+ 5.750	MSFC	---
1318	SIGNAL RECEIVED IN S-1VB FOR: FIRST BURN RELAY ON	-----	-----	S-1VB	00:09:18.414 (558.414)	TB 4+ 5.766	MDAC	---
132	END CHI FREEZE PERIOD	00:09:21.997 (561.997)	N/A		00:09:20.132 (560.132)	N/A	MSFC	---
133	BEGIN ARTIFICIAL TAU MODE	00:09:21.997 (561.997)	N/A		00:09:20.132 (560.132)	N/A	MSFC	---
134								
135A	SIGNAL FROM LVDC FOR: CHARGE ULLAGE JETTISON ON	00:09:23.937 (563.937)	TB 4+ 9.800	IU	00:09:22.497 (562.497)	TB 4+ 9.849	MSFC	---
135B	SIGNAL RECEIVED IN S-1VB FOR: CHARGE ULLAGE JETTISON ON	-----	-----	S-1VB	00:09:22.405 (562.405)	TB 4+ 9.757	MDAC	---
136A	SIGNAL FROM LVDC FOR: FIRE ULLAGE JETTISON ON	00:09:26.937 (566.937)	TB 4+ 12.800	IU	00:09:25.401 (565.401)	TB 4+ 12.753	MSFC	---
136B	SIGNAL RECEIVED IN S-1VB FOR: FIRE ULLAGE JETTISON ON	-----	-----	S-1VB	00:09:25.404 (565.404)	TB 4+ 12.756	MDAC	---
137A	SIGNAL FROM LVDC FOR: ULLAGE CHARGING RESET	00:09:27.937 (567.937)	TB 4+ 13.800	IU	00:09:26.400 (566.400)	TB 4+ 13.752	MSFC	---
137B	SIGNAL RECEIVED IN S-1VB FOR: ULLAGE CHARGING RESET	-----	-----	S-1VB	00:09:26.404 (566.404)	TB 4+ 13.756	MDAC	---
138A	SIGNAL FROM LVDC FOR: ULLAGE FIRING RESET	00:09:28.137 (568.137)	TB 4+ 14.000	IU	00:09:26.615 (566.615)	TB 4+ 13.967	MSFC	---

TABLE 4-1 (Sheet 13 of 46)

AS - 505 MISSION F
 POST FLIGHT SEQUENCE OF EVENTS
 AS OF JUNE 13, 1969

ITEM NO.	EVENT	PREDICTED TIME		SIGNAL MONITORED AT	MONITORED TIME		DATA SOURCE	ACCURACY (MS)
		TIME FROM RANGE ZERO (HR:MIN:SEC) (SEC)	TIME FROM BASE (SEC)		TIME FROM RANGE ZERO (HR:MIN:SEC) (SEC)	TIME FROM BASE (SEC)		
1308	SIGNAL RECEIVED IN S-IVB FOR: ULLAGE FIRING RESET			S-IVB	00:09:26.620 (566.620)	TB 4+ 13.972	MDAC	---
139A	SIGNAL FROM LVDC FOR: FUEL INJECTION TEMPERATURE OK BYPASS RESET	00:09:28.337 (568.337)	TB 4+ 14.200	IJ	00:09:26.819 (566.819)	TB 4+ 14.171	MSFC	---
139B	SIGNAL RECEIVED IN S-IVB FOR: FUEL INJECTION TEMPERATURE OK BYPASS RESET			S-IVB	00:09:26.820 (566.820)	TB 4+ 14.172	MDAC	---
140	END ARTIFICIAL TAU MOJE	00:09:32.497 (572.497)	N/A		00:09:28.832 (568.832)	N/A	MSFC	---
141	SIGNAL FROM LVDC FOR: TELEMETRY CALIBRATOR IN-FLIGHT CALIBRATE ON	00:09:30.937 (570.937)	TB 4+ 16.800	IJ	00:09:29.401 (569.401)	TB 4+ 16.753	MSFC	---
142	SIGNAL FROM LVDC FOR: TELEMETRY CALIBRATOR IN-FLIGHT CALIBRATE OFF	00:09:35.937 (575.937)	TB 4+ 21.600	IJ	00:09:34.404 (574.404)	TB 4+ 21.756	MSFC	---
143A	SIGNAL FROM LVDC FOR: HEAT-EXCHANGER BYPASS VALVE CONTROL ENABLE	00:09:38.137 (578.137)	TB 4+ 24.000	IJ	00:09:36.599 (576.599)	TB 4+ 23.951	MSFC	---
143B	SIGNAL RECEIVED IN S-IVB FOR: HEAT-EXCHANGER BYPASS VALVE CONTROL ENABLE			S-IVB	00:09:36.603 (576.603)	TB 4+ 23.955	MDAC	---
144A	SIGNAL FROM LVDC FOR: IN-FLIGHT CALIBRATION MODE ON	00:09:39.837 (579.837)	TB 4+ 25.700	IJ	00:09:38.320 (578.320)	TB 4+ 25.672	MSFC	---
144B	SIGNAL RECEIVED IN S-IVB FOR: IN-FLIGHT CALIBRATION MODE ON			S-IVB	00:09:38.340 (578.340)	TB 4+ 25.692	MDAC	---
145A	SIGNAL FROM LVDC FOR: TM CALIBRATE ON	00:09:40.337 (580.337)	TB 4+ 26.200	IJ	00:09:38.817 (578.817)	TB 4+ 26.169	MSFC	---
145B	SIGNAL RECEIVED IN S-IVB FOR: TM CALIBRATE ON			S-IVB	00:09:38.820 (578.820)	TB 4+ 26.172	MDAC	---
146A	SIGNAL FROM LVDC FOR: TM CALIBRATE OFF	00:09:45.337 (585.337)	TB 4+ 31.200	IJ	00:09:43.823 (583.823)	TB 4+ 31.175	MSFC	---
146B	SIGNAL RECEIVED IN S-IVB FOR: TM CALIBRATE OFF			S-IVB	00:09:43.819 (583.819)	TB 4+ 31.171	MDAC	---

TABLE 4-1 (Sheet 14 of 46)
 AS - 505 MISSION F
 POST FLIGHT SEQUENCE OF EVENTS
 AS OF JUNE 13, 1969

ITEM NO.	EVENT	PREDICTED TIME		SIGNAL MONITORED AT	MONITORED TIME		DATA SOURCE	ACCURACY (MS)
		TIME FROM RANGE ZERO (HR:MIN:SEC) (SEC)	TIME FROM BASE (SEC)		TIME FROM RANGE ZERO (HR:MIN:SEC) (SEC)	TIME FROM BASE (SEC)		
147A	SIGNAL FROM LVDC FOR: IN-FLIGHT CALIBRATION MODE OFF	00:09:45.837 (585.837)	TB 4+ 31.700	IU	00:09:44.301 (584.301)	TB 4+ 31.653	MSFC	---
147B	SIGNAL RECEIVED IN S-IVB FOR: IN-FLIGHT CALIBRATION MODE OFF	-----	-----	S-IVB	00:09:44.303 (584.303)	TB 4+ 31.655	MDAC	---
148	BL IN CH1 TILDE GUIDANCE MODE	00:11:08.747 (668.747)	N/A		00:11:09.310 (669.310)	N/A	MSFC	---
149A	SIGNAL FROM LVDC FOR: ENGINE PUMP PURGE CONTROL VALVE ENABLE ON	00:11:34.344 (694.344)	TB 5- 9.400	IU	00:11:34.573 (694.573)	TB 5- 9.407	MSFC	---
149B	SIGNAL RECEIVED IN S-IVB FOR: ENGINE PUMP PURGE CONTROL VALVE ENABLE ON	-----	-----	S-IVB	00:11:34.578 (694.578)	TB 5- 9.402	MDAC	---
150	BEGIN CH1 FREEZE PERIOD-	00:11:36.247 (696.247)	N/A		00:11:35.732 (695.732)	N/A	MSFC	---
151	STOP THIRK) PHASE IGM	00:11:36.247 (696.247)	N/A		00:11:35.732 (695.732)	N/A	MSFC	---
152								
153A	SIGNAL FROM LVDC FOR: S-IVB ENGINE CUTOFF ON	00:11:43.544 (703.544)	TB 5- 0.200	IU	00:11:43.756 (703.756)	TB 5- 0.224	MSFC	---
153B	SIGNAL RECEIVED IN S-IVB FOR: S-IVB ENGINE CUTOFF ON	-----	-----	S-IVB	00:11:43.761 (703.761)	TB 5- 0.219	MDAC	---
154	TIME BASE 5 VELOCITY CUTOFF OF FIRST S-IVB BURN	00:11:43.744 (703.744)	TB 5+ 0.000		00:11:43.980 (703.980)	TB 5+ 0.000	MSFC	---
155A	SIGNAL FROM LVDC FOR: S-IVB ENGINE CUTOFF ON	00:11:43.844 (703.844)	TB 5+ 0.100	IU	00:11:44.066 (704.066)	TB 5+ 0.096	MSFC	---
155B	SIGNAL RECEIVED IN S-IVB FOR: S-IVB ENGINE CUTOFF ON	-----	-----	S-IVB	00:11:44.069 (704.069)	TB 5+ 0.089	MDAC	---

TABLE 4-1 (Sheet 15 of 46)
 AS - 505 MISSION F
 POST FLIGHT SEQUENCE OF EVENTS
 AS OF JUNE 13, 1969

ITEM NO.	EVENT	PREDICTED TIME		SIGNAL MONITORED AT	MONITORED TIME		DATA SOURCE	ACCURACY (MS)
		TIME FROM RANGE ZERO (HR:MIN:SEC) (SEC)	TIME FROM BASE (SEC)		TIME FROM RANGE ZERO (HR:MIN:SEC) (SEC)	TIME FROM BASE (SEC)		
156A	SIGNAL FROM LVDC FOR: POINT LEVEL SENSOR DISARMING	00:11:43.944 (703.944)	TB 5+ 0.200	IJ	00:11:44.158 (704.158)	TB 5+ 0.178	MSFC	---
156B	SIGNAL RECEIVED IN S-1VB FOR: POINT LEVEL SENSOR DISARMING	-----	-----	S-1VB	00:11:44.161 (704.161)	TB 5+ 0.181	MDAC	---
157A	SIGNAL FROM LVDC FOR: S-1VB ULLAGE ENGINE NO. 1 ON	00:11:44.044 (704.044)	TB 5+ 0.300	IJ	00:11:44.252 (704.252)	TB 5+ 0.272	MSFC	---
157B	SIGNAL RECEIVED IN S-1VB FOR: S-1VB ULLAGE ENGINE NO. 1 ON	-----	-----	S-1VB	00:11:44.260 (704.260)	TB 5+ 0.280	MDAC	---
158A	SIGNAL FROM LVDC FOR: S-1VB ULLAGE ENGINE NO. 2 ON	00:11:44.144 (704.144)	TB 5+ 0.400	IJ	00:11:44.379 (704.379)	TB 5+ 0.399	MSFC	---
158B	SIGNAL RECEIVED IN S-1VB FOR: S-1VB ULLAGE ENGINE NO. 2 ON	-----	-----	S-1VB	00:11:44.386 (704.386)	TB 5+ 0.406	MDAC	---
159	SIGNAL FROM LVDC FOR: S-1VB ULLAGE THRUST PRESENT INDICATION ON	00:11:44.344 (704.344)	TB 5+ 0.600	IJ	00:11:44.551 (704.551)	TB 5+ 0.571	MSFC	---
160A	SIGNAL FROM LVDC FOR: FIRST BURN RELAY OFF	00:11:44.544 (704.544)	TB 5+ 0.800	IJ	00:11:44.732 (704.732)	TB 5+ 0.752	MSFC	---
160B	SIGNAL RECEIVED IN S-1VB FOR: FIRST BURN RELAY OFF	-----	-----	S-1VB	00:11:44.735 (704.735)	TB 5+ 0.795	MDAC	---
161A	SIGNAL FROM LVDC FOR: LOX TANK FLIGHT PRESSURE SYSTEM OFF	00:11:44.944 (704.944)	TB 5+ 1.200	IJ	00:11:45.152 (705.152)	TB 5+ 1.172	MSFC	---
161B	SIGNAL RECEIVED IN S-1VB FOR: LOX TANK FLIGHT PRESSURE SYSTEM OFF	-----	-----	S-1VB	00:11:45.162 (705.162)	TB 5+ 1.182	MDAC	---
162A	SIGNAL FROM LVDC FOR: LOX TANK PRESSURIZATION SHUTOFF VALVES CLOSE ON	00:11:45.144 (705.144)	TB 5+ 1.400	IJ	00:11:45.332 (705.332)	TB 5+ 1.352	MSFC	---
162B	SIGNAL RECEIVED IN S-1VB FOR: LOX TANK PRESSURIZATION SHUTOFF VALVES CLOSE ON	-----	-----	S-1VB	00:11:45.336 (705.336)	TB 5+ 1.356	MDAC	---
163A	SIGNAL FROM LVDC FOR: ENGINE PUMP PURGE CONTROL VALVE ENABLE ON	00:11:45.344 (705.344)	TB 5+ 1.600	IJ	00:11:45.543 (705.543)	TB 5+ 1.563	MSFC	---

TABLE 4-1 (Sheet 16 of 46)
 AS - 505 MISSION F
 POST FLIGHT SEQUENCE OF EVENTS
 AS OF JUNE 13, 1969

ITEM NO.	EVENT	PREDICTED TIME		SIGNAL MONITORED AT	MONITORED TIME		DATA SOURCE	ACCURACY (MS)
		TIME FROM R/ GE ZERO (HR:MIN:SEC) (SEC)	TIME FROM BASE (SEC)		TIME FROM RANGE ZERO (HR:MIN:SEC) (SEC)	TIME FROM BASE (SEC)		
163B	SIGNAL RECEIVED IN S-IVB FOR: ENGINE PUMP PURGE CONTROL VALVE ENABLE ON	00:11:45.553 (705.553)	---	S-IVB	00:11:45.553 (705.553)	TB 5+	MDAC	---
164	SIGNAL FROM LVDC FOR: FLIGHT CONTROL COMPUTER S-IVB BURN MODE OFF 'A'	00:11:47.244 (707.244)	TB 5+ 3.500	IU	00:11:47.438 (707.438)	TB 5+ 3.458	MSFC	---
165	SIGNAL FROM LVDC FOR: FLIGHT CONTROL COMPUTER S-IVB BURN MODE OFF 'B'	00:11:47.444 (707.444)	TB 5+ 3.700	IU	00:11:47.654 (707.654)	TB 5+ 3.674	MSFC	---
166A	SIGNAL FROM LVDC FOR: AUX. HYDRAULIC PUMP FLIGHT MODE OFF	00:11:47.844 (707.844)	TB 5+ 4.100	IU	00:11:48.031 (708.031)	TB 5+ 4.051	MSFC	---
166B	SIGNAL RECEIVED IN S-IVB FOR: AUX. HYDRAULIC PUMP FLIGHT MODE OFF	-----	-----	S-IVB	00:11:48.036 (708.036)	TB 5+ 4.056	MDAC	---
167	SIGNAL FROM LVDC FOR: TELEMETRY CALIBRATOR IN-FLIGHT CALIBRATE ON	00:11:47.944 (707.944)	TB 5+ 4.200	IU	00:11:48.132 (708.132)	TB 5+ 4.152	MSFC	---
168	SIGNAL FROM LVDC FOR: S/C CONTROL OF SATURN ENABLE	00:11:48.744 (708.744)	TB 5+ 5.000	IU	00:11:48.943 (708.943)	TB 5+ 4.963	MSFC	---
169A	SIGNAL FROM LVDC FOR: IN-FLIGHT CALIBRATION MODE ON	00:11:50.244 (710.244)	TB 5+ 6.500	IU	00:11:50.436 (710.436)	TB 5+ 6.456	MSFC	---
169B	SIGNAL RECEIVED IN S-IVR FOR: IN-FLIGHT CALIBRATION MODE ON	-----	-----	S-IVB	00:11:50.443 (710.443)	TB 5+ 6.463	MDAC	---
170A	SIGNAL FROM LVDC FOR: TM CALIBRATE ON	00:11:50.744 (710.744)	TB 5+ 7.000	IU	00:11:50.936 (710.936)	TB 5+ 6.956	MSFC	---
170B	SIGNAL RECEIVED IN S-IVR FOR: TM CALIBRATE ON	-----	-----	S-IVB	00:11:50.943 (710.943)	TB 5+ 6.963	MDAC	---
171	SIGNAL FROM LVDC FOR: TELEMETRY CALIBRATOR IN-FLIGHT CALIBRATE OFF	00:11:52.944 (712.944)	TB 5+ 9.200	IU	00:11:53.132 (713.132)	TB 5+ 9.152	MSFC	---
172	PARKING ORBIT INSERTION	00:11:53.476 (713.476)	N/A		00:11:53.760 (713.760)	N/A	MSFC	---

TABLE 4-1 (Sheet 17 of 46)

AS - 505 MISSION F
POST FLIGHT SEQUENCE OF EVENTS
AS OF JUNE 13, 1969

ITEM NO.	EVENT	PREDICTED TIME		SIGNAL MONITORED AT	MONITORED TIME		DATA SOURCE	ACCURACY (MS)
		TIME FROM RANGE ZERO (HR:MIN:SEC) (SEC)	TIME FROM BASE (SEC)		TIME FROM RANGE ZERO (HR:MIN:SEC) (SEC)	TIME FROM BASE (SEC)		
173	SIGNAL FROM LVDC FOR: S-IVB ENGINE OUT INDICATION 'A' ENABLE RESET	00:11:53.744 (713.744)	TB 5+ 10.000	IU	00:11:53.931 (713.931)	TB 5+ 9.951	MSFC	---
174	SIGNAL FROM LVDC FOR: S-IVB ENGINE OUT INDICATION 'B' ENABLE RESET	00:11:53.944 (713.944)	TB 5+ 10.200	IU	00:11:54.140 (714.140)	TB 5+ 10.160	MSFC	---
175A	SIGNAL FROM LVDC FOR: TM CALIBRATE OFF	00:11:55.744 (715.744)	TB 5+ 12.000	IU	00:11:55.933 (715.933)	TB 5+ 11.953	MSFC	---
175B	SIGNAL RECEIVED IN S-IVB FOR: TM CALIBRATE OFF	-----	-----	S-IVB	00:11:55.935 (715.935)	TB 5+ 11.955	MDAC	---
176A	SIGNAL FROM LVDC FOR: IN-FLIGHT CALIBRATION MODE OFF	00:11:56.244 (716.244)	TB 5+ 12.500	IU	00:11:56.432 (716.432)	TB 5+ 12.452	MSFC	---
176B	SIGNAL RECEIVED IN S-IVB FOR: IN-FLIGHT CALIBRATION MODE OFF	-----	-----	S-IVB	00:11:56.435 (716.435)	TB 5+ 12.455	MDAC	---
177	END CHI FREEZE PERIOD	00:12:03.744 (723.744)	N/A		00:12:03.980 (723.980)	N/A	MSFC	---
178	INITIATE MANEUVER TO ALIGN S-IVB/SC +X AXIS ALONG THE LOCAL HORIZONTAL (SC FORWARD POSITION 1 DOWN)	00:12:03.872 (723.872)	N/A		00:12:04.052 (724.052)	N/A	MSFC	---
179A	SIGNAL FROM LVDC FOR: SINGLE SIDEBAND FM TRANSMITTER OFF	00:12:05.744 (725.744)	TB 5+ 22.000	IU	00:12:05.938 (725.938)	TB 5+ 21.958	MSFC	---
179B	SIGNAL RECEIVED IN S-IVB FOR: SINGLE SIDEBAND FM TRANSMITTER OFF	-----	-----	S-IVB	00:12:05.943 (725.943)	TB 5+ 21.963	MDAC	---
180A	SIGNAL FROM LVDC FOR: LH2 TANK CONTINUOUS VENT ORIFICE SHUTOFF VALVE OPEN ON	00:12:42.744 (762.744)	TB 5+ 59.000	IU	00:12:42.945 (762.945)	TB 5+ 58.965	MSFC	---
180B	SIGNAL RECEIVED IN S-IVB FOR: LH2 TANK CONTINUOUS VENT ORIFICE SHUTOFF VALVE OPEN ON	-----	-----	S-IVB	00:12:42.952 (762.952)	TB 5+ 58.972	MDAC	---

TABLE 4-1 (Sheet 18 of 46)
 AS - 505 MISSION F
 POST FLIGHT SEQUENCE OF EVENTS
 AS OF JUNE 13, 1969

ITEM NO.	EVENT	PREDICTED TIME		SIGNAL MONITORED AT	MONITORED TIME		DATA SOURCE	ACCURACY (MS)
		TIME FROM RANGE ZERO (HR:MIN:SEC) (SEC)	TIME FROM BASE (SEC)		TIME FROM RANGE ZERO (HR:MIN:SEC) (SEC)	TIME FROM BASE (SEC)		
181A	SIGNAL FROM LVDC FOR: LM2 TANK CONTINUOUS VENT RELIEF OVERRIDE SHUTOFF VALVE OPEN ON	00:12:42.844 (762.844)	TB 5+ 59.100	IU	00:12:43.075 (763.075)	TB 5+ 59.095	MSFC	---
181B	SIGNAL RECEIVED IN S-IVB FOR: LM2 TANK CONTINUOUS VENT RELIEF OVERRIDE SHUTOFF VALVE OPEN ON	-----	-----	S-IVB	00:12:43.077 (763.077)	TB 5+ 59.097	MDAC	---
182A	SIGNAL FROM LVDC FOR: LM2 TANK CONTINUOUS VENT ORIFACE SHUTOFF VALVE OPEN OFF	00:12:44.744 (764.744)	TB 5+ 61.000	IU	00:12:44.932 (764.932)	TB 5+ 60.952	MSFC	---
182B	SIGNAL RECEIVED IN S-IVB FOR: LM2 TANK CONTINUOUS VENT ORIFACE SHUTOFF VALVE OPEN OFF	-----	-----	S-IVB	00:12:44.934 (764.934)	TB 5+ 60.954	MDAC	---
183A	SIGNAL FROM LVDC FOR: LM2 TANK CONTINUOUS VENT RELIEF OVERRIDE SHUTOFF VALVE OPEN OFF	00:12:44.844 (764.844)	TB 5+ 61.100	IU	00:12:45.032 (765.032)	TB 5+ 61.052	MSFC	---
183B	SIGNAL RECEIVED IN S-IVB FOR: LM2 TANK CONTINUOUS VENT RELIEF OVERRIDE SHUTOFF VALVE OPEN OFF	-----	-----	S-IVB	00:12:45.034 (765.034)	TB 5+ 61.054	MDAC	---
184A	SIGNAL FROM LVDC FOR: S-IVB ULLAGE ENGINE NO.1 OFF	00:13:10.744 (790.744)	TB 5+ 87.000	IU	00:13:10.947 (790.947)	TB 5+ 86.967	MSFC	---
184B	SIGNAL RECEIVED IN S-IVB FOR: S-IVB ULLAGE ENGINE NO.1 OFF	-----	-----	S-IVB	NO DATA	NO DATA	MDAC	---
185A	SIGNAL FROM LVDC FOR: S-IVB ULLAGE ENGINE NO. 2 OFF	00:13:10.844 (790.844)	TB 5+ 87.100	IU	00:13:11.041 (791.041)	TB 5+ 87.061	MSFC	---
185B	SIGNAL RECEIVED IN S-IVB FOR: S-IVB ULLAGE ENGINE NO. 2 OFF	-----	-----	S-IVB	NO DATA	NO DATA	MDAC	---
186	SIGNAL FROM LVDC FOR: S-IVB ULLAGE THRUST PRESENT INDICATION OFF	00:13:10.944 (790.944)	TB 5+ 87.200	IU	00:13:11.134 (791.134)	TB 5+ 87.154	MSFC	---

TABLE 4-1 (Sheet 19 of 46)

AS - 505 MISSION F
POST FLIGHT SEQUENCE OF EVENTS
AS OF JUNE 13, 1969

ITEM NO.	EVENT	PREDICTED TIME		SIGNAL MONITORED AT	MONITORED TIME		DATA SOURCE	ACCURACY (MS)
		TIME FROM RANGE ZERO (HR:MIN:SEC)	TIME FROM BASE (SEC)		TIME FROM RANGE ZERO (HR:MIN:SEC)	TIME FROM BASE (SEC)		
187A	SIGNAL FROM LVDC FOR: P.U. INVERTER AND D.C. POWER OFF	00:20:03.744 (1203.744)	TB 5+ 500.000	IU	NO DATA	NO DATA	MSFC	---
187B	SIGNAL RECEIVED IN S-IVB FOR: P.U. INVERTER AND D.C. POWER OFF	-----	-----	S-IVB	NO DATA	NO DATA	MDAC	---
188A	SIGNAL FROM LVDC FOR: ENGINE PUMP PURGE CONTROL VALVE ENABLE OFF	00:21:46.344 (1306.344)	TB 5+ 602.600	IU	NO DATA	NO DATA	MSFC	---
188B	SIGNAL RECEIVED IN S-IVB FOR: ENGINE PUMP PURGE CONTROL VALVE ENABLE OFF	-----	-----	S-IVB	NO DATA	NO DATA	MDAC	---
189A	SIGNAL FROM LVDC FOR: AUX. HYDRAULIC PUMP FLIGHT MODE ON	00:55:03.744 (3303.744)	TB 5+ 2603.000	IU	00:55:03.947 (3303.947)	TB 5+ 2599.967	MSFC	---
189B	SIGNAL RECEIVED IN S-IVB FOR: AUX. HYDRAULIC PUMP FLIGHT MODE ON	-----	-----	S-IVB	NO DATA	NO DATA	MDAC	---
190A	SIGNAL FROM LVDC FOR: AUX. HYDRAULIC PUMP FLIGHT MODE OFF	00:55:51.744 (3351.744)	TB 5+ 2648.000	IU	00:55:51.948 (3351.948)	TB 5+ 2647.968	MSFC	---
190B	SIGNAL RECEIVED IN S-IVB FOR: AUX. HYDRAULIC PUMP FLIGHT MODE OFF	-----	-----	S-IVB	NO DATA	NO DATA	MDAC	---
191A	SIGNAL FROM LVDC FOR: P.U. INVERTER AND D.C. POWER ON	01:35:03.744 (5703.744)	TB 5+ 5000.000	IU	01:35:03.961 (5703.961)	TB 5+ 4999.981	MSFC	---
191B	SIGNAL RECEIVED IN S-IVB FOR: P.U. INVERTER AND D.C. POWER ON	-----	-----	S-IVB	NO DATA	NO DATA	MDAC	---
192A	SIGNAL FROM LVDC FOR: AUX. HYDRAULIC PUMP FLIGHT MODE ON	01:41:43.744 (6103.744)	TB 5+ 5400.000	IU	01:41:43.962 (6103.962)	TB 5+ 5399.982	MSFC	---
192B	SIGNAL RECEIVED IN S-IVB FOR: AUX. HYDRAULIC PUMP FLIGHT MODE ON	-----	-----	S-IVB	01:41:43.952 (6103.952)	TB 5+ 5399.972	MDAC	---

TABLE 4-1 (Sheet 20 of 46)
 AS - 505 MISSION F
 POST FLIGHT SEQUENCE OF EVENTS
 AS OF JUNE 13, 1969

ITEM NO.	EVENT	PREDICTED TIME		SIGNAL MONITORED AT	MONITORED TIME		DATA SOURCE	ACCURACY (MS)
		TIME FROM RANGE ZERO (HR:MIN:SEC) (SEC)	TIME FROM BASE (SEC)		TIME FROM RANGE ZERO (HR:MIN:SEC) (SEC)	TIME FROM BASE (SEC)		
195A	SIGNAL FROM LVDC FOR: AUX. HYDRAULIC PUMP FLIGHT MODE OFF	01:42:31.744 (6151.744)	TB 5+ 5448.000	IJ	01:42:31.963 (6151.963)	TB 5+ 5447.983	MSFC	---
195B	SIGNAL RECEIVED IN S-IVB FOR: AUX. HYDRAULIC PUMP FLIGHT MODE OFF	-----	-----	S-IVB	01:42:31.957 (6151.957)	TB 5+ 5447.977	MDAC	---
194	TIME BASE 6 ENGINE FIRST RESTART PREPARATIONS	02:23:47.247 (8627.247)	TB 6+ 0.000		02:23:49.259 (8629.259)	TB 6+ 0.000	MSFC	---
195	SIGNAL FROM LVDC FOR: S-IVB RESTART ALERT ON	02:23:47.347 (8627.347)	TB 6+ 0.100	IJ	NO DATA	NO DATA	MSFC	---
196	SIGNAL FROM LVDC FOR: S/C CONTROL OF SATURN DISABLE	02:23:47.547 (8627.547)	TB 6+ 3.300	IJ	NO DATA	NO DATA	MSFC	---
197A	SIGNAL FROM LVDC FOR: AMBIENT HE SUPPLY SHUTOFF VALVE CLOSED OFF	02:23:47.947 (8627.947)	TB 6+ 0.700	IJ	NO DATA	NO DATA	MSFC	---
197B	SIGNAL RECEIVED IN S-IVB FOR: AMBIENT HE SUPPLY SHUTOFF VALVE CLOSED OFF	-----	-----	S-IVB	02:23:49.894 (8629.894)	TB 6+ 0.635	MDAC	---
198A	SIGNAL FROM LVDC FOR: IN-FLIGHT CALIBRATION MODE ON	02:23:48.247 (8628.247)	TB 6+ 1.000	IJ	NO DATA	NO DATA	MSFC	---
198B	SIGNAL RECEIVED IN S-IVB FOR: IN-FLIGHT CALIBRATION MODE ON	-----	-----	S-IVB	02:23:50.193 (8630.193)	TB 6+ 0.934	MDAC	---
199	SIGNAL FROM LVDC FOR: TELEMETRY CALIBRATOR IN-FLIGHT CALIBRATE ON	02:23:48.447 (8628.447)	TB 6+ 1.200	IJ	NO DATA	NO DATA	MSFC	---
200A	SIGNAL FROM LVDC FOR: TM CALIBRATE ON	02:23:48.647 (8628.647)	TB 6+ 1.400	IJ	NO DATA	NO DATA	MSFC	---
200B	SIGNAL RECEIVED IN S-IVB FOR: TM CALIBRATE ON	-----	-----	S-IVB	02:23:50.593 (8630.593)	TB 6+ 1.334	MDAC	---
201	SIGNAL FROM LVDC FOR: TELEMETRY CALIBRATOR IN-FLIGHT CALIBRATE OFF.	02:23:53.447 (8633.447)	TB 6+ 6.200	IJ	NO DATA	NO DATA	MSFC	---

TABLE 4-1 (Sheet 21 of 46)

AS - 505 MISSION F
 POST FLIGHT SEQUENCE OF EVENTS
 AS OF JUNE 13, 1969

ITEM NO.	EVENT	PREDICTED TIME		SIGNAL MONITORED AT	MONITORED TIME		DATA SOURCE	ACCURACY (MS)
		TIME FROM RANGE ZERO (HR:MIN:SEC)	TIME FROM BASE (SEC)		TIME FROM RANGE ZERO (HR:MIN:SEC)	TIME FROM BASE (SEC)		
202A	SIGNAL FROM LVDC FOR: TM CALIBRATE OFF	02:23:53.647 (8653.647)	TB 6+ 6.400	IU	NO DATA	NO DATA	MSFC	---
202B	SIGNAL RECEIVED IN S-1VB FOR: TM CALIBRATE OFF	-----	-----	S-1VB	02:23:55.593 (8635.593)	TB 6+ 6.334	MDAC	---
203A	SIGNAL FROM LVDC FOR: IN-FLIGHT CALIBRATION MODE OFF	02:23:54.247 (8654.247)	TB 6+ 7.000	IU	NO DATA	NO DATA	MSFC	---
203B	SIGNAL RECEIVED IN S-1VB FOR: IN-FLIGHT CALIBRATION MODE OFF	-----	-----	S-1VB	02:23:56.218 (8636.218)	TB 6+ 6.959	MDAC	---
204A	SIGNAL FROM LVDC FOR: SINGLE SIDEBAND FM TRANSMITTER ON	02:23:57.747 (8657.747)	TB 6+ 11.500	IU	NO DATA	NO DATA	MSFC	---
204B	SIGNAL RECEIVED IN S-1VB FOR: SINGLE SIDEBAND FM TRANSMITTER ON	-----	-----	S-1VB	NO DATA	NO DATA	MDAC	---
205A	SIGNAL FROM LVDC FOR: LH2 TANK VENT AND LATCHING RELIEF VALVE BOOST CLOSE ON	02:24:123.547 (8663.547)	TB 6+ 36.300	IU	NO DATA	NO DATA	MSFC	---
205B	SIGNAL RECEIVED IN S-1VB FOR: LH2 TANK VENT AND LATCHING RELIEF VALVE BOOST CLOSE ON	-----	-----	S-1VB	02:24:25.499 (8665.499)	TB 6+ 36.240	MDAC	---
206A	SIGNAL FROM LVDC FOR: LOX TANK VENT AND NPV VALVES BOOST CLOSE ON	02:24:123.747 (8663.747)	TB 6+ 36.500	IU	NO DATA	NO DATA	MSFC	---
206B	SIGNAL RECEIVED IN S-1VB FOR: LOX TANK VENT AND NPV VALVES BOOST CLOSE ON	-----	-----	S-1VB	02:24:25.691 (8665.691)	TB 6+ 36.432	MDAC	---
207	SIGNAL FROM LVDC FOR: S-1VB RESTART ALERT OFF	02:24:24.547 (8664.547)	TB 6+ 37.300	IU	NO DATA	NO DATA	MSFC	---
208A	SIGNAL FROM LVDC FOR: LH2 TANK VENT AND LATCHING RELIEF VALVE BOOST CLOSE OFF	02:24:25.547 (8665.547)	TB 6+ 38.300	IU	NO DATA	NO DATA	MSFC	---
208B	SIGNAL RECEIVED IN S-1VB FOR: LH2 TANK VENT AND LATCHING RELIEF VALVE BOOST CLOSE OFF	-----	-----	S-1VB	02:24:27.499 (8667.499)	TB 6+ 38.240	MDAC	---

TABLE 4-1 (Sheet 22 of 46)
 AS - 505 MISSION F
 POST FLIGHT SEQUENCE OF EVENTS
 AS OF JUNE 13, 1969

ITEM NO.	EVENT	PREDICTED TIME		SIGNAL MONITORED AT	MONITORED TIME		DATA SOURCE	ACCURACY (MS)
		TIME FROM RANGE ZERO (HR:MIN:SEC) (SEC)	TIME FROM BASE (SEC)		TIME FROM RANGE ZERO (HR:MIN:SEC) (SEC)	TIME FROM BASE (SEC)		
209A	SIGNAL FROM LVDC FOP: LOY TANK VENT AND NPV VALVES BOOST CLOSE OFF	02:24:25.747 (9665.747)	TB 6+ 38.500	IU	NO DATA	NO DATA	MSFC	---
209B	SIGNAL RECEIVED IN S-1VB FOR: LOY TANK VENT AND NPV VALVES BOOST CLOSE OFF	-----	-----	S-1VB	02:24:27.708 (8667.708)	TB 6+ 38.449	MDAC	---
210A	SIGNAL FROM LVDC FOR: AMBIENT REPRESS. SYSTEM MODE SELECTOR OFF AND CYRO ON	02:24:28.147 (8668.147)	TB 6+ 40.900	IU	NO DATA	NO DATA	MSFC	---
210B	SIGNAL RECEIVED IN S-1VB FOR: AMBIENT REPRESS. SYSTEM MODE SELECTOR OFF AND CYRO ON	-----	-----	S-1VB	02:24:30.099 (8670.099)	TB 6+ 40.840	MDAC	---
211A	SIGNAL FROM LVDC FOR: BURNER LM2 PROPELLANT VALVE OPEN ON	02:24:28.547 (8668.547)	TB 6+ 41.300	IU	02:24:30.529 (8670.529)	TB 6+ 41.270	MSFC	---
211B	SIGNAL RECEIVED IN S-1VB FOR: BURNER LM2 PROPELLANT VALVE OPEN ON	-----	-----	S-1VB	02:24:30.516 (8670.516)	TB 6+ 41.257	MDAC	---
212A	SIGNAL FROM LVDC FOR: BURNER EXCITERS ON	02:24:28.847 (8668.847)	TB 6+ 41.600	IU	02:24:30.826 (8670.826)	TB 6+ 41.567	MSFC	---
212B	SIGNAL RECEIVED IN S-1VB FOR: BURNER EXCITERS ON	-----	-----	S-1VB	02:24:30.808 (8670.808)	TB 6+ 41.549	MDAC	---
213A	SIGNAL FROM LVDC FOR: BURNER LOX SHUTDOWN VALVE OPEN ON	02:24:29.247 (8669.247)	TB 6+ 42.000	IU	02:24:31.211 (8671.211)	TB 6+ 41.952	MSFC	---
213B	SIGNAL RECEIVED IN S-1VB FOR: BURNER LOX SHUTDOWN VALVE OPEN ON	-----	-----	S-1VB	02:24:31.199 (8671.199)	TB 6+ 41.940	MDAC	---
214A	SIGNAL FROM LVDC FOR: LM2 TANK CONTINUOUS VENT VALVE CLOSE ON	02:24:29.447 (8669.447)	TB 6+ 42.200	IU	02:24:31.422 (8671.422)	TB 6+ 42.163	MSFC	---
214B	SIGNAL RECEIVED IN S-1VB FOR: LM2 TANK CONTINUOUS VENT VALVE CLOSE ON	-----	-----	S-1VB	02:24:31.408 (8671.408)	TB 6+ 42.149	MDAC	---

TABLE 4-1 (Sheet 23 of 46)

AS - 505 MISSION F
POST FLIGHT SEQUENCE OF EVENTS
AS OF JUNE 13, 1969

ITEM NO.	EVENT	PREDICTED TIME		SIGNAL MONITORED AT	MONITORED TIME		DATA SOURCE	ACCURACY (MS)
		TIME FROM RANGE ZERO (HR:MIN:SEC) (SEC)	TIME FROM BASE (SEC)		TIME FROM RANGE ZERO (HR:MIN:SEC) (SEC)	TIME FROM BASE (SEC)		
215A	SIGNAL FROM LVDC FOR: BURNER LH2 PROPELLANT VALVE OPEN OFF	02:24:30.047 (86/0.047)	TB 6+ 42.800	IU	02:24:32.013 (8672.013)	TB 6+ 42.754	MSFC	---
215B	SIGNAL RECEIVED IN S-IVB FOR: BURNER LH2 PROPELLANT VALVE OPEN OFF	-----	-----	S-IVB	02:24:31.999 (8671.999)	TB 6+ 42.740	MDAC	---
216A	SIGNAL FROM LVDC FOR: BURNER LOX SHUTDOWN VALVE OPEN OFF	02:24:30.747 (86/0.747)	TB 6+ 43.500	IU	02:24:32.720 (8672.720)	TB 6+ 43.461	MSFC	---
216B	SIGNAL RECEIVED IN S-IVB FOR: BURNER LOX SHUTDOWN VALVE OPEN OFF	-----	-----	S-IVB	02:24:32.708 (8672.708)	TB 6+ 43.449	MDAC	---
217A	SIGNAL FROM LVDC FOR: LH2 TANK CONTINUOUS VENT VALVE CLOSE OFF	02:24:31.447 (86/1.447)	TB 6+ 44.200	IU	02:24:33.412 (8673.412)	TB 6+ 44.153	MSFC	---
217B	SIGNAL RECEIVED IN S-IVB FOR: LH2 TANK CONTINUOUS VENT VALVE CLOSE OFF	-----	-----	S-IVB	02:24:33.400 (8673.400)	TB 6+ 44.141	MDAC	---
218A	SIGNAL FROM LVDC FOR: SECOND BURN RELAY ON	02:24:32.447 (86/2.447)	TB 6+ 45.200	IU	02:24:34.410 (8674.410)	TB 6+ 45.151	MSFC	---
218B	SIGNAL RECEIVED IN S-IVB FOR: SECOND BURN RELAY ON	-----	-----	S-IVB	02:24:34.400 (8674.400)	TB 6+ 45.141	MDAC	---
219A	SIGNAL FROM LVDC FOR: BURNER EXCITERS OFF	02:24:32.647 (8672.647)	TB 6+ 45.400	IU	02:24:34.619 (8674.618)	TB 6+ 45.359	MSFC	---
219B	SIGNAL RECEIVED IN S-IVB FOR: BURNER EXCITERS OFF	-----	-----	S-IVB	02:24:34.608 (8674.608)	TB 6+ 45.349	MDAC	---
220A	SIGNAL FROM LVDC FOR: BURNER AUTOMATIC CUTOFF SYSTEM ARM	02:24:35.247 (86/5.247)	TB 6+ 48.000	IU	02:24:37.211 (8677.211)	TB 6+ 47.952	MSFC	---
220B	SIGNAL RECEIVED IN S-IVB FOR: BURNER AUTOMATIC CUTOFF SYSTEM ARM	-----	-----	S-IVB	02:24:37.199 (8677.199)	TB 6+ 47.940	MDAC	---
221A	SIGNAL FROM LVDC FOR: LH2 TANK REPRESSURIZATION CONTROL VALVE OPEN ON	02:24:35.347 (86/5.347)	TB 6+ 48.100	IU	02:24:37.347 (8677.347)	TB 6+ 48.088	MSFC	---

TABLE 4-1 Sheet 24 of 46

AS - 505 MISSION F
POST FLIGHT SEQUENCE OF EVENTS
AS OF JUNE 13, 1969

ITEM NO.	EVENT	PREDICTED TIME		SIGNAL MONITORED AT	MONITORED TIME		DATA SOURCE	ACCURACY (MS)
		TIME FROM RANGE ZERO (HR:MIN:SEC) (SEC)	TIME FROM BASE (SEC)		TIME FROM RANGE ZERO (HR:MIN:SEC) (SEC)	TIME FROM BASE (SEC)		
221B	SIGNAL RECEIVED IN S-1VB FOR: LM2 TANK REPRESSURIZATION CONTROL VALVE OPEN ON	---	---	S-1VB	02:24:37.333 (8677.333)	TB 6+ 48.074	MDAC	---
222A	SIGNAL FROM LVDC FOR: LOX TANK REPRESSURIZATION CONTROL VALVE OPEN ON	02:24:35.547 (8675.547)	TB 6+ 40.300	IU	02:24:37.523 (8677.523)	TB 6+ 48.264	MSFC	---
222B	SIGNAL RECEIVED IN S-1VB FOR: LOX TANK REPRESSURIZATION CONTROL VALVE OPEN ON	---	---	S-1VB	02:24:37.507 (8677.507)	TB 6+ 48.248	MDAC	---
223A	SIGNAL FROM LVDC FOR: AUX. HYDRAULIC PUMP FLIGHT MODE ON	02:27:26.247 (8846.247)	TB 6+ 219.000	IU	02:27:28.225 (8848.225)	TB 6+ 218.966	MSFC	---
223B	SIGNAL RECEIVED IN S-1VB FOR: AUX. HYDRAULIC PUMP FLIGHT MODE ON	---	---	S-1VB	02:27:28.215 (8848.215)	TB 6+ 218.956	MDAC	---
224A	SIGNAL FROM LVDC FOR: CHILDDOWN SHUTOFF PILOT VALVE CLOSE OFF	02:27:46.247 (8866.247)	TB 6+ 239.000	IU	02:27:48.229 (8868.229)	TB 6+ 238.970	MSFC	---
224B	SIGNAL RECEIVED IN S-1VB FOR: CHILDDOWN SHUTOFF PILOT VALVE CLOSE OFF	---	---	S-1VB	02:27:48.222 (8868.222)	TB 6+ 238.963	MDAC	---
225A	SIGNAL FROM LVDC FOR: LOX CHILDDOWN PUMP ON	02:27:56.247 (8876.247)	TB 6+ 249.000	IU	02:27:58.231 (8878.231)	TB 6+ 248.972	MSFC	---
225B	SIGNAL RECEIVED IN S-1VB FOR: LOX CHILDDOWN PUMP ON	---	---	S-1VB	02:27:58.222 (8878.222)	TB 6+ 248.963	MDAC	---
226A	SIGNAL FROM LVDC FOR: FUEL CHILDDOWN PUMP ON	02:28:01.247 (8881.247)	TB 6+ 254.000	IU	02:28:03.212 (8883.212)	TB 6+ 253.953	MSFC	---
226B	SIGNAL RECEIVED IN S-1VB FOR: FUEL CHILDDOWN PUMP ON	---	---	S-1VB	02:28:03.197 (8883.197)	TB 6+ 253.938	MDAC	---
227A	SIGNAL FROM LVDC FOR: PREVALVES CLOSE ON	02:28:06.247 (8886.247)	TB 6+ 259.000	IU	02:28:08.232 (8888.232)	TB 6+ 258.973	MSFC	---
227B	SIGNAL RECEIVED IN S-1VB FOR: PREVALVES CLOSE ON	---	---	S-1VB	02:28:08.221 (8888.221)	TB 6+ 258.962	MDAC	---
228A	SIGNAL FROM LVDC FOR: IN-FLIGHT CALIBRATION MODE ON	02:30:27.247 (9027.247)	TB 6+ 400.000	IU	02:30:29.212 (9029.212)	TB 6+ 399.953	MSFC	---

TABLE 4-1 (Sheet 25 of 46)

AS - 505 MISSION F
POST FLIGHT SEQUENCE OF EVENTS
AS OF JUNE 13, 1969

ITEM NO.	EVENT	PREDICTED TIME		SIGNAL MONITORED AT	MONITORED TIME		DATA SOURCE	ACCURACY (MS)
		TIME FROM RANGE ZERO (HR:MIN:SEC) (SEC)	TIME FROM BASE (SEC)		TIME FROM RANGE ZERO (HR:MIN:SEC) (SEC)	TIME FROM BASE (SEC)		
2208	SIGNAL RECEIVED IN S-1VB FOR: IN-FLIGHT CALIBRATION MODE ON	02:30:27.447 (9027.447)	TB 6+ 400.200	S-1VB	02:30:29.202 (9029.202)	TB 6+ 399.943	MDAC	---
229	SIGNAL FROM LVDC JR: TELEMETRY CALIBRATOR IN-FLIGHT CALIBRATE ON	02:30:27.447 (9027.447)	TB 6+ 400.200	IU	02:30:29.422 (9029.422)	TB 6+ 400.163	MSFC	---
230A	SIGNAL FROM LVDC FOR: TM CALIBRATE ON	02:30:27.647 (9027.647)	TB 6+ 400.400	IU	02:30:29.627 (9029.627)	TB 6+ 400.368	MSFC	---
230B	SIGNAL RECEIVED IN S-1VB FOR: TM CALIBRATE ON	-----	-----	S-1VB	02:30:29.619 (9029.619)	TB 6+ 400.360	MDAC	---
231	SIGNAL FROM LVDC FOR: TELEMETRY CALIBRATOR IN-FLIGHT CALIBRATE OFF	02:30:32.447 (9032.447)	TB 6+ 405.200	IU	02:30:34.433 (9034.433)	TB 6+ 405.174	MSFC	---
232A	SIGNAL FROM LVDC FOR: TM CALIBRATE OFF	02:30:32.647 (9032.647)	TB 6+ 405.400	IU	02:30:34.613 (9034.613)	TB 6+ 405.354	MSFC	---
232B	SIGNAL RECEIVED IN S-1VB FOR: TM CALIBRATE OFF	-----	-----	S-1VB	02:30:34.601 (9034.601)	TB 6+ 405.342	MDAC	---
233A	SIGNAL FROM LVDC FOR: IN-FLIGHT CALIBRATION MODE OFF	02:30:33.247 (9033.247)	TB 6+ 406.000	IU	02:30:35.211 (9035.211)	TB 6+ 405.952	MSFC	---
233B	SIGNAL RECEIVED IN S-1VB FOR: IN-FLIGHT CALIBRATION MODE OFF	-----	-----	S-1VB	02:30:35.201 (9035.201)	TB 6+ 405.942	MDAC	---
234A	SIGNAL FROM LVDC FOR: P.U. MIXTURE RATIO 4.5 ON	02:31:17.347 (9077.347)	TB 6+ 450.100	IU	02:31:19.313 (9079.313)	TB 6+ 450.054	MSFC	---
234B	SIGNAL RECEIVED IN S-1VB FOR: P.U. MIXTURE RATIO 4.5 ON	-----	-----	S-1VB	02:31:19.301 (9079.301)	TB 6+ 450.042	MDAC	---
235	SIGNAL FROM LVDC FOR: S-1VB RESTART ALERT ON	02:32:00.647 (9120.647)	TB 6+ 493.600	IU	02:32:02.829 (9122.829)	TB 6+ 493.570	MSFC	---
236A	SIGNAL FROM LVDC FOR: S-1VB ULLAGE ENGINE NO.1 ON	02:32:03.547 (9123.547)	TB 6+ 496.300	IU	02:32:05.524 (9125.524)	TB 6+ 496.265	MSFC	---
236B	SIGNAL RECEIVED IN S-1VB FOR: S-1VB ULLAGE ENGINE NO.1 ON	-----	-----	S-1VB	02:32:05.516 (9125.516)	TB 6+ 496.257	MDAC	---

TABLE 4-1 (Sheet 26 of 46)
AS - 505 MISSION F
POST FLIGHT SEQUENCE OF EVENTS
AS OF JUNE 13, 1969

ITEM NO.	EVENT	PREDICTED TIME		SIGNAL MONITORED AT	MONITORED TIME		DATA SOURCE	ACCURACY (MS)
		TIME FROM RANGE ZERO (HR:MIN:SEC) (SEC)	TIME FROM BASE (SEC)		TIME FROM RANGE ZERO (HR:MIN:SEC) (SEC)	TIME FROM BASE (SEC)		
237A	SIGNAL FROM LVDC FOR: S-1VB ULLAGE ENGINE NO. 2 ON	02:32:03.647 (9123.647)	TB 6+ 496.400	IU	02:32:05.624 (9125.624)	TB 6+ 496.365	MSFC	---
237B	SIGNAL RECEIVED IN S-1VB FOR: S-1VB ULLAGE ENGINE NO. 2 ON	-----	-----	S-1VB	02:32:05.617 (9125.617)	TB 6+ 496.358	MDAC	---
238	SIGNAL FROM LVDC FOR: S-1VB ULLAGE T-RJST PRESENT INDICATION ON	02:32:03.747 (9123.747)	TB 6+ 496.500	IU	02:32:05.746 (9125.746)	TB 6+ 496.487	MSFC	---
239A	SIGNAL FROM LVDC FOR: LOX TANK REPRESSURIZATION CONTROL VALVE OPEN OFF	02:32:03.847 (9123.847)	TB 6+ 496.600	IU	02:32:05.840 (9125.840)	TB 6+ 496.581	MSFC	---
239B	SIGNAL RECEIVED IN S-1VB FOR: LOX TANK REPRESSURIZATION CONTROL VALVE OPEN OFF	-----	-----	S-1VB	02:32:05.833 (9125.833)	TB 6+ 496.574	MDAC	---
240A	SIGNAL FROM LVDC FOR: LH2 TANK REPRESSURIZATION CONTROL VALVE OPEN OFF	02:32:03.947 (9123.947)	TB 6+ 496.700	IU	02:32:05.938 (9125.938)	TB 6+ 496.670	MSFC	---
240B	SIGNAL RECEIVED IN S-1VB FOR: LH2 TANK REPRESSURIZATION CONTROL VALVE OPEN OFF	-----	-----	S-1VB	02:32:05.933 (9125.933)	TB 6+ 496.674	MDAC	---
241A	SIGNAL FROM LVDC FOR: BURNER LH2 PROPELLANT VALVE CLOSE ON	02:32:04.047 (9124.047)	TB 6+ 496.800	IU	02:32:06.030 (9126.030)	TB 6+ 496.771	MSFC	---
241B	SIGNAL RECEIVED IN S-1VB FOR: BURNER LH2 PROPELLANT VALVE CLOSE ON	-----	-----	S-1VB	02:32:06.025 (9126.025)	TB 6+ 496.766	MDAC	---
242A	SIGNAL FROM LVDC FOR: BURNER AUTOMATIC CUTOFF SYSTEM DISARM	02:32:04.247 (9124.247)	TB 6+ 497.000	IU	02:32:06.213 (9126.213)	TB 6+ 496.954	MSFC	---
242B	SIGNAL RECEIVED IN S-1VB FOR: BURNER AUTOMATIC CUTOFF SYSTEM DISARM	-----	-----	S-1VB	02:32:06.209 (9126.209)	TB 6+ 496.950	MDAC	---
243A	SIGNAL FROM LVDC FOR: LH2 TANK CONTINUOUS VENT VALVE CLOSE ON	02:32:04.447 (9124.447)	TB 6+ 497.200	IU	02:32:06.424 (9126.424)	TB 6+ 497.165	MSFC	---

TABLE 4-1 (Sheet 27 of 46)
 AS - 505 MISSION F
 POST FLIGHT SEQUENCE OF EVENTS
 AS OF JUNE 13, 1969

ITEM NO.	EVENT	PREDICTED TIME		SIGNAL MONITORED AT	MONITORED TIME		DATA SOURCE	ACCURACY (MS)
		TIME FROM RANGE ZERO (HR:MIN:SEC) (SEC)	TIME FROM BASE (SEC)		TIME FROM RANGE ZERO (HR:MIN:SEC) (SEC)	TIME FROM BASE (SEC)		
243B	SIGNAL RECEIVED IN S-1VB FOR: LH2 TANK CONTINUOUS VENT VALVE CLOSE ON	-----	-----	S-1VB	02:32:06.417 (9126.417)	TB 6+ 497.158	MDAC	---
244A	SIGNAL FROM LVDC FOR: AMBIENT REPRESS. SYSTEM MODE SELECTOR ON AND CRYO OFF	02:32:04.847 (9124.847)	TB 6+ 497.600	IU	02:32:06.813 (9126.813)	TB 6+ 497.554	MSFC	---
244B	SIGNAL RECEIVED IN S-1VB FOR: AMBIENT REPRESS. SYSTEM MODE SELECTOR ON AND CRYO OFF	-----	-----	S-1VB	02:32:06.809 (9126.809)	TB 6+ 497.550	MDAC	---
245A	SIGNAL FROM LVDC FOR: LH2 TANK CONTINUOUS VENT VALVE CLOSE OFF	02:32:06.447 (9126.447)	TB 6+ 499.200	IU	02:32:08.427 (9128.427)	TB 6+ 499.168	MSFC	---
245B	SIGNAL RECEIVED IN S-1VB FOR: LH2 TANK CONTINUOUS VENT VALVE CLOSE OFF	-----	-----	S-1VB	02:32:08.417 (9128.417)	TB 5+ 499.158	MDAC	---
246A	SIGNAL FROM LVDC FOR: BURNER LH2 PROPELLANT VALVE CLOSE OFF	02:32:07.047 (9127.047)	TB 6+ 499.800	IU	02:32:09.020 (9129.020)	TB 6+ 499.761	MSFC	---
246B	SIGNAL RECEIVED IN S-1VB FOR: BURNER LH2 PROPELLANT VALVE CLOSE OFF	-----	-----	S-1VB	02:32:09.009 (9129.009)	TB 6+ 499.750	MDAC	---
247A	SIGNAL FROM LVDC FOR: LOX TANK REPRESSURIZATION CONTROL VALVE OPEN ON	02:32:07.247 (9127.247)	TB 6+ 500.000	IU	02:32:09.235 (9129.235)	TB 6+ 499.976	MSFC	---
247B	SIGNAL RECEIVED IN S-1VB FOR: LOX TANK REPRESSURIZATION CONTROL VALVE OPEN ON	-----	-----	S-1VB	02:32:09.226 (9129.226)	TB 6+ 499.967	MDAC	---
248A	SIGNAL FROM LVDC FOR: BURNER LOX SHUTDOWN VALVE CLOSE ON	02:32:08.547 (9128.547)	TB 6+ 501.300	IU	02:32:10.520 (9130.520)	TB 6+ 501.261	MSFC	---
248B	SIGNAL RECEIVED IN S-1VB FOR: BURNER LOX SHUTDOWN VALVE CLOSE ON	-----	-----	S-1VB	02:32:10.508 (9130.508)	TB 6+ 501.249	MDAC	---

TABLE 4-1 (Sheet 28 of 46)

AS - 505 MISSION F
POST FLIGHT SEQUENCE OF EVENTS
AS OF JUNE 13, 1969

ITEM NO.	EVENT	PREDICTED TIME		SIGNAL MONITORED AT	MONITORED TIME		DATA SOURCE	ACCURACY (MS)
		TIME FROM RANGE ZERO (HR:MIN:SEC) (SEC)	TIME FROM BASE (SEC)		TIME FROM RANGE ZERO (HR:MIN:SEC) (SEC)	TIME FROM BASE (SEC)		
249A	SIGNAL FROM LVDC FOR: BURNER LOX SHUTDOWN VALVE CLOSE OFF	02:32:11.547 (9131.547)	TB 6+ 504.300	IU	02:32:13.536 (9133.536)	TB 6+ 504.277	MSFC	---
249B	SIGNAL RECEIVED IN S-IVB FOR: BURNER LOX SHUTDOWN VALVE CLOSE OFF	-----	-----	S-IVB	02:32:13.526 (9133.526)	TB 6+ 504.267	MDAC	---
250A	SIGNAL FROM LVDC FOR: LH2 TANK REPRESSURIZATION CONTROL VALVE OPEN ON	02:32:27.247 (9147.247)	TB 6+ 520.000	IU	02:32:29.234 (9149.234)	TB 6+ 519.975	MSFC	---
250B	SIGNAL RECEIVED IN S-IVB FOR: LH2 TANK REPRESSURIZATION CONTROL VALVE OPEN ON	-----	-----	S-IVB	02:32:29.225 (9149.225)	TB 6+ 519.966	MDAC	---
251A	SIGNAL FROM LVDC FOR: S-IVB ENGINE CUTOFF OFF	02:32:47.247 (9167.247)	TB 6+ 540.000	IU	02:32:49.225 (9169.225)	TB 6+ 539.966	MSFC	---
251B	SIGNAL RECEIVED IN S-IVB FOR: S-IVB ENGINE CUTOFF OFF	-----	-----	S-IVB	02:32:49.221 (9169.221)	TB 6+ 539.962	MDAC	---
252A	SIGNAL FROM LVDC FOR: PREVALVES CLOSE OFF	02:33:06.647 (9186.647)	TB 6+ 559.400	IU	02:33:08.613 (9188.613)	TB 6+ 559.354	MSFC	---
252B	SIGNAL RECEIVED IN S-IVB FOR: PREVALVES CLOSE OFF	-----	-----	S-IVB	02:33:08.604 (9188.604)	TB 6+ 559.345	MDAC	---
253	SIGNAL FROM LVDC FOR: S-IVB RESTART ALERT OFF	02:33:07.247 (9187.247)	TB 6+ 560.000	IU	02:33:09.211 (9189.211)	TB 6+ 559.952	MSFC	---
254A	SIGNAL FROM LVDC FOR: ENGINE READY BYPASS	02:33:15.847 (9195.847)	TB 6+ 568.600	IU	02:33:17.813 (9197.813)	TB 6+ 568.554	MSFC	---
254B	SIGNAL RECEIVED IN S-IVB FOR: ENGINE READY BYPASS	-----	-----	S-IVB	02:33:17.803 (9197.803)	TB 6+ 568.544	MDAC	---
255A	SIGNAL FROM LVDC FOR: FUEL CHILLDOWN PUMP OFF	02:33:16.647 (9196.647)	TB 6+ 569.400	IU	02:33:18.613 (9198.613)	TB 6+ 569.354	MSFC	---
255B	SIGNAL RECEIVED IN S-IVB FOR: FUEL CHILLDOWN PUMP OFF	-----	-----	S-IVB	02:33:18.604 (9198.604)	TB 6+ 569.345	MDAC	---
256A	SIGNAL FROM LVDC FOR: LOX CHILLDOWN PUMP OFF	02:33:16.847 (9196.847)	TB 6+ 549.600	IU	02:33:18.823 (9198.823)	TB 6+ 569.564	MSFC	---

TABLE 4-1 (Sheet 29 of 46)

AS - 505 MISSION F
POST FLIGHT SEQUENCE OF EVENTS
AS OF JUNE 13, 1969

ITEM NO.	EVENT	PREDICTED TIME		SIGNAL MONITORED AT	MONITORED TIME		DATA SOURCE	ACCURACY (MS)
		TIME FROM RANGE ZERO (HR:MIN:SEC) (SEC)	TIME FROM BASE (SEC)		TIME FROM RANGE ZERO (HR:MIN:SEC) (SEC)	TIME FROM BASE (SEC)		
256B	SIGNAL RECEIVED IN S-IVB FOR: LOX CHILLDOWN PUMP OFF	-----	-----	S-IVB	02:33:18.811 (9198.811)	TB 6+ 569.552	MDAC	---
257A	SIGNAL FROM LVDC FOR: S-IVB ENGINE START ON	02:33:17.247 (9197.247)	TB 6+ 570.000	IU	02:33:19.212 (9199.212)	TB 6+ 569.953	MSFC	---
257B	SIGNAL RECEIVED IN S-IVB FOR: S-IVB ENGINE START ON	-----	-----	S-IVB	02:33:19.203 (9199.203)	TB 6+ 569.944	MDAC	---
258A	SIGNAL FROM LVDC FOR: S-IVB ULLAGE ENGINE NO.1 OFF	02:33:20.247 (9200.247)	TB 6+ 573.000	IU	02:33:22.226 (9202.226)	TB 6+ 572.967	MSFC	---
258B	SIGNAL RECEIVED IN S-IVB FOR: S-IVB ULLAGE ENGINE NO.1 OFF	-----	-----	S-IVB	02:33:22.211 (9202.211)	TB 6+ 572.952	MDAC	---
259A	SIGNAL FROM LVDC FOR: S-IVB ULLAGE ENGINE NO. 2 OFF	02:33:20.347 (9200.347)	TB 6+ 573.100	IU	02:33:22.351 (9202.351)	TB 6+ 573.092	MSFC	---
259B	SIGNAL RECEIVED IN S-IVB FOR: S-IVB ULLAGE ENGINE NO. 2 OFF	-----	-----	S-IVB	02:33:22.336 (9202.336)	TB 6+ 573.077	MDAC	---
260	SIGNAL FROM LVDC FOR: S-IVB ULLAGE THRUST PRESENT INDICATION OFF	02:33:20.447 (9200.447)	TB 6+ 573.200	IU	02:33:22.445 (9202.445)	TB 6+ 573.186	MSFC	---
261	SIGNAL FROM LVDC FOR: S-IVB ENGINE OUT INDICATION 'A' ENABLE	02:33:24.047 (9204.047)	TB 6+ 576.800	IU	02:33:26.015 (9206.015)	TB 6+ 576.756	MSFC	---
262	SIGNAL FROM LVDC FOR: S-IVB ENGINE OUT INDICATION 'B' ENABLE	02:33:24.247 (9204.247)	TB 6+ 577.000	IU	02:33:26.221 (9206.221)	TB 6+ 576.962	MSFC	---
263A	SIGNAL FROM LVDC FOR: LOX TANK REPRESSURIZATION CONTROL VALVE OPEN OFF	02:33:24.447 (9204.447)	TB 6+ 577.200	IU	02:33:26.413 (9206.413)	TB 6+ 577.154	MSFC	---
263B	SIGNAL RECEIVED IN S-IVB FOR: LOX TANK REPRESSURIZATION CONTROL VALVE OPEN OFF	-----	-----	S-IVB	02:33:26.403 (9206.403)	TB 6+ 577.141	MDAC	---
264A	SIGNAL FROM LVDC FOR: LM2 TANK REPRESSURIZATION CONTROL VALVE OPEN OFF	02:33:24.647 (9204.647)	TB 6+ 577.400	IU	02:33:26.621 (9206.621)	TB 6+ 577.362	MSFC	---

TABLE 4-1 (Sheet 30 of 46)
 AS - 505 MISSION F
 POST FLIGHT SEQUENCE OF EVENTS
 AS OF JUNE 13, 1969

ITEM NO.	EVENT	PREDICTED TIME		SIGNAL MONITORED AT	MONITORED TIME		DATA SOURCE	ACCURACY (MS)
		TIME FROM RANGE ZERO (HR:MIN:SEC) (SEC)	TIME FROM BASE (SEC)		TIME FROM RANGE ZERO (HR:MIN:SEC) (SEC)	TIME FROM BASE (SEC)		
264B	SIGNAL RECEIVED IN S-IVB FOR LM2 TANK REPRESSURIZATION CONTROL VALVE OPEN OFF	-----	-----	S-IVB	02:33:26.612 (9206.612)	TB 6+ 577.353	MDAC	---
265	SIGNAL FROM LVDC FOR: FLIGHT CONTROL COMPUTER S-IVB BURN MODE ON "A"	02:33:24.847 (9204.847)	TB 6+ 577.600	IU	02:33:26.836 (9206.836)	TB 6+ 577.577	MSFC	---
266	SIGNAL FROM LVDC FOR: FLIGHT CONTROL COMPUTER S-IVB BURN MODE ON "B"	02:33:25.047 (9205.047)	TB 6+ 577.800	IU	02:33:27.013 (9207.013)	TB 6+ 577.754	MSFC	---
267A	SIGNAL FROM LVDC FOR: FUEL INJECTION TEMPERATURE OK BYPASS	02:33:25.247 (9205.247)	TB 6+ 578.000	IU	NO DATA	NO DATA	MSFC	---
267B	SIGNAL RECEIVED IN S-IVB FOR: FUEL INJECTION TEMPERATURE OK BYPASS	-----	-----	S-IVB	02:33:27.211 (9207.211)	TB 6+ 577.952	MDAC	---
268A	SIGNAL FROM LVDC FOR: LOX TANK FLIGHT PRESSURE SYSTEM ON	02:33:25.447 (9205.447)	TB 6+ 578.200	IU	02:33:27.431 (9207.431)	TB 6+ 578.172	MSFC	---
268B	SIGNAL RECEIVED IN S-IVB FOR: LOX TANK FLIGHT PRESSURE SYSTEM ON	-----	-----	S-IVB	02:33:27.420 (9207.420)	TB 6+ 578.161	MDAC	---
269A	SIGNAL FROM LVDC FOR: LOX TANK PRESSURIZATION SHUTOFF VALVES OPEN ON	02:33:25.647 (9205.647)	TB 6+ 578.400	IU	02:33:27.615 (9207.615)	TB 6+ 578.356	MSFC	---
269B	SIGNAL RECEIVED IN S-IVB FOR: LOX TANK PRESSURIZATION SHUTOFF VALVES OPEN ON	-----	-----	S-IVB	02:33:27.604 (9207.604)	TB 6+ 578.345	MDAC	---
270A	SIGNAL FROM LVDC FOR: S-IVB ENGINE START OFF	02:33:25.847 (9205.847)	TB 6+ 578.600	IU	02:33:27.824 (9207.824)	TB 6+ 578.565	MSFC	---
270B	SIGNAL RECEIVED IN S-IVB FOR: S-IVB ENGINE START OFF	-----	-----	S-IVB	02:33:27.811 (9207.811)	TB 6+ 578.552	MSFC	---
271A	SIGNAL FROM LVDC FOR: FUEL INJECTION TEMPERATURE OK BYPASS RESET	02:33:35.247 (9215.247)	TB 6+ 588.000	IU	02:33:37.213 (9217.213)	TB 6+ 587.954	MSFC	---

TABLE 4-1 (Sheet 31 of 46)
 AS - 505 MISSION F
 POST FLIGHT SEQUENCE OF EVENTS
 AS OF JUNE 13, 1969

ITEM NO.	EVENT	PREDICTED TIME		SIGNAL MONITORED AT	MONITORED TIME		DATA SOURCE	ACCURACY (MS)
		TIME FROM RANGE ZERO (HR:MIN:SEC)	TIME FROM BASE (SEC)		TIME FROM RANGE ZERO (HR:MIN:SEC)	TIME FROM BASE (SEC)		
271B	SIGNAL RECEIVED IN S-IVB FOR: FUEL INJECTION TEMPERATURE OK BYPASS RESET	-----	-----	S-IVB	02:33:37.203 (9217.203)	TB 6+ 587.944	MDAC	---
272	START FOURTH PHASE IGM	02:33:31.372 (9211.372)	N/A		02:33:38.132 (9218.132)	N/A	MSFC	---
273	BEGIN ARTIFICIAL TAU MODE	02:33:33.372 (9333.372)	N/A		02:33:33.732 (9333.732)	N/A	MSFC	---
274	STOP FOURTH PHASE IGM	02:33:33.372 (9333.372)	N/A		02:33:33.732 (9333.732)	N/A	MSFC	---
275	START FIFTH PHASE IGM	02:33:33.372 (9333.372)	N/A		02:33:33.732 (9333.732)	N/A	MSFC	---
276A	SIGNAL FROM LVDC FOR: P.U. PROGRAMMED MIXTURE RATIO OFF	02:33:32.347 (9332.347)	TB 6+ 705.100	IU	02:33:34.325 (9334.325)	TB 6+ 705.066	MSFC	---
276B	SIGNAL RECEIVED IN S-IVB FOR: P.U. PROGRAMMED MIXTURE RATIO OFF	-----	-----	S-IVB	02:35:34.317 (9334.317)	TB 6+ 705.058	MDAC	---
277	END ARTIFICIAL TAU MODE	02:33:39.372 (9339.372)	N/A		02:35:39.632 (9339.632)	N/A	MSFC	---
278	SIGNAL FROM LVDC FOR: FLIGHT CONTROL COMPUTER SWITCH POINT NO. 6	02:37:45.247 (9465.247)	TB 6+ 838.000	IU	02:37:47.224 (7467.224)	TB 6+ 837.965	MSFC	---
279A	SIGNAL FROM LVDC FOR: SECOND BURN RELAY OFF	02:37:57.247 (9477.247)	TB 6+ 850.000	IU	02:37:59.223 (9479.223)	TB 6+ 849.964	MSFC	---
279B	SIGNAL RECEIVED IN S-IVB FOR: SECOND BURN RELAY OFF	-----	-----	S-IVB	02:37:59.212 (9479.212)	TB 6+ 849.953	MDAC	---
28U	BEGIN CHI TILDE GUIDANCE MODE	02:38:39.372 (9519.372)	N/A		02:38:41.032 (9521.032)	N/A	MSFC	---
281A	SIGNAL FROM LVDC FOR: POINT LEVEL SENSOR ARMING	02:38:54.247 (9534.247)	TB 6+ 907.000	IU	02:38:56.230 (9536.230)	TB 6+ 906.971	MSFC	---
281B	SIGNAL RECEIVED IN S-IVB FOR: POINT LEVEL SENSOR ARMING	-----	-----	S-IVB	02:38:56.220 (9536.220)	TB 6+ 906.961	MDAC	---

TABLE 4-1 (Sheet 32 of 46)

AS - 505 MISSION F
POST FLIGHT SEQUENCE OF EVENTS
AS OF JUNE 13, 1959

ITEM NO.	EVENT	PREDICTED TIME		SIGNAL MONITORED AT	MONITORED TIME		DATA SOURCE	ACCURACY (MS)
		TIME FROM RANGE ZERO (HR:MIN:SEC) (SEC)	TIME FROM BASE (SEC)		TIME FROM RANGE ZERO (HR:MIN:SEC) (SEC)	TIME FROM BASE (SEC)		
282	BEGIN CHI FREEZE PERIOD-	02:39:06.872 (9546.872)	N/A		02:39:07.632 (9547.632)	N/A	MSFC	---
283	STOP FIFTH PHASE IGM	02:39:06.872 (9546.872)	N/A		02:39:07.632 (9547.632)	N/A	MSFC	---
284	END CHI TILDE GUIDANCE MODE	02:39:06.872 (9546.872)	N/A		02:39:07.632 (9547.632)	N/A	MSFC	---
285A	SIGNAL FROM LVDC FOR: S-IVB ENGINE CUTOFF ON	02:39:09.579 (9549.579)	TB 7- 0.200	IU	02:39:10.580 (9550.580)	TB 7- 0.252	MSFC	---
285B	SIGNAL RECEIVED IN S-IVB FOR: S-IVB ENGINE CUTOFF ON			S-IVB	02:39:10.570 (9550.570)	TB 7- 0.262	MDAC	---
286	TIME BASE 7 TIMED CUTOFF OF SECOND S-IVB RURN	02:39:09.779 (9549.779)	TB 7+ 0.000		02:39:10.832 (9550.832)	TB 7+ 0.000	MSFC	---
287A	SIGNAL FROM LVDC FOR: S-IVB ENGINE CUTOFF ON	02:39:09.879 (9549.879)	TB 7+ 0.100	IU	02:39:10.917 (9550.917)	TB 7+ 0.085	MSFC	---
287B	SIGNAL RECEIVED IN S-IVB FOR: S-IVB ENGINE CUTOFF ON			S-IVB	02:39:10.917 (9550.917)	TB 7+ 0.085	MDAC	---
288A	SIGNAL FROM LVDC FOR: LH2 TANK CONTINUOUS VENT ORIFICE SHUTOFF VALVE OPEN ON	02:39:10.279 (9550.279)	TB 7+ 0.500	IU	02:39:11.288 (9551.288)	TB 7+ 0.456	MSFC	---
288B	SIGNAL RECEIVED IN S-IVB FOR: LH2 TANK CONTINUOUS VENT ORIFICE SHUTOFF VALVE OPEN ON			S-IVB	02:39:11.278 (9551.278)	TB 7+ 0.446	MDAC	---
289A	SIGNAL FROM LVDC FOR: LH2 TANK CONTINUOUS VENT RELIEF OVERRIDE SHUTOFF VALVE OPEN ON	02:39:10.379 (9550.379)	TB 7+ 0.600	IU	02:39:11.387 (9551.387)	TB 7+ 0.555	MSFC	---
289B	SIGNAL RECEIVED IN S-IVB FOR: LH2 TANK CONTINUOUS VENT RELIEF OVERRIDE SHUTOFF VALVE OPEN ON			S-IVB	02:39:11.379 (9551.379)	TB 7+ 0.547	MDAC	---

TABLE 4-1 (Sheet 33 of 46)

AS - 505 MISSION F
POST FLIGHT SEQUENCE OF EVENTS
AS OF JUNE 13, 1969

ITEM NO.	EVENT	PREDICTED TIME		SIGNAL MONITORED AT	MONITORED TIME		DATA SOURCE	ACCURACY (MS)
		TIME FROM RANGE ZERO (HR:MIN:SEC) (SEC)	TIME FROM BASE (SEC)		TIME FROM RANGE ZERO (HR:MIN:SEC) (SEC)	TIME FROM BASE (SEC)		
290A	SIGNAL FROM LVDC FOR: LOX TANK NPV VALVE OPEN ON	02:39:10.479 (9550.479)	TB 7+ 0.700	IU	02:39:11.485 (9551.485)	TB 7+ 0.653	MSFC	---
290B	SIGNAL RECEIVED IN S-IVB FOR: LOX TANK NPV VALVE OPEN ON	-----	-----	S-IVB	02:39:11.478 (9551.478)	TB 7+ 0.646	MDAC	---
291A	SIGNAL FROM LVDC FOR: LH2 TANK LATCHING RELIEF VALVE OPEN ON	02:39:10.579 (9550.579)	TB 7+ 0.800	IU	02:39:11.585 (9551.585)	TB 7+ 0.753	MSFC	---
291B	SIGNAL RECEIVED IN S-IVB FOR: LH2 TANK LATCHING RELIEF VALVE OPEN ON	-----	-----	S-IVB	02:39:11.578 (9551.578)	TB 7+ 0.746	MDAC	---
292A	SIGNAL FROM LVDC FOR: LOX TANK PRESSURIZATION SHUTOFF VALVES CLOSE ON	02:39:10.779 (9550.779)	TB 7+ 1.000	IU	02:39:11.784 (9551.784)	TB 7+ 0.952	MSFC	---
292B	SIGNAL RECEIVED IN S-IVB FOR: LOX TANK PRESSURIZATION SHUTOFF VALVES CLOSE ON	-----	-----	S-IVB	02:39:11.778 (9551.778)	TB 7+ 0.946	MDAC	---
293A	SIGNAL FROM LVDC FOR: LOX TANK FLIGHT PRESSURE SYSTEM OFF	02:39:10.879 (9550.879)	TB 7+ 1.100	IU	02:39:11.886 (9551.886)	TB 7+ 1.054	MSFC	---
293B	SIGNAL RECEIVED IN S-IVB FOR: LOX TANK FLIGHT PRESSURE SYSTEM OFF	-----	-----	S-IVB	02:39:11.879 (9551.879)	TB 7+ 1.047	MDAC	---
294A	SIGNAL FROM LVDC FOR: SECOND BURN RELAY OFF	02:39:10.979 (9550.979)	TB 7+ 1.200	IU	02:39:11.983 (9551.983)	TB 7+ 1.151	MSFC	---
294B	SIGNAL RECEIVED IN S-IVB FOR: SECOND BURN RELAY OFF	-----	-----	S-IVB	02:39:11.978 (9551.978)	TB 7+ 1.146	MDAC	---
295A	SIGNAL FROM LVDC FOR: LH2 TANK REPRESSURIZATION CONTROL VALVE OPEN ON	02:39:11.079 (9551.079)	TB 7+ 1.300	IU	02:39:12.083 (9552.083)	TB 7+ 1.251	MSFC	---
295B	SIGNAL RECEIVED IN S-IVB FOR: LH2 TANK REPRESSURIZATION CONTROL VALVE OPEN ON	-----	-----	S-IVB	02:39:12.078 (9552.078)	TB 7+ 1.246	MDAC	---

TABLE 4-1 (Sheet 34 of 46)
 AS - 505 MISSION F
 POST FLIGHT SEQUENCE OF EVENTS
 AS OF JUNE 13, 1969

ITEM NO.	EVENT	PREDICTED TIME		SIGNAL MONITORED AT	MONITORED TIME		DATA SOURCE	ACCURACY (MS)
		TIME FROM RANGE ZERO (HR:MIN:SEC) (SEC)	TIME FROM RAISE (SEC)		TIME FROM RANGE ZERO (HR:MIN:SEC) (SEC)	TIME FROM BASE (SEC)		
290A	SIGNAL FROM LVDC FOR: P.U. PROGRAMMED MIXTURE RATIO OFF	02:39:11.279 (9551.279)	TB 7+ 1.500	IU	02:39:12.292 (9552.292)	TB 7+ 1.460	MSFC	---
290B	SIGNAL RECEIVED IN S-IVB FOR: P.U. PROGRAMMED MIXTURE RATIO OFF	-----	-----	S-IVB	02:39:12.287 (9552.287)	TB 7+ 1.455	MDAC	---
297A	SIGNAL FROM LVDC FOR: POINT LEVEL SENSOR JISARMING	02:39:11.479 (9551.479)	TB 7+ 1.700	IU	02:39:12.484 (9552.484)	TB 7+ 1.652	MSFC	---
297B	SIGNAL RECEIVED IN S-IVB FOR: POINT LEVEL SENSOR DISARMING	-----	-----	S-IVB	02:39:12.478 (9552.478)	TB 7+ 1.646	MDAC	---
298A	SIGNAL FROM LVDC FOR: START TANK VENT CONTROL VALVE OPEN ON	02:39:11.779 (9551.779)	TB 7+ 2.000	IU	02:39:12.782 (9552.782)	TB 7+ 1.950	MSFC	---
298B	SIGNAL RECEIVED IN S-IVB FOR: START TANK VENT CONTROL VALVE OPEN ON	-----	-----	S-IVB	02:39:12.778 (9552.778)	TB 7+ 1.946	MDAC	---
299A	SIGNAL FROM LVDC FOR: LH2 TANK CONTINUOUS VENT ORIFACE SHUTOFF VALVE OPEN OFF	02:39:12.279 (9552.279)	TB 7+ 2.500	IU	02:39:13.284 (9553.284)	TB 7+ 2.452	MSFC	---
299B	SIGNAL RECEIVED IN S-IVB FOR: LH2 TANK CONTINUOUS VENT ORIFACE SHUTOFF VALVE OPEN OFF	-----	-----	S-IVB	02:39:13.278 (9553.278)	TB 7+ 2.446	MDAC	---
300A	SIGNAL FROM LVDC FOR: LH2 TANK CONTINUOUS VENT RELIEF OVERRIDE SHUTOFF VALVE OPEN OFF	02:39:12.379 (9552.379)	TB 7+ 2.600	IU	02:39:13.404 (9553.404)	TB 7+ 2.572	MSFC	---
300B	SIGNAL RECEIVED IN S-IVB FOR: LH2 TANK CONTINUOUS VENT RELIEF OVERRIDE SHUTOFF VALVE OPEN OFF	-----	-----	S-IVB	02:39:13.395 (9553.395)	TB 7+ 2.563	MDAC	---
301A	SIGNAL FROM LVDC FOR: LH2 TANK LATCHING RELIEF VALVE LATCH ON	02:39:12.579 (9552.579)	TB 7+ 2.800	IU	02:39:13.584 (9553.584)	TB 7+ 2.752	MSFC	---

TABLE 4-1 (Sheet 35 of 46)

AS - 505 MISSION F
POST FLIGHT SEQUENCE OF EVENTS
AS OF JUNE 13, 1969

ITEM NO.	EVENT	PREDICTED TIME		SIGNAL MONITORED AT	MONITORED TIME		DATA SOURCE	ACCURACY (MS)
		TIME FROM RANGE ZERO (HR:MIN:SEC)	TIME FROM BASE (SEC)		TIME FROM RANGE ZERO (HR:MIN:SEC)	TIME FROM BASE (SEC)		
301B	SIGNAL RECEIVED IN S-IVB FOR: LH2 TANK LATCHING RELIEF VALVE LATCH ON	02:39:13.579 (9553.579)	2.746	S-IVB	02:39:13.579 (9553.579)	TB 7+	MDAC	---
302	SIGNAL FROM LVDC FOR: FLIGHT CONTROL COMPUTER S-IVB BURN MODE OFF 'A'	02:39:13.379 (9553.379)	3.600	IU	02:39:14.399 (9554.399)	TB 7+	MSFC	---
303	SIGNAL FROM LVDC FOR: FLIGHT CONTROL COMPUTER S-IVB BURN MODE OFF 'B'	02:39:13.579 (9553.579)	3.800	IU	02:39:14.583 (9554.583)	TB 7+	MSFC	---
304A	SIGNAL FROM LVDC FOR: LH2 TANK LATCHING RELIEF VALVE OPEN OFF	02:39:13.779 (9553.779)	4.000	IU	02:39:14.793 (9554.793)	TB 7+	MSFC	---
304B	SIGNAL RECEIVED IN S-IVB FOR: LH2 TANK LATCHING RELIEF VALVE OPEN OFF	-----	-----	S-IVB	02:39:14.787 (9554.787)	TB 7+	MDAC	---
305A	SIGNAL FROM LVDC FOR: AUX. HYDRAULIC PUMP FLIGHT MODE OFF	02:39:13.979 (9553.979)	4.200	IU	02:39:14.983 (9554.983)	TB 7+	MSFC	---
305B	SIGNAL RECEIVED IN S-IVB FOR: AUX. HYDRAULIC PUMP FLIGHT MODE OFF	-----	-----	S-IVB	02:39:14.978 (9554.978)	TB 7+	MDAC	---
306A	SIGNAL FROM LVDC FOR: LH2 TANK LATCHING RELIEF VALVE LATCH OFF	02:39:14.579 (9554.579)	4.800	IU	02:39:15.605 (9555.605)	TB 7+	MSFC	---
306B	SIGNAL RECEIVED IN S-IVB FOR: LH2 TANK LATCHING RELIEF VALVE LATCH OFF	-----	-----	S-IVB	02:39:15.596 (9555.596)	TB 7+	MDAC	---
307	SIGNAL FROM LVDC FOR: S/C CONTROL OF SATURN ENABLE	02:39:14.779 (9554.779)	5.000	IU	02:39:15.783 (9555.783)	TB 7+	MSFC	---
308	TRANSLUNAR INJECTION	02:39:16.590 (9556.590)	N/A		02:39:20.580 (9560.580)	N/A	MSFC	---
309	SIGNAL FROM LVDC FOR: S-IVB ENGINE OUT INDICATION 'A' ENABLE RESET	02:39:19.779 (9559.779)	10.000	IU	02:39:20.802 (9560.802)	TB 7+	MSFC	---

TABLE 4-1 (Sheet 36 of 46)

AS - 505 MISSION F
 POST FLIGHT SEQUENCE OF EVENTS
 AS OF JUNE 13, 1969

ITEM NO.	EVENT	PREDICTED TIME		SIGNAL MONITORED AT	MONITORED TIME		DATA SOURCE	ACCURACY (MS)
		TIME FROM RANGE ZERO (HR:MIN:SEC) (SEC)	TIME FROM BASE (SEC)		TIME FROM RANGE ZERO (HR:MIN:SEC) (SEC)	TIME FROM BASE (SEC)		
310	SIGNAL FROM LVDC FOR: S-IVB ENGINE OUT INDICATION *B* ENABLE RESET	02:39:19.979 (9559.979)	TB 7+ 13.200	IU	02:39:20.985 (9560.985)	TB 7+ 10.153	MSFC	---
311	END CHI FREEZE PERIOD	02:39:29.548 (9569.548)	N/A		02:39:29.582 (9569.582)	N/A	MSFC	---
312A	SIGNAL FROM LVDC FOR: SINGLE SIDEBAND FM TRANSMITTER OFF	02:39:34.779 (9574.779)	TB 7+ 25.000	IU	02:39:35.807 (9575.807)	TB 7+ 24.975	MSFC	---
312B	SIGNAL RECEIVED IN S-IVB FOR: SINGLE SIDEBAND FM TRANSMITTER OFF	-----	-----	S-IVB	02:39:35.803 (9575.803)	TB 7+ 24.971	MDAC	---
313A	SIGNAL FROM LVDC FOR: AMBIENT REPRESS. SYSTEM MODE SELECTOR OFF AND CVRD ON	02:40:10.779 (9610.779)	TB 7+ 61.000	IU	02:40:11.786 (9611.786)	TB 7+ 60.954	MSFC	---
313B	SIGNAL RECEIVED IN S-IVB FOR: AMBIENT REPRESS. SYSTEM MODE SELECTOR OFF AND CVRD ON	-----	-----	S-IVB	02:40:11.778 (9611.778)	TB 7+ 60.946	MDAC	---
314A	SIGNAL FROM LVDC FOR: LOX TANK NPV VALVE OPEN OFF	02:41:40.479 (9700.479)	TB 7+ 150.700	IU	NO DATA	NO DATA	MSFC	---
314B	SIGNAL RECEIVED IN S-IVB FOR: LOX TANK NPV VALVE OPEN OFF	-----	-----	S-IVB	NO DATA	NO DATA	MDAC	---
315A	SIGNAL FROM LVDC FOR: START TANK VENT CONTROL VALVE OPEN OFF	02:41:41.779 (9701.779)	TB 7+ 152.000	IU	NO DATA	NO DATA	MSFC	---
315B	SIGNAL RECEIVED IN S-IVB FOR: START TANK VENT CONTROL VALVE OPEN OFF	-----	-----	S-IVB	NO DATA	NO DATA	MDAC	---
316A	SIGNAL FROM LVDC FOR: LOX TANK VENT AND NPV VALVES BOOST CLOSE ON	02:41:43.479 (9703.479)	TB 7+ 153.700	IU	NO DATA	NO DATA	MSFC	---
316B	SIGNAL RECEIVED IN S-IVB FOR: LOX TANK VENT AND NPV VALVES BOOST CLOSE ON	-----	-----	S-IVB	NO DATA	NO DATA	MDAC	---

TABLE 4-1 (Sheet 37 of 46)
AS - 505 MISSION F
POST FLIGHT SEQUENCE OF EVENTS
AS OF JUNE 13, 1969

ITEM NO.	EVENT	PREDICTED TIME		SIGNAL MONITORED AT	MONITORED TIME		DATA SOURCE	ACCURACY (MS)
		TIME FROM RANGE ZERO (HR:MIN:SEC) (SEC)	TIME FROM BASE (SEC)		TIME FROM RANGE ZERO (HR:MIN:SEC) (SEC)	TIME FROM BASE (SEC)		
317A	SIGNAL FROM LVDC FOR: LOX TANK VENT AND NPV VALVES BOOST CLOSE OFF	02:41:45.479 (9705.479)	TB 7+ 155.700	IU	NO DATA	NO DATA	MSFC	---
317B	SIGNAL RECEIVED IN S-1VB FOR: LOX TANK VENT AND NPV VALVES BOOST CLOSE OFF	-----	-----	S-1VB	NO DATA	NO DATA	MDAC	---
318A	SIGNAL FROM LVDC FOR: LH2 TANK LATCHING RELIEF VALVE OPEN ON	02:54:08.779 (10448.779)	TB 7+ 899.000	IU	02:54:09.797 (10449.797)	TB 7+ 898.965	MSFC	---
318B	SIGNAL RECEIVED IN S-1VB FOR: LH2 TANK LATCHING RELIEF VALVE OPEN ON	-----	-----	S-1VB	02:54:09.791 (10449.791)	TB 7+ 898.959	MDAC	---
319	INITIATE MANEUVER TO TRANS- POSITION AND DOCKING ATTITUDE	02:54:10.497 (10450.497)	N/A		02:54:10.000 (10450.000)	N/A	MSFC	---
320A	SIGNAL FROM LVDC FOR: LH2 TANK REPRESSURIZATION CONTROL VALVE OPEN OFF	02:54:09.379 (10449.379)	TB 7+ 899.600	IU	02:54:10.398 (10450.398)	TB 7+ 899.566	MSFC	---
320B	SIGNAL RECEIVED IN S-1VB FOR: LH2 TANK REPRESSURIZATION CONTROL VALVE OPEN OFF	-----	-----	S-1VB	02:54:10.391 (10450.391)	TB 7+ 899.559	MDAC	---
321A	SIGNAL FROM LVDC FOR: LH2 TANK CONTINUOUS VENT VALVE CLOSE ON	02:54:09.579 (10449.579)	TB 7+ 899.800	IU	02:54:10.599 (10450.599)	TB 7+ 899.767	MSFC	---
321B	SIGNAL RECEIVED IN S-1VB FOR: LH2 TANK CONTINUOUS VENT VALVE CLOSE ON	-----	-----	S-1VB	02:54:10.591 (10450.591)	TB 7+ 899.759	MDAC	---
322A	SIGNAL FROM LVDC FOR: LH2 TANK LATCHING RELIEF VALVE OPEN OFF	02:54:09.779 (10449.779)	TB 7+ 900.000	IU	02:54:10.798 (10450.798)	TB 7+ 899.966	MSFC	---
322B	SIGNAL RECEIVED IN S-1VB FOR: LH2 TANK LATCHING RELIEF VALVE OPEN OFF	-----	-----	S-1VB	02:54:10.791 (10450.791)	TB 7+ 899.959	MDAC	---
323A	SIGNAL FROM LVDC FOR: LH2 TANK CONTINUOUS VENT VALVE CLOSE OFF	02:54:11.579 (10451.579)	TB 7+ 901.800	IU	02:54:12.597 (10452.597)	TB 7+ 901.765	MSFC	---

TABLE 4-1 (Sheet 38 of 46)
 AS - 505 MISSION F
 POST FLIGHT SEQUENCE OF EVENTS
 AS OF JUNE 15, 1969

ITEM I.O.	EVENT	PREDICTED TIME		SIGNAL MONITORED AT	MONITORED TIME		DATA SOURCE	ACCURACY (MS)
		TIME FROM RANGE ZERO (HR:MIN:SEC) (SEC)	TIME FROM BASE (SEC)		TIME FROM RANGE ZERO (HR:MIN:SEC) (SEC)	TIME FROM BASE (SEC)		
323B	SIGNAL RECEIVED IN S-1VB FOR: LM2 TANK CONTINUOUS VENT VALVE CLOSE OFF	02:54:12.779 (10452.779)	02:54:12.591 (10452.591)	S-1VB	02:54:12.591 (10452.591)	TB 7+ 901.759	MDAC	---
324A	SIGNAL FROM LVDC FOR: LM2 TANK VENT AND LATCHING RELIEF VALVE BOOST CLOSE ON	02:54:12.779 (10452.779)	TB 7+ 903.000	IU	02:54:13.798 (10453.798)	TB 7+ 902.966	MSFC	---
324B	SIGNAL RECEIVED IN S-1VB FOR: LM2 TANK VENT AND LATCHING RELIEF VALVE BOOST CLOSE ON	-----	-----	S-1VB	02:54:13.791 (10453.791)	TB 7+ 902.959	MDAC	---
325A	SIGNAL FROM LVDC FOR: LM2 TANK VENT AND LATCHING RELIEF VALVE BOOST CLOSE OFF	02:54:14.779 (10454.779)	TB 7+ 905.000	IU	02:54:15.797 (10455.797)	TB 7+ 904.965	MSFC	---
325B	SIGNAL RECEIVED IN S-1VB FOR: LM2 TANK VENT AND LATCHING RELIEF VALVE BOOST CLOSE OFF	-----	-----	S-1VB	02:54:15.791 (10455.791)	TB 7+ 904.959	MDAC	---
326	SIGNAL FROM LVDC FOR: IU COMMAND SYSTEM ENABLE	02:59:11.179 (10750.179)	TB 7+ 1203.400	IU	02:59:11.214 (10751.214)	TB 7+ 1200.382	MSFC	---
327	LAUNCH VEHICLE/SPACECRAFT SEPARATION	03:03:24.872 (11004.872)	N/A		03:02:51.000 (10971.000)	N/A	MSFC	---
328	HARD JOCKING ACHIEVED	03:10:39.872 (11439.872)	N/A		03:17:38.000 (11858.000)	N/A	MSFC	---
329A	SIGNAL FROM LVDC FOR: AUX. HYDRAULIC PUMP FLIGHT MODE ON	03:32:29.779 (12749.779)	TB 7+ 3200.000	IU	NO DATA	NO DATA	MSFC	---
329B	SIGNAL RECEIVED IN S-1VB FOR: AUX. HYDRAULIC PUMP FLIGHT MODE ON	-----	-----	S-1VB	03:32:30.835 (12750.835)	TB 7+ 3200.003	MDAC	---
330A	SIGNAL FROM LVDC FOR: AUX. HYDRAULIC PUMP FLIGHT MODE OFF	03:33:17.779 (12747.779)	TB 7+ 3248.000	IU	NO DATA	NO DATA	MSFC	---

TABLE 4-1 (Sheet 39 of 46)

AS - 505 MISSION F
POST FLIGHT SEQUENCE OF EVENTS
AS OF JUNE 13, 1969

ITEM NO.	EVENT	PREDICTED TIME		SIGNAL MONITORED AT	MONITORED TIME		DATA SOURCE	ACCURACY (MS)
		TIME FROM RANGE ZERO (HR:MIN:SEC) (SEC)	TIME FROM BASE (SEC)		TIME FROM RANGE ZERO (HR:MIN:SEC) (SEC)	TIME FROM BASE (SEC)		
330B	SIGNAL RECEIVED IN S-1VB FOR: AUX. HYDRAULIC PUMP FLIGHT MODE OFF	-----	-----	S-1VB	03:33:18.835 (12798.835)	T8 7+ 3248.003	MDAC	---
331A	SIGNAL FROM LVDC FOR: LH2 TANK LATCHING RELIEF VALVE OPEN ON	03:39:10.179 (13190.179)	T8 7+ 3600.400	IU	NO DATA	NO DATA	MSFC	---
331B	SIGNAL RECEIVED IN S-1VB FOR: LH2 TANK LATCHING RELIEF VALVE OPEN ON	-----	-----	S-1VB	03:39:11.245 (13151.245)	T8 7+ 3600.413	MDAC	---
332A	SIGNAL FROM LVDC FOR: LH2 TANK REPRESSURIZATION CONTROL VALVE OPEN ON	03:39:10.379 (13190.379)	T8 7+ 3600.600	IU	NO DATA	NO DATA	MSFC	---
332B	SIGNAL RECEIVED IN S-1VB FOR: LH2 TANK REPRESSURIZATION CONTROL VALVE OPEN ON	-----	-----	S-1VB	03:39:11.445 (13151.445)	T8 7+ 3600.613	MDAC	---
333A	SIGNAL FROM LVDC FOR: LH2 TANK LATCHING RELIEF VALVE LATCH ON	03:39:12.179 (13152.179)	T8 7+ 3602.400	IU	NO DATA	NO DATA	MSFC	---
333B	SIGNAL RECEIVED IN S-1VB FOR: LH2 TANK LATCHING RELIEF VALVE LATCH ON	-----	-----	S-1VB	03:39:13.245 (13153.245)	T8 7+ 3602.413	MDAC	---
334A	SIGNAL FROM LVDC FOR: LH2 TANK LATCHING RELIEF VALVE OPEN OFF	03:39:13.179 (13153.179)	T8 7+ 3603.400	IU	NO DATA	NO DATA	MSFC	---
334B	SIGNAL RECEIVED IN S-1VB FOR: LH2 TANK LATCHING RELIEF VALVE OPEN OFF	-----	-----	S-1VB	03:39:14.245 (13154.245)	T8 7+ 3603.413	MDAC	---
335A	SIGNAL FROM LVDC FOR: LH2 TANK LATCHING RELIEF VALVE LATCH OFF	03:39:14.179 (13154.179)	T8 7+ 3604.400	IU	NO DATA	NO DATA	MSFC	---
335B	SIGNAL RECEIVED IN S-1VB FOR: LH2 TANK LATCHING RELIEF VALVE LATCH OFF	-----	-----	S-1VB	03:39:15.245 (13155.245)	T8 7+ 3604.413	MDAC	---
336A	SIGNAL FROM LVDC FOR: LH2 TANK LATCHING RELIEF VALVE OPEN ON	03:54:08.779 (14048.779)	T6 7+ 4499.000	IU	NO DATA	NO DATA	MSFC	---

TABLE 4-1 (Sheet 40 of 46)

AS - 505 MISSION F
POST FLIGHT SEQUENCE OF EVENTS
AS OF JUNE 13, 1969

ITEM NO.	EVENT	PREDICTED TIME		SIGNAL MONITORED AT	MONITORED TIME		DATA SOURCE	ACCURACY (MS)
		TIME FROM RANGE ZERO (HR:MIN:SEC) (SEC)	TIME FROM BASE (SEC)		TIME FROM RANGE ZERO (HR:MIN:SEC) (SEC)	TIME FROM BASE (SEC)		
336B	SIGNAL RECEIVED IN S-IVB FOR: LH2 TANK LATCHING RELIEF VALVE OPEN ON	-----	-----	S-IVB	03:54:09.860 (14049.860)	TB 7+ 4499.028	MDAC	---
337A	SIGNAL FROM LVDC FOR: LH2 TANK REPRESSURIZATION CONTROL VALVE OPEN OFF	03:54:08.970 (14048.979)	TB 7+ 4499.200	IU	NO DATA	NO DATA	MSFC	---
337B	SIGNAL RECEIVED IN S-IVB FOR: LH2 TANK REPRESSURIZATION CONTROL VALVE OPEN OFF	-----	-----	S-IVB	03:54:10.060 (14050.060)	TB 7+ 4499.228	MDAC	---
338A	SIGNAL FROM LVDC FOR: LH2 TANK LATCHING RELIEF VALVE OPEN OFF	03:54:09.779 (14049.779)	TB 7+ 4500.000	IU	NO DATA	NO DATA	MSFC	---
338B	SIGNAL RECEIVED IN S-IVB FOR: LH2 TANK LATCHING RELIEF VALVE OPEN OFF	-----	-----	S-IVB	03:54:10.860 (14050.860)	TB 7+ 4500.028	MDAC	---
339A	SIGNAL FROM LVDC FOR: LH2 TANK VENT AND LATCHING RELIEF VALVE BOOST CLOSE ON	03:54:12.779 (14052.779)	TB 7+ 4503.000	IU	NO DATA	NO DATA	MSFC	---
339B	SIGNAL RECEIVED IN S-IVB FOR: LH2 TANK VENT AND LATCHING RELIEF VALVE BOOST CLOSE ON	-----	-----	S-IVB	03:54:13.868 (14053.868)	TB 7+ 4503.036	MDAC	---
340A	SIGNAL FROM LVDC FOR: LH2 TANK VENT AND LATCHING RELIEF VALVE BOOST CLOSE OFF	03:54:14.779 (14054.779)	TB 7+ 4505.000	IU	NO DATA	NO DATA	MSFC	---
340B	SIGNAL RECEIVED IN S-IVB FOR: LH2 TANK VENT AND LATCHING RELIEF VALVE BOOST CLOSE OFF	-----	-----	S-IVB	03:54:15.860 (14055.860)	TB 7+ 4505.028	MDAC	---
341	LEM EXTRACTION INITIATED	04:08:24.872 (14904.872)	N/A		03:56:24.000 (14184.000)	N/A	MSFC	---
342	INITIATE MANEUVER TO SLINGSHOT ATTITUDE	04:39:09.779 (16749.779)	N/A		04:42:15.801 (16935.801)	N/A	MSFC	---
343	TIME BASE 8 - INITIATION OF PROPELLANT DUMP AND STAGE SAFING	04:39:09.779 (16749.779)	TB 8+ 0.000		04:42:15.801 (16935.801)	TB 8+ 0.000	MSFC	---

TABLE 4-1 (Sheet 41 of 46)

AS - 505 MISSION F
POST FLIGHT SEQUENCE OF EVENTS
AS OF JUNE 13, 1969

ITEM NO.	EVENT	PREDICTED TIME		SIGNAL MONITORED AT	MONITORED TIME		DATA SOURCE	ACCURACY (MS)
		TIME FROM RANGE ZERO (HR:MIN:SEC)	TIME FROM BASE (SEC)		TIME FROM RANGE ZERO (HR:MIN:SEC)	TIME FROM BASE (SEC)		
344A	SIGNAL FROM LVDC FOR: S-IVB ENGINE EDS CUTOFF NO. 2 DISABLE	04:39:09.979 (16749.979)	TB 8+ 0.200	IU	NO DATA	NO DATA	MSFC	---
344B	SIGNAL RECEIVED IN S-IVB FOR: S-IVB ENGINE EDS CUTOFF NO. 2 DISABLE	-----	-----	S-IVB	04:42:15.983 (16935.983)	TB 8+ 0.182	MDAC	---
345A	SIGNAL FROM LVDC FOR: LH2 TANK CONTINUOUS VENT ORIFICE SHUTOFF VALVE OPEN ON	04:39:10.179 (16750.179)	TB 8+ D.400	IU	NO DATA	NO DATA	MSFC	---
345B	SIGNAL RECEIVED IN S-IVB FOR: LH2 TANK CONTINUOUS VENT ORIFICE SHUTOFF VALVE OPEN ON	-----	-----	S-IVB	04:42:16.182 (16936.182)	TB 8+ 0.381	MDAC	---
346A	SIGNAL FROM LVDC FOR: LH2 TANK CONTINUOUS VENT RELIEF OVERRIDE SHUTOFF VALVE OPEN ON	04:39:10.379 (16750.379)	TB 8+ C.600	IU	NO DATA	NO DATA	MSFC	---
346B	SIGNAL RECEIVED IN S-IVB FOR: LH2 TANK CONTINUOUS VENT RELIEF OVERRIDE SHUTOFF VALVE OPEN ON	-----	-----	S-IVB	04:42:16.382 (16936.382)	TB 8+ 0.501	MDAC	---
347A	SIGNAL FROM LVDC FOR: ENGINE PUMP PURGE CONTROL VALVE ENABLE ON	04:39:10.579 (16750.579)	TB 8+ 0.800	IU	NO DATA	NO DATA	MSFC	---
347B	SIGNAL RECEIVED IN S-IVB FOR: ENGINE PUMP PURGE CONTROL VALVE ENABLE ON	-----	-----	S-IVB	04:42:16.582 (16936.582)	TB 8+ 0.781	MDAC	---
348A	SIGNAL FROM LVDC FOR: LH2 TANK REPRESSURIZATION CONTROL VALVE OPEN ON	04:39:10.779 (16750.779)	TB 8+ 1.000	IU	NO DATA	NO DATA	MSFC	---
348B	SIGNAL RECEIVED IN S-IVB FOR: LH2 TANK REPRESSURIZATION CONTROL VALVE OPEN ON	-----	-----	S-IVB	04:42:16.782 (16936.782)	TB 8+ 0.981	MDAC	---
349A	SIGNAL FROM LVDC FOR: LH2 TANK CONTINUOUS VENT ORIFICE SHUTOFF VALVE OPEN OFF	04:39:12.179 (16752.179)	TB 8+ 2.400	IU	NO DATA	NO DATA	MSFC	---

TABLE 4-1 (Sheet 42 of 46)
 AS - 505 MISSION F
 POST FLIGHT SEQUENCE OF EVENTS
 AS OF JUNE 13, 1969

ITEM NO.	EVENT	PREDICTED TIME		SIGNAL MONITORED AT	MONITORED TIME		DATA SOURCE	ACCURACY (MS)
		TIME FROM RANGE ZERO (HR:MIN:SEC)	TIME FROM BASE (SEC)		TIME FROM RANGE ZERO (HR:MIN:SEC)	TIME FROM BASE (SEC)		
349B	SIGNAL RECEIVED IN S-1VB FOR: LH2 TANK CONTINUOUS VENT ORIFACE SHUTOFF VALVE OPEN OFF	-----	-----	S-1VB	04:42:18.182 (16938.182)	TB 8+ 2.381	MDAC	---
350A	SIGNAL FROM LVDC FOR: LH2 TANK CONTINUOUS VENT RELIEF OVERRIDE SHUTOFF VALVE OPEN OFF	04:39:12.379 (16752.379)	TB 8+ 2.600	IU	NO DATA	NO DATA	MSFC	---
350B	SIGNAL RECEIVED IN S-1VB FOR: LH2 TANK CONTINUOUS VENT RELIEF OVERRIDE SHUTOFF VALVE OPEN OFF	-----	-----	S-1VB	04:42:18.382 (16938.382)	TB 8+ 2.581	MDAC	---
351A	SIGNAL FROM LVDC FOR: AUX. HYDRAULIC PUMP FLIGHT MODE ON	04:50:39.779 (17459.779)	TB 8+ 690.000	IU	NO DATA	NO DATA	MSFC	---
351B	SIGNAL RECEIVED IN S-1VB FOR: AUX. HYDRAULIC PUMP FLIGHT MODE ON	-----	-----	S-1VB	04:53:45.793 (17625.793)	TB 8+ 689.992	MDAC	---
352A	SIGNAL FROM LVDC FOR: PASSIVATION ENABLE	04:50:59.779 (17459.779)	TB 8+ 710.000	IU	NO DATA	NO DATA	MSFC	---
352B	SIGNAL RECEIVED IN S-1VB FOR: PASSIVATION ENABLE	-----	-----	S-1VB	04:54:05.793 (17645.793)	TB 8+ 709.992	MDAC	---
353A	SIGNAL FROM LVDC FOR: ENGINE MAINSTAGE CONTROL VALVE OPEN ON	04:51:09.779 (17469.779)	TB 8+ 720.000	IU	NO DATA	NO DATA	MSFC	---
353B	SIGNAL RECEIVED IN S-1VB FOR: ENGINE MAINSTAGE CONTROL VALVE OPEN ON	-----	-----	S-1VB	04:54:15.792 (17655.792)	TB 8+ 719.991	MDAC	---
354A	SIGNAL FROM LVDC FOR: ENGINE HE CONTROL VALVE OPEN ON	04:51:09.979 (17469.979)	TB 8+ 720.200	IU	NO DATA	NO DATA	MSFC	---
354B	SIGNAL RECEIVED IN S-1VB FOR: ENGINE HE CONTROL VALVE OPEN ON	-----	-----	S-1VB	04:54:15.992 (17655.992)	TB 8+ 720.191	MDAC	---

TABLE 4-1 (Sheet 43 of 46)

AS - 505 MISSION F
POST FLIGHT SEQUENCE OF EVENTS
AS OF JUNE 13, 1969

ITEM NO.	EVENT	PREDICTED TIME		SIGNAL MONITORED AT	MONITORED TIME		DATA SOURCE	ACCURACY (MS)
		TIME FROM RANGE ZERO (HR:MIN:SEC) (SEC)	TIME FROM BASE (SEC)		TIME FROM RANGE ZERO (HR:MIN:SEC) (SEC)	TIME FROM BASE (SEC)		
355A	SIGNAL FROM LVDC FOR: ENGINE MAINSTAGE CONTROL VALVE OPEN OFF	04:56:09.979 (17769.979)	TB 8+ 1020.200	IU	NO DATA	NO DATA	MSFC	---
355B	SIGNAL RECEIVED IN S-1VB FOR: ENGINE MAINSTAGE CONTROL VALVE OPEN OFF	-----	-----	S-1VB	04:59:15.994 (17955.994)	TB 8+ 1020.193	MDAC	---
356A	SIGNAL FROM LVDC FOR: ENGINE HE CONTROL VALVE OPEN OFF	04:56:10.179 (17770.179)	TB 8+ 1020.400	IU	NO DATA	NO DATA	MSFC	---
356B	SIGNAL RECEIVED IN S-1VB FOR: ENGINE HE CONTROL VALVE OPEN	-----	-----	S-1VB	04:59:16.195 (17956.195)	TB 8+ 1020.394	MDAC	---
357A	SIGNAL FROM LVDC FOR: LOX TANK NPV VALVE OPEN ON	04:56:12.979 (17772.979)	TB 8+ 1023.200	IU	NO DATA	NO DATA	MSFC	---
357B	SIGNAL RECEIVED IN S-1VB FOR: LOX TANK NPV VALVE OPEN ON	-----	-----	S-1VB	04:59:18.994 (17958.994)	TB 8+ 1023.193	MDAC	---
358A	SIGNAL FROM LVDC FOR: LOX TANK NPV VALVE LATCH OPEN ON	04:56:14.979 (17774.979)	TB 8+ 1025.200	IU	NO DATA	NO DATA	MSFC	---
358B	SIGNAL RECEIVED IN S-1VB FOR: LOX TANK NPV VALVE LATCH OPEN ON	-----	-----	S-1VB	04:59:20.994 (17960.994)	TB 8+ 1025.193	MDAC	---
359A	SIGNAL FROM LVDC FOR: LOX TANK NPV VALVE OPEN OFF	04:56:15.979 (17775.979)	TB 8+ 1026.200	IU	NO DATA	NO DATA	MSFC	---
359B	SIGNAL RECEIVED IN S-1VB FOR: LOX TANK NPV VALVE OPEN OFF	-----	-----	S-1VB	04:59:21.994 (17961.994)	TB 8+ 1026.193	MDAC	---
360A	SIGNAL FROM LVDC FOR: LOX TANK NPV VALVE LATCH OPEN OFF	04:56:16.979 (17776.979)	TB 8+ 1027.200	IU	NO DATA	NO DATA	MSFC	---
360B	SIGNAL RECEIVED IN S-1VB FOR: LOX TANK NPV VALVE LATCH OPEN OFF	-----	-----	S-1VB	04:59:22.994 (17962.994)	TB 8+ 1027.193	MDAC	---
361A	SIGNAL FROM LVDC FOR: ENGINE HE CONTROL VALVE OPEN ON	04:56:19.179 (17779.179)	TB 8+ 1029.400	IU	NO DATA	NO DATA	MSFC	---

TABLE 4-1 (Sheet 44 of 46)

AS - 505 MISSION F
POST FLIGHT SEQUENCE OF EVENTS
AS OF JUNE 13, 1969

ITEM NO.	EVENT	PREDICTED TIME		SIGNAL MONITORED AT	MONITORED TIME		DATA SOURCE	ACCURACY (MS)
		TIME FROM RANGE ZERO (HR:MIN:SEC) (SEC)	TIME FROM BASE (SEC)		TIME FROM RANGE ZERO (HR:MIN:SEC) (SEC)	TIME FROM BASE (SEC)		
361B	SIGNAL RECEIVED IN S-1VB FOR: ENGINE HE CONTROL VALVE OPEN ON	-----	-----	S-1VB	04:59:25.203 (17965.203)	TB 8+ 1029.402	MDAC	---
362A	SIGNAL FROM LVDC FOR: LH2 TANK REPRESSURIZATION CONTROL VALVE OPEN OFF	05:09:10.279 (18550.279)	TB 8+ 1800.500	IU	NO DATA	NO DATA	MSFC	---
362B	SIGNAL RECEIVED IN S-1VB FOR: LH2 TANK REPRESSURIZATION CONTROL VALVE OPEN OFF	-----	-----	S-1VB	05:12:16.312 (18736.312)	TB 8+ 1800.511	MDAC	---
363A	SIGNAL FROM LVDC FOR: LH2 TANK LATCHING RELIEF VALVE OPEN ON	05:13:00.779 (18780.779)	TB 8+ 2031.000	IU	NO DATA	NO DATA	MSFC	---
363B	SIGNAL RECEIVED IN S-1VB FOR: LH2 TANK LATCHING RELIEF VALVE OPEN ON	-----	-----	S-1VB	NO DATA	NO DATA	MDAC	---
364A	SIGNAL FROM LVDC FOR: AUX. HYDRAULIC PUMP FLIGHT MODE OFF	05:13:01.979 (18781.979)	TB 8+ 2032.200	IU	NO DATA	NO DATA	MSFC	---
364B	SIGNAL RECEIVED IN S-1VB FOR: AUX. HYDRAULIC PUMP FLIGHT MODE OFF	-----	-----	S-1VB	05:16:08.016 (18968.016)	TB 8+ 2032.215	MDAC	---
365A	SIGNAL FROM LVDC FOR: LH2 TANK LATCHING RELIEF VALVE LATCH ON	05:13:02.779 (18782.779)	TB 8+ 2033.000	IU	NO DATA	NO DATA	MSFC	---
365B	SIGNAL RECEIVED IN S-1VB FOR: LH2 TANK LATCHING RELIEF VALVE LATCH ON	-----	-----	S-1VB	05:16:08.816 (18968.816)	TB 8+ 2033.015	MDAC	---
366A	SIGNAL FROM LVDC FOR: LH2 TANK LATCHING RELIEF VALVE OPEN OFF	05:13:03.779 (18783.779)	TB 8+ 2034.000	IU	NO DATA	NO DATA	MSFC	---
366B	SIGNAL RECEIVED IN S-1VB FOR: LH2 TANK LATCHING RELIEF VALVE OPEN OFF	-----	-----	S-1VB	05:16:09.816 (18969.816)	TB 8+ 2034.015	MDAC	---
367A	SIGNAL FROM LVDC FOR: LH2 TANK LATCHING RELIEF VALVE LATCH OFF	05:13:04.779 (18784.779)	TB 8+ 2035.000	IU	NO DATA	NO DATA	MSFC	---

TABLE 4-1 (Sheet 45 of 46)
AS - 505 MISSION F
POST FLIGHT SEQUENCE OF EVENTS
AS OF JUNE 13, 1969

ITEM NO.	EVENT	PREDICIED TIME		SIGNAL MONITORED AT	MONITORED TIME		DATA SOURCE	ACCURACY (MS)
		TIME FROM RANGE ZERO (HR:MIN:SEC) (SEC)	TIME FROM BASE (SEC)		TIME FROM RANGE ZERO (HR:MIN:SEC) (SEC)	TIME FROM BASE (SEC)		
367B	SIGNAL RECEIVED IN S-IVB FOR: L#2 TANK LATCHING RELIEF VALVE LATCH OFF	-----	-----	S-IVB	05:16:10.816 (18970.816)	TB 8+ 2035.015	MDAC	---
368A	SIGNAL FROM LVDC FOR: ENGINE #2 CONTROL VALVE OPEN OFF	05:11:59.779 (19079.779)	TB 8+ 2330.000	IJ	NO DATA	NO DATA	MSFC	---
368B	SIGNAL RECEIVED IN S-IVB FOR: ENGINE #2 CONTROL VALVE OPEN OFF	-----	-----	S-IVB	05:21:05.828 (19265.828)	TB 8+ 2530.027	MDAC	---
369A	SIGNAL FROM LVDC FOR: PASSIVATION DISABLE	05:11:59.979 (19079.979)	TB 8+ 2330.200	IJ	NO DATA	NO DATA	MSFC	---
369B	SIGNAL RECEIVED IN S-IVB FOR: PASSIVATION DISABLE	-----	-----	S-IVB	05:21:06.028 (19266.028)	TB 8+ 2530.227	MDAC	---
370A	SIGNAL FROM LVDC FOR: S-IVB ULLAGE ENGINE NO.1 ON	05:25:49.779 (19549.779)	TB 8+ 2800.000	IJ	NO DATA	NO DATA	MSFC	---
370B	SIGNAL RECEIVED IN S-IVB FOR: S-IVB ULLAGE ENGINE NO.1 ON	-----	-----	S-IVB	05:28:55.843 (19735.843)	TB 8+ 2800.042	MDAC	---
371A	SIGNAL FROM LVDC FOR: S-IVB ULLAGE ENGINE NO. 2 ON	05:25:49.979 (19549.979)	TB 8+ 2800.200	IJ	NO DATA	NO DATA	MSFC	---
371B	SIGNAL RECEIVED IN S-IVB FOR: S-IVB ULLAGE ENGINE NO. 2 ON	-----	-----	S-IVB	05:28:56.034 (19736.034)	TB 8+ 2800.233	MDAC	---
372A	SIGNAL FROM LVDC FOR: S-IVB ULLAGE ENGINE NO.1 OFF	05:31:00.779 (19860.779)	TB 8+ 3111.000	IJ	NO DATA	NO DATA	MSFC	---
372B	SIGNAL RECEIVED IN S-IVB FOR: S-IVB ULLAGE ENGINE NO.1 OFF	-----	-----	S-IVB	05:34:06.828 (20046.828)	TB 8+ 3111.027	MDAC	---
373A	SIGNAL FROM LVDC FOR: S-IVB ULLAGE ENGINE NO. 2 OFF	05:31:00.979 (19860.979)	TB 8+ 3111.200	IJ	NO DATA	NO DATA	MSFC	---
373B	SIGNAL RECEIVED IN S-IVB FOR: S-IVB ULLAGE ENGINE NO. 2 OFF	-----	-----	S-IVB	05:34:07.028 (20047.028)	TB 8+ 3111.227	MDAC	---
374A	SIGNAL FROM LVDC FOR: ENGINE PUMP PURGE CONTROL VALVE ENABLE OFF	05:39:10.179 (20350.179)	TB 8+ 3600.400	IJ	NO DATA	NO DATA	MSFC	---

TABLE 4-1 (Sheet 46 of 46)

AS - 505 MISSION F
 POST FLIGHT SEQUENCE OF EVENTS
 AS OF JUNE 13, 1969

ITEM NO.	EVENT	PREDICTED TIME		SIGNAL MONITORED AT	MONITORED TIME		DATA SOURCE	ACCURACY (MS)
		TIME FROM RANGE ZERO (HR:MIN:SEC) (SEC)	TIME FROM BASE (SEC)		TIME FROM RANGE ZERO (HR:MIN:SEC) (SEC)	TIME FROM BASE (SEC)		
374B	SIGNAL RECEIVED IN S-IVB FOR: ENGINE PUMP PURGE CONTROL VALVE ENABLE OFF	-----	-----	S-IVB	05:42:16.235 (20536.235)	TB 8+ 3600.434	MDAC	---
375	INITIATE MANEUVER TO COMMUNICATIONS ATTITUDE	05:40:53.790 (20453.790)	N/A		NO DATA	NO DATA	MSFC	---

TABLE 4-2

POST FLIGHT SEQUENCE FOR GROUND INITIATED COMMANDS
AS OF JUNE 13, 1969 (SHEET 1 OF 16)

EVENT	PREDICTED TIME FROM RANGE ZERO (HR:MIN:SEC) (SEC)	MONITORED TIME FROM RANGE ZERO (HR:MIN:SEC) (SEC)	DATA SOURCE
Signal from Ground for: Ambient Repress System Mode Selector OFF	2:38:00 (9,480)	2:39:25 (9,565)	MSC
Signal from Ground for: Set Antenna Low Gain	3:33:00 (12,780)	4:13:52 (15,232)	MSC
Signal from Ground for: Initiate Time Base 8	4:38:00 (16,680)	4:42:14 (16,934)	MSC
Signal from Ground for: LH2 Tank CVS Close ON	4:38:0; (16,681)	4:42:31 (16,951)	MSC
Signal Received in S-IVB for: LH2 Tank CVS Close ON	---	4:42:33.373 (16,953.373)	MDAC

TABLE 4-2
 POST FLIGHT SEQUENCE FOR GROUND INITIATED COMMANDS
 AS OF JUNE 13, 1969 (SHEET 2 OF 16)

EVENT	PREDICTED TIME FROM RANGE ZERO (HR:MIN:SEC) (SEC)	MONITORED TIME FROM RANGE ZERO (HR:MIN:SEC) (SEC)	DATA SOURCE
Signal from Ground for: S-IVB All Zeros	4:38:01 (16,681)	4:42:31 (16,951)	MSC
Signal from Ground for: LH2 Tank CVS Close OFF	4:38:01 (16,681)	4:42:31 (16,951)	MSC
Signal Received in S-IVB for: LH2 Tank CVS Close OFF	---	4:42:36.173 (16,956.173)	MDAC
Signal from Ground for: LH2 Tank Repress. Control Valve Open OFF	4:40:41 (16,841)	4:44:55 (17,095)	MSC
Signal Received in S-IVB for: LH2 Tank Repress. Control Valve Open OFF	---	4:44:56.628 (17,096.628)	MDAC

TABLE 4-2

POST FLIGHT SEQUENCE FOR GROUND INITIATED COMMANDS
AS OF JUNE 13, 1969 (SHEET 3 OF 16)

EVENT	PREDICTED TIME FROM RANGE ZERO (HR:MIN:SEC) (SEC)	MONITORED TIME FROM RANGE ZERO (HR:MIN:SEC) (SEC)	DATA SOURCE
Signal from Ground for: LH2 Tank Repress. Control Valve Open OFF (repeat)	4:40:41 (16,841)	4:44:55 (17,095)	MSC
Signal Received in S-IVB for: LH2 Tank Repress. Control Open OFF (repeat)	---	4:44:58.511 (17,098.511)	MDAC
Signal from Ground for: Ambient Repress. System Mode Select ON and Cryo OFF	4:40:41 (16,841)	4:44:55 (17,095)	MSC
Signal Received in S-IVB for: Ambient Repress. System Mode Select ON and Cryo OFF	---	4:44:59.895 (17,099.895)	MDAC
Signal from Ground for: S-IVB Ullage Engine No. 1 ON	4:41:21 (16,881)	4:45:35 (17,134)	MSC

TABLE 4-2
 POST FLIGHT SEQUENCE FOR GROUND INITIATED COMMANDS
 AS OF JUNE 13, 1969 (SHEET 4 OF 16)

EVENT	PREDICTED TIME FROM RANGE ZERO (HR:MIN:SEC) (SEC)	MONITORED TIME FROM RANGE ZERO (HR:MIN:SEC) (SEC)	DATA SOURCE
Signal Received in S-IVB for: S-IVB Ullage Engine No. 1 ON	---	4:45:36.445 (17,136.445)	MDAC
Signal from Ground for: S-IVB Ullage Engine No. 2 ON	4:41:21 (16,881)	4:45:34 (17,134)	MSC
Signal Received in S-IVB for: S-IVB Ullage Engine No. 2 ON	---	4:45:37.836 (17,137.836)	MDAC
Signal from Ground for: LOX Tank Repr. Control Valve Open ON	4:41:36 (16,896)	4:45:51 (17,151)	MSC
Signal Received in S-IVB for: LOX Tank Repr. Control Valve Open ON	---	4:45:53.135 (17,153.135)	MDAC

TABLE 4-2

POST FLIGHT SEQUENCE FOR GROUND INITIATED COMMANDS
AS OF JUNE 13, 1969 (SHEET 5 OF 16)

EVENT	PREDICTED TIME FROM RANGE ZERO (HR:MIN:SEC) (SEC)	MONITORED TIME FROM RANGE ZERO (HR:MIN:SEC) (SEC)	DATA SOURCE
Signal from Ground for: Auxiliary Hydraulic Pump ON	4:42:11 (16,931)	4:46:24 (14,184)	MSC
Signal received in S-IVB for: Auxiliary Hydraulic Pump ON	---	4:46:26.444 (17,186.444)	MDAC
Signal from Ground for: Passivation Enable	4:44:01 (17,041)	4:48:18 (17,298)	MSC
Signal Received in S-IVB for: Passivation Enable	---	4:48:19.791 (17,299.791)	MDAC
Signal from Ground for: Engine He Control Valve Open On	4:44:01 (17,041)	4:48:18 (17,298)	MSC
Signal Received in S-IVB for: Engine He Control Valve Open ON	---	4:48:20.582 (17,300.582)	MDAC

TABLE 4-2
 POST FLIGHT SEQUENCE FOR GROUND INITIATED COMMANDS
 AS OF JUNE 13, 1969 (SHEET 6 OF 16)

EVENT	PREDICTED TIME FROM RANGE ZERO (HR:MIN:SEC) (SEC)	MONITORED TIME FROM RANGE ZERO (HR:MIN:SEC) (SEC)	DATA SOURCE
Signal from Ground for: Engine Mainstage Control Valve Open ON	4:44:01 (17,041)	4:48:18 (17,298)	MSC
Signal Received in S-IVB for: Engine Mainstage Control Valve Open ON	---	4:48:21.416 (17,301.416)	MDAC
Signal from Ground for: Delay 31 Words	4:44:01 (17,041)	4:48:18 (17,298)	MSC
Signal from Ground for: Terminate	4:44:01 (17,041)	4:48:18 (17,298)	MSC
Signal from Ground for: Engine Mainstage Control Valve Open OFF	4:44:01 (17,041)	4:48:18 (17,298)	MSC
Signal Received in S-IVB for: Engine Mainstage Control Valve Open OFF	---	4:48:30.324 (17,310.324)	MDAC

TABLE 4-2

POST FLIGHT SEQUENCE FOR GROUND INITIATED COMMANDS
AS OF JUNE 13, 1969 (SHEET 7 OF 16)

EVENT	PREDICTED TIME FROM RANGE ZERO (HR:MIN:SEC) (SEC)	MONITORED TIME FROM RANGE ZERO (HR:MIN:SEC) (SEC)	DATA SOURCE
Signal from Ground for: Terminate	4:44:01 (17,041)	4:48:18 (17,298)	MSC
Signal from Ground for: Prevalves Close ON	4:44:01 (17,041)	4:48:18 (17,298)	MSC
Signal Received in S-IVB for: Prevalves Close ON	---	4:48:31.349 (17,311.349)	MDAC
Signal from Ground for: Engine He Control Valve Open OFF	4:44:01 (17,041)	4:48:18 (17,298)	MSC
Signal Received in S-IVB for: Engine He Control Valve Open Off	---	4:48:32.149 (17,312.149)	MDAC
Signal from Ground for: He Control Valve Open ON	4:44:16 (17,056)	4:48:48 (17,323)	MSC

TABLE 4-2
 POST FLIGHT SEQUENCE FOR GROUND INITIATED COMMANDS
 AS OF JUNE 13, 1969 (SHEET 8 OF 16)

EVENT	PREDICTED TIME FROM RANGE ZERO (HR:MIN:SEC) (SEC)	MONITORED TIME FROM RANGE ZERO (HR:MIN:SEC) (SEC)	DATA SOURCE
Signal received in S-IVB for: He Control Valve Open ON	---	4:48:44.700 (17,324.700)	MDAC
Signal from Ground for: Delay 42 Words	4:44:16 (17,056)	4:48:43 (17,323)	MSC
Signal from Ground for: He Control Valve Open OFF	4:44:16 (17,056)	4:48:43 (17,323)	MSC
Signal Received in S-IVB for: He Control Valve Open OFF	---	4:48:56.241 (17,336.241)	MDAC
Signal from Ground for: Passivation Disable	4:44:16 (17,056)	4:48:43 (17,323)	MSC
Signal Received in S-IVB for: Passivation Disable	---	4:48:57.041 (17,337.041)	MDAC

TABLE 4-2

POST FLIGHT SEQUENCE FOR GROUND INITIATED COMMANDS
AS OF JUNE 13, 1969 (SHEET 9 of 16)

EVENT	PREDICTED TIME FROM RANGE ZERO (HR:MIN:SEC) (SEC)	MONITORED TIME FROM RANGE ZERO (HR:MIN:SEC) (SEC)	DATA SOURCE
Signal from Ground for: LOX Tank Repress. Control Valve Open OFF	4:44:31 (17,071)	4:49:13 (17,353)	MSC
Signal Received in S-IVB for: LOX Tank Repress. Control Valve Open OFF	---	4:49:15.465 (17,355.465)	MDAC
Signal from Ground for: LH2 Tank Repress. Control Valve Open ON	4:44:31 (17,071)	4:49:13 (17,353)	MSC
Signal Received in S-IVB for: LH2 Tank Repress. Control Valve Open ON	---	4:49:16.873 (17,356.873)	MDAC
Signal from Ground for: Prevalves Open	4:44:31 (17,071)	4:49:13 (17,353)	MSC
Signal Received in S-IVB for: Prevalves Open	---	4:49:18.290	MDAC

TABLE 4-2

POST FLIGHT SEQUENCE FOR GROUND INITIATED COMMANDS
AS OF JUNE 13, 1969 (SHEET 10 OF 16)

EVENT	PREDICTED TIME FROM RANGE ZERO (HR:MIN:SEC) (SEC)	MONITORED TIME FROM RANGE ZERO (HR:MIN:SEC) (SEC)	DATA SOURCE
Signal from Ground for: Ambient Repress. System Mode Select OFF and Cryo ON	4:45:31 (17,131)	4:49:44 (17,384)	MSC
Signal Received in S-IVB for: Ambient Repress. System Mode Select OFF and Cryo ON	---	4:49:46.240 (17,386.240)	MDAC
Signal from Ground for: Passivation Enable	4:45:51 (17,151)	4:50:07 (17,407)	MSC
Signal Received in S-IVB for: Passivation Enable	---	4:50:08.471 (17,408.471)	MDAC
Signal from Ground for: Engine Ignition Phase Control Valve Open ON	4:45:51 (17,151)	4:50:07 (17,407)	MSC
Signal Received in S-IVB for: Engine Ignition Phase Control Valve Open ON	---	4:50:09.897 (17,409.897)	MDAC

TABLE 4-2
 POST FLIGHT SEQUENCE FOR GROUND INITIATED COMMANDS
 AS OF JUNE 13, 1969 (SHEET 11 OF 16)

EVENT	PREDICTED TIME FROM RANGE ZERO (HR:MIN:SEC) (SEC)	MONITORED TIME FROM RANGE ZERO (HR:MIN:SEC) (SEC)	DATA SOURCE
Signal from Ground for: Engine He Control Valve Open ON	4:45:51 (17,151)	4:50:07 (17,407)	MSC
Signal Received in S-IVB for: Engine He Control Valve Open ON	---	4:50:11.314 (17,411.314)	MDAC
Signal from Ground for: 3 Second Delay	4:45:51 (17,151)	4:50:07 (17,407)	MSC
Signal from Ground for: S-IVB Ullage Engine No. 1 OFF	4:45:51 (17,151)	4:50:07 (17,407)	MSC
Signal Received in S-IVB for: S-IVB Ullage Engine No. 1 OFF	---	4:50:15.580 (17,415.580)	MDAC
Signal from Ground for: S-IVB Ullage Engine No. 2 OFF	4:45:51 (17,151)	4:50:07 (17,407)	MSC

TABLE 4-2

POST FLIGHT SEQUENCE FOR GROUND INITIATED COMMANDS
AS OF JUNE 13, 1969 (SHEET 12 OF 16)

EVENT	PREDICTED TIME FROM RANGE ZERO (HR:MIN:SEC) (SEC)	MONITORED TIME FROM RANGE ZERO (HR:MIN:SEC) (SEC)	DATA SOURCE
Signal Received in S-IVB for: S-IVB Ullage Engine No. 2 OFF	---	4:50:16.981 (17,416.981)	MDAC
Signal from Ground for: Engine Ignition Phase Control Valve Open OFF	4:46:51 (17,151)	4:50:57 (17,457)	MSC
Signal Received in S-IVB for: Engine Ignition Phase Control Valve Open OFF	---	4:50:48.846 (17,458.846)	MDAC
Signal from Ground for: Engine He Control Valve Open OFF	4:46:51 (17,151)	4:50:57 (17,457)	MSC
Signal Received in S-IVB for: Engine He Control Valve Open OFF	---	4:51:00.263 (17,460.263)	MDAC
Signal from Ground for: LH2 CVS Orifice S/O Valve Open ON	4:47:21 (17,241)	4:51:34 (17,494)	MSC

TABLE 4-2
 POST FLIGHT SEQUENCE FOR GROUND INITIATED COMMANDS
 AS OF JUNE 13, 1969 (SHEET 13 OF 16)

EVENT	PREDICTED TIME FROM RANGE ZERO (HR:MIN:SEC) (SEC)	MONITORED TIME FROM RANGE ZERO (HR:MIN:SEC) (SEC)	DATA SOURCE
Signal Received in S-IVB for: LH2 CVS Orifice S/O Valve Open ON	----	4:51:36.063 (17,496.063)	MDAC
Signal from Ground for: LH2 CVS Relief Override S/O Valve Open ON	4:47:21 (17,241)	4:51:34 (17,494)	MSC
Signal Received in S-IVB for: LH2 CVS Relief Override S/O Valve Open ON	----	4:51:34.480 (17,497.480)	MDAC
Signal from Ground for: S-IVB All Zeros	4:47:21 (17,241)	4:51:34 (17,494)	MSC
Signal from Ground for: LH2 CVS Orifice S/O Valve Open OFF	4:47:21 (17,241)	4:51:34 (17,494)	MSC
Signal Received in S-IVB for: LH2 CVS Orifice S/O Valve Open OFF	----	4:51:40.312 (17,500.312)	MDAC

TABLE 4-2
 POST FLIGHT SEQUENCE FOR GROUND INITIATED COMMANDS
 AS OF JUNE 13, 1969 (SHEET 14 OF 16)

EVENT	PREDICTED TIME FROM RANGE ZERO (HR:MIN:SEC) (SEC)	MONITORED TIME FROM RANGE ZERO (HR:MIN:SEC) (SEC)	DATA SOURCE
Signal from Ground for: LH2 CVS Relief Override S/O Valve Open OFF	4:47:21 (17,241)	4:51:34 (17,494)	MSC
Signal Received in S-IVB for: LH2 CVS Relief Override S/O Valve Open OFF	---	4:51:41.770 (17,501.770)	MDAC
Signal from Ground for: S-IVB Ullage Engine No. 1 OFF	(no data)	5:29:01 (19,741)	MSC
Signal Received in S-IVB for: S-IVB Ullage Engine No. 1 OFF	---	5:20:03.209 (19,743.209)	MSC
Signal from Ground for: S-IVB Ullage Engine No. 2 OFF	(no data)	5:29:01 (19,741)	MSC
Signal Received in S-IVB for: S-IVB Ullage Engine No. 2 OFF	---	5:29:04.910 (19,744.910)	MDAC

TABLE 4-2
 POST FLIGHT SEQUENCE FOR GROUND INITIATED COMMANDS
 AS OF JUNE 13, 1969 (SHEET 15 OF 16)

EVENT	PREDICTED TIME FROM RANGE ZERO (HR:MIN:SEC) (SEC)	MONITORED TIME FROM RANGE ZERO (HR:MIN:SEC) (SEC)	DATA SOURCE
Signal from Ground for: Auxiliary Pump ON	(no data)	5:29:50 (19,790)	MSC
Signal Received in S-IVB for: Auxiliary Pump ON	----	5:29:52.250 (19,792.250)	MDAC
Signal from Ground for: Auxiliary Pump OFF	(no data)	5:32:06 (19,926)	MSC
Signal Received in S-IVB for: Auxiliary Pump OFF	----	5:32:08.139 (19,928.139)	MDAC
Signal from Ground for: Set Antenna Hi Gain	(no data)	6:40:51 (24,051)	MSC
Signal from Ground for: Antenna to Omni	(no data)	6:58:16 (25,080)	MSC

TABLE 4-2
 POST FLIGHT SEQUENCE FOR GROUND INITIATED COMMANDS
 AS OF JUNE 13, 1969 (SHEET 16 OF 16)

EVENT	PREDICTED TIME FROM RANGE ZERO (HR:MIN:SEC) (SEC)	MONITORED TIME FROM RANGE ZERO (HR:MIN:SEC) (SEC)	DATA SOURCE
Signal from Ground for: Set Antenna Low Gain (rejected)	(no data)	9:59:54 (35,994)	MSC
Signal from Ground for: Set Antenna Low Gain (rejected)	(no data)	10:00:33 (180,033)	MSC
Signal from Ground for: Set Antenna Low Gain (rejected)	(no data)	10:07:06 (180,426)	MSC
Signal from Ground for: Set Antenna Low Gain (rejected)	(no data)	10:08:22 (180,502)	MSC
Signal from Ground for: Set Antenna Low Gain (rejected)	(no data)	10:11:11 (180,671)	MSC

5. TEST OPERATIONS

The AS-505 space vehicle was launched at 1649:00.56 GMT from Launch Complex 39B on 18 May 1969. The overall performance of the S-IVB-505N stage was satisfactory during all phases of the countdown.

No significant S-IVB stage or equipment problems occurred during the launch countdown, and McDonnell-Douglas ground support equipment (GSE) sustained no significant damage during liftoff. The precountdown and countdown activities are reviewed and evaluated in the following paragraphs which include discussions of the prelaunch checkouts, purges, propellant and pneumatic loadings, and the terminal countdown. Significant events occurred at the following times:

<u>Event</u>	<u>Time</u>
LOX loading initiated	0733 GMT
LH2 loading initiated	1236 GMT
Cold helium loading initiated	1259 GMT
Terminal countdown initiated	1634 GMT
Liftoff	1649 GMT

5.1 Launch Vehicle Tests

The S-IVB-505N stage was subjected to the launch vehicle tests listed in table 5-1 to determine that switch selector, interfaces, etc were functional for launch. These tests were performed in the vertical assembly building (VAB) or on Pad 39B.

5.1.1 Countdown Demonstration Test (Wet)

The countdown demonstration test (CDDT) Wet began at 1100 GMT on 29 April with the count at T -113 hours 30 minutes and a scheduled cutoff at 1649 GMT on 4 May; however, because of changes to the

countdown schedule and several problems, the cutoff occurred at approximately 1408 GMT the following day. The problems included the following:

- a. Adjustments to the countdown schedule to accomplish S-IC stage fuel tank inspection because of precount fuel dumping mishap.
- b. A 12-hour slip because of spacecraft problems.
- c. A 2-hour hold to catch up the count.
- d. A count recycle from T -3 to T -22 minutes required when the guidance platform unlocked because of a Theodolite acquisition problem.

5.1.2 CDDT (Dry)

The CDDT Dry began at 1049 GMT on 6 May with a count of T -6 hours 45 minutes and a scheduled T -0 of 1649 GMT. A 12-minute hold was called at T -22 minutes because of non-MDAC problems, and T -0 occurred at approximately 1701 GMT on 6 May.

5.2 AS-505 Launch Countdown

The launch countdown activities began on 12 May and were concluded with vehicle launch on time at 1649 GMT on 18 May 1969.

Major S-IVB activities started at T -103 hours with initiation of engineering walk-around checks. MDAC operations continued on schedule until T -61 hours. During the MT-01 Measuring Scan Program a 1A66984-501 check valve in the LH2 nozzle purge line was replaced, and S-IVB power was approximately 1 hour late in being secured on 14 May.

Launch vehicle operations were resumed at T -28 hours on 16 May, and MDAC activities were accomplished smoothly. S-IVB final mechanical closeout was completed ahead of time.

The T -3 hour 30 minute final count was picked up on time at 1319 GMT; and after flight crew ingress and spacecraft close-out, the countdown progressed without incident to Space Vehicle launch at 1649:00 GMT.

5.2.1 Prelaunch Preparations and Purges

Prelaunch preparations consisted of leak checks, verification of purges and valve actuations, and analysis of the helium supply for purity and moisture content.

5.2.2 Loading Operations

Propellant tank and APS module loading and prepressurization, thrust chamber chilldown, and helium and GH2 sphere loading were all satisfactorily accomplished.

5.2.2.1 Propellant Loading

S-IVB stage LOX and LH2 loadings were uninterrupted and smoothly accomplished. Pressures, temperatures, and flowrates at significant times are presented in table 5-2.

5.2.2.2 APS Loading

APS fuel loading was initiated and completed on 22 April. Although the Module 2 fuel vent valve would not actuate on command due to a ground computer error, the APS emergency vent was actuated and fuel loading was completed with no schedule impact. APS oxidizer loading began on 24 April and was completed on 25 April.

During troubleshooting for an anomaly caused by a non-MDAC check valve problem, two MDAC lines, the oxidizer return and bleed hoses, were found to be cross-connected at the servicing cart. After the check valve problem was corrected, the system was drained and purged, and the lines were reconnected correctly. Loading data are presented in table 5-3.

5.2.2.3 Helium and GH2 Loading

Final pressurization of all S-IVB stage spheres, both cold and ambient, was accomplished without difficulty. Sphere pressurization data are presented in table 5-4.

5.2.3 Terminal Count

The sequence of terminal countdown events is presented in table 5-5.

5.2.3.1 Engine Conditioning

J-2 engine conditioning was initiated with an ambient helium purge through the start sphere. After the purge, the start sphere was chilled and pressurized with cold GH₂. Both the engine start sphere and the engine control sphere were within redline limits at liftoff.

During both CDDT and launch, the engine control sphere temperature drop was less than normal. Prior to liftoff the temperature leveled out at approximately 320 deg R which is above the nominal expected level. This item is still under investigation.

Thrust chamber jacket purge was terminated and chill was initiated at T -9 minutes 59 seconds. The thrust chamber jacket temperature was 247 deg R at liftoff.

5.2.3.2 Stage Conditioning

LOX turbopump chilldown was manually initiated at T -4 minutes 50 seconds and was normal with a LOX flowrate of 40.5 gpm unpressurized and 43.5 gpm pressurized. LH₂ turbopump chilldown, initiated at T -4 minutes 59 seconds, was also normal; the LH₂ flowrate was approximately 93 gpm unpressurized and 138 gpm pressurized.

LOX and LH₂ tank pressurization were normal and were accomplished in the expected time. Three LOX tank ullage pressure makeup cycles were accomplished between T -144 and T -122 seconds.

Stage pneumatic system loading and functions were normal during the launch countdiwn, and the regulator discharge pressure and ambient helium sphere pressure and temperature were within specifications.

5.3 Redline Limits

All redline limits for launch were satisfied. These limits are presented in report K-V-05.10/5: Apollo/Saturn V Launch Mission Rules Apollo 10 (SA-505/CSM-106/LM-4) Final, dated 2 April 1969 with revisions; and in the A41 Redline Monitoring Brief.

5.4 Countdown Problems

The following S-IVB Propulsion problems occurred during the launch countdown; however, none of these impacted the countdown schedule.

- a. During vacuum 'acket checks of model DSV-4B-438A heat exchanger, the vacuum probe on the exchanger tank was found to be leaking and was changed.
- b. During final propulsion system preparations, the engine control sphere supply vent valve failed to actuate because of a broken wire. The wire harness was replaced.
- c. During the T -9 hour countdown, LOX tank helium repressurization sphere pressure (D0254) indicated approximately 200 psi low after the last CPIF scan and was reported as a measurement failure.
- d. Measurement L0019-408 was lost during LH2 loading. The measurement was determined to be not required for flight and was waived as an active measurement prior to IAS.

5.5 Environmental Control System

5.5.1 Thermoconditioning and Purge System

The aft interstage thermoconditioning and purge system functioned properly during countdown, maintaining an APS temperature at liftoff within the design limits of 87 \pm 5 deg F.

5.6 Atmospheric Conditions

The following atmospheric conditions* prevailed for the AS-505 launch on 18 May 1969:

<u>Time (GMT)</u>	<u>Ambient Pressure (in. Hg)</u>	<u>Ambient Temperature (°F)</u>	<u>Dew Point (°F)</u>	<u>Wind Direction (deg from N)</u>	<u>Wind Velocity (knots)</u>
0800	30.09	75	69	113	14
0900	30.09	75	69	108	13
1000	30.09	76	70	113	16
1100	30.08	76	70	108	16
1200	30.09	78	71	113	15
1300	30.09	80	71	117	18
1400	30.10	81	71	121	19
1500	30.10	82	71	124	21
1600	30.10	83	71	124	20
1700	30.10	83	72	124	19

*Data taken from 204 foot level of tower No. 703, near VAB.

TABLE 5-1
LAUNCH VEHICLE TESTS

Test	Completion Date
LV Electrical Systems Test	1-8-69
LV Malfunction OAT	1-31 and 2-3-69
Service Arm OAT	2-5-69
SV OAT No. 1 Plugs In	3-4 and 3-5-69
LV Propellant Simulated Loading	3-17-69
Facility Power Out Test	3-18-69
LOX/LH2 Systems Cold Flow Test	3-25 thru 3-27-69
LV Flight Readiness System Verification Test	4-1-69
LV Flight System Redundancy Test	4-3-69
Backup Guidance Simulated Flight Test	4-8-69
Flight Readiness Test	4-9 and 4-10-69
Rerun: LOX System Cold Flow Test	4-10-69
Rerun: LOX System Cold Flow Test	4-17-69
APS Module Propellant Loading	4-22, -24 and -25-69
Countdown Demonstration Test	4-29 thru 5-6-69
SV Launch Countdown	5-12 thru 5-18-69

TABLE 5-2

S-IVB-505N STAGE PROPELLANT LOADING DATA

PARAMETER	LOX	LH2
Chilldown initiated (GMT)	0733	0742
Slow fill		
Levels (percent)	0 to 5	0 to 5
Initiation time (GMT)	0859	1236
Maximum swing arm pressure (psia)	109	N/A
Maximum ullage pressure (psia)	25	N/A
Fast fill		
Levels (percent)	5 to 96	5 to 94
Initiation time (GMT)	0902	1242
Flowrate (gpm)	900 to 1000	2800 to 3000
Swing arm pressure		
Maximum (psia)	109	81
Stabilized (psia)	101	77
Maximum ullage pressure (psia)	24	16.3
Final slow fill		
Level at initiation (percent)	96	94
Initiation time (GMT)	0922	1305
Swing arm pressure (psia)	93	71
Maximum ullage pressure (psia)	16.5	17.3
Total time required (min)	111*	39

N/A Not available

* LOX loading was delayed for approximately 1 hour because of a LOX facility power loss.

TABLE 5-3
 APS LOADING DATA

Item	Volume (in ³)	Temperature (°R)
<u>Module 1</u>		
Oxidizer System		
Loaded	4,092	538
Offloaded	180	538
Final mass (lbm)	202.6	-
Fuel System		
Loaded	4,092	543
Offloaded	80	543
Final mass (lbm)	126.0	-
<u>Module 2</u>		
Oxidizer System		
Loaded	4,092	537
Offloaded	180	537
Final mass (lbm)	203.0	-
Fuel System		
Loaded	4,092	543
Offloaded	80	543
Final mass (lbm)	126.0	-

TABLE 5-4

SPHERE PRESSURIZATION DATA

Sphere	Volume (ft ³)	Final Pressurization		Initial Pressure (psia)	Final Pressure (psia)	Liftoff Conditions	
		Initiation Time	Required Time			Pressure (psia)	Temperature (°R)
Ambient Helium							
LOX tank repressurization	9.0	T -7 hr	6 min	1,600	3,075	3,060	471
LH2 tank repressurization	27.0	T -7 hr	6 min	1,640	3,045	3,120	477
Pneumatic control	4.5	T -7 hr	6 min	1,565	3,035	3,096	532
ColA Helium	31.5	70% LH2	19 min	1,450	3,070	3,050	38.6
APS Helium							
Module 1	0.535	T -7 hr	3 min	54	3,090	3,100	549
Module 2	0.535	T -7 hr	3 min	64	3,115	3,100	547
Engine Control	0.578	T -7 hr	10 sec	1,585	3,090	3,020	320
Engine GH2 Start	4.224	T -5 min 30 sec	Approx 6 sec	1,107	1,224	1,285	277

TABLE 5-5

AS-505 TERMINAL COUNTDOWN SEQUENCE

Time from Liftoff (sec)	Event
-1159.0	Engine start sphere purge initiated
-899.8	Engine thrust chamber purge initiated
-869.5	Engine start sphere purge terminated
-869.0	Engine start sphere chilldown initiated
-599.8	Engine thrust chamber purge terminated
-599.2	Engine thrust chamber chilldown initiated
-299.5	LH2 chilldown initiated
-298.8	Engine start sphere chilldown terminated
-298.0	Engine control sphere supply closed
-289.4	LOX chilldown initiated
-284.2	LH2 prevalve closed
-284.1	LOX prevalve closed
-269.2	Cold helium crossover valve closed
-184.8	LOX fill and drain valve closed
-166.6	LOX tank vent closed
-166.6	LOX tank prepressurization initiated
-149.9	LOX tank prepressurization terminated
-96.4	LH2 tank vent closed
-96.3	LH2 tank prepressurization initiated
-83.4	LH2 tank prepressurization terminated
-39.6	LH2 directional vent to flight position
-8.8	Engine thrust chamber chilldown terminated
0	Commit and Liftoff (1649:00.000 GMT)

6. COST PLUS INCENTIVE FEE

6.1 Flight Mission Accomplishment

Flight data evaluated to establish Preconditions of Flight (PCF) and End Conditions of Flight (ECF) were obtained from observed trajectory and attitude data transmitted by magnetic tape and printout to MDAC-WD from MSFC as requested in Douglas Report DAC-56334B, Douglas S-IVB Stage Data Acquisition Requirements Document for Saturn V Flights, June 1968 revision. Tables 6-1 and 6-2 present the predicted nominal values and the allowable deviations agreed upon between Douglas and MSFC, and the actual values of PCF and ECF, respectively, achieved during the AS-505 mission of May 18, 1969.

Performance of the S-IC and S-II stages provided PCF at S-II/S-IVB Separation Command that were within allowable tolerances. Trajectory ECF at translunar orbit injection were within tolerance; also, maximum flight values of attitude errors and rates for all phases of S-IVB operation (i.e., burn phase, parking orbit phase, and translunar orbit phase) did not exceed the respective allowable tolerances. All received command signals were recognized, and all end condition command signals were given. It was concluded for purposes of incentive achievement, therefore, that all PCF and ECF were achieved.

6.2 Telemetry Performance

Evaluation of the telemetry performance indicated that the telemetry system operated at 98.9 percent efficiency during the telemetry performance evaluation period (TPEP) phase I (liftoff to first S-IVB engine cutoff plus 10 sec) and performed at 98.1 percent efficiency during the TPEP phase II (liftoff to planned LV/SC separation).

The results of the telemetry performance analysis are shown in Table 6-3.

TABLE 6-1

S-IVB-505 PRECONDITIONS OF FLIGHT (PCF)
(S-II/S-IVB SEPARATION COMMAND)

PARAMETER	UNITS	NOMINAL*	ACTUAL	ALLOWABLE DEVIATION	ACTUAL DEVIATION
Range	km	1653.6	1642.0	+34.6 -36.8	-11.6
Crossrange	km	28.9	28.8	+3.5 -3.2	-0.1
Altitude	km	188.4	187.5	+5.7 -6.4	-0.9
Velocity Vector Magnitude	m/s	6914.9	6900.7	+60.0 -80.6	-14.2
Velocity Vector Direction (Path Angle from Local Horizontal)	deg	0.72	0.73	+0.59 -0.53	+0.01
Velocity Vector Direction (Heading Azimuth from True North)	deg	82.58	82.49	+0.32 -0.37	-0.09
Pitch Attitude	deg	-97.5	-96.9	±6.0	+0.6
Pitch Rate	deg/sec	0	0	±1.5	0
Yaw Attitude	deg	+0.1	+0.1	±5.0	+0.0
Yaw Rate	deg/sec	0	0	±1.5	0
Roll Attitude	deg	0	-0.1	±5.0	-0.1
Roll Rate	deg/sec	0	0	±1.5	0

*Derived from post launch predicted trajectory for the actual flight azimuth of 72.028 degrees.

TABLE 6-2

S-IVB-505 END CONDITIONS OF FLIGHT (ECF)
S-IVB TRANSLUNAR INJECTION (SHEET 1 OF 2)

A. Trajectory Parameters (Evaluated at Translunar Injection)					
PARAMETER	UNITS	NOMINAL*	ACTUAL	ALLOWABLE DEVIATION	ACTUAL DEVIATION
Inclination	deg	31.691	31.698	±0.196	+0.007
Node	deg	123.537	123.515	±0.411	-0.022
C ₃	M ² /S ²	-1,307,603	-1,308,476	+254,667 -256,257	-873
Eccentricity	---	0.9784	0.9783	±0.0042	-0.0001
B. Attitude Control Parameters					
PARAMETER	UNITS	ALLOWABLE ENVELOPE	MAXIMUM FLIGHT VALUE		
S-IVB First Burn Phase					
Pitch Attitude Error	deg	±7.0	+2.0		
Yaw Attitude Error	deg	±7.0	-0.8		
Roll Attitude Error	deg	±5.0	+0.5		
Pitch Rate	deg/sec	±3.0	-0.9		
Yaw Rate	deg./sec	±3.0	-0.2		
Roll Rate	deg/sec	±1.5	-0.7		
Parking Orbit					
Pitch Attitude Error	deg	±4.0	+2.8		
Yaw Attitude Error	deg	±4.0	+1.3		
Roll Attitude Error	deg	±5.0	+1.3		
Pitch Rate	deg/sec	±1.5	-0.2		
Yaw Rate	deg/sec	±1.5	+0.4		
Roll Rate	deg/sec	±1.5	+0.4		

TABLE 6-2

S-IVB-505 END CONDITIONS OF FLIGHT (ECF)
 S-IVB TRANSLUNAR INJECTION (SHEET 2 OF 2)

PARAMETER	UNITS	ALLOWABLE ENVELOPE	MAXIMUM FLIGHT VALUE
Second Burn and Translunar Coast Orbit (until LM physical separation)**			
Pitch Attitude Error	deg	±7.0	-6.0
Yaw Attitude Error	deg	±7.0	-6.0
Roll Attitude Error	deg	±5.0	-0.9***
Pitch Rate	deg/sec	±2.1	-1.4
Yaw Rate	deg/sec	±2.1	+1.3
Roll Rate	deg/sec	±1.5	-1.2

*Derived from post launch predicted trajectory for May 18, 1969 first opportunity restart and a flight azimuth of 72.028 degrees.

**LM physical separation occurred one hour, 17 minutes after S-IVB second burn cutoff signal. The maximum flight values shown also apply to the period ending at initiation of the Spacecraft Evasive Maneuver which occurred 43 minutes later. Therefore, both the Contractor and the Customer's positions on attitude control ECF requirements were satisfied.

***Maximum value excluding the maneuver to spacecraft separation attitude. The allowable envelope for roll attitude error was temporarily exceeded during this period. This was a normal occurrence and is excluded for incentive purposes since the allowable envelopes are not applicable during normal transients and maneuvers.

TABLE 6-3

FLIGHT TELEMETRY PERFORMANCE SUMMARY (SHEET 1 OF 3)

ITEM	DESCRIPTION	TOTAL
1.	Total number of measurements listed in the S-IVB-505 Instrumentation Program and Components List, Drawing 1B43571, "AD"	388
2.	<p>Measurements known to be inoperative at start of automatic launch sequence.</p> <p>The function of the following measurements is to monitor the output voltage of exploding bridge-wires (EBW) by means of pulse sensors during checkout. The pulse sensors are removed prior to launch, thus making the measurements inoperative during flight.</p> <p style="padding-left: 40px;">K0141-411 Event - R/S 1 Pulse Sensor K0142-411 Event - R/S 2 Pulse Sensor K0149-404 Event - Ullage Jettison 1 P/S K0150-404 Event - Ullage Jettison 2 P/S K0169-404 Event - EBW Pulse Sensor OFF Indication K0176-404 Event - Ullage Rocket Ignition P/S 1 Ind. K0177-404 Event - Ullage Rocket Ignition P/S Ind.</p> <p>The following measurement was listed in the IP&CI, and the capability to make the measurements existed on the stage. MSFC did not require the associated rate gyro installation; therefore, the measurement is inoperative.</p> <p style="padding-left: 40px;">K0152-404 Event - Rate Gyro Wheel Speed OK Ind.</p>	8
3.	<p>Measurement failures prior to start of Automatic Launch Sequence.</p> <p style="padding-left: 40px;">D0254-403 Press - LOX Tank Repress Spheres L0019-408 Level - Liquid Hydrogen Pos C</p>	2

TABLE 6-3

FLIGHT TELEMETRY PERFORMANCE SUMMARY (SHEET 2 OF 3)

ITEM	DESCRIPTION	TOTAL
4.	<p>Measurements wholly transmitted landline to the Launch Control Center (LCC):</p> <p style="padding-left: 40px;">D0576-408 Press - Fuel Tank Ullage Umbilical H/W</p> <p style="padding-left: 40px;">D0577-406 Press - Oxid Tank Ullage Umbilical H/W</p>	2
5.	The total number of measurements to be evaluated for incentive performance for both TPEP phase I and phase II is item 1 minus the sum of items 2, 3, and 4.	376
6.	<p>Measurements which were failures during TPEP phase I (Liftoff to first S-IVB engine cutoff plus 10 sec). Details regarding these measurement failures may be obtained in section 18 of this report.</p> <p style="padding-left: 40px;">B0019-427 Acoust - Aft Skirt Sta 2880-Ext</p> <p style="padding-left: 40px;">B0025-426 Acoust - Sta 3220, Pos I-Ext</p> <p style="padding-left: 40px;">C0200-401 Temp - LH2 Injection</p> <p style="padding-left: 40px;">D0230-403 Press - GOX/GH2 Burner GH2 Injector</p>	4
7.	<p>Measurements which were failures during TPEP phase II (Liftoff to planned LV/SC separation). Details regarding these measurement failures may be obtained in section 18 of this report.</p> <p>All measurements which were failures during TPEP phase I are included as phase II failures because phase II encompasses phase I. These four measurements are shown in item 6 above.</p> <p>In addition to those measurements which were failures during TPEP phase I, the following three measurements were failures during phase II.</p> <p style="padding-left: 40px;">D0104-403 Press - LH2 Press Module Inlet</p> <p style="padding-left: 40px;">D0236-403 Press - Ambient He Pneumatic Sphere</p> <p style="padding-left: 40px;">E0239-401 Vib - LOX Turbine Bypass VLV-TAN</p>	7

TABLE 6-3

FLIGHT TELEMETRY PERFORMANCE SUMMARY (SHEET 3 OF 3)

ITEM	DESCRIPTION	TOTAL
7. (Cont)	<p>Calculation of phase I performance:</p> <p>Item 5 minus item 6, divided by item 5, multiplied by 100, and rounded off to the nearest one-tenth of one percent.</p> $\frac{376-4}{376} \times 100 = 98.9 \text{ percent}$ <p>Calculation of phase II performance:</p> <p>Item 5 minus item 7, divided by item 5, multiplied by 100, and rounded off to the nearest one-tenth of one percent.</p> $\frac{376-7}{376} \times 100 = 98.1$	
8.	<p>In addition to the failures noted above, the following measurement failed during the phase II period. Since the measurement fulfilled its intended purpose, it was not considered a failure for CPIF purposes.</p> <p>A0010-403 Accel - Gimbal Block-Pitch-Low Freq.</p>	

7. TRAJECTORY

7.1 Comparison Between Actual and Preflight Predicted Trajectories

This section presents a comparison between the actual trajectory (based on tracking and telemetry data) and the preflight predicted trajectory. The predicted trajectory for the S-IC and S-II stages is the same as that presented in the Boeing post-launch operational trajectory. The S-IVB stage portion of the predicted trajectory is the same as that presented in the Douglas predicted trajectory for a flight azimuth of 72.028 degrees. Figures are presented comparing the actual and predicted values of altitude, surface range, crossrange position, crossrange velocity, inertial velocity, axial acceleration, inertial flight path elevation angle, inertial flight path azimuth angle for the S-IC/S-II, S-IVB first burn, and S-IVB second burn phases of the mission. Figures 7-1 through 7-32 compare the actual and predicted histories for each trajectory parameter. Tables 7-1 through 7-10 show conditions at certain significant event times.

The actual trajectory of the AS-505 flight was very close to nominal. Liftoff occurred at the planned time of 11:49 AM EST at an actual flight azimuth of 72.028 deg, corresponding to a time of guidance reference release of 7.675 sec after the opening of the launch window at 72 deg. At S-II/S-IVB separation command the trajectory can be characterized as being low, short, slow, and to the left, as shown in table 7-3. To obtain the desired parking orbit the S-IVB stage burned 1.85 sec longer than predicted. Trajectory conditions at parking orbit insertion are presented in table 7-5.

S-IVB restart was accomplished over the Pacific Ocean during the first restart opportunity within 2 sec of the predicted time. The S-IVB stage burned for 1 sec less than predicted in order to obtain the desired translunar orbit. Trajectory conditions at translunar orbit injection are presented in table 7-9. Table 7-10 presents trajectory conditions at S-IVB/CSM separation.

7.2 Powered Flight Simulated Trajectory Evaluation

A five-degree-of-freedom trajectory simulation program employing a differential correction technique was used to find control parameter adjustments which would yield a trajectory simulation most closely fitting the observed trajectory in the least squares sense. The control parameters selected were engine thrust and weight flow data obtained from the engine system analysis and pitch and yaw thrust misalignment angles.

For the S-IVB first burn it was necessary to constrain the propellant consumption to the best estimate mass simulation. Only the thrust and misalignment angles were used to determine the simulated trajectory. Thrust from the propulsion tape was increased by 1.12 percent, and the simulated misalignment angles were 0.18 deg in pitch and -0.30 deg in yaw. The deviations between the observed and simulated trajectory for first burn are shown in figure 7-33. Listed below is a table of predicted and actual thrust, weight flow, and specific impulse averages:

<u>First Burn</u>	<u>Predicted Average* Value</u>	<u>Simulated Average* Value</u>
Thrust (lbF)	205,693	206,874
Weight Flow (lbm/sec)	480.28	483.13
Specific Impulse (sec)	428.35	428.25

*Averages from 90% thrust to cutoff.

For the S-IVB second burn all four control parameters were used. However, it was necessary to slightly reshape the thrust profile in order to obtain a reasonable fit of the observed trajectory. This was done by imputing a variable thrust multiplier to the thrust obtained from the propulsion tape. Figure 7-34 is a plot of the reshaped thrust and figure 7-35 is a plot of the difference in thrust between the propulsion tape thrust and the reshaped thrust used in the analysis. After the thrust had been reshaped, the differential correction technique was applied to further adjust the level of the thrust and weight flow and to determine the

misalignment angles. The thrust level was increased by 40.97 percent and the weight flow was increased by +0.11 percent. The simulated misalignment angles were +0.38 in pitch and +0.37 in yaw. The deviations between the observed and simulated trajectory for second burn are shown in figure 7-36. Listed below is a table of predicted and actual thrust, weight flow, and specific impulse averages:

<u>Second Burn</u>	<u>Predicted Average* Value</u>	<u>Simulated Average* Value</u>
Thrust (lbF)	194,064	194,979
Weight Flow (lbm/sec)	452.49	454.49
Specific Impulse (sec)	428.89	429.01

*Averages from 90% thrust to cutoff.

The pitch and yaw thrust misalignment angles presented are compared to the values established by the control system analysis in the table below:

<u>First Burn</u>	<u>Control System Analysis</u>	<u>Trajectory Simulation</u>
Pitch misalignment (deg)	+0.33	+0.18
Yaw Misalignment (deg)	+0.38	-0.30

<u>Second Burn</u>	<u>Control System Analysis</u>	<u>Trajectory Simulation</u>
Pitch misalignment (deg)	+0.51	+0.38
Yaw Misalignment (deg)	+0.45	+0.37

A positive thrust vector misalignment in the pitch plane causes a nose-above-command attitude, and a positive misalignment in the yaw plane causes a nose-left-of-commanded attitude, looking downrange.

The total vehicle weights as determined by trajectory best-estimate-mass simulation are compared with predicted at engine start command and engine cutoff command in the following table.

<u>First Burn</u>	<u>Predicted (lbm)</u>	<u>Simulated (lbm)</u>
Engine Start Command	364,528	365,110*
Engine Cutoff Command	295,267	294,906*

*Best Estimate Mass.

<u>Second Burn</u>	<u>Predicted (lbm)</u>	<u>Simulated (lbm)</u>
Engine Start Command	292,592	292,608
Engine Cutoff Command	137,434	137,526

The results of the postflight trajectory simulation can be applied to explain the deviation from predicted in the duration of the first and second burn times. The table below itemizes the contributions of the various performance parameter deviations to the observed deviations of 1.9 (long) seconds for first burn and -1.0 (short) seconds for second burn:

<u>Parameter</u>	<u>Contribution to Burntime Deviation (sec)</u>
<u>First Burn</u>	
Lower Stage Performance	+2.0
Vehicle Weight at Separation	+1.1
S-IVB Performance	-1.0
Total Explained	2.1
Total Unexplained	0.2
<u>Second Burn</u>	
Weight at Re-ignition	-1.0
S-IVB Performance	-0.2
Total Explained	-1.2
Total Unexplained	-0.2

7.3 Translunar Orbit Analysis

Following the S-IVB second cutoff the nominal timeline was followed and the S-IVB performed the scheduled attitude and venting timeline as predicted. S-IVB/SC separation occurred as predicted, the evasive maneuver was performed, and a safe distance between the CSM/LM and the S-IVB was achieved prior to the S-IVB propellant dump and safing operations. The ground commanded propellant lead sequence was performed to verify the mission rule as to the procedure to be followed in the event of a chilldown system failure. The results of the experiment are presented in paragraph 9.9.

The S-IVB successfully performed the programmed "slingshot" maneuver and was injected into a solar orbit following lunar passage at a radius of closest approach of about 2,620 n.mi. A plot of accumulated ΔV from the propellant lead experiment and the propellant dumping and safing sequence is presented in figure 7-37.

TABLE 7-1
 CONDITIONS AT MAXIMUM DYNAMIC PRESSURE

PARAMETER		UNIT	PREDICTED	ACTUAL	DEVIATION
Time from Range Zero	(t)	sec	81.125	82.600	+1.475
Dynamic Pressure	(q)	lbf/ft ²	706.7	694.2	-12.5
Altitude	(h)	ft	42,358	43,365	+1,007
Earth-Fixed Velocity	(V _E)	ft/sec	1589.4	1623.4	+34.0
Mach Number	(M)	--	1.63	1.65	+0.02
Ambient Pressure	(P _a)	lbf/ft ²	399.2	364.2	35.0
Pitch Angle of Attach	(α)	deg	0.910	2.707	+1.797
Yaw Angle of Attach	(β)	deg	0.013	-0.667	-0.680

TABLE 7-2
CONDITIONS AT S-IC/S-II SEPARATION COMMAND

PARAMETER		UNIT	PREDICTED	ACTUAL	DEVIATION
Time from Range Zero	(t)	sec	160.978	162.310	+1.323
Altitude	(h)	ft	218,176	216,185	-1.991
Surface Range	(S)	ft	304,855	311,300	+6,445
Crossrange Distance	(Y _E)	ft	1,091	1,999	+903
Crossrange Velocity	(Y _E)	ft/sec	30.2	59.2	+29.0
Earth-Fixed Velocity	(V _E)	ft/sec	7,811.3	7,833.4	+22.1
Inertial Velocity	(V _I)	ft/sec	9,024.5	9,052.8	+28.3
Inertial Flight Path Elevation Angle	(γ _{1I})	deg	19.433	18.843	-0.585
Inertial Flight Path Azimuth Angle	(γ _{2I})	deg	75.356	75.538	+0.182
Dynamic Pressure	(q)	lbf/ft ²	8.5	11.1	+2.6
Pitch Angle of Attack	(α)	deg	0.405	1.022	+0.617
Yaw Angle of Attack	(β)	deg	0.008	0.686	+0.678

TABLE 7-3
 CONDITIONS AT S-II/S-IVB SEPARATION COMMAND

PARAMETER	UNIT	PREDICTED	ACTUAL	DEVIATION
Time from Range Zero (t)	sec	555.115	553,500	-1.615
Altitude (h)	ft	618,153	615,185	-2,968
Surface Range (S)	ft	5,419,865	5,387,292	-32,573
Crossrange Distance (Y_E)	ft	94,878	94,601	-277
Crossrange Velocity (\dot{Y}_E)	ft/sec	572.9	566.4	-6.5
Earth-Fixed Velocity (V_E)	ft/sec	21,364.3	21,317.8	-46.5
Inertial Velocity (V_I)	ft/sec	22,686.7	22,639.9	-46.8
Inertial Flight Path Elevation Angle (γ_{1I})	deg	0.724	0.730	+0.006
Inertial Flight Path Azimuth Angle (γ_{2I})	deg	82.554	82.490	-0.064

TABLE 7-4

CONDITIONS AT S-IVB FIRST GUIDANCE CUTOFF COMMAND

PARAMETER	UNIT	PREDICTED	ACTUAL	DEVIATION
Time from Range Zero (t)	sec	703.477	703.770	+0.293
Altitude (h)	ft	627,590	628,177	+587
Surface Range (S)	ft	8,689,289	8,695,132	+5,843
Crossrange Distance (Y_E)	ft	203,639	203,750	+111
Crossrange Velocity (\dot{Y}_E)	ft/sec	899.2	903.3	+4.1
Inertial Velocity (V_I)	ft/sec	25,562.6	25,562.6	0
Inertial Flight Path Elevation Angle (γ_{1I})	deg	-0.001	-0.006	-0.005
Inertial Flight Path Azimuth Angle (γ_{2I})	deg	88.479	88.498	+0.019

TABLE 7-5
 CONDITIONS AT PARKING ORBIT INSERTION

PARAMETER	UNIT	PREDICTED	ACTUAL	DEVIATION
Time from Range Zero (t)	sec	713.477	713.770	+0.293
Altitude (h)	ft	627,609	627,866	+257
Surface Range (S)	ft	8,924,651	8,930,852	+6,201
Crossrange Distance (Y_E)	ft	212,716	212,872	+156
Crossrange Velocity (\dot{Y}_E)	ft/sec	915.9	920.1	+4.2
Inertial Velocity (V_I)	ft/sec	25,568.0	25,567.9	-0.1
Inertial Flight Path Elevation Angle (γ_{1I})	deg	0.001	-0.005	-0.006
Inertial Flight Path Azimuth Angle (γ_{2I})	deg	88.913	88.933	+0.020
Apogee Altitude* (h_a)	n.mi.	99.97	99.98	+0.01
Perigee Altitude* (h_p)	n.mi.	99.96	99.98	+0.02
Apogee Velocity (V_a)	ft/sec	25,567.8	25,567.9	+0.1
Perigee Velocity (V_p)	ft/sec	25,567.9	25,567.9	0
Eccentricity (e)	---	0.0000	0.0000	0
Inclination (i)	deg	32.545	32.546	+0.001
Period (P)	min	88.194	88.195	+0.001
Descending Node (θ_n)	deg	123.148	123.132	-0.016
Orbit Energy (C_3)	m ² /sec ²	-60,732,221	-60,731,288	+933

*Measured with respect to a mean earth radius of 3,443.94 n.mi.

TABLE 7-6
CONDITIONS AT TIME BASE 6

PARAMETER	UNIT	PREDICTED	ACTUAL	DEVIATION
Time from Range Zero (t)	sec	8,627.260	8,629.2698	+2.000
Altitude (h)	ft	642,839	645,964	+3,075
Surface Range (S)	ft	63,008,293	63,032,944	+23,651
Crossrange Distance (Y_E)	ft	2,085,318	2,076,109	-9,615
Crossrange Velocity (\dot{Y}_E)	ft/sec	-8,018.0	-8,027.2	-9.2
Inertial Velocity (V_I)	ft/sec	25,569.2	25,567.6	-1.6
Inertial Flight Path Elevation Angle (γ_{1I})	deg	0.023	0.032	+0.00
Inertial Flight Path Azimuth Angle (γ_{2I})	deg	91.852	91.788	-0.064
Apogee Altitude* (h_a)	n.mi.	108.54	109.50	+0.96
Perigee Altitude* (h_p)	n.mi.	102.11	102.33	+0.22
Apogee Velocity (V_a)	ft/sec	25,525.4	25,520.8	-4.7
Perigee Velocity (V_p)	ft/sec	25,571.7	25,572.2	+0.5
Eccentricity (e)	--	0.001	0.0010	+0.000
Inclination (i)	deg	32.545	32.546	+0.001
Period (P)	min	88.395	88.416	+0.021
Descending Node (θ_n)	deg	122.454	122.438	-0.016
Orbit Energy (C_2)	m ² /sec ²	-60,640,361	-60,630,733	+9.628

*Measured with respect to a mean earth radius of 3,443.94 n.mi.

TABLE 7-7

CONDITIONS AT S-IVB SECOND ENGINE START COMMAND

PARAMETER	UNIT	PREDICTED	ACTUAL	DEVIATION
Time from Range Zero (t)	sec	9,197.26	9,199.25	+1.99
Altitude (h)	ft	644,234	649,546	+5,312
Surface Range (S)	ft	54,475,045	54,450.537	-24,508
Crossrange Distance (Y_E)	ft	-2,888,220	-2,900,566	-12,346
Crossrange Velocity (\dot{Y}_E)	ft/sec	-8,796.2	-8,796.7	-0.5
Inertial Velocity (V_I)	ft/sec	25,565.7	25,561.2	-4.5
Inertial Flight Path Elevation Angle (γ_{1I})	deg	0.040	0.047	+0.007
Inertial Flight Path Azimuth Angle (γ_{2I})	deg	69.468	69.427	-0.041

TABLE 7-8
CONDITIONS AT S-IVB SECOND CUTOFF COMMAND

PARAMETER	UNIT	PREDICTED	ACTUAL	DEVIATION
Time from Range Zero (t)	sec	9,549.634	9,550.580	+0.946
Altitude (h)	ft	1,034,815	1,049,237	14,322
Surface Range (S)	ft	44,896,623	44,907,341	+10,718
Crossrange Distance (Y_E)	ft	-6,194,707	-6,199,052	-4,345
Crossrange Velocity (\dot{Y}_E)	ft/sec	-9,981.7	-9,989.8	-8.1
Inertial Velocity (V_I)	ft/sec	35,598.2	35,585.6	-12.6
Inertial Flight Path Elevation Angle (γ_{1I}')	deg	6.932	6.924	-0.008
Inertial Flight Path Azimuth Angle (γ_{2I}')	deg	61.264	61.257	-0.007

TABLE 7-9
 CONDITIONS AT TRANSLUNAR ORBIT INJECTION

PARAMETER	UNIT	PREDICTED	ACTUAL	DEVIATION
Time from Range Zero (t)	sec	9,559.63	9,560.58	+0.95
Altitude (h)	ft	1,078,918	1,093,215	+14,297
Surface Range (S)	ft	44,574,896	44,585,957	+11,061
Crossrange Distance (Y_E)	ft	-6,294,260	-6,298,653	-4,394
Crossrange Velocity (\dot{Y}_E)	ft/sec	-9,926.8	-9,933.4	-6.6
Inertial Velocity (V_I)	ft/sec	35,574.9	35,563.0	-11.9
Inertial Flight Path Elevation Angle (γ_{1I})	deg	7.386	7.379	-0.007
Inertial Flight Path Azimuth Angle (γ_{2I})	deg	61.068	61.065	-0.003
Apogee Altitude (h_a)	n.mi.	322,356.71	321,968.76	-387.95
Perigee Altitude* (h_p)	n.mi.	116.43	118.85	+2.42
Apogee Velocity (V_a)	ft/sec	392.1	392.7	+0.6
Perigee Velocity (V_p)	ft/sec	35,879.2	35,866.6	-12.6
Eccentricity (e)	--	0.978	0.978	0
Inclination (i)	deg	31.692	31.698	+0.006
Period (P)	min	27,937.1	27,888.1	-45.0
Descending Node (θ_n)	deg	123.533	123.515	-0.018
Orbit Energy (C_2)	m ² /sec ²	-1,306,937	-1,308,476	1539

*Measured with respect to a mean earth radius of 3,443.94 n.mi.

TABLE 7-10
CONDITIONS AT CSM SEPARATION

PARAMETER	UNIT	PREDICTED	ACTUAL	DEVIATION
Time from Range Zero (t)	sec	11,048,603	10,971,000	-77.603
Altitude (h)	ft	22,827,630	21,434,829	-1,392,801
Surface Range (S)	ft	18,719,558	19,323,422	+603,864
Crossrange Distance (Y_E)	ft	-15,308,546	-15,031,237	+277,309
Crossrange Velocity (\dot{Y}_E)	ft/sec	-3,689.3	-3,817.9	-128.6
Inertial Velocity (V_I)	ft/sec	25,083.7	25,501.5	+417.8
Inertial Flight Path Elevation Angle (γ_{1I})	deg	44.973	44.033	-0.940
Inertial Flight Path Azimuth Angle (γ_{2I})	deg	68.325	67.551	-0.774
Apogee Altitude* (h_a)	n.mi.	314,200.6	313,682.6	-518.0
Perigee Altitude* (h_p)	n.mi.	117.7	119.9	+2.2
Apogee Velocity (V_a)	ft/sec	402.2	403.0	+0.8
Perigee Velocity (V_p)	ft/sec	35,868.0	35,855.0	-12.1
Eccentricity (e)	--	0.9778	0.9778	0
Inclination (i)	deg	31.688	31.694	+0.006
Period (P)	min	26,906.0	26,841.3	-64.7
Descending Node (θ_n)	deg	123.522	123.505	-0.017
Orbit Energy (C_3)	m^2/sec^2	-1,339,913	-1,342,281	-2,368

*Measured with respect to a mean earth radius of 3,443.94 n.mi.

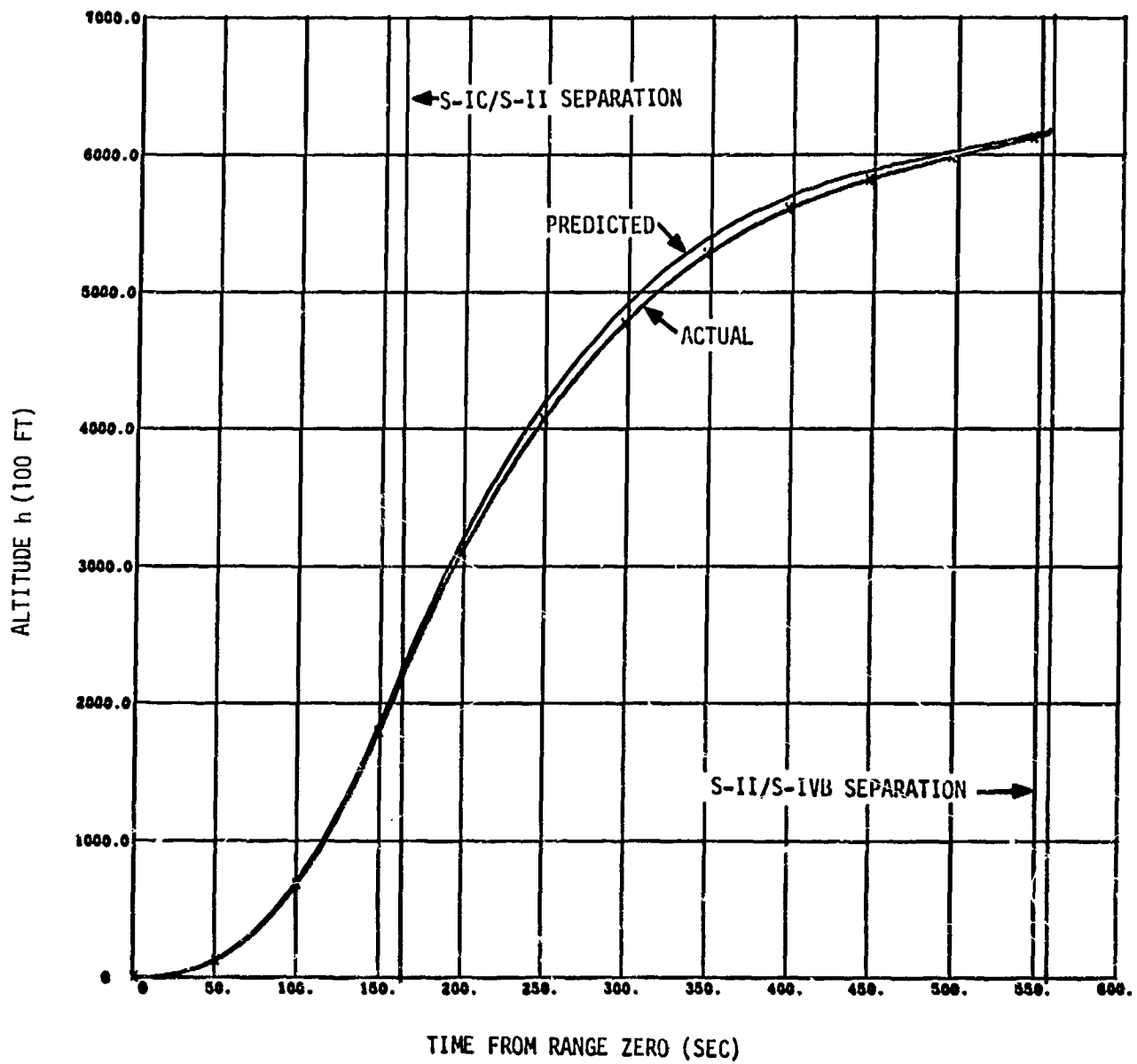

Figure 7-1 S-IC/S-II Stage Altitude History

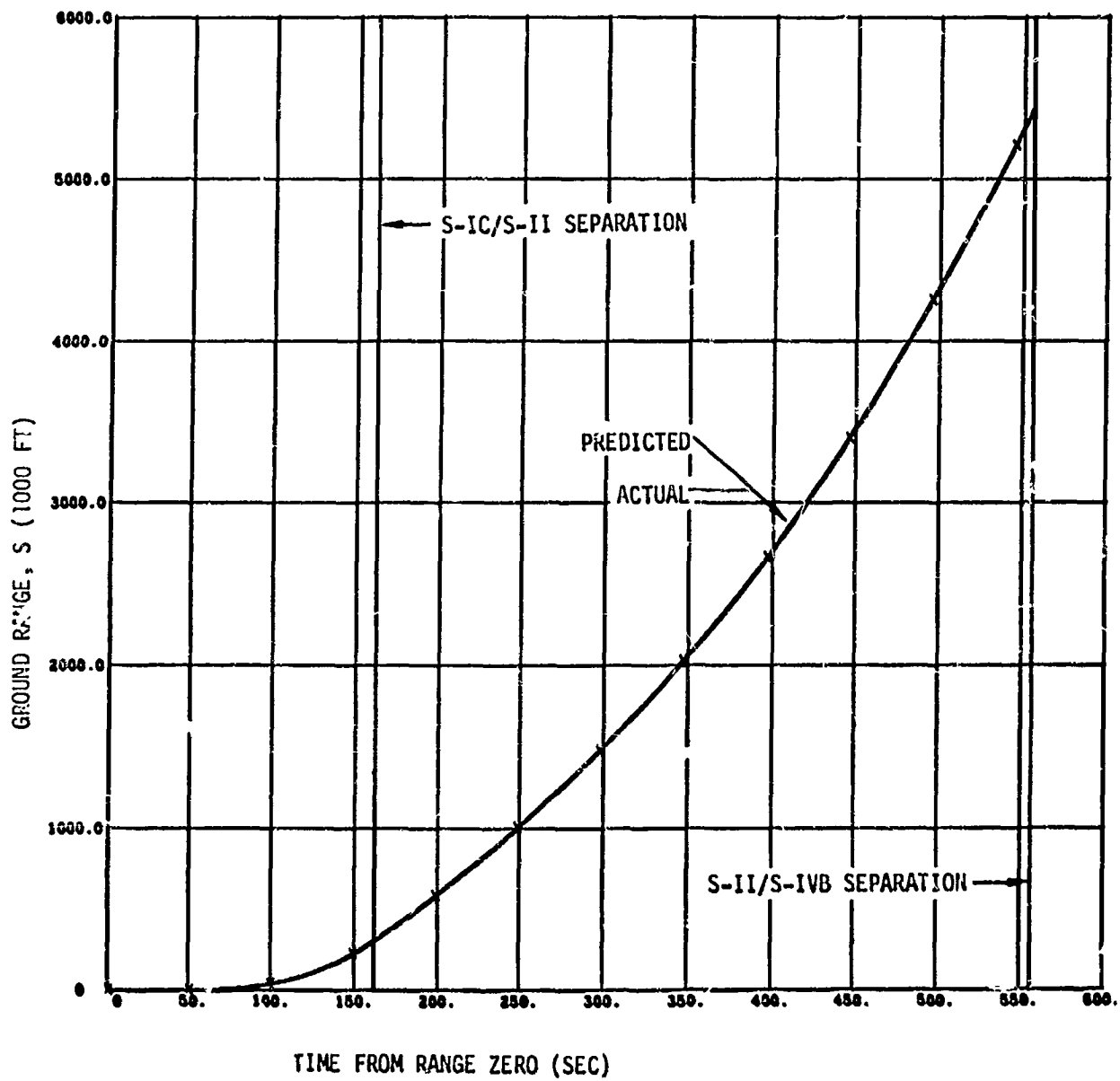

Figure 7-2 S-IC/S-II Stage Ground Range History

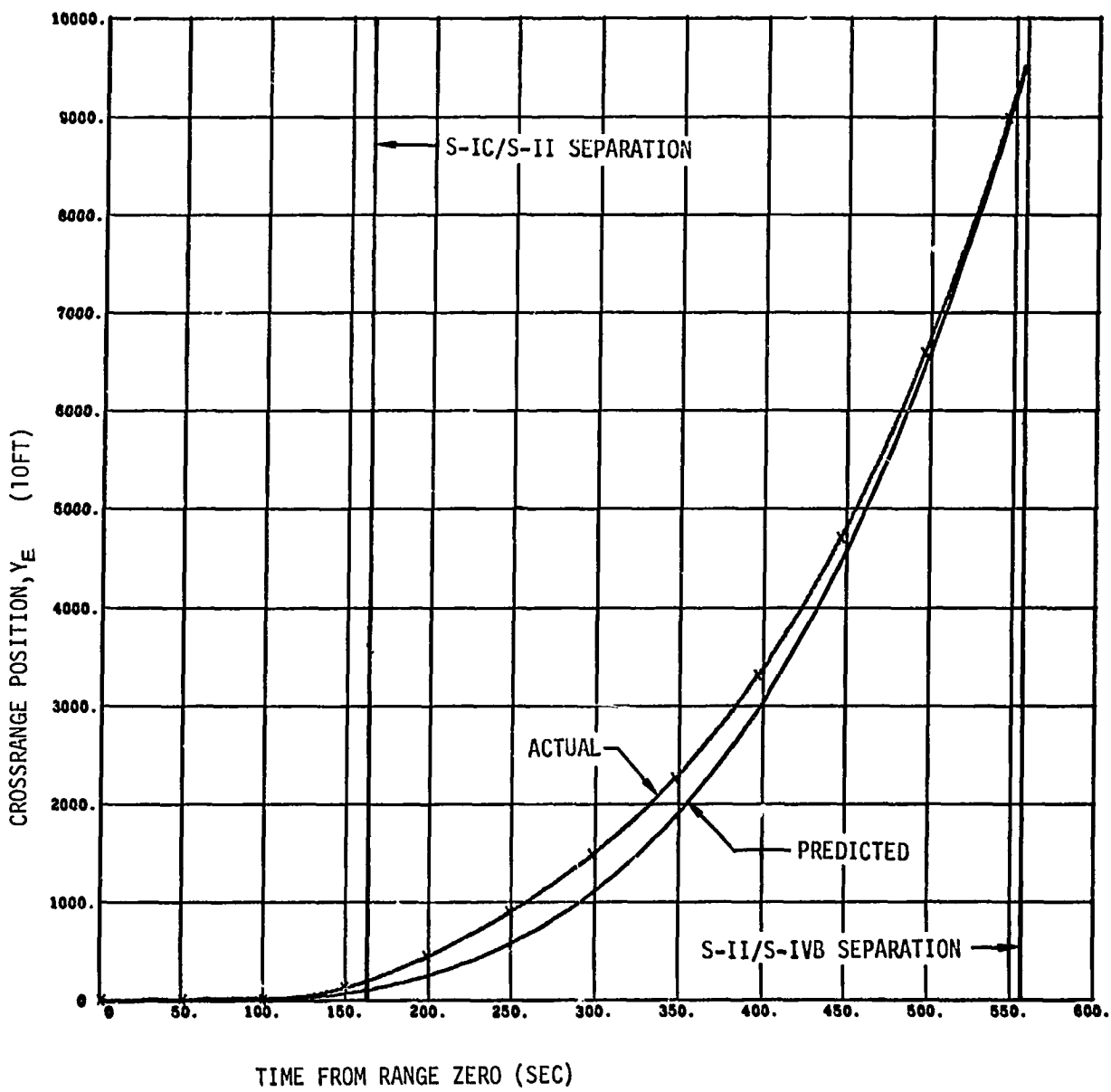

Figure 7-3 S-IC/S-II Stage Crossrange Position History

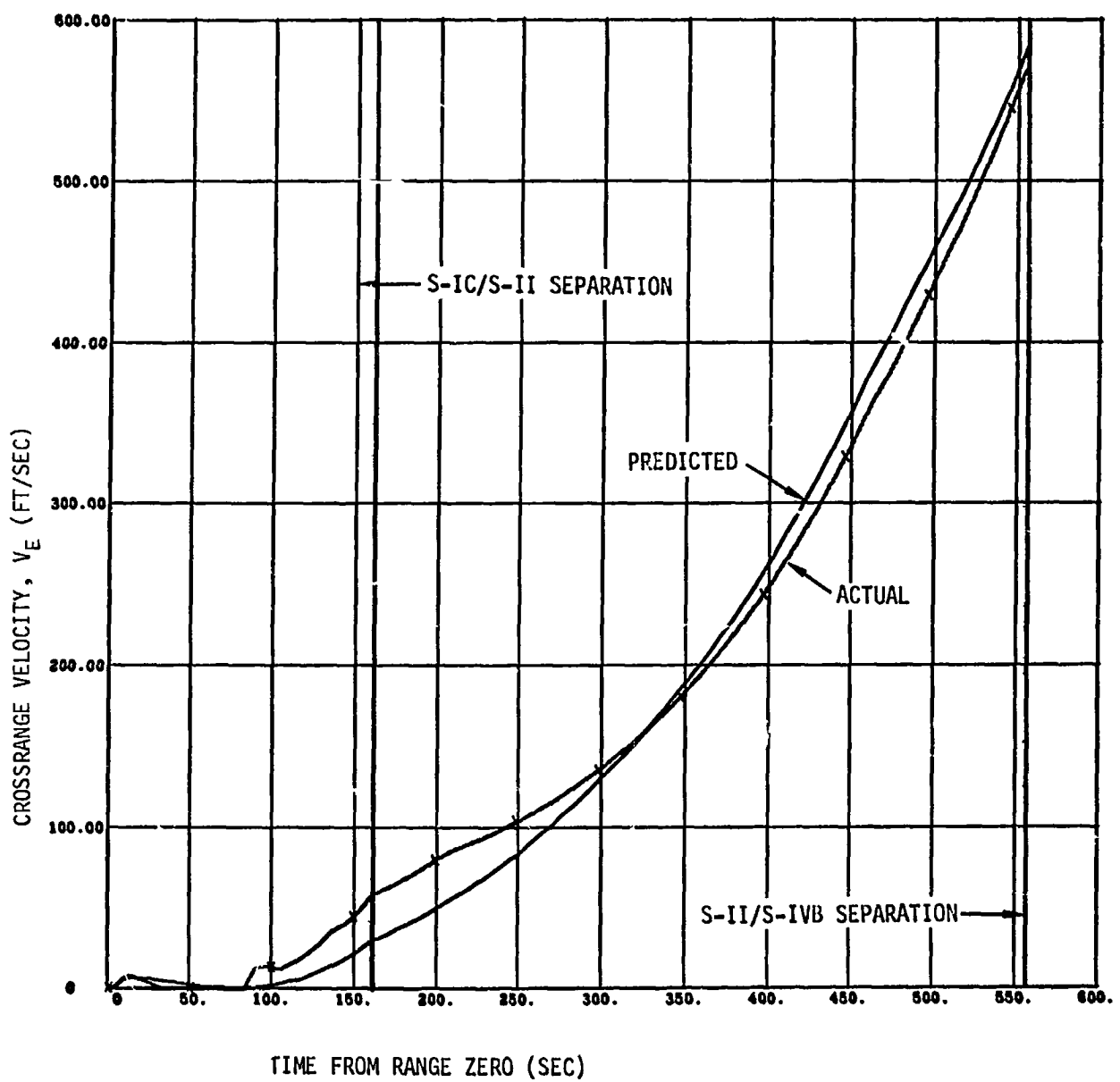

Figure 7-4 S-IC/S-II Stage Crossrange Velocity History

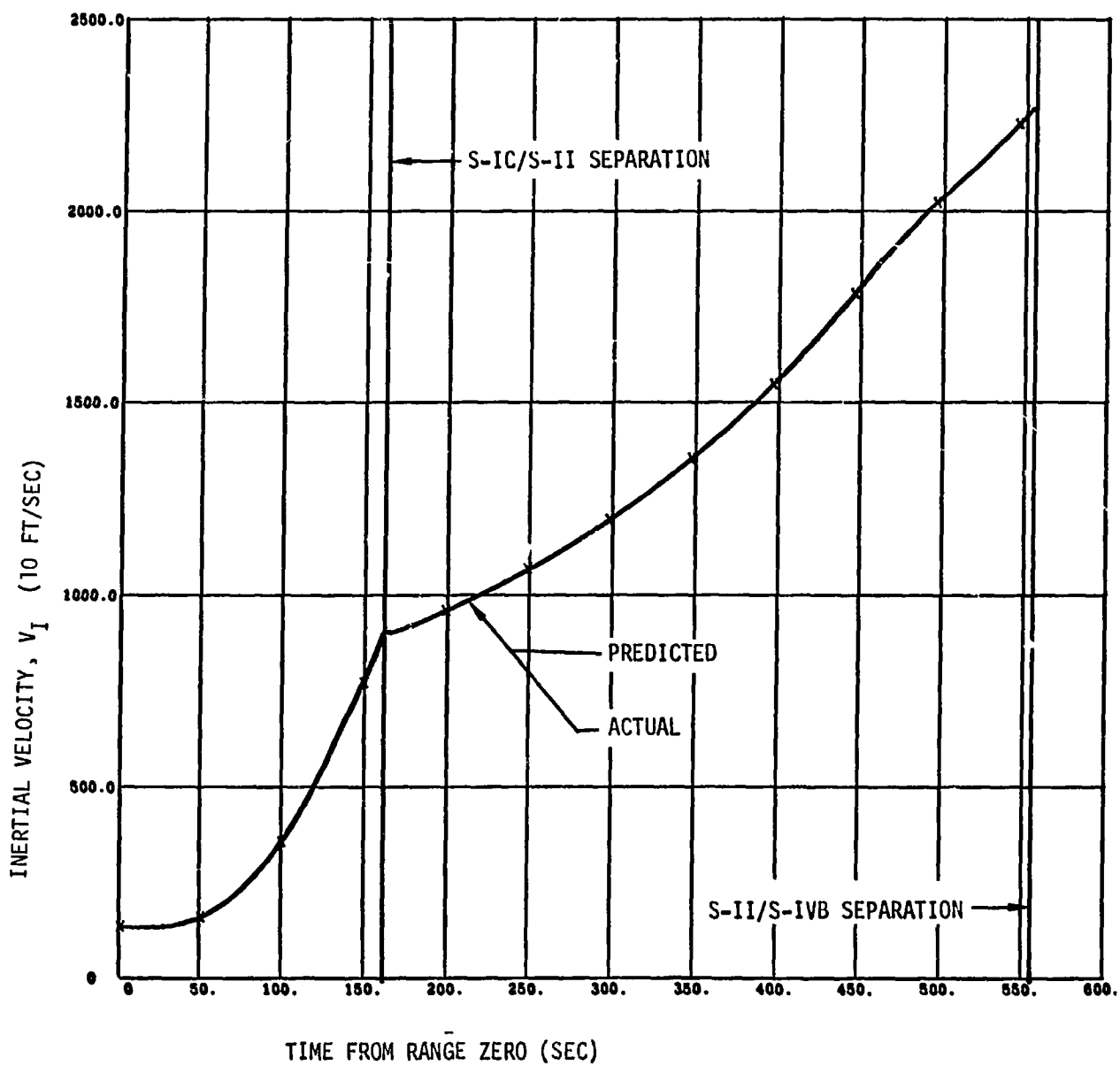

Figure 7-5 S-IC/S-II Stage Inertial Velocity History

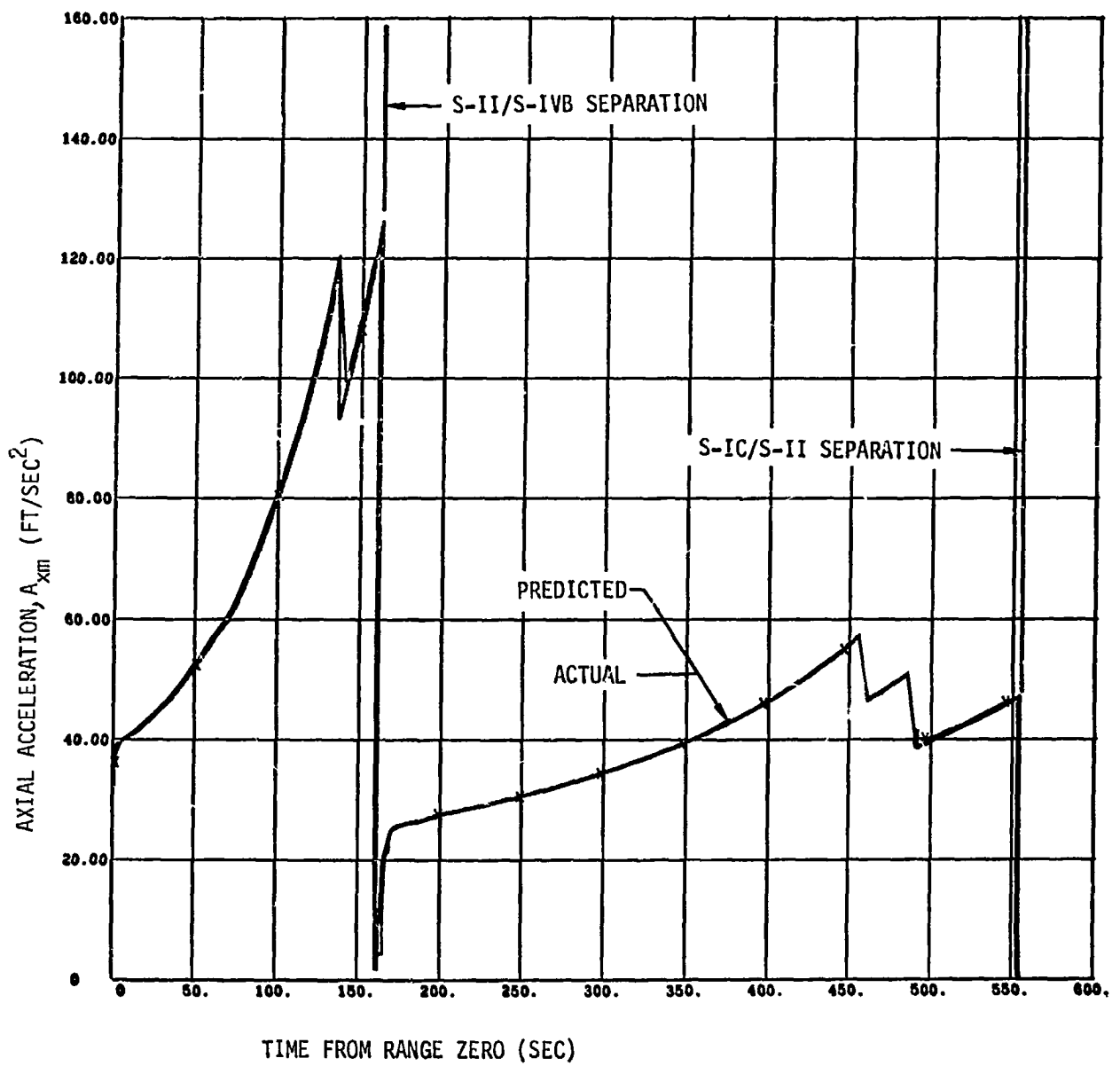

Figure 7-6 S-IC/S-II Stage Axial Acceleration History

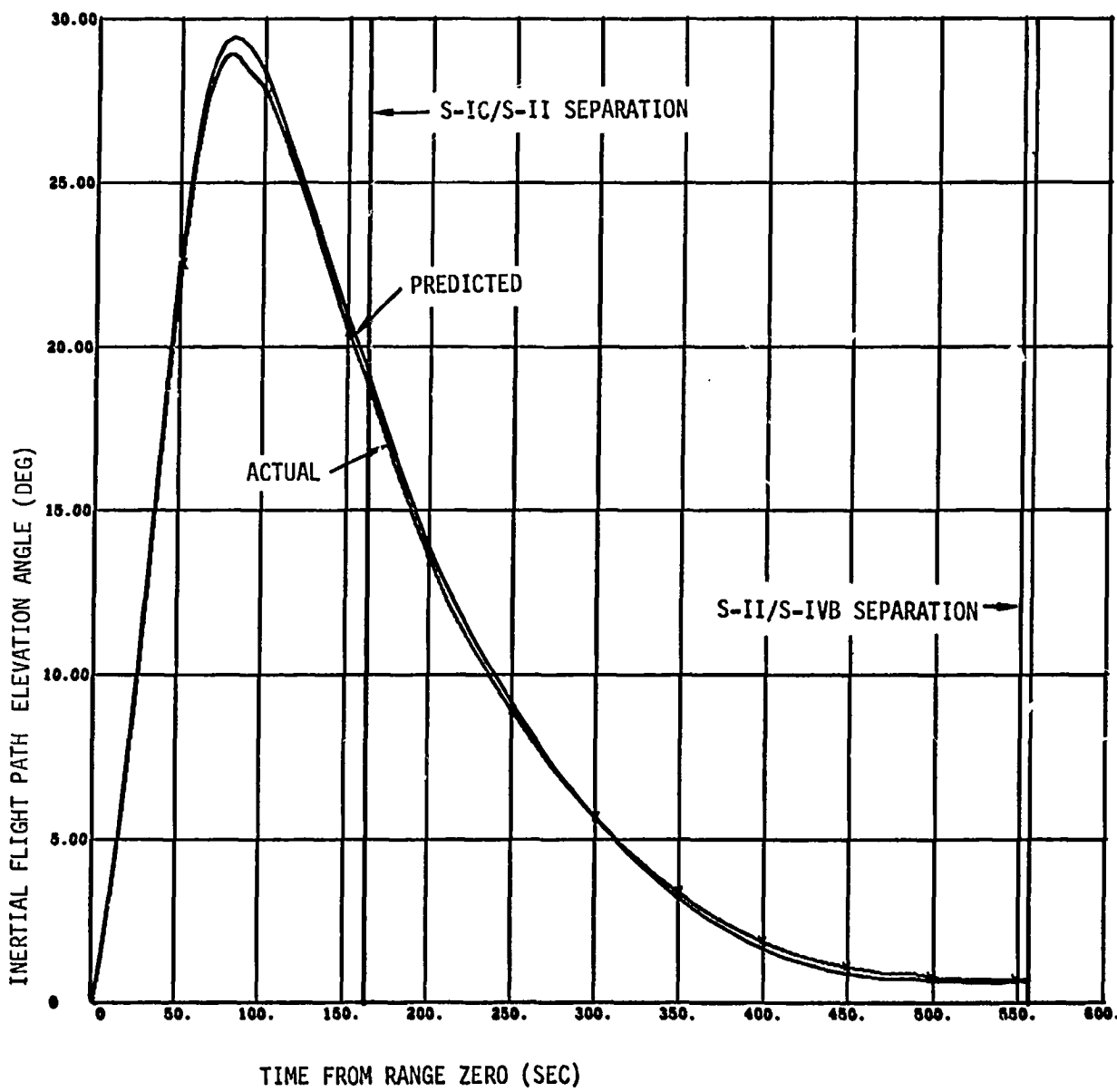

Figure 7-7 S-IC/S-II Stage Inertial Flight Path Elevation Angle History

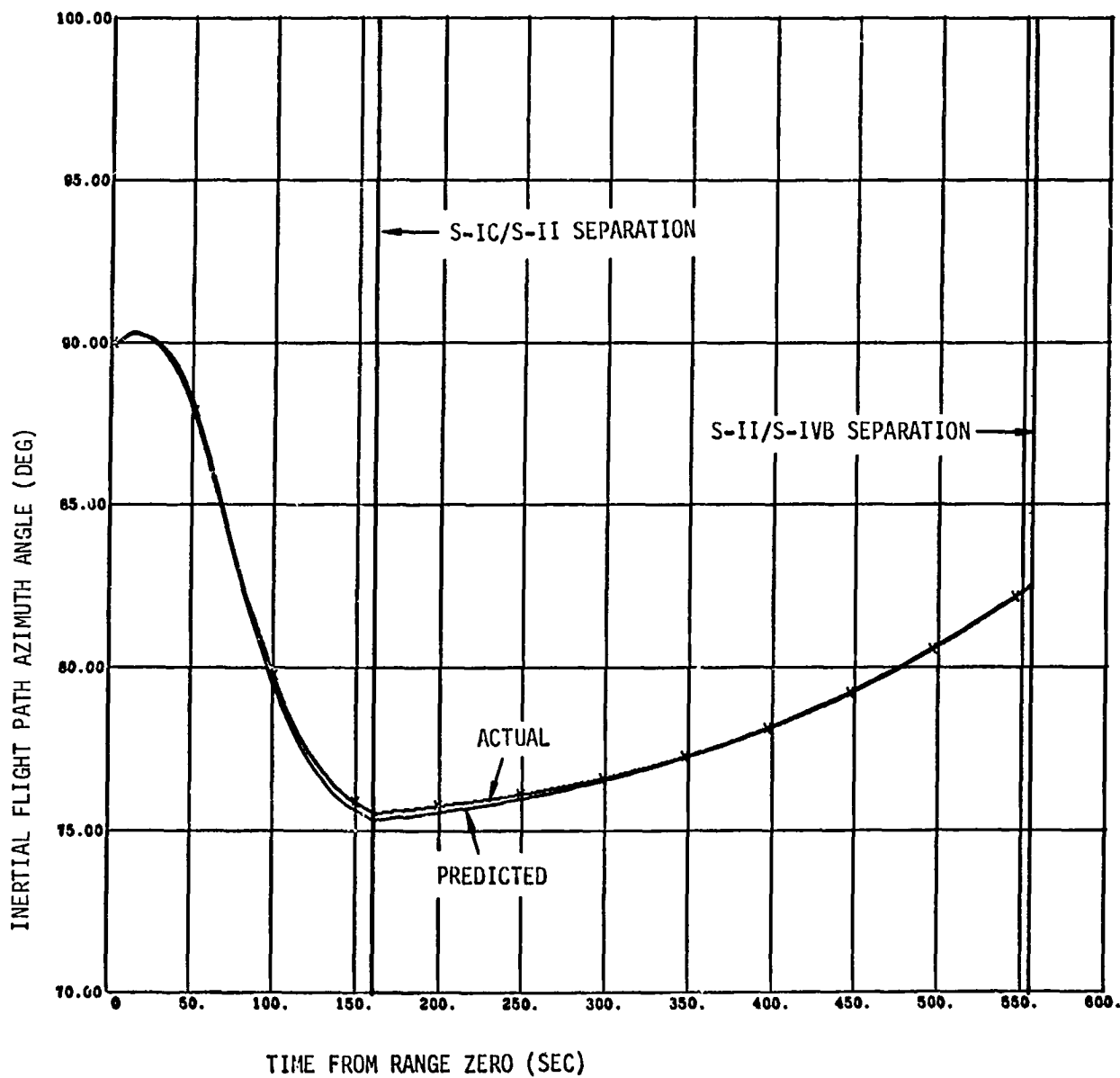

Figure 7-8 S-IC/S-II Stage Inertial Flight Path Azimuth Angle History

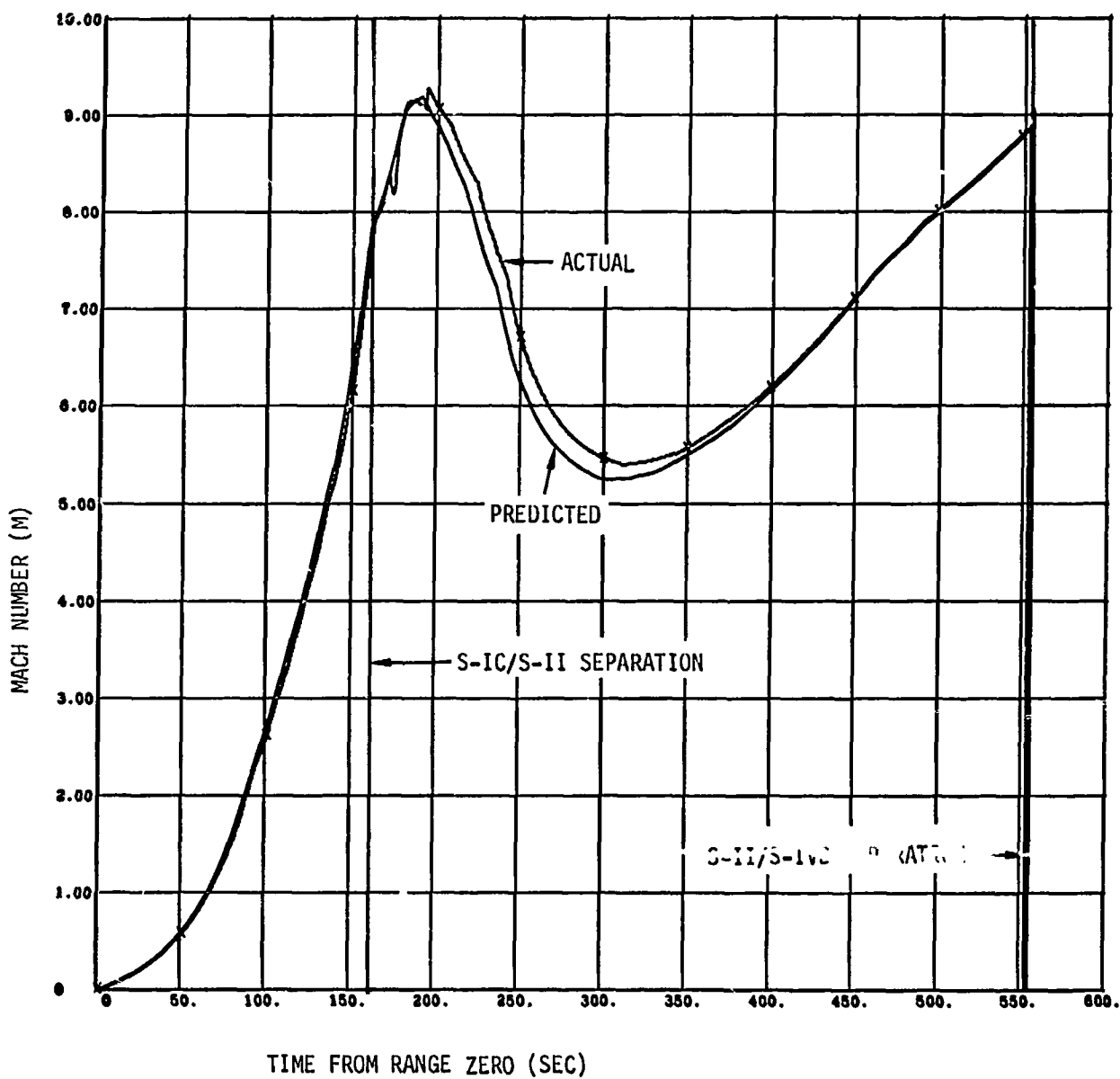

Figure 7-9 S-IC/S-II Stage Mach Number History

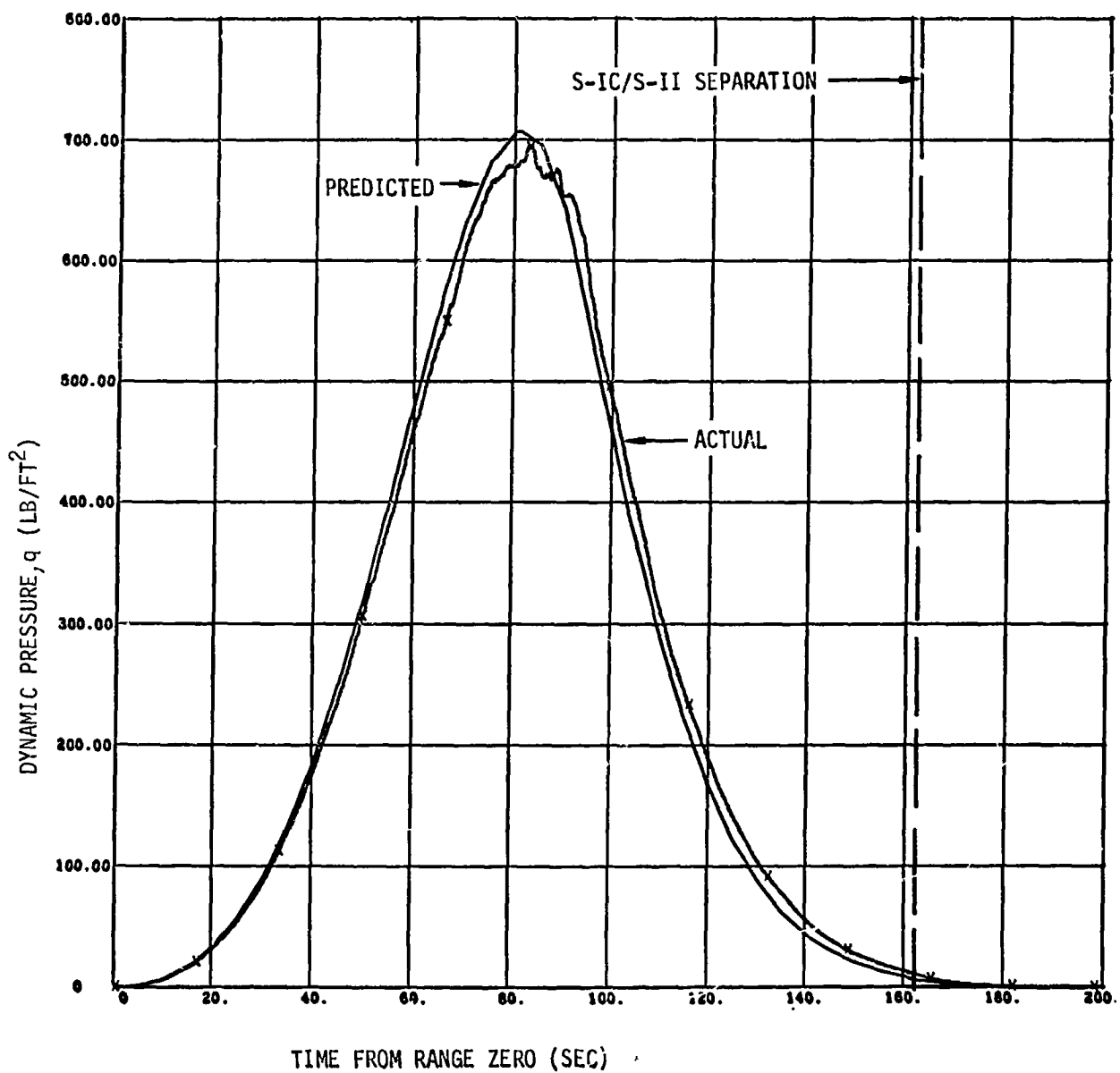

Figure 7-10 S-IC Stage Dynamic Pressure History

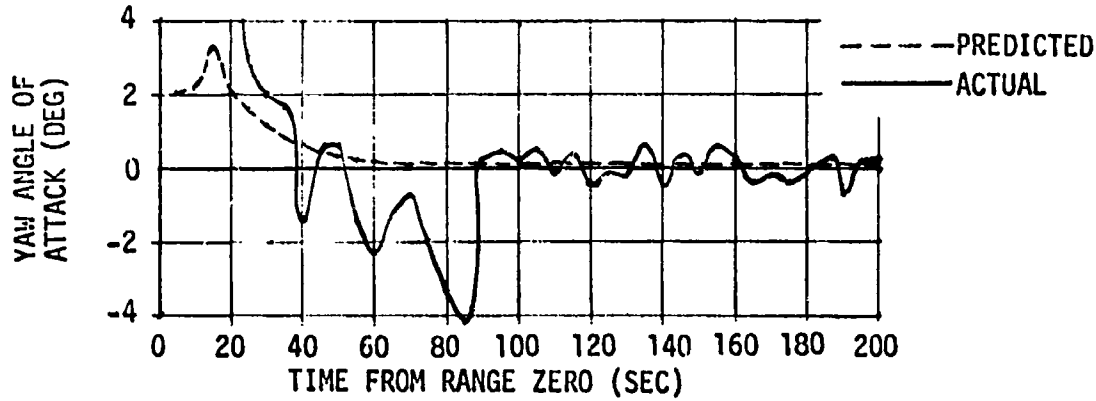
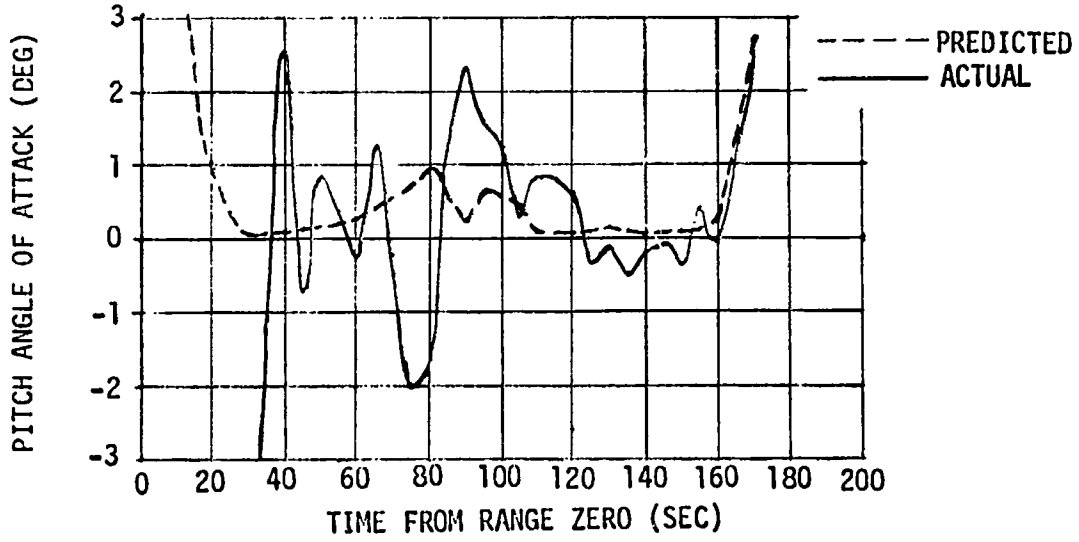
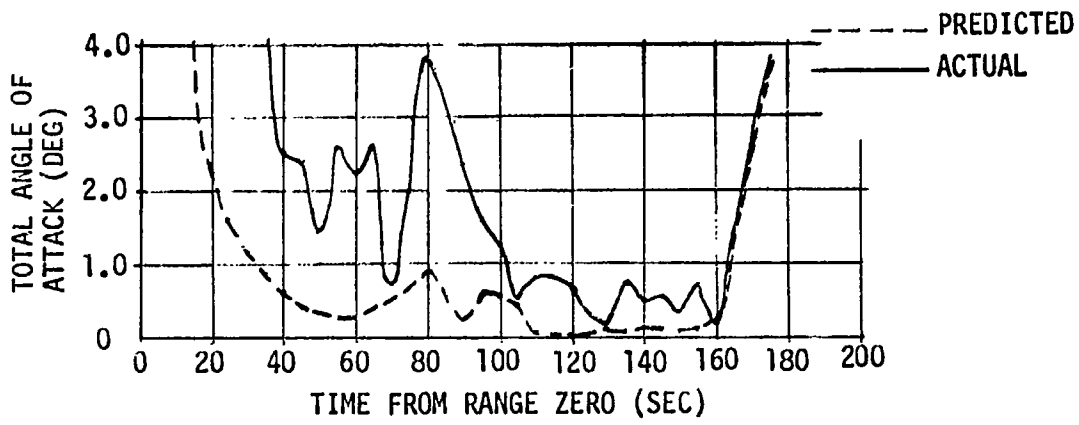

Figure 7-11 S-IC Stage Angle of Attack History

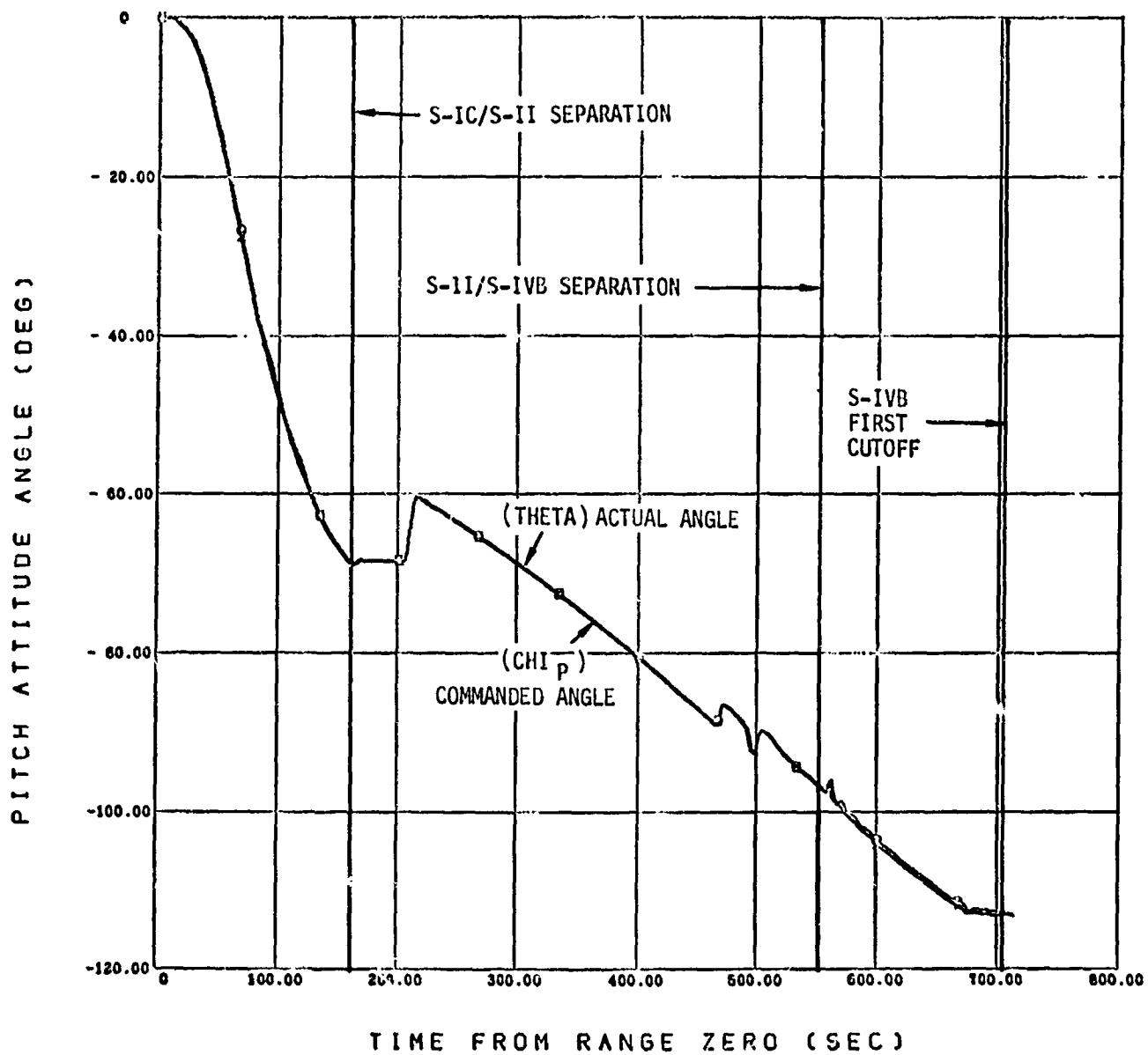

Figure 7-12 Boost Phase Pitch Attitude Angle History

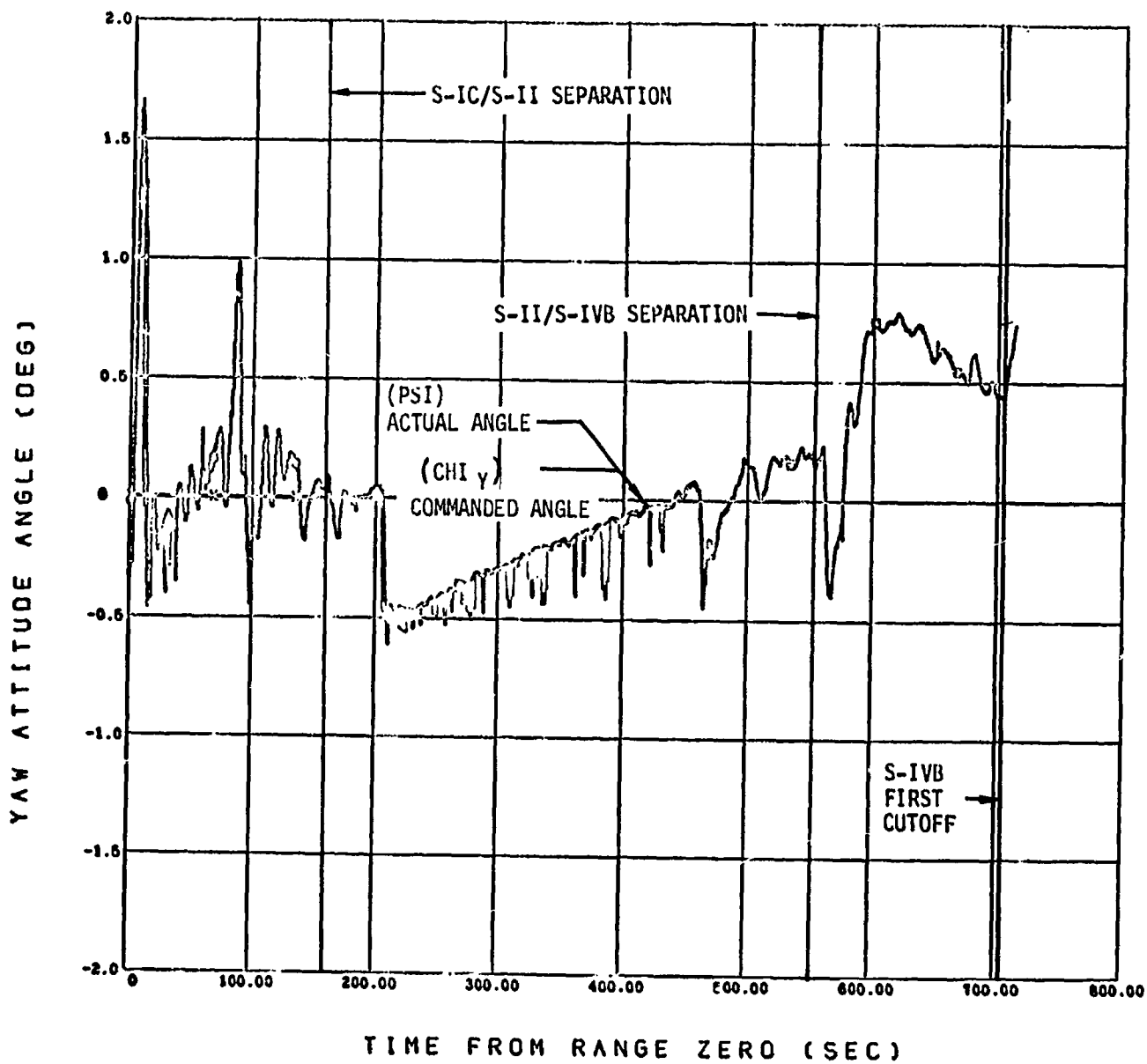

Figure 7-13 Boost Phase Yaw Attitude Angle History

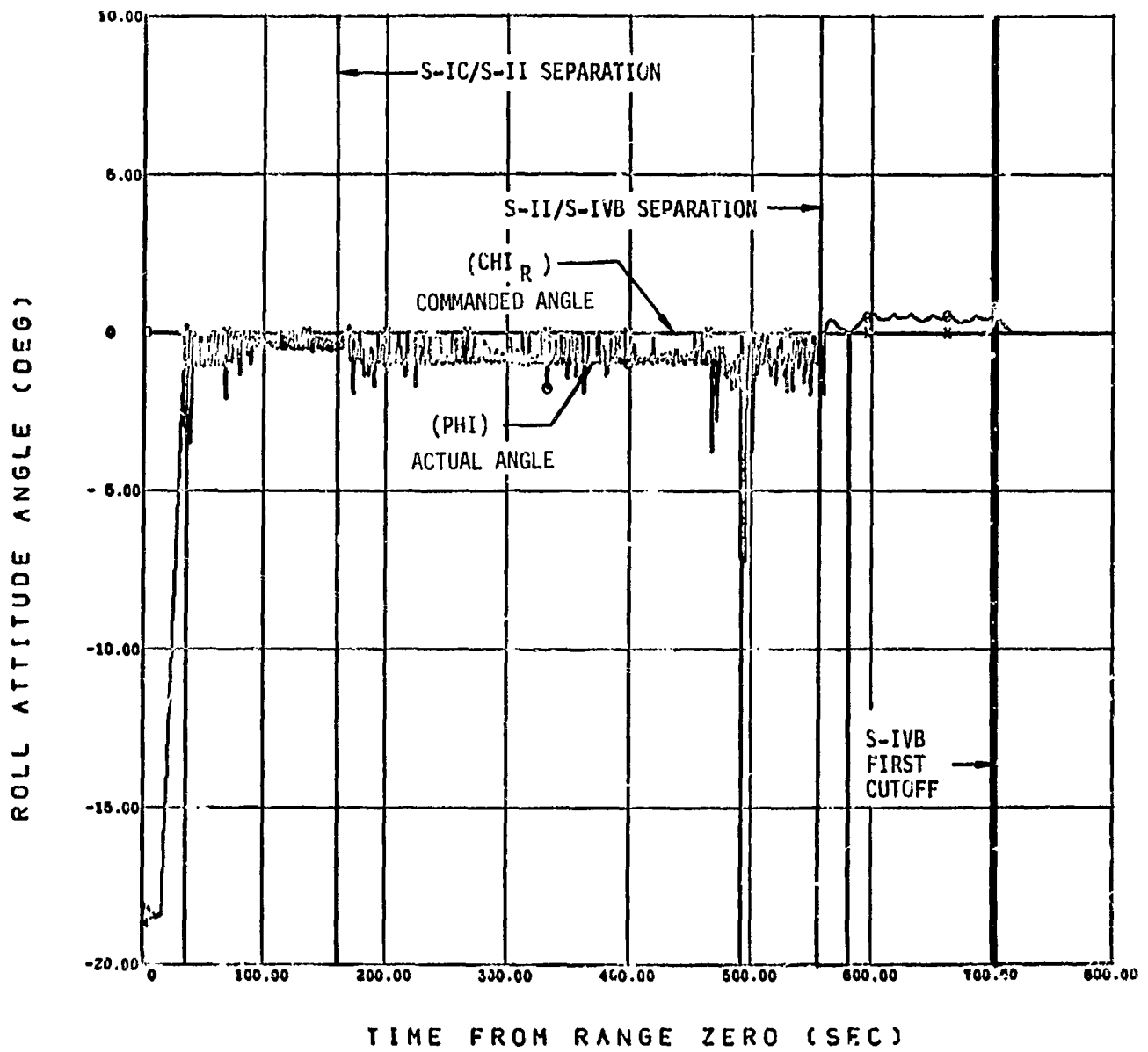

Figure 7-14 Boost Phase Roll Attitude Angle History

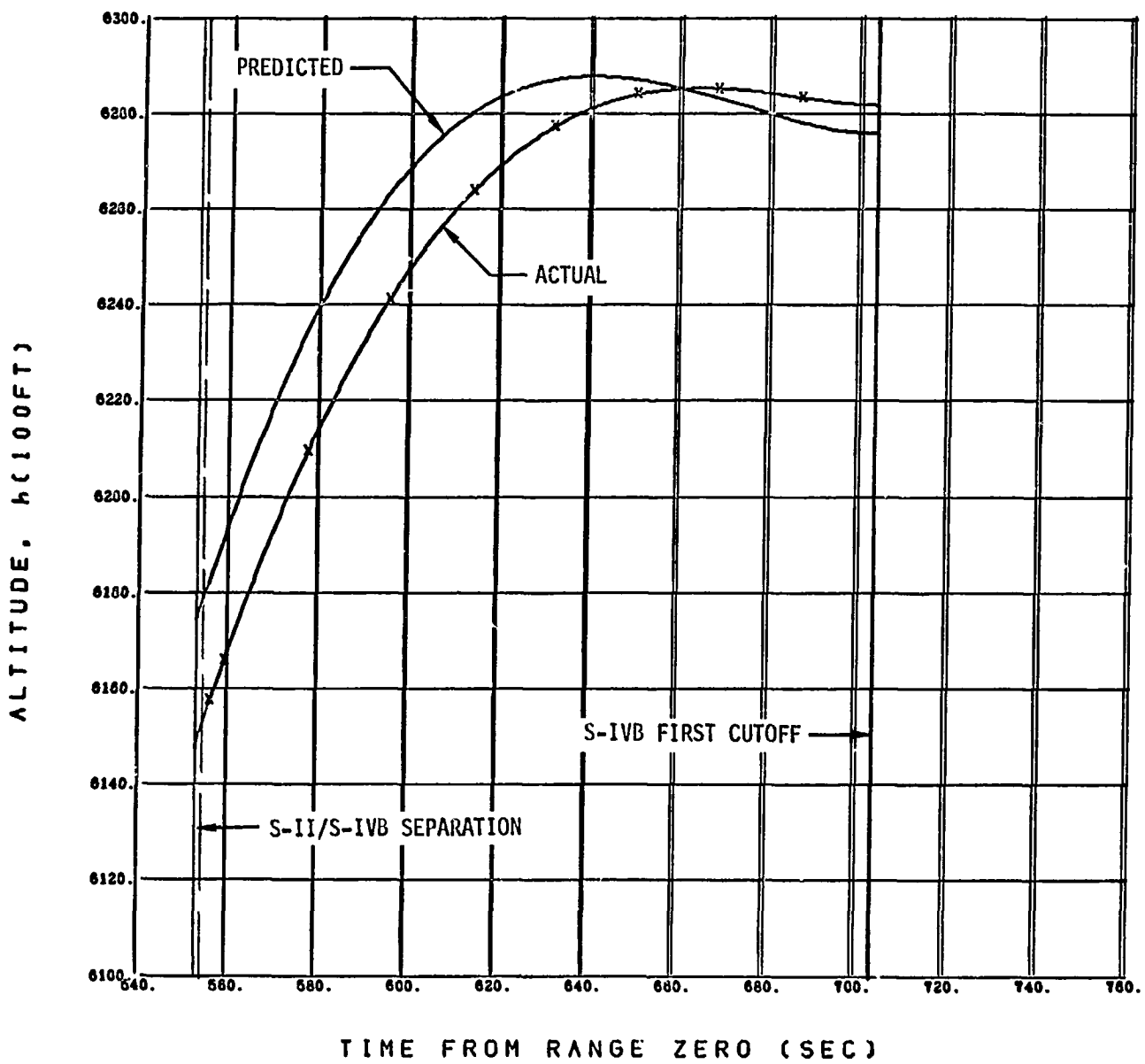

Figure 7-15 S-IVB Stage First Burn Altitude History

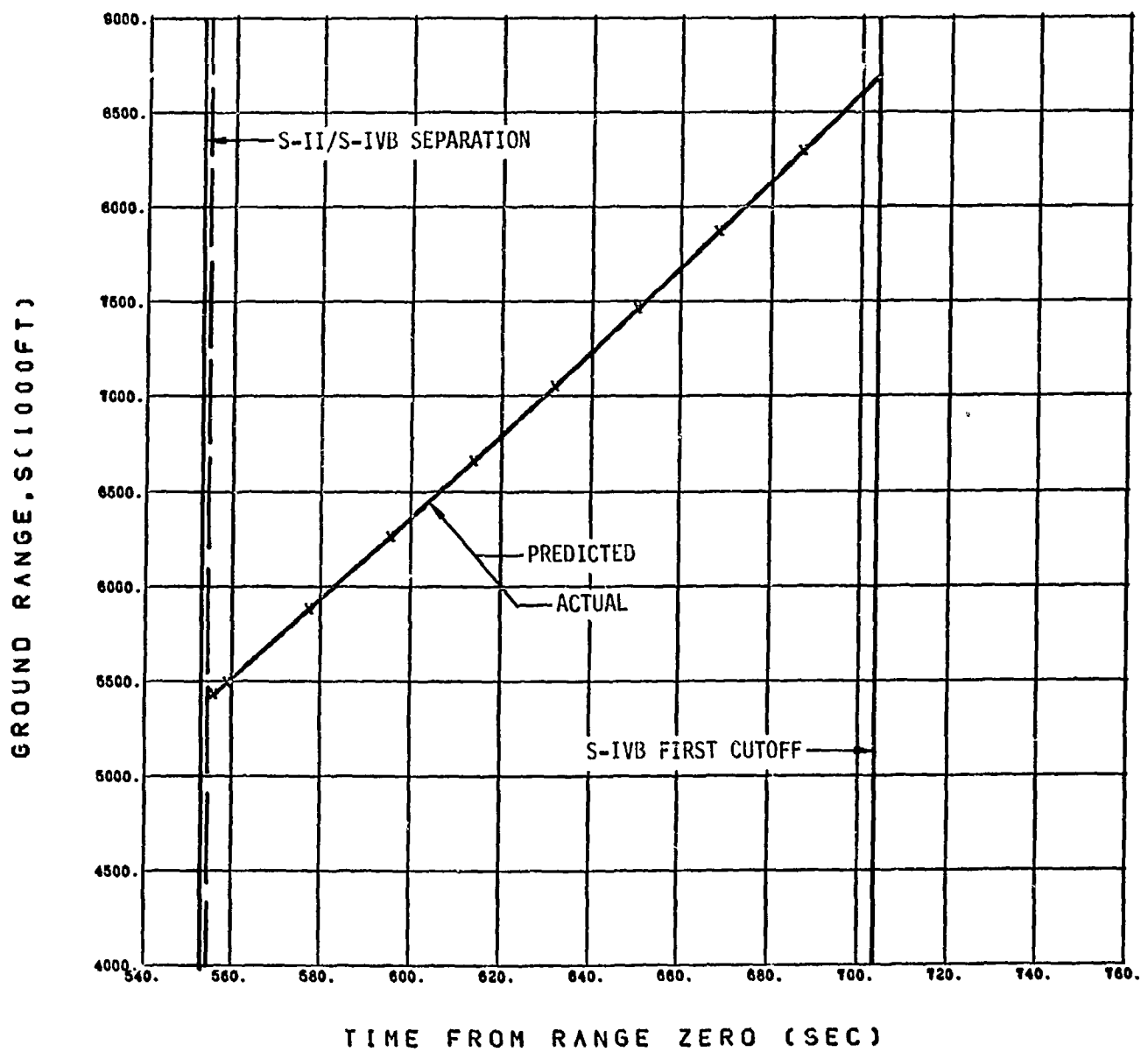

Figure 7-16 S-IVB Stage First Burn Ground Range History

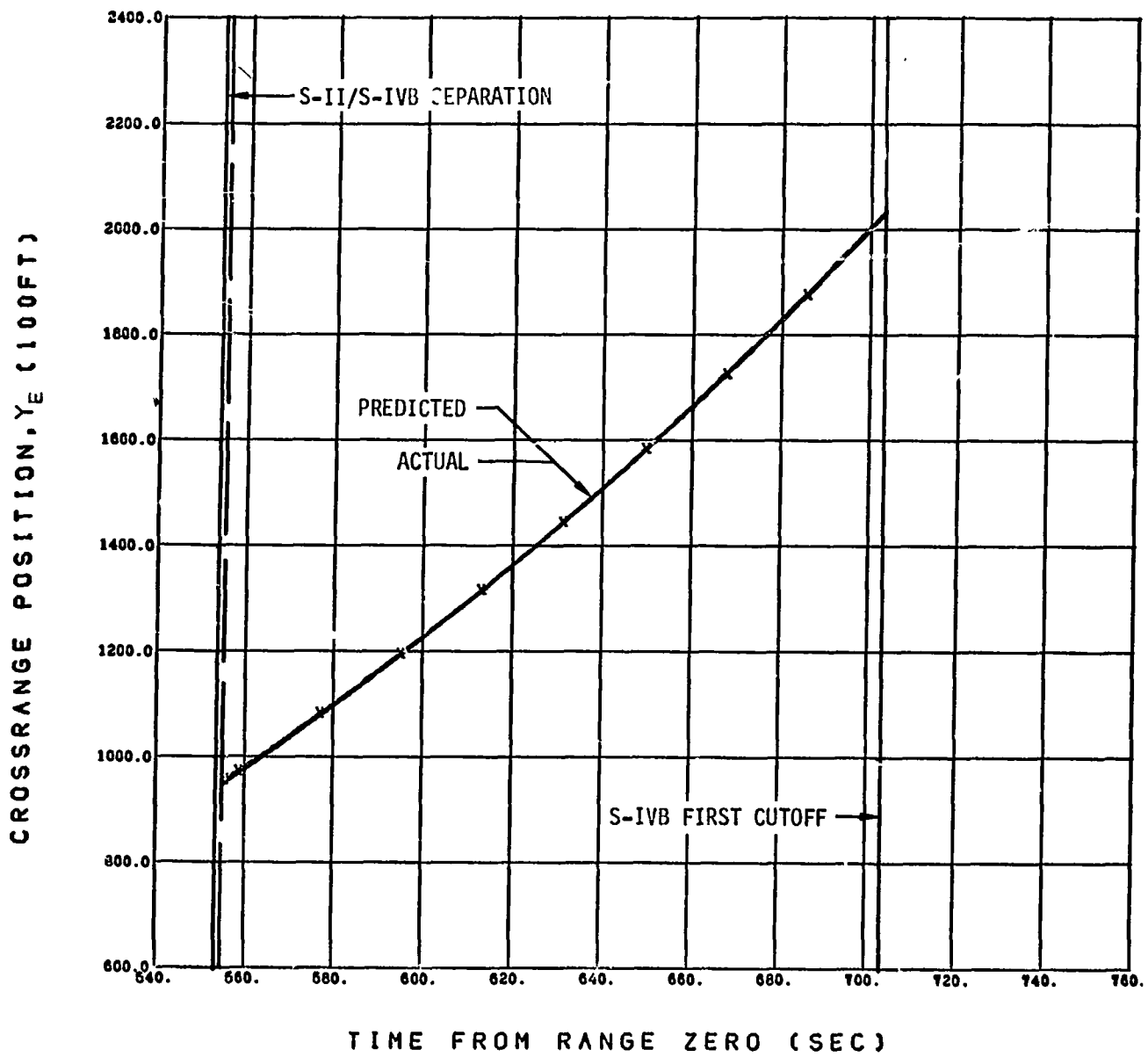

Figure 7-17 S-IVB Stage First Burn Crossrange Position History

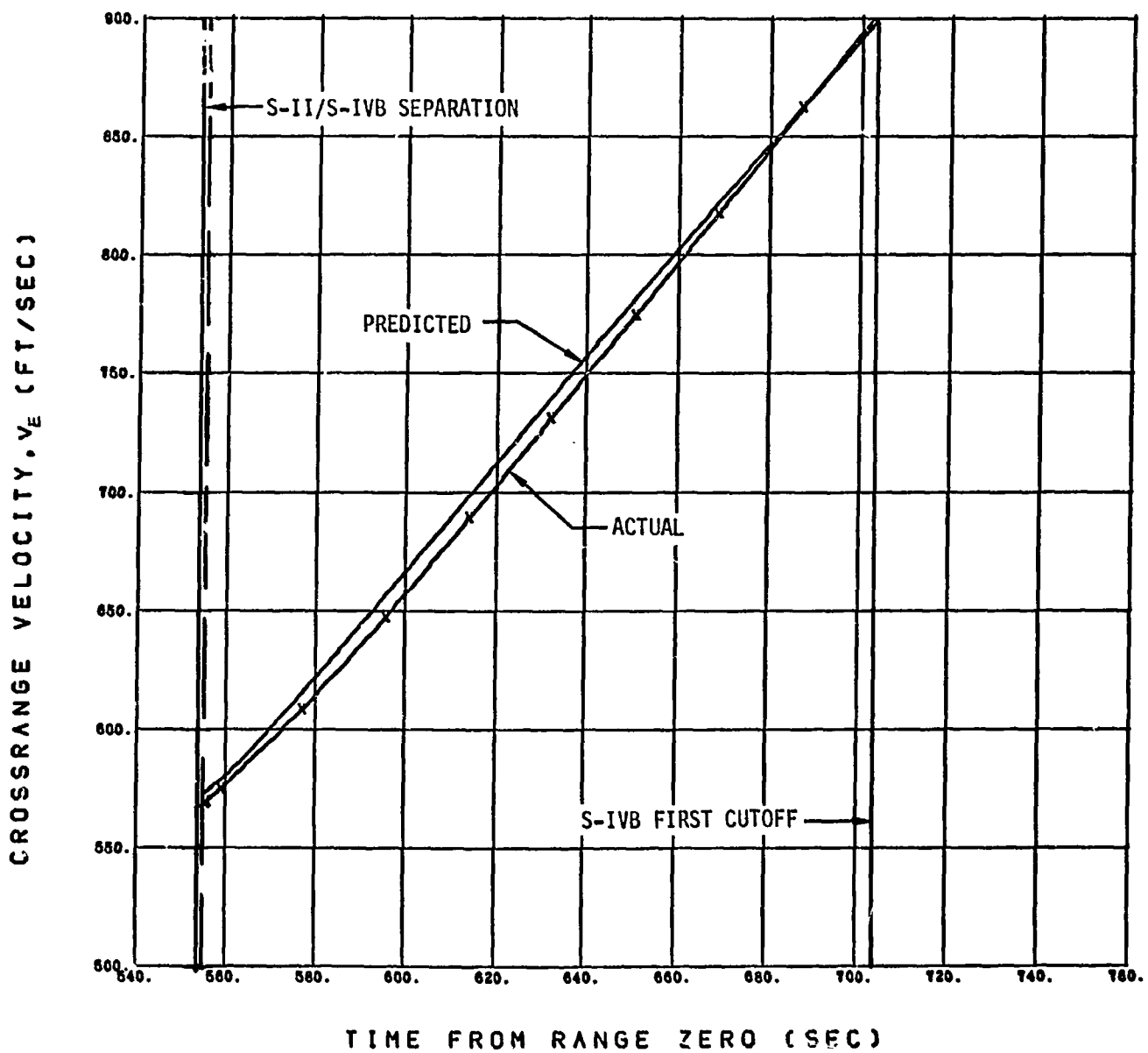

Figure 7-18 S-IVB Stage First Burn Crossrange Velocity History

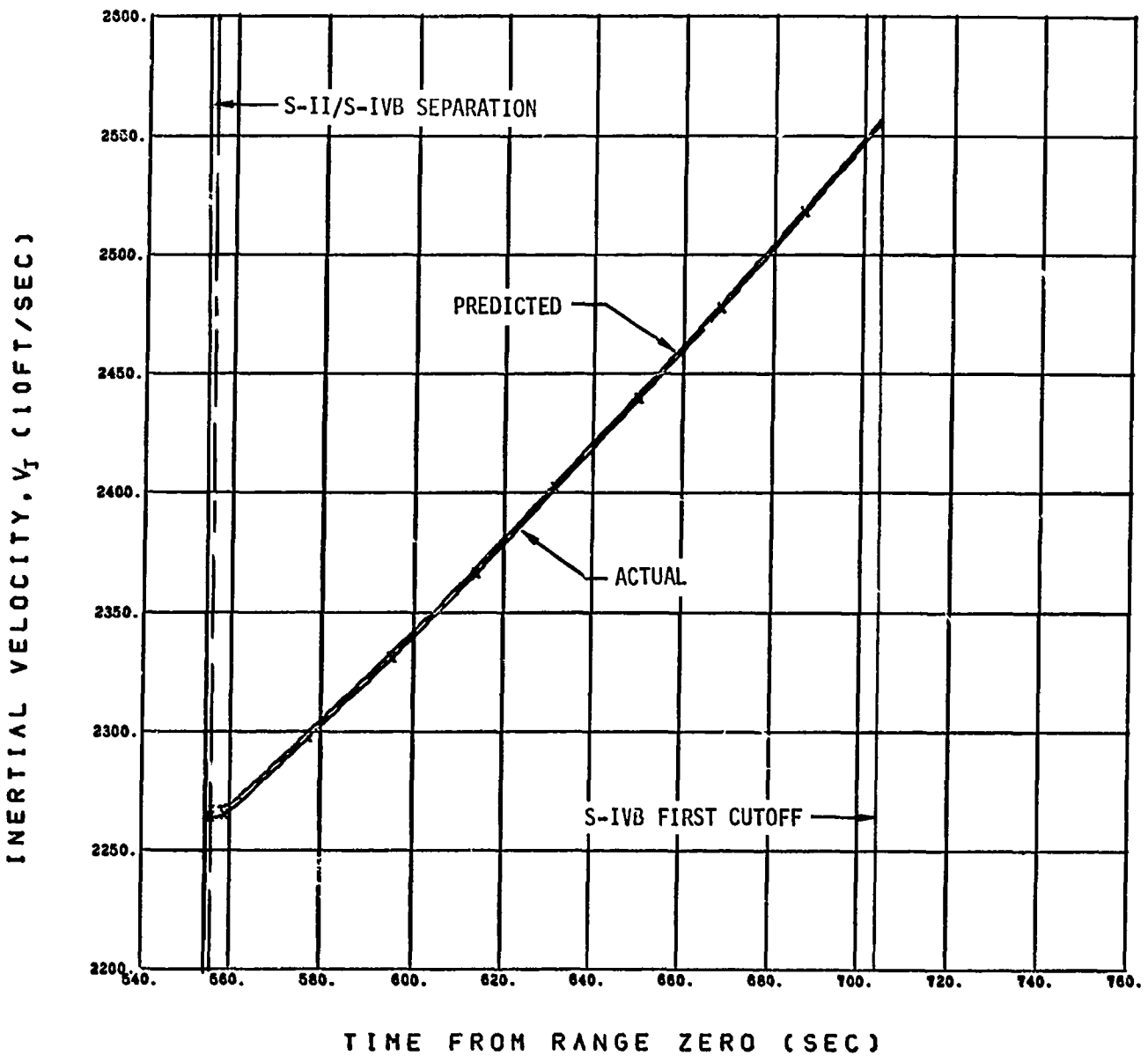

Figure 7-19 S-IVB Stage First Burn Inertial Velocity History

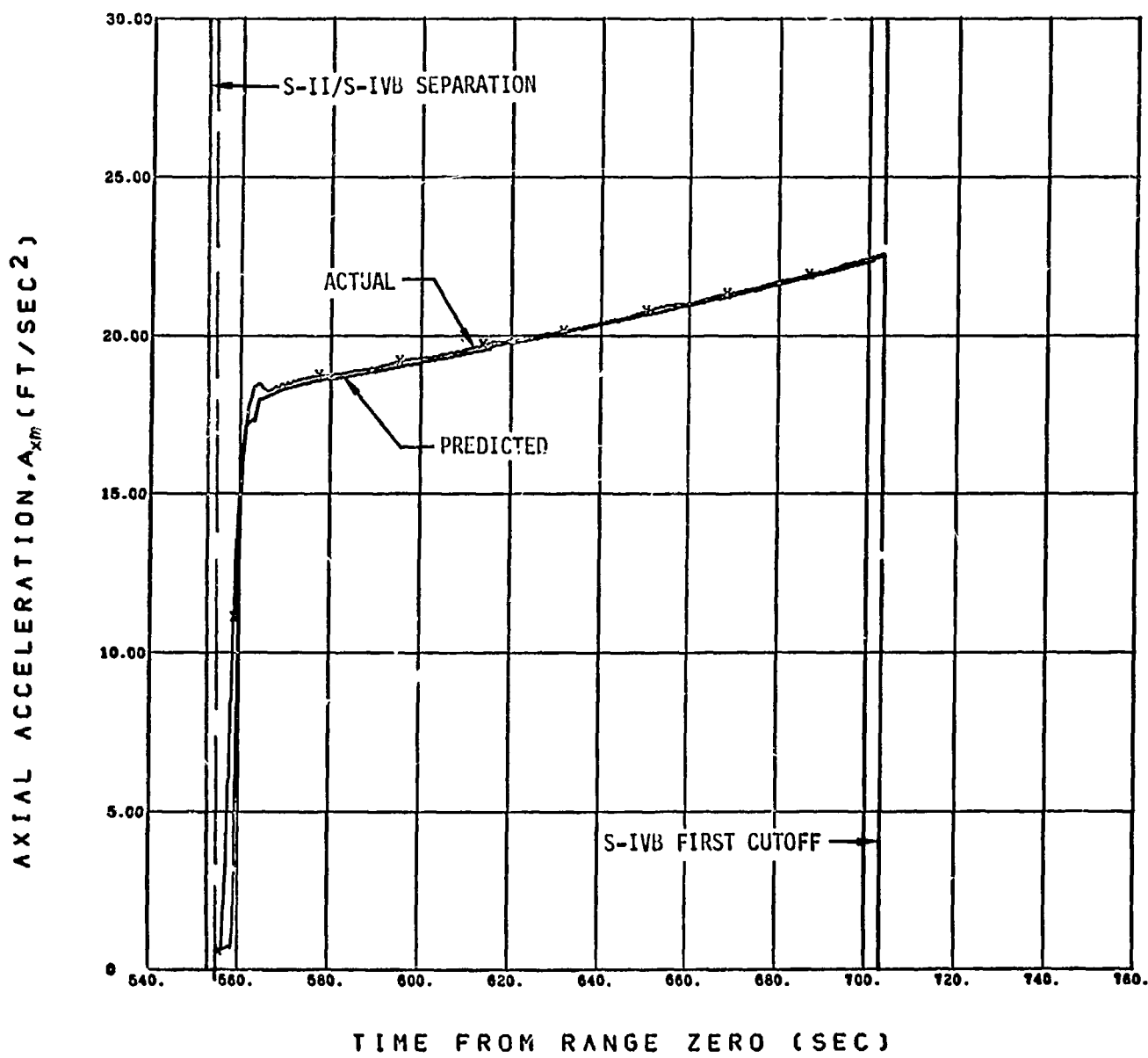

Figure 7-20 S-IVB Stage First Burn Axial Acceleration History

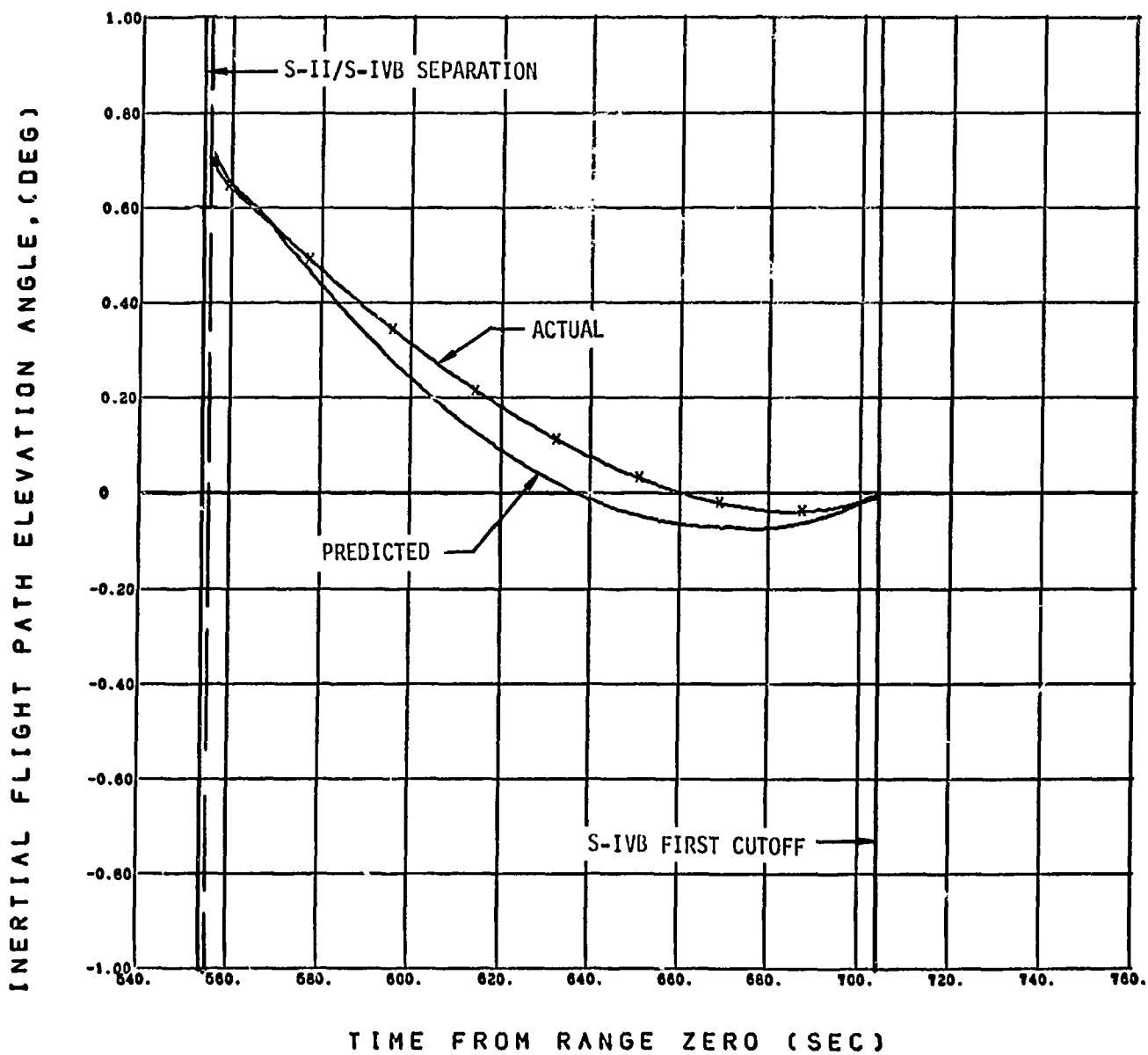

Figure 7-21 S-IVB Stage First Burn Inertial Flight Path Elevation Angle History

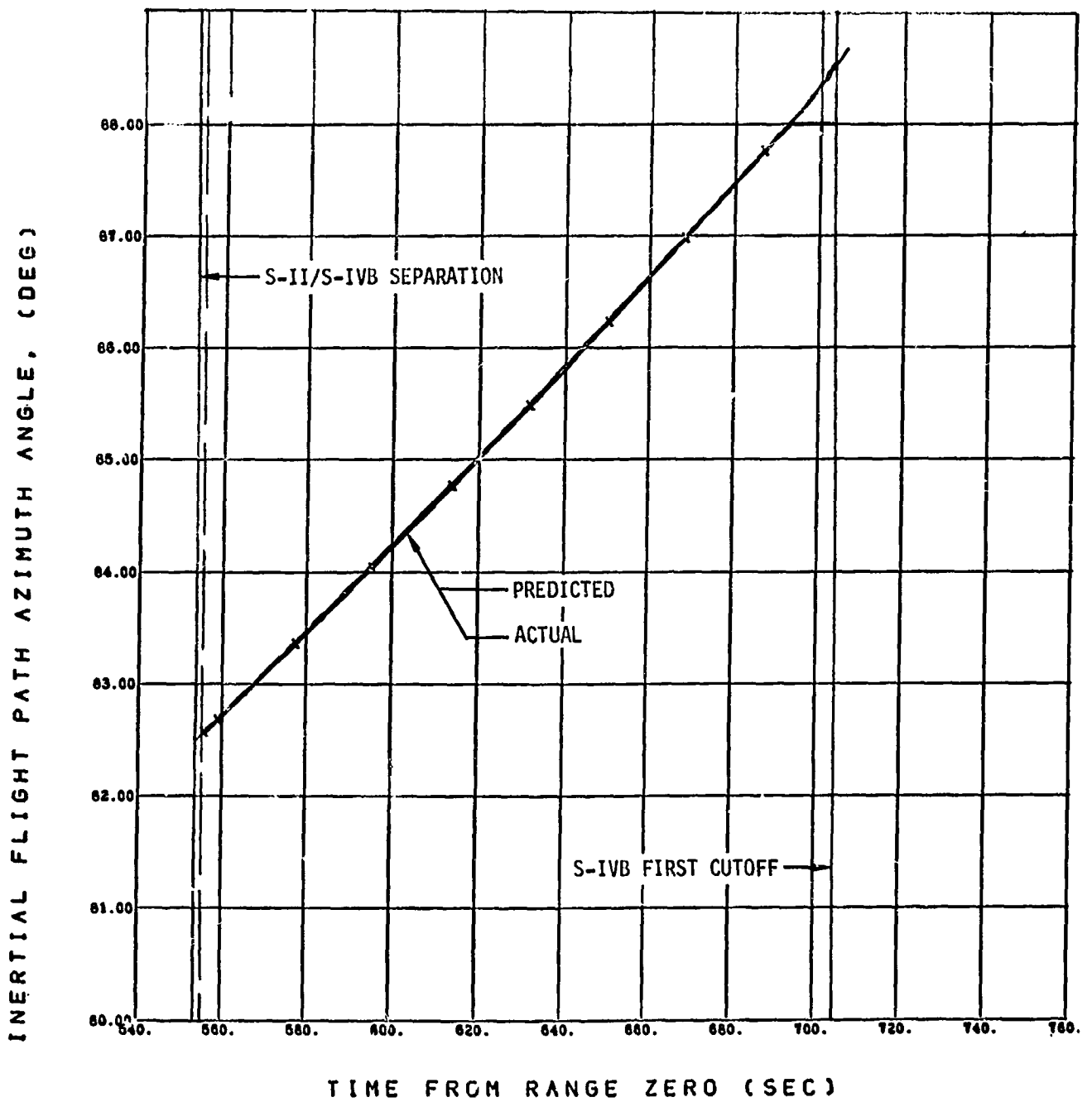

Figure 7-22 S-IVB Stage First Burn Inertial Flight Path Azimuth Angle History

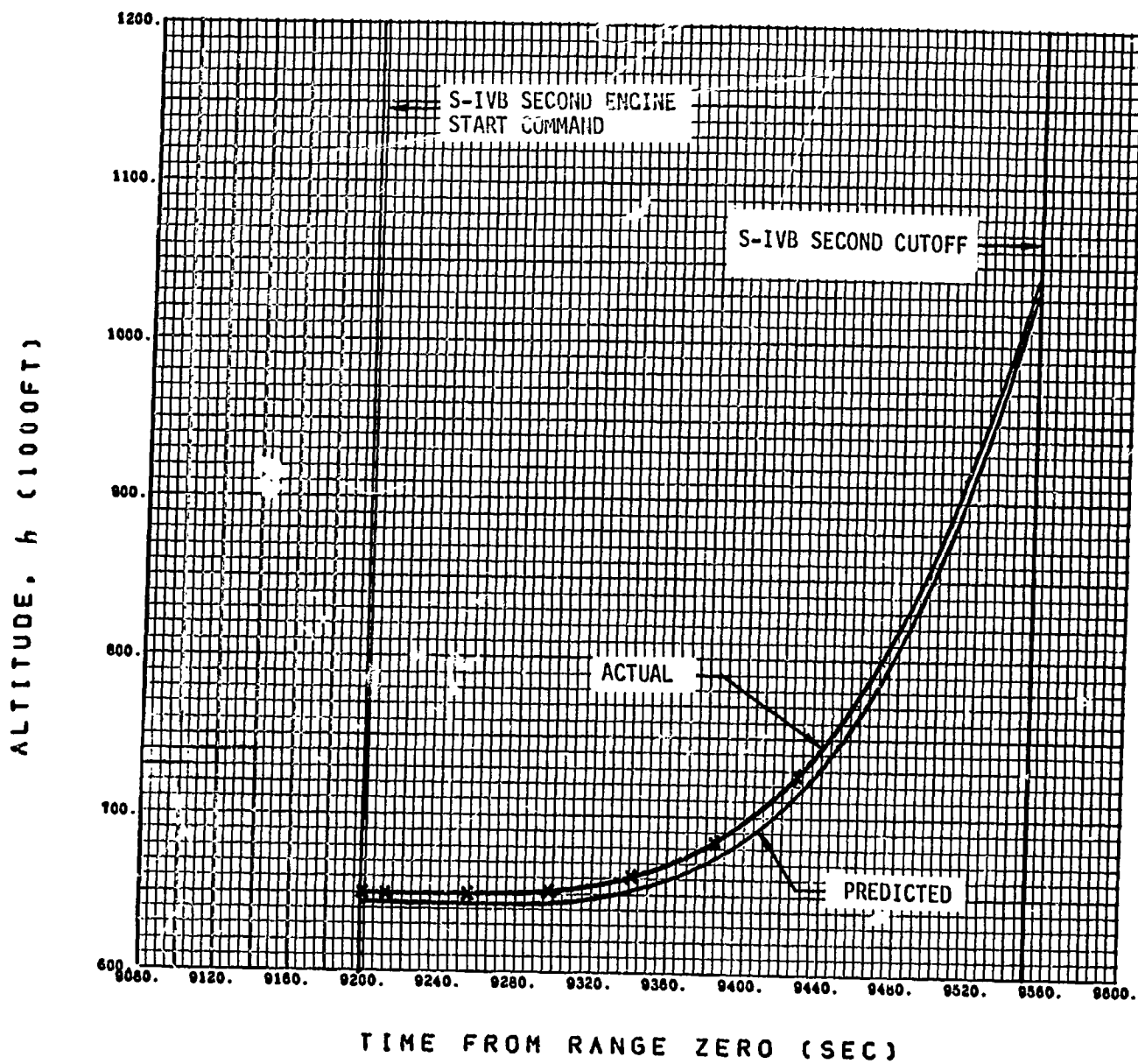

Figure 7-23 S-IVB Stage Second Burn Altitude History

GROUND RANGE, S (10,000FT)

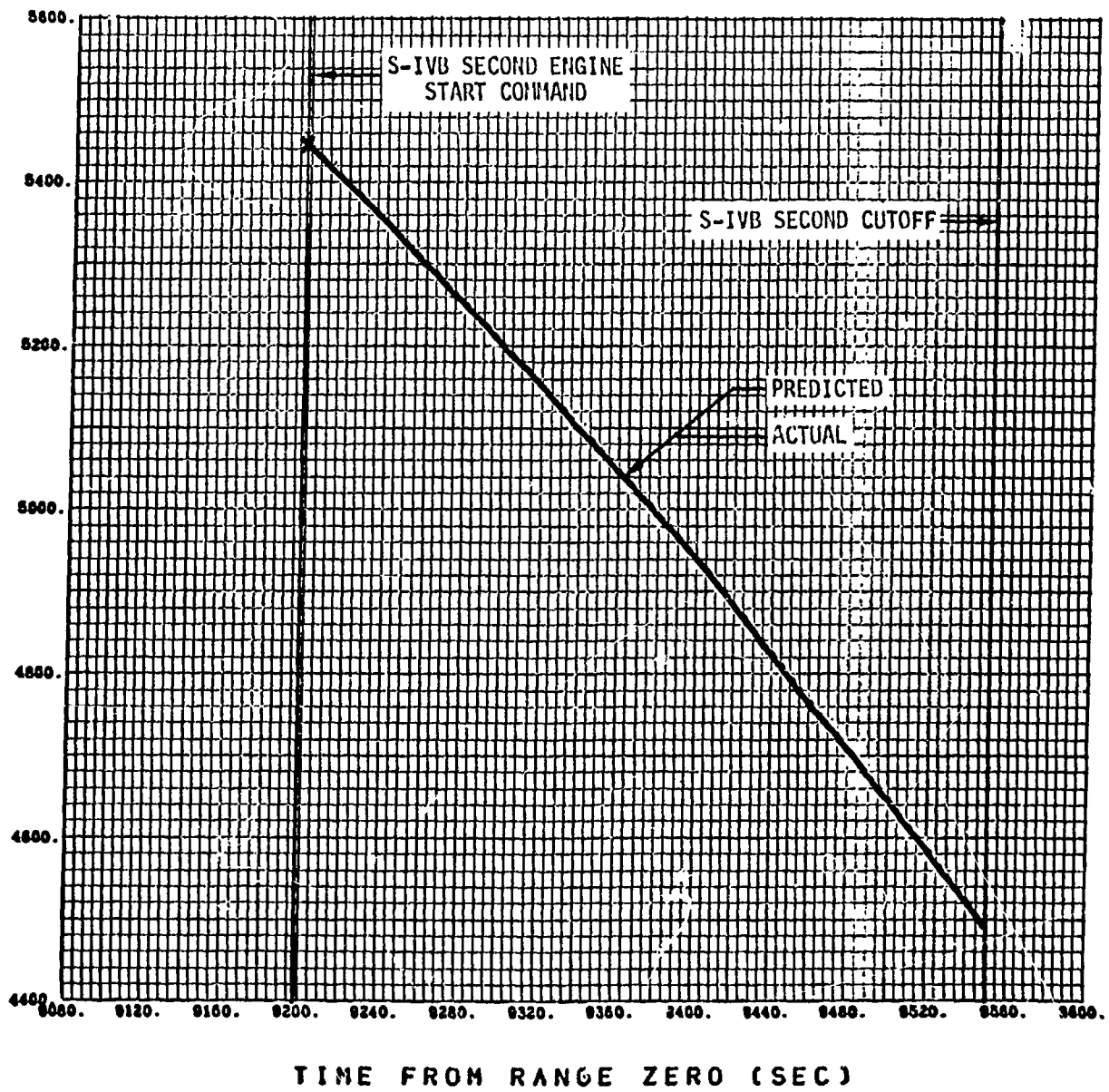

Figure 7-24 S-IVB Stage Second Burn Ground Range History

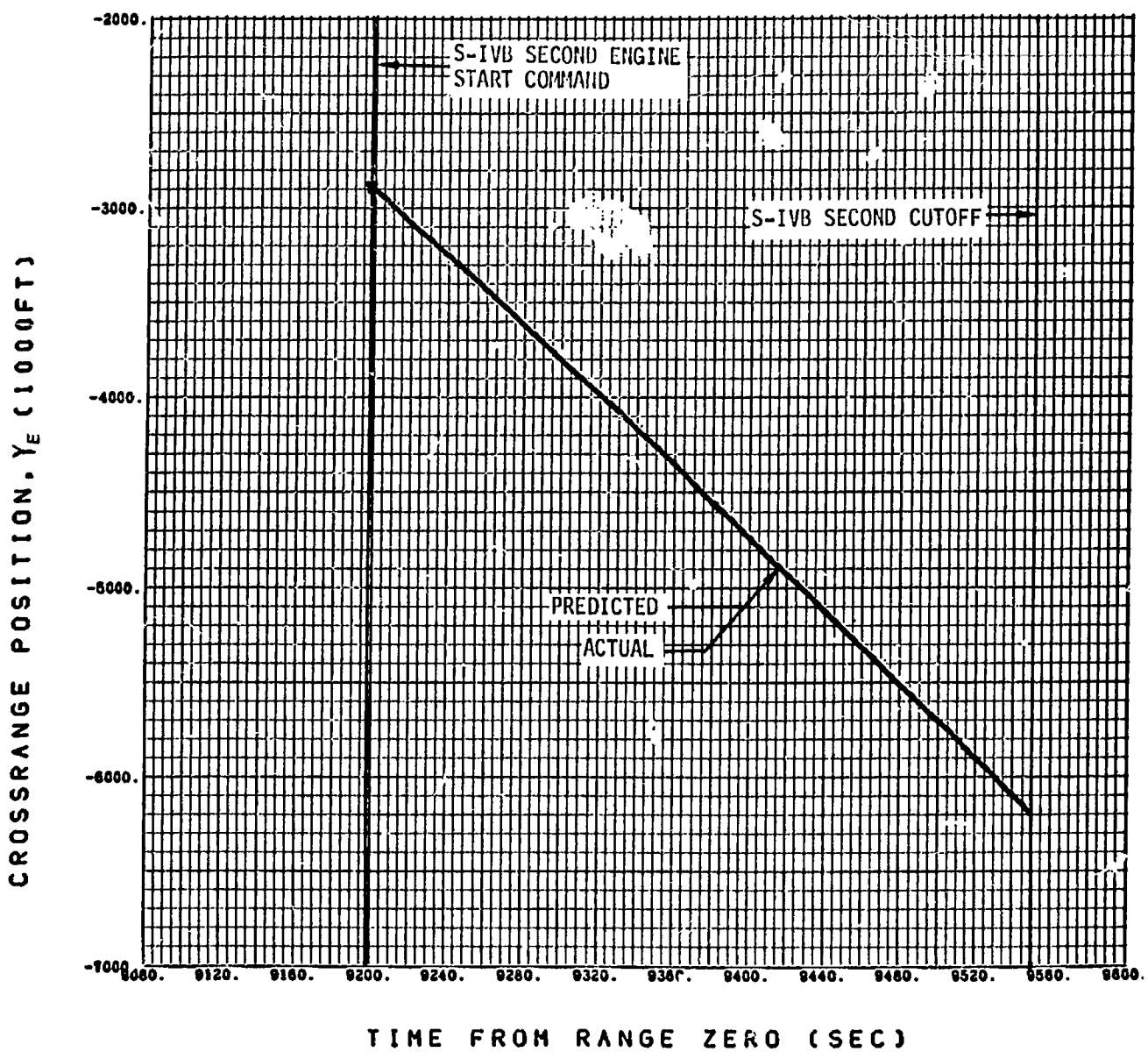

Figure 7-25 S-IVB Stage Second Burn Crossrange Position History

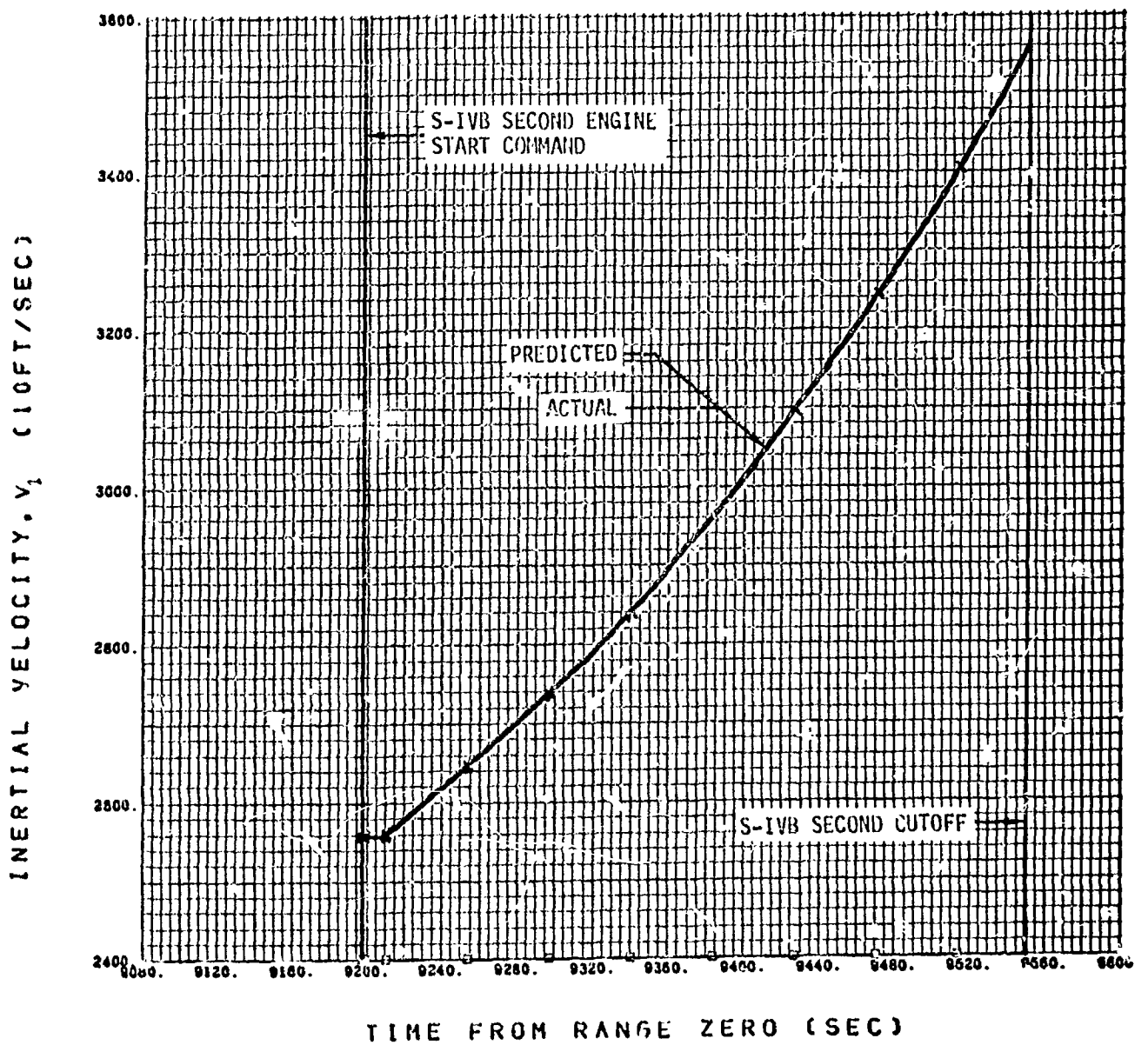

Figure 7-26 S-IVB Stage Second Burn Inertial Velocity History

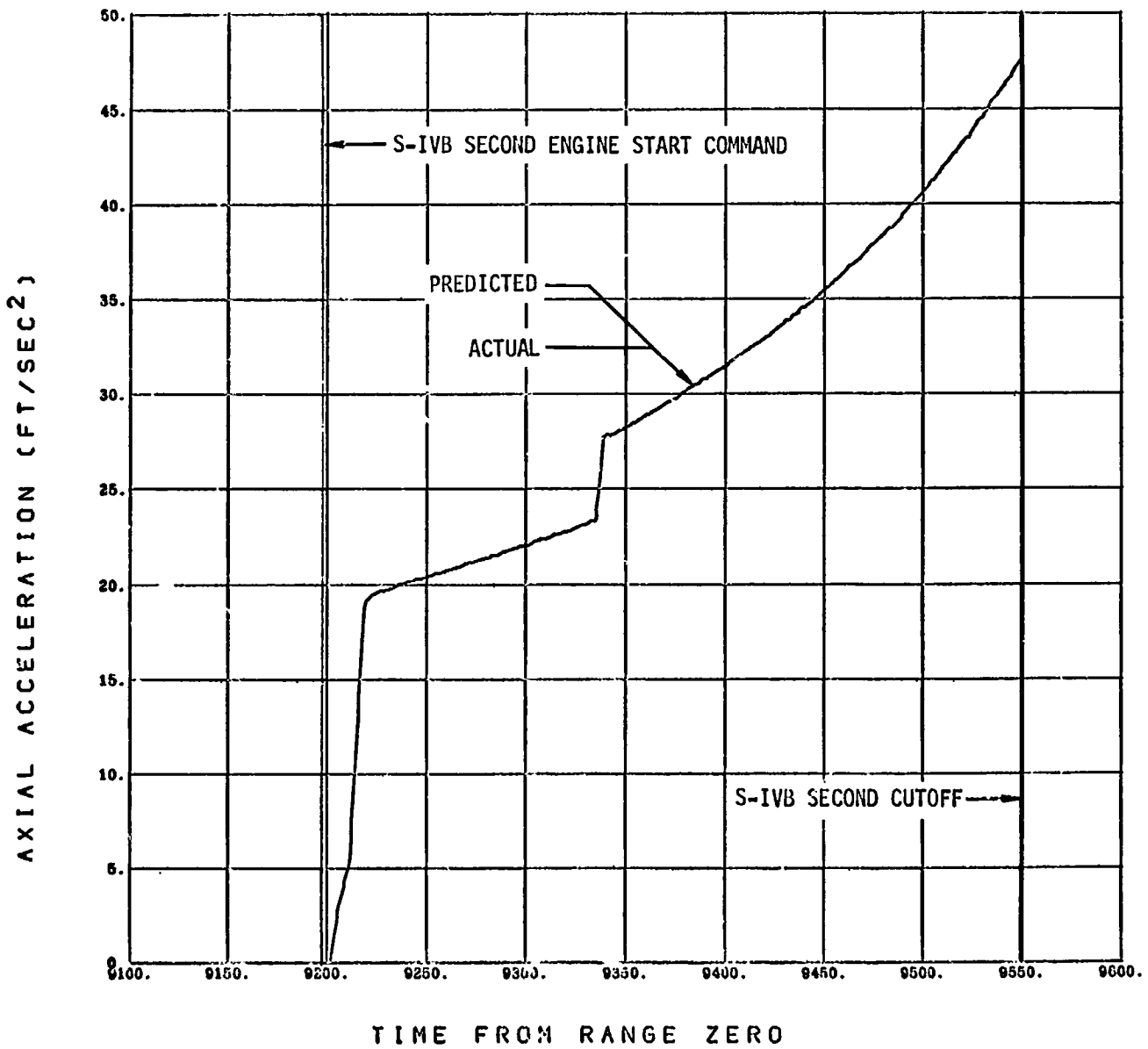

Figure 7-27 S-IVB Stage Second Burn Axial Acceleration History

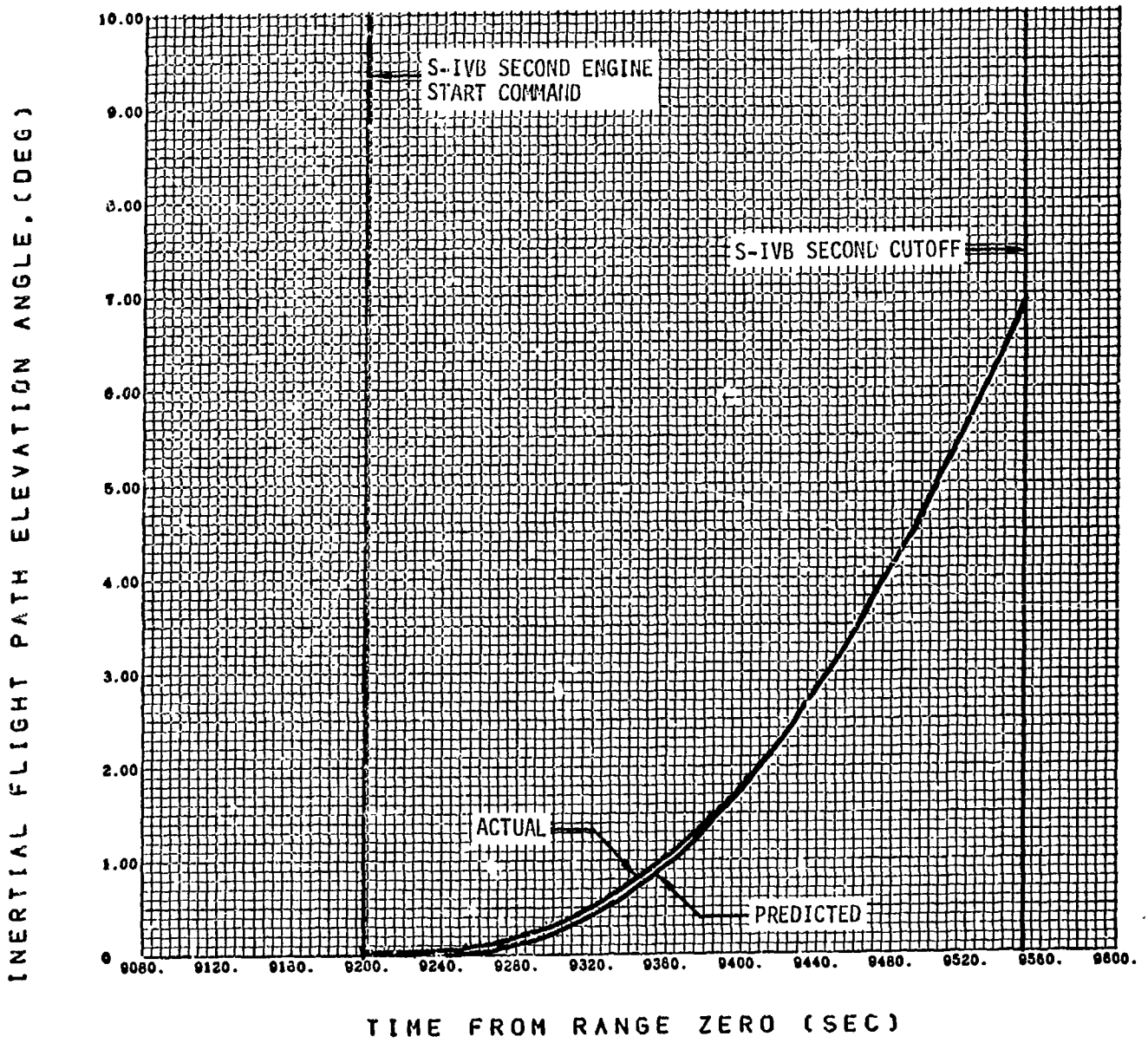

Figure 7-28 S-IVB Stage Second Burn Inertial Flight Path Elevation Angle History

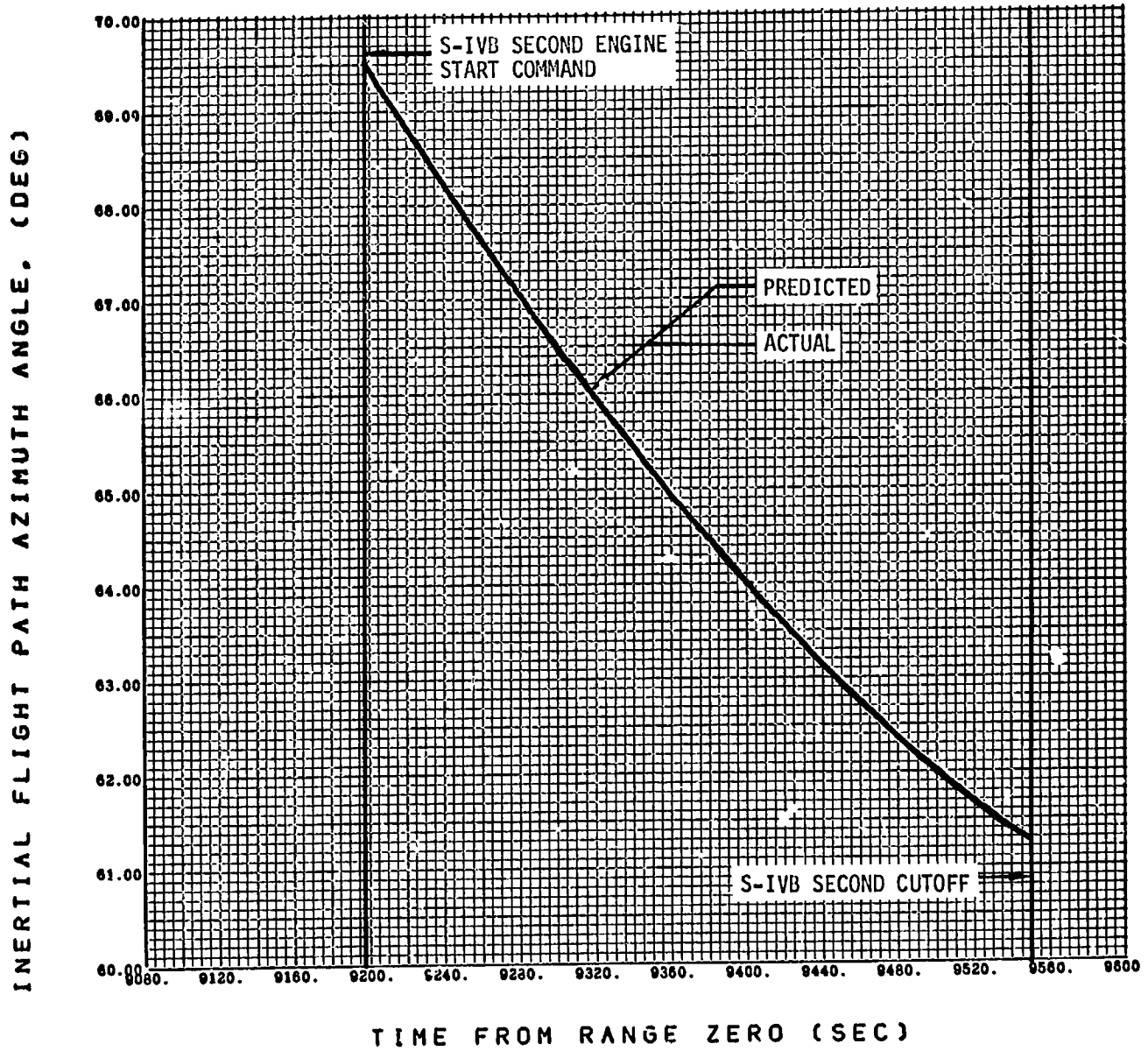

Figure 7-29 S-IVB Stage Second Burn Inertial Flight Path Azimuth Angle History

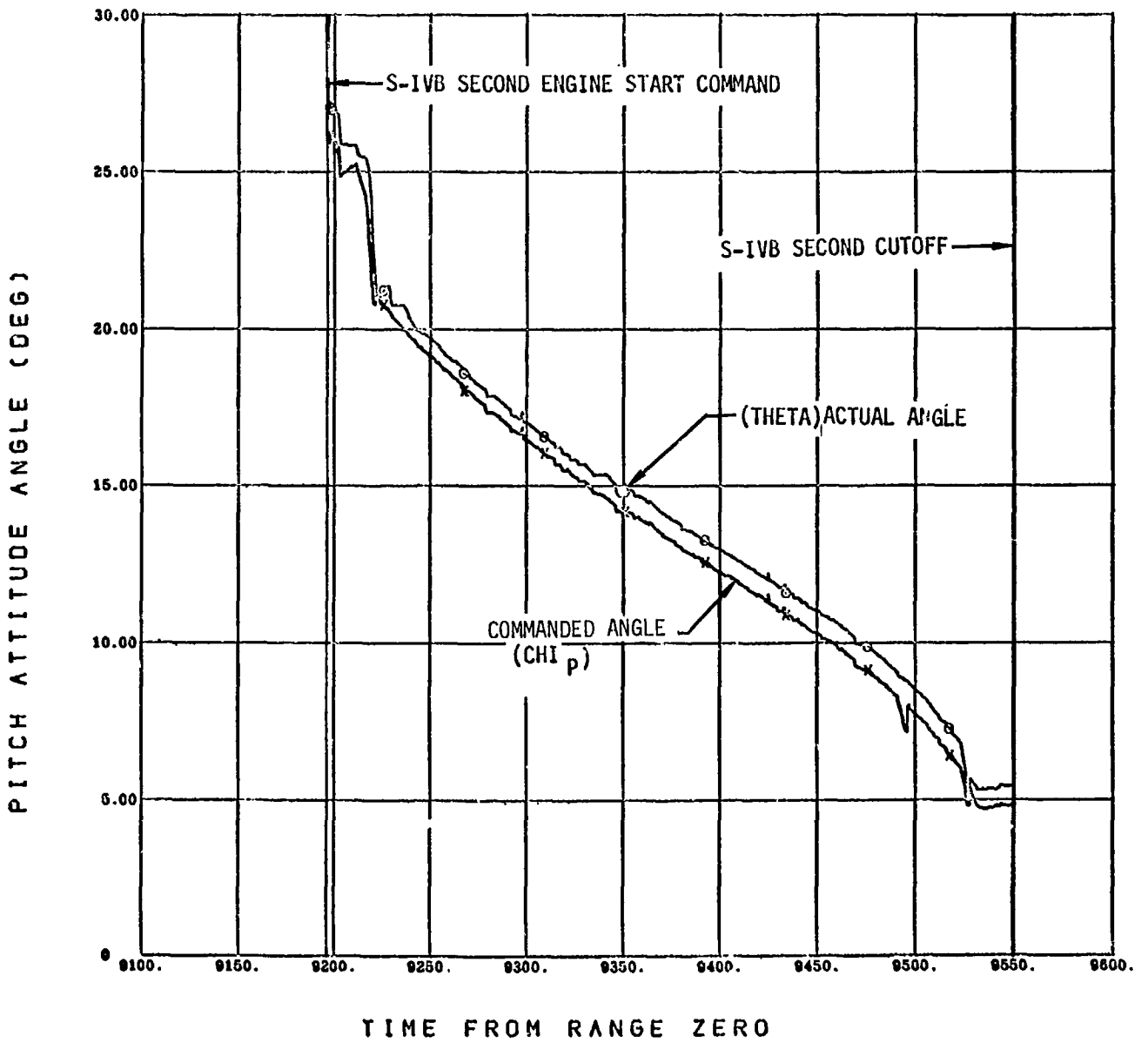

Figure 7-30 S-IVB Stage Second Burn Pitch Attitude Angle History

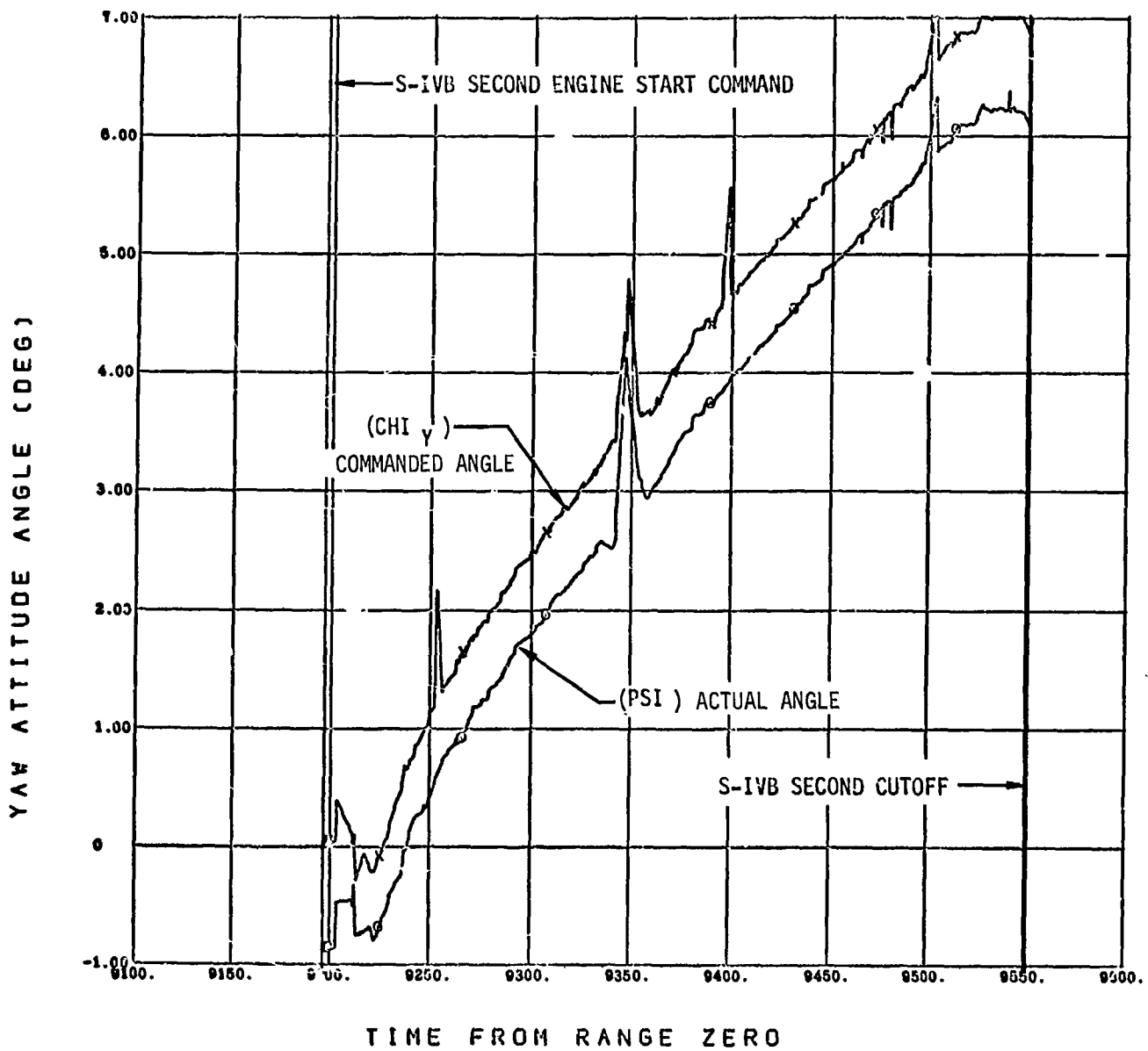

Figure 7-31 S-IVB Stage Second Burn Yaw Attitude Angle History

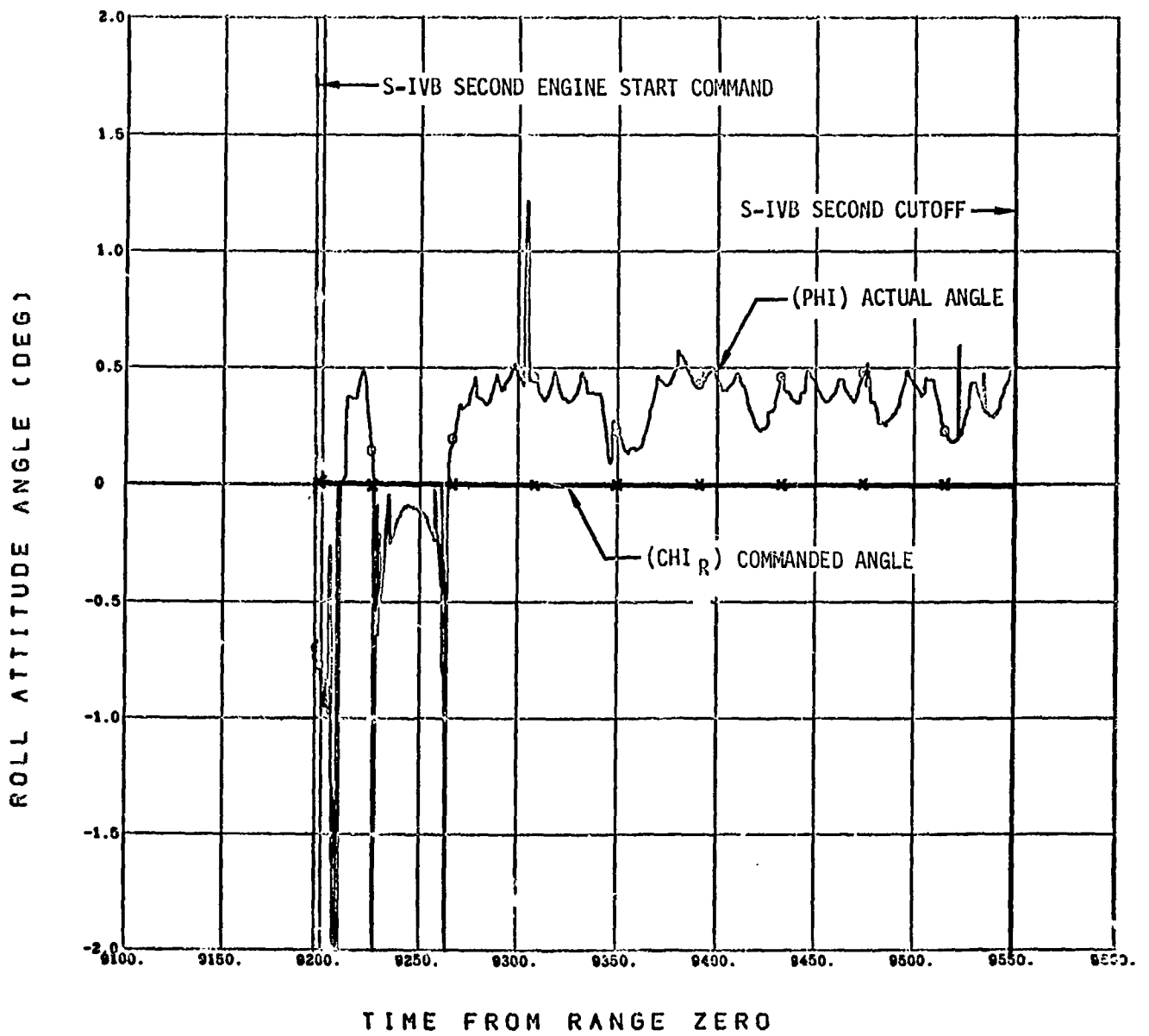
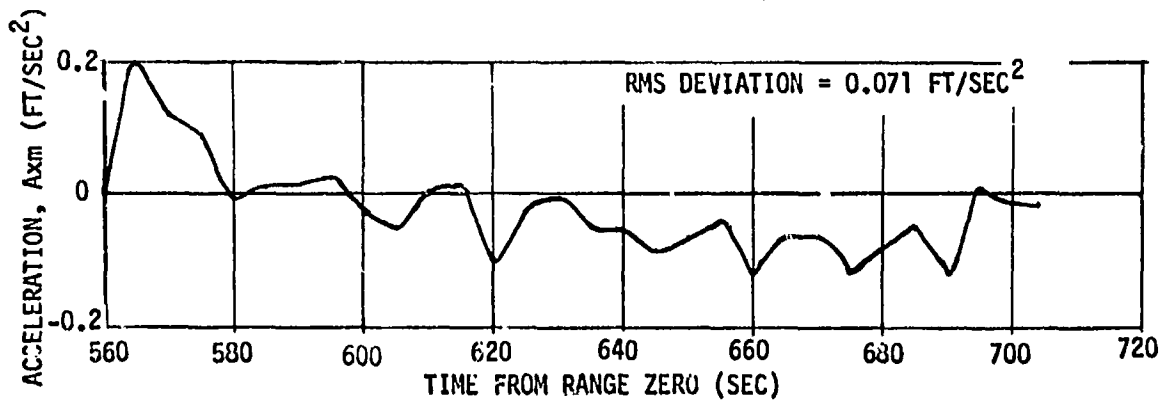
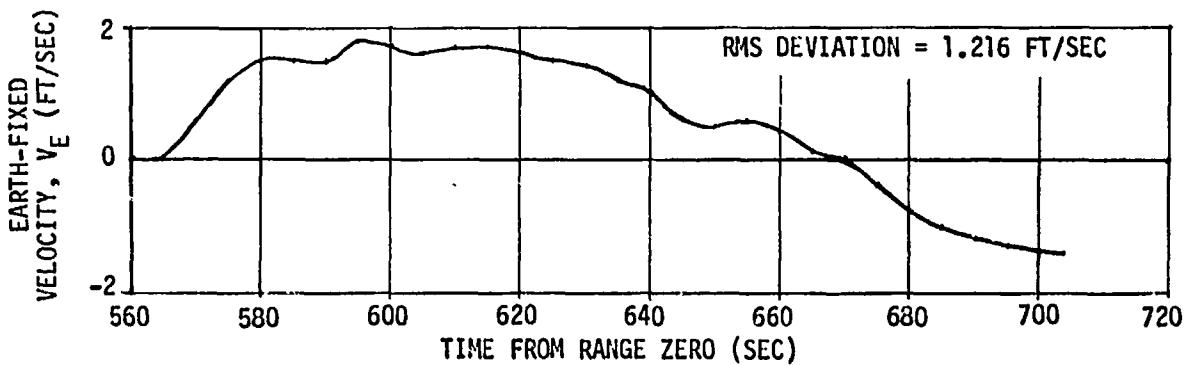
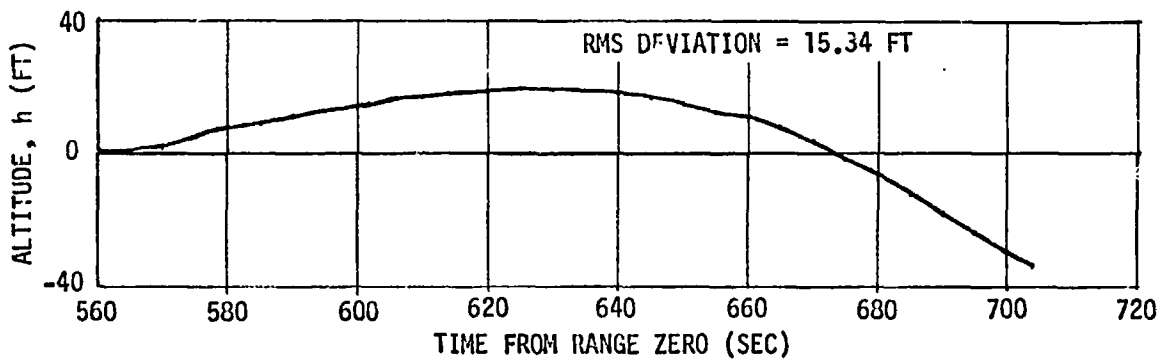
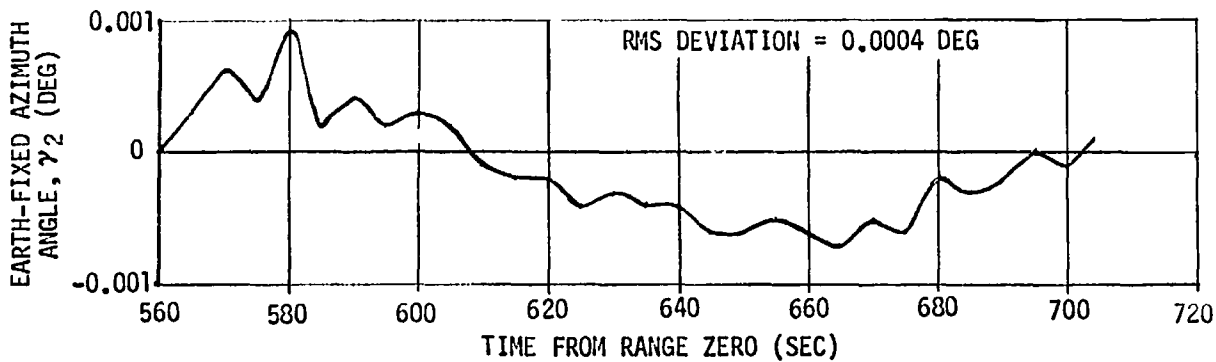

Figure 7-32 S-IVB Stage Second Burn Roll Attitude Angle History



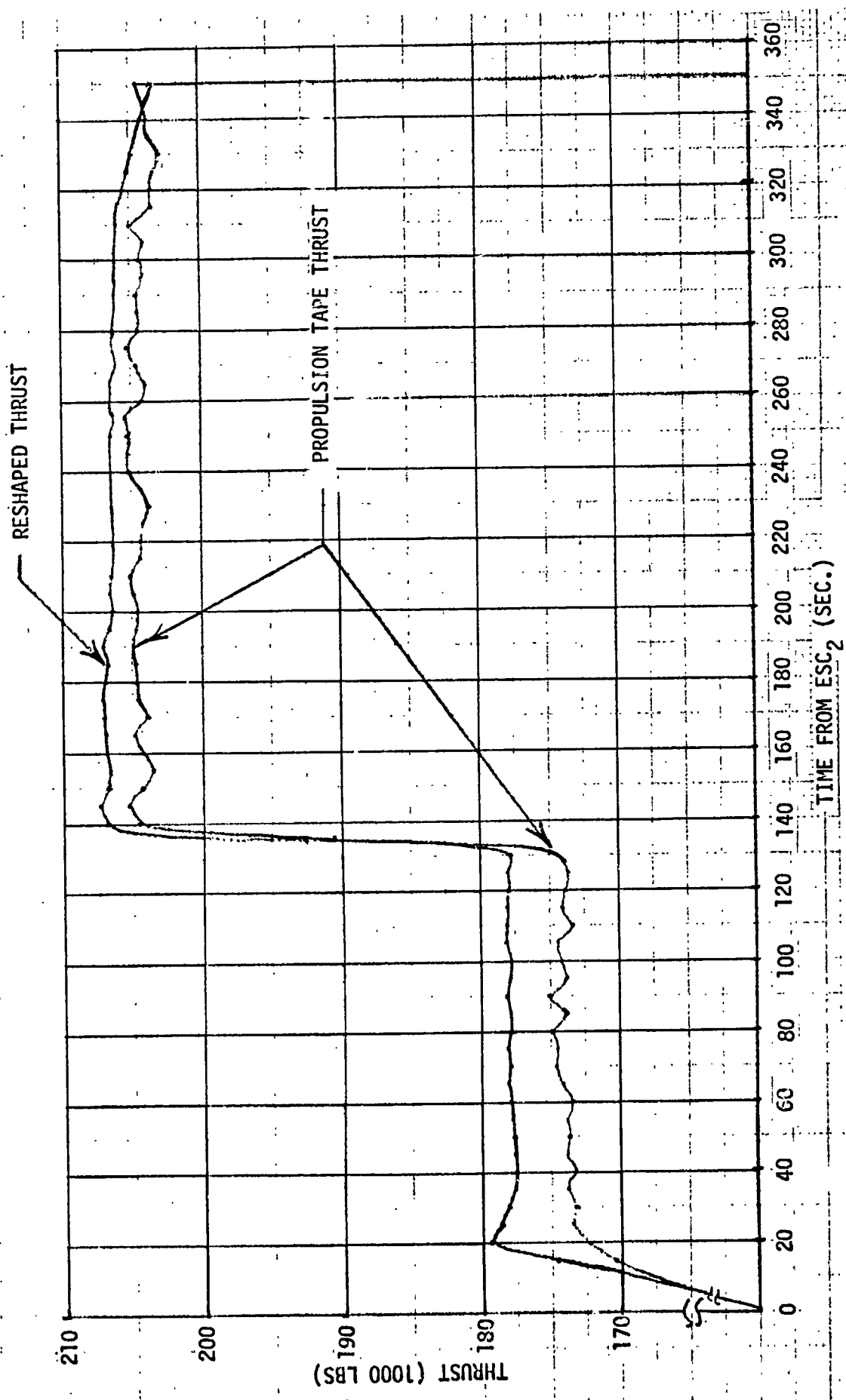

Figure 7-34 COMPARISON OF RESHAPED AND OBSERVED THRUST

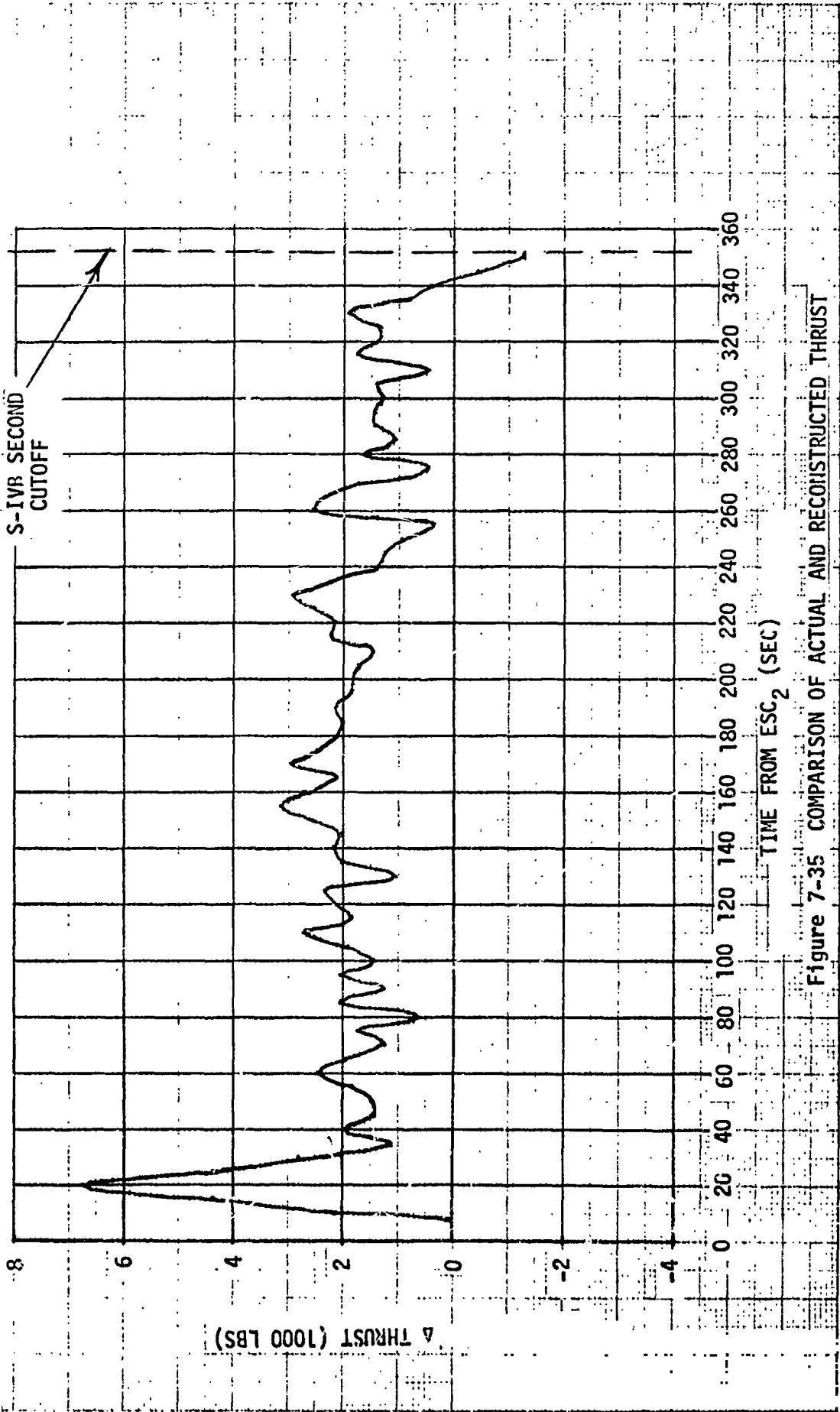

Figure 7-35 COMPARISON OF ACTUAL AND RECONSTRUCTED THRUST

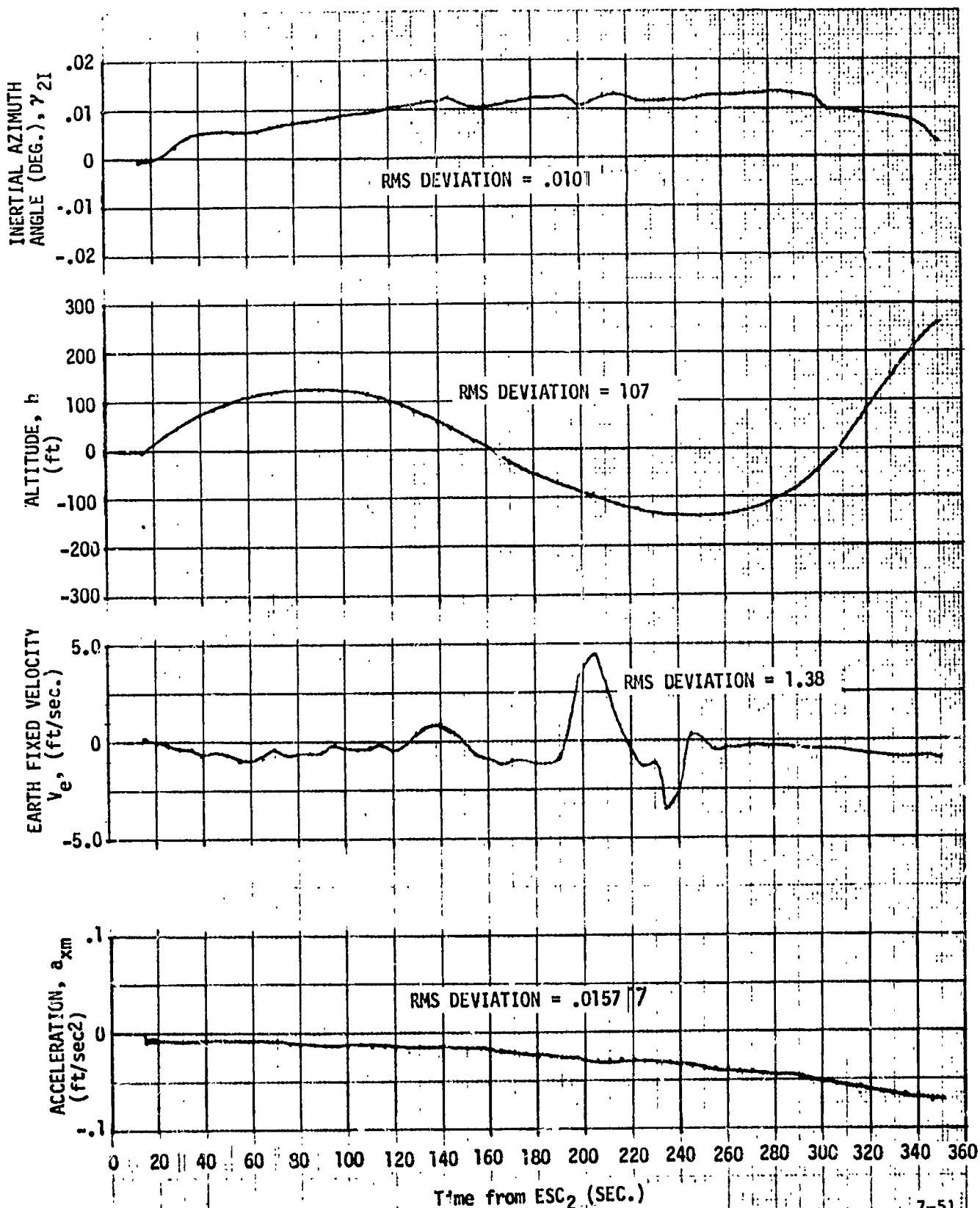

Fig. 7-36: Deviations from Observed Trajectory

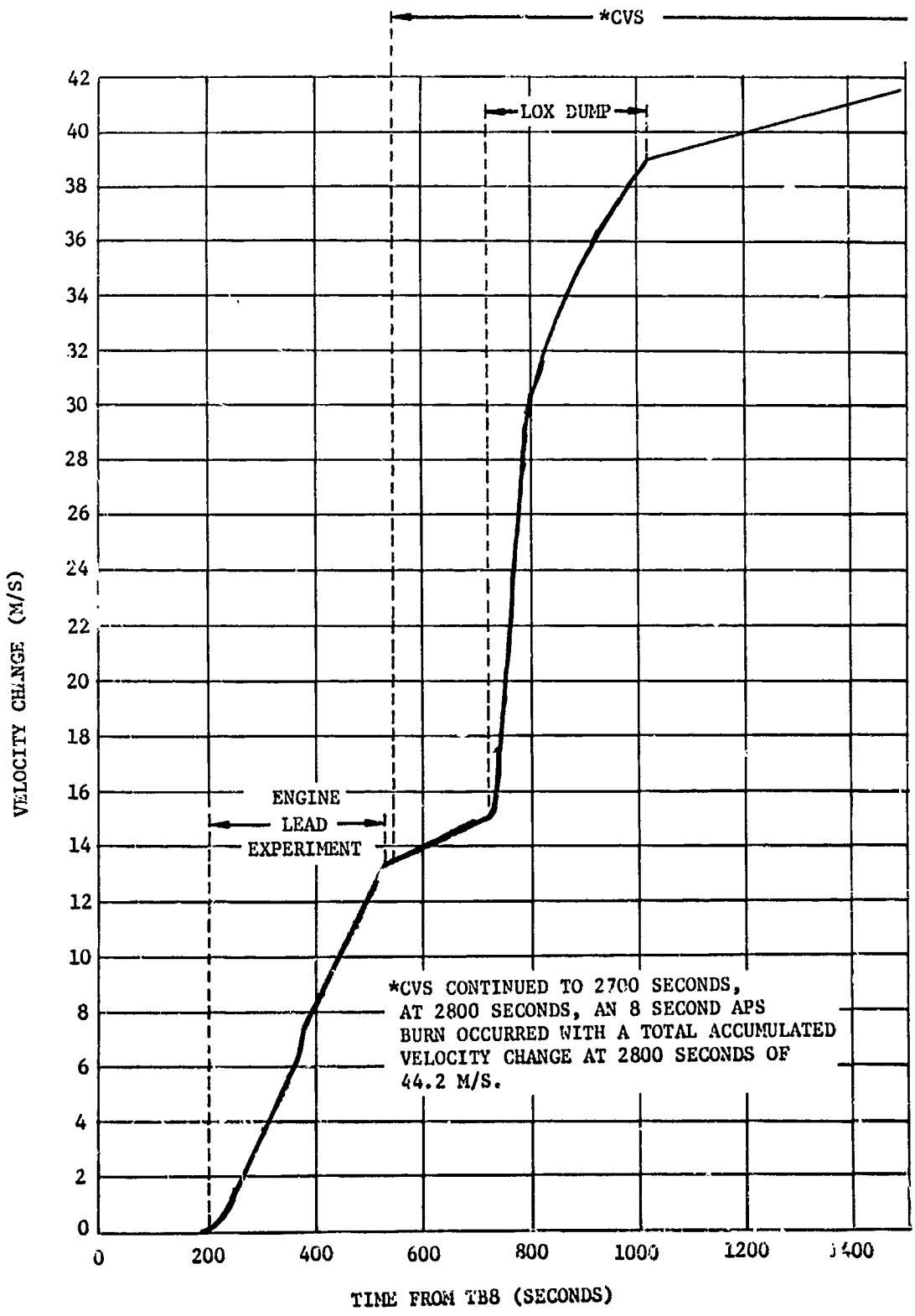

Figure 7-37. Velocity Increment Due To Slingshot Activity.

8.0 MASS CHARACTERISTICS

The AS-505 third flight stage (S-IVB-505N, IU, and payload) mass summary presented in table 8-1 are "best estimate" values.

8.1 Mass Properties Uncertainty Analysis

Figures 8-1 through 8-8 present a comparison of the predicted vehicle mass characteristics and three-sigma uncertainties versus the post flight actual mass characteristics during S-IVB stage powered flight. The predicted uncertainties were determined from a statistical analysis of component mass properties uncertainties and are referenced relative to time from S-IVB engine start command. Each of the post flight mass properties were within the predicted three-sigma uncertainty bands.

8.2 Best Estimate Ignition and Cutoff Masses

The "best estimate method" is a three dimensional statistical analysis of data from various mass measurement systems. This method develops a joint probability density function for both burns from which the most probable ignition and cutoff masses and their associated accuracies are determined.

For first burn, three measurement systems were utilized to compute the best estimate:

- (1) Flow Integral propellant consumption
- (2) Volumetric PU ignition and cutoff masses
- (3) PU indicated (corrected) ignition and cutoff masses

A further data source, the ratio of ignition mass over cutoff mass obtained from the trajectory reconstruction, was not used because the trajectory simulation could not determine this ratio with adequate accuracy due to the short burn time.

For second burn, five measurement systems were utilized to determine the best estimate values:

- (1) Flow integral propellant consumption
- (2) Trajectory reconstruction slope
- (3) PU volumetric ignition and cutoff masses
- (4) PU indicated (corrected) ignition and cutoff masses
- (5) Point level sensor cutoff mass

A brief description of the various measurement systems is presented in Section 16.

Figures 8-9 and 8-10 are graphical presentations of the best estimate analysis for first and second burns respectively. For first burn, the best estimate ignition mass is $365,070 \pm 566$ lbm and the cutoff mass is $295,025 \pm 527$ lbm. For second burn, the best estimate ignition mass is $292,204 \pm 478$ lbm and the cutoff mass is $137,540 \pm 242$ lbm.

TABLE 8-1. AS-505 THIRD STAGE FINAL FLIGHT EVALUATION MASS SUMMARY (Sheet 1 of 3)

Event	First Burn						
	S-1C Lift Off	SOLL/ S-IVB Separ.	First S-IVB E S C	End Fuel Lead	90 Percent Thrust	First S-IVB E C C	End Thrust Decay
Time From Rng. Zero	OD OH OM 0.583S	OD OH 9M 13.500S	OD OH 9M 13.600S	OD OH 9M 16.800S	OD OH 9M 19.300S	OD OH11M 43.800S	OD OH11M 45.200S
Total Seconds	0 .583	553 .500	553 .600	556 .800	559 .300	703 .800	705 .200
Launch Escape	8936	0	0	0	0	0	0
Separation Pkg	52	0	0	0	0	0	0
Ullage Rockets	254	251	248	149	137	0	0
Adapter Panels	2590	2590	2590	2590	2590	2590	2590
Command Module	12251	12251	12251	12251	12251	12251	12251
Service Module	10610	10610	10610	10610	10610	10610	10610
JPS Propellant	40590	40590	40590	40590	40590	40590	40590
Adapter Ring	98	98	98	98	98	98	98
Lunar Module	30745	30745	30745	30745	30745	30745	30745
Adapter-Fixed	1380	1380	1380	1380	1380	1380	1380
Instrument Unit	4267	4267	4267	4267	4267	4267	4267
Frust	300	100	100	100	100	100	100
S4B505 Dry Stg	25492	25492	25492	25492	25492	25492	25492
LOX in Tank	191688	191688	191688	191688	191346	133476	133336
LOX Ullage Gas	40	40	40	40	42	164	164
LOX Below Tank	367	367	367	367	397	397	397
LH2 in Tank	43334	43334	43334	43322	43210	31500	31470
LH2 Ullage Gas	46	46	46	48	50	150	151
LH2 Below Tank	48	48	48	58	58	58	48
Cold Helium	372	372	372	371	370	318	318
APS Propellant	663	663	663	663	663	660	659
GH2-Start Tank	5	5	5	5	1	4	4
AMB HE-Repress	70	70	70	70	70	70	70
Service Items	61	61	61	61	61	61	61
Total Mass	374259	365068	365065	364965	364527	294981	294771

TABLE 8-1. AS-505 THIRD FLIGHT STAGE FINAL FLIGHT EVALUATION MASS SUMMARY (Sheet 2 of 3)

Second Burn

Event	Begin Restrt Preps.	Second S-IVB E S C	End Fuel Lead	90 Percent Thrust	EMR Shift To 5.0	Second S-IVB E C C	End Thrust Decay
Time From Rng. Zero	OD 2H23M 49.200S	OD 2H33M 19.200S	OD 2H33M 27.200S	OD 2H33M 29.700S	OD 2H35M 34.300S	OD 2H39M 10.600S	CD 2H39M 12.000S
Total Seconds	8629 .200	9199 .200	9207 .200	9209 .700	9334 .300	9550 .600	9552 .000
Launch Escape	0	0	0	0	0	0	0
Separation Pkg	0	0	0	0	0	0	0
Ullage Rockets	0	0	0	0	0	0	0
Adapter Panels	2590	2590	2590	2590	2590	2590	2590
Command Module	12251	12251	12251	12251	12251	12251	12251
Service Module	10610	10610	10610	10610	10610	10610	10610
SPS Propellant	40590	40590	40590	40590	40590	40590	40590
Adapter Ring	98	98	98	98	98	98	98
Lunar Module	30745	30745	30745	30745	30745	30745	30745
Adapter-Fixed	1380	1380	1380	1380	1380	1380	1380
Instrument Unit	4267	4267	4267	4267	4267	4267	4267
Frustr	100	100	100	100	100	100	100
S4B505 Dry Stg	25492	25492	25492	25492	25492	25492	25492
LOX in Tank	133120	132934	132934	132648	91266	4897	4761
LOX Ullage Gas	380	381	381	382	432	519	520
LOX Below Tank	367	367	367	397	397	397	367
LH2 in Tank	29063	29021	28997	28869	19390	2127	2100
LH2 Ullage Gas	319	358	363	364	436	562	563
LH2 Below Tank	48	48	58	58	58	58	48
Cold Helium	318	290	287	286	235	148	148
APS Propellant	578	535	534	534	531	527	527
GH2-Start Tank	4	4	4	4	4	4	4
AMB HE-Repress	70	70	70	70	70	70	70
Service Items	61	61	61	61	61	61	61
Total Mass	292451	292191	292178	291792	241003	137493	137292

TABLE 8-1. AS-505 THIRD FLIGHT STAGE FINAL FLIGHT EVALUATION MASS SUMMARY (Sheet 3 of 3)

Event	Separation and Dump						Ullage Eng. Off
	C S M Separation	C S M Dock To L M	Lunar Module Exctrct	Begin Chldwn Exper.	End Chldwn Exper.	Begin LOX Dump	
Time From Rng. Zero	OD 3H 2M 51.000S	OD 3H17M 38.000S	OD 3H56M 24.000S	OD 4H45M 53.100S	OD 4H50M 58.900S	OD 4H54M 15.800S	OD 5H29M 4.000S
Total Seconds	10971 .000	11858 .000	14184 .000	17153 .100	17458 .900	17655 .800	19744 .000
Launch Escape	0	0	0	0	0	0	0
Separation Pkg	0	0	0	0	0	0	0
Ullage Rockets	0	0	0	0	0	0	0
Adapter Panels	0	0	0	0	0	0	0
Command Module	0	12251	0	0	0	0	0
Service Module	0	10610	0	0	0	0	0
SPS Propellant	0	40590	0	0	0	0	0
Adapter Ring	0	98	0	0	0	0	0
Lunar Module	30745	30745	0	0	0	0	0
Adapter-Fixed	1380	1380	1380	1380	1380	1380	1380
Instrument Unit	4267	4267	4267	4267	4267	4267	4267
Frustr	100	100	100	100	100	100	100
S4B505 Dry Stg	25492	25492	25492	25492	25492	25492	25492
LOX in Tank	4700	4668	4584	4477	4132	4132	0
LOX Ullage Gas	316	348	432	539	557	557	40
LOX Below Tank	303	264	159	26	13	4	0
LH2 in Tank	1668	1553	1048	664	604	562	72
LH2 Ullage Gas	371	486	390	764	824	779	149
LH2 Below Tank	48	48	48	48	48	48	48
Cold Helium	32	32	17	14	14	13	10
APS Propellant	498	495	486	464	331	329	293
GH2-Start Tank	0	0	0	0	0	0	0
AMB HE-Repress	70	70	70	70	18	18	5
Service Items	61	61	61	61	61	61	61
Total Mass	70051	133557	38534	38367	37841	37742	31916

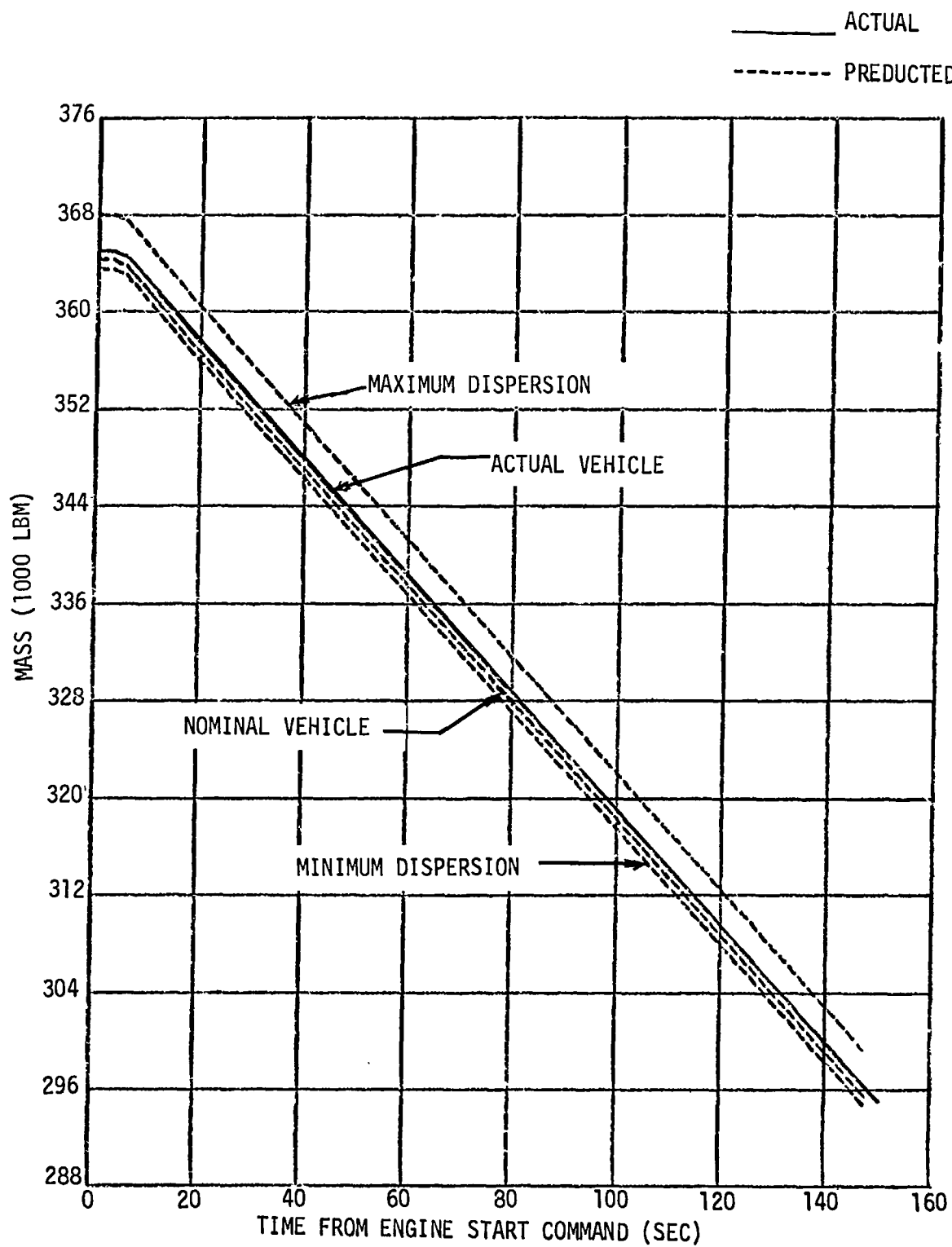

Figure 8-1. Third Flight Stage Vehicle Mass (First Burn)

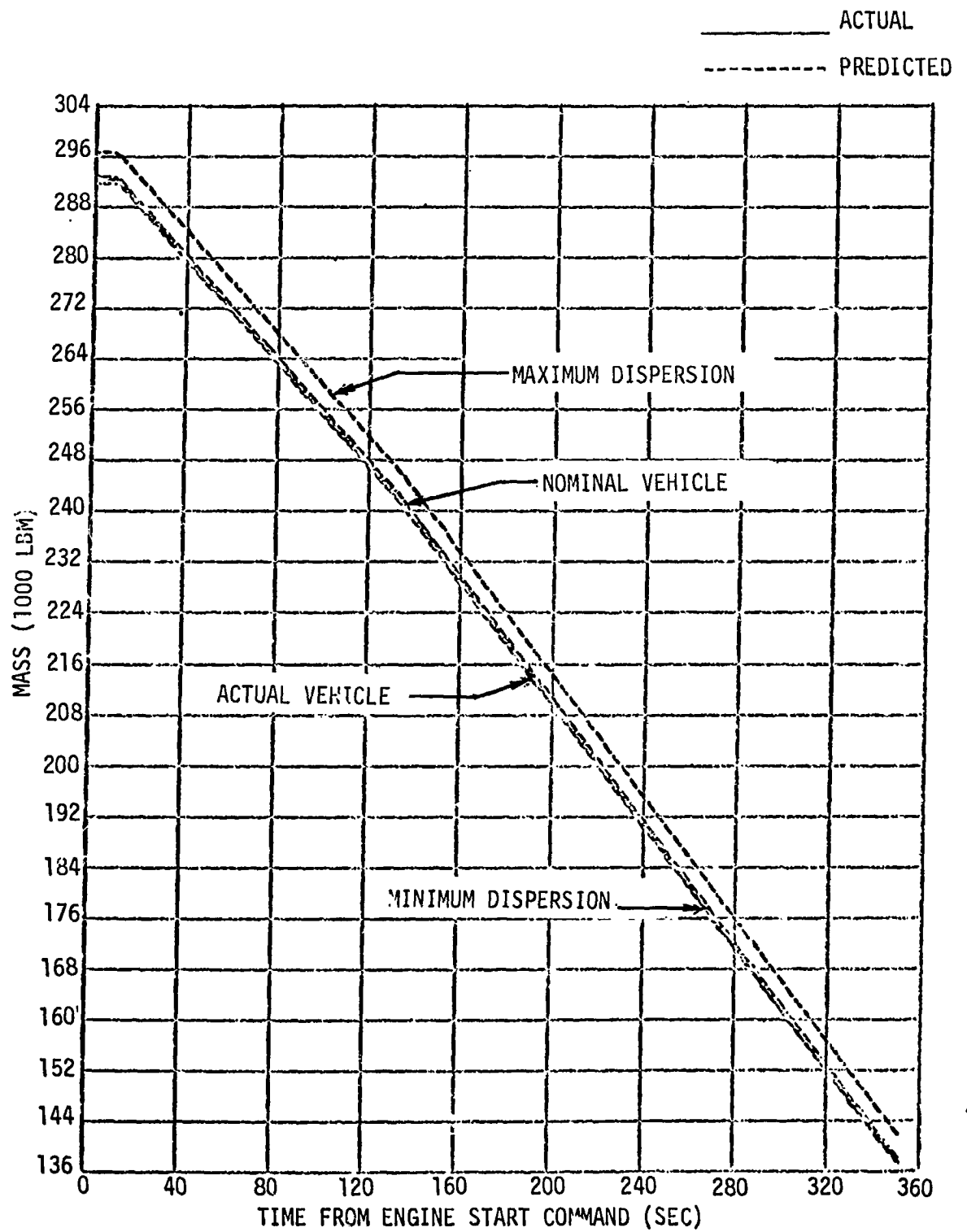

Figure 8-2. Third Flight Stage Vehicle Mass (Second Burn)

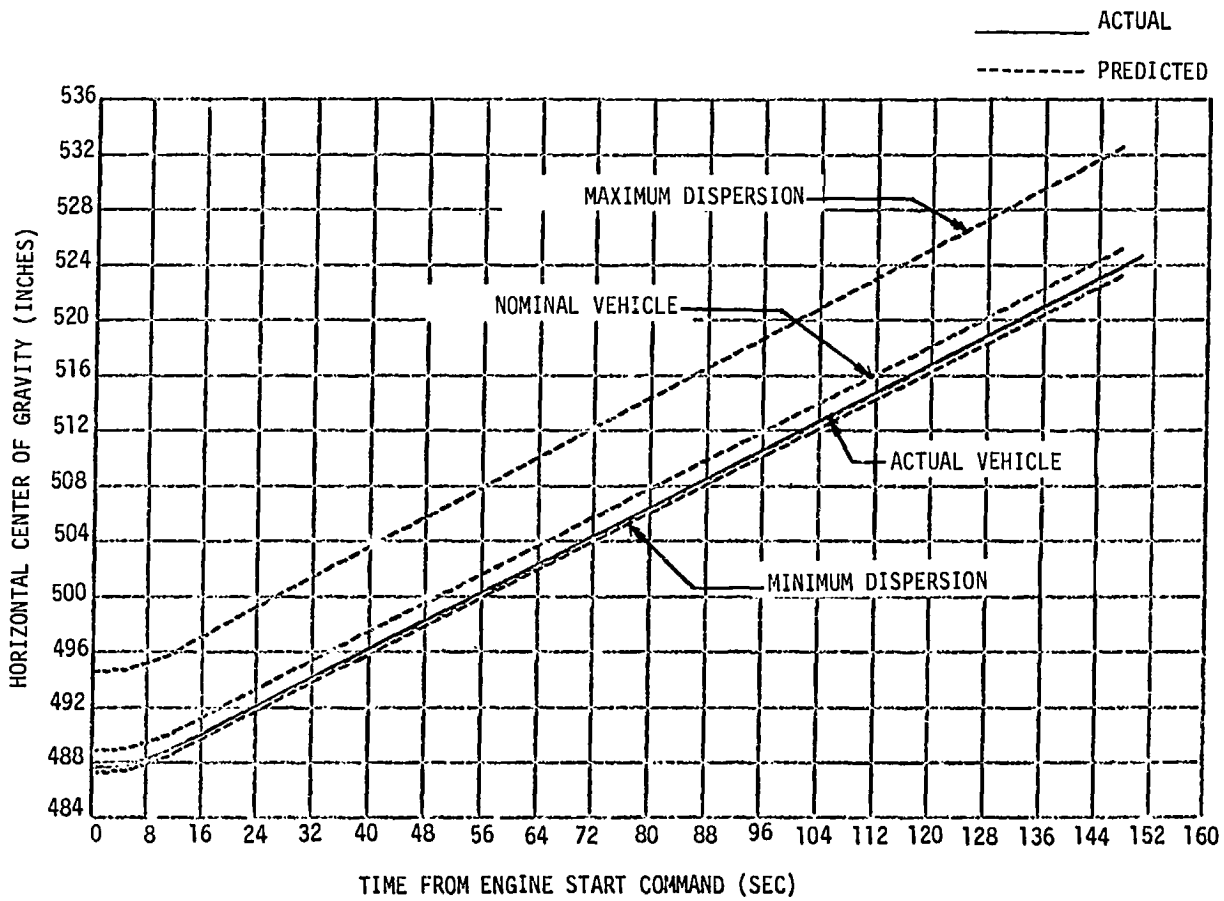

Figure 8-3. Third Flight Stage Vehicle Horizontal Center of Gravity (First Burn)

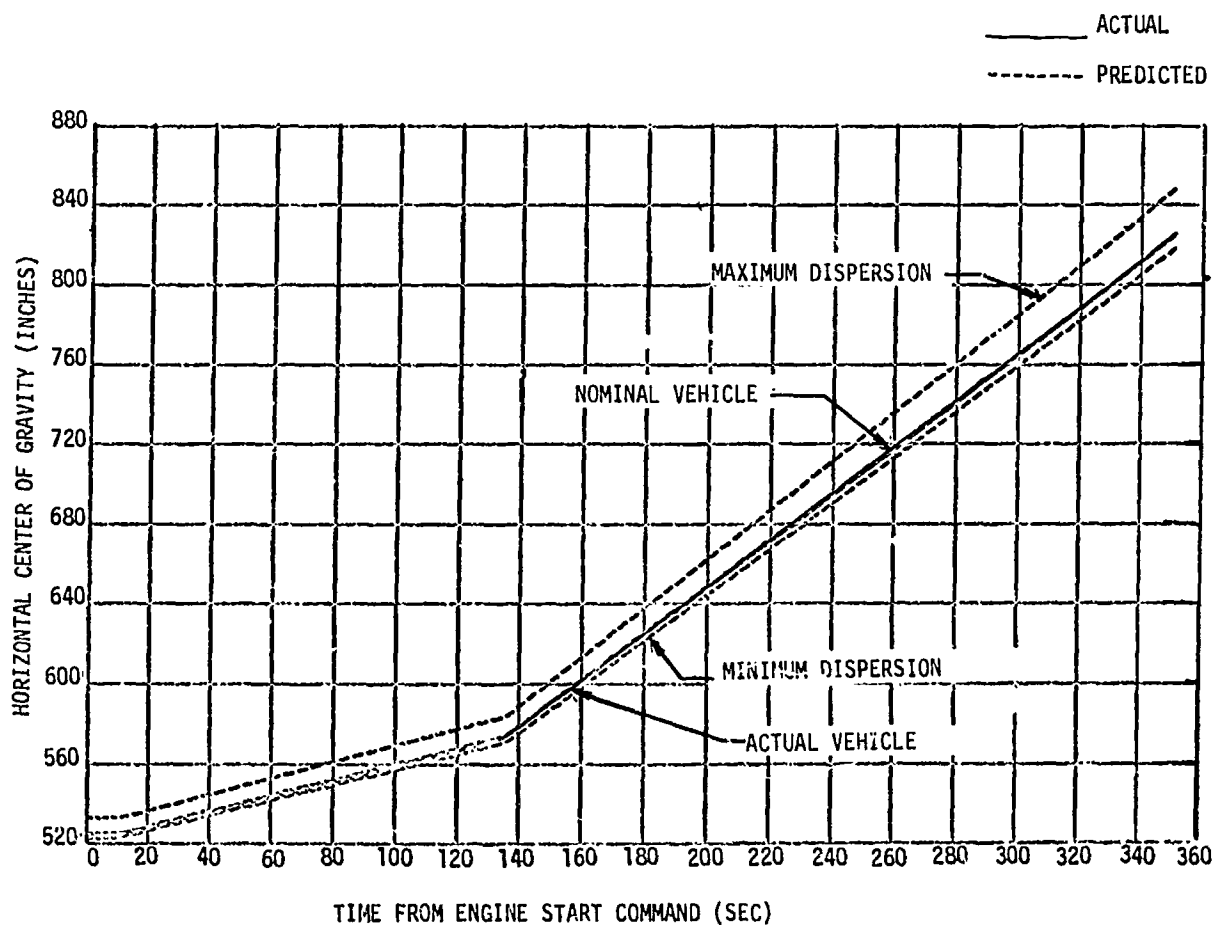

Figure 8-4. Third Flight Stage Vehicle Horizontal Center of Gravity (Second Burn)

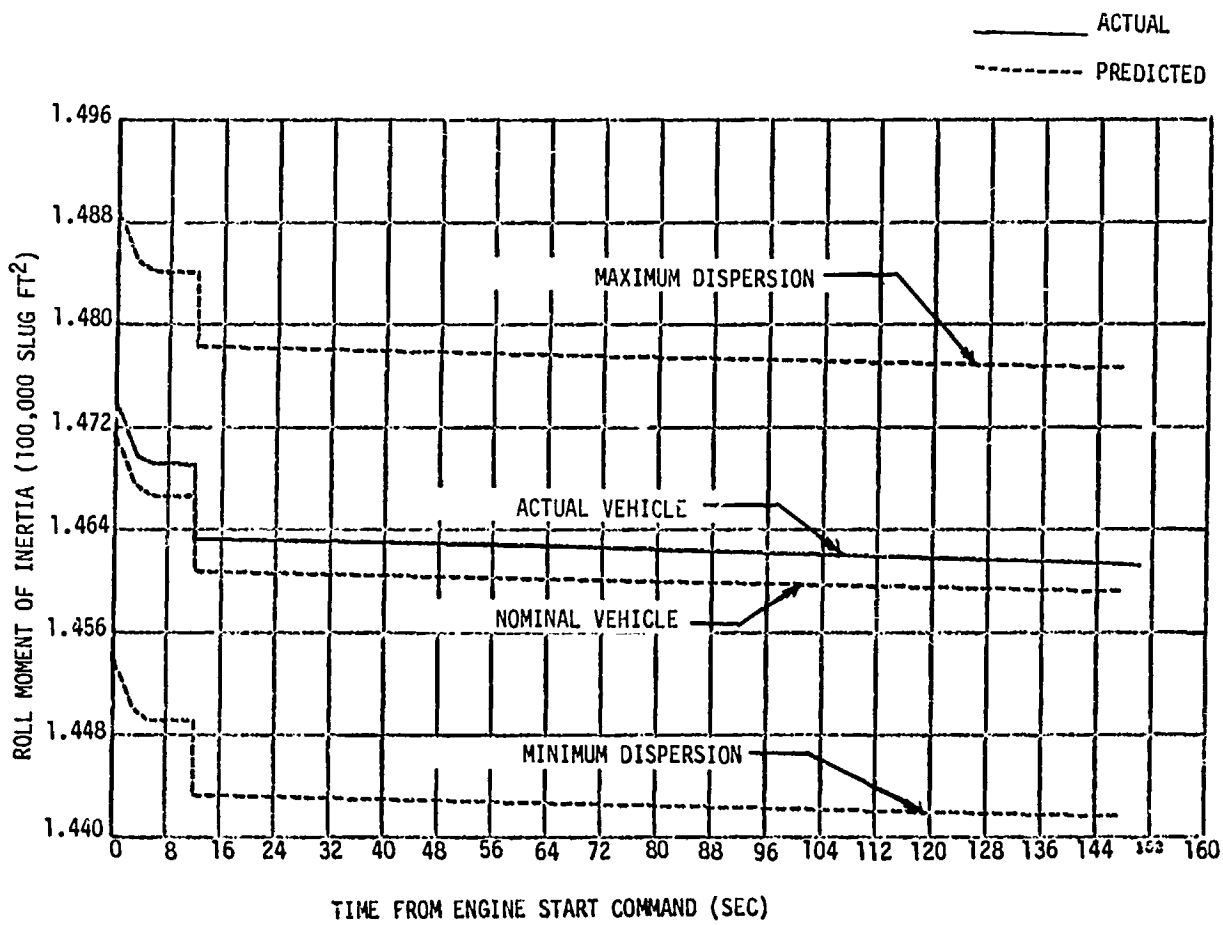

Figure 8-5. Third Flight Stage Vehicle Roll Moment of Inertia (First Burn)

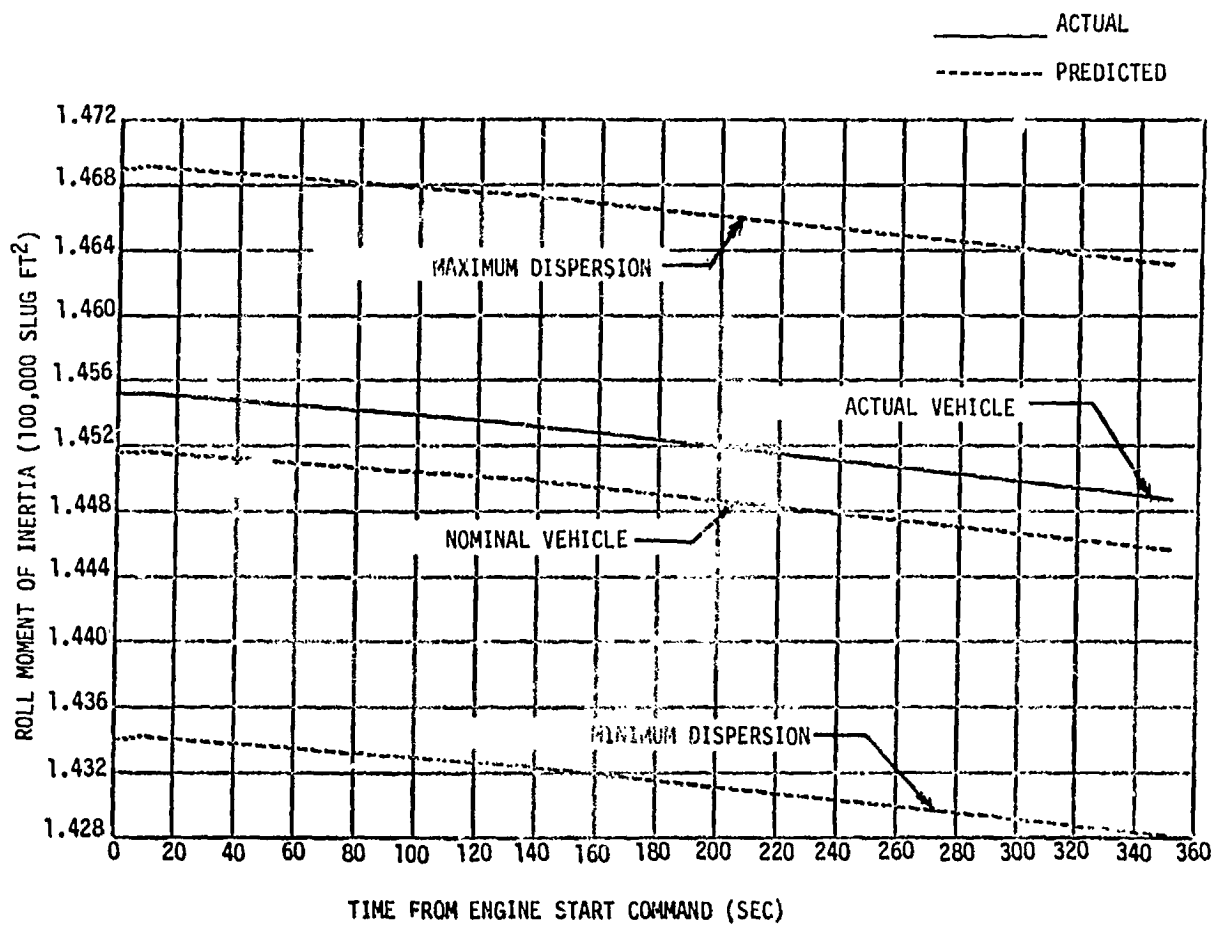

Figure 8-6. Third Flight Stage Vehicle Roll Moment of Inertia (Second Burn)

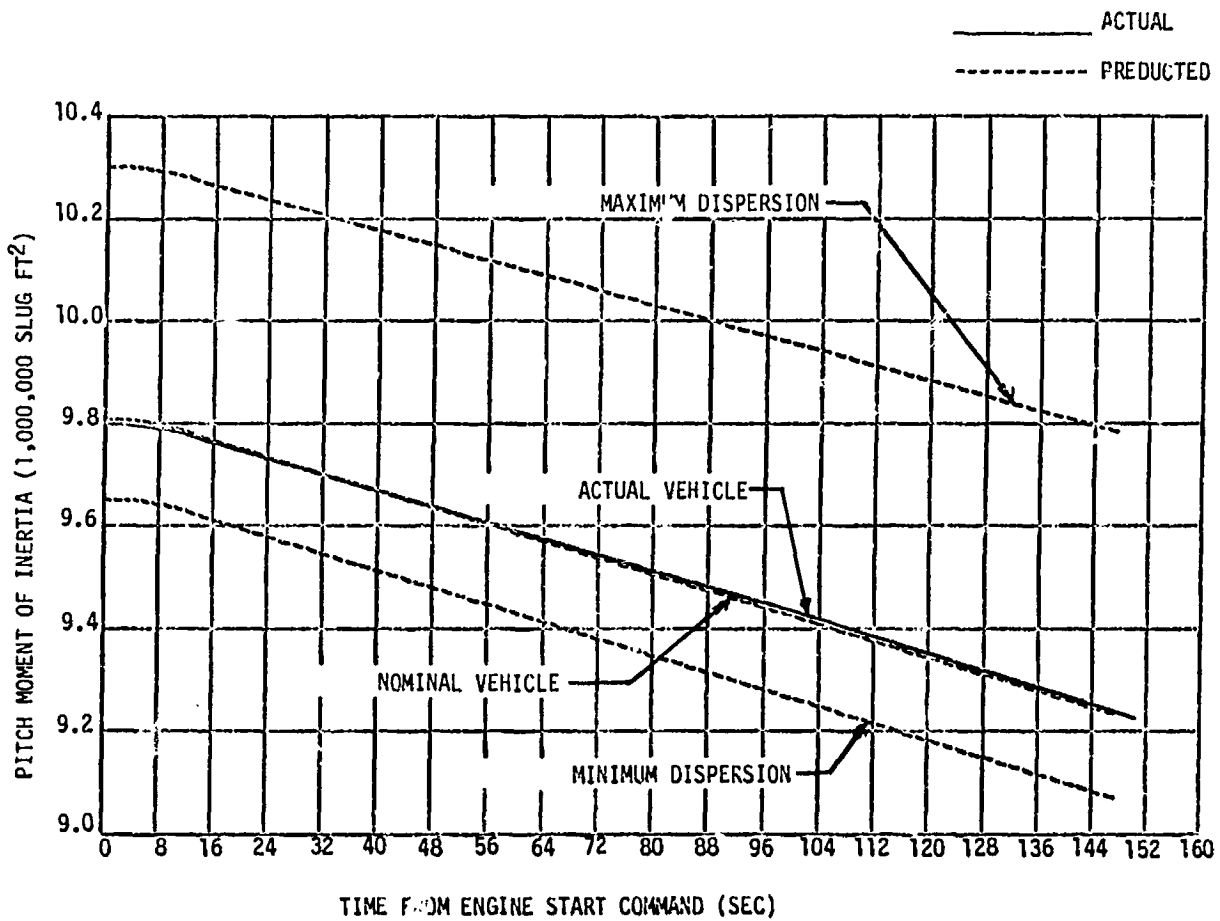

Figure 8-7. Third Flight Stage Vehicle Pitch Moment of Inertia (First Burn)

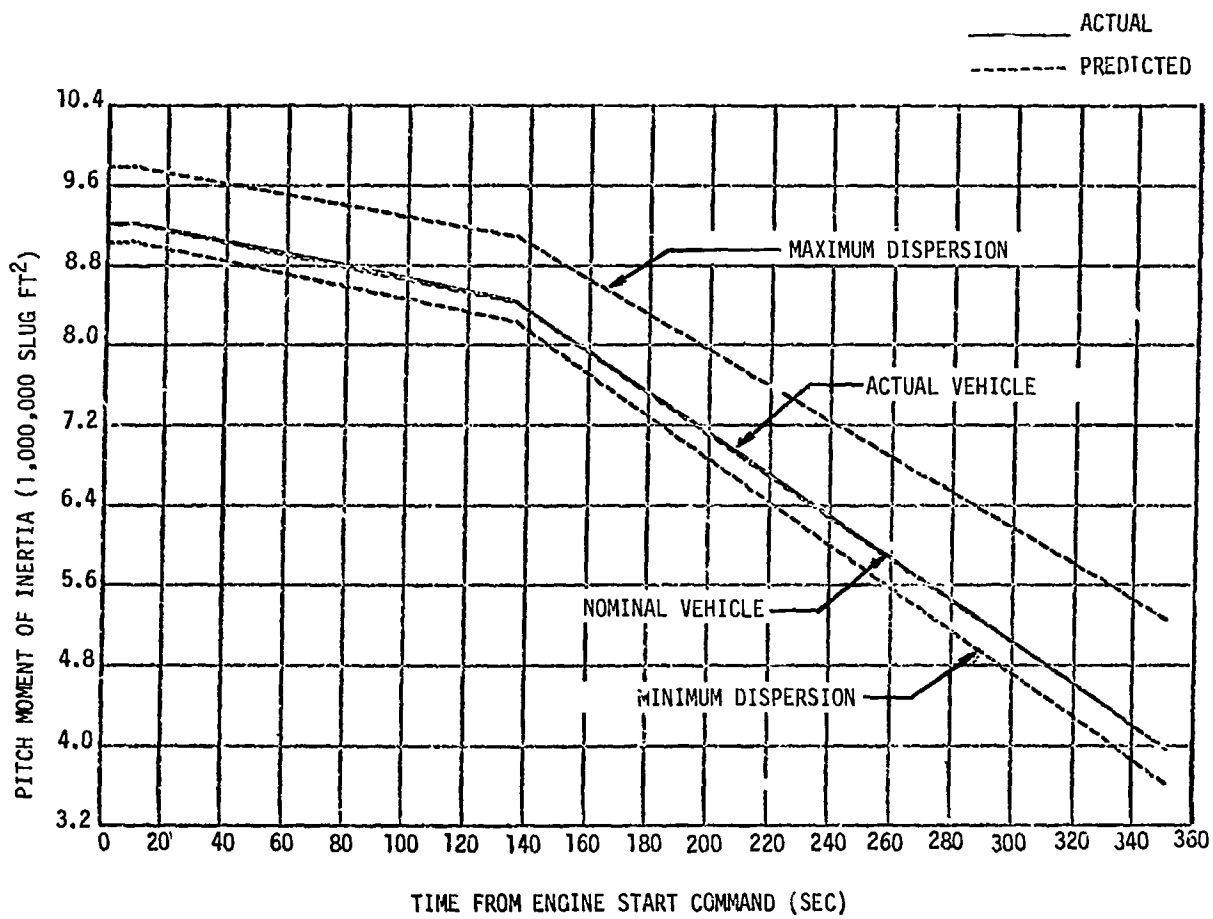

Figure 8-8. Third Flight Stage Vehicle Pitch Moment of Inertia (Second Burn)

AT IGNITION: 365,070 LBM 566
AT CUTOFF: 295,025 LBM 527

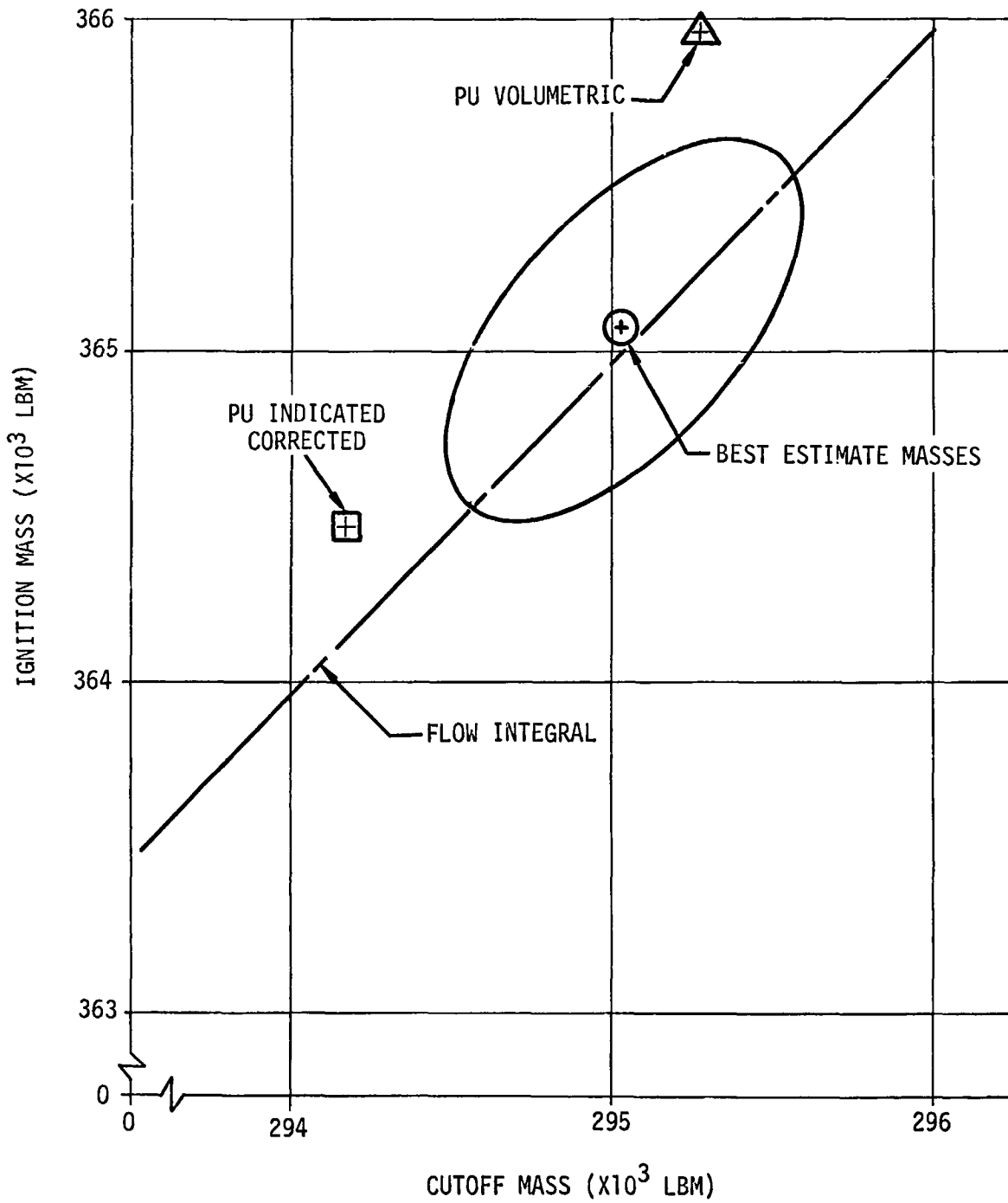

Figure 8-9. AS-505 Third Flight Stage Best Estimate Masses - Final (First Burn)

AT IGNITION: 292,204 LBM 478
 AT CUTOFF: 137,540 LBM 242

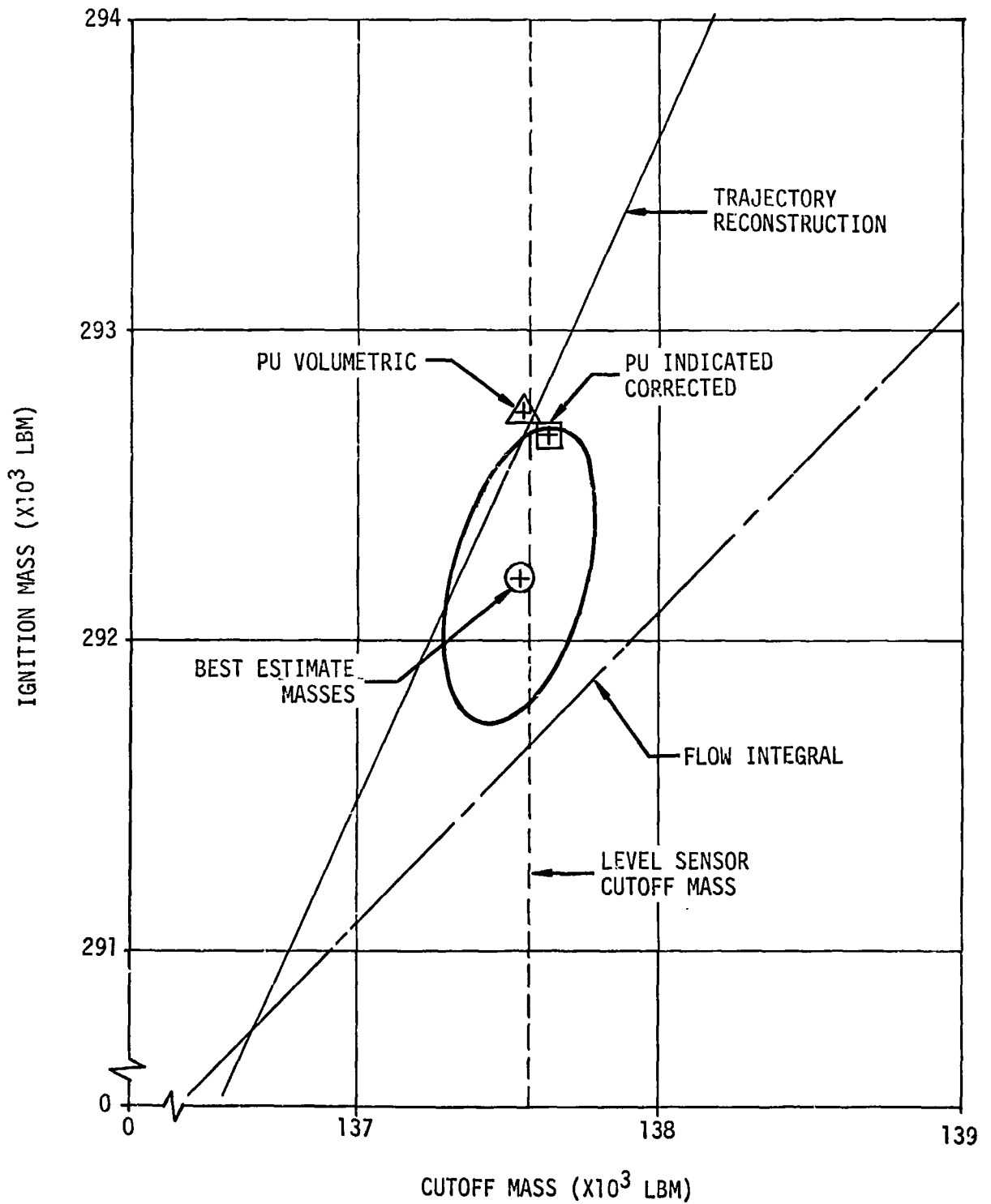

Figure 8-10. AS-505 Third Flight Step Best Estimate Masses - Final (Second Burn)

9. ENGINE SYSTEM

The main propulsion system of the S-IVB stage of the AS-505 launch vehicle consisted of a Rocketdyne J-2 engine (S/N J-2091), shown schematically in figure 9-1, and the associated propellant ducting and conditioning systems. The engine was rated to operate at 230,000 lbf thrust. As a result of the analysis of the engine and stage acceptance tests, a set of variable tags (figures 9-2 and 9-3) were established using the following engine constants.

Engine Constants

LOX flowmeter	5.5116 cycles/gal
LH2 flowmeter	1.8702 cycles/gal
LOX bootstrap orifice diameter	0.267 in.
LH2 bootstrap orifice diameter	0.475 in.
Oxidizer turbine bypass nozzle diameter	1.220 in.

The engine was equipped with a 1.0-sec start tank discharge valve (STDV) timer in the engine control circuit; however, actuation of the STDV, which determines the fuel lead duration, was controlled from the stage through the fuel injection temperature bypass circuit. Using this control, the fuel leads were 2.991 and 8.016 seconds for the first and second burns respectively.

9.1 Modifications

The engine was modified to improve restart capability. These modifications included retiming the main oxidizer valve (MOV) opening rate, reducing the augmented spark ignitor (ASI) LOX orifice size, and painting the crossover duct black. The stage PU system was modified to provide for a second burn engine start with the PU valve full open. The engine control bottle was connected with the stage ambient repressurization bottles (figure 3-1). The ASI system was modified by removing the bellows in the fuel and LOX ASI feedlines and replacing them with rigid tubular lines.

The PU valve was modified to reduce engine performance shifts. Other modifications were made involving instrumentation, but are not discussed here as they do not affect performance. Details of these modifications are presented in the Rocketdyne configuration report (R-5788).

9.2 Sequence of Events

The engine start and cutoff sequences were satisfactory in providing smooth transient operation and were compatible with engine logic. The opening and closing times for the valves were obtained from potentiometer readings as there were no closed microswitch indications for any valves on S-IVB-505N. There were no major deviations from specifications at any engine events in the first two burns. There were minor deviations which are ascribed to sampling rate errors or to the presence of liquids in the valves.

Significant engine events during the start transients are shown in figures 9-4 and 9-5. Tables 9-1 and 9-2 list the engine events for each burn.

9.3 Engine Chilldown and Conditioning

9.3.1 Turbopump Chilldown

Chilldown in conjunction with fuel lead adequately conditioned the LOX and LH2 turbopumps for a proper engine start for both first and second burns. Fuel lead was used to condition the LH2 turbopump. Figure 9-6 shows the condition of the LOX pump.

9.3.2 Thrust Chamber Chilldown

9.3.2.1 Ground Conditioning and Boost

Thrust chamber chilldown was initiated at RO -600 sec and terminated at RO -8.8 sec with a thrust chamber jacket temperature (COL99) that satisfied the maximum allowable redline limit of 330 deg R at liftoff. Thrust chamber ground conditioning and boost performance data are presented in figure 9-7.

9.3.2.2 Inflight Conditioning

Inflight conditioning of the thrust chamber was accomplished by the fuel lead which allowed hydrogen to flow through the thrust chamber jacket prior to mainstage operation. The time used for this fuel lead period is defined as the time between engine start command and STDV solenoid energize.

Fuel lead times were 2.991 and 8.016 seconds respectively for the first and second burns. The conditions and characteristics of these fuel leads are summarized in table 9-3. Flight measurements are presented in figures 9-8 and 9-9.

Both fuel lead operations (first and second burns) were satisfactory. Engine performance during the fuel lead periods is discussed in paragraphs 9.6.2 and 9.6.3.

9.3.3 Engine Start Sphere Chillover and Loading

Start sphere liftoff requirements are shown in figure 9-10 along with the actual. Sphere conditions at liftoff are compared to S-IVB-504N and S-IVB-503N flight conditions in table 9-4. The sphere warmup rate from sphere pressurization to blowdown was 1.6 deg/min; the S-IVB-504N warmup rate was 1.3 deg/min. The difference between the GH2 start sphere and engine control helium sphere temperatures on S-IVB-505N and S-IVB-504N after pressurization was 61 deg R and 25 deg R respectively. At liftoff, the respective differences had decreased to 43 and 4 deg R. The high 505N temperature differences result from a higher than normal control sphere temperature, measurement C0007,, which is believed to be inaccurate. This belief is supported by the start sphere warmup rates, which indicate more reasonable sphere temperature differences. The S-IVB-505N and S-IVB-504N warmup rates from pressurization to liftoff were 2.7 and 2.4 deg/min respectively. From liftoff to sphere blowdown, the respective warmup rates were 1.0 and 0.7 deg/min (figure 9-11).

9.3.4 Engine Control Sphere Chillover and Loading

Control sphere performance data during loading are presented in figure 9-12. Control sphere conditions at liftoff are compared with S-IVB-504N and S-IVB-503N flight conditions in table 9-5. The increase during boost is the result of boost-induced heating; similar pressure increases occurred during the boost periods of previous flights.

9.4 Start System Performance

9.4.1 First Burn

The J-2 engine start system performed as expected during first burn. The refill conditions are shown in table 9-6. Topping initiation and completion were accomplished satisfactorily and also as expected.

Following topping, heat input from the system environment caused a temperature increase and a corresponding pressure increase as shown in figure 9-13.

9.4.2 Orbital Coast

The pressure rise rate during orbital coast was 1.82 psi per minute and the start tank pressure increased from the cutoff pressure of 1,154.5 psia to the relief setting of 1,310 psia at $ECC_1 +84$ minutes. The start bottle conditions were within the required restart envelope at $ECC_1 +15.5$ minutes at a pressure of 1,200 psia. During the orbital coast period an estimated 0.28 lbm of GH_2 was vented through the relief valve. As noted on all previous flights, the measured temperature during orbital coast is invalid. Figure 9-14 compares data from 503N, 504N, and 505N stages. Corrected temperature data are also shown.

9.4.3 Second Burn and Safing

The start system performance was again as expected. The start tank conditions are shown in table 9-6. At $ESC_2 +8.016$ seconds STDV command open was given and the pressure decay initiated at $ESC_2 +8.142$ seconds.

STDV closure occurred at ESC₂ +8.820 seconds. Approximately 3.03 lbm of hydrogen was discharged during blowdown. The gaseous portion of refill was completed when the start tank pressure reached 714.6 psia at ESC₂ +15.1 seconds. Topping was completed with a start tank pressure of 1,072 psia at ESC₂ +164 seconds. Refill and topping are shown in figure 9-13 for both burns.

The unusual temperature reversal in the second burn topping phase of refill, shown in figure 9-13, is the result of PU shift from an EMR of 4.5 to 5.0 at ESC₂ +135.115. The fuel pump discharge pressure is higher at 5.0 than 4.5 and because of this, additional liquid was added to the start tank after the first topping phase had been completed and heat up had taken place. This is more easily seen in figure 9-15 (sheet 2) where comparisons between fuel pump pressure, fuel injector pressure and start tank pressure are shown during refill.

At engine cutoff the pressure had risen to 1,145 psi as shown in table 9-6 due to environmental heating.

The start tank was safed at approximately 3.5 seconds after second engine cutoff command. The pressure decay is shown in figure 9-16.

9.5 Engine Pneumatic System Performance

9.5.1 First Burn

During the AS-505 flight, the J-2 engine helium control sphere was connected to the seven stage ambient helium repress bottles. Two check valves between the control sphere and repress bottles insure that the direction of helium flow was always into the control sphere.

Table 9-5 shows pressure and temperature data and calculated mass. During both burns the ambient repress spheres replenished the control sphere. A drop in temperature due to heat transfer with the start bottle caused more mass to flow into the control bottle resulting in a slight increase in mass and pressure at first engine cutoff command. A slight

pressure decrease was noted in the ambient bottles due to the intermediate seal cavity purge during mainstage. The usage was within required limits. Pressure during the burn was higher than the nominal prediction due to a high repress sphere pressure. The predicted value was $2,935 \pm 200$ psia.

The control sphere temperature during both burns was high and outside of the predicted band. This was due to a high temperature in the control sphere at liftoff (320°R).

Due to friction in the lines, check valve flow resistance and spring forces, there was an average pressure difference between the ambient bottles and the control bottle of approximately 113 psi.

Helium usage was estimated from purge flowrates and burntimes. The fuel lead time for the first-burn engine start was 2.991 seconds, but the ignition phase control timer (0.450 ± 0.03) extended the period of high helium usage associated with the fuel lead to 3.433 seconds which was normal. Approximately 0.340 lbm was consumed during first burn.

Figure 9-17 is a plot of pressure versus temperature. Pressure and temperature versus time are shown in figure 9-18. Figure 9-19 presents regulator outlet pressure which was within predicted limits of 425 ± 25 psia.

9.5.2 Earth Orbit

Pressure buildup due to heatup was within the predicted band. Figure 9-20 is a plot of pressure versus time during Earth orbit.

9.5.3 Second Burn

The pressure during the burn was higher than the nominal prediction due to higher than anticipated pressure in the repressurization spheres. A slight normal decrease in pressure in the repressurization spheres was again noted due to the intermediate seal cavity purge.

The ignition phase control timer extended the period of high helium usage from 8.016 seconds associated with fuel lead to 8.466 seconds. The mass usage during the burn was estimated from flowrates to be approximately 0.79 lbm.

Second burn pressure and temperature are shown in figures 9-17, 9-18, and 9-19. Regulated pressure was within the predicted limits of 425 ± 25 psia.

9.5.4 Translunar Coast

Pressure buildup due to heatup was within required limits during translunar coast. Figure 9-20 is a plot of pressure versus time during the coast period.

9.5.5 Engine pneumatic System Performance During Experiment

Initial consumption during the LOX lead was greater than anticipated because the mainstage control valve was actuated approximately one second after the helium control solenoid was energized. This allowed one second of high helium usage. The difference between actual pressure drop rate and the predicted rate is due to differences in helium usage during the LOX and fuel dump periods. The usage values used for the prediction were the current Rocketdyne test values of 0.0057 lbm/sec and 0.0407 lbm/sec for LOX and fuel dump respectively. These numbers have been recently updated to 0.0063 lbm/sec and 0.0574 lbm/sec respectively which would account for the differences. As a result of this and the fact that there was no prediction for the LOX dome purge, helium usage for the remainder of the experiment was outside the predicted band. Figure 9-21 shows control bottle pressure during LOX lead, LOX dome purge, fuel lead, and LOX dump.

9.5.5.1 LOX Dump

Control bottle pressure during the LOX dump was high and outside the predicted band. This was a result of a higher than predicted pressure in the LH2 repress sphere at the end of pressurization and a corresponding

higher pressure in the control bottle. Figure 9-21 shows pressure versus time in the control sphere during the LOX dump.

9.5.5.2 Control Bottle Passivation

The control bottle was dumped as planned. Figure 9-22 is a plot of pressure versus time during the dump.

9.6 Engine Performance

9.6.1 J-2 Engine Performance Analysis Methods and Instrumentation

The performance of the engine start tank and helium control sphere was analyzed by applying thermodynamic relationships to the measured data. Start and cutoff transient thrust and impulse were determined by computer program PA53. Flowrates and consumption during the transients were determined by computer program G105. Computer program UT23A was used to investigate internal engine performance. Steady-state performance was calculated by use of computer program PA63. The results of G105 program were used in determining the best estimate of stage propellant consumption. Revised tag values, based on flight data, were generated by computer program PA63 (Rocketdyne PAST 641); the results are presented in table 9-7. Data inputs to the computer programs with the applicable biases are shown in table 9-8.

9.6.2 Fuel Lead-First Burn

The S-1VB-505N temperature and pressure data are compared to AS-504 data in figure 9-8. The AS-505 first burn data correlate very well with AS-504 data as shown. Fuel injector temperature (CO200) data as shown has a 40 degree temperature bias added due to a zero shift (table 18-3). This bias was determined by the mainstage operation of this transducer which normally is 40 degrees higher than indicated.

Table 9-3 shows that AS-505 fuel lead had a slightly higher total impulse and total flow than AS-504. This is expected since starting conditions

for AS-505 flight were slightly cooler than for the AS-504 flight. Flowrates, total flow, thrust, and total impulse presented in figure 9-23 were calculated using flowmeter, temperature, and pressure data.

9.6.3 Fuel Lead-Second Burn

Temperature and pressure data from S-IVB-505N flight are compared in figure 9-9, as to 504N data and also 503N data, where applicable. Data from 505N compares quite well with 503N data since starting conditions and ullage pressures were quite similar. The differences in thrust chamber jacket temperature (C0199) measurements of the different tests are mainly due to differences in installation. Fuel injector temperatures (C0200) on AS-505 and AS-503 differ from those on AS-504 because of different tank ullage pressures. C0200 for 505N had the 40 degree temperature bias which was discussed in paragraph 9.6.2 above.

Table 9-3 shows that the AS-505 flight had a higher total flow and total impulse than the AS-503 flight. This is expected since the AS-505 flight hardware for second burn start were generally cooler than that for AS-503. The data shown in figure 9-24 of flowrates, total flow, thrust, and total impulse were calculated using the same method as for first-burn analysis.

9.6.4 Start Transient - First and Second Burn

Engine performance during the first and second burn start transients was satisfactory. A summary of this performance is presented in table 9-9. First burn thrust buildup occurred at a null PU valve position following a 3-second fuel lead while second burn thrust buildup occurred with the PU valve fully open after an 8-second fuel lead. During first and second starts the PU valve position and MOV operation were satisfactory and good starts were obtained.

Thrust buildup to the 90 percent performance level (STDV command +2.5 sec) was within the maximum and minimum thrust limits for first and second burns as shown in figure 9-25. Since these limits were established for a null PU valve position at start and the second start occurred with a full

open PU valve, the thrust approaches the minimum limit near the end of the second burn start transient.

The thrust and total impulse at the 90 percent performance level were very similar to the S-IVB-501, 503N, and 504N flight values for both burns. The total impulse values were greater than those reported in the log book. Figure 9-25 shows the thrust chamber pressure, the thrust buildup, and total impulse during both start transients. Figures 9-26 and 9-27 show the measured flowrates, consumptions, and pump speeds during the two start transients.

9.6.5 J-2 Engine Steady State Performance - First and Second Burns

The S-IVB stage J-2 engine met all objectives during the 505 mission for both first and second burns. Plots of selected data showing engine characteristics are presented in figures 9-28 through 9-33 for first and second burns. The engine propellant inlet conditions are discussed in sections 11 and 12. The average engine performance and propellant consumption summary is presented in tables 9-10 and 9-11. The engine performance was satisfactory and near predicted for both burns. As shown in table 9-10 the engine thrust and specific impulse were slightly higher than predicted, and second burntime was 0.9 sec less than predicted. Computed engine performance parameters of thrust, ISP, EMR, LOX flow, fuel flow, and total flow for both burns are shown in figures 9-34 and 9-35. As shown in figure 9-35 actual ISP performance for the first 135 seconds of second burn was much higher than predicted. This apparent deviation is attributed mainly to the use of generalized engine performance curves derived as a function of PU valve position. This information is supplied by the engine manufacturer for all engines on which the PU valve baffles were rotated after the completion of the manufacturer's testing. None of the ground tests on engine J-2091 were performed under conditions with both the PU valve in the full open position (4.5 EMR) and the PU valve baffle rotated.

The standard altitude performance levels (engine tag values) for both burns, as determined by computer program PA63 (Past 641 deck) are shown

in table 9-11. These values are given at ESC₁ +140 sec for first burn and ESC₂ +180 sec for second burn when the PU valve was in the null position and after run-in characteristics had stabilized. The engine tag values compared to predicted are shown in figures 9-2 and 9-3. All tag parameters were close to the predicted deviations during both burns. First and second burn tag values were in good agreement during stabilized null PU valve operation. No large engine performance shifts were observed during engine operation. There appeared to be a small performance shift at ESC +330 sec possibly due to a PU valve resistance shift.

Table 9-10 shows total impulse generated during mainstage operation for first and second burns. This provided sufficient velocity gain to complete orbital insertion and, during the second burn, to provide the necessary velocity to place the payload on a translunar trajectory. Extrapolation of the propellant residuals (5,314 lbm LOX and 2,194 LH2) at second burn cutoff indicates that a LOX depletion would have occurred at ECC₂ +12.04 sec providing an additional 2.470×10^6 lbf-sec of impulse.

9.6.6 Cutoff Transients - First and Second Burn

Engine performance during both first and second burn cutoff transients was satisfactory. The time lapse between engine cutoff, as received at the engine, and thrust decrease to 11,500 lbf (5 percent thrust) was within the maximum allowable time of 800 ms for both burns. Engine performance during the cutoff transients is shown in table 9-12.

The total impulse values determined for the flight were adjusted to standard conditions (null PU and 460 deg R MOV temperature) to compare them to the logbook values. The adjusted first burn cutoff impulse was 3,012 lbf-sec lower than the logbook value while the second burn impulse was 834 lbf-sec lower.

Because MOV actuator skin temperature was not measured on this flight, cutoff impulse was corrected to predicted temperatures of -133°F for first burn and -155°F for the second.

Figure 9-36 shows the thrust chamber pressure, the thrust decrease, and total impulse for the first and second cutoff transients.

The cutoff impulse to zero thrust computed from actual trajectory data for the S-IVB first burn was 47,093 lb-sec, and for the second burn, 52,942 lb-sec. The first and second burn cutoff impulses determined from engine thrust data were 45,720 lb-sec and 47,356 lb-sec, respectively. All deviations from predicted were within the expected three-sigma tolerance. Table 9-13 presents a comparison of predicted and actual cutoff impulses for both first and second burns.

9.7 Trajectory Simulation Analysis

A five-degrees-of-freedom trajectory simulation program was used to adjust propulsion system parameter histories so that an S-IVB trajectory could be generated which closely matched the observed trajectory. To obtain this match of the observed trajectory a differential correction technique was used to adjust the levels of thrust and weight flow from those determined by engine analysis. These adjustments are summarized in the table below:

	<u>First Burn</u>	<u>Second Burn</u>
Thrust	1.12%	+0.97%
Weight Flow	*	+0.11%

*The weight flow for first burn was constrained to match the propellant consumption of the best estimate mass simulation.

These adjustments minimized, in a least squares sense, the weighted differences in earth-fixed azimuth angle, altitude, earth-fixed velocity, and axial acceleration between the observed and simulated trajectories. Average values of thrust and weight flow for both burns are presented in Section 7.

9.8 Component Operation

9.8.1 Main LOX Valve

The main LOX valve opened and closed satisfactorily for the first and second burns. The valve opening time data were as follows:

Item	Nominal	S-IVB 505N Flight		Acceptance Test
		1st Burn	2nd Burn	
First Stage Travel Time (ms)	50 ±25	88	86	67
First Stage Plateau (ms)	510 ±70	398	414	476
Second Stage Travel (ms)	1825 ±75	1760	1760	1776
Total(ms)	1285 ±170	2246	2260	2319

The flight data acquisition accuracy is probably responsible for the deviations in first stage travel and first stage plateau from the specification limits. The accuracy level is a result of the 10 sample/sec data sampling rate.

9.8.2 Engine Driven Hydraulic Pump

The engine driven hydraulic pump performed satisfactorily during first and second burn periods. The average power required by the pump was 3.85 horsepower during first burn and 4.85 horsepower during second burn.

9.8.3 Pumps and Turbines

The LH2 and LOX pumps and turbines performed satisfactorily during first and second burns. The pump speeds, discharge pressures and temperatures during these burns responded to the engine inlet conditions and changes in PU valve position. The pressure and temperature drops across the turbines were nominal. The LH2 and LOX pump and turbine data are shown

in figures 9-30, 9-31, and 9-33. The LH2 pump performance during both start transients is shown on the H-Q curve (figure 9-37) which indicate no severe trends toward the stall lines.

9.8.4 PU Valve

The PU valve overall level of performance during both starts and burns was satisfactory. At first burn engine start command (ESC_1) the PU valve was at the null (-2°) position. The valve was programmed to remain in the null position during first burn; however, when flow forces began to act on the valve, it moved an unexpected $+0.8$ deg. At second burn engine start command (ESC_2) minus 119.9 seconds, the PU valve was commanded fully open. It responded properly going to the fully open position (-30.1 deg) where it remained until $ESC_2 +135.11$ sec when the full open command was removed. Programmed time was 135.5 seconds. For the remainder of second burn the valve was in the same position as in first burn, at -1.2 deg as compared to the expected null of -1.0 deg. Also, after both engine cutoffs the valve moved close to the expected null (-2 deg) position. The inability to hold the valve in the null position under flow conditions is attributed to a difference between the actual and indicated PU valve feedback. For 505N flight the $+0.8$ deg shift in the null position during both burn periods caused an increase in thrust (1,100 lbf) and EMR ($+0.045$). The PU system performance is discussed in section 16.

9.8.5 Gas Generator

The gas generator (GG) performance was adequate. The GG chamber pressure and LH2 turbine inlet temperature indicated nominal values before and after the commanded PU valve shift. Plots of GG performance are shown in figure 9-38.

9.8.6 Augmented Spark Ignitor System

Instrumentation installed to monitor ASI system performance responded as expected. Both LOX and LH2 supply line temperatures decreased to expected

levels during burn and did not indicate any abnormal condition. Combustion chamber temperature responded during fuel lead indicating proper ignition of the ASI. The measurement was cooled by its local environment during mainstage (figures 9-39 and 9-40).

9.9. Propellant Lead Experiment

A propellant lead experiment was conducted to obtain data for use in establishing alternate restart chardown sequences. The major events in this experiment were performed in the following sequence:

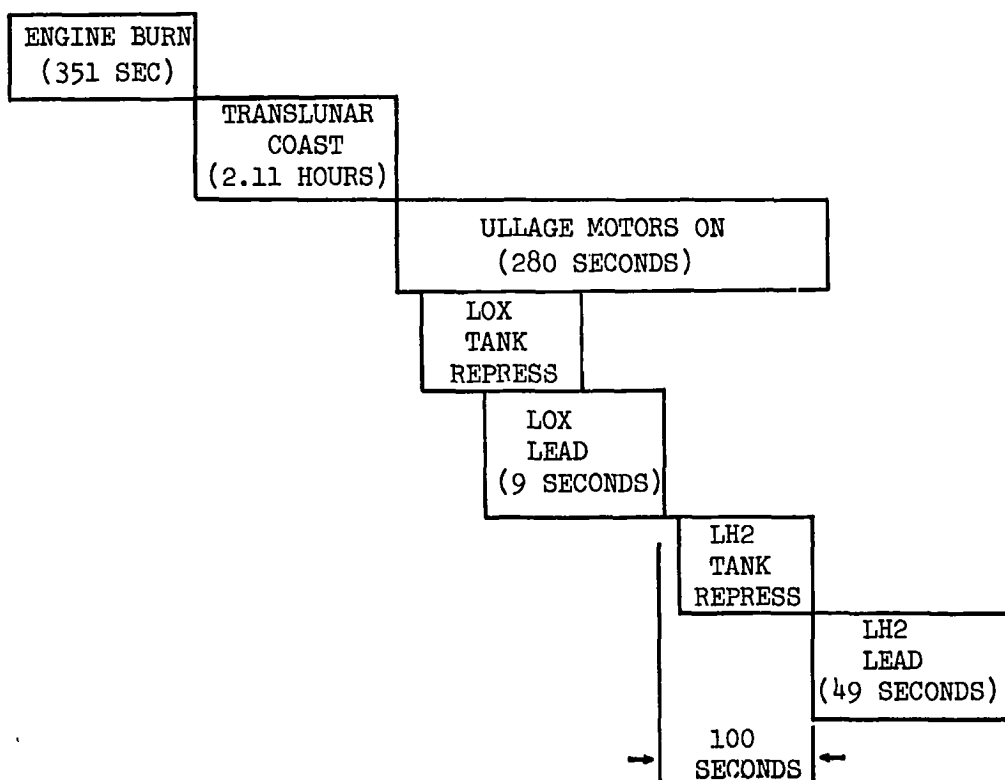

The sequence achieved during flight was generally in accord with the planned sequence. The only significant variance was an abbreviated LH2 tank repressurization (repress). This exception did not materially

affect the results as the LOX and LH2 tank pressures were within the range predicted for this experiment. Results, conditions, and performance are presented in the following sections.

9.9.1 Results

The following conclusions were made regarding the characteristics investigated during the experiment.

- a. An 8-second LOX lead will provide satisfactory LOX pump inlet start conditions for a period of 150 seconds from the beginning of LOX lead.
- b. A 100-second time delay period is satisfactory between the end of LOX lead and the beginning of fuel lead.
- c. A compromise in fuel lead time may be required.
 1. With an 8-second LOX lead the maximum fuel lead time that should be programmed to avoid thrust chamber over-chilling is 9 seconds.
 2. The minimum fuel lead time that should be programmed to obtain 100 feet of NPSH at the fuel pump inlet is 12.5 seconds.
- d. A decrease in LOX lead time below 8 seconds increases thrust chamber fuel lead time but not enough to bring it into agreement with fuel pump fuel lead time.
- e. A compromise may be desired between LOX lead time, thrust chamber fuel lead time, and fuel pump fuel lead time.
- f. Higher probabilities of success may be obtained if the fuel pump is prechilled prior to fuel lead by some other means.

The experiment results leading to these conclusions are presented in figure 9-41. This figure presents the predicted characteristics for an operational LOR mission restart procedure in which a LOX lead - wait period - fuel lead sequence is used to chill down the engine prior to initiation of mainstage operation.

LOX pump inlet chilldown and heat-up rate predictions are shown on sheet 1 of figure 9-41. The 8-second LOX lead time characteristic is based on

data obtained in this experiment corrected to the conditions of an operational LOR mission restart. Other LOX lead time characteristics shown in the figure are based on the demonstrated 8-second heat-up rate and an additional delay time calculated from previous LOX chilldown/heat-up rate analyses.

It is predicted that the temperature of the LOX in the tank will be obtained at the LOX pump inlet in approximately 3 seconds. Also, that with an 8-second LOX lead, the engine mainstage command (which occurs at STDV) may be delayed up to 150 seconds before the normal LOX NPSH start limit is reached.

The experiment also demonstrated that with an 8-second or longer LOX lead a saturated condition will exist at the pump discharge when the inlet is within the start limit. Recent information from Rocketdyne and a review of the 504N third burn LOX pump start performance indicate that a sub-cooled condition at the pump discharge is desirable but not mandatory for a successful start. It is therefore concluded that pump discharge conditions will be satisfactory if inlet conditions are satisfied.

The effects of LOX lead time and dwell time on the fuel inject temperature measurement (CO200) are shown in sheet 2 of figure 9-42. The 8-second characteristic was demonstrated during the experiment. Other LOX lead histories shown on this sheet are based on an extension of the observed chilldown rate and estimated heat-up rates. This curve indicates thrust chamber conditions and shows the relation between LOX lead time, dwell time, and thrust chamber conditions at the start of fuel lead. For example an 8-second LOX lead followed by a 100-second time delay between the end of LOX lead and the beginning of fuel lead results in a fuel lead start (main fuel valve opening) time of 108 seconds after LOX lead start. As shown on the figure this results in a fuel injector temperature of 261 degrees, which is 19 degrees less than the 280 degrees that would have existed if there had been no LOX lead. This sheet is used to establish the fuel inject temperature at the start of fuel lead for each of the constant LOX lead time curves shown on sheet 3.

Fuel injector temperature during fuel lead is a function of LOX lead time and the delay time between LOX lead and fuel lead. This is plotted on sheet 3 of figure 9-42 for a constant time of 108 seconds between LOX lead start and fuel lead start. It is based on a linear relation between the initial fuel inject temperature (CO200) and chilldown time. Two chilldown models are shown. One is based on the 505N experiment and the other on the 504N third burn extended fuel lead experiment. The maximum prechill model (505N experiment) is a minimum fuel lead time case because it had maximum feed system chilling prior to fuel lead. The ullage motors were on for an extended period of time prior to fuel lead and were most effective in settling propellants into the fuel feed system because of low vehicle mass in the order of 30,000 pounds. The applied LOX lead settling thrust chilled down the thrust chamber directly and also chilled the inlet system by adding settling impulse. In this case the LOX lead impulse would also be most effective because of the low vehicle mass. The 8-second LOX lead time curve in this model is based on the 505N experiment data corrected to a tank pressure of 31 psia.

The minimum prechill model (504N experiment) is the maximum chilldown time case. In this case ullage motor operation was at a minimum and vehicle mass was high in the order of 300,000 pounds. This resulted in a minimum amount of inlet system chilldown prior to fuel lead. Also, in this case LOX lead was not used; therefore no prechill resulted from this source. The minimum prechill model curves were prepared using 504N data corrected to 31 psia for the zero LOX lead time curve. Sheet 3 provides the basis for the injector temperature limits shown on sheet 4 of figure 9-41.

The predictable band for fuel injector temperature versus fuel lead time for an 8-second LOX lead followed by a 100-second wait period before start of fuel lead is shown on sheet 4 of figure 9-42. The minimum allowable fuel lead time, as established by a 310°R maximum injector temperature limit, is 4.5 seconds. The maximum allowable fuel lead time is 9 seconds and was established by the engine requirement that the

temperature should not be at or below 40°R for more than 3 seconds prior to STDV; however, if the LOX lead time is extended beyond 8 seconds the allowable fuel lead time decreases below 9 seconds.

Fuel pump inlet conditioning criteria are also shown on figure 9-41 (sheet 4). These are based on 505N and 504N extended fuel lead data corrected to operational tank pressures. The minimum fuel lead time side of the shaded area is 505N. The other side (maximum time) of the curve is 504N. This band is due to the effect on flowrate of prechilling conditions discussed in connection with sheet 3. The dashed lines of constant mass flow indicate the major phases of the conditioning process. These points are based primarily on data from the 504N experiment. At approximately 3 seconds of fuel lead all-liquid at zero NPSH will exist at the stage-engine interface. This occurs when approximately 3 pounds of fuel have passed through the injector of the engine. This figure predicts that a minimum of 10 and a maximum of 12.5 seconds will be required to achieve 100 feet of NPSH. A constant propellant quantity line is used as the NPSH criteria on the basis of constant initial thermal conditions and constant heat load removed per pound of propellant discharged.

These predictions show (sheet 4 of figure 9-41) that the thrust chamber will be in a satisfactory start condition at any fuel lead time between 4.5 and 9 seconds. The thrust chamber therefore requires a maximum programmed fuel lead time of 9 seconds while the pump requires a minimum of 12.5 seconds. Obviously both requirements cannot be met. It is therefore necessary to consider methods of increasing thrust chamber fuel lead time or decreasing pump fuel lead time.

Thrust chamber fuel lead time may be increased by decreasing LOX lead time. Figure 9-41 (sheet 3) indicates that the trade-off is in the order of 8 to 1. That is, an 8-second decrease in LOX lead time results in a 1-second increase in thrust chamber fuel lead time. This trade-off factor has not been well established, therefore it is not considered to be conclusive at this time. One factor not completely reflected in these data is the influence of settling thrust (from LOX lead and ullage motor

operations) on thrust chamber chilldown. It is possible that the highest probability of success sequence involves a dual compromise. For example, a 4-second LOX lead in combination with a 12-second fuel lead might result in optimum risk between LOX pump, fuel pump, and thrust chamber chilldown requirements.

Fuel pump fuel lead requirements may be decreased by either of two methods:

- a. Increased prechilling of the feed system and pump inlet by maximizing propellant settling impulse (ullage motor operation).
- b. Prechilling the pump by some other means.

The chilldown effects of ullage motor operations were observed in the experiment; however, it is extremely difficult to assess these effects and establish meaningful trade-off factors between ullage motor operations and pump fuel lead time requirements. The effect from this source between 505N and 504N experiments is in the order of 2 seconds. This is the difference in 505N and 504N 100 feet NPSH fuel lead times shown in figure 9-42 and indicates that pump chilldown time is not greatly sensitive to the prefuel lead acceleration environment. During the 505N experiment 275 seconds of ullage motor operation prior to fuel lead were applied to a vehicle mass in the order of 30,000 pounds; while during the 504N experiment, 30 seconds of ullage motor operation were applied to a vehicle mass in the order of 290,000 pounds. These data therefore reflect a g-load x time factor of 88.5 to one for the 2-second change in pump chilldown time shown in figure 9-42.

A higher probability of success might be obtained with LOX lead and fuel lead optimized independently of fuel pump chilldown. This would require a separate method of fuel pump chilldown, and LOX lead times would probably be extended to obtain an additional margin of assurance. Fuel lead would not be critical and would be in the order of 3 seconds. Fuel pump chilldown in this case would be taken well into the steady state region to obtain a high probability of success.

9.9.2 Propellant Tank Conditions

LOX tank conditions from 9,500 seconds after liftoff to 17,500 seconds after liftoff are shown in figure 9-43. The dotted line on the LOX tank temperature curve is the extrapolated off scale LOX temperature. Important events are shown on the bottom grid of the figure.

The off scale temperature is the result of maneuvers during this period. As shown in the figure, three different maneuvers brought about changes in one or both of the parameters. The maneuver induced liquid and ullage mixing, resulting in rapid evaporation of some liquid which caused an ullage pressure increase and a LOX liquid temperature decrease. The maneuvers occurred at 10,450, 10,971, 14,184, and 16,748 seconds. The pressure rise at 14,184 and 16,748 seconds was quite small, indicating that the oxygen partial pressure in the ullage was almost in equilibrium with the saturation pressure corresponding to the LOX bulk temperature.

The estimated LOX liquid mass history (figure 9-44) during LOX lead corresponds with transducer indications. Transducer C0369 was above the surface and C0368 was submerged. C0040 and C0368 were off-scale low thus indicating liquid. C0369 was off scale high indicating that it was sensing ullage gas. The locations of these measurements and their corresponding liquid level sensing points are shown in figure 9-45.

The fuel tank conditions are presented in figure 9-46, which shows that the temperature went off scale low during both blowdowns. The dotted lines on the temperature plot are the extrapolated off-scale traces. The bottom grid shows the tank blowdown periods (vent valves open) and the tank repressurization and fuel lead periods.

Estimated LH2 mass history during the fuel lead is shown in figure 9-47. The band is due to variations in boiloff estimates. During the experiment C0052 indicated that it was sensing a subcooled liquid while C0370 and C0369 both indicated that they were sensing a superheated gas; therefore the actual quantity of liquid was near the lower extremity of the band shown in figure 9-47. The location of these measurements in the tanks and their corresponding liquid level points are shown in figure 9-45.

9.9.3 Turbopump and Thrust Chamber

The turbopump and thrust chamber conditions during the experiment were established by the tank conditions as described in the previous paragraph and the events occurring during the experiment. A detailed listing of events is included in figure 9-48. The measurements observed during the experiment are presented in the following sections of the report. In calculations that were performed, the following biases were applied to the recorded data. These were determined from comparisons at known saturated conditions or other calibration points and correlations with well established engine characteristics.

C0003 +0.3°R
C0200 +40°R
D0002 +0.1 psi
D0003 +0.4 psi
D0004 +2.0 psi
D0005 +2.0 psi
D0008 +8.9 psi
D0009 -0.3 psi
F0001 -10 gpm

9.9.3.1 LOX Pump Inlet Conditions

LOX pump inlet pressure during LOX lead was relatively constant at 29.4 psia (figure 9-49). Inlet temperature was off-scale high at the start coming on scale and subsequently going off scale low at approximately 4 seconds.

Off-scale low temperature readings (figure 9-49) were due to maneuver-induced liquid and ullage gas mixing and subsequent evaporation as discussed in the previous section. Pressure spikes occurred following LOX dump during the period when the prevalues were closed. During this period thermal expansion caused the pressure to rise above tank pressure. The first peak occurred at 17,315 seconds while both the prevalue and the bleed valve were closed. In this case the pressure went off scale high.

Whether it reached the setting of the thermal relief valve in the pre valve (65 to 85 psid) is not known.

After the first peak the pressure dropped to an intermediate plateau (17,320 seconds) following opening of the bleed valve before gradually drying during the remainder of the period the bleed valve was open. Since the cracking pressure of the relief valve in the bleed line is very low (0.3 psid) the pressure during this period was established by the flowrate through the bleed line. During the second spike (17,327 to 17,340 seconds) the pre valve and the bleed valve were both closed causing the pressure to again go off-scale high. During both of these periods pump inlet temperature remained off-scale low thus indicating that the heat source causing this pressure rise was located at some other point in the system.

The LOX lead succeeded in chilling the LOX inlet system and in obtaining a subcooled propellant condition at the pump inlet. The required normal start condition (9°R subcooling) was attained in 3 seconds and the condition approaching tank subcooling was reached in an estimated 5 seconds (figure 9-50). Since LOX pump inlet temperature was off scale low after 4 seconds, the degree of subcooling achieved was not calculated after 4 seconds of LOX lead.

Following LOX lead there were 100 seconds of heat-up time prior to initiation of fuel lead. During this time the LOX pump inlet temperature remained subcooled rising at a rate of approximately 0.075°R per second.

9.9.3.2 LOX Pump Discharge Conditions

LOX pump outlet temperature was off scale high at the start of LOX lead. It decreased rapidly (figure 9-51) during the first part of the 9-second LOX lead period. A saturated condition was reached in 5 seconds and approximately 4° subcooling was apparent at the end of LOX lead (figure 9-50). Following LOX lead the degree of subcooling increased. This was due to thermal relief characteristics of the closed system

(paragraph 9.9.3.1) and occurred while the prevalues and the bleed valves were closed. After two such artificial subcooling excursions (figure 9-50), the pressure stabilized at the level existing in the tank. At this time (LOX lead start plus 40 seconds) a saturated or slightly sub-cooled condition was present at the pump outlet. A saturated condition existed (figure 9-50) until 137 seconds after the start of LOX lead.

After LOX lead the LOX pump discharge temperature was influenced by opening and closing of the bleed valve and the prevalue as discussed in paragraph 9.9.3.1. During these periods and when the bleed valve was open fluid flowed from the LOX inlet system into the bleed valve. Since the temperature indicator (C0133) is located near the bleed valve tapoff it indicates the temperature of the fluid flowing from the pump discharge area into the bleed line. When the bleed valve is closed, C0133 indicates local conditions because any flow that takes place during this time is in the other direction; i.e., reverse flow from the engine area through the thermal relief valve in the prevalue into the tank.

Observation of the data (figures 9-49 and 9-51) indicates that the major heat source following LOX lead was in the pump as the pump discharge area. The fact that discharge pressure and temperature were decreasing (figure 9-51) from 17,340 seconds and stabilized at 17,350 seconds indicates a diminishing heat load. Constant pressure and temperature were reached before the prevalue was opened (17,358 seconds) thus indicating a relatively stable condition in the engine LOX feed and pumping system.

9.9.3.3 LOX Pump Start Requirements

The conditions for the LOX pump at several time points is shown in figure 9-52, which indicates that the inlet was not within start requirements at the end of 8 seconds of fuel lead. This was expected since the ullage was only repressurized to 29.3 psia instead of the nominal 40 psia for an LOR mission. Since the pump inlet was substantially subcooled, the start condition for the LOR mission can be projected at constant temperature to 40 psia. This allows the point to be well within the start box and is very comparable to 504N start conditions.

LOX pump outlet conditions at several different times during the experiment is shown in figure 9-53. The point of note is that which shows the end of 9 seconds of fuel lead, as it indicates saturated conditions. The projection for the LOR mission conditions of 40 psia ullage follows the saturation curve to 40 psia pressure. This is still out of the start box; however, recent information from Rocketdyne and a review of the 504 third burn pump start performance indicate that a subcooled condition at the pump discharge is desirable but not mandatory for a successful start.

9.9.3.4 Fuel Pump Inlet Conditions

Fuel pump inlet conditions are shown in figure 9-54. Liquid was first measured at the pump inlet approximately 75 seconds after the ullage engines were started. At the initiation of fuel lead, the fuel pump inlet pressure and temperature indicated saturated conditions at the pump inlet, and warm gas existed at the pump outlet with the injector exposed to vacuum at a warm temperature.

When the prevalues are closed and the bleed valves opened, the pressure rises to the cracking pressure of the bleed line check valve. When the bleed valves and the prevalues are both closed, the pressure increases to the setting of the thermal relief in the prevalues, and temperature measurement (C0003) indicates the local conditions. When the valves are both opened the pressure decreases to the tank pressure.

The pressure and temperature increases that occurred while the prevalue was closed (figure 9-55) indicate the thermal conditions at the pump inlet prior to the fuel lead experiment. While the bleed valve was open thermal relief was accomplished through the bleed system. During this period the pressure increase was the result of thermal relief flow through the bleed valve and bleed line into the fuel tank. While the bleed valve was closed the pressure increased either to the level established by heat up rate and leakage flow or to the saturation pressure of the warmest liquid in the feed system. Since the pump inlet pressure and temperature

follow the saturation line it is concluded that the heat-up rate at this time is not great and that liquid (at some quality) existed in the system at least down to the temperature sensing measurement (C0003).

Fuel tank pressure was close to predicted, resulting in 1.7 deg R of subcooling in the LH2 tank at the start of fuel lead (figure 9-55), as compared to approximately 3 deg R for 504N third burn fuel lead (figure 9-56). During fuel lead, the pump inlet apparently remained saturated because of the combined effects of low NPSH and tank pressure.

The data show that the 504N pump inlet went saturated at 3 to 5 seconds and at a tank condition of 1.2 to 1.4 degrees of subcooling. At this time in the 505N fuel lead, 1.7 degrees of subcooling existed in the tank but the tank was at a lower pressure. The data may be incorrect; however, it is indicated that conditions for both 505N and 504N were on the borderline early in the fuel lead period. 505N apparently stayed below the transition point during the entire 49 seconds while 504N progressed into a fully subcooled condition due to an increasing NPSH and higher tank pressure.

9.9.3.5 Fuel Pump Outlet Conditions

Fuel pump outlet conditions are shown in figure 9-57. The fuel pump outlet temperature was off scale high before fuel lead start, indicating all gas at the outlet. The pressure at the outlet increased as the pre-valves and bleed valves closed, then decreased to tank pressure and followed the inlet pressure characteristics as they opened. With the application of the appropriate bias to pressure curve D0008, saturated conditions are indicated just prior to the end of fuel lead. After fuel lead was terminated, the temperature and pressure rose to saturated state and remained there until about 17,565 seconds. At this time the temperature went off scale high with no change in pressure, indicating that the mass had become all gas and was no longer saturated.

9.9.3.6 Fuel Pump Start Requirements

The condition of the pump inlet during fuel lead and the projected condition for the LOR mission is shown in figure 9-58. As discussed in paragraph 9.9.3.4, fuel pump inlet conditions were saturated during the experiment. The condition between saturation and the start box (point 2) was predicted for an 8-second fuel lead in an operational LOR mission contingency restart with an 8-second LOX lead and a 100-second wait period.

9.9.3.7 Engine Hardware Conditions

Thrust chamber jacket temperature (C0199) presented in figure 9-59 showed little effect of the 90 second LOX lead because of the slow reaction of this transducer to small temperature changes. During fuel lead, this temperature dropped due to the fuel flowing through the thrust chamber tubes. After fuel lead completion, the chamber slowly heated up again.

Fuel injector temperature C0200 during the experiment is shown in figure 9-59 which indicates about a 35 degree drop in temperature at the fuel injector due to the LOX lead. During the period following LOX lead the temperature indicator (C0200) increased approximately 16°R ($0.16^{\circ}\text{R}/\text{sec}$) reaching 261°R at the initiation of fuel lead. Therefore, the 100-second heat-up period partially compensated for the injector chilling resulting from LOX lead while maintaining required LOX pump inlet start requirements.

When LH2 lead started, the temperature rose 100 degrees due to the fluid cooling down the pump and thrust chamber tubes then continued down and off scale low, indicating subcooled conditions at the injector. A 40 degree zero shift occurred prior to the experiment.

It should be noted that the fuel injector temperature response during the 5-minute LOX dump indicates that an additional 110° downward shift occurred. This shift must have occurred at some time following the off scale low indication during the fuel lead.

Figures 9-60 and 9-61 depict the predicted LOX pump inlet NPSH at engine start command as a function of LOX lead time, delay time, and ullage pressure. Delay time is defined as the time between end of LOX lead and the beginning of fuel lead. The first figure shows where the 505N experiment data falls on the predicted curve indicating about 14.5 ft NPSH for the conditions of 9 seconds LOX lead and 100 seconds delay time with ullage pressure equal to 29.3 psia.

Figure 9-61 shows the predicted NPSH for a 40 psi ullage pressure and the 505N experiment sequence; it indicates that 36.3 ft of NPSH would be achieved for this sequence. This curve also contains the sequence for the LOR mission with an 8 second LOX lead and 100 second delay time. Both points indicate that either sequence would be adequate to obtain the 31.9 ft minimum required head. These curves were derived from a previous analysis which used past flights for normal conditions of heat up rates and pump conditions.

9.9.4 Propellant Lead Performance

9.9.4.1 LOX Lead Performance

The LOX flowrate increased very rapidly after the initiation of LOX lead, reaching a steady state flowrate of 62 lbm/sec by the end of the 8.9 second LOX lead (figure 9-62). During the first 3.6 seconds, the flow was limited by choked gas flow conditions at the injector. After this time, the flowrate increased rapidly as two-phase flow existed at the pump discharge, and the flowmeter data was used directly for determining flowrate.

Considerable thrust and impulse were produced during LOX lead (figure 9-63). During the initial choked gas flow period a thrust of 300 lbf was obtained, later reaching a maximum value of 930 lbf at the end of LOX lead. The total impulse produced during the 8.9 second LOX lead was 4,950 lbf sec, produced by 270 lbm of LOX dumped overboard.

9.9.4.2 LH2 Lead Performance

As fuel lead progressed, the fluid quality (lbm gas/lbm mixture) decreased at the pump discharge and at the injector (figure 9-64). The system operating paths are shown on a temperature-entropy diagram in figure 9-65. The fluid quality at pump discharge conditions stabilized at approximately 0.05 lbm gas/lbm mixture at 15 seconds after initiation of fuel lead. The fluid quality at the injector decreased from 1 lbm gas/lbm mixture at 9.3 seconds to 0.2 lbm gas/lbm mixture at 30 seconds after start of fuel lead. The fuel qualities stabilized as the heat input rates and flowrates stabilized.

On the 505N flight, the first liquid was obtained at the injector 9.3 seconds after start of fuel lead. This was 4.7 seconds earlier than for 504N third burn as the result of less heat input to the fluid from the thrust chamber due to the chilling effects of the 8.9 second LOX lead. The flowrate during the early part of fuel lead (approximately the first 7 seconds) was similar to 504N third burn fuel lead (figure 9-66). During this time, the flow was limited by choked gas flow through the injector and the injector gas temperatures were similar. As the injector gas temperature dropped rapidly and the two-phase flow was established throughout the system, the flowrate increased rapidly. This point was reached approximately 4.5 seconds earlier on 505N than on 504N due to a cooler thrust chamber on 505N.

The flowrate reached a nearly steady state value of approximately 10 lbm/sec after 15 seconds of fuel lead as the pump discharge quality stabilized. The flowrate continued to increase slightly reaching 10.7 lbm/sec 30 seconds after the start of fuel lead when the injector quality stabilized. This steady-state flowrate was less than that observed on 504N flight third burn fuel lead (14 lbm/sec) due to a lower LH2 tank ullage pressure on 505N flight.

A total of 400 lbm of fuel was dumped overboard during the 47.5 seconds of fuel lead. No indications of any appreciable ullage gas ingestion were observed. The indicated increased volumetric flowrate (flowmeter data) can be accounted for by the computed increasing flowrate. There was no

indication of increasing quality during the fuel lead. Also the ullage pressure shows no more than 0.05 psi drop during the entire fuel lead. Isothermal expansion during the fuel lead could account for as much as 0.19 psi drop in pressure, and no apparent self-pressurizing was observed during the period immediately following the end of fuel lead. It is therefore concluded that appreciable gas ingestion did not occur.

The thrust increased rapidly when fuel lead was initiated and maintained an approximate level of 350 lbf during the fuel lead (figure 9-67). The relatively constant thrust was due to the compensating factors of increasing flowrate and decreasing specific impulse. The total impulse contributed by the fuel lead was 16,400 lbf sec (figure 9-67).

9.10 Reported Vibration

A special investigation was initiated concerning reported vibrations in the 15 to 20 hertz (Hz) frequency range. Since FM data are required for evaluation in this range, useful flight measurements are limited to LOX pump discharge and fuel injection pressure measurements (D0009 and D0004 respectively). During S-II stage experience with propellant feed system-engine instabilities (POGO), LOX pump discharge pressure (D0009) was the prime instability indicator. Expanded and amplified brush plots of D0009 and D0004 measurements were obtained and evaluated for the S-IVB in this and previous flights and acceptance tests. No pressure fluctuations of a disturbing magnitude were found; however, an indication of a 22 to 23 Hz frequency was apparent in the D0009 measurement.

Reproductions of 503N and 505N pressure traces are shown in figure 9-68. These figures represent typical samples during burn. The noted 22 to 23 Hz oscillation was randomly noted approximately 50 percent of the time during mainstage on 505N. There was no apparent correlation between the observed 23 Hz oscillations and the reported astronaut comments or the other vibration measurement indicators.

Rocketdyne test data indicate that the D0009 measurement as presented is not an accurate measurement of amplitude; however, its frequency response is correct. Amplitude correction factor data supplied by Rocketdyne

indicate an amplification factor of 3.35 at 23 Hz and an EMR of 5.0. This factor applied to AS 505 data yields a maximum actual oxidizer pump discharge pressure variation of 20.4 psi peak to peak. This variation, when converted directly to thrust, results in a thrust variation of 4,600 lbf peak to peak. Additional data indicating the behavior of S-IVB measurements in other frequency ranges are presented in paragraph 25.4. It is concluded that unsatisfactory POGO effects are either not present in the S-IVB system or the present instrumentation is not sensitive enough to detect them.

TABLE 9-1 (Sheet 1 of 5)
ENGINE SEQUENCE (505N-FIRST BURN)

Control Events		Contingent Events		Actual Time (ms)	
Meas No.	Event and Comment	Meas No.	Event and Comment	From ESC	From Specified Reference
K0021 (K0021)	*Engine Start Command P/U			0	
		K0007 (K0531)	Helium Control Solenoid Engr P/U	9	9
		K0010 (K0454)	Thrust Chamber Spark on P/U	9	9
		K0011 (K0455)	Gas Generator Spark on P/U	9	9
		K0006 (K0535)	Ign. Phase Control Solenoid Engr P/U	0	0
		K0012 (K0530)	Engine Ready D/O	30	30
		K0126 (K0558)	LOX Bleed Valve Closed P/U	205	196
		K0127 (K0557)	LH2 Bleed Valve Closed P/U	205	196
		K0020 (K0627)	ASI LOX Valve Open P/U	119	110

(K000X) Actual number from acceptance firing event recorder.

*Engine ready and stage separation signals (or simulation) are required before this command will be executed. This command also actuates a 640 ±30 ms timer which controls energizing of the start tank discharge solenoid valve (K0096).

P/U - Pickup

D/O - Dropout

TABLE 9-1 (Sheet 2 of 5)
ENGINE SEQUENCE (505N-FIRST BURN)

Control Events		Contingent Events		Nominal Time From Specified Reference		Actual Time (ms)	
Meas No.	Event and Comment	Meas No.	Event and Comment			From ESC	From Specified Reference
		K0119 (G500)	Main Fuel Valve Closed D/O	60 ±30 ms from K0006 P/U		44	44
		K0118 (G505)	Main Fuel Valve Open P/U	110 ±60 ms from K0119 D/O		150	106
K0096 (K0536)	*Start Tank Disc Control Solenoid Engr P/U			3,000 ±40 ms from K0021 P/U		2991	2991
K0021 (K0021)	Engine Start D/O			200 ±20 ms from K0096 P/U		3178	187
		K0123 (G508)	Start Tank Disc Valve Closed D/O	100 ±20 ms from K0096		3154	163
		K0122 (G508)	Start Tank Disc Valve Open P/U	105 ±20 ms from K0123 D/O		3254	100
K0005 (K0538)	Mainstage Control Solenoid Engr P/U			450 ±30 ms from K0096 P/U		3433	442
		K0096 (K0536)	Start Tank Disc Control Solenoid Engr D/O	450 ±30 ms from K0096		3441	450
		K0121 (G507)	Main LOX Valve Closed D/O	50 ±20 ms from K0005		3448	15

*An indication of fuel injection temperature of -50 ±40 deg F (or simulation) is required before this command will be executed. This command also actuates a 450 ±30 ms timer which controls the start of mainstage.

P/U - Pickup

D/O - Dropout

TABLE 9-1 (Sheet 3 of 5)
ENGINE SEQUENCE (505N-FIRST BURN)

Control Events		Contingent Events		Nominal Time From Specified Reference	Actual Time (ms)	
Meas No.	Event and Comment	Meas No.	Event and Comment		From ESC	From Specified Reference
		K0116 (G509)	Gas Generator Valve Closed D/O		3497	
		K0122 (G508)	Start Tank Disc Valve Open D/O	95 ±20 ms from K0096	3554	113
		K0117 (G509)	Gas Generator Valve Open P/U		3709	
		K0124 (G510)	LOX Turbine Bypass Valve Open D/O		3726	
			LOX Turbine Bypass Valve 80% Closed	400 +150 ms from K0122 -50	3926	372
		K0123 (G508)	Start Tank Disc Valve Closed P/U	250 ±40 ms from K0122	3792	238
		K0125 (G510)	*LOX Turbine Bypass Valve Closed P/U		3976	
K0158 (K0572)	Mainstage Press Switch #1 Depress D/O				4744	
K0159	Mainstage Press Switch #2 Depress D/O				4744	
		K0120 (G507)	Main LOX Valve Open P/U	2,435 ±145 ms from K0005	5694	2261

*Within 5,000 ms of K0005 (Normally = 500 ms)

P/U - Pickup

D/O - Dropout

TABLE 9-1 (Sheet 4 of 5)
ENGINE SEQUENCE (505N-FIRST BURN)

Control Events		Contingent Events		Nominal Time From Specified Reference	Actual Time (ms)	
Meas No.	Event and Comment	Meas No.	Event and Comment		From ESC	From Specified Reference
		K0010 (K0454)	Thrust Chamber Spark on D/O	3,300 ±200 ms from K0005 P/U	6733	3300
		K0011 (K0455)	Gas Generator Spark On D/O	3,300 ±200 ms from K0005 P/U	6733	3300
K0140 (K0522)	Engine Cutoff P/U (New time reference)			0	0	
		K0005 (K0538)	Mainstage Control Solenoid Engr D/O	Within 10 ms of K0013	0	0
		K0006 (K0535)	Ign. Phase Control Solenoid Engr D/O	Within 10 ms of K0013	0	0
		K0020 (K0622)	ASI LOX Valve Open D/O		52	
		K0120 (G507)	Main Oxidizer Valve Open D/O	50 ±15 ms from K0005	61	61
		K0117 (G509)	Gas Generator Valve Open D/O	15 +25 ms from K0006	21	21
		K0118 (G506)	Main Fuel Valve Open D/O	95 ±25 ms from K0006	107	107
		K0121 (G507)	Main Oxidizer Valve Closed P/U	120 ±15 ms from K0120	247	186

P/U - Pickup

D/O - Dropout

TABLE 9-1 (Sheet 5 of 5)
ENGINE SEQUENCE (505N-FIRST BURN)

Control Events		Contingent Events		Nominal Time From Specified Reference	Actual Time (ms)	
Meas No.	Event and Comment	Meas No.	Event and Comment		From ECC	From Specified Reference
		K0116 (G509)	Gas Generator Valve Closed P/U	500 ms from K0006	401	401
		K0119 (G506)	Main Fuel Valve Closed P/U	225 ±25 ms from K0118	457	350
K0158 (K0572)	*Mainstage Press Switch A Depress P/U				261	
K0159 (K0573)	*Mainstage Press Switch B Depress P/U				261	
K0007 (K0531)	Helium Control Solenoid Engr D/O			1,000 ±110 ms from K0013	1000	1000
		K0125 (G510)	Oxid Turbine Bypass Valve Closed D/O		246	
		K0124 (G510)	Oxid Turbine Bypass Valve Open P/U	10,000 ms from K0005	921	921
K0126 (K0558)	LOX Bleed Valve Closed D/O			30,000 ms from K0005	6647	66.7
K0127 (K0557)	LH2 Bleed Valve Closed D/O			30,000 ms from K0005	7230	7230

*Signal drops out when pressure reaches 420 ±10 psig.

P/U - Pickup

D/O - Dropout

TABLE 9-2. (Sheet 1 of 5)
ENGINE SEQUENCE (505N-SECOND BURN)

Control Events		Contingent Events		Nominal Time From Specified Reference	Actual Time (ms)	
Meas No.	Event and Comment	Meas No.	Event and Comment		From ESC	From Specified Reference
K0021 (K0021)	*Engine Start Command P/U			0	0	
		K0007 (K0531)	Helium Control Solenoid Engr P/U	Within 10 ms of K0021	0	0
		K0010 (K0454)	Thrust Chamber Spark on P/U	Within 10 ms of K0021	0	0
		K0011 (K0455)	Gas Generator Spark on P/U	Within 10 ms of K0021	0	0
		K0006 (K0535)	Ign Phase Control Solenoid Engr P/U	Within 20 ms of K0021	0	0
		K0012 (K0530)	Engine Ready D/O	Within 20 ms of K0006	69	69
		K0126 (K0558)	LOX Bleed Valve Closed P/U	Within 200 ms of K0007	242	242
		K0127 (K0557)	LH2 Bleed Valve Closed P/U	Within 200 ms of K0007	161	161
		K0020 (K0627)	ASI LOX Valve Open P/U	Within 200 ms of K0007	136	136

(K0XXX) Actual number from acceptance firing event recorder.

*Engine ready and stage separation signals (or simulation) are required before this command will be executed. This command also actuates a 640 ±30 ms timer which controls energizing of the start tank discharge solenoid valve (K0096).

P/U - Pickup

D/O - Dropout

TABLE 9-2 (Sheet 2 of 5)
ENGINE SEQUENCE (505N-SECOND BURN)

Control Events		Contingent Events		Nominal Time From Specified Reference	Actual Time (ms)	
Meas No.	Event and Comment	Meas No.	Event and Comment		From ESC	From Specified Reference
		K0119 (G506)	Main Fuel Valve Closed D/O	60 ±30 ms from K0006	10	10
		K0118 (G506)	Main Fuel Valve Open P/U	110 ±60 ms from K0199	172	162
K0096 (K0536)	*Start Tank Disc Control Solenoid Engr			8,000 ±40 ms from K0021 P/U	8016	8016
K0021 (K0021)	Engine Start D/O			600 ±20 ms from K0096 P/U	8616	600
		K0123 (G508)	Start Tank Disc Valve Closed D/O	100 ±20 ms from K0096	8142	126
		K0122 (G508)	Start Tank Disc Valve Open P/U	105 ±20 ms from K0123	8310	168
K0005 (K0538)	Mainstage Control Solenoid Engr			450 ±30 ms from K0096	8466	450
		K0096 (K0536)	Start Tank Disc Control Solenoid Engr D/O	450 ±30 ms from K0096 P/U	8474	458
		K0121 (G507)	Main LOX Valve Closed D/O	50 ±20 ms from K0005	8500	34

*An indication of fuel injection temperature of -150 ±40 deg F (or simulation) is required before this command will be executed. This command also actuates a 450 ±30 ms timer which controls the start of mainstage.

P/U - Pickup

D/O - Dropout

TABLE 9-2 (Sheet 3 of 5)
ENGINE SEQUENCE (505N-SECOND BURN)

Control Events		Contingent Events		Nominal Time From Specified Reference	Actual Time (ms)	
Meas No.	Event and Comment	Meas No.	Event and Comment		From ESC	From Specified Reference
		K0116 (G509)	Gas Generator Valve Closed D/O		8550	
		K0122 (G508)	Start Tank Disc Valve 95 ±20 ms from K0096 Open D/O		8560	86
		K0117 (G509)	Gas Generator Valve Open P/U		8745	
		K0124 (G510)	LOX Turbine Bypass Valve Open D/O		8676	
			LOX Turbine Bypass Valve 80% Closed	400 +150 ms from K0122	8890	330
		K0123 (G508)	Start Tank Disc Valve Closed P/U	250 ±40 ms from K0122	8820	260
		K0125 (G510)	*LOX Turbine Bypass Valve Closed P/U		8958	
K0158 (K0572)	Mainstage Press Switch #1 Depress D/O				9843	
K0159	Mainstage Press Switch #2 Depress D/O				9843	
		K0120 (G507)	Main LOX Valve Open P/U	2.435 ±145 ms from K0005	10760	2294

*Within 5,000 ms of K0005 (Normally = 500 ms)

P/U - Pickup

D/O - Dropout

TABLE 9-2 (Sheet 4 of 5)
ENGINE SEQUENCE (505N-SECOND BURN)

Control Events		Contingent Events		Nominal Time From Specified Reference	Actual Time (ms)	
Meas No.	Event and Comment	Meas No.	Event and Comment		From ESC	From Specified Reference
		K0010 (K0454)	Thrust Chamber Spark on D/O	3,300 ±200 ms from K0005 P/U	11758	3292
		K0011 (K0455)	Gas Generator Spark on D/O	3,300 ±200 ms from K0005 P/U	11758	3292
K0140 (K0522)	Engine Cutoff PU (New time ref.)			0	0	
		K0005 (K0538)	Mainstage Control Solenoid Engr D/O	Within 10 ms of K0013	10	10
		K0006 (K0535)	Ign Phase Control Solenoid Engr D/O	Within 10 ms of K0013	10	10
		K0020 (K0622)	ASI LOX Valve Open D/O		70	
		K0120 (G507)	Main Oxidizer Valve Open D/O	50 ±15 ms from K0005	57	47
		K0117 (G509)	Gas Generator Valve Open D/O	75 ⁺²⁵ ₋₃₅ ms from K0006	17	7
		K0118 (G506)	Main Fuel Valve Open D/O	90 ±25 ms from K0006	127	117
		K0121 (G507)	Main Oxidizer Valve Closed P/U	120 ±15 ms from K0120	257	200
		K0116 (G509)	Gas Generator Valve Closed P/U	500 ms from K0006	377	367

P/U - Pickup
D/O - Dropout

TABLE 9-2 (Sheet 5 of 5)

ENGINE SEQUENCE (505N-SECOND BURN)

Control Events		Contingent Events		Nominal Time From Specified Reference	Actual Time (ms)	
Meas No.	Event and Comment	Meas No.	Event and Comment		From ECC	From Specified Reference
		K0119 (G506)	Main Fuel Valve Closed P/U	225 ±25 ms from K0118	479	352
K0158 (K0572)	*Mainstage Press Switch A Depress P/U				279	
K0159 (K0573)	*Mainstage Press Switch B Depress P/U			*	279	
K0007 (K0531)	Helium Control Solenoid Engr D/O			1,000 ±110 ms from K0013	1002	1002
		K0125 (G510)	Oxid Turbine Bypass Valve Closed D/O		237	
		K0124 (G510)	Oxid Turbine Bypass Valve Open P/U	10,000 ms from K0005	747	737
K0126 (K0558)	LOX Bleed Valve Closed D/O			30,000 ms from K0005	7427	7417
K0127 (K0557)	LH2 Bleed Valve Closed P/O			30,000 ms from K0005	7380	7370

*Signal drops out when pressure reaches 420 ±10 psig

P/U - Pickup

D/O - Dropout

TABLE 9-3. FUEL LEAD CONDITIONS

	S-IVB-501 Flight		S-IVB-502 Flight		S-IVB-503N Flight		S-IVB-504N Flight			S-IVB-505N Flight		Exp. Lead
	First Start	Second Start	First Start	Second Start	First Start	Second Start	First Start	Second Start	Third Start	First Start	Second Start	
Estimated Thrust Chamber Bulk Temp. at Fuel Lead Start (deg R)	242*	443*	265*	411*	278*	433*	285**	528**	575**	285**	500**	478**
Fuel Lead Duration (sec)	3	8	3	8	3	8	3	8	52	3	8	49
Fuel Temp. at the Injector at Fuel Lead Termination (Deg R)	40	165	55	34	60	30	Off Scale Low	Off Scale Low	Off Scale Low	Off Scale Low	Off Scale Low	Off Scale Low
Fuel Passing Through MFV During Fuel Lead (lbm)	15	25	14	39	11	35	11	30		13.5	38.5	-
Fuel Between Injector and MFV at Fuel Lead Termination (lbm)	4	8	4.5	14.5	6	9	2	9		4	10	-
Total Effective Impulse During Fuel Lead (lbf-sec)	1400	3200	1250	3050	770	3650	1470	4210	19500	1535	4190	
Fuel Passing Through Injector During Fuel Lead (lbm)	11	17	9.5	24.5	5	26	9	21	555	9.5	28.5	

*This is the average of the temperature measurements C0199, C0385, and C0386.
 **C0385 and C0386 were removed after 503N flight. This is only C0199

TABLE 9-4
ENGINE START SPHERE DATA

Parameter	Temperature (°R)			Pressure (psia)			Mass (lbm)		
	505 Flight	504N Flight	503N Flight	505 Flight	504N Flight	503N Flight	505 Flight	504N Flight	503N Flight
Liftoff	277	275	269	1,285	1,310	1,300	3.56	3.54	3.62
Liftoff Requirements	See liftoff box								
First Engine Start Command	285	281	273	1,315	1,310	1,301	3.52	3.70	3.78
After First Start Sphere Blowdown	186	184	173	125	130	115	0.53	0.56	0.50
First Engine Cutoff Command	224	205	208	1,155	1,259	1,130	3.99	4.87	4.30
Total GH2 Usage During First Start	---	---	---	---	---	---	2.99	3.14	3.23
Second Engine Start Command	270	280	263	1,311	1,312	1,310	3.71	3.72	3.95
After Second Start Sphere Blowdown	172	192	164	148	150	140	0.68	0.62	0.68
Second Engine Cutoff Command	206	186	211	1,145	1,068	1,175	4.30	4.56	4.41
Total GH2 Usage During Second Start	---	---	---	---	---	---	3.03	3.10	3.27

TABLE 9-5
CONTROL SPHERE DATA

Parameter	Temperature (°R)			Pressure (psia)			Mass* (lbm)		
	505N Flight	504N Flight	503N Flight	505N Flight	504N Flight	503N Flight	505N Flight	504N Flight	503N Flight
Required at Liftoff	N/A	290 ±30**	290 ±30**	2,800 to 3,200			---	---	---
Actual at Liftoff	320	279	278	3,020	3,095	2,930	1.76	1.96	1.89
Before First Burn Engine Start	318	270	273	3,101	3,141	1,960	1.78	2.09	1.91
After First Burn Engine Cutoff	298	225	240	2,979	3,043	2,820	1.80	2.10	2.06
Before Second Burn Engine Start	294	262	252	3,097	3,380	3,079	1.90	2.27	2.13
After Second Burn Engine Cutoff	265	240	217	2,972	3,098	1,947	2.14	2.27	2.35
Before Third Burn Engine Start	---	232	---	---	3,215+	---	---	2.41	---
After Third Burn Engine Cutoff	---	216	---	---	1,636+	---	---	1.42	---
Mass Used - First Burn	---	---	---	---	---	---	0.34++	0.35++	0.48++
Mass Used - Second Burn	---	---	---	---	---	---	0.79++	0.168++	---
Mass Used - Third Burn	---	---	---	---	---	---	---	2.11++	---

*As calculated from measured temperature and pressure.

**Actual requirement is start sphere temperature ±30 deg R.

+Backup measurement DC2/2

++Mass used by engine from control sphere and stage repressurization spheres was estimated from flowrates and burntime.

TABLE 9-6
START BOTTLE REFILL PERFORMANCE

FIRST BURN

	Time From ESC (sec)	Actual Data			Predicted		
		Pressure	Temperature	Mass	Pressure	Temperature	Mass
First Engine Start	0	1,315	285	3.52	1,320	275	3.66
End of Blowdown	4.15	125	186	0.53	180	174	0.82
Topping Initiation	6.15	805.6	231	2.74	852	225	2.97
Topping Completion	53.0	1,081	203	4.13	1,048	187	4.36
First Engine Cutoff	150.1	1154.5	223.8	3.99	1,175	210	4.33

SECOND BURN

	Time From ESC (sec)	Actual Data			Predicted		
		Pressure	Temperature	Mass	Pressure	Temperature	Mass
Second Engine Start	0	1310.5	269.6	3.71	1,320	248	4.06
End of Blowdown	8.80	147.6	171.5	0.68	160	167	0.76
Topping Initiation	15.1	714.6	213.7	2.62	750	221	2.67
Topping Completion	164	1,072	188	4.43	1,095	185	4.61
Second Engine Cutoff	351.4	1,145	206.2	4.30	1,110	188	4.59

TABLE 9-7
 J-2 ENGINE STEADY PERFORMANCE COMPARED TO PREDICTED
 (STDV +2.5 SEC TO ECO)

PARAMETER	OVERALL PERFORMANCE			
	ACTUAL	PREDICTED	ACTUAL DEVIATION	PERCENT DEVIATION
Thrust (lbf)				
First Burn	205,815	205,693	+122	+0.059
Second Burn	194,241	194,064	+177	+0.091
Total Flowrate (lbm/sec)				
First Burn	478.71	480.28	-1.57	-0.327
Second Burn	450.89	452.49	-1.60	-0.353
LOX Flowrate (lbm/sec)				
First Burn	398.96	400.59	-1.63	-0.407
Second Burn	373.58	374.43	-0.85	-0.227
LH2 Flowrate (lbm/sec)				
First Burn	79.74	79.69	+0.05	+0.063
Second Burn	77.31	78.06	-0.75	-0.961
Engine Mixture Ratio				
First Burn	4.992	5.027	-0.035	-0.696
Second Burn	4.821	4.788	+0.033	+0.689
Specific Impulse				
First Burn	429.15	428.35	+0.80	+0.187
Second Burn	430.77	428.98	+1.79	+0.417

TABLE 9-8
DATA INPUTS TO COMPUTER PROGRAMS (SHEET 1 OF 2)

Parameter	Program	Selection	Bias		Reason	
			First Burn	Second Burn		
Chamber Pressure	PA53 (Start)	D0001	-15	-15	Rocketdyne estimation of purge effect	
		Total	-1.00	+0.50	Zero shift correction of transducer	
	PA53 (Cutoff)	D0001	-16.00	-14.50	Rocketdyne estimation of purge effect	
		Total	-15	-15	Zero shift correction of transducer	
	G105-1	D0001		+0.50	+1.04	Rocketdyne estimation of purge effect
			Total	-14.50	-13.96	Correction to obtain established ISP.
PA63	D0001		-15	-15	Rocketdyne estimation of purge effect	
		Total	-2.56	None	Correction to obtain established ISP.	
LOX Flowrate	G105-1	F0001	-15	-15	Rocketdyne estimation of purge effect	
		Total	-2.56	None	Correction to obtain established ISP.	
	PA63	F0001	-18.4 gpm	-6.8	Correction to agree with flowmeter cycle count.	
		Total	-1.92 pips	-0.850 pips	Correction to agree with output of G105.	

TABLE 9-8
DATA INPUTS TO COMPUTER PROGRAMS (SHEET 2 OF 2)

Parameter	Program	Selection	Bias		Reason
			First Burn	Second Burn	
Fuel Flowrate	G105-1	F0002	-82.1 gpm	-51.1 gpm	Correction to agree with flowmeter cycle count.
Fuel Turbine Inlet Temp.	PA63 G105-1	F0002 C0002	-2.25 pips +49.7°R	-1.85 pips +49.7°R	
Gas Generator Chamber Pressure	PA63	C0002	+49.7°R	+49.7°R	Measurement C0001 required variable bias and was not usable in the analysis program.
	G105-1	D0010	None	None	
	PA63	D0010	-3.3	-3.3	
Thrust Chamber Fuel Injection Temp.	PA63	C0231	-4°R	-4°R	Correction to agree with calculated performance. Measurement C0200 was invalid.

TABLE 9-9
J-2 ENGINE START TRANSIENTS

Parameter	505N Log Book	501 Flight		503N Flight		504N Flight			505N Flight	
		1st Burn	2nd Burn	1st Burn	2nd Burn	1st Burn	2nd Burn	3rd Burn	1st Burn	2nd Burn
Time of STDV Command (sec from ESC)	1.0	3.008	7.998	2.983	7.991	2.924	8.007	7.997***	2.991	8.016
Thrust at 90 percent performance level (lbf)	185,000**	183,125	166,364	183,862	165,686	191,211	159,035	146,433	185,282	161,270
Total Impulse from engine start command to 90 percent performance level* (lbf-sec)	--	188,864	192,634	185,332	188,245	192,327	177,724	N/A	190,945	183,438
Total Impulse from STDV command to 90 percent performance level* (lbf-sec)	144,900**	187,464	189,444	184,562	184,596	190,857	173,514	167,767	189,410	179,248

*Defined as STDV command +2.5 seconds.

**Based on stabilized thrust at null PU and standard altitude conditions.

***Time from I.U. engine start command; 43.591 seconds after ground (Houston) engine start command.

TABLE 9-10

S-IVB TOTAL J-2 PROPULSION PERFORMANCE

PARAMETER	FIRST BURN			SECOND BURN			TOTAL		
	ACTUAL	PREDICTED	% DEV	ACTUAL	PREDICTED	% DEV	ACTUAL	PREDICTED	% DEV
	Impulse (lbf-sec) (1) Mainstage	29.77x10 ⁶	29.39x10 ⁶	+1.29	66.21x10 ⁶	66.33x10 ⁶	-0.18	95.98x10 ⁶	95.72x10 ⁶
Impulse (lbf-sec) to Depletion	DNA	DNA		68.63x10 ⁶	68.08x10 ⁶	+0.88			
Burntime (sec) (1) Mainstage	144.648	142.9	+1.22	340.852	341.8	-0.28	485.501	484.7	+0.16
Burntime (sec) to Depletion	DNA	DNA		352.89	350.33				
Consumption (1)(2)									
LOX (lbm)	57,935	57,249	+1.20	127,356	127,998	-0.50	185,291	185,247	+0.02
LH2 (lbm)	11,660	11,387	+2.40	26,677	26,683	+0.02	38,337	38,070	+0.70

(1) STDV +2.5 seconds to engine cutoff command (predicted burn times are per MDAC aero.)

(2) Propellants exhausted through J-2 engine only.

DNA - Does not apply

TABLE 9-11
 S-IVB STEADY STATE PERFORMANCE
 (PERFORMANCE AT STANDARD ALTITUDE CONDITIONS)

PARAMETER	FLIGHT		STAGE ¹ ACCEPTANCE (FLIGHT PREDICTED)	ACTUAL-FLIGHT PREDICTED		3-SIGMA RUN TO RUN	
	FIRST ² BURN	SECOND ³ BURN		FIRST BURN	SECOND BURN	1st BURN	2nd BURN
Thrust	204,965	204,712	205,235	-270	-52.3	2216	2955
EMR	4.964	5.026	4.972	-0.008	0.054	0.03	0.04
ISP	429.5	429.7	428.4	1.1	1.3	2.46	3.33

1. For first and second burns the same tag value was used.
2. Time slice at SEC +140 seconds.
3. Time slice at ESC +180 seconds.

TABLE 9-12
J-2 ENGINE CUTOFF TRANSIENTS

	Flight		Predicted		Deviation		J-2 Engine Log Book
	First Burn	Second Burn	First Burn	Second Burn	First Burn	Second Burn	
Time for thrust decrease to 11,500 lbf (ms)	408	470	--	--	--	--	367
PU valve position at engine cutoff (deg)	-1.2	-1.2	-2.0	-2.0	0	+0.65	-2.0
Thrust at cutoff (lbf)	207,684	204,045	206,280	204,570	+1,404	-525	
Actual total impulse							
To 5% thrust (lbf-sec)	38,602	40,780	41,544 +4200 -4000	42,498 +4200 -4000	-2,942	-1,718	--
To zero thrust (lbf-sec)	45,720	47,356	47,944 +4200 -4000	48,898 +4200 -4000	-2,224	-1,542	--
Total impulse to 5% thrust adjusted to null PU valve position and 460 deg R MOV actuator temperature (lbf-sec)	32,233	34,411	--	--	--	--	35,245

TABLE 9-13
AS-505 S-IVB CUTOFF IMPULSE

	Predicted	Actual-Trajectory	Actual-Engine
<u>First Burn</u>			
Cutoff Impulse (lb-sec)	47,944 +4200 -4000	47,093	45,720
<u>Second Burn</u>			
Cutoff Impulse (lb-sec)	48,898 +4200 -4000	52,942	47,356

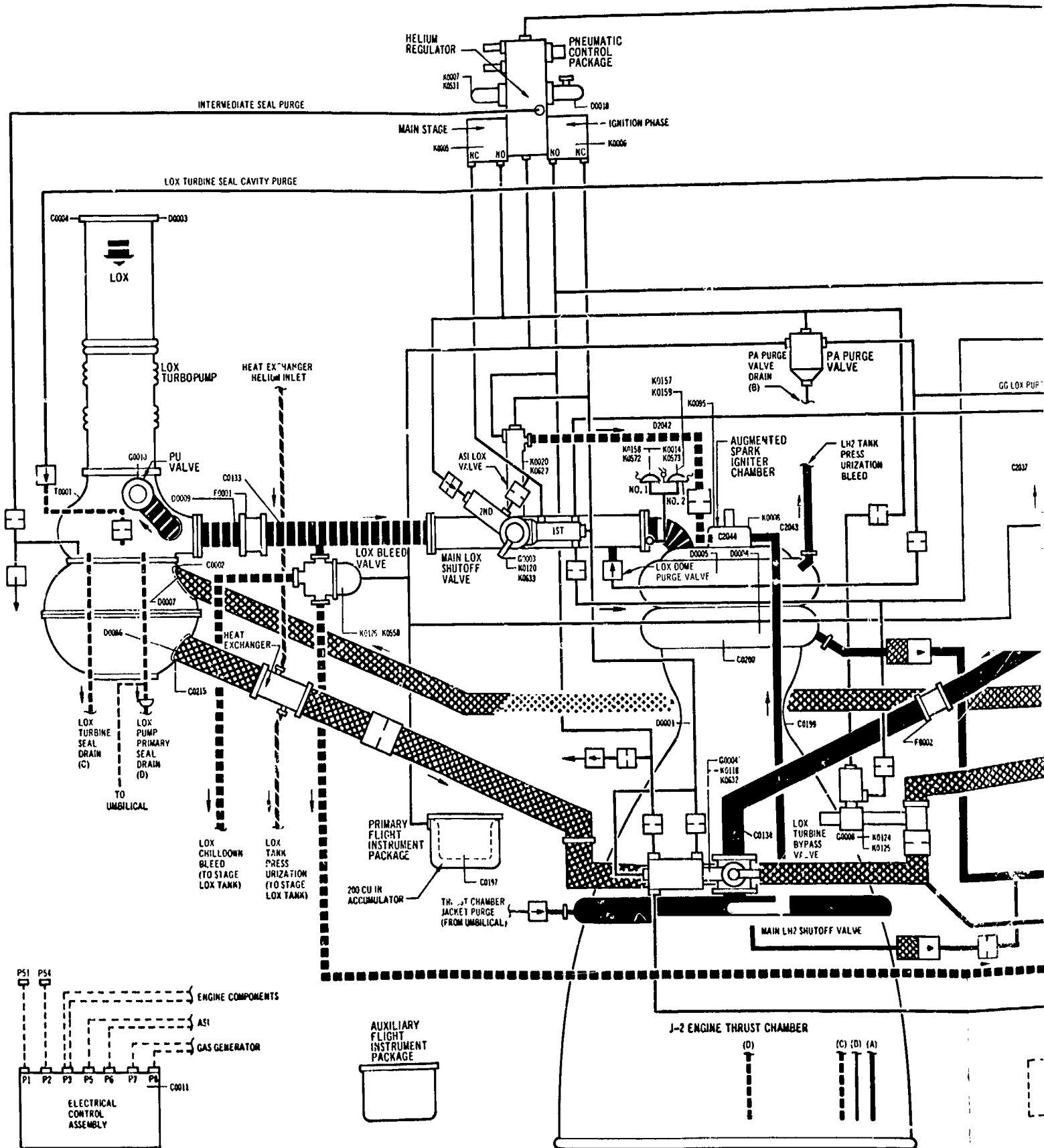

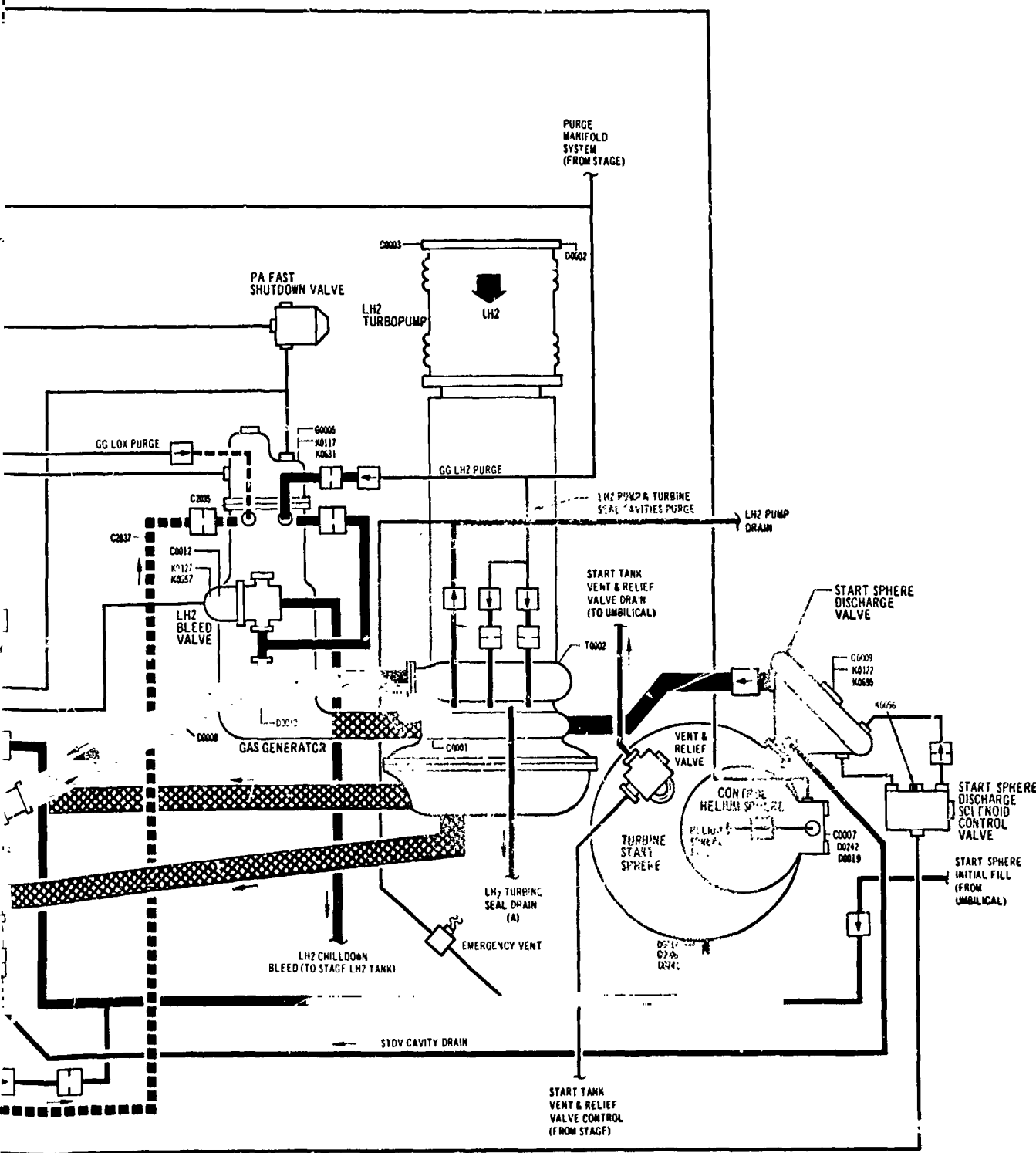

ENGINE AREA AMBIENT
C807

Figure 9-1. J-2 Engine System and Instrumentation
 FOLDOUT FRAME 2

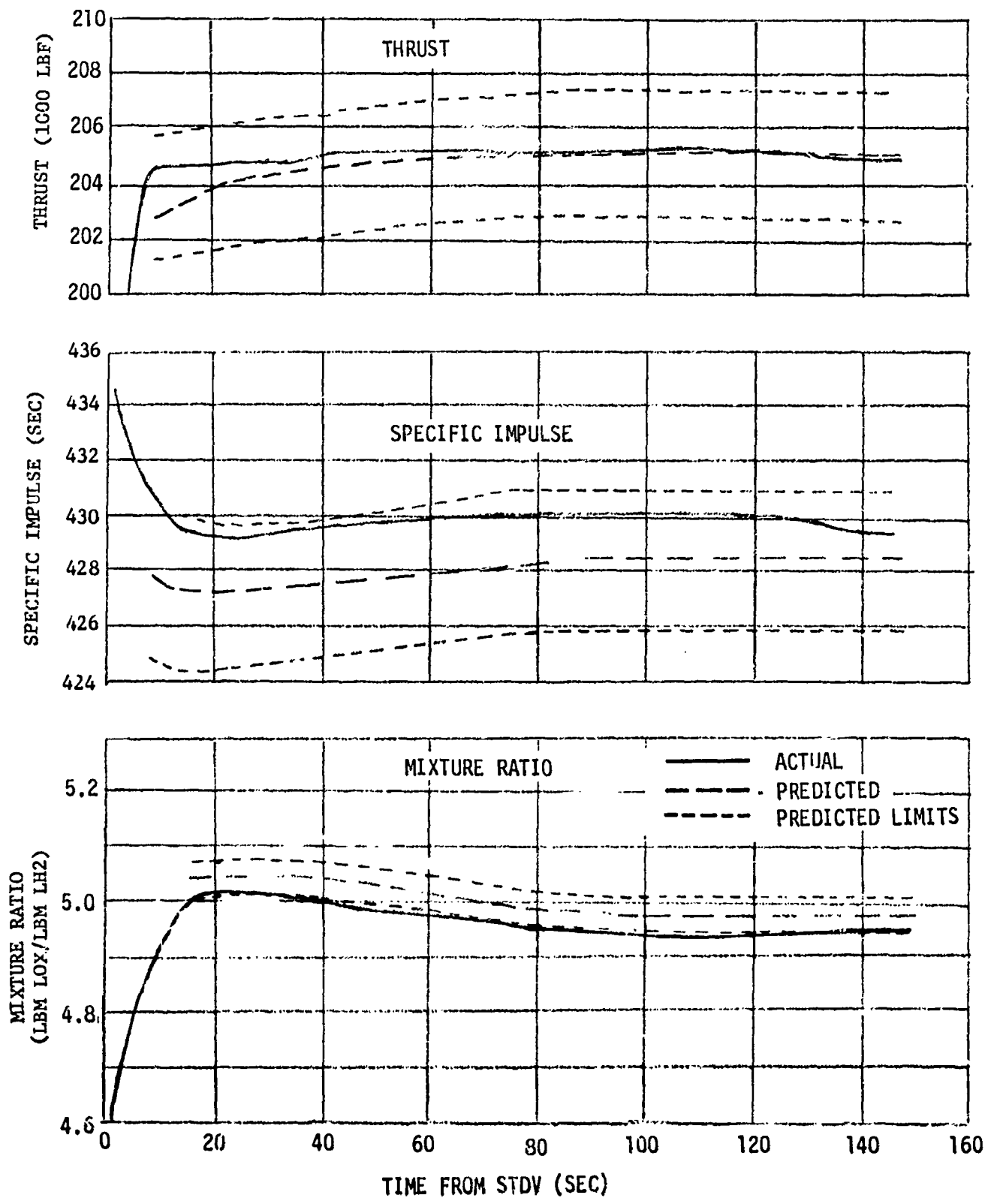

Figure 9-2. First Burn Tag Values (Sheet 1 of 2)

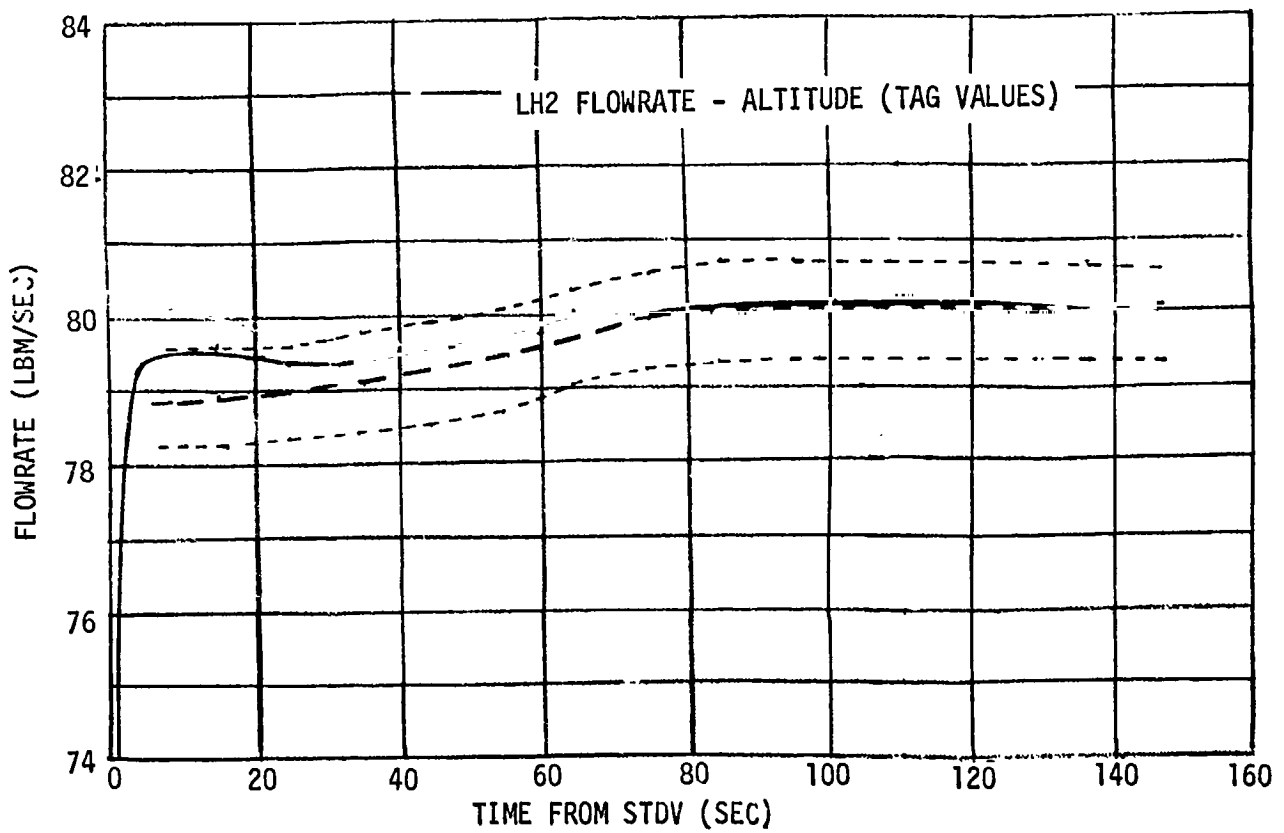
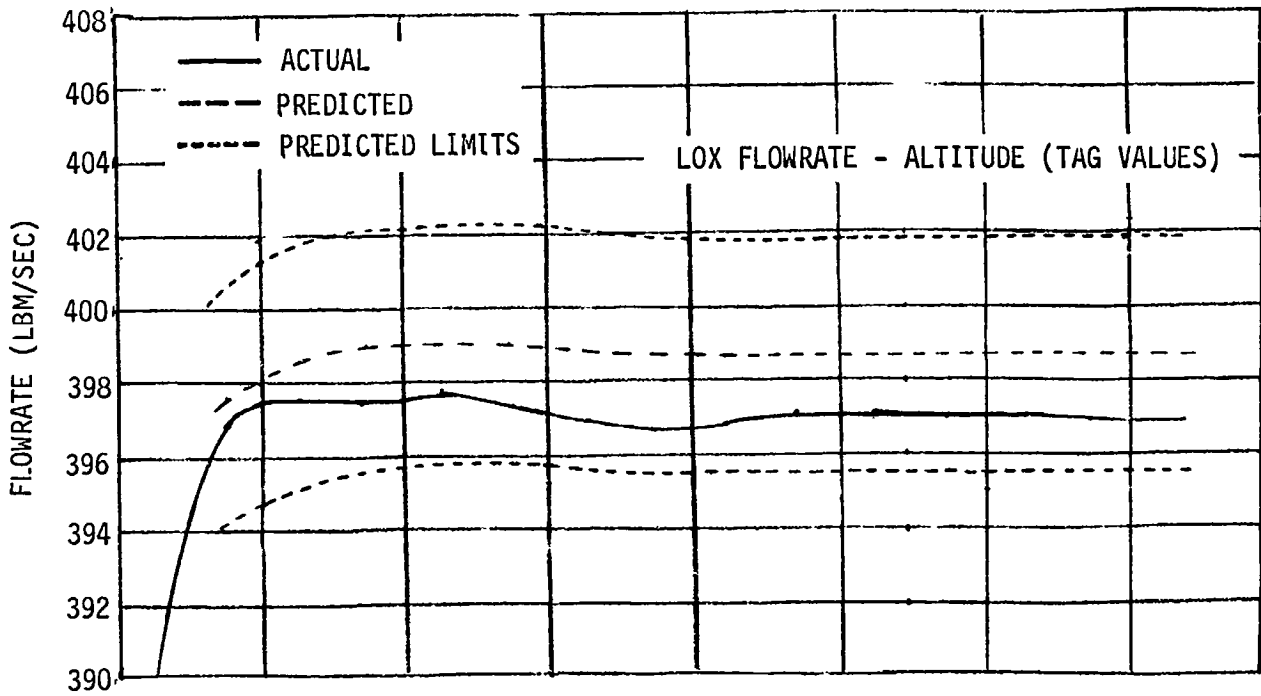

Figure 9-2. First Burn Tag Values (Sheet 2 of 2)

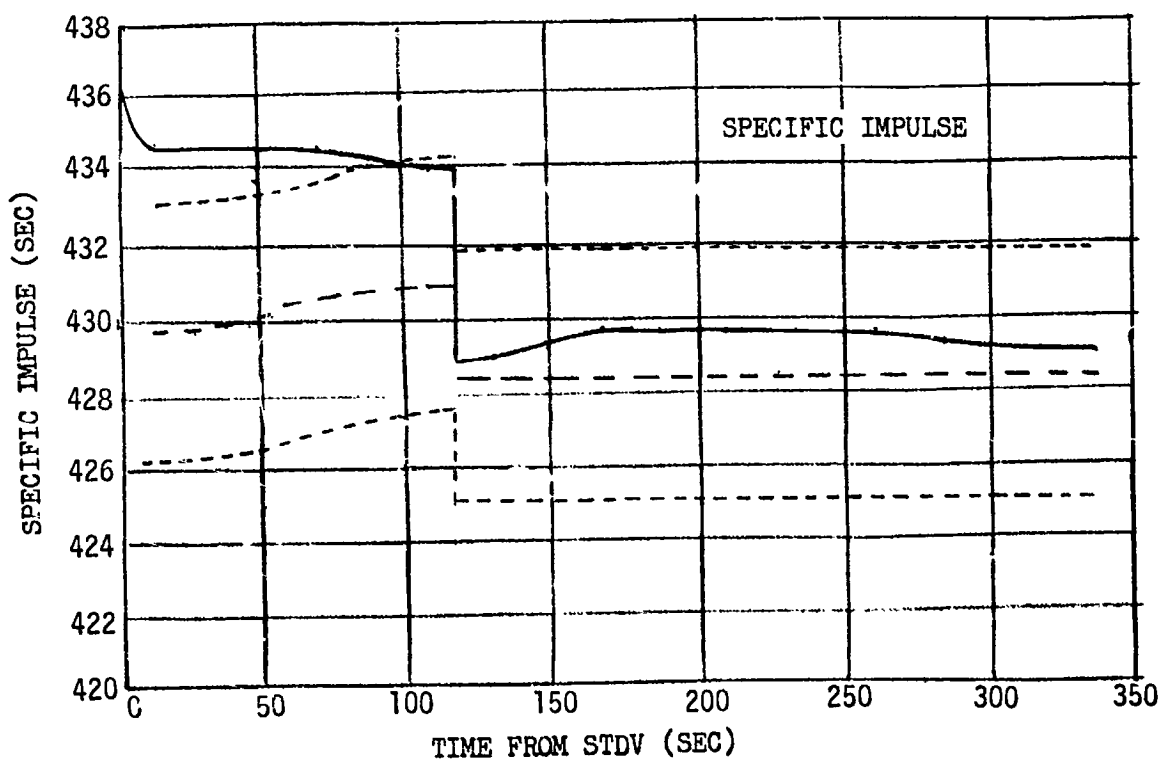
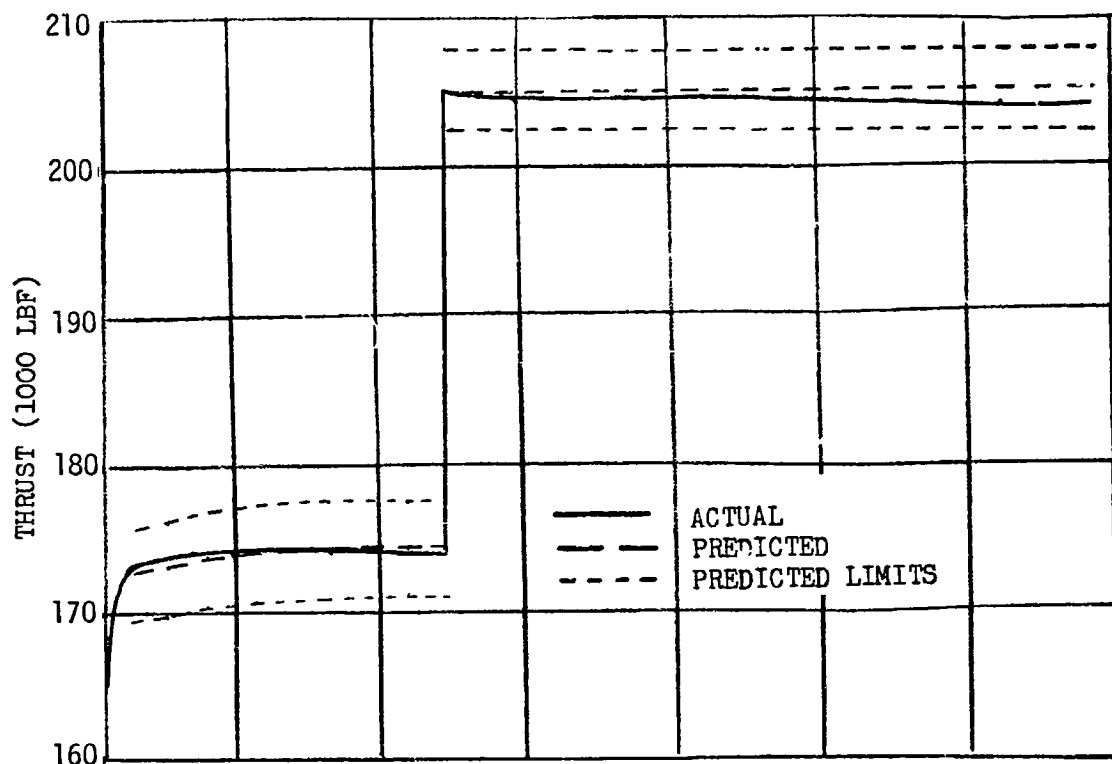

Figure 9-3. Second Burn Tag Values (Sheet 1 of 2)

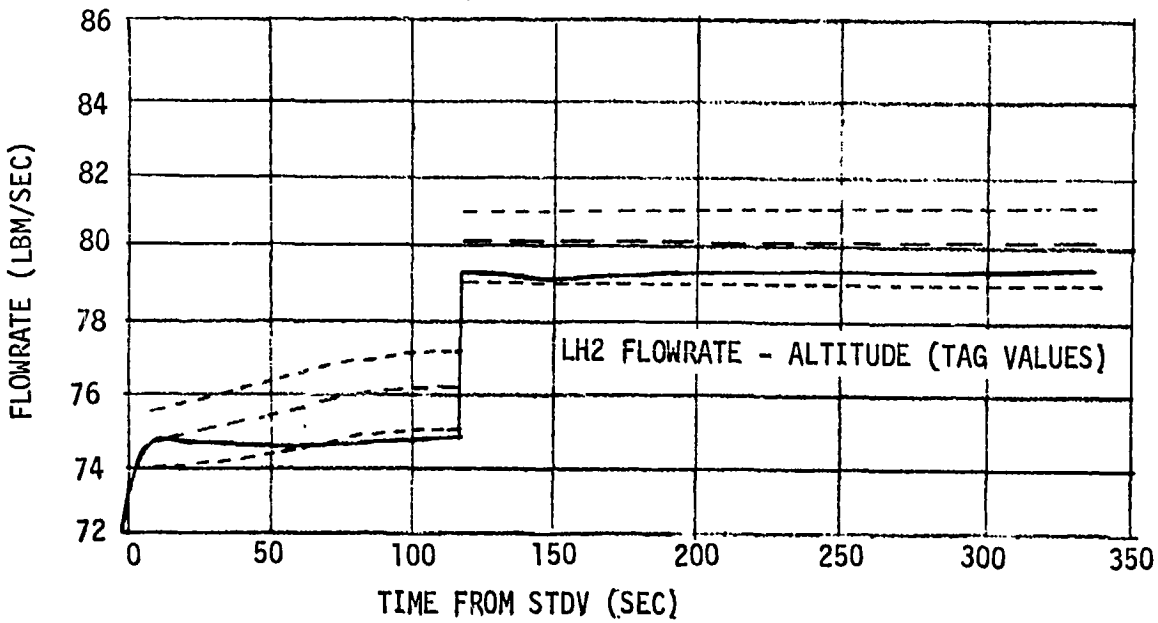
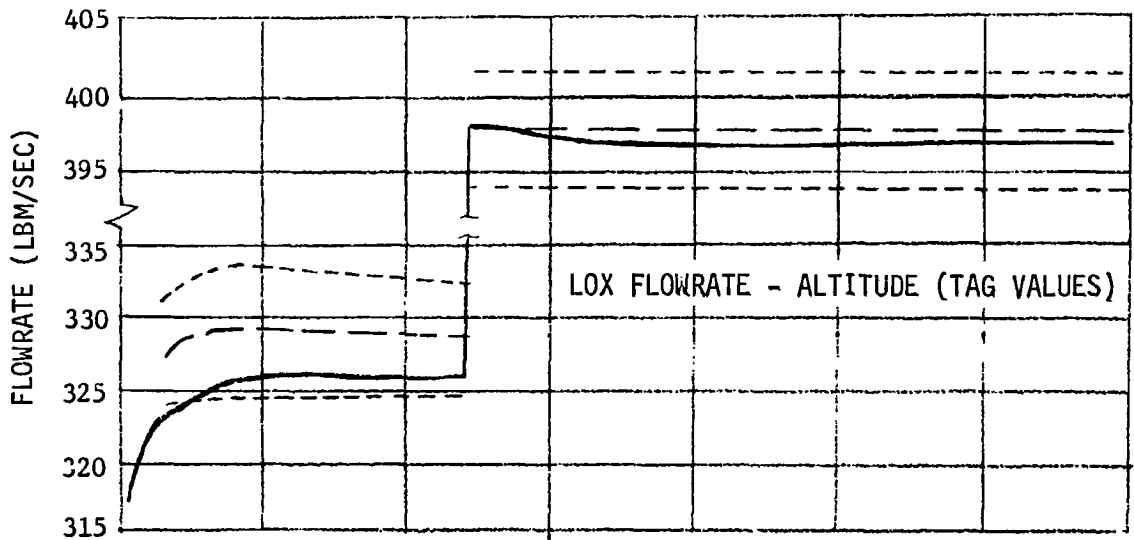
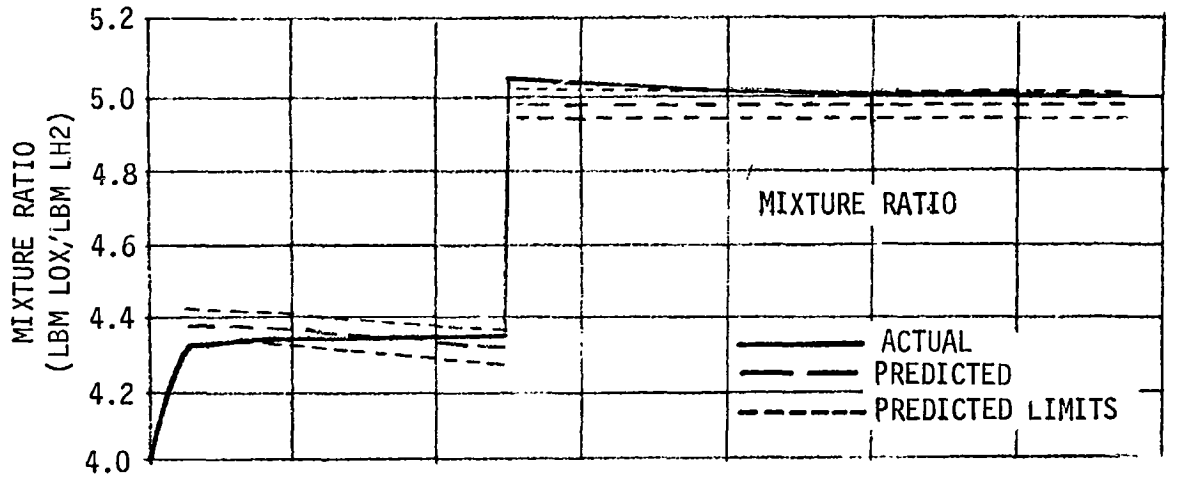

Figure 9-3. Second Burn Tag Values (Sheet 2 of 2)

EVENTS

IGNITION PHASE

ENGINE START COMMAND P/U
 HELIUM CONTROL SOLENOID ENERGIZE P/U
 THRUST CHAMBER SPARK ON P/U
 GAS GENERATOR SPARK ON P/U
 IGNITION PHASE CONT SOLENOID ENERG P/U
 ASI LOX VALVE OPEN P/U
 LOX BLEED VALVE CLOSED P/U
 LH2 BLEED VALVE CLOSED P/U
 MAIN FUEL VALVE CLOSED D/O
 MAIN FUEL VALVE OPEN P/U
 ENGINE START COMMAND D/O

PUMP SPIN PHASE

START TANK DISCH CONT SOLENOID ENERG P/U
 START TANK DISCHARGE VALVE CLOSED D/O
 START TANK DISCHARGE VALVE OPEN P/U

MAINSTAGE PHASE

MAINSTAGE CONTROL SOLENOID ENERGIZE P/U
 START TANK DISCH CONT SOLENOID ENERG D/O
 MAIN LOX VALVE CLOSED D/O
 GAS GENERATOR VALVE CLOSED D/O
 START TANK DISCHARGE VALVE OPEN D/O
 GAS GENERATOR VALVE OPEN P/U
 LOX TURBINE BYPASS VALVE OPEN D/O
 START TANK DISCHARGE VALVE CLOSED P/U
 LOX TURBINE BYPASS VALVE CLOSED P/U
 MAINSTAGE PRESS. SWITCH NO. 1 PRESS. P/U
 MAINSTAGE PRESS. SWITCH NO. 2 PRESS. P/U
 MAIN LOX VALVE OPEN P/U
 THRUST CHAMBER SPARK ON D/O
 GAS GENERATOR SPARK ON D/O

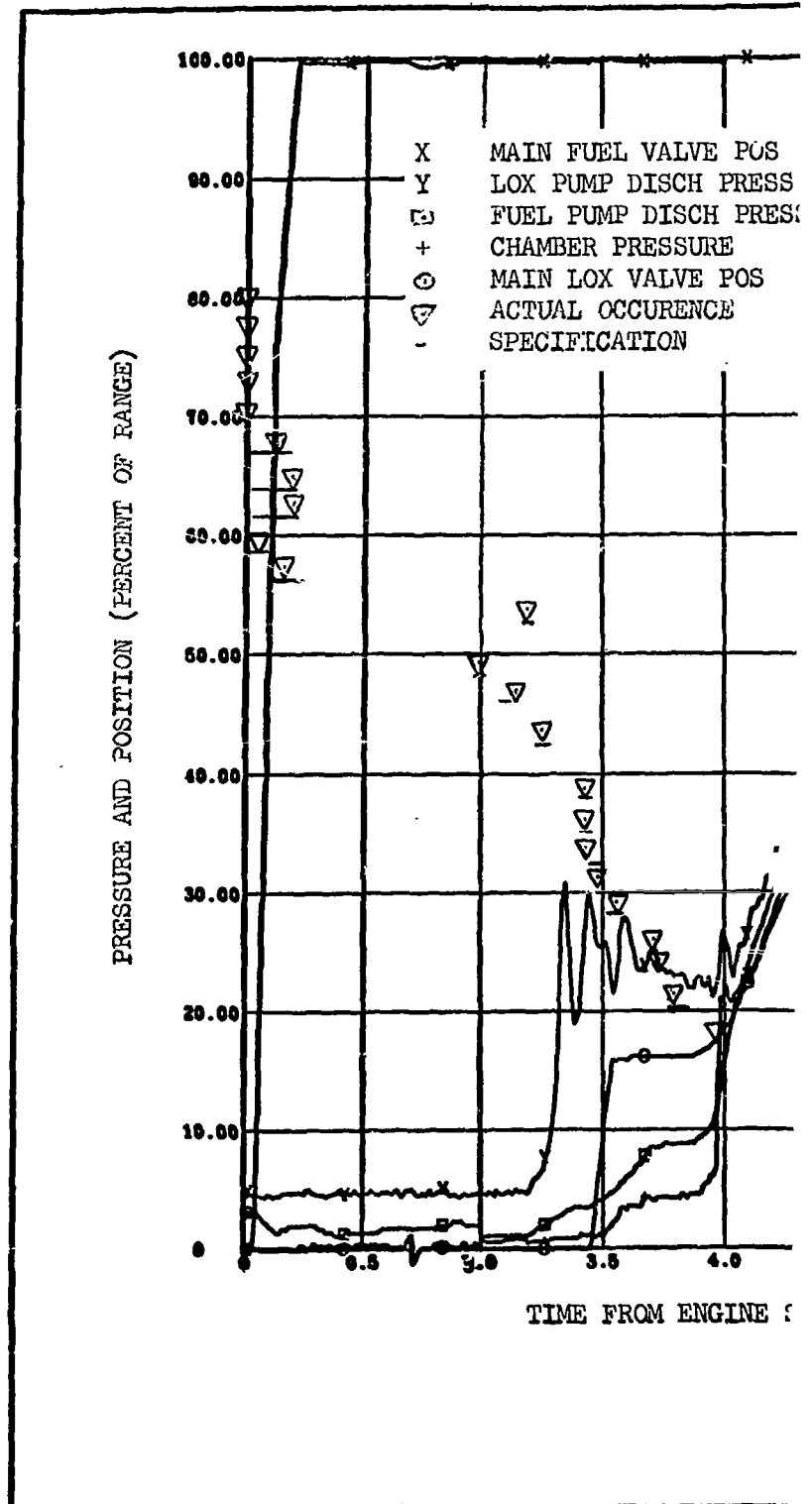

Figure 9-4. Engine Start Sequence--First

FOLDOUT FRAME

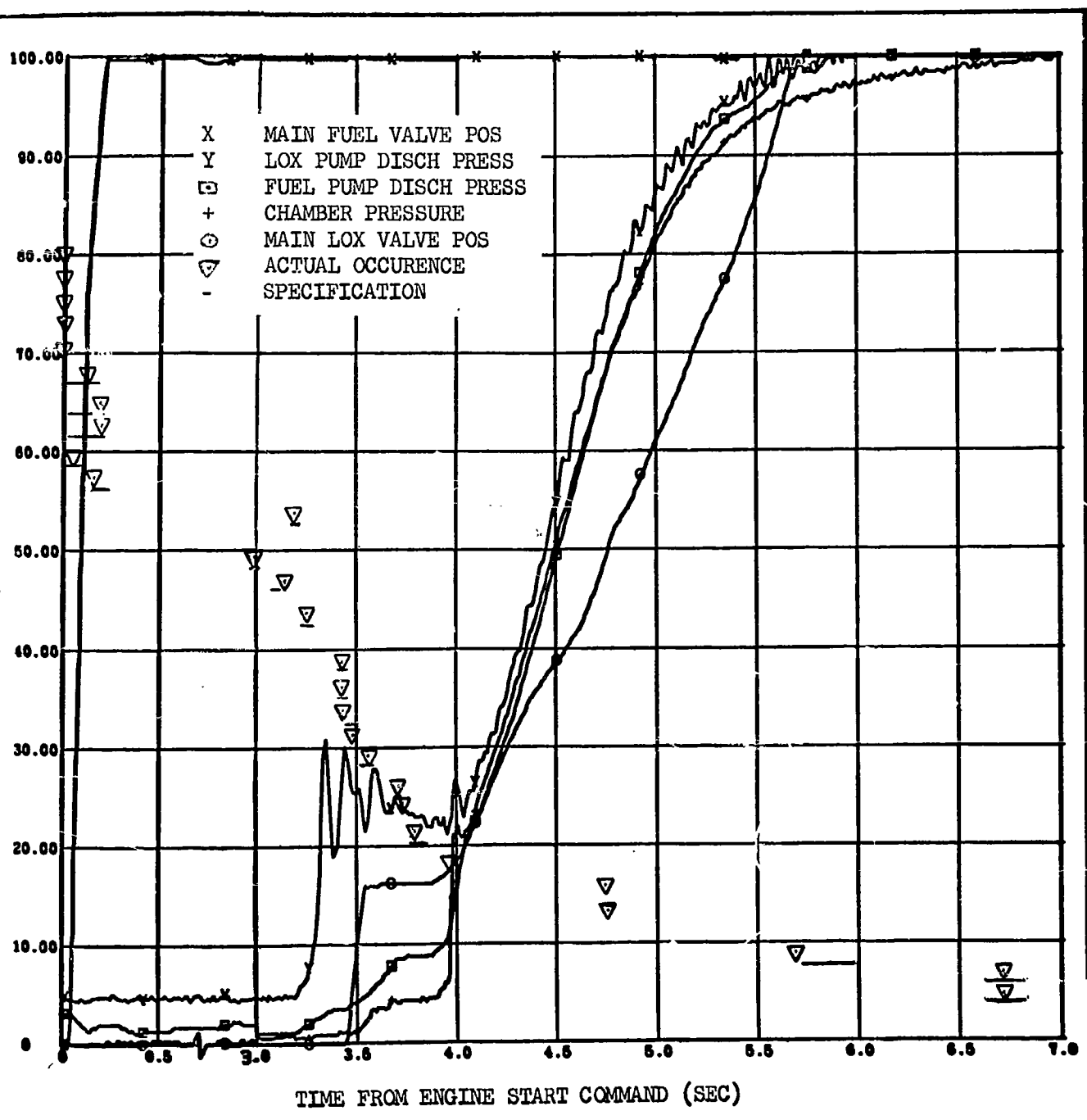

Figure 9-4. Engine Start Sequence--First Burn

FOLDOUT FRAME 2

EVENTS

IGNITION PHASE

ENGINE START COMMAND P/U
 HELIUM CONTROL SOLENOID ENERGIZE P/U
 THRUST CHAMBER SPARK ON P/U
 GAS GENERATOR SPARK ON P/U
 IGNITION PHASE CONT SOLENOID ENERG P/U
 ASI LOX VALVE OPEN P/U
 LOX BLEED VALVE CLOSED P/U
 LH2 BLEED VALVE CLOSED P/U
 MAIN FUEL VALVE CLOSED D/O
 MAIN FUEL VALVE OPEN P/U
 ENGINE START COMMAND D/O

PUMP SPIN PHASE

START TANK DISCH CONT SOLENOID ENERG P/U
 START TANK DISCHARGE VALVE CLOSED D/O
 START TANK DISCHARGE VALVE OPEN P/U

MAINSTAGE PHASE

MAINSTAGE CONTROL SOLENOID ENERGIZE P/U
 START TANK DISCH CONT SOLENOID ENERG D/O
 MAIN LOX VALVE CLOSED D/O
 GAS GENERATOR VALVE CLOSED D/O
 START TANK DISCHARGE VALVE OPEN D/O
 GAS GENERATOR VALVE OPEN P/U
 LOX TURBINE BYPASS VALVE OPEN D/O
 START TANK DISCHARGE VALVE CLOSED P/U
 LOX TURBINE BYPASS VALVE CLOSED P/U
 MAINSTAGE PRESS. SWITCH NO. 1 PRESS. P/U
 MAINSTAGE PRESS. SWITCH NO. 2 PRESS. P/U
 MAIN LOX VALVE OPEN P/U
 THRUST CHAMBER SPARK ON D/O
 GAS GENERATOR SPARK ON D/O

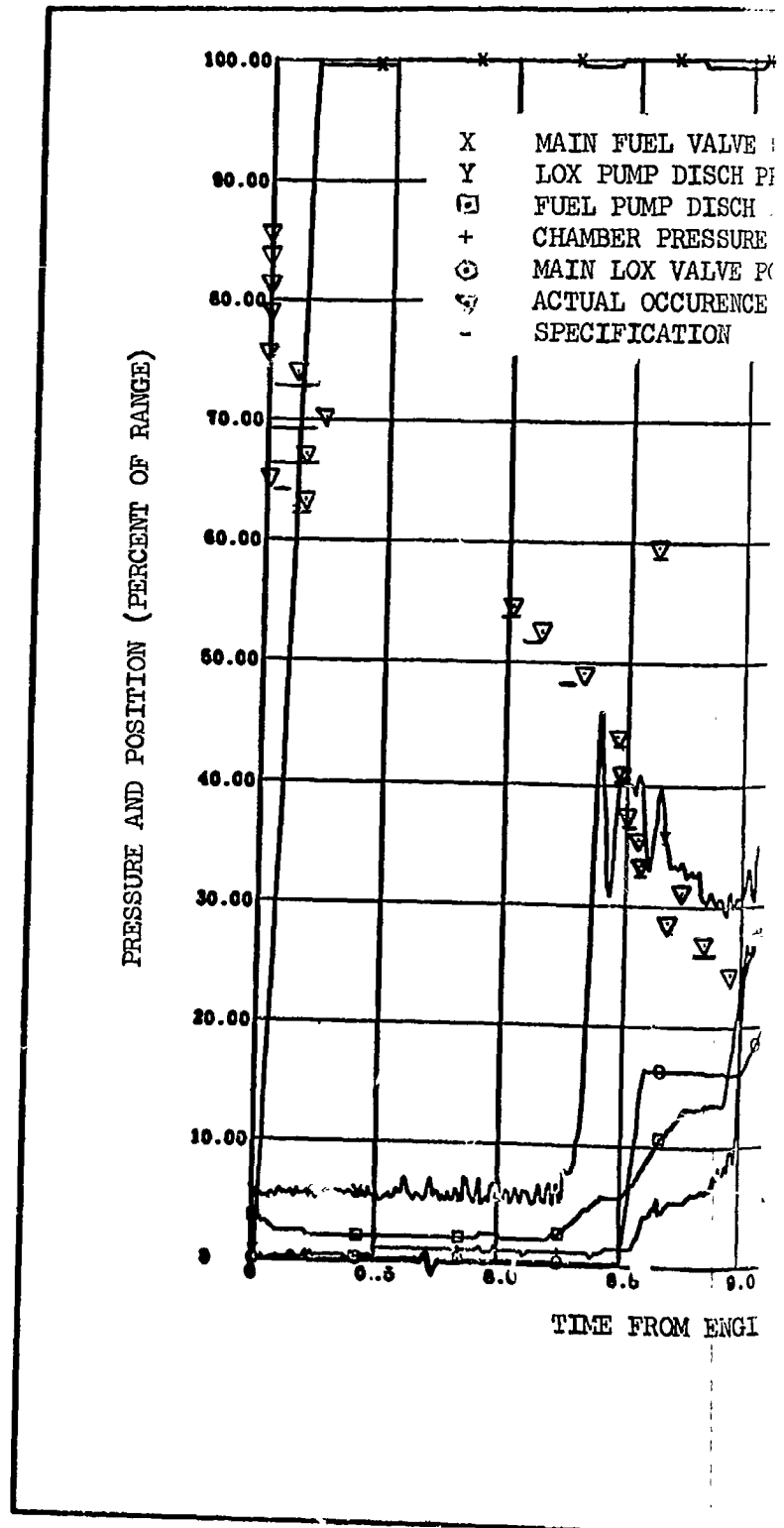
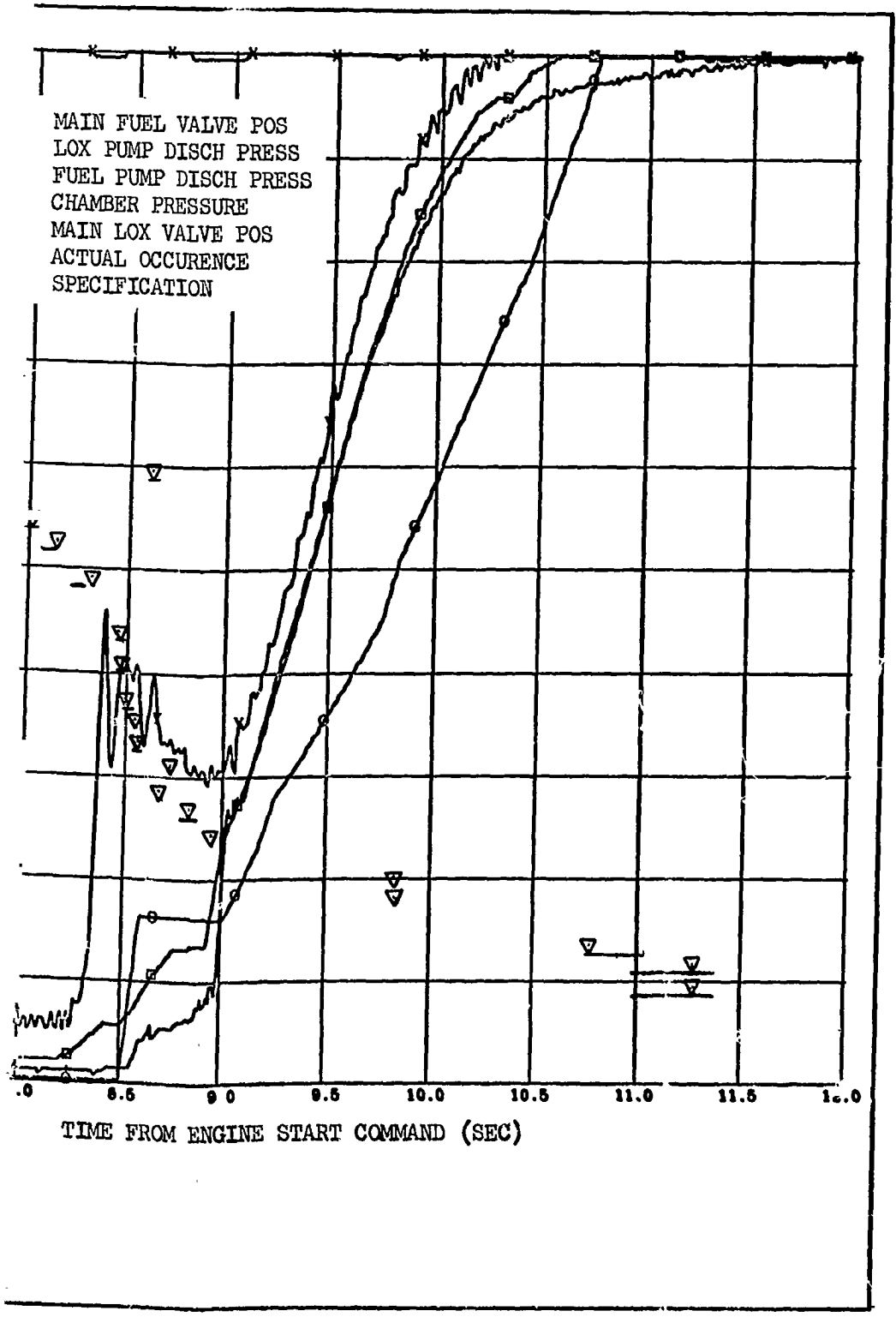

Figure 9-5. Engine Start Sequence--Second



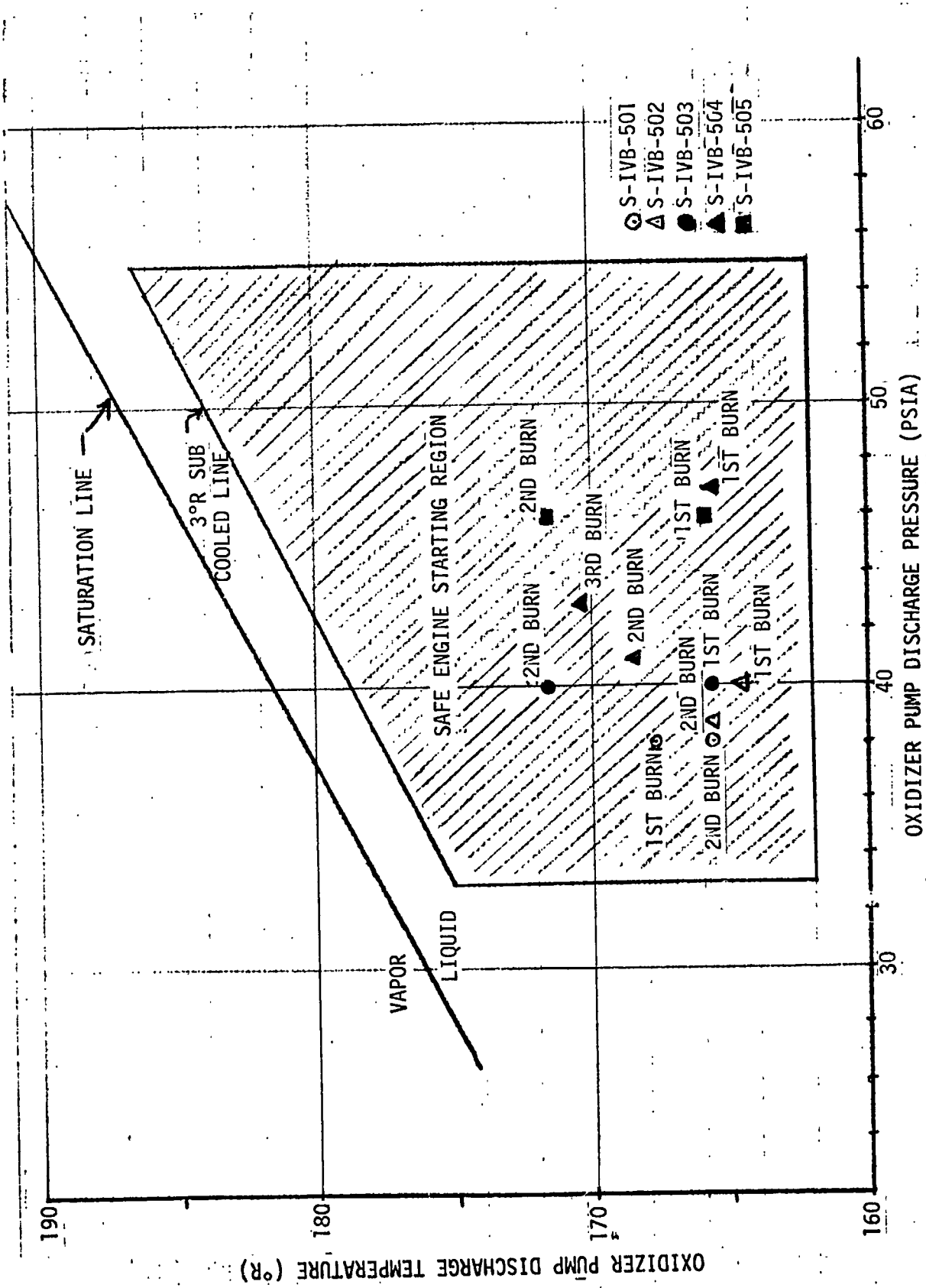

Figure 9-6. Oxidizer Pump Discharge Pressure Versus Temperature

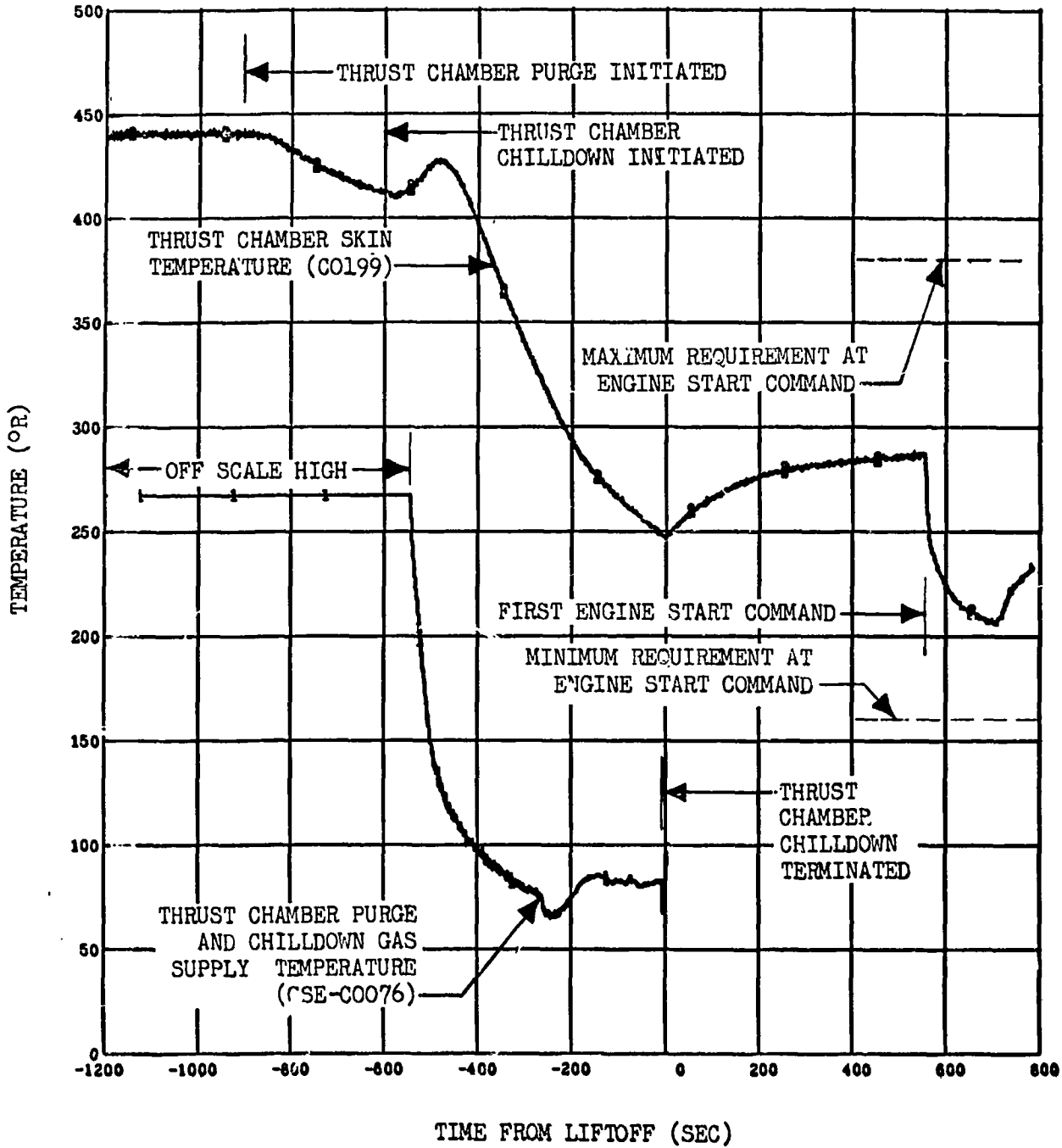

Figure 9-7. Thrust Chamber Chilledown--First Burn

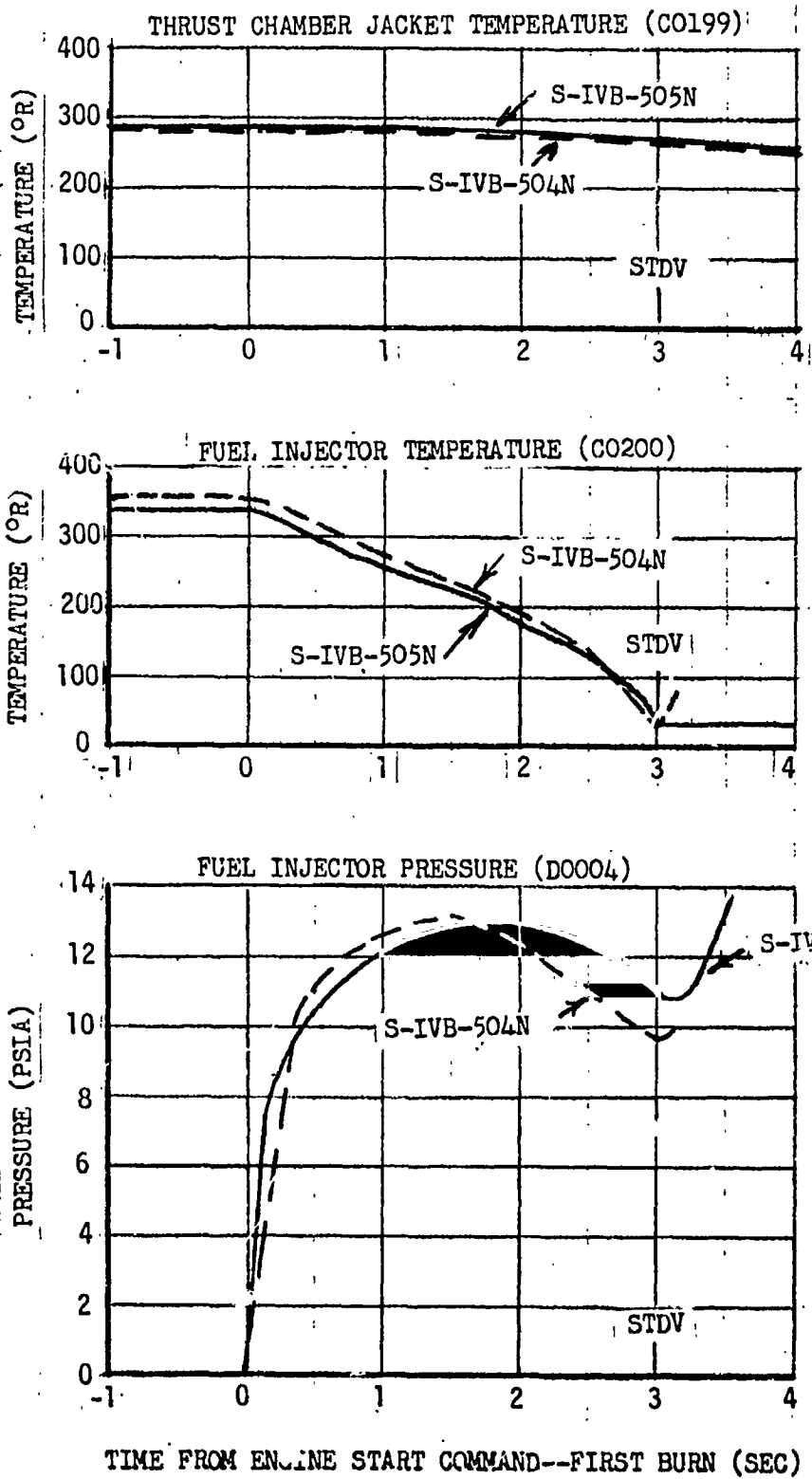

Figure 9-8. Fuel Lead--First Burn

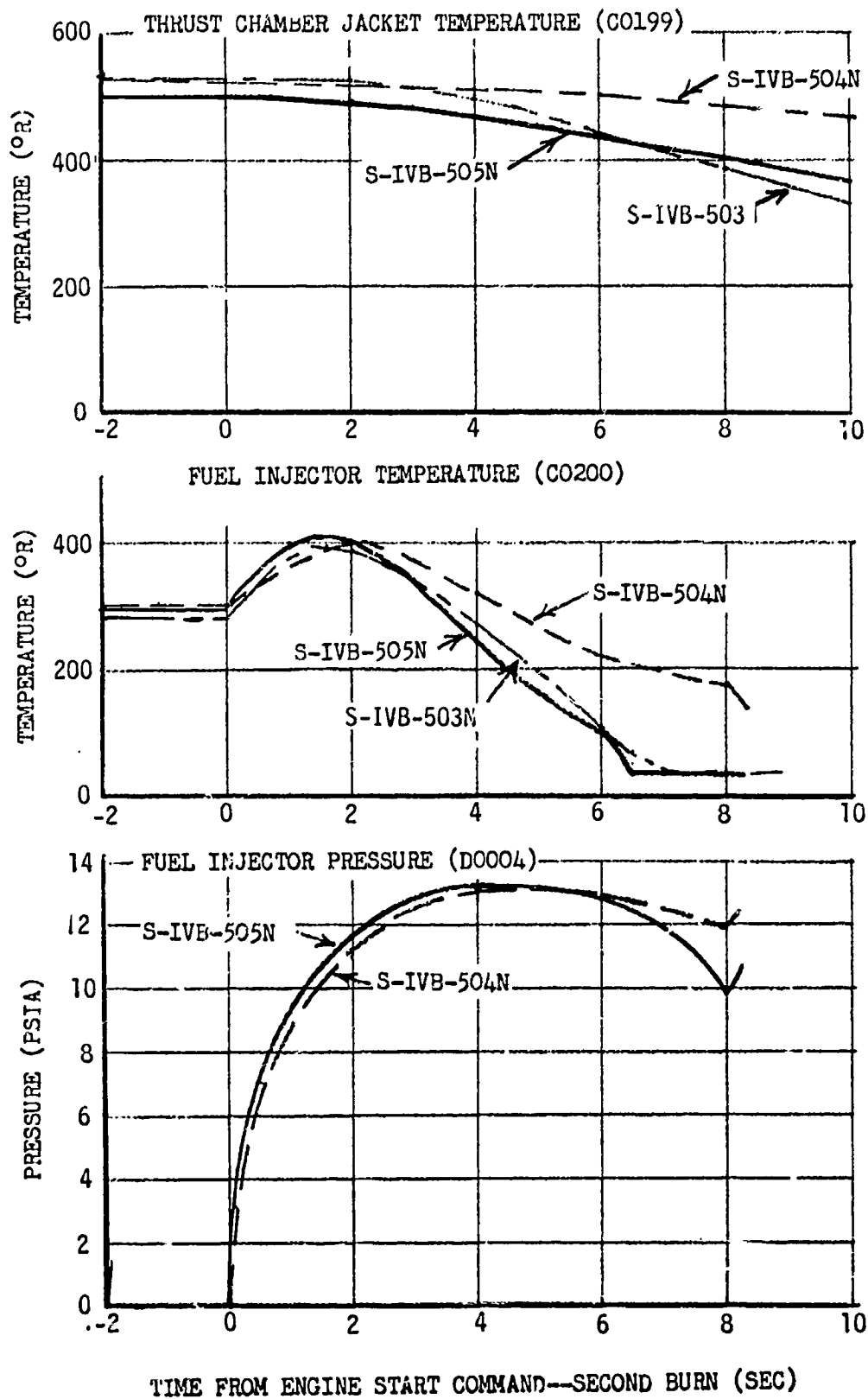

Figure 9-9. Fuel Lead--Second Burn

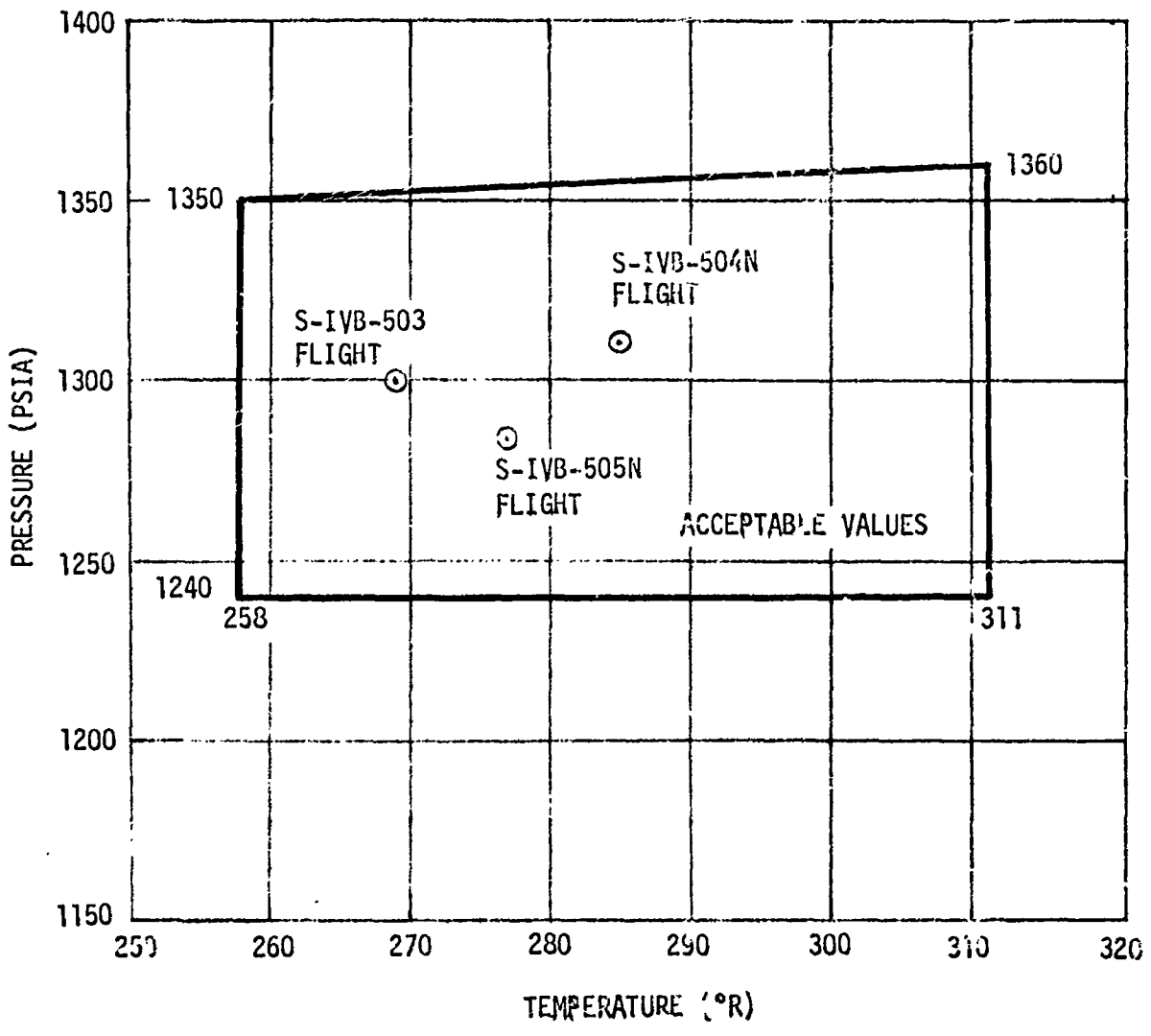

Figure 9-10. GH2 Start Sphere Critical Limits At Liftoff

FIRST BURN

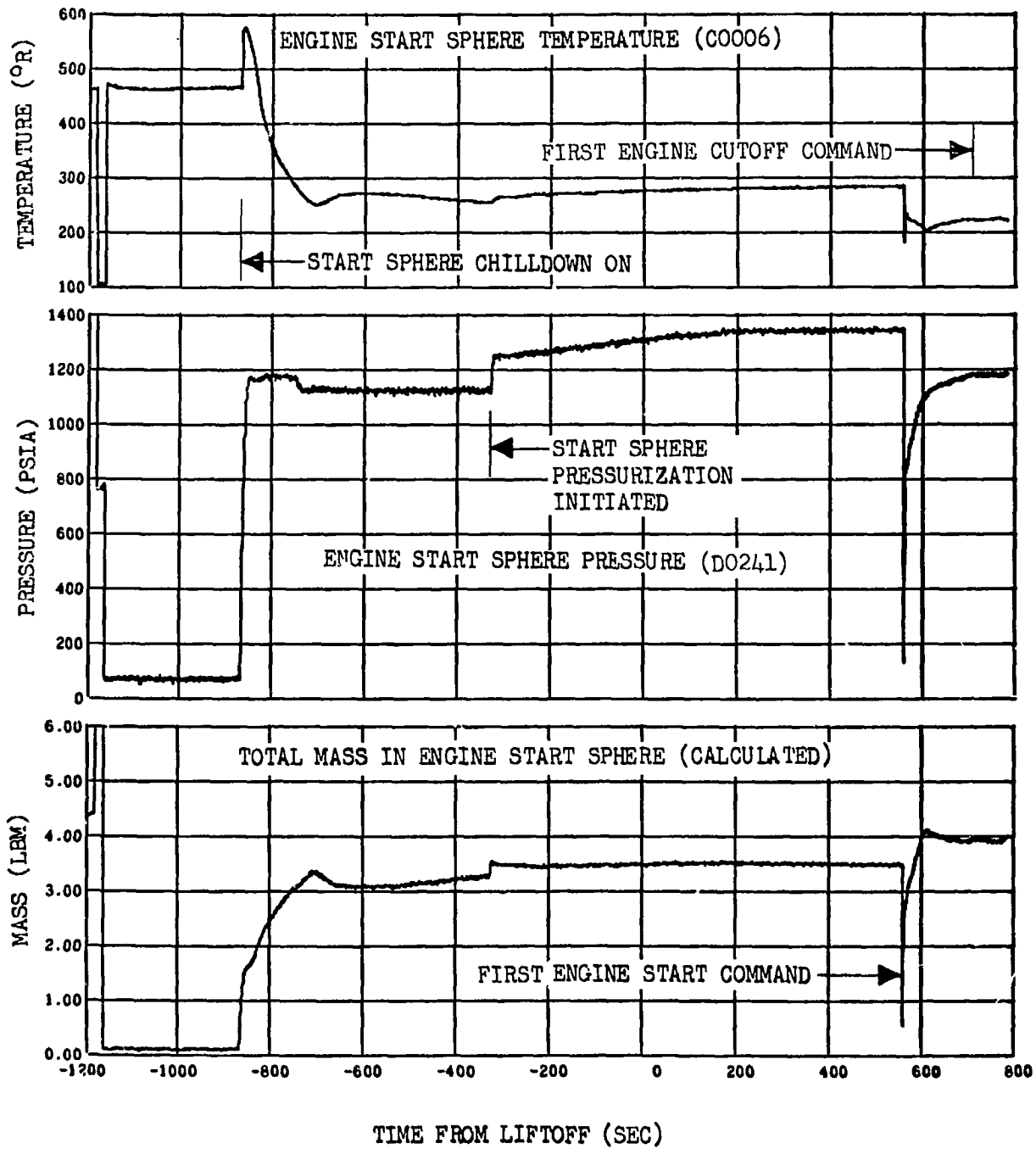

Figure 9-11. Engine Start Sphere Performance (Sheet 1 of 2)

SECOND BURN

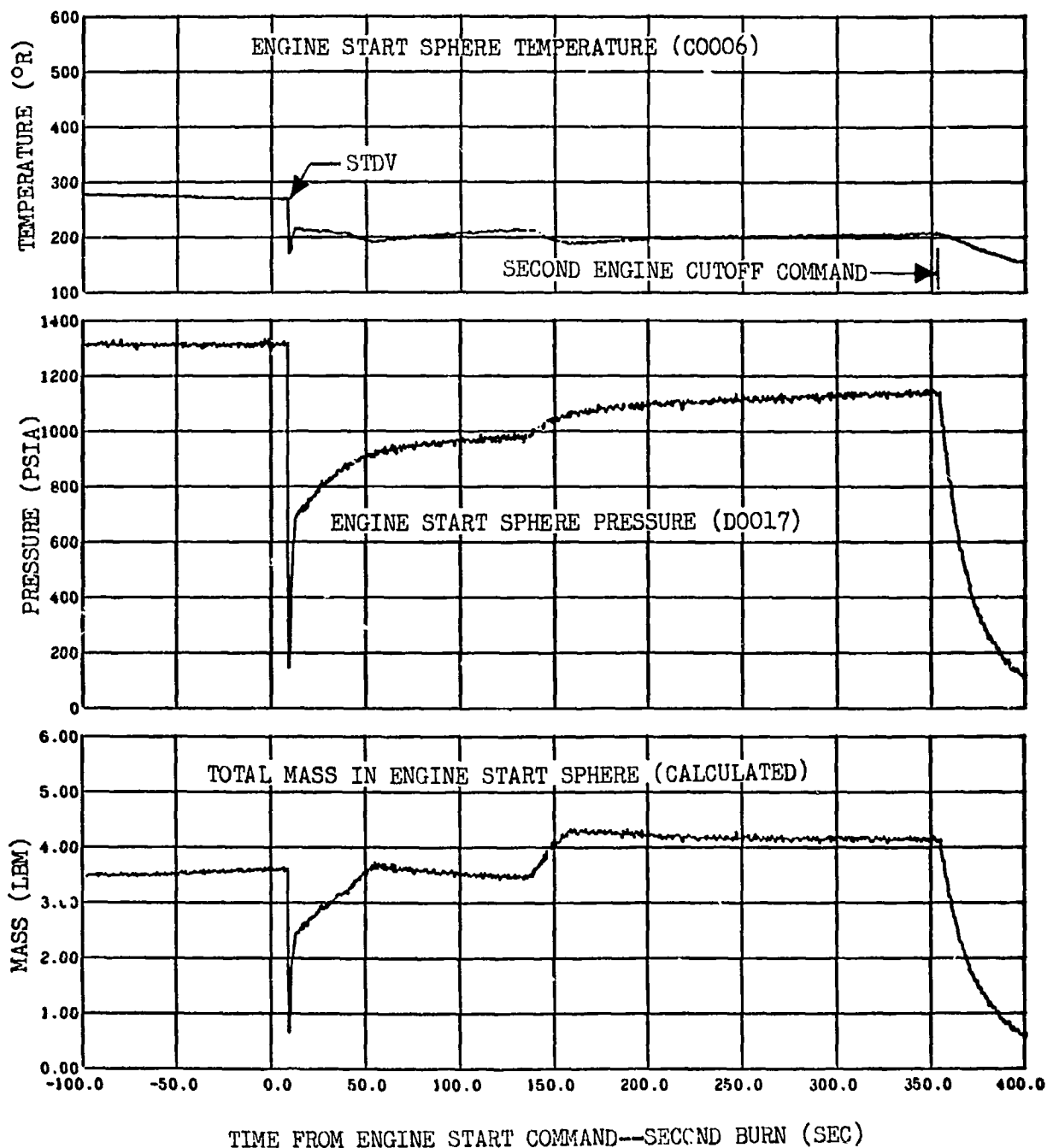

Figure 9-11. Engine Start Sphere Performance (Sheet 2 of 2)

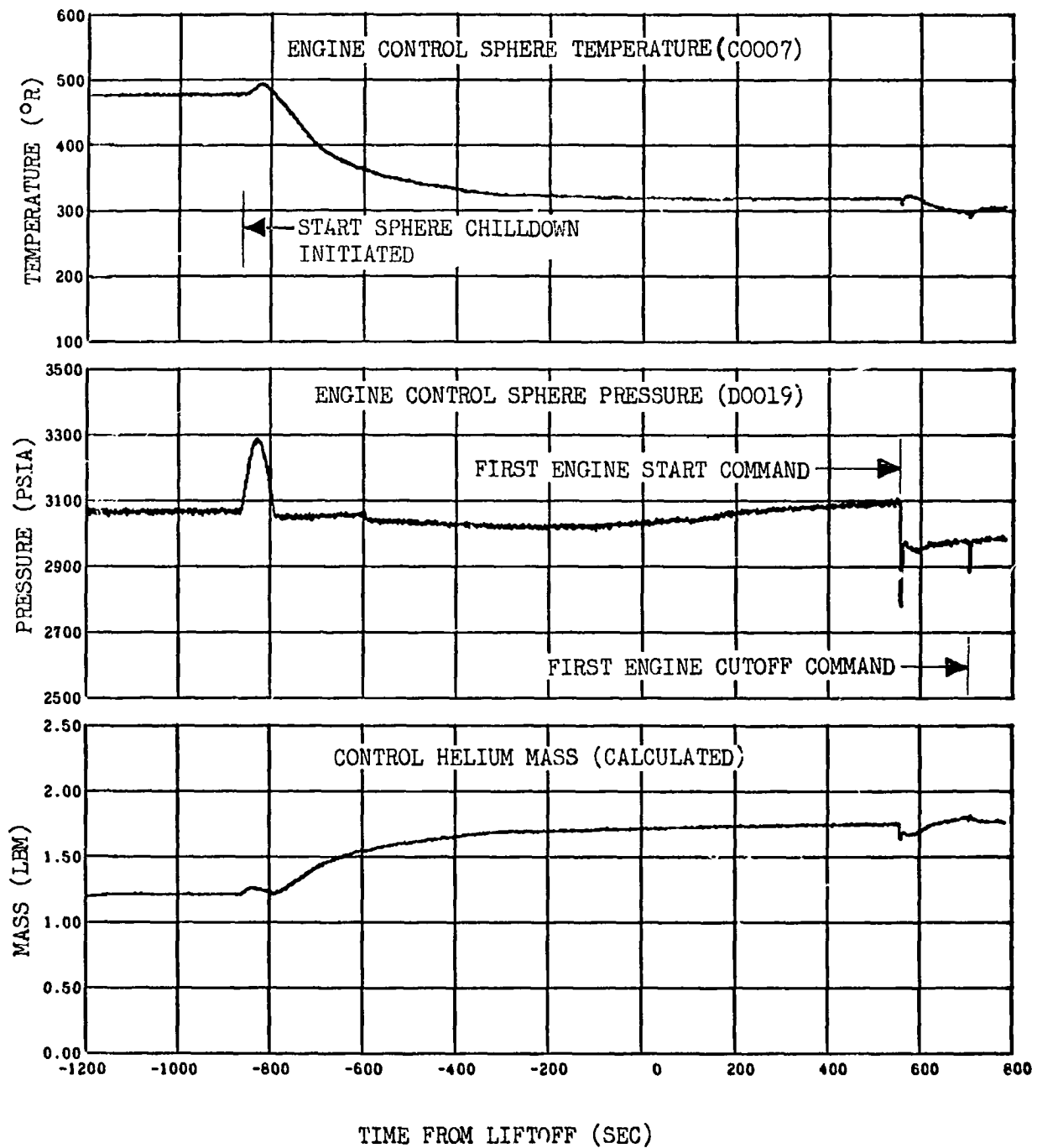

Figure 9-12. Engine Control Sphere Performance--First Burn

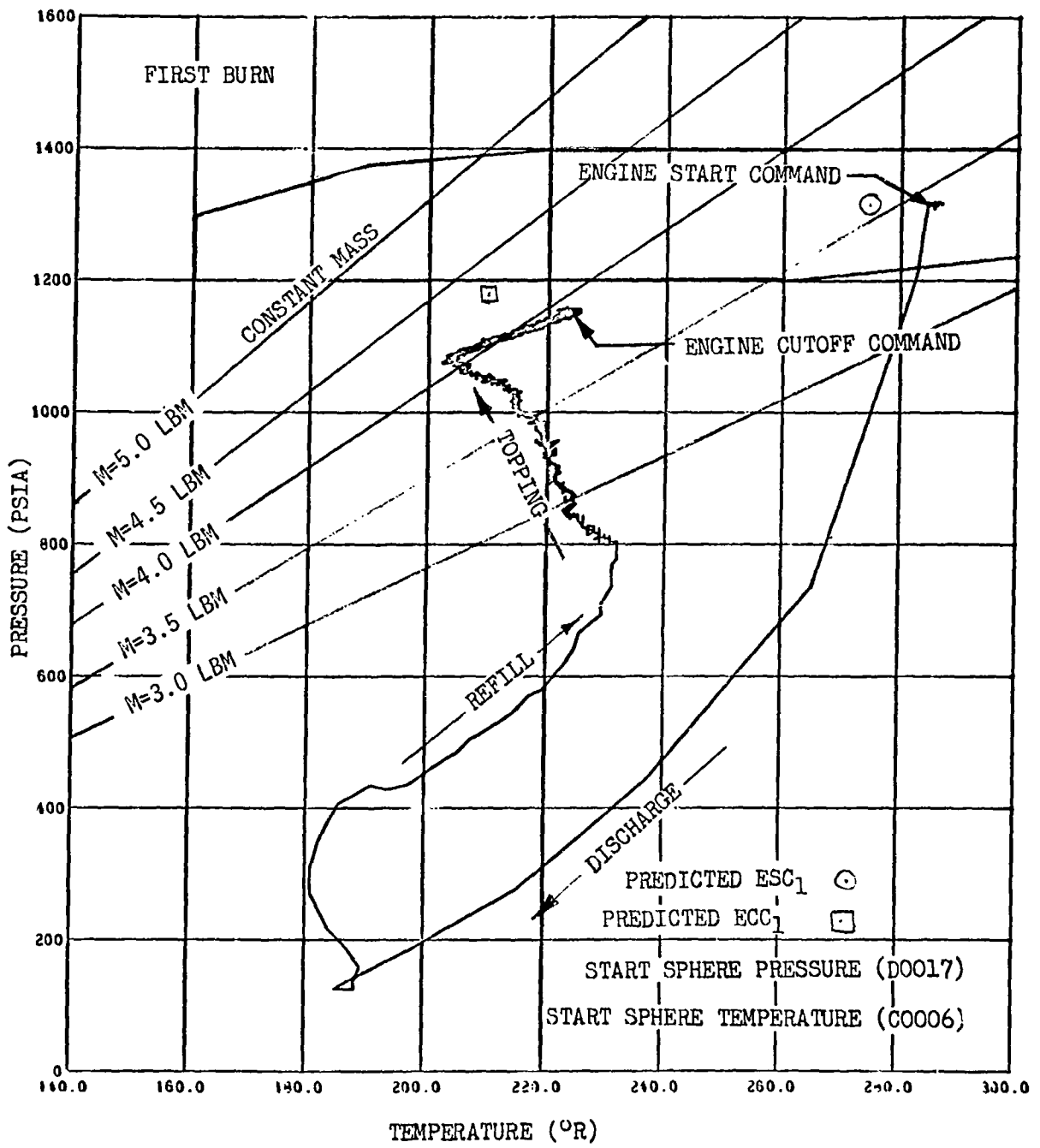

Figure 9-13. Start Sphere Refill Performance (Sheet 1 of 2)

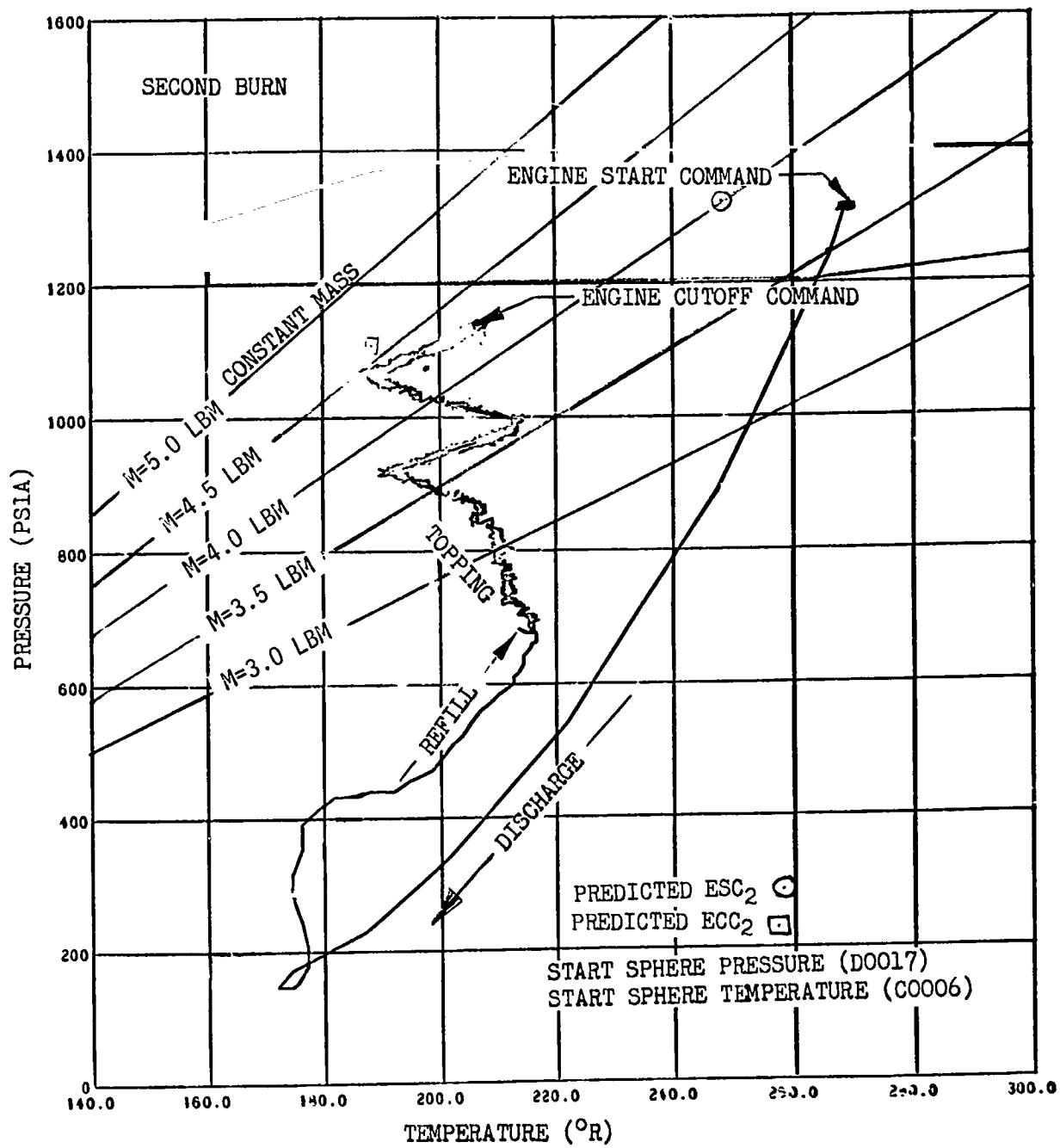

Figure 9-13. Start Sphere Refill Performance (Sheet 2 of 2)

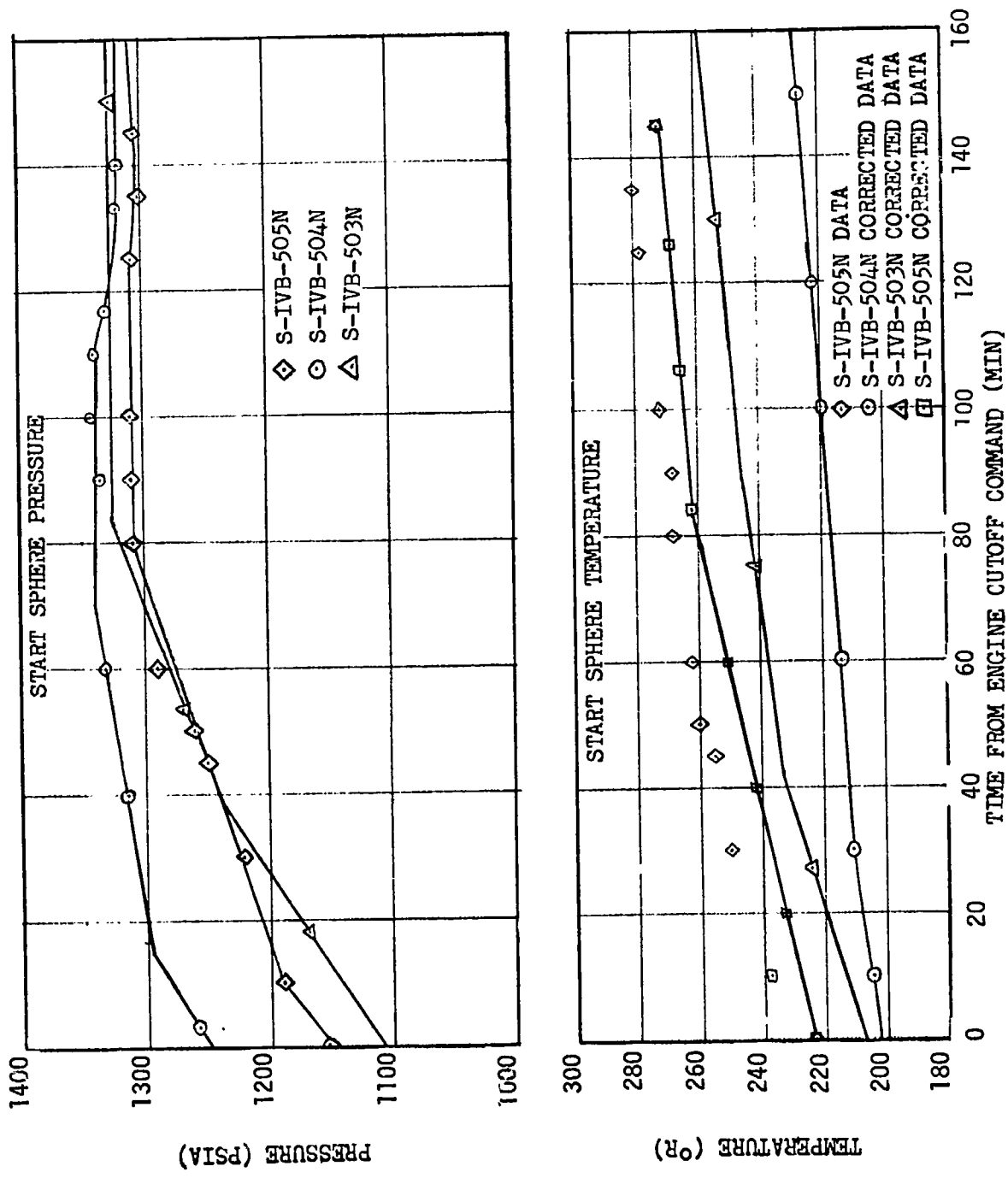

Figure 9-14. Start Sphere Conditions--Earth Orbit

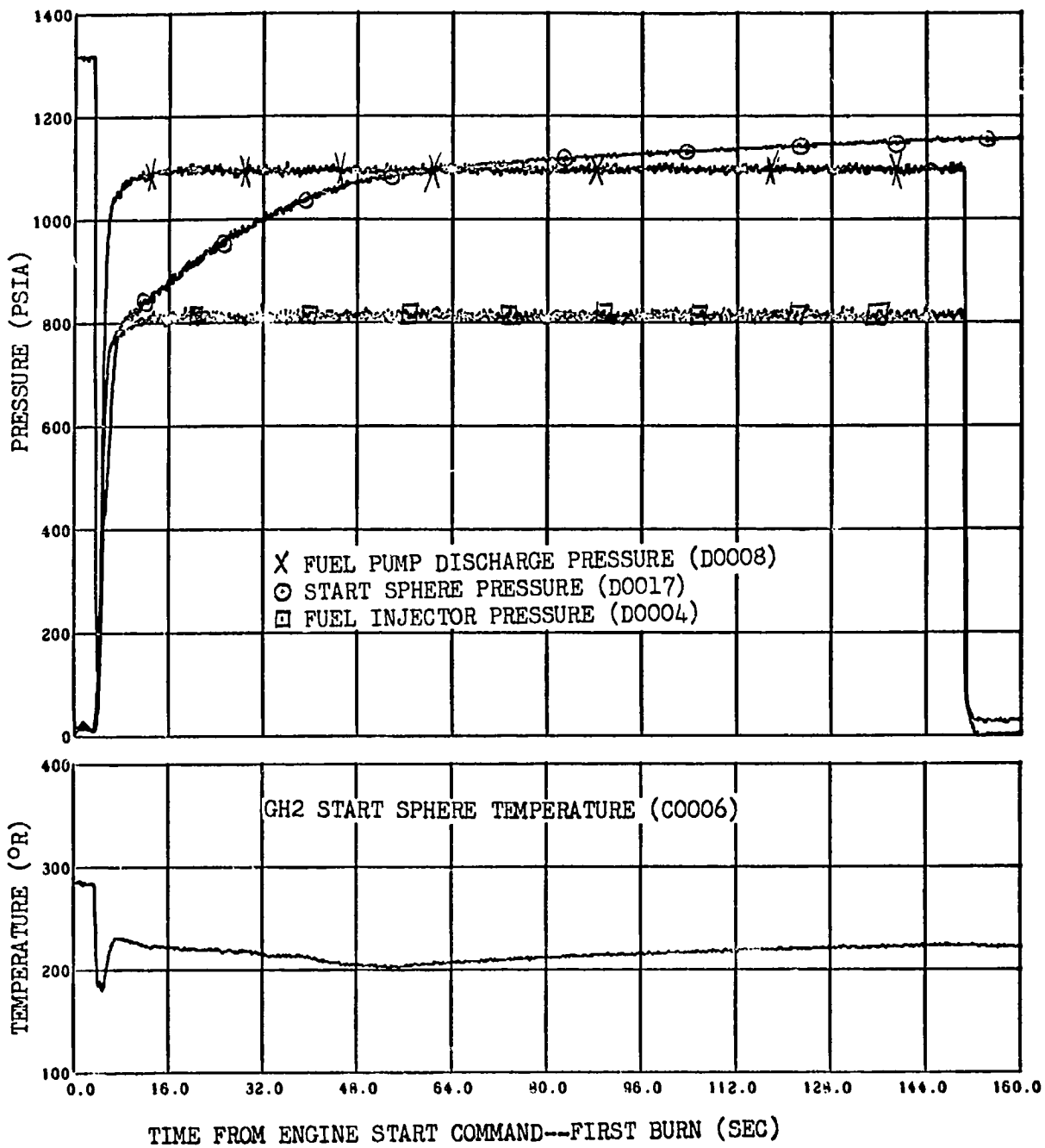

Figure 9-15. Start Sphere Refill (Sheet 1 of 2)

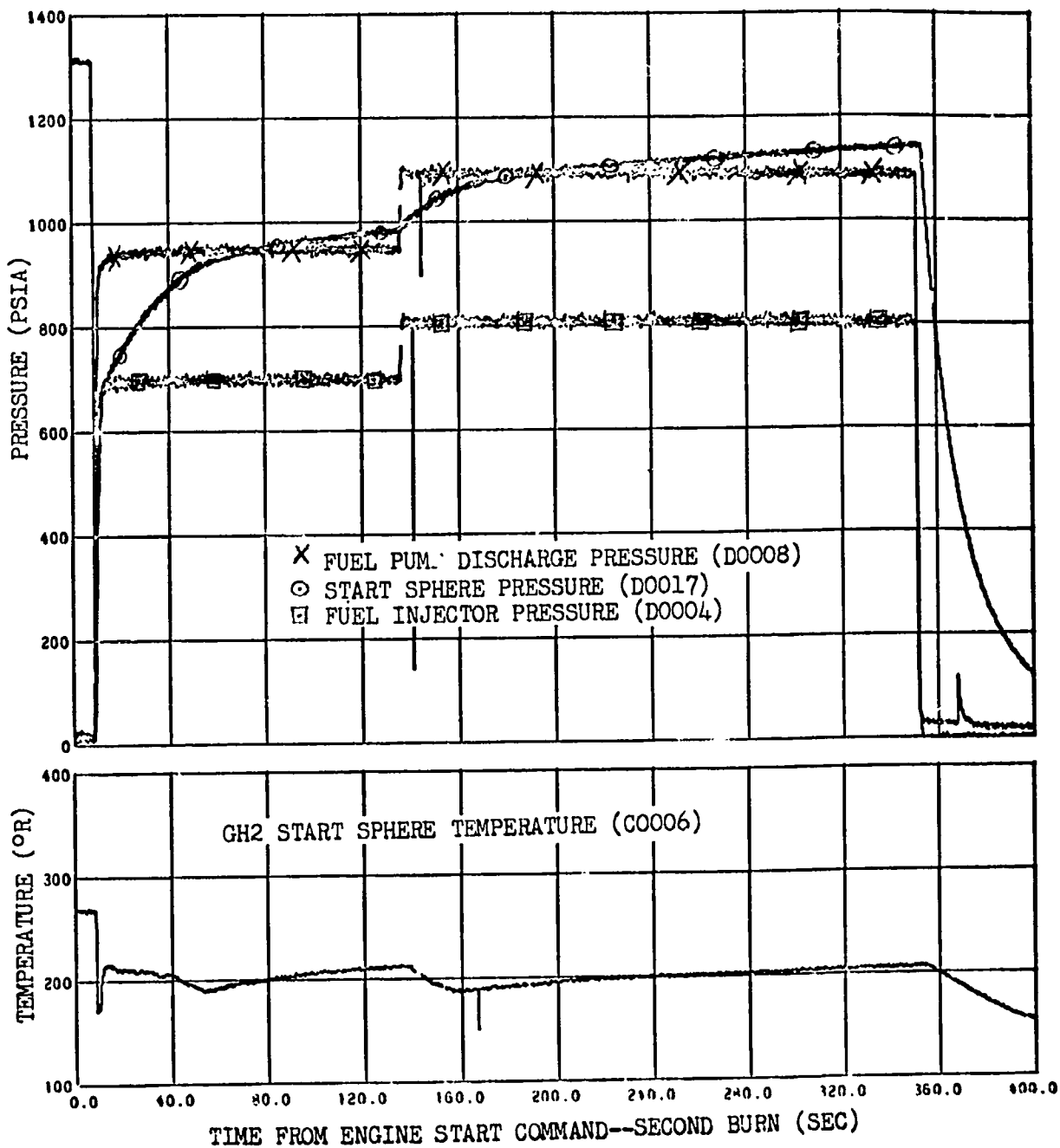

Figure 9-15. Start Sphere Refill (Sheet 2 of 2)

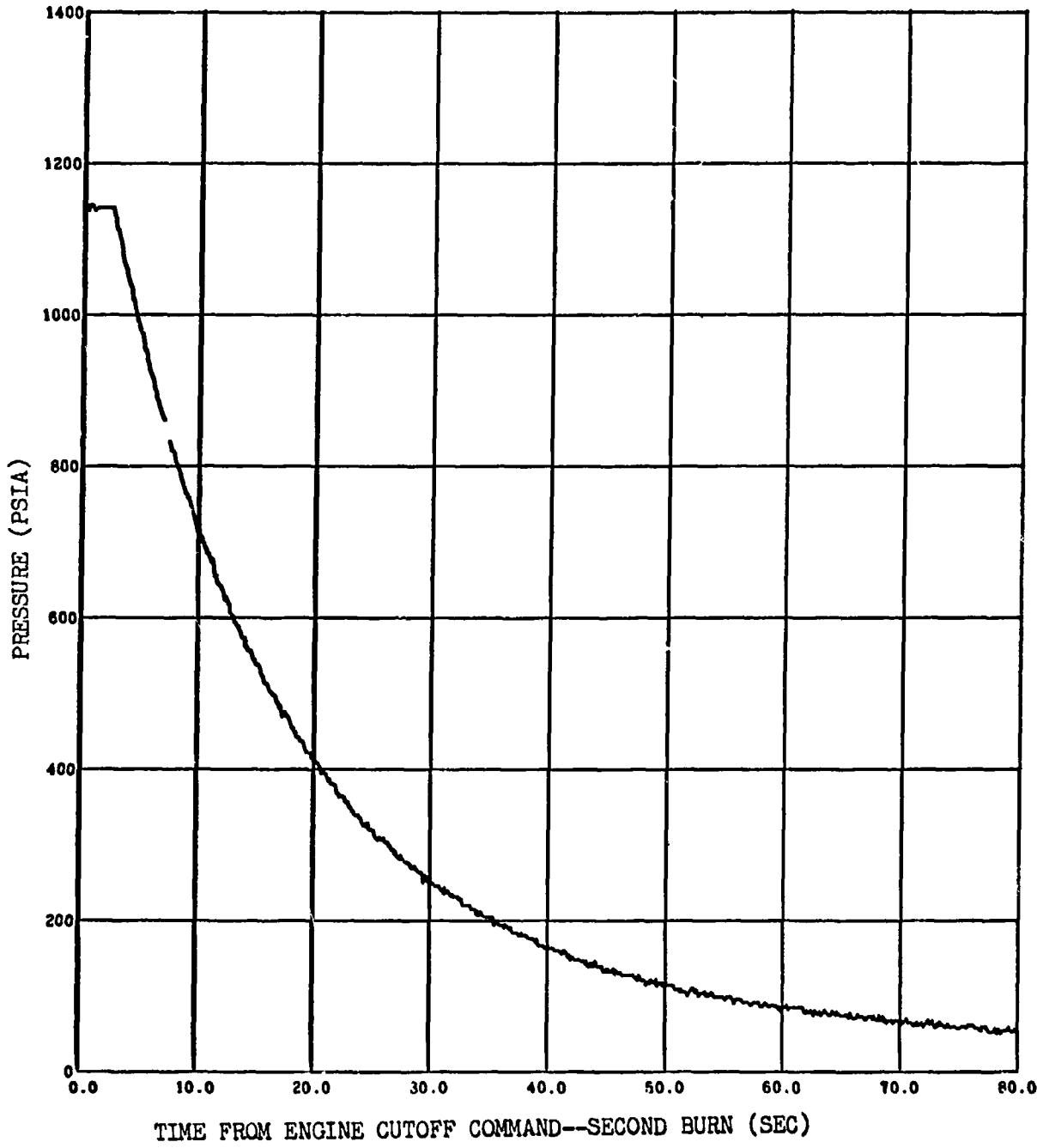

Figure 9-16. Start Sphere Safing

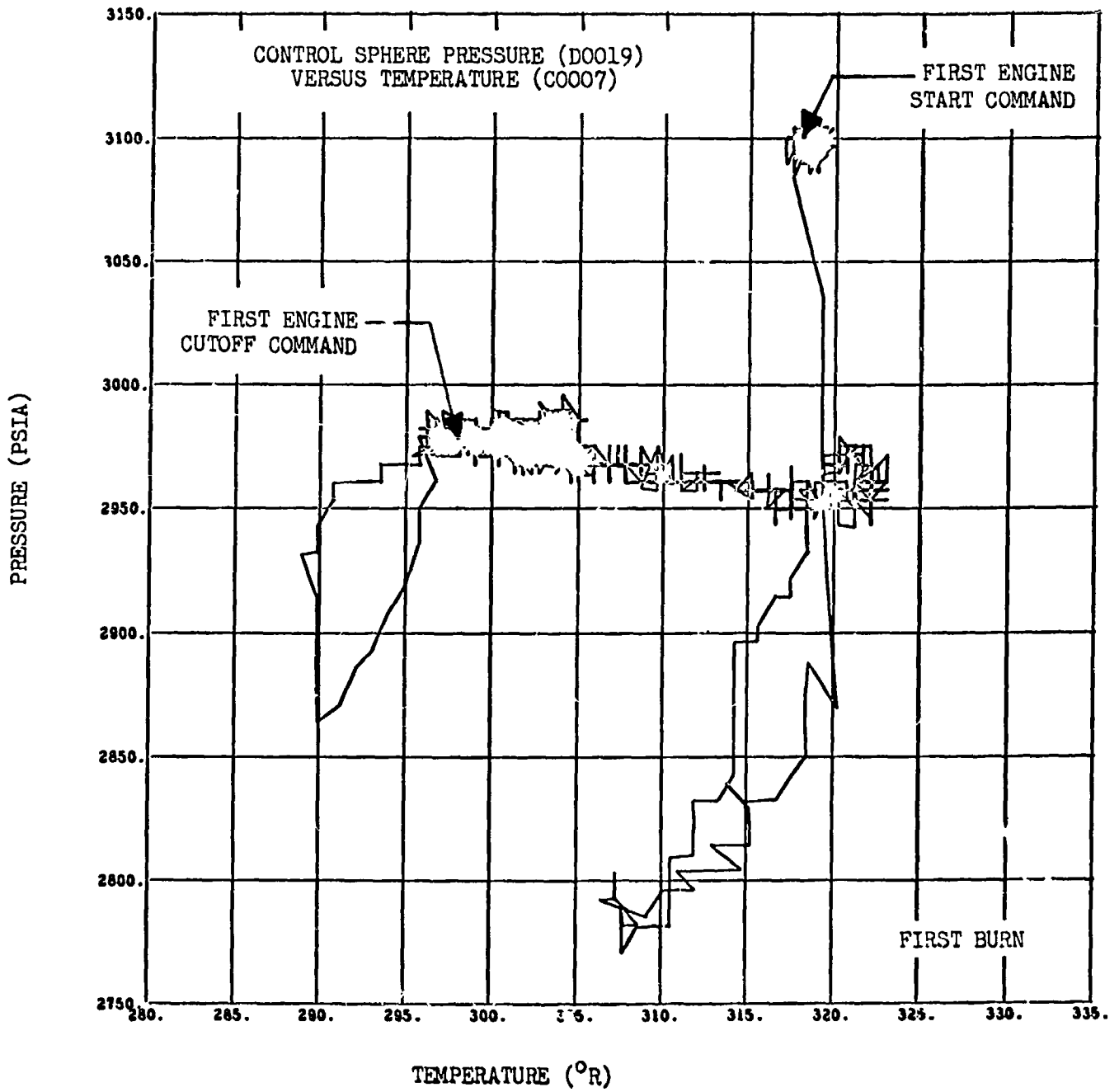

Figure 9-17. Control Sphere Performance (Sheet 1 of 2)

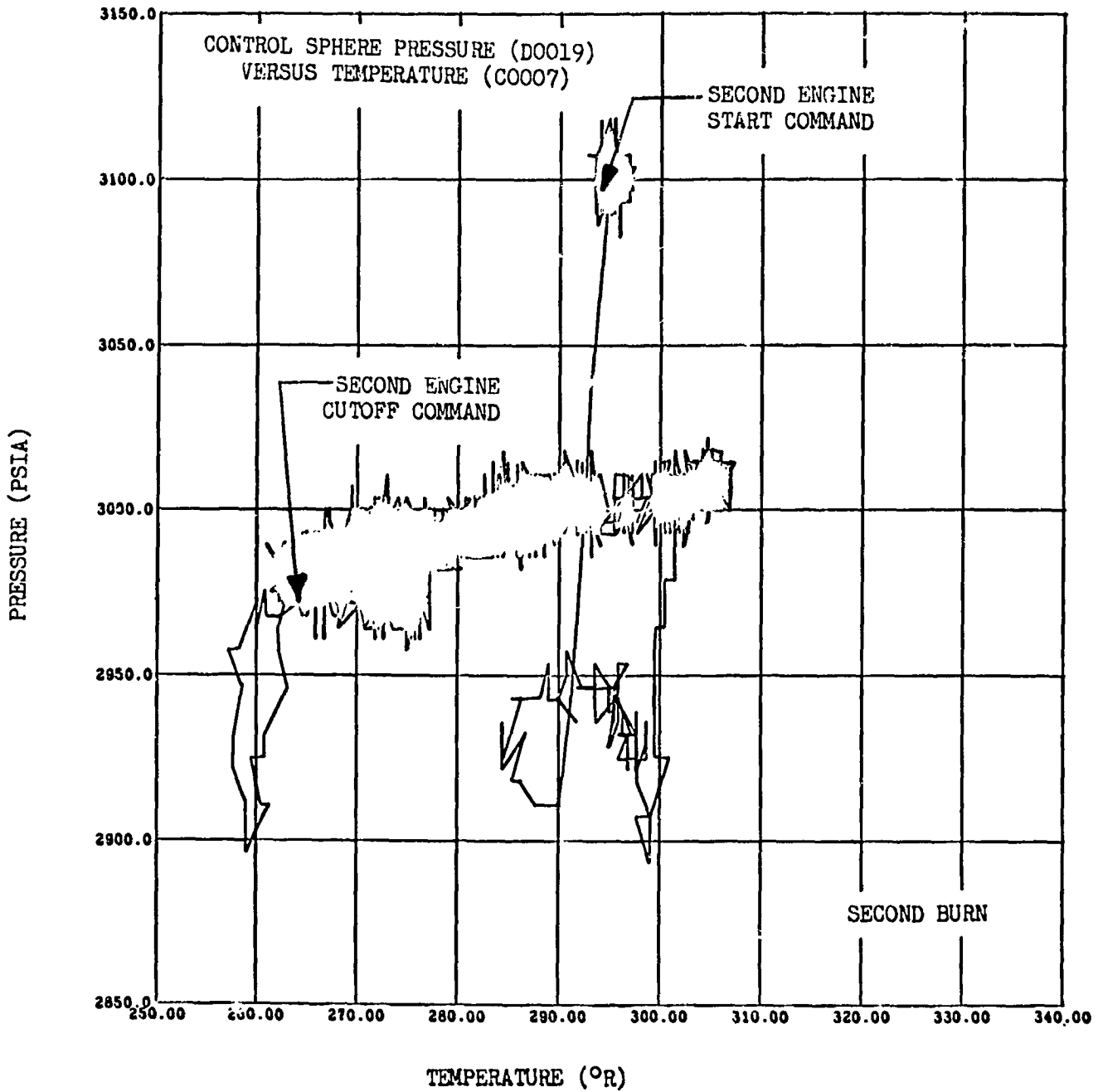

Figure 9-17. Control Sphere Performance (Sheet 2 of 2)

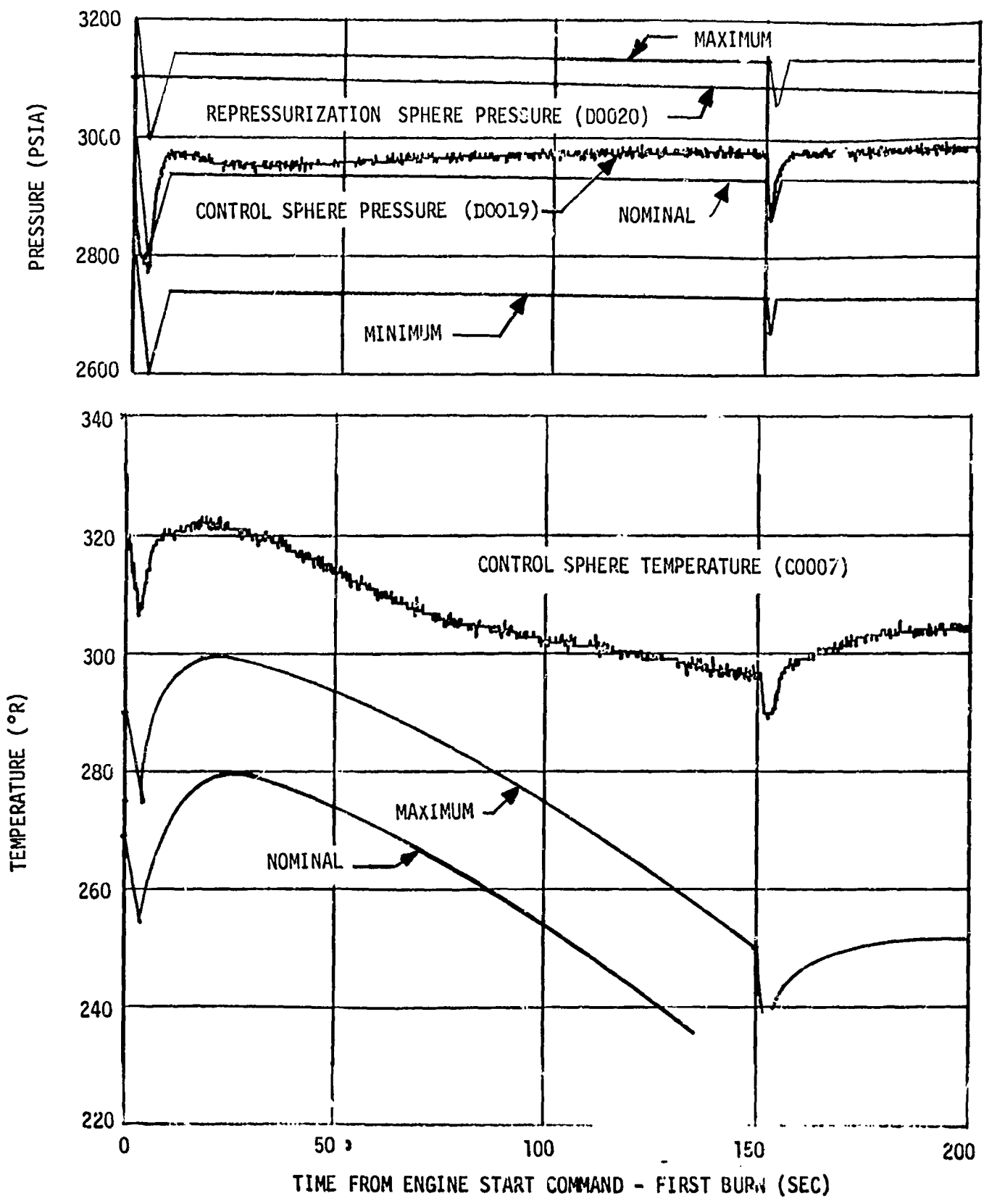

Figure 9-18. Control Sphere Conditions (Sheet 1 of 2)

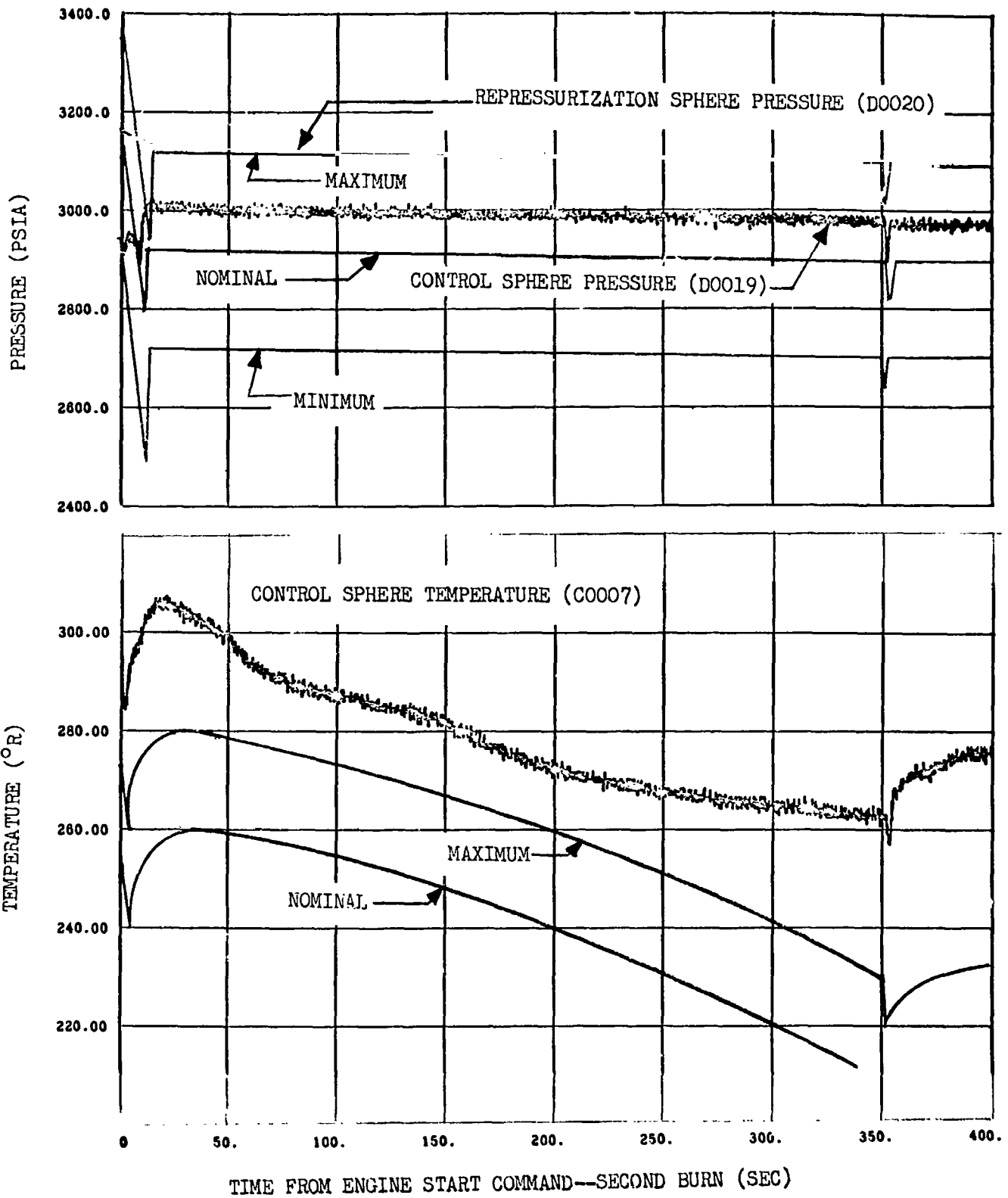

Figure 9-18. Control Sphere Conditions (Sheet 2 of 2)

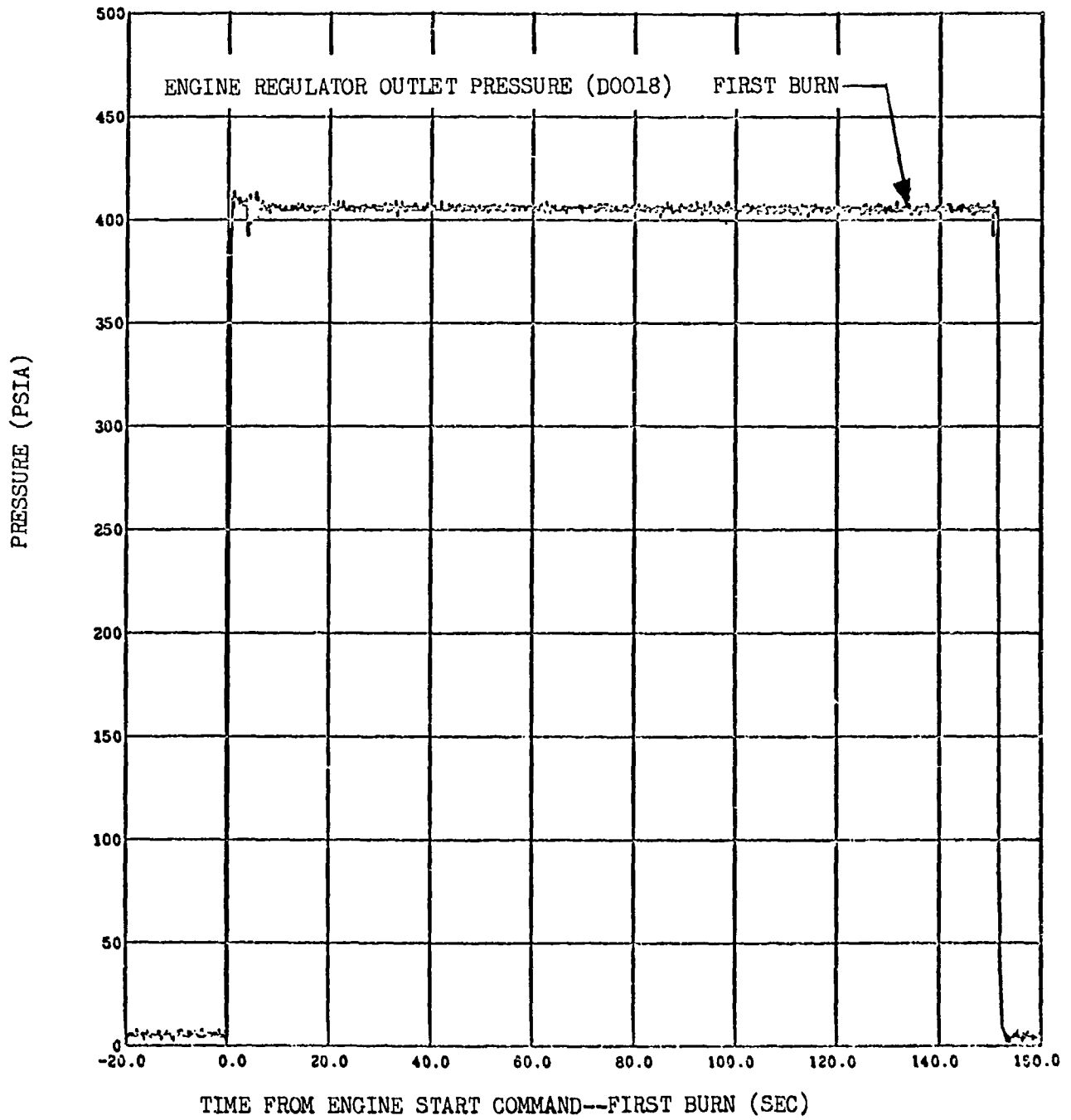

Figure 9-19. Engine Regulator Outlet Pressure (Sheet 1 of 2)

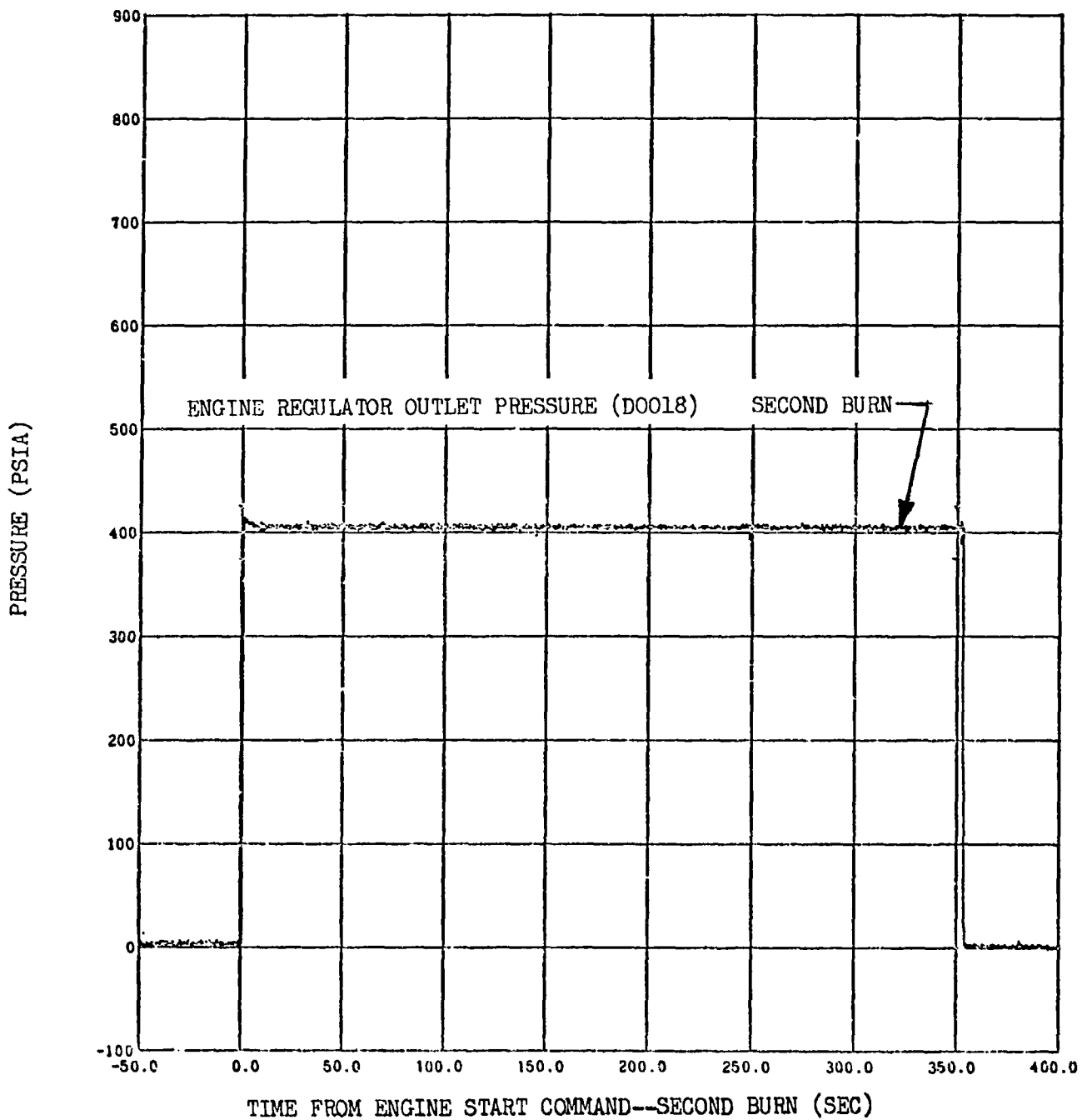

Figure 9-19. Engine Regulator Outlet Pressure (Sheet 2 of 2)

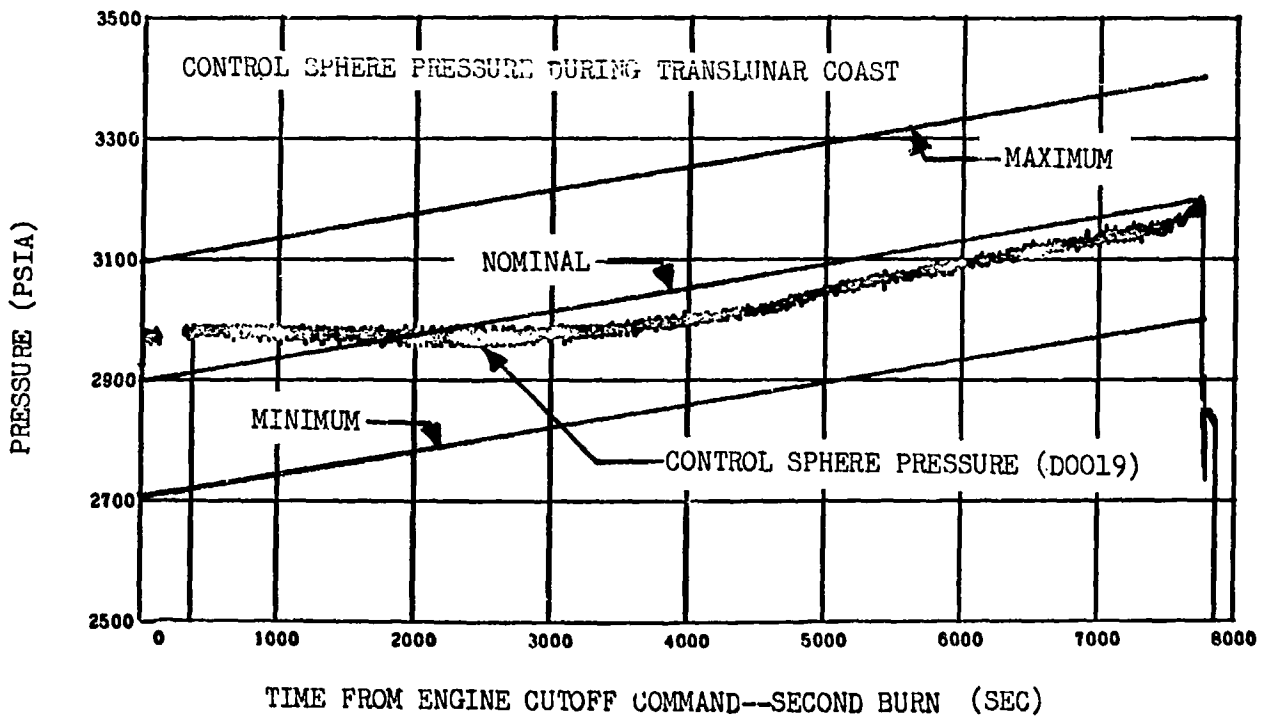
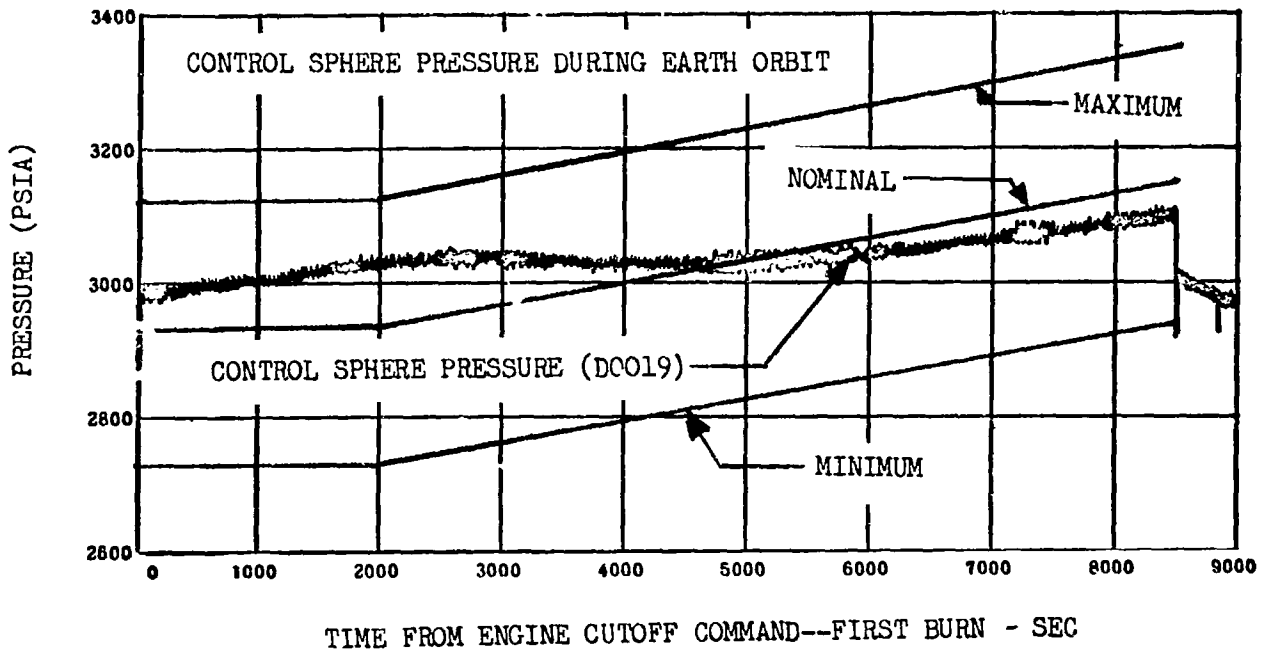

Figure 9-20. Control Sphere Performance During Coast

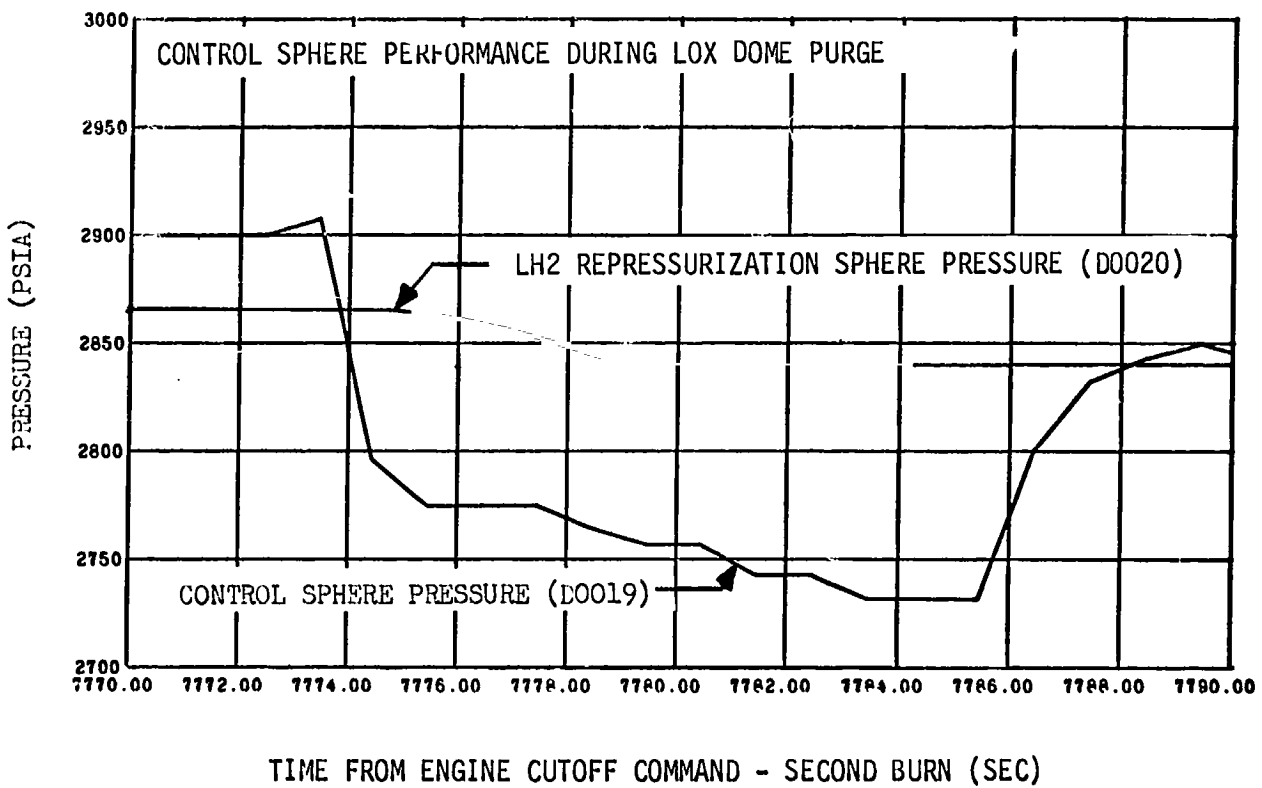
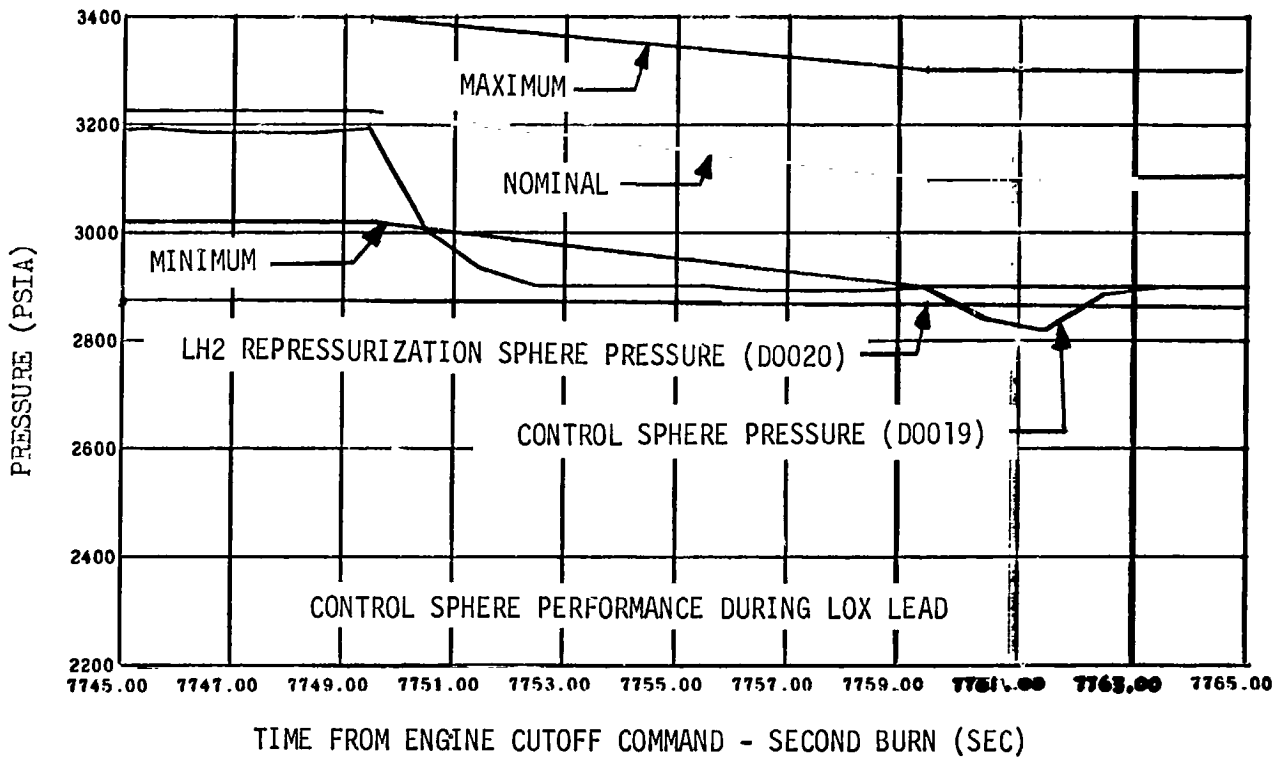

Figure 9-21. Engine Control Sphere Performance During Fuel Lead Experiment (Sheet 1 of 2)

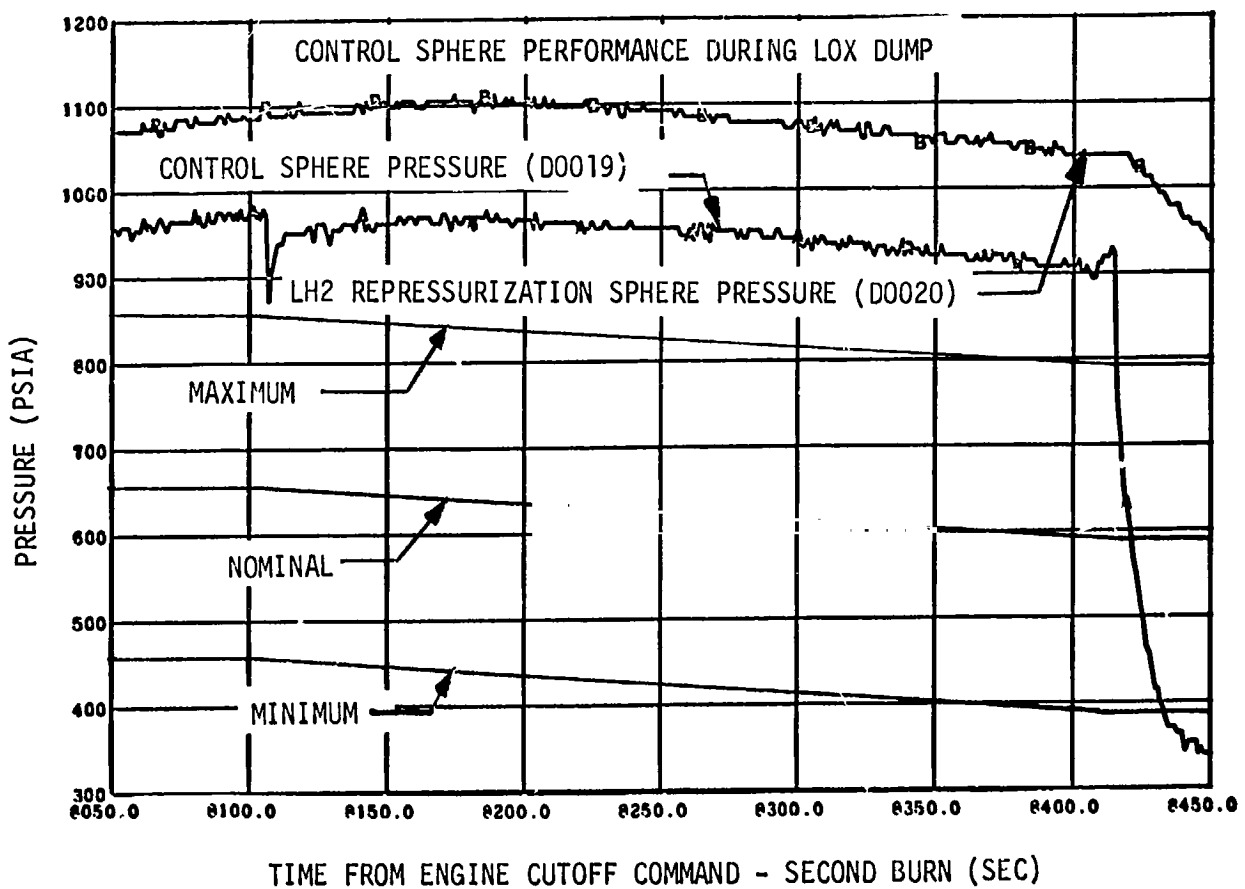
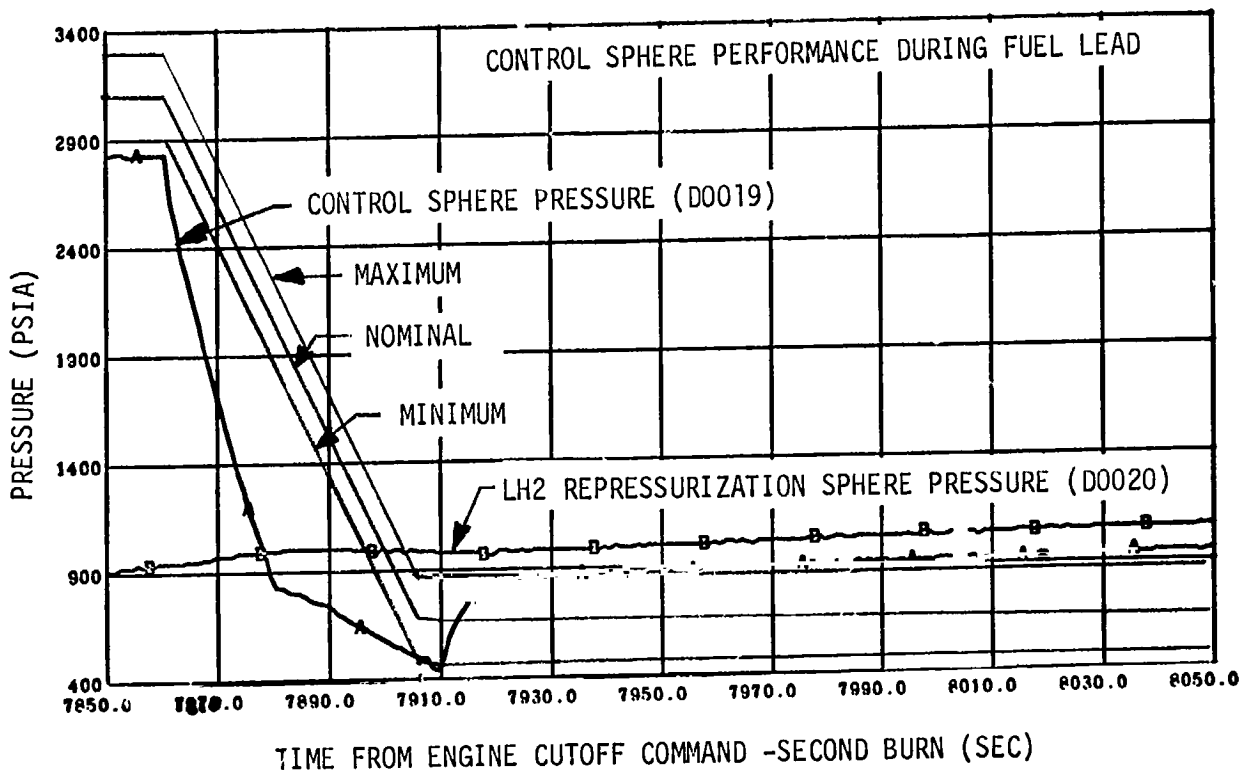

Figure 9-21. Engine Control Sphere Performance During Fuel Lead Experiment (Sheet 2 of 2)

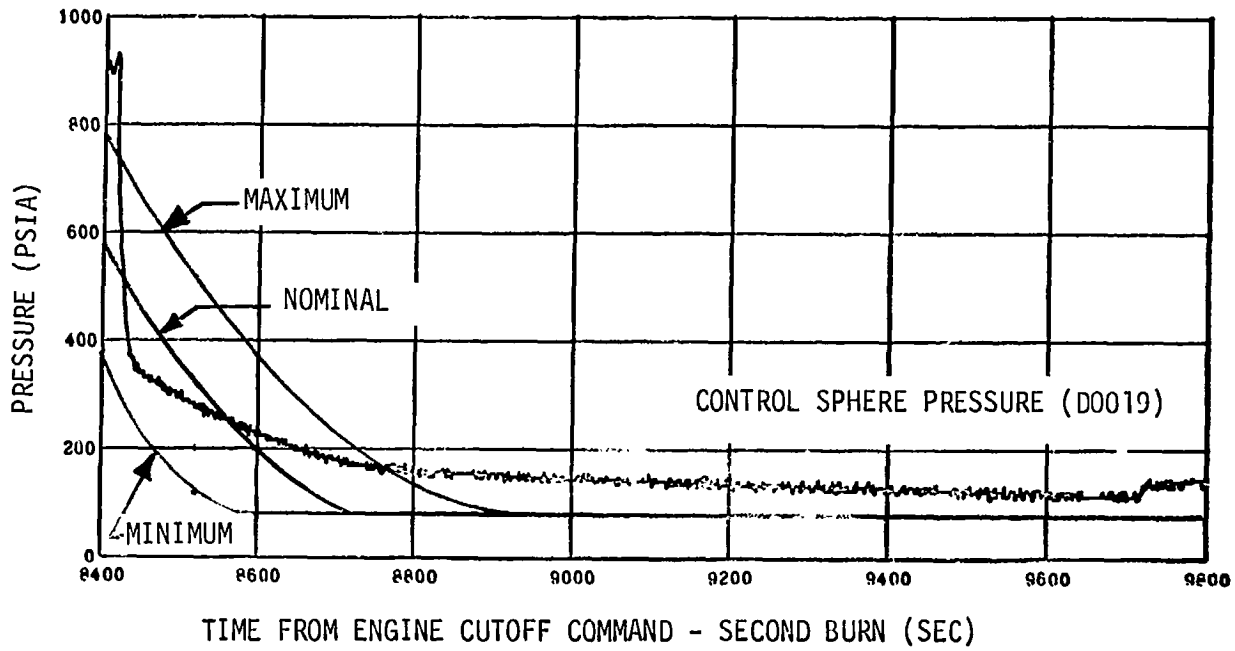

Figure 9-22. Control Sphere Pressure - Passivation

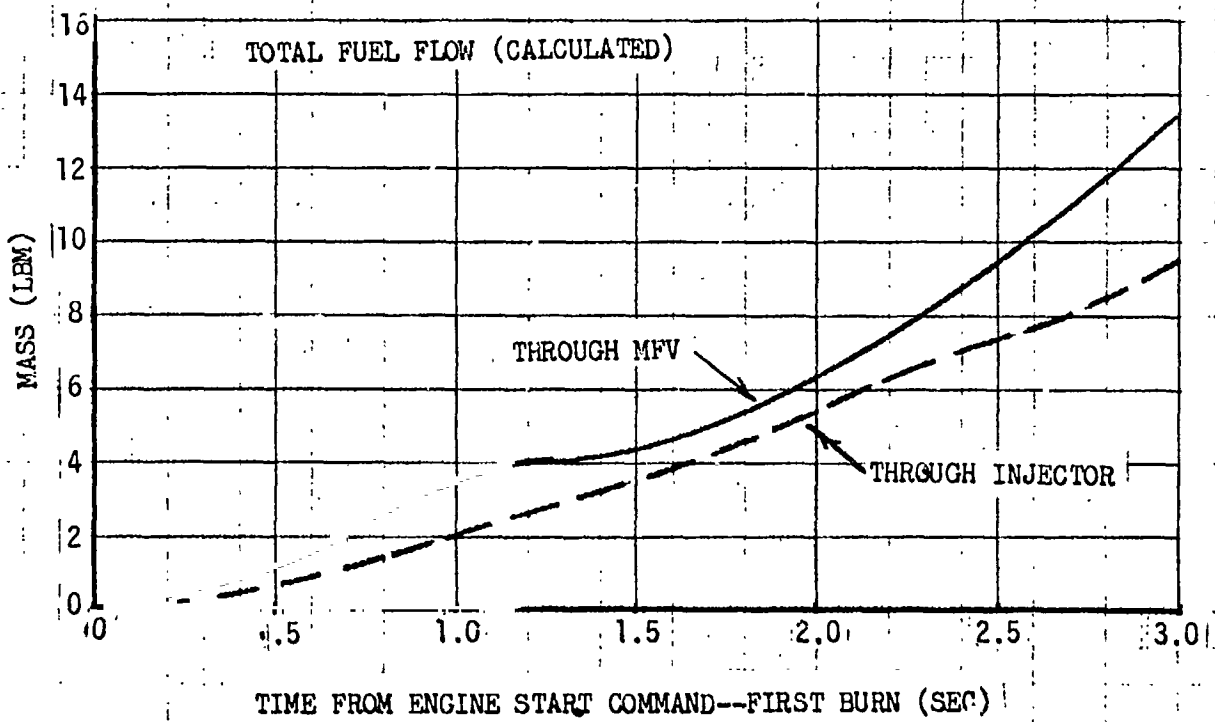
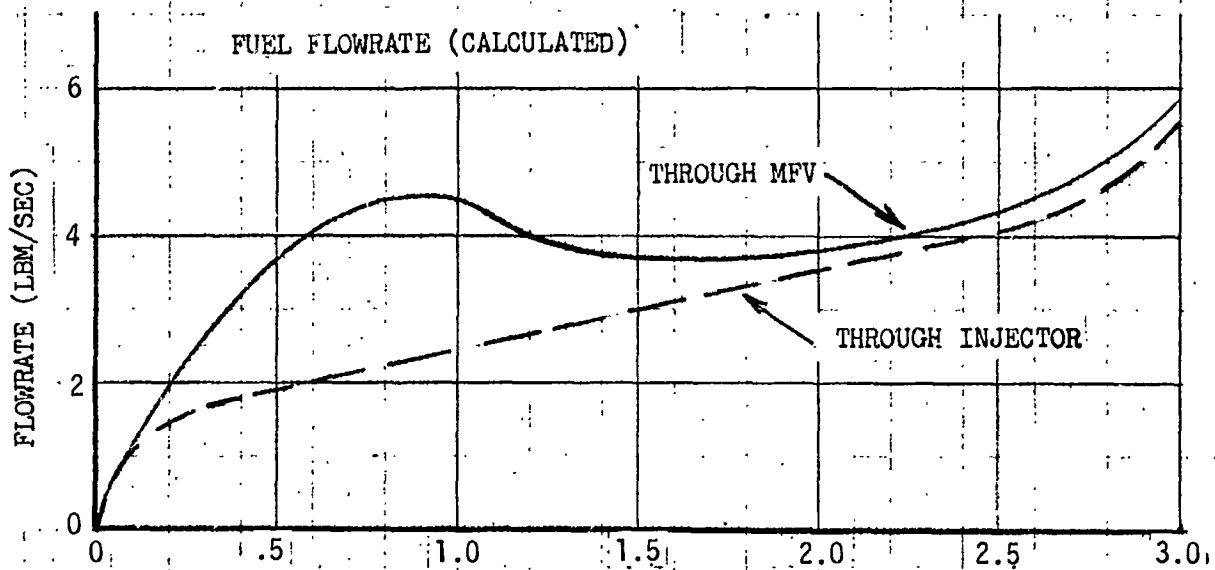

Figure 9-23. Fuel Lead Characteristics--First Burn (Sheet 1 of 2)

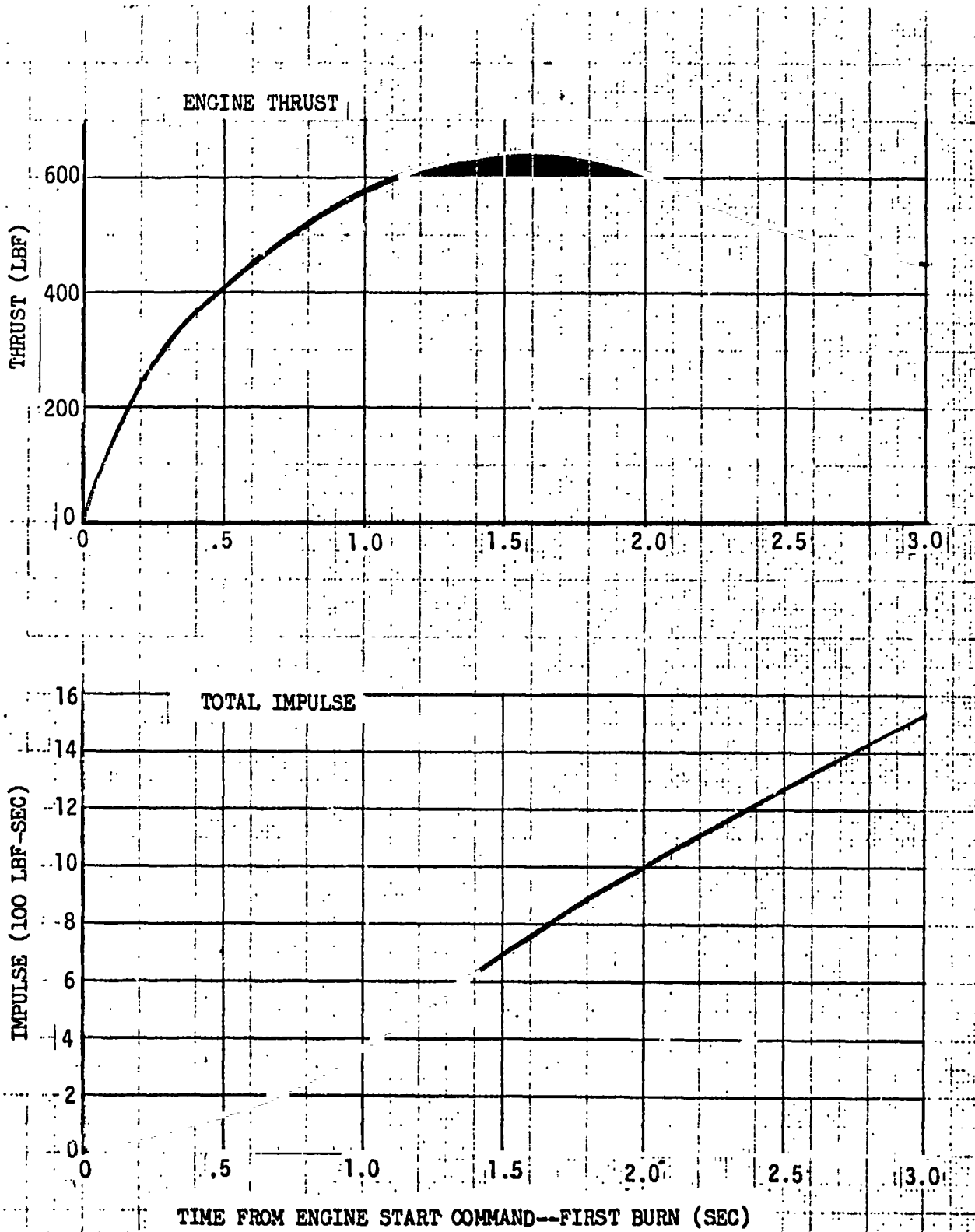

Figure 9-22. Fuel Lead Characteristics--First Burn (Sheet 2 of 2)

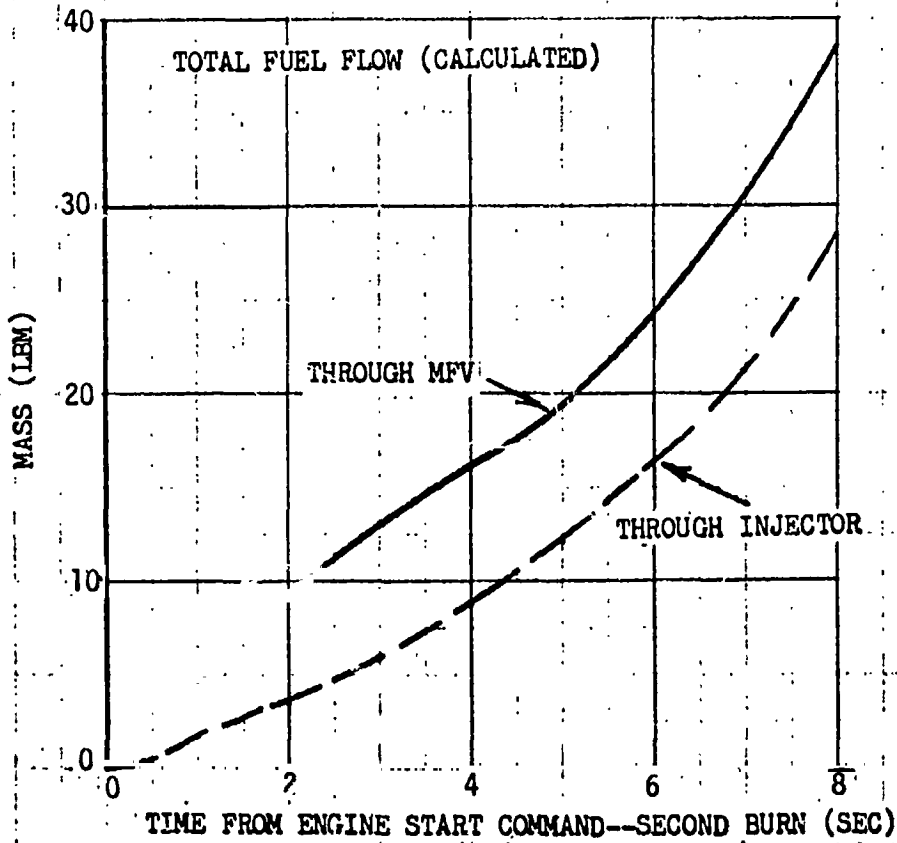
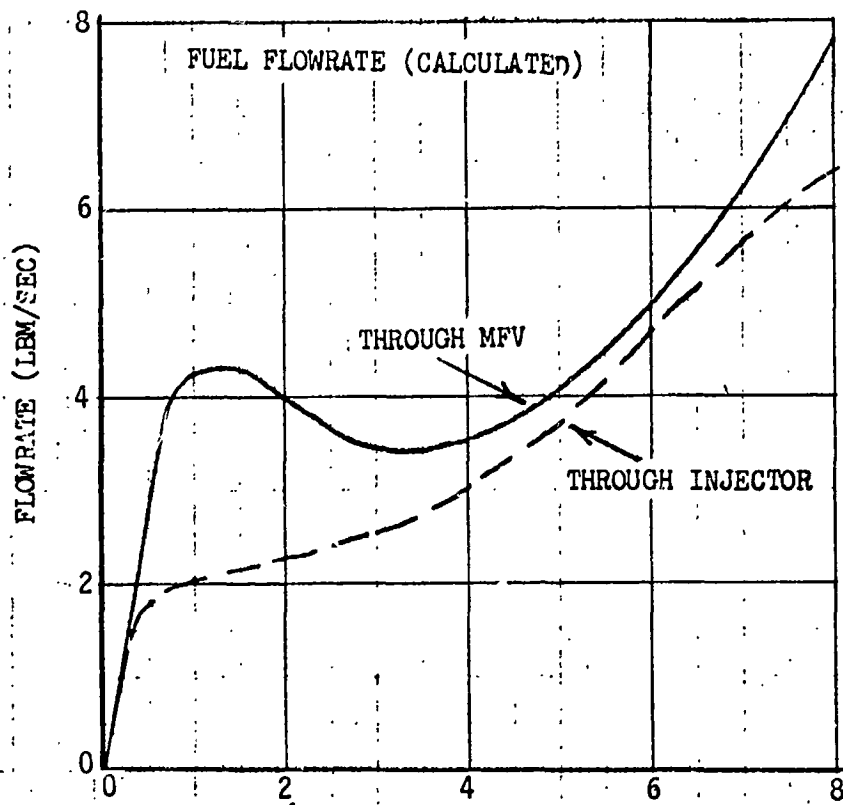

Figure 9-24. Fuel Lead Characteristics--Second Burn (Sheet 1 of 2)

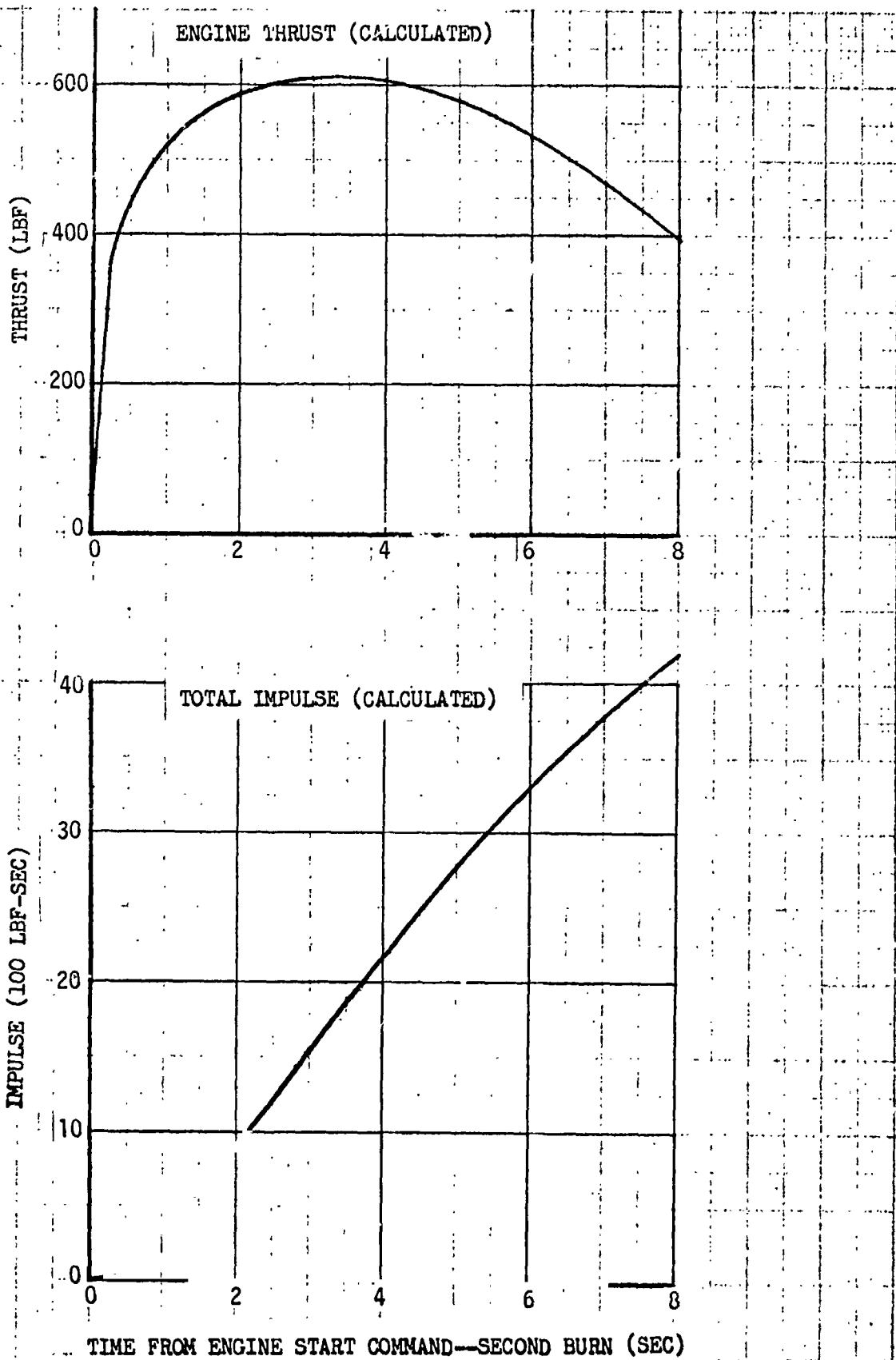

Figure 9-24. Fuel Lead Characteristics--Second Burn (Sheet 2 of 2)

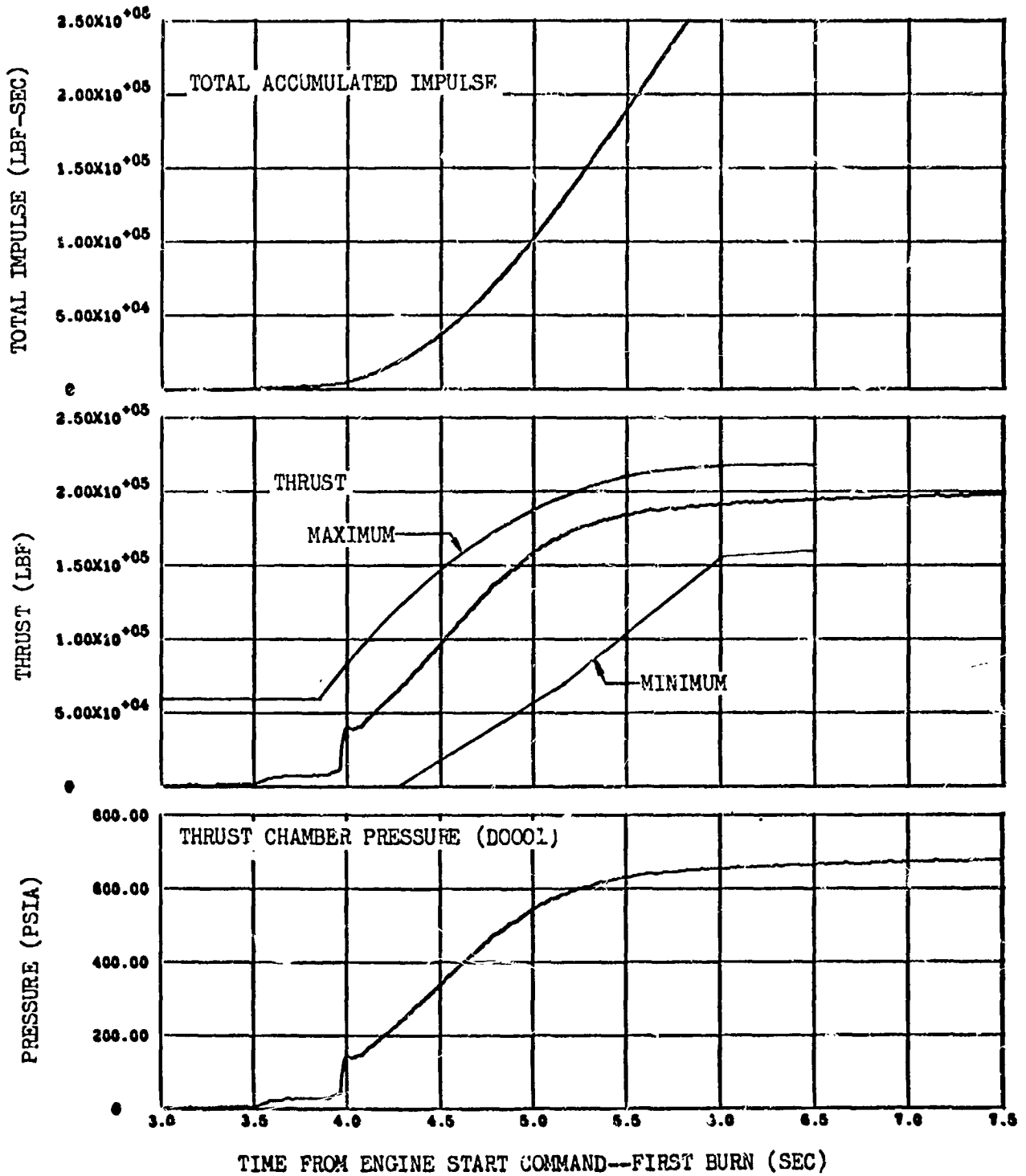

Figure 9-25. Engine Start Transient Characteristics (Sheet 1 of 2)

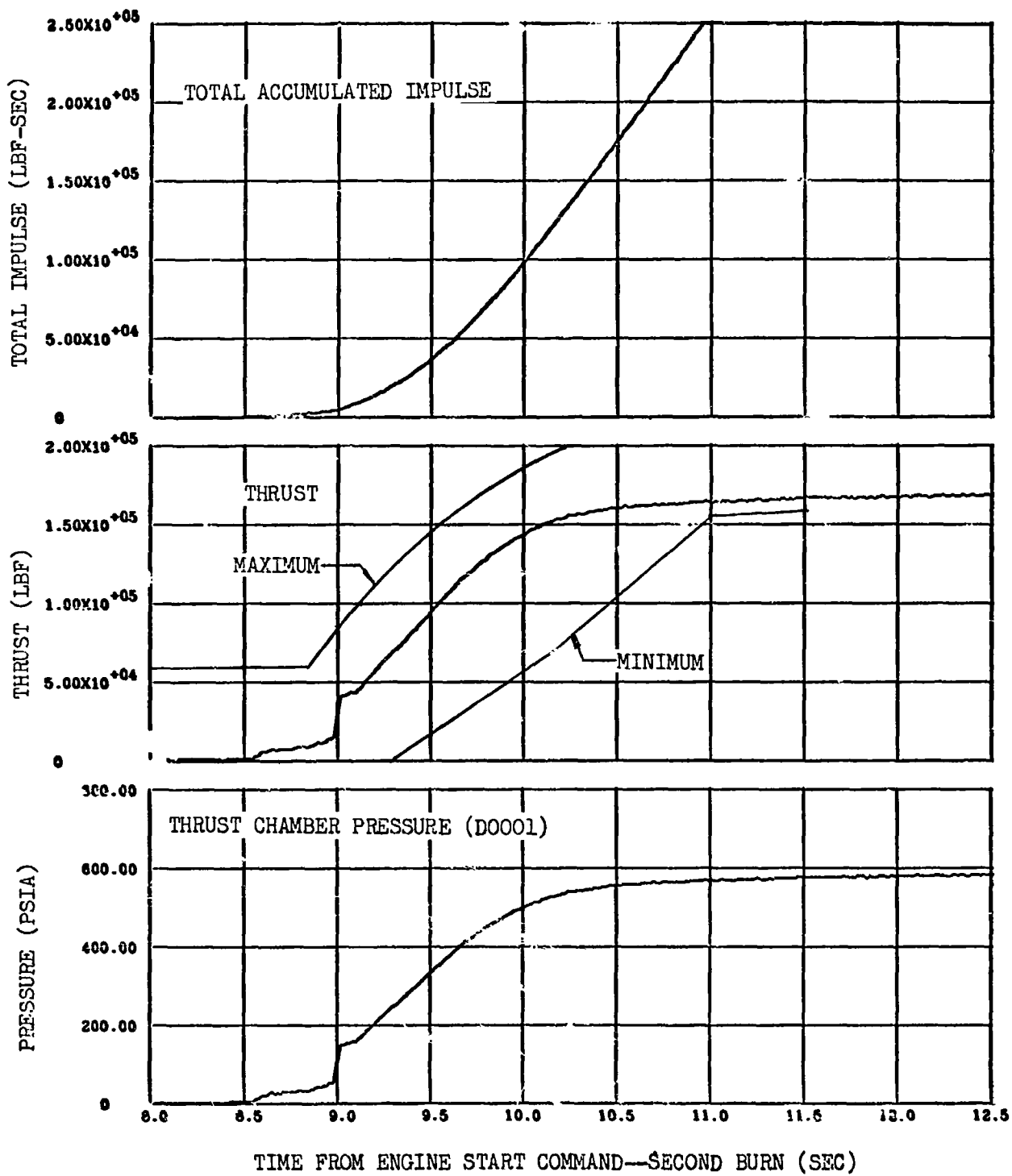

Figure 9-25. Engine Start Transient Characteristics (Sheet 2 of 2)

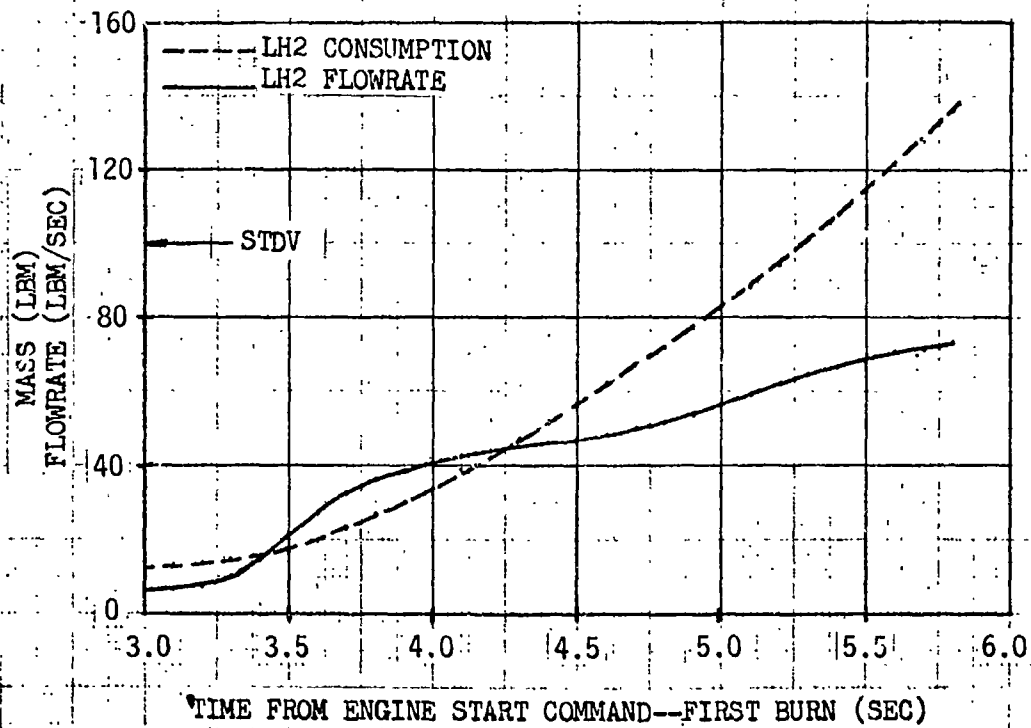
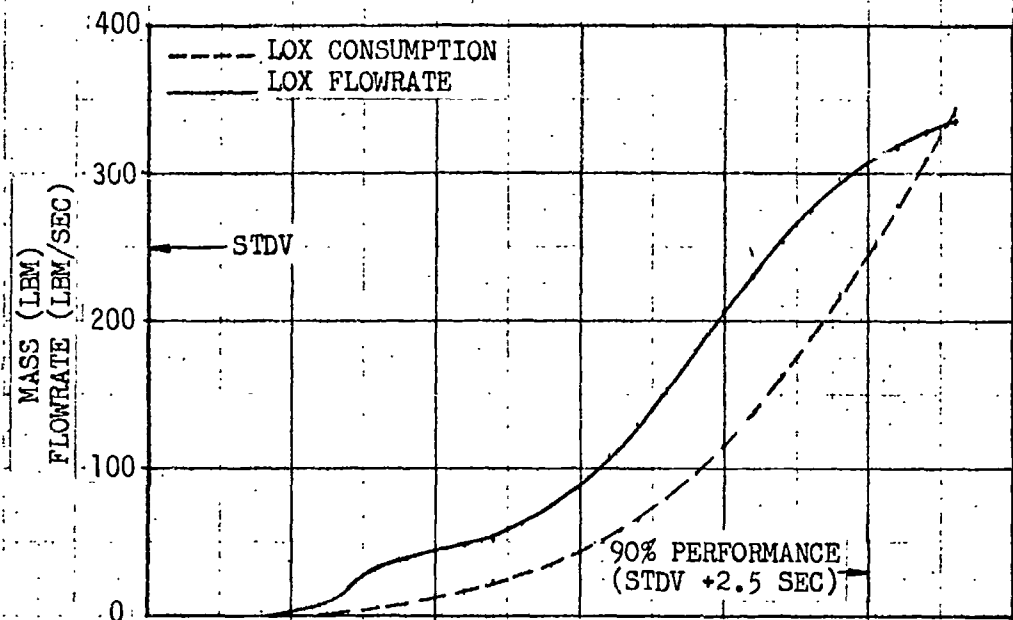

Figure 9-26. LOX and LH2 Consumption During Start Transient (Sheet 1 of 2)

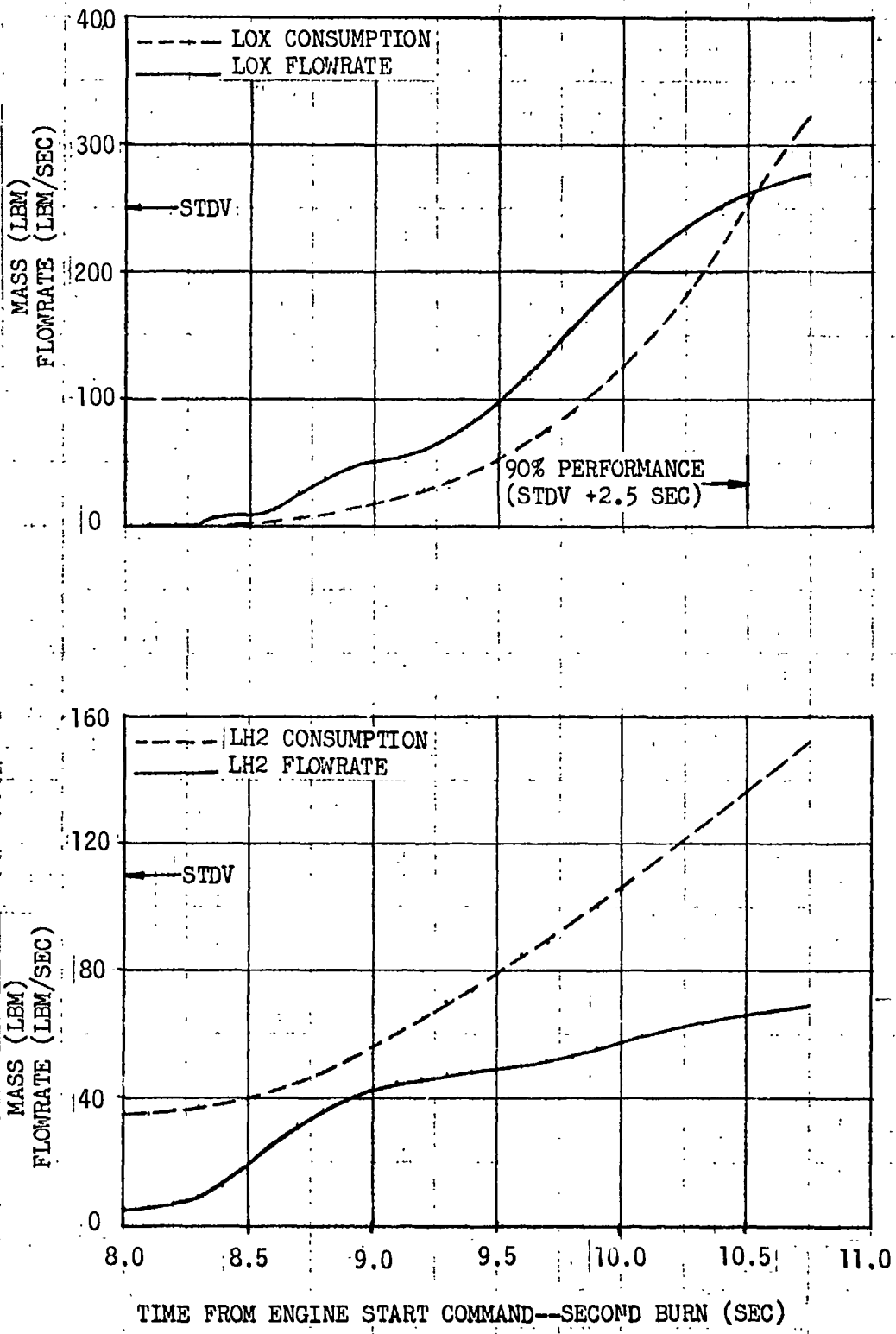

Figure 9-26. LOX and LH2 Consumption During Start Transient (Sheet 2 of 2)

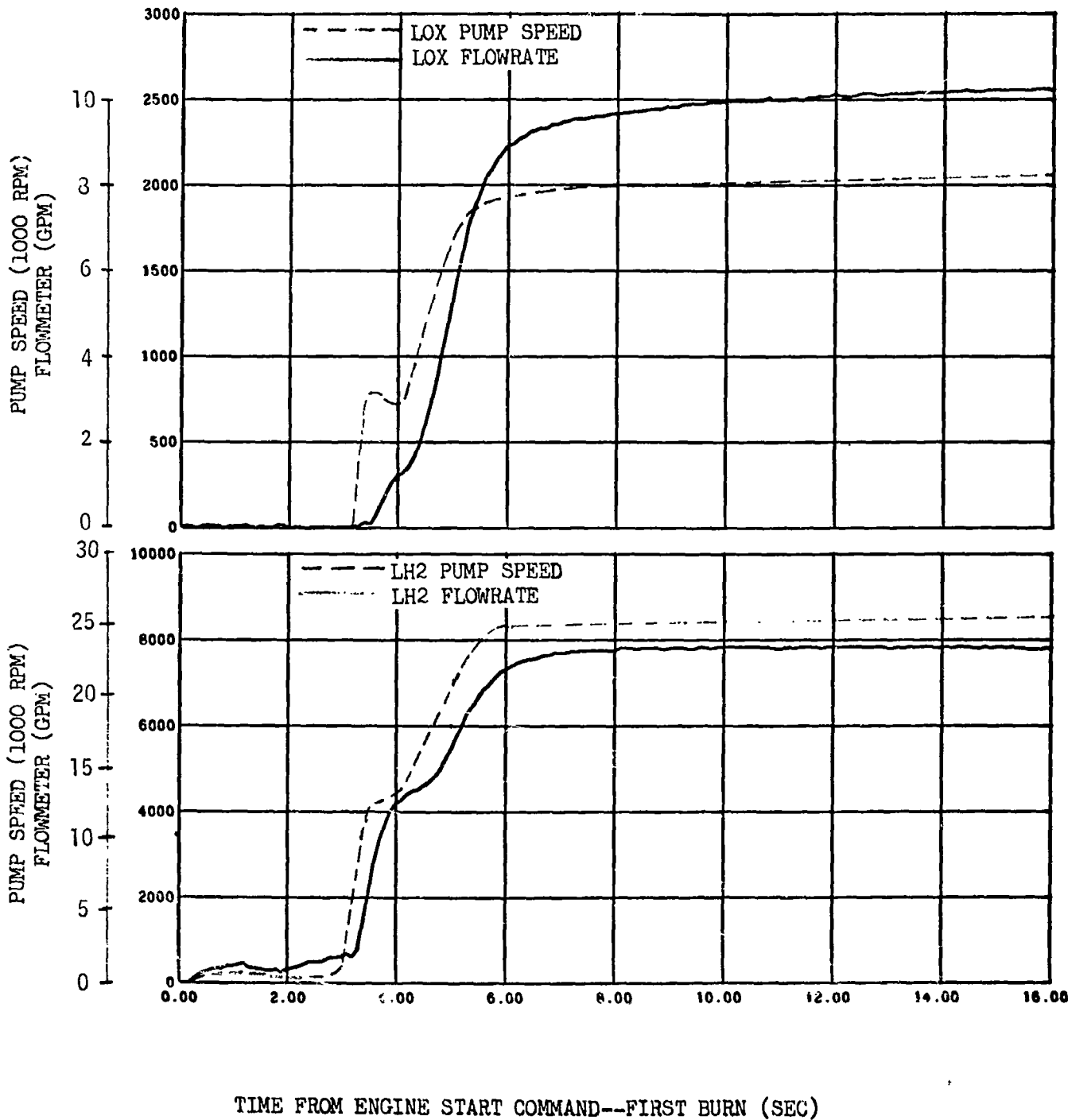

Figure 9-27. LOX and LH2 Pump Performance (Sheet 1 of 2)

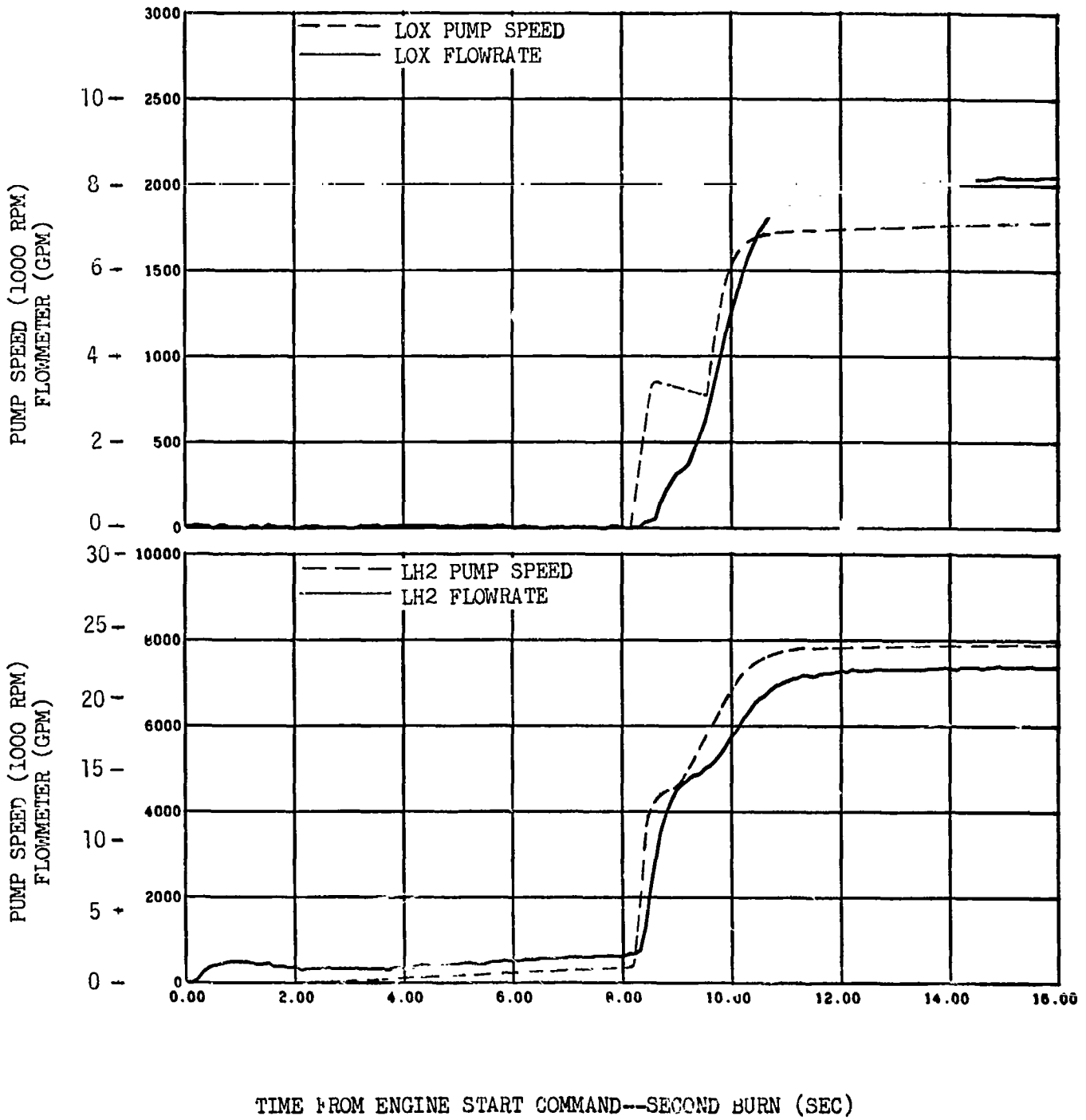

Figure 9-27. LOX and LH2 Pump Performance (Sheet 2 of 2)

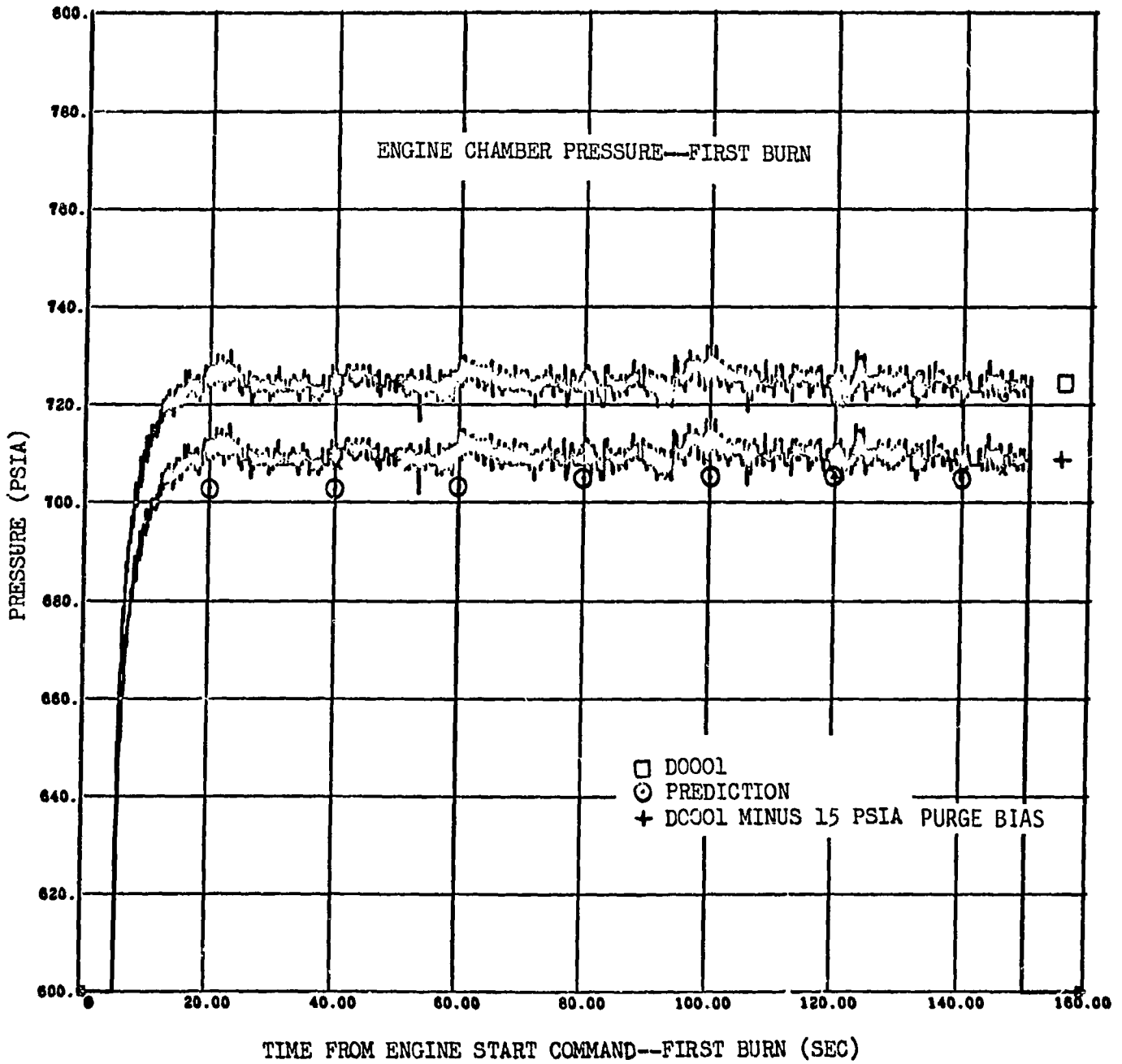

Figure 9-28. Engine Chamber Pressure (Sheet 1 of 2)

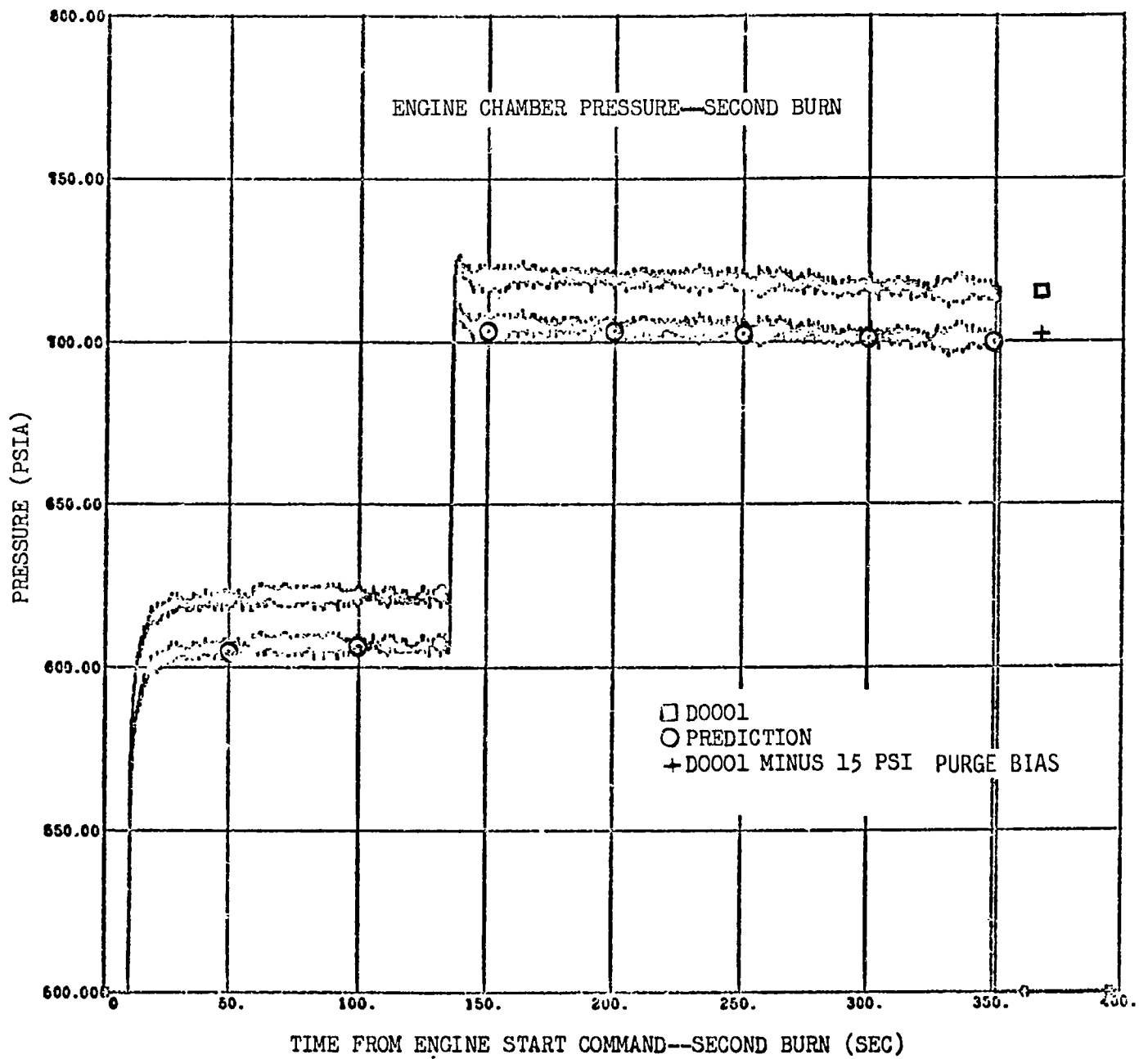

Figure 9-28. Engine Chamber Pressure (Sheet 2 of 2)

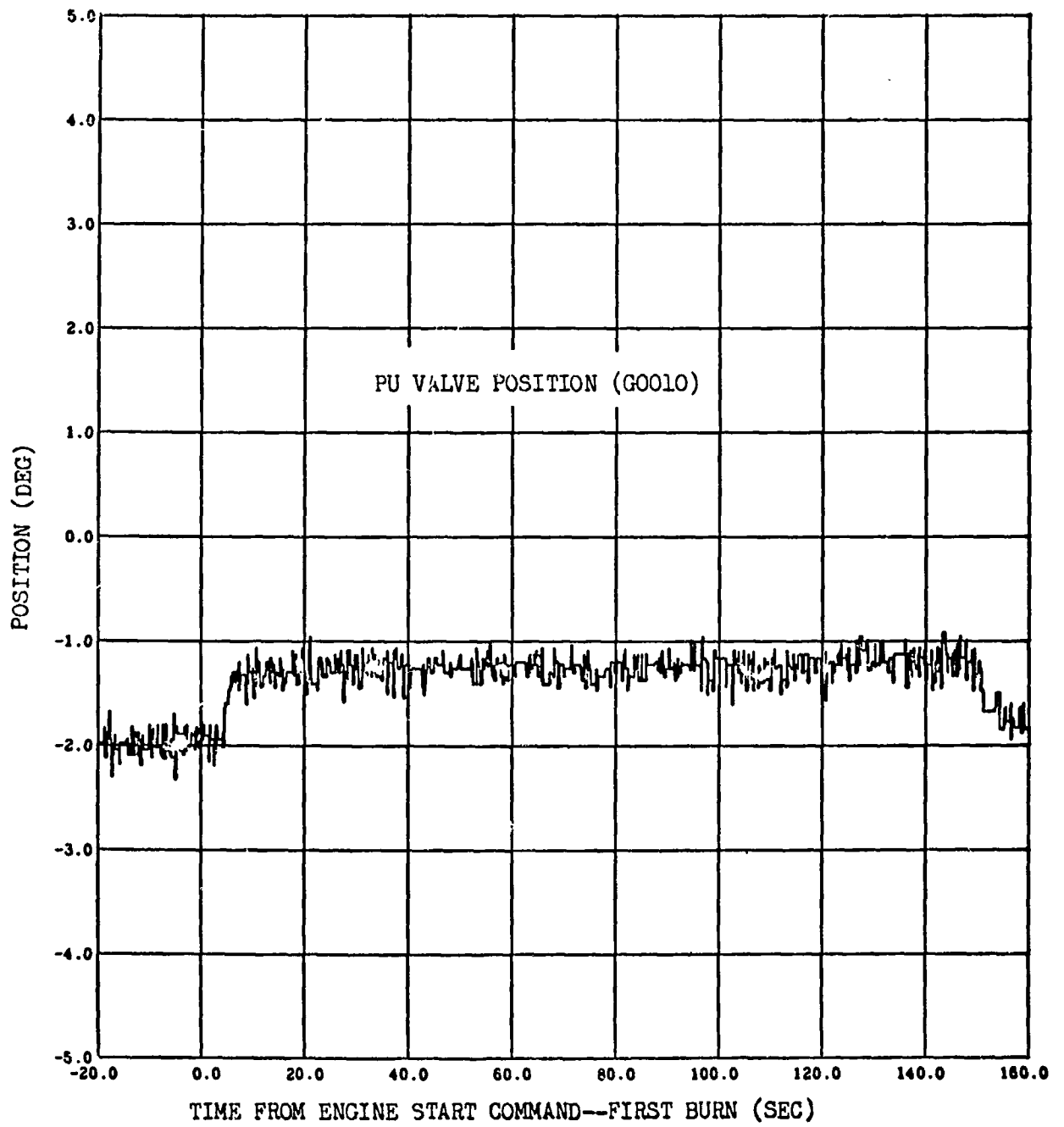

Figure 9-29. PU Valve Operation (Sheet 1 of 2)

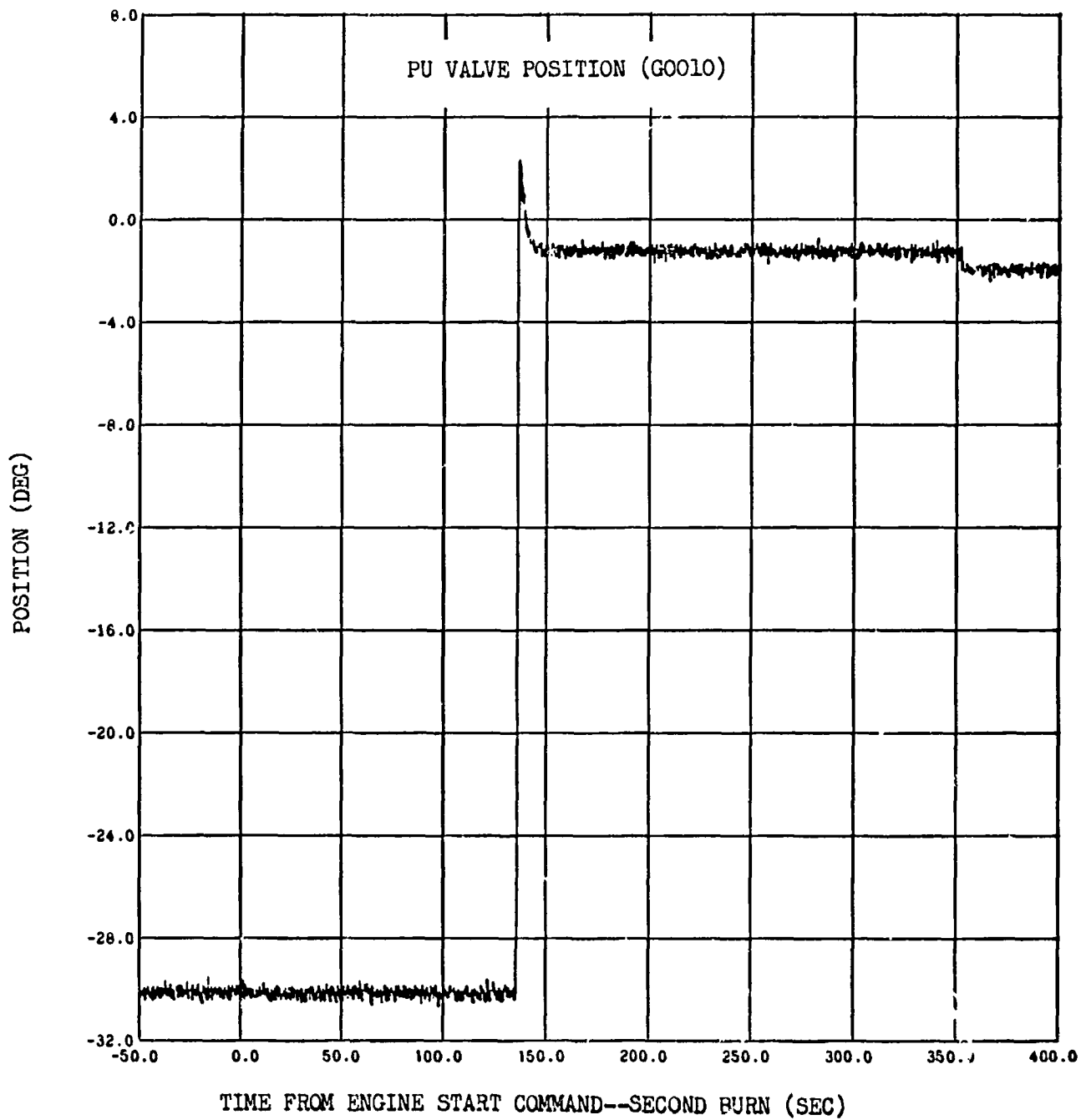

Figure 9-29. PU Valve Position (Sheet 2 of 2)

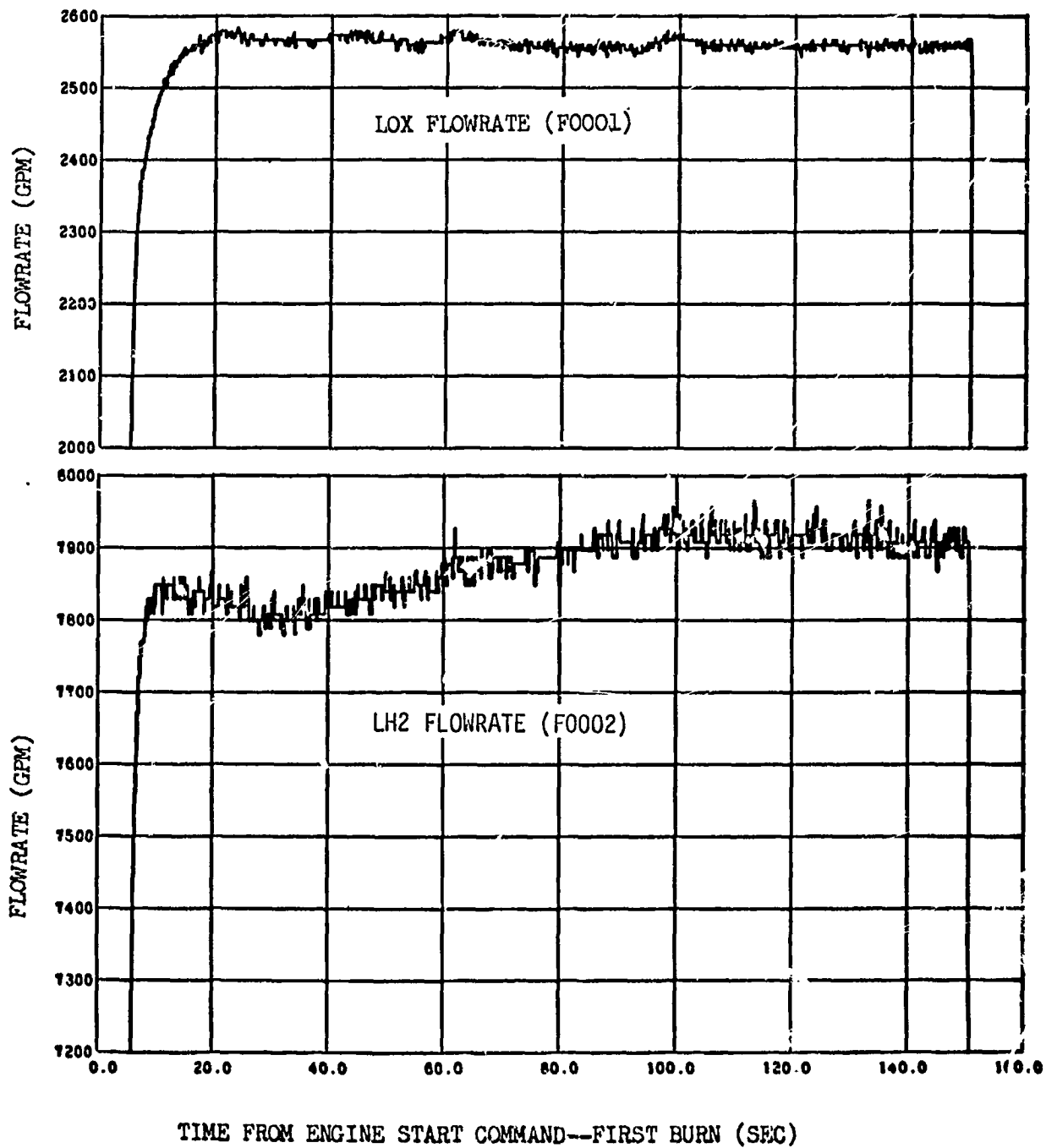

Figure 9-30. J-2 Engine Flowrates (Sheet 1 of 2)

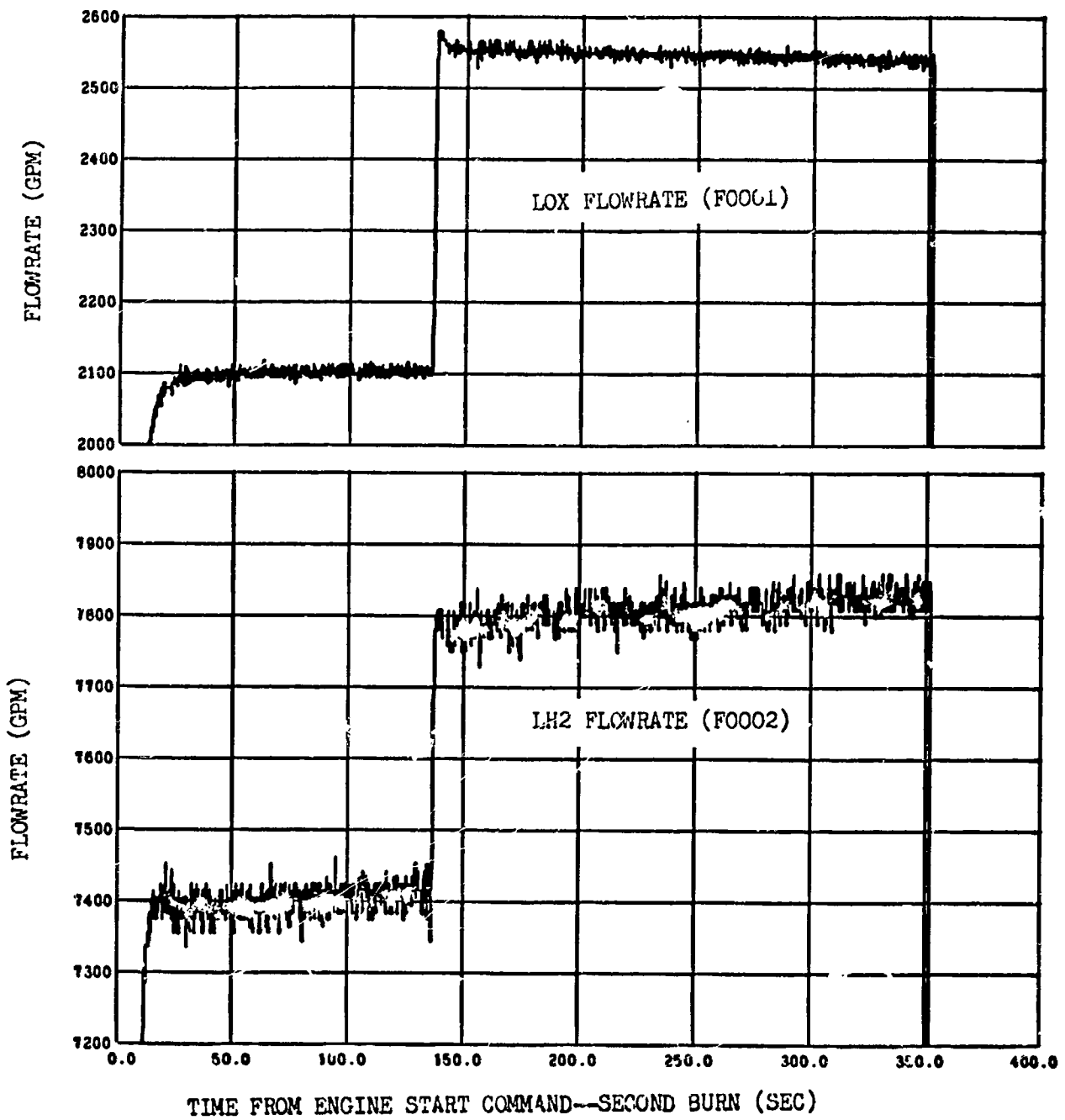

Figure 9-30. J-2 Engine Flowrates (Sheet 2 of 2)

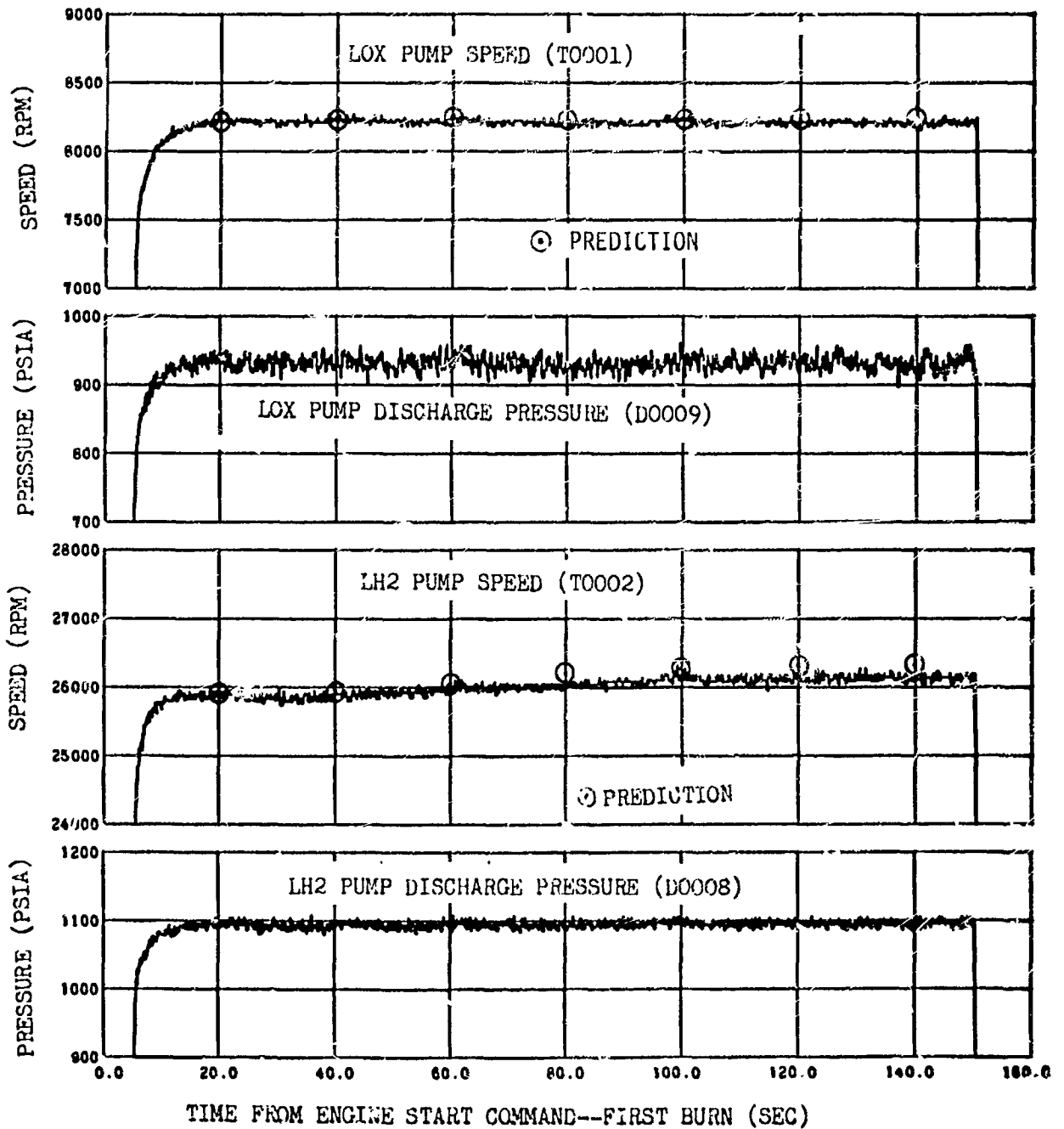

Figure 9-31. Engine Pump Operating Characteristics (Sheet 1 of 2)

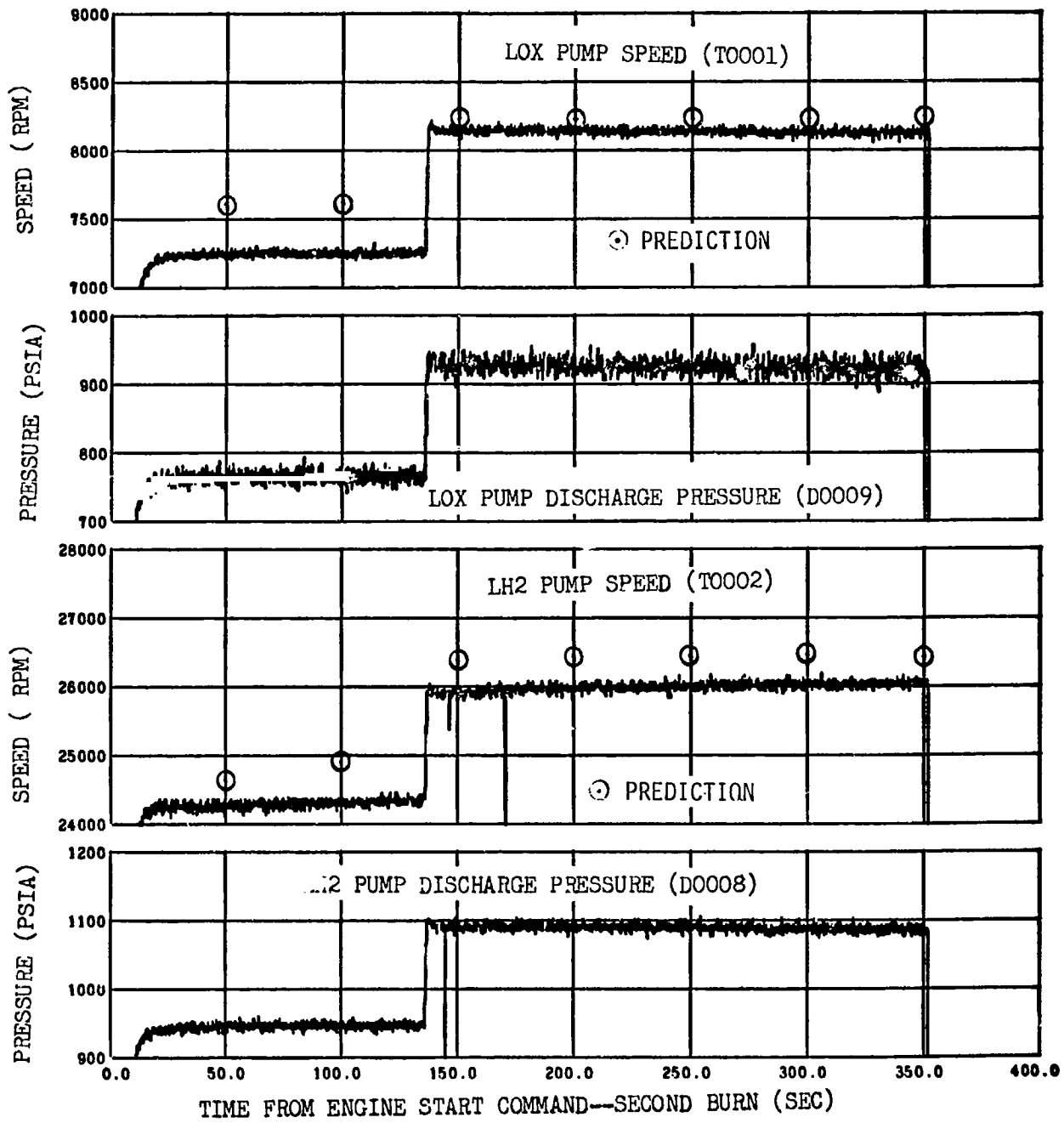

Figure 9-31. Engine Pump Operating Characteristics (Sheet 2 of 2)

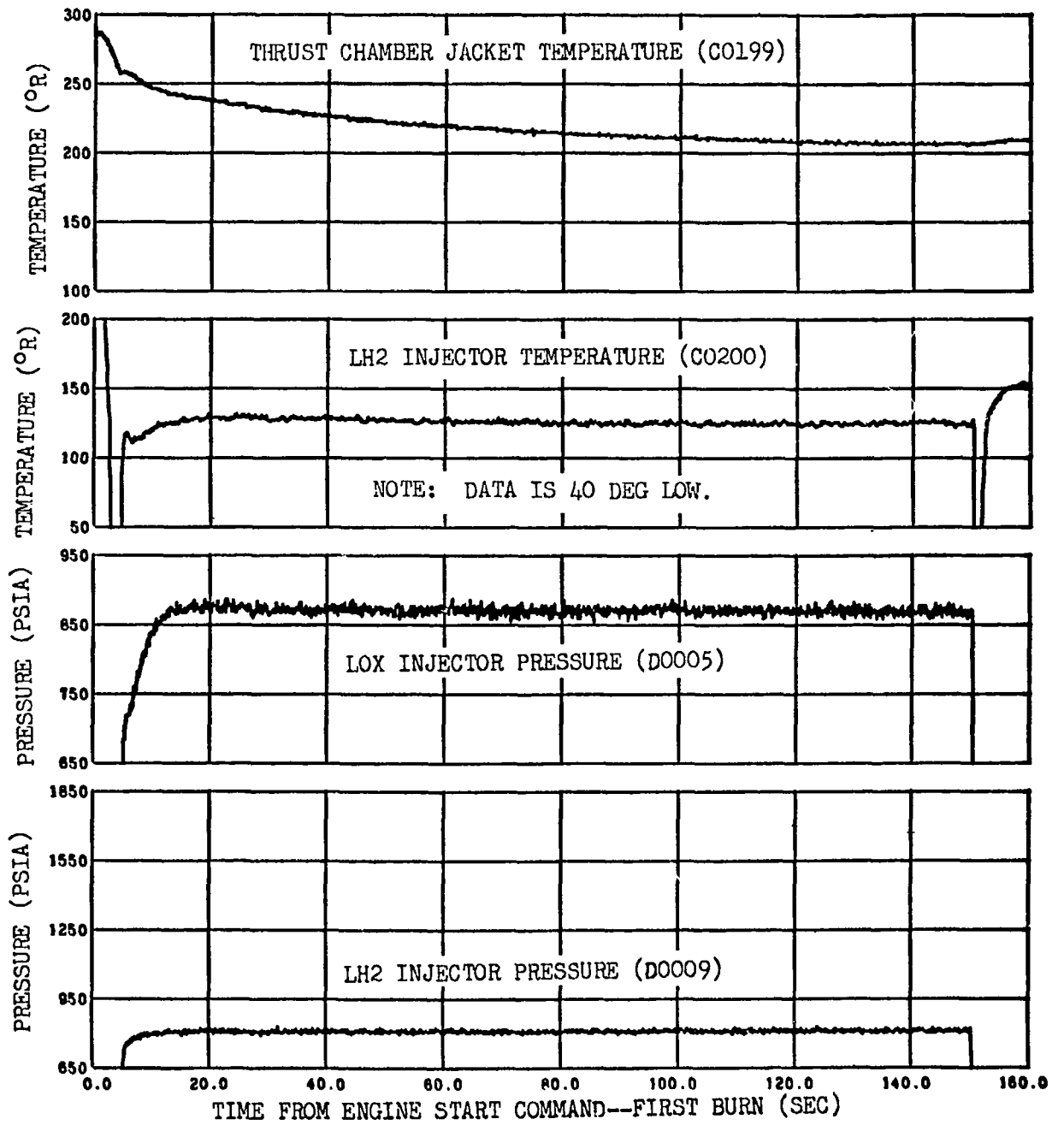

Figure 9-32. J-2 Engine Injector Supply Conditions (Sheet 1 of 2)

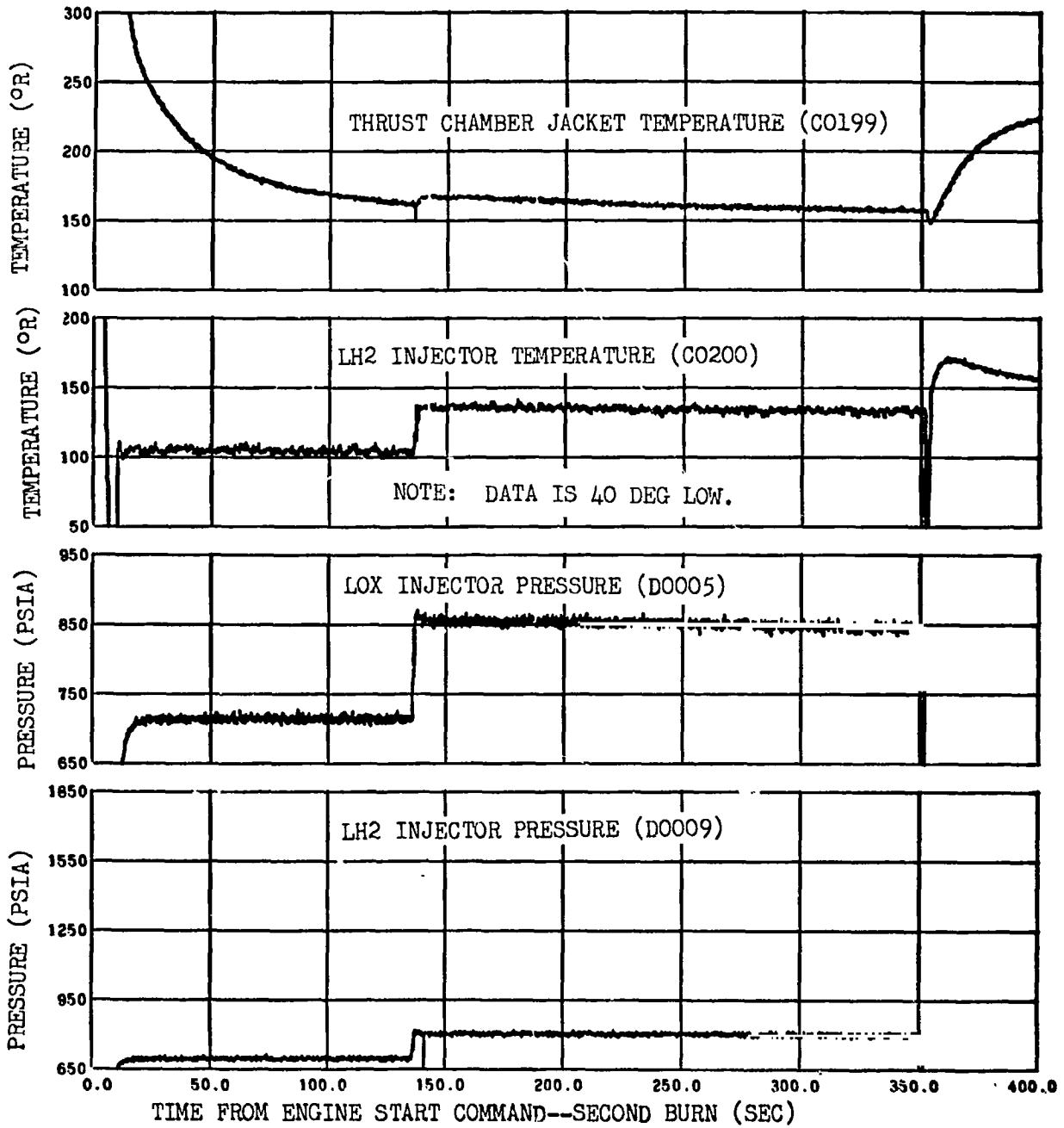

Figure 9-32. Engine Injector Supply Conditions (Sheet 2 of 2)

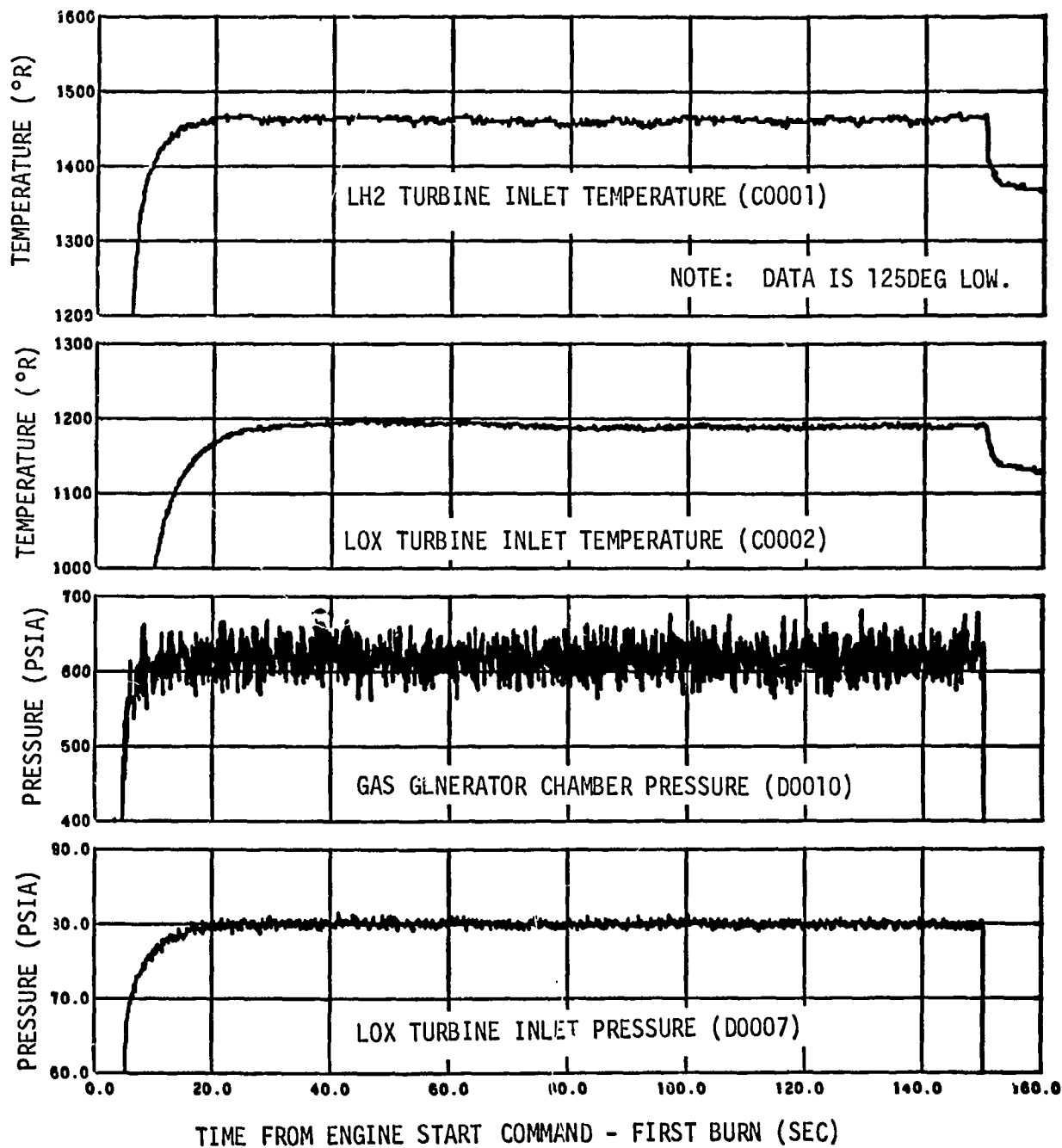

Figure 9-33. Turbine Operating Conditions (Sheet 1 of 2)

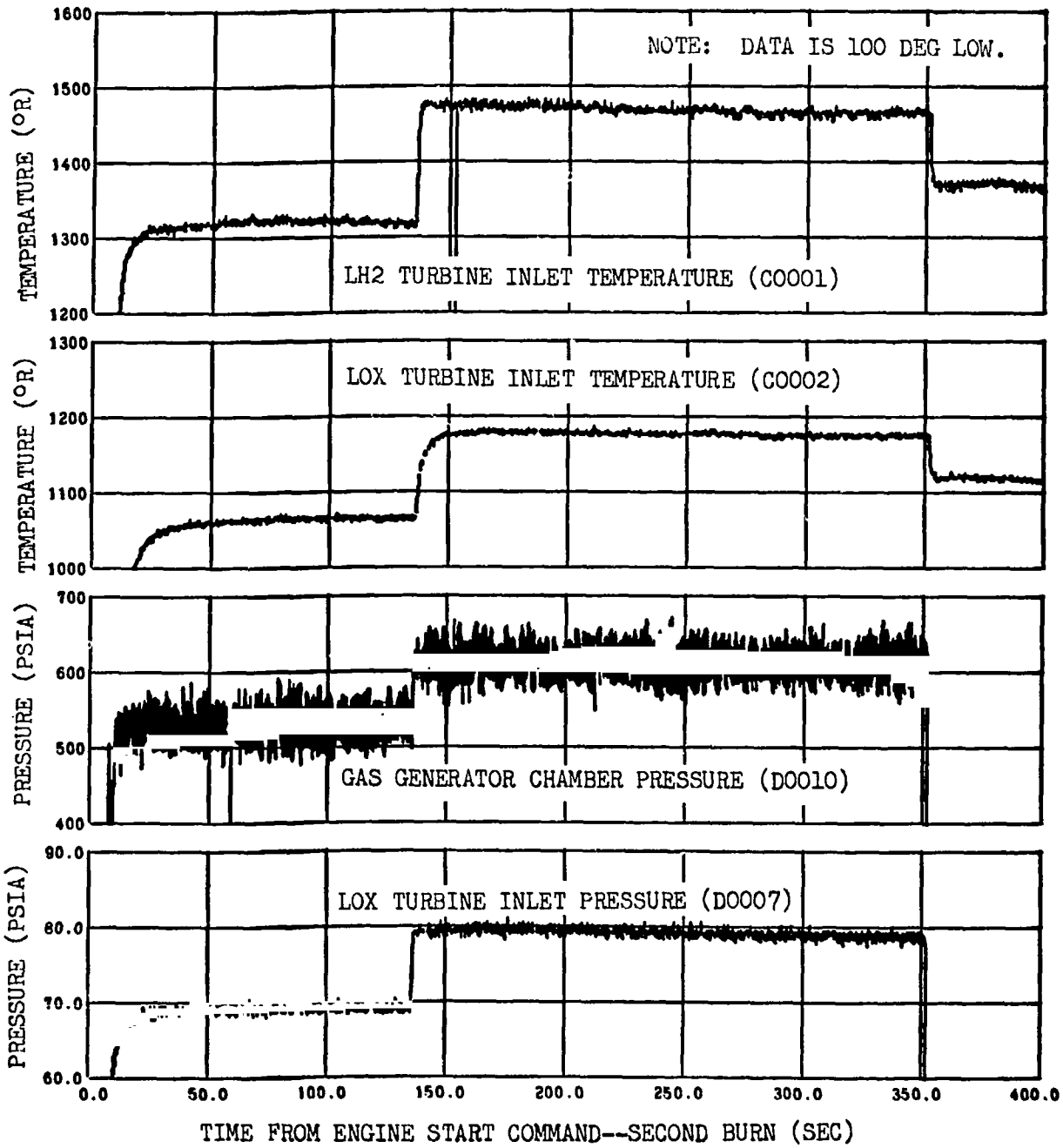

Figure 9-33. Turbine Operating Conditions (Sheet 2 of 2)

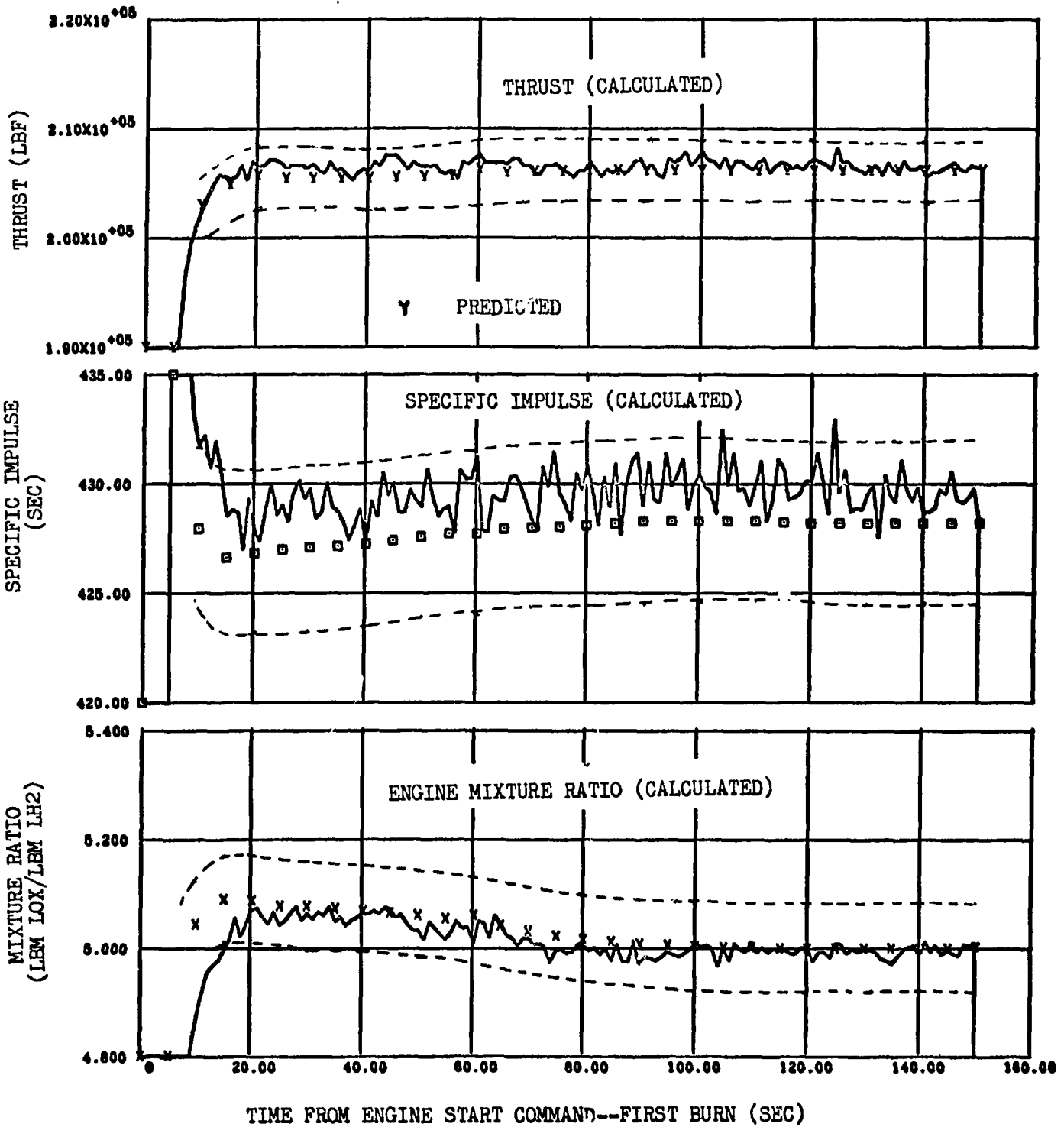

Figure 9-34. Engine Steady State Performance--First Burn (Sheet 1 of 3)

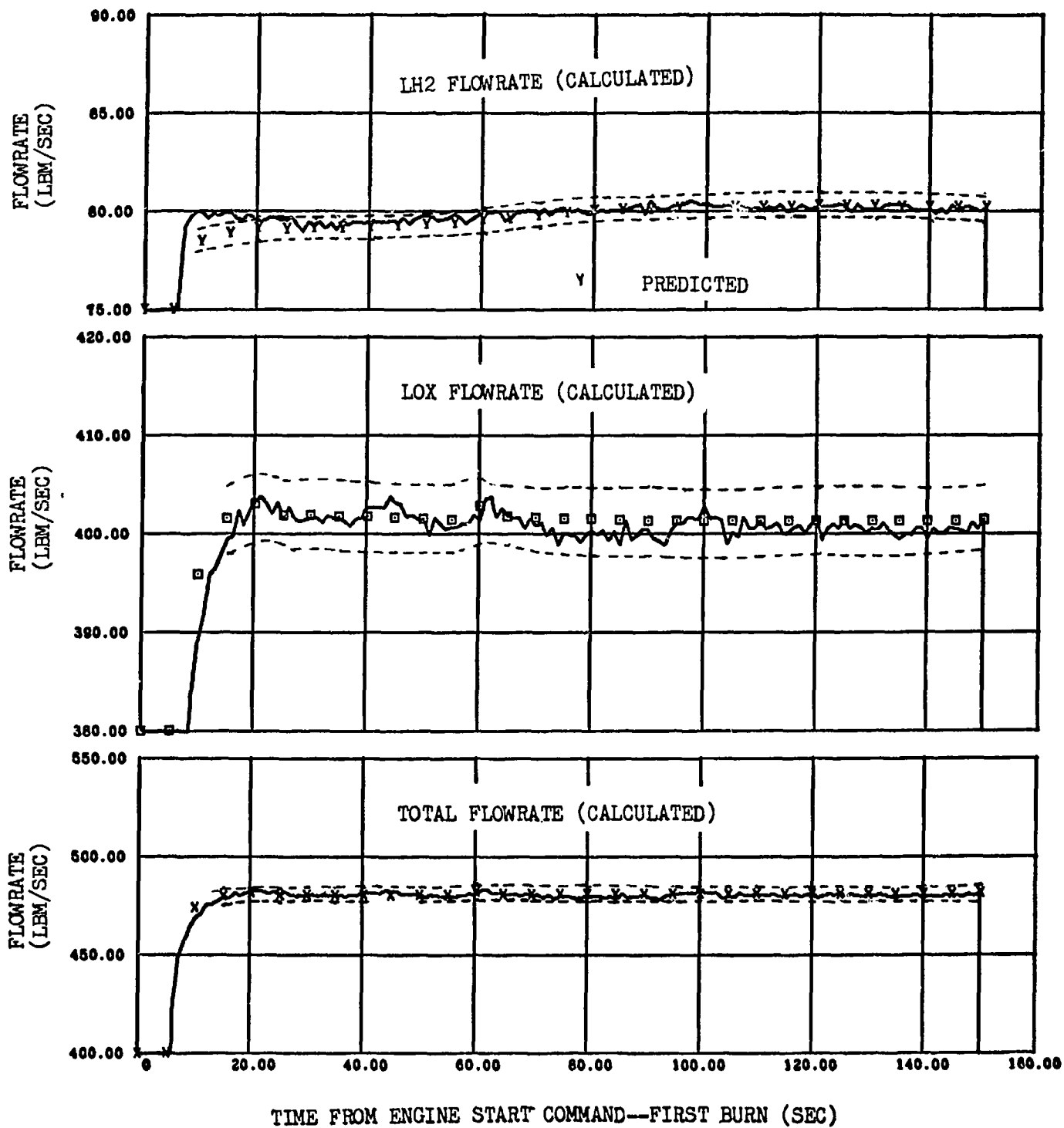

Figure 9-34. Engine Steady State Performance--First Burn (Sheet 2 of 3)

THRUST (100 LBF)

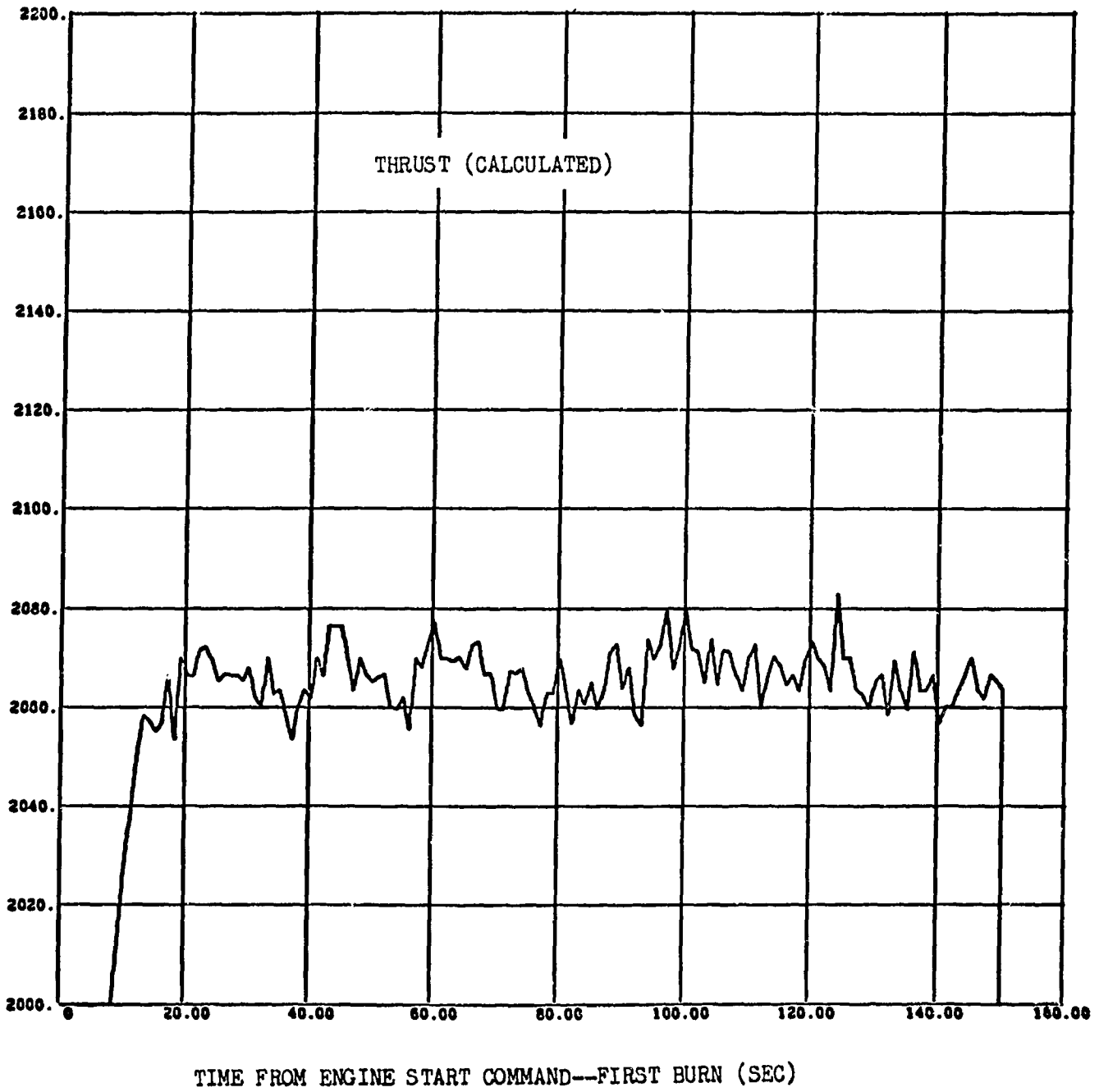

Figure 9-34. Engine Steady State Performance--First Burn (Sheet 3 of 3)

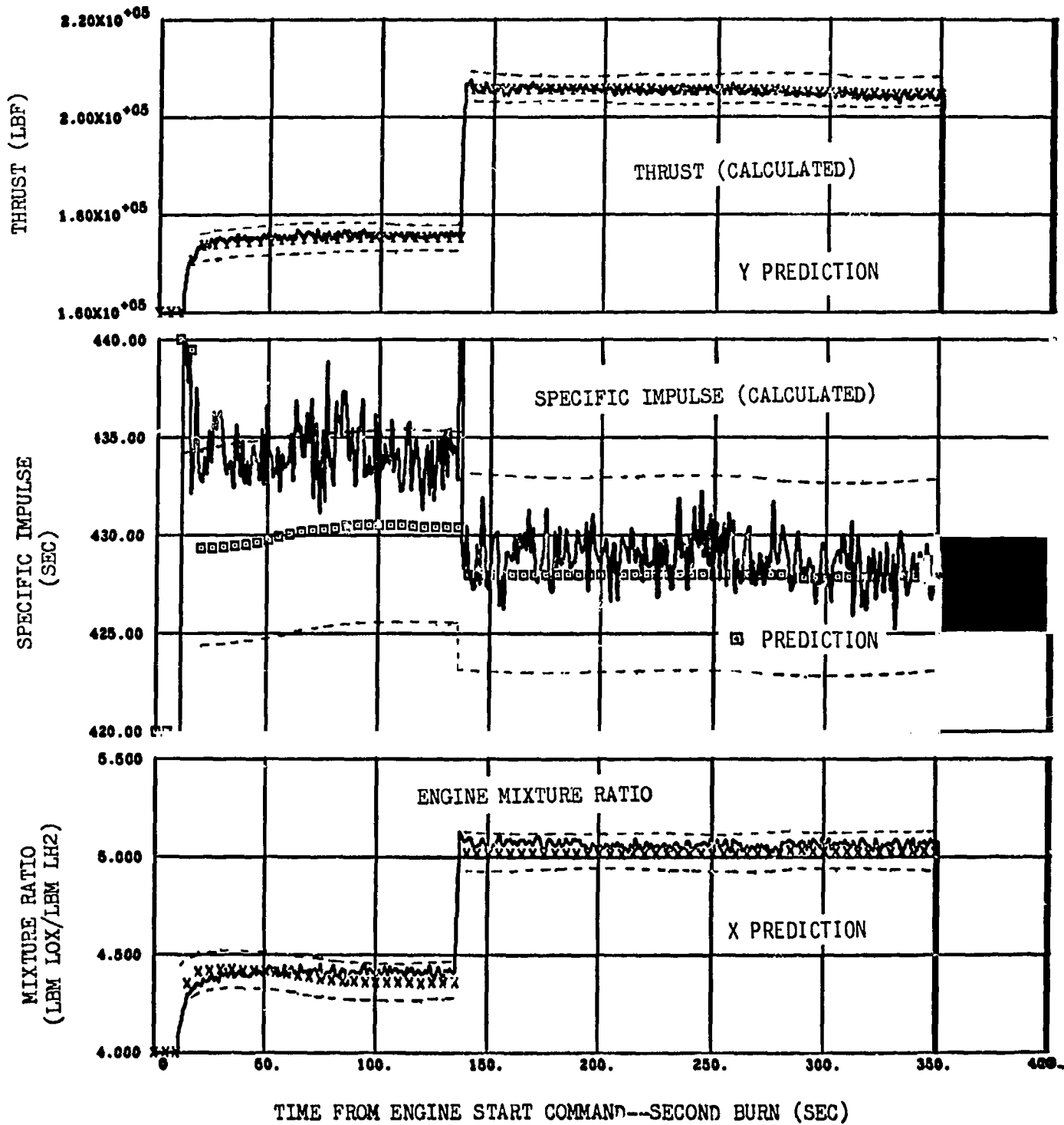

Figure 9-35. Engine Steady State Performance--Second Burn (Sheet 1 of 3)

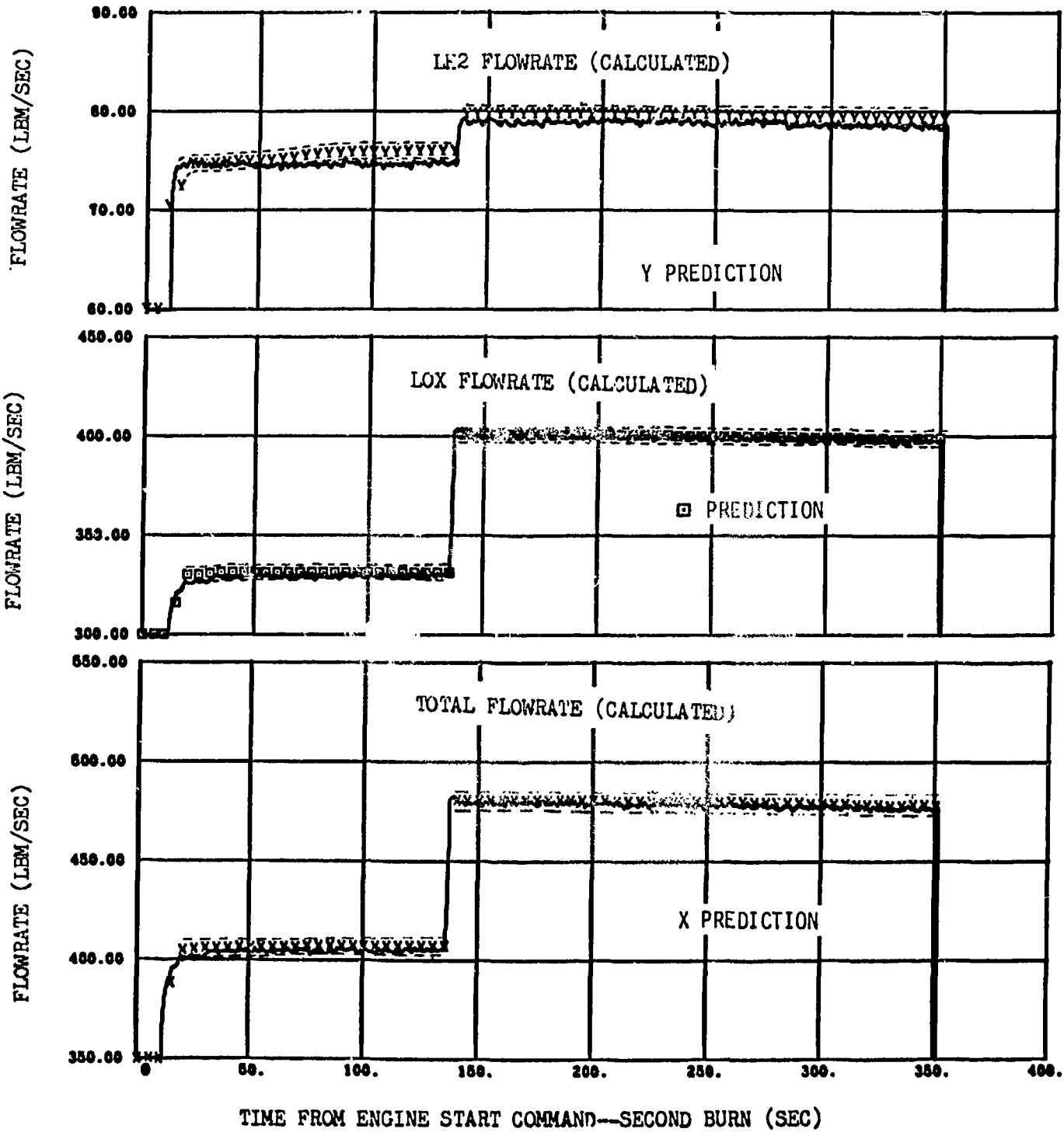

Figure 9-35. Engine Steady State Performance--Second Burn (Sheet 2 of 3)

S-IVB-505N FLIGHT

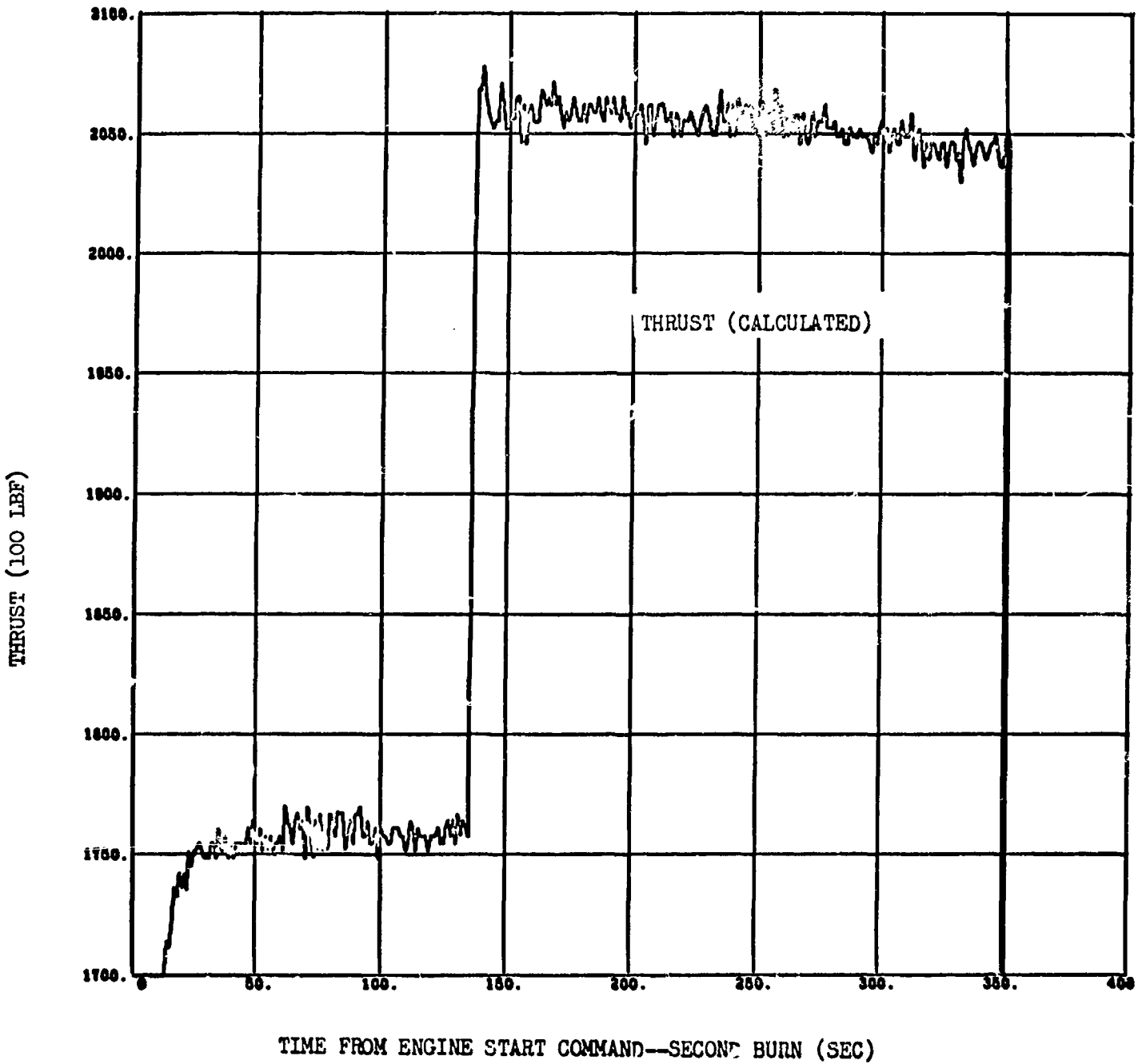

Figure 9-35. Engine Steady State Performance--Second Burn (Sheet 3 of 3)

S-IVB-505N FLIGHT

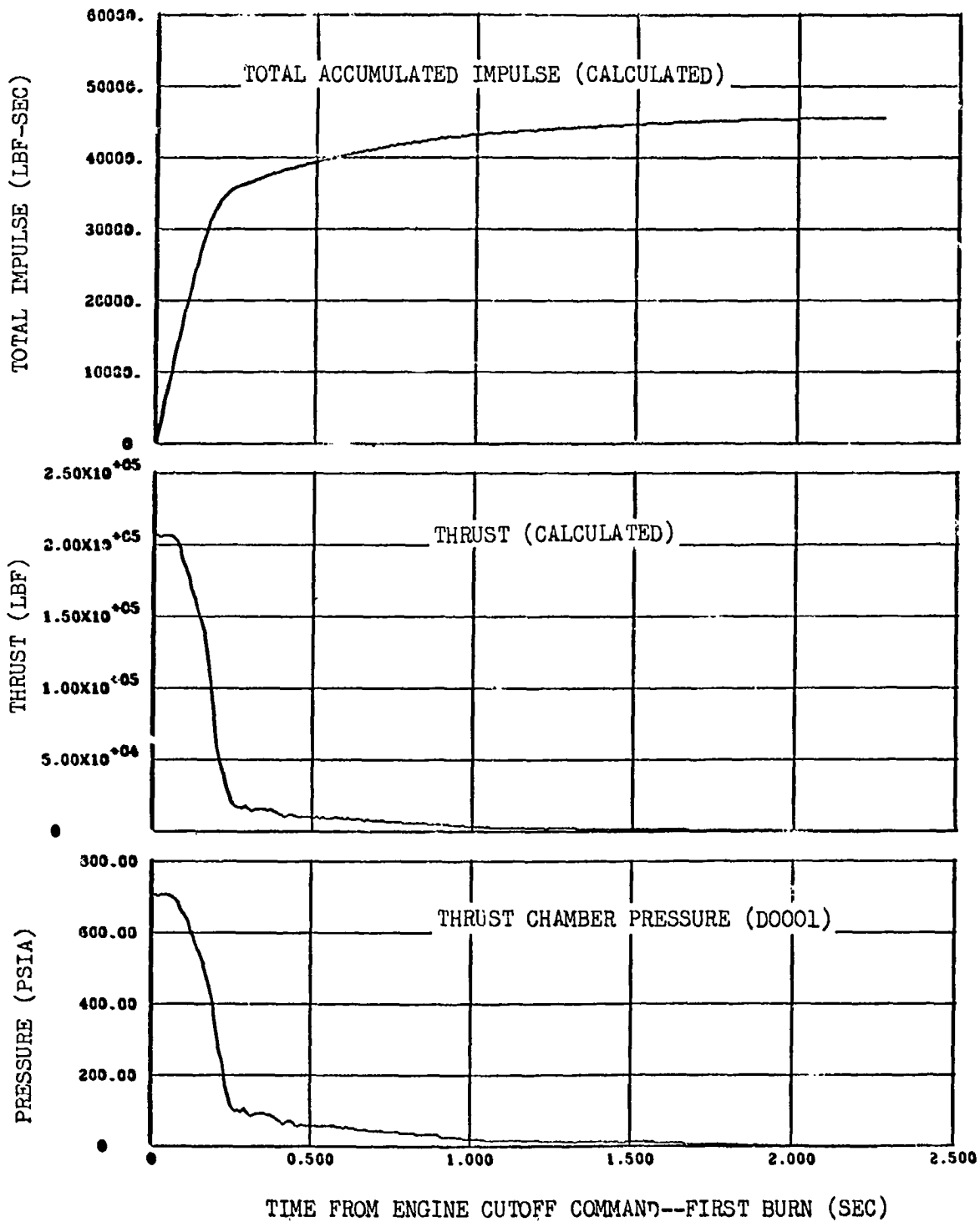

Figure 9-36. Engine Cutoff Transient Characteristics (Sheet 1 of 2)

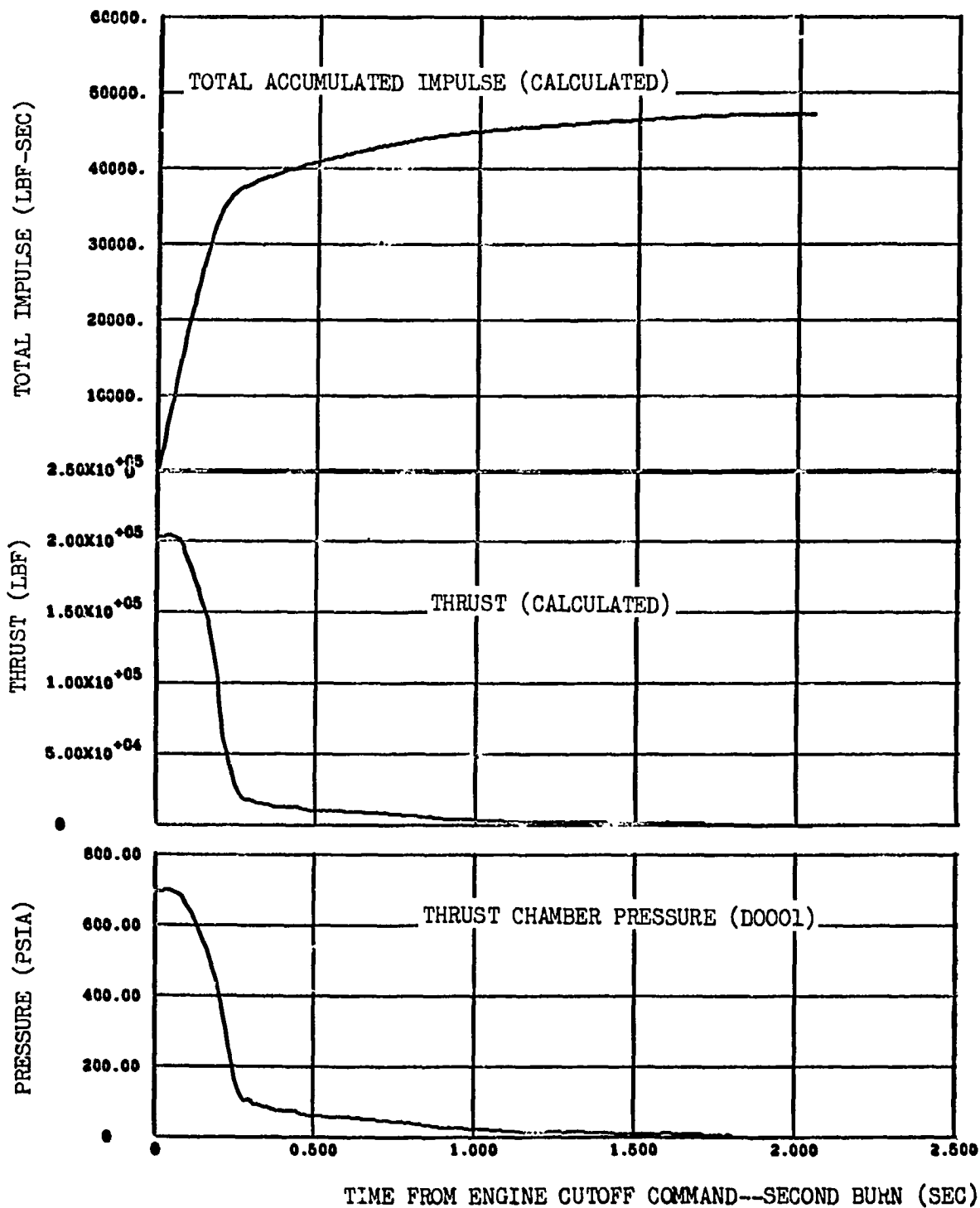

Figure 9-36. Engine Cutoff Transient Characteristics (Sheet 2 of 2)

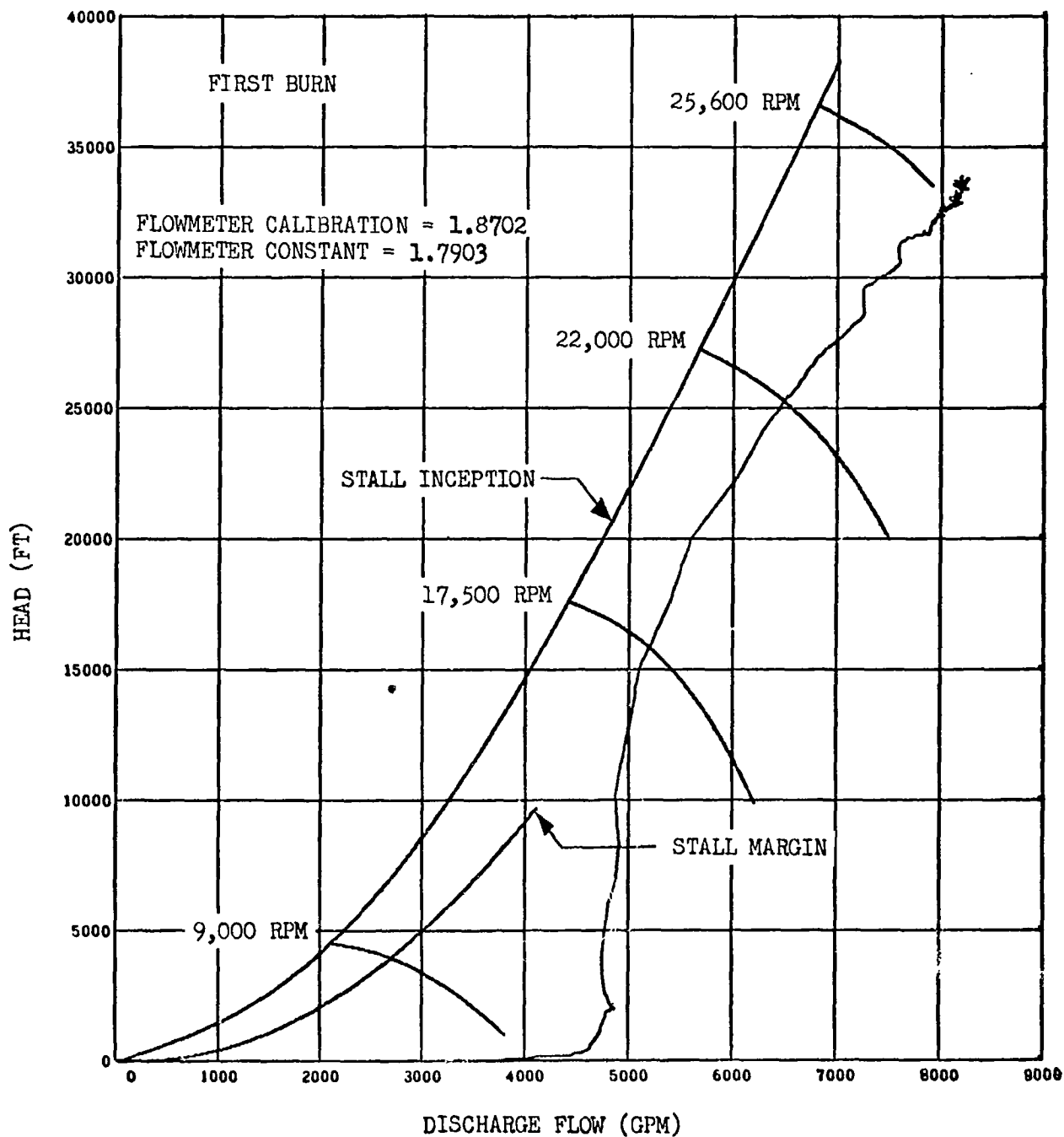

Figure 9-37. LH2 Pump Performance During Engine Start (Sheet 1 of 2)

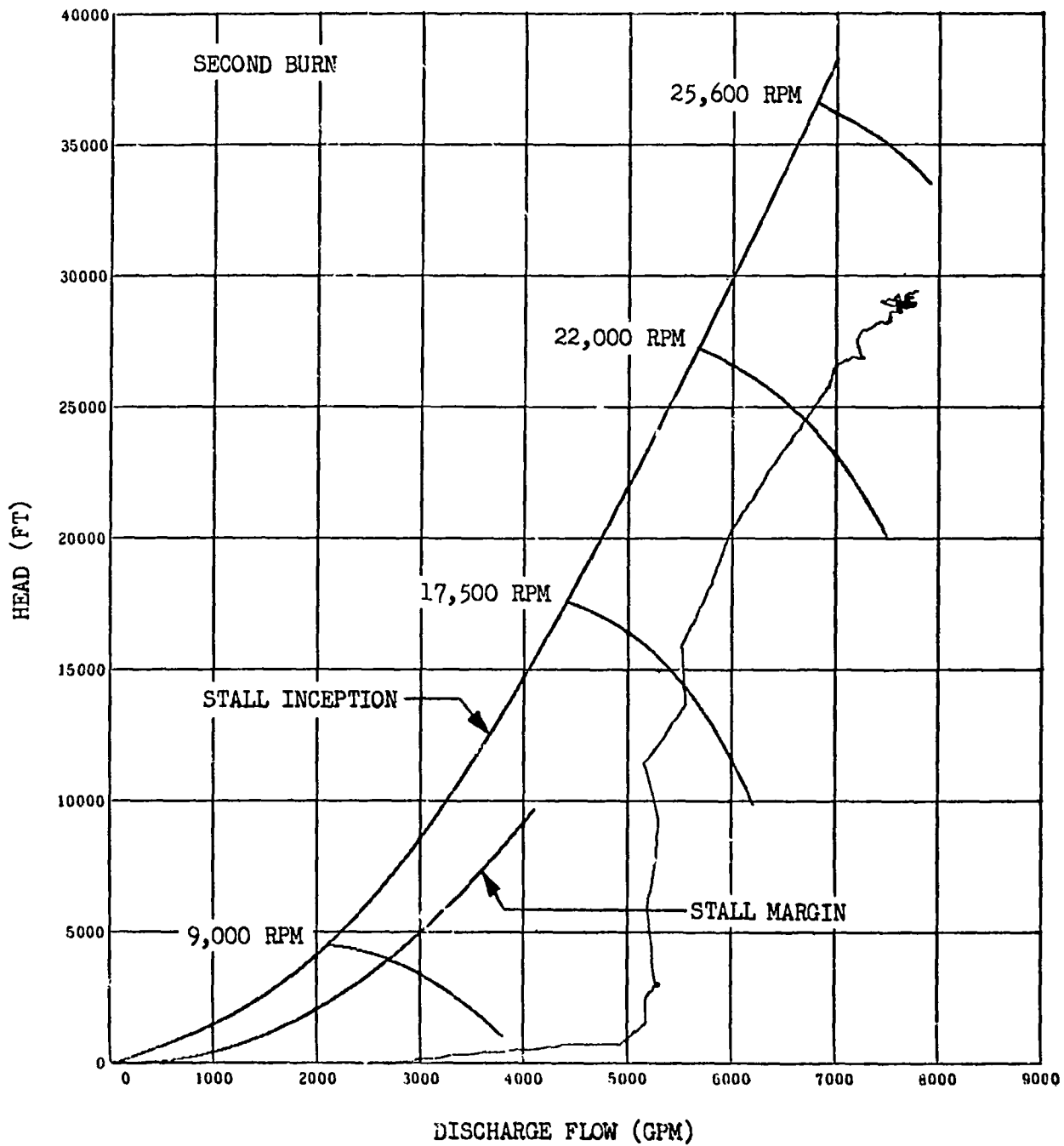

Figure 9-37. LH2 Pump Performance During Engine Start (Sheet 2 of 2)

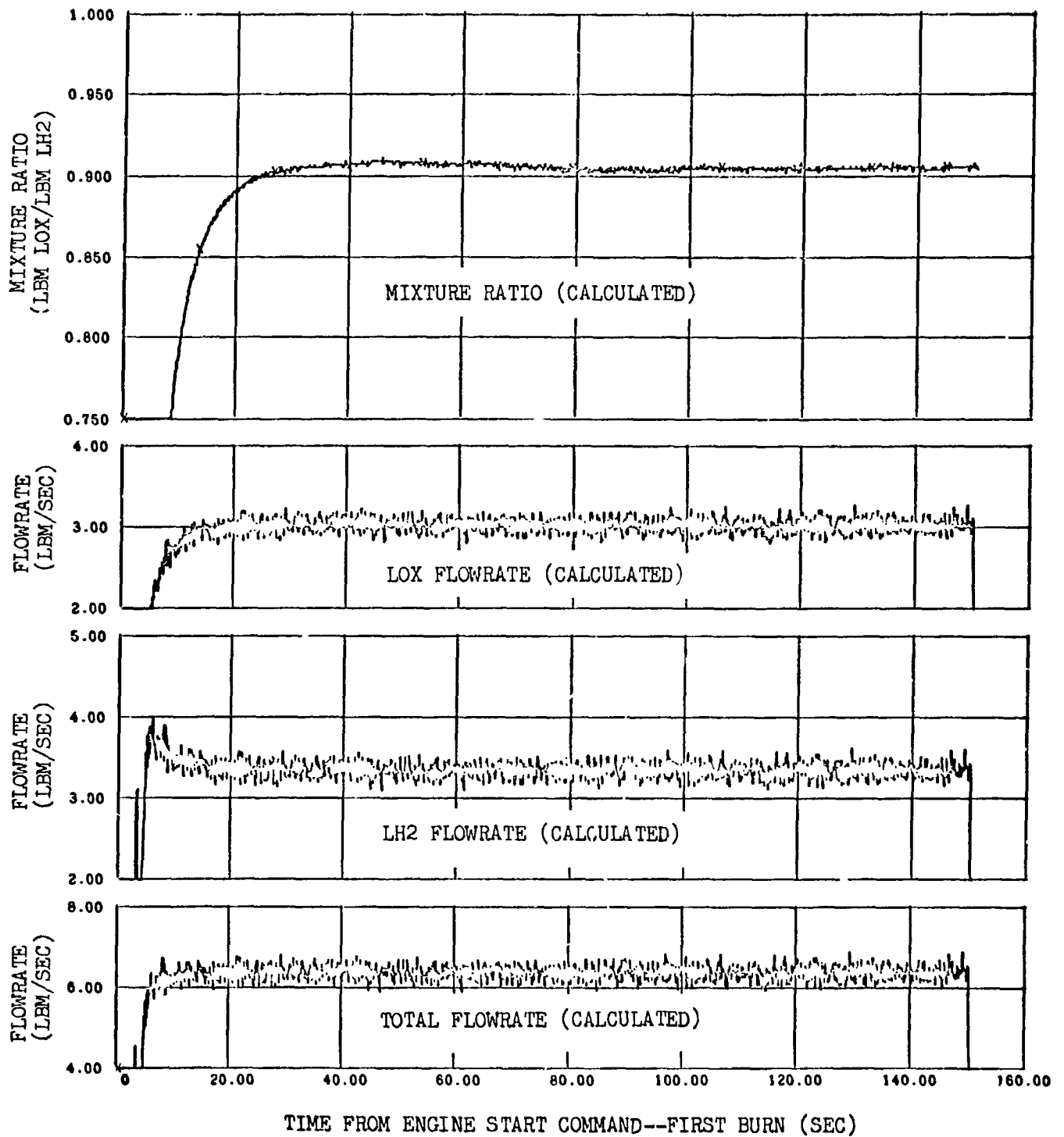

Figure 9-38. Gas Generator Performance (Sheet 1 of 2)

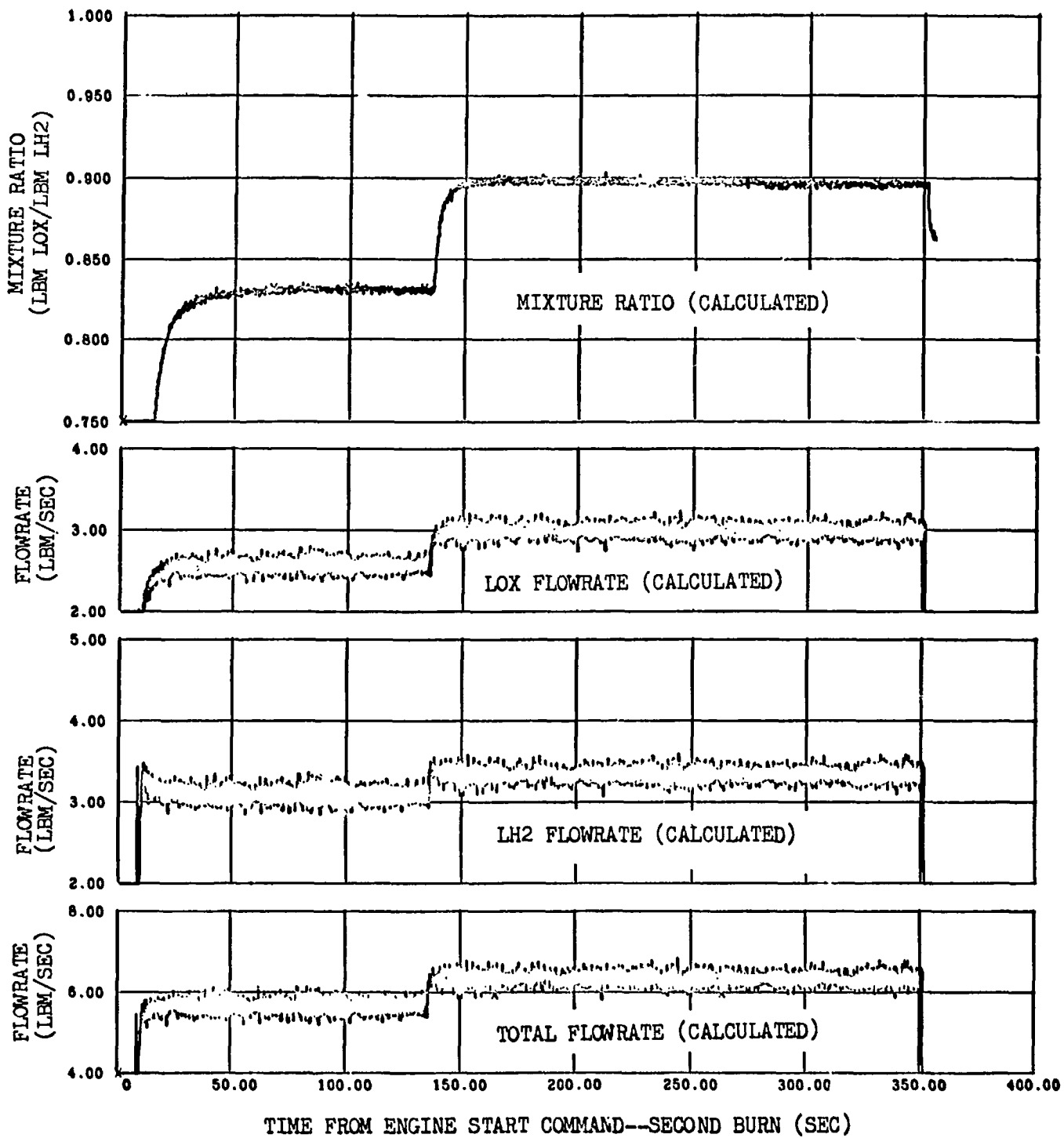

Figure 9-38. Gas Generator Performance (Sheet 2 of 2)

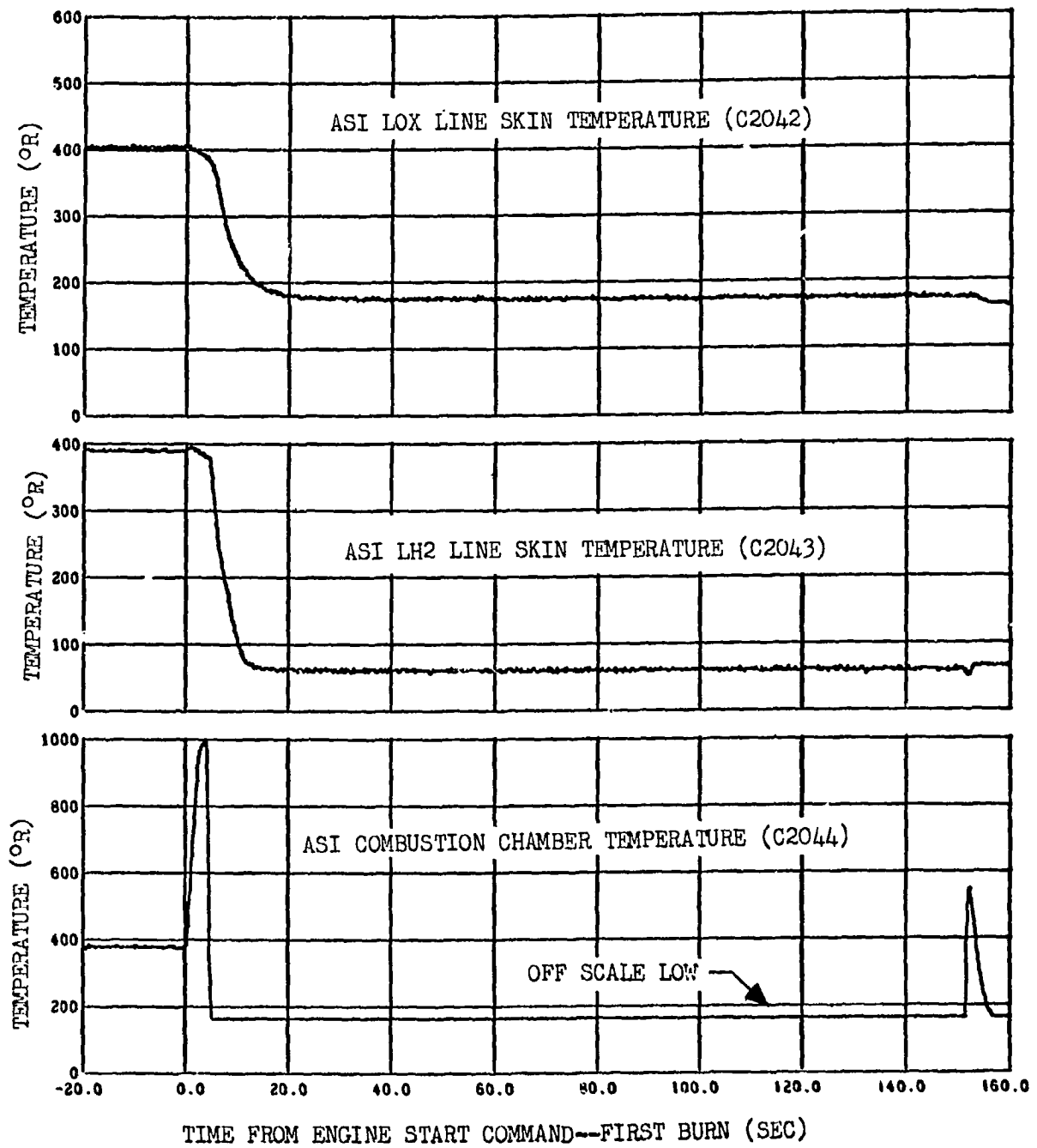

Figure 9-39. ASI Temperatures--First Burn

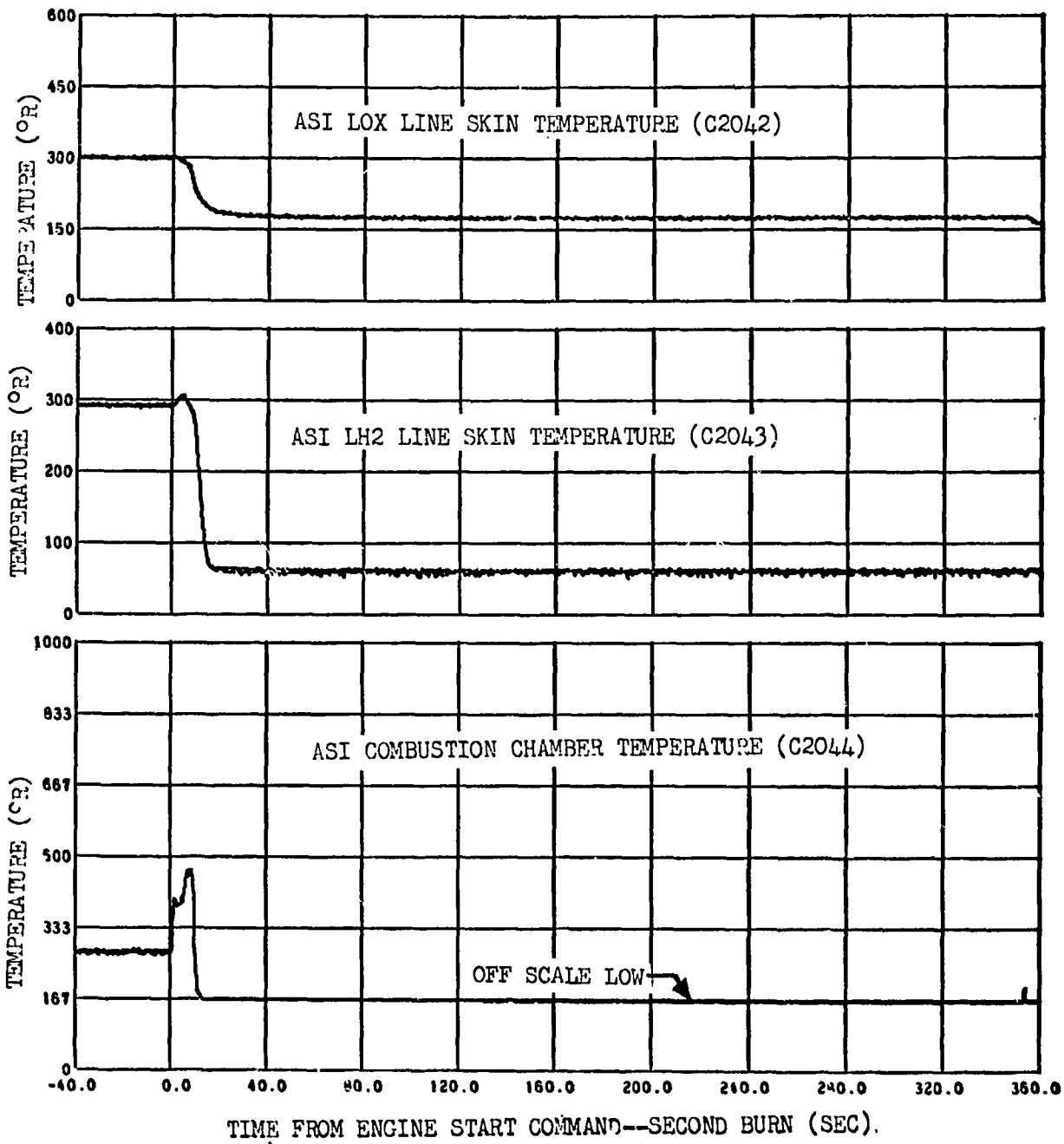

Figure 9-40. ASI Temperatures--Second Burn

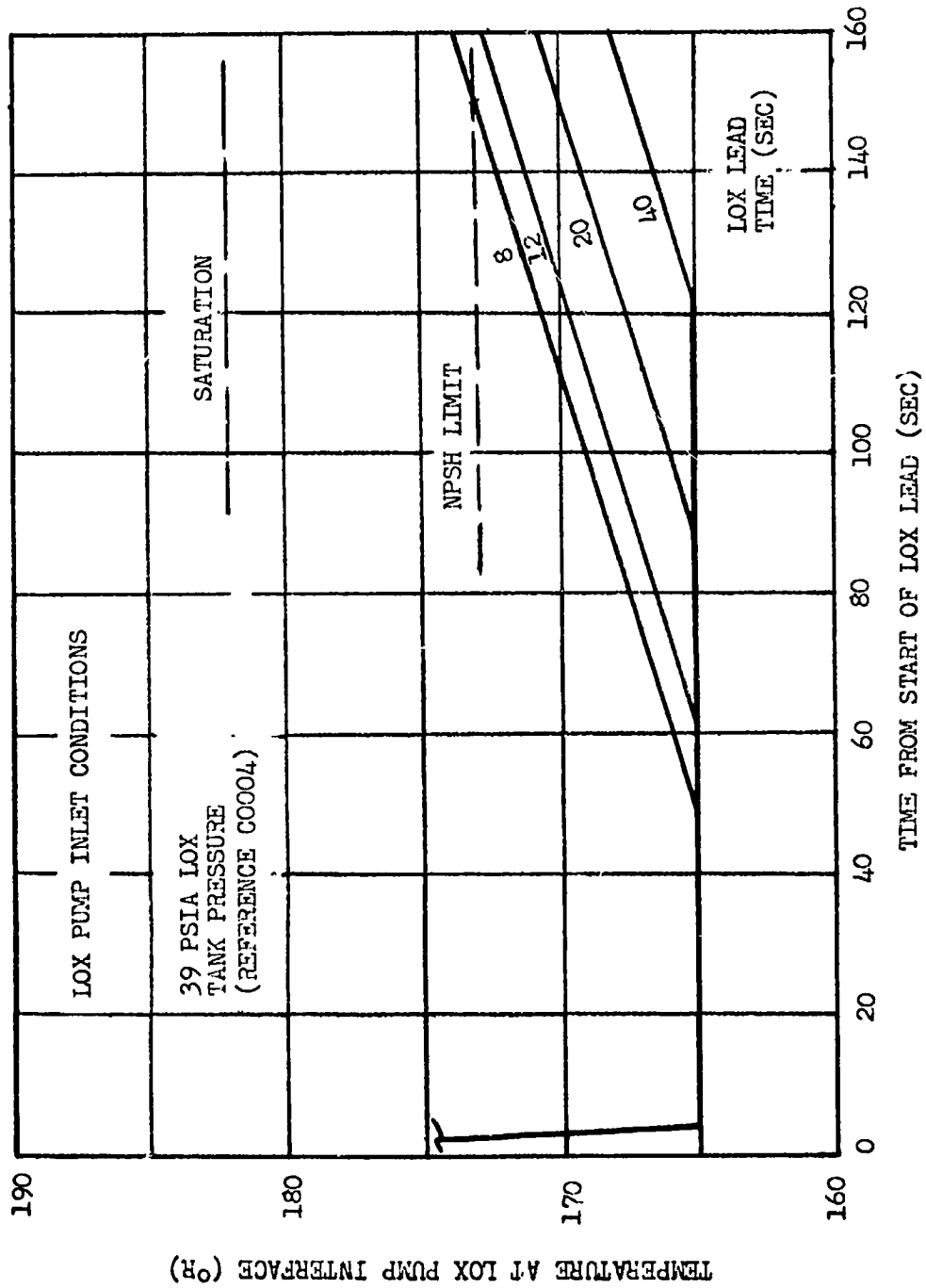

Figure 9-41. LOR Mission Operational Contingency Restart Characteristics (Sheet 1 of 4)

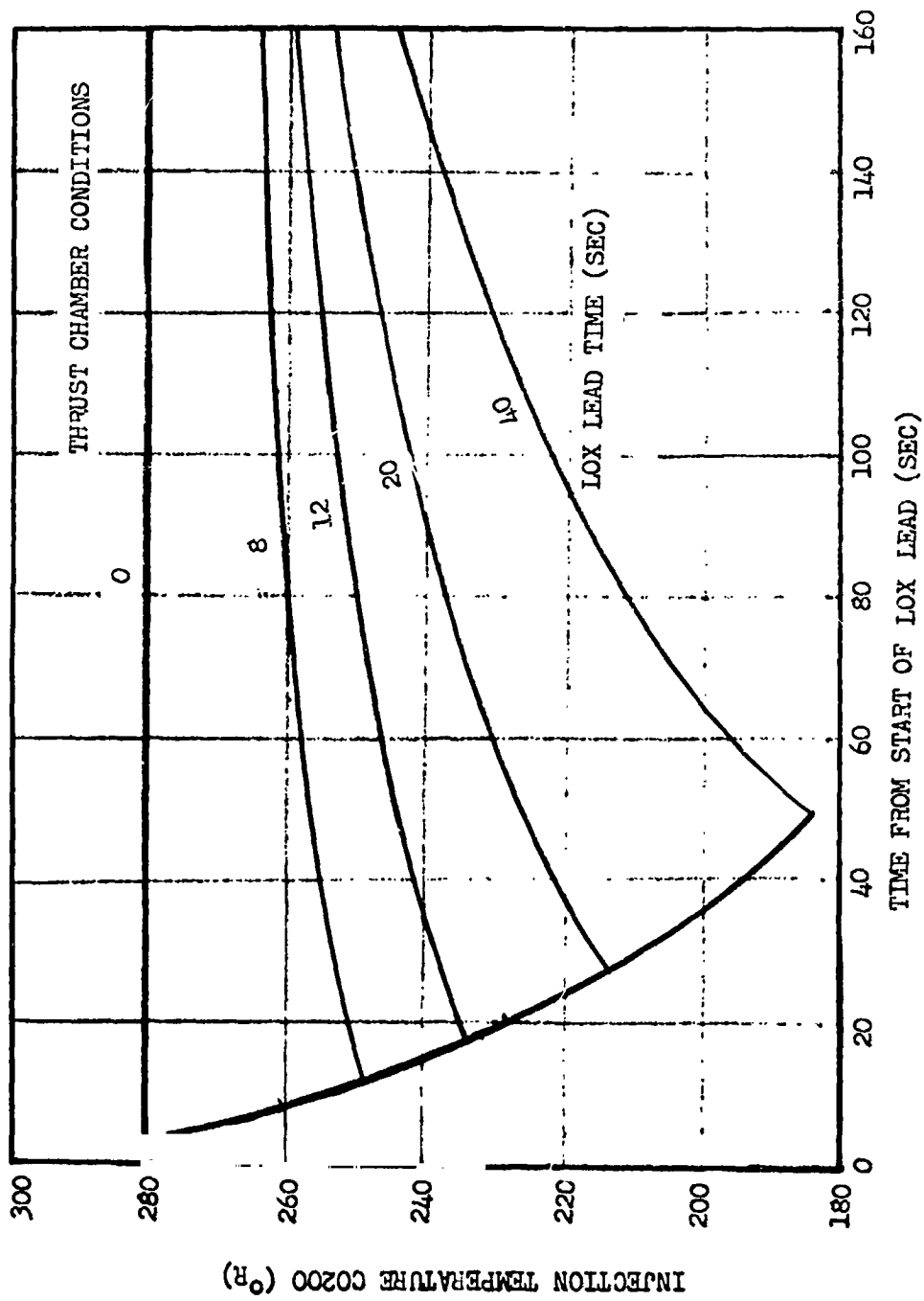

Figure 9-41. LOR Mission Operational Contingency Restart Characteristics (Sheet 2 of 4)

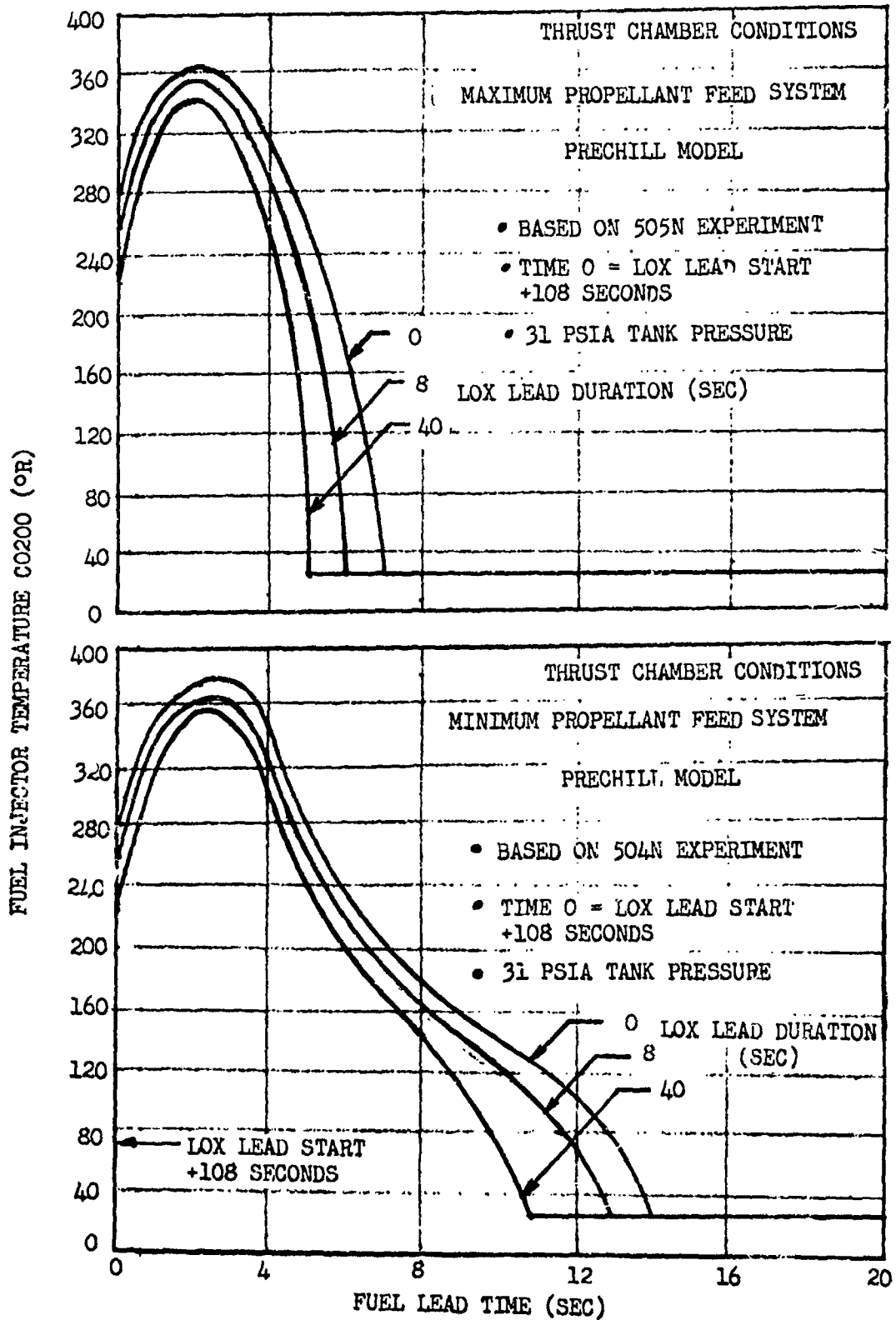

Figure 9-41. LOR Mission Operational Contingency Restart Characteristics (Sheet 3 of 4)

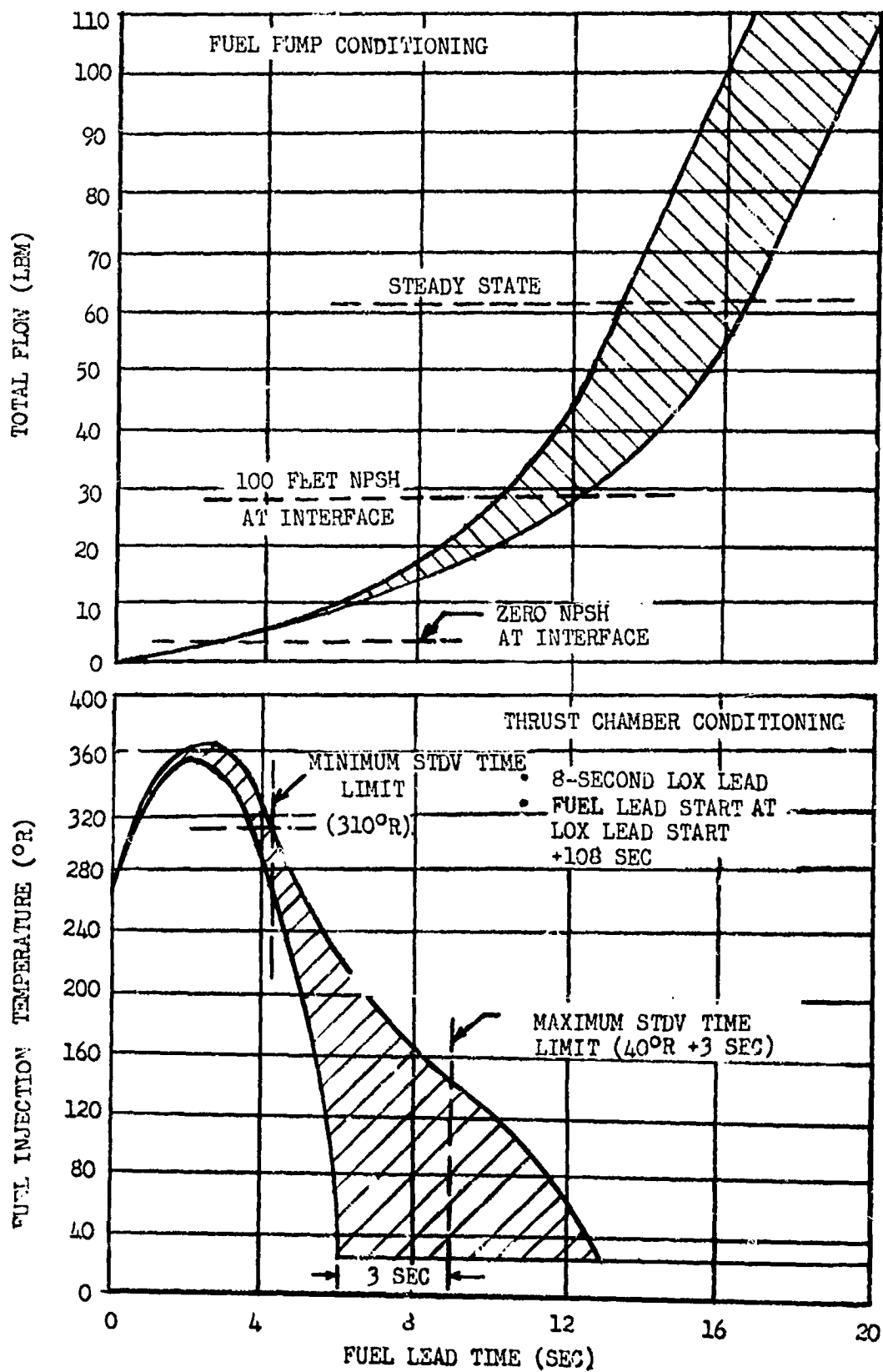

Figure 9-41. LOR Mission Operational Contingency Restart Characteristics (Sheet 4 of 4)

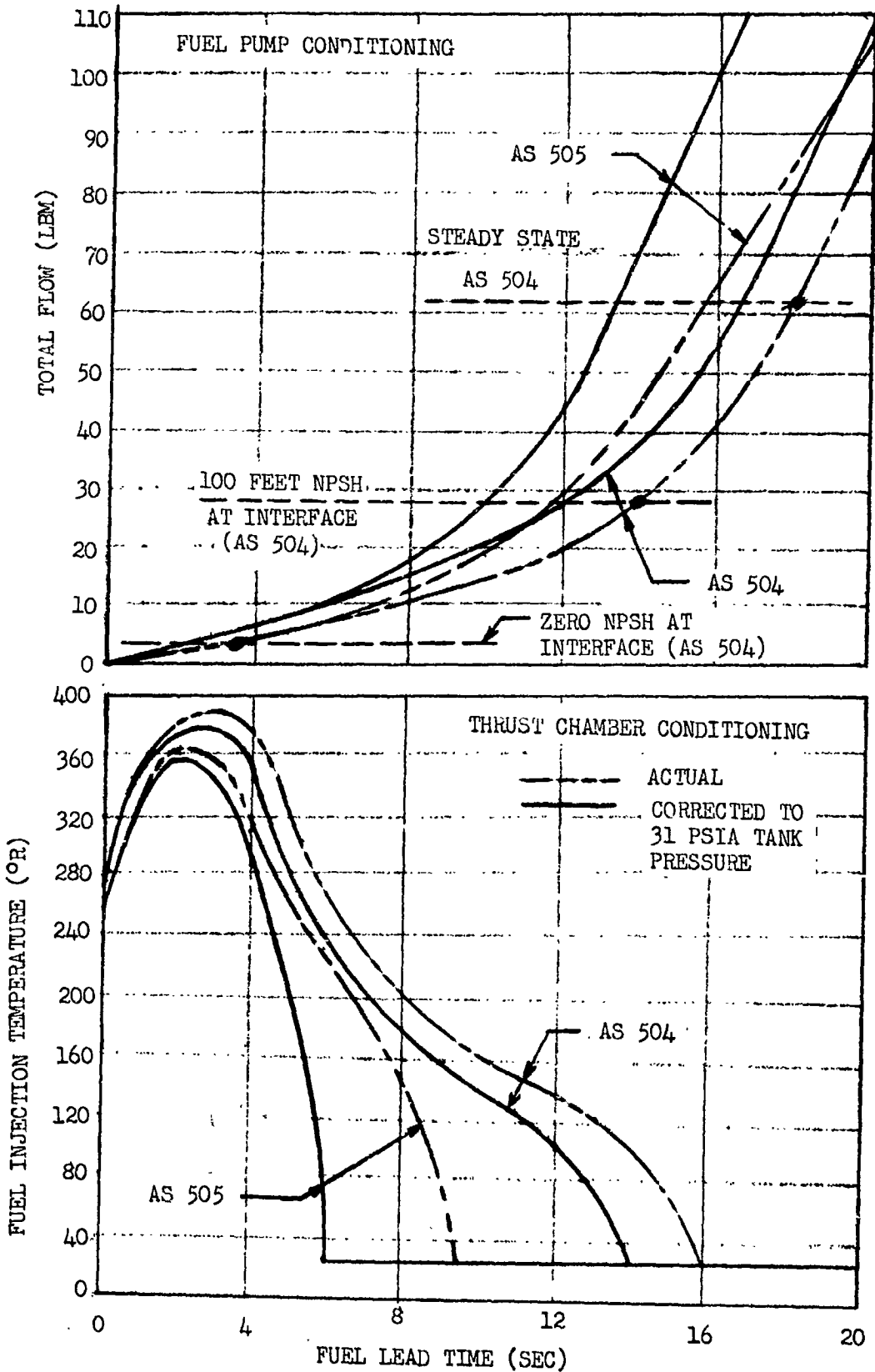

Figure 9-42. Propellant Lead Experiment Chilldown Characteristics

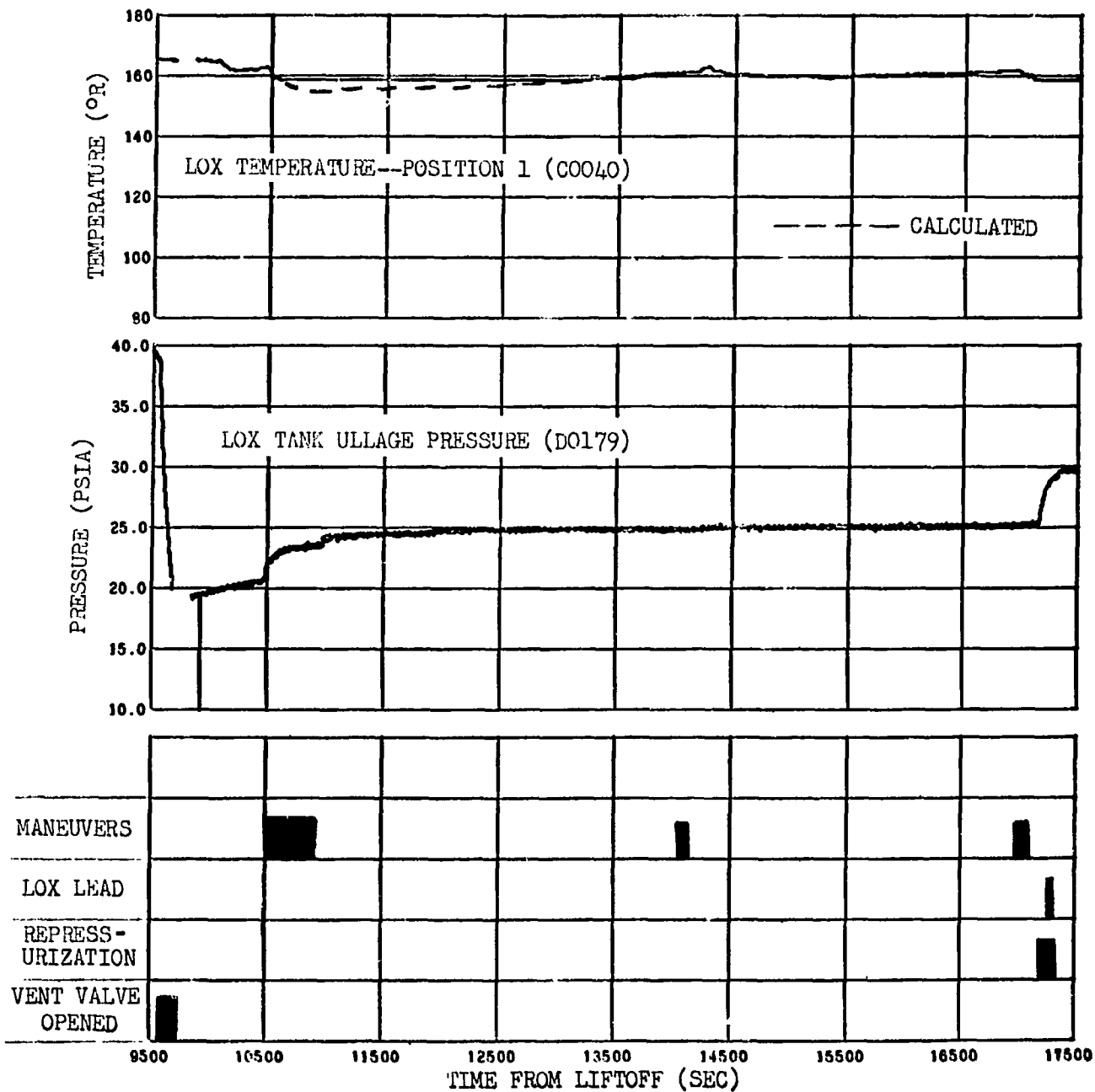

Figure 9-43. LOX Tank Conditions

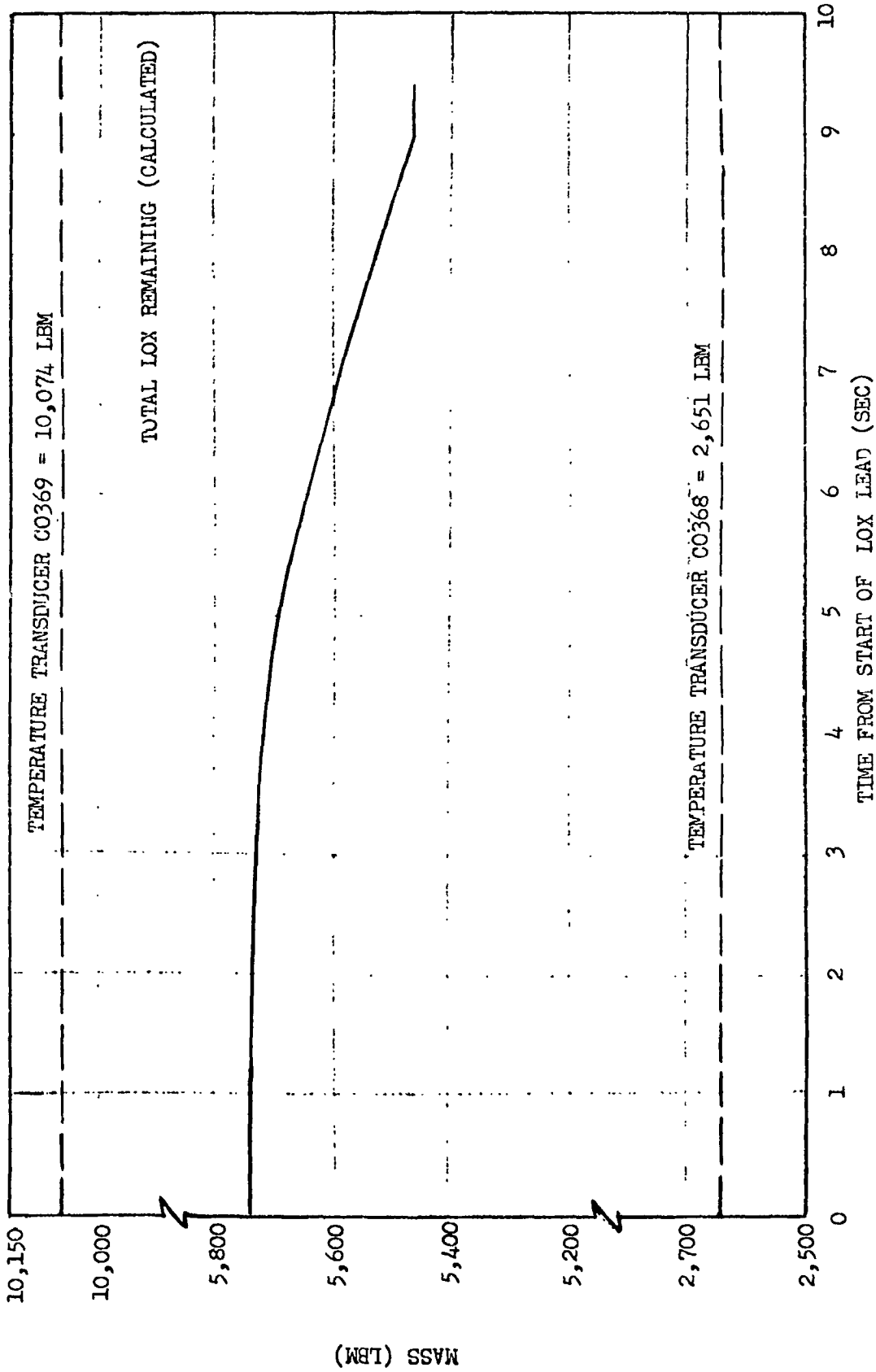
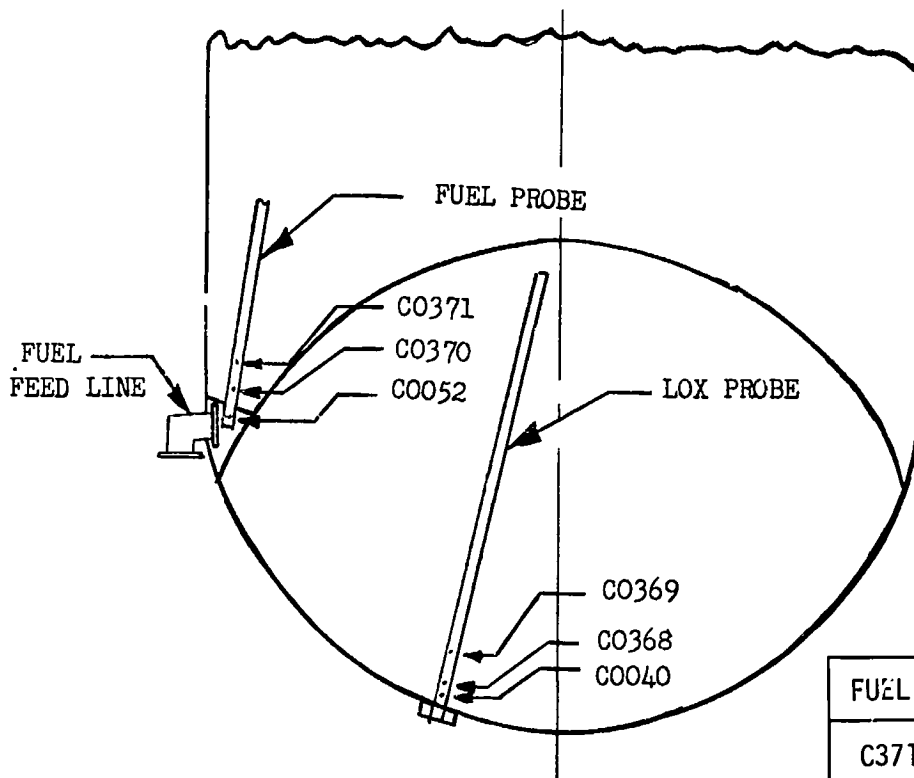
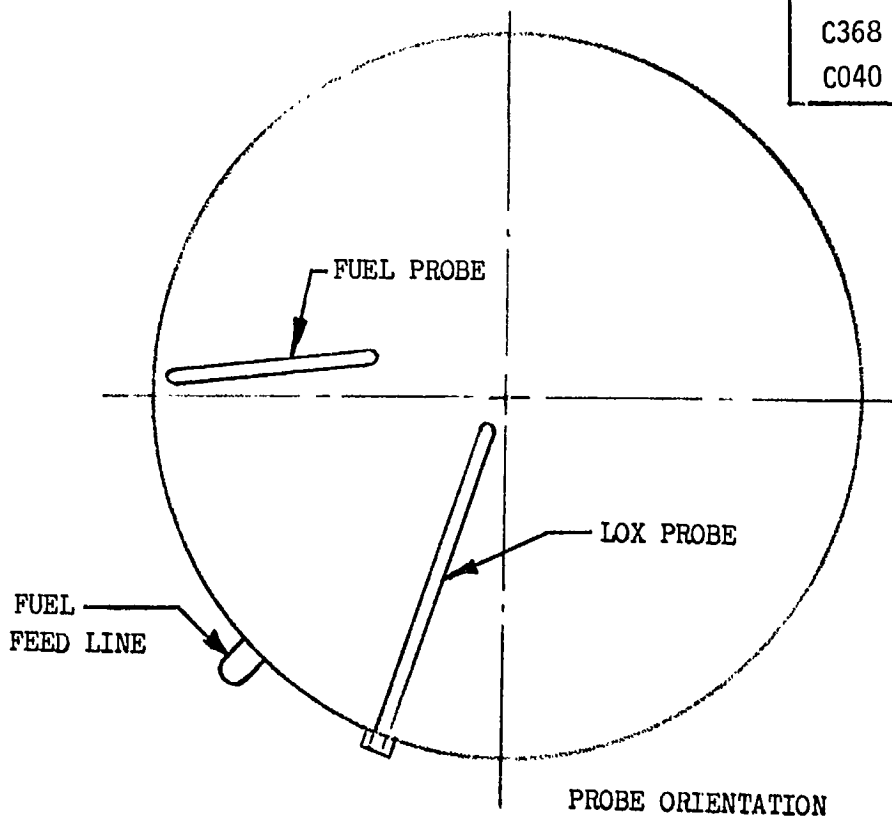

Figure 9-44. LOX Mass in Tank



MEASUREMENT
LIQUID LEVEL
LOCATIONS

FUEL	LBM	FT ³
C371	2383	539.38
C370	1025	232.0
C052	263	60.57
LOX		
C369	9920	138.55
C368	2610	36.43
C040	1350	18.85



PROBE ORIENTATION

Figure 9-45. Temperature Measurement Location

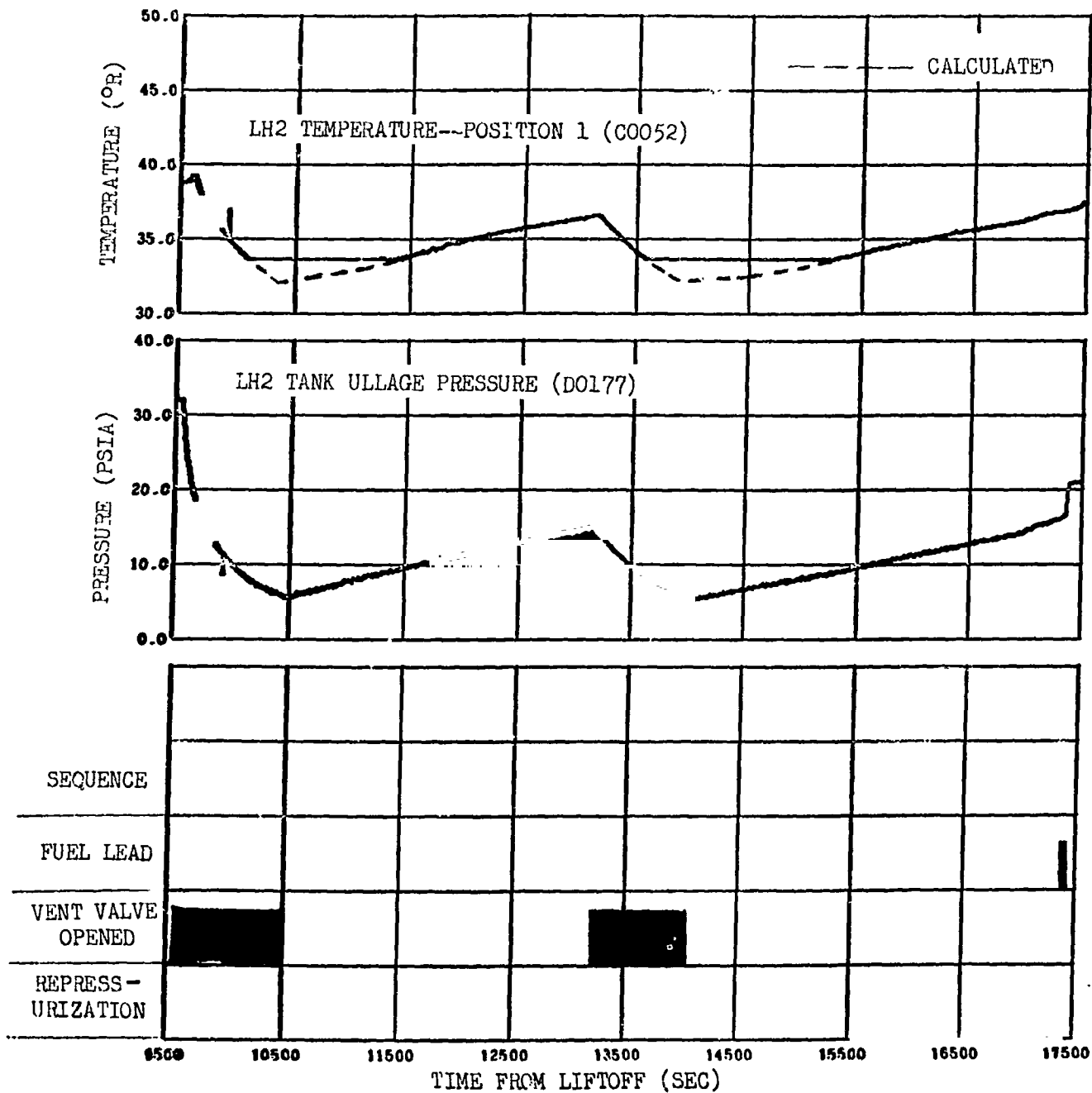

Figure 9-46. Fuel Tank Conditions

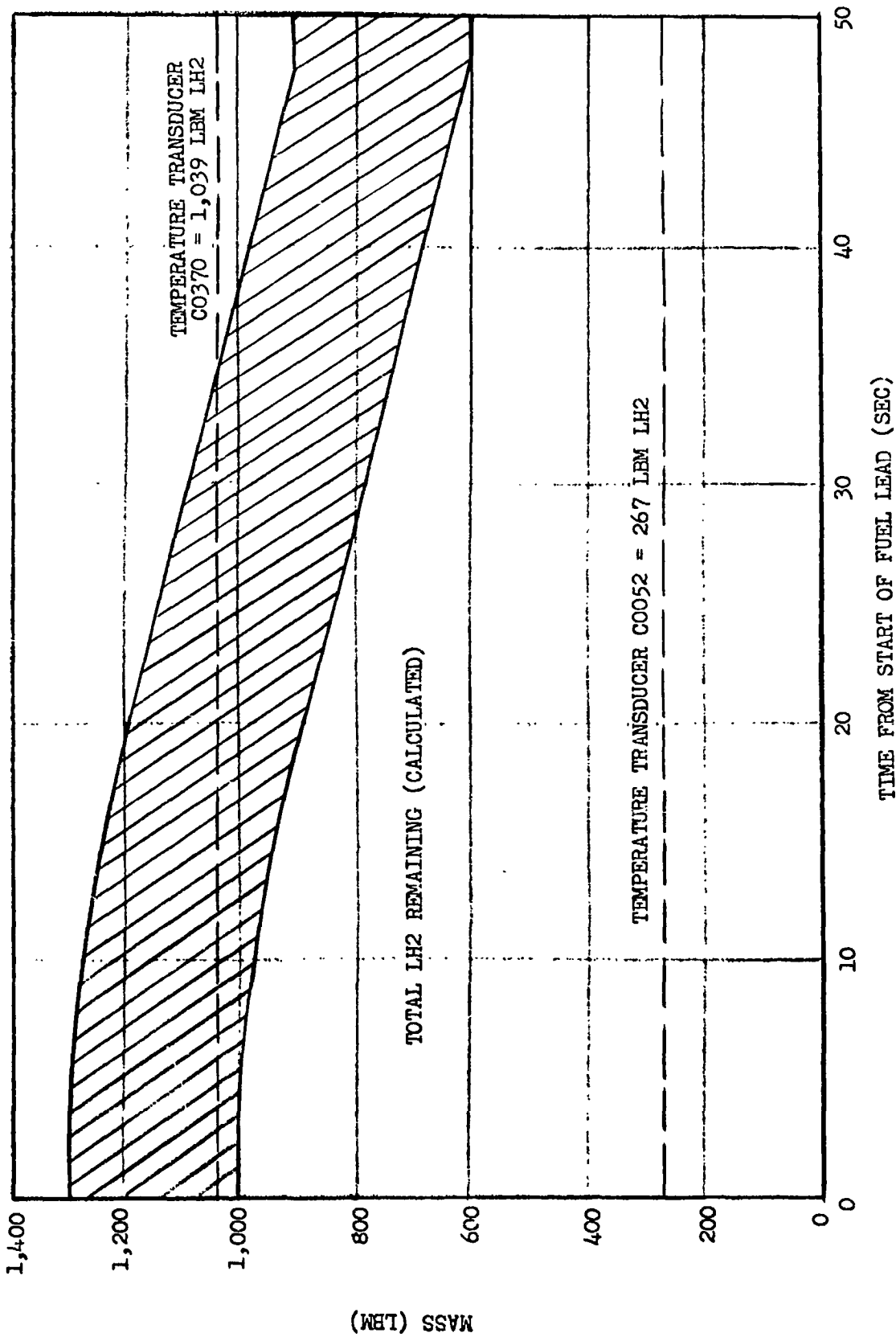

Figure 9-47. LH2 Mass in Tank

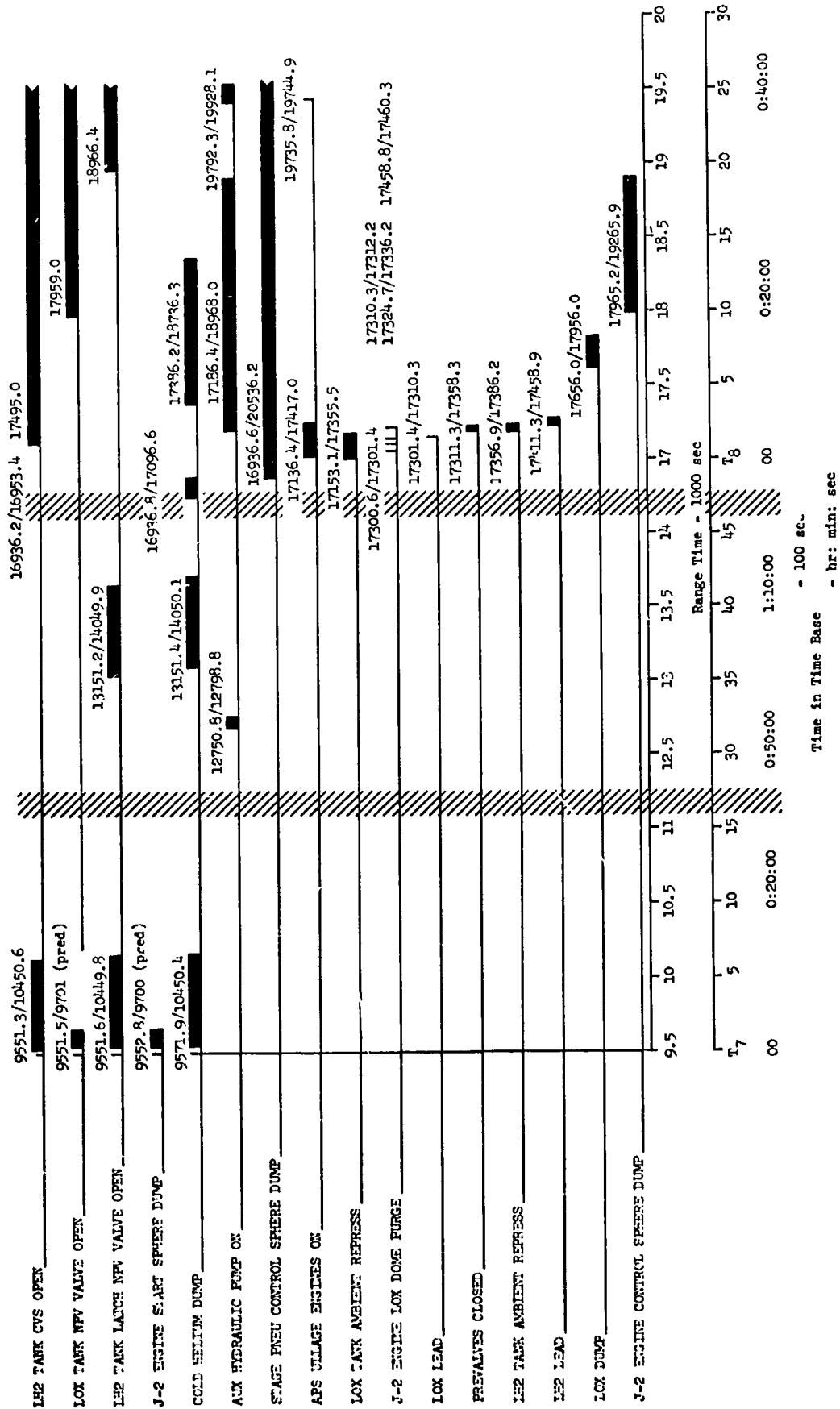

Figure 9-48 S-IVB Propellant Lead Experiment and Orbital Safing Sequence

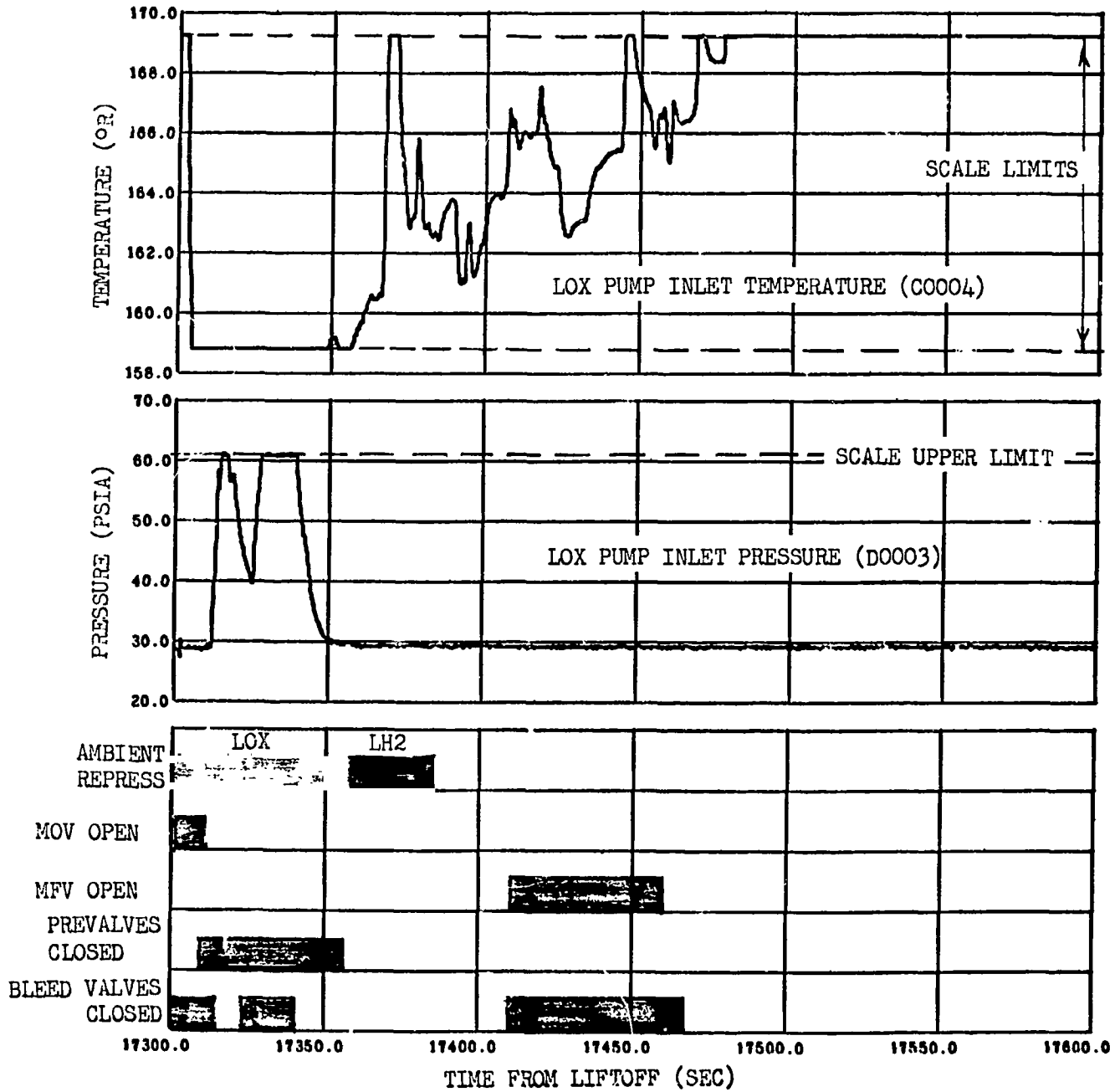

Figure 9-49. LOX Pump Inlet Conditions For Propellant Lead Experiment

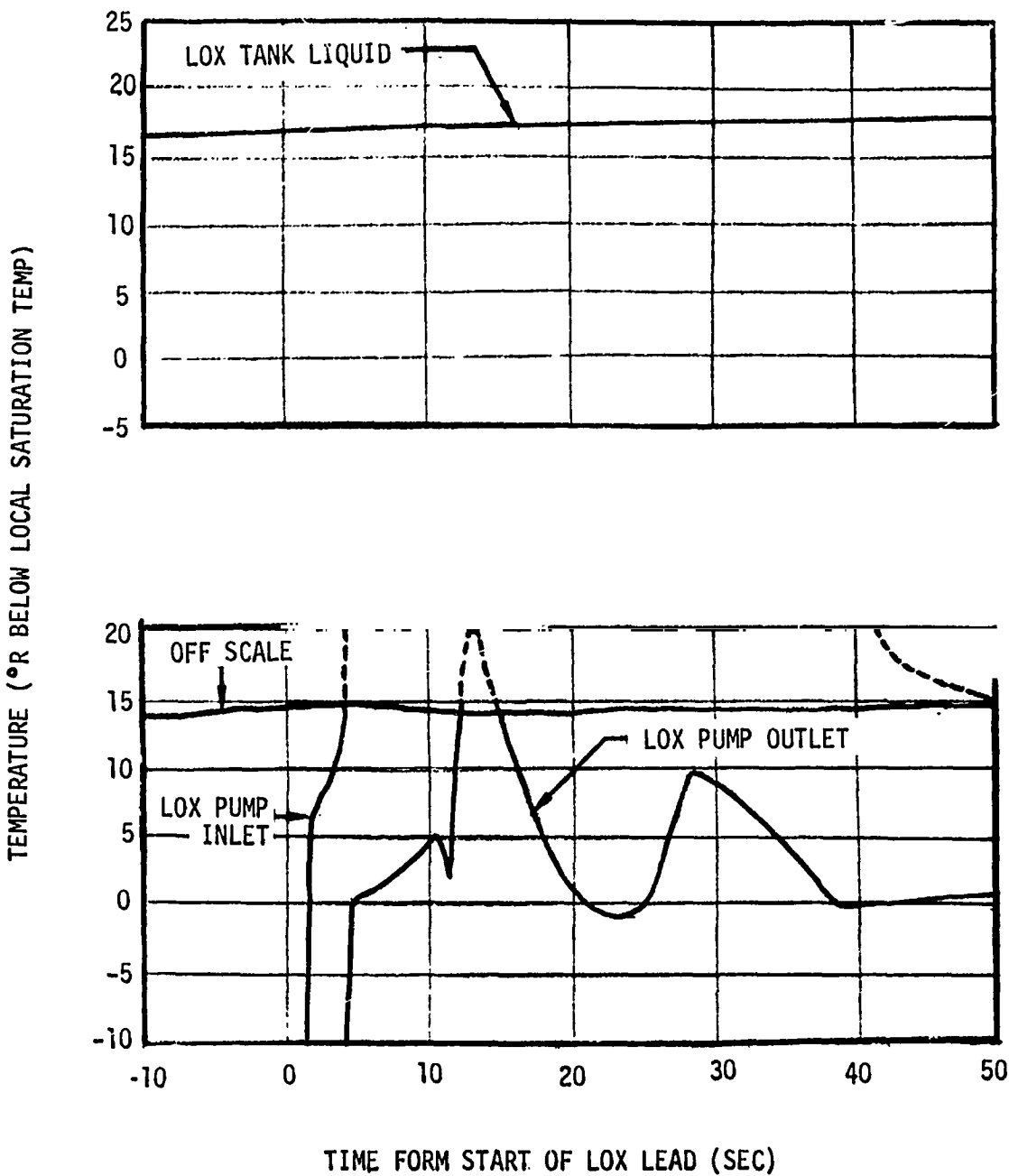

Figure 9-50. LOX Lead Subcooling

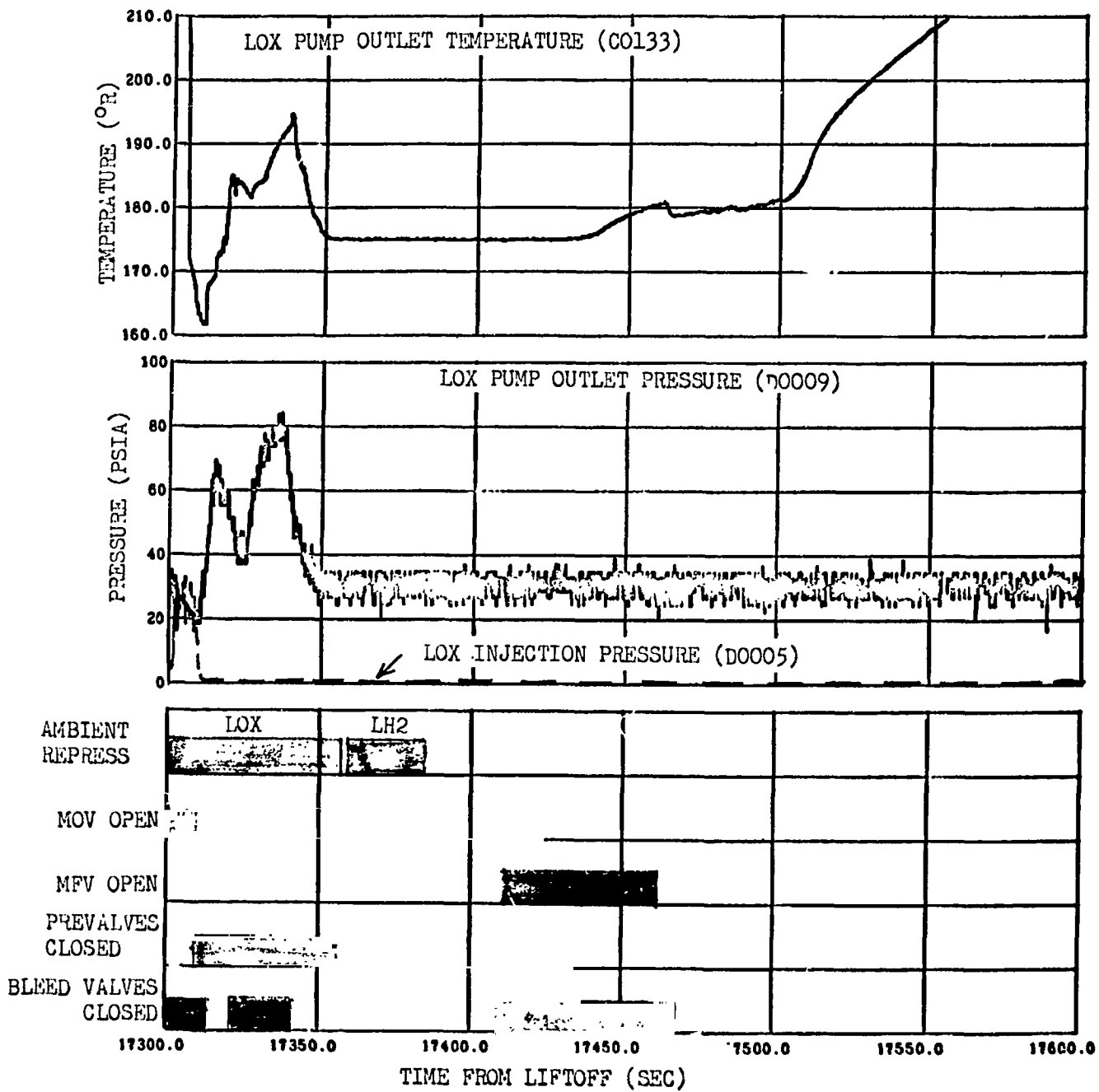

Figure 9-51. LOX Pump Outlet Conditions for Propellant Lead Experiment

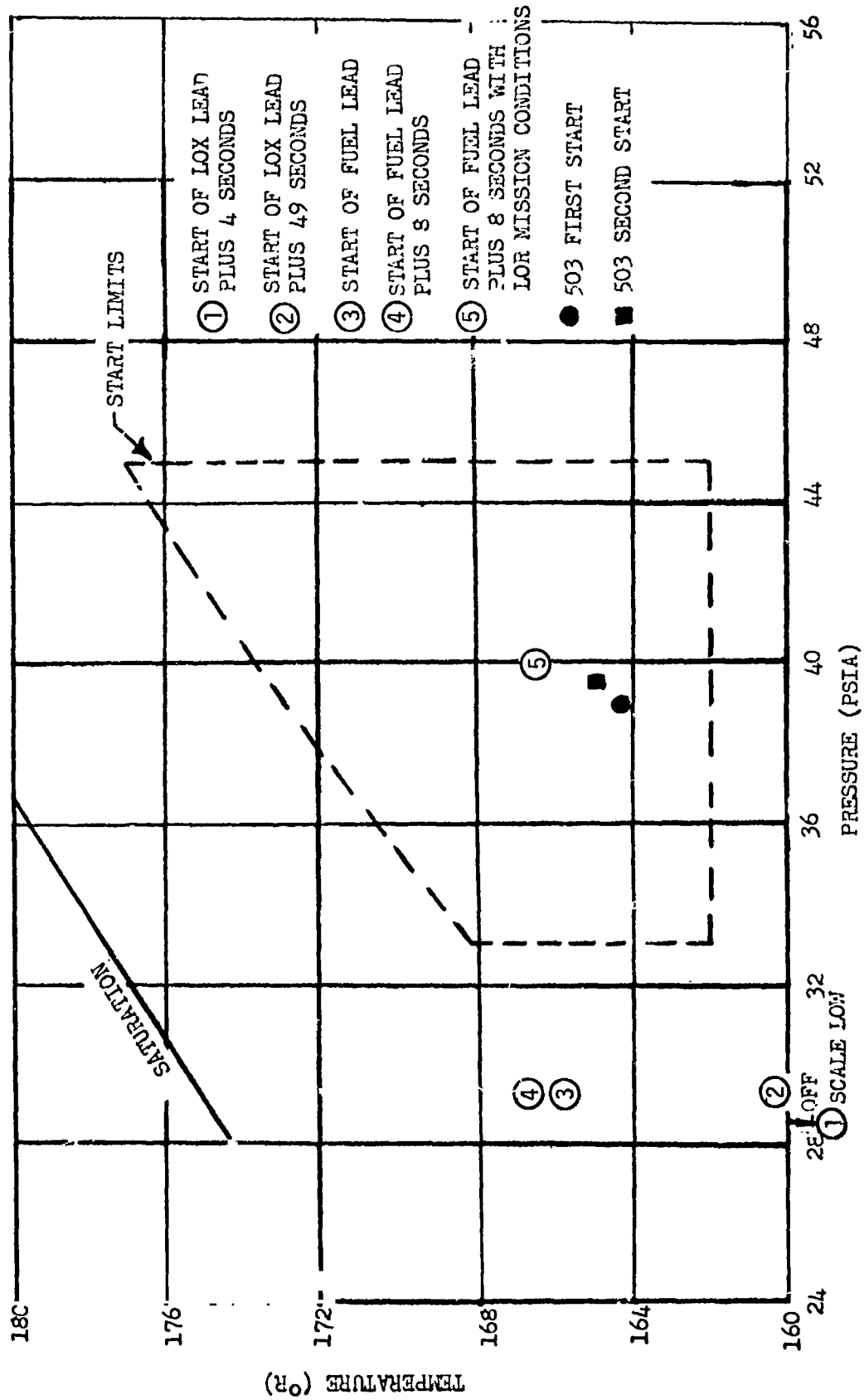

Figure 9-52. LOX Pump Inlet Conditioning for Propellant Lead Experiment

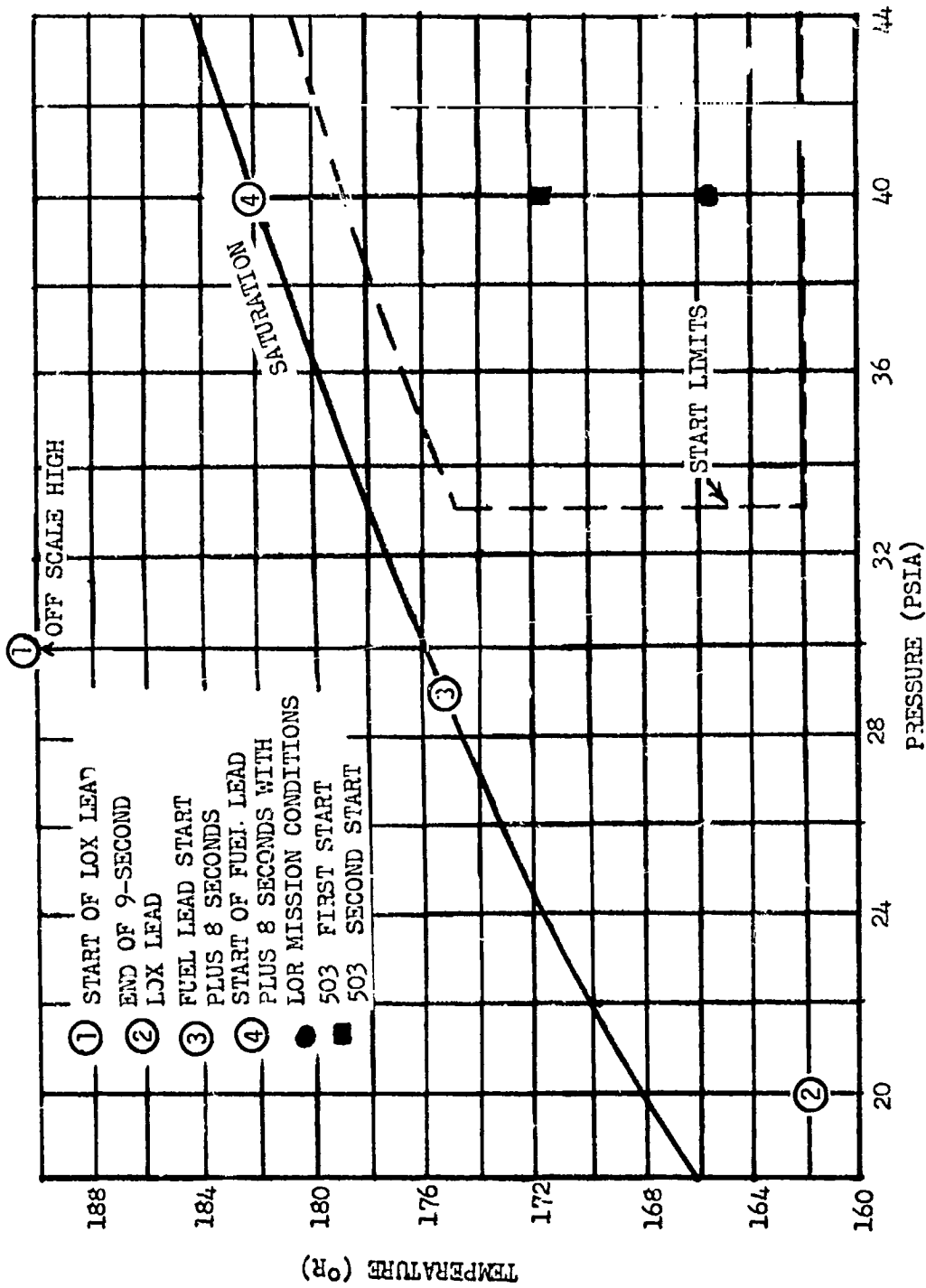

Figure 9-53. LOX Pump Outlet Conditioning for Propellant Lead Experiment

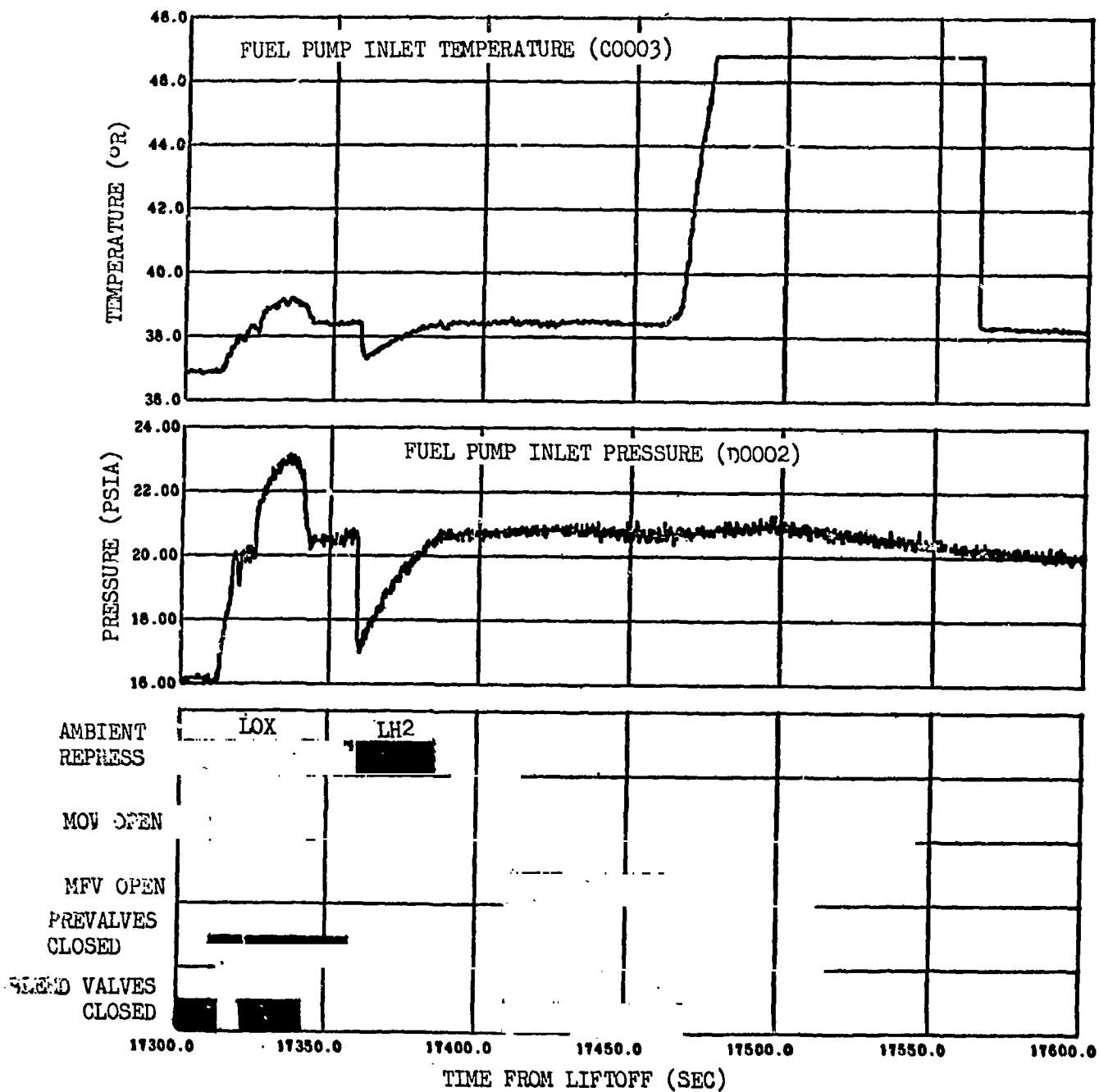

Figure 9-54. Fuel Pump Inlet Conditions for Propellant Lead Experiment

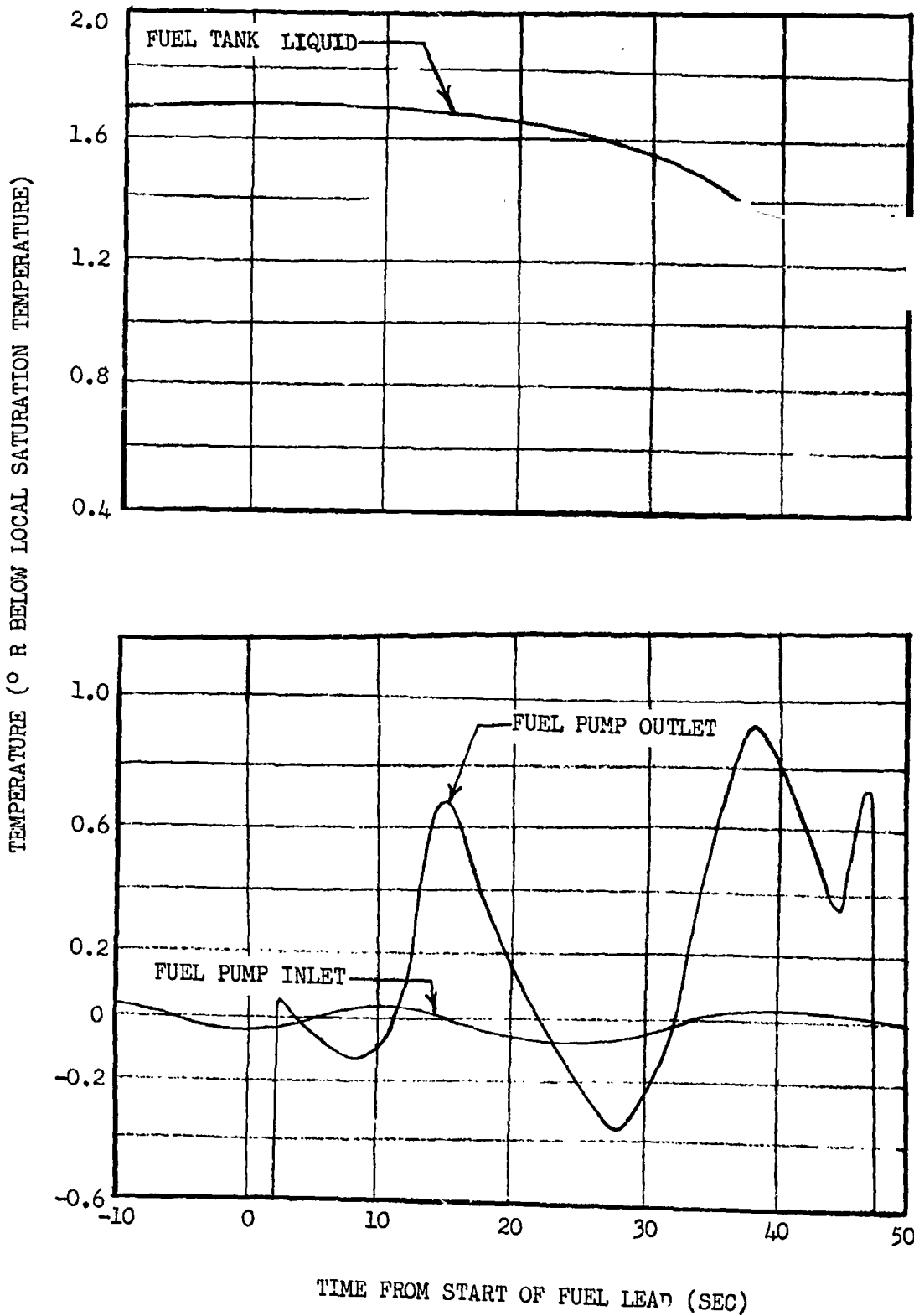

Figure 9-55. Fuel Lead Subcooling

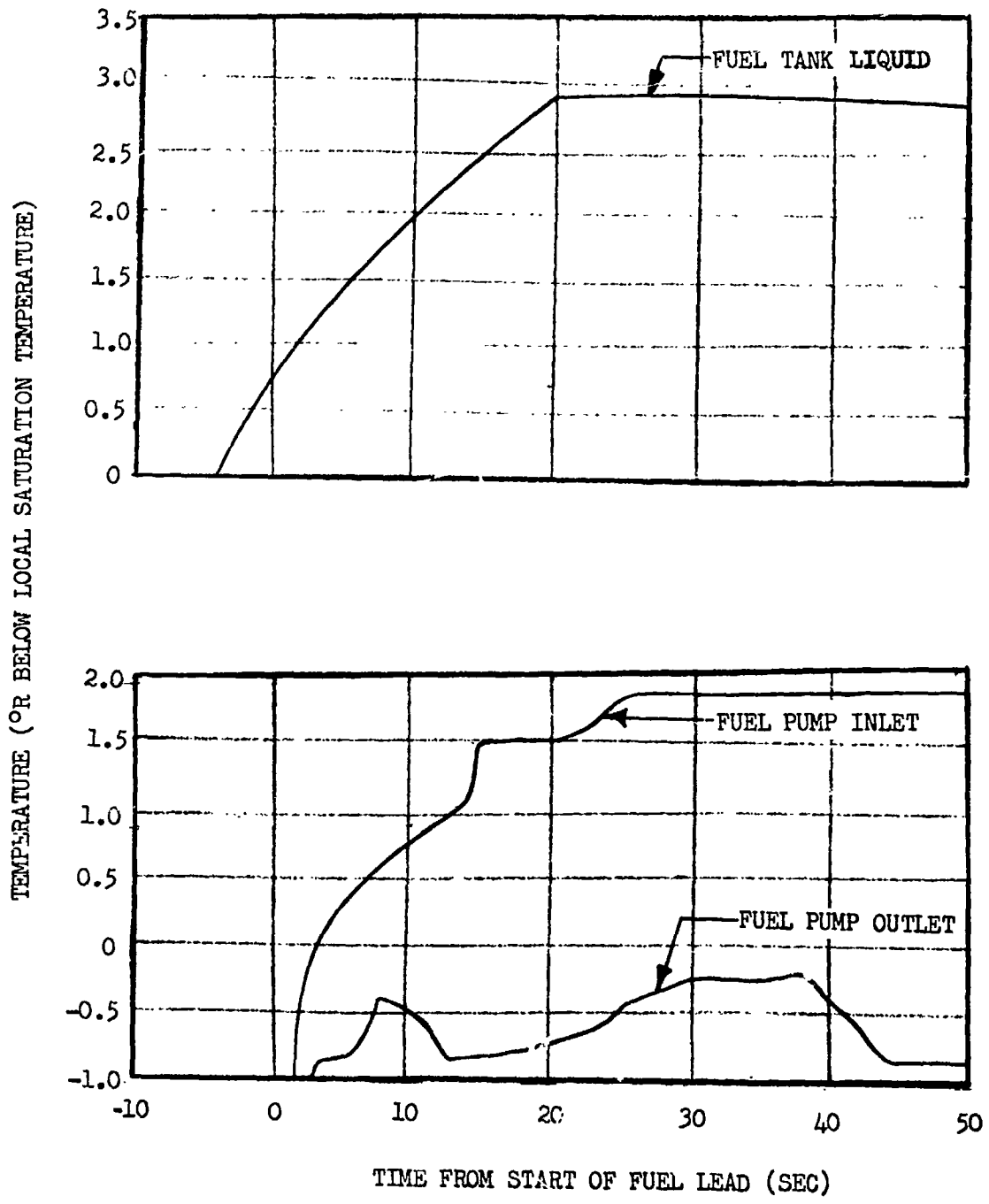

Figure 9-56. Fuel Lead Subcooling

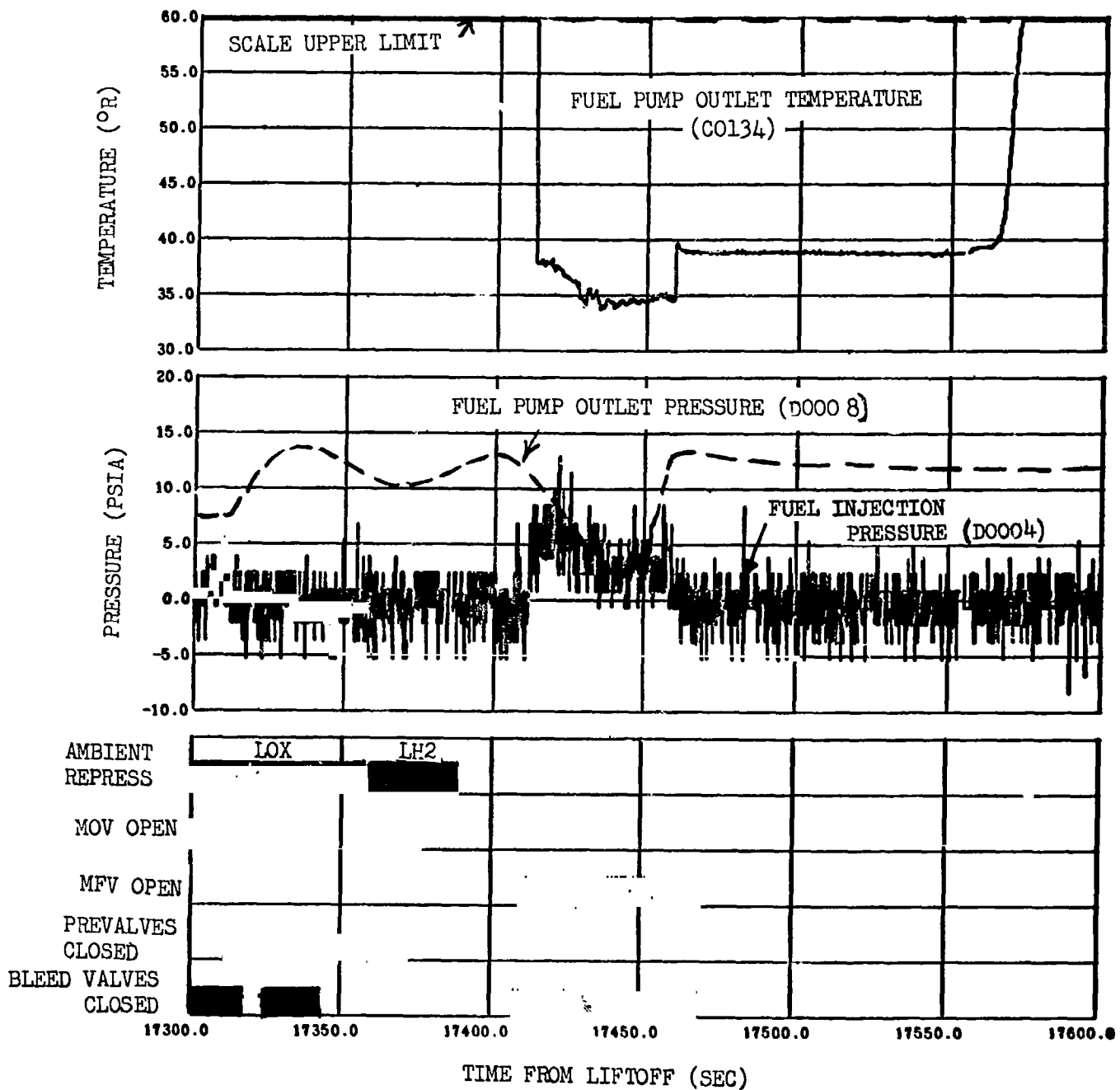

Figure 9-57. Fuel Pump Outlet Conditions for Propellant Lead Experiment

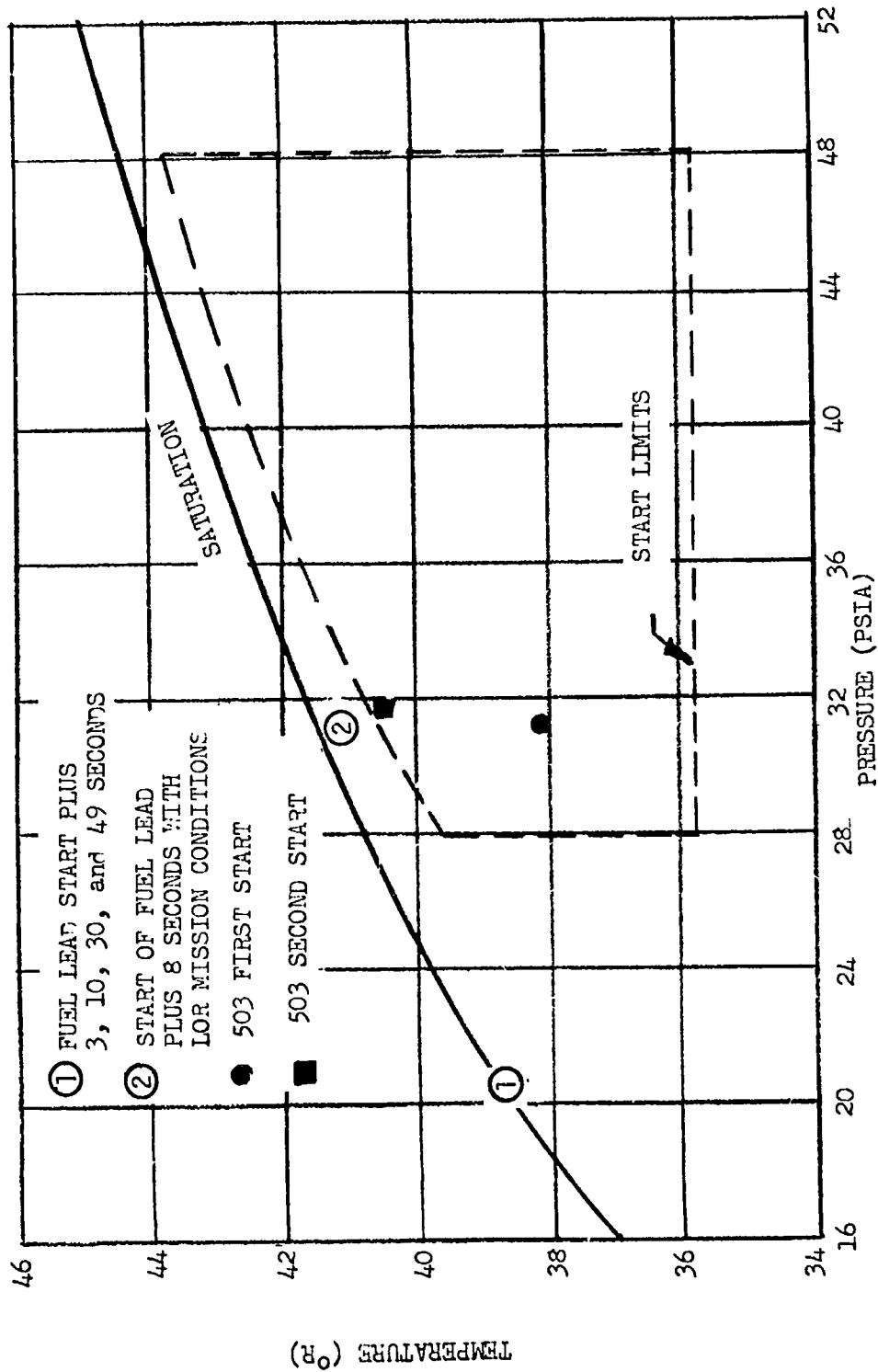

Figure 9-58. Fuel Pump Inlet Conditioning for Propellant Lead Experiment

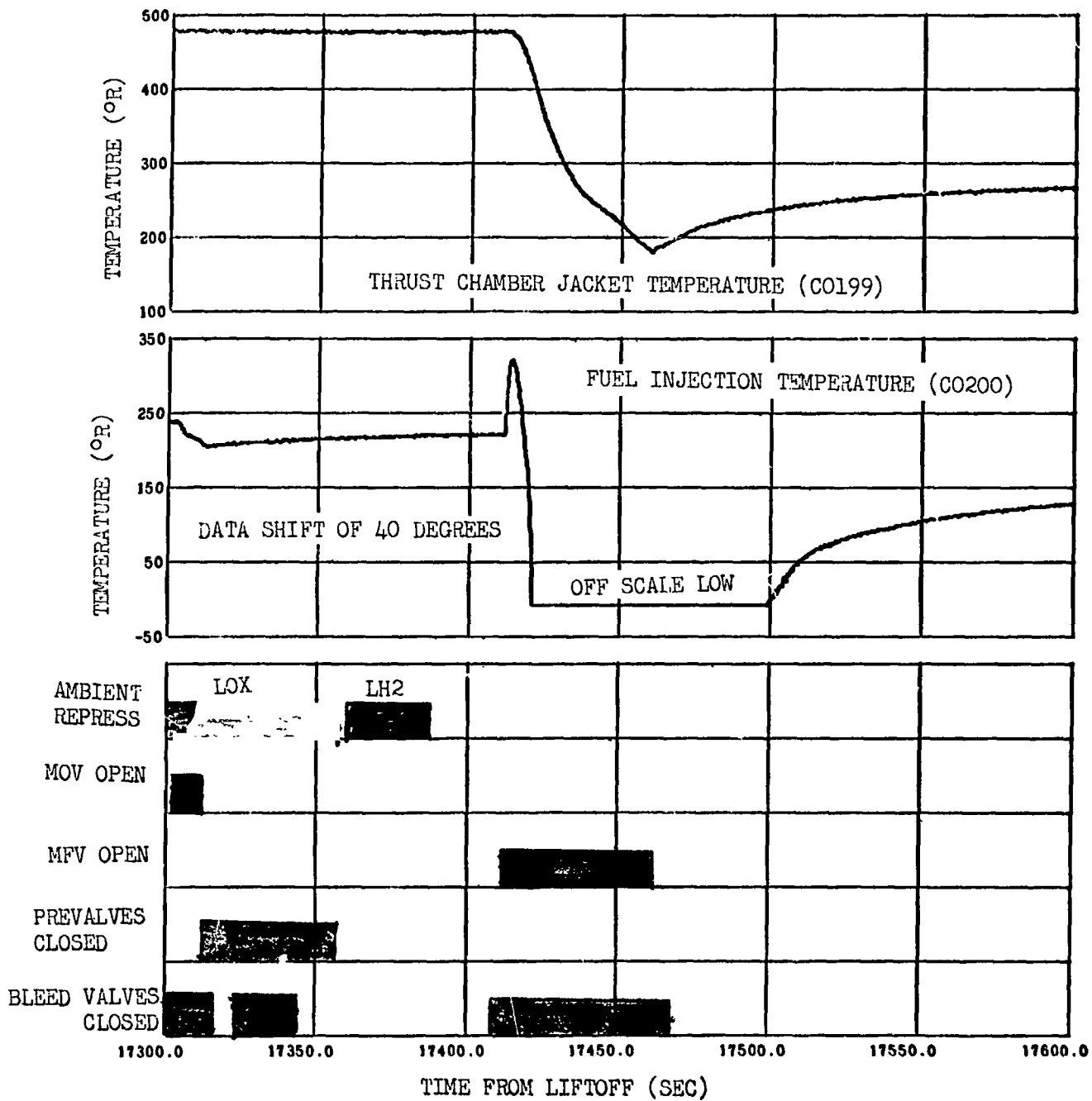

Figure 9-59. Hardware Conditions for Propellant Lead Experiment

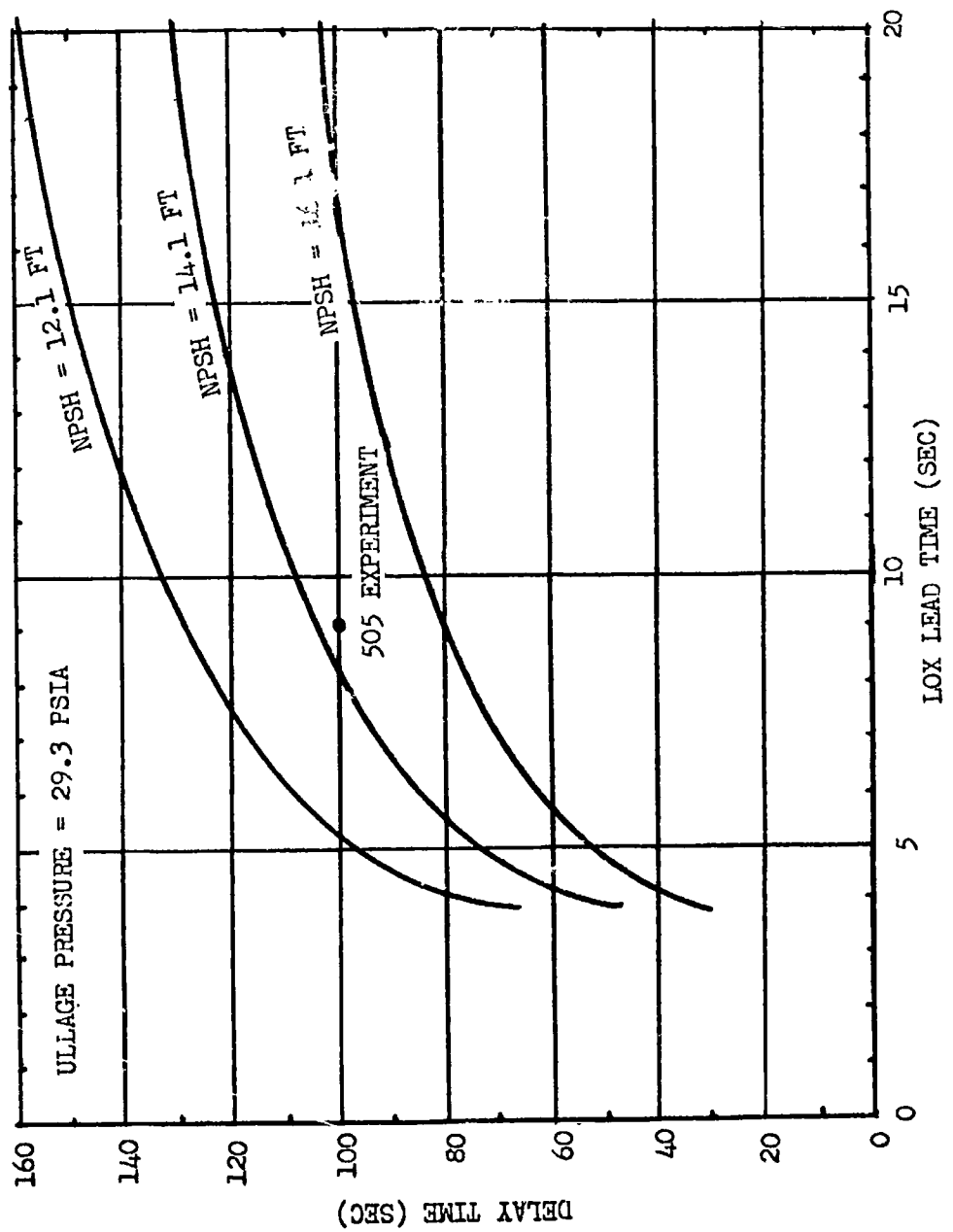

Figure 9-60. LOX Lead Time vs Delay Time vs LOX Inlet NPSH for Experiment

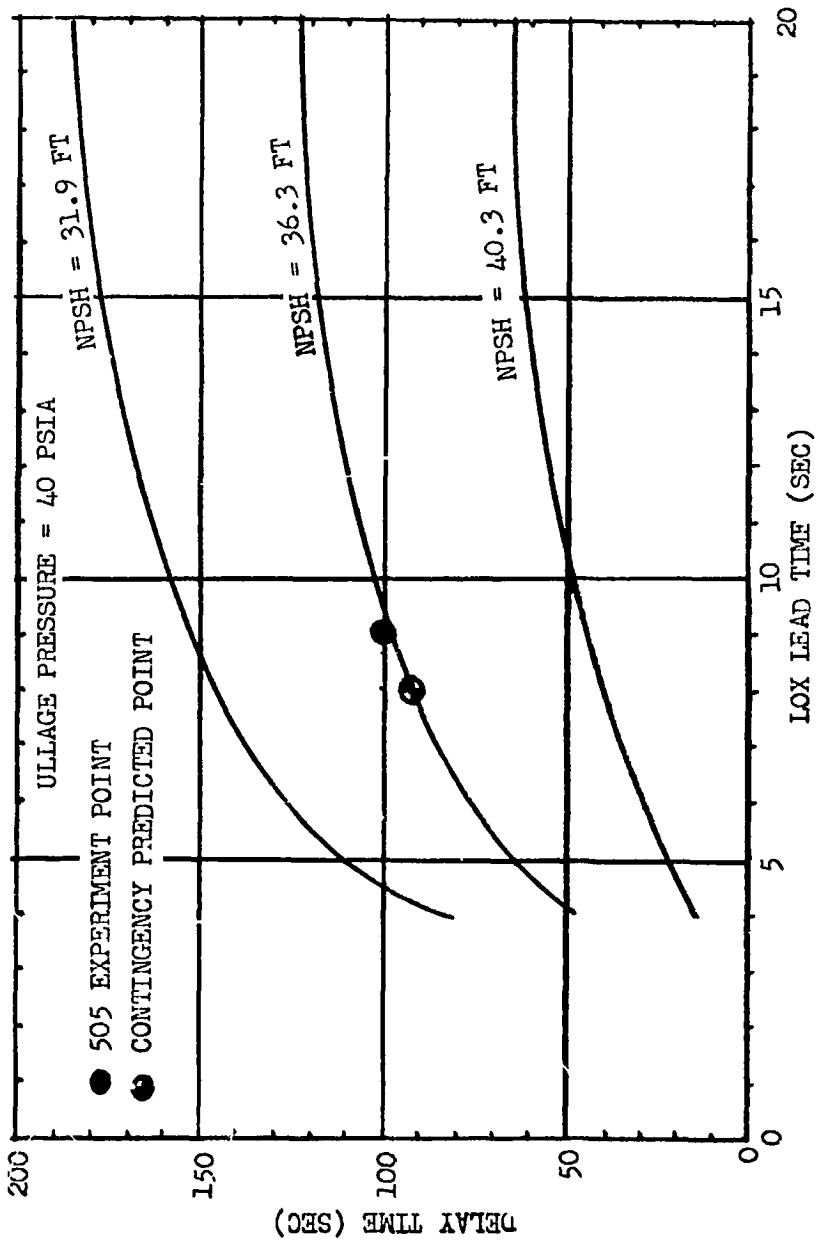

Figure 9-61. LOX Lead Time vs Delay Time vs LOX Inlet NPSH - Contingency Propellant Lead Prediction

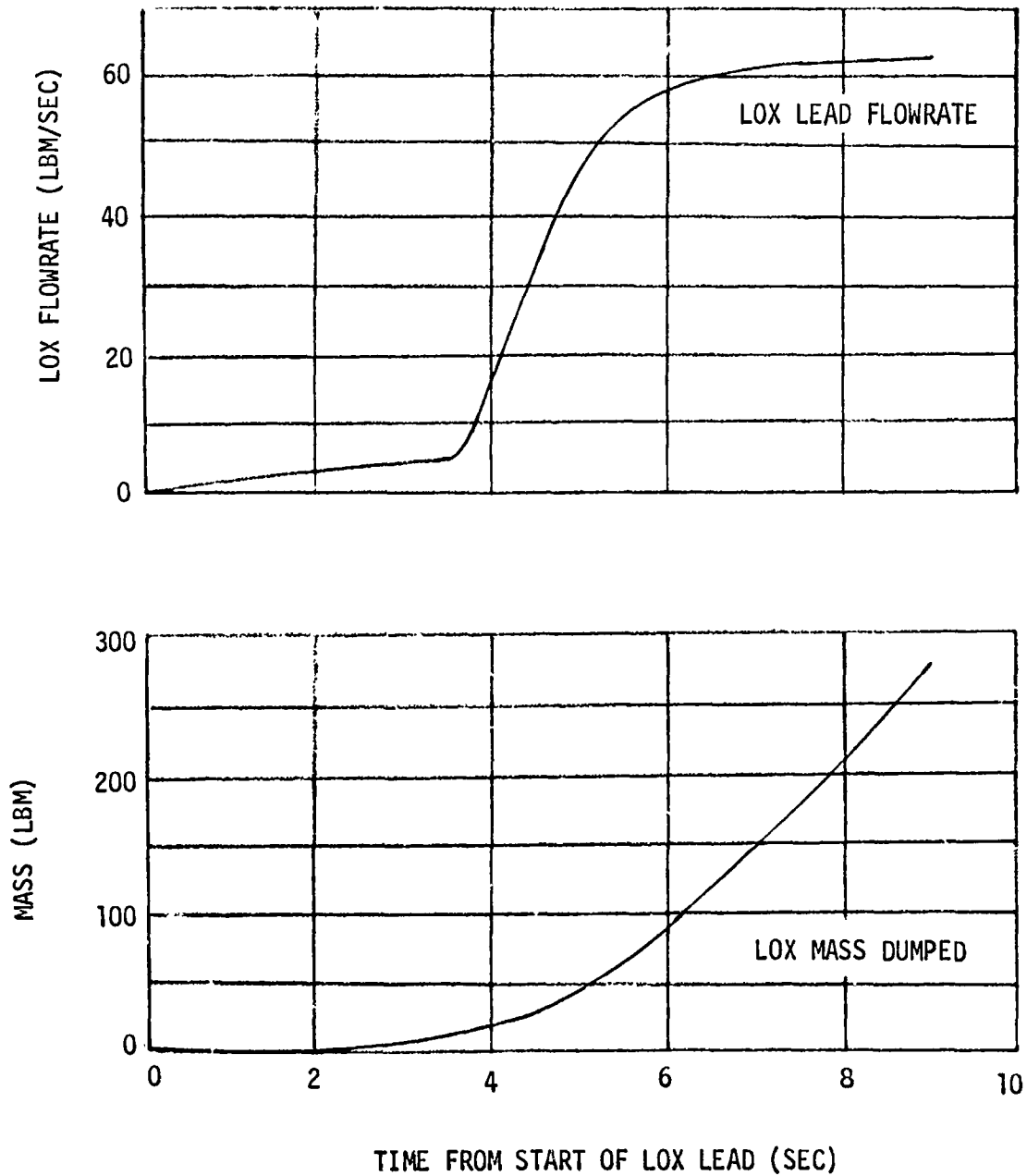

Figure 9-62. LOX Lead Flowrate and Mass Overboard

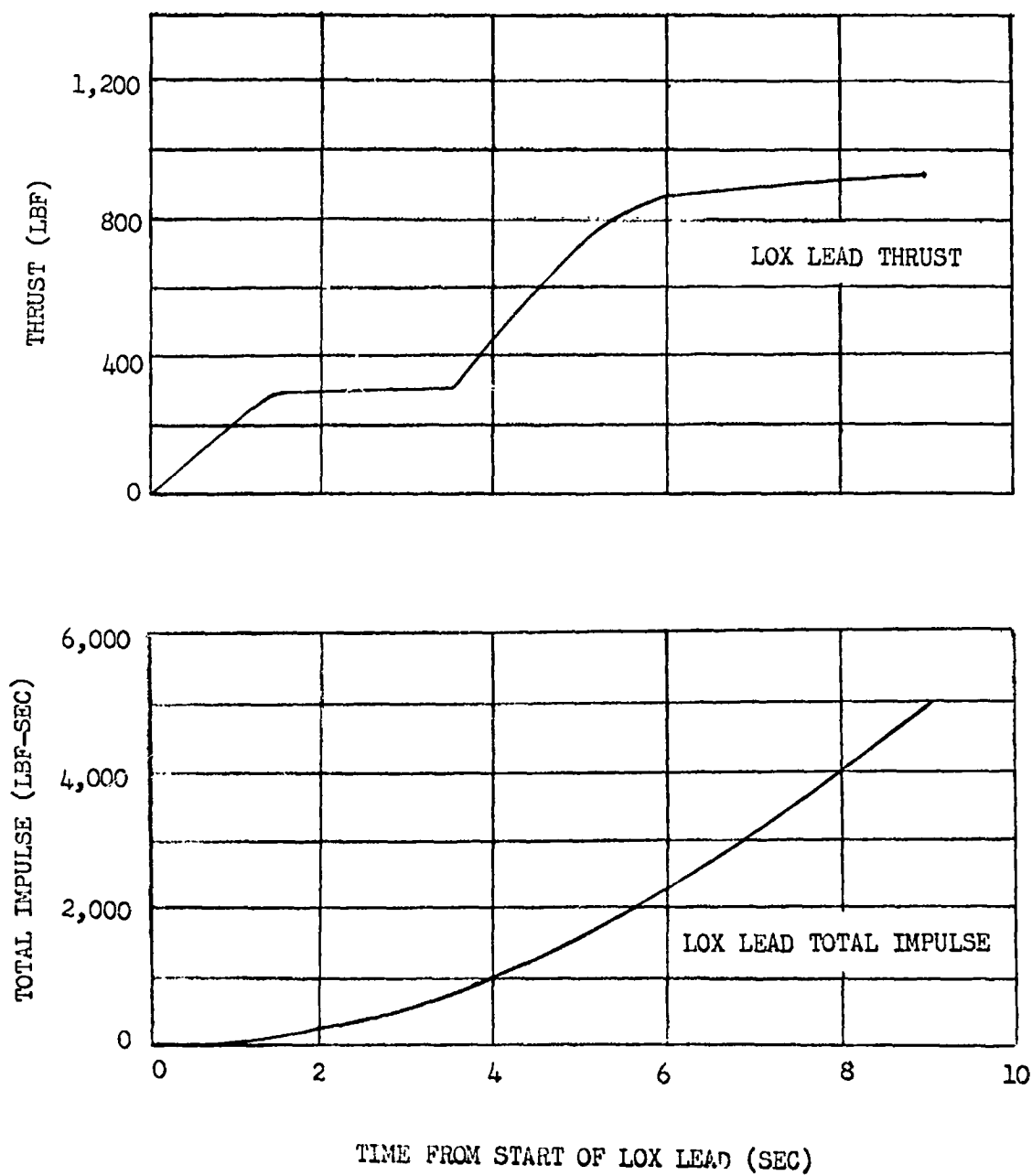

Figure 9-63. LOX Lead Thrust and Total Impulse

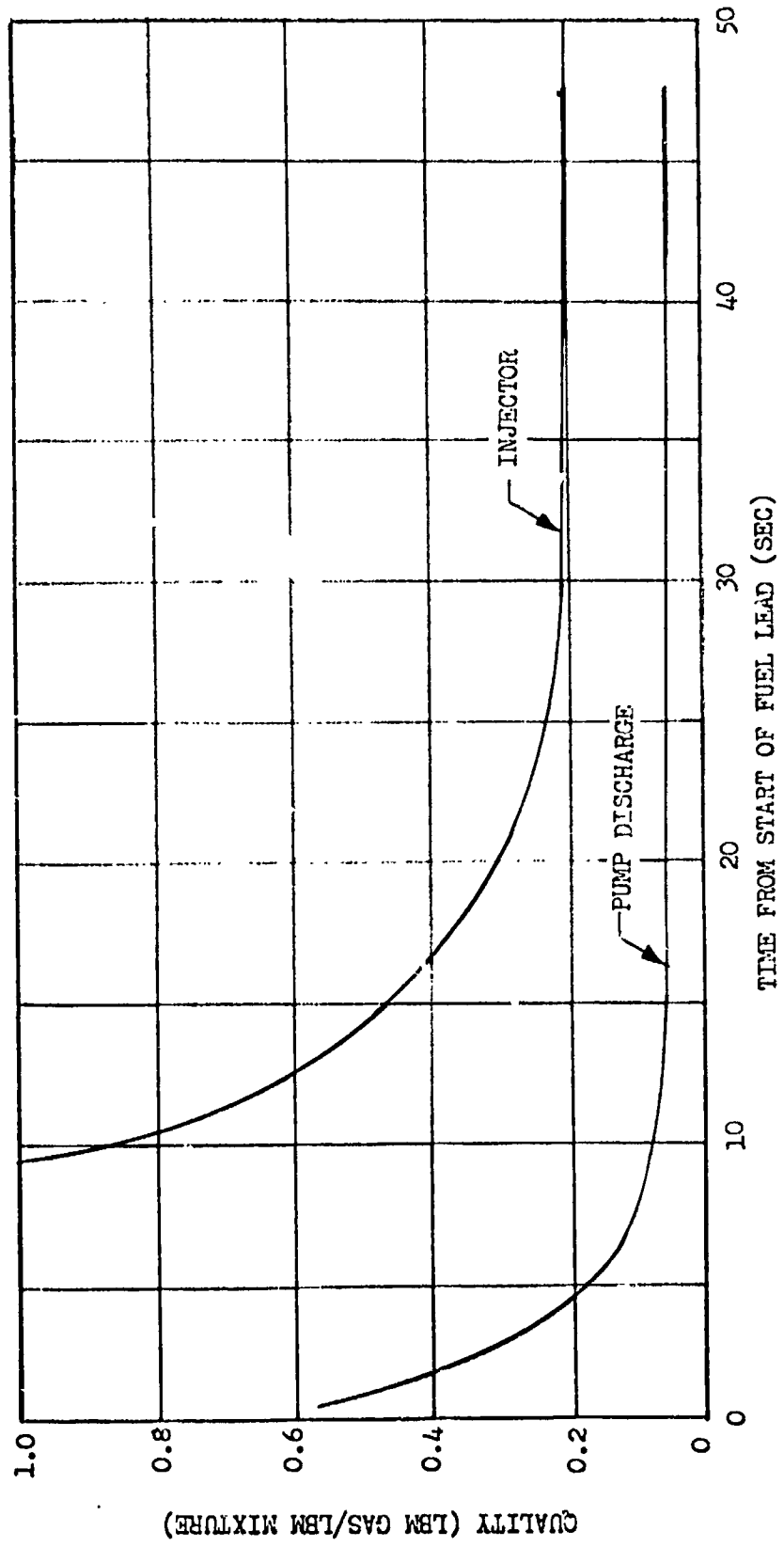

Figure 9-64. Fuel Lead Quality

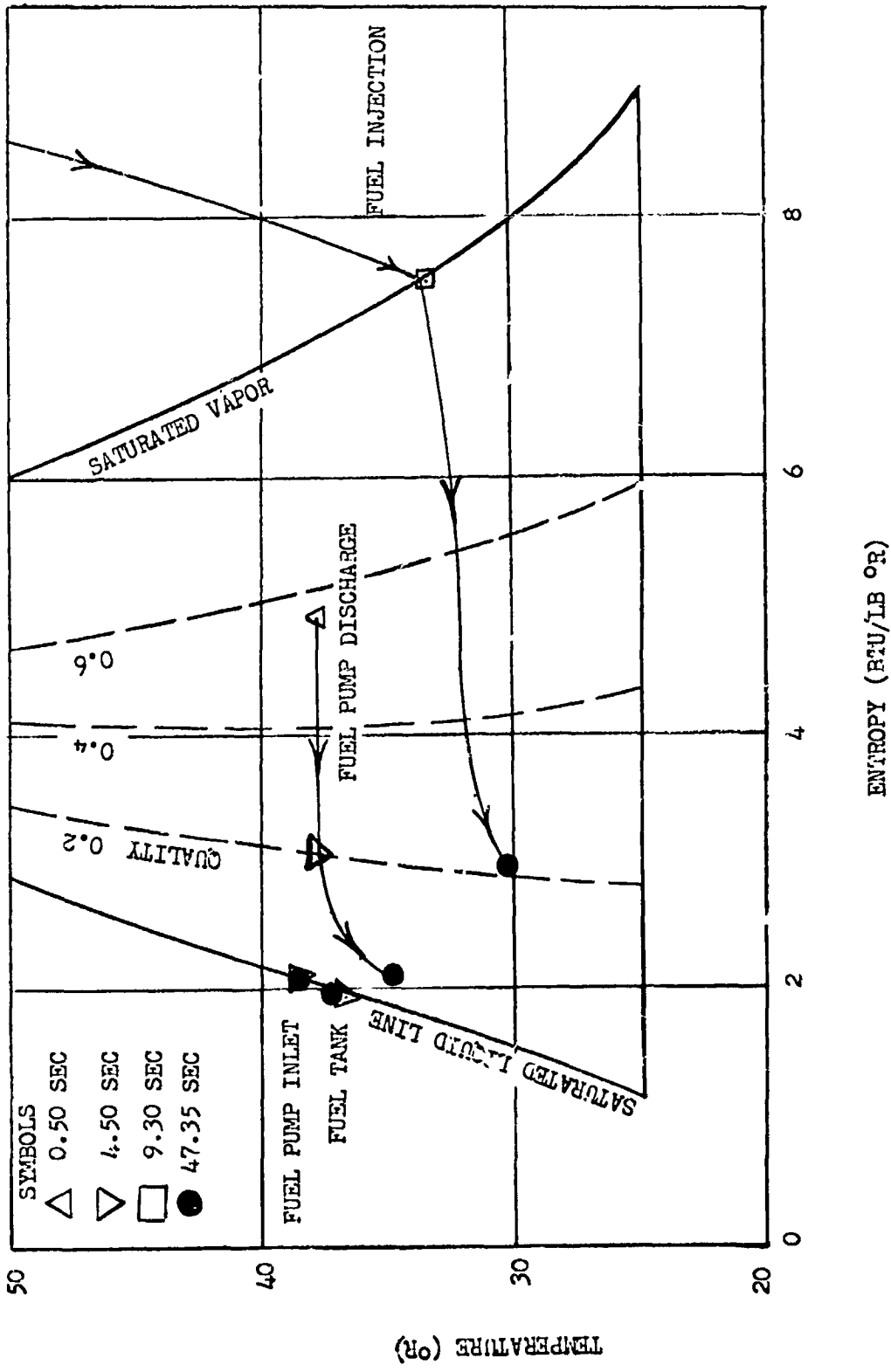

Figure 9-65. Fuel Lead Performance (Temperature-Entropy Diagram)

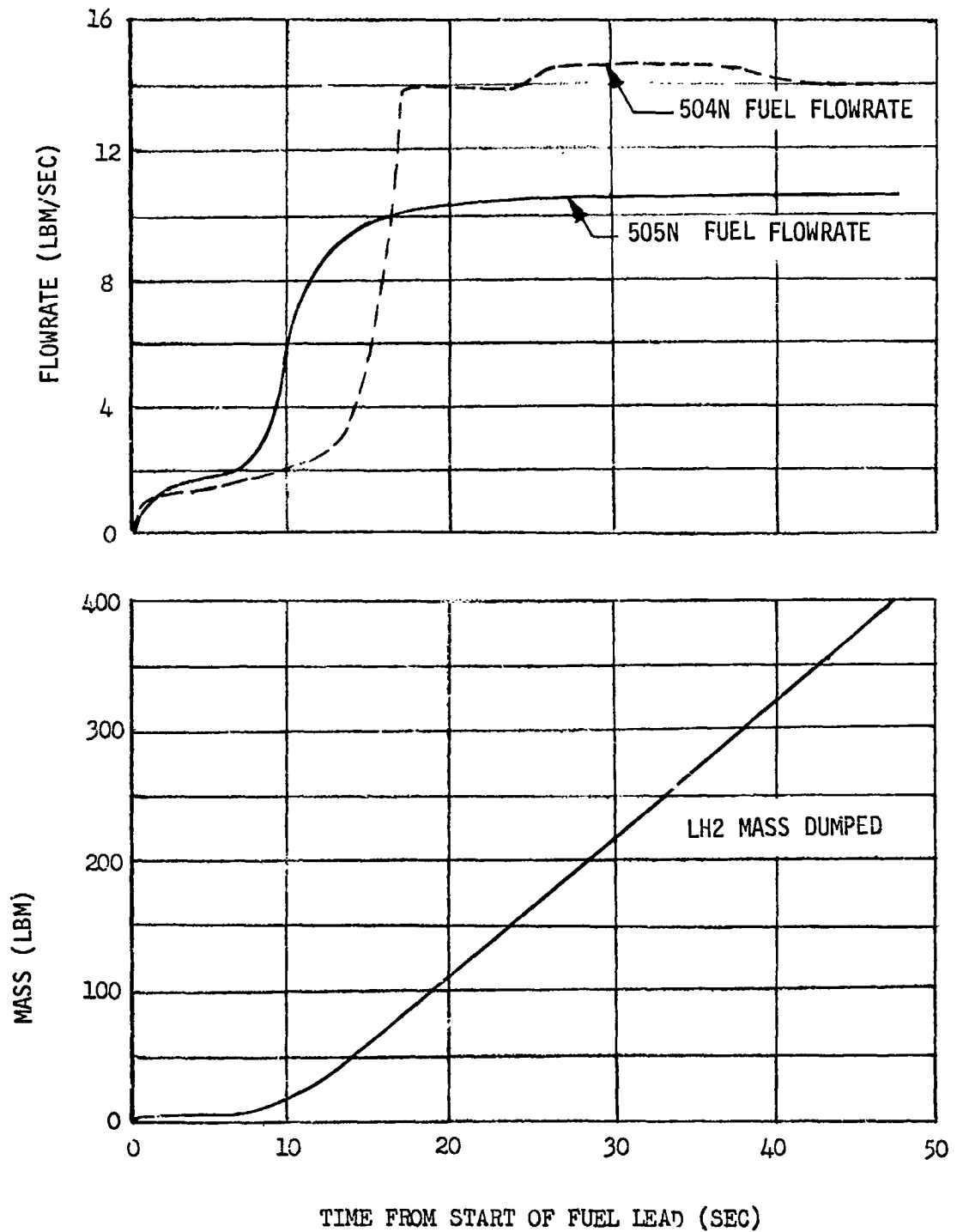

Figure 9-66. Fuel Lead Flowrate and Mass Overboard

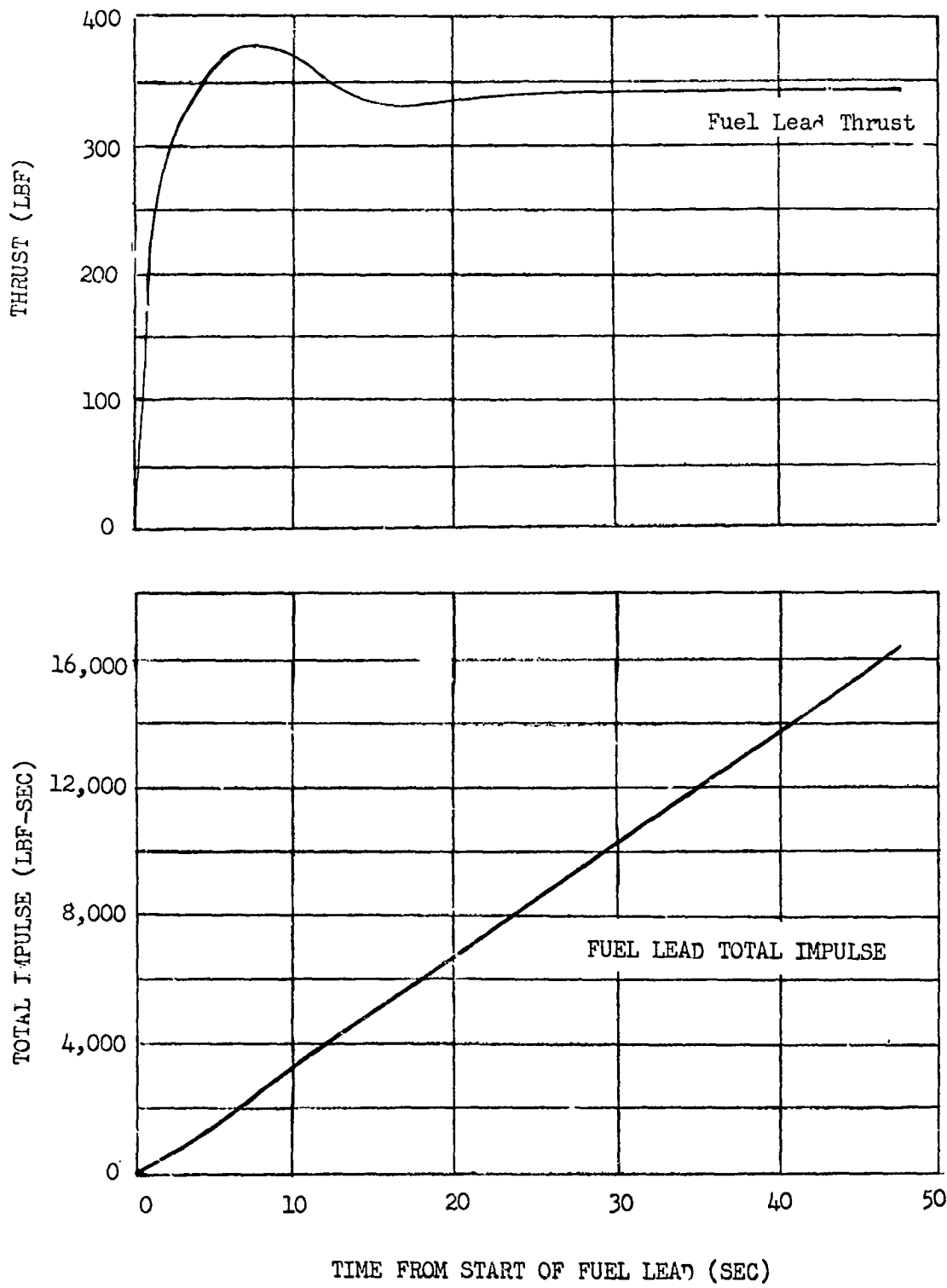
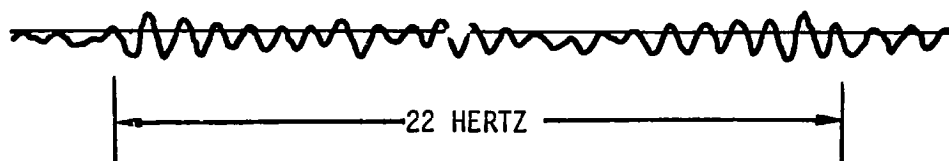

Figure 9-67. Fuel Lead Thrust and Total Impulse

LOX PUMP DISCHARGE PRESSURE (D0009) VARIATION

S-IVB-503N
(TYPICAL)



S-IVB-505N
(ESC₁+70 SEC)

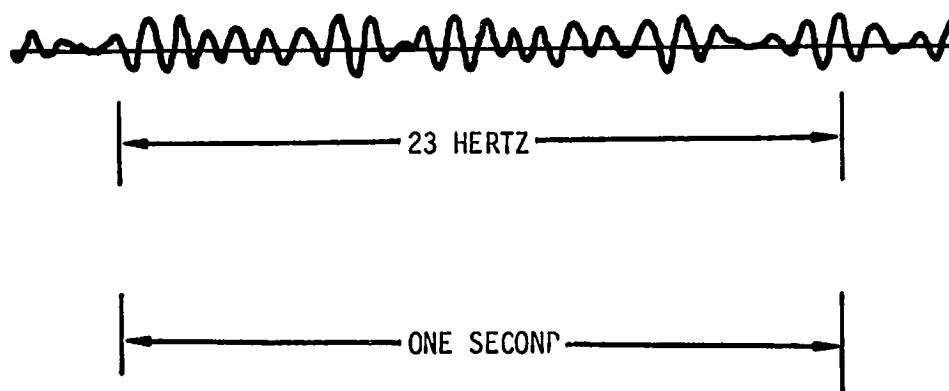

Figure 9-j8. LOX Feed System Stability

10. SOLID ROCKET PERFORMANCE

The solid rocket motors on the AS-505N launch vehicle performed satisfactorily and accomplished their intended purpose. The S-II stage was separated from the S-IVB stage by the retrorockets, and the S-IVB propellants were settled prior to engine start by the ullage rockets.

10.1 Retrorockets

The four retrorockets mounted on the S-IVB stage performed satisfactorily and separated the S-II stage from the S-IVB stage. Neither chamber pressure nor retrorocket event times were recorded. The retrorockets were fired at approximately 553.5 seconds after liftoff as indicated by the telemetry data dropout that has occurred at retrorocket ignition during this and several past tests. The time compares well with 554.79 seconds, the predicted time, since the first and second stage burntime was approximately 1.3 seconds shorter than predicted.

10.2 Ullage Rockets

Ullage rocket performance was satisfactory. The ullage rocket ignition command was given at RO +553.404 seconds, with the jettison command at RO +565.404 seconds. These times compare well with the predicted times of 554.8 and 566.8 seconds, respectively, because of the difference in burntimes discussed previously. No instrumentation existed to measure the chamber pressure of the ullage rockets.

11. OXIDIZER SYSTEM

The oxidizer system performed adequately, supplying LOX to the engine pump inlet within the specified operating limits throughout J-2 engine operation. The NPSP available at the LOX pump inlet exceeded the engine manufacturer's minimum requirement at all times.

The LOX tank was repressurized with ambient helium in preparation for the propellant leak experiment and LOX dump. Propellant dump occurred as predicted, and the LOX tank was adequately safed by latching open the LOX NPV valves.

11.1 LOX Tank Pressurization Control

The LOX tank pressurization system (figure 11-1) satisfactorily maintained pressure in the LOX tank during all periods of the flight. The LOX tank pressurization module regulator performed as expected. The LOX tank pressurization system operated normally during first and second burns. Three overcontrol cycles were required for first burn, instead of the predicted one cycle; none was required during second burn, as predicted.

LOX tank repressurization was not required during the restart preparation period.

11.1.1 First Burn

11.1.1.1 Prepressurization and Boost

The LOX tank was satisfactorily prepressurized within 17 seconds (figure 11-2). Three makeup cycles were required to maintain the LOX tank ullage pressure above the lower pressure switch setting before the ullage temperature stabilized. Table 11-1 compares the prepressurization data from 504N and 503N flights with that from the 505N flight. The ullage pressure increased from 39.8 psia at RO -96 seconds to 42.9 psia at liftoff, due to stage geometric change during LH2 tank prepressurization and to the purges of the LOX vent valve and the LOX pressure sense line.

The LOX ullage pressure decreased during S-IC and S-II boost because of the stage geometric change caused by axial acceleration and because of ullage collapse. The average decay rate was 1.4 and 0.33 psi/min during S-IC and S-II boosts, respectively. At S-IC and S-II cutoffs, the abrupt termination of acceleration caused sharp pressure increases.

A modified pressurization sequence that inhibited makeup cycles during boost was utilized for the second time on 505N. The sequence eliminated the possibility of cold helium depletion prior to first burn that could result if a shutoff valve failed open during a boost makeup cycle. The minimum ullage pressure during boost was 37.2 psia. When the inhibit was removed at RO +496 seconds, a makeup cycle occurred and increased the ullage pressure from 37.2 to 41.6 psia.

11.1.1.2 Pressurization--First Burn

The LOX tank ullage pressure was 39.9 psia at first burn engine start command, satisfying the engine start requirements, and was sufficient throughout S-IVB powered flight to meet the minimum NPSP requirements. The ullage pressure, pressurant flowrate, and related parameters are shown in figure 11-3. Table 11-2 compares the pressurization system performance of 505N flight to that of 504N and 503N flights.

The LOX pressurization system was programmed to the overcontrol mode, and cold helium flow was initiated at STOV -3.5 seconds. The resulting high initial helium flowrate caused the LOX nonpropulsive vent (NPV) and relief valve to relieve four times while maintaining the ullage pressure between 41.7 and 42.7 psia. Pressure switch control of the pressurization mode was enabled at STOV +20 seconds, and three additional overcontrol cycles were required during first burn. The pressurization sequence permitted helium flow to continue for 1.4 seconds after first engine cutoff command, with the overcontrol valve programmed open at ECC₁ +1.2 seconds. The helium added to the LOX tank after first engine cutoff command increased the ullage pressure from 39.4 to 40.3 psia.

11.1.1.3 Cold Helium Supply--First Burn

The cold helium supply was adequate to meet boost and first burn requirements. Due to a preprogrammed inhibit, there was only one makeup cycle, just prior to engine start, using approximately 0.6 lbm of cold helium. Mass calculations based upon sphere temperature and pressure during burn differ slightly (15 percent) from the results obtained from flow integration. This difference is the highest when flowrate through the LOX pressurization overcontrol valve is being calculated. The flowrate calculation method and effective area of the overcontrol valve are under investigation. The cold helium supply system data are presented in table 11-3 and figure 11-4.

11.1.1.4 J-2 Heat Exchanger--First Burn

The J-2 heat exchanger performance data are presented in figure 11-5 and compared to 504N and 503N flight data in table 11-4. A spike was observed in the heat exchanger helium flowrate at $ECC_1 + 1.2$ seconds when the heat exchanger bypass valve was programmed open. The spike, a result of increasing the controlling flow area, is normal for the pressurization sequence used and has been observed on previous flights.

11.1.2 Second Burn

11.1.2.1 Repressurization

LOX tank repressurization was not required for restart because the LOX tank ullage pressure was above the lower pressure switch setting. The ullage pressure was 39.9 psia at second engine start command.

11.1.2.2 Pressurization--Second Burn

The LOX tank pressurization system performed satisfactorily during second burn. The ullage pressure was sufficient to meet minimum NPSP requirements throughout the burn. The ullage pressure and related

pressurization system data are shown in figure 11-6. The system performance for S-IVB-505N flight is compared to that of 504N and 503N flights in table 11-2.

As predicted, no overcontrol cycles were required during second burn; however, the ullage pressure was slightly higher than anticipated at second engine start command and increased as predicted because of low LOX usage during 4.5 EMR operation. At approximately 134 seconds a LOX NPV occurred. Shortly after this an EMR change to 5.0 caused greater LOX usage and the ullage pressure began to increase slowly. At approximately 200 seconds the cold helium sphere pressure dropped to a level that decreased the helium flowrate to the tank. The ullage pressure then

decreased at a more rapid rate, but did not reach the lower pressure switch setting at second engine cutoff.

11.1.2.3 Cold Helium Supply--Second Burn

The cold helium supply was adequate to meet second burn requirements. Mass calculations based upon sphere temperature and pressure during burn were comparable to the results obtained from flow integration. The cold helium supply system data are presented in table 11-3 and figure 11-7.

11.1.2.4 J-2 Heat Exchanger--Second Burn

The J-2 heat exchanger performed satisfactorily during second burn. The performance data are presented in figure 11-8 and compared to 504N and 503N flight data in table 11-4.

An EMR change at ESC₂ +135 seconds caused an increase in heat exchanger outlet temperature, C0009, because of a change in turbine exhaust temperature.

As on first burn, a spike in the heat exchanger helium flowrate occurred during the cutoff sequence because the heat exchanger bypass valve was programmed open before the cold helium flow was terminated.

11.2 Pressurization System Conditions During Coast

11.2.1 LOX Tank Ambient Repressurization

Ambient helium repressurization of the LOX tank was satisfactorily accomplished in preparation for the propellant lead experiment and LOX dump. Repressurization was initiated at approximately RO +17,153 seconds and was terminated 202 seconds later. Helium supply pressure dropped from 2,840 psia to 130 psia while approximately 14.2 lbm of helium were added to the tank ullage. The ullage pressure increased from 25.4 psia to only 29.7 psia because of the large ullage volume (figure 11-9).

11.2.2 LOX Tank Conditions During Coast

The LOX tank pressure and temperatures exhibited normal profiles during Earth orbit and translunar coast (figures 11-10 and 11-11). During orbit a temperature gradient gradually developed in the LOX tank; ullage temperatures decreased in the forward end of the tank, and liquid temperatures increased in the aft end. The liquid remained subcooled until LOX tank venting during passivation.

During translunar coast the ullage pressure increased significantly because of a maneuver to separation attitude at approximately RO +10,450 seconds. The resulting slosh wave increased the temperature of the ullage gas by mixing it with the warmer LOX. The GOX component of the ullage was no longer saturated, and evaporation of LOX occurred until a saturated condition was regained. Because the ullage temperature increased due to contact with warm LOX and the ullage mass increased due to evaporation, the ullage pressure increased from 20.6 to 23.3 psia. Similar but smaller ullage pressure increases occurred at approximately RO +10,962 seconds and RO +14,184 seconds with CSM separation and LM extraction, respectively.

11.2.3 LOX Tank Venting During Coast

The initial blowdown of the LOX tank started at RO +9,551 seconds. The programmed 150-second vent was performed satisfactorily. The ullage pressure dropped from 39 to 19 psia. Tank ullage data are presented in figure 11-11. Tank ullage conditions indicate a homogeneous two-gas mixture in the ullage prior to the vent. Calculations based on these tank conditions indicate that 218 lbm of gas were vented including 48 lbm of helium. At the termination of vent, the ullage consisted of 89 lbm of helium and 320 lbm of GOX.

The LOX NPV valve was programmed permanently open at RO +17,957 seconds. The ullage pressure dropped from 12 psia at the start of venting to 0 psia at RO +21,000 seconds. Final LOX NPV data appear in figure 11-12.

11.2.4 Cold Helium Supply System During Coast

The cold helium sphere conditions for Earth orbit are shown in figure 11-13 and for translunar coast in figure 11-14. No leakage was evident during Earth parking orbit or prior to cold helium dump. The teflon-coated aluminum conoseals appear to have provided a tight system. Cold helium leak check instrumentation further substantiated that no leakage occurred during coast phases.

11.3 LOX Pump Chillover

11.3.1 First Burn

First burn chillover performance was acceptable. Significant data are presented in table 11-5. Plots of stage parameters and calculated values of interest are presented in figures 11-15 and 11-16.

The calculation of steady state heat input to section 1 (tank to pump inlet) was made using the LOX bulk temperature (C0040) and indicated negligible heat input to section 1 prior to liftoff. The LOX bulk temperature was also used for the S-IVB-504N flight calculation and yielded a similar trend, though at a higher heating level due to lower

bulk temperatures. After liftoff, the bulk temperatures decreased to a level that yielded a reasonable heat input to section 1 for chilldown operation during boost.

11.3.2 Second Burn

Second burn chilldown performance was nominal in all respects and did not reflect the apparent deviation noted for boost in the previous paragraph. Significant data are presented in table 11-5; plots of stage parameters and calculated values of interest are presented in figures 11-17 and 11-18.

11.4 Engine LOX Supply

The engine LOX supply system (figure 11-19) delivered the necessary quantity of LOX to the engine during first and second burns.

11.4.1 First Burn

The NPSP at the LOX pump inlet was well above that required at first engine start command and throughout first burn. The pump inlet conditions are presented in figure 11-20. A correlation between the inlet temperature and pressure indicates that the pump inlet conditions were within the LOX pump operating region (figure 11-21). The effect of decreasing LOX mass on pump inlet temperature is shown in figure 11-22.

11.4.2 Second Burn

The NPSP at the LOX pump inlet was well above that required at second engine start command and throughout second burn. The pump inlet conditions are presented in figure 11-23. A correlation between the inlet temperature and pressure indicates that the pump inlet conditions were within the operating region (figure 11-24). The effect of decreasing LOX mass on the pump inlet temperature is shown in figure 11-22.

TABLE 11-1
LOX TANK PREPRESSURIZATION DATA

PARAMETER	S-IVB-505N FLIGHT	S-IVB-504N FLIGHT	S-IVB-503N FLIGHT
Prepressurization duration (sec)	17	22	17
Number of makeup cycles from GSE	3	3	3
Number of makeup cycles during boost	1*	1*	2
Prepressurization helium			
Flowrate (lbm/sec)	0.31	0.33	0.28**
Mass added to LOX tank during Prepressurization (lbm)	5.4	7.2	4.7**
Mass added to LOX tank during GSE makeup cycles (lbm)	2.1	2.6	1.3
Ullage pressure			
At prepressurization initiation (psia)	15.3	15.2	15.3
At prepressurization termination (psia)	41.1	40.8	40.5
At liftoff (psia)	42.9	41.0	41.8
At pressurization initiation (psia)	39.9	40.0	39.2
Events (sec from liftoff)			
Prepressurization initiation	-167	-167	-167
Prepressurization termination	-150	-145	-150
Engine start command	553.6	537.3	525.0
Pressurization initiation	553.1	536.7	524.5

*Makeup cycles were inhibited during boost until approximately 49 seconds after liftoff.

**These values are approximately 10 percent high because the orifice temperatures were off scale high throughout the prepressurization period.

TABLE 11-2
LOX TANK PRESSURIZATION DATA

PARAMETER	S-IVB-505N FLIGHT		S-IVB-504N FLIGHT		S-IVB-503N FLIGHT	
	FIRST BURN	SECOND BURN	FIRST BURN	SECOND BURN	THIRD BURN	SECOND BURN
Number of secondary flow intervals*	4	0	5	0	0	0
Pressure control band						
Minimum (psia)	38.5	N/A	38.2	N/A	N/A	N/A
Maximum (psia)	40.3	N/A	40.0	N/A	N/A	N/A
Ullage pressure						
At engine start command (psia)	40.8	39.9	40.8	42.3	41.5	39.0
At engine cutoff command (psia)	39.4	38.8	40.1	40.7	42.2	38.4
Pressurant total flowrate						
During undercontrol (lbm/sec)	0.26 to 0.35	0.27 to 0.45	0.26 to 0.32	0.22 to 0.33	0.30 to 0.43	0.27 to 0.36
During overcontrol (lbm/sec)	0.36 to 0.43	N/A	0.36 to 0.42	N/A	N/A	0.40 to 0.42

N/A - Not applicable

*Includes the programmed overcontrol cycle during the start transient.

TABLE 11-3
COLD HELIUM SUPPLY DATA

PARAMETER	S-IVB-505N FLIGHT		S-IVB-504N FLIGHT		S-IVB-503N FLIGHT	
	FIRST BURN	SECOND BURN	FIRST BURN	SECOND BURN	THIRD BURN	SECOND BURN
Pressure						
At liftoff (psia)	3,050	N/A	3,090	N/A	N/A	N/A
At engine start command (psia)	3,020	1,420	3,010	1,550	1,393	1,350
At engine cutoff command (psia)	1,630	525	1,850	1,213	608	560
Average Temperature						
At liftoff (deg R)	38.6	N/A	39.3	N/A	N/A	N/A
At engine start command (deg R)	38.7	34.0	38.8	34.0	36.1	33.2
At engine cutoff command (deg R)	31.6	34.2	32.1	30.8	31.8	41.0
Helium Mass						
At engine start command (lbm)	376	297	379	309	286.9	297
At engine cutoff command (lbm)	323	163	332	291.6	207.0	184
Usage calculated from sphere conditions (lbm)	53	134	47	17.4	79.9	113
Usage calculated by integration of flowrate (lbm)	49.7	137	41.9	15.3	93	124

N/A Not applicable

TABLE 11-4
J-2 HEAT EXCHANGER PERFORMANCE DATA

	S-IVB-505N FLIGHT		S-IVB-504N FLIGHT			S-IVB-503N FLIGHT	
	FIRST BURN	SECOND BURN	FIRST BURN	SECOND BURN	THIRD BURN	FIRST BURN	SECOND BURN
Flowrate through heat exchanger							
During overcontrol (lbm/sec)	0.20	N/A	0.20	N/A	N/A	0.21	N/A
During undercontrol (lbm/sec)	0.09	0.07 to 0.11	0.085	0.095	0.085 to 0.105	0.09	0.09
Heat exchanger inlet temperature							
During overcontrol (°R)	73	N/A	73	N/A	N/A	65	N/A
During undercontrol (°F)	70	47	86	75	53	60	40
Minimum (°R)	70	45	76	72	48	48	35
Heat exchanger outlet temperature							
An end of 50-sec transient (°R)	900	825	965	900	900	875	865
During overcontrol (°R)	930	N/A	1005	N/A	N/A	870	N/A
During undercontrol (°R)	975	985	1020	925	930	925	930
At engine cutoff command (°R)	975	985	1010	925	740	930	940
Heat exchanger outlet pressure							
During overcontrol (psia)	340	N/A	340	N/A	N/A	335	N/A
During undercontrol (psia)	400	415 to 335	390	400	400	400	405 to 320
Average LOX vent inlet pressure							
During overcontrol (psia)	59	N/A	63	N/A	N/A	60	N/A
During undercontrol (psia)	49	51	50	50	51	51	50
Maximum LOX vent inlet temperature (°R)	430	390	458	369	340	420	370

TABLE 11-5

LOX CHILLDOWN SYSTEM PERFORMANCE DATA (Sheet 1 of 3)

Parameter	S-IVB-505N Flight		S-IVB-504N Flight		S-IVB-503N Flight	
	First Burn	Second Burn	First Burn	Second Burn	First Burn	Second Burn
NFSP						
At engine start command						
With chill pump head (psi)	26.9	N/A	25.0	N/A	25.8	N/A
Without chill pump head (psi)	24.9	22.9	23.0	24.0	23.8	22.0
Minimum required at engine start (psi)	12.8	12.8	12.8	12.8	12.8	12.8
At prevalve open command (psi)	43.1	31.2	41.2	32.5	45.2	32.0
Pump inlet conditions						
Pressure at engine start command						
With chill pump head (psia)	43.4	N/A	43.5	N/A	41.7	N/A
Without chill pump head (psia)	41.4	40.5	41.5	42.3	39.7	39.8
Temperature at engine start command (deg R)	164.5	165.4	165.0	166.2	164.5	165.5
Average flow coefficient (sec ² /in ² -ft ²)	16.0	16.0	17.6	17.6	17.9	17.9
Heat absorption rate (Btu/hr)						
Section 1 (tank to pump inlet)						
Ground	0	N/A	2,700	N/A	2,500	N/A
Boost-Orbit	6,000	0	9,000	6,200	0	0

*The high NFSP and pump inlet pressure are due to the chill pump head.
N/A Not applicable

TABLE 11-5
LOX CHILLDOWN SYSTEM PERFORMANCE DATA (Sheet 2 of 3)

Parameter	S-IVB-505N Flight		S-IVB-504N Flight		S-IVB-503N Flight	
	First Burn	Second Burn	First Burn	Second Burn	First Burn	Second Burn
Section 2 (pump inlet to bleed valve)						
Ground	30,000	N/A	42,000*	N/A	25,000	N/A
Boost-Orbit	12,000	17,000	9,500*	5,000*	7,000	12,500
Section 3 (bleed valve to tank inlet)						
Ground	14,000	N/A	*	*	2,500	N/A
Boost-Orbit	9,000	13,000	*	*	500	1,000
Total						
Ground	44,000	N/A	44,700	N/A	30,000	N/A
Boost-Orbit	27,000	30,000	28,500	11,200	7,500	13,500
Chilldown flowrate						
Unpressurized (gpm)	40.2	N/A	40.0	N/A	39.9	N/A
Pressurized (gpm)	43.5	43.5	42.0	42.0	41.7	42.0
Chilldown system pressure drop						
Unpressurized (psi)	9.5	N/A	9.5	N/A	10.2	N/A
Pressurized (psi)	10.2	10.0	10.0	10.0	10.8	12.0

*Heat inputs for sections 2 and 3 were combined because temperature transducer C0013, LOX bleed valve temperature, was not on the stage.

N/A Not applicable

TABLE 11-5
LOX CHILLDOWN SYSTEM PERFORMANCE DATA (Sheet 3 of 3)

Parameter	S-IVB-505N Flight		S-IVB-504N Flight		S-IVB-503N Flight	
	First Burn	Second Burn	First Burn	Second Burn	First Burn	Second Burn
Events (sec from liftoff)						
Chiltdown initiation	-299.534	-320.980	-289.306	-321.012	-289.062	-321.021
Prevalve closed	-284.007	-310.981	-283.794	-310.398	-284.064	-310.399
Prepressurization initiation*	-166.564	N/A	-166.554	N/A	-166.590	N/A
Prevalve open command	552.922	-10.598	536.514	-10.067	524.315	-10.615
Prevalve closed signal dropout	553.748	-9.523	537.481	-9.421	525.162	-9.418
Prevalve open signal pickup	555.165	-7.773	539.064	-7.504	526.745	-7.630
Chiltdown pump off	553.304	-0.391	536.956	-0.384	524.690	-0.416
Engine start command	553.621	0	537.264	0	524.998	0

*Repressurization on second burn
N/A Not applicable

TABLE 11-6
LOX PUMP INLET CONDITION DATA (Sheet 1 of 2)

Parameter	S-IVB-505N Flight		S-IVB-504N Flight		S-IVB-503N Flight	
	First Burn	Second Burn	First Burn	Second Burn	First Burn	Second Burn
Pump Inlet Conditions						
Static pressure at engine start command						
With chilldown pump head (psi)	43.4	N/A	43.5	N/A	41.7	N/A
Without chilldown pump head (psi)	41.4	40.5	41.5	42.3	39.7	39.8
Temperature at engine start command (deg R)	164.5	165.4	165.0	166.2	164.5	165.5
Temperature at engine cutoff command (deg R)	165.4	165.2	164.8	165.8	164.4	165.7
NPSP Requirements						
Minimum at engine start command (psi)	12.8	12.8	12.8	12.8	12.8	12.8
At high EMR (psi)*	N/A	N/A	20.3	N/A	N/A	N/A
After EMR cutback (psi)*	15.2	15.2	N/A	15.2	15.2	15.1
NPSP Available						
At engine start command (psi)						
With chilldown pump head (psi)	26.9	N/A	25.0	N/A	25.8	N/A
Without chilldown pump head (psi)	24.9	22.9	23.0	24.0	23.8	22.0
At start tank discharge valve open command (psi)	26.9	23.1	25.3	23.8	27.0	21.7

* These requirements are variable with acceleration. The values presented are maximum. Figures 11-10 and 11-11 graphically display the requirement.
N/A Not applicable

TABLE 11-6

LOX PUMP INLET CONDITION DATA (Sheet 2 of 2)

Parameter	S-IVB-505N Flight		S-IVB-504N Flight		S-IVB-503N Flight	
	First Burn	Second Burn	First Burn	Second Burn	First Burn	Second Burn
Maximum during firing (psi)	29.8	28.5	29.6	29.8	29.7	26.8
Time of maximum (sec from ESC)	14.0	13.0	8	30	18.0	29.5
Minimum during firing (psi)	25.1	22.5	24.0	22.9	24.5	22.8
Time of minimum (sec from ESC)	93	7.5	34	9	51.5	324.0
At engine cutoff command (psi)	26.1	24.5	25.5	27.4	26.5	22.8
LOX Feed Duct						
At 5.0:1 EMR						
Pressure drop (psi)	1.3	1.7	N/A	2.1	1.9	2.0
Flowrate (lbm/sec)	402	401	N/A	399	393	391
At 4.5:1 EMR						
Pressure drop (psi)	N/A	0.7	N/A	N/A	N/A	N/A
Flowrate (lbm/sec)	N/A	329	N/A	N/A	N/A	N/A

N/A Not applicable

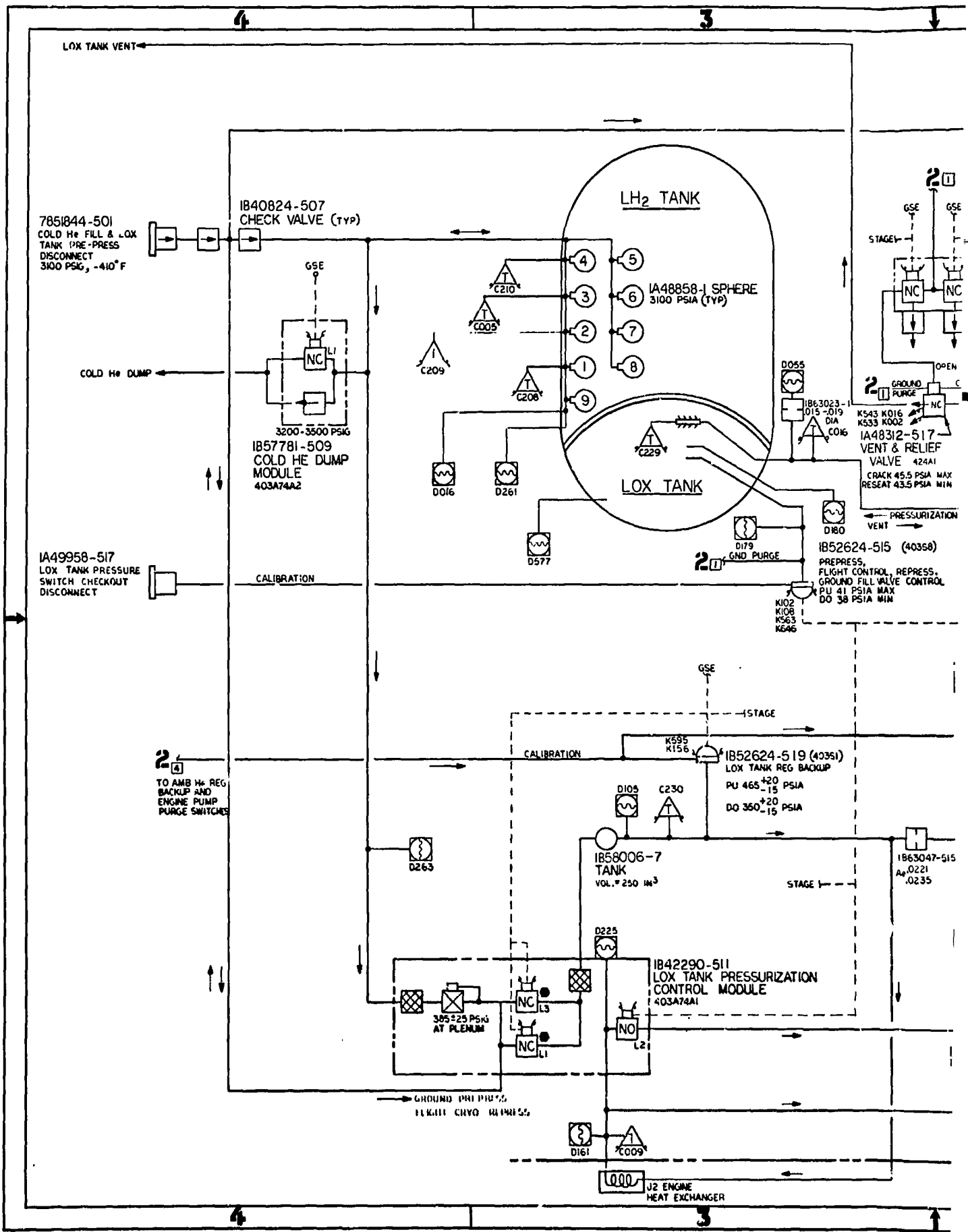

FOLDOUT FRAME

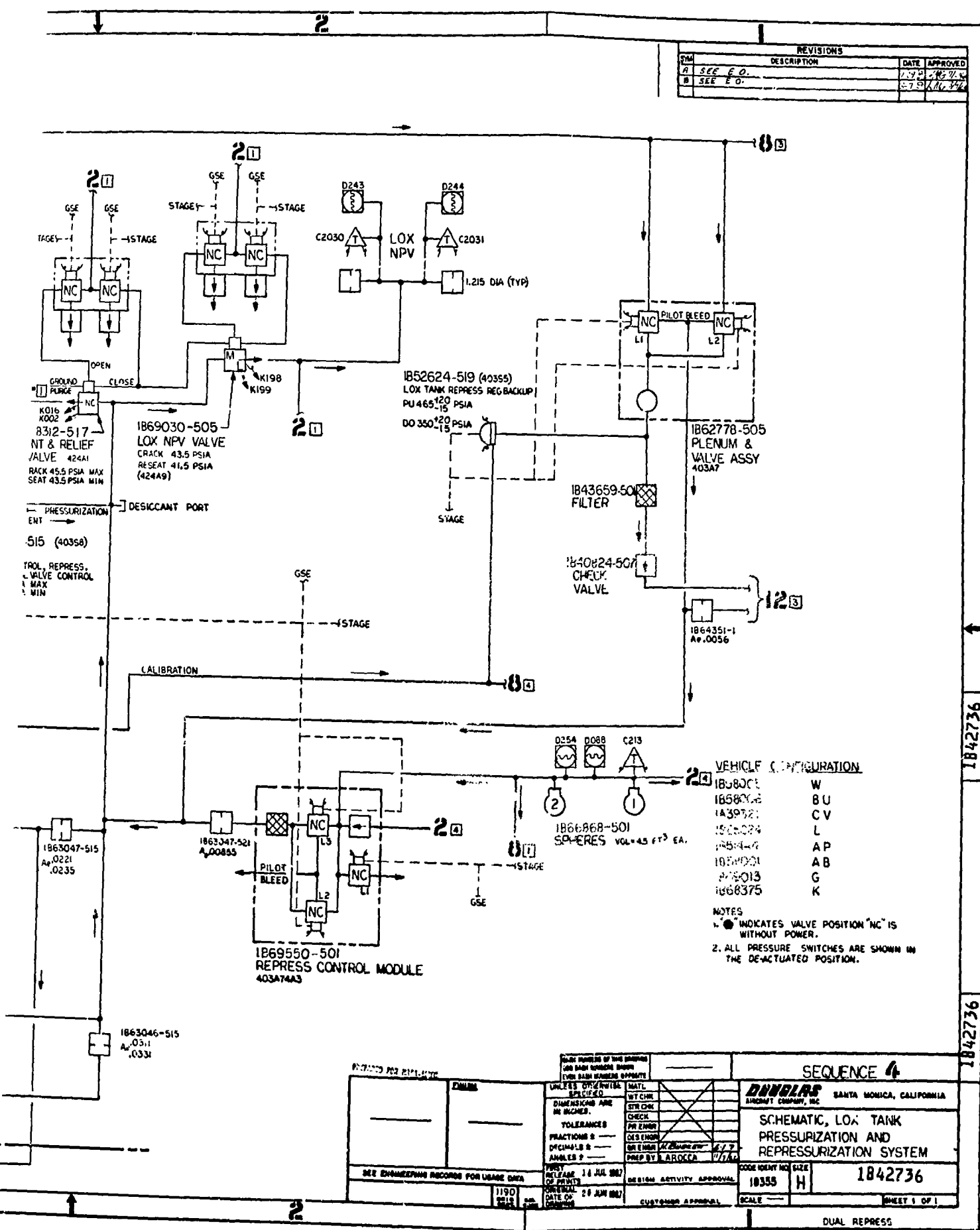

REVISIONS			
SYM	DESCRIPTION	DATE	APPROVED
A	SEE E.O.	1-27-54	[Signature]
B	SEE E.O.	2-7-54	[Signature]

VEHICLE CONFIGURATION

1868001	W
1868002	BU
1839721	CV
1828024	L
1854442	AP
1834001	AB
185013	G
1868375	K

NOTES
 1. ● INDICATES VALVE POSITION "NC" IS WITHOUT POWER.
 2. ALL PRESSURE SWITCHES ARE SHOWN IN THE DEACTUATED POSITION.

DRAWING FOR REVISIONS		PART NUMBER OF THE DRAWING AND PART NUMBER SHOWN EVEN PART NUMBER OPPOSITE		SEQUENCE 4	
UNLESS OTHERWISE SPECIFIED		MATERIAL		DUNLAP SANTA MONICA, CALIFORNIA	
DIMENSIONS ARE IN INCHES		WT. CHK		18355	
TOLERANCES		STR. CHK		H	
FRACTIONS 1/16		CHECK		1842736	
DECIMALS 1/1000		PR. ENGR		10355	
ANGLES 1/16		DES. ENGR		H	
PREP BY AROCCA		DR. ENGR		1842736	
PREP BY AROCCA		PREP BY AROCCA		1842736	
DESIGN ACTIVITY APPROVAL		DESIGN ACTIVITY APPROVAL		1842736	
CUSTOMER APPROVAL		CUSTOMER APPROVAL		1842736	
SEE ENGINEERING RECORDS FOR USAGE DATA		SEE ENGINEERING RECORDS FOR USAGE DATA		1842736	
1190		1190		1842736	
DATE OF CHANGE		DATE OF CHANGE		1842736	
DATE OF CHANGE		DATE OF CHANGE		1842736	

Figure 11-1. Schematic, LOX Tank Pressurization and Re-pressurization System
 FOLDOUT FRAME 2 11-17

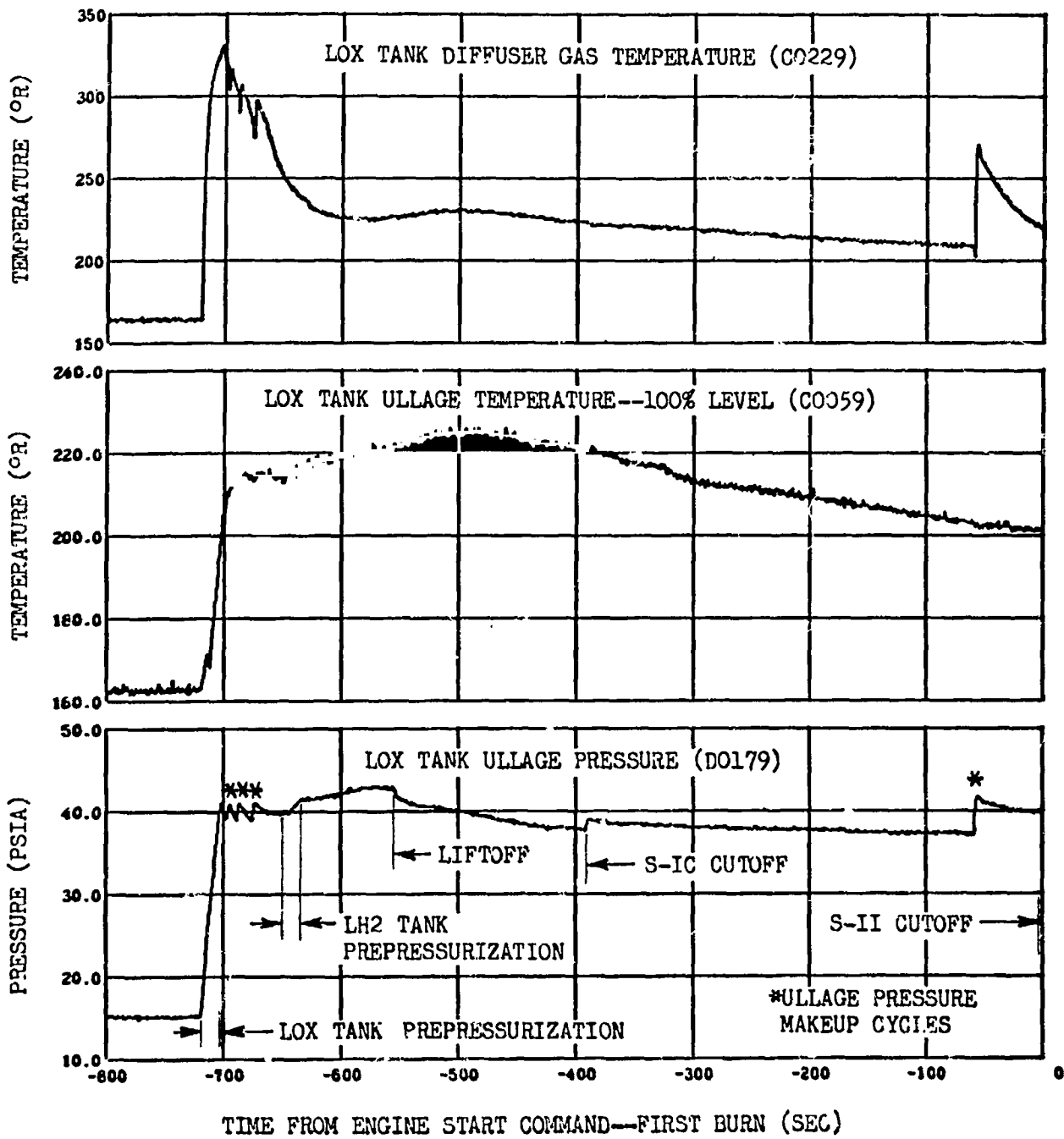

Figure 11-2. LOX Tank Conditions During Prepressurization and Boost (Sheet 1 of 2)

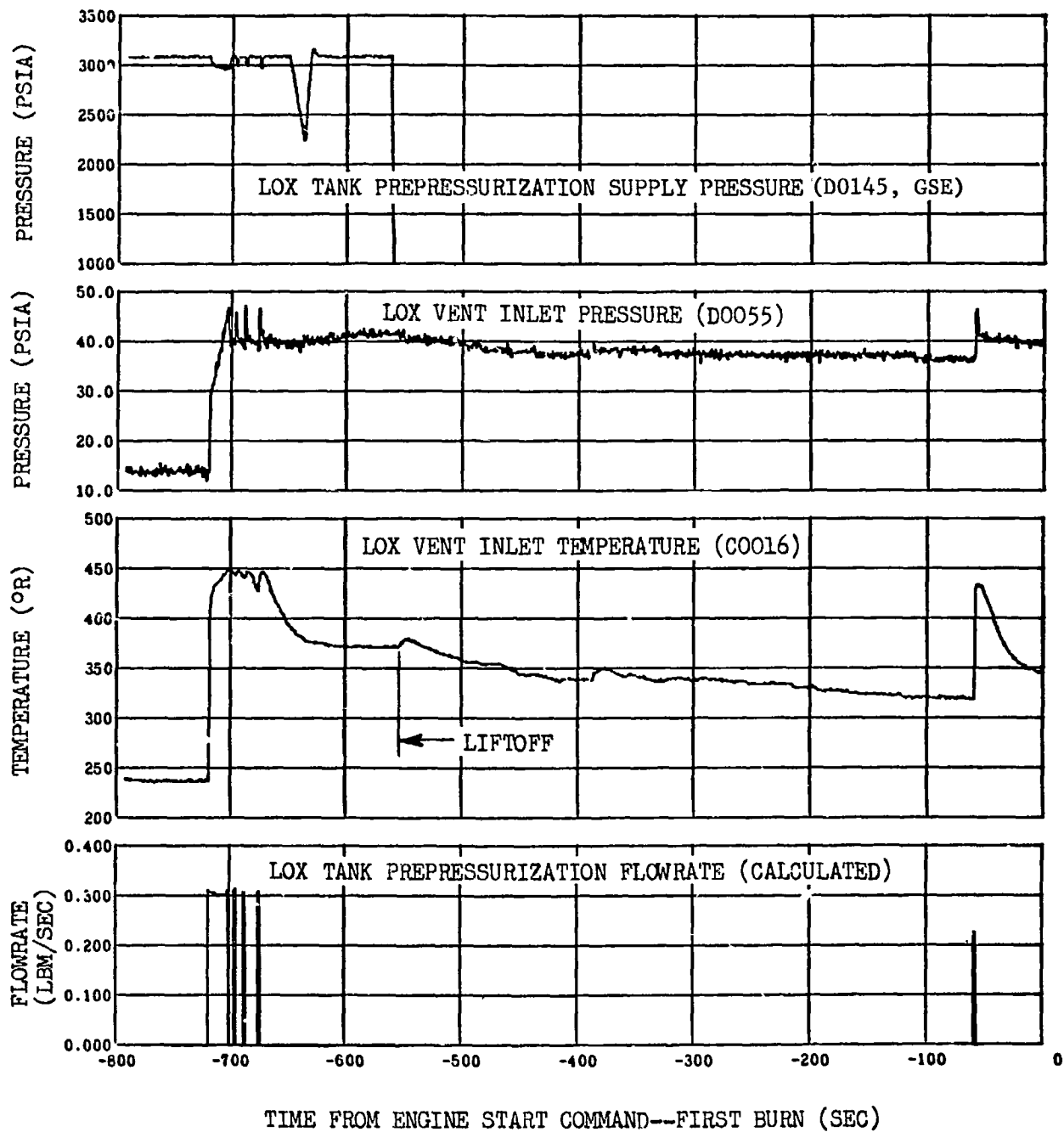

Figure 11-2. LOx Tank Conditions During Prepressurization and Boost (Sheet 2 of 2)

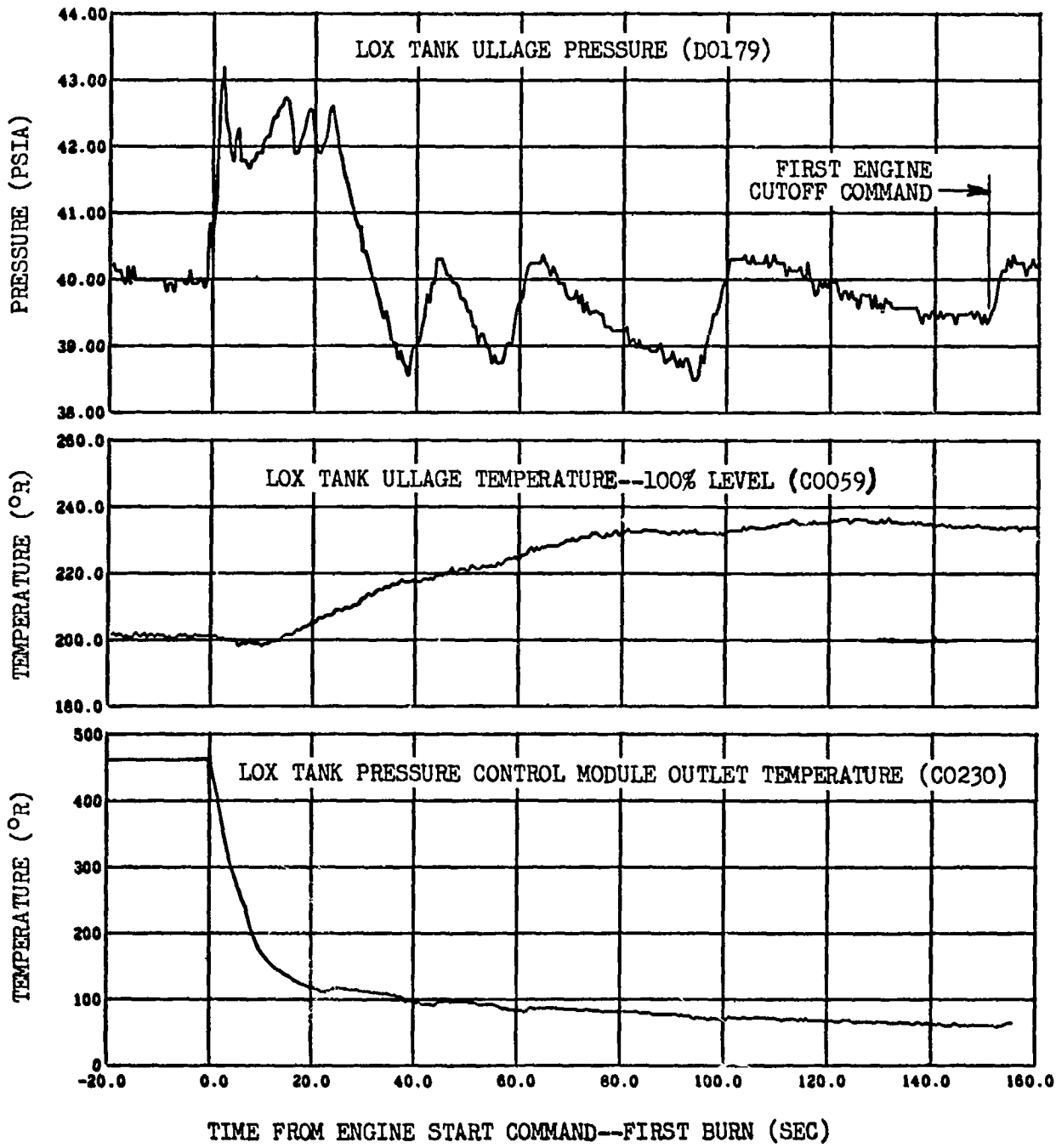

Figure 11-3. LOX Tank Pressurization System Performance--First Burn (Sheet 1 of 2)

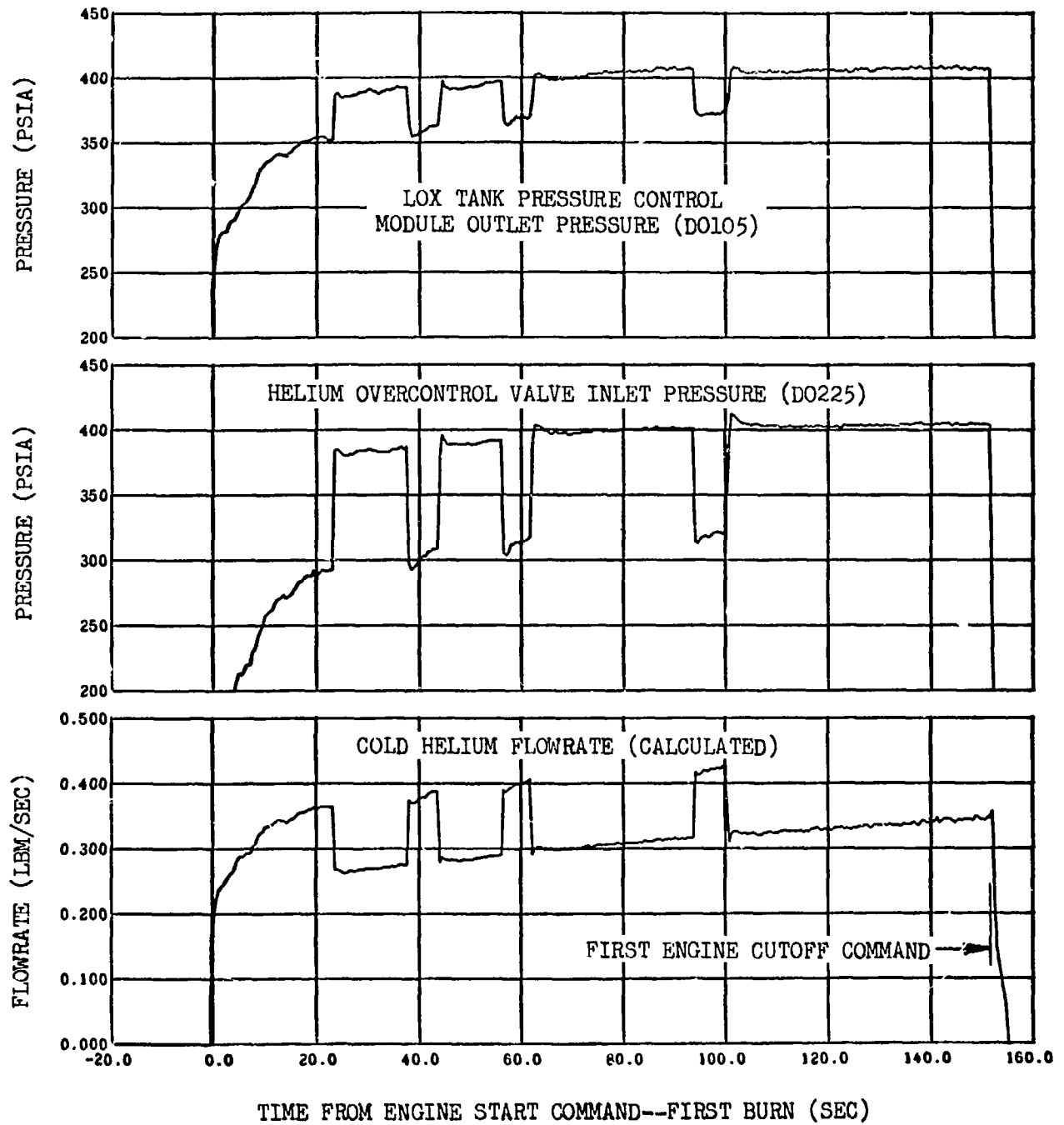

Figure 11-3. LOX Tank Pressurization System Performance--First Burn (Sheet 2 of 2)

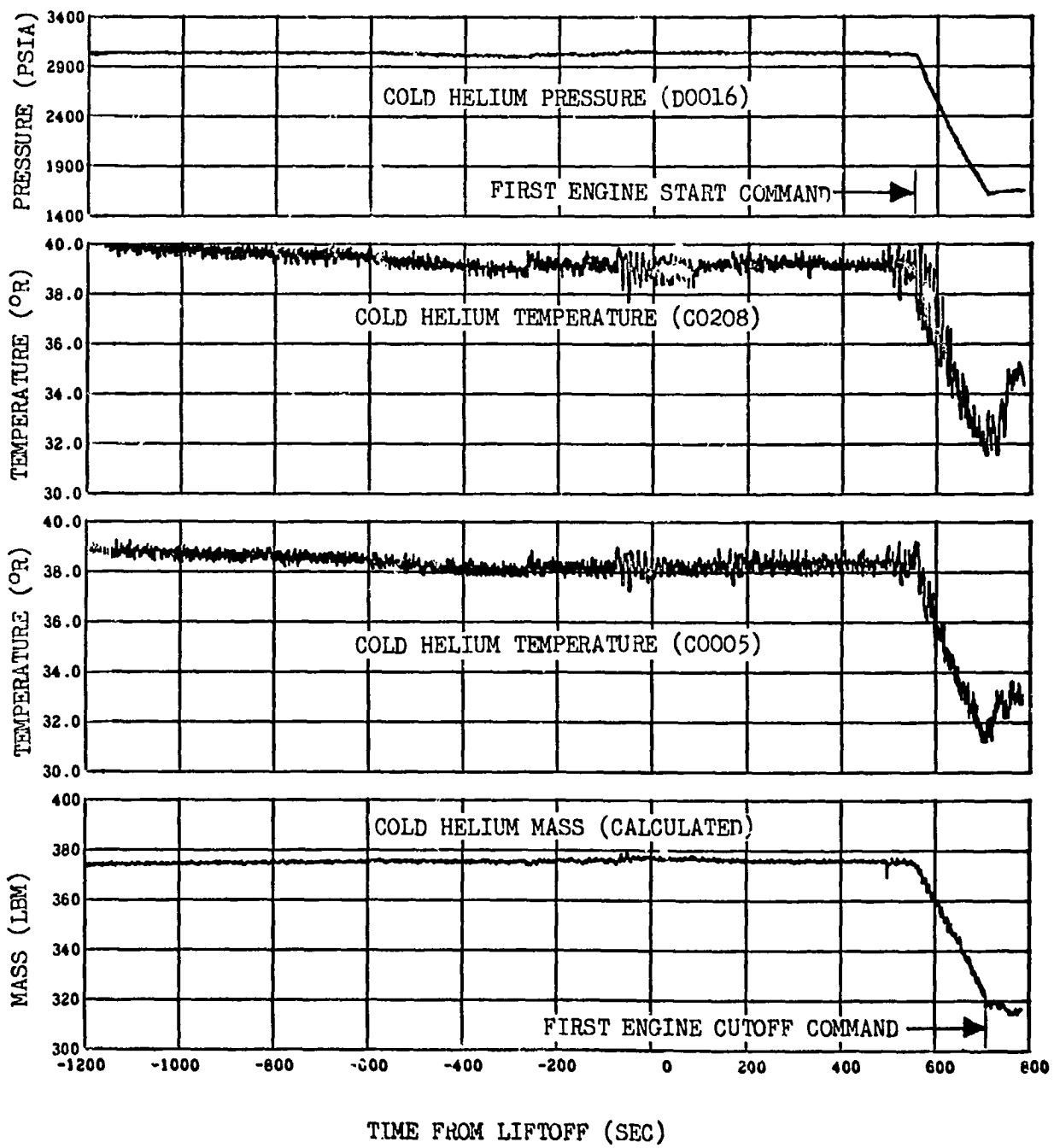

Figure 11-4. Cold Helium Supply--Boost and First Burn

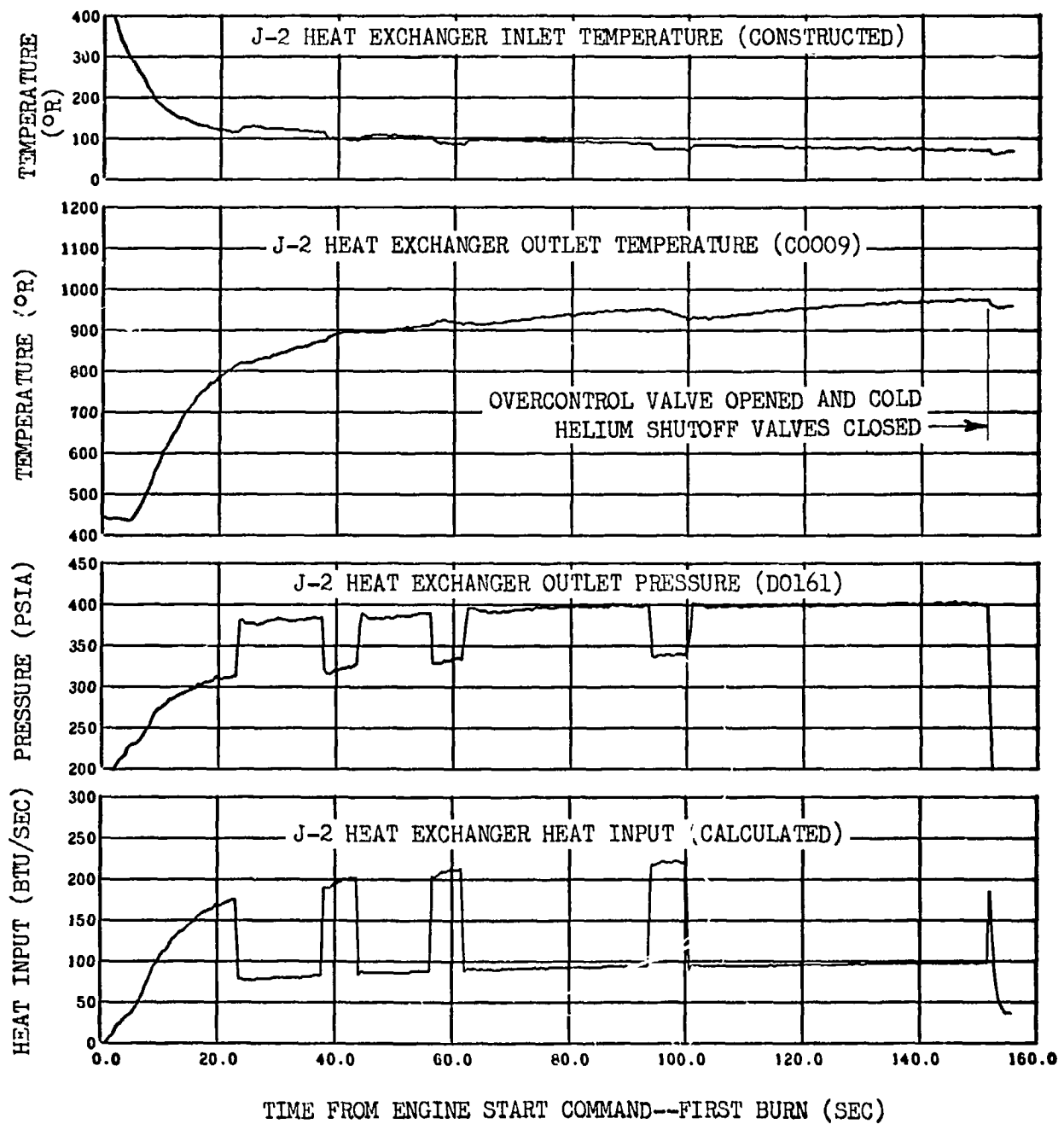

Figure 11-5. J-2 Heat Exchanger Performance--First Burn (Sheet 1 of 2)

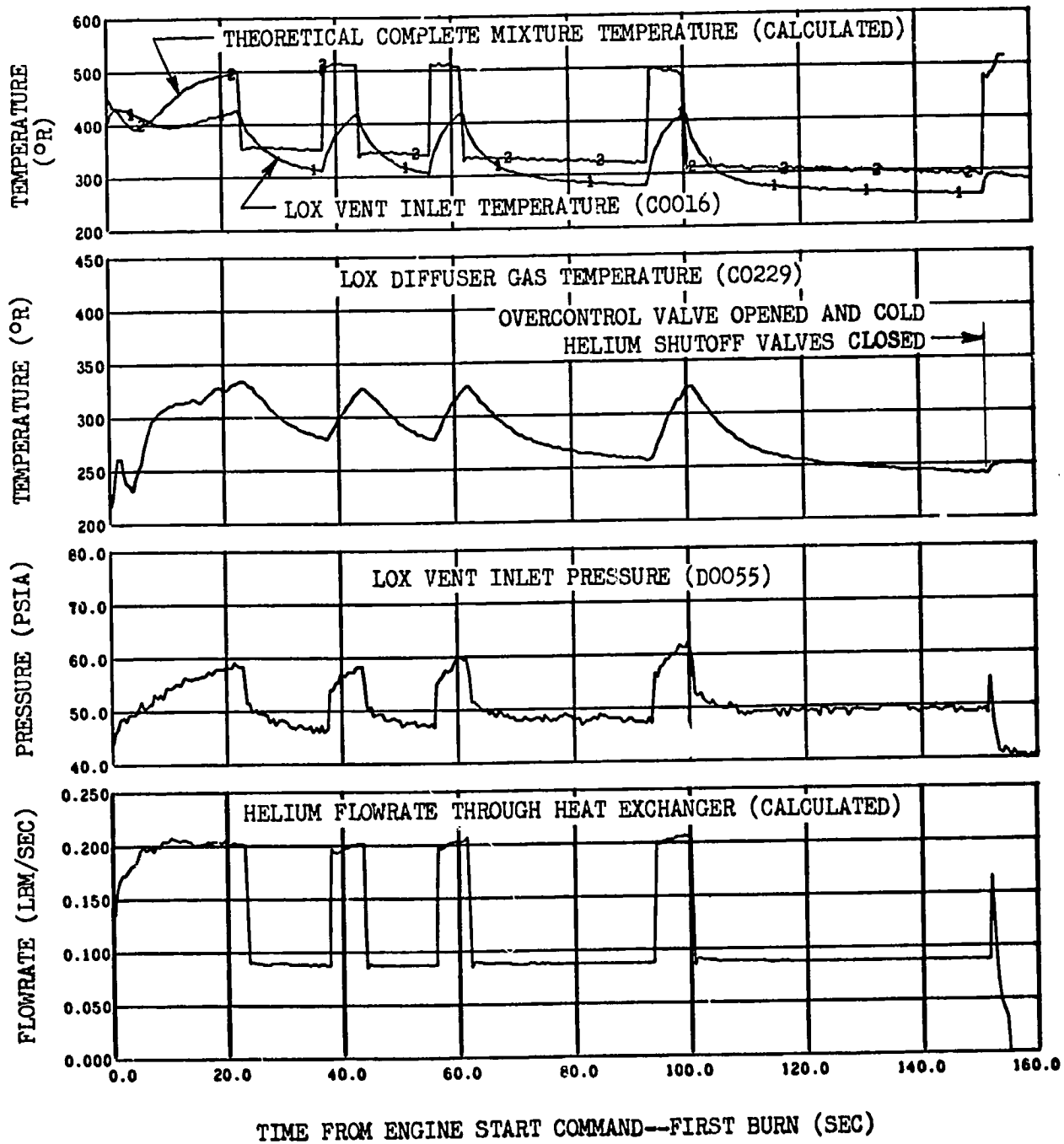

Figure 11-5. J-2 Heat Exchanger Performance--First Burn (Sheet 2 of 2)

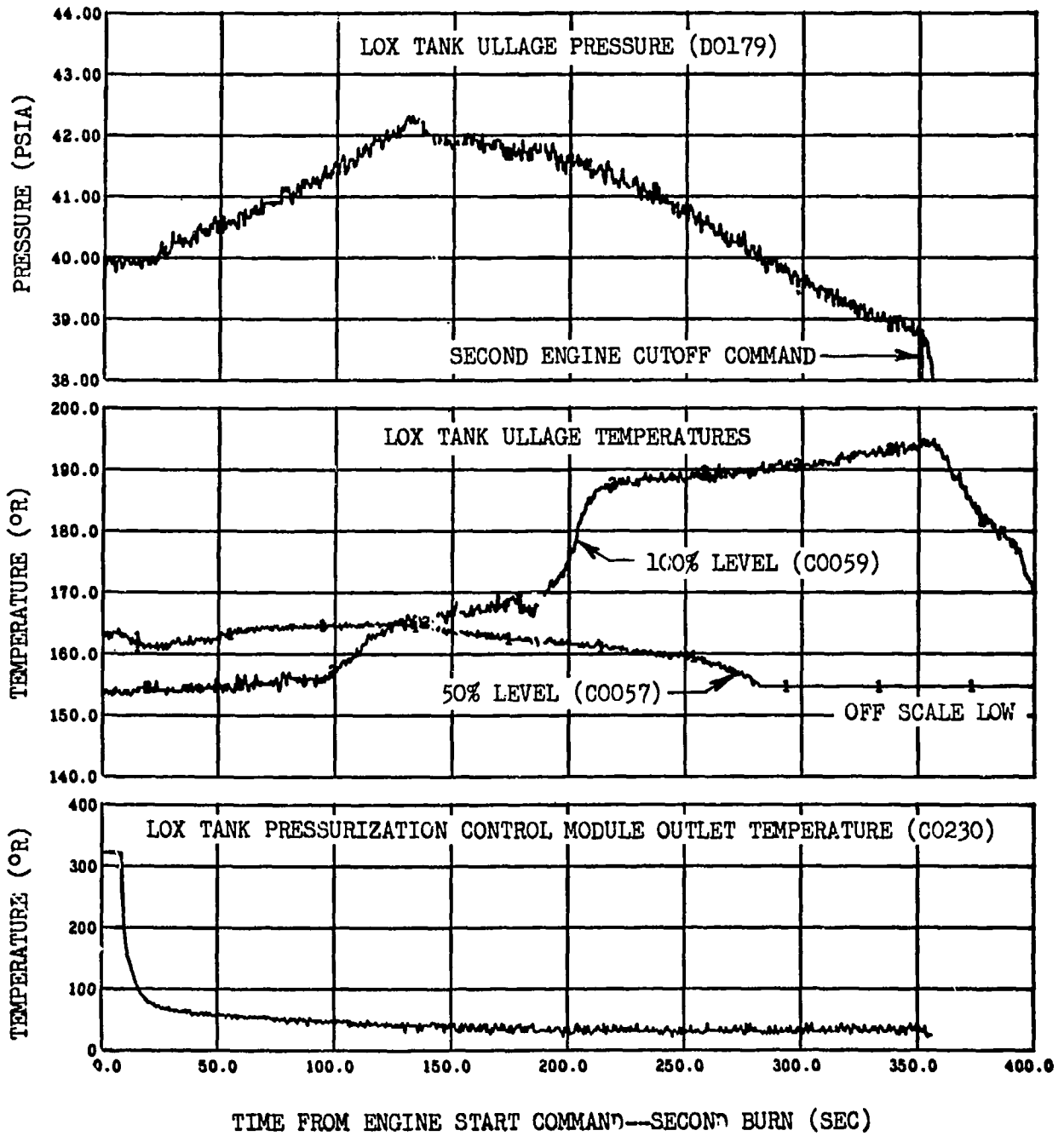

Figure 11-6. LOX Tank Pressurization System Performance--Second Burn (Sheet 1 of 2)

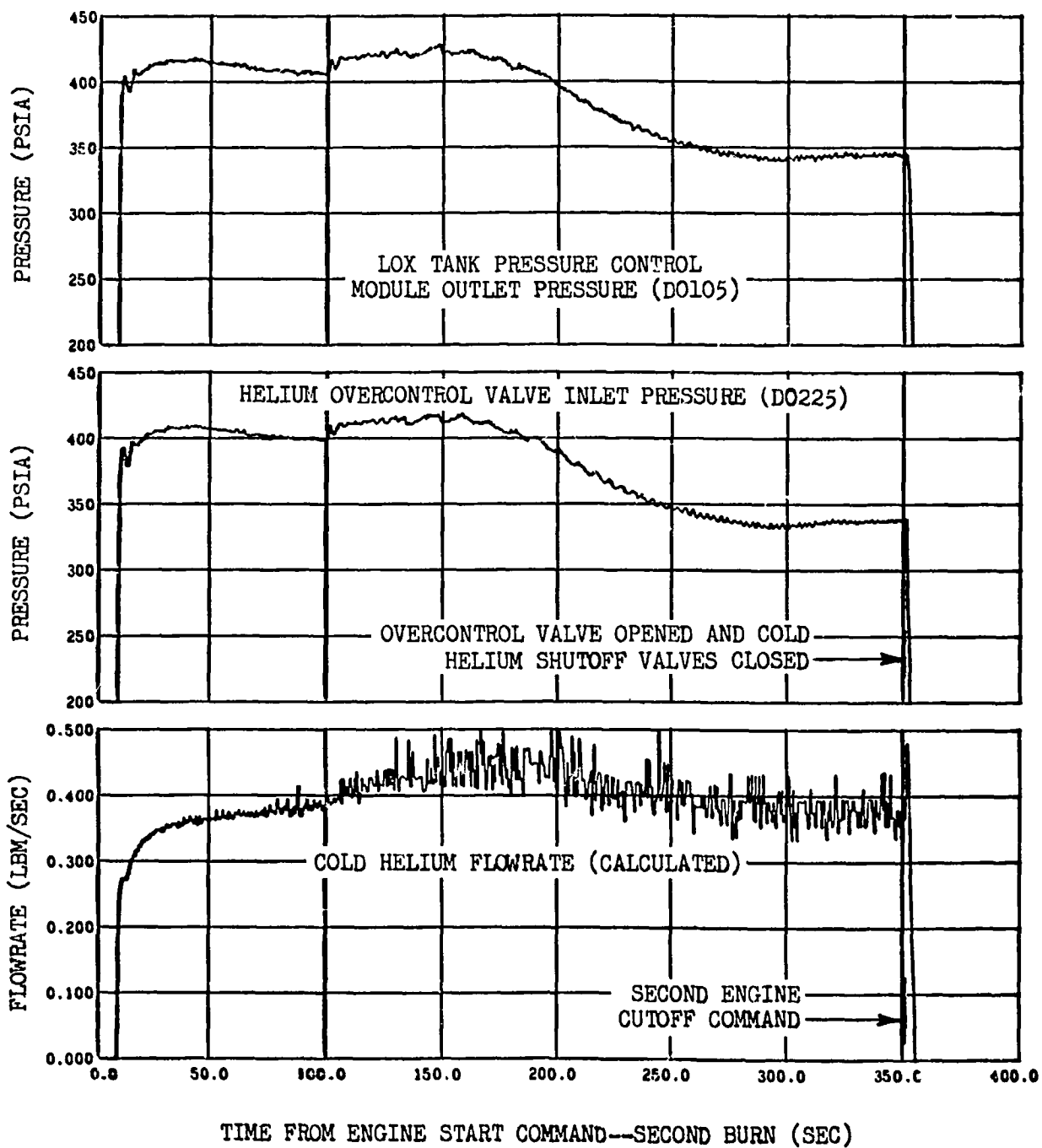

Figure 11-6. LOX Tank Pressurization System Performance--Second Burn (Sheet 2 of 2)

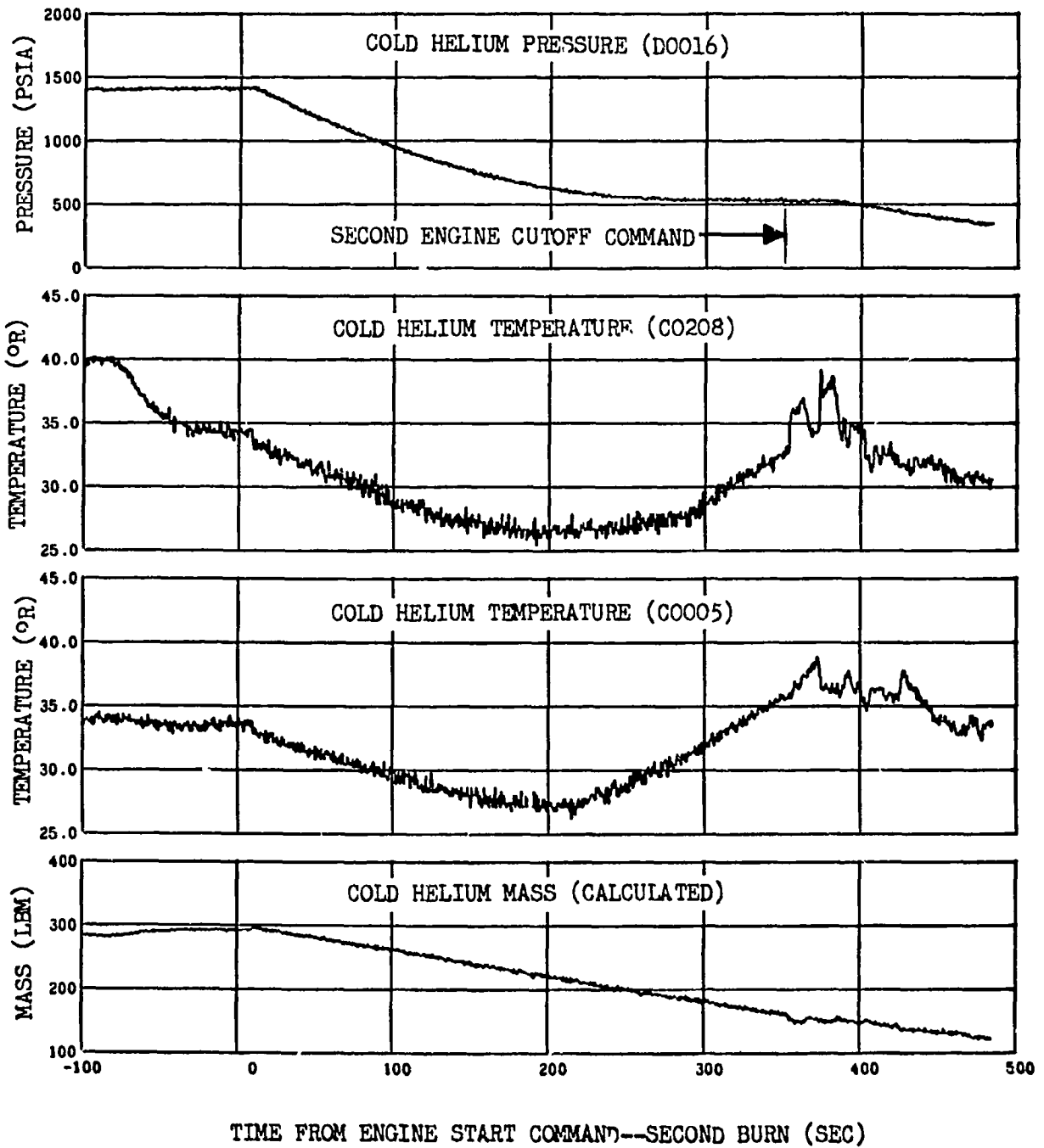

Figure 11-7. Cold Helium Supply--Second Burn

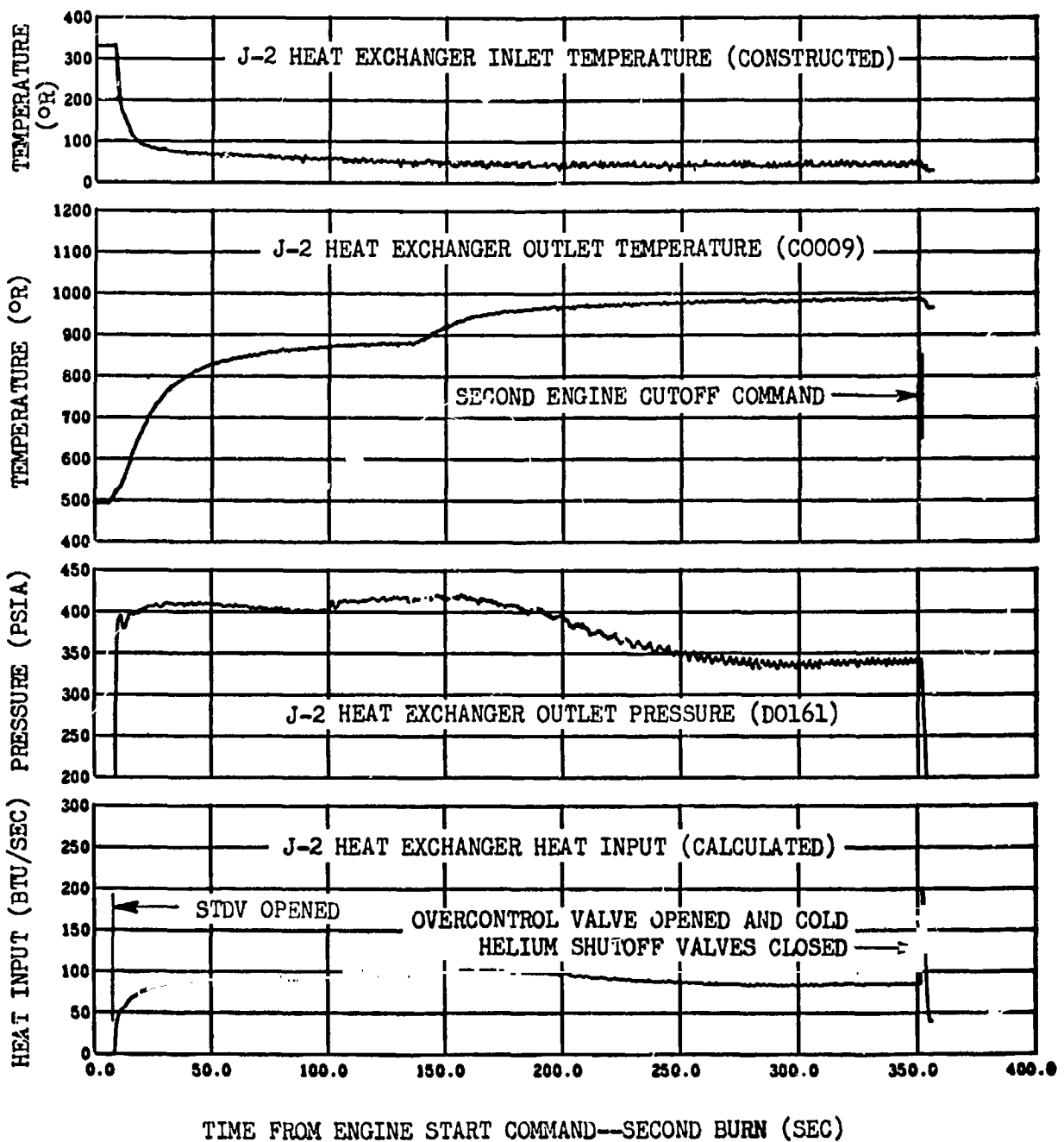

Figure 11-8. J-2 Heat Exchanger Performance--Second Burn (Sheet 1 of 2)

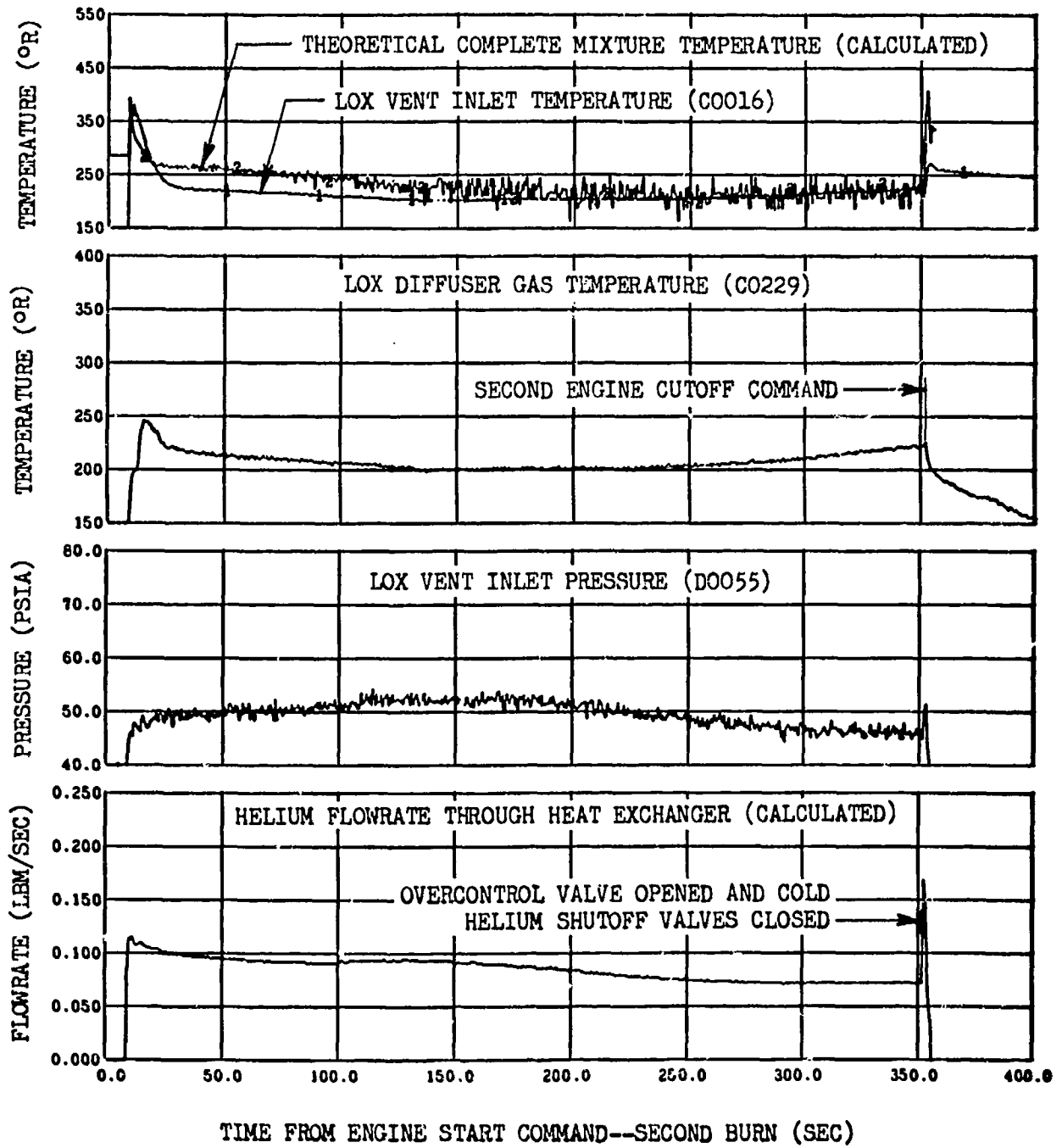

Figure 11-8. J-2 Heat Exchanger Performance--Second Burn (Sheet 2 of 2)

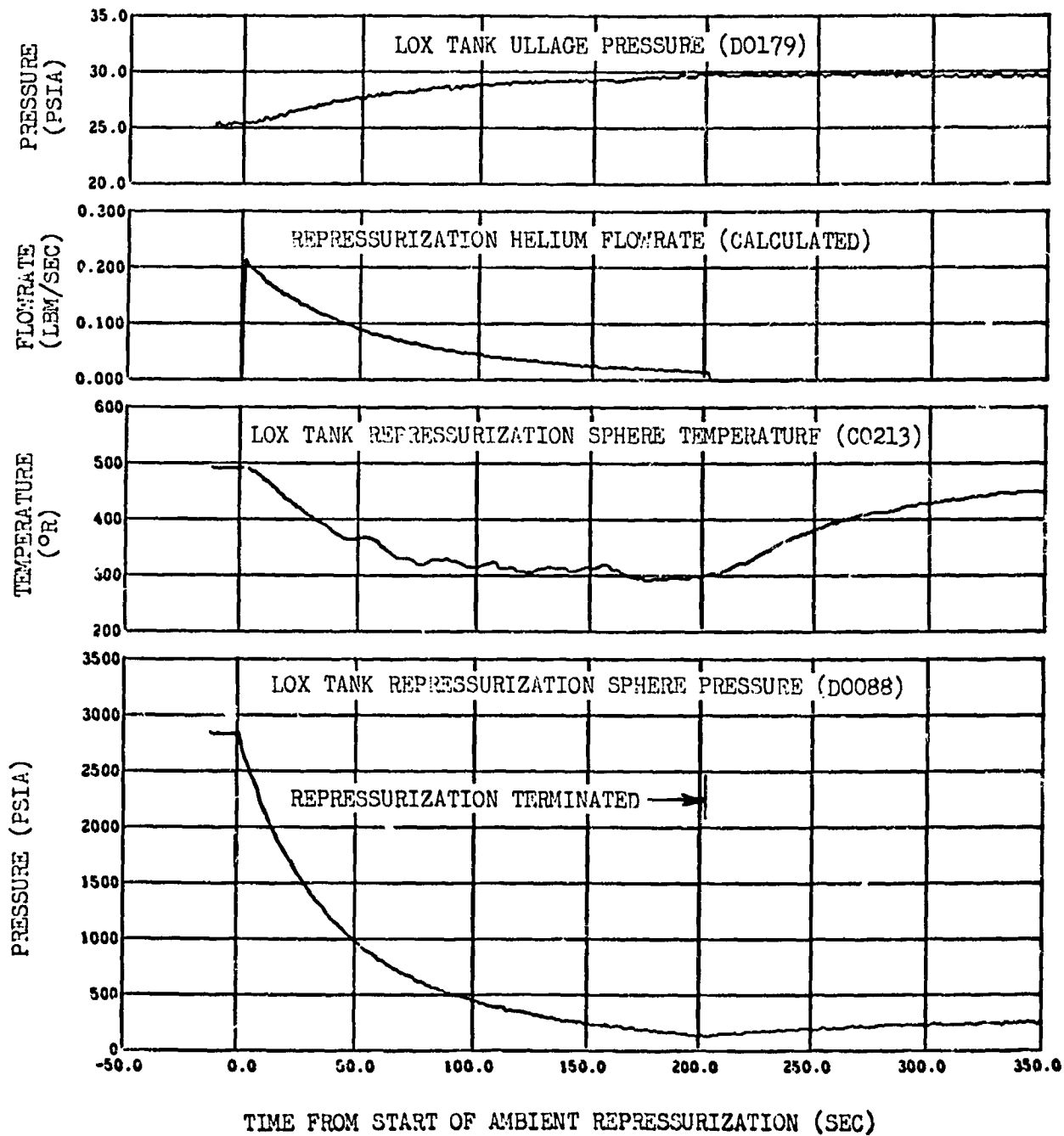

Figure 11-9. LOX Tank Ambient Helium Repressurization System Performance

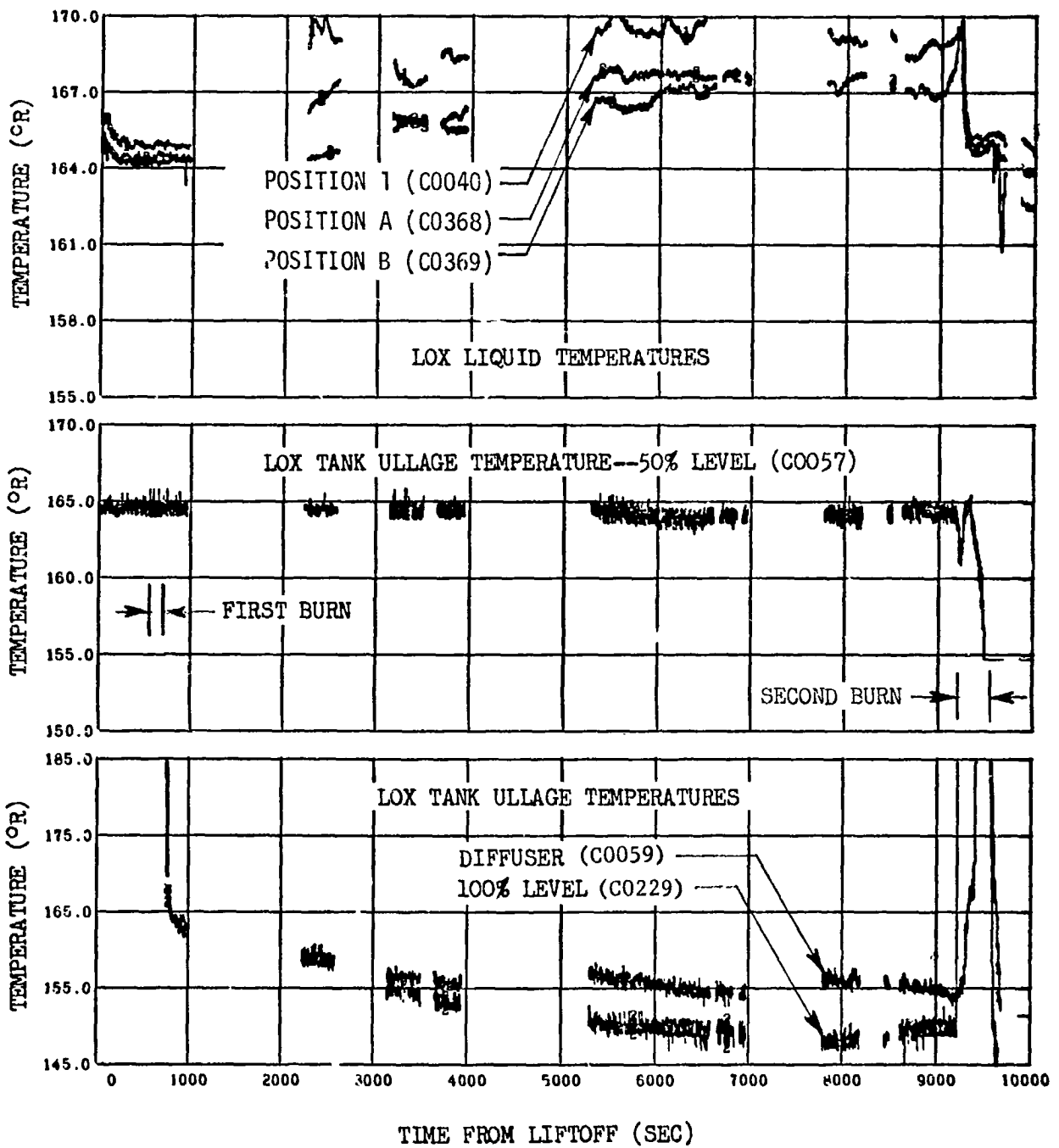

Figure 11-10. LOX Tank Conditions During Orbit and Translunar Coast (Sheet 1 of 2)

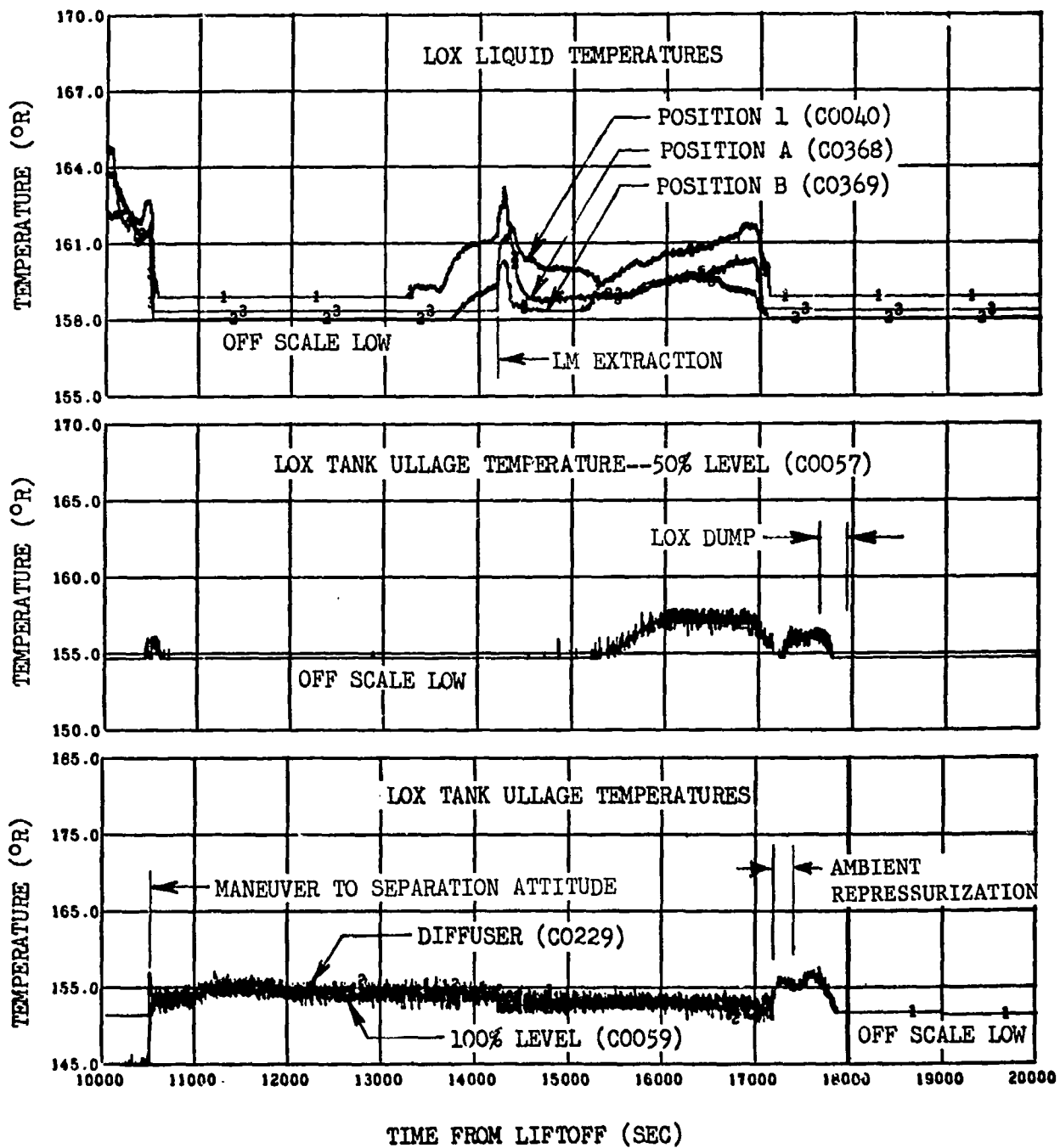

Figure 11-10. LOX Tank Conditions During Orbit and Translunar Coast (Sheet 2 of 2)

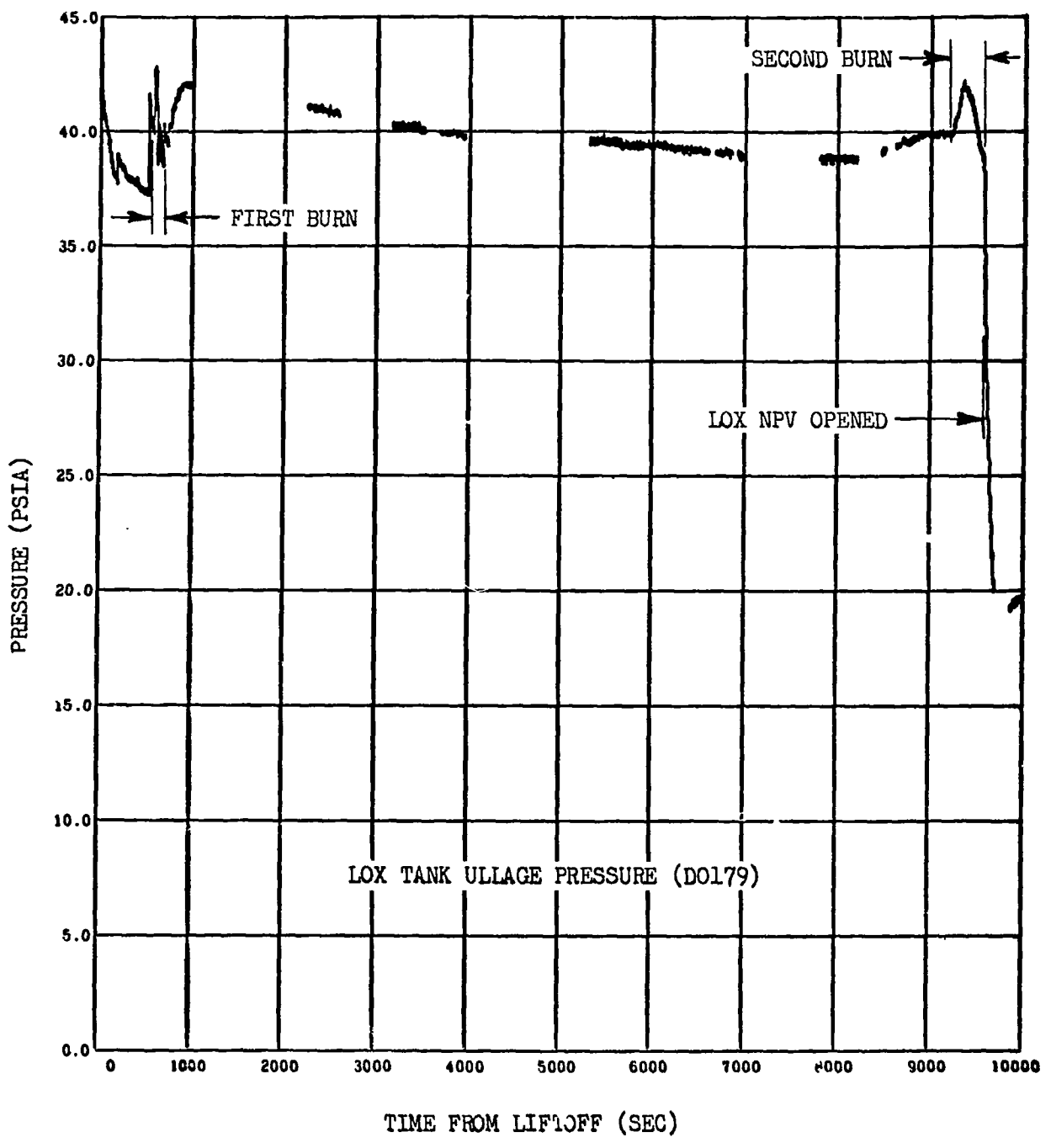

Figure 11-11. LOX Tank Ullage Pressure During Orbit and Translunar Coast (Sheet 1 of 2)

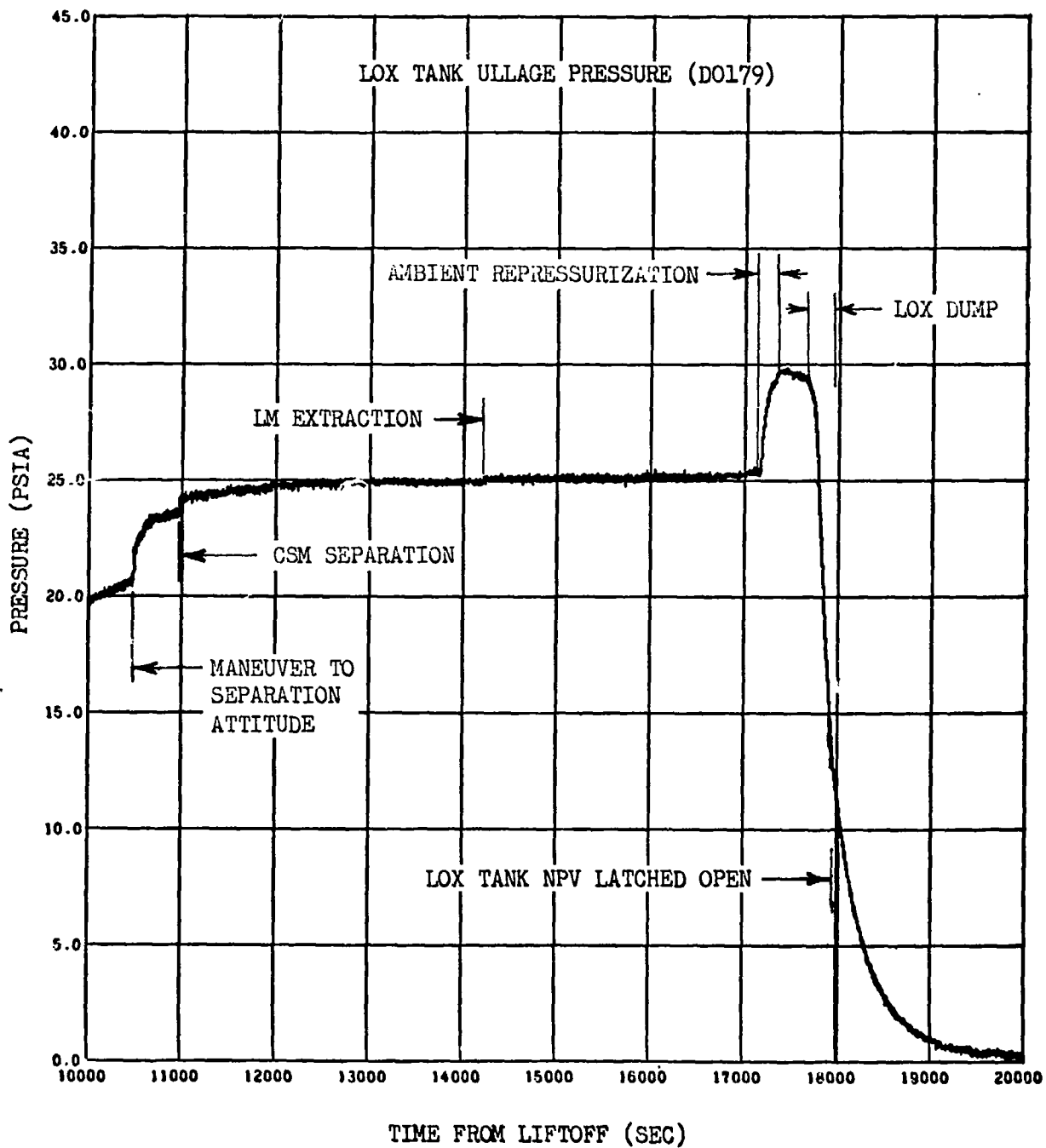

Figure 11-11. LOX Tank Ullage Pressure During Orbit and Translunar Coast (Sheet 2 of 2)

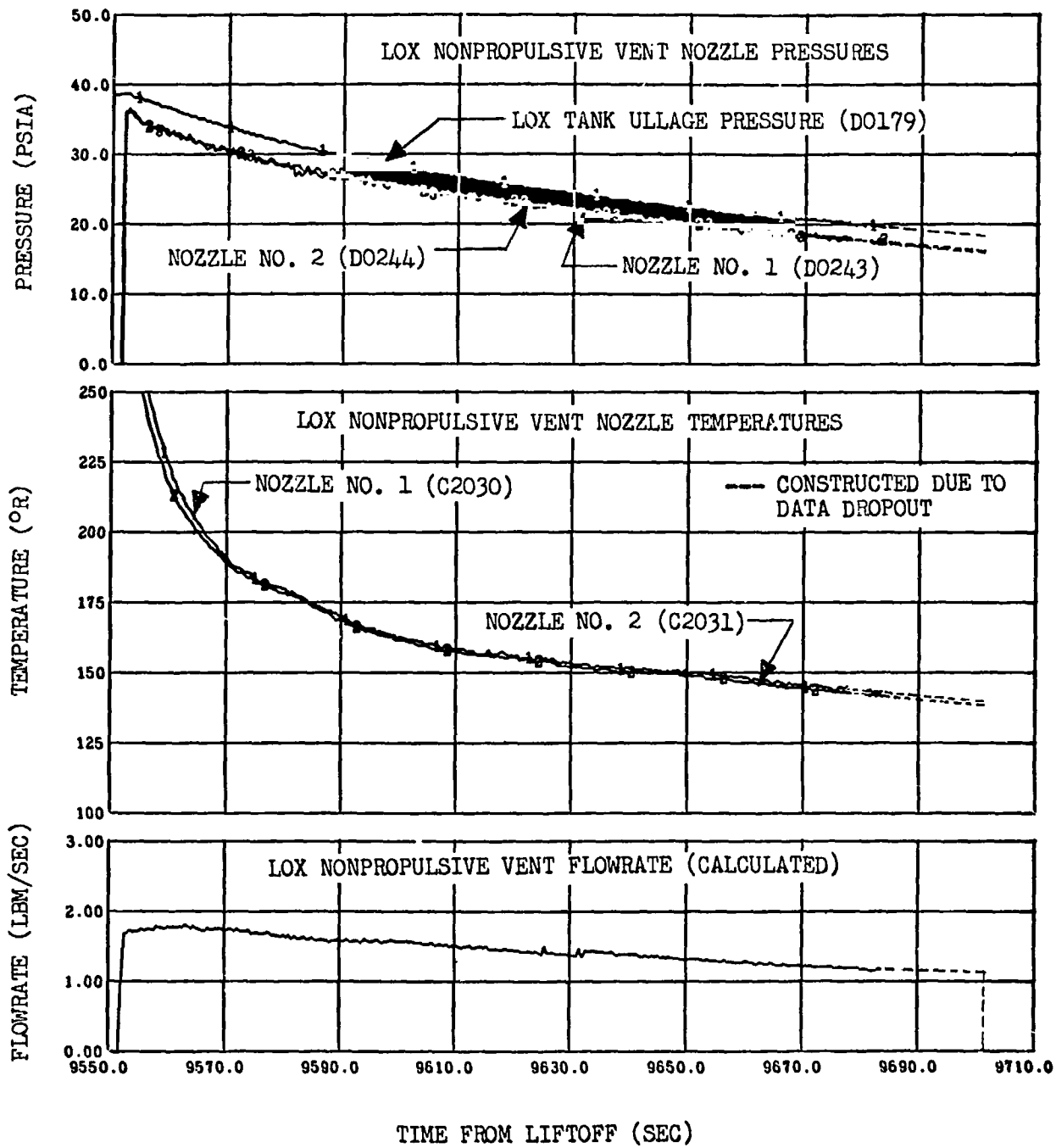

Figure 11-12. LOX Nonpropulsive Vent System Performance--Translunar Coast
 (Sheet 1 of 2)

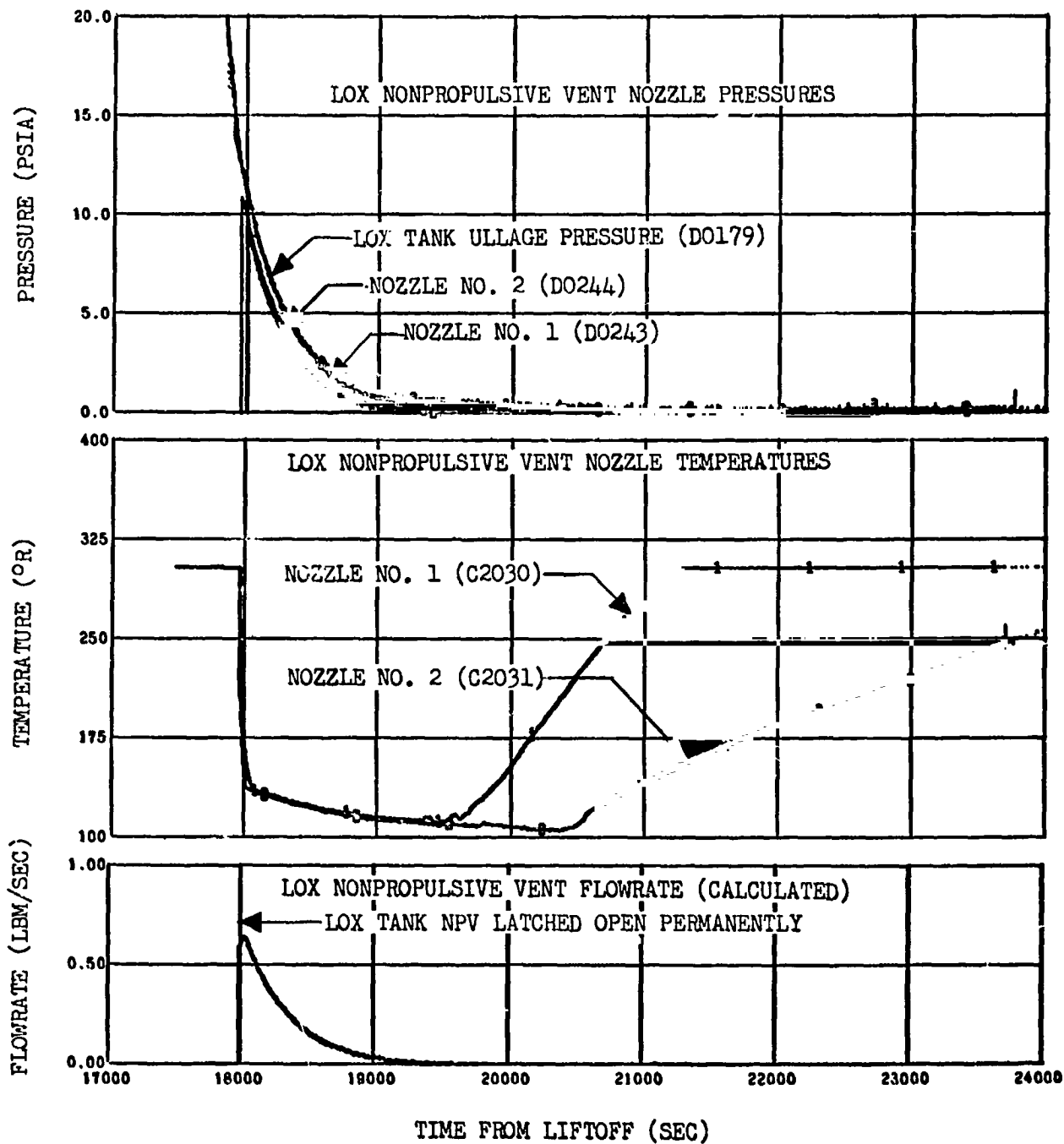

Figure 11-12. LOX Nonpropulsive Vent System Performance--
Translunar Coast (Sheet 2 of 2)

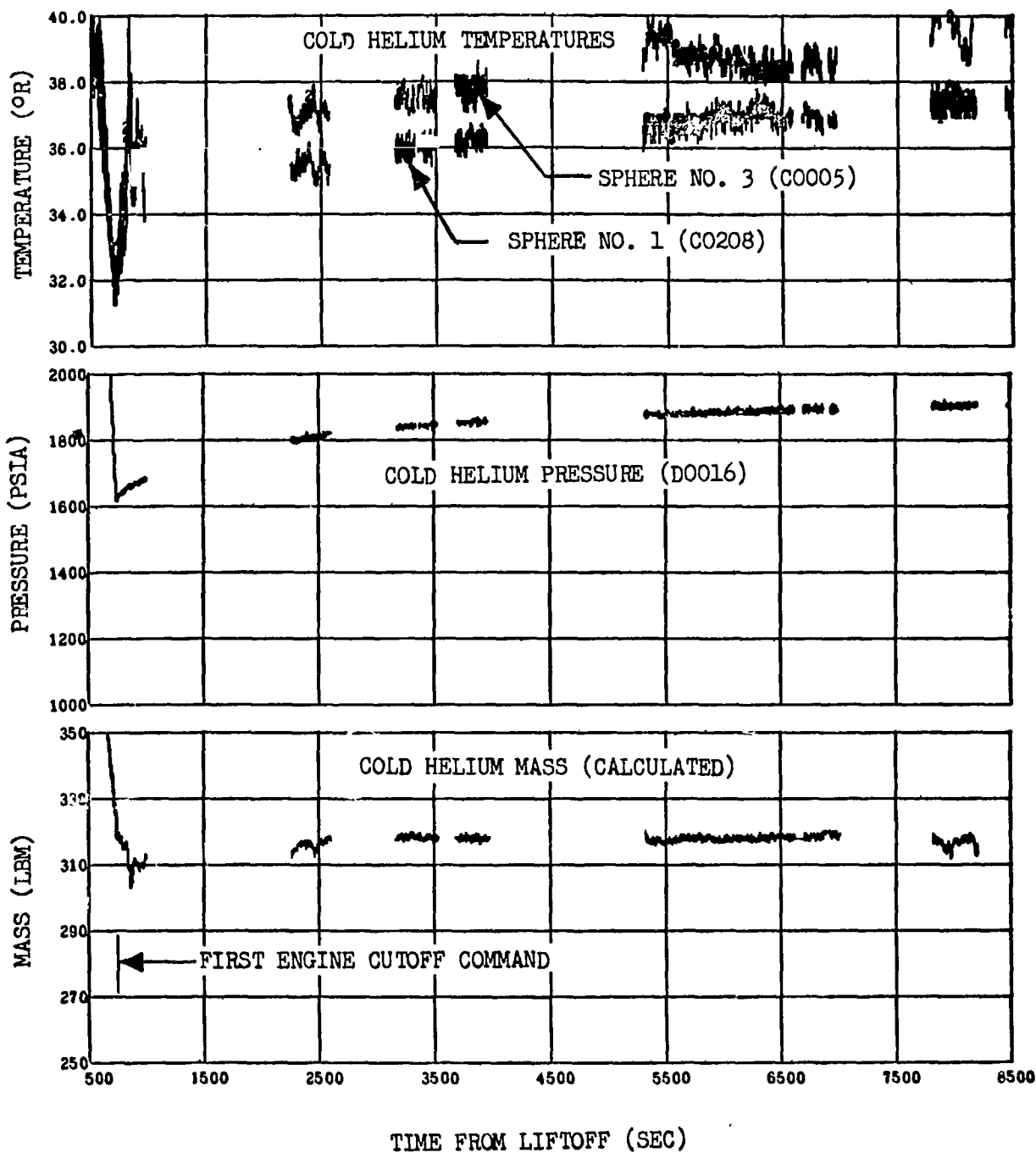

Figure 11-13. Cold Helium Sphere Conditions--Earth Orbit

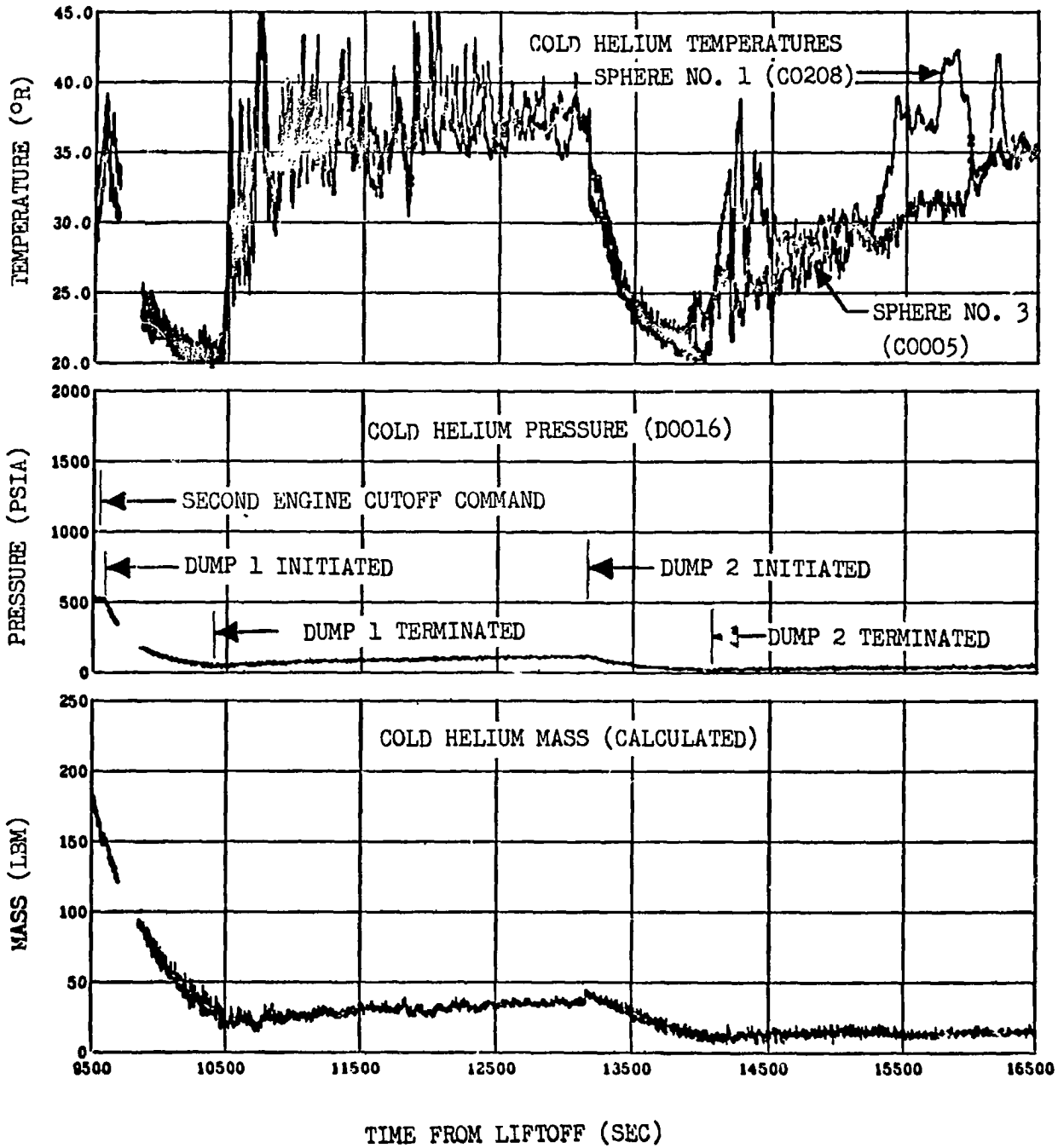

Figure 11-14. Cold Helium Sphere Conditions--
 Translunar Coast and Dump (Sheet 1 of 2)

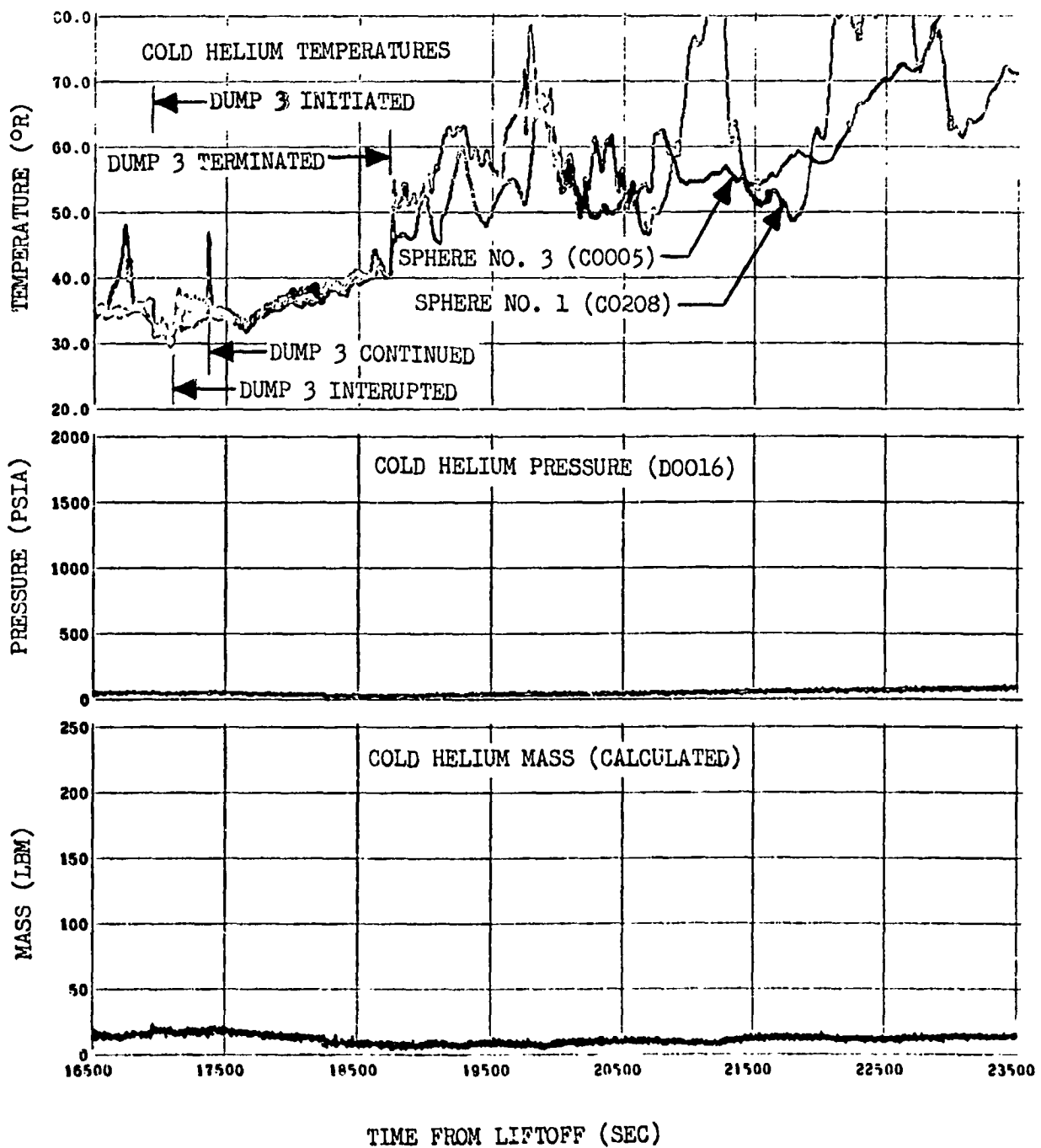

Figure 11-14. Cold Helium Sphere Conditions---
Translunar Coast and Dump (Sheet 2 of 2)

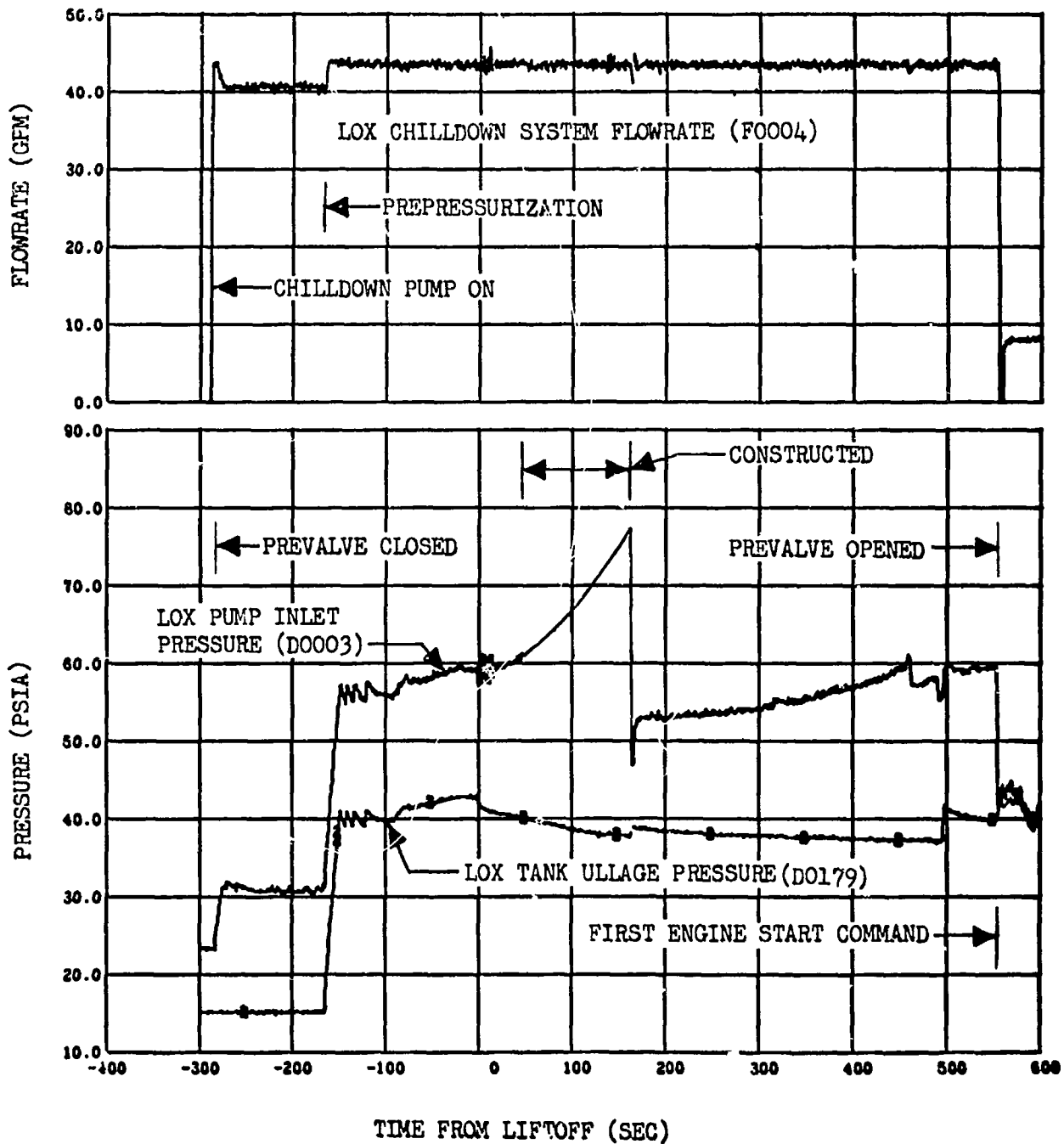

Figure 11-15. LOX Pump Chilldown System Operation-- Boost and First Burn (Sheet 1 of 2)

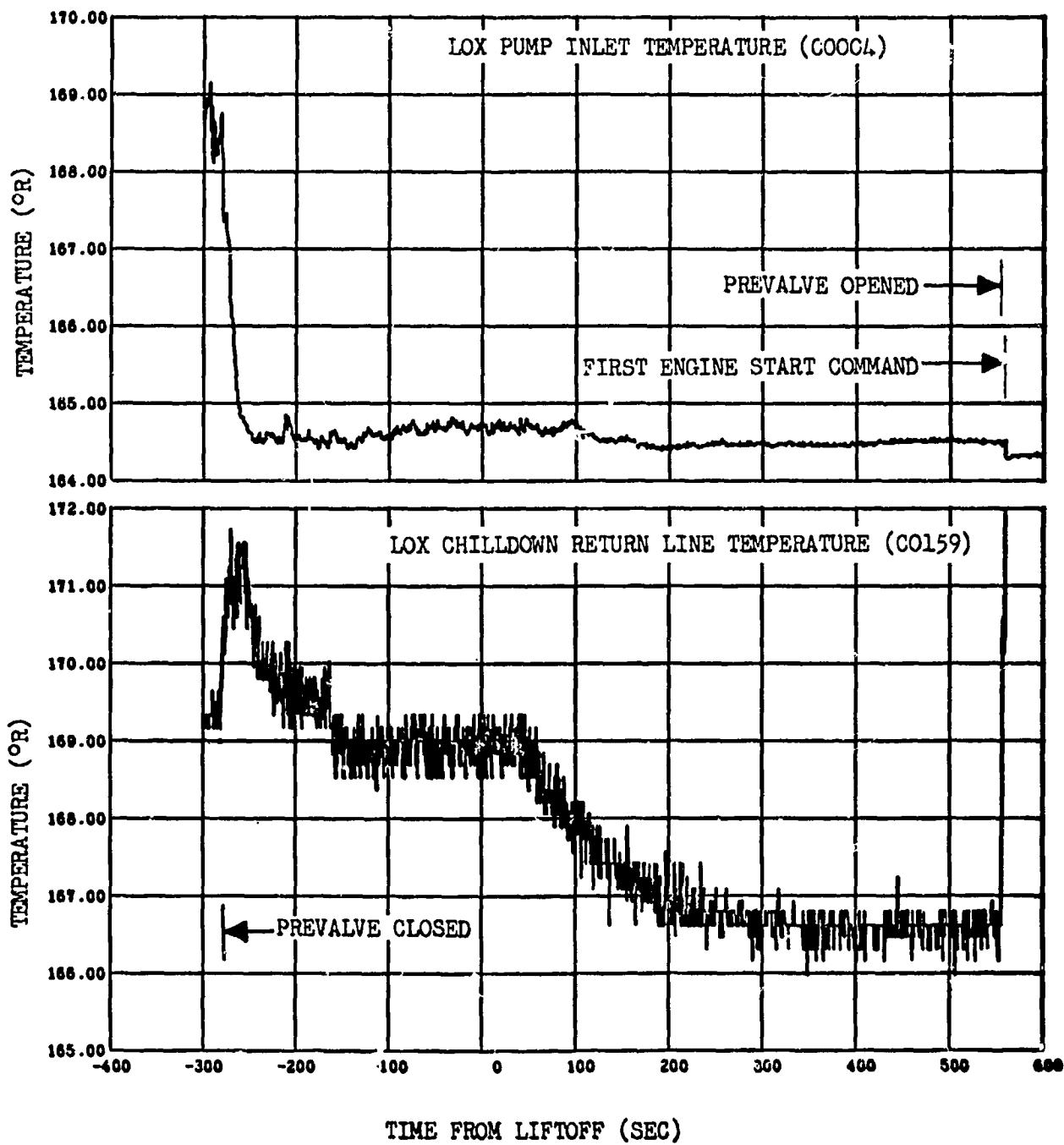

Figure 11-15. LOX Pump Chilledown System Operation-- Boost and First Burn (Sheet 2 of 2)

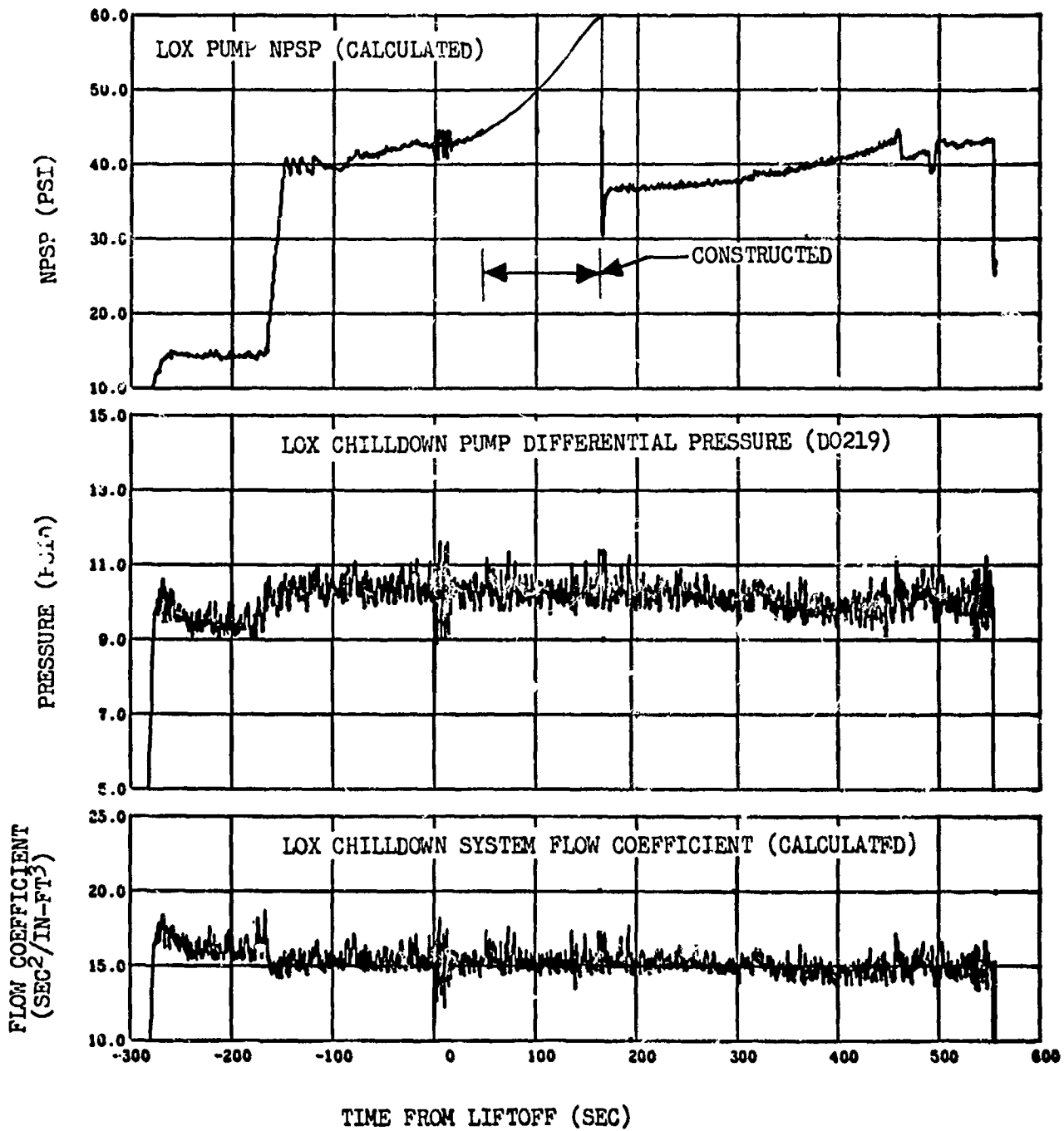

Figure 11-16. LOX Pump Chilldown System Performance—
Boost and First Burn (Sheet 1 of 2)

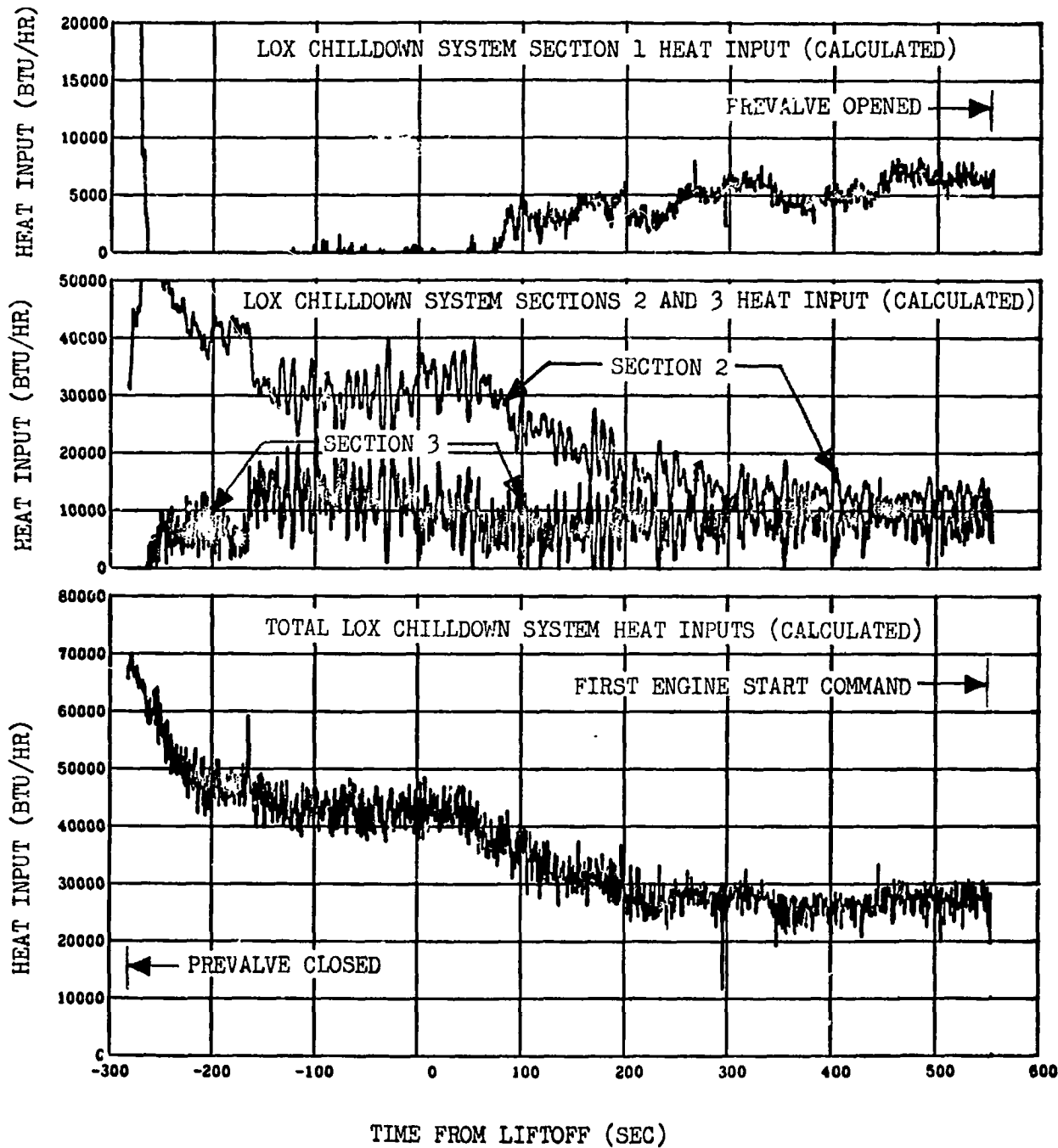

Figure 11-16. LOX Pump Chilldown System Performance-- Boost and First Burn (Sheet 2 of 2)

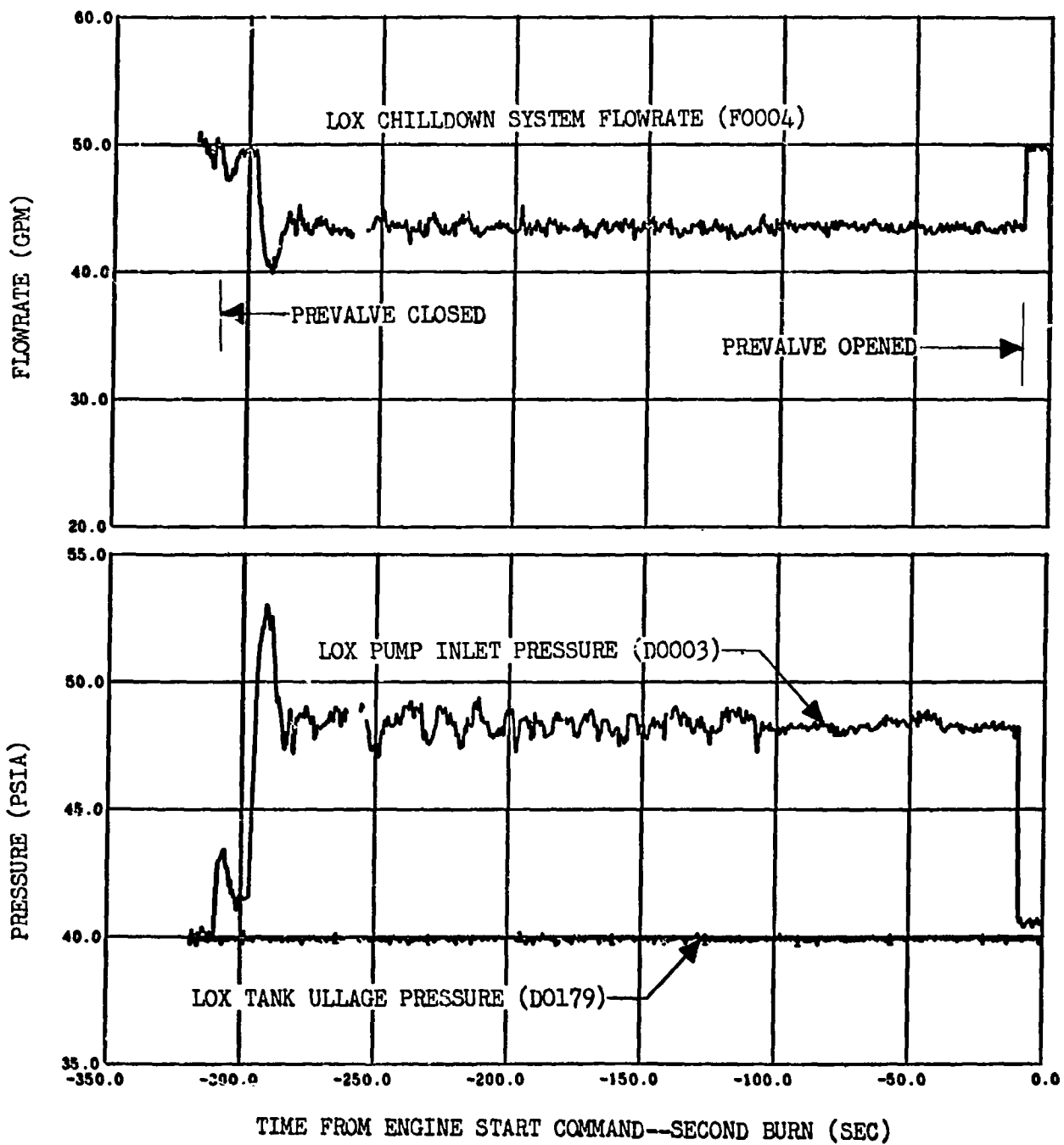

Figure 11-17. LOX Pump Chilldown System Operation--Second Burn
 (Sheet 1 of 2)

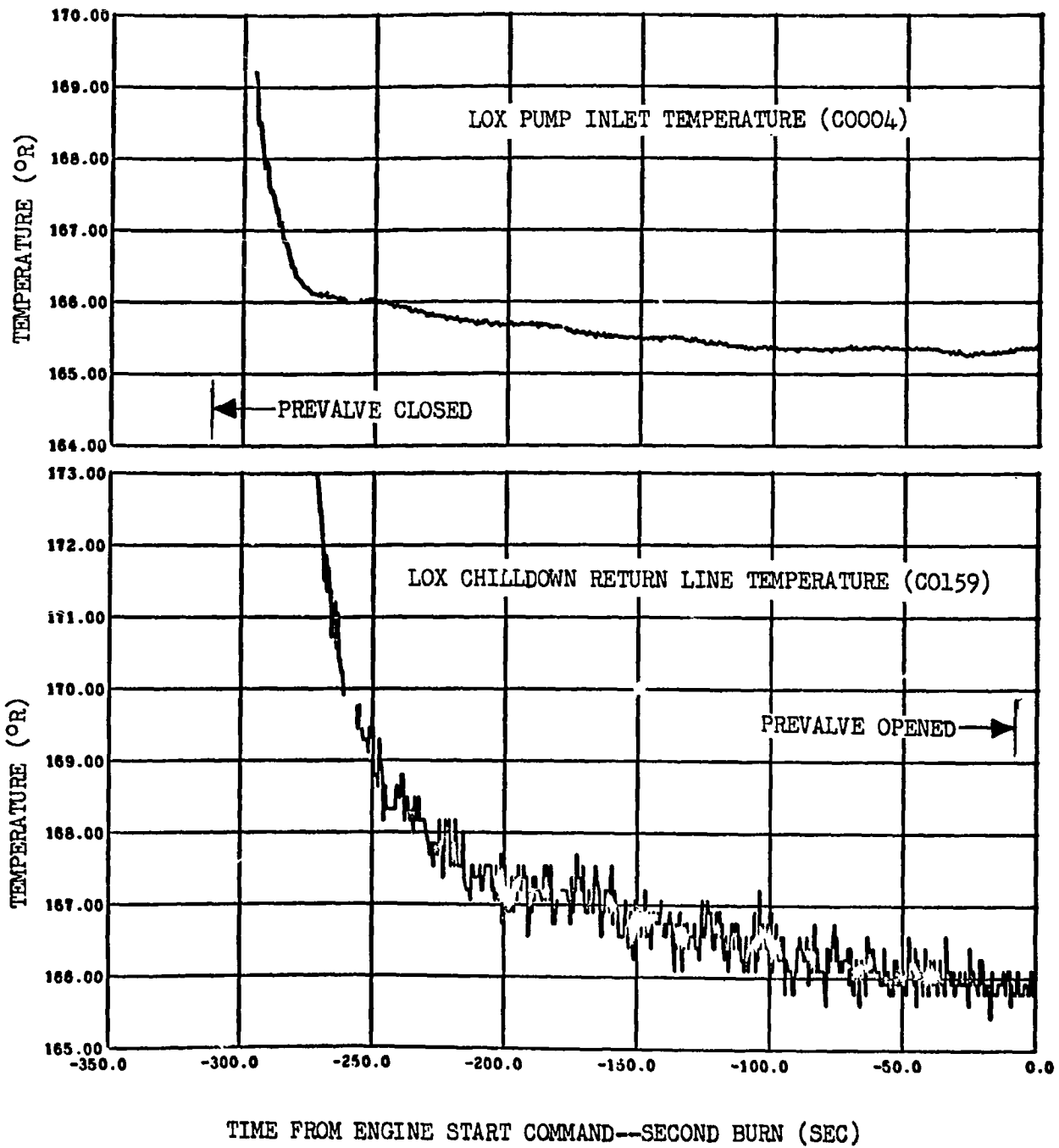

Figure 11-17. LOX Pump Chilldown System Operation--Second Burn (Sheet 2 of 2)

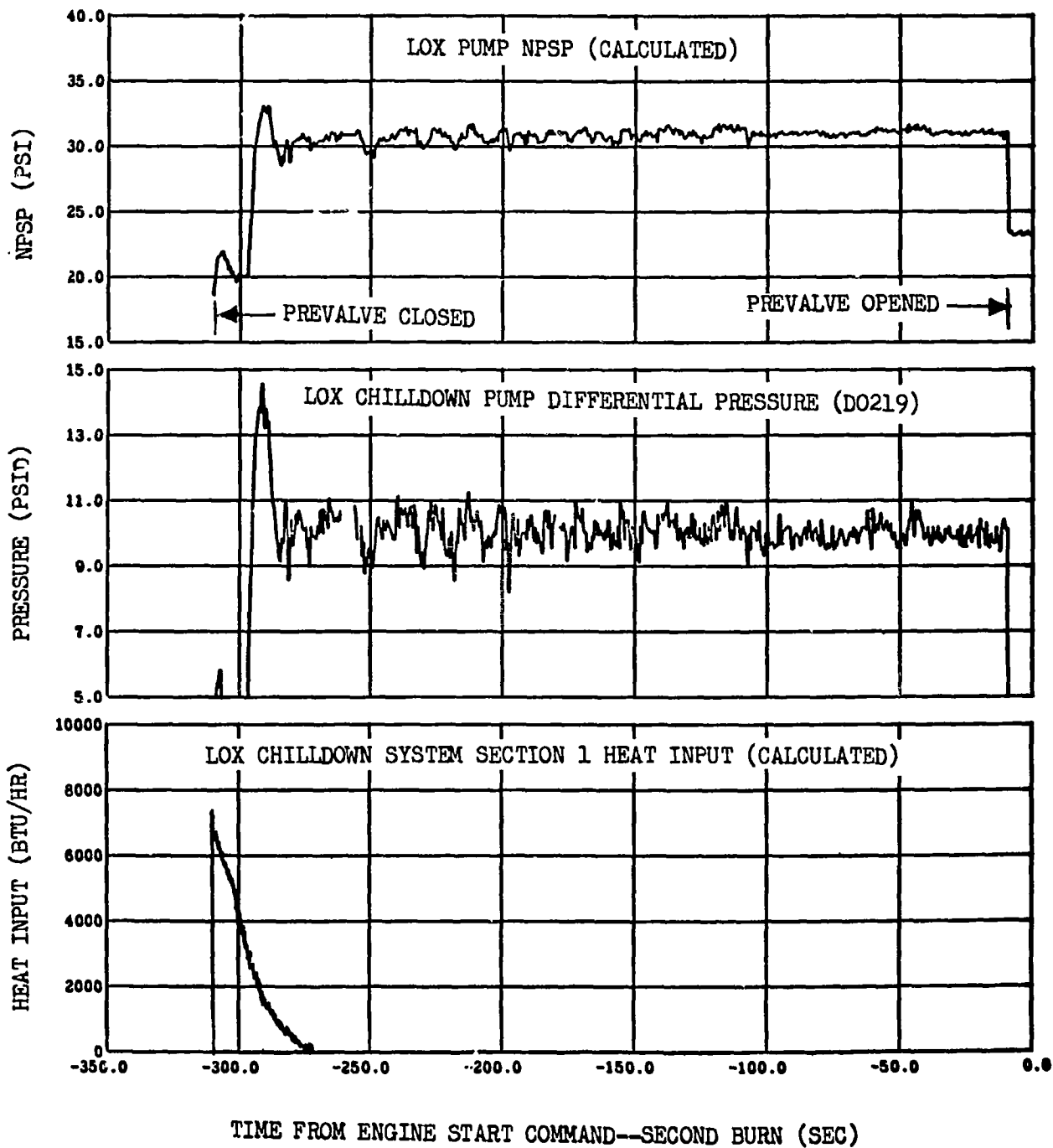

Figure 11-18. LOX Pump Chilldown System Performance--Second Burn (Sheet 1 of 2)

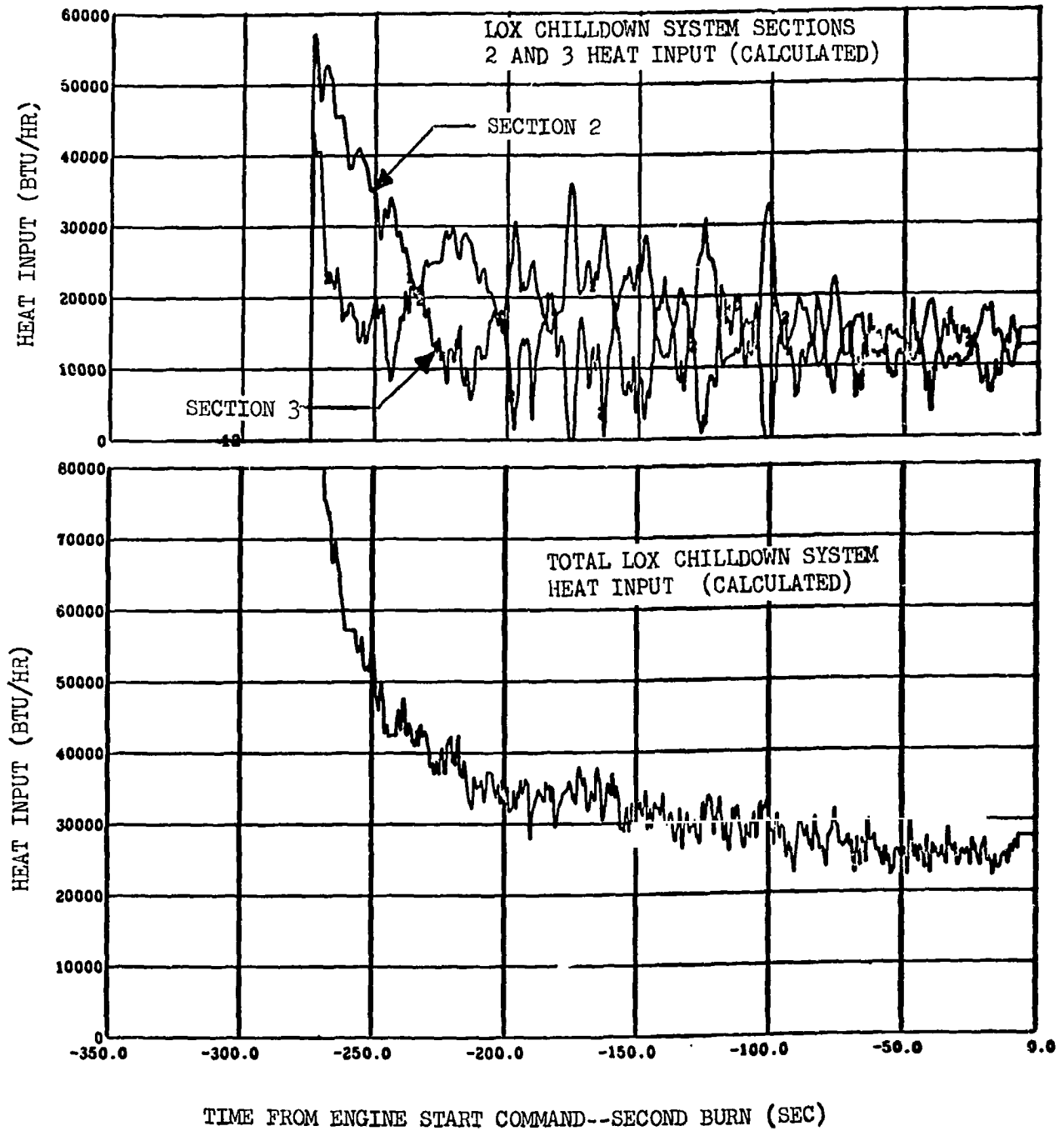
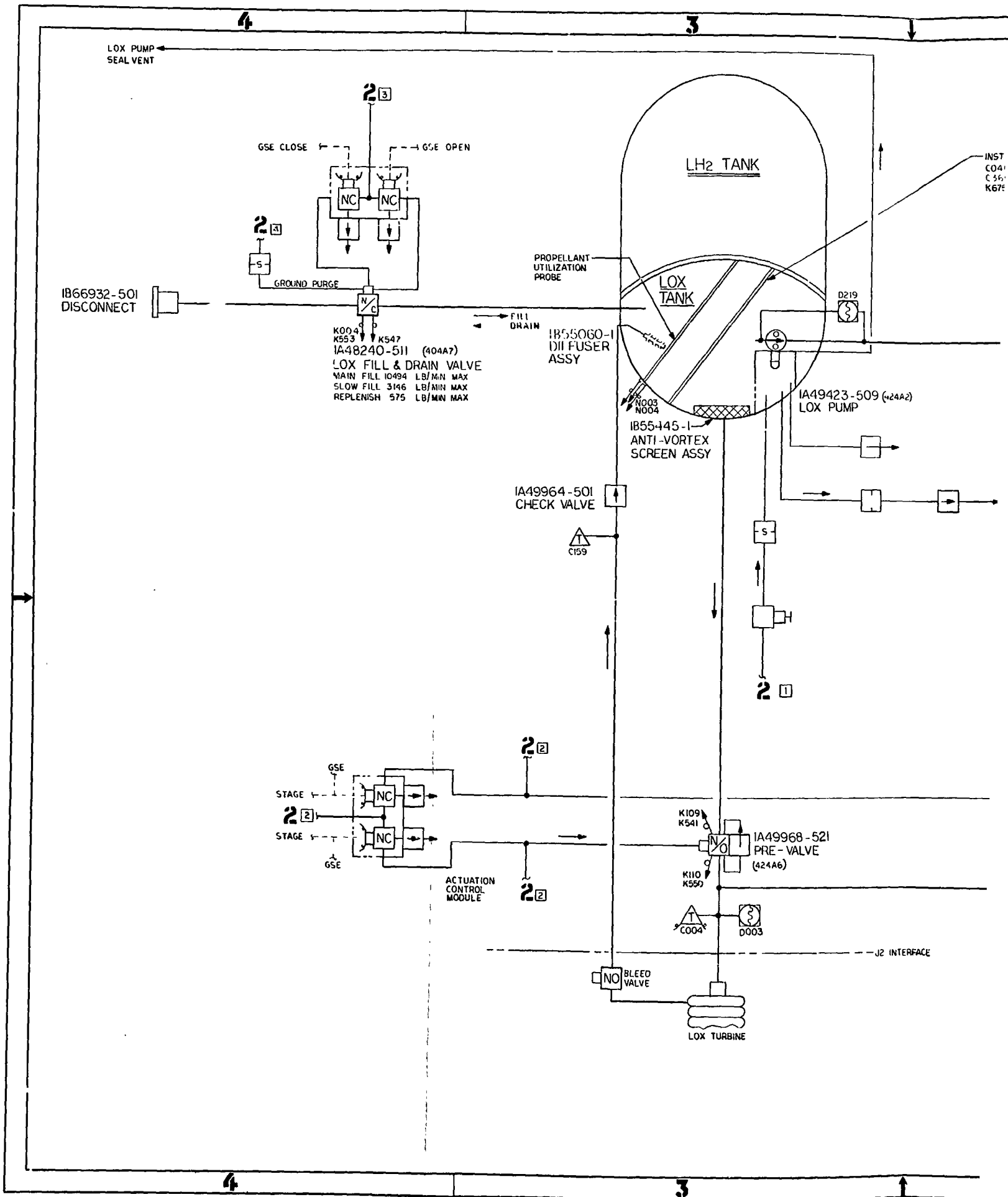
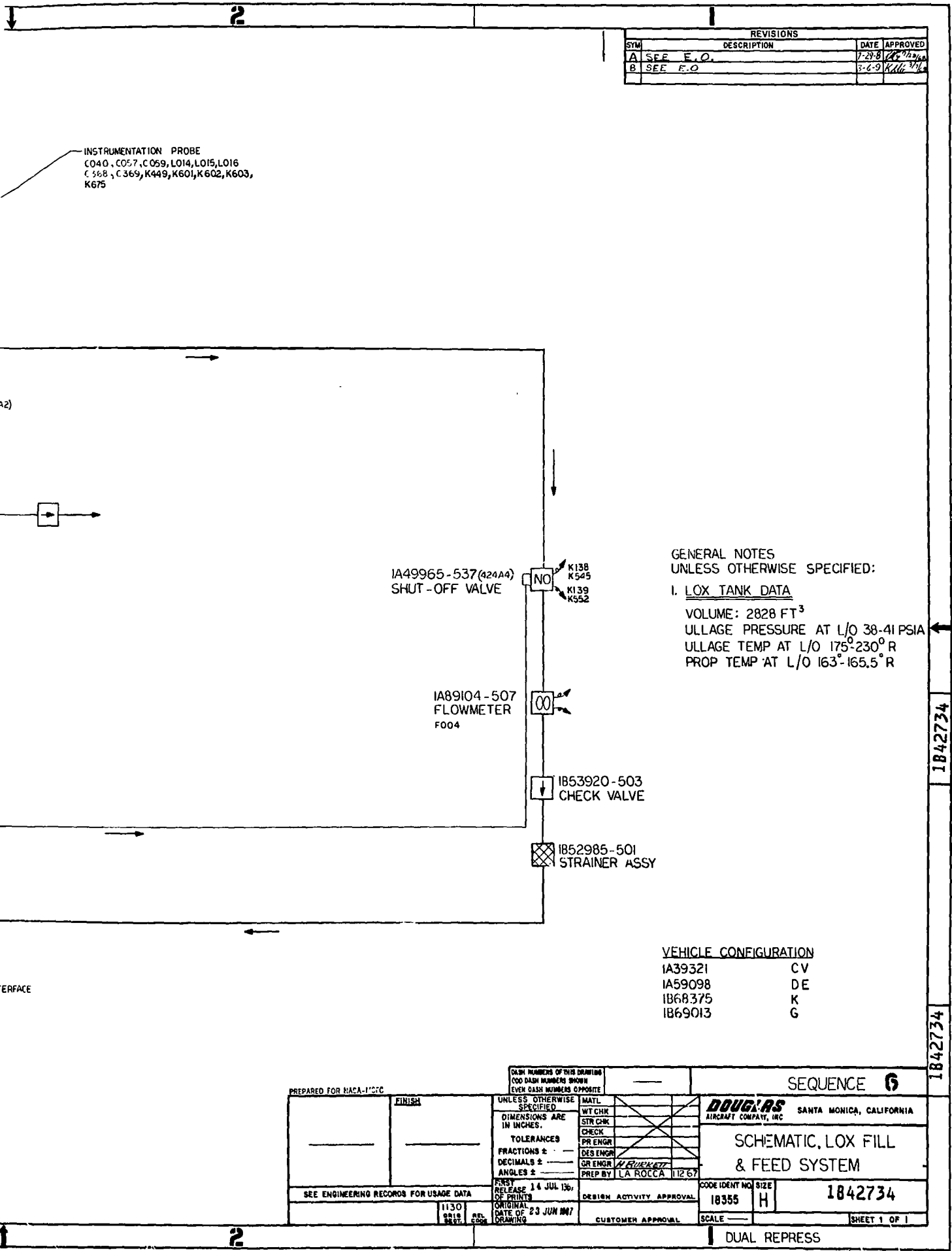

Figure 11-18. LOX Pump Chilldown System Performance--Second Burn (Sheet 2 of 2)





REVISIONS			
SYM	DESCRIPTION	DATE	APPROVED
A	SEE E.O.	7-29-8	[Signature]
B	SEE F.O.	3-6-9	[Signature]

INSTRUMENTATION PROBE
 C040, C057, C059, L014, L015, L016
 C368, C369, K449, K601, K602, K603,
 K675

GENERAL NOTES
 UNLESS OTHERWISE SPECIFIED:

I. LOX TANK DATA
 VOLUME: 2828 FT³
 ULLAGE PRESSURE AT L/O 38-41 PSIA
 ULLAGE TEMP AT L/O 175°-230°R
 PROP TEMP AT L/O 163°-165.5°R

VEHICLE CONFIGURATION

IA39321	CV
IA59098	DE
IB68375	K
IB69013	G

PREPARED FOR NACA-117C		DASH NUMBERS OF THIS DRAWING 100 DASH NUMBERS SHOWN EVEN DASH NUMBERS OPPOSITE		SEQUENCE 6	
FINISH	UNLESS OTHERWISE SPECIFIED	MATL	SANTA MONICA, CALIFORNIA		
SEE ENGINEERING RECORDS FOR USAGE DATA	DIMENSIONS ARE IN INCHES.	WTCHK	SCHEMATIC, LOX FILL & FEED SYSTEM		
1130	TOLERANCES	STRCHK	CODE IDENT NO SIZE		
REL. CODE	FRACTIONS ±	CHECK	18355	H	1842734
DATE OF ORIGINAL DRAWING	DECIMALS ±	PR ENGR	SCALE		
DATE OF 23 JUN 1967	ANGLES ±	DES ENGR	SHEET 1 OF 1		
	FIRST RELEASE 14 JUL 1967	GR ENGR	DUAL REPRESS		
	DATE OF 23 JUN 1967	PREP BY LA ROCCA 11267			

FOLDOUT FRAME 2 Figure 11-19. Schematic, LOX Fill & Feed System

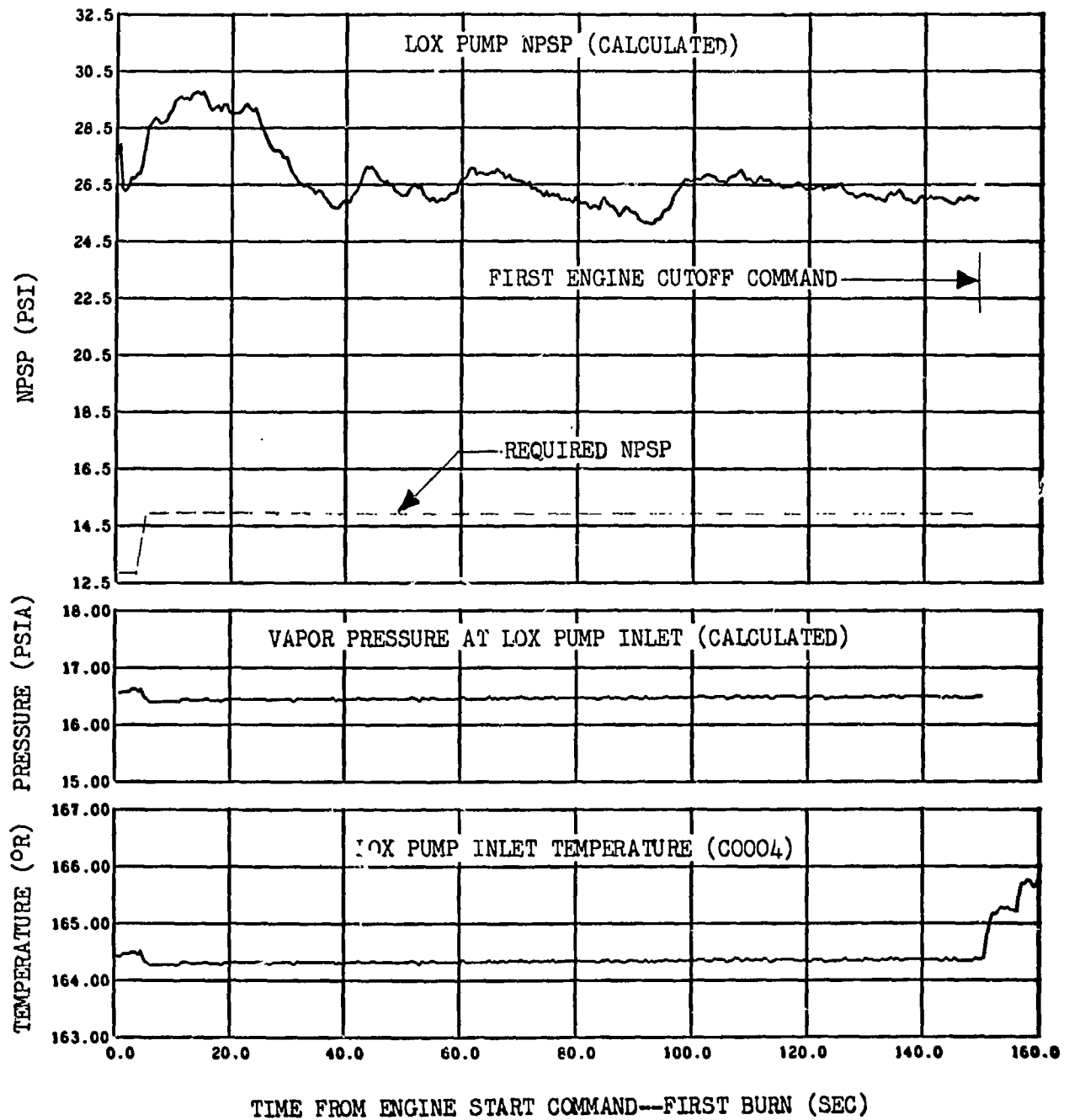

Figure 11-20. LOX Pump Inlet Conditions--First Burn
(Sheet 1 of 2)

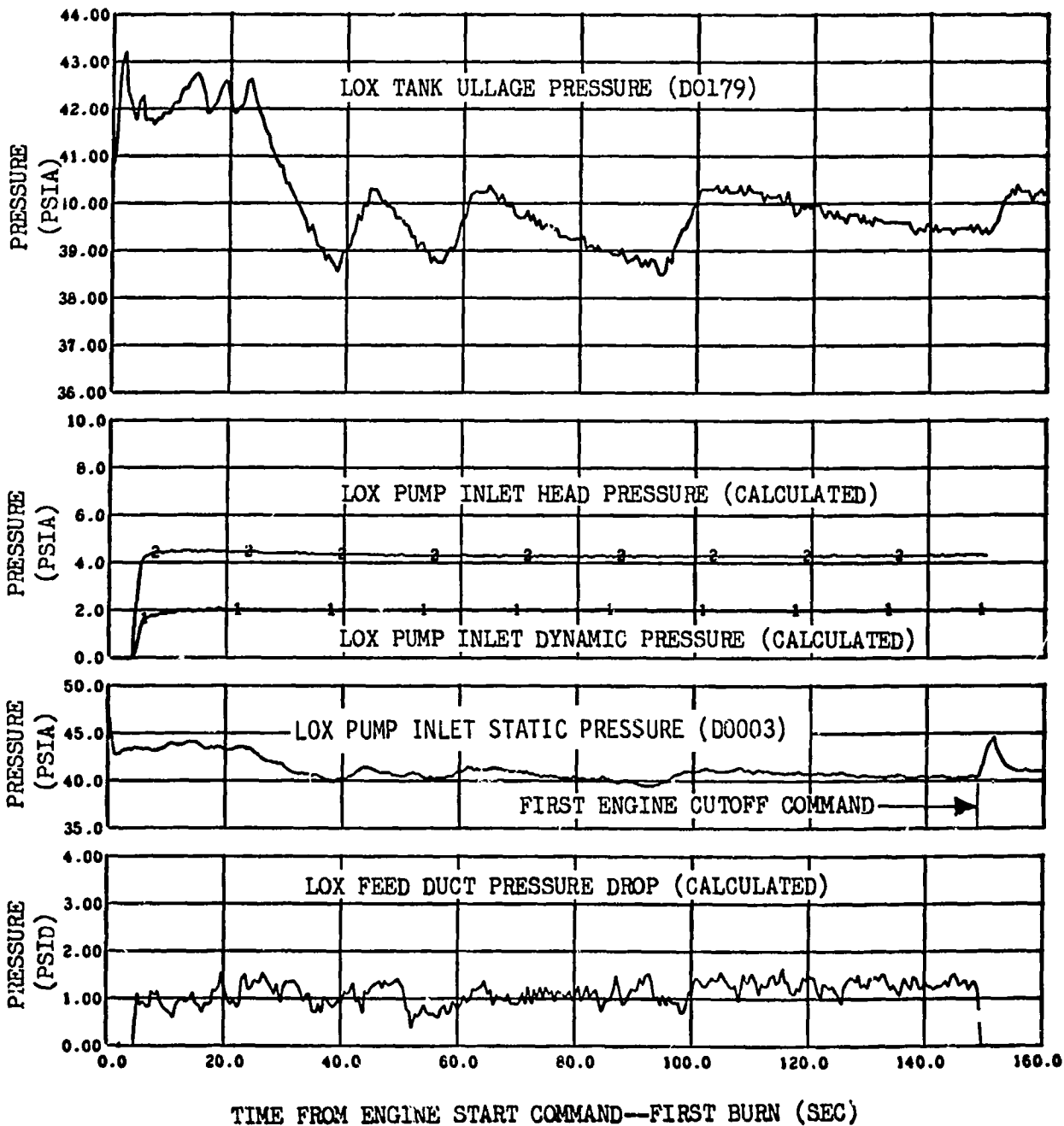

Figure 11-20. LOX Pump Inlet Conditions--First Burn
(Sheet 2 of 2)

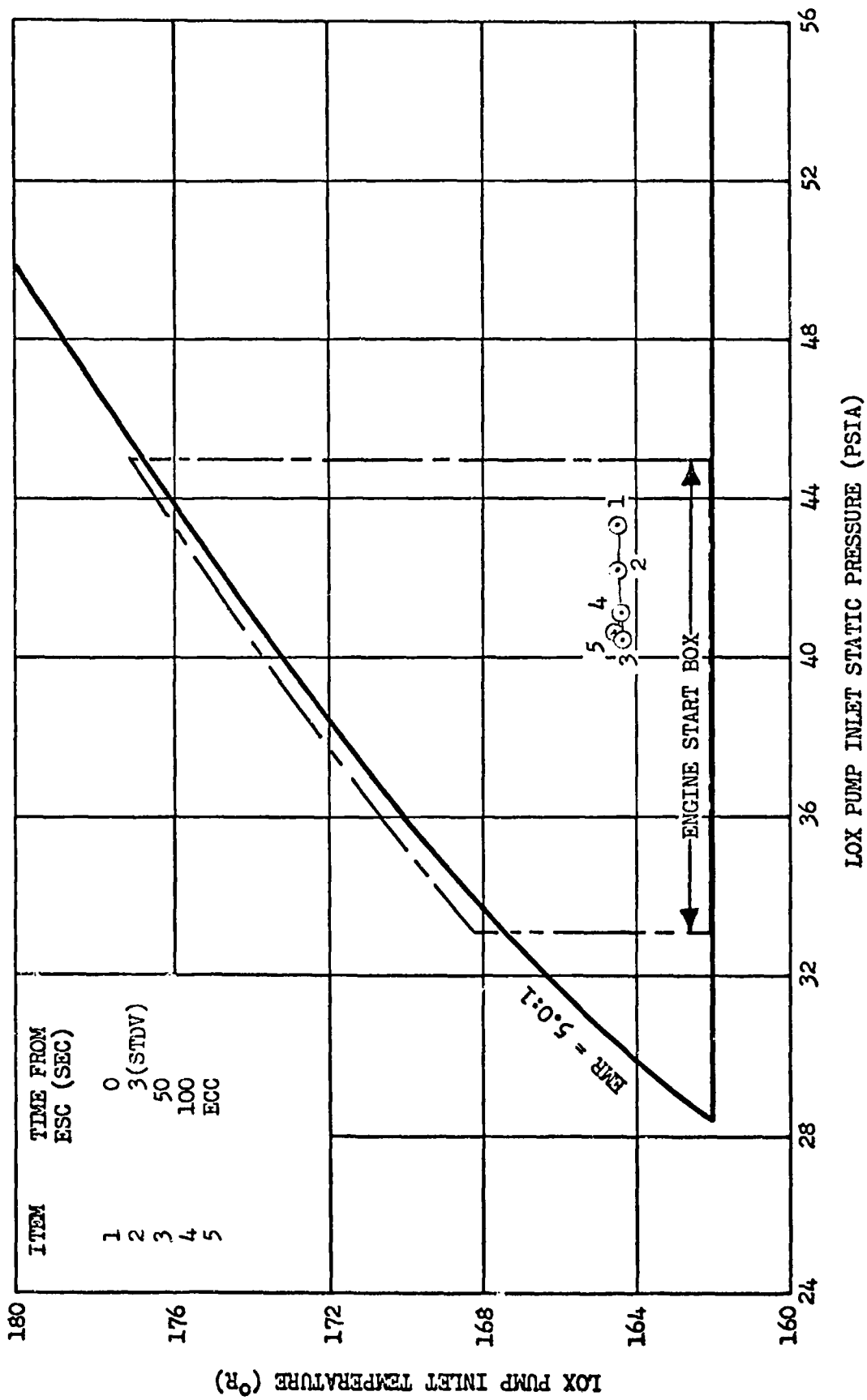

Figure 11-21. LOX Pump Inlet Conditions During Firing --FIRST BURN

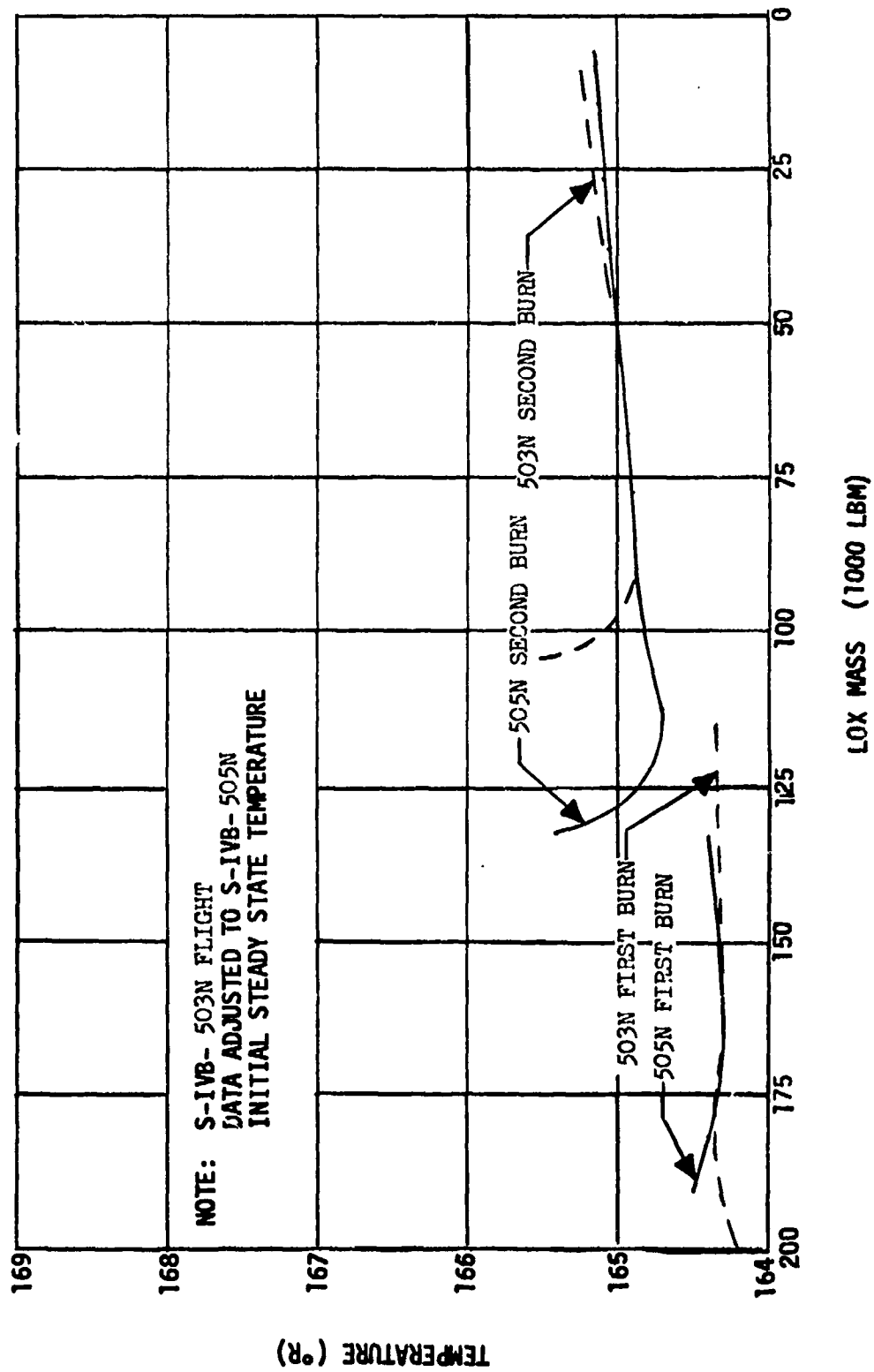

Figure 11-22. Effect of LOX Mass Level on LOX Pump Inlet Temperature

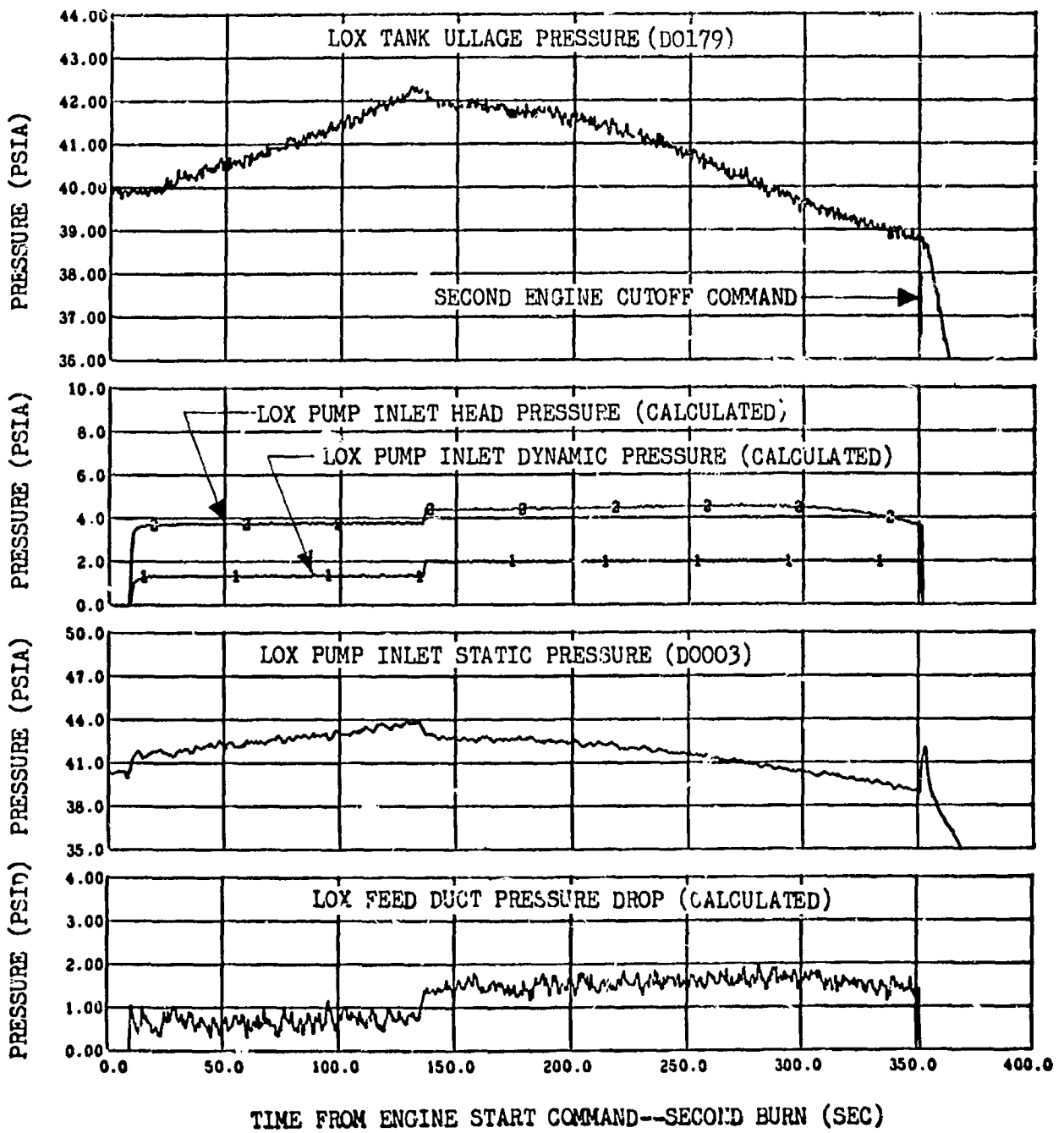

Figure 11-23. LOX Pump Inlet Conditions--Second Burn
 (Sheet 1 of 2)

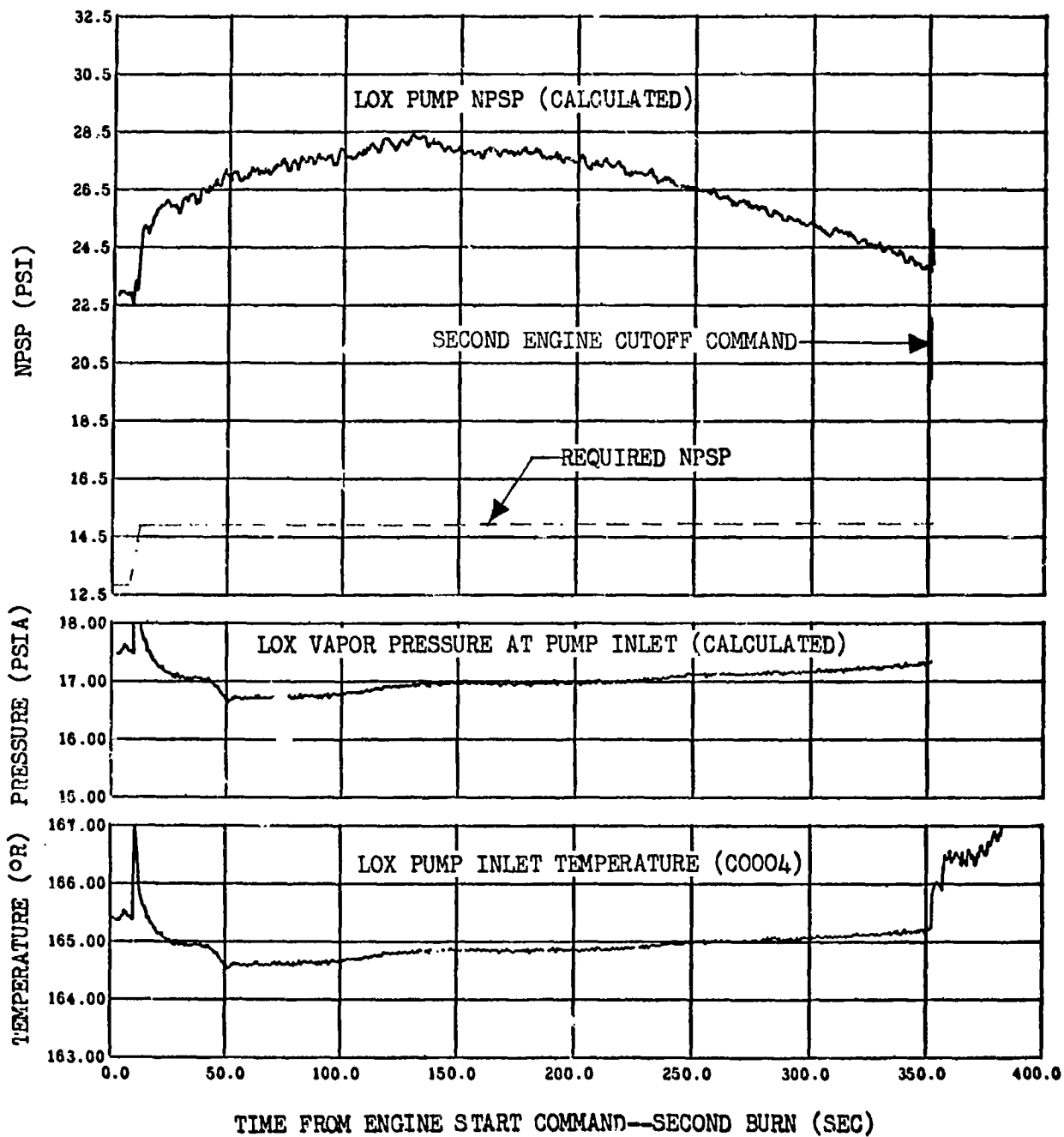

Figure 11-23. LOX Pump Inlet Conditions--Second Burn
(Sheet 2 of 2)

12. FUEL SYSTEM

The fuel system supplied LH2 to the engine as expected, and the NPSP exceeded minimum requirements at all times.

12.1 LH2 Tank Pressurization Control

The LH2 tank pressurization system (figure 12-1) satisfactorily accomplished prepressurization, first burn GH2 pressurization, O₂-H₂ burner repressurization, and second burn GH2 pressurization. An ambient repressurization of the tank was successfully performed prior to the fuel lead experiment.

12.1.1 First Burn

12.1.1.1 Prepressurization

The LH2 tank was satisfactorily prepressurized in 13.1 seconds. This time was normal for the small initial LH2 ullage volume (550 ft³). Conditions from prepressurization until first engine start command (ESC₁) are summarized in figure 12-2 and compared to S-IVB-503N and 504N flight data in table 12-1.

A minor decay and subsequent recovery in LH2 tank ullage pressure occurred during the 70 seconds following liftoff. This decay probably resulted from ullage gas cooling due to sloshing; however, ullage temperature data are not available to confirm this. The effect was accentuated by the small initial ullage volume. The LH2 tank ullage pressure was at relief conditions, 31.8 psia, for the remainder of boost.

12.1.1.2 Pressurization - First Burn

At first burn engine start command, the LH2 tank ullage pressure was 31.8 psia. The GH2 pressurization system performance was nominal during first burn.

The LH2 tank ullage pressure was at relief conditions throughout the burn, resulting in approximately 13 lbm of vented ullage gas. Conditions during first burn LH2 tank pressurization are summarized in figure 12-3 and compared with S-IVB-504N and 5-3N flight data in table 12-2.

12.1.2 Second Burn

12.1.2.1 O₂-H₂ Burner Repressurization

The O₂-H₂ burner was utilized to repressurize the LH2 tank in preparation for S-IVB second burn. The repressurization rate was 3.59 psi/min. Burner start command was followed by a 6.8-second lag before initiation of repressurization in order to provide higher burner chamber pressure and improved combustion stability during the start transient. The LH2 tank conditions are shown in figure 13-3; significant data are compared to 504N and 503N flight data in table 12-3.

12.1.2.2 Pressurization - Second Burn

At second burn engine start command (ESC₂), the LH2 tank ullage pressure was 31.5 psia. The GH2 pressurization flowrate was adequate to satisfactorily accomplish LH2 tank second burn pressurization.

The ullage pressure profile indicated possible relieving during the first 40 sec of pressurization, but the NPV nozzle pressure indicated that no venting occurred during this period. The pressurization system responded normally to the engine mixture ratio change, and the ullage pressure reached the relief level (31.9 psia) at ESC₂ +230 sec. The initiation of step pressurization resulted in an ullage pressure increase and more pronounced venting, as indicated by the intermittent drop out of the closed talkback on both the vent valve and the latching vent valve. A total of approximately 33 lbm of ullage gas was vented during second burn.

Conditions during second burn LH2 tank pressurization are summarized in figure 12-4 and compared to S-IVB-504N and 503N flight data in table 12-2.

12.2 Pressurization System Conditions During Coast

12.2.1 LH2 Tank Ambient Repressurization

Ambient repressurization of the LH2 tank was satisfactorily accomplished in preparation for the propellant lead experiment. The sphere pressure dropped from 2,810 to 730 psia during the repressurization, while 24.8 lbm of helium were added to the LH2 tank ullage. Repressurization was initiated at RO +17,357 sec and was terminated after 29 sec in order to guarantee adequate helium for engine pneumatic control during the propellant lead experiment. Due to the short repressurization and to the large ullage volume, the ullage pressure only increased from 16.6 to 20.8 psia. Ambient repressurization data are shown in figure 12-5.

12.2.2 LH2 Tank Nonpropulsive Vent and Relief Valve Operation

The nonpropulsive vent (NPV) and relief valves operated satisfactorily during boost. The valves apparently feathered to maintain the ullage pressure at 31.8 psia. After first engine start command, the ullage again reached relief conditions and remained at 31.9 psia.

During second burn, the ullage reached relief conditions, and the relief valves apparently feathered again, controlling ullage pressure at 31.9 psia from ESC₂ +230 sec until step pressurization. After step pressurization (ESC₂ +280 sec) the ullage pressure increased to 32.2 psia, and the valves began a distinct relief function. A time correlation has been made between this venting, during which NPV nozzle pressure oscillations occurred, and the 46-Hz vibrations observed in the forward skirt area. This vibration is discussed in section 25.

After second burn, two programmed vents were performed prior to the propellant lead experiment. The NPV was permanently latched open after the experiment. These vents are discussed in paragraph 27.2. Data are presented in figure 12-6.

12.2.3 LH2 Tank Continuous Vent

The continuous vent system (CVS) performed satisfactorily, maintaining the LH2 tank ullage pressure at an average level of 19.5 psia and providing an average acceleration of 6×10^{-5} g's for propellant settling during earth parking orbit. The LH2 disturbances caused by the pitch maneuver to local horizontal at RO +723 sec were settled by CVS acceleration prior to LH2 tank cryogenic repressurization. The CVS was initiated at 763 sec after liftoff, as indicated by the data (figures 12-7 through 12-10). Earth orbit CVS activity terminated at RO +8,671 sec. The calculated boiloff during earth orbit was 2,230 lbm. This is in good agreement with the PU indicated boiloff of 2,373 lbm.

A programmed 900-sec continuous vent was initiated after second engine cutoff command in conjunction with opening of the latching relief valve. The CVS was activated at second engine cutoff command (RO +9,551 sec) and provided 2×10^{-5} g's to settle liquid residuals. The ullage pressure dropped to 5.8 psia by the termination of the combined CVS and NPV operation. Data for the first CVS operation after translunar injection (TLI) appear in figures 12-9 and 12-10. The boiloff during time base 7 was approximately 1,300 lbm.

The CVS was again activated at RO +16,936 sec because of the fuel lead experiment; it was closed at RO +16,953 sec by ground command. After the experiment, the CVS was opened permanently at RO +17,497 sec and provided an average acceleration of 2.5×10^{-4} g's which settled the LH2 residual prior to permanent opening of the NPV valve. Data for the final propulsive vent are presented in figures 12-11 and 12-12.

12.2.4 LH2 Tank Passivation

The LH2 tank passivation was adequately performed after the fuel lead experiment. Passivation was started by permanent activation of the CVS at RO +17,497 sec. Data for final CVS operation is presented in figures 12-11 and 12-12. At RO +18,966 sec, the LH2 NPV valve was latched open permanently. Final NPV data are presented in figure 12-13.

At the end of the fuel lead experiment, data showed that the LH2 tank contained 333 lbm of liquid and 787 lbm of GH2. Analysis of available data, assuming zero liquid entrainment in the gas flow out of the vent system, indicated that total mass flow is in close agreement with total liquid and ullage mass in the tank at the end of the fuel lead experiment. The ullage pressure was nearly zero at RO +28,000 sec (figure 12-13).

12.3 LH2 Pump Chilldown

12.3.1 First Burn

The LH2 pump chilldown system performed satisfactorily. Table 12-4 compares significant LH2 chilldown system performance data with that from S-IVB-504N and 503N flights. The chilldown system temperatures, pressures, and calculated performance are presented in figures 12-14 and 12-15.

12.3.2 Second Burn

The LH2 pump chilldown for second burn differed from that of first burn in that the engine supply line and pump were initially full of superheated gas, as opposed to a saturated liquid. Performance was normal, and the NPSP was adequate to meet requirements at second engine start command.

Significant data are presented in figures 12-16 and 12-17 and are compared to previous flight data in table 12-6.

12.4 Engine LH2 Supply

The engine LH2 supply system (figure 12-18) met all demands for fuel during first and second burn.

12.4.1 First Burn

The NPSP at the LH2 pump inlet was well above that required at first engine start command and throughout first burn. The pump inlet conditions are presented in figure 12-19. A correlation between the inlet temperature and pressure indicates that the inlet conditions were within the LH2 pump operating region throughout the burn (figure 12-20). The relationship between the mass in the tank and the pump inlet temperature is shown in figure 12-21.

12.4.2 Second Burn

The NPSP, LH2 pump interface static pressure, and LH2 pump interface temperature during restart are shown in figure 12-22. The fuel pump inlet pressure and temperature were plotted in the second start region (figure 12-23) and indicate that the engine fuel pump inlet conditions were satisfactorily met. Table 12-5 compares the LH2 supply data with that from S-IVB-504N and 503N flights.

TABLE 12-1

LH2 TANK PREPRESSURIZATION DATA

PARAMETER	S-IVB-505N FLIGHT	S-IVB-504N FLIGHT	S-IVB-503N FLIGHT
Prepressurization duration (sec)	13.1	12.3	12.8
Ullage volume (cu ft)	550	495	540.0
Helium mass added (lbm)	4.4	4.66	4.85
Ullage pressure			
At prepressurization initiation (psia)	16.0	15.3	15.3
At prepressurization termination (psia)	31.7	31.7	32.1
At liftoff (psia)	31.5	31.1	31.3
At engine start command (psia)	31.8	31.4	31.7
Events (sec from liftoff)			
Prepressurization initiation	-96.4	-96.3	-96.3
Prepressurization termination	-83.3	-84.0	-83.5
Engine start command	553.6	537.3	524.9

TABLE 12-2
LH2 TANK PRESSURIZATION DATA

PARAMETER	S-IVB-505N FLIGHT		S-IVB-504N FLIGHT		S-IVB-503 FLIGHT	
	FIRST BURN	SECOND BURN	FIRST BURN	SECOND BURN	THIRD BURN	SECOND BURN
Pressure switch setting						
Lower (psia)	28.2	28.2	28.6	28.6	28.6	28.7
Upper (psia)	30.3	30.3	30.3	30.3	30.3	30.6
Ullage pressure						
At engine start command (psia)	31.8	31.5	31.4	30.7	29.55**	31.5
At engine cutoff command (psia)	31.9	32.1	31.6	30.8	31.6	32.0
GH2 pressurant flowrate*						
Undercontrol--high EMR (lbm/sec)	0.72	0.71	0.76	---	---	---
Undercontrol--low EMR (lbm/sec)		0.66	---	0.72	0.69+	0.67
Step+--low EMR (lbm/sec)			---	---	---	1.06
Step--high EMR (lbm/sec)		1.14	---	---	---	---
Total GH2 added (lbm)	105	267.9	9.32	43.3	120.6	234.2

*On 505F high EMR = 5.0:1, low EMR = 4.5:1

**Ullage pressure 8 seconds before STDV3

+Pressurization flowrate during first 150 seconds of burn

++Average GH2 pressurant flowrate during last 46 seconds of S-IVB-503 second burn

TABLE 12-3

LH2 TANK BURNER REPRESSURIZATION DATA

Parameter	S-IVB-505N Flight	S-IVB-504N Flight	S-IVB-503N Flight
Repressurization duration (sec)	182.0*	180.4*	168.4*
Ullage volume (ft ³)	3,740	3,690	3,887
Ullage pressure			
At repressurization initiation (psia)	19.2	19.2	19.4
At repressurization termination (psia)	30.3	30.4	30.2
Rise rate (psi/min)	3.59	3.72	3.85
Repressurization helium usage (lbm)	25.4	24.6	24.02

* Does not include the lag in repressurization initiation following burner start command.

TABLE 12-4 (Sheet 1 of 3)
LH2 CHILLDOWN SYSTEM PERFORMANCE DATA

Parameter	S-IVB-505N Flight		S-IVB-504N Flight		S-IVB-503N Flight	
	First Burn	Second Burn	First Burn	Second Burn	First Burn	Second Burn
NFSP						
At engine start command (psi)						
With chill pump head	15.2	N/A	13.7	N/A	19.16	N/A
Without chill pump head	7.2	7.6	6.2	2.0	11.06	4.86
Minimum required at engine start (psi)	4.53	4.53	4.53	4.53	4.53	4.53
Maximum during chilldown (psi)	24.6	14.7	23.7	8.3	24.7	15.0
Average flow coefficient (sec ² /in ² ft ²)	19.0	19.0	17.6	17.6	18.1	18.1
Fuel quality in sections* 2 and 3 (lb gas/lb mixture)						
Maximum during unpressurized chilldown	0.045	N/A	0.036	N/A	0.036	N/A
At prepressurization	0.041	N/A	0.034	N/A	0.033	N/A
Fuel pump inlet conditions						
Static pressure at engine start command (psi)						
With chill pump head	38.5	N/A	35.0	N/A	38.1	N/A
Without chill pump head	30.5	31.6	27.5	30.4	30.0	31.8

*Section 1 is tank to pump inlet; section 2 is pump inlet to bleed valve exit; section 3 is bleed valve exit, to tank.

N/A Not applicable

TABLE 12-4 (Sheet 2 of 3)
LH2 CHILLDOWN SYSTEM PERFORMANCE DATA

Parameter	S-IVB-505N Flight		S-IVB-504N Flight		S-IVB-503N Flight	
	First Burn	Second Burn	First Burn	Second Burn	First Burn	Second Burn
Chilldown pump pressure differential						
Unpressurized (psi)	9.4	N/A	9.2	N/A	9.2	N/A
Pressurized (psi)	7.9	7.0	7.4	7.2	8.0	7.7
Events (sec**)						
Chilldown initiation	-299.534	-316.005	-299.542	-316.005	-299.450	-315.991
Prevalve closed	-284.090	-310.981	-283.846	-310.709	-284.410	-310.399
CVS closed	N/A	-527.651	N/A	-527.390	N/A	-527.650
Pressurization	-56.414	-521.869	-96.320	-521.866	-96.316	-521.872
Prevalve open command	552.922	-10.598	536.514	-10.607	524.315	-10.615
Prevalve closed signal dropout	553.809	-9.606	537.481	-9.421	525.162	-9.668
Prevalve open signal pickup	555.332	-7.689	539.146	-7.254	526.828	-7.713
Chilldown pump off	554.804	-7.598	538.406	-0.592	526.215	-0.608
Engine start command	553.621	0	537.264	0	524.998	0

**All first burn data are referenced to liftoff; all second burn data are referenced to second engine start command.

N/A Not applicable

TABLE 12-4 (Sheet 3 of 3)
LH2 CHILLDOWN SYSTEM PERFORMANCE DATA

Parameter	S-IVB-505N Flight		S-IVB-504N Flight		S-IV3-503N Flight	
	First Burn	Second Burn	First Burn	Second Burn	First Burn	Second Burn
Temperature at engine start command (deg R)	38.5	40.4	38.4	40.9	38.1	40.5
Amount of subcooling at engine start (deg R) (degrees below saturation at pump inlet)	4.7	1.4	4.1	0.5	5.1	1.2
Heat absorption rate during unpressurized chilldown						
Section 1* (Btu/hr)	20,000	N/A	19,500	N/A	22,000	N/A
Section 2 and 3* (Btu/hr)	27,500	N/A	26,500	N/A	23,000	N/A
Total (Btu/hr)	47,500	N/A	46,000	N/A	45,000	N/A
Heat absorption rate during pressurized chilldown						
Section 1* (Btu/hr)	1,200	3,500	8,000	27,000	2,500	1,000
Section 2* (Btu/hr)	12,000	} 25,000	4,500	} 7,500	7,500	} 22,000
Section 3* (Btu/hr)	4,000		3,000		7,500	
Total (Btu/hr)	17,200	28,500	15,500	34,500	17,500	23,000
Chilldown flowrate						
Unpressurized (gpm)	94	N/A	98	N/A	100	N/A
Pressurized (gpm)	138	137	139	140	141	140

*Section 1 is tank to pump inlet; section 2 is pump inlet to bleed valve exit; section 3 is bleed valve exit to tank.

N/A Not applicable

TABLE 12-5 (Sheet 1 of 2)
LH2 PUMP INLET CONDITION DATA

Parameter	S-IVB-505N Flight		S-IVB-504N Flight		S-IVB-503N Flight	
	First Burn	Second Burn	First Burn	Second Burn	First Burn	Second Burn
Pump Inlet Conditions						
Static pressure at engine start command (psia)						
With chill pump head	38.5	N/A	35.0	N/A	38.1	N/A
Without chill pump head	30.5	31.6	27.5	30.4	30.0	31.8
Static pressure at engine cutoff (psia)	30.4	30.8	31.8	29.8	30.2	32.0
Temperature at engine start (deg R)	38.5	40.4	38.4	40.9	38.1	40.5
Temperature at engine cutoff (deg R)	38.7	39.4	38.0	38.5	38.1	39.3
NPSP Requirements						
Minimum at engine start command (psi)	4.53	4.53	4.53	4.53	4.4	4.4
At high EMR (psi)	N/A	N/A	5.3	N/A	N/A	N/A
After EMR cutback (psi)	4.98	4.98	N/A	4.98	5.0	5.0
NPSP Available						
At engine start command (psi)						
With chill pump head	15.2	N/A	13.7	N/A	19.2	N/A
Without chill pump head	7.2	7.6	6.2	2.0	11.1	4.9
At start tank discharge valve open cmd (psi)	11.5	9.5	9.8	4.8	13.9	8.6

N/A Not applicable

TABLE 12-5 (Sheet 2 of 2)
LH2 PUMP INLET CONDITION DATA

Parameter	S-IVB-505N Flight		S-IVB-504N Flight		S-IVB-503N Flight	
	First Burn	Second Burn	First Burn	Second Burn	First Burn	Second Burn
Maximum during engine burn (psi)	15.2	11.4	14.4	12.2	14.2	11.8
Minimum during engine burn (psi)	11.0	7.3	12.4	2.0	12.8	9.1
At engine cutoff command (psi)	12.0	10.0	14.4	12.3	13.5	9.8
LH2 Feed Duct						
At 5.0:1 EMR						
Pressure drop (psi)	0.8	0.8	N/A	0.7	0.9	0.9
Flowrate (lbm/sec)	80.8	79.7	N/A	80.5	80.1	79.8
At 4.5:1 EMR						
Pressure drop (psi)	N/A	0.9	N/A	N/A	N/A	N/A
Flowrate (lbm/sec)	N/A	74.8	N/A	N/A	N/A	N/A

N/A Not applicable

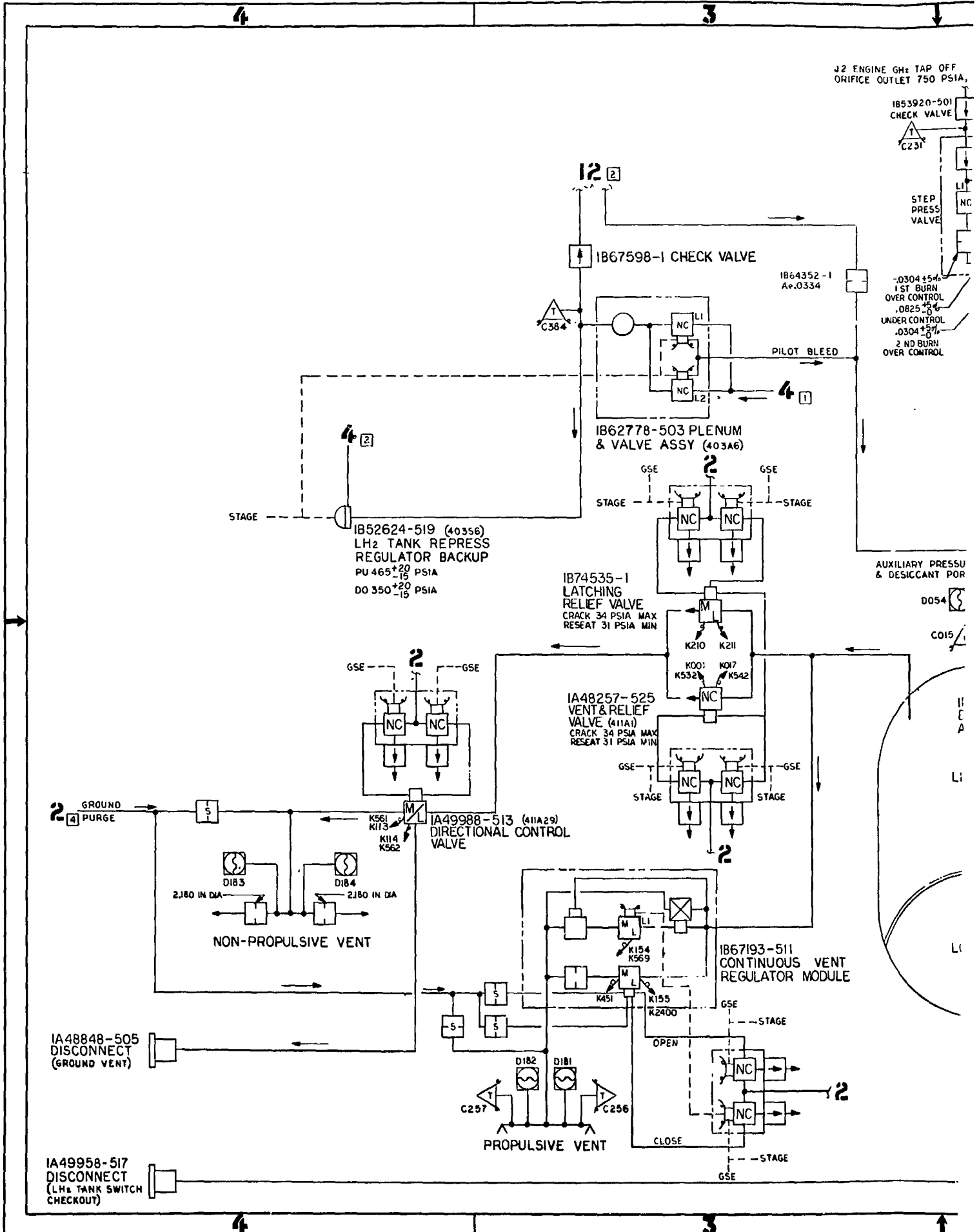

FOLDOUT FRAME

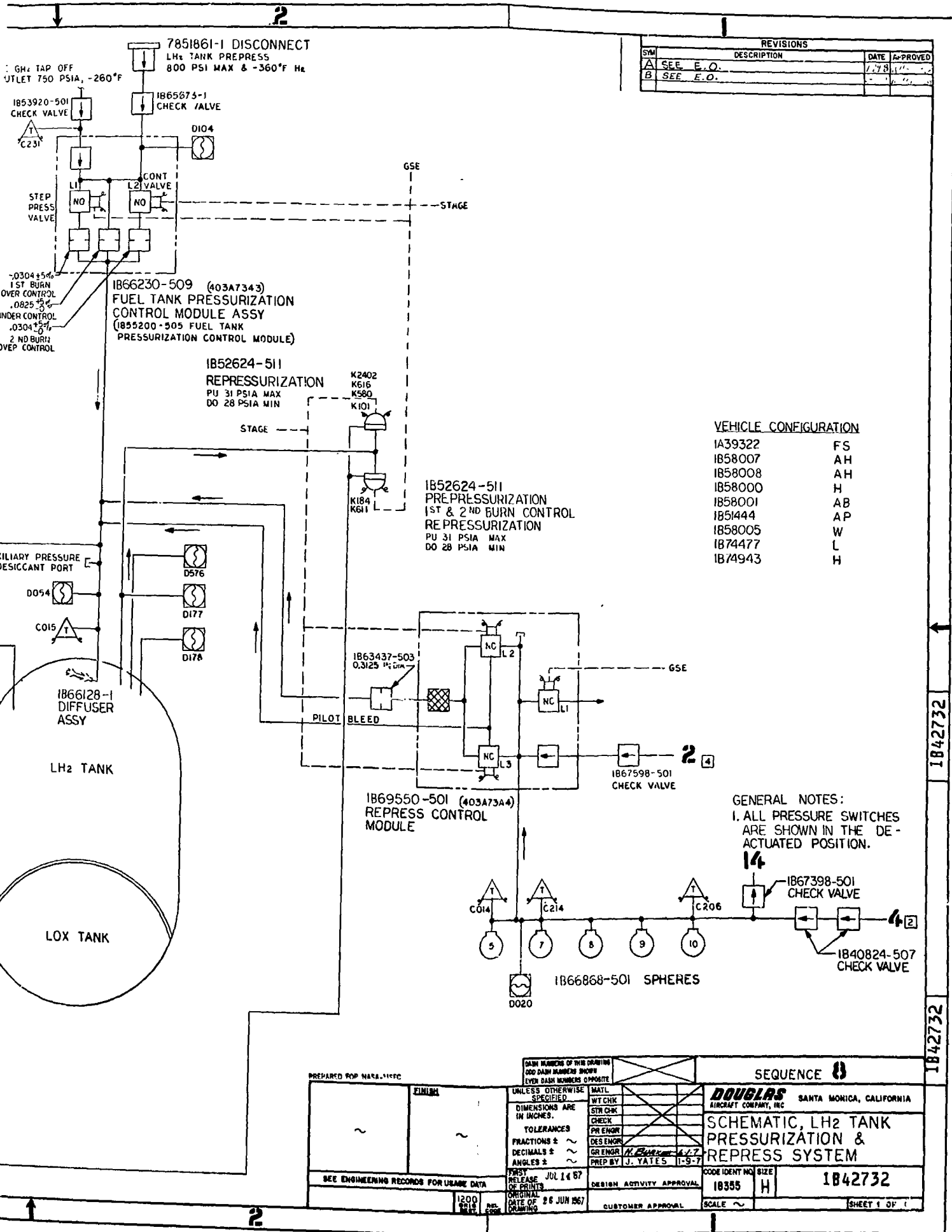

REVISIONS			
SYM	DESCRIPTION	DATE	APPROVED
A	SEE E.O.	1/78	
B	SEE E.O.		

VEHICLE CONFIGURATION

IA39322	FS
IB58007	AH
IB58008	AH
IB58000	H
IB58001	AB
IB51444	AP
IB58005	W
IB74477	L
IB74943	H

GENERAL NOTES:
 1. ALL PRESSURE SWITCHES ARE SHOWN IN THE DE-ACTUATED POSITION.

PREPARED FOR NASA-114FC		DRAW NUMBER OF THIS DRAWING 500 DRAW NUMBER BODY EVEN DRAW NUMBER OPPOSITE		SEQUENCE 8	
FINISH	UNLESS OTHERWISE SPECIFIED DIMENSIONS ARE IN INCHES. TOLERANCES FRACTIONS ± DECIMALS ± ANGLES ±	MAIL WT CHK STY CHK CHECK PR ENGR DES ENGR GR ENGR PREP BY J. YATES 1-9-7	DOUGLAS AIRCRAFT COMPANY, INC. SANTA MONICA, CALIFORNIA		SCHEMATIC, LH2 TANK PRESSURIZATION & REPRESS SYSTEM
SEE ENGINEERING RECORDS FOR USAGE DATA	FIRST RELEASE OF PRINTS DATE OF PRINTING 1200 26 JUN 1967	DESIGN ACTIVITY APPROVAL	CODE IDENT NO 18355	SIZE H	1842732
		CUSTOMER APPROVAL	SCALE		SHEET 1 OF 1

Figure 12-1. Schematic, LH2 Tank Pressurization & Repress System
 FOLDOUT FRAME 2 12-15

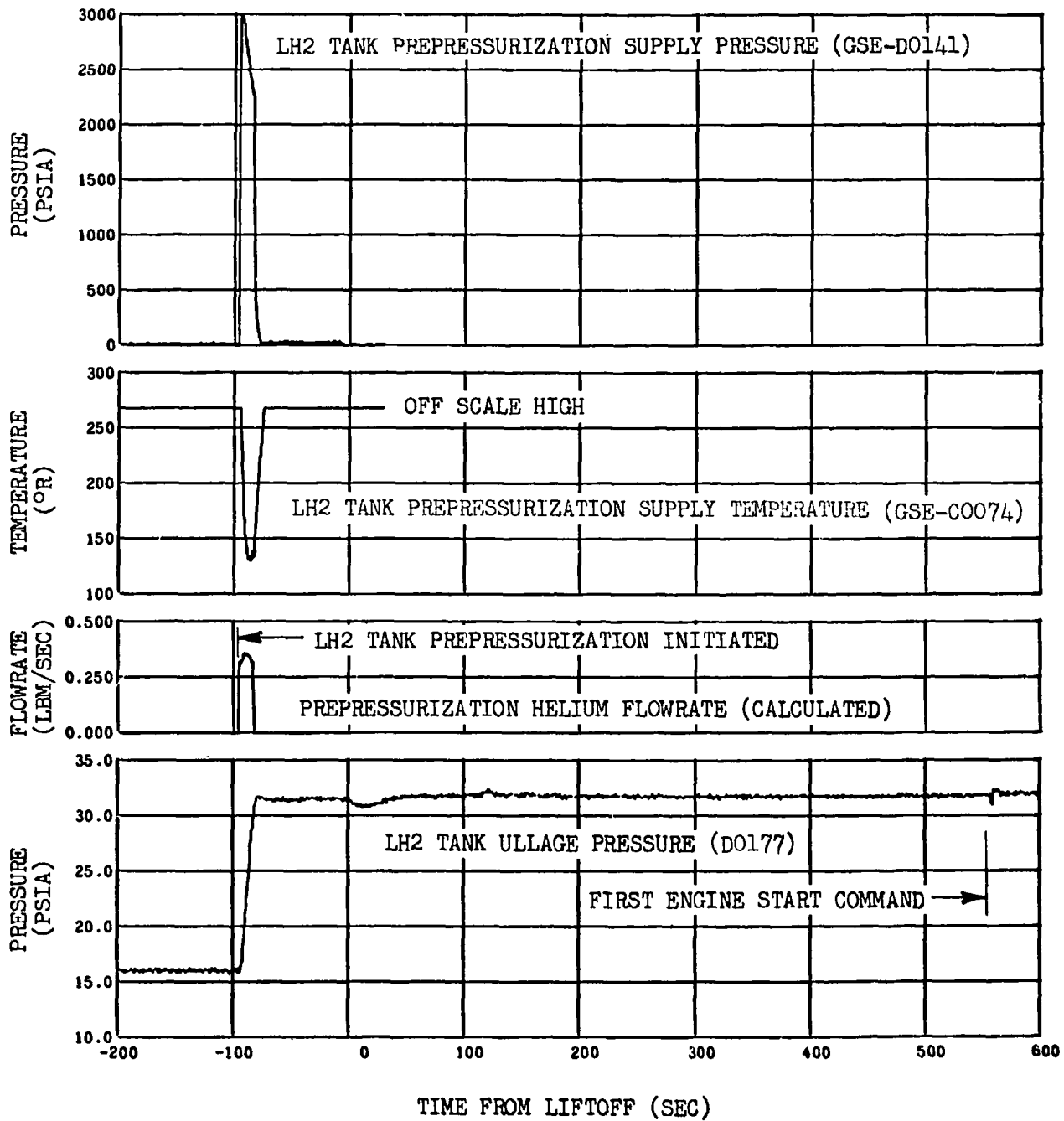

Figure 12-2. LH2 Tank Prepressurization System Performance

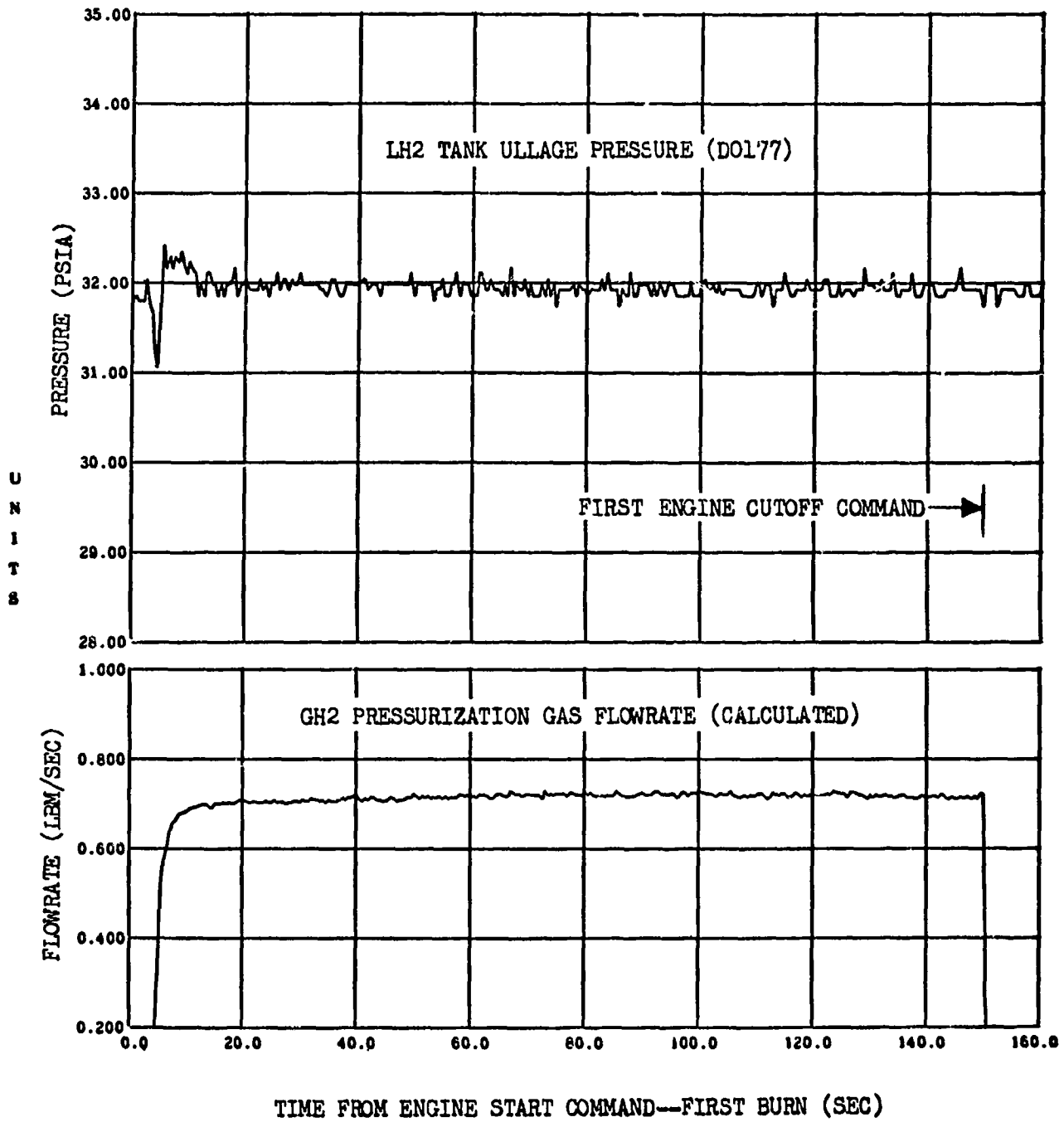

Figure 12-3. LH2 Tank Pressurization System Performance--
First Burn (Sheet 1 of 2)

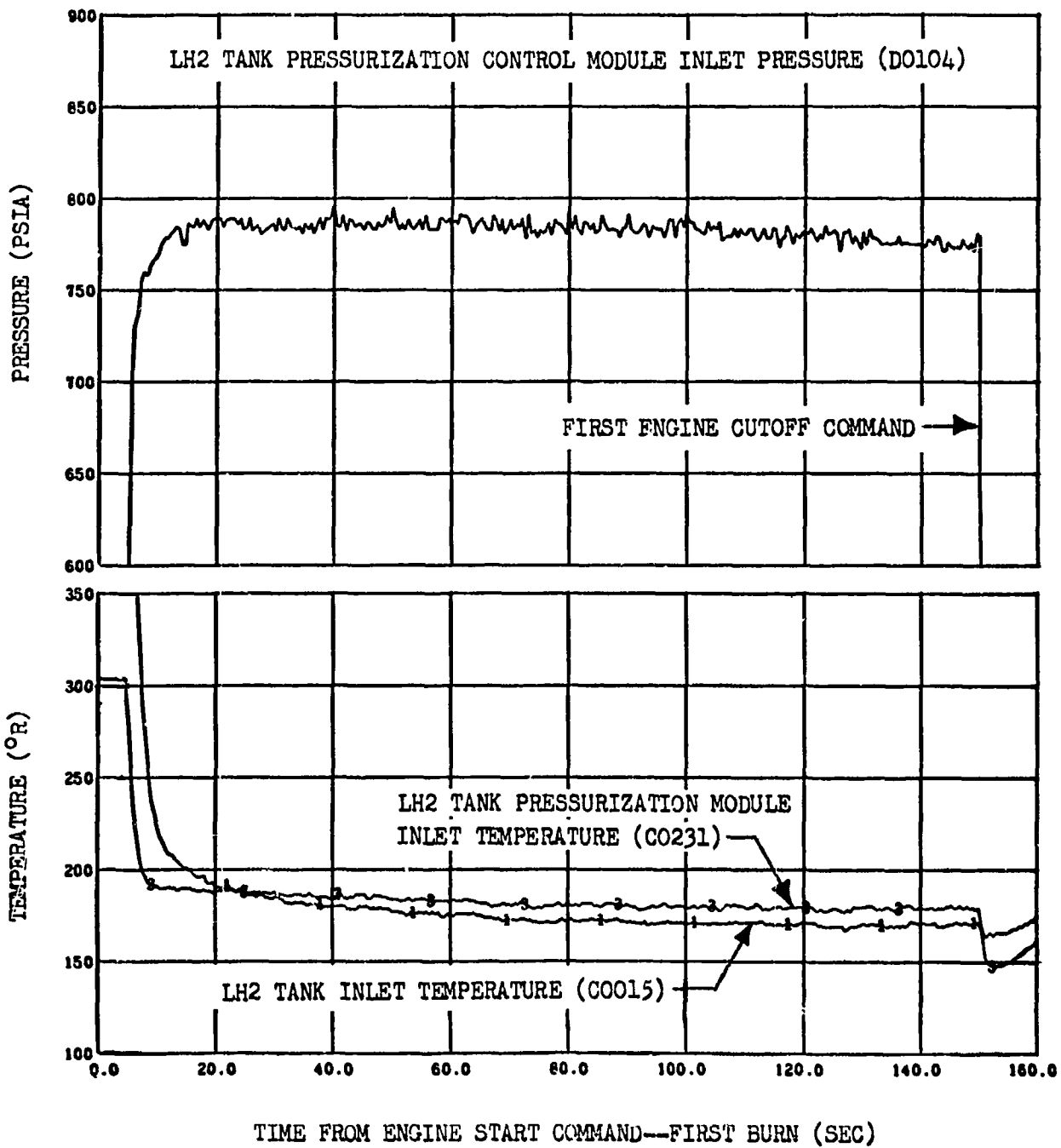

Figure 12-3. LH2 Tank Pressurization System Performance--
 First Burn (Sheet 2 of 2)

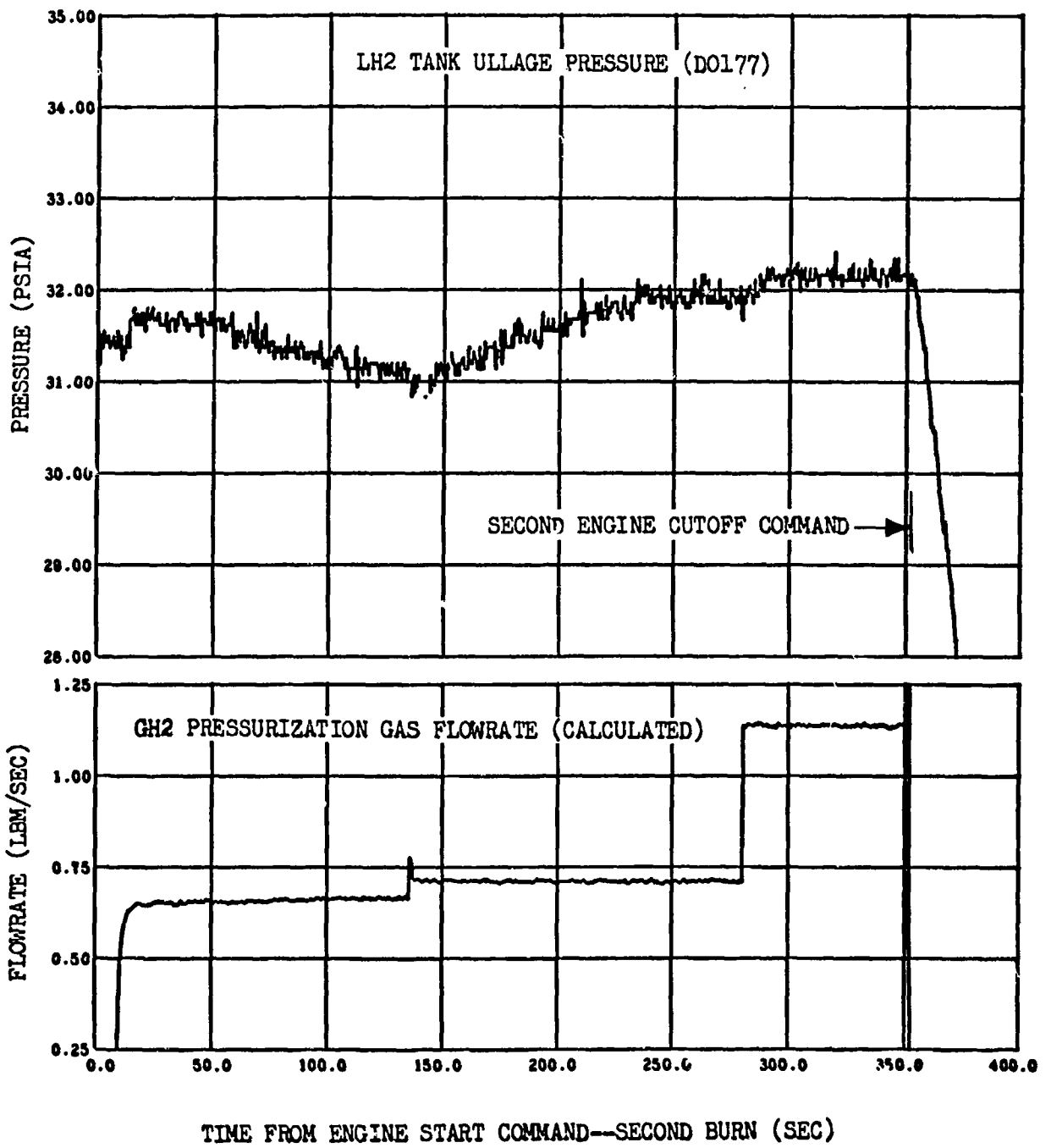

Figure 12-4. LH2 Tank Pressurization System Performance--
Second Burn (Sheet 1 of 2)

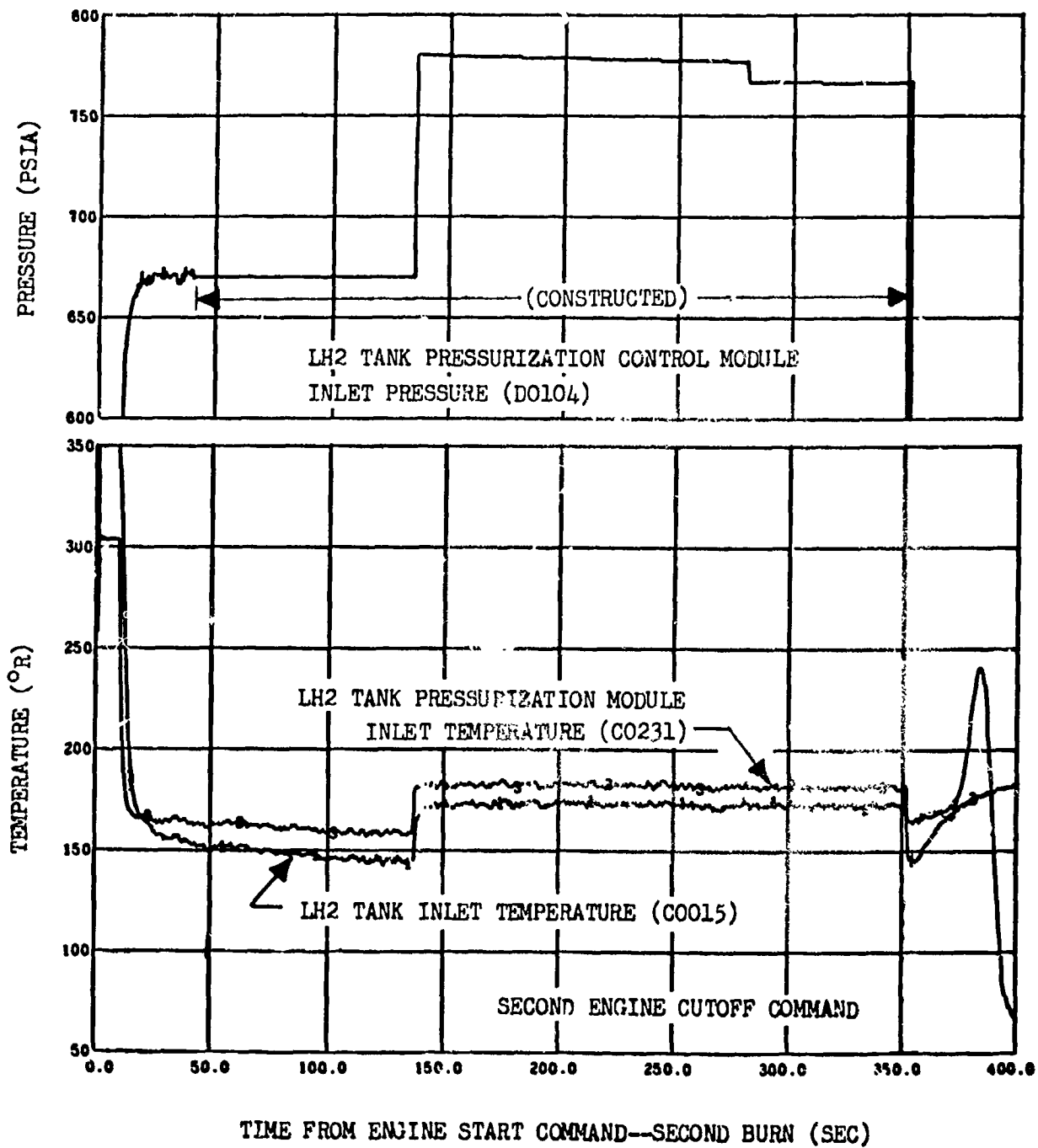

Figure 12-4. LH2 Tank Pressurization System Performance--
Second Burn (Sheet 2 of 2)

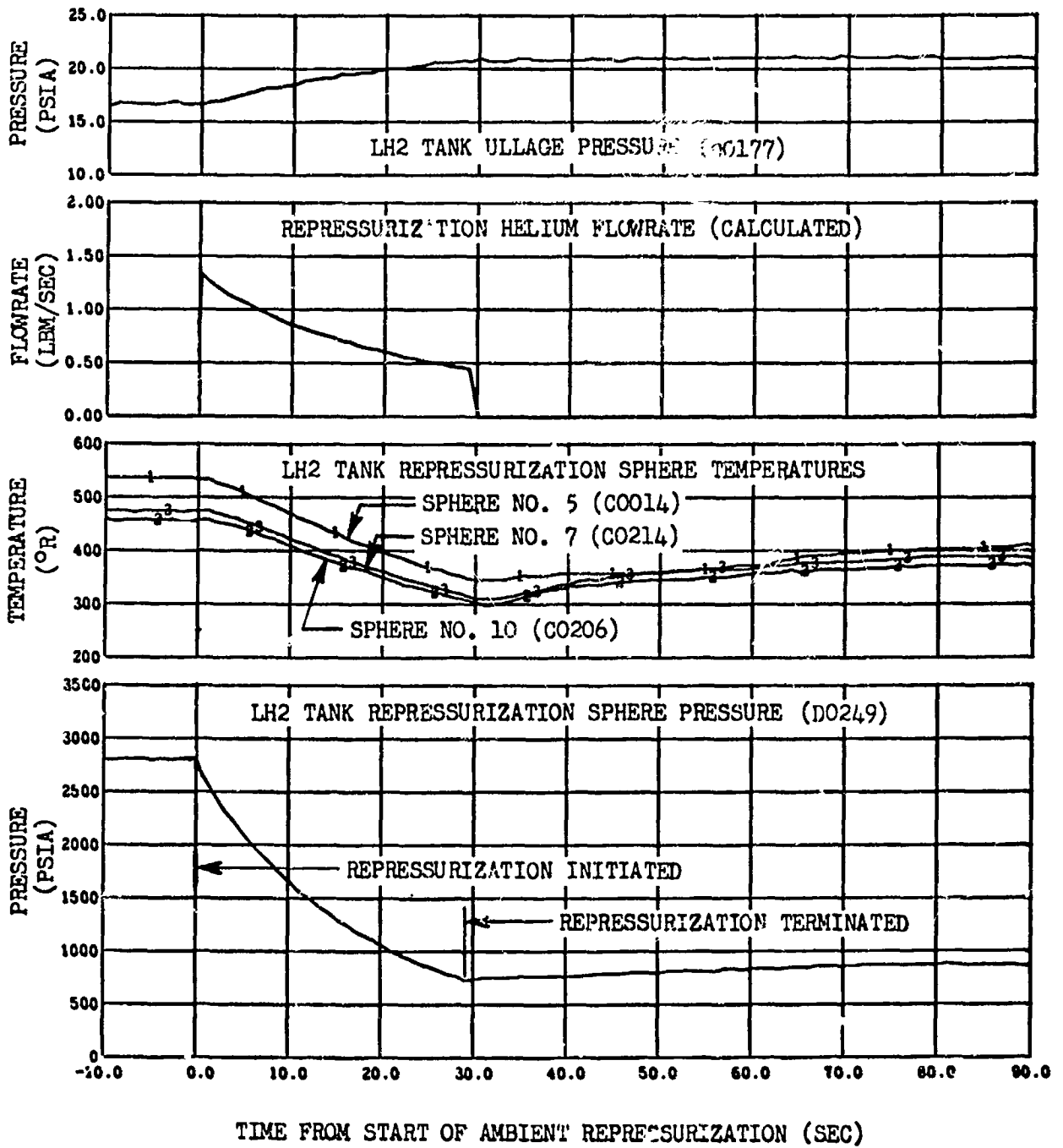

Figure 12-5. LH2 Tank Ambient Helium Repressurization System Performance.

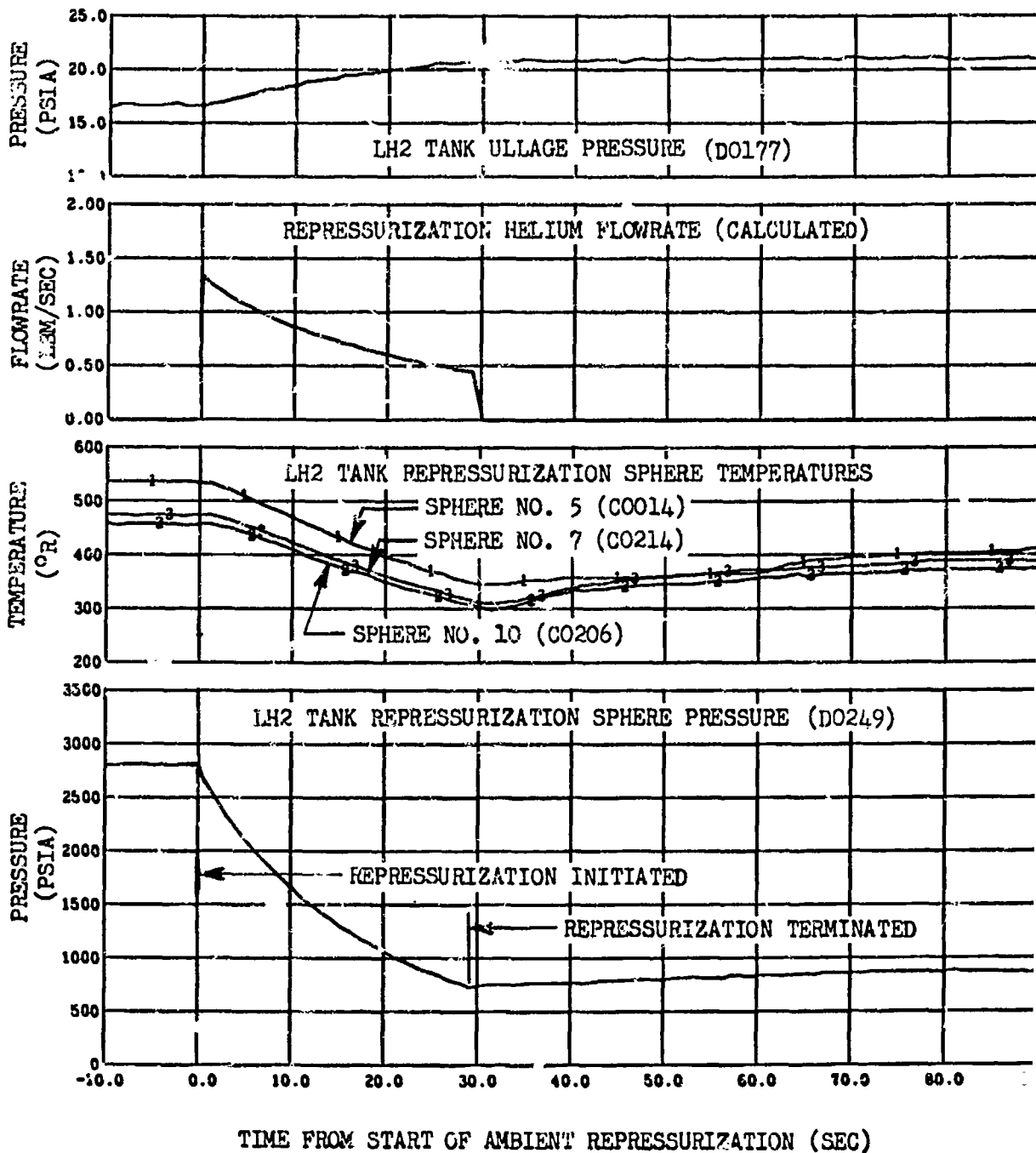

Figure 12-5. LH2 Tank Ambient Helium Repressurization System Performance

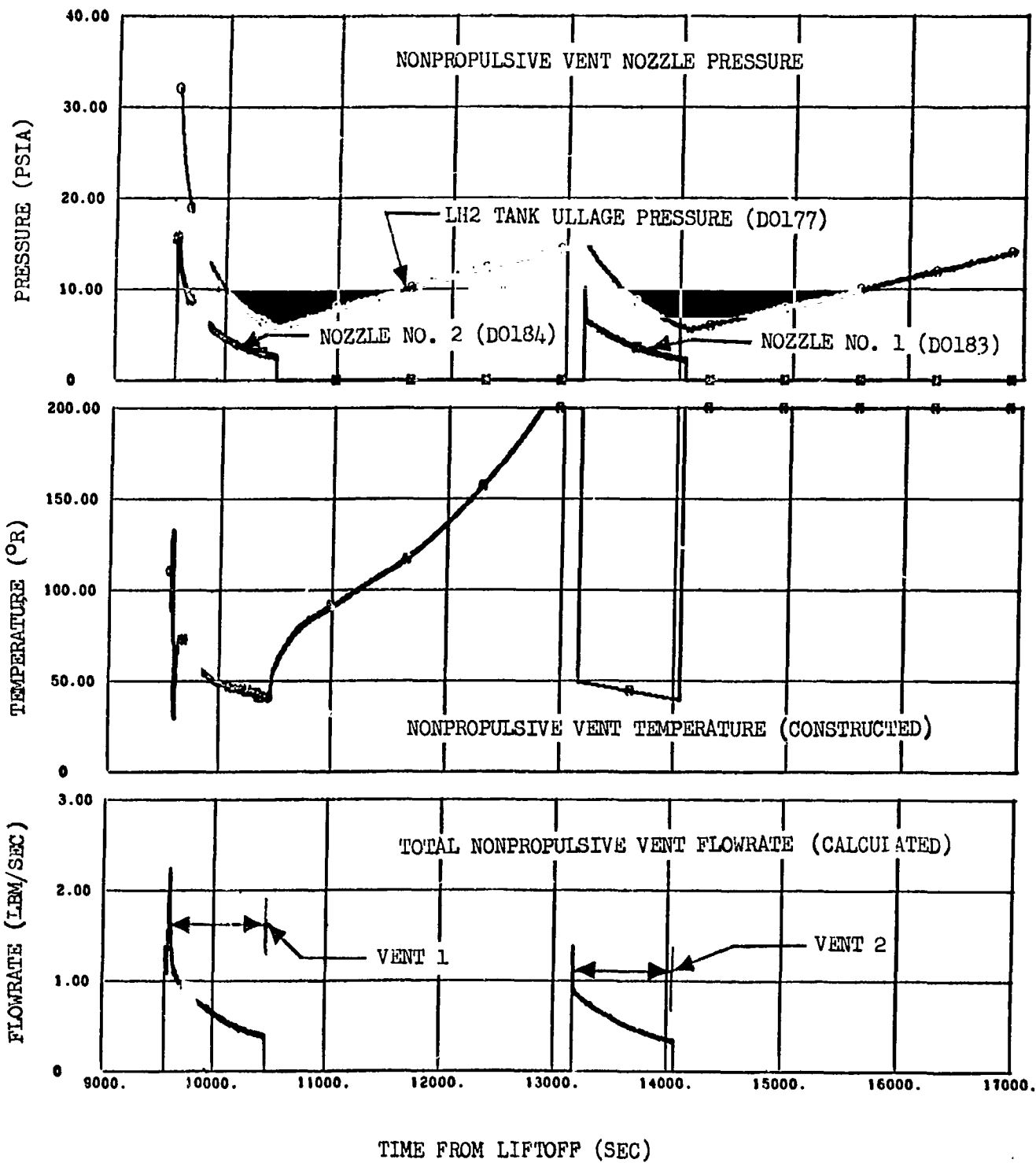

Figure 12-6. Nonpropulsive Vent System Operation--Translunar Coast

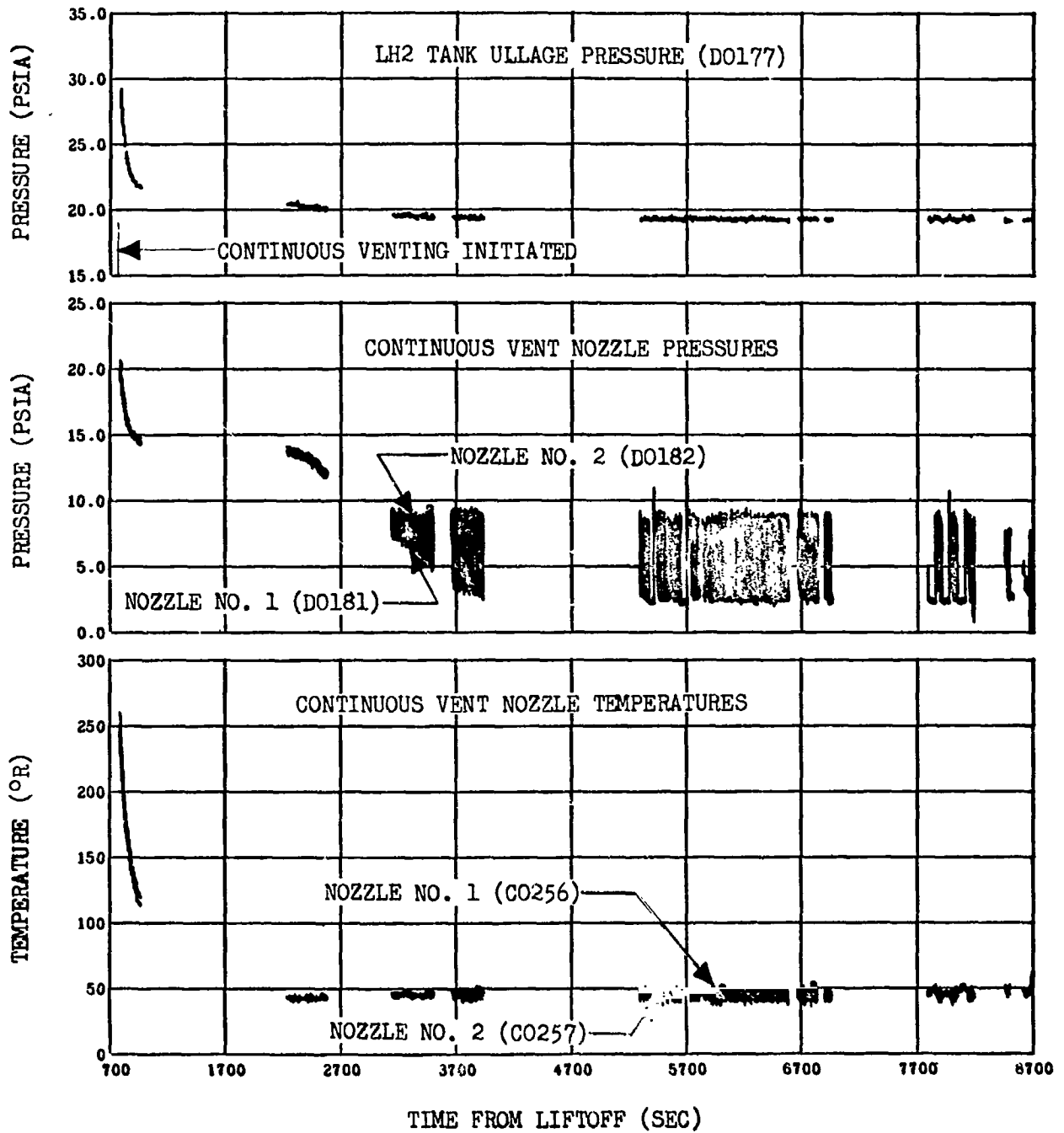

Figure 12-7. LH2 Tank Continuous Vent System Operation--
Earth Orbit

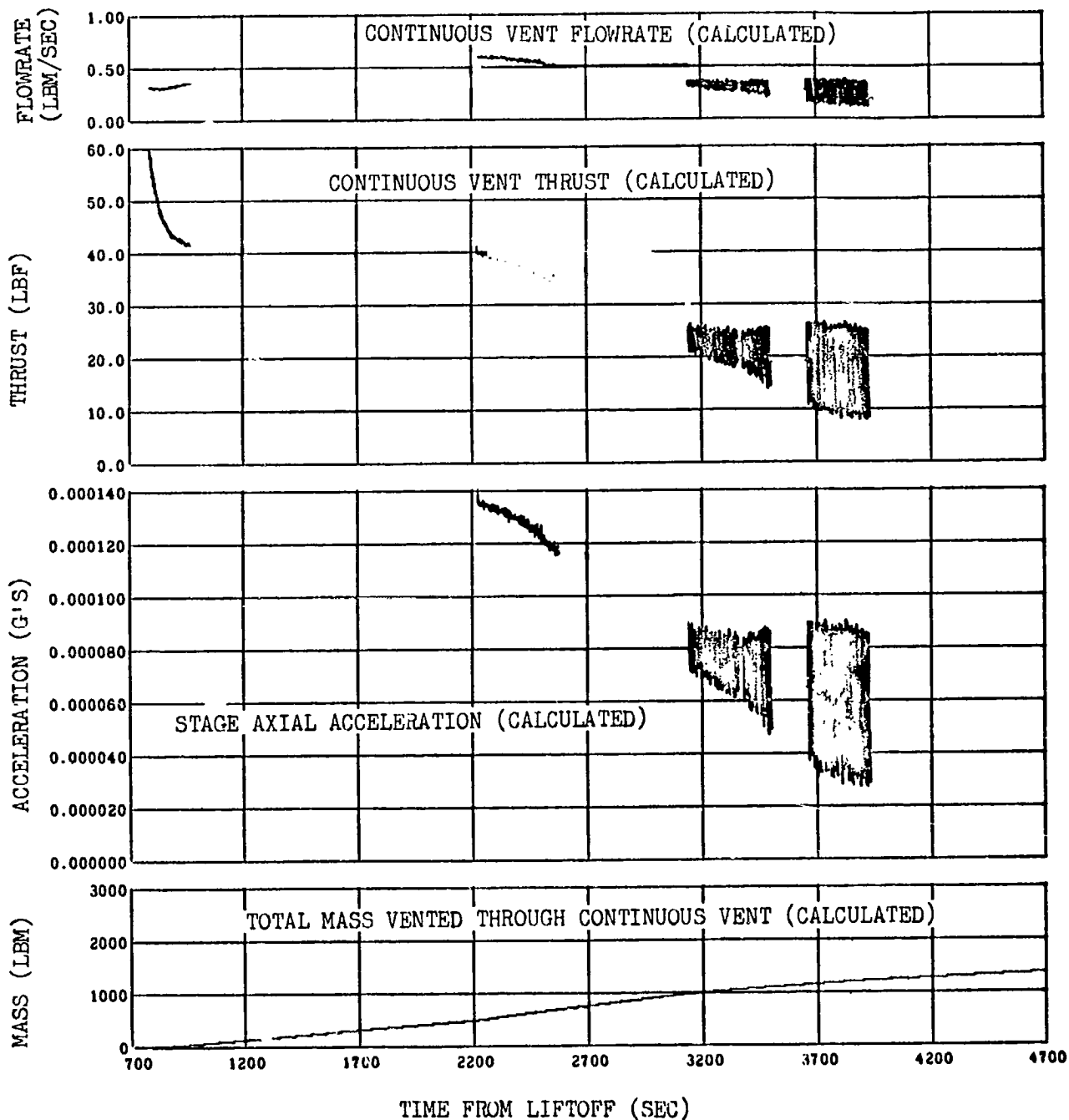

Figure 12-8. LH2 Tank Continuous Vent System Performance--
Earth Orbit (Sheet 1 of 2)

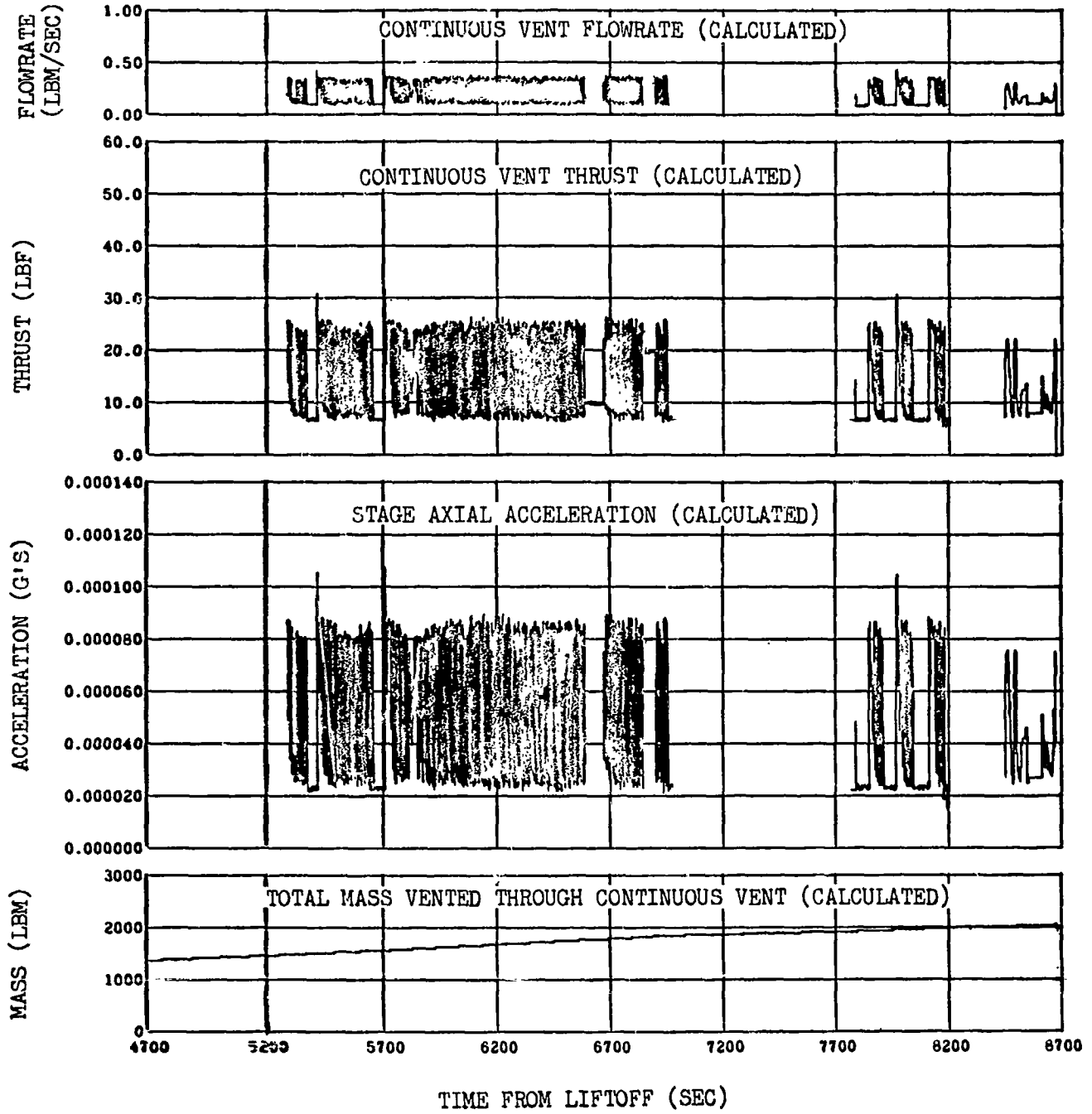

Figure 12-8. LH2 Tank Continuous Vent System Performance--
Earth Orbit (Sheet 2 of 2)

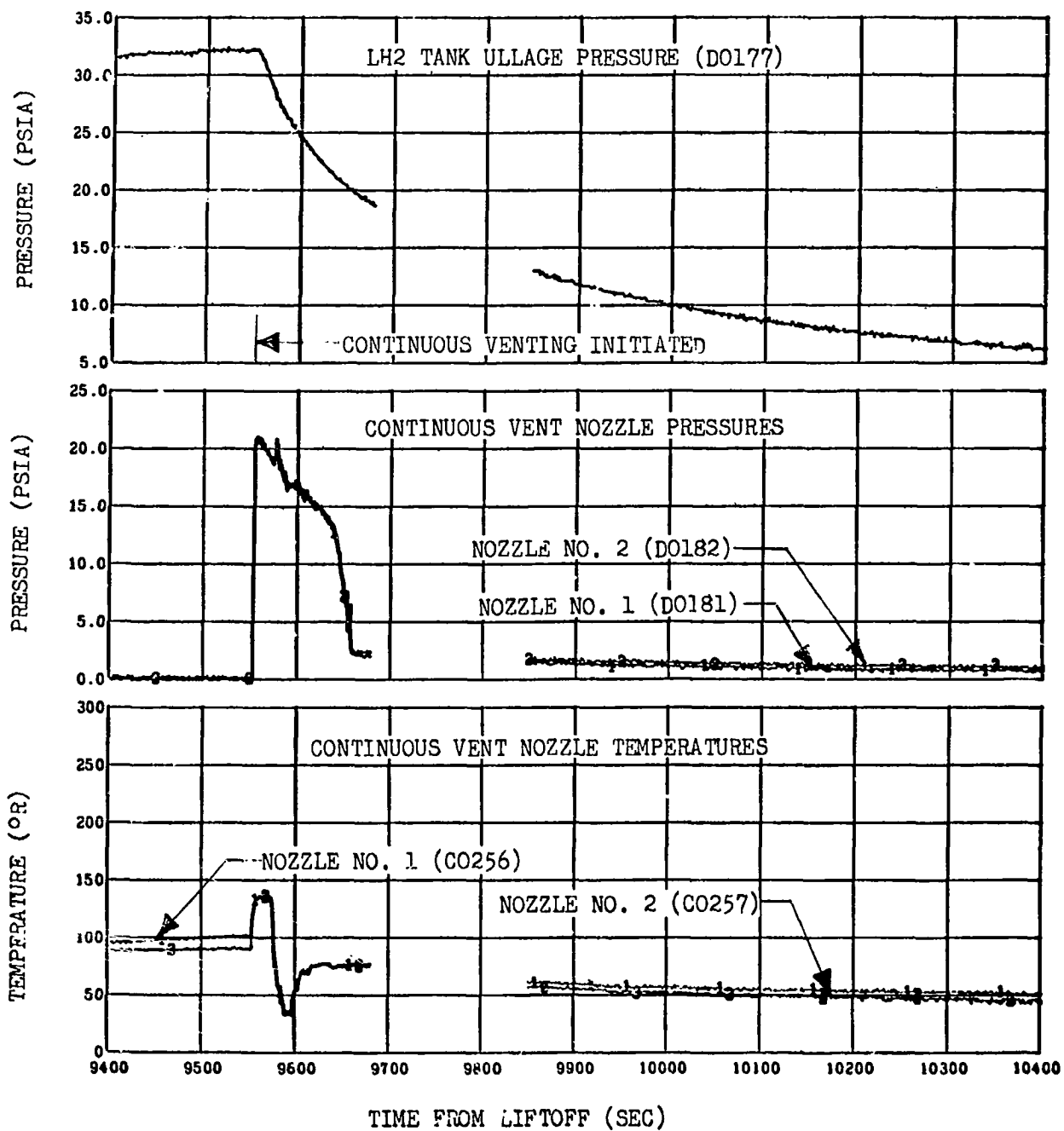

Figure 12-9. LH2 Tank Continuous Vent System Operation-- Translunar Coast

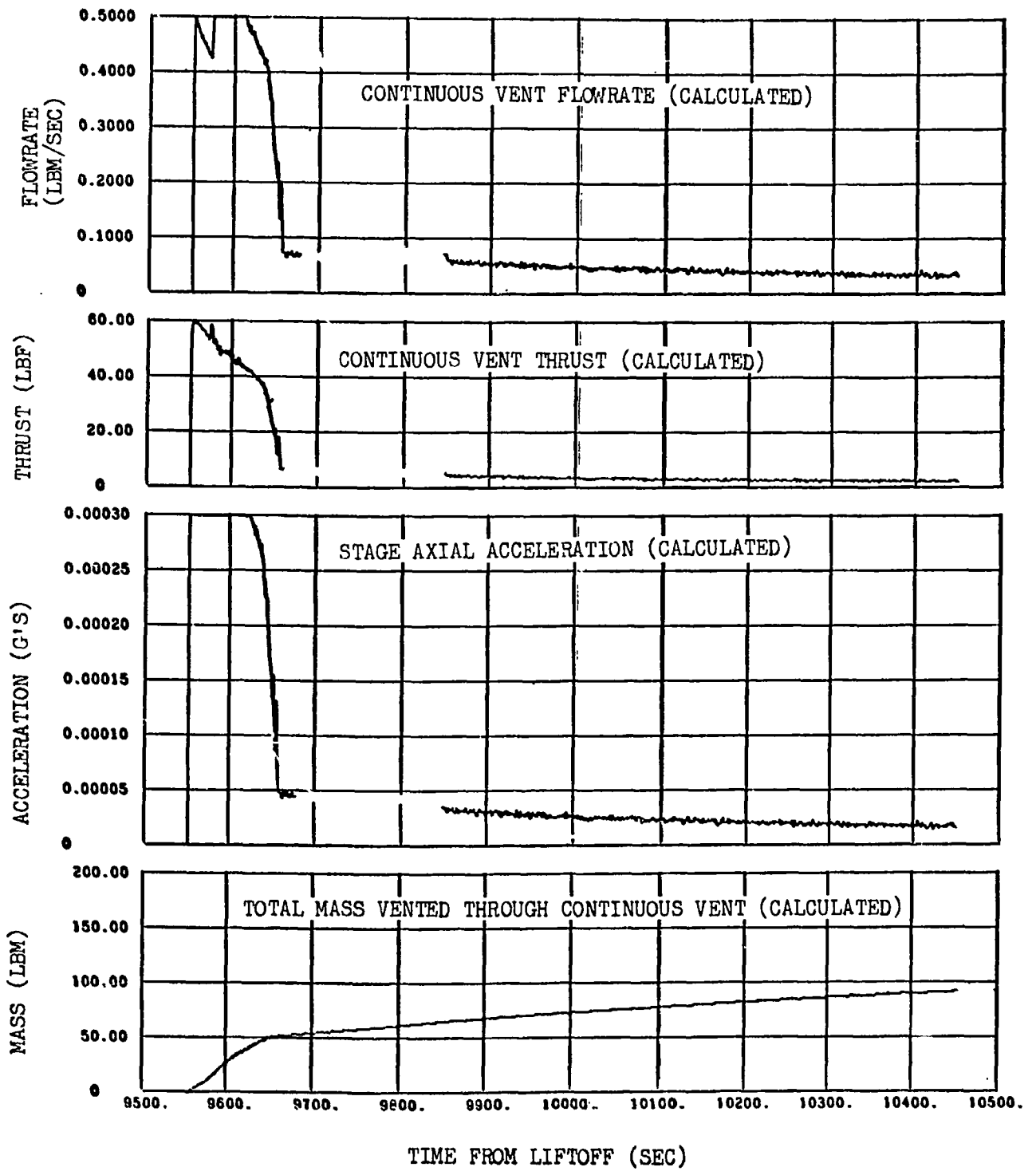

Figure 12-10. LH2 Tank Continuous Vent System Performance---
Translunar Coast

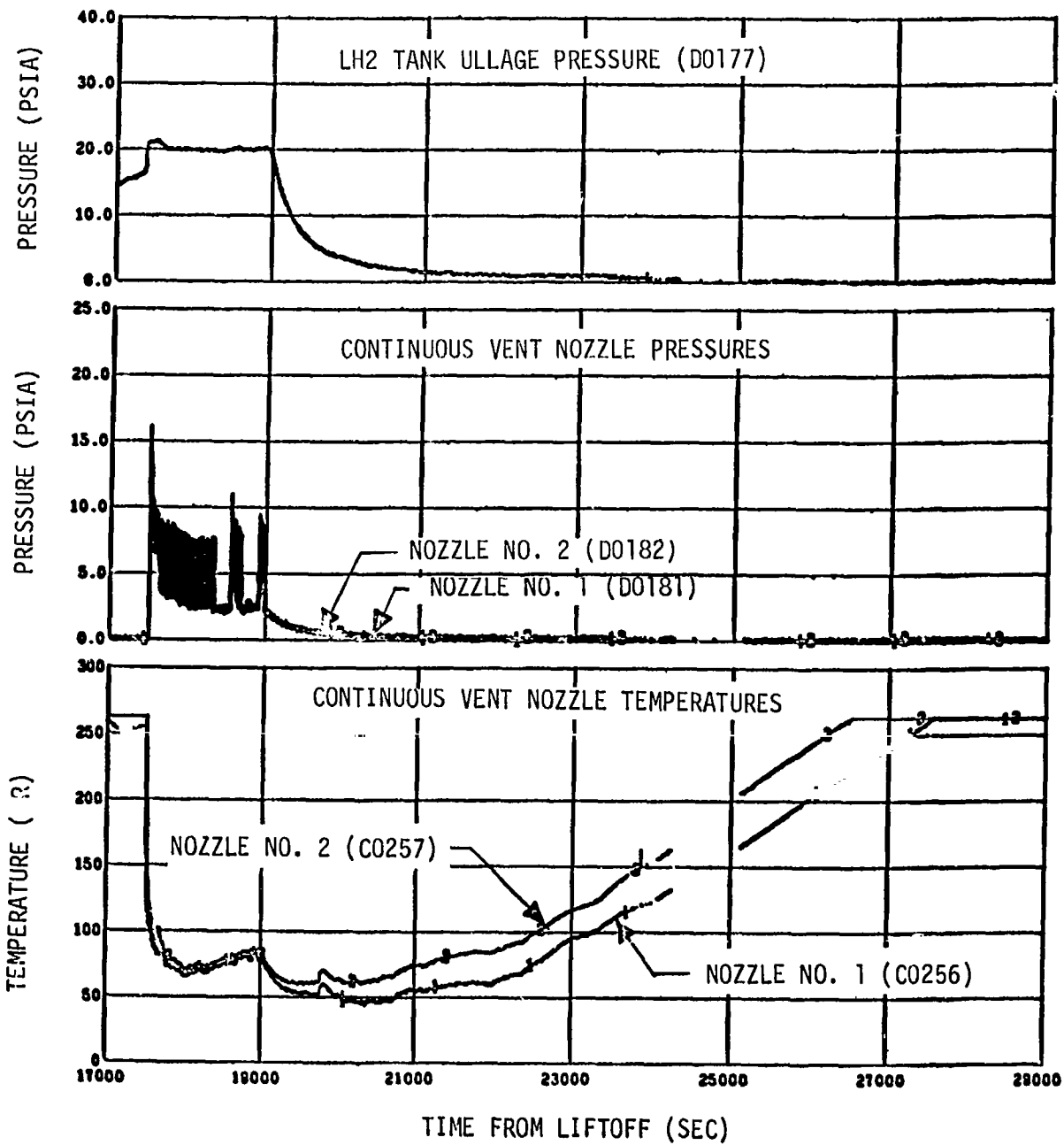

Figure 12-11. LH2 Tank Continuous Vent System Operation
During LH2 Tank Passivation

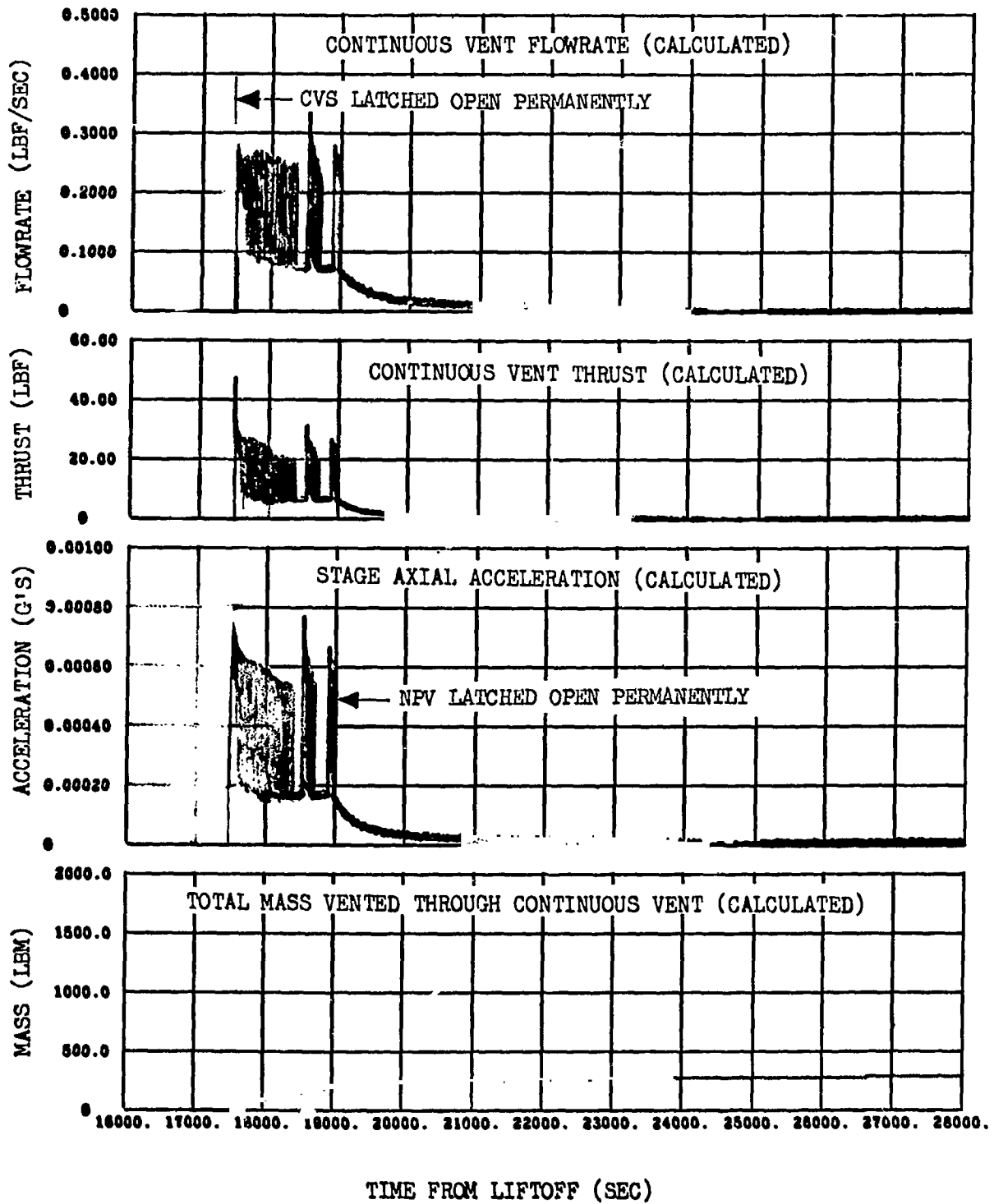

Figure 12-12. LH2 Tank Continuous Vent System Performance During LH2 Tank Passivation

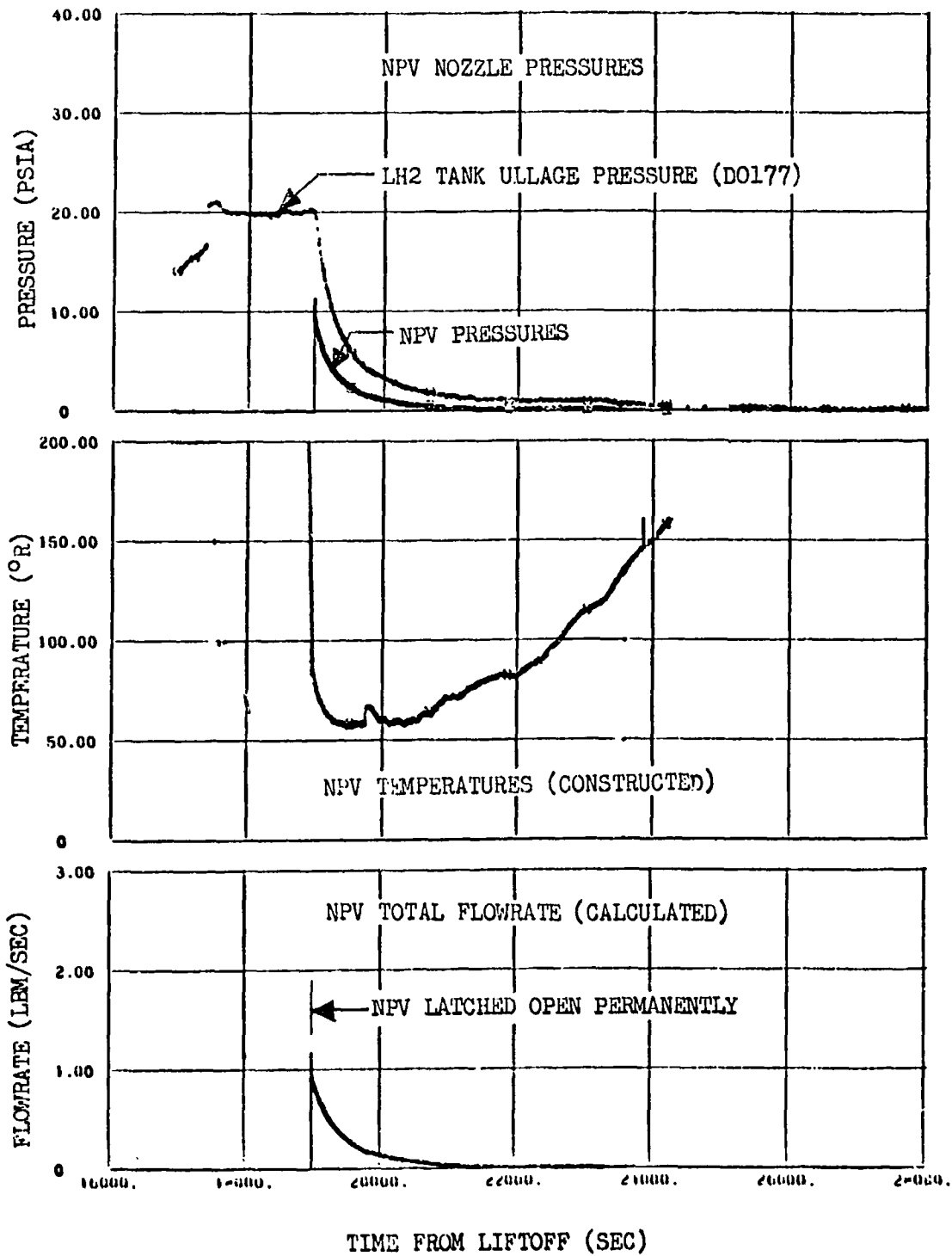

Figure 12-13. NPV Operation During LH2 Tank Passivation

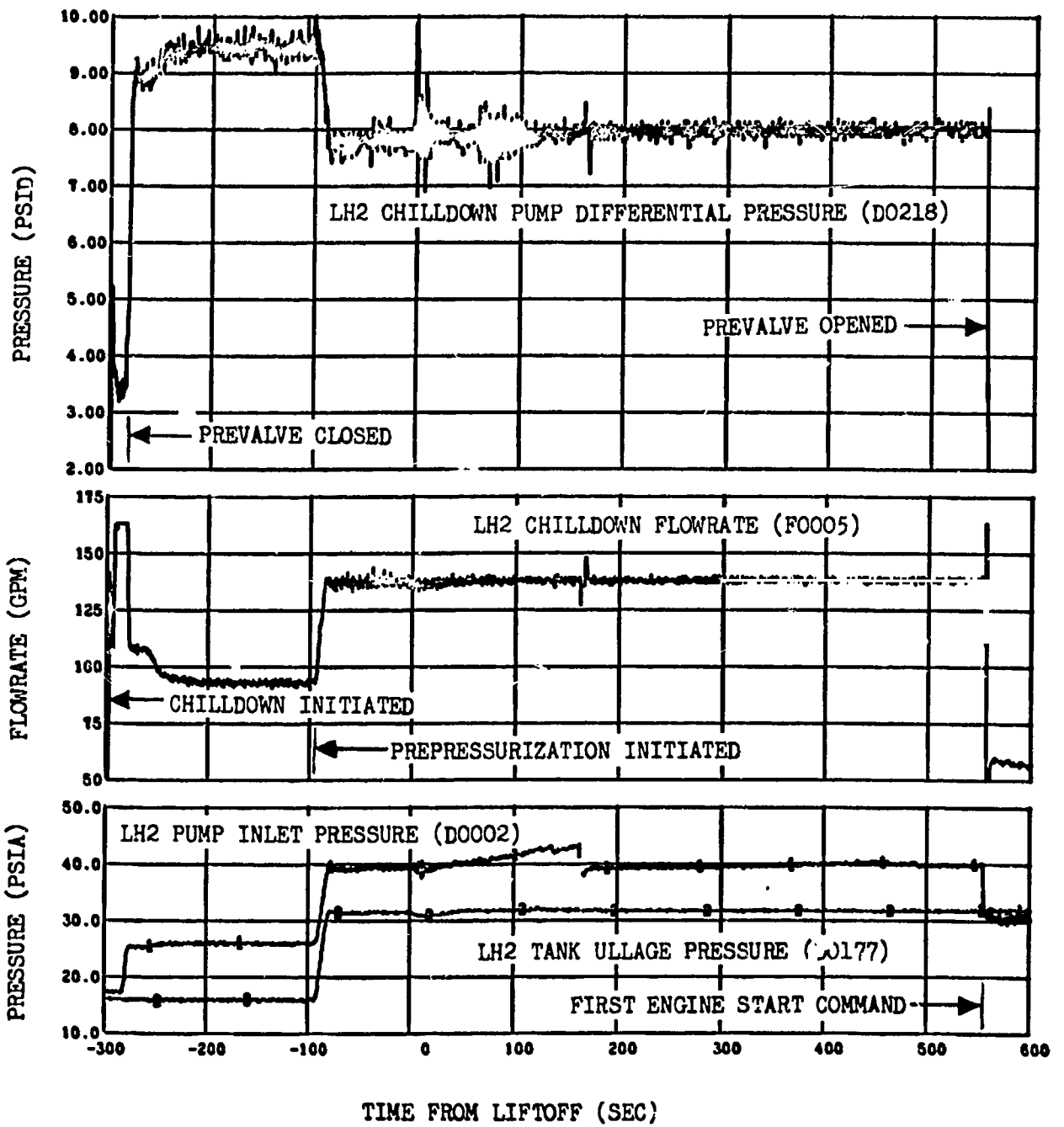

Figure 12-14. LH2 Pump Chilldown Performance--First Burn (Sheet 1 of 2)

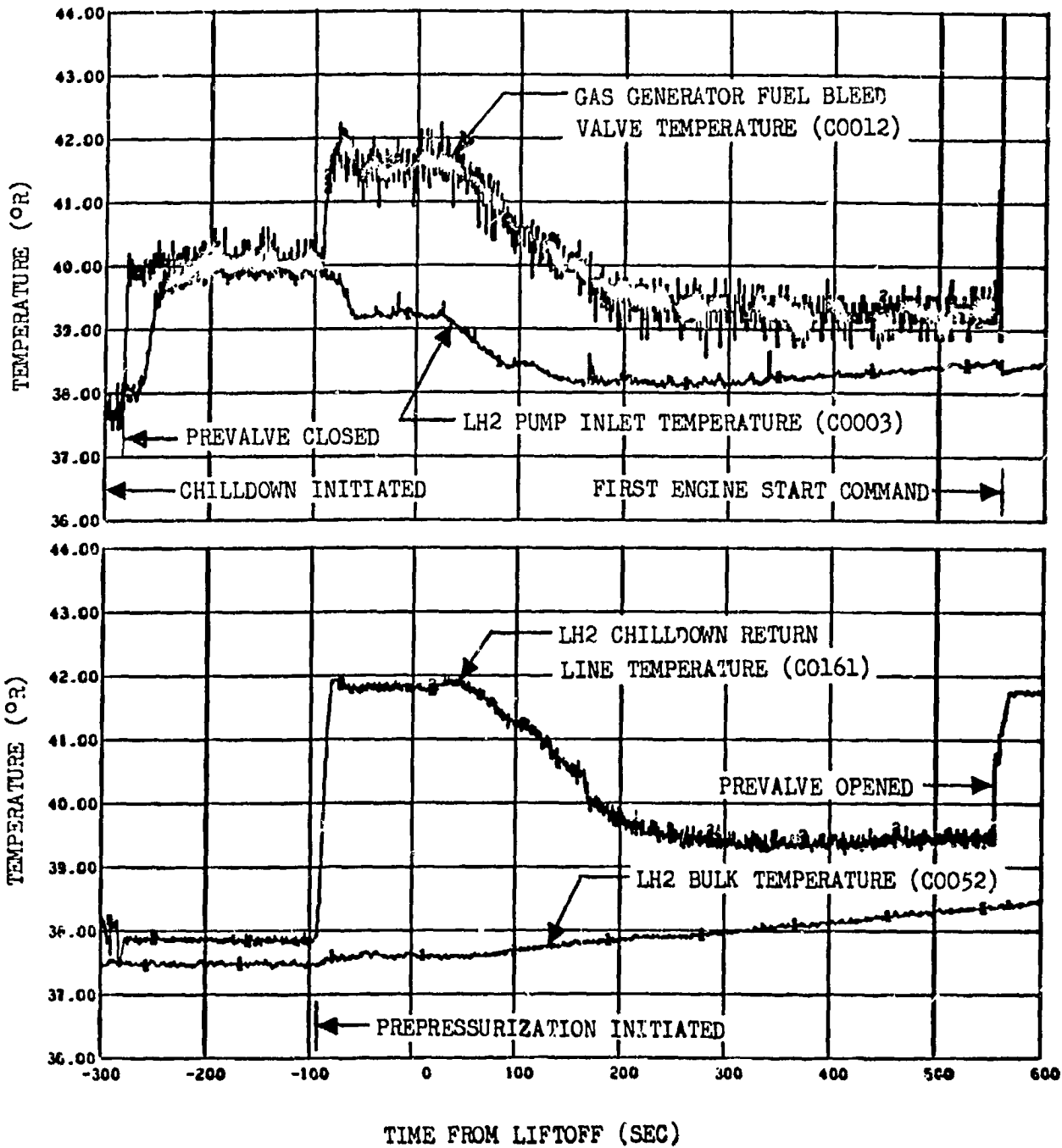

Figure 12-14. LH2 Pump Chilldown Performance--First Burn (Sheet 2 of 2)

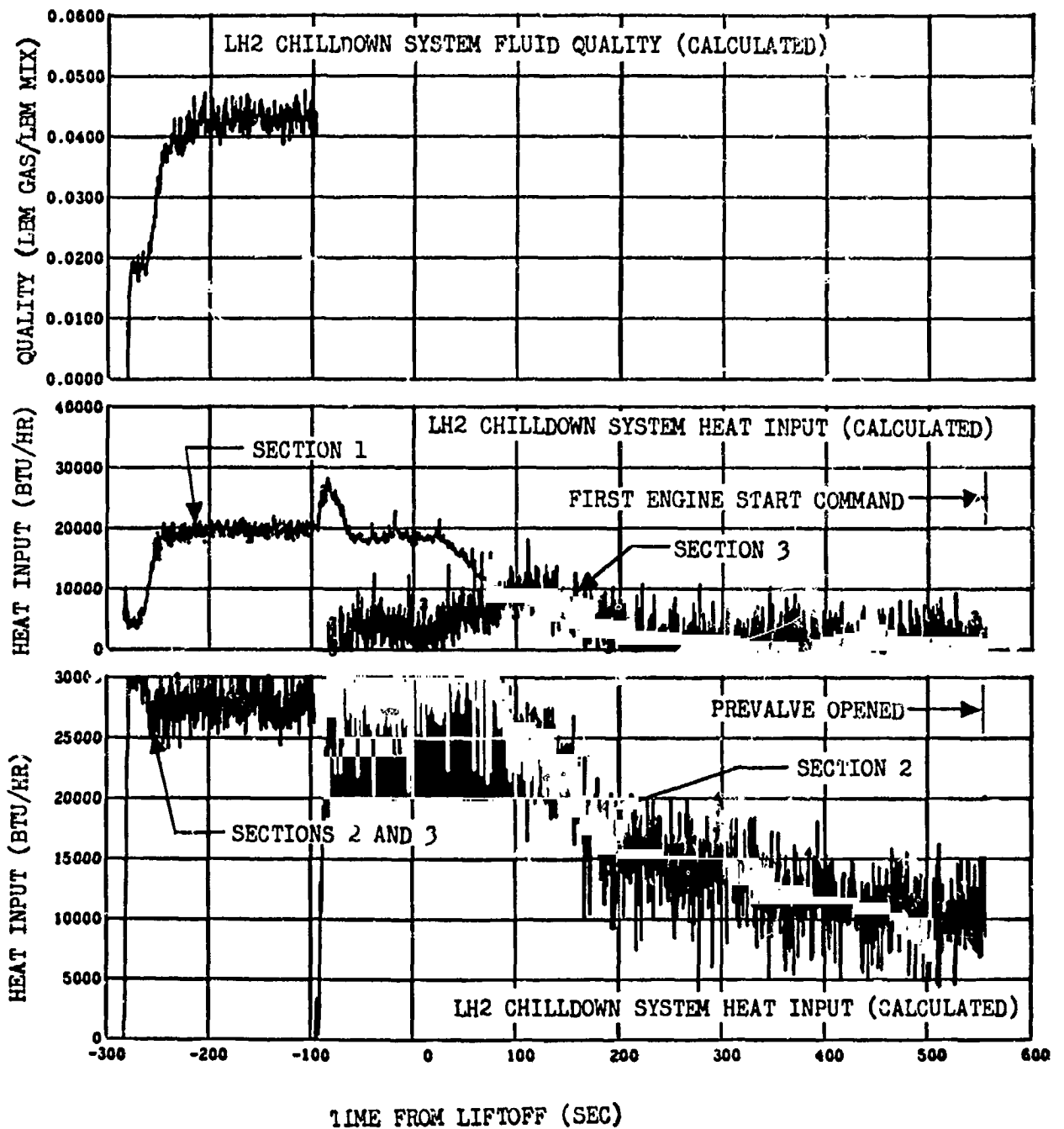

Figure 12-15. LH2 Pump Chilldown--First Burn (Sheet 1 of 2)

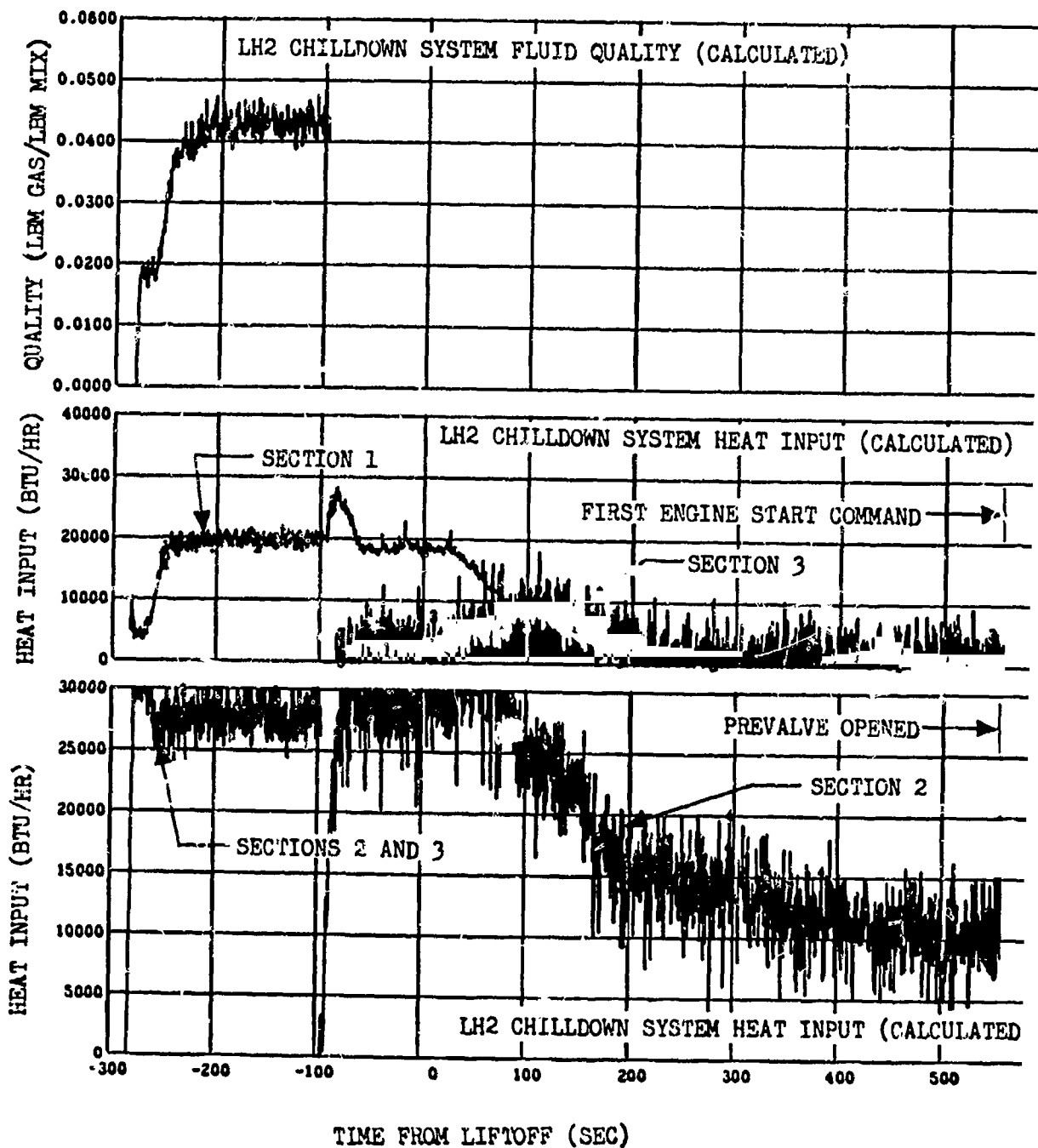

Figure 12-15. LH2 Pump Chilldown--First Burn (Sheet 1 of 2)

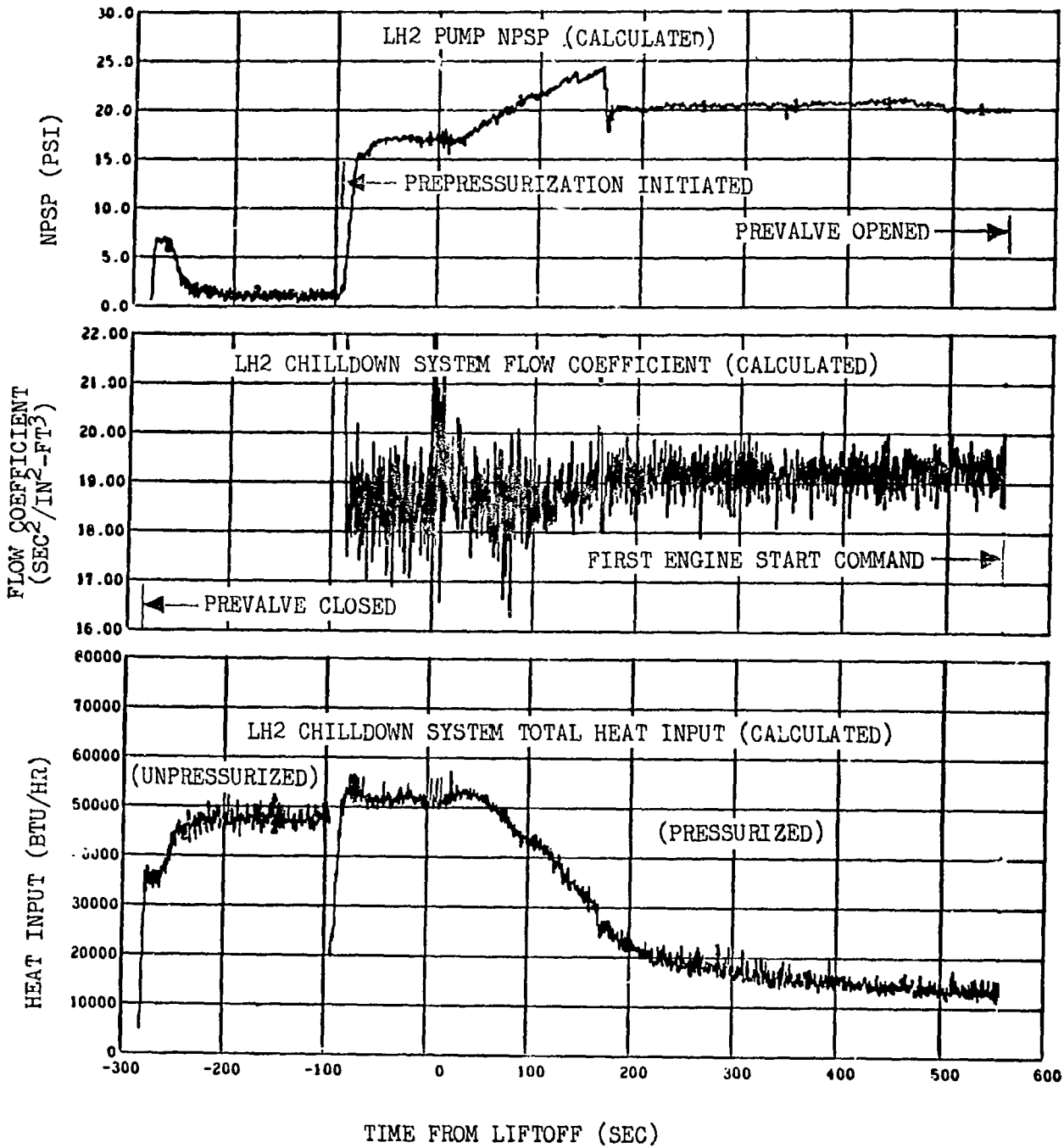

Figure 12-15. LH2 Pump Chillo-down--First Burn (Sheet 2 of 2)

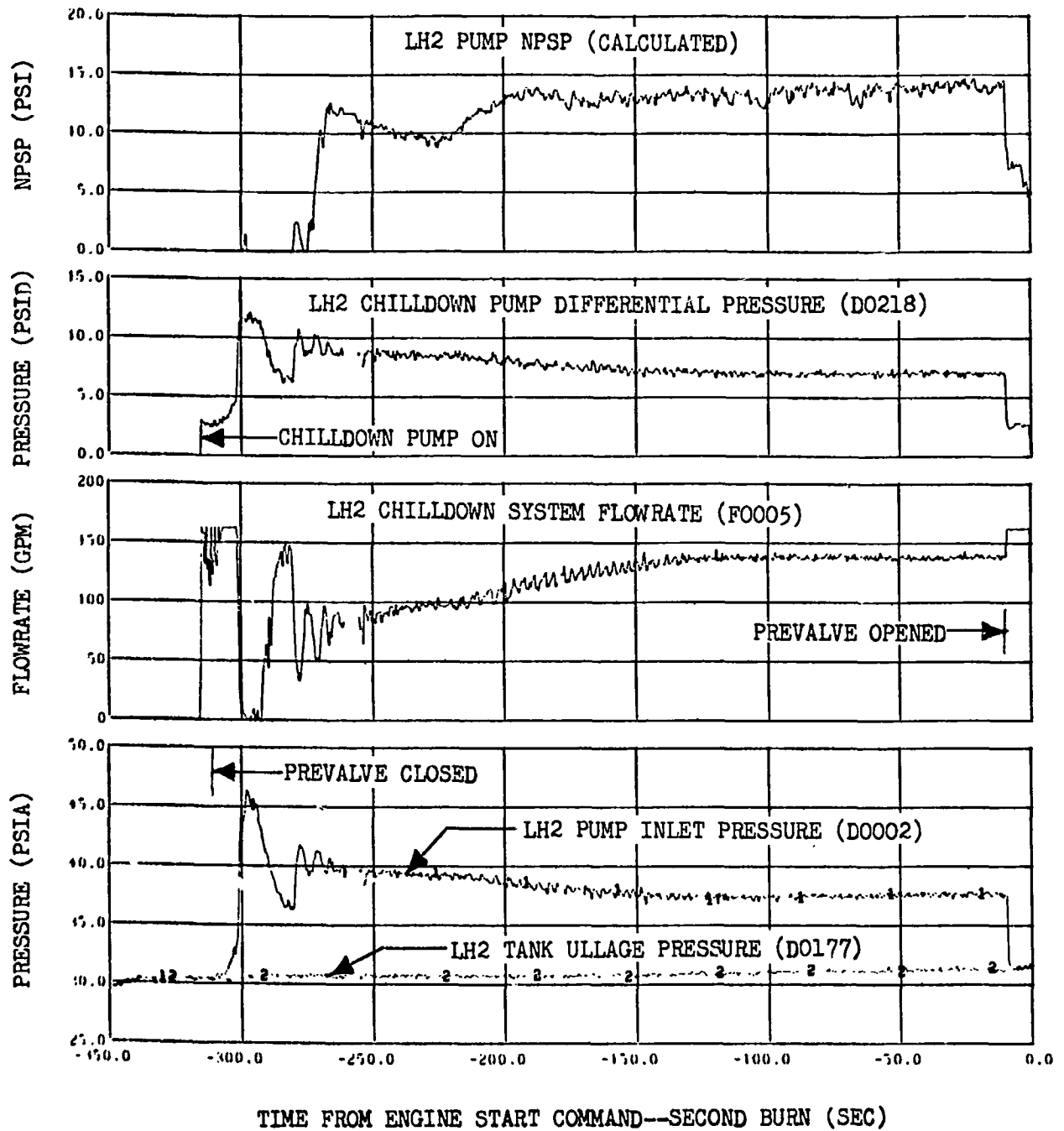

Figure 12-16. LH2 Pump Chilldown System Performance-- Second Burn (Sheet 1 of 2)

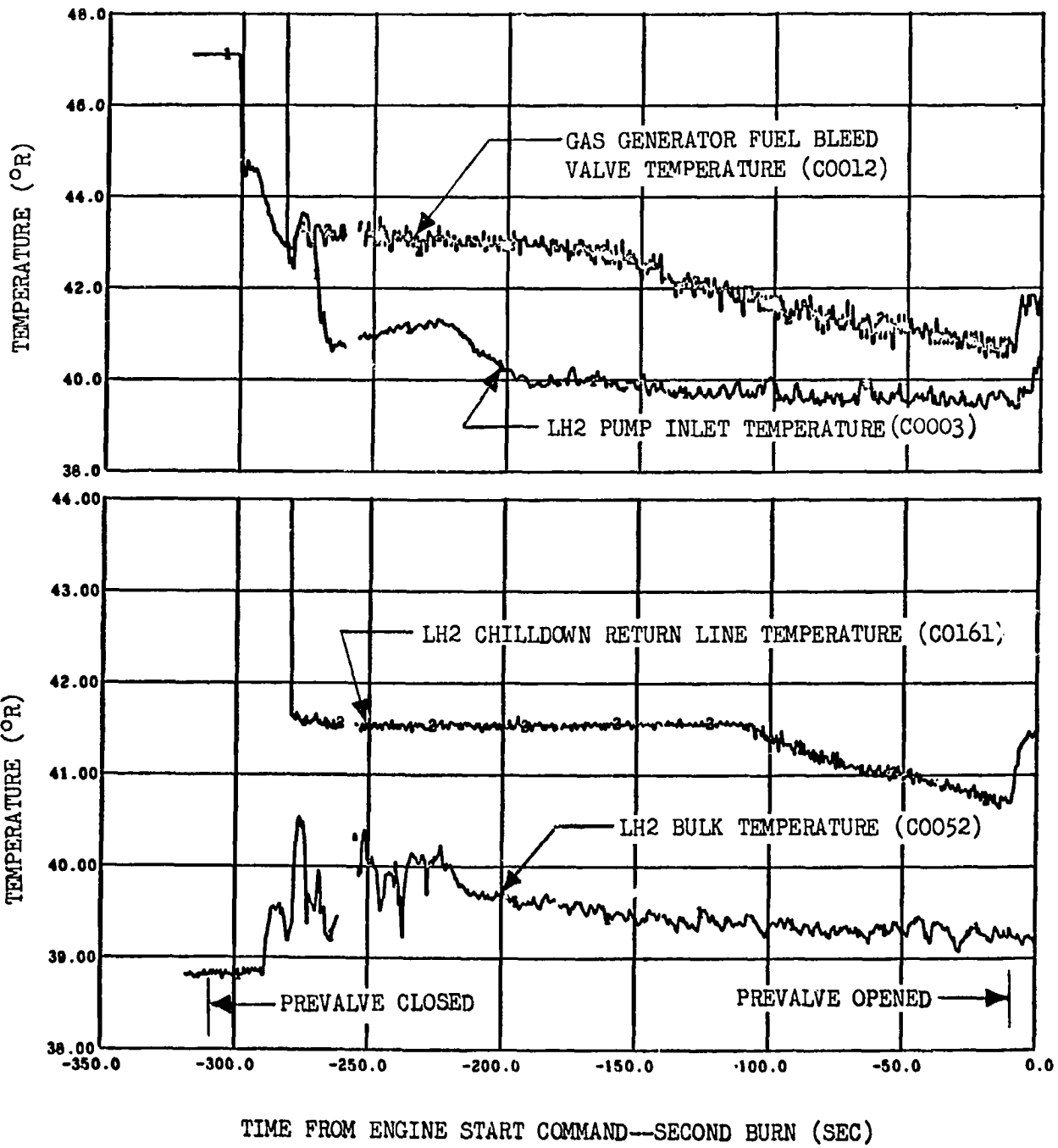

Figure 12-16. LH2 Pump Chilldown System Performance--
Second Burn (Sheet 2 of 2)

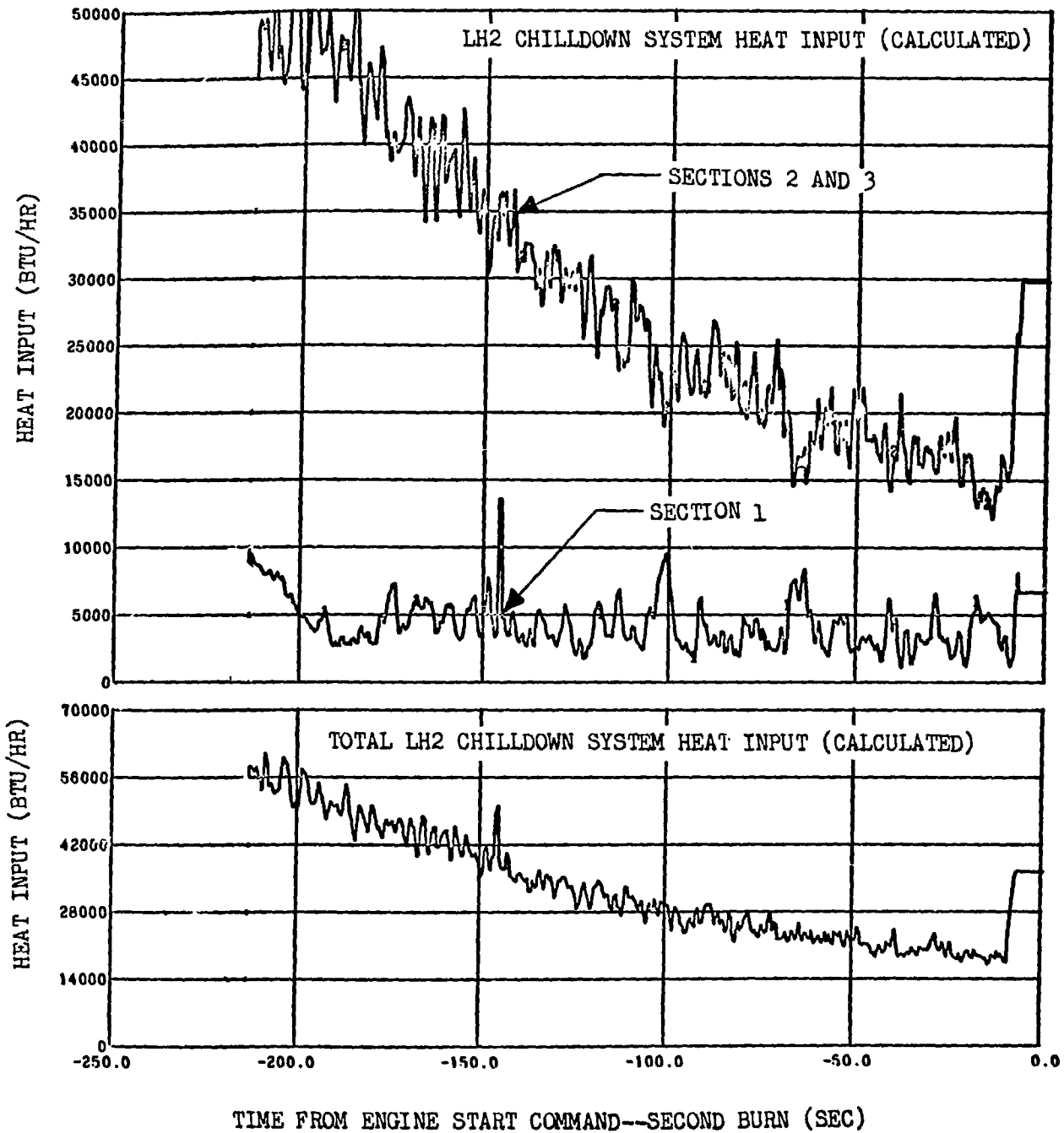
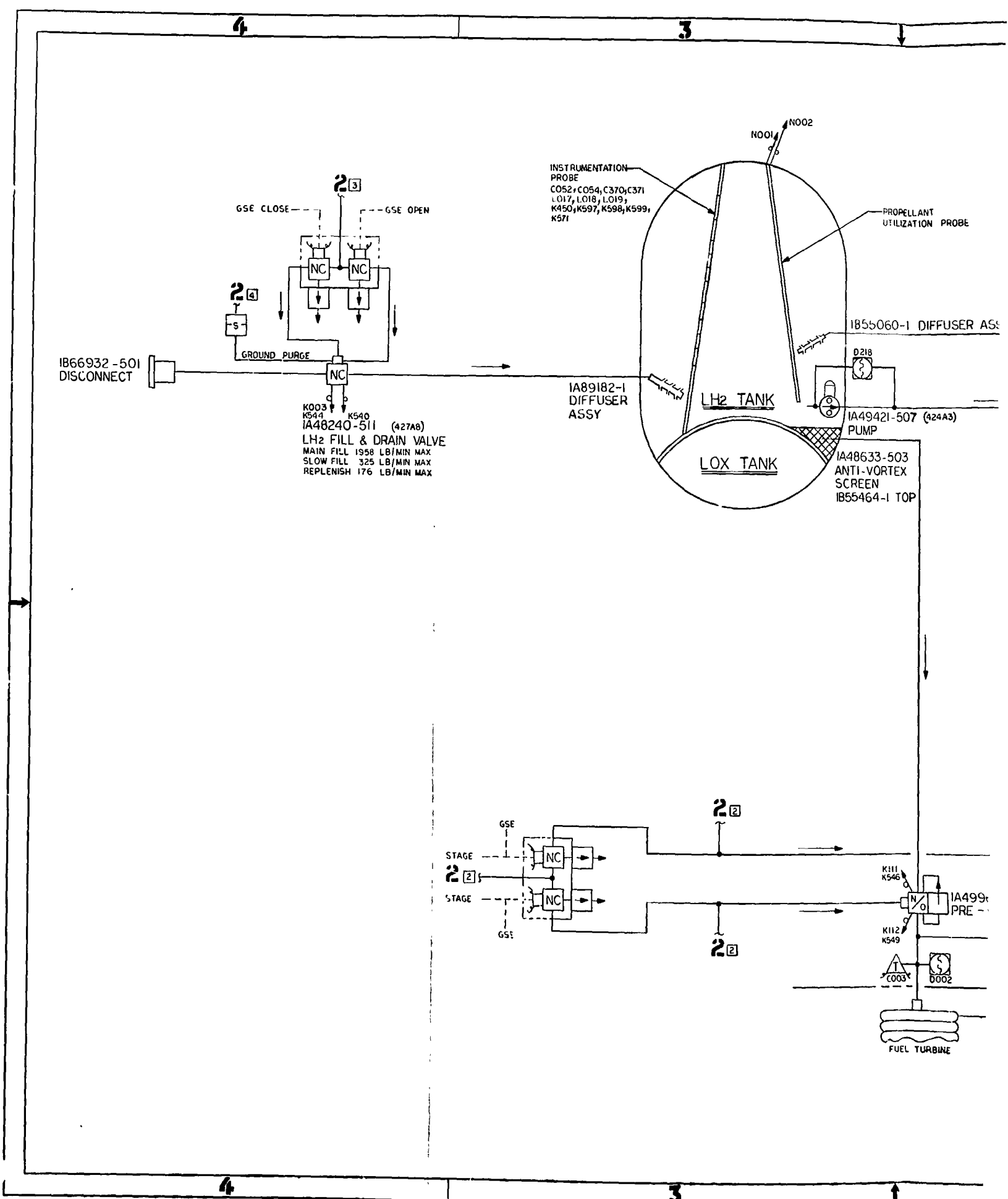

Figure 12-17. LH2 Pump Chilldown--Second Burn



2

REVISIONS			
SYM	DESCRIPTION	DATE	APPROVED
A	SEE E.O.	1-7-8	[Signature]
B	SEE E.O.	1-11-8	[Signature]

PROBE

FUSER ASSY ←

(A3)

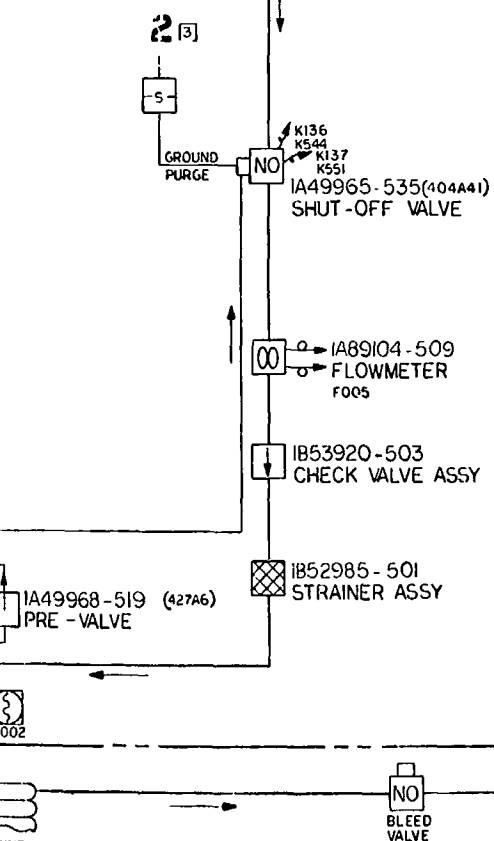

GENERAL NOTES
UNLESS OTHERWISE SPECIFIED:

- I. LH₂ TANK DATA
- VOLUME 10,409.5 FT³
 - ULLAGE PRESSURE AT L/O 31-34 PSIA
 - ULLAGE TEMP AT L/O 150°-200°R
 - PROPELLANT TEMP AT L/O 37°-38°R

VEHICLE CONFIGURATION

IA39322	FS
IA59098	DE
IB74943	H
IB74477	L

1B66041

DASH NUMBERS OF THIS DRAWING
000 DASH NUMBERS SHOWN
EVEN DASH NUMBERS OPPOSITE

SEQUENCE 10

UNLESS OTHERWISE SPECIFIED	MATL	DOUGLAS SANTA MONICA, CALIFORNIA AIRCRAFT COMPANY, INC.
	WT CHK	
DIMENSIONS ARE IN INCHES.	STR CHK	SCHEMATIC, LH ₂ FILL & FEED SYSTEM
TOLERANCES	CHECK	
FRACTIONS ±	PR ENGR	CODE IDENT NO SIZE 10355 H 1B66041
DECIMALS ±	DES ENGR	
ANGLES ±	GR ENGR	DESIGN ACTIVITY APPROVAL SCALE --- SHEET 1 OF 1
FIRST RELEASE OF PRINTS	PREP BY L. AROCCA 12-67	
SEE ENGINEERING RECORDS FOR USAGE DATA	DATE OF 26 APR 1966	ORIGINAL DATE OF 26 APR 1966 DRAWING
1130	REL. COOP.	

2

DUAL REPRESS

Figure 12-18 Schematic, LH₂ Fill & Feed System
FOLDOUT FRAME 2

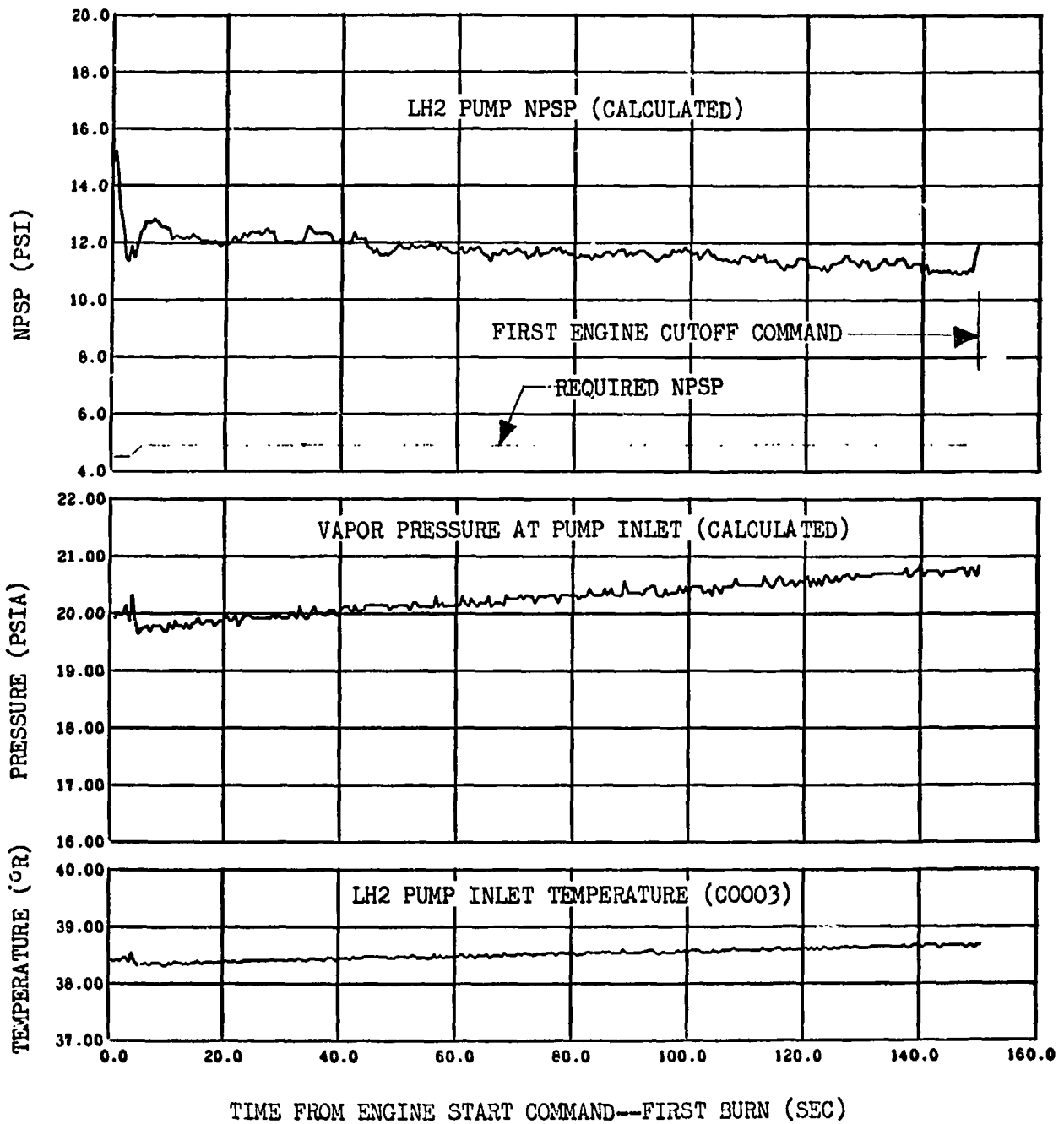

Figure 12-19. LH2 Pump Inlet Conditions--First Burn
(Sheet 1 of 2)

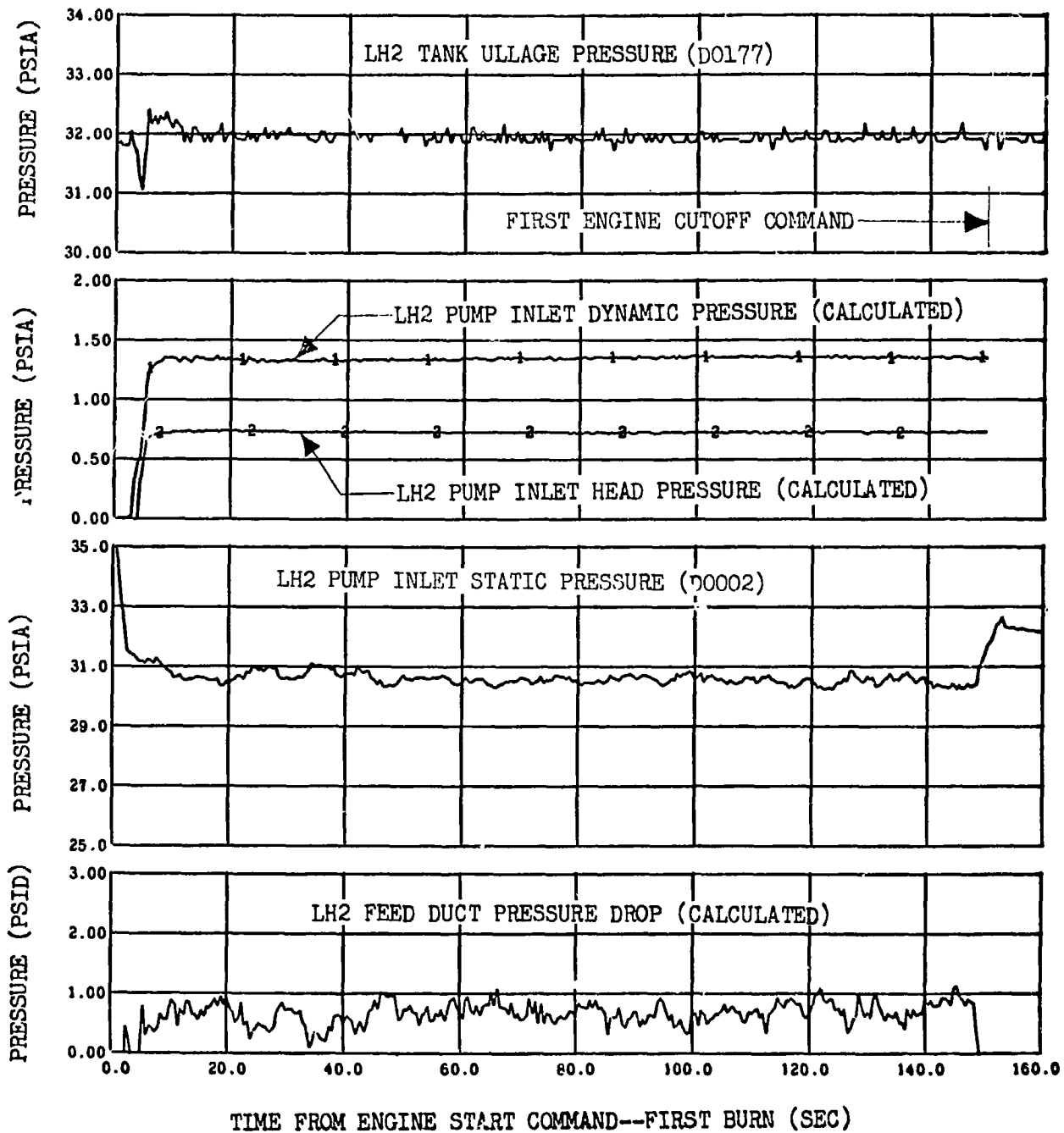

Figure 12-19. LH2 Pump Inlet Conditions--First Burn
(Sheet 2 of 2)

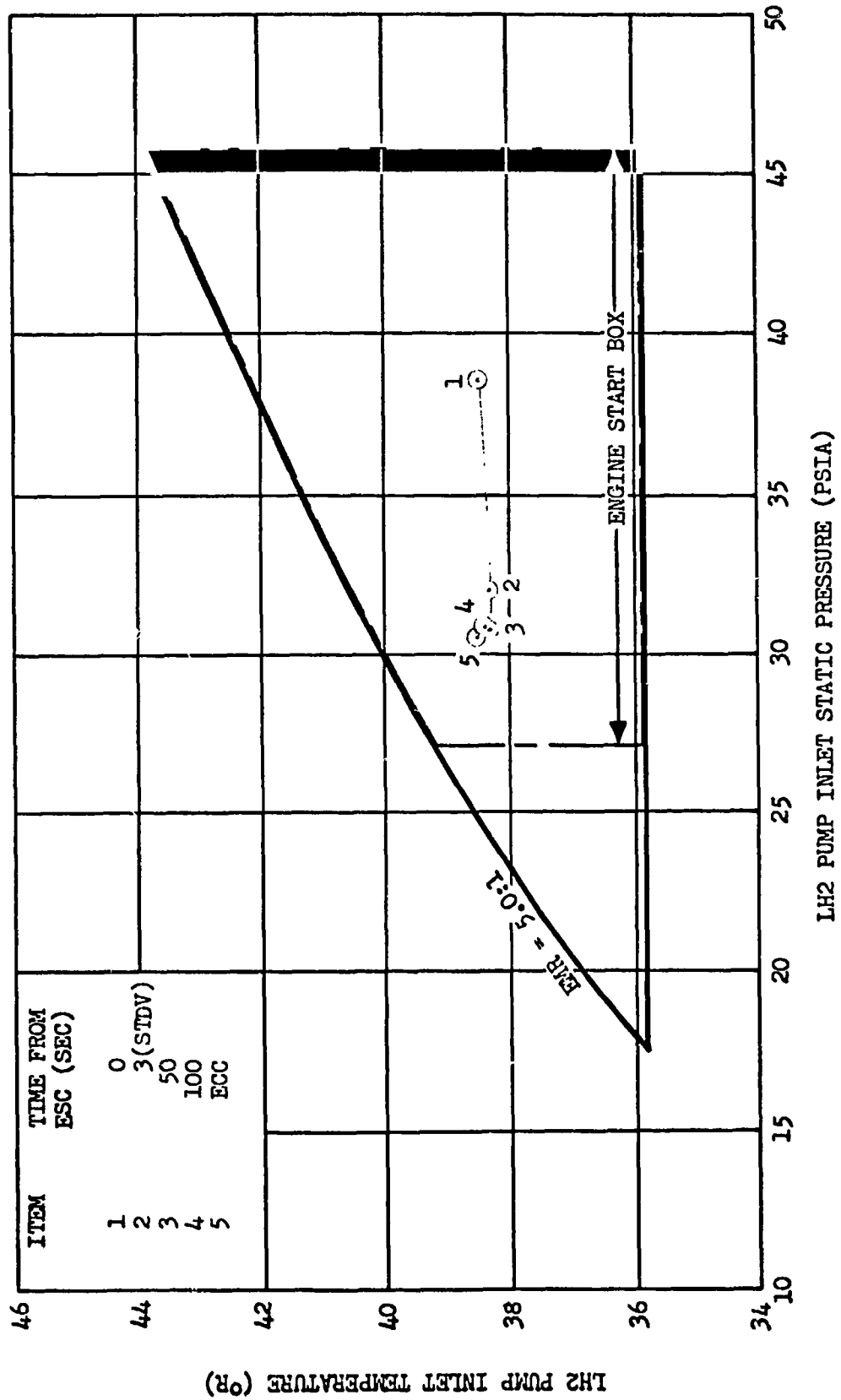

Figure 12-20. LH2 Pump Inlet Conditions During Firing--First Burn

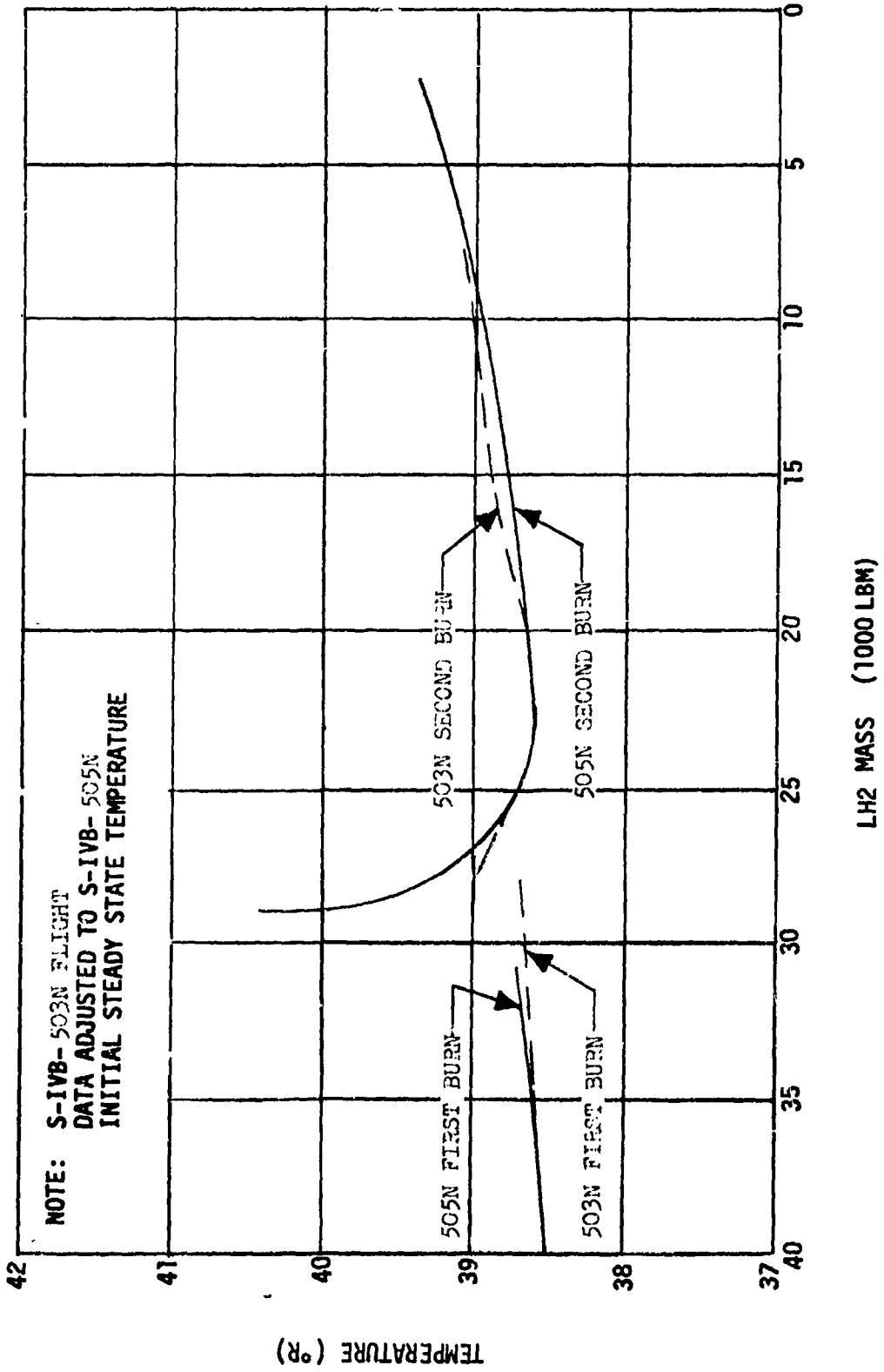

Figure 12-21. Effect of LH2 Mass Level on LH2 Pump Inlet Temperature :

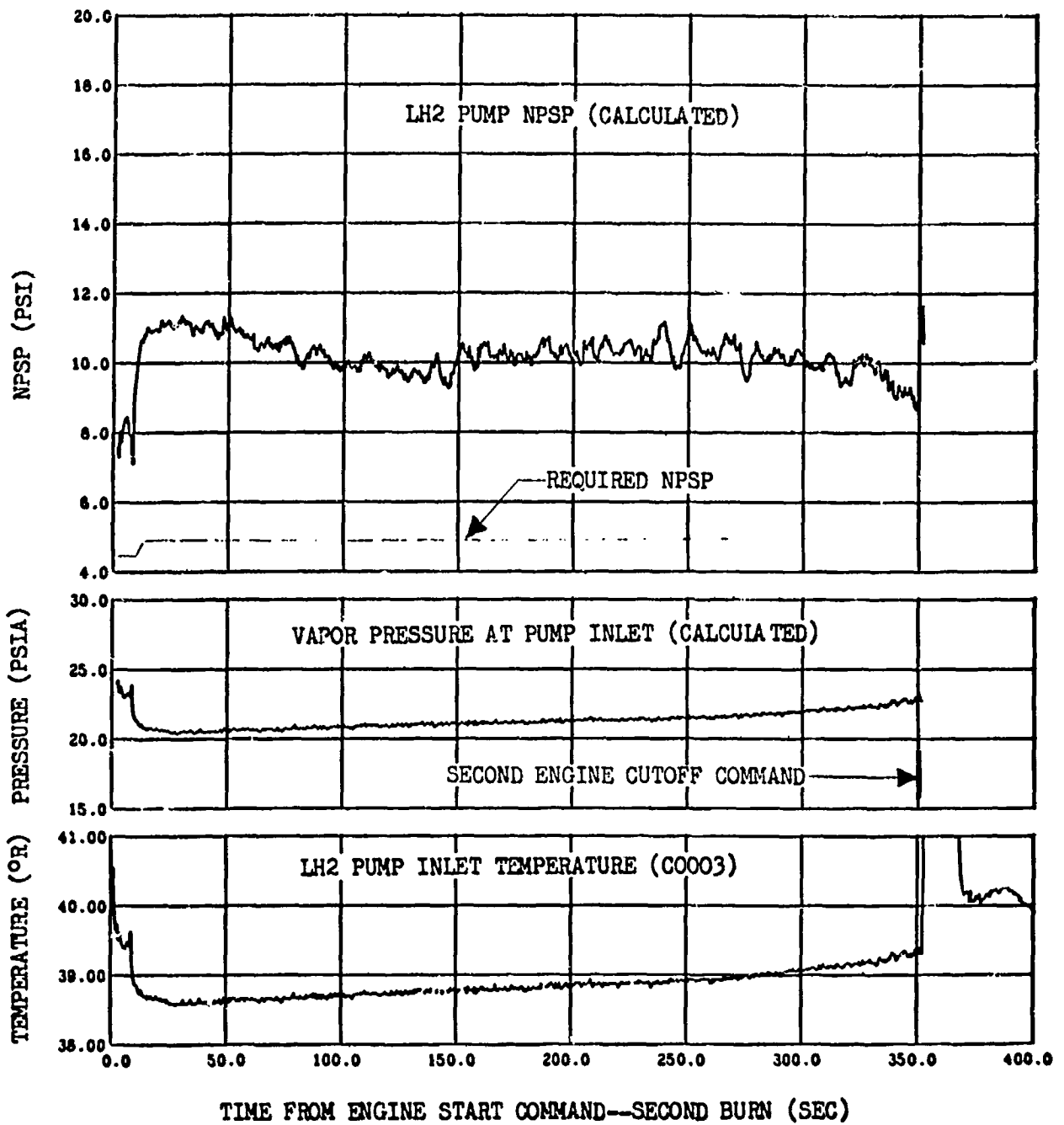

Figure 12-22. LH2 Pump Inlet Conditions--Second Burn
 (Sheet 1 of 2)

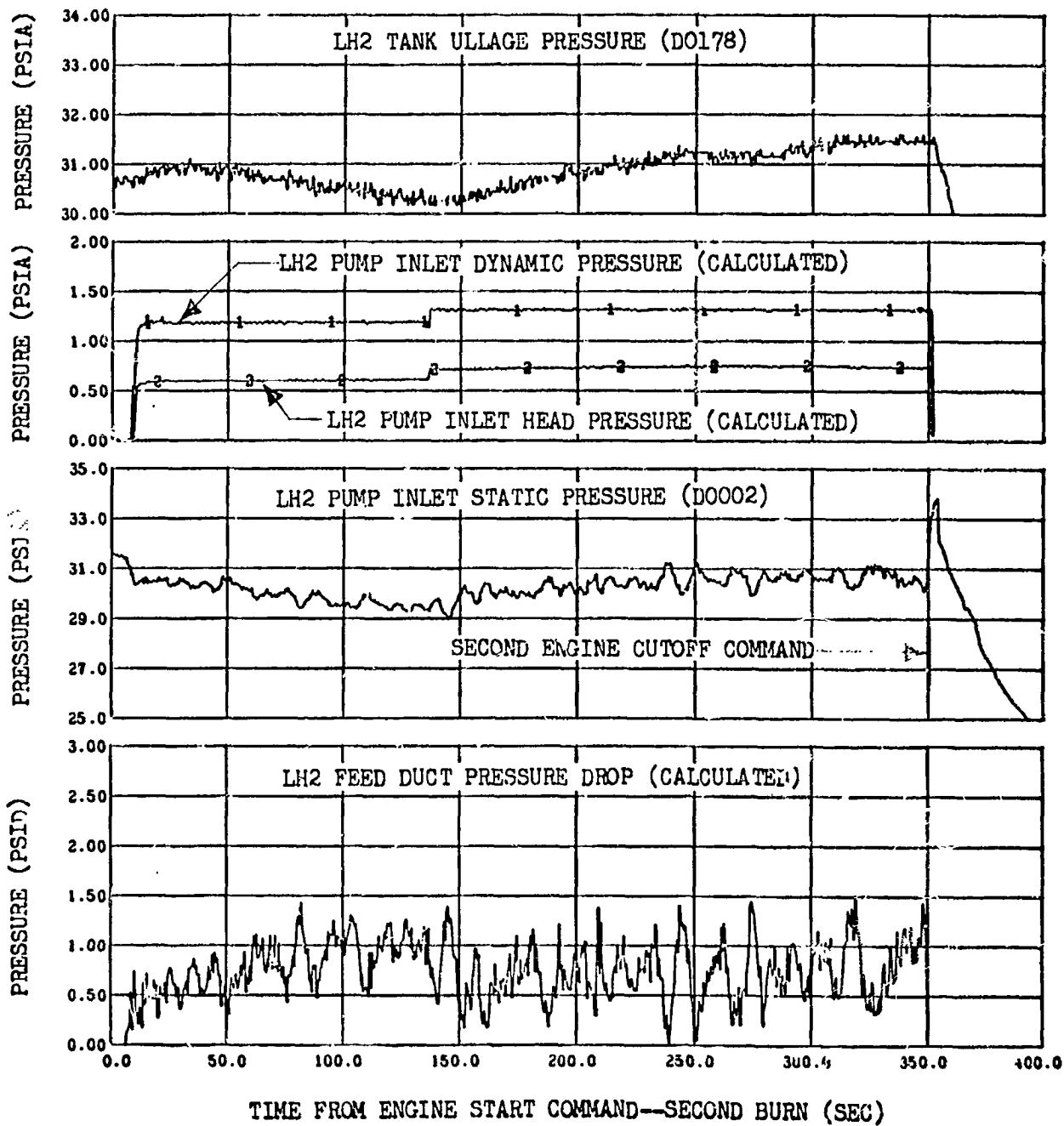

Figure 12-22. LH2 Pump Inlet Conditions--Second Burn
(Sheet 2 of 2)

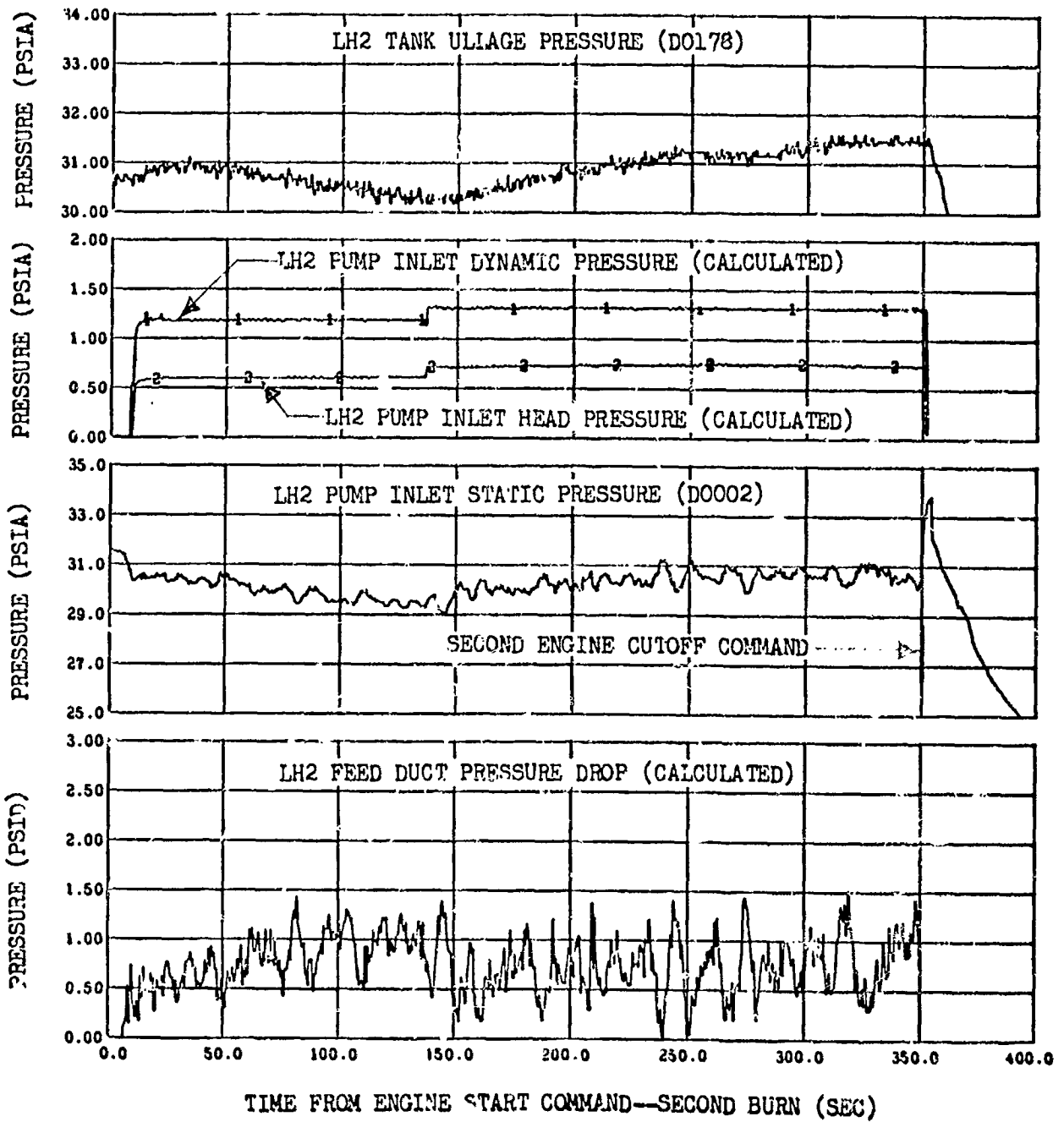

Figure 12-22. LH2 Pump Inlet Conditions--Second Burn
(Sheet 2 of 2)

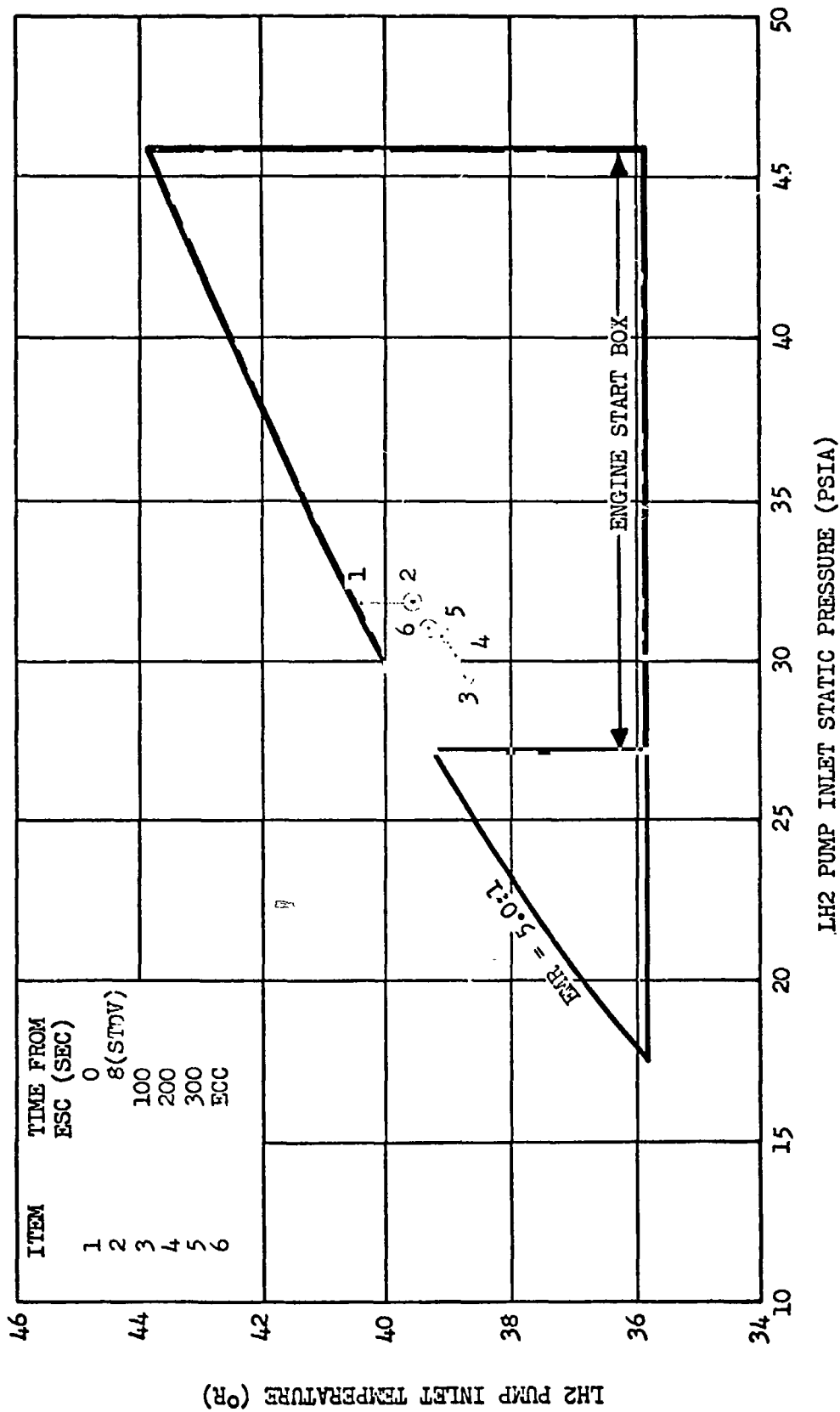

Figure 12-23. LH2 Pump Inlet Conditions During Firing--Second Burn

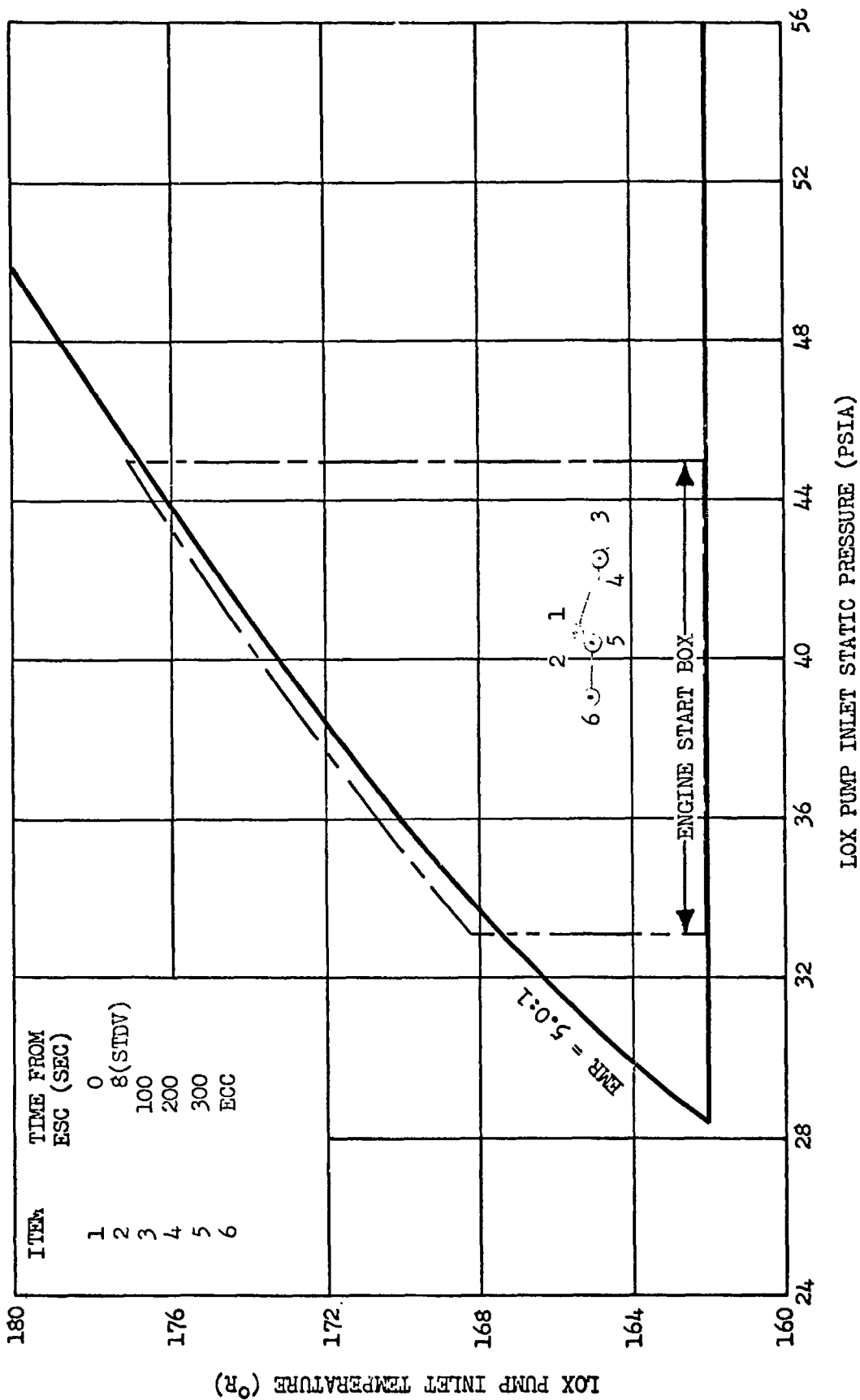

Figure 12-24. LOX Pump Inlet Conditions During Firing--Second Burn

13. OXYGEN-HYDROGEN BURNER SYSTEM

The S-IVB-505N stage utilized the O_2-H_2 burner (figure 13-1) as the primary method of repressurization for the S-IVB second burn. LH2 tank repressurization was satisfactorily accomplished by the O_2-H_2 burner prior to second burn; LOX tank repressurization was not required.

13.1 Burner Performance

The performance of the burner during restart preparations was satisfactory. Data profiles (figure 13-2) were similar to those from previous ground tests and from 504N flight; however, as compared to 503N flight, temperature levels were generally higher. These temperature differences were the result of mixture ratio variations that occur because the supply pressures (LOX and LH2 ullage pressures) to the burner are variable from flight to flight. Performance data are presented in figure 13-2 and are summarized in table 13-1.

The burner chamber pressure and temperature increases were normal after termination LH2 tank repressurization and were comparable to acceptance test results. At 78 sec after burner start command, an 18 psi drop occurred in the burner LH2 pressurization coil pressure (D0231). This pressure drop is similar to those that were observed on S-IVB-504N and 507 acceptance tests. Although the shifts do not have a significant effect upon repressurization, the cause is presently under investigation.

13.2 LH2 Tank Repressurization

Repressurization of the LH2 tank by the O_2-H_2 burner was satisfactory and as expected. Pertinent data are presented in figure 13-3 and are compared to previous flight data in table 13-1.

13.3 Cold Helium Supply

The cold helium spheres provided adequate helium (25.4 lbm) for cryogenic repressurization. The quantity of helium used for repressurization was very near that used for 504N and 503N flights. The cold helium supply temperatures and pressures after burner start were as expected (figure 13-4). System performance is compared to previous test data in table 13-1.

TABLE 13-1

O2-H2 BURNER PERFORMANCE DATA

Parameter	S-IVB-505N Flight	S-IVB-504N Flight	S-IVB-503N Flight
Duration of burner operation (sec)	460	460	460
Lag in pressurant flow after burner start (sec)	6.8	6.7	6.7
Cold helium supply			
Initial pressure (psia,	1,915	2,060	1,860
Initial average temperature (°R)	37.8	37.6	38.0
Initial mass (lbm)	314	332	319
Useage during burner operation (lbm)	25.4	24.6	25.0
Burner propellant supply during burner operation			
LH2 supply pressure range (psia)	19.2-31.0	19.2-31.0	19.4-31.2
LOX supply pressure range (psia)	39.6-39.8	42.0-42.2	39.1
LH2 tank repressurization*			
Ullage volume (cu ft)	3,740	3,690	3,887
Initial pressure (psia)	19.2	19.2	19.4
Final pressure (psia)	30.3	30.4	30.2
Duration (sec)	182.0	180.4	168.4
Average pressurization rate (psi/min)	3.59	3.72	3.85
Average total heat flux** (Btu/hr)	250,000	245,000	223,000
Ambient heating rate** of pressurant gas (Btu/hr)	17,100	16,100	15,200
Pressurant helium through burner (lbm)	24.2	23.5	24.0
Pressurant helium through valve pilot bleed (lbm)	1.16	1.15	0.99
Total helium required (lbm)	25.4	24.6	25.0

* LOX tank repressurization was not required for these flights.

** Measured from 40 deg R reference base.

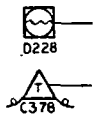
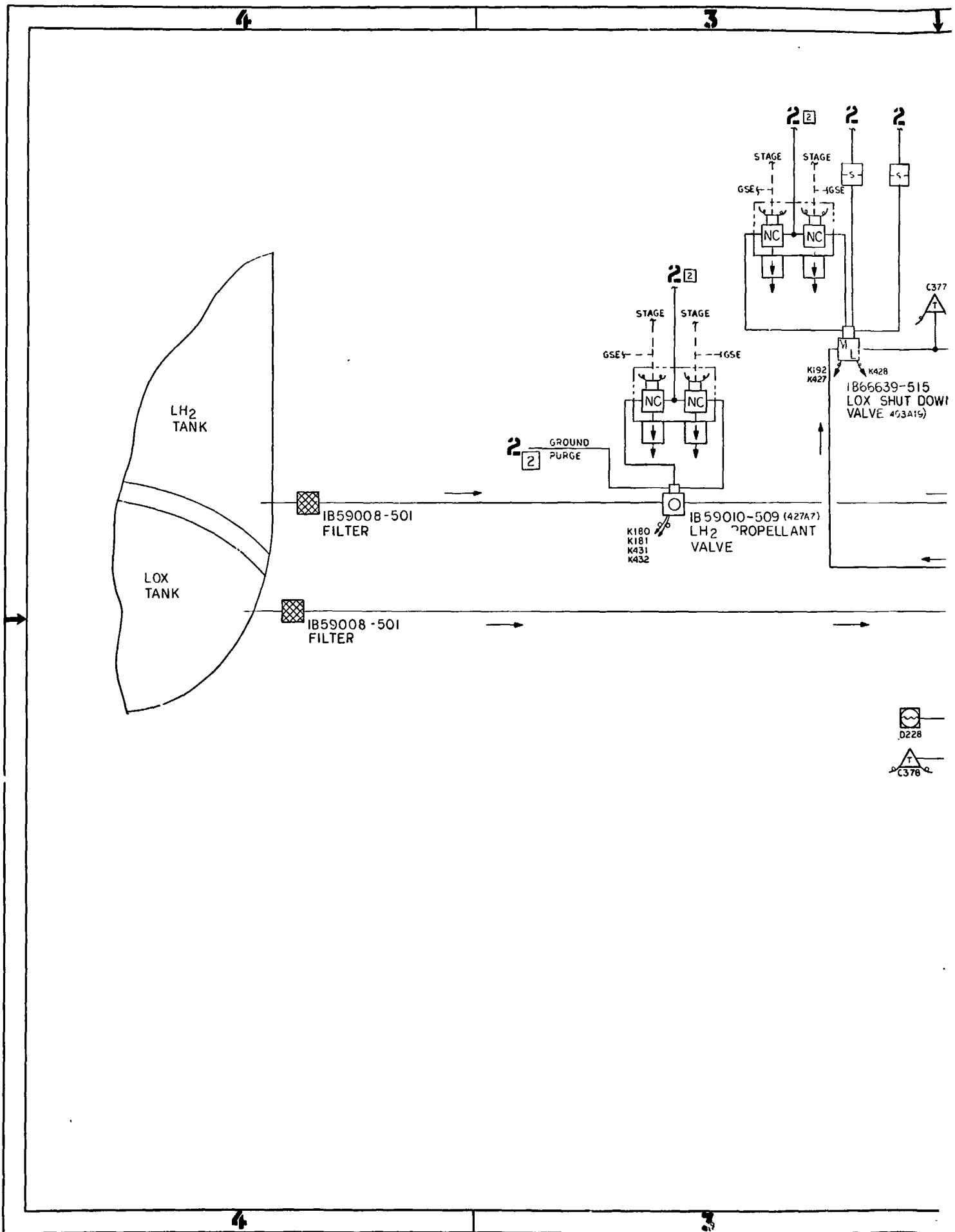

FOLDOUT FRAME

REVISIONS			
SYM	DESCRIPTION	DATE	APPROVED
A	SEE E.O.	11/8/46	[Signature]
B	SEE E.O.	3/10/47	[Signature]

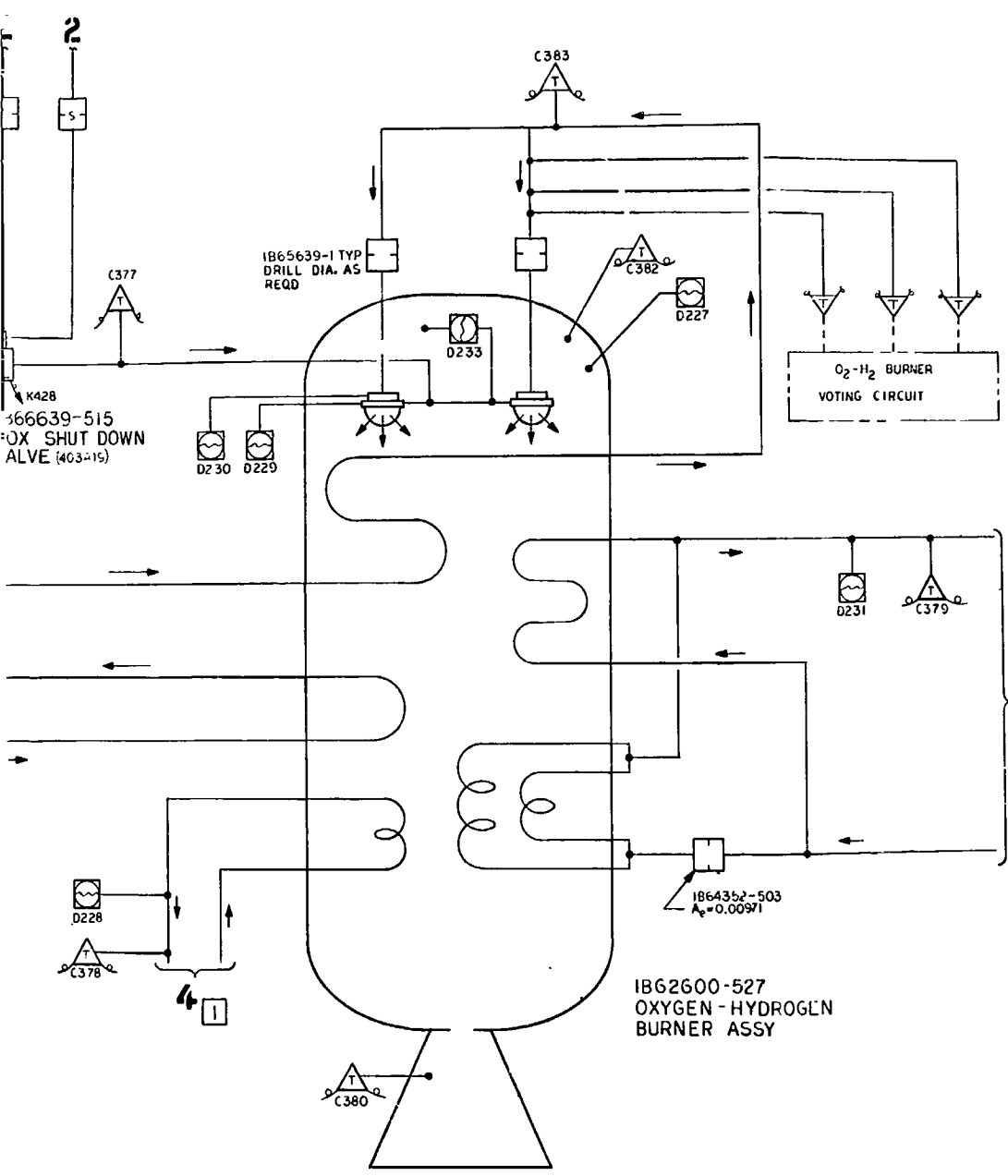

VEHICLE CONFIGURATION
 IB62600 AS
 IB62676 Z

IB66043

PREPARED FOR NASA-LISFC		SEQUENCE 12	
UNLESS OTHERWISE SPECIFIED DIMENSIONS ARE IN INCHES. TOLERANCES FRACTIONS ± DECIMALS ± ANGLES ±	MATL WTCHK STRCHK CHECK PR ENGR DES ENGR GR ENGR PREP BY	DOUGLAS AIRCRAFT COMPANY, INC. SANTA MONICA, CALIFORNIA	
		SCHEMATIC, OXYGEN HYDROGEN BURNER	
SEE ENGINEERING RECORDS FOR USAGE DATA	FIRST RELEASE OF PRINTS JUL 14 '67 ORIGINAL DATE OF DRAWING APR 1966	DESIGN ACTIVITY APPROVAL 18355 H	CODE IDENT NO SIZE 1866043 H
1760	AD. 6500	CUSTOMER APPROVAL	SCALE

Figure 13-1. Schematic, Oxygen Hydrogen Burner

FOLDOUT FRAME 2

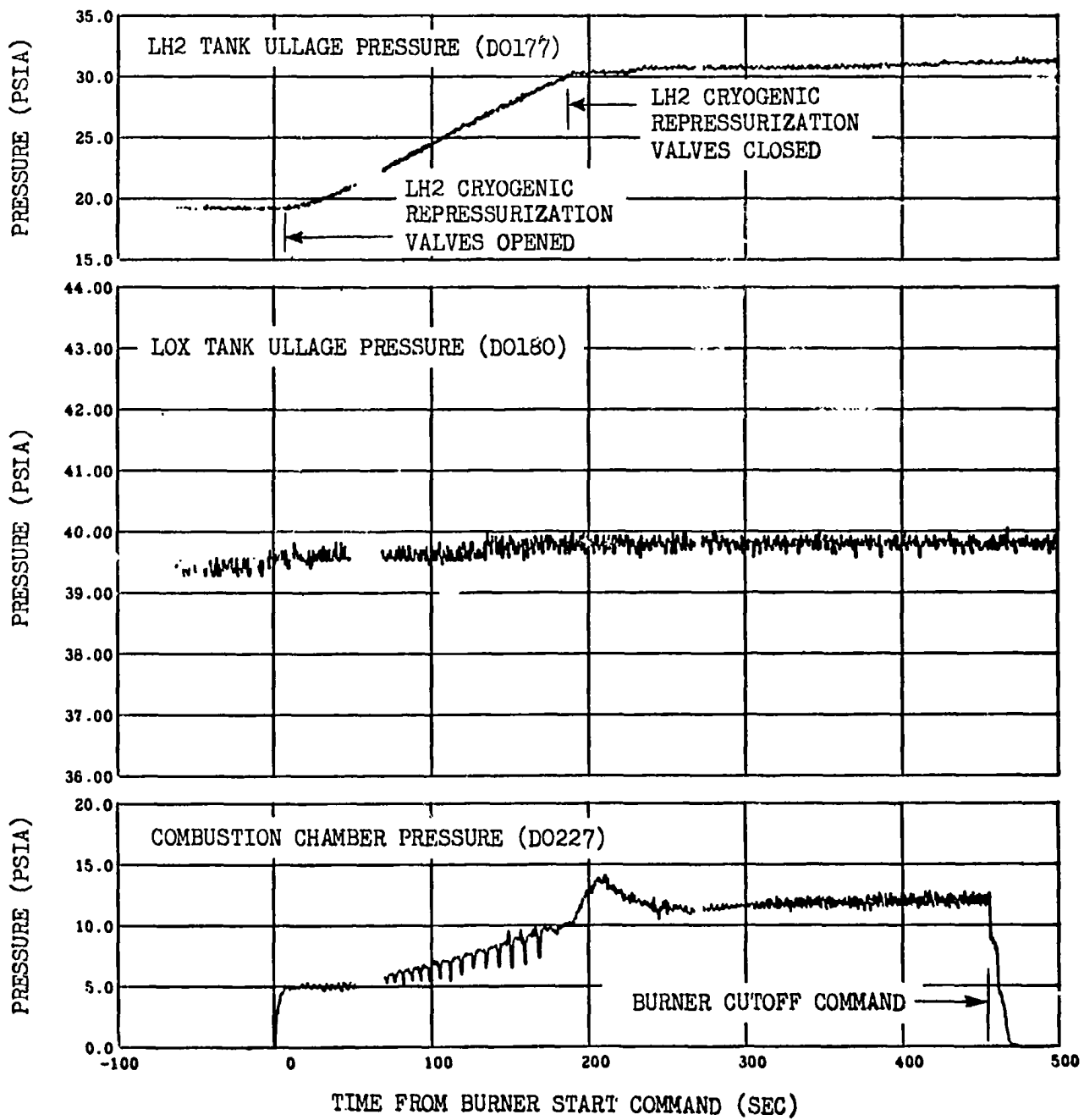

Figure 13-2. O2-H2 Burner Operation (Sheet 1 of 2)

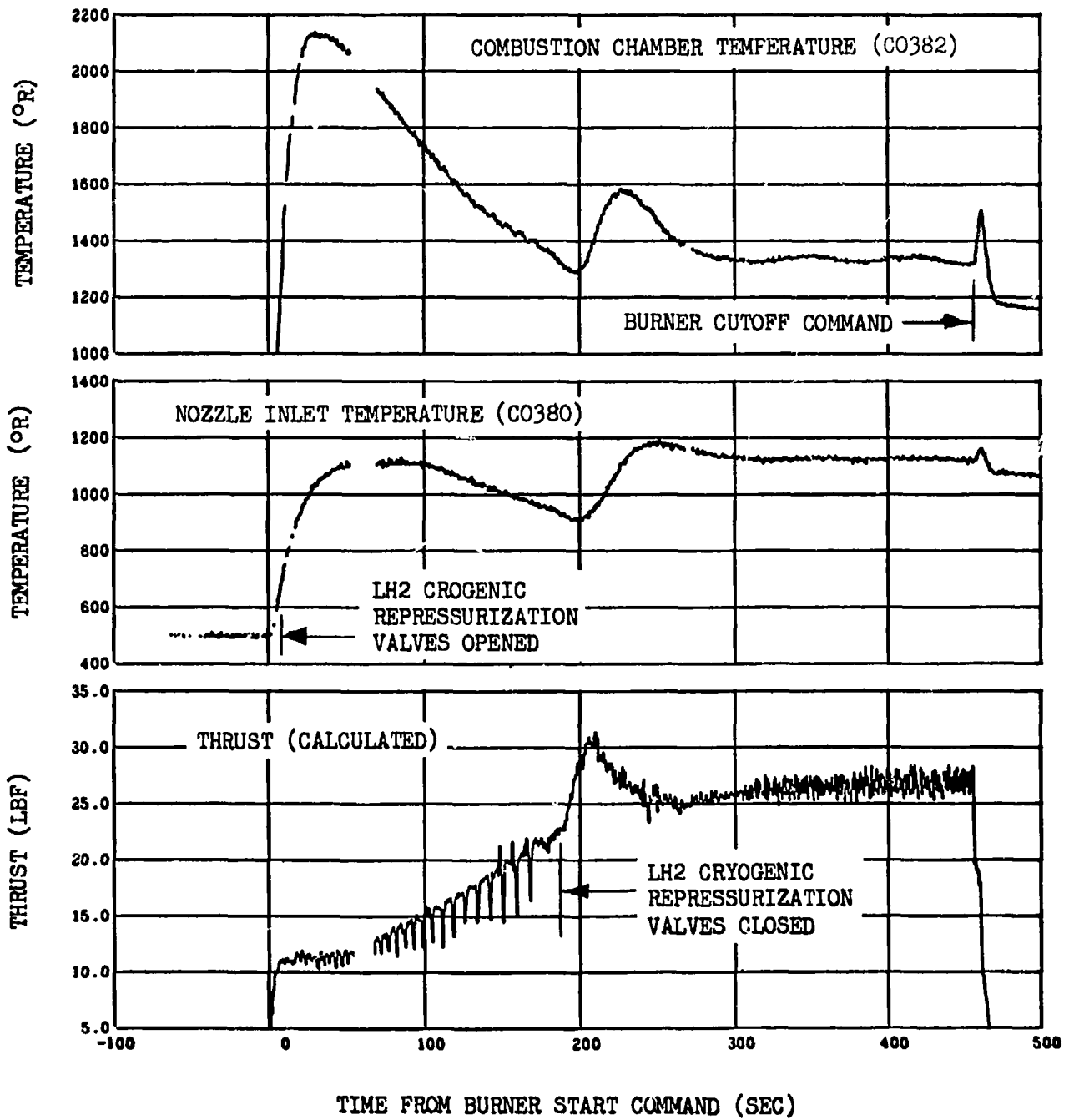

Figure 13-2. O2-H2 Burner Operation (Sheet 2 of 2)

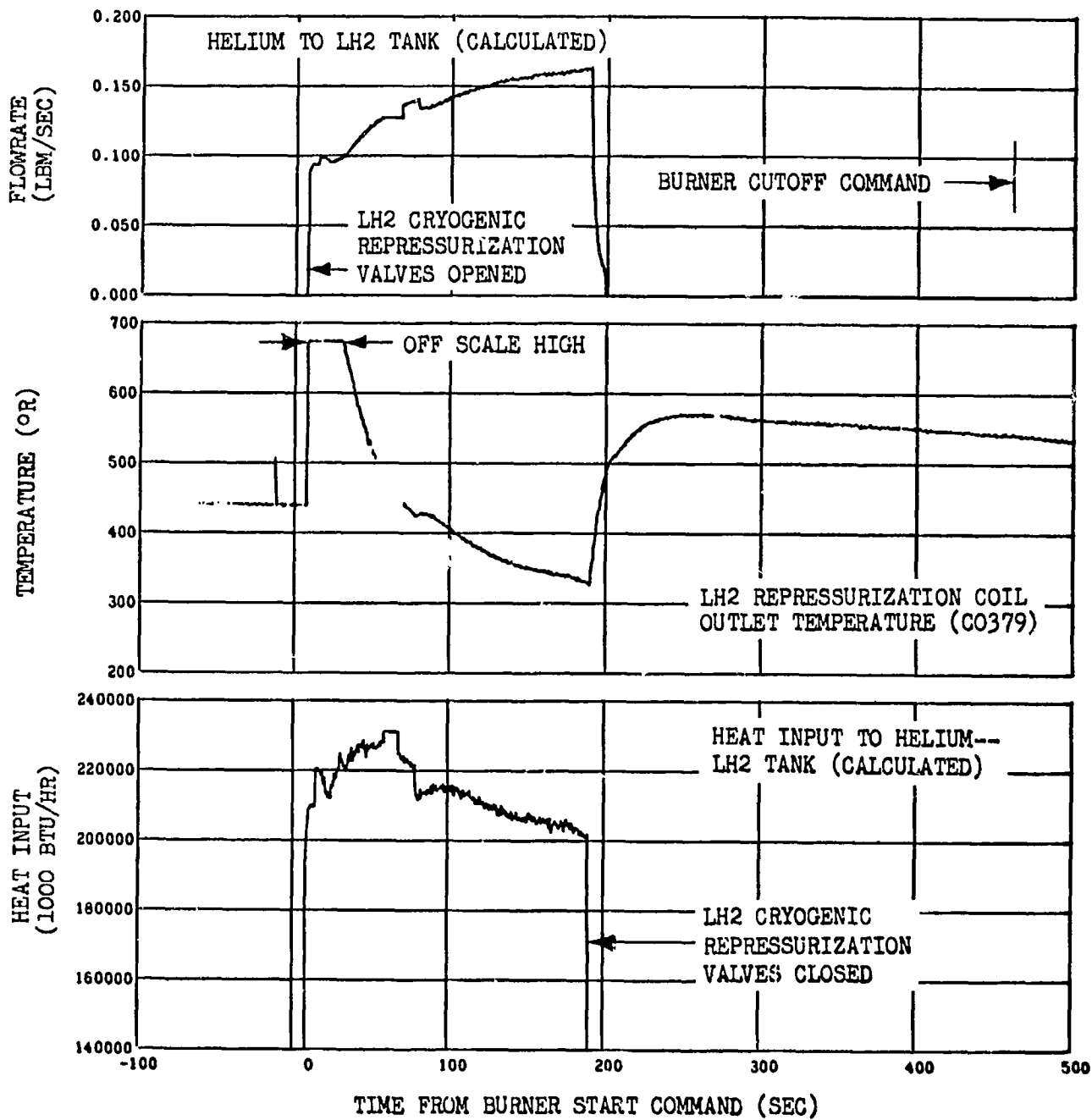

Figure 13-3. LH2 Tank Burner Repressurization

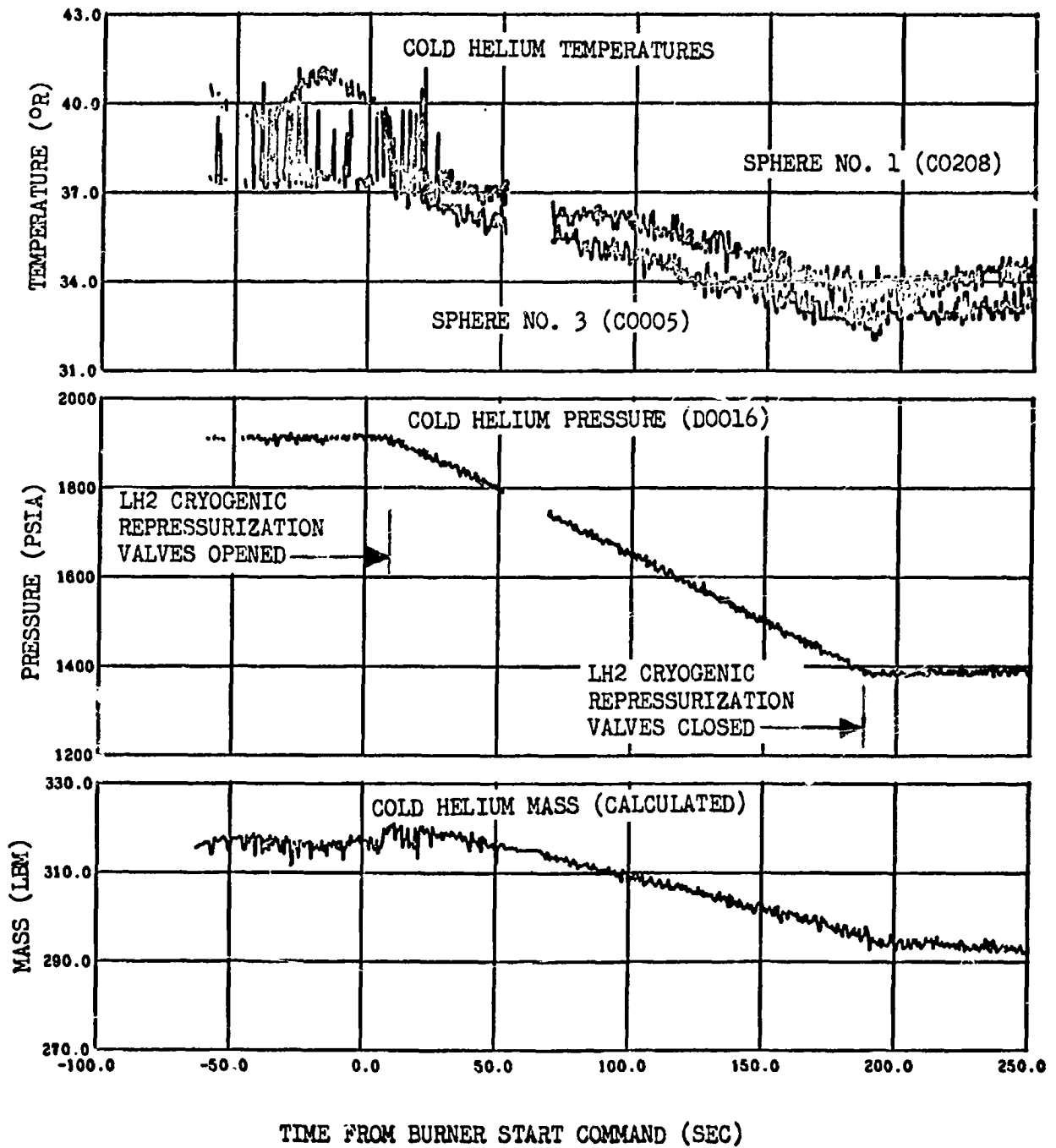

Figure 13-4. Cold Helium Sphere Conditions During O₂-H₂ Burner Operation

14. AUXILIARY PROPULSION SYSTEM

The attitude of the S-IVB stage is controlled by two auxiliary propulsion system (APS) modules mounted 180 degrees apart on the aft skirt of the stage. Each module is a self-contained unit composed of four basic systems: (1) the oxidizer system; (2) the fuel system; (3) the helium pressurization system; and (4) the engines (figure 14-1). The Instrument Unit, mounted above the S-IVB stage, provides signals for operation of the APS modules.

Each module contains two 150-pound-thrust engines which provide roll control during S-IVB powered flight, and yaw and roll control during the coast periods. A third 150-pound-thrust engine in each module provides pitch control during coast periods. Each module also contains a 72-pound-thrust engine which supplies axial thrust on the vehicle to provide propellant slosh control and settling.

14.1 APS Flight Operation

The APS operation was nominal throughout its design life. The attitude control, maneuvering, and ullaging requirements of the mission were all fulfilled.

14.1.1 APS Flight Objectives

The APS flight objectives were to verify the ability of the APS to provide thrust on demand for roll control during the S-IVB J-2 engine first and second burns; for roll, pitch, and yaw control after J-2 engine cutoff; and for propellant settling. These objectives were successfully met during the flight.

14.1.2 APS Flight Description

Approximately 1 second after S-II engine cutoff, the APS was activated to provide roll control during S-IVB J-2 first burn.

Following S-IVB J-2 engine cutoff, APS pitch and yaw control was activated to maintain the vehicle in the desired attitude. The APS ullage engines fired 86.7 seconds following J-2 first burn to provide slosh control and propellant settling. The ullage engines were fired a second time for 76.7 seconds to provide a positive acceleration on the vehicle from burner cutoff until J-2 restart. The ullage engines were started approximately 5 seconds before O2-H2 burner shutdown and were cut off 3 seconds after second J-2 engine start command.

During the second J-2 engine burn the APS pitch and yaw control was deactivated, and the APS provided roll control only. Following J-2 cutoff the APS pitch and yaw control was reactivated.

The ullage engines were fired a third time for 279.1 seconds to settle propellants for the propellant lead experiment.

A fourth APS ullage engine burn was programmed for 311 seconds. This fourth ullage engine burn was originally required to provide the final velocity increment for attaining the desired sling shot velocity. However, with the delta velocity obtained from the preplanned propellant lead experiment, the required velocity contribution by the last ullage engine burn could be significantly reduced. Therefore, the fourth ullage engine burn was terminated by ground command 8.1 seconds after ullage engine start.

14.1.2 APS Flight Description

Approximately 1 second after S-II engine cutoff, the APS was activated to provide roll control during S-IVB J-2 first burn.

Following S-IVB J-2 engine cutoff, APS pitch and yaw control was activated to maintain the vehicle in the desired attitude. The APS ullage engines fired 86.7 seconds following J-2 first burn to provide slosh control and propellant settling. The ullage engines were fired a second time for 76.7 seconds to provide a positive acceleration on the vehicle from burner cutoff until J-2 restart. The ullage engines were started approximately 5 seconds before O2-H2 burner shutdown and were cut off 3 seconds after second J-2 engine start command.

During the second J-2 engine burn the APS pitch and yaw control was deactivated, and the APS provided roll control only. Following J-2 cutoff the APS pitch and yaw control was reactivated.

The ullage engines were fired a third time for 279.1 seconds to settle propellants for the propellant lead experiment.

A fourth APS ullage engine burn was programmed for 311 seconds. This fourth ullage engine burn was originally required to provide the final velocity increment for attaining the desired sling shot velocity. However, with the delta velocity obtained from the preplanned propellant lead experiment, the required velocity contribution by the last ullage engine burn could be significantly reduced. Therefore, the fourth ullage engine burn was terminated by ground command 8.1 seconds after ullage engine start.

14.2 APS System Operation

The performance of all APS systems in both modules was satisfactory. The only problem experienced during this flight was a helium leak in the module 1 pressurization system. This leak will be discussed in detail below.

14.2.1 Helium Pressurization System

Module 1 developed a helium leak approximately 6 hr 15 min after liftoff. The initial leak rate was approximately 65 scim, and the leak continued at this rate until 7 hr 10 min after liftoff. This is slightly larger than the 61 scim (67 psia per hr) allowable liftoff helium leak rate. At 7 hr 10 min after liftoff the leakage increased to approximately 180 scim and continued at this rate until loss of signal (LOS) which occurred at 10 hr 54 min after liftoff (figure 14-2).

The time at which the leak started and the leakage rate was determined by comparing the change in the helium bottle mass with the mass of helium that should have been used in displacing the APS propellant. The quantity of helium required to displace the propellants was determined from the impulse obtained from the integral of the engine chamber pressures until loss of chamber pressure data at 4 hr 22 min after liftoff. From 4 hr 22 min until the loss of helium bottle data at 10 hr 54 min after liftoff, the propellant usage was approximated from the engine valve actuation event data.

It should be noted that, during the flight of AS-504, module 2 experienced a similar leak which started when the helium bottle temperature decreased from 555 deg R to 525 deg R. The leak stopped when the bottle temperature increased from a low of 492 deg R to 515 deg R. In the case of AS-505 the leak started when the helium bottle temperature decreased to 485 deg R. The helium bottle temperature in module 1 continued to decrease to 425 deg R at loss of data. In both flights the module which experienced the colder environmental temperatures experienced a leak. The location of

the leak is impossible to predict with the data available. Furthermore, there is no way to isolate the system leak to either the high pressure or low pressure portion of the pressurization system.

The APS modules during this flight encountered severe environmental conditions. The module temperatures remained close to ambient during earth orbit; however, after translunar injection the S-IVB was oriented such that module 1 faced dark space while module 2 faced the sun.

The helium leak started after the APS had exceeded its design life. The APS was designed to complete a maximum of 4.5 hr of earth orbit and a maximum of 2 hr of translunar coast, the translunar coast period being the more severe environment. In this flight the APS encountered 2.5 hr of earth orbit and 3.75 hr of translunar coast prior to the start of the leak (1.75 hr beyond the APS design lifetime for translunar coast).

The investigation of the helium leak problem is continuing. Component environmental testing and the possibility of more insulation in the forward portion of the module are presently being considered. No changes have been recommended for the AS-506 flight. If the leak observed during the 505 flight had occurred at the start of the mission, the mission still would have been accomplished. Also, if as suspected, the leak is due to low temperature effects the leak would not occur until after 2 hr of translunar coast. While in earth orbit both modules maintained temperatures close to liftoff values.

The module 2 helium pressurization system operation was normal. The helium bottle conditions are presented as a function of mission time in figures 14-3 through 14-7. Helium bottle initial and final conditions are presented in table 14-1.

The range of regulator outlet pressures, ullage pressures, and propellant manifold pressures are presented in table 14-2. These pressure values were satisfactory and within instrumentation accuracy of the required values of 193 to 203 for regulator outlet pressure, and 188 to 200 psia for ullage and manifold pressure except during the latter portion of the mission. The cold temperature of module 1 after Ro +8 hours caused the regulator pressure to increase approximately 5 psi. The high temperature in module 2 caused the regulator pressure to decrease 3 psi. Since the regulator is not temperature compensated, these pressure trends would be expected. Furthermore, the changes experienced in the regulator pressures have been experienced by regulators during quality testing at similar environmental conditions.

14.2.2 APS Propellant System

Both the fuel and oxidizer systems of Modules 1 and 2 performed as expected during the flight. The propellant quantities remaining and the propellant temperatures are presented as a function of mission time in figures 14-8 through 14-11. The nominal and 3-sigma predicted usages are included in the propellant mass figures for comparison. From this it can be seen that the propellant usage was slightly less than predicted. The propellant temperatures remained within the required range of 480 to 585 deg R. The maximum temperatures recorded in the propellant control module was 568 deg R in module 2. The minimum propellant temperature recorded was 525 deg R in module 1. The bulk temperature of propellants in the bladder would be somewhere between these temperature values.

The propellant usage presented in figures 14-9 and 14-11 and table 14-3 were obtained from the helium bottle pressure, volume, and temperature (PVT method). This method assumes that all the helium which leaves the high pressure helium system enters the low pressure system and expells propellant. Because of the helium leakage in module 1, the PVT

program could not be used directly in determining propellant usage once the leakage occurred. The PVT program was modified to account for the helium leakage as shown in figure 14-2.

14.3 Engine Performance

The performance of the APS engines was satisfactory throughout the mission. The engine chamber pressure ranged from 90 to 100 psia.

The longest attitude control engine steady state burn time was 8.3 seconds on engine No. 5 during the pitch maneuver to separation attitude at RO +10,452 seconds. The majority of pulses during the flight were of minimum pulse width as shown in figures 14-12 through 14-15.

The total APS impulse for the attitude control engines in each module is presented as a function of mission in figures 14-16 and 14-17. Module 1 supplied a total impulse of 11,125 lbf-sec for attitude control. The quantity of propellant for attitude control to this time was 51.9 lbm; therefore, the average specific impulse was 214 seconds. The module 2 attitude control total impulse was 11,296 lbf-sec. The quantity of propellant used for attitude control to this time was 45.1 lbm; therefore, the average specific impulse of module 2 attitude control engines was 250 seconds. Since propellant usage is determined from helium bottle conditions the low ISP value in the case of module 1 would tend to indicate the leak in module 1 started sooner than indicated in figure 14-2. However, it was too small prior to 6.25 hours after liftoff to determine.

Figures 14-12 through 14-15 show that the engine performance agreed closely with the engine manufacturer's test data obtained at simulated altitude conditions. The variation from the TRW 2-sigma variation can be attributed to the methods used in determining the performance. The pulse width was determined from the time the chamber pressure increased

to 10 psia until it dropped to 10 psia. Since the engine chamber pressures were only sampled at 120 samples per second, an accurate pulse width could not be obtained. The pulse width determined by this method could be longer than actual, and the resulting thrust value obtained by dividing the impulse by pulse width would then be lower than actual.

The ullage engine chamber pressures were normal during the four ullage engine burns, ranging from 95 to 100 psia.

TABLE 14-1

HELIUM BOTTLE CONDITIONS

Parameter	Module 1		Module 2	
	Initial	Final (RO +38,329 sec)	Initial	Final (RO +38,329 sec)
Pressure (psia)	3,100	992	3,100	2,327
Temperature (deg R)	549	429	547	632
Mass (lbm)	1.026	0.446	1.030	0.692
Usage (lbm)	--	0.58*	--	0.338

*Approximate helium leakage mass = 0.24 lbm. Therefore, approximately 0.34 lbm of helium was used to expel propellant.

TABLE 14-2
 APS MODULE PERFORMANCE SPAN

	Module 1		Module 2	
	Fuel	Oxidizer	Fuel	Oxidizer
Ullage Pressure (psia)	190-198	186-198	185-192	180-183
Propellant Manifold Pressure (psia)	186-194	196-200	180-190	182-190
Regulator Outlet Pressure (psia)	182-202		186-194	

TABLE 14-3
S-IVB APS PROPELLANT CONSUMPTION

Time Period	Module at Position I		Module at Position II	
	Oxidizer	Fuel	Oxidizer	Fuel
Initial Load	202.6	126.0	203.0	126.0
First J-2 Burn (Roll Control)	0.6	0.4	0.6	0.4
J-2 ECO to End of 1st APS Ullaging	12.9	10.2	12.9	10.2
End of 1st Ullage Burn to Start of T6	10.6	6.9	7.7	4.6
Restart Preparations	14.3	10.8	11.8	9.2
2nd J-2 Burn (Roll Control)	0.7	0.5	0.7	0.4
ECO to 3rd Ullage Burn	21.0	13.0	20.7	12.9
3rd Ullage Burn	35.2	27.8	40.2	31.7
3rd Ullage Burn to 4th Ullage Burn	8.7	5.4	12.7	7.9
4th Ullage Burn	2.0	1.6	2.1	1.9
4th Ullage Burn to Loss of Data	8.9*	5.6*	8.9	5.6
Total Usage	114.9	82.2	118.3	84.8

Note: The APS propellant consumption presented in this table was determined from helium bottle conditions [pressure, volume, temperature (PVT) method]

*The PVT method used in determining propellant consumption could not be used directly for module 1 after the helium leak occurred. Since pulsing of module 1 was approximately equal to the pulsing of module 2 during this period (obtained by comparing the number of valve actuations of each module), the module 1 usage was assumed equal to module 2 usage.

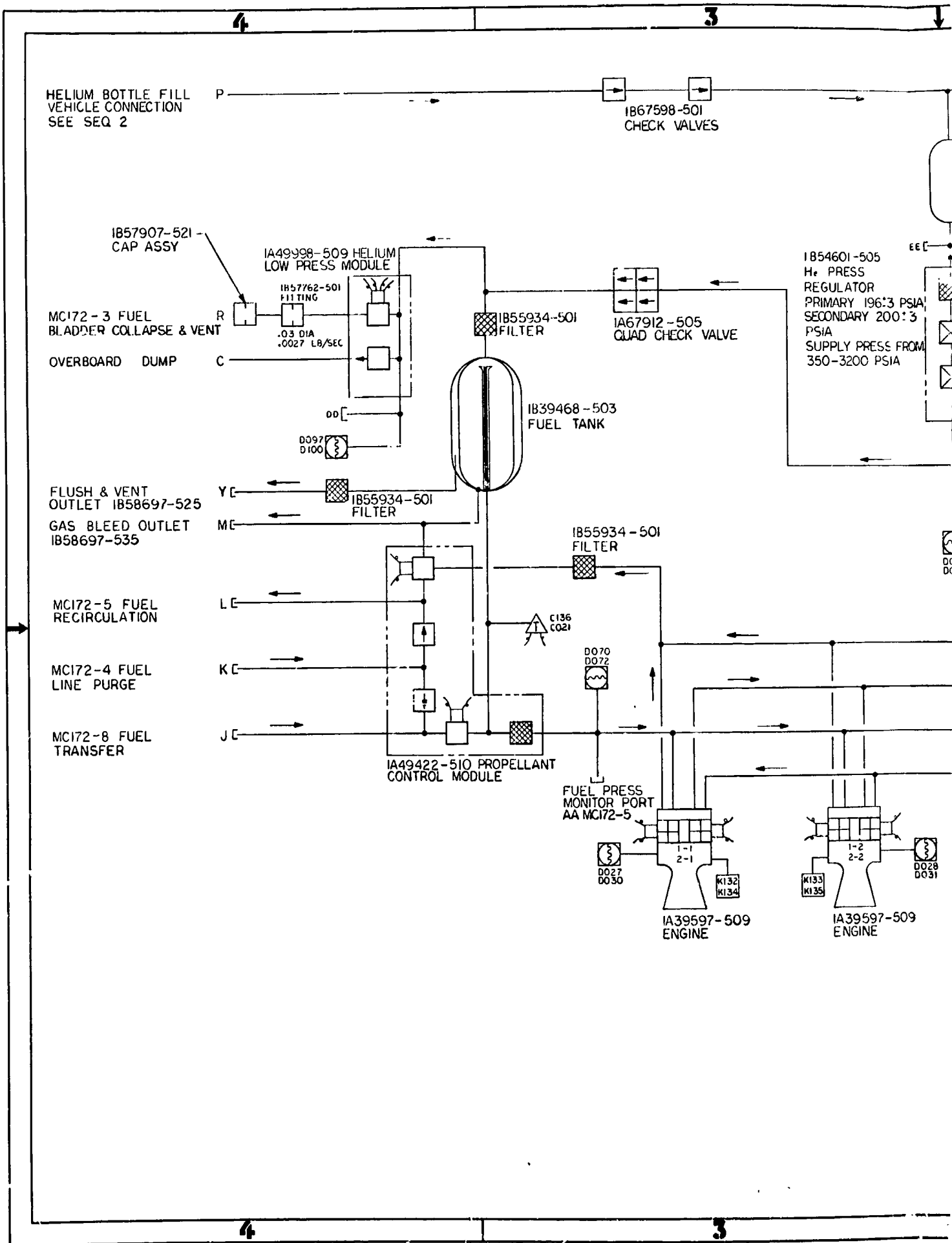

FOLDOUT FRAME

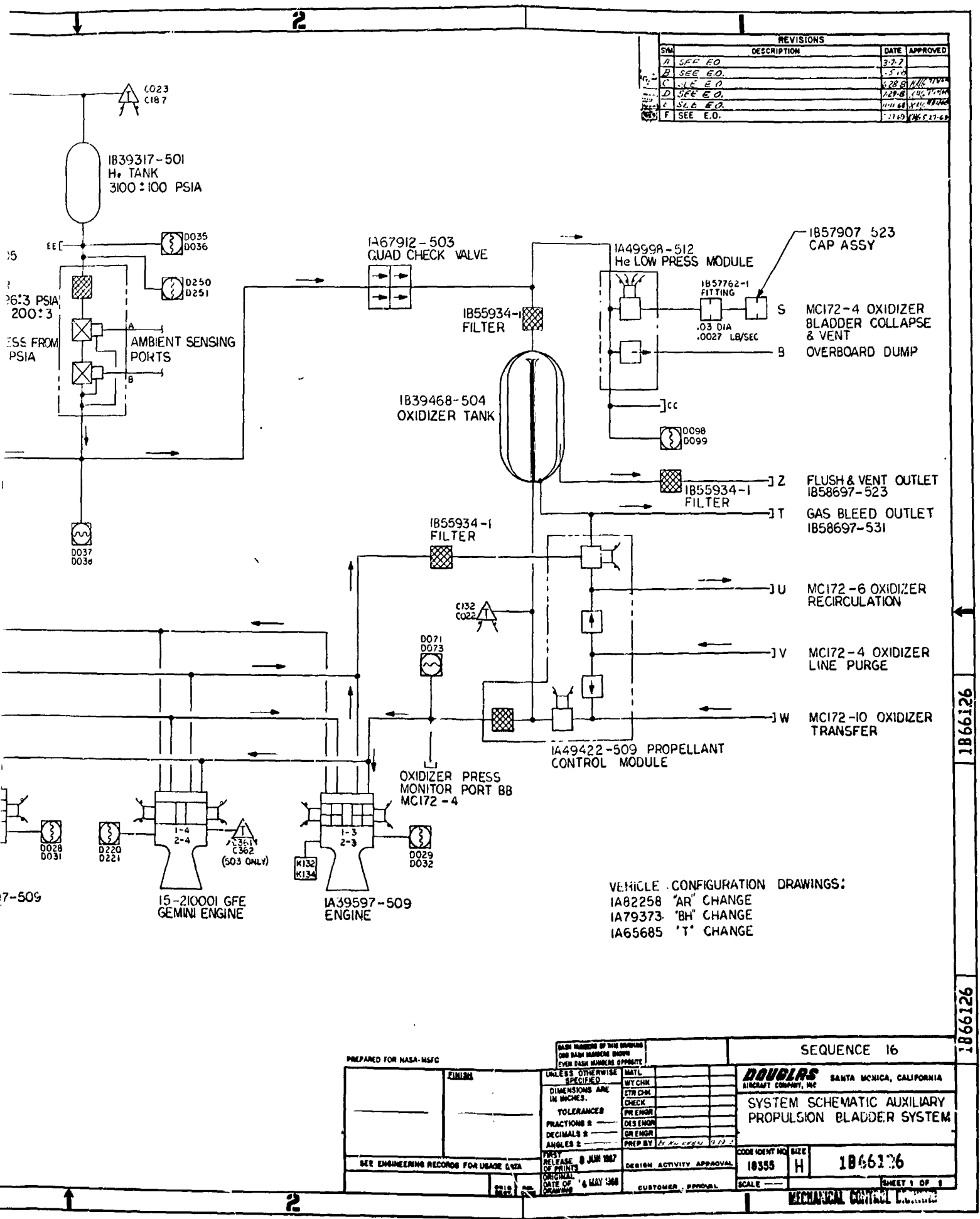

REVISIONS			
SM	DESCRIPTION	DATE	APPROVED
A	SEE E.O.	3-2-7	
B	SEE E.O.	5-1-6	
C	SEE E.O.	6-28-6	
D	SEE E.O.	12-2-6	
E	SEE E.O.	1-11-68	
F	SEE E.O.	11-14-68	

VEHICLE CONFIGURATION DRAWINGS:
 IA82258 "AR" CHANGE
 IA79373 "BH" CHANGE
 IA65685 "T" CHANGE

PREPARED FOR NASA-MSFC		SEQUENCE 16	
UNLESS OTHERWISE SPECIFIED		DOUGLAS AIRCRAFT COMPANY, INC. SANTA MONICA, CALIFORNIA	
DIMENSIONS ARE IN INCHES.		SYSTEM SCHEMATIC AUXILIARY PROPULSION BLADDER SYSTEM	
TOLERANCES		CODE IDENT NO. SIZE	
FRACTIONS: 1/16, 1/32, 1/64		18355 H 1866126	
DECIMALS: .005, .010, .015, .020, .030, .040, .050, .060, .070, .080, .090, .100		DESIGN ACTIVITY APPROVAL	
ANGLES: 1/2, 1/4, 1/8, 1/16, 1/32, 1/64		DATE OF ORIGINAL DRAWING: 14 JUN 1967	
SEE ENGINEERING RECORDS FOR USAGE DATA		CUSTOMER: APPROVAL	
DATE OF PRINTING: 14 MAY 1968		SCALE: _____	
DRAWN BY: _____		MECHANICAL CONTROL DRAWING	

Figure 14-1. Schematic, Auxiliary Propulsion Bladder System
 FOLDOUT FRAME 14-11

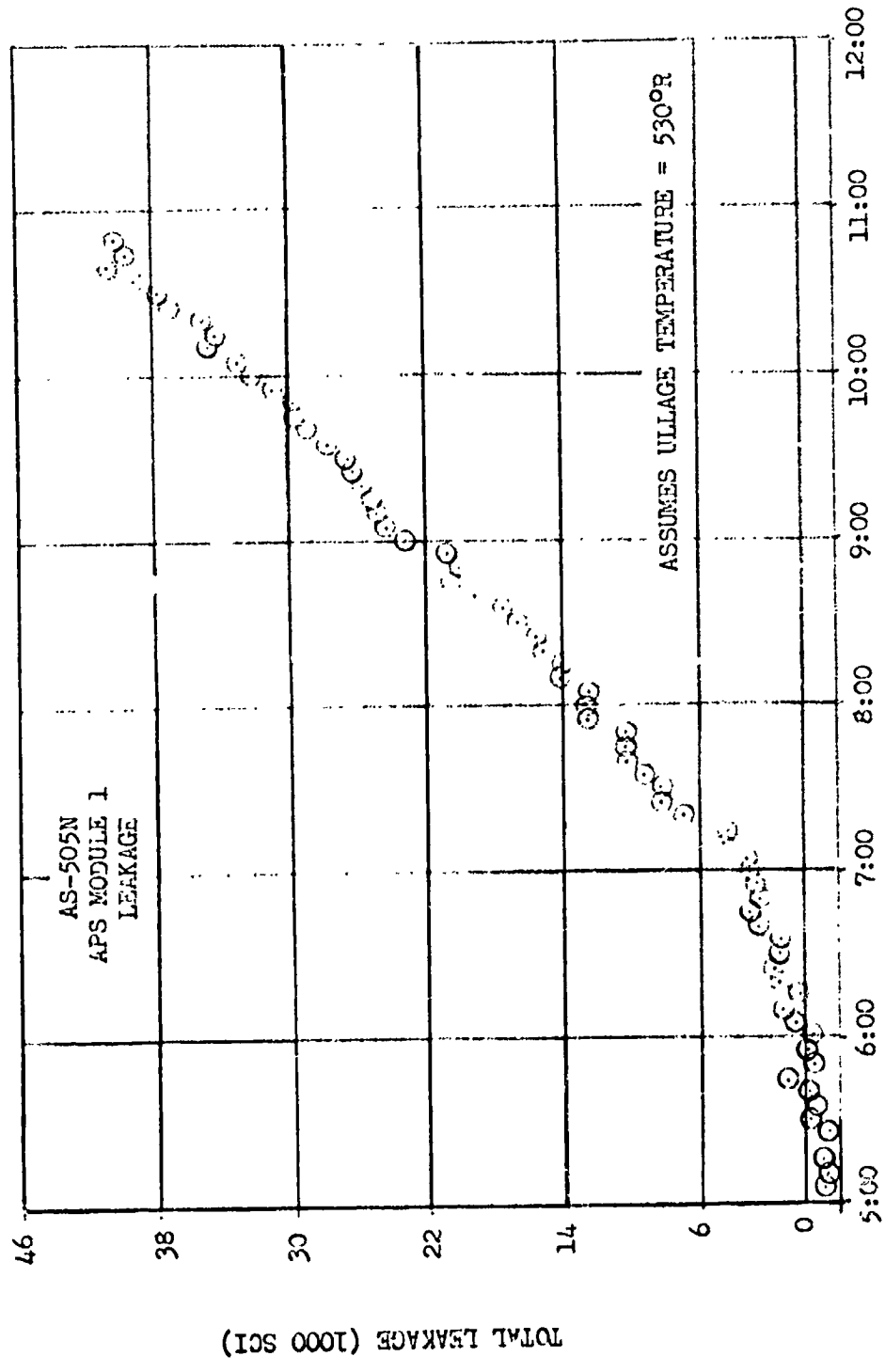

TIME FROM LIFTOFF (HRS)

Figure 14-2. APS Module 1 Helium Leakage

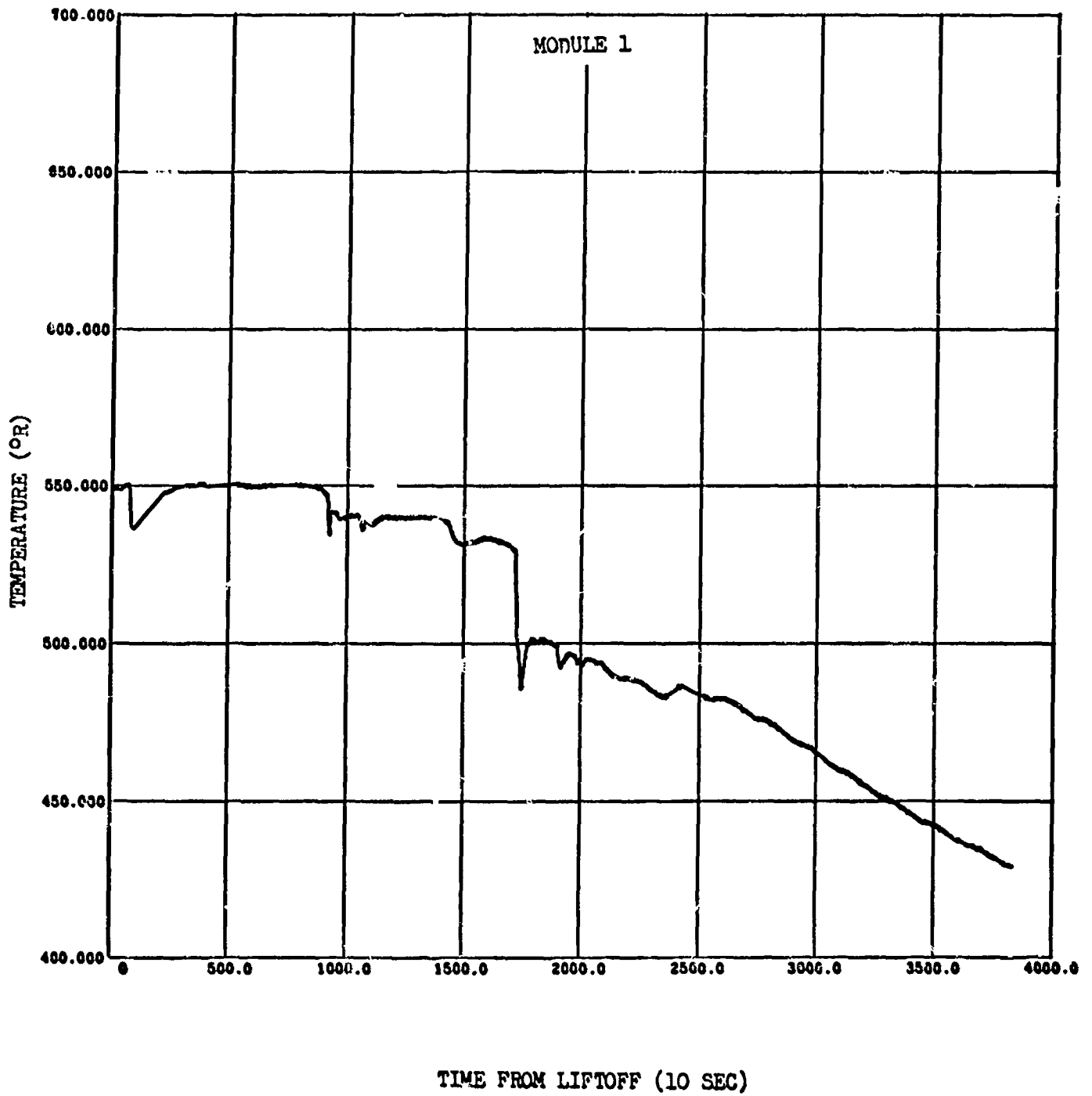

Figure 14-3. APS Module 1 Helium Bottle Temperatures

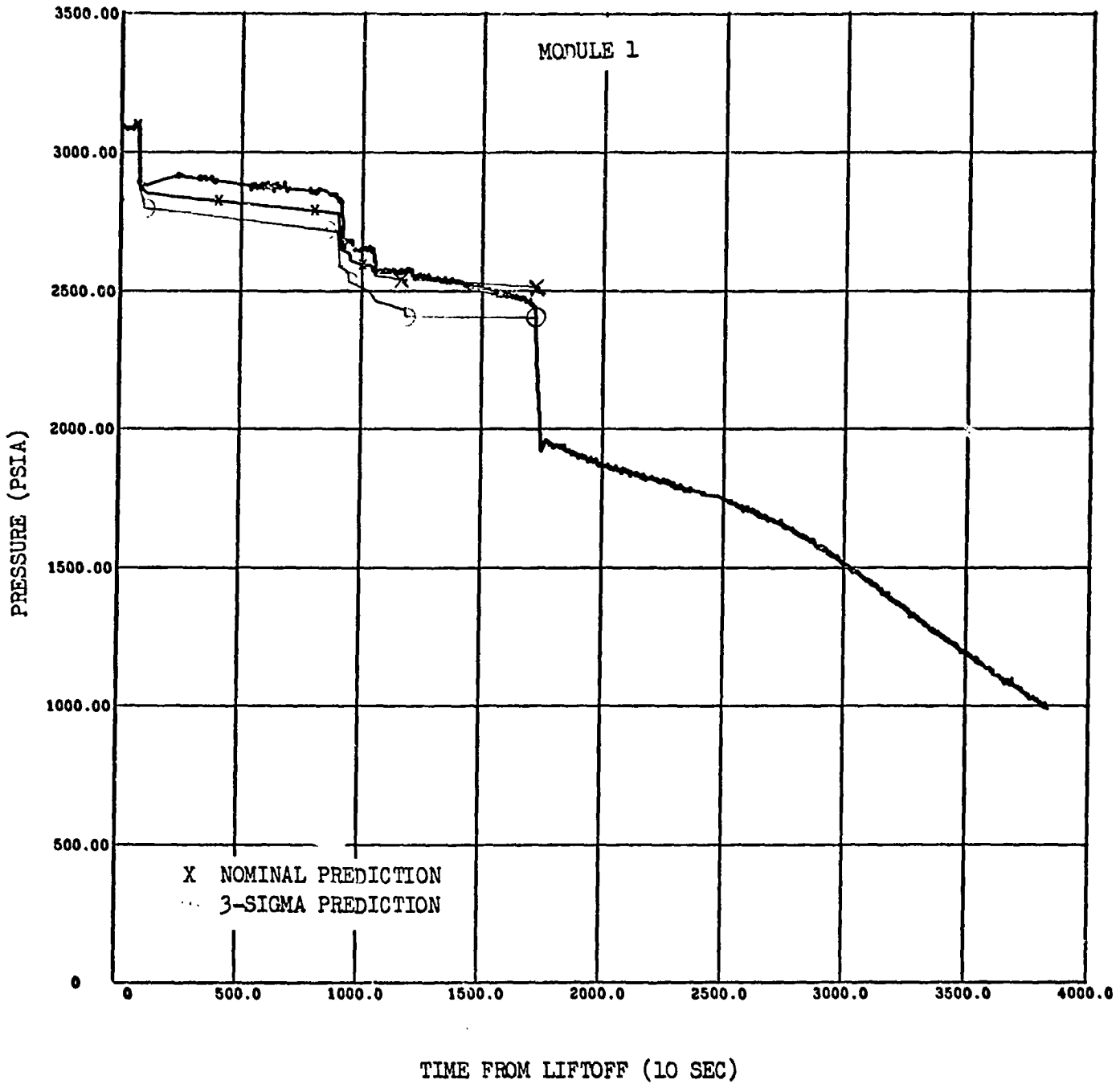

Figure 14-4. APS Module 1 Helium Bottle Pressure

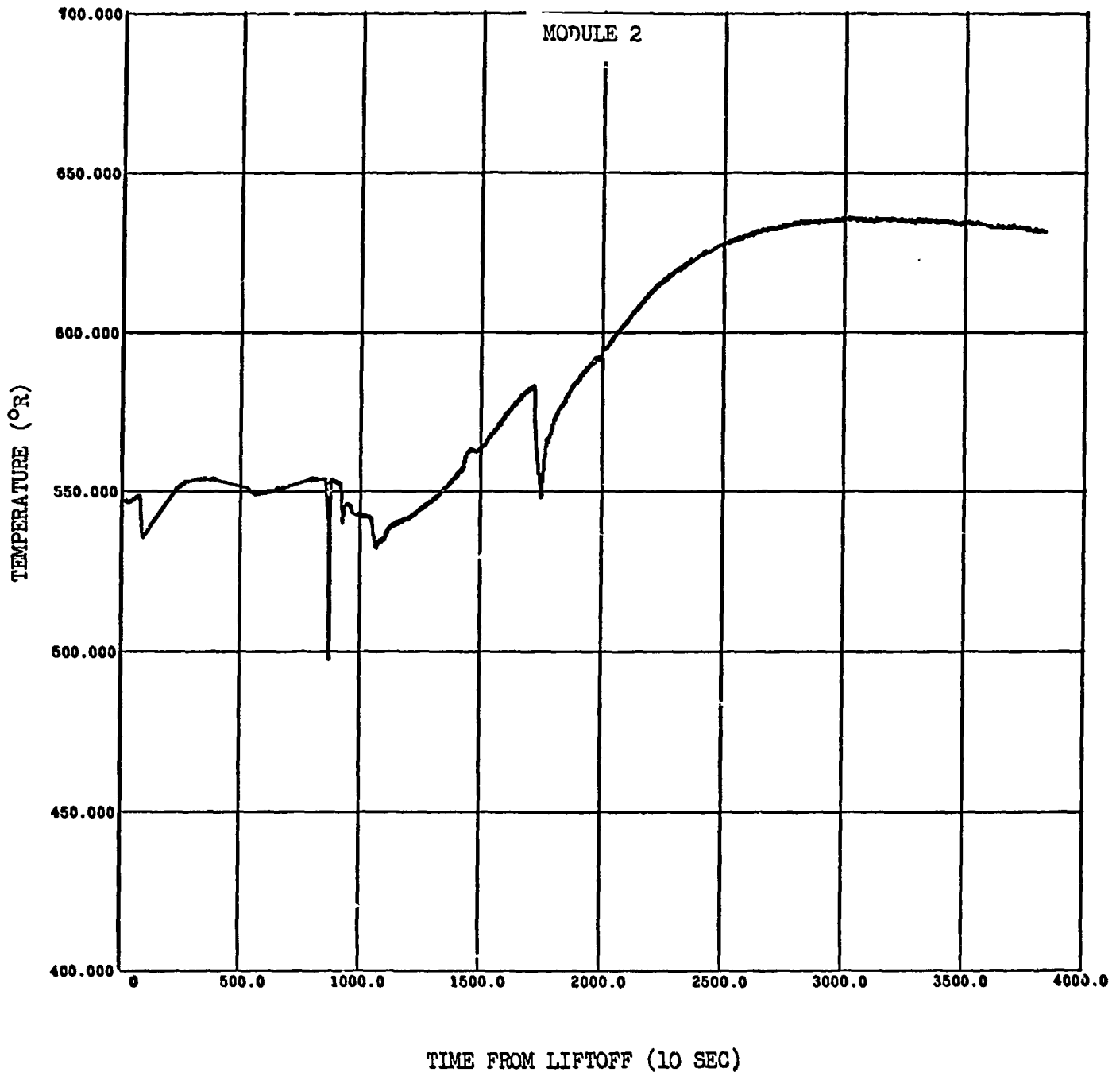

Figure 14-5. APS Module 2 Helium Bottle Temperature

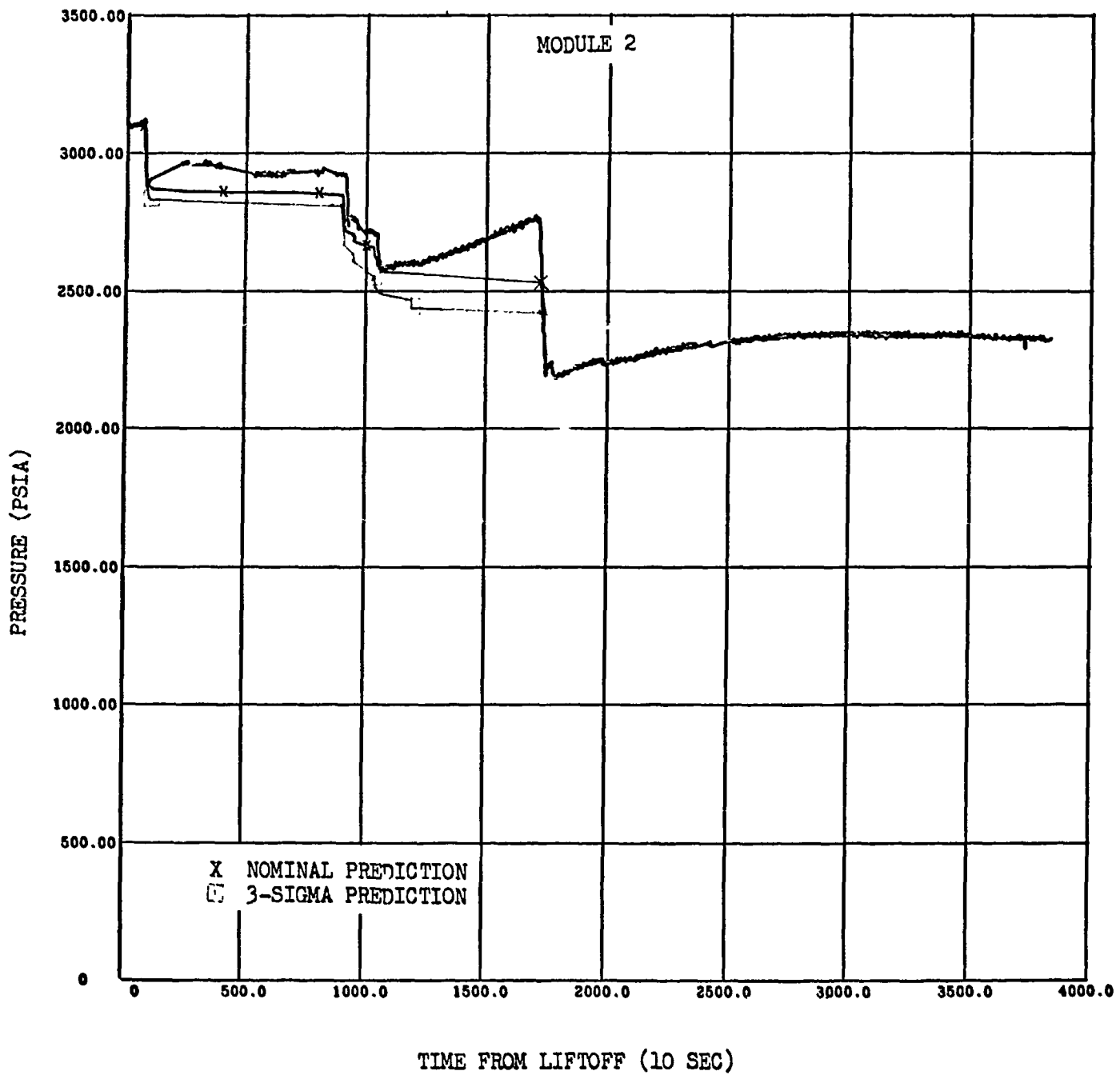

Figure 14-6. APS Module 2 Helium Bottle Pressure

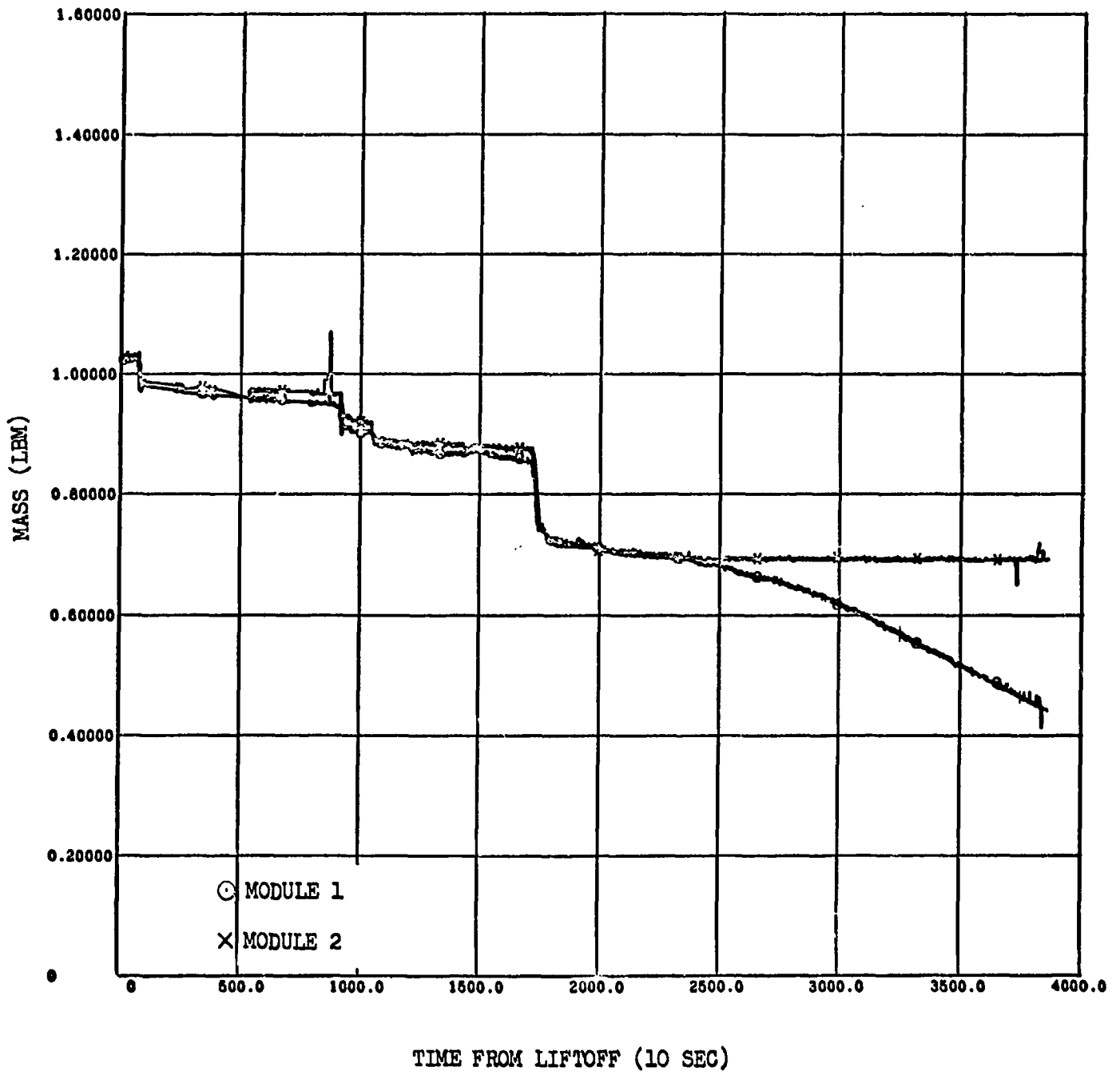

Figure 14-7. APS Helium Mass

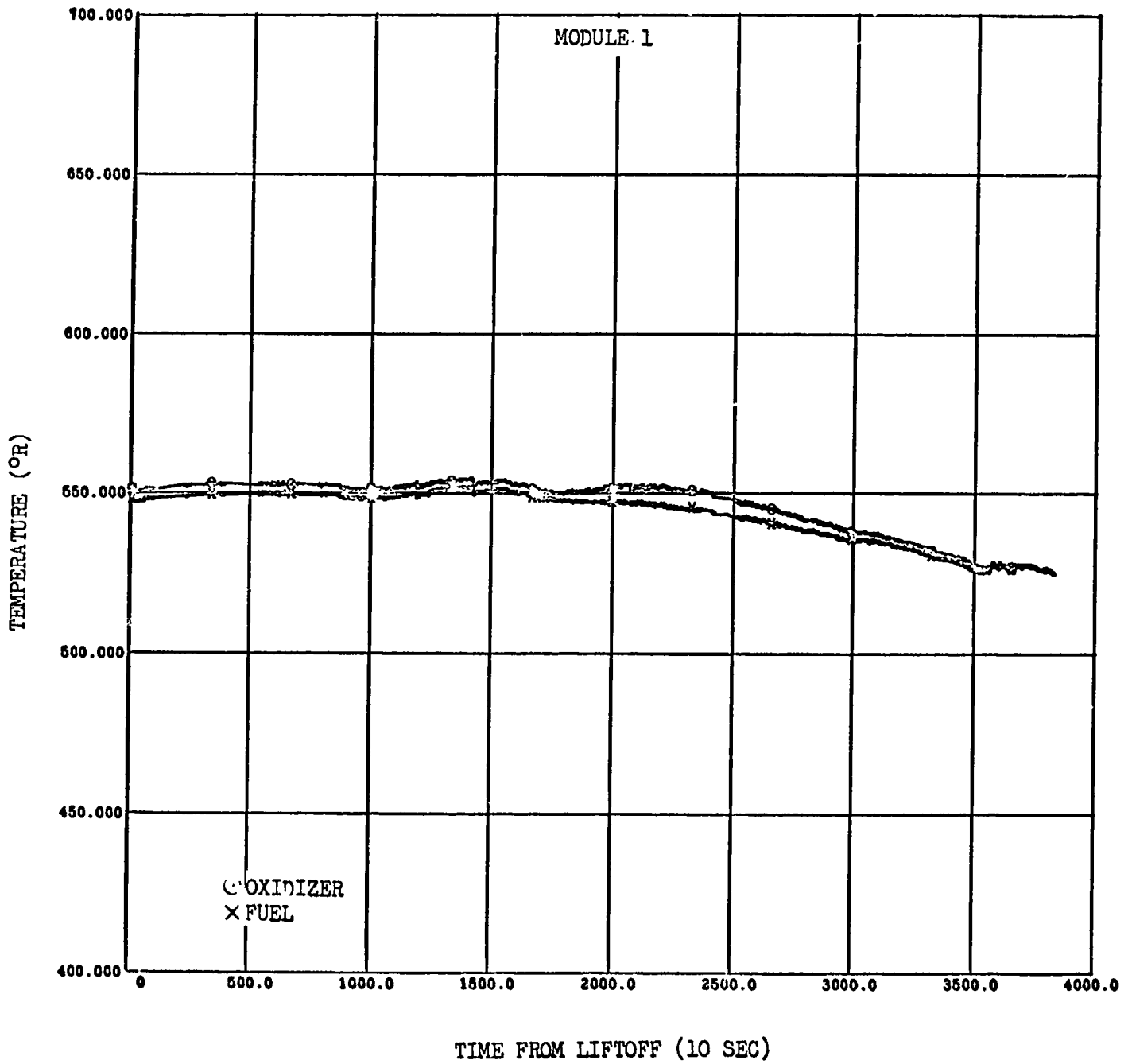

Figure 14-8. APS Module 1 Propellant Temperatures

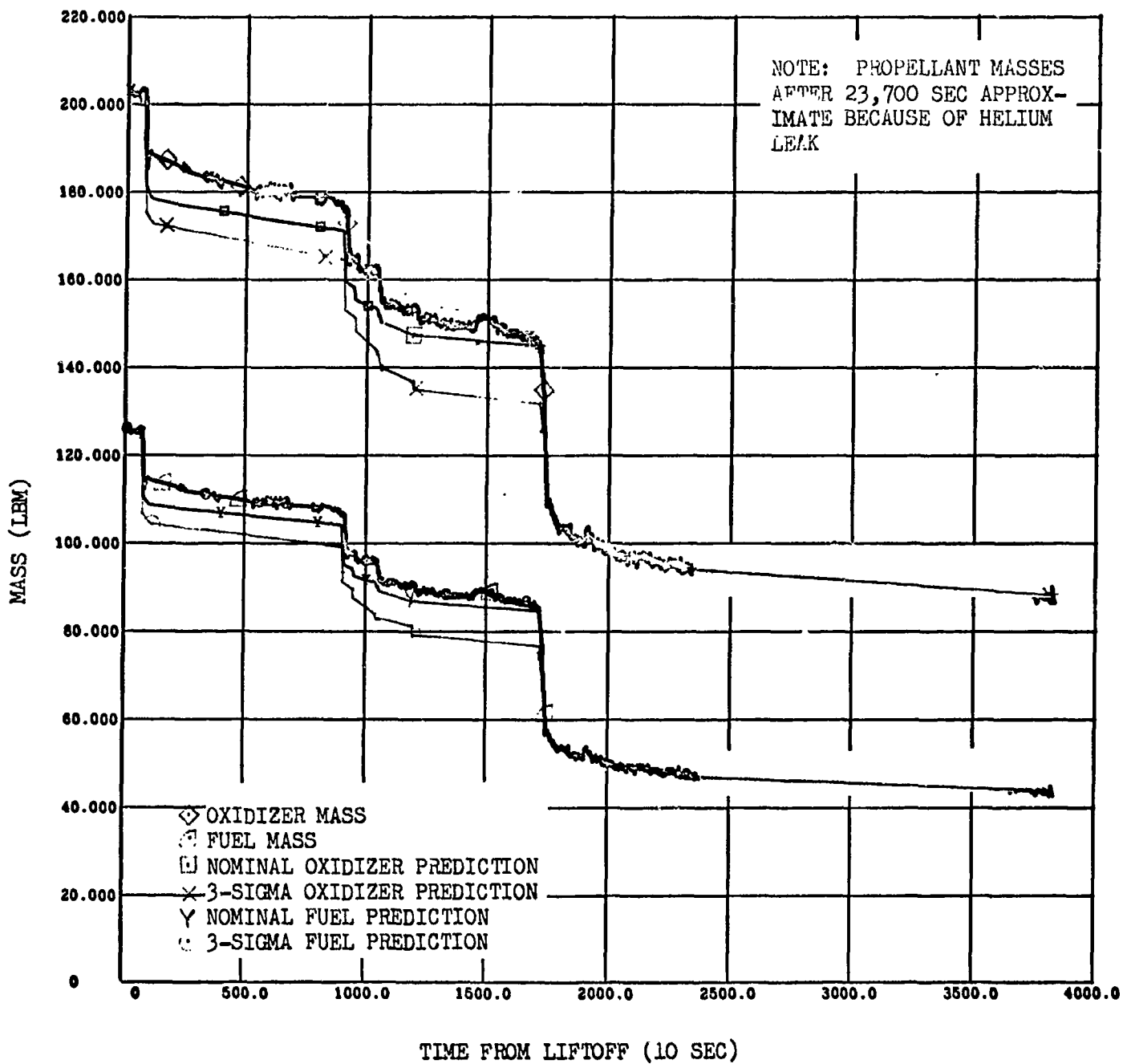

Figure 14-9. APS Module 1 Propellant Masses

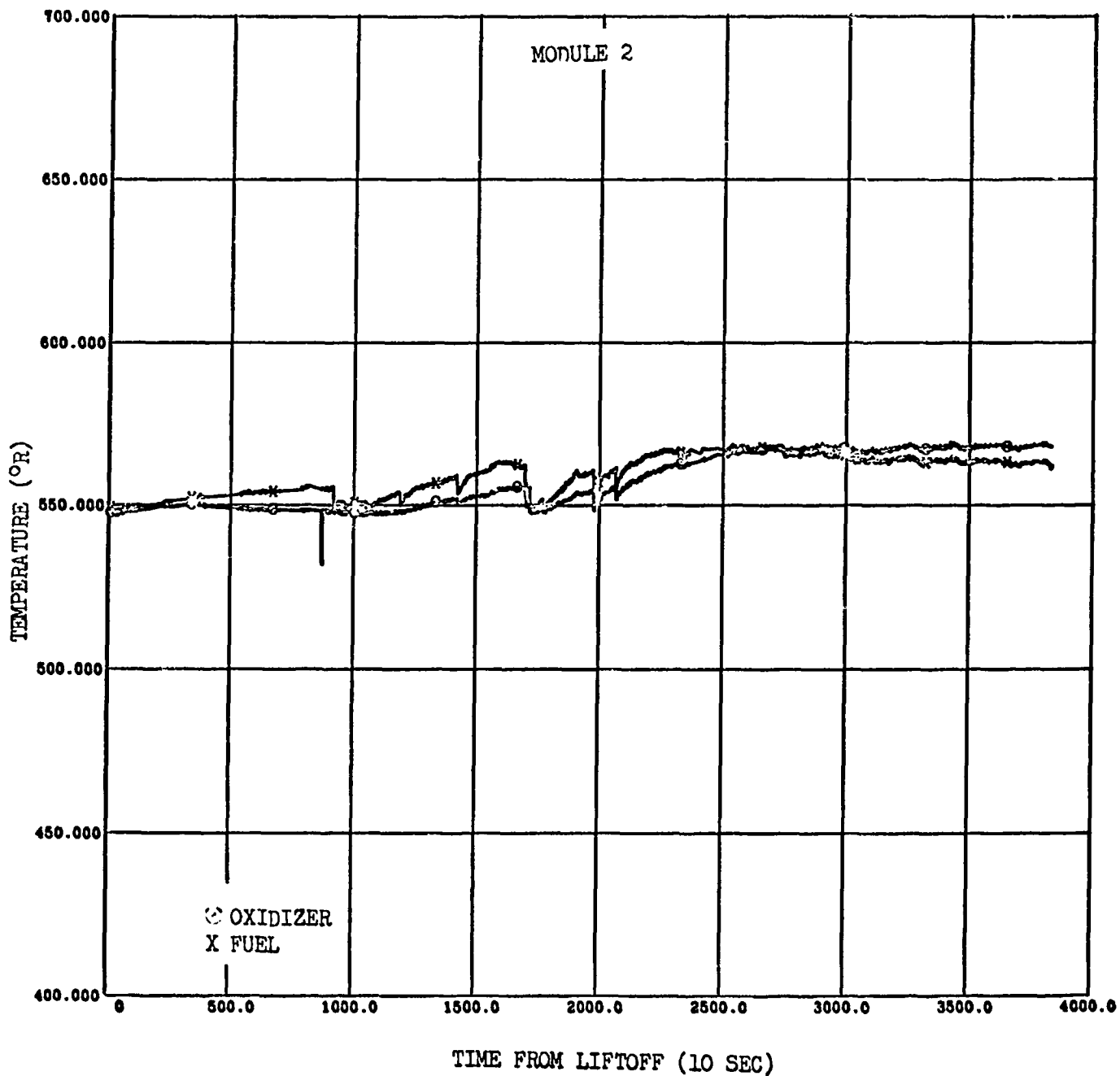

Figure 14-10. APS Module 2 Propellant Temperatures

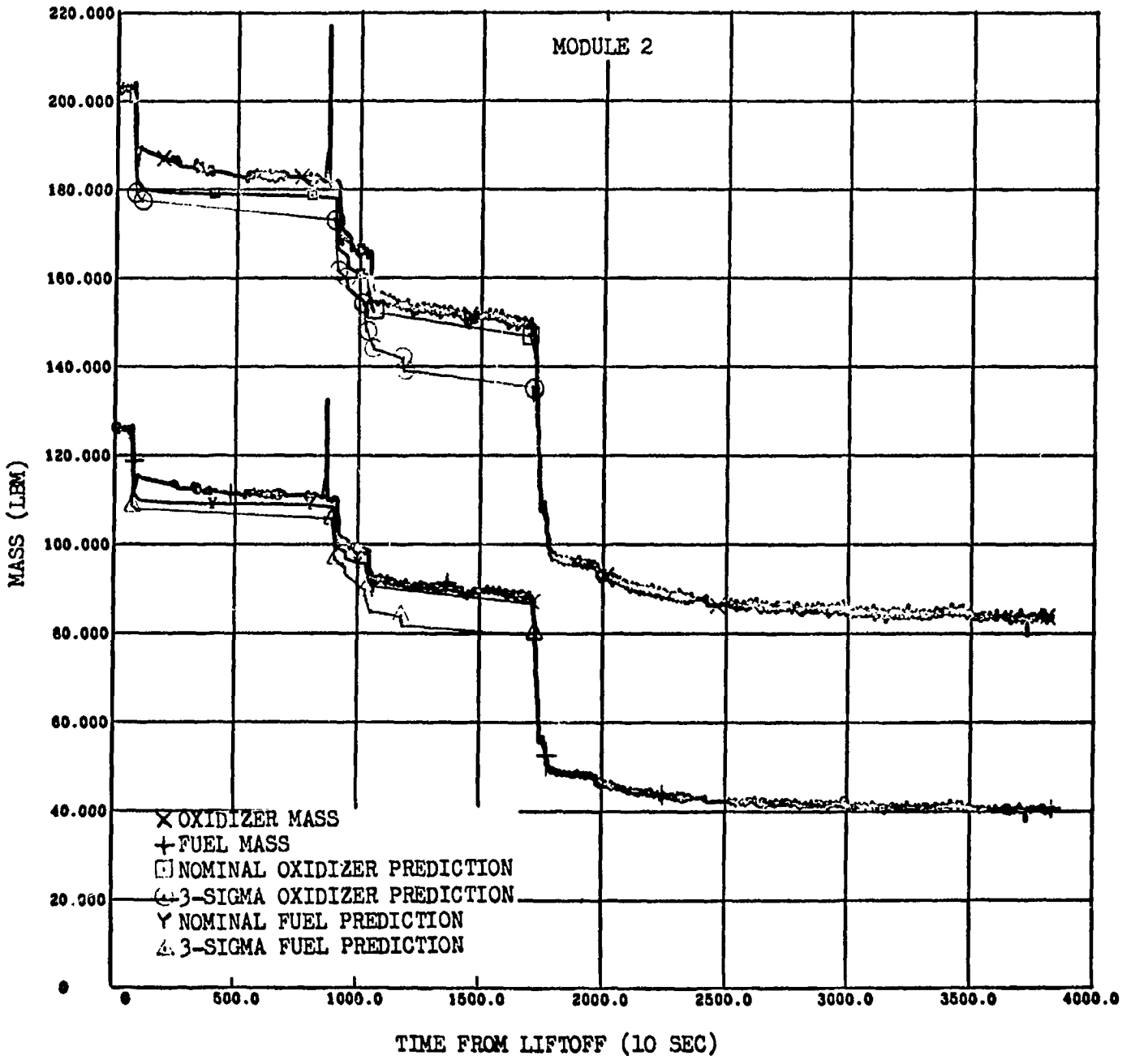

Figure 14-11. APS Module 2 Propellant Masses

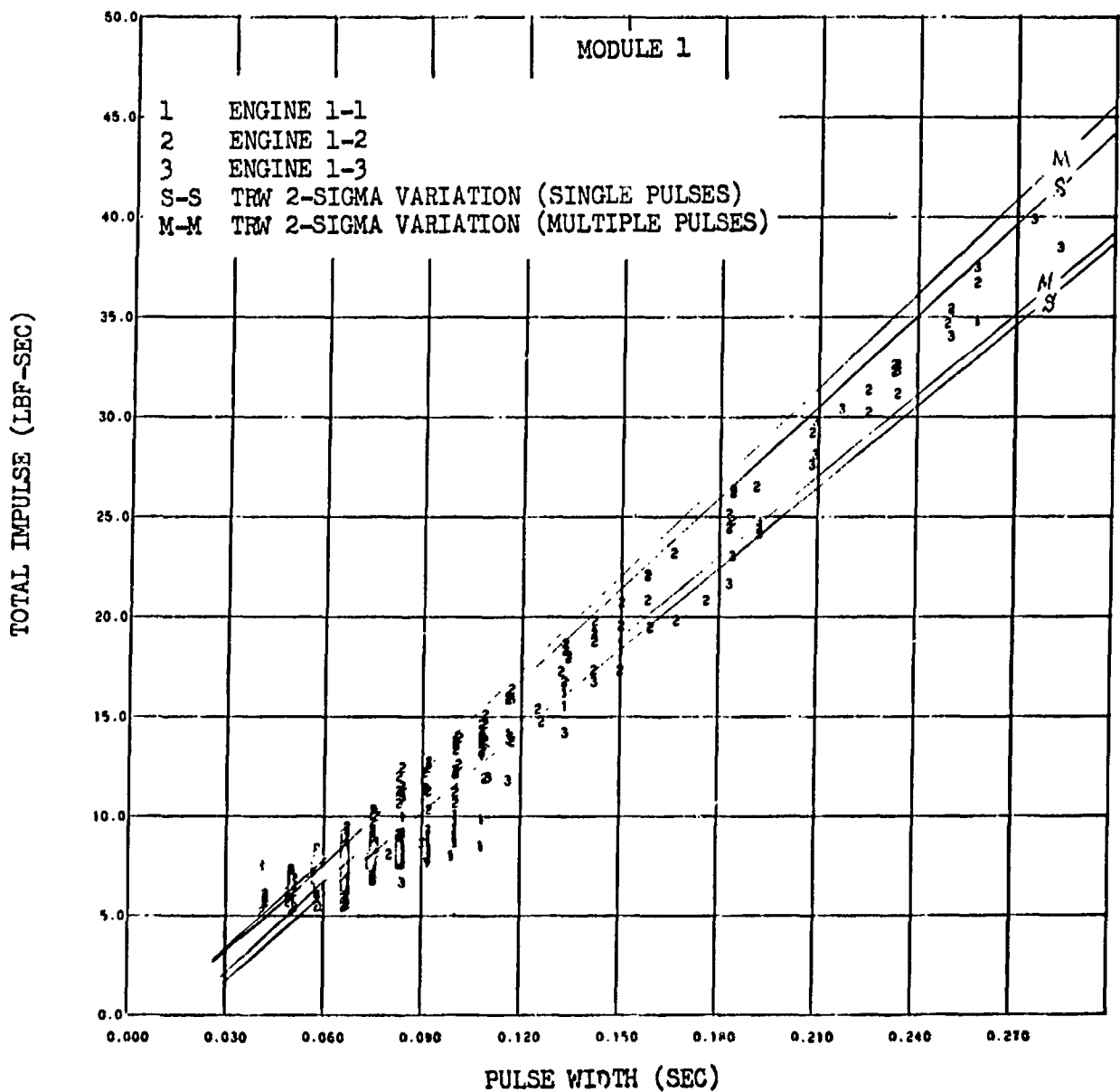

Figure 14-12. APS Total Impulse per Pulse (Module 1)

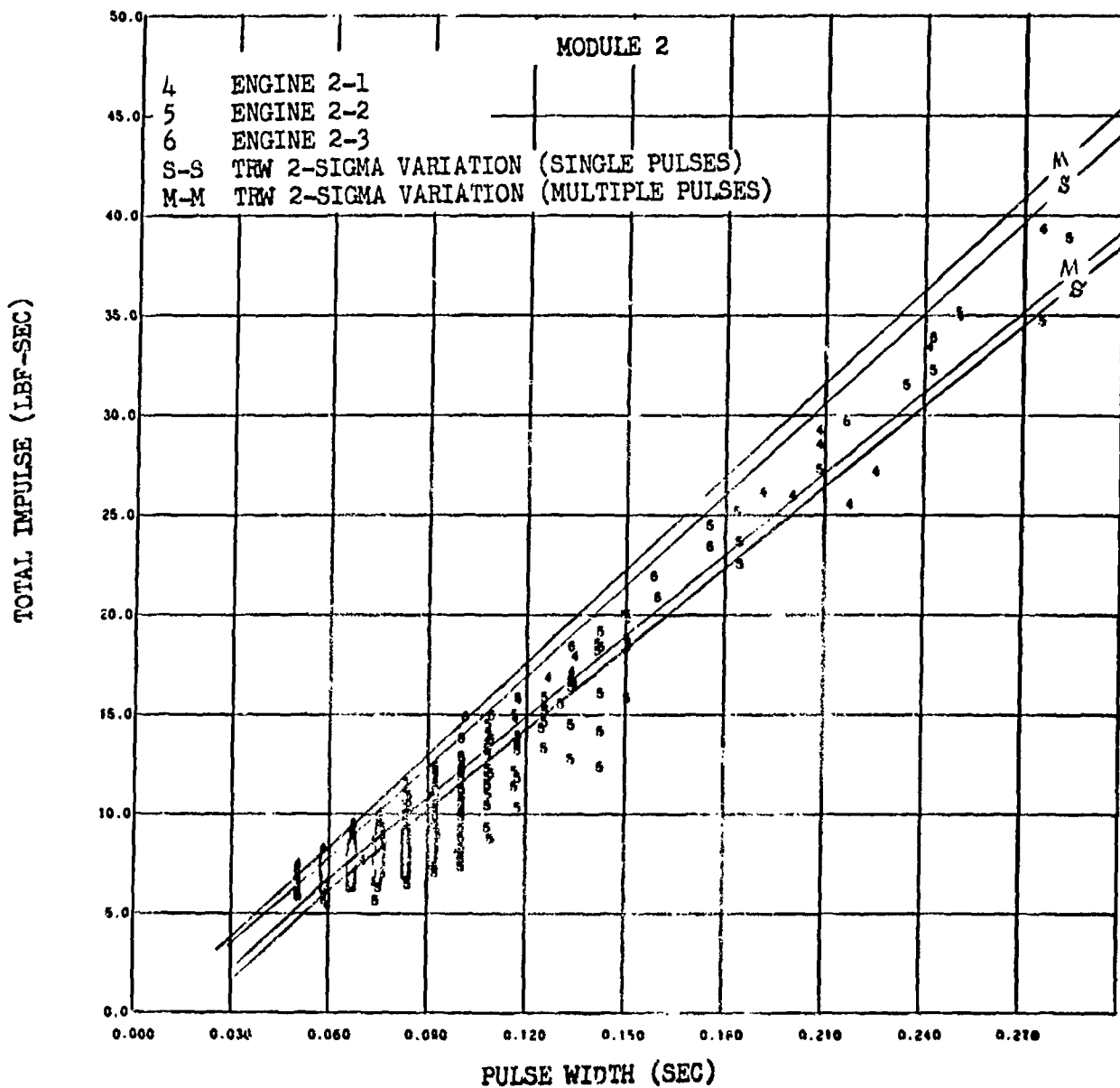

Figure 14-13. APS Total Impulse per Pulse (Module 2)

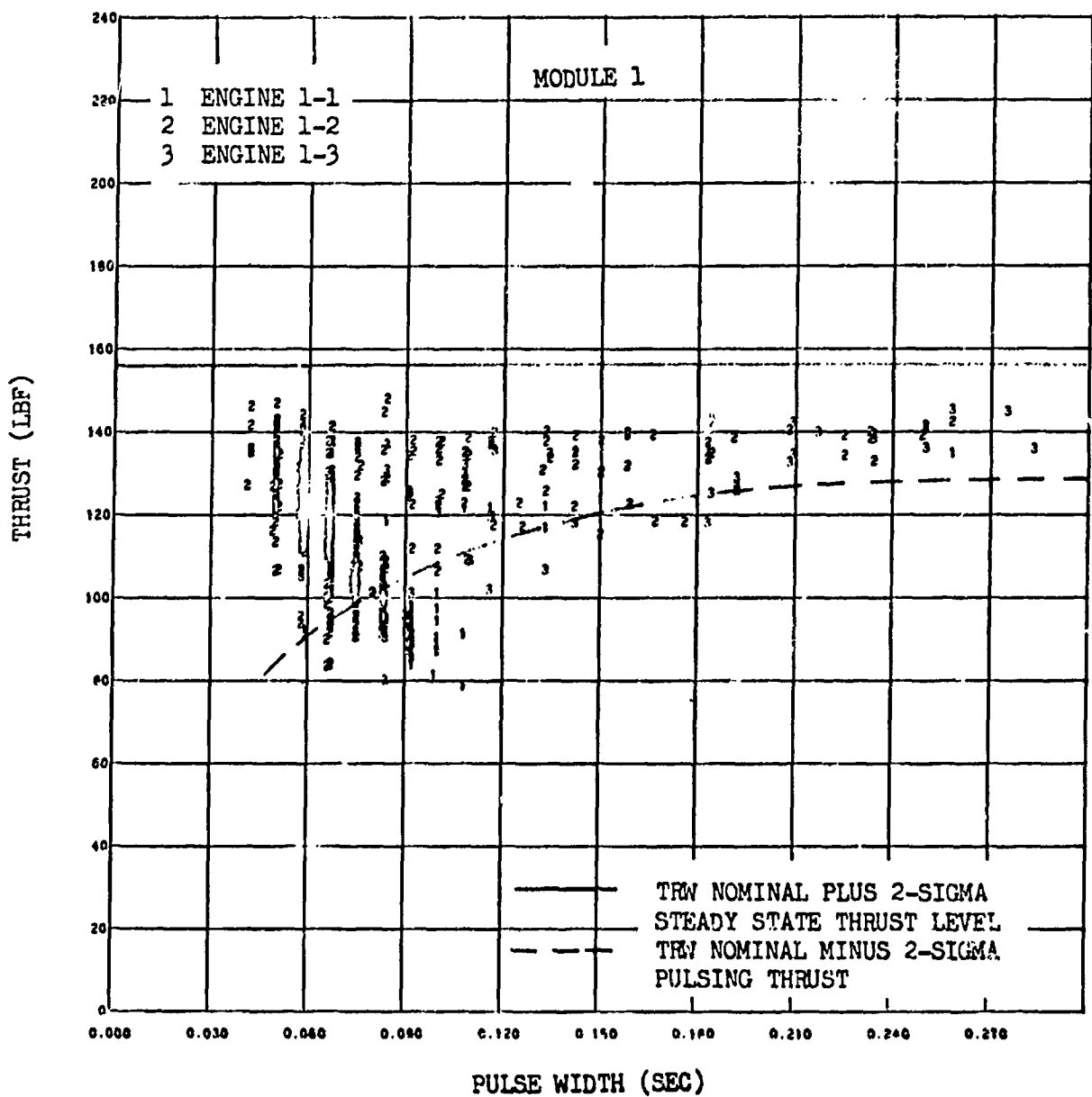

Figure 14-14. APS Thrust (Module 1)

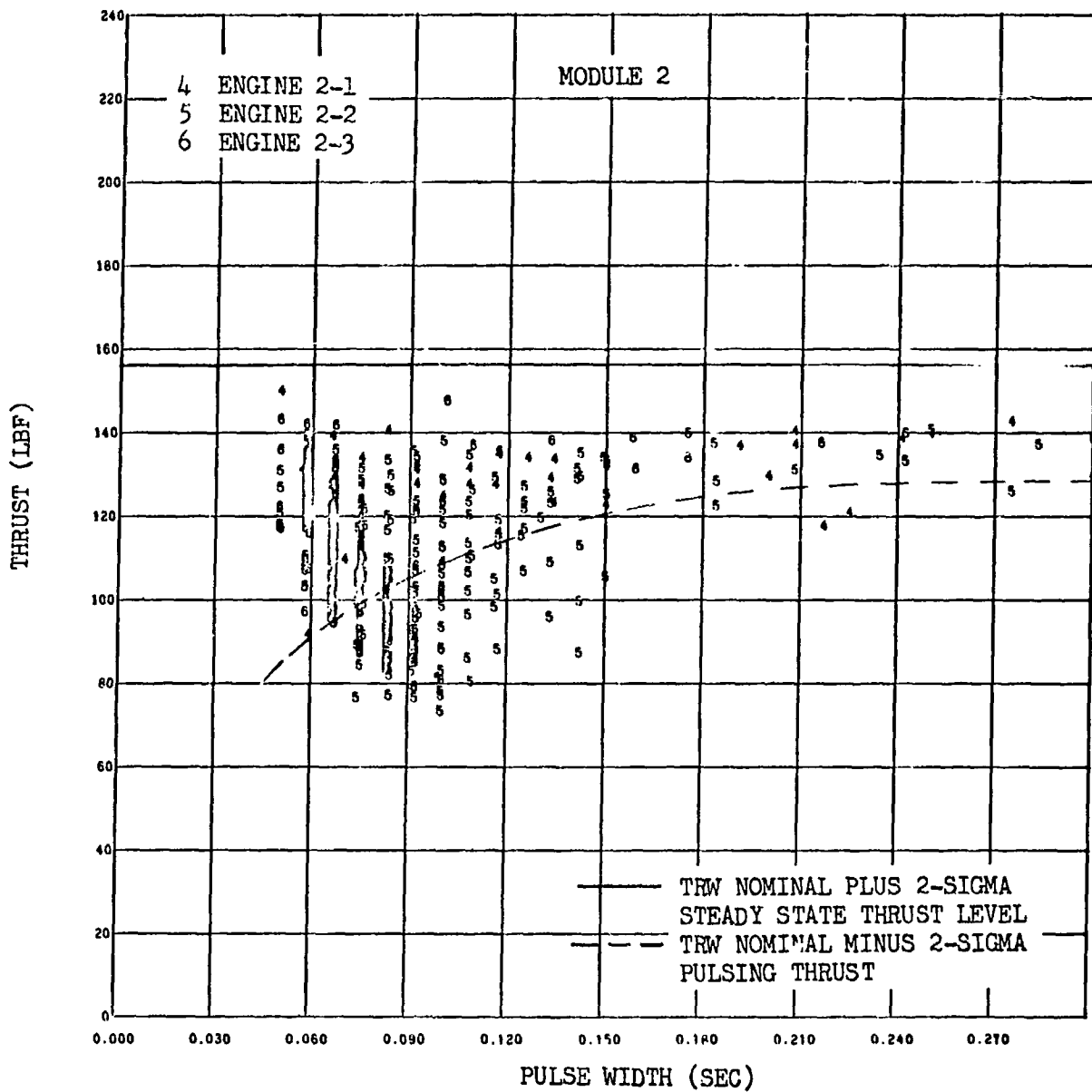

Figure 14-15. APS Thrust (Module 2)

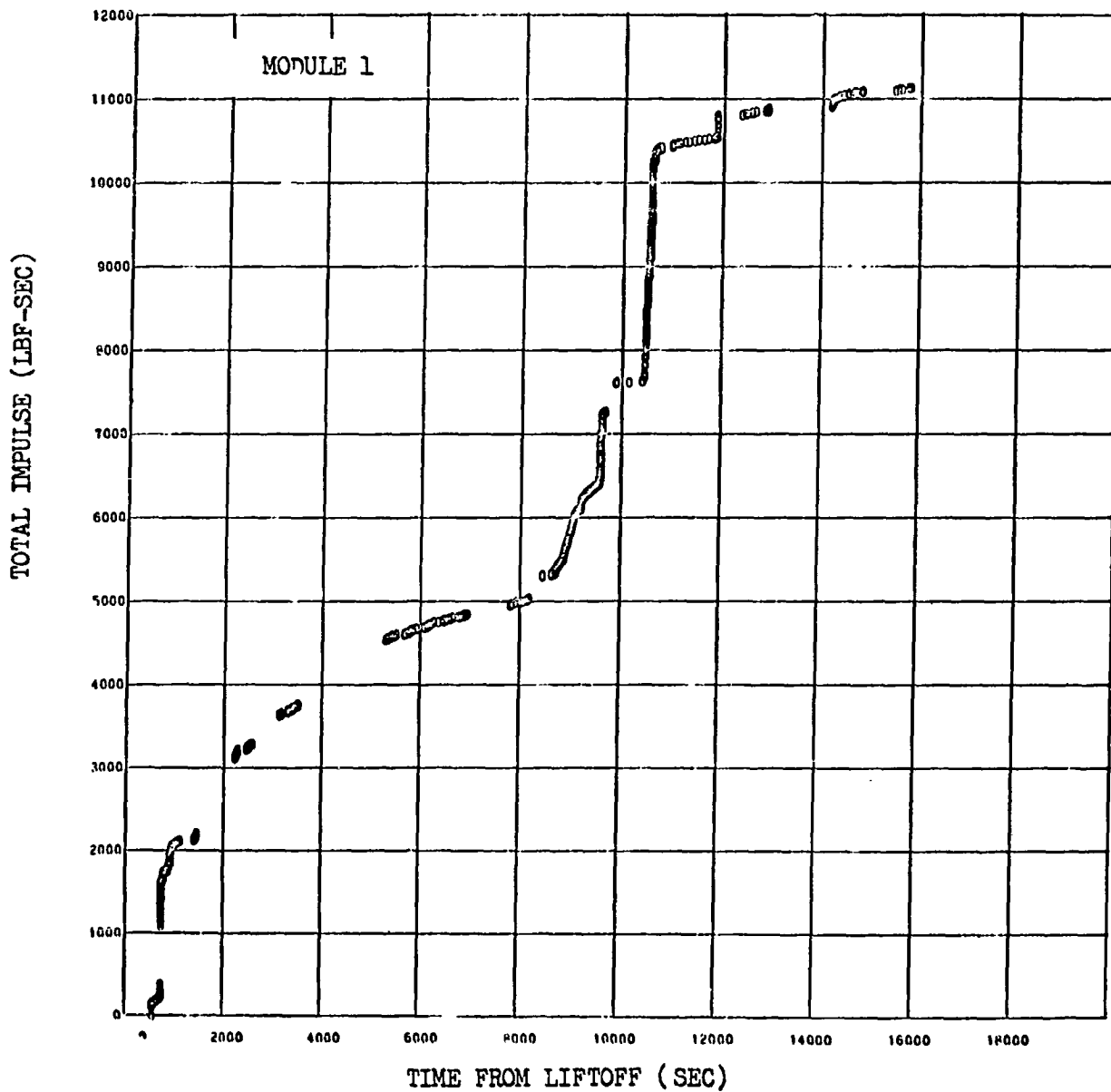

Figure 14-16. APS Total Impulse (Module 1 Attitude Control Engines)

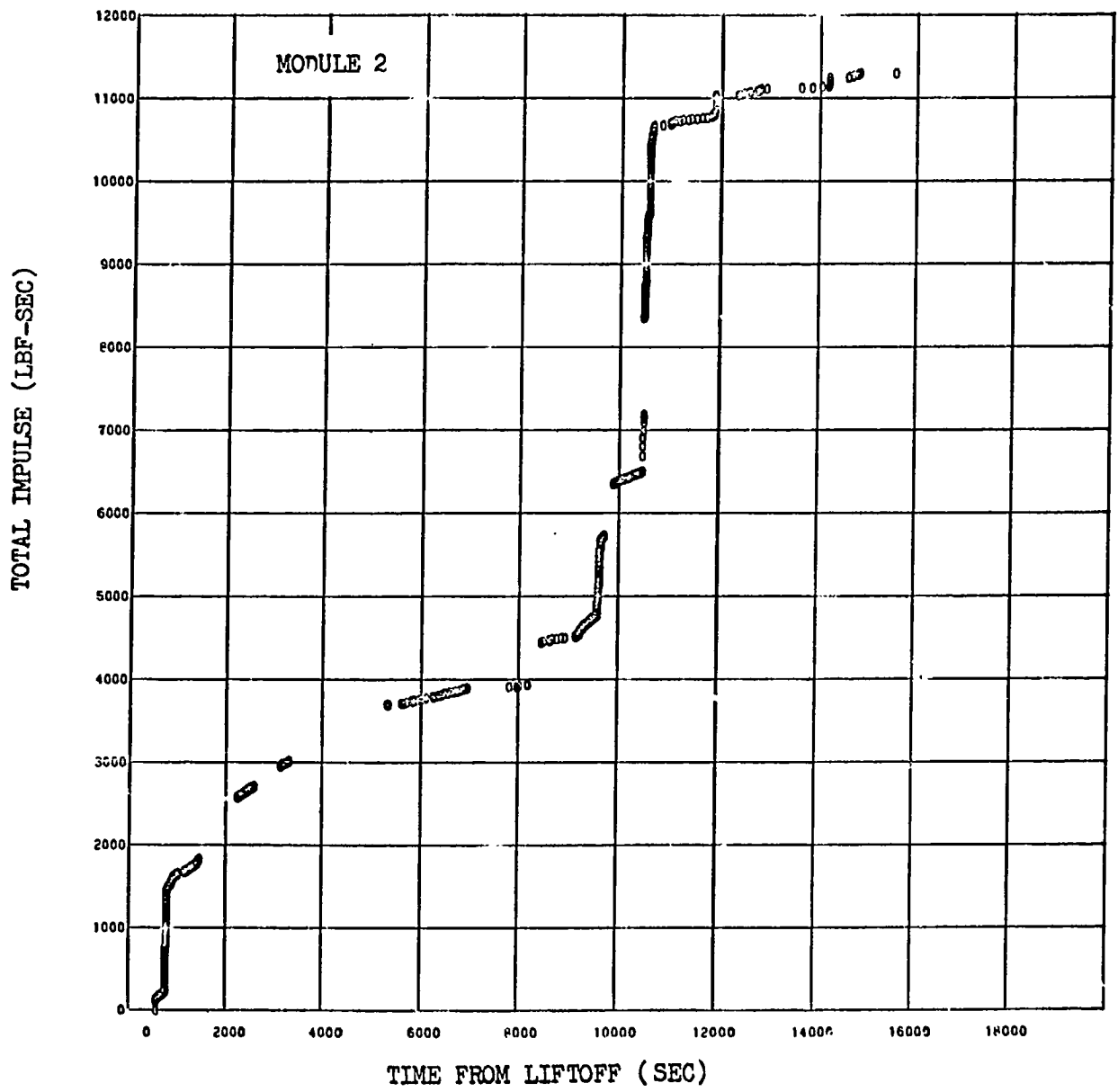

Figure 14-17. APS Total Impulse (Module 2 Attitude Control Engines)

15. PNEUMATIC CONTROL AND PURGE SYSTEM

The pneumatic control and purge system (figure 15-1) performed satisfactorily throughout the flight. The S-IVB-505N flight pneumatic control and purge system differed from those on previous flights in that the pneumatic control sphere was supplemented by the LOX tank repressurization spheres. The helium supply was therefore more than adequate to meet all mission requirements and to accomplish all purges. No helium leakage was evident during orbital periods.

15.1 Pneumatic Control

Significant valve actuations through the end of first burn and the resulting demands on the system are shown in figure 15-2. S-IVB-505N was the first flight stage to utilize a control helium regulator that was calibrated to revised specifications; this resulted in a reduced lock-up pressure as compared to previous flight stages. The control helium regulator discharge pressure (00014) was within a nominal operating band during the entire flight. The pneumatic usage rate during periods of prevalues closed could not be calculated accurately due to the new configuration. The pneumatic system performance data during the first and second orbits, second burn, and translunar coast are shown in figures 15-3 through 15-6.

Pneumatic system performance data at significant times are compared with S-IVB-504N and 503N flight data in table 15-1.

15.2 Ambient Helium Purges

The ambient helium supply was adequate for pneumatic control and purging, and all system operation was nominal.

The engine pump purge was initiated 9 seconds before first engine cutoff command and operated nominally for its 10-minute duration. The LOX chill-down pump motor container purge pressure was nominal for both first and second burns. The LOX chill-down pump motor container purge pressure is shown in figures 15-7 and 15-8.

TABLE 15-1
PNEUMATIC CONTROL AND PURGE SYSTEM DATA

Parameter	S-IVB-505N Flight*		S-IVB-504N Flight		S-IVB-503N Flight	
	First Burn	Second Burn	First Burn	Second Burn	First Burn	Second Burn
Sphere Volume (cu ft)	4.5	4.5	4.5	4.5	4.5	4.5
Sphere Pressure (psia)						
At liftoff	3,096	--	3,152	--	2,997	--
At engine start command	3,050	3,025	3,135	2,400	2,884	2,185
At engine cutoff command	3,050	3,020	3,128	2,400	2,874	2,215
Sphere Temperature (deg R)						
At liftoff	532	--	532	--	534	--
At engine start command	527	518	528	483	527	497
At engine cutoff command	527	511	528	482	527	503
Helium Mass (lbm)						
At liftoff	8.6	--	8.8	--	8.36	--
Initiation of control sphere dump	8.8	--	6.4	--	6.2	--
Termination of control sphere dump	4.6	--	1.8	--	1.5	--
Regulator Outlet Pressure						
Maintained pressure band (psia)	505 to 508	488 to 509	605 to 608	550 to 558	522 to 535	520 to 540
Minimum system pressure during start and cutoff transient (psia)	470	488	598	550	495	472
Average LOX chilldown motor container purge pressure (psia)	56	51	50	44	54	49.5

*The pneumatic control sphere on this stage is connected to the LOX tank repressurization spheres.

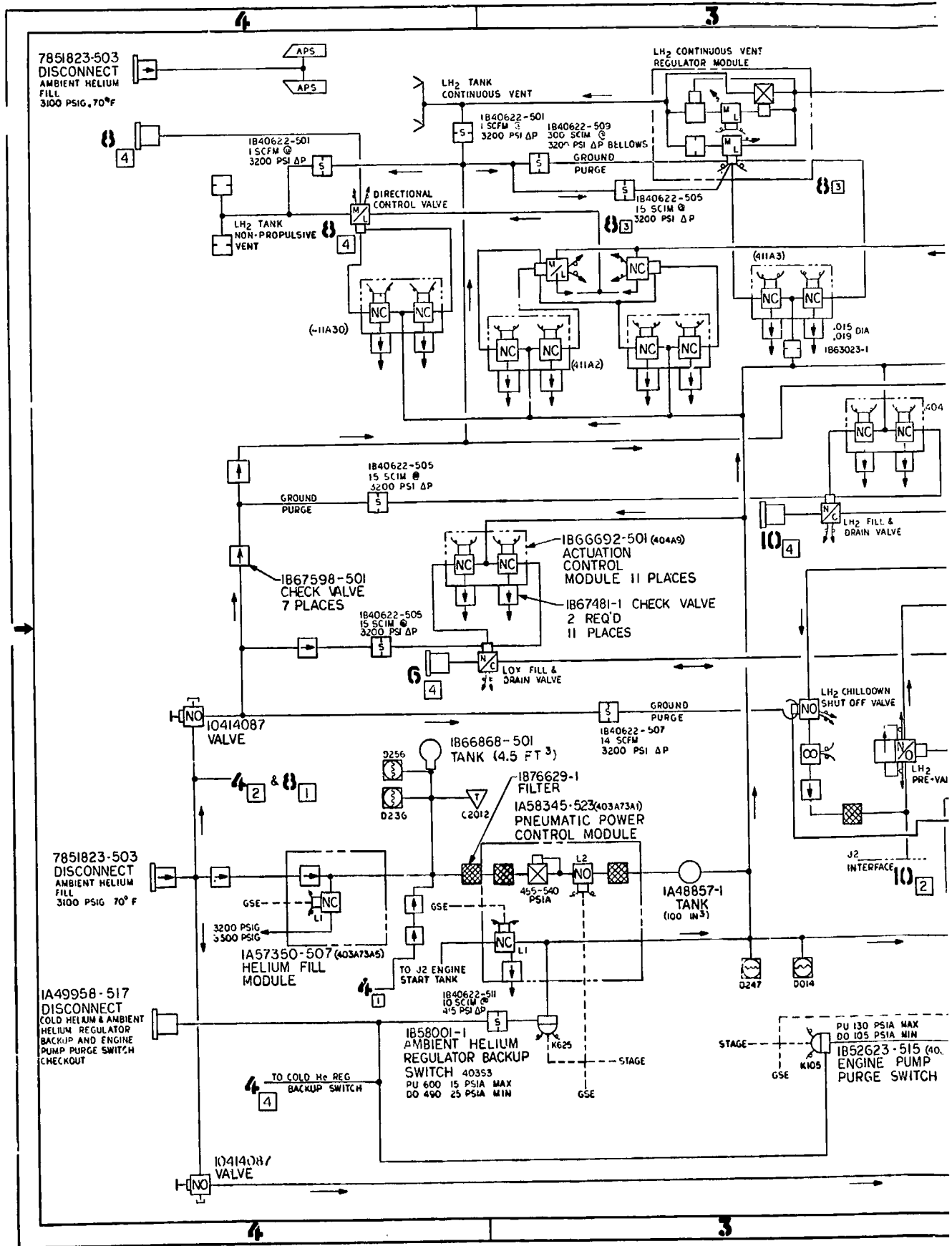

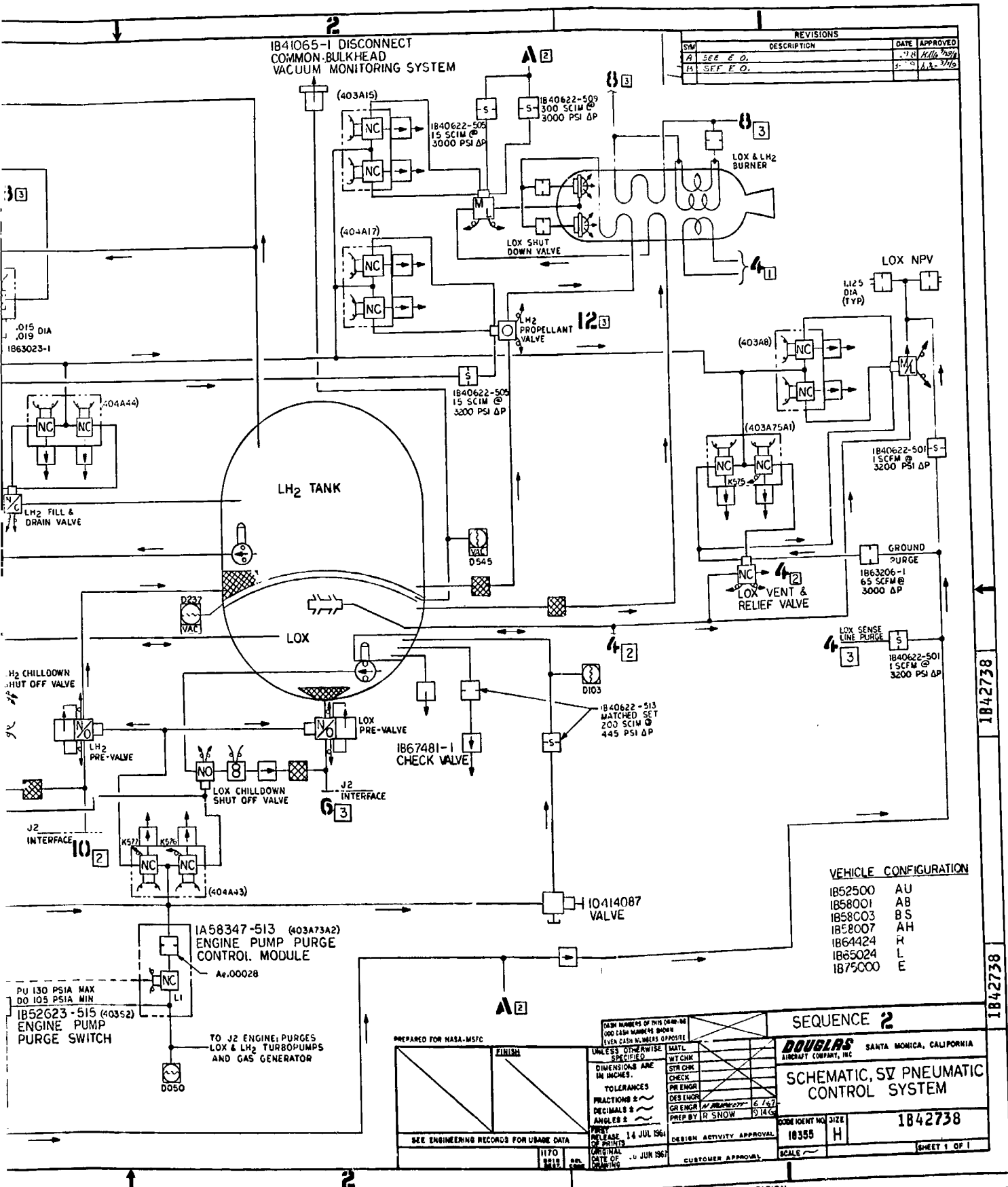

Figure 15-1. Schematic, SV Pneumatic Control System
EOLDOUT FRAME 2

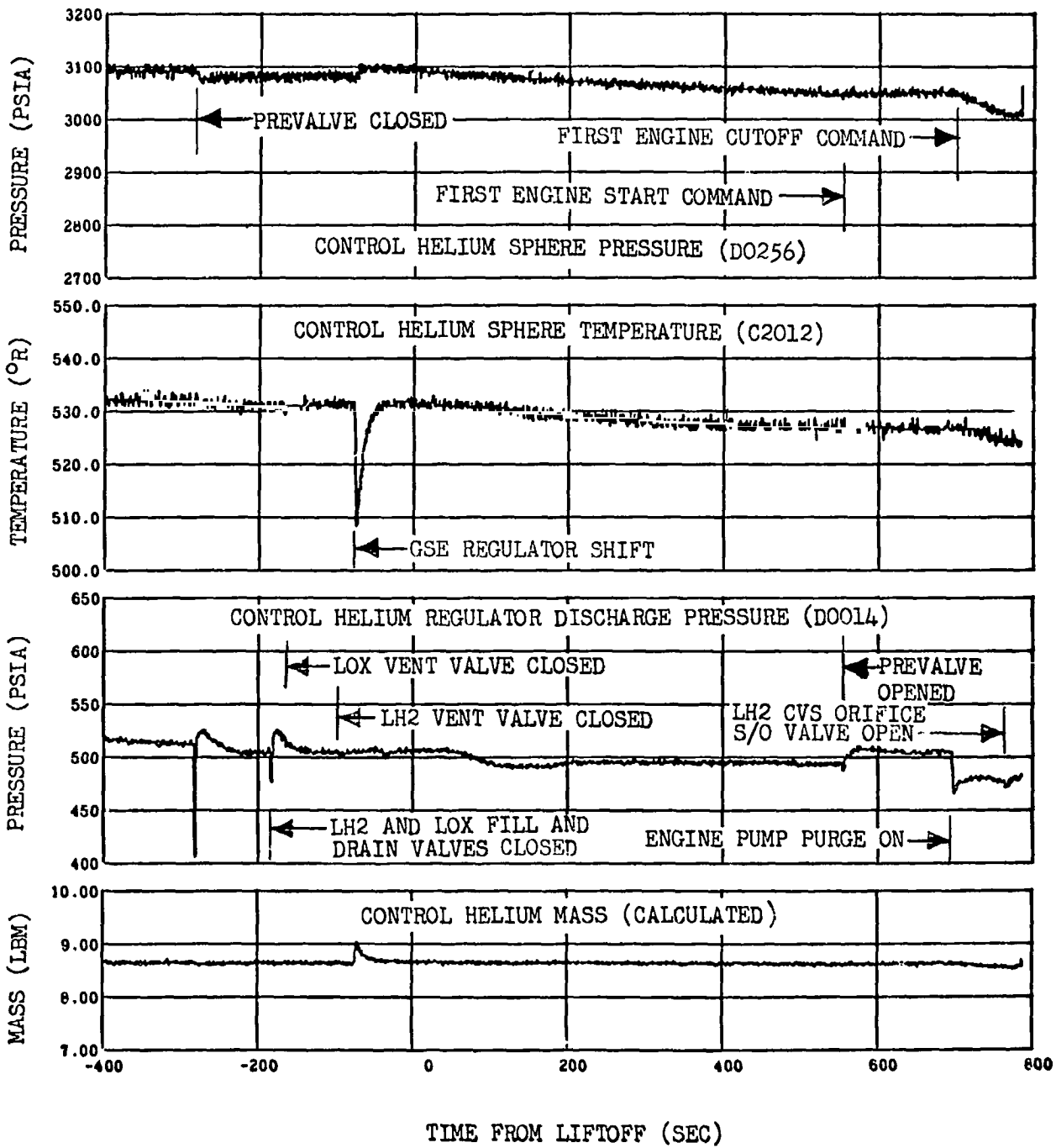

Figure 15-2. Pneumatic Control and Purge System Performance-- Boost and First Burn

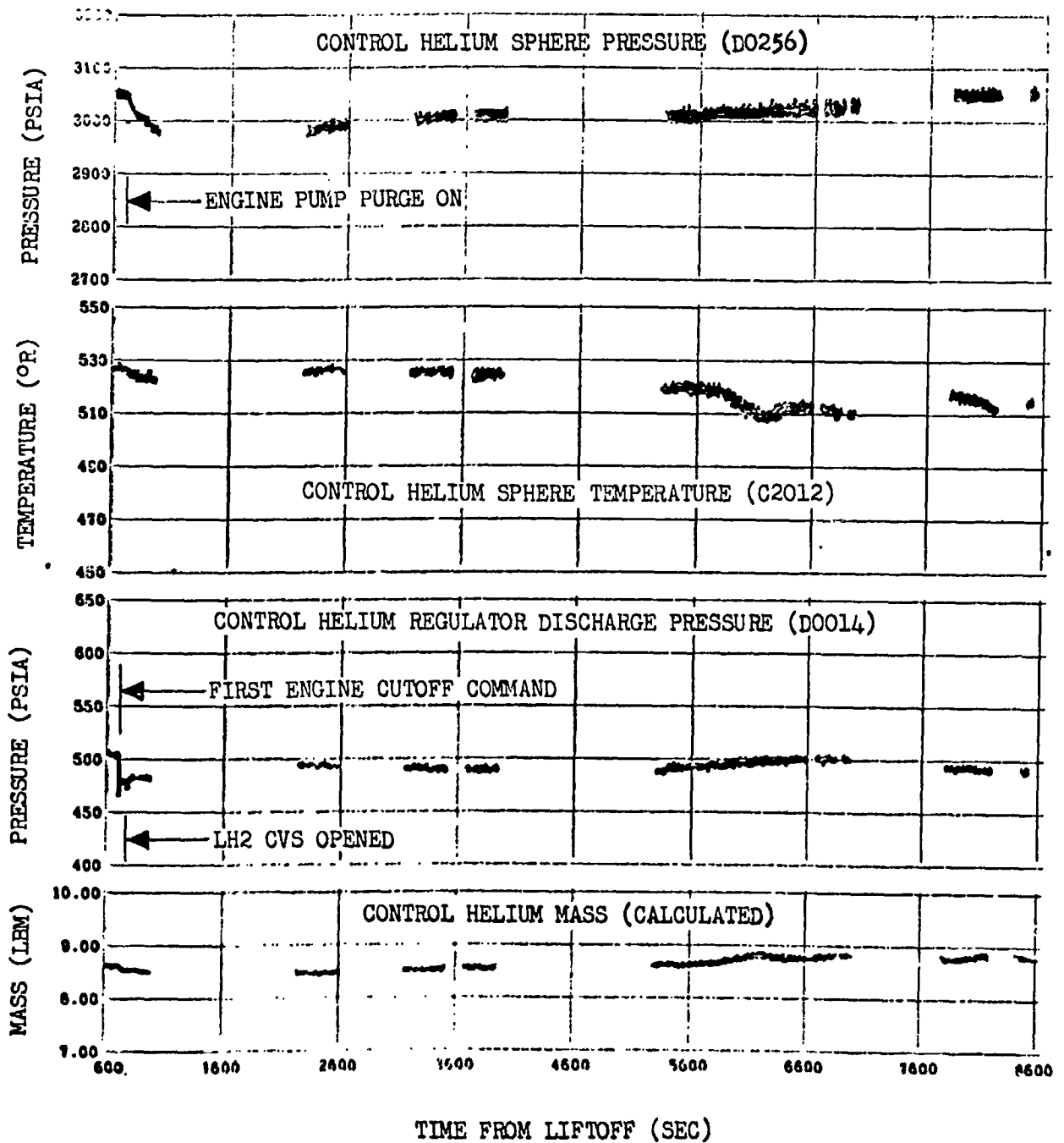

Figure 15-3. Pneumatic Control and Purge System Performance-- Earth Orbit

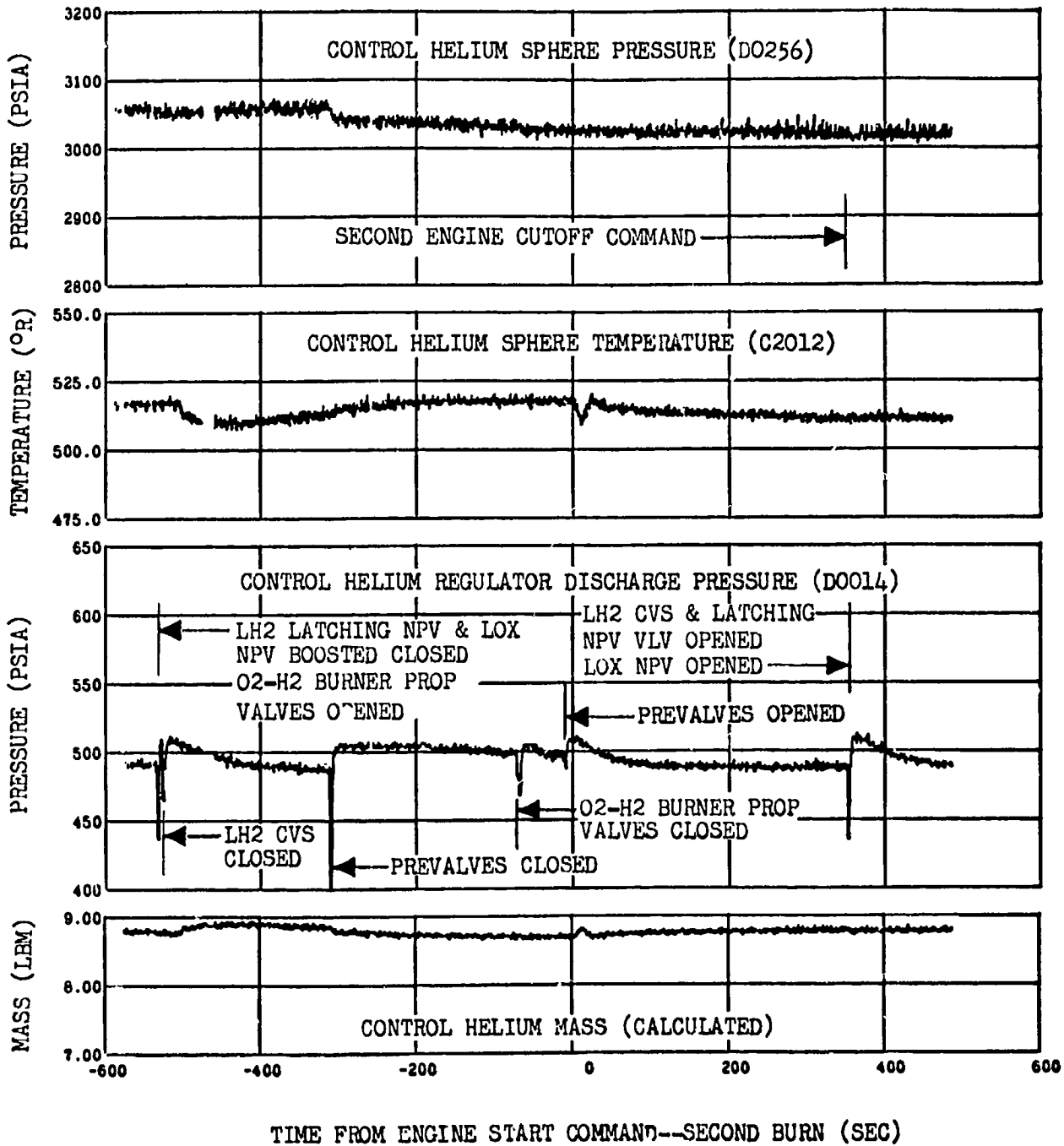

Figure 15-4. Pneumatic Control and Purge System Performance--Second Burn

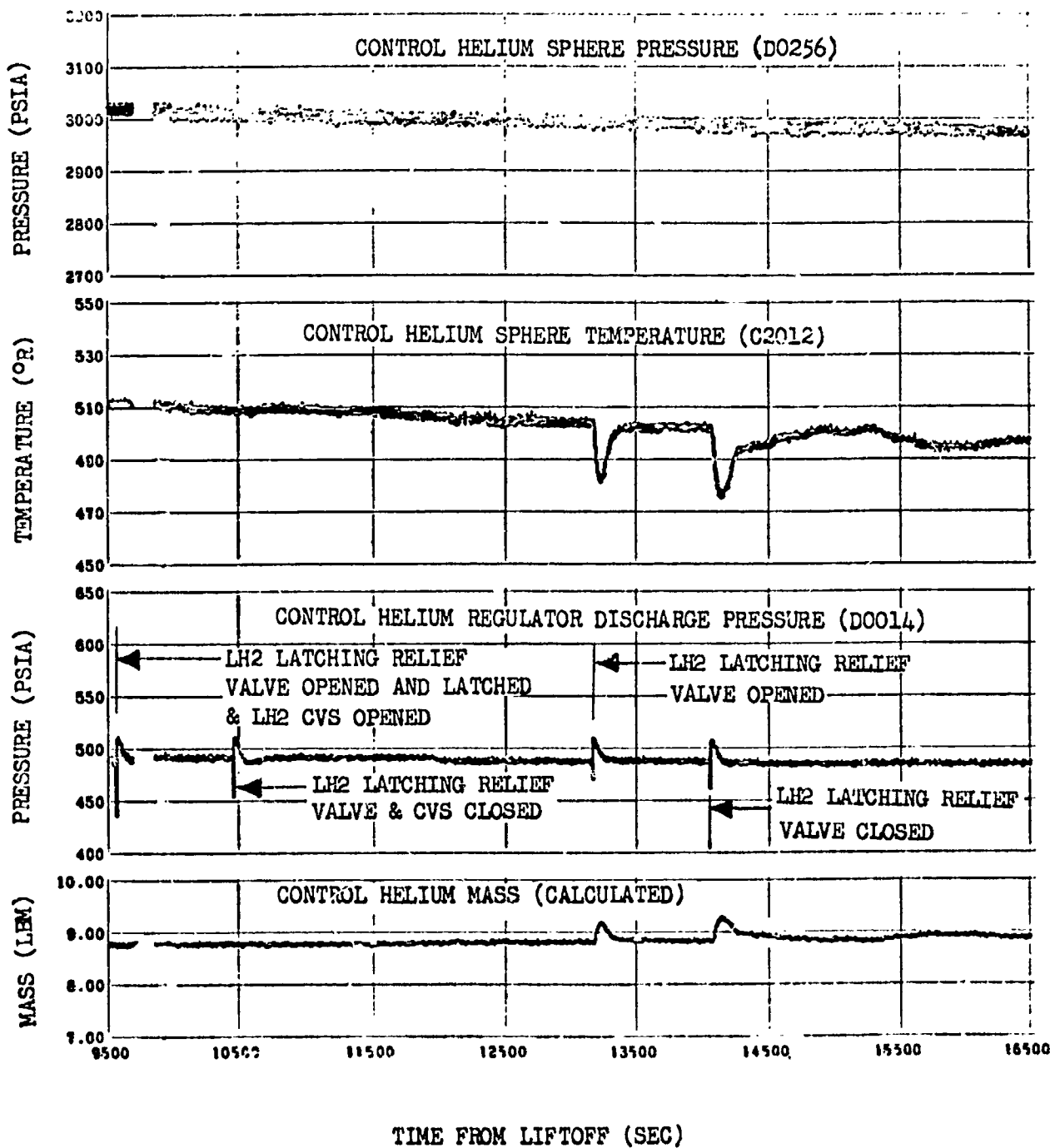

Figure 15-5. Pneumatic Control and Purge System Performance-- Translunar Coast

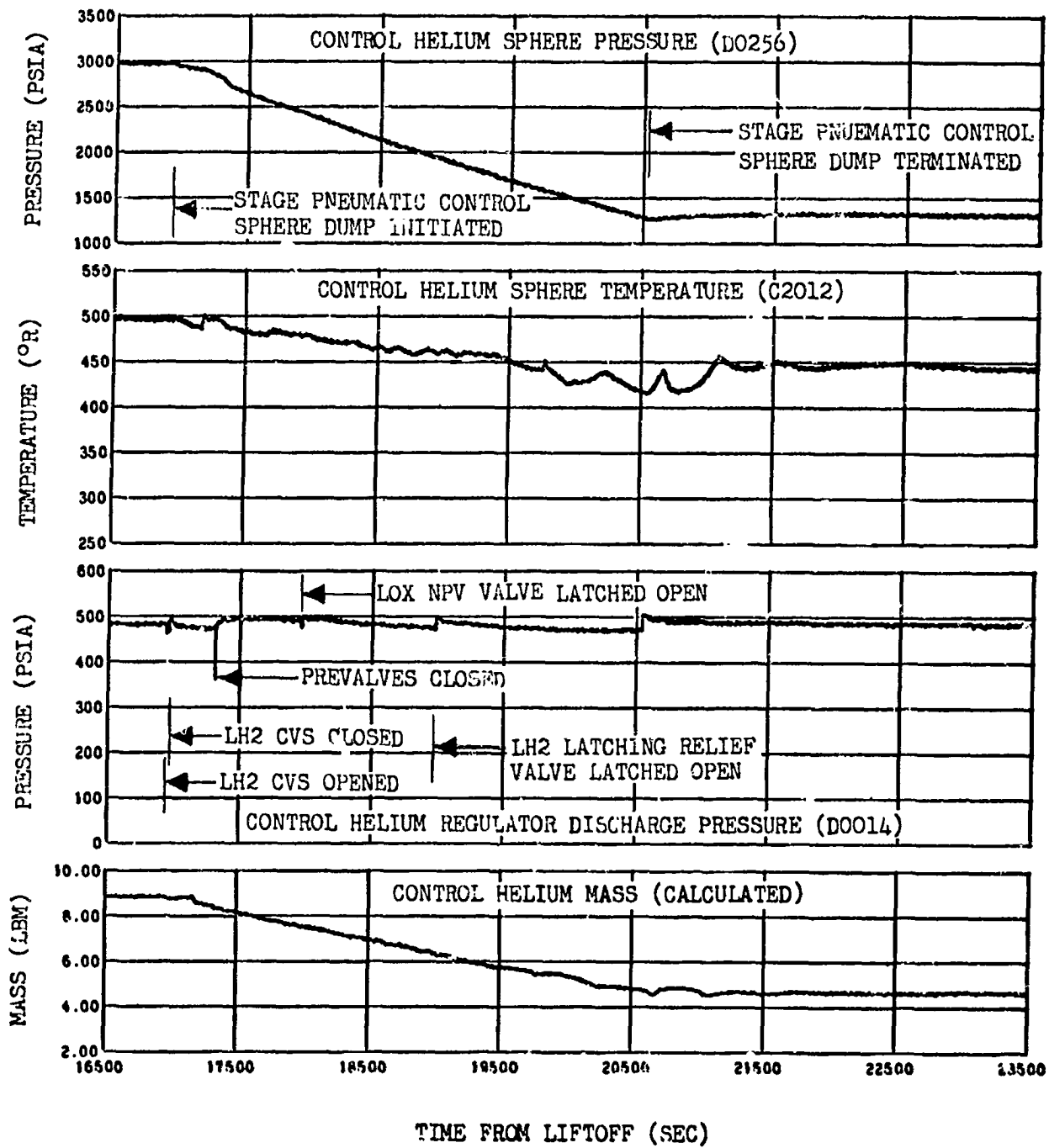

Figure 15-6. Pneumatic Control and Purge System Performance-- Translunar Coast and Dump

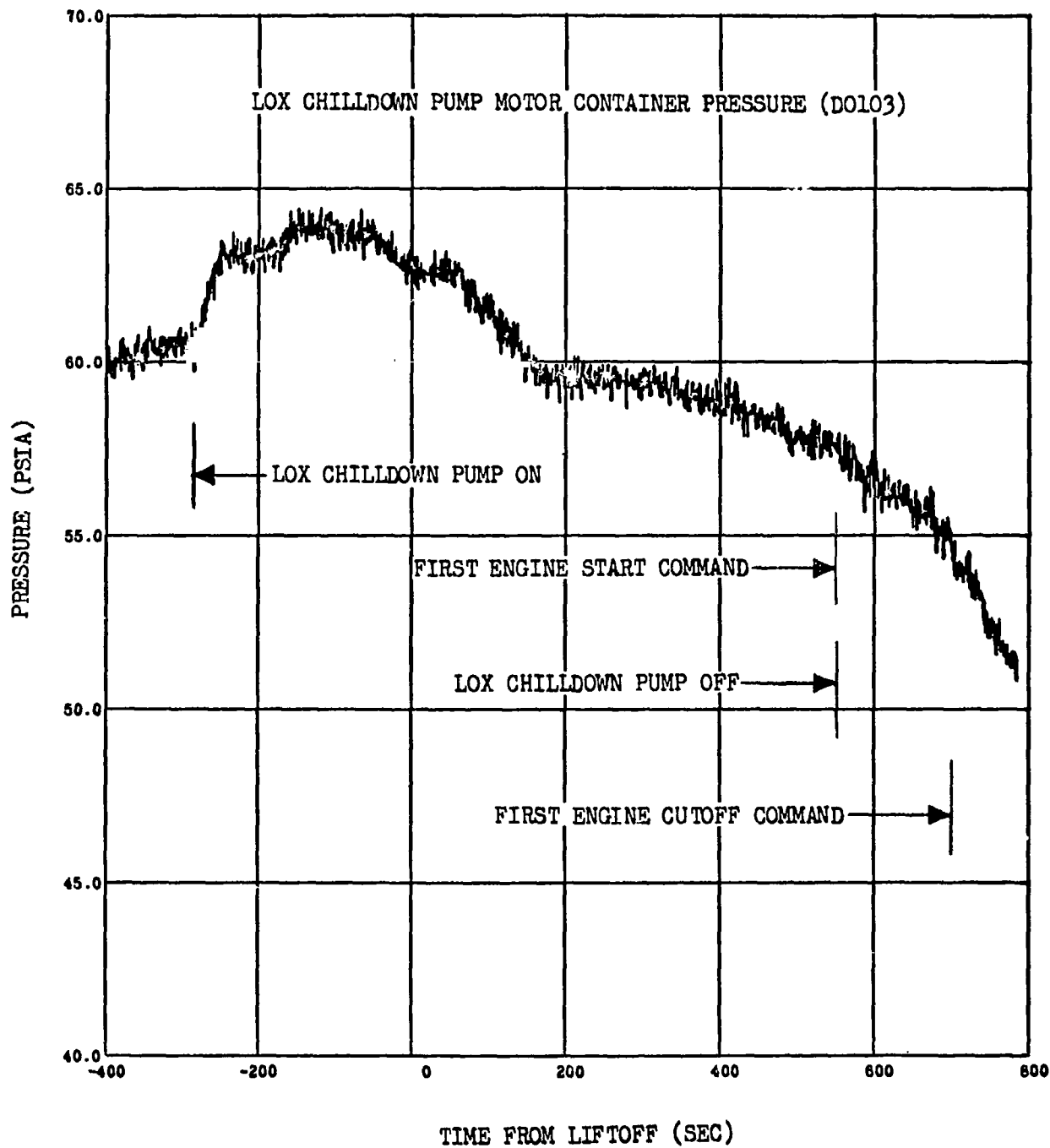

Figure 15-7. LOX Chilldown Pump Motor Container Purge Performance-- First Burn

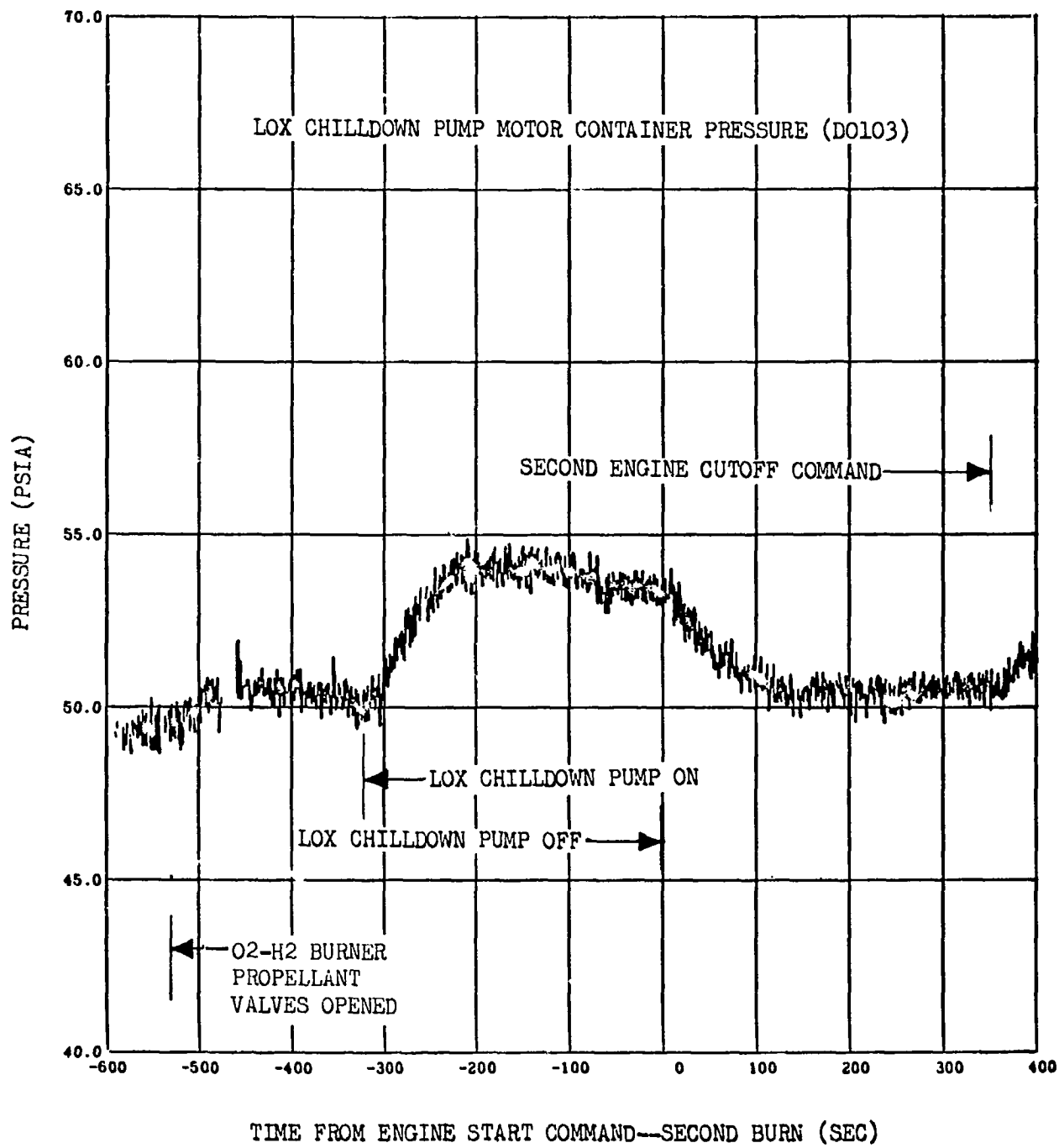

Figure 15-8. LOX Chilldown Pump Motor Container Purge Performance-- Second Burn

16. PROPELLANT UTILIZATION

The propellant utilization (PU) system successfully accomplished the requirements associated with propellant loading and management during burn. The best estimate propellant mass values at liftoff were 192,055 lbm LOX and 43,382 lbm LH2. These values are well within the required +1.12 percent stage loading accuracy.

The total propellant residuals at second Engine Cutoff Command (ECC₂) were 5,314 lbm LOX and 2,194 lbm LH2. The usable masses at ECC₂ were 1,434 lbm LH2 and 4,903 lbm LOX. By extrapolating at flowrates of 398 lbm per second LOX and 78.6 lbm per sec LH2, LOX depletion would have occurred 12.3 sec after ECC₂, with 467 lbm usable LH2 remaining.

The PU system was operated inflight in the open loop mode. The PU valve operation was controlled in response to launch vehicle digital computer (LVDC) issued commands. The PU valve was positioned at null for start and remained at null, except for flow disturbances, throughout the first burn operation. At Time Base 6 (TB6 +450.089 sec the PU valve was positioned at the low EMR stop for restart. At ESC₂ +135.104 sec the PU valve was commanded to the null position. By ESC₂ +136.014 sec the valve had arrived at the null position where it remained for the duration of the second burn operation.

The rise of propellants within the mass sensors due to capillary action during the low acceleration coast period was noted as on previous Saturn V flight stages. The capillary action had no effect upon the PU system operation due to the open loop mode of operation.

16.1 PU Mass Sensor Calibration

The preflight propellant masses at the full point calibration points were determined from the S-IVB-505 acceptance firing full load data. The acceptance firing full load masses were determined by the flow integral analysis method. The capacitance values corresponding to the full load masses were actual measured test data.

The propellant masses at the lower calibration point were computed from unique tank volumes and predicted propellant density data. The corresponding capacitance values were determined from the fast drain data obtained during the S-IVB stage acceptance firing.

The following table presents a summary of the PU mass sensor calibration data:

SENSOR	FULL POINT		EMPTY POINT	
	MASS (lbm)	CAPACIT. (pf)	MASS (lbm)	CAPACIT. (pf)
LOX	191,152	410.58	1,343	281.47
LH2	43,500	1,180.11	200	971.41

16.2 Propellant Mass History

The predicted, measured and best estimate propellant masses at significant flight events are presented in table 16-1. The best estimate propellant masses are derived by subtracting nonpropellants (dry stage, ullage gases, etc.) from the AS-505 third stage best estimate masses presented in section 8. The remaining propellant mass is then divided into LOX and LH2 according to the prevailing mixture ratio at the specific flight event.

The propellant mass measurement systems represented in table 16-1 are:

- a. PU indicated
- b. PU indicated corrected
- c. PU volumetric
- d. Flight flow integral
- e. Trajectory reconstruction

A brief description of each measurement system is as follows:

- a. The PU indicated method measures propellant mass from the raw PU probe output which is reduced according to the preflight flow integral calibration slope.

- b. The PU indicated corrected method is constituted in a manner similar to item a. above but it also includes adjustments for acceptance firing flow integral non-linearity and PU flight dynamic effects.
- c. The PU volumetric masses are derived from raw PU probe output data which are reduced according to volumetric calibration slopes and adjusted for flight dynamics effects and volumetric tank to sensor mismatch. The calibration slopes (lbm/pf) were computed from the capacitance-propellant mass relationships at the upper and lower probe active element extremities. Propellant masses at the extremities were calculated from unique tank volume determined from tank measurements and propellant density.
- d. The flight flow integral method consists of determining the LOX and LH2 mass flowrates and integrating as a function of time to obtain total consumed propellant masses during engine burn. The flow integral propellant masses at first Engine Start Command (ESC₁) are determined by adding propellant at second Engine Cutoff Command (ECC₂) to the total propellant consumed by the engine during all three burns, the fuel pressurant added to the ullage, and the propellant lost to boiloff.
- e. The trajectory reconstruction method determines vehicle mass changes from thrust/acceleration relationship.

The results of the five methods of propellant evaluation are presented in table 16-1. The desired and best estimate values are shown in addition to the mass values determined by the various measurement systems. The deviation of each value from the best estimate is also shown.

The best estimate total propellant mass at liftoff was 235,437 lbm which is 785 lbm greater than desired. Both LOX and LH2 masses were well within the guaranteed loading accuracy of ± 1.12 percent. The liftoff mass, as determined by each individual measurement system compared to the best estimate, is within the accuracy constraints for each system.

The best estimate total propellant mass at second Engine Cutoff Command (ECC₂) is 7,479 lbm which is 788 lbm greater than predicted. No significant differences exist in total propellant consumption between measurement systems.

16.2.1 Orbital Boiloff

The LOX usage between first burn Engine Cutoff Command (ECC₁) and second Engine Start Command (ESC₂) as determined by ullage gas mass analysis was

413 lbm including first engine burn thrust decay, orbital boiloff, O_2-H_2 burner usage and second burn engine chilldown. The total LH2 usage as determined by the PU mass sensor data in conjunction with a ullage gas mass analysis between ECC_1 and ESC_2 was 2,427 lbm and included the effects of orbital boiloff (2,373 lbm), first burn engine thrust decay, O_2-H_2 burner usage and second burn engine chilldown.

16.2.2 Propellant Residuals

The propellant residuals were computed at second Engine Cutoff Command (ECC_2) by means of the residual point level sensors and the PU mass sensors. Two level sensors activated in each propellant tank during the second burn operation (L.S. L0015 and L0016 in the LOX tank and L.S. L0018 and L0019 in the fuel tank).

The level sensor residuals were generated using the engine consumption data to extrapolate from each level sensor activation to ECC_2 . An average level sensor residual was computed from the two level sensors in each tank. The final propellant residual masses at Engine Cutoff Command is the weighted average of the level sensor and PU mass sensor residuals. This value is considered the most accurate determination of propellant residuals.

Table 16-2 summarizes the propellant residual data determined by the PU mass sensor and the point level sensors.

Total masses at ECC_2 were 5,314 lbm LOX and 2,194 lbm LH2. These total masses include unusable masses of 511 lbm LOX and 760 lbm LH2. By extrapolating to depletion cutoff at propellant flowrates 398.0 lbm/sec LOX and 78.6 lbm/sec LH2, LOX depletion would occur 12.3 sec after ECC_2 with a usable propellant residual of 467 lbm LH2.

16.2.3 PU Efficiency

The open loop PU efficiency was found to be 99.98 percent and is based on utilizing the extrapolated flowrate and usable LH2 residual less bias of section 16.2.2.

16.2.4 Total PU Volumetric Method Mass Sensor Flight Correction

Figures 16-1 and 16-2 present a comparison of the predicted and post-flight evaluation total correction to the indicated propellant mass, as determined by the PU volumetric method, for the LOX and LH2 mass sensors. The total predicted mass correction is the sum of the predicted effects due to cg offset, changing tank shape inflight, volumetric tank-to-sensor mismatch, and the difference in preflight flow integral and volumetric calibration slopes.

16.3 PU System Response

Since the system was flown open loop, there were no cutback dispersions experienced. Similarly, there were no PU system induced thrust variations at any time during engine burn as a result of operating in an open loop fashion.

First and second burn null operation displayed a PU valve response approximately 0.8 deg higher than predicted. This condition is apparently due to a flow response of the PU valve.

Figure 16-3 presents the PU valve position history. The small overshoot when the valve returns to null during second burn is nominal for this type of operation of the PU ratio valve.

16.4 Anomalies

No PU system anomalies occurred during the S-IVB-505 flight.

TABLE 16-1
S-IVB-505N MASS HIS

EVENT		PREDICTED MASS (LBM)	PU IND. MASS (LBM)	PU IND. CORRECTED (LBM)	PU VOL. MASS (LBM)	FLOW INTEGRAL (LBM)	TRAJECTORY MASS (LBM)
Lift-off	LOX	191,152	191,466	191,466	192,856	191,471	
	LH2	43,500	43,386	43,386	43,545	43,222	
	Total	234,652	234,852	234,852	236,401	234,693	
First Eng. St. Comm.	LOX	191,152	191,238	191,458	192,778	191,471	
	LH2	43,500	43,317	43,367	43,542	43,222	
	Total	234,652	234,555	234,825	236,320	234,693	
First Eng. Cut Off Comm.	LOX	132,741	133,302	133,127	134,102	133,284	
	LH2	31,761	31,310	31,405	31,550	31,450	
	Total	164,502	164,612	164,532	165,652	164,734	
First Burn Consumption	LOX	58,411	57,936	58,331	58,676	58,187	
	LH2	11,739	12,007	11,962	11,992	11,772	
	Total	70,150	69,943	70,293	70,668	69,959	
Orbital Consumption	LOX	323	413	413	413	323	
	LH2	2,517	2,357	2,432	2,427	2,432	
	Total	2,840	2,770	2,845	2,840	2,755	
Second Eng. St. Comm.	LOX	132,418	132,889	132,714	133,689	132,961	
	LH2	29,244	28,953	28,973	29,123	29,018	
	Total	161,662	161,842	161,687	162,812	161,979	162,436
Second Eng. Cut Off Comm.	LOX	4,440	5,386	5,396	5,336	5,314	
	LH2	2,251	2,216	2,186	2,153	2,194	
	Total	6,691	7,602	7,582	7,489	7,508	7,309
Second Burn Consumption	LOX	127,978	127,503	127,318	128,353	127,647	
	LH2	26,993	26,737	26,787	26,970	26,824	
	Total	154,971	154,240	154,105	155,323	154,471	155,127

FOLDOUT FRAME

BLE 16-1

MASS HISTORY TABLE

ORY	BEST EST. MASS (I.BM)	DEVIATION FROM BEST ESTIMATE MASS					
		PREDICTED	PU IND.	PU IND. CORRECTED	PU VOL.	FLOW INTEGRAL	TRAJECTORY
	192,055	-903 (0.47%)	-589 (0.31%)	-589 (0.31%)	-801 (0.42%)	-584 (0.30%)	
	43,382	+118 (0.27%)	+4 (0.01%)	+4 (0.01%)	+163 (0.38%)	-160 (0.37%)	
	235,437	-785 (0.33%)	-585 (0.25%)	-585 (0.25%)	+964 (0.41%)	-744 (0.32%)	
	192,055	-903 (0.47%)	-817 (0.43%)	-597 (0.31%)	+723 (0.38%)	-584 (0.30%)	
	43,382	+118 (0.27%)	-65 (0.15%)	-15 (0.03%)	+160 (0.37%)	-160 (0.37%)	
	235,437	-785 (0.38%)	-882 (0.37%)	-612 (0.26%)	+883 (0.38%)	-744 (0.32%)	
	133,873	-1132 (0.59%)	-571 (0.30%)	-746 (0.39%)	+229 (0.12%)	-589 (0.31%)	
	31,558	+203 (0.47%)	-248 (0.57%)	-153 (0.35%)	-8 (0.02%)	-108 (0.25%)	
	165,431	-929 (0.39%)	-819 (0.35%)	-899 (0.38%)	+221 (0.09%)	-697 (0.30%)	
	58,182	+229 (0.12%)	-246 (0.13%)	-149 (0.07%)	+494 (0.26%)	+5 (0.00%)	
	11,824	-85 (0.20%)	+183 (0.42%)	+138 (0.32%)	+168 (0.39%)	-52 (0.12%)	
	70,006	+144 (0.06%)	-63 (0.03%)	+287 (0.12%)	+662 (0.28%)	-47 (0.02%)	
	572	-249 (0.13%)	-159 (0.08%)	-159 (0.08%)	-159 (0.08%)	-249 (0.13%)	
	2,489	+28 (0.06%)	-132 (0.30%)	-57 (0.13%)	-62 (0.14%)	-57 (0.13%)	
	3,061	-221 (0.09%)	-291 (0.12%)	-216 (0.09%)	-221 (0.09%)	-306 (0.13%)	
6	133,301	-883 (0.46%)	-412 (0.21%)	-587 (0.31%)	+388 (0.20%)	-340 (0.18%)	
	29,069	+175 (0.40%)	-116 (0.27%)	-96 (0.22%)	+54 (0.12%)	-51 (0.12%)	
	162,370	-708 (0.30%)	-528 (0.22%)	-683 (0.29%)	+442 (0.19%)	-391 (0.17%)	+66 (0.03%)
9	5,294	-854 (0.44%)	+92 (0.05%)	+102 (0.05%)	+42 (0.02%)	+20 (0.01%)	
	2,185	+66 (0.15%)	+31 (0.07%)	+1 (0.00%)	-32 (0.07%)	+9 (0.02%)	
	7,479	-788 (0.33%)	+123 (0.05%)	+103 (0.04%)	+10 (0.00%)	+29 (0.01%)	-170 (0.07%)
7	128,007	-29 (0.02%)	-504 (0.26%)	-689 (0.36%)	+346 (0.18%)	-360 (0.19%)	
	26,884	+109 (0.25%)	-147 (0.34%)	-97 (0.22%)	+86 (0.20%)	-60 (0.14%)	
	154,891	+80 (0.03%)	-651 (0.28%)	-786 (0.33%)	+432 (0.18%)	-420 (0.18%)	+236 (0.10%)

EOLDOUT FRAME 2

TABLE 16-2
PROPELLANT RESIDUAL SUMMARY

	LEVEL SENSOR NO. (LEVEL SENSOR ACTIVATION TIME-SEC)					
	LOX TANK			LH2 TANK		
	L0015 (R0 +9,537.2)	L0016 (R0 +9,521.9)	ECC2 (R0 +9,550.57)	L0018 (R0 +9,543.3)	L0019 (R0 +9,535.3)	ECC2 (R0 +9,550.57)
PU Mass Sensor Mass - lbm	10,981	16,860	5,336	2,792	3,320	2,156
Level Sensor Mass - lbm	10,673	16,707		2,732	3,466	
Level Sensor Extrapolated Residual - lbm	5,360	5,288	5,304*	2,162	2,263	2,207*
Weighted Average Residual - lbm			5,314			2,194

*Statistical average of level sensor residuals

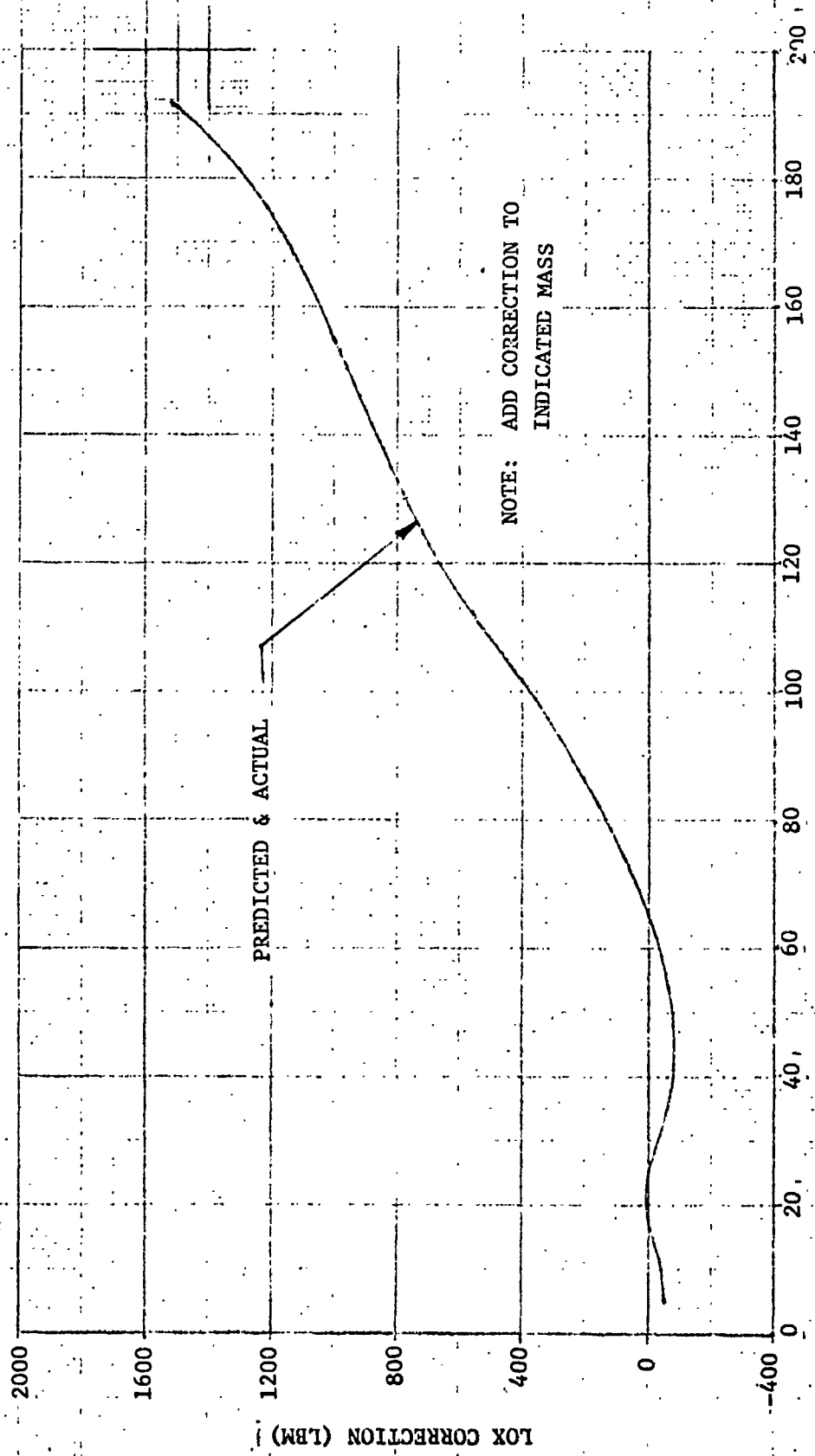

LOX INDICATED MASS (THOUSANDS OF LBM)

Figure 16-1. LOX S-IVB-505 Stage Total Volumetric Flight PU Mass Correction

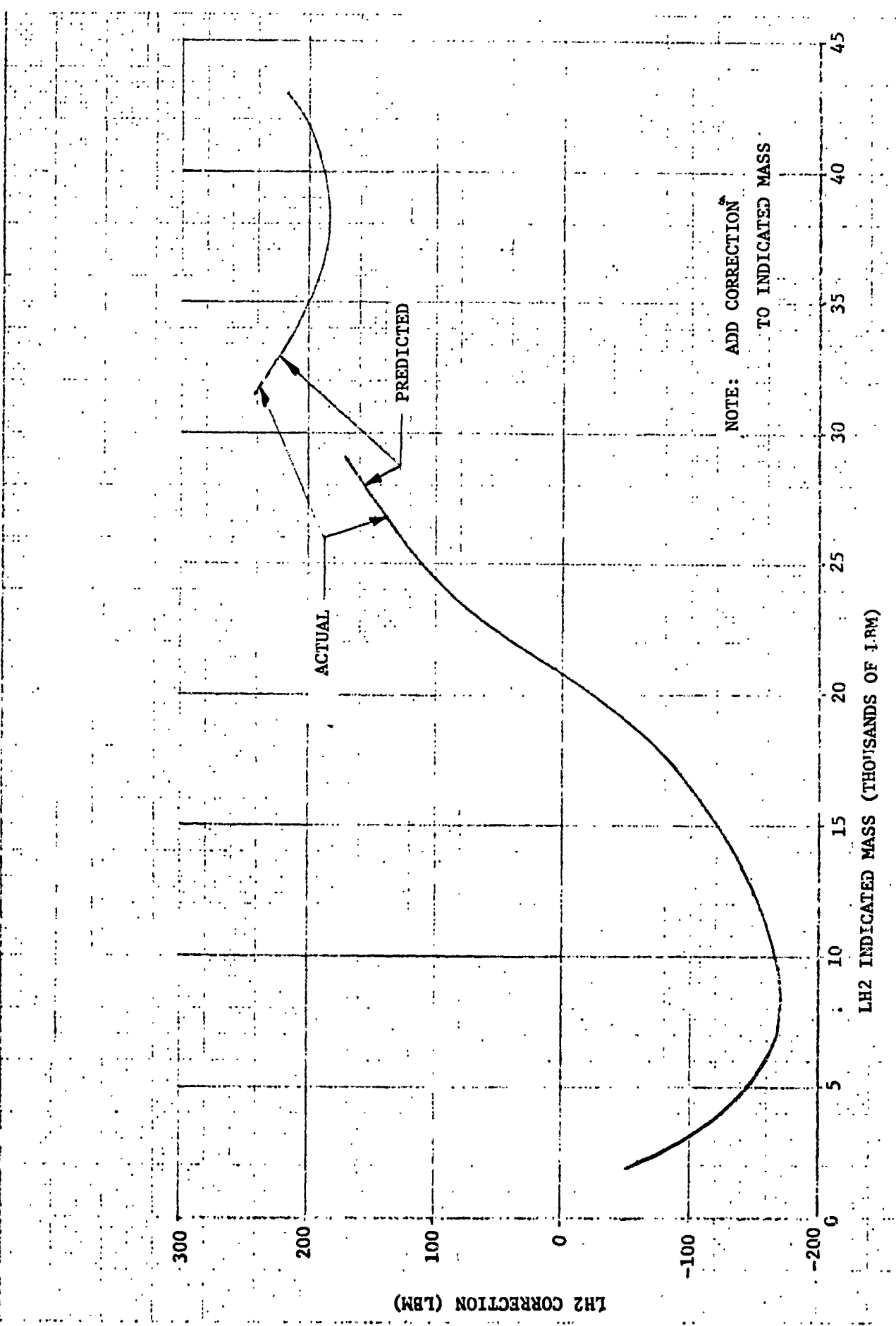

Figure 16-2. LH2 S-IVB-505 Stage Total Volumetric Flight PU Mass Correction

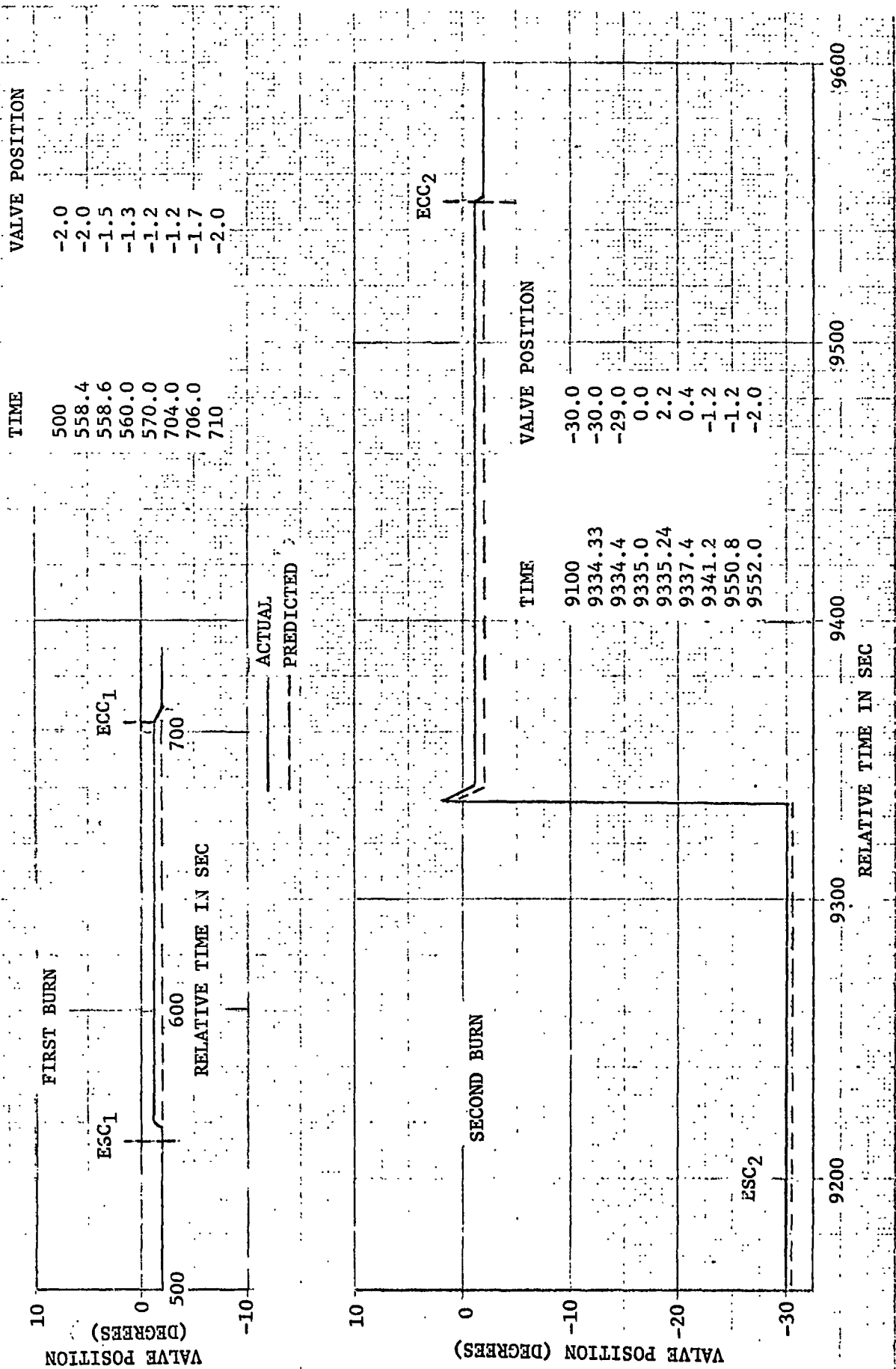

Figure 16-3. PU Valve Response History

17. S-II/S-IVB STAGE SEPARATION

S-II/S-IVB Separation Dynamics

The analysis of separation dynamics was done by comparing the data from the AS-505 flight to that of AS-503 and AS-501. Since the data compared very closely, detailed reconstruction was not performed to determine precisely the lateral clearance used and the separation completion time. From the comparative analysis performed it can be estimated that a detailed reconstruction would yield a separation completion time of approximately 1.0 sec and a lateral clearance utilization of less than 5 in.

Table 17-1 contains significant times and events for the S-II/S-IVB separation.

Figure 17-1 shows the longitudinal accelerometer data for the S-II and S-IVB stages. The S-II stage showed the effect of the early S-II center engine cutoff and a light stage weight. The angular rates for both the S-II and S-IVB stages are presented in figure 17-2. The S-IVB rates were all small with pitch and yaw rates less than ± 0.3 deg/sec.

TABLE 17-1
AS-505 SEPARATION EVENTS

EVENT	MONITORED TIME (505)	ΔTIME FROM SEPARATION COMMAND				
		501	502	503	504	505
S-II Engine Cutoff	552.64	-0.77	-0.766	-0.858	-0.923	-0.86
S-IVB Ullage Rocket Ignition	553.391	-0.091	-0.12	-0.119	-0.096	-0.109
Separation Command	553.500	0	0	0	0	0
S-II Retrorocket Ignition	553.500	0	0	0	0	0
First Axial Motion		0.052	0.049	N/A	N/A	N/A
S-IVB Engine Start Command	553.591	0.189	0.192	0.096	0.092	0.091
Separation		1.044	0.99			

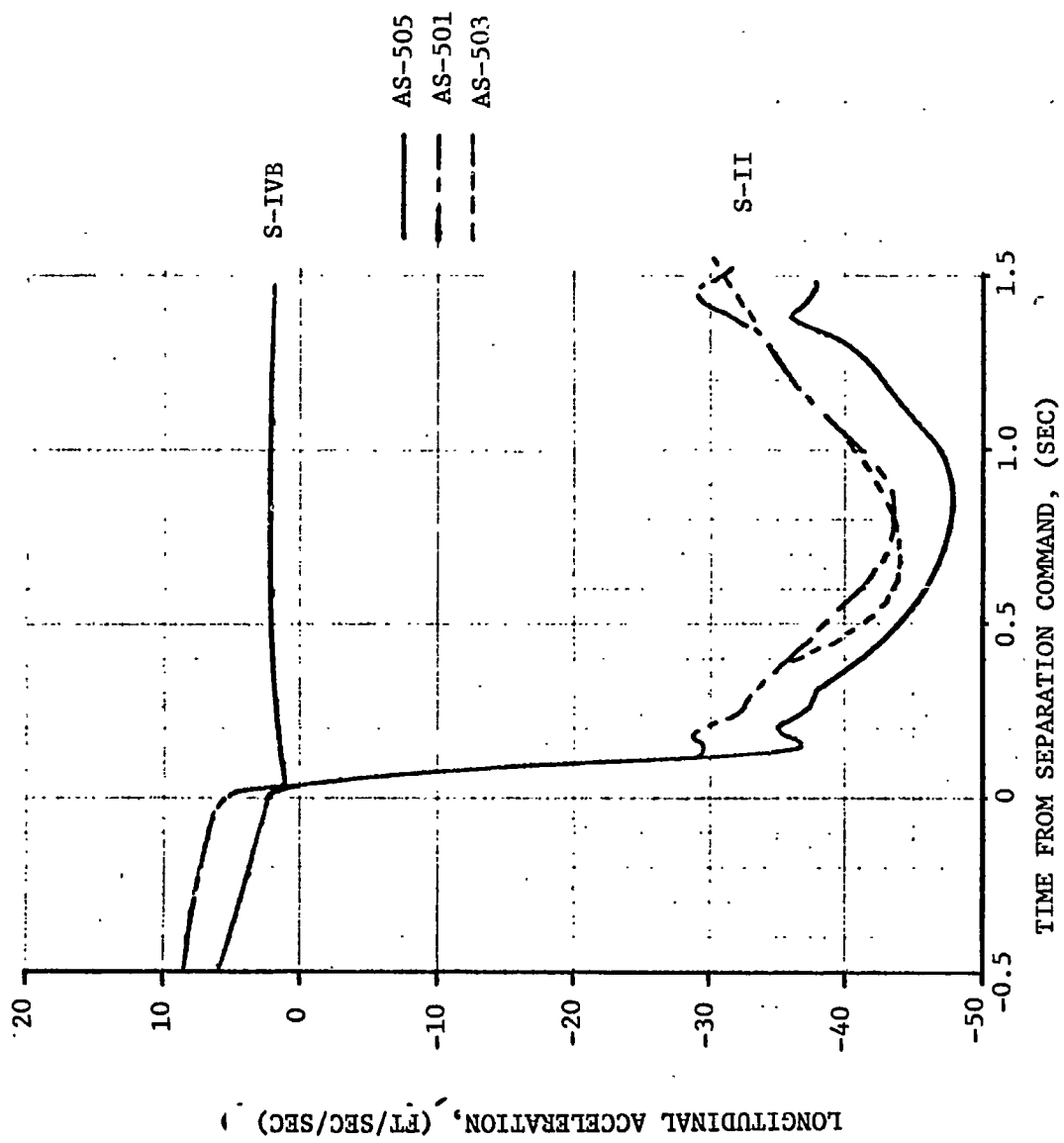

Figure 17-1 Longitudinal Acceleration

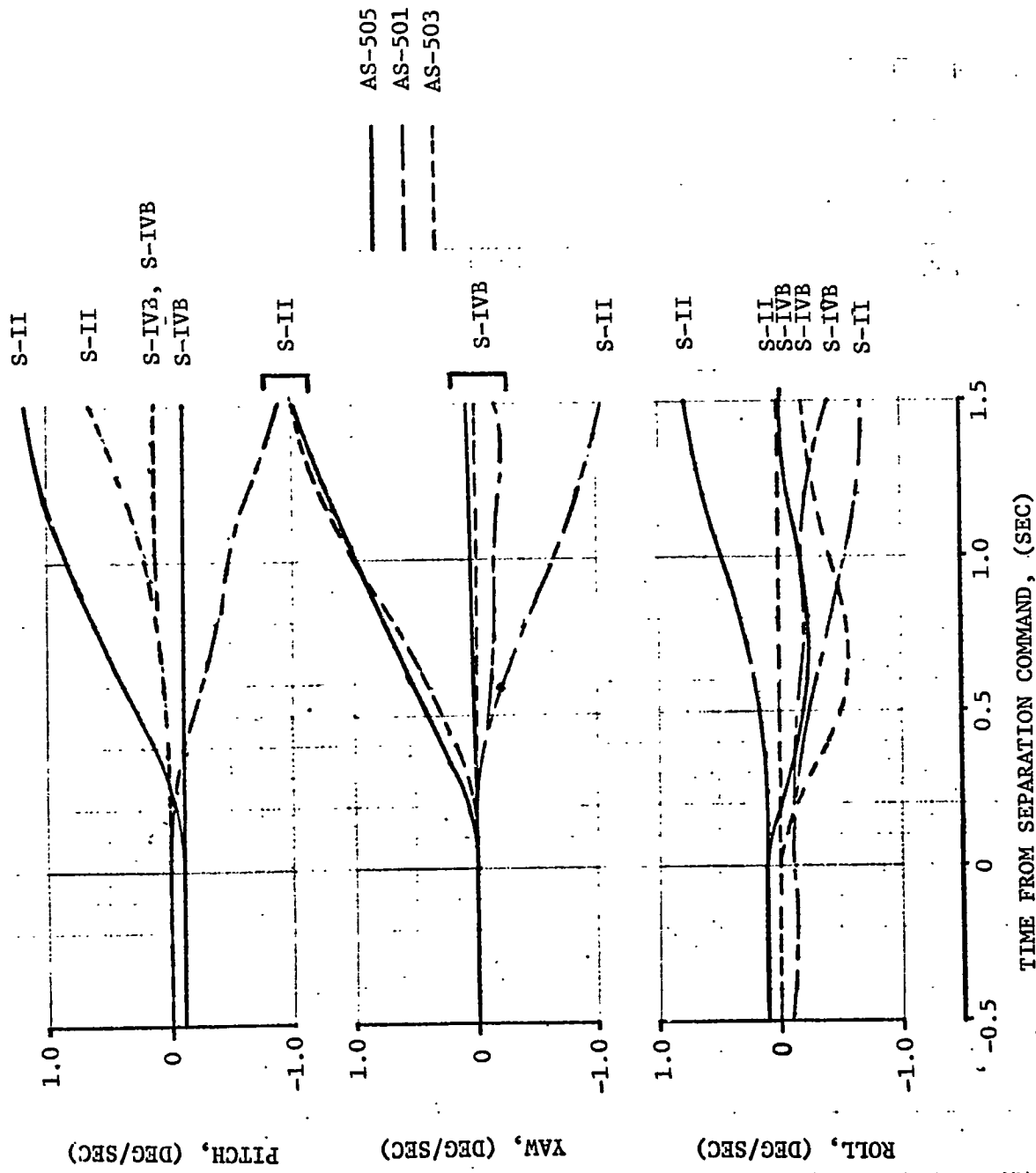

Figure 17-2 Angular Velocity

18. DATA ACQUISITION SYSTEM

18.1 Data Acquisition System Objective

The objective of the Data Acquisition System was to gather information describing stage environments and the performance of stage systems. The measurements so utilized are specified in the Instrumentation Program and Components List (MDAC-WD Drawing 1B43571, "AD" change). The information acquired from the measurements was converted into a telemetry format, transmitted to ground stations located throughout the flight path, and recorded on magnetic tape.

The data reduced and processed from the recorded magnetic tape was evaluated to requirements specified in the Instrumentation Program and Components List. The evaluation period was from the start of automatic sequence to the loss of telemetry data. The incentive areas of Data Acquisition System evaluation are defined as Phase I and Phase II. Phase I encompasses liftoff to S-IVB Engine Cutoff Command (ECC) +10 sec to S-IVB/Lunar Module separation. The nonincentive phase of flight test is subsequent to S-IVB/Lunar Module separation and encompasses the passivation and retrograde slingshot maneuver.

18.2 Summary of Performance

The performance of the Data Acquisition System was very good throughout the S-IVB stage flight mission. Measurement data from the PCM/FM, and SSB subsystems was reduced without difficulty. The system performed as designed and there were no system malfunctions. Summarization of the evaluations for Phases I and II is presented below:

Total Measurements Assigned	388
Checkout Only Measurements	7
Landline Measurements	2
Measurements inoperative due to stage configuration	1
Measurements deleted prior to start of automatic launch sequence	2

Total Active Measurements	376
Phase I Measurement Failures	4
Phase II Measurement Failures	7
Phase I Measurement Efficiency	98.9%
Phase II Measurement Efficiency	98.1%

A detailed measurement flight status is presented in table 18-1.

18.3 Instrumentation System Performance

The performance of the S-IVB-505 instrumentation system was good throughout the flight evaluation period. Four measurements were considered as Phase I evaluation period failures. An additional three measurements failed during the Phase II evaluation period. One measurement failed during the Phase II evaluation period, but had fulfilled its intended purpose and was not considered a failure for CPIF purposes. Table 18-2 discusses those measurements deleted from CPIF consideration.

Table 18-3 elaborates each measurement failure. Measurements which were not failures, but considered as anomalies, are covered in table 18-4.

The Remote Automatic Calibration System (RACS) calibration levels were evaluated at RO -1,206 sec. One measurement (D0254-403 Press LOX Tk Repress Spheres) exceeded the 2 percent tolerance criteria. This measurement had been deleted prior to the start of the automatic sequence and is discussed in table 18-2.

18.4 Telemetry System Performance

The airborne S-IVB Telemetry System was composed of one PCM, one FM, and one SSB subsystem. Performance of the Telemetry System was satisfactory throughout the flight.

18.4.1 Pulse Code Modulation Subsystem

Both the CP1B0 and the DP1B0 Model 270 multiplexers were properly synchronized to their respective PCM/DDAS Assembly. The PCM wave train was properly serialized and sync words properly coded. Analog-to-digital conversion was uniform throughout the life of the stage.

The evaluation of the PCM System in-flight calibrations verified all channels were within system tolerances.

18.4.2 Frequency Modulation Subsystem

The performance of the individual subcarrier oscillators (SCO) were all within their respective band tolerance limits. The system calibrations were verified at RO +578.8 and RO +9,029.6 sec. All calibration levels were present and easily distinguishable.

18.4.3 Single Sideband Subsystem

Data from the Single Sideband Subsystem verified its proper operation. The Model 245 Multiplexer properly sampled the measurements assigned to the subchannels. The 1,700 Hz calibration signal was 1,693 Hz, which was within the tolerance limits.

The evaluation of the SSB System in-flight calibrations verified all channels were within system tolerances.

18.4.4 Calibration Subsystem

The Remote Automatic Calibration System (RACS), used for prelaunch instrumentator system evaluation, was exercised at 1628:54 hr GMT, (RO -1,206 sec). High mode, low mode, and return to run mode were initiated at 1628:54, 1629:14, and 1629:34 hr GMT, respectively. Calibration levels for both PCM and FM were verified on all channels having RACS calibration capabilities.

18.4.5 Radio Frequency Subsystem

The performance of the RF subsystem is presented in table 18-5. Only the operation of the PCM RF transmitter can be evaluated in depth for the S-IVB stage. Measurements which monitor the PCM transmitter forward and reflected power were provided but no provisions were made to monitor the RF power parameters of the FM or SSB transmitters. Proper performance

of the FM and SSB RF subsystems is considered verified with the evaluation of reduced data from the subsystems. RF blackout due to flame attenuation was observed during S-IC/S-II separation for a period of approximately one second on TEL-4 (Cape Area) data. No loss of data was noted during S-II/S-IVB separation.

PCM data from the CP1 data link, which is transmitted on VHF, was lost at approximately RO +15,780 sec from both the Hawaii and Guaymas ground stations. The DP1 PCM data passes through the instrument unit (IU) and is transmitted on VHF as well as S-Band. Data has been reviewed through RO +29,000 sec from the Goldstone ground station on the S-Band data link. An analysis of data beyond RO +29,000 was made to verify S-IVB stage life and system performance. Loss of IU S-Band data was observed to occur at RO +39,120 sec.

18.4.6 Signal Strength

Figures 18-1 through 18-5 indicate the actual versus predicted signal strength for S-IVB telemetry receiving stations. These predictions were made with the EA16A computer program.

Stations included are:

1. TEL-4 (Cape Kennedy) - Launch
2. Bermuda - Launch
3. Vanguard Ship - Orbit Insertion
4. Mercury Ship - Second Burn

Received signal strength data for these stations were the ones available for evaluation at this time.

Predicted versus actual levels for TEL-4 were quite close; the Vanguard ship station during second burn, however, was 30 dB higher than predicted. The Bermuda station did not receive as much signal during early acquisition as predicted; this could be due to ground station antenna pointing errors.

Mercury Ship signal strength plots show a complete loss of signal strength between RO +8,910 and RO +9,015 sec. This loss is unexplained but is most probably due to ground station problems, since reduced data from the Carnarvon ground station, through this same time period, verifies proper S-IVB transmitter operation.

18.4.7 Electromagnetic Compatibility

A review of S-IVB-505 telemetry flight data revealed no significant data degradation due to Electromagnetic Interference (EMI). Two measurements (D0020-403 Press - Fuel Tank He Bottle Repress and D0088-403 Press - LOX Tank Repress Spheres) exhibited spikes and level shifts at S-II/S-IVB separation and a discussion of these measurement anomalies can be found in table 18-4 of this report.

These spikes and shifts have been observed on prior flight stages and are due to reflection and rectification of RF energy from the telemetry transmitter at the time of S-II/S-IVB separation. This effect is not seen prior to the separation because of the shielding provided by the S-II stage. Installation of filter pin connectors on stages 506 and subs will minimize this effect.

TABLE 18-1 (Sheet 1 of 2)
MEASUREMENT STATUS

<u>Measurements Assigned by IP&CL (MDAC-WD Dwg 1B43571 "AD" Change)</u>		388
<u>Checkout Only Measurements</u>		7
K0141-411	Event - R/S 1 Pulse Sensor	
K0142-411	Event - R/S 2 Pulse Sensor	
K0149-404	Event - Ullage Jettison 1 P/S	
K0150-404	Event - Ullage Jettison 2 P/S	
K0169-404	Event - EBW Pulse Sensor OFF Ind	
K0176-404	Event - Ullage Rkt Ign P/S 1 Ind	
K0177-404	Event - Ullage Rkt Ign P/S 2 Ind	
<u>Landline Measurements</u>		2
D0576-408	Press - Fuel Tank Ullage Umb - H/W	
D0577-406	Press - Oxid Tank Ullage Umb - H/W	
<u>Measurements Inoperative Due to Stage Configuration</u>		1
K0152-404	Event - Rate Gyro Wheel Speed OK Indication	
<u>Measurements Deleted Prior to Start of Automatic Launch Sequence</u>		2
D0254-403	Press - LOX Tank Repress Spheres	
L0019-408	Level - Liquid Hydrogen Pos C	
<u>Total Active Measurements</u>		376
<u>Phase I Failures</u>		4
B0019-427	Acoust - Aft Skirt Sta 2880 - Ext	
B0025-426	Acoust - Sta 3220, Pos I - Ext	
C0200-401	Temp - LH2 Injection	
D0230-403	Press - GOX/GH2 Burner GH2 Injector	

TABLE 18-1 (Sheet 2 of 2)
MEASUREMENT STATUS

<u>Phase II Failures (Phase II Encompasses Phase I)</u>		7
D0104-403	Press - LH2 Press Module Inlet	
D0236-403	Press - Ambient He Pneumatic Sphere	
E0239-401	Vib - LOX Turbine Bypass Vlv - TAN	
<u>Phase I Measurement Efficiency</u>		98.5%
<u>Phase II Measurement Efficiency</u>		98.1%
<u>Non-Incentivized Measurement Failures</u>		1
A0010-403	Accel - Gimbal Block - Pitch LF	
<u>Measurement Anomalies</u>		
B0016-411	Acous - Fwd Skirt Sta 3216 - Int	10
C0001-401	Temp - Fuel Turbine Inlet	
C0199-401	Temp - Thrust Chamber Jacket	
D0020-403	Press - Fuel Tk He Bottle Repress	
D0071-414	Press - Oxid Sup Manf Mod 1 (APS)	
D0073-415	Press - Oxid Sup Manf Mod 2 (APS)	
D0088-403	Press - LOX Tank Repress Sphere	
D0233-403	Press - O2/H2 Inj Spool Chamb Diff	
N0018-411	Misc - PCM/FM Transmitter Output Power	
N0055-411	Misc - T/M RF System Refl Power	

TABLE 18-2
MEASUREMENT FAILURES NOT AFFECTING CPIF

A0010-403 Accel - Gimbal Block, Pitch, LF

The measurement indicated invalid off-scale-high data subsequent to R0 +1,200 sec (500 sec after orbital insertion). Prior to the failure, noisy data was exhibited and at R0 +1,215 sec the data started increasing and obtained the 100 percent level in 12 sec. The off-scale-high indication was obtained 17 sec after the first indication of failure.

This transducer was designed to be thermodynamically insulated from the mounting structure through the launch period only. Thus, failure of this measurement could be expected, as the temperature in the gimbal block area did exceed the minimum design value for the installation. Since the measurement fulfilled its intended purpose, it was not considered a failure for CPIF purposes.

D0254-403 Press - LOX Tank Repress Spheres

This measurement slowly degraded to a reading of approximately 250 psi lower than expected during the countdown and was deleted as an active measurement for CPIF purposes.

At present a possible amplifier balance problem is suspected and the measurement is still under investigation.

L0019-408 Level - Liquid Hyd Pos C

This measurement dropped out for a period of 7 min after it had become wet during LH2 loading. This same condition was noted during the CDDT and post-test troubleshooting yielded inconclusive results. Since the measurement was not mandatory or highly desirable for flight, no effort was made to replace the measurement. The problem was attributed to an opening of a cryogenic feedthrough connector and the measurement was deleted as an active measurement prior to the start of the Automatic Sequence.

TABLE 18-3 (Sheet 1 of 2)
MEASUREMENT FAILURES

PHASE I FAILURES

B0019-427 Acoustic - Aft Skirt, Sta 2880, Ext

B0025-426 Acoustic - Fwd Skirt, Sta 3220, Posit 1, Ext

These measurements both indicated a significant decrease in sound pressure levels during the period prior to Max Q, where the fluctuating pressure levels were expected to increase. Measurement B0019-424 decreased at R0 +63 sec and measurement B0025-426 decreased at R0 +46 sec. The problem is not completely resolved at this time, however, a decrease in amplifier gain is suspected.

C0200-401 Temp - LH₂ Injection

This measurement was reading 30 deg R to 40 deg R colder than previously observed on other flight stages. Investigation did not reveal any apparent instrumentation malfunction. The RACS calibration levels verified that the signal conditioning was within acceptable limits. At present the shift in temperature levels is unexplainable and is still under investigation.

D0230-403 Press - GOX/GH₂ Burner GH₂ Injection

Data from this measurement exhibited a 3 psia (10 percent) higher pressure than was expected, although the data trend performed as expected. The problem was apparent prior to liftoff and the offset remained fairly constant throughout flight.

The measurement utilizes a "split-package" strain gage type pressure transducer, where the sensing unit is located at the measured parameter and the amplifier package is located on the thrust structure. Calibration levels for the measurement system were verified to be correct and it is believed that a problem existed with the sensing unit. Further investigation will be accomplished to fully analyze the failure.

TABLE 18-3 (Sheet 2 of 2)
MEASUREMENT FAILURES

PHASE II FAILURES

D0104-403 Press - LH2 Press Module Inlet

The pressure levels and characteristics of this measurement varied during the second burn period, and did not correlate with other engine pressure measurements. The transducer utilized for the measurement is a "split-package" type of hardware installation and a possible degradation of the amplifier unit is suspected. Further investigation will be accomplished.

D0236-403 Press - Ambient He Pneumatic Sphere

The data level from this measurement shifted abruptly off-scale-high at RO +9,571 sec, after second S-IVB engine cutoff. The measurement utilizes a single package strain gage type pressure transducer and the abrupt shift indicates an open circuit occurred in the bridge.

This measurement also exhibited a slight RFI spike during S-II/S-IVB separation. This problem has been observed on previous flight stages and corrective action has been taken to implement RFI filters in the transducers with 506 and subs.

E0239-401 Vib - LOX Turbine Bypass Vlv - Tan

This measurement began exhibiting erratic data at approximately RO +9,208.3 sec, one second after second engine ignition. The malfunction appears as a loosened coaxial connector causing vibration signal discontinuity, occurring just after a high vibration response possibly resulting from the engine propellants igniting. Thereafter, typical coaxial problem responses were observed, as seen on other flight stages with similar problems, and data was unrecoverable throughout the second burn period. Precautions were observed prior to launch to preclude this type of malfunction, and therefore this failure is considered random.

TABLE 18-4 (Sheet 1 of 2)
MEASUREMENT ANOMALIES

B0016-411 Acous - Fwd Skirt Sta 3216 - Int

The data information from this measurement exhibited intermittent drop-outs between RO +65 and RO +85 sec. Information levels between the drop-outs was retrievable and therefore the measurement was not considered a failure. The problem was attributed to a damaged coaxial cable and/or a damaged or loosened connector between the sound pressure sensor and the amplifier.

C0001-401 Temp - Fuel Turbine Inlet

The temperature seen on this measurement was reading about 100 deg R lower than the expected level during both burn periods. However, the measurement was considered usable for analysis by the evaluating technology and was not deemed a failure. Other than the "lower than expected" level, the measurement responded very well to dynamic temperature conditions and the RACS calibrations were verified to be correct. Further investigation is necessary to fully analyze the temperature anomaly.

C0199-401 Temp - Thrust Chamber Jacket

Measurement response to temperature change during S-IVB first burn was slower than expected and approximately 50 deg R higher than flight stage 503 during the corresponding period. However, other than the slower than expected temperature response, the data information through this period and the remainder of the flight was usable to the evaluating technology. The temperature anomaly is attributed to a slight debonding of the "surface-probe" type sensor during the first engine burn period.

D0020-403 Press - Fuel Tank He Bottle Repress

D0088-403 Press - LOX Tank Repress Spheres

Measurement D0020-403 exhibited a 250 psia positive spike and measurement D0088-403 exhibited a negative 250 psia spike plus a negative offset of approximately 70 psia at S-II/S-IVB separation. The level shifts are within tolerance and the data is acceptable for use. These measurement anomalies were due to RFI and similar problems were observed on flight stages 503 and 504 at S-II/S-IVB separation. Corrective action for the RFI problem has been incorporated and transducers with RFI filters will be used on S-IVB-506 and subs.

TABLE 18-4 (Sheet 2 of 2)
MEASUREMENT ANOMALIES

D0071-414 Press - Oxid Sup Manifold Mod 1 (APS)

D0073-415 Press - Oxid Sup Manifold Mod 2 (APS)

D0233-403 Press - O2/H2 Inj Spool Chamb Diff

These measurements exhibited noise at liftoff and Max Q. These measurements use potentiometer type pressure transducers which are known to be susceptible to a high vibration environment. Since the APS or the O2/H2 burner is not exercised during the boost period, no loss of data occurred. The measurements are considered valid except for the anomalous periods during boost.

N0018-411 Misc - PCM/FM Transmitter Output Power

The data exhibited slow variations in transmitter output power that does not appear as true information. From past stages, the temperature variations of the cold plate corresponds fairly well with the variation of output power. It is known that the power detectors are temperature sensitive, thus it was concluded on this stage that the transmitter variations are due to the cold plate. Presently, complete data has not been received from the IU links to fully support the above analysis and verification is pending further investigations.

N0055-411 Misc - T/M RF System Refl Power

The data indicated an unusual increase in reflected power of 0.7 mv between RO +10,962 sec and RO +14,195 sec. These times correlate very closely with spacecraft separation/SLA panel deployment (RO +10,962) and LM extraction (RO +14,184), respectively. After deployment of the SLA panels, RF reflections from the LM into the S-IVB forward skirt area, will affect the RFI susceptible detectors causing response to the stray RF. Extracting the LM from the Launch Vehicle removes the reflecting source causing the measurement to perform normally.

TABLE 18-5
RF SYSTEM PERFORMANCE

	<u>RO -10</u>	<u>RO +500</u>	<u>RO +9,100</u>
PCM/FM Xmtr Output Pwr (watts) (Prelaunch Minimum - 15 watts)	16.5	16.7	18.9
RF System VSWR (Prelaunch Maximum - 1.7:1)	1.64:1	1.74:1	1.45:1

PREDICTED VS. ACTUAL SIGNAL STRENGTH

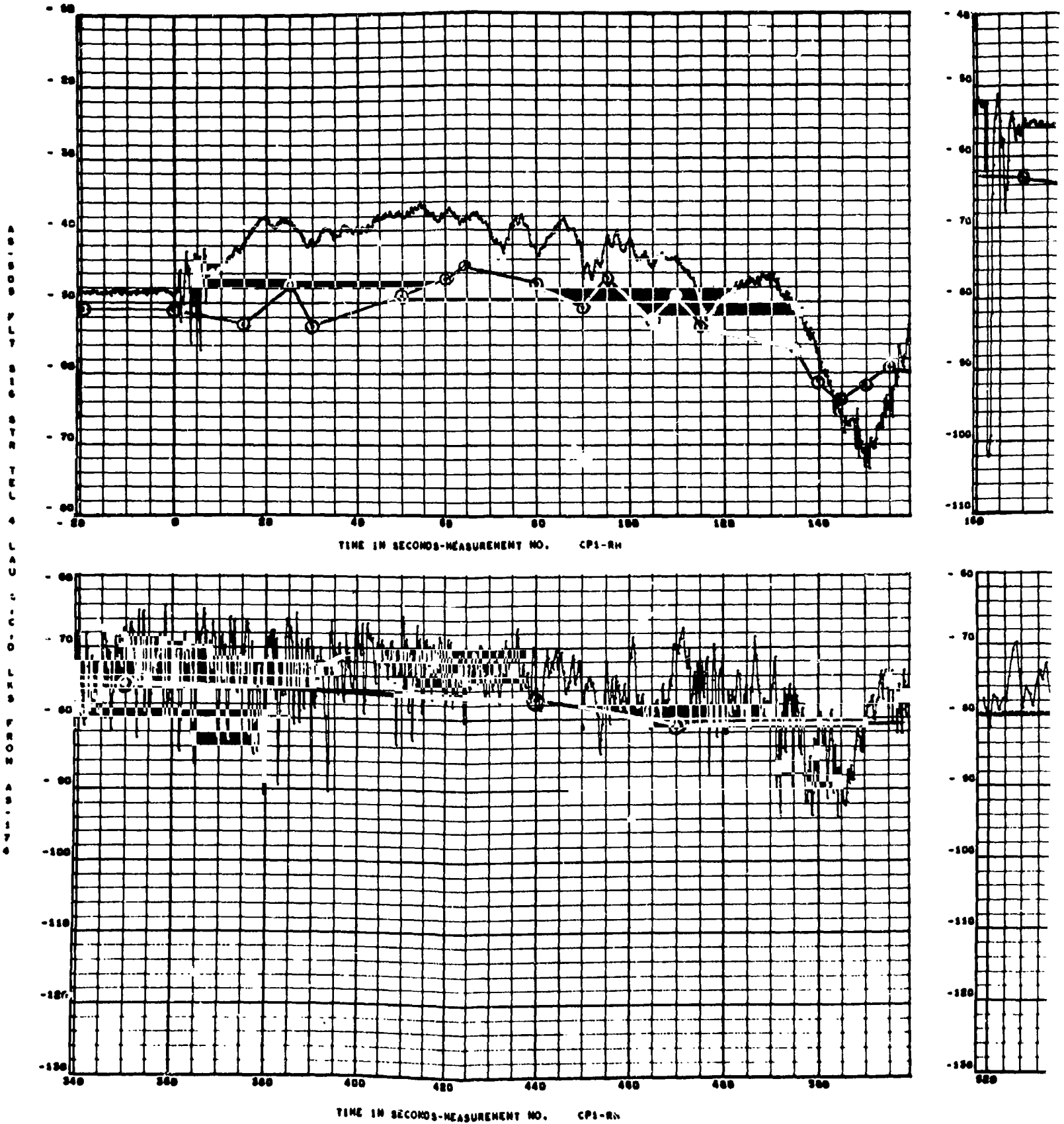

FOLDOUT FRAME

Figure 18-1. AS-505 Flight - TEL 4 Ground Station

AL STRENGTH (dBm)

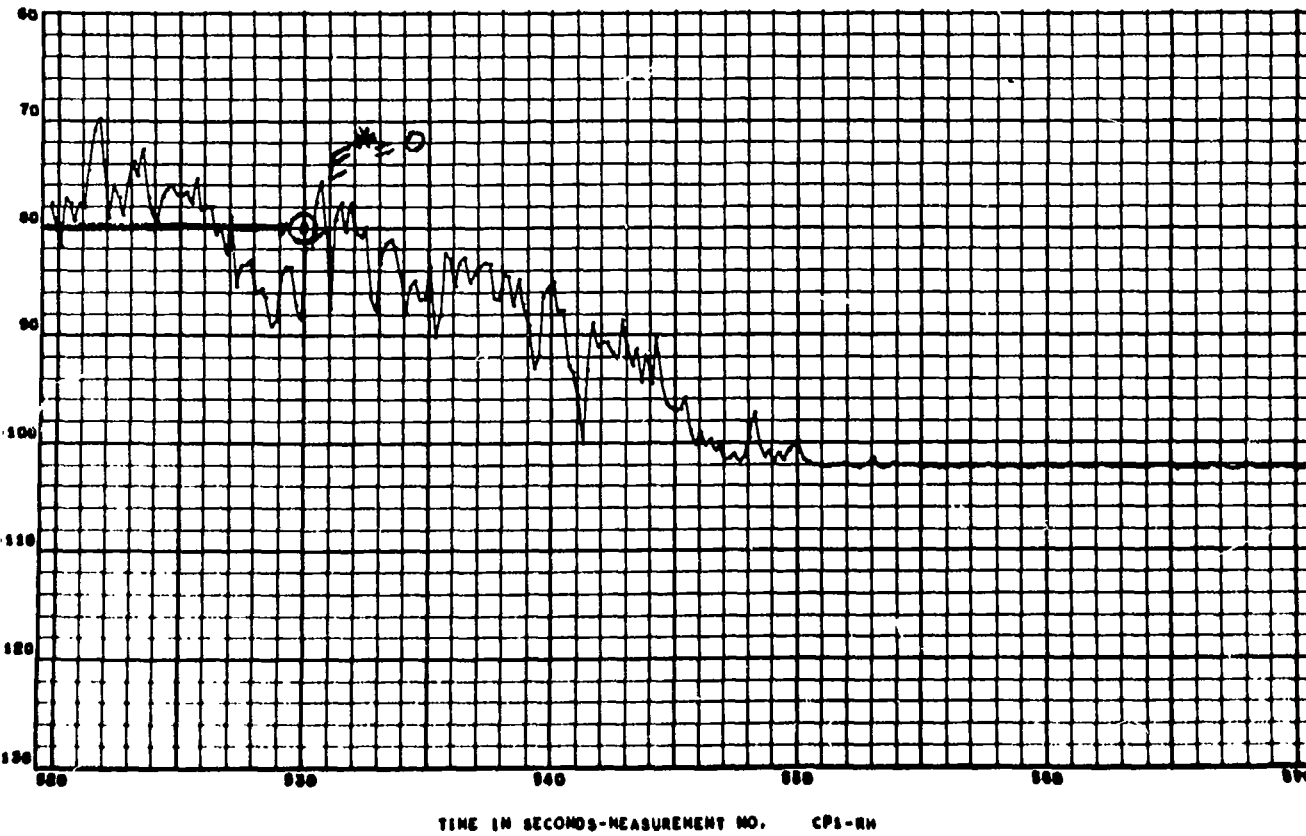
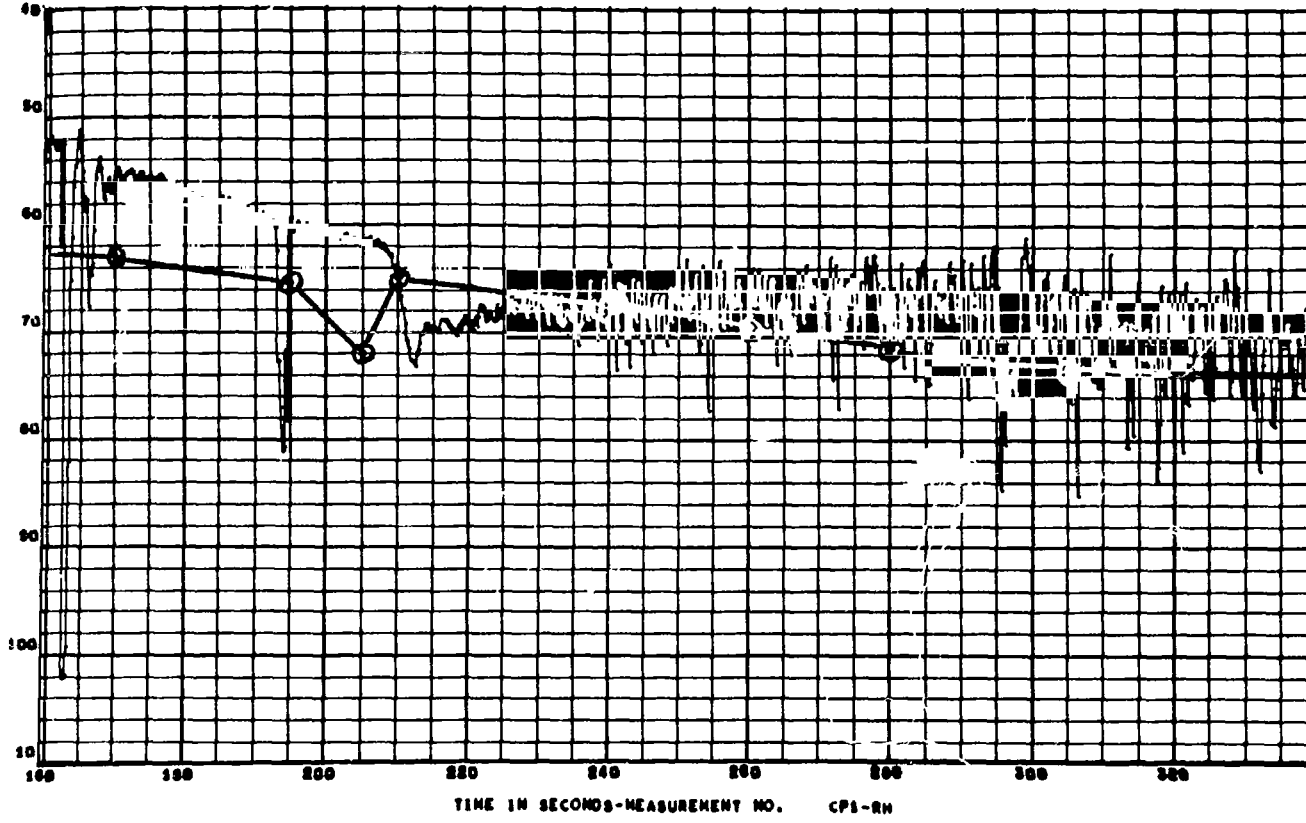

ound Station

FOLDOUT FRAME 2

PREDICTED VS. ACTUAL SIGNAL S

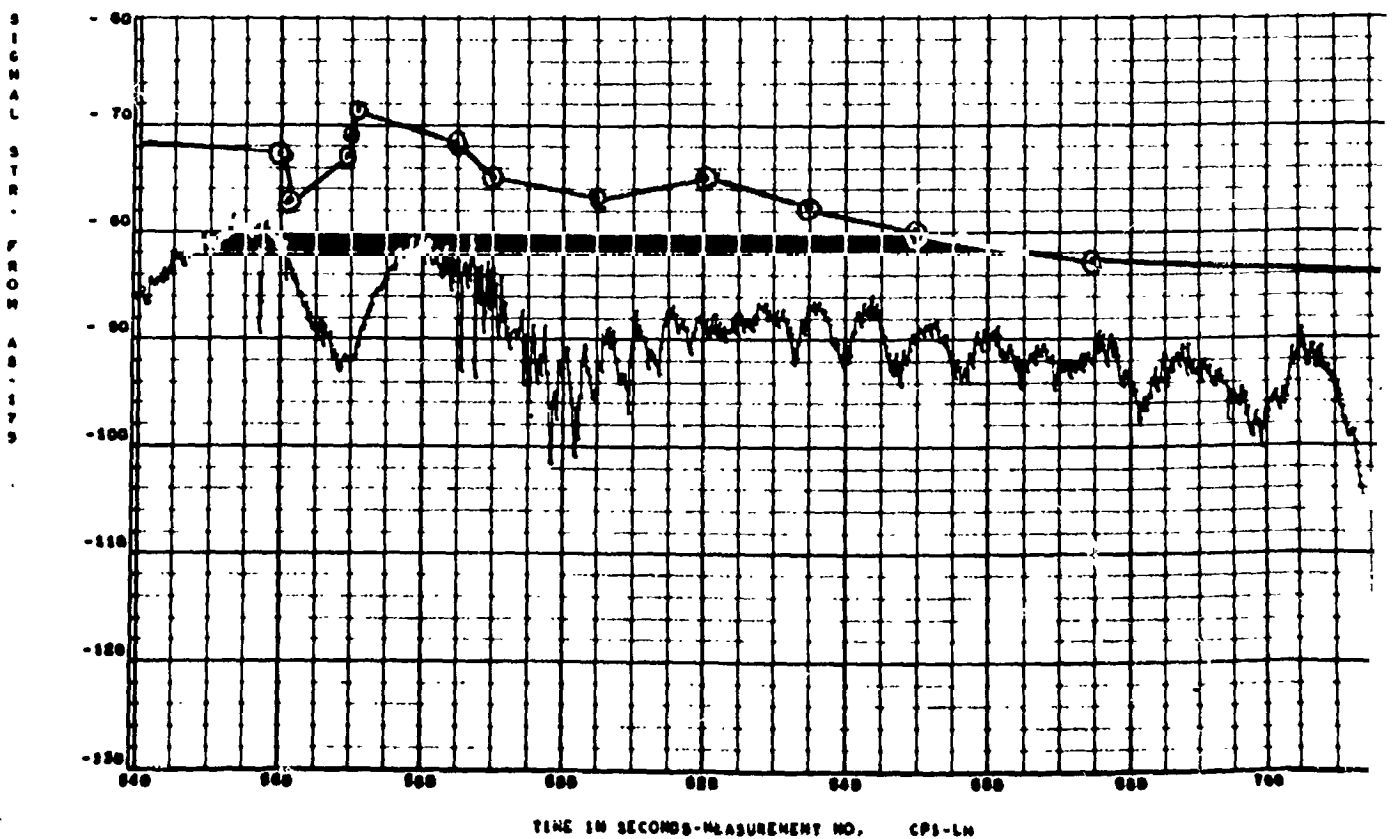
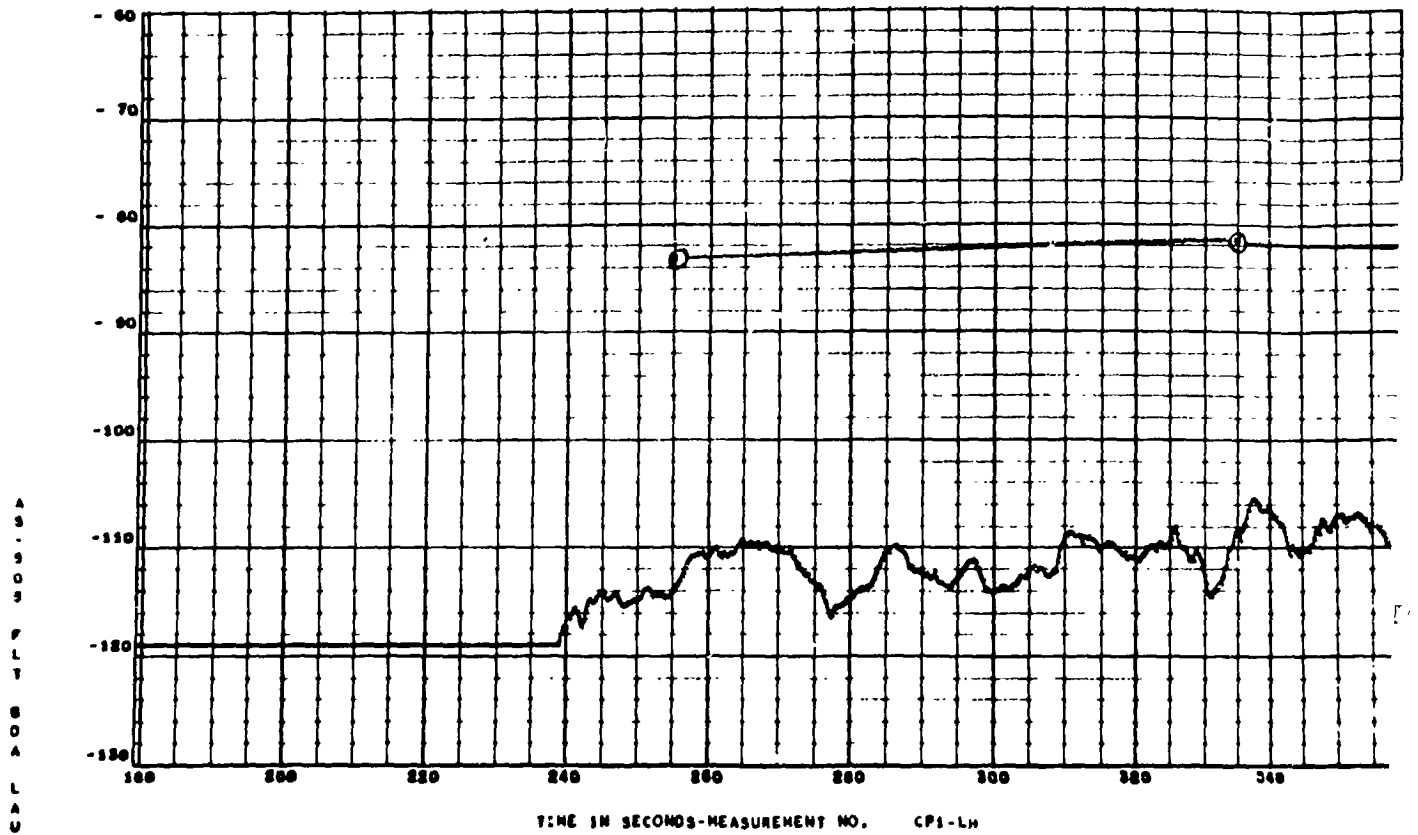
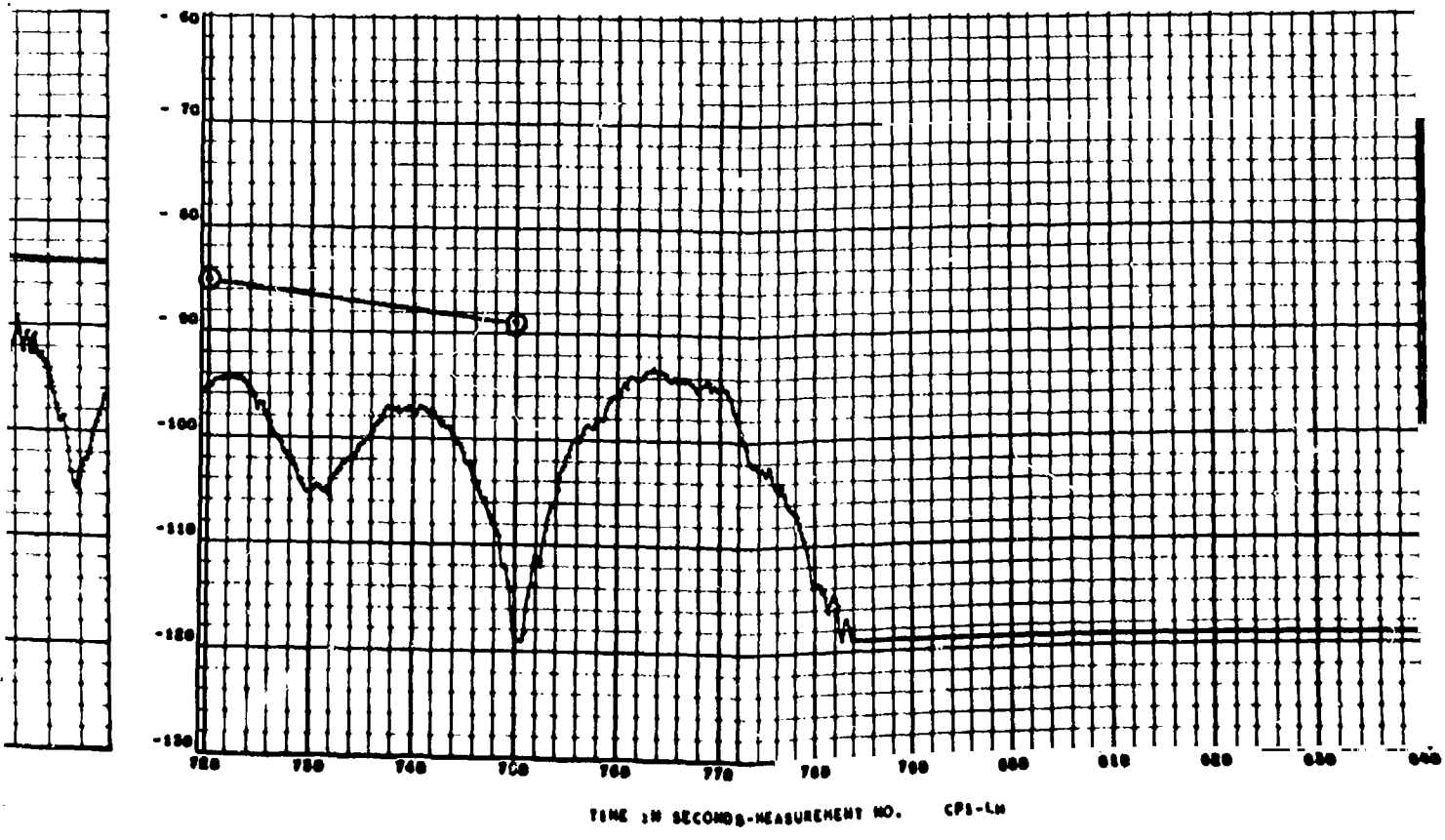
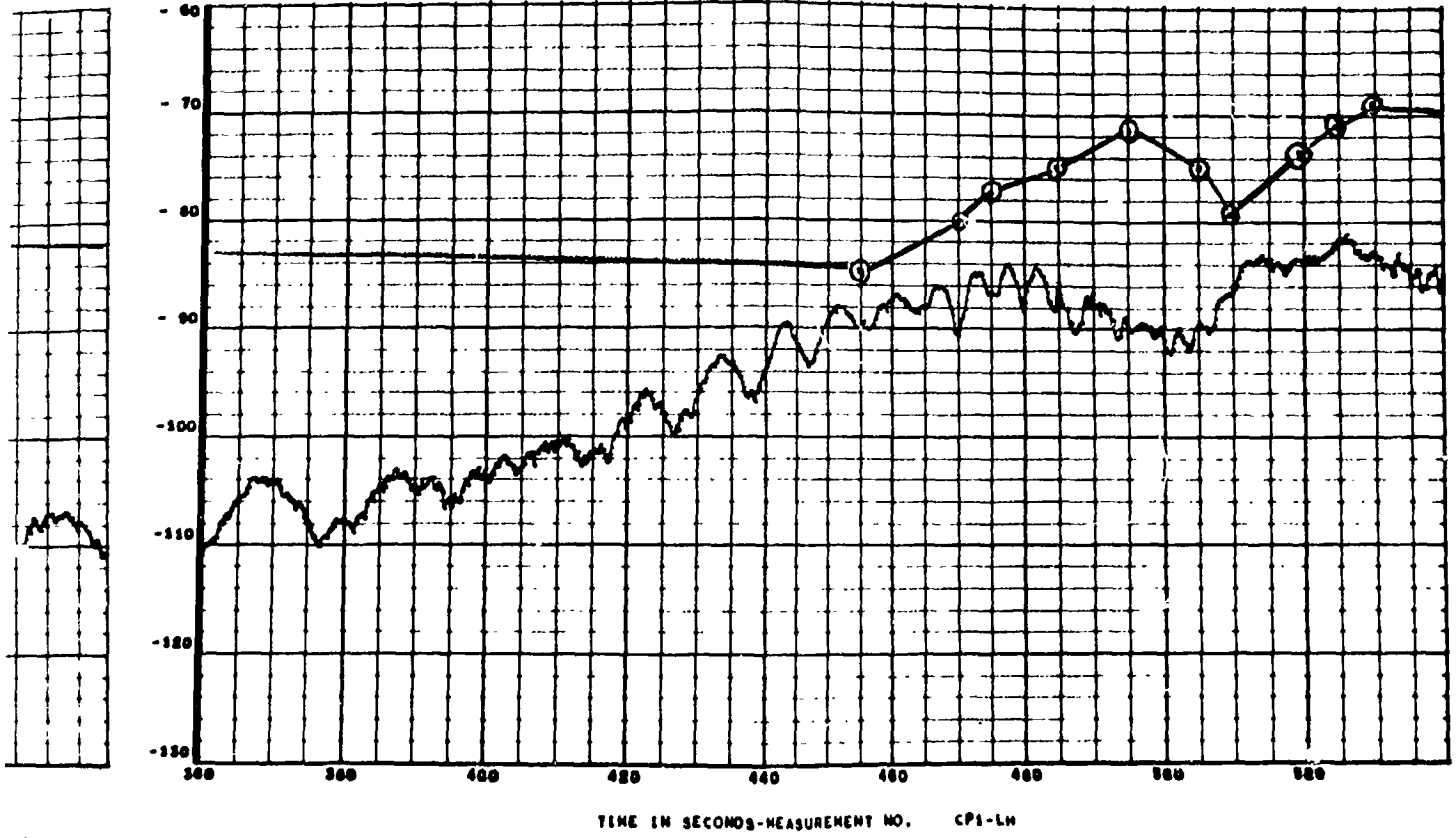

Figure 18-2. AS-505 Flight - C.

SIGNAL STRENGTH (dBm)



t - Bermuda Ground Station

EOLDOUT FRAME 2

PREDICTED VS. ACTUAL SIGNAL STRENGTH (dBm)

AS-505 FLTS/S VANGARD REV 1 MIX 2020 AS-505

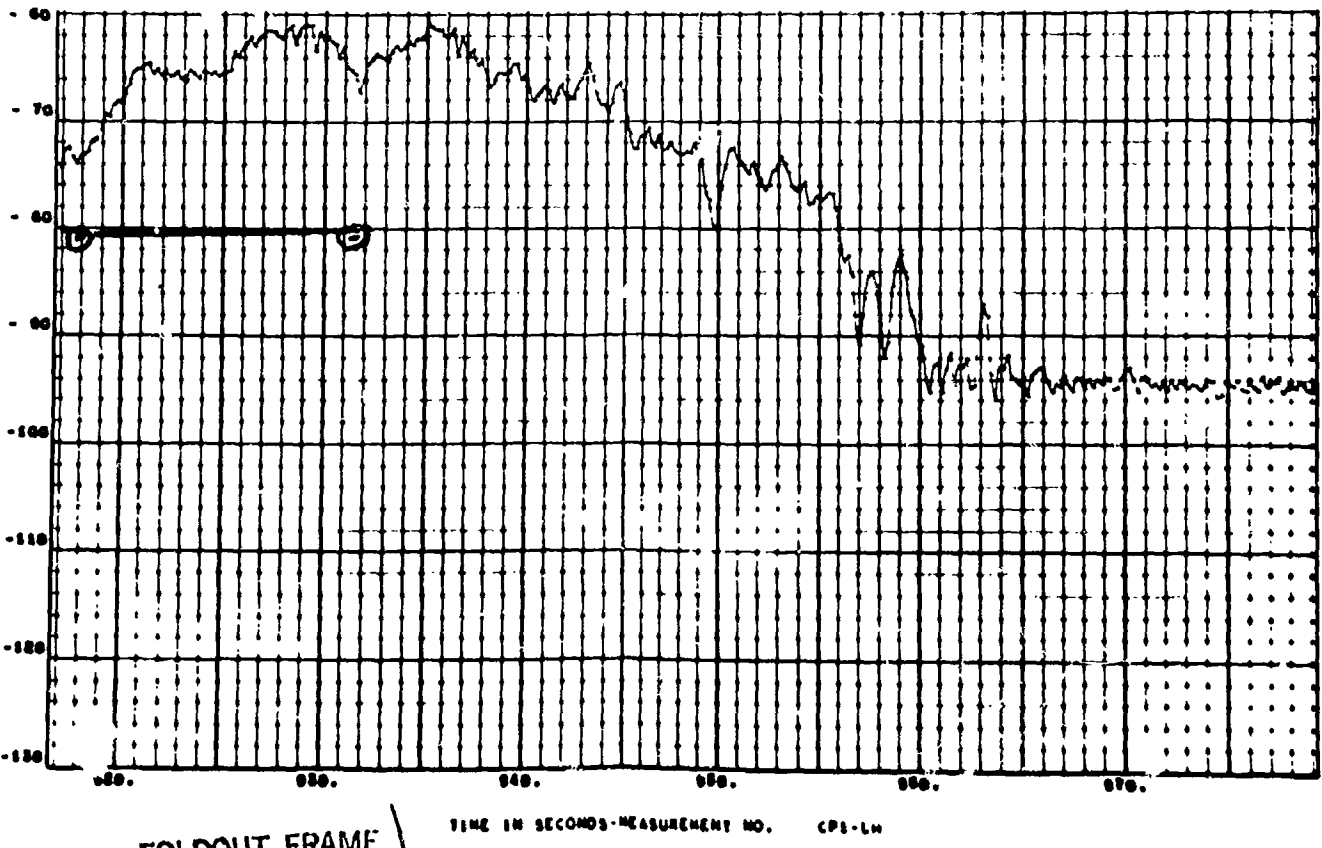
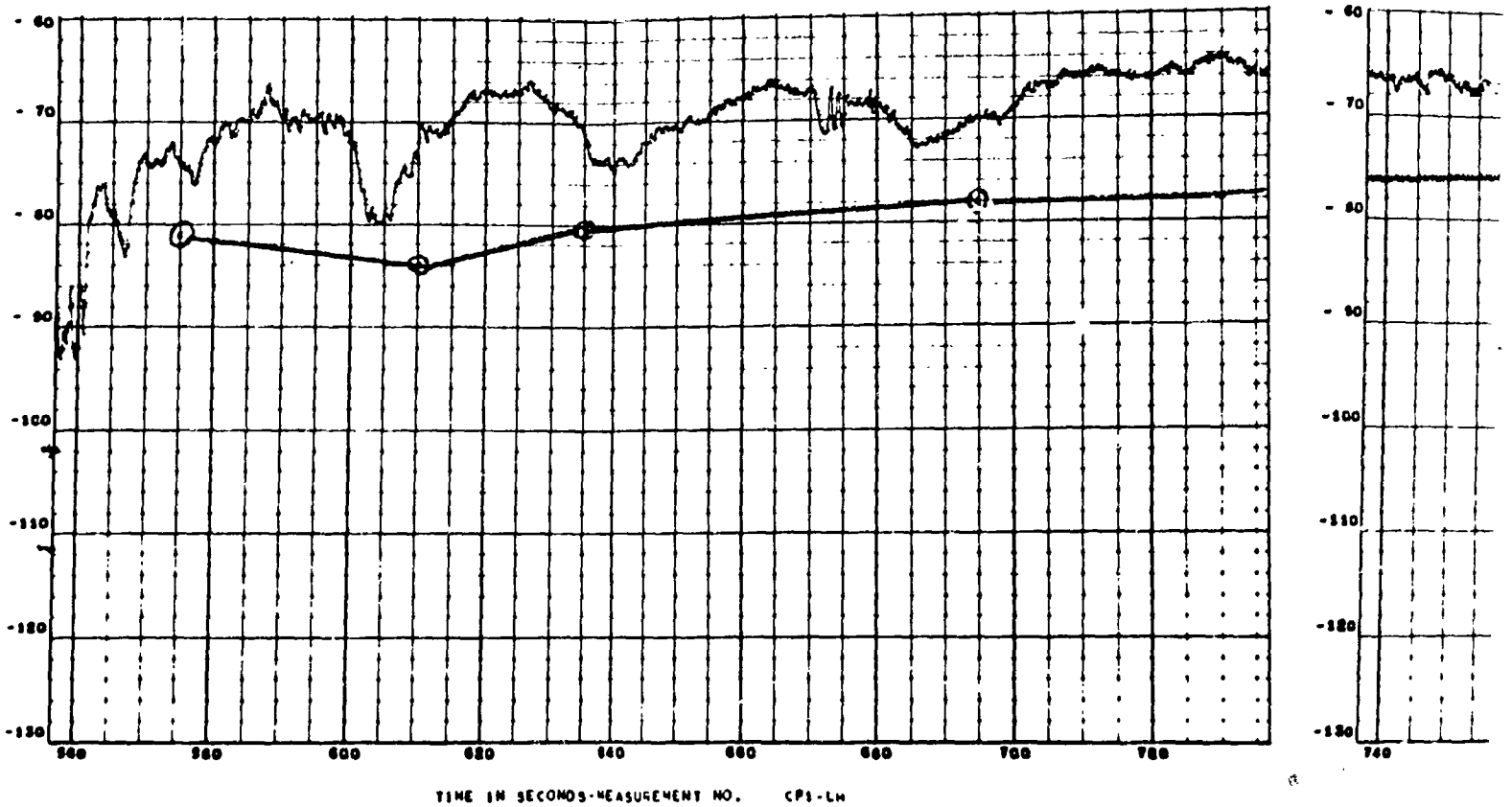

FOLDOUT FRAME

FOLDOUT FR

Figure 18-3. AS-505 Flight - Vanguard Ship Station

STRENGTH (dBm)



TIME IN SECONDS-MEASUREMENT NO. CPS-LH

FOURTH FRAME 2

Ship Station

PREDICTED VS. ACTUAL SIGNA

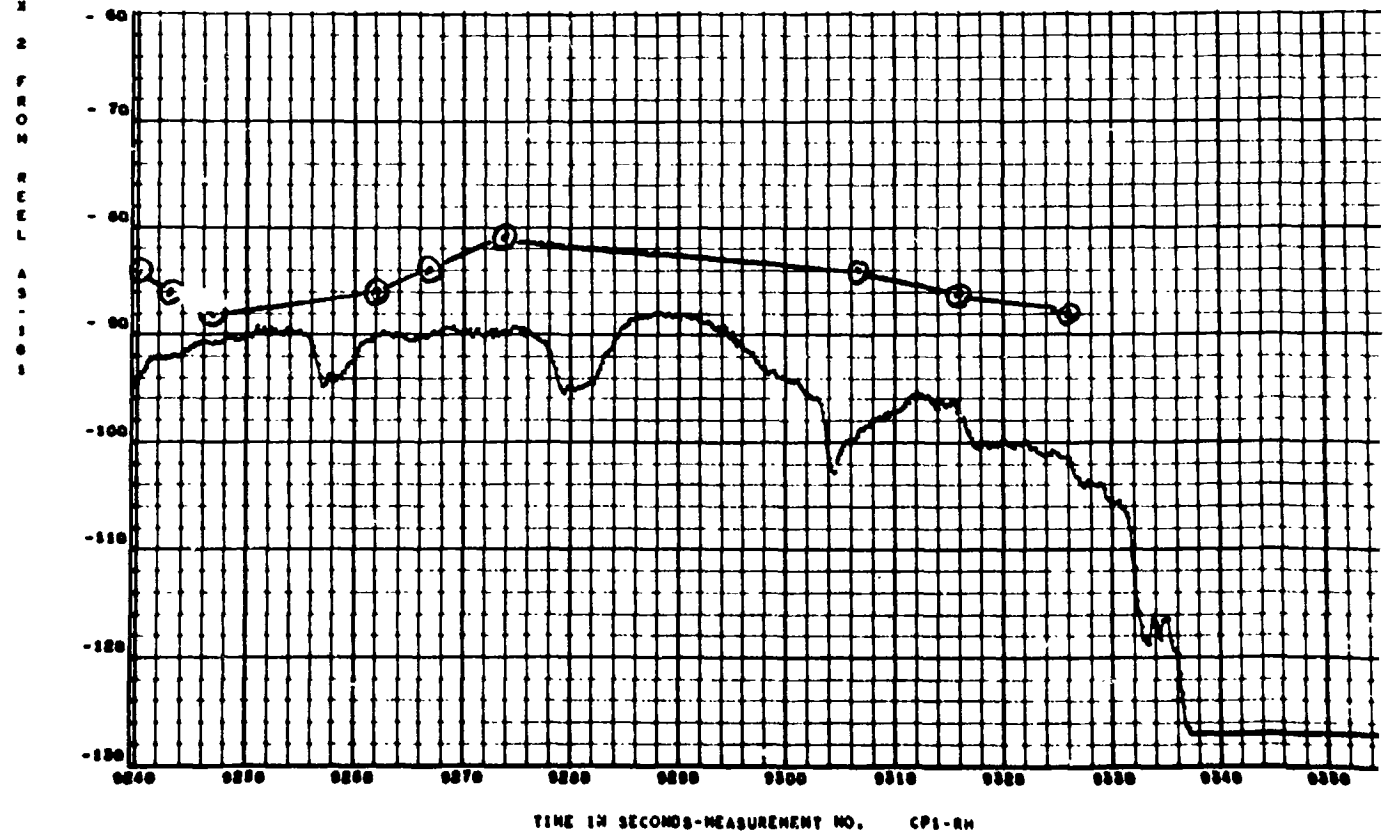
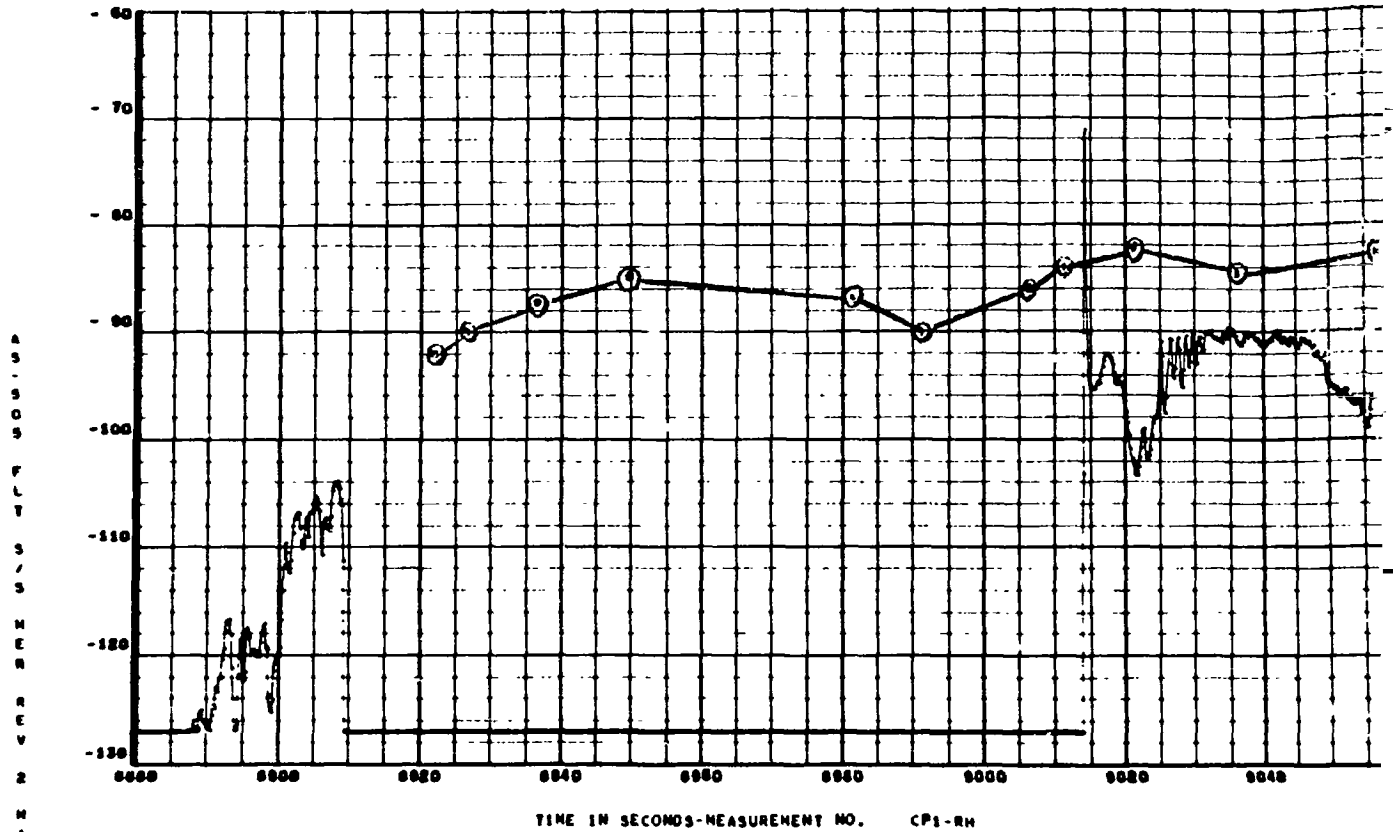

FOLDOUT FRAME \

Figure 18-4. AS-505 Flight - Mercury

ACTUAL SIGNAL STRENGTH (dBm)

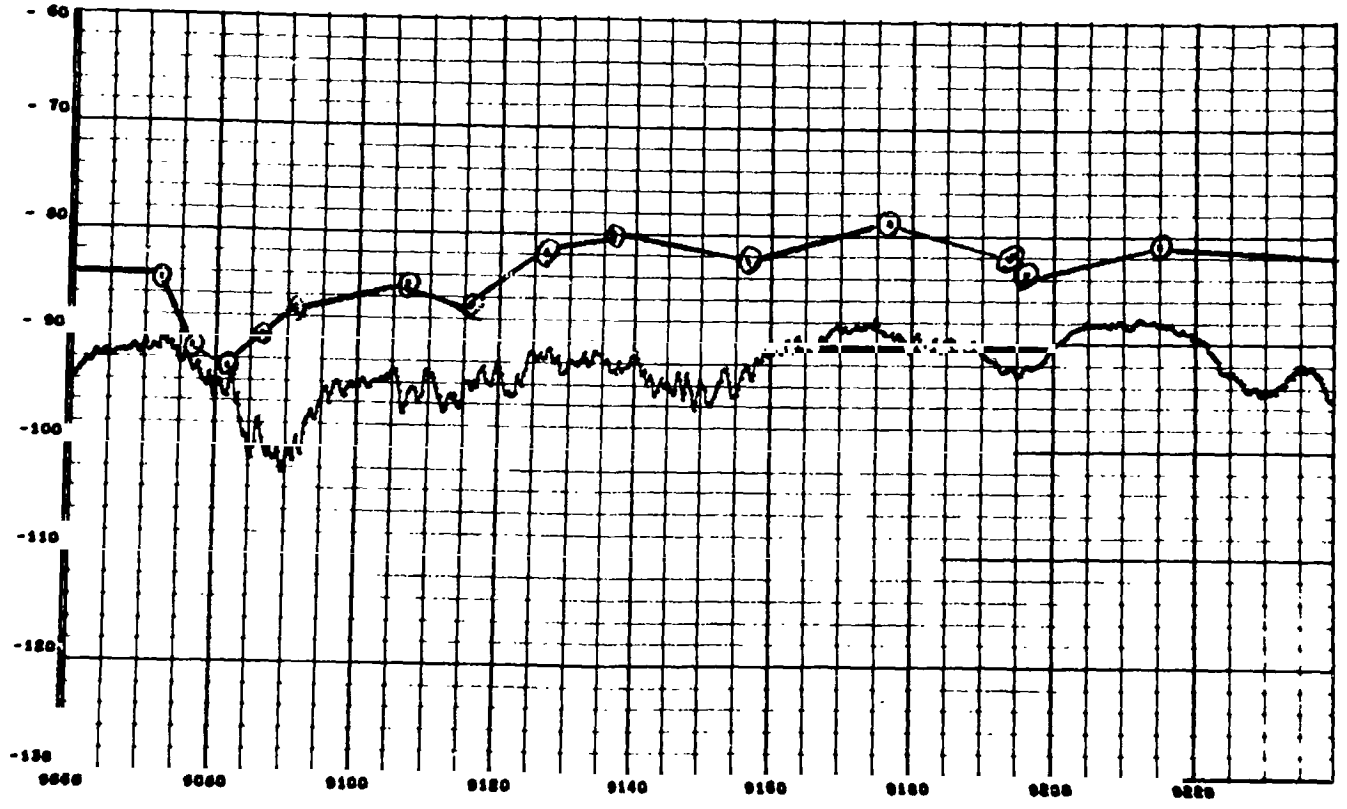
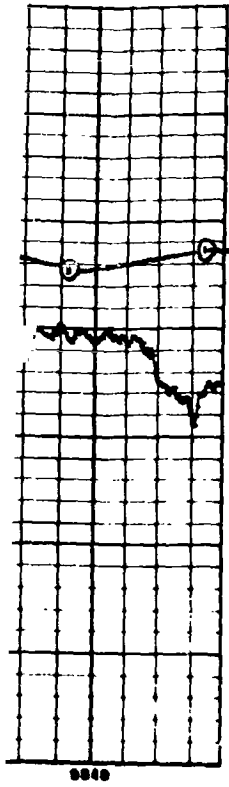

TIME IN SECONDS-MEASUREMENT NO. CPS-RH

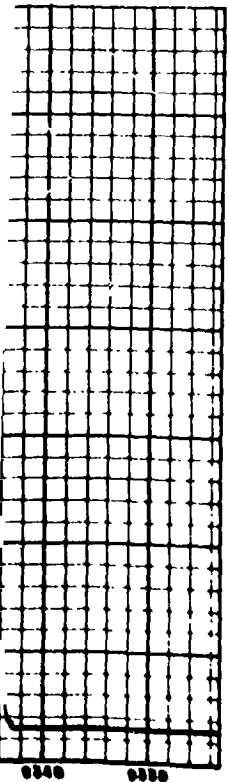

PREDICTED VS. ACTUAL SIGNAL STRENGTH (dBm)

AS-505
 FLTS/S
 MER
 REV
 2
 NIK
 I
 FROM
 AS-227

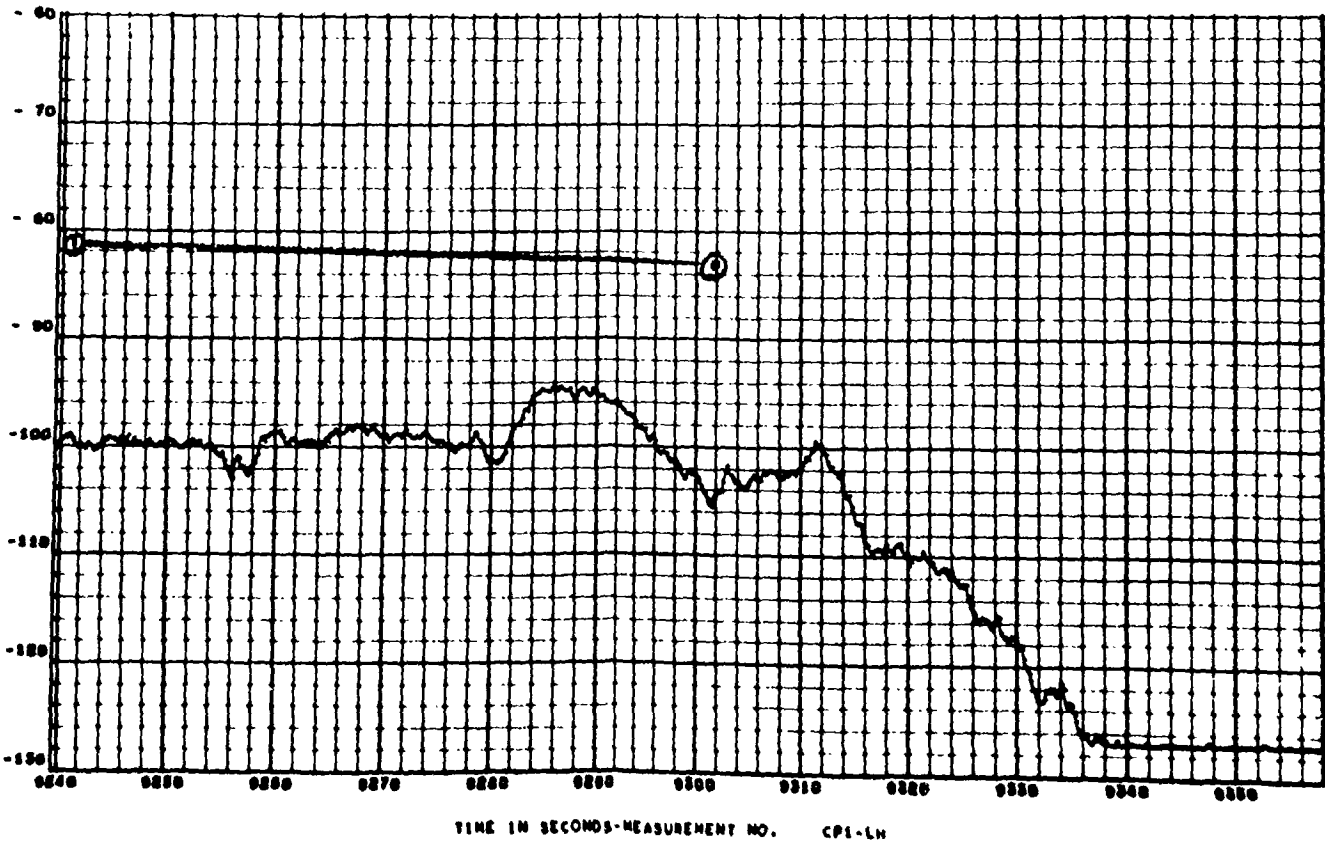
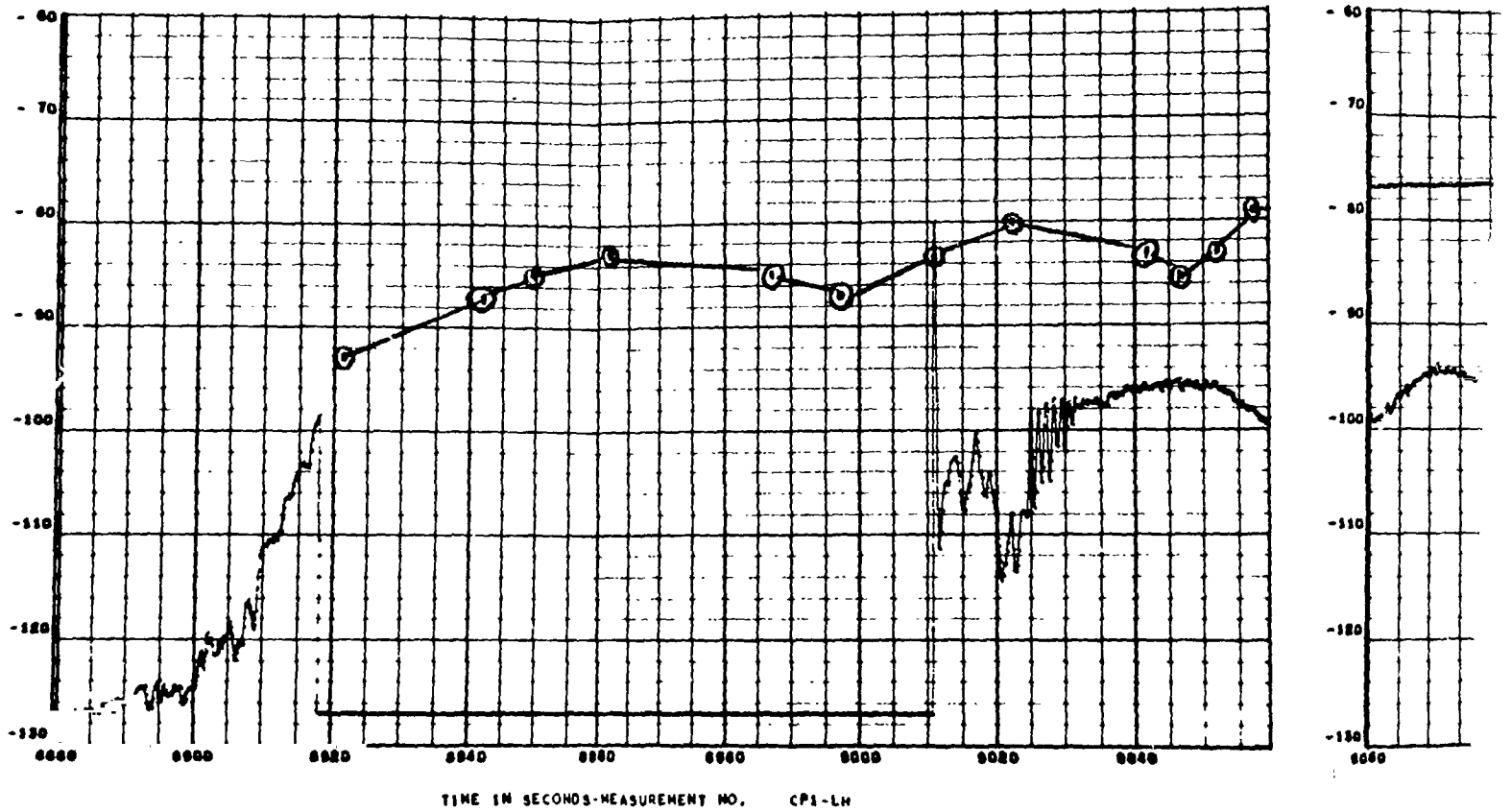

L SIGNAL STRENGTH (dBm)

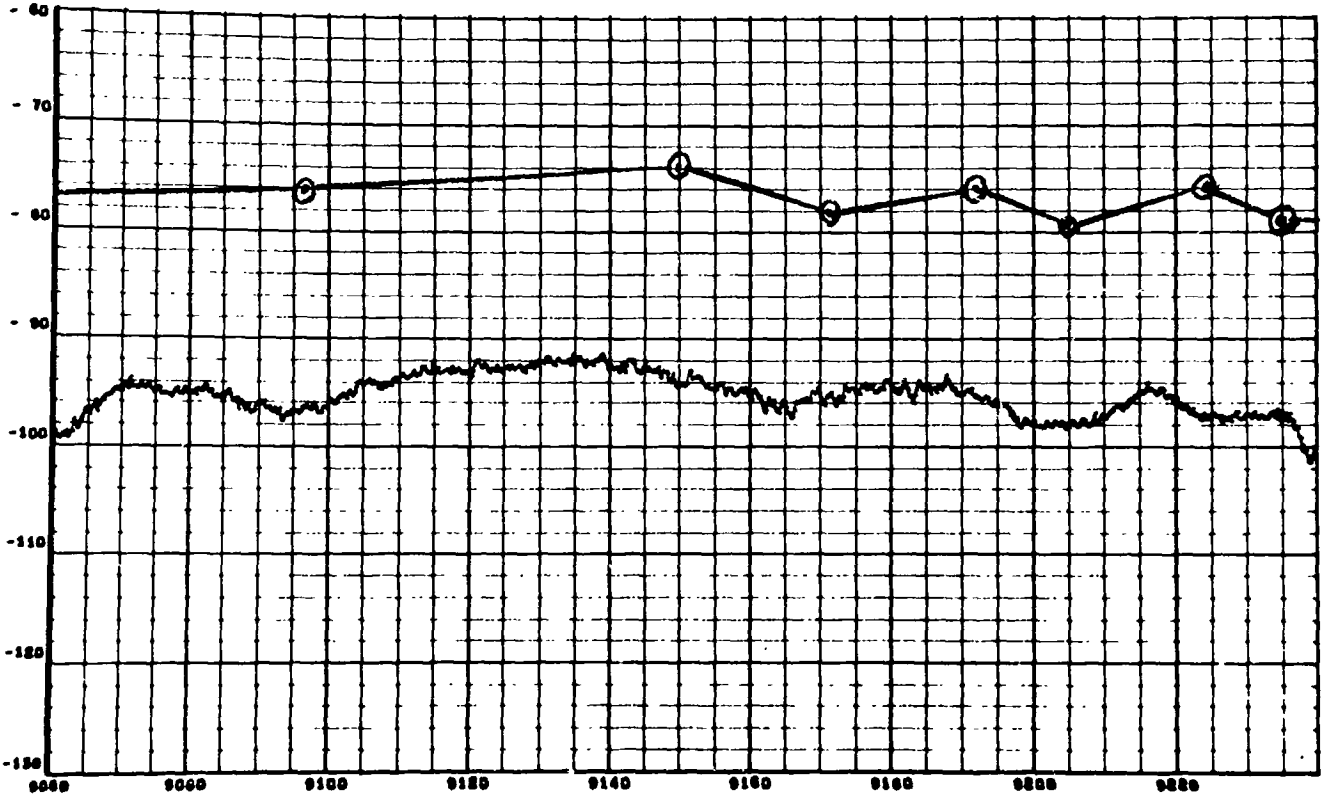
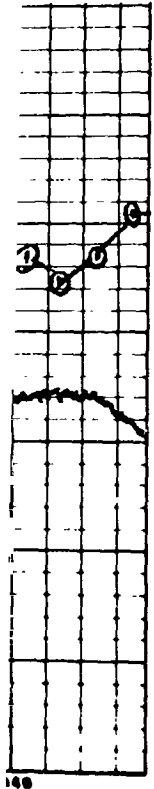

TIME IN SECONDS-MEASUREMENT NO. CP1-LH

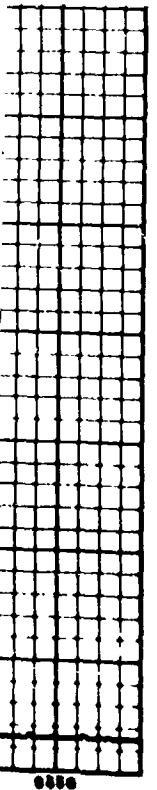

FOLDOUT FRAME 2

19. ELECTRICAL POWER AND CONTROL SYSTEM

19.1 Power System

The electrical power system performed satisfactorily throughout the S-IVB mission, up to and including passivation.

19.1.1 Flight Batteries

All batteries performed within the expected limits as verified from the load profiles and temperature data shown in figures 19-1 to 19-4.

The predicted usage, projected out to 6 1/2 hr (RO +23,400 sec), and the actual usage of the batteries to when data was lost at 10 hr 52 min (RO +39,120 sec) is as follows:

	<u>Predicted Usage (max)</u>	<u>Preflight Usage</u>	<u>Total Actual Usage (10 hr 52 min)</u>
Fwd No. 1	177.23 A/H	14.30 A/H	230.70 A/H
Fwd No. 2	24.10 A/H	1.28 A/H	32.23* A/H
Aft No. 1	104.62 A/H	28.76 A/H	113.98 A/H
Aft No. 2	45.92 A/H	7.27 A/H	39.72 A/H

*Fwd battery No. 2 voltage output fell below its minimum operating limits of 24.5 volts (depletion) at 7 hr 30 min (RO +27,000 sec).

19.1.2 PU Static Inverter Converter

The PU static inverter converter operated within the design limits during the boost and restart flight evaluation periods.

Voltage and frequency levels during the flight are given below:

MEASUREMENT	ACCEPTABLE RANGE	ACTUAL VALUES			
		FIRST BURN		SECOND BURN	
		MIN	MAX	MIN	MAX
M0001-411 Volt - PU Inv Conv	115 \pm 3.45 vrms	114.7	114.8	114.7	115.2
M0004-411 Volt - PU Inv Conv 5 vdc	4.9 \pm 0.2 vdc	4.86	4.93	4.80	4.89
M0012-411 Freq - PU Inv Conv	400 \pm 6 Hz	402.6	403.3	403.5	404
M0023-411 Volt -	21.0 \pm 1.5 -1.0 vdc	21.87	21.89	21.95	22.00

19.1.3 Chiltdown Inverters

The LOX and LH2 chiltdown inverters operated as expected during both the boost and restart periods.

Voltage and frequency levels during the flight are given below:

LOX Chiltdown Inverter

MEASUREMENT	ACCEPTABLE RANGE	ACTUAL VALUES			
		FIRST BURN		SECOND BURN	
		MIN	MAX	MIN	MAX
M0027-404 Volt - LOX C/D Inv, Phase A/B	55 \pm 5 vac	53.5	55.9	55.9	56.7
M0040-404 Volt - LOX C/D Inv, Phase A/C	55 \pm 5 vac	53.6	56.5	55.6	56.6
M0029-404 Freq -	400 \pm 4 Hz	401.1	401.3	400.3	401.0

LH2 Chillover Inverter

MEASUREMENT	ACCEPTABLE RANGE	ACTUAL VALUES			
		FIRST BURN		SECOND BURN	
		MIN	MAX	MIN	MAX
M0026-404 Volt - LH2 C/D Inv, Phase A/B	55 \pm 5 vac	54.0	56.5	55.6	56.4
M0041-404 Volt - LH2 C/D Inv, Phase A/C	55 \pm 5 vac	53.6	56.3	55.5	56.5
M0028-404 Freq - LH2 C/D Inv	400 \pm 4 Hz	400.0	402.0	401.3	401.9

19.1.4 5 Volt Excitation Modules

The 5 volt excitation modules operated within the design limits during all phases of the mission.

Voltage and frequency levels during flight are given below:

MEASUREMENT	ACCEPTABLE RANGE	ACTUAL VALUES			
		FIRST BURN		SECOND BURN	
		MIN	MAX	MIN	MAX
M0024-411 Volt - 5 Volt Excit Mod, Fwd	5 \pm 0.030 vdc	5.00	5.00	5.01	5.01
M0043-411 Freq - 5 Volt Excit Mod, Fwd	2,000 \pm 200 Hz	2,000	2,005	1,985	2,000
M0068-411 Volt - 5 Volt Excit Mod, Fwd 2	5 \pm 0.030 vdc	4.985	4.996	4.995	4.999
M0025-404 Volt - 5 Volt Excit Mod, Aft	5 \pm 0.030 vdc	5.01	5.01	4.997	5.005
M0042-404 Freq - 5 Volt Excit Mod, Aft	2,000 \pm 200 Hz	1,989	1,995	2,000	1,995

19.2 Electrical Control System

The sequence of events, which is a part of section 4 of the Flight Evaluation Report input, details the times of occurrence for significant events during the S-IVB-505 flight. Discrete and analog data which are responses to the switch selector commands sent to the stage are furnished in this sequence, and this data was used to evaluate the operational integrity of the electrical control system.

19.2.1 J-2 Engine Control System

The data verified that the engine control system responded properly to the start and cutoff commands sent for first and second burn.

First Burn Engine Start Command (ESC) was sent at RO +553.595 sec, and Engine Cutoff Command (ECC) was sent at RO +703.761 sec. The resultant burn time was 150.166 sec. The respective times for second burn were:

ESC: RO +9,199.203 sec

ECC: RO +9,550.570 sec

Total Burn Time: 351.367 sec

19.2.2 Stage Control Pressure Switches

Evaluation of the event and pressure measurements associated with the stage pressure switches verified that, from an electrical control standpoint, they operated as expected during the flight.

Data evaluation indicates that the stage control valves operated normally throughout the flight. It was noted that the LH₂ Tank NPV valve talkback showed a period of cycling near the end of second burn. This anomaly has been noted by the appropriate technology (Propulsion), and it is described in section 12.2.2.

19.2.4 Auxiliary Propulsion System (APS)

An evaluation of the event measurements on the engine feed valves verified that the stage electrical control system operated as expected to send commands to these valves.

	<u>"ON" Value</u>
K0132-404 Event - APS Eng 1-1/1-3 Feed Valves Open	3.8 vdc
K0133-404 Event - APS Eng 1-2 Feed Valves Open	3.8 vdc
K0134-404 Event - APS Eng 2-1/2-3 Feed Valves Open	3.8 vdc
K0135-404 Event - APS Eng 2-2 Feed Valves Open	3.8 vdc

19.2.5 Separation Exploding Bridgewire (Ullage Rocket EBW) System

The measurements listed below verified the operational integrity of the stage electrical control system in providing the commands necessary to charge, fire, and jettison the ullage rockets.

	<u>Specified*</u> <u>Min Value</u>	<u>Actual</u> <u>Value</u>
M0064-404 Volts - Ullage Rocket Ign, EBW F/U 1	3.9 vdc	4.3 vdc
M0065-404 Volts - Ullage Rocket Ign, EBW F/U 2	3.9 vdc	4.25 vdc
M0066-404 Volts - Ullage Rocket Jett, EBW F/U 1	3.9 vdc	4.2 vdc
M0067-404 Volts - Ullage Rocket Jett, EBW F/U 2	3.9 vdc	4.3 vdc

*The specified minimum value necessary to ignite an EBW detonator.

19.2.6 O₂-H₂ Burner

The stage electrical control system functioned properly to send commands to the burner and to provide power for the operation of the burner. This was verified by the fact that the O₂-H₂ burner was successfully used to repressurize the stage for second burn.

19.2.7 Passivation System

The requirements for propellant dumping and stage safing in the terminal phase of the mission involved maintaining electrical control over various S-IVB stage and J-2 engine valves. Evaluation of the various pressure measurements associated with the passivation system verified that the stage and engine valves operated as expected. Therefore, passivation of the cold helium spheres, the ambient helium repressurization spheres, the S-IVB stage pneumatic control helium sphere, the engine start tank, and the engine control helium sphere was accomplished.

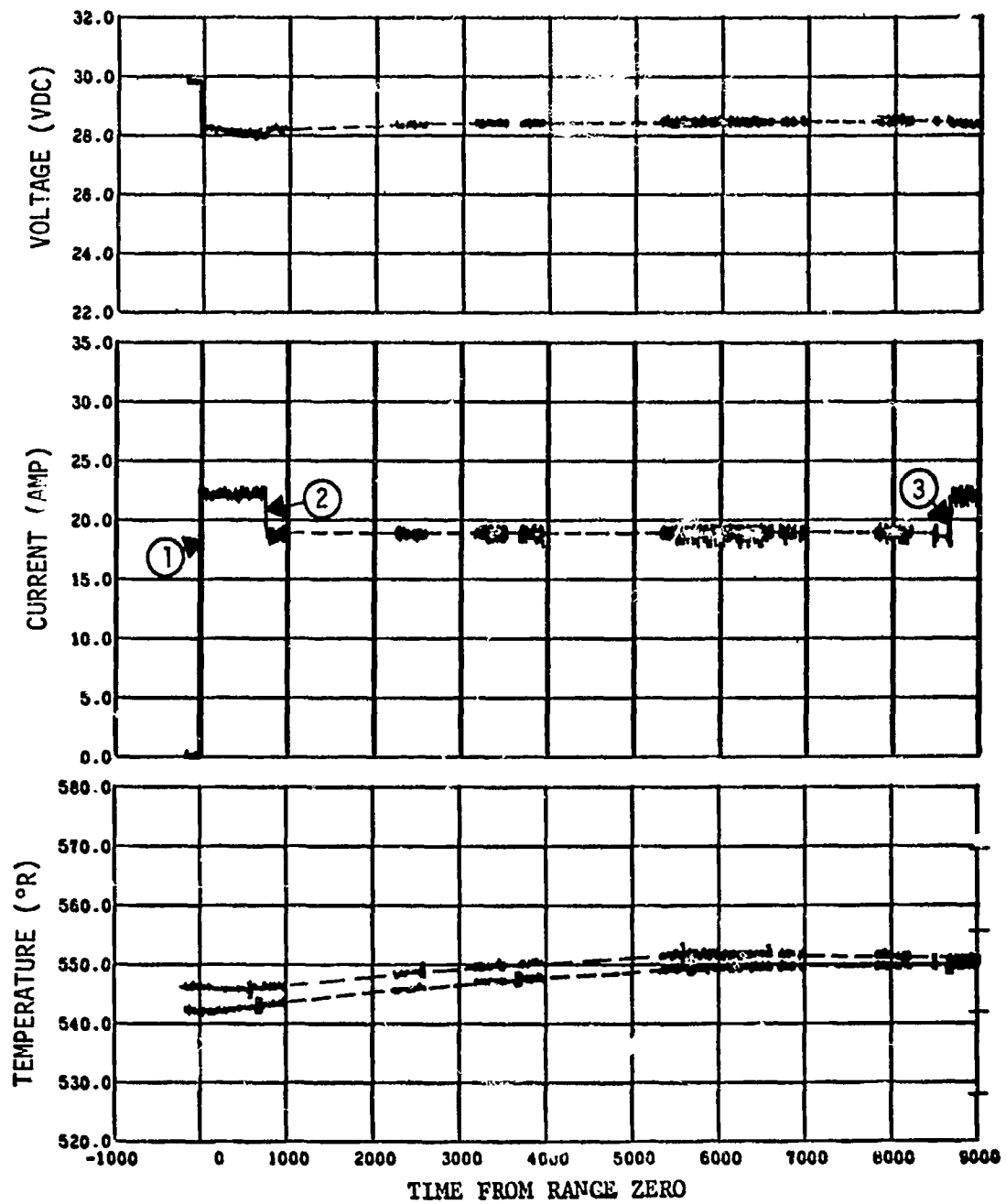

- ① - TRANSFER TO INTERNAL
- ② - SSB/FM XMTR OFF
- ③ - SSB/FM XMTR ON
- EXPECTED VALUE DURING PERIODS OF NO COVERAGE

Figure 19-1. Fwd Battery No. 1 (Sheet 1 of 3)

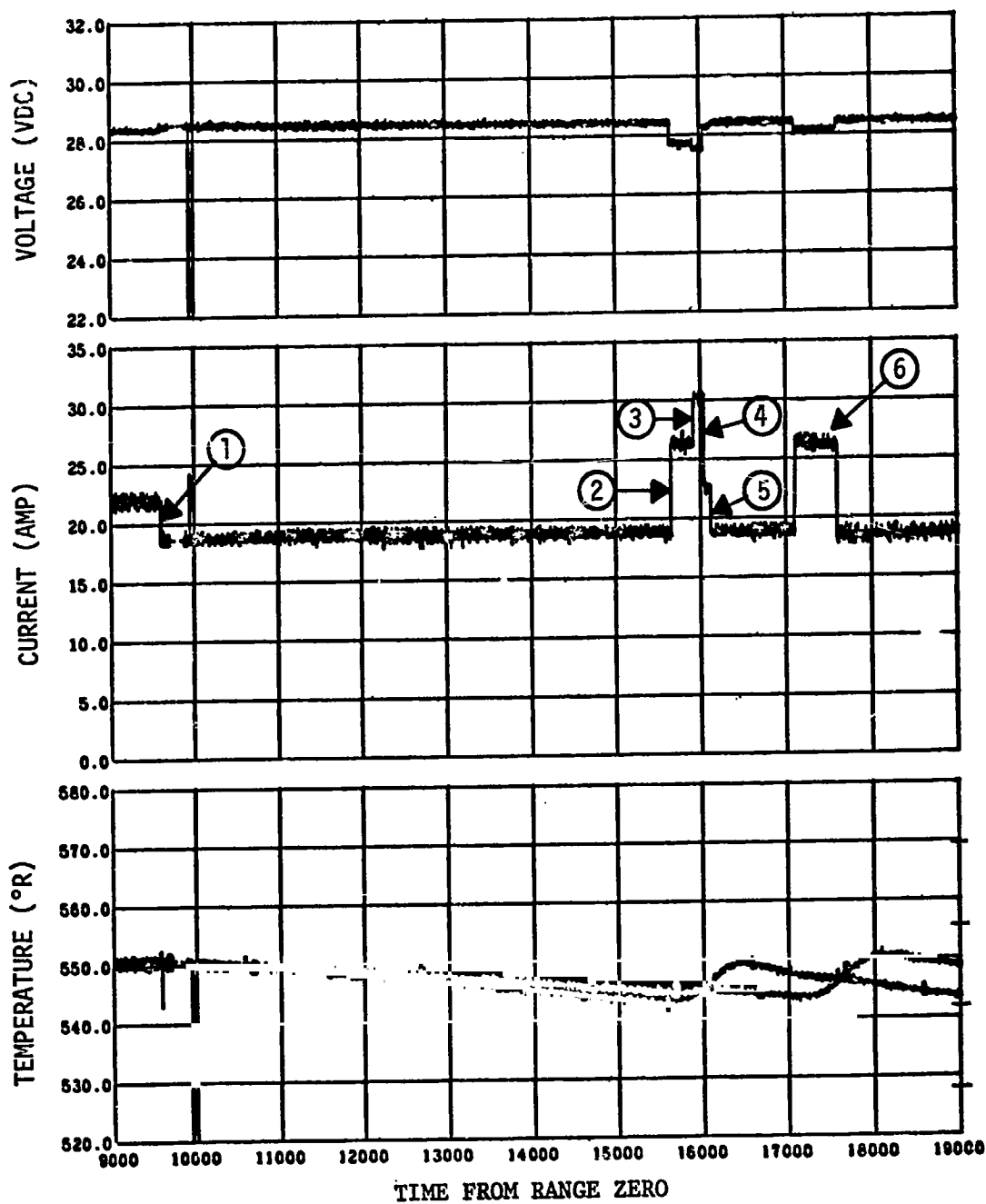

- ① - SSB/FM XMTR OFF
- ② - FWD BATT 1 HEATER CYCLE (UNIT 1) ON
- ③ - FWD BATT 2 HEATER CYCLE ON
- ④ - FWD BATT 1 HEATER CYCLE (UNIT 1) OFF
- ⑤ - FWD BATT 2 HEATER CYCLE OFF
- ⑥ - FWD BATT 1 (UNIT 2) HEATER CYCLE
- EXPECTED VALUE DURING PERIODS OF NO COVERAGE

Figure 19-1. Fwd Battery No. 1 (Sheet 2 of 3)

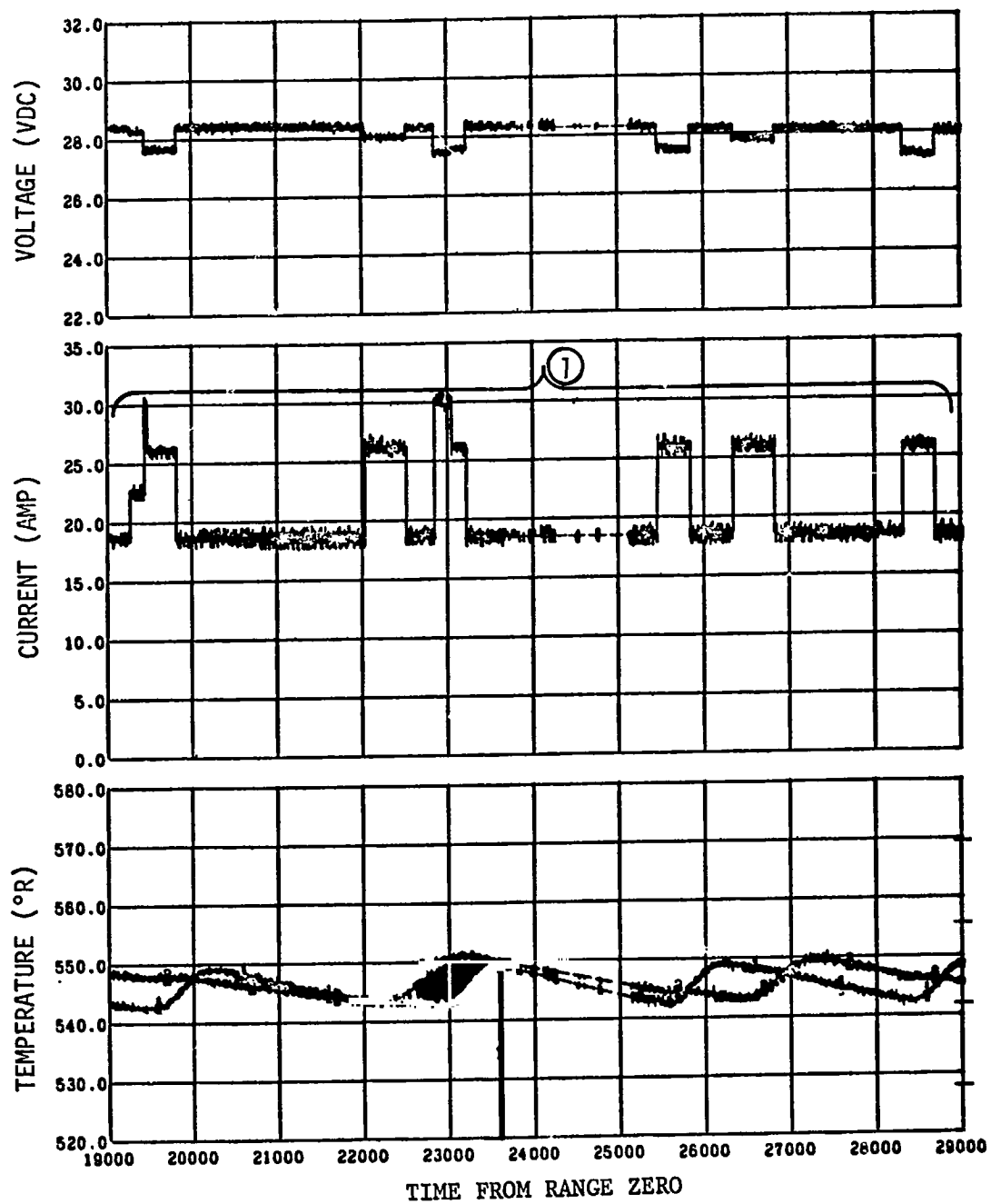

① - HEATER CYCLING
 ---- EXPECTED VALUE DURING PERIODS OF NO COVERAGE

Figure 19-1. Fwd Battery No. 1 (Sheet 3 of 3)

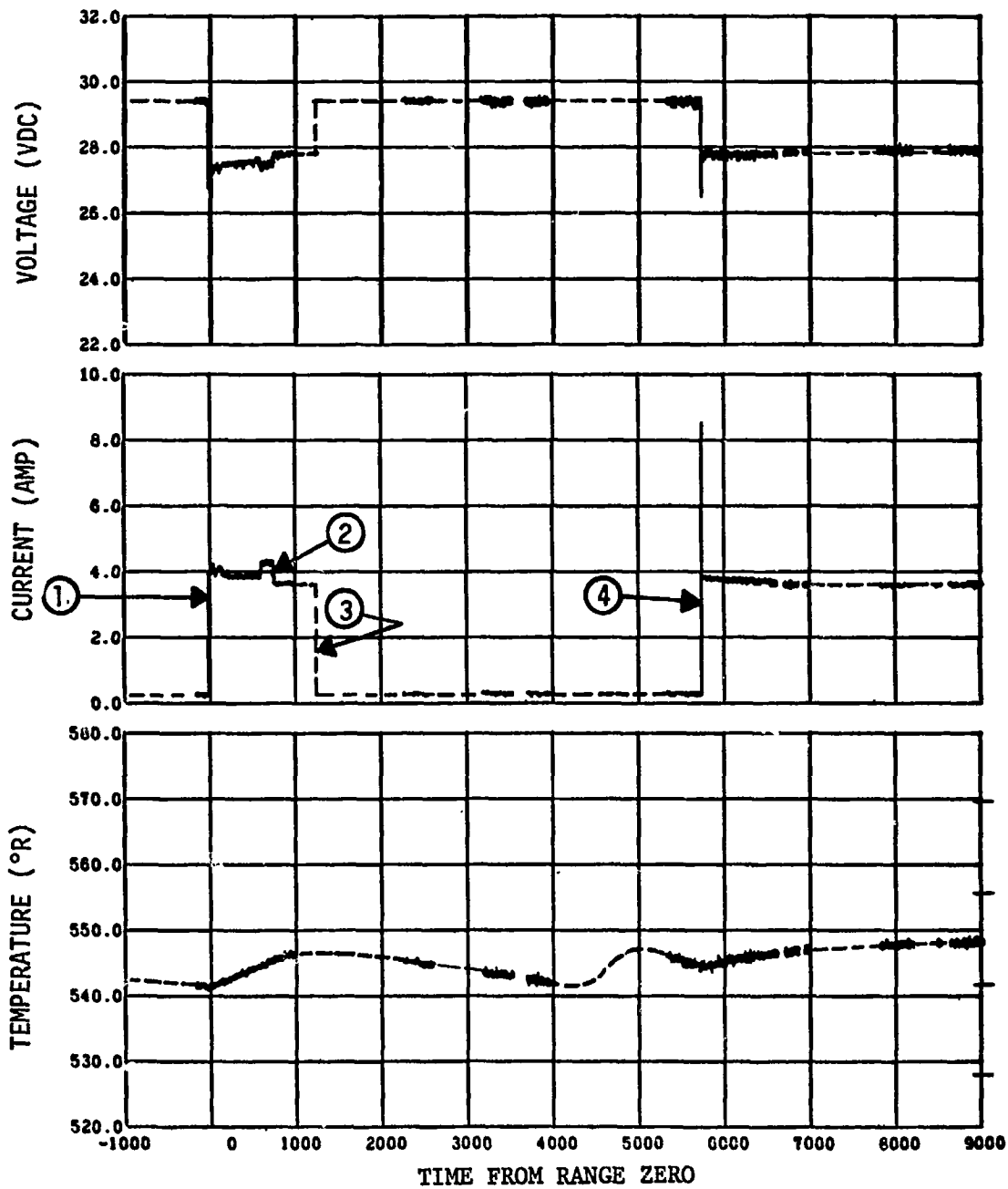

- ① - TRANSFER TO INTERNAL POWER
- ② - RANGE SAFETY SYSTEM NO. 2 OFF
- ③ - PU INVERTER AND DC POWER OFF
- ④ - PU INVERTER AND DC POWER ON
- EXPECTED VALUE DURING PERIODS OF NO COVERAGE

Figure 19-2. Fwd Battery No. 2 (Sheet 1 of 3)

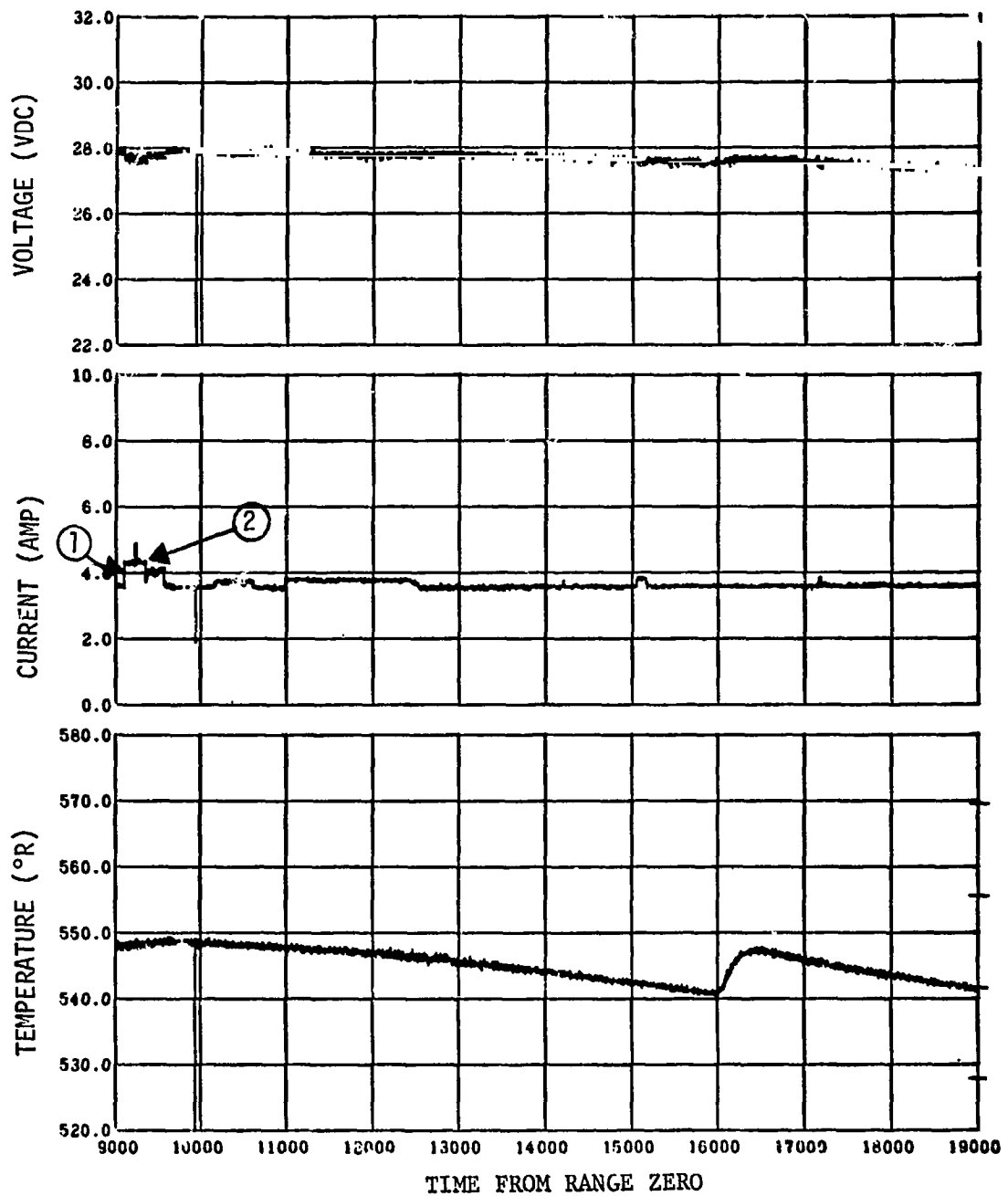

- ① - PU VALVE HARDOVER POSITION ON
- ② - PU VALVE HARDOVER POSITION OFF
- EXPECTED VALUE DURING PERIODS OF NO COVERAGE

Figure 19-2. Fwd Battery No. 2 (Sheet 2 of 3)

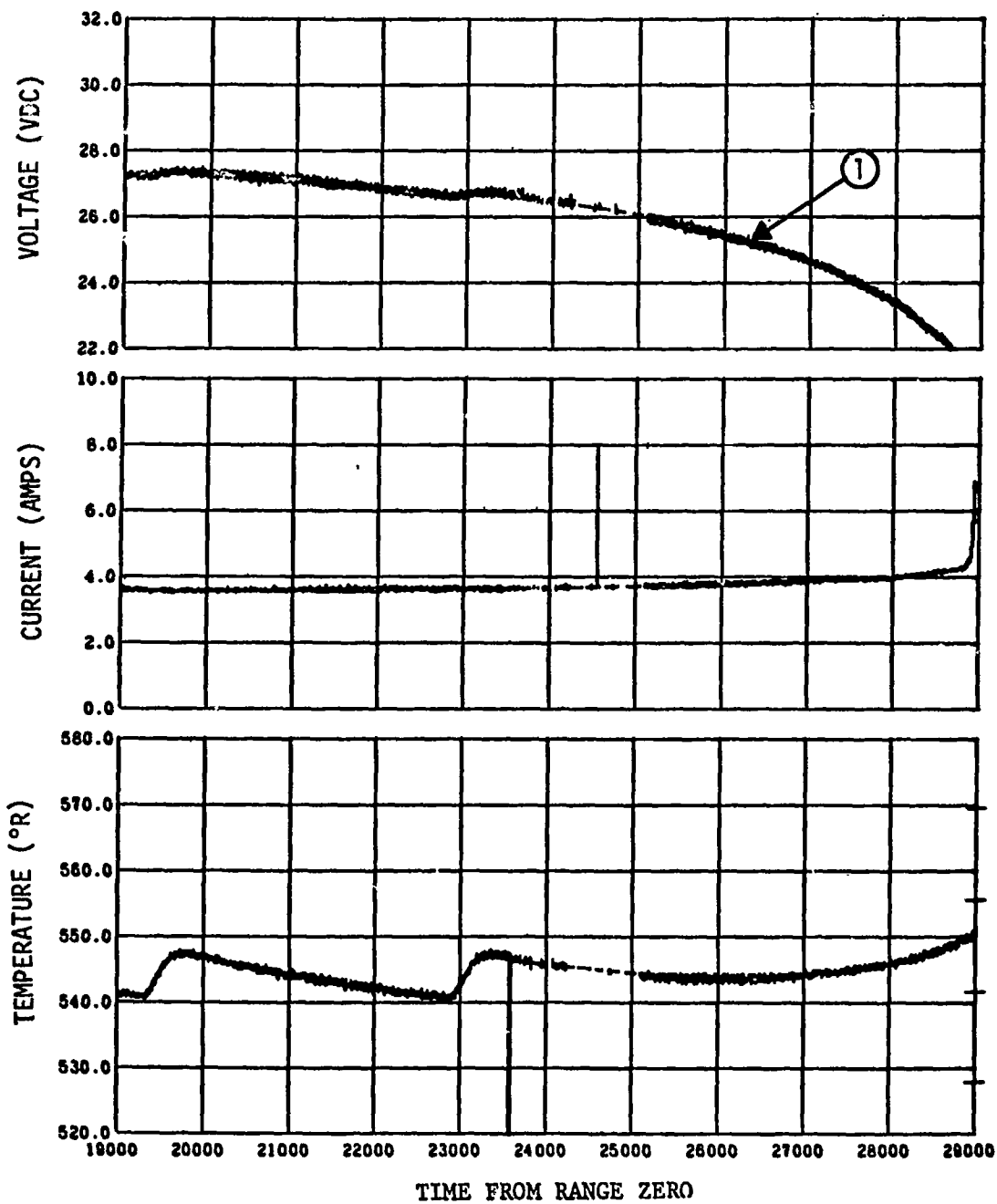

① - FORWARD BATTERY NO. 2 DEPLETION
 - - - - - EXPECTED VALUE DURING PERIODS OF NO COVERAGE

Figure 19-2. Fwd Battery No. 2 (Sheet 3 of 3)

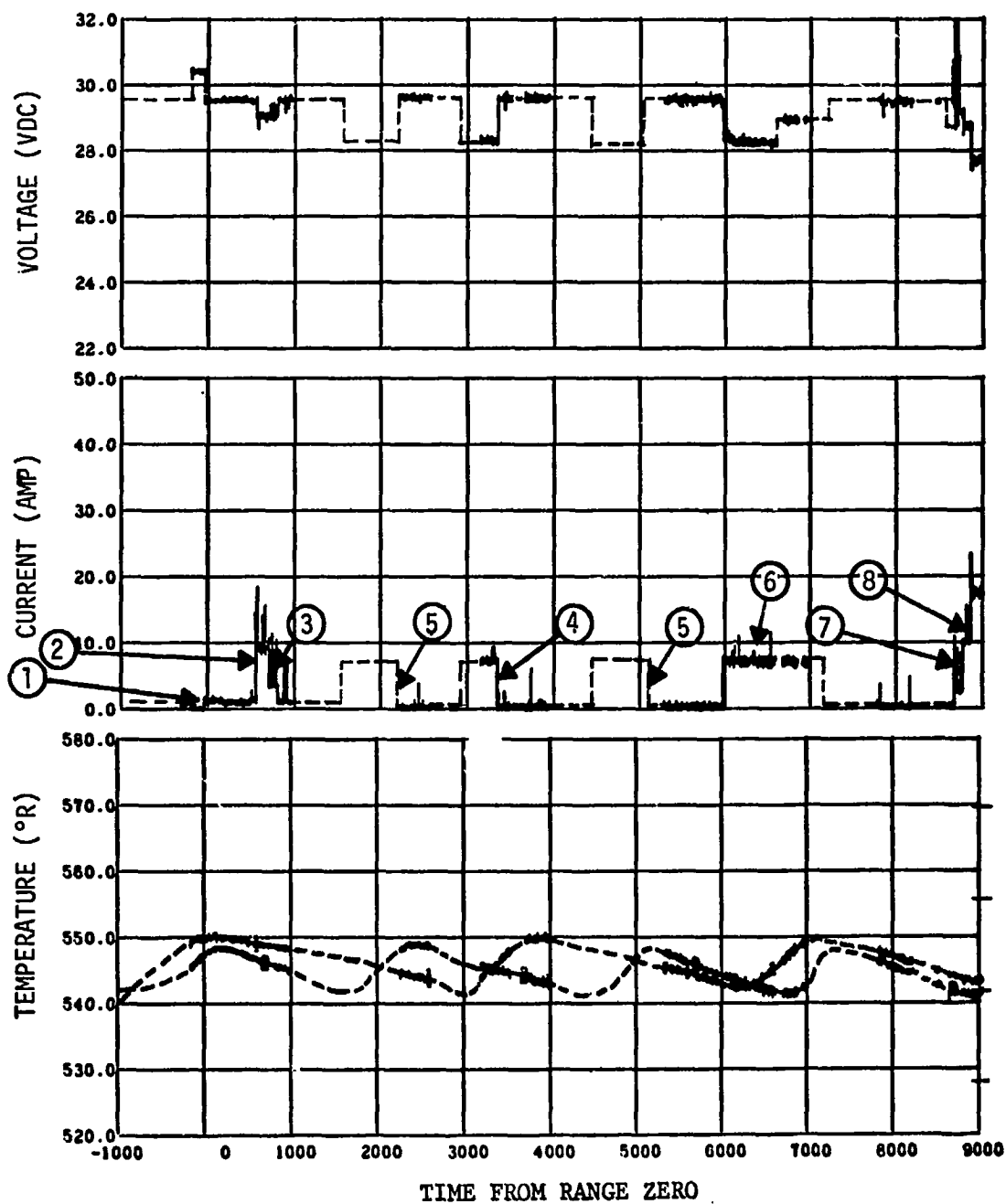

- ① - TRANSFER TO INTERNAL
- ② - ENGINE START
- ③ - ENGINE CUTOFF
- ④ - AFT BATT NO. 1 UNIT 1 HEATER CYCLE
- ⑤ - AFT BATT NO. 1 UNIT 2 HEATER CYCLE
- ⑥ - HEATER CYCLING
- ⑦ - BURNER REPRESS
- ⑧ - AFT BATT NO. 1 HEATER CYCLE
- EXPECTED VALUE DURING PERIODS OF NO COVERAGE

Figure 19-3. Aft Battery No. 1 (Sheet 1 of 3)

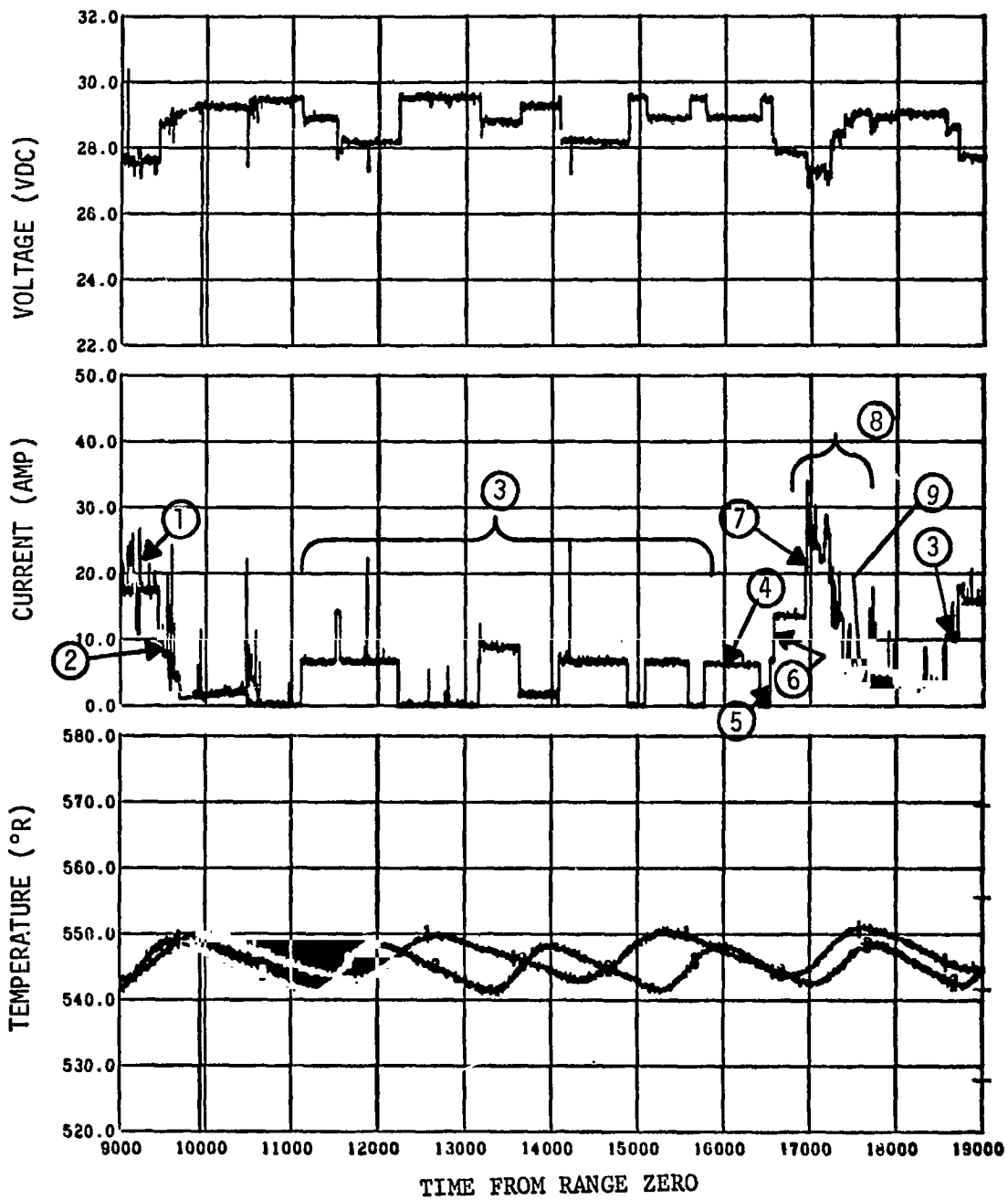

- | | |
|------------------------------------|---|
| ① - ENGINE START ON | ⑥ - AFT BATT 1 UNIT 2 HEATER CYCLE |
| ② - ENGINE CUTOFF | ⑦ - AFT BATT 2 UNIT 1 HEATER CYCLE |
| ③ - AFT BATT 1 HEATER CYCLING | ⑧ - FUEL LEAD EXPERIMENT |
| ④ - AFT BATT 2 UNIT 2 HEATER CYCLE | ⑨ - START OF PASSIVATION |
| ⑤ - AFT BATT 1 UNIT 1 HEATER CYCLE | ---- EXPECTED VALUE DURING PERIODS OF NO COVERAGE |

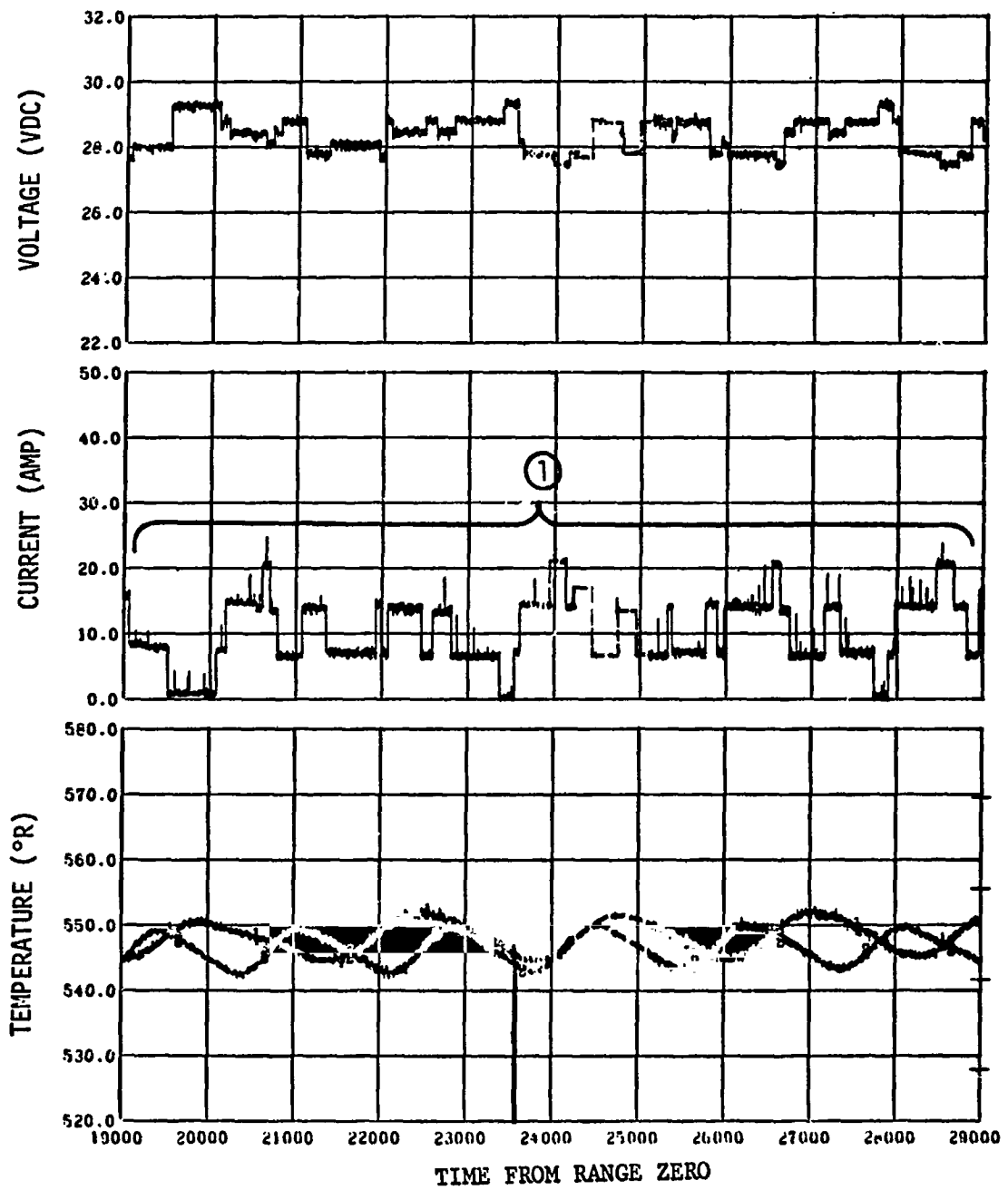

① - AFT BATT 1 AND 2 HEATER CYCLING
 --- EXPECTED VALUE DURING PERIODS OF NO COVERAGE

Figure 19-3. Aft Battery No. 1 (Sheet 3 of 3)

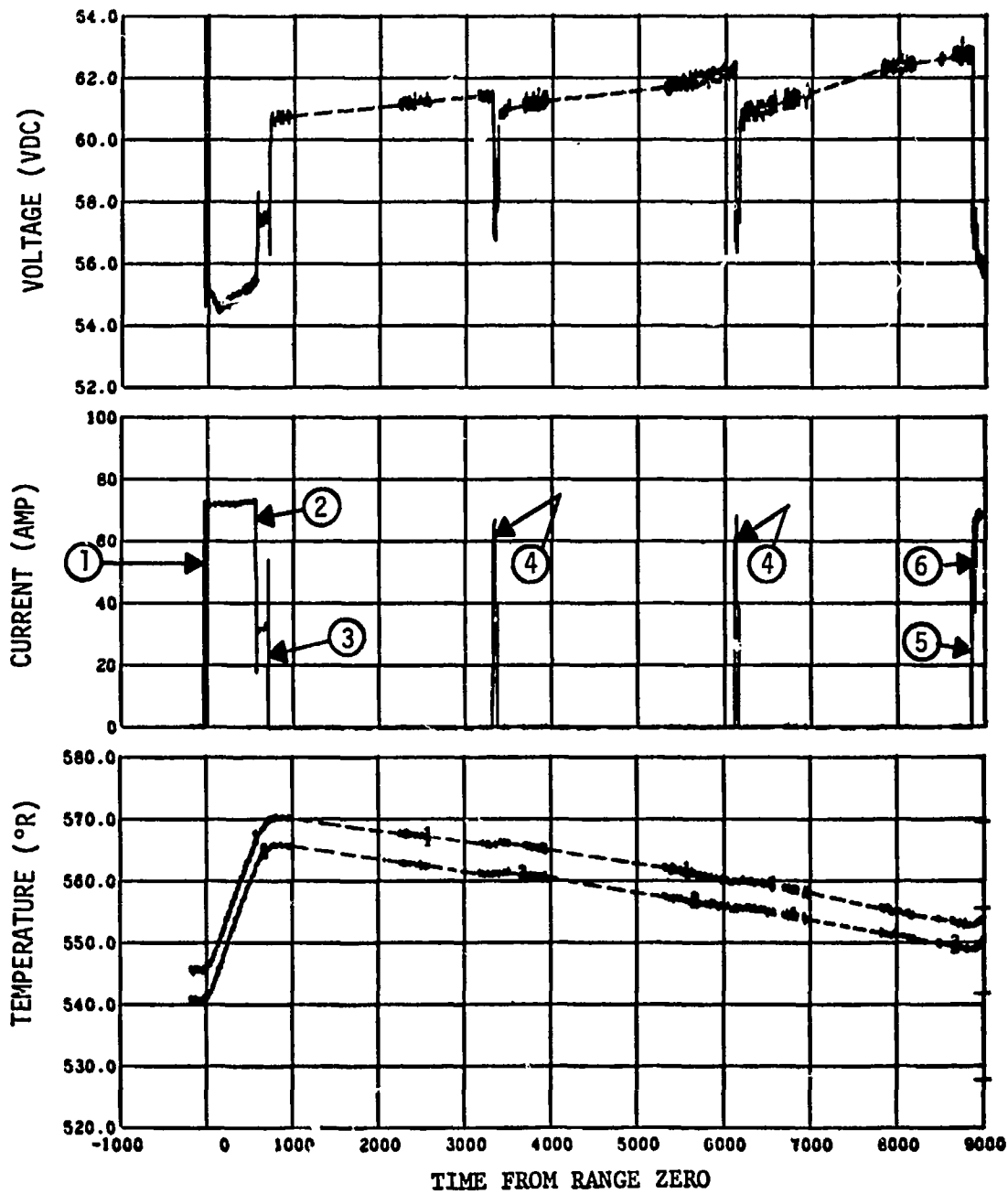

- ① - TRANSFER TO INTERNAL
- ② - LOX AND LH2 CHILLDOWN PUMPS OFF
- ③ - AUXILIARY HYDRAULIC PUMP OFF
- ④ - AUXILIARY HYDRAULIC PUMP CYCLE
- ⑤ - AUXILIARY HYDRAULIC PUMP ON
- ⑥ - LOX AND LH2 CHILLDOWN PUMPS ON
- EXPECTED VALUE DURING PERIODS OF NO COVERAGE

Figure 19-4. Aft Battery No. 2 (Sheet 1 of 3)

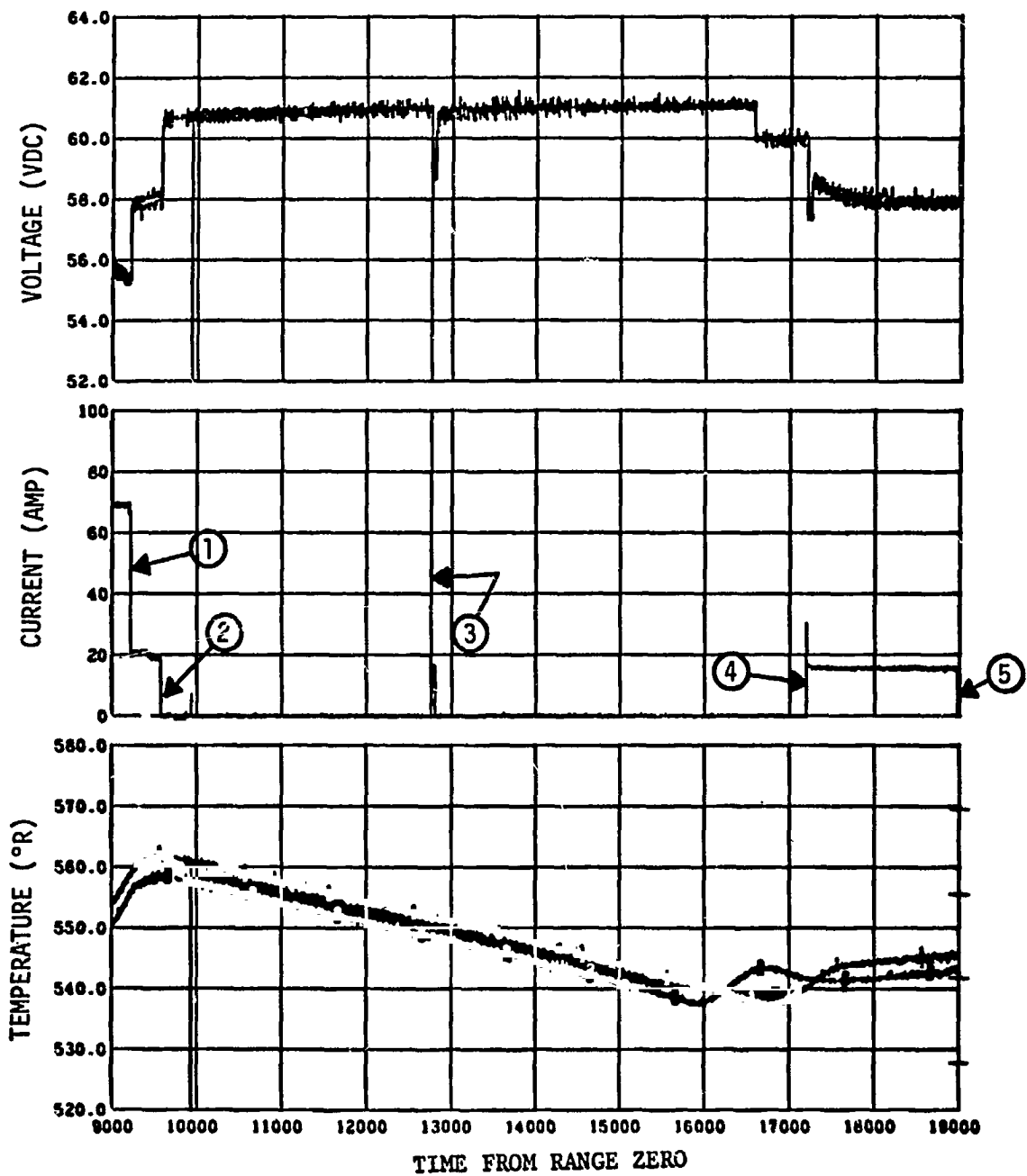

- ① - LOX AND LH2 CHILLDOWN PUMPS OFF
- ② - AUXILIARY HYDRAULIC PUMP OFF
- ③ - AUXILIARY HYDRAULIC PUMP CICLE
- ④ - AUXILIARY HYDRAULIC PUMP ON
- ⑤ - AUXILIARY HYDRAULIC PUMP OFF
- EXPECTED VALUE DURING PERIODS OF NO COVERAGE

Figure 19-4. Aft Battery No. 2 (Sheet 2 of 3)

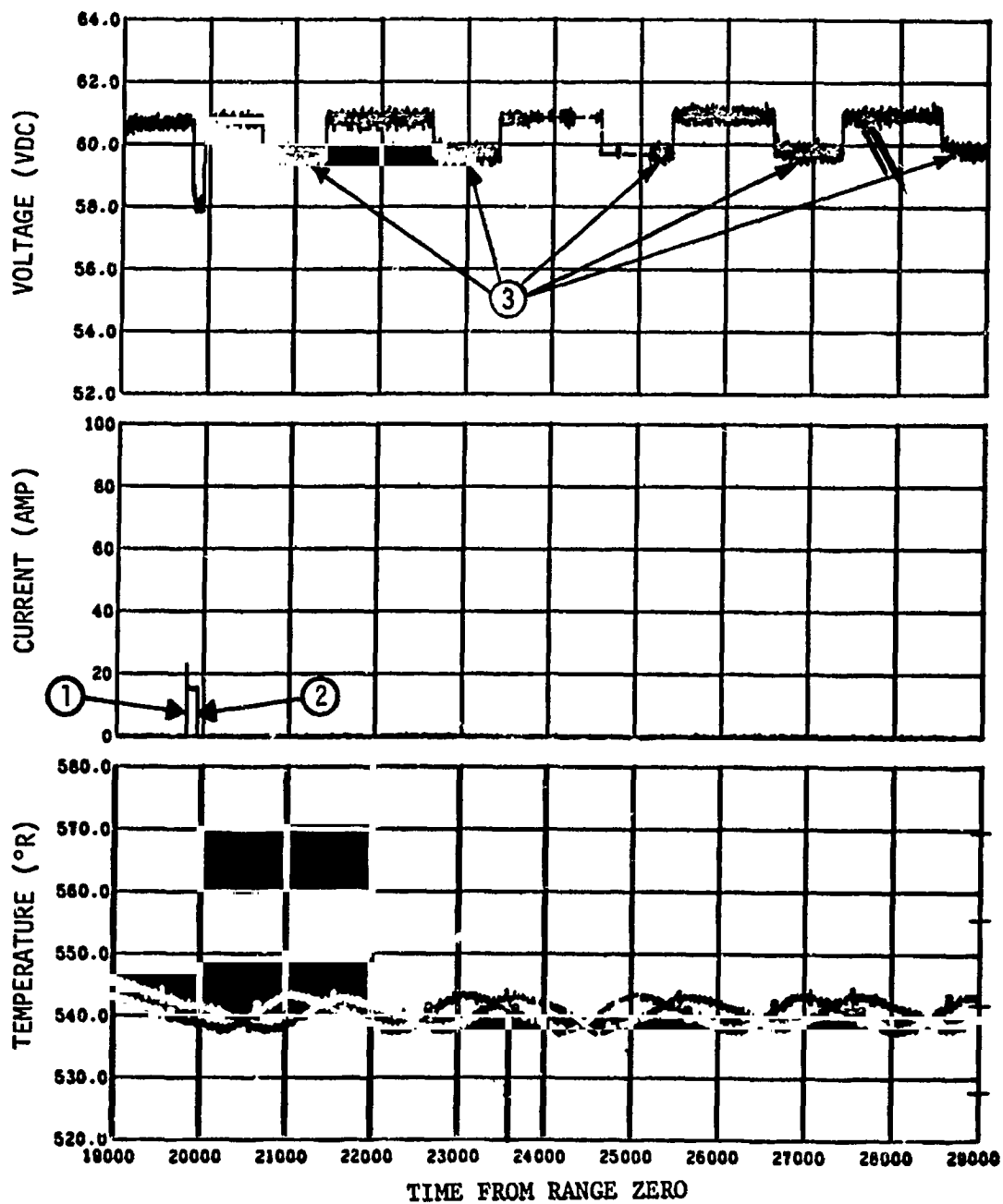

- ① - AUXILIARY HYDRAULIC PUMP ON
- ② - AUXILIARY HYDRAULIC PUMP OFF
- ③ - EFFECT OF AFT 2 UNIT 1 HEATER CYCLE ON VOLTAGE MEASUREMENT
- EXPECTED VALUE DURING PERIODS OF NO COVERAGE

Figure 19-4. Aft Battery No. 2 (Sheet 3 of 3)

20. RANGE SAFETY SYSTEM PERFORMANCE

The Range Safety System was not required for propellant dispersion during the flight. All indications are that it operated properly and would have satisfactorily terminated an abnormal flight.

20.1 Controllers

The controllers are designed to distribute command signals for engine cutoff, exploding bridgewire (EBW) charge and fire, and to distribute power to the range safety components. No abnormal conditions were evident.

20.2 Firing Unit Monitors

The following measurements indicate that the EBW firing units were not charged throughout the flight.

M0030-411 Volt - F/U 1 EBW Range Safety

M0031-411 Volt - F/U 2 EBW Range Safety

20.3 Receivers Signal Strength

An RF carrier was received by the stage until the Range Safety System was safed at $R_0 + 715.3$ seconds. Range Safety Receiver 1 Low Level Signal Strength (N0057-411) was 3.5 volts and Range Safety Receiver 2 Low Level Signal Strength (N0062-411) was 3.6 volts. A momentary signal strength decrease of 0.7 seconds duration was observed on both receivers at $R_0 + 121.2$ seconds. This was due to the range safety control transfer from the omni-directional to a directional antenna.

Several other perturbations were also observed as follows:

- a) One data sample (83 ms) decrease at $R_0 + 148.1$ on both Receivers.
- b) Data dropout for approximately 1 second during SIC/SII separation.
- c) Slight perturbation noticed on both receivers at $R_0 + 195$; possibly due to S-II second plane separation disturbance.

These disturbances were attributed to RF phenomena that are not predictable. At no time, except for the switch-over point and at S-IC/S-II separation, was the range safety system not prepared for flight termination.

During S-IVB burn, no perturbation of signal strengths were observed until range safety "safe" indication.

21. FLIGHT CONTROL

21.1 S-IVB Powered Flight Control System Evaluation

The S-IVB Thrust Vector Control (TVC) System provided satisfactory pitch and yaw control during powered flight. The APS provided satisfactory roll control during first and second burns.

During S-IVB Stage first and second burns, control system transients were experienced at S-II/S-IVB separation, guidance initiation, EMK shift, Chi tilde, and J-2 engine cutoff.

21.1.1 Control System Evaluation During First Burn

The S-IVB first burn attitude control system response to guidance commands for pitch, yaw, and roll are presented in figures 21-1, 21-2, and 21-3, respectively. The significant events related to control system operation are indicated in each figure. The maximum attitude errors and rates occurred at IGM initiation. A summary of the maximum values of critical flight control parameters during first burn is presented in table 21.1. No unexpected variations in any control system parameters were observed during first burn.

The responses of the pitch and yaw control loops indicate that the TVC system provided satisfactory S-IVB Stage control. The initial transients in both planes damped out as expected at the control frequency of 0.1 Hertz.

The effective thrust vector misalignment is defined as the difference between the actuator position and the thrust vector position resulting from actuator tolerances, actuator/engine alignment, thrust eccentricity, thrust misalignment with respect to the engine centerline and electrical biases. The predicted pitch actuator trim angle required to trim the thrust vector through the vehicle total cg during first burn was +0.11 degree (retract), whereas the actual deflection was +0.44 degree (retract). This resulted in an effective pitch thrust vector misalignment of +0.33 degree (retract). The effective yaw thrust vector misalignment was -0.38 degree (retract).

The roll control system operation appeared normal during first burn. Following disturbances resulting from separation and guidance initiation, a one-sided limit cycle operation was observed until S-IVB cutoff. This limit cycle operation resulted from a clockwise (looking forward) steady state roll disturbing torque of approximately 14.1 n-m (10.4 lbf-ft). The steady-state roll disturbing torque experienced on previous flights has ranged from 20 lbf-ft counter-clockwise to 40 lbf-ft clockwise and has generally been attributed to engine exhaust gas swirl.

Propellant slosh heights and frequencies during first burn were obtained from the Propellant Utilization (PU) probe data. The LOX slosh parameters are presented in figure 21-4. LH2 sloshing was negligible and, therefore, LH2 sloshing parameters have been omitted. The LOX slosh frequencies were near the predicted frequencies throughout first burn. Both the frequencies and slosh heights are comparable to those experienced on previous flights. Propellant sloshing did not have any appreciable effect on the response of the control system.

21.1.2 Control System Evaluation During Second Burn

The S-IVB second burn attitude control system response to guidance commands for pitch, yaw, and roll are presented in figures 21-5, 21-6, and 21-7, respectively. The significant events related to control system operation are indicated on each figure. The maximum attitude errors and rates occurred at IGM initiation and EMR shift. A summary of the maximum values of critical flight control parameters during second burn is presented in table 21-2.

The pitch actuator trim position increased 0.14 degrees at EMR shift and decreased 0.12 degrees at Chi tilde. Pitch, yaw, and roll rate measurements indicate a small, high-frequency oscillation from range zero plus 9,480.0 seconds until the end of second burn. These variations from the expected response did not impair the ability of the control system to provide satisfactory control during second burn. The initial transients in each plane damped out as expected at the control frequency of 0.1 Hertz.

Since the pitch actuator exhibited a change in trim position at both EMR shift and at Chi tilde, the effective thrust vector misalignment was evaluated for three distinct periods. The predicted pitch actuator trim angle prior to the EMR shift was +0.14 degree (retract), whereas the actual trim angle was +0.50 degree (retract). This resulted in an effective thrust vector misalignment of +0.36 degree (retract). Similar computations resulted in an effective pitch thrust vector misalignment of +0.41 degree after the EMR shift and +0.32 degree after Chi tilde. The last two values include the effect of a +0.06 degree pitch actuator null shift at 9,320.0 seconds.

The effective yaw thrust vector misalignment was -0.35 degree (retract) prior to EMR shift, -0.35 degree after EMR shift, and -0.41 degree after Chi tilde.

The increase in the pitch actuator trim position (effective misalignment) at the EMR shift is due to a compression of the forward portion of the J-2 engine and the S-IVB thrust structure casting, and a +0.06 degree pitch actuator null shift. The expected actuator deflection due to the compression resulting from a 30,000 lbf thrust increase is 0.12 degree (retract). Expected actuator deflections of this magnitude may not be observed because of the non-linearities between actuator position and engine position. Static friction may result in actuator deflection to engine deflection errors of ± 0.10 degree. The decrease in the pitch actuator trim position and the change in both pitch and yaw actuator effective misalignments at Chi tilde may also be attributed to control system nonlinearities.

The roll control system operation appeared normal during second burn. Following disturbances resulting from restart transients a one-sided limit cycle operation was observed until S-IVB cutoff. The limit cycle resulted from a clockwise (looking forward) steady-state roll disturbing torque of approximately 16.77 n-m (12.36 lbf-ft).

The LOX and LH2 slosh parameters for second burn are presented in figures 21-8 and 21-9, respectively. The LOX slosh frequencies were near the predicted values until the last 80 seconds of the burn. Both the LOX slosh frequencies and heights are comparable to those experienced on previous

flights. The LH2 slosh frequencies were consistently above the predicted values as experienced on previous flights until the last 25 seconds of the burn. The LH2 slosh heights are also comparable to those experienced on previous flights until the last 25 seconds of the burn. The sudden decrease in LH2 slosh frequency and increase in slosh height coincided with the attitude control system transient experienced at Chi tilde and with the LH2 propellant level decreasing below the top of the common bulkhead.

21.2 Attitude Control During Coast

The AACS provided satisfactory orientation and stabilization during the coast periods of flight. Some of the more significant events in the attitude timeline presented in table 21-3 are discussed in the following paragraphs.

Maneuver to Local Horizontal After First S-IVB Burn

Following S-IVB first cutoff, the vehicle was oriented to the local horizontal. The pitch and yaw maneuvers of approximately 6.0 and 0.6 degrees, respectively, were initiated at $R_o + 724.1$ seconds. The APS response shown in figure 21-10 is normal and as expected. The firing pattern is typical for propellant motion disturbances in the main tanks. Figures 21-10, 21-11, and 21-12 show the pitch, yaw, and roll attitude control during the orientation to the local horizontal.

During steady state operation the LH2 continuous vent operation caused APS engines I_p and III_{IV} to respond as expected because of the vehicle CG location.

Orientation to TD&E Attitude

In order to achieve the TD&E attitude, multiple axes maneuvers were initiated at $R_o + 10,450$ seconds. The maneuvers were approximately +120.0, +40.0, and -180.0 degrees in pitch, yaw, and roll, respectively. Figures 21-13, 21-14, and 21-15 show attitude control during the TD&E orientation and the effects of crosscoupling in the different axes. The crosscoupling is a normal and expected phenomena.

Spacecraft Separation

S-IVB/CSM separation was initiated at $R_o +10,962.4$ seconds with minimum disturbances to the S-IVB Stage. Figures 21-16, 21-17, and 21-18 show pitch, yaw, and roll control during spacecraft separation.

Hard Docking

The CSM hard docked to the S-IVB/LM at $R_o +11,855.95$ seconds. Figures 21-19, 21-20, and 21-21 show pitch, yaw, and roll control during the hard docking. The hard docking disturbed the S-IVB sufficiently to cause the APS to respond with non-minimum pulse width firings; however, the disturbance was within the expected range.

LM Extraction

The control system response during and just after LM extraction are presented in figures 21-22, 21-23, and 21-24. Disturbances during LM extraction were greater than was experienced on AS-504 but well within control system capabilities.

Slingshot Maneuver, Propellant Lead Experiment, and LOX Dump

At $R_o +16,935.8$ seconds, TB8 was initiated, and with its initiation the vehicle was maneuvered in pitch, yaw, and roll to achieve the desired slingshot attitude. Figures 21-25, 21-26, and 21-27 show pitch, yaw, and roll control during the maneuver to slingshot attitude.

During the periods of the propellant lead experiment (consisting of APS ullage burn, LOX lead, and LH2 lead) and LOX dump, the control system responded satisfactorily in response to the disturbances experienced. Several disturbances were encountered during this period which caused slightly larger than normal attitude transients. Three transients of interest are briefly discussed in the following paragraphs. Pitch, yaw, and roll control during these periods of interest are shown in figures 21-25, 21-26, and 21-27.

At Ro +17,134 seconds the APS ullage engines were commanded on by Ground Command for a 276 second burn. However, since each engine is commanded on separately, ullage engine No. 1 came on approximately 1.25 seconds before engine No. 2.

During this brief period, a large positive pitch disturbing moment was applied to the vehicle driving it across the attitude error deadband. Before reaching the deadband limit, however, ullage engine No. 2 came on; this caused a small net negative pitch moment (due to cg offset). The negative moment reduced the body rate to zero and returned the vehicle to the -1 degree attitude error limit.

During the fuel (LH2) lead, a similar vehicle response was encountered. A possible explanation is that due to the valve opening at fuel lead initiation there was a thrust vector transient in the pitch axis which settled out under steady state conditions and, due to the valve closing at fuel lead termination, a thrust vector transient was induced in the yaw axis.

The third transient of interest occurs midway through LOX dump at which time the APS responded to a positive pitch moment. The probable reason for this moment is that liquid flow through the engine had ceased and gas flow alone was occurring, causing a shift in thrust vector alignment. Changes in the thrust vector misalignment were experienced on previous missions during the propellant dump phases when liquid flow changed to gas flow.

The thrust vector misalignment during the liquid flow phase of the LOX dump was +0.02 degree and +0.58 degree for pitch and yaw, respectively.

The APS ullage engines came on at Ro +19,735.8 seconds to supply additional change in velocity for slingshot, but was determined to be unnecessary and was terminated by ground command at Ro +19,743.2 seconds.

APS Propellant Requirements

APS propellant consumption was below the predicted mean. The APS section has detailed propellant consumption values for the mission. A helium leak in Module 1 became apparent after five hours which is also discussed in the APS section of this report.

APS impulse requirements for several events (TD&E maneuver, spacecraft separation, docking, and LM extraction) are shown in table 21-4.

TABLE 21-1
 MAXIMUM VALUES OF CRITICAL FLIGHT CONTROL PARAMETERS

AS-505 FIRST BURN

PARAMETERS	S-IVB/S-II SEPARATION AND GUIDANCE INITIATION	CHI TILDE GUIDANCE MODE	J-2 CUTOFF
Pitch Attitude Error (Deg)	+2.02	+0.82	+0.40
Yaw Attitude Error (Deg)	-0.84	-0.79	-0.74
Roll Attitude Error (Deg)	+0.50	+0.45	+0.50
Pitch Rate (Deg/Sec)	-0.88	+0.25	+0.15
Yaw Rate (Deg/Sec)	-0.18	+0.075	0.0
Roll Rate (Deg/Sec)	-0.65	+0.075	0.0
Pitch Actuator Position (Deg)	+1.4	+0.7	+0.5
Yaw Actuator Position (Deg)	-0.65	-0.65	-0.55

No significant transient at Chi freeze.

TABLE 21-2
 MAXIMUM VALUES OF CRITICAL FLIGHT CONTROL PARAMETERS
 AS-505 SECOND BURN

PARAMETER	ESC AND GUIDANCE INITIATION	EMR SHIFT	CHI TILDE GUIDANCE MODE	J-2 CUTOFF
Pitch Attitude Error (Deg)	+2.20	+0.82	+1.53	+0.70
Yaw Attitude Error (Deg)	-0.70	-1.65	-0.8	-0.70
Roll Attitude Error (Deg)	-0.90	+0.55	+0.47	+0.55
Pitch Rate (Deg/Sec)	-1.38	-0.225	-0.74	0.0
Yaw Rate (Deg/Sec)	+0.30	+0.575	+0.06	-0.10
Roll Rate (Deg/Sec)	+0.13	+0.16	+0.06	+0.08
Pitch Actuator Position (Deg)	+1.35	+0.70	+0.93	+0.55
Yaw Actuator Position (Deg)	-0.80	-1.05	-0.75	-0.68

No significant transient at Chi freeze.

TABLE 21-3
MANEUVER REQUIREMENTS FOR "F" MISSION

MANEUVER	SEC
1. Maintain commanded cutoff inertial attitude.	TB5 + 0
2. Initiate maneuver to align the S-IVB/SC +X axis along the local horizontal (CSM forward, Position I down) and maintain orbital rate.	TB5 + 20
3. Maintain commanded cutoff inertial attitude.	TB7 + 0
4. Initiate maneuver to align the S-IVB/SC +X axis along the local horizontal (CSM forward, Position I down). Maintain with respect to local reference.	TB7 + 20
5. Initiate maneuver to the S-IVB/SC separation and communications attitude. The attitude is defined in the local reference system which is frozen inertially at TB7 + 900 seconds. When the desired SC separation attitude was attained, the vehicle attitude was frozen inertially. This maneuver had to be completed by TB7 + 1200 seconds. TD&E attitude: pitch = 120°, Yaw = 40°, Roll = 180°.	TB7 + 900
6. Initiate by DCS command, the maneuver to the S-IVB slingshot attitude. The attitude is defined with respect to the local horizontal reference as: pitch = 194°, yaw = 0°, roll = 180°. (Position I down.) Maintain orbital rate. (This DCS command also initiated flight sequence TB8 which includes the propellant dump and safing sequences and APS ullage operation.)	TB7 + 7200
7. Initiate maneuver to align the S-IVB Stage in a final communications attitude. The S-IVB +X axis is aligned along the local horizontal (retrograde) with Position I down. Maintain orbital rate.	TB8 + 3705

TABLE 21-4
 APS IMPULSE REQUIREMENTS FOR ATTITUDE CONTROL (LB-SEC)

EVENT	ENGINE I P	ENGINE I II	ENGINE I IV	MODULE 1	ENGINE III P	ENGINF III II	ENGINE III IV	MODULE 2
TD&E Maneuver (10452-10623 sec)	1202.2	880.7	673.6	2756.4	2654.1	800.0	709.2	4163.2
Spacecraft Separation (10962-10964 sec)	21.9	0	0	21.9	0	27.17	0	27.17
Docking (11857-11861 sec)	7.01	118.8	133.4	259.3	61.1	73.0	78.5	212.7
LM Extraction (14185-14186 sec)	0	43.09	7.41	50.5	38.90	33.45	23.46	95.81

NOTE: Time intervals noted are those in which attitude control system firing activity appeared to be directly related to the corresponding event.

- ▽ 1 S-IVB BURN MODE ON 'A'
- ▽ 2 GUIDANCE INITIATION
- ▽ 3 CHI TILDE
- ▽ 4 CHI FREEZE
- ▽ 5 S-IVB ENGINE CUTOFF

$R_0 + 553.812$
 $R_0 + 560.132$
 $R_0 + 669.310$
 $R_0 + 697.252$
 $R_0 + 703.980$

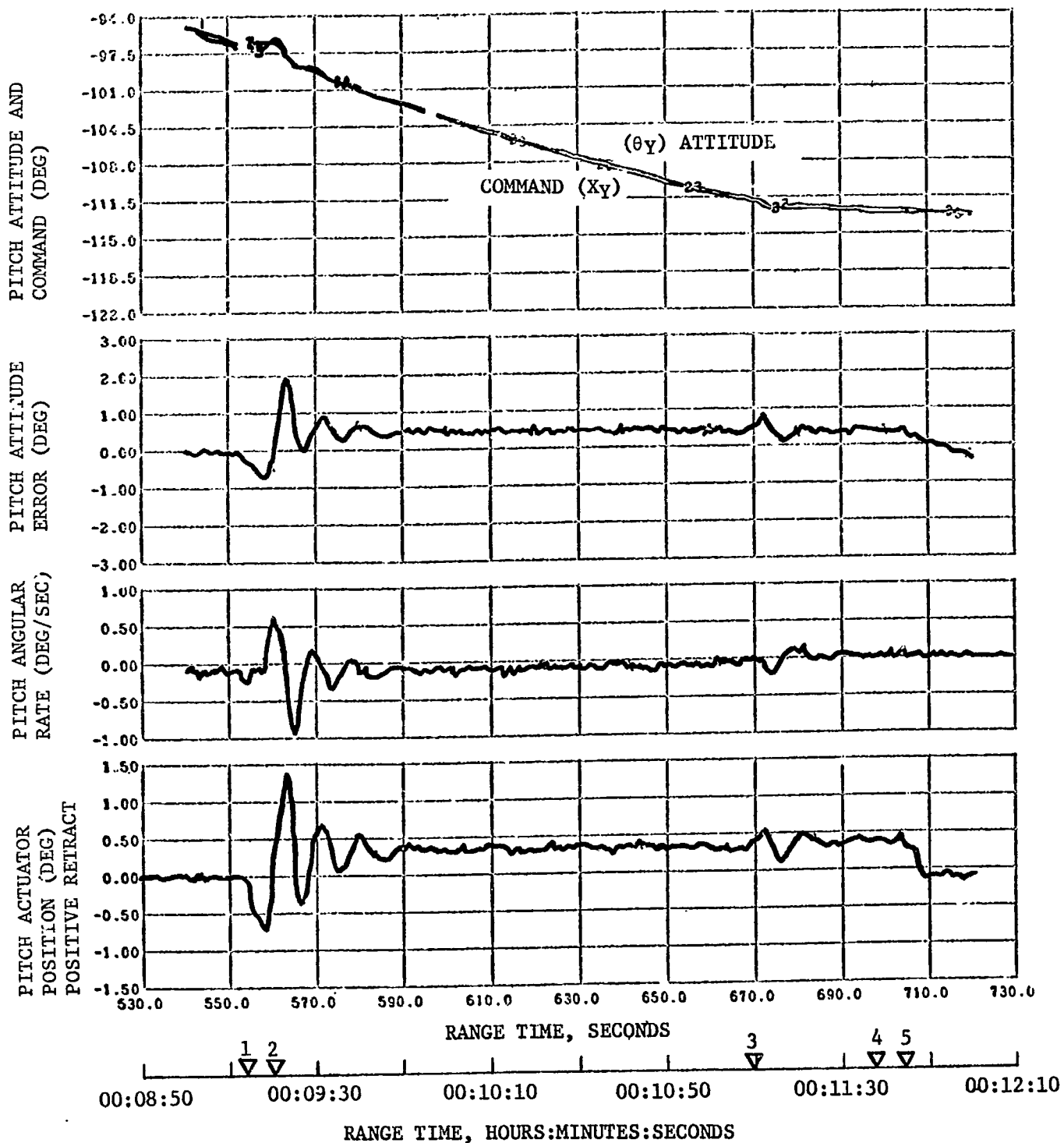

Figure 21-1. Pitch Attitude Control During S-IVB First Burn

▽	S-IVB BURN MODE ON 'A'	$R_0 + 553.812$
▽	GUIDANCE INITIATION	$R_0 + 560.132$
▽	CHI TILDE	$R_0 + 669.310$
▽	CHI FREEZE	$R_0 + 697.252$
▽	S-IVB ENGINE CUTOFF	$R_0 + 703.980$

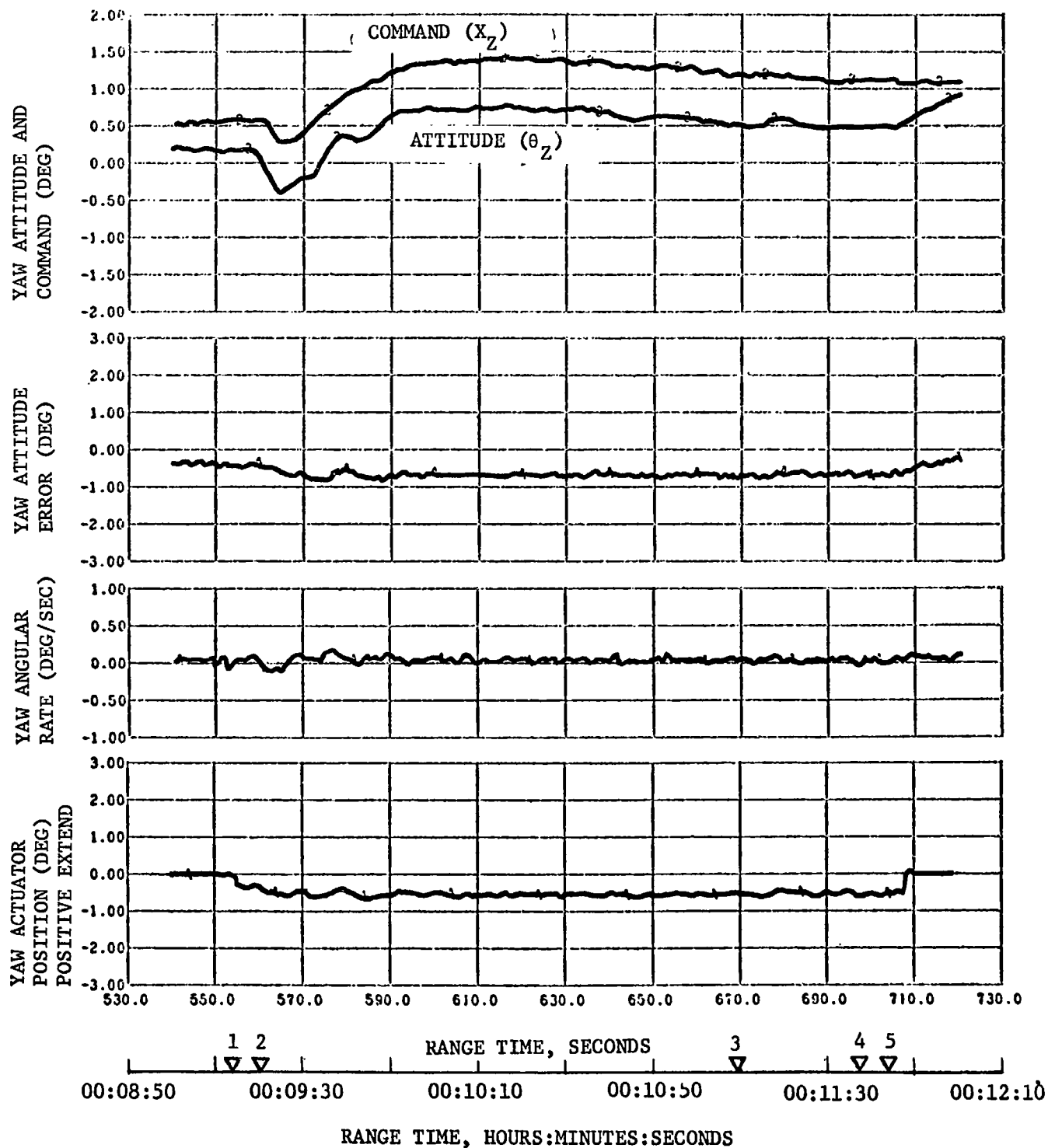

Figure 21-2. Yaw Attitude Control During S-IVB First Burn

- | | | |
|---|------------------------|-----------------|
| ▽ | S-IVB BURN MODE ON 'A' | $R_o + 553.812$ |
| ▽ | GUIDANCE INITIATION | $R_o + 560.132$ |
| ▽ | CHI TILDE | $R_o + 669.310$ |
| ▽ | CHI FREEZE | $R_o + 697.252$ |
| ▽ | S-IVB ENGINE CUTOFF | $R_o + 703.980$ |

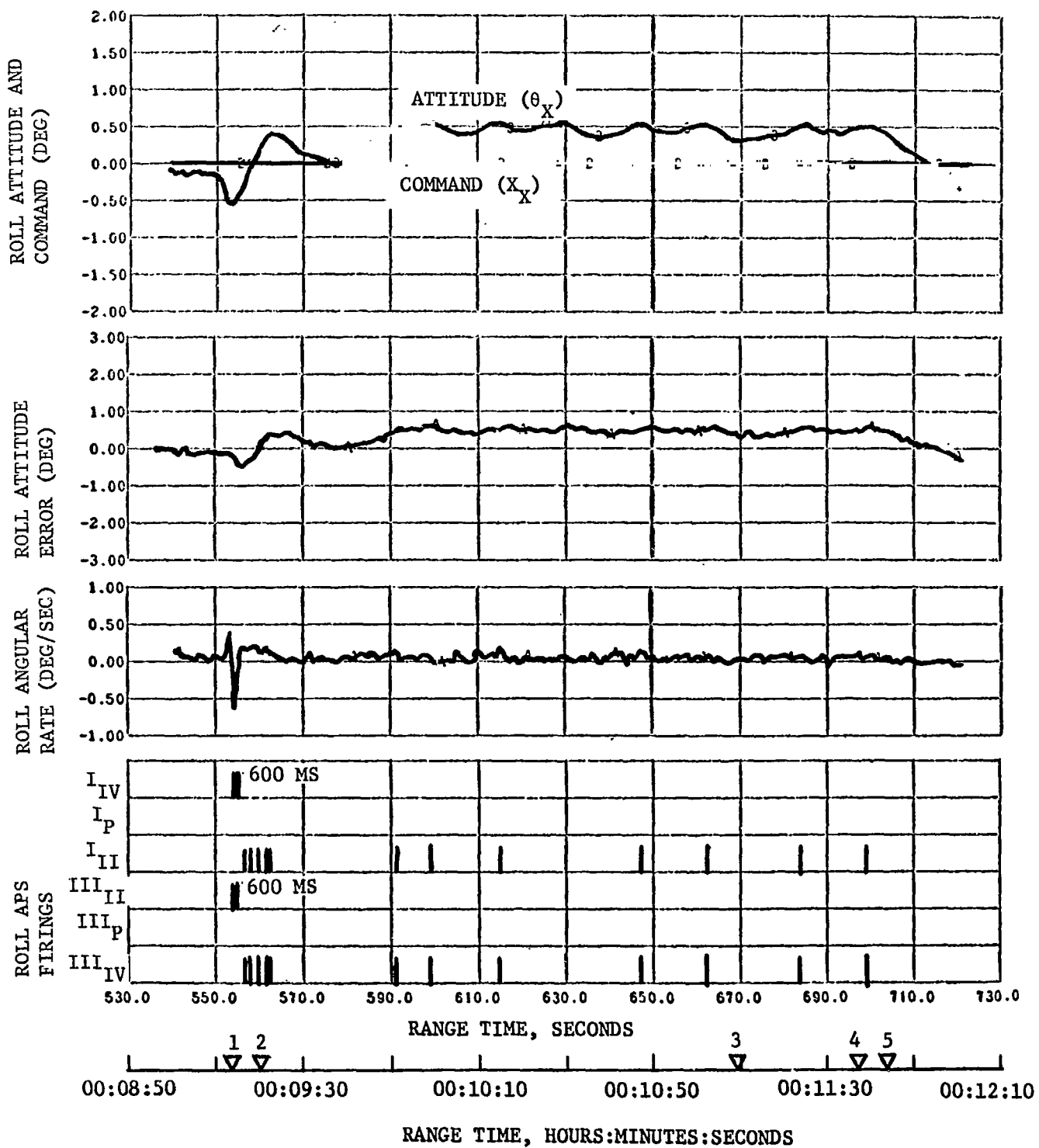
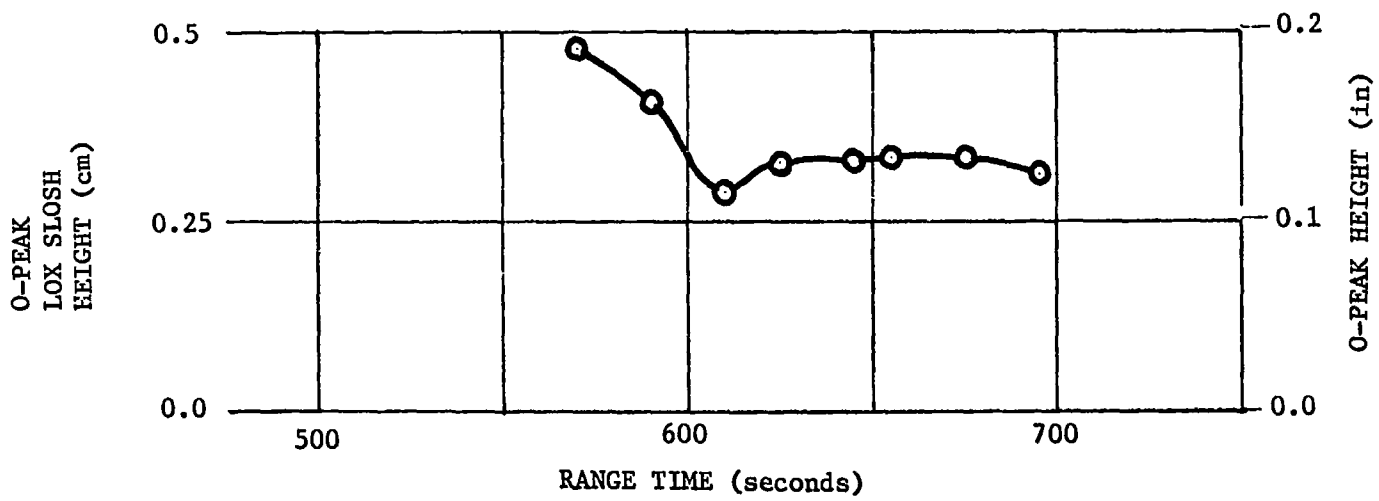
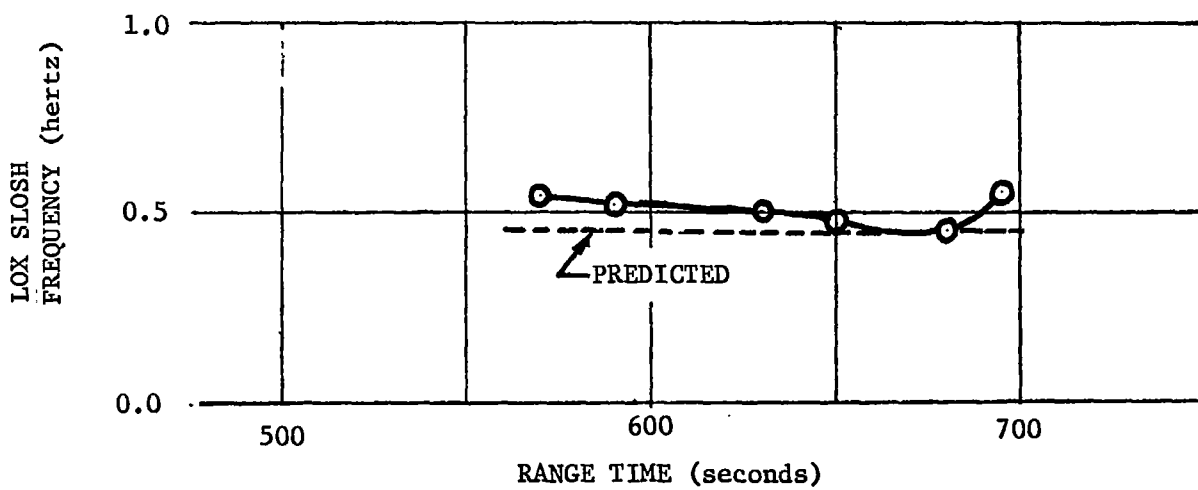

Figure 21-3. Roll Attitude Control During S-IVB First Burn



Note: No Significant LH2 SLOSH Occurred

Figure 21-4. LOX SLOSH Frequency and Height During S-IVB Stage First Burn

- | | | |
|----|------------------------|------------------|
| ▽1 | S-IVB BURN MODE ON 'A' | $R_0 + 9206.786$ |
| ▽2 | GUIDANCE INITIATION | $R_0 + 9215.000$ |
| ▽3 | EMR SHIFT | $R_0 + 9334.275$ |
| ▽4 | CHI TILDE | $R_0 + 9521.592$ |
| ▽5 | CHI FREEZE | $R_0 + 9549.729$ |
| ▽6 | S-IVB ENGINE CUTOFF | $R_0 + 9550.781$ |

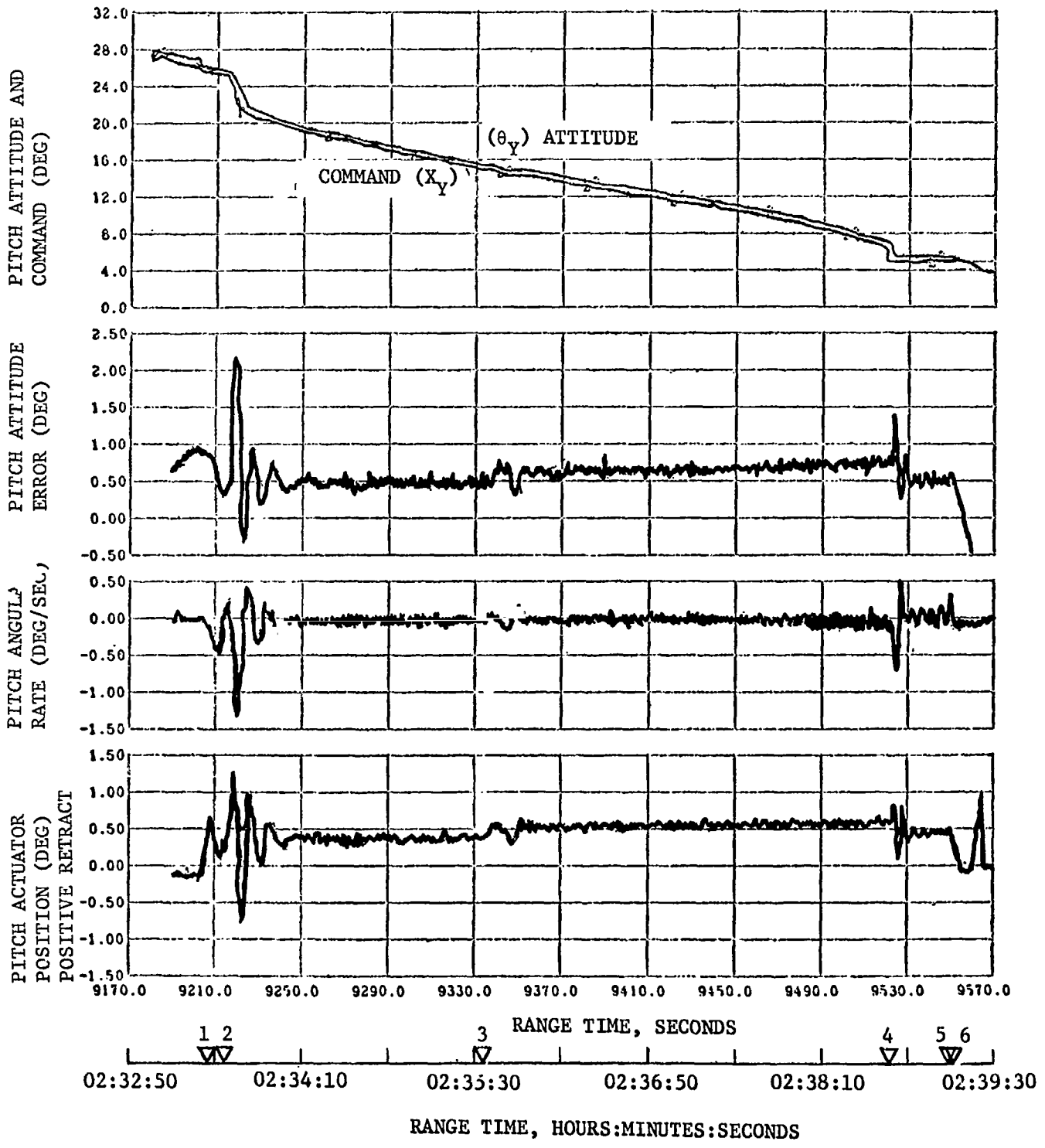

Figure 21-5. Pitch Attitude Control During S-IVB Second Burn

- | | | |
|---|------------------------|---------------------------|
| ▽ | S-IVB BURN MODE ON 'A' | R ₀ + 9206.786 |
| ▽ | GUIDANCE INITIATION | R ₀ + 9215.600 |
| ▽ | EMR SHIFT | R ₀ + 9334.275 |
| ▽ | CHI TILDE | R ₀ + 9521.592 |
| ▽ | CHI FREEZE | R ₀ + 9549.729 |
| ▽ | S-IVB ENGINE CUTOFF | R ₀ + 9550.781 |

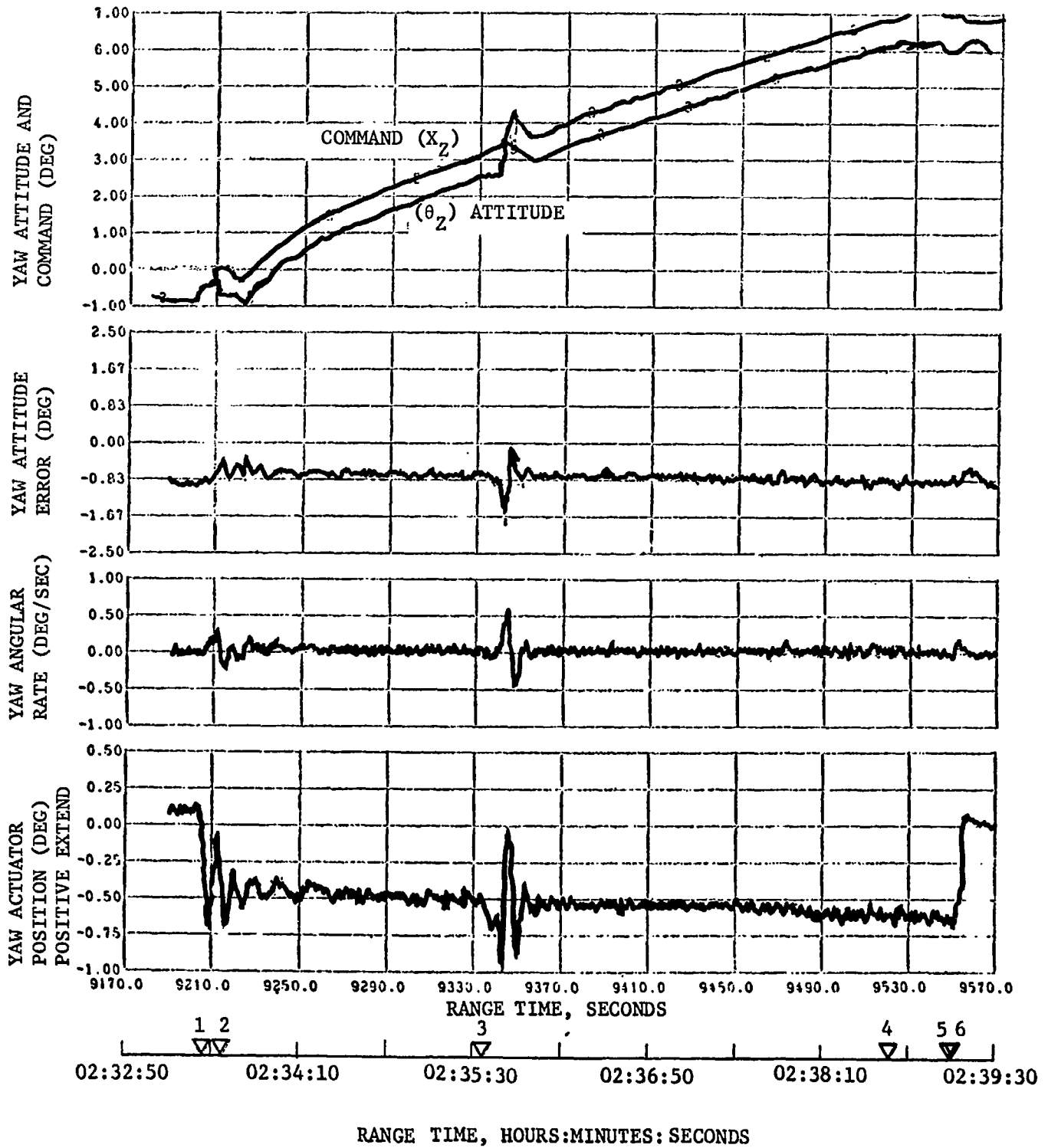

Figure 21-6. Yaw Attitude Control During S-IVB Second Burn

- | | | |
|---|------------------------|------------------|
| ▽ | S-IVB BURN MODE ON 'A' | $R_o + 9206.786$ |
| ▽ | GUIDANCE INITIATION | $R_o + 9215.000$ |
| 3 | EMR SHIFT | $R_o + 9334.275$ |
| 4 | CHI TILDE | $R_o + 9521.592$ |
| 5 | CHI FREEZF | $R_o + 9549.729$ |
| 6 | S-IVB ENGINE CUTOFF | $R_o + 9550.781$ |

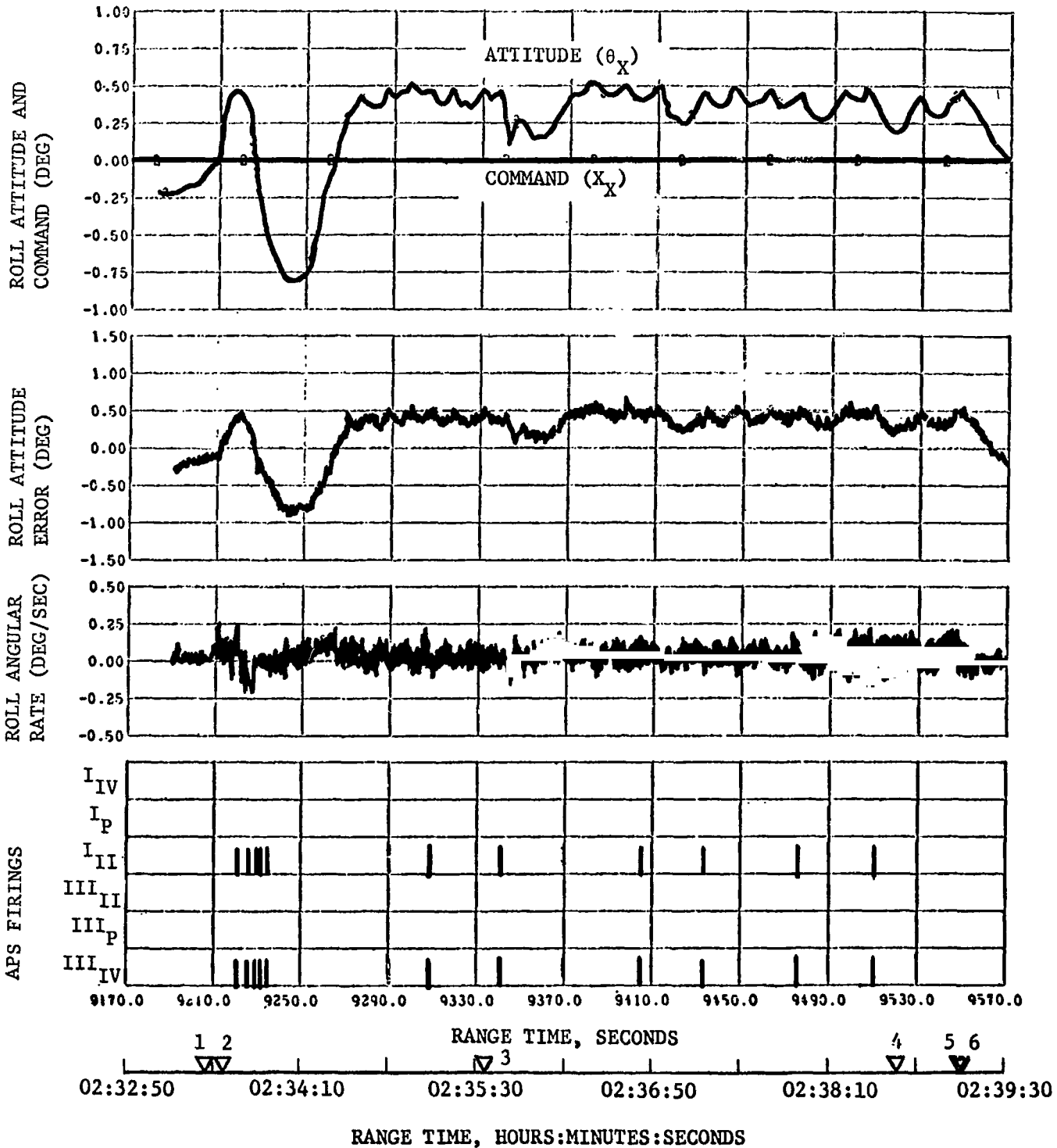

Figure 21-7. Roll Attitude Control During S-IVB Second Burn

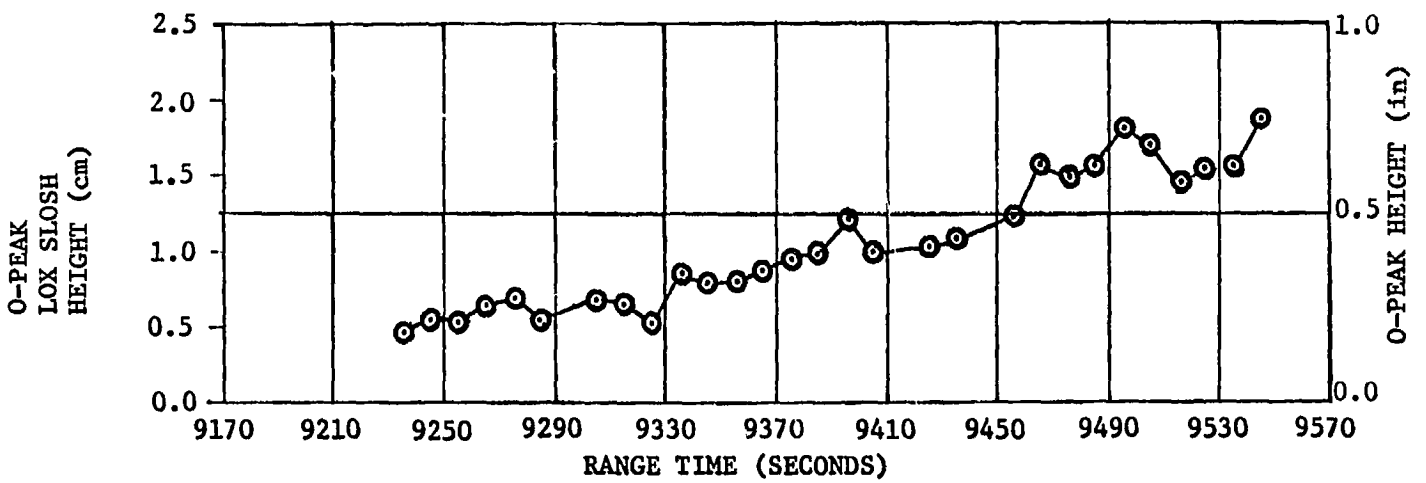
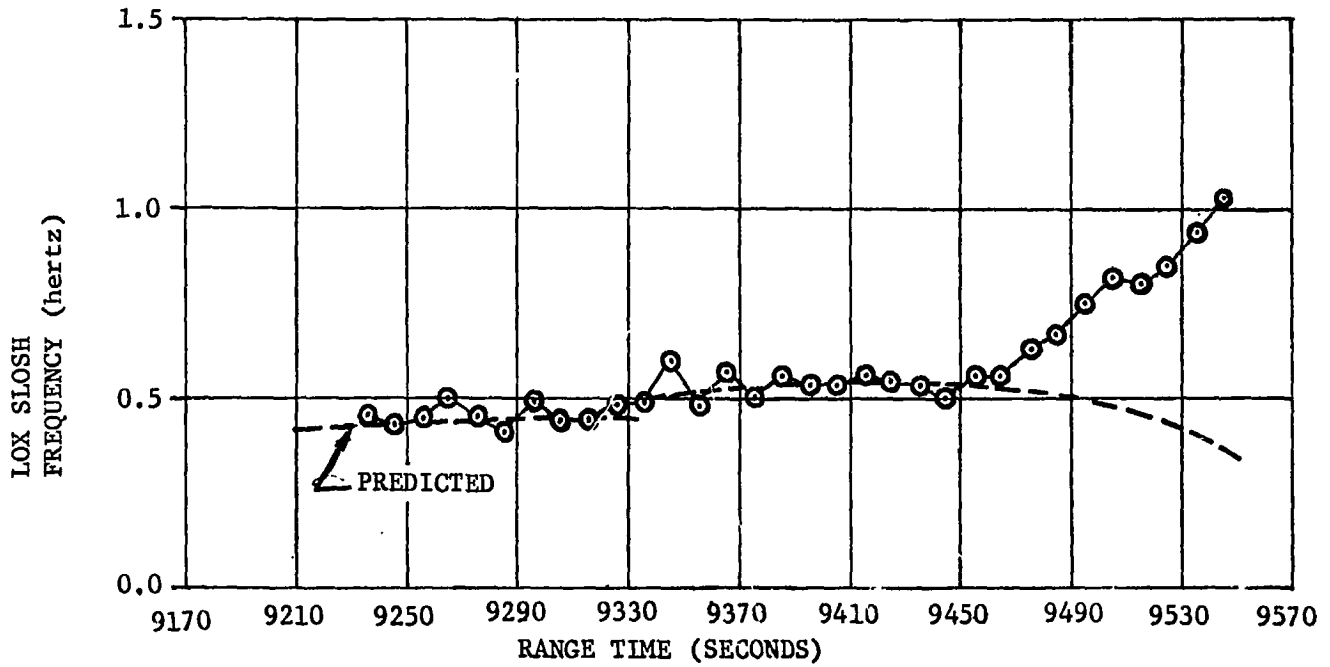

Figure 21-8. LOX Slosh Frequency and Height During S-IVB Stage Second Burn

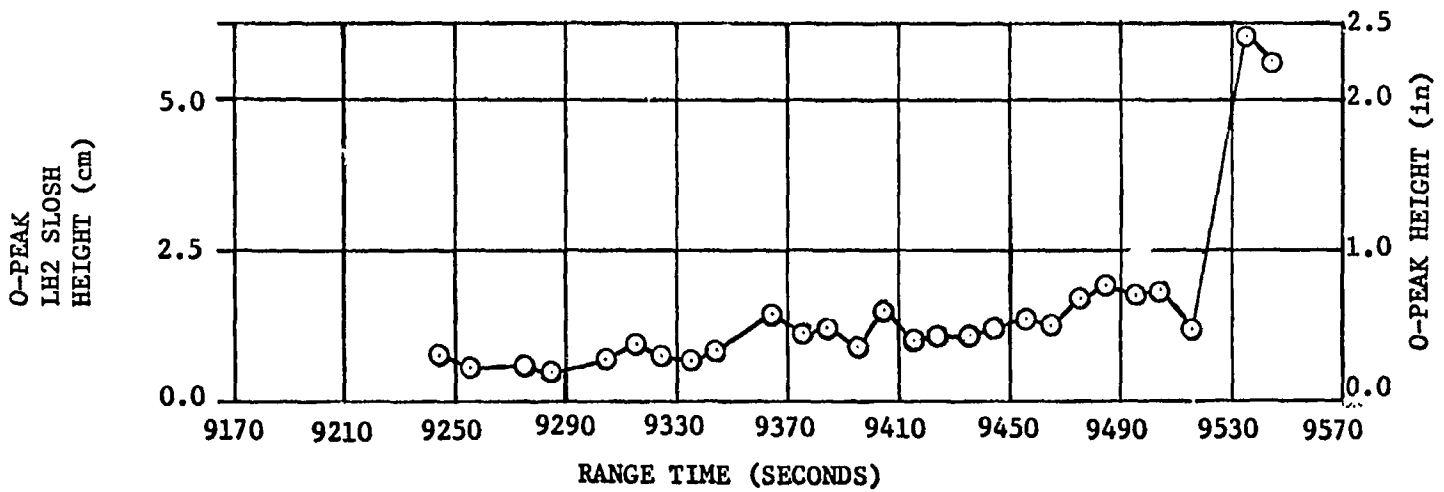
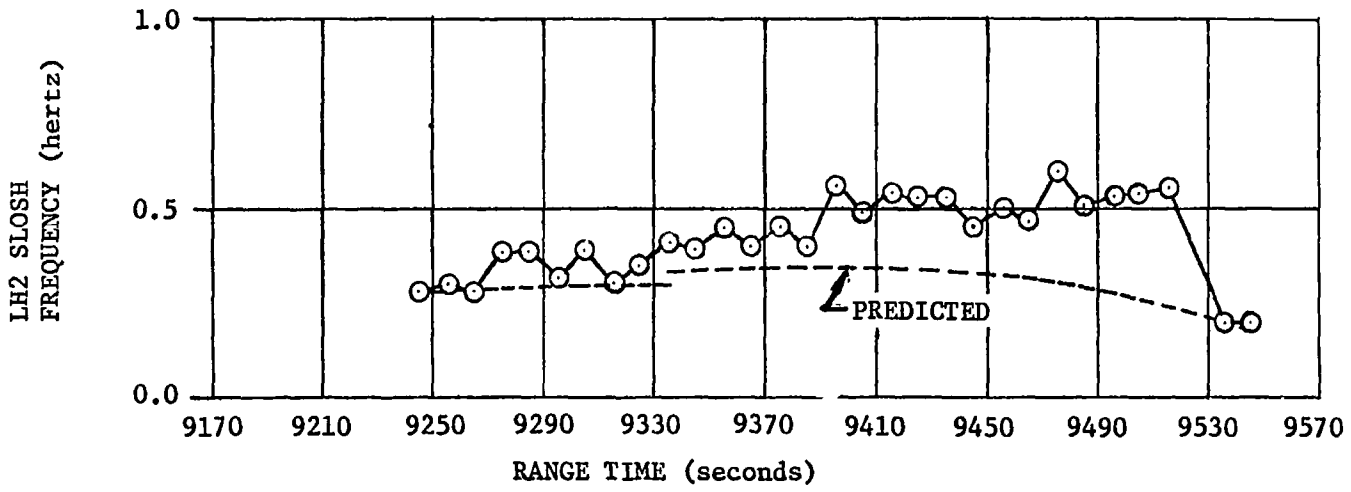

Figure 21-9. LH2 SLOSH Frequency and Height During S-IVB Stage Second Burn

- ▽ S-IVB ENGINE CUTOFF
- ▽ FCC S-IVB BURN MODE OFF
- ▽ INITIATE MANEUVER TO LOCAL HORIZONTAL

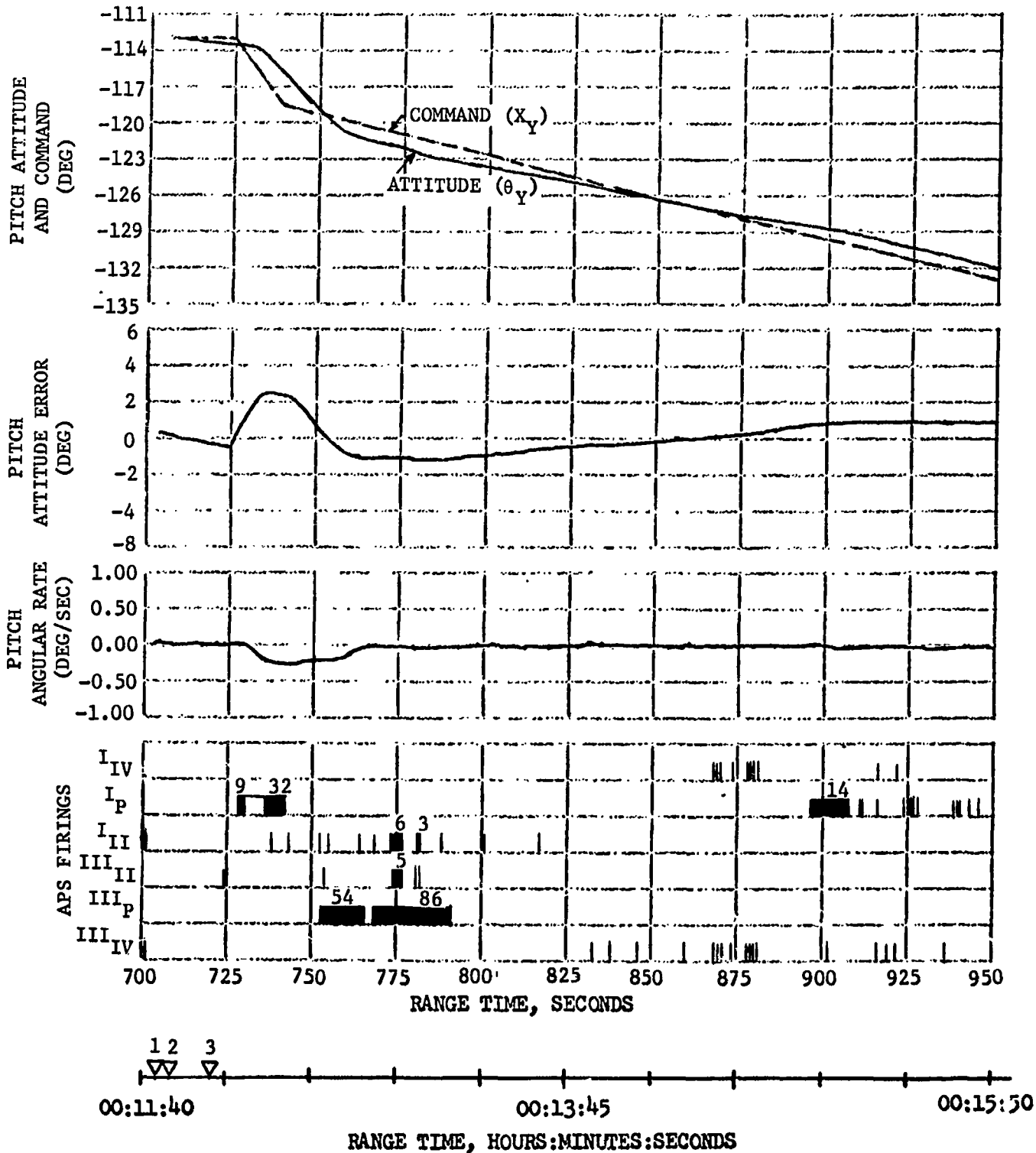

Figure 21-10. Pitch Attitude Control During the Maneuver to Local Horizontal After S-IVB First Burn

- ▽ S-IVB ENGINE CUTOFF
- ▽ FCC S-IVB BURN MODE OFF
- ▽ INITIATE MANEUVER TO LOCAL HORIZONTAL

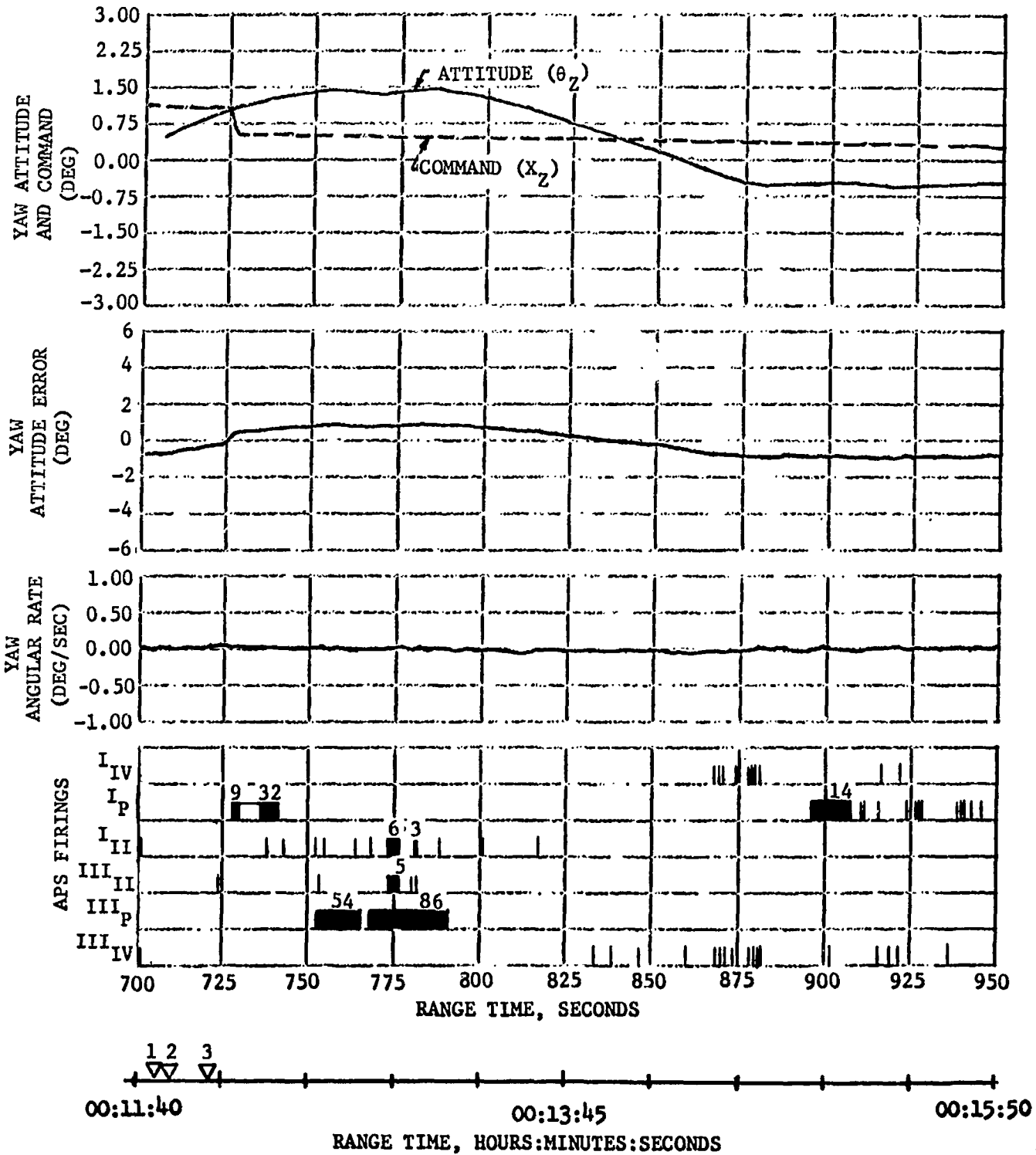

Figure 21-11. Yaw Attitude Control During the Maneuver to Local Horizontal After S-IVB First Burn

- ▽ S-IVB ENGINE CUTOFF
- ▽ FCC S-IVB BURN MODE OFF
- ▽ INITIATE MANEUVER TO LOCAL HORIZONTAL

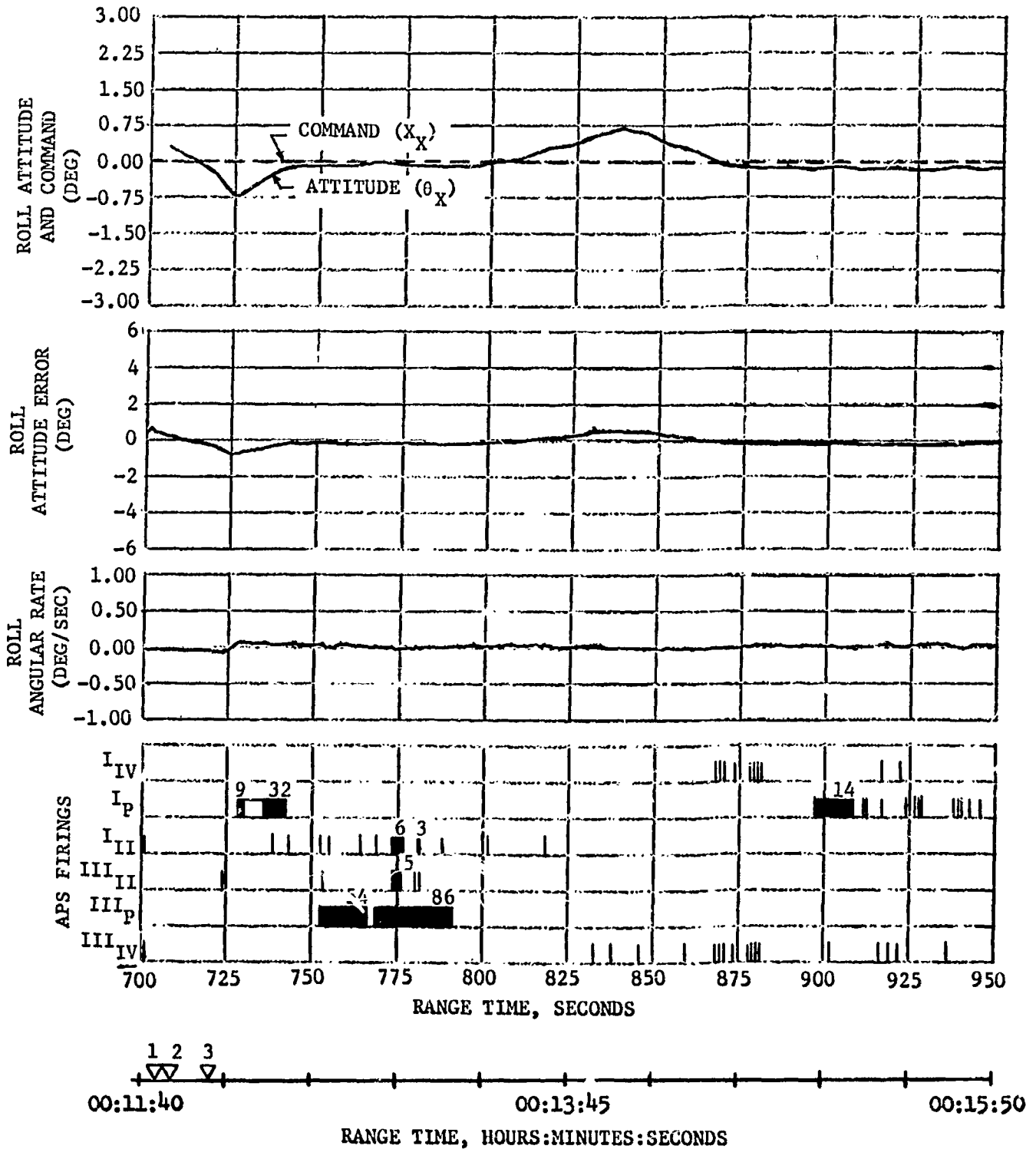

Figure 21-12 Roll Attitude Control During the Maneuver to Local Horizontal After S-IVB First Burn

▽ INITIATE MANEUVER TO TD&E ATTITUDE

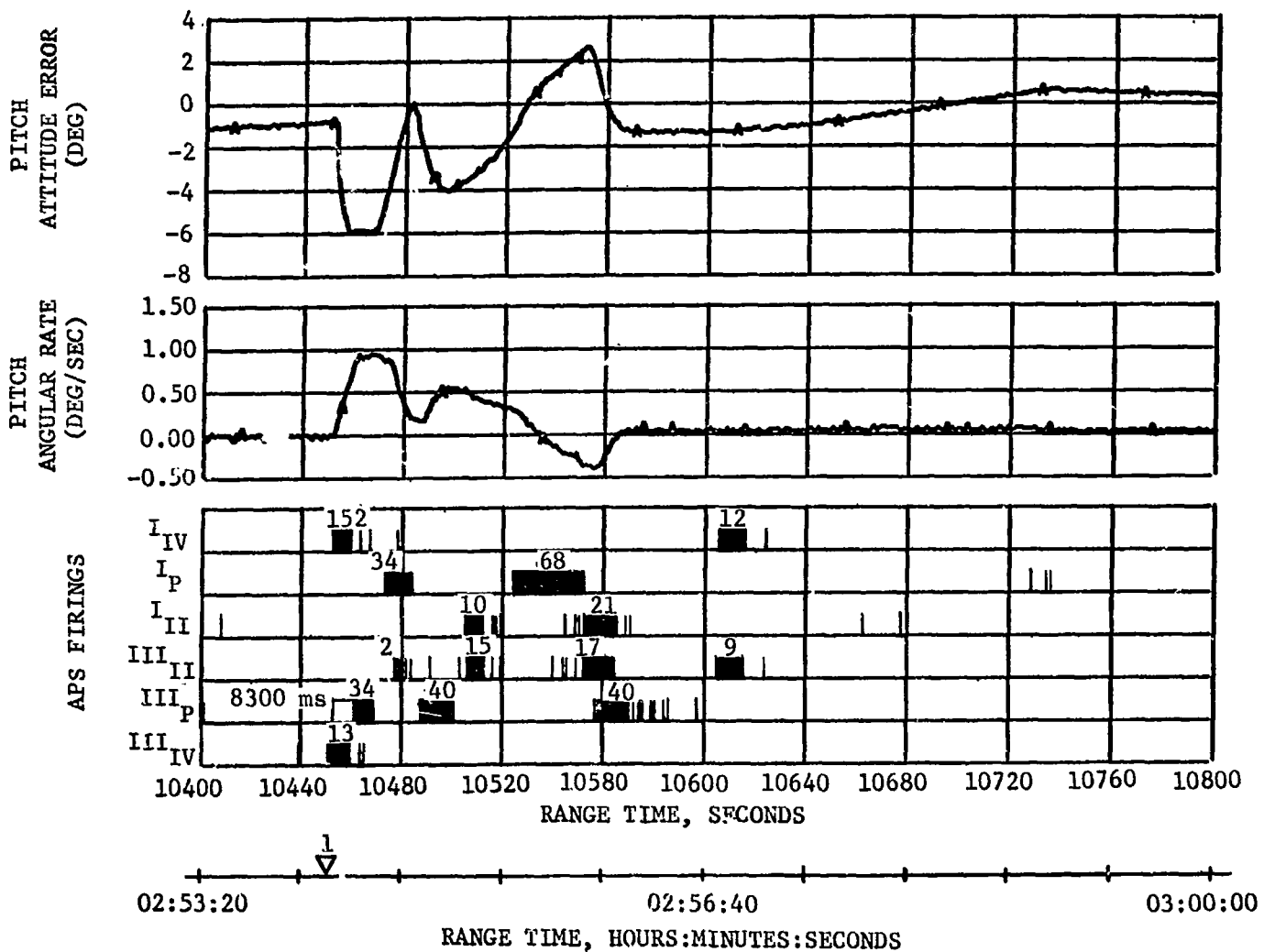

Figure 21-13. Pitch Attitude Control During Orientation to TD&E Attitude

▽ INITIATE MANEUVER TO TD&E ATTITUDE

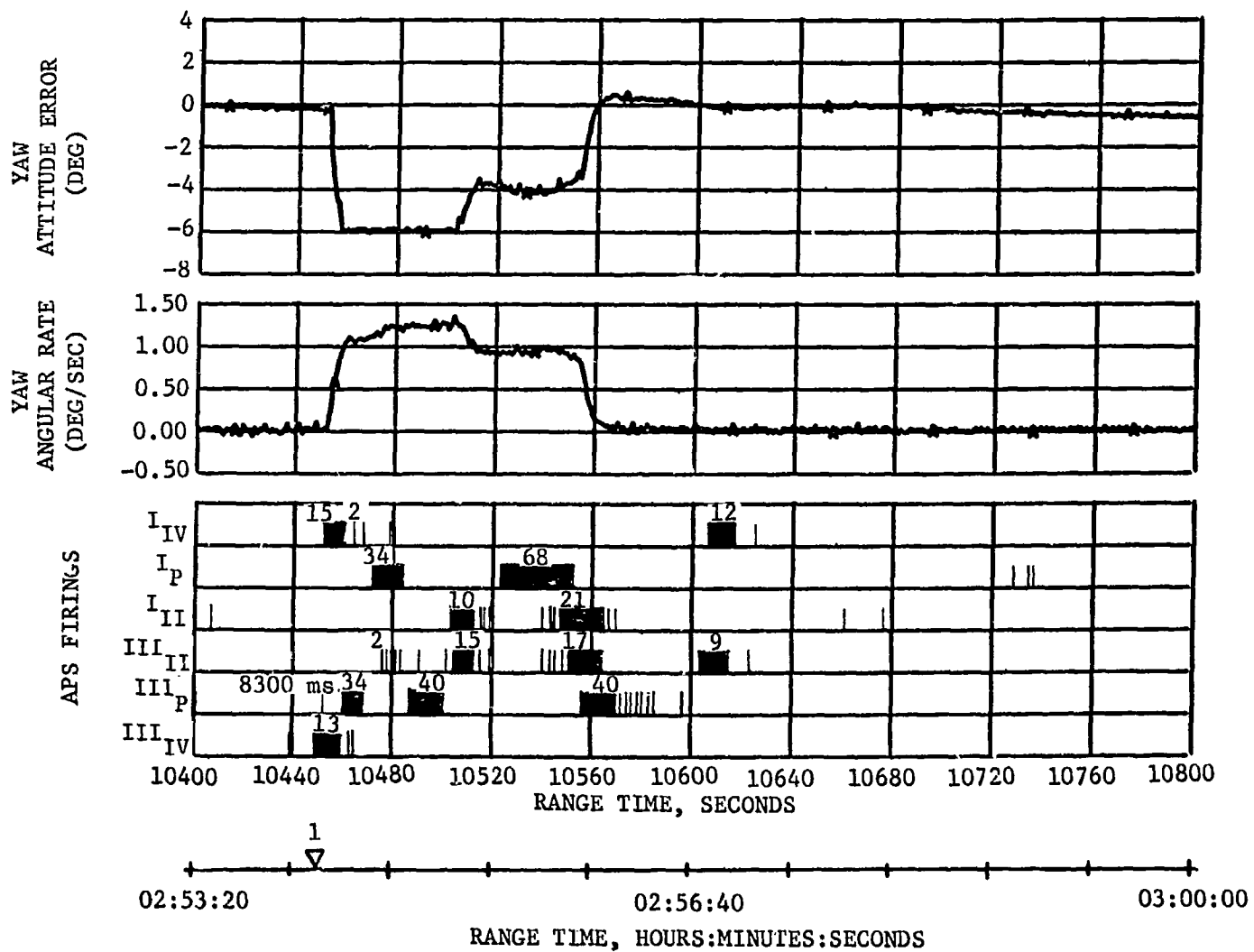

Figure 21-14. Yaw Attitude Control During Orientation to TD&E Attitude

▽ INITIATE MANEUVER TO TD&E ATTITUDE

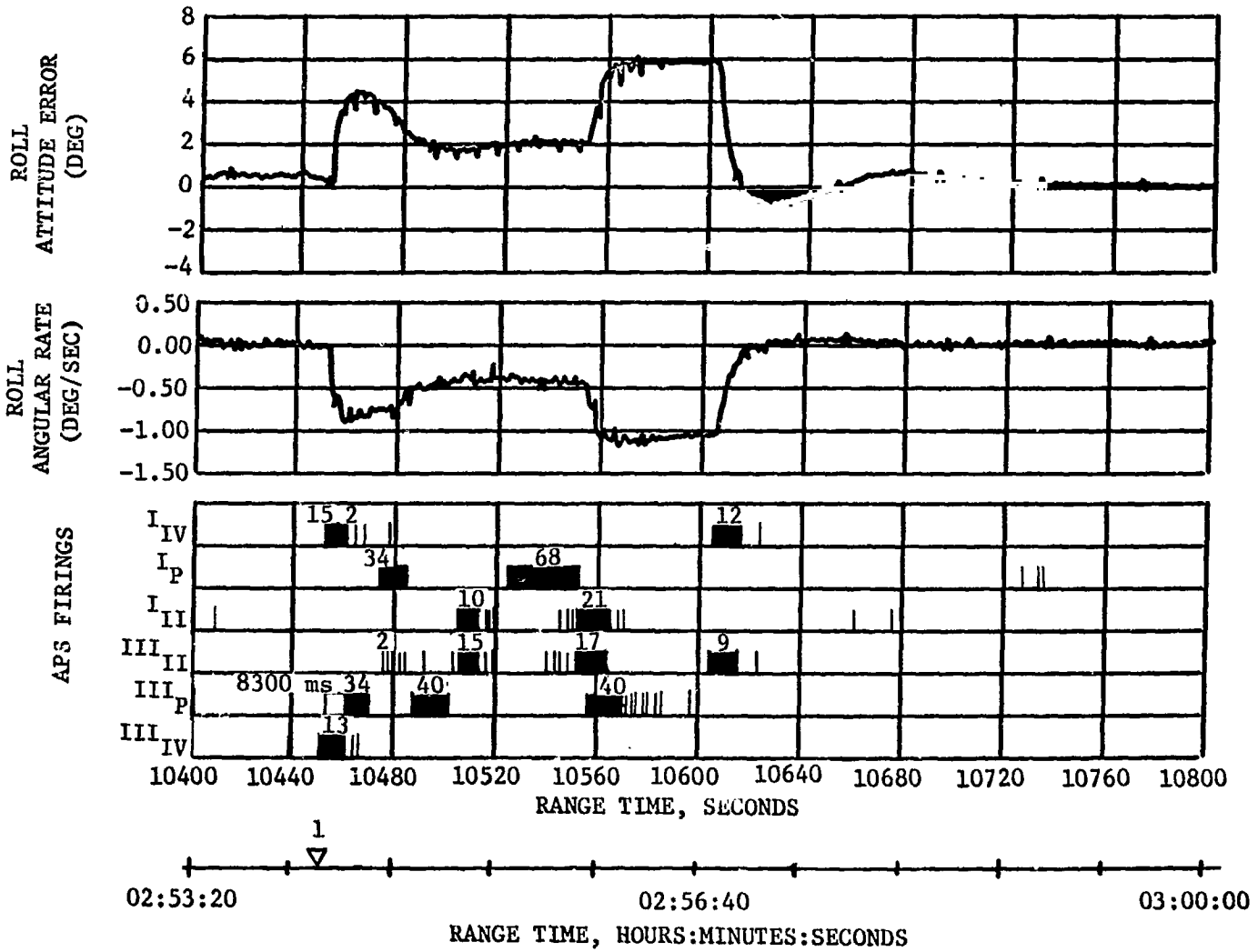

Figure 21-15. Roll Attitude Control During Orientation to TD&E Attitude

▽ S-IVB/CSM SEPARATION

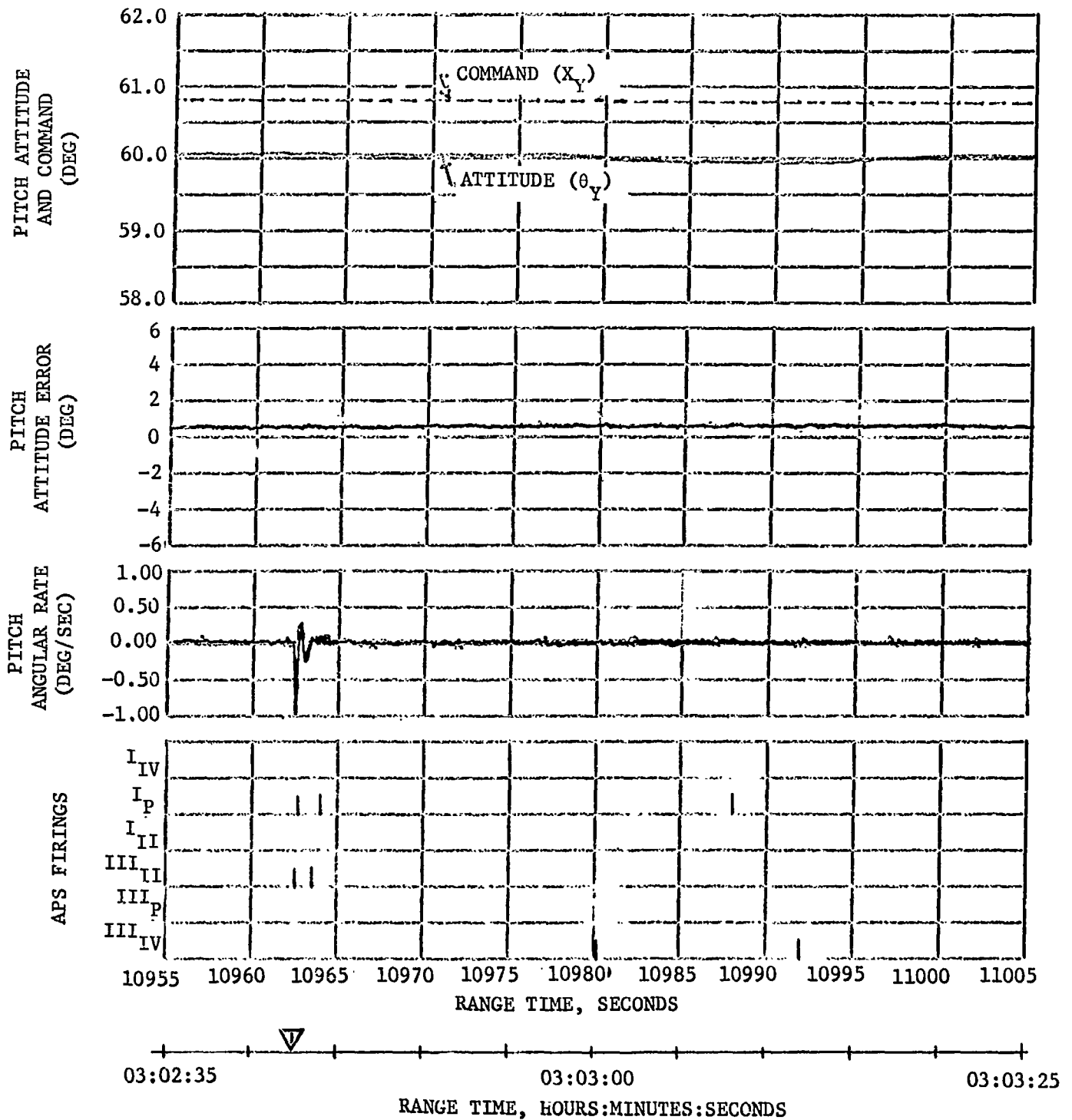

Figure 21-16. Pitch Attitude Control During S-IVB/CSM Separation

▽ S-IVB/CSM SEPARATION

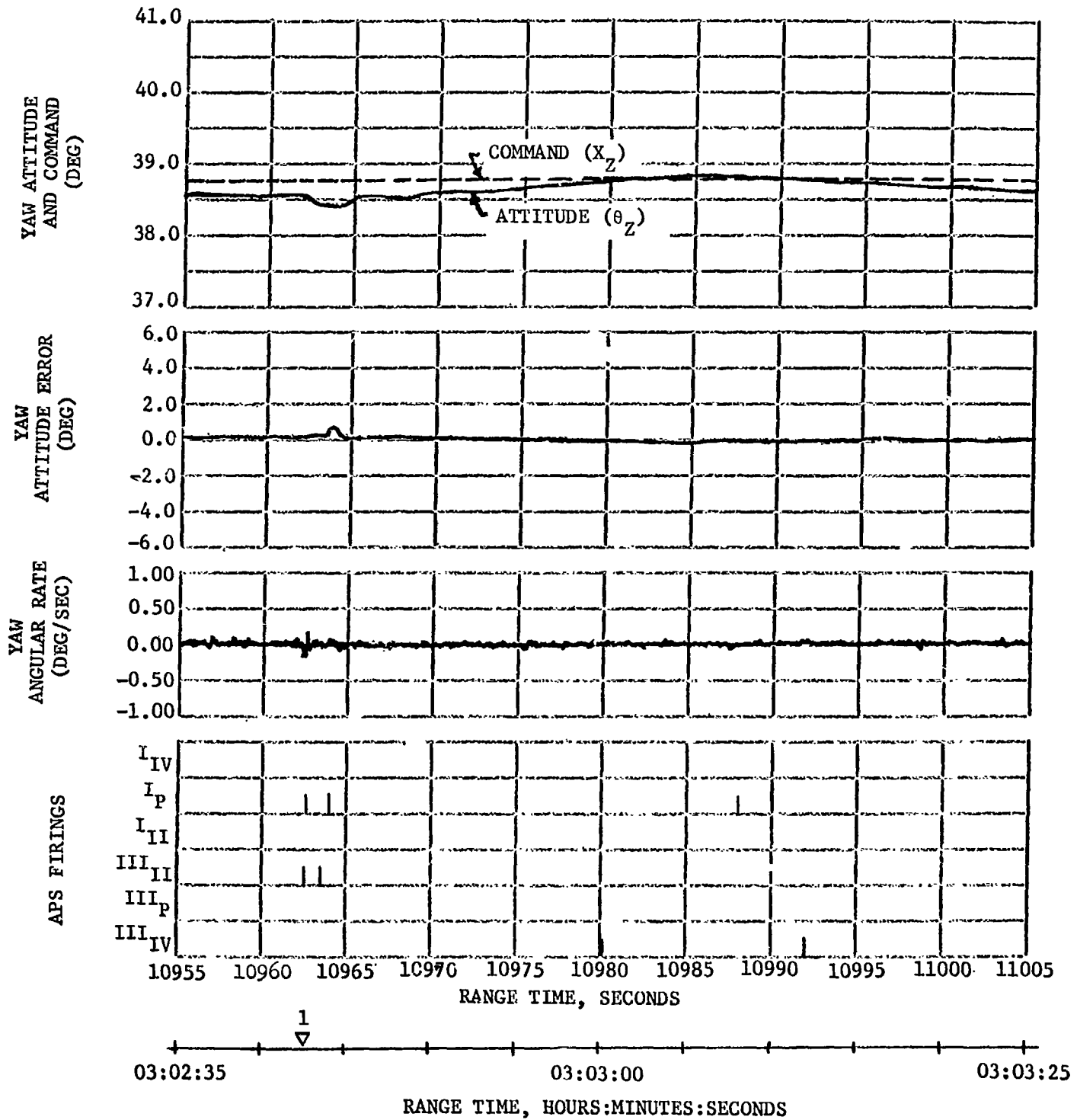

Figure 21-17. Yaw Attitude Control During S-IVB/CSM Separation

▽ S-IVB/CSM SEPARATION

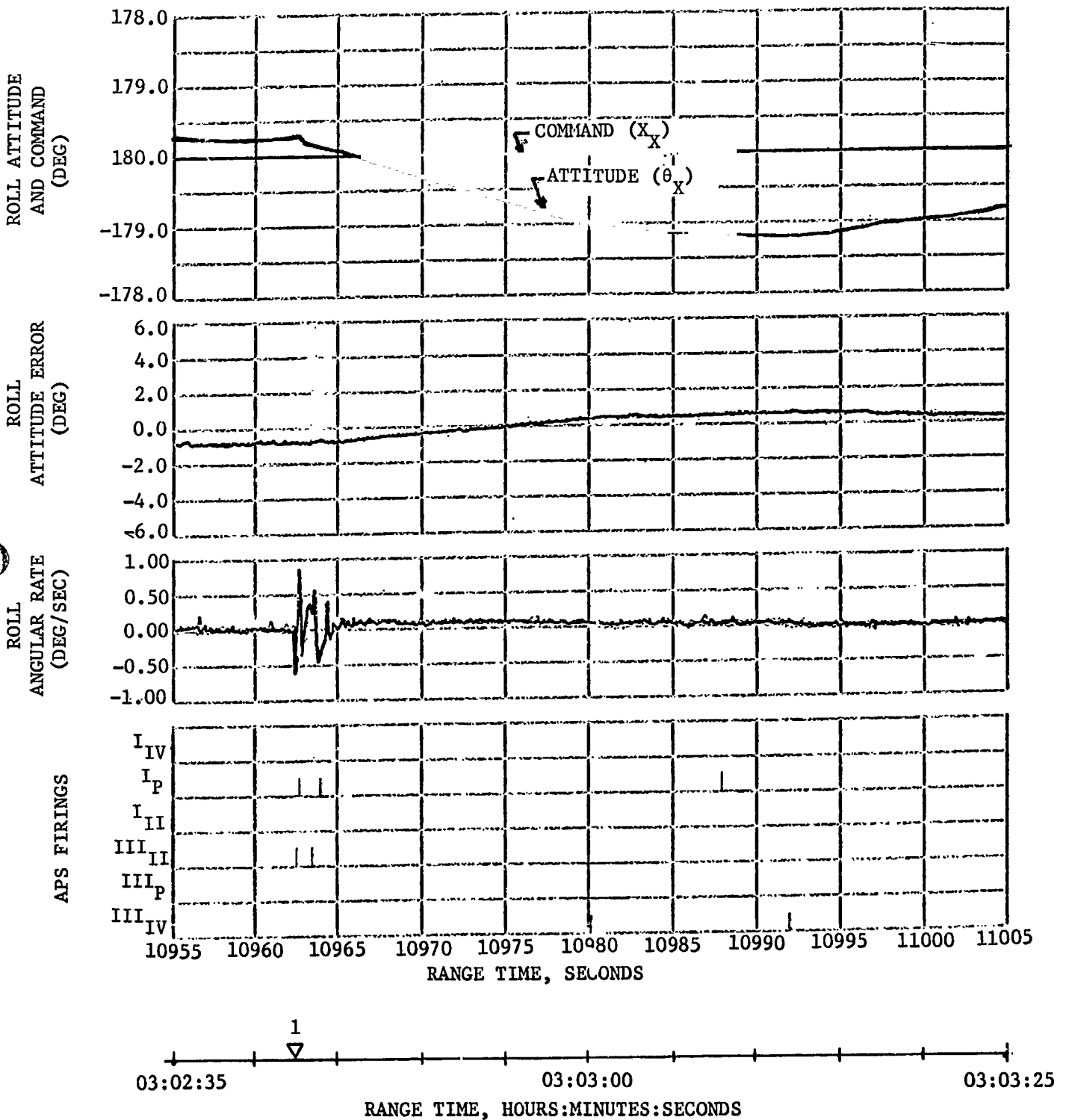

Figure 21-18. Roll Attitude Control During S-IVB/CSM Separation

▽ CSM/S-IVB-LM HARD DOCKING
 * NON MINIMUM PULSE

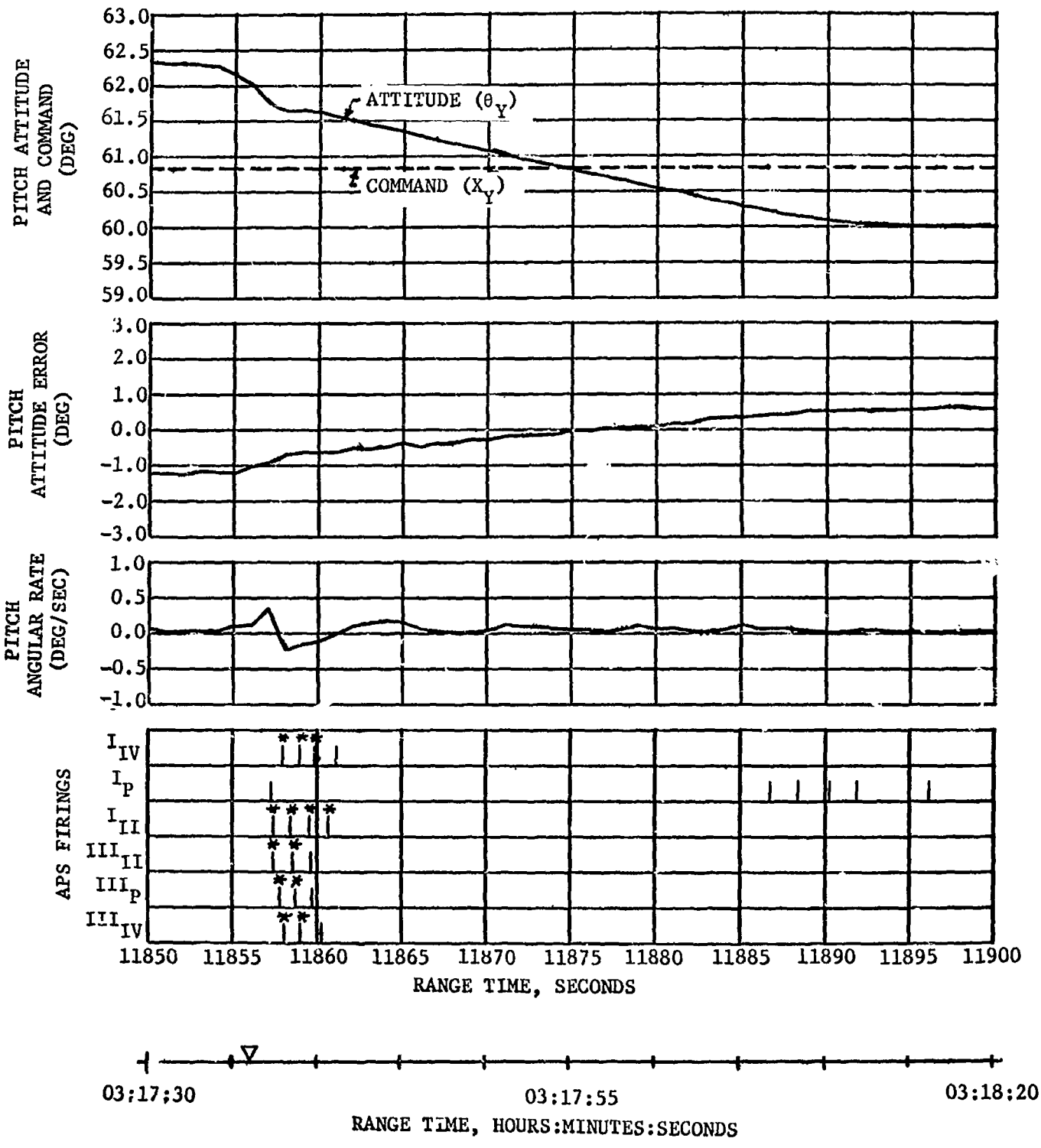

Figure 21-19. Pitch Attitude Control During Hard Docking

▽ CSM/S-IVB-LM HARD DOCKING

* NON MINIMUM PULSE

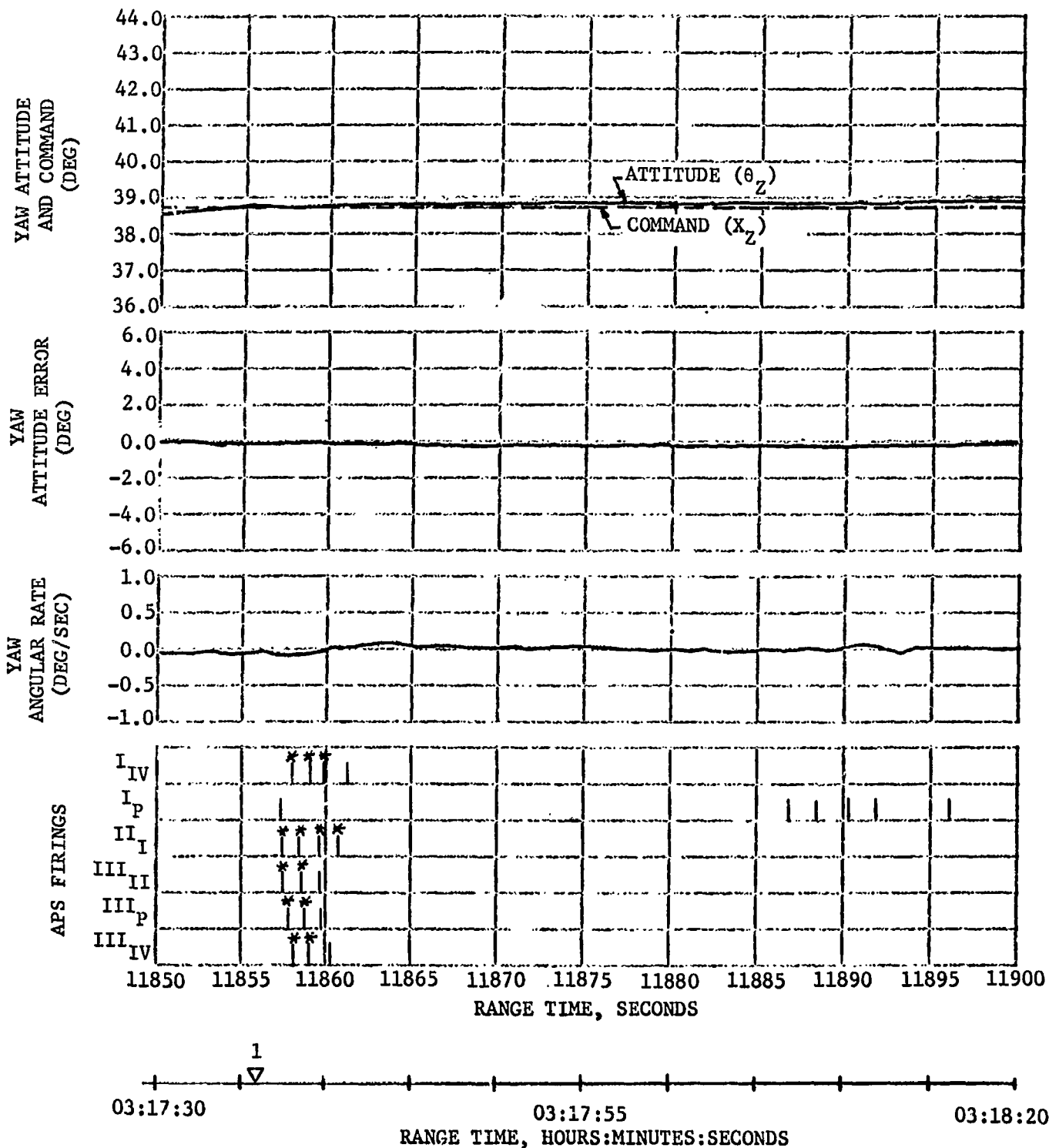

Figure 21-20. Yaw Attitude Control During Hard Docking

▽ CSM/S-IVB-LM HARD DOCKING
 * NON MINIMUM PULSE

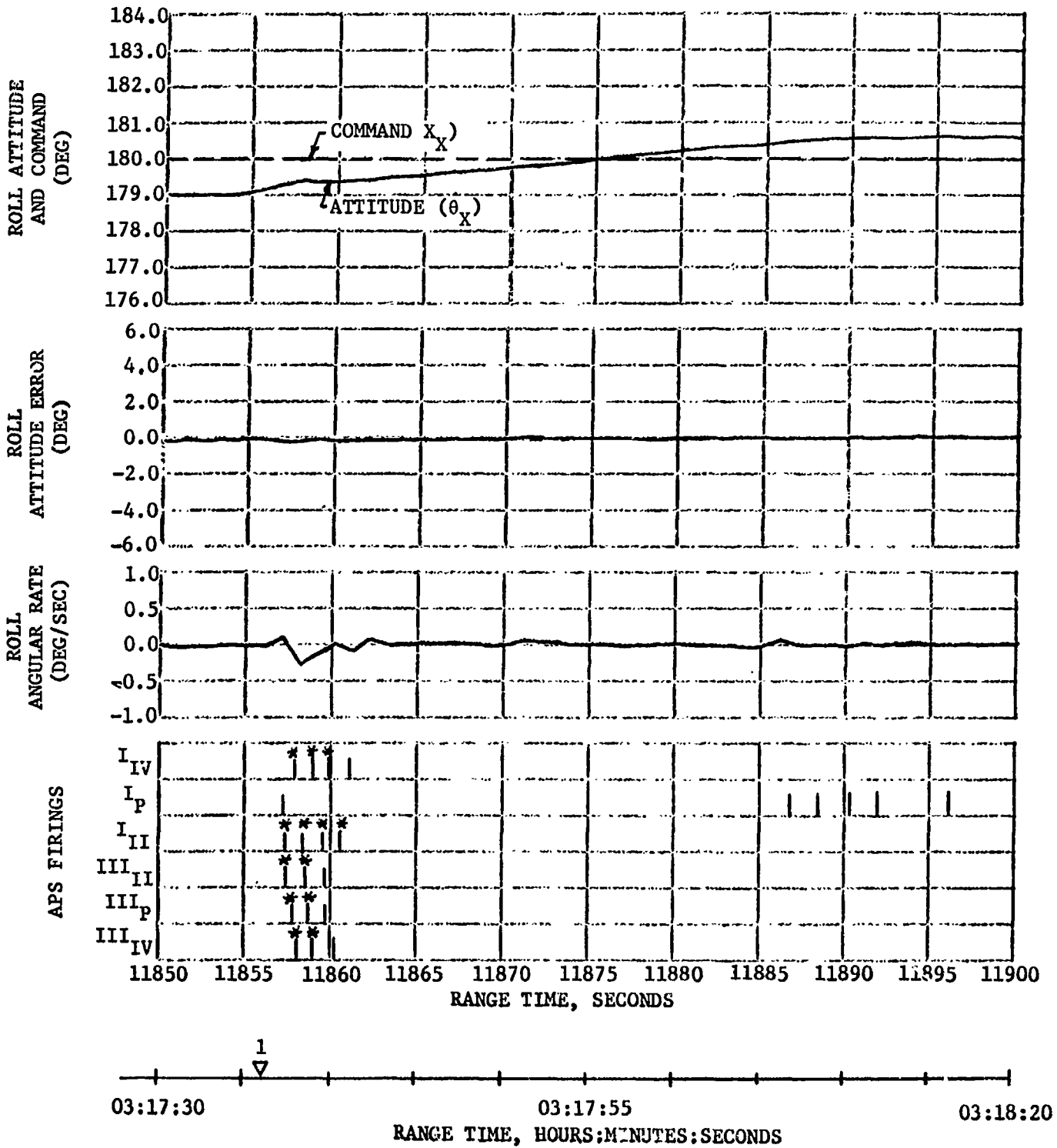

Figure 21-21. Roll Attitude Control During Hard Docking

▽ LM EXTRACTION

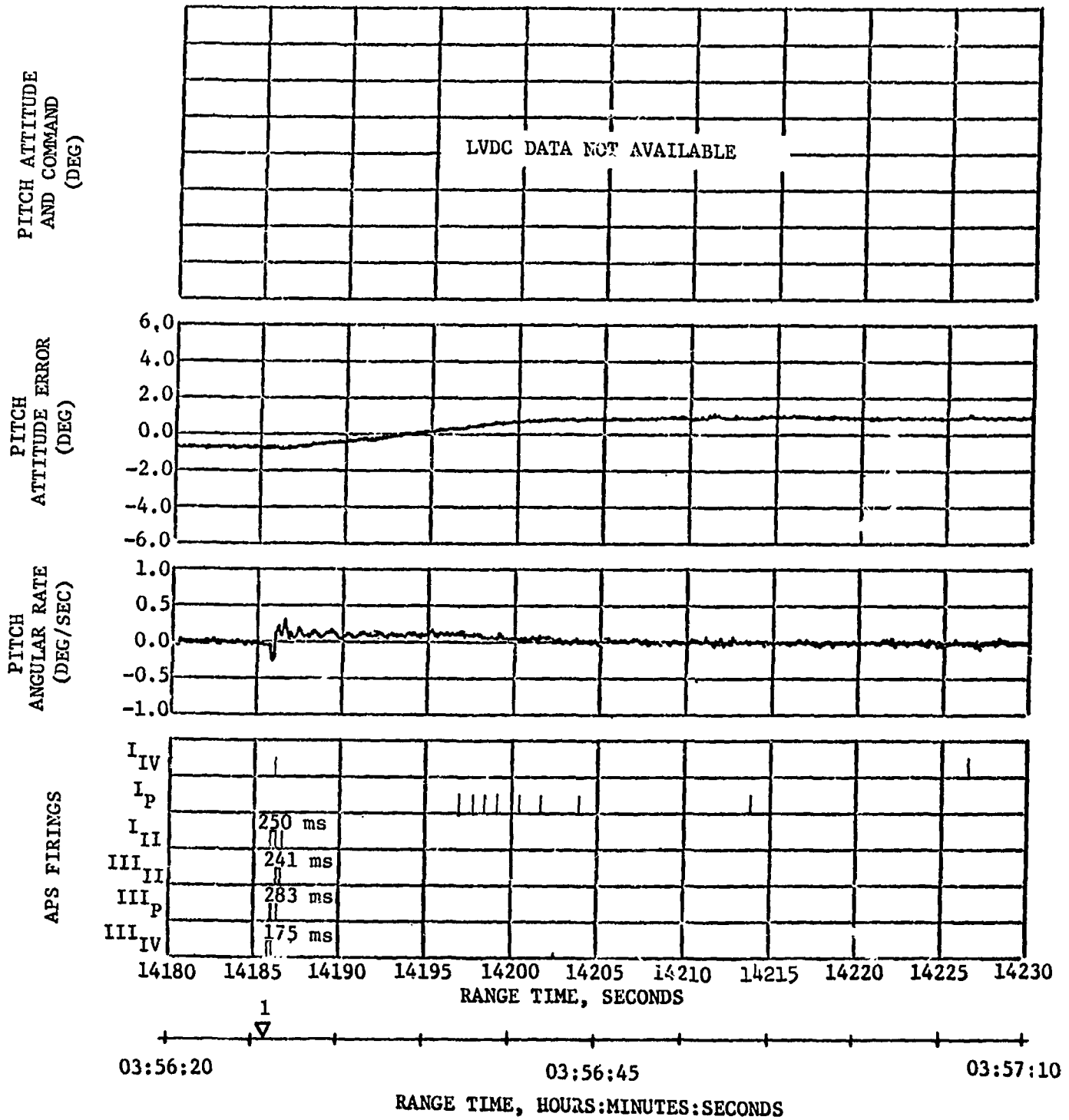

Figure 21-22. Pitch Attitude Control During LM Extraction

▽ LM EXTRACTION

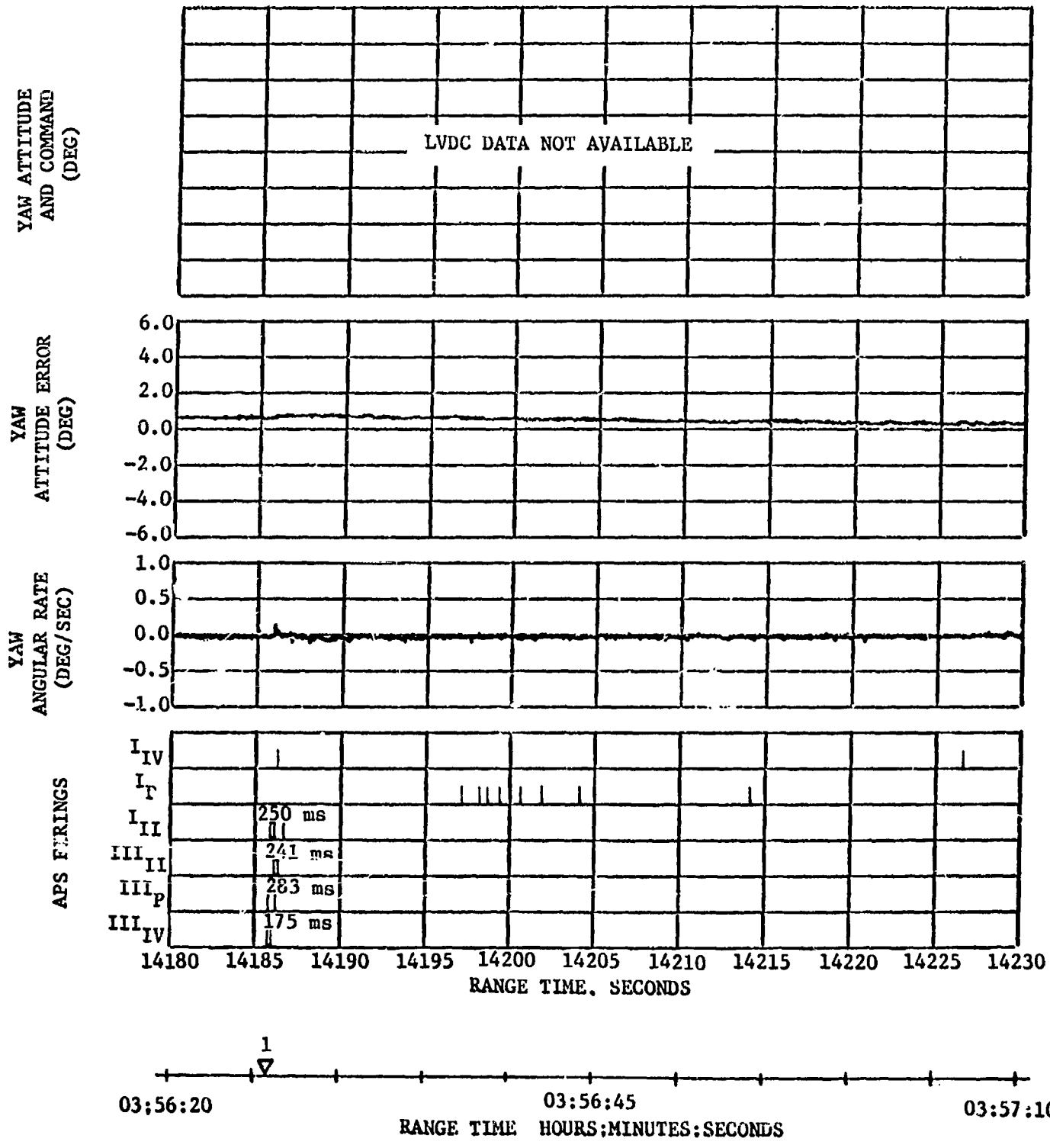
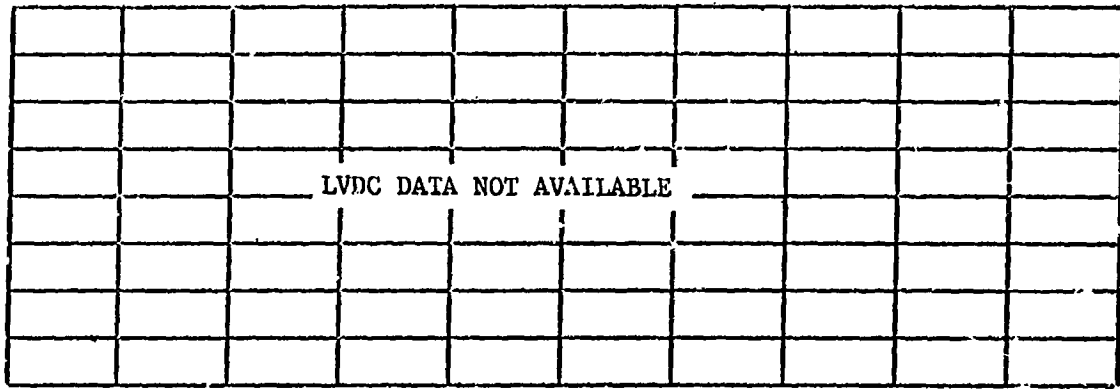

Figure 21-23. Yaw Attitude Control During LM Extraction

▽ LM EXTRACTION

ROLL ATTITUDE
AND COMMAND
(DEG)



ROLL
ATTITUDE ERROR
(DEG)

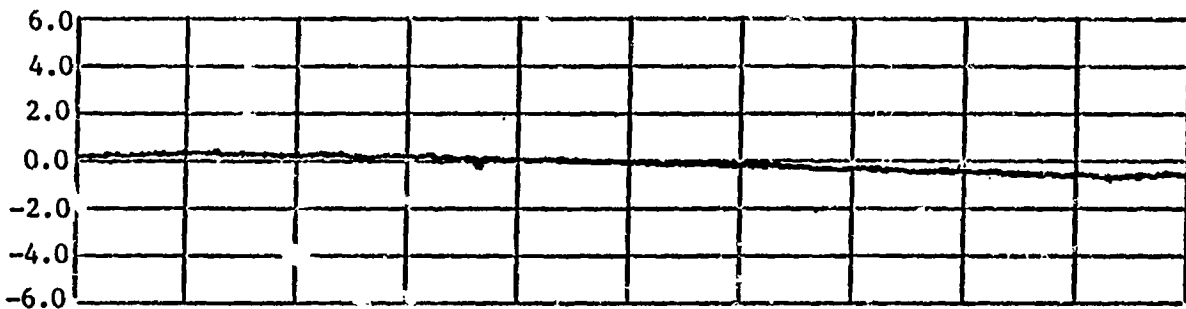

ROLL
ANGULAR RATE
(DEG/SEC)

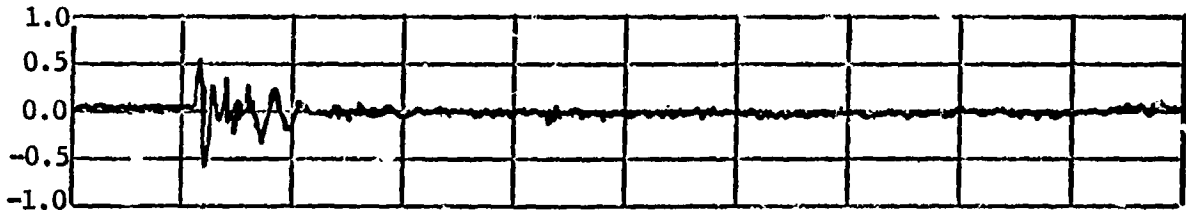

APS FIRINGS

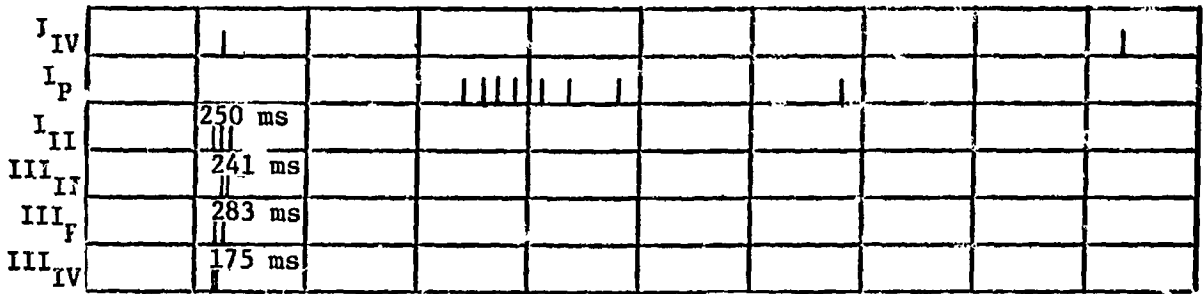

14180 14185 14190 14195 14200 14205 14210 14215 14220 14225 14230
RANGE TIME, SECONDS

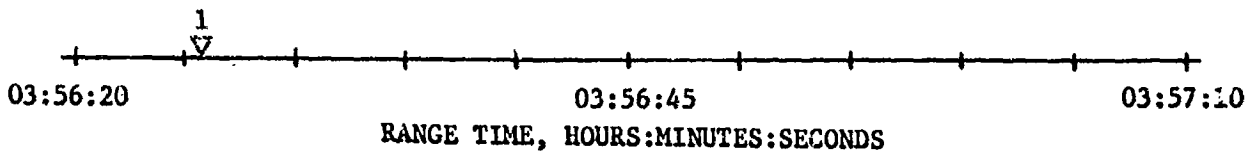

Figure 21-24. Roll Attitude Control During LM Extraction

- ▽ INITIATE MANEUVER TO SLINGSHOT ATTITUDE
- ▽ APS ULLAGE ENGINES ON
- ▽ INITIATE LOX LEAD 8 SEC
- ▽ INITIATE FUEL LEAD 53 SEC
- ▽ APS ULLAGE ENGINES OFF
- ▽ LH2 CVS ON
- ▽ INITIATE LOX DUMP

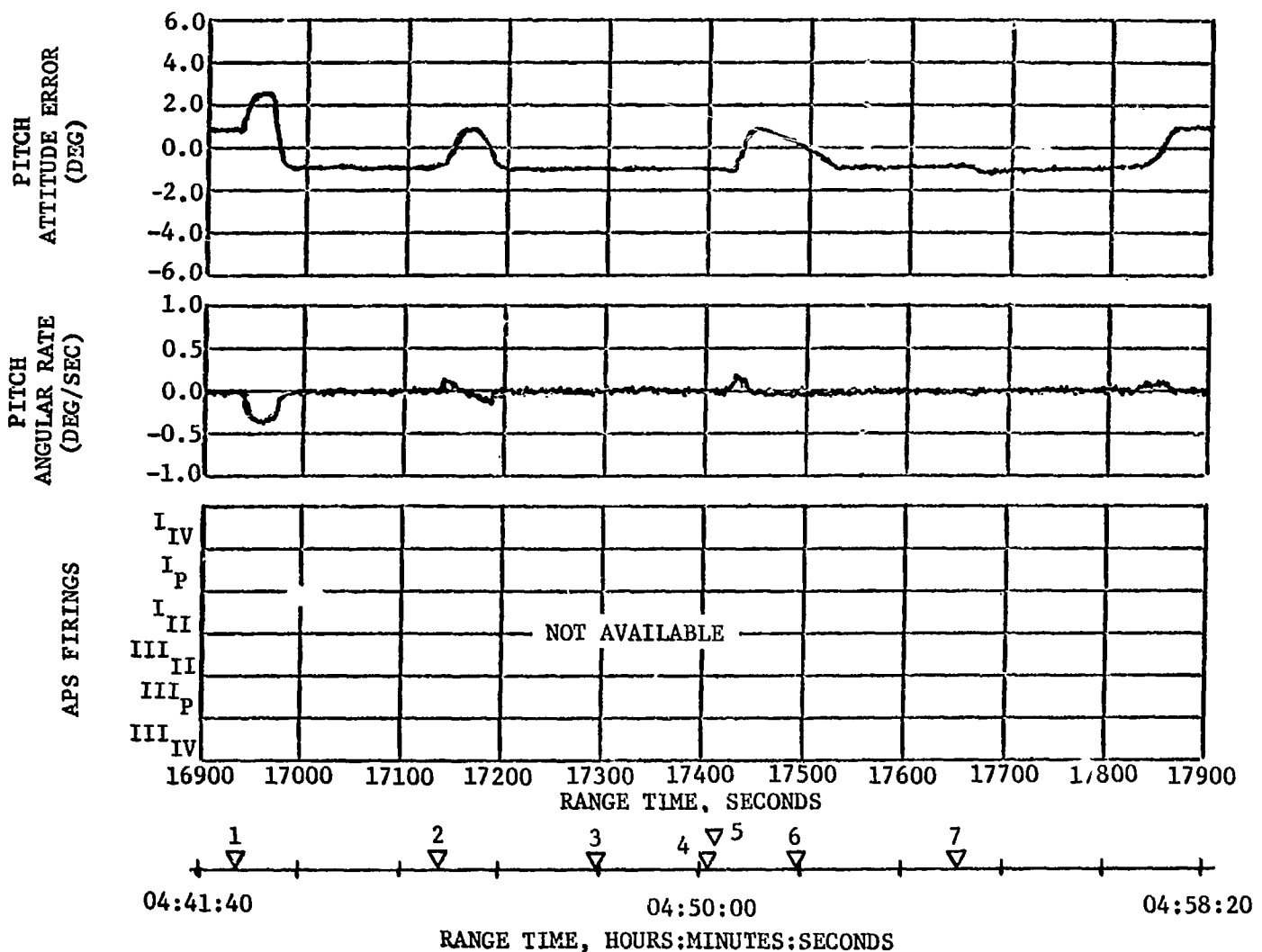

Figure 21-25. Pitch Attitude Control During Orientation to Slingshot Attitude, Propellant Lead Experiment, and LOX Dump

- ▽ 1 INITIATE MANEUVER TO SLINGSHOT ATTITUDE
- ▽ 2 APS ULLAGE ENGINES ON
- ▽ 3 INITIATE LOX LEAD 8 SEC
- ▽ 4 INITIATE FUEL LEAD 53 SEC
- ▽ 5 APS ULLAGE ENGINES OFF
- ▽ 6 LH2 CVS ON
- ▽ 7 INITIATE LOX DUMP

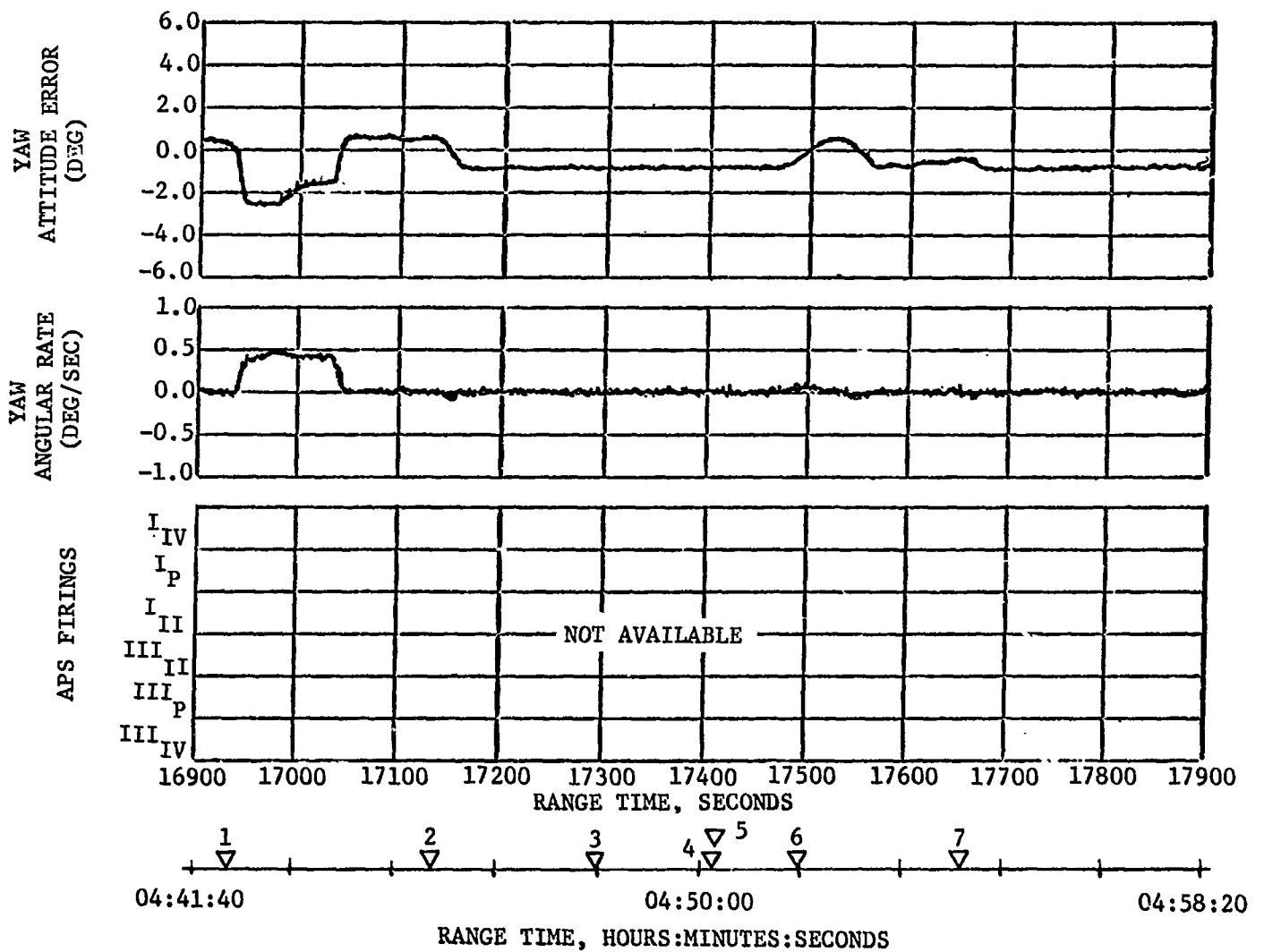

Figure 21-26. Yaw Attitude Control During Orientation to Slingshot Attitude, Propellant Lead Experiment, and LOX Dump

- ▽ 1 INITIATE MANEUVER TO SLINGSHOT ATTITUDE
- ▽ 2 APS ULLAGE ENGINES ON
- ▽ 3 INITIATE LOX LEAD 8 SEC
- ▽ 4 INITIATE FUEL LEAD 53 SEC
- ▽ 5 APS ULLAGE ENGINES OFF
- ▽ 6 LH2 CVS ON
- ▽ 7 INITIATE LOX DUMP

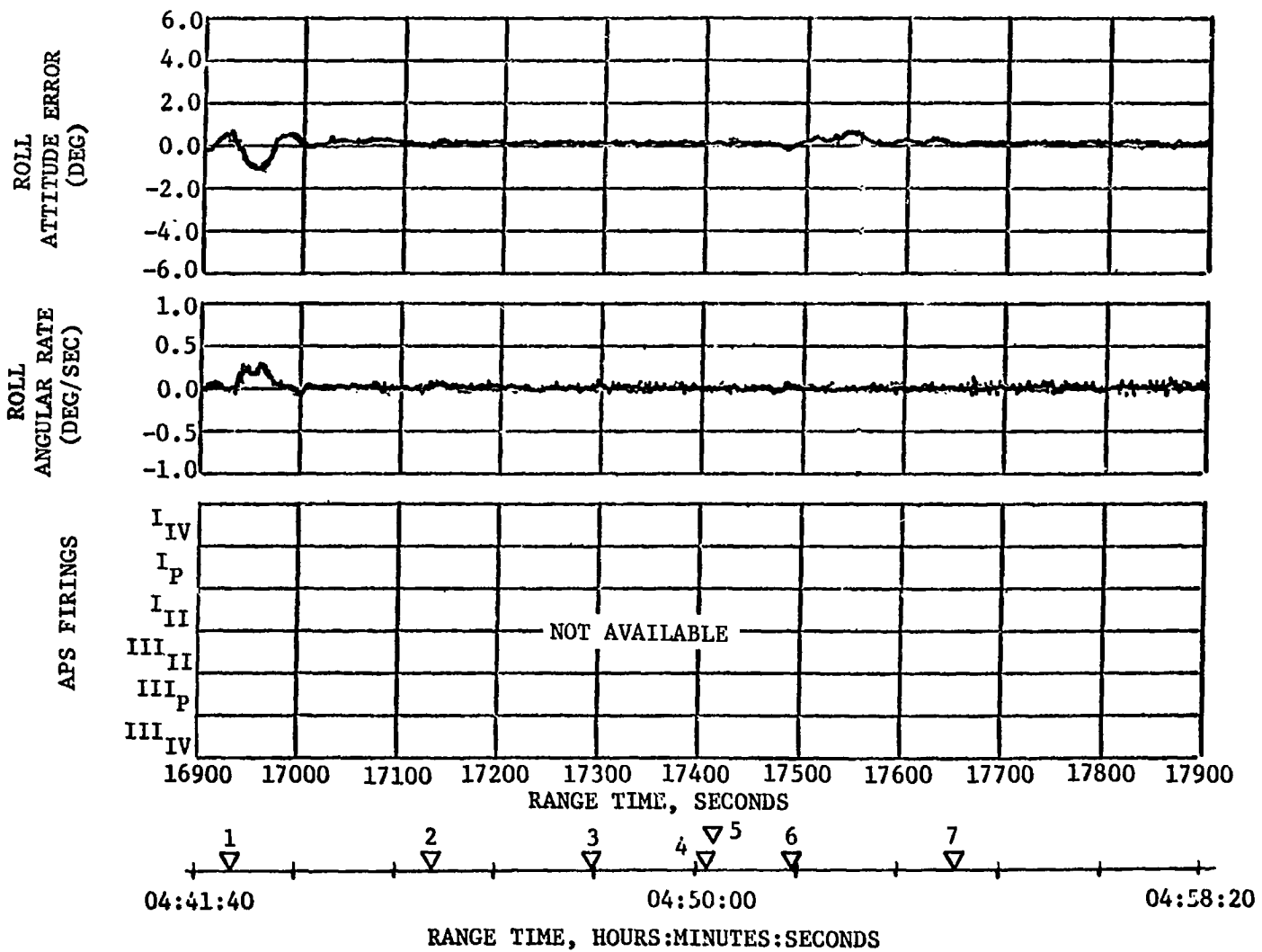

Figure 21-27. Roll Attitude Control During Orientation to Slingshot Attitude, Propellant Lead Experiment, and LOX Dump

22. HYDRAULIC SYSTEM

22.1 Hydraulic System Operation

22.1.1 General (Figure 22-1)

The hydraulic system performed within the predicted limits after liftoff and up to second burn. No overboard venting of system fluid was evident as a result of reservoir fluid expansion. There were three thermal cycles during orbital coasts as shown in figure 22-1. System internal leakage was within the predicted limits (0.4 to 0.8 gpm).

One anomaly occurred after second burn when the auxiliary hydraulic pump failed to supply normal system pressure. Although pump performance was degraded, the engine was centered for the propellant lead experiment and propellant dump.

22.1.2 Boost and First Burn (Figure 22-2 through 22-7)

During S-1C/S-11 boost all system fluid temperatures rose steadily when the auxiliary pump was operating and convection cooling was decreasing. The supply pressure was nearly constant at 3630 psia which was within the allowable of 3515 to 3665 psia.

System internal fluid leakage was shared by the main engine driven and auxiliary hydraulic pump after engine start. This was characterized by a slight increase in system pressure and the auxiliary pump motor current draw decreasing to 32 amperes. The above-mentioned current indicates that the auxiliary pump was supplying approximately 0.4 gpm of the total flow. Power extracted from the engine by the main pump was 3.85 horsepower during burn.

22.1.3 Parking Orbit and Second Burn (Figure 22-6 through 22-13)

Two 48 second thermal cycles were programmed during coast phase. These cycles were programmed for circulating the system fluid to more evenly distribute the system heat.

The auxiliary hydraulic pump was activated to the flight mode ON for second start engine preparation. The system operation was normal with a pressure of 3635 psia. After engine start the system pressure increased to 3770 psia exceeding the nominal pump setting of 3515 to 3665 psia. System leakage was provided by the engine driven pump. Horsepower extracted from the turbopump by the engine driven pump was 4.85 hp. Pump inlet and reservoir oil temperatures increased at normal rates of 9.4 and 3.6°F/min respectively. Engine deflections were nominal during the burn.

22.1.4 Translunar Injection Coast and Propellant Dump (Figure 22-14 through 22-19)

Degraded performance of the auxiliary hydraulic pump was observed during this period. Data indicates that the anomaly occurred during second burn. This is evident by an immediate decrease in pressure after engine cutoff. Pressure would normally start decreasing after auxiliary hydraulic pump flight mode off (TB 7 + 4.1 sec). Auxiliary pump motor amperage further substantiates this by not increasing after ECO₂. (See figure 22-10)

There was no system pressure indicated during third thermal cycle and propellant lead and dump experiments with the auxiliary hydraulic pump operating. There was no change in reservoir level accumulator gas pressure and reservoir oil pressure at pump start. The auxiliary pump motor current load indicated a steady draw of approximately 17 amperes in comparison to a normal draw of 38 to 45 amperes. The pump did develop sufficient pressure and flow however to center the engine slowly within 30 seconds.

Laboratory tests were run in an effort to simulate the 505N anomaly. From the tests run, it was concluded that the most likely cause of the in-flight anomaly was the failure of the auxiliary pump compensator spring guide.

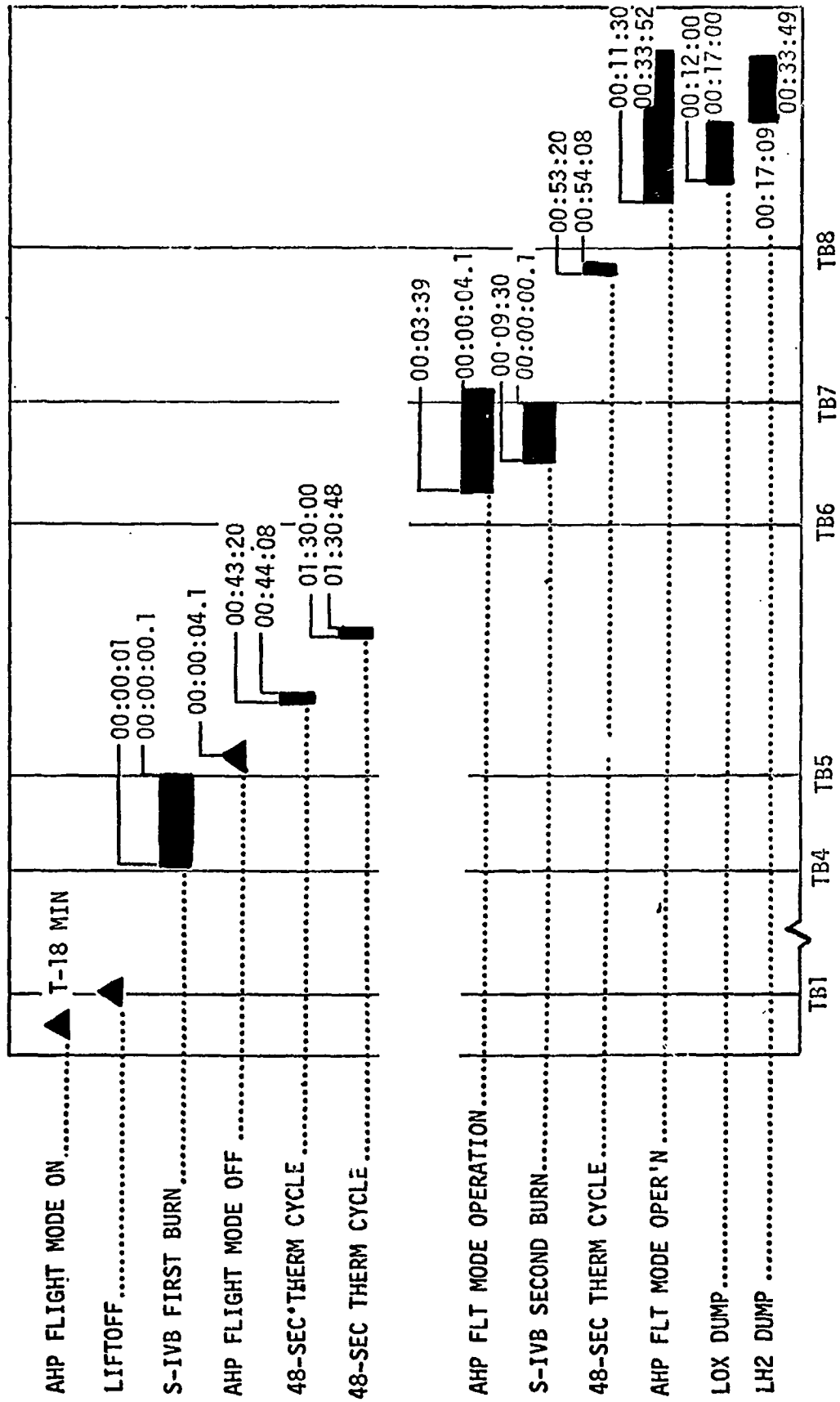

Figure 22-1. Hydraulic System Functional Sequence.

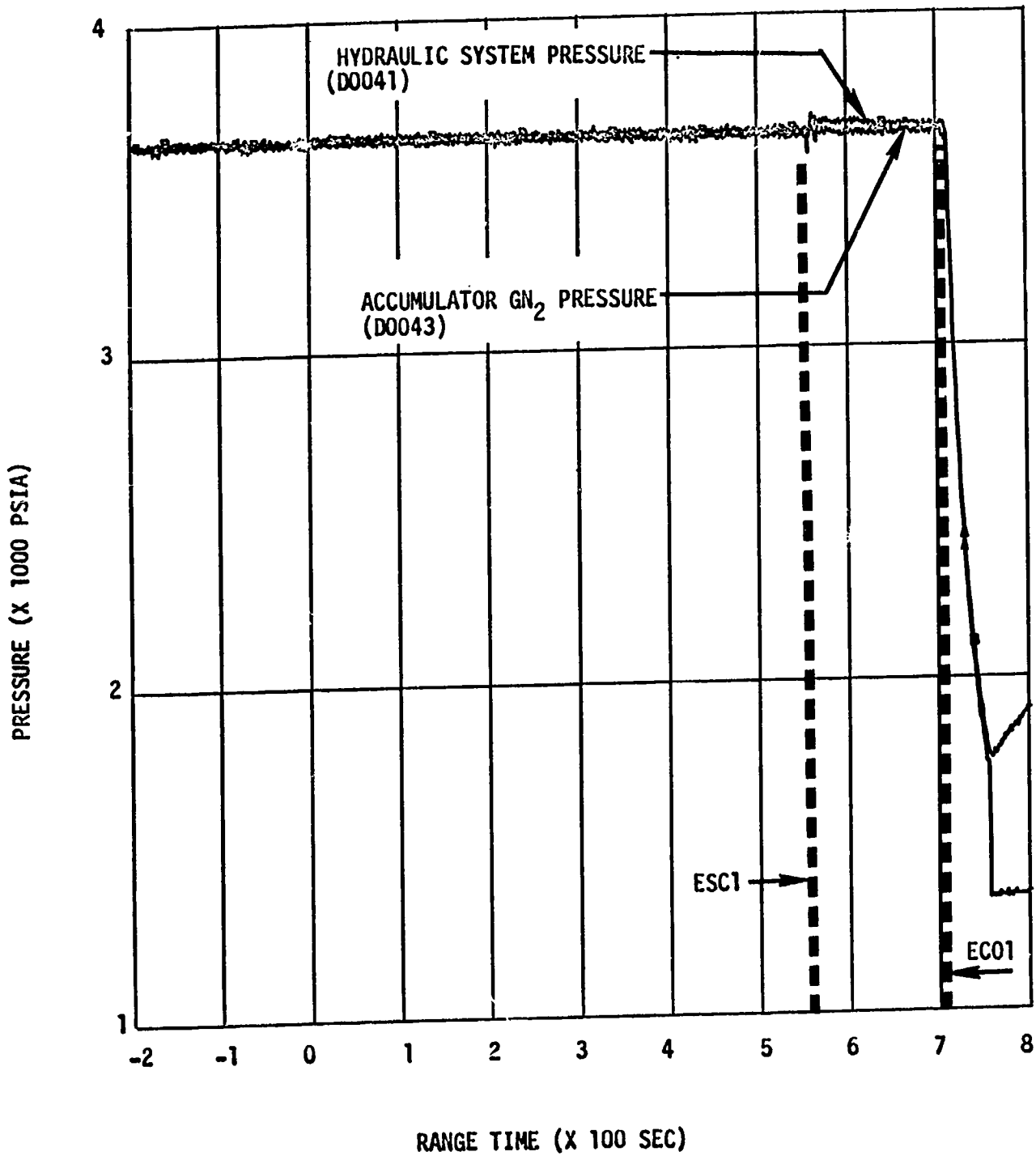

Figure 22-2. Hydraulic System Pressures - Boost & 1st Burn

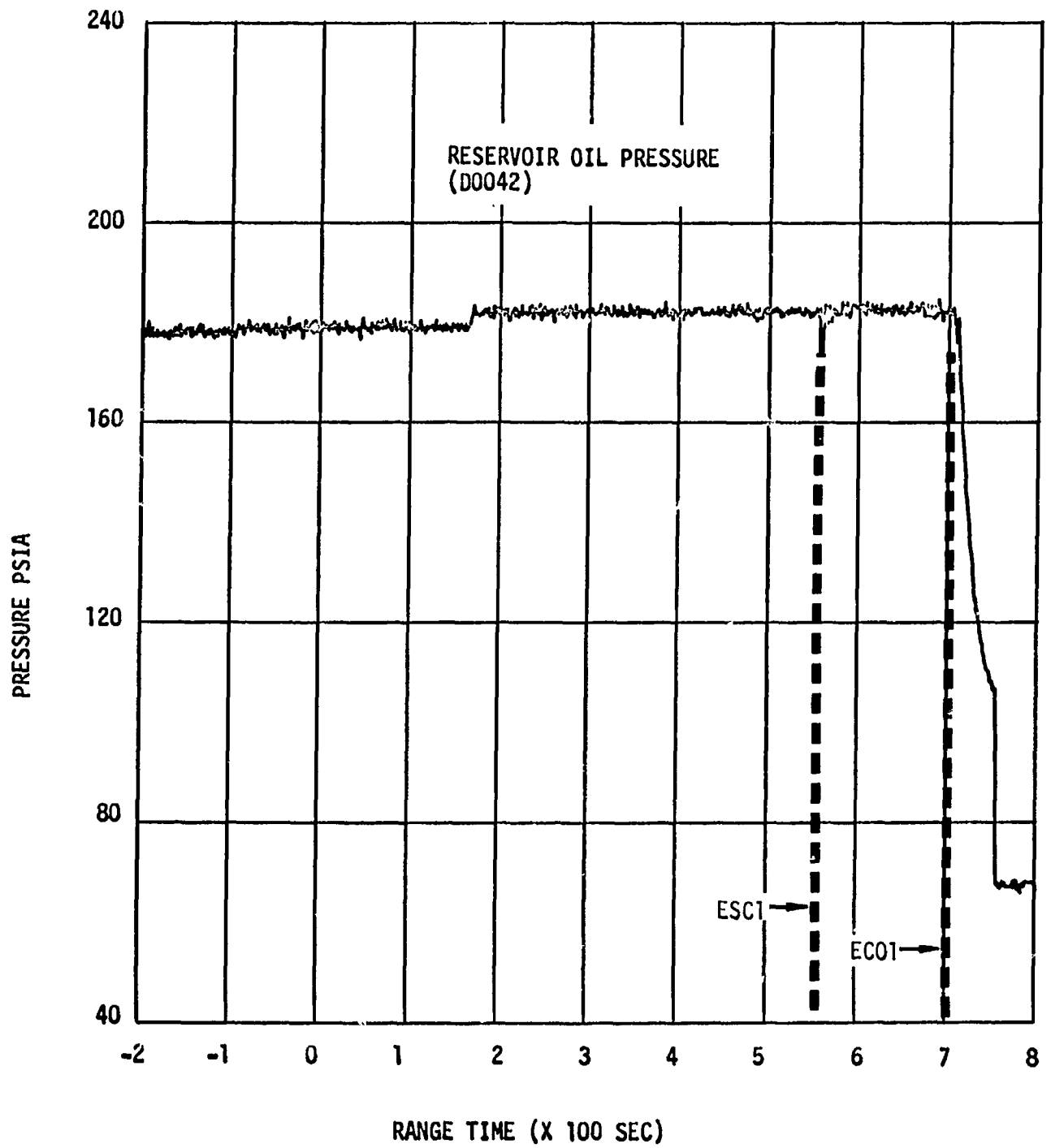

Figure 22-3. Reservoir Oil Press - Boost & 1st Burn

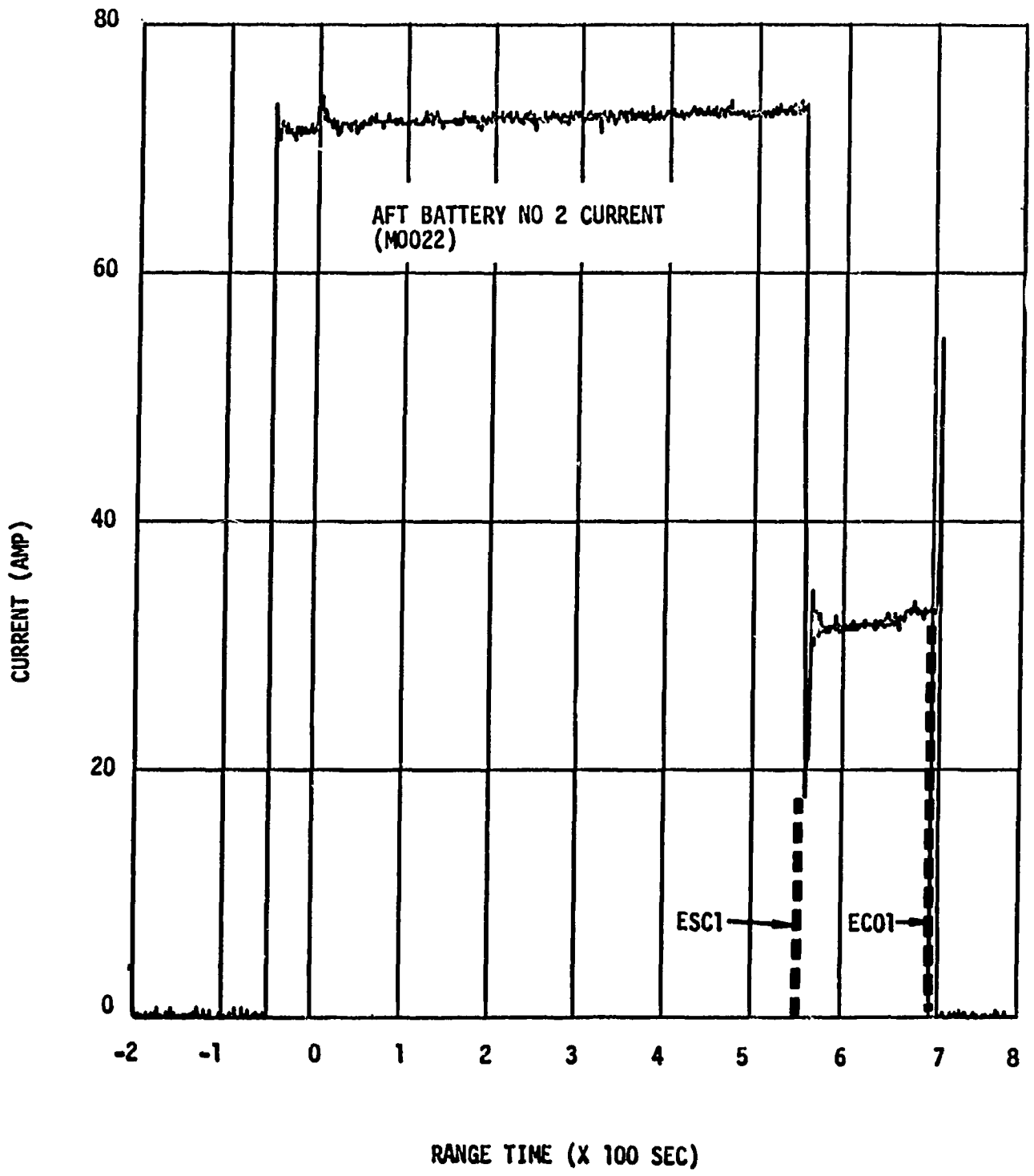

Figure 22-4. Aft Battery No. 2 Current Boost & 1st Burn

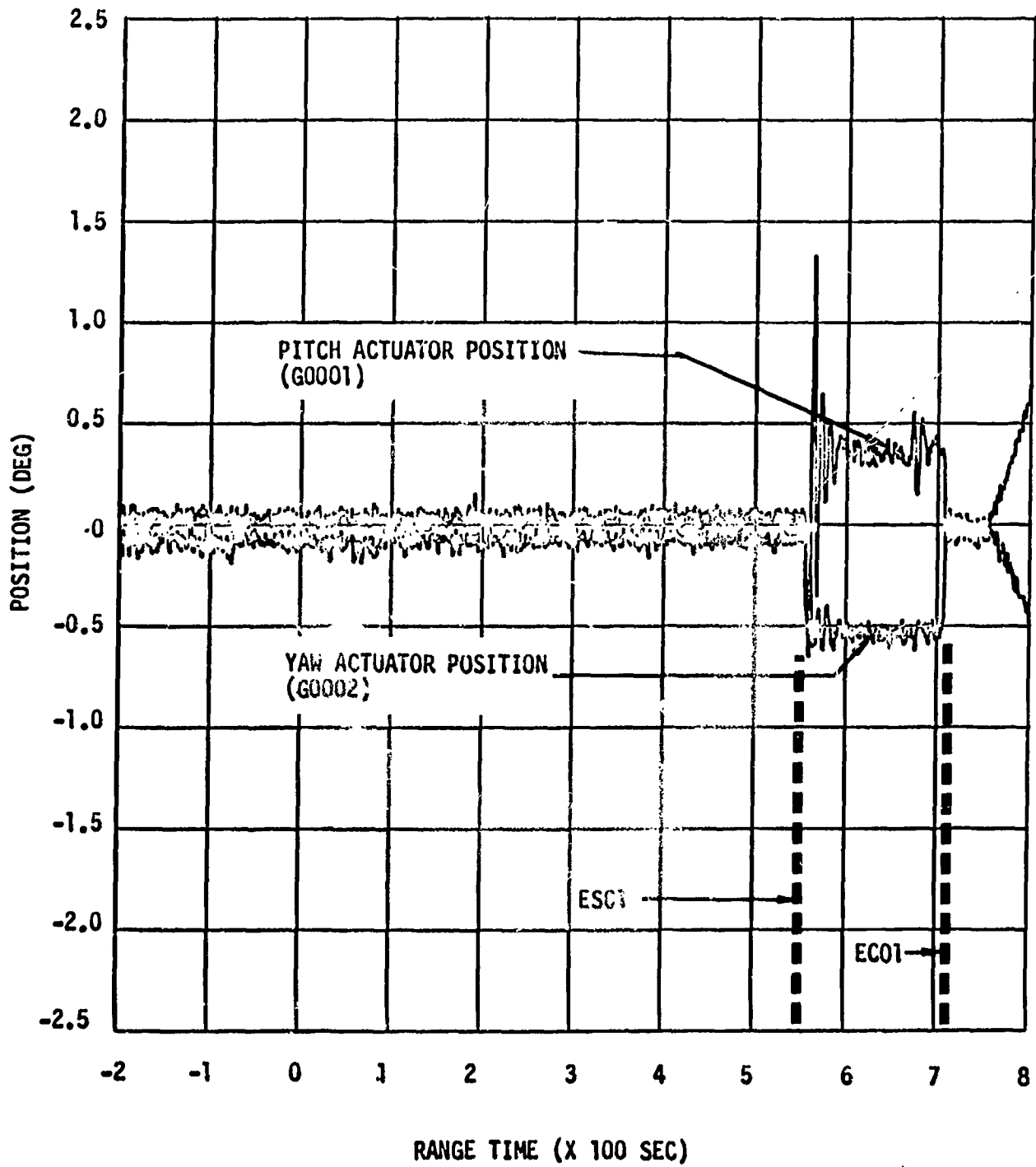

Figure 22-5. Hydraulic Actuator Positions Boost & 1st Burn

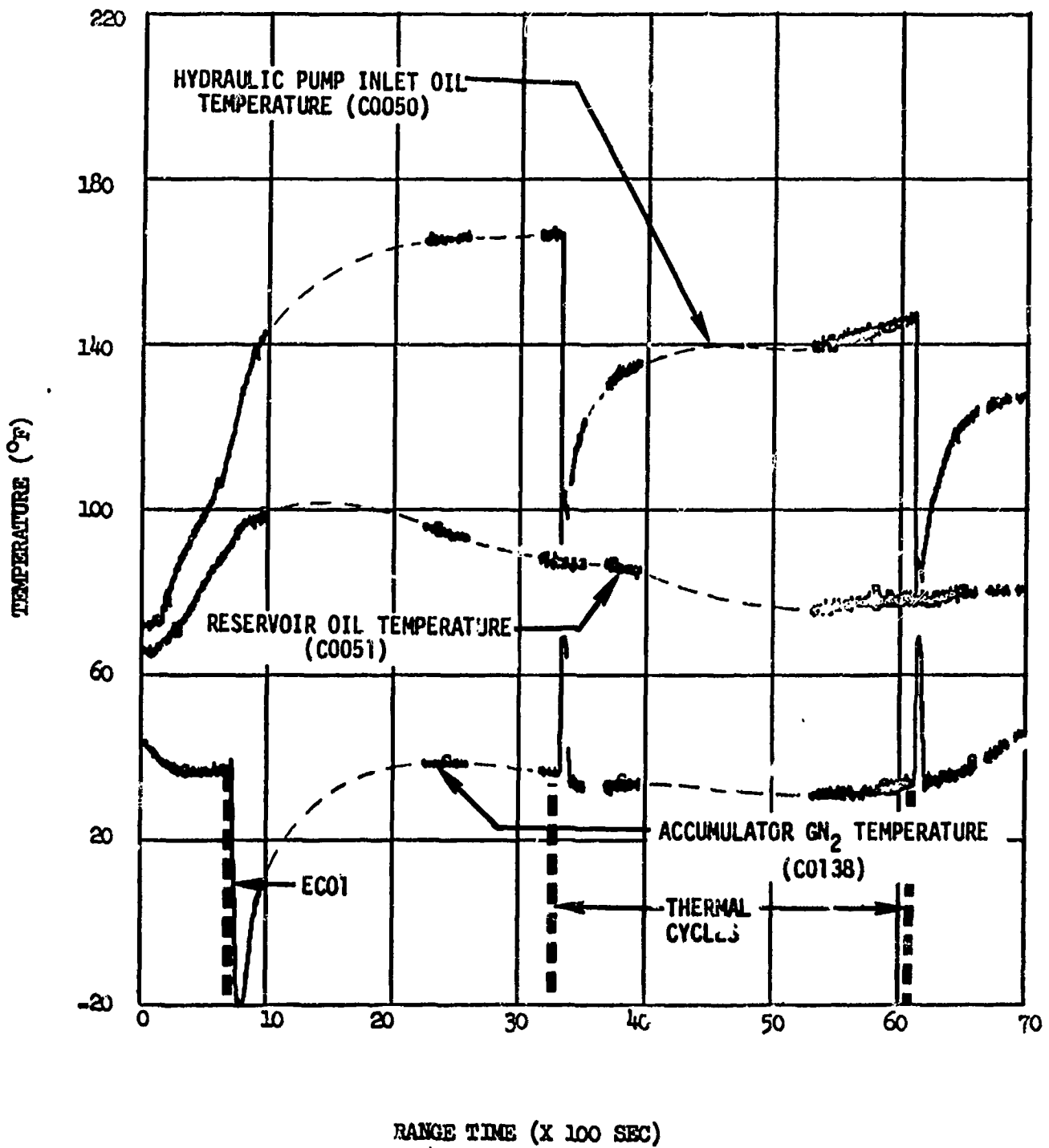

Figure 22-6. Hydraulic System Temperatures - Orbital Coast

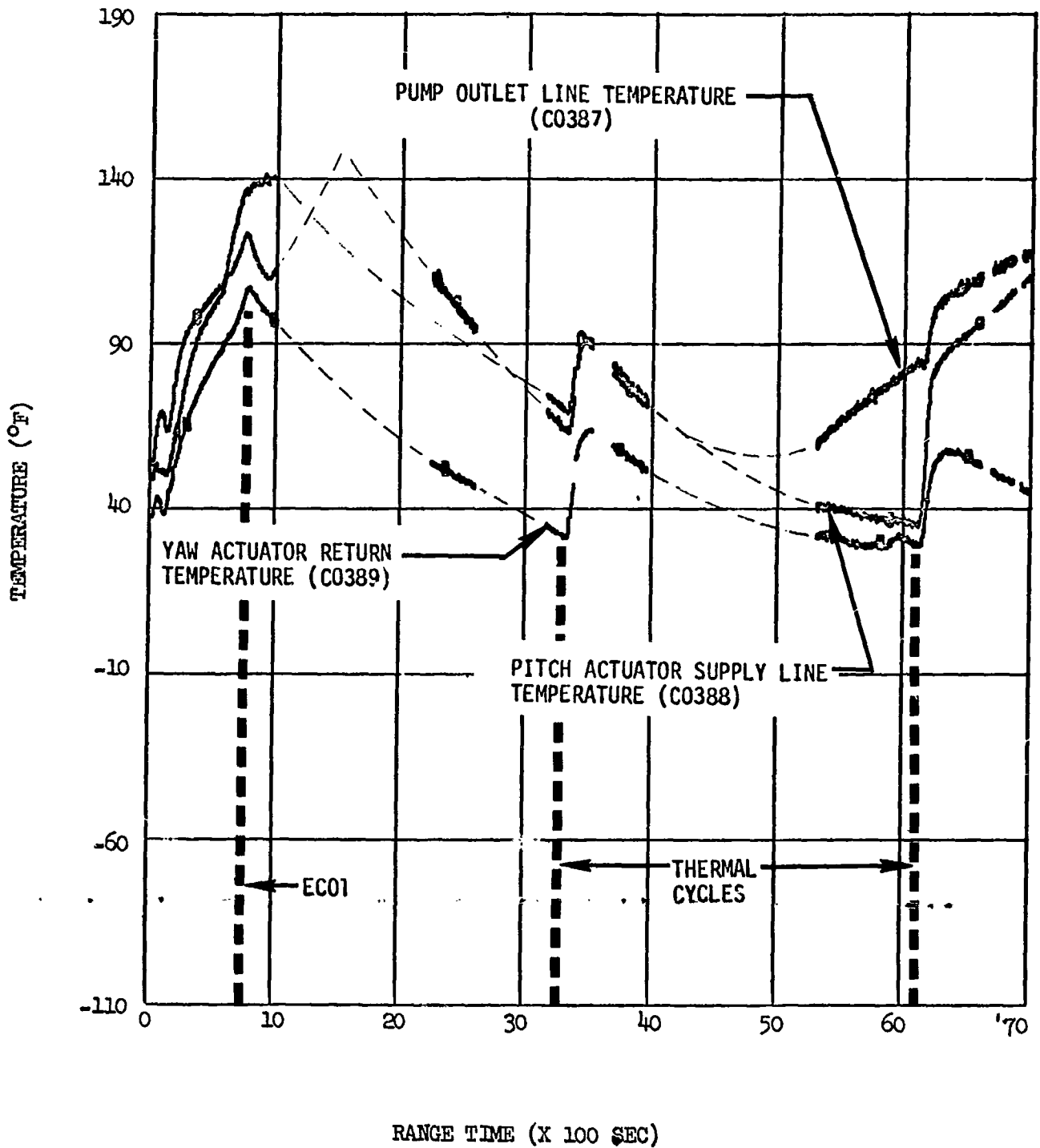

Figure 22-7. Hydraulic System Line Temps - Orbital Coast

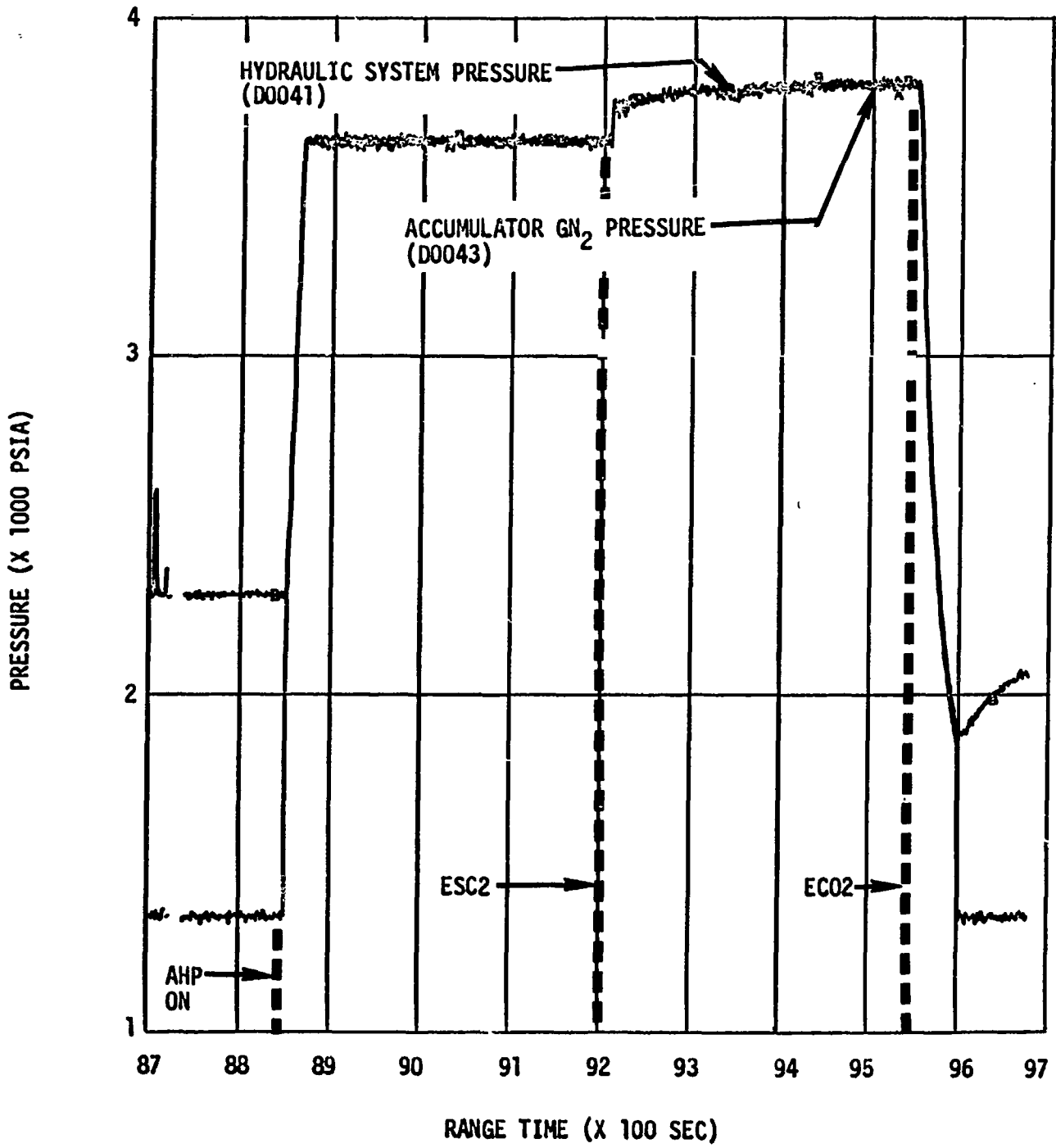

Figure 22-8. Hydraulic System Pressures - Second Burn

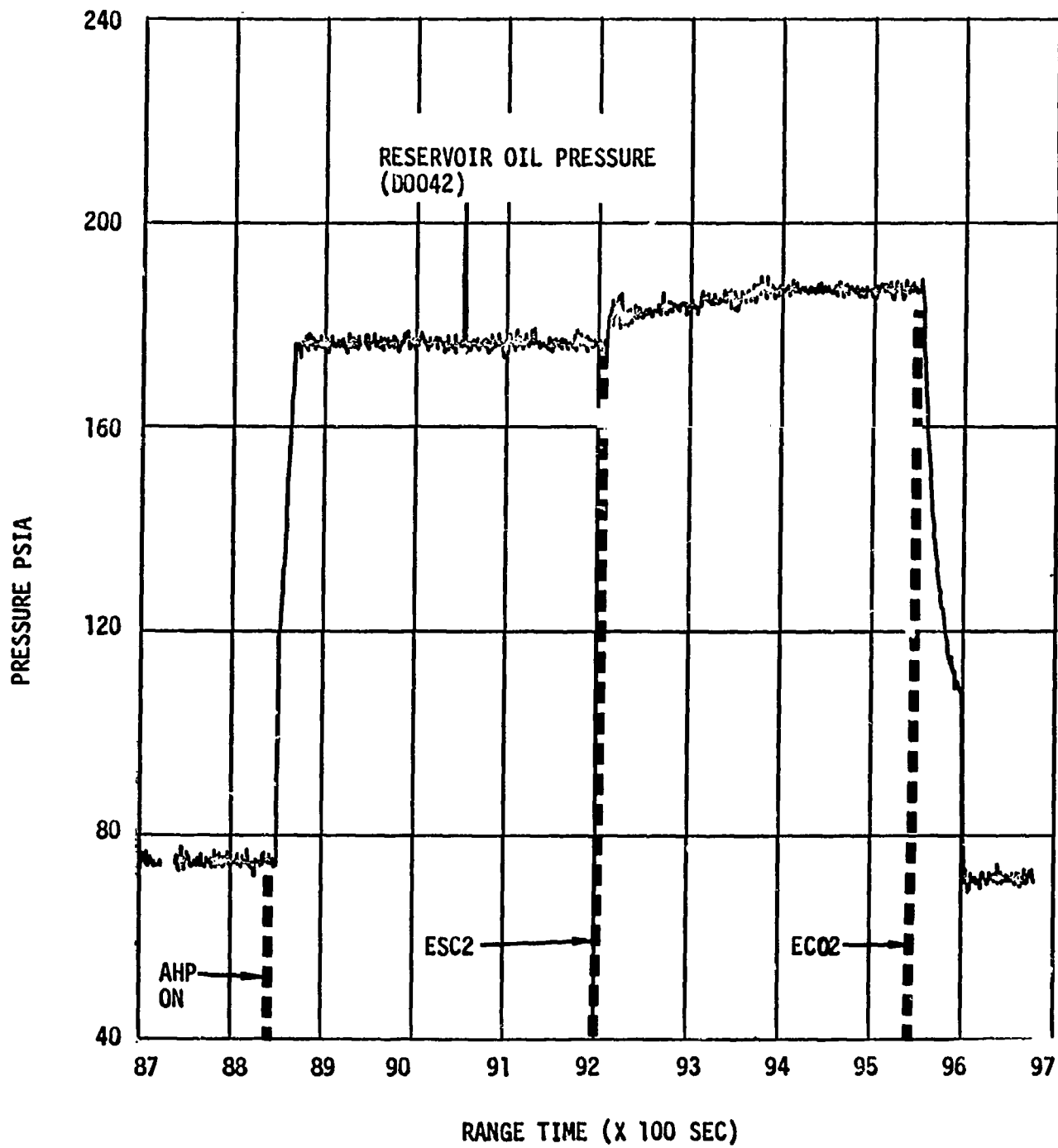

Figure 22-9. Reservoir Oil Pressure - Second Burn

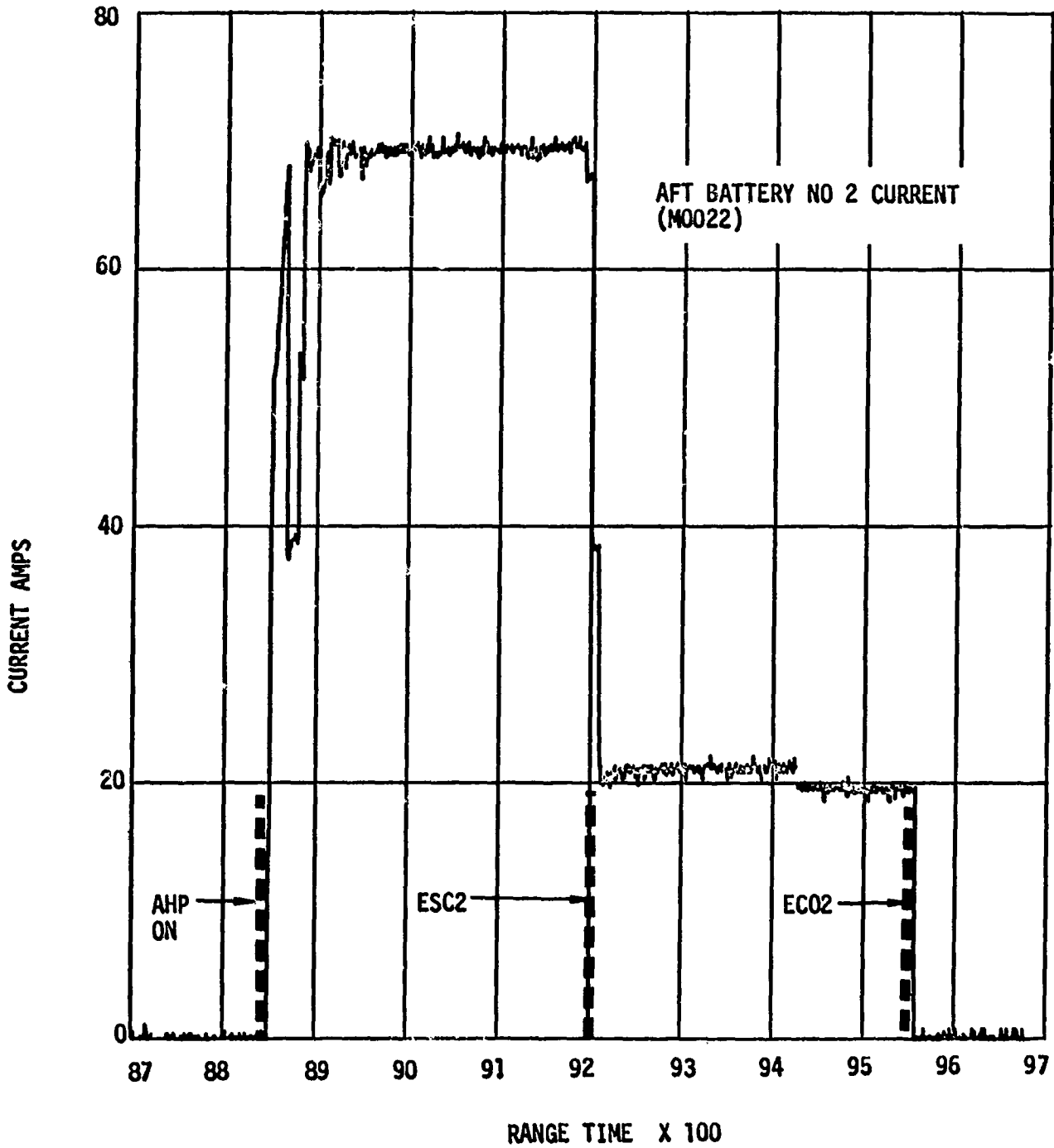

Figure 22-10. Aft Battery No. 2 Current - Second Burn

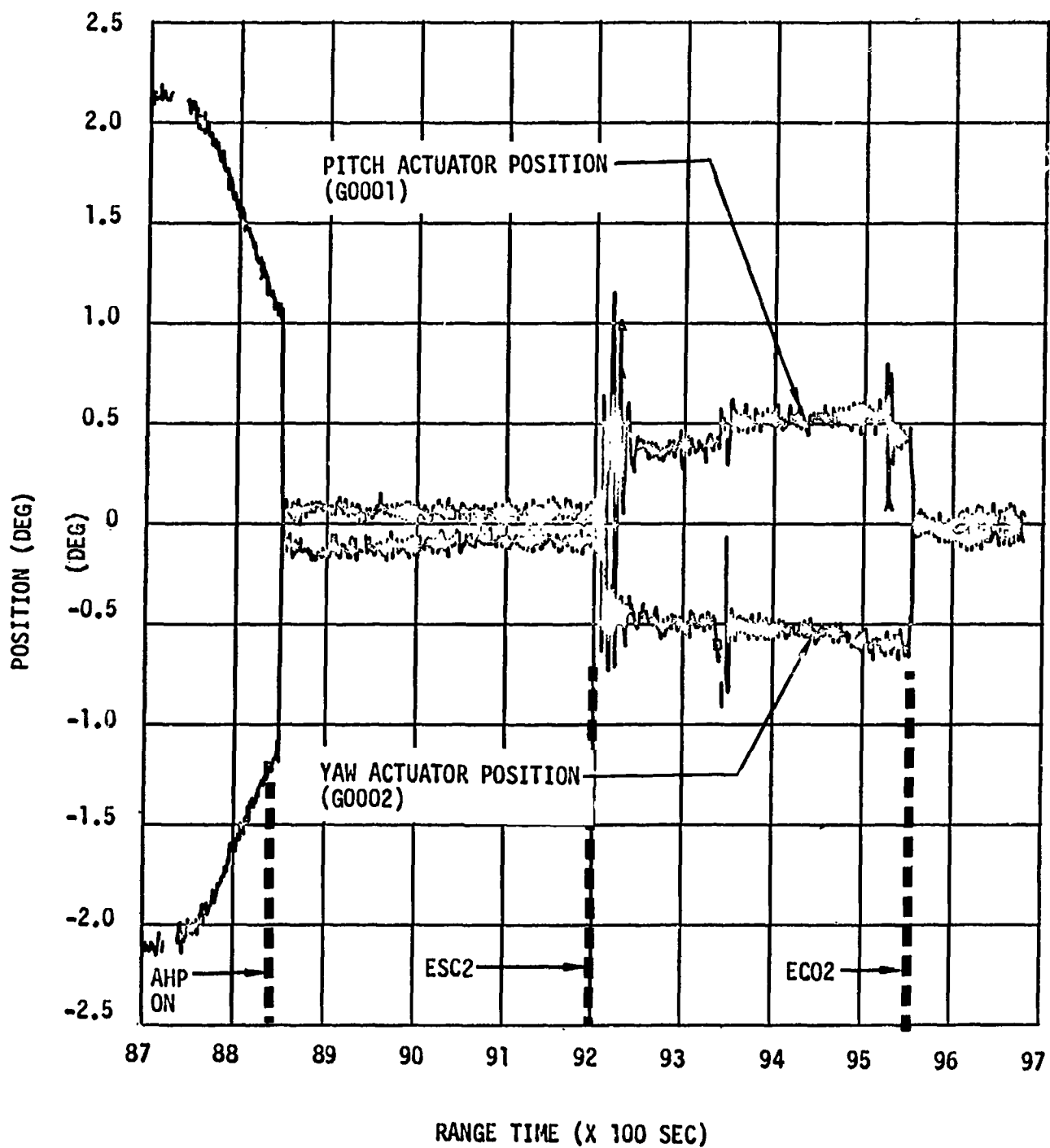

Figure 22-11. Hydraulic Actuator Positions - Second Burn

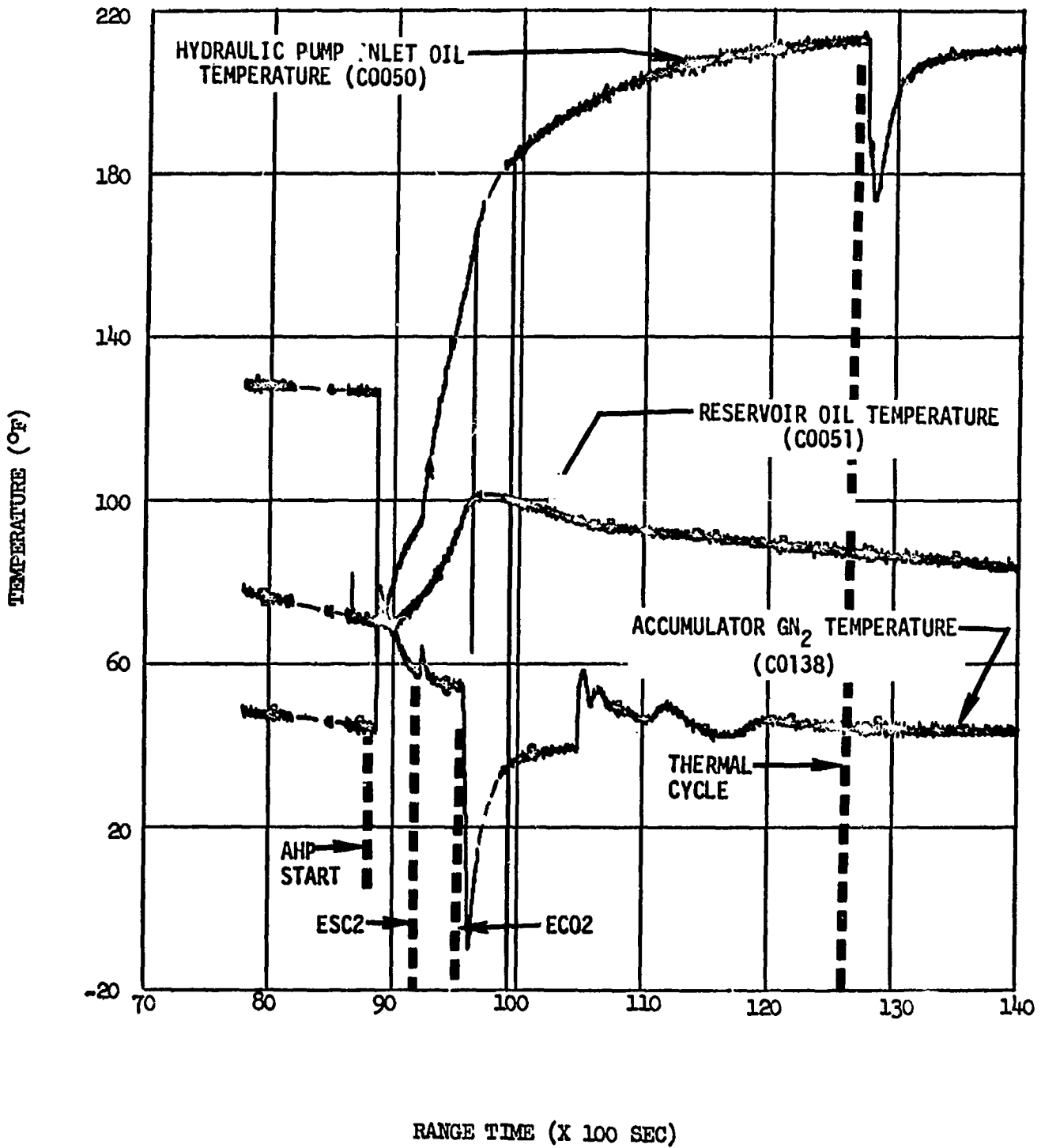

Figure 22-12. Hydraulic System Temps - 2nd Burn & TLI

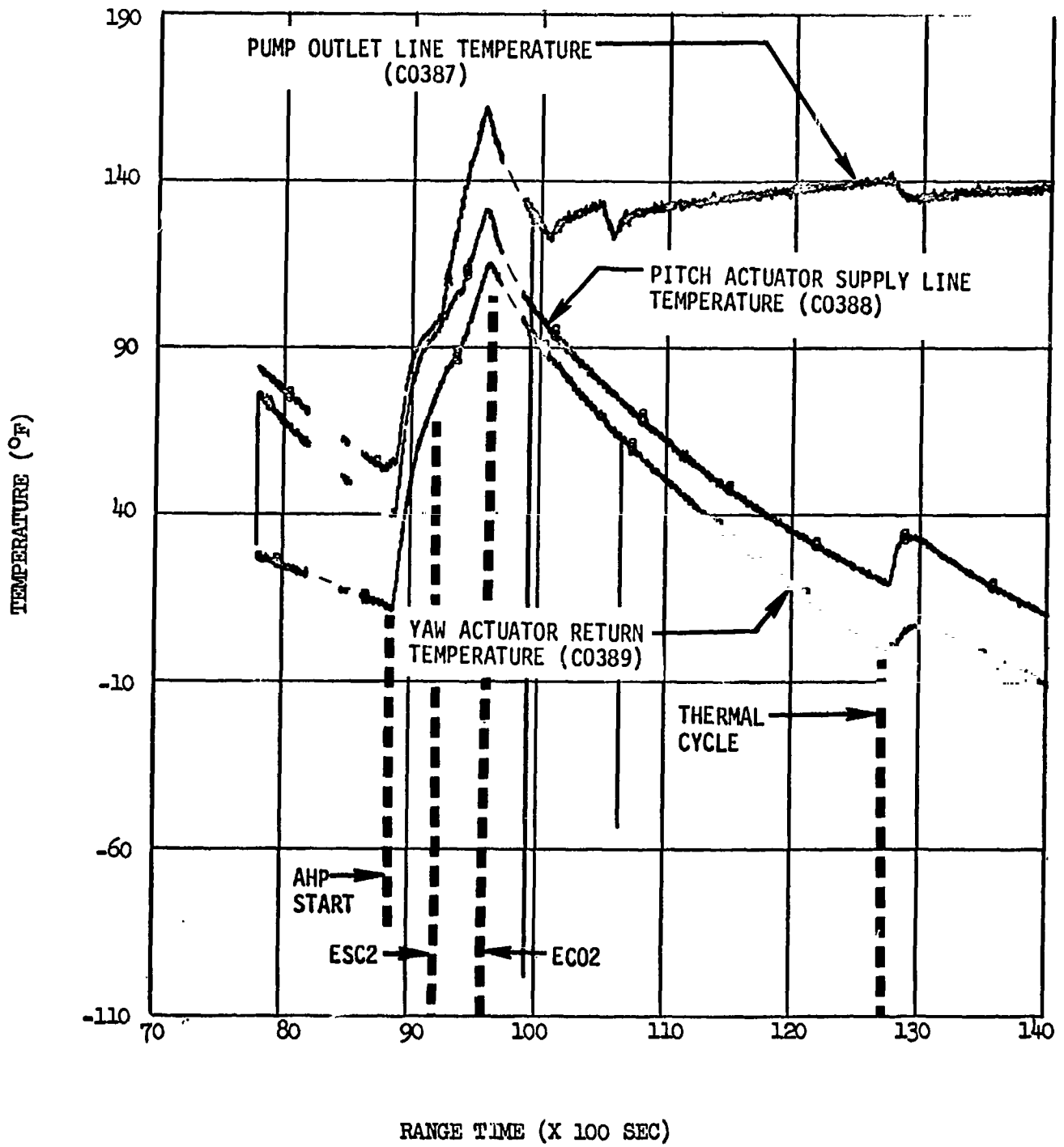

Figure 22-13. Hydraulic Line Temps - 2nd Burn & TLI

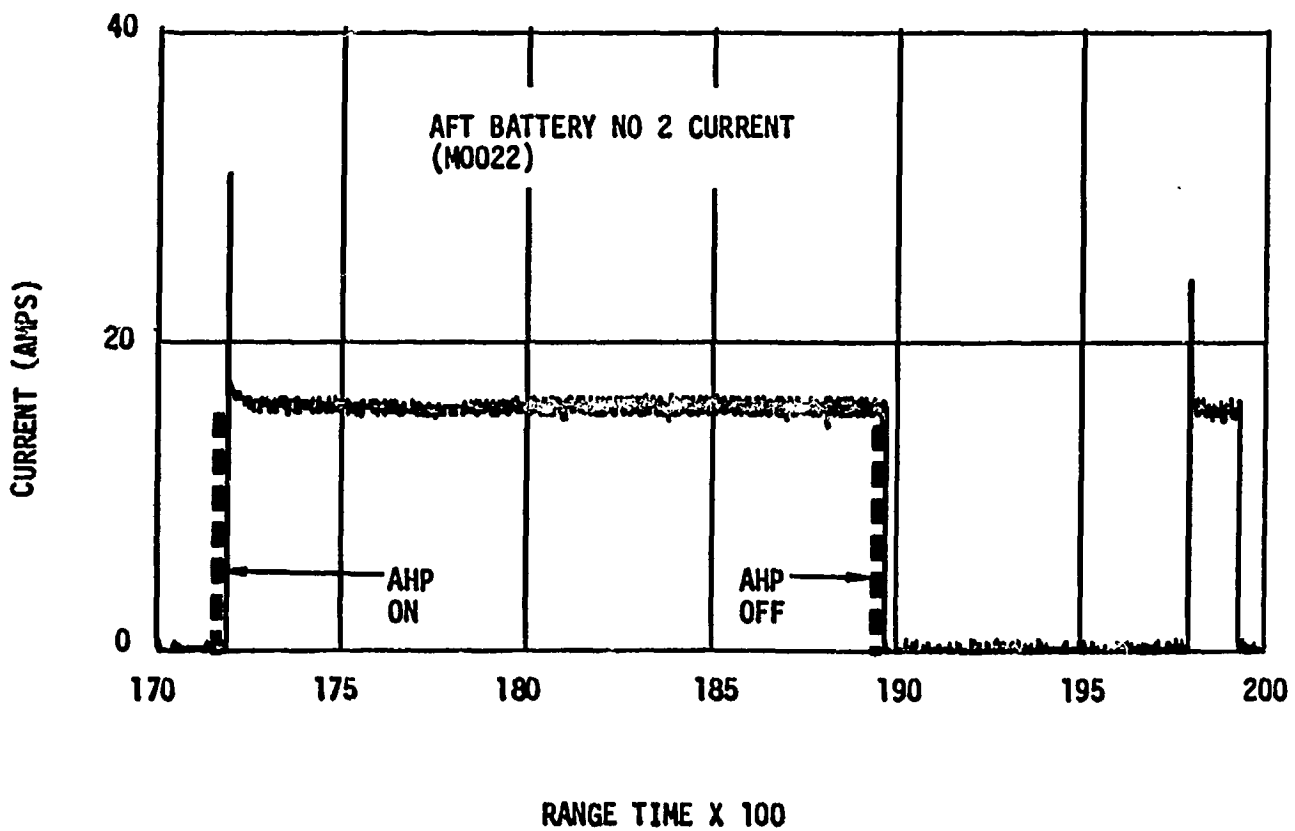

Figure 22-14. Aft Battery No. Current - Propellant Dump

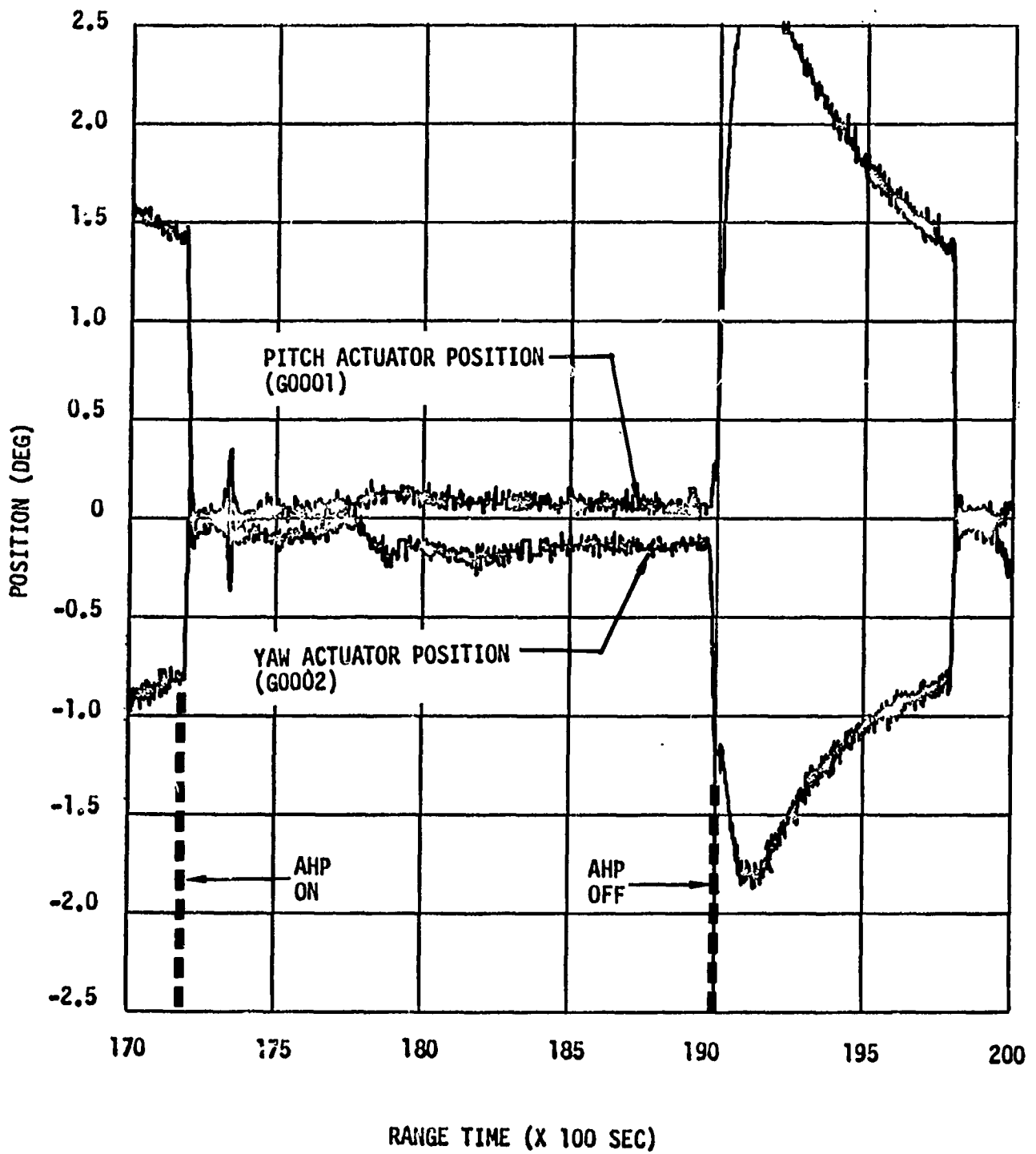

Figure 22-15. Hydraulic Actuator Positions - Propellant Dump

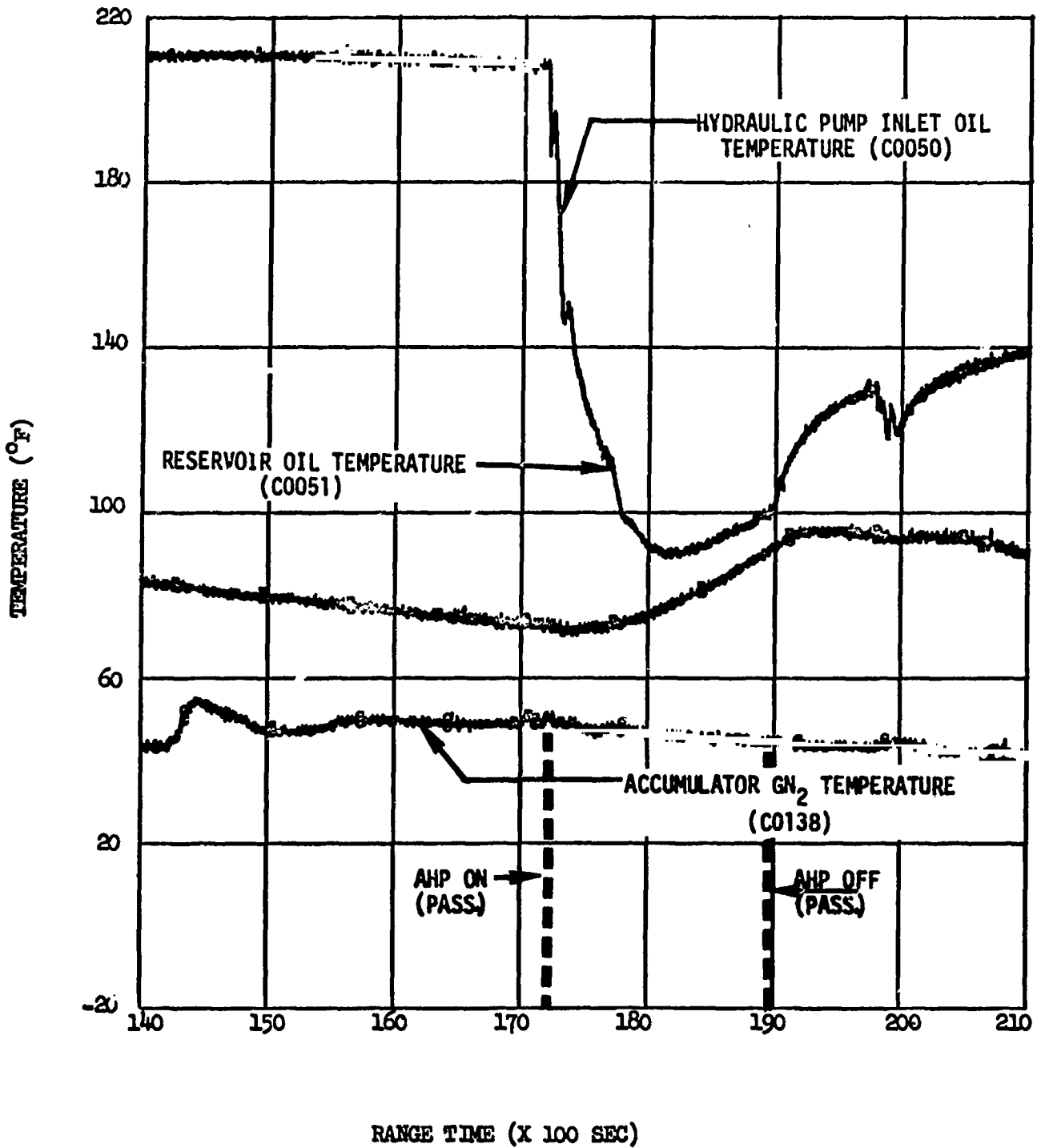

Figure 22-16. Hydraulic System Temps - Propellant Dump

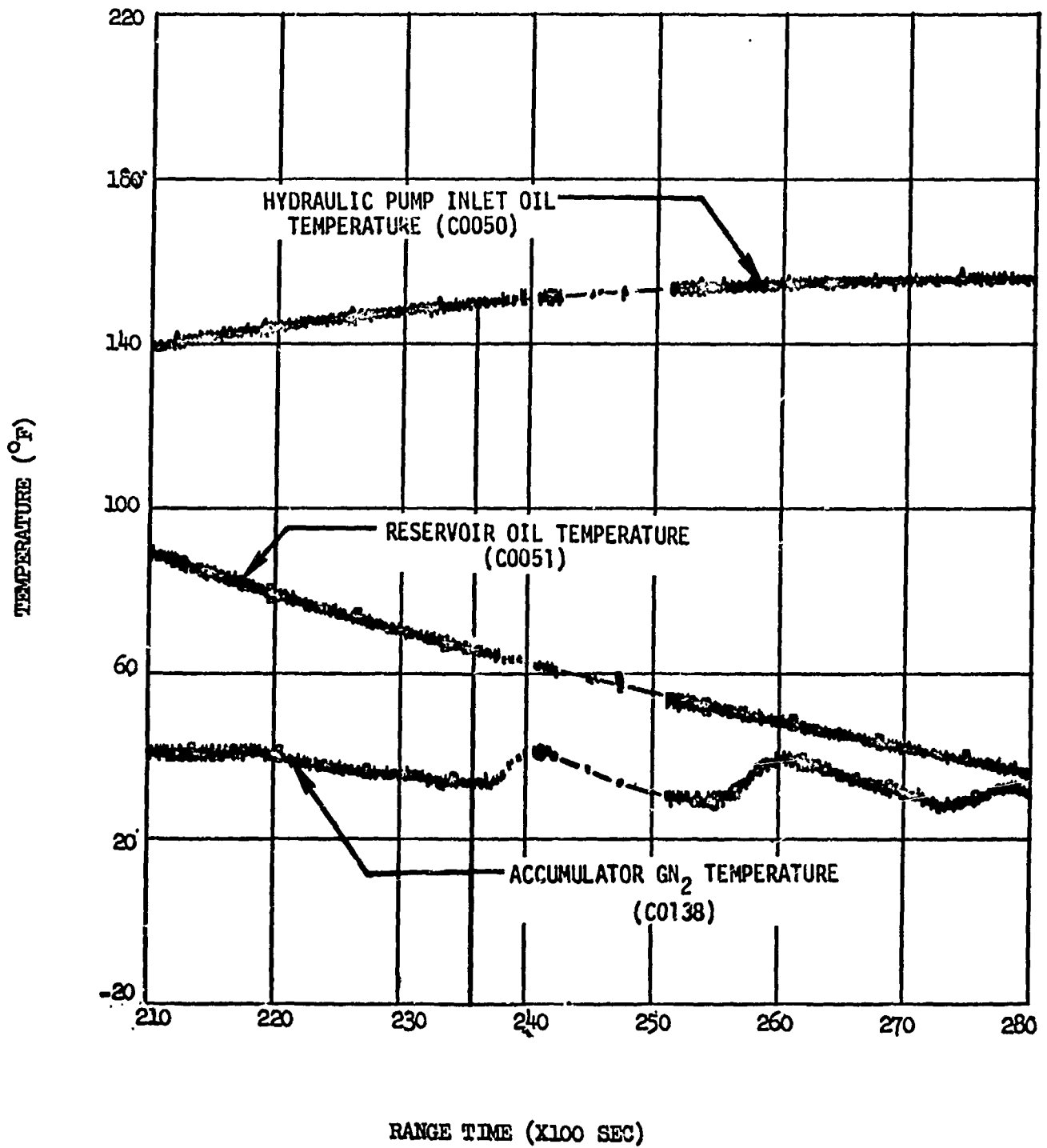

Figure 22-17. Hydraulic System Temps - Translunar Coast

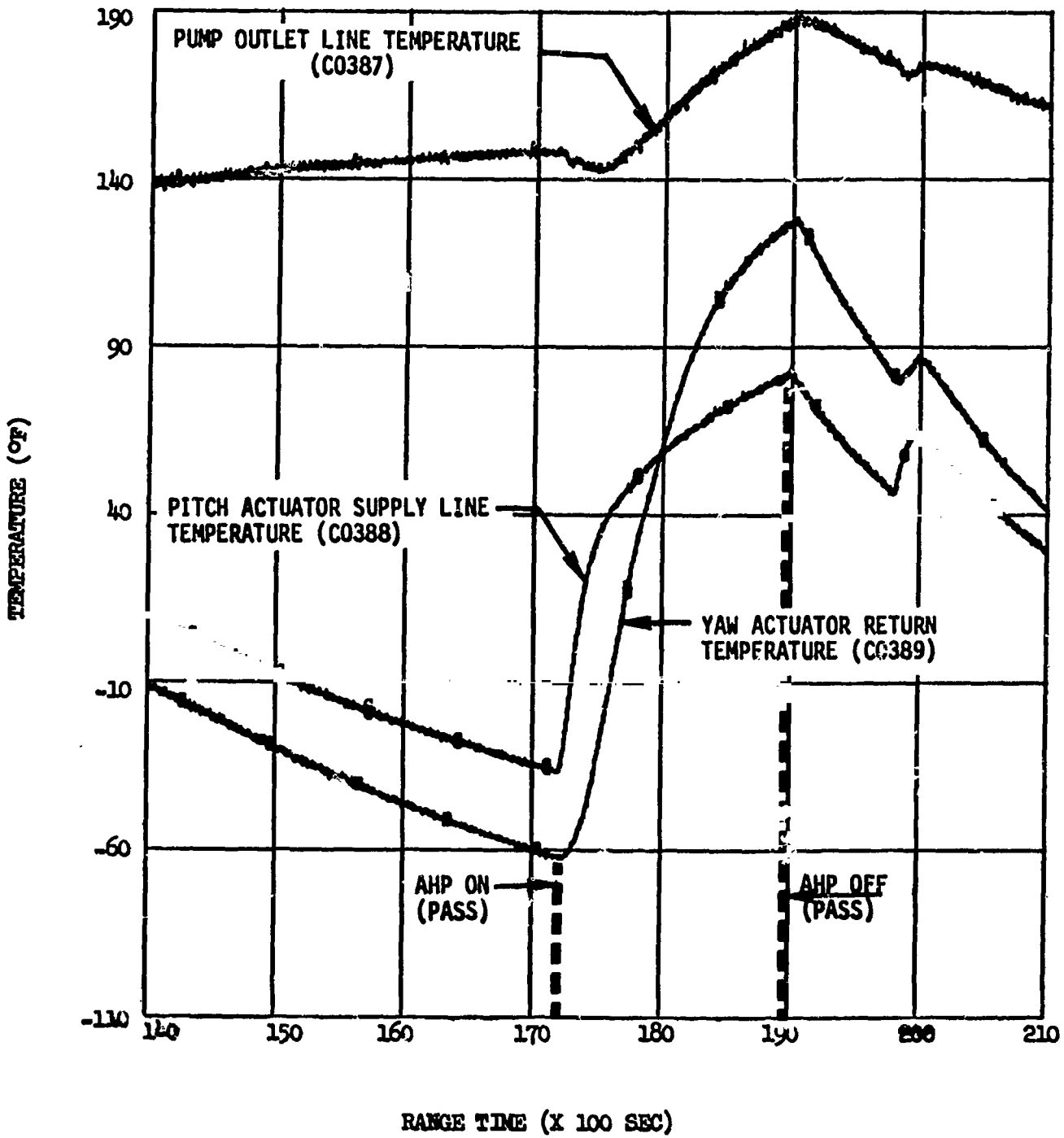

Figure 22-18. Hydraulic System Line Temp - Propellant Dump

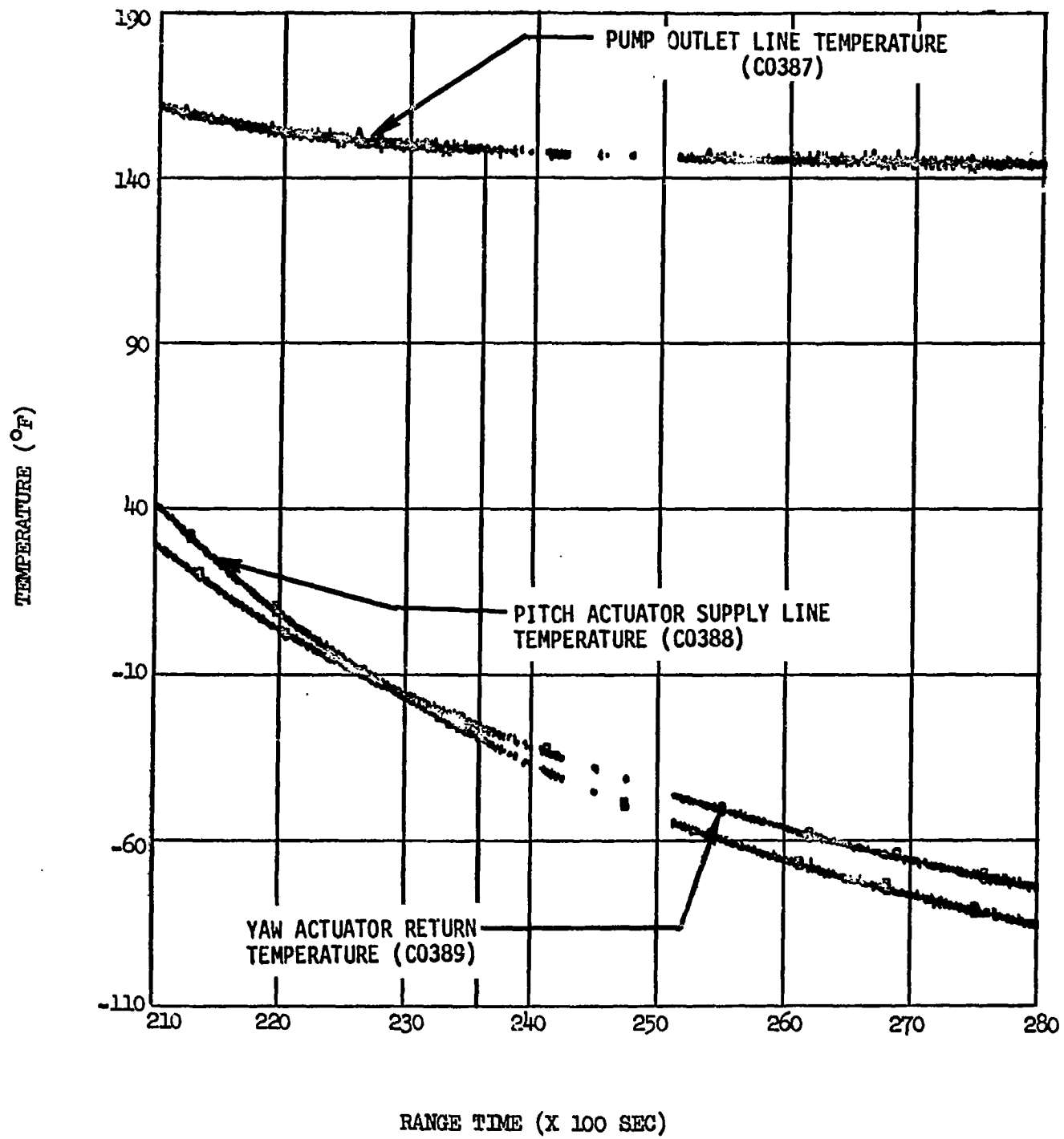

Figure 22-19. Hydraulic System Line Temps - Translunar Coast

23. STAGE STRUCTURE AND ENVIRONMENT

23.1 Flight Load Conditions and Structural Integrity

An evaluation of strain, acceleration, and pressure data from the S-IVB Stage for the AS-505 Trajectory indicated adequate structural strength existed in the stage for the conditions encountered.

Body bending moments were less than the maximum predicted values due to comparatively moderate wind shears and gusts. A maximum vehicle axial acceleration of 3.92 g was obtained compared to the mission restricted nominal acceleration of 4.0 g. Axial loads computed from flight strain gage data are in general agreement with preflight computed axial loads from lift-off to about 70 seconds of flight time. Beyond that flight time, the axial loads during S-IC Stage boost computed from strain gage data deviated from predicted values apparently due to thermal effects on the structure from aerodynamic heating.

Axial stringer strain measurements from the Forward Skirt and Aft Skirt showed significant strain changes prior to lift-off due to differential structural expansions and contractions from cryogenic propellant loading and also from propellant tank pressurization. Flight measured stringer strains during critical S-IC Stage boost were affected considerably by differential structural expansions and contractions resulting from aerodynamic heating after about 60 seconds of flight time. The total accumulative loads in the stringers were evaluated and found to show positive margins of safety.

The LH2 Tank and LOX Tank ullage pressures did not exceed the vent and relief pressure values. The differential tankage pressures acting on the Common Bulkhead were as expected. The internal pressure of the Common Bulkhead remained substantially constant at less than one psia as predicted.

23.1.1 Description of Strain Gage Installations

Thirty-two axial strain gages were installed on external hat stringers: 16 on the Forward Skirt and 16 on the Aft Skirt as shown in figure 23.1. Two strain gages were installed at each of the 16 measurement locations, of which one gage was mounted to the side of the stringer near the neutral axis, and the other to the top of the stringer. The dual stringer strain gage installation permitted the evaluation of strains at the stringer neutral axis and, hence, more accurate calculations of stringer axis loads and body bending moments. The dual gage installations also provide data from which stringer internal bending moments could be evaluated.

23.1.2 Forward Skirt Stringer Strains

The strain histories for the 16 gages on the Forward Skirt are presented in figures 23.2 through 23.5. All measured strains have been adjusted to the computed correct strain corresponding to the 1 g axial load condition. The adjustment to each measured strain at lift-off was applied uniformly to the corresponding measured strain trace throughout flight, so that measured strain increments during flight were not affected. The increments of strain on the S-IVB Stage due to bending moments from ground winds were computed and found to be less than 1 percent of the average maximum strains at OBECO. Ground wind strains have been neglected in the adjustments to corrected strains at lift-off.

The maximum and minimum strain envelopes shown in figures 23.2 through 23.5 were calculated from design conditions and include the effects of maximum expected aerodynamic gusts and wind shears. The strain envelopes for the top mounted gages were computed using coefficients obtained from the AS-501 Vehicle calibration test conducted April 19, 1967 (Reference: Memorandum A41-860-M&R-M-58, dated 5-31-67). The top gage strain envelope was determined in this manner since the top gage is influenced by stringer bending caused by axial load whereas the side gage is relatively unaffected. The side gage is near the neutral axis and the strain envelope can be closely computed by the stringer axial load divided by the stringer skin area and the modulus of elasticity.

The stringer gages on the Forward Skirt (figures 23.2 through 23.5) provided axial strain histories substantially as expected except at times approaching Center Engine Cutoff (CECO) and Outboard Engine Cutoff (OBECO). At these flight times, airloads and body bending should be small. Hence, the strain traces ideally would converge approximately to a common value at OBECO. The non-convergence of the measured strains near the end of S-IC powered flight is due in part to differential structural expansion or contraction from aerodynamic heating.

The stringer top mounted gages on the Forward Skirt (figures 22.4 and 22.5) were displaced from the stringer neutral axis and were responsive to local stringer bending. These data were used in analyzing the stringers for local bending.

23.1.3 Aft Skirt Stringer Strains

The strain histories for the 16 Aft Skirt strain gages are shown in figures 23.6 through 23.9. The top mounted gages on the Aft Skirt were also responsive to local stringer bending. The non-convergence of the strain traces at OBECO discussed in paragraph 23.1.2, and the deviation from the lower design envelope is again attributed primarily to the strains from differential structural expansions and contractions due to aerodynamic heating.

23.1.4 Forward and Aft Skirt Adjusted Stringer Strains and Loads

The stringer flight loads of table 23.1 were calculated from adjusted measured strains. The strains were adjusted to show correct 1 g strains prior to S-IVB propellant loading. Therefore, all thermal strains are included for an individual stringer. As indicated in table 23.1, stringer measured loads calculated from the strains are less than the stringer design loads, except for the stringer axial load on the Forward Skirt at OBECO. This measured load is not critical, however, and a positive margin is still maintained.

23.1.5 Axial Loads

The strain data measured for stations 3145 and 2821 during flight were used for computing axial load histories as presented in figures 23.10 and 23.11. The measured strain data were converted to stringer neutral axis strains, and adjusted to remove the internal strains induced by differential expansions and contractions from aerodynamic heating. From these adjusted data, the axial flight loads at the respective stations were computed. These axial load histories are shown compared to pre-flight computed axial loads. The divergence of the flight measured plots above 70 seconds of flight time is attributed to thermal effects on the structure from aerodynamic heating.

Axial load factors measured during powered flight are presented in table 23.2. The maximum acceleration of 3.92 g occurred at S-IC Stage OBECO. This value was less than the mission restricted nominal acceleration of 4.0 g.

23.1.6 Body Bending Moments

The strain data measured during flight were also used in computing bending moment histories, as shown in figure 23.12 for the Forward Skirt and figure 23.13 for the Aft Skirt. In each case, the measured strain data at three stringer locations were converted to stringer neutral axis strains, and adjusted to remove internal strains induced by aerodynamic heating. From these adjusted data, the maximum bending moments at the respective stations from flight loads were computed. In the figures, the computed flight moment histories are shown compared to pre-flight computed design limit moments. The design curve is a partial envelope covering the time of maximum αq and showing the total effect of discrete wind shears and gusts occurring at each time point. The curves show the S-IVB-505N Stage was subjected to significant aerodynamic loading at max αq , but still relatively moderate as compared to maximum design values.

23.1.7 LH2 and LOX Tank Ullage Pressures

The maximum LH2 ullage pressure recorded during pre-launch and flight was 32.2 psia. This value was less than the maximum vent ullage pressure of 34.0 psia used in the design of LH2 Tank.

The maximum vent ullage pressure used in the LOX Tank was 43.5 psia. The maximum ullage pressure recorded during pre-launch and flight was 43 psia.

23.1.8 Common Bulkhead Environment

The maximum ullage differential pressures on the Common Bulkhead during pre-launch, powered flight, orbital coast, and translunar trajectory to the time of propellant tankage depressurizations were +24.9 psid and -18.2 psid. A positive differential pressure indicates the LOX Tank ullage pressure exceeds the LH2 Tank ullage pressure. The measured maximum positive differential pressure was less than the corresponding Common Bulkhead limit structural capability of 30.0 psid. The maximum negative differential pressure was within the corresponding limit capability of -26.0 psid.

The measured Common Bulkhead internal pressure, over the total time of propellant tankage pressurizations, was approximately zero psia and did not approach the pressure relief valve setting of 1.0 psia. This was indicative of a sound bulkhead.

TABLE 23-1
 MAXIMUM LOCAL STRINGER BENDING MOMENTS AND AXIAL LOADS
 AFT AND FORWARD SKIRTS



STRAIN ADJUSTMENT	SKIRT	STATION	CONDITION	MAXIMUM FLIGHT LOAD (CALCULATED FROM TOP AND SIDE STRAIN GAGES)		LOAD USED IN DESIGN ANALYSIS (LIMIT)	
				MOMENT (IN. LB)	AXIAL LOAD (LBS)	MOMENT (IN. LB)	AXIAL LOAD (LBS)
1 & Prior to Propellant Loading	Aft	2821	Max αq OBECO	-1165	-6578	-6800	-14,168
	Fwd	3145	Max αq OBECO	-1918	-8854	-5700	-11,756
				+307	-4785	+1857	-8,287
				+710*	-5285*	+1080	-4,804

*Margin of safety = 54.3 percent based on design interaction curve.

TABLE 23-2
AXIAL LOAD FACTORS DURING POWERED FLIGHT

CONDITION	MAXIMUM MEASURED LOAD FACTOR (g)	FLIGHT TIME OF MEASUREMENT (SEC.)	PREDICTED LOAD FACTOR (g)	FLIGHT TIME OF PRED. L.F. (SEC.)
S-IC Lift-off	1.21	2.0	1.25	2.0
S-IC CECO*	3.65	135.2	3.74	135.0
S-IC OBECO**	3.92	161.6	3.81	159.9
S-II CECO	1.81	460.6	----	----
S-II OECO	1.45	552.6	1.46	554
S-IVB (1 Burn Cutoff)	0.70	703.8	0.7	703
S-IVB (2 Burn Cutoff)	1.49	9550.6	1.49	9548

*Condition S-IC CECO Design Load Factor = 4.72 g at 146 sec.

**Mission restricted nominal load factor = 4.0 g

FWD SKIRT LOOKING AFT STA. 3145

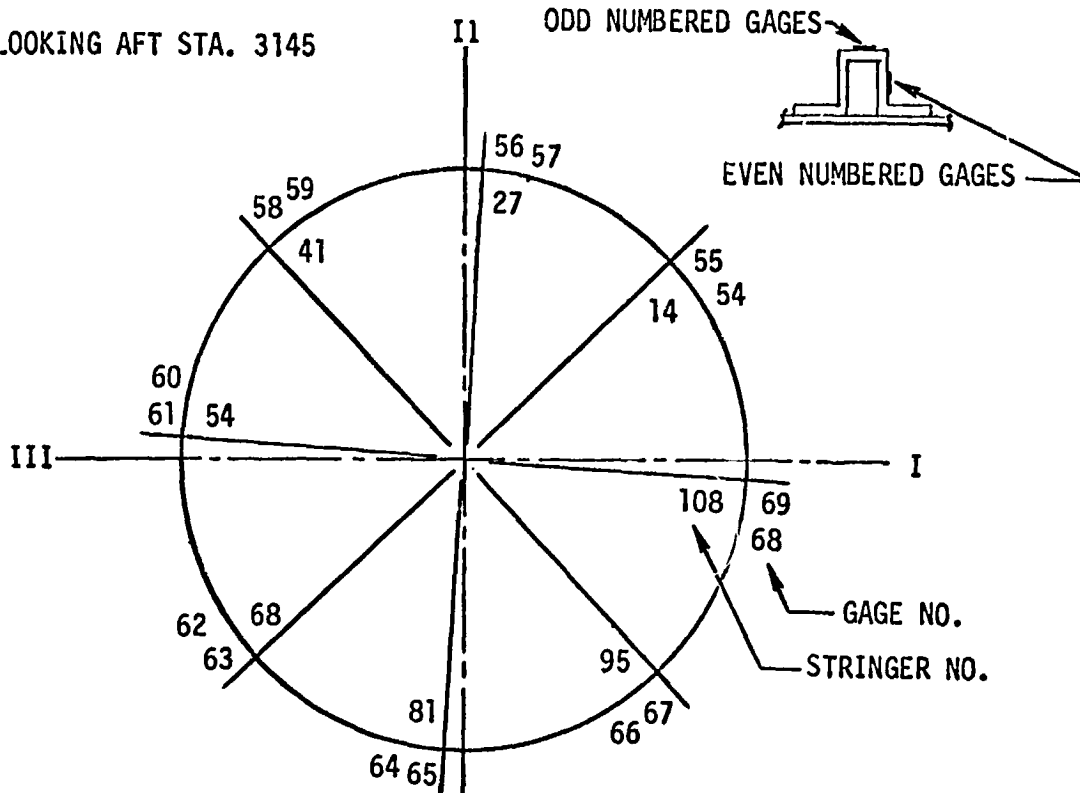

AFT SKIRT LOOKING AFT STA. 2821

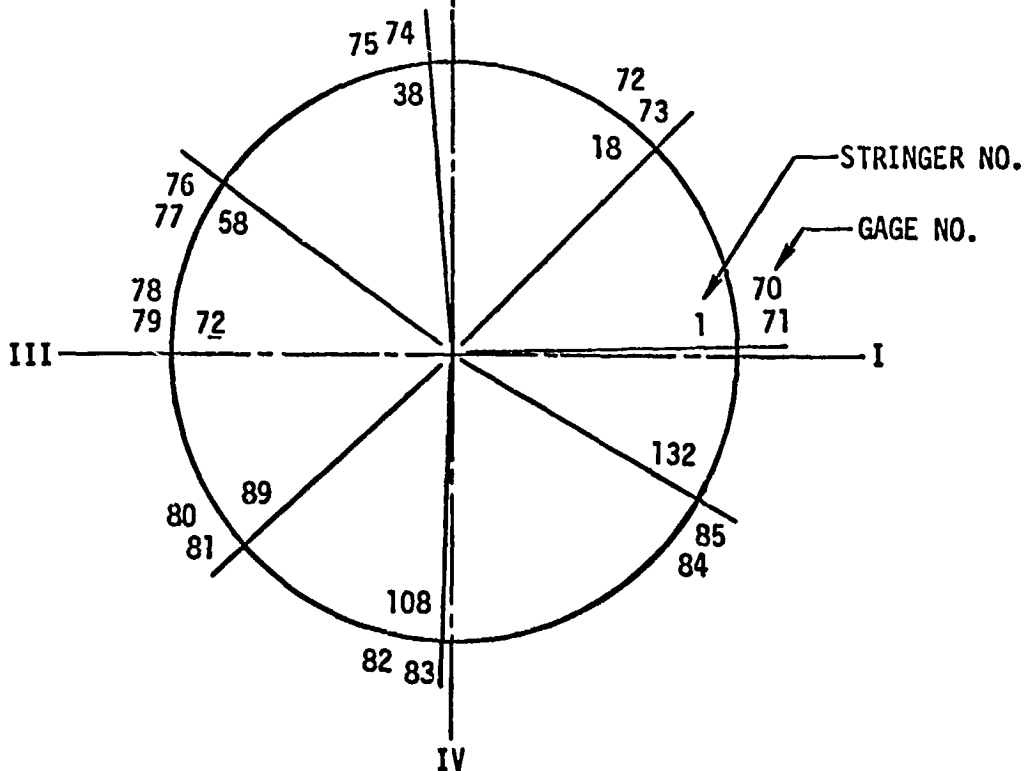

Figure 23-1. Stringer Strain Gage Locations

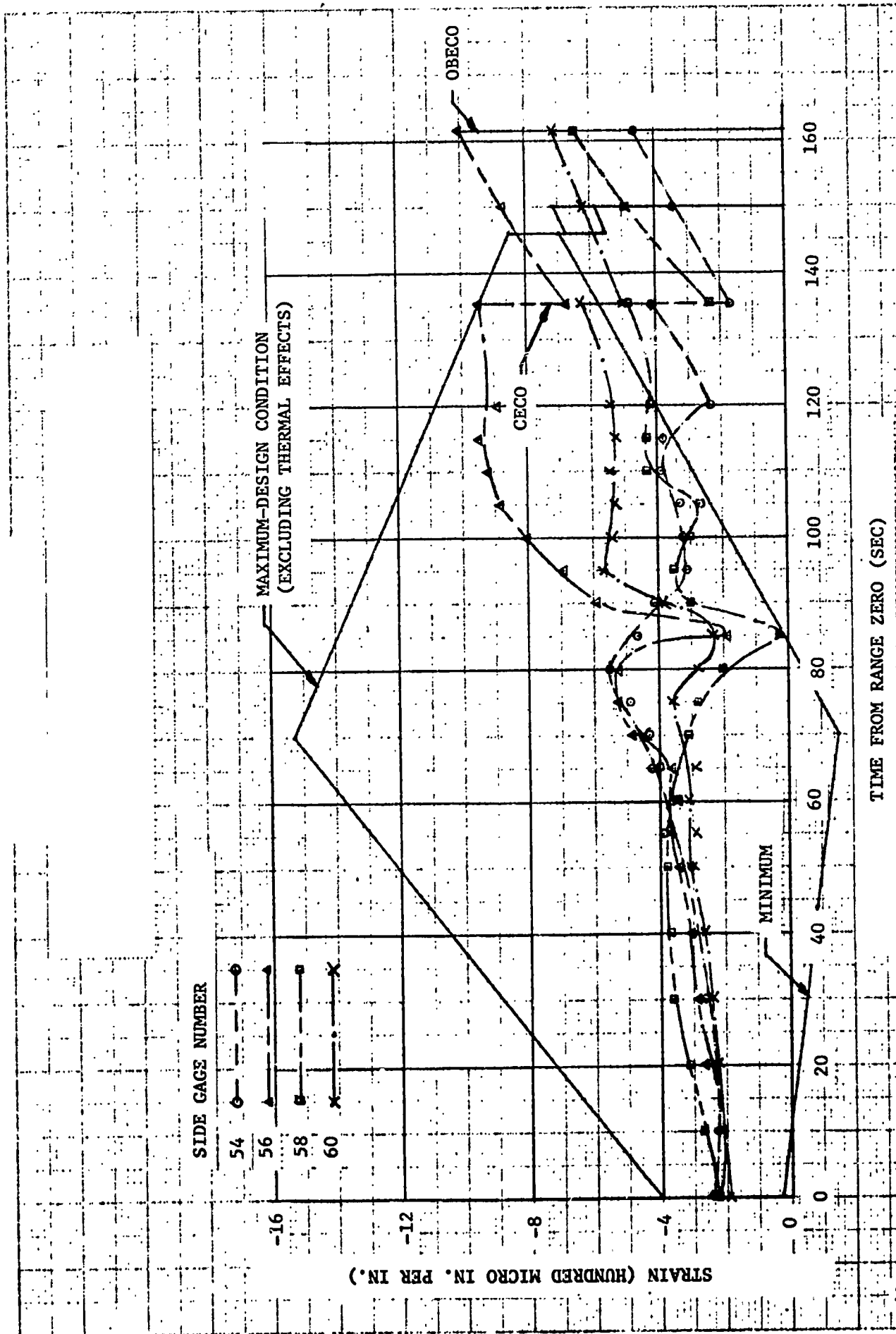

Figure 23-2. AS-505 Flight Axial Strain vs Flight Time
Forward Skirt Station 3145

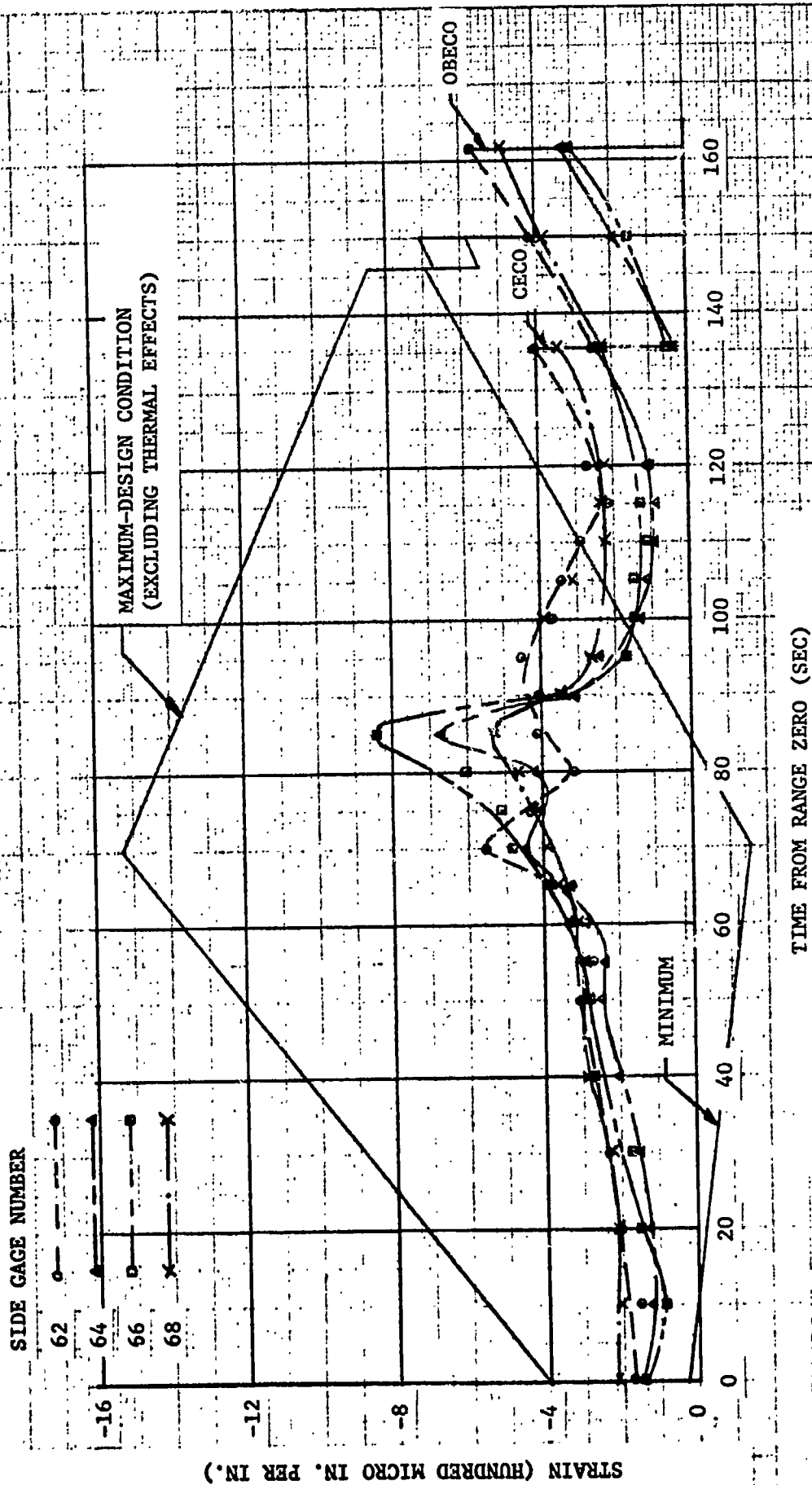

Figure 23-3. AS-505 Flight Axial Strain vs Flight Time Forward Skirt Station 3145

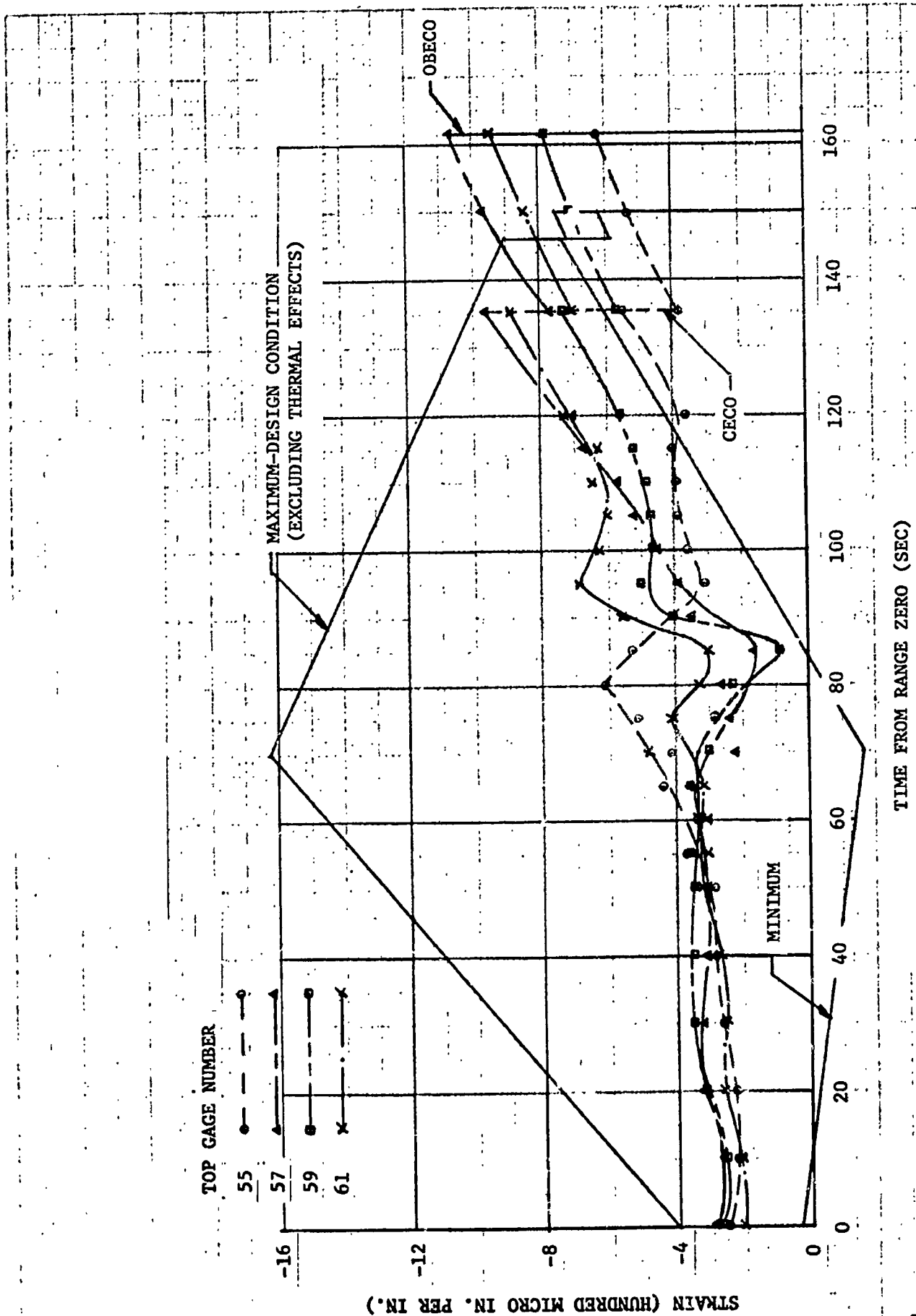

Figure 23-4. AS-505 Flight Axial Strain vs Flight Time
Forward Skirt Station 31.5

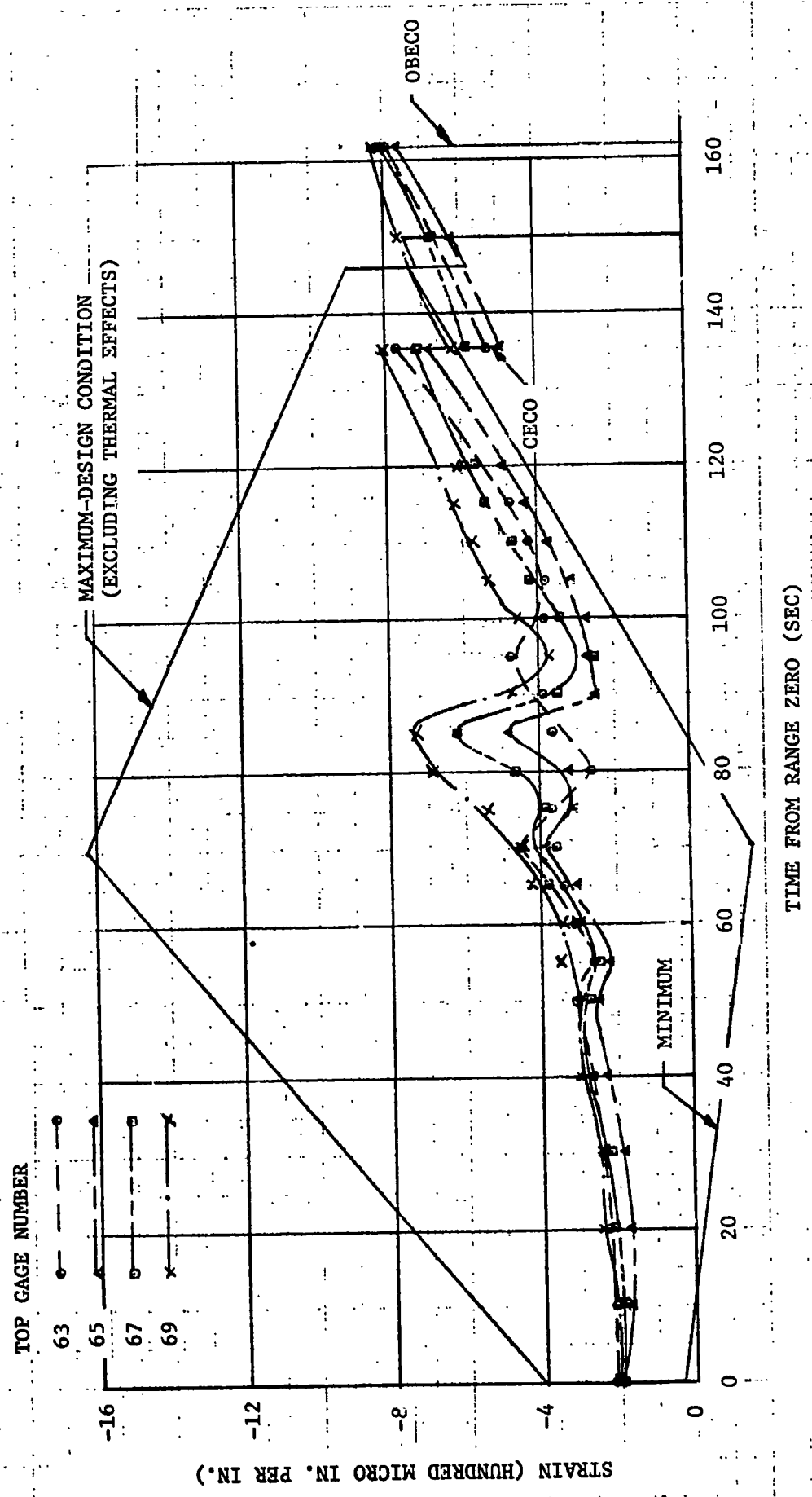

Figure 23-5. AS-505 Flight Axial Strain vs Flight Time
Forward Skirt Station 3145

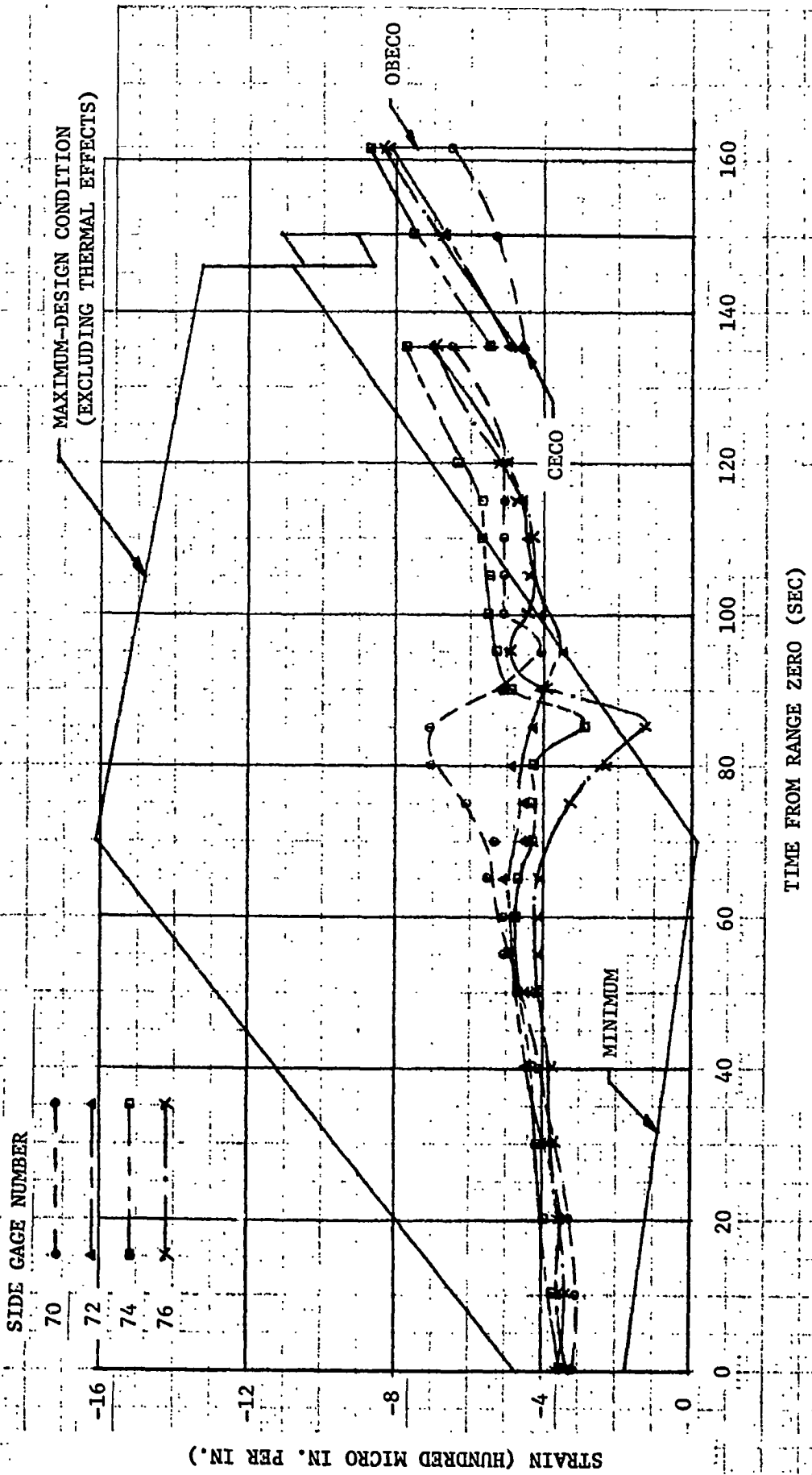

Figure 23-6. AS-505 Flight Axial Strain vs Flight Time
Aft Skirt Station 2821

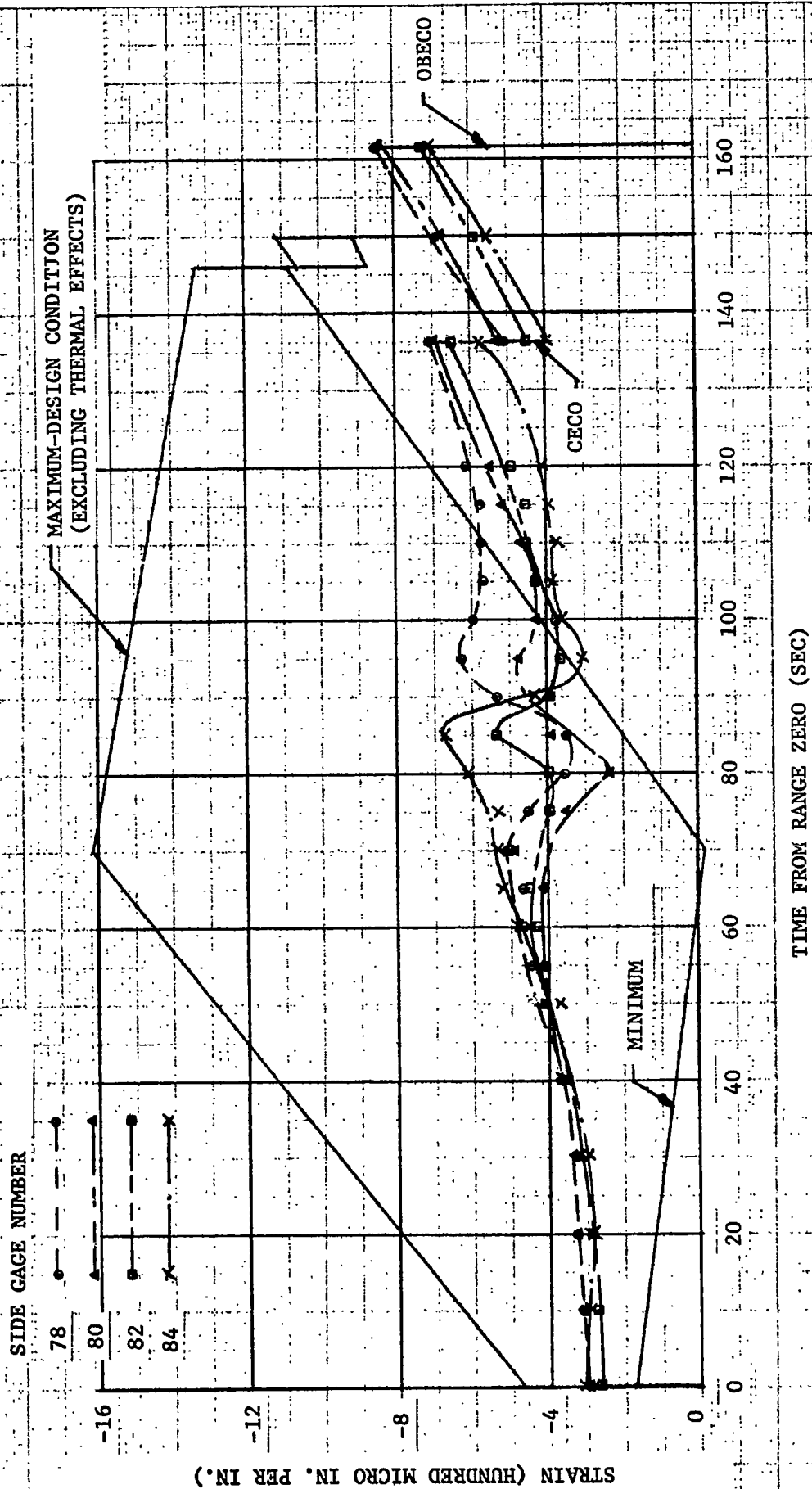

Figure 23-7. AS-505 Flight Axial Strain vs Flight Time
Aft Skirt Station 2821

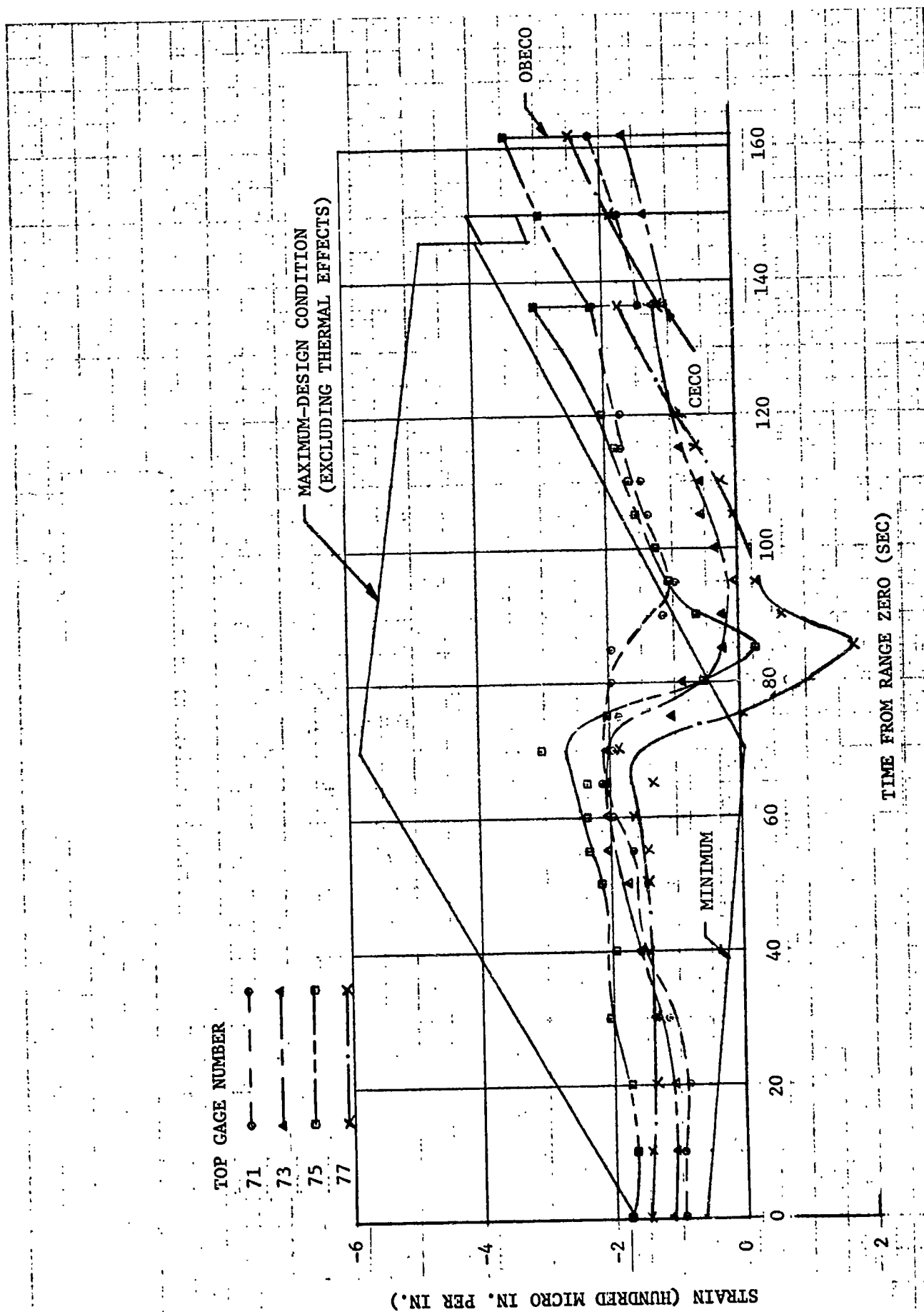

Figure 23-8. AS-505 Flight Axial Strain vs Flight Time
Aft Skirt Station 2821

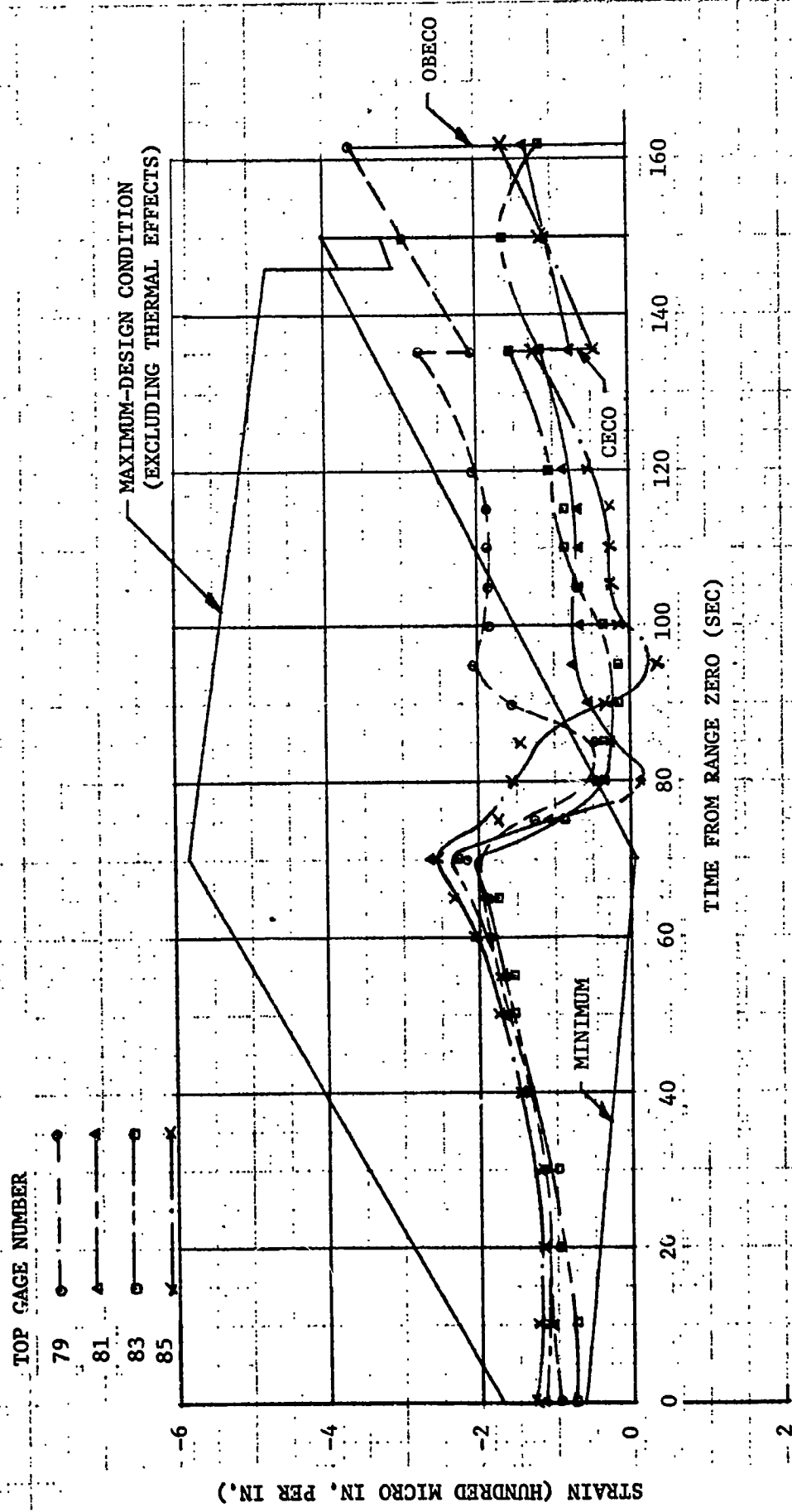

Figure 23-9. AS-505 Flight Axial Strain vs Flight Time
Aft Skirt Station 2821

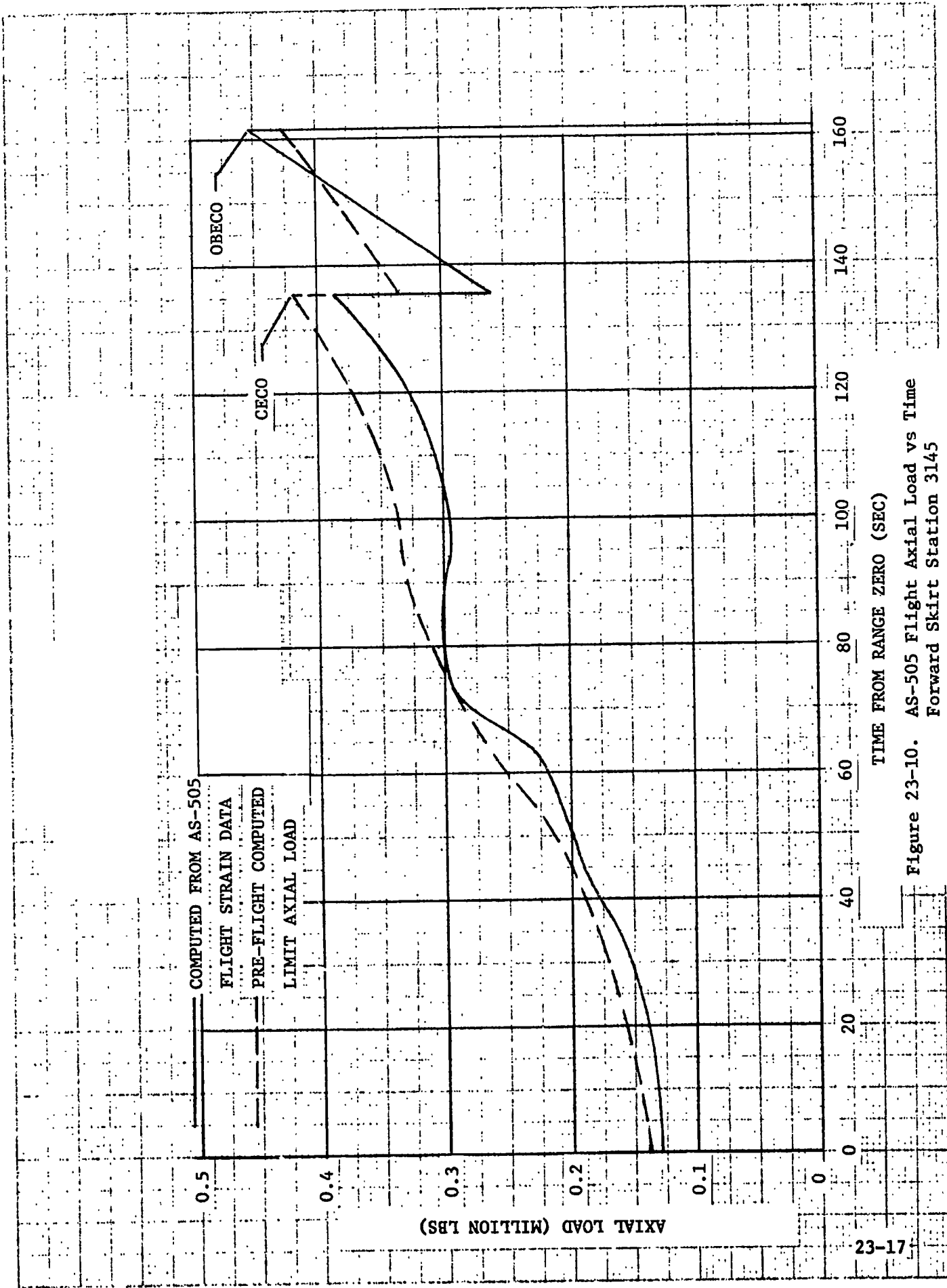

Figure 23-10. AS-505 Flight Axial Load vs Time
Forward Skirt Station 3145

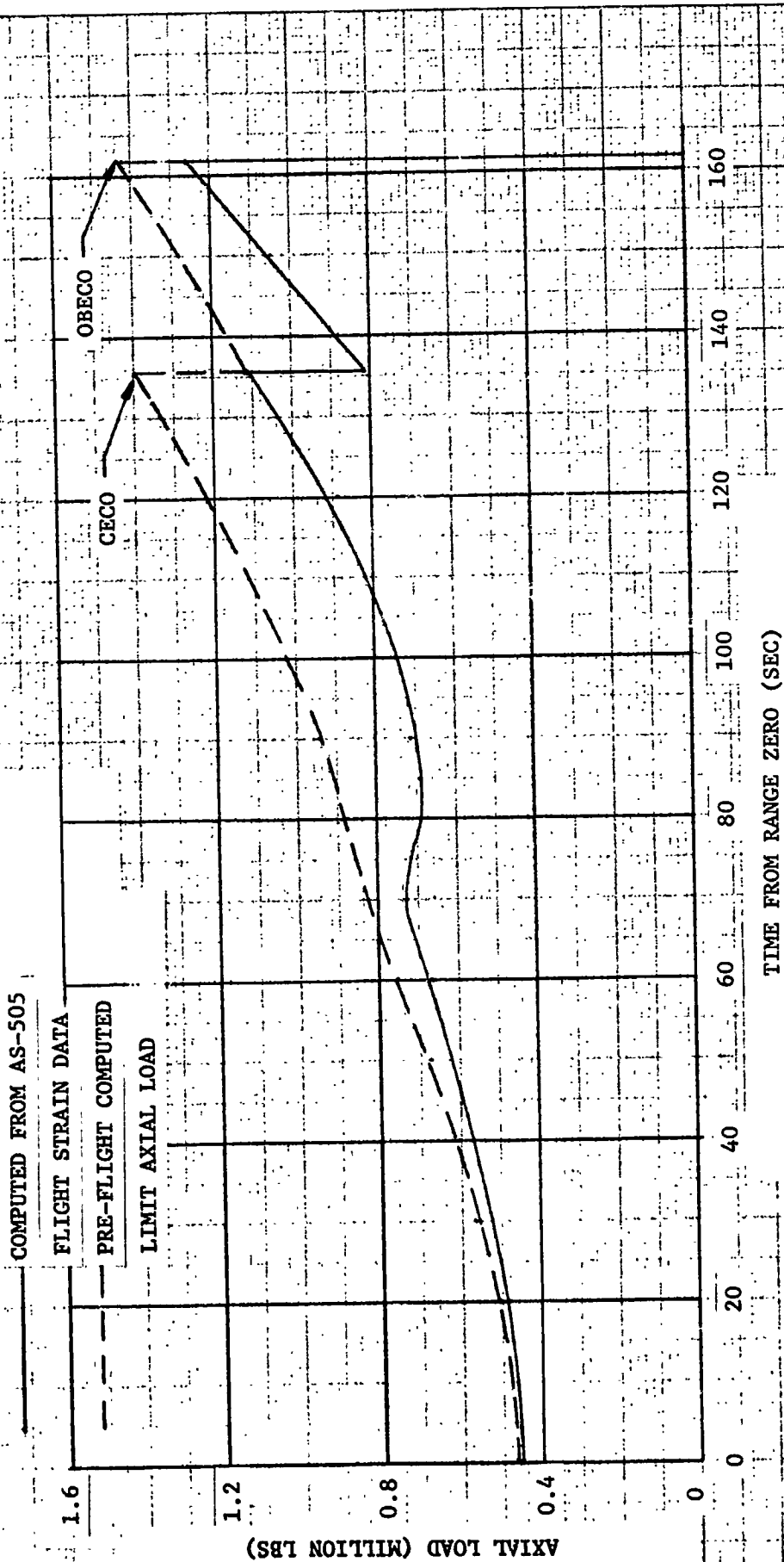
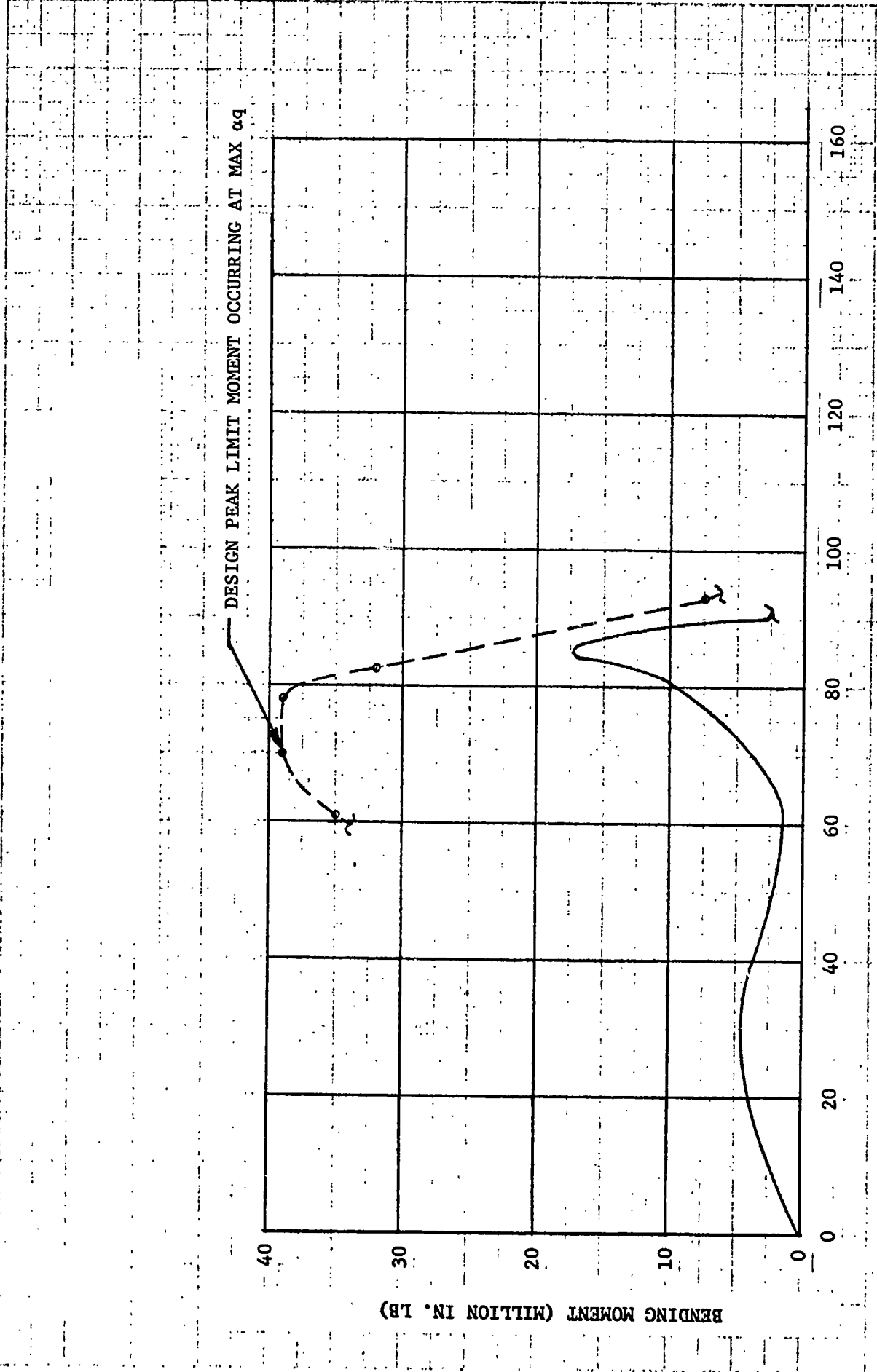

Figure 23-11. AS-505 Flight Axial Load vs Time
Aft Skirt Station 2821



TIME FROM RANGE ZERO (SEC.)

Figure 23-12. AS-505 Flight Stage Bending Moment vs Time
Forward Skirt Station 3145

DESIGN PEAK LIMIT MOMENT OCCURRING AT MAX αq

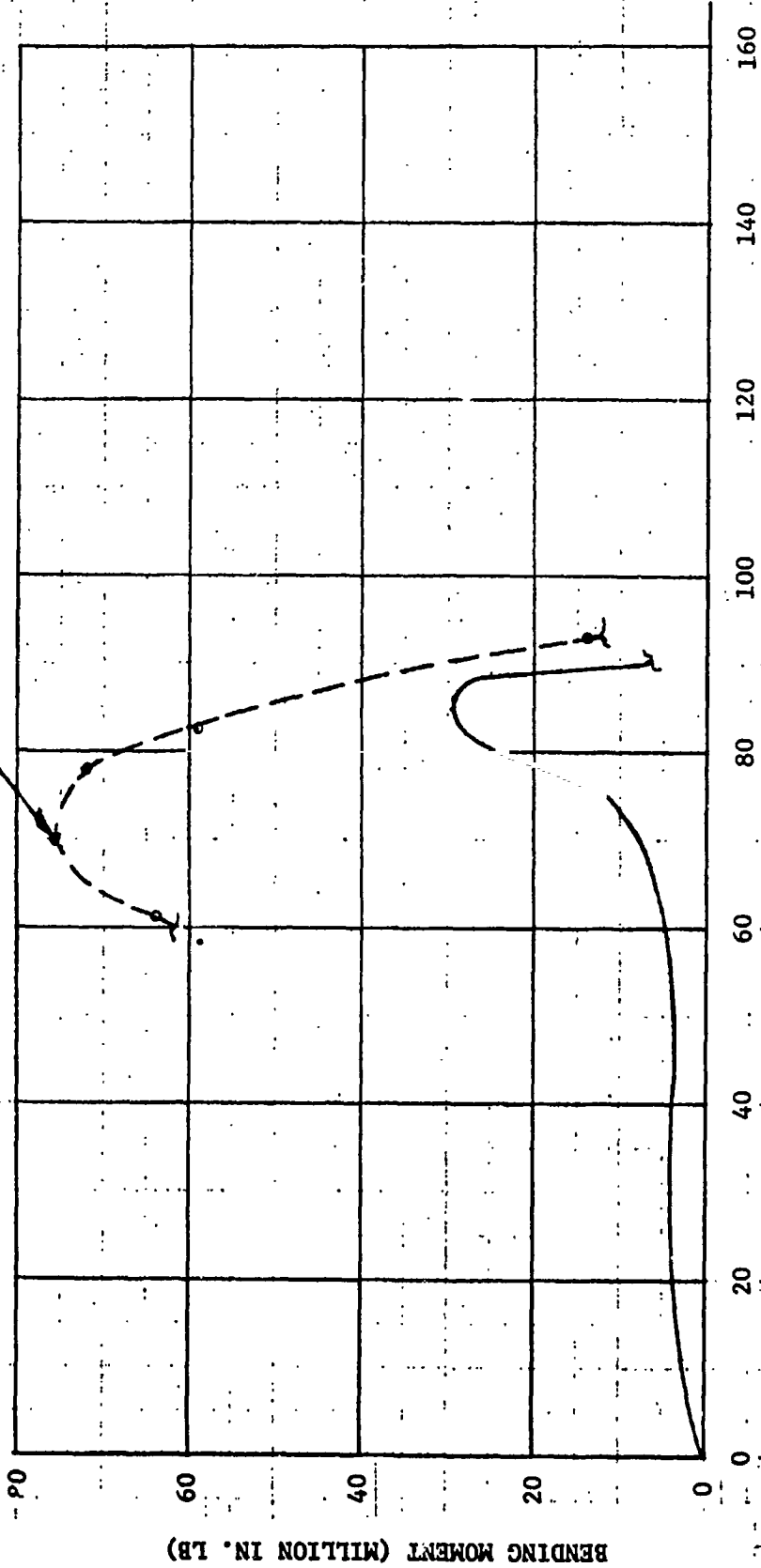

TIME FROM RANGE ZERO (SEC)

Figure 23-13. AS-505 Flight Stage Bending Moment vs Time
Aft Skirt Station 2821

24. FORWARD SKIRT THERMOCONDITIONING SYSTEM

The thermoconditioning system operated normally during boost and flight. All parameters were within their design limits with respect to temperature, pressure, and flow.

24.1 Temperature

The methanol-water control temperature (C0015-601), which is the inlet temperature for the S-IVB stage thermoconditioning panel system, remained within its interface limits of 45 to 70 degrees F throughout flight until the end of data. The exit temperature (C0026-601) corresponded with the inlet temperature throughout the flight to within 9°F.

24.2 Pressure

The S-IVB manifold inlet pressure (D0017-601) was essentially constant at 42 to 45 psia until the end of data.

24.3 Flow

The flowrate through the S-IVB system (F0010-601) remained essentially constant, varying from 7.5 to 7.8 gallons per minute in the course of the flight.

25. ACOUSTIC AND VIBRATION ENVIRONMENT

A total of 47 acoustic, vibration, acceleration, body bending, and strain measurements were monitored on the S-IVB-505N Stage. All of the measurements provided usable data. The acoustic and vibration environments were comparable to those measured on the AS-503 flight. The low frequency measurements showed several variations from those on the AS-503 flight. The three most significant differences were the increase in amplitude of the 19 HZ oscillations during first burn, the occurrence of 45 HZ oscillations during second burn, and the intermittent buildup of 15 HZ oscillations at the end of the second burn. The low frequency vibration levels were well within the stage design criteria. The dynamic strains measured on both ASI lines were in good agreement with those from the AS-503 flight.

25.1 Data Acquisition and Reduction

A list of the 30 vibration, 4 acoustic, 2 body bending, 5 acceleration, and 6 strain measurements is given in table 25-1; measurement locations are shown in figure 25-1. These measurements were similar to those monitored on the AS-503 flight. Overall levels during specific flight periods are presented in the table.

The data were acquired via the FM/FM and SSB/FM telemetry systems. The FM/FM system was used to provide low frequency (down to DC) data and the SSB/FM system provided 50 to 3,000 HZ data. The preflight sweep calibration for the SSB system showed data were recoverable down to 30 HZ.

Two separate time sharing arrangements were utilized to obtain more measurements than the number of allocated telemetry channels. One method provided data for 3 or 6 sec for every 12 sec commutation period. This method prevented the acquisition of maximum response amplitudes and specific events (liftoff, separation, etc.) for some of the measurements. The vibration levels for the time shared measurements are estimated between the time intervals of the measured data and are shown in the time-history plots by smooth lines. The other method consisted of monitoring a group of measurements continuously during the S-IC powered flight and then switching to monitor a second group of measurements during the S-II/S-IVB period of flight. The measurements were chosen so that the maximum

amplitudes for each measurement occurred during the time period when that particular measurement was being monitored.

The data from the measurements were corrected for data acquisition system and data reduction filter rolloff characteristics. The corrections were applied to the spectrum plots and to the overall levels in table 25-1. Because there was no convenient way to correct the time-history plots, the levels shown may differ from the values in the table.

Both analog and digital techniques were utilized in reducing the data. The final analyses consisted of root-mean-square (rms) composite time-history, and one-third octave band and PSD spectrum plots (figures 25-2 through 25-42).

25.2 Vibration Environment

The S-IVB Stage vibration environment was induced by acoustical noise, aerodynamic pressure fluctuations, and mechanical excitation. The predominant sources were the F-1 engine exhaust noise during launch, unsteady aerodynamic flow conditions during the transonic period of flight, boundary layer turbulence during the period of high dynamic pressures, J-2 engine combustion chamber processes during S-IVB powered flight, staging transients at separation, and S-IVB engine ignition and cutoff. Twenty-seven vibration pickups were located on the S-IVB Stage to determine the response amplitudes of stage structure and components to these excitation sources.

For discussion purposes, the measurements were grouped in the following manner: engine measurements, measurements aft of the common bulkhead, and forward skirt measurements.

25.2.1 Engine Measurements

The twelve measurements on the engine included one on the chamber dome, one at each turbopump (LOX and LH2), three at the main fuel valve, three at the LOX turbine bypass valve, one on the fuel ASI block, and two at the ASI LOX valve. The data from these measurements are shown in figures 25-2 through 25-12.

One of the measurements provided data only during portions of the flight due to an instrumentation malfunction. No data are presented for the S-IC powered portion of flight because the measurements were not monitored during this time period. Data from engine measurements on previous flights indicated that the vibration was negligible during S-IC powered flight. The high frequency vibration generated by the S-II Stage engines is not detectable on the S-IVB Stage during S-II powered flight. The amplitudes (above 45 HZ) during both S-IVB burns were in good agreement with those measured during the AS-503 flight. The low frequency (below 45 HZ) vibrations are discussed in Section 25.4.

25.2.2 Measurements Aft of the Common Bulkhead

These measurements included one at the helium bottle on the thrust structure, one at the LOX chilldown pump on the aft bulkhead, four on the LH2 feedline, one at the forward support of the retrorocket between Positions I and IV, three on APS Module No. 1 and two on Ambient Panel No. 15 next to the chilldown inverter. Composite time-histories and PSD plots during selected time periods for these measurements are presented in figures 25-14 through 25-25. The measured data were in close agreement with those from the AS-503 flight except for the 45 HZ vibration noted during the latter portion of second burn. The 45 HZ phenomenon is discussed in Section 25.4

25.2.3 Forward Skirt Measurements

The measurements on the forward skirt were monitored at the LH2 vent disconnect and on the continuous vent module. The data are shown in figures 25-26, 25-27 and 25-28. Comparison of the data with those from the AS-503 flight showed good agreement with the exception of the occurrence of a 45 HZ vibration during the AS-505 flight. A discussion of the phenomenon is presented in Section 25.4.

25.3 Acoustic Environment

The acoustic environment was produced by F-1 engine exhaust noise at launch, unsteady flow conditions during the transonic period of flight (near Mach 1), and by boundary layer pressure fluctuations during the period of high dynamic pressures. There were four microphones on the S-IVB Stage to measure this environment. Two (external and internal) were located on the aft skirt near Position I, approximately 36 in. forward of the separation plane. The other two were located on the forward skirt near Position I (external) and Position II (internal), approximately 6 in. aft of the field splice.

Composite time-history and one-third octave band plots for these measurements are shown in figures 25-29 through 25-32. Both external measurements provided data only during portions of the flight due to an instrumentation malfunction. The amplitudes during the periods of valid data were comparable to those from previous flights. The internal levels were in good agreement with previous flights.

25.4 Low Frequency Measurements

There were ten measurements installed on the S-IVB Stage primarily to measure low frequency vibration during S-IC and S-II Stage powered flight. Three were located on the forward skirt, one on the aft skirt, three on the gimbal block and three on the J-2 engine. The data from these measurements are shown in figures 25-33 through 25-42.

The low frequency oscillations (5 to 6 hertz) measured on the S-IVB Stage during S-IC Stage powered flight were comparable to the AS-503 levels and were considered negligible. The levels during S-II Stage powered flight were much lower than measured during the AS-503 flight. The maximum level on the J-2 engine gimbal block in the thrust direction (A012) was only 0.01 G (0 to peak) compared to 0.33 G (0 to peak) at 19 Hertz on the AS-503 flight.

The low frequency vibrations measured during the S-IVB powered flight phase of the AS-505 flight were comparable to those measured on the AS-503 flight except for three time periods; one was during first burn, the other two were during second burn. Table 25-2 shows the maximum low frequency vibration measured during the S-IVB Stage 19 Hertz, 45 Hertz, and 15 Hertz oscillations.

The first variation from AS-503 levels occurred during first burn when a 19 Hertz sinusoidal oscillation began on the J-2 engine gimbal block (A012) about Ro +592 seconds, reached a maximum of 0.3 G (0 to peak) at Ro +620 seconds, and decayed to negligible vibration by Ro +639 seconds. Both the oxidizer pump discharge pressure (D009) and the main LH2 injector pressure (D004) showed increases in 19 Hertz oscillations during this time period. Maximum pressure variations at 19 Hertz were ± 4.4 psia for D009 and ± 1.3 psia for D004.

The second variation occurred during second burn when a 45 Hertz, approximately sinusoidal vibration began abruptly at Ro +9,481.8 seconds and continued until ECO₂. The maximum vibration levels occurred in the forward skirt area with lower vibration levels observed at other locations on the stage. Measurement E099 (forward skirt body bending-pitch) indicated a maximum of 0.58 G (0 to peak). Following step pressurization, the NPV nozzle pressures increased, as expected. At Ro +9,481.3 the NPV pressures began oscillating at about ± 2 psia and continued until ECO₂. It could not be determined if the pressure was oscillating at 45 Hertz, because of the low sample rate on the pressure measurements (D183 and D184). Because of the close time correlation it appears that the oscillating pressures in the NPV system caused the forward skirt to vibrate at 45 Hertz.

The third phenomenon on AS-505 was the occurrence of intermittent oscillations that first began about Ro +9,435 seconds. Both the frequency and amplitude of these oscillations increased slightly during powered flight; the maximum level on the gimbal block was 0.06 G (0 to peak) at a frequency of 15.5 Hertz and occurred just before cutoff. Similar oscillations occurred during the AS-503 flight, with the maximum level occurring earlier in flight.

The maximum level on the AS-503 gimbal block was 0.04 G (0 to peak) and occurred about 20 seconds prior to cutoff. Since the oscillations were intermittent rather than steadily increasing, there was no indication of a POGO instability.

These low frequency vibrations are very low in amplitude, the maximum was only 40 percent of the stage dynamic design criteria. These vibrations did not affect structural integrity or stage performance.

25.5 Dynamic Strain Measurements

There were six strain measurements monitored on the LOX and LH2 ASI lines. The measured amplitudes from these measurements were very low (table 25-1). The overall strains ranged from 8.5 to 63 μ in./in. rms which were in agreement with those measured on the AS-503 flight.

MEAS NO.	MEASUREMENT	DIREC
<u>VIBRATION</u>		
E0042-403	Helium Bottle, Thrust Structure	Pitch
E0091-411	Field Splice PP I	Thrus
E0092-404	Station 2748 PP II	Thrus
E0099-4__	Bending Mode, Forward	Pitch
E0100-411	Bending Mode, Forward	Yaw
E0209-401	Chamber Dome	Thrus
E0210-401	LH2 Turbopump	Later
E0211-401	LOX Turbopump	Later
E0222-404	LH2 Feedline at Tank	Thrus
E0223-404	LH2 Feedline at Tank	Radia
E0224-404	Chilldown Inverter, Ambient Panel	Thrus
E0225-404	Chilldown Inverter, Ambient Panel	Radia
E0226-404	LH2 Prevalve	Thrus
E0227-404	LH2 Prevalve	Radia
E0228-411	LH2 Vent Disconnect	Thrus
E0229-411	LH2 Vent Disconnect	Radia
E0230-414	APS Propellant Control Module	Radia
E0231-414	APS Propellant Control Module	Tang
E0232-411	Continuous Vent Module	Radia
E0233-424	LOX Chilldown Pump	Norma To De
E0234-414	APS Helium Regulator	Tang
E0235-423	Retrorocket Fwd Support	Radia
E0236-401	Main Fuel Valve	Tang
E0237-401	Main Fuel Valve	Radia
E0238-401	Main Fuel Valve	Thrus
E0239-401	LOX Turbine Bypass Valve	Tang
E0240-401	LOX Turbine Bypass Valve	Radia
E0241-401	LOX Turbine Bypass Valve	Thrus

FOLDOUT FRAME (

TABLE 25-1
COMPOSITE LEVELS
(Sheet 1 of 2)

	DIRECTION	FREQUENCY RANGE (Hz)	S-IC POWERED FLIGHT LEVELS		S-IVB POWERED FLIGHT LEVELS	
			LIFTOFF	MAX INFLIGHT	FIRST BURN	SECOND BURN
				<u>ACCELERATION (grms)</u>		
ure	Pitch	40 to 3,000	1.6	1.1	3.1	2.8
	Thrust	1 to 220	0.84	0.62	0.06	0.12
	Thrust	1 to 220	0.16	0.41	0.14	0.1
	Pitch	1 to 50	0.28	0.29	0.07	0.41
	Yaw	1 to 30	0.25	0.24	0.06	0.37
	Thrust	40 to 3,000	NM	NM	9.4	8.5
	Lateral	40 to 3,000	NM	NM	19.8	17.9
	Lateral	40 to 3,000	NM	NM	42.8	50.8
	Thrust	40 to 3,000	1.0	1.4	1.8	2.0
	Radial	40 to 3,000	2.2	2.7	1.6	1.4
Panel	Thrust	40 to 3,000	1.5	1.2	NM	NM
Panel	Radial	40 to 3,000	4.0	1.8	NM	NM
	Thrust	40 to 3,000	1.8	1.2	2.3	2.6
	Radial	40 to 3,000	2.0	1.1	2.1	1.1
	Thrust	40 to 3,000	2.0	2.3	0.6	1.8
	Radial	40 to 3,000	3.1	3.8	NM	NM
le	Radial	40 to 3,000	2.3	4.6	NM	NM
e	Tangential	40 to 3,000	2.4	5.7	NF	NF
	Radial	40 to 3,000	3.6	2.4	NM	NM
	Normal To Dome	40 to 3,000	3.9	1.8	NM	NM
	Tangential	40 to 3,000	5.4	11.3	NM	NM
	Radial	40 to 3,000	3.2	1.9	NM	NM
	Tangential	40 to 3,000	NM	NM	6.5	6.3
	Radial	40 to 3,000	NM	NM	6.5	5.8
	Thrust	40 to 3,000	NM	NM	10.3	9.8
	Tangential	40 to 3,000	NM	NM	8.7	1
	Radial	40 to 3,000	NM	NM	8.6	7.1
	Thrust	40 to 3,000	NM	NM	18.2	15.2

TABLE 25-1
COMPOSITE LEVELS
(Sheet 2 of 2)

MEAS NO.	MEASUREMENT	DIRECTION	FREQUENCY RANGE (Hz)	LI
<u>VIBRATION (Continued)</u>				
E0242-401	Fuel ASI Block	Radial	40 to 3,000	
E0243-401	ASI LOX Valve	Radial	40 to 3,000	
E0245-401	ASI LOX Valve	Thrust	40 to 3,000	
E0251-401	Chamber Dome	Thrust	1 to 220	
<u>ACOUSTICS</u>				
B0016-411	Forward Skirt	Internal	30 to 2,500	1
B0019-427	Aft Skirt	External	30 to 2,500	1
B0022-404	Aft Skirt	Internal	30 to 2,500	1
B0025-426	Forward Skirt	External	30 to 2,500	
<u>ACCELERATION</u>				
A0010-403	Gimbal Block	Pitch	1 to 30	
A0011-403	Gimbal Block	Yaw	1 to 30	
A0012-403	Gimbal Block	Thrust	1 to 50	
A0013-401	J-2 Engine Skirt	Pitch	1 to 50	
A0014-401	J-2 Engine Skirt	Yaw	1 to 50	
<u>STRAIN</u>				
S0102-401	LOX ASI Line - 1	Axial	10 to 1,600	
S0103-401	LOX ASI Line - 2	Axial	10 to 1,600	
SG104-401	LH2 ASI Line - 1	Axial	10 to 1,600	
S0105-401	LH2 ASI Line - 2	Axial	10 to 1,600	
S0106-401	LH2 ASI Line - 3	Axial	10 to 1,600	
S0107-401	LH2 ASI Line - 4	Axial	10 to 1,600	

I - Invalid Data

NM - Measurement Not Monitored

ND - No Data

NF - System Noise Floor

FOLDOUT FRAME |

S-IC POWERED FLIGHT LEVELS		S-IVB POWERED FLIGHT LEVELS	
LIFTOFF	MAX INFLIGHT	FIRST BURN	SECOND BURN
<u>ACCELERATION (grms)</u>			
NM	NM	36.7	30.3
NM	NM	14.7	16.2
NM	NM	21.6	20.6
0.37	0.31	0.27	0.58
<u>SOUND PRESSURE LEVEL (dB)</u>			
140.3	129.0	NM	NM
151.7	I	NM	NM
148.8	128.8	NM	NM
150.6	I	NM	NM
<u>ACCELERATION (grms)</u>			
0.04	0.02	0.01	I
0.1	0.02	0.01	0.02
0.1	0.02	0.2	0.05
0.07	0.04	0.15	0.09
0.13	0.04	0.18	0.12
<u>STRAIN (μIN/IN. rms)</u>			
NF	NF	20	35.5
NF	NF	8.5	14.1
NF	NF	17.7	30
NF	NF	20	30
NF	NF	50	63.1
NF	NF	31.6	26.6

EOLDOUT FRAME 2

TABLE 25-2
S-IVB STAGE LOW FREQUENCY VIBRATION SUMMARY

MEAS. NO.	AREA MONITORED	19 HERTZ LEVEL G (0 TO PK)	RANGE TIME (SEC)	45 HERTZ LEVEL G (0 TO PK)	RANGE TIME (SEC)	15 HERTZ LEVEL G (0 TO PK)	RANGE TIME (SEC)
E091	Fwd Field Splice - Thrust	0.08	620	0.10	9483	0.01	9550
E099	Fwd Bending Mode - Pitch	0.04	610	0.53	9483	0.01	9550
E100	Fwd Bending Mode - Yaw	0.07	600	0.52	9483	0.01	9550
E092	Aft Separation Plane - Thrust	0.16	620	0.08	9483	0.04	9550
A010	Gimbal Block - Pitch	0.01	620	I	9483	I	9550
A011	Gimbal Block - Yaw	0.01	620	0.01	9483	0.03	9550
A012	Gimbal Block - Thrust	0.30	620	0.08	9483	0.06	9550
E251	J-2 Chamber Dome - Thrust	0.28	620	0.05	9483	0.07	9550
A013	J-2 Engine Skirt - Pitch	0.17	620	0.10	9483	0.13	9550
A014	J-2 Engine Skirt - Yaw	0.21	620	0.13	9483	0.17	9550
E228	Fwd Skirt LH2 Vent Disconnect - Thrust	N/A	---	0.18	9485*	N/A	---
E231	APS Propellant Control Module - Radial	N/A	---	0.18	9483	N/A	---
E226	LH2 Prevalve - Thrust	N/A	---	0.12	9483	N/A	---
E227	LH2 Prevalve - Radial	N/A	---	0.08	9483	N/A	---
E223	LH2 Feedline at Tank - Radial	N/A	---	0.06	9488*	N/A	---
E042	Thrust Structure at Helium Bottie - Pitch	N/A	---	0.03	9485*	N/A	---

*Parameter not monitored at 9483 sec.

I - Data invalid

NA - Data not available due to SSB response

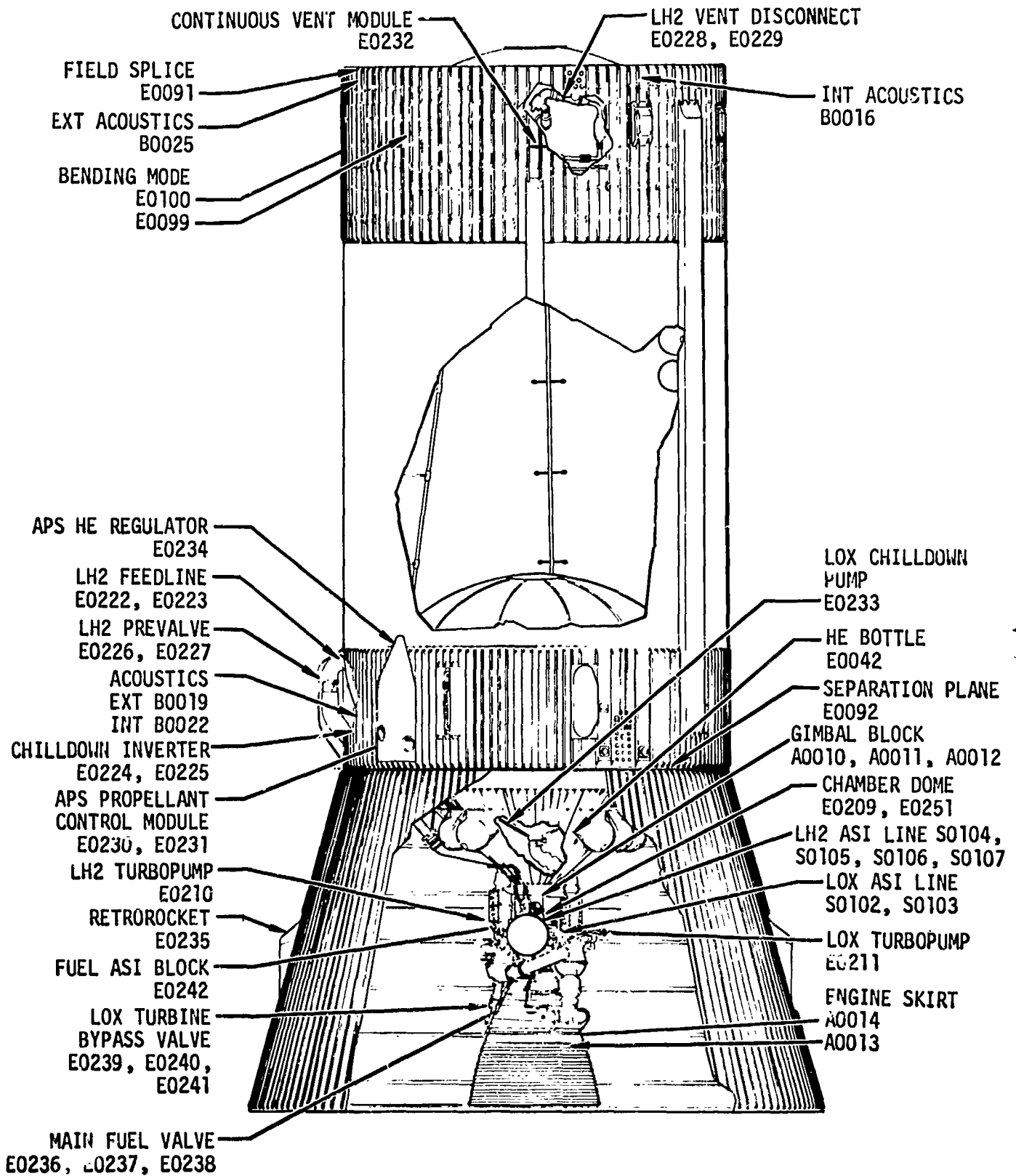
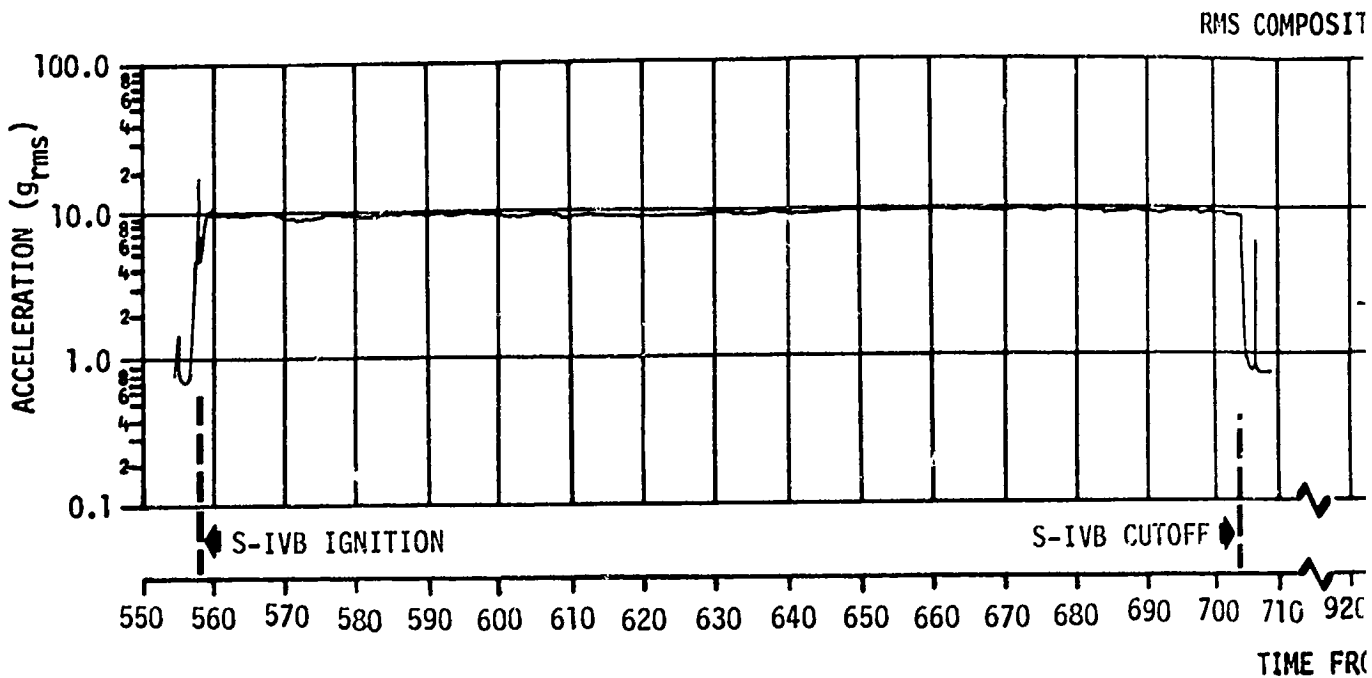

Figure 25-1. Measurement Locations



NOTE:
 DATA NOT VALID BELOW 40 HZ
 BECAUSE OF SSB RESPONSE

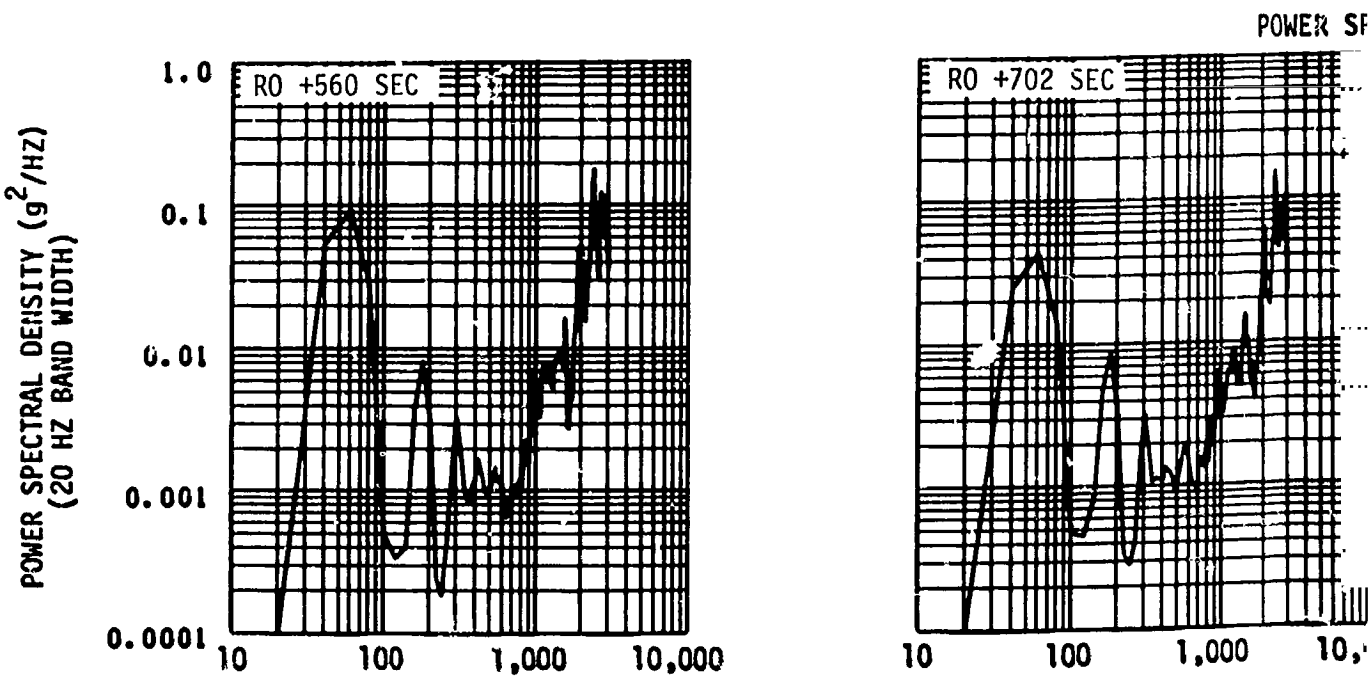
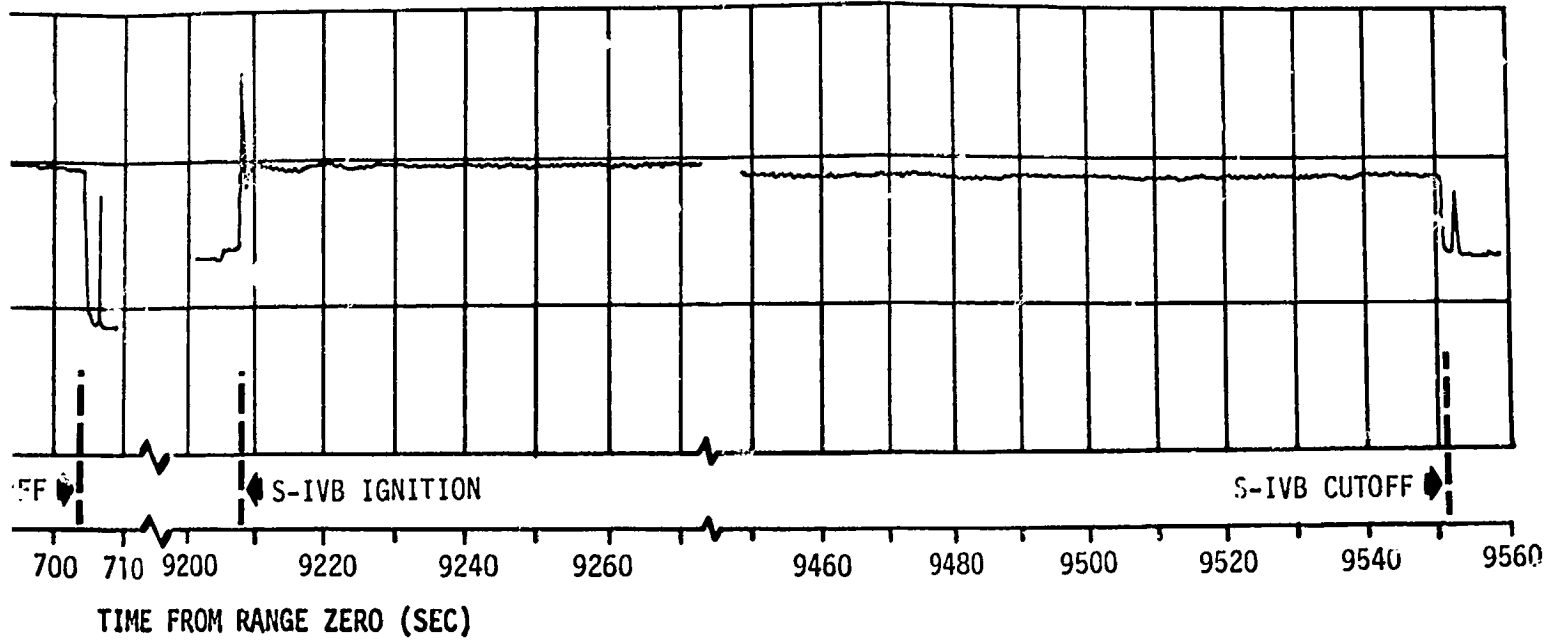

Figure 25-2. Vibration Measured on Combustion

EOLDOUT FRAME

RMS COMPOSITE TIME-HISTORY



POWER SPECTRAL DENSITY PLOTS

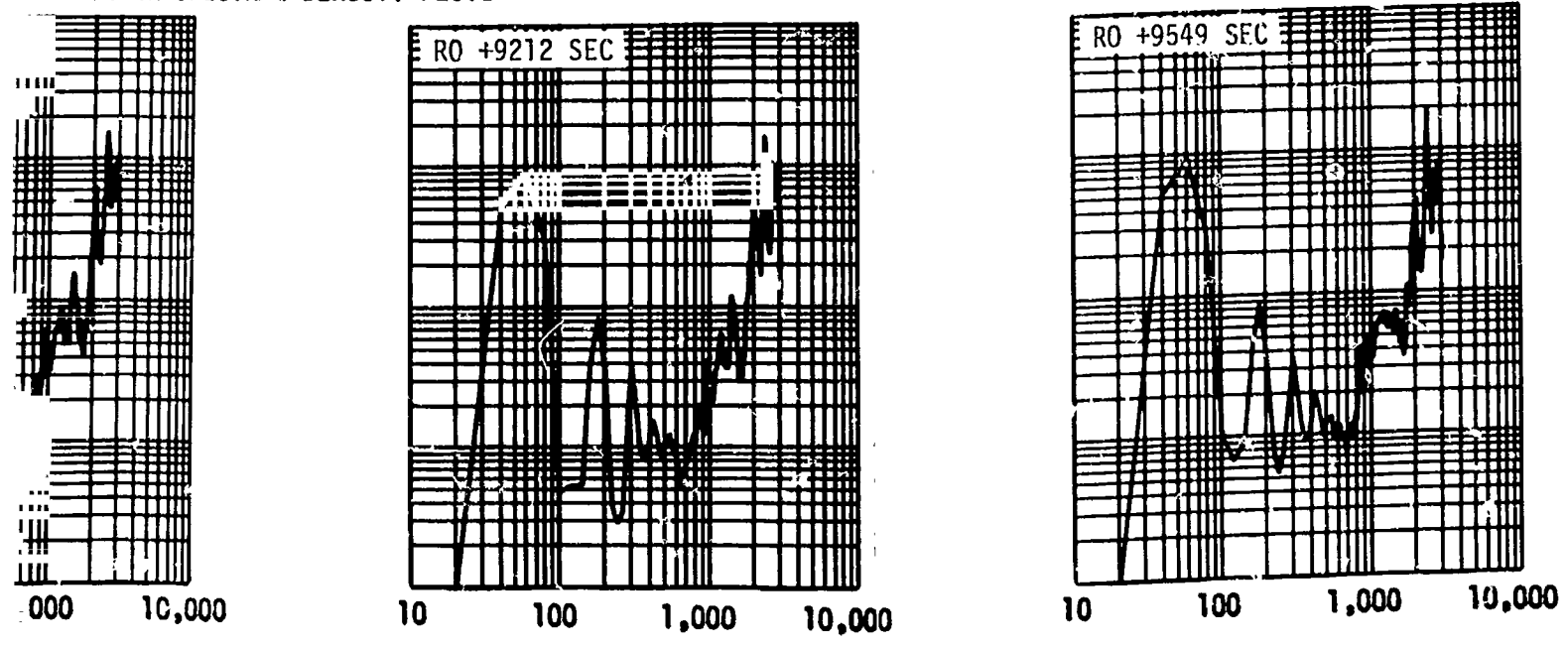

Combustion Chamber Dome, Thrust Direction - E0209-401

EOLDOUT FRAME 2

RMS COMPOSITE TIME-HISTOR

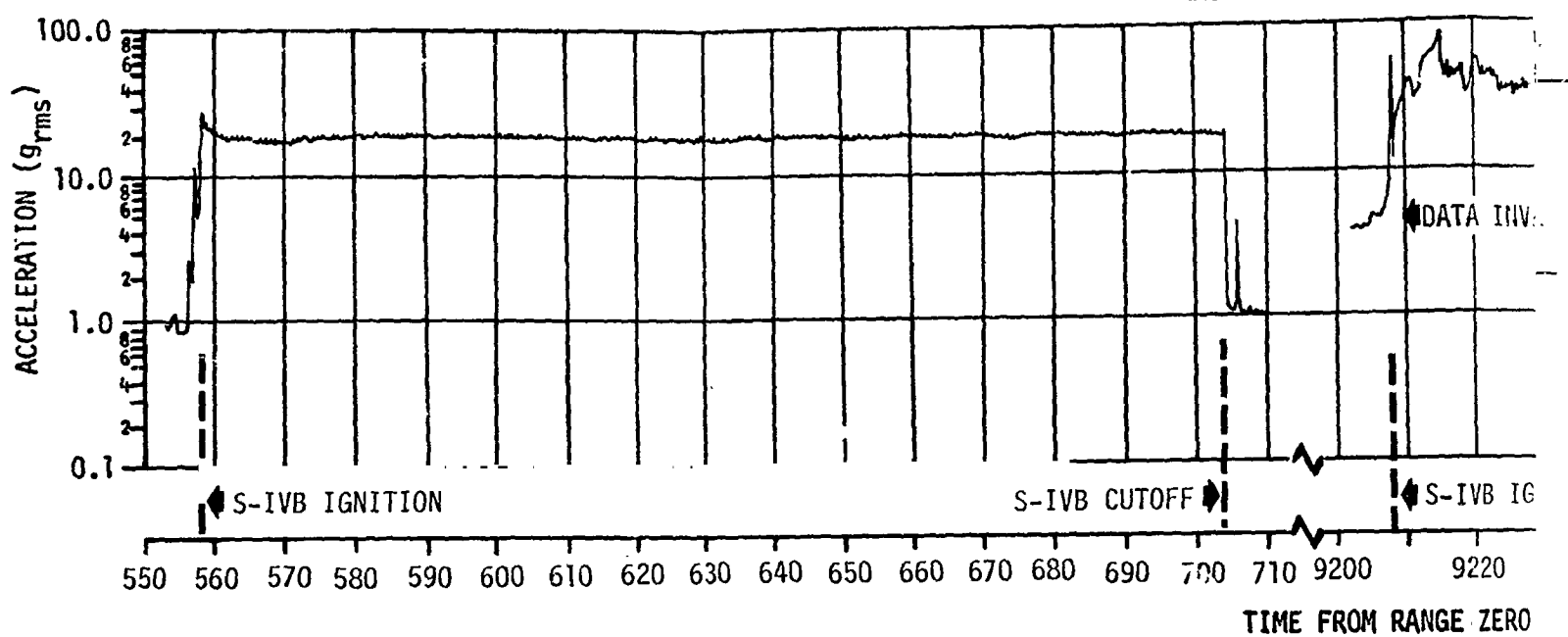

NOTE:
DATA NOT VALID BELOW 40 HZ
BECAUSE OF SSB RESPONSE

POWER SPECTRAL DENSITY

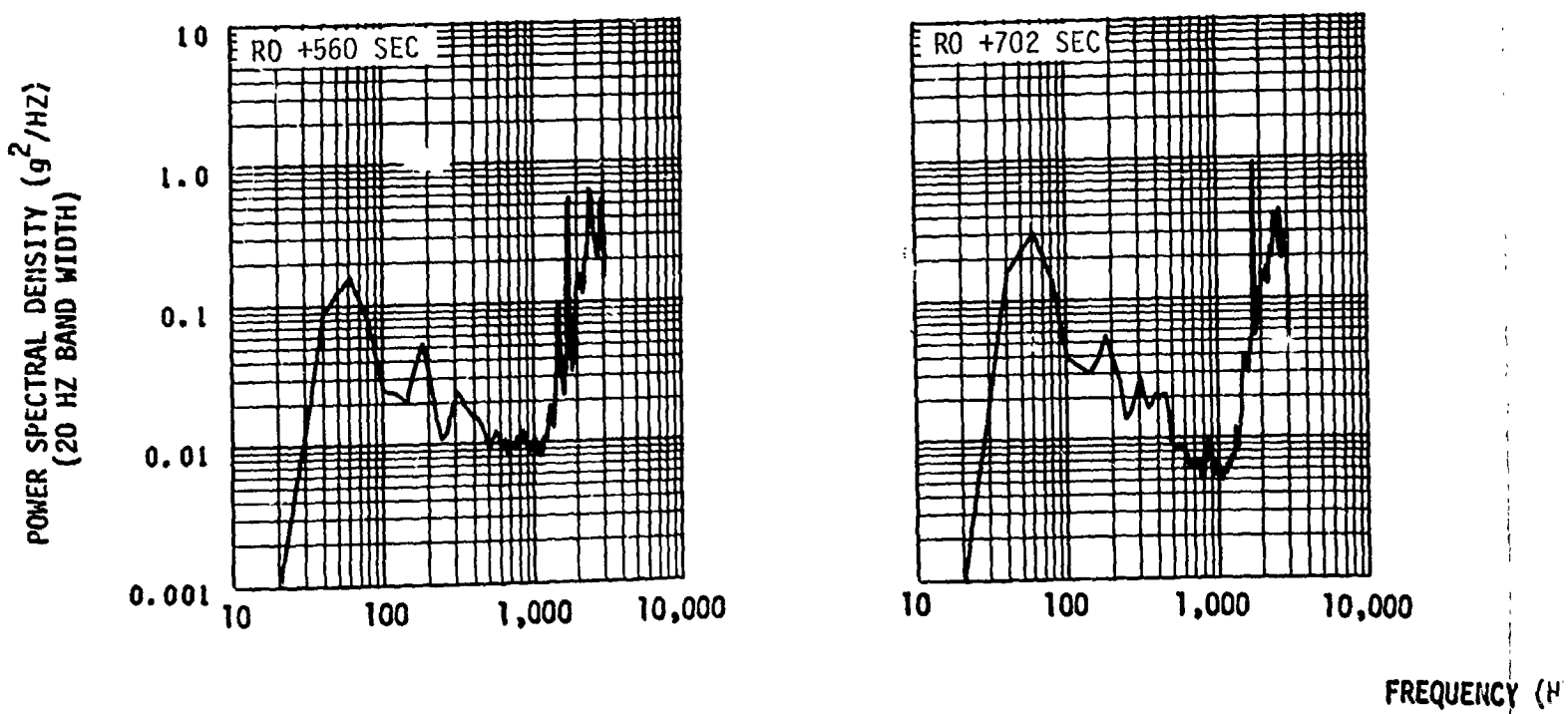
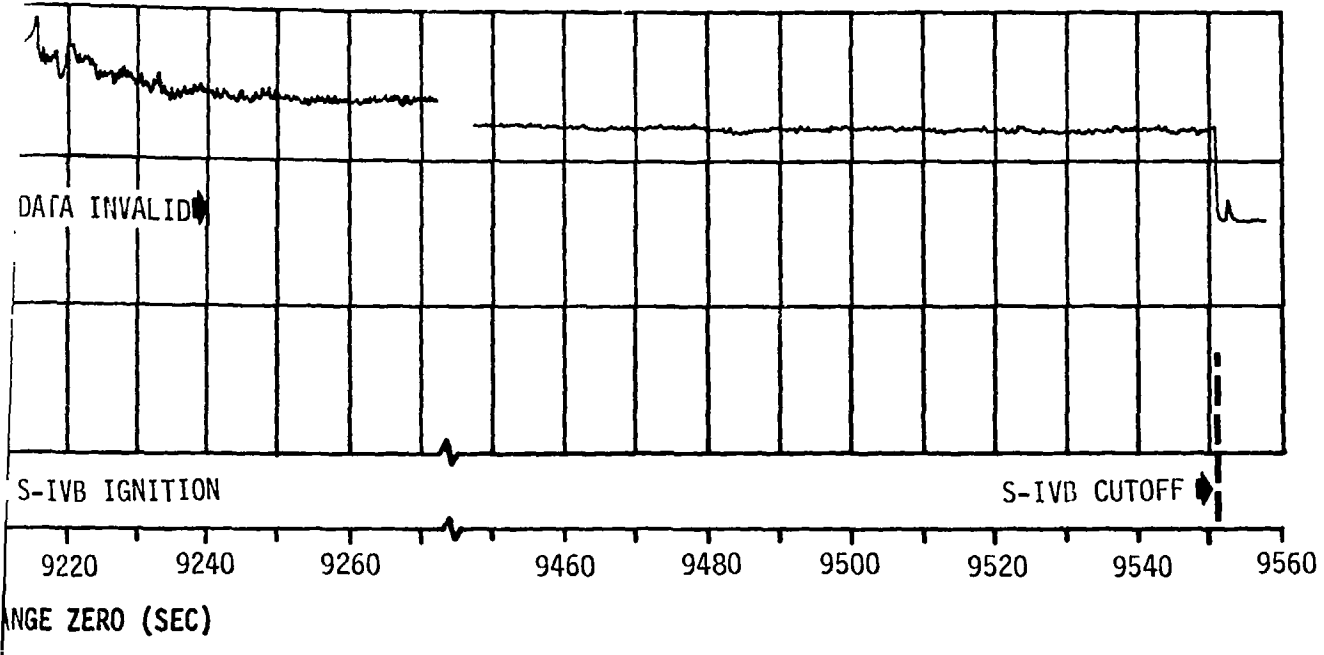
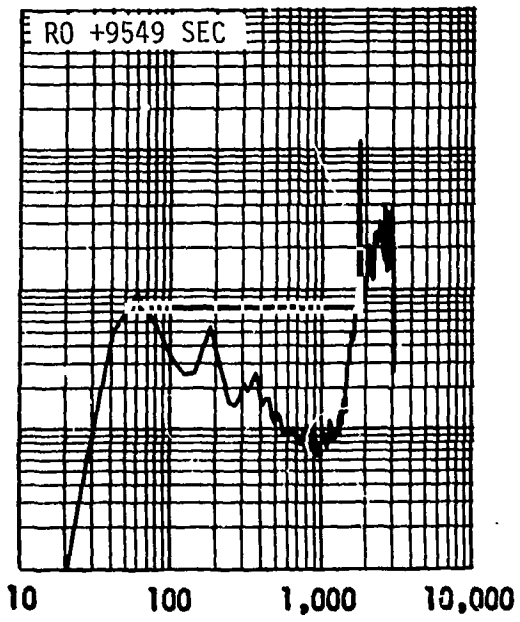
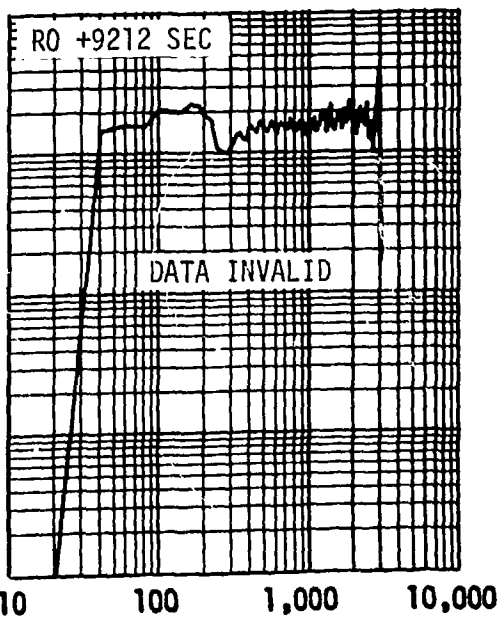

Figure 25-3. Vibration Measured at LH2 Turbopump, Radial FOLDOUT FRAME

IE-HISTORY



RAIAL DENSITY PLOTS



QUENCY (HZ)

p, Radial Direction - E0210-401

EOLDOUT FRAME 2

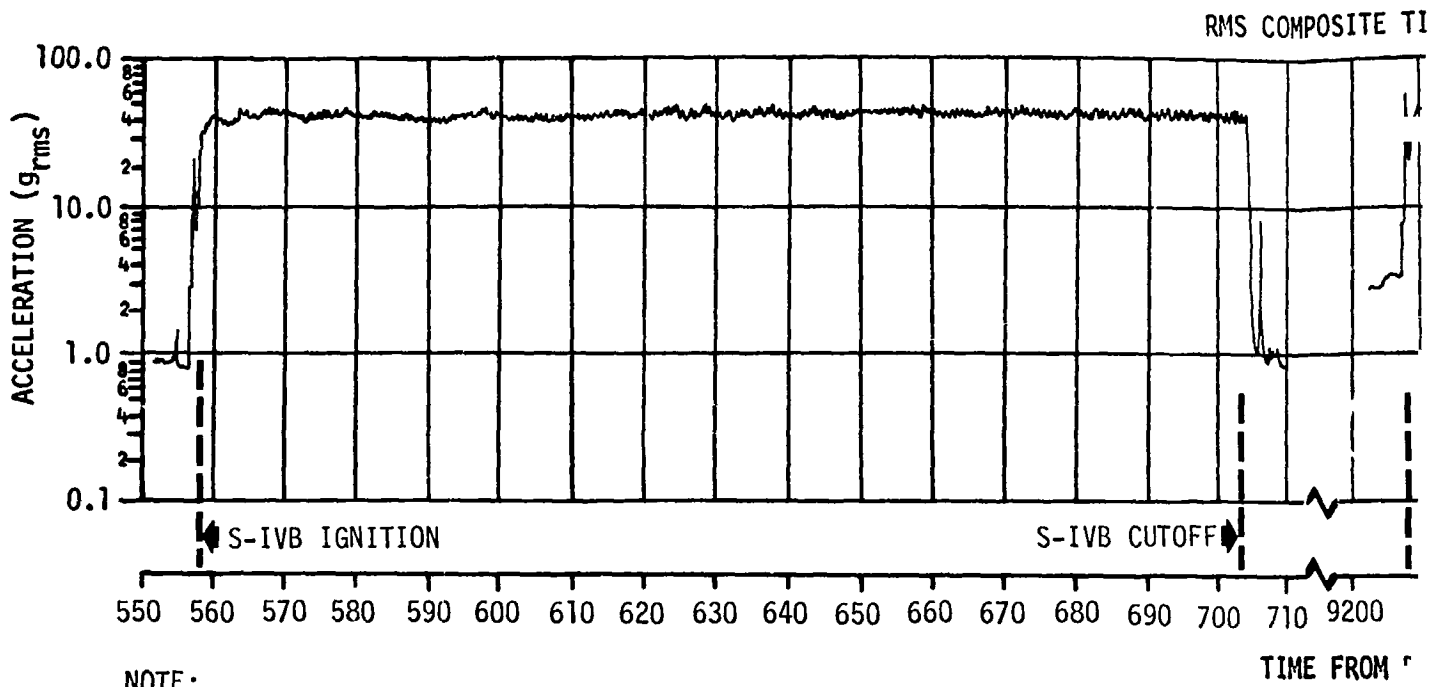

NOTE:
DATA NOT VALID BELOW 40 HZ
BECAUSE OF SSB RESPONSE

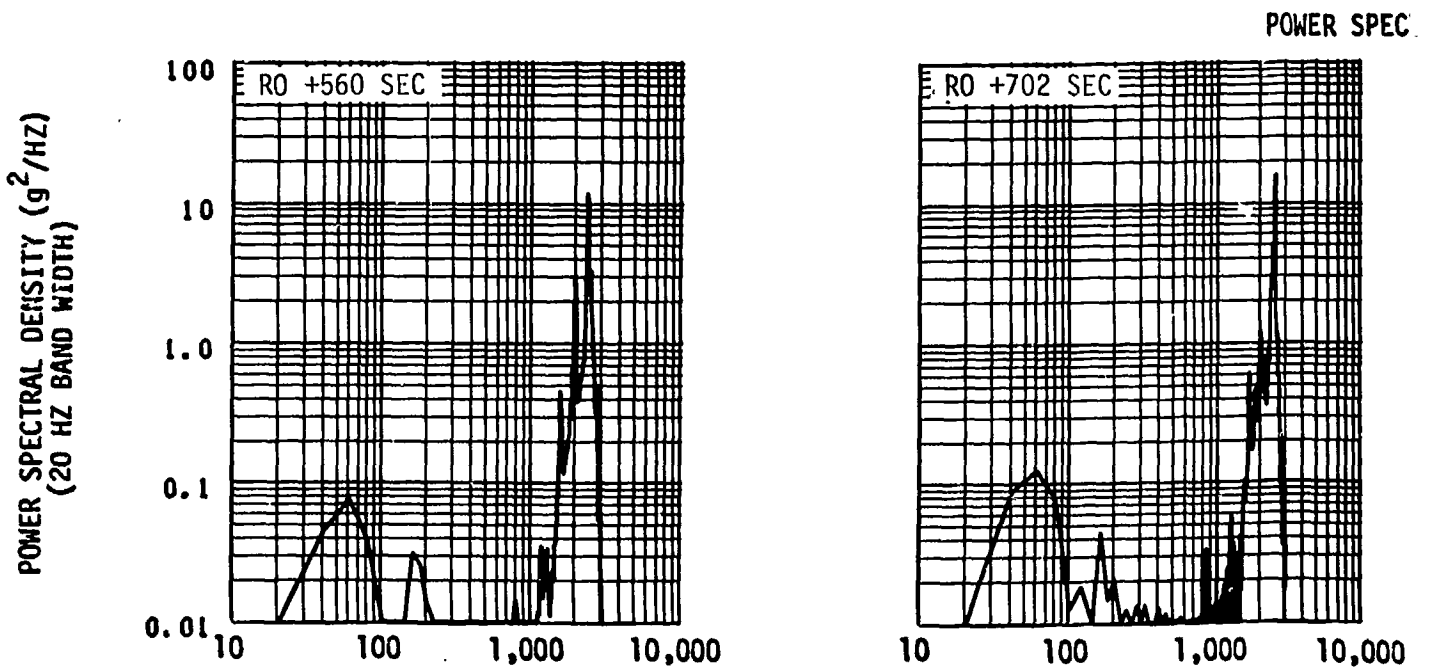

FOLDOUT FRAME

Figure 25-4. Vibration Measured at LOX Turb

RMS COMPOSITE TIME-HISTORY

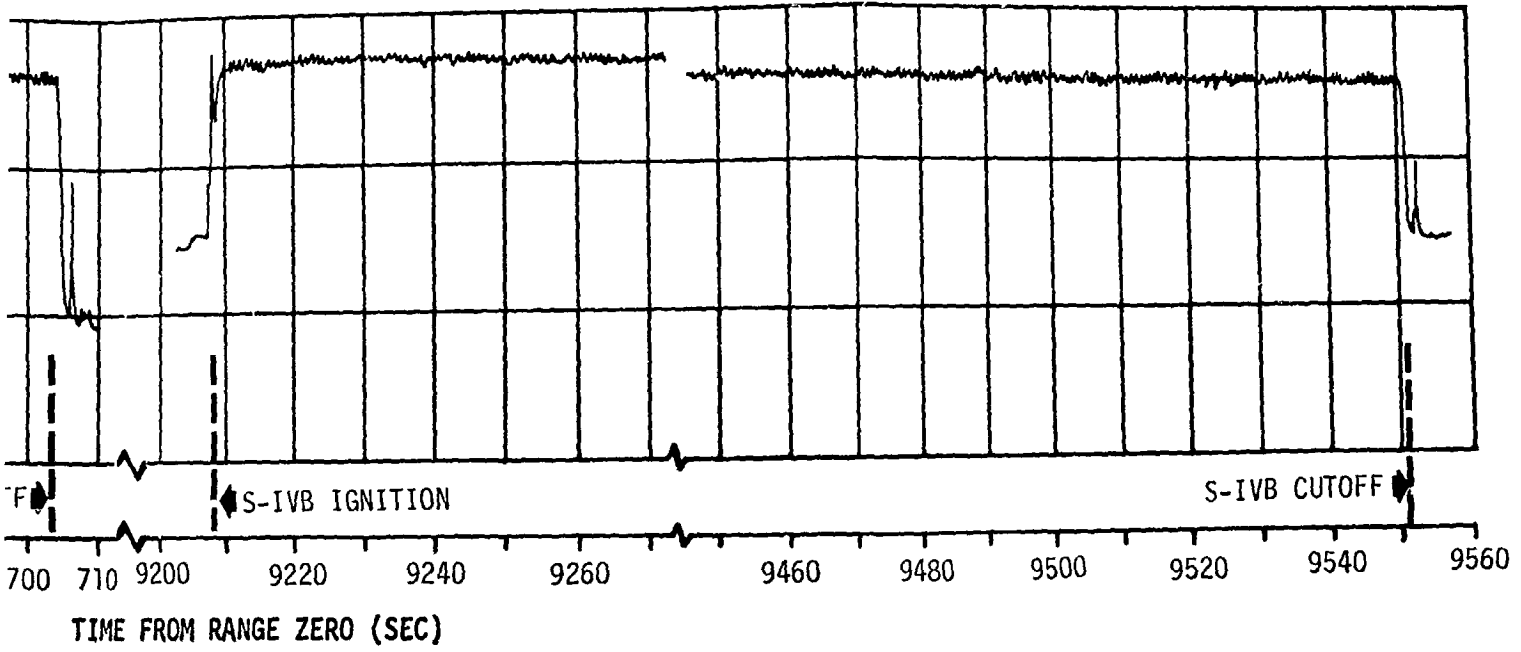

POWER SPECTRAL DENSITY PLOTS

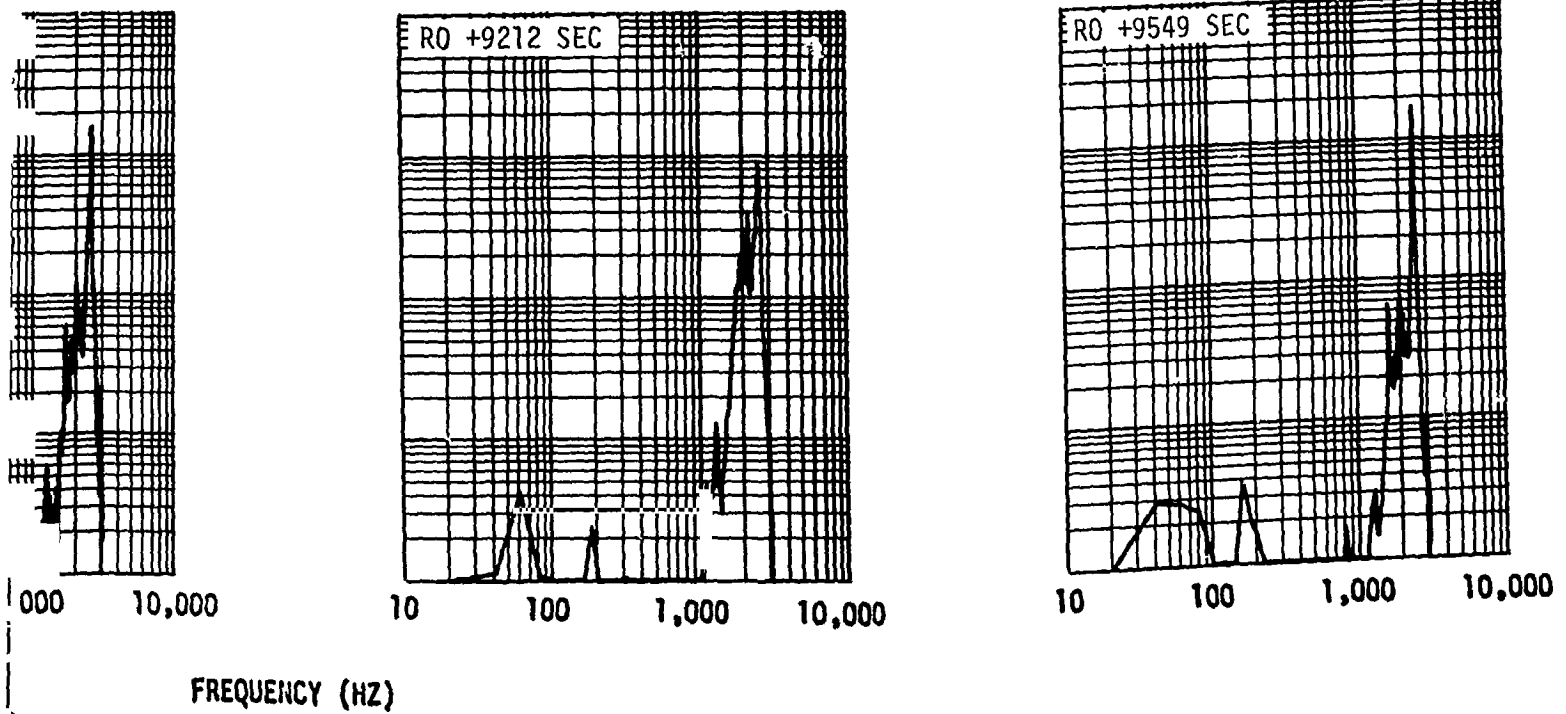

ed at LOX Turbopump, Radial Direction - E0211-401

EOLDOUT FRAME

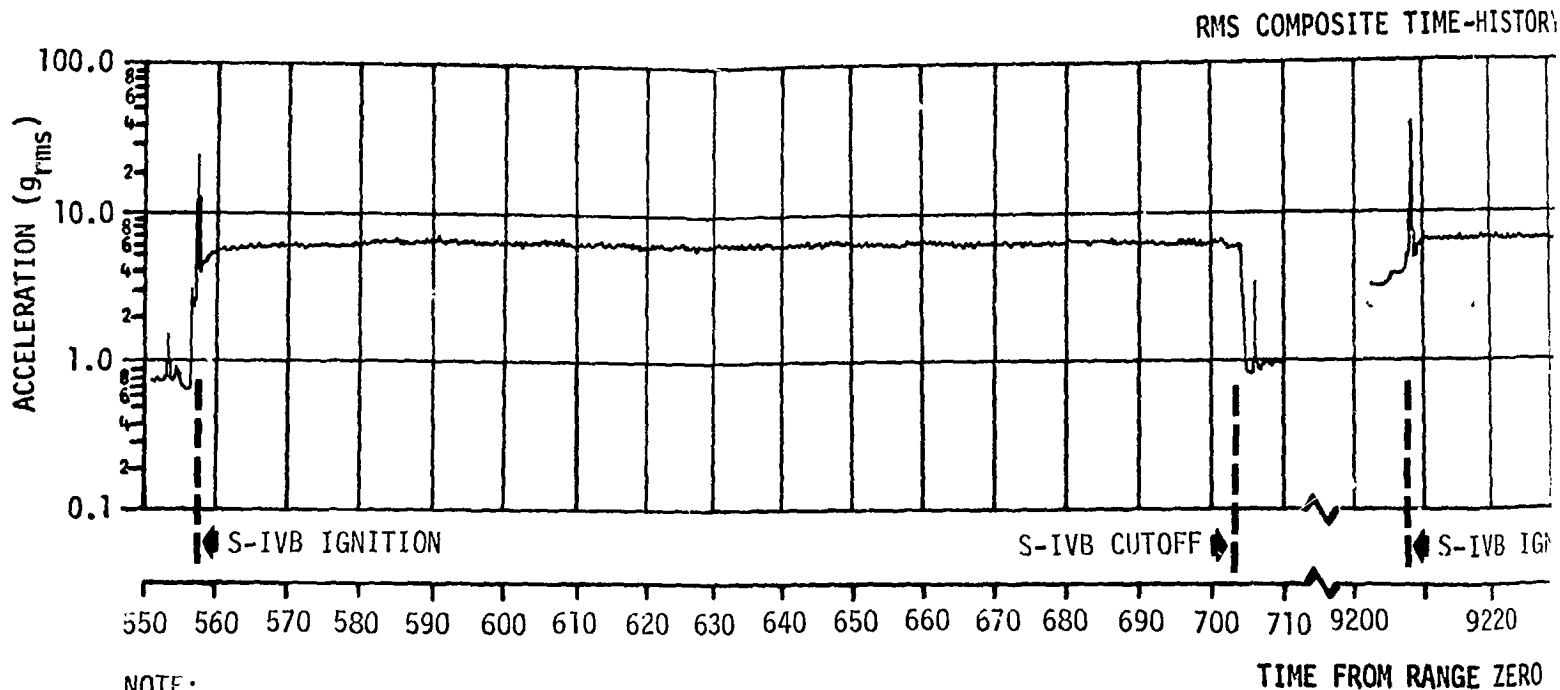

NOTE:
DATA NOT VALID BELOW 40 HZ
BECAUSE OF SSB RESPONSE

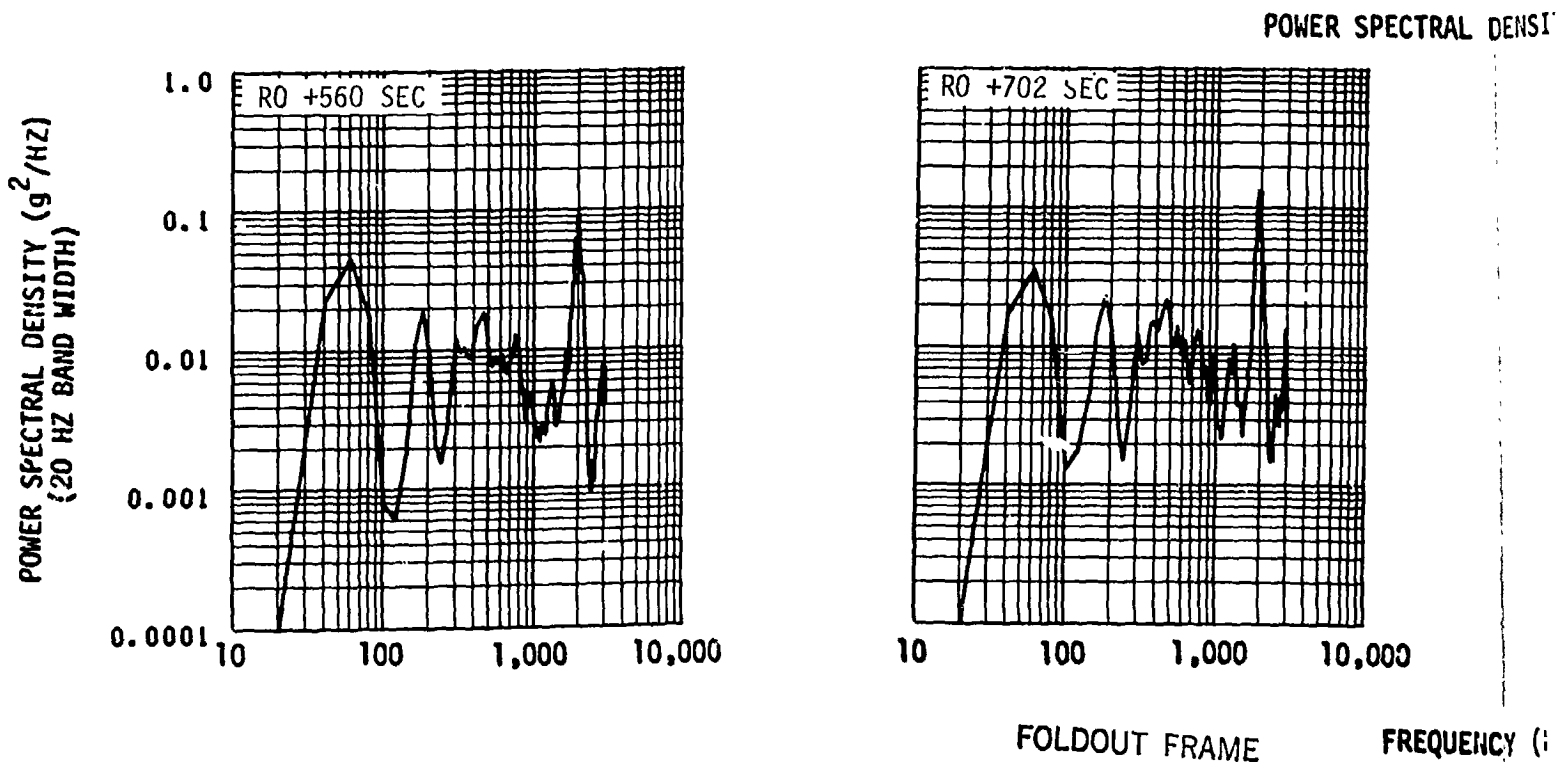

FOLDOUT FRAME

Figure 25-5. Vibration Measured on Main Fuel Valve, Tangent

TIME-HISTORY

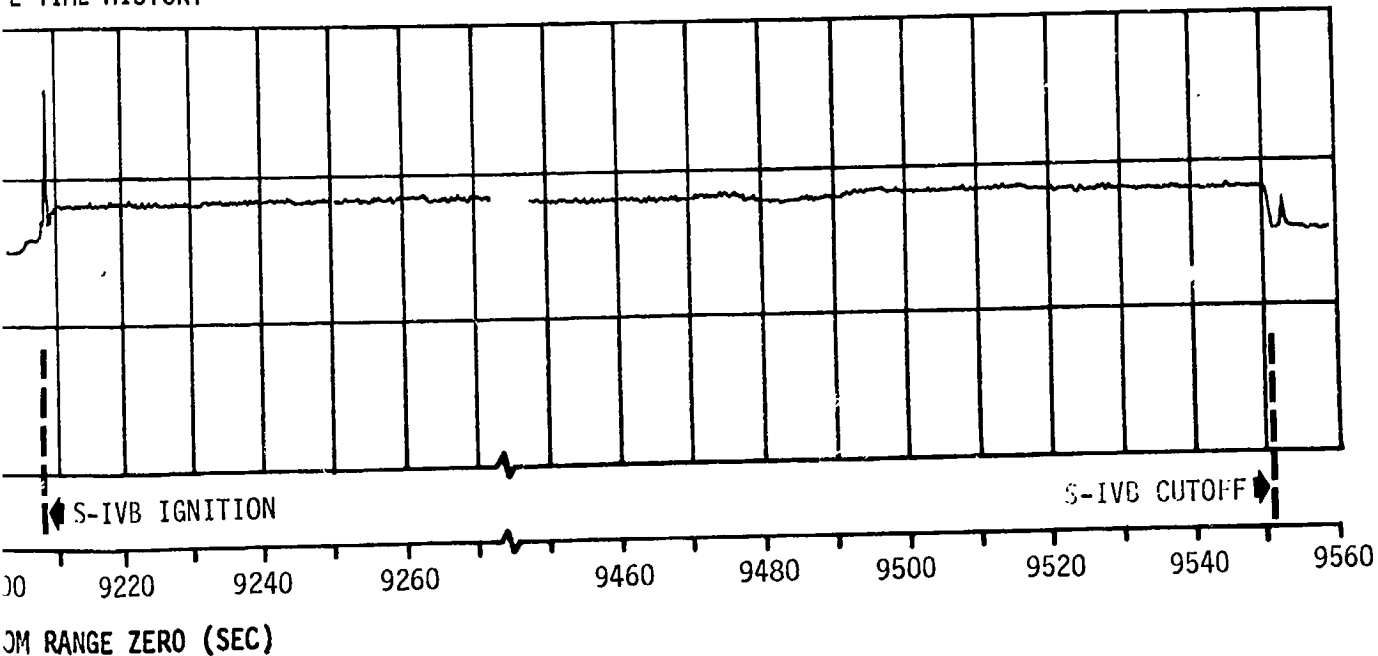

SPECTRAL DENSITY PLOTS

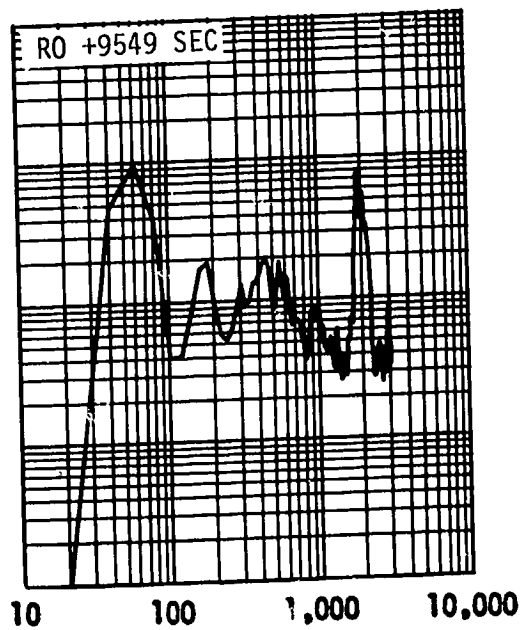
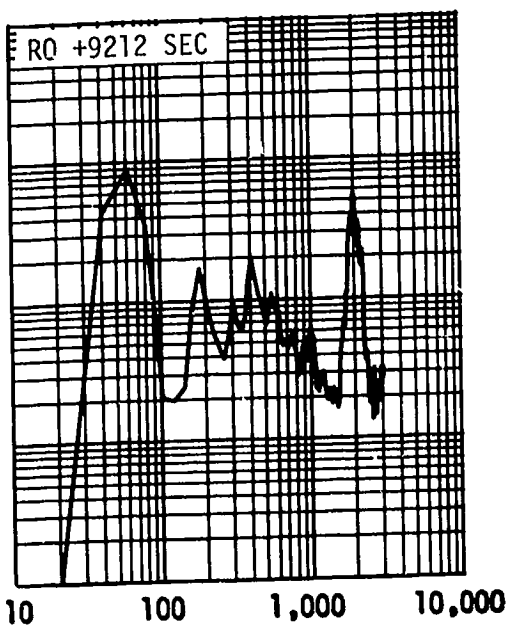

FREQUENCY (HZ)

ive, Tangential Direction - E0236-401

FOLDOUT FRAME 2

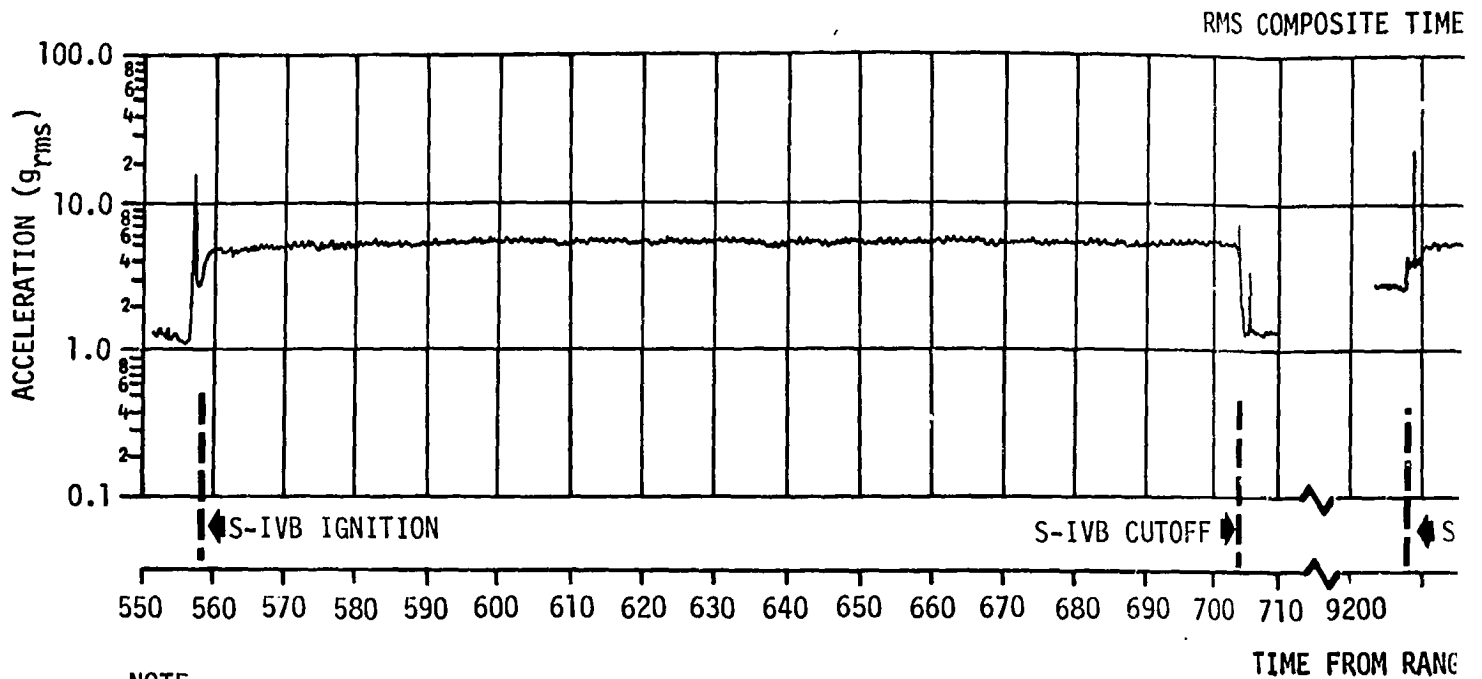

NOTE:
DATA NOT VALID BELOW 40 HZ
BECAUSE OF SSB RESPONSE

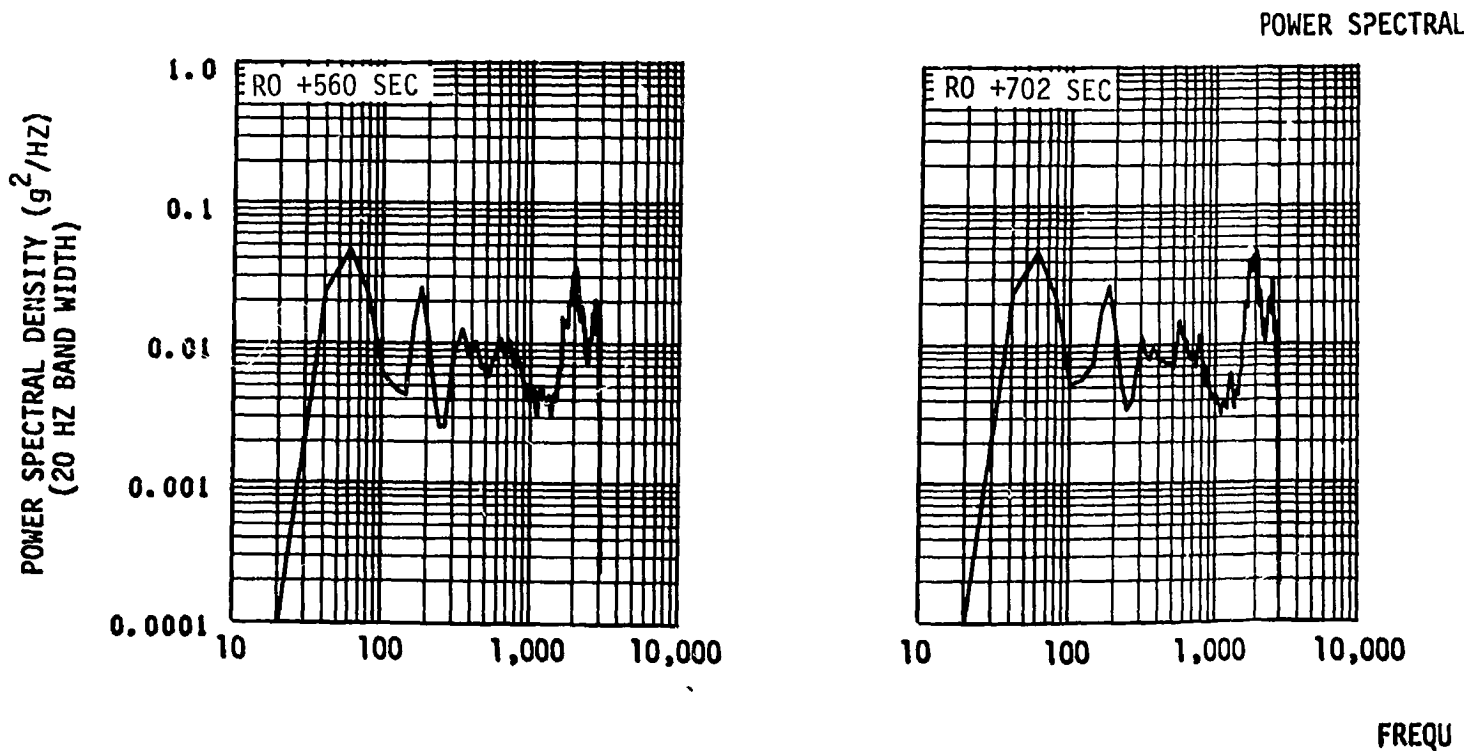

FOLDOUT FRAME

Figure 25-6. Vibration Measured on Main Fuel Valve

COMPOSITE TIME-HISTORY

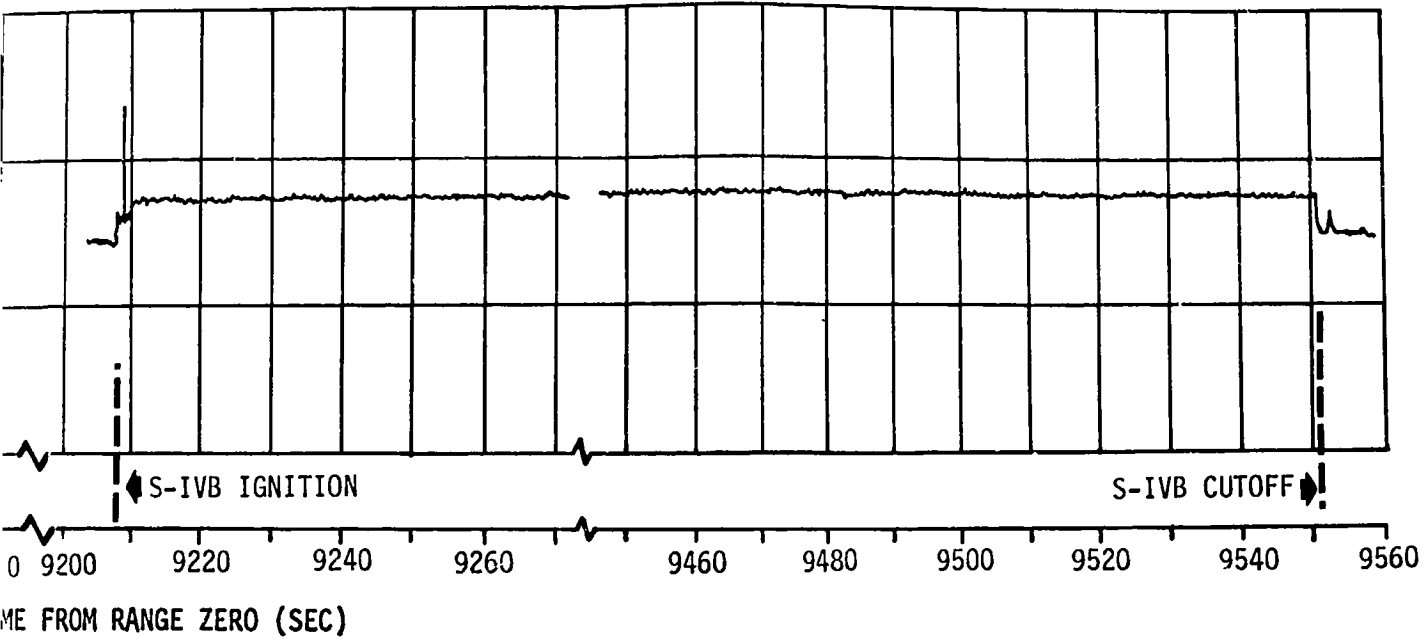

POWER SPECTRAL DENSITY PLOTS

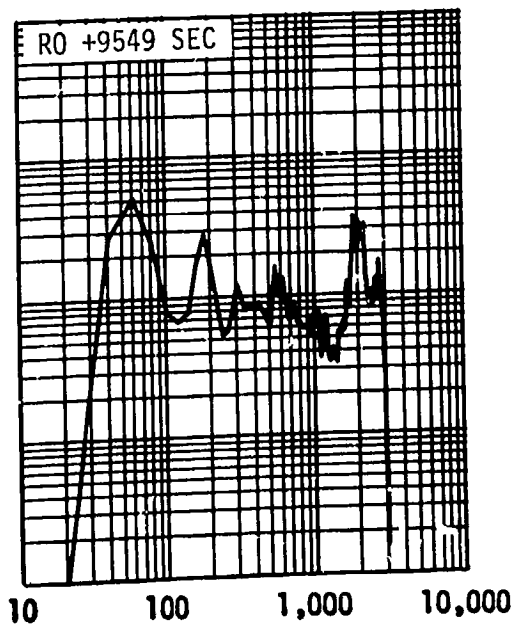
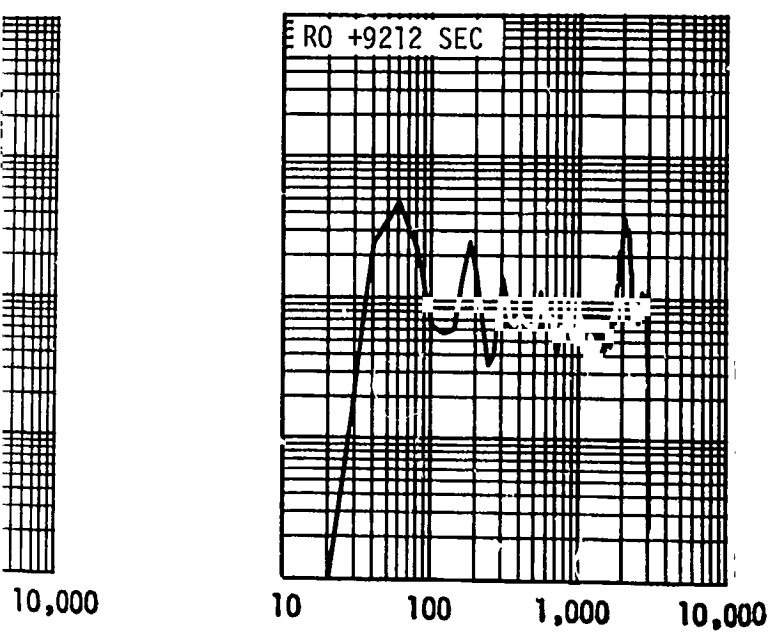

FREQUENCY (HZ)

Fuel Valve, Radial Direction - E0237-401

FOLDOUT FRAME 2

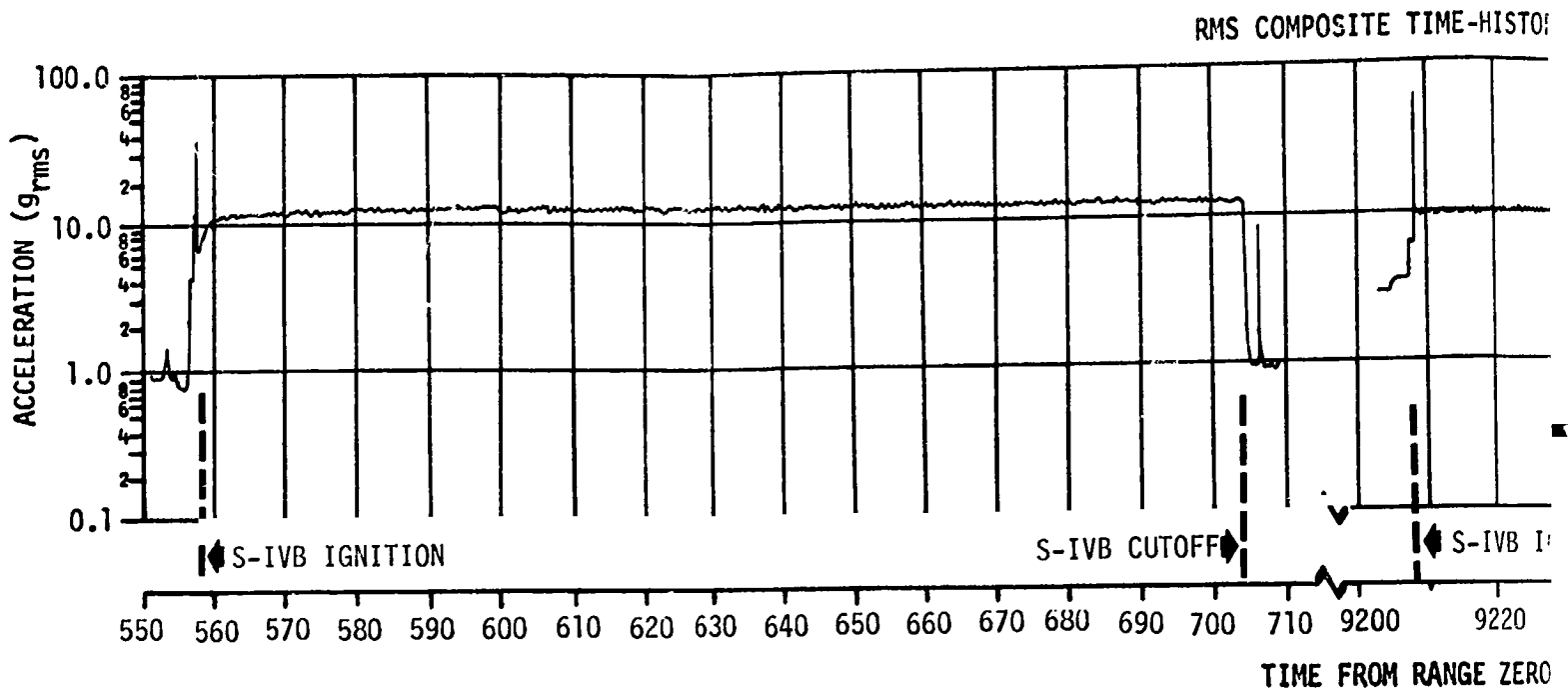

NOTE:
DATA NOT VALID BELOW 40 HZ
BECAUSE OF SSB RESPONSE

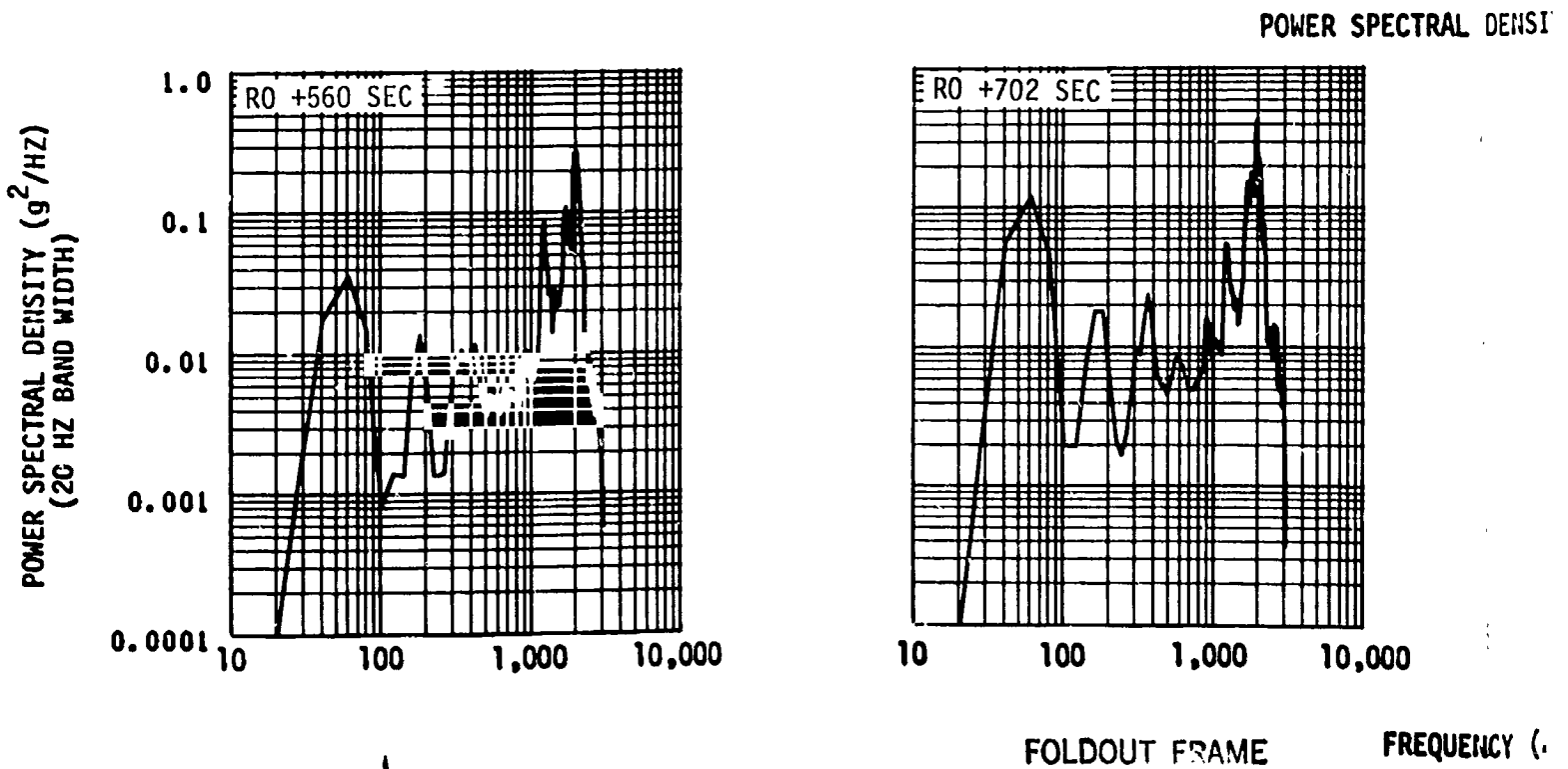

FOLDOUT FRAME 1

Figure 25-7. Vibration Measured on Main Fuel Valve, Thrust

IE-HISTORY

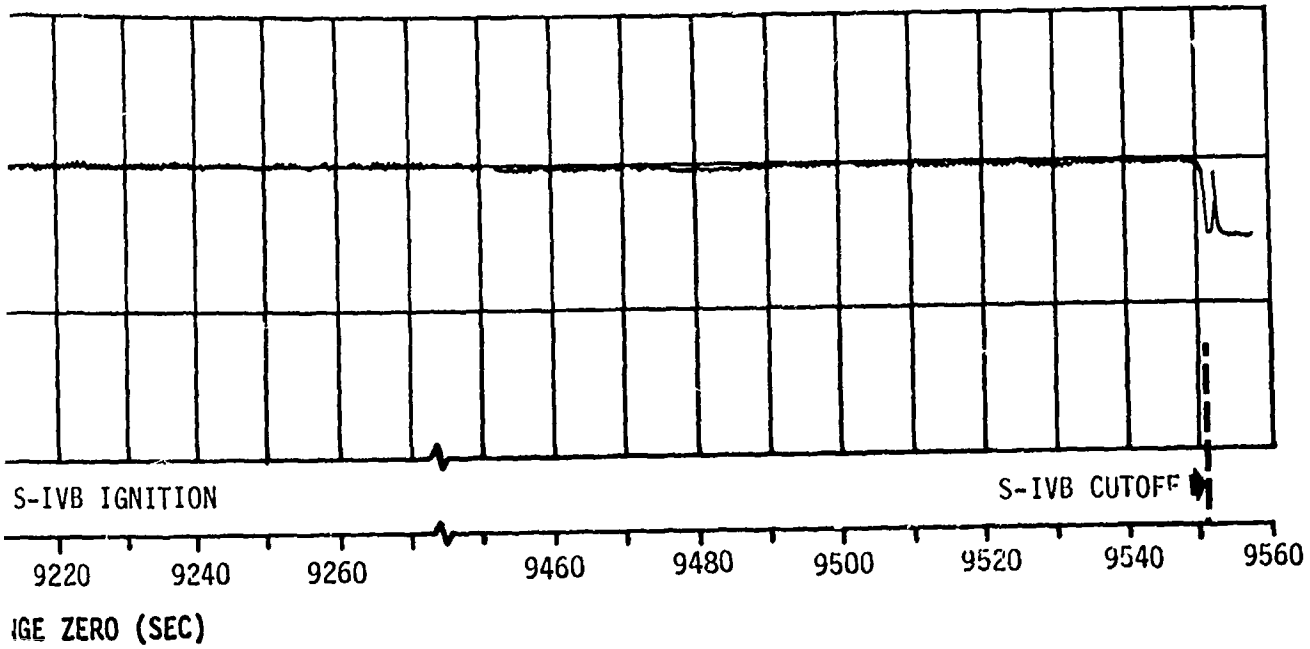

AL DENSITY PLOTS

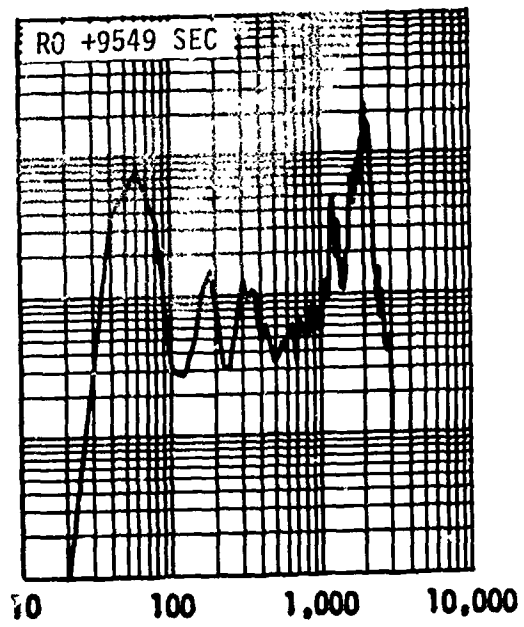
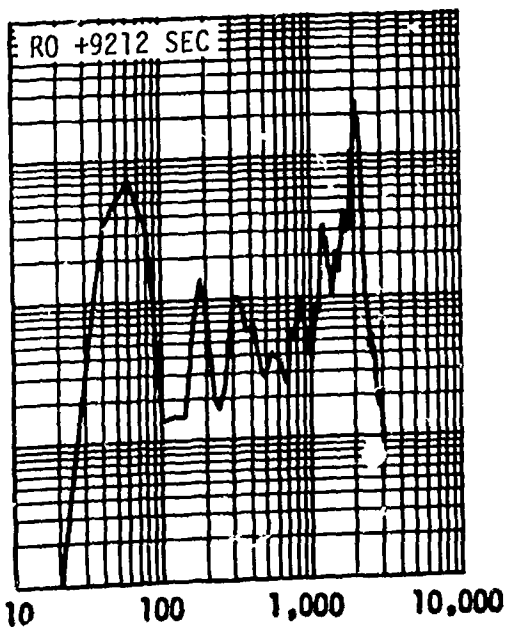

FREQUENCY (HZ)

3, Thrust Direction - E0238-401

FOLDOUT FRAME 2

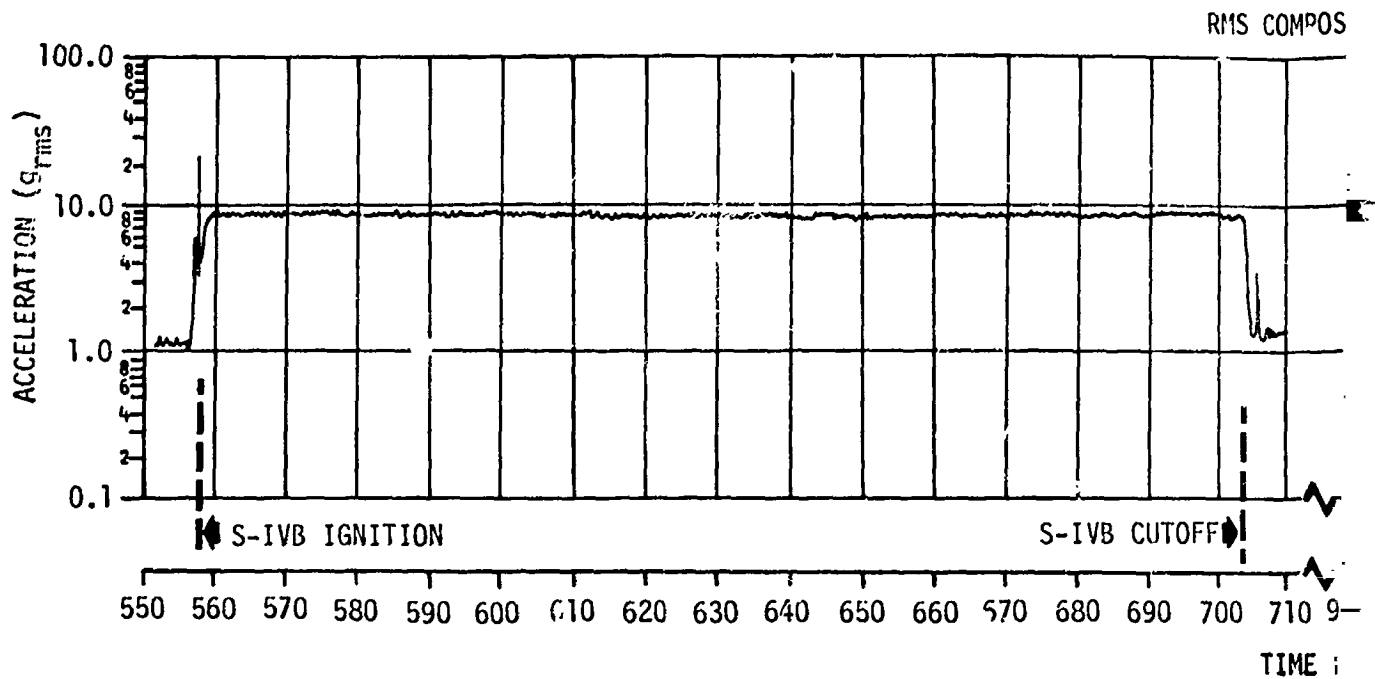

NOTE:
DATA NOT VALID BELOW 40 HZ
BECAUSE OF SSB RESPONSE

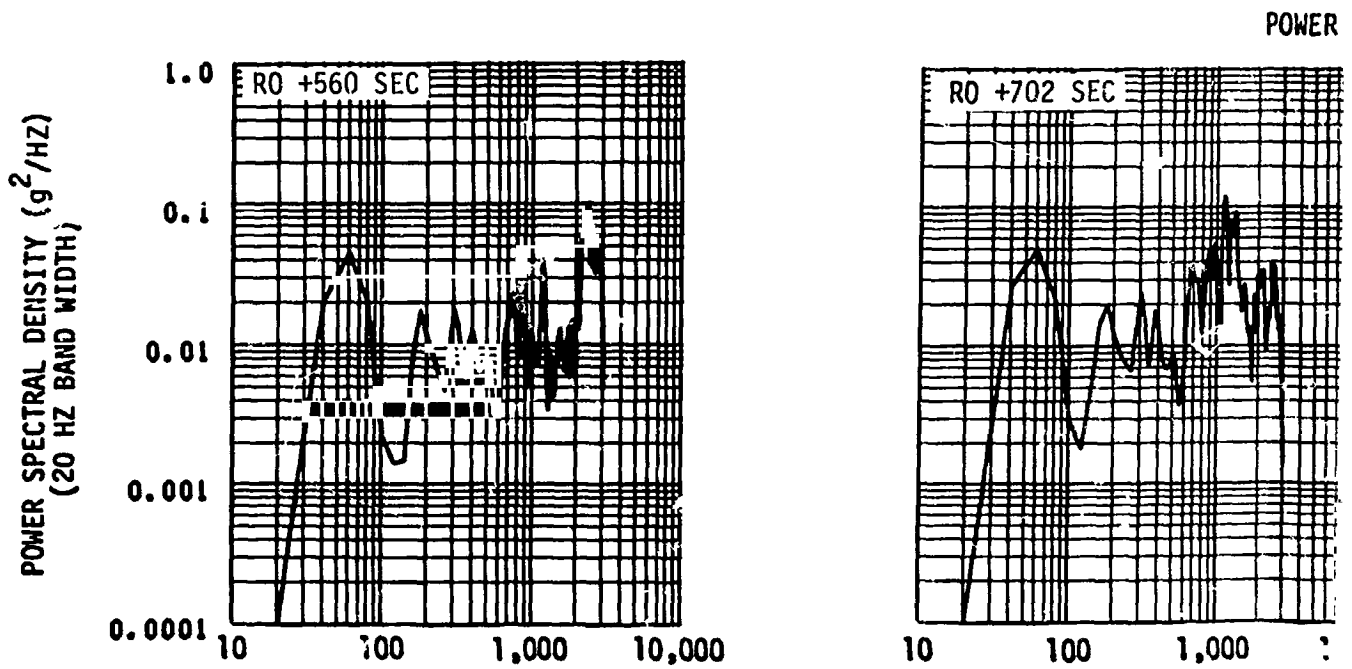

FOLDOUT FRAME

Figure 25-8. Vibration Measured on LOX Turbine

SITE TIME-HISTORY

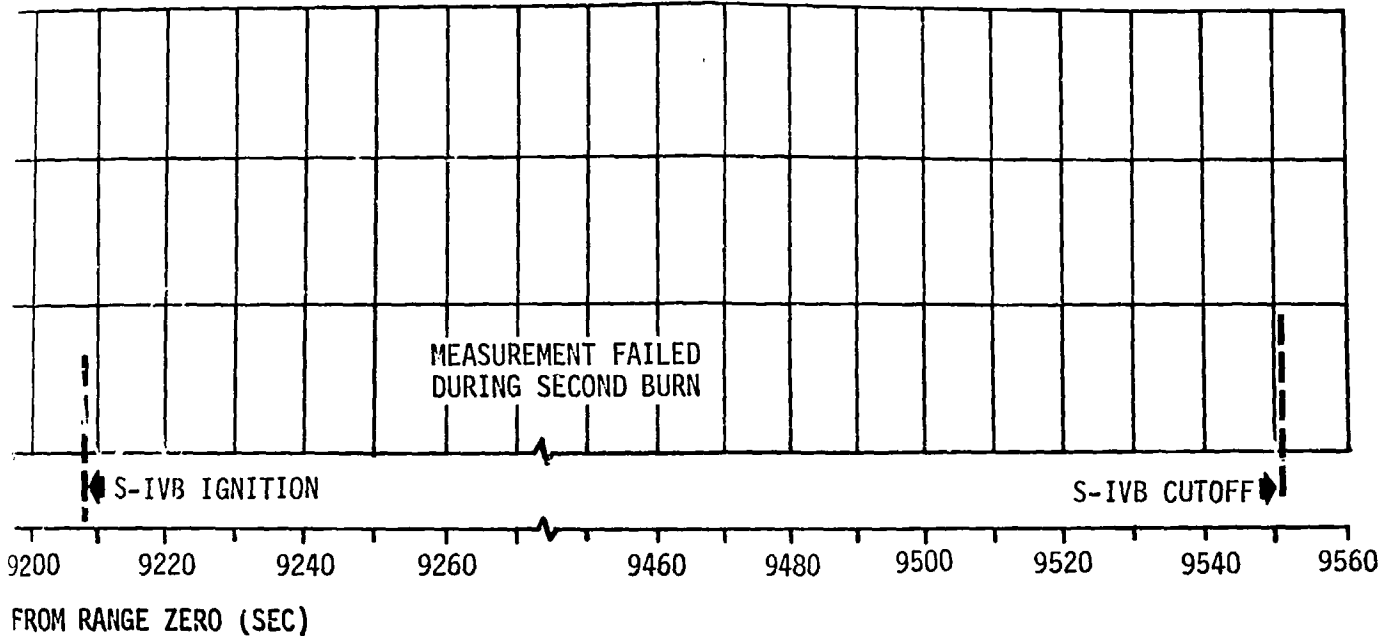

SPECTRAL DENSITY PLOTS

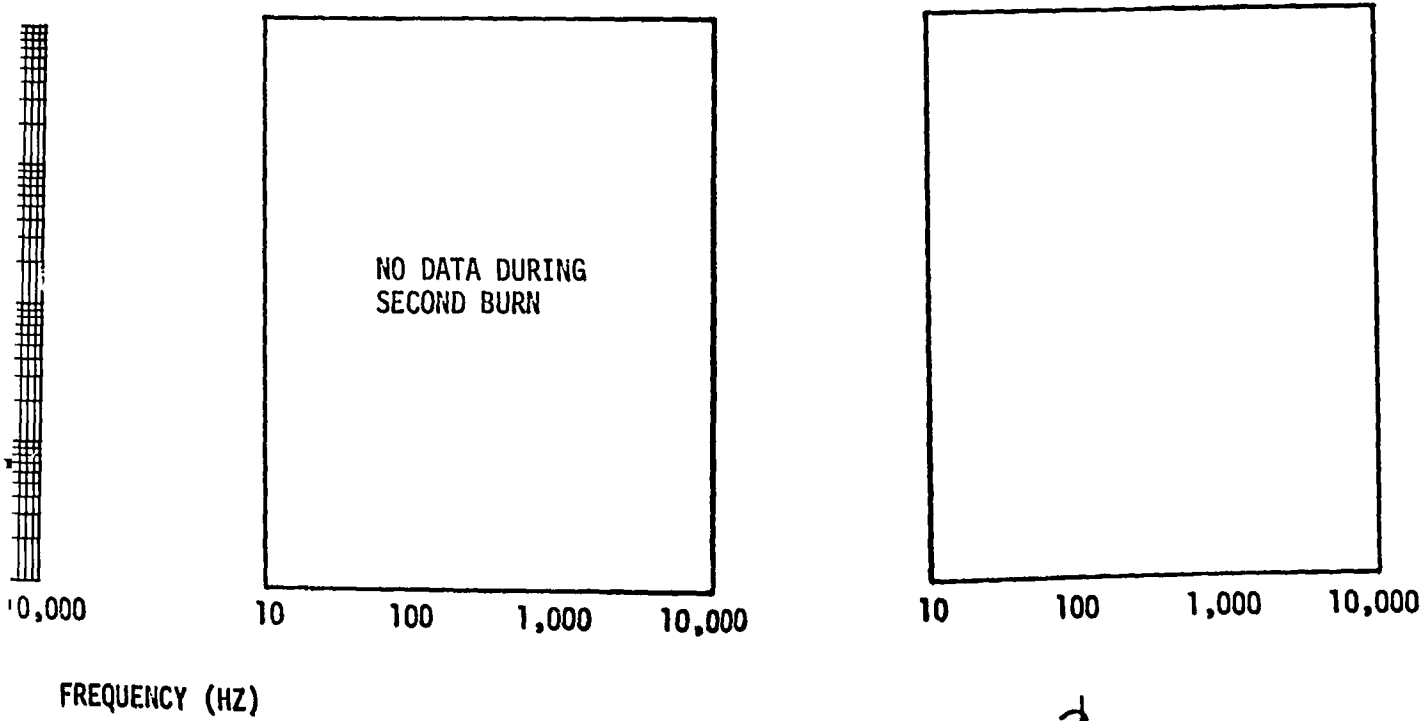

Bypass Valve, Tangential Direction - E0239-401

FOLDOUT FRAME 2

RMS COMPOSITE TIME-HISTORY

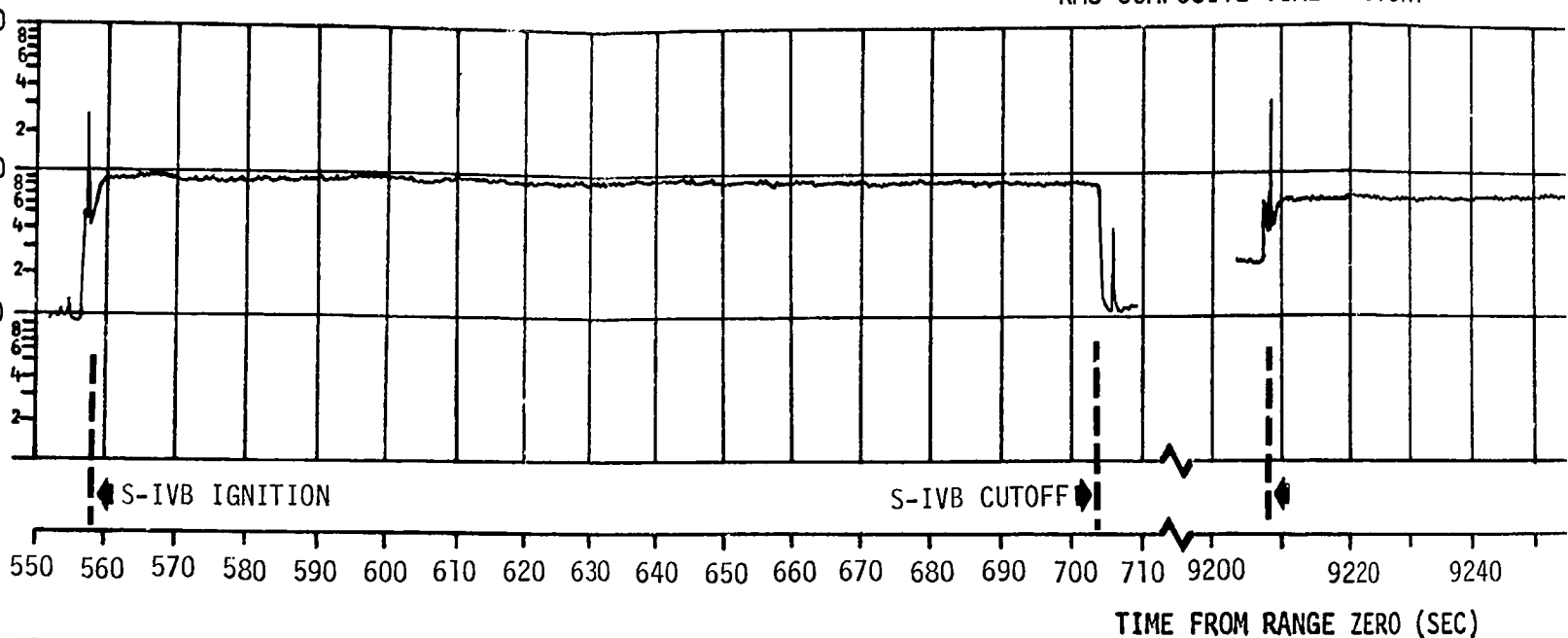

NOTE:
DATA NOT VALID BELOW 40 HZ
BECAUSE OF SSB RESPONSE

POWER SPECTRAL DENSITY PLOTS

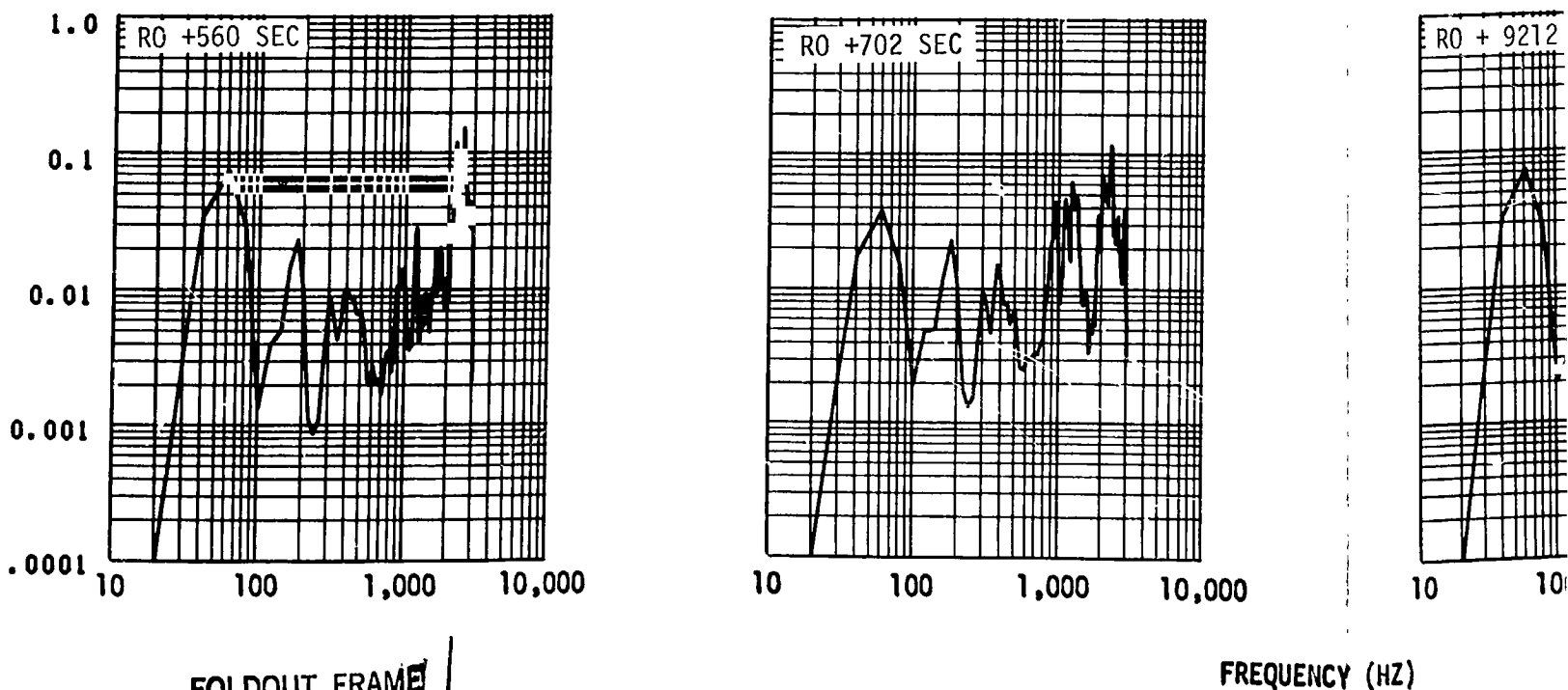

FOLDOUT FRAME

FREQUENCY (HZ)

Figure 25-9. Vibration Measured on LOX Turbine Bypass Valve, Radial Directi

TORY

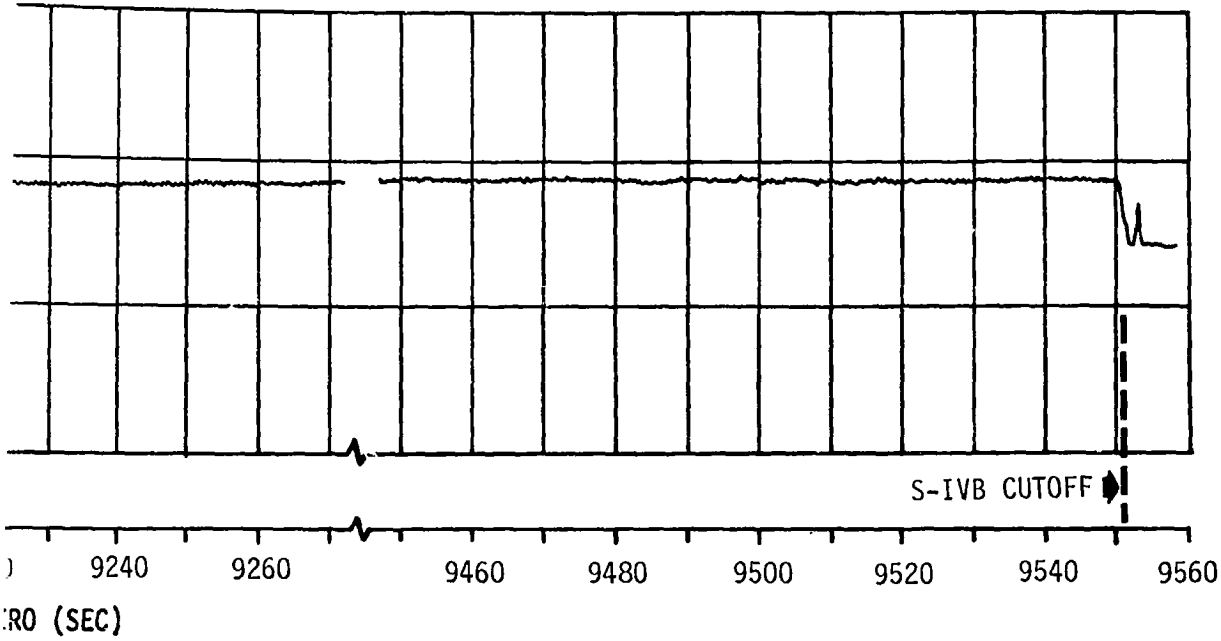

SITY PLOTS

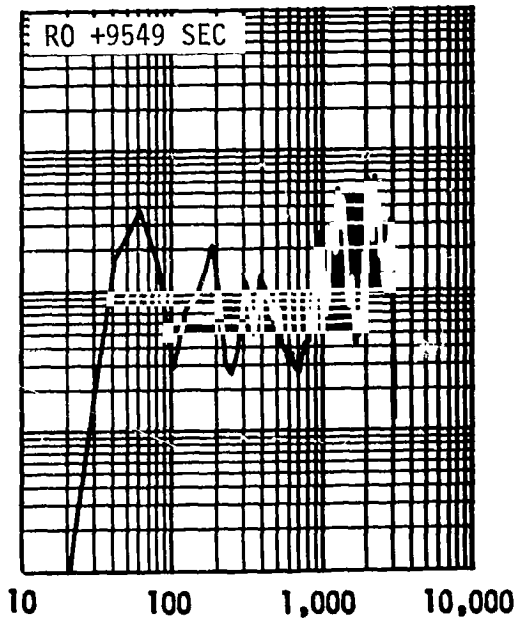
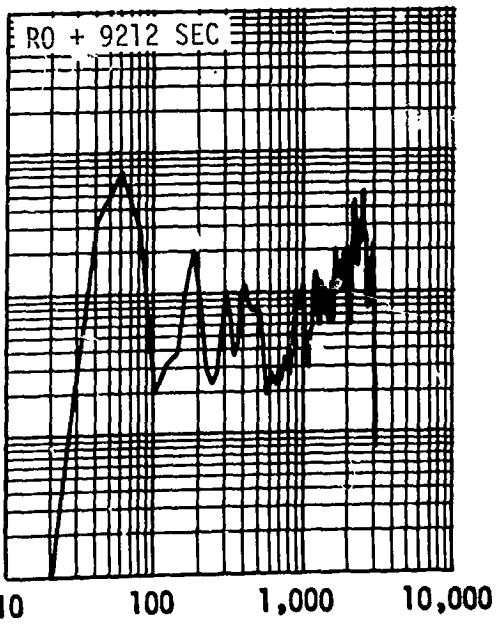

(HZ)

Radial Direction - E0240-401

FOLDOUT FRAME 2

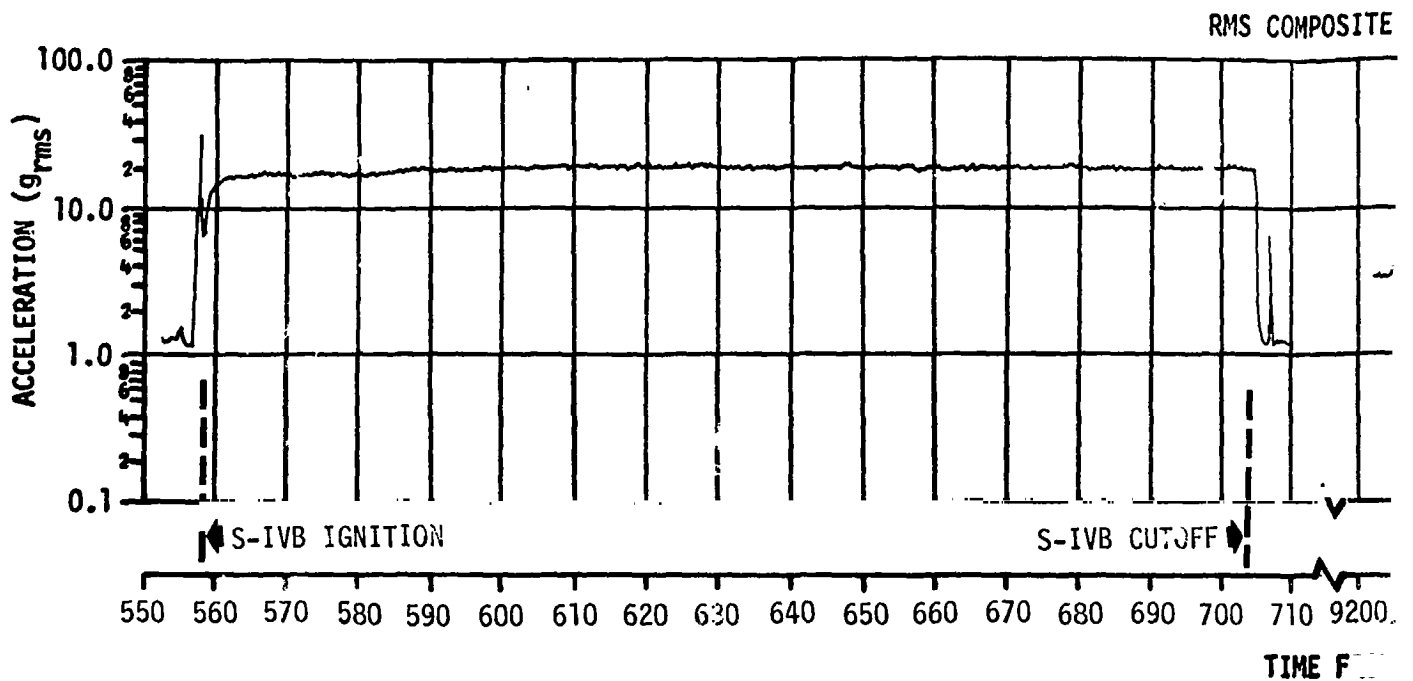

NOTE:
DATA NOT VALID BELOW 40 HZ
BECAUSE OF SSB RESPONSE

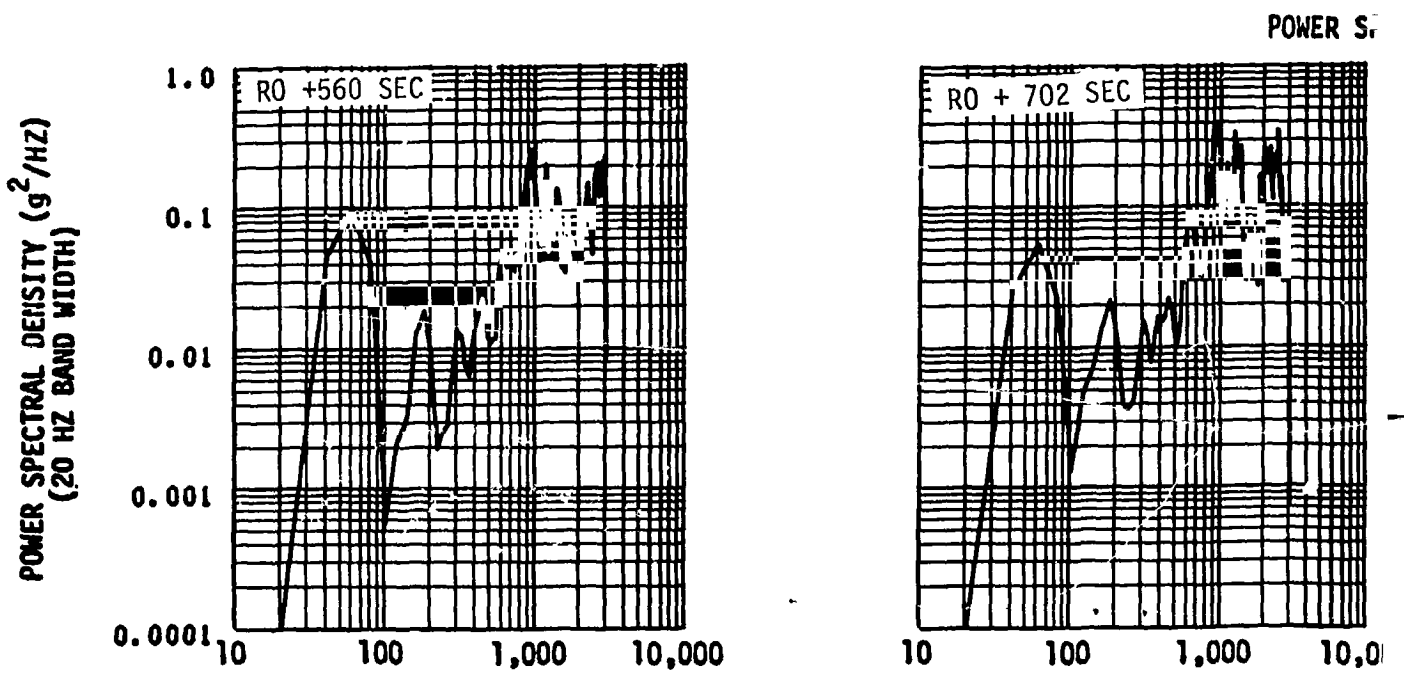

FOLDOUT FRAME

Figure 25-10. Vibration Measured on LOX Turbine

COMPOSITE TIME-HISTORY

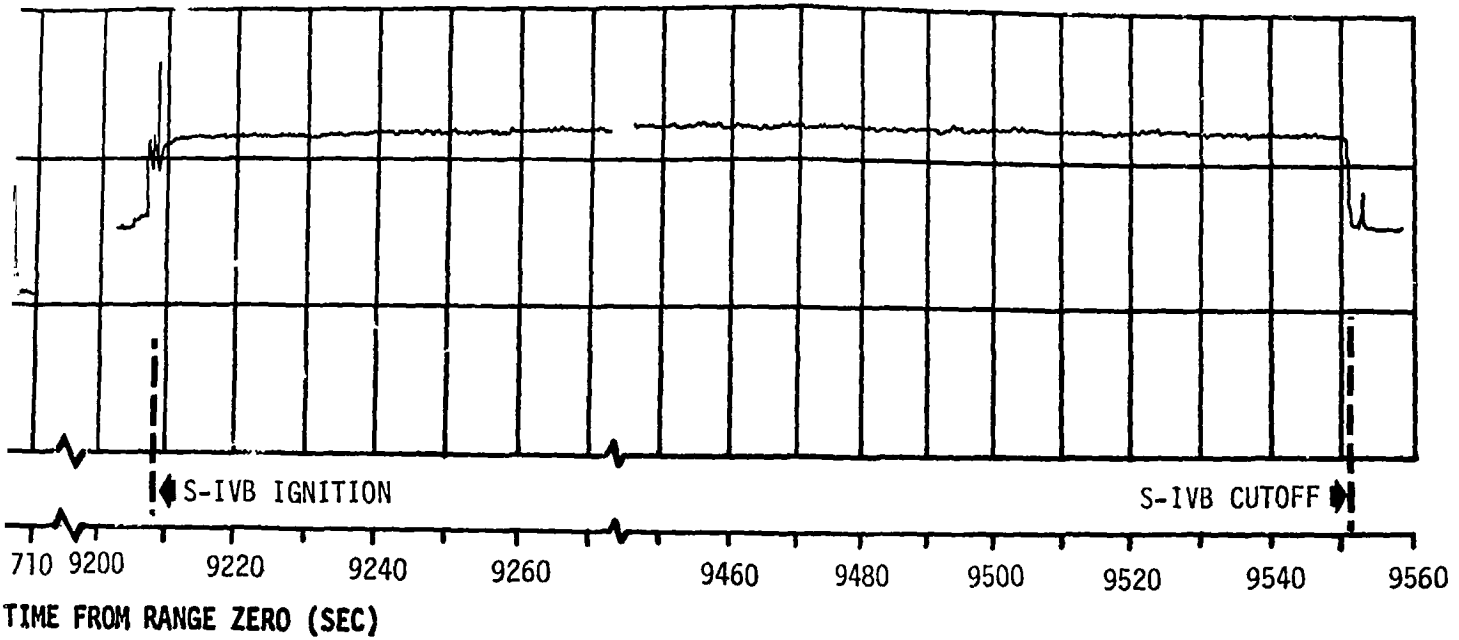

POWER SPECTRAL DENSITY PLOTS

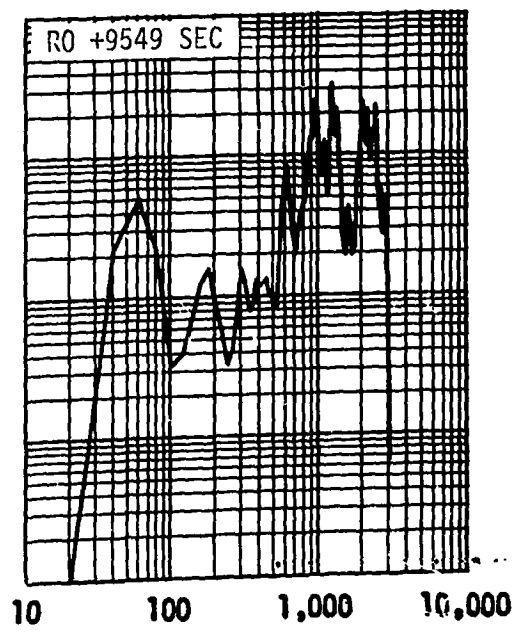
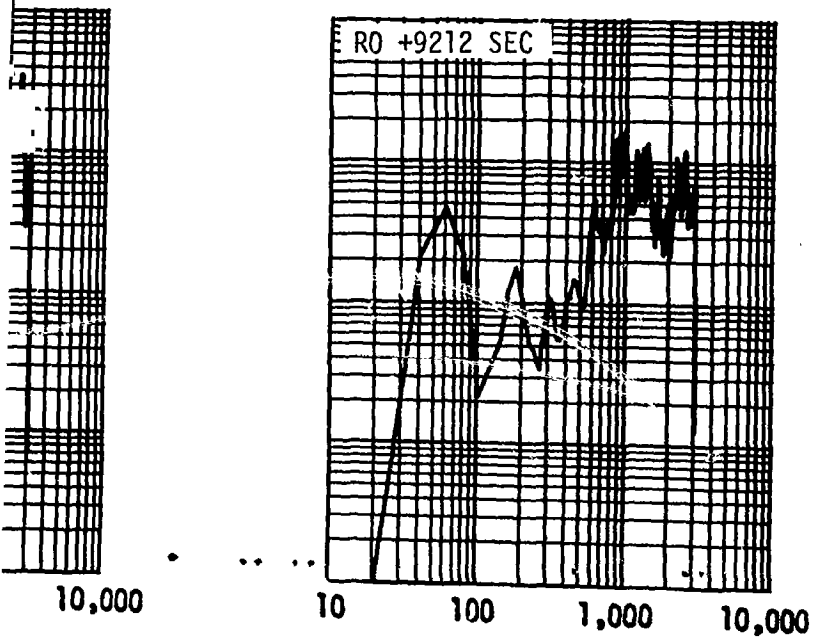

FREQUENCY (HZ)

X Turbine Bypass Valve, Thrust Direction - E0241-401

FOLDOUT FRAME 2

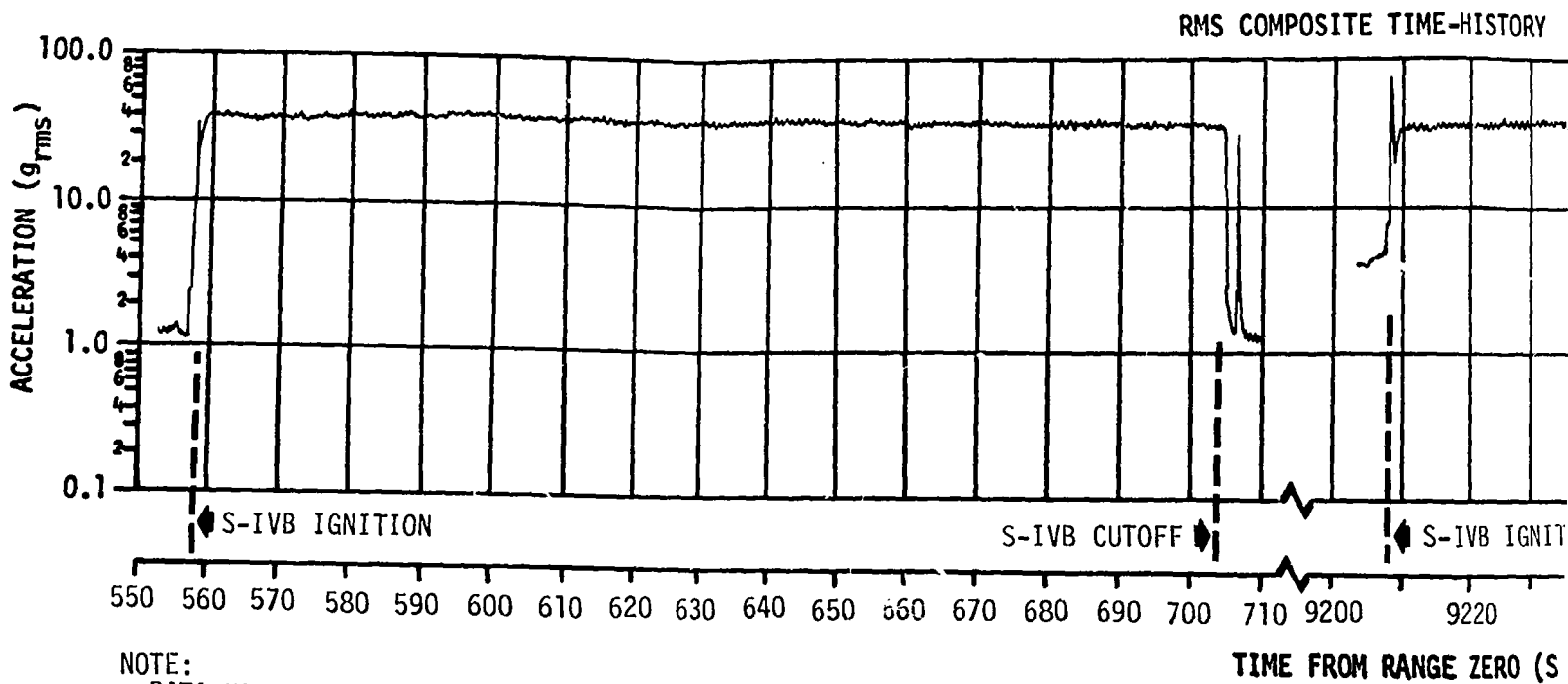

NOTE:
 DATA NOT VALID BELOW 40 HZ
 BECAUSE OF SSB RESPONSE

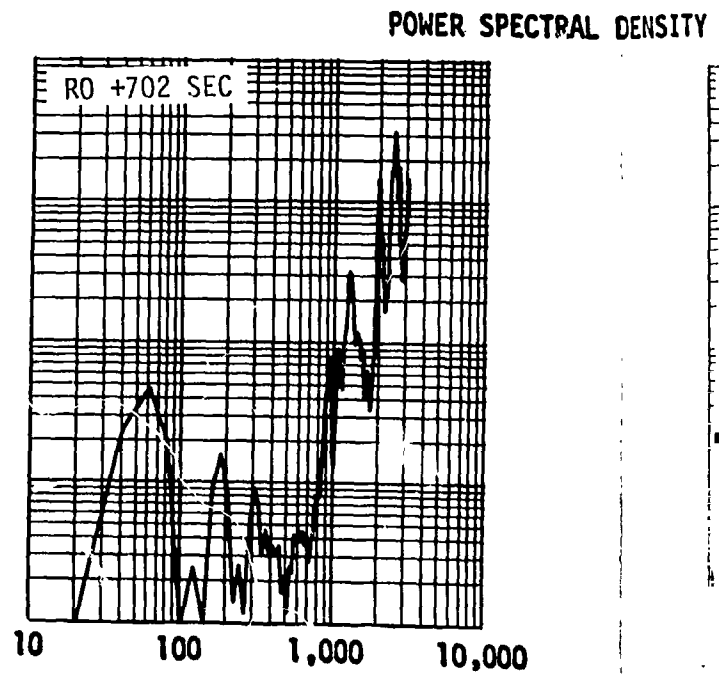
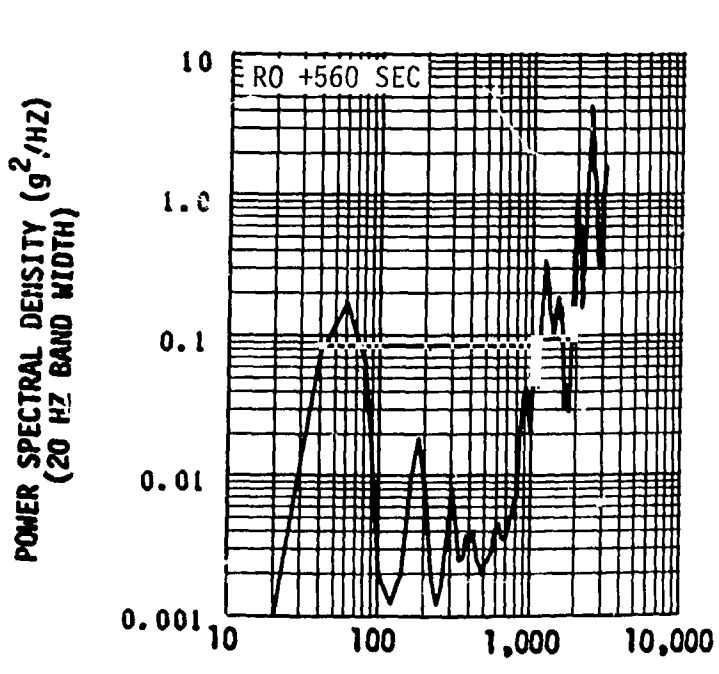

FOLDOUT FRAME

Figure 25-11. Vibration Measured on Fuel ASI Block, Radi

ME-HISTORY

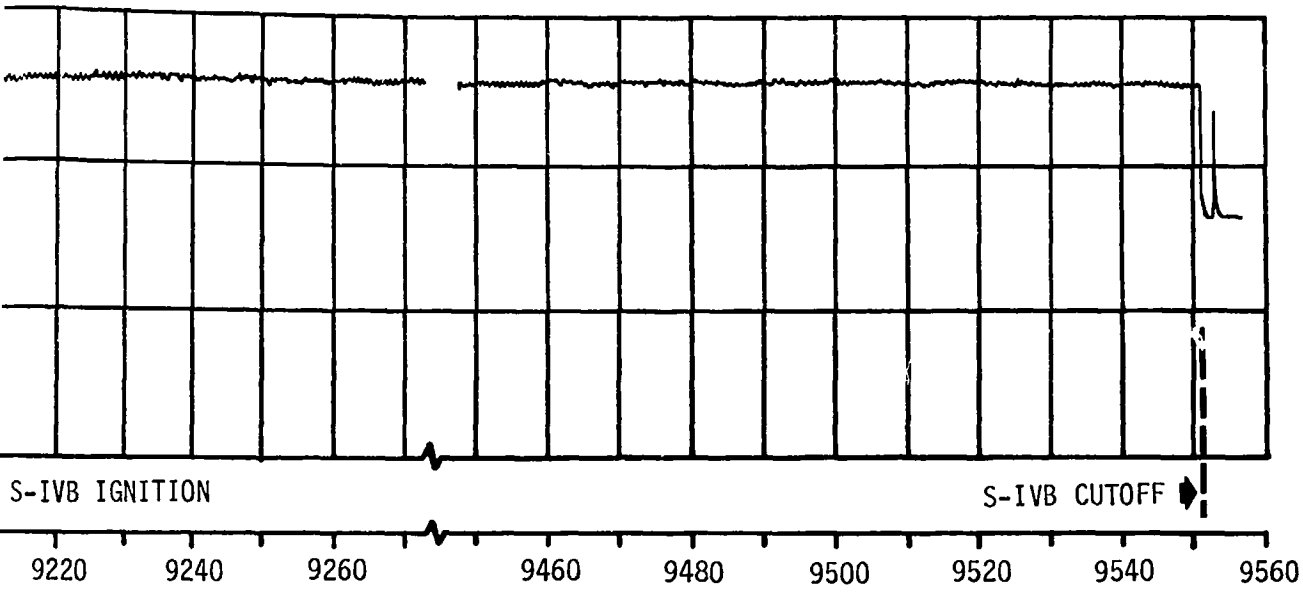

TIME ZERO (SEC)

AL DENSITY PLOTS

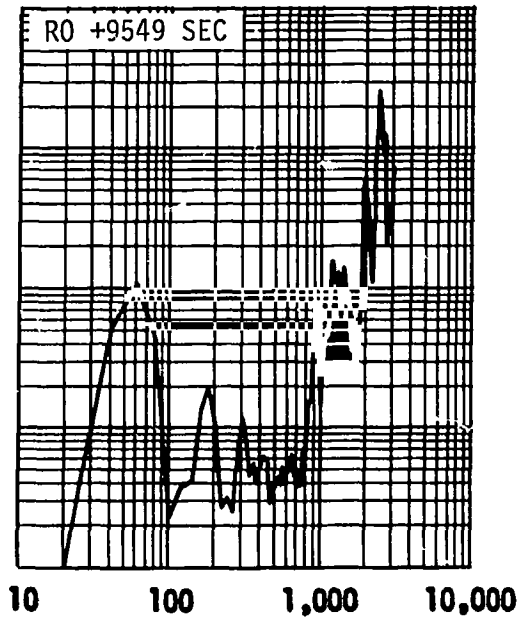
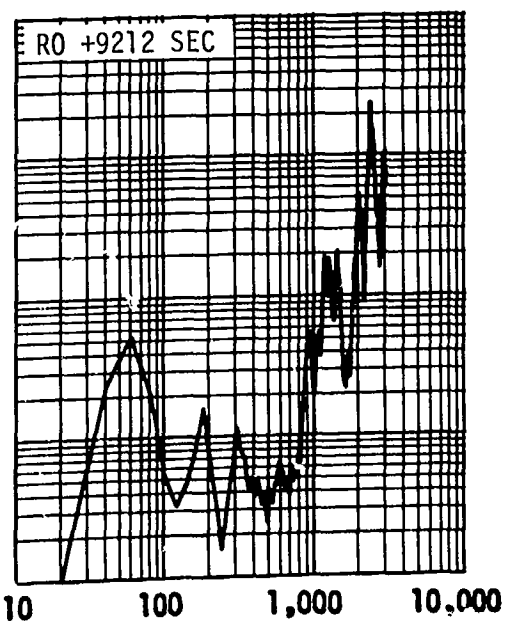

DENSITY (HZ)

FOLDOUT FRAME 2

Rock, Radial Direction - E0242-401

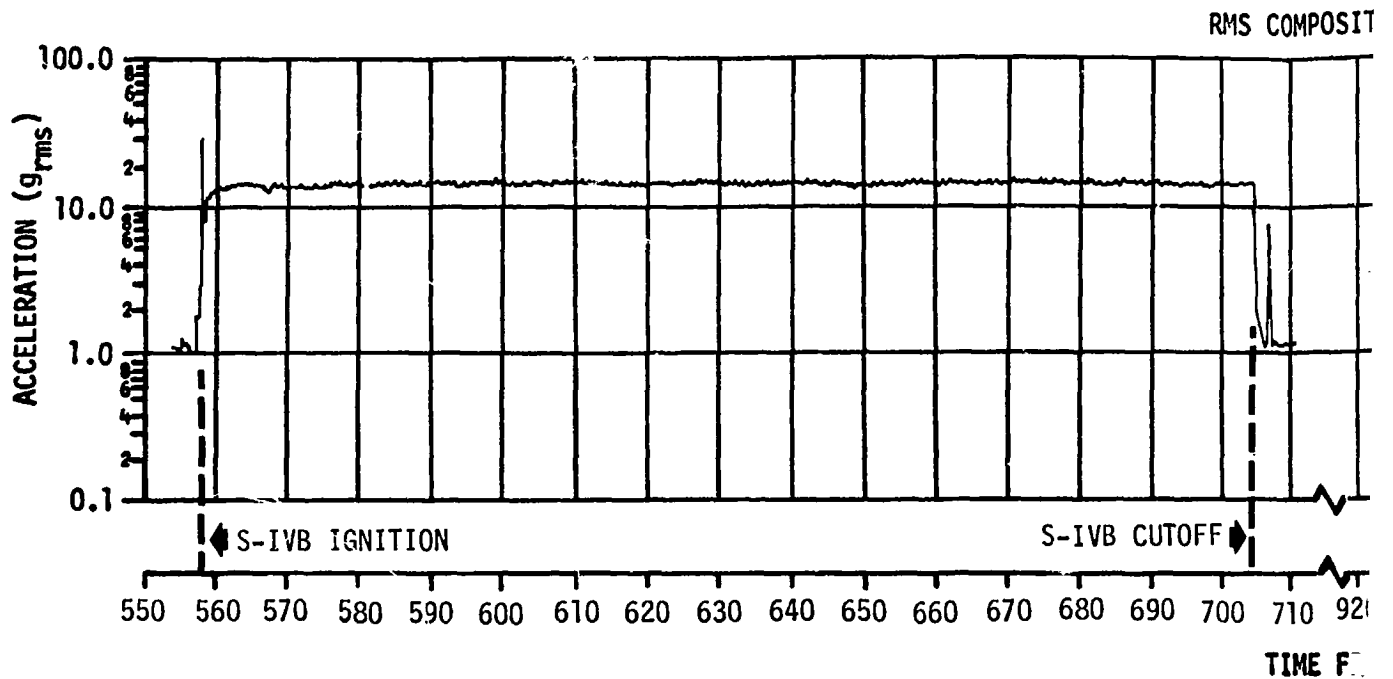

NOTE:
DATA NOT VALID BELOW 40 HZ
BECAUSE OF SSB RESPONSE

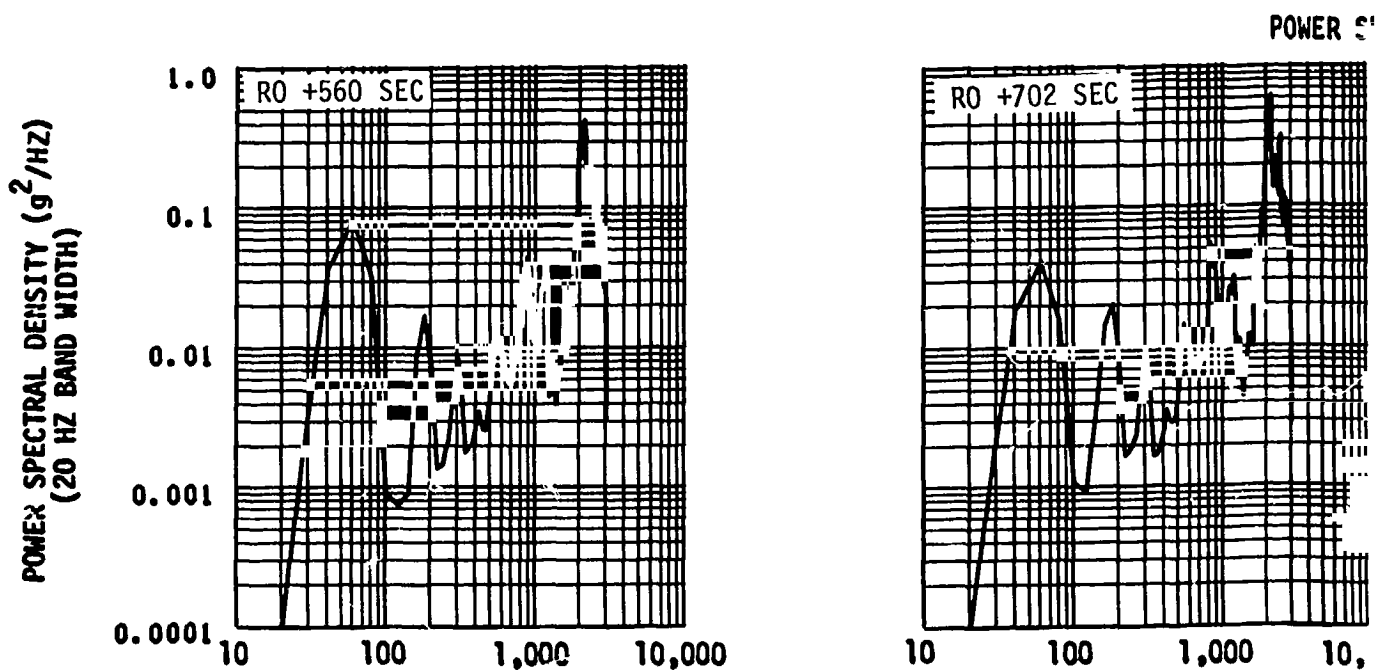

FOLDOUT FRAME

Figure 25-12. Vibration Measured on AS7

RMS COMPOSITE TIME-HISTORY

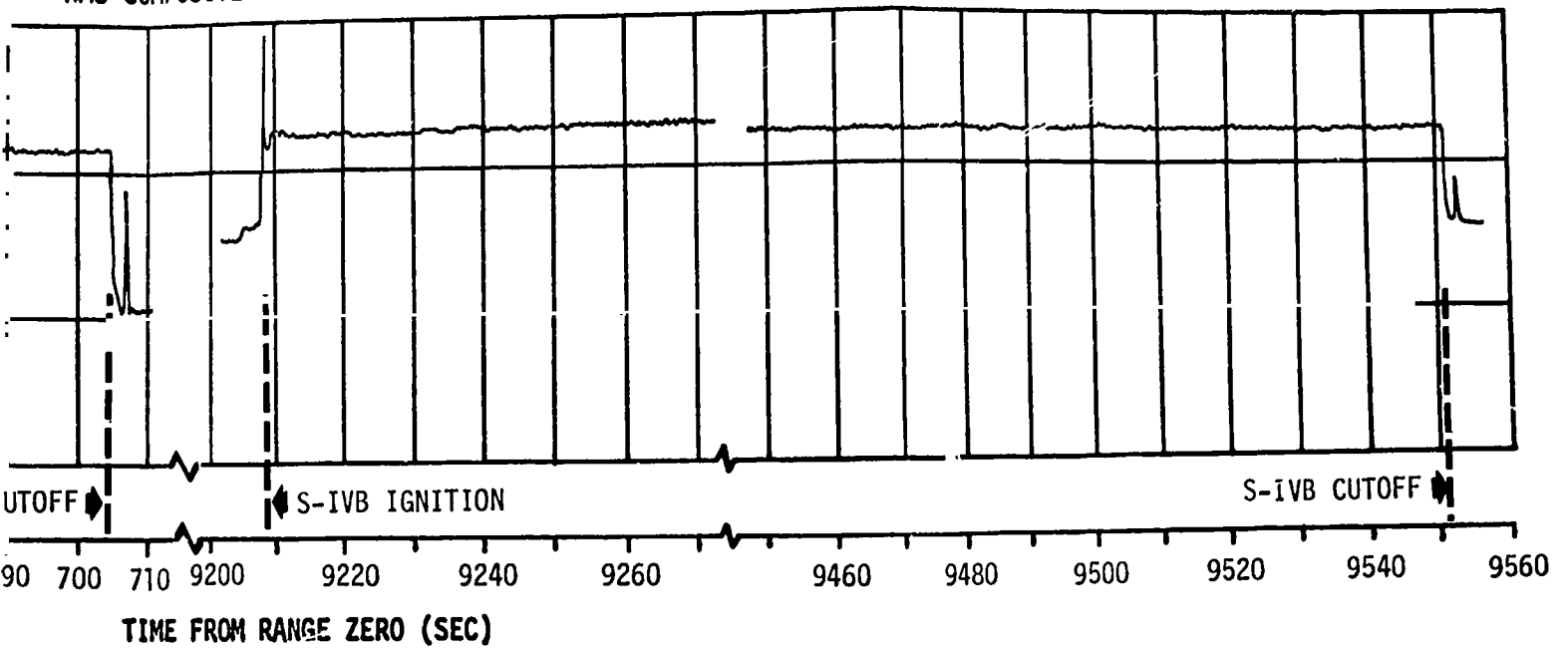

POWER SPECTRAL DENSITY PLOTS

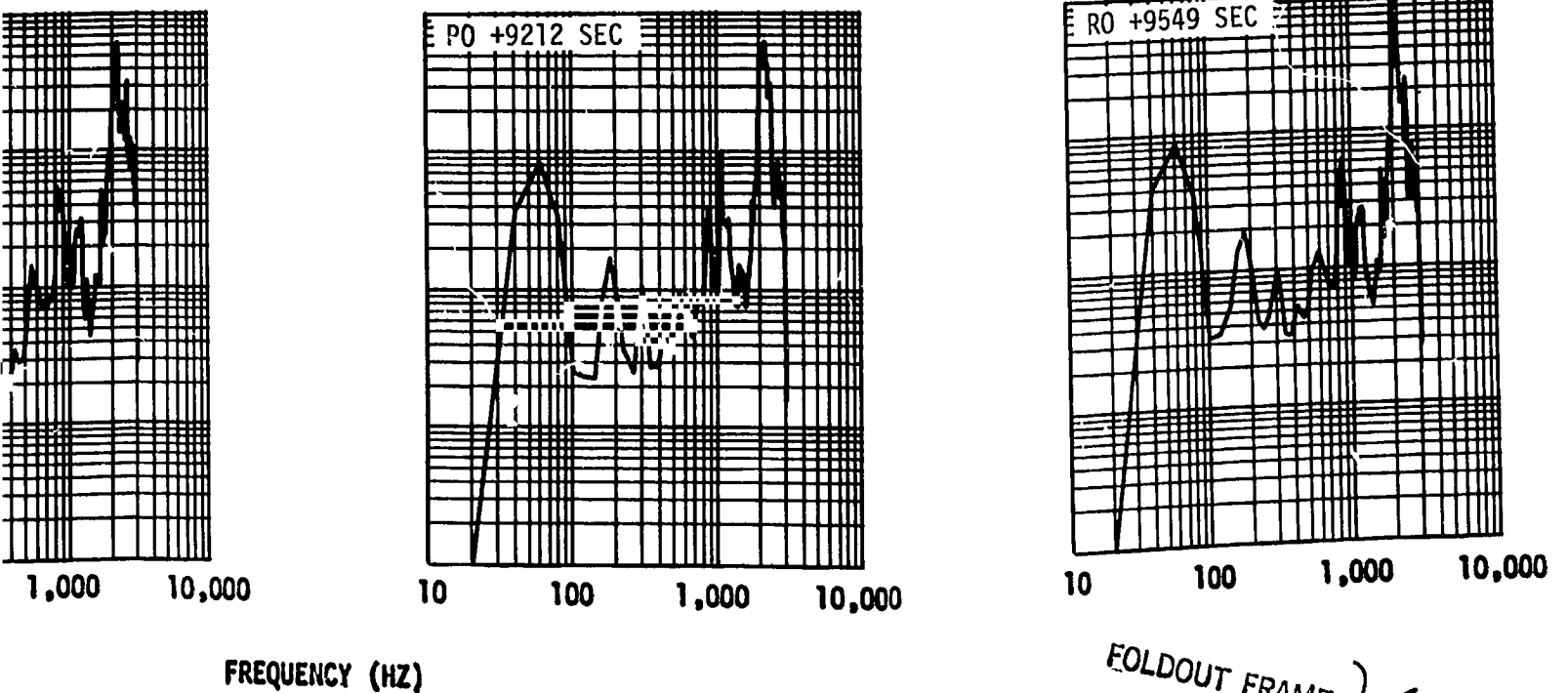

FOLDOUT FRAME 2

Measured on ASI LOX Valve, Radial Direction - E0243-401

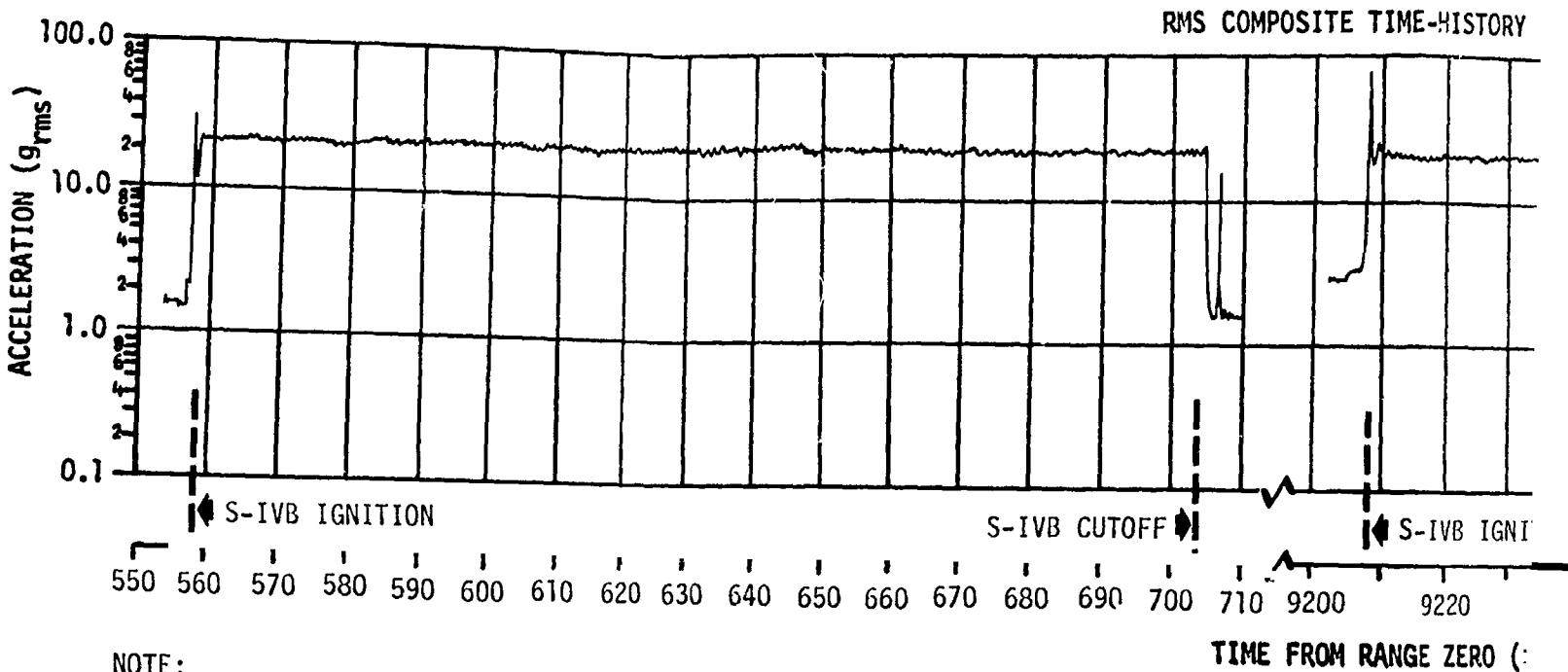

NOTE:
DATA NOT VALID BELOW 40 HZ
BECAUSE OF SSB RESPONSE

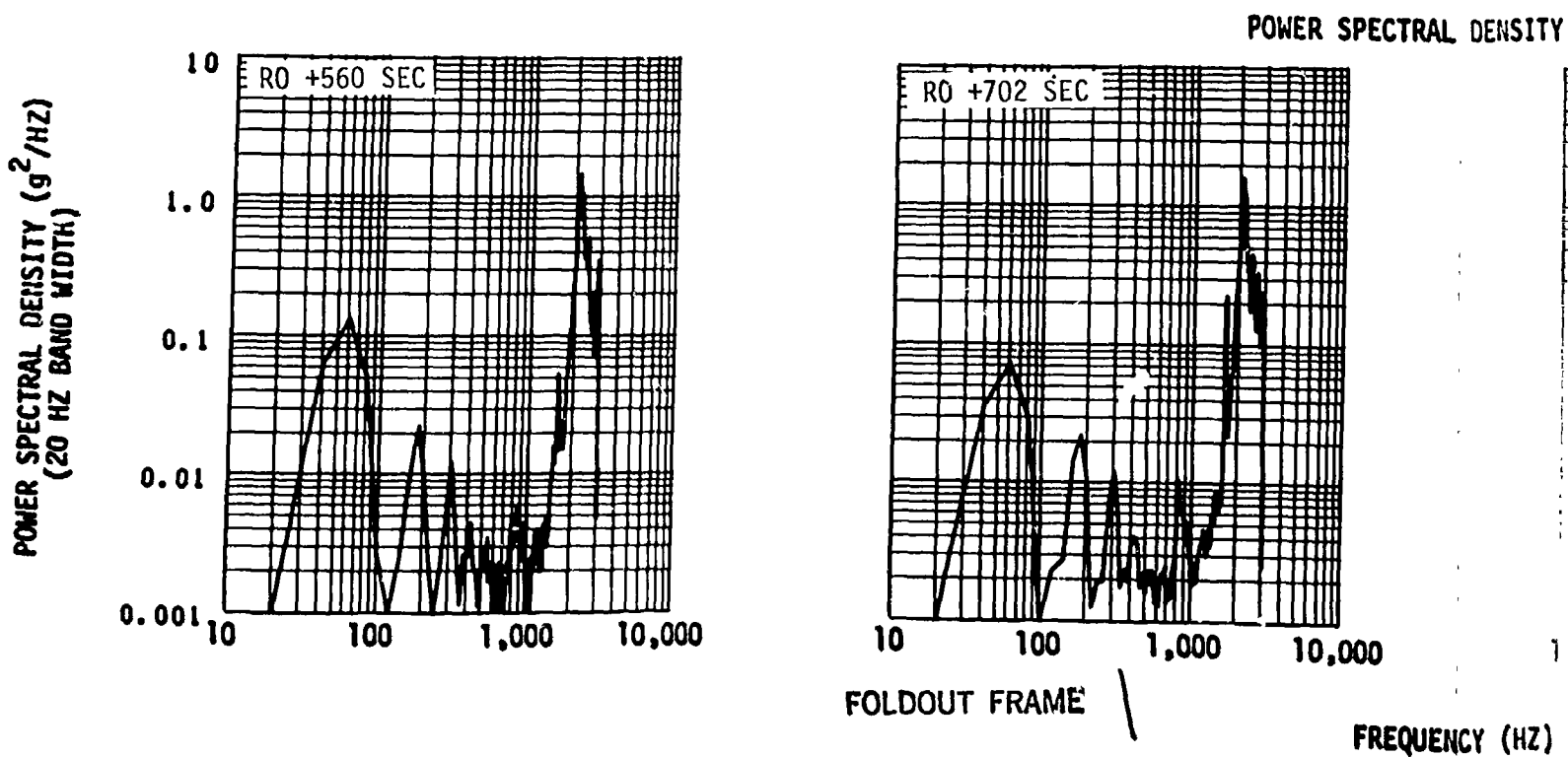
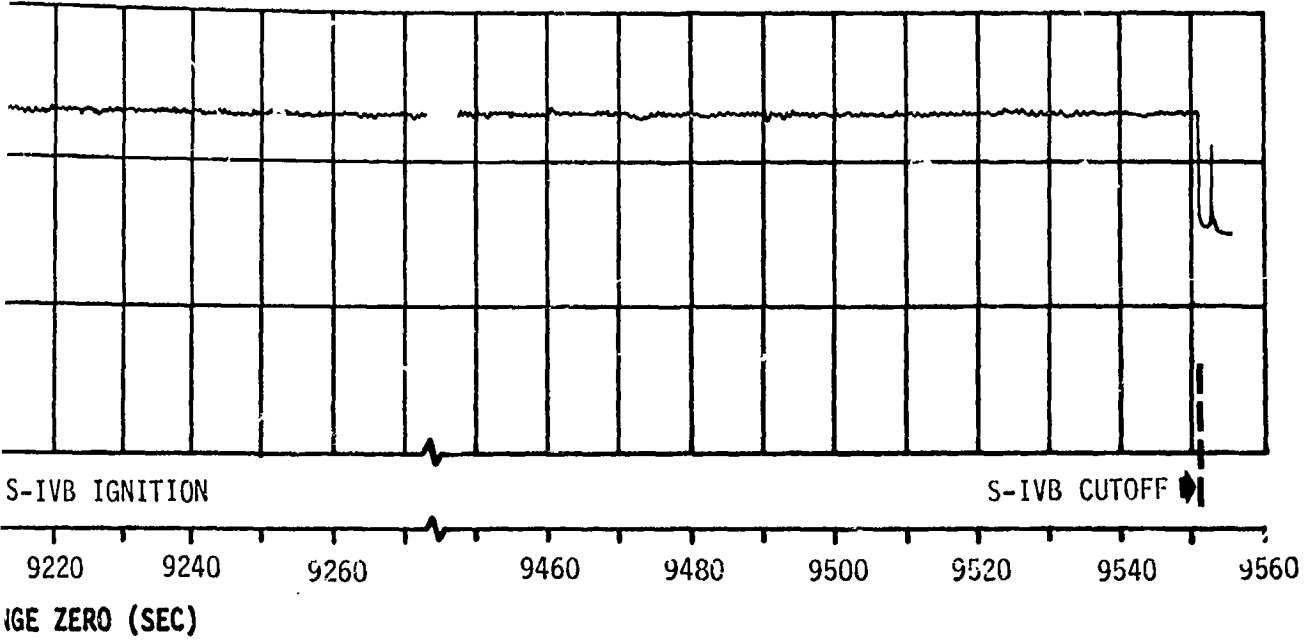
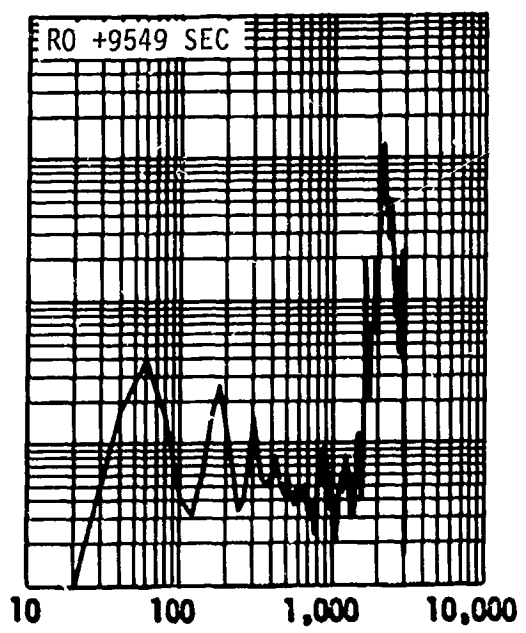
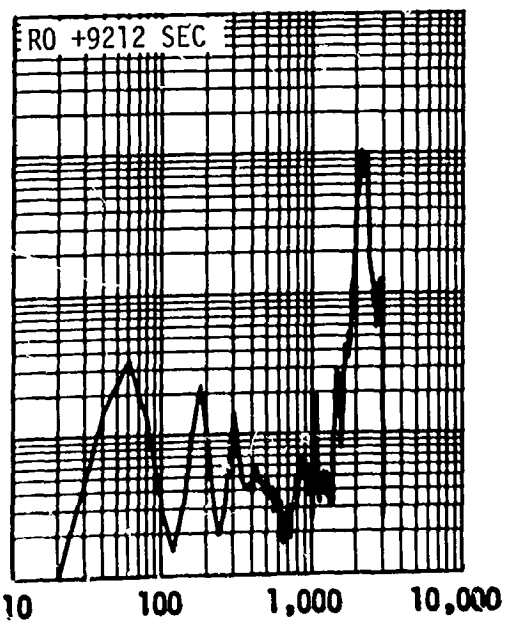

Figure 25-13. Vibration Measured on ASI LOX Valve, Thru

E-HISTORY



AL DENSITY PLOTS



UENCY (HZ)

Valve, Thrust Direction - E0245-401 FOLDOUT FRAME 2

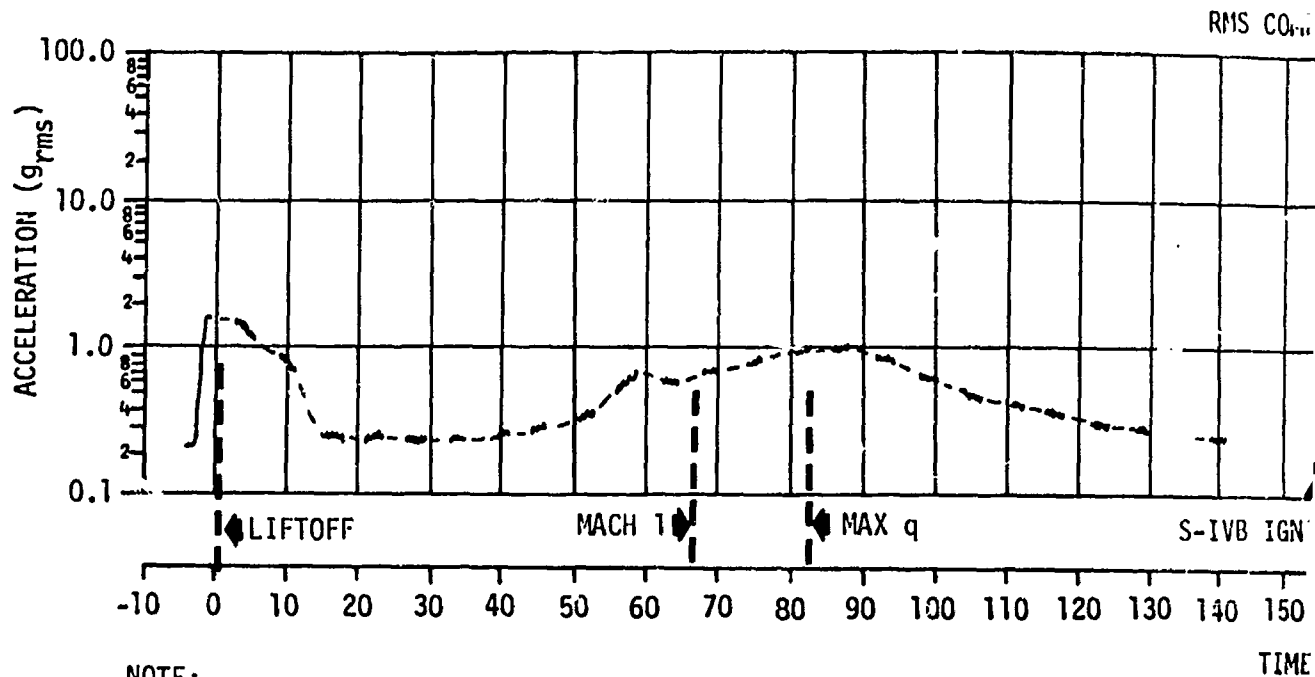

NOTE:
DATA NOT VALID BELOW 40 HZ
BECAUSE OF SSB RESPONSE

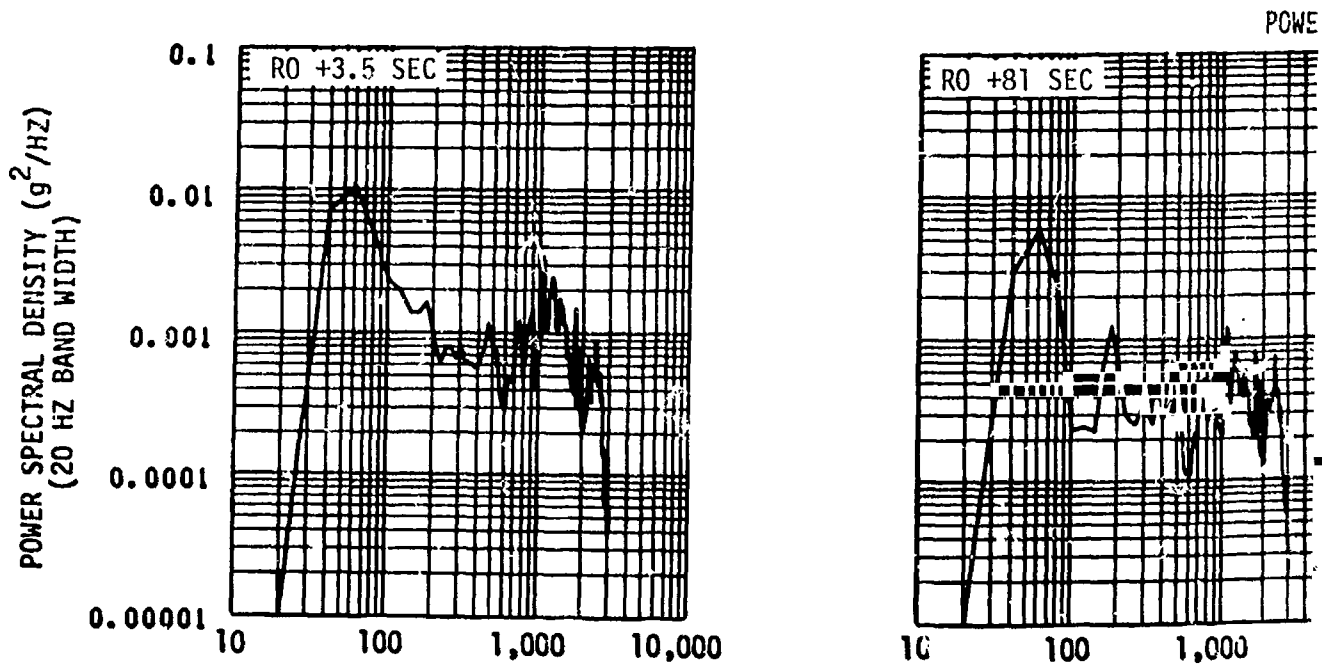

FOLDOUT FRAME

Figure 25-14. Vibration Measured at Input t

RMS COMPOSITE TIME-HISTORY

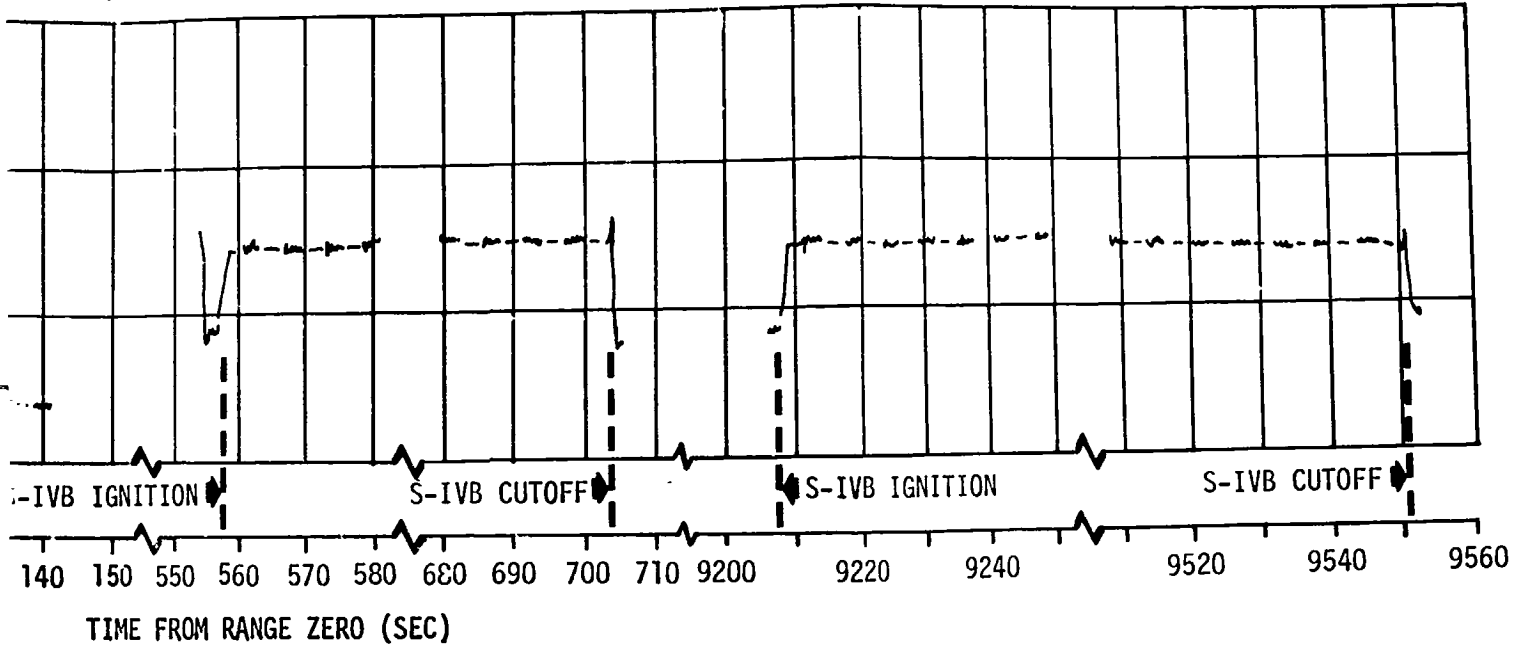

POWER SPECTRAL DENSITY PLOTS

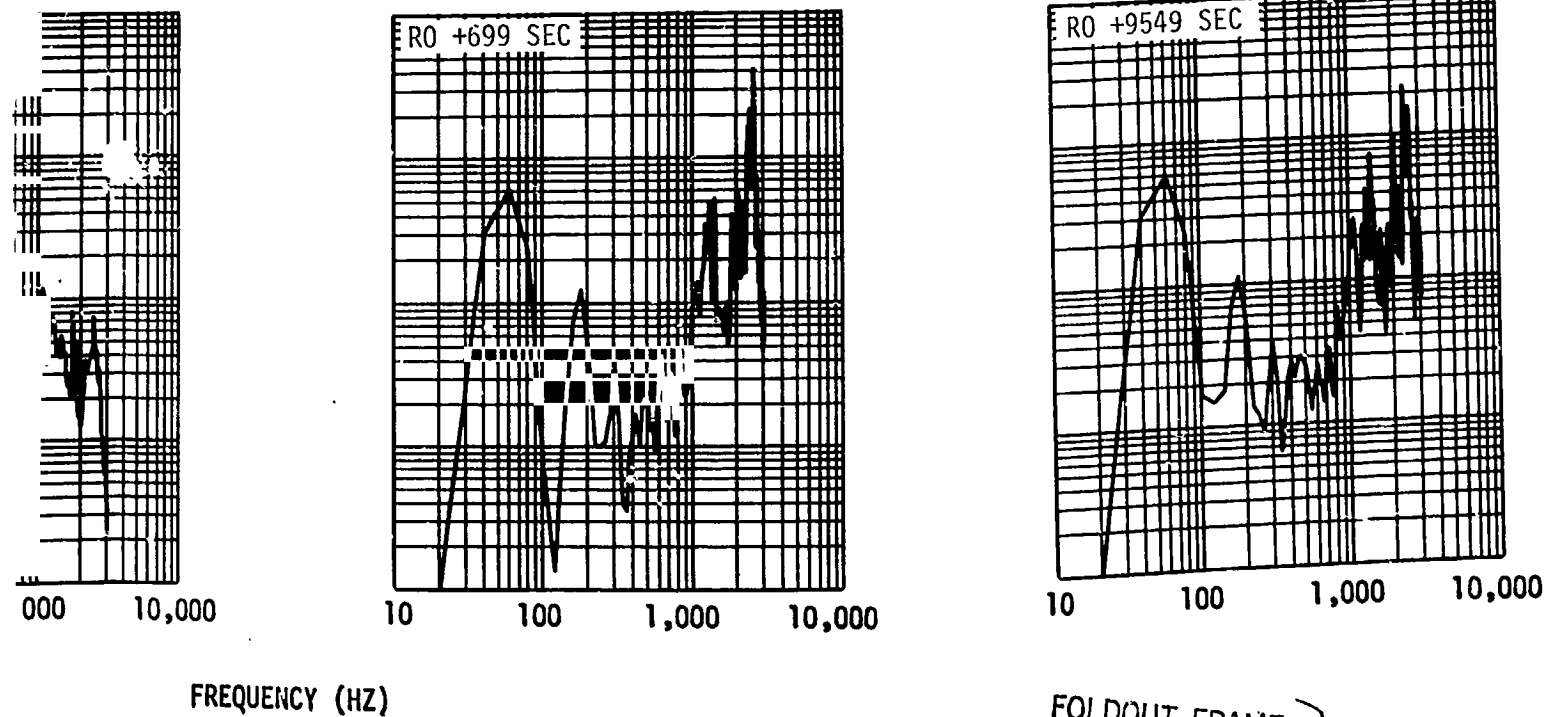

FOLDOUT FRAME 2

Input to Helium Bottle, Pitch Direction - E0042-403

RMS COMPOSITE TIME-HISTORY

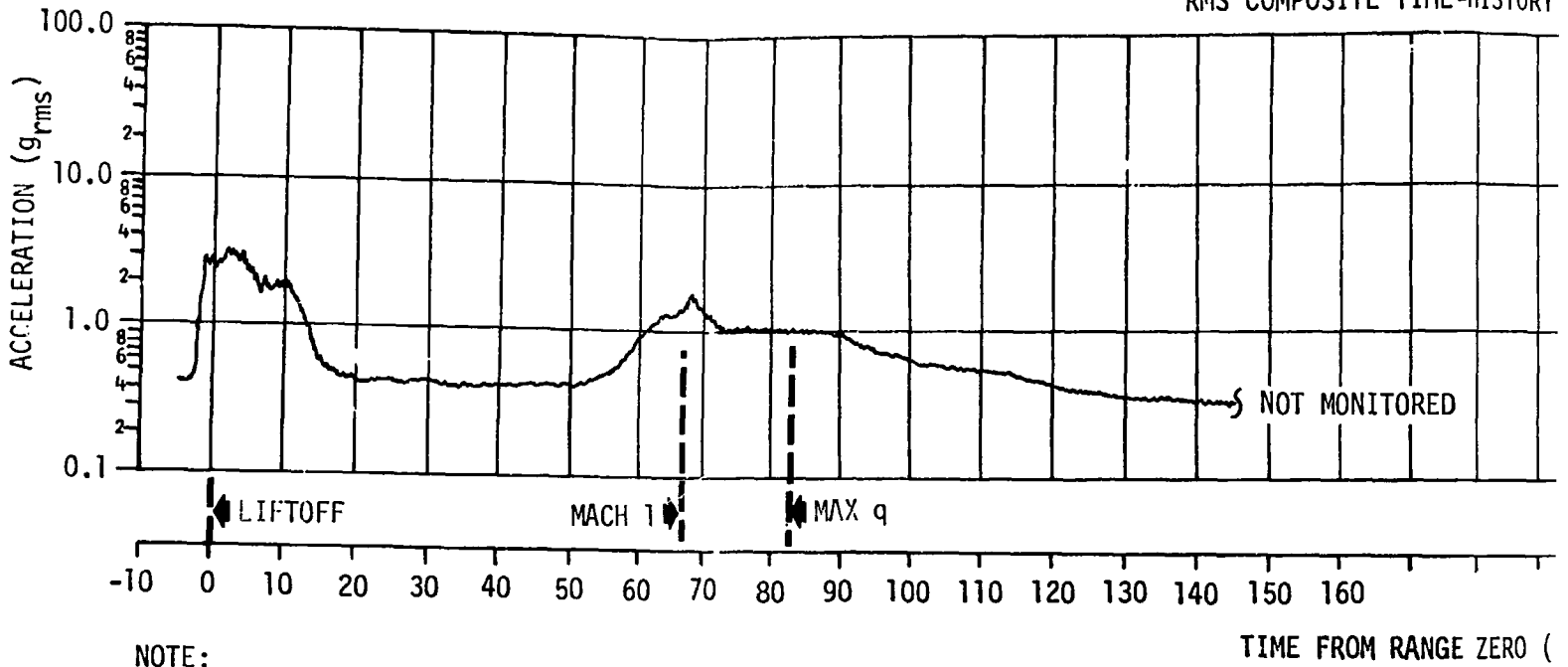

NOTE:
DATA NOT VALID BELOW 40 HZ
BECAUSE OF SSB RESPONSE

POWER SPECTRAL DENSITY

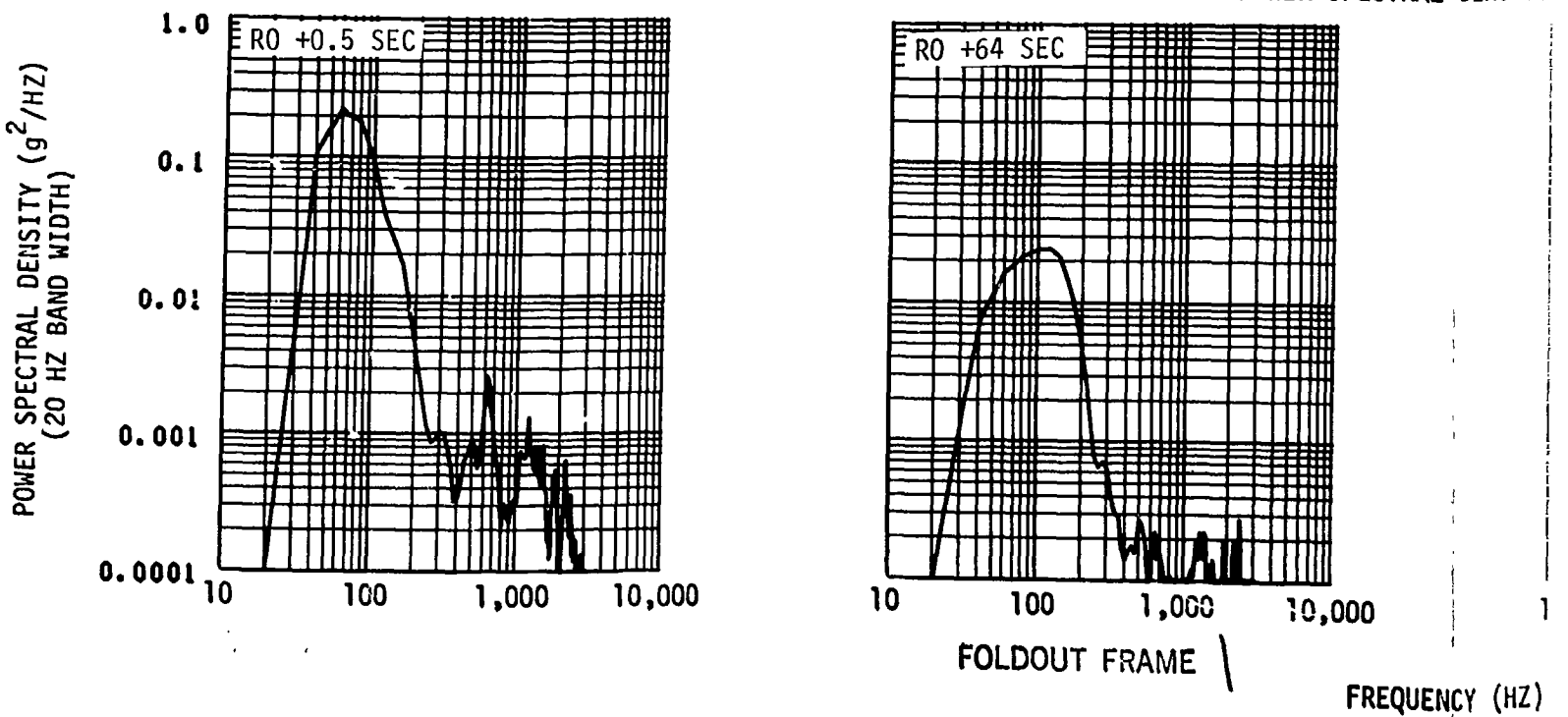
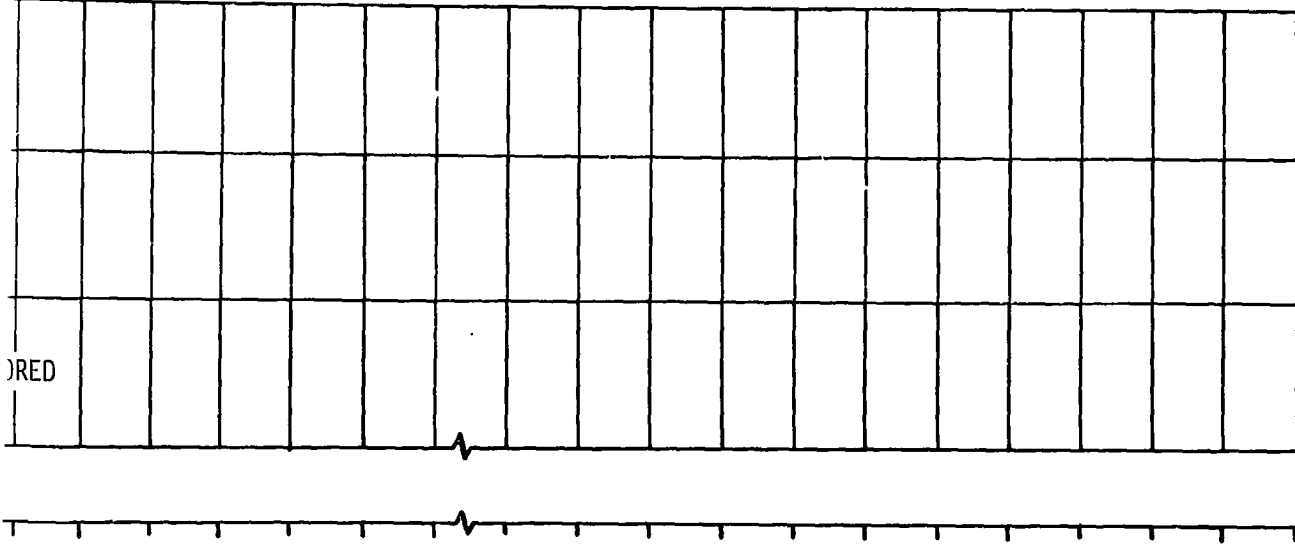

Figure 25-15. Vibration Measured at LOX Chilldown Pump,

TIME-HISTORY



RANGE ZERO (SEC)

SPECTRAL DENSITY PLOTS

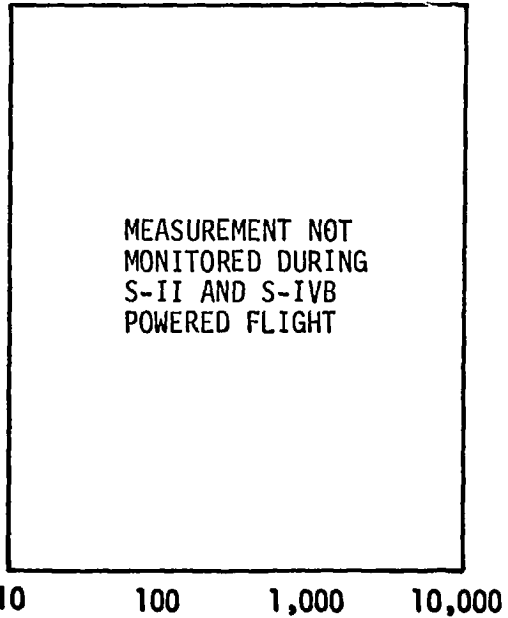
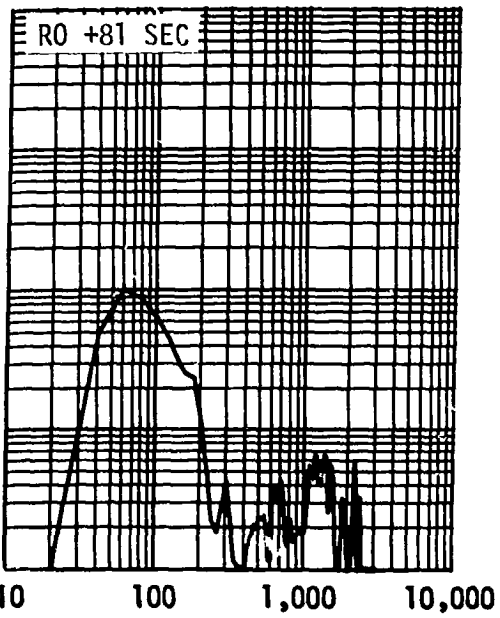

FREQUENCY (HZ)

FOLDOUT FRAME 2

Shutdown Pump, Normal to Dome - E0233-424

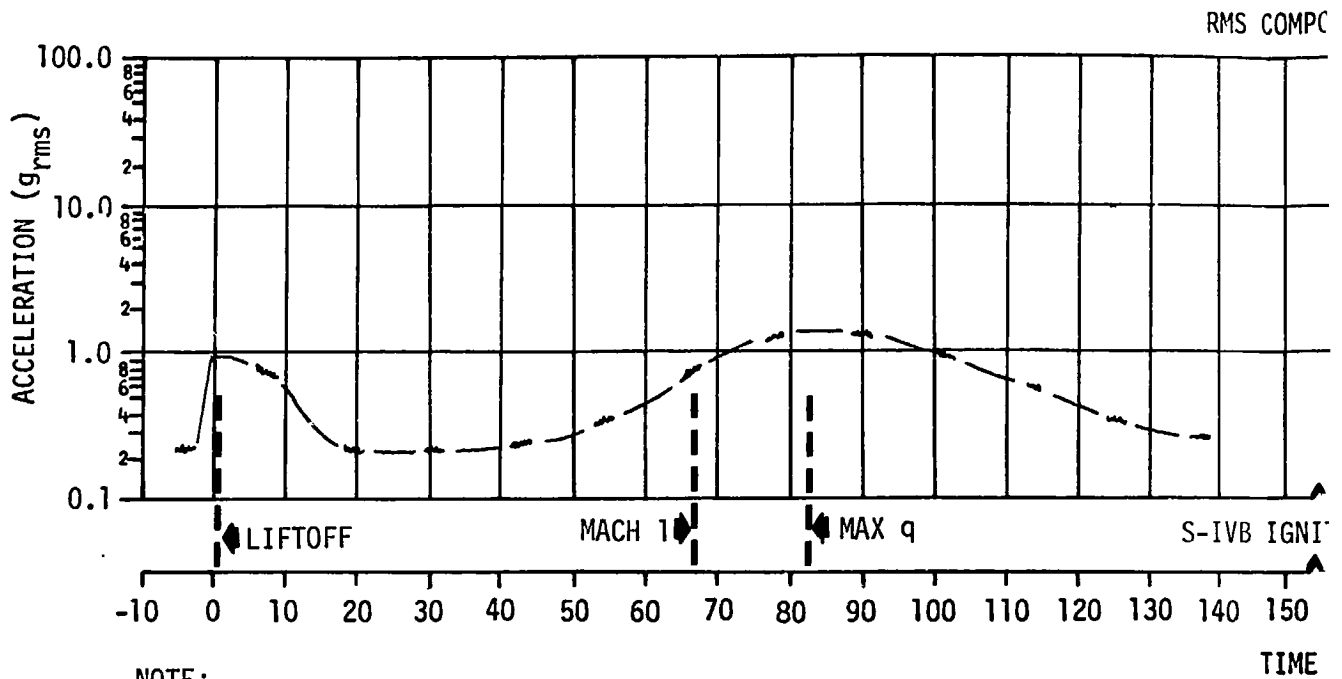

NOTE:
 DATA NOT VALID BELOW 40 HZ
 BECAUSE OF SSB RESPONSE

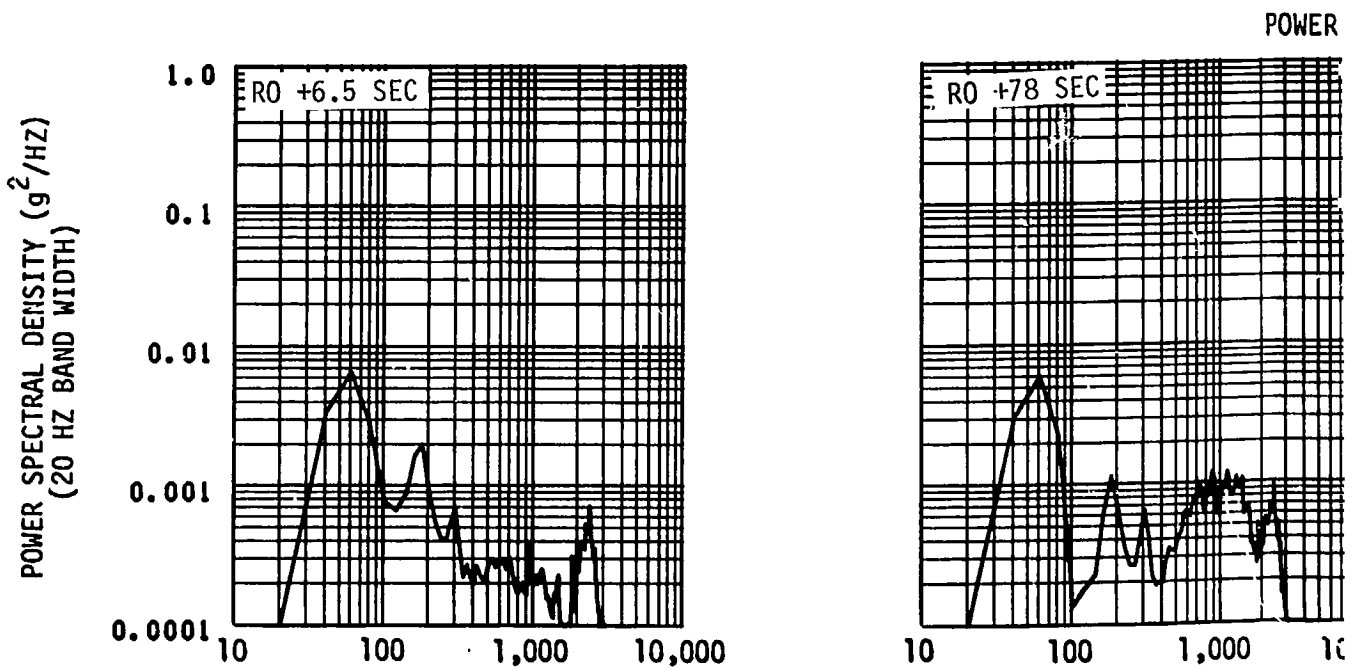

FOLDOUT FRAME

Figure 25-16. Vibration Measured on LH2 :

OSITE TIME-HISTORY

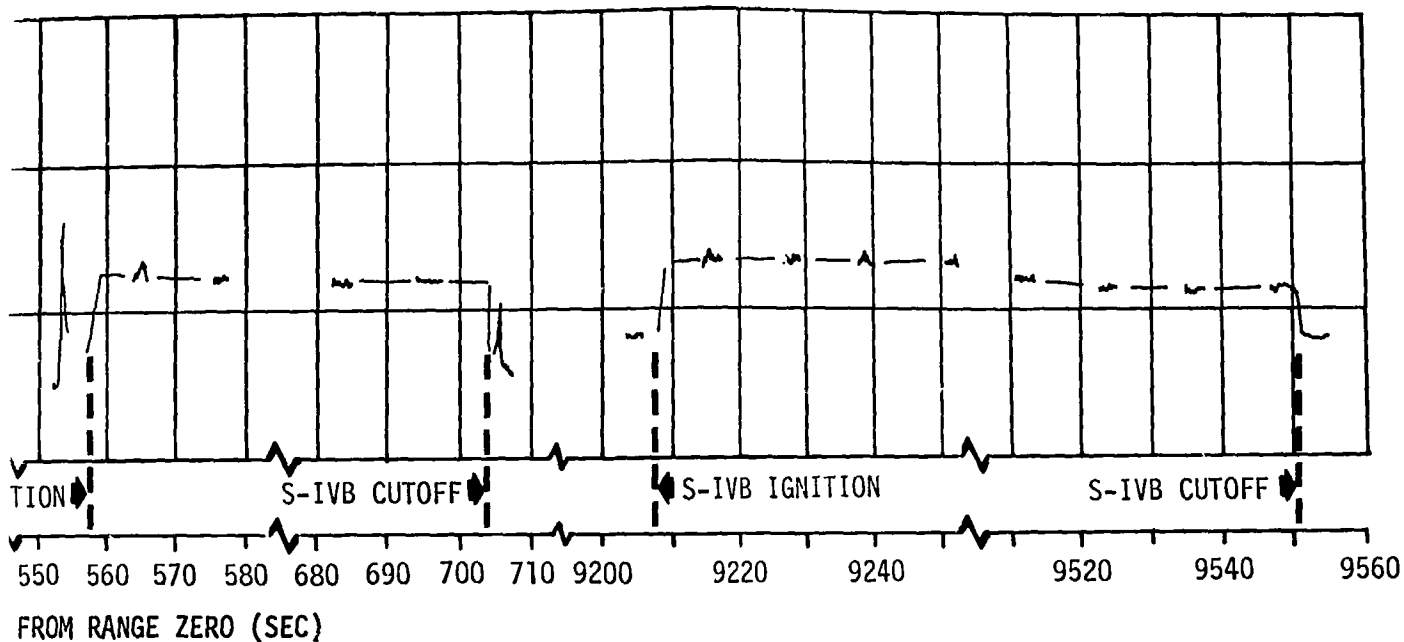

SPECTRAL DENSITY PLOTS

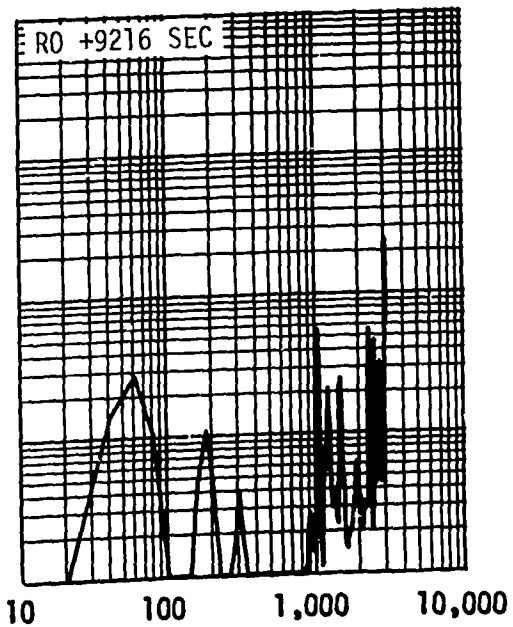
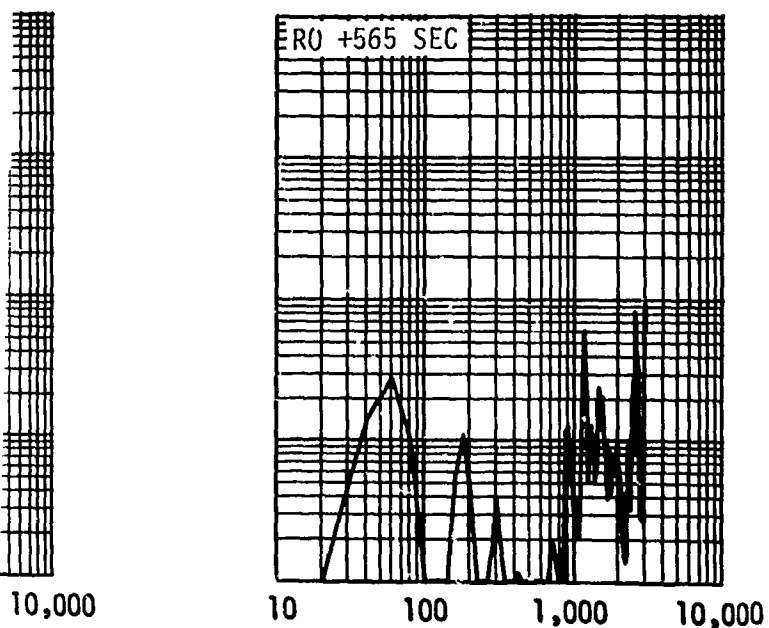

FREQUENCY (HZ)

EQLDOUT FRAME 2

2 Feedline at Tank, Thrust Direction - E0222-404

RMS COMPOSITE TIME-HISTORY

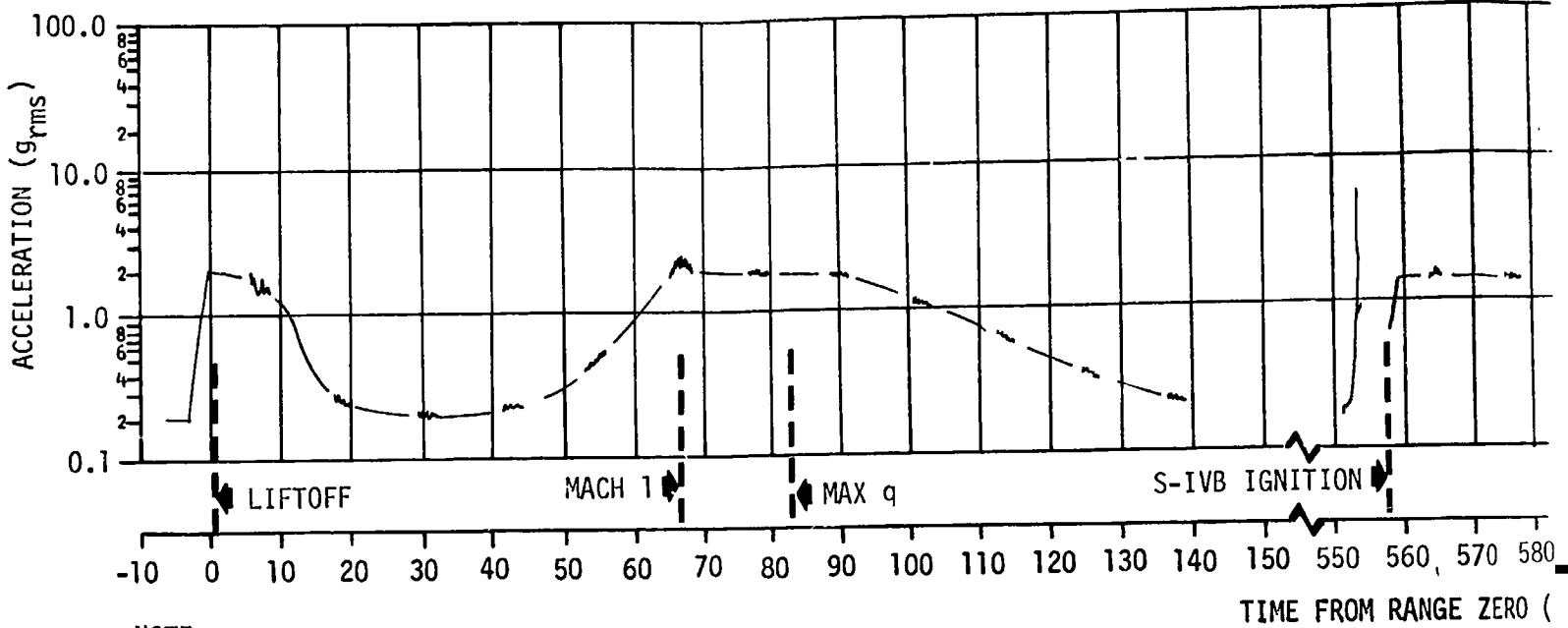

NOTE:
DATA NOT VALID BELOW 40 HZ
BECAUSE OF SSB RESPONSE

POWER SPECTRAL DENSITY

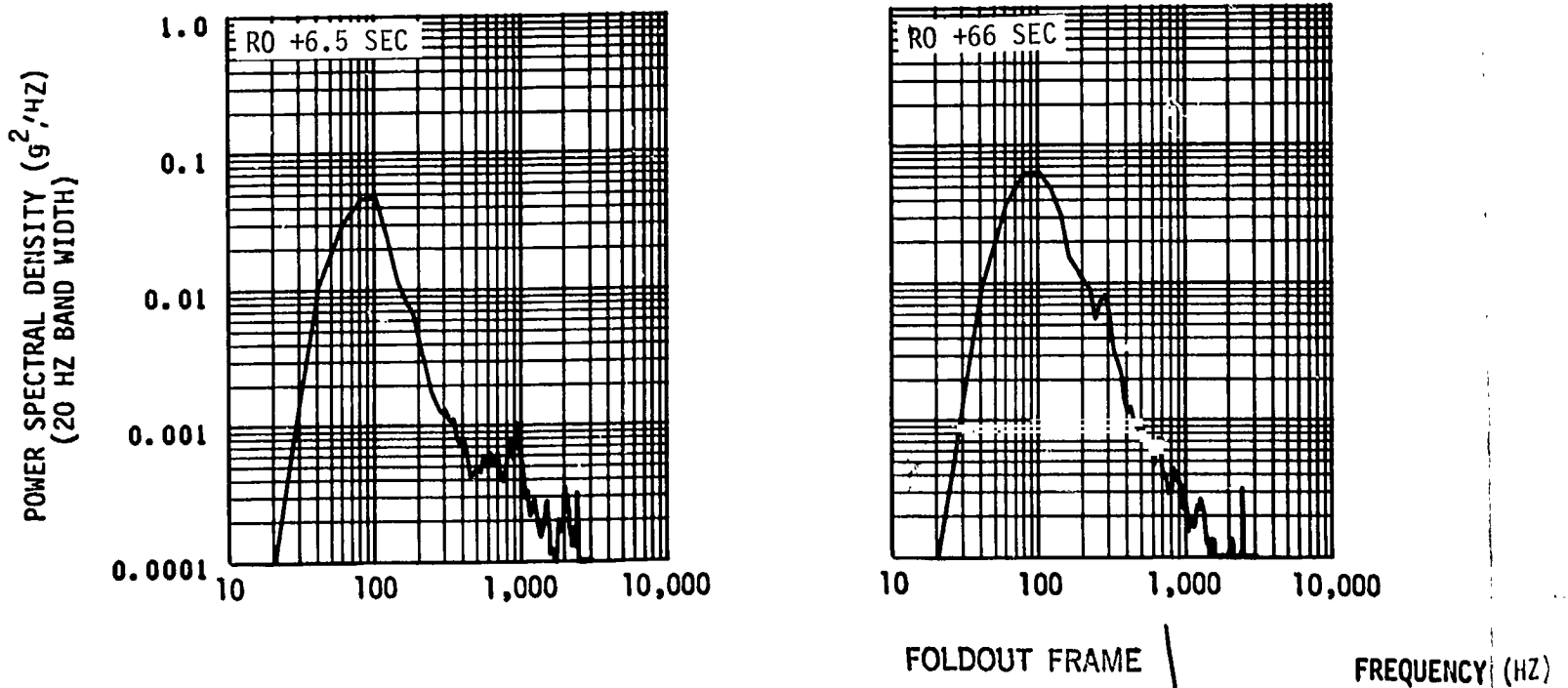
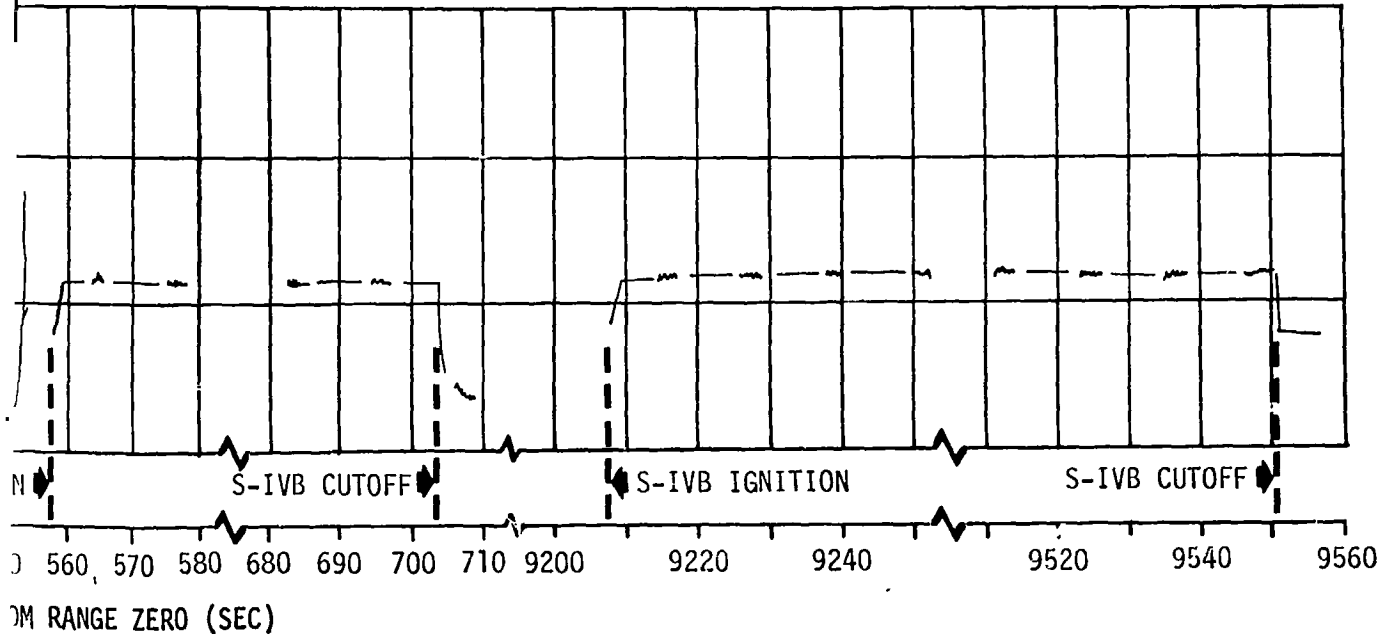
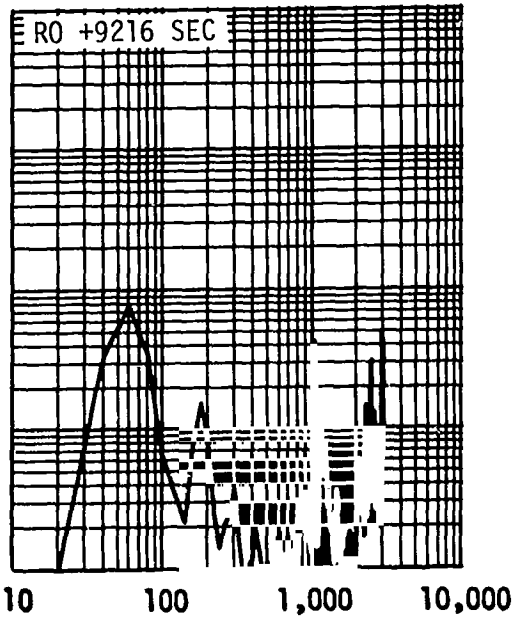
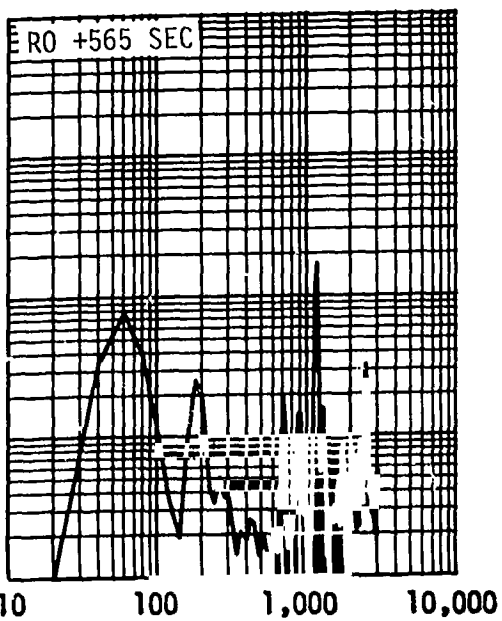

Figure 25-17. Vibration Measured on LH2 Feedline at Tan:

E TIME-HISTORY



SPECTRAL DENSITY PLOTS



FREQUENCY (HZ)

FOLDOUT FRAME 2

Baseline at Tank, Radial Direction - E0223-404

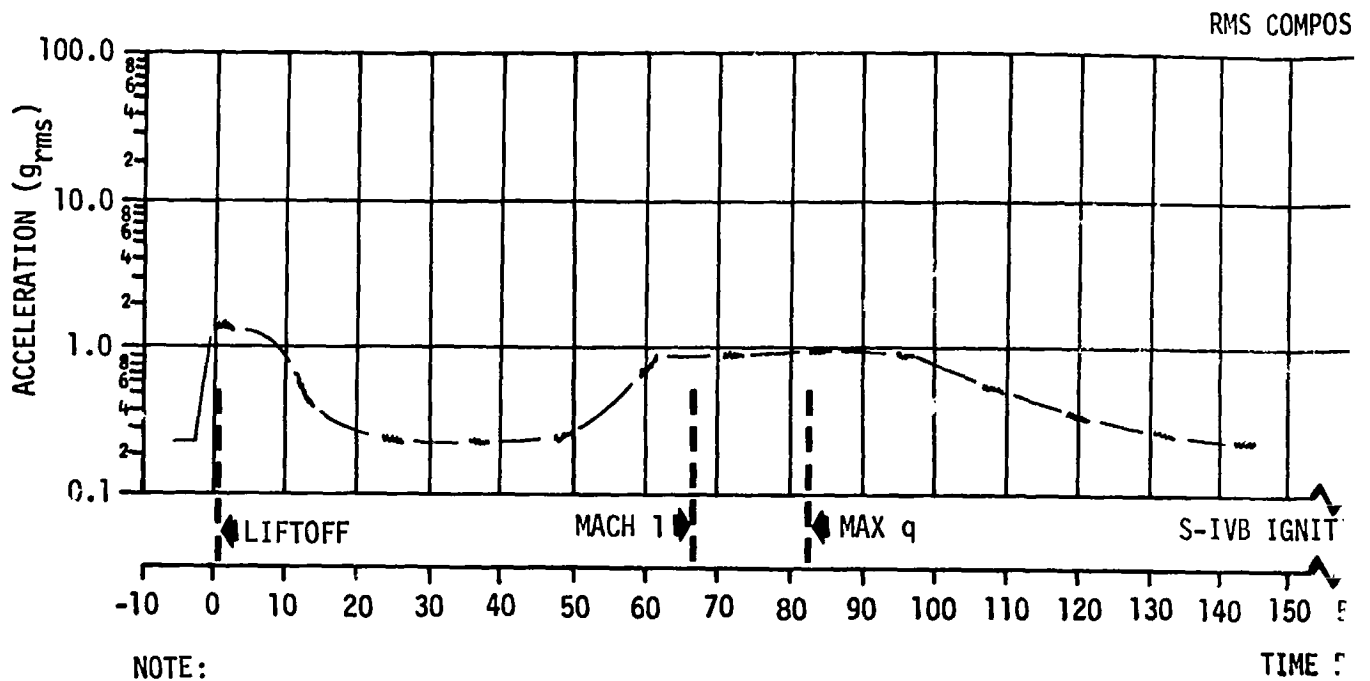

NOTE:
 DATA NOT VALID BELOW 40 HZ
 BECAUSE OF SSB RESPONSE

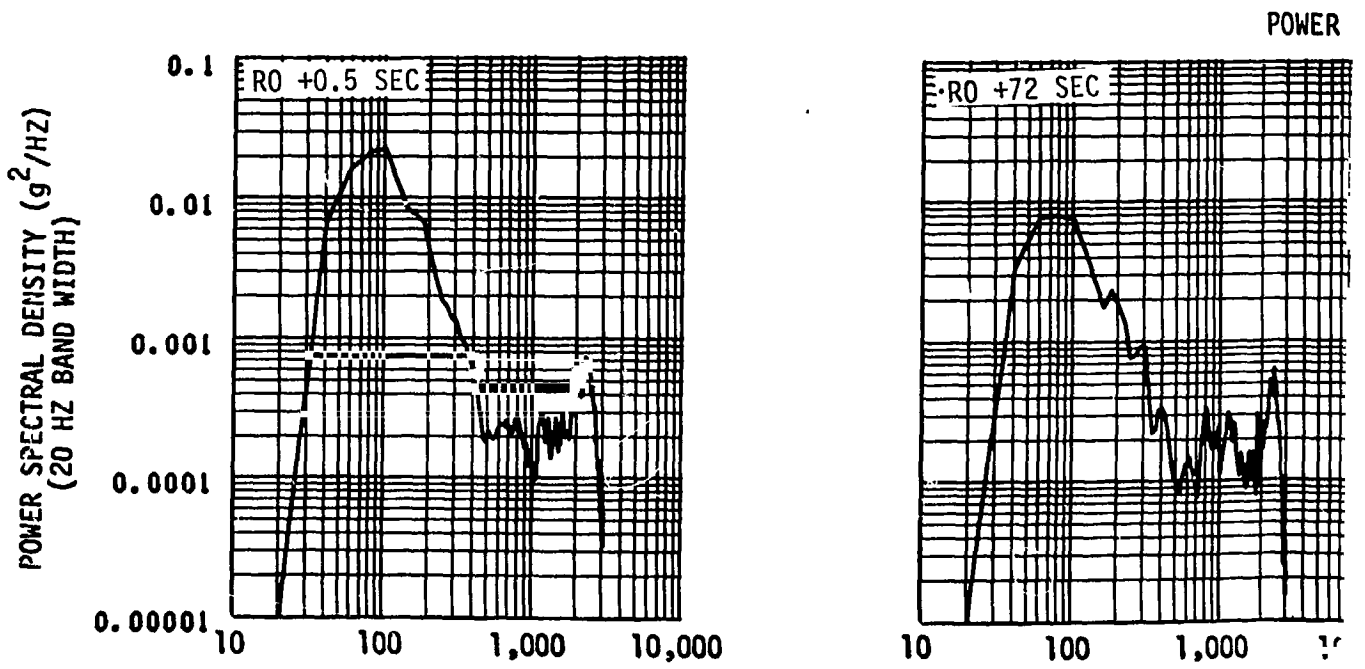

FOLDOUT FRAME

Figure 25-18. Vibration Measured at

COMPOSITE TIME-HISTORY

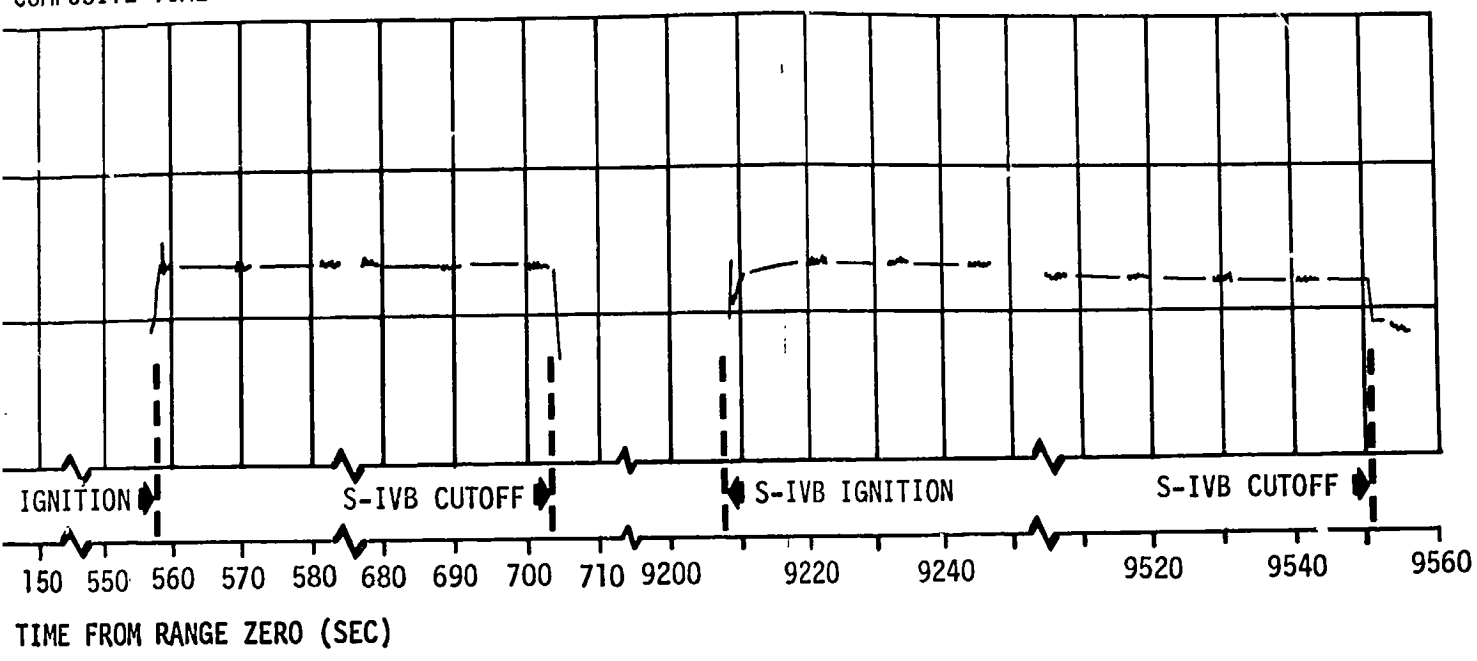

POWER SPECTRAL DENSITY PLOTS

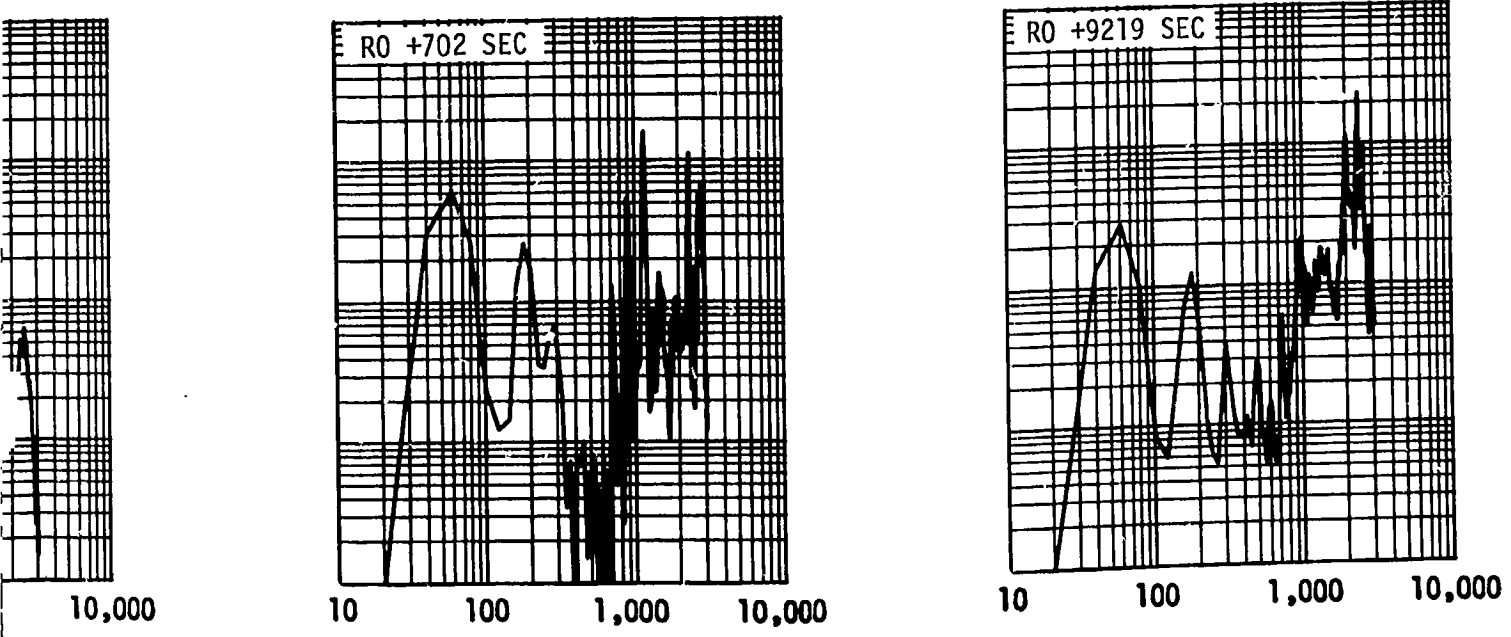

FREQUENCY (HZ)

red at LH2 Prevalve, Thrust Direction - E0226-404

EOLDOUT FRAME 2

RMS COMPOSITE TIME-HISTOR

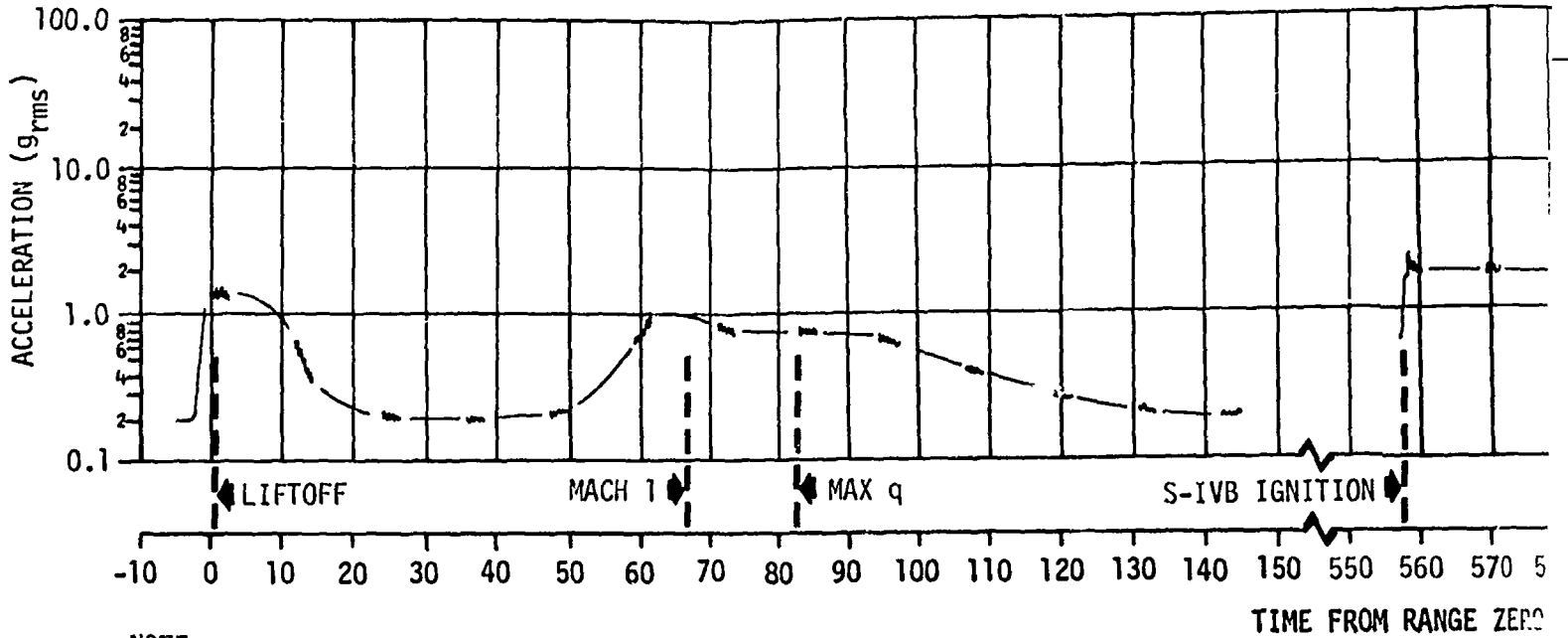

NOTE:
DATA NOT VALID BELOW 40 HZ
BECAUSE OF SSB RESPONSE

POWER SPECTRAL DENSITY

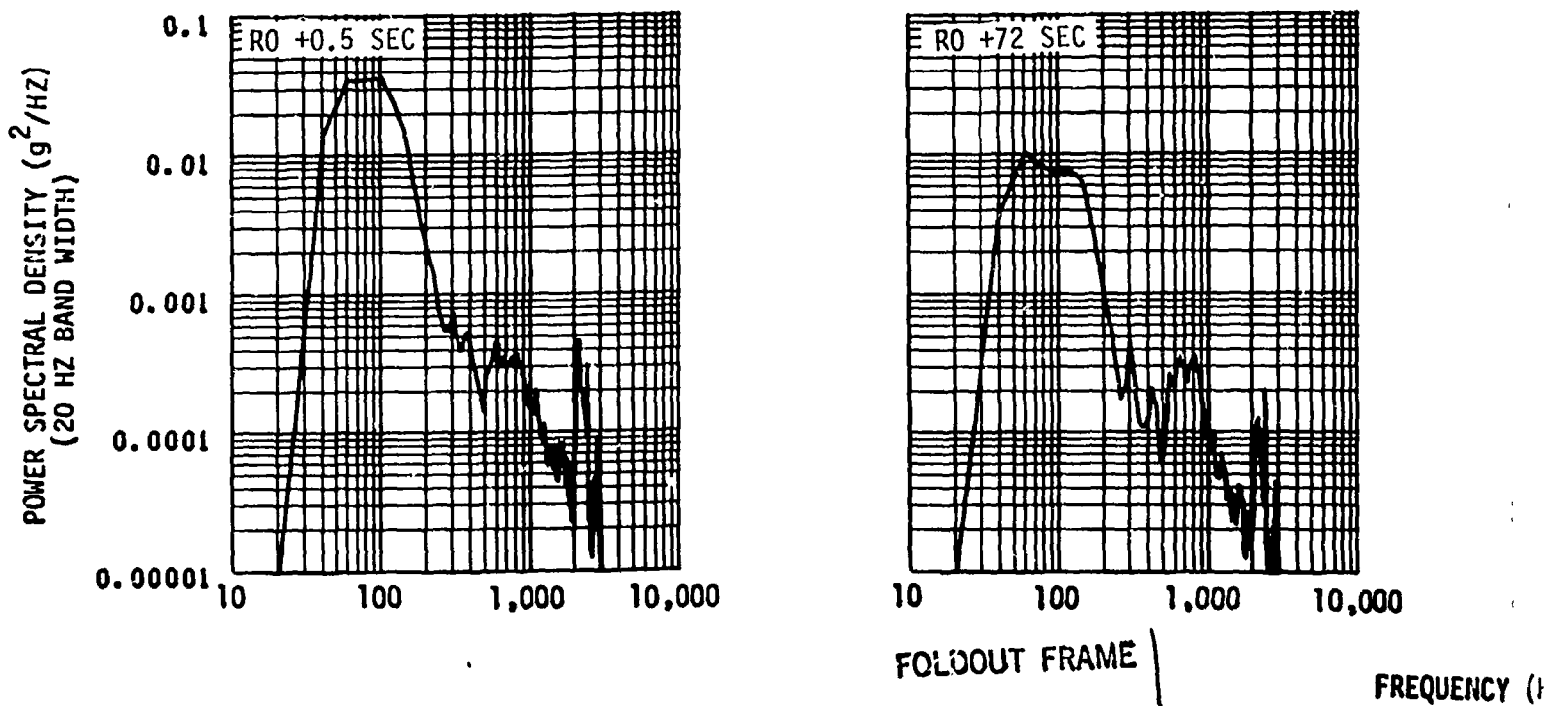
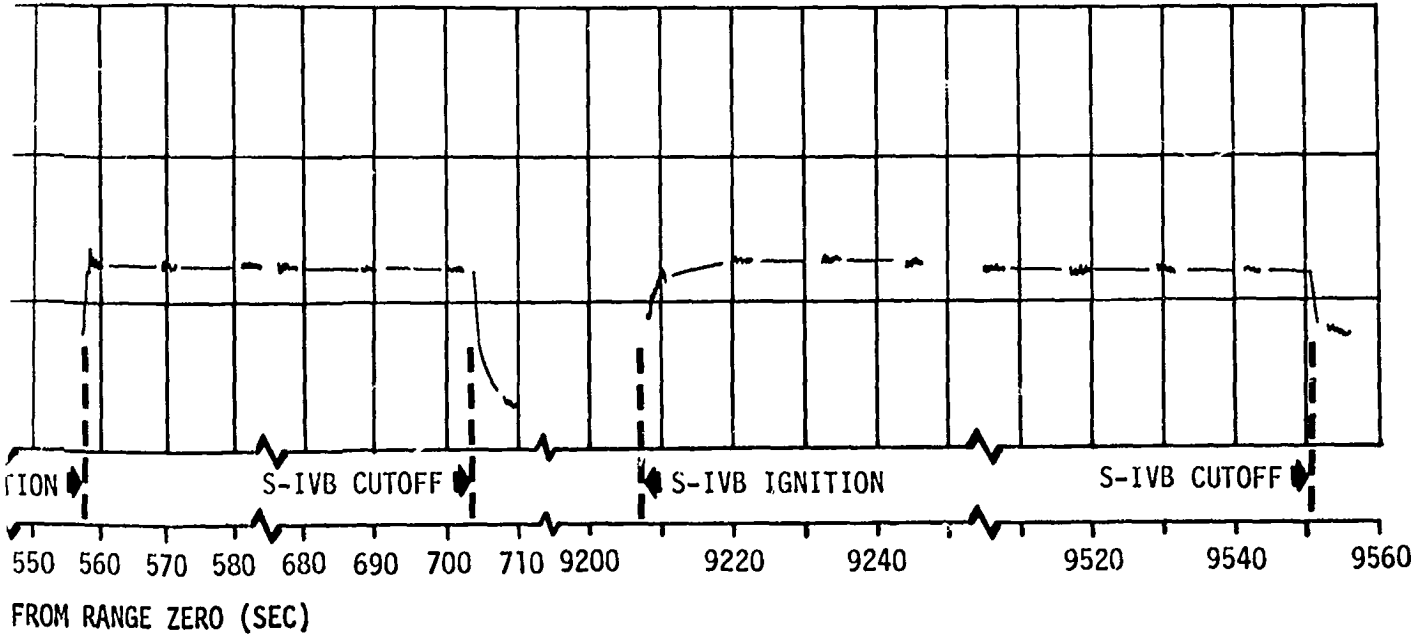
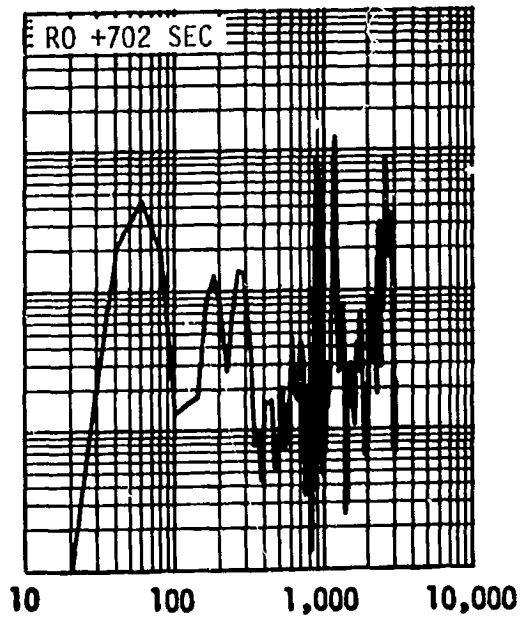
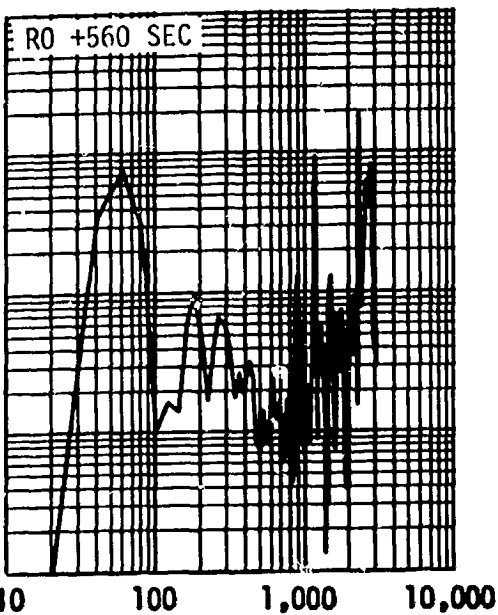

Figure 25-19. Vibration Measured at LH2 Prevalve, R

SITE TIME-HISTORY



SPECTRAL DENSITY PLOTS



FREQUENCY (HZ)

FOLDDOUT FRAME 2

LH2 Prevalve, Radial Direction - E0227-404

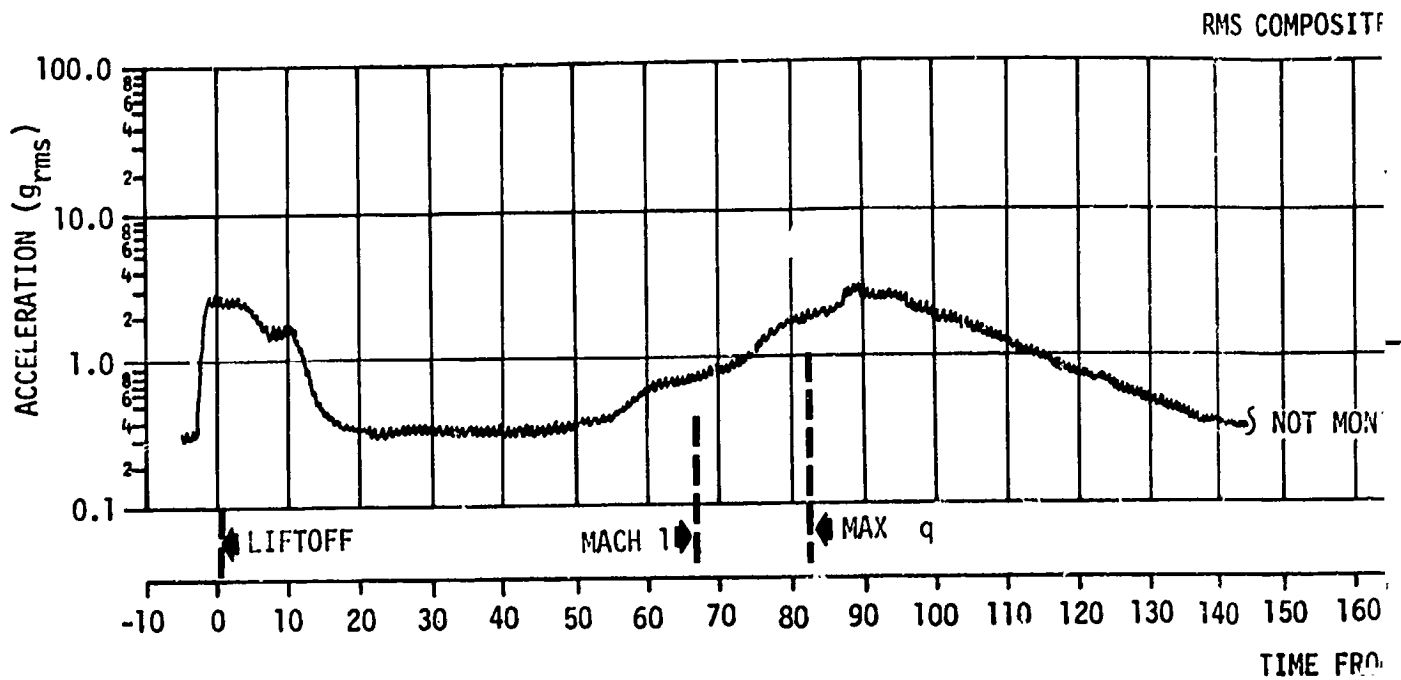

NOTE:
DATA NOT VALID BELOW 40 HZ
BECAUSE OF SSB RESPONSE

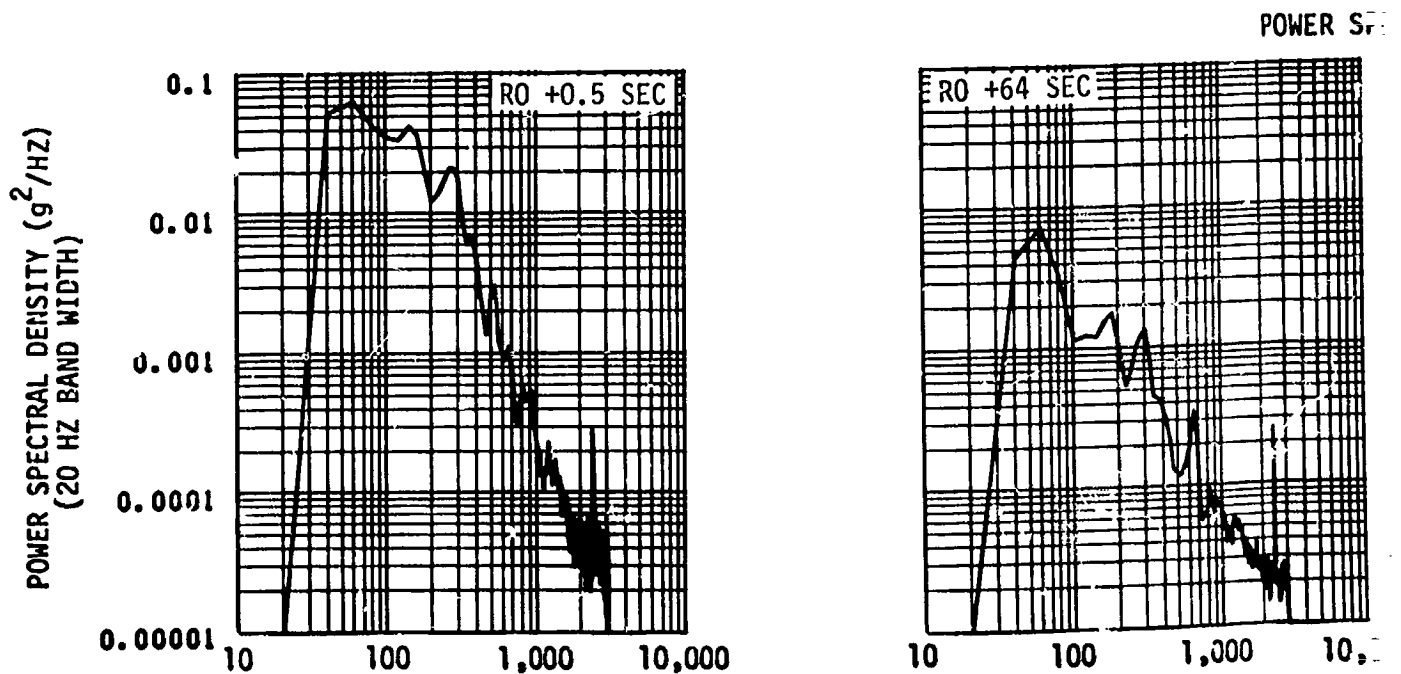

FOLDOUT FRAME

FOLDOUT

Figure 25-20. Vibration Measured at Forward Support

S COMPOSITE TIME-HISTORY

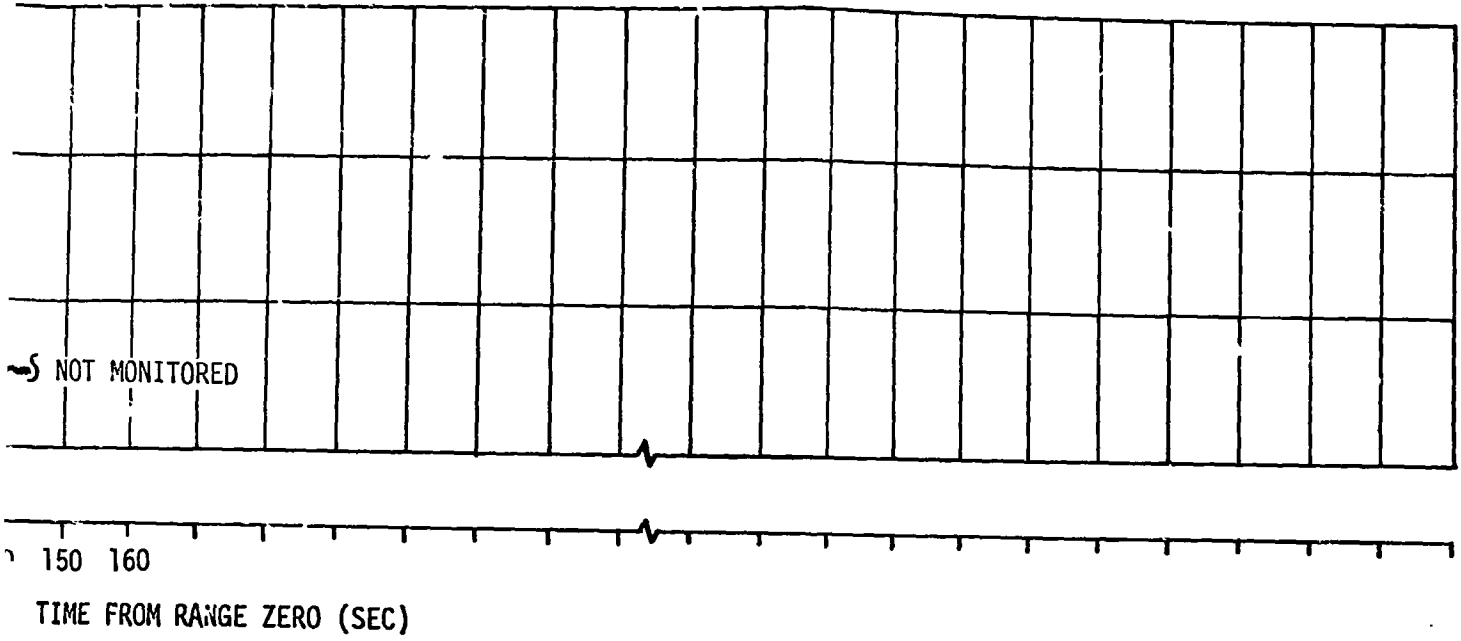

POWER SPECTRAL DENSITY PLOTS

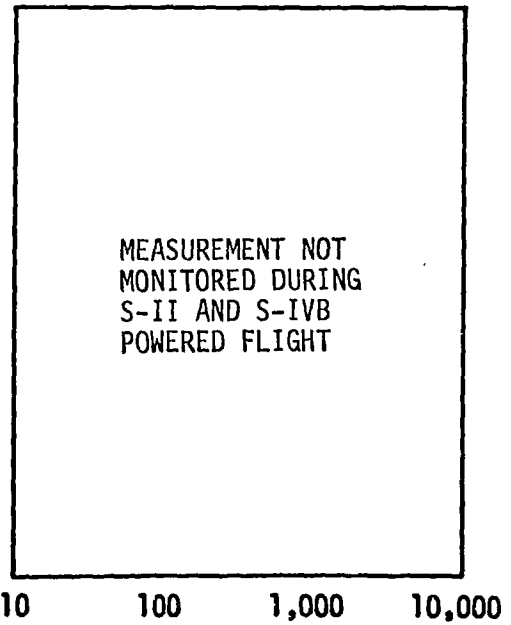
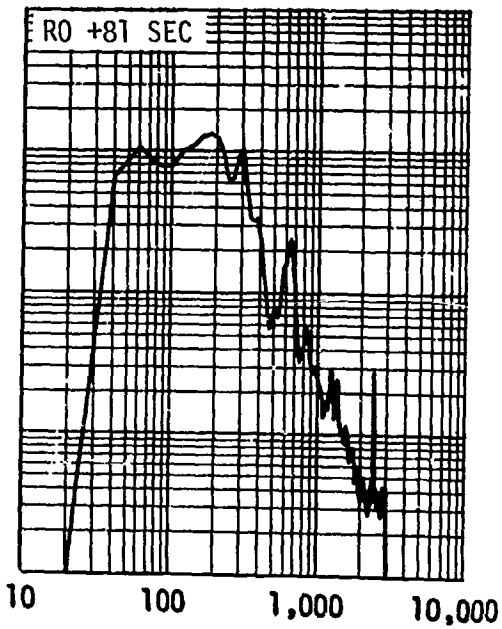
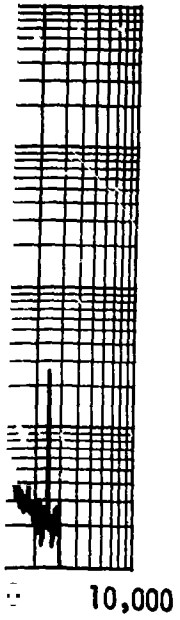

FREQUENCY (HZ)

FOLDOUT FRAME 2

rd Support of Retrorocket No. 4, Radial Direction - E0235-423

RMS COMPOSITE TIME-HISTORY

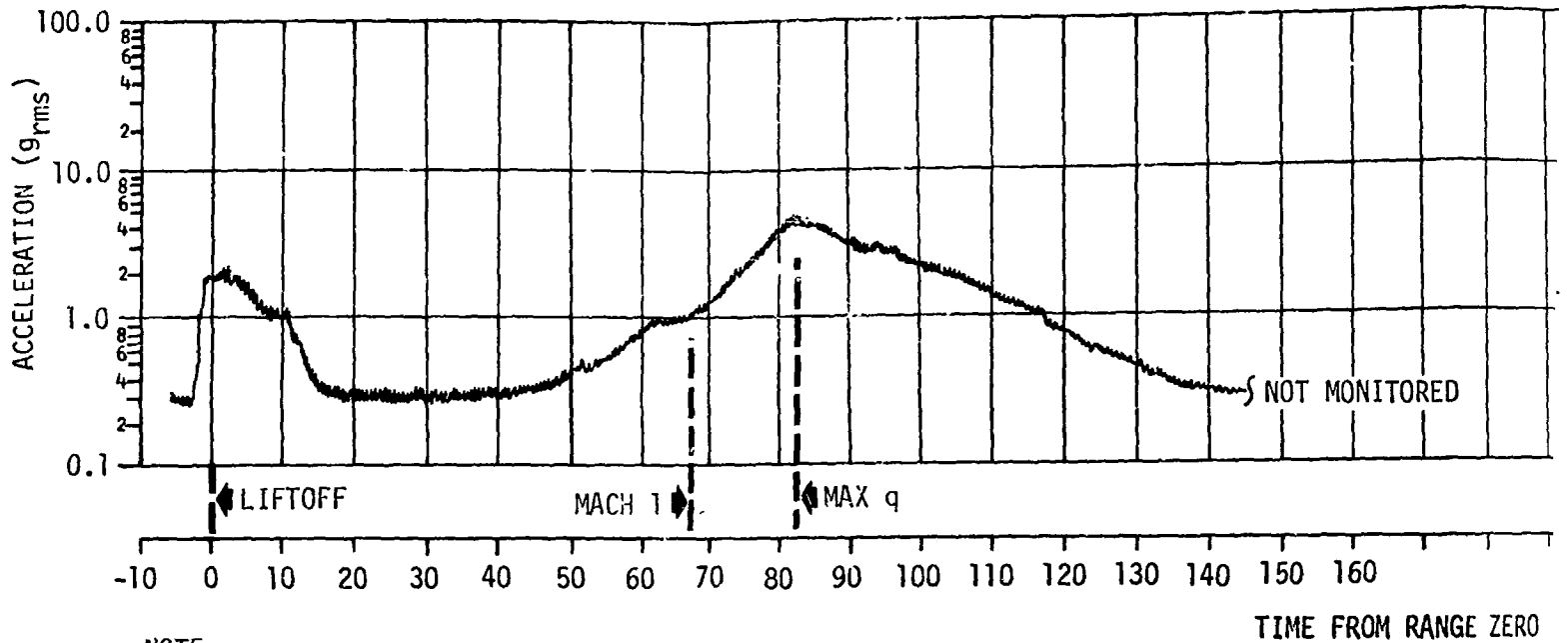

NOTE:
DATA NOT VALID BELOW 40 HZ
BECAUSE OF SSB RESPONSE

POWER SPECTRAL DENSITY

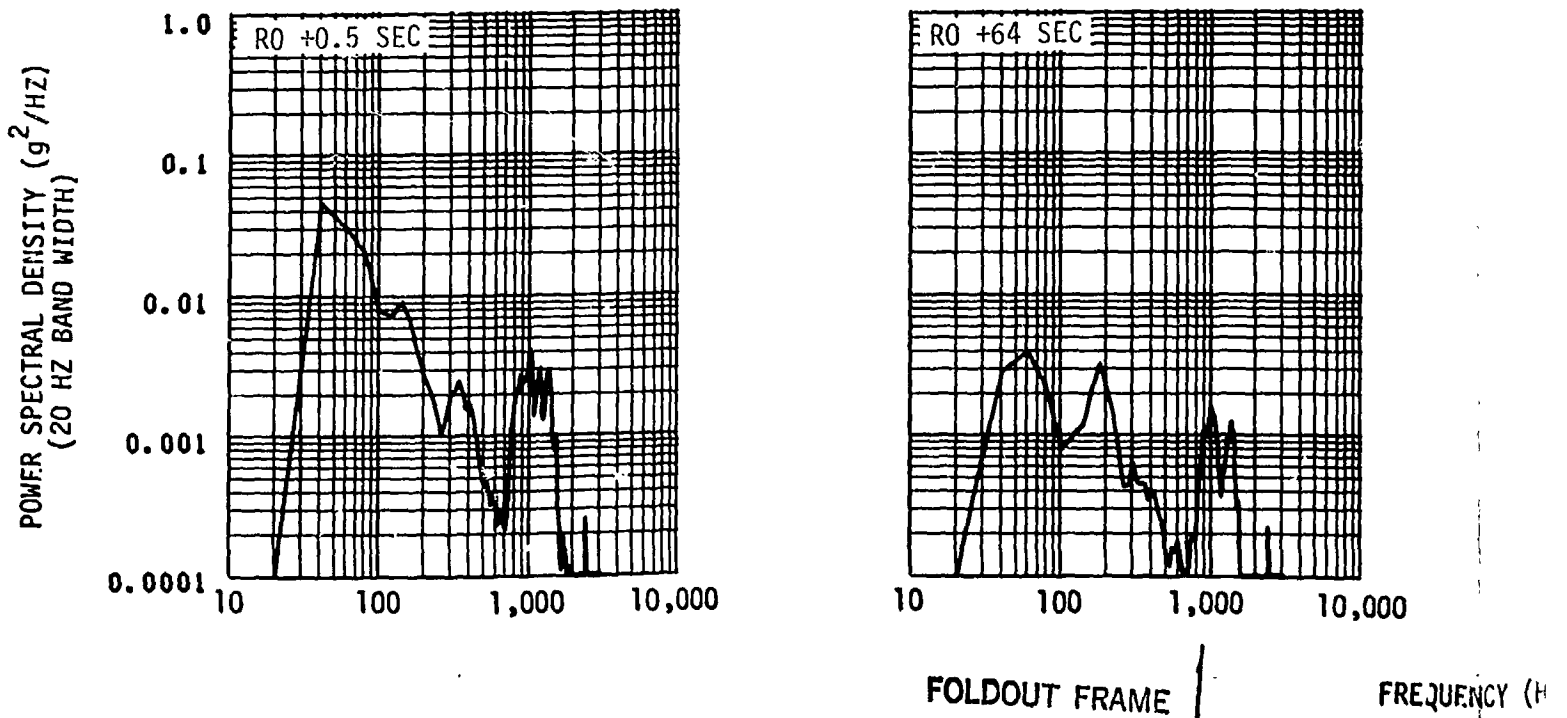
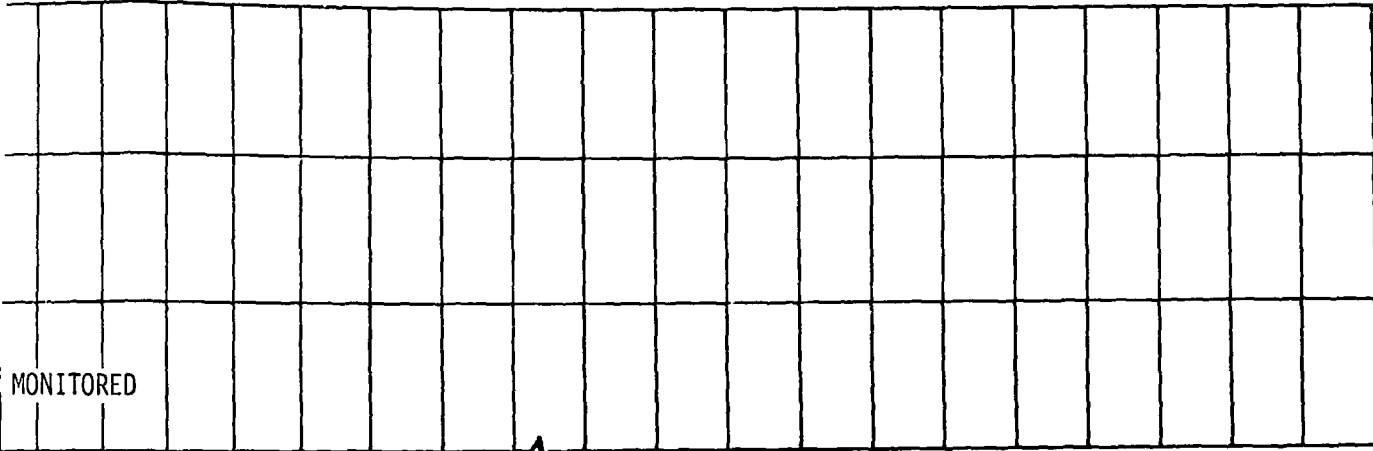

Figure 25-21. Vibration Measured on APS No. 1 Propellant Contr

OSITE TIME-HISTORY



160

FROM RANGE ZERO (SEC)

SPECTRAL DENSITY PLOTS

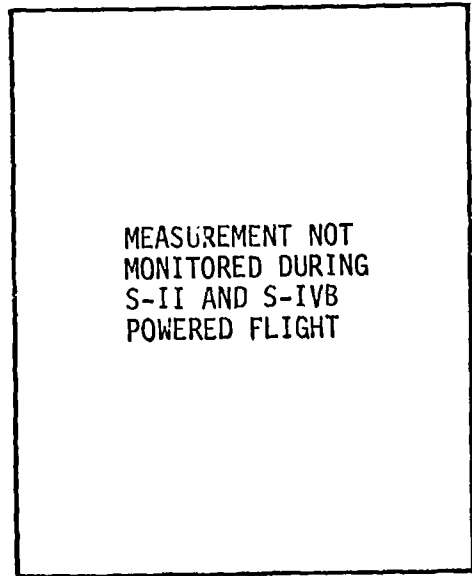
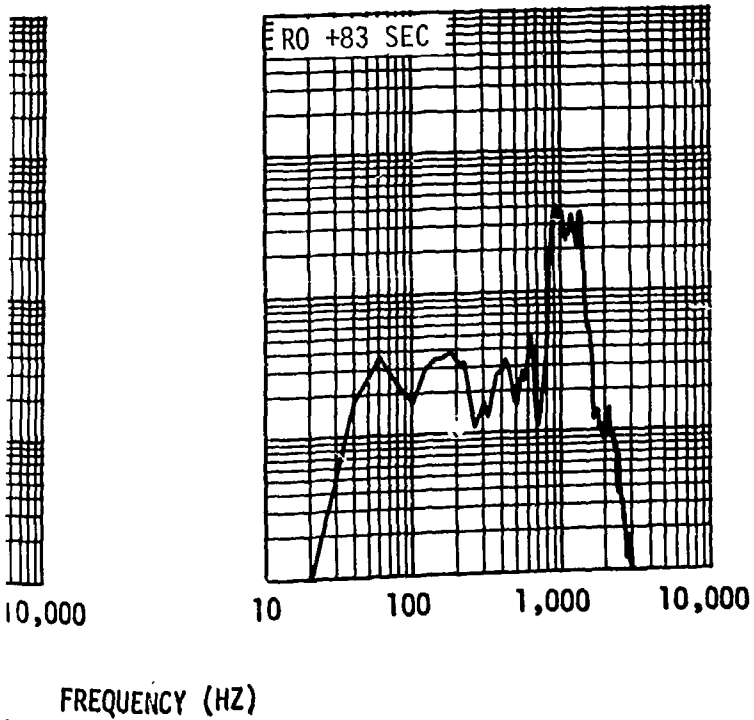

10 100 1,000 10,000

FOLDOUT FRAME 2

Propellant Control Module, Radial Direction - E0230-414

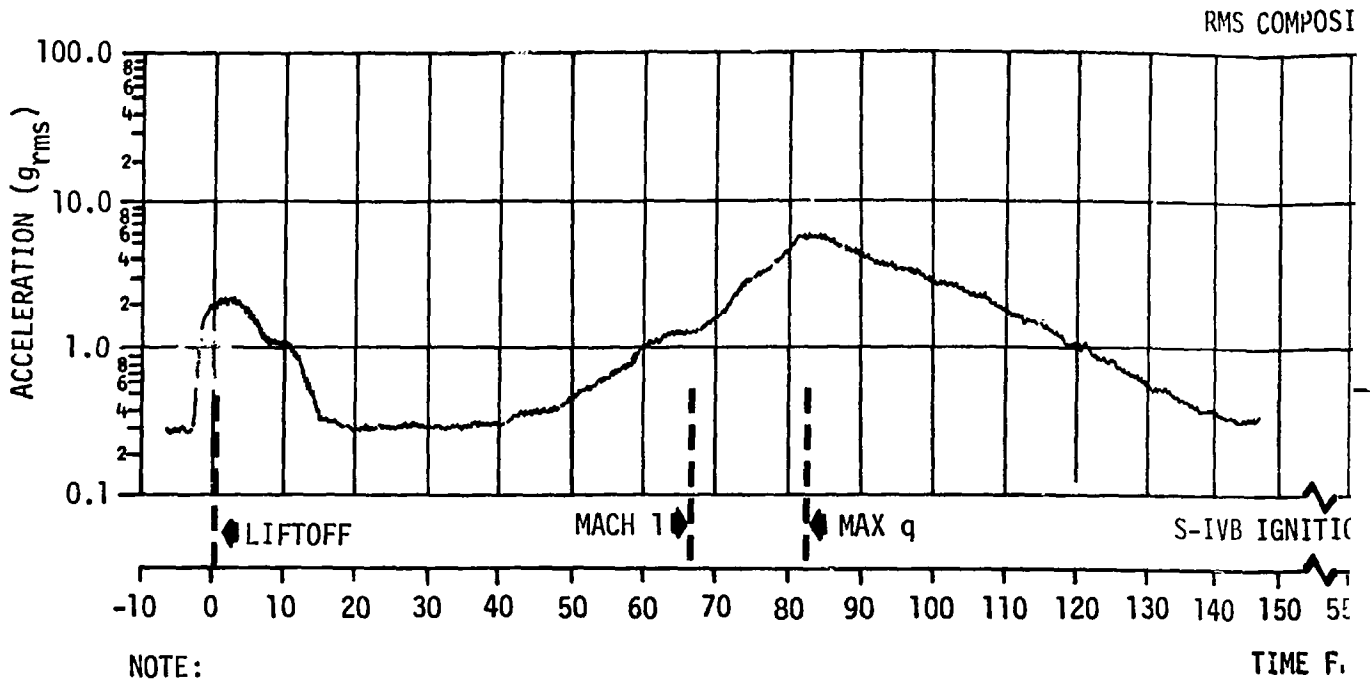

NOTE:
 DATA NOT VALID BELOW 40 HZ
 BECAUSE OF SSB RESPONSE

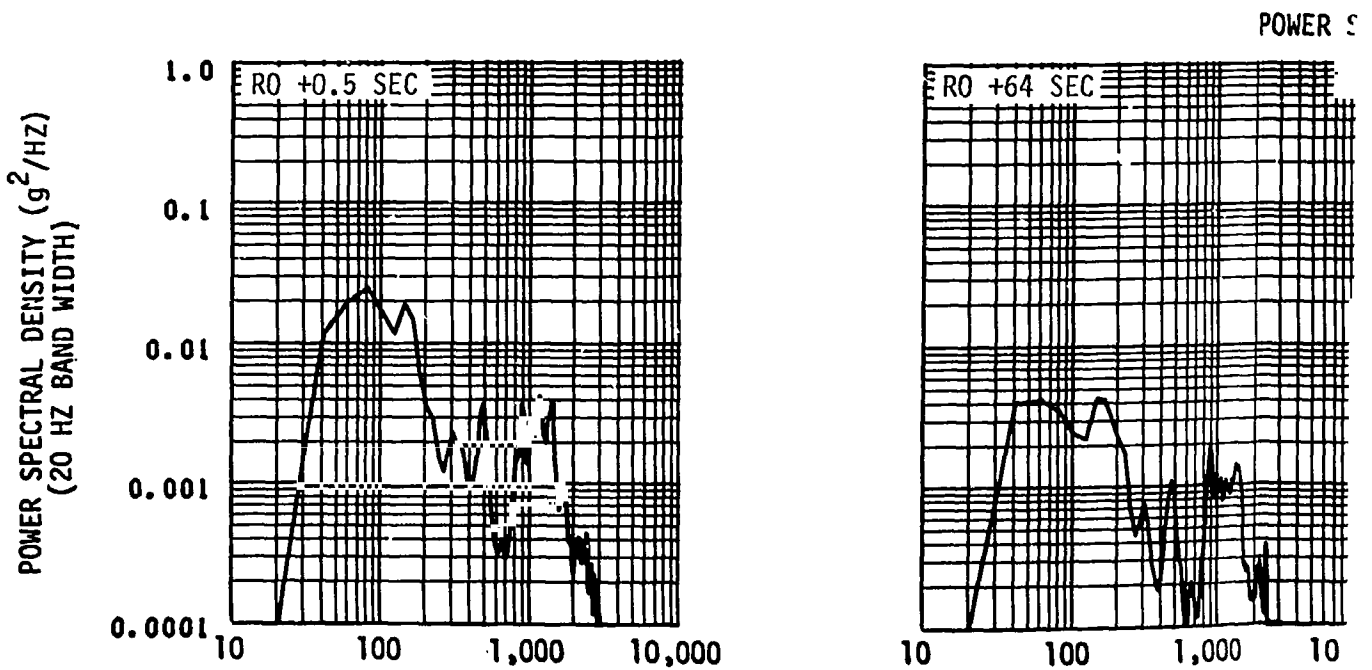

FOLDOUT FRAME |

Figure 25-22. Vibration Measured on APS No. 1 Prop

COMPOSITE TIME-HISTORY

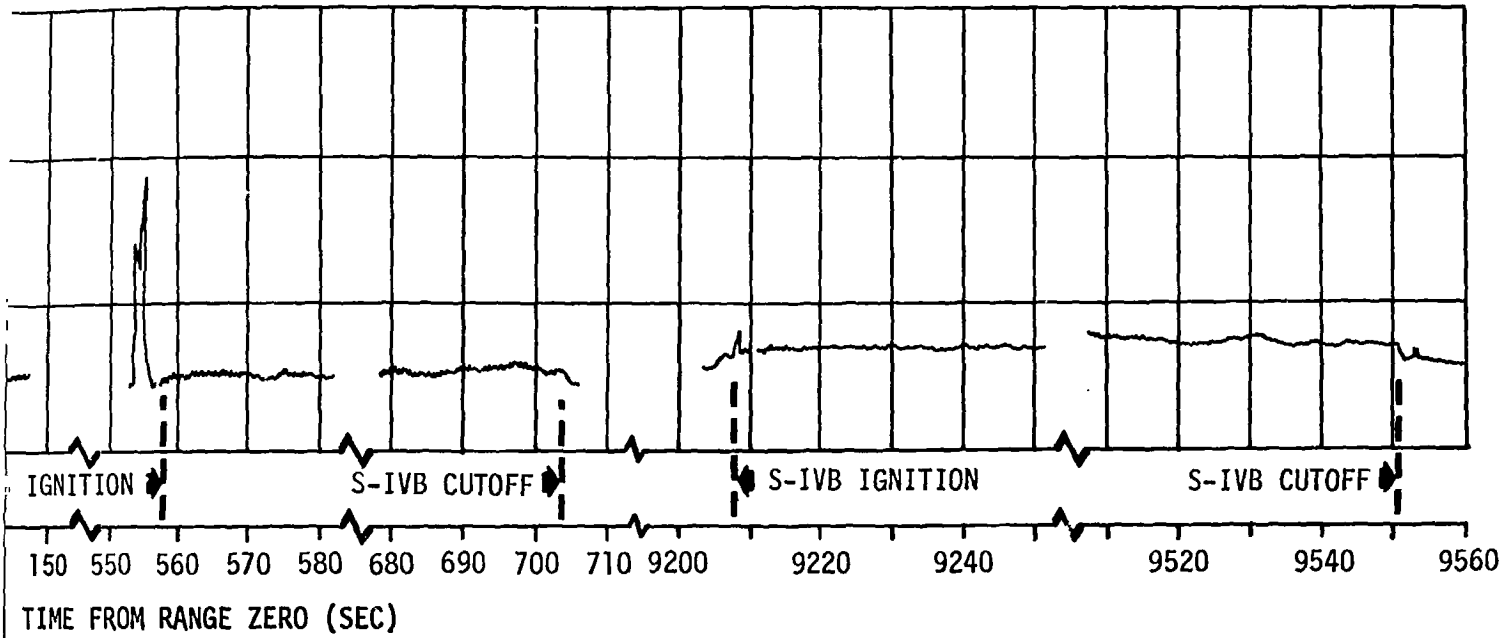

POWER SPECTRAL DENSITY PLOTS

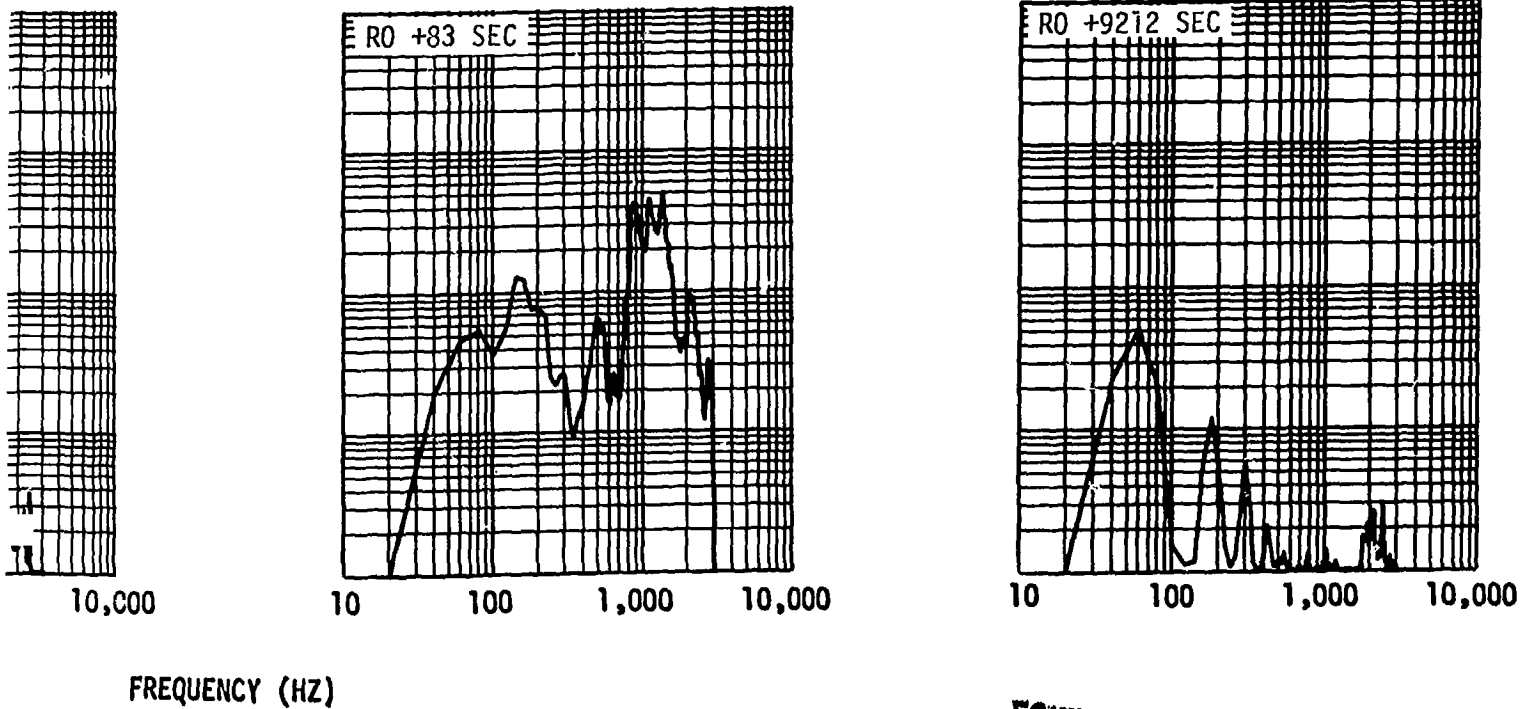

1 Propellant Control Module, Tangential Direction - E0231-414

FOLDOUT FRAME

RMS COMPOSITE TIME-HISTORY

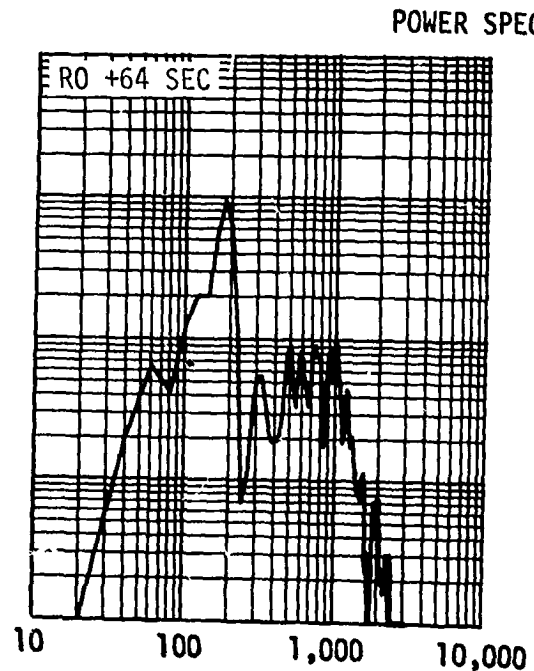
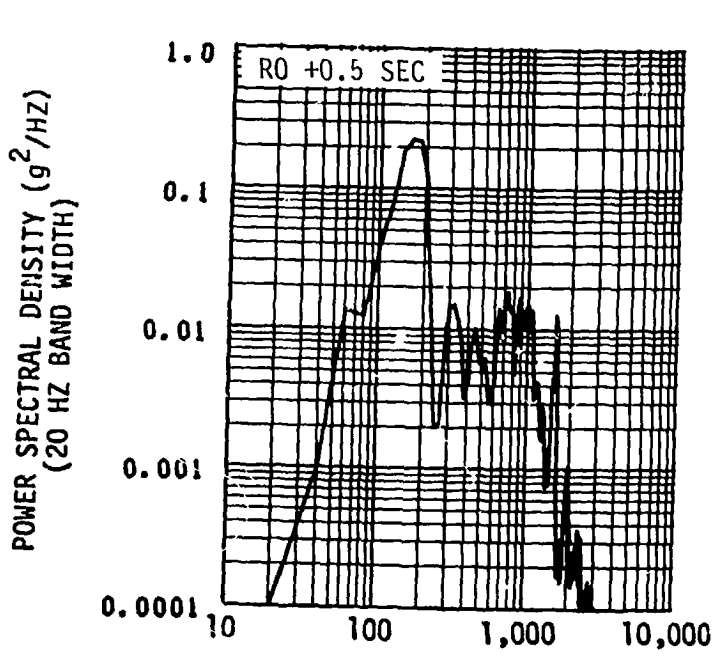
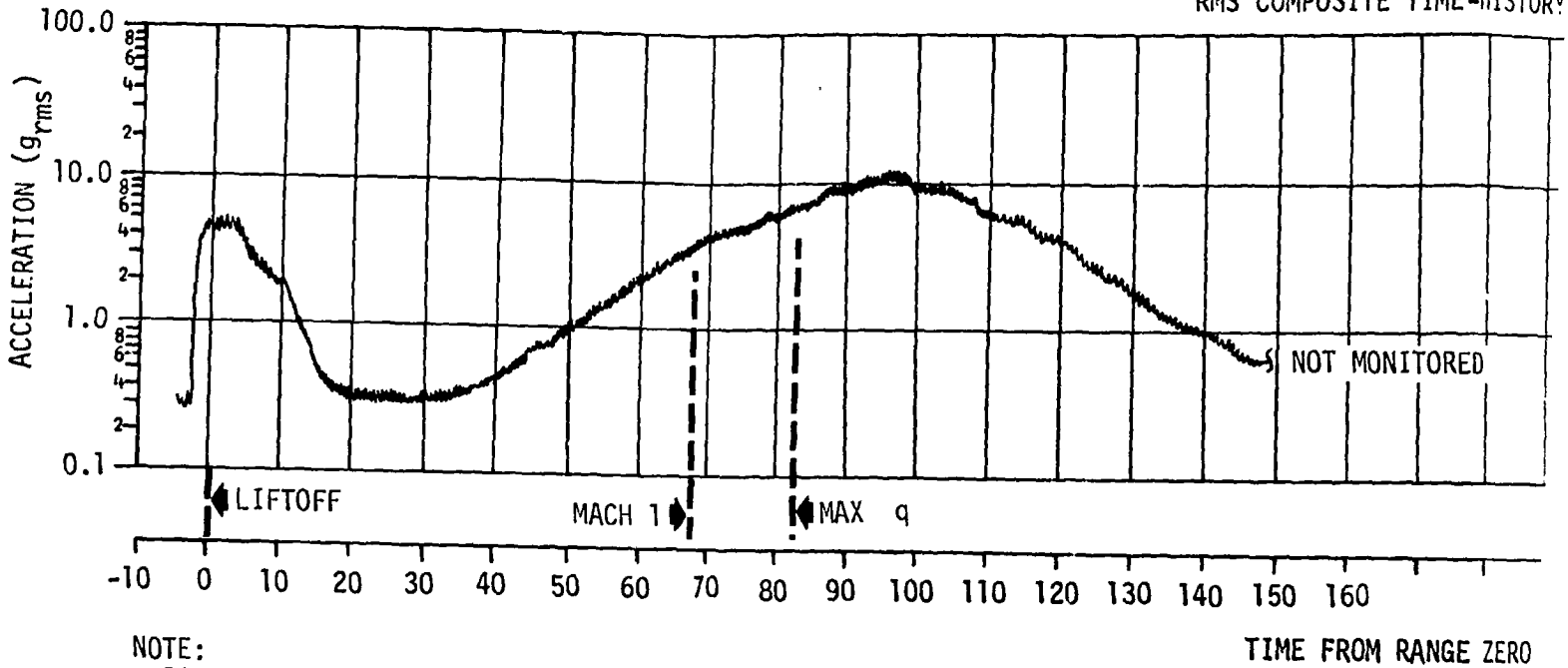

FOLDOUT FRAME | FREQUENCY (

Figure 25-23. Vibration Measured at APS No. 1 Helium Regulat

E TIME-HISTORY

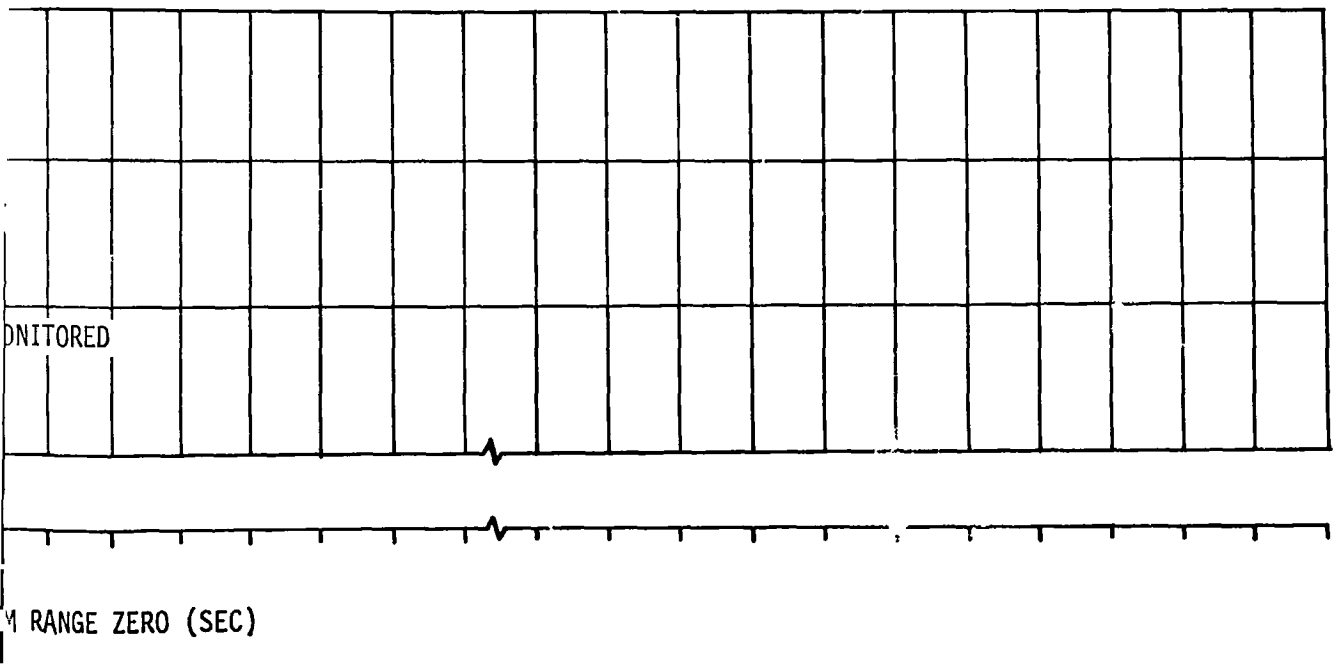

CENTRAL DENSITY PLOTS

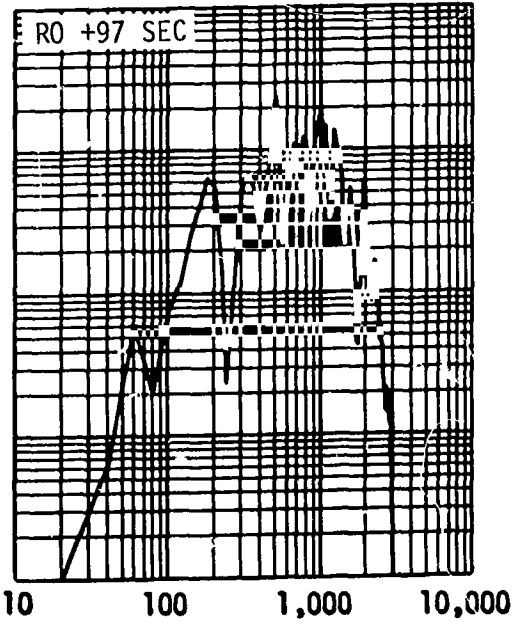
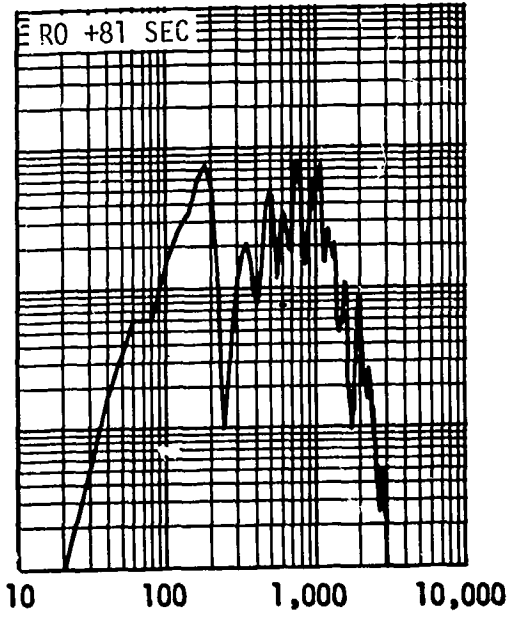

FREQUENCY (HZ)

um Regulator, Tangential Direction - E0234-414

FOLDOUT FRAME 2

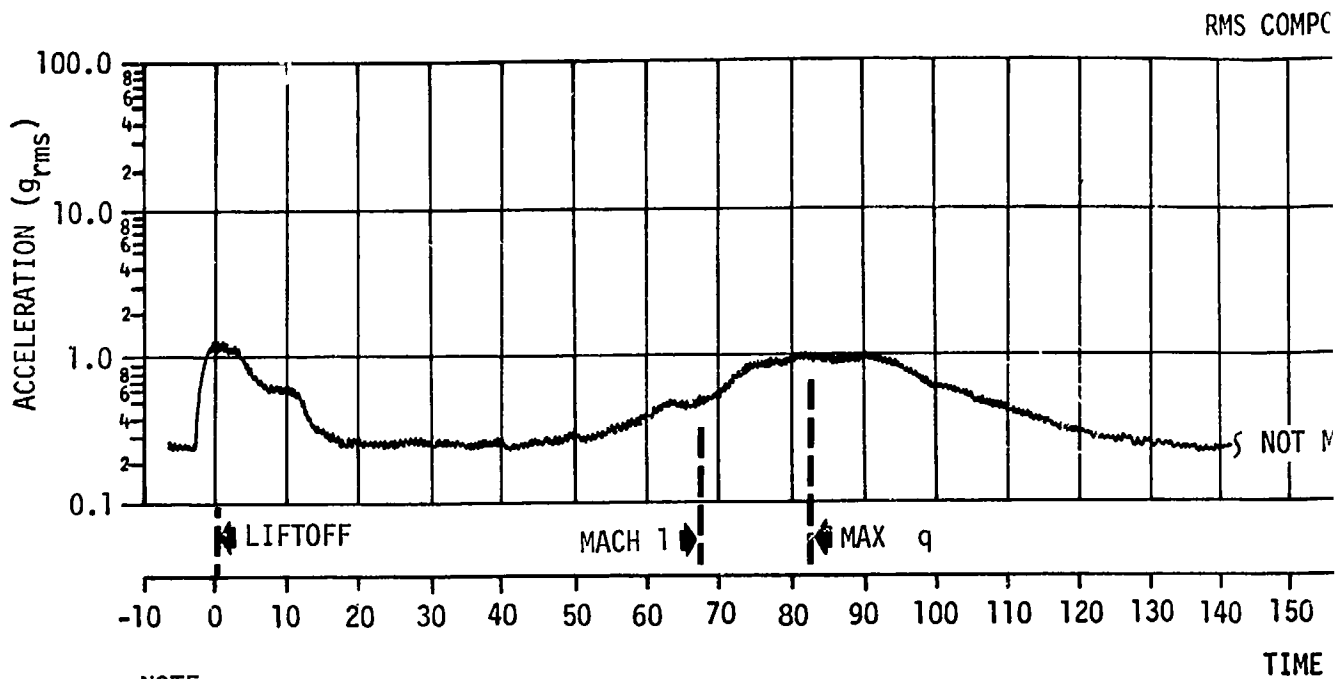

NOTE:
DATA NOT VALID BELOW 40 HZ
BECAUSE OF SSB RESPONSE

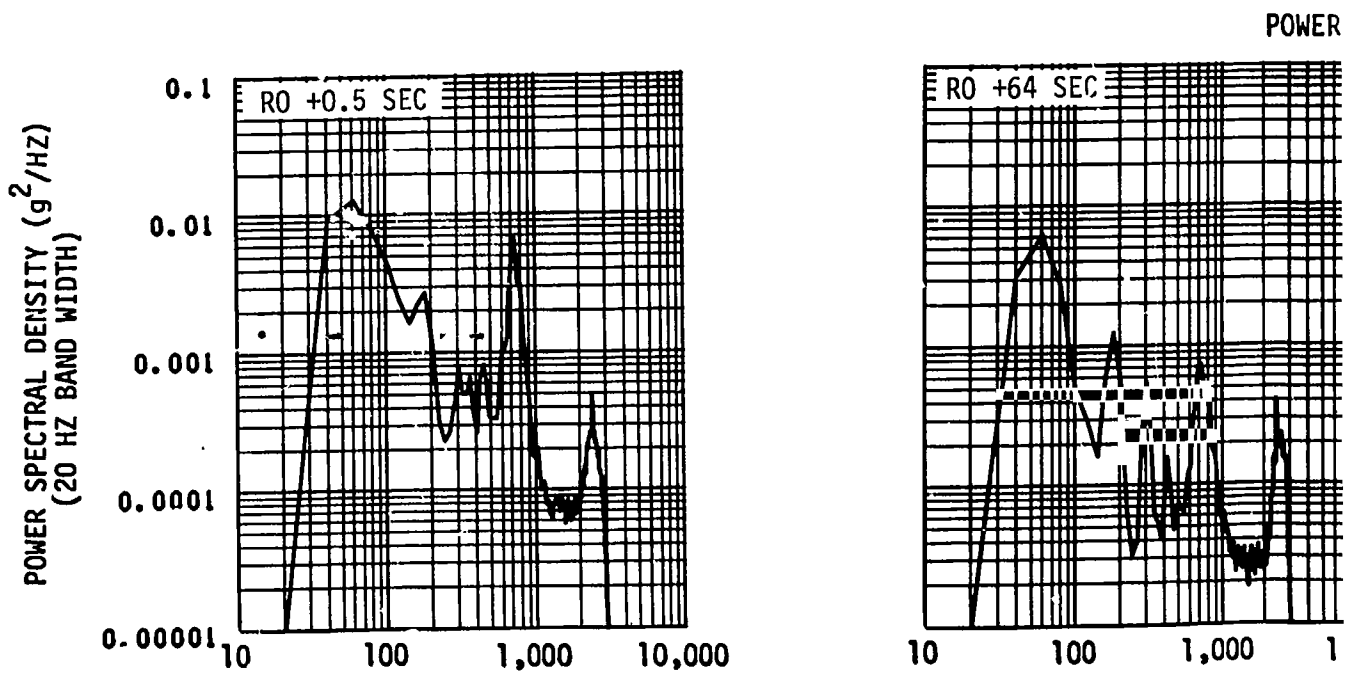

FOLDOUT FRAME

Figure 25-24. Vibration Measured at Chi

RMS COMPOSITE TIME-HISTORY

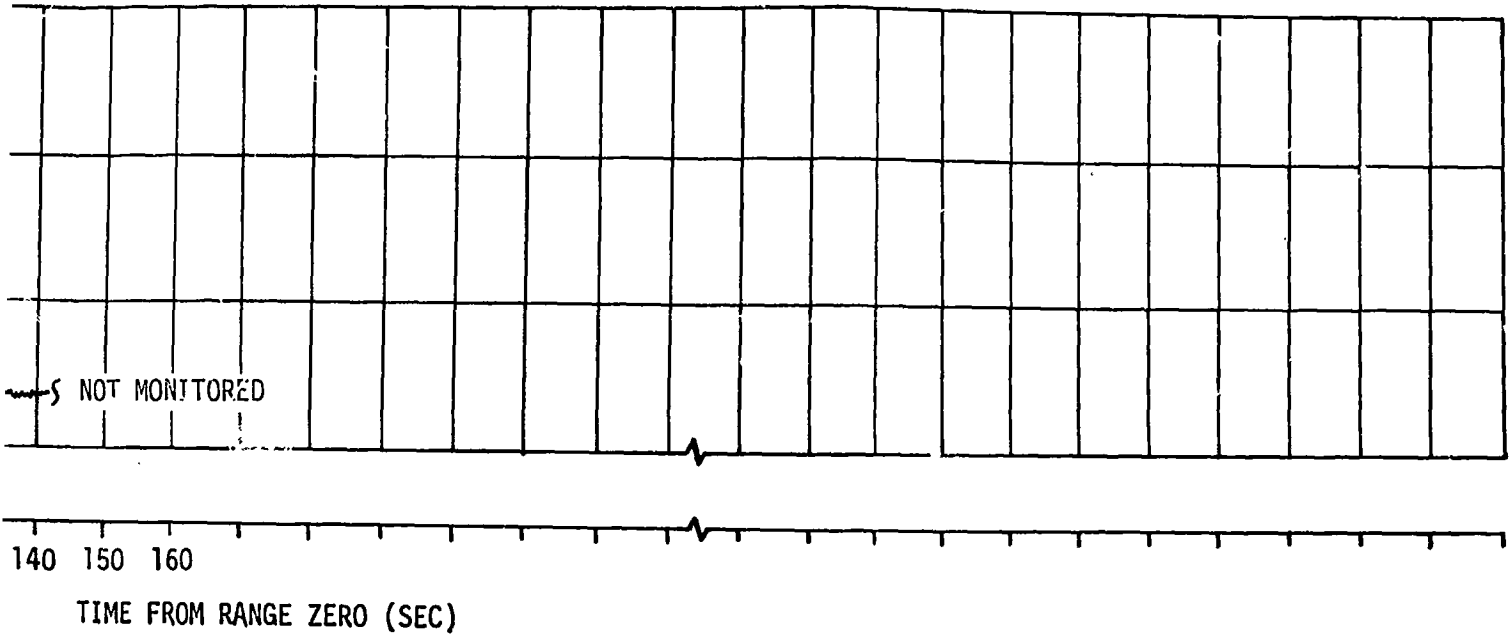

POWER SPECTRAL DENSITY PLOTS

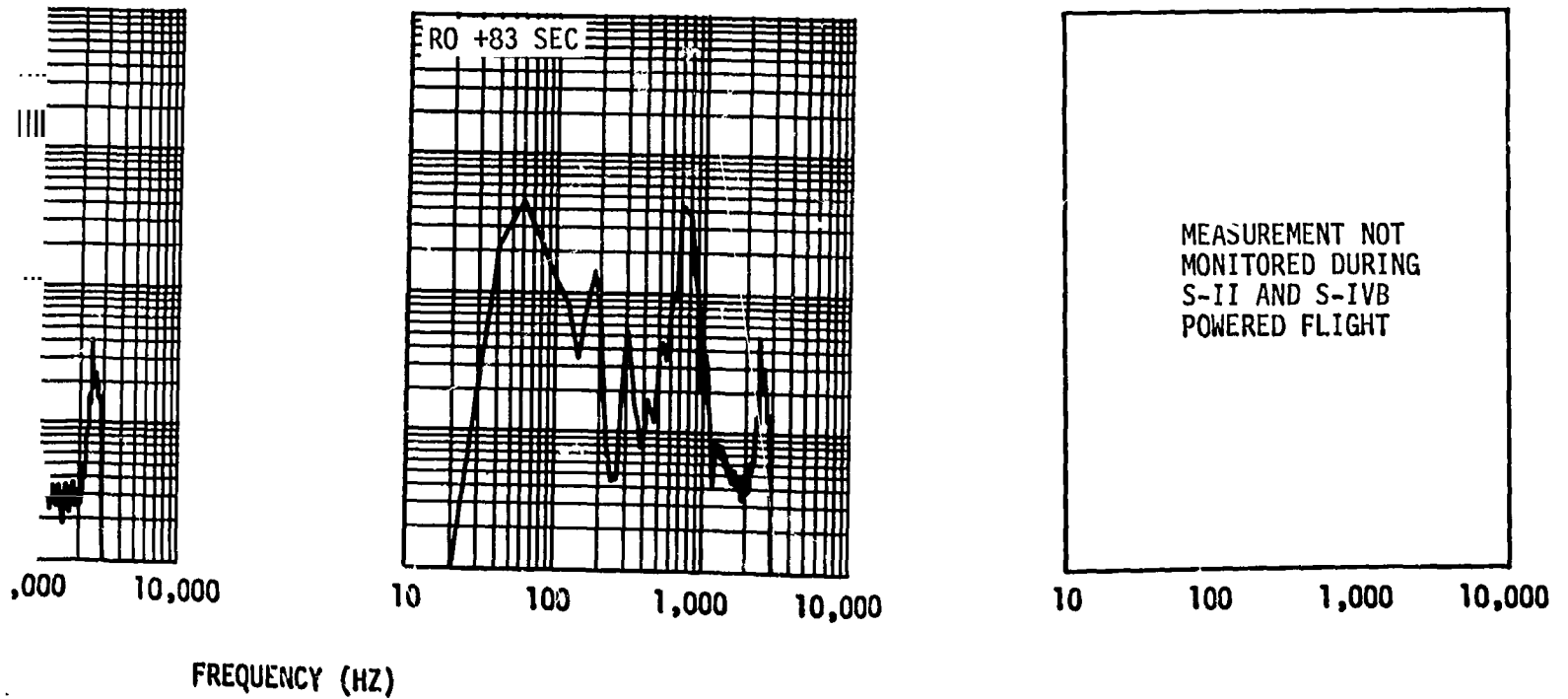

red at Chillo down Inverter, Thrust Direction - E0224-404

FOLDOUT FRAME 2

RMS COMPOSITE TIME-HISTORY

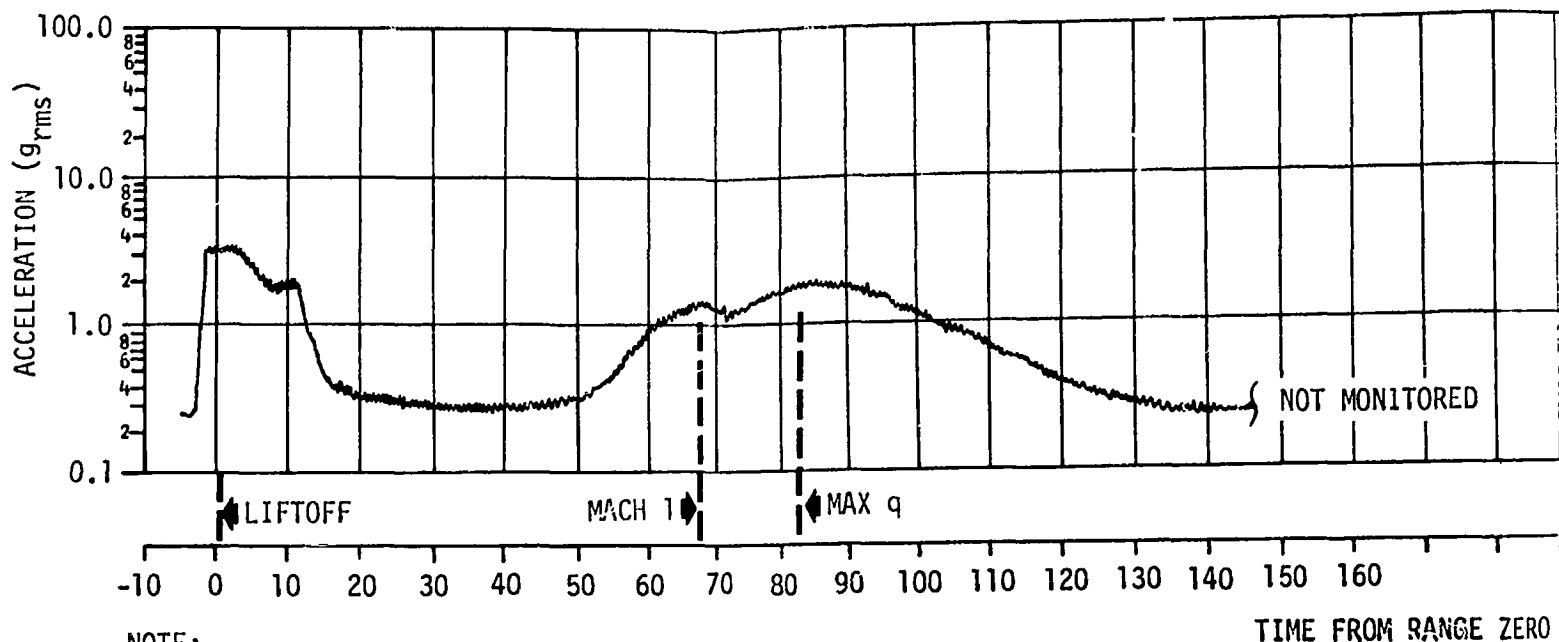

NOTE:
 DATA NOT VALID BELOW 40 HZ
 BECAUSE OF SSB RESPONSE

POWER SPECTRAL DENSITY

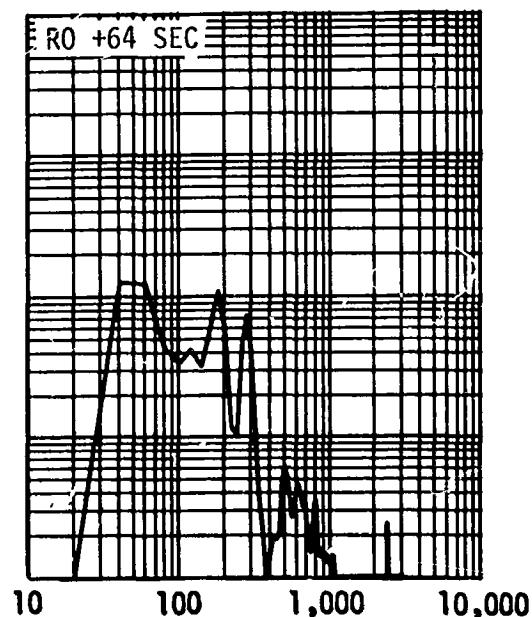
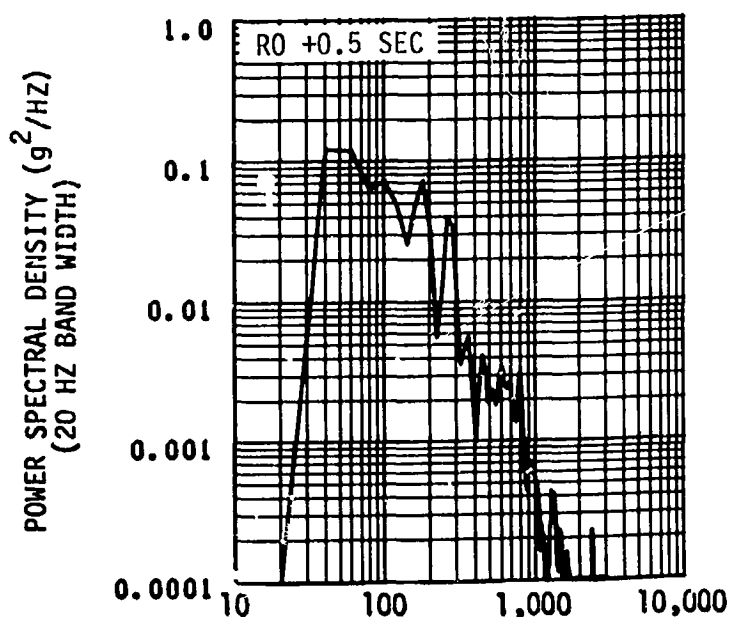
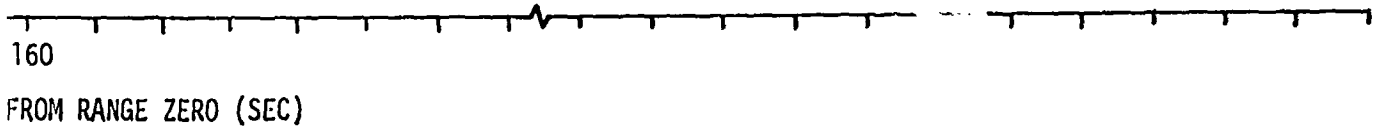
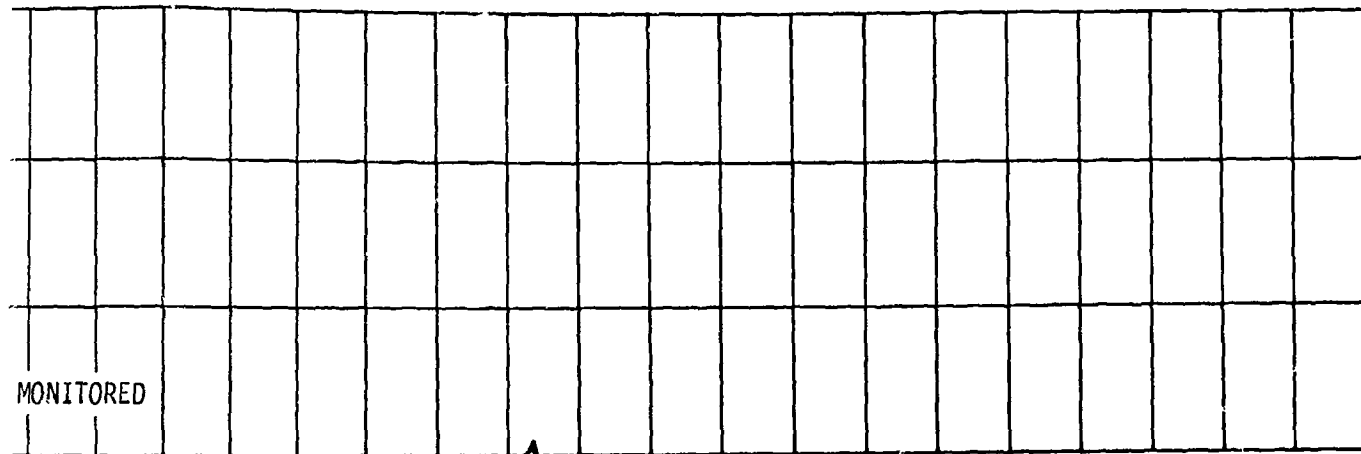
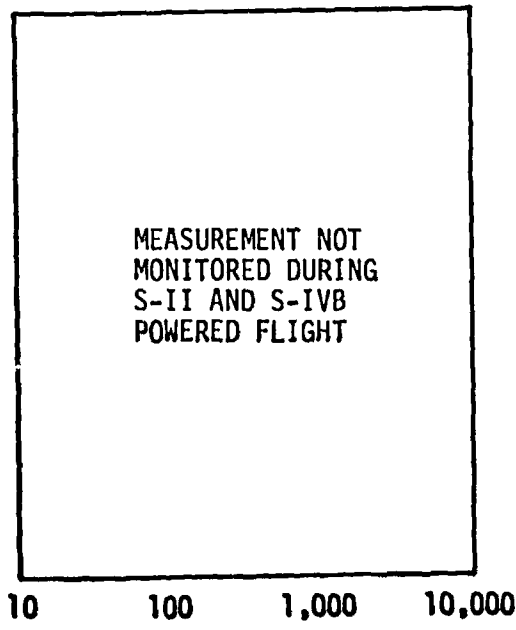
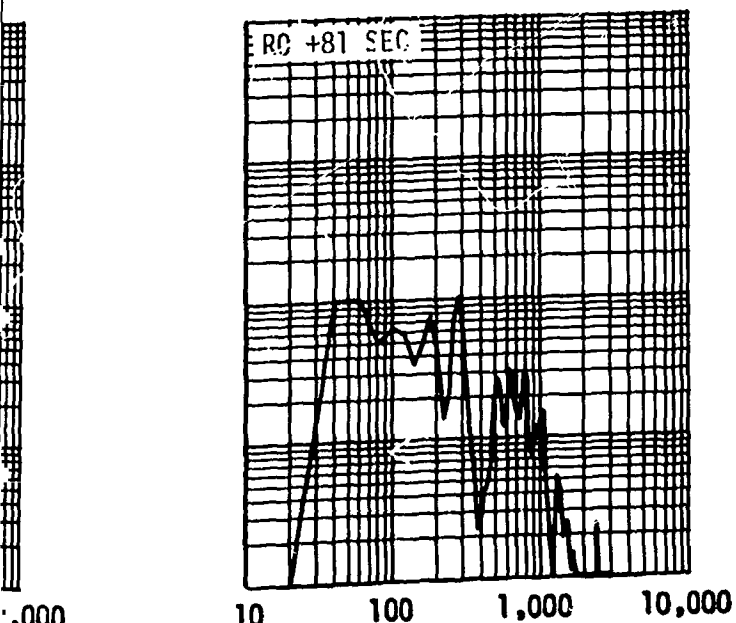

Figure 25-25. Vibration Measured at Chillover Inverter

SITE TIME-HISTORY



SPECTRAL DENSITY PLOTS



ldown Inverter, Radial Direction - E0225-40 FOLDOUT FRAME

2

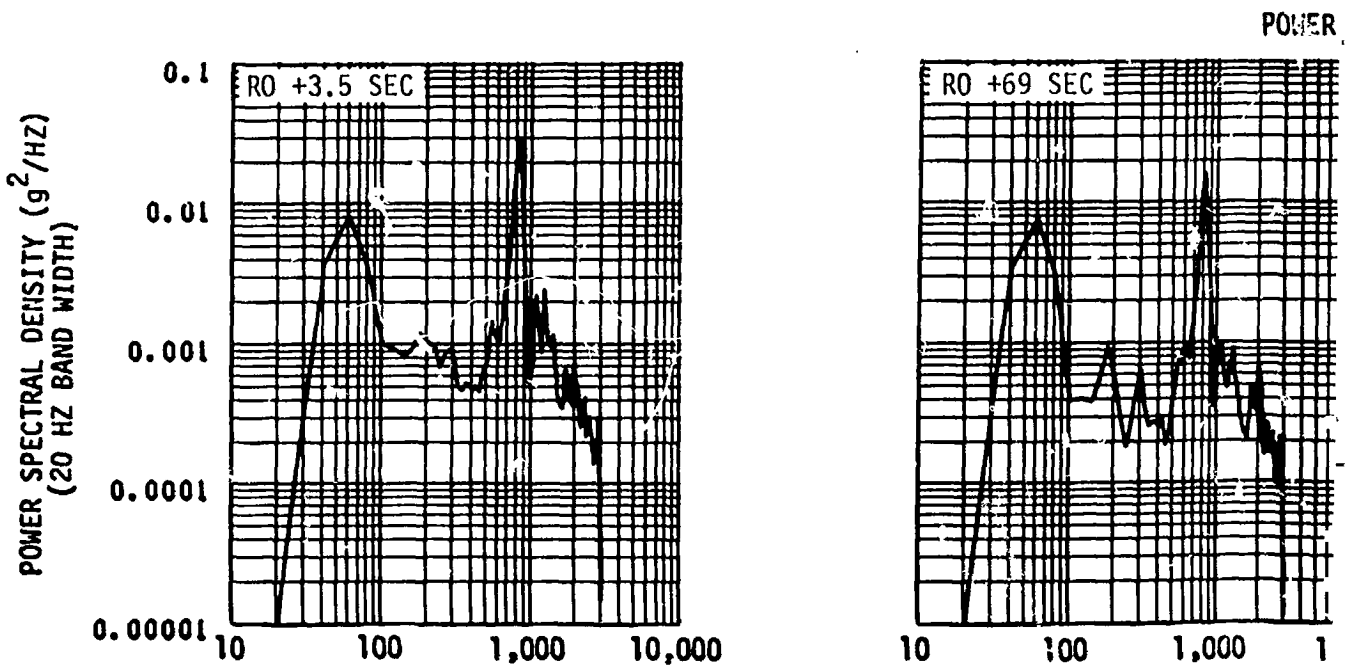
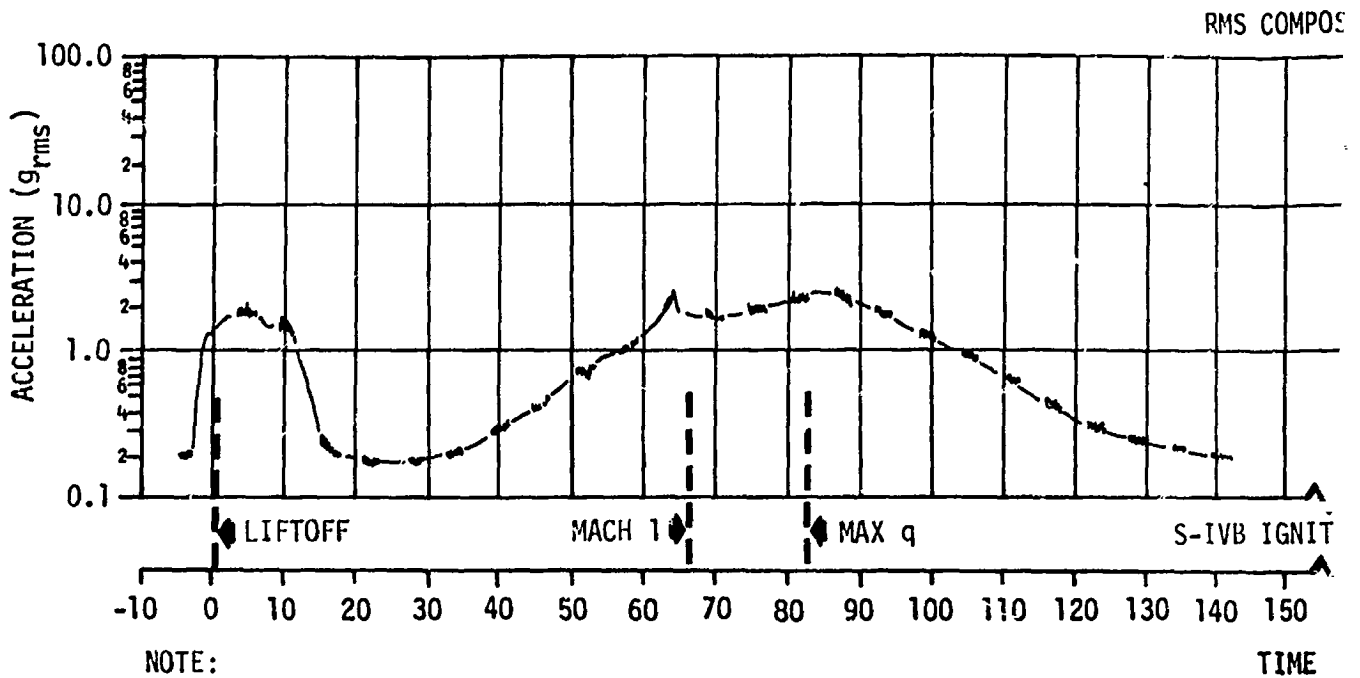

FOLDOUT FRAME

Figure 25-26. Vibration Measured at LH2 "

RMS COMPOSITE TIME-HISTORY

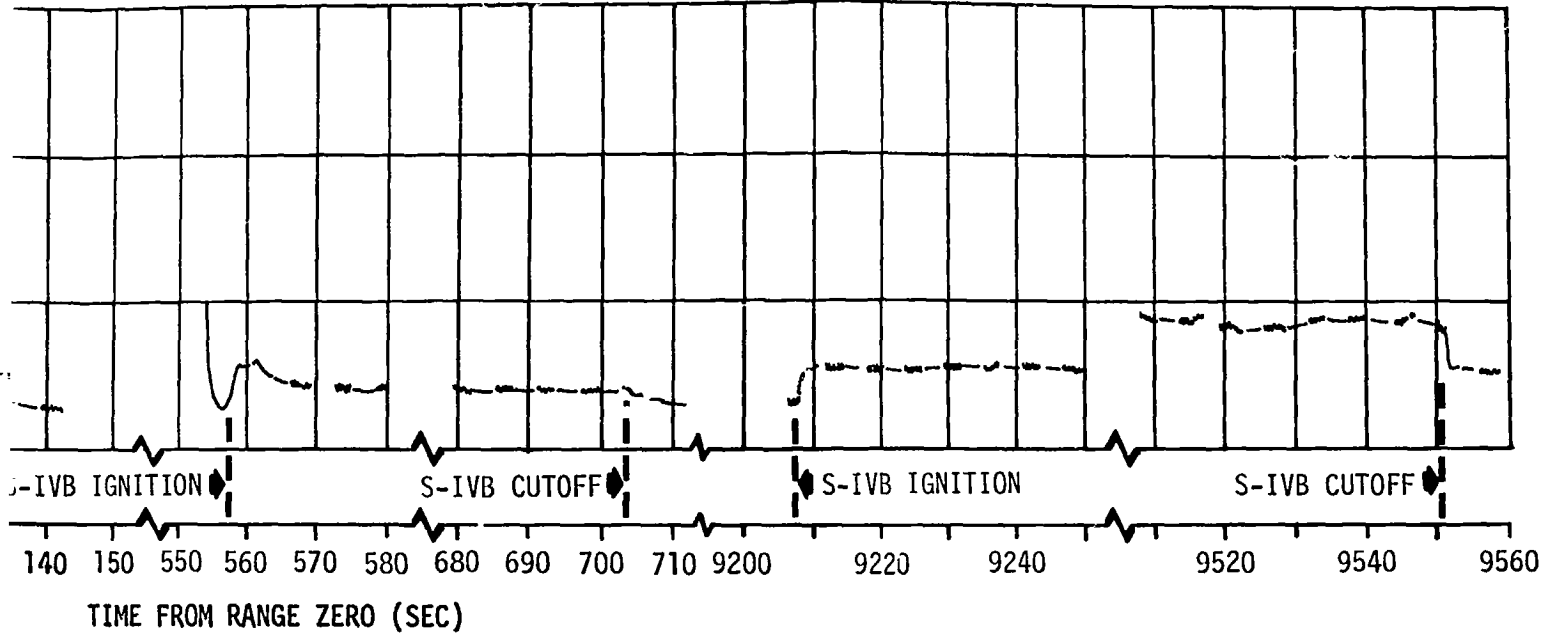

POWER SPECTRAL DENSITY PLOTS

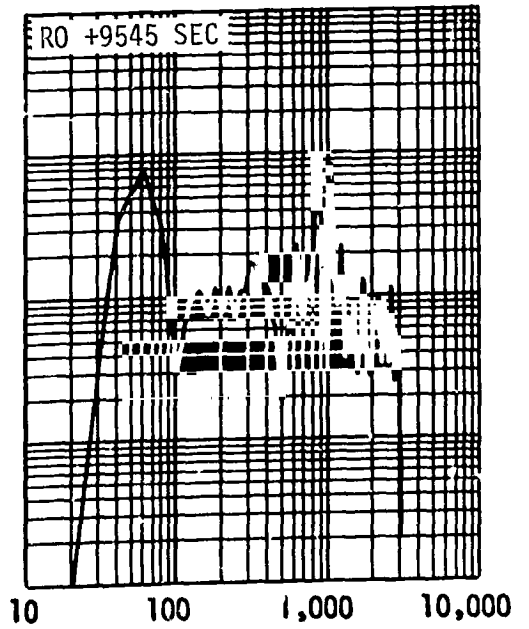
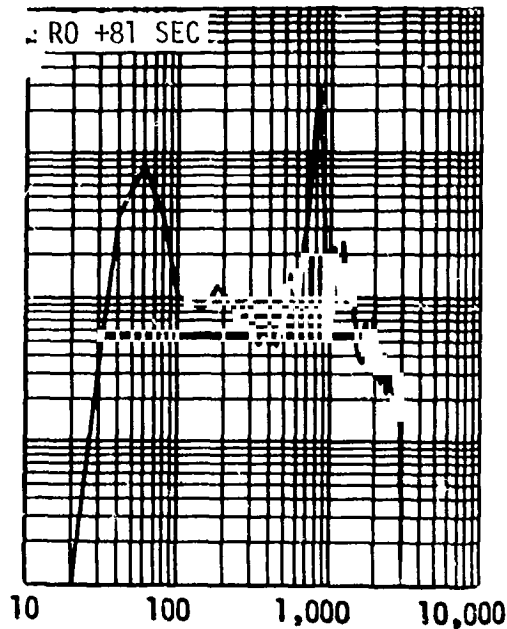
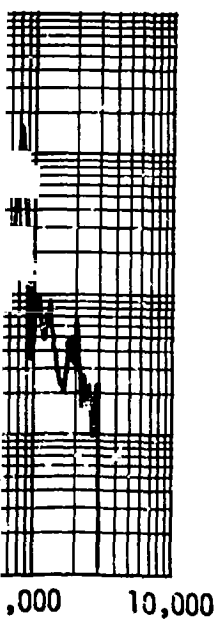

FREQUENCY (HZ)

at LH2 Vent Disconnect, Thrust Direction - E0228-411

FOLDOUT FRAME 2

RMS COMPOSITE TIME-HISTORY

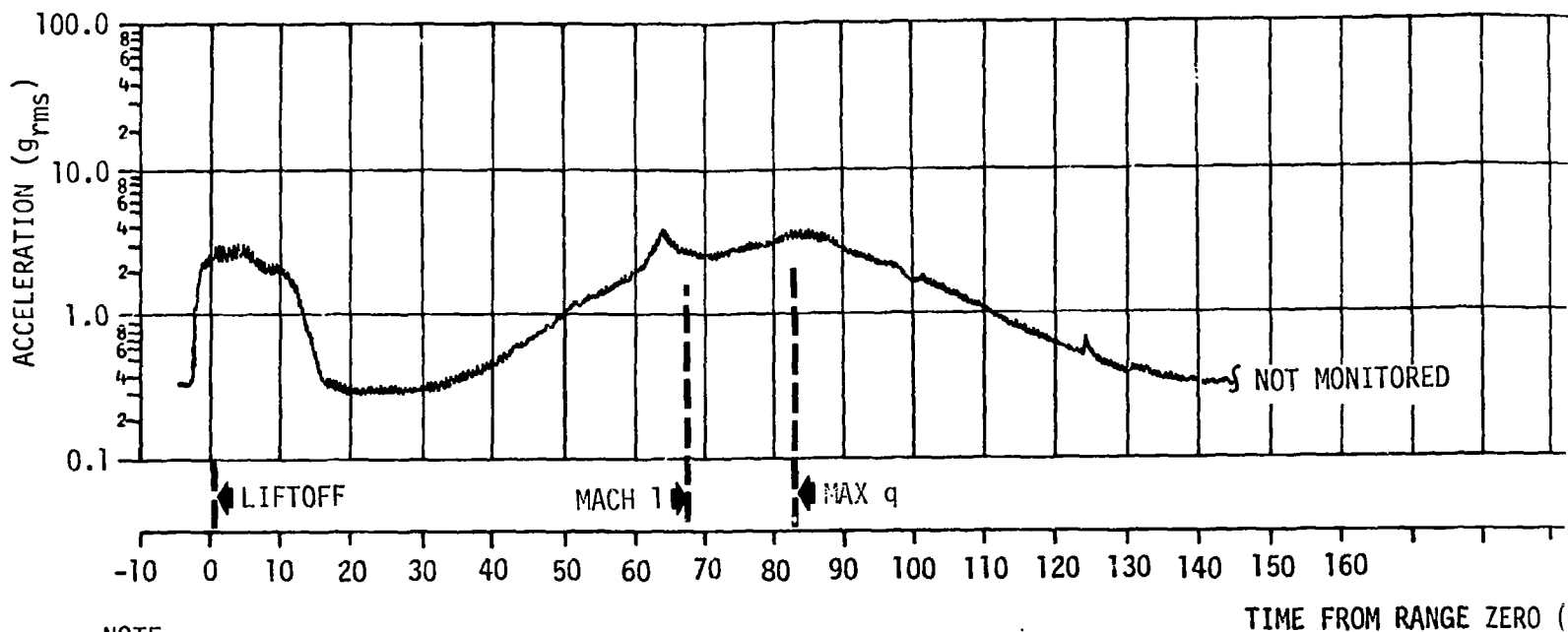

NOTE:
DATA NOT VALID BELOW 40 HZ
BECAUSE OF SSB RESPONSE

POWER SPECTRAL DENSITY

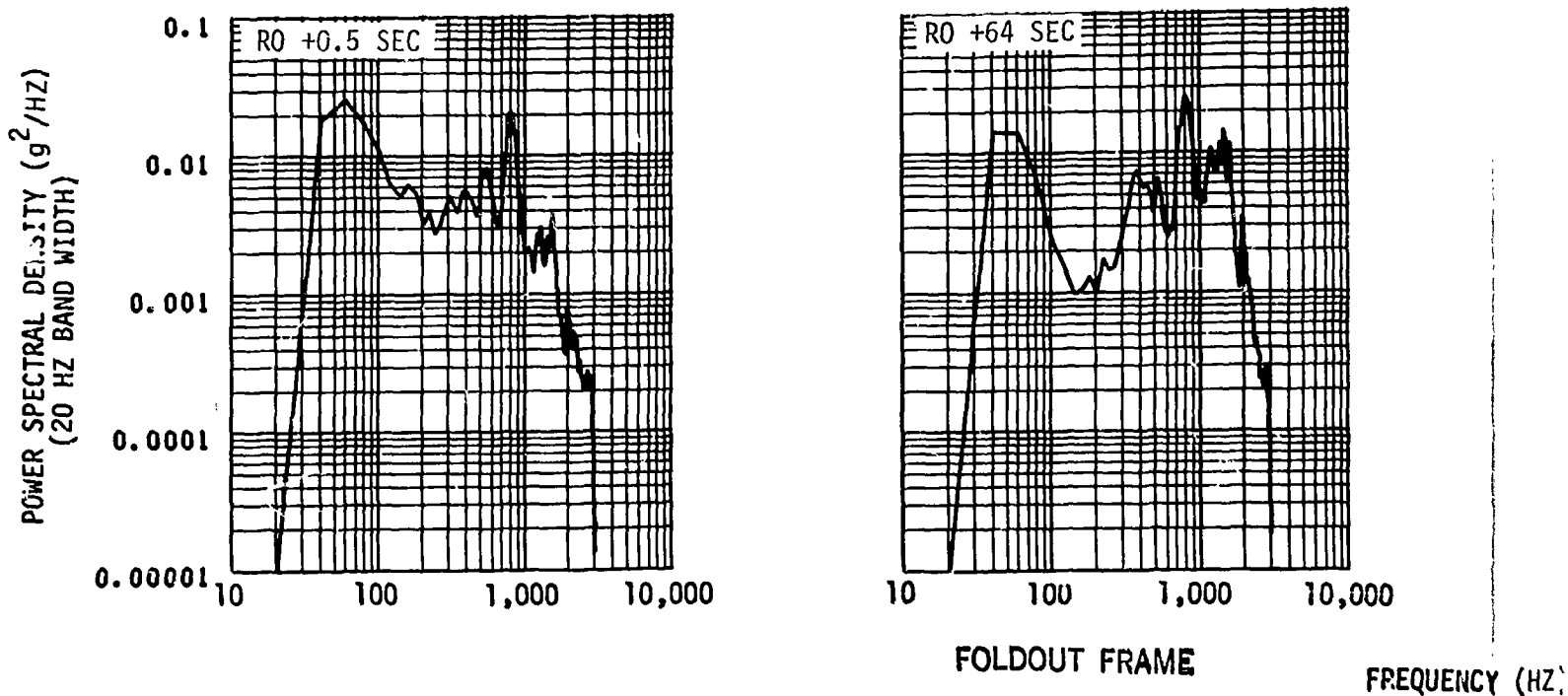
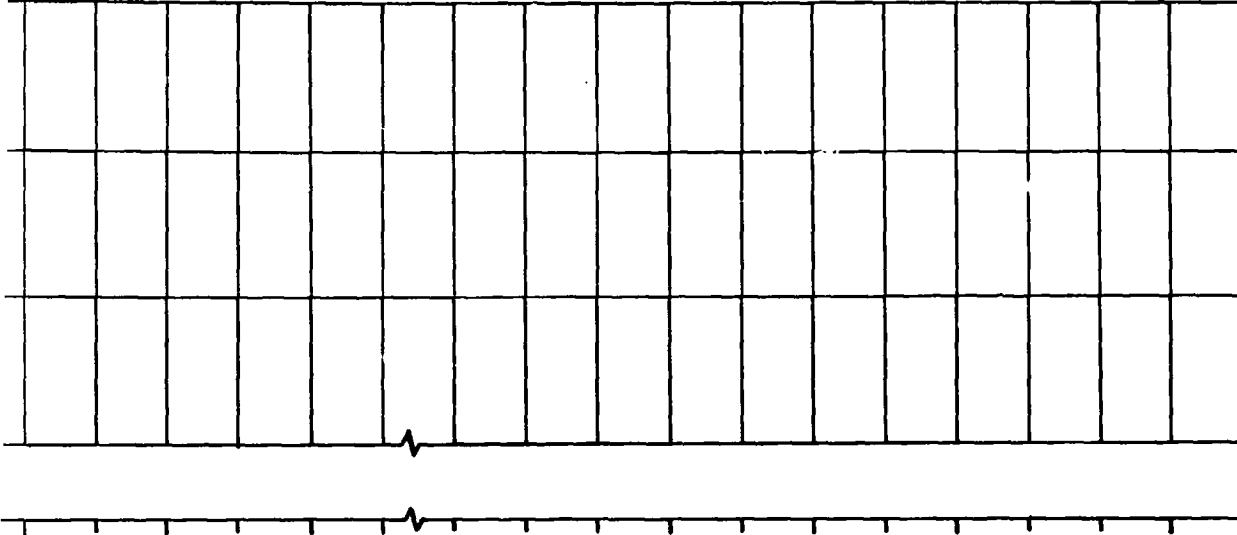

Figure 25-27. Vibration Measured at LH2 Vent Disconnect,

HISTORY



ZERO (SEC)

DENSITY PLOTS

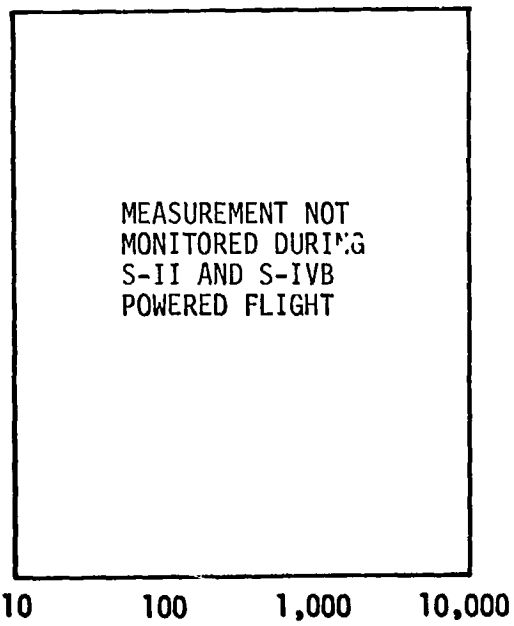
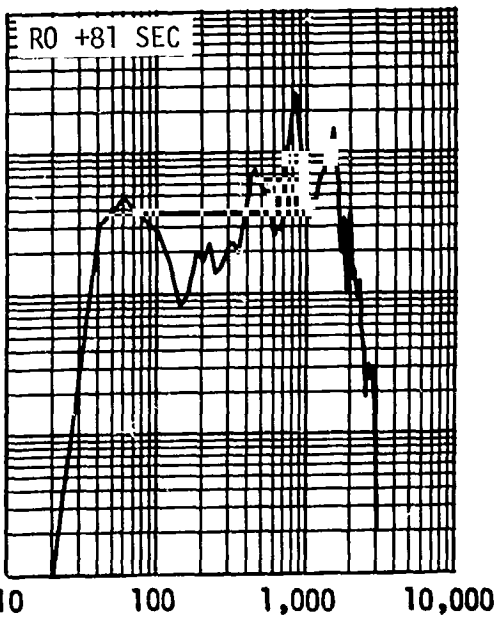

NCY (HZ)

Connect, Radial Direction - E0229-41 FOLDOUT FRAME

2

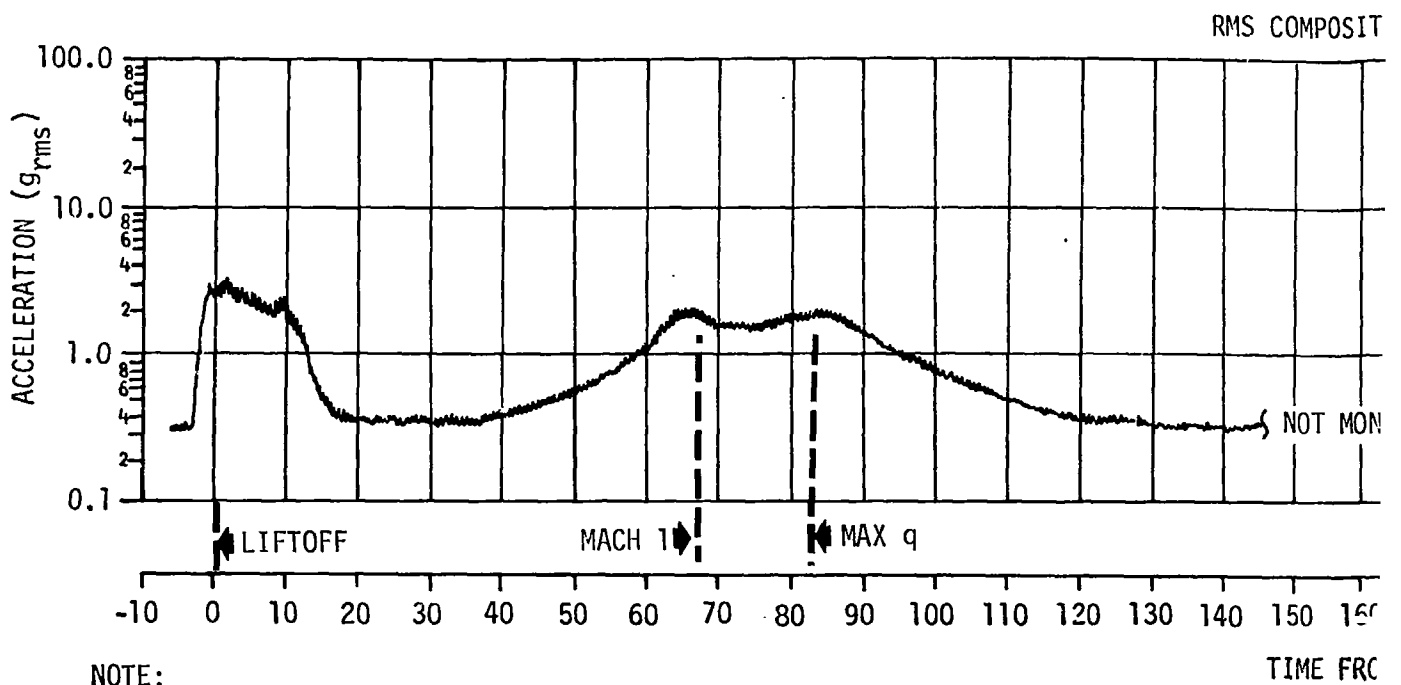

NOTE:
DATA NOT VALID BELOW 40 HZ
BECAUSE OF SSB RESPONSE

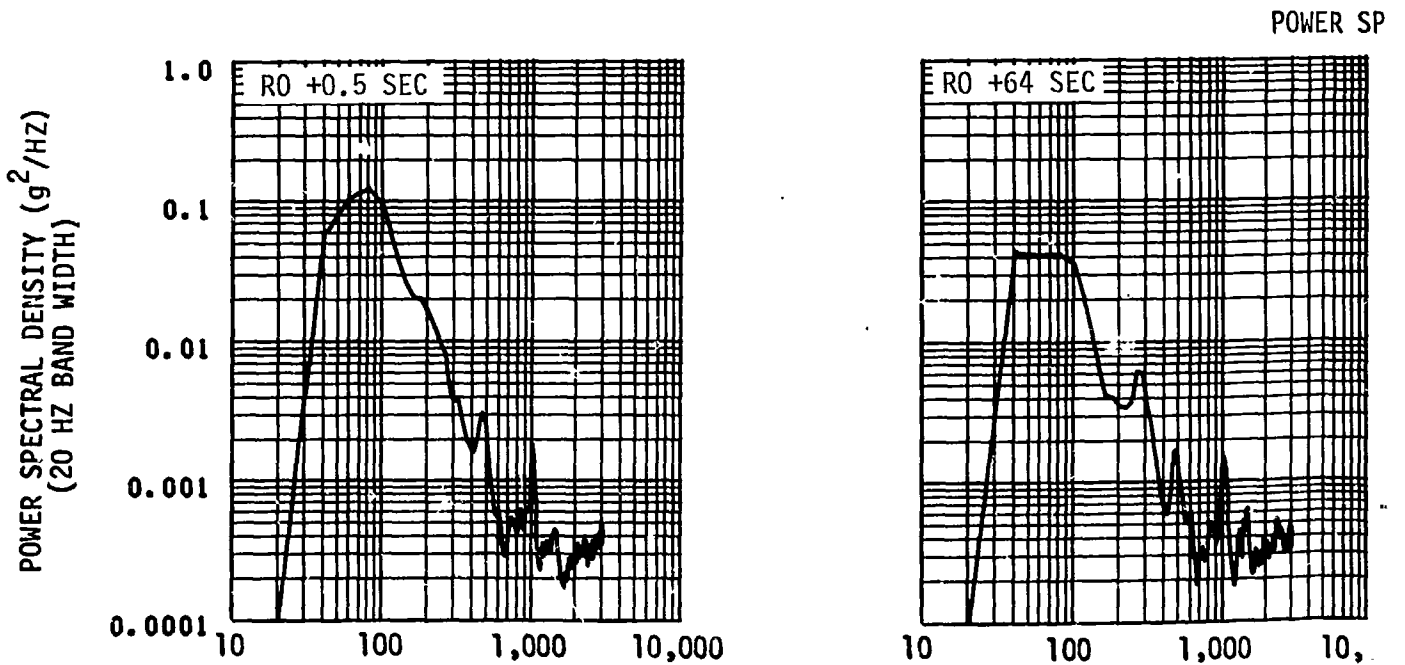

FOLDOUT FRAME

Figure 25-28. Vibration Measured on Contin...

COMPOSITE TIME-HISTORY

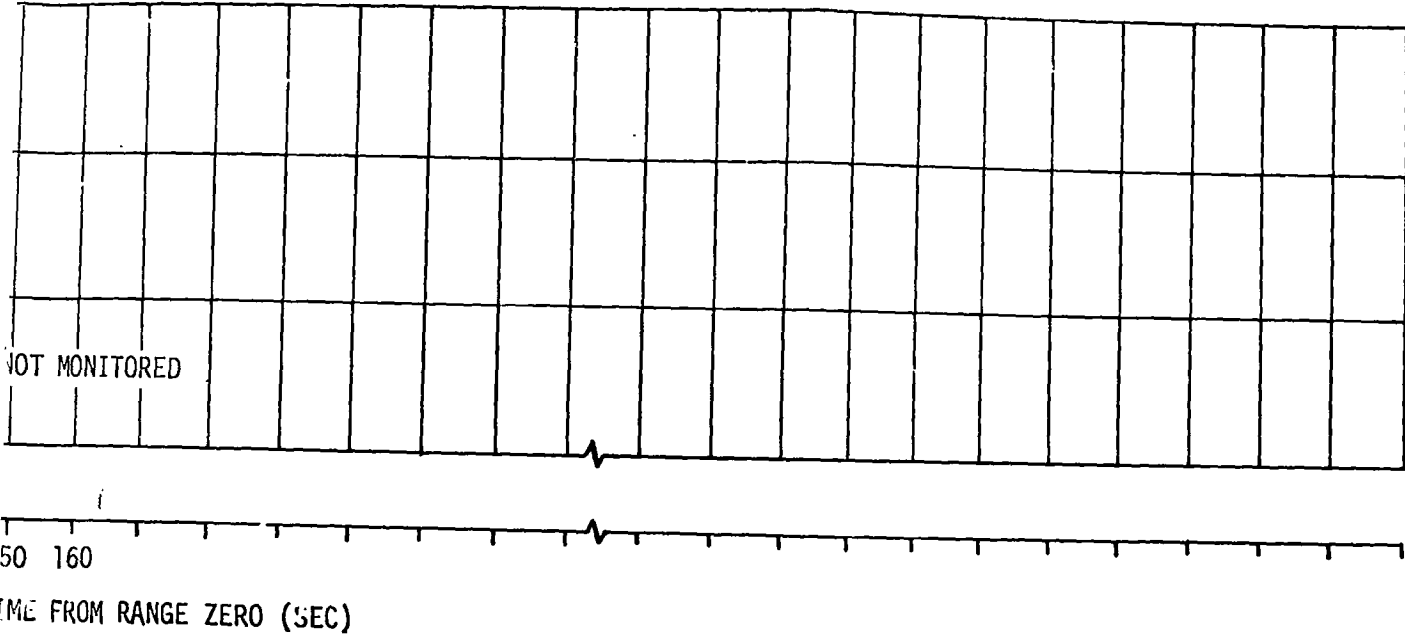

POWER SPECTRAL DENSITY PLOTS

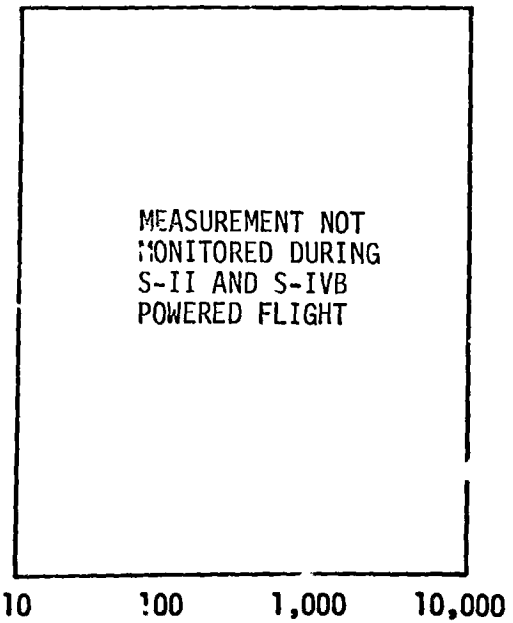
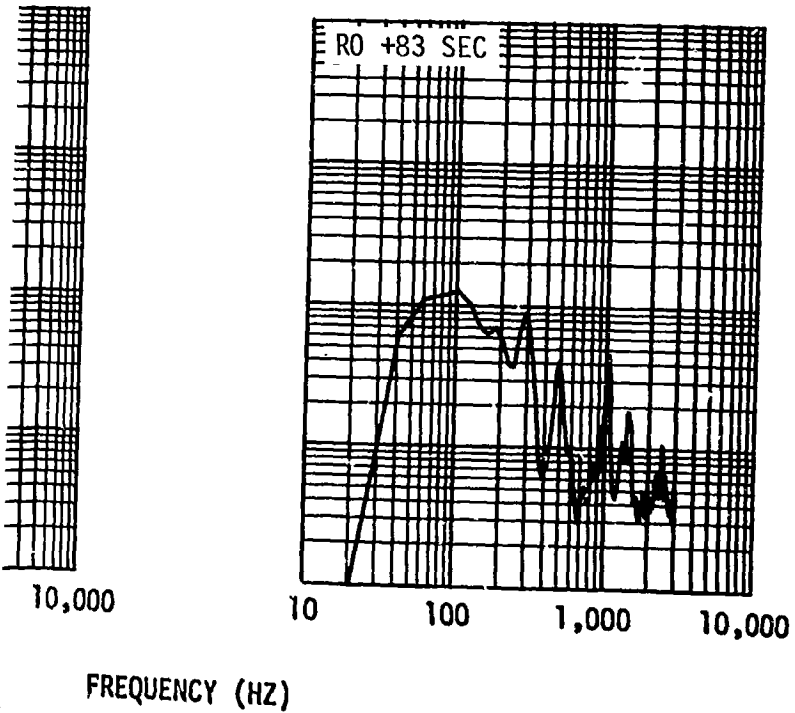

FOLDOUT FRAME 2

Continuous Vent Module, Radial Direction - E0232-411

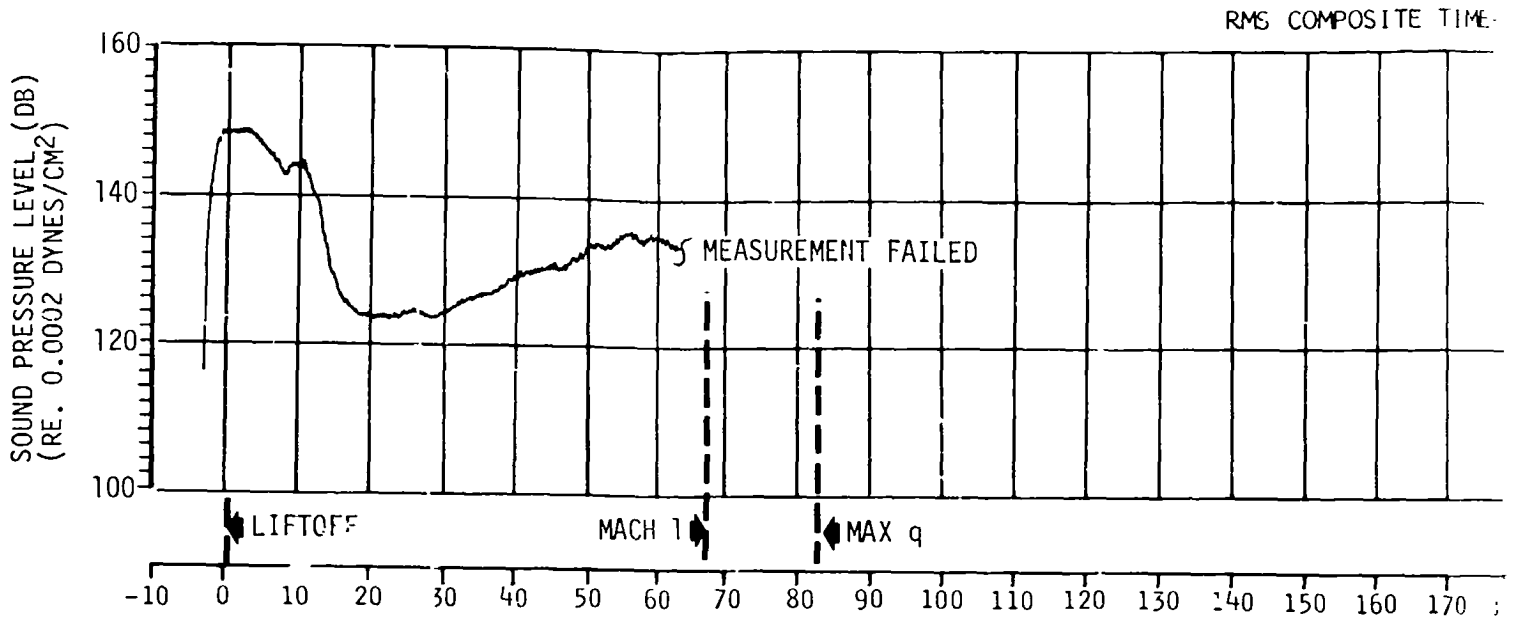

NOTE:
DATA NOT VALID BELCW 30 HZ
BECAUSE OF SSB RESPONSE

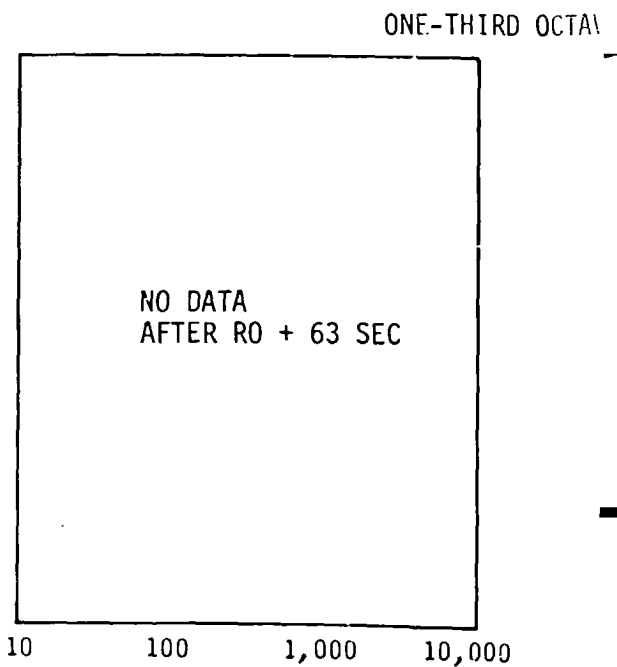
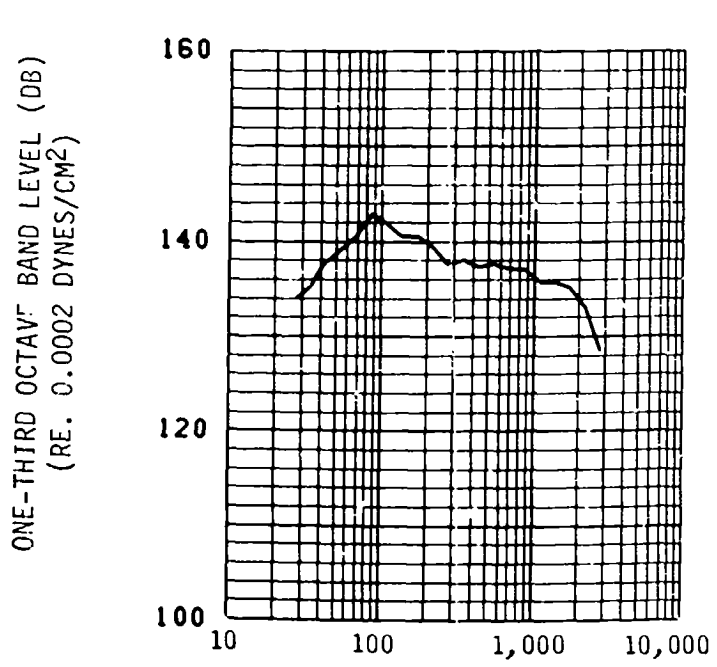

FOLDOUT FRAME

Figure 25-29. External Sound Pressure Levels Me

ITE TIME-HISTORY

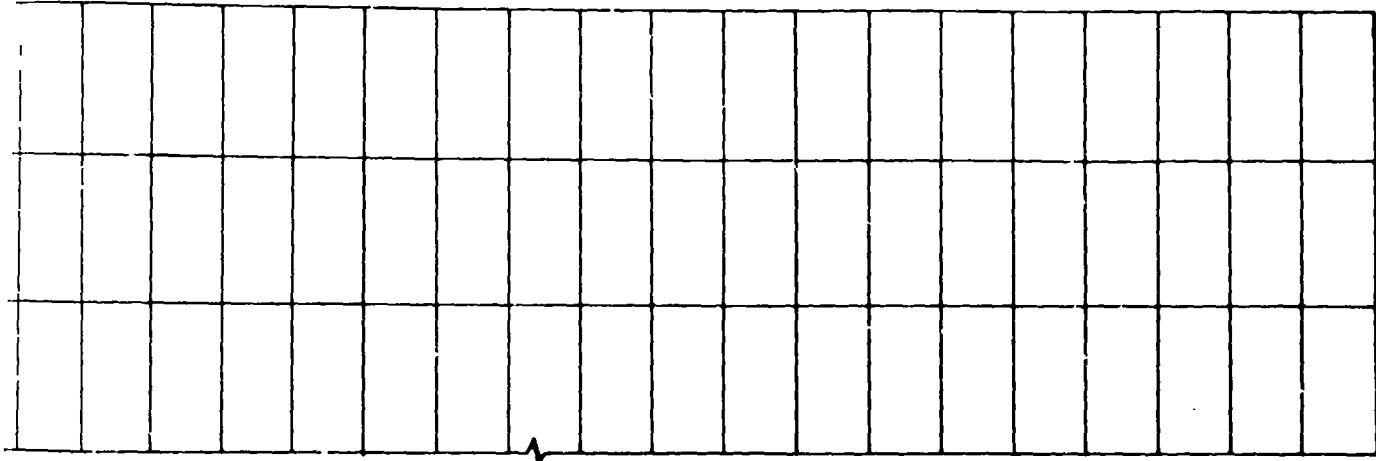

160 170 180 190 200 210 220 230 240 250 260 270 280 290 300 310 320 330 340 350 360 370 380 390 400 410 420 430 440 450 460 470 480 490 500 510 520 530 540 550 560 570 580 590 600 610 620

FROM RANGE ZERO (SEC)

THIRD OCTAVE BAND PLOTS

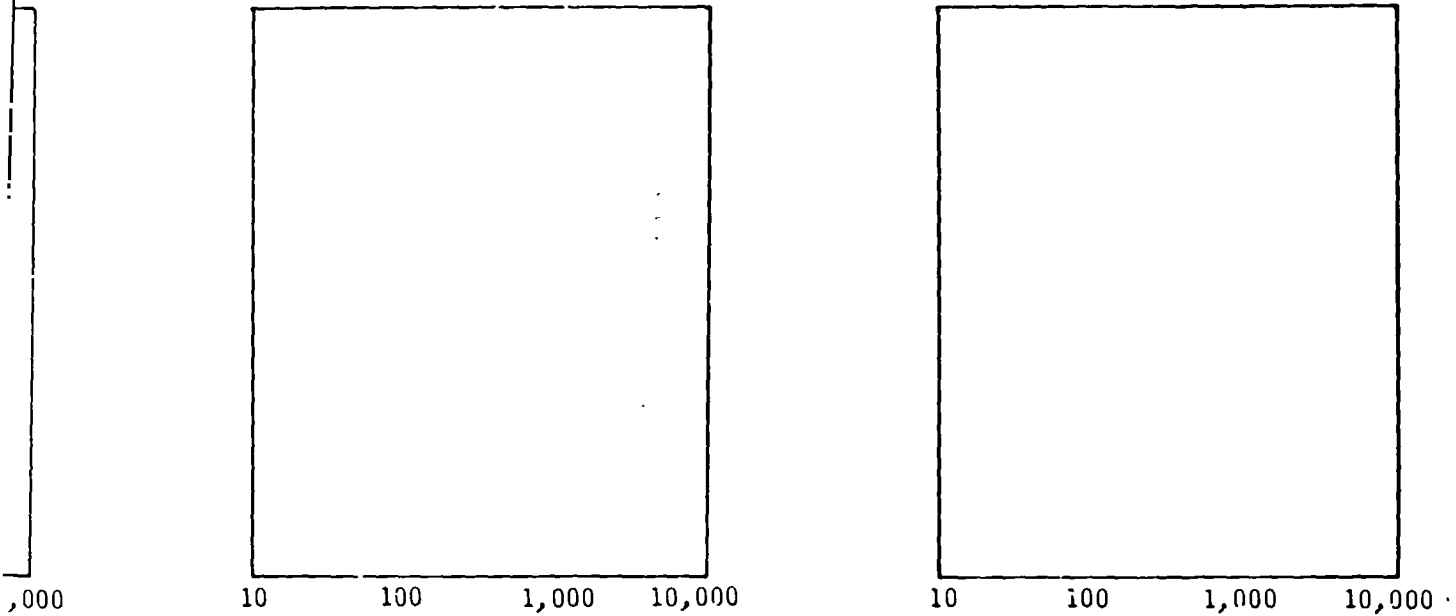

FREQUENCY (HZ)

FOLDOUT FRAME 2

Levels Measured on Aft Skirt - B0019-427

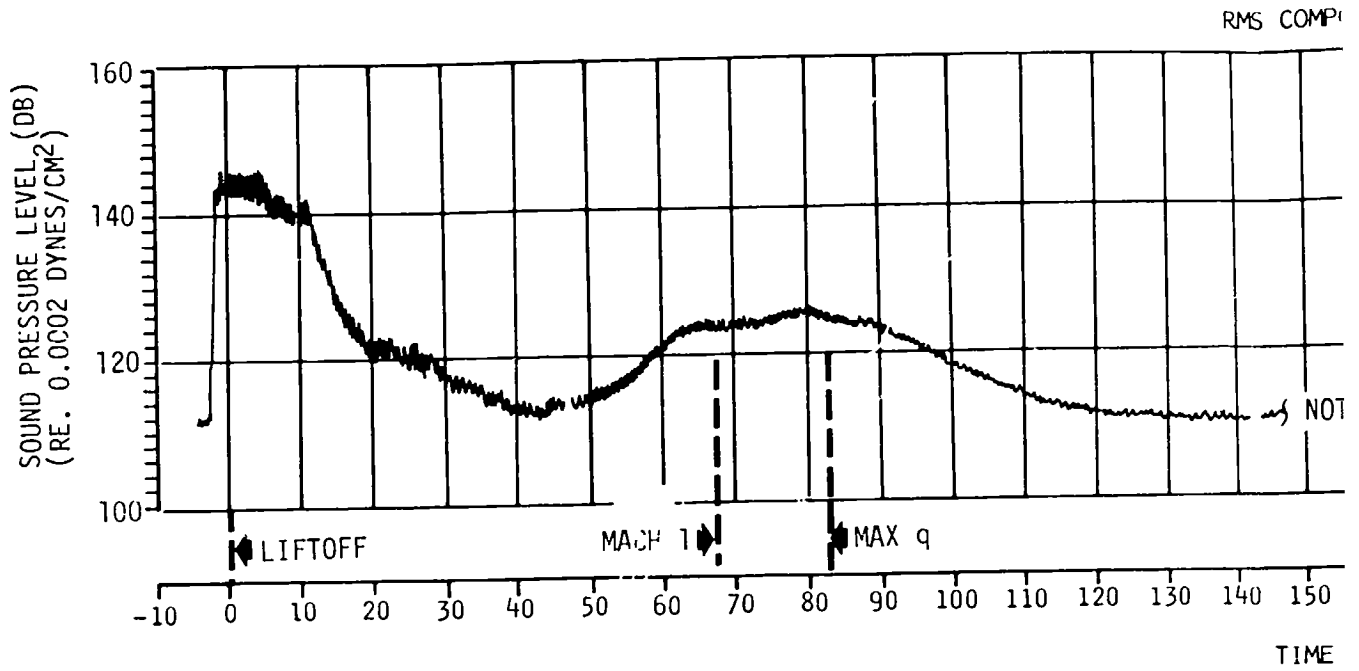

NOTE:
DATA NOT VALID BELOW 30 HZ
BECAUSE OF SSB RESPONSE

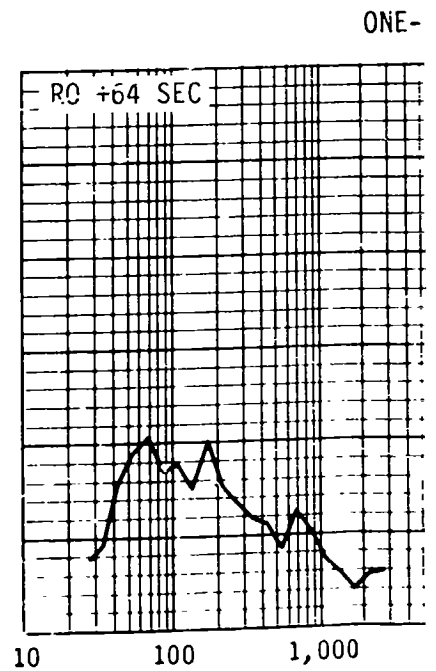
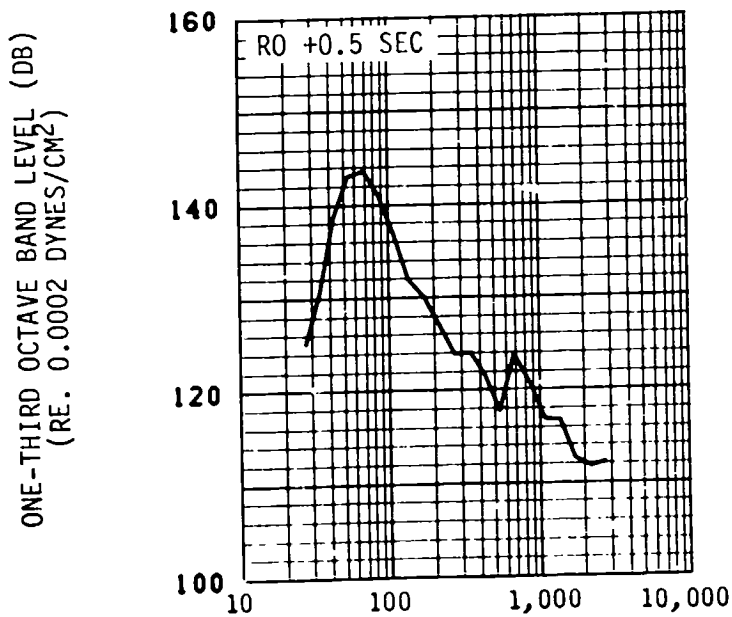

FOLDOUT FRAME

Figure 25-30. Internal Sound Pres

RMS COMPOSITE TIME-HISTORY

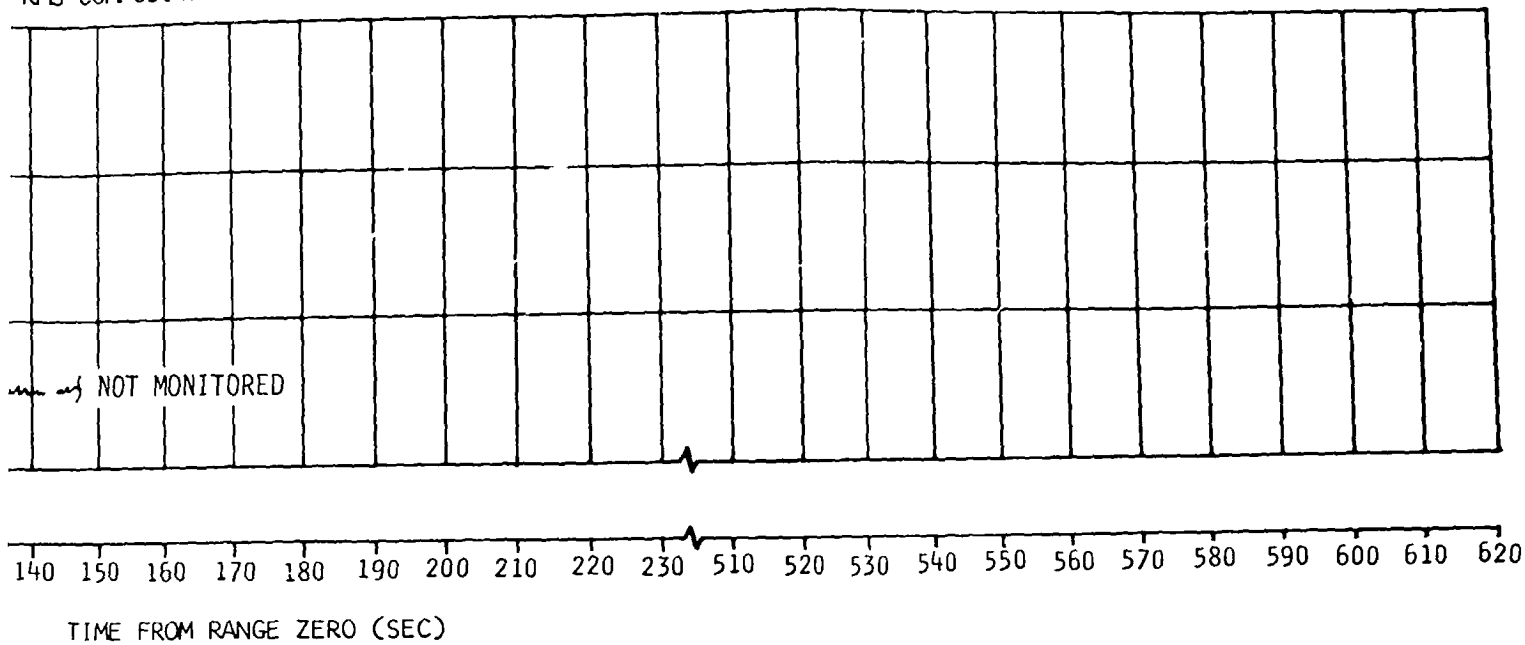

ONE-THIRD OCTAVE BAND PLOTS

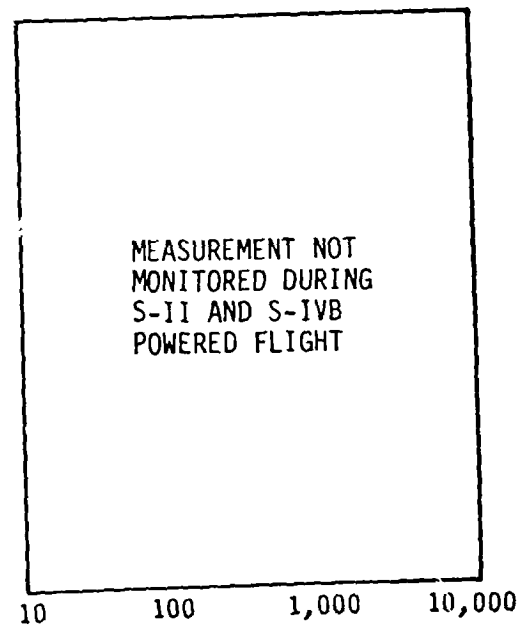
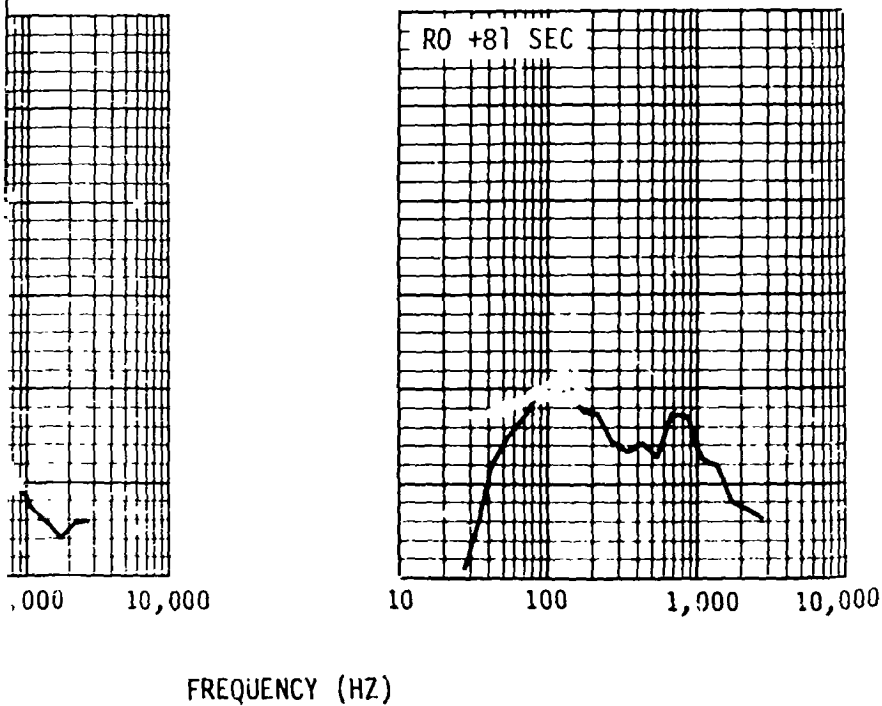

FOLDOUT FRAME

and Pressure Levels Measured on Aft Skirt - B0022-404

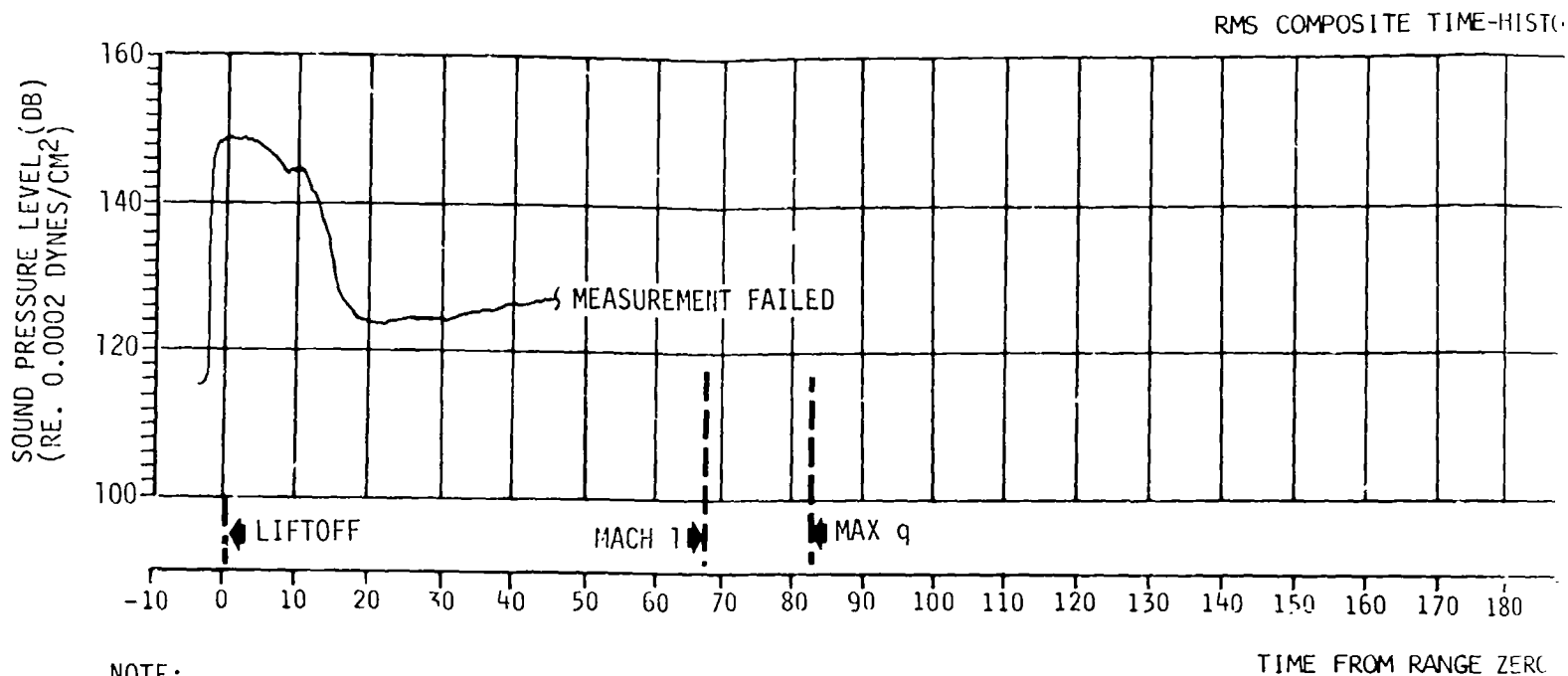

NOTE:
DATA NOT VALID BELOW 30 HZ
BECAUSE OF SSB RESPONSE

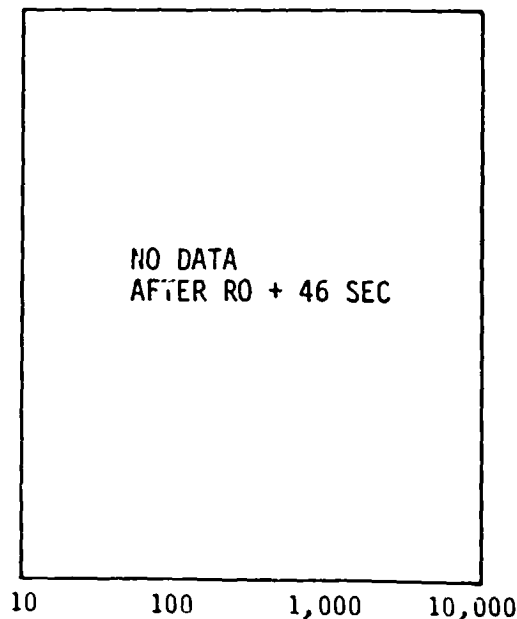
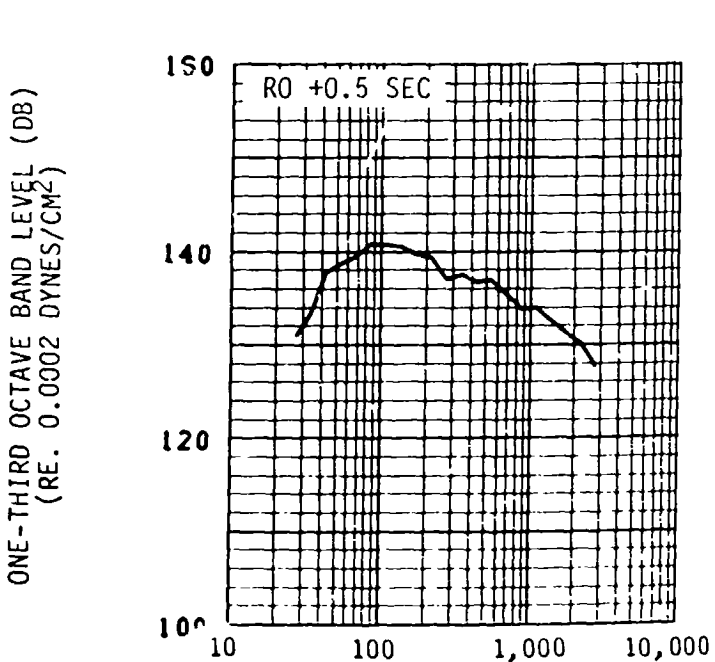

FREQUENCY (

Figure 25-31. External Sound Pressure Levels Measure

1-HISTORY

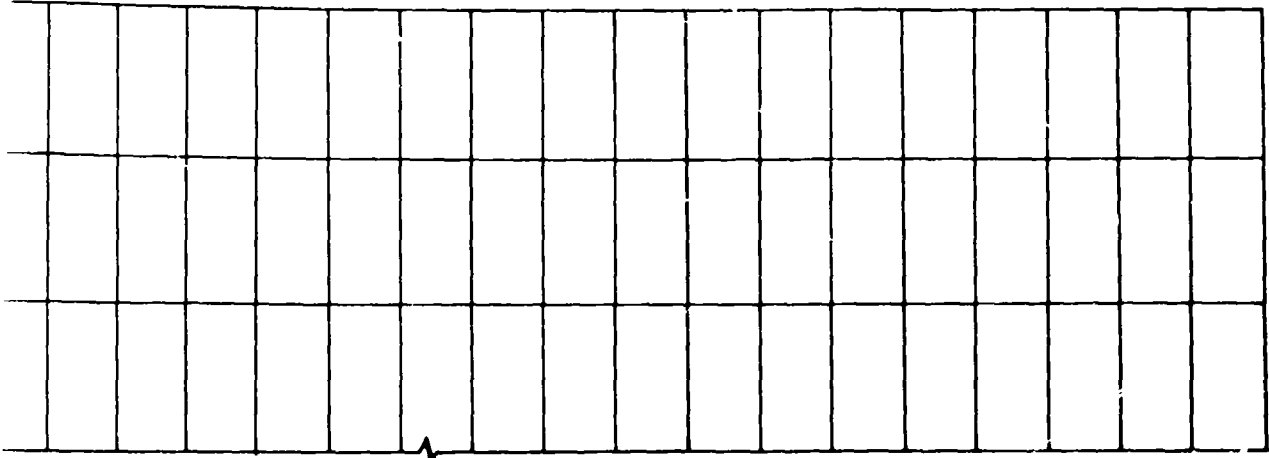

180 190 200 210 220 230 510 520 530 540 550 560 570 580 590 600 610 620

TIME ZERO (SEC)

AVE BAND PLOTS

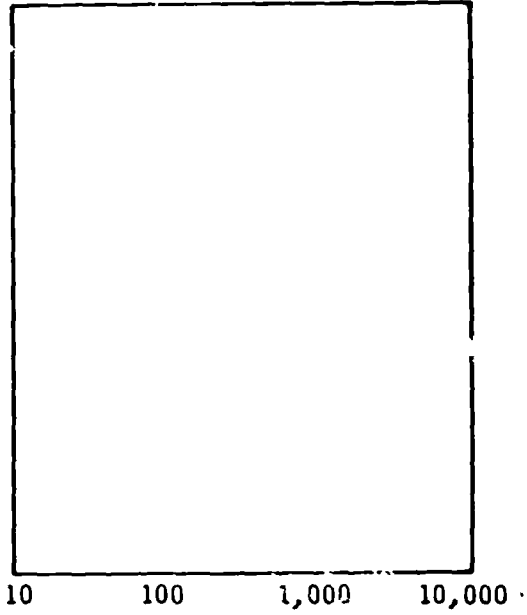
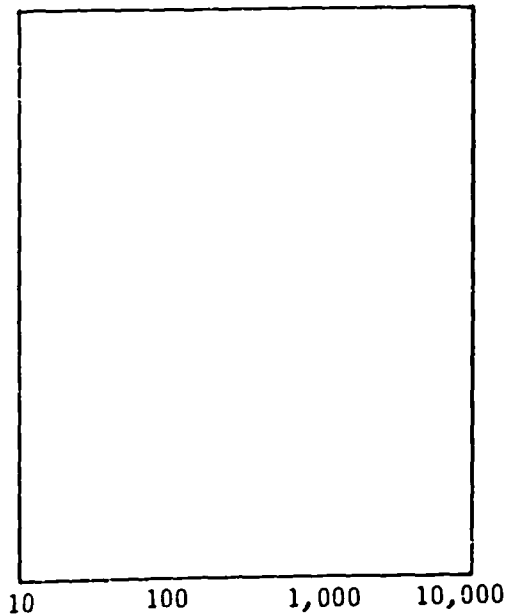

FREQUENCY (HZ)

Measured on Forward Skirt - B0025-426 FOLDOUT FRAME 2

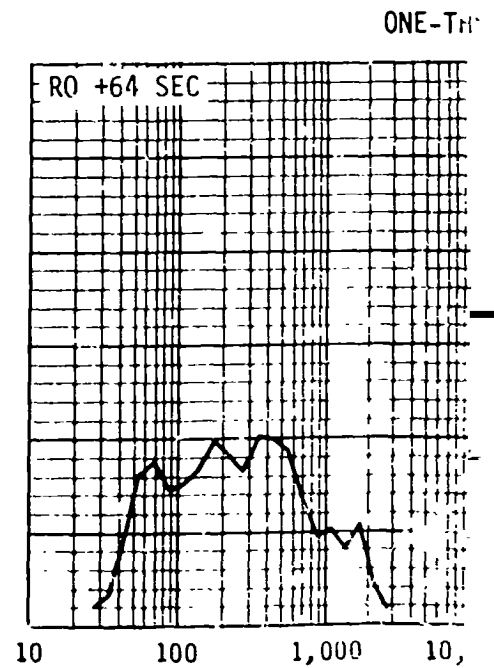
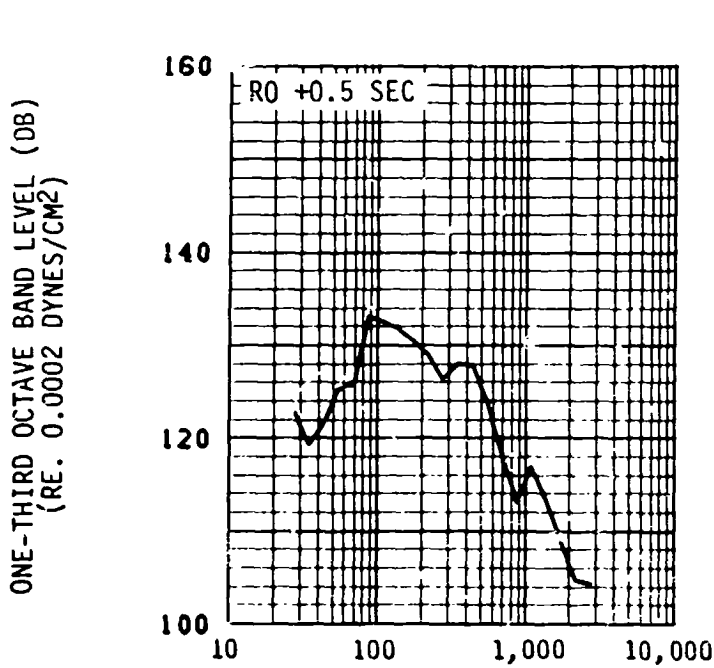
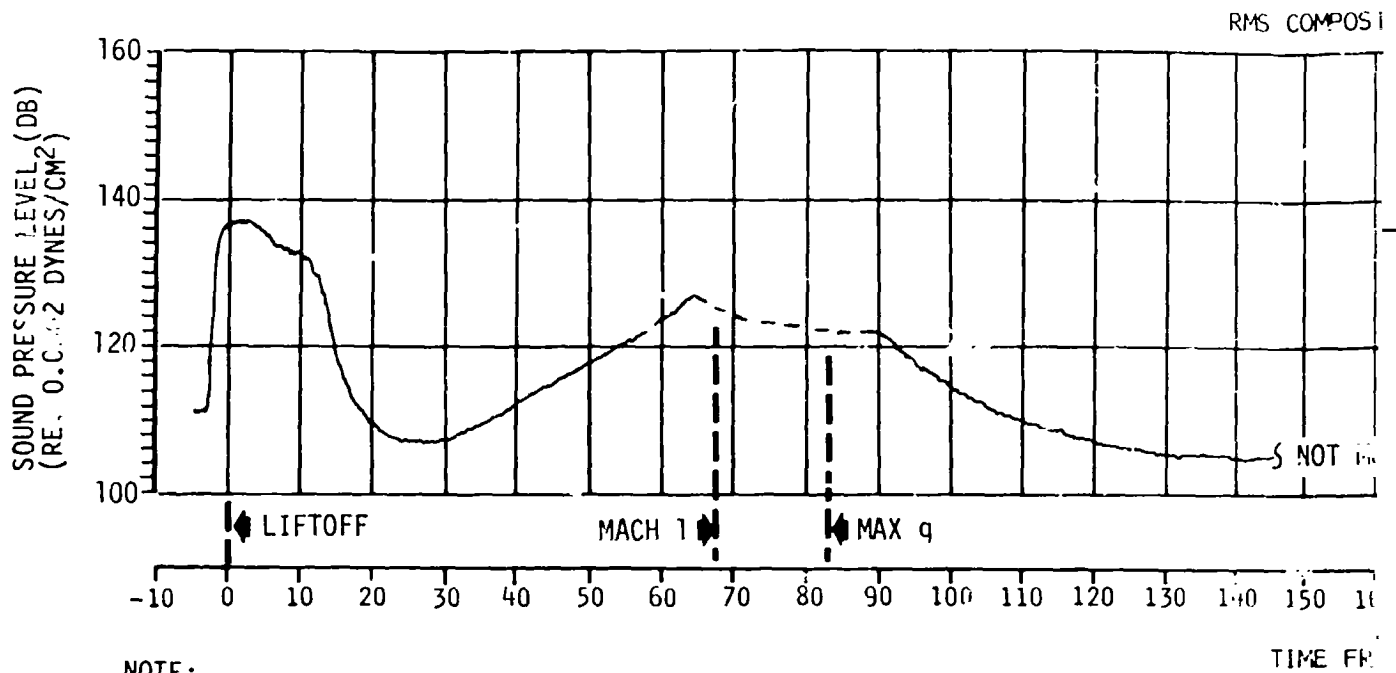

FOLDOUT FRAME

Figure 25-32. Internal Sound Pressure L

RMS COMPOSITE TIME-HISTORY

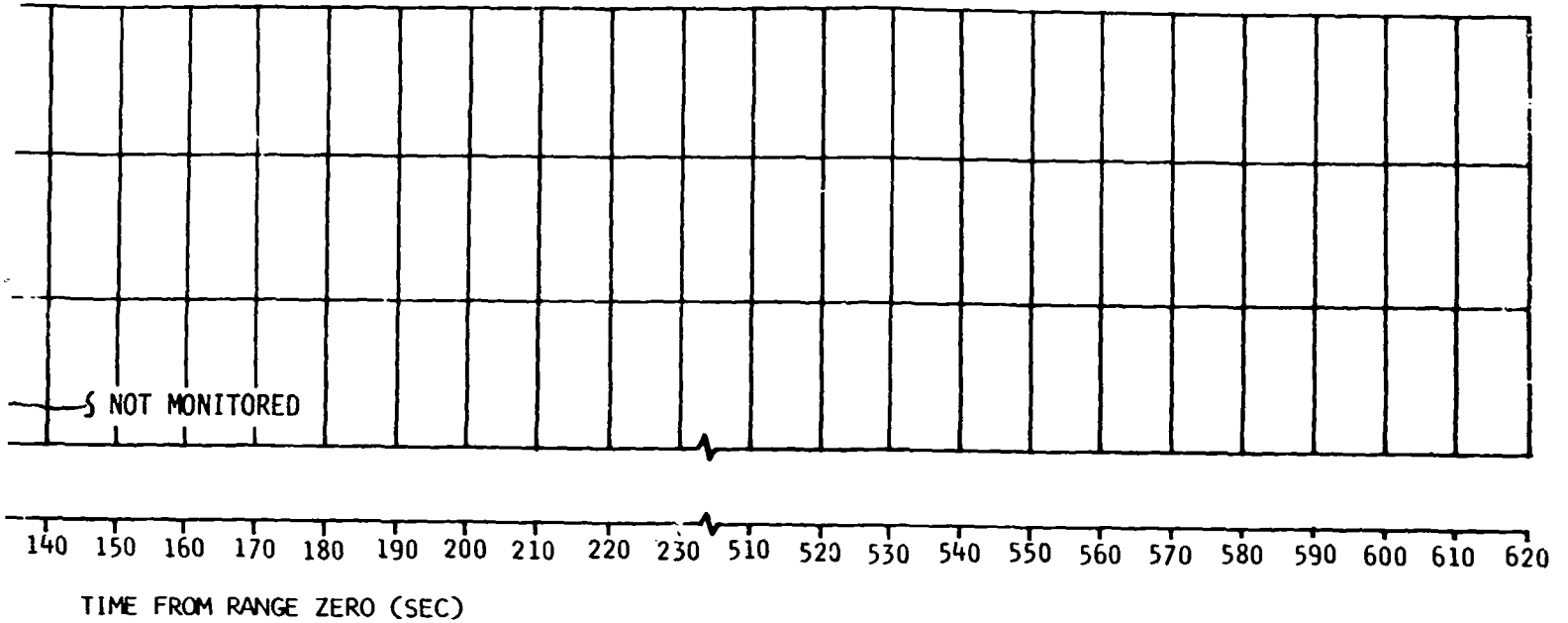

ONE-THIRD OCTAVE BAND PLOTS

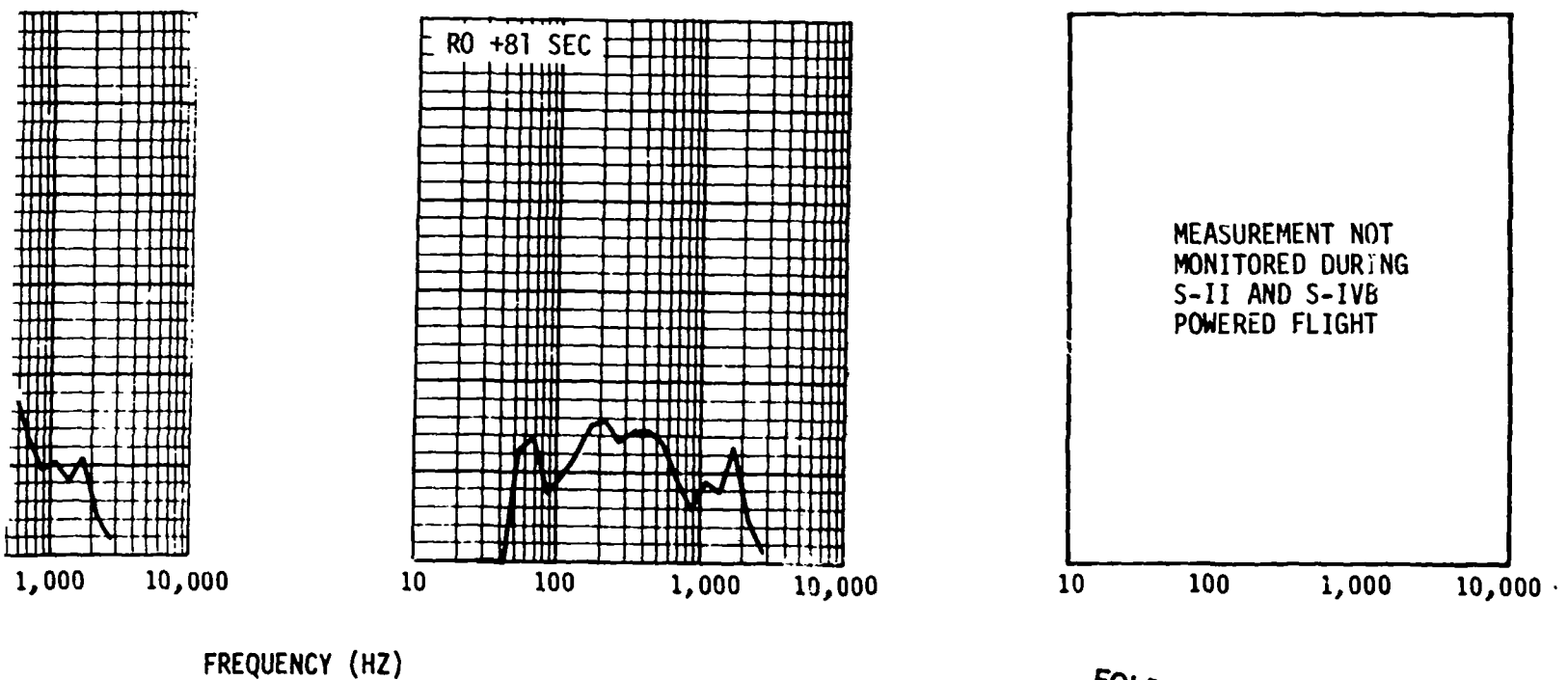

Pressure Levels Measured on Forward Skirt - B0016-411

FOLDOUT FRAME 2

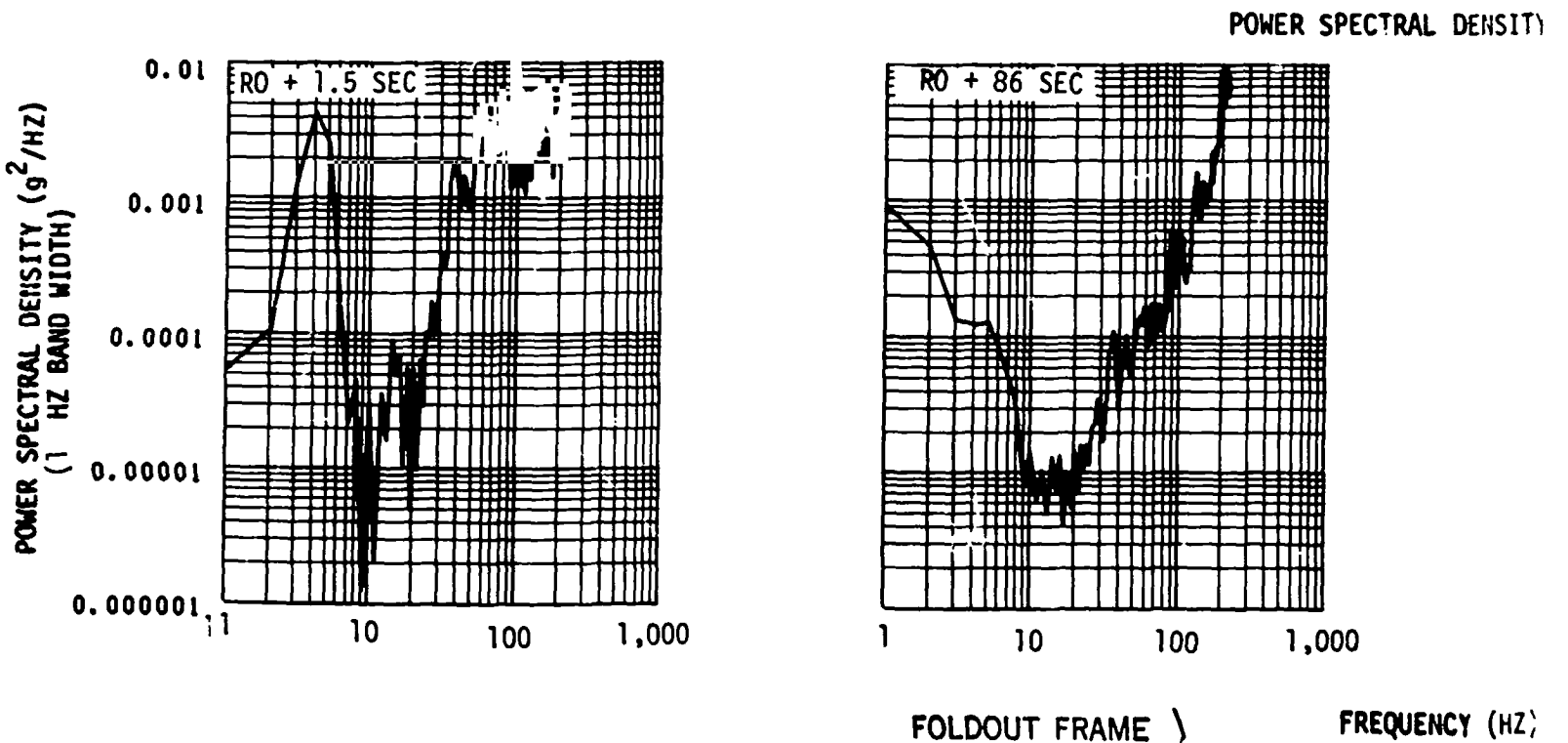
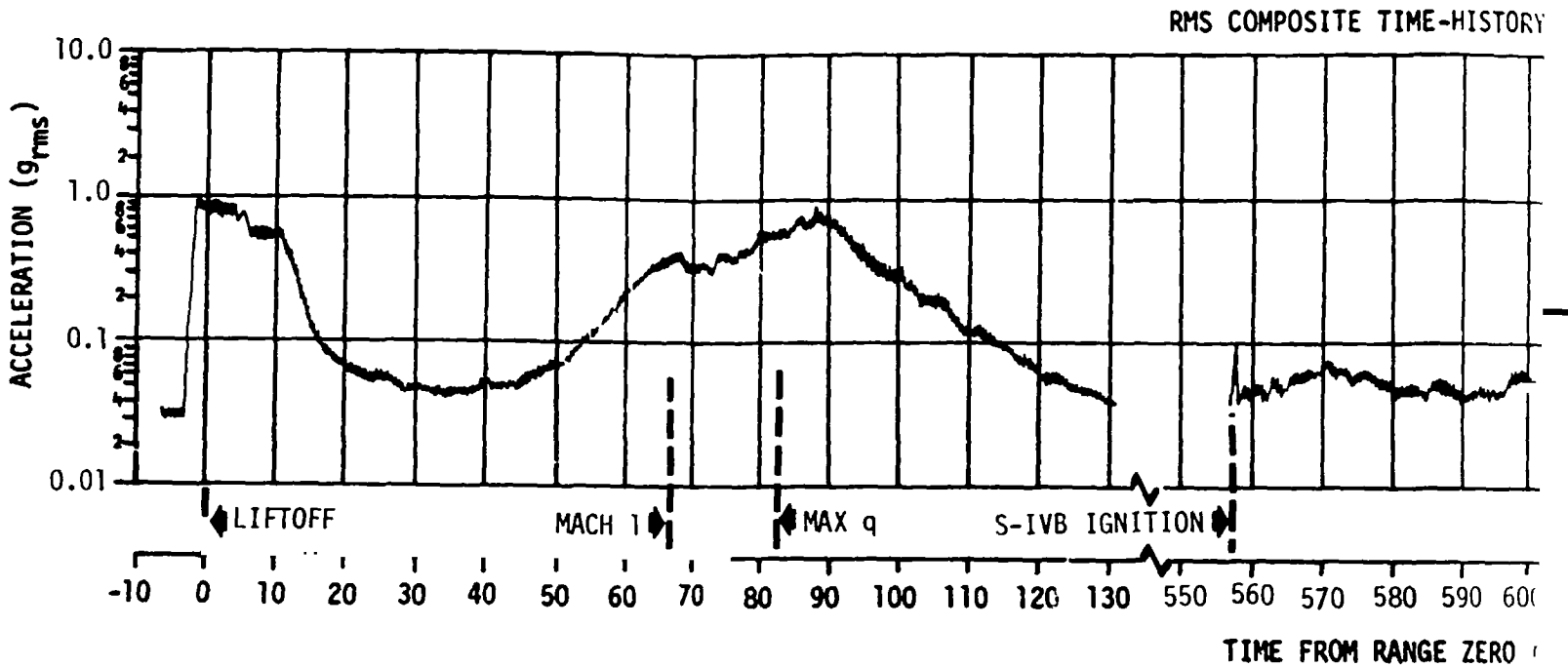
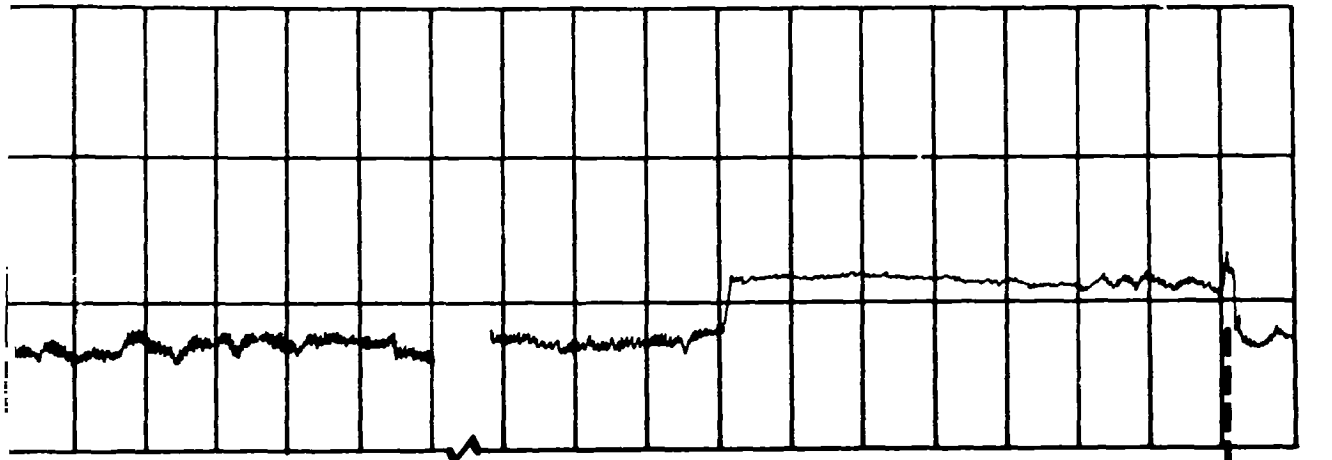

Figure 25-33. Vibration Measured on Field Splice Position I, T

TIME-HISTORY



80 590 600 610 620 630 640 9460 9480 9500 9520 9540 9560

RANGE ZERO (SEC)

SPECTRAL DENSITY PLOTS

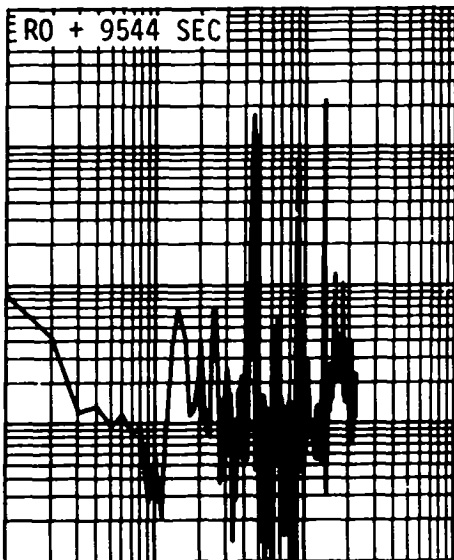
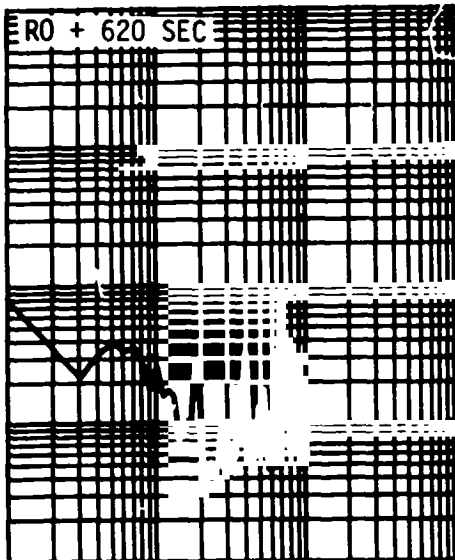

1 10 100 1,000

1 10 100 1,000

FREQUENCY (HZ)

Position I, Thrust Direction - E0091-411

FOLDOUT FRAME 2

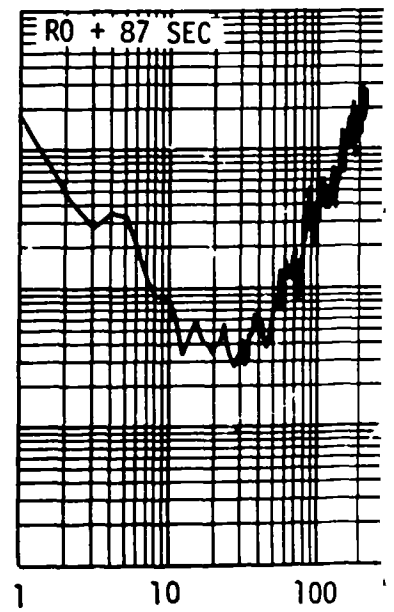
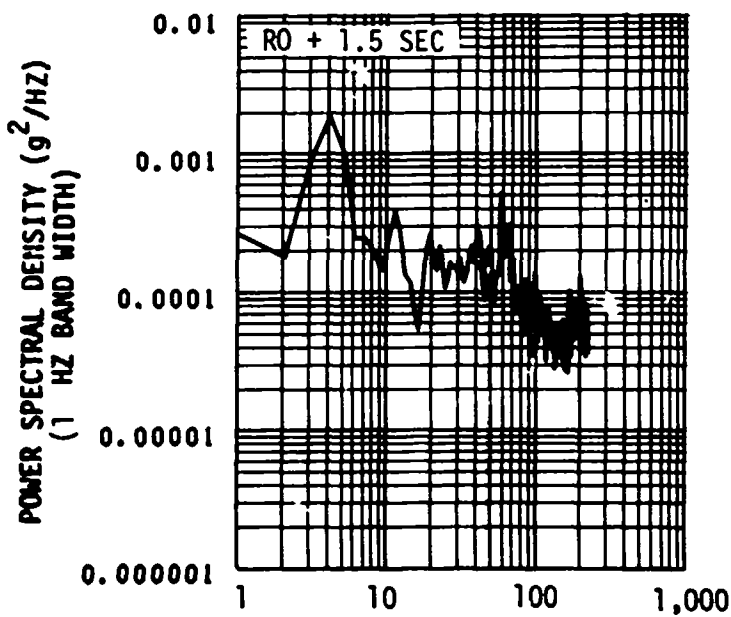
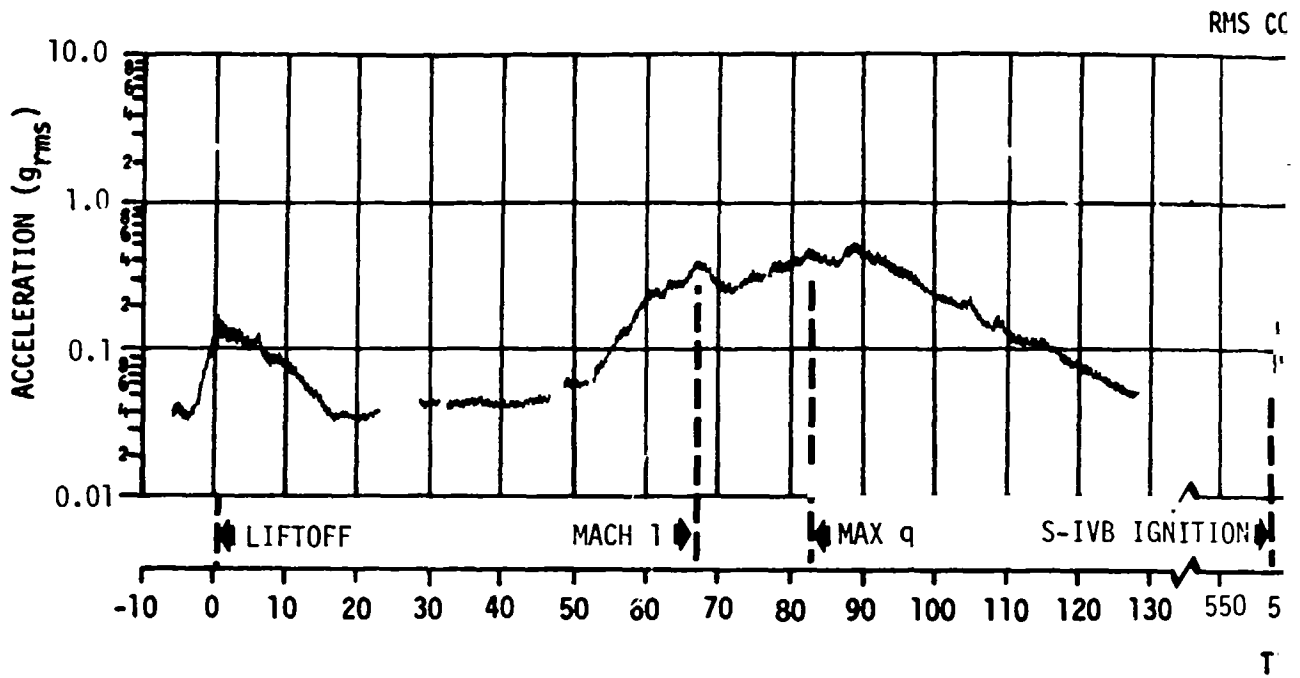

FOLDOUT FRAME

Figure 25-34. Vibration Measured on Separat

IMS COMPOSITE TIME-HISTORY

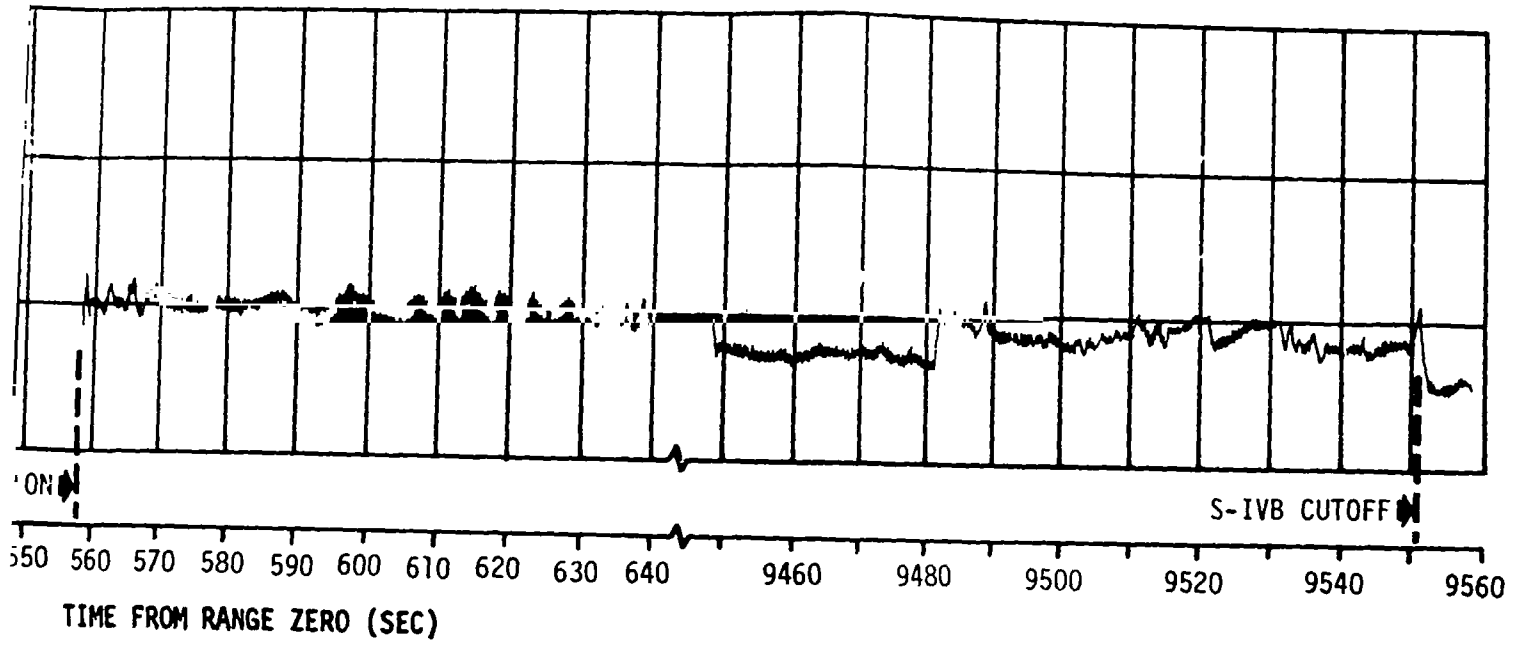

POWER SPECTRAL DENSITY PLOTS

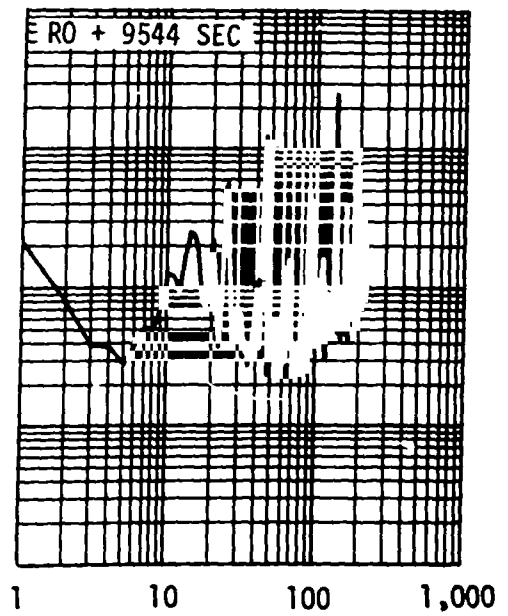
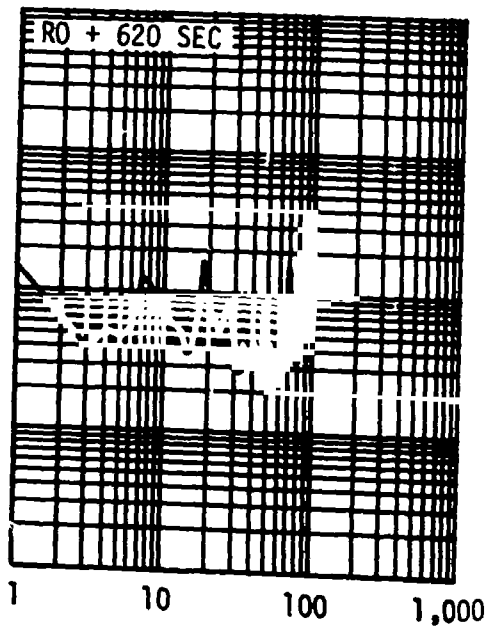
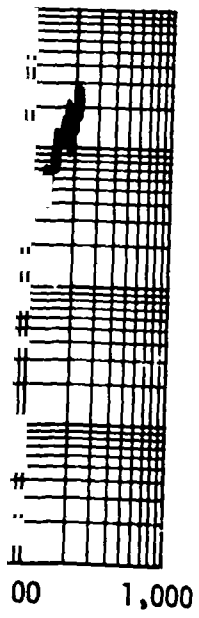

FREQUENCY (HZ)

FOLDOUT FRAME 2

Separation Plane Position II, Thrust Direction - E0092-404

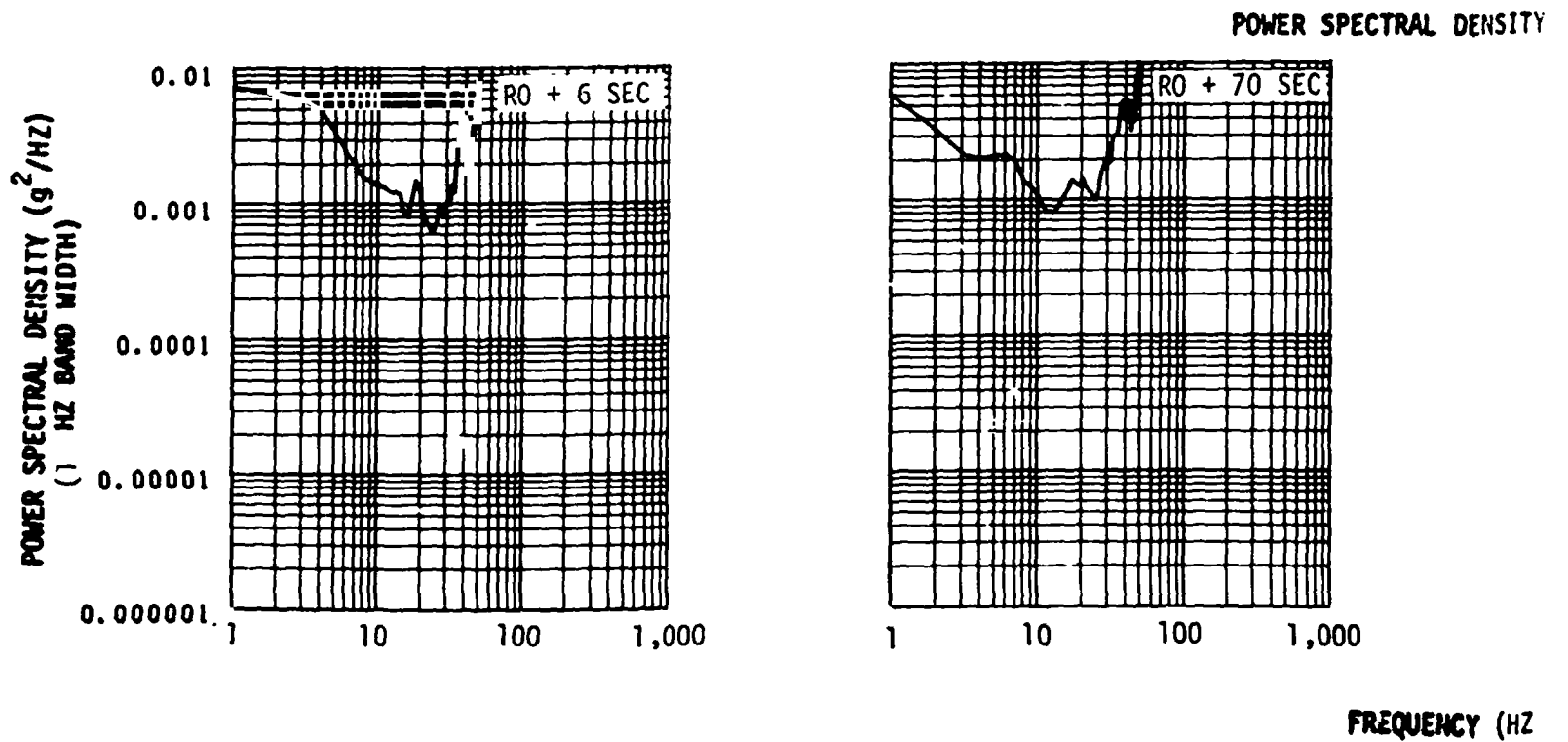
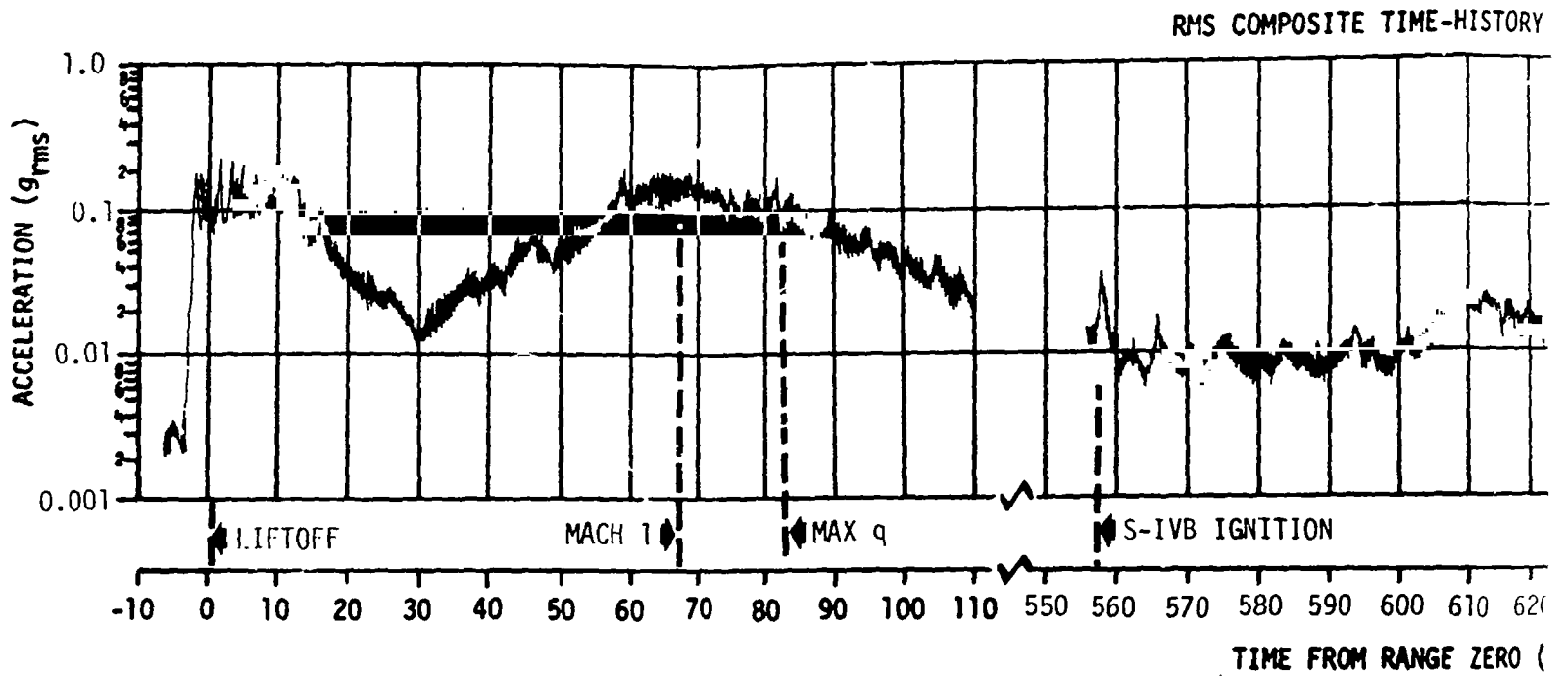
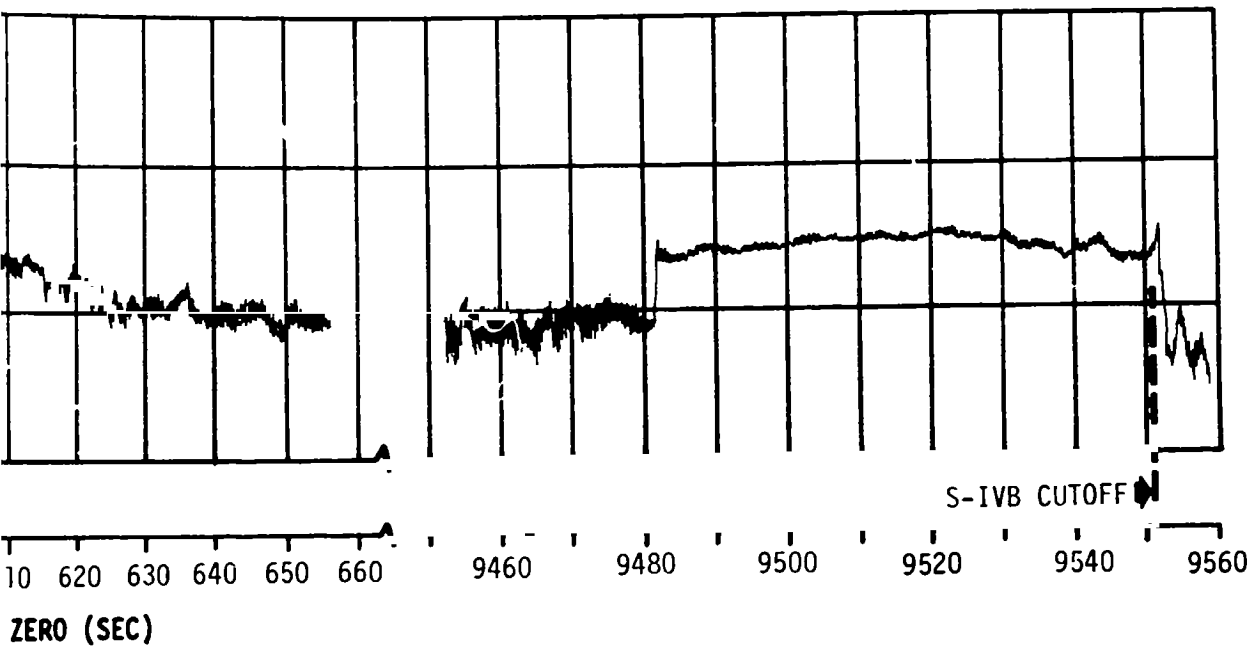
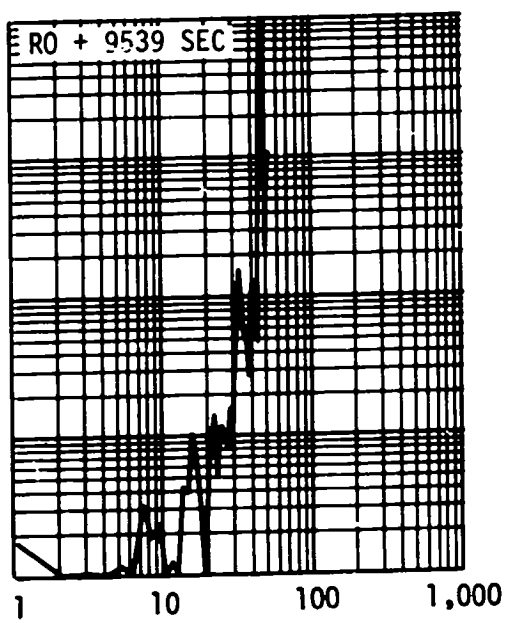
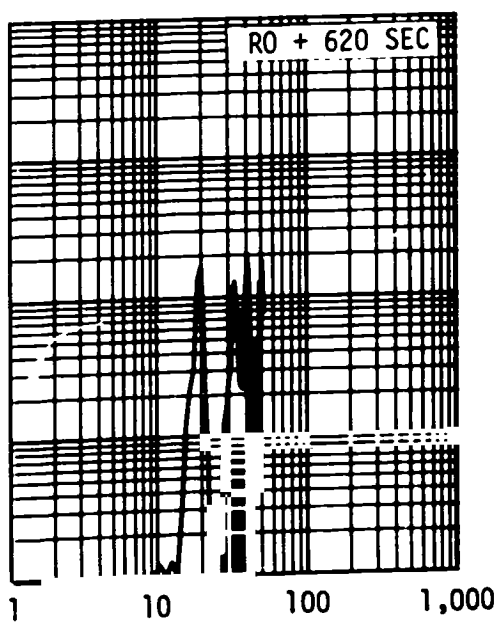

Figure 25-35. Forward Skirt Body Bending, Pitch Direct

ISTORY



DENSITY PLOTS



Y (HZ)

irection - E0099-411

FOLDOUT FRAME 2

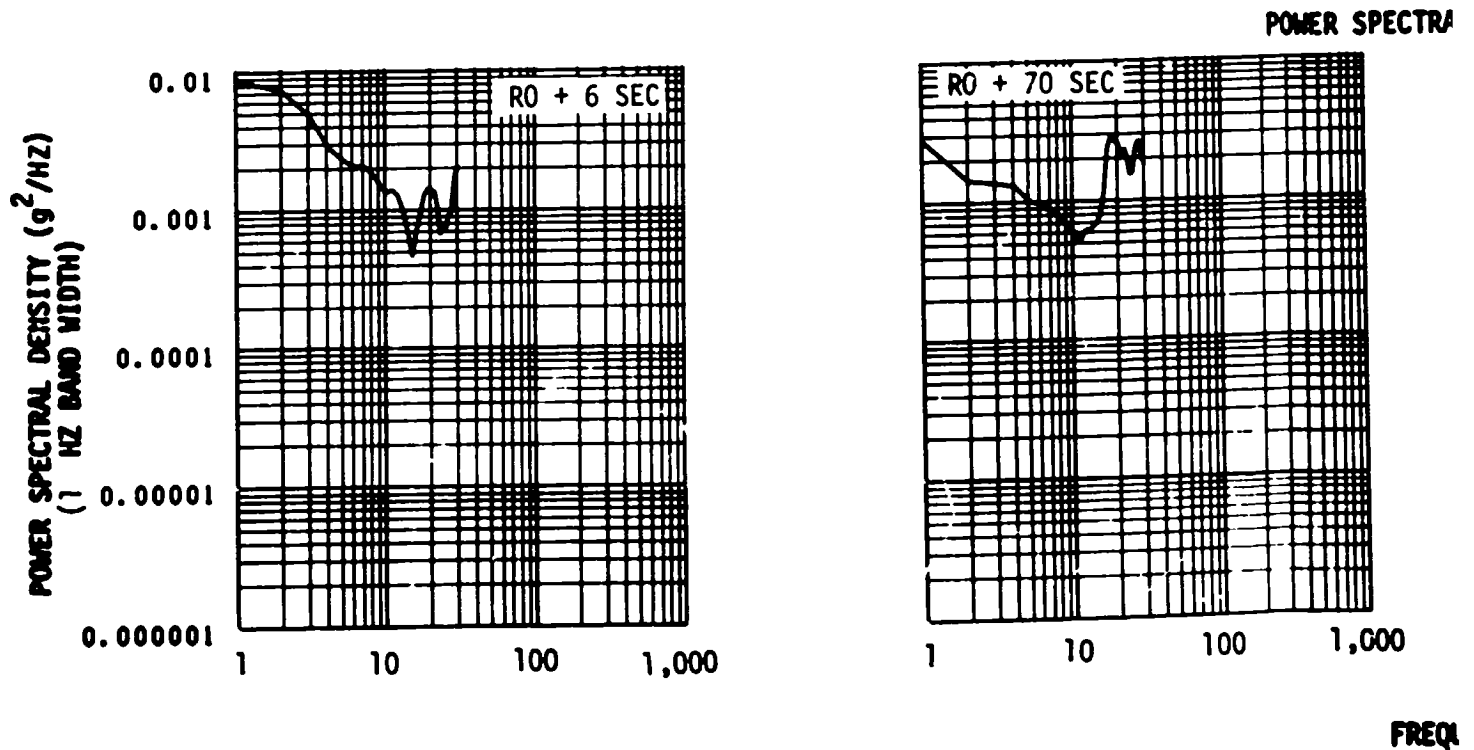
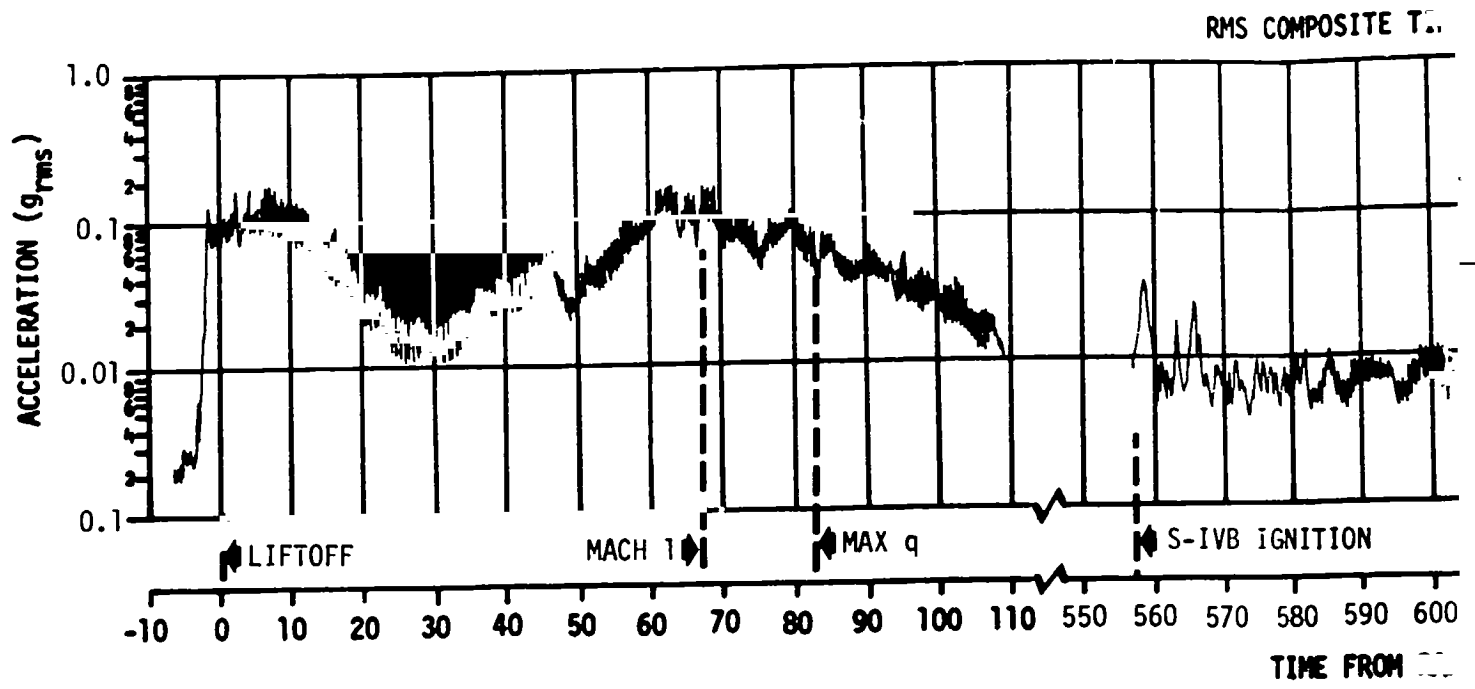

FOLDOUT FRAME

Figure 25-36. Forward Skirt Body Bending,

ITE TIME-HISTORY

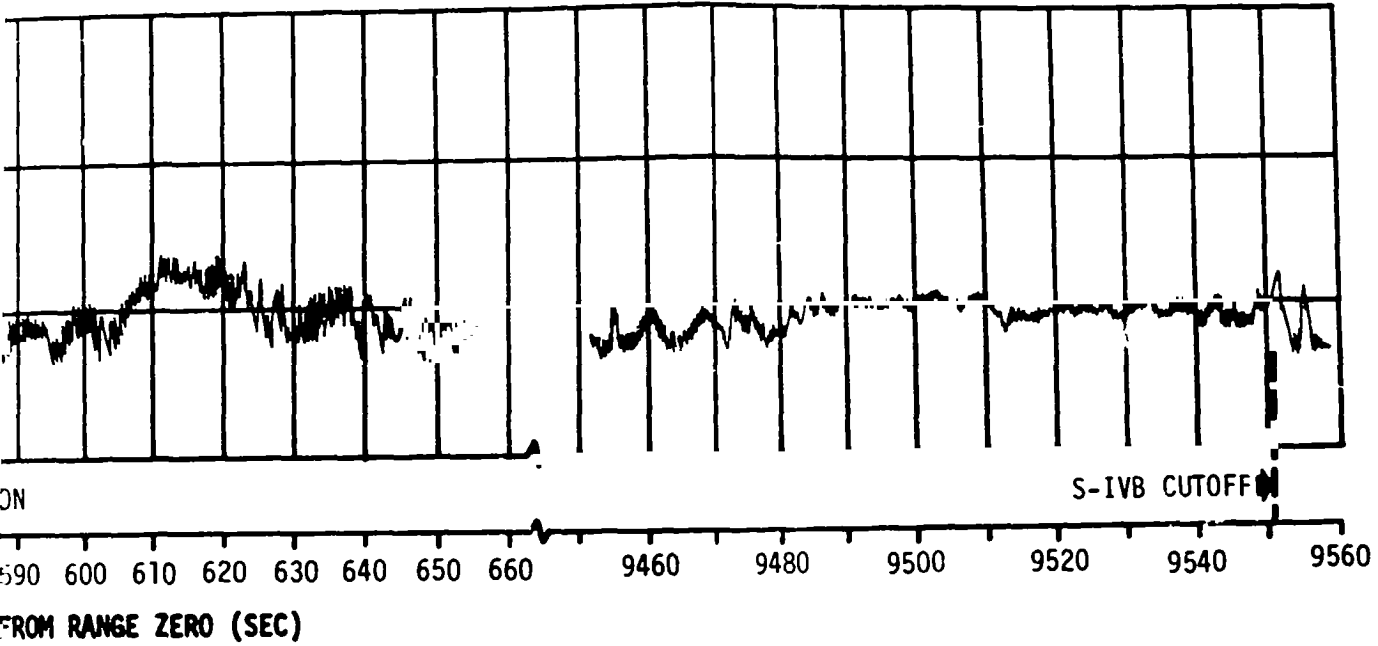

SPECTRAL DENSITY PLOTS

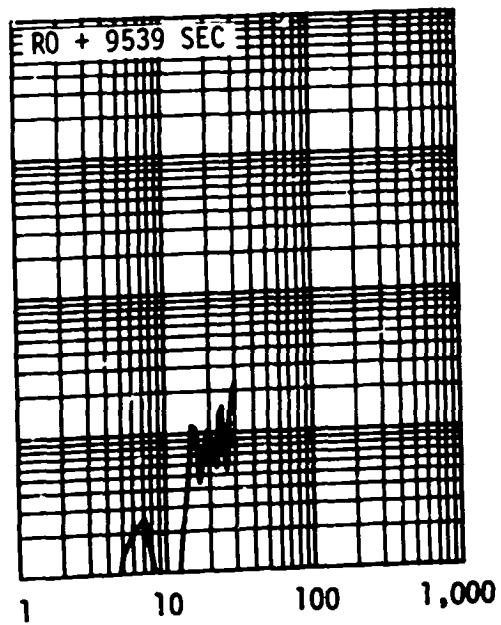
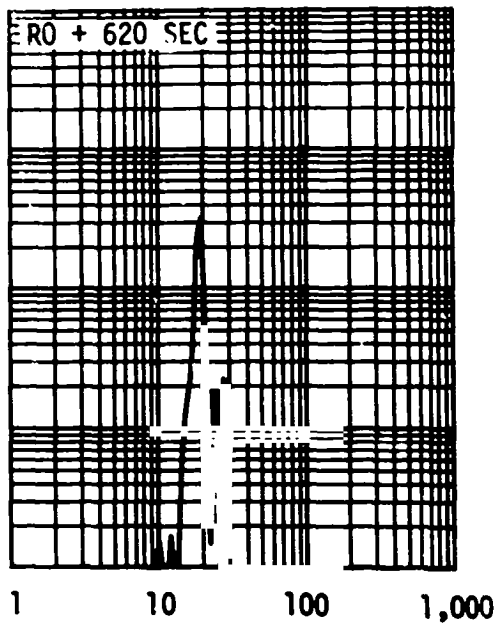

FREQUENCY (HZ)

FOLDOUT FRAME 2

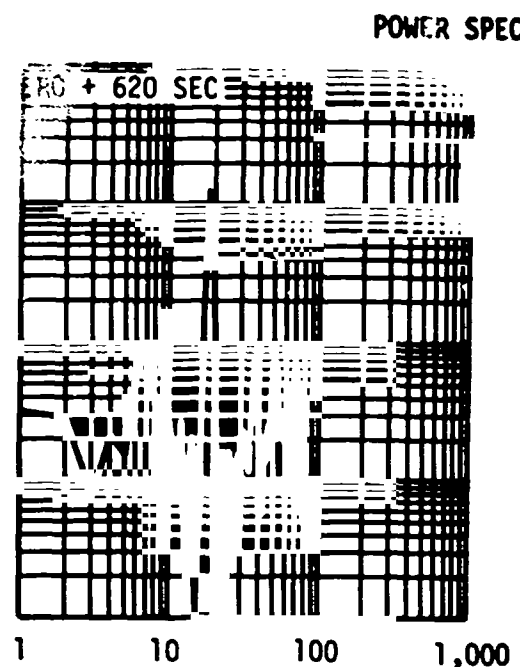
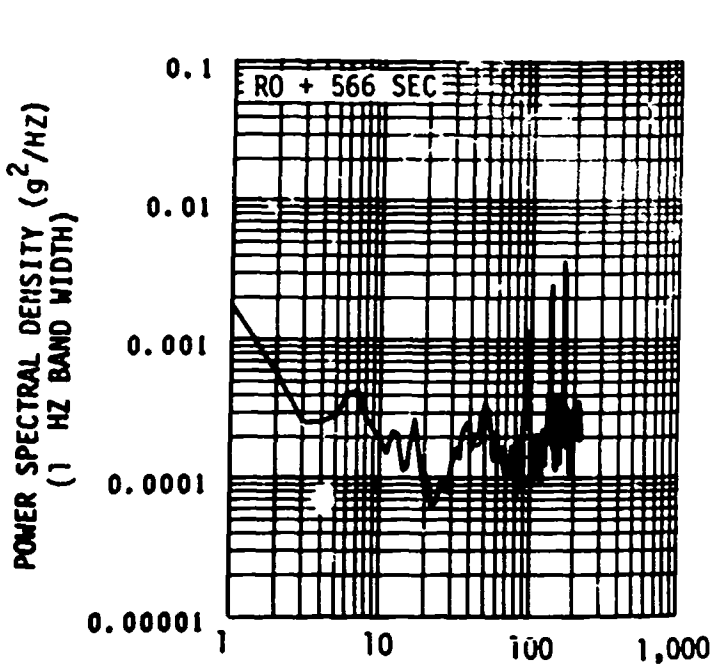
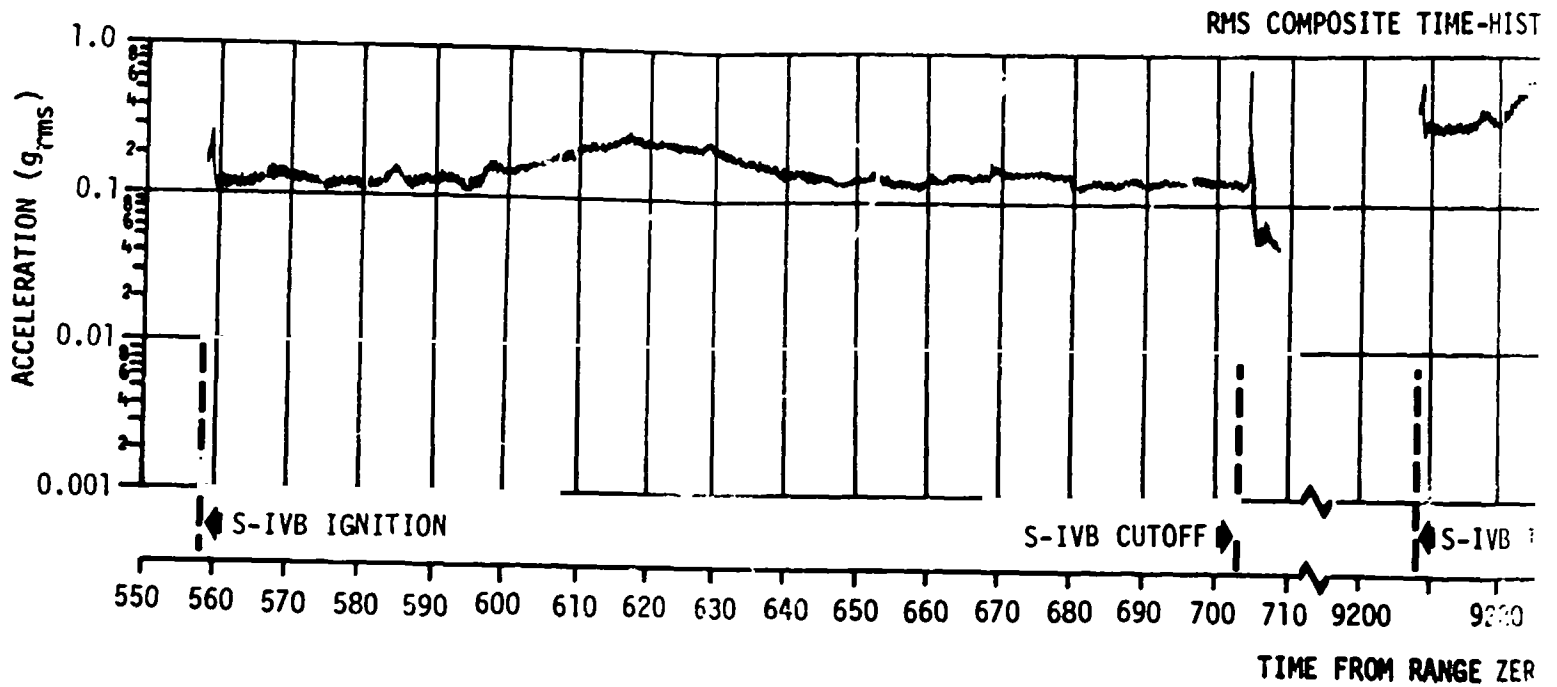

FREQUENCY (

Figure 25-37. Vibration Measured on Combustion Chamber Dome

TE TIME-HISTORY

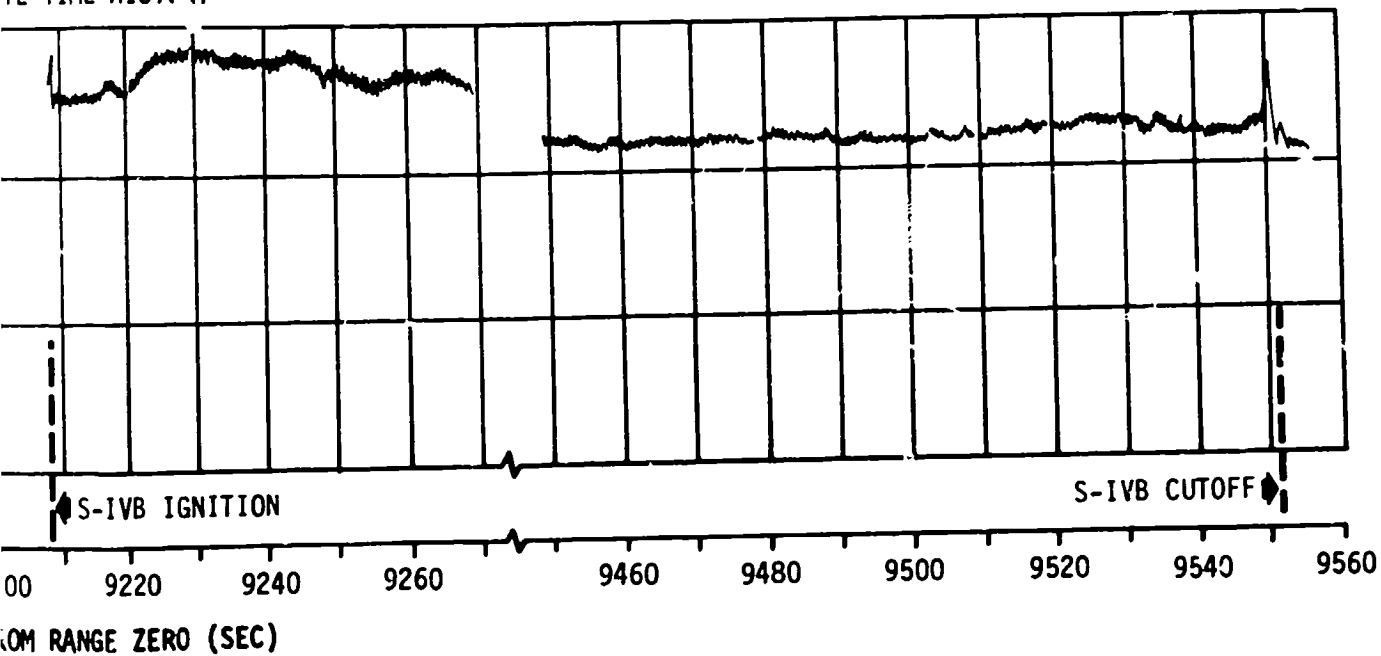

SPECTRAL DENSITY PLOTS

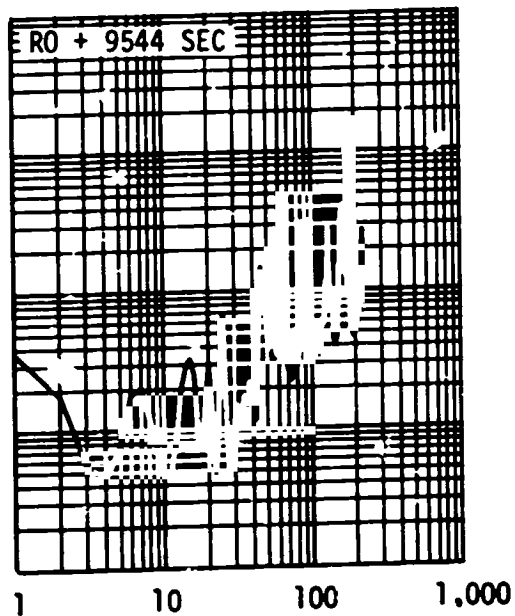
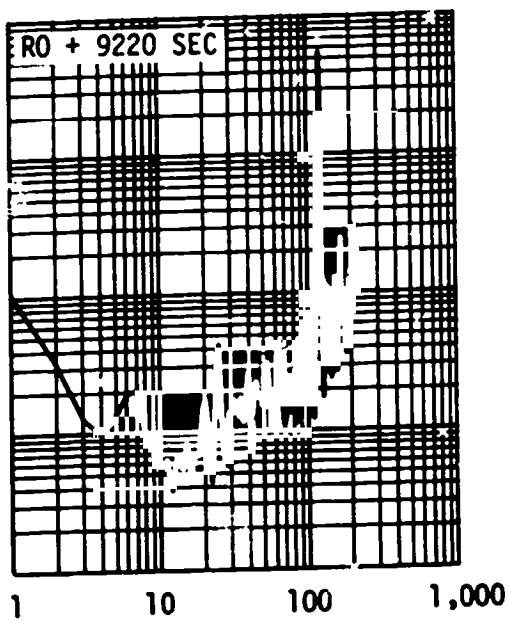

FREQUENCY (HZ)

Chamber Dome, Thrust Direction - E0251-401

FOLDOUT FRAME 2

RMS COMP

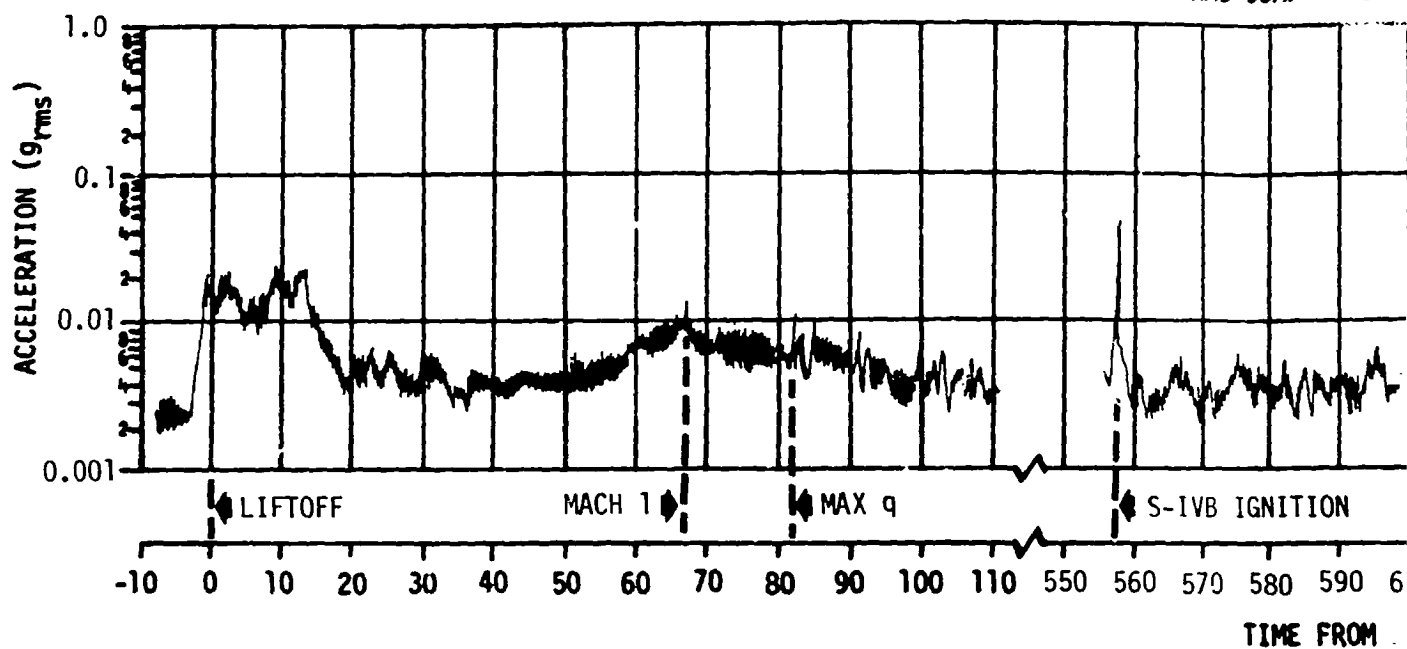

POWER SPEC

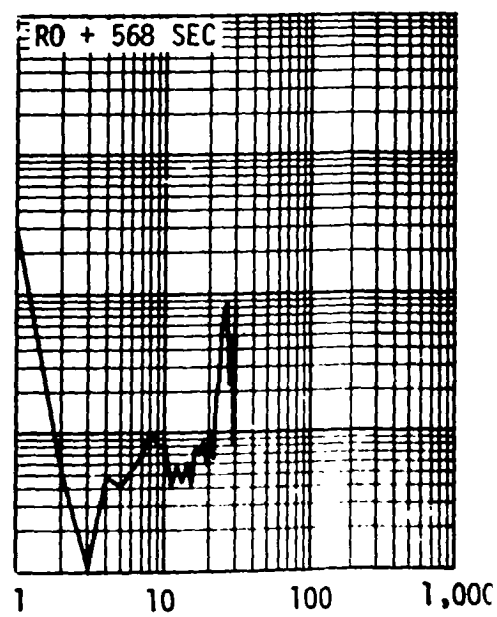
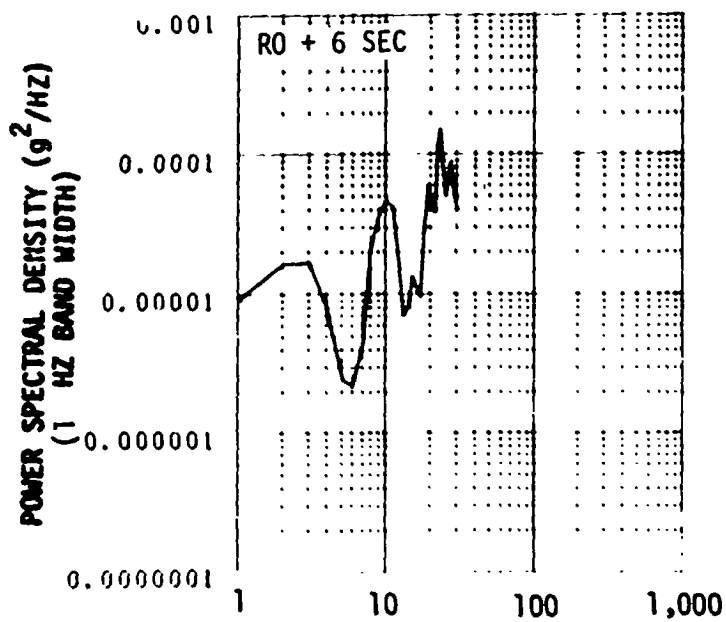

FOLDOUT FRAME

F

Figure 25-38. Acceleration Measured on Gimbal

COMPOSITE TIME-HISTORY

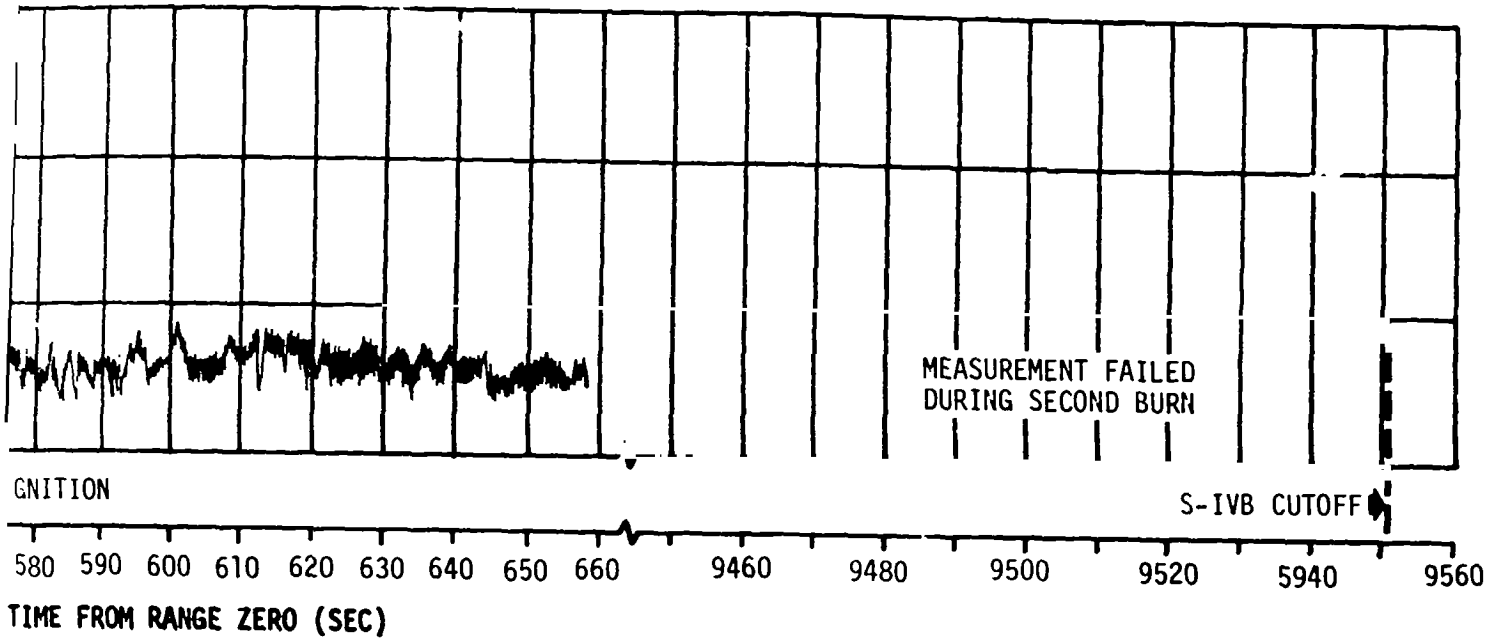

POWER SPECTRAL DENSITY PLOTS

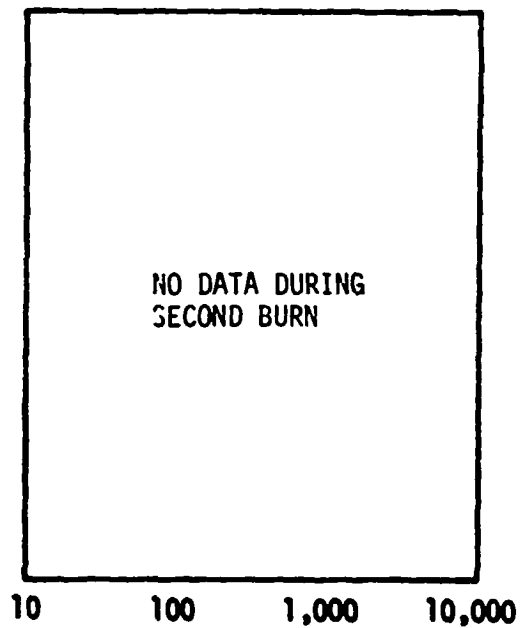
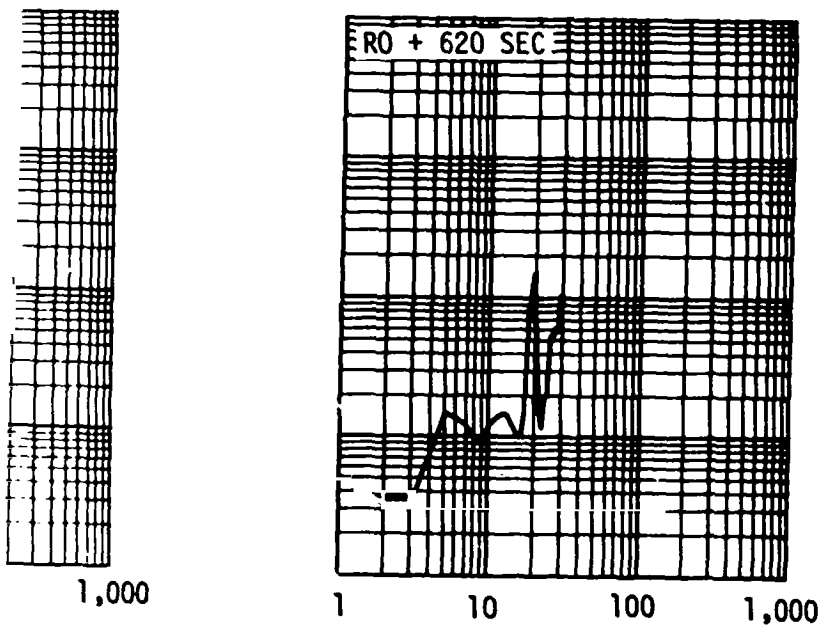

FREQUENCY (HZ)

EOLDOUT FRAME }

on Gimbal Block, Pitch Direction - A0010-403

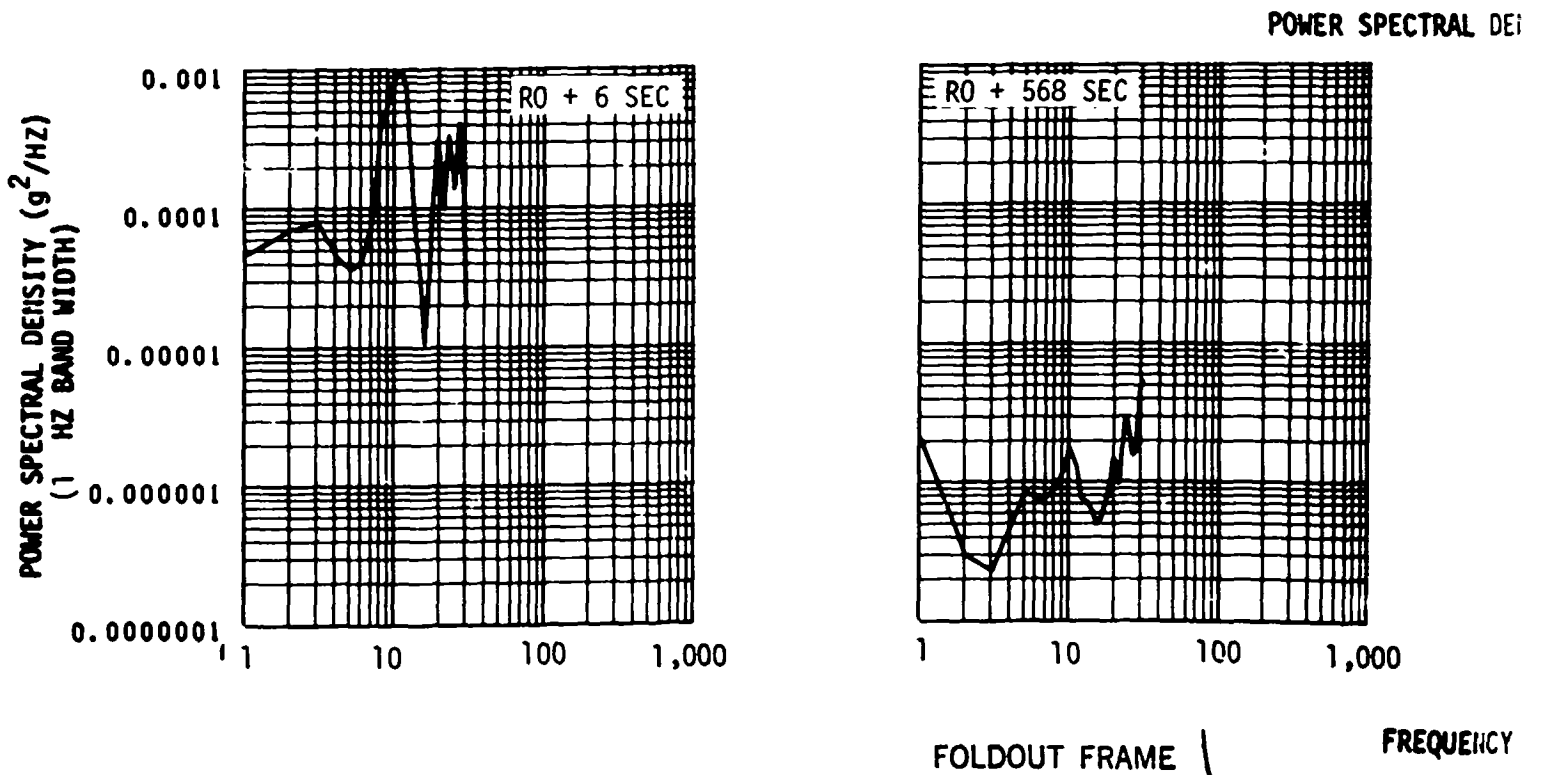
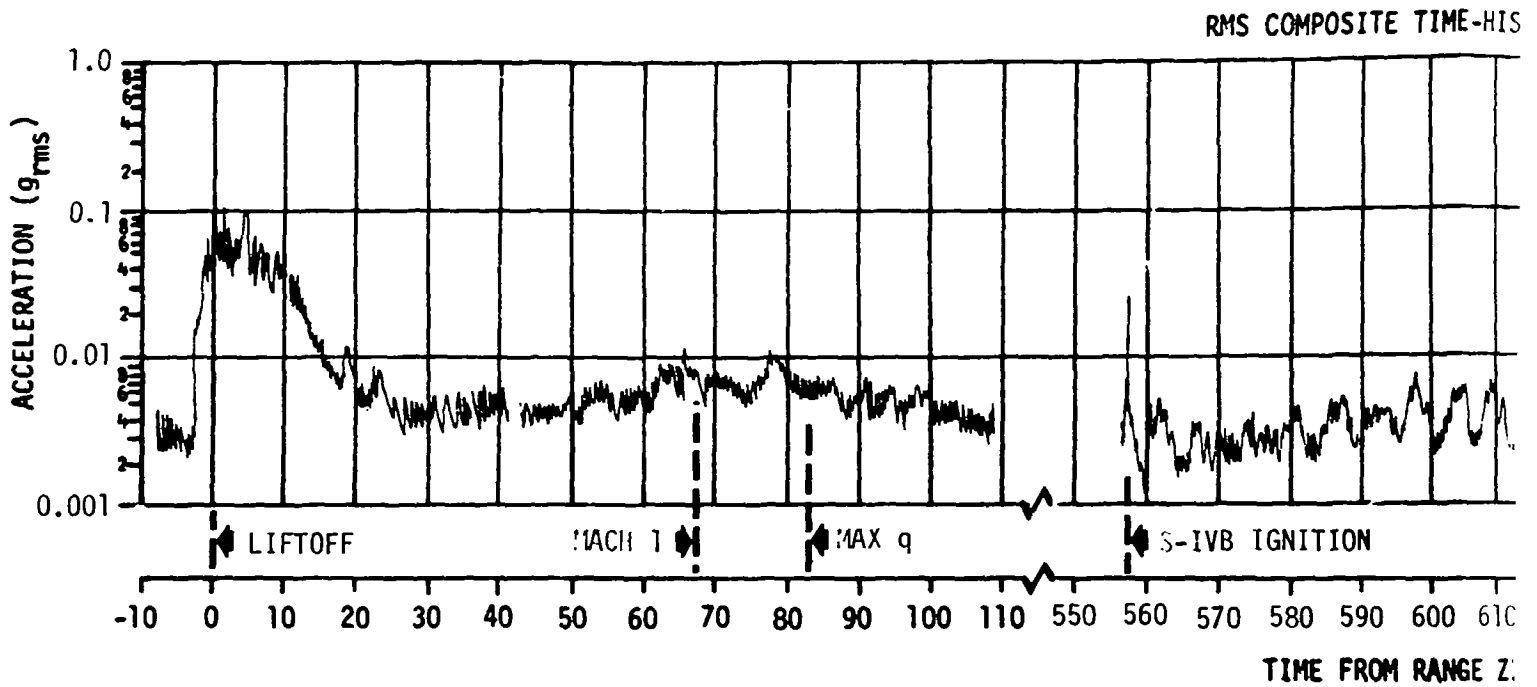
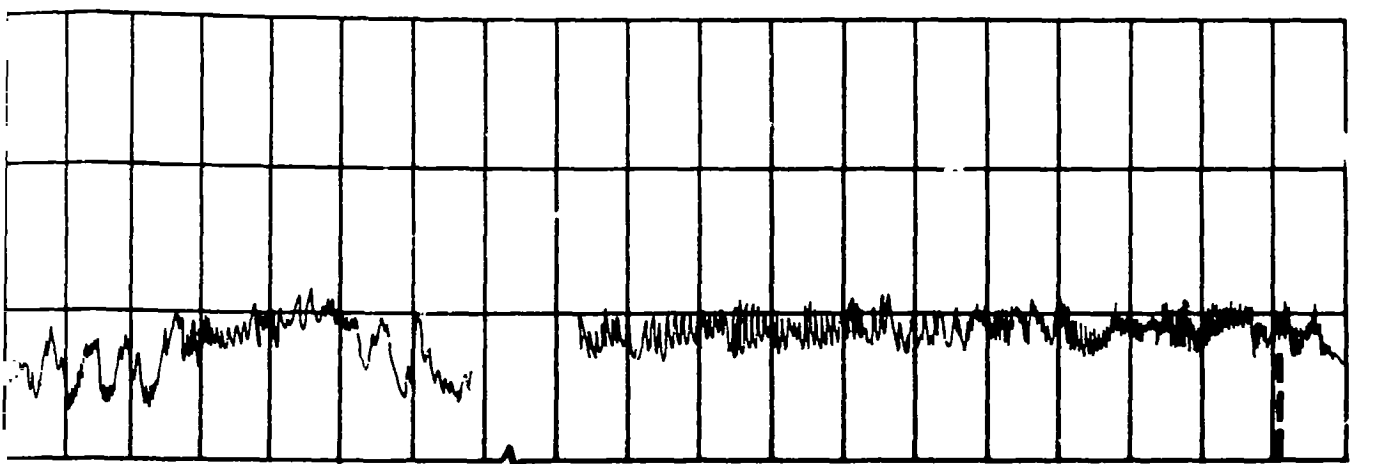

Figure 25-39. Acceleration Measured on Gimbal Block.

TE TIME-HISTORY



S-IVB CUTOFF

0 600 610 620 630 640 650 660 9460 9480 9500 9520 9540 9560

OM RANGE ZERO (SEC)

SPECTRAL DENSITY PLOTS

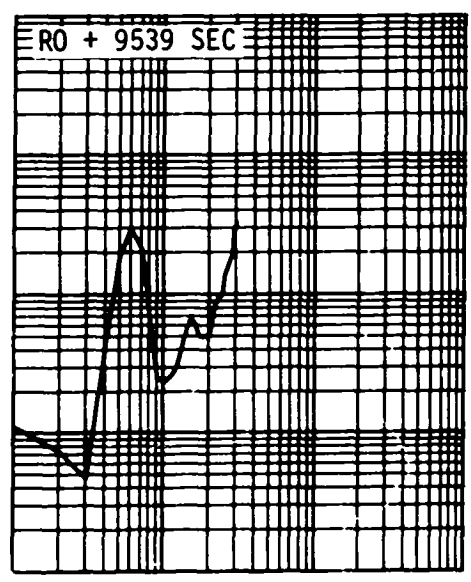
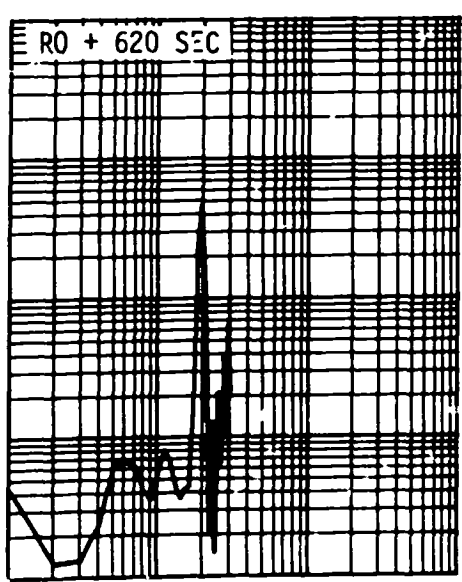

1 10 100 1,000

1 10 100 1,000

FREQUENCY (HZ)

FOLDOUT FRAME 2

al Block, Yaw Direction - A0011-403

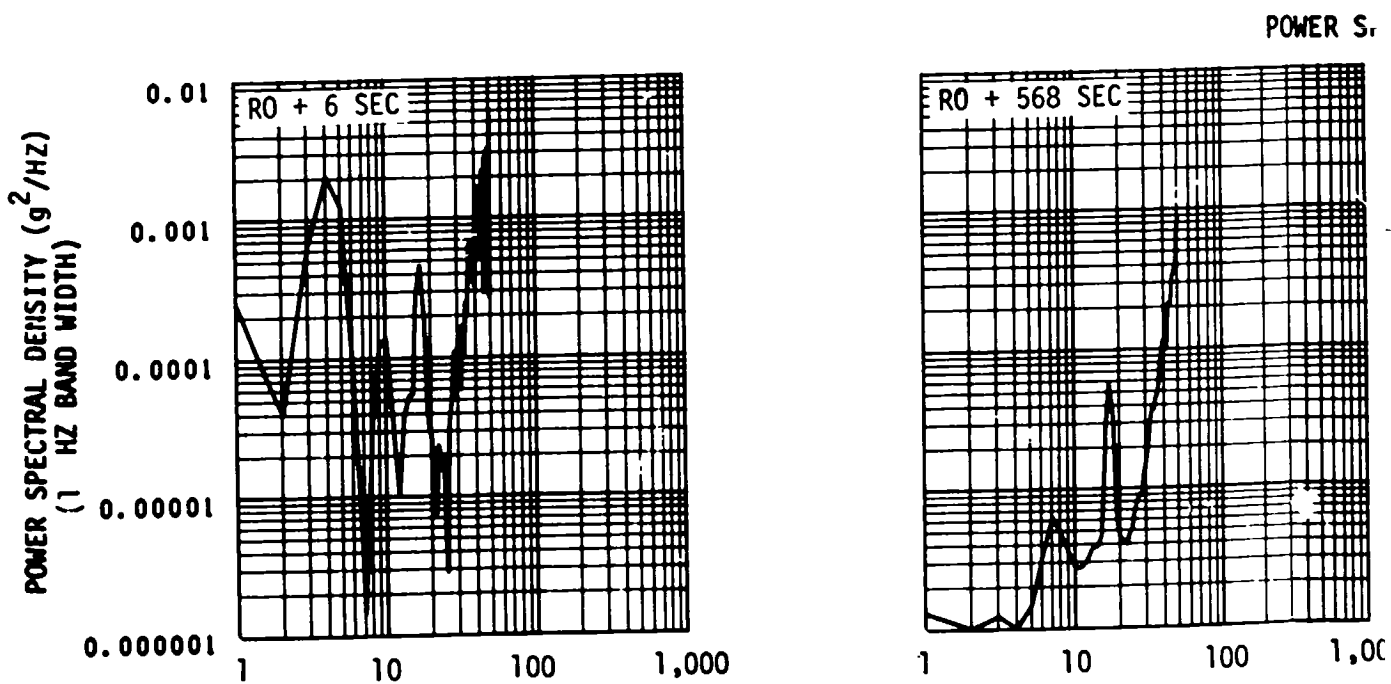
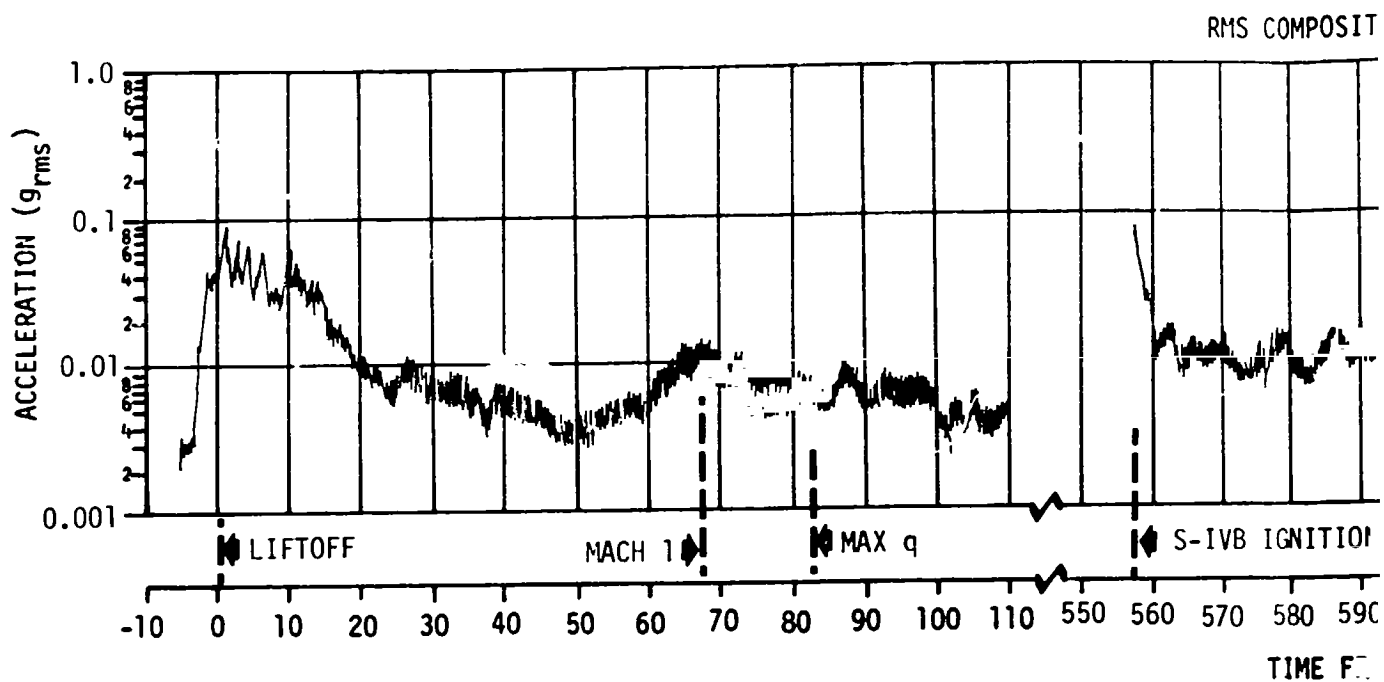

EOLDOUT FRAME

Figure 25-40. Acceleration Measured on Gimba

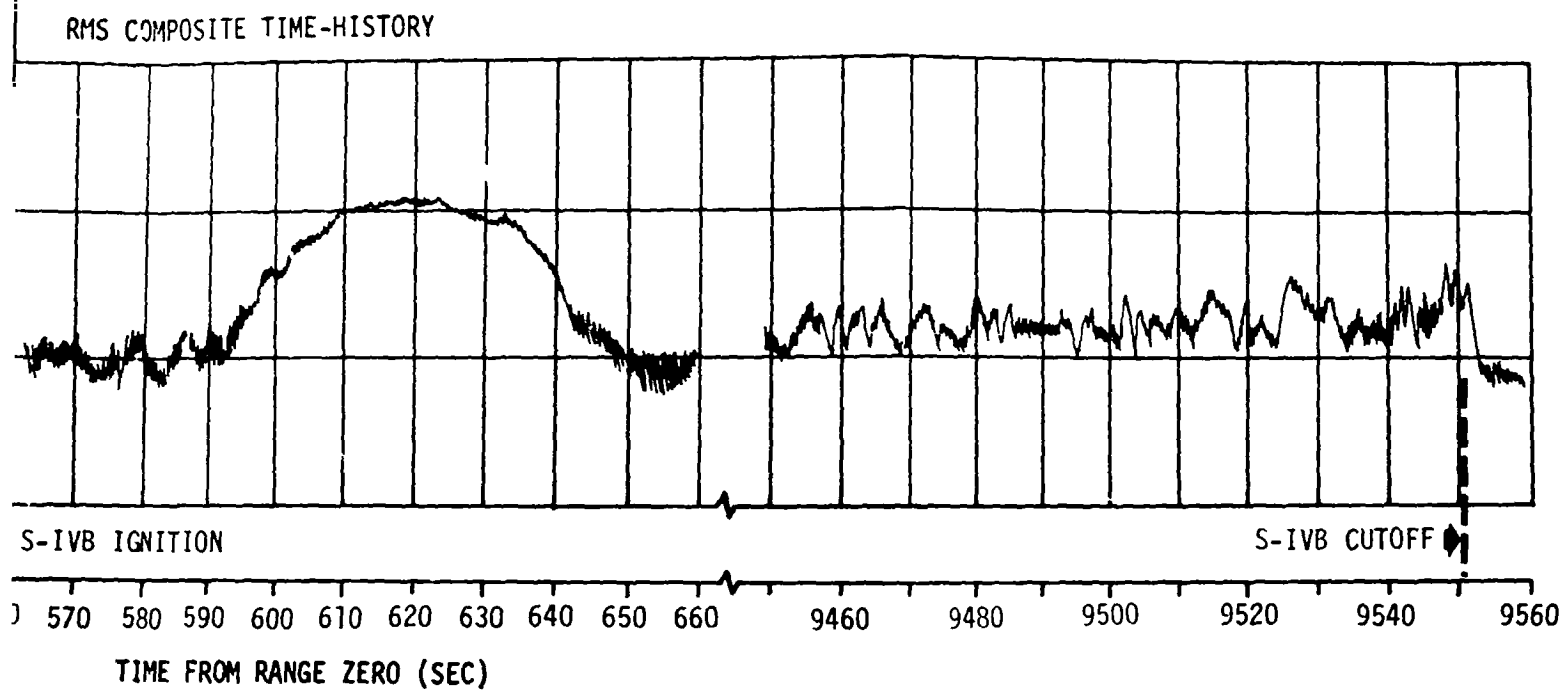

POWER SPECTRAL DENSITY PLOTS

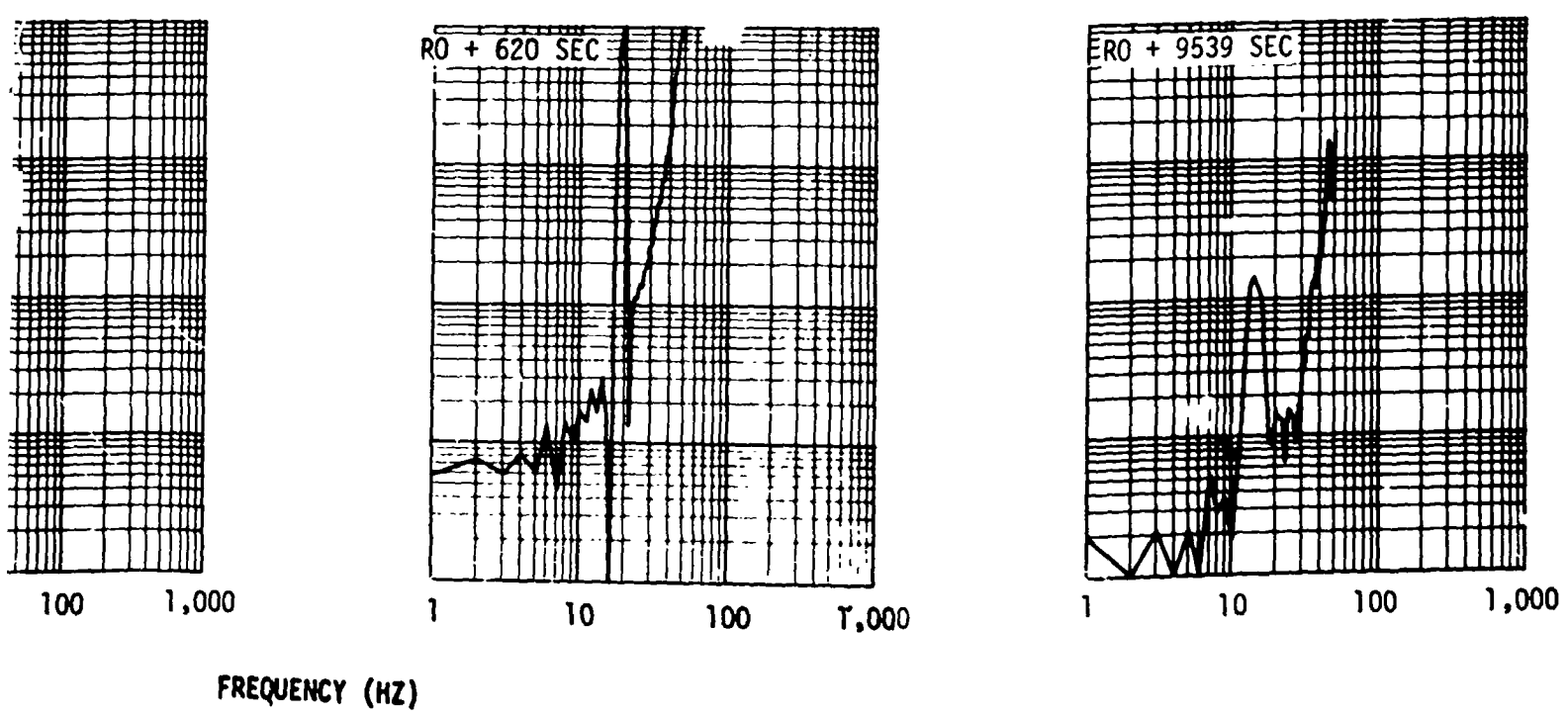

asured on Gimbal Block, Thrust Direction - A0012-403

EGLDOUT FRAME 2

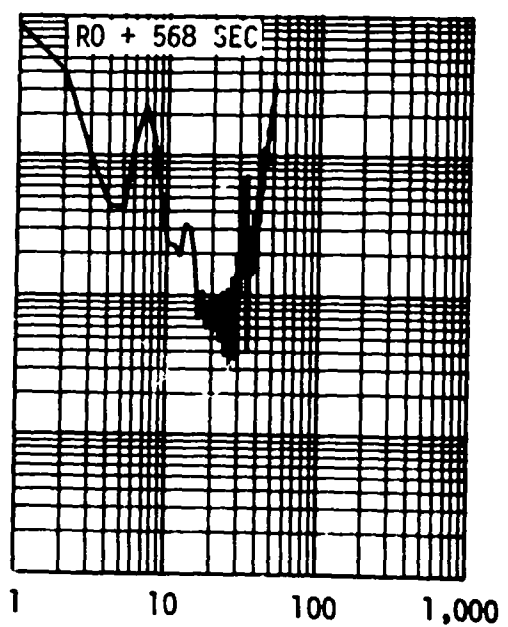
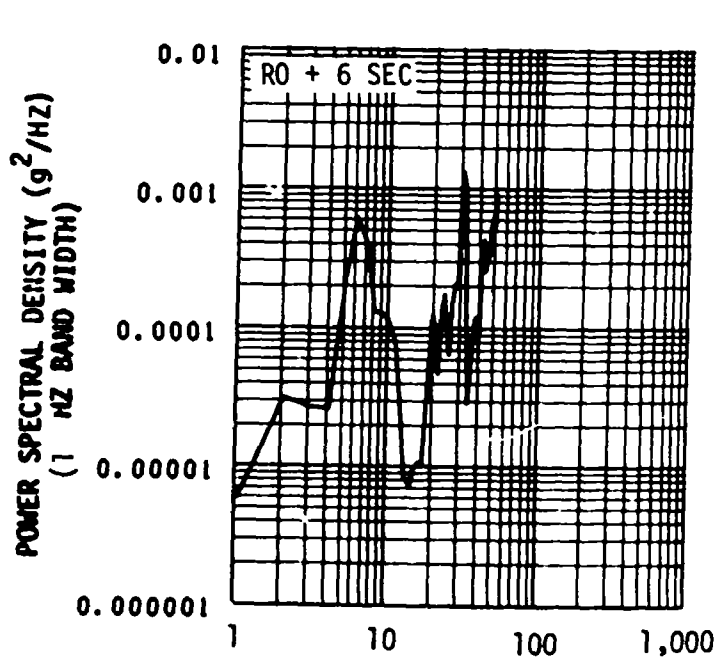
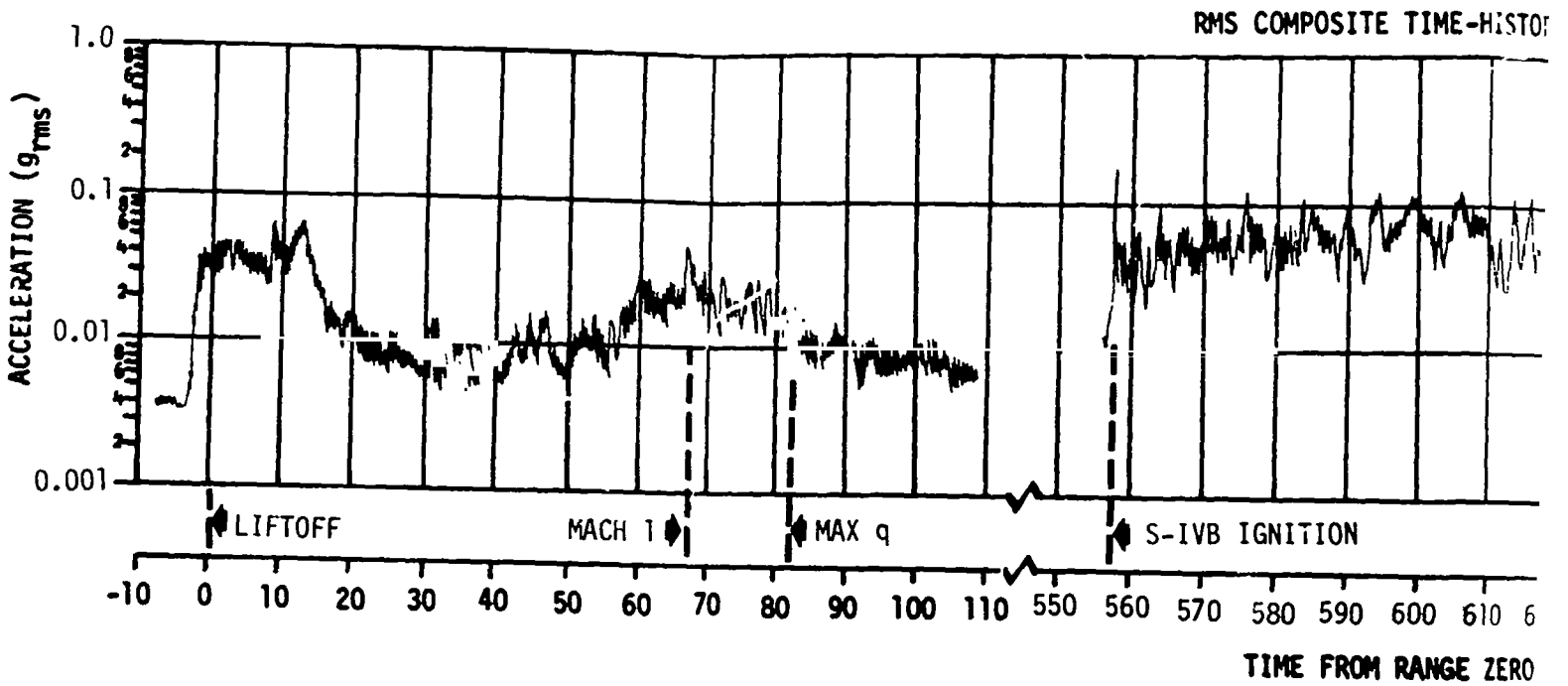

FOLDOUT FRAME

FREQUENCY (Hz)

Figure 25-41. Acceleration Measured on J-2 Engine Skirt, Pit

FOLDOUT FRAME

TIME-HISTORY

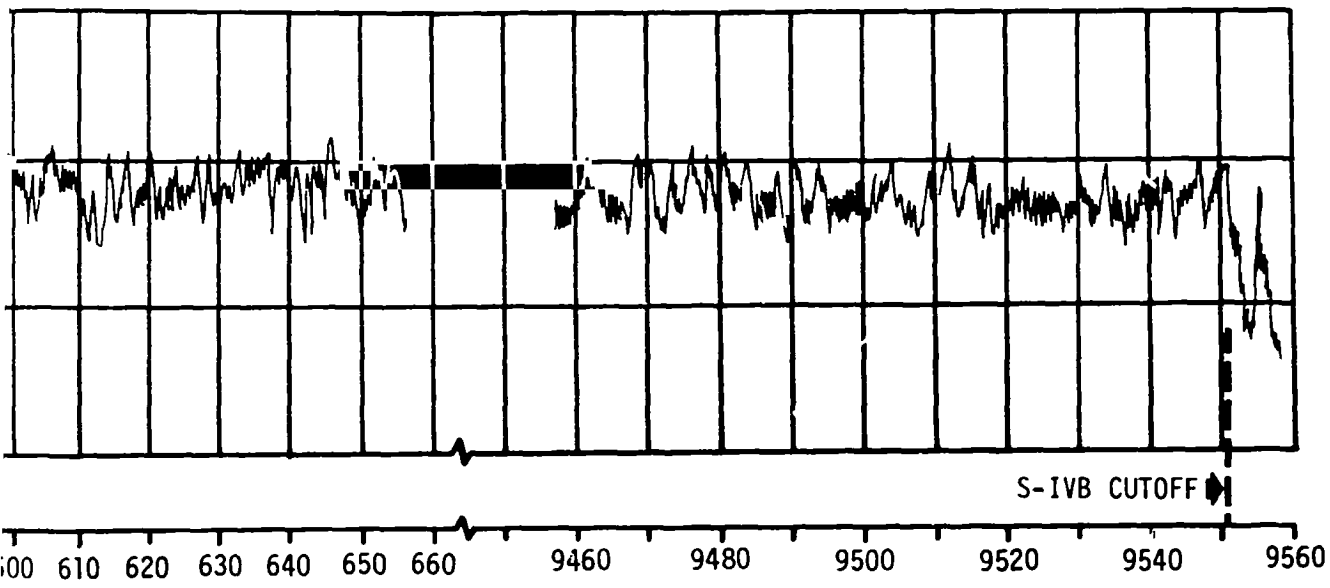

RANGE ZERO (SEC)

SPECTRAL DENSITY PLOTS

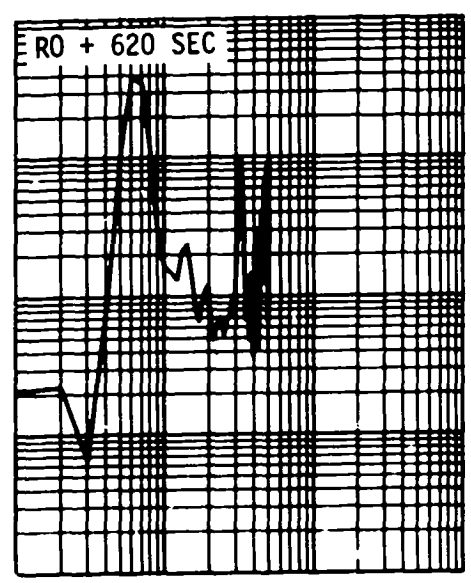

FREQUENCY (HZ)

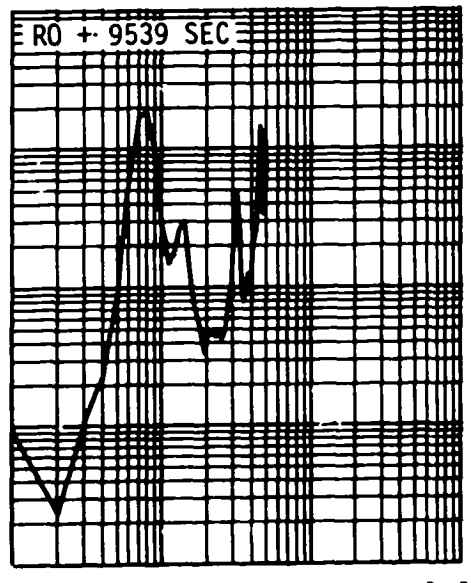

FOLDOUT FRAME 2

FOLDOUT FRAME

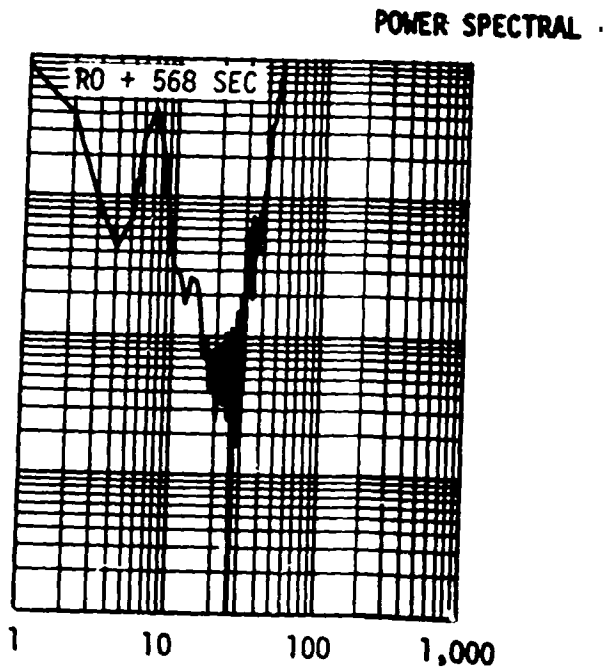
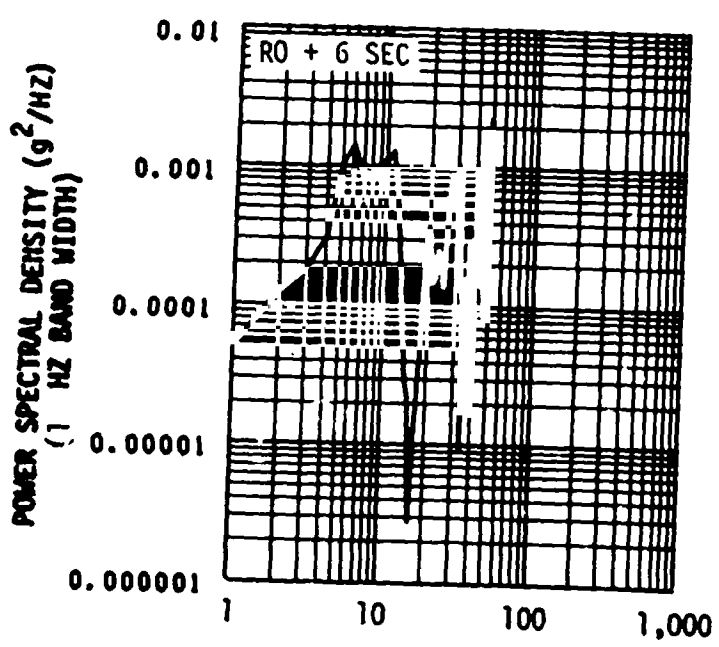
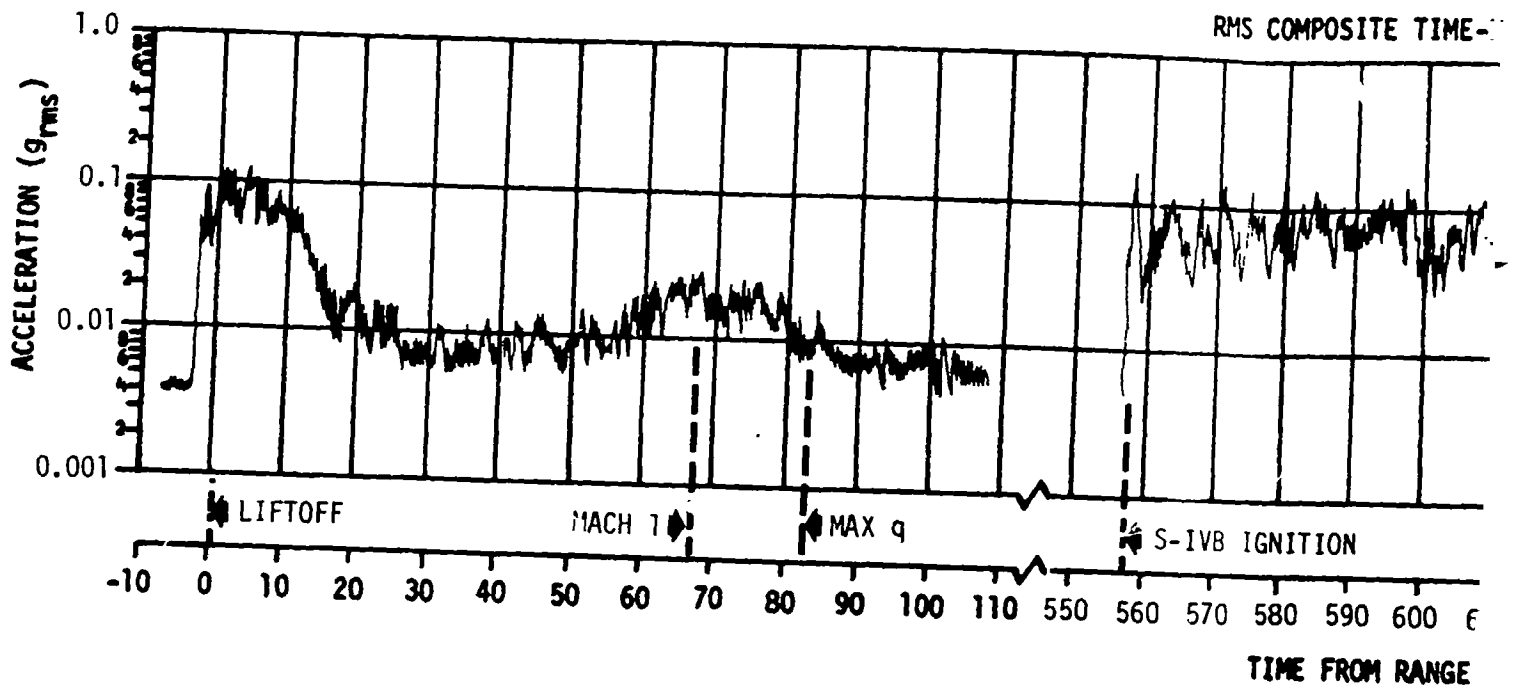

EOLDOUT FRAME

FREQUE

Figure 25-42. Acceleration Measured on J-2 Engine

COMPOSITE TIME-HISTORY

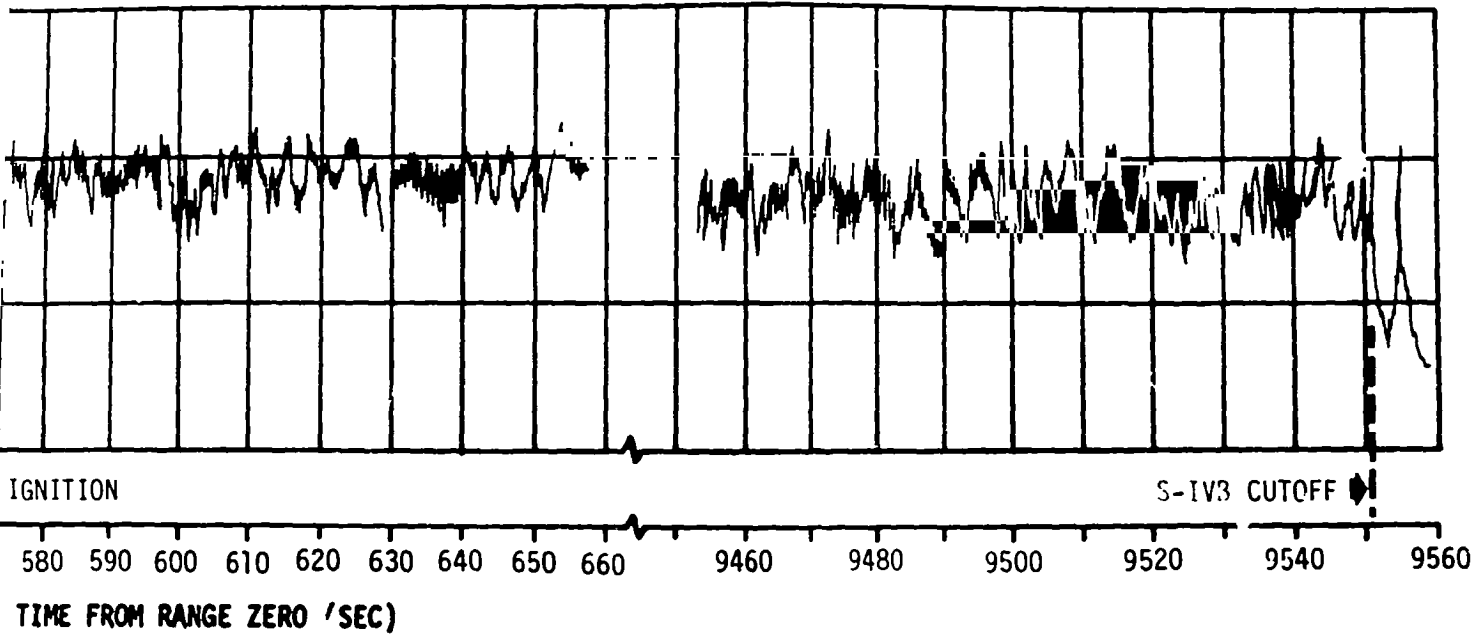

POWER SPECTRAL DENSITY PLOTS

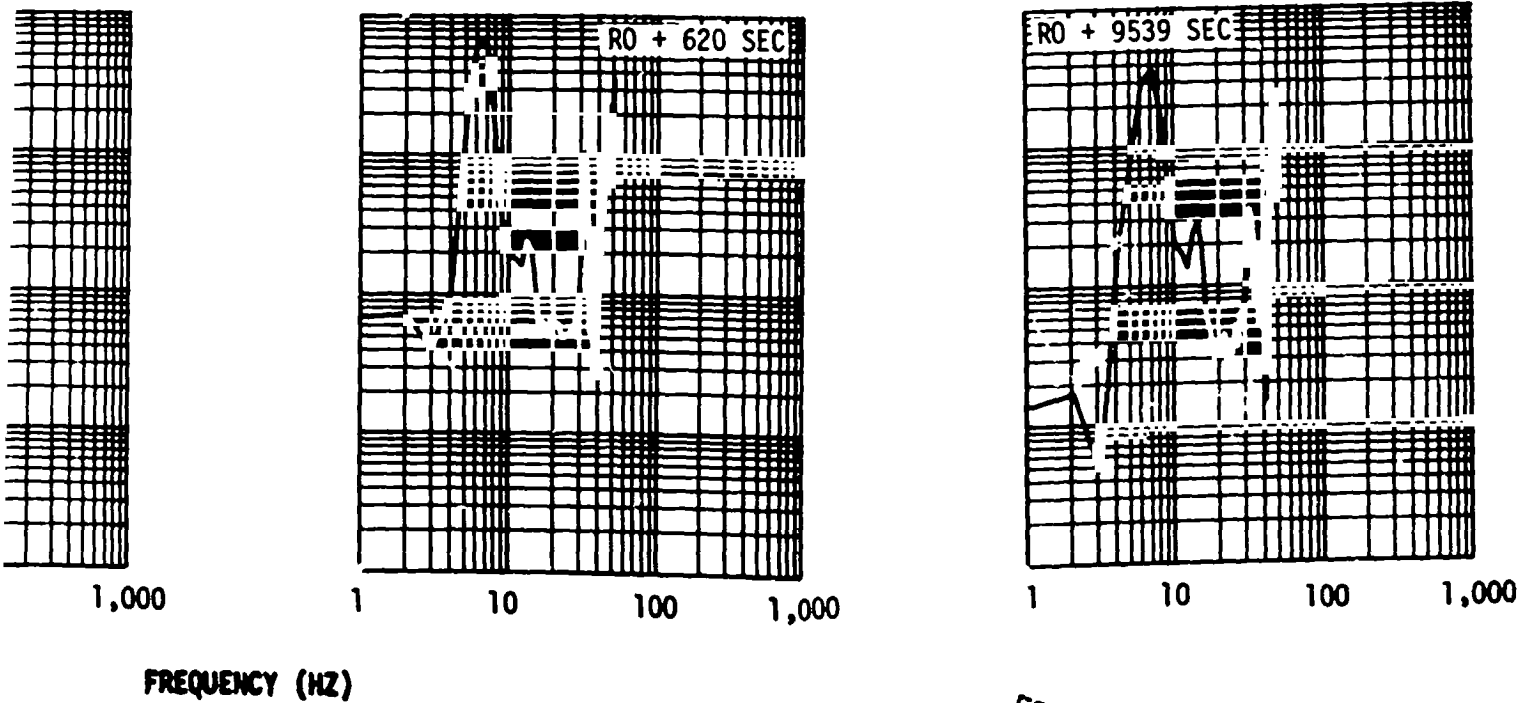

on J-2 Engine Skirt, Yaw Direction - A0014-401

FOLDOUT FRAME 2

26. AERO/THERMODYNAMIC ENVIRONMENT

26.1 Compartment Venting

There were two pressure taps on the S-IVB-505N Stage. Measurement D0051 recorded the internal pressure in the forward compartment and measurement D0052 recorded the internal pressure in the aft compartment. The S-IVB-502, S-IVB-503N, S-IVB-504N and S-IVB-505N Stages had identical vent areas of 0.097 m^2 (150 in.²) in the forward compartment and 0.103 m^2 (160 in.²) for the aft compartment. The internal pressure minus ambient pressure data as a function of time are shown in figures 26-1 and 26-2 for the forward and aft compartments, respectively. To properly evaluate the data they are replotted as a function of Mach number in figures 26-3 and 26-4. Critical structural loading occurs from Mach one to the maximum dynamic pressure at $M = 1.62$. The forward and aft compartment flight data fall within their respective design pressure differential band during this critical structural loading flight period.

26.2 Thermodynamic Environment

26.2.1 Structural Heating

The mission profile of the AS-505 flight produced nominal thermal environments for the S-IVB stage components and structure. The thermal severity of the AS-505 boost trajectory was comparable to that of AS-504, AS-503 and AS-501, and cooler than that of AS-502 and the thermal design trajectory (figure 26-5). There was no instrumentation from which structural temperatures could be obtained; however, due to the above consideration, it is apparent that the S-IVB stage structural temperatures were within the design limits for the boost phase.

26.2.2 Propellant Heating

Propellant heating could not be determined from the existing temperature sensors in either the LH2 or LOX tanks. However, boiloff data obtained from the propellant utilization (PU) probe readings indicate that propellant heating was within predicted limits.

26.2.3 Propellant Behavior

No unusual propellant behavior could be detected from the limited instrumentation in either the LH2 or LOX tanks.

26.2.4 Electrical Components

Temperatures of the S-IVB Stage batteries were measured by three transducers on the forward batteries and four transducers on the aft batteries. These sensors indicate that these batteries remained within their operational temperature limits during the contractually defined mission.

26.2.5 O₂H₂ Burner

Four temperature sensors were located on the O₂H₂ burner support struts, two on an aft strut and two on the forward cone strut. The aft strut sensor C0391 was off-scale low throughout the flight, as expected. The temperature responses of sensors C0392, C0393, and C0394 were as expected during both burner operations.

26.2.6 Auxiliary Propulsion System (APS)

The temperatures of the APS were within the design limits during the low earth orbit and the two hours following translunar injection that constitutes the S-IVB phase of the mission based on data from temperature sensors C0021, C0022, C0023, C0132, C0136, and C0187.

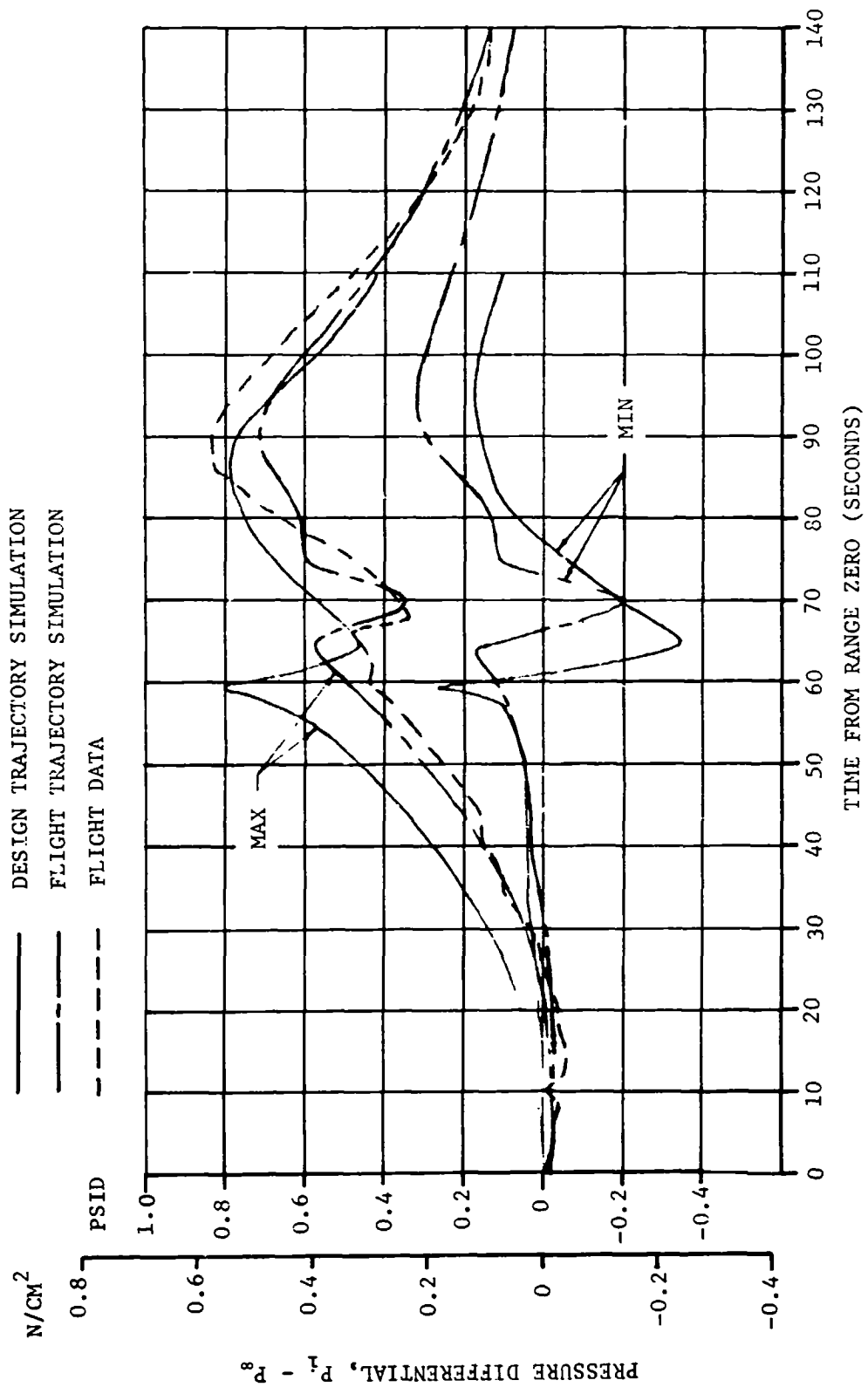

Figure 26-1. Saturn V-505N Forward Compartment Internal Pressure Minus Ambient Pressure

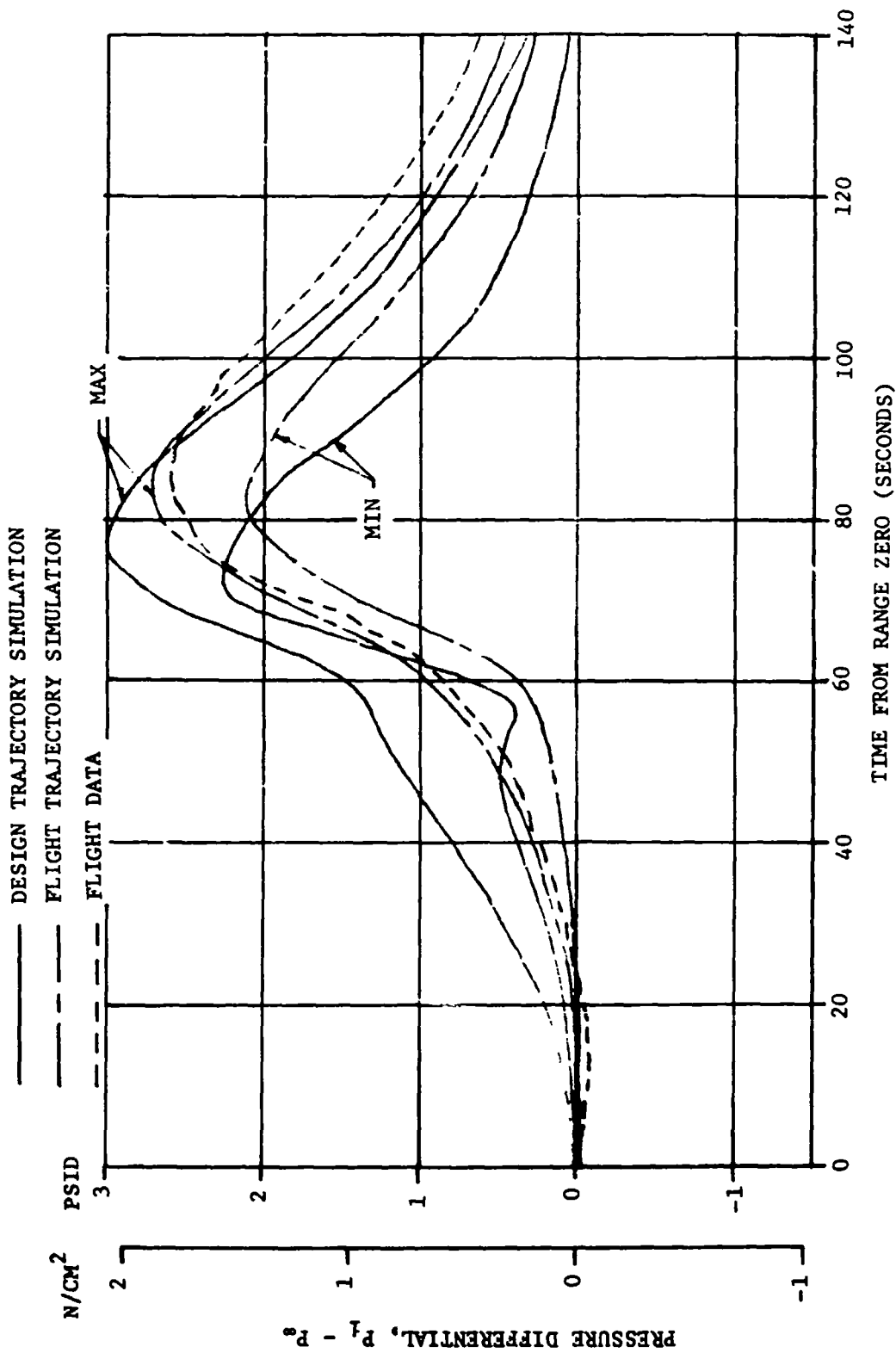

Figure 26-2. Saturn V-505N Aft Compartment Internal Pressure Minus Ambient Pressure

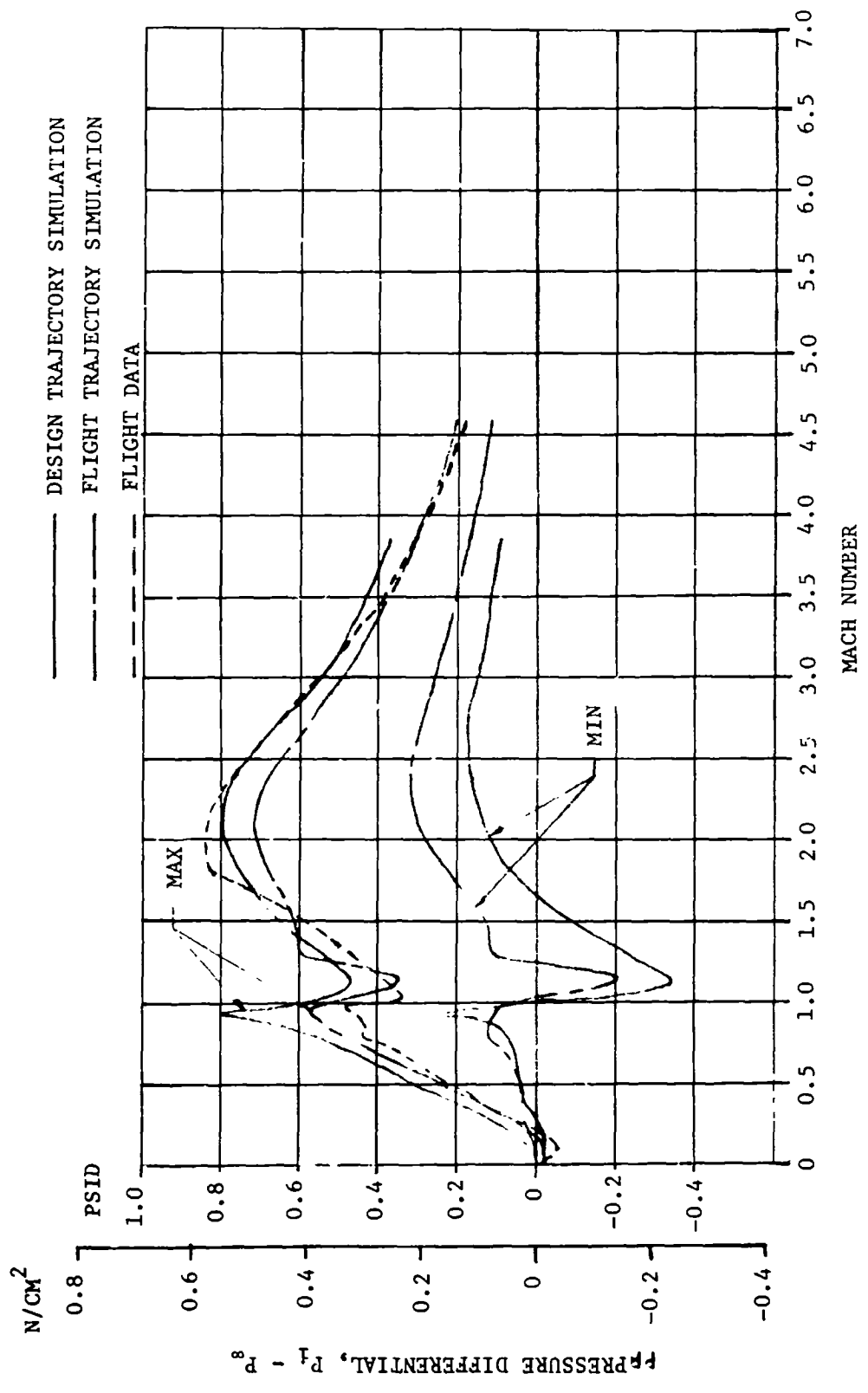

Figure 26-3. Saturn V-505N Forward Compartment Internal Pressure Minus Ambient Pressure

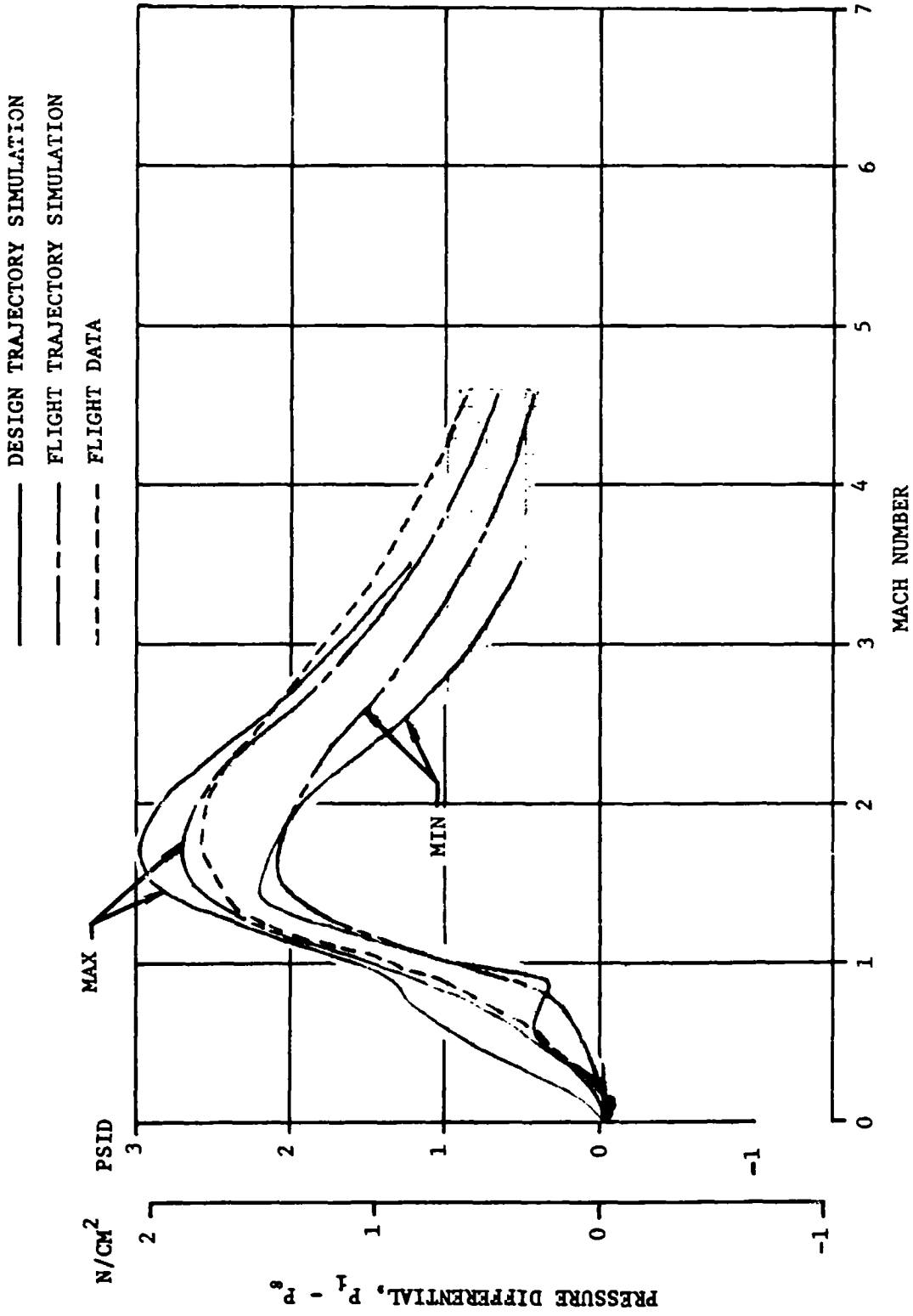

Figure 26-4. Saturn V-505N Aft Compartment Internal Pressure Minus Ambient Pressure

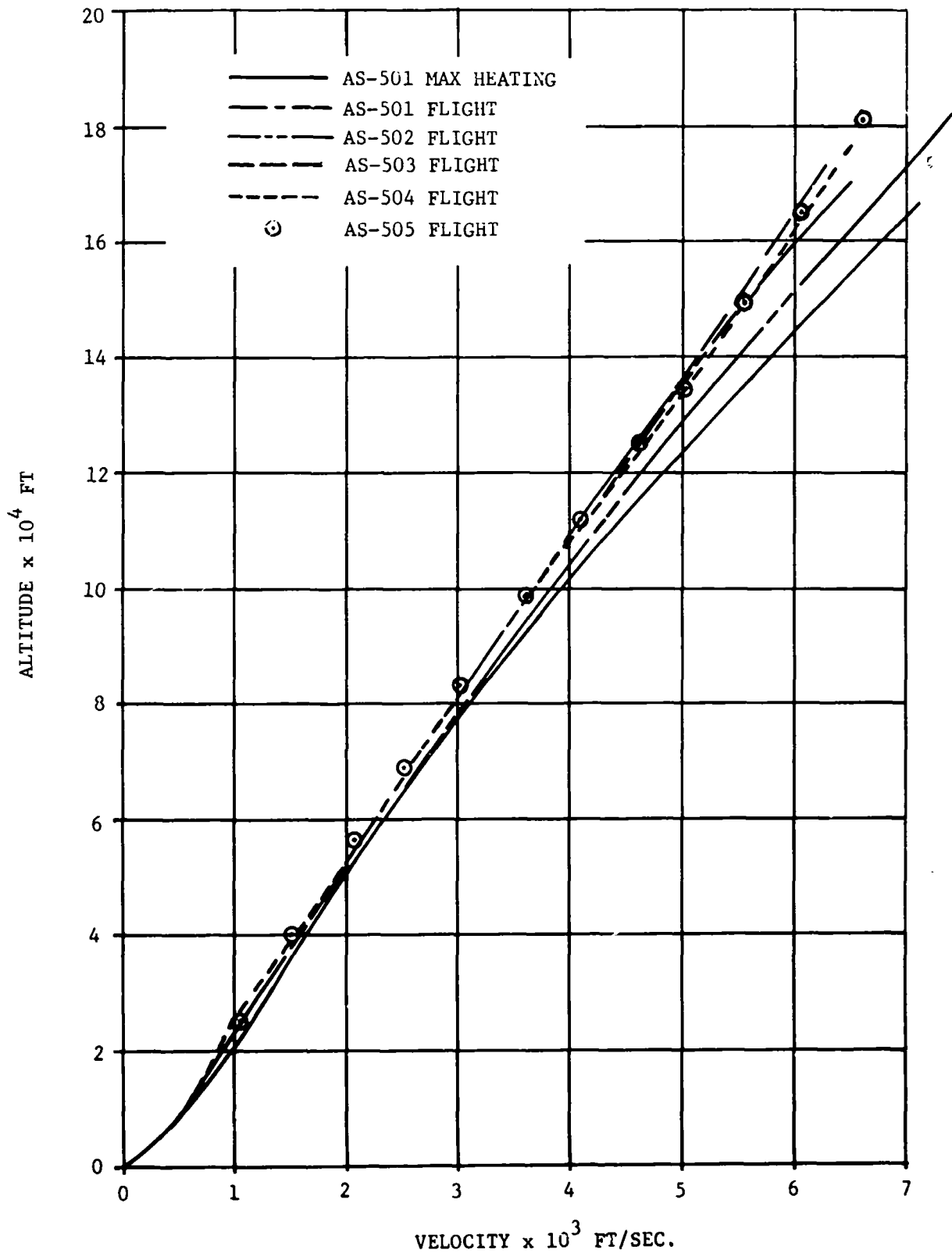

Figure 26-5. Saturn V Flight Trajectories Comparison

27. PROPELLANT DUMP

27.1 LOX Dump

The LOX dump was accomplished satisfactorily. The 300 sec programmed dump was initiated at RO +17,656 seconds. Hardware chilldown was accomplished during the early part of dump and during a prior propellant lead experiment at RO +17,301 seconds. All the LOX that left the tank during the first few seconds of dump was vaporized as it flowed through the engine and was dumped as gas. The flow then became two-phase, and the flowrate increased until a steady state (all liquid) rate of 411 gpm (64.8 lbm/sec) was established approximately 7 seconds after the initiation of LOX dump.

At the initiation of LOX dump, the ullage pressure was 29.4 psia. It started to drop at an increasing rate until the calculated LOX residual of 4,510 lbm was largely depleted. At 55 seconds after dump initiation, the measured LOX flowrate increased sharply indicating that gas ingestion had begun. During the initial portion of the gas ingestion period (55 to 84 seconds after the start of dump), the thrust and flowrate decreased rapidly, and the rate of ullage pressure decay increased. Gas ingestion was well established after this period, and liquid flow ended about 250 seconds after initiation of dump. The LOX tank pressure was 12.3 psia at the end of LOX dump.

The steady state LOX dump thrust was 975 lbf. Total impulse during LOX dump was 92,120 lbf-sec. Liquid flowrate, thrust, ullage pressure, and residuals are shown in figure 27-1.

27.2 High-Pressure Sphere Passivation

27.2.1 Cold Helium Dump

The cold helium spheres were passivated during three programmed cold helium dumps. This was accomplished by opening the LH2 cryogenic repressurization valves that allow the cold helium to flow through the O₂-H₂ burner, into the LH2 tank, and out the LH2 NPV and CVS. At

RO +17,097 sec the third cold helium dump was discontinued for 289 seconds by ground command. This allowed ambient repressurization of the fuel and LOX tanks for the propellant load experiment. The cold helium supply system data are presented in figure 11-16 and Table 27-1.

27.2.2 Ambient Repressurization Helium Dump

Ambient repressurization helium dump was adequately accomplished by opening the engine helium control solenoid valve. The LOX and LH₂ tank ambient repressurization helium flowed through the interconnected system into the engine pneumatic control sphere and was vented overboard through the gas generator and LOX dome purge lines. Dump data are presented in figure 27-2 and Table 27-1.

27.2.3 Pneumatic Control and Purge Helium Dump

The pneumatic control and purge helium was dumped through the engine pump purge module. At approximately RO +16,936 seconds, the dump was initiated and the control sphere pressure decayed as predicted. Safing was terminated at RO +20,536 seconds. Pertinent system data are presented in figure 15-7 and Table 27-1.

TABLE 27-1
HIGH PRESSURE SPHERE PASSIVATION

PARAMETER	COLD HELIUM			AMBIENT REPRESSURIZATION HELIUM	PNEUMATIC CONTROL AND PURGE HELIUM
	FIRST DUMP	SECOND DUMP	THIRD DUMP		
Initiation (sec from R_0)	9,572	13,151	16,937	17,965	16,936
Duration (sec)	878	899	1,511	1,301	3,600
Helium pressure					
At dump initiation (psia)	520	100	50	900	2,950
At dump termination (psia)	50	10	10	110	1,260
Helium mass dumped (lbm)	120	28	6	17.9	4.2

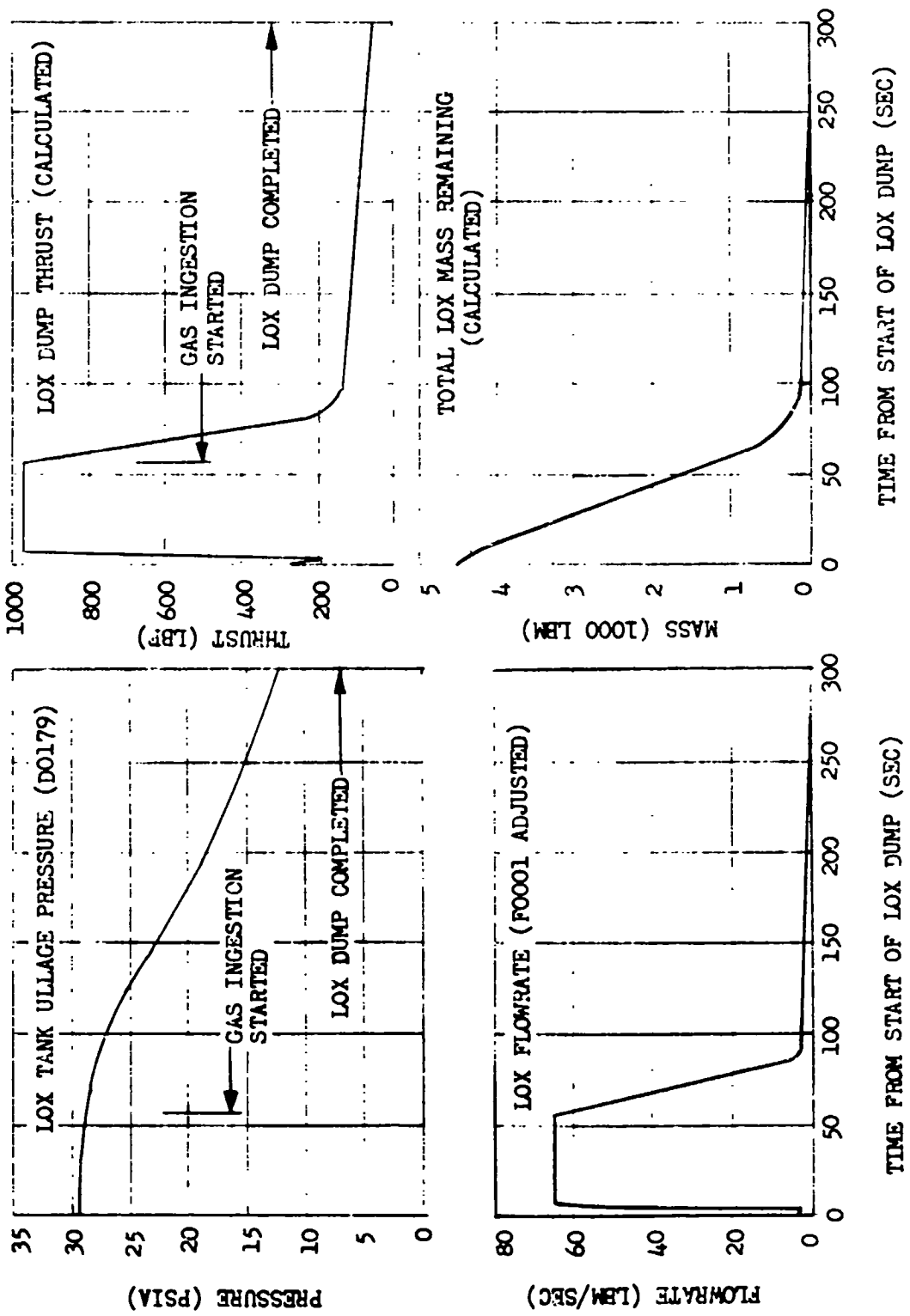

Figure 27-1. LOX Tank Dump

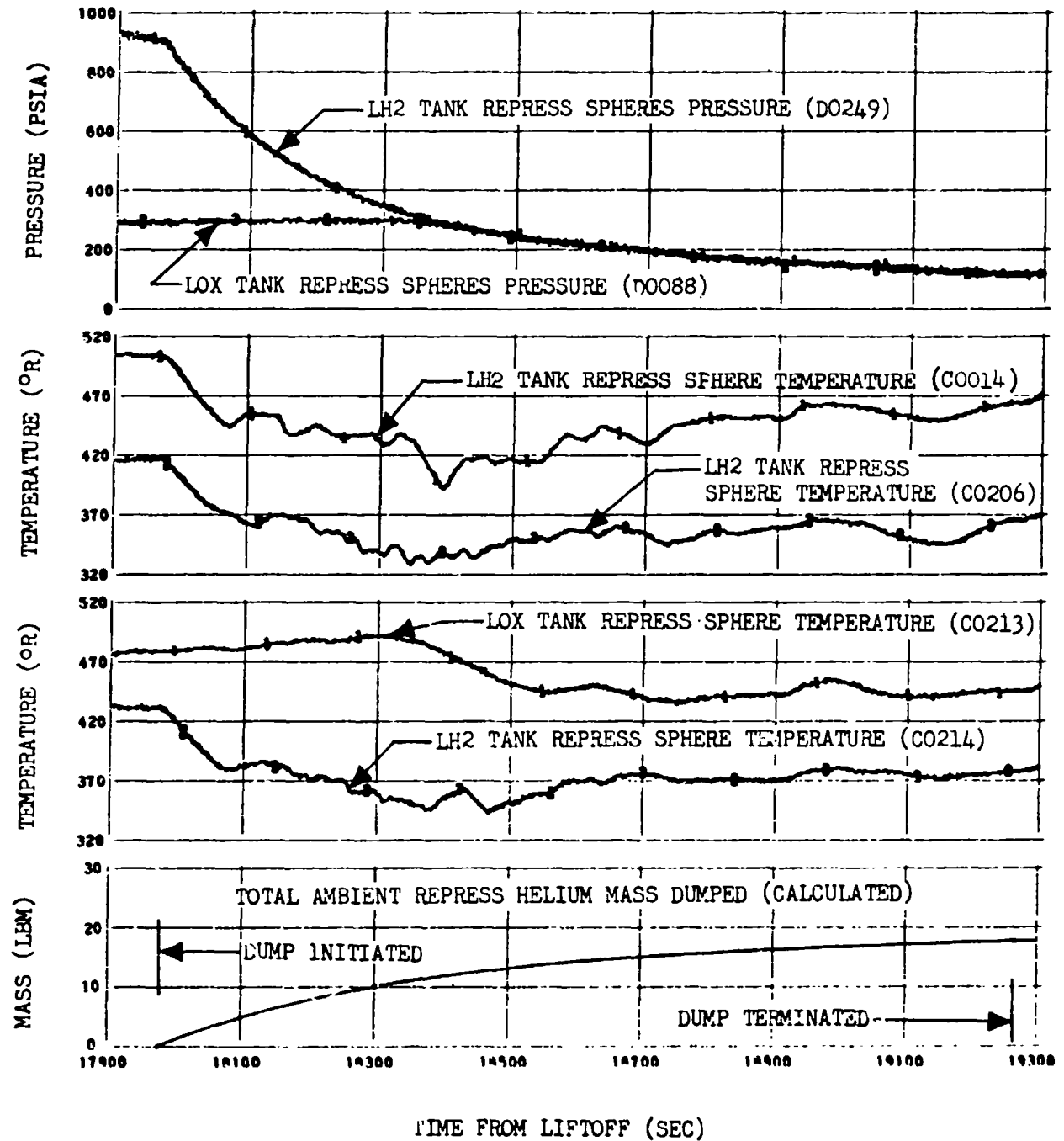

Figure 27-2. Ambient Repressurization Helium Dump

1. GLOSSARY AND ABBREVIATIONS

This appendix (table AP 1-1) lists the commonly used S-IVB-505 stage flight evaluation terms and abbreviations together with their definitions.

TABLE AP 1-1 (Sheet 1 of 11)
GLOSSARY AND ABBREVIATIONS

<u>Abbreviation</u>	<u>Terms</u>	<u>Definition</u>
AACS	--	Auxiliary attitude control system (see APS)
ac	--	Alternating current
AEDC	--	Arnold Engineering Development Center
--	Aerodynamically induced vibration	The oscillation of a mechanical system when set into motion by the turbulent boundary layer during flight. It is dependent on the shape and velocity of the body
AHP	--	Auxiliary hydraulic pump
amp	--	Ampere
ANT	--	AFETR Station on Antigua Island
APS	--	Auxiliary propulsion system (see AACS)
AS	--	Apollo Saturn
ASC	--	AFETR Station on Ascension Island
ASI	--	Augmented spark igniter
AST	--	All systems test
A_t	--	Throat area
aux	--	Auxiliary
--	Average mixture ratio	The time average of the propellant mixture ratio over 1-sec time intervals between 90 percent thrust buildup and Engine Cutoff Command
--	Average limit or specific impulse	Determined between the time of 90 percent thrust and Engine Cutoff Command
A_w	--	Wind azimuth (deg)
A_{XM}	--	Axial acceleration (ft/sec ²)
BDA	--	Bermuda
BGR	--	Bridge gain ratio
Btu	--	British thermal unit
BSC	--	Burner Start Command
C_3	--	Orbit energy
CCS	--	Command communication system
CCW	--	Counterclockwise
CDDT	--	Countdown demonstration test
CECO	--	S-IC stage Center Engine Cutoff Command
CEI	--	Contract end item
CDF	--	Confined detonating fuse

TABLE AP 1-1 (Sheet 2 of 11)
GLOSSARY AND ABBREVIATIONS

<u>Abbreviation</u>	<u>Terms</u>	<u>Definition</u>
C_T	--	Thrust coefficient
C_f	Collapse factor	A measure of the effectiveness of pressurization defined as: $C_f = \frac{M_{\text{actual}}}{M_{\text{theoretical}}}$, where M_{actual} : is the mass necessary to pressurize the propellant tank (lbm) $M_{\text{theoretical}}$: is the mass necessary to pressurize the propellant tank if heat and mass transfer across the ullage boundaries are neglected (lbm)
CHI	--	Major loop guidance command
CHIX	--	Major loop guidance command in roll (axis)
CHIY	--	Major loop guidance command in pitch (axis)
CHIZ	--	Major loop guidance command in yaw (axis)
--	Composite data (acoustic and vibration)	The total energy of the oscillatory phenomenon, consisting of all frequencies and amplitudes sensed by the transducers, so represents the phenomenon at the point of measurement within the limitations of the data acquisition and reduction systems
CIF	--	Central instrumentation facility
CPIF	--	Cost plus incentive fee
cpm	--	Cycles per minute
cps	--	Cycles per second (Hz)
CRO	--	Carnarvon
CSM	--	Command service module
cu in.	--	Cubic inches
CVS	--	Continuous vent system
CW	--	Clockwise
CYI	--	Grand Canary Island
db	--	Decibel
dbm	--	10 log P (milliwatts) where p = power
dbw	--	10 log P (watts)
dc	--	Direct current
DCS	--	Digital command system
DDAS	--	Digital data acquisition
deg	--	Degree
--	Depletion Engine Cutoff Command	The time that engine cutoff was, or would be, initiated by the depletion level sensors
DNA	--	Does not apply
D/O	--	Dropout
e	--	Eccentricity
EA	--	Electronics assembly

TABLE AP 1-1 (Sheet 3 of 11)
GLOSSARY AND ABBREVIATIONS

<u>Abbreviation</u>	<u>Terms</u>	<u>Definition</u>
EBW	--	Exploding bridgewire
ECA	--	Electrical control assembly
ECC	--	Engine Cutoff Command
ECF	--	End conditions of flight
ECP	--	Engineering change proposal
ECS	--	Environmental control system
EDS	--	Emergency detection system
--	Effective burntime	The engine burntime from 90 percent thrust buildup to Engine Cutoff Command
E/I	--	External/internal
EMC	--	Electromagnetic compatibility
EMI	--	Electromagnetic interference
EMR	Engine propellant mixture ratio	The ratio of engine LOX mass flowrate to LH2 mass flowrate includes gas generator operations
eng	--	Engine
--	Engine cutoff transient	Engine operation during the period from the Engine Cutoff Command until the end of thrust decay
ESC	--	Engine Start Command
EST	--	Eastern standard time
--	Engine start transient	Engine operation during the period from the Engine Start Command until the time of 90 percent thrust (approximately a 3-sec period)
--	Engine steady-state operation	Engine operation during the period from the time of 90 percent thrust until Engine Cutoff Command
ETD	--	End of thrust decay
ETR	--	Eastern test range
°F	--	Degree Fahrenheit
F	Stage longitudinal thrust	Thrust (lbf) developed by the J-2 engine. Ullage rocket thrust is not included
F _a	--	Ullage rocket thrust (lbf)
--	Flow integral propellant mass history	That propellant mass history determined by combining independent engine analyses by a statistical method
Γ/B	--	Feedback
FCC	--	Flight control computer
FIOR	--	Flight Information and Operations Report
FM	--	Frequency modulation
fps	--	Feet per second
ft	--	Foot
FTC	--	Florida Test Center
F/U	--	Firing unit

TABLE AP 1-1 (Sheet 4 of 11)
GLOSSARY AND ABBREVIATIONS

<u>Abbreviation</u>	<u>Terms</u>	<u>Definition</u>
fwd	--	Forward
g	Gravitational acceleration	The acceleration produced by the force of gravity, which varies with the altitude and elevation of the point of observation. The value 32.1739 ft/sec ² has been chosen as the standard by international agreement for sea level at 45° north latitude
GBI	--	AFETR Station on Grand Bahama Island
GCC	--	Guidance Cutoff Command
G.E.T.	--	Ground elapsed time
GG	--	Gas generator
GH2	--	Gaseous hydrogen
GMT	--	Greenwich mean time
GN2	--	Gaseous nitrogen
GOK	--	Gaseous oxygen
gpm	--	Gallons per minute
grms	--	Gravity root mean square
GRR	--	Guidance reference release
GSE	--	Ground support equipment
GYM	--	Gusynas
h	--	Altitude
h _a	--	Apogee altitude
HAW	--	Hawaii
He	--	Helium
HF	--	High frequency
Hg	--	Mercury
hp	--	Perigee Altitude
hr	--	Hour
H/W	--	Hardwire
Hz	Hertz	Cycles per second
i	--	Inclination
IAS	--	Initiation of automatic sequence
IECO	--	S-IC stage Inboard Engine Cutoff Command
IGM	--	Iterative guidance mode
in.	--	Inches
in./in.	--	Inches per inch (strain)
IP&CL	--	Instrumentation Program and Components List
ips	--	Inches per second
IRIG	--	Inter range instrumentation group

TABLE AP 1-1 (Sheet 5 of 11)
GLOSSARY AND ABBREVIATIONS

<u>Abbreviation</u>	<u>Terms</u>	<u>Definition</u>
I _{sp}	--	Specific impulse
IU	--	Instrument unit
k	--	Insulation thermal conductivity
km	--	Kilometer
kc	--	Kilocycles
KSC	--	Kennedy Space Center
ksi	--	1,000 lb/in. ²
L	--	Trajectory fit parameter
lbf	--	Pounds force
lbm	Pounds mass	1/32.1739 slug
lbm/hr	--	Pounds mass, hour
lbm/sec	--	Pounds mass, second
lb/pf	--	Pounds per picofarad
LC	--	Launch Complex
L/C	--	Loading Computer
LCC	--	Launch control center
LES	--	Launch escape system
LET	--	Launch escape tower
--	Level sensor residuals	Those propellant residuals above the main propellant valves determined by combining data from one or more level sensors by a statistical method and extrapolating to Engine Cutoff Command
LH2	--	Liquid hydrogen
LM	--	Lunar module
LO	--	Vehicle liftoff time
--	Look angle	Angle between the vehicle centerline and the line of sight, measured from the rear of the vehicle (deg)
LOS	--	Loss of signal
LOX	--	Liquid oxygen
L/S	--	Level sensor
LTA	--	Lunar test article (Structural representation of LM)
LV	--	Launch vehicle
LVDC	--	Launch vehicle digital computer
M	--	Mach number
M	Stage propellant mass flowrate (lbm/sec)	Engine propellant mass flowrate (includes propellant flowrate for gas generator operation)
M _f	Stage LH2 mass flowrate (lbm/sec)	Engine LH2 mass flowrate (includes LH2 flowrate for gas generator operation)
M _o	Stage LOX mass flowrate (lbm/sec)	Engine LOX mass flowrate (includes LOX flowrate for gas generator operation)

TABLE AP 1-1 (Sheet 6 of 11)
GLOSSARY AND ABBREVIATIONS

<u>Abbreviation</u>	<u>Terms</u>	<u>Definition</u>
ma	--	Milliampere
M&A	--	Manufacturing and assembly building (STC)
max q	--	Maximum dynamic pressure
mbars	--	Millibars
MCC	--	Mission control center
MDAC-WD	--	McDonnell Douglas Astronautics Company - Western Division
MDAC-WD/FTC	--	McDonnell Douglas Astronautics Company - Western Division/ Florida Test Center
MDAC-WD/HB	--	McDonnell Douglas Astronautics Company - Western Division/ Huntington Beach
MDAC-WD/STC	--	McDonnell Douglas Astronautics Company - Western Division/ Sacramento Test Center
MDF	--	Mild detonating fuse
MFV	--	Main fuel valve
MHz	--	Millihertz
MILA	--	Merritt Island Florida
μin./in.	Micro inch per inch	Millionth of an inch per inch
min	--	Minute(s)
ML CHI	--	Minor loop guidance command
ML CHIX	--	Minor loop guidance command in roll (axis)
ML CHIY	--	Minor loop guidance command in pitch (axis)
ML CHIZ	--	Minor loop guidance command in yaw (axis)
MOI	--	Moment of inertia
MOV	--	Main oxidizer valve
MR	--	Mixture ratio
ms	Millisecond	Thousandth of a sec
MSC	--	Manned Spacecraft Center, Houston, Texas
MSFC	--	Marshall Space Flight Center
MSFN	--	Manned space flight network
MSL	--	Mean sea level
mv	--	Millivolt
mrx	--	Multiplexer
N/A	--	Not applicable
NASA	--	National Aeronautics and Space Administration
NC	--	Normally closed
--	Ninety percent thrust buildup	Time from Engine Start Command until the last engine chamber pressure (injector end) reaches 618 psia

TABLE AP 1-1 (Sheet 7 of 11)
GLOSSARY AND ABBREVIATIONS

<u>Abbreviation</u>	<u>Terms</u>	<u>Definition</u>
nmi	--	Nautical miles
NO	--	Normally open
No.	--	Number
N ₂ O ₄	NTO	Nitrogen Tetroxide
NFSP	--	Net positive suction pressure
NPV	-	Nonpropulsive vent
OAT	--	Overall test
OECO	--	S-IC stage Outboard Engine Cutoff Command
O-P	--	Zero to peak
P	--	Geodetic latitude
P	--	Period (time of one orbit)
P	--	Pitch
P _a	--	Ambient pressure
P _c	--	Combustion chamber pressure measured at the injector
PA	--	Pressure actuated
PAM	--	Pulse amplitude modulation
PCF	--	Preconditions of flight
PCM	--	Pulse code modulation
pf	--	Picofarad
--	Phase I	Time from liftoff to ECC1 +10 sec
--	Phase II	Time from liftoff to planned LV/SC separation
Phi	--	Roll angle
PMR	Programmed mixture ratio	A method of controlling the PU valve mixture ratio to obtain maximum efficiency of the stage. The propellant loading is provided to cause the PU system to command the PU valve against the LOX rich stop for the initial portion of flight and then decrease to a lower mixture ratio during the final portion of flight
P/N	--	Part number
P-P	--	Peak to peak
PP	--	Position planes
ppm	--	Parts per million
--	Propellant residuals	The sum of LOX and LH2 remaining onboard at Engine Cutoff Command. The residuals include both usable and trapped propellants.
PS	--	Pressurization system
P/S	--	Pulse sensor
PSD	--	Power spectral density
psi	--	Pounds per square inch
Psi	--	Yaw angle
psia	--	Pounds per square inch absolute

TABLE AP 1-1 (Sheet 8 of 11)
GLOSSARY AND ABBREVIATIONS

<u>Abbreviation</u>	<u>Terms</u>	<u>Definition</u>
psid	--	Pounds per square inch differential
psig	--	Pounds per square inch gauge
PTCS	--	Propellant tanking computer system
P/U	--	Pickup
PU	--	Propellant utilization
--	PU system propellant mass history	That propellant mass history determined for flight by the PU system
--	PU system residuals	Those propellant residuals above the main propellant valves determined by the PU system
q	--	Dynamic pressure
R	--	Rankine
R_A	--	Radius of apogee
RACS	--	Remote analog calibration system
RASH	--	Remote analog sub-multiplexer
R&D	--	Research and development
RCS	--	Reaction control system
RDSM	--	Remote digital sub-multiplexer
reg	--	Regulator
RF	--	Radio frequency
RFI	--	Radio frequency interference
RFR	--	Reference mixture ratio
rms	--	Root mean square
R/MAA	--	Rocketdyne, North American Aviation
RO	--	An event time used as reference for S-IVB stage flight evaluation sequence of events. Defined as the first Greenwich mean time second prior to vehicle liftoff
rpm	--	Revolutions per minute
R/S	--	Range safety
RSCR	--	Range safety command receiver
rss	--	Root sum square
S	--	Surface range (ft)
SC	--	Spacecraft
scfm	--	Standard cubic ft/min
scim	--	Standard cubic in./min
sco	--	Subcarrier oscillator
sec	--	Seconds
S-IB	--	First stage of the Saturn IB (200) series of vehicles
S-IC	--	First stage of the Saturn V (500) series of vehicles

TABLE AP 1-1 (Sheet 9 of 11)
GLOSSARY AND ABBREVIATIONS

<u>Abbreviation</u>	<u>Terms</u>	<u>Definition</u>
S-II	--	Second stage of the Saturn V (500) series of vehicles
S-IVB	--	Second stage of the Saturn IB (200) series of vehicles and third stage of Saturn V (500) series of vehicles
SLA	--	Spacecraft LM adapter
--	Slug	English system unit of mass
SLV	--	Saturn launch vehicle
SM	--	Santa Monica
SM	--	Service module
SMC	--	Steering misalignment correction
S/N	--	Serial number
SPS	--	Service propulsion system
sps	--	Sample per second
SOV	--	Shutoff valve
SSB	--	Single sideband
SSS	--	Stage switch selector
sta	--	Station
--	Statistical weighted average loaded propellants	The most accurate determination of actual propellant load at liftoff as derived from the statistically weighted average mass
--	Statistical weighted average mass determination	A statistical combination of the PU system, engine system, flight simulation, and propellant level sensors at Engine Start Command and Engine Cutoff Command
--	Statistical weighted average residual propellants	The most accurate determination of actual propellant residual at Engine Cutoff Command as derived from the statistically weighted average mass determination method
STC	--	Sacramento Test Center
STD	--	Start tank discharge
STDV	--	Start tank discharge valve
S/V	--	Space vehicle
sw	--	Switch
Sw sel	--	Switch selector
T	--	Countdown time from prospective liftoff or as specifically defined in the text
TB	--	Time base
T/C	--	Thermal cycle
Tel 2	--	Telemetry station at KSC
Tel 3	--	Cape Kennedy Telemetry Station IV
Tel 4	--	Merritt Island Telemetry Station IV
TEX	--	Corpus Christi, Texas
Theta	--	Pitch angle
tk	--	Tank

TABLE AP 1-1 (Sheet 10 of 11)
GLOSSARY AND ABBREVIATIONS

<u>Abbreviation</u>	<u>Term</u>	<u>Definition</u>
TLI	--	Translunar injection
T/M	--	Telemetry
--	Total depletion burntime	The engine burntime from Engine Start Command to the time that the Depletion Engine Cutoff Command would have been initiated
--	Total propellants consumed	That amount of liquid propellants consumed from Engine Start Command to Engine Cutoff Command includes engine consumption, boiloff, and LH2 tank pressurant
TPEP	--	Telemetry performance evaluation period
--	Total stage burntime	The engine burntime from Engine Start Command to Engine Cutoff Command
--	Total stage mass history	A compilation of all final hardware, propellant, and gas masses. The measured and computed mass of each constituent is adjusted within its accuracy band so that the total stage mass at Engine Start Command and Engine Cutoff Command agrees with the total stage mass as determined by the Statistical Weighted Average mass determination method
TP&E	--	Test Planning and Evaluation
TVCS	--	Thrust vector control system
--	Unusable propellants	Those propellants remaining after a propellant depletion cutoff. This includes the propellant in the tank below the depletion sensor, propellant in the feed duct, and trapped propellants. It does not include sensor lag time or the propellant consumed during engine cutoff but does include sensor time delay
U/R	--	Ullage rocket
--	Usable residual	Propellants in excess of trapped propellants left onboard a stage after powered flight has been terminated by some specified cutoff criteria
USB	--	Unified S-band
V	--	Volt
V_A	--	Apogee velocity
V_E	--	Relative velocity
V_I	--	Inertial velocity
V_P	--	Perigee velocity
V_{RH}	--	Freestream velocity
V_W	--	Wind velocity (speed)
VAB	--	Vehicle Assembly Building, KSC, Florida
vac	--	Voltage, alternating current
VCL	--	Vehicle checkout laboratory
VCO	--	Voltage controlled oscillator
vdc	--	Voltage, direct current
VHF	--	Very high frequency
V_I	--	Inertial velocity
VSE	--	Vehicle support equipment

TABLE AP i-1 (Sheet 11 of 11)
GLOSSARY AND ABBREVIATIONS

<u>Abbreviations</u>	<u>Terms</u>	<u>Definition</u>
VSWR	--	Voltage standing wave ratio
W	--	Watt
WRO	--	DAC work release order
wt	--	Weight
\dot{W}_T	--	Time rate of change of total vehicle weight
X_E	--	Downrange distance
\dot{X}_E	--	Downrange velocity
Y	--	Yaw
Y_E	--	Vertical distance
\dot{Y}_E	--	Vertical velocity
Y_{E_c}	--	Crossrange distance
\dot{Y}_{E_c}	--	Crossrange velocity
α	--	Angle of attack
α_p	--	Pitch angle of attack
αq	--	Product of angle of attack and dynamic pressure
α_y	--	Yaw angle of attack
β	--	Yaw angle of attack
γ_1	--	Earth fixed flight path elevation angle
Δw	--	Delta weight
θ_n	--	Descending node
γ_{1I}'	--	Inertial flight path elevation angle
γ_{2I}'	--	Inertial flight path azimuth angle
μ	--	Longitude
μv	--	Microvolt