

SATURN S-IVB-205 STAGE FLIGHT EVALUATION REPORT

SM-46990
DECEMBER 1968

PREPARED BY:
SATURN S-IVB TEST PLANNING AND
EVALUATION COMMITTEE AND
COORDINATED BY: D. J. KATZ
PROJECT OFFICE - TEST
HUNTINGTON BEACH DEVELOPMENT ENGINEERING

PREPARED FOR:
NATIONAL AERONAUTICS AND
SPACE ADMINISTRATION
UNDER NASA CONTRACT NAS7-101

H. B. Mitchell for

APPROVED BY: A. P. O'NEAL, DIRECTOR
HUNTINGTON BEACH DEVELOPMENT ENGINEERING -
SATURN/APOLLO PROGRAM

MCDONNELL DOUGLAS ASTRONAUTICS COMPANY
WESTERN DIVISION

5301 Bolsa Avenue, Huntington Beach, California 92647 (714) 897-0311

1. The first part of the document discusses the importance of maintaining accurate records of all transactions and activities. It emphasizes the need for transparency and accountability in financial reporting.

2. The second part of the document outlines the various methods and techniques used to collect and analyze data. It highlights the importance of using reliable sources and ensuring the accuracy of the information gathered.

3. The final part of the document provides a summary of the key findings and conclusions. It reiterates the importance of ongoing monitoring and evaluation to ensure the effectiveness of the program and to identify areas for improvement.

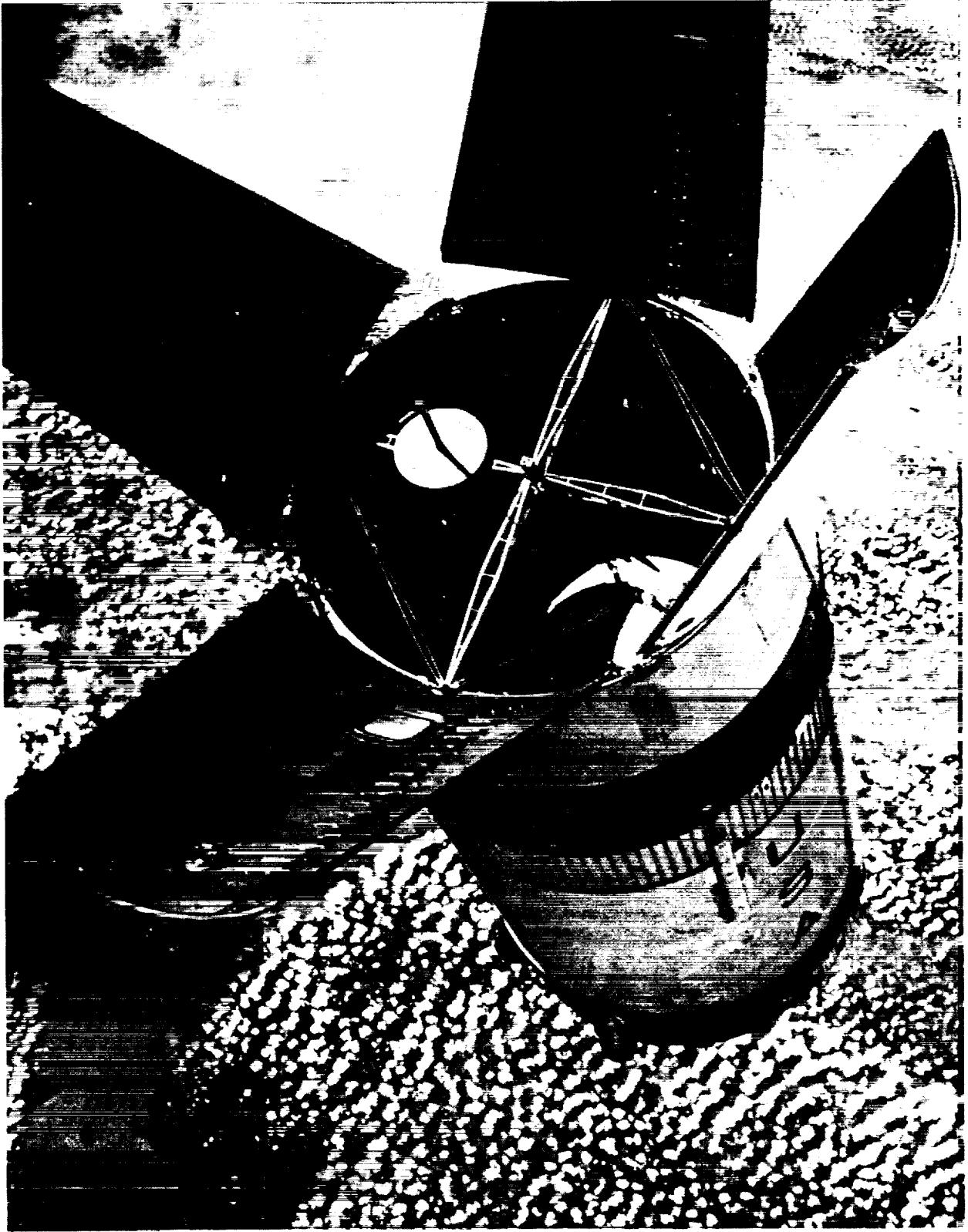

SATURN S-IVB-205 IN ORBIT



ABSTRACT

This report presents the evaluation results of the prelaunch countdown, powered flight, and orbital phase of the S-IVB-205 stage which was launched 11 October 1968 as the second stage of the Saturn AS-205 vehicle.

The report is a contractual document as outlined in NASA Report MSFC-DRL-021, Contract Data Requirements, Saturn S-IVB Stage and GSE, dated 1 August 1968, Revision B. It was prepared by the Saturn S-IVB Test Planning and Evaluation Committee and coordinated by the Saturn S-IVB Project Office of the McDonnell Douglas Astronautics Company - Western Division.

DESCRIPTORS

Data Evaluation	S-IVB-205
Flight Test	Saturn AS-205 Vehicle
Saturn V	Countdown



PREFACE

The purpose of this report is to present the evaluation results of the prelaunch countdown, powered flight, and orbital phase of the S-IVB-205 stage which was launched on 11 October 1968 as the second stage of the Saturn AS-205 vehicle.

This report was prepared in compliance with the National Aeronautics and Space Administration Contract NAS7-101. It is published in accordance with NASA Report MSFC-DRL-021, Contract Data Requirements, Saturn S-IVB Stage and GSE, dated 1 August 1968, Revision B, which delineates the data required from the McDonnell Douglas Astronautics Company.

This document was prepared by the Saturn S-IVB Test Planning and Evaluation Committee and coordinated by the Saturn S-IVB Project Office of the McDonnell Douglas Astronautics Company - Western Division.



TABLE OF CONTENTS

<u>Section</u>		<u>Page</u>
1.	INTRODUCTION	1-1
	1.1 General	1-1
	1.2 History	1-1
2.	FLIGHT AND STAGE SUMMARY	2-1
	2.1 Flight Summary	2-1
	2.2 Mission Objectives	2-2
	2.3 Stage Summary	2-3
3.	STAGE CONFIGURATION	3-1
4.	TEST OPERATIONS	4-1
	4.1 Propulsion System Checkout	4-1
	4.2 Launch Vehicle Tests	4-1
	4.3 APS Preparations	4-2
	4.4 AS-205 Launch Countdown--514011	4-2
	4.5 Redline Limits	4-4
	4.6 Atmospheric Conditions	4-4
5.	COST PLUS INCENTIVE FEE	5-1
6.	TRAJECTORY	6-1
	6.1 Comparison Between Actual and Preflight Predicted Trajectories	6-1
	6.2 Evaluation of Vehicle Performance Effects on Observed Trajectory	6-1
7.	MASS CHARACTERISTICS	7-1
	7.1 Mass Characteristics Summary	7-1
	7.2 Mass Properties Uncertainty Analysis	7-1
	7.3 Second Flight Stage Best Estimate Ignition and Cutoff Masses	7-1
8.	ENGINE SYSTEM	8-1
	8.1 Engine Chilloidn and Conditioning	8-1
	8.2 Start Sphere Performance	8-2
	8.3 Control Sphere Performance	8-3
	8.4 Engine Performance Analysis Methods and Instrumentation	8-4
	8.5 Engine Performance	8-4
	8.6 Component Operation	8-8
	8.7 Engine Sequence	8-10
9.	SOLID ROCKETS	9-1
	9.1 Retrorockets	9-1
	9.2 Ullage Rockets	9-1
10.	OXIDIZER SYSTEM	10-1
	10.1 LOX Tank Pressurization Control	10-1
	10.2 Cold Helium Supply	10-1
	10.3 J-2 Heat Exchanger	10-1
	10.4 LOX Chilloidn	10-2
	10.5 Engine LOX Supply	10-2
11.	FUEL SYSTEM	11-1
	11.1 Pressurization Control and Internal Environment	11-1
	11.2 LH2 Chilloidn	11-2
	11.3 Engine LH2 Supply	11-2

TABLE OF CONTENTS (Continued)

<u>Section</u>		<u>Page</u>
12.	AUXILIARY PROPULSION SYSTEM	12-1
	12.1 Propellant and Pressurization Systems	12-1
	12.2 Engine Performance	12-1
13.	PNEUMATIC CONTROL AND PURGE SYSTEM	13-1
14.	PROPELLANT UTILIZATION	14-1
	14.1 PU Mass Sensor Calibration	14-1
	14.2 Propellant Mass History	14-2
	14.3 PU System Response	14-5
	14.4 Anomalies	14-5
15.	S-IB/S-IVB STAGE SEPARATION	15-1
16.	DATA ACQUISITION SYSTEM	16-1
	16.1 Summary of Performance	16-1
	16.2 Instrumentation System Performance	16-1
	16.3 Telemetry System Performance	16-2
	16.4 RF System Performance	16-2
	16.5 Calibration System	16-2
	16.6 Electromagnetic Compatibility	16-3
	16.7 Signal Strength	16-3
17.	ELECTRICAL SYSTEM	17-1
	17.1 Electrical Control System	17-1
	17.2 Electrical Power System	17-2
	17.3 Exploding Bridgewire System	17-2
18.	RANGE SAFETY SYSTEM	18-1
	18.1 Controllers	18-1
	18.2 Firing Units Monitors	18-1
	18.3 Receivers Signal Strength	18-1
19.	FLIGHT CONTROL	19-1
	19.1 Powered Flight	19-1
	19.2 Attitude Control During Orbital Coast	19-2
20.	HYDRAULIC SYSTEM	20-1
	20.1 Hydraulic System Operation	20-1
21.	VIBRATION ENVIRONMENT	21-1
	21.1 Data Acquisition and Reduction	21-1
	21.2 Vibration Measurements	21-2
22.	ORBITAL SAFING	22-1
	22.1 System Dump	22-1
	22.2V Vent Systems	22-2

APPENDICES

<u>Appendix</u>		
1.	SEQUENCE OF EVENTS	AP 1-1
2.	GLOSSARY AND ABBREVIATIONS	AP 2-1

LIST OF TABLES

<u>Table</u>		<u>Page</u>
3-1	Saturn S-IVB-205 Stage and GSE Orifices	3-2
3-2	Pressure Switch Checkout Data	3-4
4-1	Integrated Launch Vehicle Tests	4-5
4-2	S-IVB-205 Stage Propellant Loading Data	4-5
4-3	Launch-Sphere Pressurization Data	4-6
4-4	Terminal Countdown Sequence S-IVB-205 Flight	4-7
4-5	S-IVB-205 Launch Atmospheric Conditions	4-8
5-1	Mission Accomplishment - Preconditions of Flight	5-2
5-2	Mission Accomplishment - End Conditions of Flight	5-3
5-3	Flight Telemetry Performance Summary	5-4
6-1	Surface Weather Conditions at Time of Launch	6-3
6-2	Trajectory Conditions at Significant Event Times	6-4
6-3	Significant Deviations of Actual Trajectory from Propellant Simulation	6-5
6-4	Contributions to Trajectory Deviations at Orbit Insertion	6-6
6-5	Performance Comparisons with R&D Vehicles	6-6
7-1	Mass Summary	7-2
7-2	Best Estimate Program Input Values Unique Measurement Systems	7-3
8-1	Thrust Chamber Chilldown	8-11
8-2	Engine GH2 Start Sphere Performance	8-11
8-3	Engine Control Sphere Performance	8-11
8-4	Comparison of Computer Program Results	8-12
8-5	Data Inputs to Computer Programs	8-12
8-6	Engine Performance	8-13
8-7	Engine Performance and Data Shift Summary	8-13
8-8	Engine Sequence	8-14
10-1	LOX Tank Pressurization Data	10-3
10-2	Cold Helium Supply Data	10-4
10-3	J-2 Heat Exchanger Performance Data	10-4
10-4	LOX Chilldown System Performance Data	10-5
11-1	LH2 Tank Pressurization Data	11-4
11-2	LH2 Chilldown System Performance Data	11-5
11-3	LH2 Pump Inlet Condition Data	11-6
12-1	APS Liftoff and Final Conditions	12-3
12-2	Propellant Usage	12-3
13-1	Pneumatic Control and Purge System Data	13-1
14-1	Propellant Mass History	14-6
14-2	Propellant Residual Summary	14-7
14-3	PU Valve Response at Significant Times	14-7
15-1	Separation Events	15-1
16-1	Measurement Status	16-5
16-2	Measurement Failures	16-6
16-3	Measurement Problems	16-7
17-1	Five-Volt Excitation Modules Performance	17-3
19-1	Maximum Values of Critical Flight Control Parameters - S-IVB Powered Flight	19-4
19-2	APS Impulse Summary	19-5
21-1	Composite Vibration Levels	21-2
AP 1-1	AS-205 Sequence of Events	AP 1-3
AP 2-1	Glossary and Abbreviations	AP 2-1

LIST OF ILLUSTRATIONS

<u>Figure</u>		<u>Page</u>
1-1	S-IVB-205 Stage Checkout and Test History	1-2
3-1	Propulsion System Configuration and Instrumentation	3-5
3-2	Electrical Control System	3-6
3-3	Hydraulic System	3-7
3-4	Data Acquisition System	3-8
6-1	S-IB Axial Acceleration History	6-7
6-2	S-IB Dynamic Pressure History	6-8
6-3	S-IB Angle of Attack History	6-9
6-4	S-IVB Attitude History	6-12
6-5	S-IVB Ground Range History	6-13
6-6	S-IVB Crossrange Position History	6-14
6-7	S-IVB Crossrange Velocity History	6-15
6-8	S-IVB Inertial Velocity History	6-16
6-9	S-IVB Axial Acceleration History - S-IB/S-IVB Separation	6-17
6-10	S-IVB Inertial Flight Path Elevation Angle History	6-18
6-11	S-IVB Inertial Flight Path Azimuth Angle History	6-19
6-12	Trajectory Reconstruction Simulation Deviations	6-20
6-13	Thrust and Weight Flow from Trajectory Reconstruction	6-21
6-14	Thrust and Velocity Gained due to LOX Dump	6-22
7-1	AS-205 Second Flight Stage Vehicle Mass	7-4
7-2	AS-205 Second Flight Stage Vehicle Longitudinal Center of Gravity	7-5
7-3	AS-205 Second Flight Stage Vehicle Roll Moment of Inertia	7-6
7-4	AS-205 Second Flight Stage Vehicle Pitch Moment of Inertia	7-7
7-5	AS-205 Second Flight Stage Best Estimate Masses	7-8
8-1	J-2 Engine System and Instrumentation	8-17
8-2	Thrust Chamber Chilldown	8-18
8-3	Engine Start and Control Sphere Performance	8-19
8-4	GH2 Start Sphere Critical Limits at Liftoff	8-20
8-5	Engine Start Sphere Performance	8-20
8-6	Start Sphere Orbital Conditions	8-21
8-7	Control Sphere Orbital Conditions	8-22
8-8	J-2 Thrust Chamber Pressure	8-23
8-9	J-2 Engine Injector Supply Conditions	8-24
8-10	PU Valve Operation	8-25
8-11	J-2 Engine Pump Operating Conditions	8-26
8-12	Turbine Inlet Operating Conditions	8-27
8-13	LOX and LH2 Flowrate	8-28
8-14	Engine Tag Values	8-29
8-15	Specific Impulse Versus Engine Mixture Ratio	8-30
8-16	Engine Start Transient Characteristics	8-31
8-17	Engine Steady-State Performance	8-32
8-18	S-IVB Change in Velocity Due to Cutoff Impulse	8-35
8-19	Engine Cutoff Transient Characteristics	8-36
8-20	LH2 Pump Performance During Engine Start	8-37
8-21	Gas Generator Performance	8-38
8-22	ASI Temperatures	8-39
8-23	Engine Start Sequence	8-40

LIST OF ILLUSTRATIONS (Continued)

<u>Figure</u>		<u>Page</u>
10-1	LOX Tank Pressurization System	10-7
10-2	LOX Tank Conditions - Prepressurization and Boost	10-8
10-3	LOX Tank Pressurization System Performance	10-9
10-4	Cold Helium Supply	10-10
10-5	J-2 Heat Exchanger Performance	10-11
10-6	LOX Pump Chillover System Operation	10-12
10-7	LOX Pump Chillover Characteristics	10-13
10-8	LOX Supply System	10-14
10-9	LOX Pump Inlet Conditions	10-15
10-10	LOX Pump Inlet Conditions During Firing	10-16
10-11	Effect of LOX Mass Level on LOX Pump Inlet Temperature	10-17
11-1	LH2 Tank Pressurization System	11-7
11-2	LH2 Tank Prepressurization System Performance	11-8
11-3	LH2 Tank Pressurization System Performance	11-9
11-4	LH2 Tank Venting During Engine Operation	11-10
11-5	LH2 Pump Chillover Operation	11-11
11-6	LH2 Pump Chillover Characteristics	11-12
11-7	LH2 Supply System	11-13
11-8	LH2 Pump Inlet Conditions	11-14
11-9	LH2 Pump Inlet Conditions During Firing	11-15
11-10	Effect of LH2 Mass Level on LH2 Pump Inlet Temperature	11-16
12-1	Auxiliary Propulsion System and Instrumentation	12-4
12-2	APS Propellant Conditions	12-5
12-3	APS Total Impulse	12-6
12-4	APS Engine Performance	12-7
13-1	Pneumatic Control and Purge System	13-2
13-2	Pneumatic Control and Purge System Performance	13-3
14-1	Total LOX Sensor Mass Correction as Determined by the Volumetric Method	14-8
14-2	Total LH2 Sensor Mass Correction as Determined by the Volumetric Method	14-9
14-3	LOX Normalized Probe Linearity	14-10
14-4	LH2 Normalized Probe Linearity	14-11
15-1	Longitudinal Acceleration	15-2
15-2	Angular Velocities	15-3
17-1	Forward Battery No. 1 - Launch Phase	17-4
17-2	Forward Battery No. 2 - Launch Phase	17-4
17-3	Aft Battery No. 1 - Launch Phase	17-5
17-4	Aft Battery No. 2 - Launch Phase	17-5
17-5	Forward Battery No. 1 - Orbit	17-6
17-6	Forward Battery No. 2 - Orbit	17-6
17-7	Aft Battery No. 1 - Orbit	17-7
17-8	Aft Battery No. 2 - Orbit	17-7
19-1	Pitch Attitude Control - Powered Flight	19-6
19-2	Yaw Attitude Control - Powered Flight	19-7
19-3	Roll Attitude Control - Powered Flight	19-8
19-4	LH2 SLOSH - Powered Flight	19-9
19-5	LOX SLOSH - Powered Flight	19-10
19-6	Pitch Attitude Control - S-IVB Alignment with Local Horizontal	19-11
19-7	Yaw Attitude Control - S-IVB Alignment with Local Horizontal	19-12
19-8	Roll Attitude Control - S-IVB Alignment with Local Horizontal	19-13

LIST OF ILLUSTRATIONS (Continued)

<u>Figure</u>		<u>Page</u>
19-9	Pitch Attitude Control - LOX Dump	19-14
19-10	Yaw Attitude Control - LOX Dump	19-15
19-11	Roll Attitude Control - LOX Dump	19-16
19-12	Pitch Attitude Control - Manual Control	19-17
19-13	Yaw Attitude Control - Manual Control	19-18
19-14	Roll Attitude Control - Manual Control	19-19
19-15	Pitch Attitude Control - S-IVB/CSM Separation	19-20
19-16	Yaw Attitude Control - S-IVB/CSM Separation	19-21
19-17	Roll Attitude Control - S-IVB/CSM Separation	19-22
19-18	Module 1 APS Propellant Required for Attitude Control	19-23
19-19	Module 2 APS Propellant Required for Attitude Control	19-24
20-1	System Pressure and Pump Current Load - Boost and Powered Flight	20-3
20-2	Reservoir Pressure and Oil Level - Boost and Powered Flight	20-4
20-3	Main Pump Inlet and Reservoir Oil Temperatures - Boost and Powered Flight	20-5
20-4	Accumulator GN2 Pressure and Temperature - Boost and Powered Flight	20-6
20-5	Hydraulic System Temperatures - Orbital Coast	20-7
20-6	Pressures and Reservoir Oil Level - Orbital Coast	20-8
20-7	Hydraulic System Temperatures - Orbital Safing	20-9
20-8	Hydraulic System Measurements - Orbital Safing	20-10
20-9	Actuator Positions - Orbital Safing	20-11
21-1	Vibration Measurement Locations	21-3
21-2	Vibration Measured on Combustion Chamber Dome, Thrust Direction - E0209-401	21-4
21-3	Vibration Measured at LOX Turbopump, Lateral Direction - E0211-401	21-5
21-4	Vibration Measured on Main Fuel Valve, Tangential Direction - E0236-401	21-6
21-5	Vibration Measured on Main Fuel Valve, Radial Direction - E0237-401	21-7
21-6	Vibration Measured on Fuel ASI Block, Radial Direction - E0242-401	21-8
21-7	Vibration Measured on ASI LOX Valve, Radial Direction - E0243-401	21-9
21-8	Vibration Measured on ASI LOX Valve, Longitudinal Direction - E0245-401	21-10
22-1	LOX Tank Dump	22-5
22-2	First and Second Cold Helium Dump	22-7
22-3	Pneumatic Control System Conditions During Orbit	22-8
22-4	LOX Tank Ullage Pressure During Orbit	22-9
22-5	LOX Tank Venting During Orbit	22-10
22-6	LH2 Tank Ullage Pressure During Safing	22-11
22-7	Fuel NPV Nozzle Temperature and Pressure Comparison (204F and 205F)	22-12
22-8	Mass in LH2 Tank During Orbital Safing	22-13

SECTION 1

INTRODUCTION

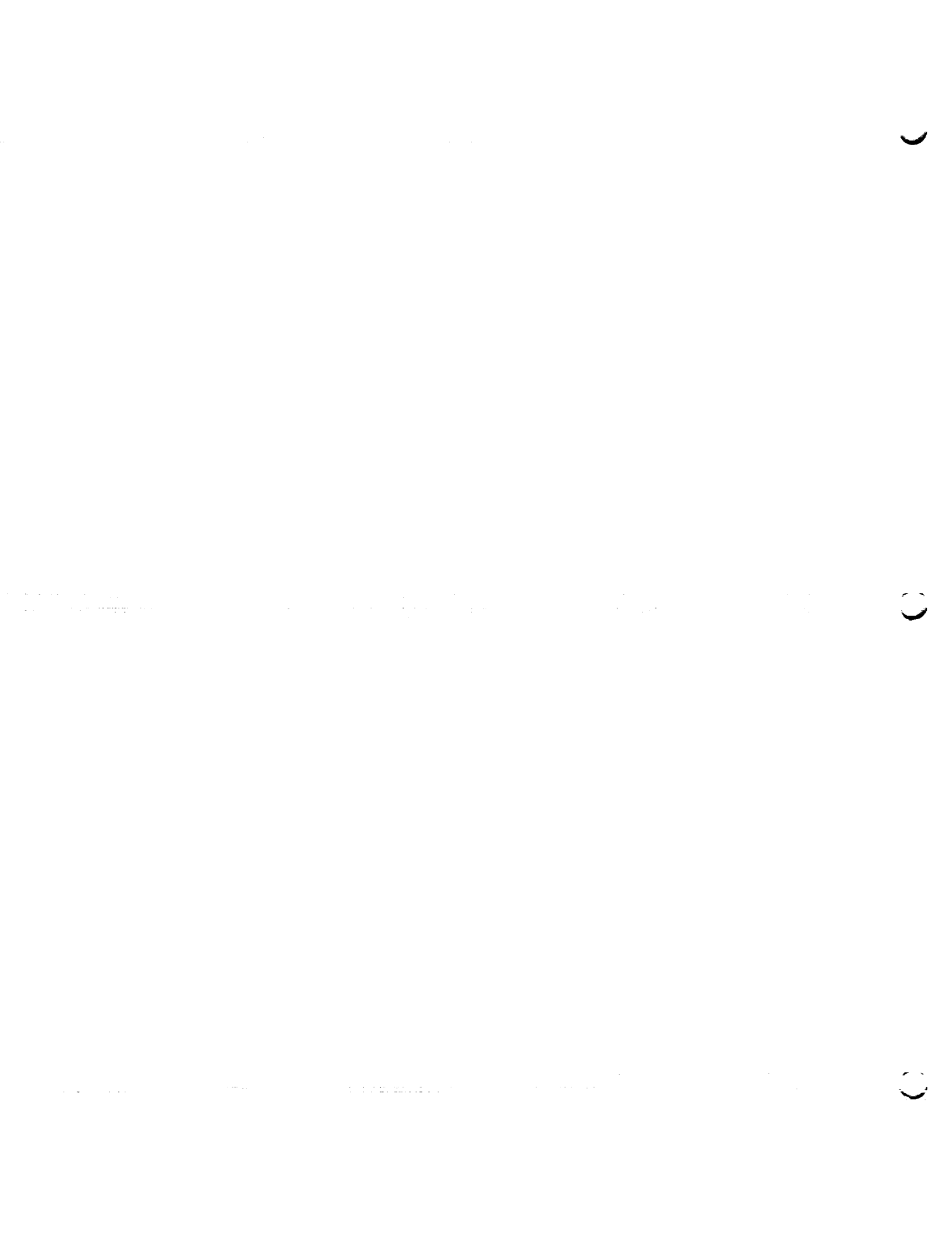

1. INTRODUCTION

1.1 General

This report presents the results of analyses that were performed by McDonnell Douglas Astronautics Company-Western Division (MDAC-WD) personnel on the countdown, launch, and flight of the Saturn S-IVB-205 stage.

This evaluation report also describes tests conducted at Kennedy Space Center (KSC), and pertinent modifications made to the S-IVB and related ground support equipment.

This report is authorized by NASA Contract NAS7-101, and is the final report on the S-IVB-205 stage by the MDAC-WD S-IVB Test Planning and Evaluation Committee, Huntington Beach, California.

1.2 History

The S-IVB-205 stage was assembled at MDAC-WD, Huntington Beach, California, where a limited checkout was performed in the vehicle checkout laboratory prior to shipping the stage to Sacramento Test Center (STC). The stage was installed on Beta Test Stand III on 15 April 1966 where the acceptance firing was conducted 2 June 1966. No confidence firings on the two auxiliary propulsion system modules were scheduled. Evaluation and analysis of the acceptance firing is presented in MDAC-WD Report SM-47471, Saturn S-IVB-205 Stage Acceptance Firing Report. A number of modifications were made prior to and after the stage entered an extended storage at STC.

The S-IVB-205 stage was shipped to KSC and was mated to the AS-205 launch vehicle on Launch Complex 34. The AS-205 vehicle was launched on 11 October 1968 at 15:02:45 Greenwich Mean Time. Figure 1-1 presents significant checkout and test history dates.

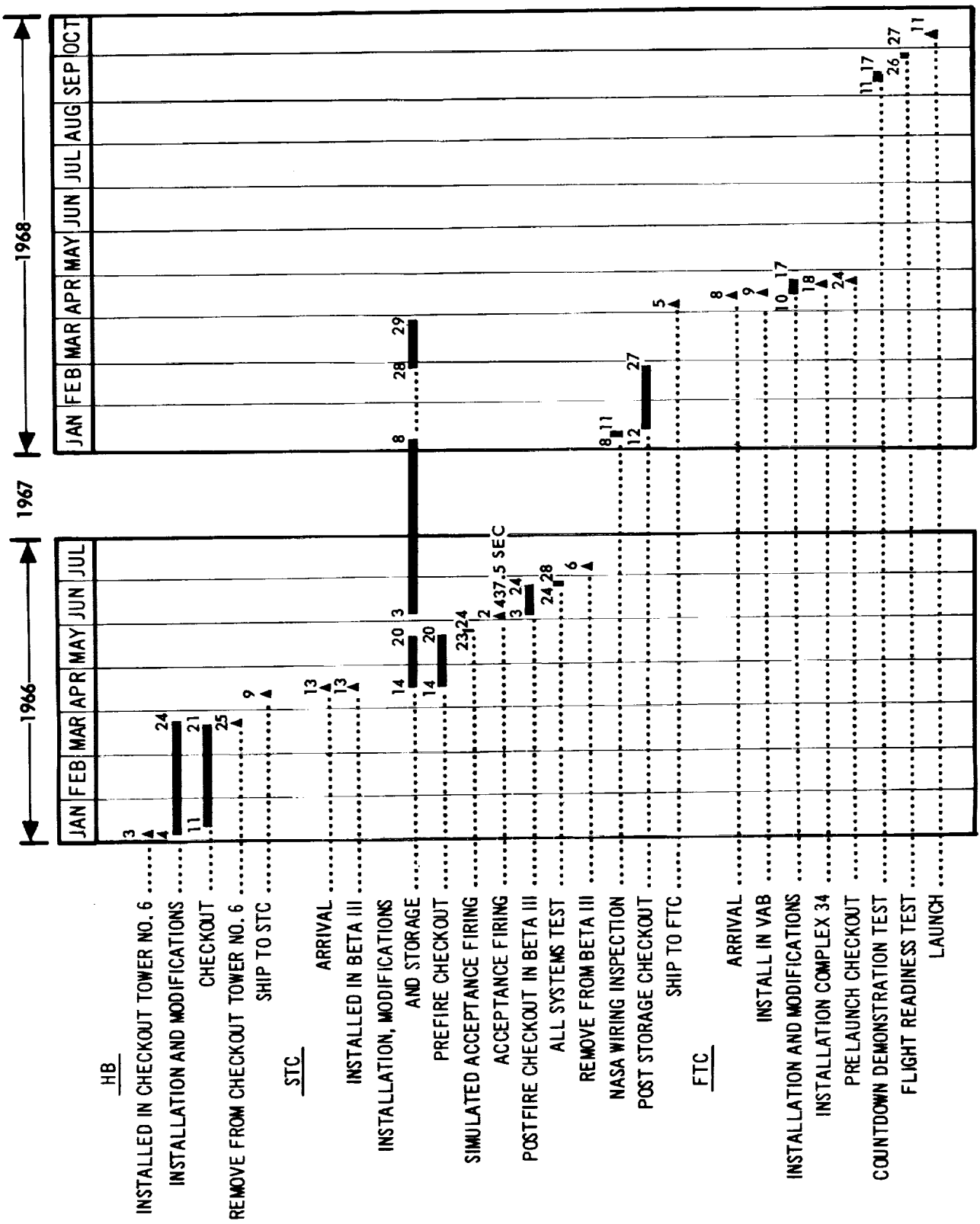

Figure 1-1. S-IVB-205 Stage Checkout and Test History

C



SECTION 2

FLIGHT AND STAGE SUMMARY



2. FLIGHT AND STAGE SUMMARY

2.1 Flight Summary

2.1.1 Mission

The S-IVB-205 stage was the second stage of the AS-205 launch vehicle which served as booster for the Apollo 7 mission. AS-205 was launched 11 October 1968 at 11:02:45 AM EDT. AS-205 was the first manned Apollo and it placed the Command and Service Module (CSM) with its three astronauts into a 120.0 by 152.3 nmi elliptical orbit with an inclination of 31.6 deg. Insertion occurred at RO +626.76 sec.

Over the United States, 1 1/2 hr after liftoff, the instrument unit (IU) automatically initiated the S-IVB orbital safing sequence which dumped the LOX through the J-2 engine, vented the LH2 through the LH2 tank vent system, vented the cold helium spheres, S-IVB ambient pneumatic sphere, and J-2 engine control sphere. This was done to ensure a safe S-IVB stage for a CSM rendezvous one day later.

Over Carnarvon, 2 1/2 hr after liftoff, the crew exercised the manual S-IVB/IU orbital attitude control capability. This consisted of a 3 min test of the closed loop spacecraft/launch vehicle control system by the performing of manual pitch, yaw, and roll maneuvers. After completion of the test, the crew switched attitude control back to the automatic launch vehicle system and the normal attitude timeline was resumed.

Launch vehicle/spacecraft (LV/SC) separation was accomplished over Hawaii 2 hr 55 min after liftoff by a manual signal given by the crew. The crew then performed a simulated transposition and docking maneuver with the S-IVB and took pictures of the S-IVB with the spacecraft lunar module (LM) adapter panels in the deployed position.

The day after liftoff, the crew initiated a rendezvous with the expended S-IVB/IU to simulate a LM rescue capability by the CSM.

2.1.2 Countdown and Launch

The AS-205 launch countdown was initiated at 0600 GMT on 8 October 1968. The countdown proceeded on schedule until T -6 min 15 sec when a 2 min 45 sec hold was called due to the J-2 thrust chamber chilldown taking longer than expected. The count resumed with no problems and liftoff occurred at 15:02:45.323 GMT.

2.1.3 S-IB Powered Flight

The AS-205 vehicle lifted off on a launch azimuth of 100 deg E of N from launch complex 34. The vehicle rolled to a flight azimuth of 72 deg E of N at RO +10.31 sec. The sequence of significant occurrences were as follows:

Guidance Reference Release (GRR)	RO -4.97 sec
Range Zero (RO)	15:02:45 GMT
IU Umbilical disconnect (TBl)	RO +0.36 sec
Mach 1	RO +62.3 sec
Max q	RO +75.5 sec

TB2	RO +137.49 sec
OECO	RO +144.323 sec
S-IB/S-IVB physical separation	RO +145.59 sec

2.1.4 S-IVB Powered Flight

After S-IB/S-IVB separation the retrorockets forced the S-IB stage away from the S-IVB and the ullage rockets fired and settled the S-IVB propellants. Engine Start Command (ESC) occurred at RO +147.08 sec, initiating a 1-sec fuel lead and subsequent thrust buildup.

The open-loop propellant utilization (PU) system was commanded from 5.5 to 4.5 engine mixture ratio (EMR) at ESC +308.775 sec. Guidance was staged at RO +455.68 sec and went into the artificial tau mode for 36.28 sec. At RO +592.65 sec the chi tilde mode was initiated. Guidance commands were frozen (chi freeze) 4.013 sec before S-IVB cutoff and were held constant through the cutoff transient. J-2 Engine Cutoff Command occurred at RO +616.757 sec with a total burntime of 469.749 sec.

2.1.5 Orbital Safing

At TB4 +0.384 sec the first of three programmed nonpropulsive vents of the LH2 tank was initiated. The second programmed nonpropulsive vent was initiated at TB4 +2,629.967 sec and the third at TB4 +5,065.948 sec. Because the LH2 residual was not vented completely during the three programmed vents, four additional ground commanded vents were required to safe the LH2 tank.

A dump of LOX through the J-2 engine was initiated at TB4 +5,051.951 sec and terminated at TB4 +5,772.965 sec.

A cold helium dump was initiated at TB4 +5,531.962 sec and terminated 2,868 sec later. The cold helium dump was repeated at TB4 +15,599.95 sec for 1,200 sec.

The stage pneumatic sphere dump was initiated at TB4 +11,236.960 sec but was terminated early in order to have pneumatic control pressure available to operate the LH2 vent and relief valve during the extended LH2 tank passivation.

2.2 Mission Objectives

MDAC-WD considers the Flight Mission Directive for Apollo Saturn IB Missions, Revision 1 prepared by the Saturn I/IB Program Office, Marshall Space Flight Center, Huntsville, Alabama dated 15 August 1968 as the official document for providing identification and control of launch vehicle mission requirements. The AS-205 launch vehicle mission objectives are summarized and discussed as follows:

Principal Detailed Objectives

- | | |
|---|--------------------|
| 1. Demonstrate the adequacy of the launch vehicle attitude control system for orbital operation | objective achieved |
| 2. Demonstrate S-IVB orbital safing capability | objective achieved |

3. Evaluate S-IVB J-2 engine ASI line modification objective achieved

Secondary Detailed Test Objectives

1. Evaluate the S-IVB/IU orbital lifetime capability objective achieved
2. Demonstrate CSM manual launch vehicle orbital attitude control objective achieved

2.3 Stage Summary

Performance of the MDAC-WD built S-IVB-205 was satisfactory during countdown, boost, and orbit. No significant anomalies occurred during the flight.

Orbital safing of the S-IVB was accomplished, but the LH2 tank passivation required four ground commanded vents in addition to the three programmed vents.

The LOX tank dump essentially ended at R0 +6,341 sec when the main oxidizer valve closed to the 15 percent open position due to the depletion of engine pneumatics. This condition was expected since pneumatic pressure is required to fully close the valve.

2.3.1 Test Operations

The launch day countdown was initiated on 8 October 1968 and culminated in a successful launch at 15:02:45 GMT on 11 October 1968. The S-IVB portion of the countdown proceeded satisfactorily, and all stage systems responded correctly to commands. The only problem was thrust chamber chilldown which was slower than expected.

2.3.2 Cost Plus Incentive Fee

Performance of the S-IB stage provided preconditions of flight (PCF) at S-IB/S-IVB Separation Command that were within tolerance. Trajectory derived end conditions of flight (ECF) at orbit insertion were within tolerance; also, maximum flight values of attitude errors and rates for both phases of S-IVB operation (powered flight and orbit phase) did not exceed the respective allowable tolerances. All received command signals were recognized, and all end condition command signals were given. It was concluded for purposes of incentive achievement, therefore, that all PCF and ECF were achieved.

Evaluation of the telemetry performance indicated that the telemetry system operated at a 99.2 percent efficiency during the telemetry performance evaluation period (TPEP) phase I and performed at 99.2 percent efficiency during TPEP phase II.

2.3.3 Trajectory

The actual trajectory of the AS-205 flight was very close to nominal. At S-IB/S-IVB Separation Command the trajectory can be characterized as being slightly off nominal. The slow and low trajectory of the S-IB stage caused the S-IVB stage to burn slightly longer than predicted in order to obtain the desired cutoff conditions. An orbit was obtained which was very near to that predicted.

2.3.4 Mass Characteristics

At S-IVB-205 Engine Start Command the mass of the remaining AS-205 vehicle was 305,685 ±641 lbm. At S-IVB-205 Engine Cutoff Command, mass of the remaining AS-205 vehicle was 67,720 ±159 lbm. All total vehicle mass characteristics parameters were within tolerance throughout the flight.

2.3.5 Engine System

The engine system performed satisfactorily during the S-IVB-205 flight. The engine was operated with the PU system in the open loop mode, and PU valve cutback to the low EMR position was commanded as planned. The propellant utilization efficiency was 99.8 percent.

2.3.6 Solid Rockets

The solid rocket motors on the AS-205 launch vehicle performed satisfactorily and accomplished their intended purpose. The S-IB was separated from the S-IVB by the retrorockets, and the S-IVB propellants were settled prior to engine start by the ullage rockets.

2.3.7 Oxidizer System

The oxidizer system performed as designed and supplied LOX to the engine within the specified limits. The LOX tank pressurization system satisfactorily controlled pressure in the LOX tank during all periods of flight.

2.3.8 Fuel System

The fuel system performed as designed and supplied LH2 to the engine within the limits defined in the engine specification. The GSE and airborne LH2 tank pressurization systems satisfactorily controlled the LH2 tank ullage pressure during countdown, boost, and powered flight.

2.3.9 Auxiliary Propulsion System

Both auxiliary propulsion system modules operated very well and functioned as required to perform the attitude corrections desired. The modules supplied roll control to the vehicle during S-IVB powered flight and pitch and yaw control at S-IVB engine cutoff. The two APS modules then functioned to compensate for induced disturbances and to maneuver the vehicle.

2.3.10 Pneumatic Control and Purge System

The pneumatic control and purge system performed satisfactorily throughout the flight. The helium supply to the system was adequate for both pneumatic valve control and purging; the regulated pressure was maintained within acceptable limits; and all components functioned normally.

2.3.11 Propellant Utilization System

The propellant utilization (PU) system successfully met the loading accuracy requirements of the stage. The best estimate propellant mass values at liftoff were 193,360 lbm LOX and 39,909 lbm LH2. These values are well within the required ±1.12 percent stage loading accuracy.

After velocity cutoff the usable propellant residuals were extrapolated to depletion. This extrapolation indicates that a LOX depletion would have occurred 3.08 sec after velocity cutoff with an LH2 usable residual (less bias) of 538 lbm. This yields an open loop efficiency of 99.8 percent.

The PU system was operated inflight in the open loop mode and the mixture ratio valve operation was wholly in response to launch vehicle digital computer issued commands.

2.3.12 S-IB/S-IVB Stage Separation

The separation analysis was done by a comparison of AS-205 data with the AS-204 separation data. The majority of the data compared very closely for the two vehicles.

2.3.13 Data Acquisition System

The performance of the data acquisition system was very good throughout both phases of evaluation. All systems performed as designed, and no system malfunctions were observed.

A summarization of the S-IVB-205 measurements is presented below:

Measurements Assigned	379
Checkout Only Measurements	12
Landline Measurements	114
Vibration Measurements Deleted from Incentive	8
Measurements Inoperative due to Stage Configuration	2
Measurements Deleted Prior to Liftoff	0
Total Active Incentive Measurements at Liftoff	243
Phase I Measurement Failures	2
Phase II Measurement Failures	2
Phase I Measurement Efficiency	99.2%
Phase II Measurement Efficiency	99.2%
Measurement Failures not Affecting CPIF	2

The performance of the pulse code modulation (PCM) system was excellent.

The RF system performed without difficulty in the transmission of airborne data to ground stations located throughout the orbital flight path.

2.3.14 Electrical System

The electrical control system and electrical power system performed satisfactorily throughout the launch and orbital phases of flight. All responses to switch selector commands were satisfactory. The J-2 engine control system and APS electrical control system performed properly. All control pressure switches and electrically controlled valves operated

satisfactorily. The exploding bridgewire (EBW) system charged, fired, and jettisoned the ullage rockets as expected. All batteries performed within expected limits. The chilldown inverter, static inverter-converter, and 5 V excitation modules operated normally. The frequency measurement of the static inverter-converter shifted downward at RO +5,540 sec but this was an instrumentation problem and not a power system problem.

2.3.15 Range Safety System

The range safety system was not required for propellant dispersion during flight. All indications showed that it operated properly and would have satisfactorily terminated the flight if commanded by the range safety officer.

A momentary signal strength dropout of 2 sec was observed at RO +121 sec due to range safety command control difficulties.

2.3.16 Flight Control

The S-IVB thrust vector control system provided satisfactory control in the pitch and yaw planes during powered flight. The auxiliary propulsion system (APS) provided satisfactory roll control during powered flight and satisfactory pitch, yaw, and roll control during orbital coast.

2.3.17 Hydraulic System

The S-IVB hydraulic system performance was within predicted limits and the entire system operated satisfactorily throughout flight. There was one 48-sec thermal cycle which was programmed during the first orbit.

2.3.18 Vibration

Eight vibration measurements were monitored on the J-2 engine. One measurement did not provide usable data. The measured vibration levels were in agreement with those measured by Rocketdyne during engine ground tests.

2.3.19 Orbital Safing

Orbital safing was accomplished satisfactorily. Operation was as predicted with the exception of the LH2 tank safing. LH2 tank safing required approximately 18,500 sec to complete as opposed to a predicted 6,000 sec. As a result of unanticipated venting conditions, the LH2 tank safing required four ground commanded vents in addition to the three programmed vents.

2.3.20 Stage Structure

A review of S-IVB-205 flight data revealed no structural anomalies. Photographs of the S-IVB taken from the command module during orbit disclosed no loss of bonded insulation nor structural damage. The structural integrities of the LH2 tank, LOX tank, and common bulkhead were verified by telemetry pressure data. From the time of LH2 tank loading until the end of tank depressurizations in orbit, the common bulkhead internal pressure remained at 0.45 psia or less, indicating a sound bulkhead. The maximum LH2 ullage pressure of 32.3 psia was below the limit design LH2 ullage pressure of 39.0 psia. The maximum LOX ullage pressure

was 43.1 psia which did not exceed the limit design LOX ullage pressure of 44.0 psia. At RO +11,354 sec the LH2 ullage pressure had increased to 21.6 psia while the LOX ullage pressure was 0.4 psia. The resulting differential pressure across the common bulkhead was -21.2 psid, which exceeded the limit value of -20.0 psid prescribed by flight mission rule No. 5-7. At that time the LH2 tank vent valve was activated by the Corpus Christi ground control station to reduce the differential pressure. The maximum negative pressure was well below the ultimate capability of the common bulkhead of -32.5 psid. The maximum measured acceleration during critical first stage launch was 4.25 g which did not exceed the S-IVB-205 predicted axial load factor of 4.26 g.

2.3.21 Forward Skirt Thermoconditioning System

The forward skirt thermoconditioning system operated satisfactorily throughout powered flight. The temperature of the coolant supplied was within the specification limits for the entire flight.

2.3.22 Common Bulkhead Vacuum Monitoring System

The bulkhead internal pressure was satisfactory throughout the count, less than 0.2 psia at liftoff, and indicative of a sound bulkhead throughout the flight.

2.3.23 Aft Skirt Thermoconditioning and Purge System

The aft purge maintained the APS modules' oxidizer and fuel tank temperatures within their launch limits during the countdown.

2.3.24 Exploding Ordnance Equipment

All exploding bridgewire (EBW) initiated ordnance systems performed as required. The stage separation system, which utilizes a dual mild detonating fuse (MDF) assembly, functioned on command and effected a complete separation of the S-IVB from the S-IB. The ullage rockets and retrorockets fired; thus, normal separation sequence was accomplished.

2.3.25 Thermal Environment

The mission profile of the AS-205 flight produced nominal thermal environments for the S-IVB components and structure. The boost trajectory was cooler than the thermal design trajectory and the orbital environments resulted in nominal heat inputs.

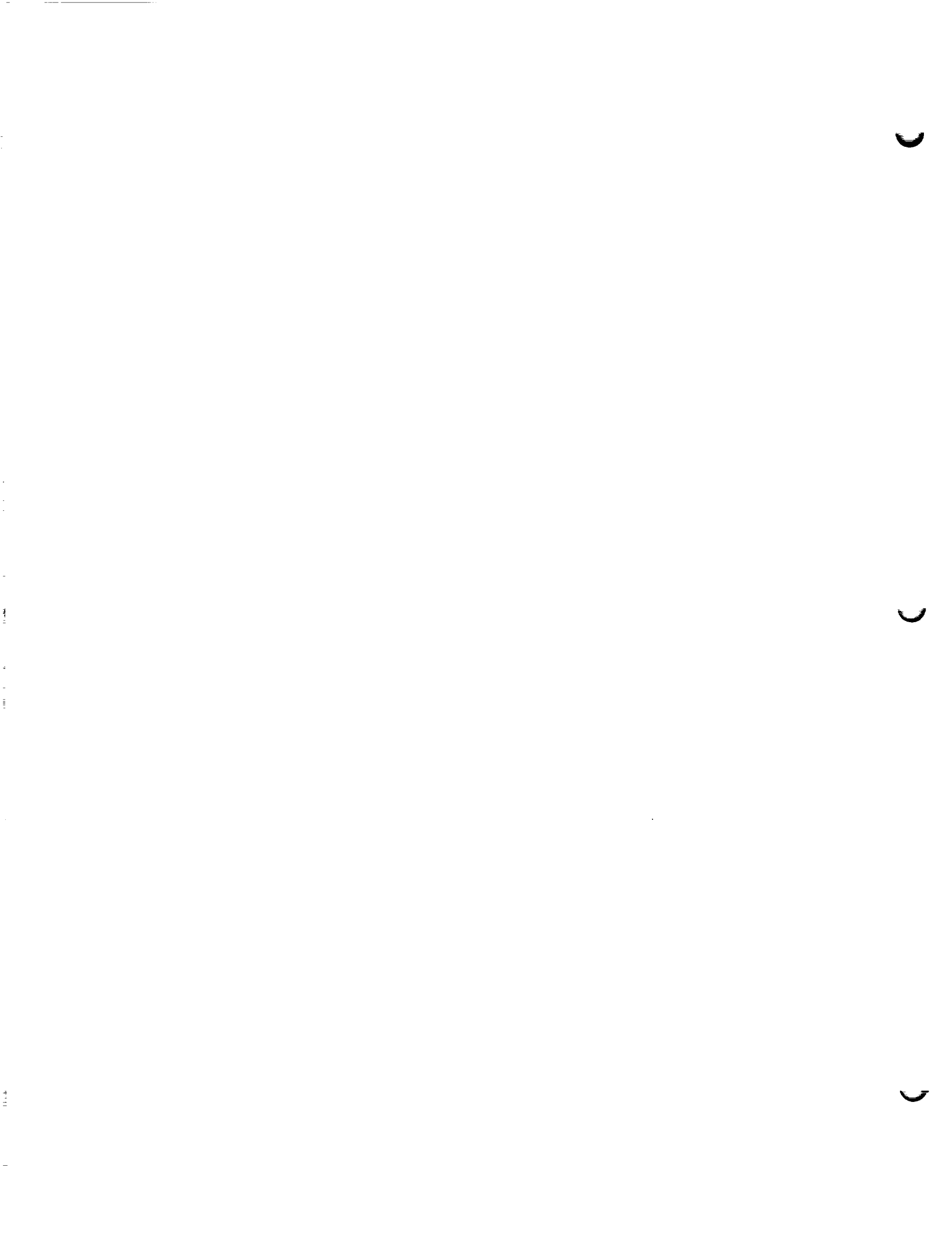

SECTION 3

STAGE CONFIGURATION

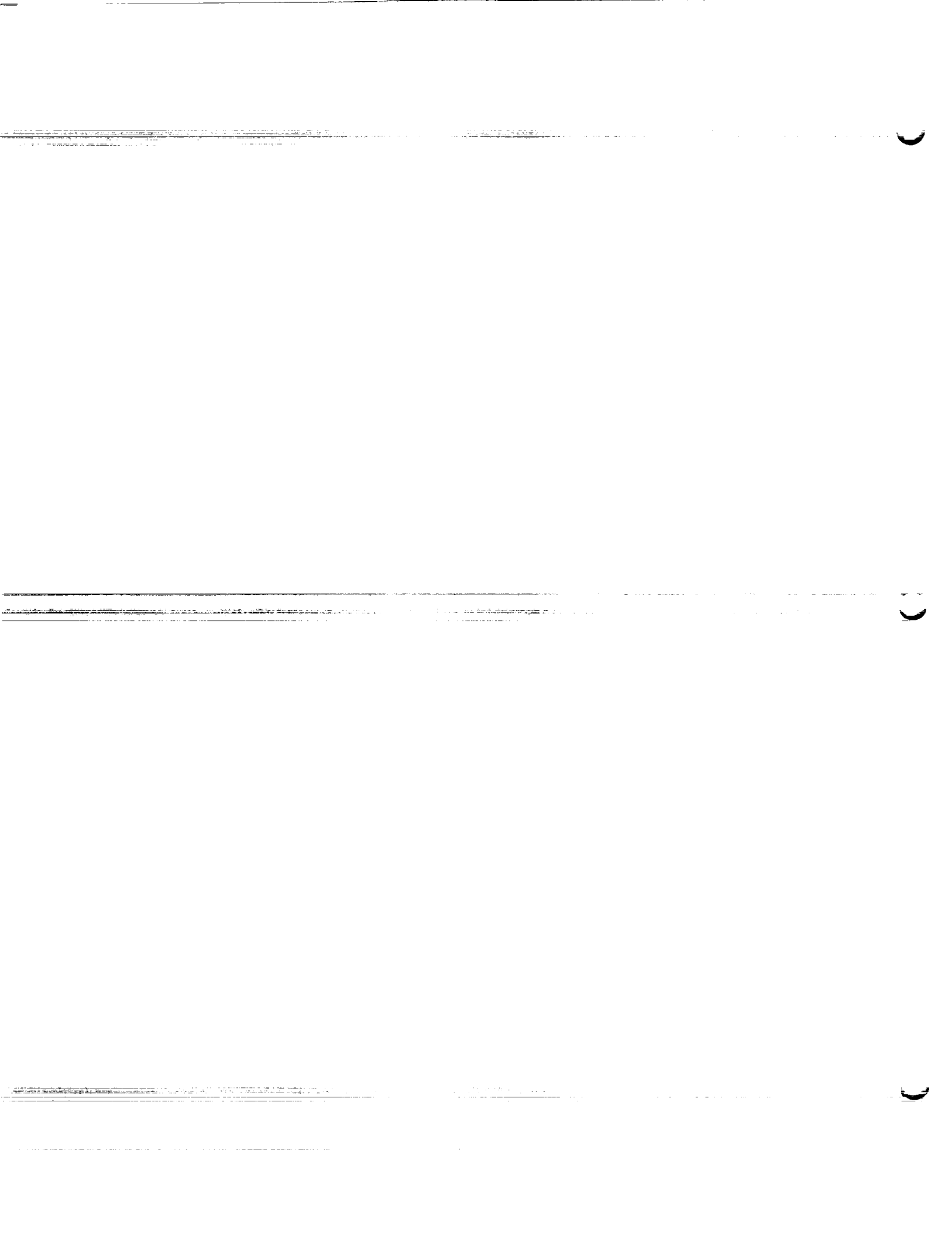

3. STAGE CONFIGURATION

Table 3-1 presents the S-IVB-205 stage and GSE orifice data and table 3-2 presents the pressure switch checkout data.

The general configuration of the S-IVB 205 stage is described in MDAC-WD Report No. SM-46978A S-IVB-205 Stage Flight Test Plan, dated 18 November 1966, revised September 1968. This stage was equipped with a Rocketdyne 225,000 lbf thrust engine, serial number J-2033; additional stage information is presented in the following documents:

- a. MDAC-WD Report No. SM-47455, Saturn S-IVB-205 Stage Acceptance Firing Test Plan dated March 1966, revised May 1966, revised June 1966.
- b. MDAC-WD drawing 1B62934D, S-IVB-205 Stage End Item Test Plan, dated 6 October 1967.
- c. MDAC-WD Report No. SM-56354 Narrative End Item Report on Saturn S-IVB-205 (MDAC-WD S/N 2005), dated July 1966.
- d. MDAC-WD Report No. SM-47184, Saturn S-IVB/IB Range Safety Report, dated 19 November 1965, revised 28 February 1966.

Figure 3-1 is a schematic of the S-IVB-205 propulsion system and shows the locations of the telemetry instrumentation from which the data was obtained. Figure 3-2 shows a block diagram of the electrical control system. Figure 3-3 is a schematic of the hydraulic system. Figure 3-4 is a block diagram of the data acquisition system.

TABLE 3-1 (Sheet 1 of 2)
SATURN S-IVB-205 STAGE AND GSE ORIFICES

DESCRIPTION	ORIFICE SIZE OR NOMINAL FLOWRATE	COEFFICIENT OF DISCHARGE	EFFECTIVE AREA (IN. ²)	DESCRIPTION	ORIFICE SIZE OR NOMINAL FLOWRATE	COEFFICIENT OF DISCHARGE	EFFECTIVE AREA (IN. ²)
Stage							
LH2 chilldown valve purge	14 scfm with 3,200 psid	--	sintered	LOX tank sensing line purge	200 scfm with 550 psia	--	sintered
LH2 fill and drain valve purge	15 scfm with 3,200 psid	--	sintered	LOX tank vent and relief valve purge	65 scfm with 3,200 psid	--	sintered
LOX fill and drain valve purge	15 scfm with 3,200 psid	--	sintered	Engine purge control module	0.00166 lbm/sec with 475 psig in and 85 psig out	--	--
LOX tank pressurization module heat exchanger primary	0.196 in. dia	0.90	0.0271	Pneumatic Console 432			
LOX tank pressurization module heat exchanger bypass	0.166 in. dia	0.90	0.0195	Console 432 stage 1 bleed	--	--	--
LH2 tank pressurization module-overcontrol	--	--	0.107	Mainstage OK pressure switch checkout, fine	0.025 in. dia	--	--
LH2 tank pressurization module-undercontrol	--	--	0.0730	Pressure switch checkout, low pressure, coarse (used with All793)	0.015 in. dia	--	--
LH2 tank pressurization module-step	--	--	0.1686	Pressure switch checkout, low	0.015 in. dia	--	--
LH2 tank nonpropulsive vent purge	1 scfm with 3,200 psid	--	sintered	Pressure switch checkout, high pressure, fine	0.018 in. dia	--	--
LH2 tank nonpropulsive vent No. 1	2.180 in. dia	--	--	Pressure switch checkout, high pressure, coarse (used with All806)	0.018 in. dia	--	--
LH2 tank nonpropulsive vent No. 2	2.180 in. dia	--	--	LH2 system checkout supply, coarse (used with All824)	0.016 in. dia	--	--
LOX chilldown pump purge	37 scfm with 475 psid	--	sintered	LH2 system checkout supply, fine	0.016 in. dia	--	--
				LOX system checkout supply, coarse (used with All837)	0.016 in. dia	--	--

TABLE 3-1 (Sheet 2 of 2)
SATURN S-IVB-205 STAGE AND GSE ORIFICES

DESCRIPTION	ORIFICE SIZE OR NOMINAL FLOWRATE	COEFFICIENT OF DISCHARGE	EFFECTIVE AREA (IN. ²)	DESCRIPTION	ORIFICE SIZE OR NOMINAL FLOWRATE	COEFFICIENT OF DISCHARGE	EFFECTIVE AREA (IN. ²)
LOX system checkout supply, fine	0.016 in. dia	--	--	Cold helium sphere pressurization supply (same orifice as above)		--	--
Console 432 GN2 inerting supply	0.031 in. dia	--	--	Stage 3 regulator outlet bleed	0.03 lbm/min	--	sintered
APS helium sphere fill	0.027 in. dia	--	--	Stage 3 regulator inlet	0.180 in. dia	--	--
Mainstage OK pressure switch checkout, coarse (used with ALL779)	0.025 in. dia	--	--	Heat Exchanger (438)			
Stage 2 regulator vent	--	--	--	LH2 tank prepressurization supply	0.162 in. dia	0.90	0.01855
Stage 1 regulator dome bleed	--	--	--	Circuit number 1 vent	0.081 in. dia	--	--
Stage 4 regulator vent	--	--	--	LH2 umbilical vent	0.055 in. dia	--	--
Stage 5 regulator vent	--	--	--	GH2 regulator dome bleed	0.03 in. dia	--	sintered
Pneumatic Console 433							
2,000 psig cold purge valve supply	Variable	--	--				
750 psig cold purge valve supply	Variable	--	--				
Umbilical purge supply bleed	Variable	--	--				
Umbilical purge supply	0.305 in. dia	--	--				
Thrust chamber jacket purge and chilldown supply	0.072 in. dia	--	--				
Engine control helium sphere supply	0.125 in. dia	--	--				
LOX tank prepressurization supply, located in model 315 (aft umb kit)	0.114 in. dia	--	--				

TABLE 3-2
PRESSURE SWITCH CHECKOUT DATA

NOMENCLATURE	SPECIFICATION	PICKUP PSIA	DROPOUT PSIA	DEAD BAND
LOX Tank Prepress P/N 7851847-533AE Serial No. 104	Pickup: 41.0 psia max. Dropout: 36.5 psia min. Dead Band: 0.5 psi min.	39.9	37.8	2.1
Cold He. Reg. Backup P/N 7851830-517 Serial No. 101	Pickup: 440-491 psia Dropout: 329-376 psia Dead Band: None	461	358	103
Engine Pump Purge P/N 1A67002-509 Serial No. 113	Pickup: 136 psia max. Dropout: 99 psia min. Dead Band: 3.0 psi min.	121	108	13
LH2 Tk Fill Valve Control P/N 7851860-537 Serial No.	Pickup: 34 psia max. Dropout: 31 psia min. Dead Band: 0.5 psi min.	33.4	31.1	2.3
LH2 Flight Control P/N 7851860-539 Serial No. 200	Pickup: 31.5 psia max. Dropout: 27.8 psia min. Dead Band: 0.5 psi min.	30.25	28.25	2.0
Control He Reg Backup P/N 7851830-521 Serial No. 102	Pickup: 579-621 psia Dropout: 459-521 psia Dead Band: None	602	491	111
Mainstage OK No. 1 P/N NA5-27302 Serial No. 25317	Pickup: 515 <u>+36</u> psia Dropout = Pickup minus 75 <u>+61</u> psia	520	441	79
Mainstage OK No. 2 P/N NA5-27302 Serial No. 25237	Pickup: 515 <u>+36</u> <u>+61</u> psia Dropout = Pickup minus 75 <u>+61</u> , -36 psia	538	468	70

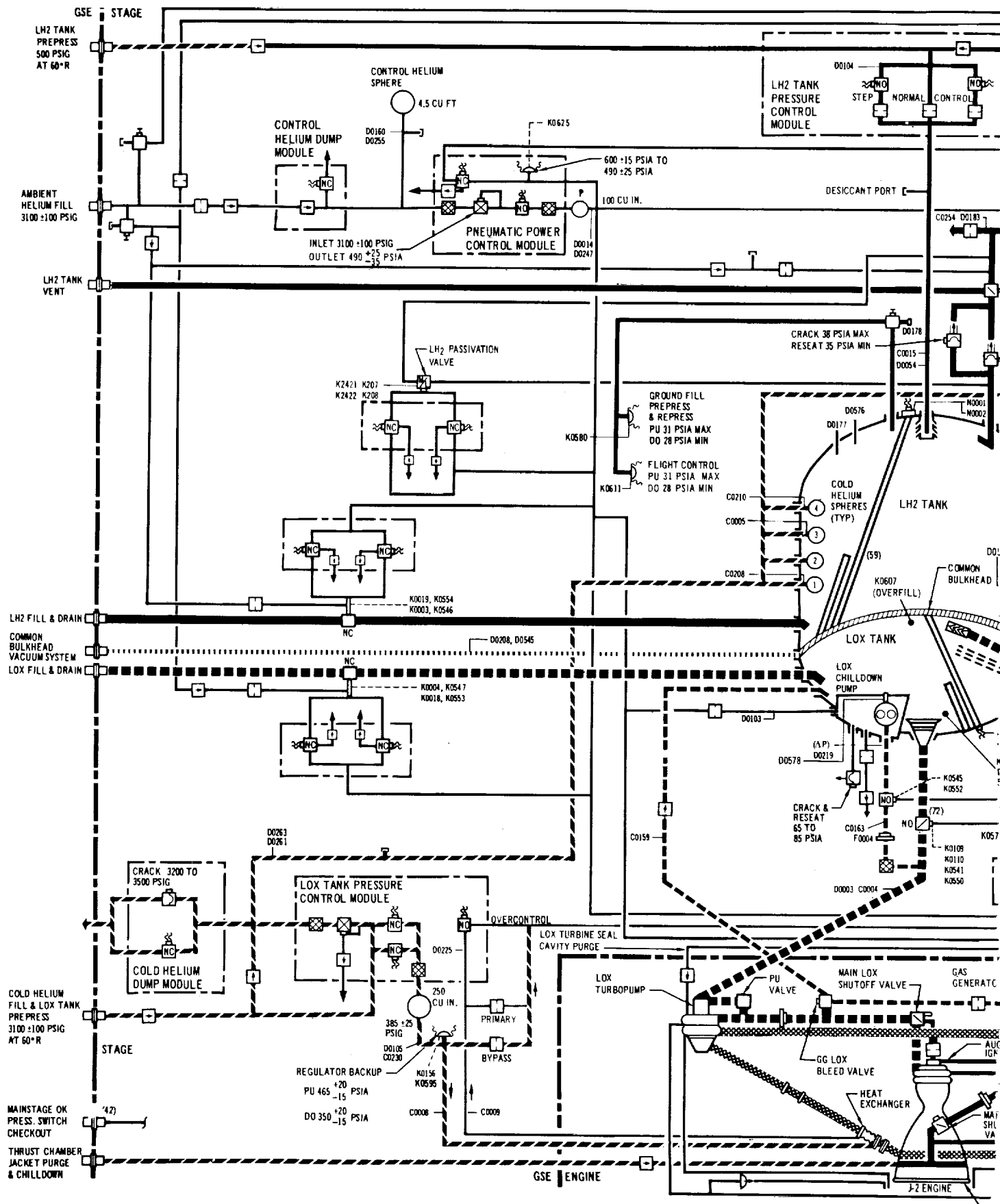

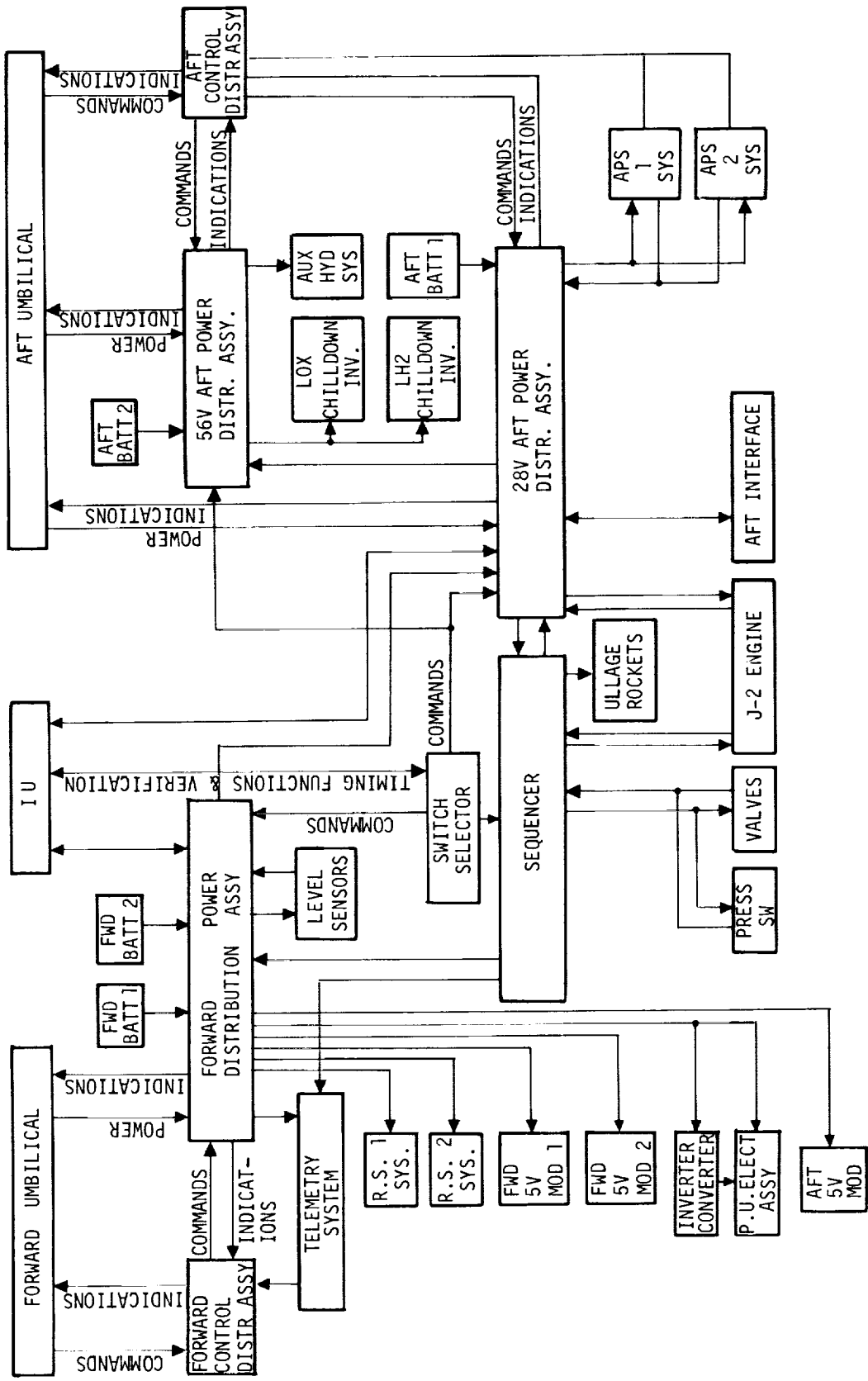

Figure 3-2. Electrical Control System

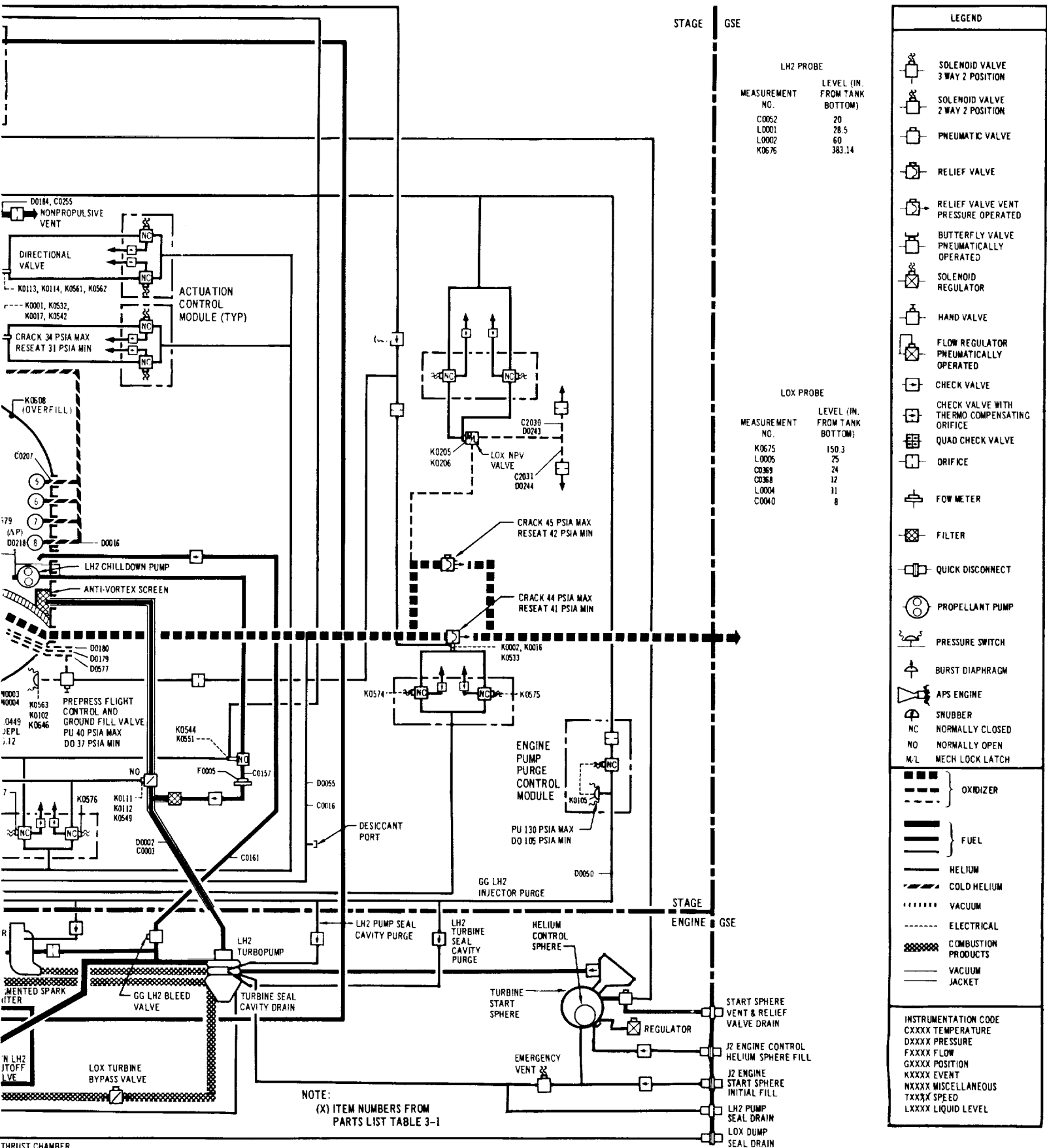

Figure 3-1. Propulsion System Configuration and Instrumentation

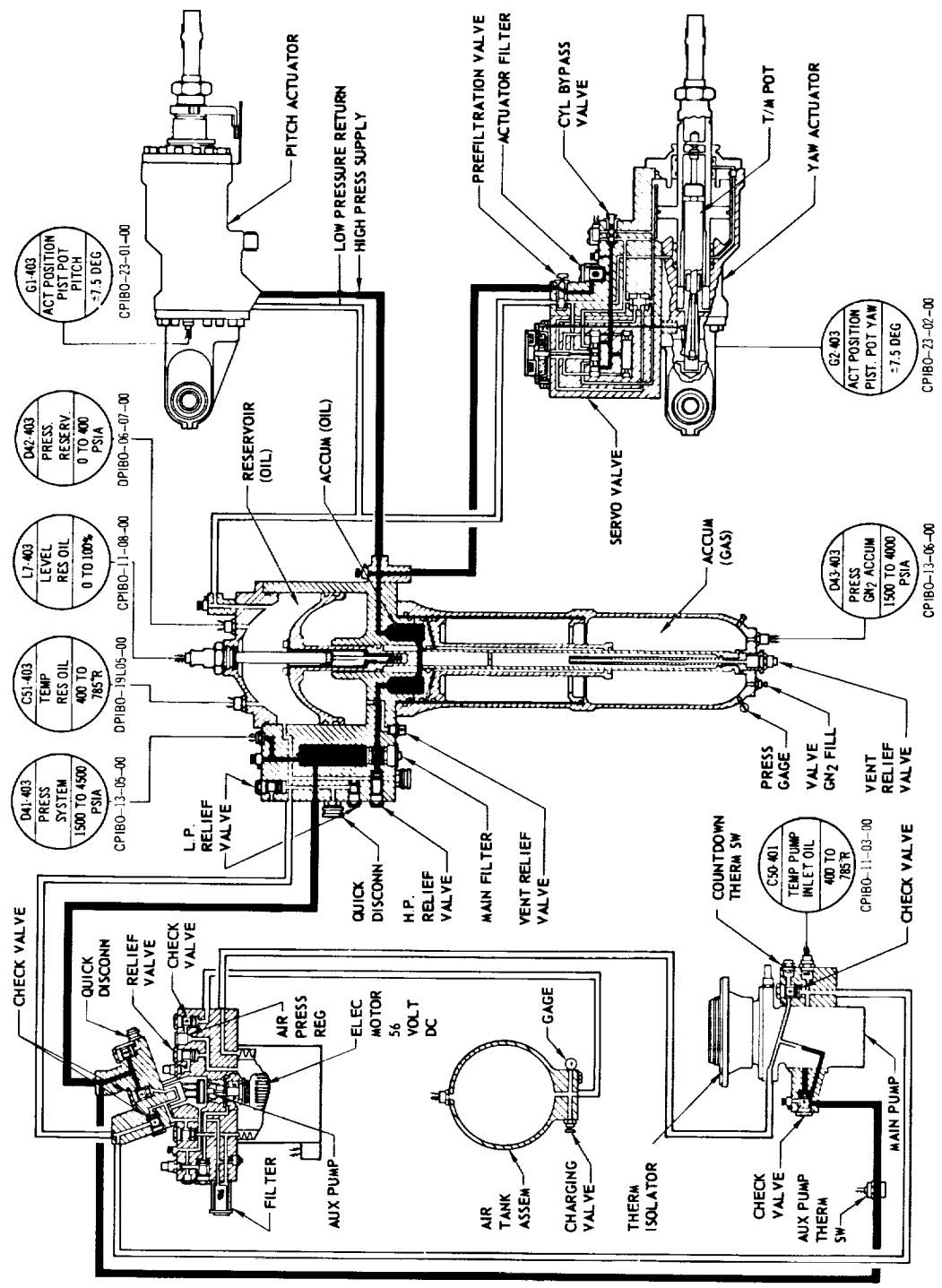

Figure 3-3. Hydraulic System

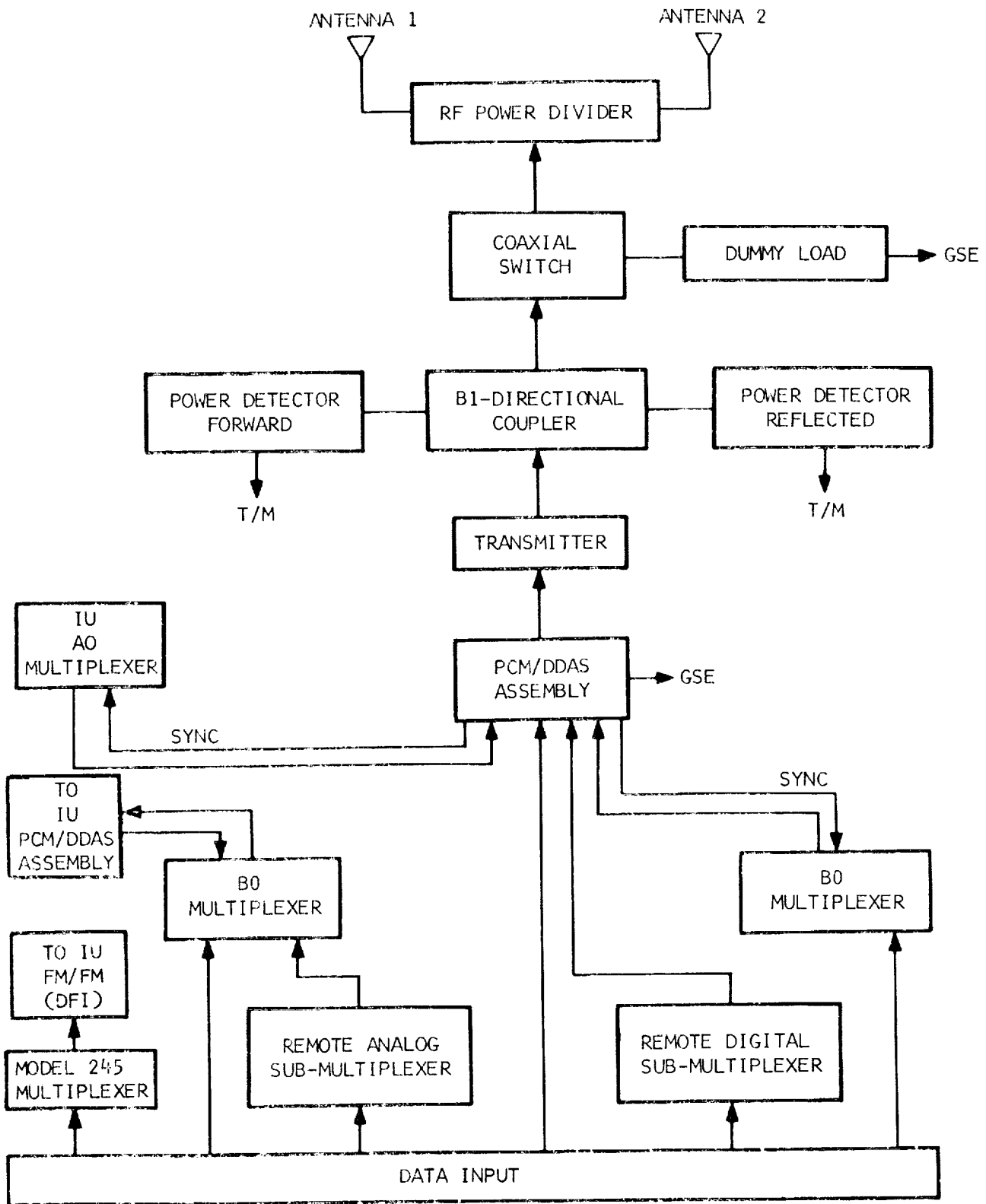
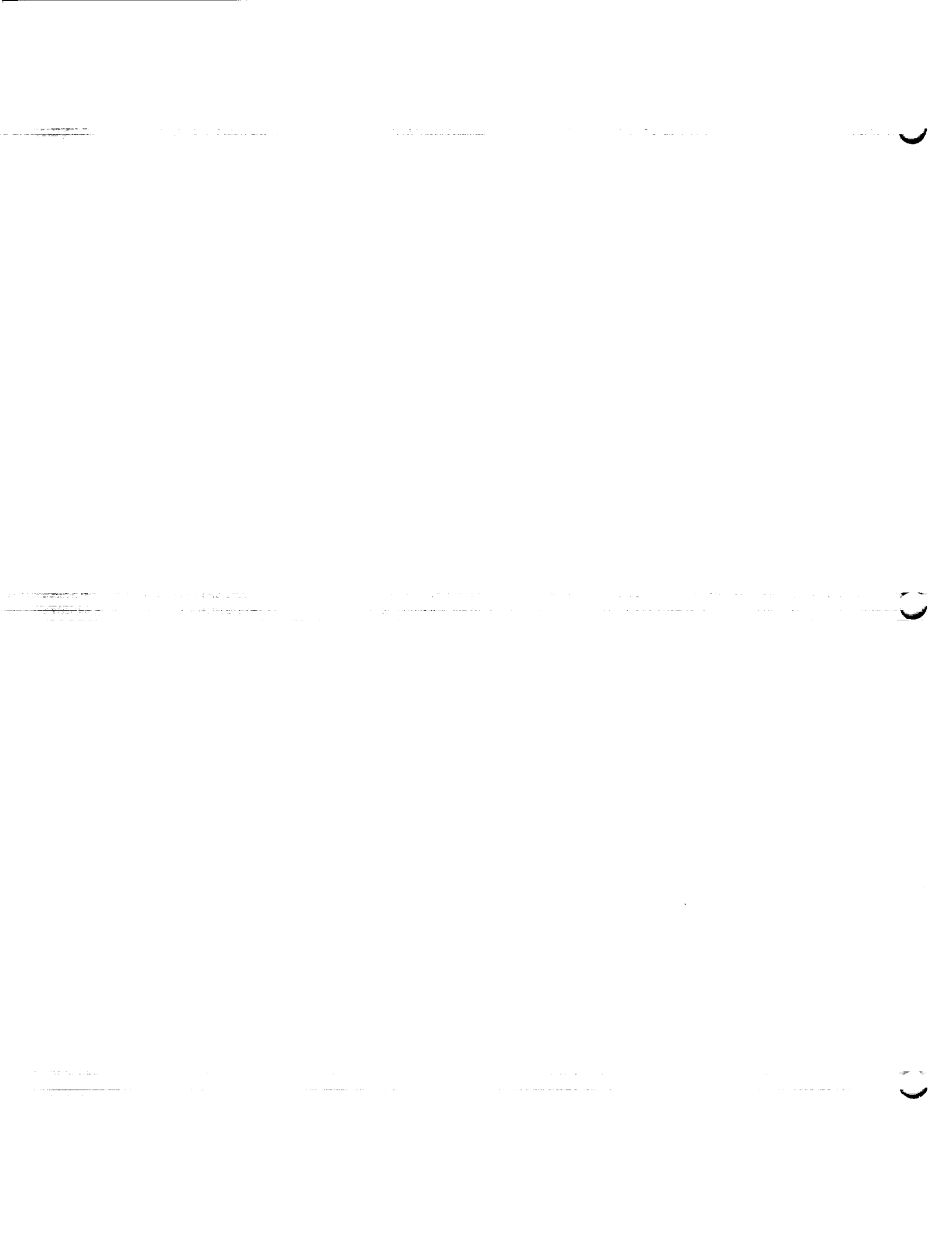

Figure 3-4. Data Acquisition System



SECTION 4

TEST OPERATIONS



4. TEST OPERATIONS

The launch day countdown was initiated at 0600 Greenwich Mean Time (GMT) on 8 October 1968 and culminated in a successful launch at 15:02:45 GMT on 11 October 1968.

The S-IVB portion of the countdown proceeded satisfactorily, and all stage systems responded correctly to commands. The only problems and unexpected items noted during the launch countdown were:

- a. LOX chilldown pump purge seal leakage was above the maximum allowable of 25 scim.
- b. S-IVB thrust chamber chilldown was slower than expected.

The countdown demonstration test (CDDT) was satisfactorily conducted between 12 and 16 September 1968. Prelaunch checkouts, auxiliary propulsion system (APS) preparations, and the launch countdown are discussed in the following paragraphs.

Significant countdown events occurred at the following times:

<u>Event</u>	<u>Time</u>
LOX loading initiated	0904:35 GMT
LH2 loading initiated	1025:59 GMT
Cold gas loading initiated	1120:29 GMT
Terminal count initiated	1442:00 GMT
Liftoff	1502:45 GMT

4.1 Propulsion System Checkout

The S-IVB-205 stage arrived at the Florida Test Center (FTC) 7 April 1968 and was transferred to the vehicle assembly building, low bay 8 April; it was erected on Complex 34 16 April. Propulsion subsystem checkout procedure I-24135 was started on 17 April and completed on 11 September.

The APS module engine valve current and voltage signature test procedure 1B62276 (NASA I-24156) was performed 10 May on module 1 and 20 May on module 2. The results of both tests were satisfactory.

The J-2 engine (S/N 2033) sequence test was conducted 14 August in accordance with TCP I-24136. The test consisted of two purge runs and three data verification runs. All parameters were within specification.

4.2 Launch Vehicle Tests

After the S-IVB-205 stage was erected at complex 34, it was subjected to the launch vehicle tests listed in table 4-1.

4.2.1 Countdown Demonstration Test

The CDDT was initiated at 0900 GMT on 12 September with the count at T -72 hr. The planned cutoff at T -3 sec occurred at 2214:32 GMT on 16 September. This test was conducted at launch complex 34 in accordance with Kennedy Space Center (KSC) procedure I-20049, revision 001 and consisted of two segments identified as CDDT wet and CDDT dry. During the wet test all launch vehicle cryogenics were loaded. The recycle for CDDT dry included cryogenic drain, vehicle dryout, and umbilical safing. The dry test was performed with the launch vehicle devoid of propellants and with reduced pressures in the spheres.

The first terminal count sequence was terminated because of launch vehicle digital computer/ground computer interface problem. Several other minor problems occurred and were corrected, and the CDDT was satisfactorily concluded.

4.2.2 Flight Readiness Test

The flight readiness test was conducted on 26 and 27 September in accordance with procedure I-20035 and included a pneumatic engine sequence and APS dry fire. No anomalies occurred during the APS dry fire, but several occurred during the engine sequence. The anomalies were corrected, and the engine sequence test was again performed to verify the integrity of the new pneumatic control package and to reverify the times of the engine sequence of events.

4.3 APS Preparations

The APS modules were loaded with propellants on 4 October in accordance with MDAC-WD procedure S-I-24157 revision 001, which covers APS module loading only. The APS modules were not test fired. Both oxidizer and fuel were loaded without incident; 1 hr 2 min were required for oxidizer and 43 min were required for fuel.

The module 1 100-percent fuel indication dropped out 35 min after the module was fully loaded, and the fuel fill valve was found to be leaking internally at 0.75 in./hr under blanket pressure and 2.4 in./hr under flight pressure. The tank was drained and refilled without problem, and no further leakage was observed after the module port was capped off. The modules were pressurized to flight pressure for a 1-hr APS helium sphere leak check; and neither helium sphere leakage nor any noticeable bellows movement was detected.

4.4 AS-205 Launch Countdown--514011

The AS-205 space vehicle launch countdown was initiated at 0600 GMT 8 October 1968 with the count at T -72 hr; liftoff occurred at 1502:45.323 GMT on 11 October. The countdown was conducted in accordance with KSC procedure I-20048 revision 001. The MDAC-WD preparation and securing steps were conducted in accordance with procedure I-20060.

4.4.1 Prelaunch Preparations and Purges

The prelaunch preparations and purges were accomplished in accordance with MDAC-WD procedures and were the same for launch countdown and CDDT. However, during the T -2 day

propulsion preparations, excessive leakage was measured at the LOX chilldown pump purge seal. Although the leakage was dispositioned as acceptable to engineering, it resulted in a lower LOX chilldown pump container pressure (49 psia) than the 60 psia noted during CDDT.

4.4.2 Component Tests

The engine sequence test was conducted at T -2 days 6 hr. All valves and timers functioned properly, and helium consumption was well within Rocketdyne requirements.

All stage and GSE component functions were accomplished as they were during CDDT with the exception of bottle mass decay checks and the cold helium regulator check which were not performed during the launch countdown.

4.4.3 Loading Operations

LOX and LH2 tank loading, thrust chamber chilldown, and helium and GH2 sphere loading were all satisfactorily accomplished. Data are presented in tables 4-2 and 4-3.

4.4.4 Terminal Countdown

The launch terminal count was initiated at T -30 min and was completed without any significant problems except thrust chamber chilldown. During this period, final engine conditioning was accomplished. The sequence of countdown events is presented in table 4-4.

4.4.4.1 Engine Conditioning

J-2 engine conditioning was initiated at T -20 min with a 50-psig ambient helium purge of the J-2 engine start sphere. Other engine purges were performed and, at T -10 min, thrust chamber chilldown was initiated with cold helium from circuits 2 and 3 of the GSE heat exchanger. At approximately T -7 min, the thrust chamber was noted to be chilling improperly and, at T -6 min 15 sec, a hold was called for 2 min 45 sec. Although the maximum temperature at T -8 min was not significantly higher than S-IVB-502, which also had a scheduled 10-min chilldown period, the temperature difference compared to S-IVB-502 was maintained as chilldown progressed. Since the redline limit at initiation of automatic sequence (IAS) was lower for S-IVB-205 (315 deg R versus 345 deg R), the hold was called to ensure that the redline requirements were met at IAS and liftoff. The results of engine conditioning produced the following:

	<u>At IAS</u>	<u>At Liftoff</u>
Thrust chamber jacket temperature (deg R)	261	258*
Engine start sphere pressure (psia)	1,250	1,271
Engine start sphere temperature (deg R)	268	271
Engine control sphere pressure (psia)	3,179	3,250
Engine control sphere temperature (deg R)	280	283

*Maximum allowable is 265 deg R.

4.4.4.2 Stage Conditioning

LOX turbopump chilldown was initiated at T -9 min 50 sec. The chilldown flowrate was 40 gpm unpressurized and 43 gpm pressurized. The chilldown was normal and resulted in LOX pump inlet conditions at T -19 sec of 165.2 deg R and 59.1 psia.

LH2 turbopump chilldown was initiated at T -10 min. The flowrate was 101 gpm unpressurized and 139 gpm pressurized; the chilldown was normal and resulted in LH2 pump inlet conditions at T -19 sec of 39.1 deg R and 39.4 psia.

4.5 Redline Limits

All redline limits for launch vehicle parameters were satisfied. The redlines are presented in NASA Report K-IB-02.10/5: Apollo/Saturn IB Launch Mission Rules Apollo 7 (SA-205/CSM-101), Revision A, Change 2, dated 10 October 1968; in MDAC-WD Report SM-46978: Saturn S-IVB-205 Stage Flight Test Plan, Revision A, dated September 1968; and in the A41 Redline Monitoring Brief.

4.6 Atmospheric Conditions

The atmospheric conditions on the launch day are presented in table 4-5.

TABLE 4-1
INTEGRATED LAUNCH VEHICLE TESTS

TITLE	PROCEDURE	DATE
Launch Vehicle Electrical Systems Test	I-21042 Rev 001	5-20-68
LOX System Simulate and Malfunction Test	I-20028 Rev 001	6-5-68
Launch Vehicle Propellant Dispersion Systems Functional Test	I-20042 Rev 001	6-14-68
LH2 System Simulate and Malfunction Test	I-20029	6-17-68
Umbilical Swing Arm Qualification Test	I-26007	6-27-68
Launch Vehicle Emergency Detection Systems Test	I-20009	7-10-68
Launch Complex Power Failure Test	I-20072 Rev 001	7-16-68
LH2 Cold Flow Test	I-20075 Rev 001	7-31-68
Launch Vehicle Sequence Malfunction Test	I-20031 Rev 001	8-1-68
Launch Vehicle MCC-H Interface Test	I-20056 Rev 001	8-22-68
Space Vehicle Plugs In OAT	I-20033 Rev 001	8-31-68
Space Vehicle Plugs Out OAT	I-20034 Rev 001	9-3-68 9-4-68 9-5-68

TABLE 4-2
S-IVB-205 STAGE PROPELLANT LOADING DATA

PARAMETER	UNIT	LOX	LH2
Chiltdown initiated	GMT	0930:15	1033:00
Slow fill			
Levels	percent	0 to 5	0 to 5
Initiation time	GMT	0938:15	1043:05
Flowrate	gpm	**	300
Maximum ullage pressure	psia	31.0	17.0
Fast fill			
Levels	percent	5 to 96	5 to 96
Initiation time	GMT	0943:21	1054:01
Flowrate	gpm	830	2250
Maximum ullage pressure	psia	29.6	17.2
Final slow fill			
Level at initiation	percent	96	96
Initiation time	GMT	1006:10	1121:20
Flowrate	gpm	**	
Maximum ullage pressure	psia	19.7	17.2
Total time required	min	38	52

**Not available.

TABLE 4-3
LAUNCH-SPHERE PRESSURIZATION DATA

SPHERE	VOLUME, (FT ³)	MEAS. NO. pres/temp	INITIATION TIME	TIME REQ'D	INITIAL PRESSURE (psia)	FINAL PRESSURE (psia)	PRESSURE AT RO (psia)	TEMPERATURE AT RO (°R)
Control helium	4.5	D0160-403 C0200-401	T-3 hr 42 min	3.6 min*	1,440	2,400	3,075	460**
Cold helium	28.0	D0016-425 C0207-425	T-3 hr 42 min	3.6 min*	1,260	2,700**	3,080	38
APS module 1	0.160	D0064-414 C0166-414	T-3 hr 42 min	1.4 min	1,430	3,100	3,130	557
APS module 2	0.160	D0068-415 C0167-415	T-3 hr 42 min	1.4 min	1,430	3,100	3,150	540
Engine control helium	0.518	D0019-401 C0007-401	T-3 hr 38 min				3,250	284
Engine GH2 start	4.225	D0017-401 C0006-401	T-5 hr 11 min	9 sec	1,088	1,267	1,280	275

*Time required for pressure increase shown. Pressure was still rising at end of available data print out.

**Control helium sphere temperature, taken from aft interstage ambient temperature.

TABLE 4-4
 TERMINAL COUNTDOWN SEQUENCE S-IVB-205 FLIGHT

FUNCTION	TIME FROM LIFTOFF (MIN:SEC)
Start Tank Vent Open	-22:45
Start Tank Purge Valve Open	-22:45
Thrust Chamber Purge Valve Open	-17:46
Start Tank Supply Valve Open	-17:16
Start Tank Purge Valve Closed	-17:15
LOX Tank Vent Valve Cycled	-15:22
LH2 Tank Vent Valve Cycled	-15:17
Cold Heat Exchanger Circuit Vent Open	-15:16
LH2 Chilldown Pump ON	-12:46
Thrust Chamber Purge Valve Closed	-12:44
Thrust Chamber Chilldown Valve Opened	-12:44
LOX Chilldown Pump ON	-12:35
LH2 Prevalve Closed	-12:30
LOX Prevalve Closed	-12:30
Cold Helium Crossover Valve Closed	-10:58
Cold Helium Crossover Valve Open	-10:08
Cold Heat Exchanger Circuit 1 Vent Open	- 8:36
Cold Heat Exchanger Circuit 1 Vent Closed	- 5:30
Start Tank Vent Closed	- 5:15
Engine Control Helium Supply Valve Closed	- 4:59
Engine Control Helium Supply Vent Open	- 4:58
Start Tank Supply Vent Cycled	- 4:56
Cold Helium Crossover Valve Closed	- 3:29
LOX Vent Closed	- 2:43
LOX Tank Pressurized	- 2:27
LOX Fill and Drain Valve Closed	- 2:25
LH2 Tank Vent Valve Closed	- 1:52
LH2 Tank Ground Prepressurization Supply Valve Open	- 1:52
LH2 Tank Ground Prepressurization Supply Valve Closed	- 1:34
LH2 Fill and Drain Valve Closed	- 1:32
Power Transfer Complete	- 0:28
LH2 Directional Vent to Flight Position	- 0:28
S-IVB Ready for Launch	- 0:28
Commit and Liftoff	0

TABLE 4-5
S-IVB-205 LAUNCH ATMOSPHERIC CONDITIONS

TIME (GMT)	AMBIENT TEMPERATURE (°F)	DEW POINT (°F)	AMBIENT PRESSURE (in. of Hg)	WIND SPEED (knots)	WIND DIRECTION FROM NORTH (DEG)
1000	78	70	29.955	14	90
1100	78	70	29.970	14	80
1200	78	70	29.990	15	80
1300	80	71	30.00	13	100
1400	82	72	30.025	13	90
1500	82	72	30.040	17	80

SECTION 5

COST PLUS INCENTIVE FEE

1. The first part of the document is a list of names and addresses.



2. The second part of the document is a list of names and addresses.



3. The third part of the document is a list of names and addresses.



5. COST PLUS INCENTIVE FEE

Flight Mission Accomplishment

Flight data evaluated to establish preconditions of flight (PCF) and end conditions of flight (ECF) were obtained from observed trajectory and attitude data transmitted by magnetic tape and printout to McDonnell Douglas Astronautics Company (MDAC-WD) from MSFC as requested in MDAC-WD Report No. SM-46538, Douglas S-IVB Stage Data Acquisition Requirements Document for Saturn IB Flights, Revision C, dated June 1968,

Performance of the S-IB stage provided PCF at S-IB/S-IVB Separation Command that were within allowable tolerances. Trajectory ECF at orbit insertion were within tolerance; also, maximum flight values of attitude errors and rates for both phases of S-IVB operation (powered flight and orbit phase) did not exceed the respective allowable tolerances. All received command signals were recognized, and all end condition command signals were given. It was concluded for purposes of incentive achievement, therefore, that all PCF and ECF were achieved.

Table 5-1 presents the nominal values for PCF and the allowable deviations agreed upon between MDAC-WD and NASA, and the actual values obtained during the AS-205 mission of 11 October 1968. The actual values were all within tolerance. All received commands were recognized, and all end condition commands were given. The extent of the agreement is set forth in NASA Letter I-CO-S-IVB-8-927, dated 17 September 1968, and MDAC-WD Letter A3-131-5,3,1,13-L-4575, dated 27 September 1968.

Table 5-2 presents the nominal values for ECF and the allowable deviations agreed upon between MDAC-WD and NASA as set forth in NASA Letter I-CO-S-IVB-8-927, dated 17 September 1968, and MDAC-WD Letter A3-131-5,3,1,13-L-4575, dated 27 September 1968, and the actual values obtained during the AS-205 mission of 11 October 1968. The actual values were all within tolerance, all received commands were recognized, and all end condition commands were given,

Evaluation of the telemetry performance indicated that the telemetry system operated at a 99.2 percent efficiency during the telemetry performance evaluation period (TPEP) phase I (liftoff to S-IVB engine cutoff +10 sec) and performed at 99.2 percent efficiency during the TPEP phase II (liftoff until planned launch vehicle/spacecraft separation, 2 hr, 55 min following guidance reference release).

The results of the telemetry performance analysis are shown in table 5-3.

TABLE 5-1
MISSION ACCOMPLISHMENT - PRECONDITIONS OF FLIGHT

PARAMETER	UNITS	NOMINAL	ACTUAL	ALLOWABLE DEVIATION*	ACTUAL DEVIATION
Range	km	61.82	62.15	+5.04 -4.11	0.33
Crossrange	km	-0.03	0.14	+3.52 -3.59	0.17
Altitude	km	61.91	61.84	+2.29 -2.93	-0.07
Velocity Vector Magnitude	ms	2,326.1	2,320.3	+42.0 -46.2	-5.8
Velocity Vector Direction	deg	63.40	63.68	+2.13 -1.94	0.28
Pitch Attitude	deg	-59.31	-59.15	+3.0 -3.0	0.16
Pitch Rate	deg/sec	0.00	0.02	+1.5 -1.5	0.02
Yaw Attitude	deg	-0.07	-0.09	+3.0 -3.0	-0.02
Yaw Rate	deg/sec	0.00	0.20	+1.5 -1.5	0.20
Roll Attitude	deg	0.00	0.49	+6.8 -6.8	0.49
Roll Rate	deg/sec	0.00	0.05	+1.5 -1.5	0.05

NOTE: PCF are evaluated at the instant of Separation Command

*Deviations consist of allowable error plus evaluation uncertainty.

TABLE 5-2
MISSION ACCOMPLISHMENT - END CONDITIONS OF FLIGHT

PARAMETER	UNITS	TRAJECTORY PARAMETERS (EVALUATED AT ORBIT INSERTION)			ATTITUDE CONTROL PARAMETERS		
		NOMINAL	ACTUAL	ALLOWABLE DEVIATION*	ACTUAL DEVIATION	ALLOWABLE ENVELOPE	MAXIMUM FLIGHT VALUE
Range	km	1,891.2	1,892.3	+78.99 -73.86	1.1	--	--
Crossrange	km	148.8	148.6	+5.56 -5.08	-0.2	--	--
Attitude	km	228.0	228.1	+1.35 -1.36	0.1	--	--
Velocity Vector Magnitude	ms	7,787.4	7,788.6	+6.1 -6.1	1.2	--	--
Velocity Vector Direction	deg	90.002	89.995	+0.076 -0.076	-0.007	--	--
S-IVB Burn Phase:							
Pitch Attitude Error	deg	--	--	--	--	+9.0	+2.1
Yaw Attitude Error	deg	--	--	--	--	+9.0	-2.8
Roll Attitude Error	deg	--	--	--	--	+13.5	+1.1
Pitch Rate	deg/sec	--	--	--	--	+3.0	+1.3
Yaw Rate	deg/sec	--	--	--	--	+3.0	+1.0
Roll Rate	deg/sec	--	--	--	--	+1.5	-0.5
Orbit (to SCM separation)**							
***Pitch Attitude Error	deg	--	--	--	--	+4.0	+1.5
***Yaw Attitude Error	deg	--	--	--	--	+4.0	+1.0
***Roll Attitude Error	deg	--	--	--	--	+4.0	+1.0
Pitch Rate	deg/sec	--	--	--	--	+1.0	-0.41
Yaw Rate	deg/sec	--	--	--	--	+1.0	+0.3
Roll Rate	deg/sec	--	--	--	--	+1.5	+0.5

NOTE: Trajectory ECF are evaluated at orbit insertion (10 sec after S-IVB Engine Cutoff Command).

*Deviations consist of allowable error plus evaluation uncertainty

**CSM - separation occurred 2 hr, 55 min after liftoff

***Excluding normal transients and periods of manned (astronaut) control.

TABLE 5-3 (Sheet 1 of 2)
 FLIGHT TELEMETRY PERFORMANCE SUMMARY

ITEM	DESCRIPTION	TOTAL
1.	Total number measurements listed in the S-IVB-205 Instrumentation Program and Components List (IP&CL) MDAC-WD Drawing 1B4355AH Change.	379
2.	<p>Measurements listed in the IP&CL which are not wholly on the S-IVB-205 stage:</p> <p>Measurements transmitted by the IU telemetry link:</p> <p>EO209-401 VIB - Combustion Chamber Dome-Long</p> <p>EO210-401 VIB - LH2 Turbo Pump-Lateral</p> <p>EO211-401 VIB - LOX Turbo Pump-Lateral</p> <p>EO236-401 VIB - Main Fuel VLV-Tangential</p> <p>EO237-401 VIB - Main Fuel VLV-Radial</p> <p>EO242-401 VIB - Fuel ASI Block-Radial</p> <p>EO243-401 VIB - ASI LOX VLV-Radial</p> <p>EO245-401 VIB - ASI LOX VLV-Longitudinal</p> <p>Measurements wholly transmitted landline to the launch control center.</p>	8
3.	<p>Measurements that are for checkout only and are not transmitted during flight:</p> <p>The function of the following measurements is to monitor the output voltage of exploding bridgewires (EBW) by means of pulse sensors during checkout.</p> <p>The pulse sensors are removed prior to launch, thus making the measurements inoperative during flight.</p> <p>K0141-411 Event R/S 1 Pulse Sensor</p> <p>K0142-411 Event R/S 2 Pulse Sensor</p> <p>K0143-404 Event - U/R 1 Ignition Pulse Sensor 1</p> <p>K0144-404 Event - U/R 1 Ignition Pulse Sensor 2</p> <p>K0145-404 Event - U/R 2 Ignition Pulse Sensor 1</p> <p>K0146-404 Event - U/R 2 Ignition Pulse Sensor 2</p> <p>K0147-404 Event - U/R 3 Ignition Pulse Sensor 1</p> <p>K0148-404 Event - U/R 3 Ignition Pulse Sensor 2</p> <p>K0149-404 Event - Ullage Jettison 1 Pulse Sensor</p> <p>K0150-404 Event - Ullage Jettison 2 Pulse Sensor</p> <p>K0169-404 Event - EBW Pulse Sensor OFF Indication</p>	114
4.	<p>The following measurement was listed in the IP&CL, and the capability to make the measurements existed on the stage. MSFC did not require the associated rate gyro installation, therefore, the measurement is inoperative.</p> <p>K0152-404 Event - Rate Gyro Wheel Speed OK Ind</p>	1

TABLE 5-3 (Sheet 2 of 2)
 FLIGHT TELEMETRY PERFORMANCE SUMMARY

ITEM	DESCRIPTION	TOTAL
5.	The following measurement was replaced by a shorting plug: K0095-401 Event - Thrust Chamber LH2 Injector Temp OK	1
6.	The following measurement is used for checkout only. The IU flight sequencing tape is not programmed to activate this measurement in flight. Therefore, it is inoperative. K0168-404 Event - Switch Selector Register Test	1
7.	Measurements known to be inoperative at start of automatic launch sequence, or become inoperative prior to start of automatic launch sequence - 0.	0
8.	The total number of measurements to be evaluated for incentive performance for both TPEP phase I and phase II is item 1 minus the sum of items 2, 3, 4, 5, 6, and 7. Phase I Phase II	243 243
9.	Measurements which were failures during TPEP phase I (liftoff to S-IVB engine cutoff +10 sec). Details regarding these measurement failures may be obtained in section 17 of this report. C2044-401 Temperature - ASI Combustion Chamber D0104-403 Pressure - LH2 Pressure Module I Inlet	2
10.	Measurements which were failures during TPEP phase II liftoff until planned LV/SC separation. (2 hours, 55 minutes following guidance reference release.) All measurements which were failures during TPEP phase I are included as phase II failures because phase II encompasses phase I. These two measurements are given in item 9 above. There were no other phase II failures.	2
11.	Calculation of phase I performance: Item 8 minus item 9 divided by item 8, multiplied by 100, and rounded off to the nearest one-tenth of one percent $\frac{243-2}{243} \times 100 = 99.2\%$	
12.	Calculation of phase II performance: Item 8 minus item 10 divided by item 8 multiplied by 100, and rounded off to the nearest one-tenth of one percent $\frac{243-2}{243} \times 100 = 99.2\%$	

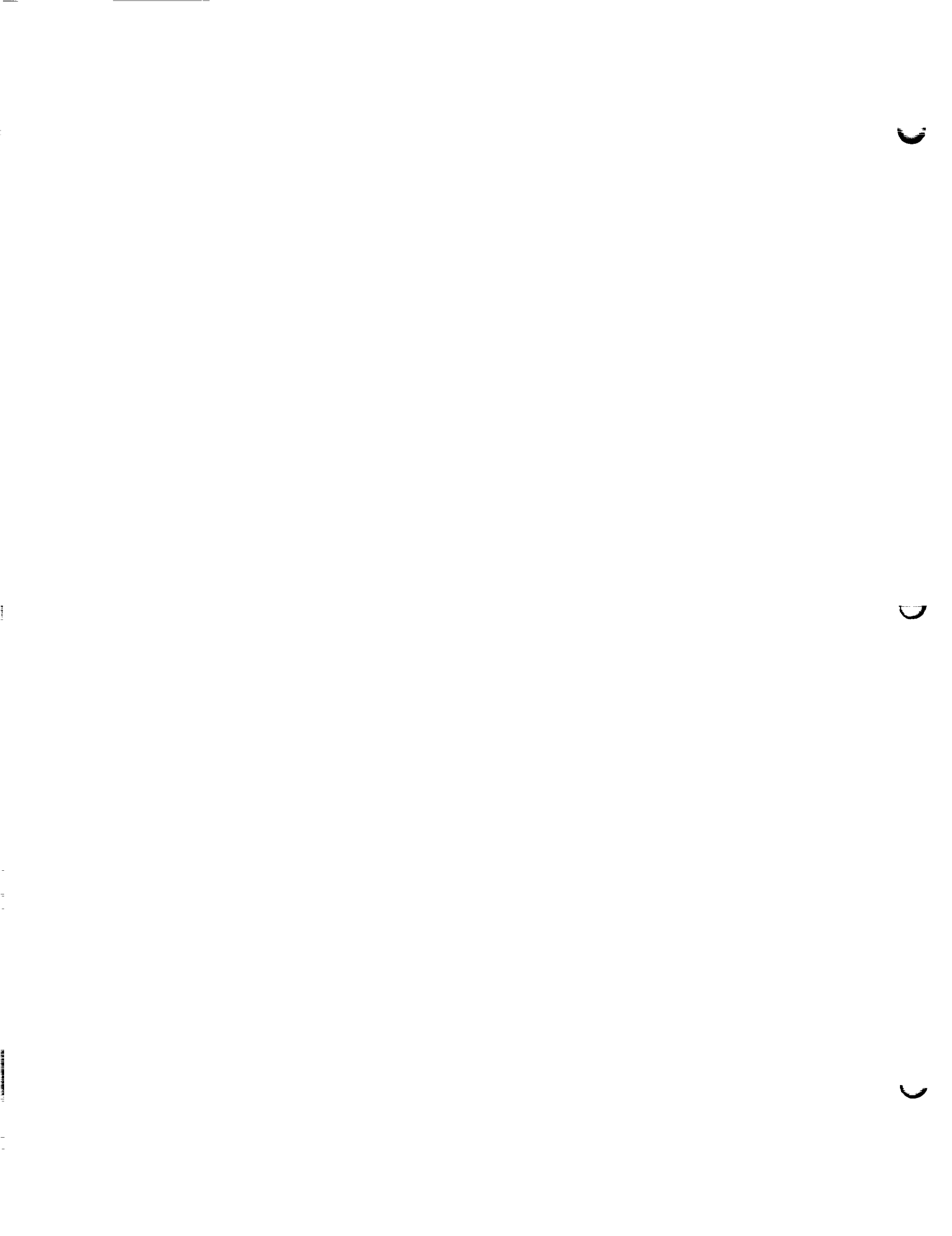

SECTION 6

TRAJECTORY



6. TRAJECTORY

6.1 Comparison Between Actual and Preflight Predicted Trajectories

This section presents a comparison between the actual trajectory (based on tracking and telemetry data) and the preflight predicted trajectory. The predicted trajectory for the S-IB stage is the same as that presented in the Chrysler final operational trajectory. The S-IVB stage portion of the predicted trajectory is presented in MDAC-WD Report No. SM-4697&A, S-IVB-205 Stage Flight Test Plan, dated September, 1968. Figures are presented comparing the actual and predicted values of altitude, surface range, crossrange position, crossrange velocity, inertial velocity, axial acceleration, inertial flight path elevation angle, and inertial flight path azimuth angle for the S-IVB powered flight phase of the mission. Figures 6-1 through 6-11 compare the actual and predicted histories for each trajectory parameter. Table 6-1 summarizes surface weather conditions at time of launch, and table 6-2 shows conditions at certain significant event times.

The actual trajectory of the AS-205 flight was very close to nominal. At S-IB/S-IVB Separation Command the trajectory can be characterized as being slow, low, long, and to the right. This can be seen in table 6-2. The slow and low trajectory of the S-IB stage caused the S-IVB stage to burn slightly longer than predicted in order to obtain the desired cutoff conditions. An orbit was obtained which was very near to that predicted.

6.2 Evaluation of Vehicle Performance Effects on Observed Trajectory

As stated in paragraph 6.1, the AS-205 actual trajectory closely matched the predicted. Only small deviations in the end conditions of flight were observed. Table 6-3 lists the most significant of these parameters. Total deviations are categorized as S-IB and S-IVB performance contributions. The S-IB contributions are due to the off-nominal conditions provided to the S-IVB by the S-IB at physical separation. These had significant effects only on the downrange position and the time of orbit insertion. S-IVB performance contributed significantly to all parameters listed. Unexplained portions of the total deviations presented in table 6-3 may be considered as evaluation uncertainty or IU dispersions.

Table 6-4 lists the contribution that S-IVB performance deviation made to the trajectory deviations shown in table 6-3. Initial weight, thrust, and weight flow deviations explain the S-IVB contribution to the range and insertion time deviations. Cutoff impulse deviation explains the S-IVB contribution to inertial velocity and apogee radius.

Actual S-IVB thrust and weight flow data used above was obtained from a five-degrees-of-freedom trajectory simulation program. Propulsion system parameters were adjusted so that an S-IVB trajectory could be generated to closely match the observed trajectory. Differences between the observed and simulated trajectories are presented in figure 6-12. Thrust and weight flow from the propulsion tape were increased by 0.41 and 0.31 percent, respectively, during high stop operation and increased by 1.13 and 0.01 percent, respectively, during low

stop operation. Plots of the corresponding thrust and weight flow are presented in figure 6-13. Listed below is a table of predicted and actual thrust, weight flow and specific impulse averages.

<u>Parameter</u>	<u>Predicted</u>	<u>Actual</u>
Total average thrust (lbf)	208,956	209,142
Total average weight flow (lbm/sec)	490.4	490.1
Total average specific impulse (sec)	426.1	426.7
Average thrust at the high mixture ratio (lbf)	226,684	226,702
Average weight flow at the high mixture ratio (lbm/sec)	534.6	535.7
Average specific impulse at the high mixture ratio (sec)	424.0	423.2
Average thrust at the low mixture ratio (lbf)	174,942	174,405
Average weight flow at the low mixture ratio (lbm/sec)	405.9	405.9
Average specific impulse at the low mixture ratio (sec)	430.9	429.7

The pitch and yaw thrust misalignment angles established by the control system and trajectory analysis, compare favorably. The values obtained are given below.

<u>Parameter</u>	<u>Control Analysis Value</u>	<u>Simulated Value</u>
Pitch thrust misalignment (deg)	+0.55	+0.45
Yaw thrust misalignment (deg)	+0.41	+0.30

A positive pitch misalignment produces a nose-above-commanded and a positive yaw misalignment produces a nose-left-of-commanded attitude (looking downrange). The steady-state thrust vector as determined by flight simulation was located relative to the vehicle as shown below:

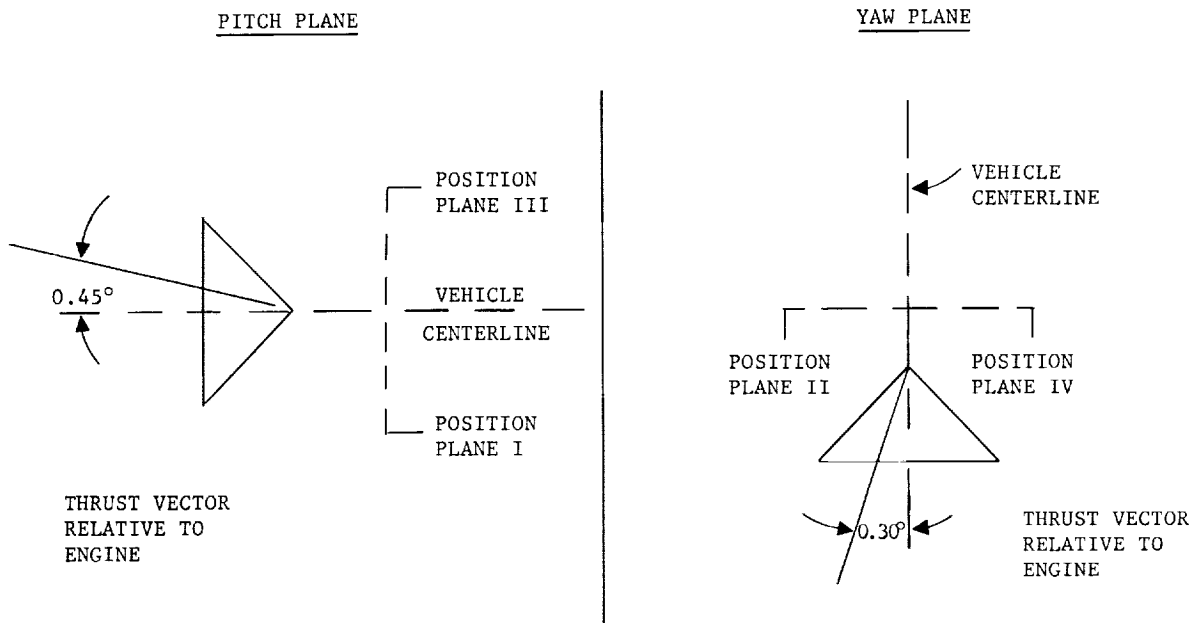

The S-IVB weights and predicted values as determined from trajectory reconstruction are:

	<u>Predicted</u>	<u>Simulated</u>
Engine Start Command (lbf)	305,764	305,725
Engine Cutoff Command (lbf)	67,748	67,710

A comparison of certain performance characteristics between AS-205 (the first operational Saturn IB vehicle) and the R&D vehicles AS-201 through AS-204 is presented in table 6-5.

6.2.1 S-IVB Orbital Deviation

Due to a deviation in the S-IVB orbit, it was reported necessary for the spacecraft to have an unscheduled burn to establish the proper phase relationship for the rendezvous maneuver. The deviation in the S-IVB orbit was caused by a series of unscheduled LH2 nonpropulsive vents which impinged on the open SLA panels. Analysis performed by MDAC-WD determined that the resulting force on the panels was sufficient to cause the S-IVB orbit to be slightly lower and faster than nominal after launch vehicle/spacecraft (LV/SC) separation. This could have set up the improper phase relationship observed. Sufficient detailed information on the S-IVB and spacecraft orbits during this time period is not available at this time to perform a detailed analysis. Since the SLA panels will be jettisoned on future flights, this problem will not recur.

Figure 6-14 presents the predicted and actual thrust and velocity change associated with the LOX dump, the actual as determined from inertial platform accelerometer data. The actual LOX residual was close to the predicted value of 1,707 lbf. The large deviation between actual and predicted thrust and velocity gain can be explained by the fact that a three-sigma high LOX residual of 2,600 lbf was used in generating the predicted thrust data. This LOX dump impulse produced the deviation in apogee altitude at LV/SC separation presented in table 6-2.

TABLE 6-1
SURFACE WEATHER CONDITIONS AT TIME OF LAUNCH

Parameter	Units	Actual
Range Time	sec	0.00
Clouds		
Amount	%	30
Coverage	-	Scattered
Base	ft	2,100
Visibility	nmi	10
Pressure at mean sea level	mbars	1,017
Dry Bulb Temperature	deg F	82
Relative Humidity	%	65
Wind Direction	deg	80
Wind Speed	knots	17

TABLE 6-2 (Sheet 1 of 2)
 TRAJECTORY CONDITIONS AT SIGNIFICANT EVENT TIMES

PARAMETER	SYMBOL	UNITS	PREDICTED	ACTUAL	DEVIATION	PARAMETER	SYMBOL	UNITS	PREDICTED	ACTUAL	DEVIATION
CONDITIONS AT MAXIMUM DYNAMIC PRESSURE											
Range time	(t)	sec	75.00	75.50	0.50	Range time	(t)	sec	614.54	616.76	2.22
Dynamic pressure	(q)	lbf/ft ²	659.7	654.8	-4.9	Altitude	(h)	ft	747,857	748,371	514
Altitude	(h)	ft	40,428	39,902	-526	Surface range	(S)	ft	5,965,677	5,974,801	9,124
Relative velocity	(V _E)	ft/sec	1,485.8	1,459.4	-26.4	Crossrange distance	(Y _E)	ft	304,504	304,101	-403
Mach number	(M)	-	1.51	1.48	-0.03	Crossrange velocity	(Y _E)	ft/sec	1,770.2	1,770.9	0.2
Ambient pressure	(P _a)	lbf/ft ²	415.3	429.4	14.1	Inertial velocity	(V _I)	ft/sec	25,527.1	25,525.9	-1.2
Pitch angle of attack	(α)	deg	-0.74	1.60	2.34	Inertial flight path elevation angle	(γ _I ')	deg	-0.007	0.000	0.007
Yaw angle of attack	(β)	deg	0.04	1.10	1.06	Inertial flight path azimuth angle	(γ _{2I} ')	deg	85,891	85,906	0.015
CONDITIONS AT S-IB/S-IVB SEPARATION SIGNAL											
Range time	(t)	sec	144.41	145.59	1.18	Range time	(t)	sec	624.54	626.76	2.22
Altitude	(h)	ft	203,117	202,874	-243	Altitude	(h)	ft	747,893	748,437	544
Surface range	(S)	ft	202,822	204,092	1,270	Surface range	(S)	ft	6,199,275	6,208,434	9,159
Crossrange distance	(Y _E)	ft	-98	444	542	Crossrange distance	(Y _E)	ft	322,300	321,903	-397
Crossrange velocity	(Y _E)	ft/sec	3.6	14.3	10.7	Crossrange velocity	(Y _E)	ft/sec	1,787.0	1,787.6	0.6
Inertial velocity	(V _I)	ft/sec	7,631.6	7,612.6	-19.0	Inertial velocity	(V _I)	ft/sec	25,547.4	25,553.2	5.8
Inertial flight path elevation angle	(γ _I ')	deg	26.595	26.321	-0.274	Inertial flight path elevation angle	(γ _I ')	deg	-0.002	0.005	0.007
Inertial flight path azimuth angle	(γ _{2I} ')	deg	75.699	75.792	0.093	Inertial flight path azimuth angle	(γ _{2I} ')	deg	86.303	86.318	0.015
Dynamic pressure	(q)	lbf/ft ²	10.6	10.7	0.1	Apogee altitude*	(h _A)	nmi	148.8	152.3	3.5
Pitch angle of attack	(α)	deg	-0.04	0.31	0.35	Perigee altitude*	(h _P)	nmi	120.0	120.0	0.0
Yaw angle of attack	(β)	deg	-0.07	-0.52	-0.45	Apogee velocity	(V _A)	ft/sec	25,342.4	25,323.7	-18.7

Deviation = Actual minus Predicted

*Measured with respect to a mean earth radius of 3,443.94 nmi.

TABLE 6-2 (Sheet 2 of 2)
TRAJECTORY CONDITIONS AT SIGNIFICANT EVENT TIMES

PARAMETER	SYMBOL	UNITS	PREDICTED	ACTUAL	DEVIATION	PARAMETER	SYMBOL	UNITS	PREDICTED	ACTUAL	DEVIATION
Perigee velocity	(V _p)	ft/sec	25,547.4	25,553.2	5.8	Eccentricity	(e)	-	0.0074	0.0066	-0.0008
Eccentricity	(e)	-	0.0040	0.0045	0.0005	Inclination	(i)	deg	31.637	31.639	0.002
Inclination	(i)	deg	31.605	31.608	0.003	Period	(P)	min	90.01	89.93	-0.08
Period	(P)	min	89.48	89.55	0.07	Descending node	(θ _n)	deg	118.097	118.197	0.100
Descending node	(θ _n)	deg	118.912	119.009	0.097	Orbit energy	(C ₃)	m ² /sec ²	-59,927,391	-59,947,223	-19,832
Orbit energy	(C ₃)	m ² /sec ²	-60,157,329	-60,117,775	39,554						
CONDITIONS AT S-IVB/CSM SEPARATION											
Range time	(t)	sec	10,495.00	10,507.00	12.00						
Altitude	(h)	ft	796,860	808,973	12,113						
Surface Range	(S)	ft	28,802,187	28,570,131	-232,056						
Crossrange distance	(Y _E)	ft	-9,590,675	-9,589,091	1,584						
Crossrange velocity	(Y _E)	ft/sec	652.0	771.9	119.9						
Inertial velocity	(V _I)	ft/sec	25,521.1	25,500.1	-21.0						
Inertial flight path elevation angle	(γ ₁)	deg	-0.315	-0.303	0.012						
Inertial flight path azimuth angle	(γ ₂)	deg	60.800	60.931	0.131						
Apogee altitude*	(h _A)	nmi	175.0	169.9	-5.1						
Perigee altitude*	(h _p)	nmi	121.8	122.9	1.1						
Apogee velocity	(V _A)	ft/sec	25,207.7	25,236.3	28.6						
Perigee velocity	(V _p)	ft/sec	25,583.6	25,568.9	-14.7						

TABLE 6-3
SIGNIFICANT DEVIATIONS OF ACTUAL TRAJECTORY FROM PREFLIGHT SIMULATION

PARAMETER*	SYMBOL	UNITS	TOTAL DEVIATION	S-IB CONTRIBUTION	S-IVB CONTRIBUTION
Range	S	ft	9,159	+1,014	+7,105
Inertial velocity	V _I	ft/sec	5.8	0.0	+5.3
Radius of apogee	R _A	nmi	3.5	0.0	+3.0
Range time	t	sec	2.22	1.93	+0.28

*Evaluated at Orbit Insertion

Deviation=Actual minus predicted
 *Measured with respect to a mean earth radius of 3,443.94 nmi.
 **MDAC-WD data indicates that this time is in error.
 LV/SC separation occurred at R0 + 10,502.4 sec.

TABLE 6-4
CONTRIBUTIONS TO TRAJECTORY DEVIATIONS AT ORBIT INSERTION

PARAMETER	SYMBOL	RANGE TIME - t (sec)	RANGE - S (ft)	VELOCITY - V _I (ft/sec)	RADIUS OF APOGEE (nmi)
Loading and Payload Weight	W _O	+0.05	1,276	0.0	0.0
Thrust	F _T	+0.45	+11,484	0.0	0.0
Weight Flow	Ẇ _T	-0.22	-5,615	0.0	0.0
Cutoff Impulse		0.00	0.0	+5.3	+3.0
TOTAL S-IVB Contribution		+0.28	+7,105	+5.3	+3.0

TABLE 6-5
PERFORMANCE COMPARISONS WITH R&D VEHICLES

PARAMETER	SYMBOL	AS-201	AS-202	AS-203	AS-204	AS-205
Deviation from predicted thrust	%	-2.03	+2.07	-1.00	+1.00	+0.09
Deviation from predicted weight flow	%	-2.61	+1.37	-1.00	+1.30	-0.06
Deviation from predicted Isp	%	+0.57	+0.05	-0.14	-0.30	+0.09
Deviation from predicted loading:						
LOX	%	-0.15	+0.11	+0.17	-0.43	+0.03
LH2	%	+0.23	-0.15	-0.20	+0.21	+0.66
Deviation from predicted cutoff impulse 3-sigma deviation = 10%	%	+29.0	9.7	-6.1	+1.0	-10.6
Thrust Misalignment						
Pitch	Deg	+0.54	+0.27	+1.09	+0.20	+0.45
Yaw	Deg	0.00	-0.51	+0.08	+0.50	0.30

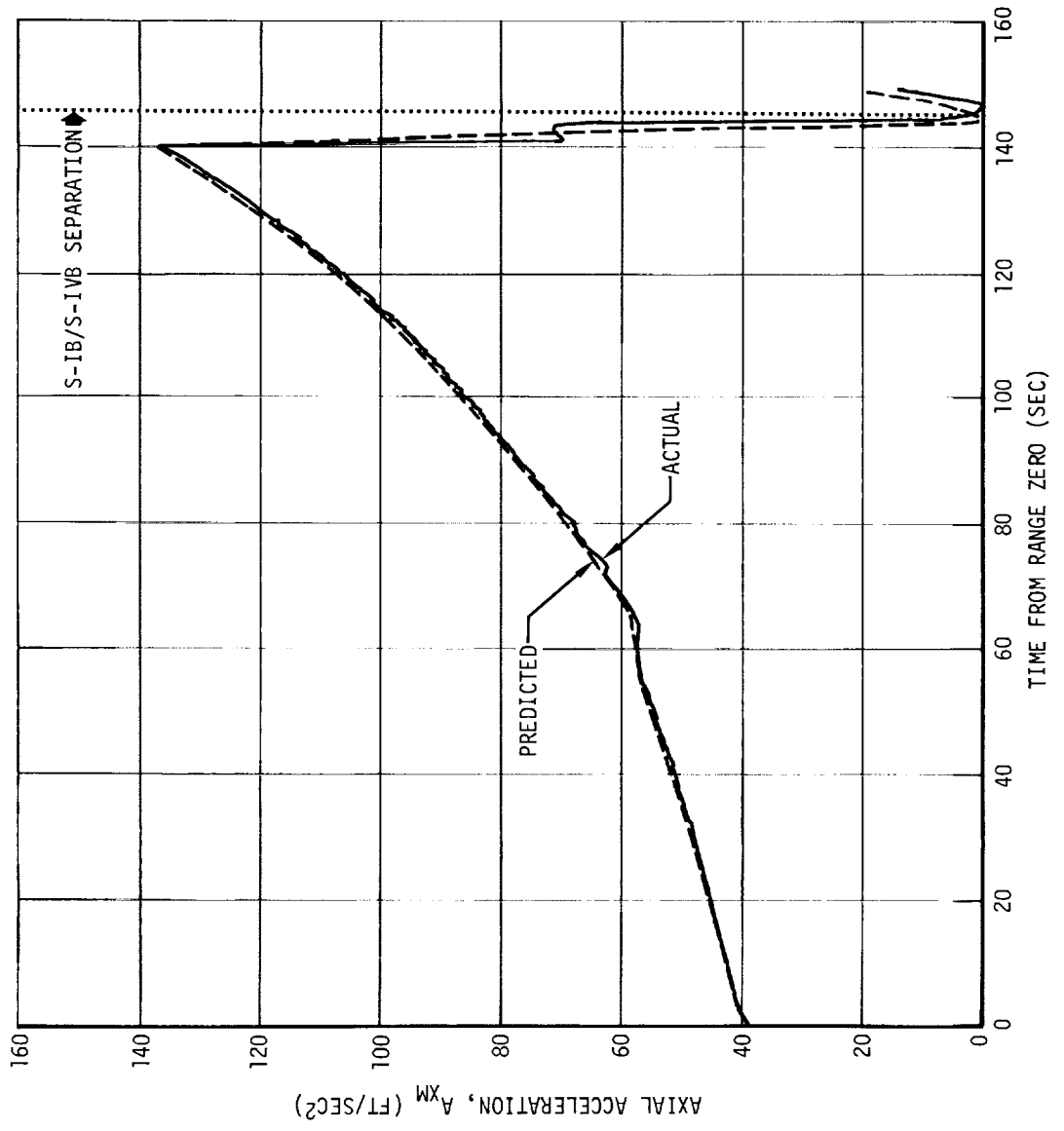

Figure 6-1. S-IB Axial Acceleration History

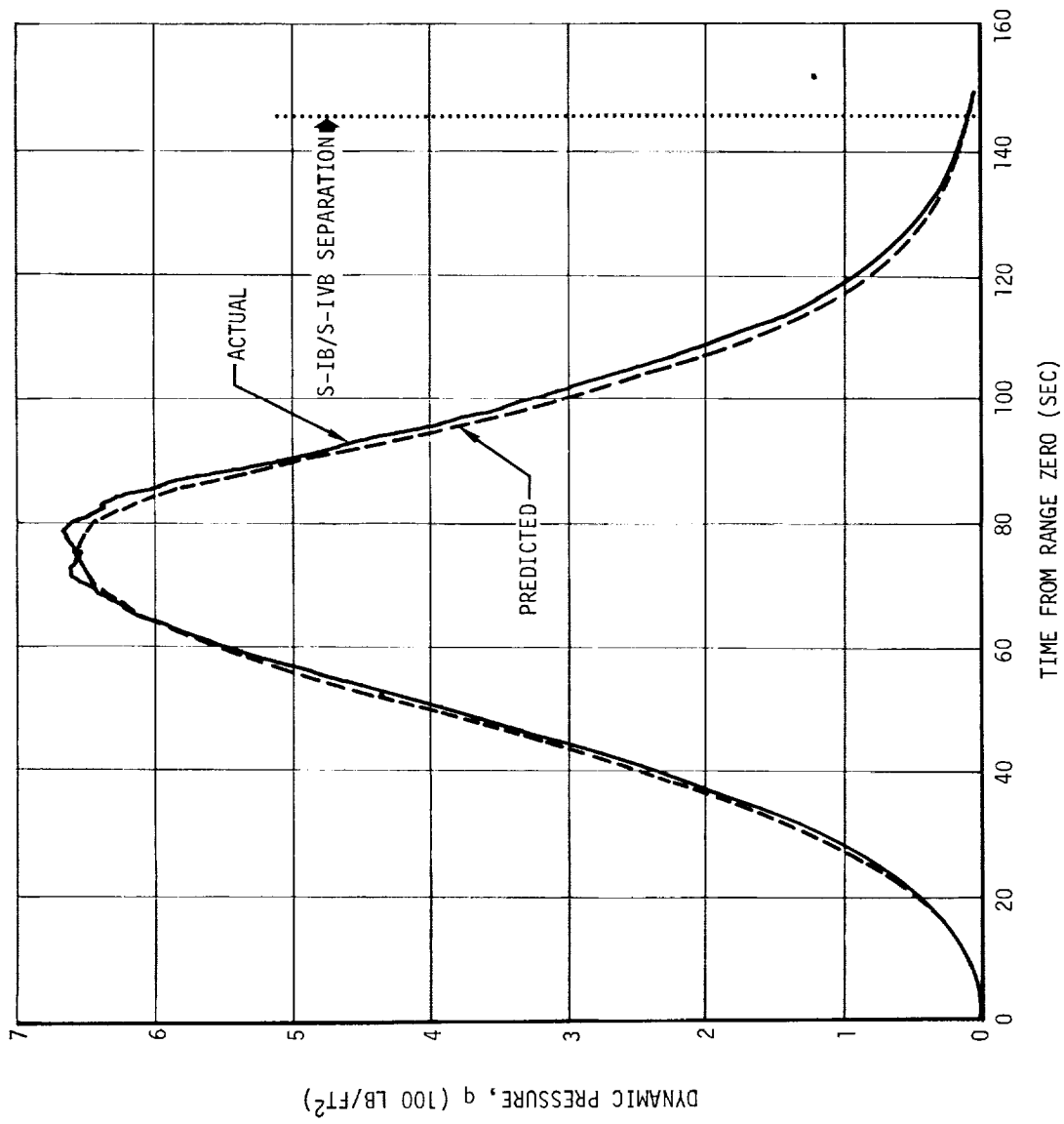

Figure 6-2. S-IB Dynamic Pressure History

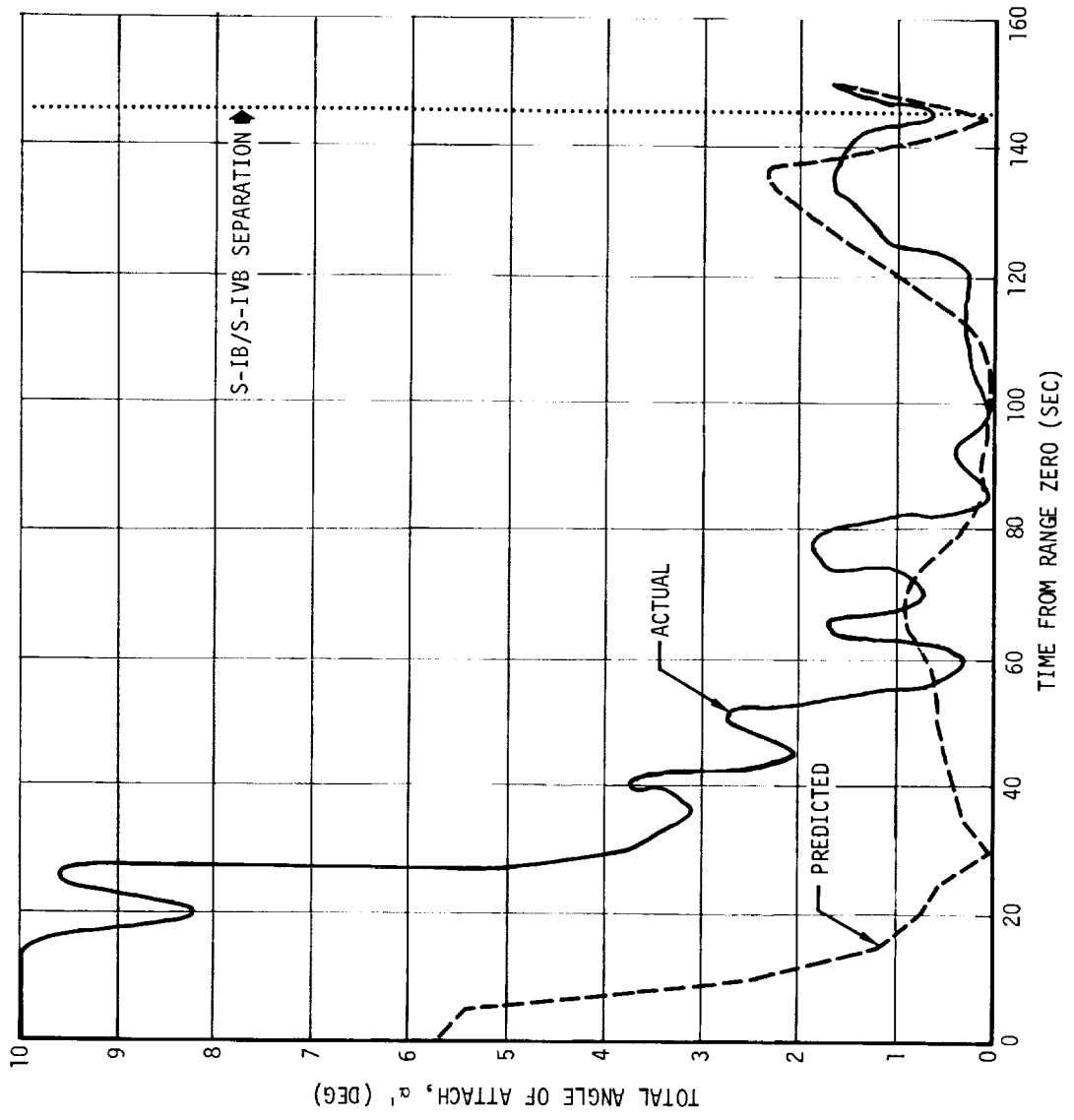

Figure 6-3. S-IB Angle of Attack History (Sheet 1 of 3)

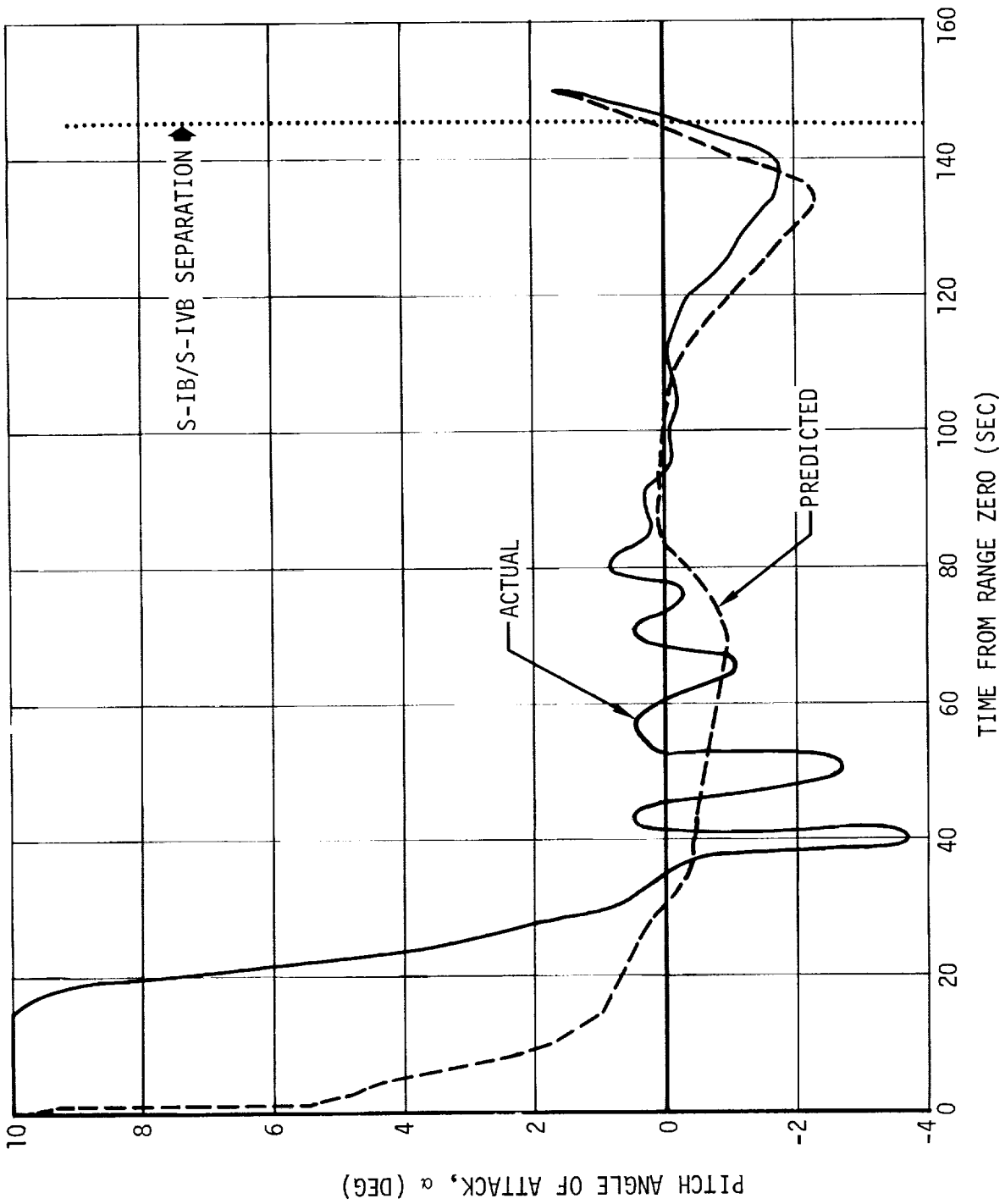

Figure 6-3. S-IB Angle of Attack History (Sheet 2 of 3)

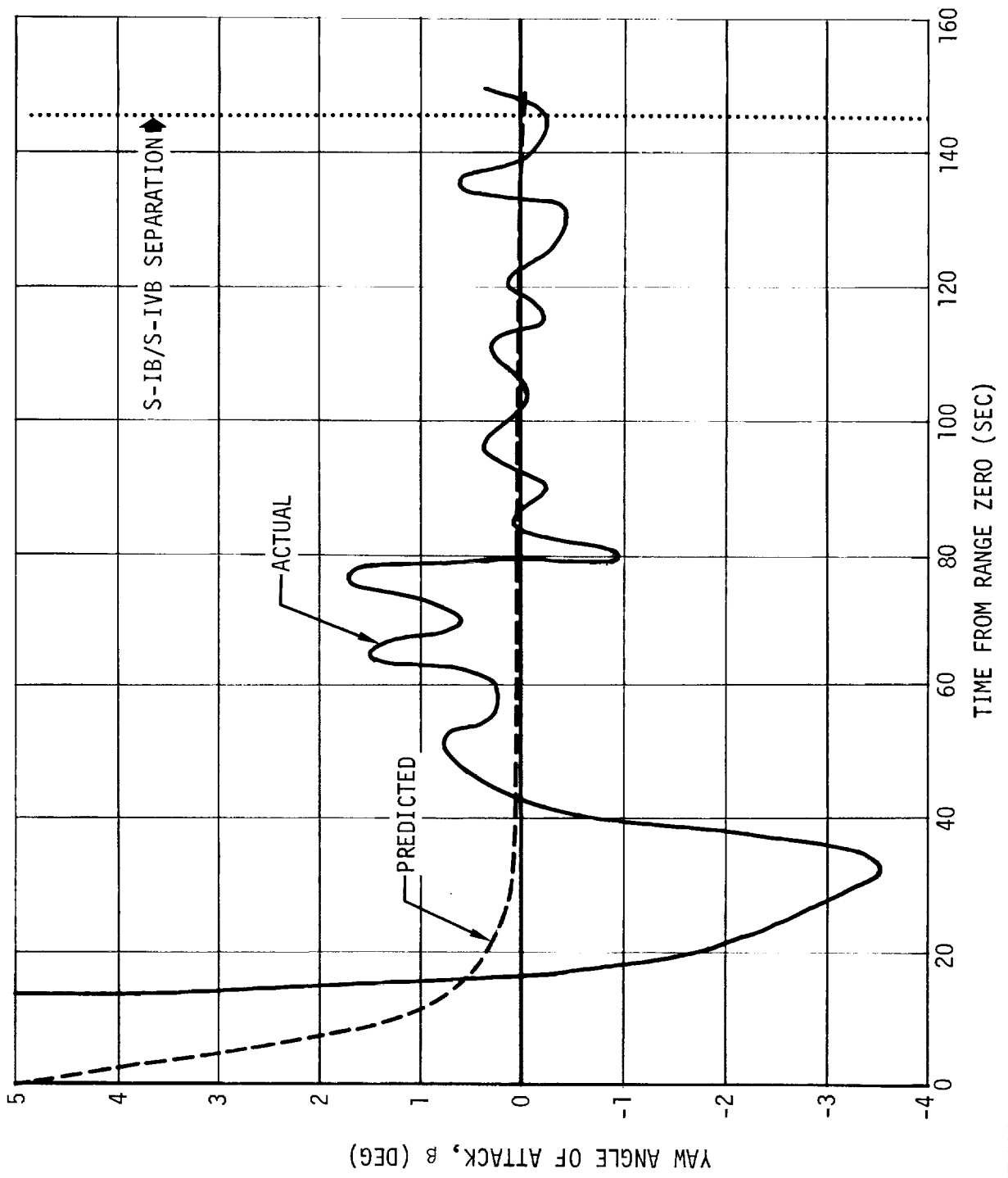

Figure 6-3. S-IB Angle of Attack History (Sheet 3 of 3)

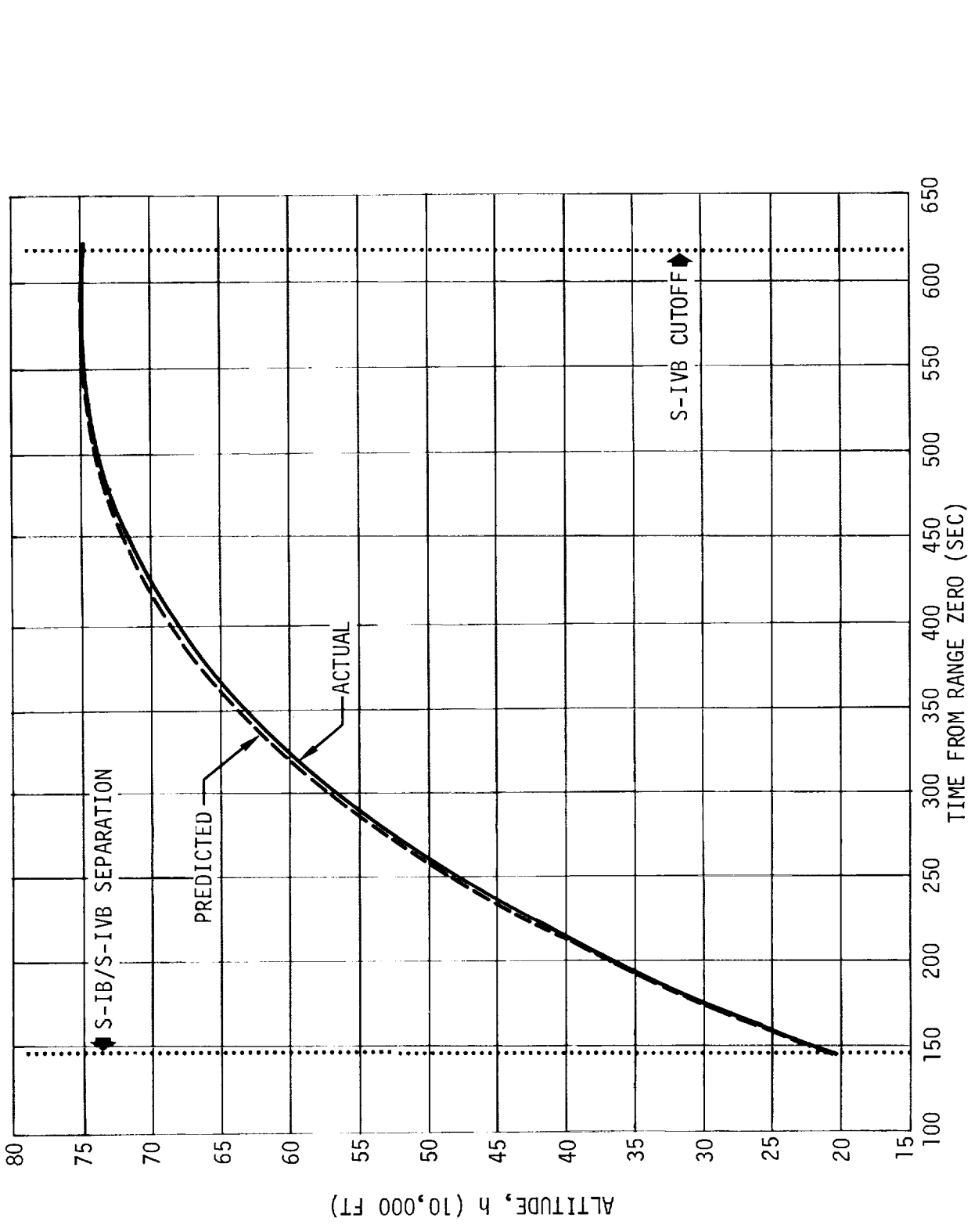

Figure 6-4. S-IVB Altitude History

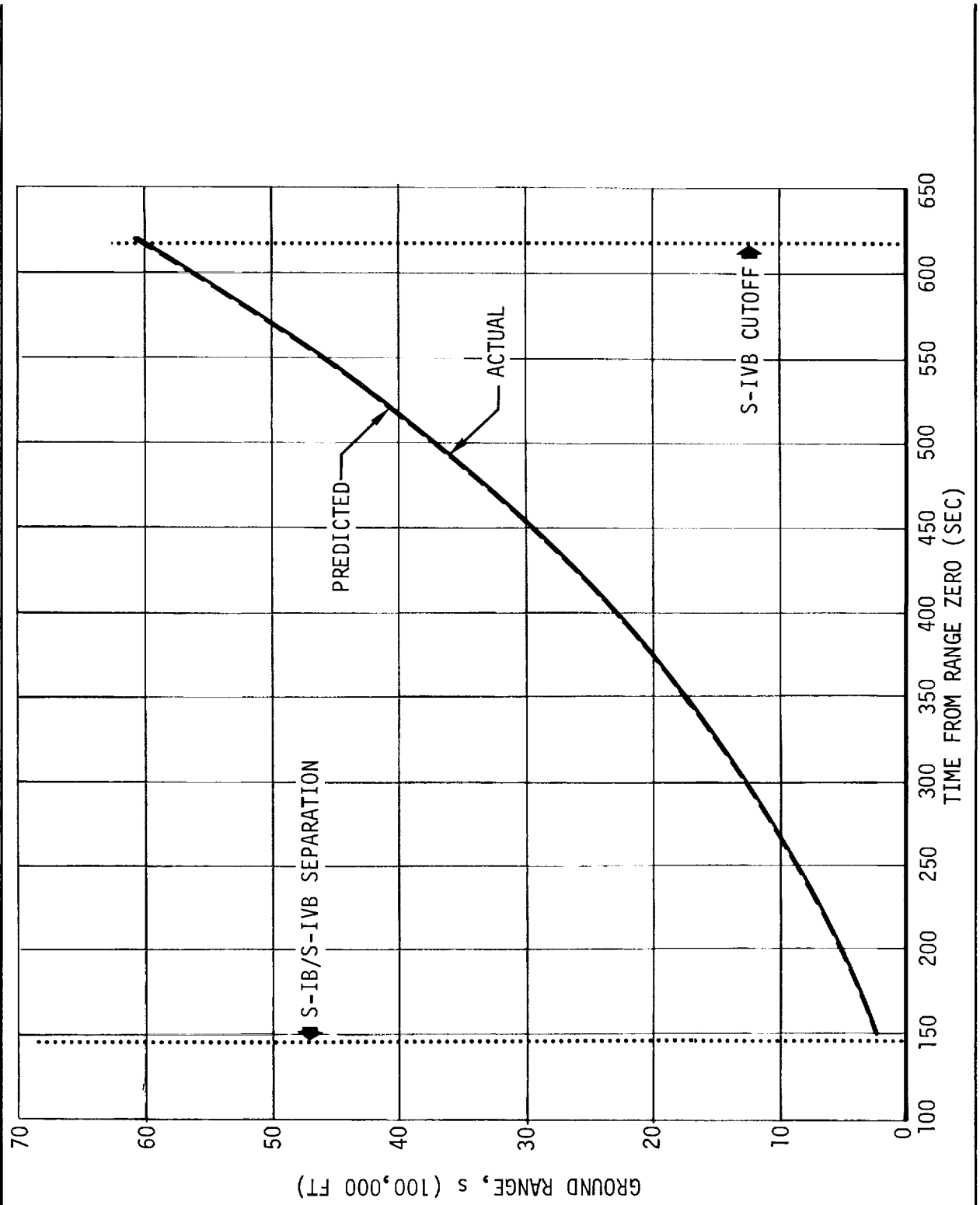

Figure 6-5. S-IVB Ground Range History

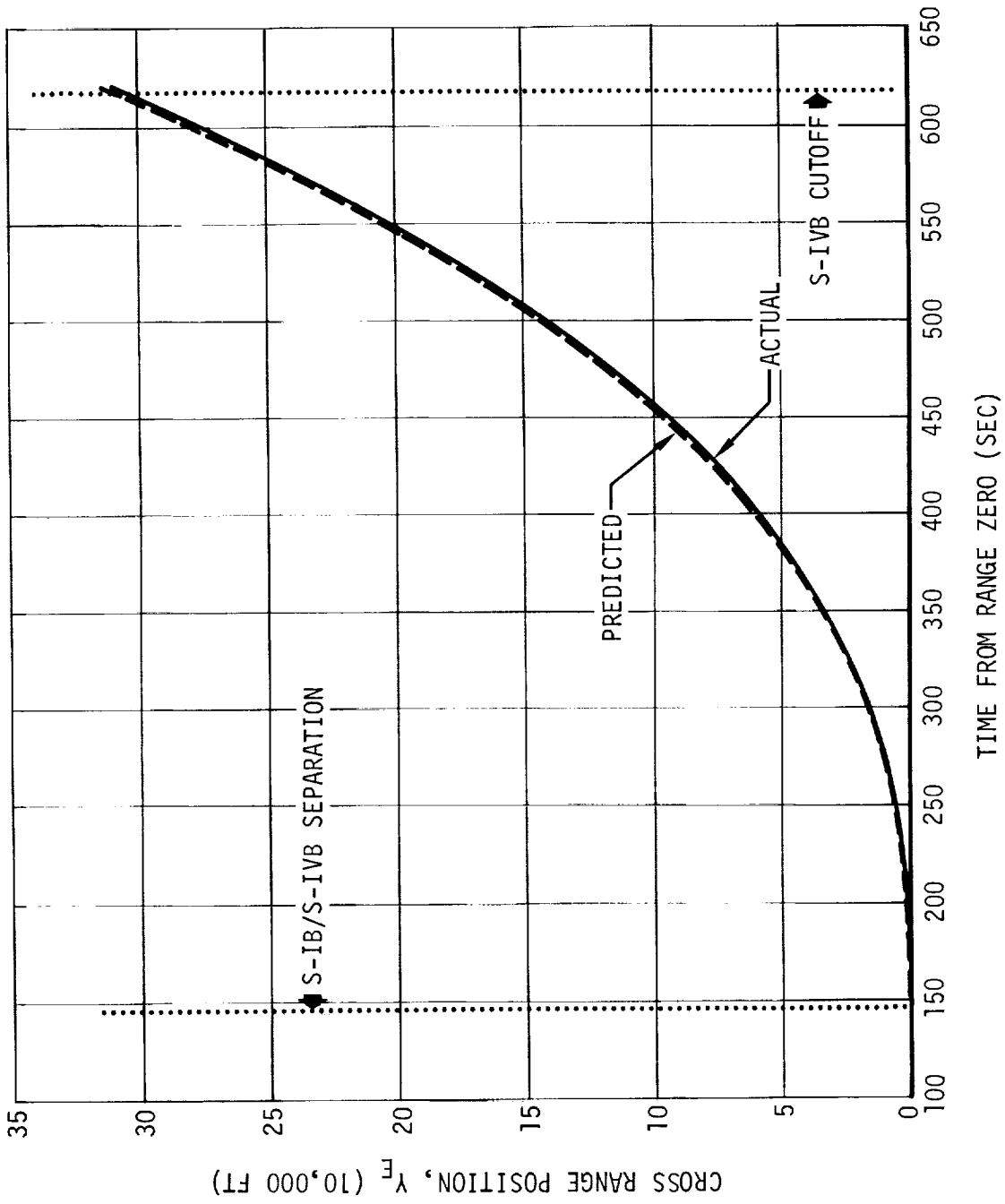

Figure 6-6. S-IVB Crossrange Position History

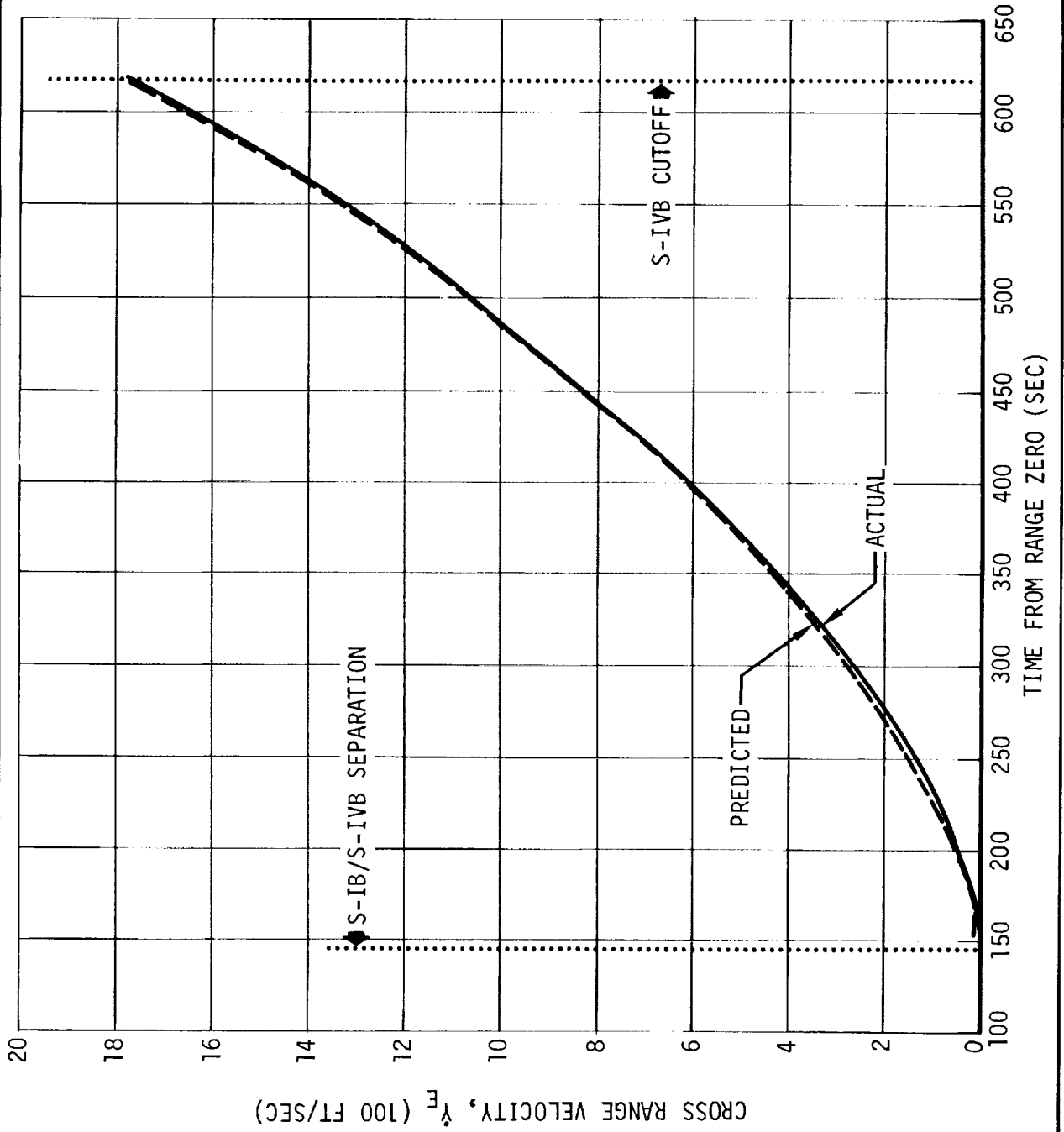

Figure 6-7. S-IVB Crossrange Velocity History

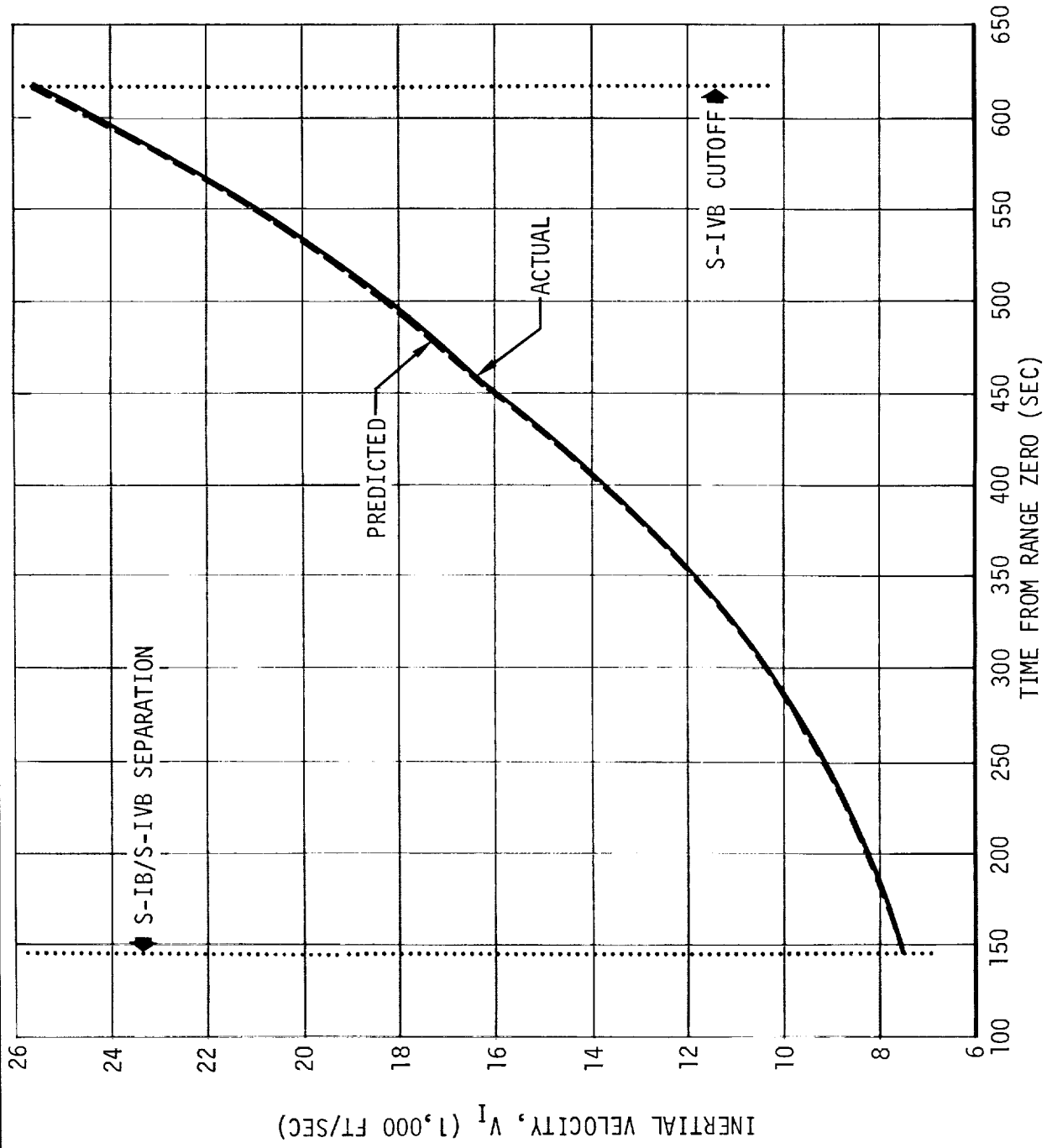

Figure 6-8. S-IVB Inertial Velocity History

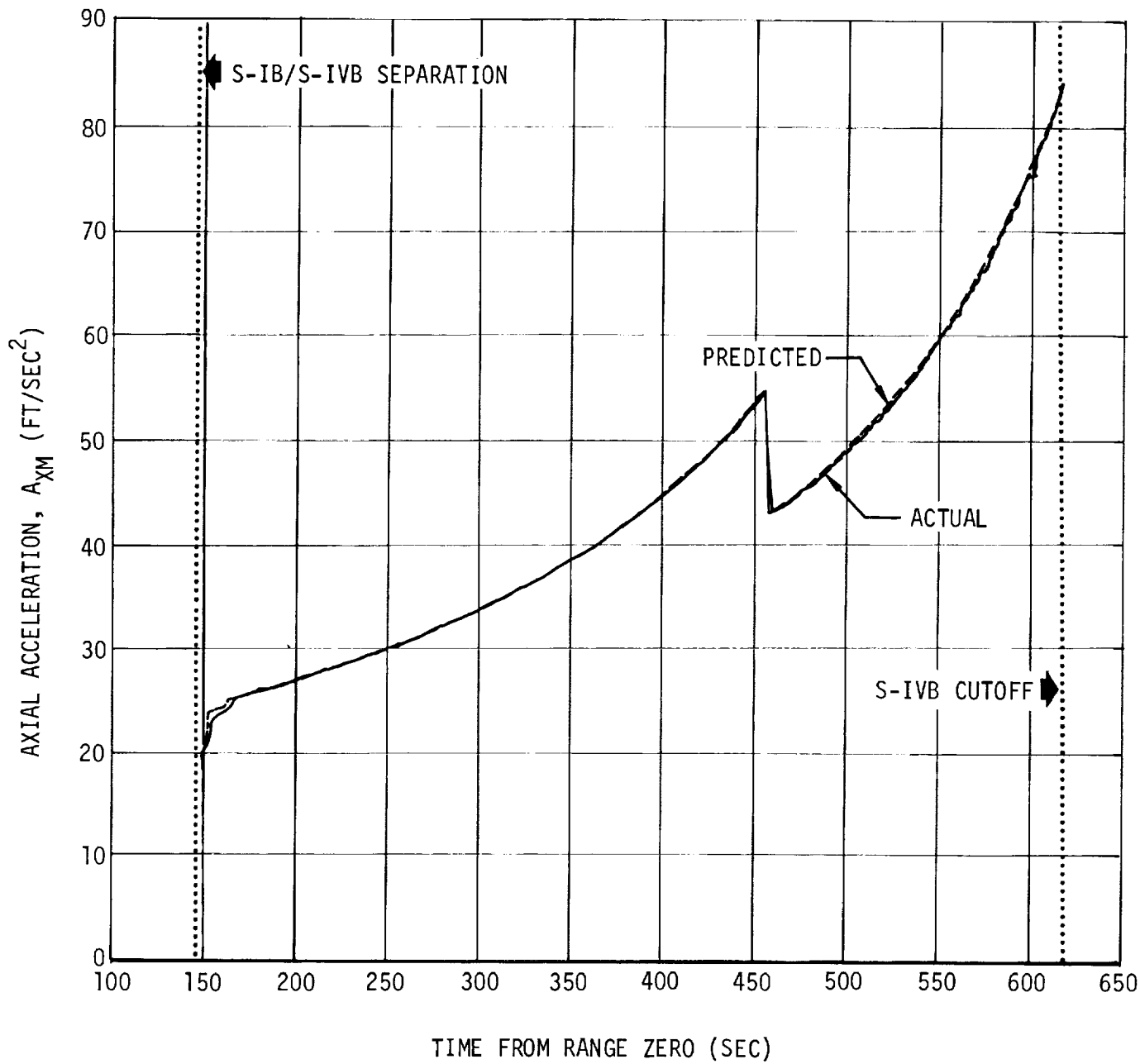

Figure 6-9. S-IVB Axial Acceleration History S-IB/S-IVB SEPARATION

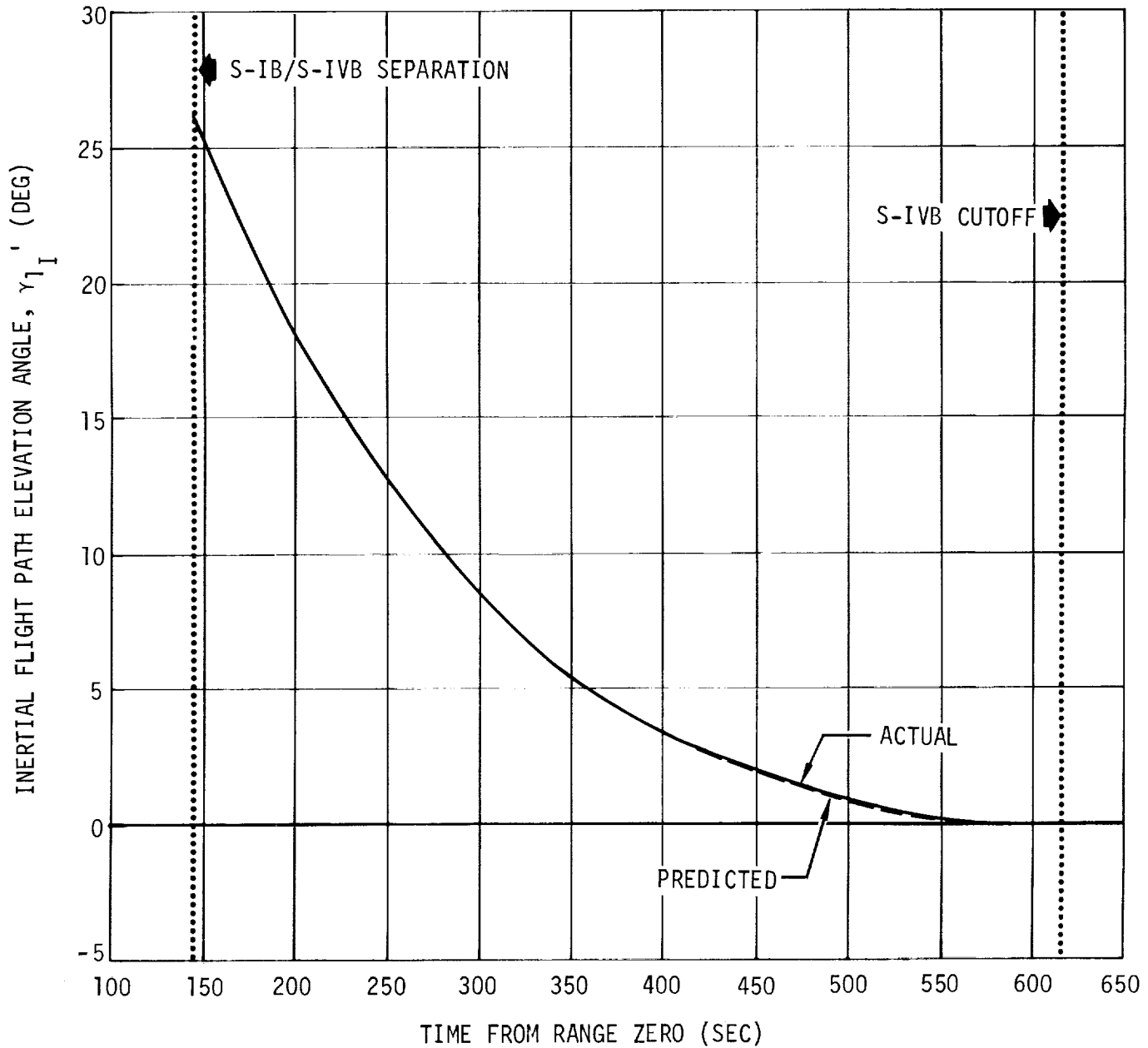

Figure 6-10. S-IVB Inertial Flight Path Elevation Angle History

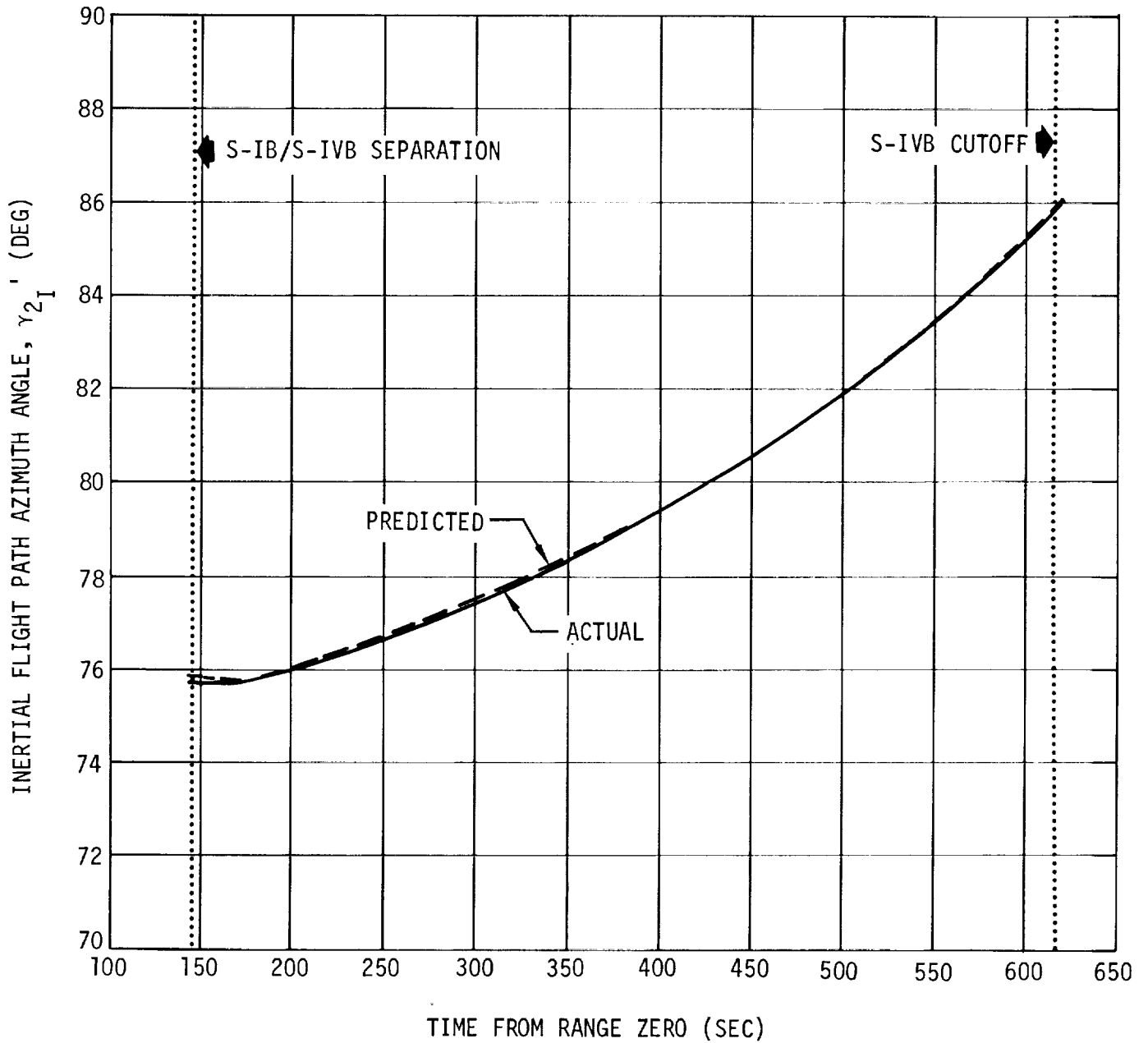
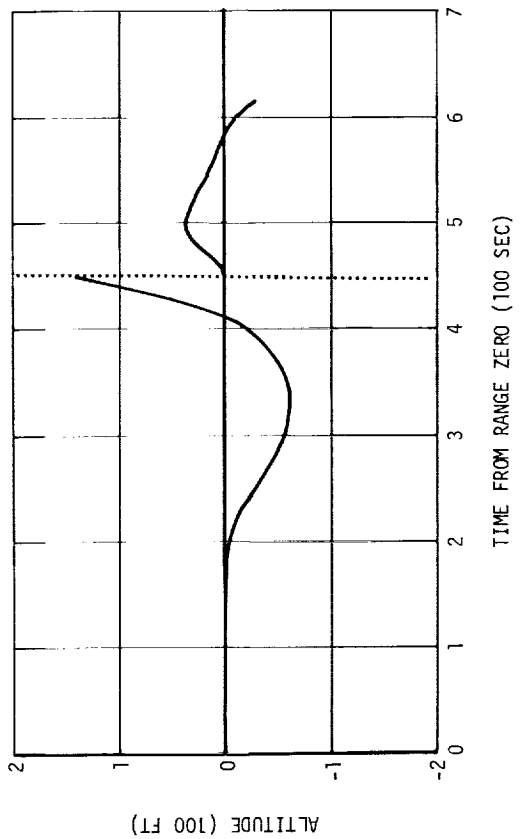
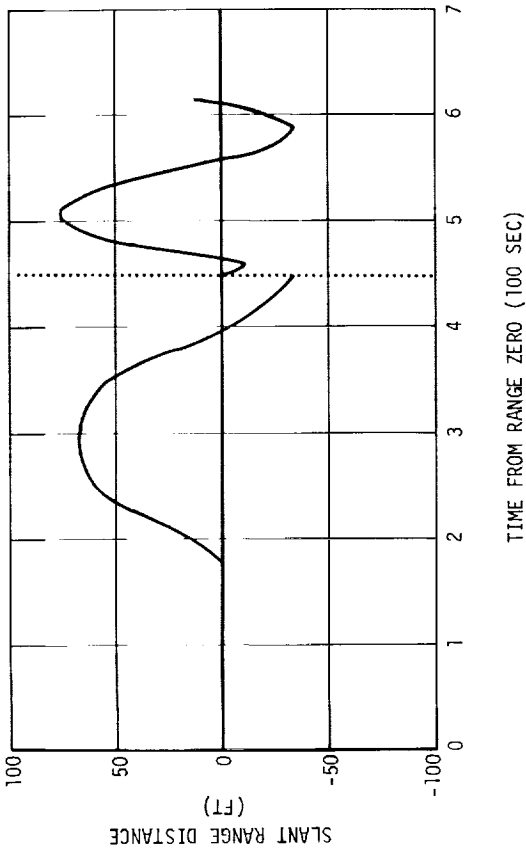

Figure 6-11. S-IVB Inertial Flight Path Azimuth Angle History



NOTE: DISCONTINUITY AT 450 SEC DUE TO INITIALIZATION OF SECOND SEGMENT OF TRAJECTORY RECONSTRUCTION

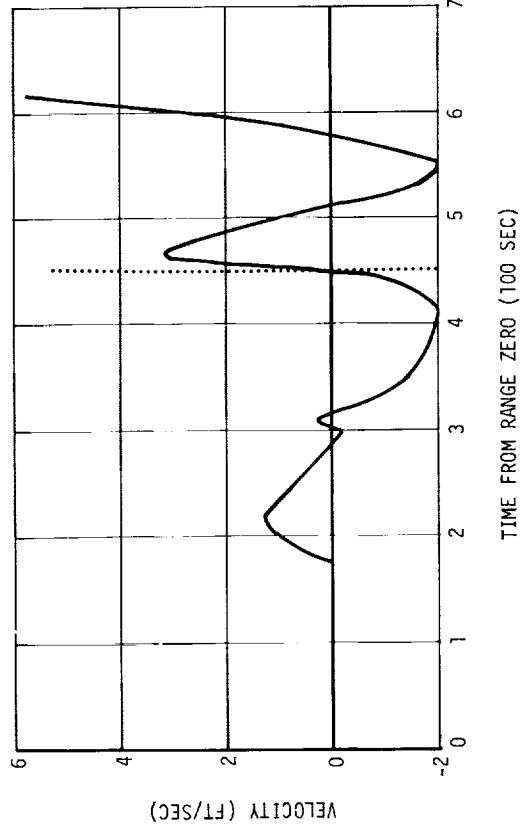
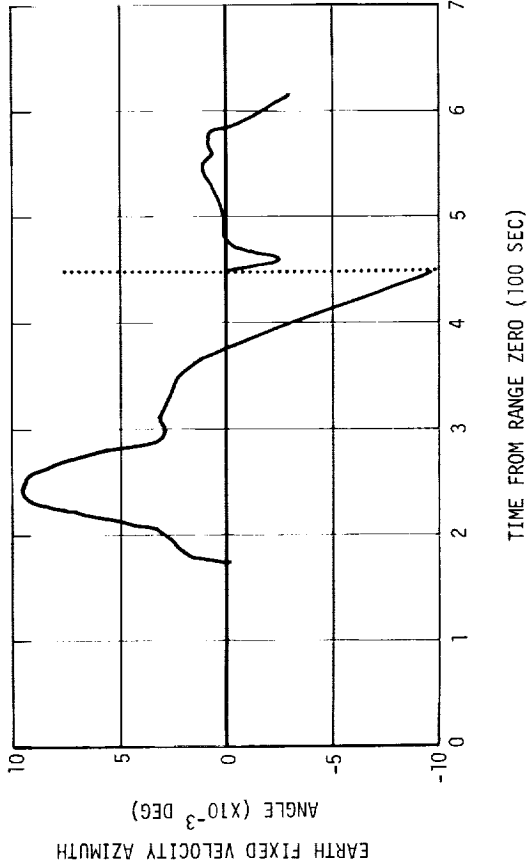

Figure 6-12. Trajectory Reconstruction Simulation Deviations

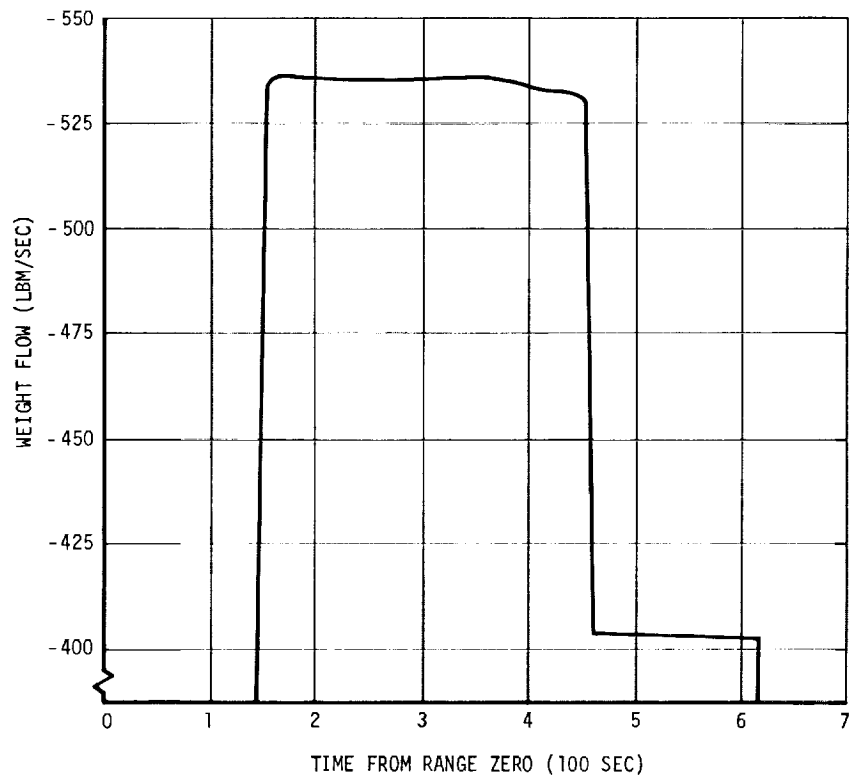
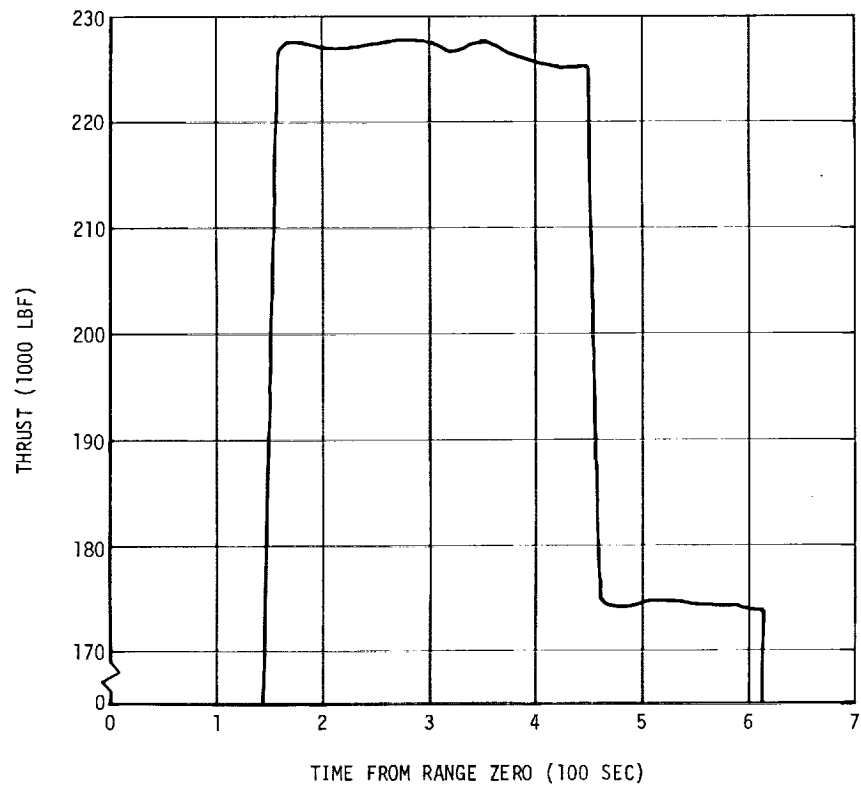

Figure 6-13. Thrust and Weight Flow from Trajectory Reconstruction

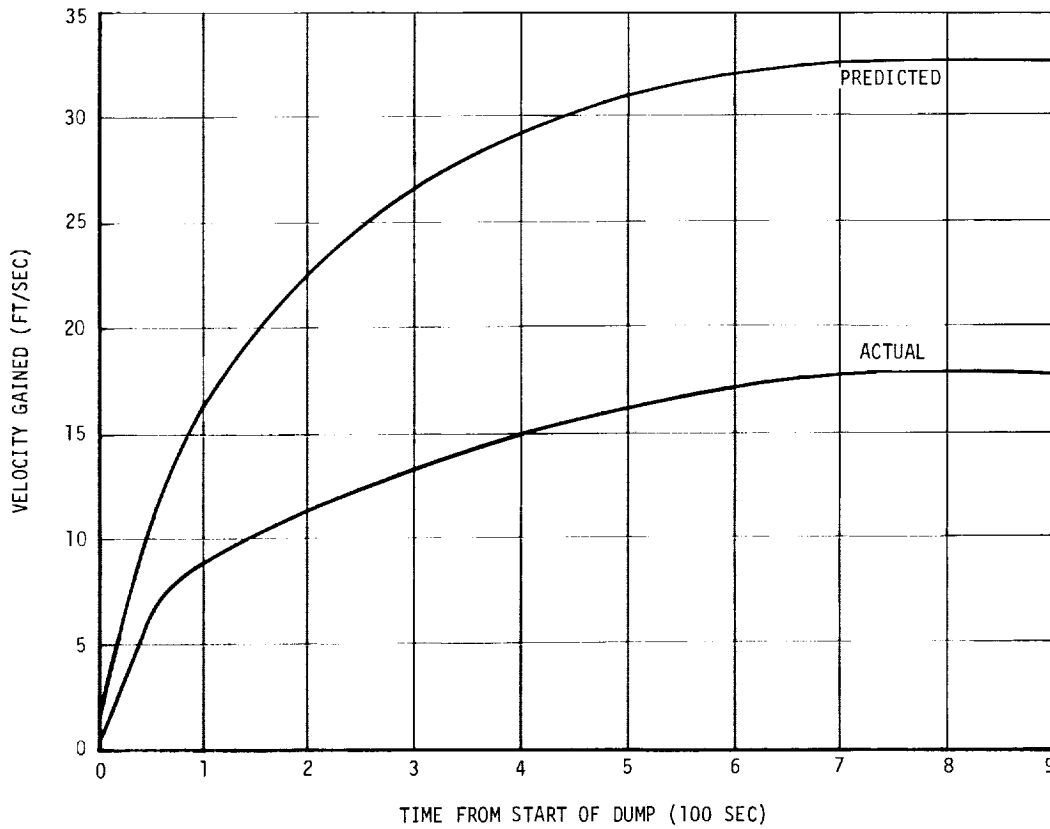
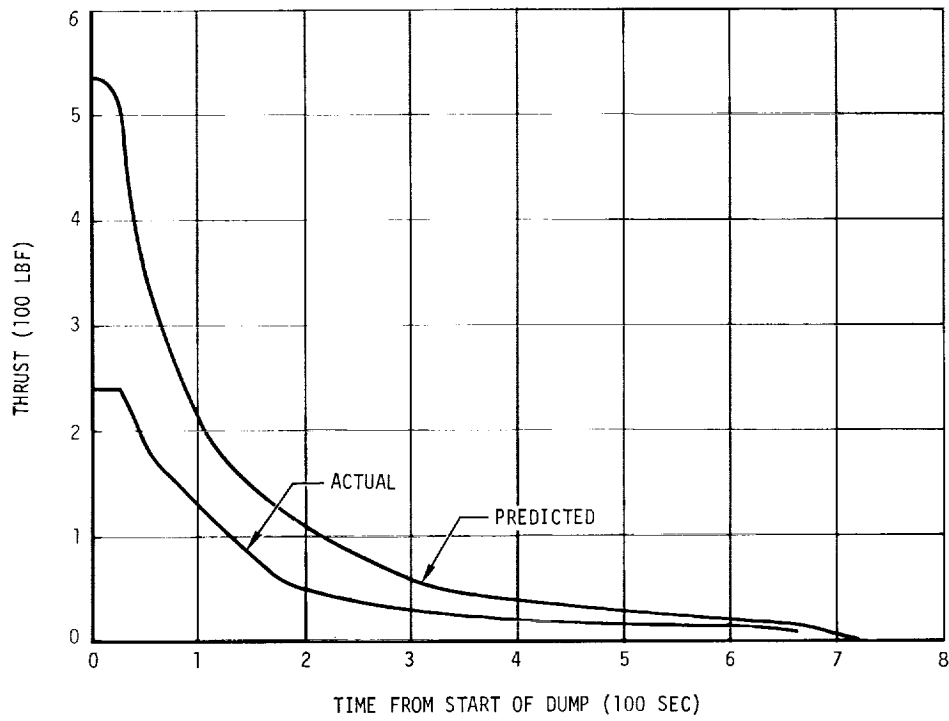

Figure 6-14. Thrust and Velocity Gained due to LOX Dump



SECTION 7

MASS CHARACTERISTICS



~~SECRET~~ ~~CONFIDENTIAL~~ ~~SECRET~~



~~SECRET~~ ~~CONFIDENTIAL~~ ~~SECRET~~



7. MASS CHARACTERISTICS

7.1 Mass Characteristics Summary

The AS-205 second flight stage (S-IVB-205, IU, and payload) mass summary, presented in table 7-1, is a best estimate value.

7.2 Mass Properties Uncertainty Analysis

Figures 7-1 through 7-4 present a comparison of the predicted vehicle mass characteristics and three-sigma uncertainties versus the postflight actual vehicle mass characteristics during S-IVB powered flight. The predicted uncertainties were determined from a statistical analysis of component mass properties uncertainties and are referenced relative to time from S-IVB Engine Start Command. Each of the postflight mass properties were within the predicted three-sigma uncertainty bands.

7.3 Second Flight Stage Best Estimate Ignition and Cutoff Masses

The best estimate method is a three-dimensional statistical analysis of data from five mass measurement systems. This method develops a joint probability density function from which the most probable values and accuracies for ignition and cutoff masses are determined.

Two measurement systems provide unique values for ignition mass and three measurement systems provide unique values for cutoff mass and two methods were used to provide a linear relationship between ignition and cutoff mass. The five measurement systems used in determining the best estimate masses are: (1) PU Volumetric, (2) PU Indicated (Corrected), (3) level sensors, (4) flow integral and (5) trajectory reconstruction. These measurement systems are described briefly in section 14.

Figure 7-5 is a graphical presentation of the best estimate analysis for ignition and cutoff mass. The second flight stage ignition mass was 305,685 \pm 641 lbm and the cutoff mass was 67,720 \pm 159 lbm.

7.3.1 Best Estimate Program Input

Table 7-2 presents a summary of the values used for the best estimate analysis. For the unique measurement systems, only the total mass values and associated uncertainties are used for program input. The linear relationship values are presented as utilized for the best estimate analysis.

TABLE 7-1
MASS SUMMARY

EVENT	S-IB LIFT OFF	S-IB S-IVB SEP	S-IVB ESC	S-IVB 90 PCT THRUST	EMR CUT BACK	S-IVB ECC	S-IVB ETD	START LOX DUMP	END LOX DUMP	CSM SEPAR	END PASSI- VATION
SEPARATION PKG	34	0	0	0	0	0	0	0	0	0	0
ULLAGE ROCKETS	395	386	319	218	0	0	0	0	0	0	0
LAUNCH ESCAPE	8,874	8,874	8,874	8,874	0	0	0	0	0	0	0
COMMAND MODULE	12,356	12,356	12,356	12,356	12,356	12,356	12,356	12,356	12,356	0	0
SERVICE MODULE	10,584	10,584	10,584	10,584	10,584	10,584	10,584	10,584	10,584	0	0
SM OXIDIZER	5,903	5,903	5,903	5,903	5,903	5,903	5,903	5,903	5,903	0	0
SM FUEL	3,652	3,652	3,652	3,652	3,652	3,652	3,652	3,652	3,652	0	0
SLA RING	91	91	91	91	91	91	91	91	91	0	0
ADAPTER (SLA)	3,852	3,852	3,852	3,852	3,852	3,852	3,852	3,852	3,852	3,852	3,852
INSTRUMNT UNIT	4,263	4,263	4,263	4,263	4,263	4,263	4,263	4,263	4,263	4,263	4,263
S4B205 DRY STG	21,852	21,852	21,852	21,852	21,852	21,852	21,852	21,852	21,852	21,852	21,852
LOX IN TANK	192,963	192,963	192,963	192,665	54,661	1,214	1,124	532	0	0	0
LOX ULLAGE GAS	33	33	33	34	192	275	275	673	212	0	0
LOX BELOW TANK	367	367	367	397	397	397	367	367	0	0	0
LH2 IN TANK	39,861	39,861	39,861	39,765	14,352	2,444	2,414	1,494	1,277	518	0
LH2 ULLAGE GAS	138	138	138	140	329	429	429	413	231	990	33
LH2 BELOW TANK	48	48	48	58	58	58	48	48	48	48	0
COLD HELIUM	336	336	336	335	229	172	171	171	158	16	3
APS PROPELLANT	135	135	135	135	132	131	131	122	119	98	69
GH2-START TANK	5	5	5	1	1	1	1	1	0	0	0
SERVICE ITEMS	56	56	56	56	56	56	56	56	56	56	56
FROST	300	103	100	100	100	100	100	100	100	100	100
TOTAL MASS	306,098	305,858	305,787	305,331	133,060	67,830	67,669	66,529	64,754	31,793	30,228
TIME FROM RANGE ZERO (sec)	0.359	145.581	147.008	149.540	455.783	616.757	618.160	5,668.948	6,389.962	10,502.388	18,685.619

TABLE 7-2
 BEST ESTIMATE PROGRAM INPUT VALUES
 UNIQUE MEASUREMENT SYSTEMS

EVENT	UNIQUE MEASUREMENT SYSTEM	LOX (LBM)		LH2 (lbm)		NON-PROPELLANTS (lbm)		TOTAL (lbm)	
		VALUE	UNCERTAINTY	VALUE	UNCERTAINTY	VALUE	UNCERTAINTY	VALUE	UNCERTAINTY
ESC	PU Volu-metric	193,010	±960	39,931	±262	72,446	±145	305,387	±1,006
	PU Indi-cated (Cor-rected)	193,330	±1,380	39,740	±284	72,446	±145	305,516	±1,416
ECC	PU Volu-metric	1,615	±492	2,492	±130	63,657	±162	67,764	±534
	PT Level Sensor	1,577	±166	2,492	±130	63,657	±162	67,726	±266
	PU Indi-cated (Cor-rected)	1,615	±492	2,585	±120	63,657	±162	67,857	±534

LINEAR RELATIONSHIPS

EVENT	MEASUREMENT SYSTEM	SLOPE	INTERCEPT (lbm)	UNCERTAINTY (lbm)
ESC to ECC	Flow Integral	1.0	238,513	±1,403
	Trajectory Reconstruction	4.51521	0	±916

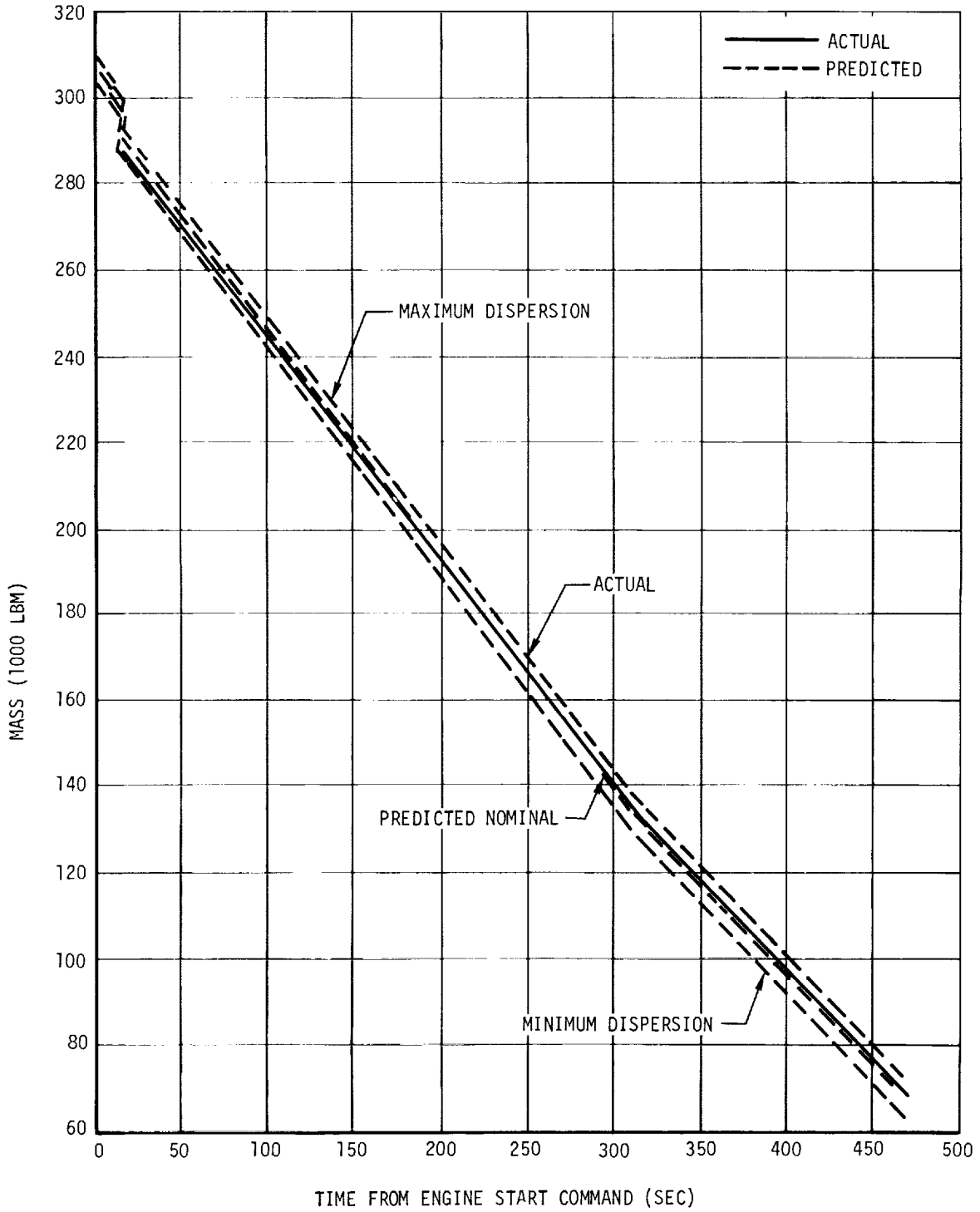

Figure 7-1. AS-205 Second Flight Stage Vehicle Mass

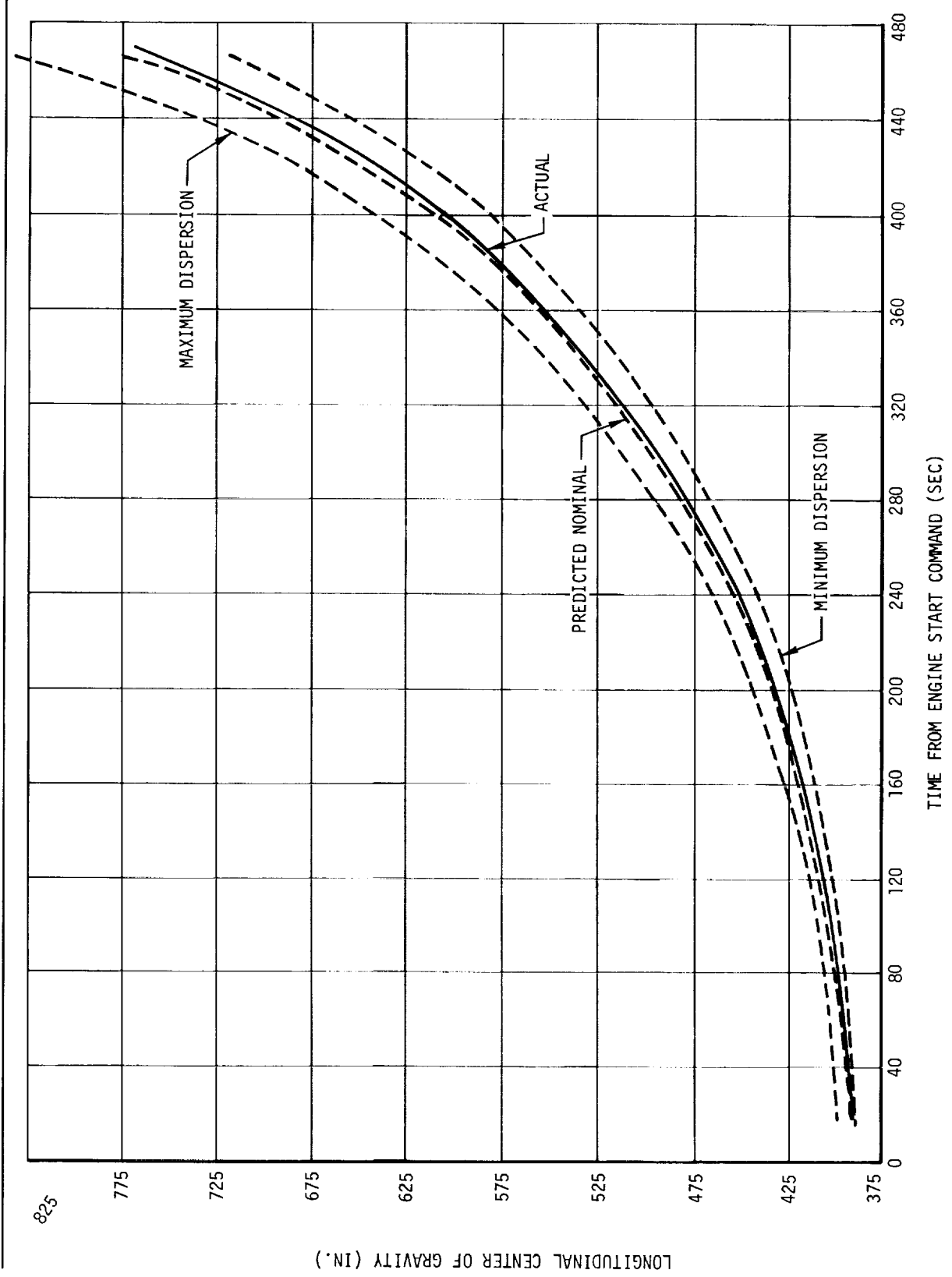

Figure 7-2. AS-205 Second Flight Stage Vehicle Longitudinal Center of Gravity

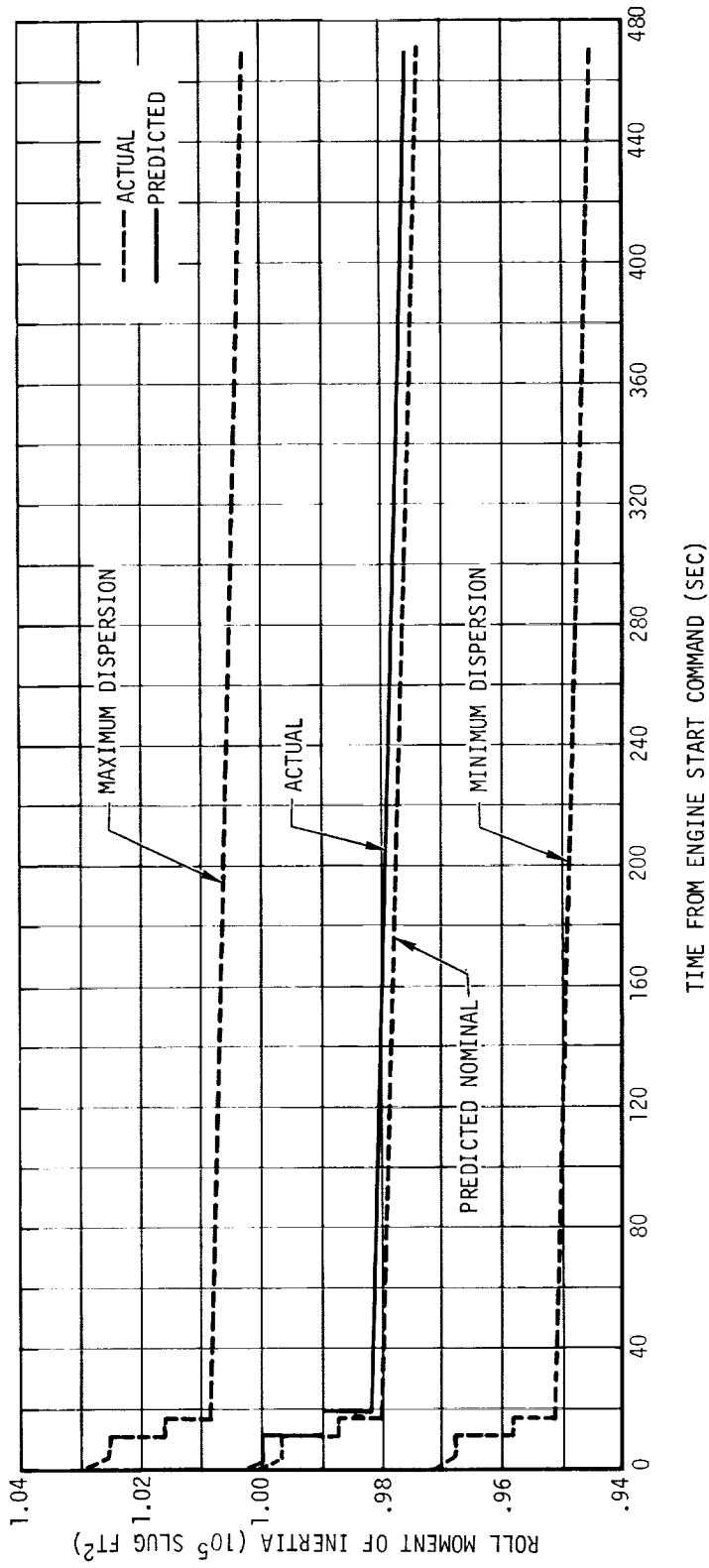

Figure 7-3. AS-205 Second Flight Stage Vehicle Roll Moment of Inertia

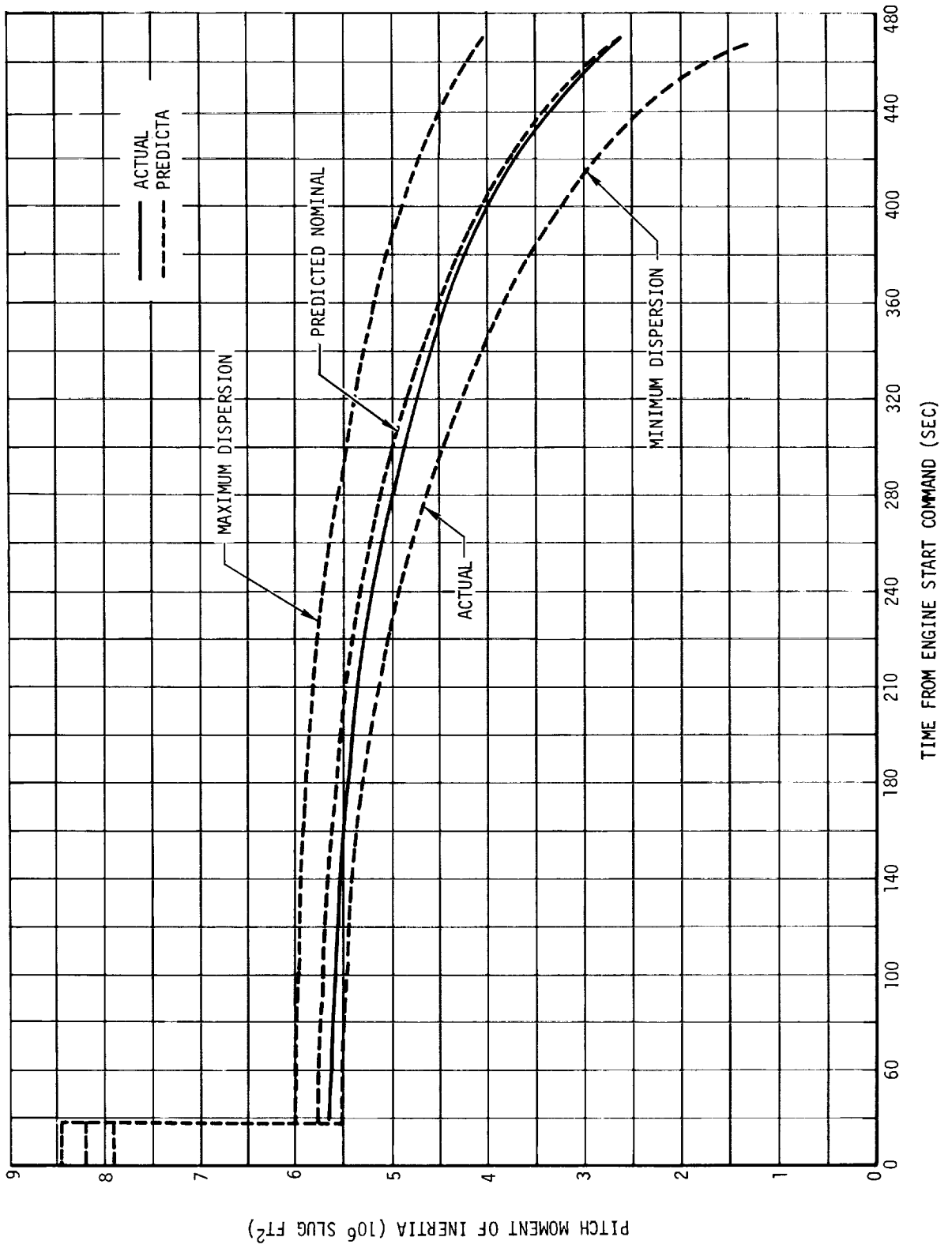

Figure 7-4. AS-205 Second Flight Stage Vehicle Pitch Moment of Inertia

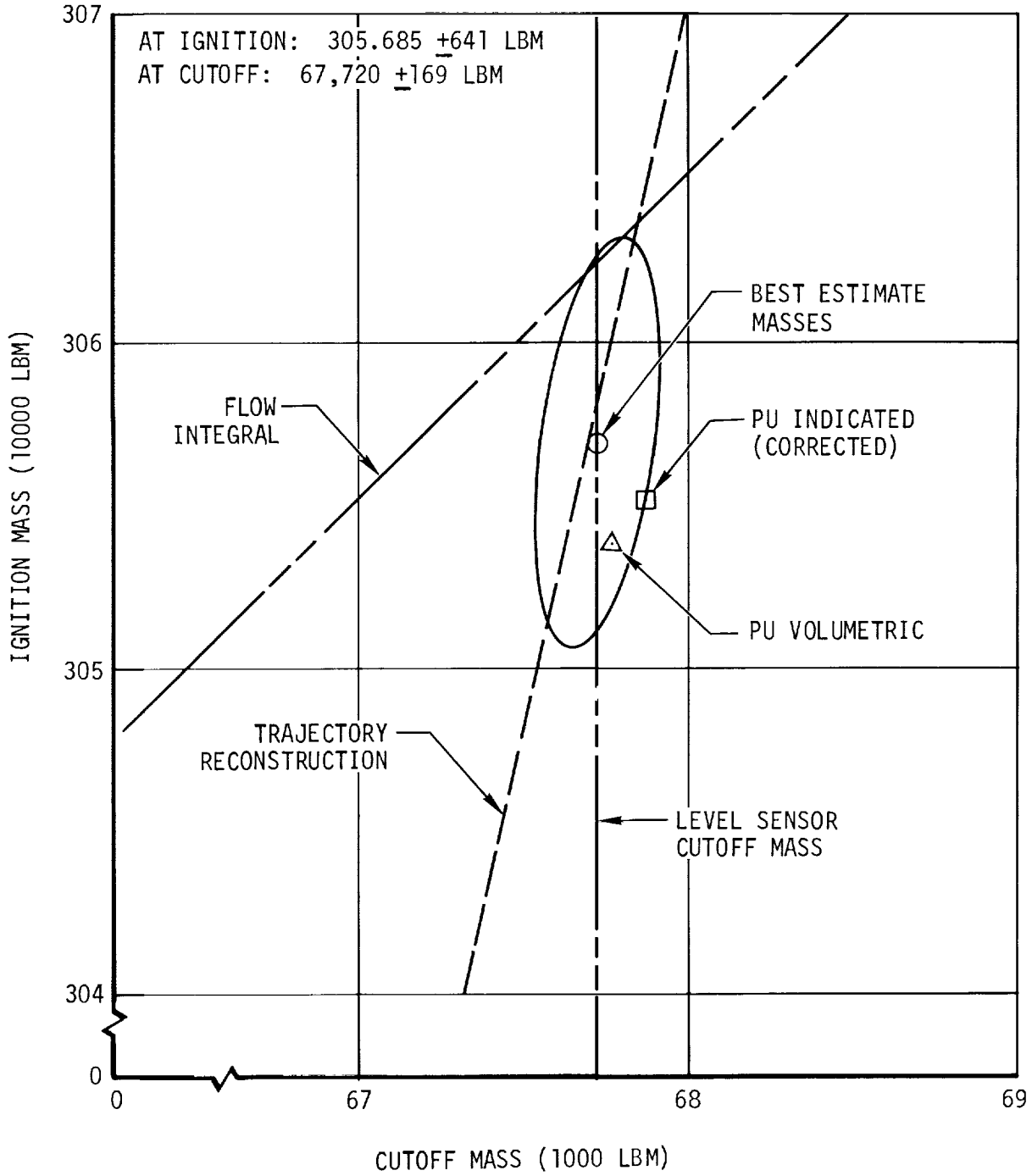
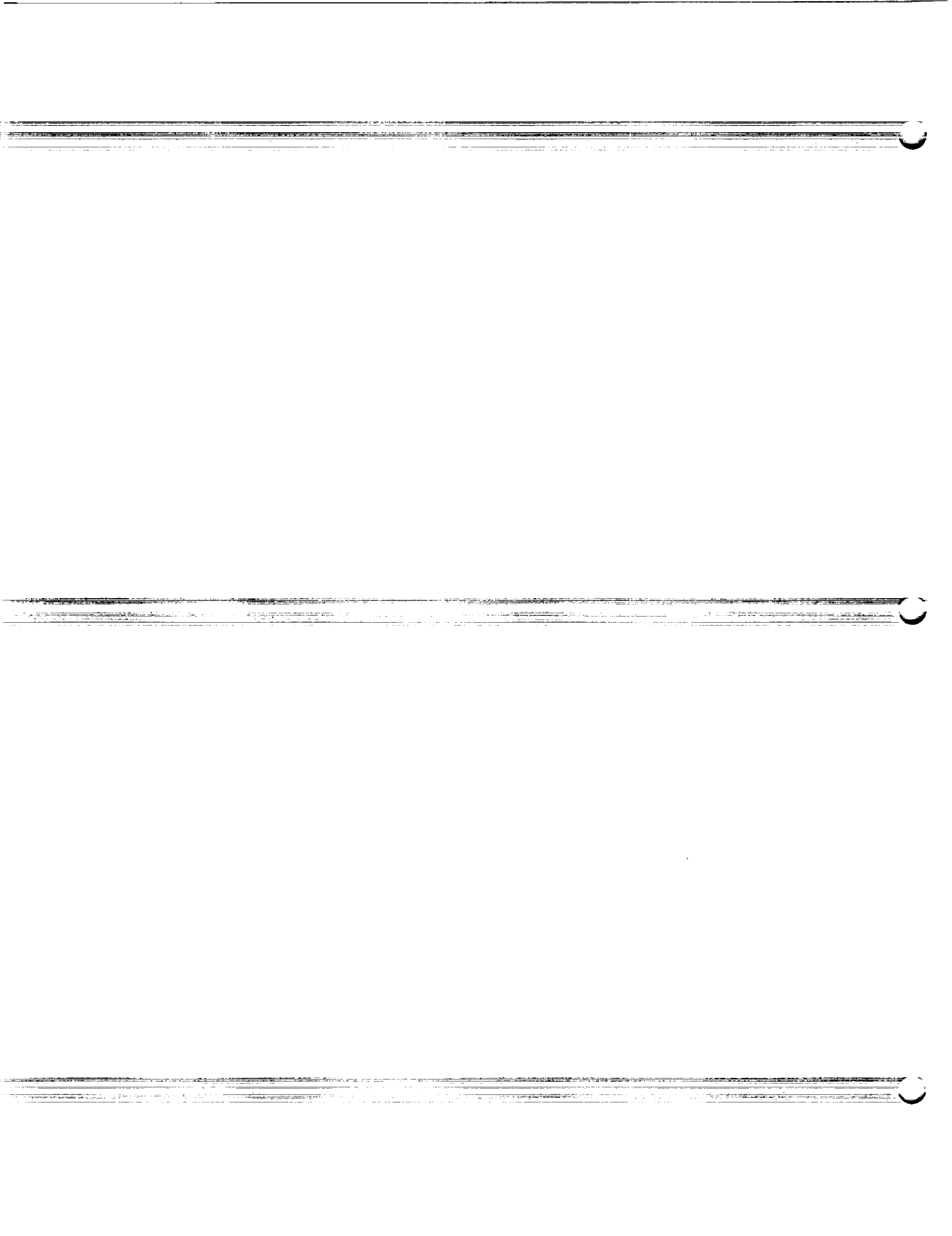

Figure 7-5. AS-205 Second Flight Stage Best Estimate Masses

SECTION 8

ENGINE SYSTEM



8. ENGINE SYSTEM

The main propulsion system of the S-IVB stage of the AS-205 launch vehicle consisted of a 225,000-lbf-thrust Rocketdyne J-2 engine, S/N J-2033, shown schematically in figure 8-1 with the associated propellant ducting and conditioning systems. As a result of the analysis of the engine and stage acceptance tests, the following 60-sec tag values were established with the engine constants presented.

TAG VALUES

Thrust (F)	227,249 lbf
Engine mixture ratio (EMR)	5.464
Specific impulse (Isp)	425.5 sec

ENGINE CONSTANTS

LOX flowmeter	5.5779 cycles/gal
LH2 flowmeter	1.8008 cycles/gal
LOX boot strap orifice	0.256 sq in.
LH2 boot strap orifice	0.466 sq in.
LOX turbine bypass nozzle	1.080 sq in.

The engine was equipped with a 0.640 sec start tank discharge valve (STDV) delay timer in the engine control circuit; however, actuation of the STDV, which determines the fuel lead duration, was controlled by an IU command at Engine Start Command (ESC) +1 sec through the fuel injection temperature bypass circuit. There were no engine modifications that affected performance, except for the addition of a poppet orifice to the main oxidizer valve (MOV) opening system which provided a more rapid start transient. The start tank refill lines were blocked with blank orifices to prevent refill.

Significant engine events during the S-IVB powered flight phase of the 205 mission were as follows:

<u>EVENT</u>	<u>REFERENCE TIME</u>			
	<u>ESC</u>	<u>Range Zero</u>	<u>Prediction</u>	<u>% Dev.</u>
Engine Start Command	0	+147.008	148.8	-1.22
Engine Cutoff Command	+469.749	+616.757	621.1	-0.69

Comparisons are made to the predicted propulsion system performance as published to Marshall Space Flight Center (MSFC) in MDAC-WD letter A3-250-KCBC-L-4184 dated 23 September 1968.

8.1 Engine Chillover and Conditioning

8.1.1 Engine Turbopump Chillover

The engine LOX and LH2 turbopumps were adequately chilled, and the temperatures and pressures were within the required band at Engine Start Command (paragraphs 10.4 and 11.2).

8.1.2 Thrust Chamber Chilldown

Thrust chamber chilldown was initiated at T -10 min (RO -12 min 45 sec). The thrust chamber jacket temperature response was slightly slower than usual, and it appeared that a blockage may have occurred in the ground support equipment (GSE). The GSE heat exchanger crossover valve was closed for 50 sec and reopened to verify flow through both coils of the heat exchanger. This procedure further reduced the rate of chilldown, and raised doubts that the temperature requirement would be met at initiate automatic sequence (IAS). To avoid calling a hold after IAS, which would have caused a countdown recycle to T -15 min, a hold was called out at RO -6 min 15 sec. After 165 sec, the chilldown was progressing satisfactorily, and the countdown was resumed. When chilldown was terminated at liftoff (figure 8-2) the temperature was 258 deg R which was below the redline maximum of 265 deg R. At S-IVB Engine Start Command, the temperature was 283 deg R, which was within the requirement of 240 ±50 deg R. Significant data are presented in table 8-1.

8.1.3 Engine Start Sphere Chilldown and Loading

Engine start sphere chilldown and loading met the requirements for engine start (table 8-2 and figures 8-3, 8-4, and 8-5). Further information is presented in section 4.

8.1.4 Engine Control Sphere Chilldown and Loading

Engine control sphere conditioning was adequate; and all objectives were accomplished. Significant control sphere performance data are presented in table 8-3 and figure 8-3.

8.1.5 Engine Environment

Measurement C2037 gas generator (GG) LOX bootstrap line temperature and C0010 engine area ambient temperature exhibited normal characteristics. Measurement C2037 is of particular interest in this flight for two reasons: (1) it was one of the primary indicators of the failure that occurred during AS-502 flight; and (2) it is critical with respect to a successful start. During AS-205 flight, C2037 exhibited none of the aberration that occurred during the 502 flight. At 80 min after engine cutoff it indicated 455 deg R compared to 320 deg R during the S-IVB-502 flight. Acceptable start limits are 468 to 394 deg R at the 80 min restart time point. The 205 flight C2037 measurements therefore substantiates the previously reported 502 failure analysis. It also indicates that a condition suitable for 80-min starts, from a GG LOX supply line temperature standpoint, will exist during future flights with a similar environment.

8.2 Start Sphere Performance

8.2.1 During Engine Operation

The engine start sphere conditions at S-IVB Engine Start Command were 1,293 psia and 273.1 deg R with a mass of 3.75 lbm (figures 8-3 and 8-4) as compared to the predicted values of 1,260 psia, 280 deg R, and 3.36 lbm. The deviation produced a negligible effect on the start transient.

Start Tank Discharge Valve (STDV) Open Command occurred at ESC +0.983 sec, and the pressure decay initiated at ESC +1.2 sec. The blowdown was terminated by the STDV closure at ESC +1.786 sec. Figure 8-5 shows a plot of the start tank blowdown and the resulting bottle conditions until engine cutoff. Accepting the minimum recorded pressure of 160 psia to be correct, a minimum temperature resulting from an adiabatic blowdown to this pressure is 150 deg R, as compared to the recorded temperature of 195 deg R.

The mass was calculated at the adiabatic end conditions (0.84 lbm) and at the actual data end conditions (0.65 lbm). These two masses were taken as the maximum and minimum possible mass left in the bottle after blowdown. Mass remaining, based on measured data alone, ranges from 0.65 lbm to 0.97 lbm. The discrepancy is due to inaccurate temperature indications after blowdown.

The measured pressure deviated from the prediction after the start tank blowdown. The actual pressure initially rose at a faster rate than the prediction; however, it was at a lower value at engine cutoff. The deviation was due to improper predicted heat inputs based on AS-204 flight during which the bottle was refilled.

The conditions in the start tank at engine cutoff were a pressure of 312 psia and a temperature between 290 and 360 deg R.

8.2.2 During Orbit

After engine cutoff heat input from the surroundings caused a temperature and corresponding pressure increase; however, as during the AS-204 and 501 missions, the measured temperature did not indicate reasonable agreement with gas laws (figure 8-6).

The close proximity of the uninsulated temperature transducer to the turbine crossover duct exposed the transducer to a high temperature (approximately 1,200 deg R) at Engine Cutoff Command (ECC). It appears that the transducer measures local conditions and is not indicative of the hydrogen gas bulk temperature. Perturbations in the g forces on the stage such as indicated by venting or propellant dumping and impingement of vented gases on the start sphere, were reflected in the temperature measurement as shown in figure 8-6, thereby, indicating the lack of convection induced mixing in the 0 g environment. Assuming the pressure measurement to be correct, a bulk temperature was calculated using perfect gas laws. The results are shown in figure 8-6.

8.3 Control Sphere Performance

8.3.1 During Engine Operation

At Engine Start Command during the AS-205 mission, the conditions in the engine helium sphere were 3,290 psia, 284 deg R and 2.07 lbm. During the start transient, the pressure in the helium control sphere decreased 425 psia as compared to the predicted value of 440 psia. The pressure at ECO +1 sec was 2,183 psia. The nominal prediction was 2,100 psia. The temperature was 248 deg R and helium consumption was 0.43 lbm., both of which were well within the range of expected values. During the cutoff transient, the pressure decay was as predicted. Figure 8-3 shows both the predicted and flight control sphere pressure profiles.

8.3.2 During Orbit

The control sphere temperature transducer sensor is located in a region of high velocity and senses total local temperature during rapid blowdowns. Therefore, the bulk temperature must be estimated. The transducer is also afflicted with the 0-g heat transfer problems of the start tank temperature transducer although to a lesser degree. The pressure data are considered more reliable. Figure 8-7 shows the pressure build up from engine cutoff to the initiation of the passivation experiment due to heat input. The pressure and temperature as recorded at the start of the LOX dump were 2,420 psia and 290 deg R. The helium was dumped through the regulator and terminated when the pressure in the control sphere reached 50 psia. This is approximately equal to the spring force of the main regulator which closed at this point and prohibited any further dumping of helium.

8.4 Engine Performance Analysis Methods and Instrumentation

Engine performance for the powered flight portion of the S-IVB-205 mission was calculated by use of computer programs PA63, AA89, and G105-1. The average of the results of PA63 and G105-1, which is considered to be the best current estimate of engine performance, was calculated by computer program PA49. Revised tag values based on flight data were generated by computer program PA63 (Rocketdyne PAST.641). The results of PA49 program were used in determining the best estimate of stage propellant consumption. Computer program UT23A was used to investigate internal engine performance. Computer program PA53 was used to compute start and cutoff transient performance. A description of the operation and a comparison of the results of each program is presented in table 8-4. Data inputs to the computer programs with the applicable bias are shown in table 8-5.

8.5 Engine Performance

The S-IVB J-2 engine met all objectives during the 205 mission. Plots of selected data showing engine characteristics are presented in figures 8-8 through 8-14 for engine main-stage operation. The engine propellant inlet conditions are discussed in sections 10 and 11. The engine performance level at STDV +60 sec as determined by computer program PA63 at standard altitude conditions was as follows:

<u>Parameter</u>	<u>Flight</u>	<u>Stage Acceptance*</u> <u>(Predicted $\pm 3\sigma$)</u>	<u>Engine Accept</u>	<u>% Dev. Flt.</u> <u>to Pred.</u>
Thrust (lbf)	227,249	225,657 ± 2901	225,343	+0.71
EMR	5,464	5.484 ± 0.09	5.51	-0.36
Specific impulse (sec)	425.5	423.2 ± 2.7	422.2	+0.54

*Used for flight prediction

A plot of these and other performance values is shown in figure 8-14. All tag values were within the 60-sec, three-sigma run-to-run deviations. The composite values for steady-state performance with a comparison to the predicted, as well as overall engine average

performance from the 90-percent performance level (chamber pressure = 618 psia [including bias] by definition) to Engine Cutoff Command are presented in table 8-6. The variation of the site I_{sp} with mixture ratio is shown in figure 8-15. The stage propellant and impulse summary is presented in table 8-6. All values were within the prediction accuracy of 1 percent.

8.5.1 Start Transient

Engine performance during the start transient was satisfactory. A summary of engine performance during the start transient is presented in the following table:

<u>Parameter</u>	<u>Flight</u>	<u>Acceptance Firing</u>	<u>J-2 Engine Log Book</u>
Time of STDV Command (sec from ESC)	0.983	0.646	1.0
Time from STDV to 90% performance level* (sec)	2.25	2.66	2.16
Thrust rise time** (sec)	1.83	2.21	1.70
Total impulse to 90% performance level* (lbf sec)	148,013	196,343	144,200***

*Defined as chamber pressure = 618 psia.

**Time from initial thrust rise after STDV to 90 percent performance level

***Based on stabilized thrust at null PU and at standard altitude conditions.

Engine thrust buildup occurred at a null PU valve position following a 1 sec fuel lead. The fuel lead, PU valve position, and main oxidizer valve operation were satisfactory and a good start was obtained. Thrust buildup to the 90 percent performance level (chamber pressure = 618 psia) was within the maximum and minimum thrust limits shown in figure 8-16.

Thrust buildup during flight was faster than during the acceptance firing. This was largely due to the expected shorter MOV opening time during flight. The total impulse during start (to the 90 percent performance level) was slightly greater than the engine log book value and much less than the acceptance firing value. These total impulse values were approximately proportional to the thrust rise times and were largely the result of the various MOV opening times during the three tests.

There was some thrust instability during the start transient from STDV +1 to +2.2 sec. This was reflected in some of the engine pressure data and in the main LOX valve position data. However, this instability was within the Arnold Engineering Development Center (AEDC) testing experience limits and was not considered to be a problem.

The 205 flight start transient buildup was slightly faster than that observed during the 204 flight start transient.

8.5.2 Steady-State Operation

The engine performed satisfactorily during the steady-state portion of engine burn. Figures 8-8 through 8-14 contain plots of selected data used as input values to the engine performance computer programs. Sections 10 and 11 contain a discussion of the engine turbopump inlet conditions; figure 8-17 presents the computed performance parameters.

A negative shift in engine performance was observed at ESC +244 sec (RO +391 sec). This shift was observed on the parameters listed in table 8-7 which also contains the observed magnitudes. These magnitudes were similar to the shift which occurred during the S-IVB-205 acceptance firing. The performance shift during the flight did not recover to the original level but persisted until PU valve cutback at ESC +308.8 sec. These performance shifts have been associated with a positive shift in GG LOX feedline resistance.

Table 8-6 compares average performance values with predicted performance values during closed PU valve and reference mixture ratio operation. All values were within the 1 percent accuracy of the prediction. The specific impulse exhibited a relatively high deviation (-1.18 percent) during open PU valve operation. Following ESC +375 sec an observed shift in measured chamber pressure produced an average thrust reduction of 900 lbf. This reduction in performance was not observed on other related engine instrumentation. Neither the gas generator nor PU valve resistance indicated any change during this period. It is concluded that the indicated thrust reduction was caused by an erroneous chamber pressure measurement of approximately -2.5 psi following ESC +375 sec. Therefore the indicated specific impulse deviation calculated after cutback is invalid. The actual average thrust and specific impulse following cutback are estimated to be 175,000 lbf and 429.7 sec, respectively. The deviation from prediction would then be revised to be -0.03 percent and -0.3 percent for thrust and specific impulse respectively. The actual engine performance tag value trends were very close to those predicted based on acceptance firing (figure 8-14).

Engine thrust variations produced by closed loop PU system operation were nonexistent during this open loop flight, therefore, the variation limits are not applicable.

8.5.3 Cutoff Transient

Engine performance during the engine cutoff transient was satisfactory. The time lapse between engine cutoff, as received at the engine, and thrust decrease to 11,250 lbf (5 percent rated thrust) was within the maximum allowable time of 800 ms. Figure 8-19 shows the thrust chamber pressure; the thrust decrease, and total impulse during the cutoff transient. Engine performance during the cutoff transient is presented in the following table:

Parameter	Unit	Flight	Predicted	Deviation (Actual- Predicted)	J-2 Engine Log Book
Time for thrust decrease to 11,250 lbf	ms	497	400*	+97	475
PU valve position at Engine Cutoff Command	deg	-28.5	-28.5 ±2	0	-0.1
Thrust at cutoff command	lbf	172,793	174,390	-1,597	204,723
Actual total impulse	lbf-sec				
To 5% thrust		41,261	39,697 ^{+4,200} _{-4,000}	+1,564	--
To zero thrust		47,127	46,097 ^{+4,200} _{-4,000}	+1,030	--
Total impulse to 5% thrust adjusted to null PU valve position and 460 deg R MOV actuator temperature	lbf-sec	41,485	--	--	39,602

*Maximum allowable = 800 ms

The total impulse value determined for the flight was adjusted to standard conditions (null PU and 460 deg R MOV temperature) to compare it to the value obtained from the engine log book. The MOV actuator was not instrumented and the temperature used in the adjustment was assumed to be the same as that observed at S-IVB-501 first burn cutoff. The temperature during flight was probably colder, however, since the MOV started to close late and remained open longer than expected. A 20 deg colder actuation gas temperature will explain the 1,883 lbf-sec difference between the adjusted total impulse value from the flight and that from the log book. This variation is well within the allowable tolerance.

The cutoff impulse to zero thrust computed from actual trajectory data was 57,682 lbf-sec, which deviates very significantly from both the predicted value of 46,097 lbf-sec and the actual value of 47,127 lb-sec as determined from engine thrust data. The cutoff impulse value from trajectory analysis was determined from observed trajectory data generated by MSFC; the cause of the discrepancy has not been determined. Figure 8-18 compares the two values for actual velocity gain during the cutoff transient to the predicted velocity gain and its predicted three-sigma deviation. The velocity gain as computed from engine analysis data is close to predicted, while the gain as computed from trajectory data exceeds considerably the predicted three-sigma maximum. The only explanation of this deviation could be an error in cutoff time of approximately 0.060 sec which cannot be substantiated. The cutoff impulse and velocity change were as follows:

	Unit	Predicted	Actual-Trajectory Data	Actual-Engine Data
Cutoff Impulse	lbf-sec	46,097 ^{+4,200} _{-4,000}	57,682	47,127
Velocity Change	ft/sec	21.9 ±2.5	27.4	22.2

8.5.4 Trajectory Reconstruction Analysis

Using a trajectory simulation program, propulsion system parameter histories were adjusted so that an S-IVB trajectory could be generated to closely match the observed trajectory. To obtain this match of the observed trajectory it was necessary to adjust the levels of thrust and weight flow from those determined by engine analysis. Before cutback the thrust and weight flow determined by engine analysis were increased by 0.41 and 0.31 percent respectively, after cutback the engine analysis thrust and weight flow were increased by 1.13 and 0.01 percent respectively. The corresponding change in specific impulse over the values determined from engine analysis were 0.10 percent increase in specific impulse before cutback and a 1.12 percent increase in specific impulse after cutback.

Histories of simulated thrust and weight flow are presented in figure 6-13. The average values for these parameters are presented in paragraph 6.3.

8.6 Component Operation

8.6.1 Main Oxidizer Valve

The MOV opened and closed satisfactorily during engine burn. The opening time data were as follows:

<u>Time (ms)</u>	<u>Specification</u>	<u>Preflight Checkout</u>	<u>Acceptance Firing</u>	<u>Flight</u>
First stage travel time	50 ±25	40	61	88
First stage plateau time	365 ±75	402	500	417
Second stage travel time	1,390 ±40	1,420	1,930	2,100
Total time	1,805 ±140	1,862	2,491	2,605

The flight data were taken from 12 sps data which was the best available, but somewhat affected the accuracy of the reported times. However, with careful interpretation of the data, reasonably good accuracy was obtained. The given specification times are for a dry valve at ambient temperature. During the preflight checkout when these same conditions existed, all valve opening times were within specifications, as shown in the preceding table.

The MOV exhibited longer than expected flight travel times during the engine start transient. However, the start transient was satisfactory. The first stage travel time was 13 ms longer than the specification. This is normal with valves not incorporating the thermal compensating orifice and reflects approximately the same results as the S-IVB-204 flight. The second stage travel time was 710 ms longer than specification. Approximately 500 ms can be attributed to the reasons described for the first stage excessive travel time. The remainder can be attributed to the thrust instability during the start transient. The instability was within the AEDC testing experience limits and was not considered to be a problem.

The MOV closing time was 233 ms which was 83 ms longer than specification. This resulted in a slightly higher than expected cutoff impulse.

The MOV was not fully close at the end of the LOX dump sequence as expected. This was due to lack of pneumatic pressure on the closing port. Approximately 30 psia is required to fully close the valve.

8.6.2 Pumps and Turbines

The LH2 and LOX pumps and turbines performed satisfactorily throughout the engine firing. The pump speeds and discharge pressures and temperatures responded as expected to PU valve cutback and also to engine inlet conditions. The pressure and temperature increases across the pumps were satisfactory, although a 480 psi spike was observed in the fuel pump discharge pressure at approximately ESC +2.0 sec. This rise was only observed on one data sample which was considered to be invalid since the increase was not reflected in the flow-rate data. However at this same time a 15 psi rise was observed in chamber pressure and was attributed to transient thrust instability which has occurred for short periods in past tests at AEDC.

Temperatures and pressures for both turbines responded as expected to PU system cutback. The pressure and temperature drops across the turbines were nominal. The LH2 and LOX pump and turbine data are shown in figures 8-11 and 8-12. The LH2 pump performance during start is also shown on the pump discharge pressure vs flowrate (H-Q) curve (figure 8-20) which indicated no severe trends toward the stall line.

8.6.3 PU Valve

The PU valve performed satisfactorily. At Engine Start Command, the PU valve was at -0.59 deg which was within the required range of 0 ± 2 deg. The PU valve remained in the null position (0 deg) during the start transient until PU activation at ESC +6 sec. At that time the valve started closing, reaching the fully closed position (31.7 deg) at ESC +6.9 sec. The valve remained in the fully closed position (high EMR) until PU valve cutback at ESC +308.8 sec. The predicted time of PU cutback was ESC +308.7 sec. The valve was commanded open to -28.5 deg, where it remained until engine cutoff. After cutoff, the PU valve started closing to the null position, but did not reach null due to deactivation of the PU system. PU valve response to PU system commands is further discussed in section 14. Plots of PU valve performance are shown in figure 8-10.

8.6.4 Gas Generator

The GG performance was satisfactory. The GG chamber pressure and LH2 turbine inlet temperature indicated nominal values before and after EMR cutback (except at time of the engine performance shift as noted in paragraph 8.5.2). The GG flowrates and mixture ratio were nominal, and sufficient energy was delivered to the turbines to assure satisfactory operation. Plots of GG performance are shown in figure 8-21.

8.6.5 Engine Driven Hydraulic Pump

The engine driven hydraulic pump performed satisfactorily during engine burn. The average power required by the pump was 5.2 hp as determined by a flight reconstruction computer program.

8.6.6 ASI System

Both the LOX and the ASI feed system and combustor performed satisfactorily as indicated by the available instrumentation. A summary of the LOX line skin and combustion temperature measurements (figure 8-22) follows:

C2043 SKIN TEMPERATURE ASI LINE

The measurement exhibited valid data until RO +415 sec. At this time noise, along with a decrease in temperature readings began. This continued until engine cutoff. Because of the magnitude of the noise and the readings during this period, it is believed this is invalid data. Offscale low readings remained until RO +1,000 sec. At this time, the readings began a gradual rise to the steady-state temperature of 250 deg R. However between RO +1,200 and RO +1,300 sec several dropouts occurred.

It is believed that the reasons for the data discrepancies are the following. During stage separation the retrorocket impingement may have destroyed some of the insulation surrounding the sensor leads. This condition along with the leads being near a cryogenic environment could have made the sensor quite sensitive to any vibration. This would result in large changes in electrical resistance (therefore invalid data) or total electrical discontinuity.

C2044 ASI COMBUSTION CHAMBER TEMPERATURE

The measurement exhibited valid data until ESC +1.85 sec. At this time the transducer failed, going offscale high. No other data correlated to give an indication that high temperatures should exist at that time.

The additional vibration instrumentation installed for ASI system evaluation is discussed in section 21. Also refer to section 16 for general instrumentation summary.

8.7 Engine Sequence

The engine start and cutoff sequences were satisfactory and were compatible with the engine logic and flight test plan. Table 8-8 shows the times of the significant flight events compared to the nominal times. Figure 8-22 shows the engine power rise as controlled by the sequence of events. Some inconsistencies are necessarily introduced into the sequencing because different sources of data must be used to obtain sequence times. Valve opening or closing times were obtained from either micro switches or potentiometer positions. In all cases, valve opening or closing times were obtained from one source or the other, but not a combination of the two, in order to eliminate as many inconsistencies as possible.

Events occurring prior to start tank discharge control solenoid energized were not available due to a data blackout during this period. The GG valve opening time appears to be slightly longer than nominal as has been observed on all previous S-IVB flights. The MOV closed microswitch appears to have been late in dropping out. The MOV opening time was longer than normal due to a thrust instability in the engine system at start. The validity of the fuel pump discharge pressure spike at ESC + 2.0 sec is questionable although fuel injector and chamber pressures seem to substantiate the trend.

Engine cutoff events occurred near the nominal times although there were a few exceptions. The MOV open dropout and closed pickup occurred later than nominal. Main fuel valve closed pickup occurred later than nominal and the GC valve closed pickup occurred earlier than nominal. It should be noted that nominal times are based on ambient conditions.

TABLE 8-1
THRUST CHAMBER CHILLDOWN

PARAMETER	UNIT	S-IVB-205	S-IVB-204	S-IVB-203
Engine start requirement	deg R	240 ±50	260 ±50	260 ±50
Thrust chamber chilldown initiated	sec from liftoff	-765	-1,021	-900
Thrust chamber chilldown terminated	sec from liftoff	0	0	0
Thrust chamber skin temperature at end of chilldown	deg R	258	238	227
Thrust chamber temperature at engine start	deg R	283	255	255

TABLE 8-2
ENGINE GH2 START SPHERE PERFORMANCE

PARAMETER	TEMPERATURE (°R)			PRESSURE (psia)			MASS (lbm)		
	205 FLT	204 FLT	203 FLT	205 FLT	204 FLT	203 FLT	205 FLT	204 FLT	203 FLT
Liftoff	271	272	278	1,278	1,323	1,300	3.49	3.49	3.48
Liftoff requirement	SEE LIFTOFF BOX			SEE LIFTOFF BOX			SEE LIFTOFF BOX		
At Engine Start Command	273	274	278	1,293	1,342	1,307	3.49	3.62	3.48
After start sphere blowdown	199	197	210	158	200	160	0.62	0.78	0.54
At Engine Cutoff Command	254	194	215	312	1,365	1,150	0.96	5.20	4.51
Total GH2 usage during start	-	-	-	-	-	-	2.87	2.84	2.94

TABLE 8-3
ENGINE CONTROL SPHERE PERFORMANCE

PARAMETER	TEMPERATURE (°R)			PRESSURE (psia)			MASS (lbm)*		
	205 FLT	204 FLT	203 FLT	205 FLT	204 FLT	203 FLT	205 FLT	204 FLT	203 FLT
Engine start requirement		290 ±30		2,800 to 3,450			-	-	-
At liftoff	283	278	275	3,240	3,029	3,320	2.07	1.98	2.16
At Engine Start Command	284	278	278	3,290	3,044	3,335	2.07	1.98	2.15
At ECC +1 sec	248	193	193	2,183	1,585	1,960	1.64	1.55	1.87
Total helium usage during burn	-	-	-	-	-	-	0.43	0.43	0.28

*Mass data calculated from indicated pressure and temperature readings

TABLE 8-4
COMPARISON OF COMPUTER PROGRAM RESULTS

PROGRAM	INPUT	METHOD	RESULTS AT ESC +60 sec
AA89	LOX and LH2 pump inlet pressures and temperatures, PU valve position, and engine tag values.	Influence equations relate nominal inlet conditions to nominal performance. Using actual inlet conditions, PU valve position and engine tag values, the actual performance is simulated.	F = 227,327 lbf W _T = 537.37 lbf/sec I _{SP} = 423.04 sec EMR = 5.511
G105	LOX and LH2 flowmeters, pump discharge pressures and temperatures, chamber pressures, chamber thrust area.	Flowrates are computed from flowmeter data and propellant densities. The C _F is determined from equation C _F = f(P _C , EMR) and thrust is calculated from equation F = C _F A _T P _C .	F = 228,905 lbf W _T = 537.18 lbf/sec I _{SP} = 427.12 sec EMR = 5.502
PA63	Pump inlet and outlet conditions, PU valve position, chamber pressure, turbine inlet and outlet conditions, flowmeter speed.	Math models or rocket engine components are linked together by program which iterates among the component models until an operating point is reached where the power required by the pumps "balances" the power available from the turbines.	F = 228,681 lbf W _T = 537.81 lbf/sec I _{SP} = 425.02 sec EMR = 5.502
PA49	G105 and PA63 outputs.	Averaging of PA63 and G105 and comparing to predicted.	F = 228,793 lbf W _T = 537.28 lbf/sec I _{SP} = 425.7 sec EMR = 5.511
UT23A	All measured engine data.	Calculates turbopump and feed system performance using classical methods.	Does not calculate engine output performance, refer to paragraphs 9.5.1 and 9.5.3.
PA53	Thrust chamber pressure.	Thrust is computed from equation F = f(P _C). The impulse is determined from integrated thrust.	Computes transient start and cutoff data only. Refer to paragraphs 8.5.1 and 8.5.3.

F = Thrust, W_T = Total Weight Flowrate, I_{SP} = Specific Impulse, EMR = Engine Mixture Ratio

TABLE 8-5
DATA INPUTS TO COMPUTER PROGRAMS

PARAMETER	PROGRAM	SELECTION	BIAS	REASON
Chamber Pressure	G105*	D0001 (TM/FM)	-15.0 psia	-15 psi Rocketdyne estimation of P _C purge effect
	PA53 (Start)	D0001(TM/FM)	98.6%	Agree with bias of steady state programs at ESC +60 sec
			-3.85 psi	Data zero shift at engine start
	(Cutoff)		97.9%	Agree with bias of steady-state programs at Engine Cutoff Command
			-1.992	Post-test data zero shift
LH2 Pump Disch Press.	G105*	D0008(TM/PCM)	0%	
LH2 Pump Disch Temp.	G105*	C0134(TM/PCM)	0%	
LOX Pump Disch Press.	G105*	D0009(TM/PCM)	0%	
LOX Pump Disch Temp.	G105*	C0133(TM/PCM)	0%	
LH2 Flowrate	G105*	F0002(TM/FM)	0%	Note: There were no pip counts on 205 flight.
LOX Flowrate	G105*	F0001(TM/FM)	0%	
LH2 Pump Inlet Press.	AA89	D0002(TM/PCM)	+1.38 psi	Dynamic head adjustment
LH2 Pump Inlet Temp.	AA89	C0003(TM/PCM)	0%	
LOX Pump Inlet Press.	AA89	D0003(TM/PCM)	+2.6 psi	Dynamic head adjustment
LOX Pump Inlet Temp.	AA89	C0004(TM/PCM)	0%	
PU Valve Position	AA89	G0010(TM/PCM)	0%	

TM = telemetry, FM = frequency modulated, PCM = pulse code modulated
*Bias apply to PA63 also

TABLE 8-6
ENGINE PERFORMANCE

PARAMETER	UNIT	CLOSED PU VALVE OPERATION			OPEN PU VALVE * OPERATION			OVERALL PERFORMANCE -90% THRUST TO ECC		
		ACTUAL	PREDICTED	% DEV	ACTUAL	PREDICTED	% DEV	ACTUAL	PREDICTED	% DEV
Thrust s	lbf	226,817	226,687	+0.50	174,088	175,058	-0.50	208,514	208,850	-0.16
Total Flowrate	lbm/sec	536.2	534.6	+0.30	407.23	406.14	+0.27	491.34	490.15	+0.24
LOX Flowrate	lbm/sec	453.7	452.4	+0.29	332.52	330.92	+0.48	411.58	410.37	+0.29
LH2 Flowrate	lbm/sec	82.44	82.23	+0.26	74.71	75.22	-0.68	79.76	79.78	-0.02
Engine Mixture Ratio		5.504	5.501	+0.05	4.451	4.400	+1.16	5.137	5.122	+0.29
Specific Impulse	sec	423.03	424.01	-0.23	427.49	431.0	-0.81	424.66	426.5	-0.43

PARAMETER	UNIT	MAINSTAGE **			TO DEPLETION ***		
		ACTUAL	PREDICTED	% DEV	ACTUAL	PREDICTED	% DEV
Burntime	sec	466.524	470.075	-0.76	469.954	472.605	-0.56
Consumption							
LOX	lbm	191,897	191,633	-0.07	193,258	192,828	+0.22
LH2	lbm	37,175	37,555	-0.99	37,509	37,793	-0.75
Total Impulse	lbf/sec	97.19X10 ⁶	98.04X10 ⁶	-0.87	97.94X10 ⁶	98.68X10 ⁶	-0.75

*Refer to remarks in paragraph 8.5.2
 **Mainstage is time from 90 percent thrust to cutoff.
 ***Depletion is time from Engine Start Command to LOX load = 518 lbm.

TABLE 8-7
ENGINE PERFORMANCE AND DATA SHIFT SUMMARY

PARAMETER	MAGNITUDE
1. Main Chamber Pressure	D0001 - 6 psi
2. LOX Injector Pressure	D0005 - 5 psi
3. Fuel Pump Discharge Pressure	D0008 - 10 psi
4. Fuel Turbine Inlet Temperature	C0001 - 15°R
5. LOX Turbine Inlet Temperature	C0002 - 10°R
6. LOX Flowrate	F0001 - 10 gpm
7. Fuel Flowrate	F0002 - 30 gpm

TABLE 8-8 (Sheet 1 of 3)
ENGINE SEQUENCE

CONTROL EVENTS		CONTINGENT EVENTS		NOMINAL TIME FROM SPECIFIED REFERENCE (AMBIENT, DRY)	ACTUAL TIME (ms)	
MEAS NO.	EVENT AND COMMENT	MEAS NO.	EVENT AND COMMENT		FROM ESC	FROM SPECIFIED REFERENCE
K0021 (K0021)	*Engine Start Command P/U			0	N/A	N/A
		K0007 (K0531)	Helium Control Solenoid Enrg P/U	Within 10 ms of K0021	N/A	N/A
		K0010 (K0454)	Thrust Chamber Spark on P/U	Within 10 ms of K0021	N/A	N/A
		K0011 (K0455)	Gas Generator Spark on P/U	Within 10 ms of K0021	N/A	N/A
		K0006 (K0535)	Ignition Phase Control Solenoid Enrg P/U	Within 20 ms of K0021	N/A	N/A
		K0012 (K0530)	Engine Ready D/O	Within 20 ms of K0006	N/A	N/A
		K0126 (K0558)	LOX Bleed Valve Closed P/U	Within 130 ms of K0007	N/A	N/A
		K0127 (K0557)	LH2 Bleed Valve Closed P/U	Within 130 ms of K0007	N/A	N/A
		K0020 (K0627)	ASI LOX Valve Open P/U	Within 20 ms of K0006	N/A	N/A
		K0119 (G506)	Main Fuel Valve Closed D/O	60 ±30 ms from K0006	N/A	N/A
		K0118 (G506)	Main Fuel Valve Open P/U	80 ±50 ms from K0119	N/A	N/A
K0008 (K0537)	**Ignition Detected			Within 250 ms of K0021 P/U	N/A	N/A
K0021 (K0021)	†Engine Start D/O			Approx 200 ms from K0021 P/U	N/A	N/A
K0096 (K0536)	††Start Tank Disc Control Solenoid Enrg			1,000 ±40 ms from K0021 P/U	983	983
		K0123 (G508)	Start Tank Disc Valve Closed D/O	100 ±20 ms from K0096	1,202	219
		K0122 (G508)	Start Tank Disc Valve Open P/U	105 ±20 ms from K0123	1,285	83
K0005 (K0538)	Mainstage Control Solenoid Enrg			450 ±30 ms from K0096	1,425	442
		K0096 (K0536)	Start Tank Disc Control Solenoid Enrg D/O	450 ±30 ms from K0096	1,433	450

(K0XXX) Actual number from acceptance firing event recorder.

*Engine ready and stage separation signals (or simulation) are required before this command will be executed. This command also actuates a 640 ±30 ms timer which controls energizing of the start tank discharge solenoid valve (K0096).

**This signal must be received within 1,110 ±60 ms of K0021 P/U or cutoff will be initiated.

†This signal drops out after a time sufficient to lock in the engine electrical.

††An indication of fuel injection temperature of -150 ±40 deg F (or simulation) is required before this command will be executed. This command also actuates a 450 ±30 ms timer which controls the start of mainstage.

P/U - Pickup D/O - Dropout N/A - Not available

TABLE 8-8 (Sheet 2 of 3)
ENGINE SEQUENCE

CONTROL EVENTS		CONTINGENT EVENTS		NOMINAL TIME FROM SPECIFIED REFERENCE (AMBIENT, DRY)	ACTUAL TIME (ms)			
MEAS NO.	EVENT AND COMMENT	MEAS NO.	EVENT AND COMMENT		FROM ESC	FROM SPECIFIED REFERENCE		
K0158 (K0572)	Mainstage Press Switch #1 Depress D/O	K0121 (G507)	Main LOX Valve Closed D/O	50 ±20 ms from K0005	1,513	88		
		K0116 (G509)	Gas Generator Valve Closed D/O	140 ±10 ms from K0005	1,610	185		
		K0122 (G508)	Start Tank Disc Valve Open D/O	95 ±20 ms from K0096 D/O	1,618	185		
		K0117 (G509)	Gas Generator Valve Open P/U	50 ±30 ms from K0116	1,703	93		
		K0124 (G510)	LOX Turbine Bypass Valve Open D/O		1,711			
			LOX Turbine Bypass Valve 80% Closed	400 ⁺¹⁵⁰ ms from K0122 - 50	1,910	292		
		K0123 (G508)	Start Tank Disc Valve Closed P/U	250 ±40 ms from K0122	1,786	168		
		K0125 (G510)	*LOX Turbine Bypass Valve Closed P/U		1,960			
		K0159	Mainstage Press Switch #2 Depress D/O			2,727		
						2,727		
				K0120 (G507)	Main LOX Valve Open P/U	2,435 ±145 ma from K0005	4,118	2,605
				K0010 (K0454)	Thrust Chamber Spark on D/O	3,300 ±200 ms from K0005 P/U	4,700	3,275
				K0011 (K0455)	Gas Generator Spark on D/O	3,300 ±200 ms from K0005 P/U	4,700	3,275
		CSS-22						
		K0013 (K0522)	Engine Cutoff PU (New time reference)			0	0	
		K0005 (K0538)	Mainstage Control Solenoid Enrg D/O	Within 10 ms of K0013	0	0		
		K0006 (K0535)	Ignition Phase Control Solenoid Enrg D/O	Within 10 ms of K0013	0	0		
		K0020 (K0622)	ASI LOX Valve Open D/O		86			
		K0120 (G507)	Main Oxidizer Valve Open D/O	50 ±15 ms from K0005	94	94		
		K0117 (G509)	Gas Generator Valve Open D/O	75 ⁺²⁵ ms from K0006 -35	67	67		
		K0018 (G506)	Main Fuel Valve Open D/O	90 ±25 ms from K0006	89	89		
		K0121 (G507)	Main Oxidizer Valve Closed P/U	120 ±15 ms from K0120	327	233		
		K0116 (G509)	Gas Generator Valve Closed P/U	500 ms from K0006	255	255		
		K0119 (G506)	Main Fuel Valve Closed P/U	225 ±25 ms from K0018	447	358		

*Within 5,000 ms of K0005 (Normally = 500 ms)

P/U - Pickup D/O - Dropout

TABLE 8-8 (Sheet 3 of 3)
ENGINE SEQUENCE

CONTROL EVENTS		CONTINGENT EVENTS		NOMINAL TIME FROM SPECIFIED REFERENCE (AMBIENT, DRY)	ACTUAL TIME (ms)	
MEAS NO.	EVENT AND COMMENT	MEAS NO.	EVENT AND COMMENT		FROM ESC	FROM SPECIFIED REFERENCE
K0158 (K0572)	Mainstage Press Switch A Depress P/U		At injection pressure of 500 ±30 psia		294	
K0159 (K0573)	Mainstage Press Switch B Depress P/U		At injection pressure of 500 ±30 psia		294	
K0191 (K0610)	Mainstage OK D/O		At 20 to 105 psi below P/U			
K0C07 (K0531)	Helium Control Solenoid Enrg D/O			1,000 ±110 ms from K0013	984	984
SS-22 K0507	PU Activate Switch D/O			N/A		
		K0125 (G510)	Oxidizer Turbine Bypass Valve Closed D/O		199	
		K0124 (G510)	Oxidizer Turbine Bypass Valve Open P/U	10,000 ms from K0005	878	777
K0126 (K0558)	LOX Bleed Valve Closed D/O			30,000 ms from K0005	2,943	2,943
K0127 (K0557)	LH2 Bleed Valve Closed D/O			30,000 ms from K0005	2,943	2,943

P/U - Pickup

D/O - Dropout

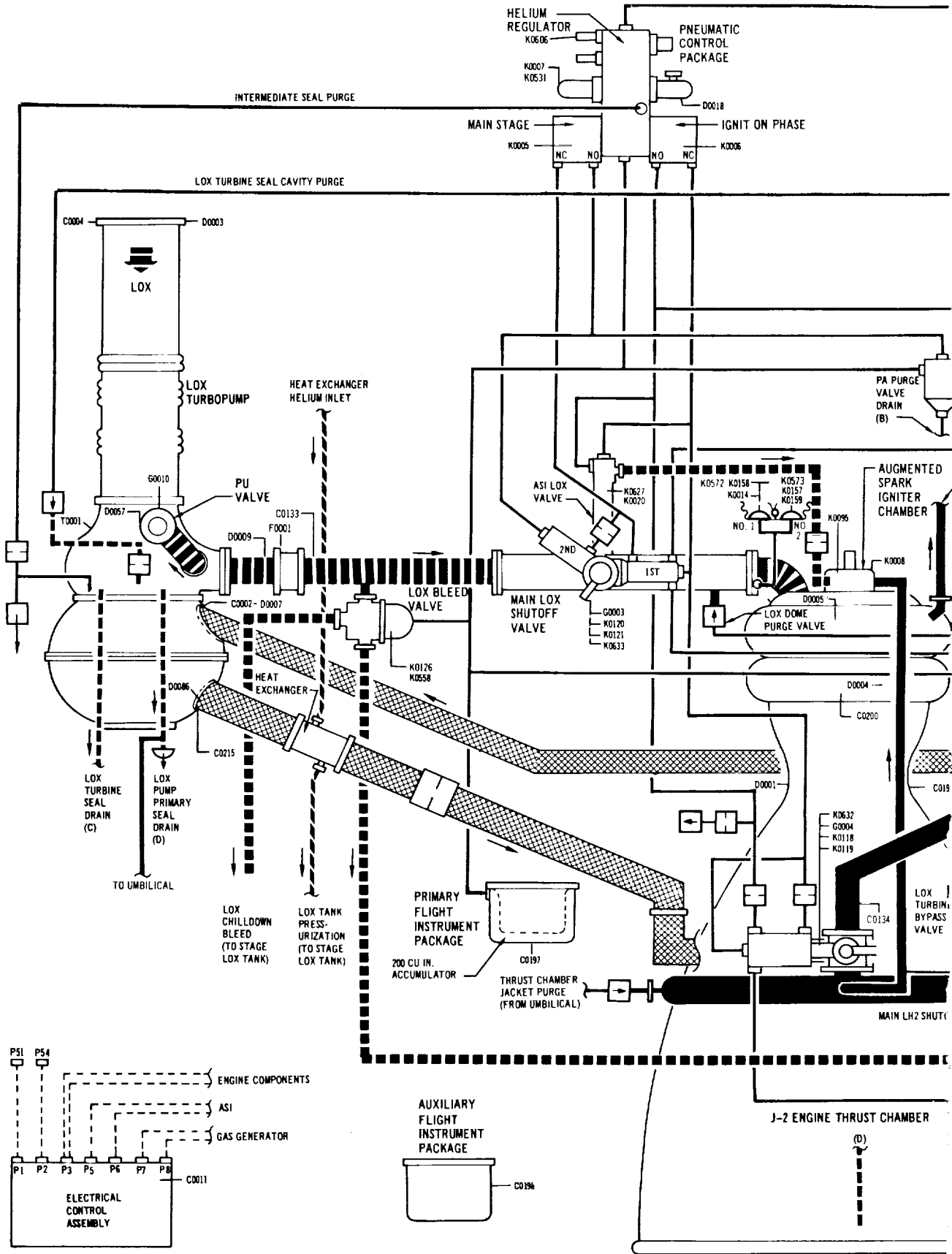

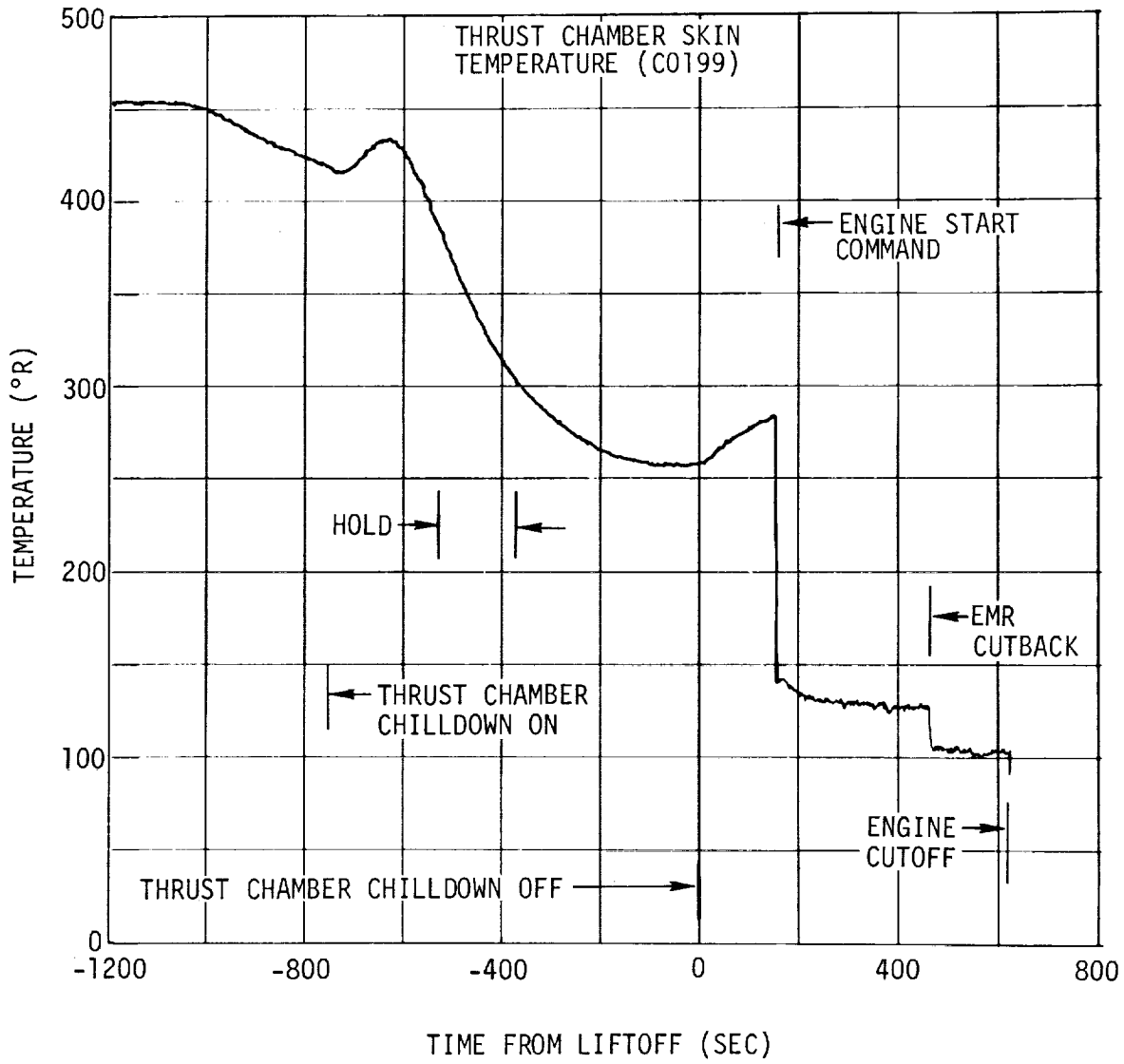

Figure 8-2. Thrust Chamber Chilldown

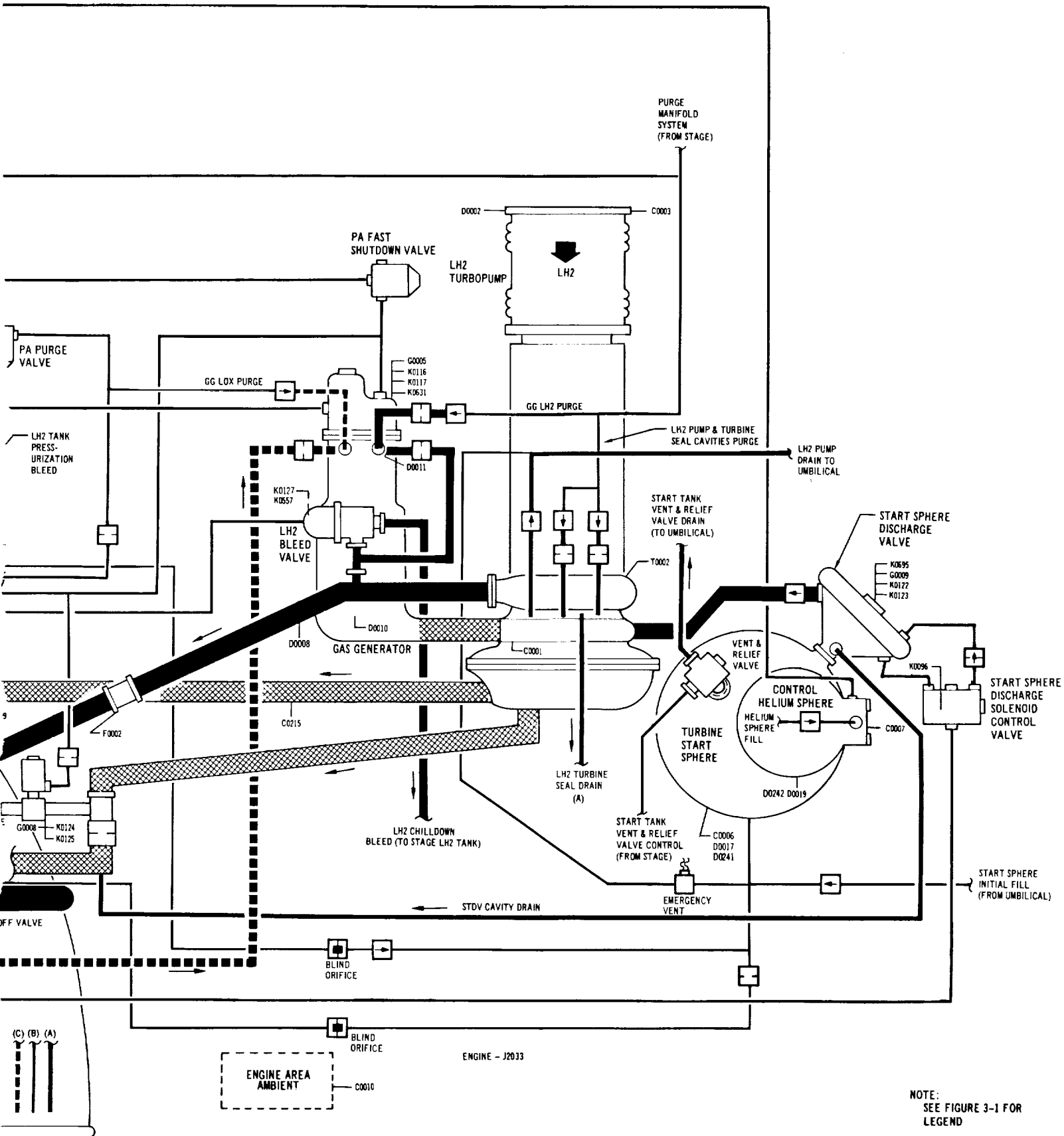

Figure 8-1. J-2 Engine System and Instrumentation

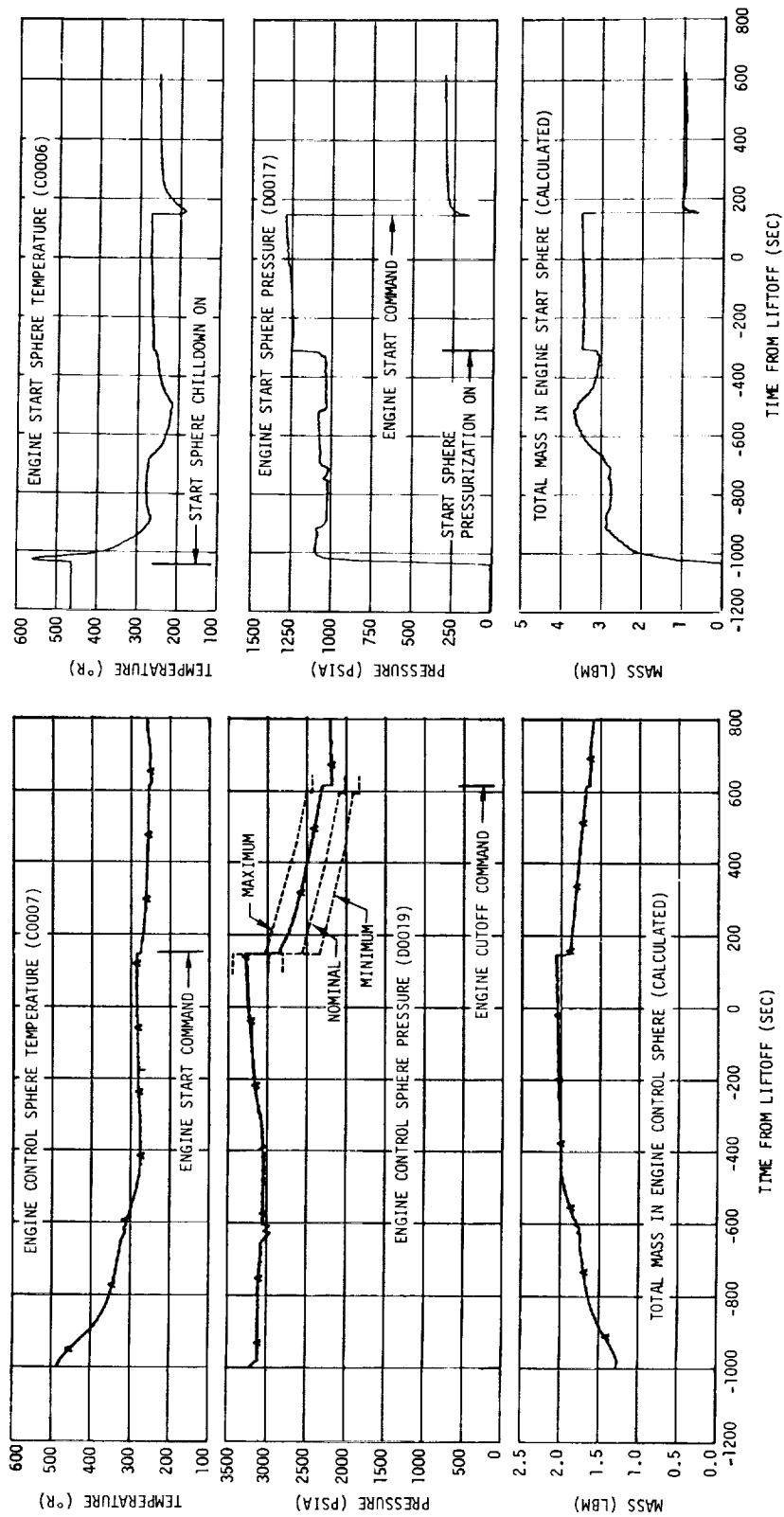

Figure 8-3. Engine Start and Control Sphere Performance

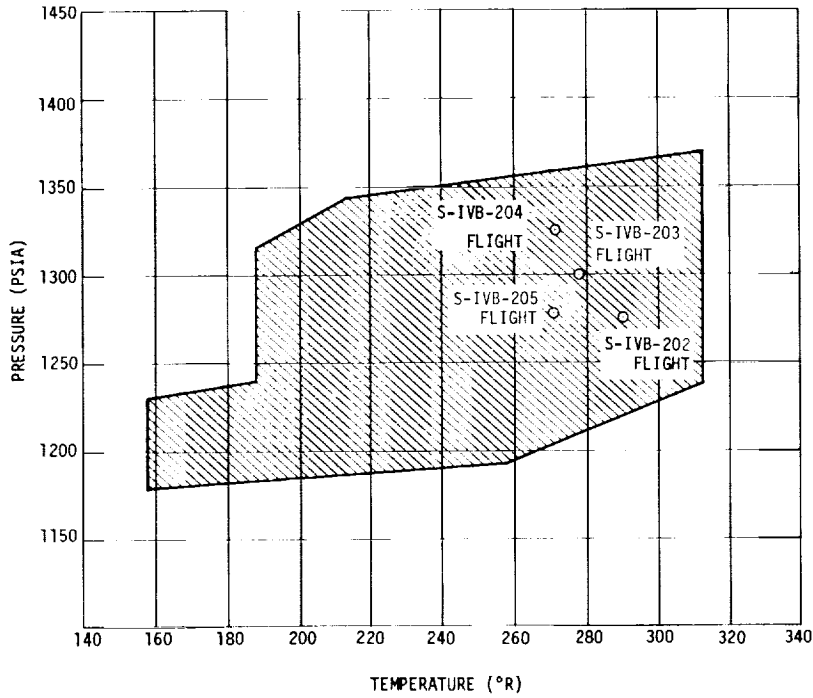

Figure 8-4. GH2 Start Sphere Critical Limits at Liftoff

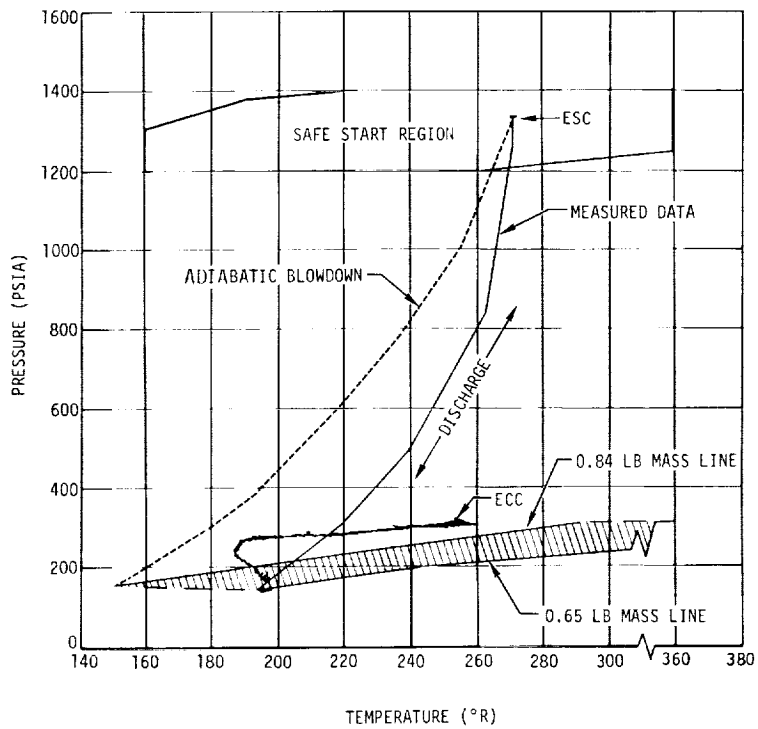

Figure 8-5. Engine Start Sphere Performance

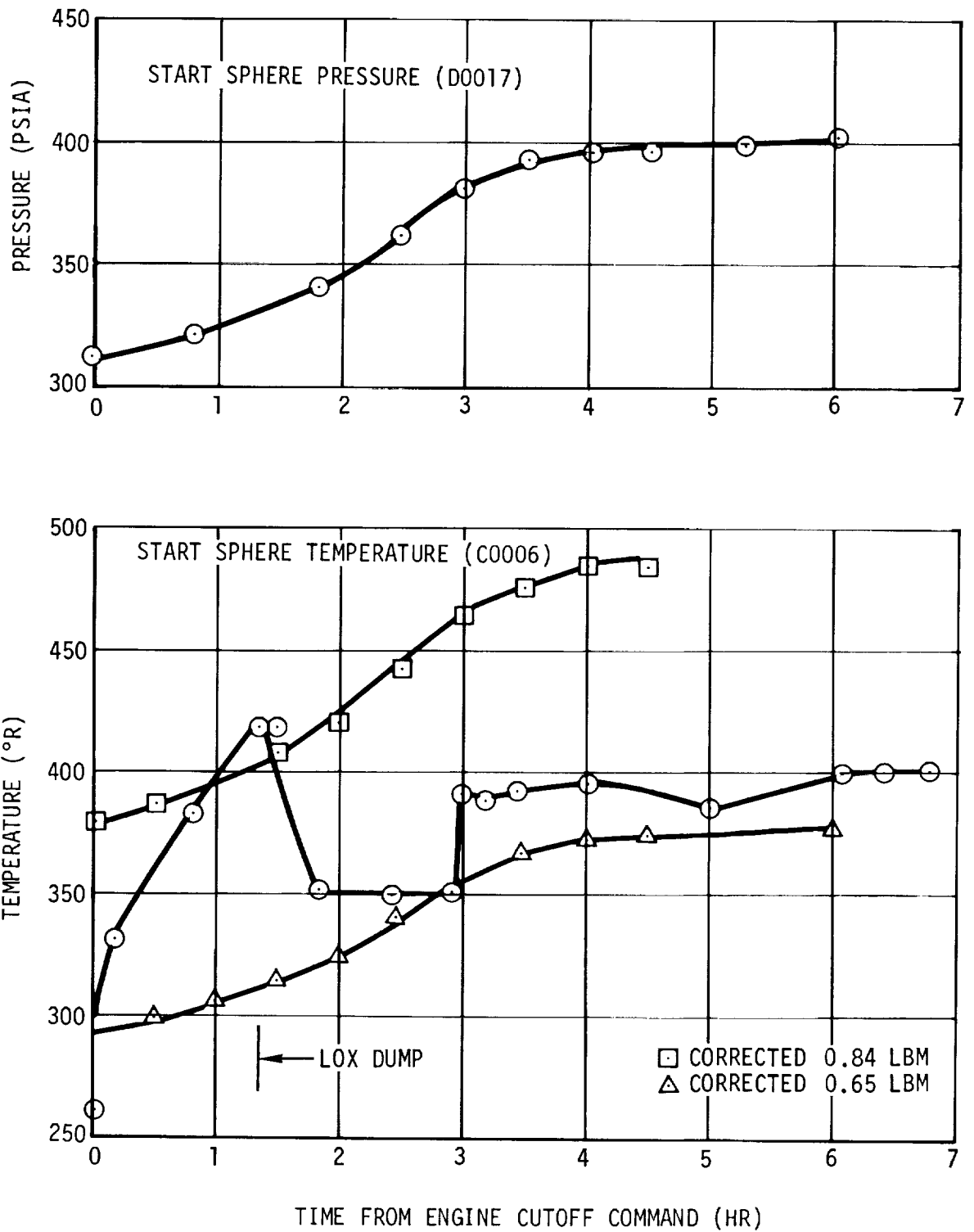

Figure 8-6. Start Sphere Orbital Conditions

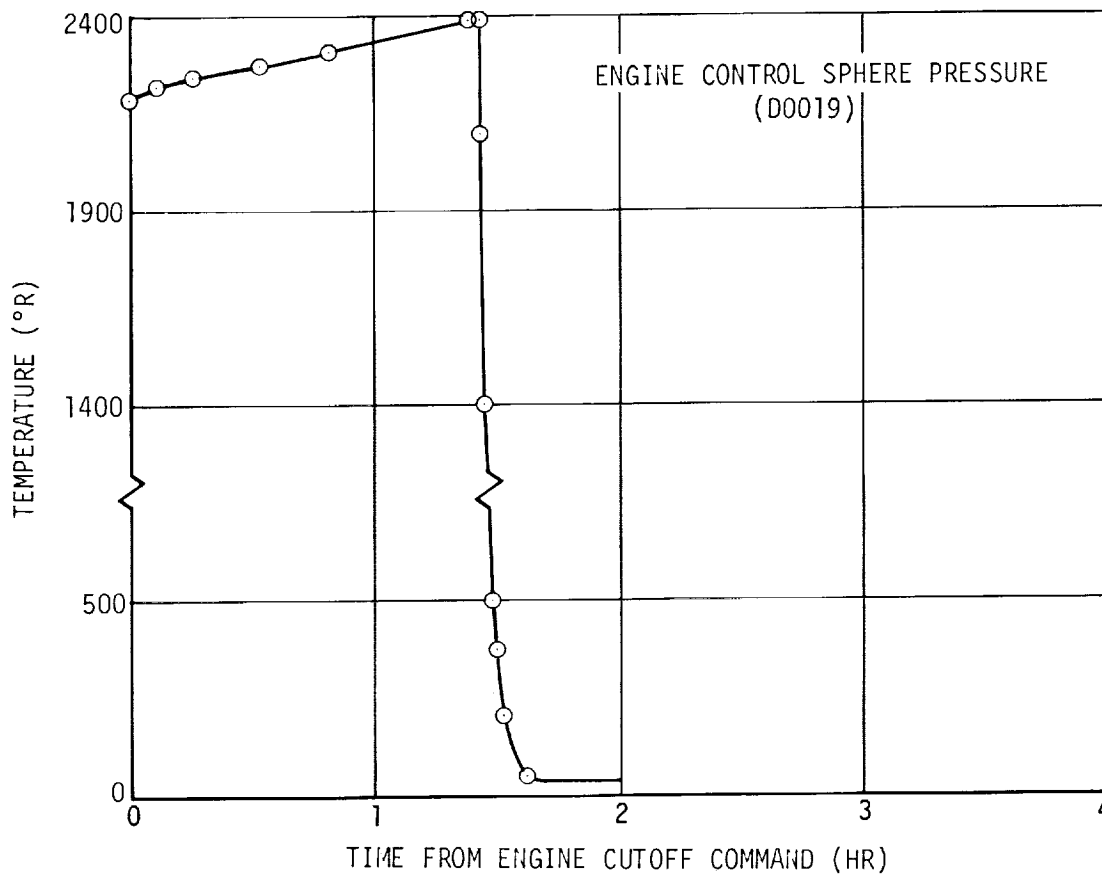
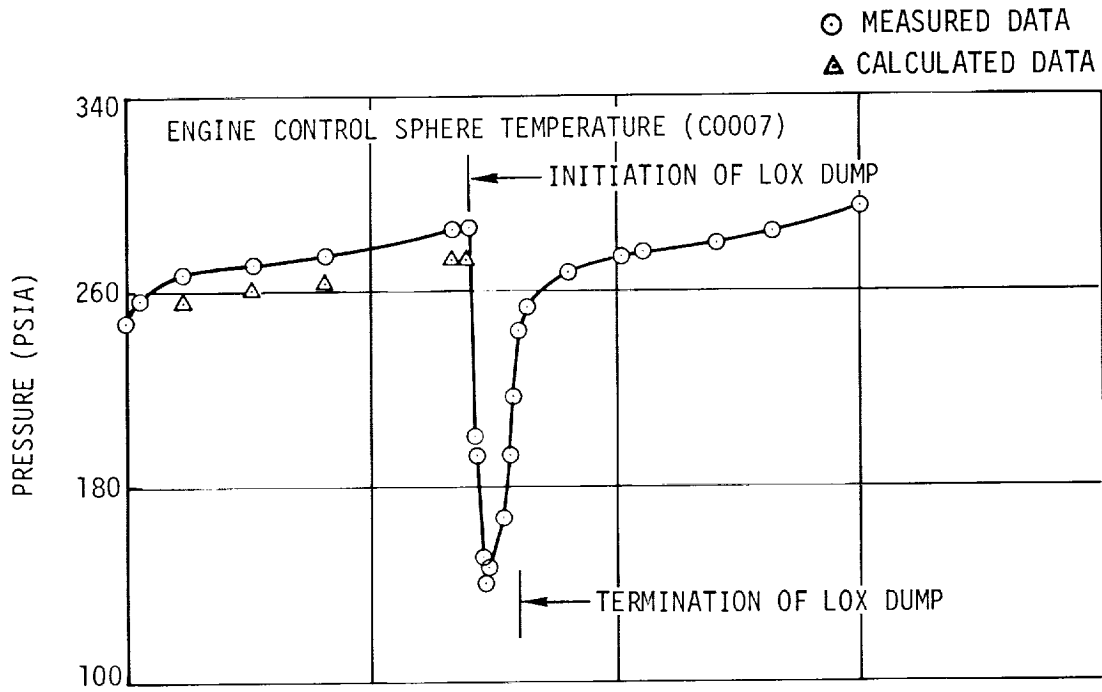

Figure 8-7. Control Sphere Orbital Conditions

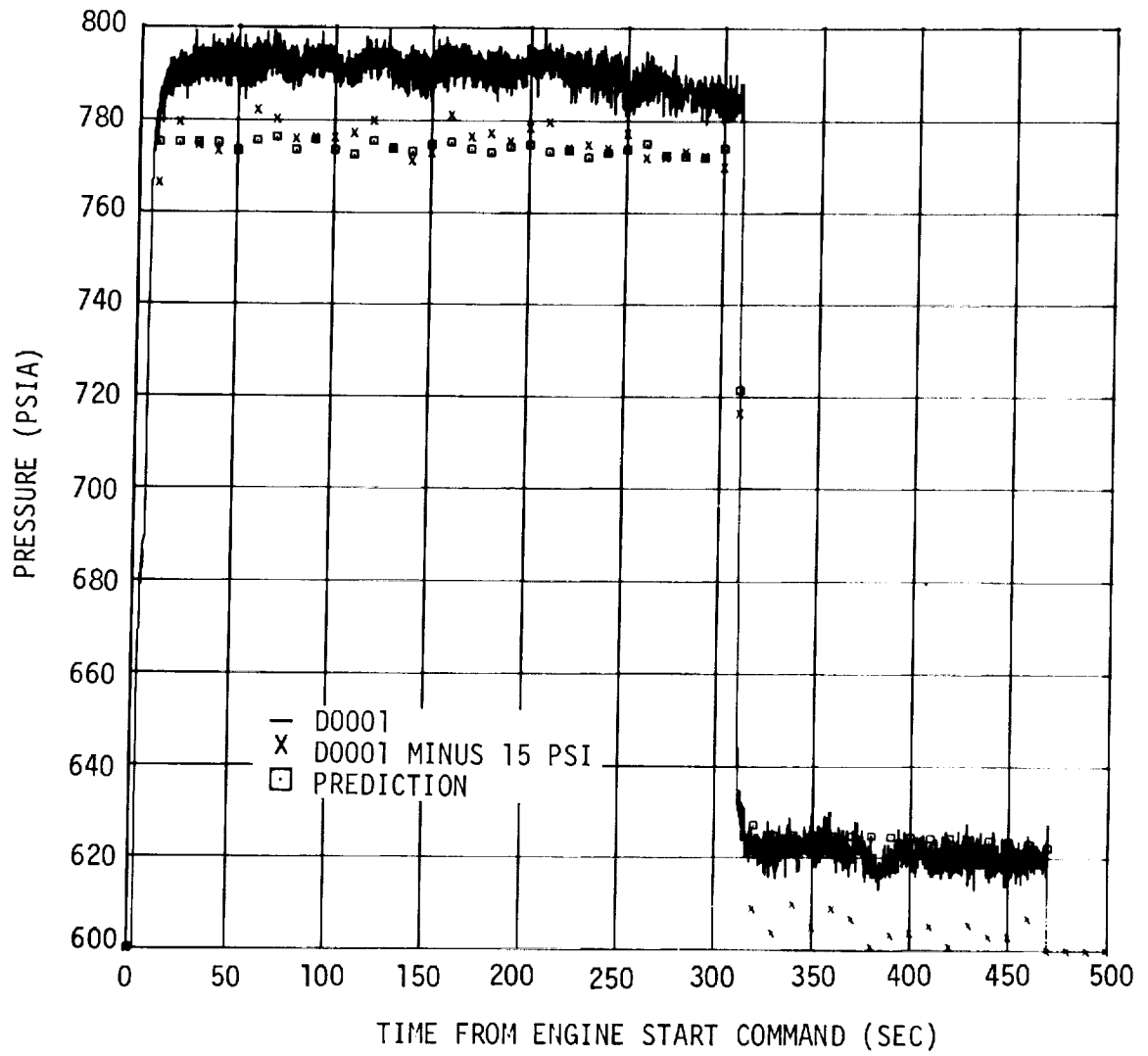

Figure 8-8. J-2 Thrust Chamber Pressure

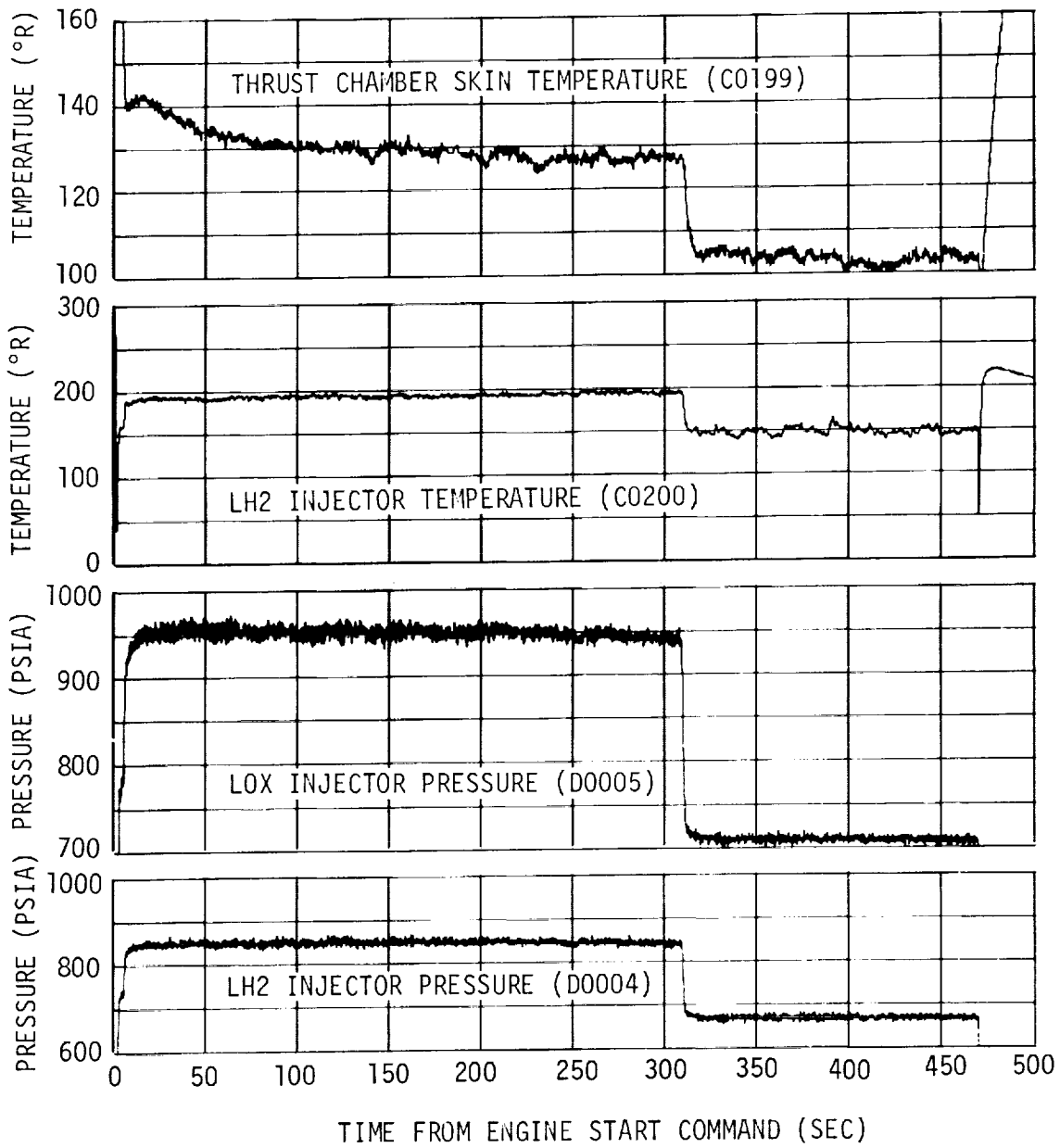

Figure 8-9. J-2 Engine Injector Supply Conditions

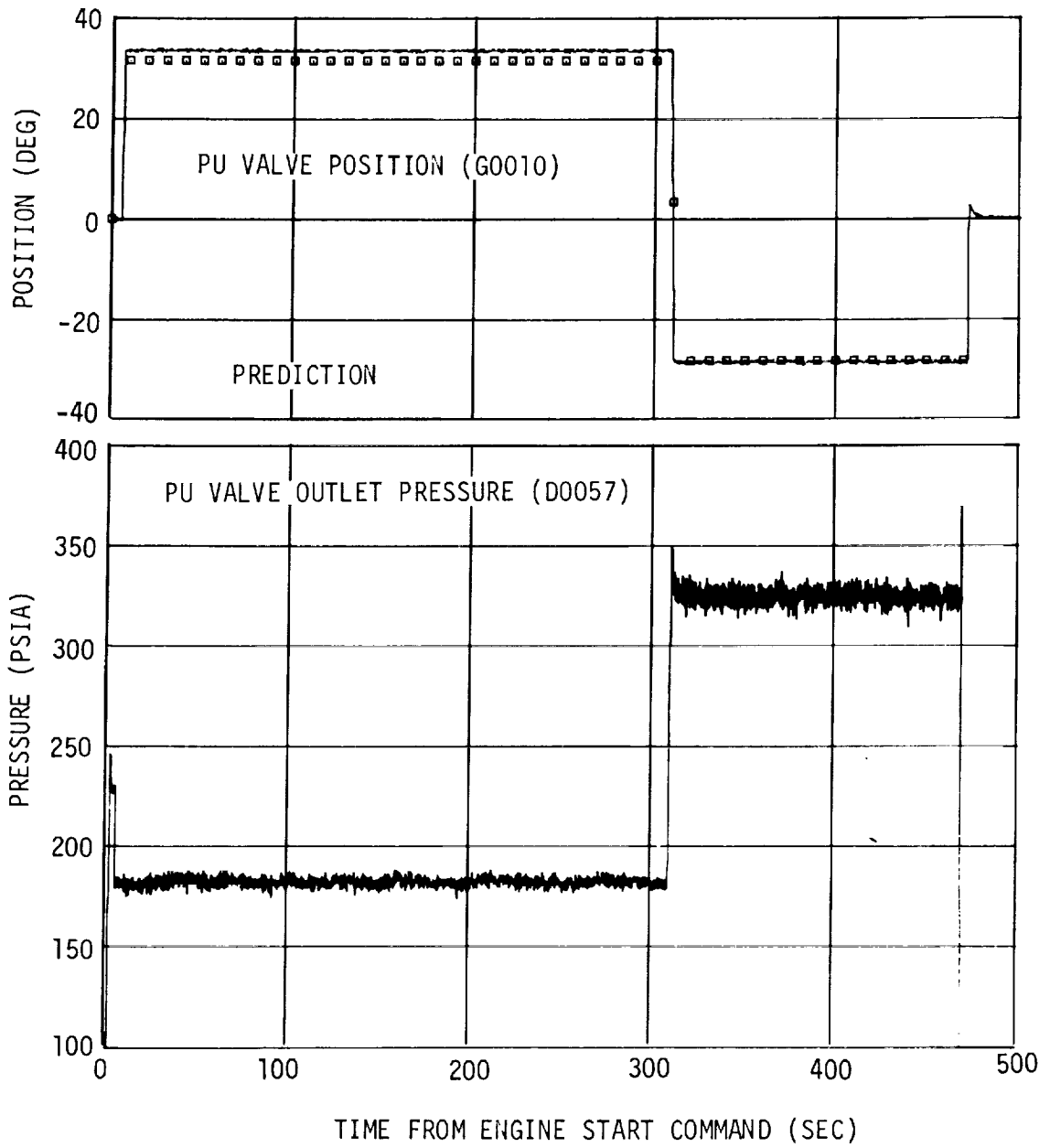

Figure 8-10. PU Valve Operation

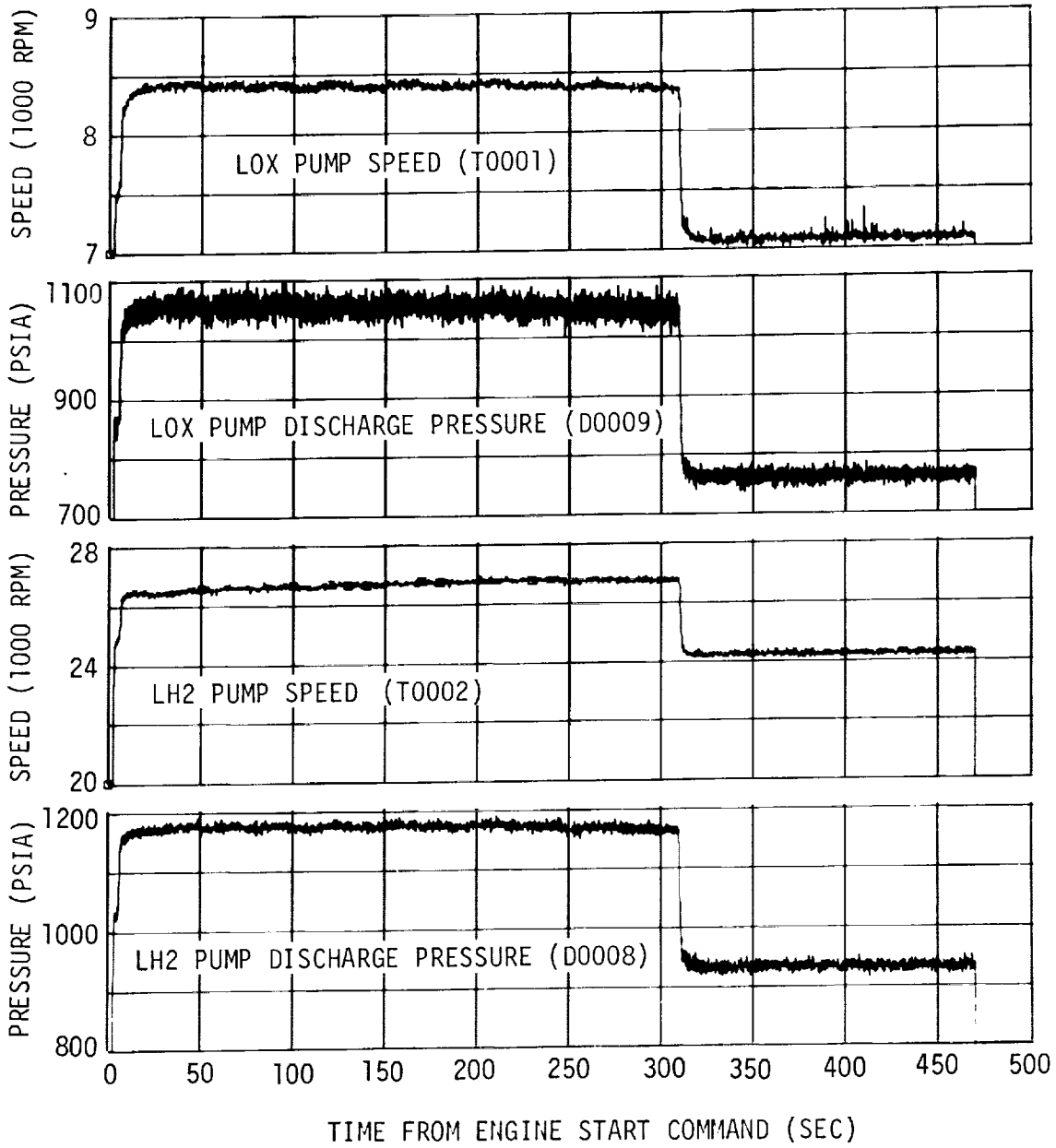

Figure 8-11. J-2 Engine Pump Operating Conditions

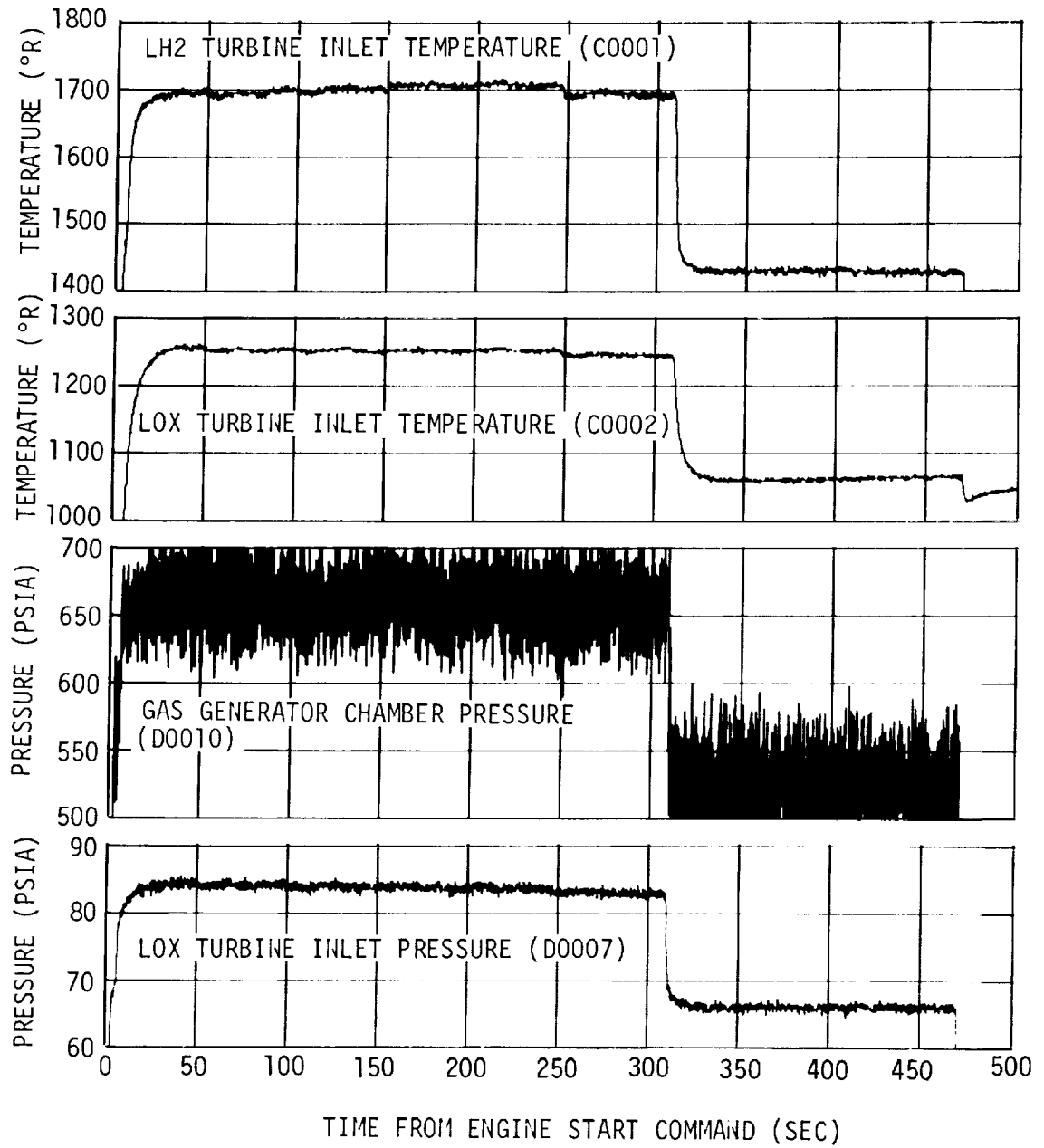

Figure 8-12. Turbine Inlet Operating Conditions

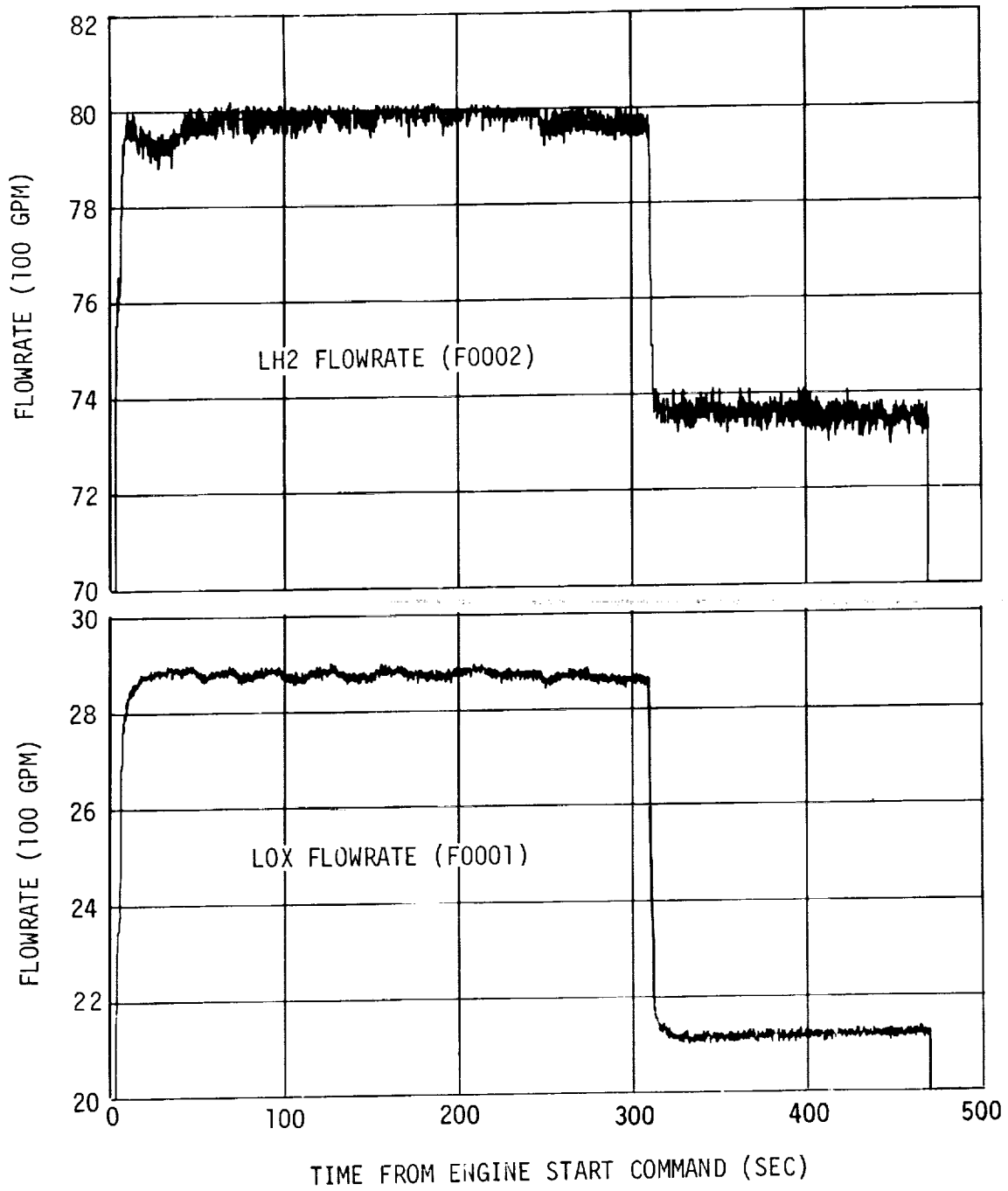

Figure 8-13. LOX and LH2 Flowrate

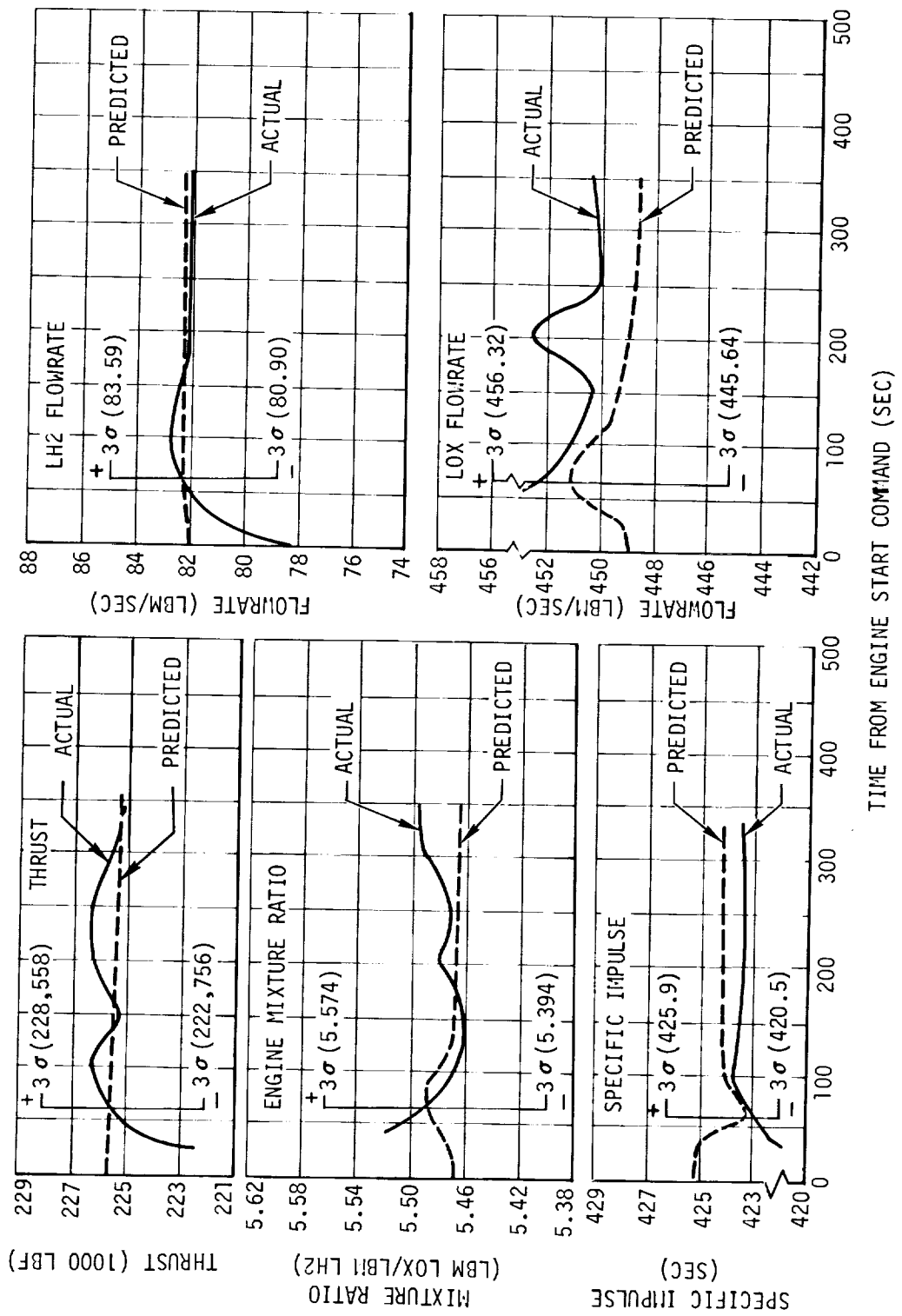

Figure 8-14. Engine Tag Values

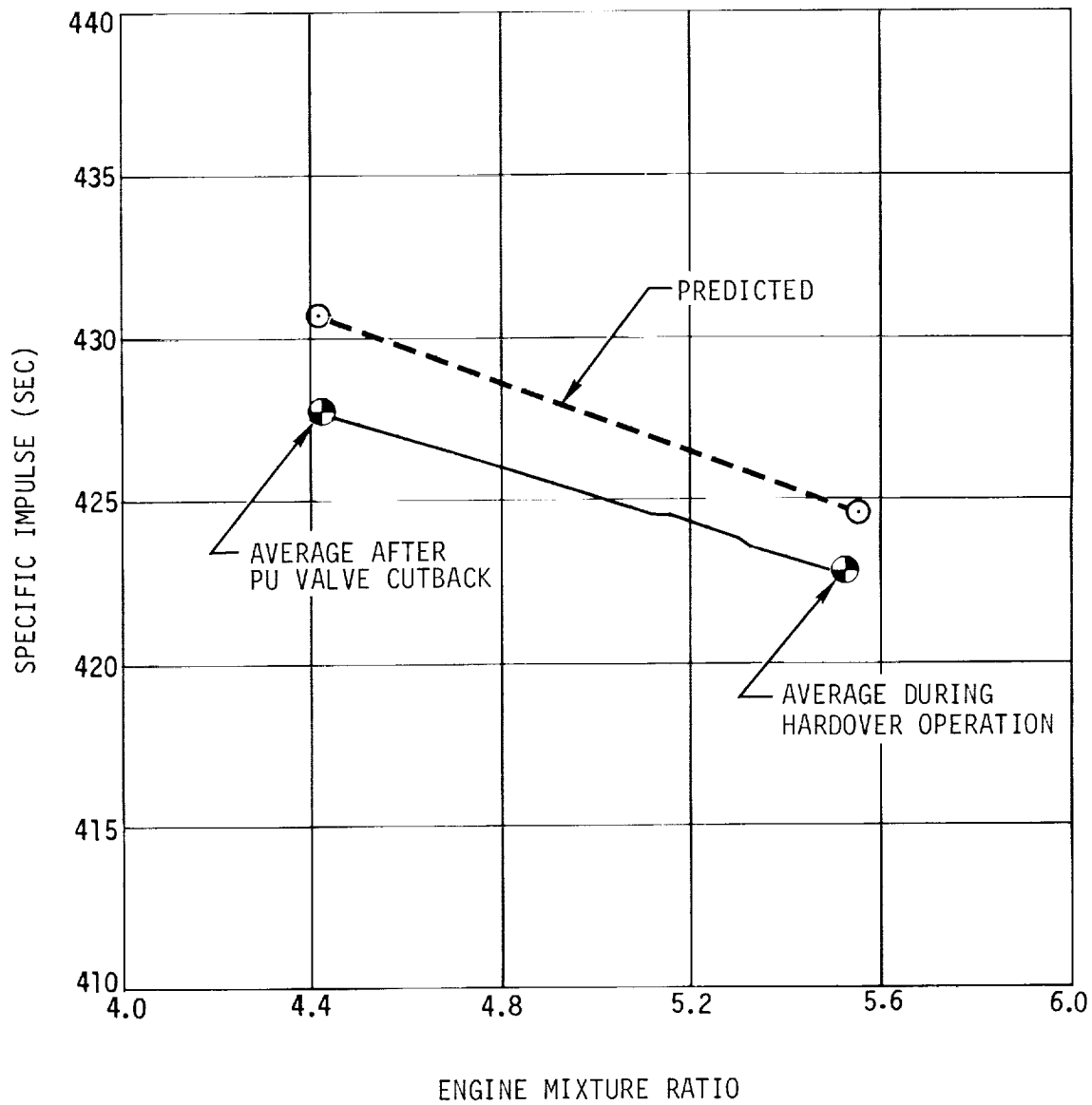

Figure 8-15. Specific Impulse Versus Engine Mixture Ratio

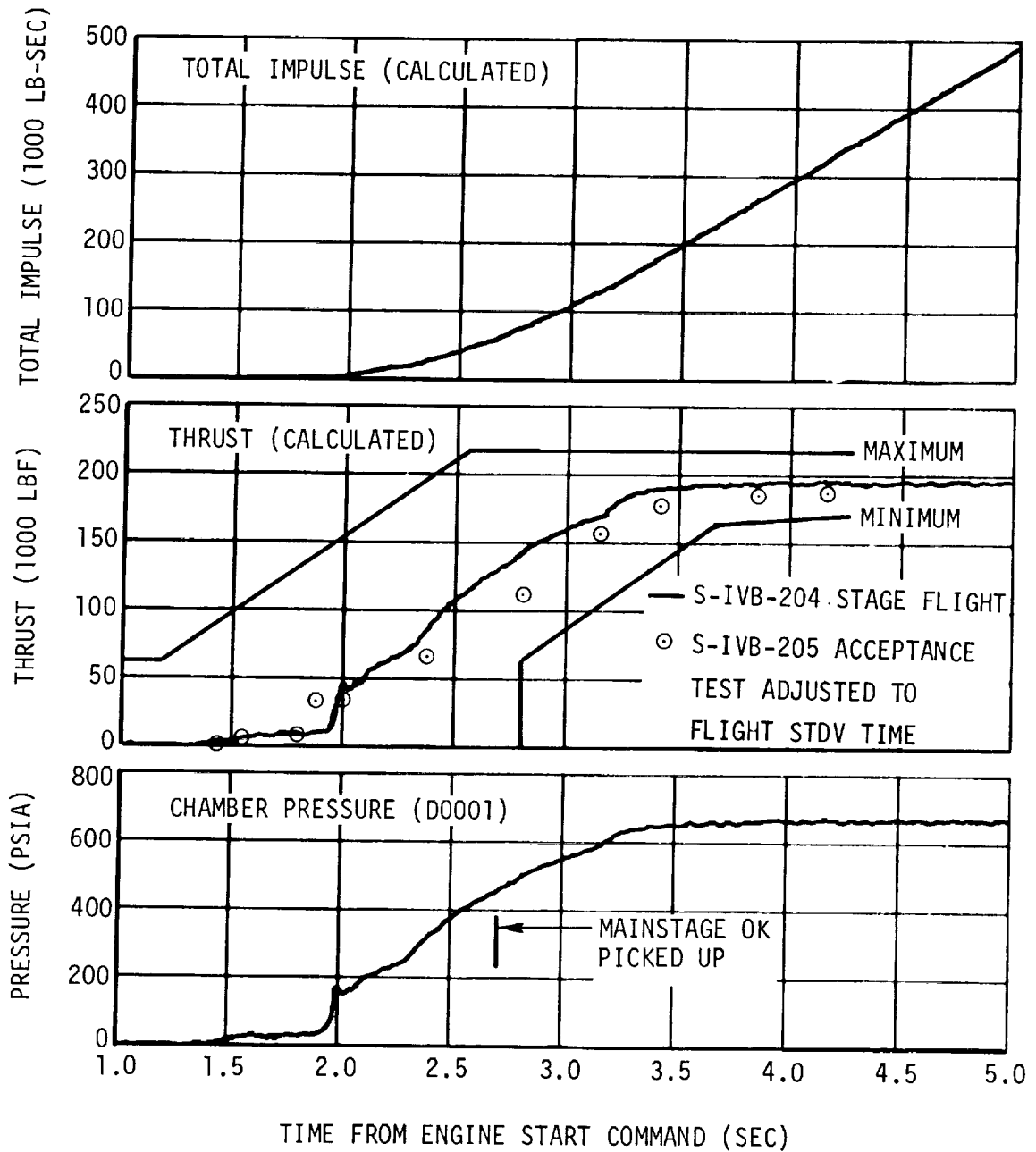

Figure 8-16. Engine Start Transient Characteristics

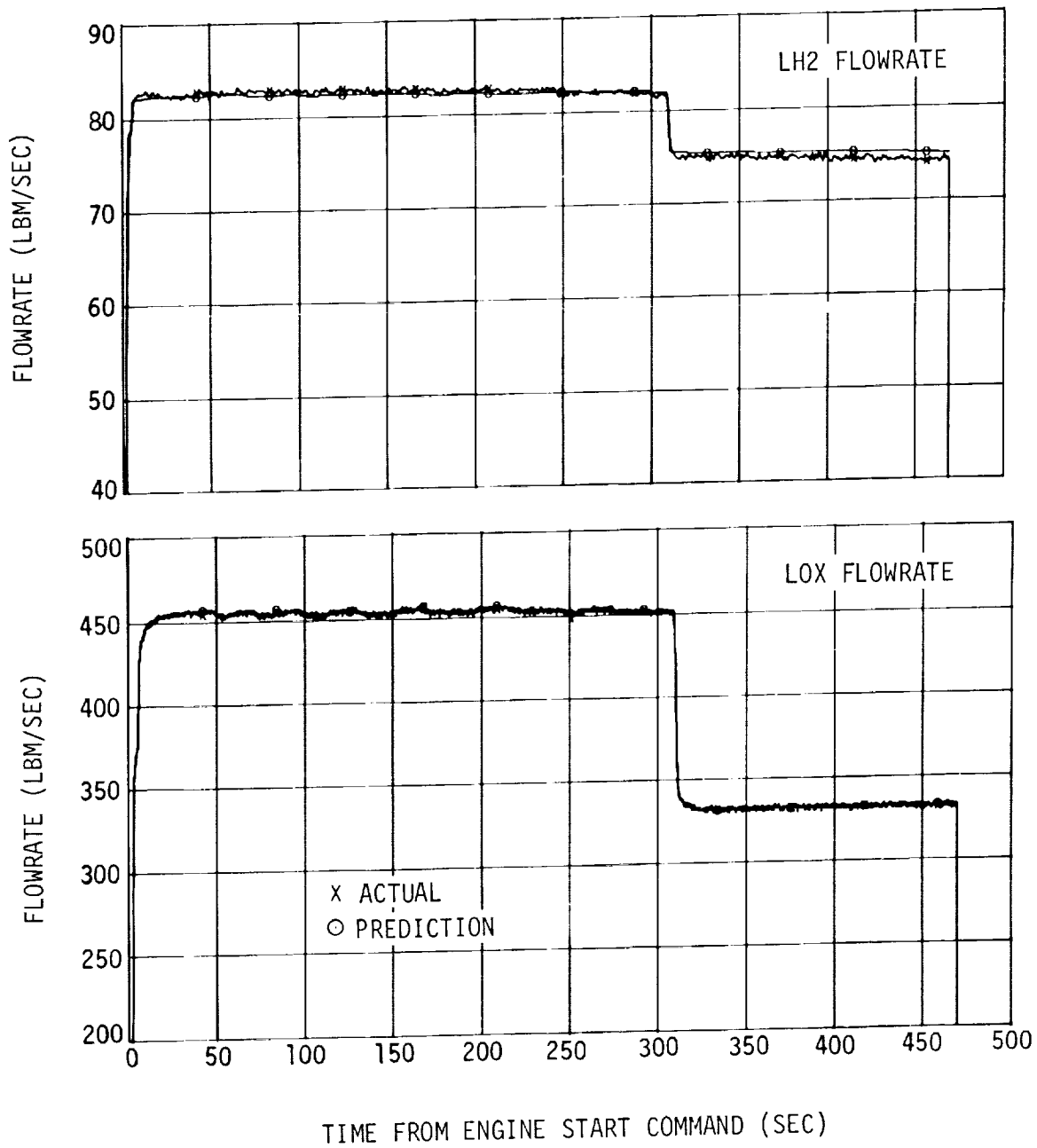

Figure 8-17. Engine Steady-State Performance (Sheet 1 of 3)

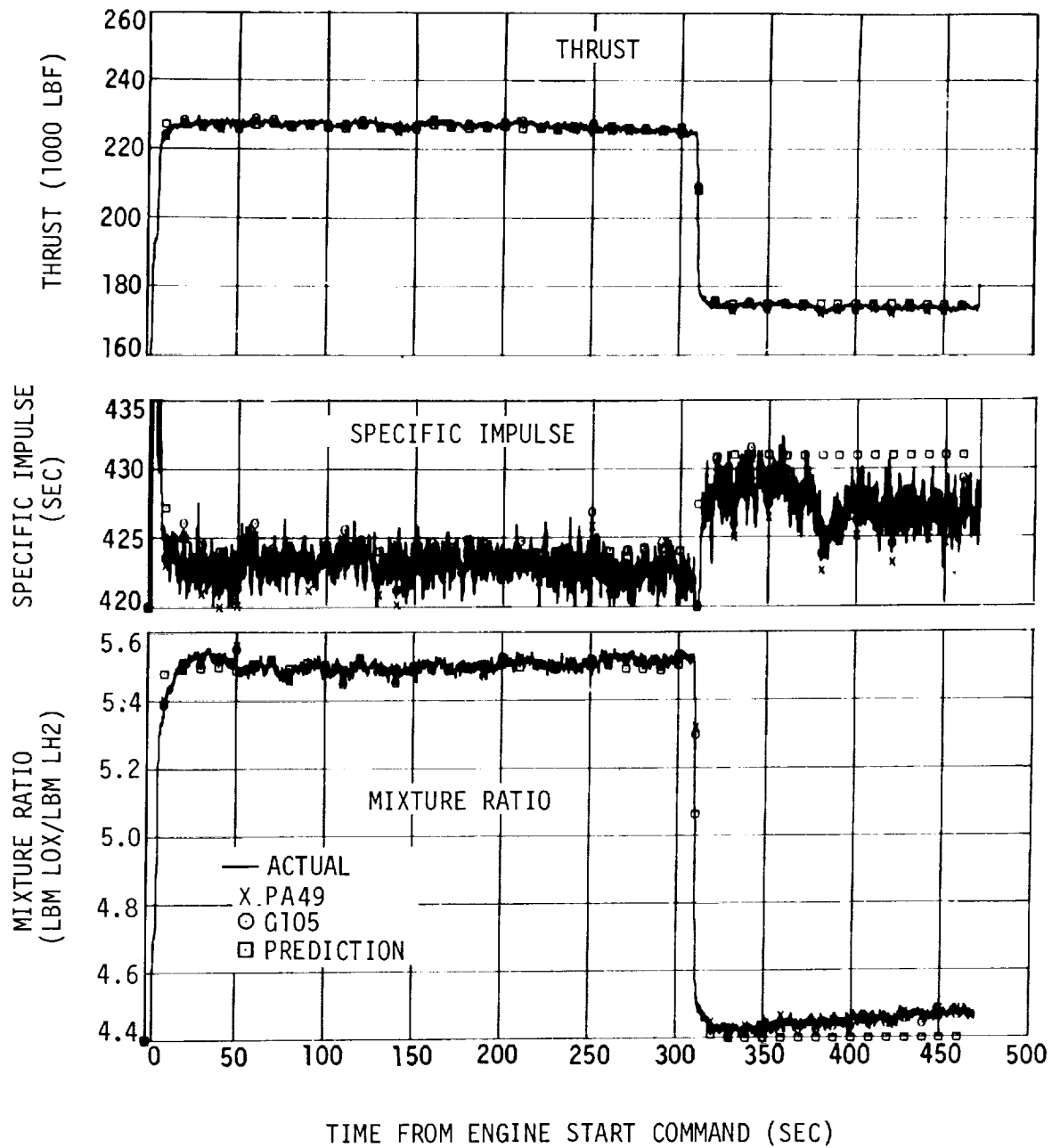

Figure 8-17. Engine Steady-State Performance (Sheet 2 of 3)

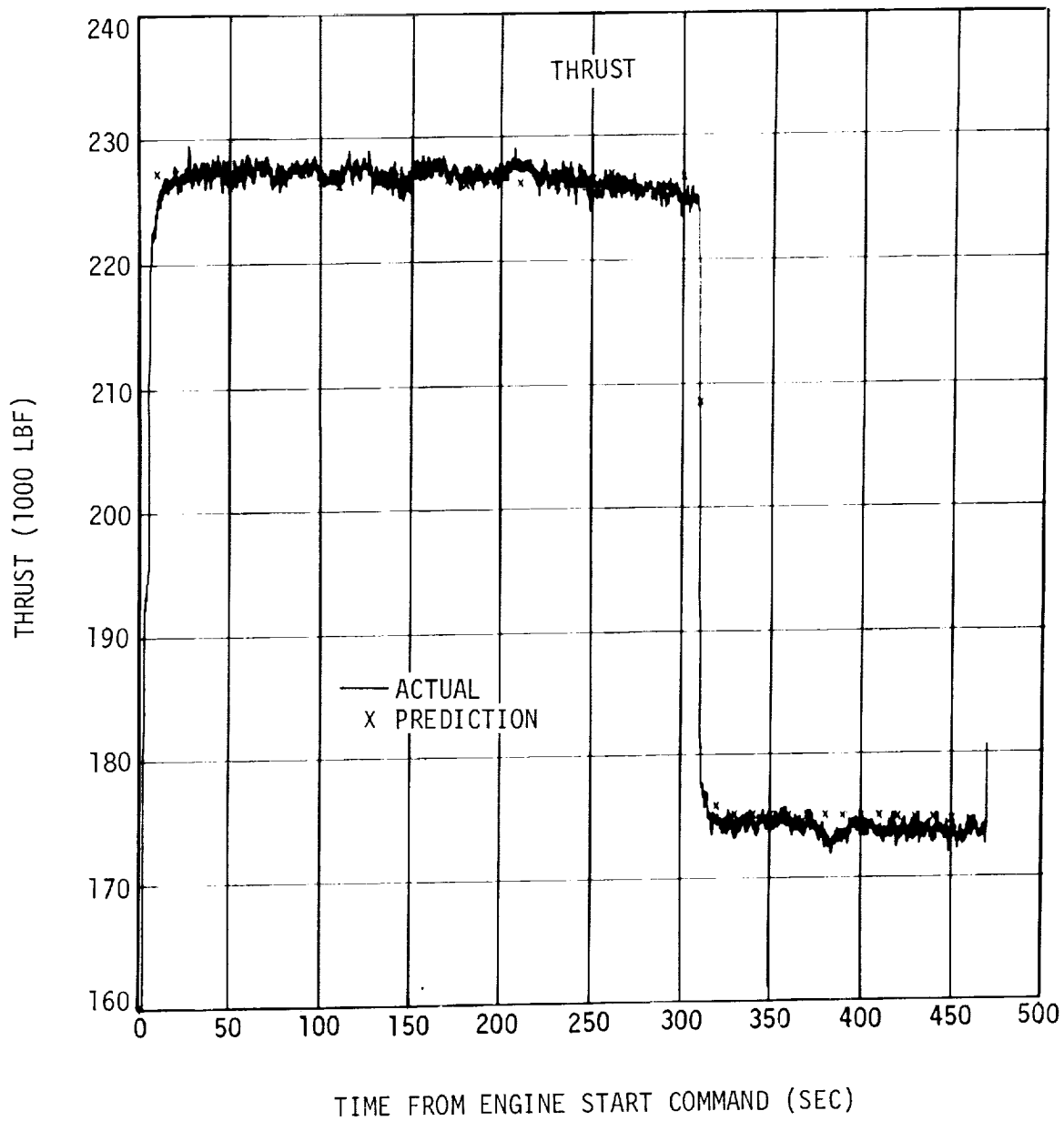

Figure 8-17. Engine Steady State Performance (Sheet 3 of 3)

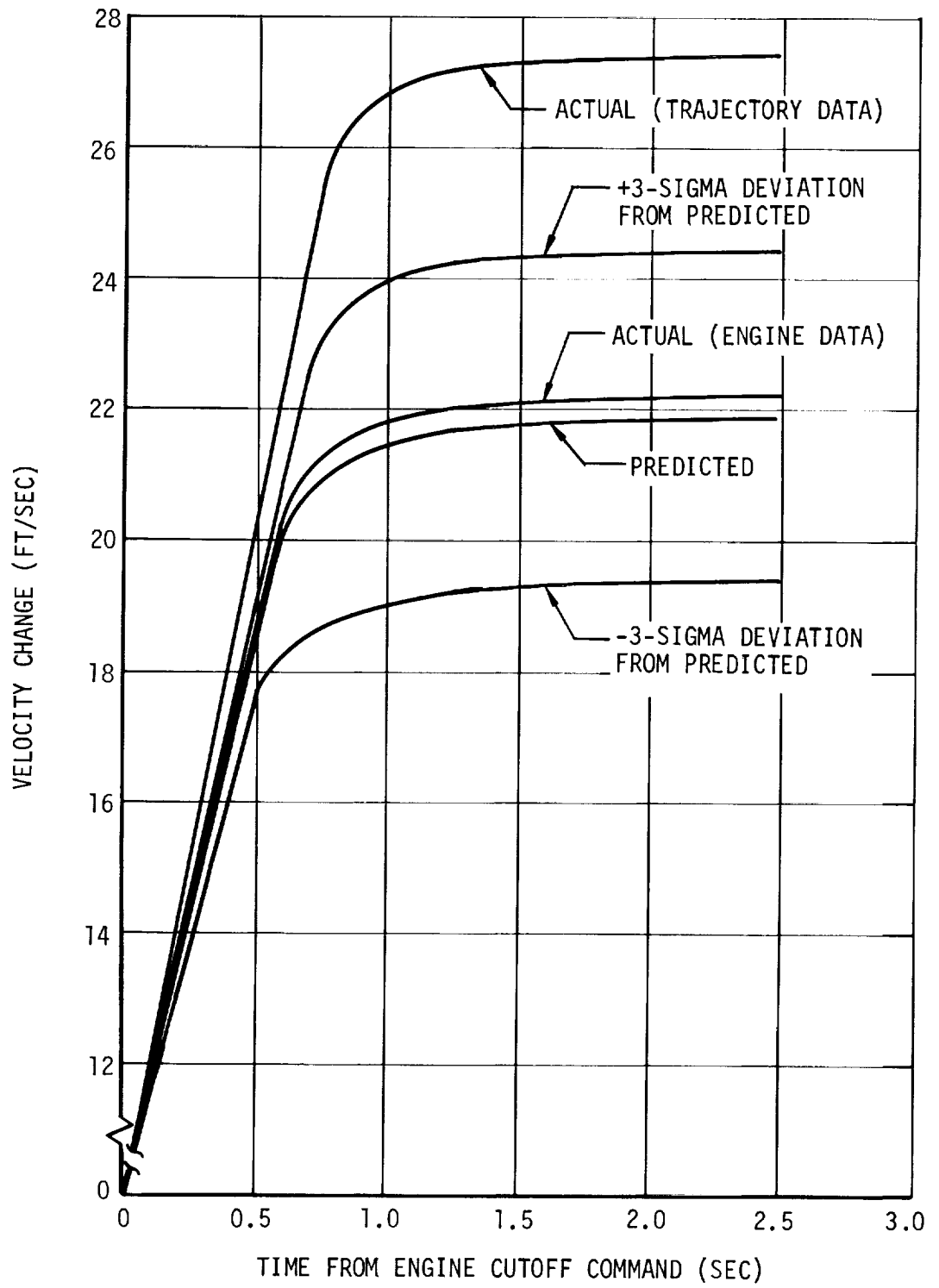

Figure 8-18. S-IVB Change in Velocity Due to Cutoff Impulse

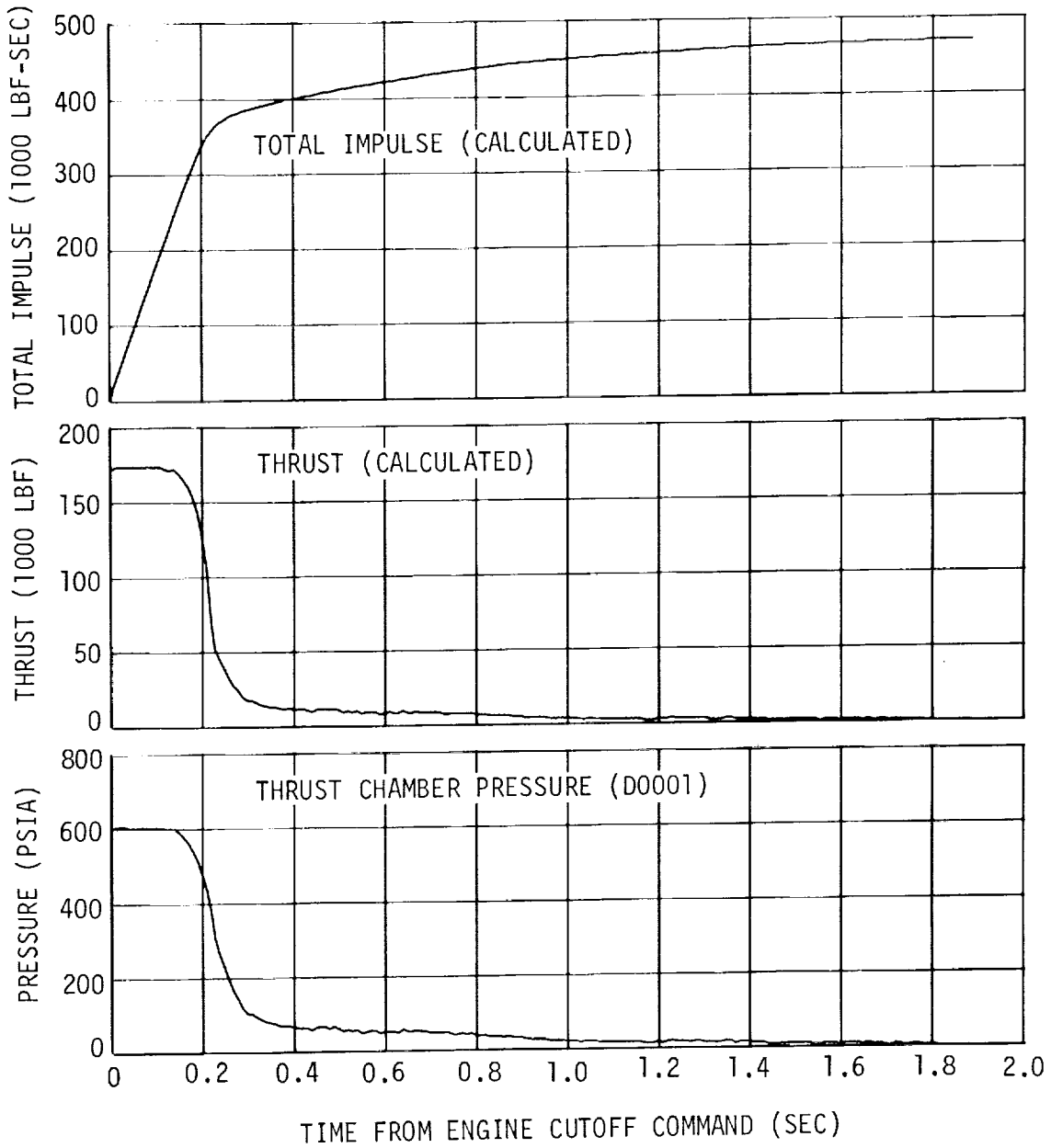

Figure 8-19. Engine Cutoff Transient Characteristics

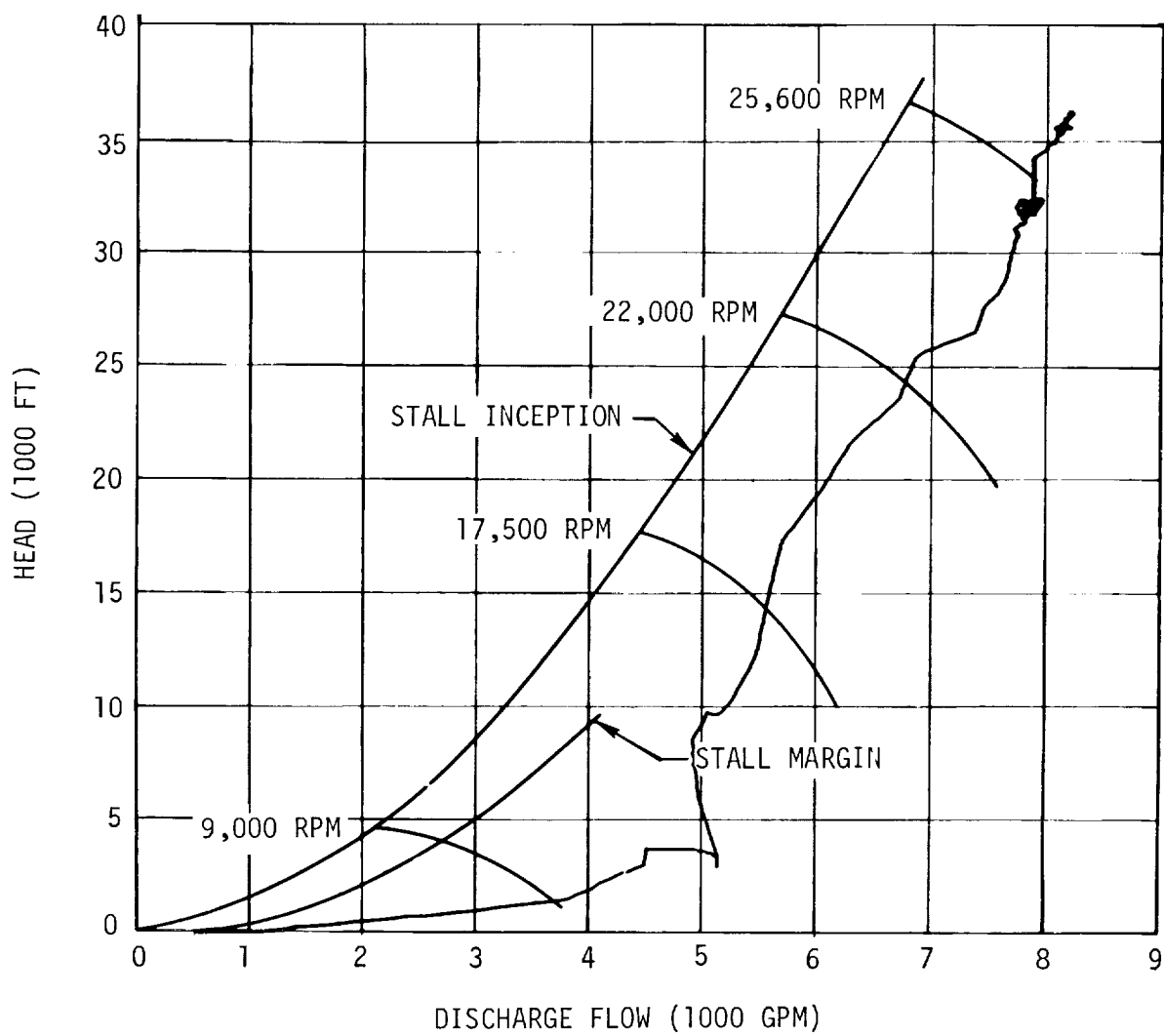

Figure 8-20. LH2 Pump Performance During Engine Start

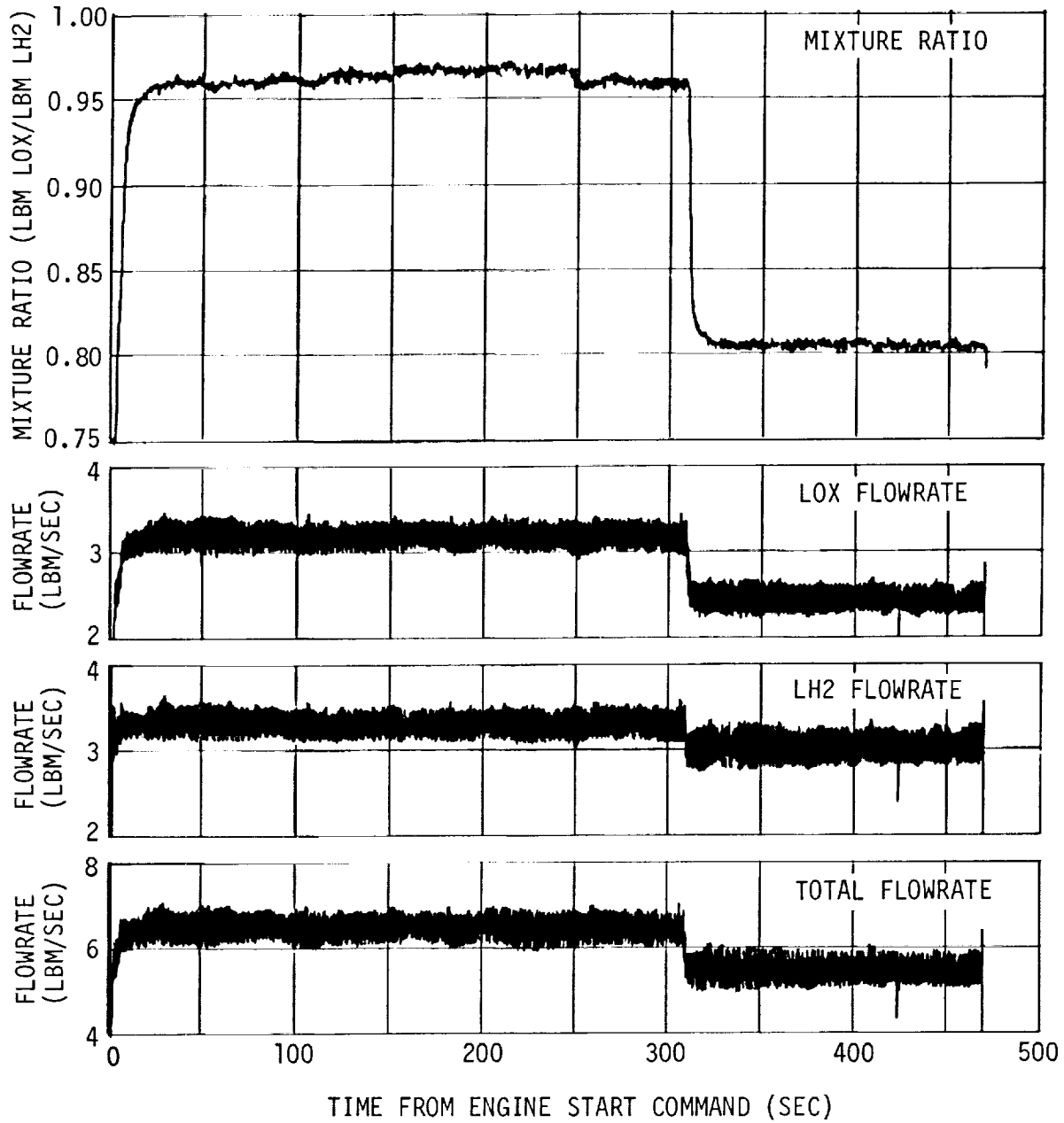

Figure 8-21. Gas Generator Performance

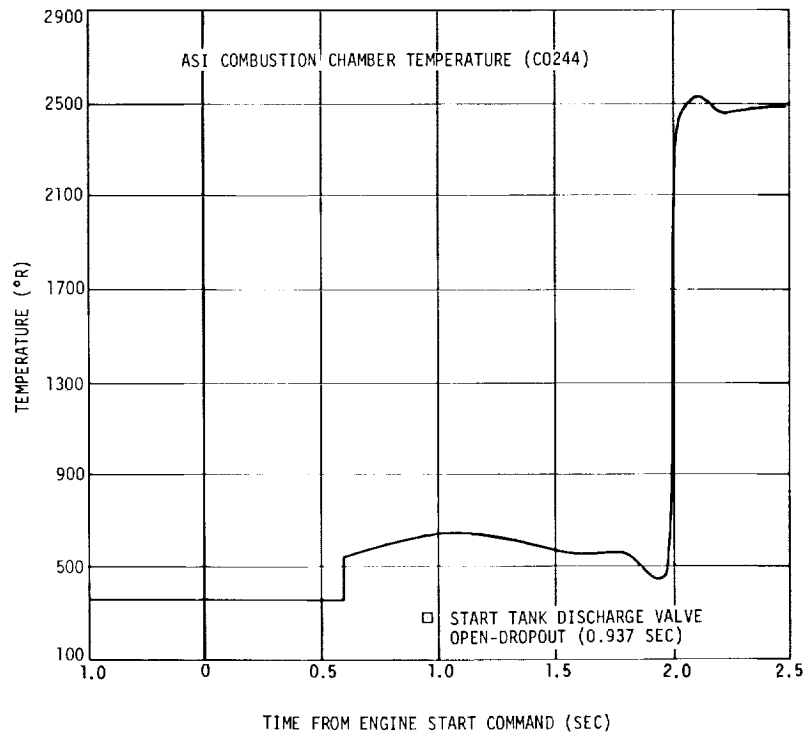
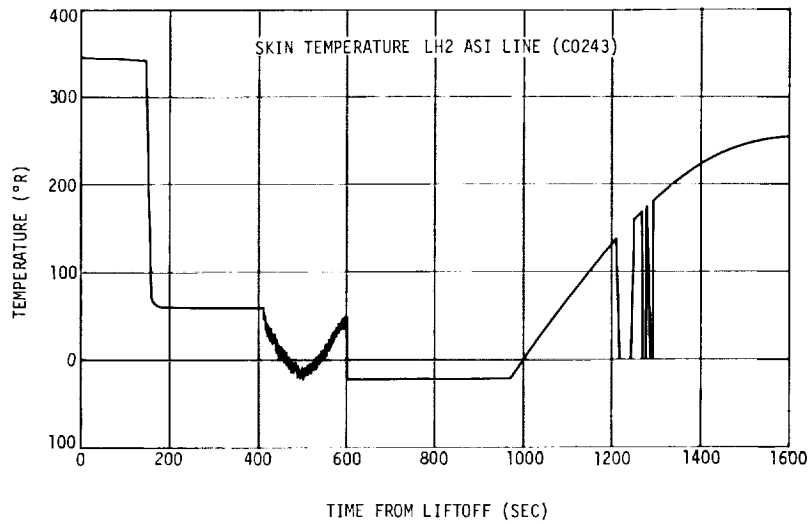

Figure 8-22. ASI Temperatures

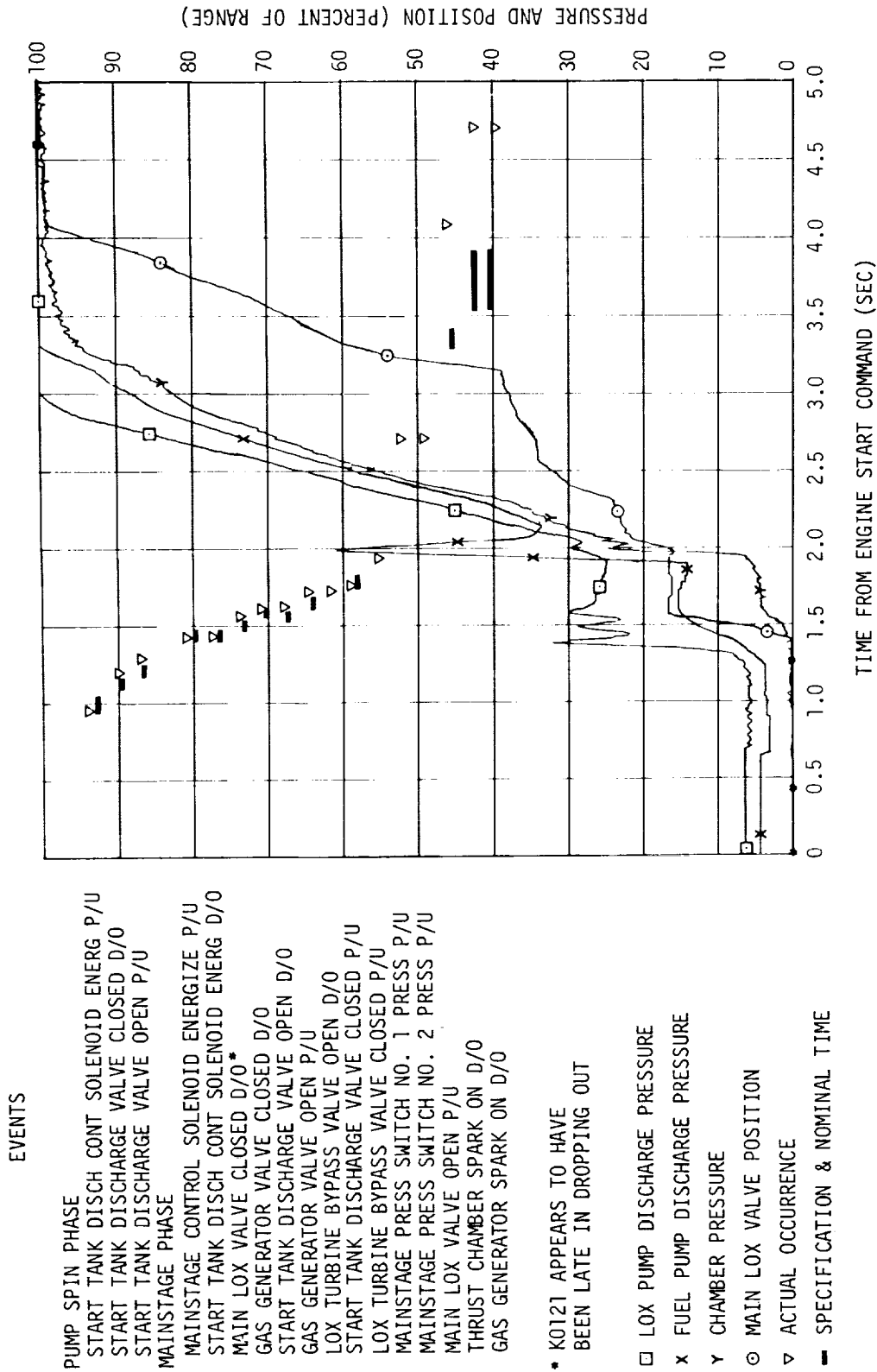

Figure 8-23. Engine Start Sequence

C



C

SECTION 9

SOLID ROCKETS







9. SOLID ROCKET

The solid rocket motors on the AS-205 launch vehicle performed satisfactorily and accomplished their intended purpose. The S-IB stage was separated from the S-IVB stage by the retrorockets, and the S-IVB propellants were settled prior to engine start by the ullage rockets.

9.1 Retrorockets

The four retrorockets mounted on the S-IB stage performed satisfactorily and separated the S-IB stage from the S-IVB stage. Neither chamber pressure nor retrorocket event times were recorded. The retrorockets were fired approximately 146.8 sec after liftoff as indicated by the telemetry data dropout that has occurred at retrorocket ignition during this and several past tests. The time compares well with RO +144.7 sec, the predicted time, since the first stage burn time was approximately 1.2 sec longer than predicted.

9.2 Ullage Rockets

Ullage rocket performance was satisfactory. The Ullage Rocket Ignition Command was given at RO +145.377 sec, with the Jettison Command at RO +154.476 sec. These times compare well with the predicted times of RO +144.7 and RO +153.6 sec, respectively, because of the difference in burn times discussed previously. No instrumentation existed to measure the chamber pressure of the ullage rockets.

Average performance values received from NASA/MSFC, as calculated from acceleration data, are shown below compared with nominal values.

	<u>Average</u>	<u>Nominal at 520°R</u>
Burntime (sec)	1.49	1.52
Thrust per motor (lbf)	37,696	36,720
Total impulse per motor (lb-sec)	56,167	57,337





SECTION 10

OXIDIZER SYSTEM



10. OXIDIZER SYSTEM

The oxidizer system performed as designed and supplied LOX to the engine within the specified limits. The LOX tank was adequately safed subsequent to burn (section 23).

10.1 LOX Tank Pressurization Control

The LOX tank pressurization system (figure 10-1) satisfactorily controlled pressure in the LOX tank during all periods of flight. The LOX pressurization module regulator performed as expected.

10.1.1 Prepressurization

LOX tank prepressurization was satisfactory and was followed by a gradual LOX tank pressure increase (caused by common bulkhead depression during LH2 tank prepressurization, and by vent valve and sensing line purges) until a LOX tank vent occurred at RO -1 sec. Subsequent to liftoff the ullage pressure gradually decreased because of the LOX tank volumetric increase with increasing acceleration. Significant LOX prepressurization data are presented in figure 10-2 and compared to previous flight data in table 10-1.

10.1.2 Pressurization

The LOX tank pressurization system performance was satisfactory during engine operation (figure 10-3) and compared reasonably well with that from previous flights. Secondary flow was required seven times, instead of the expected eight times. The actual pressurant flow-rate was slightly higher than predicted.

The 205 flight S-IVB LOX tank pressurization data are compared with that from other flights in table 10-1. The modified LOX tank pressurization system sequence, utilized for the first time during the S-IVB-506N acceptance firing, was also employed during S-IVB-205 flight. The LOX tank pressurization control module shutoff valves were opened at ESC -2.5 sec, and the heat exchanger control valve was programmed to the open position during cold helium lead and during the first 21 sec of engine burn. (During prior flights the shutoff valves were not opened until Start Tank Discharge Valve (STDV) Command -0.2 sec, and the control valve was maintained closed by the pressure switch until the ullage pressure had dropped below the lower switch setting.) The resulting high initial flowrate completely eliminated the usual LOX ullage pressure dip. This modified pressurization sequence is planned for all future flights.

10.2 Cold Helium Supply

The cold helium sphere pressurant supply was adequate throughout the mission. The helium usage and sphere conditions at significant times during the flight are shown in table 10-2 and figure 10-4.

The initiation of cold helium passivation occurred at RO +6,149 sec. The cold helium dump is discussed in section 23.

10.3 J-2 Heat Exchanger

The J-2 heat exchanger operated satisfactorily. Pertinent data are presented in figure 10-5 and compared with previous flight data in table 10-3.

10.4 LOX Chilldown

The LOX pump chilldown system performed adequately. At Engine Start Command the NPSP at the pump inlet was above the minimum requirement.

Recirculation chilldown was started at RO -764 sec and was terminated shortly before Engine Start Command. The pre valve was commanded open at ESC -5 sec to remove any bubbles that might have collected under the valve during chilldown. The chilldown pump was then turned off, although the chilldown shutoff valve remained open.

After prepressurization, the ullage pressure varied with the normal makeup cycles until liftoff. During this time interval, the LOX pump inlet pressure followed the ullage pressure trend. After liftoff the ullage pressure decreased, while the chilldown system pressures increased as a result of the increasing vehicle acceleration. The LOX pump inlet pressure increased beyond 60 psia at RO +4 sec, thus exceeding the range of the transducer. From that time until S-IB cutoff, the LOX pump inlet pressure was calculated by adding the chilldown pump developed head and liquid head pressures (determined from predicted vehicle acceleration data) to the ullage pressure.

During the chilldown process the LOX was subcooled throughout the recirculation system. Significant data are presented in figures 10-6 and 10-7 and are compared to previous flight data in table 10-4.

10.5 Engine LOX Supply

The LOX supply system (figure 10-8) delivered the necessary quantity of LOX to the engine pump inlet throughout engine operation and maintained the pressure and temperature conditions within a range that provided a LOX pump NPSP above the minimum requirements. Figure 10-9 presents the data and the calculated performance; table 10-5 compares the S-IVB-205 stage data and calculated performance with that from previous tests.

The LOX pump inlet temperature and pressure were plotted in the engine LOX pump operating region (figure 10-10) and showed that the LOX pump inlet conditions were satisfactory throughout engine operation.

In figure 10-11 the LOX pump inlet temperature is plotted against the mass remaining in the tank during engine operation and compared to the S-IVB-204 flight test data.

TABLE 10-1
LOX TANK PRESSURIZATION DATA

PARAMETER	UNITS	S-IVB-205 FLIGHT	S-IVB-204 FLIGHT
Prepressurization duration	sec	16	14
Number of makeup cycles		2	1
Number of secondary flow intervals		7	7
Prepressurization helium			
Flowrate	lbm/sec	0.32	0.22 to 0.25
Mass added to LOX tank during prepressurization	lbm	5.1	3.2
Mass added to LOX tank during makeup cycles	lbm	1.3	0.26
Pressure control band			
Minimum	psia	37.3	37.7
Maximum	psia	39.2	39.6
Ullage pressure			
At prepressurization initiation	psia	15.3	15.4
At prepressurization termination	psia	38.9	40.3
At liftoff	psia	41.5	42.3
At Engine Start Command	psia	39.6	40.0
Minimum during start transient	psia	37.2*	34.9
At Engine Cutoff Command	psia	37.8	39.3
Pressurant total flowrate			
During undercontrol	lbm/sec	0.25 to 0.33	0.27 to 0.31
During overcontrol	lbm/sec	0.37 to 0.45	0.37 to 0.42
Maximum LOX tank vent inlet temperature	deg R	502	513
Events	sec from liftoff		
Prepressurization initiation	sec	-163	-163
Engine Start Command	sec	+147	+145

*See paragraph 10.1.2 for explanation of effects of pressurization sequence change.

TABLE 10-2
COLD HELIUM SUPPLY DATA

PARAMETER	UNITS	S-IVB-205 FLIGHT	S-IVB-204 FLIGHT
Pressure			
At liftoff	psia	3,081	2,958
At Engine Start Command	psia	3,100	2,927
At Engine Cutoff Command	psia	1,107	1,179
Average temperature			
At liftoff	deg R	37.6	40.9
At Engine Start Command	deg R	37.9	40.4
At Engine Cutoff Command	deg R	47.3 to 48.8	48.9 to 56.2
Helium mass			
At Engine Start Command	lbm	349	334
At Engine Cutoff Command	lbm	186	175
Usage calculated from sphere conditions	lbm	163	159
Usage calculated by integration of flowrate	lbm	158	149

TABLE 10-3
J-2 HEAT EXCHANGER PERFORMANCE DATA

PARAMETER	UNITS	S-IVB-205 FLIGHT	S-IVB-204 FLIGHT
Flowrate through heat exchanger			
During overcontrol	lbm/sec	0.20	0.19
During undercontrol	lbm/sec	0.075	0.07
Heat exchanger inlet temperature			
During overcontrol	deg R	43 to 76	45 to 60
During undercontrol	deg R	50 to 75	50 to 75
Minimum	deg R	43	46
Heat exchanger outlet temperature			
At end of 50-sec transient	deg R	950	950
During overcontrol	deg R	960 to 988	981 to 1,003
During undercontrol	deg R	962 to 1,040	990 to 1,054
At Engine Cutoff Command	deg R	920	952
Heat exchanger outlet pressure			
During overcontrol	psia	327 to 340	334 to 347
During undercontrol	psia	400 to 429	369 to 402
Average LOX vent inlet pressure			
During overcontrol	psia	68	67
During undercontrol	psia	48	48
Maximum LOX vent inlet temperature	deg R	502	513

*Transducer D0055 was faulty on S-IVB-203.

TABLE 10-4
LOX CHILLDOWN SYSTEM PERFORMANCE DATA

PARAMETER	UNIT	S-IVB-205 FLIGHT	S-IVB-204 FLIGHT
NPSP			
At Engine Start Command	psi	24.4	22.64
Minimum required at engine start	psi	12.8	12.8
At opening of prevalve	psi	43.3	43.01
LOX pump inlet conditions at engine start command			
Pressure	psia	41.5	39.9
Temperature	deg R	165.1	165.1
Amount of subcooling	deg R	17.4	16.6
Average flow coefficient	sec ² /in ² ft ³	16.2	20.4
Heat absorption rate			
	Btu/hr		
Section 1 (tank to pump inlet)		3,500	5,000
Section 2 (pump inlet to bleed valve)		33,000	18,000
Section 3 (bleed valve to tank inlet)		33,000	6,000
Total		36,500	29,000
Chiltdown flowrate			
Unpressurized	gpm	40.0	36.8
Pressurized	gpm	43.0	38.3
Chiltdown pump pressure differential (pressurized)			
		10.5	10.5
Events (sec from liftoff)			
Chiltdown initiation	sec	-764	-588.032
Prevalve closed	sec	-753	-582.016
Prevalve Open Command	sec	141.960	140.269
Prevalve closed signal dropout	sec	143.036	141.288
Prevalve open signal pickup	sec	144.286	143.088
Delay between Prevalve Open Command and pickup of open signal	sec	2.326	2.819
Chiltdown shutoff valve closed	sec	*	568.071
Engine Start Command	sec	147.008	144.905

*Did not close

TABLE 10-5
LOX PUMP INLET CONDITION DATA

PARAMETER	UNITS	S-IVB-205 FLIGHT	S-IVB-204 FLIGHT
Pump inlet conditions			
Static pressure at engine start	psia	41.5	39.9
Temperature at engine start	deg R	165.1	165.1
Temperature at engine cutoff	deg R	166.3	166.3
NPSP			
Required at Engine Start Command	psi	12.8	12.8
Available at Engine Start Command	psi	24.4	22.6
Maximum during firing	psi	28.7	27.0
Minimum during firing	psi	23.6	21.8
At Engine Cutoff Command	psi	24.2	24.8
LOX feed duct			
At high EMR			
Pressure drop	psi	2.4	2.3
Flowrate	lbm/sec	454	445
After EMR cutback			
Pressure drop	psi	1.2	*
Flowrate	lbm/sec	334	363

*Calculation inaccurate

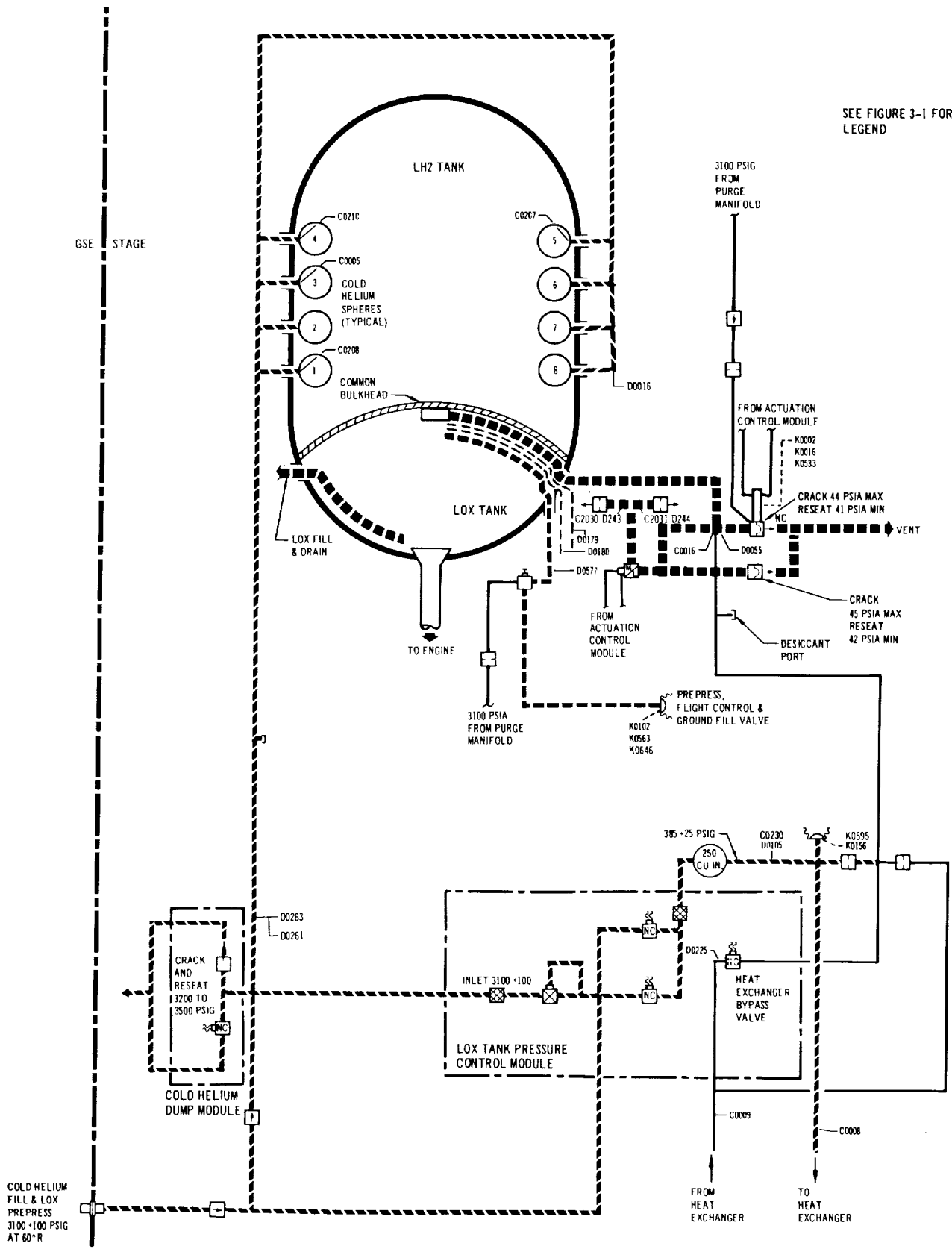

Figure 10-1. LOX Tank Pressurization System

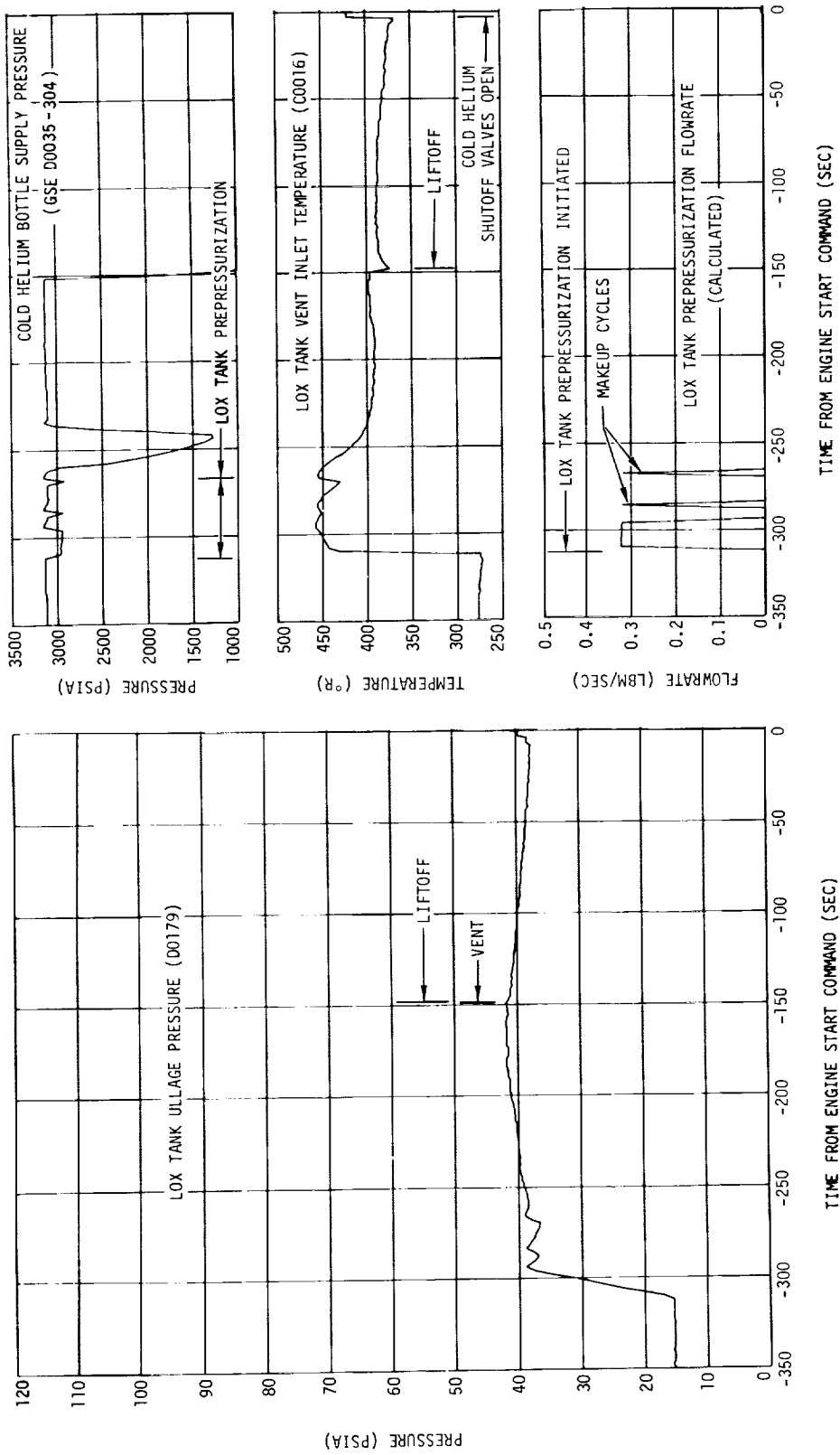

Figure 10-2. LOX Tank Conditions - Prepressurization and Boost



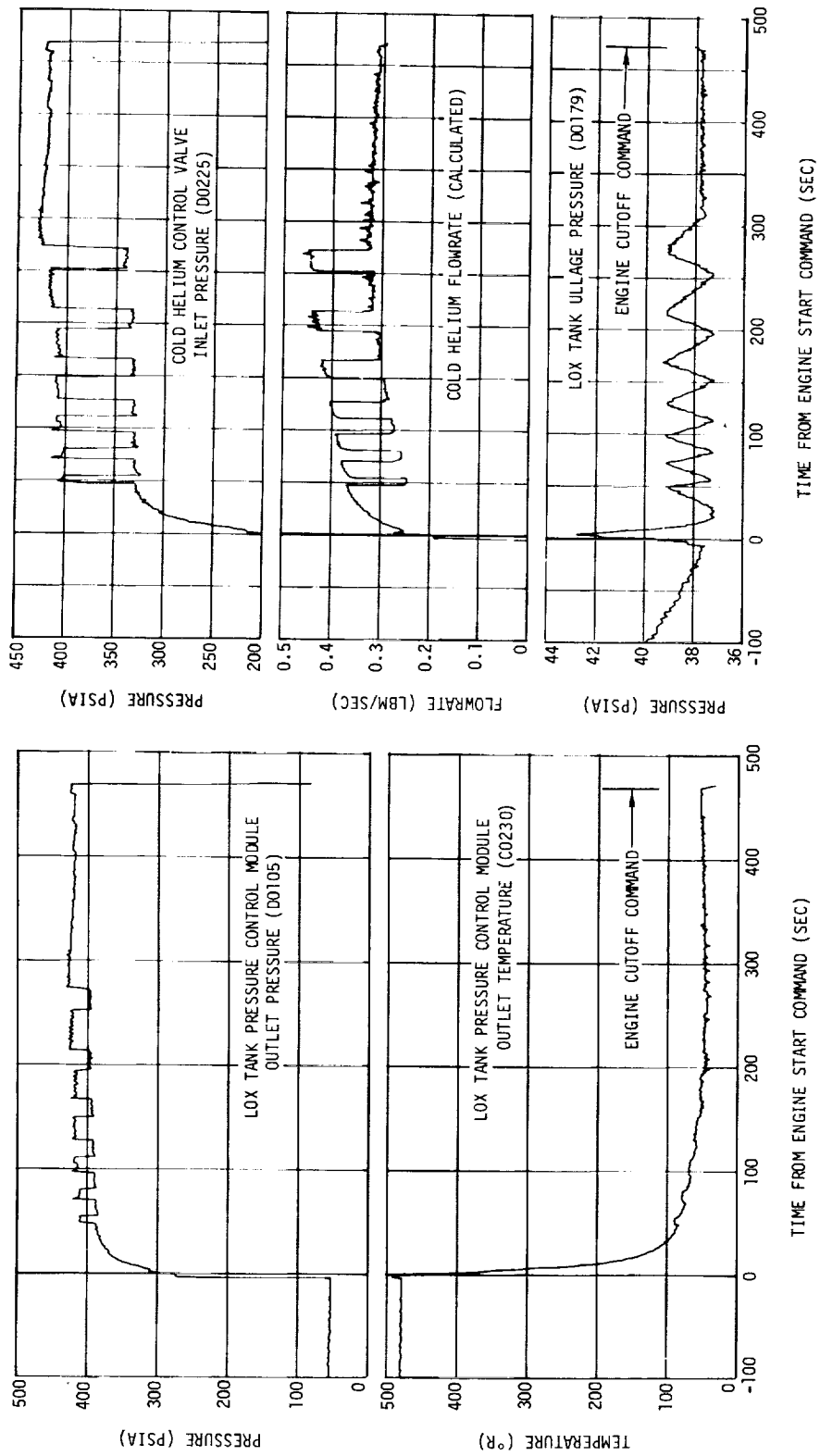

Figure 10-3. LOX Tank Pressurization System Performance

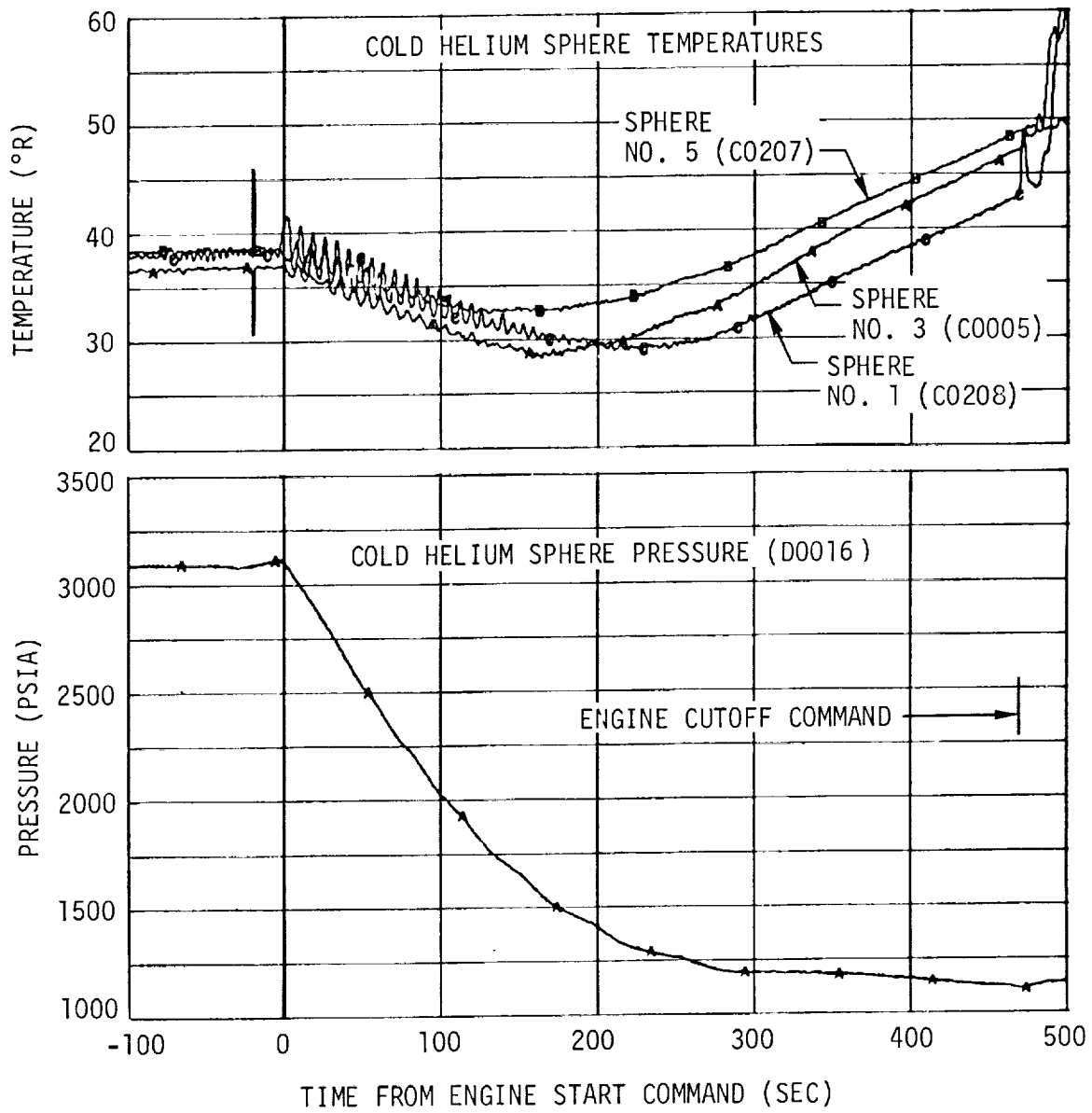

Figure 10-4. Cold Helium Supply

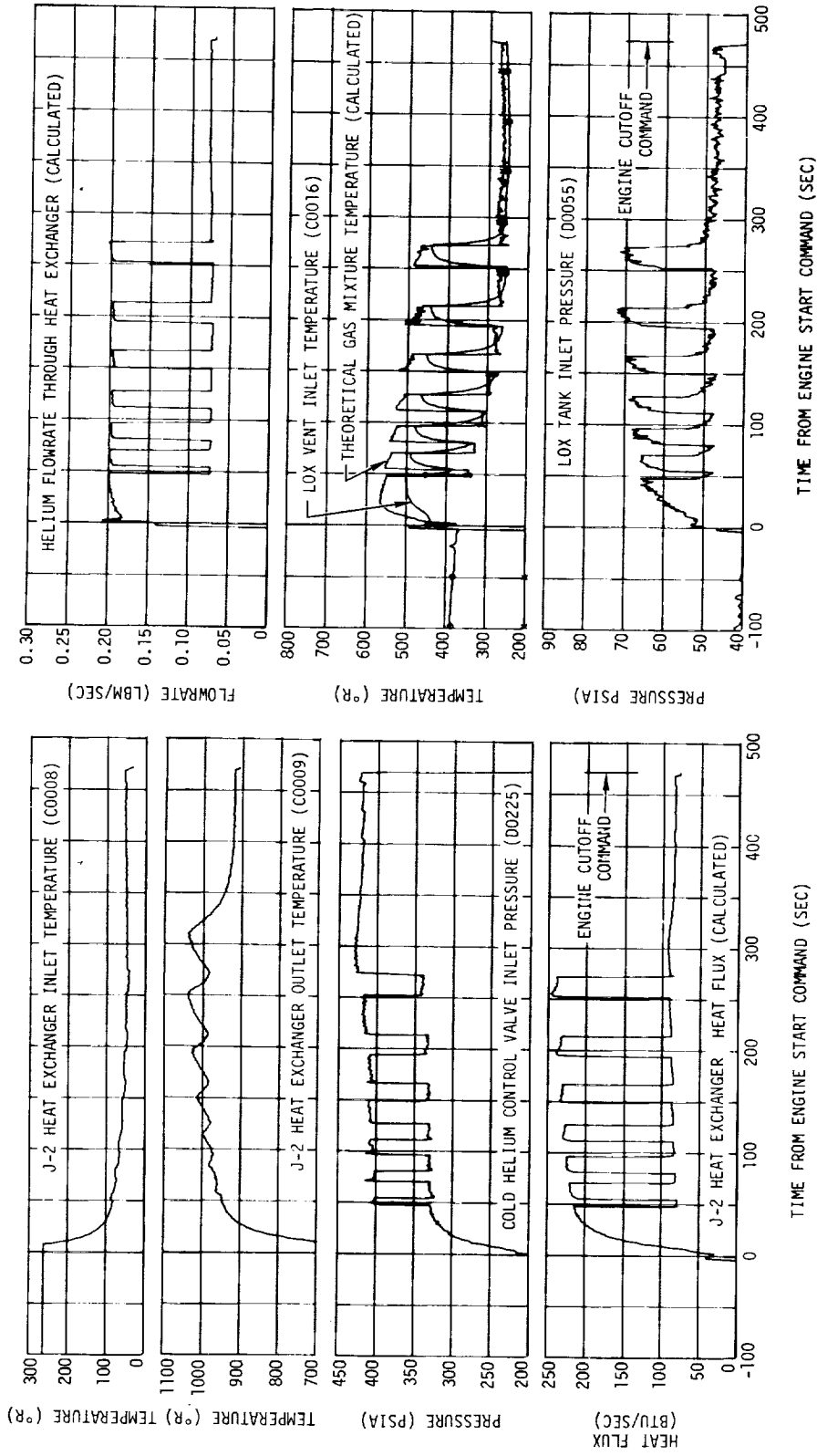

Figure 10-5. J-2 Heat Exchanger Performance

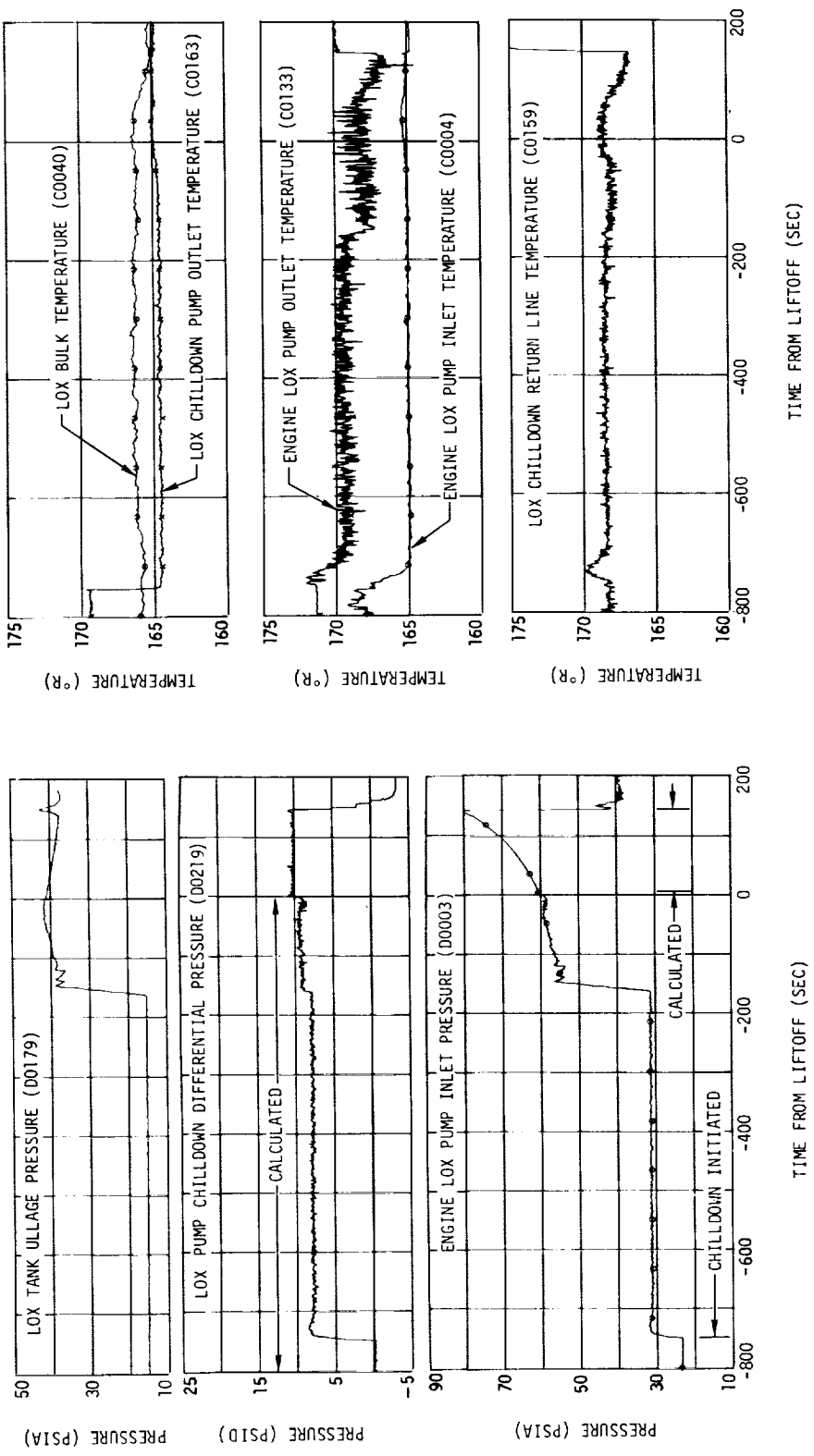

Figure 10-6. LOX Pump Chilldown System Operation

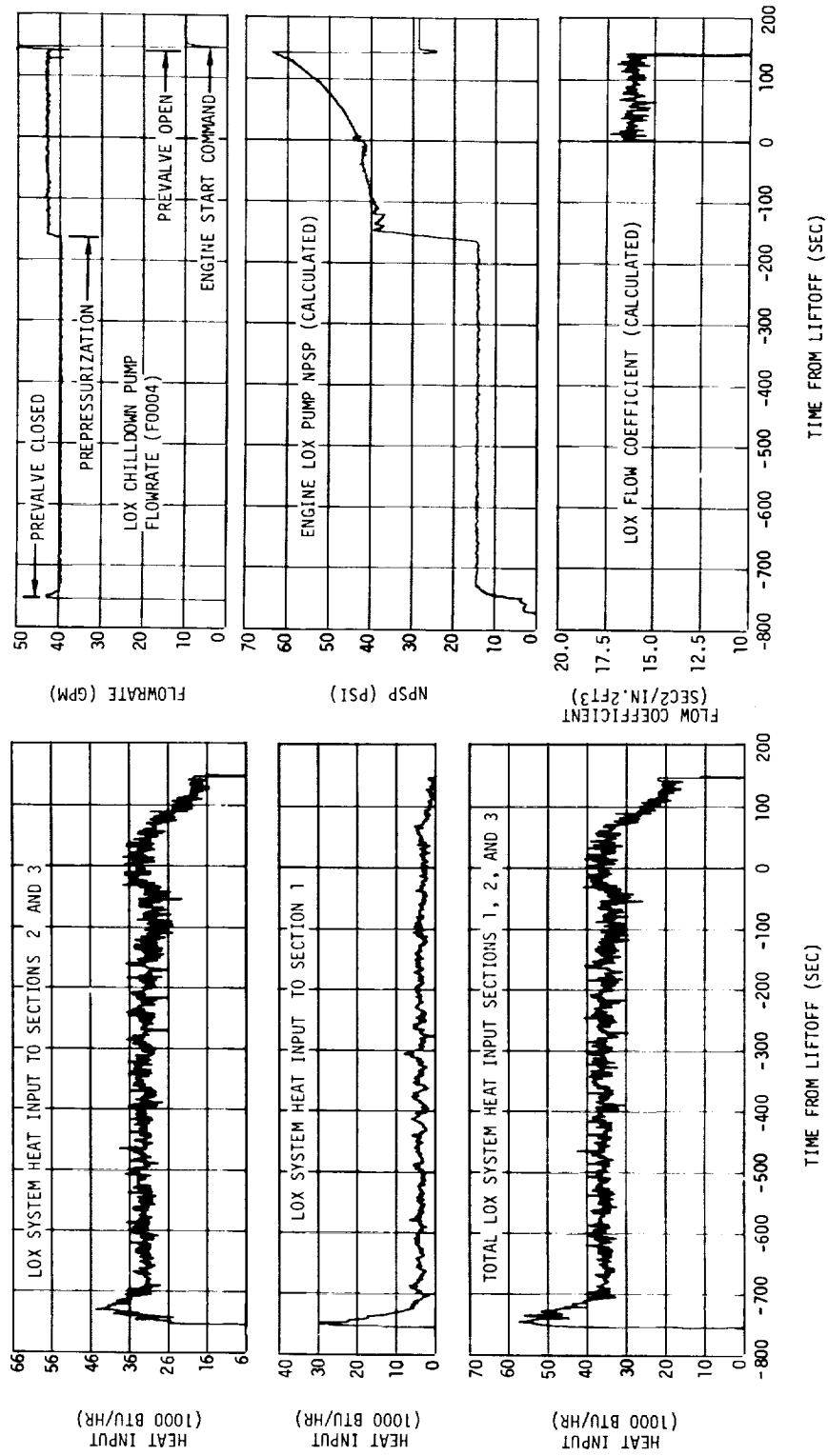

Figure 10-7. LOX Pump Chilldown Characteristics

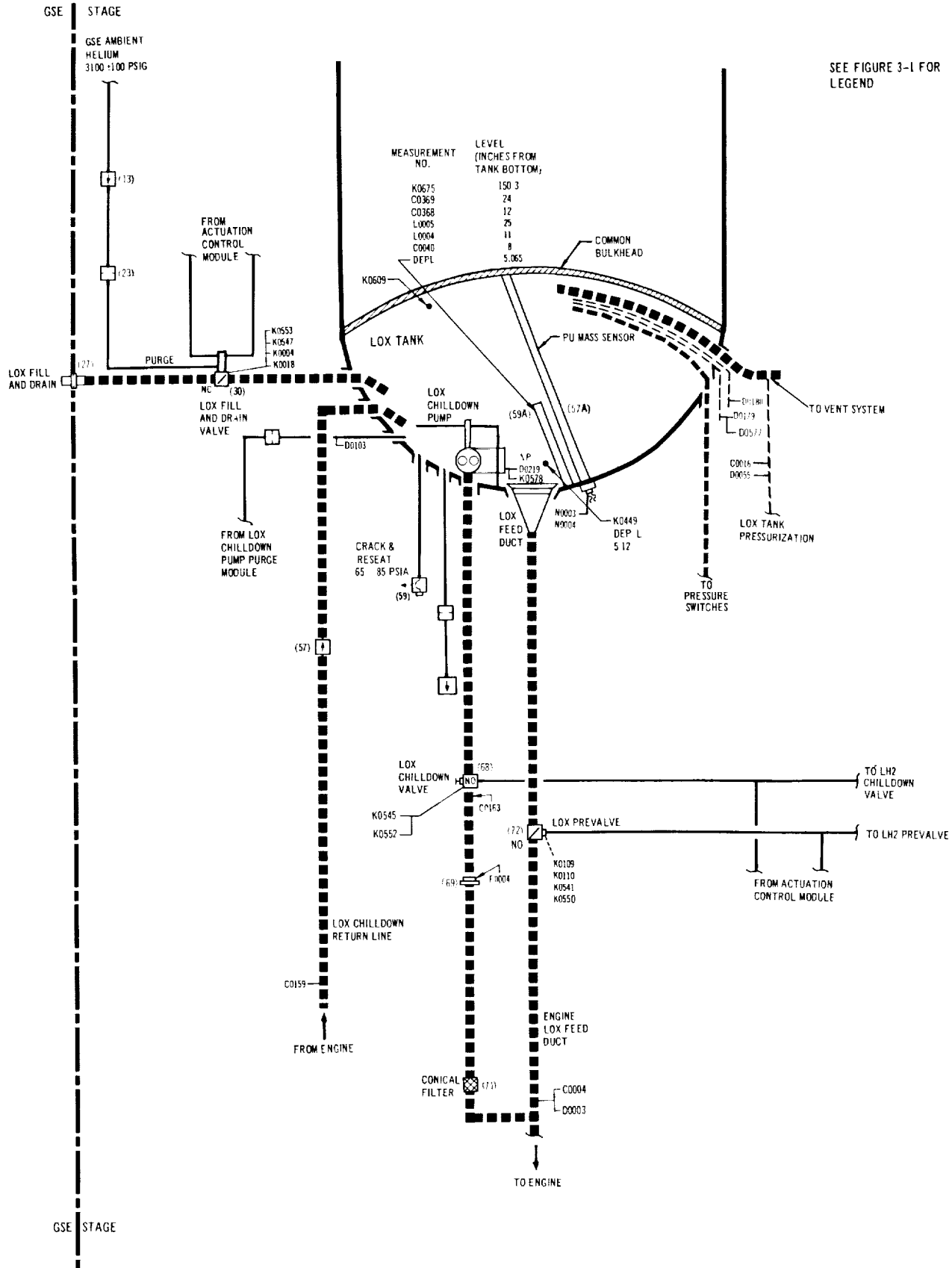

Figure 10-8. LOX Supply System

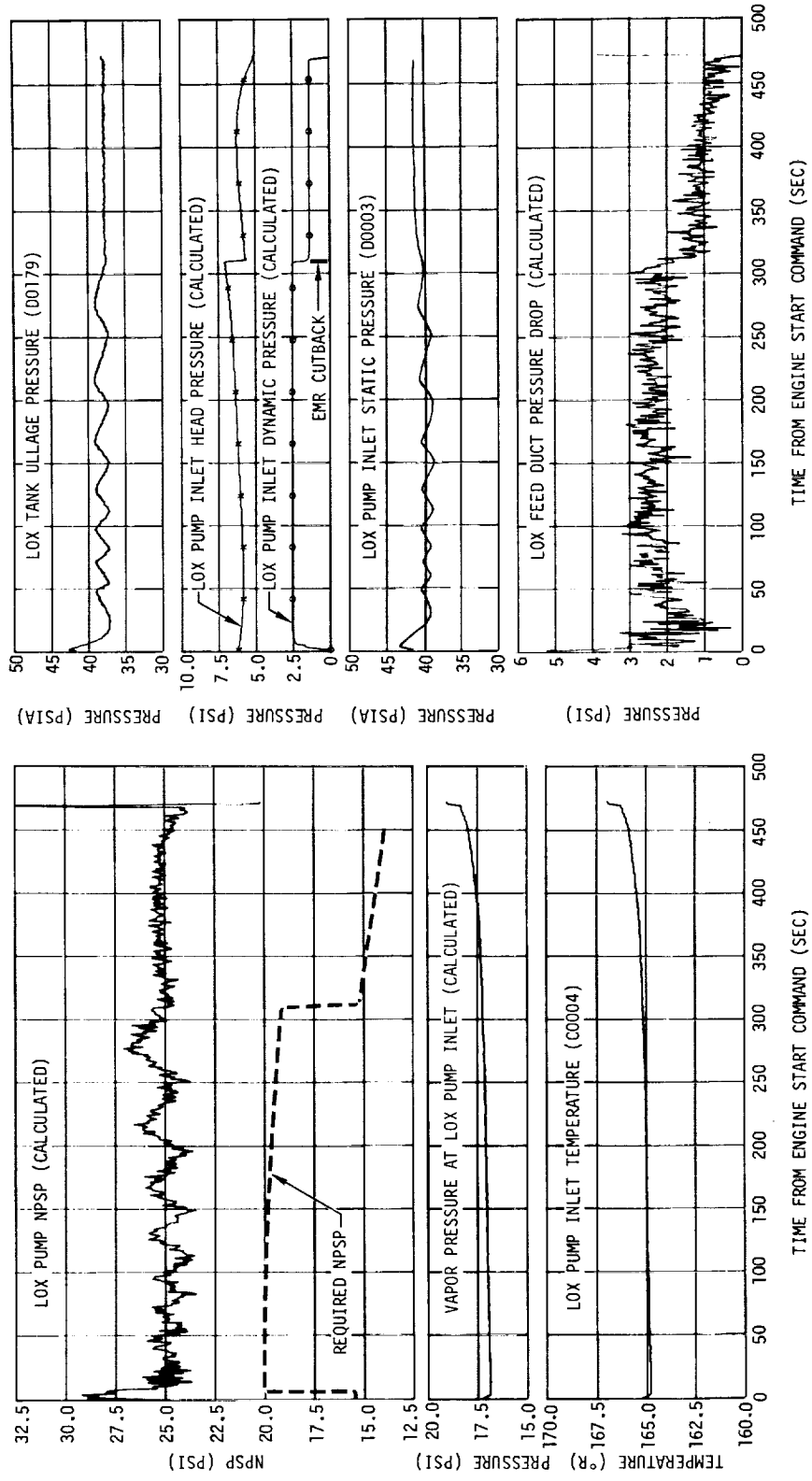

Figure 10-9. LOX Pump Inlet Conditions

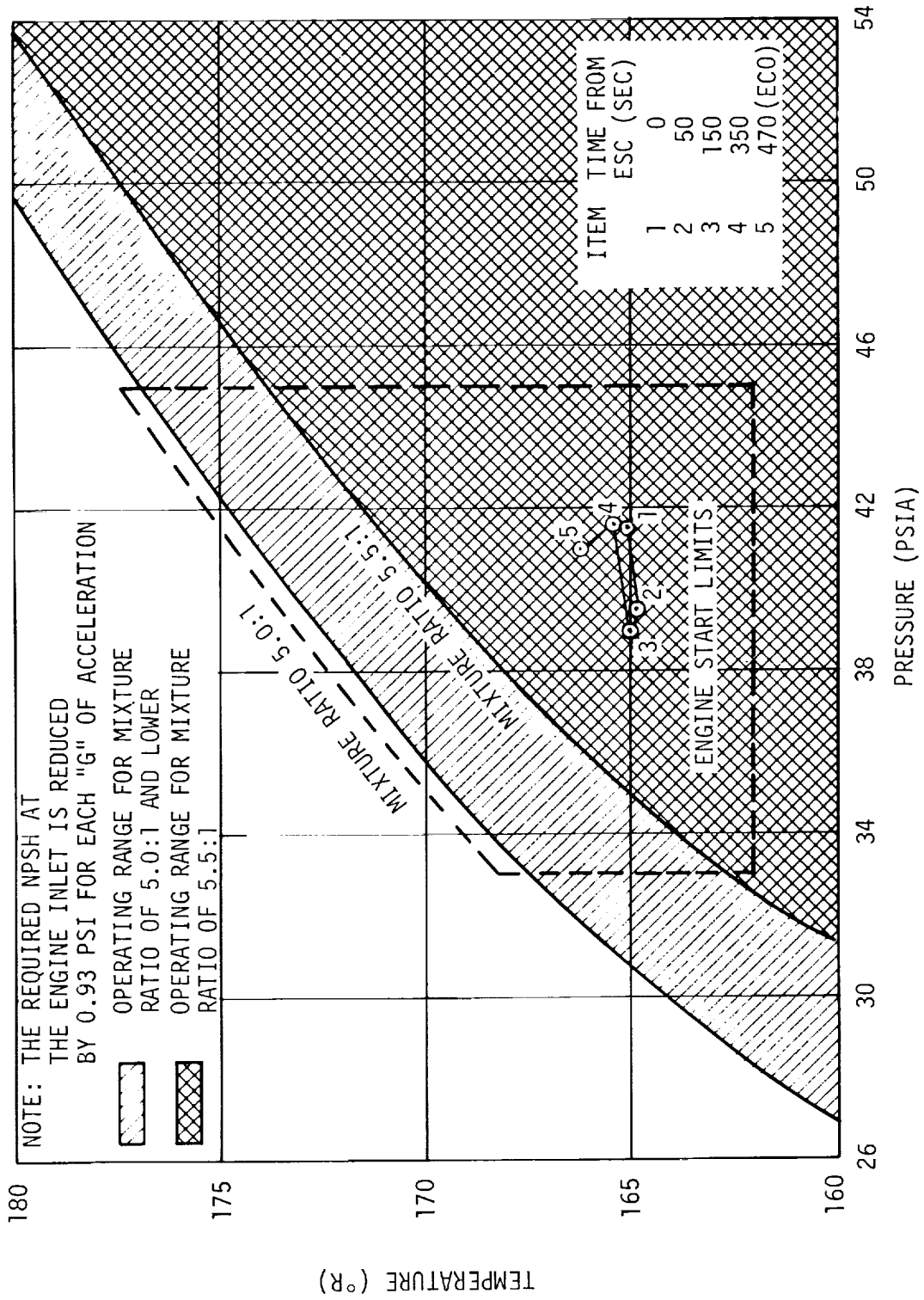

Figure 10-10. LOX Pump Inlet Conditions During Firing



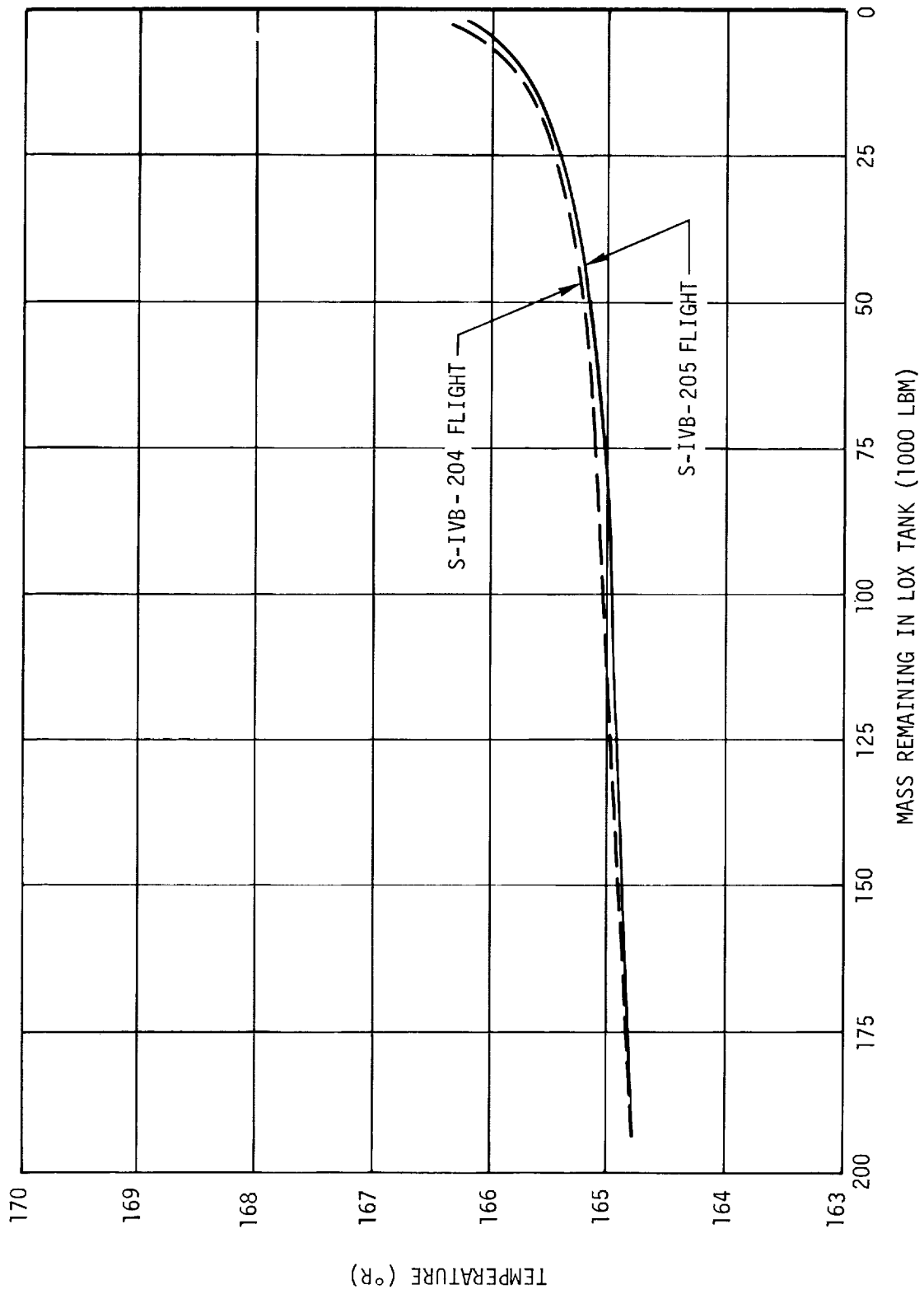
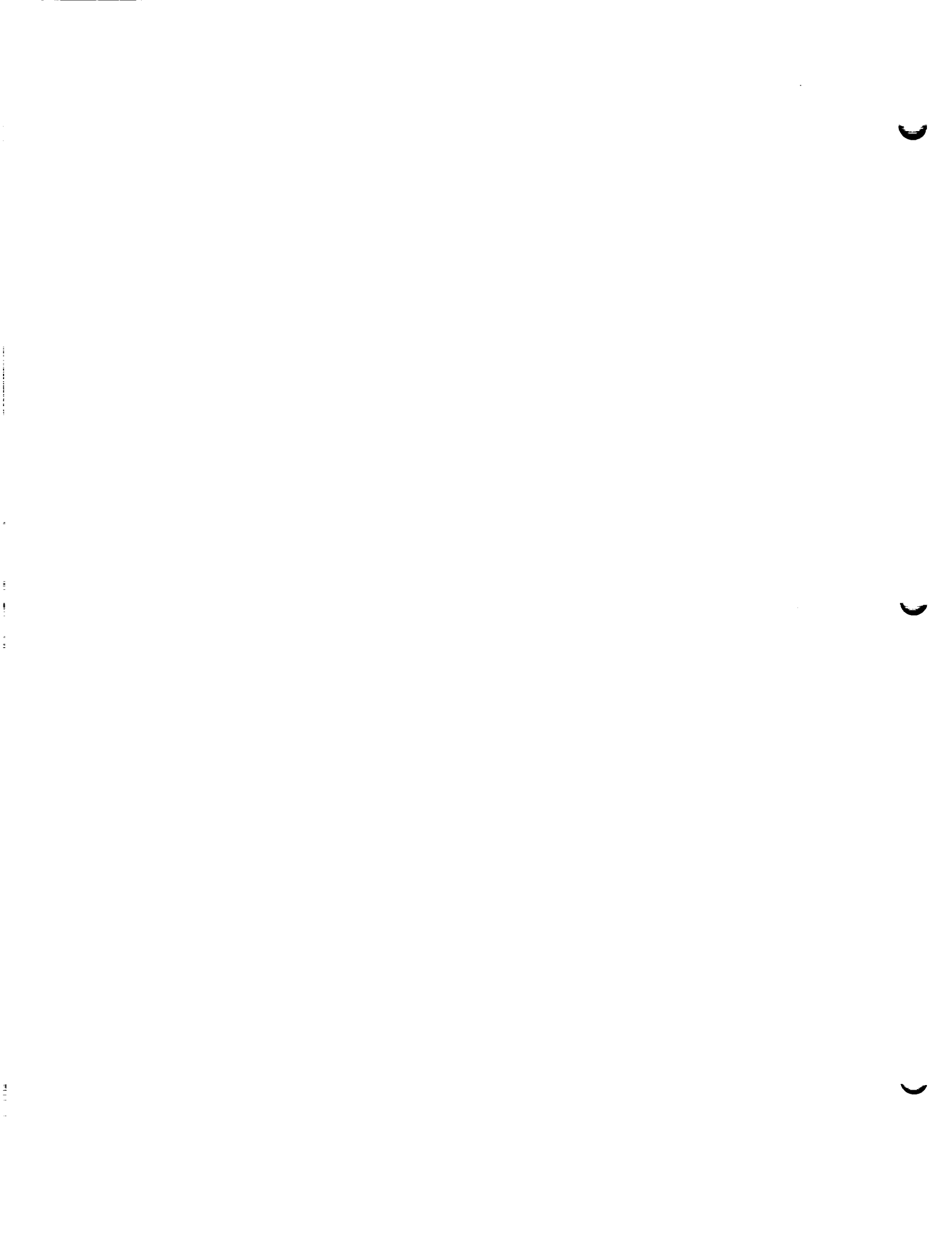

Figure 10-11. Effect of LOX Mass Level on LOX Pump Inlet Temperature



SECTION II

FUEL SYSTEM







11. FUEL SYSTEM

The fuel system performed as designed and supplied LH2 to the engine within the limits defined in the engine specification.

11.1 Pressurization Control and Internal Environment

The GSE and airborne LH2 tank pressurization systems (figure 11-1) satisfactorily controlled the LH2 tank ullage pressure during countdown, boost, and powered flight.

11.1.1 Prepressurization

The LH2 tank was satisfactorily prepressurized with helium. Subsequent to prepressurization the ullage pressure continued to increase as the ullage warmed, reaching a relief condition of 32.1 psia at approximately T -20 sec. Relieving was continuous from that time through Engine Start Command (ESC) with the exception of a period from liftoff to RO +60 sec. This temporary drop in ullage pressure resulted from the increased boiloff caused by vibration at booster ignition and liftoff. Figure 11-2 presents the prepressurization data; table 11-1 compares the S-IVB-205 data with that from previous flights.

The prepressurization duration (18 sec) was considerably less than it was during previous Saturn IB flights as a result of the initial ullage volume being smaller than usual, and ullage pressure requirements being revised due to fracture mechanics considerations. The prepressurization requirement was reduced from 34 psia to a nominal 31 psia on this stage.

During prepressurization, the stage LH2 pressurization module inlet pressure (D0104) peaked at 875 psia as compared to a nominal 550 psia on past flights. This condition was also noted on the AS-205 CDDT. This was a result of reducing the pressurization module orifice sizes on this stage, thereby increasing the percentage of flow resistance and pressure loss downstream of this measurement. The quick-disconnect fitting in the line upstream of this measurement had been qualified at 750 psia; however, previous testing has indicated that the quick-disconnect fitting will maintain its structural integrity to pressures in excess of 2,000 psia. Therefore no problems were anticipated, nor did any occur during the launch countdown.

11.1.2 Pressurization

During engine operation, LH2 pressurization was satisfactorily accomplished by GH2 bleed from the J-2 engine (figure 8-1 and 11-1). Although operation was nominal, it differed from previous flights in that the vent system relieved during the entire engine operation period. This behavior resulted because the pressurization module control orifices had been resized, with the consideration that the ullage pressure should be maintained near the high edge of the pressurization range. This was compounded by the fact that the tank vent/relief valve apparently began relieving at 32.1 psia, 1.9 psi below the nominal, and 1.1 psi below previous relief levels for this valve. Pressurization system data are presented in figure 11-3 and compared to AS-204 data in table 11-1.

Because D0104 (pressurization module inlet pressure) failed to provide valid data after ESC +198 sec, the GH2 flowrate could not be calculated directly. Consequently, a pressure-time profile for D0104 subsequent to ESC +198 sec was reconstructed based on relationships with other system measurements determined from previous testing (figure 11-3). The flowrates and the total GH2 mass added during pressurization were calculated using this reconstruction and agreed very closely with predictions.

11.1.3 LH2 Tank Venting During Engine Operation

The LH2 tank ullage pressure relieved slightly during the engine burn period, with significant flow occurring briefly after Engine Start Command and all through step pressurization (ESC +300 sec to Engine Cutoff Command). These periods of significant venting were indicated both by valve talkback and by vent nozzle pressure data. Flow could not be calculated prior to step pressurization due to the gas temperature measurement being offscale high. Subsequent to step pressurization initiation, the vent flowrate varied between 0.12 and 0.20 lbm/sec (figure 11-4).

The talkbacks during these periods make it apparent that the vent/relief valve began relieving at 32.1 to 32.2 psia in contrast to the component acceptance test level of 33.2 psia. Although a definite statement cannot be made, it is probable that the backup relief valve did not open.

11.2 LH2 Chilldown

The LH2 chilldown system performed satisfactorily. At Engine Start Command, the NPSP was well above the minimum requirement. System temperatures, pressures, and LH2 flowrate are presented in figures 11-5 and 11-6.

Chilldown was initiated at T -764 sec. During unpressurized chilldown, subcooled conditions existed at the pump inlet. The chilldown flowrate stabilized within 60 sec after initiation. The liquid entering the system was sufficiently subcooled after pressurization to absorb all the heat input to the system without vaporizing.

When steady-state conditions were achieved after prepressurization, subcooled LH2 at the pump inlet and return line exit indicated subcooled liquid throughout the chilldown system.

During pressurized chilldown prior to liftoff, the LH2 pump inlet NPSP was 19.0 psi. It increased during boost, and the head developed due to acceleration increased and the system temperatures decreased. Heat leakage into the fuel system is shown in figure 11-6 and is compared with the corresponding preliftoff data from the AS-204 flight in table 11-2.

11.3 Engine LH2 Supply

The engine LH2 supply system (figure 11-7) provided LH2 to the engine within specifications throughout the engine firing period. The minimum available NPSP during engine operation occurred at cutoff and was above the allowable minimum NPSP at that time. Figure 11-8 presents the data and calculated performance; table 11-3 compares the data to that of previous tests.

LH2 pump inlet pressure and temperature during engine operation are presented in figure 11-9 which shows that the engine LH2 pump inlet conditions were met satisfactorily throughout engine operation.

Figure 11-10 is a plot of the pump inlet temperature as a function of the propellant mass remaining within the LH2 tank and includes S-IVB-204 flight test data for comparison. The data used for comparison have been biased to the LH2 pump inlet temperature observed at Engine Start Command of S-IVB-205 flight to correct for instrument error, different heating during pressurization, and other test to test variations. As the figure shows, the data from the two tests agree closely.

TABLE 11-1
LH2 TANK PRESSURIZATION DATA

PARAMETER	UNITS	S-IVB-205 FLIGHT	S-IVB-204 FLIGHT
Prepressurization duration	sec	18	46
Helium prepressurization mass added	lbm	10.7	25
Ullage pressure			
At prepressurization initiation	psia	16.0	16.2
Rate of increase after prepressurization	psi/min	1.14	1.58
At prepressurization termination	psia	30.4	33.7
At liftoff	psia	32.1	36.4
At Engine Start Command	psia	32.1	39.2
At Engine Cutoff Command	psia	32.3	38.7
Pressure switch setting			
Lower	psia	28.3	31.6
Upper	psia	30.3	33.5
Events (sec from liftoff)	sec		
GH2 Pressurant flowrate			
Undercontrol	lbm/sec	0.64	0.61
Overcontrol	lbm/sec	*	*
Step before cutback	lbm/sec	0.92	1.27
Step after cutback	lbm/sec	0.87	
Total GH2 added	lbm	349	357
Prepressurization initiation		-113	-113
Prepressurization termination		-95	-67
Engine Start Command		147.008	144.9
Step pressurization		447.0	445.1
Relief valve opening		**	477.9

*The overcontrol mode was not required during 204 or 205 powered flight.

**The vent/relief and/or the backup relief valves were venting continuously throughout powered flight.

TABLE 11-2
LH2 CHILLDOWN SYSTEM PERFORMANCE DATA

PARAMETER	UNITS	S-IVB-205 FLIGHT	S-IVB-204 FLIGHT
NPSP		\	
At Engine Start Command	psi	14.3	20.18
Minimum required at engine start	psi	4.53	6.3
At opening of pre valve	psi	26.45	26.54
Fuel pump inlet conditions at Engine Start Command			
Pressure	psia	32.78	39.83
Temperature	deg R	37.94	38.08
Amount of subcooling	deg R	4.01	5.40
Average flow coefficient	sec ² /in ² ft ³	16.3	17.1
Fuel quality in sections* 2 and 3	lb gas/lb mixture		
Maximum during unpressurized chilldown		0.04	0.057
Heat absorption rate during unpressurized chilldown			
Section 1*	Btu/hr	16,500	25,500
Sections 2 and 3*	Btu/hr	26,000	31,500
Total	Btu/hr	42,500	57,000
Heat absorption rate during pressurized chilldown			
Section 1	Btu/hr	14,000	27,500
Section 2	Btu/hr	29,500	27,500
Section 3	Btu/hr		
Total	Btu/hr	43,500	60,000
Chilldown flowrate			
Unpressurized	gpm	N/A	86
Pressurized	gpm	N/A	145
Chilldown pump pressure differential	psi		
Pressurized		N/A	7.8

N/A Not available

*Section 1 is tank to pump inlet; section 2 is pump inlet to bleed valve; section 3 is bleed valve to tank.

**Sections 2 and 3 could not be calculated separately.

TABLE 11-2 (Cont)

PARAMETER	UNITS	S-IVB-205 FLIGHT	S-IVB-204 FLIGHT
Events (sec from liftoff)	sec		
Chilldown initiation		-764	-598.107
Prevalve closed		-753	-582.170
Prepressurization initiation		-112.25	-112.409
Prevalve Open Command		141.960	140.269
Prevalve closed signal dropout		142.895	141.288
Prevalve open signal pickup		144.536	143.088
Delay between Prevalve Open Command and pickup of open signal		2.566	2.819
Chilldown shutoff valve closed		**	568.071
Engine Start Command		147.008	144.905

**Not closed

TABLE 11-3
LH2 PUMP INLET CONDITION DATA

PARAMETER	UNITS	S-IVB-205 FLIGHT	S-IVB-204 FLIGHT
Pump inlet conditions			
Static pressure at engine start	psia	32.8	39.8
Temperature at engine start	deg R	37.9	38.1
Temperature at engine cutoff	deg R	39.4	40.1
NPSP			
Required at engine start	psi	4.53	6.3
Available at Engine Start Command (psi)	psi	14.3	20.2
Maximum during burn	psi	14.8	22.0
Minimum during burn	psi	10.0	14.5
At Engine Cutoff Command	psi	10.0	14.5
LH2 feed duct			
At high EMR			
Pressure drop	psi	0.9	0.8
Flowrate	lbm/sec	83	76
After EMR cutback			
Pressure drop	psi	0.7	0.7
Flowrate	lbm/sec	75	72

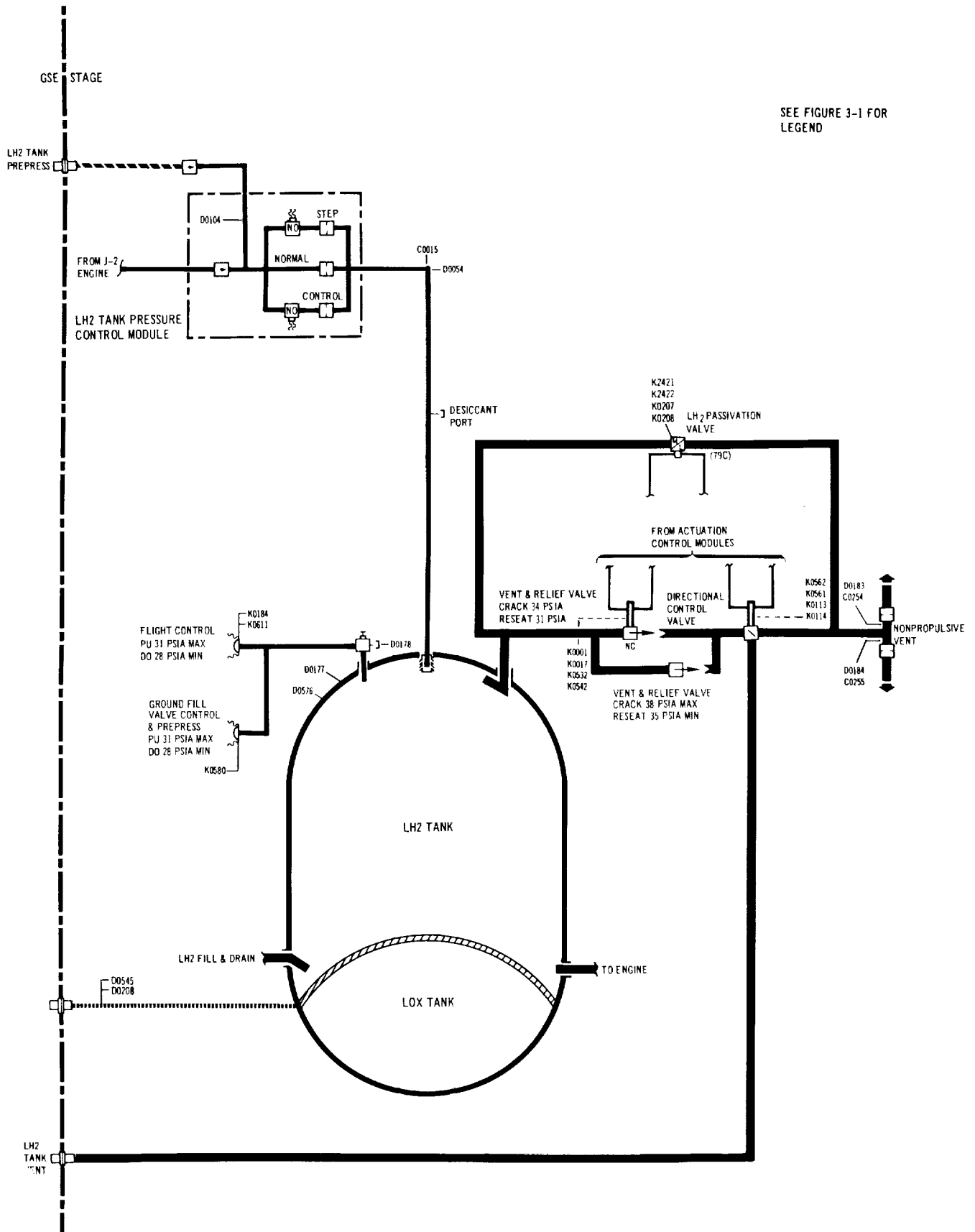

SEE FIGURE 3-1 FOR LEGEND

Figure 11-1. LH2 Tank Pressurization System

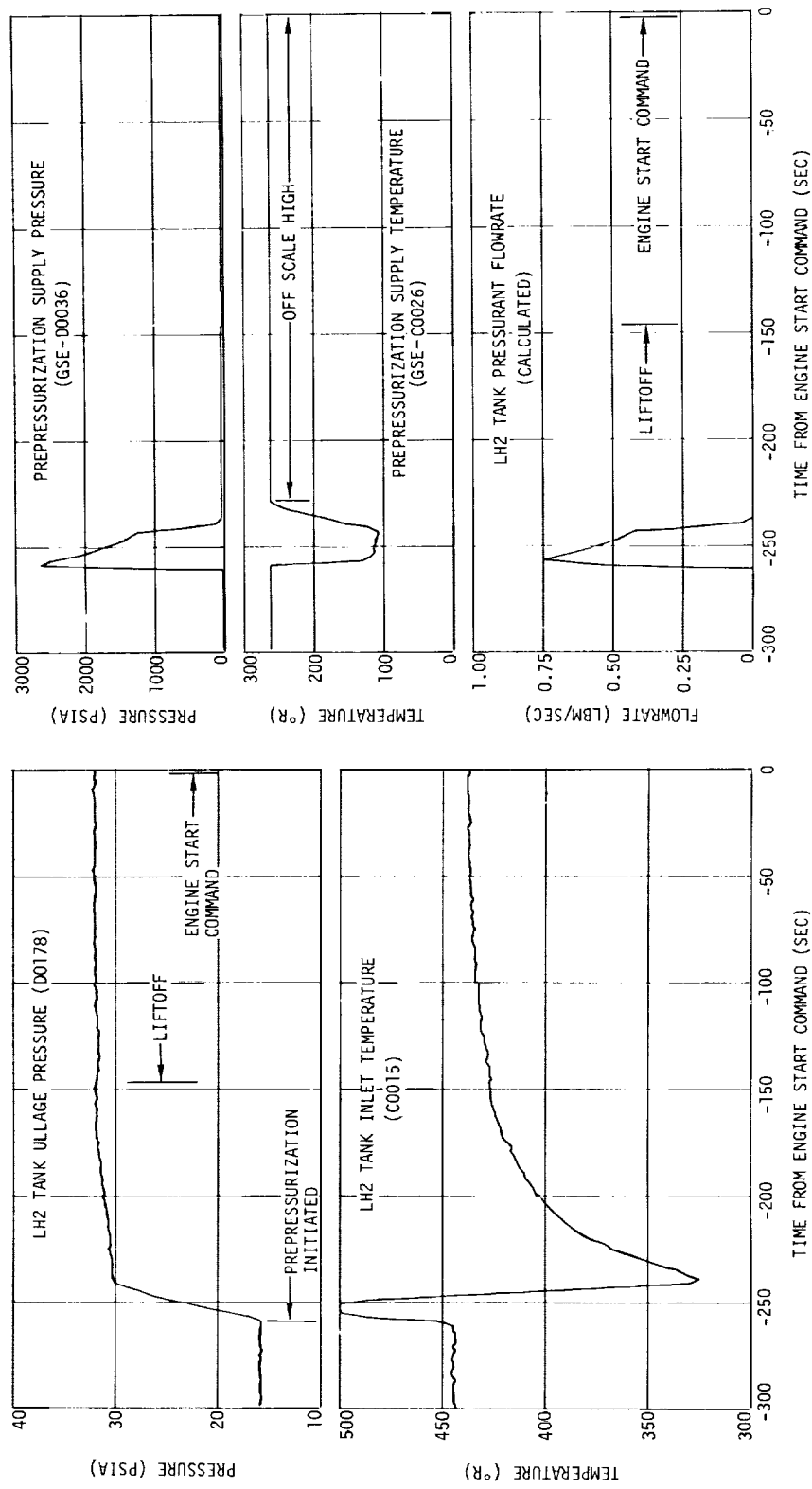

Figure 11-2. LH2 Tank Prepressurization System Performance

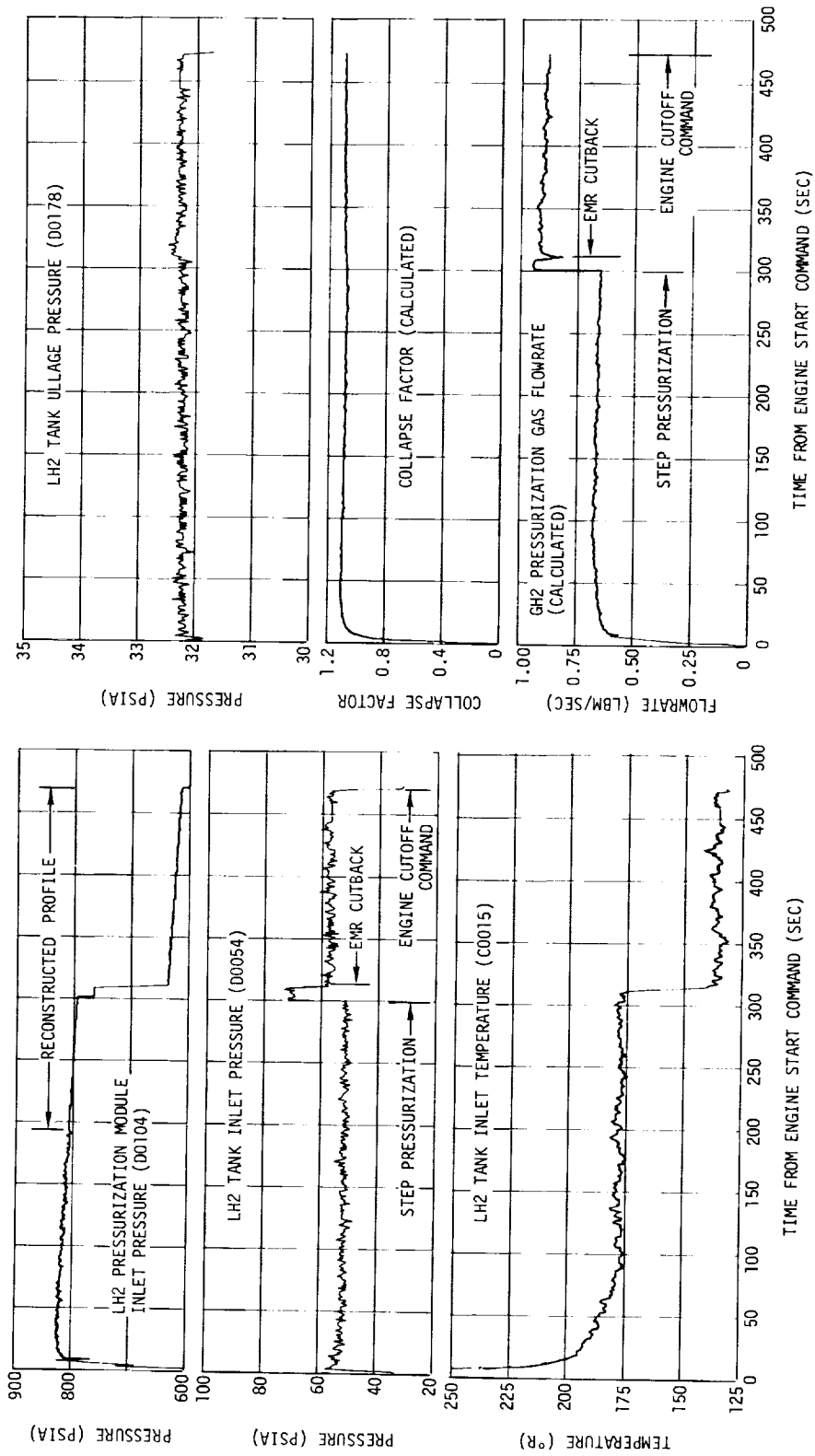

Figure 11-3. LH2 Tank Pressurization System Performance

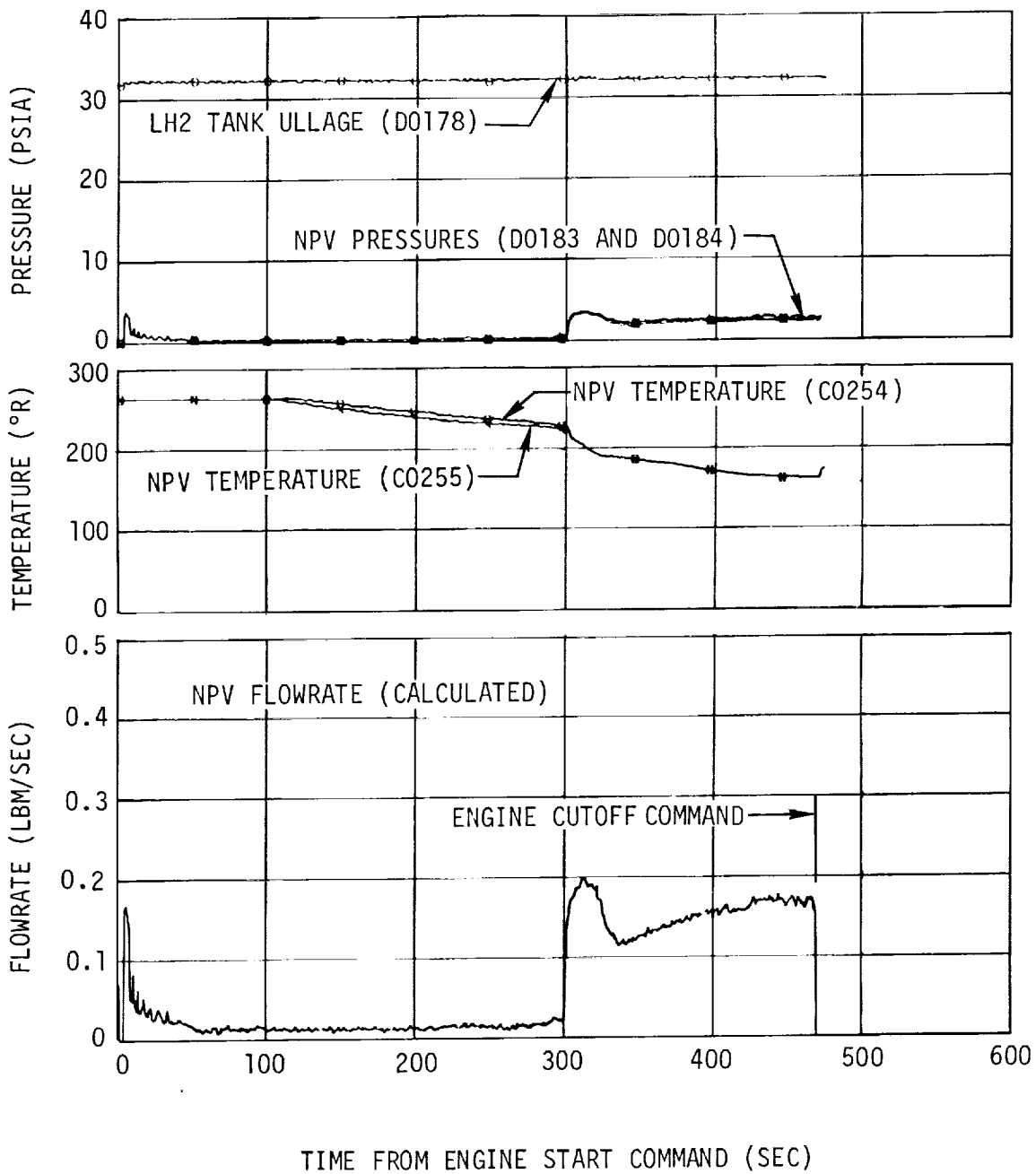

Figure 11-4. LH2 Tank Venting During Engine Operation

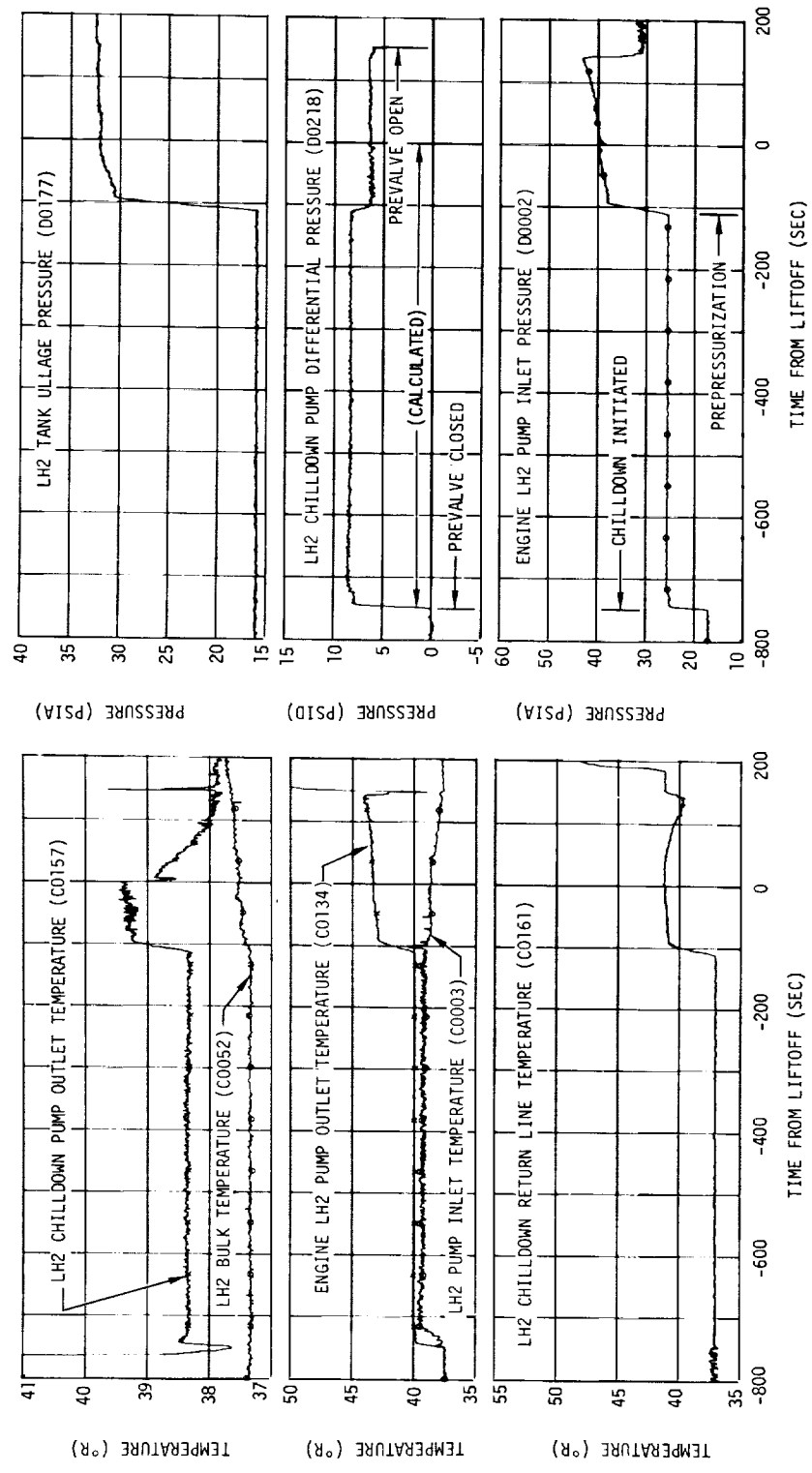

Figure 11-5. LH2 Pump Chilldown Operation

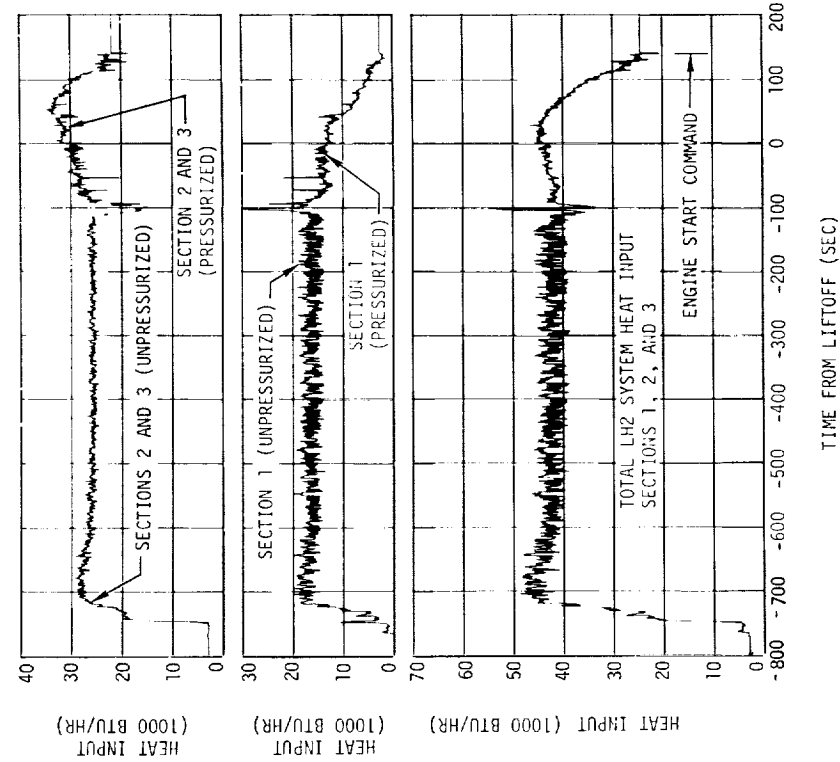
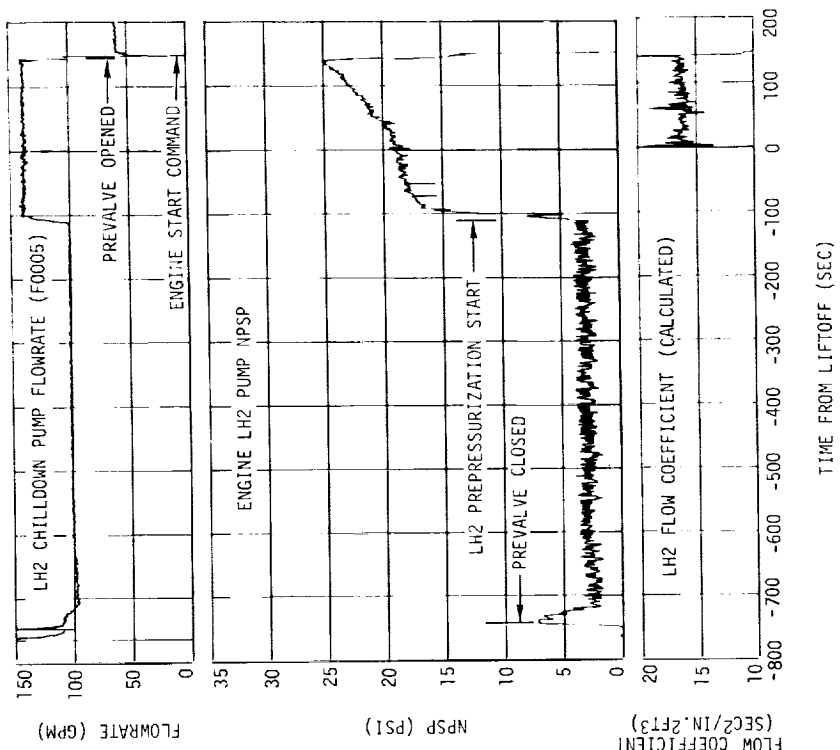

Figure 11-6. LH2 Pump Chilldown Characteristics

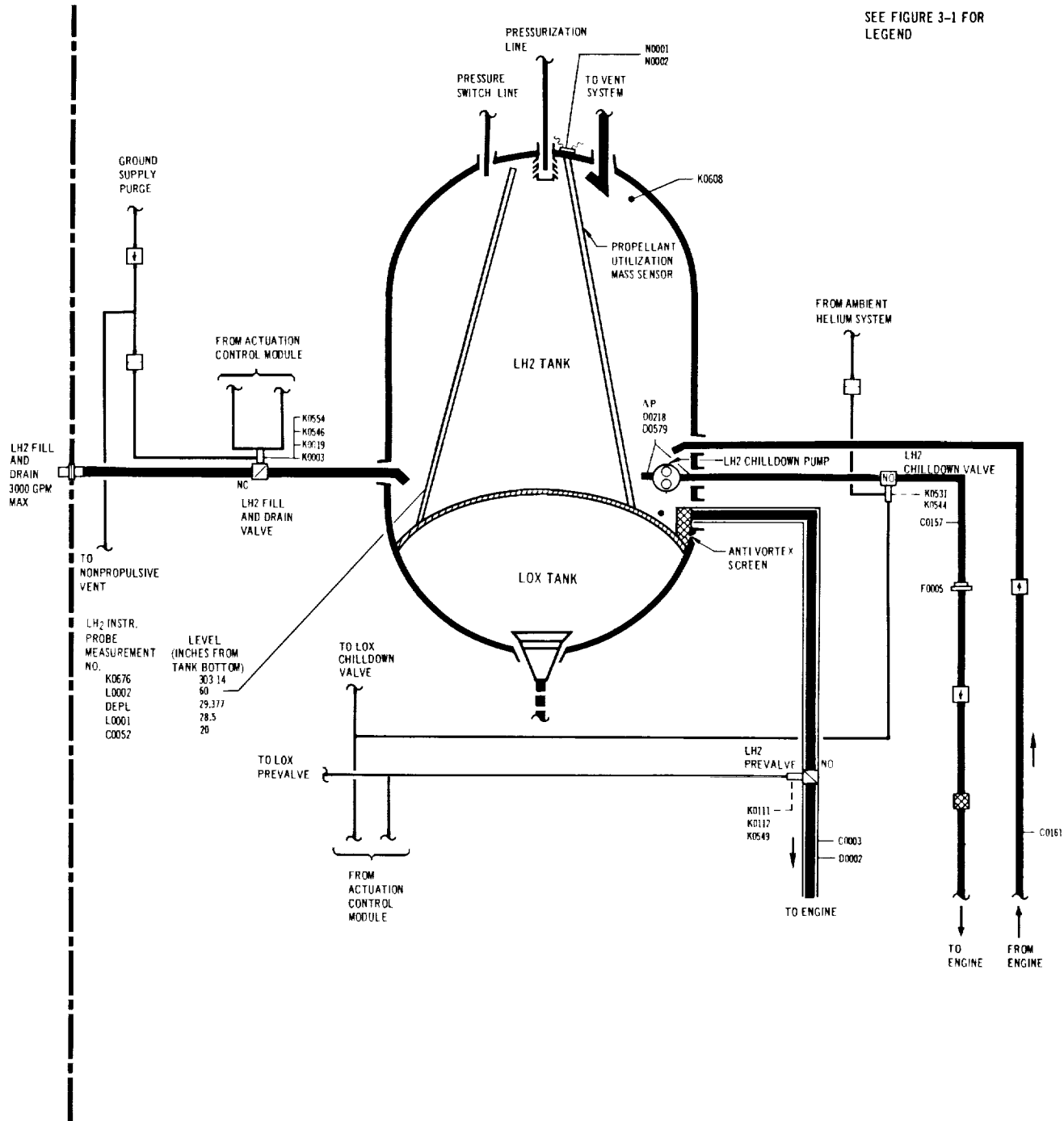

Figure 11-7. LH2 Supply System

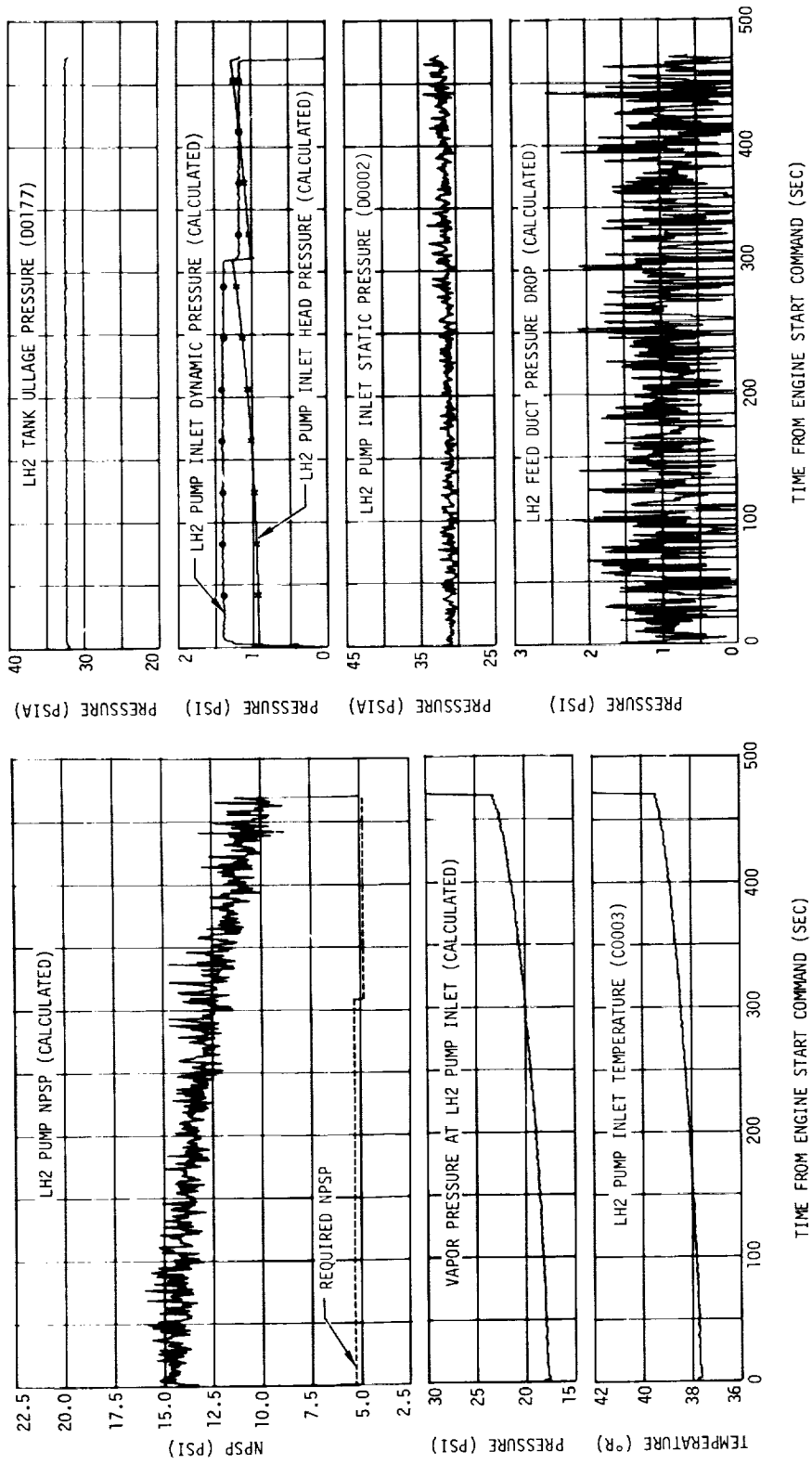

Figure 11-8. LH2 Pump Inlet Conditions

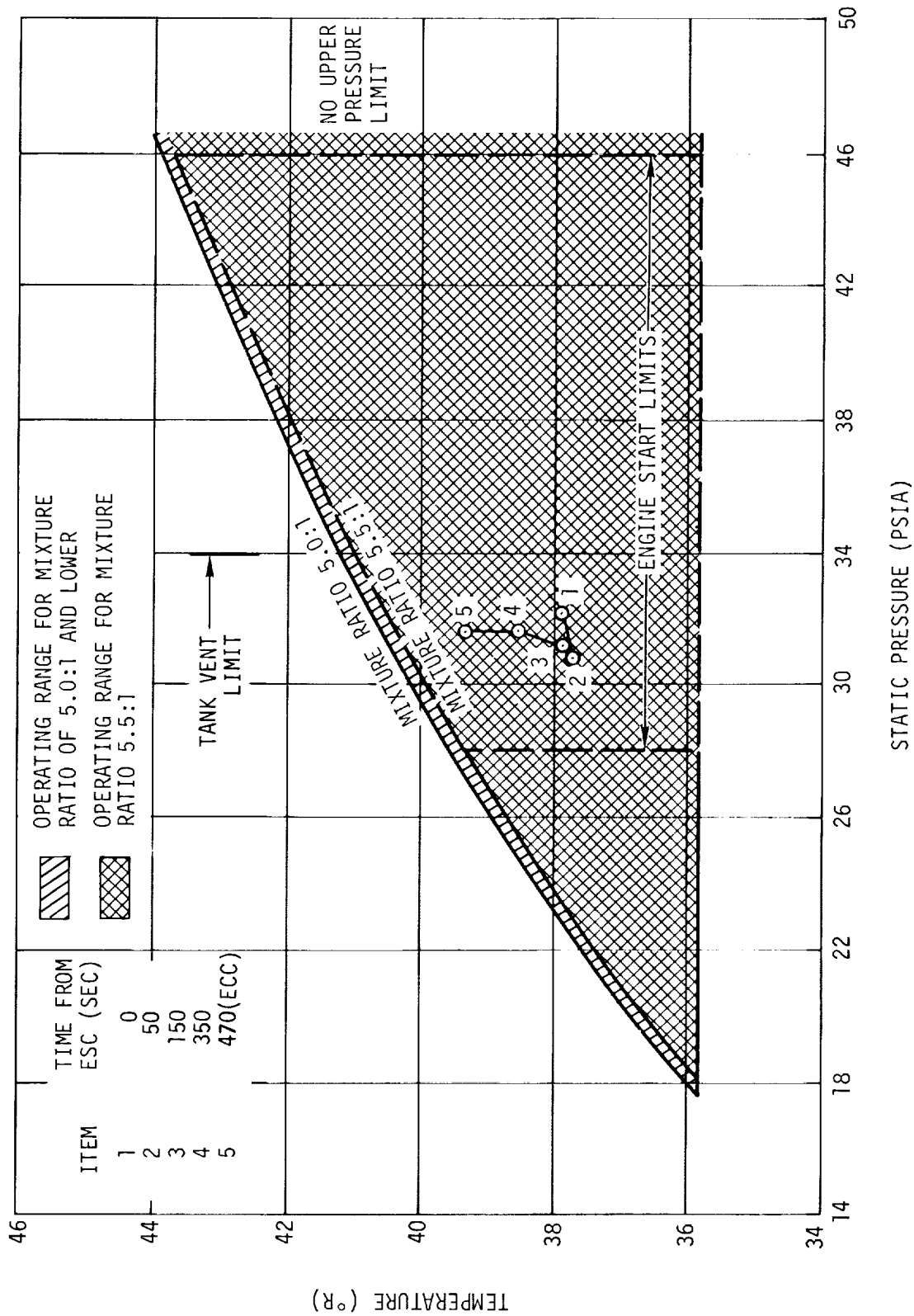

Figure 11-9. LH2 Pump Inlet Conditions During Firing

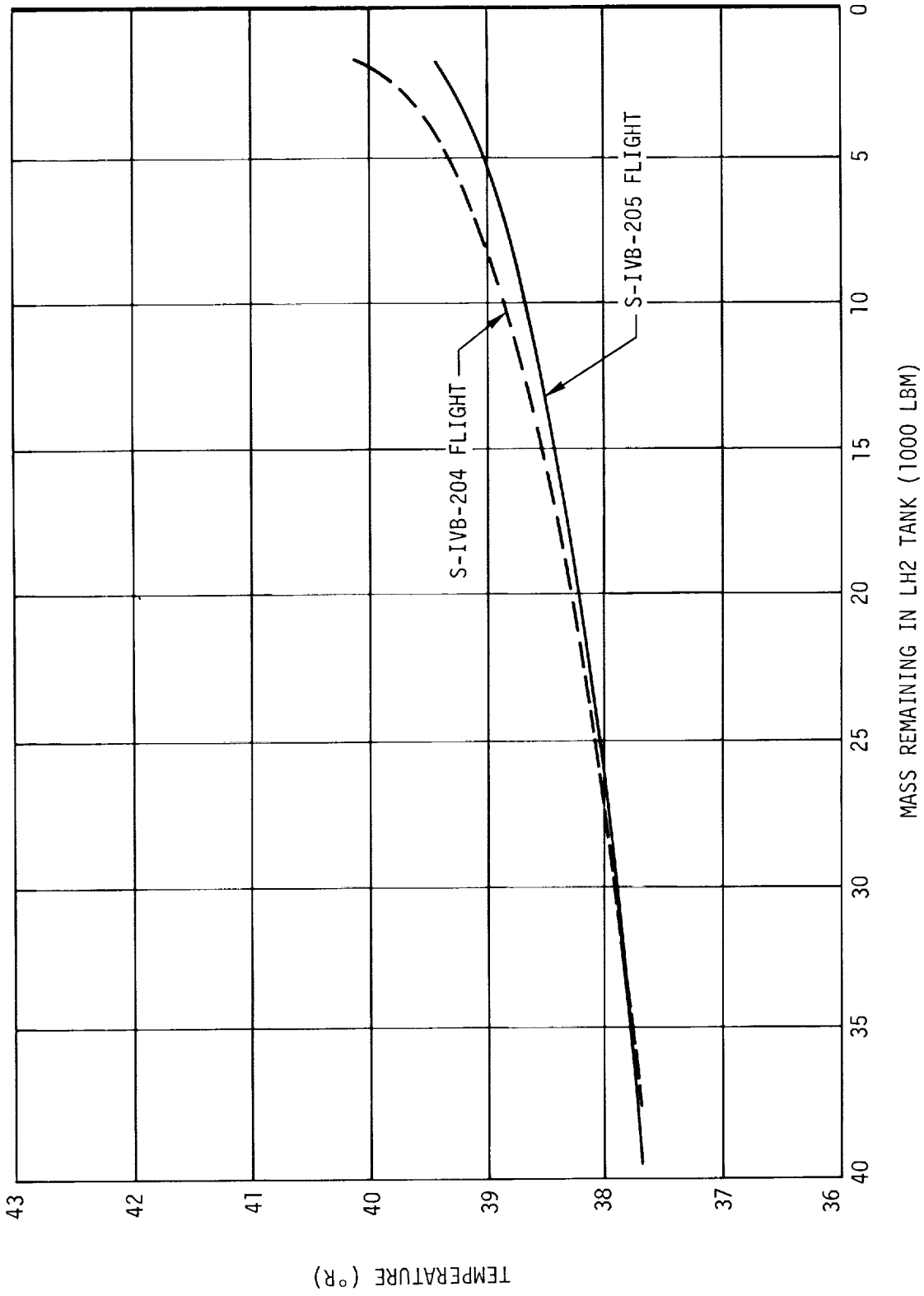

Figure 11-10. Effect of LH2 Mass Level on LH2 Pump Inlet Temperature



2



[Faint, illegible text covering the main body of the page]

SECTION 12

AUXILIARY PROPULSION SYSTEM

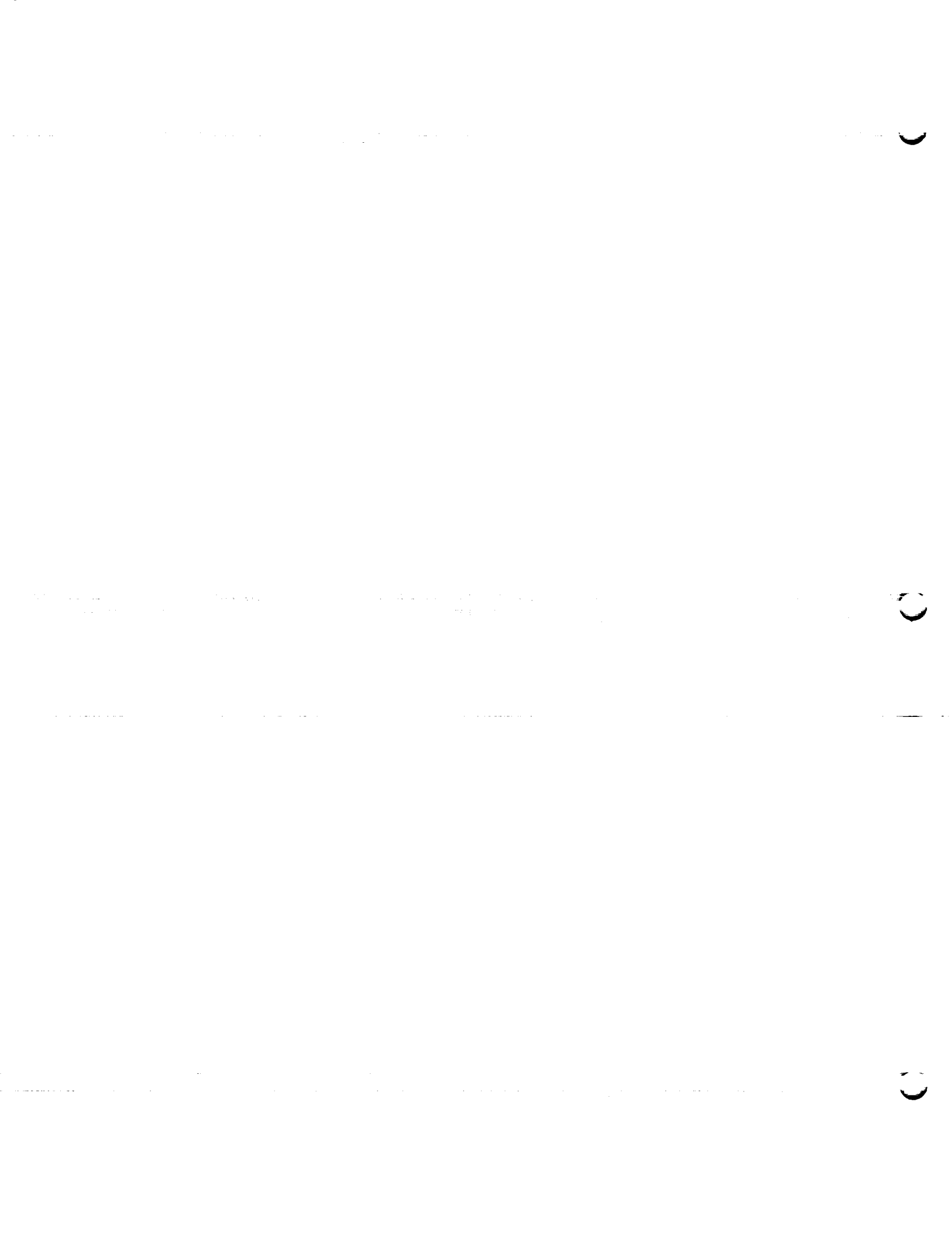

12. AUXILIARY PROPULSION SYSTEM

The auxiliary propulsion system (APS) flight data indicated that the two modules (figure 12-1) operated very well. The pulsing sequences of the six engines indicated that both modules functioned as required to perform the attitude corrections desired.

The APS supplied roll control to the vehicle during S-IVB powered flight. At S-IVB engine cutoff, the APS pitch and yaw control were activated to maintain the vehicle in the desired attitude. After this time, the two APS modules functioned to compensate for induced disturbances and to maneuver the vehicle.

12.1 Propellant and Pressurization Systems

The oxidizer systems, fuel systems, and helium pressurization systems operated normally, and no difficulties were encountered. Table 12-1 presents the initial and final propellant and helium bottle conditions for each module. This table also gives the total propellant and helium usage for each module. There appeared to be a helium leak of approximately 3 scim from module 1 during the mission. This leakage rate was well below the allowable limit of 35 scim.

Table 12-2 gives the APS propellant usage for the various mission events. The average engine mixture ratios for the mission from liftoff to RO +55,780 sec was 1.65 to 1 and 1.67 to 1 for modules 1 and 2, respectively, which agrees well with the expected nominal of 1.65 to 1.

The APS propellant quantities remaining and the propellant temperatures are presented as a function of mission time in figure 12-2. Propellant depletion occurred in both modules sometime between Redstone orbit 10 (RO +57,410 sec) and Canary orbit 11 (RO +58,780 sec). The exact time of depletion is not known because of lack of station coverage in this time interval.

The APS propellant temperatures ranged from 499 to 562 deg R, well within the allowable limits of 480 to 585 deg R.

The helium regulator outlet pressures were as expected throughout the mission, ranging from 193 to 198 psia once the pressure decreased from the sea level referenced regulator pressure to the altitude referenced pressure. The desired range is 196 \pm 3 psia.

12.2 Engine Performance

The sum of the total impulse of each module is presented as a function of mission time in figure 12-3. This figure only extends to RO +28,600 sec because of the scarcity of data beyond this point. The average specific impulses of modules 1 and 2 were 215 and 218 sec, respectively, for this portion of the mission, which agrees well with the 213 sec expected for minimum pulsing operation.

The APS engine operation was satisfactory. The chamber pressures ranged from 90 to 100 psia. These values were obtained mainly from 0.065 sec pulses which were sampled every 0.008 sec with straight lines drawn between the sample points to simulate an analog trace. Because of the method, it was impossible to obtain accurate readings on short pulses. Engine No. 1 in

module 2 was consistently lower than the other engines, ranging from 90 to 95 psia. None of the engines had any apparent chamber pressure decay during the mission. The chamber pressure values recorded were in accord with the propellant manifold pressures which ranged from 190 to 196 psia.

Figure 12-4 shows that the engine performance agreed closely with the engine manufacturer's test data obtained at simulated altitude conditions. The variation from the TRW two-sigma variation can be attributed to the methods used in determining the performance. The pulse width was determined from the time that chamber pressure increases to 10 psia until it drops to 10 psia. Since AS-205 was an operational vehicle, the engine chamber pressures were sampled at 120 sps. Therefore, an accurate pulse width could not be obtained. The pulse width determined by this method could be longer than actual, and the resulting thrust value obtained by dividing the impulse by pulse width would be lower than actual. This is also responsible for the indication of low total impulse at pulse widths of about 0.085 sec. These pulses were probably minimum pulses of only 0.060 sec duration which would make the total impulse per pulse agree with the TRW two-sigma values.

TABLE 12-1
APS LIFTOFF AND FINAL CONDITIONS

PARAMETER	UNITS	MODULE 1			MODULE 2		
		INITIAL	RO +55,780 (sec)	RO +58,800 (sec)	INITIAL	RO +55,780 (sec)	RO +58,800 (sec)
<u>Oxidizer</u>							
Bellow height	in.	9.90	1.55	0	9.80	3.05	0
Temperature	°R	556	564	--	543	500	--
Mass	lbm	39.0	6.1	0	39.2	12.2	0
Usage	lbm	--	32.9	39.0	--	27.0	39.2
<u>Fuel</u>							
Bellow height	in.	9.90	1.60	0	9.80	3.05	0
Temperature	°R	552	560	--	540	500	--
Mass	lbm	23.9	3.9	0	23.8	7.6	0
Usage	lbm	--	20.0	23.9	--	16.2	23.8
<u>Helium</u>							
Pressure	psia	3,110	1,900	1,690	3,130	2,010	1,570
Temperature	°R	555	567	567	543	500	493
Mass	lbm	0.3035	0.1901	0.1691	0.3122	0.2238	0.1773
Usage*	lbm	--	0.1134	0.1344	--	0.0884	0.1349
Usage**	lbm	--	0.0975	0.1159	--	0.0885	0.1305

*Usage calculated by change in helium sphere conditions.

**Usage calculated by change of ullage volume.

TABLE 12-2
PROPELLANT USAGE

EVENTS	MODULE NO. 1				MODULE NO. 2			
	OXIDIZER USED		FUEL USED		OXIDIZER USED		FUEL USED	
	lbm	%	lbm	%	lbm	%	lbm	%
Roll control during S-IVB powered flight	1.1	2.8	0.7	2.9	1.2	3.1	0.7	2.9
Coast period from end of powered flight until start of LOX dump	3.2	8.2	2.0	8.4	2.0	5.1	1.3	5.4
LOX dump	1.6	4.1	1.0	4.2	0.8	2.0	0.5	2.1
Coast period from LOX dump to start of manual control	0.8	2.1	0.5	2.1	0.1	0.3	0.1	0.4
Astronaut manual control	3.5	9.0	2.1	8.8	3.5	8.9	2.2	9.2
Coast period from manual control thru retrograde	5.4	13.8	3.2	13.4	4.4	11.2	2.7	11.3
Coast period from the end of retrograde to RO +55,780	17.3	44.4	10.5	43.9	15.0	38.2	8.7	36.4
TOTAL	32.9	84.4	20.0	83.7	27.0	68.8	16.2	67.7

Average EMR module 1 = 1.65

Average EMR module 2 = 1.67

Note: All the propellant was depleted by RO +58,800 sec. This was at Canary Island during eleventh orbit.

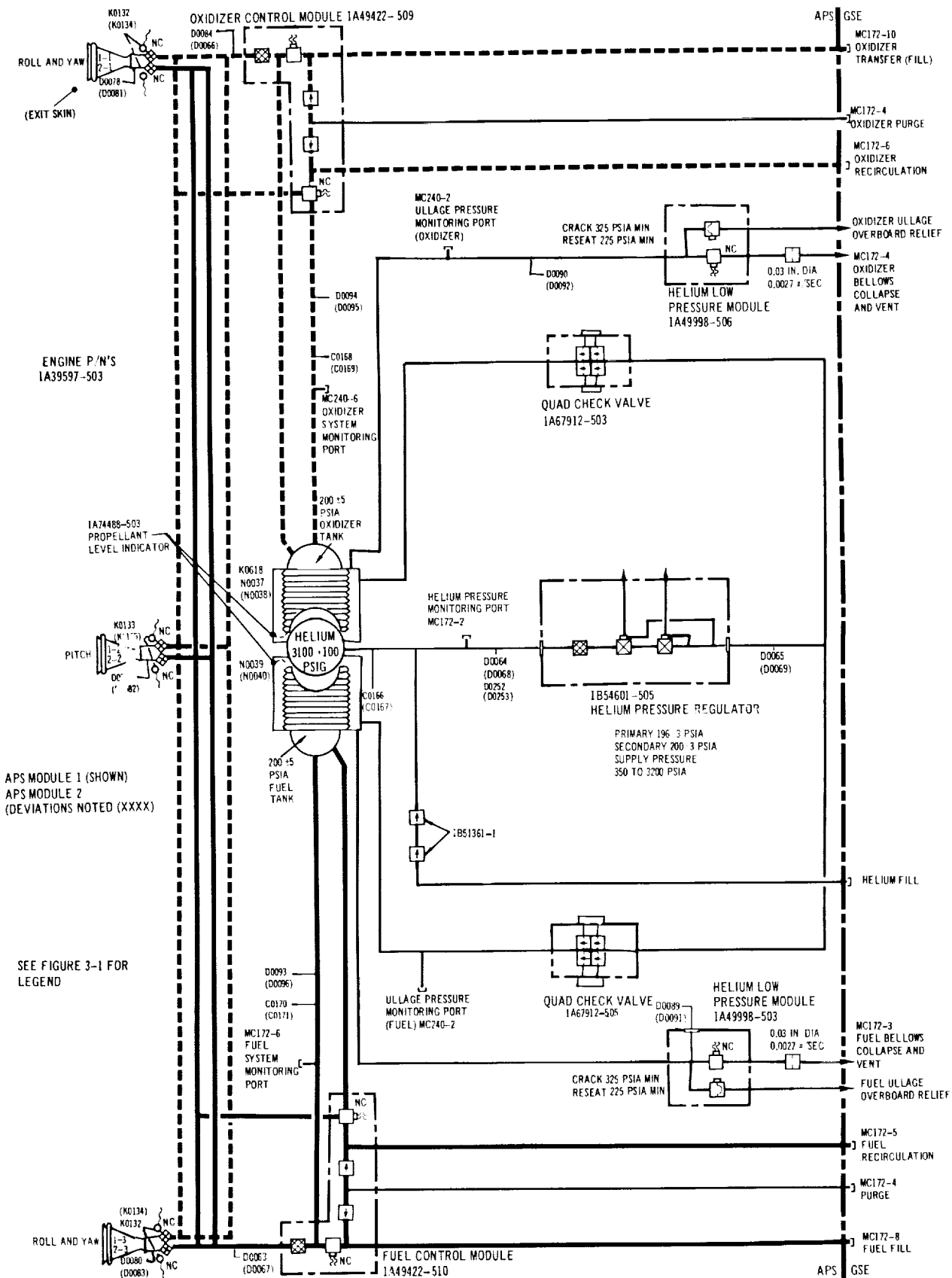

Figure 12-1. Auxiliary Propulsion System and Instrumentation

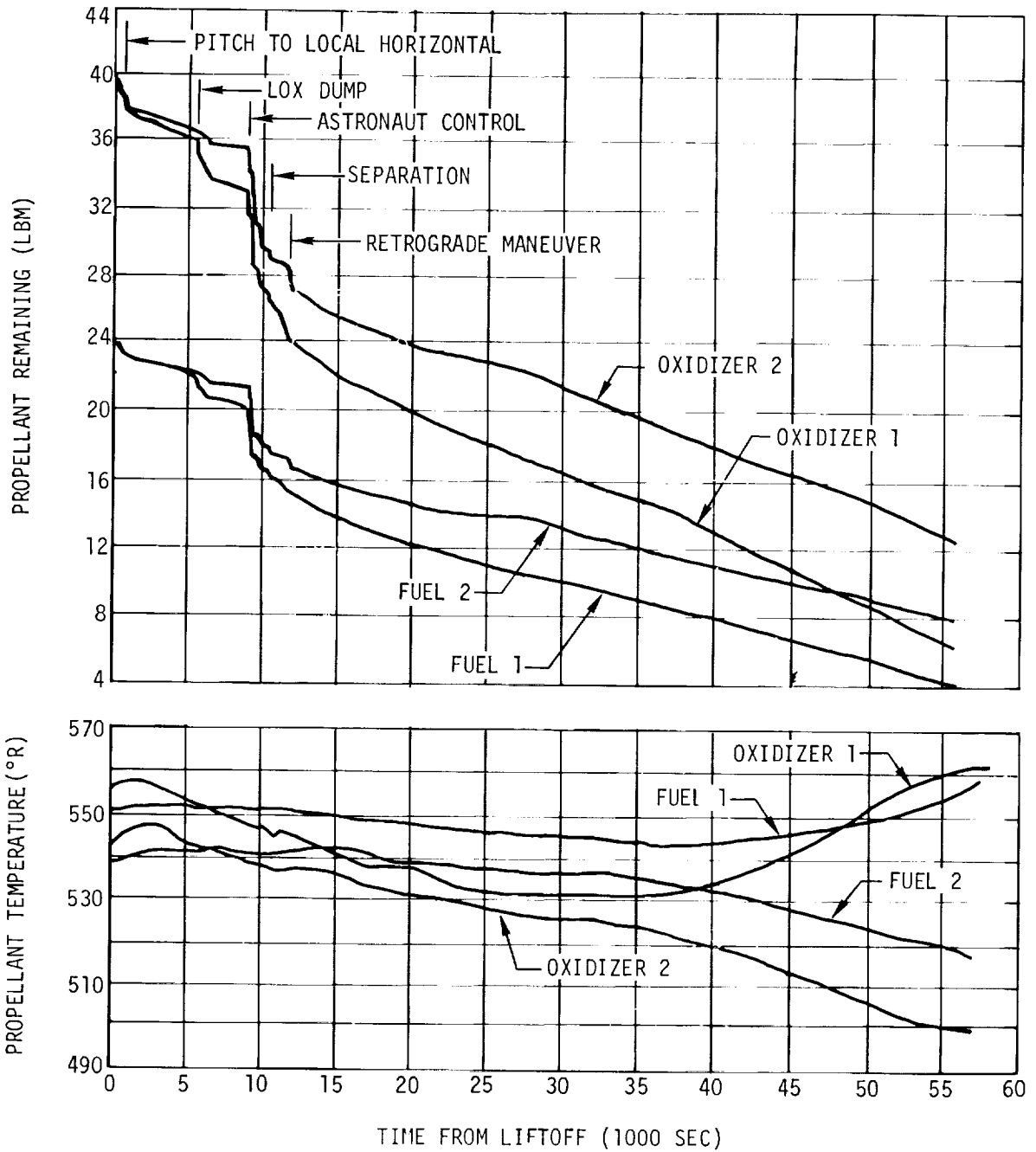

Figure 12-2. APS Propellant Conditions

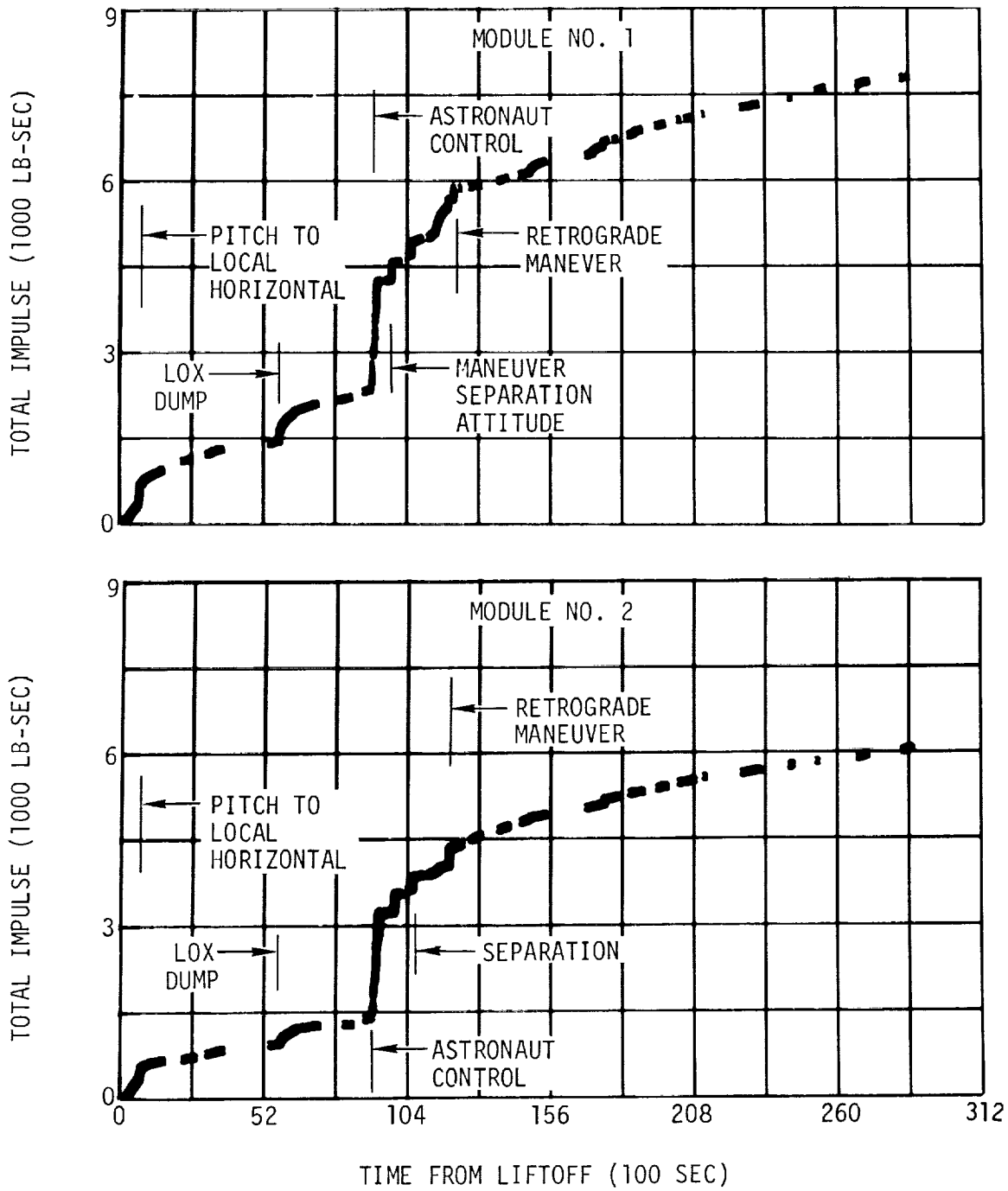

Figure 12-3. APS Total Impulse

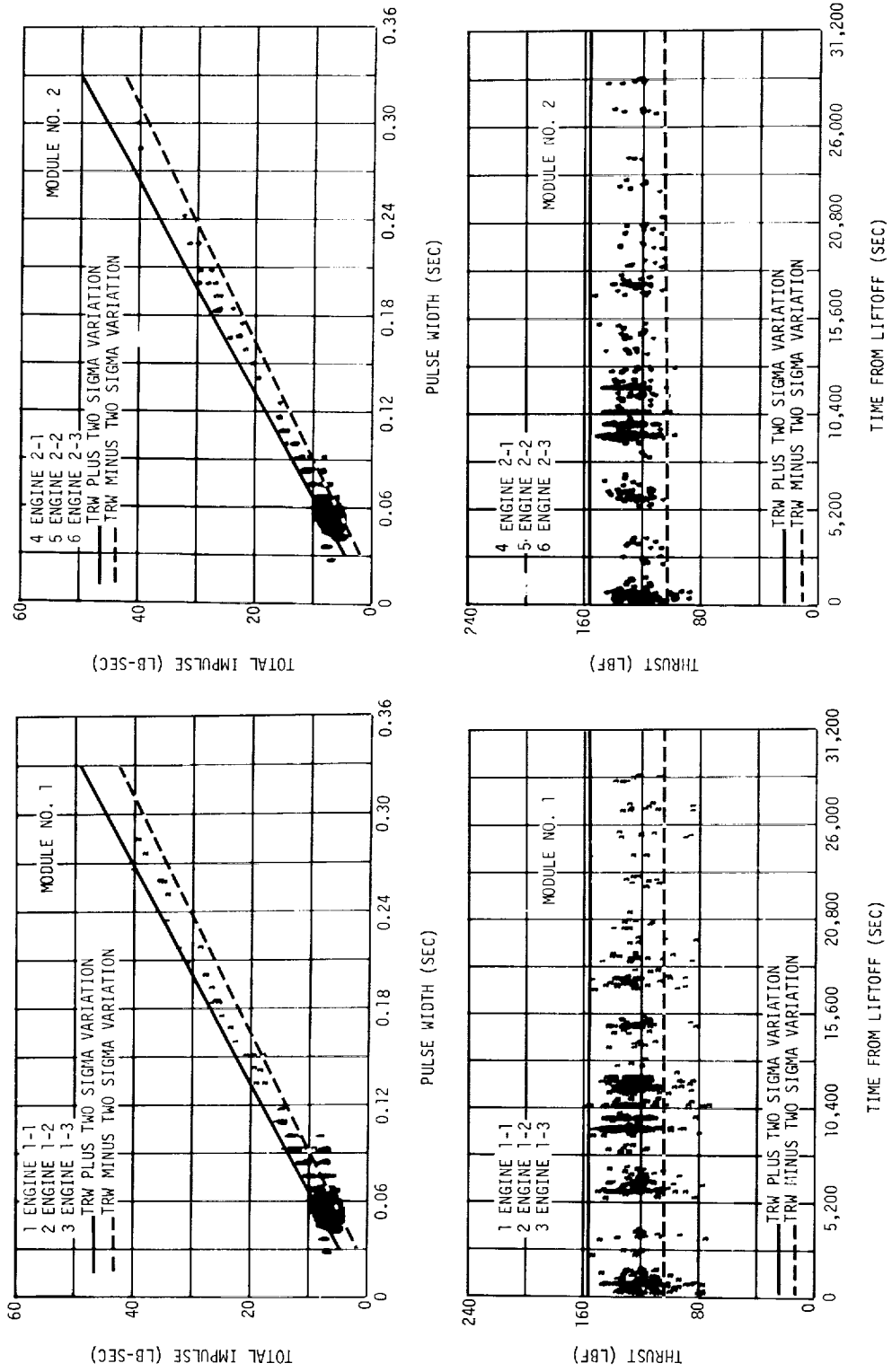

Figure 12-4. APS Engine Performance





SECTION 13

PNEUMATIC CONTROL AND PURGE SYSTEM



13. PNEUMATIC CONTROL AND PURGE SYSTEM

The pneumatic control and purge system (figure 13-1) performed satisfactorily throughout the flight. The helium supply to the system was adequate for both pneumatic valve control and purging; the regulated pressure was maintained within acceptable limits; and all components functioned normally.

Ambient helium sphere conditions at significant times during boost and powered flight are shown in table 13-1. Pneumatic control system data during prelaunch, boost, and burn periods are shown in figure 13-2. Pneumatic helium usage during orbit is discussed in section 22.

All stage and GSE purges were satisfactorily accomplished throughout the countdown.

TABLE 13-1
PNEUMATIC CONTROL AND PURGE SYSTEM DATA

PARAMETER	UNITS	S-IVB-205 FLIGHT	S-IVB-204 FLIGHT	S-IVB-203 FLIGHT
Sphere volume	cu ft	4.5	4.5	4.5
Sphere pressure				
At liftoff	psia	3,067	3,032	3,113
At Engine Start Command	psia	3,068	3,011	3,089
At Engine Cutoff Command	psia	3,090	3,040	3,087
Sphere temperature				
At liftoff	deg R	N/A	459	492
At Engine Start Command	deg R	N/A	456	490
At Engine Cutoff Command	deg R	N/A	461	490
Helium mass				
At liftoff	lbm	N/A	9.90	9.56
At Engine Start Command	lbm	N/A	9.90	9.49
At Engine Cutoff Command	lbm	N/A	9.90	9.47
Usage during engine operation	lbm	N/A	0	0.02
Regulator outlet pressure				
Maintained pressure band	psia	525 to 565	530 to 565	535 to 540
Minimum system pressure during start and cutoff transient	psia	401	409	410
Average LOX chilldown motor container purge pressure	psia	55	63	52

N/A = Not available. Sphere temperature measurements have been removed from the S-IVB-205 and subsequent stages.

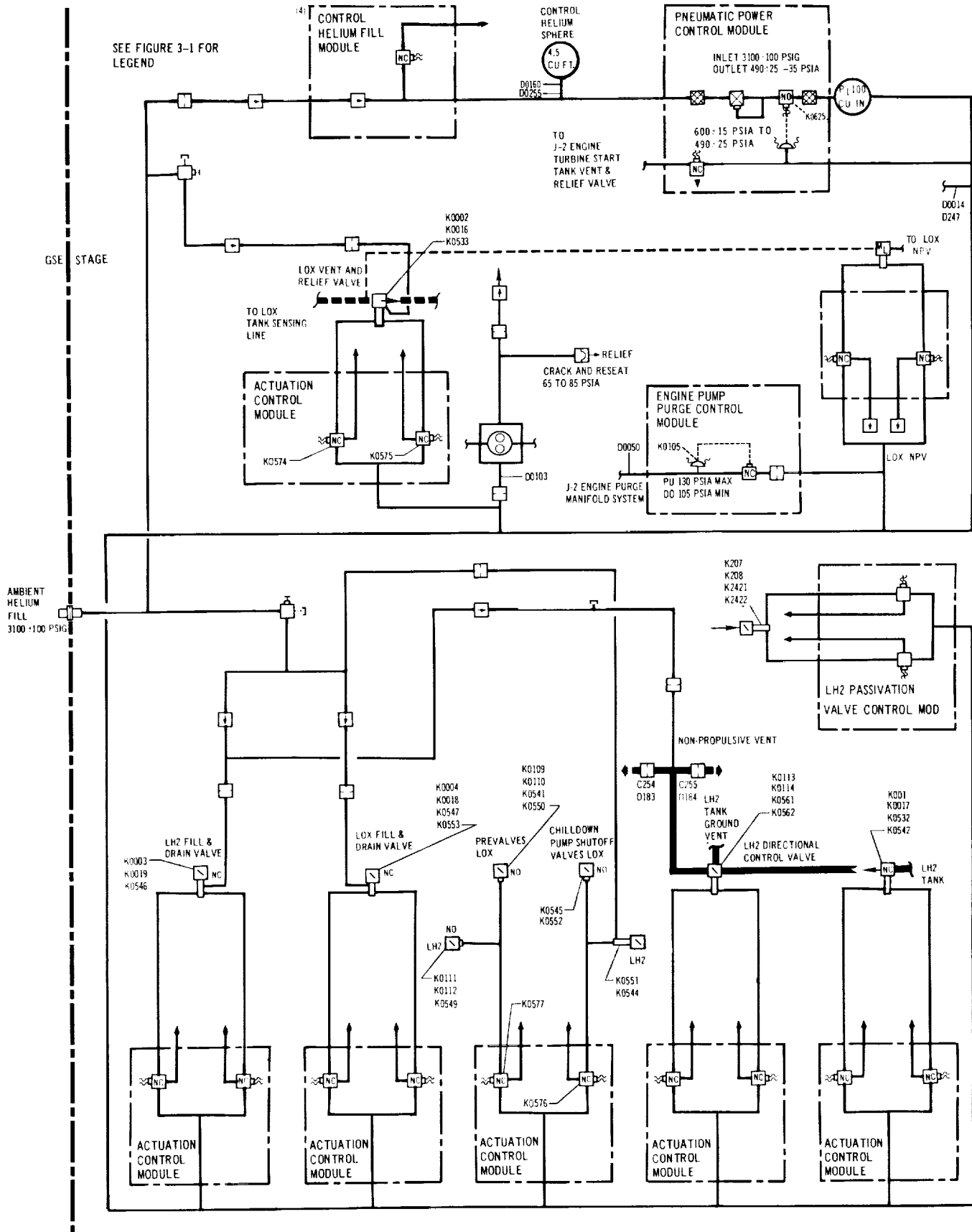

Figure 13-1. Pneumatic Control and Purge System

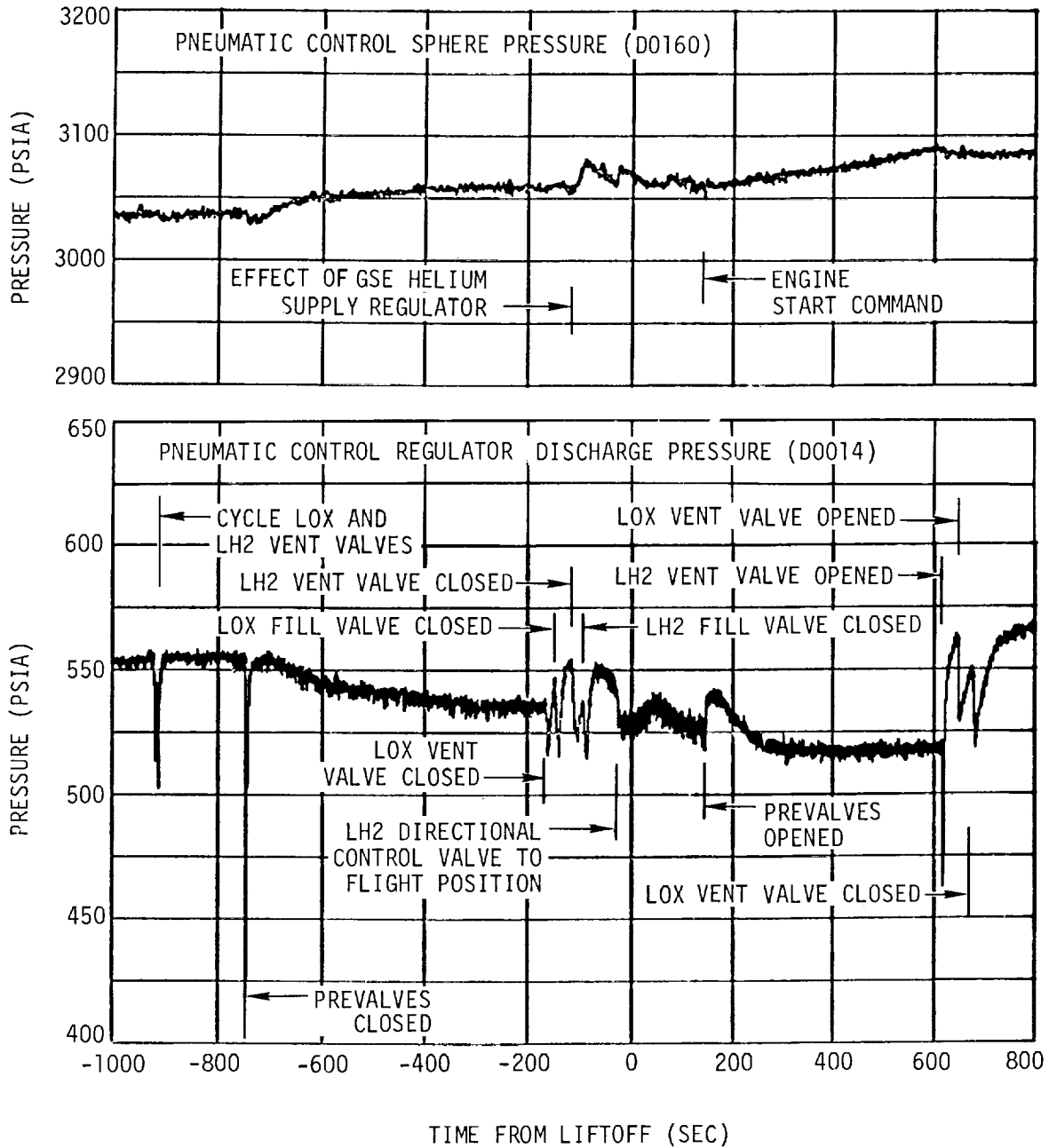

Figure 13-2. Pneumatic Control and Purge System Performance



SECTION 14

PROPELLANT UTILIZATION



1. The first part of the document discusses the importance of maintaining accurate records of all transactions.

2. It also highlights the need for regular audits to ensure compliance with financial regulations.

3. Furthermore, the document emphasizes the role of technology in streamlining financial processes.

4. Finally, it concludes by stating that transparency and accountability are essential for long-term success.



5. The second section of the document focuses on the challenges faced by small businesses in the current market.

6. It identifies key factors such as inflation and supply chain disruptions as major obstacles.

7. The document also discusses various strategies that businesses can adopt to overcome these challenges.

8. Additionally, it provides insights into how government support and industry collaboration can be beneficial.



9. The final part of the document offers a comprehensive overview of the current economic landscape.

10. It includes a detailed analysis of market trends and forecasts for the coming year.

11. The document also provides a list of resources and contacts for further information.

12. In conclusion, the document serves as a valuable guide for anyone looking to navigate the complexities of the modern business environment.



14. PROPELLANT UTILIZATION

The propellant utilization (PU) system successfully met the loading accuracy requirements of the stage and satisfactorily accomplished propellant management during engine burn. The best estimate propellant mass values at liftoff were 193,360 lbm LOX and 39,909 lbm LH2. These values are well within the required ± 1.12 percent stage loading accuracy.

The total propellant residuals at Engine Cutoff Command (ECC) were 1,581 lbm LOX and 2,492 lbm LH2. The usable masses at Engine Cutoff Command were 1,732 lbm LH2 and 1,063 lbm LOX. By extrapolating, to depletion cutoff at propellant flowrates of 74.5 lbm/sec LH2 and 332 lbm/sec LOX, depletion cutoff would have occurred 3.2 sec after Engine Cutoff Command with a usable LH2 residual of 1,494 lbm. The higher LH2 residual is due to the open loop mode of PU system operation and the 1,040 lbm LH2 bias load to insure LOX depletion.

The PU system was operated inflight in the open loop mode. The PU valve operation was controlled in response to launch vehicle digital computer (LVDC) issued commands. The PU valve was positioned at null during engine start and remained there until the PU MR 5.5 ON Command was issued at RO +152.976 sec. Following receipt of this command, the mixture ratio valve moved to the LOX rich stop until the PU MR 5.5 OFF Command was received at RO +455.591 sec. At RO +455.783 sec, the PU MR 4.5 ON Command was received followed by a corresponding valve motion to the low EMR stop where it remained until engine cutoff. Since the source of these commands were LVDC originated, the difference between actual and predicted time was less than 50 ms.

14.1 PU Mass Sensor Calibration

The preflight propellant masses at the full point calibration points were determined from the S-IVB-205 acceptance firing full load data. The acceptance firing full load masses were determined by the flow integral analysis method. The capacitance values corresponding to the full load masses were actual measured test data.

The propellant masses at the lower calibration point were computed from unique tank volumes and predicted propellant density data. The corresponding capacitance values were determined from the fast drain data obtained during the S-IVB stage acceptance firing.

The following table presents a summary of the PU mass sensor calibration data:

SENSOR	FULL POINT		EMPTY POINT	
	MASS (lbm)	CAPACITANCE (pf)	MASS (lbm)	CAPACITANCE (pf)
LOX	189,957	409.55	1,270	282.06
LH2	36,344	1,152.24	206	974.55

14.2 Propellant Mass History

The predicted, measured, and best estimate propellant masses at significant flight events are presented in table 14-1. The best estimate propellant masses are derived by subtracting nonpropellants (dry stage, ullage gases, etc.) from the AS-205 second stage best estimate masses presented in section 7. The remaining propellant mass is then divided into LOX and LH2 according to the prevailing mixture ratio at the specific flight event time.

The propellant mass measurement systems represented in table 14-1 are:

- a. PU indicated,
- b. PU indicated-corrected,
- c. PU volumetric,
- d. Flight flow integral,
- e. Trajectory reconstruction.

A brief description of each measurement system is as follows:

- a. The PU indicated method measures propellant mass from the raw PU probe output which is reduced according to the preflight flow integral calibration slope.
- b. The PU indicated corrected method is constituted in a manner similar to item (a) above but it also includes adjustments for acceptance firing flow integral non-linearity and PU flight dynamics effects.
- c. The PU volumetric masses are derived from raw PU probe output data which are reduced according to volumetric calibration slopes and adjusted for flight dynamics effects and volumetric tank to sensor mismatch. The calibration slopes (lbm/pf) were computed from the capacitance-propellant mass relationships at the upper and lower probe active element extremities. Propellant masses at the extremities were calculated from unique tank volume determined from tank measurements and propellant density.
- d. The flight flow integral method consists of determining the LOX and LH2 mass flow-rates and integrating as a function of time to obtain total consumed propellant masses during engine burn. The flow integral propellant masses at Engine Start Command (ESC) are determined by adding propellant at Engine Cutoff Command to the total propellant consumed by the engine, the fuel pressurant added to the ullage, and the propellant lost to boiloff.
- e. The trajectory reconstruction method determines vehicle mass changes from thrust/acceleration relationships.

The results of the five methods of propellant mass evaluation are presented in table 14-1.

The best estimate total propellant mass at liftoff was 233,269 lbm which is 349 lbm greater than desired. Both LOX and LH2 masses were well within the guaranteed loading accuracy of ± 1.12 percent. The liftoff mass, as determined by each individual in measurement system compared to the best estimate, is within the accuracy constraints for each system.

The best estimate total propellant mass at Engine Cutoff Command is 4,073 lbm which is 306 lbm greater than predicted. No significant differences exist in total propellant consumption between measurement systems: The best estimate total consumption is 229,166 lbm which is 13 lbm greater than predicted.

14.2.1 Propellant Loading

Propellant loading was accomplished automatically by the loading computer. Table 14-1 presents a tabulation of the LOX, LH2, and total propellant mass at liftoff. The desired and best estimate values are shown in addition to the mass values determined by the various measurement systems. The deviation of each value from the best estimate is also shown.

The loading computer values at liftoff were 0.01 percent for LOX and 0.13 percent for LH2 which were well within the 0.5 percent loading computer accuracy.

The postflight best estimate total propellant liftoff mass was 233,269 lbm which is 319 lbm greater than desired; the LOX mass was 193,360 lbm which is 87 lbm less than desired; the LH2 mass was 39,909 lbm which was 262 lbm less than desired.

Both LOX and LH2 were within the required loading accuracy of ± 1.12 percent.

14.2.2 Propellant Residuals

The Propellant residuals were computed at Engine Cutoff Command by means of the residual point level sensors and the PU mass sensors. Two level sensors were activated in the LOX tank during the engine burn and were used for residual computation (level sensors L0004 and L0005).

Because of the high cutoff residual in the LH2 tank the residual level sensors did not activate; therefore, the residual was determined from the PU mass probe only.

The LOX tank point level sensor residuals were generated using the engine consumption data to extrapolate from each level sensor activation to Engine Cutoff Command. An average level sensor residual was computed from the two level sensors in the LOX tank. The final LOX propellant residual mass at engine cutoff is the weighted average of the level sensor and PU mass sensor residuals. This value is considered the most accurate determination of propellant residuals.

Table 14-2 summarizes the propellant residual data determined by the PU mass sensor and point level sensors.

Total masses at Engine Cutoff Command were 1,581 lbm LOX and 2,492 lbm LH2. These total masses include unusable masses of 518 lbm LOX and 760 lbm LH2. The usable masses at Engine Cutoff Command were 1,063 lbm LOX and 1,732 lbm LH2. By extrapolating to depletion cutoff at

propellant flowrates of 332 lbm/sec LOX and 74.5 lbm/sec LH2, LOX depletion would occur 3.2 sec after Engine Cutoff Command with a propellant residual of 559 lbm LOX and 2,254 lbm LH2.

The following table presents the deviations that effected the difference in residuals between best estimate and predicted.

	<u>LOX (lbm)</u>	<u>LH2 (lbm)</u>
Loading deviation (PU indicated minus predicted)	117	64
Mass capacitance deviations at liftoff (Best estimate minus PU indicated)	-30	198
Flowrate deviations (Consumed predicted minus consumed best estimate)	152	231
Unexplained	<u>-30</u>	<u>0</u>
Total at ECC (Best estimate minus predicted)	209	493

14.2.3 PU Efficiency

The open loop PU efficiency was found to be 99.8 percent, and is based on utilizing the extrapolated flowrate and usable LH2 residual less bias of section 14.2.2.

14.2.4 Total PU Volumetric Method Mass Sensor Flight Corrections

Figures 14-1 and 14-2 present a comparison of the predicted and postflight evaluation total correction to the indicated propellant mass, as determined by the PU volumetric method, for the LOX and LH2 mass sensors. The total predicted mass correction is the sum of the predicted effects due to cg offset, changing tank shape inflight, volumetric tank-to-sensor mismatch, and the difference in preflight flow integral and volumetric calibration slopes. The postflight correction for the LOX mass sensor includes the actual correction due to the above effects in addition to a linear correction due to an empty capacitance deviation from predicted. Due to the relatively small LOX residual at Engine Cutoff Command, the LOX level went below the lower sensor extremity subsequent to cutoff. The data then exhibits normal increasing mass associated with 0 g. The capacitance (empty capacitance) when the total LOX probe was exposed to ullage gas was 0.19 pf less than predicted based on acceptance firing data. A cursory evaluation of the ullage conditions between the acceptance firing and flight do not account for this difference in empty capacitance values. The measured flight empty capacitance value requires a 293 lbm adjustment to the indicated mass at the bottom of the probe; this adjustment diminishes to zero correction at the top of the probe. The actual LH2 correction data is in very good agreement with the predicted. The deviation between the predicted and actual LOX correction is caused primarily by the empty capacitance shift.

14.2.5 PU Nonlinearity Analysis

A comparison of the predicted and actual LOX and LH2 mass sensor nonlinearities as determined by the flow integral method is presented in figures 14-3 and 14-4. The predicted flow integral nonlinearity was obtained from smoothed acceptance firing data and predicted inflight dynamics effects. The flow integral actual data are smoothed nonlinearities from the flight flow integral analysis which include inflight dynamics effect.

14.3 PU System Response

Table 14-3 contains a compilation of the actual engine mixture ratio commands and accompanying response.

Since the system was flown open loop, there were no cutback dispersions experienced. Similarly, there were no PU induced thrust variations at anytime during engine burn as a result of operating in an open loop fashion, except for the mixture ratio shift.

14.4 Anomalies

No PU system anomalies occurred during the S-IVB-205 flight.

TABLE 14-1
PROPELLANT MASS HISTORY

EVENT	PRE-DICTED MASS	PU INDICATED MASS	PU INDICATED MASS (CORRECTED)	PU VOLUMETRIC MASS	FLOW INTEGRAL MASS	TRAJECTORY RECONSTRUCTION MASS	BEST ESTIMATE MASS	DEVIATION FROM BEST ESTIMATE MASS					TRAJECTORY RECONSTRUCTION
								PREDICTION	PU INDICATED	PU INDICATED (CORRECTED)	PU VOLUMETRIC	FLOW INTEGRAL	
Liftoff	193,273	193,390	193,460	193,040	193,956		193,360	-87(.04%)	+30(.02%)	+100(.05%)	-320(.17%)	+596(.31%)	
	39,647	39,711	39,761	39,931	40,101		39,909	-262(.66%)	-198(.50%)	-148(.37%)	+22(.06%)	+192(.48%)	
Engine Start Command (ESCI)	232,920	233,101	233,221	232,971	234,057		233,269	-349(.15%)	-168(.07%)	-48(.02%)	-298(.12%)	+788(.34%)	
	193,273	193,230	193,430	193,010	193,956		193,330	-57(.02%)	-100(.05%)	+100(.05%)	-320(.16%)	+626(.32%)	
PU Valve Outback	39,647	39,600	39,761	39,931	40,101		39,909	-262(.65%)	-309(.77%)	-148(.37%)	+22(.05%)	+192(.48%)	
	232,920	232,830	233,191	232,941	234,057	233,279	233,239	-319(.13%)	-409(.17%)	-48(.02%)	-298(.12%)	+818(.35%)	+40(.02%)
Engine Cutoff Command (ECCI)	1372	1386	1615	1615	1581		1581	-209(.11%)	-195(.10%)	+34(.02%)	+34(.02%)	0	
	1999	2627	2585	2492	2492		2492	+493(1.24%)	+135(.34%)	+93(.23%)	0	0	
Propellant Consumed	3371	4013	4200	4107	4073	4053	4073	-702(.30%)	-60(.03%)	+127(.05%)	+34(.01%)	0	-20(.01%)
	191,901	191,844	191,815	191,395	192,375		191,749	+152(.08%)	+95(.04%)	+66(.03%)	-354(.18%)	+626(.32%)	
	37,648	36,973	37,176	37,439	37,609		37,417	+231(.58%)	-444(1.18%)	-241(.64%)	+22(.05%)	+192(.48%)	
	229,549	228,817	228,991	228,834	229,984	229,226	229,166	+383(.16%)	-349(.15%)	-175(.08%)	-332(.14%)	+818(.35%)	+60(0.03%)

TABLE 14-2
PROPELLANT RESIDUAL SUMMARY

	LEVEL SENSOR (ACTIVATION TIME)			
	LOX TANK			LH2 TANK
	L0005 RO +591.727	L0004 RO +614.892	ECC RO +616.757	ECC RO +616.757
PU Mass Sensor Mass - lbm	9,917	1,955	1,615	2,492
Level Sensor Mass - lbm	9,833	2,174	--	--
Level Sensor Extrapolated Residual - lbm	1,640	1,564	1,577	--
Weighted Average Residual - lbm	--	--	1,581	2,492

TABLE 14-3
PU VALVE RESPONSE AT SIGNIFICANT TIMES

PU RATIO VALVE COMMAND	PU RATIO VALVE RESPONSE	TIME FROM RANGE ZERO
PU mixture ratio 5.5 ON	PU valve at null position (0 deg)	-600
		152.976
	PU valve leaves null (0 deg)	153.0
PU mixture ratio 5.5 OFF	PU valve at 5.5 position (33.8 deg)	153.9
		455.591
PU mixture ratio 4.5 ON		455.783
	PU valve leaves 5.5 position (33.8 deg)	455.8
S-IVB ECO	PU valve at 4.5 position (-28.8 deg)	457.9
		616.757
PU mixture ratio 4,5 OFF		619.165
	PU valve leaves 4.5 position (-28.8 deg)	619.5
PU inverter and DC power OFF	PU valve at null position (0 deg)	621.1
		857.01

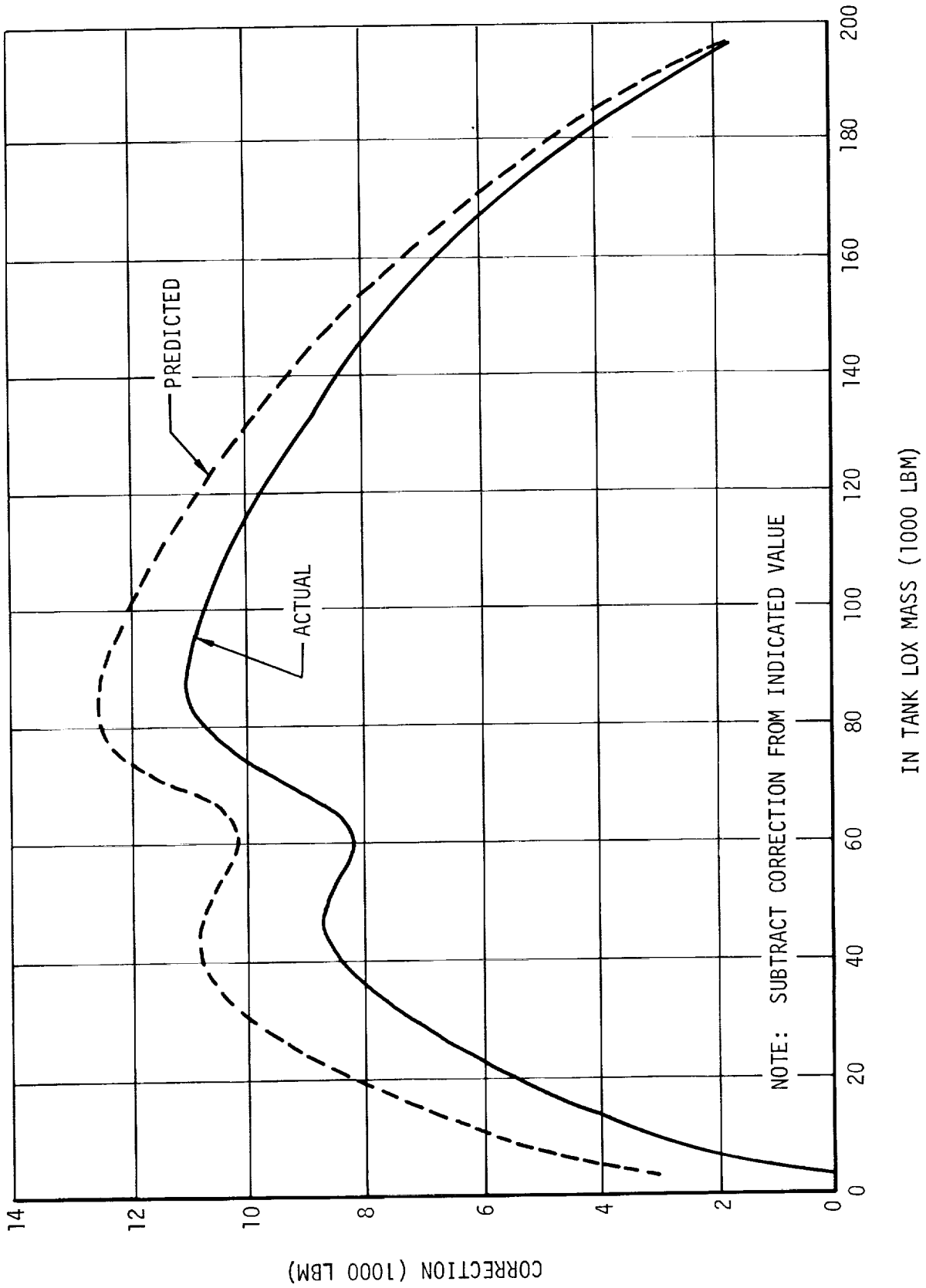

Figure 14-1. Total LOX Sensor Mass Correction as Determined by the Volumetric Method

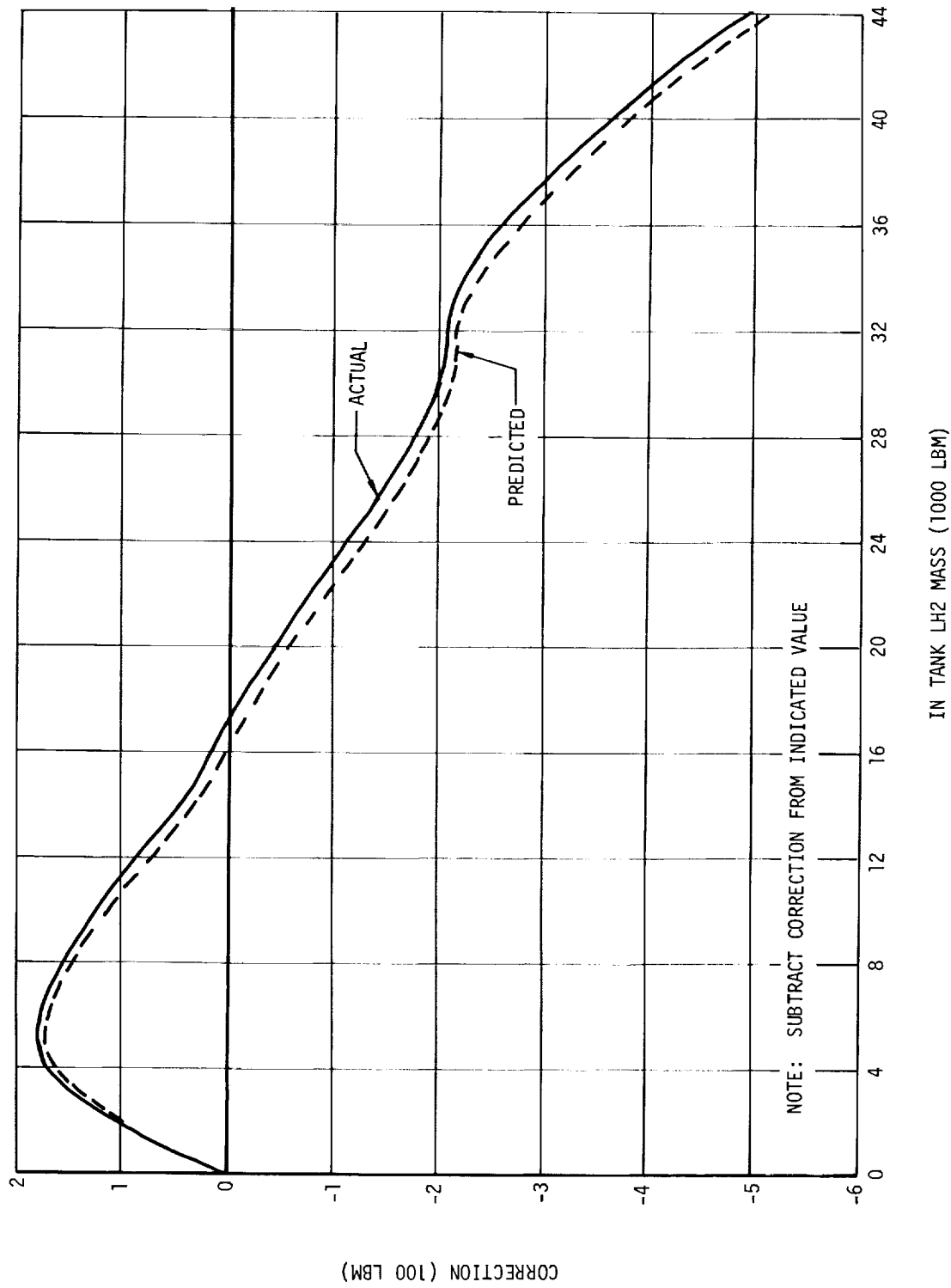

Figure 14-2. Total LH2 Sensor Mass Correction as Determined by the Volumetric Method

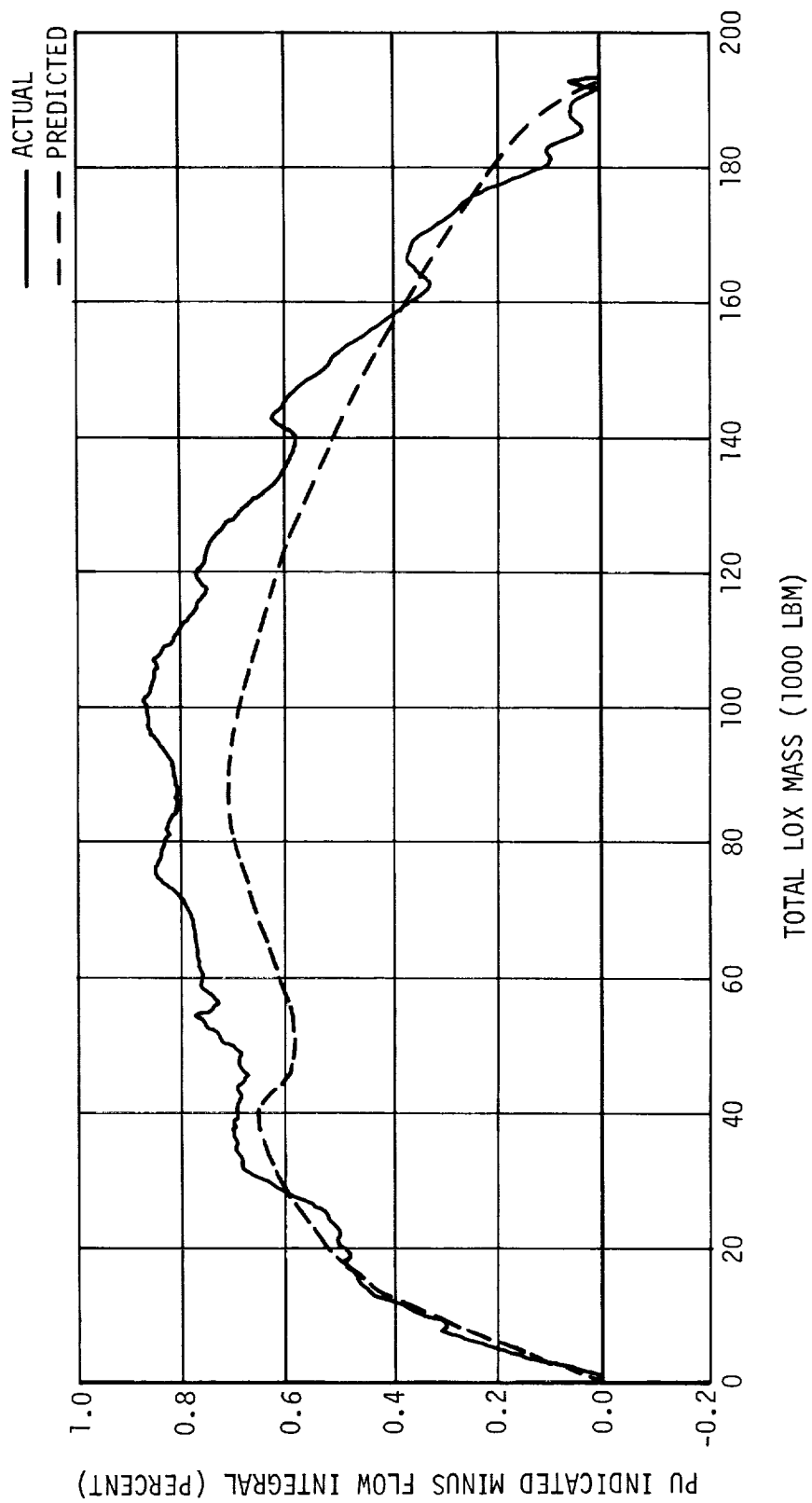

Figure 14-3. LOX Normalized Probe Linearity

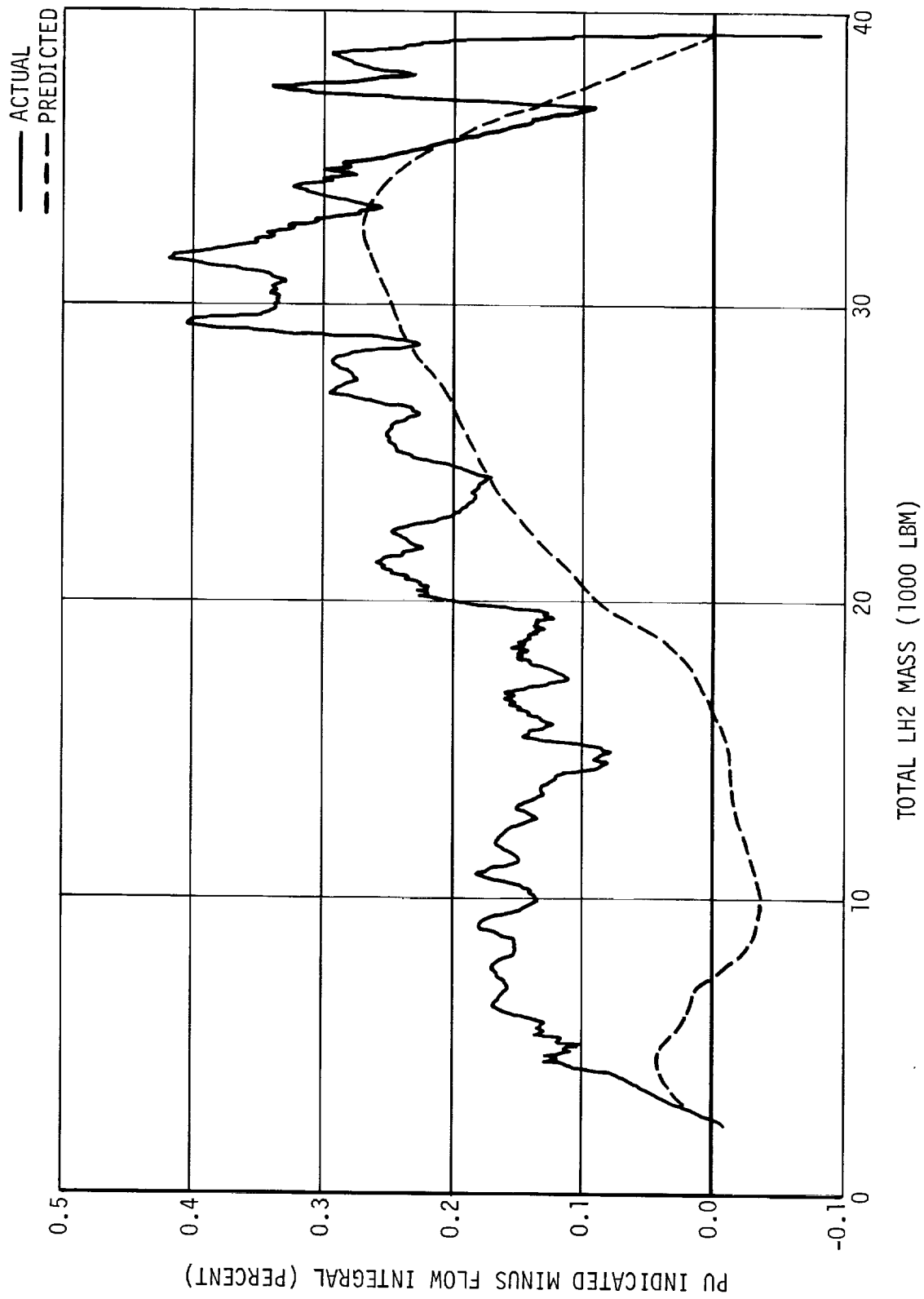
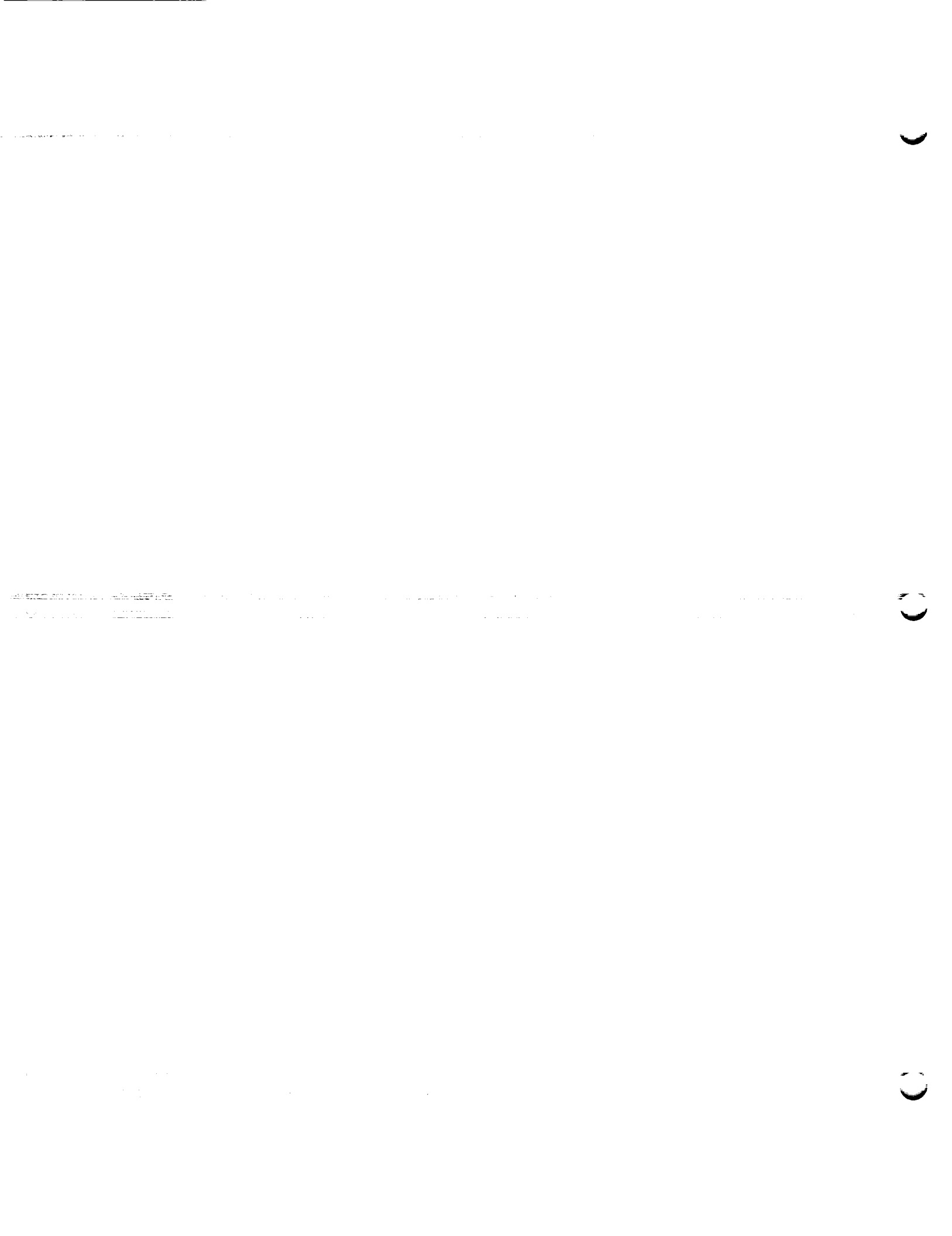

Figure 14-4. LH2 Normalized Probe Linearity





15. S-IB/S-IVB STAGE SEPARATION

The separation analysis was done by a comparison of AS-205 data with the AS-204 separation data. Table 15-1 summarizes the separation events and compares them with AS-204. The majority of the data compared very closely for the two vehicles. The longitudinal accelerations compared well with AS-205 showing a slightly higher retrorocket thrust (figure 15-1). The comparison of the angular velocities (figure 15-2) for both stages was good. The magnitude of the yaw and roll rates were close, but with the direction being opposite on the roll rate for both stages. The pitch rate for AS-205 was slightly larger and the direction reversed from that of AS-204 for both stages.

Since the separation data of AS-204 and AS-205 compares well, an in-depth analysis was not performed to establish precisely the clearance distance used and the separation completion time. From the evaluation performed it can be estimated that a detailed analysis would yield a separation completion time of 0.96 sec and a lateral clearance utilization of approximately 5 in.

TABLE 15-1
SEPARATION EVENTS

EVENT	TIME FROM RANGE ZERO (Sec)	TIME FROM SEPARATION COMMAND (Sec)	
	AS-205	AS-205	AS-204
S-IB OEEO	144.323	-1.27	-1.25
S-IVB Ullage Rocket Ignition	145.377	-0.223	-0.2
Separation Command	145.59	0.0	0.0
S-IB Retrorocket Ignition	145.59	0.0	0.0
First Axial Motion	145.68*	0.09*	0.09
Separation Complete	146.59*	0.96*	0.97
S-IVB Engine Start Command	147.008	1.42	1.4

*Estimated based on comparison with AS-204 data

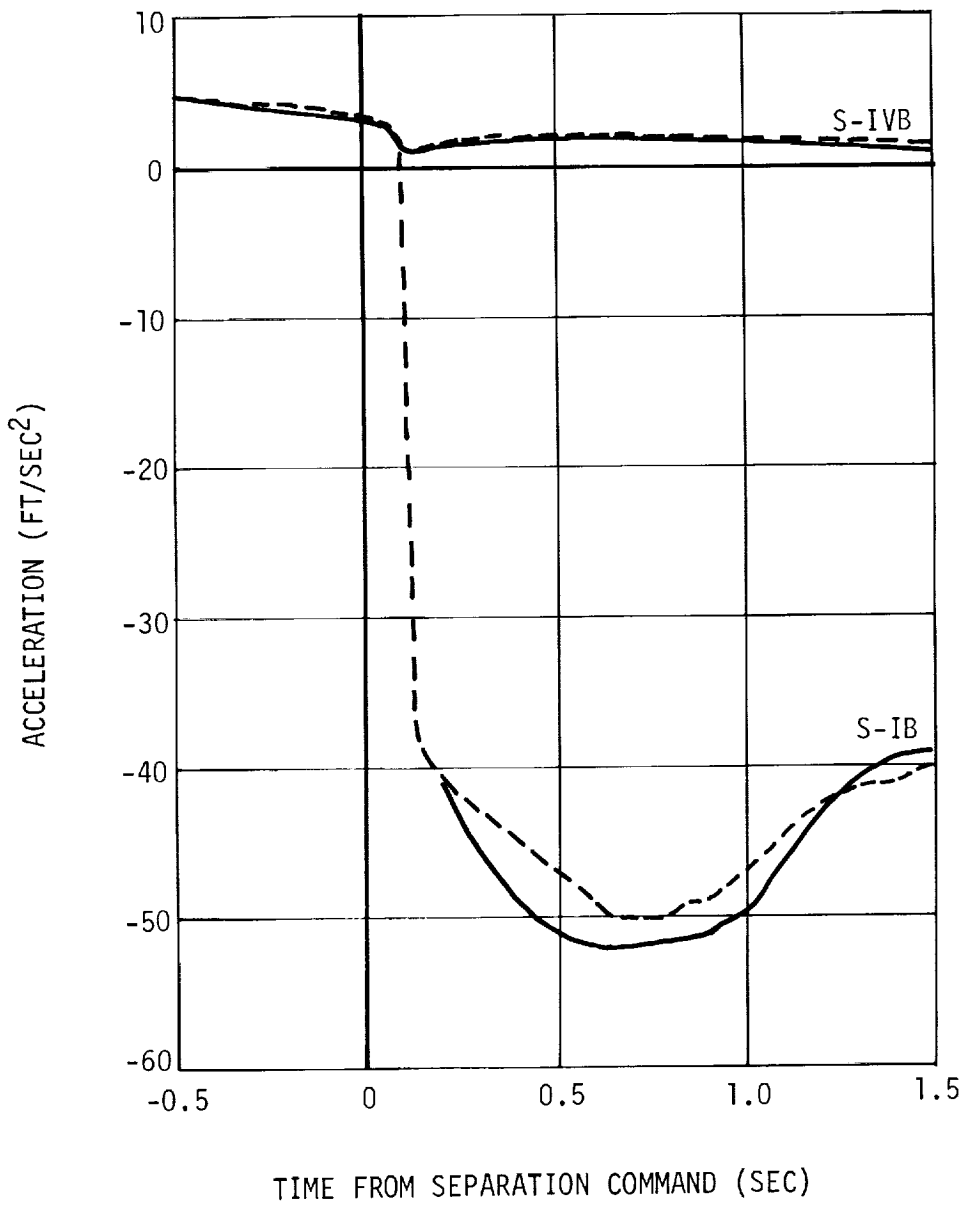

--- AS-204
 — AS-205

Figure 15-1. Longitudinal Acceleration

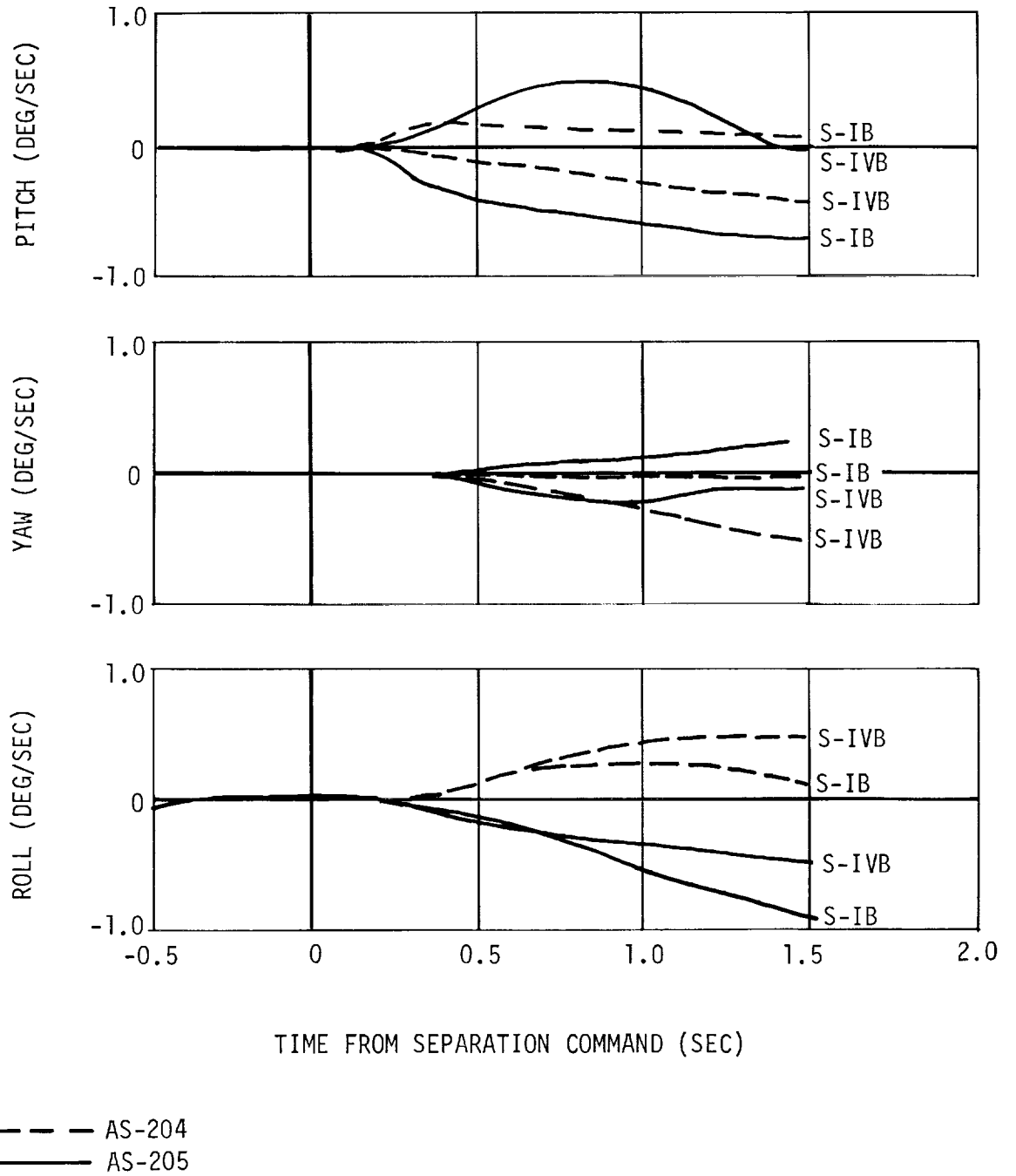

Figure 15-2. Angular Velocities



SECTION 16

DATA ACQUISITION SYSTEM



16. DATA ACQUISITION SYSTEM

Measurement evaluations will be performed in two phases. For incentive purposes, phase I will cover liftoff to S-IVB engine cutoff +10 sec, and phase II shall encompass liftoff to planned launch vehicle spacecraft (LV/SC) separation.

16.1 Summary of Performance

Measurements assigned to the data acquisition system which are evaluated in this report are specified in the Instrumentation Program and Components List (IP&CL), MDAC-WD Drawing No. 1B43558 ("AH" change).

The performance of the data acquisition system was very good throughout both phases of evaluation. All systems performed as designed, and no system malfunctions were observed.

A summarization of the AS-205 launch vehicle measurements is presented below:

Measurements assigned	379
Checkout only measurements	12
Landline measurements	114
Vibration measurements deleted from incentive	8
Measurements inoperative due to stage configuration	2
Measurements deleted prior to liftoff	0
Total active incentive measurements at liftoff	243
Phase I measurement failures	2
Phase II measurement failures	2
Phase I measurement efficiency	99.2%
Phase II measurement efficiency	99.2%
Measurement failures not affecting cost plus incentive fee (CPIF)	2

A detailed measurement status is presented in table 16-1.

16.2 Instrumentation System Performance

The performance of the instrumentation system was very good throughout both evaluation phases. Two measurements were classified as phase I failures, and both measurements were classified as a phase II failures under the CPIF evaluation rules. An additional measurement failure was noted during phase I, however, it was one of the eight vibration measurements deleted from the incentive evaluation. One measurement failure occurred during phase II but it had fulfilled its intended purpose and is not a CPIF failure.

Phase I measurement failures were C2044-401, Temp-ASI Combustion Chamber and D0104-403, Press-LH2 Press Module Inlet. The measurement failure occurring during phase II was C0001- 401, Temp-LH2 Turbine Inlet. The non-incentive measurement failure was E0210-401, Vibration LH2 Turbo-Pump-Lateral.

The nine measurements which deviated from expected performance but provided usable flight information and have been classified as measurement anomalies are:

C0369-406	Temp-LOX-Position "B"
C2043-401	Temp-Skin LH2-ASI Line
D0009-401	Press-LOX Pump Discharge
D0066-415	Press-Oxidizer Sup Manf Mod 2 (APS)
D0084-414	Press-Oxidizer Sup Manf Mod 1 (APS)
E0243-401,	Vib-ASI LOX Valve-Radial
M0012-411	Freq-PU Static Inverter-Converter
M0069-404	Volt-Aft T/M Full Scale Reference
N0055-411	Misc-T/M RF Syst Refl Power

One measurement, K0008-401 Event-Ignition Detected, is simulated utilizing a dummy ignition detection probe. The ON indication is expected at liftoff and it will remain on until the termination of engine control power. No correlation can be made to the actual detection of engine ignition. The measurement performed as expected.

Detailed evaluations of measurement failures and anomalies are presented in tables 16-2 and 16-3 respectively.

16.3 Telemetry System Performance

The performance of the pulse code modulation (PCM) system was excellent. All multiplexers were properly synchronized and their outputs properly interlaced as attested by the reduced data.

16.4 RF System Performance

The RF system performed without any difficulty in the transmission of airborne data to ground stations located throughout the orbital flight path during the phase I and phase II evaluation period. Approximately 0.75 sec of data blackout was observed at RO+146.7 sec on the data from Bermuda. As a result, the exact S-IVB engine start time was not retrievable. At liftoff, the RF assembly power output was 20.5 W with the RF system VSWR at 1.46:1.

Subsequent data evaluated after phase II, at RO +64,000 sec from Canary Island, indicate the loss of RF transmitter power on the S-IVB CP1 data link. A check of forward battery No. 1 voltage indicated 29 vdc and a load current of 6 amp. Nominal loading of forward battery No. 1, without the battery heaters, was 9.5 amp.

16.5 Calibration System

16.5.1 Telemetry

Inflight 270 multiplexer calibrations were evaluated at RO +663 sec, RO +11,131 sec and RO +22,543 sec. The calibration at RO +128 sec indicated average data point dispersions of ± 12 bits (60 mv) with periodic data points of ± 17 bits (85 mv). This was due to the chill-down pumps being on at this time. At the other calibration times, the chilldown pumps were off and the data dispersions were within the acceptable bit counts of ± 8 bits (approximately 40 mv).

16.5.2 RACS

RACS calibration was evaluated at RO -1,464 sec. Two measurements showed minor problems and they are fully detailed in table 16-3 as anomalies.

C0369-406, Temp - LOX - Position B, indicated a negative shift in calibration of slightly greater than 2 percent.

D0009-401, Press - LOX Pump Discharge, remained in high RACS until prelaunch checkout group power was turned off. This problem did not present any difficulty for flight.

16.6 Electromagnetic Compatibility

An electromagnetic compatibility (EMC) review of flight data showed a 2 percent peak-to-peak noise on measurement M0069-404--Volt-Aft TM Full Scale Ref during chilldown pump operation. This noise increased to 4 percent after external to internal power transfer.

The noise level on this measurement is caused by coupling from the 56 V power distribution onto the 5 V signal line of the aft 5 V excitation module. The increased noise level at power transfer is caused by a common vehicle structural ground between the chilldown inverters and the aft 5 V excitation module.

The noise on this reference channel does not adversely affect interpretation of flight data. The noise occurrence is during chilldown operation and does not coincide with significant flight events.

16.7 Signal Strength

Approximately 20 percent of the actual RF signal strength plots expected from all tracking stations have been received and analyzed. Because insufficient data is available, an overall statement of the degree of acceptability of the system performance cannot be made. Therefore, particular points of data dropouts are discussed with respect to RF signal strength.

The following data dropouts are the only RF signal strength problems identified to date:

- a. The Bermuda tracking station had a 2 sec data loss at RO +326 sec. Examination of the received RF signal strength for left hand circular polarization shows a signal strength drop to -119 dbm which substantiates the data loss. At the same time, the received RF signal strength at Tel 4 was -45 dbm and at MILA-CIF was -85 dbm and there was no data loss. It was noted that the Bermuda tracking station antenna elevation angle was only 4 deg at the time of dropout; therefore, the loss could have been caused by interference at the tracking station. It was concluded that the data loss was due to either a low gain portion of the vehicle antenna pattern or problems at the tracking station. Efforts to isolate and recommend resolutions for the problem will be continued.
- b. The Corpus Christi tracking station had a data loss at RO +5,810 sec which lasted less than 1 sec. Examination of both right and left hand circularly polarized signal strengths showed a severe drop in RF signal strength at this time. The

signal strength at the tracking station at Guaymas was approximately -80 dbm and there was no corresponding data loss. Examination of the preflight predicted trajectory did not reveal any reason for dropout due to antenna coverage. The shape of the signal strength versus time plot does not have the general appearance of losses due to vehicle antenna pattern variations. It is expected that this data loss is caused by receiving station parameters.

- c. The Corpus Christi tracking station had a data dropout at R0 +11,450 sec which lasted 167 ms. Examination of the RF signal strength substantiates this because there was a drop to -109 dbm. The antenna patterns and the preflight predicted trajectory were examined and there was no apparent reason for the data loss. This data loss is as yet unresolved and is currently being investigated.

TABLE 16-1
MEASUREMENT STATUS

1.	Total number measurements listed in IP&CL (1b43558 "AH")	379
2.	Checkout only measurements	12
	K0141-411 Event-R/S 1 Pulse Sensor	
	K0142-411 Event-R/S 2 Pulse Sensor	
	K0143-404 Event-U11 Rkt 1 Ign Pulse Sensor 1	
	K0144-404 Event-U11 Rkt 1 Ign Pulse Sensor 2	
	K0145-404 Event-U11 Rkt 2 Ign Pulse Sensor 1	
	K0146-404 Event-U11 Rkt 2 Ign Pulse Sensor 2	
	K0147-404 Event-U11 Rkt 3 Ign Pulse Sensor 1	
	K0148-404 Event-U11 Rkt 3 Ign Pulse Sensor 2	
	K0149-404 Event-U11 Rkt Jettison 1 P/S	
	K0150-404 Event-U11 Rkt Jettison 2 P/S	
	K0168-404 Event-Switch Selector Register Test	
	K0169-404 Event-EBW Pulse Sensor Off Indication	
3.	Landline measurements	114
4.	Vibration measurements deleted from incentive	8
	E0209-401 Vibration - Combustion Chamber Dome-Longitudinal	
	E0210-401 Vibration - LH2 Turbo Pump-Lateral	
	E0211-401 Vibration - LOX Turbo Pump-Lateral	
	E0236-401 Vibration - Main LH2 Valve Tangential	
	E0237-401 Vibration - Main LH2 Valve Radial	
	E0242-401 Vibration - LH2 ASI Block Radial	
	E0243-401 Vibration - ASI LOX Valve - Radial	
	E0245-401 Vibration - ASI LOX Valve - Longitudinal	
5.	Measurements inoperative due to stage configuration	2
	K0095-401 Event - Thrust Chamber LH2 Inj Temp OK	
	K0152-404 Event - Rate Gyro Wheel Speec OK Ind	
6.	Measurement failure prior to liftoff	0
7.	Total active incentive measurements at liftoff	243
8.	Phase I measurement failures	2
	C2044-401 Temp - ASI Combustion Chamber	
	D0104-403 Press - LH2 Press Module Inlet	
9.	Measurement failure occurring during phase II	1
	C0001-401 Temp - LH2 Turbine Inlet	
10.	Non-incentive measurement failure	1
	E0210-401 Vibration LH2 Turbo Pump - Lateral	
11.	Problem measurements	9
	C0369-406 Temp - LOX, Position B	
	C2043-401 Temp - Skin, LH2 ASI Line	
	D0009-401 Press - LOX Pump Discharge	
	D0066-415 Press - Oxidizer Supply Manf, Mod 2 (APS)	
	D0084-414 Press - Oxidizer Supply Manf, Mod 1 (APS)	
	E0243-401 Vib - ASI LOX Valve Rad	
	M0012-411 Freq - PU Static Inverter-Converter	
	M0069-404 Volt - Aft T/M Full Scale Ref	
	N0055-411 Misc - T/M RF Syst Refl Power	

TABLE 16-2
MEASUREMENT FAILURES

LAUNCH PHASE

C2044-401 Temp - ASI Combustion Chamber

The measurement indicated a failure at RO +149.1 sec, 2 sec after the Engine Start Command. The sensor circuit opened causing the channel to exhibit an off-scale-high condition. The malfunction was probably caused by high vibration experienced in the ASI vicinity. This transducer was supplied and installed at the launch site by Rocketdyne.

D0104-403 Press - LH2 Press Module Inlet

This measurement failed to exhibit valid data subsequent to RO +350 sec. The unusual pressure decrease after RO +350 sec and the off-scale-low indication at cutoff cannot be explained fully at the present time. Trend-type information, however, was recovered during the invalid period. During orbit, the measurement followed the ullage pressure behavior as expected. This malfunction is unlike any previously experienced on these strain gage type pressure sensors.

E0210-410 Vib - LH2 Turbo Pump - Lat

This measurement failed to indicate valid data from liftoff. The band edge to band edge excursions of the data was experimentally duplicated in the laboratory when a diode in the inverter circuitry of the transducer was open circuited. This failure is considered a random-type failure.

ORBIT PHASE

C0001-401 Temp - LH2 Turbine Inlet

The measurement failed at TO +1,170 sec by indicating an abrupt off-scale-low response. The malfunction was attributed to a shorted sensor or open circuiting of the temperature bridge reference resistor circuitry. Observations during orbit did not indicate recovery from the malfunction. The sensor was supplied by Rocketdyne with the J-2 engine. The measurement operated satisfactorily during boost and S-IVB burn which fulfilled its intended purpose.

TABLE 16-3 (Sheet 1 of 2)
MEASUREMENT PROBLEMS

C0369-406 Temp - LOX, Position B

Both high and low preflight RACS levels were slightly over 2 percent low. Since the RACS levels indicate a linear shift downward, a positive 2 percent data compensation could be applied to retrieve more accurate information. Data history indicates that the RACS calibrations for the measurement was initially low although within the acceptable tolerance of 2 percent.

C2043-401 Temp - Skin LH2 ASI Line

The measurement exhibited invalid data from RO +415 sec to RO +1,000 sec. Another period of data discrepancy was observed between RO +1,200 and RO +1,300 sec before the measurement performed as expected for the duration of the flight. Analysis of the problem during the periods of invalid data indicate that the sensor-lead junction of the lead which ties into the reference resistor of the temperature bridge developed high junction resistance. This can be attributed to a low temperature shock of the sensor installation causing a partial severance of electrical continuity during cryogenic temperature periods. Such a problem can result in the measurement being susceptible to vibration during the engine burn period as seen between RO +415 and RO +590 sec. It can also result in sudden off-scale-low indications as observed between RO +1,200 and RO +1,300 sec. The transducer was provided and installed by Rocketdyne at KSC.

D0009-401 Press - LOX Pump Discharge

The data indicated a prelaunch ambient pressure of approximately 80 percent of its range. It was determined that the high RACS relay was energized during the preflight RACS checkout and did not drop out on command. Malfunction analysis disclosed that the channel decoder output gate remained in the open condition maintaining power to the high RACS relay. Removing the prelaunch checkout group power at RO +1,160 sec removed power from the channel decoder which in turn permitted the RACS relay to drop out. Subsequent normal operation was verified.

D0066-415 Press - Oxidizer Supply Manf, Module 2 (APS)

D0084-414 Press - Oxidizer Supply Manf, Module 1 (APS)

High noise levels were observed during liftoff and maximum q periods. These potentiometer-type pressure transducers are susceptible to high mechanical vibrations which are present during liftoff and maximum q periods. Since the APS is not exercised during the first stage boost period, no loss of data was incurred.

E0243-401 Vib - ASI LOX Valve, Rad

Unusual low frequency (12 Hz) oscillations were observed during sampling

TABLE 16-3 (Sheet 2 of 2)
MEASUREMENT PROBLEMS

periods between RO +152 and RO +310 sec; data were also lost at this time. Analysis has isolated the malfunction to the charge amplifier section of the amplifier unit. This malfunction appears to be a random-type problem since the transducer system has no history of similar anomalies.

M0012-411 Freq - PU Static Inverter-Converter

The measurement indicated a frequency decrease of 6 Hz from RO +5,450 to RO +5,840 sec. Since analysis did not reveal any malfunction of the PU inverter-converter output voltages, it indicated a measurement system malfunction. Two components make up the instrumentation monitoring system-- the frequency standard and the frequency converter. The probabilities of malfunction is either an increase in frequency of the frequency standard, or a degradation of the frequency converter output. Investigation is proceeding to define the problem area.

M0069-404 Volt - Aft T/M Full Scale Ref

The measurement exhibited noise during the operation of the chilldown pumps. Peak-to-peak noise levels were 1.5 percent on external power and 2.5 percent on internal power. Since the chilldown pumps are turned off prior to engine start, no degradation of data occurs during the primary data evaluation period of engine burn. The problem is due to coupling between the 5 V line and the 56 V power distribution lines and a common vehicle structural ground between the chilldown inverters and the aft 5 V module.

During the second revolution over Carnarvon, RO +8,700 to RO +9,400 sec, the measurement indicated approximately 1.5 percent lower than the nominal level of 5 vdc. Since the aft 5 V module 5 vdc remained stable, an instrumentation anomaly is suspected and investigation into the problem is being continued. Subsequent data show that the voltage recovered to its nominal value of 5 vdc.

N0055-411 Misc - T/M RF System Refl Power

The measurement exhibited several variations of reflected power during launch and orbital phases. These changes of power were not believed to be actual shift in levels. As on previous stages, changes in reflected power levels were observed for no apparent reason. The RF antenna system is a passive system, therefore, changes in reflected power would be mechanically induced. Mechanical integrity has been proven on previous stages; however, the detectors are still under scrutiny.

SECTION 17

ELECTRICAL SYSTEM

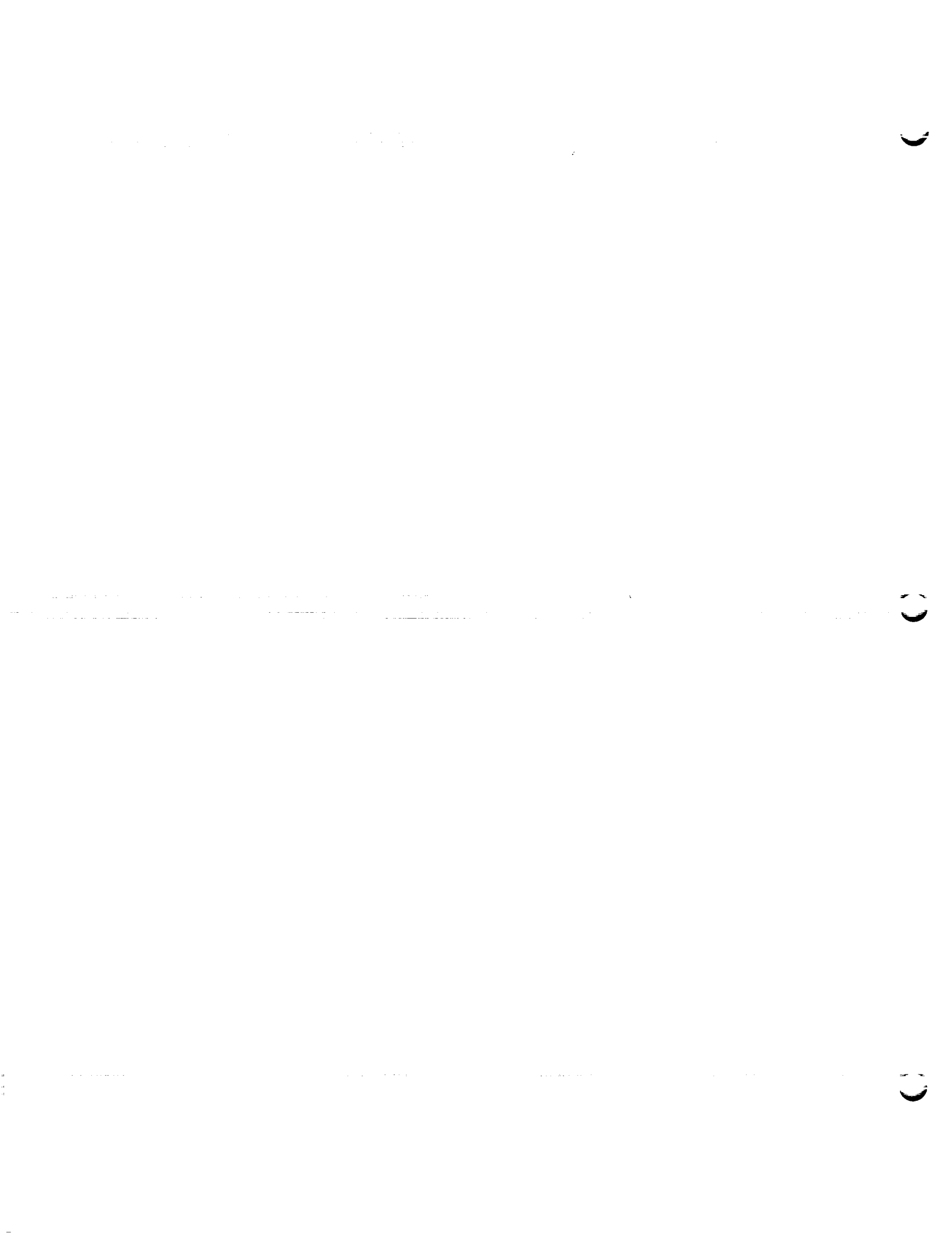

17. ELECTRICAL SYSTEM

The electrical control system and electrical power system performed satisfactorily throughout the launch (phase I) and orbital (phase II) phases of flight.

17.1 Electrical Control System

The operational integrity of the stage electrical control system is verified in the sequence of events of this evaluation. All responses to switch selector commands were satisfactory.

17.1.1 J-2 Engine Control System

All J-2 engine event measurements verified that the engine control system had responded properly to the Engine Start and Cutoff Commands. Engine start was initiated at RO +147.008 sec with engine velocity cutoff initiated at RO +616.757 sec, resulting in a total engine burntime of 469.749 sec. The telemetry event measurements which describe engine performance occurred in the proper sequential order and within the specified incremental times.

17.1.2 Control Pressure Switches

A review of the event and pressure measurements verified that each control pressure switch functioned properly during flight. The LOX orbital coast vent low pressure switch was installed but was not made operational for flight. No data is available to evaluate its performance.

17.1.3 APS Electrical Control System

A review of the APS feed valve and chamber pressure data verified that the APS electrical control system performed as expected during flight.

17.1.4 Chilldown Shutoff Valves

The LOX and LH₂ chilldown shutoff valves which are normally open valves operated properly as indicated by the chilldown flow measurements.

17.1.5 Vent Valves

The vent valve measurements indicate that the LOX and LH₂ vent valves responded to their respective commands during flight and operated properly.

17.1.6 Fill and Drain Valves

The LOX and LH₂ fill and drain valves were commanded close through the umbilical prior to liftoff and remained closed through flight.

17.2 Electrical Power System

The electrical power system performed satisfactorily throughout flight.

17.2.1 Flight Batteries

All batteries performed within the expected limits as verified from the load profiles and temperature data shown in figures 17-1 through 17-8.

17.2.2 Chiltdown Inverter

There were no direct measurements to verify the electrical parameters of the chiltdown inverters. However, the acceptable performance of the chiltdown pumps verified their operation.

17.2.3 5-Volt Excitation Modules

All three 5 vdc excitation modules performed satisfactorily during flight. See table 17.1 for the performance values.

17.2.4 Static Inverter-Converter

The static inverter-converter operated within design limits throughout the flight. Measurement M0012-411, Freq-Static Inverter-Converter, exhibited a shift in frequency from 401 Hz at RO +5,540 sec to 395 Hz at RO +5,840 sec. After a study of the problem, it was resolved that the apparent degradation of the frequency measurement is an instrumentation anomaly. The converter frequency is determined by the regulated 21 vdc, measurement M0023-411, therefore, it would reflect the frequency change. A change in measurement M0023-411 was not noted over the period of anomaly. See table 17-1 for the static inverter-converter performance values.

17.3 Exploding Bridgewire System

The exploding bridgewire (EBW) system charged, fired, and jettisoned the ullage rockets as expected. EBW ullage rocket firing units were charged at RO +140.8 sec and ignited at RO +144.5 sec. EBW ullage rocket jettison firing units were charged at RO +153.6 sec and fired at RO +156.7 sec. The following measurements describe the performance of the EBW system.

<u>Measurement No.</u>	<u>Measurement Nomenclature</u>	<u>Acceptable Range</u>	<u>Actual Value</u>
M0032-416	Volt - F/U 1 EBW Ullage Rocket 1	4.2 ±0.3 vdc	4.29 vdc
M0033-416	Volt - F/U 2 EBW Ullage Rocket 1	4.2 ±0.3 vdc	4.29 vdc
M0034-417	Volt - F/U 1 EBW Ullage Rocket 2	4.2 ±0.3 vdc	4.29 vdc

<u>Measurement No.</u>	<u>Measurement Nomenclature</u>	<u>Acceptable Range</u>	<u>Actual Value</u>
M0035-417	Volt - F/U 2 EBW Ullage Rocket 2	4.2 ±0.3 vdc	4.35 vdc
M0036-418	Volt - F/U 1 EBW Ullage Rocket 3	4.2 ±0.3 vdc	4.22 vdc
M0037-418	Volt - F/U 2 EBW Ullage Rocket 3	4.2 ±0.3 vdc	4.25 vdc
M0038-404	Volt - F/U 1 EBW Ullage Rocket Jettison	4.2 ±0.3 vdc	4.13 vdc
M0039-404	Volt - F/U 2 EBW Ullage Rocket Jettison	4.2 ±0.3 vdc	4.27 vdc

TABLE 17-1
FIVE-VOLT EXCITATION MODULES PERFORMANCE

MEASUREMENT NO.	MEASUREMENT NOMENCLATURE	ACCEPTABLE RANGE	ACTUAL VALUES	
			MINIMUM	MAXIMUM
M0024-411	Volt - 5 Volt Excitation Mod Fwd.	5.000 ±0.025 vdc	5.016 vdc	5.017 vdc
M0068-411	Volt - 5 Volt Excitation Mod Fwd 2	5.000 ±0.025 vdc	5.009 vdc	5.010 vdc
M0025-404	Volt - 5 Volt Excitation Mod Aft	5.000 ±0.025 vdc	5.023 vdc	5.023 vdc
M0001-411	Volt - Static Inverter-Converter	115.00 ±3.45 vrms	115 vrms	115 vrms
M0004-411	Volt - Static Inverter-Converter 5 Volts DC	4.9 ±0.1 vdc	4.950 vdc	4.982 vdc
M0012-411	Freq - Static Inverter-Converter	400 ±6 H _z	395 H _z *	401 H _z
M0023-411	Volt - Static Inverter-Converter 21 Volts DC	21.0 ± ^{1.5} _{1.0} vdc	21.9 vdc	22.1 vdc

*Attributed to measurement anomaly.

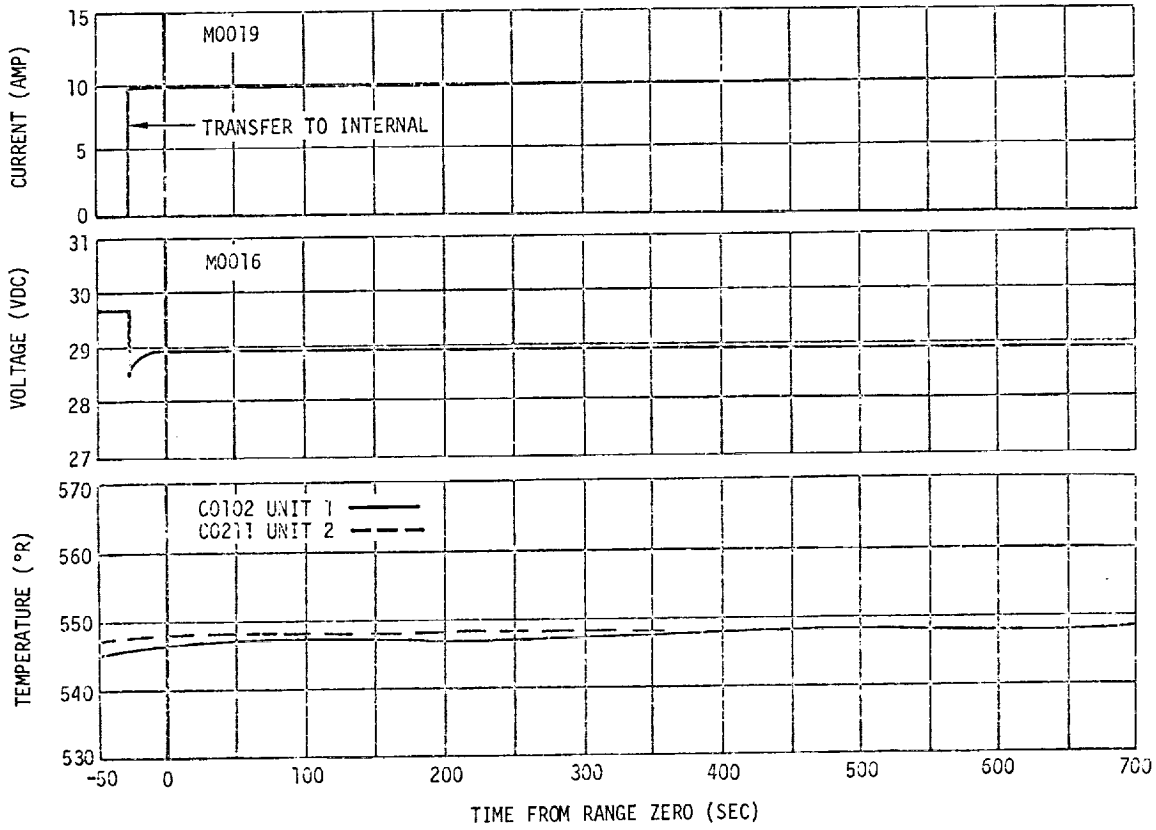

Figure 17-1. Forward Battery No. 1 - Launch Phase

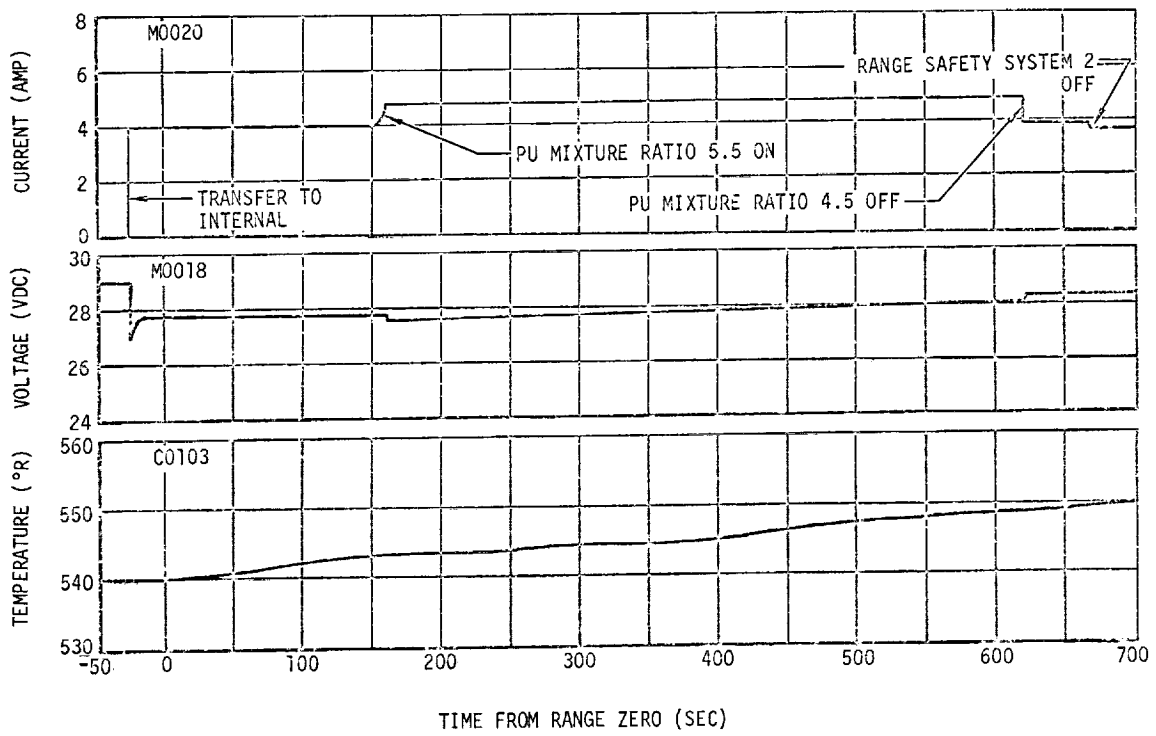

Figure 17-2. Forward Battery No. 2 - Launch Phase

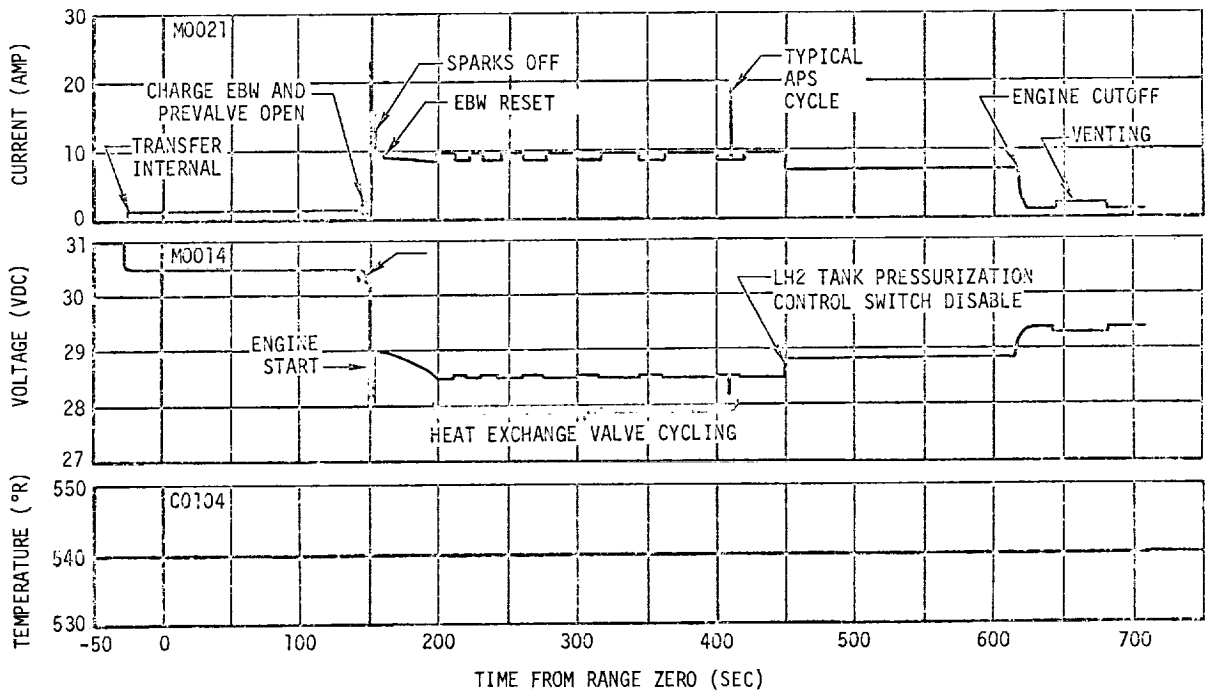

Figure 17-3. Aft Battery No. 1 - Launch Phase

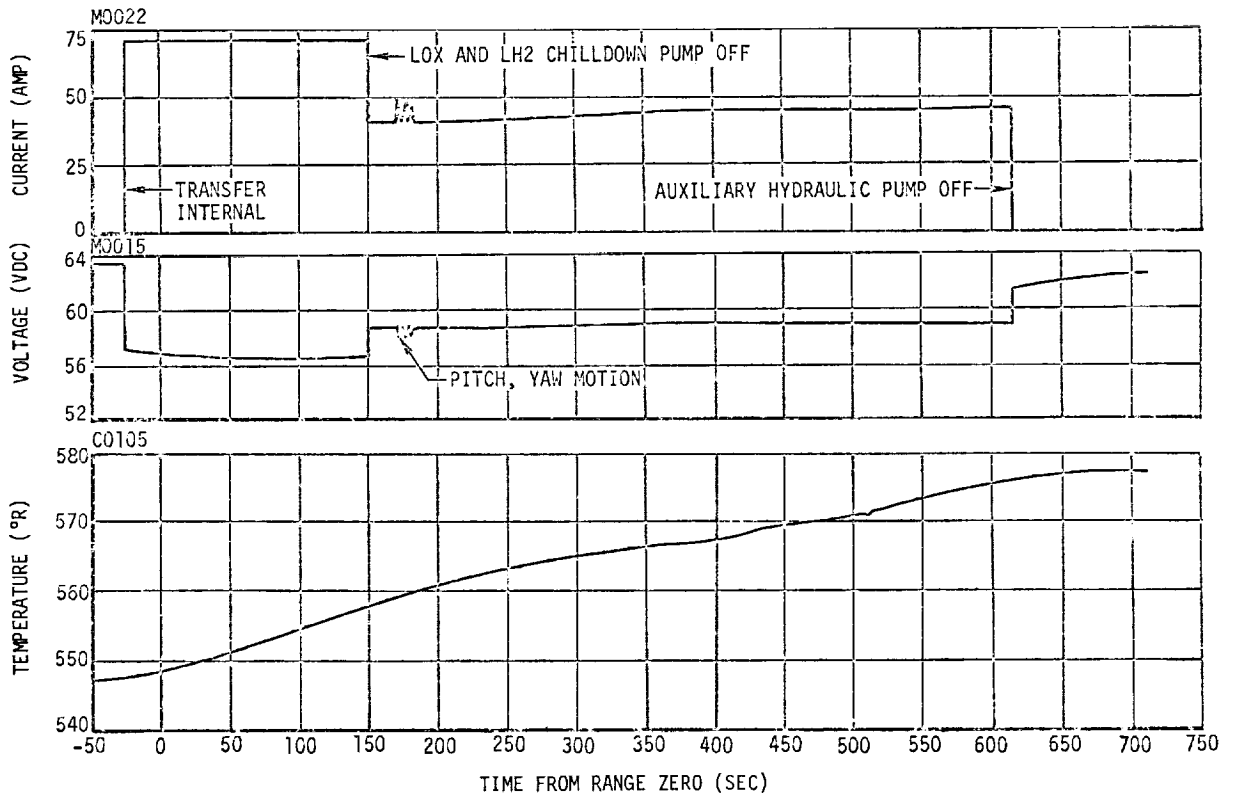

Figure 17-4. Aft Battery No. 2 - Launch Phase

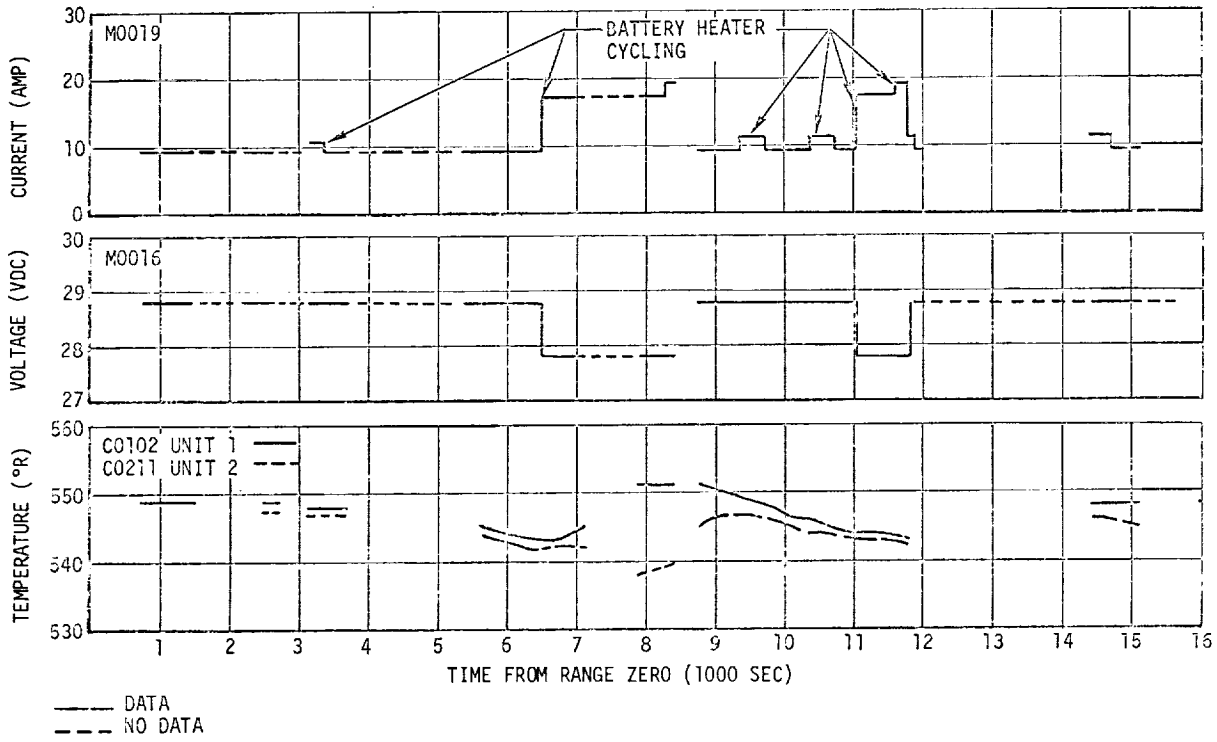

Figure 17-5. Forward Battery No. 1 - Orbit

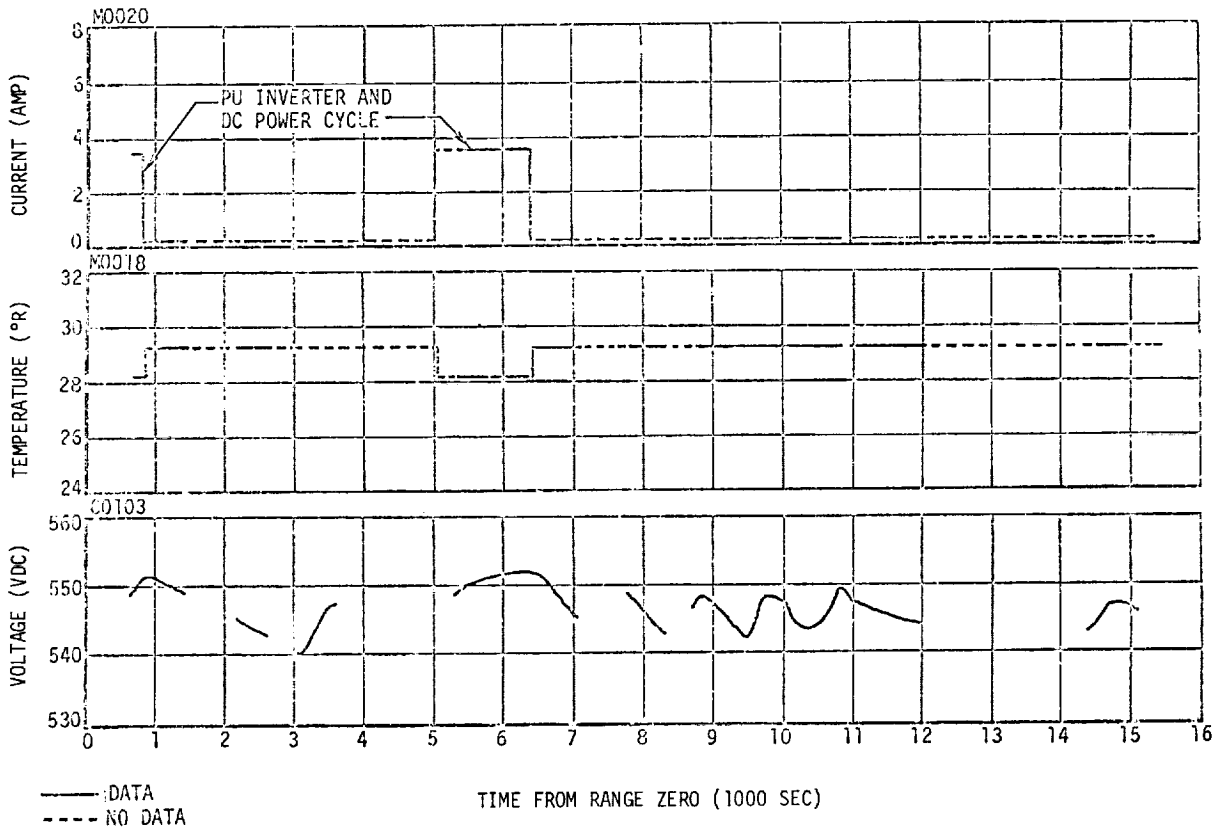

Figure 17-6. Forward Battery No. 2 - Orbit

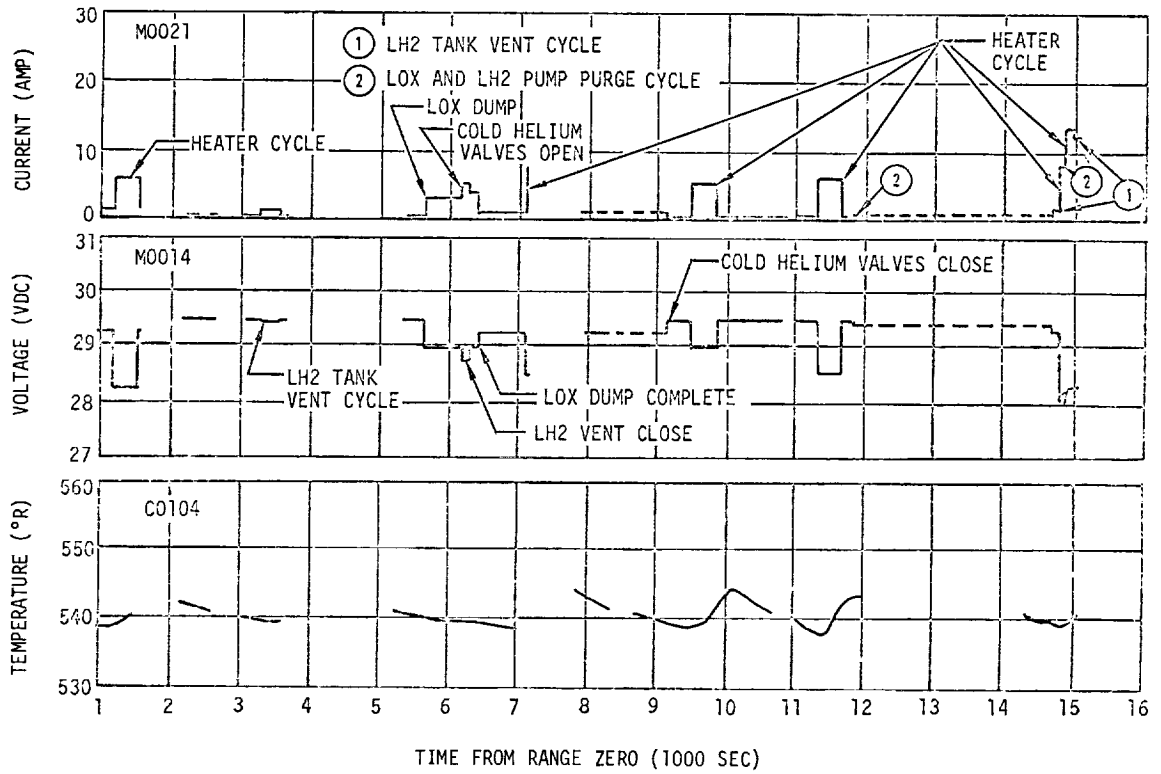

Figure 17-7. Aft Battery No. 1 - Orbit

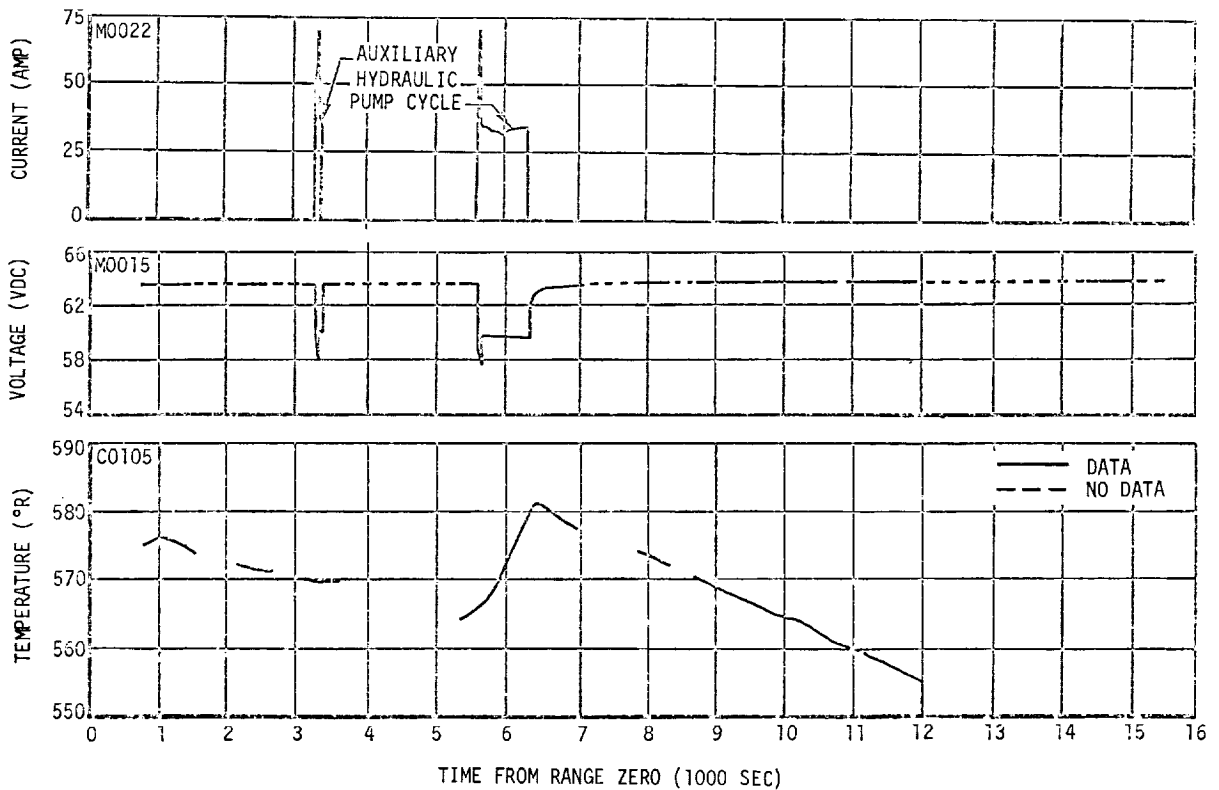

Figure 17-8. Aft Battery No. 2 - Orbit



SECTION 18

RANGE SAFETY SYSTEM

18. RANGE SAFETY SYSTEM

The range safety system was not required for propellant dispersion during flight. All indications showed that it operated properly and would have satisfactorily terminated an erratic flight.

18.1 Controllers

The controllers are designed to distribute command signals for engine cutoff, exploding bridgewire (EBW) charge and fire, and to distribute power to the range safety components. Performance was satisfactory throughout range safety operation.

18.2 Firing Units Monitors

The following measurements indicate that the firing units were not charged throughout flight.

M0030-411 Volt - F/U 1 EBW Range Safety

M0031-411 Volt - F/U 2 EBW Range Safety

18.3 Receivers Signal Strength

An RF carrier was received by the stage until the range safety system was safed at approximately RO +670.5 sec. Range safety receiver 1 low level signal strength was 3.75 V and range safety receiver 2 low level signal strength was 3.72 V. A momentary signal strength dropout of 2 sec was observed at RO +121 sec due to range safety command control transfer difficulties.



SECTION 19

FLIGHT CONTROL



19. FLIGHT CONTROL

The thrust vector control system provided satisfactory control in the pitch and yaw planes during powered flight. The auxiliary propulsion system (APS) provided satisfactory roll control during powered flight and satisfactory pitch, yaw, and roll control during orbital coast.

19.1 Powered Flight

The attitude and control system response to guidance commands for the pitch, yaw, and roll axes are presented in figure 19-1, 19-2, and 19-3, respectively. Significant events related to control system operations are indicated on each figure.

As experienced on previous flights, a steady-state roll torque (approximately 15.7 ft lbf clockwise looking forward) required roll control APS firing throughout powered flight. This roll torque is considerably less than the maximum steady-state roll torque previously experienced (AS-502 40 ft lbf).

Thrust vector misalignment was +0.55 deg and -0.41 deg in pitch and yaw, respectively (using actuator position convention).

Sinusoidal variations were detected on both hydraulic actuators throughout powered flight. The variations were approximately 0.05 deg peak-to-peak amplitude with a frequency of 0.4 Hz. The frequency corresponds closely with the telemetered LH2 slosh frequency and, therefore, it is assumed that the LH2 slosh mass was the driving force. Similar actuator oscillations have been evidenced on previous Saturn flights. Maximum actuator oscillations observed to date were 0.1 deg peak-to-peak between 0.4 and 0.8 Hz on AS-201. The frequencies corresponded closely with LH2 slosh frequencies. The propellant sloshing did not have a significant effect on the control system operation.

A sudden shift in the pitch and yaw actuator positions and attitude errors was noted following the programmed engine mixture ratio (EMR) shift at approximately RO +456 sec. The shift in actuator position appears to have been caused by the relaxation of the thrust structure following PU cutback which resulted in a decrease in thrust of approximately 51,000 lbf. The thrust structure relaxation required the extension of both actuators to reposition the thrust vector through the center of gravity and a shift in attitude errors was required to keep the actuators in the new trim position. This noted shift in the actuator positions and attitude errors at the time of PU cutback was more abrupt than on previous flights. This is attributed to the rapid change in thrust and acceleration (less than 2 sec) resulting from the programmed EMR shift on AS-205 as opposed to a much slower change in thrust and acceleration experienced on previous flights which employed closed loop PU system operation.

Maximum values of attitude errors, angular rates, and actuator position are summarized for significant events during powered flight in table 19-1.

Propellant sloshing was observed on data obtained from the LH2 and LOS PU sensors. The propellant slosh amplitudes and frequencies were comparable to that experienced on previous flights and did not have an appreciable effect on the control system.

The LH2 slosh amplitudes and frequencies experienced during powered flight are shown in figure 19-4. The maximum LH2 slosh amplitude indicated at the PU sensor was 9.37 in.

zero-to-peak (corrected for probe attenuation). The LH2 slosh frequency correlated well with the predicted LH2 first mode slosh frequency. Previous Saturn IB flights have exhibited an LH2 slosh frequency near the first mode frequency.

The LOX slosh amplitudes and frequencies during S-IVB powered flight are shown in figure 19-5. The maximum LOX slosh amplitude observed at the PU sensor was 0.25 in. zero-to-peak. The LOX slosh frequency correlated with the predicted LOX first mode slosh frequency with the exception of the time interval between RO +300 and RO +350 sec when LOX sloshing appeared to be driven by the LH2 sloshing at the LH2 first mode frequency.

19.2 Attitude Control During Orbital Coast

Following S-IVB cutoff and configuration to coast control mode, normal programmed pitch and yaw maneuvers were executed (TB4 +20 sec) to align the stage with the local horizontal and establish the desired yaw attitude, respectively. Disturbances were noted during the 30 sec. propulsion LOX vent occurring at TB4 +30.2 sec. Attitude control during the interval appeared normal. The control system response to guidance commands and stage disturbances during the interval are shown for the pitch, yaw, and roll axes in figures 19-6, 19-7, and 19-8, respectively.

Attitude control during the LOX dump (RO +5,669 to RO +6,390 sec) appeared normal. Pitch, yaw, and roll control system parameters and associated APS engine firing during this interval are shown in figures 19-9, 19-10, and 19-11, respectively. Thrust vector misalignments during dump were:

<u>Pitch</u>	<u>Yaw</u>	
0.34 deg	0.65 deg	(RO +5,669 to RO +5,750 sec liquid dump)
0.15 deg	-0.41 deg	(RO +5,750 to RO +6,100 sec gaseous dump)

Manual control of the S-IVB was initiated at approximately RO +9,050 sec. During a 3 min control interface exercise, the crew performed various pitch, yaw, and roll maneuvers. Control system commands and corresponding vehicle responses including APS engine firings during manual control of the S-IVB are shown in figures 19-12, 19-13, and 19-14 for the pitch, yaw, and roll axes, respectively. The vehicle command and response during manual control correlated well with the scheduled timeline and expected vehicle response. The actual APS propellant usage during manual control (5.6 lbm module 1 and 5.7 lbm module 2) correlates closely with the predicted usage of 5.2 lbm per module.

Attitude control during spacecraft separation appeared normal. The control system response in the pitch, yaw, and roll axes during this interval are shown in figures 19-15, 19-16, and 19-17, respectively.

APS propellant requirements for attitude control during this mission correlated closely with the nominal predicted propellant requirements. A comparison of actual and predicted APS propellant usage for attitude control is shown in figures 19-18 and 19-19 for modules 1 and 2 respectively. Some deviation between the actual and nominal predicted usage was noted for module 2 during the LOX dump. Slightly less APS propellant was required than predicted from the module. This is attributed primarily to a difference in the actual thrust misalignment and that used to determine the mean predicted usage.

A summary of APS impulse requirements for attitude control during significant events is presented in table 19-2. APS propellant depletion occurred between Redstone revolution 10 (15 hr 56 min G.E.T.) and Canary Island revolution 11 (16 hr 29 min G.E.T.). Available control system data indicated that APS firing frequency increased over Redstone, revolution 10. It was reported that IU batteries were near marginal values for the ST-124M-3 stable platform stability loop which is the probable cause for the increased frequency of commands to fire APS engines. Canary Island, revolution 11, data showed all attitude errors increasing toward maximum negative values and APS propellant depleted. It was reported that the IU battery that supplies launch vehicle digital computer negative bias voltage had dropped below the required voltage; therefore, the attitude errors being sent to the control system were erroneous. There is insufficient data to determine the exact reason and time of loss of attitude control. APS propellant depletion occurred on AS-204 at approximately 10 hr G.E.T. The extended control system lifetime of AS-205 over AS-204 is attributed primarily to a higher AS-205 orbit resulting in lower aerodynamic disturbances than AS-204.

TABLE 19-1
 MAXIMUM VALUES OF CRITICAL FLIGHT CONTROL PARAMETERS - S-IVB POWERED FLIGHT

PARAMETERS	UNIT	S-IVB/S-IB SEPARATION	GUIDANCE INITIATION	FLIGHT CONTROL COMPUTER GAIN CHANGE	ARTIFICIAL TAU GUIDANCE	CHI TILDE GUIDANCE MODE	CHI FREEZE & ENGINE CUTOFF
Attitude error							
Pitch	deg	+1.7	+1.9	+1.3	+1.3	+2.1	+0.9
Yaw	deg	-1.1	-2.8	-1.2	-1.3	-1.2	-1.2
Roll	deg	+1.1	-0.5	+0.7	+0.7	+0.7	+0.6
Angular rate							
Pitch	deg/sec	+0.3	+1.3	-0.2	-0.3	-1.1	-0.5
Yaw	deg/sec	-0.2	+1.0	0.0	0.0	0.0	0.0
Roll	deg/sec	-0.5	0.0	0.0	0.0	0.0	0.0
Actuator position*							
Pitch	deg	0.9	1.1	0.7	0.7	0.8	0.8
Yaw	deg	0.6	1.0	0.6	0.7	0.6	0.7

*Retracted position

TABLE 19-2
APS IMPULSE SUMMARY

EVENT	UNITS	MODULE 1	MODULE 2	APS ENGINE					
				I _{IV} (1)	I _P (2)	I _{II} (3)	III _{II} (4)	III _P (5)	III _{IV} (6)
Powered flight: separation, guidance initiation and ullage rkt jettison RO +145 to RO +210 sec	lbf-sec	139.4	150.3	51.1	0.0	88.3	59.4	0.0	90.9
Limit cycle operations for remaining burntime RO +210 to RO +617 sec	lbf-sec	251.5	274.5	0.0	0.0	251.5	0.0	0.0	274.5
Initial recovery follow- ing J-2 cutoff: 617 to 636 (includes LH2 venting)	lbf-sec	0.0	21.8	0.0	0.0	0.0	19.7	0.0	2.07
Alignment to local horizontal following J-2 cutoff 636 to 678 sec (includes LOX and LH2 venting)	lbf-sec	391.6	162.0	40.2	252.7	98.7	70.3	5.7	86
LOX main engine dump 5,669 to 6,390 sec	lbf-sec	560.8	264.0	209.9	289.8	61.1	62.9	0.0	201.1
Manual steering control 9,050 to 9,240 sec	lbf-sec	1,839.5	1,511.2	487.4	838.6	513.5	463.8	612.8	434.6
Initiate neg 20 deg pitch maneuver 9,840 to 10,270	lbf-sec	22.2	255.3	15.5	0.0	6.7	0.0	239.8	15.5
S-IVB/CSM separation 10,500 to 10,515 sec	lbf-sec	208.9	199.3	84.7	41.7	82.5	101.5	0.0	97.8
Initiate maneuver to align vehicle retrograde with local horizontal 11,816 to 11,840 sec	lbf-sec	144.1	299.2	68.3	0	75.8	63.9	170.0	65.3

- 1 S-IB/S-IVB SEPARATION, S-IVB ENGINE START, FLIGHT CONTROL COMPUTER BURN MODE ON
- 2 INITIATE ITERATIVE GUIDANCE MODE
- 3 INITIATE ARTIFICIAL TAU MODE
- 4 INITIATE CHI TILDE GUIDANCE
- 5 INITIATE CHI FREEZE
- 6 S-IVB ENGINE CUTOFF, FLIGHT CONTROL COMPUTER BURN MODE OFF

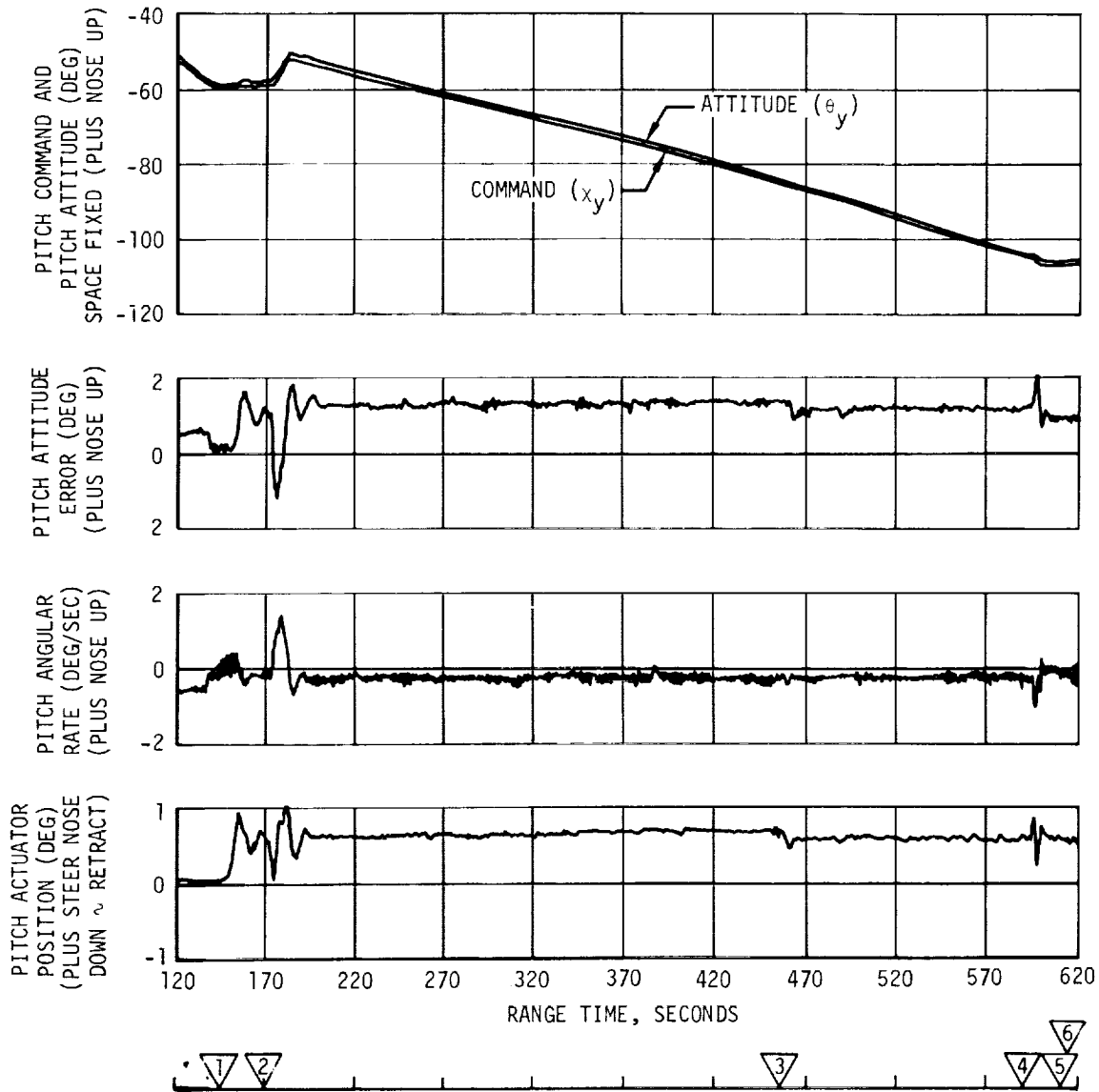

Figure 19-1. Pitch Attitude Control - Powered Flight

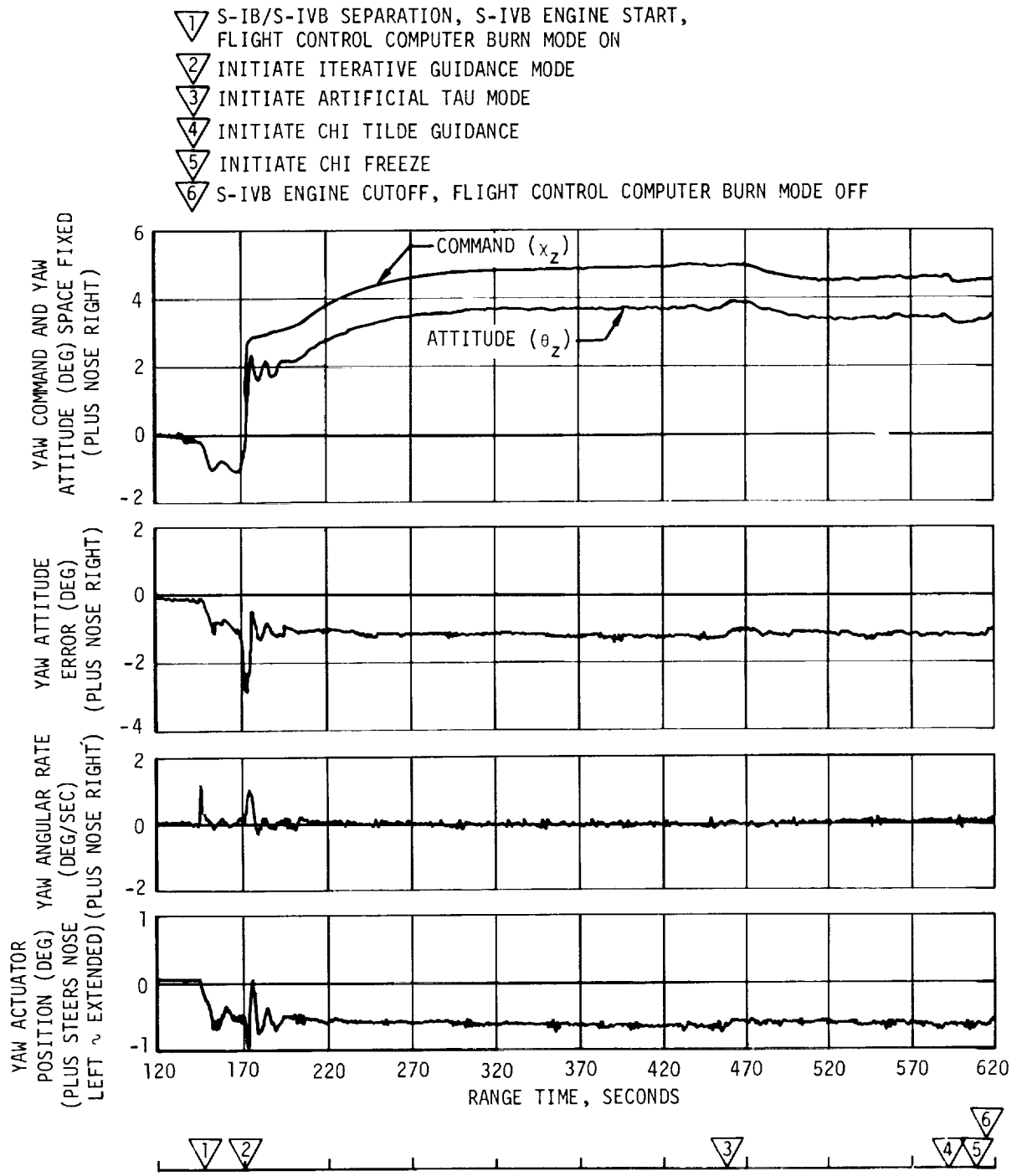

Figure 19-2. Yaw Attitude Control - Powered Flight

- ▽ 1 S-IB/S-IVB SEPARATION, S-IVB ENGINE START, FLIGHT CONTROL COMPUTER BURN MODE ON
- ▽ 2 INITIATE ITERATIVE GUIDANCE MODE
- ▽ 3 INITIATE ARTIFICIAL TAU MODE
- ▽ 4 INITIATE CHI TILDE GUIDANCE
- ▽ 5 INITIATE CHI FREEZE
- ▽ 6 S-IVB ENGINE CUTOFF, FLIGHT CONTROL COMPUTER BURN MODE OFF

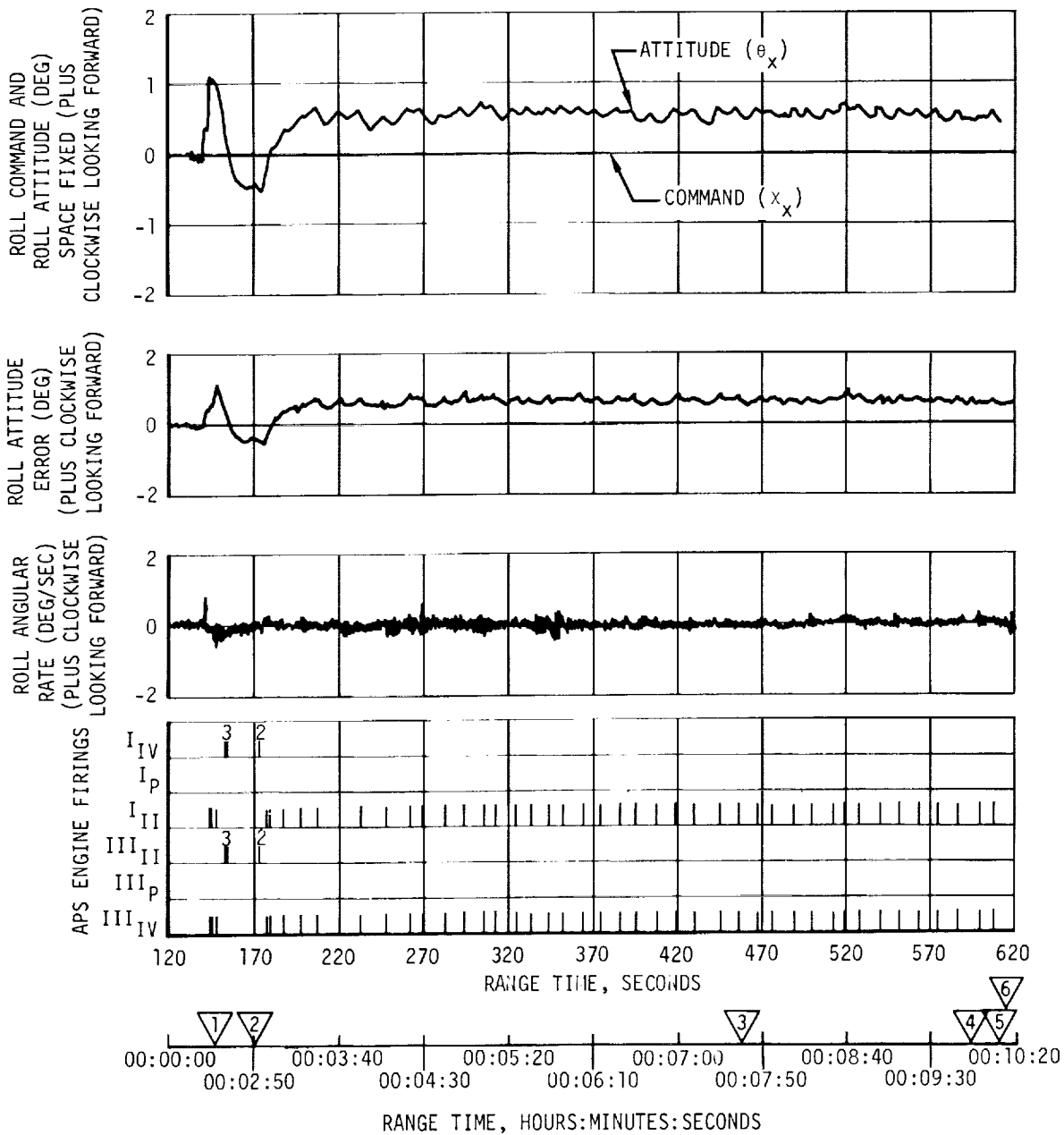

Figure 19-3. Roll Attitude Control - Powered Flight

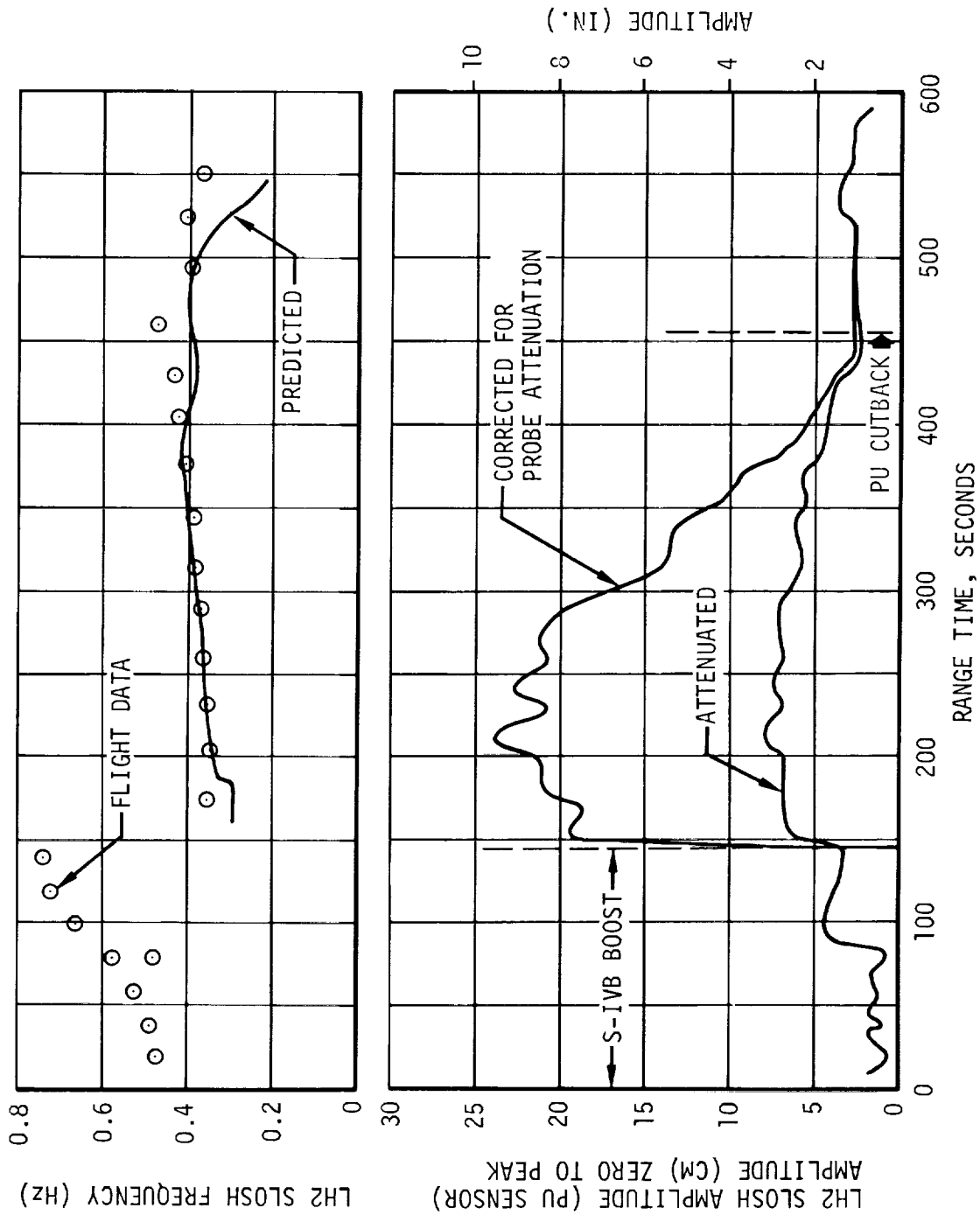

Figure 19-4. LH2 Slosh - Powered Flight

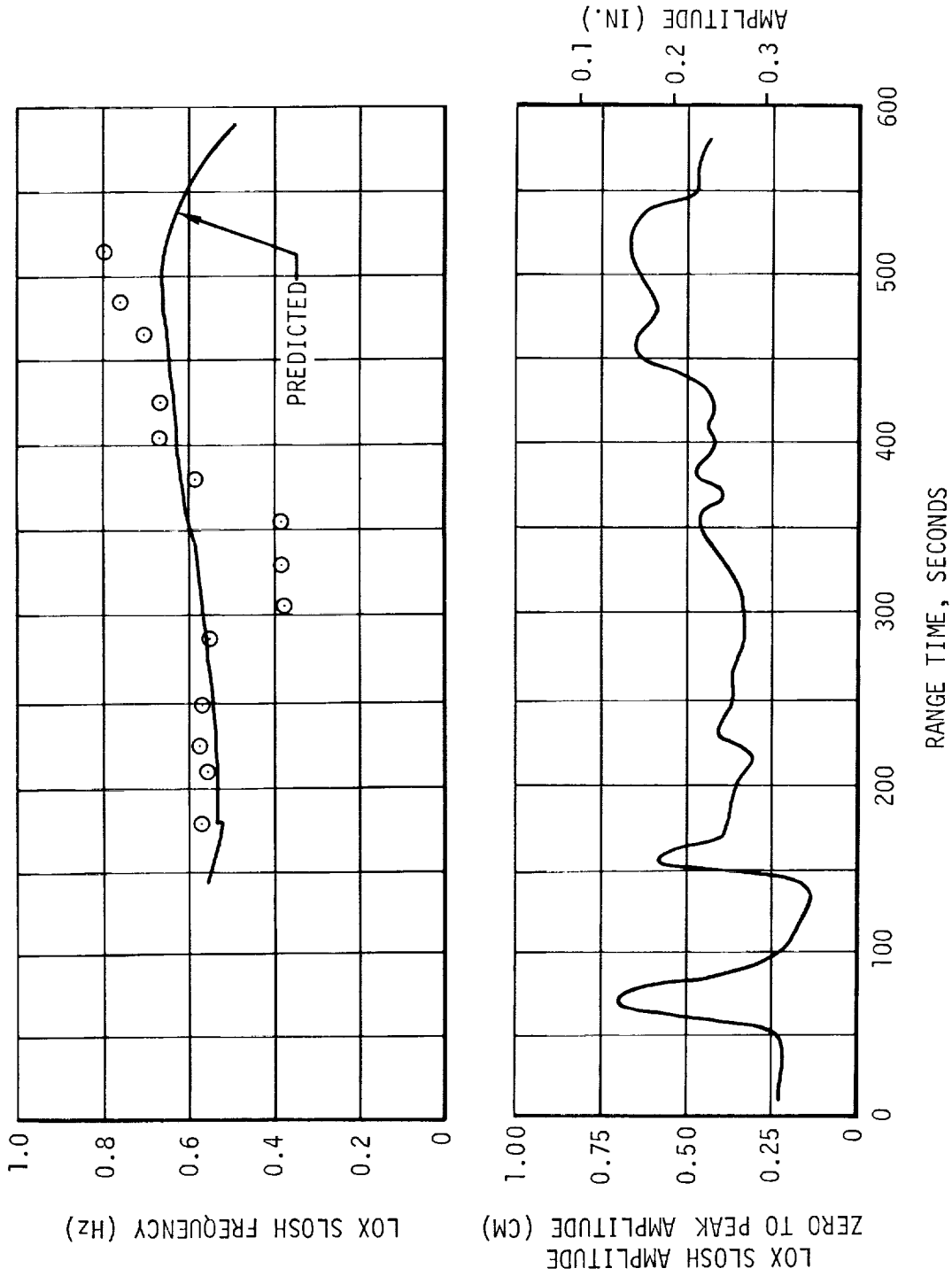

Figure 19-5. LOX Slosh - Powered Flight

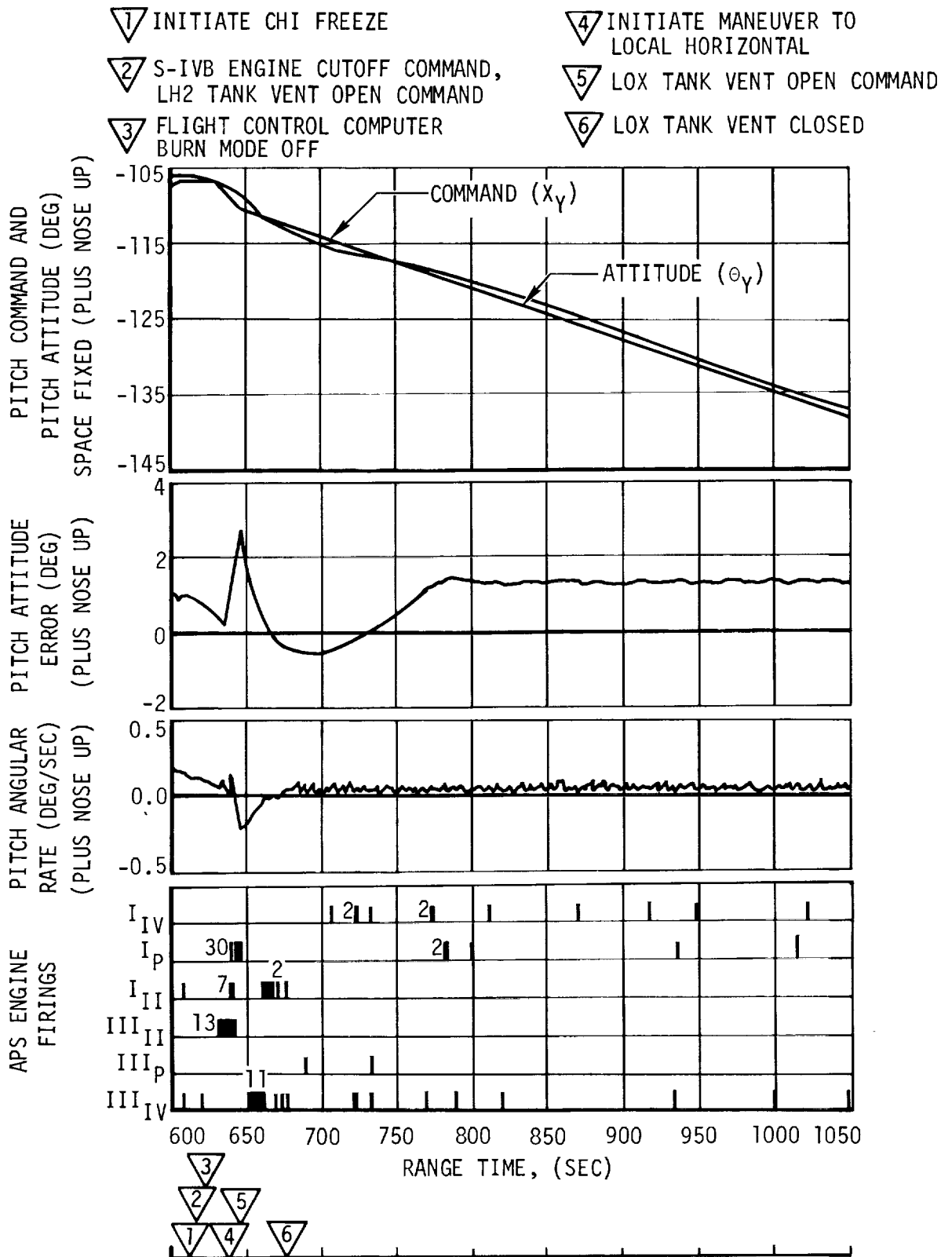

Figure 19-6. Pitch Attitude Control - S-IVB Alignment with Local Horizontal

- 1 INITIATE CHI FREEZE
- 2 S-IVB ENGINE CUTOFF COMMAND, LH2 TANK VENT OPEN COMMAND
- 3 FLIGHT CONTROL COMPUTER BURN MODE OFF
- 4 INITIATE MANEUVER TO LOCAL HORIZONTAL
- 5 LOX TANK VENT OPEN COMMAND
- 6 LOX TANK VENT CLOSED

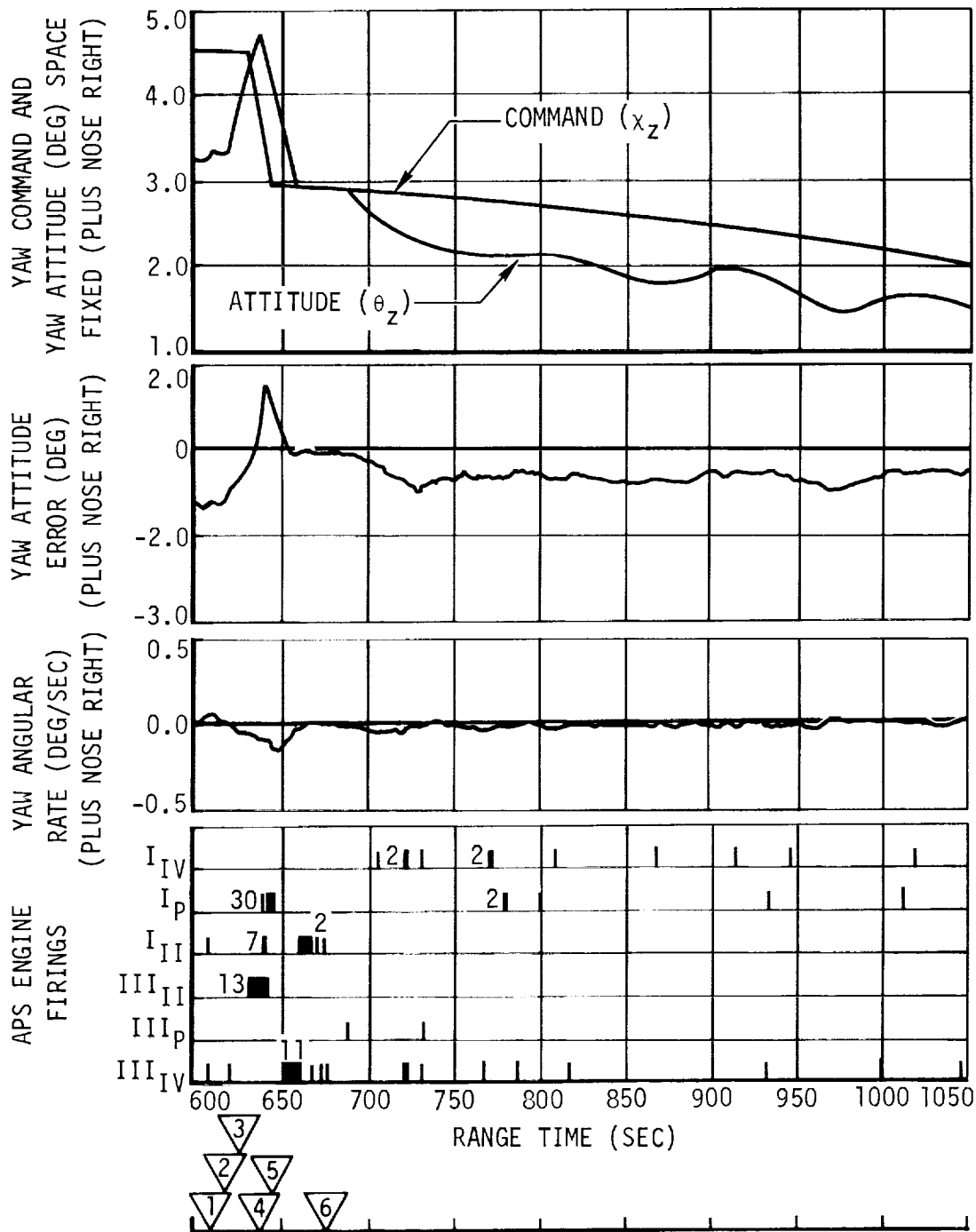

Figure 19-7. Yaw Attitude Control - S-IVB Alignment with Local Horizontal

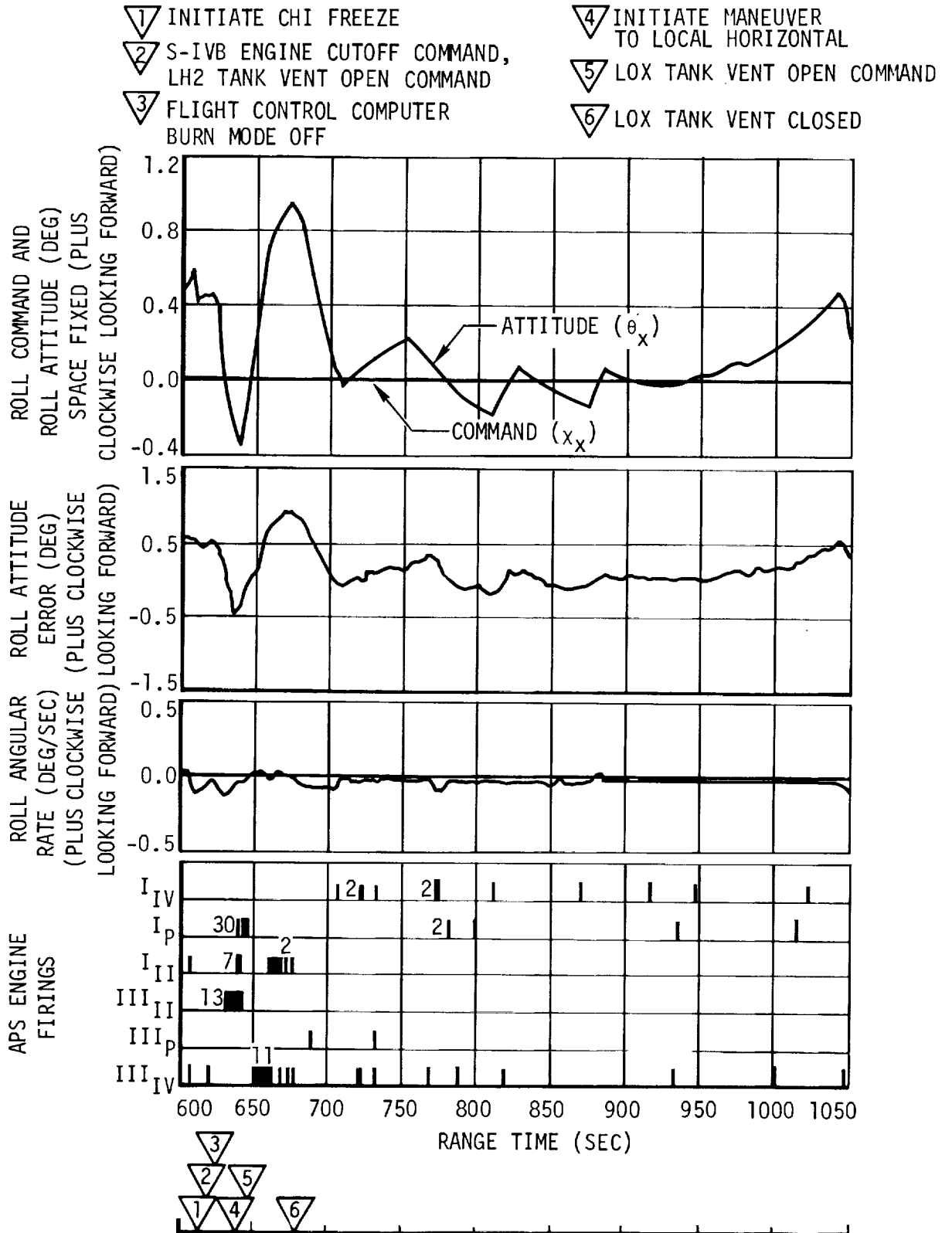

Figure 19-8. Roll Attitude Control - S-IVB Alignment with Local Horizontal

- ▽ 1 INITIATE LOX DUMP
- ▽ 2 TERMINATE LOX DUMP

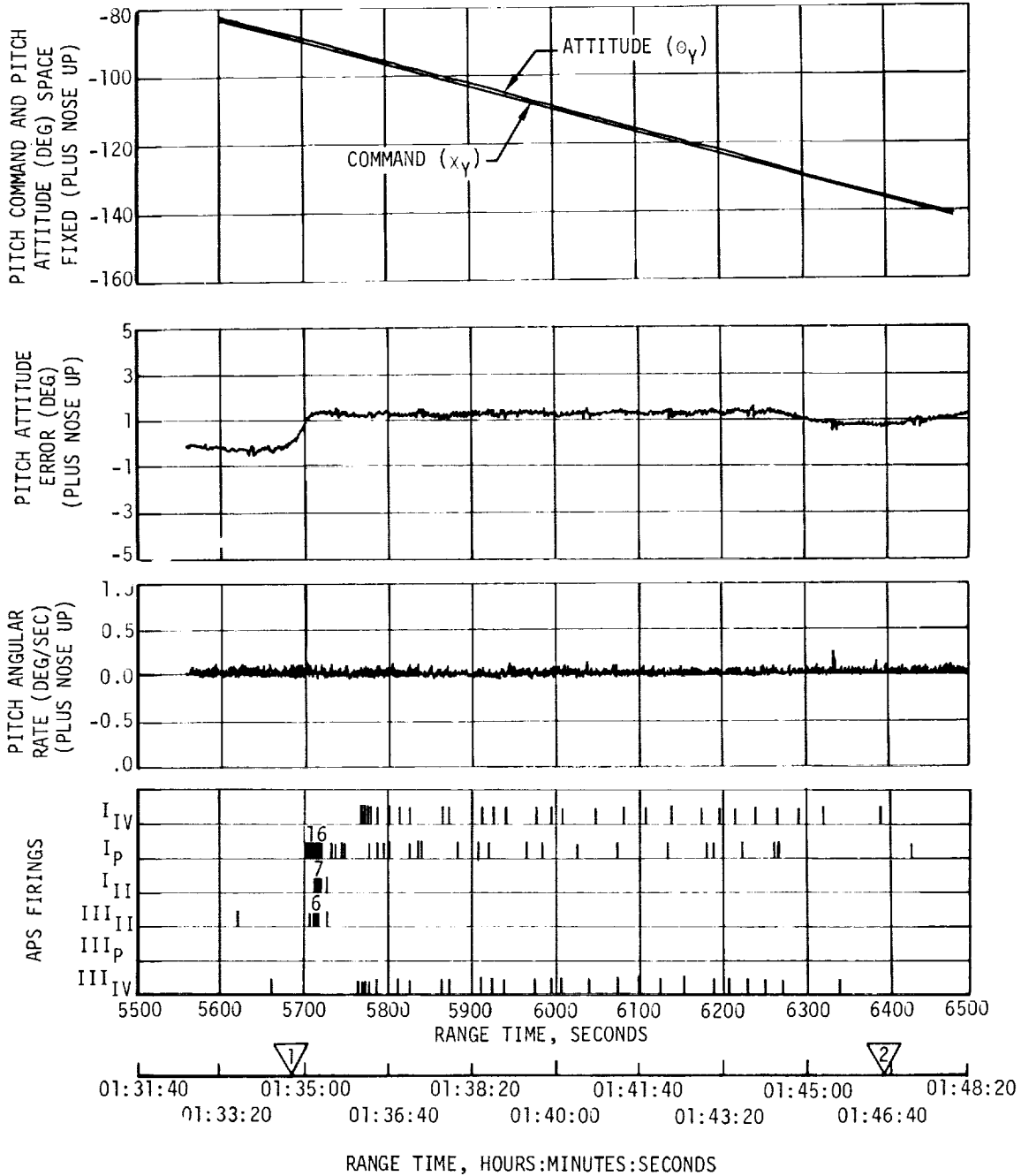

Figure 19-9. Pitch Attitude Control - LOX Dump

- ▽ 1 INITIATE LOX DUMP
- ▽ 2 TERMINATE LOX DUMP

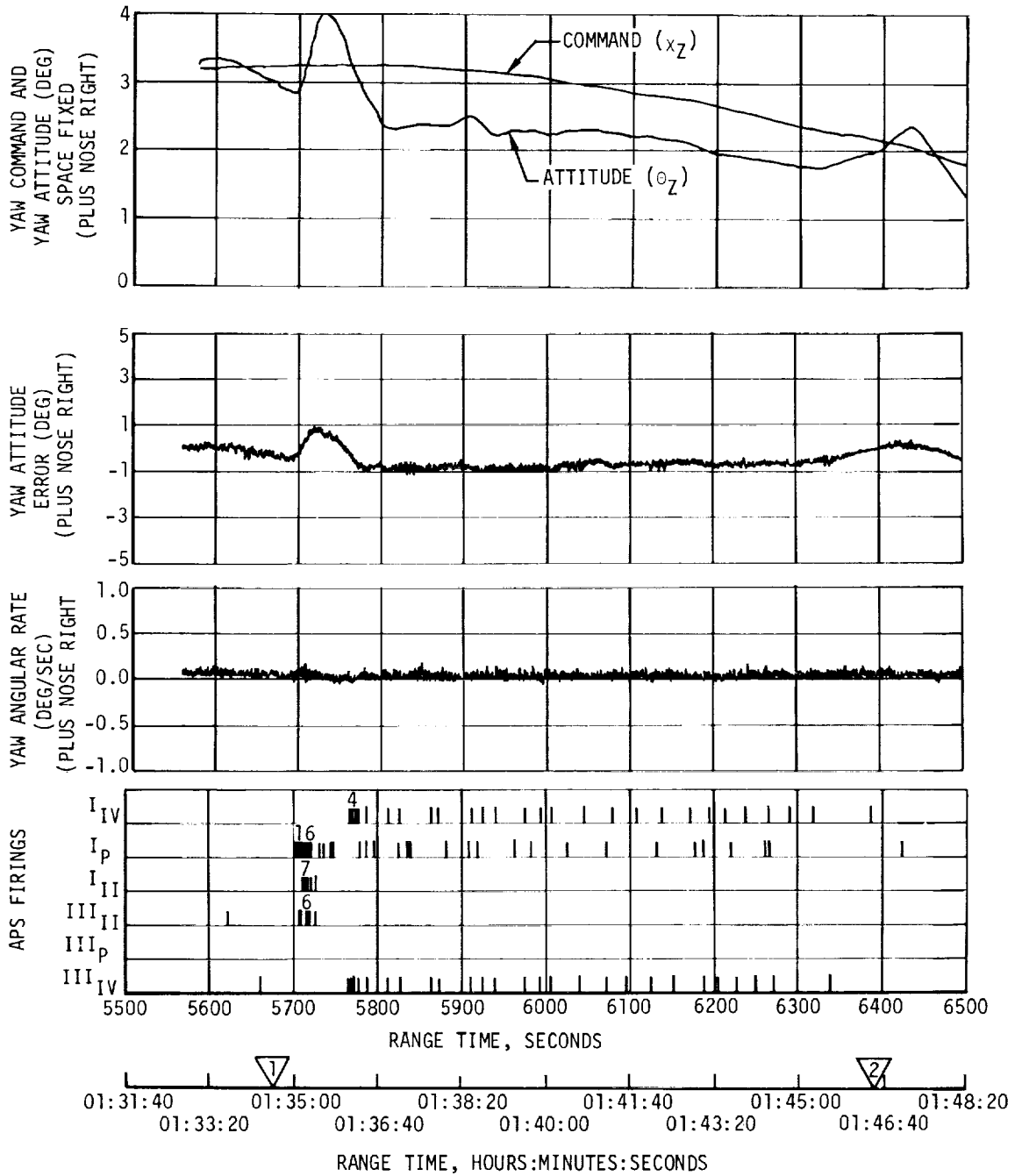

Figure 19-10. Yaw Attitude Control - LOX Dump

- ▽ 1 INITIATE LOX DUMP
- ▽ 2 TERMINATE LOX DUMP

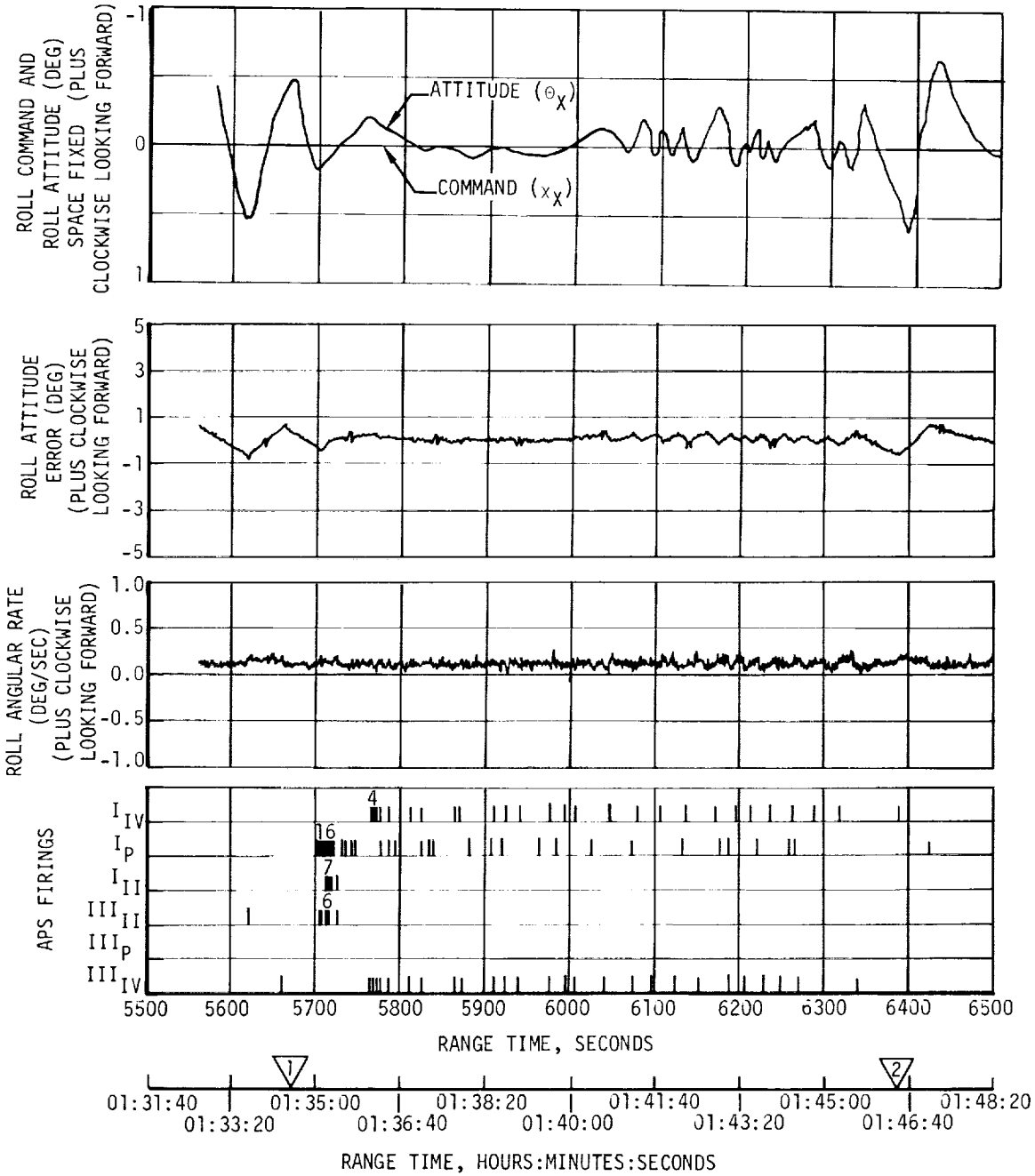

Figure 19-11. Roll Attitude Control - LOX Dump

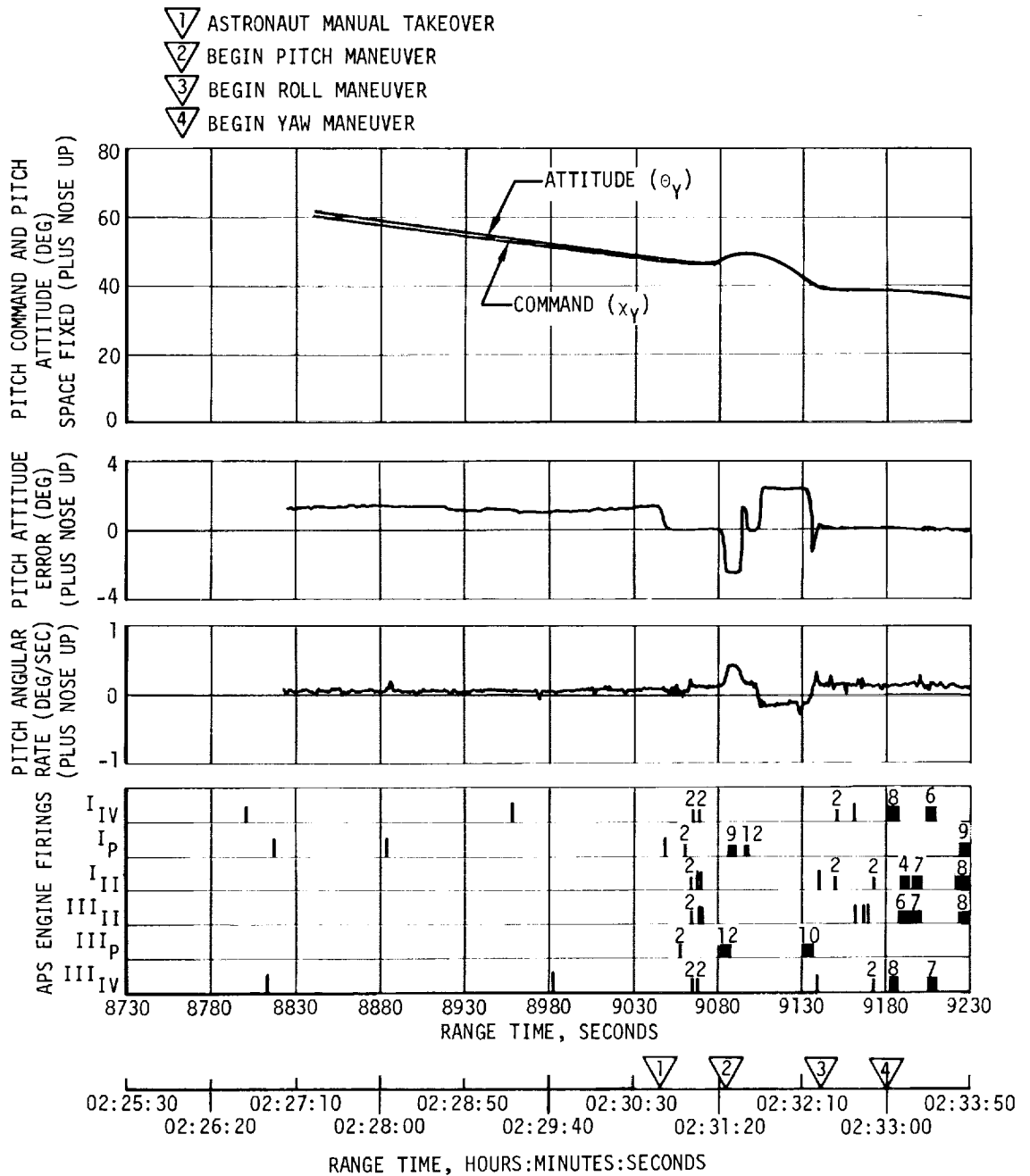

Figure 19-12. Pitch Attitude Control - Manual Control

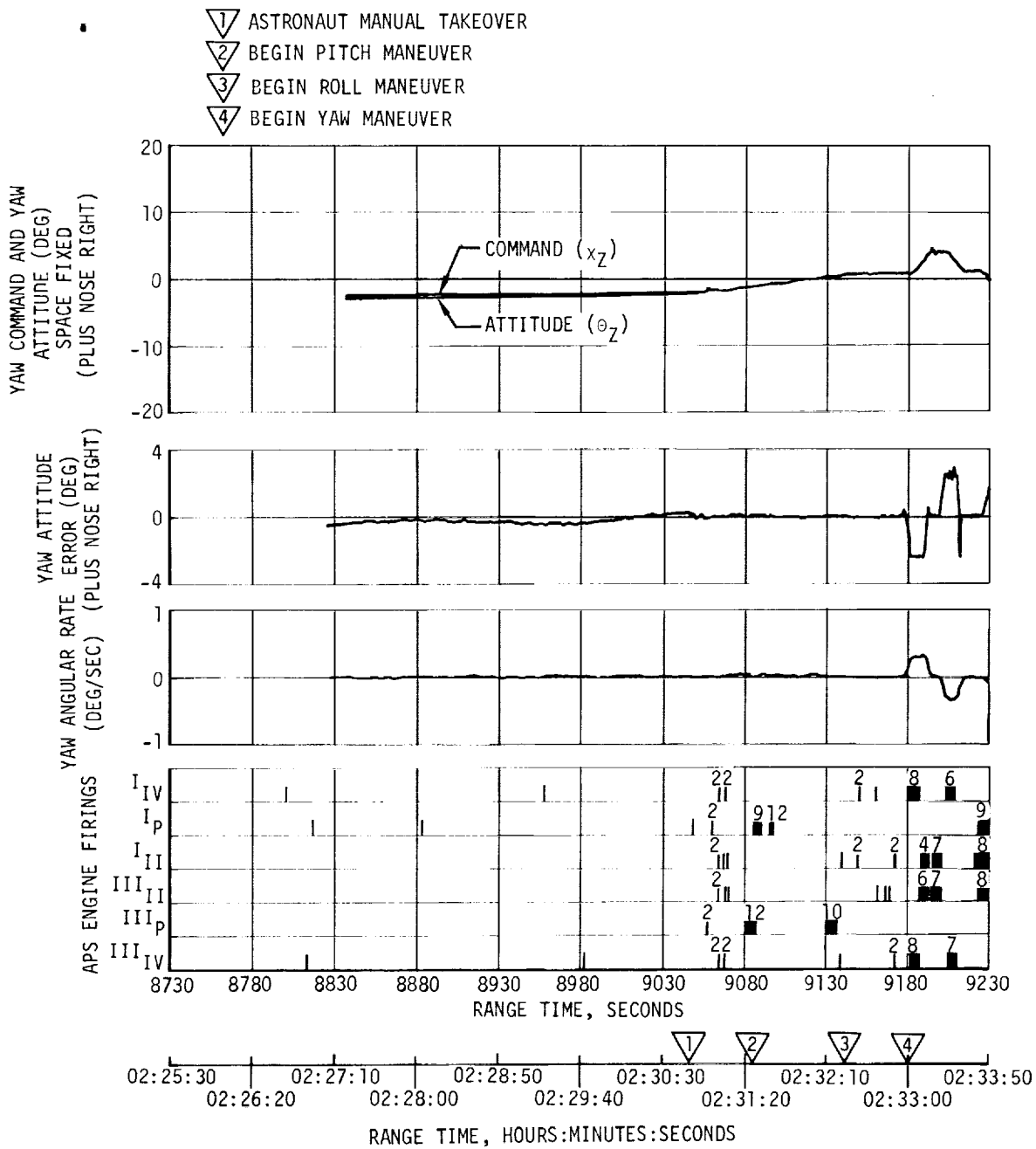

Figure 19-13. Yaw Attitude Control - Manual Control

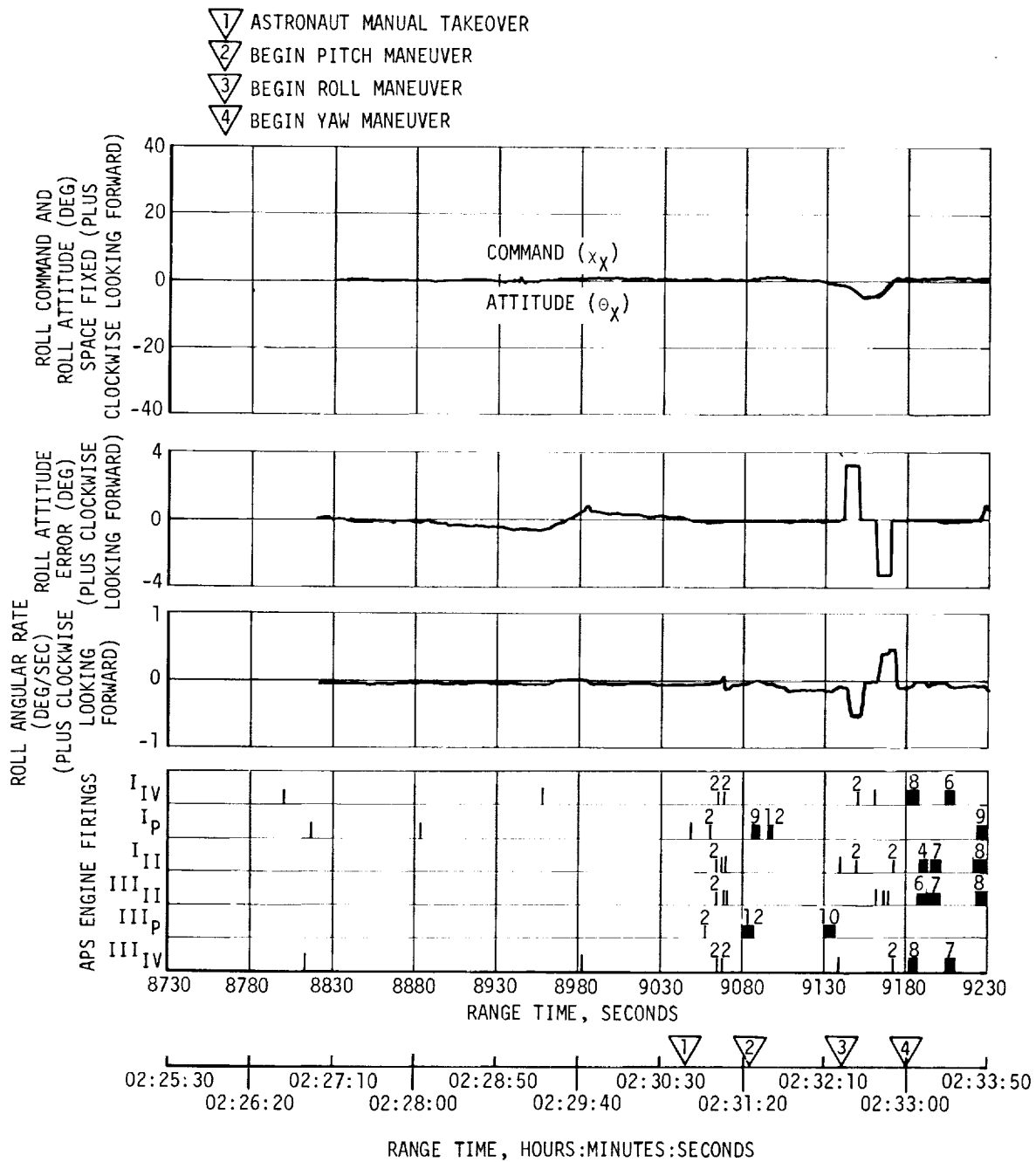

Figure 19-14. Roll Attitude Control - Manual Control

1 S-IVB/CSM SEPARATION

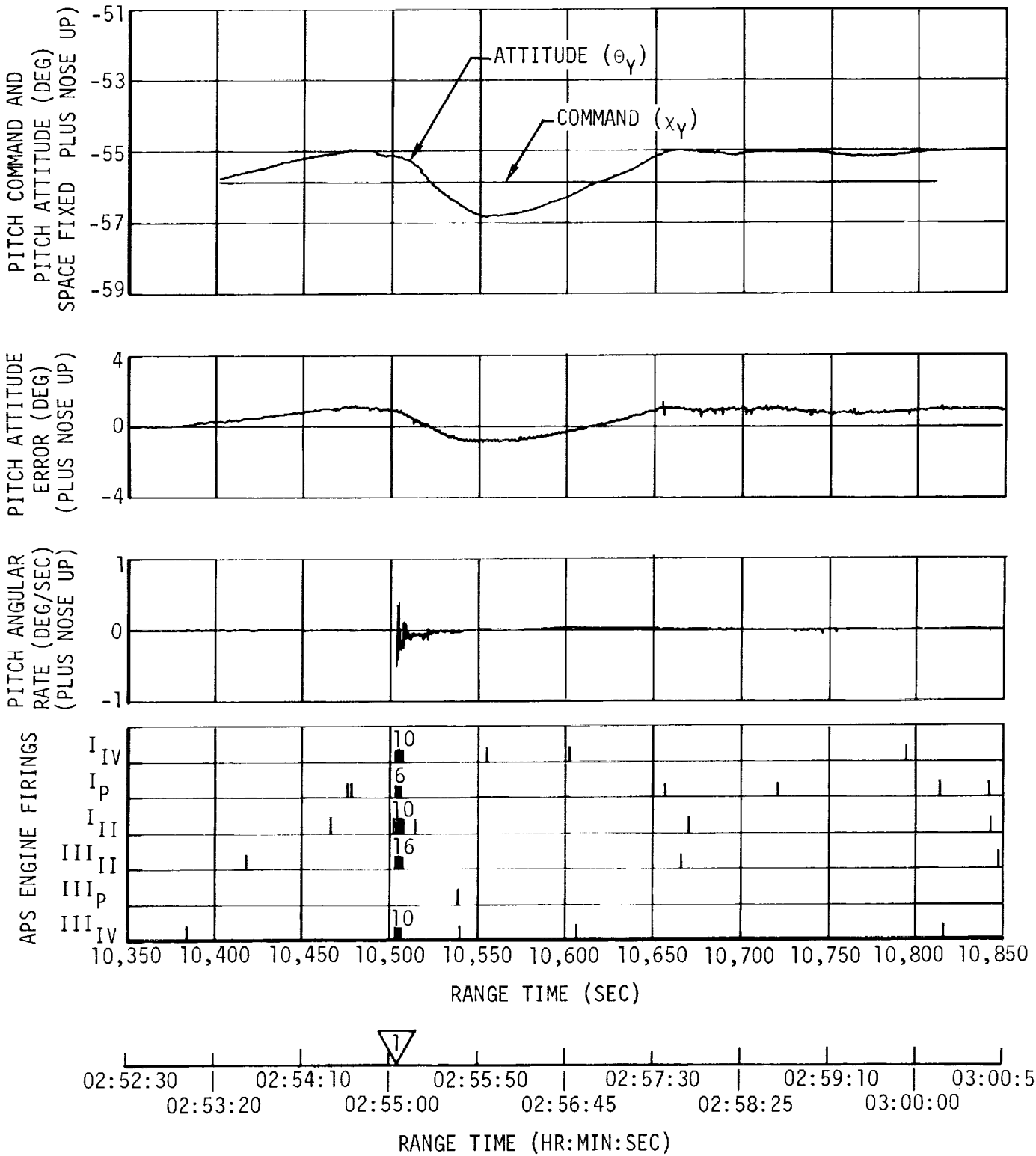

Figure 19-15. Pitch Attitude Control - S-IVB/CSM Separation

▽ S-IVB/CSM SEPARATION

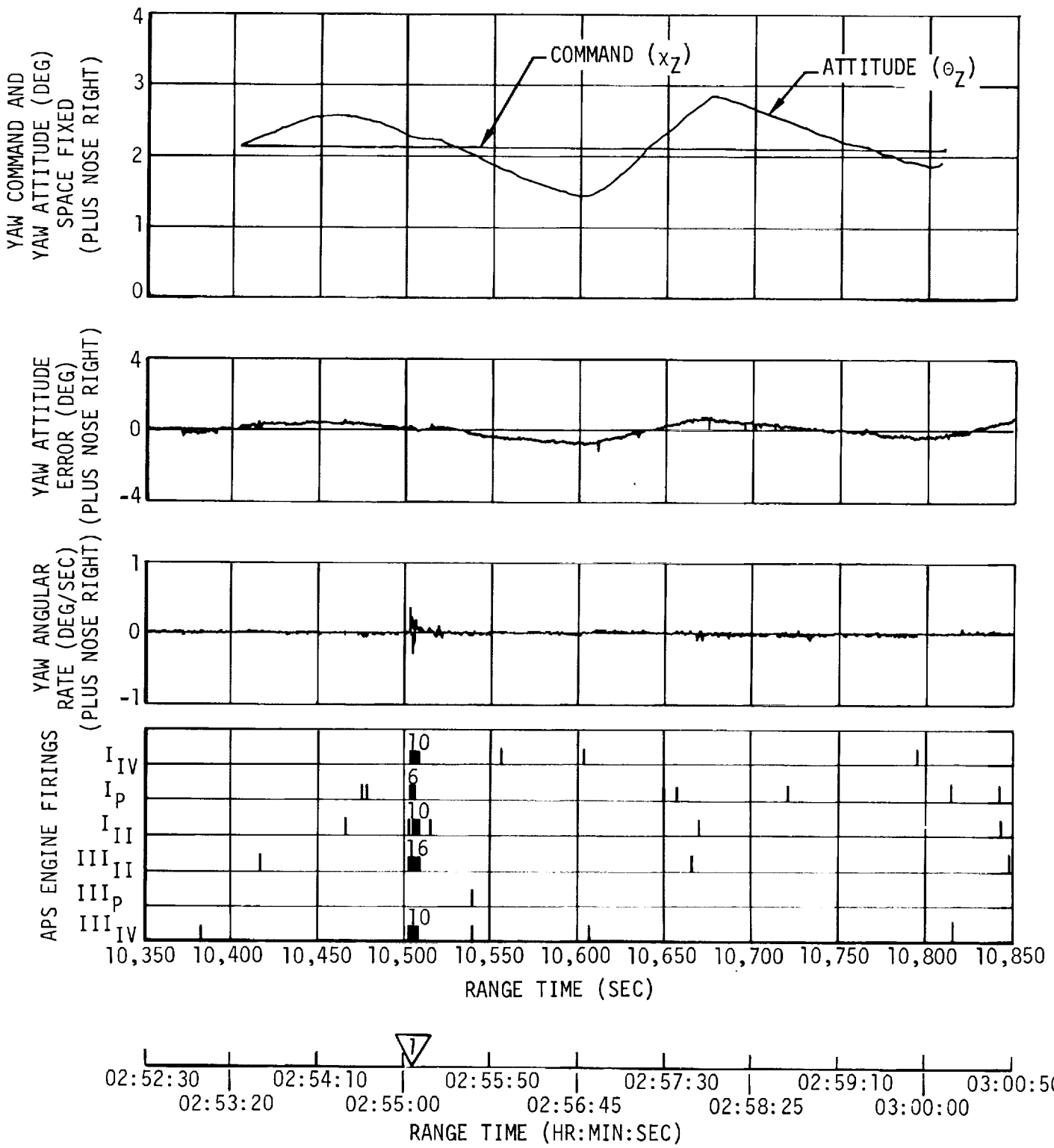

Figure 19-16. Yaw Attitude Control - S-IVB/CSM Separation

▽ S-IVB/CSM SEPARATION

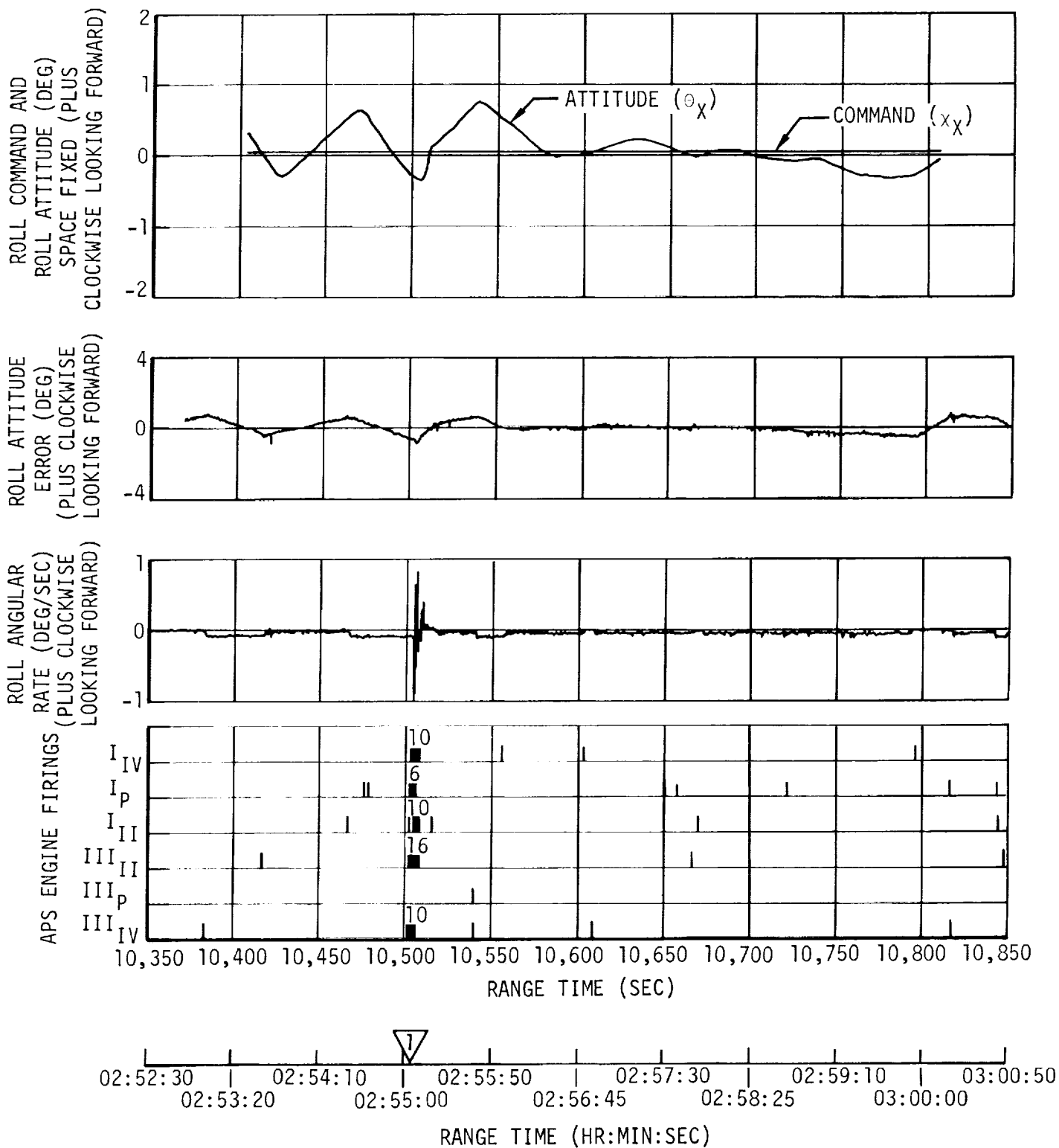

Figure 19-17. Roll Attitude Control - S-IVB/CSM Separation

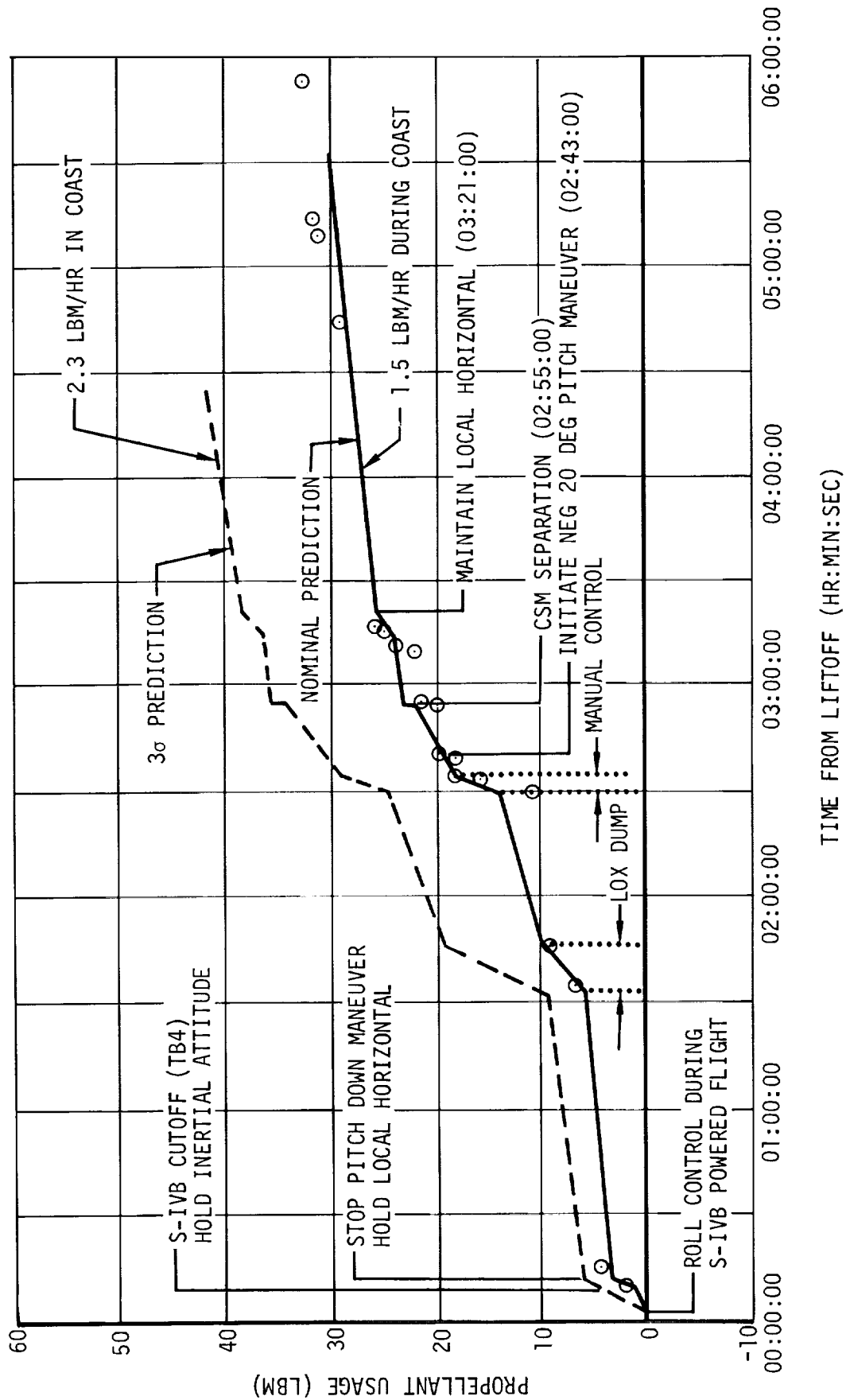

Figure 19-18. Module 1 APS Propellant Required for Attitude Control

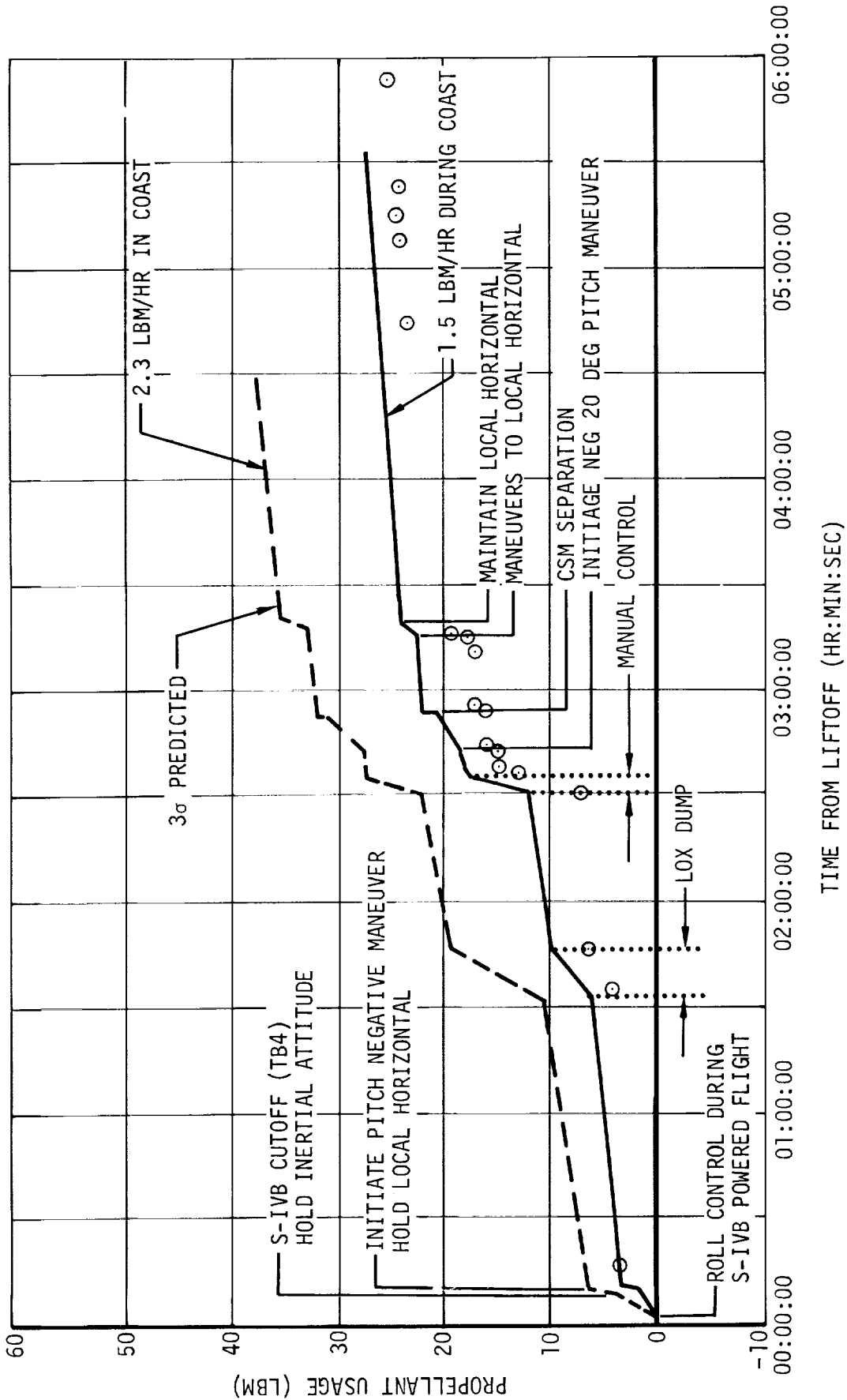
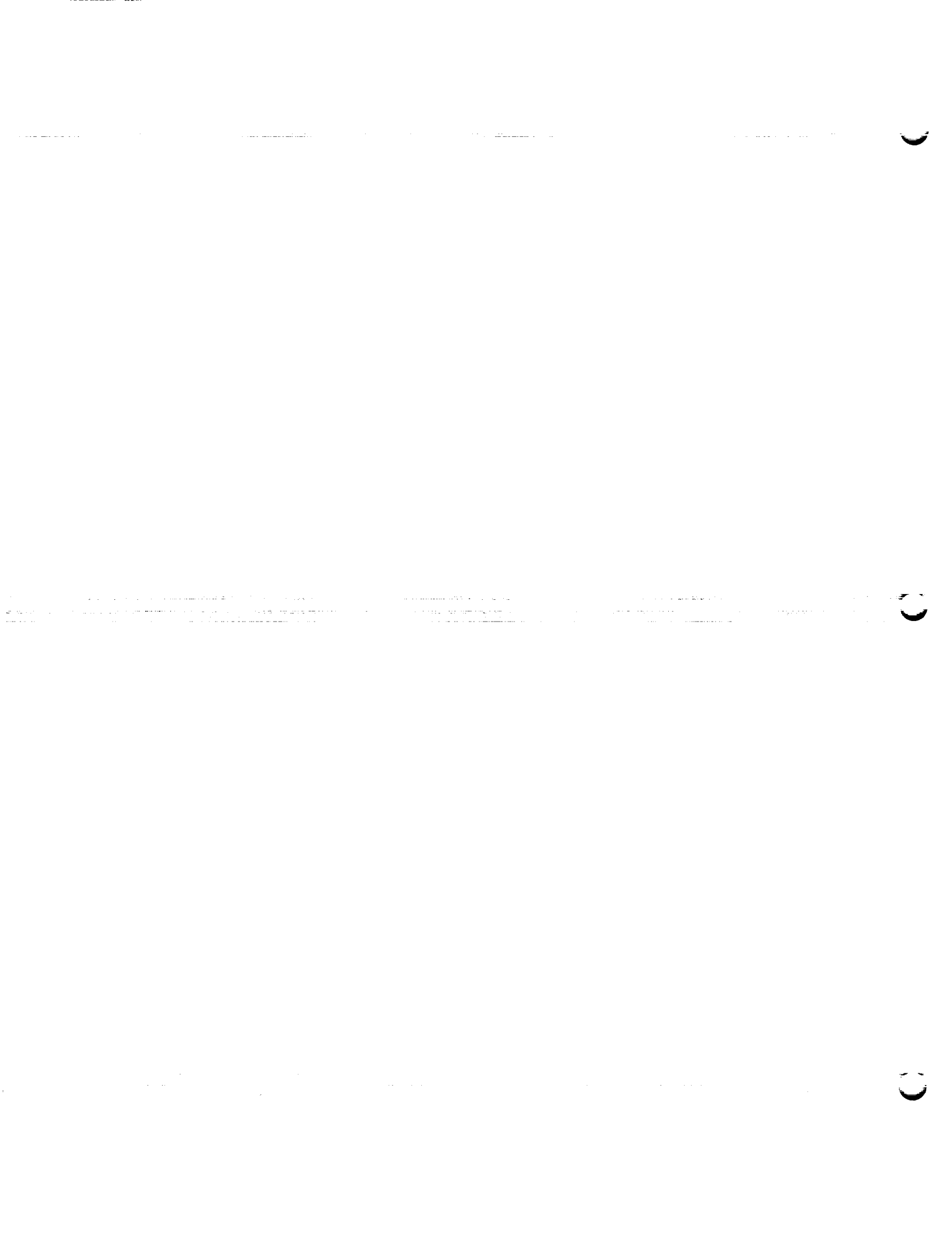

Figure 19-19. Module 2 APS Propellant Required for Attitude Control

SECTION 20

HYDRAULIC SYSTEM



20. HYDRAULIC SYSTEM

20.1 Hydraulic System Operation

20.1.1 General

The hydraulic system performance was within predicted values and the entire system operated satisfactorily throughout the flight. All redline limits were met prior to liftoff. There was one 48-sec thermal cycle (T/C) which was programmed during first orbit. System internal leakage was 0.59 gpm which is within the 0.4 to 0.8 gpm allowable range.

20.1.2 Prelaunch

During countdown the auxiliary hydraulic pump was switched to coast thermal mode at T -6 hr, just prior to start of propellant loading. There were two manually controlled thermal cycles during this period of approximately 12 min duration each. The auxiliary hydraulic pump was turned on until the pump inlet temperature (C0050) rose from approximately -10 to 65 deg F. Reservoir oil temperature rose from 35 to 50 deg F. The accumulator was precharged to 2,350 psia at 70 deg F. Reservoir oil level (auxiliary pump off) was 82 percent at 57 deg F. The auxiliary hydraulic pump was turned on "Flight Mode" at approximately T -11 min. After stabilization the following measurements were recorded:

System pressure (D0041):	3,600 psia
Reservoir pressure (D0042):	170 psia
Reservoir oil level (L0007):	19%
Pump inlet temperature (C0050):	50°F
Reservoir oil temperature (C0051):	41°F

20.1.3 Boost and Powered Flight

During the boost phase the oil temperature rose steadily as auxiliary pump operation warmed the oil. The auxiliary pump furnished most of the system internal leakage flow (0.59 gpm) during burn as indicated by the pump current load (40 to 45 amp). Reservoir fluid level increased to 25 percent during engine burn due to thermal expansion resulting from the oil temperature increase. The revision to 92 percent static level occurred after the Flight Mode Off Command. Figures 20-1 through 20-4 show significant hydraulic system performance parameters during boost and powered flight. The engine driven hydraulic pump extracted approximately 2.5 hp during engine burn.

20.1.4 Orbital Coast

After engine cutoff the main pump inlet oil temperature continued to rise due to the transfer of heat from the LOX turbine housing to the pump manifold. The auxiliary hydraulic pump was started at R0+2,710 sec by IU command to begin a programmed 48 sec thermal cycle. Figures 20-5 and -6 show hydraulic system performance during orbital coast.

Turning on the auxiliary hydraulic pump caused the hydraulic actuators to center themselves. However, it was noted that the pitch actuator did move out to +0.18 deg over a 30 sec period. Then the actuator proceeded to the null position. A 1.1 ma bias signal was applied to the pitch hydraulic servo. This corresponds to a 0.16 deg position.

20.1.5 Orbital Safing (LOX Dump)

The auxiliary hydraulic pump was started at R0 +5,031 sec, approximately 20 sec prior to the start of LOX dump. The auxiliary pump was operated 642 sec during this phase to keep the J-2 engine centered.

During this activity the pitch and yaw actuators each drifted about zero moving out to a maximum of +0.12 and -0.12 deg respectively. The rate of movement varied between 0.005 and 0.05 cps. A bias signal was applied to the pitch and yaw actuators of +1.2 and -0.3 ma. This corresponds to a +0.17 and -0.04 deg pitch and yaw engine position respectively. Similar actuator activity on previous flights under similar conditions is noted (vehicle 501 prior to second burn). Actuator performance is not degraded due to this apparent 1 percent drift in position at these low cyclic conditions. Figures 20-7 through 20-9 shows significant hydraulic system performance parameters during orbital safing.

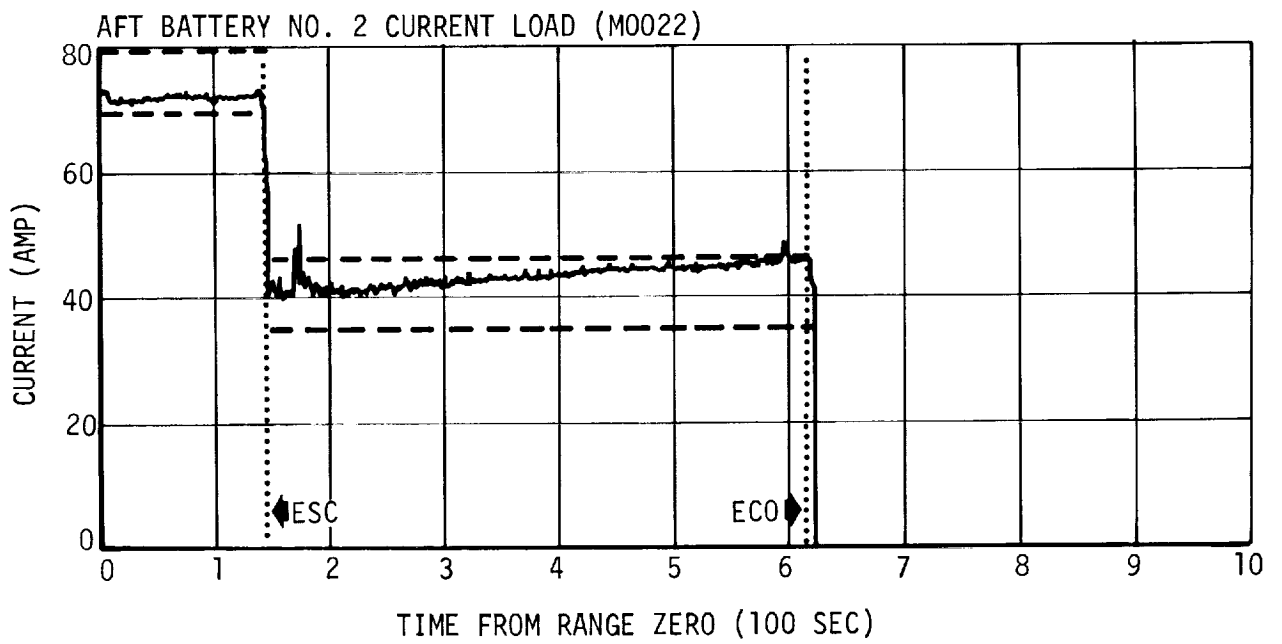
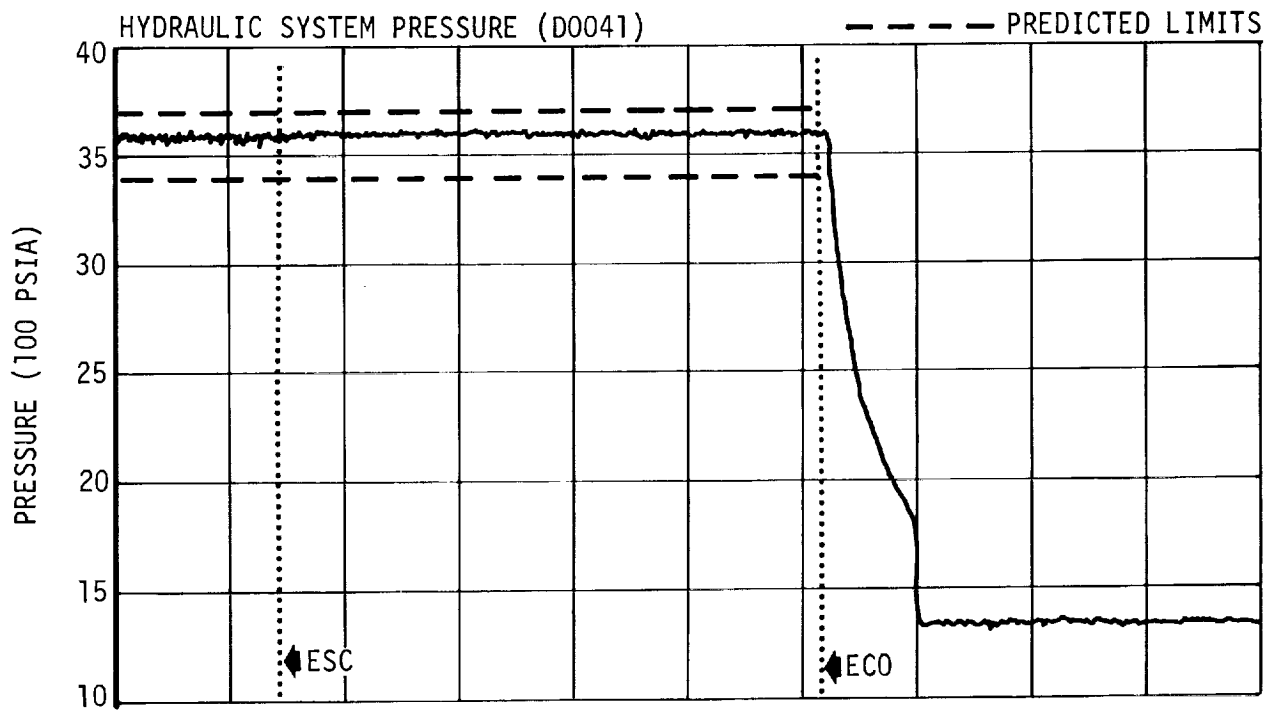

Figure 20-1. System Pressure and Pump Current Load - Boost and Powered Flight

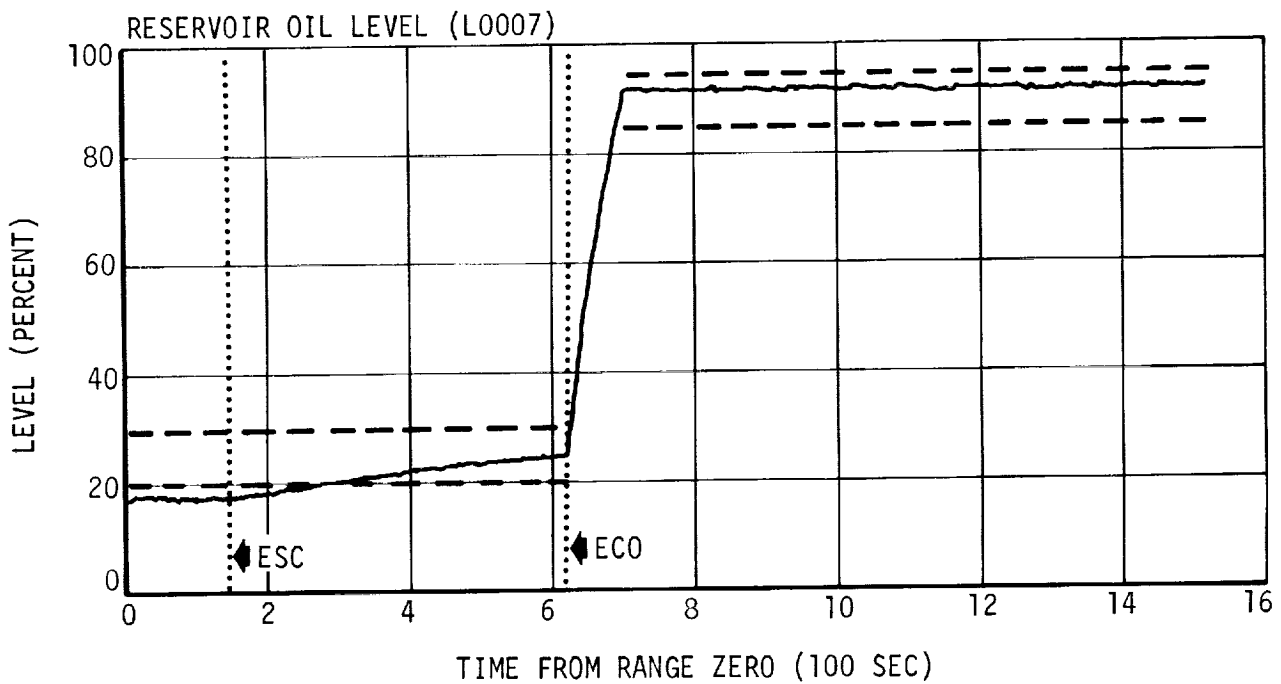
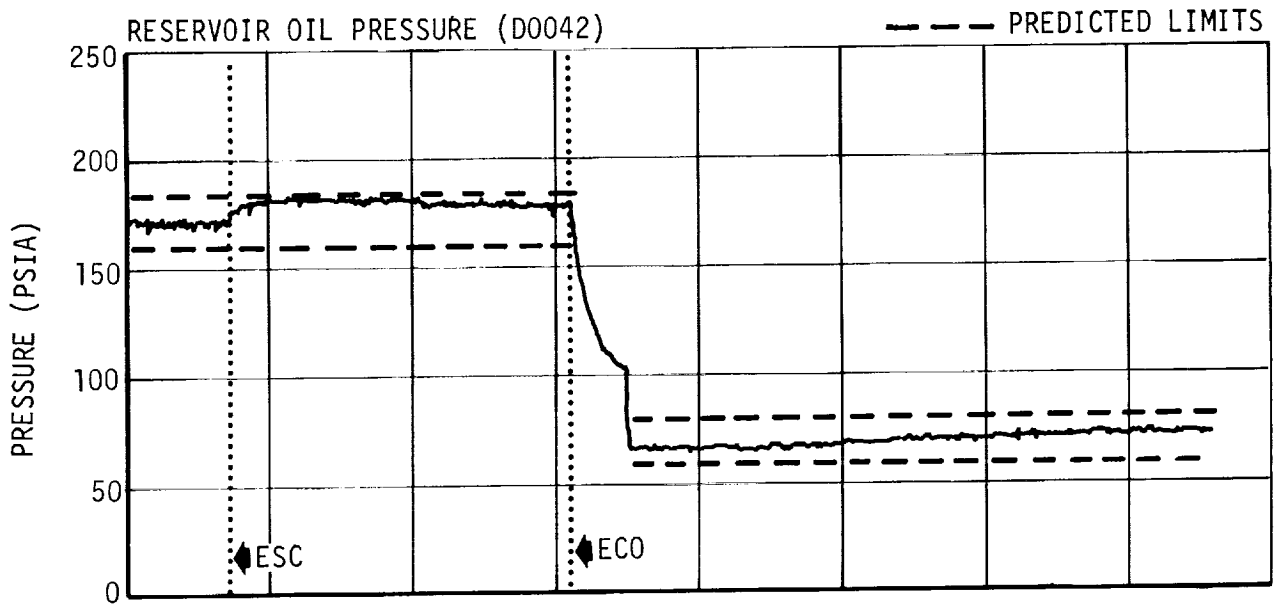

Figure 20-2. Reservoir Pressure and Oil Level - Boost and Powered Flight

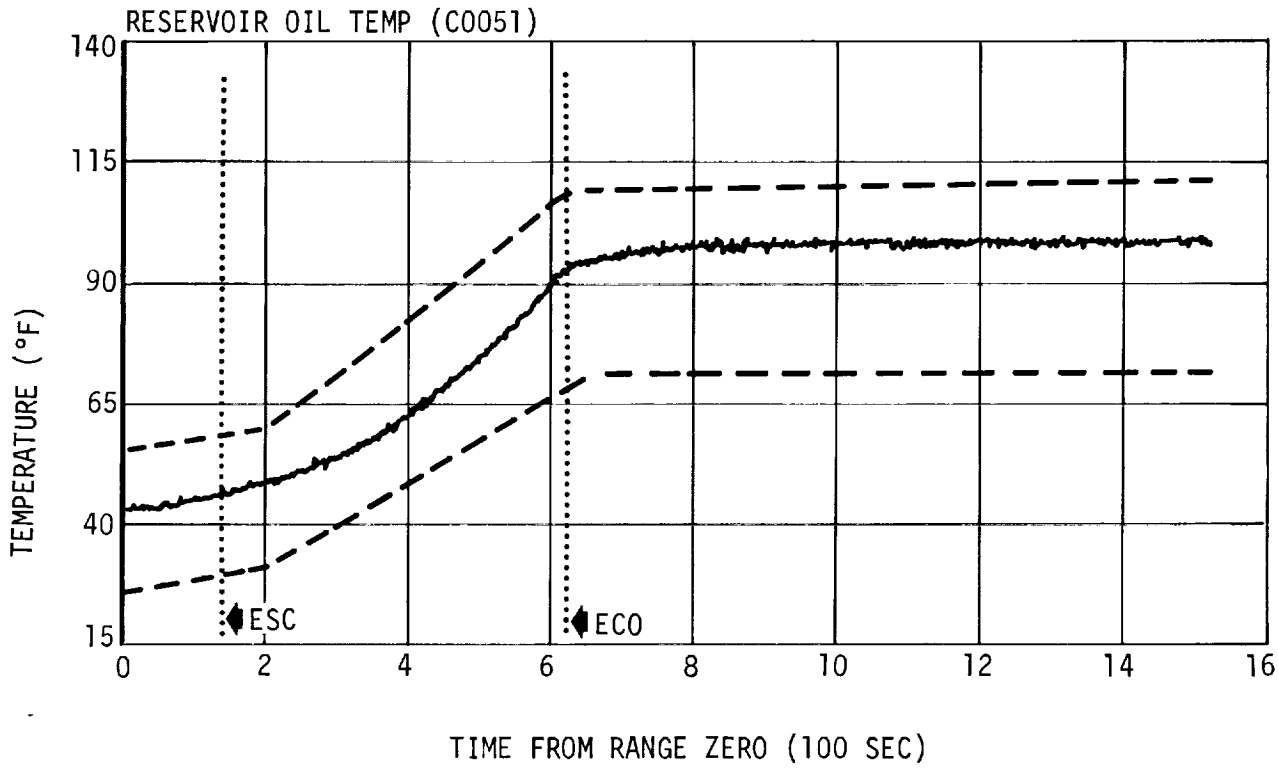
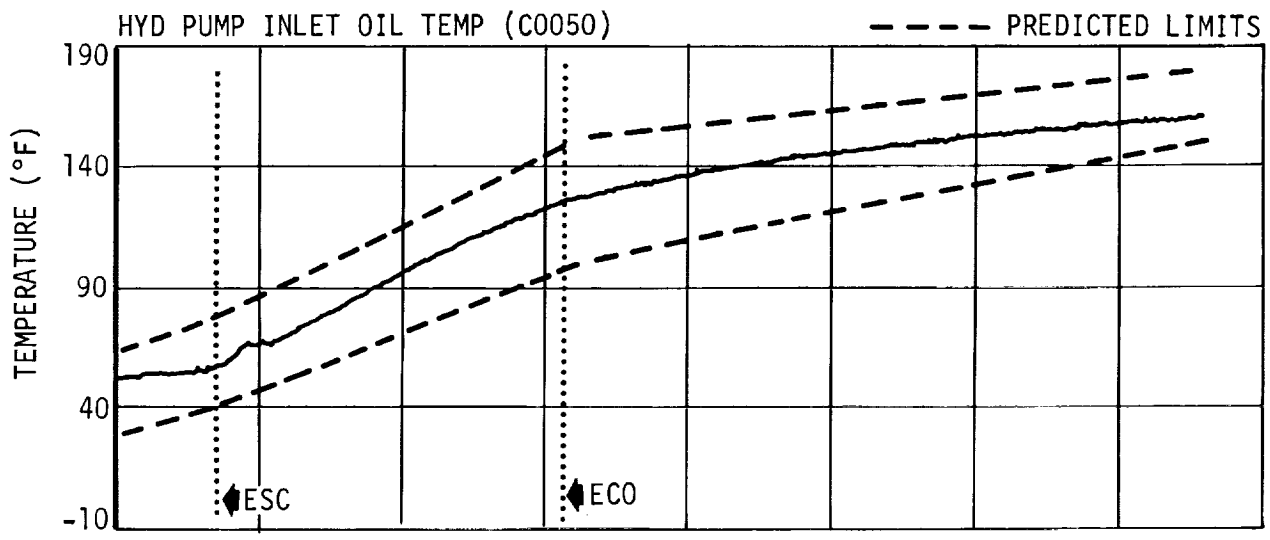

Figure 20-3. Main Pump Inlet and Reservoir Oil Temperatures - Boost and Powered Flight

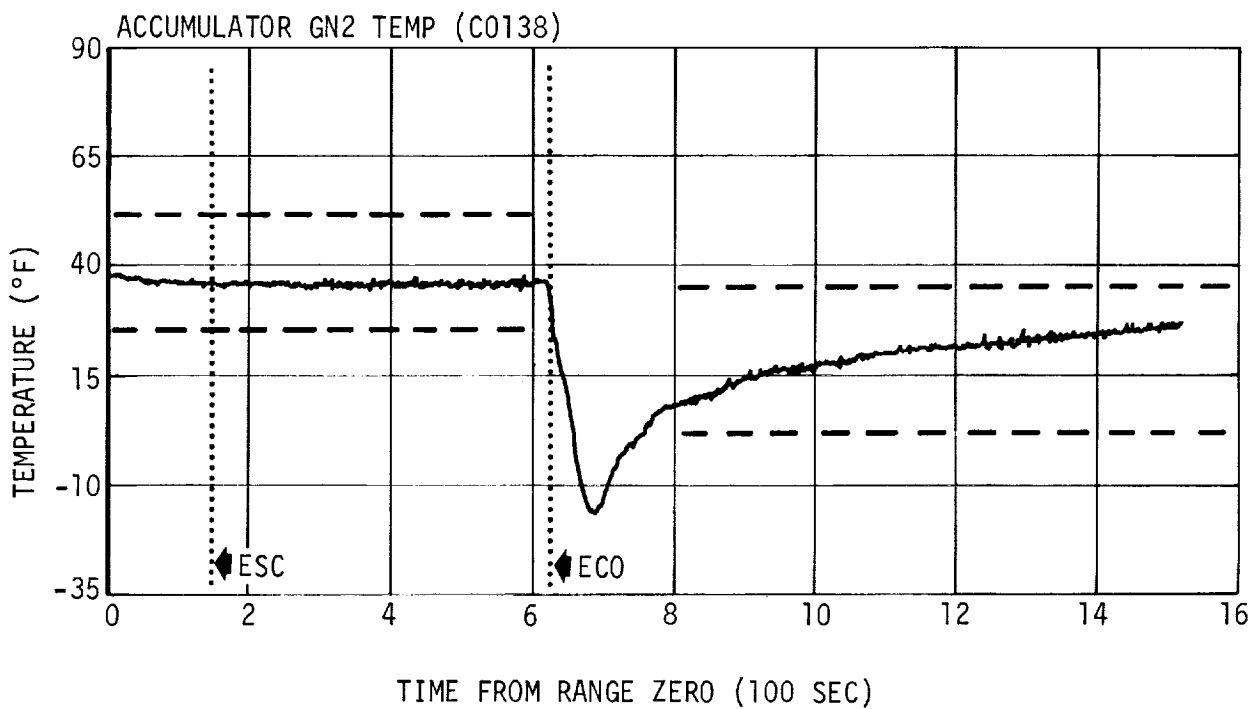
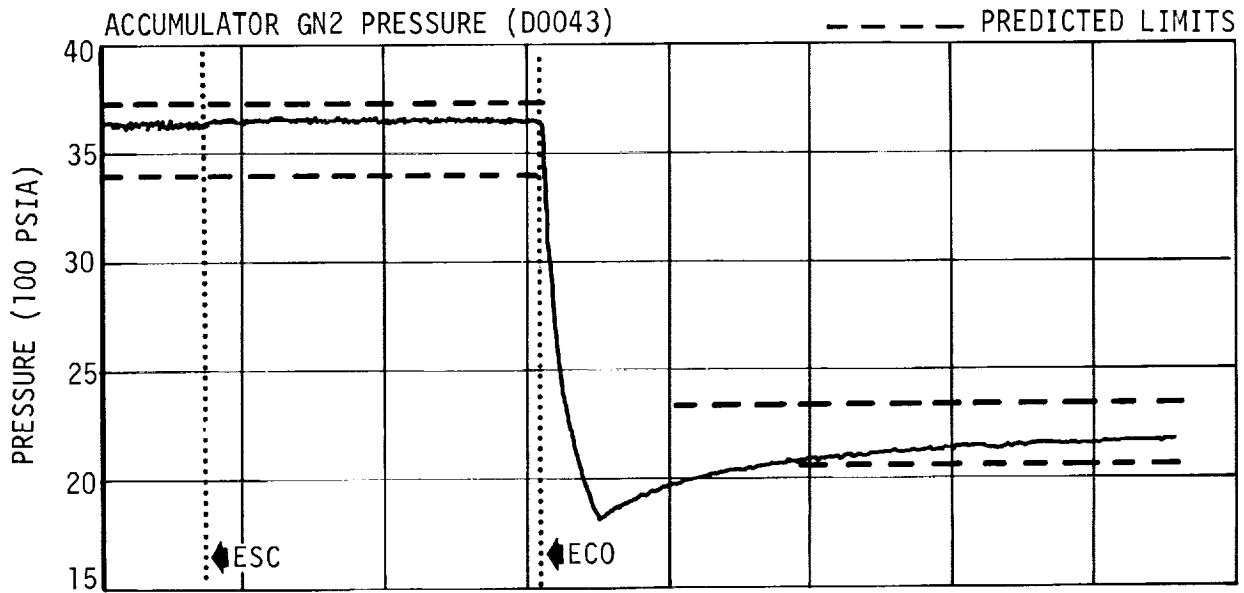

Figure 20-4. Accumulator GN2 Pressure and Temperature - Boost and Powered Flight

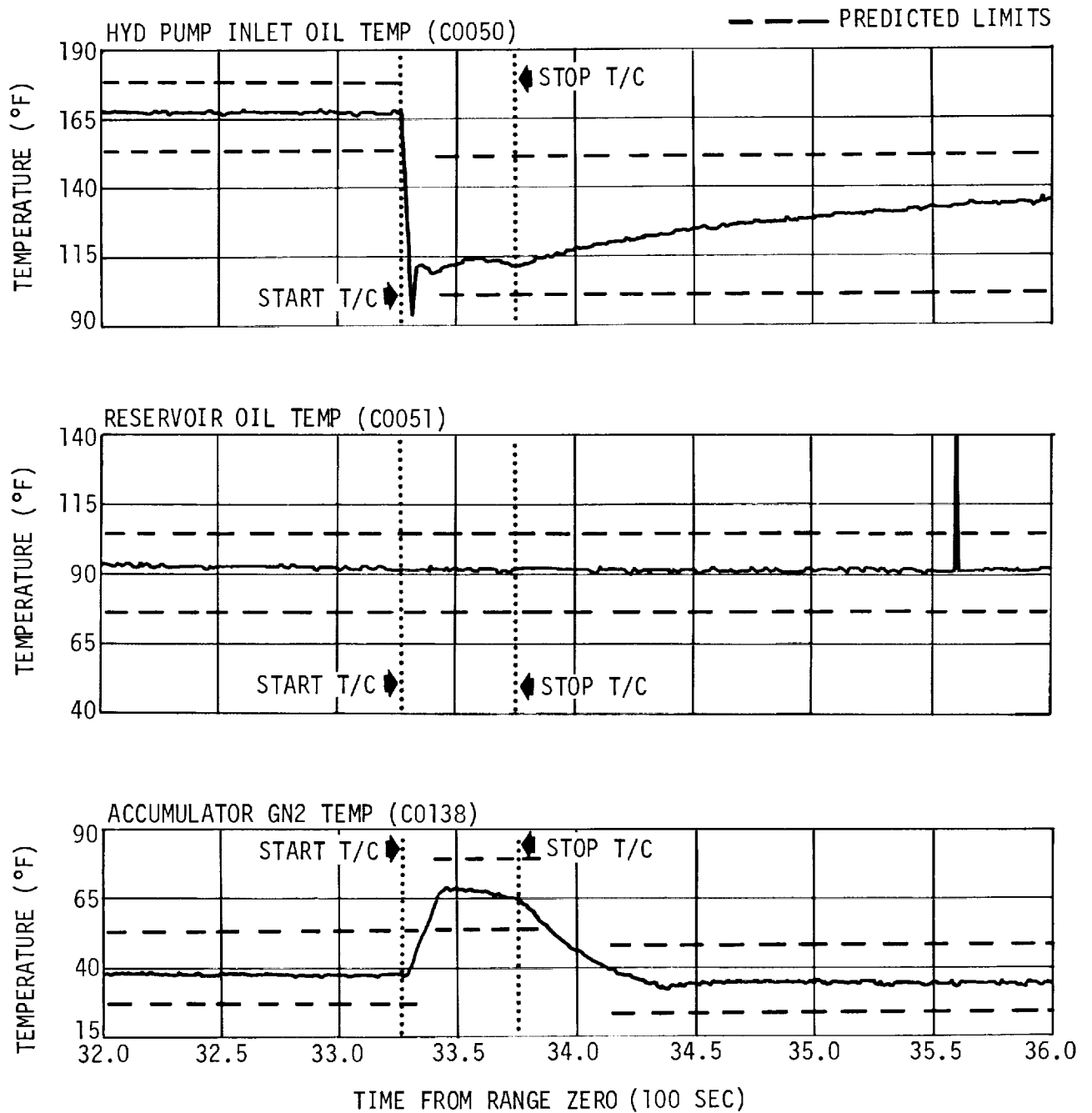

Figure 20-5. Hydraulic System Temperatures - Orbital Coast

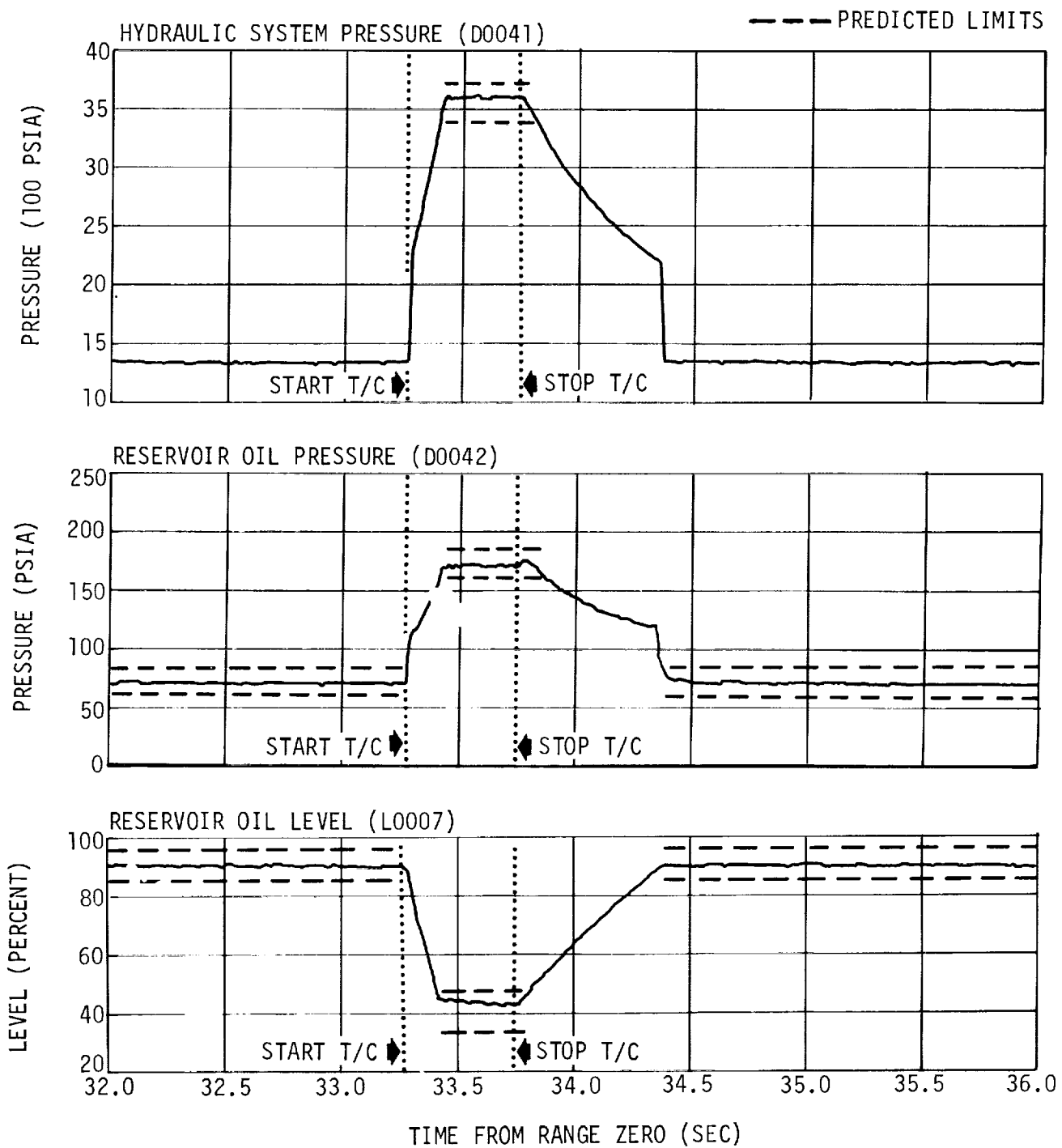

Figure 20-6. Pressures and Reservoir Oil Level - Orbital Coast

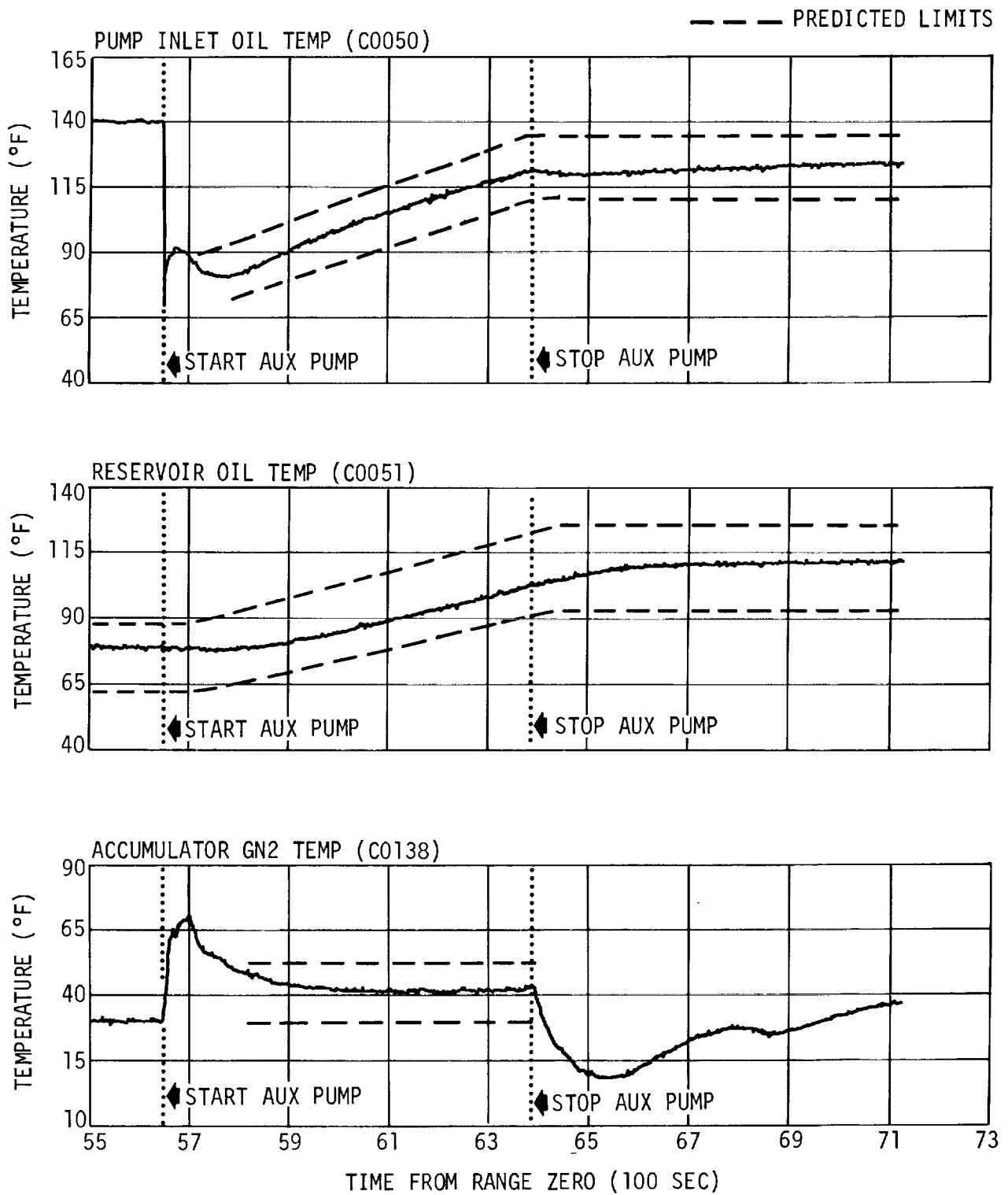

Figure 20-7. Hydraulic System Temperatures - Orbital Safing

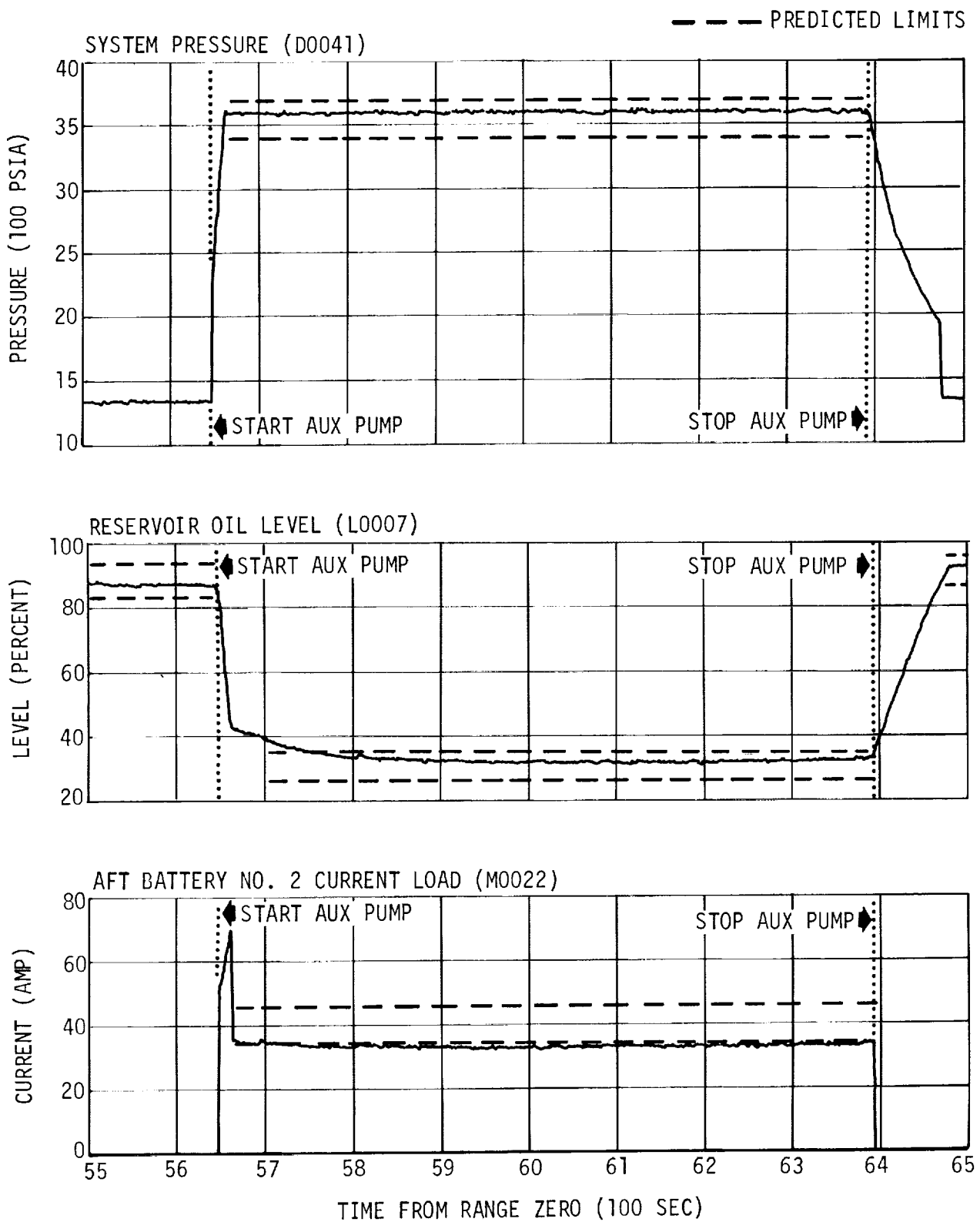

Figure 20-8. Hydraulic System Measurements - Orbital Safing

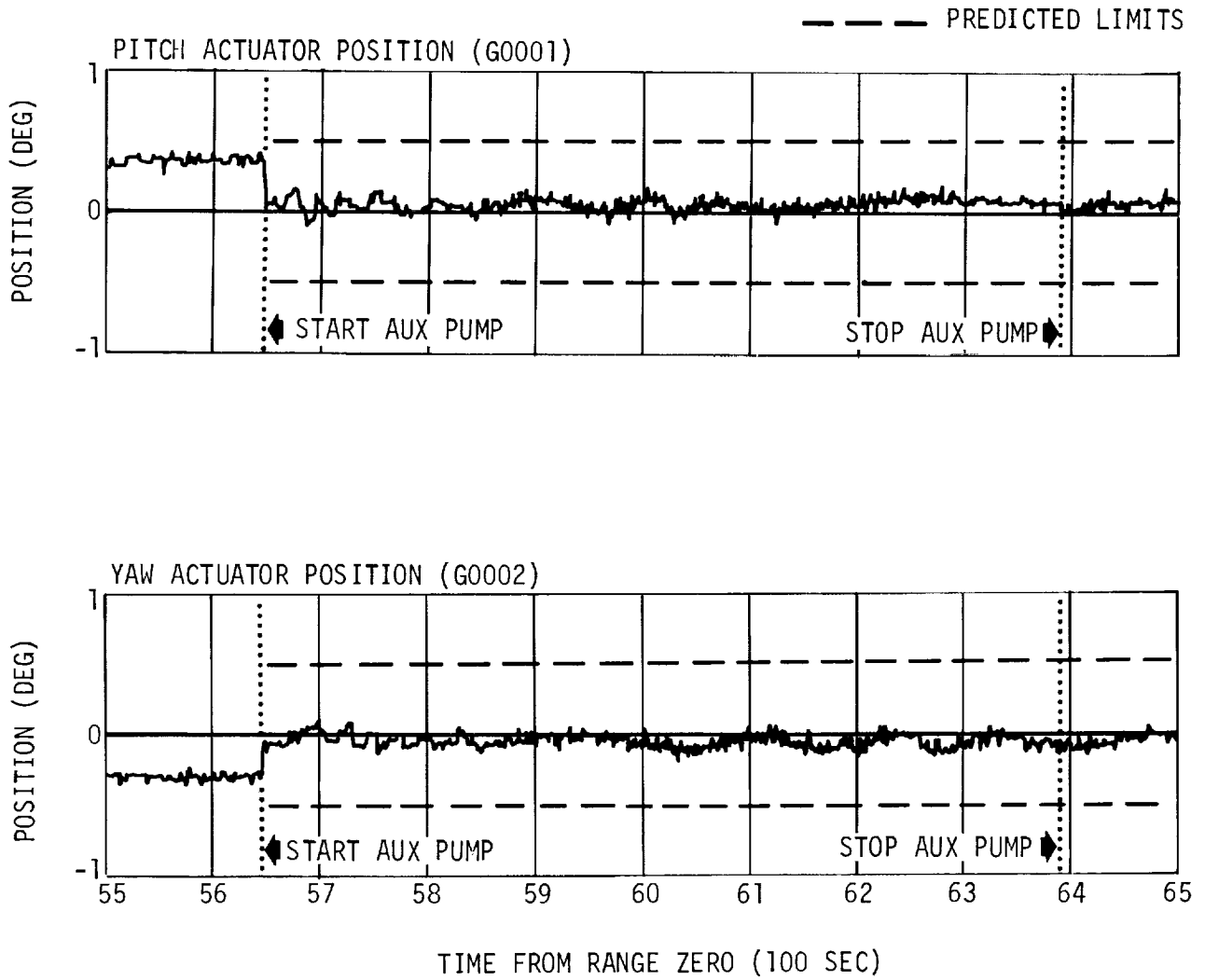

Figure 20-9. Actuator Positions - Orbital Safing



SECTION 21

VIBRATION ENVIRONMENT



21. VIBRATION ENVIRONMENT

Eight vibration measurements were monitored on the J-2 engine. One measurement did not provide usable data. The measured vibration levels were in agreement with those measured by Rocketdyne during engine ground tests.

21.1 Data Acquisition and Reduction

A list of the eight vibration measurements is presented in table 21-1. Overall levels during powered flight are also presented in the table. The accelerometer locations are shown in figure 21-1.

The data from these measurements were acquired via the instrument unit (IU) FM/FM telemetry link. Four measurements were time-shared on channel 17 and four on channel 18. The frequency response of the measurements from channel 17 was limited to 1,580 Hz and 2,100 Hz from channel 18.

A higher than normal system noise level existed on these measurements and is attributed to the interaction of the S-IVB measurement system with the IU telemetry system. The high background noise tended to mask the data during periods of low vibration (S-IB powered flight) and from the measurements with a low overall amplitude (E0209, E0236, and E0237).

Both analog and digital techniques were utilized in reducing the data. The final analysis consisted of root-mean-square (rms) composite time-history and power spectral density (PSD) plots (figures 21-2 through 21-8).

21.2 Vibration Measurements

The eight vibration measurements were located on the J-2 Engine. These included three measurements (combustion chamber dome, LH2 turbopump, and LOX turbopump) which were made on previous flights and five (two on main fuel valve, one on fuel ASI block, and two on ASI LOX valve) which were monitored for the first time. No data were obtained from the LH2 turbopump measurement due to an instrumentation malfunction at liftoff. The data from the ASI LOX valve measurement were invalid between RO +152.4 and RO +310.3 sec and valid during the remaining portions of flight. The remaining six measurements provided usable data throughout the flight. No data are presented for the S-IB powered flight time period because the data were not distinguishable from the system noise.

The vibration levels on the combustion chamber dome and LOX turbopump were in agreement with previously recorded levels. The increase in amplitude at approximately RO +455 sec on the LOX turbopump (figure 21-3) correlates in time with a change in EMR and is considered normal. The overall amplitudes from the new measurements (figures 21-4 through 21-8) were in good agreement with those obtained by Rocketdyne during the engine ground tests.

The PSD plots prior to RO +608 sec showed increasing levels below 80 Hz and a predominant peak at 950 Hz; both were not present in the plots after RO +607 sec. These differences

could be attributed to noise problems at the receiving stations. The data prior to RO +608 sec was received at KSC and the data after RO +607 sec was received at Bermuda,

TABLE 21-1
COMPOSITE VIBRATION LEVELS

MEASUREMENT NO.	MEASUREMENT	DIRECTION	FREQUENCY RANGE (Hz)	MAX VIBRATION LEVEL DURING S-IVB BURN (grms)
E0209-401	Combustion Chamber Dome	Thrust	5-2100	8
E0210-401	LH2 Turbopump	Lateral	5-2100	No Data
E0211-401	LOX Turbopump	Lateral	5-2100	36
E0236-401	Main Fuel Valve	Tangential	5-1600	8
E0237-401	Main Fuel Valve	Radial	5-1600	7
E0242-401	Fuel ASI Block	Radial	5-1600	15
E0243-401	ASI LOX Valve	Radial	5-2100	20
E0245-401	ASI LOX Valve	Longitudinal	5-1600	15

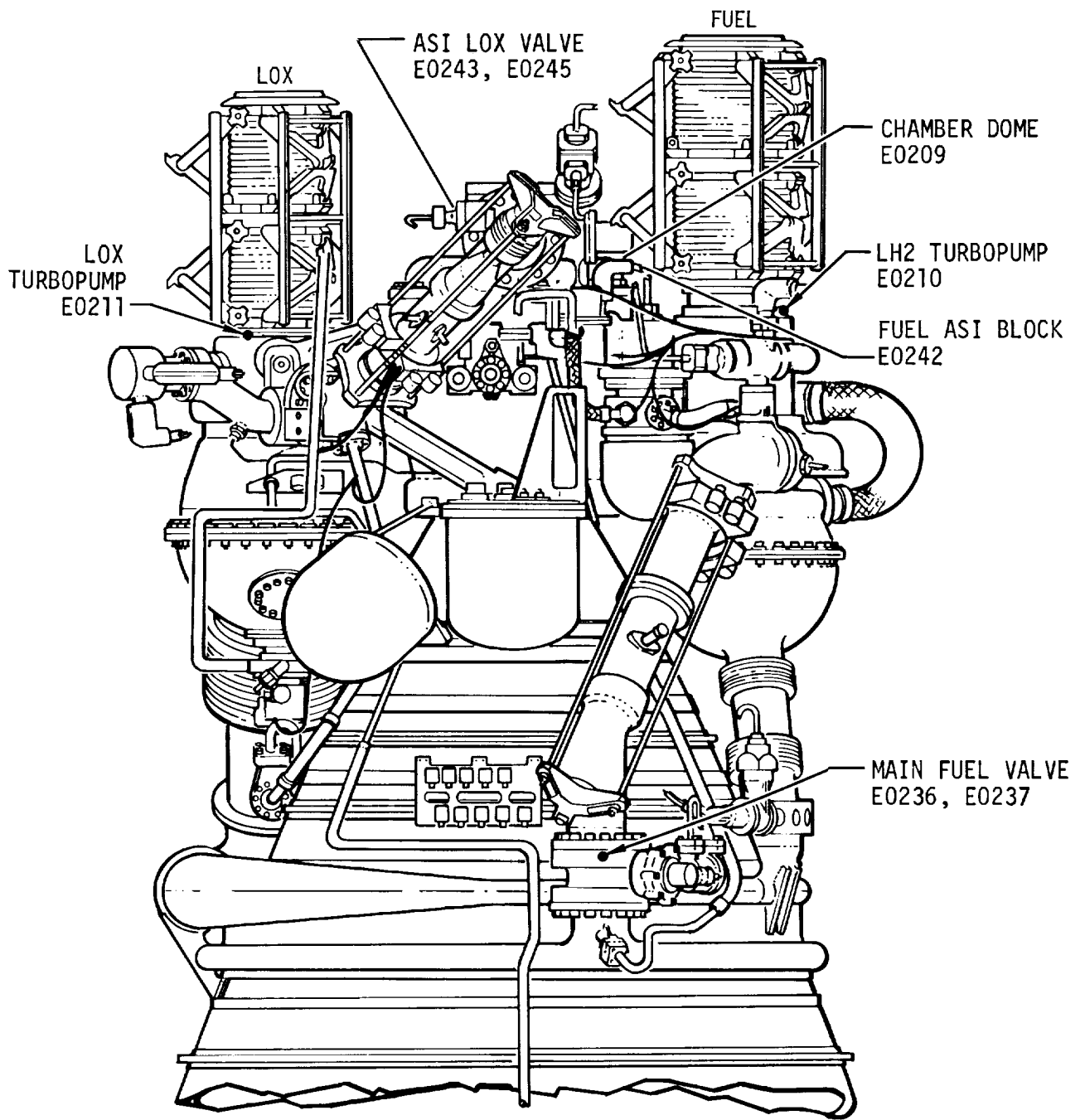
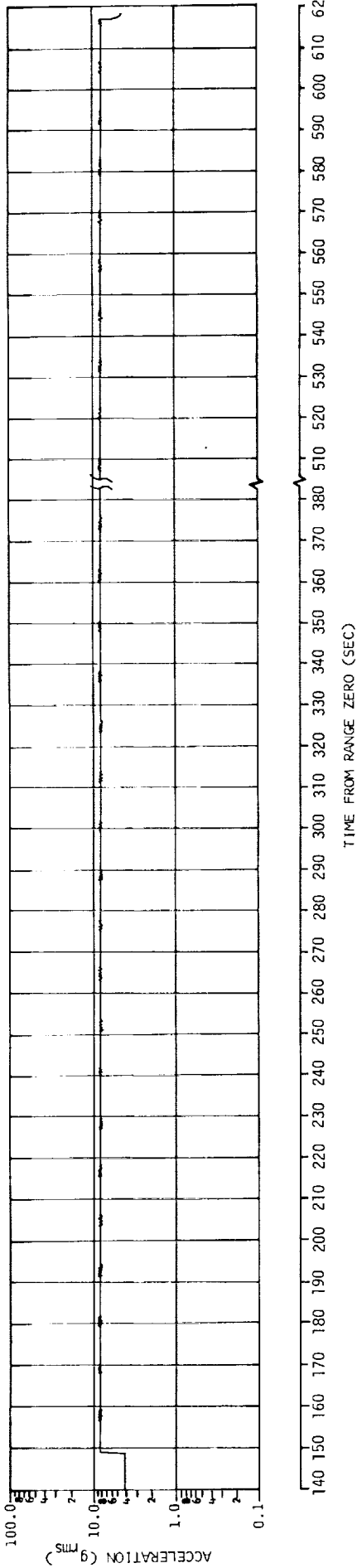

Figure 21-1. Vibration Measurement Locations

RMS COMPOSITE TIME-HISTORY



POWER SPECTRAL DENSITY PLOTS

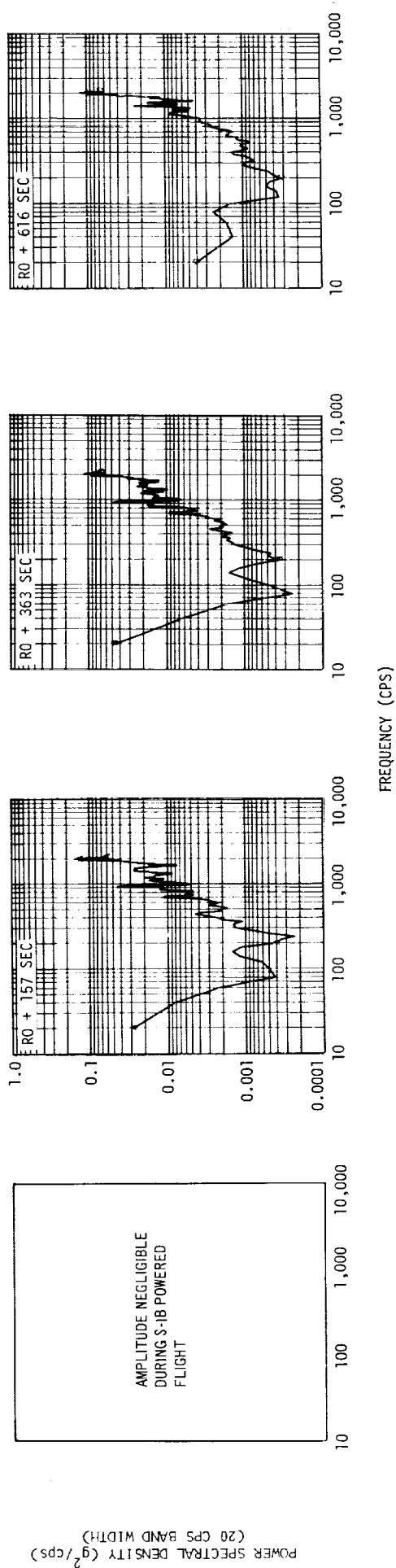

Figure 21-2. Vibration Measured on Combustion Chamber Dome, Thrust Direction - E0209-401

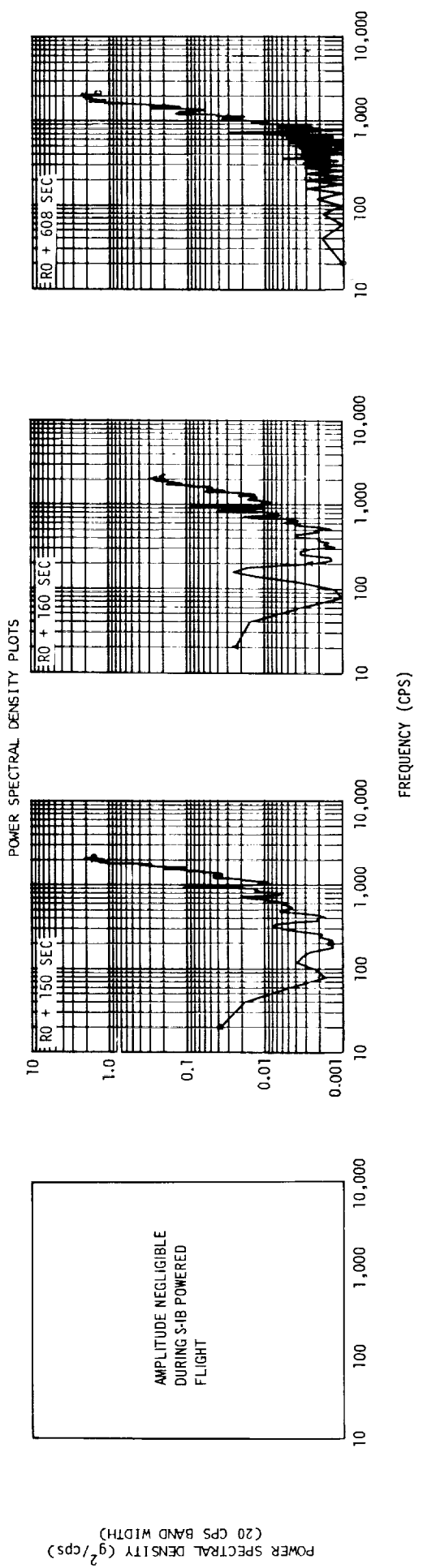
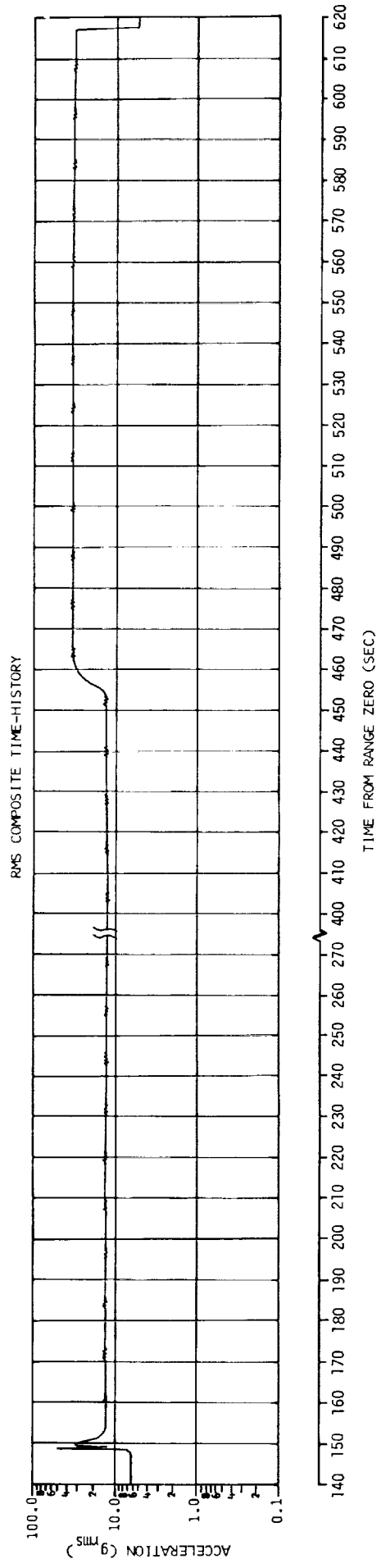
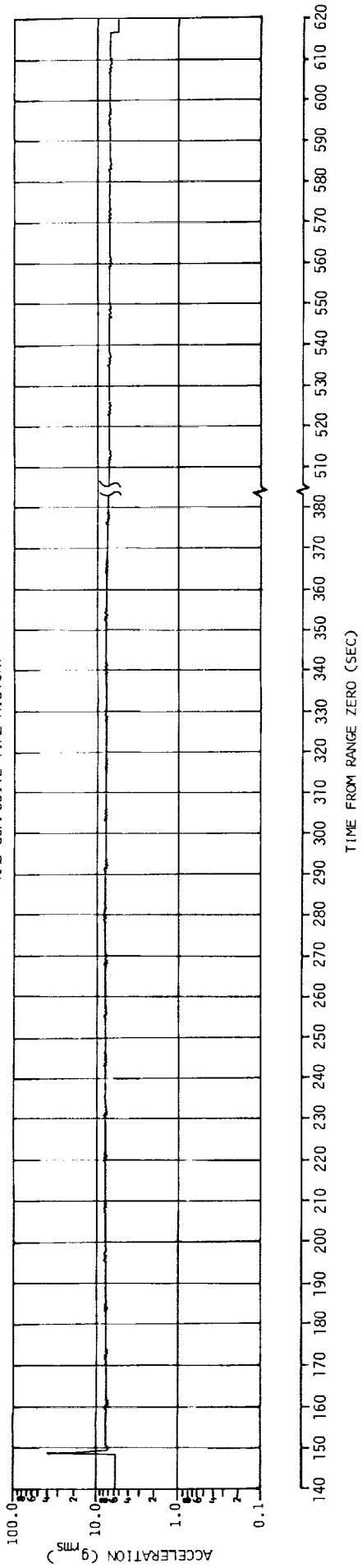

Figure 21-3. Vibration Measured at LOX Turbopump, Lateral Direction - E0211-401

RMS COMPOSITE TIME-HISTORY



POWER SPECTRAL DENSITY PLOTS

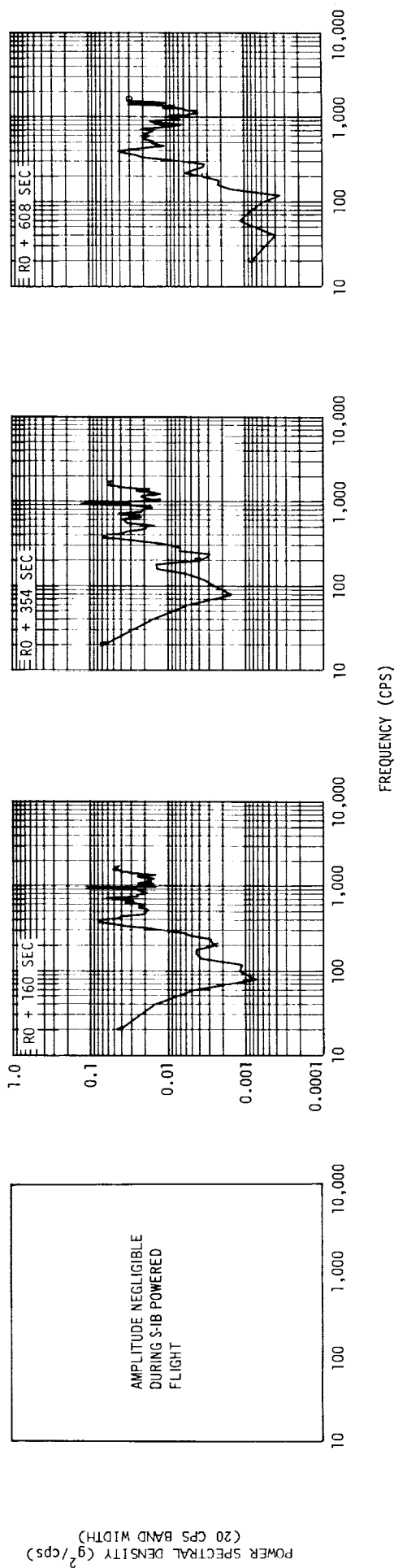

Figure 21-4. Vibration Measured on Main Fuel Valve, Tangential Direction - E0236-401

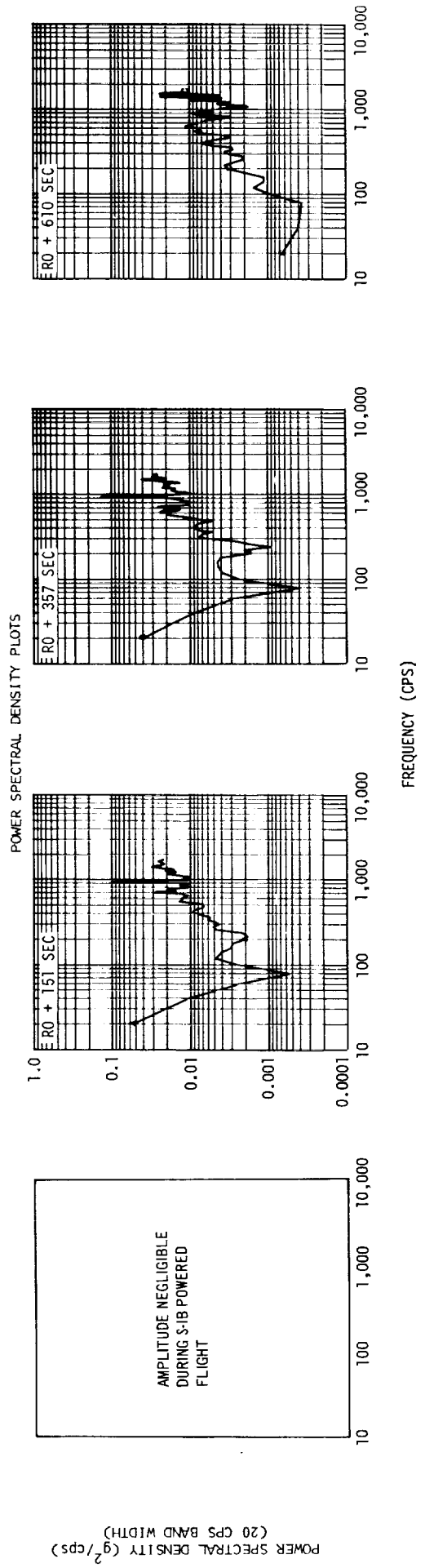
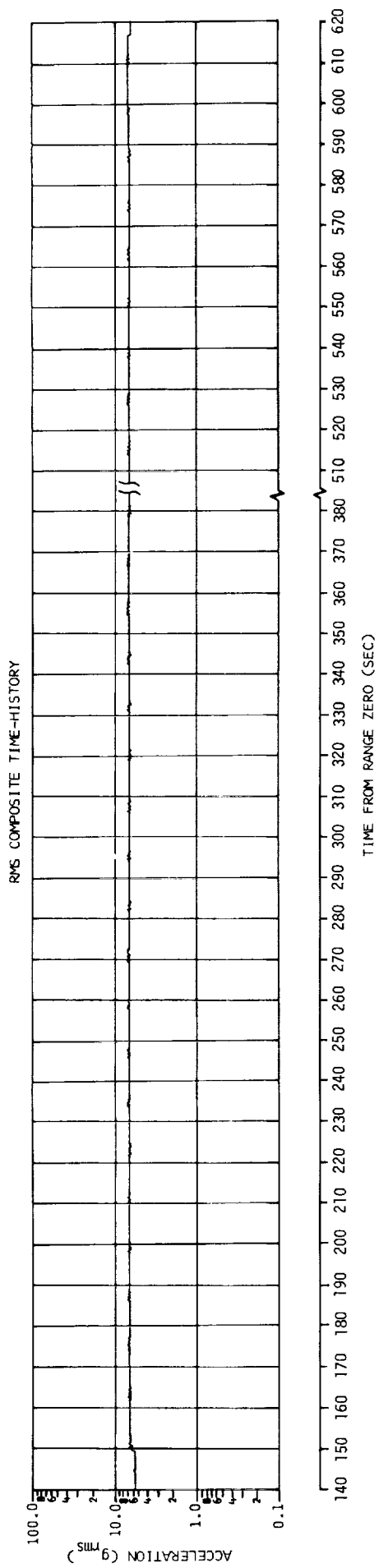
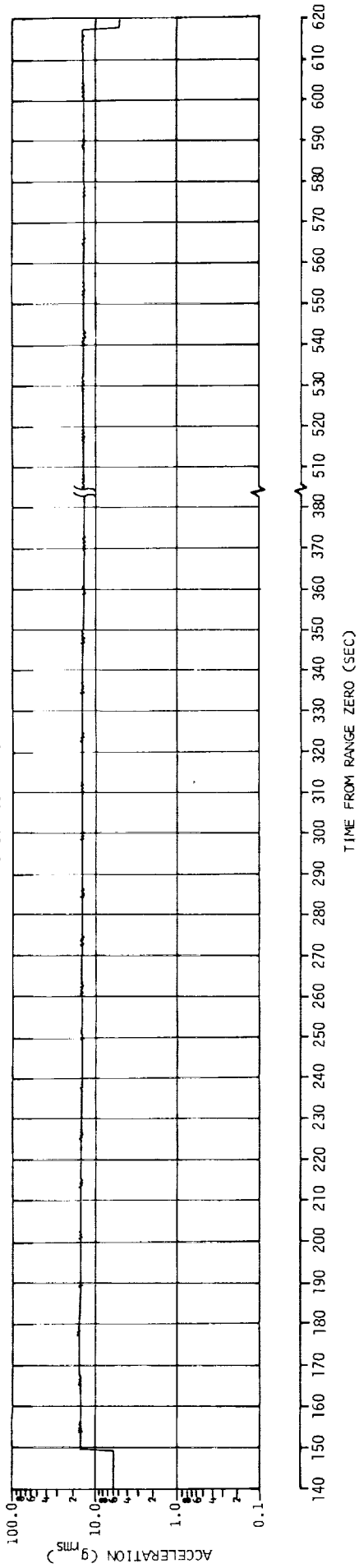
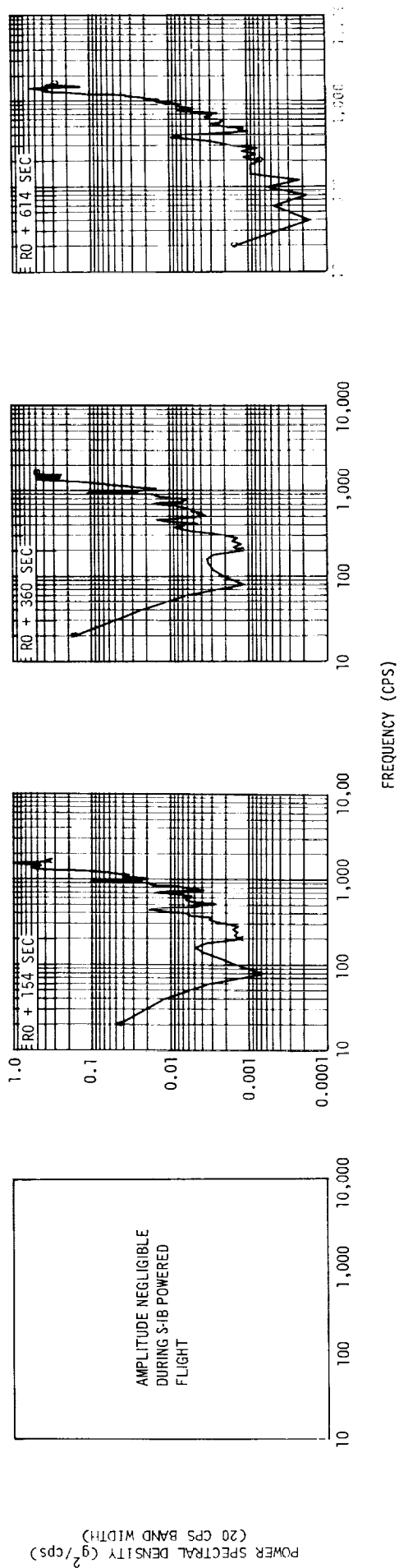

Figure 21-5. Vibration Measured on Main Fuel Valve, Radial Direction - E0237-401

RMS COMPOSITE TIME-HISTORY



POWER SPECTRAL DENSITY PLOTS



AMPLITUDE NEGLIGIBLE
DURING S-B POWERED
FLIGHT

Figure 21-6. Vibration Measured on Fuel ASI Block, Radial Direction - E0242-401

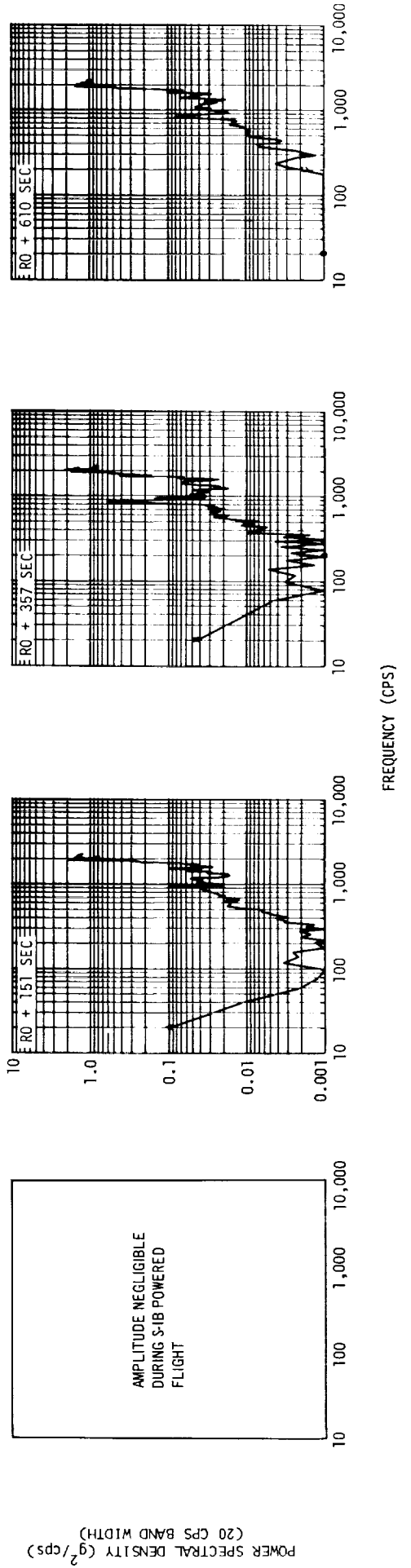
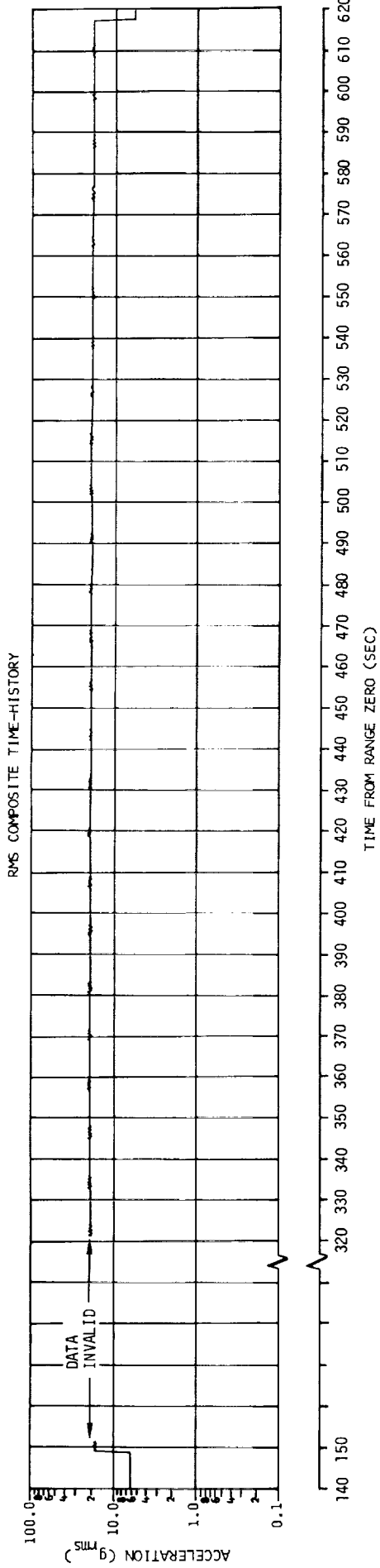
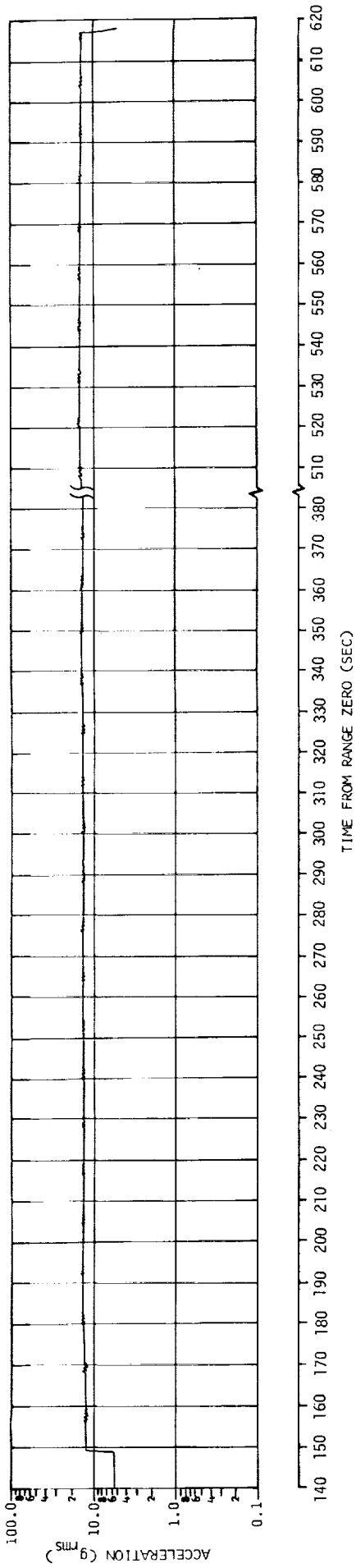

Figure 21-7. Vibration Measured on ASI LOX Valve, Radial Direction - E0243-401

RMS COMPOSITE TIME-HISTORY



POWER SPECTRAL DENSITY PLOTS

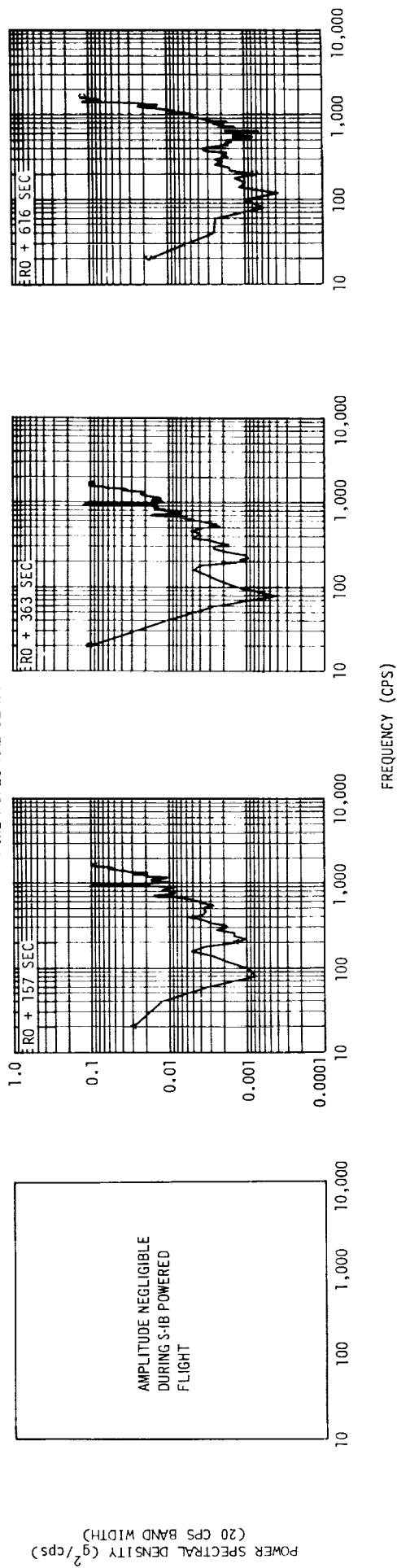
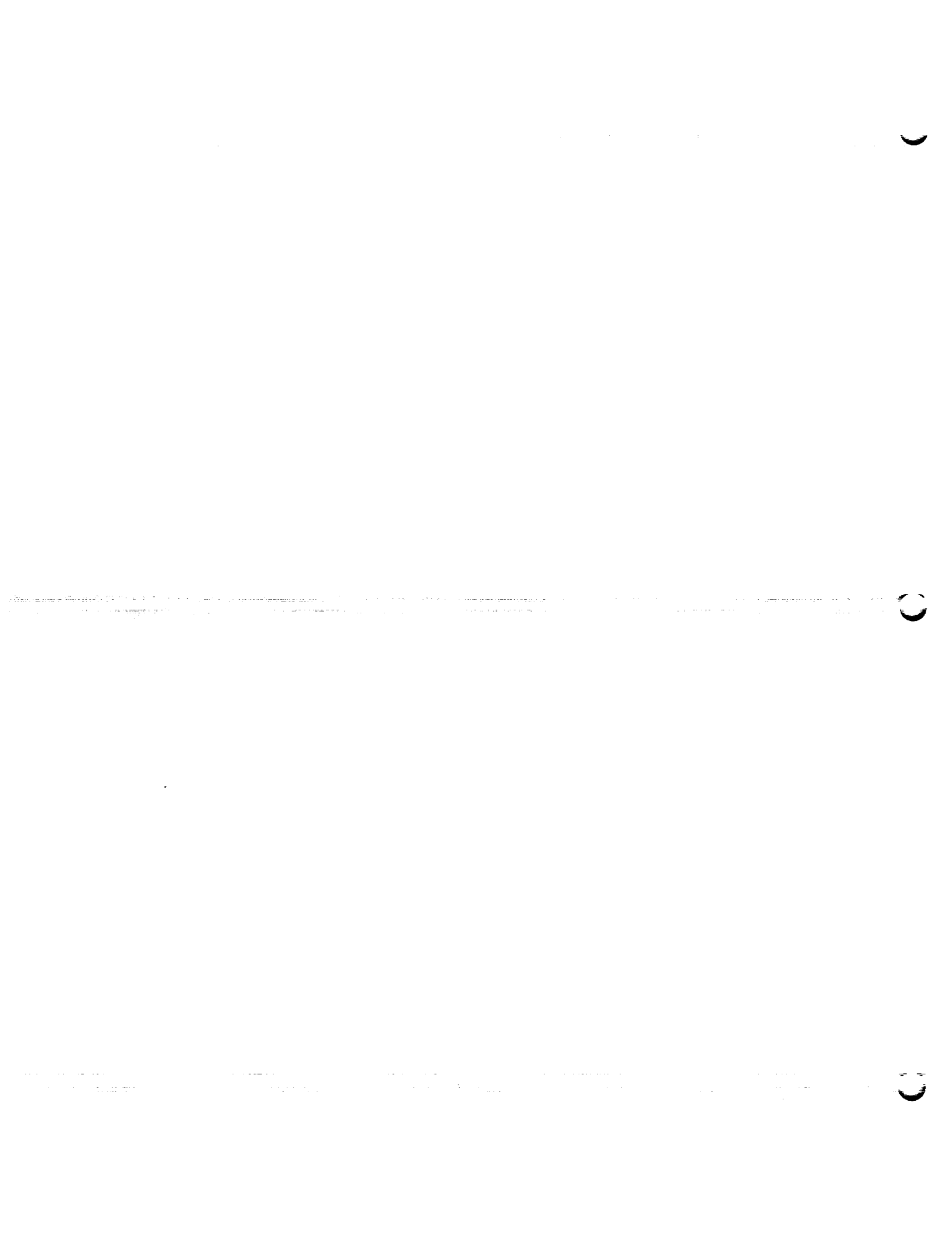

Figure 21-8. Vibration Measured on ASI LOX Valve, Longitudinal Direction - E0245-401

SECTION 22

ORBITAL SAFING



22. ORBITAL SAFING

22.1 System Dump

22.1.1 LOX Dump

The LOX tank dump was accomplished satisfactorily. All LOX residual was dumped well within the planned period of 720 sec. When LOX dump was initiated at RO +5,669 sec, the hardware was warm. During the first 13 sec of dump all the LOX flowing from the tank was vaporized and left the engine as gas. The ullage pressure remained constant indicating the flow was primarily LOX boiloff in the engine feed system and not ullage gas. Therefore, at dump initiation the LOX residual was at least partly settled in the tank. As hardware chilldown proceeded, the gas flowrate increased and the temperature decreased, thus the thrust was maintained at a relatively constant level. During the remainder of the chilldown period, the dump thrust and liquid flowrate increased rapidly as two phase flow was established. Due to the small liquid residual remaining in the tank at the start of LOX dump, a steady-state liquid flow condition was not established before gas injection began.

Thirty-three sec after dump initiation, the ullage pressure began decreasing, indicating that gas ingestion had begun. During the initial portion of the gas ingestion period (33 to 53 sec after starting dump), the thrust and flowrate decreased rapidly and the ullage pressure decreased slightly. After this period gas ingestion was well established and the ullage pressure decreased at 0.10 psi/sec (very close to the S-IVB-204 rate).

Ullage gas dumping continued after the liquid dump was completed. The LOX tank dump essentially ended at RO +6,341 sec when the main oxidizer valve (MOV) closed to the 15 percent open position due to the depletion of the engine pneumatics. This condition was expected since pneumatic pressure is required to fully close the valve.

At the start of LOX dump, a LOX residual of 1,070 lbm remained in the tank. Ninety-eight percent of this residual was dumped within 65 sec of dump initiation. The total LOX residual was dumped within 130 sec. The maximum LOX dump thrust of 445 lbf and maximum flowrate of 33 lbm/sec occurred 33 sec after starting LOX dump. The total impulse before MOV closure was 36,200 lbf sec, resulting in a velocity increase of 17.6 ft/sec. A small residual thrust, developed through the partially open MOV, decayed from 2.5 lbf at MOV closure to 0 lbf at RO +10,500 sec (approximate time ullage pressure reached 0 psia), providing an additional impulse of 3,100 lbf sec. The ullage pressure, thrust, liquid flowrate, LOX residual, and low range chamber pressure data are shown in figure 22-1.

22.1.2 Cold Helium Dump

Cold helium safing was accomplished by opening the cold helium shutoff valves, thus allowing the cold helium to flow out through the engine and the LOX tank nonpropulsive vent (NPV). The first cold helium dump started at RO +6,149 sec and terminated 2,868 sec later. The second dump was of 1,200 sec duration and started RO +16,217 sec. The safing requirements were that the cold helium be dumped for at least 30 min and that the resulting pressure in the bottles should be 50 psia or less.

During the first phase of safing, cold helium flowed into the LOX tank, pressurizing it from approximately 3.5 to 6.8 psia. After reaching this maximum, the ullage pressure slowly decreased to 0 psia. This area is further discussed in paragraph 22.2.1.

At the end of cold helium sphere safing the sphere pressure and average temperature were 0 psia and 77 deg R, respectively, indicating negligible residual mass. Flowrate integral calculations during engine burn (158 lbm) and during the first and second cold helium dump (170 and 13.7 lbm), respectively, indicate that 2.0 lbm remained in the sphere after safing (figure 22-2). The safing requirements were met since the cold helium was dumped for at least 30 min and the resulting bottle pressure was less than 50 psia.

22.1.3 Stage Pneumatics Dump

The pneumatic supply was more than adequate to meet the requirements of the AS-205 orbital mission. Based on predicted leakage, the maximum pressure was expected to be 3,200 psia at the start of passivation (RO +11,854 sec) and to decrease to 700 psia during the programmed 1.5-hr passivation. The passivation was accomplished by dumping the stage pneumatics through the engine pump purge module. The pressure was 3,230 psia initially and decreased to 1,500 psia at RO +14,882 sec representing an average pressure decay rate of 34.8 psia/min as opposed to the predicted 21.0 psia/min, which was based on an isothermal process (figure 22-3).

The passivation which was proceeding satisfactorily was terminated early so that the additional required LH2 vent and relief valve actuations could be performed. After passivation, the sphere pressure increased (due to orbital heating) to approximately 1,700 psia by RO +17,000 sec and remained at that level for the remainder of the flight.

22.2 Vent Systems

22.2.1 LOX Tank Venting

The LOX tank orbital venting operations were satisfactorily accomplished. The only deviation from expected performance was the high ullage pressure decay rate which occurred during the first cold helium dump. This rapid decay was a result of the incomplete closure of the main oxidizer valve (discussed in paragraph 22.1.1), not the performance of the LOX venting system. Mission success was not affected.

Two programmed vents occurred during orbit. The first vent occurred 30.5 sec after J-2 engine cutoff and dropped the ullage pressure from 37.3 to 15.5 psia in 30 sec. The second vent, which employed the LOX NPV, began at RO +5,679 sec when the NPV valve was latched open and remained in this position for the rest of the mission.

The LOX tank ullage pressure decayed from 23.5 to 3.5 psia during LOX dump due to ullage gas ingestion and NPV venting. The first cold helium dump began at RO +6,149 sec. Since the helium flowrate into the tank exceeded the gas ingestion flowrate out, the tank was pressurized to 5.8 psia. The gradual closure of the MOV (RO +6,275 to RO +6,341 sec) decreased the gas ingestion flowrate, thus causing an additional pressure rise which reached 6.8 psia at RO +6,500 sec. The ullage pressure began to decay because the cold

helium flowrate dropped below the gas ingestion flowrate. The LOX tank pressure reached 0 psia at approximately RO +10,500 sec. The gas ingestion through the partially open MOV resulted in an unexpectedly high pressure decay rate. During the second cold helium dump (RO +16,217 sec) the ullage pressure rose to approximately 1 psia and then decayed back to 0 psia. Figure 22-4 presents the ullage pressure history; figure 22-5 shows the LOX tank venting during orbit.

22.2.2 LH2 Tank Venting

The LH2 tank vent and relief valve and the mechanically latched passivation valve performed adequately and responded satisfactorily to all preprogrammed and commanded vents. Since the preprogrammed vent sequence for these valves was not adequate to safe the tank under actual orbital conditions, the tank safing sequence was supplemented by four additional ground commanded vents. Of the 2,505 lbm of LH2 and approximately 460 lbm of GH2 in the tank at Engine Cutoff Command, approximately 40 lbm of GH2 remained at the end of the final vent.

The three preprogrammed vents through the vent/relief valve, in combination with the passivation valve which was opened at Engine Cutoff Command, controlled the LH2 tank ullage pressure approximately as predicted (figure 22-6). The pressure continued to rise after this time, however, and at RO +11,354 sec, the vent/relief valve was commanded open in observance of a mission rule that prohibits a common bulkhead delta pressure in excess of 20 psi. Although the delta pressure reached 21.6 psi, thus slightly exceeding the mission rule, a hazardous condition was not considered to exist. The remaining vents were initiated at much lower pressures (figure 22-6).

After the preprogrammed vent at RO +6,300 sec, the LH2 tank continued to self-pressurize because the hydrogen which had been vented from the tank was very close to 100 percent gas. This is contrary to the two-phase flow that had been anticipated. The lack of liquid entrainment resulted in a much lower rate of LH2 depletion and, consequently, an extended period of boiloff.

The ullage pressure rise rate was temporarily increased at approximately RO +9,000 sec by the astronaut-controlled attitude maneuvering and, at approximately RO +10,400 sec, by disturbances induced by spacecraft separation and the retrograde maneuver. Because of these activities LH2 came in contact with the warm tank walls, and an increase in boiloff rate resulted.

Analysis of the available data, assuming no liquid entrainment in the gas flow out of the vent system, indicates that the total mass flow is in close agreement with the total liquid and ullage mass in the tank at Engine Cutoff Command. The total mass of hydrogen at Engine Cutoff Command was determined to be approximately 2,950 lbm; the calculated mass vented during the passivation period was 2,924 lbm with a residual of approximately 40 lbm, for a total of 2,964 lbm. Additionally, the temperature history of the vent nozzles, both in level and profile, indicated 100 percent gas flow. Figure 22-7 compares the temperature histories of typical vents for the AS-204 and 205 flights. The AS-204 profile shows a rapid temperature decrease indicative of liquid entrainment in the gas flow, which is in

contrast to AS-205. A calculation of the energy of the hydrogen flowing out of the vents on AS-205 also supports the assumption that virtually all of the liquid was boiled off inside the tank.

Analysis of the system indicates that the average heat transfer rate into the LH2 tank from Engine Cutoff Command to the end of the seventh vent was approximately 106,000 Btu/hr. Initial and final conditions were used in the calculations with consideration being given to energy absorbed initially from the warm hardware (109,000 Btu) and to the energy in the vented gas (519,000 Btu) during the 5.2-hr period. Figure 23-8 is a mass history of LH2 remaining in the tank from Engine Cutoff Command to depletion. An attempt is being made to correlate the heat transfer and mass history in order to develop a more definitive representation of the phenomenon occurring in the LH2 tank.

The prediction for LH2 tank safing on the S-IVB-205 stage was strongly influenced by the safing experiment performed on the 204 stage on which the residual was assumed to be 2,640 lbm. In retrospect, the AS-204 data do not appear to provide a representative model, as is apparent in figure 22-7. Predictions based solely on theoretical considerations not influenced by AS-204 would have been much closer to the observed performance. The difference in entrainment is considered to be a result of liquid positioning in the tank. On the AS-205 mission, the liquid mass was located away from the vent inlet; whereas on AS-204, the liquid was positioned near the forward end of the tank. An examination of measurement C0052 (LH2 bulk temperature) supports this assumption. C0052, which is near the bottom of the tank, was covered with liquid until approximately RO +17,000 sec on AS-205, whereas it was covered until approximately RO +2,250 sec on AS-204.

Although available data are insufficient to make precise calculations, a possible cause of the different positioning of the liquid is the reduced drag on the AS-205 during the first 10,500 sec of orbit and the retrograde attitude subsequent to this time.

The S-IVB-205 operated in an orbit 30 to 50 mi higher than the S-IVB-204; the spacecraft lunar module adapter (SLA) panels were opened on the 204 mission at approximately RO +3,000 sec, as compared to RO +10,500 sec on 205. These factors, in addition to different atmospheric conditions, resulted in a drag level that was lower on the 205 stage by a factor varying from four to ten prior to RO +3,000 sec, and from eight to forty from then until spacecraft separation at RO +10,500 sec. This reduced drag and resulting reduced deceleration, as compared to the 204 mission, yielded a much lower force tending to displace the liquid to the forward end of the tank near the vent inlet.

This disparity in drag levels between the two stages was further compounded by the axial thrust developed through the engine during and subsequent to the LOX dump (paragraph 22.1.1). This thrust would have overcome the unsettling forces due to orbital drag. Additionally, after spacecraft separation, the stage assumed a retrograde attitude. Orbital drag in this position would tend to settle the liquid to the aft end of the tank rather than to cause propellant dispersion within the tank.

Subsequent stages on which a safing operation is to be performed will be equipped with a larger latching vent/relief valve which should eliminate ullage pressure problems of the type that occurred on this mission.

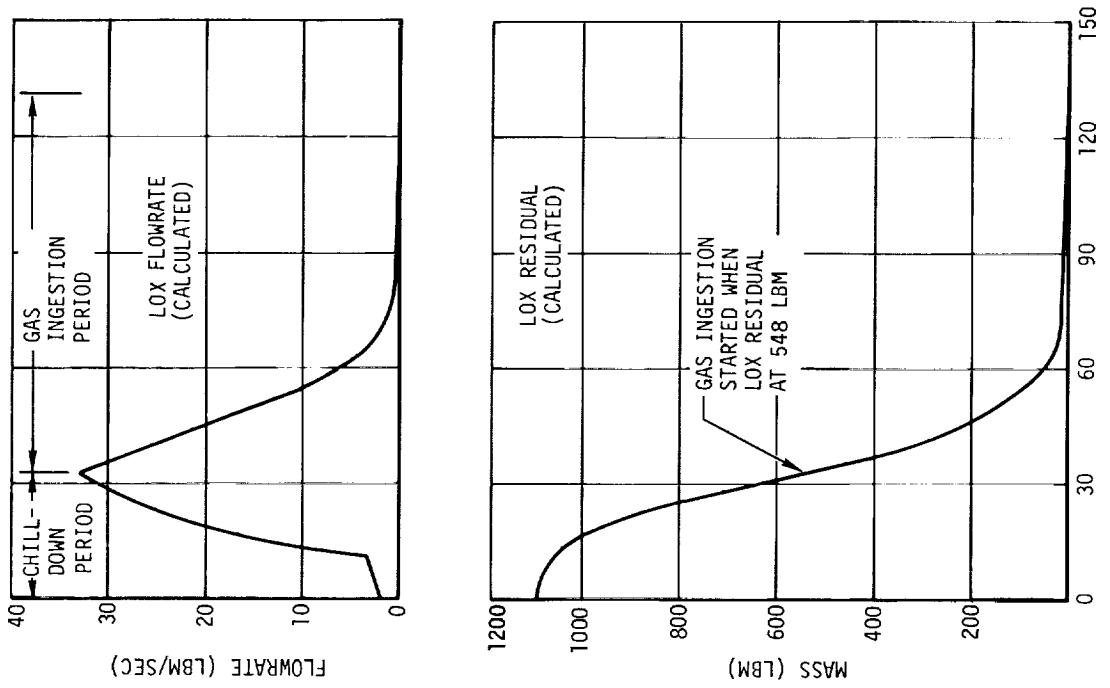
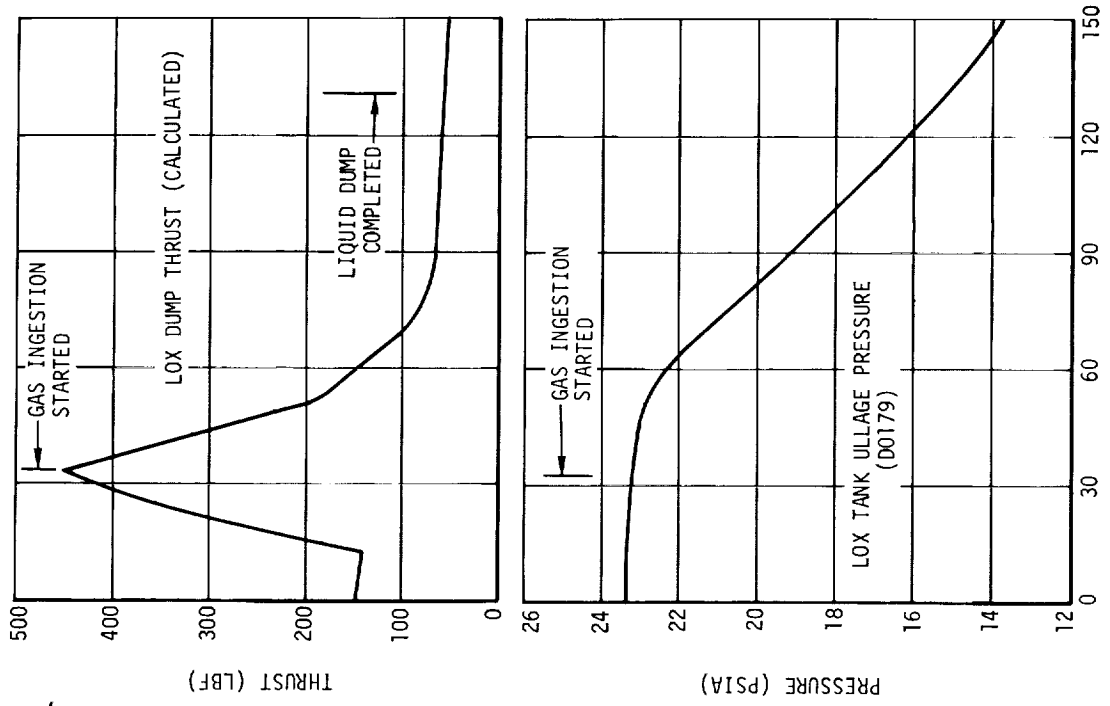

TIME FROM INITIATION OF LOX DUMP (SEC)

Figure 22-1. LOX Tank Dump (Sheet 1 of 2)

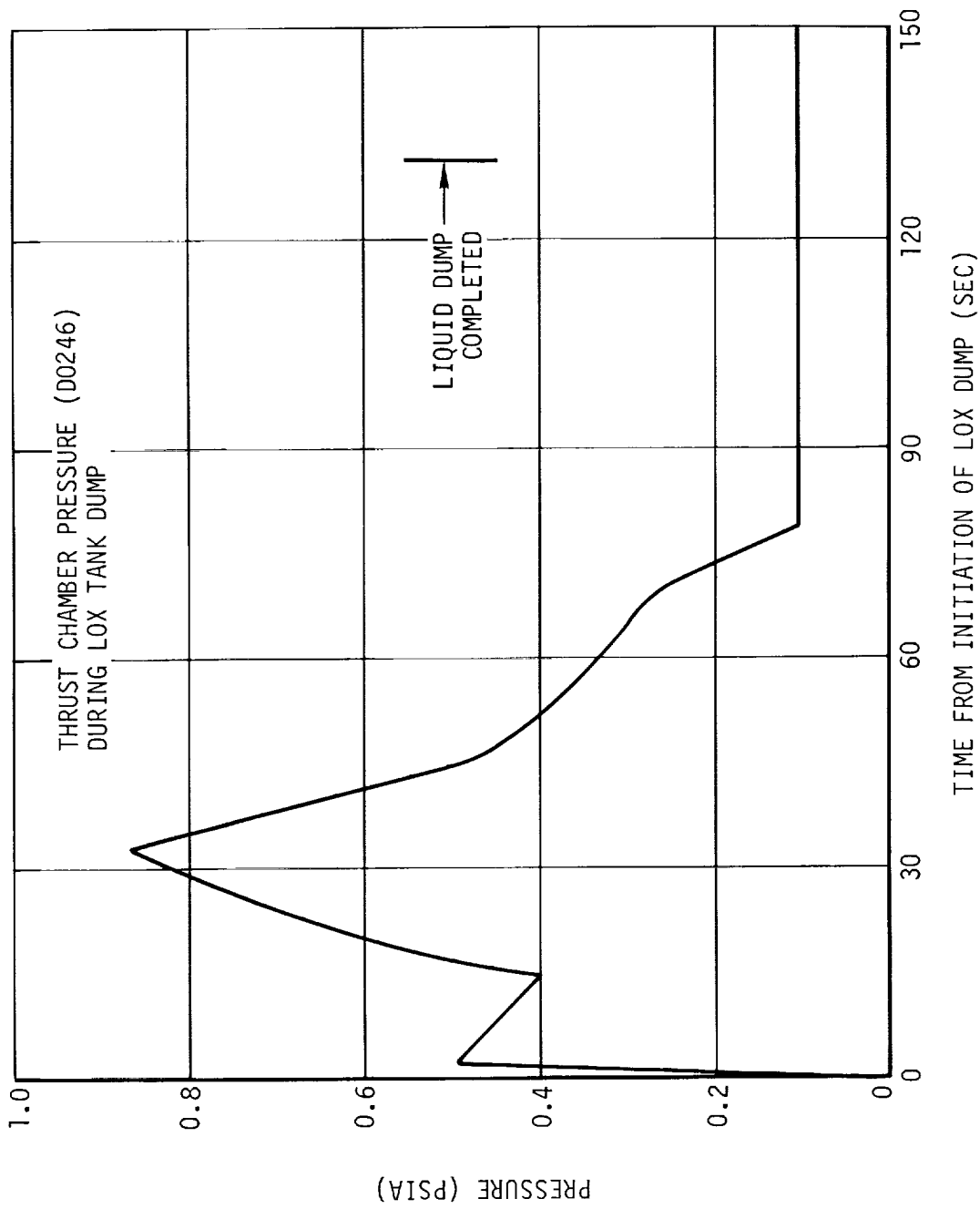

Figure 22-1. LOX Tank Dump (Sheet 2 of 2)



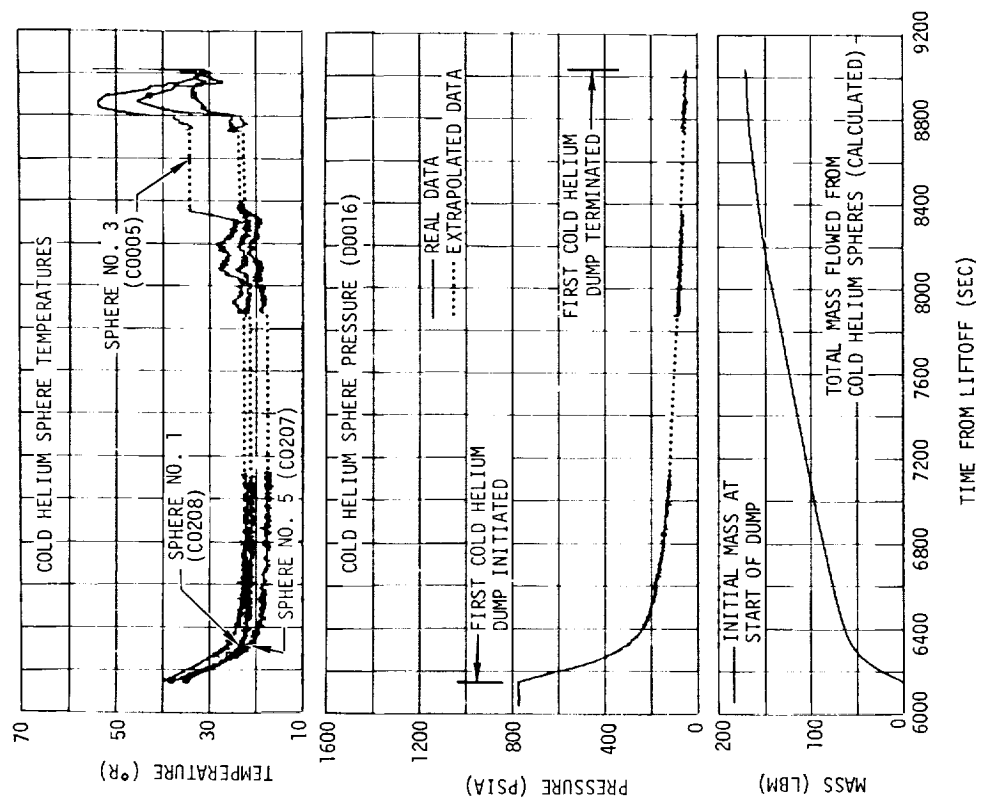
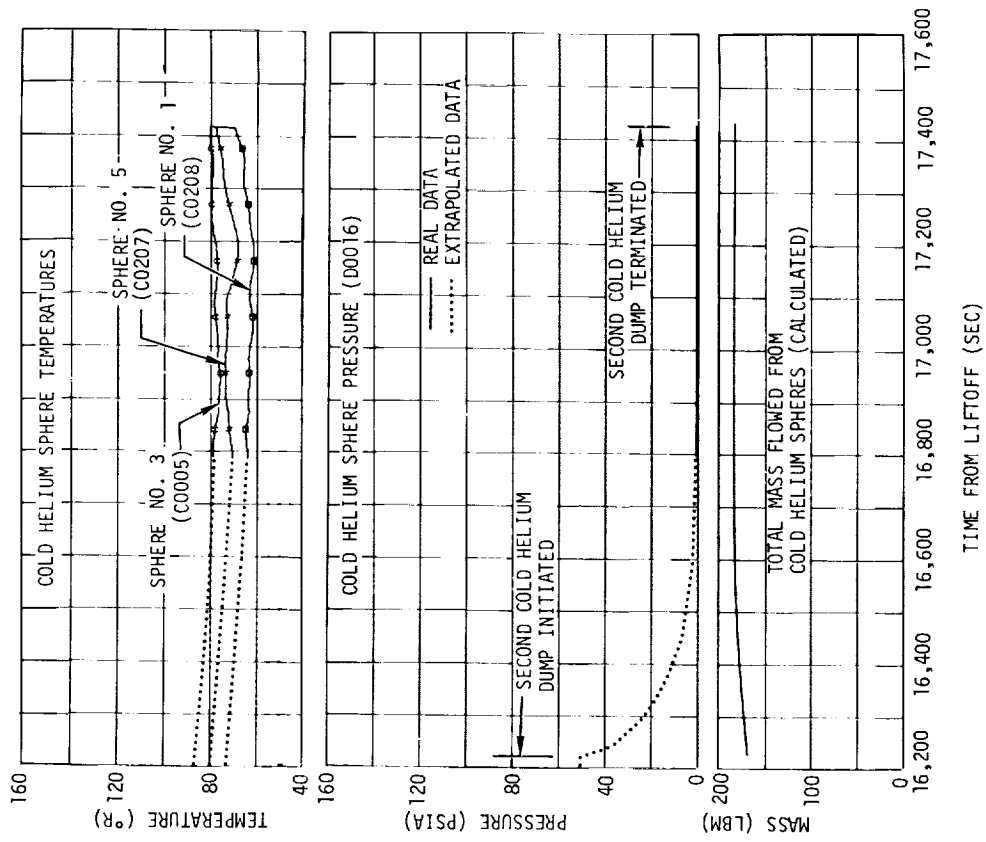

Figure 22-2. First and Second Cold Helium Dump

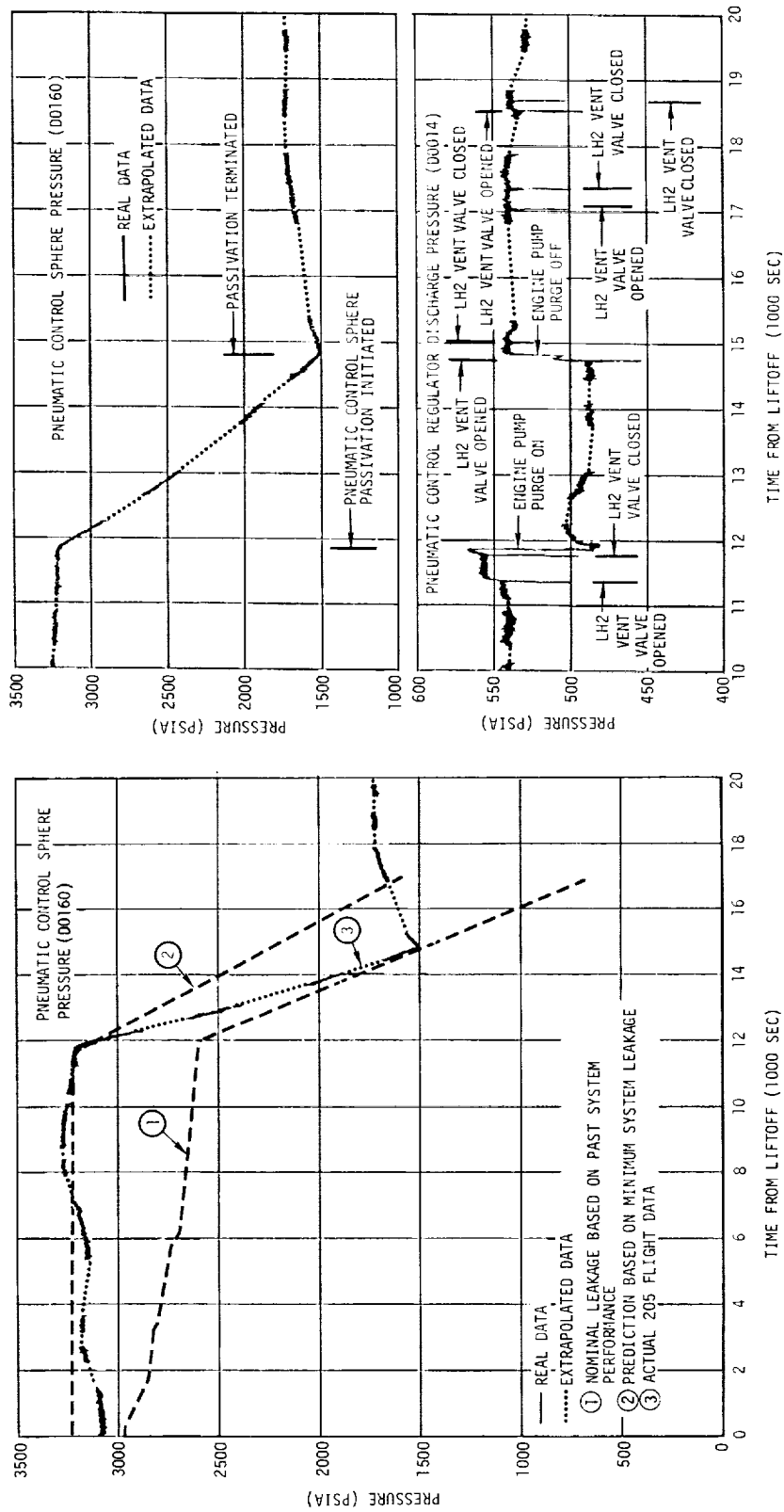

Figure 22-3. Pneumatic Control System Conditions During Orbit

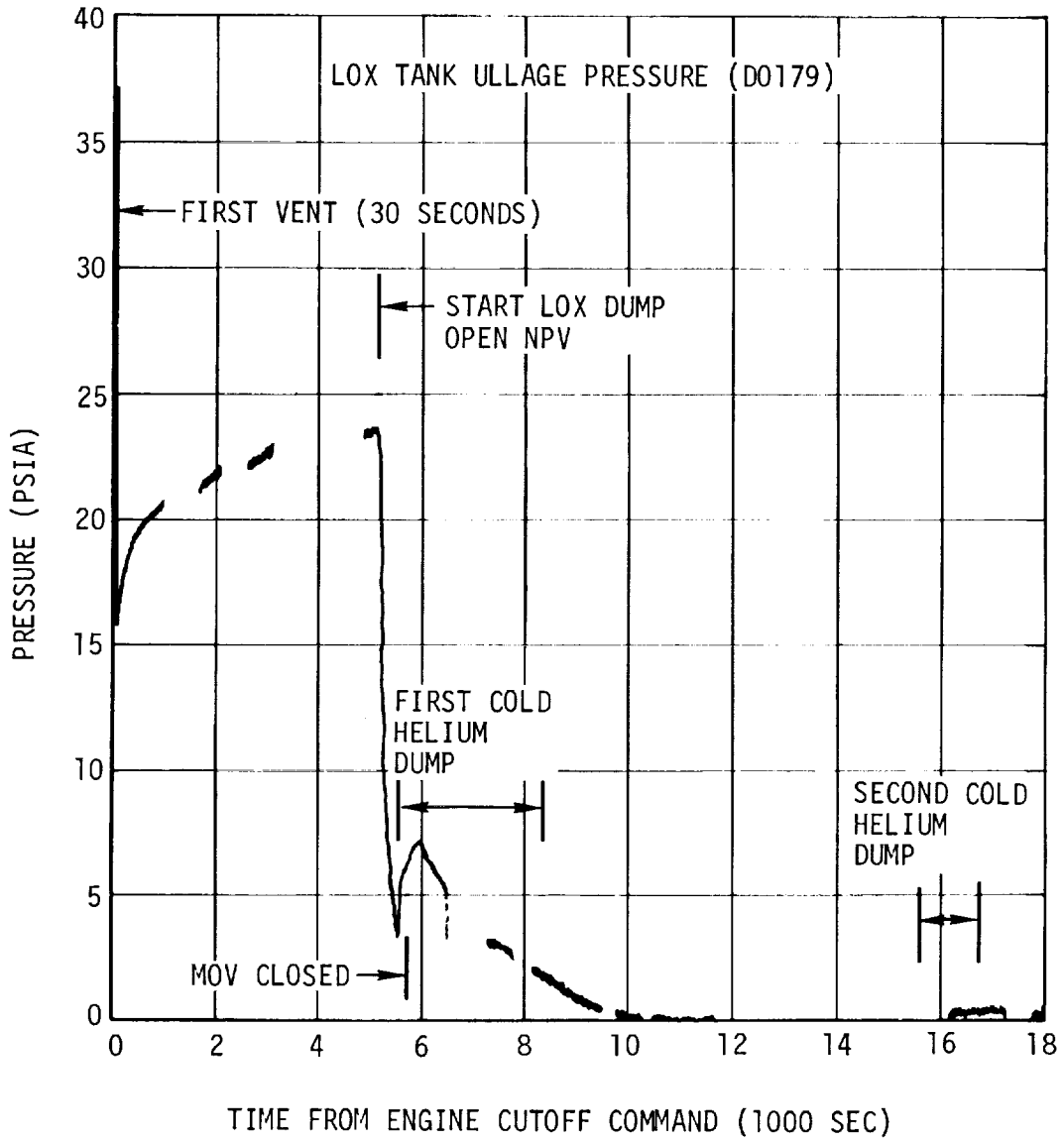

Figure 22-4. LOX Tank Ullage Pressure During Orbit

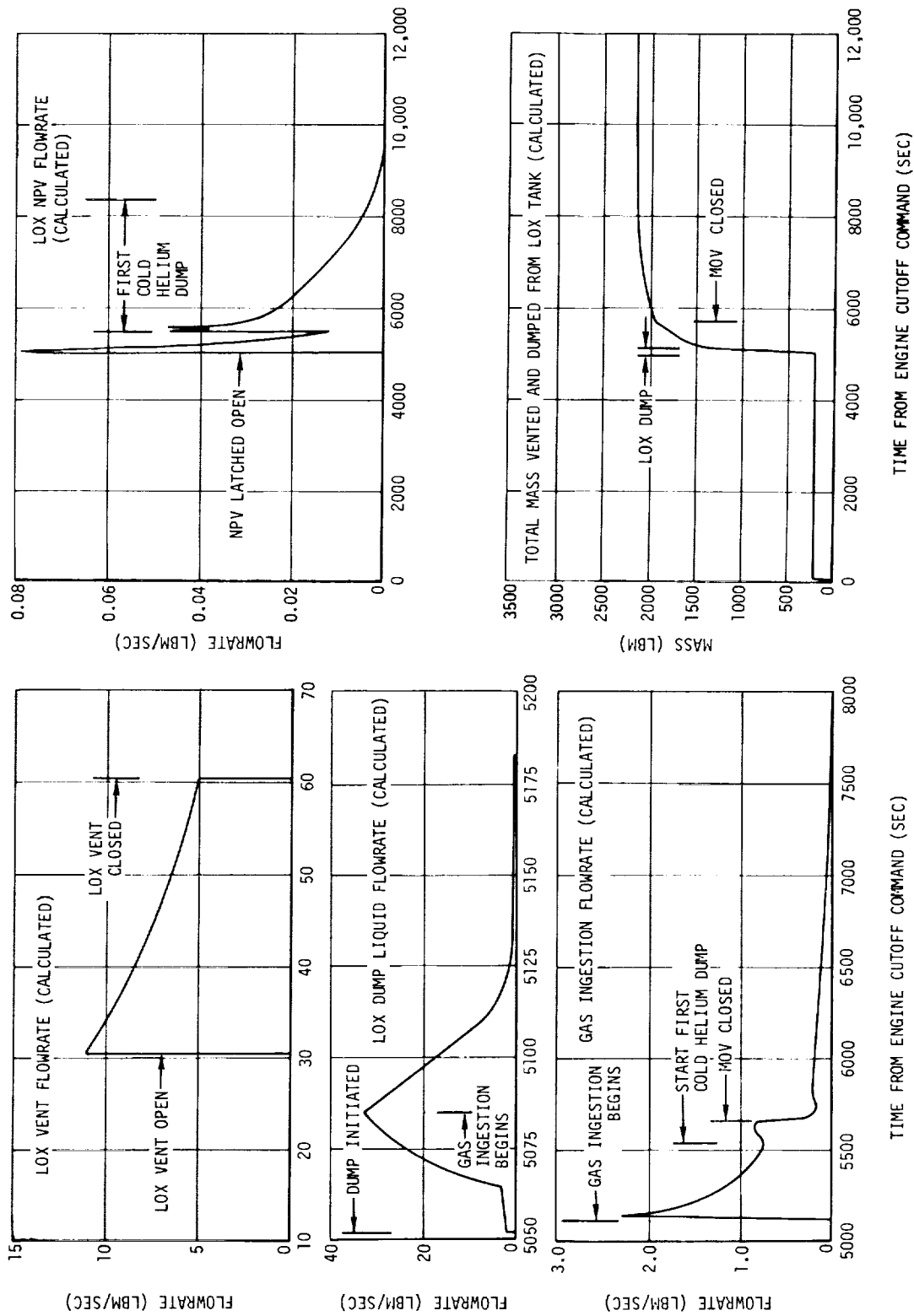

Figure 22-5. LOX Tank Venting During Orbit

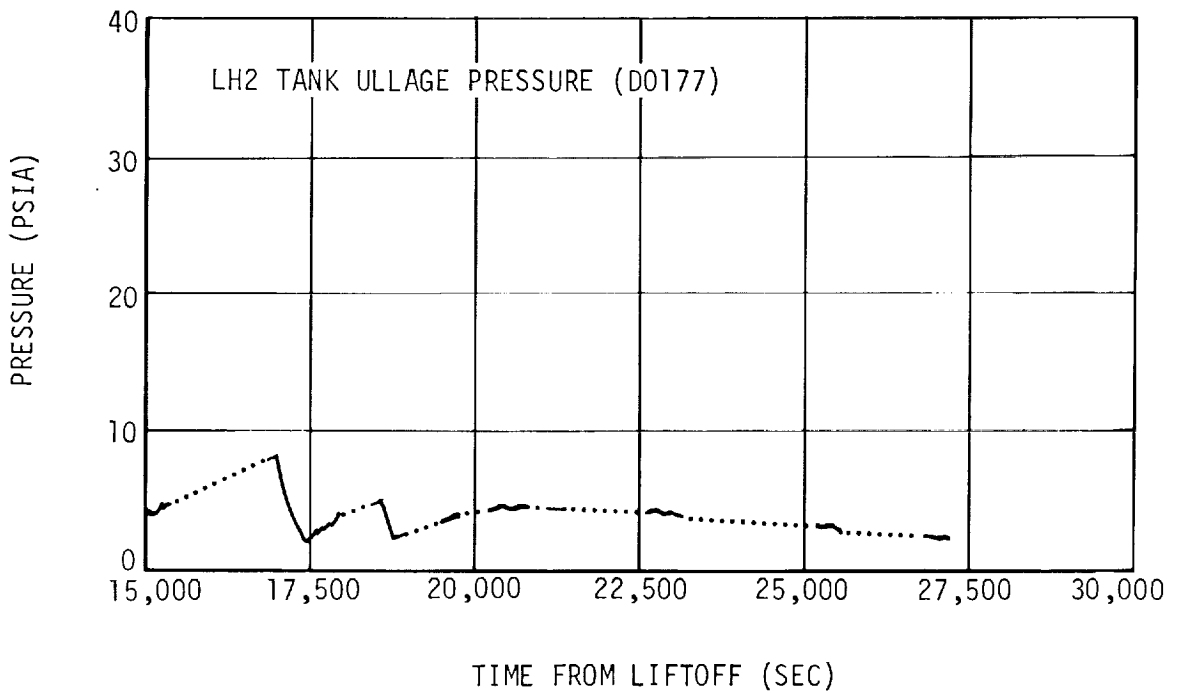
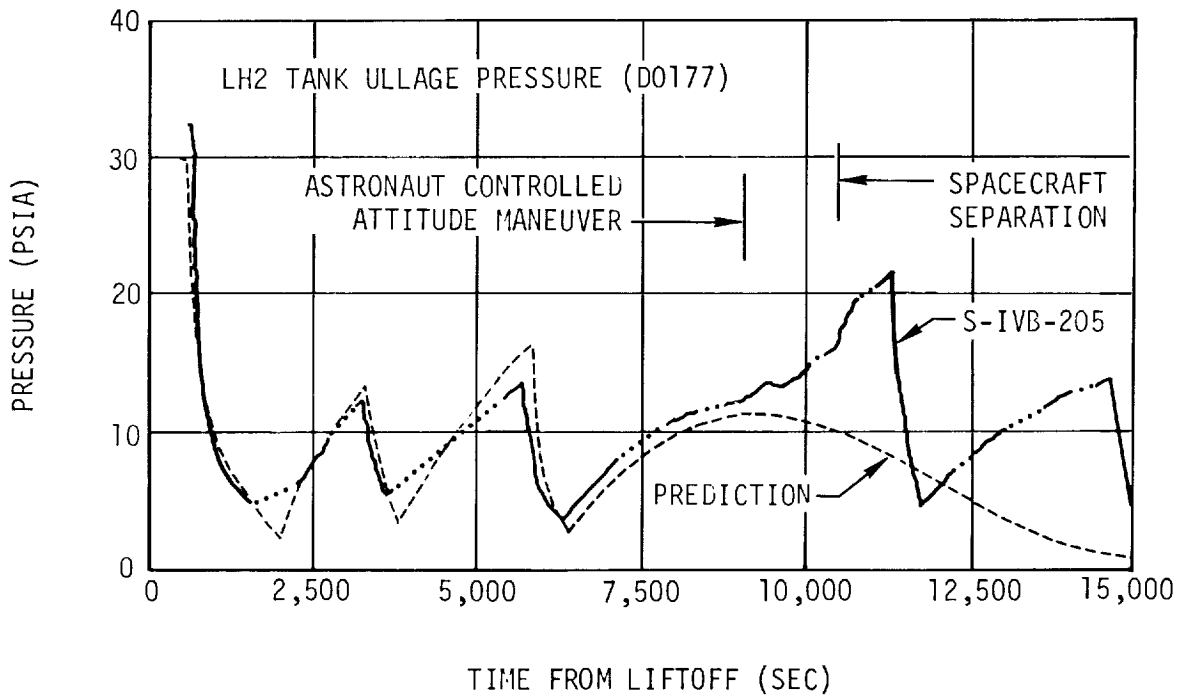

Figure 22-6. LH2 Tank Ullage Pressure During Safing

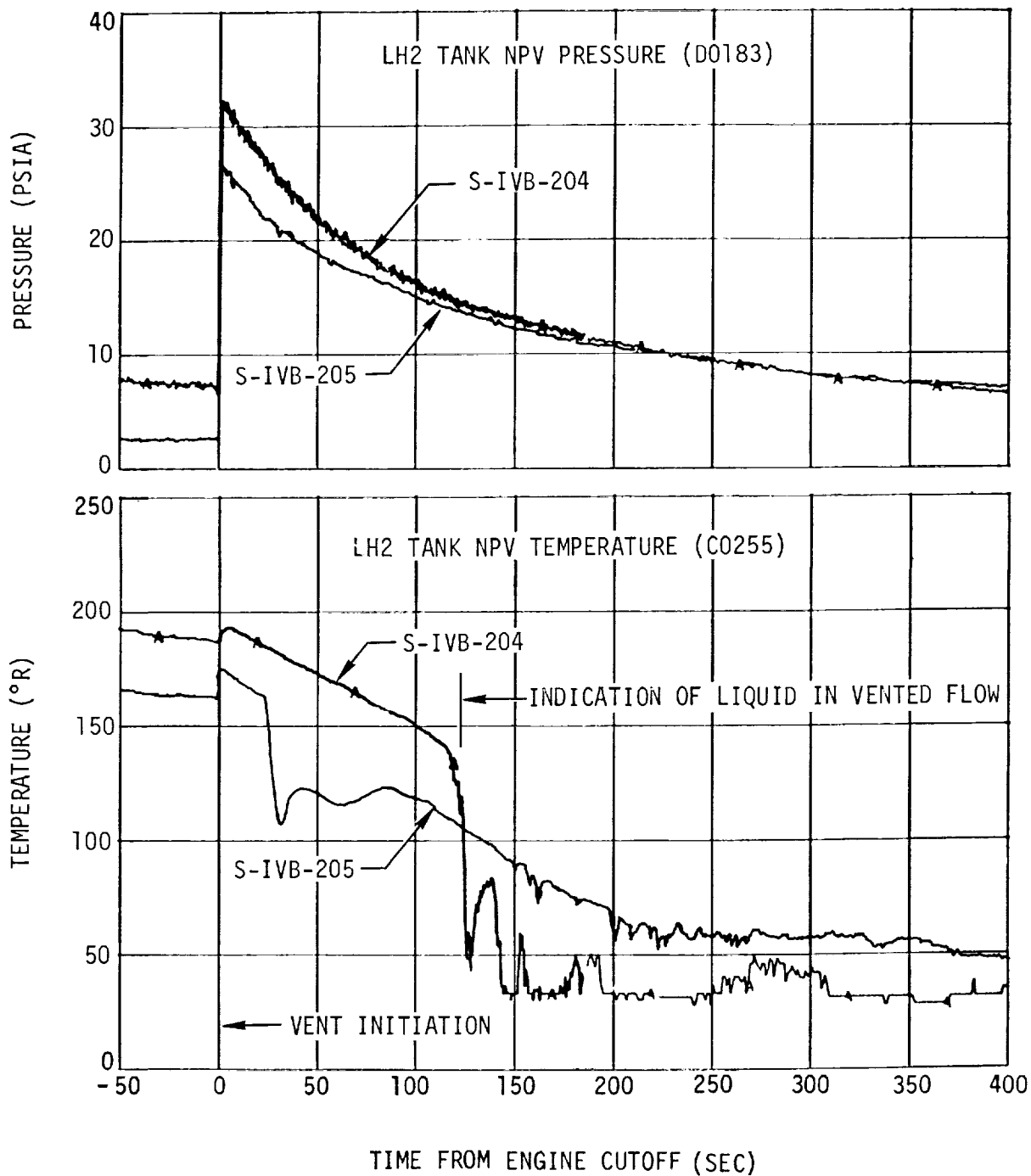

Figure 22-7. Fuel NPV Nozzle Temperature and Pressure Comparison (204F and 205F)

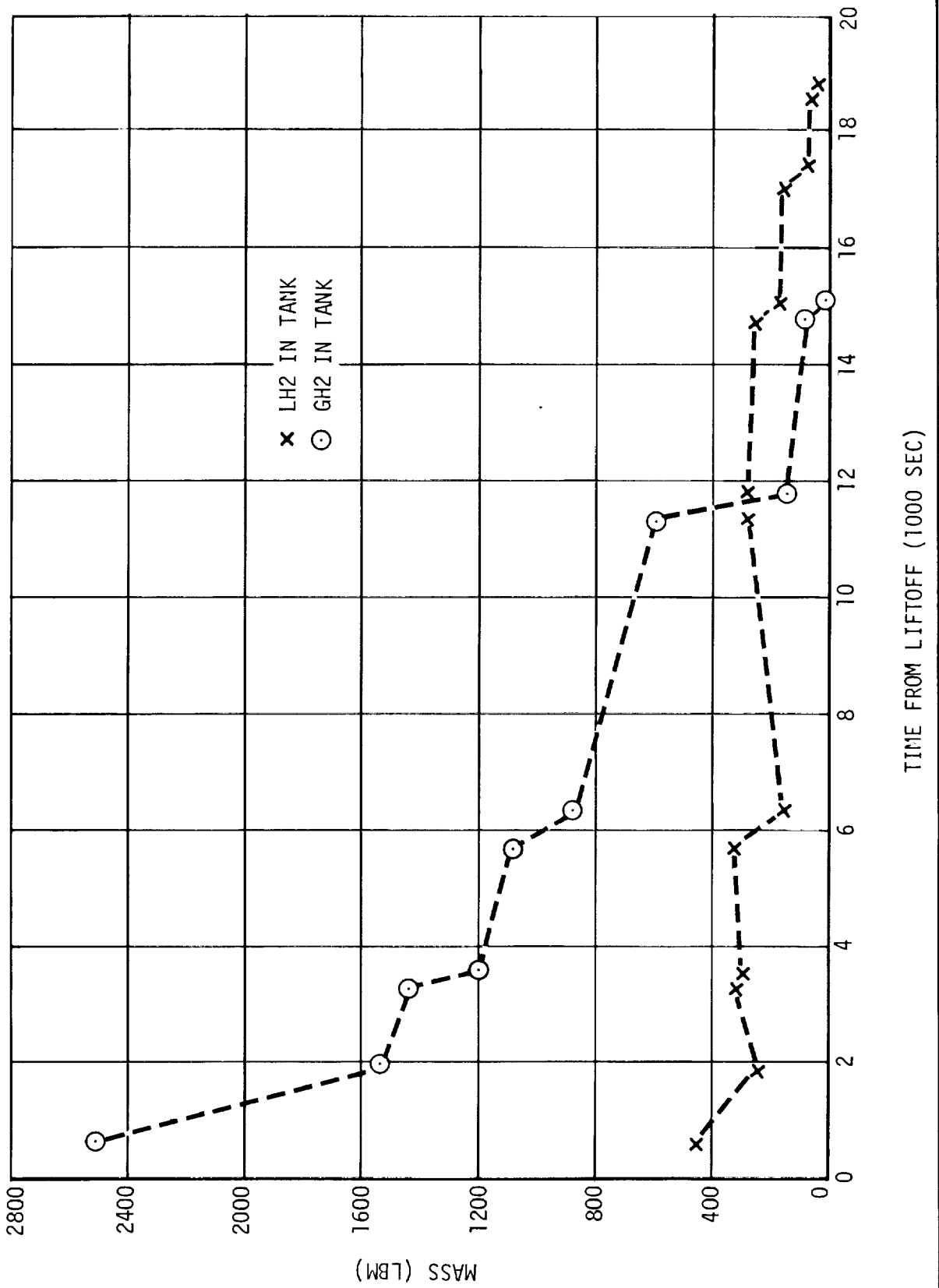
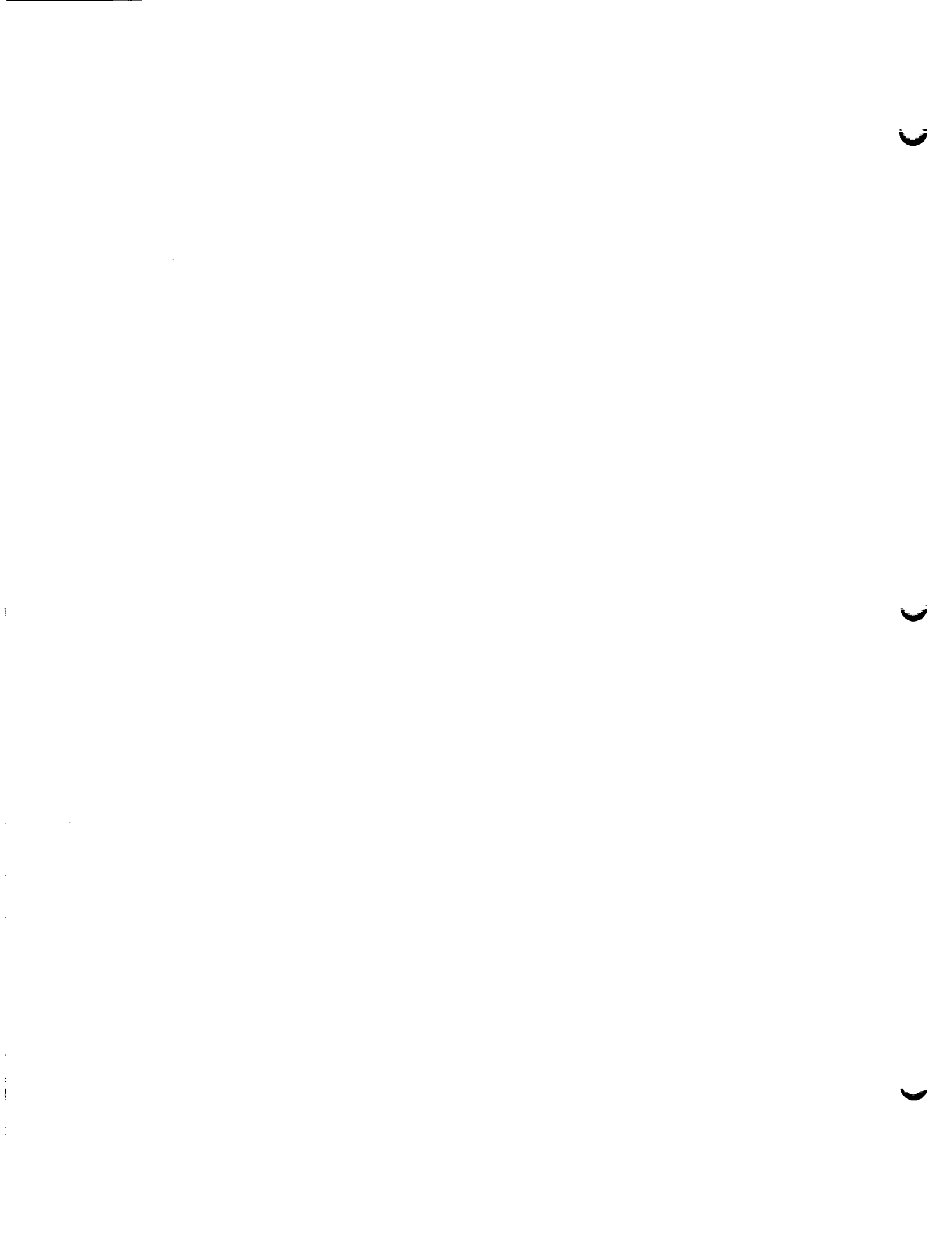

Figure 22-8. Mass in LH2 Tank During Orbital Safing



APPENDIX I

SEQUENCE OF EVENTS



1. SEQUENCE OF EVENTS

1.1 Postflight Sequence

Table AP-1 presents the AS-205 predicted and actual sequence of events. Four types of items are presented in this sequence.

- a. LVDC commands - These items initiate from the launch vehicle digital computer (LVDC) in the instrument unit (IU) to perform vehicle system functions.
- b. Incidents - These items are monitored occurrences such as the time of maximum dynamic pressure.
- c. Responses - These items are responses to commands that are issued from the LVDC and are monitored in the S-IVB.
- d. Ground commands - These commands originate at ground stations and are transmitted to the launch vehicle.

All events are preceded by an item number. Sequential series of related commands and responses are listed under the same event number with lower case letters distinguishing separate items.

1.2 Predicted and Monitored Times

The predicted times in this sequence were obtained from McDonnell Douglas Astronautics - Western Division (MDAC-WD) Report No. SM-46978A, S-IVB-205 Stage Flight Test Plan, revised September 1968.

Commands issued from the LVDC to the S-IB stage, S-IVB stage, and the IU stage were monitored at the LVDC. Times for these items were obtained from MSFC. Commands issued from the LVDC to the S-IVB stage were monitored as responses at the S-IVB stage switch selector (SSS). These items were obtained from MDAC-WD data.

Times for incidents were obtained from postflight analysis of parameters associated with each event.

The time from range zero is provided for all items. Range zero, the integer second prior to liftoff, occurred at 1502:45.000 GMT. A time from base (TB) is given for all LVDC commands (and their responses) which were preprogrammed. A time from base is not applicable (N/A) for items such as incidents and commands that were not preprogrammed.

1.3 Time Bases

Four sequential series of preprogrammed commands were issued from the LVDC. Each sequential series was initiated by the establishment of its time base in the LVDC. Listed below are the four time bases with their respective originating events:

- a. Time base 1, TB1: IU umbilical disconnect
- b. Time base 2, TB2: S-IB propellant level sensor actuation

- c. Time base 3, TB3: S-IB outboard engine cutoff
- d. Time base 4, TB4: S-IVB engine cutoff

A special sequence was used during TB4 for calibration of the IU telemetry and S-IVB telemetry. This special sequence consists of four SSS commands and is initiated by the LVDC using special tracking station acquisition logic.

TABLE AP 1-1 (Sheet 1 of 30)
AS-205 SEQUENCE OF EVENTS

ITEM NO.	EVENT	PREDICTED TIME		SIGNAL MONITORED AT	MONITORED TIME		DATA SOURCE	ACCURACY (ms)
		TIME FROM RANGE ZERO (hr:min:sec) (sec)	TIME FROM BASE (sec)		TIME FROM RANGE ZERO* (hr:min:sec) (sec)	TIME FROM BASE (sec)		
1	Guidance Reference Release	00:00:05.0 (-5.0)	N/A	IU	00:00:04.97 (-4.97)	N/A	MSFC	--
2	S-IB Engine Start	00:00:03.1 (-3.1)	N/A	IU	00:00:02.94 (-2.94)	N/A	MSFC	--
3	Range Zero	00:00:00.0 (0.0)	N/A	IU	00:00:00.000 (0.000)	N/A	MSFC	--
4	First Vertical Motion	00:00:00.0 (0.0)	N/A	N/A	00:00:00.17 (0.17)	N/A	MSFC	--
4.1	First Motion Switch No. 1	N/A	N/A	N/A	00:00:00.27 (0.27)	N/A	MSFC	--
4.2	First Motion Switch No. 2	N/A	N/A	N/A	00:00:00.29 (0.29)	N/A	MSFC	--
5	Liftoff-Start of Time Base No. 1 (TBI); IU Umbilical Disconnect	00:00:00.0 (0.0)	TBI +0.0	IU	00:00:00.359 (0.359)	TBI +0.000	MSFC	--
6	Signal from LVDC for: Sensor Bias On	00:00:00.0 (0.0)	TBI +5.0	IU	00:00:05.311 (5.311)	TBI +4.952	MSFC	--
7	Signal from LVDC for: Multiple Engine Cutoff Enable	00:00:10.0 (10.0)	TBI +10.0	IU	00:00:10.309 (10.309)	TBI +9.950	MSFC	--
8	Start Roll and Pitch	00:00:10.0 (10.0)	N/A	IU	00:00:10.31 (10.31)	N/A	MSFC	--
9	Signal from LVDC for: Telemeter Calibration On	00:00:20.0 (20.0)	TBI +20.0	IU	00:00:20.321 (20.321)	TBI +19.962	MSFC	--
10	Signal from LVDC for: Telemeter Calibration Off	00:00:25.0 (25.0)	TBI +25.0	IU	00:00:25.317 (25.317)	TBI +24.958	MSFC	--
11	Signal from LVDC for: Telemeter Calibration In-Flight Calibrate On	00:00:27.0 (27.0)	TBI +27.0	IU	00:00:27.322 (27.322)	TBI +26.963	MSFC	--
12	Signal from LVDC for: LOX Tank Relief Control Valve Enable	00:00:29.8 (29.8)	TBI +29.8	IU	00:00:30.110 (30.110)	TBI +29.751	MSFC	--
13	Signal from LVDC for: Telemetry Calibration In-Flight Calibrate Off	00:00:32.0 (32.0)	TBI +32.0	IU	00:00:32.316 (32.316)	TBI +31.957	MSFC	--
14	End Roll	N/A	N/A	IU	00:00:38.48 (38.48)	N/A	MSFC	--

TABLE AP 1-1 (Sheet 2 of 30)
AS-205 SEQUENCE OF EVENTS

ITEM NO.	EVENT	PREDICTED TIME		SIGNAL MONITORED AT	MONITORED TIME		DATA SOURCE	ACCURACY (ms)
		TIME FROM RANGE ZERO (hr:min:sec) (sec)	TIME FROM BASE (sec)		TIME FROM RANGE ZERO* (hr:min:sec) (sec)	TIME FROM BASE (sec)		
15	Signal from LVDC for: Launch Vehicle Engines EDS Cutoff Enable	00:00:40.0 (40.0)	TB1 +40.0	IU	00:00:40.325 (40.325)	TB1 +39.966	MSFC	--
16	Signal from LVDC for: Cooling System Electrical Assembly Power Off	00:01:15.0 (75.0)	TB1 +75.0	IU	00:01:15.309 (75.309)	TB1 +74.950	MSFC	--
16.1	Maximum Dynamic Pressure	00:01:15.0 (75.0)	N/A	N/A	00:01:15.5 (75.5)	N/A	MSFC	--
17	Signal from LVDC for: Telemetry Calibrator In-Flight Calibrate On	00:01:30.2 (90.2)	TB1 +90.2	IU	00:01:30.514 (90.514)	TB1 +90.155	MSFC	--
18	Signal from LVDC for: Telemetry Calibrator In-Flight Calibrate Off	00:01:35.2 (95.2)	TB1 +95.2	IU	00:01:35.510 (95.510)	TB1 +95.151	MSFC	--
19	Signal from LVDC for: Flight Control Computer Switch Point No. 1	00:01:40.0 (100.0)	TB1 +100.0	IU	00:01:40.321 (100.321)	TB1 +99.962	MSFC	--
20	Signal from LVDC for: Flight Control Computer Switch Point No. 2	00:01:40.2 (100.2)	TB1 +100.2	IU	00:01:40.511 (100.511)	TB1 +100.152	MSFC	--
21	Signal from LVDC for: Telemeter Calibration On	00:01:59.8 (119.8)	TB1 +119.8	IU	00:02:00.109 (120.109)	TB1 +119.750	MSFC	--
22	Signal from LVDC for: Flight Control Computer Switch Point No. 3	00:02:00.0 (120.0)	TB1 +120.0	IU	00:02:00.311 (120.311)	TB1 +119.952	MSFC	--
23	Signal from LVDC for: IU Control Accelerometer Power Off	00:02:00.2 (120.2)	TB1 +120.2	IU	00:02:00.525 (120.525)	TB1 +120.166	MSFC	--
24	Signal from LVDC for: Telemeter Calibration Off	00:02:04.8 (124.8)	TB1 +124.8	IU	00:02:05.109 (125.109)	TB1 +124.750	MSFC	--
25a	Signal from LVDC for: TM Calibrate On	00:02:07.7 (127.7)	TB1 +127.7	IU	00:02:08.015 (128.015)	TB1 +127.656	MSFC	--
25b	Signal Received in S-IVB for: TM Calibrate On	00:02:07.7 (127.7)	TB1 +127.7	S-IVB	00:02:08.020 (128.020)	TB1 +127.661	MDAC-WD	+0 -9
26a	Signal from LVDC for: TM Calibrate Off	00:02:08.7 (128.7)	TB1 +128.7	IU	00:02:09.011 (129.011)	TB1 +128.651	MSFC	--

TABLE AP 1-1 (Sheet 3 of 30)
AS-205 SEQUENCE OF EVENTS

ITEM NO.	EVENT	PREDICTED TIME		SIGNAL MONITORED AT	MONITORED TIME		DATA SOURCE	ACCURACY (ms)
		TIME FROM RANGE ZERO (hr:min:sec) (sec)	TIME FROM BASE (sec)		TIME FROM RANGE ZERO* (hr:min:sec) (sec)	TIME FROM BASE (sec)		
26b	Signal Received in S-IVB for: TM Calibrate Off	00:02:08.7 (128.7)	TB1 +128.7	S-IVB	00:02:09.103 (129.103)	TB1 +128.744	MDAC-WD	+0 -9
27	Signal from LVDC for: Excess Rate (P,Y,R) Auto-Abort Inhibit Enable	00:02:12.6 (132.6)	TB1 +132.6	IU	00:02:12.908 (132.908)	TB1 +132.549	MSFC	--
28	Signal from LVDC for: Excess Rate (P,Y,R) Auto-Abort Inhibit and Switch Rate Gyro-SC Indication "A"	00:02:12.8 (132.8)	TB1 +132.8	IU	00:02:13.110 (133.110)	TB1 +132.751	MSFC	--
29	Signal from LVDC for: S-IB Two Engines Out Auto-Abort Inhibit Enable	00:02:13.0 (133.0)	TB1 +133.0	IU	00:02:13.327 (133.327)	TB1 +132.968	MSFC	--
30	Signal from LVDC for: Propellant Level Sensors Enable	00:02:13.2 (133.2)	TB1 +133.2	IU	00:02:14.010 (134.010)	TB1 +133.651	MSFC	--
31	Signal from LVDC for: Propellant Level Sensors Enable	00:02:13.7 (133.7)	TB1 +133.7	IU	00:02:14.010 (134.010)	TB1 +133.651	MSFC	--
32	Stop Pitch	00:02:14.66 (134.66)	N/A	IU	00:02:14.26 (134.26)	N/A	MSFC	--
33	Signal from LVDC for: S-IB Propellant Level Sensor Actuation	00:02:16.9 (136.9)	TB2 +0.0	IU	00:02:17.489 (137.489)	TB1 +137.130	MSFC	--
	Start of Time Base No. 2 (TB2)	00:02:16.9 (136.9)	TB2 +0.0	IU	00:02:17.490 (137.490)	TB2 +0.000	MSFC	--
34	Signal from LVDC for: Excess Rate (Roll) Auto-Abort Inhibit Enable	00:02:17.1 (137.1)	TB2 +0.2	IU	00:02:17.643 (137.643)	TB2 +0.153	MSFC	--
35	Signal from LVDC for: Excess Rate (Roll) Auto-Abort Inhibit and Switch Rate Gyros SC Indication "B"	00:02:17.3 (137.3)	TB2 +0.4	IU	00:02:17.860 (137.860)	TB2 +0.370	MSFC	--
36	Signal from LVDC for: Inboard Engines Cutoff	00:02:20.1 (140.1)	TB2 +3.2	IU	00:02:20.644 (140.644)	TB2 +3.154	MSFC	--
37	Signal from LVDC for: Auto-Abort Enable Relays Reset	00:02:20.3 (140.3)	TB2 +3.4	IU	00:02:20.861 (140.861)	TB2 +3.371	MSFC	--

TABLE AP 1-1 (Sheet 4 of 30)
AS-205 SEQUENCE OF EVENTS

ITEM NO.	EVENT	PREDICTED TIME		SIGNAL MONITORED AT	MONITORED TIME		DATA SOURCE	ACCURACY (ms)
		TIME FROM RANGE ZERO (hr:min:sec) (sec)	TIME FROM BASE (sec)		TIME FROM RANGE ZERO* (hr:min:sec) (sec)	TIME FROM BASE (sec)		
38a	Signal from LVDC for: Charge Ullage Ignition EBW Firing Units	00:02:20.5 (140.5)	TB2 +3.6	IU	00:02:21.041 (141.041)	TB2 +3.551	MSFC	--
38b	Signal Received in S-IVB for: Charge Ullage Ignition EBW Firing Units	00:02:20.5 (140.5)	TB2 +3.6	S-IVB	00:02:21.052 (141.052)	TB2 +3.562	MDAC-WD	+0 -9
39	Signal from LVDC for: Q-Ball Power Off	00:02:20.9 (140.9)	TB2 +4.0	IU	00:02:21.453 (141.453)	TB2 +3.963	MSFC	--
40a	Signal from LVDC for: Prevalves Open	00:02:21.4 (141.4)	TB2 +4.5	IU	00:02:21.953 (141.953)	TB2 +4.463	MSFC	--
40b	Signal Received in S-IVB for: Prevalves Open	00:02:21.4 (141.4)	TB2 +4.5	S-IVB	00:02:21.960 (141.960)	TB2 +4.470	MDAC-WD	+0 -9
40c 1)	Fuel Pre-Valve Closed (Drop Out)	--	N/A	S-IVB	00:02:22.895 (142.895)	N/A	MDAC-WD	+0 -84
2)	Oxidizer Pre-Valve Closed (Drop Out)	--	N/A	S-IVB	00:02:23.036 (143.036)	N/A	MDAC-WD	+0 -84
3)	Oxidizer Pre-Valve Open (Pick Up)	--	N/A	S-IVB	00:02:24.286 (144.286)	N/A	MDAC-WD	+0 -84
4)	Fuel Pre-Valve Open (Pick-Up)	--	N/A	S-IVB	00:02:24.536 (144.536)	N/A	MDAC-WD	+0 -84
41	Signal from LVDC for: LOX Depletion Cutoff Enable	00:02:21.6 (141.6)	TB2 +4.7	IU	00:02:22.140 (142.140)	TB2 +4.650	MSFC	--
42	Signal from LVDC for: Fuel Depletion Cutoff Enable	00:02:22.6 (142.6)	TB2 +5.7	IU	00:02:23.160 (143.160)	TB2 +5.670	MSFC	--
43	Signal from LVDC for: S-IB Outboard Engines Cutoff	00:02:23.1 (143.1)	TB3 +0.0	IU	00:02:24.318 (144.318)	TB2 +6.828	MSFC	--
	Start of Time Base No. 3 (TB3)	00:02:23.1 (143.1)	TB3 +0.0	IU	00:02:24.319 (144.319)	TB3 +0.000	MSFC	--
44	S-IB Outboard Engines Cutoff	--	N/A	IU	00:02:24.323 (144.323)	N/A	MSFC	--
45a	Signal from LVDC for: LOX Tank Flight Pressurization Switch Enable	00:02:23.3 (143.3)	TB3 +0.2	IU	00:02:24.49 (144.49)	TB3 +0.17	MSFC	--
45b	Signal Received in S-IVB for: LOX Tank Flight Pressurization Switch Enable	00:02:23.3 (143.3)	TB3 +0.2	S-IVB	00:02:24.493 (144.493)	TB3 +0.170	MDAC-WD	+0 -9

TABLE AP 1-1 (Sheet 5 of 30)
AS-205 SEQUENCE OF EVENTS

ITEM NO.	EVENT	PREDICTED TIME		SIGNAL MONITORED AT	MONITORED TIME		DATA SOURCE	ACCURACY (ms)
		TIME FROM RANGE ZERO (hr:min:sec) (sec)	TIME FROM BASE (sec)		TIME FROM RANGE ZERO* (hr:min:sec) (sec)	TIME FROM BASE (sec)		
46a	Signal from LVDC for: Engine Cutoff Signal Off	00:02:23.5 (143.5)	TB3 +0.4	IU	00:02:24.670 (144.670)	TB3 +0.351	MSFC	--
46b	Signal Received in S-IVB for: Engine Cutoff Signal Off	00:02:23.5 (143.5)	TB3 +0.4	S-IVB	00:02:24.677 (144.677)	TB3 +0.358	MDAC-WD	+0 -9
46c	Engine Cutoff Command On (Drop Out)	--	N/A	S-IVB	00:02:24.678 (144.678)	N/A	MDAC-WD	+0 -84
47a	Signal from LVDC for: Ullage Rockets Ignition	00:02:24.2 (144.2)	TB3 +1.1	IU	00:02:25.370 (145.370)	TB3 +1.051	MSFC	--
47b	Signal Received in S-IVB for: Ullage Rockets Ignition	00:02:24.2 (144.2)	TB3 +1.1	S-IVB	00:02:25.377 (145.377)	TB3 +1.058	MDAC-WD	+0 -9
48	Signal from LVDC for: S-IB/S-IVB Separation On	00:02:24.4 (144.4)	TB3 +1.3	IU	00:02:25.581 (145.581)	TB3 +1.262	MSFC	--
49	Signal from LVDC for: Flight Control Computer S-IVB Burn Mode On "A"	00:02:24.6 (144.6)	TB3 +1.5	IU	00:02:25.770 (145.770)	TB3 +1.451	MSFC	--
50	Signal from LVDC for: Flight Control Computer S-IVB Burn Mode On "B"	00:02:24.8 (144.8)	TB3 +1.7	IU	00:02:25.97 (145.97) (Note 7)	TB3 +1.65 (Note 7)	MSFC	--
51a	Signal from LVDC for: Engine Ready Bypass On	00:02:25.0 (145.0)	TB3 +1.9	IU	00:02:26.17 (146.17) (Note 7)	TB3 +1.85 (Note 7)	MSFC	--
51b	Signal Received in S-IVB for: Engine Ready Bypass On	00:02:25.0 (145.0)	TB3 +1.9	S-IVB	00:02:26.193 (146.193)	TB3 +1.870	MDAC-WD	+0 -9
52a	Signal from LVDC for: LH2 Chilldown Pump Off	00:02:25.2 (145.2)	TB3 +2.1	IU	00:02:26.37 (146.37) (Note 7)	TB3 +2.05 (Note 7)	MSFC	--
52b	Signal Received in S-IVB for: LH2 Chilldown Pump Off	00:02:25.2 (145.2)	TB3 +2.1	S-IVB	00:02:26.375 (146.375)	TB3 +2.052	MDAC-WD	+0 -9
53a	Signal from LVDC for: LOX Chilldown Pump Off	00:02:25.4 (145.4)	TB3 +2.3	IU	00:02:26.575 (146.575)	TB3 +2.256	MSFC	--
53b	Signal Received in S-IVB for: LOX Chilldown Pump Off	00:02:25.4 (145.4)	TB3 +2.3	S-IVB	00:02:26.608 (146.608)	TB3 +2.285	MDAC-WD	+0 -9
54	Signal from LVDC for: S-IVB Engine Out Indication "A" Enable	00:02:25.5 (145.5)	TB3 +2.4	IU	00:02:26.672 (146.672)	TB3 +2.353	MSFC	--

TABLE AP 1-1 (Sheet 6 of 30)
AS-205 SEQUENCE OF EVENTS

ITEM NO.	EVENT	PREDICTED TIME		SIGNAL MONITORED AT	MONITORED TIME		DATA SOURCE	ACCUFACY (ms)
		TIME FROM RANGE ZERO (hr:min:sec) (sec)	TIME FROM BASE (sec)		TIME FROM RANGE ZERO* (hr:min:sec) (sec)	TIME FROM BASE (sec)		
55	Signal from LVDC for: S-IVB Engine Out Indication "B" Enable	00:02:25.7 (145.7)	TB3 +2.6	IU	00:02:26.882 (146.882)	TB3 +2.563	MSFC	+0 -9
56a	Signal from LVDC for: Engine Ignition Sequence Start	00:02:25.8 (145.8)	TB3 +2.7	IU	00:02:26.97 (146.97)	TB3 +2.65	MSFC	--
56b	Signal Received in S-IVB for: Engine Ignition Sequence Start	00:02:25.8 (145.8)	TB3 +2.7	S-IVB	00:02:27.008 (147.008) (Note 1)	TB3 +2.715	MDAC-WD	Note 1
56c	1) Engine Start-On (Pick Up)	--	N/A	S-IVB	00:02:27.426 (147.426) (Note 1)	N/A	MDAC-WD	Note 1
	2) Ignition Phase Control Sol-Energized (Pick Up)	--	N/A	S-IVB	00:02:27.443 (147.443) (Note 1)	N/A	MDAC-WD	Note 1
	3) Helium Control Sol-Energized (Pick Up)	--	N/A	S-IVB	00:02:27.443 (147.443) (Note 1)	N/A	MDAC-WD	Note 1
	4) Thrust Chamber Spark System-On (Pick Up)	--	N/A	S-IVB	00:02:27.433 (147.433) (Note 1)	N/A	MDAC-WD	Note 1
	5) GG Sparks System-On (Pick Up)	--	N/A	S-IVB	00:02:27.433 (147.433) (Note 1)	N/A	MDAC-WD	Note 1
	6) Oxidizer Bleed Valve Closed (Pick Up)	--	N/A	S-IVB	00:02:27.453 (147.453) (Note 1)	N/A	MDAC-WD	Note 1
	7) Fuel Bleed Valve-Closed (Pick Up)	--	N/A	S-IVB	00:02:27.453 (147.453) (Note 1)	N/A	MDAC-WD	Note 1
	8) Main Fuel Valve-Open (Pick Up)	--	N/A	S-IVB	00:02:27.462 (147.462) (Note 1)	N/A	MDAC-WD	Note 1
	9) Main Fuel Valve Closed (Drop Out)	--	N/A	S-IVB	00:02:27.462 (147.462) (Note 1)	N/A	MDAC-WD	Note 1
57a	Signal from LVDC for: Engine Ignition Sequence Start Relay Reset	00:02:26.3 (146.3)	TB3 +3.2	IU	00:02:27.47 (147.47) (Note 7)	TB3 +3.15 (Note 7)	MSFC	--
57b	Signal Received in S-IVB for: Engine Ignition Sequence Start Relay Reset	00:02:26.3 (146.3)	TB3 +3.2	S-IVB	00:02:27.538 (147.538) (Note 1)	TB3 +3.215	MDAC-WD	Note 1

TABLE AP 1-1 (Sheet 7 of 30)
AS-205 SEQUENCE OF EVENTS

ITEM NO.	EVENT	PREDICTED TIME		SIGNAL MONITORED AT	MONITORED TIME		DATA SOURCE	ACCURACY (ms)
		TIME FROM RANGE ZERO (hr:min:sec) (sec)	TIME FROM BASE (sec)		TIME FROM RANGE ZERO* (hr:min:sec) (sec)	TIME FROM BASE (sec)		
57c	1) Engine Start-On (Drop Out)	--	N/A	S-IVB	00:02:27.485 (147.485)	N/A	MDAC-WD	+0 -9
	2) Start Tank Discharge Control Sol-Energized (Pick Up)	--	N/A	S-IVB	00:02:27.991 (147.991)	N/A	MDAC-WD	+0 -9
	3) Start Tank Discharge Valve-Open (Pick Up)	--	N/A	S-IVB	00:02:28.293 (148.293)	N/A	MDAC-WD	+0 -84
	4) Mainstage Control Sol-Energized (Pick Up)	--	N/A	S-IVB	00:02:28.433 (148.433)	N/A	MDAC-WD	+0 -9
	5) Start Tank Discharge Control Sol-Energized (Drop Out)	--	N/A	S-IVB	00:02:28.441 (148.441)	N/A	MDAC-WD	+0 -9
	6) Main Oxidizer Valve-Closed (Drop Out)	--	N/A	S-IVB	00:02:28.543 (148.543)	N/A	MDAC-WD	+0 -84
	7) Gas Generator Valve Open (Pick Up)	--	N/A	S-IVB	00:02:28.711 (148.711)	N/A	MDAC-WD	+0 -84
	8) Oxid Turb Bypass Valve Closed (Pick Up)	--	N/A	S-IVB	00:02:48.968 (148.968)	N/A	MDAC-WD	+0 -84
	9) Mainstage OK Press Switch 1 (Pick Up)	--	N/A	S-IVB	00:02:49.710 (149.710)	N/A	MDAC-WD	+0 -84
	10) Mainstage OK Press Switch 2 (Pick Up)	--	N/A	S-IVB	00:02:49.718 (149.718)	N/A	MDAC-WD	+0 -84
	11) Mainstage OK Press Switch 1 Depress (Drop Out)	--	N/A	S-IVB	00:02:49.735 (149.735)	N/A	MDAC-WD	+0 -84
	12) Mainstage OK Press Switch 2 Depress (Drop Out)	--	N/A	S-IVB	00:02:49.735 (149.735)	N/A	MDAC-WD	+0 -84
	13) Main Oxidizer Valve Open (Pick Up)	--	N/A	S-IVB	00:02:30.876 (150.876)	N/A	MDAC-WD	+0 -84
58a	Signal from LVDC for: Fuel Injection Temperature OK Bypass	00:02:26.8 (146.8)	TB3 +3.7	IU	147.97 (Note 7)	3.65 (Note 7)	MSFC	--

TABLE AP 1-1 (Sheet 8 of 30)
AS-205 SEQUENCE OF EVENTS

ITEM NO.	EVENT	PREDICTED TIME		SIGNAL MONITORED AT	MONITORED TIME		DATA SOURCE	ACCURACY (ms)
		TIME FROM RANGE ZERO (hr:min:sec) (sec)	TIME FROM BASE (sec)		TIME FROM RANGE ZERO* (hr:min:sec) (sec)	TIME FROM BASE (sec)		
58b	Signal Received in S-IVB for: Fuel Injection Temperature OK Bypass	00:02:26.8 (146.8)	TB3 +3.7	S-IVB	00:02:27.985 (147.985)	TB3 +3.662	MDAC-WD	+0 -9
59a	Signal from LVDC for: LH2 Tank Pressurization Control Switch Enable	00:02:28.4 (148.4)	TB3 +5.3	IU	00:02:29.570 (149.570)	TB3 +5.251	MSFC	--
59b	Signal Received in S-IVB for: LH2 Tank Pressurization Control Switch Enable	00:02:28.4 (148.4)	TB3 +5.3	S-IVB	00:02:29.577 (149.577)	TB3 +5.258	MDAC-WD	+0 -9
60a	Signal from LVDC for: PU MR 5.5 On	00:02:31.8 (151.8)	TB3 +8.7	IU	00:02:32.97 (152.97)	TB3 +8.65	MSFC	--
60b	Signal Received in S-IVB for: PU MR 5.5 On	00:02:31.8 (151.8)	TB3 +8.7	S-IVB	00:02:32.976 (152.976)	TB3 +8.653	MDAC-WD	+0 -9
60c	PU System Ratio Valve (Change)	--	N/A	S-IVB	00:02:33.0 (153.0)	N/A	MDAC-WD	
61a	Signal from LVDC for: Charge Ullage Jettison EBW Firing Units	00:02:33.3 (153.3)	TB3 +10.2	IU	00:02:34.469 (154.469)	TB3 +10.150	MSFC	--
61b	Signal Received in S-IVB for: Charge Ullage Jettison EBW Firing Units	00:02:33.3 (153.3)	TB3 +10.2	S-IVB	00:02:34.476 (154.476)	TB3 +10.157	MDAC-WD	+0 -9
62a	Signal from LVDC for: Ullage Rockets Jettison	00:02:36.4 (156.4)	TB3 +13.3	IU	00:02:37.580 (157.580)	TB3 +13.261	MSFC	--
62b	Signal Received in S-IVB For: Ullage Rockets Jettison	00:02:36.4 (156.4)	TB3 +13.3	S-IVB	00:02:37.592 (157.592)	TB3 +13.269	MDAC-WD	+0 -9
63a	Signal from LVDC for: Fuel Injection Temperature OK Bypass Reset	00:02:36.8 (156.8)	TB3 +13.7	IU	00:02:37.968 (157.968)	TB3 +13.649	MSFC	--
63b	Signal Received in S-IVB for: Fuel Injection Temperature OK Bypass Reset	00:02:36.8 (156.8)	TB3 +13.7	S-IVB	00:02:37.976 (157.976)	TB3 +13.657	MDAC-WD	+0 -9
64a	Signal from LVDC for: Ullage EBW Firing Units Charge Relays Reset	00:02:42.4 (162.4)	TB3 +19.3	IU	00:02:43.570 (163.570)	TB3 +19.251	MSFC	--
64b	Signal Received in S-IVB for: Ullage EBW Firing Units Charge Relays Reset	00:02:42.4 (162.4)	TB3 +19.3	S-IVB	00:02:43.583 (163.583)	TB3 +19.264	MDAC-WD	+0 -9

TABLE AP 1-1 (Sheet 9 of 30)
AS-205 SEQUENCE OF EVENTS

ITEM NO.	EVENT	PREDICTED TIME		SIGNAL MONITORED AT	MONITORED TIME		DATA SOURCE	ACCURACY (ms)
		TIME FROM RANGE ZERO (hr:Min:sec) (sec)	TIME FROM BASE (sec)		TIME FROM RANGE ZERO* (hr:min:sec) (sec)	TIME FROM BASE (sec)		
65a	Signal from LVDC for: Ullage Pockets Ignition and Jettison Relays Reset	00:02:42.6 (162.6)	TB3 +19.5	IU	00:02:43.771 (163.771)	TB3 +19.452	MSFC	--
65b	Signal Received in S-IVB for: Ullage Rockets Ignition and Jettison Relays Reset	00:02:42.6 (162.6)	TB3 +19.5	S-IVB	00:02:43.783 (163.783)	TB3 +19.464	MDAC-WD	+0 -9
65.1	Launch Escape Tower Jettison	00:02:43.11 (163.1)	N/A	N/A	00:02:46.539 (166.539)	N/A	MSFC	--
66a	Signal from LVDC for: Heat Exchange Bypass Valve Enable On	00:02:47.1 (167.1)	TB3 +24.0	IU	00:02:48.269 (168.269)	TB3 +23.951	MSFC	--
66b	Signal Received in S-IVB for: Heat Exchange Bypass Valve Enable On	00:02:47.1 (167.1)	TB3 +24.0	S-IVB	00:02:48.283 (168.283)	TB3 +23.965	MDAC-WD	+0 -9
67	Signal from LVDC for: Telemetry Calibrator In-Flight Calibrate On	00:02:48.5 (168.5)	TB3 +25.4	IU	00:02:49.670 (169.670)	TB3 +25.351	MSFC	--
68	Initiate IGM	00:02:48.1 (168.1)	N/A	N/A	00:02:50.93 (170.93)	N/A	MSFC	--
69	Signal from LVDC for: Telemetry Calibrator In-Flight Calibrate Off	00:02:53.5 (173.5)	TB3 +30.4	IU	00:02:54.669 (174.669)	TB3 +30.350	MSFC	--
70	Signal from LVDC for: Water Collant Valve Open	00:03:00.1 (180.1)	TB3 +37.0	IU	00:03:01.270 (181.270)	TB3 +36.951	MSFC	--
71	Signal from LVDC for Flight Control Computer Switch Point No. 4	00:03:05.1 (185.1)	TB3 +42.0	IU	00:03:06.271 (186.271)	TB3 +41.952	MSFC	--
72	Initiate Steering Misalignment Correction	00:03:20.0 (200.0)	N/A	N/A	00:03:21.56 (201.56)	N/A	MSFC	--
73	Signal from LVDC for: Flight Control Computer Switch Point No. 5	00:05:46.8 (346.8)	TB3 +203.7	IU	00:05:47.970 (347.970)	TB3 +203.651	MSFC	--
74	Signal from LVDC for: Telemetry Calibrator In-Flight Calibrate On	00:05:48.5 (348.5)	TB3 +205.4	IU	00:05:49.684 (349.684)	TB3 +205.365	MSFC	--
75	Signal from LVDC for: Telemetry Calibrator In-Flight Calibrate Off	00:05:53.5 (353.5)	TB3 +210.4	IU	00:05:54.672 (354.672)	TB3 +210.353	MSFC	--

TABLE AP 1-1 (Sheet 10 of 30)
AS-205 SEQUENCE OF EVENTS

ITEM NO.	EVENT	PREDICTED TIME		SIGNAL MONITORED AT	MONITORED TIME		DATA SOURCE	ACCURACY (ms)
		TIME FROM RANGE ZERO (hr:min:sec) (sec)	TIME FROM BASE (sec)		TIME FROM RANGE ZERO* (hr:min:sec) (sec)	TIME FROM BASE (sec)		
76a	Signal from LVDC for: LH2 Tank Pressurization Control Switch Disable	00:07:26.0 (446.0)	TB3 +302.9	IU	00:07:27.170 (447.170)	TB3 +302.851	MSFC	--
76b	Signal Received in S-IVB for: LH2 Tank Pressurization Control Switch Disable	00:07:26.0 (446.0)	TB3 +302.9	S-IVB	00:07:27.184 (447.184)	TB3 +302.865	MDAC-WD	+0 -9
77a	Signal from LVDC for: PU MR 5.5 Off	00:07:34.4 (454.4)	TB3 +311.3	IU	00:07:35.579 (455.579)	TB3 +311.260	MSFC	--
77b	Signal Received in S-IVB for: PU MR 5.5 Off	00:07:34.4 (454.4)	TB3 +311.3	S-IVB	00:07:35.591 (455.591)	TB3 +311.272	MDAC-WD	+0 -9
78	Initiation of Guidance Staging Initiation of Artificial Tau Mode	00:07:34.0 (454.0)	N/A	N/A	00:07:35.68 (455.68)	N/A	MSFC	--
79a	Signal from LVDC for: PU MR 4.5 On	00:07:34.6 (454.6)	TB3 +311.5	IU	00:07:35.770 (455.770)	TB3 +311.451	MSFC	--
79b	Signal Received in S-IVB for: PU MR 4.5 On	00:07:34.6 (454.6)	TB3 +311.5	S-IVB	00:07:35.783 (455.783)	TB3 +311.464	MDAC-WD	+0 -9
79c	1) PU System Ratio Valve (Change)	N/A	N/A	S-IVB	00:07:36.0 (456.0)	N/A	MDAC-WD	--
80	End of Artificial Tau Mode	00:08:09.6 (489.6)	N/A	N/A	00:08:11.946 (491.946)	N/A	MDAC-WD	--
81	Water Collant Valve Closed	Variable	Vairable	N/A	00:08:02.365 (482.365)	TB3 +338.046	MSFC	--
82	Signal from LVDC for: Telemetry Calibrator In-Flight Calibrate On	00:08:18.5 (498.5)	TB3 +355.4	IU	00:08:19.671 (499.671)	TB3 +355.352	MSFC	--
83	Signal from LVDC for: Telemetry Calibrator In-Flight Calibrate Off	00:08:23.5 (503.5)	TB3 +360.4	IU	00:08:24.686 (504.686)	TB3 +360.367	MSFC	--
84	Initiation of Chi Tilde	00:09:49.5 (589.5)	N/A	N/A	00:09:52.65 (592.65)	N/A	MSFC	--
85	Initiation of Chi Freeze	00:10:09.5 (609.5)	N/A	N/A	00:10:12.734 (612.734)	N/A	MDAC-WD	--
86a	Signal from LVDC for: S-IVB Engine Cutoff	00:10:14.5 (614.5)	N/A	IU	00:10:16.747 (616.747)	N/A	MSFC	--
86b	Signal Received in S-IVB for: S-IVB Engine Cutoff	00:10:14.5 (614.5)	N/A	S-IVB	00:10:16.757 (616.757)	N/A	MDAC-WD	+0 -9

TABLE AP 1-1 (Sheet 11 of 30)
AS-205 SEQUENCE OF EVENTS

ITEM NO.	EVENT	PREDICTED TIME		SIGNAL MONITORED AT	MONITORED TIME		DATA SOURCE	ACCURACY (ms)
		TIME FROM RANGE ZERO (hr:min:sec) (sec)	TIME FROM BASE (sec)		TIME FROM RANGE ZERO* (hr:min:sec) (sec)	TIME FROM BASE (sec)		
86c	1) Mainstage Control Sol-Energized (Drop Out)	--	N/A	S-IVB	00:10:16.757 (616.757)	N/A	MDAC-WD	+0 -9
	2) Ignition Phase Control Sol-Energized (Drop Out)	--	N/A	S-IVB	00:10:16.757 (616.757)	N/A	MDAC-WD	+0 -9
	3) Cutoff Signal (Pick Up)	--	N/A	S-IVB	00:10:16.775 (616.775)	N/A	MDAC-WD	+0 -84
	4) ASI LOX Valve Open (Drop Out)	--	N/A	S-IVB	00:10:16.843 (616.843)	N/A	MDAC-WD	+0 -84
	5) Mainstage OK Press Switch 1 (Drop Out)	--	N/A	S-IVB	00:10:17.025 (617.025)	N/A	MDAC-WD	+0 -84
	6) Main Oxidizer Valve Closed (Pick Up)	--	N/A	S-IVB	00:10:17.026 (617.026)	N/A	MDAC-WD	+0 -84
	7) Mainstage OK Press Switch 2 (Drop Out)	--	N/A	S-IVB	00:10:17.034 (617.034)	N/A	MDAC-WD	+0 -84
	8) Mainstage OK Press Switch 1 Depress (Pick Up)	--	N/A	S-IVB	00:10:17.051 (617.051)	N/A	MDAC-WD	+0 -84
	9) Mainstage OK Press Switch 2 Depress (Pick Up)	--	N/A	S-IVB	00:10:17.051 (617.051)	N/A	MDAC-WD	+0 -84
	10) Oxid Turb Bypass Valve Open (Pick Up)	--	N/A	S-IVB	00:10:17.534 (617.534)	N/A	MDAC-WD	+0 -84
	11) Helium Control Sol-Energized (Drop Out)	--	N/A	S-IVB	00:10:17.741 (617.741)	N/A	MDAC-WD	+0 -9
	12) Oxidizer Bleed Valve Closed (Drop Out)	--	N/A	S-IVB	00:10:19.700 (619.700)	N/A	MDAC-WD	+0 -84
	13) Fuel Bleed Valve Closed (Drop Out)	--	N/A	S-IVB	00:10:19.700 (619.700)	N/A	MDAC-WD	+0 -84
87a	Signal from LVDC for: Propellant Depletion Cutoff Arm	00:10:14.7 (614.7)	TB3 +471.6	IU	(Note 2)	--	--	--
87b	Signal Received in S-IVB for: Propellant depletion Cutoff Arm	00:10:14.7 (614.7)	TB3 +471.6	S-IVB	(Note 2)	--	--	--
88	Signal from LVDC for: Set Time Base No. 4 (TB4)	00:10:14.7 (614.7)	TB4 +0.0	IU	00:10:16.998 (616.998)	TB4 +0.000	MSFC	--

TABLE AP 1-1 (Sheet 12 of 30)
AS-205 SEQUENCE OF EVENTS

ITEM NO.	EVENT	PREDICTED TIME		SIGNAL MONITORED AT	MONITORED TIME		DATA SOURCE	ACCURACY (ms)
		TIME FROM RANGE ZERO (hr:min:sec) (sec)	TIME FROM BASE (sec)		TIME FROM RANGE ZERO* (hr:min:sec) (sec)	TIME FROM BASE (sec)		
89a	Signal from LVDC for: S-IVB ECO	00:10:14.7 (614.7)	TB4 +0.0	IU	00:10:17.079 (617.079)	TB4 +0.081	MSFC	--
89b	Signal Received in S-IVB for: S-IVB ECO	00:10:14.7 (614.7)	TB4 +0.0	S-IVB	00:10:17.090 (617.090)	TB4 +0.092	MDAC-WD	+0 -9
90a	Signal from LVDC for: LH2 Tank Vent Valve Open	00:10:15.1 (615.1)	TB4 +0.4	IU	00:10:17.369 (617.369)	TB4 +0.371	MSFC	--
90b	Signal Received in S-IVB for: LH2 Tank Vent Valve Open	00:10:15.1 (615.1)	TB4 +0.4	S-IVB	00:10:17.382 (617.382)	TB4 +0.384	MDAC-WD	+0 -9
90c	1) Fuel Vent Valve Closed (Drop Out)	--	N/A	S-IVB	(Note 3)	N/A	MDAC-WD	--
	2) Fuel Vent Valve Open (Pick Up)	--	N/A	S-IVB	00:10:17.509 (617.509)	N/A	MDAC-WD	+0 -84
91a	Signal from LVDC for: Passivation "B" Enable	00:10:15.2 (615.2)	TB4 +0.5	IU	00:10:17.465 (617.465)	TB4 +0.467	MSFC	--
91b	Signal Received in S-IVB for: Passivation "B" Enable	00:10:15.2 (615.2)	TB4 +0.5	S-IVB	00:10:17.473 (617.473)	TB4 +0.475	MDAC-WD	+0 -9
92a	Signal from LVDC for: LH2 Tank Passivation Valve Open Enable	00:10:15.3 (615.3)	TB4 +0.6	IU	00:10:17.556 (617.556)	TB4 +0.558	MSFC	--
92b	Signal Received in S-IVB for: LH2 Tank Passivation Valve Open Enable	00:10:15.3 (615.3)	TB4 +0.6	S-IVB	00:10:17.565 (617.565)	TB4 +0.567	MDAC-WD	+0 -9
92c	1) LH2 Passivation Valve Open (Pick Up)	--	N/A	S-IVB	00:10:17.668 (617.668)	N/A	MDAC-WD	+0 -84
	2) LH2 Passivation Valve Closed (Drop Out)	--	N/A	S-IVB	00:10:17.668 (617.668)	N/A	MDAC-WD	+0 -84
93a	Signal from LVDC for: LOX Tank Flight Pressurization Shutoff Valves Close	00:10:15.5 (615.5)	TB4 +0.8	IU	00:10:17.764 (617.764)	TB4 +0.767	MSFC	--
93b	Signal Received in S-IVB for: LOX Tank Flight Pressurization Shutoff Valves Close	00:10:15.5 (615.5)	TB4 +0.8	S-IVB	00:10:17.773 (617.773)	TB4 +0.780	MDAC-WD	+0 -9
94a	Signal from LVDC for: Passivation "A" Enable	00:10:15.7 (615.7)	TB4 +1.0	IU	00:10:17.947 (617.947)	TB4 +0.949	MSFC	--

TABLE AP 1-1 (Sheet 13 of 30)
AS-205 SEQUENCE OF EVENTS

ITEM NO.	EVENT	PREDICTED TIME		SIGNAL MONITORED AT	MONITORED TIME		DATA SOURCE	ACCURACY (ms)
		TIME FROM RANGE ZERO (hr:min:sec) (sec)	TIME FROM BASE (sec)		TIME FROM RANGE ZERO* (hr:min:sec) (sec)	TIME FROM BASE (sec)		
94b	Signal Received in S-IVB for: Passivation "A" Enable	00:10:15.7 (615.7)	TB4 +1.0	S-IVB	00:10:17.957 (617.957)	TB4 +0.959	MDAC-WD	+0 -9
95a	Signal from LVDC for: LOX Tank Flight Pressurization Switch Disable	00:10:15.9 (615.9)	TB4 +1.2	IU	00:10:18.151 (618.151)	TB4 +1.153	MSFC	--
95b	Signal Received in S-IVB for: LOX Tank Flight Pressurization Switch Disable	00:10:15.9 (615.9)	TB4 +1.2	S-IVB	00:10:18.165 (618.165)	TB4 +1.167	MDAC-WC	+0 -9
96a	Signal from LVDC for: Propellant Depletion Cutoff Disarm	00:10:16.5 (616.5)	TB4 +1.8	IU	00:10:18.749 (618.749)	TB4 +1.751	MSFC	--
96b	Signal Received for: Propellant Depletion Cutoff Disarm	00:10:16.5 (616.5)	TB4 +1.8	S-IVB	00:10:18.757 (618.757)	TB4 +1.759	MDAC-WD	+0 -9
97a	Signal from LVDC for: PU MR 4.5 Off	00:10:15.9 (615.9)	TB4 +2.2	IU	00:10:19.152 (619.152)	TB4 +2.154	MSFC	--
97b	Signal Received in S-IVB for: PU MR 4.5 Off	00:10:16.9 (616.9)	TB4 +2.2	S-IVB	00:10:19.165 (619.165)	TB4 +2.167	MDAC-WD	+0 -9
97c	1) PU System Ratio Valve (Change)	--	N/A	S-IVB	00:10:19.5 (619.5)	N/A	MDAC-WD	+0 -84
98a	Signal from LVDC for: LH2 Tank Passivation Valve Open Disable	00:10:17.4 (617.4)	TB4 +2.7	IU	00:10:19.653 (619.653)	TB4 +2.655	MSFC	--
98b	Signal Received in S-IVB for: LH2 Tank Passivation Valve Open Disable	00:10:17.4 (617.4)	TB4 +2.7	S-IVB	00:10:19.665 (619.665)	TB4 +2.667	MDAC-WD	+0 -9
99	Signal from LVDC for: Flight Control Computer S-IVB Burn Mode Off "A"	00:10:18.2 (618.2)	TB4 +3.5	IU	00:10:20.447 (620.447)	TB4 +3.450	MSFC	--
100	Signal from LVDC for: Flight Control Computer S-IVB Burn Mode Off "B"	00:10:18.4 (618.4)	TB4 +3.7	IU	00:10:20.656 (620.656)	TB4 +3.658	MSFC	--
101a	Signal from LVDC for: Auxiliary Hydraulic Pump Flight Mode Off	00:10:18.6 (618.6)	TB4 +3.9	IU	00:10:20.870 (620.870)	TB4 +3.872	MSFC	--
101b	Signal Received in S-IVB for: Auxiliary Hydraulic Pump Flight Mode Off	00:10:18.6 (618.6)	TB4 +3.9	S-IVB	00:10:20.881 (620.881)	TB4 +3.883	MDAC-WD	+0 -9

TABLE AP 1-1 (Sheet 14 of 30)
AS-205 SEQUENCE OF EVENTS

ITEM NO.	EVENT	PREDICTED TIME		SIGNAL MONITORED AT	MONITORED TIME		DATA SOURCE	ACCURACY (ms)
		TIME FROM RANGE ZERO (hr:min:sec) (sec)	TIME FROM BASE (sec)		TIME FROM RANGE ZERO* (hr:min:sec) (sec)	TIME FROM BASE (sec)		
102	Signal from LVDC for: Rate Measurements Switch	00:10:20.7 (620.7)	TB4 +6.0	IU	00:10:22.953 (622.953)	TB4 +5.955	MSFC	--
103	Signal from LVDC for: Initiate Maneuver to Align the S-IVB/IU/CSM with Local Horizontal (Position 1 Down) and Maintain with Respect to Local Horizontal	00:10:34.7 (634.7)	N/A	IU	00:10:26.748 (626.748)	N/A	MSFC	--
104a	Signal from LVDC for: LOX Tank Vent Valve Open	00:10:44.9 (644.9)	TB4 +30.2	IU	00:10:47.165 (647.165)	TB4 +30.167	MSFC	--
104b	Signal Received in S-IVB for: LOX Tank Vent Valve Open	00:10:44.9 (644.9)	TB4 +30.2	S-IVB	00:10:47.180 (647.180)	TB4 +30.182	MDAC-WD	+0 -9
104c	1) Oxid Tank Vent Valve Open (Pick Up)	--	N/A	S-IVB	00:10:47.258 (647.258)	N/A	MDAC-WD	+0 -84
	2) Oxid Tank Vent. Valve Closed (Drop Out)	--	N/A	S-IVB	00:10:47.265 (647.265)	N/A	MDAC-WD	+0 -84
105	Signal from LVDC for: Telemetry Calibrator In-Flight Calibrate On	Variable	Variable	IU	00:10:60.669 (660.669)	TB4 +43.672	MSFC	--
106a	Signal from LVDC for: TM Calibrate On	Variable	Variable	IU	00:10:63.669 (663.669)	TB4 +46.671	MSFC	--
106b	Signal Received in S-IVB for: TM Calibrate On	Variable	Variable	S-IVB	00:10:63.677 (663.677)	TB4 +46.679	MDAC-WD	+0 -9
107a	Signal from LVDC for: TM Calibrate On	Variable	Variable	IU	00:10:64.668 (664.668)	TB4 +47.671	MSFC	--
107b	Signal Received in S-IVB for: TM Calibrate Off	Variable	Variable	S-IVB	00:10:64.677 (664.677)	TB4 +47.680	MDAC-WD	+0 -9
108	Signal from LVDC for: Telemetry Calibrator In Flight Calibrate Off	Variable	Variable	IU	00:10:65.669 (665.669)	TB4 +48.671	MSFC	--
109a	Signal from LVDC for: LOX Tank Vent Valve Close	00:11:14.9 (674.9)	TB4 +60.2	IU	00:11:17.166 (677.166)	TB4 +60.168	MSFC	--
109b	Signal Received in S-IVB for: LOX Tank Vent Valve Close	00:11:14.9 (674.9)	TB4 +60.2	S-IVB	00:11:17.177 (677.177)	TB4 +60.179	MDAC-WD	+0 -9

TABLE AP 1-1 (Sheet 15 of 30)
AS-205 SEQUENCE OF EVENTS

ITEM NO.	EVENT	PREDICTED TIME		SIGNAL MONITORED AT	MONITORED TIME		DATA SOURCE	ACCURACY (ms)
		TIME FROM RANGE ZERO (hr:min:sec) (sec)	TIME FROM BASE (sec)		TIME FROM RANGE ZERO* (hr:min:sec) (sec)	TIME FROM BASE (sec)		
109c	1) Oxid Tank Vent Valve Open (Drop Out)	--	N/A	S-IVB	00:11:17.508 (677.508)	N/A	MDAC-WD	+0 -84
	2) Oxid Tank Vent Valve Closed (Pick Up)	--	N/A	S-IVB	00:11:17.595 (677.595)	N/A	MDAC-WD	+0 -84
110a	Signal from LVDC for: LOX Tank Vent Valve Boost Close On	00:11:17.9 (677.9)	TB4 +63.2		00:11:20.153 (680.153)	TB4 +63.156	MSFC	--
110b	Signal Received in S-IVB for: LOX Tank Vent Valve Boost Close On	00:11:17.9 (677.9)	TB4 +63.2	S-IVB	00:11:20.168 (680.168)	TB4 +63.171	MDAC-WD	+0 -9
111a	Signal from LVDC for: LOX Tank Vent Valve Boost Close Off	00:11:19.9 (679.9)	TB4 +65.2	IU	00:11:22.166 (682.166)	TB4 +65.169	MSFC	--
111b	Signal Received in S-IVB for: LOX Tank Vent Valve Boost Close Off	00:11:19.9 (679.9)	TB4 +65.2	S-IVB	00:11:22.177 (682.177)	TB4 +65.179	MDAC-WD	+0 -9
112a	Signal from LVDC for: PU Inverter and DC Power Off	00:14:14.7 (854.7)	TB4 +240.0	IU	00:14:16.948 (856.948)	TB4 +239.951	MSFC	--
112b	Signal Received in S-IVB for: PU Inverter and DC Power Off	00:14:14.7 (854.7)	TB4 +240.0	S-IVB	00:14:17.010 (857.010)	TB4 +240.012	MDAC-WD	+0 -9
117a	Signal from LVDC for: LH2 Tank Vent Valve Close	00:31:15.1 (1,875.1)	TB4 +1,260.4	IU	00:31:17.348 (1,877.348) (Note 7)	TB4 +1,260.35 (Note 7)	MSFC	--
117b	Signal Received in S-IVB for: LH2 Tank Vent Valve Close	00:31:15.1 (1,875.1)	TB4 +1,260.4	S-IVB	-- (Note 4)	-- (Note 4)	MDAC-WD	--
117c	1) Fuel Vent Valve Open (Drop Out)	--	N/A	S-IVB	-- (Note 4)	N/A	MDAC-WD	--
	2) Fuel Vent Valve Closed (Pick Up)	--	N/A	S-IVB	-- (Note 4)	N/A	MDAC-WD	--
118a	Signal from LVDC for: LH2 Tank Vent Valve Boost Close On	00:31:18.1 (1,878.1)	TB4 +1,263.4	IU	00:31:20.348 (1,880.348) (Note 7)	TB4 +1,263.35 (Note 7)	MSFC	--
118b	Signal Received in S-IVB for: LH2 Tank Vent Valve Boost Close On	00:31:18.1 (1,878.1)	TB4 +1,263.4	S-IVB	-- (Note 4)	-- (Note 4)	MDAC-WD	--
119a	Signal from LVDC for: LH2 Tank Vent Valve Boost Close Off	00:31:20.1 (1,880.1)	TB4 +1,265.4	IU	00:31:22.348 (1,882.348) (Note 7)	TB4 +1,265.35 (Note 7)	MSFC	--

TABLE AP 1-1 (Sheet 16 of 30)
AS-205 SEQUENCE OF EVENTS

ITEM NO.	EVENT	PREDICTED TIME		SIGNAL MONITORED AT	MONITORED TIME		DATA SOURCE	ACCURACY (ms)
		TIME FROM RANGE ZERO (hr:min:sec) (sec)	TIME FROM BASE (sec)		TIME FROM RANGE ZERO* (hr:min:sec) (sec)	TIME FROM BASE (sec)		
119b	Signal Received in S-IVB for: LH2 Tank Vent Valve Boost Close Off	00:31:20.1 (1,880.1)	TB4 +1,265.4	S-IVB	-- (Note 4)	-- (Note 4)	MDAC-WD	--
120	Signal from LVDC for: Telemetry Calibrate In-Flight Calibrate On	Variable	Variable	IU	00:53:36.019 (3,216.019)	TB4 +2,599.021	MSFC	--
121a	Signal from LVDC for: TM Calibrate On	Variable	Variable	IU	00:53:39.019 (3,219.019)	TB4 +2,602.022	MSFC	--
121b	Signal Received in S-IVB for: TM Calibrate On	Variable	Variable	S-IVB	00:53:39.034 (3,219.034)	TB4 +2,602.037	MDAC-WD	+0 -9
122a	Signal from LVDC for: TM Calibrate Off	Variable	Variable	IU	00:53:40.022 (3,220.022)	TB4 +2,603.024	MSFC	--
122b	Signal Received in S-IVB for: TM Calibrate Off	Variable	Variable	S-IVB	00:53:40.034 (3,220.034)	TB4 +2,603.036	MDAC-WD	+0 -9
123	Signal from LVDC for: Telemetry Calibrator In-Flight Calibrate Off	Variable	Variable	IU	00:53:41.018 (3,221.018)	TB4 +2,604.020	MSFC	--
124a	Signal from LVDC for: LH2 Tank Vent Valve Open	00:54:04.7 (3,244.7)	TB4 +2,630.0	IU	00:54:06.947 (3,246.947)	TB4 +2,629.949	MSFC	--
124b	Signal Received in S-IVB for: LH2 Tank Vent Valve Open	00:54:04.7 (3,244.7)	TB4 +2,630.0	S-IVB	00:54:06.965 (3,246.965)	TB4 +2,629.967	MDAC-WD	+0 -9
124c	1) Fuel Vent Valve Closed (Drop Out)	--	N/A	S-IVB	(3,247.009)	N/A	MDAC-WD	+0 -84
	2) Fuel Vent Valve Open (Pick Up)	--	N/A	S-IVB	(3,247.061)	N/A	MDAC-WD	+0 -84
125a	Signal from LVDC for: Auxiliary Hydraulic Pump Flight Mode On	00:55:24.7 (3,324.7)	TB4 +2,710.0	IU	00:55:26.947 (3,326.947)	TB4 +2,709.949	MSFC	--
125b	Signal Received in S-IVB for: Auxiliary Hydraulic Pump Flight Mode On	00:55:24.7 (3,324.7)	TB4 +2,710.0	S-IVB	00:55:26.964 (3,326.964)	TB4 +2,709.966	MDAC-WD	+0 -9
126a	Signal from LVDC for: Auxiliary Hydraulic Pump Flight Mode Off	00:56:12.7 (3,372.7)	TB4 +2,758.0	IU	00:56:14.948 (3,374.948)	TB4 +2,757.950	MSFC	--

TABLE AP 1-1 (Sheet 17 of 30)
AS-205 SEQUENCE OF EVENTS

ITEM NO.	EVENT	PREDICTED TIME		SIGNAL MONITORED AT	MONITORED TIME		DATA SOURCE	ACCURACY (ms)
		TIME FROM RANGE ZERO (hr:min:sec) (sec)	TIME FROM BASE (sec)		TIME FROM RANGE ZERO* (hr:min:sec) (sec)	TIME FROM BASE (sec)		
126b	Signal Received in S-IVB for: Auxiliary Hydraulic Pump Flight Mode Off	00:56:12.7 (3,372.7)	TB4 +2,758.0	S-IVB	00:56:14.959 (3,374.959)	TB4 +2,757.961	MDAC-WD	+0 -9
127a	Signal from LVDC for: LH2 Tank Vent Valve Close	00:59:04.7 (3,544.7)	TB4 +2,930.0	IU	00:59:06.947 (3,546.947)	TB4 +2,929.949	MSFC	--
127b	Signal Received in S-IVB for: LH2 Tank Vent Valve Close	00:59:04.7 (3,544.7)	TB4 +2,930.0	S-IVB	00:59:06.964 (3,546.964)	TB4 +2,929.966	MDAC-WD	+0 -9
127c	1) Fuel Vent Valve Open (Drop Out)	--	N/A	S-IVB	00:59:07.547 (3,547.547)	N/A	MDAC-WD	+0 -84
	2) Fuel Vent Valve Closed (Pick Up)	--	N/A	S-IVB	00:59:07.880 (3,547.880)	N/A	MDAC-WD	+0 -84
128a	Signal from LVDC for: LH2 Tank Vent Valve Boost Close On	00:59:07.7 (3,547.7)	TB4 +2,933.0	IU	00:59:09.948 (3,549.948)	TB4 +2,932.950	MSFC	--
128b	Signal Received in S-IVB for: LH2 Tank Vent Valve Boost Close On	00:59:07.7 (3,547.7)	TB4 +2,933.0	S-IVB	00:59:09.964 (3,549.964)	TB4 +2,932.966	MDAC-WD	+0 -9
129a	Signal from LVDC for: LH2 Tank Vent Valve Boost Close Off	00:59:09.7 (3,549.7)	TB4 +2,935.0	IU	00:59:11.949 (3,551.949)	TB4 +2,934.951	MSFC	--
129b	Signal Received in S-IVB for: LH2 Tank Vent Valve Boost Close Off	00:59:09.7 (3,549.7)	TB4 +2,935.0	S-IVB	00:59:11.964 (3,551.964)	TB4 +2,934.966	MDAC-WD	+0 -9
130a	Signal from LVDC for: PU Inverter and DC Power On	01:24:26.7 (5,066.7)	TB4 +4,452.0	IU	01:24:28.948 (5,068.948) (Note 7)	TB4 +4,451.95 (Note 7)	MSFC	--
130b	Signal Received in S-IVB for: PU Inverter and DC Power ON	01:24:26.7 (5,066.7)	TB4 +4,452.0	S-IVB	-- (Note 5)	-- (Note 5)	MDAC-WD	--
131	Signal from LVDC for: Telemetry Calibrator In-Flight Calibrate On	Variable	Variable	IU	01:30:55.997 (5,455.997)	TB4 +4,838.999	MSFC	--
132a	Signal from LVDC for: TM Calibrate On	Variable	Variable	IU	01:30:58.996 (5,458.996)	TB4 +4,841.998	MSFC	--
132b	Signal Received in S-IVB for: TM Calibrate On	Variable	Variable	S-IVB	01:30:59.010 (5,459.010)	TB4 +4,842.012	MDAC-WD	+0 -9
133a	Signal from LVDC for: TM Calibrate Off	Variable	Variable	IU	01:30:59.996 (5,459.996)	TB4 +4,842.999	MSFC	--

TABLE AP 1-1 (Sheet 18 of 30)
AS-205 SEQUENCE OF EVENTS

ITEM NO.	EVENT	PREDICTED TIME		SIGNAL MONITORED AT	MONITORED TIME		DATA SOURCE	ACCURACY (ms)
		TIME FROM RANGE ZERO (hr:min:sec) (sec)	TIME FROM BASE (sec)		TIME FROM RANGE ZERO* (hr:min:sec) (sec)	TIME FROM BASE (sec)		
133b	Signal Received in S-IVB for: TM Calibrate Off	Variable	Variable	S-IVB	01:31:00.010 (5,460.010)	TB4 +4,843.013	MDAC-WD	+0 -9
134	Signal from LVDC for: Telemetry Calibrator In-Flight Calibrate Off	Variable	Variable	IU	01:31:00.998 (5,460.998)	TB4 +4,844.000	MSFC	--
135a	Signal from LVDC for: Auxiliary Hydraulic Pump Flight Mode On	01:34:04.7 (5,644.7)	TB4 +5,030.0	IU	01:34:06.948 (5,646.948)	TB4 +5,029.950	MSFC	--
135b	Signal Received in S-IVB for: Auxiliary Hydraulic Pump Flight	01:34:04.7 (5,644.7)	TB4 +5,030.0	S-IVB	01:34:06.943 (5,646.943)	TB4 +5,029.950	MDAC-WD	+0 -9
136a	Signal from LVDC for: Engine Mainstage Control Valve Open On	01:34:26.5 (5,666.5)	TB4 +5,051.8	IU	01:34:28.748 (5,668.748)	TB4 +5,051.750	MSFC	--
136b	Signal Received in S-IVB for: Engine Mainstage Control Valve	01:34:26.5	TB4 +5,051.8	S-IVB	01:34:28.748 (5,668.748)	TB4 +5,051.750	MDAC-WD	+0 -9
136c	Mainstage Control Sol-Energized (Pick Up)	--	N/A	S-IVB	01:34:28.761 (5,668.761)	N/A	MDAC-WD	+0 -9
137a	Signal from LVDC for: Engine He Control Valve Open On (Start LOX Dump)	01:34:26.7 (5,666.7)	TB4 +5,052.0	IU	01:34:28.946 (5,668.946)	TB4 +5,051.949	MSFC	--
137b	Signal Received in S-IVB for: Engine He Control Valve Open On (Start LOX Dump)	01:34:26.7 (5,666.7)	TB4 +5,052.0	S-IVB	01:34:28.948 (5,668.948)	TB4 +5,051.951	MDAC-WD	+0 -9
137c	Helium Control Sol-Energized (Pick Up)	--	N/A	S-IVB	01:34:28.961 (5,668.961)	N/A	MDAC-WD	+0 -9
138a	Signal from LVDC for: LOX Tank NPV Valve Open On	01:34:36.7 (5,676.7)	TB4 +5,062.0	IU	01:34:38.947 (5,678.947)	TB4 +5,061.949	MSFC	--
138b	Signal Received in S-IVB for: LOX Tank NPV Valve Open On	01:34:36.7 (5,676.7)	TB4 +5,062.0	S-IVB	01:34:38.947 (5,678.947)	TB4 +5,061.949	MDAC-WD	+0 -9
138c	1) LOX Passivation Valve Open (Pick Up)	--	N/A	S-IVB	01:34:39.062 (5,679.062)	N/A	MDAC-WD	+0 -84
	2) LOX Passivation Valve Closed (Drop Out)	--	N/A	S-IVB	01:34:39.070 (5,679.070)	N/A	MDAC-WD	+0 -84

TABLE AP 1-1 (Sheet 19 of 30)
AS-205 SEQUENCE OF EVENTS

ITEM NO.	EVENT	PREDICTED TIME		SIGNAL MONITORED AT	MONITORED TIME		DATA SOURCE	ACCURACY (ms)
		TIME FROM RANGE ZERO (hr:min:sec) (sec)	TIME FROM BASE (sec)		TIME FROM RANGE ZERO* (hr:min:sec) (sec)	TIME FROM BASE (sec)		
139a	Signal from LVDC for: LOX Tank NPV Valve Open Off	01:34:38.7 (5,678.7)	TB4 +5,064.0	IU	01:34:40.949 (5,680.949)	TB4 +5,063.951	MSFC	--
139b	Signal Received in S-IVB for: LOX Tank NPV Valve Open Off	01:34:38.7 (5,678.7)	TB4 +5,064.0	S-IVB	01:34:40.947 (5,680.947)	TB4 +5,063.949	MDAC-WD	+0 -9
140a	Signal from LVDC for: LH2 Tank Vent Valve Open	01:34:40.7 (5,680.7)	TB4 +5,066.0	IU	01:34:42.948 (5,682.948)	TB4 +5,065.950	MSFC	--
140b	Signal Received in S-IVB for: LH2 Tank Vent Valve Open	01:34:40.7 (5,680.7)	TB4 +5,066.0	S-IVB	01:34:42.946 (5,682.946)	TB4 +5,065.948	MDAC-WD	+0 -9
140c	1) Fuel Vent Valve Closed (Drop Out)	--	N/A	S-IVB	01:34:43.003 (5,683.003)	N/A	MDAC-WD	+0 -84
	2) Fuel Vent Valve Open (Pick Up)	--	N/A	S-IVB	01:34:43.087 (5,683.087)	N/A	MDAC-WD	+0 -84
141a	Signal from LVDC for: LOX Tank Flight Pressurization Shutoff Valves	01:42:26.7 (6,146.7)	TB4 +5,532.0	IU	01:42:28.949 (6,148.949)	TB4 +5,531.951	MSFC	--
141b	Signal Received in S-IVB for: LOX Tank Flight Pressurization Shutoff Valves Open (Cold He Dump)	01:42:26.7 (6,146.7)	TB4 +5,532.0	S-IVB	01:42:28.960 (6,148.960)	TB4 +5,531.962	MDAC-WD	+0 -9
142a	Signal from LVDC for: LH2 Tank Vent Valve Close	01:44:40.7 (6,280.7)	TB4 +5,666.0	IU	01:44:42.949 (6,282.949)	TB4 +5,665.951	MSFC	--
142b	Signal Received in S-IVB for: LH2 Tank Vent Valve Close	01:44:40.7 (6,280.7)	TB4 +5,666.0	S-IVB	01:44:43.004 (6,283.004)	TB4 +5,666.006	MDAC-WD	+0 -9
142c	1) Fuel Vent Valve Open (Drop Out)	--	N/A	S-IVB	01:44:43.551 (6,283.551)	N/A	MDAC-WD	+0 -84
	2) Fuel Vent Valve Closed (Pick Up)	--	N/A	S-IVB	01:44:43.880 (6,283.880)	N/A	MDAC-WD	+0 -84
143a	Signal from LVDC for: LH2 Tank Vent Valve Boost Close On	01:44:43.7 (6,283.7)	TB4 +5,669.0	IU	01:44:45.948 (6,285.948)	TB4 +5,668.950	MSFC	--
143b	Signal Received in S-IVB for: LH2 Tank Vent Valve Boost Close On	01:44:43.7 (6,283.7)	TB4 +5,669.0	S-IVB	01:44:45.961 (6,285.961)	TB4 +5,668.963	MDAC-WD	+0 -9
144a	Signal from LVDC for: LH2 Tank Vent Valve Boost Close Off	01:44:45.7 (6,285.7)	TB4 +5,671.0	IU	01:44:47.949 (6,287.949)	TB4 +5,670.951	MSFC	--

TABLE AP 1-1 (Sheet 20 of 30)
AS-205 SEQUENCE OF EVENTS

ITEM NO.	EVENT	PREDICTED TIME		SIGNAL MONITORED AT	MONITORED TIME		DATA SOURCE	ACCURACY (ms)
		TIME FROM RANGE ZERO (hr:min:sec) (sec)	TIME FROM BASE (sec)		TIME FROM RANGE ZERO* (hr:min:sec) (sec)	TIME FROM BASE (sec)		
144b	Signal Received in S-IVB for: LH2 Tank Vent Valve Boost Close Off	01:44:45.7 (6,285.7)	TB4 +5,671.0	S-IVB	01:44:47.962 (6,287.962)	TB4 +5,670.964	MDAC-WD	+0 -9
145a	Signal from LVDC for: Engine Main-Stage Control Valve Open Off	01:46:26.7 (6,386.7)	TB4 +5,677.2	IU	01:46:28.947 (6,388.947)	TB4 +5,771.949	MSFC	--
145b	Signal Received in S-IVB for: Engine Mainstage Control Valve Open Off	01:46:26.7 (6,386.7)	TB4 +5,677.2	S-IVB	01:46:28.963 (6,388.963)	TB4 +5,771.965	MDAC-WD	+0 -9
145c	Mainstage Control Sol-Energized (Drop Out)	--	N/A	S-IVB	01:46:28.962 (6,388.962)	N/A	MDAC-WD	+0 -9
146a	Signal from LVDC for: Engine He Control Valve Open Off (Terminate LOX Dump)	01:46:27.7 (6,387.7)	TB4 +5,773.0	IU	01:46:29.947 (6,389.947)	TB4 +5,772.950	MSFC	--
146b	Signal Received in S-IVB for: Engine He Control Valve Open Off (Terminate LOX Dump)	01:46:27.7 (6,387.7)	TB4 +5,773.0	S-IVB	01:46:29.962 (6,389.962)	TB4 +5,772.965	MDAC-WD	+0 -9
146c	Helium Control Sol-Energized (Drop Out)	--	N/A	S-IVB	01:46:29.962 (6,389.962)	N/A	MDAC-WD	+0 -9
147a	Signal from LVDC for: Auxiliary Hydraulic Pump Flight Mode Off	01:46:29.7 (6,389.7)	TB4 +5,775.0	IU	01:46:31.949 (6,391.949)	TB4 +5,774.952	MSFC	--
147b	Signal Received in S-IVB for: Auxiliary Hydraulic Pump Flight Mode Off	01:46:29.7 (6,389.7)	TB4 +5,775.0	S-IVB	01:46:31.962 (6,391.962)	TB4 +5,774.965	MDAC-WD	+0 -9
148a	Signal from LVDC for: PU Inverter and DC Power Off	01:46:39.7 (6,399.7)	TB4 +5,785.0	IU	01:46:41.948 (6,401.948)	TB4 +5,784.950	MSFC	--
148b	Signal Received in S-IVB for: PU Inverter and DC Power Off	01:46:39.7 (6,399.7)	TB4 +5,785.0	S-IVB	01:46:41.961 (6,401.961)	TB4 +5,784.963	MDAC-WD	+0 -9
149a	Signal from LVDC for: Passivation "A" Disable	01:46:54.7 (6,414.7)	TB4 +5,800.0	IU	01:46:56.949 (6,416.949)	TB4 +5,799.951	MSFC	--
149b	Signal Received in S-IVB for: Passivation "A" Disable	01:46:54.7 (6,414.7)	TB4 +5,800.0	S-IVB	01:46:56.961 (6,416.961)	TB4 +5,799.963	MDAC-WD	+0 -9
150a	Signal from LVDC for: Passivation "B" Disable	01:46:54.9 (6,414.9)	TB4 +5,800.2	IU	01:46:57.148 (6,417.148)	TB4 +5,800.150	MSFC	--

TABLE AP 1-1 (Sheet 21 of 30)
AS-205 SEQUENCE OF EVENTS

ITEM NO.	EVENT	PREDICTED TIME		SIGNAL MONITORED AT	MONITORED TIME		DATA SOURCE	ACCURACY (ms)
		TIME FROM RANGE ZERO (hr:min:sec) (sec)	TIME FROM BASE (sec)		TIME FROM RANGE ZERO* (hr:min:sec) (sec)	TIME FROM BASE (sec)		
150b	Signal Received in S-IVB for: Passivation "B" Disable	01:46:54.9 (6,414.9)	TB4 +5,800.2	S-IVB	01:46:57.161 (6,417.161)	TB4 +5,800.163	MDAC-WD	+0 -9
151	Signal from LVDC for: Telemetry Calibrator In-Flight Calibrate On	Variable	Variable	IU	01:53:19.961 (6,799.961)	TB4 +6,182.963	MSFC	--
152a	Signal from LVDC for: TM Calibrate On	Variable	Variable	IU	01:53:22.962 (6,802.962)	TB4 +6,185.964	MSFC	--
152b	Signal Received in S-IVB for: TM Calibrate On	Variable	Variable	S-IVB	01:53:22.977 (6,802.977)	TB4 +6,185.979	MDAC-WD	+0 -9
153a	Signal from LVDC for: TM Calibrate Off	Variable	Variable	IU	01:53:23.960 (6,803.960)	TB4 +6,186.962	MSFC	--
153b	Signal Received in S-IVB for: TM Calibrate Off	Variable	Variable	S-IVB	01:53:23.977 (6,803.977)	TB4 +6,186.979	MDAC-WD	+0 -9
154	Signal from LVDC for: Telemetry Calibrator In-Flight Calibrate Off	Variable	Variable	IU	01:53:24.960 (6,804.960)	TB4 +6,187.963	MSFC	--
155	Signal from LVDC for: Telemetry Calibrator In-Flight Calibrate On	Variable	Variable	IU	02:28:16.019 (8,896.019)	TB4 +8,279.021	MSFC	--
156a	Signal from LVDC for: TM Calibrate On	Variable	Variable	IU	02:28:19.017 (8,899.017)	TB4 +8,282.020	MSFC	--
156b	Signal Received in S-IVB for: TM Calibrate On	Variable	Variable	S-IVB	02:28:19.034 (8,899.034)	TB4 +8,282.037	MDAC-WD	+0 -9
157a	Signal from LVDC for: TM Calibrate Off	Variable	Variable	IU	02:28:20.019 (8,900.019)	TB4 +8,283.002	MSFC	--
157b	Signal Received in S-IVB for: TM Calibrate Off	Variable	Variable	S-IVB	02:28:20.033 (8,900.033)	TB4 +8,283.016	MDAC-WD	+0 -9
158	Signal from LVDC for: Telemetry Calibrator In-Flight Calibrate Off	Variable	Variable	IU	02:28:21.018 (8,901.018)	TB4 +8,284.020	MSFC	--

TABLE AP 1-1 (Sheet 22 of 30)
AS-205 SEQUENCE OF EVENTS

ITEM NO.	EVENT	PREDICTED TIME		SIGNAL MONITORED AT	MONITORED TIME		DATA SOURCE	ACCURACY (ms)
		TIME FROM RANGE ZERO (hr:min:sec) (sec)	TIME FROM BASE (sec)		TIME FROM RANGE ZERO* (hr:min:sec) (sec)	TIME FROM BASE (sec)		
159a	Signal from LVDC for: LOX Tank Flight Pressurization Shutoff Valves Close (Terminate Cold He Dump)	02:30:14.7 (9,014.7)	TB4 +8,400.0	IU	02:30:16.948 (9,016.948)	TB4 +8,399.950	MSFC	--
159b	Signal Received in S-IVB for: LOX Tank Flight Pressurization Shutoff Valves Close (Terminate Cold He Dump)	02:30:14.7 (9,014.7)	TB4 +8,400.0	S-IVB	02:30:16.953 (9,016.953)	TB4 +8,399.955	MDAC-WD	+0 -9
160	Begin Manual Control of S-IVB Attitude from CSM	02:29:55.0 (8,995.0)	N/A	N/A	02:30:49.088 (9,049.088)	N/A	MSFC	--
161	End Manual Control of S-IVB Attitude from CSM	02:32:55.0 (9,175.0)	N/A	N/A	02:33:44.988 (9,224.988)	N/A	MSFC	--
162	Pitch Down 20 (Position 1 Down) and Maintain Orbital Rate	02:42:55.0 (9,775.0)	N/A	N/A	02:42:56 (9,776)	N/A	MDAC-WD	--
163	Initiate and Maintain Inertial Attitude Hold	02:51:10.0 (10,270.0)	N/A	N/A	--	N/A	MDAC-WD	--
164	Signal from LVDC for: Telemetry Calibrator In-Flight Calibrate On	Variable	Variable	IU	02:54:16.935 (10,456.935)	TB4 +9,839.007	MSFC	--
165a	Signal from LVDC for: TM Calibrate On	Variable	Variable	IU	02:54:19.004 (10,459.004)	TB4 +9,842.006	MSFC	--
165b	Signal Received in S-IVB for: TM Calibrate On	Variable	Variable	S-IVB	02:54:19.005 (10,459.005)	TB4 (9,842.007	MDAC-WD	+0 -9
166a	Signal from LVDC for: TM Calibrate Off	Variable	Variable	IU	02:54:20.005 (10,460.005)	TB4 +9,843.007	MSFC	--
166b	Signal Received in S-IVB for: TM Calibrate Off	Variable	Variable	S-IVB	02:54:20.005 (10,460.005)	TB4 +9,843.007	MDAC-WD	+0 -9
167	Signal from LVDC for: Telemetry Calibrator In-Flight Calibrate Off	Variable	Variable	IU	02:54:21.004 (10,461.004)	TB4 +9,844.007	MSFC	--
168	LV/CSM Separation	02:54:55.0 (10,495.0)	N/A	N/A	2:55:02.388 (10,502.388)	N/A	MSFC	--

TABLE AP 1-1 (Sheet 23 of 30)
AS-205 SEQUENCE OF EVENTS

ITEM NO.	EVENT	PREDICTED TIME		SIGNAL MONITORED AT	MONITORED TIME		DATA SOURCE	ACCURACY (ms)
		TIME FROM RANGE ZERO (hr:min:sec) (sec)	TIME FROM BASE (sec)		TIME FROM RANGE ZERO* (hr:min:sec) (sec)	TIME FROM BASE (sec)		
169	Signal from LVDC for: Telemetry Calibrator In-Flight Calibrate On	Variable	Variable	IU	03:05:27.989 (11,127.989)	TB4 +10,510.991	MSFC	--
170a	Signal from LVDC for: TM Calibrate On	Variable	Variable	IU	03:05:30.987 (11,130.987)	TB4 +10,513.989	MSFC	--
170b	Signal Received in S-IVB for: TM Calibrate On	Variable	Variable	S-IVB	03:05:30.997 (11,130.997)	TB4 +10,513.999	MDAC-WD	+0 -9
171a	Signal from LVDC for: TM Calibrate Off	Variable	Variable	IU	03:05:31.988 (11,131.988)	TB4 +10,514.990	MSFC	--
171b	Signal Received in S-IVB for: TM Calibrate Off	Variable	Variable	S-IVB	03:05:31.997 (11,131.997)	TB4 +10,514.999	MDAC-WD	+0 -9
172	Signal from LVDC for: Telemetry Calibrator In-Flight Calibrate Off	Variable	Variable	IU	03:05:32.987 (11,132.987)	TB4 +10,515.989	MSFC	--
173a	Signal from LVDC for: LH2 Tank Vent Valve Open	N/A	N/A	IU	03:09:14.478 (11,354.478)	TB4 +10,737.480 (Note 8)	MSFC	--
173b	Signal Received in S-IVB for: LH2 Tank Vent Valve Open	N/A	N/A	S-IVB	03:09:14.474 (11,354.474)	TB4 +10,737.476 (Note 8)	MDAC-WD	+0 -9
173c	1) Fuel Vent Valve Closed (Drop Out)	N/A	N/A	S-IVB	03:09:14.564 (11,354.564)	N/A	MDAC-WD	+0 -84
	2) Fuel Vent Valve Open (Pick Up)	N/A	N/A	S-IVB	03:09:14.582 (11,354.582)	N/A	MDAC-WD	+0 -84
174a	Signal from LVDC for: LH2 Tank Vent Valve Close	N/A	N/A	IU	03:15:56.110 (11,756.110)	TB4 +11,139.113 (Note 8)	MSFC	--
174b	Signal Received in S-IVB for: LH2 Tank Vent Valve Close	N/A	N/A	S-IVB	03:15:56.123 (11,756.123)	TB4 +11,139.126 (Note 8)	MDAC-WD	+0 -9
174c	1) Fuel Vent Valve Open (Drop Out)	N/A	N/A	S-IVB	03:15:56.641 (11,756.641)	N/A	MDAC-WD	+0 -84
	2) Fuel Vent Valve Closed (Pick Up)	N/A	N/A	S-IVB	03:15:56.942 (11,756.942)	N/A	MDAC-WD	+0 -84
175a	Signal from LVDC for: LH2 Tank Vent Valve Boost Close On	N/A	N/A	IU	03:15:56.996 (11,756.996)	TB4 +11,139.999 (Note 8)	MSFC	--

TABLE AP 1-1 (Sheet 24 of 30)
AS-205 SEQUENCE OF EVENTS

ITEM NO.	EVENT	PREDICTED TIME		SIGNAL MONITORED AT	MONITORED TIME		DATA SOURCE	ACCURACY (ms)
		TIME FROM RANGE ZERO (hr:min:sec) (sec)	TIME FROM BASE (sec)		TIME FROM RANGE ZERO* (hr:min:sec) (sec)	TIME FROM BASE (sec)		
175b	Signal Received in S-IVB for: LH2 Tank Vent Valve Boost Close On	N/A	N/A	S-IVB	03:15:57.006 (11,757.006)	TB4 +11,140.009 (Note 8)	MDAC-WD	+0 -9
176a	Signal from LVDC for: LH2 Tank Vent Valve Boost Close Off	N/A	N/A	IU	03:16:03.347 (11,763.347)	TB4 +11,146.349 (Note 8)	MSFC	--
176b	Signal Received in S-IVB for: LH2 Tank Vent Valve Boost Close Off	N/A	N/A	S-IVB	03:16:03.355 (11,763.355)	TB4 +11,146.357 (Note 8)	MDAC-WD	+0 -9
177	Initiate Maneuver to Align S-IVB/IU Retrograde with Local Horizontal. Roll to Position 1 Up and Maintain Orbital Rate	03:16:55.0 (11,815.0)	N/A	N/A	03:16:58.0 (11,818)	N/A	MDAC-WD	--
178a	Signal from LVDC for: LOX and LH2 Pump Seal Purge On (Start Stage Control Sphere He Dump)	03:17:31.7 (11,851.7)	TB4 +11,237.0	IU	03:17:33.948 (11,853.948)	TB4 +11,236.950	MSFC	--
178b	Signal Received in S-IVB for: LOX and LH2 Pump Seal Purge On (Start Stage Control Sphere He Dump)	03:17:31.7 (11,851.7)	TB4 +11,237.0	S-IVB	03:17:33.958 (11,853.958)	TB4 +11,236.960	MDAC-WD	+0 -9
179	Signal from LVDC for: Telemetry Calibrator In-Flight Calibrate On	Variable	Variable	IU	03:31:36.051 (12,696.051)	TB4 +12,079.054	MSFC	--
180a	Signal from LVDC for: TM Calibrate On	Variable	Variable	IU	03:31:39.047 (12,699.047)	TB4 12,082.050	MSFC	--
180b	Signal Received in S-IVB for: TM Calibrate On	Variable	Variable	S-IVB	03:31:39.063 (12,699.063)	TB4 +12,082.066	MDAC-WD	+0 -9
181a	Signal from LVDC for: TM Calibrate Off	Variable	Variable	IU	03:31:40.054 (12,700.054)	TB4 +12,083.056	MSFC	--
181b	Signal Received in S-IVB for: TM Calibrate Off	Variable	Variable	S-IVB	03:31:40.072 (12,700.072)	TB4 +12,083.084	MDAC-WD	+0 -9
182	Signal from LVDC for: Telemetry Calibrator In-Flight Calibrate Off	Variable	Variable	IU	03:31:41.048 (12,701.048)	TB4 +12,084.050	MSFC	--

TABLE AP 1-1 (Sheet 25 of 30)
AS-205 SEQUENCE OF EVENTS

ITEM NO.	EVENT	PREDICTED TIME		SIGNAL MONITORED AT	MONITORED TIME		DATA SOURCE	ACCURACY (ms)
		TIME FROM RANGE ZERO (hr:min:sec) (sec)	TIME FROM BASE (sec)		TIME FROM RANGE ZERO* (hr:min:sec) (sec)	TIME FROM BASE (sec)		
183	Signal from LVDC for: Telemetry Calibrator In-Flight Calibrate On	Variable	Variable	IU	--	--	--	--
184a	Signal from LVDC for: TM Calibrate On	Variable	Variable	IU	04:02:50.952 (14,570.952)	TB4 +13,953.954	MSFC	--
184b	Signal Received in S-IVB for: TM Calibrate On	Variable	Variable	S-IVB	04:02:50.969 (14,570.969)	TB4 +13,953.969	MDAC-WD	+0 -9
185a	Signal from LVDC for: TM Calibrate Off	Variable	Variable	IU	04:02:51.952 (14,571.952)	TB4 +13,954.955	MSFC	--
185b	Signal Received in S-IVB for: TM Calibrate Off	Variable	Variable	S-IVB	04:02:51.969 (14,571.969)	TB4 +13,954.962	MDAC-WD	+0 -9
186	Signal from LVDC for: Telemetry Calibrator In-Flight Calibrate Off	Variable	Variable	IU	--	--	--	--
187a	Signal from LVDC for: LH2 Tank Vent Valve Open	N/A	N/A	IU	04:05:47.266 (14,747.266)	TB4 +14,130.268 (Note 8)	MSFC	--
187b	Signal Received in S-IVB for: LH2 Tank Vent Valve Open	N/A	N/A	S-IVB	04:05:47.274 (14,747.274)	TB4 +14,130.276 (Note 8)	MDAC-WD	+0 -9
187c	1) Fuel Vent Valve Closed (Drop Out)	N/A	N/A	S-IVB	04:05:47.326 (14,747.326)	N/A	MDAC-WD	+0 -84
	2) Fuel Vent Valve Open (Pick Up)	N/A	N/A	S-IVB	04:05:47.391 (14,747.391)	N/A	MDAC-WD	+0 -84
188a	Signal from LVDC for: LOX and LH2 Pump Seal Purge Off	N/A	N/A	IU	04:07:01.265 (14,821.265)	TB4 +14,204.267 (Note 8)	MSFC	--
188b	Signal Received in S-IVB for: LOX and LH2 Pump Seal Purge Off	N/A	N/A	S-IVB	04:07:01.276 (14,821.276)	TB4 +14,204.278 (Note 8)	MDAC-WD	+0 -9
189a	Signal from LVDC for: LH2 Tank Vent Valve Close	N/A	N/A	IU	--	-- (Note 8)	MSFC	--

TABLE AP 1-1 (Sheet 26 of 30)
AS-205 SEQUENCE OF EVENTS

ITEM NO.	EVENT	PREDICTED TIME		SIGNAL MONITORED AT	MONITORED TIME		DATA SOURCE	ACCURACY (ms)
		TIME FROM RANGE ZERO (hr:min:sec) (sec)	TIME FROM BASE (sec)		TIME FROM RANGE ZERO* (hr:min:sec) (sec)	TIME FROM BASE (sec)		
189b	Signal Received in S-IVB for LH2 Tank Vent Valve Close	N/A	N/A	S-IVB	04:10:08.445 (15,008.445)	TB4 +14,391.447 (Note 8)	MDAC-WD	+0 -9
189c	1) Fuel Vent Valve Open (Drop Out)	N/A	N/A	S-IVB	04:10:09.214 (15,009.214)	N/A	MDAC-WD	+0 -84
	2) Fuel Vent Valve Closed (Pick Up)	N/A	N/A	S-IVB	04:10:09.214 (15,009.964)	N/A	MDAC-WD	+0 -84
190a	Signal from LVDC for: LH2 Tank Vent Valve Boost Close-On	N/A	N/A	IU	--	-- (Note 8)	MSFC	--
190b	Signal Received in S-IVB for: LH2 Tank Vent Valve Boost Close On	N/A	N/A	S-IVB	04:10:09.253 (15,009.253)	TB4 +14,392.255 (Note 8)	MDAC-WD	+0 -9
191a	Signal from LVDC for: LH2 Tank Vent Valve Boost Close Off	N/A	N/A	IU	--	-- (Note 8)	MSFC	--
191b	Signal Received in S-IVB for LH2 Tank Vent Valve Boost Close Off	N/A	N/A	S-IVB	04:10:15.711 (15,015.711)	TB4 +14,398.713 (Note 8)	MDAC-WD	+0 -9
192	Signal from LVDC for: Telemetry Calibrator In-Flight Calibrate On	Variable	Variable	IU	--	-- (Note 6)	MSFC	--
193a	Signal from LVDC for: TM Calibrate On	Variable	Variable	IU	--	-- (Note 6)	MSFC	--
193b	Signal Received in S-IVB for: TM Calibrate ON	Variable	Variable	S-IVB	--	(Note 6)	MDAC-WD	+0 -9
194a	Signal from LVDC for: TM Calibrate Off	Variable	Variable	IU	--	-- (Note 6)	MSFC	--
194b	Signal Received in S-IVB for: TM Calibrate Off	Variable	Variable	S-IVB	--	-- (Note 6)	MDAC-WD	--
195	Signal from LVDC for: Telemetry Calibrator In-Flight Calibrate Off	Variable	Variable	IU	--	-- (Note 6)	MSFC	--

TABLE AP 1-1 (Sheet 27 of 30)
AS-205 SEQUENCE OF EVENTS

ITEM NO.	EVENT	PREDICTED TIME		SIGNAL MONITORED AT	MONITORED TIME		DATA SOURCE	ACCURACY (ms)
		TIME FROM RANGE ZERO (hr:min:sec) (sec)	TIME FROM BASE (sec)		TIME FROM RANGE ZERO* (hr:min:sec) (sec)	TIME FROM BASE (sec)		
196a	Signal from LVDC for: LOX Tank Flight Pressurization Shutoff Valves Open (Start Second Cold He Dump)	04:30:14.7 (16,214.7)	TB4 +15,600.0	IU	04:30:16.948 (16,216.948)	TB4 +15,599.95	MSFC	--
196b	Signal Received in S-IVB for: LOX Tank Flight Pressurization Shutoff Valves Open (Start Second Cold He Dump)	04:30:14.7 (16,214.7)	TB4 +15,600.0	S-IVB	--	-- (Note 6)	MDAC-WD	--
197	Navigation Update: Update LVDC Information Regarding Launch Vehicle State Vector Parameters	--	--	N/A	04:31:02 (16,262)	N/A (Note 8)	MSFC	--
198	Sector Dump Downlink to Ground Station the Contents of an LVDC Memory Sector	N/A	N/A	N/A	04:31:31 (16,291)	-- (Note 8)	MSFC	--
199	Signal from LVDC for: Telemetry Calibrator In-Flight Calibrate On	Variable	Variable	IU	04:40:07.980 (16,807.980)	TB4 +16,190.982	MSFC	--
200a	Signal from LVDC for: TM Calibrate On	Variable	Variable	IU	04:40:10.980 (16,810.980)	TB4 +16,193.982	MSFC	--
200b	Signal Received in S-IVB for: TM Calibrate On	Variable	Variable	S-IVB	04:40:10.988 (16,810.988)	TB4 +16,193.990	MDAC-WD	+0 -9
201a	Signal from LVDC for: TM Calibrate Off	Variable	Variable	IU	04:40:11.978 (16,811.978)	TB4 +16,194.980	MSFC	--
201b	Signal Received in S-IVB for: TM Calibrate Off	Variable	Variable	S-IVB	04:40:11.988 (16,811.988)	TB4 +16,194.990	MDAC-WD	+0 -9
202	Signal from LVDC for: Telemetry Calibrator In-Flight Calibrate Off	Variable	Variable	IU	04:40:12.980 (16,812.980)	TB4 +16,195.982	MSFC	--

TABLE AP 1-1 (Sheet 28 of 30)
AS-205 SEQUENCE OF EVENTS

ITEM NO.	EVENT	PREDICTED TIME		SIGNAL MONITORED AT	MONITORED TIME		DATA SOURCE	ACCURACY (ms)
		TIME FROM RANGE ZERO (hr:min:sec) (sec)	TIME FROM BASE (sec)		TIME FROM RANGE ZERO* (hr:min:sec) (sec)	TIME FROM BASE (sec)		
203a	Signal from LVDC for: LOX and LH2 Pump Seal Purge Off (Terminate Stage Control Sphere He Dump)	04:41:22.0 (16,882.0)	TB4 +16,267.3	IU	04:41:24.247 (16,884.247)	TB4 +16,267.249	MSFC	--
203b	Signal Received in S-IVB for: LOX and LH2 Pump Seal Purge Off (Terminate Stage Control Sphere He Dump)	04:41:22.0 (16,882.0)	TB4 +16,267.3	S-IVB	04:41:24.262 (16,884.262)	TB4 +16,267.264	MDAC-WD	+0 -9
204a	Signal from LVDC for: LH2 Tank Vent Valve Open	N/A	N/A	IU	04:43:55.847 (17,035.847)	TB4 +16,418.850 (Note 8)	MSFC	--
204b	Signal Received in S-IVB for: LH2 Tank Vent Valve Open	N/A	N/A	S-IVB	04:43:55.855 (17,035.855)	TB4 +16,418.858 (Note 8)	MDAC-WD	+0 -9
204c	1) Fuel Vent Valve Closed (Drop Out)	N/A	N/A	S-IVB	04:43:55.926 (17,035.926)	N/A	MDAC-WD	+0 -84
	2) Fuel Vent Valve Open (Pick Up)	N/A	N/A	S-IVB	04:43:55.926 (17,035.926)	N/A	MDAC-WD	+0 -84
205a	Signal from LVDC for: LH2 Tank Vent Valve Close	N/A	N/A	IU	04:49:01.727 (17,341.727)	TB4 +16,724.729 (Note 8)	MSFC	--
205b	Signal Received in S-IVB for: LH2 Tank Vent Valve Close	N/A	N/A	S-IVB	04:49:01.721 (17,341.721)	TB4 +16,724.723 (Note 8)	MDAC-WD	+0 -9
205c	1) Fuel Vent Valve Open (Drop Out)	N/A	N/A	S-IVB	04:49:02.228 (17,342.228)	N/A	MDAC-WD	+0 -84
	2) Fuel Vent Valve Closed (Pick Up)	N/A	N/A	S-IVB	04:49:02.561 (17,342.561)	N/A	MDAC-WD	+0 -84
206a	Signal from LVDC for: LH2 Tank Vent Valve Boost Close On	N/A	N/A	IU	04:49:02.627 (17,342.627)	TB4 +16,725.629 (Note 8)	MSFC	--
206b	Signal Received in S-IVB for: LH2 Tank Vent Valve Boost Close On	N/A	N/A	S-IVB	04:49:02.621 (17,342.621)	TB4 +16,725.623 (Note 8)	MDAC-WD	+0 -9

TABLE AP 1-1 (Sheet 29 of 30)
AS-205 SEQUENCE OF EVENTS

ITEM NO.	EVENT	PREDICTED TIME		SIGNAL MONITORED AT	MONITORED TIME		DATA SOURCE	ACCURACY (ms)
		TIME FROM RANGE ZERO (hr:min:sec) (sec)	TIME FROM BASE (sec)		TIME FROM RANGE ZERO* (hr:min:sec) (sec)	TIME FROM BASE (sec)		
207a	Signal from LVDC for: LH2 Tank Vent Valve Boost Close Off	N/A	N/A	IU	04:49:08.579 (17,348.579)	TB4 +16,731.581 (Note 8)	MSFC	--
207b	Signal Received in S-IVB for: LH2 Tank Vent Valve Boost Close Off	N/A	N/A	S-IVB	04:49:08.578 (17,348.578)	TB4 +16,731.580 (Note 8)	MDAC-WD	+0 -9
208a	Signal from LVDC for: LOX Tank Flight Pressurization Shutoff Valves Close	04:50:14.7 (17,414.7)	TB4 +16,800.0	IU	04:50:16.951 (17,416.951)	TB4 +16,799.954	MSFC	--
208b	Signal Received in S-IVB for: LOX Tank Flight Pressurization Shutoff Valves Close	04:50:14.7 (17,414.7)	TB4 +16,800.0	S-IVB	04:50:16.950 (17,416.950)	TB4 +16,799.953	MDAC-WD	+0 -9
209a	Signal from LVDC for: LH2 Tank Vent Valve Open	N/A	N/A	IU	--	-- (Note 8)	MSFC	--
209b	Signal Received in S-IVB for: LH2 Tank Vent Valve Open	N/A	N/A	S-IVB	05:08:59.182 (18,539.182)	TB4 +17,922.184 (Note 8)	MDAC-WD	+0 -9
209c	1) Fuel Vent Valve Closed (Drop Out)	N/A	N/A	S-IVB	05:08:59.226 (18,539.226)	N/A	MDAC-WD	+0 -84
	2) Fuel Vent Valve Open (Pick Up)	N/A	N/A	S-IVB	05:08:59.237 (18,539.237)	N/A	MDAC-WD	+0 -84
210a	Signal from LVDC for: LH2 Tank Vent Valve Closed	N/A	N/A	IU	--	-- (Note 8)	MSFC	--
210b	Signal Received in S-IVB for: LH2 Tank Vent Valve Closed	N/A	N/A	S-IVB	05:11:24.844 (18,684.844)	TB4 +18,067.846 (Note 8)	MDAC-WD	+0 -9
210c	1) Fuel Vent Valve Open (Drop Out)	N/A	N/A	S-IVB	05:11:25.313 (18,685.313)	TB4 +18,068.315	MDAC-WD	+0 -84
	2) Fuel Vent Valve Closed (Pick Up)	N/A	N/A	S-IVB	05:11:25.563 (18,685.563)	TB4 +18,068.565	MDAC-WD	+0 -84
211a	Signal from LVDC for: LH2 Tank Vent Valve Boost Close On	N/A	N/A	IU	--	-- (Note 8)	MSFC	--

TABLE AP 1-1 (Sheet 30 of 30)
AS-205 SEQUENCE OF EVENTS

ITEM NO.	EVENT	PREDICTED TIME		SIGNAL MONITORED AT	MONITORED TIME		DATA SOURCE	ACCURACY (ms)
		TIME FROM RANGE ZERO (hr:min:sec) (sec)	TIME FROM BASE (sec)		TIME FROM RANGE ZERO* (hr:min:sec) (sec)	TIME FROM BASE (sec)		
211b	Signal Received in S-IVB for: LH2 Tank Vent Valve Boost Close On	N/A	N/A	S-IVB	05:11:25.619 (18,685.619)	TB4 +18,068.621 (Note 8)	MDAC-WD	+0 -9
212a	Signal from LVDC for: LH2 Tank Vent Valve Boost Close Off	N/A	N/A	IU	--	-- (Note 8)	MSFC	--
212b	Signal Received in S-IVB for: LH2 Tank Vent Valve Boost Close Off	N/A	N/A	S-IVB	05:12:01.358 (18,721.358)	TB4 +18,104.360 (Note 8)	MDAC-WD	+0 -9

NOTE: DEFINITIONS

1. These commands and events occurred during the RF blackout period. The command times listed are MDAC-WD calculated times. The event times listed are the times when the event indications were verified after acquisition of signal following blackout.
2. This command was not issued.
3. This indication is not seen at this time because the vent valve cracked open to prevent tank overpressure at RO+448.25 sec.
4. These commands and events occurred between Canary Islands and Tananarive stations. The vent valve was verified Closed at Tananarive at RO+2,208.282.
5. This command was given prior to acquisition of signal at Guaymas. The PU was verified On after acquisition of signal.
6. These commands occurred over Hawaii as scheduled. Data was not reduced to obtain the exact times.
7. These are MSFC calculated times.
8. These functions were initiated by ground controller action.

KEY:

-- Not Available
N/A Not Applicable



1. GLOSSARY AND ABBREVIATIONS

This appendix (table AP 2-1) lists the commonly used S-IVB-205 stage flight evaluation terms and abbreviations together with their definitions.

TABLE AP 2-1 (Sheet 1 of 4)
GLOSSARY AND ABBREVIATIONS

<u>Abbreviation</u>	<u>Terms</u>	<u>Definition</u>
AACS	--	Auxiliary attitude control system (see APS)
ac	--	Alternating current
AEDC	--	Arnold Engineering Development Center
amp	--	Ampere
APS	--	Auxiliary propulsion system (see AACS)
ASI	--	Augmented spark igniter
A_t	--	Throat area
aux	--	Auxiliary
C_3	--	Orbit energy
CDDT	--	Countdown demonstration test
CPIF	--	Cost plus incentive fee
cps	--	Cycles per second
CSM	--	Command service module
CVS	--	Continuous vent system
db	--	Decibel
dbm	--	10 log P (milliwatts) where p = power
deg	--	Degree
e	--	Eccentricity
EBW	--	Exploding bridgewire
ECC	--	Engine Cutoff Command
ECF	--	End conditions of flight
ECP	--	Engineering change proposal
EMC	--	Electromagnetic compatibility
EMR	Engine propellant mixture ratio	The ratio of engine LOX mass flowrate to LH2 mass flowrate includes gas generator operations
ESC	--	Engine Start Command
°F	--	Degree Fahrenheit
ft	--	Foot
g	Gravitational acceleration	The acceleration produced by the force of gravity, which varies with the altitude and elevation of the point of observation. The value 32.1739 ft/sec ² has been chosen as the standard by international agreement for sea level at 45° north latitude
GBI	--	AFETR Station on Grand Bahama Island
G.E.T.	--	Ground elapsed time
GH2	--	Gaseous hydrogen

TABLE AP 2-1 (Sheet 2 of 4)
GLOSSARY AND ABBREVIATIONS

<u>Abbreviation</u>	<u>Terms</u>	<u>Definition</u>
GMT	--	Greenwich mean time
gpm	--	Gallons per minute
grms	--	Gravity root mean square
GSE	--	Ground support equipment
GYM	--	Guaymas
h	--	Altitude
h_a	--	Apogee altitude
HAW	--	Hawaii
Hg	--	Mercury
h_p	--	Perigee altitude
Hz	Hertz	Cycles per second
i	--	Inclination
in.	--	Inches
IP&CL	--	Instrumentation Program and Components List
I_{sp}	--	Specific Impulse
IU	--	Instrument unit
KSC	--	Kennedy Space Center
lbf	--	Pounds force
lbm	Pounds mass	1/32.1739 slug
lbm/sec	--	Pounds mass, second
lb/pf	--	Pounds per picofarad
LH2	--	Liquid hydrogen
LOX	--	Liquid oxygen
LV	--	Launch vehicle
LVDC	--	Launch vehicle digital computer
M	--	Mach number
ma	--	Milliampere
mbars	--	Millibars
max q	--	Maximum dynamic pressure
MDAC-WD	--	McDonnell Douglas Astronautics - Western Division
MDAC-WD/FTC	--	McDonnell Douglas Astronautics - Western Division/Florida Test Center
MDAC-WD/HB	--	McDonnell Douglas Astronautics - Western Division/Huntington Beach
MDAC-WD/STC	--	McDonnell Douglas Astronautics - Western Division/Sacramento Test Center
MDF	--	Mild detonating fuse

TABLE 2-1 (Sheet 3 of 4)
GLOSSARY AND ABBREVIATIONS

<u>Abbreviation</u>	<u>Terms</u>	<u>Definition</u>
min	--	Minutes
MOV	--	Main oxidizer valve
MR	--	Mixture ratio
ms	Millisecond	Thousandth of a sec
MSFC	--	Marshall Space Flight Center
mv	--	Millivolt
NASA	--	National Aeronautics and Space Administration
nmi	--	Nautical miles
No.	--	Number
NPSP	--	Net positive suction pressure
OAT	--	Overall test
OECCO	--	S-IC stage Outboard Engine Cutoff Command
P	--	Period (time of one orbit)
P_a	--	Ambient pressure
P_c	--	Combustion chamber pressure measured at the injector
PCF	--	Preconditions of flight
pf	--	Picofarad
psi	--	Pounds per square inch
psia	--	Pounds per square inch absolute
psig	--	Pounds per square inch gauge
P/U	--	Pickup
PU	--	Propellant utilization
q	--	Dynamic pressure
R	--	Rankine
R_A	--	Radius of apogee
RACS	--	Remote analog calibration system
R&D	--	Research and development
RF	--	Radio frequency
rms	--	Root mean square
RO	--	An event time used as reference for S-IVB stage flight evaluation sequence of events. Defined as the first Greenwich mean time second prior to vehicle liftoff
scim	--	Standard cubic in./min
sec	--	Seconds
S-IB	--	First stage of the Saturn IB (200) series of vehicles
S-IVB	--	Second stage of the Saturn IB (200) series of vehicles and third stage of Saturn V (500) series of vehicles

TABLE AP 2-1 (Sheet 4 of 4)
GLOSSARY AND ABBREVIATIONS

<u>Abbreviation</u>	<u>Terms</u>	<u>Definition</u>
SLA	--	Spacecraft IM adapter
S/N	--	Serial number
sps	--	Samples per second
SSS	--	Stage switch selector
STC	--	Sacramento Test Center
STDV	--	Start tank discharge valve
Tel 4	--	Merritt Island Telemetry Station IV
T/M	--	Telemetry
TPEP	--	Telemetry performance evaluation period
V	--	Volt
V_A	--	Apogee velocity
V_E	--	Relative velocity
V_I	--	Inertial velocity
V_P	--	Perigee velocity
vac	--	Voltage, alternating current
vdc	--	Voltage, direct current
VSWR	--	Voltage standing wave ratio
W	--	Watt
Y_E	--	Vertical distance
\dot{Y}_E	--	Vertical velocity
α	--	Angle of attack
β	--	Yaw angle of attack
θ_n	--	Descending node
γ_{1_I}	--	Inertial flight path elevation angle
γ_{2_I}	--	Inertial flight path azimuth angle

2



2



DISTRIBUTION LIST

2





DISTRIBUTION LIST

HUNTINGTON BEACH (A3)

KO10 Senior Director - Saturn/Apollo Programs
KY00 Director - Saturn Program Production
KODO Director - Huntington Beach Development Engineering
KOE0 Director - Saturn/Apollo Program Extension
KWA0 Supervisor - System Engineering
KYCO Manager - S-IVB Series Stages
N5B0 Branch Manager - Saturn Contracts
HAAA Manager - Vehicle Flight Readiness
KWA0 Supervisor - System Engineering
KCDE (Rocketdyne) via J. Boyde
KN00 Deputy Chief Design Engineer - Saturn Development Engineering
KA00 Chief Engineer - Mechanics & Reliability
KAB0 Branch Chief - Structural Mechanics
KB00 Chief Engineer - Structural/Mechanical
KACO Branch Chief - Flight Mechanics
KCO0 Chief Engineer - Propulsion
KCBO Branch Chief - Analysis
KCBC System Performance
KCO0 Deputy Branch Chief - Propulsion Design
KCDO Branch Chief - Test
KDO0 Chief Engineer - Saturn Electronics
KDDH Section Chief - Electronics TP&E
KDLD Branch Chief - Electronic-Stage Design
L110 Chief - Data Reduction Engineering
LCCO Branch Chief - Saturn Support Branch
KADO Branch Chief - Reliability Engineering
KPO0 Chief Engineer - Saturn Vehicle Checkout
Laborities Qualification Test Programs
KKBO Project Engineer - Test
KKBL Assistant Project Engineer - Operations Support
KKBO Assistant Project Engineer - Test
KKBJ Assistant Project Engineer - System Test
5284 Library
KEBG Records

S-IVB TP&E COMMITTEE MEMBERS (A3)

KBDB Project Support
KCBC System Performance
KDDH Electronics
LCCO Saturn Support Branch

PROPELLANT UTILIZATION PANEL (A3)

KKBH PU Panel Chairman - TP&E
KDLD PU Panel - Electronics

FLORIDA TEST CENTER (A41)

HE00 S. D. Truhan
HEBB H. N. Dell
KKG0 F. D. Comer
KAOC J. F. Ryan
KBDE G. C. Norvell
KCDD P. A. Kremer
KDDD L. H. Dybevick
KDDD D. W. Tutwiler
KKG0 J. R. Shaffer

SACRAMENTO TEST CENTER (A45)

KKHO E. R. Jacobs
KCDC A. C. Polansky

MANNED SPACE CENTER (A57)

KO10 K. J. Patelski

MARSHALL SPACE FLIGHT CENTER

KLCO L. A. Garrett

NASA/MARSHALL SPACE FLIGHT CENTER

H. S. Garret

TP&E - Files

