

68-89

Lib

JAN 8 1969

Technical Library, Ballcomm, Inc.
N73-70284

(NASA-CR-129974) APOLLO CSM 101 GUIDANCE
AND NAVIGATION FILTER BOX ASSEMBLY
QUALIFICATION TEST, P/N V36-442330 P.W.
Edwards (North American Rockwell Corp.)
Aug. 1968 245 p

Unclas
00/99 37740

SD 68-687

APOLLO CSM 101 GUIDANCE AND NAVIGATION
FILTER BOX ASSEMBLY
QUALIFICATION TEST
V36-442330

August 1968

Contract NAS9-150, SA 300, Exhibit I, Paragraph 7.7

ATR 492117B CTR 25492117 LR 6227-9001

Prepared by

Electrical Systems Unit

Approved by

D.K. Bailey

D.K. Bailey, Manager
Laboratories and Test

SPACE DIVISION
NORTH AMERICAN ROCKWELL CORPORATION

DRA

SD 68-687

APOLLO CSM 101 GUIDANCE AND NAVIGATION
FILTER BOX ASSEMBLY
QUALIFICATION TEST
V36-442330

August 1968

Contract NAS9-150, SA 300, Exhibit I, Paragraph 7.7

ATR 492117B

CTR 25492117

LR 6227-9001

Prepared by

Electrical Systems Unit

Approved by



D.K. Bailey, Manager
Laboratories and Test

SPACE DIVISION
NORTH AMERICAN ROCKWELL CORPORATION

TECHNICAL REPORT INDEX/ABSTRACT

ACCESSION NUMBER				DOCUMENT SECURITY CLASSIFICATION UNCLASSIFIED			
TITLE OF DOCUMENT APOLLO CSM 101 GUIDANCE AND NAVIGATION FILTER BOX ASSEMBLY QUALIFICATION TEST, P/N V36-442330						LIBRARY USE ONLY	
AUTHOR(S) EDWARDS, P.W.							
CODE QNO85282		ORIGINATING AGENCY AND OTHER SOURCES SPACE DIVISION OF NORTH AMERICAN ROCKWELL CORPORATION, DOWNEY, CALIFORNIA				DOCUMENT NUMBER SD68-687	
PUBLICATION DATE 00AUG68				CONTRACT NUMBER NAS9-150			
DESCRIPTIVE TERMS *APOLLO PROJECT, *GUIDANCE AND NAVIGATION FILTER BOX ASSEMBLY V36-442330, *QUALIFICATION TESTING, *ELECTRICAL, *FUNCTIONAL, *VIBRATION, *SALT FOG, *OXYGEN-HUMIDITY, *HIGH/LOW TEMPERATURE-LIFE, *VACUUM/TEMPERATURE, *ACCELERATION, *SHOCK.							

<p>ABSTRACT</p> <p>THIS REPORT DESCRIBES THE QUALIFICATION TEST OF THE APOLLO GUIDANCE AND NAVIGATION FILTER BOX ASSEMBLY, P/N V36-442330, S/N 06362AAH3858, CONDUCTED TO DEMONSTRATE THE ELECTRO-MECHANICAL AND ENVIRONMENTAL CAPABILITIES OF THE TEST SPECIMEN.</p> <p>THE ELECTRICAL TESTS PERFORMED WERE INSULATION RESISTANCE, CONTINUITY, CAPACITANCE, AND DIELECTRIC STRENGTH.</p> <p>THE MECHANICAL TESTS PERFORMED WERE VIBRATION, ACCELERATION, AND SHOCK.</p> <p>THE ENVIRONMENTAL TESTS PERFORMED WERE SALT FOG, OXYGEN-HUMIDITY, HIGH/LOW TEMPERATURE-LIFE, AND VACUUM/TEMPERATURE.</p> <p>TEST RESULTS, INCLUDING TABULATED DATA, ARE DOCUMENTED IN THIS REPORT AND DEMONSTRATE THE CAPABILITY OF THE G&N FILTER BOX ASSEMBLY TO MEET THE REQUIREMENTS OF ATR 492117B.</p>
--

FOREWORD

This document was prepared by the Electrical Systems Unit, Electronic Systems Branch of Laboratories and Test, for the Apollo Equipment Group in accordance with ATR 492117B. It is submitted as a final report of the qualification testing to remove a flight constraint on CSM 101.

All testing of the guidance and navigation filter box assembly, P/N V36-442330, S/N 06362 AAH3858, was accomplished within the Downey Facility from 10 July through 15 August under the cognizance of NASA and North American Rockwell Quality Control. The testing was a coordinated effort within Laboratories and Test under the direction of D. K. Bailey, Manager.

SUMMARY

Qualification testing of the Apollo guidance and navigation filter box assembly, P/N V36-442330, S/N 06362 AAH3858 was accomplished to the requirements of ATR 492117B per Laboratories and Test Qualification Test Plan QTP IL 6227-801A. The electrical functional tests, insulation resistance, continuity, and capacitance tests were performed before and after each environmental exposure and at selected times during the exposure. Dielectric strength tests were performed before and after each test phase and at selected intervals during the oxygen-humidity exposure.

The test results met the requirements of ATR 492117B.

CONTENTS

	Page
INTRODUCTION	1
TEST OBJECTIVE	3
TEST SPECIMEN	3
TEST SETUP	3
TEST OPERATIONS AND RESULTS	3
Test Procedures	3
Examination of Product	8
Functional Test	8
Environmental Tests	10
POST TEST	15
Physical Inspection	15
Disposition of Test Specimen	15
CONCLUSION	15
APPENDIXES	
A. APOLLO TEST REQUEST (ATR)	A-1
B. QUALIFICATION TEST PROCEDURE (QTP)	B-1
C. FUNCTIONAL	C-1
D. VIBRATION	D-1
E. CORROSIVE-CONTAMINANTS, OXYGEN-HUMIDITY (CCOH)	E-1
F. HIGH/LOW TEMPERATURE-LIFE	F-1
G. VACUUM	G-1
H. ACCELERATION	H-1
I. SHOCK	I-1
J. SUPPLEMENTARY DOCUMENTS	J-1

ILLUSTRATIONS

Figure		Page
1	Vibration Test Setup	4
2	Y Axis Vibration	5
3	Oxygen-Humidity Chamber	6
4	High/Low Temperature-Life Chamber	7
5	Vacuum Test Setup	13
6	Specimen Mounted in Vacuum Chamber	14
7	G&N Filter Box Assembly View	16
8	G&N Filter Box Chassis Inspection	17

INTRODUCTION

The Apollo guidance and navigation (G&N) filter box assembly is used as an integral component of the guidance and navigation system and is used to attenuate noise on selected signal lines during launch and mission operations.

Electrically, the G&N filter consists of 49 feed-through circuits. Twelve of these circuits contain miniature Pi (π) type filter networks; the remainder (37) are jumper wires from one connector to the other.

TEST OBJECTIVE

The objective of this qualification test was to provide data to Apollo Engineering on the functional capability of the G&N filter box when exposed to the environmental conditions defined by ATR 492117B.

TEST SPECIMEN

The G&N filter box, P/N V36-442330, S/N 06362 AAH3858, manufactured by North American Rockwell Corporation was the subject of the qualification test. No other components of the G&N system were required for this test.

TEST SETUP

Block diagrams of the functional test setups appear at the end of detailed test procedure IL 6227-801A, Appendix B. Figures 1 through 4 and 6 illustrate the test specimen mounted for vibration, corrosive-contaminants/oxygen humidity (CCOH), high/low temperature, and vacuum tests. Photographs of the test setup for acceleration and shock are not shown because their setups were similar to that of vibration.

Test equipment lists and pertinent test system diagrams are found in the respective functional test data or environmental test data (Appendixes C through I).

TEST OPERATIONS AND RESULTS

TEST PROCEDURES

The requirements of ATR 492117B were implemented through use of a detailed test procedure (QTP). The procedure IL 6227-801A defines test operational details and sequences, and is included as Appendix B. The test sequences and location of related documentation are summarized in Table 1.

7008-81-1258A

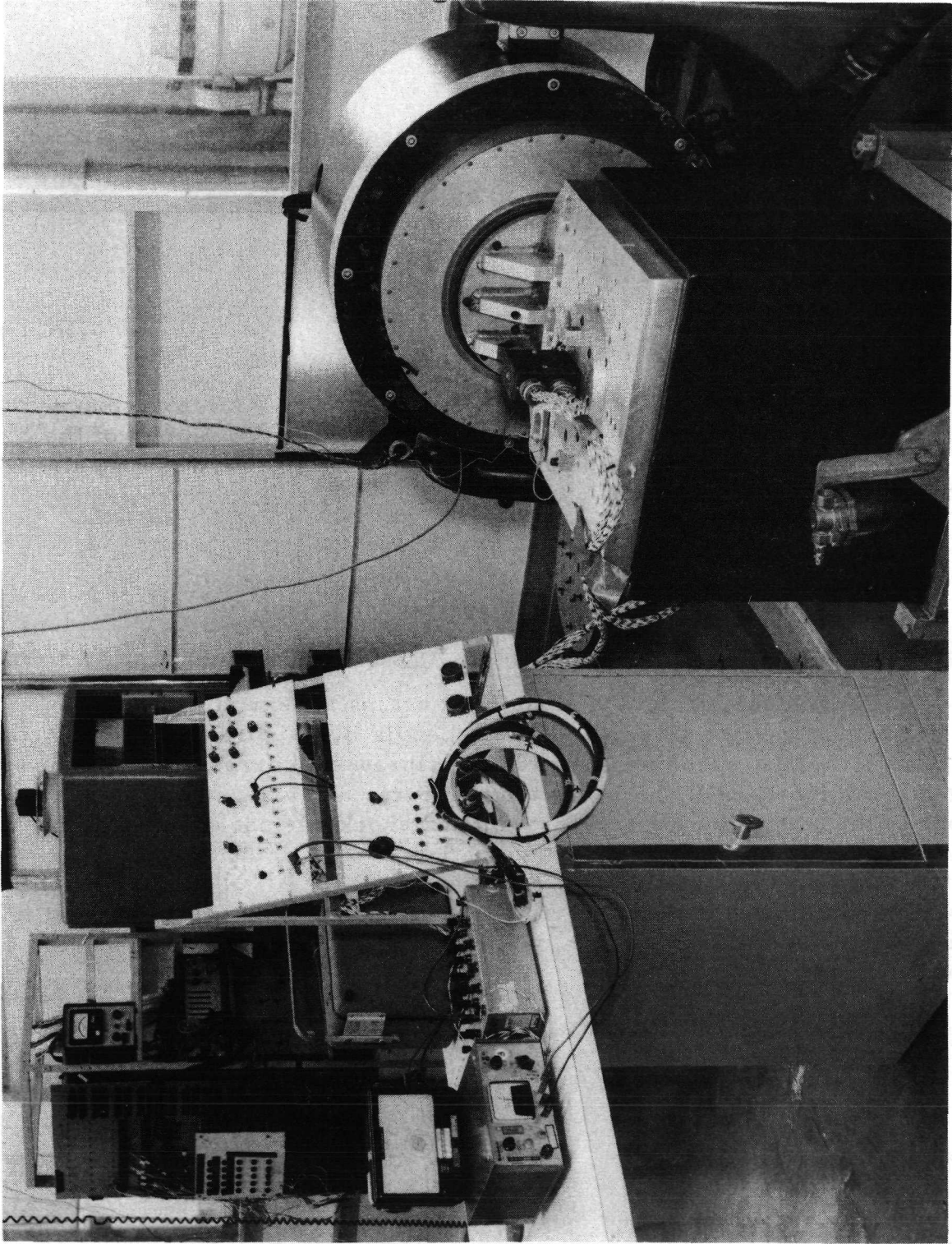

Figure 1. Vibration Test Setup

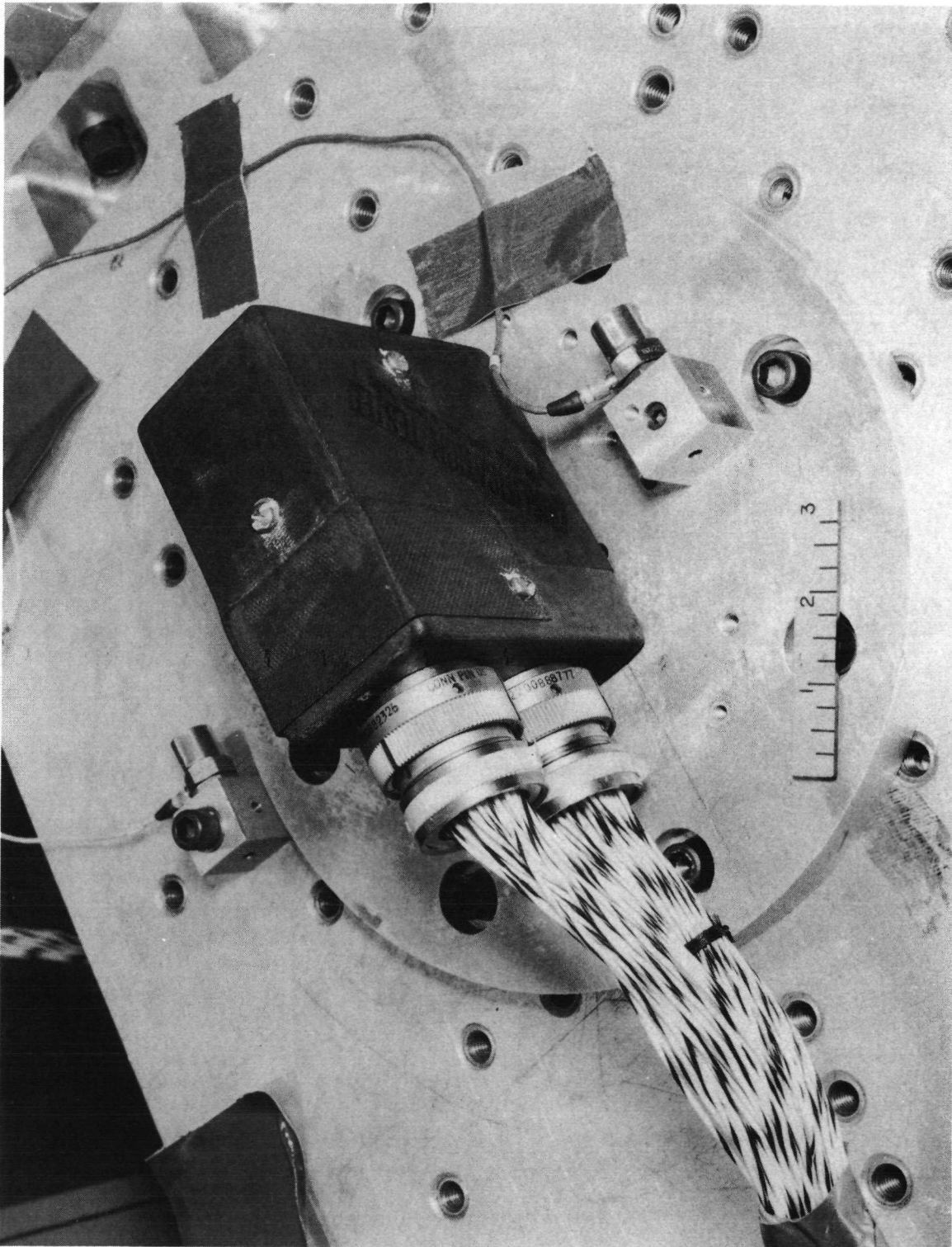

Figure 2. Y Axis Vibration

7008-81-1258B

7008-81-1264B

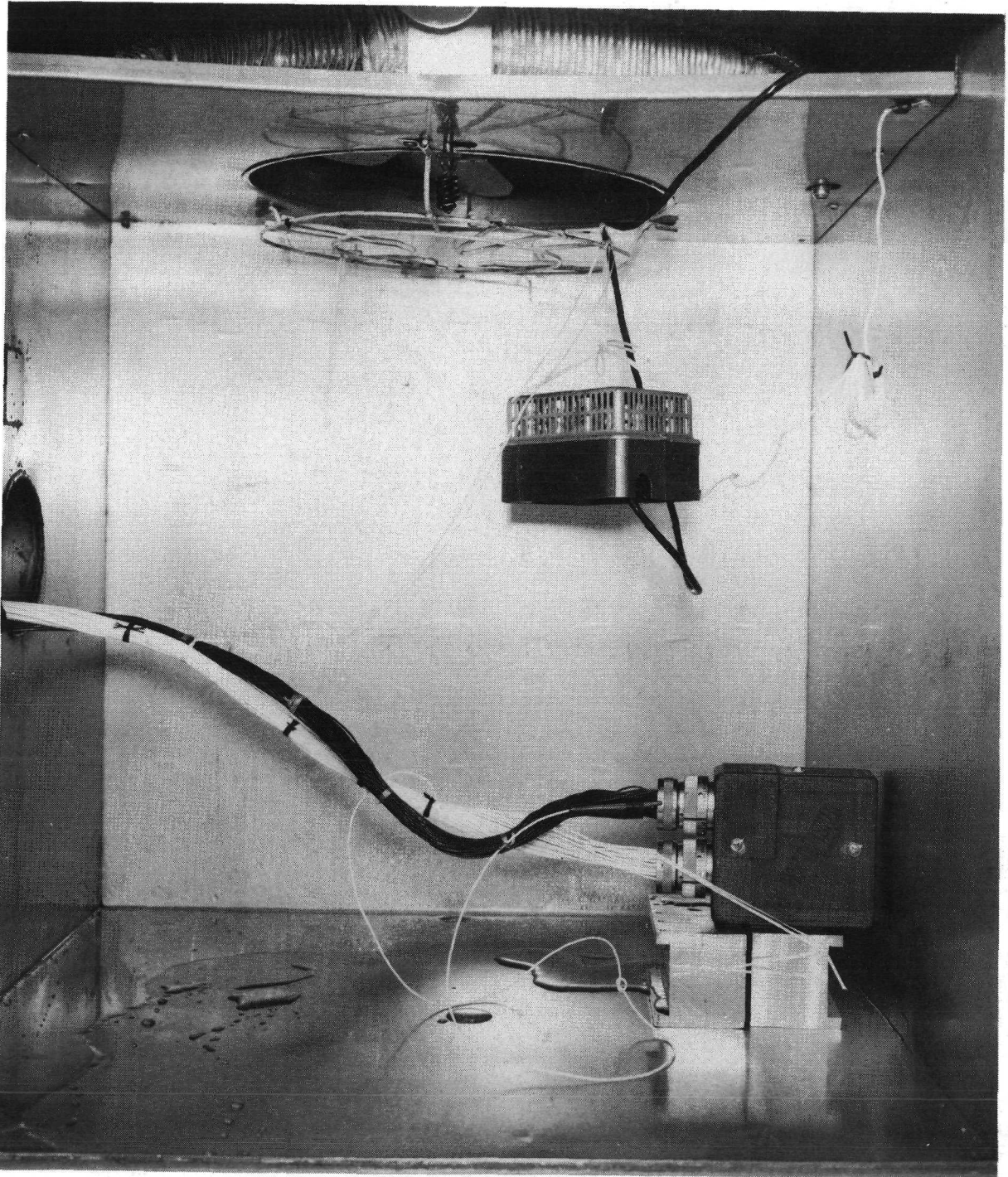
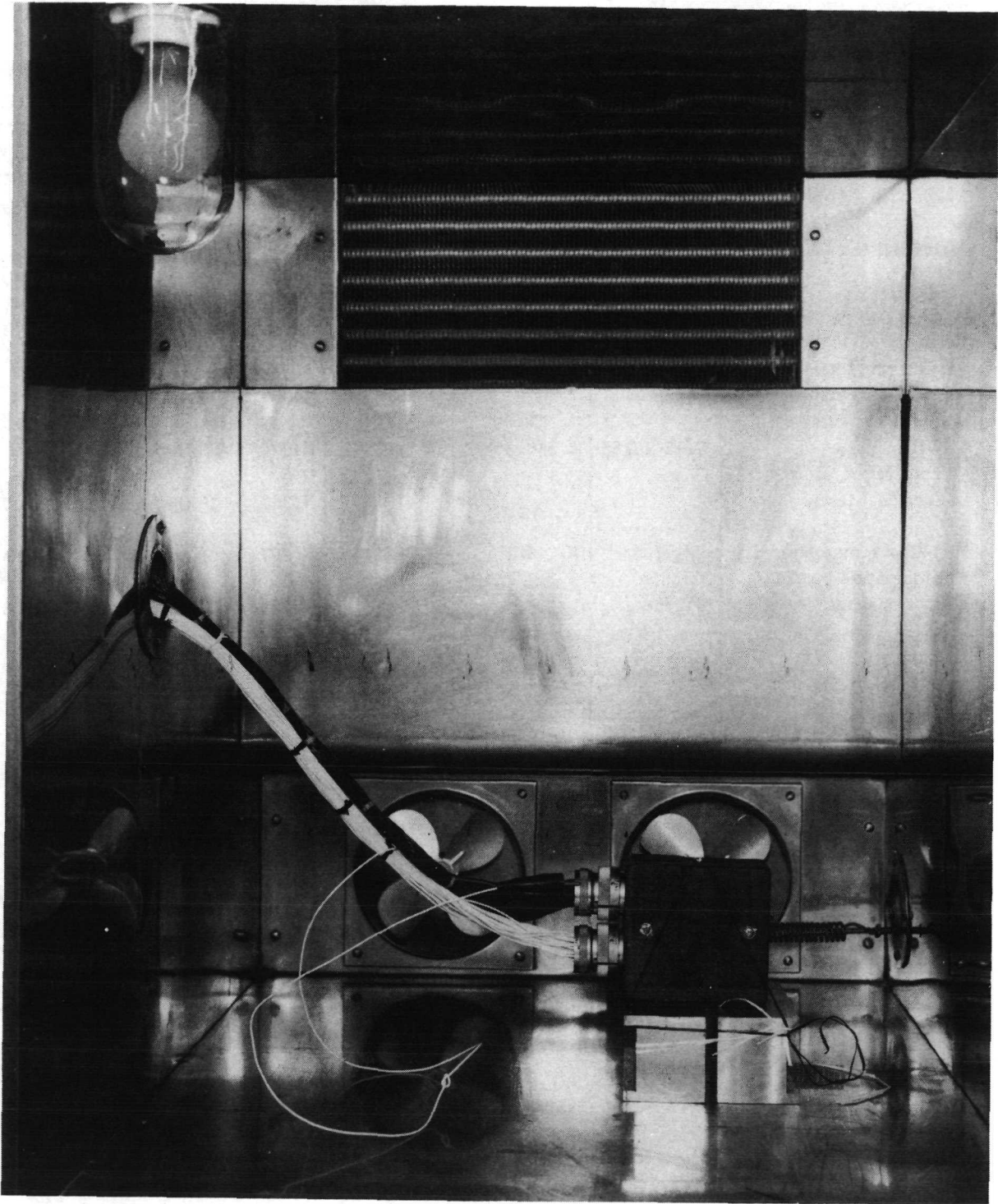

Figure 3. Oxygen-Humidity Chamber



7008-81-1264A

Figure 4. High/Low Temperature - Life Chamber

SPACE DIVISION OF NORTH AMERICAN ROCKWELL CORPORATION

Table 1. Test Sequence

Test	Date	Procedure-IL-6227-801A		Laboratory Notes		
		Appendix B		Book No.	Pages	Report Page
		Paragraph No.	Report Pages			
Examination of product	7/10/68	5.1/6.1.1	B-6	N1997	4	C-3
*Functional test (initial)	7/10/68	5.2.3/6.1.2	B-6, 7	N1997 N6097	9 through 12 1 through 24	C-4-7 C-40-62
Vibration Spectrum plots Functional tests	7/10-11/68	5.4/6.2	B-8, 9	N5778 N1997	16 through 23 12 through 15	D-1-8 D-9-38 C-7-10
CCOH Temperature plots Functional tests	7/11-17/68	5.5/6.3	B-8, -11	N4694 N1997	29 through 36 16 through 22	E-1-8 E-9-15 C-11-17
High/low temperature-life Temperature plots Functional tests	7/17/68 through 8/3/68	5.6/6.4	B-12	N1997 N1997	40 and 41 23 through 33	F-18, 19 F-1-17 C-18-28
Vacuum Functional tests	8/3-7/68	5.7/6.5	B-13	N2907 N1997	1 through 10 33 through 39, 42, 43	G-1-10 C-28-36
Acceleration Functional tests	8/8/68	5.8/6.6	B-13	N5778 N1997	28 through 30 44	H-1-3 C-37
Shock Impulse data Functional	8/8-9/68	5.9/6.7	B-14	N5778 N1997	31 through 33 44 through 46	I-1-3 I-4-11 C-37, 39
End of test	8/12/68	6.8	B-24	N1997	45 and 46	C-38, 39

*All insulation resistance, continuity and capacitance test data were recorded in tabular form to facilitate comparison and evaluation (Reference Laboratory Notebook N6097, Pages 1-24).

EXAMINATION OF PRODUCT

The test specimen was visually inspected for quality craftsmanship. The assembly housing and connectors were found to be free of cracks, scratches, and surface contamination.

FUNCTIONAL TEST

The functional test consisted of four steps.

Step 1: Insulation Resistance

Insulation resistance (IR) was measured using a megohm bridge. Initially (prior to any environmental exposure), the applied potential was 200 ± 10 vdc, with a limit of 90 megohms minimum. Following vibration, high/low temperature-life, vacuum, acceleration, and shock tests, the applied voltage was 100 ± 10 vdc, with a limit of 90 megohms minimum. After the salt fog and oxygen-humidity tests, the applied voltage was 100 ± 10 vdc, with a limit of 10 megohms minimum.

Insulation resistance was measured between ground and each individual feed-through circuit. No out-of-tolerance (IR) conditions were observed throughout the qualification testing.

Step 2: Continuity

Continuity was measured using a multimeter VOM. Each feed-through circuit was measured on the RX1 range, with a resistance limit of 0.5 ohms maximum allowed (exclusive of harness resistance). Each circuit was measured from end-to-end. All continuity measurements were within the specified limit.

Step 3: Capacitance

The capacitance was measured using an impedance bridge. The shunt capacitance of each filter was measured between case ground and each terminal. The Pi (π) network being symmetrical, both values should be nearly identical. Initially, the specified minimum capacitance was 5500 picofarads. During the high/low temperature-life test, multiple test difficulties were encountered. Capacitance data obtained after eleven hours of exposure at 40 F indicated 14 of 24 readings were below specification limits. At this time, it was suspected by Engineering, that moisture accumulation in the test equipment connectors, as a result of exposure to the CCOH test, was affecting capacitance values. The connectors were thoroughly cleansed and dried, and sealing plugs were installed (Reference DR A96675, Appendix J, page J-1).

The high/low temperature-life test was restarted; and after approximately 24 hours of exposure to 40 F, the functional test data indicated that 6 of 24 readings were below the specification limit. An urgent temperature evaluation by North American Rockwell Corporation and the manufacturer, Allen Bradley, revealed this condition was normal. At high and low temperatures relative to ambient, the capacitance profile was "bell shaped." The enclosed test data obtained at ambient, +125 F, and +135 F temperatures indicate all capacitance readings were in excess of 5500 picofarads.

SPACE DIVISION OF NORTH AMERICAN ROCKWELL CORPORATION

The specification limit was lowered to 3500 picofarads minimum at all temperatures outside the range of 70 to 78 F (Reference DR A110406, Appendix J, page J-2, and ATR 492117A, Appendix A).

No other capacitance test anomalies were observed for the remainder of qualification testing.

Step 4: Dielectric Strength

Dielectric strength was measured using an ac/dc Hypot instrument. The initial test was performed at a potential of 355 ± 10 ac for a period of 5 (+0.0, -0.5) seconds between all pins of P1 and P2 tied together and ground. The inadvertent application of 355 vac rms (instead of 375 vdc) exceeded the ATR requirements by approximately 25 percent. The failure criterion was a current in excess of 2 milliamperes. All dielectric tests performed after and during the environmental exposure were conducted at a potential of 280 ± 5 vdc. No discrepancies were observed on any dielectric strength test throughout the qualification testing.

ENVIRONMENTAL TESTS

Vibration

Vibration testing of the G&N filter box assembly was conducted per Paragraph 5.4 of the QTP (Appendix B). The test specimen was mounted typically as shown in Figures 1 and 2 (Y axis). No response accelerometers were mounted on the specimen because of the rigidity of the fixture (see IL SD/AD/68-055, letter of waiver Appendix J, page J-4).

The sequence of tests was as follows:

1. Resonance search in each axis.
2. Equalization and 2.5-minute high-level random vibration in each axis.
3. Equalization and 12.5-minute low-level random vibration in each axis.

Functional tests were performed per Paragraph 5.4 of the QTP (Appendix B) before and after resonance search and following the final random vibration in each axis. However, the post-vibration functional was performed after the test specimen was mounted in the salt spray chamber.

SPACE DIVISION OF NORTH AMERICAN ROCKWELL CORPORATION

During each of the vibration runs, each circuit in the specimen was continuously energized with 100 milliamperes of dc current and was monitored for discontinuities greater than 70 microseconds. No discontinuities were observed.

Corrosive Contaminants, Oxygen-Humidity (CCOH)

The CCOH test was performed per Paragraph 5.5 of the QTP (Appendix B). The photograph (Figure 3) shows the specimen mounted in the oxygen-humidity chamber.

The specimen was subjected to a one-hour salt spray, preceded by a functional test and followed by a functional test and a visual examination. The filter box was then subjected to a 120-hour oxygen-humidity test, and functional testing was performed at the time interval indicated per Paragraph 5.5 of the QTP.

At the end of 96 hours (4 cycles of 24-hour temperature cycling), the specimen was inadvertently subjected to an additional cycle instead of being stabilized at 60 ± 10 F for the remaining 24-hour period. Apollo Engineering and Reliability reviewed the over-test and granted a disposition to continue with the test. No anomalies were observed (Reference DR A110403, Appendix J, page J-3, and ATR 492117A, Appendix A).

High/Low Temperature-Life

As shown in Figure 4, the specimen was mounted in the temperature chamber and subjected to a 15-day temperature test per Paragraph 5.6 of the QTP (Appendix B). The temperature exposure was as follows:

1. 40 F for 96 hours
2. 125 F for 240 hours
3. 200 F for 30 minutes
4. Ambient for 2 hours
5. -20 F for 24 hours

All temperature transitions were accomplished at a rate that did not exceed 5 F per minute.

Functional testing was conducted periodically at specified intervals throughout the thermal exposure. No anomalies, except as noted in the functional tests, were observed (Ref DR's A96675 and A110406, Appendix J, pages J-1, 2).

Vacuum

The vacuum test was conducted per Paragraph 5.7 of the QTP (Appendix B). Functional tests were performed periodically at specified intervals. The specimen temperature was reduced to 40 F, and then the chamber pressure was reduced to 1×10^{-4} millimeters of mercury (mm Hg). The temperature was maintained at 40 ± 5 F for 50 hours and then increased to 135 ± 10 F at a rate that did not exceed 5 F per minute. The temperature was maintained at 135 ± 10 F for 50 hours, then reduced to ambient at the 5 F per minute maximum rate.

Figure 5 shows the vacuum test system and the functional test setup. Figure 6 is a photograph of the specimen mounted in the vacuum chamber. The specimen was turned on edge to show the location of the thermocouples. During the test, the side with the thermocouples was placed downward on the aluminum panel, separated from the panel only by the case screwheads.

At all times when functional testing was not in progress, each of the twelve filter circuits was continuously energized with an 800 Hz 110 ± 10 milli-ampere a-c current. Prior to and following each functional test, the applied voltage and current through each filter were recorded in the laboratory notes. No discrepancies were observed.

Acceleration

The specimen was mounted on a centrifuge and subjected to six 5-minute exposures of 20 ± 1 g continuously (each direction of the three mutually perpendicular axes). Each circuit was continuously monitored with a d-c current of 100 milliamperes for a discontinuity in excess of 70 microseconds. No discontinuities were observed.

Functional tests were performed while the specimen was mounted on the fixture prior to and following acceleration exposure; the dielectric strength was performed after acceleration exposure. No discrepancies were observed.

Shock

The specimen was mounted on the shock impulse machine and subjected to a mechanical shock test in each direction of the three mutually perpendicular axes. During each shock, all circuits were continuously energized with a d-c current of 100 milliamperes and monitored for a discontinuity in excess of 70 microseconds. No discontinuity was observed.

7008-66-49A

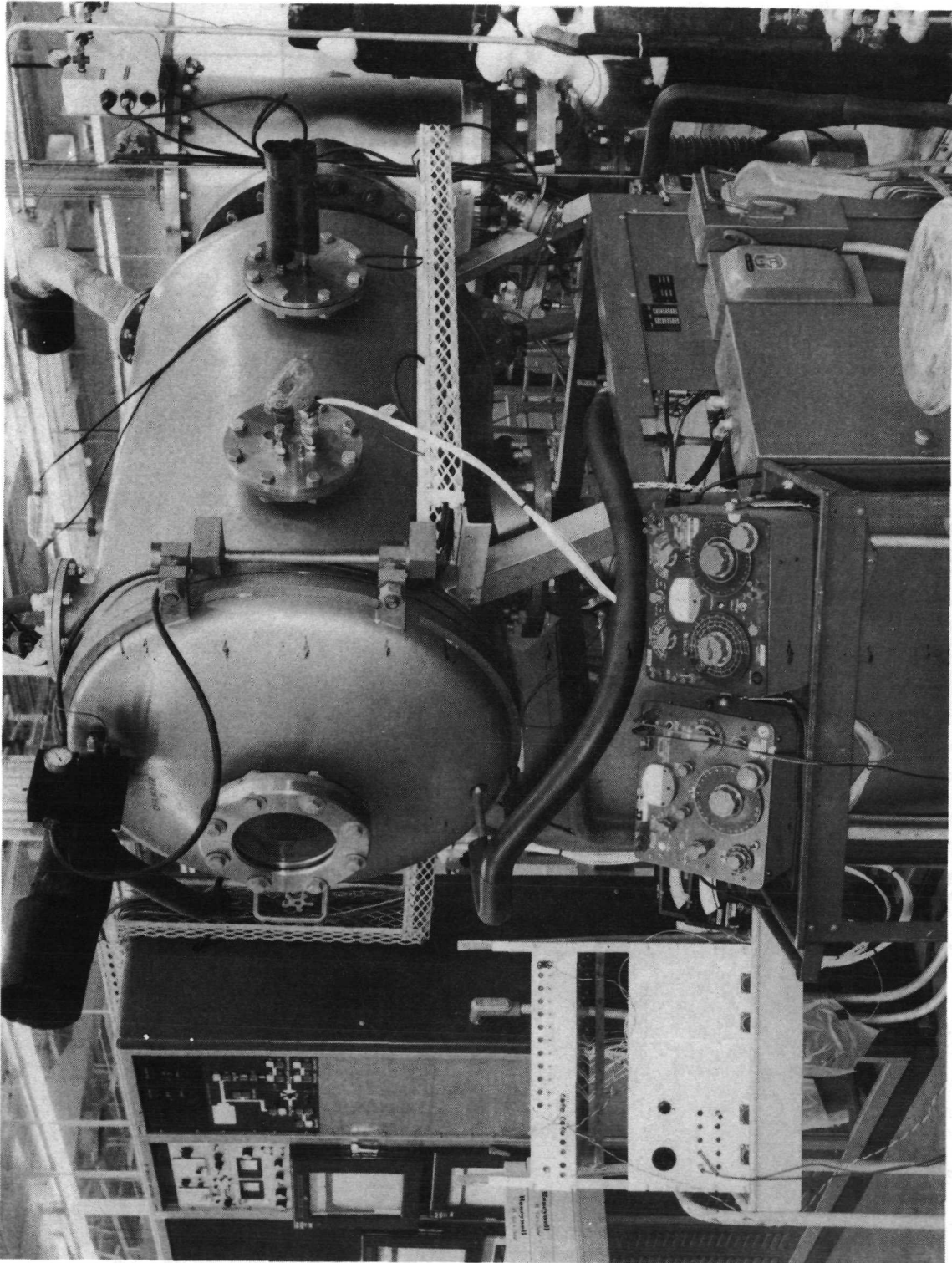

Figure 5. Vacuum Test Setup

7008-66-49B

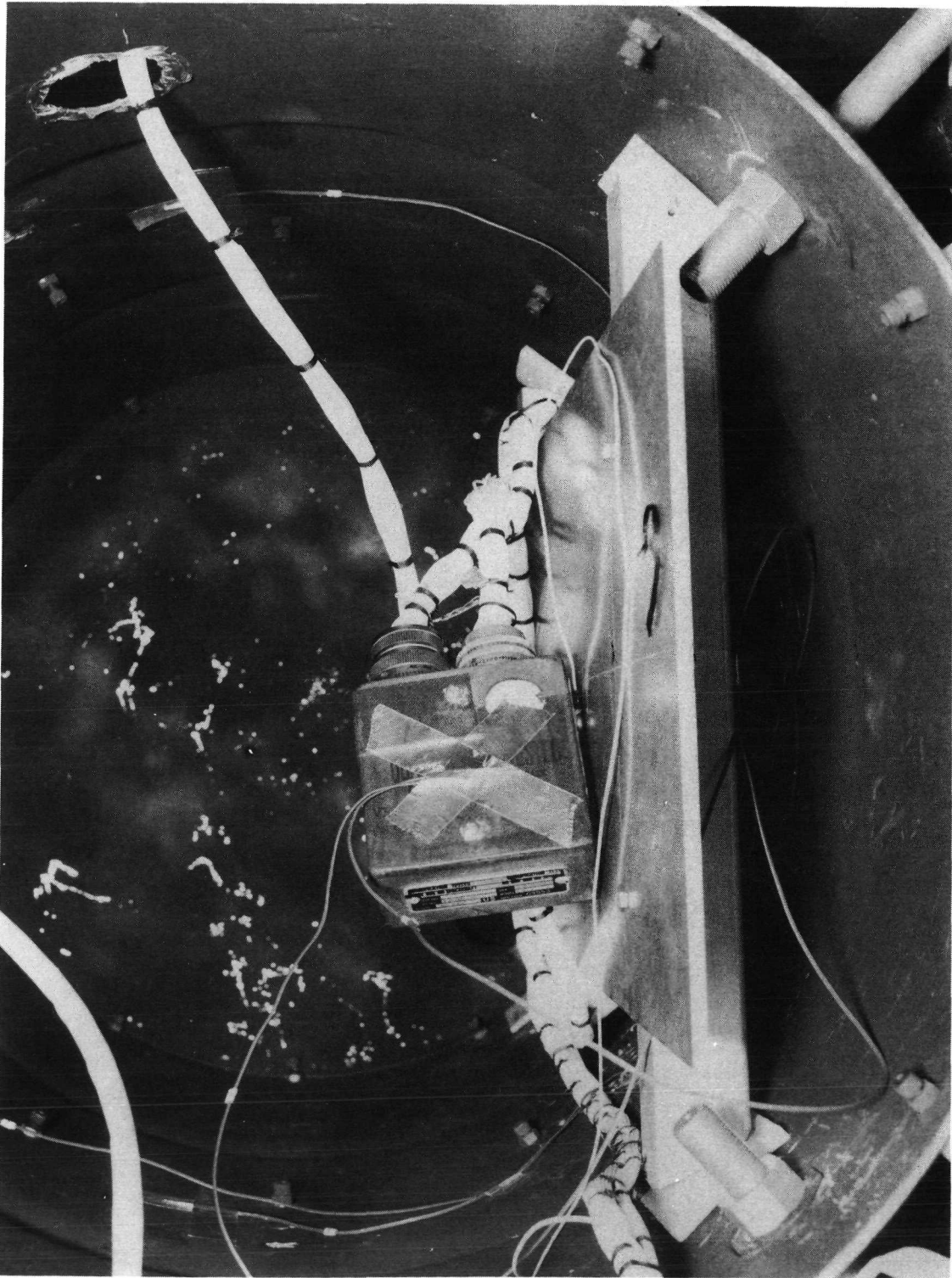

Figure 6. Specimen Mounted in Vacuum Chamber

SPACE DIVISION OF NORTH AMERICAN ROCKWELL CORPORATION

Functional tests were performed while the specimen was mounted on the fixture prior to and following the shock exposures; the dielectric strength test was performed after shock exposure. No discrepancies were observed.

POST TEST

PHYSICAL INSPECTION

The exterior and interior of the G&N filter box assembly (Figure 7) were inspected for damage resulting from exposure to the environmental tests. Figure 8 partially illustrates that there was no damage; i. e., dents, scratches, broken wires, or contamination inside or outside the box.

DISPOSITION OF TEST SPECIMEN

Parts Replacement Request No. S09143, NR Form 17A, was initiated by the RTE and approved by NR Inspection. The laboratory notebook was closed out, and the test specimen and control documents were shipped to Bonded Storage (D/052-343) via Material Requisition/Transfer Order No. S000502, NR Form M918-K.

CONCLUSION

The G&N filter box assembly V36-442330, S/N 06362 AAH3858, specimen performed satisfactorily when tested in accordance with ATR 492117B and QTP IL 6227-801A.

Although test difficulties did occur on three separate occasions, each of these cases was satisfactorily resolved (Reference DR's A96675, A110406, and A110403, Appendix J, pages J-1 through J-3).

7008-66-50B

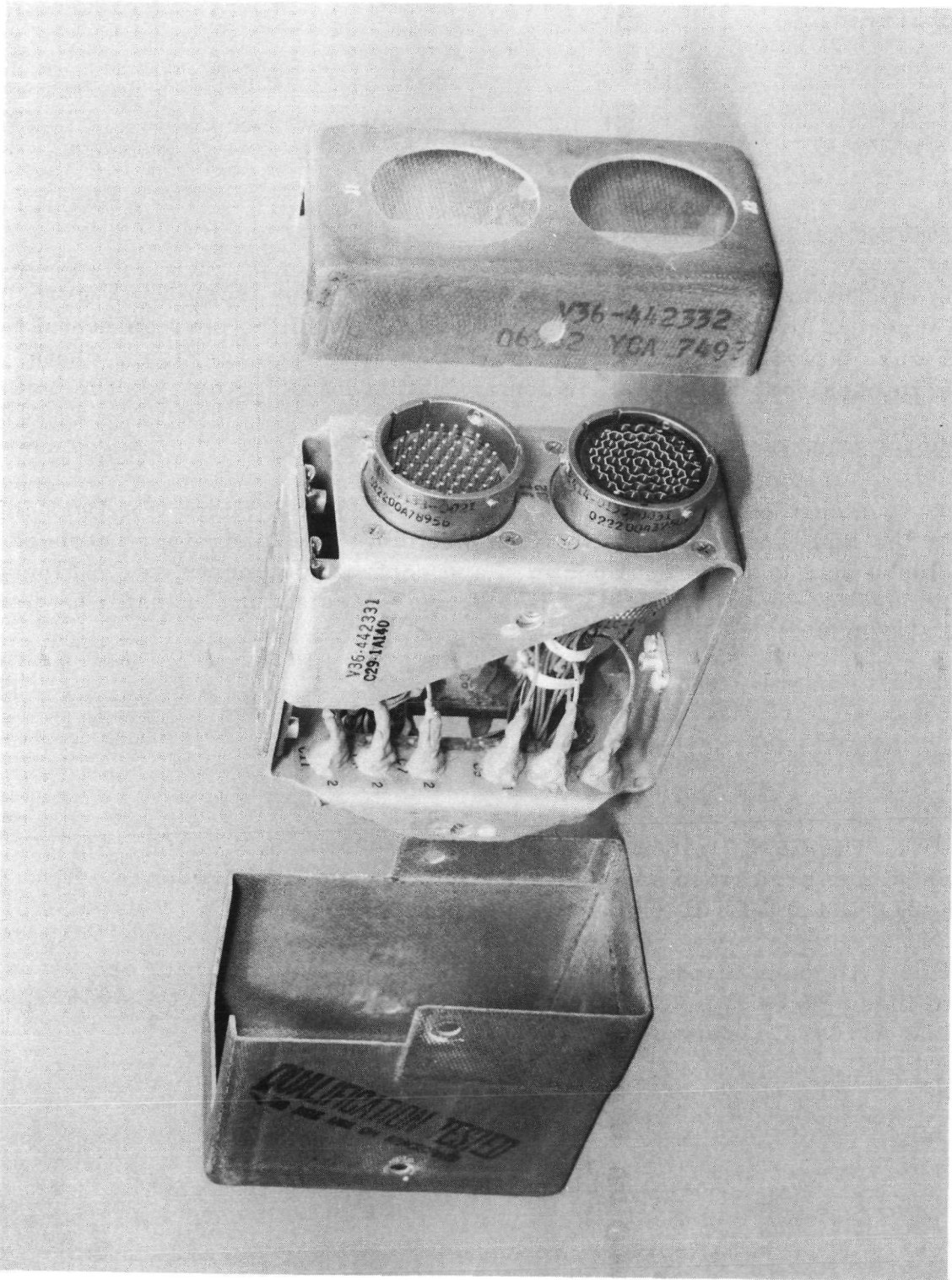

Figure 7. G&N Filter Box Assembly View

7008-66-50A

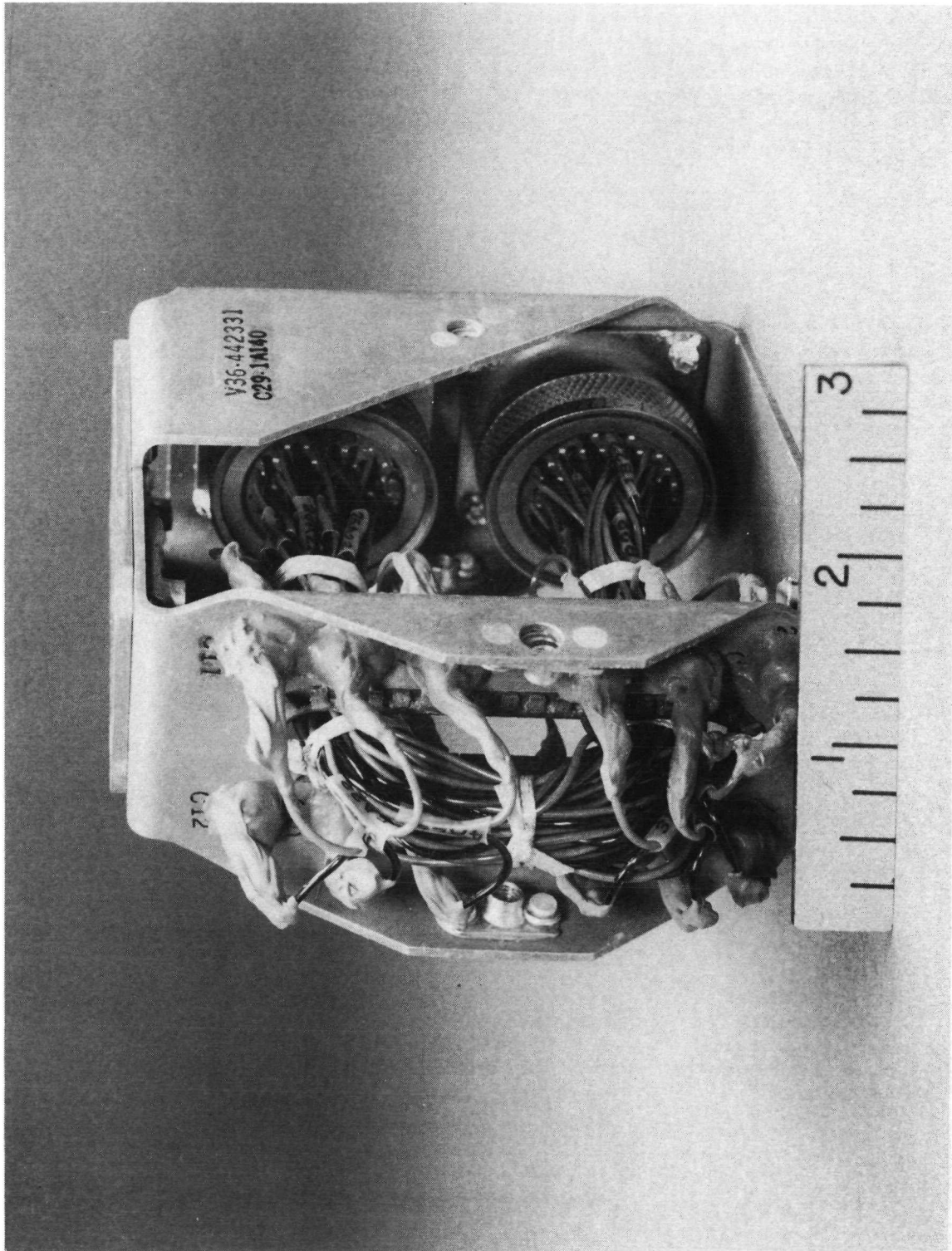



Figure 8. G&N Filter Box Chassis Inspection

APPENDIX A

APOLLO TEST REQUEST (ATR)

SPACE DIVISION OF NORTH AMERICAN ROCKWELL CORPORATION

SPACE DIVISION NORTH AMERICAN ROCKWELL CORPORATION					
TEST REQUEST 					
PROJECT Apollo		TR NUMBER 492117		CHK. R	
TITLE OF TEST Guidance and Navigational Filter Box Assembly			PAGE 1 OF 12		
TYPE OF TEST QUALIFICATION					
ENG. ORIGINATOR R. W. Gibb	ENG. COORDINATOR S. V. McKeever	PHONE 1305	LEDGER ACC 3501	G.O. 7140	SUB- ACT 2144
TEST AGENCY L&T	TEST COORDINATOR R.L. Beigay/C.C. Shepherd	PHONE 5715	SWA 20772	IDWA	EOPR
FLIGHT CONSTRAINT 101	VEHICLE EFFECTIVITY 101 thru 104, 106 and Subs	TYPE OF REPORT SD Cat. 1			
INSPECTION REQUIRED	YES	TEST REPORT DISTRIB.		SCHEDULE	
	<input checked="" type="checkbox"/>	R.W. Gibb	695-412	Start:	7-10-68
	NO	M.J.O'Toole	695-331	Complete:	8-9-68 8-14-68
	SD	C.E. Farner	695-330	TAR:	8-22-68 8-30-68
NASA	<input checked="" type="checkbox"/>	J.R. West, Jr.	099-220		
TEST SPECIMEN V36-442330 (Quantity 1) Hardware shall be furnished by Dept. 098-212 (Ref. EO N711570)	REFERENCES V36-442330 734-945072 MC999-0050C CTR 25492117 MCR 6783		MA0203-0622 V36-444011		
TEST OBJECTIVE AND BRIEF DESCRIPTION OF EFFORT					
OBJECTIVE: To qualify the above test specimen for S/C 101 thru 104, 106 and Subs					
EFFORT: (See Sheet 2)					
APPROVAL SIGNATURES (AS APPL.)					
TEST REQUESTER <i>S.V. McKeever</i>	<i>6/25/68</i>	OTHER <i>S. J. Bellington</i>		<i>6/27/68</i>	
REQUESTER SUPERVISION <i>R.W. Gibb</i>	<i>6-25-68</i>	OTHER <i>L. Laboranti</i>		<i>7/1/68</i>	
PROJECT ENGINEER <i>W. A. ...</i>	<i>7-1-68</i>	OTHER			
RELIABILITY <i>C.E. ...</i>	<i>6-28-68</i>	OTHER			
SYSTEMS INTEGRATION		OTHER			
TEST AGENCY <i>C.C. Shepherd</i>	<i>7-2-68</i>	RELEASED BY DEVELOPMENT ANALYSIS <i>S. J. Bellington</i>		<i>7/2/68</i>	

FORM 2924-S REV 10-67

SPACE DIVISION NORTH AMERICAN ROCKWELL CORPORATION			
TEST REQUEST CHANGE NOTICE		TR NUMBER 492117	CHG. A
PROJECT Apollo			
TITLE OF TEST Guidance and Navigational Filter Box Assembly		PAGE 1A OF 12	
		SCHEDULE CHANGE 8-16-68	
DETAIL DESCRIPTION OF CHANGE(S) AND REASON FOR CHANGE			
<p>∅ Added test requirements in accordance with MCR 6783A as follows:</p> <p style="margin-left: 40px;">Low temperature - 20 F</p> <p style="margin-left: 40px;">Vacuum - 40 and 135 F at 1×10^{-4} mm Hg</p> <p style="margin-left: 40px;">Acceleration - 20 g's</p> <p>Revised the capacitance measurement requirements during and after temperature environment. The original requirements did not consider the component parameter variation during temperatures. The tolerance range of the component consists of a barrel type of plot. This was verified by an individual component test (4 units) and by the supplier (Allen Bradley).</p>			
TEST REQUESTER <i>Bill McKenna</i> <i>UMK</i>	7/27/68	OTHER <i>[Signature]</i>	7-29-68
REQUESTER SUPERVISION <i>[Signature]</i>	7-29-68	OTHER <i>L. Labovantz</i>	7/30/68
PROJECT ENGINEER <i>[Signature]</i>	7-30-68	OTHER	
RELIABILITY <i>[Signature]</i>	7-30-68	OTHER	
SYSTEMS INTEGRATION		OTHER	
TEST AGENCY <i>R. Bergay</i>	7/31/68	RELEASED BY DEVELOPMENT ANALYSIS <i>[Signature]</i>	7/31/68

FORM 2924-R REV 10-67

SPACE DIVISION OF NORTH AMERICAN ROCKWELL CORPORATION

SPACE DIVISION NORTH AMERICAN ROCKWELL CORPORATION			
TEST REQUEST CHANGE NOTICE			
PROJECT APOLLO		TR NUMBER 492117	CHG. B
TITLE OF TEST GUIDANCE AND NAVIGATIONAL FILTER BOX ASSEMBLY		PAGE 1a OF 12	
		SCHEDULE CHANGE ---	
DETAIL DESCRIPTION OF CHANGE(S) AND REASON FOR CHANGE			
<p>Ø 1 Revised vacuum temperature monitoring method to agree with the capability of the vacuum chamber. The test specimen was monitored as follows: $40 \pm 5^{\circ}\text{F}$ and $135 \pm 10^{\circ}\text{F}$.</p>			
TEST REQUESTER <i>S. W. McKever</i>	8/13/68	OTHER <i>[Signature]</i>	8/15/68
REQUESTER SUPERVISION <i>RW [Signature]</i>	8/14/68	OTHER <i>[Signature]</i>	8/15/68
PROJECT ENGINEER <i>[Signature]</i>	8-15-68	OTHER	
RELIABILITY <i>CDE [Signature]</i>	8/15/68	OTHER	
SYSTEMS INTEGRATION		OTHER	
TEST AGENCY <i>M.M. [Signature]</i>	8/15/68	RELEASED BY DEVELOPMENT ANALYSIS <i>[Signature]</i>	8/15/68

FORM 2924-R REV 10-67

ATR 492117B
Page 2

EFFORT: Perform the test program defined herein:

The test agency shall submit a detail test procedure to the requester for approval prior to start of testing. The test procedure shall specify applicable documents, drawings, step-by-step procedures, test equipment with range, accuracy and frequency of calibration, test setup schematics, and sample data sheets. Failure notification and failure reporting shall be in accordance with NR/SD Policies and Procedures J-403.

The laboratory test notes shall be arranged in such a manner that the discussion, notes, and any analysis appear in one separate section and the data sheets appear in a section by themselves. Data sheets shall be maintained for all tests specified herein, i.e., Insulation Resistance Tests, Performance Tests, etc.

TR 492117B
Page 3

1.0 Introduction

The following requirements constitute the Qualification Test Program for the Guidance and Navigation Filter Box Assembly, P/N V36-442330. The assembly, located in the Command Module, Right Hand Lower Equipment Bay ($X_c = 30"$, $Y_c = 20"$, and $Z_c = 46"$), is used to filter switching transients in the Guidance and Navigation System.

2.0 General Requirements

- 2.1 All test fixtures shall have the approval of Apollo CSM Dynamics, Dept. 099-220.
- 2.2 During all testing, the Safety Requirements specified in MA0203-0622, paragraph 3.2, shall be adhered to.
- 2.3 Parenthetical paragraphs refer to Specification MC999-0050 "C" unless otherwise specified.
- 2.4 One (1) Specimen shall be subjected to the tests described herein in the order listed.

2.5 Functional Test

The functional test shall be in accordance with specification MA0203-0622, paragraph 4.1, except for insulation resistance and capacitance requirements which vary as indicated for the following environments.

(A) Insulation Resistance

1. Initial - The applied voltage shall be 200 ± 10 vdc.
2. Vibration, High/Low Temperature - Life, Vacuum, Acceleration, and Shock - per Specification MA0203-0622.
3. Humidity, Oxygen, Corrosion Contaminants.
 - (a) Salt Fog - The Functional test before and after shall be per Specification MA0203-0622 with the exception that after the salt fog test the insulation resistance reading shall be 10 megohms minimum.
 - (b) Humidity, Oxygen - The Functional test per specification MA0203-0622 with the exception that the insulation resistance reading shall be 10 megohms minimum.

(B) Capacitance

The capacitance reading shall be greater than 5,500 picofarads at room ambient temperature ($70 - 78^\circ\text{F}$) and shall be greater than 3,500 picofarads at all other test temperature conditions.

2.6 Dielectric Strength Test

Using a megohm bridge, apply a test potential of 375 ± 10 vdc for a period of $5.0 \pm 0.0, -0.5$ seconds, between all pins of P1 and P2, tied together, and chassis ground. Rate of voltage application shall not exceed 100 volts per second. Leakage current shall be less than 2 milliamperes. Test shall be conducted in accordance with MIL-STD-202, Method 301.

3.0 Test Requirements

3.1 Visual Examination

Prior to test, the test specimen shall be visually inspected for Inspection Stamps or other evidence to verify that it has passed assembly and acceptance inspection and has been approved by Engineering.

3.2 Vibration

Perform a Functional and Dielectric Strength Test per paragraph 2.5 and 2.6 after test specimen is mounted to the vibrator head.

3.2.1 Resonance Search (4.8.2.1)

Subject the test specimen to a sinusoidal resonance search for $10 \pm 1, -0$ minutes in each of the orthogonal axes (see Figure I) in accordance with the requirements of Specification MC999-0050 except that the applied frequency shall be $10 - 2000$ cps with an input of $2 g$'s peak ($+0, -1g$).

3.2.2 Random Vibration (4.8.2.2)

Level A - Subject the test specimen to the following vibration levels for $2.50 \pm 0.25, -0.00$ minutes per axis in each of the three orthogonal axes (see Figure I) as follows: 3 db/octave linear increase to $0.067 g^2/cps$ from 20 to 80 cps; constant at $0.067 g^2/cps$ from 80 to 2000 cps.

Level B - Apply for $12.5 \pm 1, -0$ minutes per axis in each of the three orthogonal axes (see Figure I) as follows: 3 db/octave linear increase to $0.003 g^2/cps$ from 20 to 80 cps; constant at $0.003 g^2/cps$ from 80 to 2000 cps.

3.2.3 Prior to and after the final random vibration exposure period in each level, perform the functional test as specified in paragraph 2.5. However, the final functional test may be performed after the test specimen is mounted in the salt spray chamber per paragraph 3.3.1.1.

3.2.4 During vibration all electrical circuits shall be monitored for discontinuity in excess of 70 ± 7 microseconds. The electrical circuit shall be energized by applying to each of the positive (+)

3.2.4 -- (continued)

test points 28.5 plus or minus 1.5 vdc and connecting a suitable load resistor to the minus (-) test points. A dc current of 0.1 min., 0.15 maximum amperes shall flow through each circuit (see Table I for connecting points).

Table I (Monitoring Circuit)

From (+)	To (-)
J2-P	J2-H
J2-S	J2-W
J2-J	J2-F
J2-J	J1-GG
J2-BB	J2-DD
J2-Z	J2-T

3.2.5 When discontinuity occurs, an oscilloscope shall be connected in the circuit and the duration of the discontinuity shall be noted and recorded.

3.3 Humidity, Oxygen, Corrosion Contaminants

3.3.1 The test specimen shall be placed in the salt spray test cabinet in a position to simulate spacecraft installation, see Figure I. All electrical terminations shall be brought out separately; and all contacts (pin insert) of the test setup connectors shall contain termination lead or a connector sealing plug.

3.3.1.1 Prior to salt spray, perform a functional test as specified in paragraph 2.5.

3.3.1.2 Perform a salt spray test per Procedure 1, Method 509 of MIL-STD-810 with the following exceptions:

1. Salt solution shall be 1% by weight.
2. Test duration shall be one hour.
3. Cabinet conditions shall be ambient.

TR 492117B
Page 6

- 3.3.1.3 Upon completion of the salt spray test, while the test specimen is still in the cabinet perform a functional test as specified in paragraph 2.5.
- 3.3.1.4 Visual examination shall be performed on the external surfaces of the test specimen after the unit is removed from the salt spray cabinet. All deterioration or corrosion shall be recorded. No attempt shall be made to clean the test specimen. In addition, care shall be taken to prevent salt residue from being removed from the test specimen during handling.
- 3.3.2 The test specimen shall be transferred to an oxygen humidity chamber within one hour after salt spray test. The test specimen shall be installed in the same manner as noted in paragraph 3.3.
- 3.3.2.1 Prior to evacuation, perform a functional test as specified in paragraph 2.5.
- 3.3.2.2 The chamber shall be evacuated to a pressure of 20 mm Hg at ambient temperature conditions and back filled with commercial oxygen 95 \pm 5 percent until the chamber pressure increases to 5.0 \pm 0.2 psia. Chamber temperature shall be increased to 125 \pm 5 F. Then proceed with the following steps:
1. Maintain these conditions for 12 hours.
 2. Perform a functional test as specified in paragraph 2.5.
- 3.3.2.3 Maintain the oxygen environment at 5.0 \pm 0.2 psia and introduce sufficient moisture to obtain a relative humidity 95 \pm 5 percent with distilled water having a Ph factor of 6.5 to 7.5. Chamber temperature shall be reduced to and maintained at 74 \pm 10 F.

After the conditions of 3.3.2.3 have been verified, the chamber temperature, pressure, and humidity shall be varied as follows:

1. Increase the temperature to 125 \pm 5F, -15 F in 2 hours \pm 15 minutes. During this period, the pressure shall be 5.0 \pm 0.5 psia, the relative humidity shall be 95 \pm 5, -15 %, and the O₂ shall be 95 \pm 5, -15 %.
2. Maintain the temperature of 125 \pm 5F, -15 F for 6 hours \pm 15 minutes. During this period, the pressure shall be 5 \pm 0.2 psia, the relative humidity shall be 95 \pm 5%, and the O₂ shall be 95 \pm 5%.
3. Decrease the temperature to 60 \pm 10F in 10 hours \pm 15 minutes. During this period, the pressure shall be 5.0 \pm 0.5 psia, the relative humidity shall be 95 \pm 5, -15 %, and the O₂ shall be 95 \pm 5, -15 %.

3.3.2.3 (continued)

4. Maintain the temperature of 60 ± 10 F for 6 hours ± 15 minutes. During this period, the pressure shall be 5.0 ± 0.2 psia, the relative humidity shall be $95 \pm 5\%$, and the O_2 shall be $95 \pm 5\%$.
5. Steps 1 through 4 constitute one 24-hour cycle and shall be repeated continuously for a total of four cycles.
6. After the fourth cycle the chamber shall remain constant at 60 ± 10 F until the total test time of 120 hours minimum are accumulated. During this period, the pressure shall be 5.0 ± 0.2 psia, the relative humidity shall be $95 \pm 5\%$, and the O_2 shall be $95 \pm 5\%$.
7. Perform a functional test as specified in paragraph 2.5 at the following intervals: 6, 22, 30, 46, 54, 70, 78, 94, 102, and 118 ± 1 hours.

3.3.2.4 After the oxygen humidity chamber has returned to room ambient condition (temperature and pressure) and while the test specimen is still in the chamber perform a functional test as specified in paragraph 2.5. (The chamber door may be open during this functional test.)

3.3.2.5 Visual examination shall be performed on the external surfaces of the test specimen after the unit is removed from the chamber. All deterioration or corrosion shall be recorded.

3.4 High/Low Temperature - Life

3.4.1 The test specimen shall be mounted in a High/Low temperature chamber; and no attempt shall be made to clean the test specimen. The position of the test specimen and test setup installation shall be as noted in paragraph 3.3.1.

3.4.2 Prior to lowering the temperature, perform a functional test as specified in paragraph 2.5 and a dielectric strength test as specified in paragraph 2.6 except the applied voltage shall be 280 ± 5 vdc.

3.4.3 Perform High/Low Temperature Test as follows: (14 days)

1. Chamber temperature shall be decreased at a rate not greater than 5 F/minute from room ambient to 40 ± 5 F. The chamber shall be reduced to and maintained at 40 ± 5 F for 96 ± 1 hours.

3.4.3 -1. (continued)

Perform a functional test approximately every 24 hours, and during the last functional test perform a dielectric strength test as specified in paragraph 3.4.2.

2. Chamber temperature shall be increased at a rate no greater than 5 F/minute from $+40$ to 125 ± 5 F. The chamber shall be maintained at 125 ± 5 F for 240 ± 1 hours. During this period, perform a functional test approximately every 24 hours; and during the last functional test perform a dielectric strength test as specified in paragraph 3.4.2.
3. Chamber temperature shall be increased at a rate no greater than 5 F/minute from 125 to 200 ± 5 F. The chamber shall be maintained at 200 ± 5 F for $30(+30, -5)$ minutes.

After stabilization for 15 minutes at 200 F perform a functional and dielectric strength test as specified in paragraph 3.4.2.

4. Chamber temperature shall be decreased at a rate no greater than 5 F/minute from 200°F to room ambient. Allow test specimen 2 hours minimum to stabilize at room ambient temperature and perform a functional and dielectric strength test as specified in paragraph 3.4.2.
5. Chamber temperature shall be decreased at a rate not greater than 5 F/minute from room ambient to -20 ± 5 F. The chamber shall be maintained at -20 ± 5 F for 24 ± 1 hours. No functional testing is to be conducted during this period.
6. Chamber temperature shall be increased at a rate not greater than 5 F/minute from -20 F to room ambient. Allow test specimen 2 hours minimum to stabilize at room ambient temperature and perform a functional and dielectric strength test as specified in paragraph 3.4.2. (The chamber door may be open during this functional test.)

3.5 Vacuum (4.4)

3.5.1 The test specimen shall be mounted in a vacuum chamber; perform a functional test as specified in paragraph 2.5 while the chamber is at room ambient condition.

3.5.2 Perform the vacuum test at a vacuum of at least 1×10^{-4} mm Hg and with the test specimen temperature at $40 \pm 5^{\circ}\text{F}$ for 50 ± 5 hours. Temperature shall be decreased at a rate not greater than 5 F/minute from room ambient to 40 ± 5 F. (Thermocouple shall be located approximately as shown in Figure 1).

After the test specimen has been stabilized at the required vacuum and temperature perform a functional test as specified in paragraph 2.5. Repeat the functional test approximately at the following times: 24 and 50 hours.

TR 492117B

Page 9

- 3.5.3 The test specimen temperature shall be increased at a rate not greater than 5 F/minute from 40 to 135 ± 10 F. The test specimen temperature shall be maintained at 135 ± 10 for $50 \begin{smallmatrix} +5 \\ -0 \end{smallmatrix}$ hours.

After the test specimen has been stabilized at the required vacuum and temperature, perform a functional test as specified in paragraph 2.5. Repeat the functional test again approximately at the following times: 24 and 50 hours.

- 3.5.4 The test specimen temperature shall be decreased at a rate no greater than 5 F/minute from 135 F to room ambient.

After the test specimen has been stabilized at the required vacuum and temperature for 1 hour, perform a functional test as specified in paragraph 2.5.

- 3.5.5 After chamber temperature and pressure has returned to room ambient condition, perform a functional and dielectric strength test as specified in paragraph 3.4.2.

- 3.5.6 During the vacuum test, at temperatures of 40 and 135 F, all electrical circuits shall be energized by applying to each of the positive (+) test points 26 ± 0.26 V (rms), 800 cycles and connecting a suitable load resistor to the minus (-) test points. An AC current of 110 ± 10 milliamps shall flow through each circuit (See Table II for connecting points). These circuits shall be monitored throughout the test, the reading shall be recorded approximately every 24 hours and at the end of the test.

TABLE II

From (+)	To (-)
J2-P	J1-P
R	R
K	K
L	L
<u>G</u>	<u>G</u>
<u>H</u>	<u>H</u>
S	S
<u>M</u>	<u>M</u>
<u>X</u>	<u>X</u>
N	N
<u>V</u>	<u>V</u>
<u>W</u>	<u>W</u>

φ 3.6 Acceleration (4.10)

- 3.6.1 The assembly shall be subjected to an acceleration test by applying 20 ± 1 g's in each direction of three mutually perpendicular axes as indicated by Figure I. The acceleration shall be applied for 5 +1, -0 minutes in each direction of each axis.
- 3.6.2 Monitor for discontinuity during the acceleration test as specified in paragraph 3.2.4.
- 3.6.3 Prior to acceleration test, after the assembly has been mounted on the fixture, perform a functional test as specified in paragraph 2.5; and subsequent to the completion of the acceleration exposure, perform the functional and dielectric strength test as specified in paragraph 3.4.2.

φ 3.7 Shock (4.9)

- 3.7.1 The Assembly shall be subjected to a terminal peak sawtooth pulse in both directions in each of the orthogonal axes (six shocks total). Magnitudes and directions shall be outlined in Table III and Figure I. The total pulse duration shall be 10 to 15 milliseconds including a decay time no greater than 10 percent of the total duration.
- 3.7.2 Monitor for discontinuity during shock test as specified in paragraph 3.2.4.
- φ 3.7.3 Prior to and subsequent to the complete shock exposure, perform the functional and during the last functional test perform a dielectric strength test as specified in paragraph 3.4.2. These functional tests are for engineering reference only.

4.0 Visual Examination

The external and internal surfaces of the test specimen shall be visually inspected and there shall be no evidence of structural damage resulting from the foregoing test. All damage shall be recorded.

TR 492117B
Page 11Table III
(Shock Test)

Magnitude	Axis
20 g	-X
35 g	$\pm Y$
78 g	+X, +Z, -Z

TR 492117B
Page 12

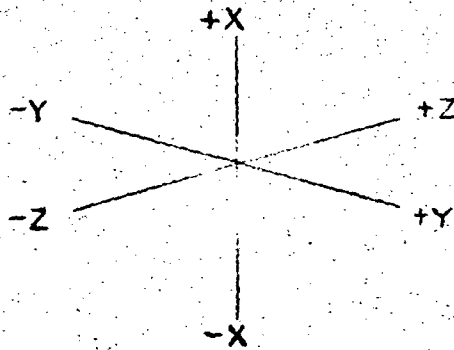
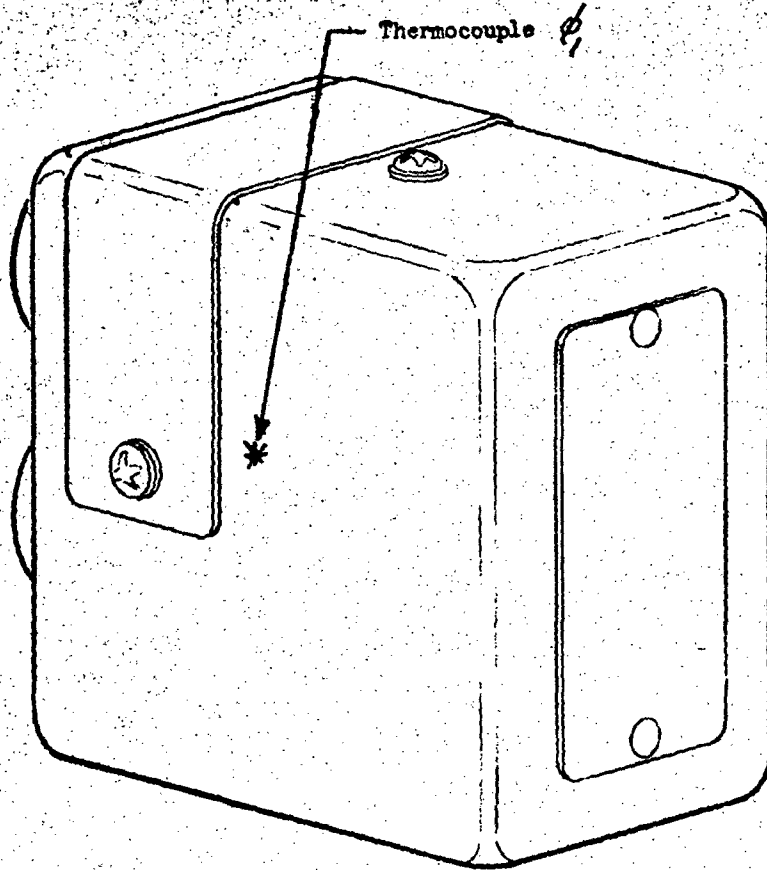

Figure I

APPENDIX B

QUALIFICATION TEST PROCEDURE (QTP)

APOLLO CSM 101
LR 6227
ATR 492117B

IL-6227-801 A
Page 1 of 33
29 June 1968
Revised 8-13-68

LABORATORIES AND TEST
QUALIFICATION TEST PROCEDURE
FOR GUIDANCE AND NAVIGATION
FILTER BOX ASSEMBLY
V36-442330

Prepared by: P. W. Edwards 8-13-68
P. W. Edwards, RTE
Electrical Systems Unit
Laboratories and Test

Approved by: C. C. Shepherd
C. C. Shepherd, Supervisor
Electrical Systems Unit
Laboratories and Test

Requestor : R. W. Gibb
R. W. Gibb, Supervisor
Electrical Equipment Group
Design Engineering, Apollo

TABLE OF CONTENTS

<u>PARAGRAPH NO.</u>	<u>TITLE</u>	<u>PAGE NO.</u>
1.0	INTRODUCTION	4
2.0	SCOPE	4
3.0	APPLICABLE DOCUMENTS	4
4.0	GENERAL REQUIREMENTS	5
	4.1 Safety	5
	4.2 Quality Assurance Provisions	5
	4.3 Data and Reports	5
5.0	DETAIL REQUIREMENTS	6
	5.1 Visual Examination	6
∅	5.2 Functional Tests	6
	5.3 Dielectric Strength	7
∅	5.4 Vibration	8
	5.5 Corrosive Contaminants, Oxygen-Humidity	9
∅	5.6 High/Low Temperature - Life	12
∅	5.7 Vacuum	13
∅	5.8 Acceleration	13
	5.9 Mechanical Shock	14
6.0	STEP-BY-STEP PROCEDURE	14
	6.1 Pre-Test Functions	14
	6.2 Vibration	16
	6.3 CCOH	17
∅	6.4 High/Low Temperature - Life	19
∅	6.5 Vacuum	21

IL-6227-801

Page 3

TABLE OF CONTENTS (CONTINUED)

<u>PARAGRAPH NO.</u>	<u>TITLE</u>	<u>PAGE NO.</u>
∅	6.6 Acceleration.	22
	6.7 Shock	23
∅	6.8 Post Qualification Test Examination	24

LIST OF ILLUSTRATIONS

<u>FIGURE NO.</u>	<u>TITLE</u>	<u>PAGE NO.</u>
1A	ELECTRICAL TEST SETUP-CONTINUITY AND INSULATION RESISTANCE.	25
1B	ELECTRICAL TEST SETUP - DIELECTRIC STRENGTH.	26
2A	DCN CHATTER CHECKERS (COMMON POS.)	27
2B	CIRCUIT JUMPERS.	28
3	AXES DEFINITIONS	29
4	TEST HARNESES & CONNECTOR HOOKUP.	30
5	VACUUM TEST AC LOAD PANEL.	31
6	VACUUM TEST HARNESS (OUTSIDE).	32
7	VACUUM TEST HARNESS (INSIDE)	33

1.0 INTRODUCTION

The Guidance and Navigation Filter Box Assembly, V36-442330, which is located in the Command Module, Right Hand Lower Equipment Bay, is used to filter switching transients in the Guidance and Navigation System.

2.0 SCOPE

One test specimen shall be subjected to the Qualification Tests described below, and in the order listed.

2.1 Functional Test

2.2 Dielectric Strength Test

2.3 Vibration:

2.3.1 Sinusoidal

2.3.2 Random

2.4 CCOH:

2.4.1 Salt Spray

2.4.2 Oxygen - Humidity

2.5 High/Low Temperature - Life

2.6 Vacuum

2.7 Acceleration

2.8 Shock

3.0 APPLICABLE DOCUMENTS

3.1 ATR 492117B

3.2 V36-442330NC

3.3 V36-945106NC

3.4 MA0203-0622NC

3.5 MC999-0050C

Apollo Test Request - Qualification Test, Guidance and Navigation Filter Box Assembly

Box Assembly - C&N Filter (EO M672744)

Schematic Diagram - Guidance and Navigation Filter Box (No EO's)

Guidance and Navigation Filter Assembly, Functional and Vibration Acceptance Test Procedure For - EO M672833

General Test Requirements For Apollo Sub-contractors and Suppliers (EO M615051)

3.6 T&QA M2.4.1 Laboratories & Test Quality Assurance Responsibilities

4.0 GENERAL REQUIREMENTS

The test specimen shall be subjected to the tests described herein without degradation of performance or structural integrity. Failure to meet specified tolerance levels shall constitute a failure and shall be reported in accordance with NR/SD Policies and Procedures N-403.

Unless otherwise specified, all environmental tests shall be performed at room ambient temperature and conditions.

Any special test fixtures required shall be in accordance with Specification MC999-0050C.

4.1 Safety:

Normal safety precautions shall be observed at all times. Precaution shall also be taken to ensure that the test item incurs no damage as a result of handling.

4.2 Quality Assurance Provisions:

4.2.1 All testing shall be performed per T&QA M2.4.1.

4.2.2 Equipment used shall have a valid calibration decal effective for the estimated test phase period.

4.2.3 All tests shall be witnessed and certified by NR/SD and NASA Inspection personnel.

4.2.4 Cognizant engineering personnel shall be notified prior to the start of tests.

4.3 Data and Reports:

4.3.1 All data recorded or noted visually shall be tabulated in an Engineering/Laboratory Notebook and verified for accuracy by NR/SD Inspection personnel. All test setups shall be described, with complete electrical schematics maintained of the circuitry. Circuits and/or schematics contained herein need not be repeated in the Engineering Laboratory Notebook.

4.3.2 A Space Division, Category I Test Report shall be issued after completion of testing.

5.0 DETAIL REQUIREMENTS

5.1 Visual Examination:

5.1.1 The test specimen shall be visually examined for conformance to production drawings and for evidence that the unit has passed assembly and acceptance inspection. Apollo Engineering shall determine whether the unit is acceptable for Qualification Testing and shall so state in the Engineering/Laboratory Notebook.

5.1.2 Following the test efforts described herein, the specimen shall again be examined under the direction of Apollo Engineering and/or Reliability for structural or electrical damage.

5.2 Functional Tests:

5.2.1 Insulation Resistance

Using a megohm bridge, apply a test potential of 200±10 VDC and measure the resistance from each pin on Connector J1 to the chassis, individually. Allow the meter to stabilize for a minimum of 30 seconds before recording each measurement.

Any resistance reading less than 90 megohms shall be considered a test failure, except when otherwise noted.

5.2.2 Continuity

5.2.2.1 Using an ohmmeter, verify that continuity exists between the following pins:

<u>From</u>	<u>To</u>	<u>From</u>	<u>To</u>
J1-C	J2-C	J1-H	J2-H
J1-F	J2-F	J1-J	J2-J
J1-G	J2-G	J1-K	J2-K
J1-L	J2-L	J1-J	J2-J
J1-M	J2-M	J1-K	J2-K
J1-N	J2-N	J1-M	J2-M
J1-P	J2-P	J1-N	J2-N
J1-R	J2-R	J1-P	J2-P
J1-S	J2-S	J1-R	J2-R
J1-T	J2-T	J1-S	J2-S
J1-U	J2-U	J1-T	J2-T
J1-V	J2-V	J1-U	J2-U
J1-X	J2-X	J1-V	J2-V
J1-Y	J2-Y	J1-W	J2-W
J1-Z	J2-Z	J1-X	J2-X
J1-A	J2-A	J1-Y	J2-Y
J1-B	J2-B	J1-Z	J2-Z
J1-C	J2-C	J1-AA	J2-AA

IL-6227-801

Page 7

5.2.2.1 (Cont'd.)

<u>From</u>	<u>To</u>	<u>From</u>	<u>To</u>
J1-D	J2-D	J1-BB	J2-BB
J1-E	J2-E	J1-CC	J2-CC
J1-F ₂	J2-F	J1-DD	J2-DD
J1-G	J2-G	J1-EE	J2-EE
J1-H	J2-H	J1-FF	F2-FF
J1-I	J2-I	J1-GG	J2-GG
		J1-HH	J2-HH

5.2.2.2 During the initial and final continuity test, record the measured resistance for each of the pins listed above. All other continuity tests shall be compared with the initial check, but need not be recorded, except when dissimilarity is observed.

5.2.3 Capacitance Test

Using an impedance bridge, measure the capacitance between each of the following connector pins and chassis. Any reading less than 5,500 picofarads at room ambient temperature (70-78°F) and less than 3,500 picofarads at all other test temperatures shall be considered a test failure. The test voltage applied by the bridge shall be verified as being greater than 0.5 volts rms and less than 7.0 volts rms at 1,000 cps.

<u>Pin (To Chassis)</u>	<u>Pin (To Chassis)</u>
J1-K	J2-K
J1-L	J2-L
J1-N	J2-N
J1-P	J2-P
J1-R	J2-R
J1-S	J2-S
J1-G	J2-G
J1-H	J2-H
J1-M	J2-M
J1-V	J2-V
J1-W	J2-W
J1-X	J2-X

5.3 Dielectric Strength:

Using a megohm bridge, apply a test potential of 375 ± 10 VDC for a period of 5.0(+0.0, -0.5) seconds, between all pins of J1 tied together and to chassis ground. Rate of voltage application shall not exceed 100 volts per second. Current leakage shall be less than 2 milliamperes (in accordance with MIL-STD-202, Method 301).

IL-6227-801
Page 8

5.4 Vibration:

5.4.1 Sinusoidal Resonance Search

- 5.4.1.1 Prior to the start of the resonance search and after the specimen has been mounted to the vibration fixture, an initial Functional and Dielectric Strength Test shall be conducted as specified in Paragraphs 5.2 and 5.3.
- 5.4.1.2 A resonance search shall be conducted in each of the three orthogonal axes (Ref. Figure 3) in accordance with the requirements of MC999-0050C, Paragraph 4.8.2.1, except for the following:
- Frequency Range: 10 cps to 2000 cps, 2(+0,-1) g
Sweep Rate: 10(+1,-0) minutes per axis
- 5.4.1.3 Response accelerometers shall be used. The location and number shall be determined prior to the test by Apollo CSM Dynamics, Department 099-220.
- 5.4.1.4 All response accelerometers and the control accelerometer shall be FM tape recorded and plotted on Form 2974 log paper and properly identified.
- 5.4.1.5 A functional test shall be conducted as specified in Paragraph 5.2, following completion of the resonance search.

5.4.2 Random Vibration

- 5.4.2.1 Two levels of random vibration spectrum levels shall be applied to the specimen in each of the three orthogonal axes. (See Figure 3)

Level A - Duration is 2.5(+0.25, -0) minutes
20 to 80 cps - 3 db/octave linear
increase to 0.067 g^2/cps

80 to 2000 cps - Constant at 0.067 g^2/cps

Level B - Duration is 12.5(+1.0, -0) minutes
20 to 80 cps - 3 db/octave linear
increase to 0.003 g^2/cps

80 to 2000 cps - Constant at 0.003 g^2/cps

NOTE: The durations shown do not include equalization time which shall be conducted prior to the start of the "X" axis and one of the two remaining axes.

IL-6227-801

Page 9

5.4.2.2 During the above vibration tests, the circuits listed in Figure 2A shall be energized and monitored for discontinuities greater than 70 microseconds. If discontinuity occurs an oscilloscope shall be connected in the circuit and discontinuity duration shall be noted and recorded.

5.4.2.3 A functional test shall be conducted as specified in Paragraph 5.2, following final random vibration exposure in each level. However, the final functional test may be performed after the test specimen is mounted in the salt spray chamber.

5.5 Corrosive Contaminants, Oxygen-Humidity:

5.5.1 Salt Spray

5.5.1.1 The test specimen shall be placed into a salt spray cabinet in a position which simulates spacecraft installation. (See Figure 3)

5.5.1.2 Prior to the salt spray application, and after installation into the chamber, the specimen shall be subjected to the functional tests specified in Paragraph 5.2.

5.5.1.3 The salt spray application shall be in accordance with Method 509, Procedure I, of MIL-STD-810, with the following exceptions:

(a) The salt solution shall be 1 percent by weight.

(b) The test duration shall be 1 hour.

(c) Cabinet conditions shall be ambient.

5.5.1.4 Subsequent to the salt spray exposure, while the specimen is still installed in the chamber, conduct the functional test as specified in Paragraph 5.2.

5.5.1.5 Visual examination shall be performed on the external surfaces of the specimen after the unit has been removed from the salt spray cabinet. All deterioration or corrosion shall be recorded.

5.5.1.6 No attempt shall be made to clean the test specimen and care shall be exercised to prevent salt residue from being removed from the specimen during handling.

5.5.2 Oxygen - Humidity

- 5.5.2.1 The test specimen shall be transferred from the salt spray cabinet to an oxygen - humidity chamber within one hour after completion of the Salt Spray test. The specimen shall be installed in the manner described in Paragraph 5.3.1.1.
- 5.5.2.2 Prior to pressure evacuation, the functional test of Paragraph 5.2 shall be performed.
- 5.5.2.3 The test chamber shall be evacuated to a pressure of 20 mm Hg at ambient temperature conditions and back filled with commercial oxygen(95±5 percent) until the chamber pressure increases to 5.0±0.2 psia.
- Chamber temperature shall be 125±5F.
- These conditions shall be maintained for a period of 12 hours.
- 5.5.2.4 Following the 12-hour exposure, perform the functional test as specified in Paragraph 5.2.
- 5.5.2.5 Maintain the oxygen environment at 5.0±0.2 psia and introduce sufficient moisture to obtain a relative humidity of 95±5 percent, with distilled water having a pH factor of 6.5 to 7.5. Chamber temperature shall be maintained at 74±10F.
- 5.5.2.6 After the conditions of the above have been verified, the chamber temperature, pressure, and humidity shall be varied as follows:

- | | |
|-------------------|--|
| (a) Temperature | - Increase to 125(+5, -15)F
in 2 hours ±15 minutes |
| Pressure | - 5.0±0.5 psia |
| Relative Humidity | - 95(+5, -15 percent) |
| Oxygen | - 95(+5, -15 percent) |
| (b) Temperature | - Maintained at 125(+5, -15F)
for 6 hours ±15 minutes |
| Pressure | - 5±0.2 psia |
| Relative Humidity | - 95±5 percent |
| Oxygen | - 95±5 percent |

IL-6227-801

Page 11

5.5.2.6 (Cont'd.)

- | | |
|-------------------|---|
| (c) Temperature | - Decrease to $60 \pm 10^{\circ}\text{F}$ in
10 hours ± 15 minutes |
| Pressure | - 5.0 ± 0.5 psia |
| Relative Humidity | - $95(+5, -15)$ percent |
| Oxygen | - $95(+5, -15)$ percent |
| (d) Temperature | - Maintained at $60 \pm 10^{\circ}\text{F}$
for 6 hours ± 15 minutes |
| Pressure | - 5.0 ± 0.2 psia |
| Relative Humidity | - 95 ± 5 percent |
| Oxygen | - 95 ± 5 percent |

5.5.2.7 Steps (a) through (d) above, constitute one 24-hour cycle, and shall be repeated continuously for a total of four cycles.

5.5.2.8 After the fourth cycle, the chamber temperature shall remain at $60 \pm 10^{\circ}\text{F}$ until the total test time of 120 hours minimum is accumulated. During this period, the pressure shall be 5.0 ± 0.2 psia, the relative humidity 95 ± 5 percent, and the oxygen at 95 ± 5 percent.

5.5.2.9 The functional tests of Paragraph 5.2 shall be conducted throughout the 120-hour exposure at the following intervals: 6, 22, 30, 46, 54, 70, 78, 94, 102, and 118 ± 1 hours.

5.5.2.10 Following the oxygen - humidity test, after the chamber has returned to room ambient condition (temperature and pressure), and while the specimen is still in the chamber, perform the functional test of Paragraph 5.2. (The chamber door may be open during this functional test.)

5.5.2.11 Visual examination shall be performed on the external surfaces of the test specimen after the unit has been removed from the chamber. All deterioration or corrosion shall be recorded.

5.6 High/Low Temperature - Life:

- 5.6.1 The test specimen shall be mounted in a high/low temperature chamber, and no attempt shall be made to clean the test specimen. The position of the specimen shall be as noted in Paragraph 5.3.1.1. (See Figure 3)
- 5.6.2 Prior to lowering the temperature, perform the functional test of Paragraph 5.2 and the Dielectric Strength test of Paragraph 5.3, except the applied voltage shall be 280 ± 5 VDC.
- 5.6.3 Perform the High/Low Temperature Test for fourteen days, as follows:

<u>Temperature</u>	<u>Duration/Delta Change</u>	<u>Functional</u>
1. Ambient to $40 \pm 5F$	5F/minute maximum	
2. $40 \pm 5F$	96 \pm 1 hour	Every 24 hours per Paragraph 5.2*
3. $40 \pm 5F$ to $125 \pm 5F$	5F/minute maximum	
4. $125 \pm 5F$	240 \pm 1 hour	Every 24 hours per Paragraph 5.2*
5. $125 \pm 5F$ to $200 \pm 5F$	5F/minute maximum	
6. $200 \pm 5F$	30 \pm 30 minutes 5	Functional and Dielectric Strength when stabilized per Paragraph 5.6.2
7. $200 \pm 5F$ to Ambient	5F/minute maximum	
8. Ambient	2 hours	Functional and Dielectric Strength after 2 hours per Paragraph 5.6.2.
9. Ambient to $-20 \pm 5F$	5F/minute maximum	
10. $-20 \pm 5F$	24 \pm 1 hour	No Functional
11. $-20 \pm 5F$ to Ambient	5F/minute maximum	
12. Ambient	2 hours	Functional and Dielectric Strength after 2 hours per Paragraph 5.6.2.

* During the last functional, perform a dielectric strength test as described in Paragraph 5.6.2.

∅ 5.7 Vacuum:

5.7.1 The test specimen shall be mounted in a vacuum chamber; perform a functional test as specified in Paragraph 5.2 while the chamber is at room ambient condition. (Install T/C as shown in Figure 3)

5.7.2 Perform the vacuum test at a pressure of 1×10^{-4} mm Hg maximum with a specimen case temperature as follows:

<u>Temperature</u>	<u>Duration/Delta Change</u>	<u>Functional</u>
1. Ambient to $40 \pm 5F$	5F/minute maximum	After stabilizing, perform functional at 2, 24, and 40 hours
2. $40 \pm 5F$	50 ± 5 hours	
3. $40 \pm 5F$ to $135 \pm 10F$	5F/minute maximum	After stabilizing, perform functional at 2, 24, and 40
4. $135 \pm 10F$	50 ± 5 hours	
5. $135 \pm 10F$ to Ambient	5F/minute maximum	Stabilize and perform a functional test.
6. Ambient	1 hour	

5.7.3 All filter circuits shall be continuously energized with an AC current of 110 ± 10 milliamperes at 26 ± 0.26 VRMS, 800 cycles connected through a suitable load resistor. Current through each circuit shall be measured before and after each of the above functional tests. (See Figure 5)

∅ 5.8 Acceleration:

5.8.1 The assembly shall be subjected to an acceleration test by applying 20 ± 1 g's for 5 ± 1 minutes in each direction of three mutually perpendicular axes, as indicated by Figure 3.

5.8.2 Monitor for discontinuity during the acceleration test per Paragraph 5.4.2.2.

5.8.3 Prior to acceleration test, after the assembly has been mounted on the fixture, perform a functional test per Paragraph 5.2, and subsequent to the completion of the acceleration exposure, perform the functional and dielectric strength tests per Paragraph 5.6.2.

5.9 Mechanical Shock:

5.9.1 The test specimen shall be subjected to a terminal peak sawtooth pulse in both directions of the three orthogonal axes (see Figure 3) for a total of six shocks. The total pulse duration shall be 10 to 15 milliseconds, including a decay time no greater than 10 percent of the total duration.

5.9.2 Magnitudes and directions of shock shall be as follows:

Magnitude	Axis
20g	-X
35g	+Y, -Y
78g	+X, +Z, -Z

5.9.3 During the above shock test, the circuits listed in Figure 2A shall be energized and monitored for discontinuities greater than 70 microseconds.

6.0 STEP-BY-STEP PROCEDURE

6.1 Pre-Test Functions:

6.1.1 Specimen Acceptance (5.1) (_____ hrs. _____ 1968)

6.1.2 Functional Test (5.2) (_____ hrs. _____ 1968)

6.1.2.1 The specimen shall be mounted to the vibration test fixture.

6.1.2.2 Connect the specimen to the test equipment using Figure 4.1 (Functional Tests). (P5 and P6 to J3 and J4)

6.1.2.3 Insulation Resistance (Paragraph 5.2.1, Ref. Figure 1A).

6.1.2.3.1 Connect positive lead of megohm bridge to TPI and negative lead to chassis ground.

6.1.2.3.2 Adjust megohm bridge for 200±10 VDC.

6.1.2.3.3 Conduct the Insulation Resistance Test of Paragraph 6.1.1 by moving Switch S30 from Position 1 through 23, allowing 30 seconds minimum stabilization for each step.

IL-6227-801
Page 15

- 6.1.2.3.4 Connect positive lead of megohmmeter to TP3 and repeat Paragraph 6.1.2.3.3.
- 6.1.2.3.5 Connect positive lead of megohmmeter to TP5 and move Switch S31 from Position 1 through 3, allowing 30 seconds minimum stabilization for each step.
- 6.1.2.3.6 Disconnect megohmmeter.
- 6.1.2.4 Continuity: (5.2.2)
 - 6.1.2.4.1 Connect an ohmmeter across TP1 and TP2.
 - 6.1.2.4.2 Conduct the continuity test by moving Switch S30 from Positions 1 through 23, allowing sufficient time between switch movement for meter stabilization.
 - 6.1.2.4.3 Connect the ohmmeter across TP3 and TP4 and repeat Paragraph 6.1.2.4.2.
 - 6.1.2.4.4 Connect the ohmmeter across TP5 and TP6 and move Switch S31 from Position 1 through 3.
 - 6.1.2.4.5 Disconnect ohmmeter.
- 6.1.2.5 Capacitance Test: (5.2.3)
 - 6.1.2.5.1 Connect the negative lead of an impedance bridge to the chassis ground and the positive lead to TP1.
 - 6.1.2.5.2 Measure capacitance by placing Switch S30 to the following positions: 4, 6, 7, 8, 9, 22, and 23.
 - 6.1.2.5.3 Connect the positive lead of the impedance bridge to TP2 and placing S30 to the following positions: 4, 6, 7, 8, 9, 22, 23.
 - 6.1.2.5.4 Connect the positive lead of the impedance bridge to TP3 and measure capacitance by placing Switch S30 to the following positions: 3, 6, 13, 14, and 15.

IL 6227-801

Page 16

6.1.2.5.5 Connect the positive lead to TP4 and measure capacitance by placing Switch S30 to the following positions: 3, 6, 13, 14, and 15.

6.1.2.5.6 Disconnect the impedance bridge.

6.1.3 Dielectric Strength (5.3) (_____ hrs. _____ 1968)

6.1.3.1 Connect the specimen to the test equipment using Figure 4.2. (Dielectric Strength Test) harness (P5 and P6 to J5 and J6).

6.1.3.2 Attach positive lead of megohm bridge to TP7 and the negative lead to chassis ground.

6.1.3.3 Adjust for a test potential of 375 ± 10 VDC and record meter reading.

6.2 Vibration: (5.2)

6.2.1 Resonance Search axis (_____ hrs. _____ 1968).

Conduct per Paragraph 5.4.1.

6.2.2 Resonance Search axis (_____ hrs. _____ 1968).

Conduct per Paragraph 5.4.1.

6.2.3 Resonance Search axis (_____ hrs. _____ 1968).

Conduct per Paragraph 5.4.1.

6.2.4 Post-Test Functional (_____ hrs. _____ 1968).

Repeat Paragraph 6.1.2, except IR voltage is 100 ± 10 VDC.

6.2.5 Remove test harness (Figure 4.2).

6.2.6 Connect the test specimen to the chatter detection equipment (Reference Figure 4.3) utilizing the test harness P1 and P2.

6.2.7 Random Vibration, Levels A & B, axis (_____ hrs. _____ 1968).

6.2.7.1 Turn on power supply and set at 28.5 ± 1.5 VDC.

6.2.7.2 Turn on S1 through S20 (Figures 2(A) and 2(B) ref.)

NOTE: Load currents are set at 100 ma and can be verified by rotating S21 from Position 1 through 6 and opening the proper switch, as described below:

6.2.7.2 (Cont'd.)

<u>Switch</u>	<u>Position</u>	<u>Open Switch</u>	<u>Read Current</u>
S21	1	S15	100 ma
S21	2	S16	
S21	3	S17	
S21	4	S18	
S21	5	S19	
S21	6	S20	100 ma

Upon completion of load current verification, verify S15 through S20 are in the ON position and S21 is OFF. (See Figure 2).

6.2.7.3 Hook up DCN chatter checkers. (See Figure 2).

Verify chatter checkers are operational and set at 70 ± 7 microseconds. Operation of the chatter checkers can be verified by opening Switches S15 through S20.

6.2.7.4 Verify S15 through S20 ON - Reset chatter checkers.

6.2.7.5 Start Random Vibration.

6.2.8 Random Vibration, Levels A & B, axis (____ hrs. _____ 1968).

Repeat Paragraphs 6.2.7.1 through 6.2.7.5.

6.2.9 Random Vibration, Levels A & B, axis (____ hrs. _____ 1968).

6.2.9.1 Repeat Paragraphs 6.2.7.1 through 6.2.7.5.

6.2.9.2 Remove chatter checker hookup and test harness.

6.2.10 Post-Test Functional (____ hrs. _____ 1968).

Repeat Paragraph 6.1.2 (except IR voltage is 100 ± 10 VDC and resistance shall be 90 megohms minimum).

6.3 COOH (5.5):

6.3.1 Pre-Test Functional (____ hrs. _____ 1968).

Repeat Paragraph 6.1.2 (except IR voltage is 100 ± 10 VDC and resistance shall be 90 megohms minimum) after installation of specimen in the salt spray cabinet.

6.3.2 Salt Spray (5.5.1) (____ hrs. _____ 1968).

6.3.3 Post-Test Functional (____ hrs. _____ 1968).

Repeat Paragraph 6.1.2 (except IR voltage is 100 ± 10 VDC and resistance shall be 10 megohms minimum) with specimen still in the salt spray cabinet.

IL-6227-801

Page 18

6.3.4 Visual Examination (____ hrs. _____ 1968).

Visually examine the specimen following removal from the salt spray cabinet. Note condition in Laboratory Notebook.

6.3.5 Pre-Oxygen-Humidity Functional (____ hrs. _____ 1968).

Repeat Paragraph 6.1.2 (except IR voltage is 100+10 VDC and resistance shall be 10 megohms minimum) after installation of specimen in the oxygen-humidity chamber (within 1 hour after 6.3.4).

6.3.6 Twelve-Hour Dry Oxygen (5.5.2)

6.3.6.1 Start (____ hrs. _____ 1968).

6.3.6.2 Stop (____ hrs. _____ 1968).

6.3.7 Post-Oxygen Functional (____ hrs. _____ 1968).

Repeat Paragraph 6.1.2 (except IR voltage is 100+10 VDC and resistance shall be 10 megohms minimum).

6.3.8 Oxygen-Humidity (24 Hours)

6.3.8.1 Time zero (____ hrs. _____ 1968).

Temperature increased to 125F in two hours.

6.3.8.2 Time plus 6 hours (____ hrs. _____ 1968).

Repeat Paragraph 6.1.2 (except IR voltage is 100+10 VDC and resistance shall be 10 megohms minimum).

6.3.8.3 Time plus 22 hours (____ hrs. _____ 1968).

Repeat Paragraph 6.1.2 (except IR voltage is 100+10 VDC and resistance shall be 10 megohms minimum).

6.3.8.4 Time plus 30 hours (____ hrs. _____ 1968).

Repeat Paragraph 6.1.2 (except IR voltage is 100+10 VDC and resistance shall be 10 megohms minimum).

6.3.8.5 Time plus 46 hours (____ hrs. _____ 1968).

Repeat Paragraph 6.1.2 (except IR voltage is 100+10 VDC and resistance shall be 10 megohms minimum).

IL 6227-801
Page 19

6.3.8.6 Time plus 54 hours (____ hrs. _____ 1968).

Repeat Paragraph 6.1.2 (except IR voltage is 100+10 VDC and resistance shall be 10 megohms minimum).

6.3.8.7 Time plus 70 hours (____ hrs. _____ 1968).

Repeat Paragraph 6.1.2 (except IR voltage is 100+10 VDC and resistance shall be 10 megohms minimum).

6.3.8.8 Time plus 78 hours (____ hrs. _____ 1968).

Repeat Paragraph 6.1.2 (except IR voltage is 100+10 VDC and resistance shall be 10 megohms minimum).

6.3.8.9 Time plus 94 hours (____ hrs. _____ 1968).

Repeat Paragraph 6.1.2 (except IR voltage is 100+10 VDC and resistance shall be 10 megohms minimum).

6.3.8.10 Time plus 102 hours (____ hrs. _____ 1968).

Repeat Paragraph 6.1.2 (except IR voltage is 100+10 VDC and resistance shall be 10 megohms minimum).

6.3.8.11 Time plus 118 hours (____ hrs. _____ 1968).

Repeat Paragraph 6.1.2 (except IR voltage is 100+10 VDC and resistance shall be 10 megohms minimum).

6.3.9 Post Oxygen-Humidity Functional

After chamber has returned to room ambient temperature, repeat Paragraph 6.1.2 (except IR voltage is 100+10 VDC and resistance reading shall be 10 megohms minimum).

6.3.10 Visual Examination (____ hrs. _____ 1968).

Visually examine the test specimen following removal from the chamber. Note condition in Laboratory Notebook.

6.4 High/Low Temperature - Life (5.6):

6.4.1 Pre-Test Functional (____ hrs. _____ 1968).

Repeat Paragraph 6.1.2 (except IR voltage is 100+10 VDC and resistance shall be 90 megohms minimum) after installation of the specimen in the chamber.

6.4.2 Dielectric Strength (____ hrs. _____ 1968).

Repeat paragraph 6.1.3 except the applied voltage shall be 280±5 VDC.

6.4.3 Fourteen Day High/Low Temperature as follows:

6.4.3.1 40°F for 96 hours.

6.4.3.1.1 T + 24 hours - Functional per paragraph 6.1.2 (____ hrs. _____ 1968).

6.4.3.1.2 T + 48 hours - Functional per paragraph 6.1.2 (____ hrs. _____ 1968).

6.4.3.1.3 T + 72 hours - Functional per paragraph 6.1.2 (____ hrs. _____ 1968).

6.4.3.1.4 T + 96 hours - Functional per paragraph 6.1.2 (____ hrs. _____ 1968).

Dielectric Strength per paragraph 6.1.3 except applied voltage shall be 280±5 VDC.

6.4.3.2 125°F for 240 hours.

6.4.3.2.1 T + 24 hours - Functional per paragraph 6.1.2 (____ hrs. _____ 1968).

6.4.3.2.2 T + 48 hours - Functional per paragraph 6.1.2 (____ hrs. _____ 1968).

6.4.3.2.3 T + 72 hours - Functional per paragraph 6.1.2 (____ hrs. _____ 1968).

6.4.3.2.4 T + 96 hours - Functional per paragraph 6.1.2 (____ hrs. _____ 1968).

6.4.3.2.5 T + 120 hours - Functional per paragraph 6.1.2 (____ hrs. _____ 1968).

6.4.3.2.6 T + 144 hours - Functional per paragraph 6.1.2 (____ hrs. _____ 1968).

6.4.3.2.7 T + 168 hours - Functional per paragraph 6.1.2 (____ hrs. _____ 1968).

6.4.3.2.8 T + 192 hours - Functional per paragraph 6.1.2 (____ hrs. _____ 1968).

IL 6227-801
Page 21

6.4.3.2.9 T + 216 hours - Functional per paragraph
6.1.2 (___ hrs. _____ 1968).

6.4.3.2.10 T + 240 hours - Functional per paragraph
6.1.2 (___ hrs. _____ 1968).

Dielectric Strength per paragraph 6.1.3
except the applied voltage shall be
280±5 VDC.

6.4.3.3 125F to 200F, 30 minutes (___ hrs. _____ 1968).

6.4.3.3.1 After 15 minute stabilization - Functional
test per paragraph 6.1.2.

6.4.3.3.2 Perform a Dielectric Strength test per
paragraph 6.1.3, except the applied
voltage shall be 280±5 VDC.

6.4.3.4 200F to ambient (___ hrs. _____ 1968).

6.4.3.4.1 After 2 hours minimum stabilization, at
room ambient, Functional test per para-
graph 6.1.2.

6.4.3.4.2 Perform a Dielectric Strength test per
paragraph 6.1.3, except the applied
voltage shall be 280±5 VDC.

∅ 6.4.3.5 Ambient to -20°F (___ hrs. _____ 1968). Soak for
24 hours. No Functional.

∅ 6.4.3.6 -20F to ambient (___ hrs. _____ 1968).

6.4.3.6.1 After 2 hours minimum stabilization at
room ambient, Functional test per para-
graph 6.1.2.

6.4.3.6.2 Perform a Dielectric Strength test per
paragraph 6.1.3, except the applied
voltage shall be 280±5 VDC.

∅ 6.5 VACUUM (5.7)

6.5.1 Pretest Functional (___ hrs. _____ 1968).

6.5.2 40F -- Vacuum test (50 hours)

Connect specimen to electrical setup as shown in Figure 5.
Apply 26±0.26 V(rms) and monitor for 110±10 milliamps throughout
the 50-hour test phase. (Figure 5)

- 6.5.2.1 Start Vacuum test, time zero (____ hrs. _____ 1968).
- 6.5.2.2 T + 2 hours - Functional test per paragraph 6.1.2 (____ hrs. _____ 1968).
- 6.5.2.3 T + 24 hours - Functional test per paragraph 6.1.2 (____ hrs. _____ 1968) and record ampere reading.
- 6.5.2.4 T + 48 hours - Functional test per paragraph 6.1.2 (____ hrs. _____ 1968) and record ampere reading.

6.5.3 135F - Vacuum test (50 hours)

Specimen to be monitored for 110+10 milliamps throughout the 50-hour test phase, as shown in Figure 5.

- 6.5.3.1 Start 135F - Vacuum test, time zero (____ hrs. _____ 1968).
- 6.5.3.2 T + 2 hours - Functional test per paragraph 6.1.2 (____ hrs. _____ 1968).
- 6.5.3.3 T + 24 hours - Functional test per paragraph 6.1.2 (____ hrs. _____ 1968) and record ampere reading.
- 6.5.3.4 T + 48 hours - Functional test per paragraph 6.1.2 (____ hrs. _____ 1968) and record ampere reading.

6.5.4 135F to ambient (5F/minute) (____ hrs. _____ 1968).

- 6.5.4.1 After a one-hour ambient stabilization Functional test per paragraph 6.1.2.
- 6.5.4.2 Perform Functional test per paragraph 6.1.2 and Dielectric Strength test per paragraph 6.1.3.

Ø 6.6 ACCELERATION (5.8)

6.6.1 Pre test operation (____ hrs. _____ 1968).

- 6.6.1.1 Install the test specimen on the fixture and connect specimen to electrical setup as shown in Figure 4.1 utilizing the Functional test harness.
- 6.6.1.2 Perform the Functional test of paragraph 6.1.2.

- 6.6.1.3 Disconnect the functional test harness from the test specimen and connect the specimen to the chatter detector panel (Figure 4.3) utilizing the test harness connector P1 and P2.
- 6.6.1.4 Repeat paragraphs 6.2.7.1 through 6.2.7.4.
- 6.6.2.1 20g acceleration + x axis (___ hrs. ___ 1968).
- 6.6.2.2 20g acceleration - x axis (___ hrs. ___ 1968).
- 6.6.2.3 20g acceleration + y axis (___ hrs. ___ 1968).
- 6.6.2.4 20g acceleration - y axis (___ hrs. ___ 1968).
- 6.6.2.5 20g acceleration + z axis (___ hrs. ___ 1968).
- 6.6.2.6 20g acceleration - z axis (___ hrs. ___ 1968).
- 6.6.3 Disconnect chatter monitor harness and connect the specimen per Figure 4.1.
 - 6.6.3.1 Perform the Functional test of paragraph 6.1.2.
 - 6.6.3.2 Repeat Dielectric Strength test of paragraph 6.1.3 except the applied voltage shall be 280+5 VDC.

6.7 SHOCK (5.9)

- 6.7.1 Pre Test Operation (___ hrs. ___ 1968).
 - 6.7.1.1 After installation of the test specimen to the test fixture perform the Functional test of paragraph 6.1.2.
 - 6.7.1.2 Remove Test Harness (Figure 4.1).
 - 6.7.1.3 Connect the test specimen to the chatter detector panel (Figure 4.3) utilizing the test harness connectors P1 and P2.
 - 6.7.1.4 Repeat paragraphs 6.2.7.1 through 6.2.7.4.
- 6.7.2 20g Shock Test "-X" Axis (___ hrs. ___ 1968).
- 6.7.3 35g Shock Test "+Y" Axis (___ hrs. ___ 1968).

6.7.4 35g Shock Test "-Y" Axis (____ hrs. _____ 1968).

6.7.5 78g Shock Test "+X" Axis (____ hrs. _____ 1968).

6.7.6 78g Shock Test "+Z" Axis (____ hrs. _____ 1968).

6.7.7 78g Shock Test "-Z" Axis (____ hrs. _____ 1968).

6.7.7.1 Repeat Functional test of paragraph 6.1.2.

6.7.7.2 Repeat Dielectric Strength test of paragraph 6.1.2.

6.7.7.3 These tests for engineering information only.

6.8 POST QUALIFICATION TEST EXAMINATION (____ hrs. _____ 1968).

∅

6.8.1 Visually examine the test specimen and note condition as compared with initial pre-test examination (internal and external).

6.8.2 End of test is accomplished by review of data with Apollo Engineering, who shall so state in the Engineering/Laboratory Notebook.

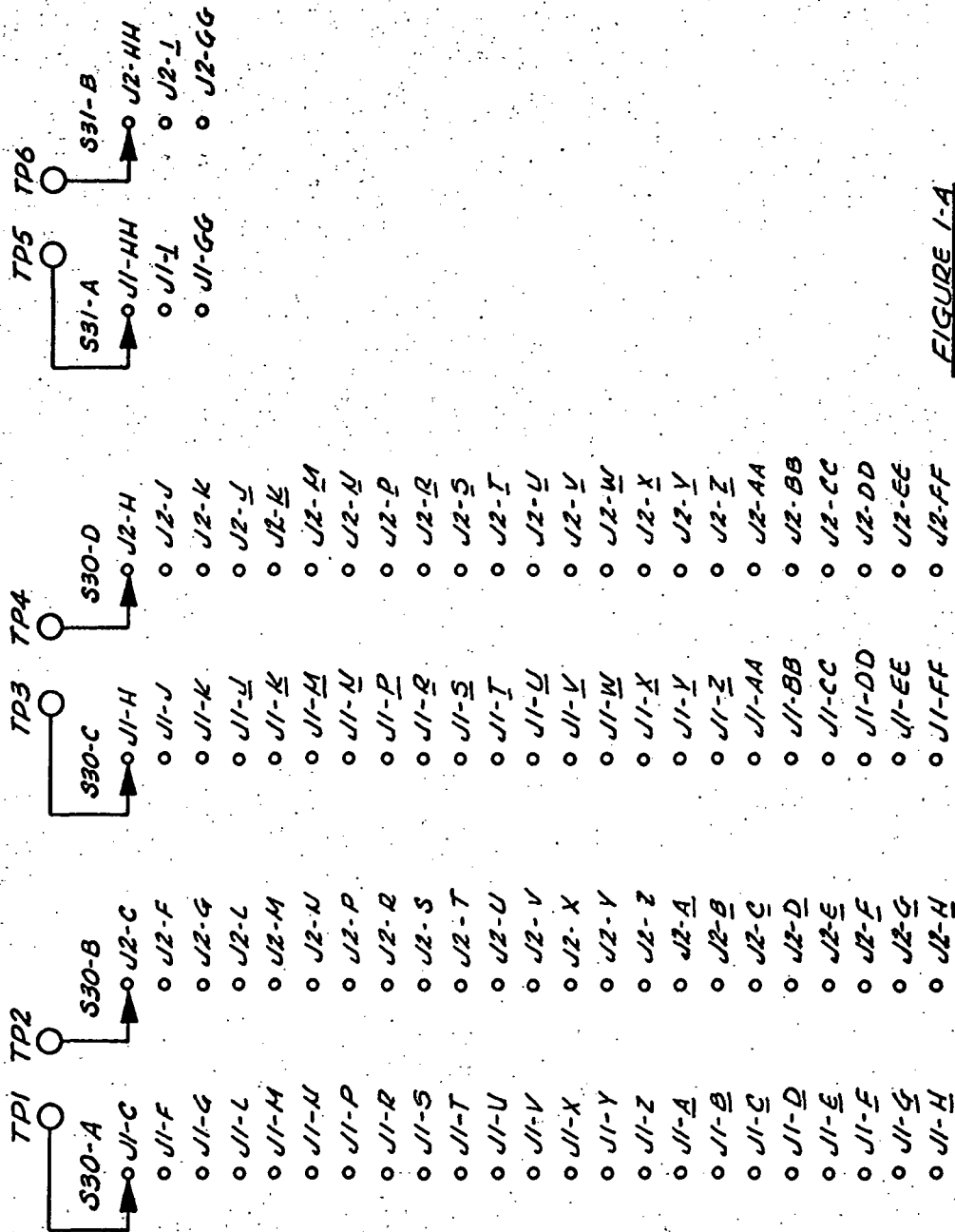

FIGURE 1-A
ELECTRICAL TEST SETUP
CONTINUITY & INSULATION RESIS.

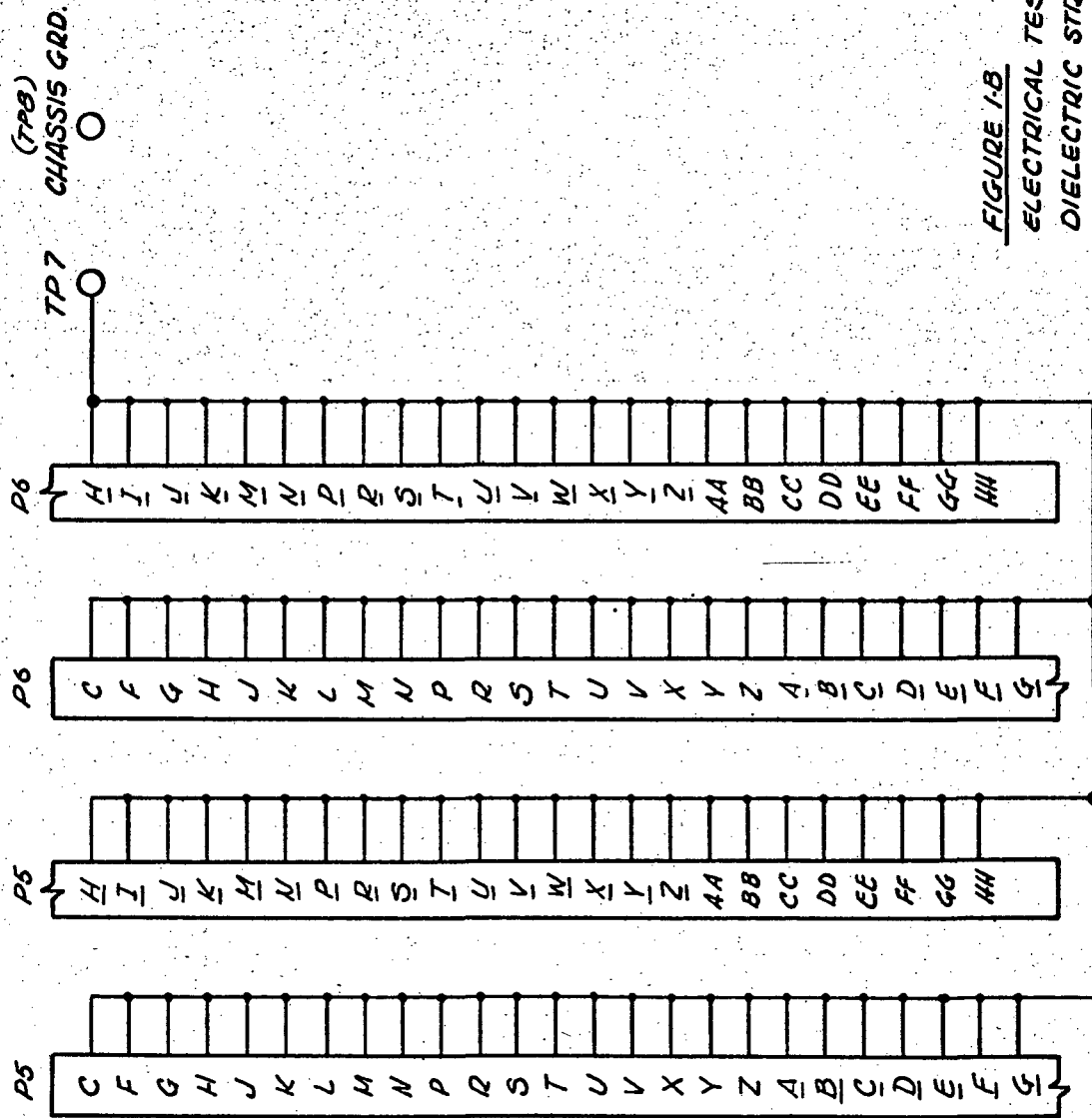

FIGURE 1.8
ELECTRICAL TEST SETUP
DIELECTRIC STRENGTH

IL-6227-801
Page 27

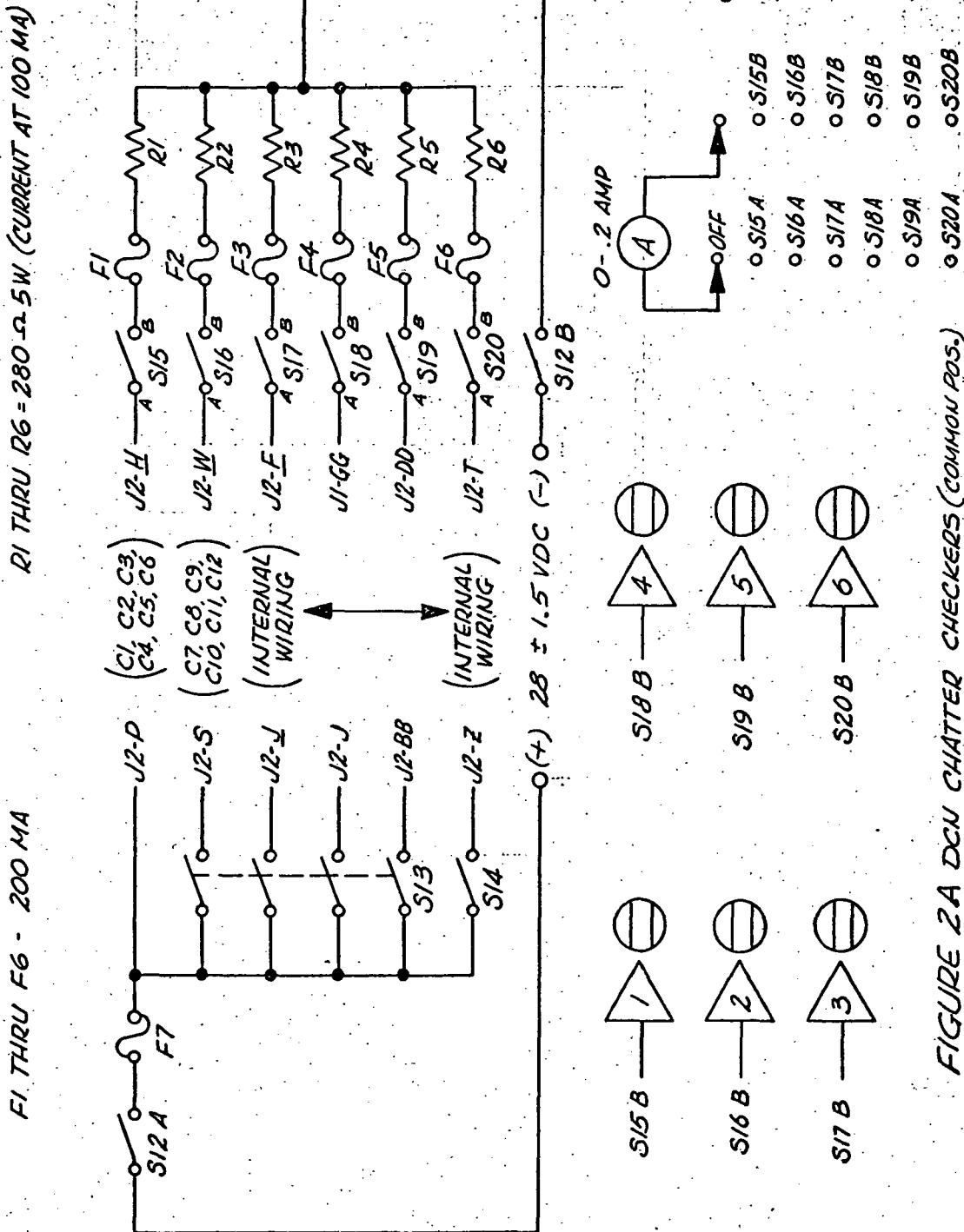

FIGURE 2A DCU CHATTER CHECKERS (COMMON POS.)

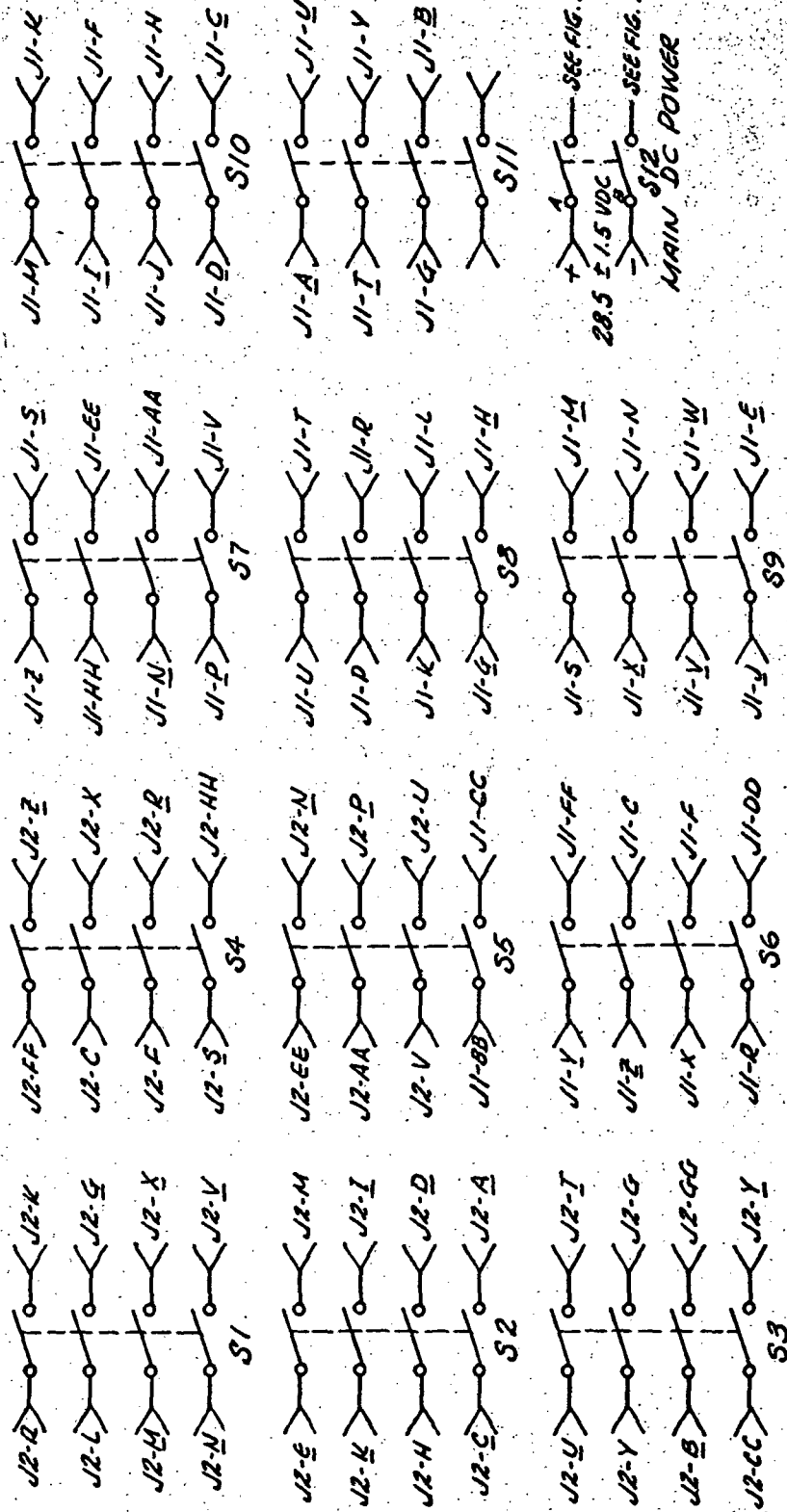

FIGURE 2 B CIRCUIT JUMPERS

IL-6227-801
Page 29

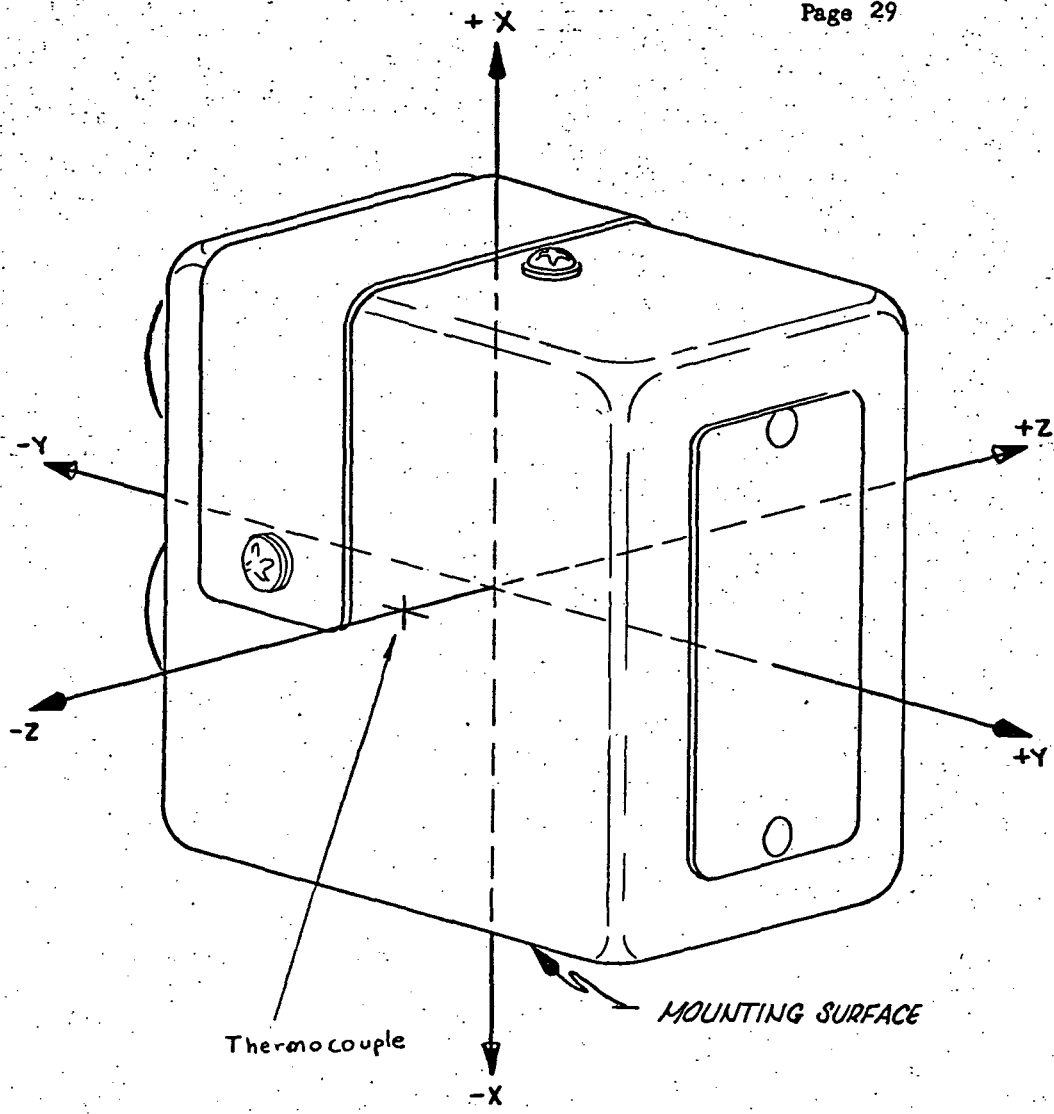

FIGURE 3. AXIS DEFINITION
(SPACECRAFT ORIENTED)

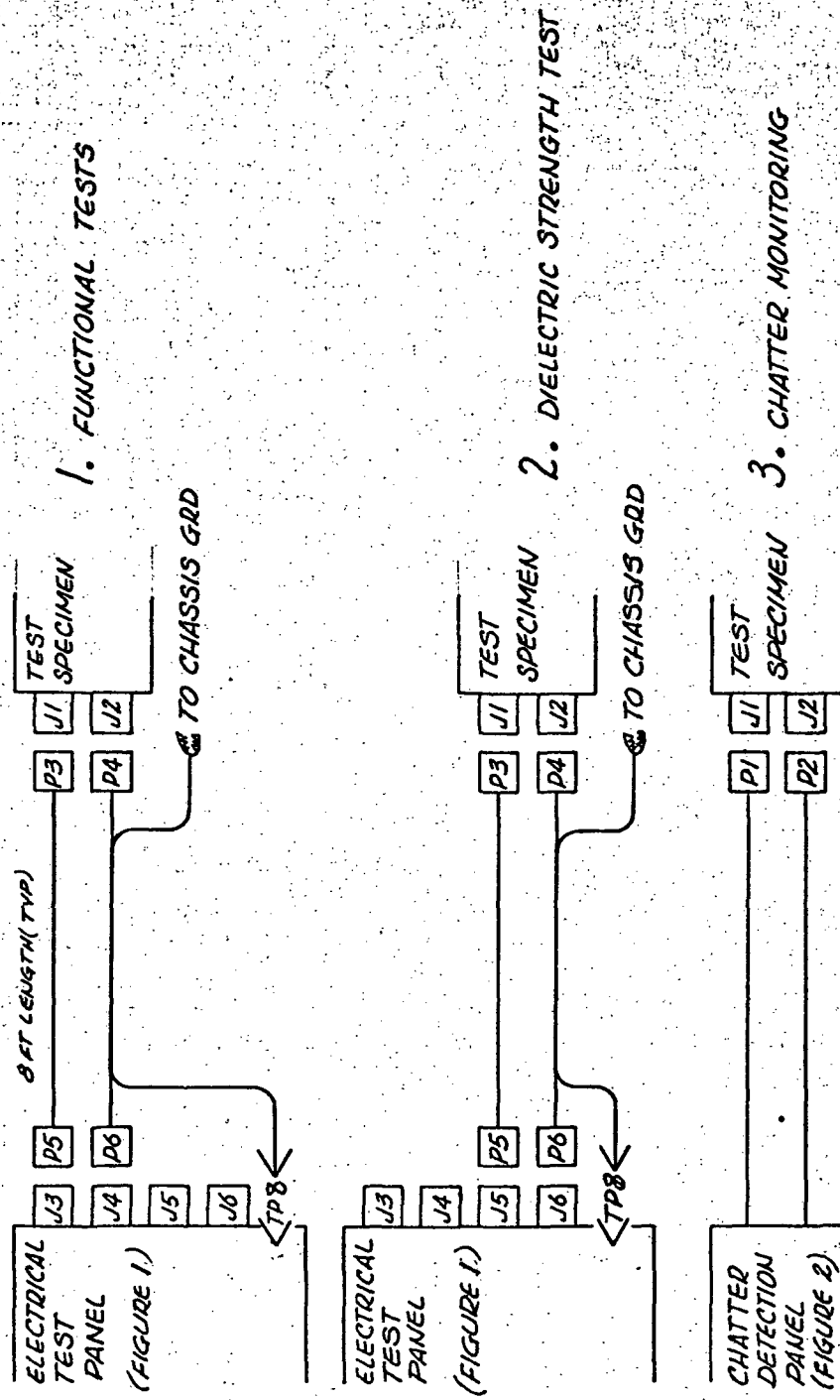

FIGURE 4. TEST HARNESSES & CONNECTOR HOOK-UP

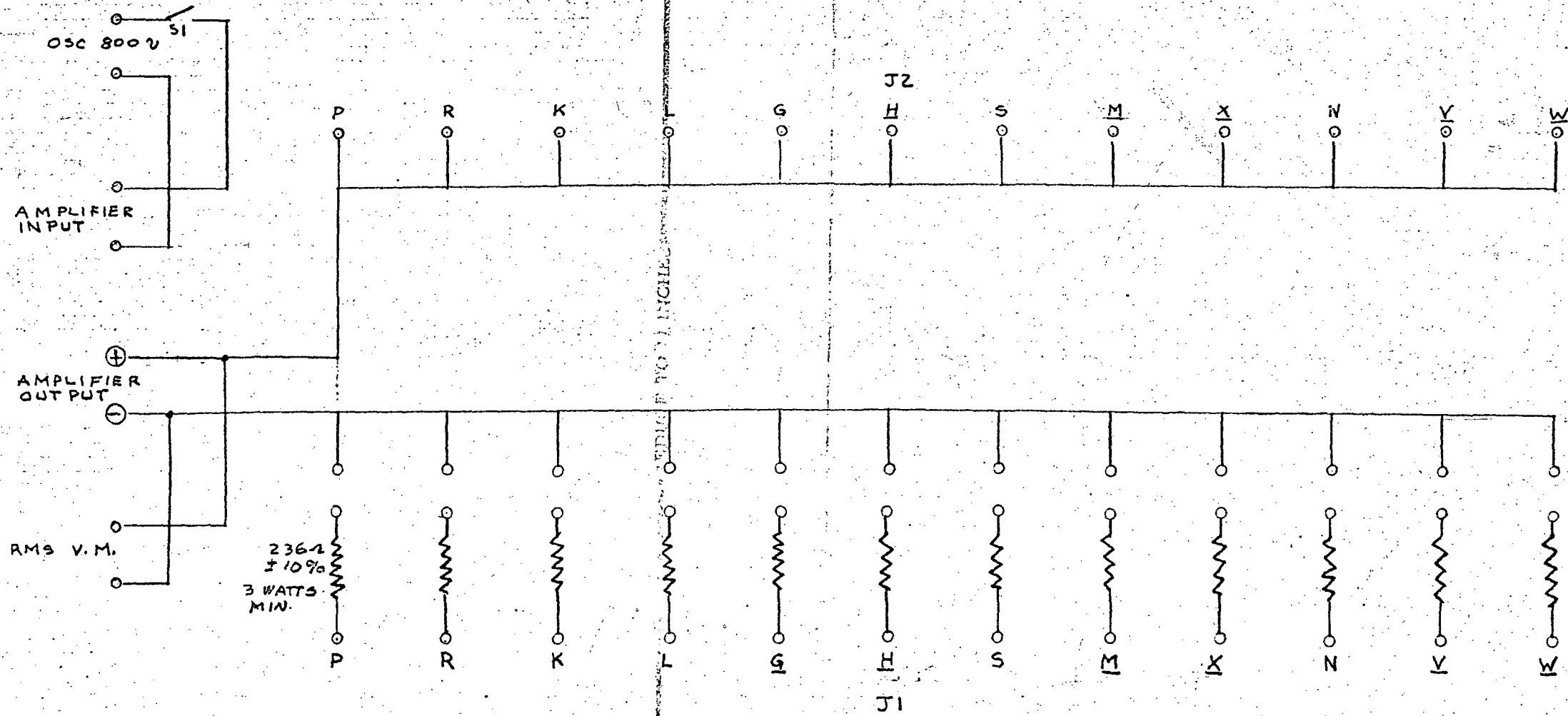
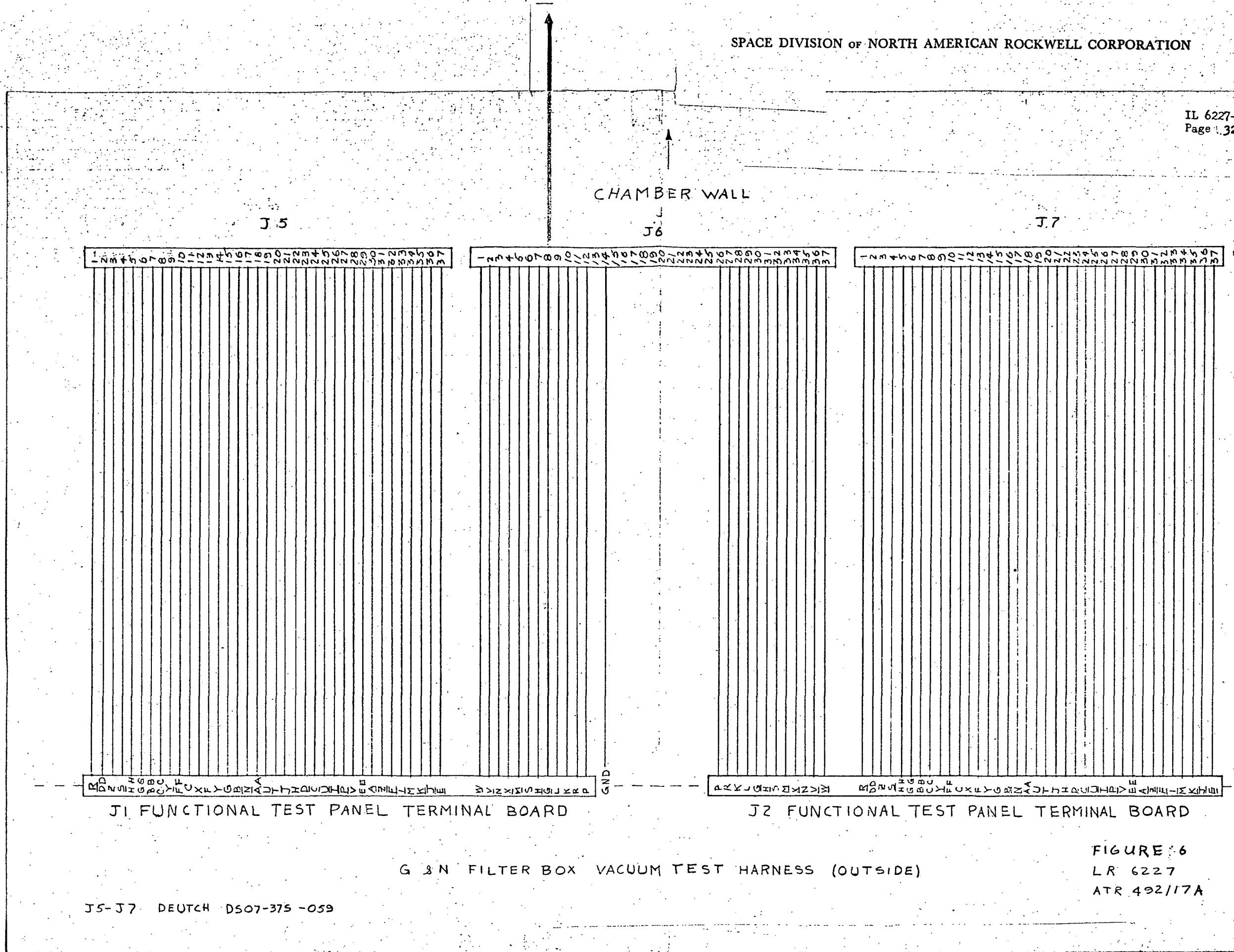

FIGURE 5
G & N FILTER BOX VACUUM TEST
AC LOAD PANEL
LR 6227
ATR 492117A



G & N FILTER BOX VACUUM TEST HARNESS (OUTSIDE)

FIGURE 6
LR 6227
ATR 492/17A

J5-J7 DEUTCH DS07-375-059

CHAMBER WALL

J1

J2

J3

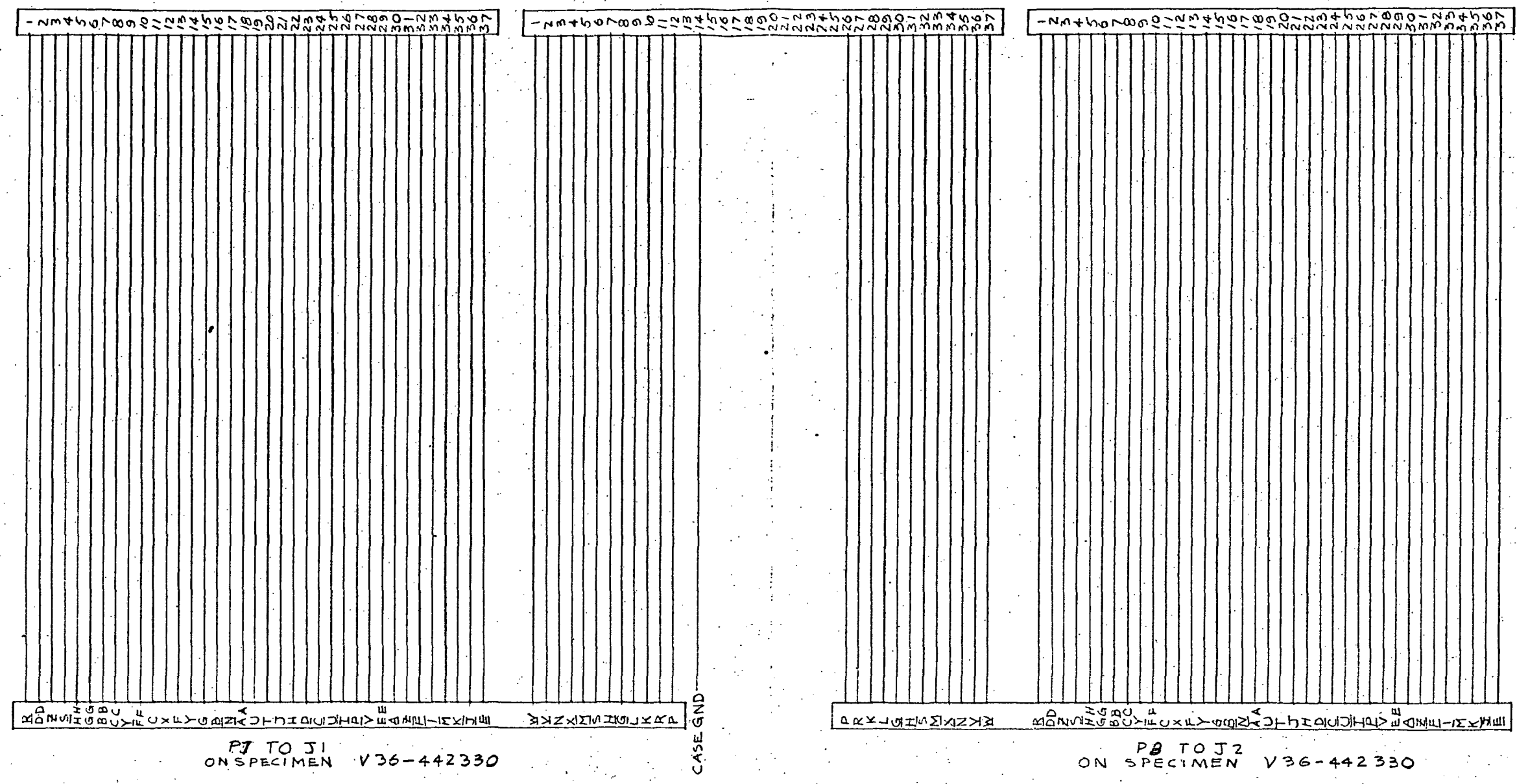

J1-J3 DEUTCH 13084-375-5020
P7 ME 414-0135-0021
P8 ME 414-0082-4335

G & N FILTER BOX VACUUM TEST HARNESS (INSIDE)

FIGURE 7
LR 6227
ATR 492117A

B-35, B-36

APPENDIX C
FUNCTIONAL

North American Aviation, Inc. 

N 1997-1

DIVISION SPACE DIVISION - DOWNEY, CALIFORNIA		
PROJECT NO: LR 6227	CONTRACT NO. ATR 492117	DATE 10 JULY 1968

QUALIFICATION TEST

GUIDANCE AND NAVIGATION FILTER BOX ASSEMBLY

V36-442330

SERIAL No. 06362AAH3858

APPLICABLE DOCUMENTS

ATR 492117 APOLLO TEST REQUEST - QUAL TEST FOR
 GEN FILTER BOX ASSEMBLY

IL-6227-801 LET TEST PROCEDURE

MAO203-0622 FUNCTIONAL TEST PROCEDURES FOR
 GEN FILTER BOX ASSY.

DE V36-444011 - ELECTRICAL SYSTEMS INSTALLATION ^{UE} DRAWING
V34-94 5072 - SCHEMATIC DIAGRAM
V36-442330 - BOX ASSEMBLY
EO 11672744 DE 

(CONT ON N 1997-3)

FORM 893-G REV. 7-68

INSTRUCTIONS

STATE OBJECT OF EXPERIMENT, TEST, DESIGN, OR INVENTION AND DESCRIBE IN SUFFICIENT DETAIL TO BE UNDERSTANDABLE AND REPRODUCIBLE BY ANOTHER ENGINEER. USE SKETCHES OR MAKE REFERENCE TO DRAWINGS OR PHOTOGRAPHS, IF ANY, BY NUMBER. ALL PAGES CONTAINING SUBJECT MATTER WHICH MAY BE INVENTIVE MUST BE WITNESSED.

SIGNATURE: R. G. Schrey 7-10 1968

WITNESSED AND UNDERSTOOD: R. Lytle 7-10 1968

North American Aviation, Inc. 

N 1997-3

DIVISION <i>SPACE (41)</i>		
PROJECT NO. <i>LR6227</i>	CONTRACT NO. <i>ATR 492117</i>	DATE <i>10 JULY 1968</i>

*GEN. FILTER BOX ASSY. PN V36-442330, SN 06362AAH3858
(CONT. FROM PAGE N1997-1)
(PAGE N1997-2 INDEX PAGE VOIDED) PWE/NAR
TEST SPECIMEN DELIVERY*

*LABORATORIES AND TEST, D/098-212, HAS RECEIVED
A GUIDANCE AND NAVIGATION FILTER BOX ASSEMBLY
FOR USE IN THE QUALIFICATION TEST PROGRAM OF
ATR 492117.  ATTACHED TO THE SPECIMEN WERE
THE FOLLOWING :*

902-W-1 TAG # MA 084304

*PN V36-442330
SN 06362AAH3858
ACCT NO. 3001 REC 00103
CONTR. 7494 DEPT. 668*

*PHYS. 7-10-68 (STAMPED NAR & NASA)
FUNCT. 7-4-68 (STAMPED NAR & NASA)*

EOS WORKED M672744 (7-7-68)

C-2

FORM 489-G REV. 7-66

INSTRUCTIONS

STATE OBJECT OF EXPERIMENT, TEST, DESIGN, OR INVENTION AND DESCRIBE IN SUFFICIENT DETAIL TO BE UNDERSTANDABLE AND REPRODUCIBLE BY ANOTHER ENGINEER. USE SKETCHES OR MAKE REFERENCE TO DRAWINGS OR PHOTOGRAPHS, IF ANY, BY NUMBER. ALL PAGES CONTAINING SUBJECT MATTER WHICH MAY BE INVENTIVE MUST BE WITNESSED.

SIGNATURE: *R. G. Schroyer* 7-10-68
WITNESSED AND UNDERSTOOD: *[Signature]* 7-10-68

North American Aviation, Inc. 

N 1997- 4

DIVISION SPACE (41)		
PROJECT NO: APOLLO LK6227	CONTRACT NO. ATR 492117	DATE 7-10-68

GEN FILTER BOX ASSEMBLY V36-442330, SN 06362AAH 3858

VISUAL EXAMINATION

THE TEST SPECIMEN APPEARS PHYSICALLY SOUND AND ACCEPTABLE FOR THE QUALIFICATION TEST OF ATR 492117.

OK TO START TEST

THE TEST SPECIMEN IS EQUAL TO THAT DEFINED IN THE APPROVED TEST REQUEST (ATR 492117) AND THE TEST SET UP IS ADEQUATE TO MEET THE REQUIREMENTS SPECIFIED.

SIGNED R. G. Schuyf 7-10-68
LET RESPONSIBLE TEST ENGINEER

CONCURRENCE L. S. Luera 695-412
10 July 1968
APOLLO ENGINEERING

CONCURRENCE R. Lyke 7-10-68 
PAR/SD INSPECTION

CONCURRENCE J. P. Johnson 7-10-68
NASA INSPECTION

(CONTINUED ON PAGE N1997-9)

INSTRUCTIONS

STATE OBJECT OF EXPERIMENT, TEST DESIGN, OR INVENTION AND DESCRIBE IN SUFFICIENT DETAIL TO BE UNDERSTANDABLE AND REPRODUCIBLE BY ANOTHER ENGINEER. USE SKETCHES OR MAKE REFERENCE TO DRAWINGS OR PHOTOGRAPHS, IF ANY, BY NUMBER. ALL PAGES CONTAINING SUBJECT MATTER WHICH MAY BE INVENTIVE MUST BE WITNESSED.

SIGNATURE: R. G. Schuyf 7-10-1968

WITNESSED AND UNDERSTOOD } R. Lyke 7-10-1968

FORM 105-G REV. 7-68

North American Aviation, Inc. 

N 1997-9

DIVISION <u>SPACE (41)</u>		
PROJECT NO: <u>LR 6227</u>	CONTRACT NO. 184 <u>ATR 4912 492117</u>	DATE <u>10 JULY 1968</u>

G & N FILTER BOX ASSEMBLY V36-442330 S/N 06362AAH3858
 PWE/MPR [CONT. FROM N 1997-40 - PGS. N1997-5 thru 8 Voided to permit recopy-
 ing F.T. data (on those pages) into a more clearer tabular format - see below]
 ALL PARAGRAPH NUMBERS REFERENCED ON SUBSEQUENT
 NOTEBOOK PAGES CORRESPOND TO THOSE IN THE STEP-BY-
 STEP PROCEDURES OF IC 6227-801 (PARA. 60)

6.1.2 FUNCTIONAL TESTS

6.1.2.3 INSULATION RESISTANCE

(TP1)	SW. - POS.	CONTACT	MEGOHM		SW. - POS.	CONTACT	MEGOHM	
	30-1	J1-C	∞		30-20	J1-E	∞	
	2	F	↑ ↓	(TP3) 30-1				
	3	G			2	J		
	4	L			3	K		
	5	M			4	J		
	6	N			5	K		
	7	P			6	M		
	8	R			7	N		
	9	S			8	P		
	10	T			9	R		
	11	U			10	S		
	12	V			11	T		
	13	X			12	U		
	14	Y			13	V		
	15	Z			14	W		
	16	A			15	X		
	17	B						
	18	C						
	19	D						

FORM 993-G REV. 7-68

INSTRUCTIONS
 STATE OBJECT OF EXPERIMENT, TEST, DESIGN, OR INVENTION AND DESCRIBE IN SUFFICIENT DETAIL TO BE UNDERSTANDABLE AND REPRODUCIBLE BY ANOTHER ENGINEER. USE SKETCHES OR MAKE REFERENCE TO DRAWINGS OR PHOTOGRAPHS, IF ANY, BY NUMBER. ALL PAGES CONTAINING SUBJECT MATTER WHICH MAY BE INVENTIVE MUST BE WITNESSED.

SIGNATURE: R.G. Schroyf 7-10 1968
 WITNESSED AND UNDERSTOOD } J. Ingram 7-11 1968

North American Aviation, Inc. 

N 1997-10

DIVISION

SPACE (41)

PROJECT NO:

A POLLO LR 6227

CONTRACT NO.

ATR 492117

DATE

10 JULY 1968

G & N FILTER BOX ASSY

6.1.2.3 INSULATION RESISTANCE (CONTINUED)

SW-POS	CONTACT	MEG OHMS	SW-POS	CONTACT	MEG OHMS
(TP3) 30-16	J1-Y	∞	(TP3) 30-22	J1-EE	∞
17	Z	↑ ↓	23	FF	↑ ↓
18	AA		(TP3) 31-1	HH	
19	BB		2	I	
20	CC		3	GG	
21	DD				

6.1.2.4 CONTINUITY

SW-POS.	FROM-TO	OHMS	SW-POS.	FROM-TO	OHMS
(TP1-2) 30-1	J1-C, J2-E =	.3	30-16	J1-A, J2-A	.4
2	F F	.3	17	B B	.4
3	G G	.3	18	C C	.4
4	L L	.3	19	D D	.4
5	M M	.3	20	E E	.4
6	N N	.3	21	E E	.4
7	P P	.3	22	G G	.4
8	R R	.3	23	H H	.4
9	S S	.3	(TP3-4) 30-1	J1-H, J2-H =	.38
10	T T	.3	2	J J	.38
11	U U	.4	3	K K	.38
12	V V	.4	4	J J	.38
13	X X	.4	5	K K	.4
14	Y Y	.3	6	M M	.4
15	Z Z	.4	7	N N	.4

INSTRUCTIONS

STATE OBJECT OF EXPERIMENT, TEST, DESIGN, OR INVENTION AND DESCRIBE IN SUFFICIENT DETAIL TO BE UNDERSTANDABLE AND REPRODUCIBLE BY ANOTHER ENGINEER. USE SKETCHES OR MAKE REFERENCE TO DRAWINGS OR PHOTOGRAPHS, IF ANY, BY NUMBER. ALL PAGES CONTAINING SUBJECT MATTER WHICH MAY BE INVENTIVE MUST BE WITNESSED.

SIGNATURE: R. G. Schreff 7-11 1968

WITNESSED AND UNDERSTOOD } J. Ingram 7-11 1968

FORM 493-G REV. 7-66

North American Aviation, Inc. 

N 1997-11

DIVISION SPACE (41)		
PROJECT NO. APOLLO LR 6227	CONTRACT NO. ATR 492117	DATE 10 JULY 1968

GEN FILTER BOX ASSY

6.1.3.4 CONTINUITY (CONTINUED)

SW-POS	FROM	TO	OHMS	SW-POS	FROM TO	OHMS
30-8	J1-P	J2-P	.4	30-18	J1-AA J2-AA	.4
9	R	R	.4	19	BB BB	.4
10	S	S	.4	20	CC CC	.4
11	T	T	.4	21	DD DD	.4
12	U	U	.4	22	EE EE	.4
13	V	V	.4	23	FF FF	.4
14	W	W	.4	(TP5-6) 31-1	HH HH	.4
15	X	X	.4	2	I I	.4
16	Y	Y	.4	3	GG GG	.4
17	Z	Z	.4			

6.1.3.5 CAPACITANCE TEST

SW-POS	CONTACT	PICOFARADS	SW-POS	CONTACT	PICOFARADS
(TP1) 30-4	J1-L	9500	30-22	J2-G	8000
6	N	8600	23	H	8300
7	P	8800	(TP3) 3	J1-K	8100
8	R	7600	6	M	8600
9	S	8800	13	V	8800
22	G	8100	14	W	7900
23	H	8400	15	X	8600
(TP2) 30-4	J2-L	9400	(TP4) 3	J2-K	8000
6	N	8500	6	M	8600
7	P	8700	13	V	8700
8	R	7500	14	W	7800
9	S	8700	15	X	8500

FORM ASS-G REV. 7-66

INSTRUCTIONS

STATE OBJECT OF EXPERIMENT TEST, DESIGN, OR INVENTION AND DESCRIBE IN SUFFICIENT DETAIL TO BE UNDERSTANDABLE AND REPRODUCIBLE BY ANOTHER ENGINEER. USE SKETCHES OR MAKE REFERENCE TO DRAWINGS OR PHOTOGRAPHS, IF ANY, BY NUMBER. ALL PAGES CONTAINING SUBJECT MATTER WHICH MAY BE INVENTIVE MUST BE WITNESSED.

SIGNATURE: R.G. Schrey 7-11 1968
 WITNESSED AND UNDERSTOOD } J.C. Ingram 7-11 1968

North American Aviation, Inc. 

N 1997-12

DIVISION

SPACE (41)

PROJECT NO:

LR 6227

CONTRACT NO.

ATR 492117

DATE

10 JULY 1968

GEN FILTER BOX ASSY

PARA. 6.1.3 DIELECTRIC STRENGTH

APPLIED 355 E 10 VRMS. CURRENT LEAKAGE
LESS THAN .01 MILLIAMPERES

11 JULY 1968

6.2.1 RESONANT SEARCH X AXIS (0040 HRS) RUN #1

6.2.2 RESONANT SEARCH Y AXIS (0110 HRS) RUN #2

6.2.3 RESONANT SEARCH Z AXIS (0137 HRS) RUN #3

6.2.4 POST-TEST FUNCTIONAL

INSULATION RESISTANCE, CONTINUITY AND CAPACITANCE
TEST CONDUCTED AS SPECIFIED. ALL READINGS
WERE WITHIN SPECIFIED LIMITS. VALUES HAVE BEEN
RECORDED ON A DATA SHEET AND VERIFIED BY
NIR INSPECTION. *

6.2.7 RANDOM VIBRATION, LEVEL I, Z AXIS (0435 HRS)

RUN #4 (EQUALIZATION) 6 SEC.

RUN #5 (EQUALIZATION) 5 SEC. (0503)

RUN #6 (EQUALIZATION) 5 SEC. (0530)

RUN #7 (RANDOM VIBR.) 2.5 MIN. (0623 HRS)

NO CONTACT DISCONTINUITIES OBSERVED

[* PG N6097-7 VOIDED (NO DATA ON PAGE) & OMITTED] ←

* PREVIOUSLY RECORDED FUNCTIONAL TEST DATA (LAB NOTE-
BOOK N1997 PAGES 9 THRU 11) INSULATION RESISTANCE,
CONTINUITY, AND CAPACITANCE AND ALL SUBSEQUENT
FUNCTIONAL DATA WILL BE RECORDED IN LAB NOTEBOOK PAGES 11 & 24.*

INSTRUCTIONS

STATE OBJECT OF EXPERIMENT, TEST, DESIGN, OR
INVENTION AND DESCRIBE IN SUFFICIENT DETAIL TO
BE UNDERSTANDABLE AND REPRODUCIBLE BY ANOTHER
ENGINEER. USE SKETCHES OR MAKE REFERENCE TO
DRAWINGS OR PHOTOGRAPHS, IF ANY, BY NUMBER. ALL
PAGES CONTAINING SUBJECT MATTER WHICH MAY BE IN-
VENTIVE MUST BE WITNESSED.

SIGNATURE:

R.G. Schrey 7-11 1968

WITNESSED
AND
UNDERSTOOD

J. Ingram 7-11 1968

FORM 483-G REV. 7-68

North American Aviation, Inc. 

N 1997-13

DIVISION SPACE (41)		
PROJECT NO. LR 6221	CONTRACT NO. ATR 492117	DATE 11 JULY 1968

GEN FILTER BOX ASSY

^{BPE} 6.2.8 RANDOM VIBRATION, LEVEL I, Y AXIS
 RUN #8 (EQUALIZATION) 5 SEC (0643)
 RUN #9 (EQUALIZATION) 5 SEC (0713)
 RUN #10 (RANDOM VIBR.) 2.5 MIN. (0758)
 NO DISCONTINUITIES OBSERVED

6.2.9 RANDOM VIBRATION, LEVEL I, X AXIS
 RUN #11 (EQUALIZATION) 7 SEC (0848)
 RUN #12 (EQUALIZATION) 6 SEC (1007)
 RUN #13 (RANDOM VIBRATION) 2.5 MIN (1050)
 NO DISCONTINUITIES OBSERVED

6.2.10 POST-LEVEL 1 VIBRATION FUNCTIONAL TEST (1300)

^{RLW} INSULATION RESISTANCE, CONTINUITY AND CAPACITANCE TEST CONDUCTED AS SPECIFIED. ALL READINGS WERE WITHIN THE SPECIFIED LIMITS. VALUES HAVE BEEN RECORDED ON A DATA SHEET AND VERIFIED BY N R INSPECTION.

^{9 PE} 6.2.11 RANDOM VIBRATION, LEVEL 2 - X AXIS
 RUN #14 (EQUALIZATION) 6 SEC 1320
 RUN #15 (EQUALIZATION) 6 SEC 1430
 RUN #16 (EQUALIZATION) 5 SEC 1503
 RUN #17 (RANDOM VIBR) 1.5 MIN. (1550)
 NO DISCONTINUITIES OBSERVED

FORM 193-G REV. 7-68

INSTRUCTIONS

STATE OBJECT OF EXPERIMENT, TEST, DESIGN, OR INVENTION AND DESCRIBE IN SUFFICIENT DETAIL TO BE UNDERSTANDABLE AND REPRODUCIBLE BY ANOTHER ENGINEER. USE SKETCHES OR MAKE REFERENCE TO DRAWINGS OR PHOTOGRAPHS, IF ANY, BY NUMBER. ALL PAGES CONTAINING SUBJECT MATTER WHICH MAY BE INVENTIVE MUST BE WITNESSED.

SIGNATURE: R. J. Pettit 7-11-1968
 WITNESSED AND UNDERSTOOD: J. A. Pettit 7-11-1968

North American Aviation, Inc. 

N 1997-14

DIVISION SPACE (41)		
PROJECT NO: LR 6227	CONTRACT NO: ATR 6227 492117	DATE 11 JULY 1968

GEN FILTER BOX ASSY

8 PE 
 6.2.12 RANDOM VIBRATION, LEVEL 2, Y AXIS
 RUN # 18 (EQUALIZATION) 6 SEC. (1500) ^{7 PE}
 RUN # 19 (RANDOM VIBR.) 12.5 MIN. (1550) ^{PE}
 NO DISCONTINUITIES OBSERVED.

7 PE 
 6.2.13 RANDOM VIBRATION, LEVEL 2, Z AXIS, ^{9 PE}
 RUN # 20 (EQUALIZATION) 8 SEC (1714)
 RUN # 21 (EQUALIZATION) 10 SEC (1950)
 RUN # 22 (RANDOM VIBR.) 12.5 MIN. (2127)
 NO DISCONTINUITIES OBSERVED

THE ABOVE VIBRATIONS TESTS HAVE BEEN CONDUCTED IN ACCORDANCE WITH THE REQUIREMENTS PRESCRIBED BY IL 6227-801 AND ATR 492117, FOR CONCURRING VIBRATION NOTES REFER TO THE DYNAMIC NOTEBOOK, PAGES N5778-16 THROUGH N5778-22 

END OF VIBRATION TEST

SIGNED: R. G. Schroy
 LET RESPONSIBLE TEST ENGINEER

CONCURRENCE: J. H. Petty 7-11-68 
 NR/SD INSPECTION

FORM 493-G REV. 7-66

INSTRUCTIONS

STATE OBJECT OF EXPERIMENT, TEST DESIGN, OR INVENTION AND DESCRIBE IN SUFFICIENT DETAIL TO BE UNDERSTANDABLE AND REPRODUCIBLE BY ANOTHER ENGINEER. USE SKETCHES OR MAKE REFERENCE TO DRAWINGS OR PHOTOGRAPHS, IF ANY, BY NUMBER. ALL PAGES CONTAINING SUBJECT MATTER WHICH MAY BE INVENTIVE MUST BE WITNESSED.

SIGNATURE: R. G. Schroy 7-11 19 68
 WITNESSED AND UNDERSTOOD } J. H. Petty 7-11  19 68

North American Aviation, Inc. 

N 1997-15

DIVISION SPACE (41)		
PROJECT NO: LR6227	CONTRACT NO. ATR 492117	DATE 11 JULY 1968

GEN FILTER BOX ASSY

ELECTRICAL EQUIPMENT USED DURING VIBRATION EFFORT

INSULATION RESISTANCE

MEGOHM BRIDGE, GENERAL RADIO - MOD. 1644-A, N 770971, CAL DUE 9-27-68

CONTINUITY

VOM, SIMPSON - MOD Z69AF, PN F322706, CAL. DUE 8-23-68

CAPACITANCE TEST

IMPEDENCE BRIDGE, GENL. RADIO - MOD. 1650-A, S009-492, CAL. DUE 10-10-68

CHATTER DETECTION

CHATTER DETECTOR, NR/SD - MOD DEN-6, SN4, CALIB. DUE 10-8-68

POWER SUPPLY, KEPCO ABC40-025M, S007978, CAL. DUE 8-13-68

FORM 492-G REV. 7-66

INSTRUCTIONS

STATE OBJECT OF EXPERIMENT, TEST, DESIGN, OR INVENTION AND DESCRIBE IN SUFFICIENT DETAIL TO BE UNDERSTANDABLE AND REPRODUCIBLE BY ANOTHER ENGINEER. USE SKETCHES OR MAKE REFERENCE TO DRAWINGS OR PHOTOGRAPHS, IF ANY, BY NUMBER. ALL PAGES CONTAINING SUBJECT MATTER WHICH MAY BE INVENTIVE MUST BE WITNESSED.

SIGNATURE: R.G. Schroy 7-11 1968
 WITNESSED AND UNDERSTOOD } R. Jurno 7-11 1968

North American Aviation, Inc. 

N 1997-16

DIVISION SPACE (41)		
PROJECT NO: APOLLO LR 6227	CONTRACT NO. ATR 492-117	DATE 11 JULY 1968

GEN FILTER BOX ASSY

6.3.1 PRE TEST FUNCTIONAL (SALT SPRAY)

INSULATION RESISTANCE, CONTINUITY AND CAPACITANCE TEST CONDUCTED AS SPECIFIED. ALL READINGS WERE WITHIN SPECIFIED LIMITS. VALUES HAVE BEEN RECORDED ON A DATA SHEET AND VERIFIED BY NR INSPECTION.  7-11-8

6.3.2 SALT SPRAY EXPOSURE STARTED, 2315 HRS

THE SALT SPRAY PORTION OF THE TEST PER PARA. 5.5.1 CONDUCTED IN ACCORDANCE WITH METHOD 509, PROCEDURE 1, OF MIL-STD-810. HAD A P.H. READING OF 6.6 AND A SPECIFIC GRAVITY READING OF 1.0053. TEC  7-11-8

6.3.3 POST TEST FUNCTIONAL (0015 HRS, 7-11)

INSULATION RESISTANCE, CONTINUITY AND CAPACITANCE TEST HAS BEEN CONDUCTED AS SPECIFIED. ALL READINGS WERE WITHIN SPECIFIED LIMITS. VALUES HAVE BEEN RECORDED AND VERIFIED BY NR INSPECTION  7-12-8

6.3.4 VISUAL EXAMINATION

NO VISUAL DAMAGE OR SALT DEPOSIT COLLECTIONS. UNIT DOES NOT EXHIBIT ANY GREAT MOISTURE CONDENSATION  7-12-8

FORM 488-G REV. 7-66

INSTRUCTIONS

STATE OBJECT OF EXPERIMENT, TEST, DESIGN, OR INVENTION AND DESCRIBE IN SUFFICIENT DETAIL TO BE UNDERSTANDABLE AND REPRODUCIBLE BY ANOTHER ENGINEER. USE SKETCHES OR MAKE REFERENCE TO DRAWINGS OR PHOTOGRAPHS, IF ANY, BY NUMBER. ALL PAGES CONTAINING SUBJECT MATTER WHICH MAY BE INVENTIVE MUST BE WITNESSED.

SIGNATURE: R.G. Schroyer 7-12 1968
 WITNESSED AND UNDERSTOOD: E. Hembel 7-12 1968

North American Aviation, Inc. 

N 1997-17

DIVISION

SPACE (A1)

PROJECT NO:

APOLLO

CONTRACT NO.

LR 6227 ATR 492 117

DATE

12 JULY 1968

GEN. FILTER BOX ASSEMBLY

TEST SPECIMEN TRANSFERRED TO OXYGEN HUMIDITY
AT 0045 HOURS.  7-12-68

6.3.5 PRETEST FUNCTIONAL (12-HR DRY OXYGEN)

INSULATION RESISTANCE, CONTINUITY AND CAPACITANCE
TEST HAS BEEN CONDUCTED AS SPECIFIED. ALL
READINGS WERE WITHIN SPECIFIED LIMITS. VALUES
HAVE BEEN RECORDED AND VERIFIED BY NR INSPECTION.

 7-12-68

6.3.6 12 HOUR DRY OXYGEN

START EVACUATION 0300 HRS

 7-12-68

OXYGEN SENSOR ON CHAMBER ISOLATED AND REPAIRED.

0700 START 12 HOUR DRY OXYGEN ENVIRONMENT.

6.3.7 POST-TEST FUNCTIONAL

INSULATION RESISTANCE, CONTINUITY AND
CAPACITANCE TEST HAS BEEN CONDUCTED AS
SPECIFIED. ALL READINGS WERE WITHIN SPECIFIED
LIMITS. VALUES HAVE BEEN RECORDED AND
VERIFIED BY NR INSPECTION.  7-12-68

FORM 199-0 REV. 7-60

INSTRUCTIONS

STATE OBJECT OF EXPERIMENT, TEST, DESIGN, OR
INVENTION AND DESCRIBE IN SUFFICIENT DETAIL TO
BE UNDERSTANDABLE AND REPRODUCIBLE BY ANOTHER
ENGINEER. USE SKETCHES OR MAKE REFERENCE TO
DRAWINGS OR PHOTOGRAPHS, IF ANY, BY NUMBER. ALL
PAGES CONTAINING SUBJECT MATTER WHICH MAY BE IN-
VENTIVE MUST BE WITNESSED.

SIGNATURE:

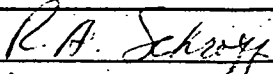
 7-12-68

WITNESSED
AND
UNDERSTOOD

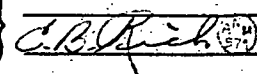
 7-12-68

North American Aviation, Inc. 

N 1997-18

DIVISION SPACE (41)		
PROJECT NO. LR 6227	CONTRACT NO. ATR 492117	DATE 13 JULY 1968

GN FILTER BOX ASSY

6.3.8.2 FUNCTIONAL TEST FOLLOWING 6 HOURS OF OXYGEN - HUMIDITY EXPOSURE

INSULATION RESISTANCE, CONTINUITY, AND CAPACITANCE TEST HAS BEEN CONDUCTED AS SPECIFIED. ALL READINGS WERE WITHIN SPECIFIED LIMITS. VALUES HAVE BEEN RECORDED ON DATA SHEETS AND VERIFIED BY NR INSPECTION.  7-13-68

6.3.8.3 FUNCTIONAL TEST FOLLOWING 22 HOURS OF OXYGEN - HUMIDITY EXPOSURE.

INSULATION RESISTANCE, CONTINUITY, AND CAPACITANCE TEST HAS BEEN CONDUCTED AS SPECIFIED. ALL READINGS WERE WITHIN SPECIFIED LIMITS. VALUES HAVE BEEN RECORDED ON DATA SHEETS AND VERIFIED BY NR INSPECTION.  7-13-68

6.3.8.4 FUNCTIONAL TEST FOLLOWING 30 HOURS OF OXYGEN - HUMIDITY EXPOSURE.

INSULATION RESISTANCE AT 100 VDC, CONTINUITY AND CAPACITANCE TEST HAS BEEN CONDUCTED AS SPECIFIED. ALL READINGS WERE WITHIN SPECIFIED LIMITS. VALUES HAVE BEEN RECORDED ON DATA SHEETS AND VERIFIED BY N. R. INSPECTION.  7-14-68

C-13

FORM 100-G REV. 7-68

INSTRUCTIONS

STATE OBJECT OF EXPERIMENT TEST DESIGN, OR INVENTION AND DESCRIBE IN SUFFICIENT DETAIL TO BE UNDERSTANDABLE AND REPRODUCIBLE BY ANOTHER ENGINEER. USE SKETCHES OR MAKE REFERENCE TO DRAWINGS OR PHOTOGRAPHS, IF ANY, BY NUMBER. ALL PAGES CONTAINING SUBJECT MATTER WHICH MAY BE INVENTIVE MUST BE WITNESSED.

SIGNATURE: R. H. G. Watt 7-14 1968
 WITNESSED AND UNDERSTOOD: E. Kernahek 7-14 1968

North American Aviation, Inc. 

N 1997-19

DIVISION SPACE (041)		
PROJECT NO: LR 6227	CONTRACT NO. ATR 492117	DATE 14 JULY 1968

GEN FILTER BOX ASSY.

6.3.8.5 FUNCTIONAL TEST FOLLOWING 46 HOURS OF OXYGEN - HUMIDITY EXPOSURE.

INSULATION RESISTANCE, CONTINUITY AND CAPACITANCE TEST HAS BEEN CONDUCTED AS SPECIFIED. ALL READINGS WERE WITHIN SPECIFIED LIMITS. VALUES HAVE BEEN RECORDED ON DATA SHEETS AND VERIFIED BY NR INSPECTION.

 7-14-68

6.3.8.6 FUNCTIONAL TEST FOLLOWING 54 HOURS OF OXYGEN - HUMIDITY EXPOSURE

INSULATION RESISTANCE AT 100 VDC, CONTINUITY AND CAPACITANCE TEST HAS BEEN CONDUCTED AS SPECIFIED. ALL READINGS WERE WITHIN SPECIFIED TOLERANCE. VALUES HAVE BEEN RECORDED ON DATA SHEETS AND VERIFIED BY N.R. INSPECTION  7-15-68 0300 TIME

6.3.8.7 FUNCTIONAL TEST FOLLOWING 70 HOURS OF OXYGEN - HUMIDITY EXPOSURE

INSULATION RESISTANCE, CONTINUITY AND CAPACITANCE TEST HAS BEEN CONDUCTED AS SPECIFIED. ALL READINGS WERE WITHIN SPECIFIED LIMITS. VALUES HAVE BEEN RECORDED ON DATA SHEETS AND VERIFIED BY NR INSPECTION.

 7-15-68

C-14

FORM 492-G REV. 7-68

INSTRUCTIONS

STATE OBJECT OF EXPERIMENT; TEST, DESIGN, OR INVENTION AND DESCRIBE IN SUFFICIENT DETAIL TO BE UNDERSTANDABLE AND REPRODUCIBLE BY ANOTHER ENGINEER. USE SKETCHES OR MAKE REFERENCE TO DRAWINGS OR PHOTOGRAPHS, IF ANY, BY NUMBER. ALL PAGES CONTAINING SUBJECT MATTER WHICH MAY BE INVENTIVE MUST BE WITNESSED.

SIGNATURE: R.G. Schuyler 7-15-68
 WITNESSED AND UNDERSTOOD: J. J. Remedios 7-15-68

North American Aviation, Inc. 

N 1997-20

DIVISION <u>SPACE (41)</u>		
PROJECT NO. <u>LR 6227</u>	CONTRACT NO. <u>ATR 992117</u>	DATE <u>16 JULY 1968</u>

GEN FILTER BOX ASSY.

6.3.8.8. FUNCTIONAL TEST FOLLOWING 678 HOURS OF OXYGEN-HUMIDITY EXPOSURE.

INSULATION RESISTANCE, CONTINUITY AND CAPACITANCE TEST HAS BEEN CONDUCTED AS SPECIFIED. ALL READINGS WERE WITHIN SPECIFIED LIMITS. VALUES HAVE BEEN RECORDED ON DATA SHEETS AND VERIFIED BY N.R. INSPECTION.

 7-16-68

6.3.8.9 FUNCTIONAL TEST FOLLOWING 94 HOURS OF OXYGEN-HUMIDITY EXPOSURE.

INSULATION RESISTANCE, CONTINUITY AND CAPACITANCE TEST HAS BEEN CONDUCTED AS SPECIFIED. ALL READINGS WERE WITHIN SPECIFIED LIMITS. VALUES HAVE BEEN RECORDED ON DATA SHEETS AND VERIFIED BY N.R. INSPECTION

 7-16-68

6.3.8.10 FUNCTIONAL TEST FOLLOWING 103 HOURS OF OXYGEN - HUMIDITY EXPOSURE

INSULATION RESISTANCE, CONTINUITY AND CAPACITANCE TEST HAS BEEN CONDUCTED AS SPECIFIED. ALL READINGS WERE WITHIN SPECIFIED LIMITS. VALUES HAVE BEEN RECORDED ON DATA SHEETS AND VERIFIED BY N.R. INSPECTION

 7-17-68

FORM 99-G REV. 7-66

INSTRUCTIONS

STATE OBJECT OF EXPERIMENT, TEST, DESIGN, OR INVENTION AND DESCRIBE IN SUFFICIENT DETAIL TO BE UNDERSTANDABLE AND REPRODUCIBLE BY ANOTHER ENGINEER. USE SKETCHES OR MAKE REFERENCE TO DRAWINGS OR PHOTOGRAPHS, IF ANY, BY NUMBER. ALL PAGES CONTAINING SUBJECT MATTER WHICH MAY BE INVENTIVE MUST BE WITNESSED.

SIGNATURE: R. G. Schuff 7-17-68
 WITNESSED AND UNDERSTOOD } J. Ingram 7-17-68

North American Aviation, Inc. 

N 1997-21

DIVISION SPACE (04D)		DATE 17 JULY 1968
PROJECT NO: APOLLO LR 6227	CONTRACT NO. ATR 492117	

GEN FILTER BOX ASSEMBLY

A DISPOSITION RECORD (DR 110403) HAS BEEN INITIATED BY NR INSPECTION FOLLOWING OVER-EXPOSURE DURING THE OXYGEN-HUMIDITY TEST. THE ATR REQUIREMENTS (TR 492117) AND THE IC TEST PLAN (IC 6227-801) STIPULATE THAT THE OXYGEN-HUMIDITY TEST SHALL CONSIST OF 4 CYCLES, EACH HAVING A DURATION OF 24 HOURS. AT THE COMPLETION OF THE REQUIRED TIME (96 HOURS) THE SPECIMEN WAS INADVERTENTLY ALLOWED TO CONTINUE WITH AN ADDITIONAL CYCLE INSTEAD OF MAINTAINING CONDITIONS WITH THE TEMPERATURE AT $60 \pm 10^\circ F$.

THE OVER-TEST HAS BEEN REVIEWED BY APOLLO ENGINEERING AND BY RELIABILITY PERSONNEL. THE CONDITIONS STATED ABOVE HAVE BEEN ACCEPTED AND THE DISPOSITION TO "CONTINUE WITH TEST" HAS BEEN MADE AS NO ANOMOLIES HAVE OCCURED.

6.3.8.11 FUNCTIONAL TEST FOLLOWING 118 HOURS OF OXYGEN-HUMIDITY EXPOSURE

INSULATION RESISTANCE, CONTINUITY AND CAPACITANCE TEST HAS BEEN CONDUCTED AS SPECIFIED. ALL READINGS WERE WITHIN SPECIFIED LIMITS. VALUES HAVE BEEN RECORDED ON DATA SHEETS AND VERIFIED BY NR INSPECTION

 7-17-68

(-10)

FORM 499-G REV. 7-66

INSTRUCTIONS

STATE OBJECT OF EXPERIMENT, TEST, DESIGN, OR INVENTION AND DESCRIBE IN SUFFICIENT DETAIL TO BE UNDERSTANDABLE AND REPRODUCIBLE BY ANOTHER ENGINEER. USE SKETCHES OR MAKE REFERENCE TO DRAWINGS OR PHOTOGRAPHS. IF ANY, BY NUMBER. ALL PAGES CONTAINING SUBJECT MATTER WHICH MAY BE INVENTIVE MUST BE WITNESSED.

SIGNATURE: R.A. Schroyer 7-17-68
 WITNESSED AND UNDERSTOOD: E. Hemachek 7-17-68

North American Aviation, Inc. 

N 1997-22

DIVISION SPACE (041)

PROJECT NO: APOLLO LR 6227

CONTRACT NO. ATR 492117

DATE 17 July 1968

GEN FILTER BOX ASSEMBLY

6.3.9 POST-OXYGEN-HUMIDITY TEST (AMBIENT CONDITIONS) FUNCTIONAL TEST

INSULATION RESISTANCE, CONTINUITY, AND CAPACITANCE TEST HAS BEEN CONDUCTED AS SPECIFIED. ALL READINGS WERE WITHIN SPECIFIED LIMITS. VALUES HAVE BEEN RECORDED ON DATA SHEETS AND VERIFIED BY NR INSPECTION.

THE PRECEDING COOH TESTS HAVE BEEN CONDUCTED IN ACCORDANCE WITH ATR492117 AND IL 6237-801 EXCEPT FOR THOSE CONDITIONS NOTED ON PAGE N1997-21. FOR CORRELATING NOTES DEDICTING CLIMATIC CONDITIONS REFER TO LAB NOTEBOOK PAGES N4694-29 THRU N4694-36

6.3.10 VISUAL EXAMINATION

NO SIGN OF CORROSION OR DETERIORATION. THERE IS SLIGHT EVIDENCE OF RUST FORMING ON THE MOUNTING PLATE. SOME SALT PARTICLES ARE IN EVIDENCE AROUND AND WITHIN THE TWO CONNECTORS.

THIS COMPLETES THE COOH REQUIREMENTS AND THE UNIT IS NOW ACCEPTABLE FOR HIGH/LOW TEMP.-LIFE

SIGNED: R.G. Schroyf 7-17-68 E. Hennesch
 CONCURRENCE NR INSPECTION

INSTRUCTIONS

STATE OBJECT OF EXPERIMENT, TEST, DESIGN, OR INVENTION AND DESCRIBE IN SUFFICIENT DETAIL TO BE UNDERSTANDABLE AND REPRODUCIBLE BY ANOTHER ENGINEER. USE SKETCHES OR MAKE REFERENCE TO DRAWINGS OR PHOTOGRAPHS, IF ANY, BY NUMBER. ALL PAGES CONTAINING SUBJECT MATTER WHICH MAY BE INVENTIVE MUST BE WITNESSED.

SIGNATURE: R.G. Schroyf 7-17-68

WITNESSED AND UNDERSTOOD E. Hennesch 7-17-68

ORM 485-G REV. 7-68

North American Aviation, Inc. 

N 1997-23

DIVISION <u>SPACE (09H)</u>	
PROJECT NO. <u>ATL 0 LR 0227</u>	CONTRACT NO. <u>ATK 492.117</u>
DATE <u>17 JULY 1968</u>	

GEN FILTER BOX ASSEMBLY

6.4.1 PRE-TEST FUNCTIONAL - HIGH/LOW TEMP. - LIFE (2300)

INSULATION RESISTANCE, CONTINUITY AND CAPACITANCE TEST CONDUCTED AS SPECIFIED. ALL READINGS WERE WITHIN SPECIFIED LIMITS. VALUES HAVE BEEN RECORDED ON DATA SHEETS AND VERIFIED BY NR INSPECTION. 7-17-68 

6.4.2 DIELECTRIC STRENGTH (2230)

APPLIED 280 IS VDC, CURRENT LEAKAGE LESS THAN 2 MILLIAMP 7-17-68 

6.4.3 14-DAY HIGH/LOW TEMP. - LIFE

TEST START: 2305 HRS 7-17-68 

6.4.3.1.1 FUNCTIONAL TEST FOLLOWING ELEVEN HOURS OF 40 DEGREE F

INSULATION RESISTANCE, CONTINUITY TESTS CONDUCTED AS SPECIFIED AND ALL READINGS WERE WITHIN LIMITS. THE CAPACITANCE TEST READINGS INDICATED 14 OF THE ~~23~~²⁴ MEASUREMENTS WERE OUT OF TOLERANCE. VALUES HAVE BEEN RECORDED FOR EACH MEASUREMENT AND VERIFIED BY NR INSPECTION.

CONTINUED ON PAGE N1997-23 ^{4 215} 

FORM 493-G REV. 7-66

INSTRUCTIONS
STATE OBJECT OF EXPERIMENT, TEST, DESIGN, OR INVENTION AND DESCRIBE IN SUFFICIENT DETAIL TO BE UNDERSTANDABLE AND REPRODUCIBLE BY ANOTHER ENGINEER. USE SKETCHES OR MAKE REFERENCE TO DRAWINGS OR PHOTOGRAPHS, IF ANY, BY NUMBER. ALL PAGES CONTAINING SUBJECT MATTER WHICH MAY BE INVENTIVE MUST BE WITNESSED.

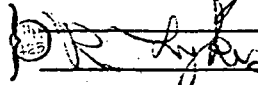
SIGNATURE: RA Schreyer 7-18-68
WITNESSED AND UNDERSTOOD:  7-18-68

North American Aviation, Inc. 

N 1997-24

DIVISION SPACE 41		
PROJECT NO: APOLLO LR 6227	CONTRACT NO. ATR 472117	DATE 18 JULY 1968

GEN FILTER BOX ASSEMBLY

AT 1352 THE TEMPERATURE CHAMBER BEGAN A 5°F PER MINUTE RETURN TO AMBIENT CONDITIONS. THE TEMPERATURE TEST HAS BEEN STOPPED DUE TO THE OUT-OF-TOLERANCE CAPACITANCE READINGS NOTED ON PAGE N1997-23.

DR A96675 HAS BEEN INITIATED AND APOLLO ENGINEERING AND RELIABILITY NOTIFIED.

THE TEST SETUP, MATING CONNECTORS HAVE BEEN REMOVED AND CLEANED AS DIRECTED BY DR A96675 AND SEALING PLUGS HAVE BEEN INSTALLED.

THE CAPACITANCE TEST WAS REPERN AS DIRECTED AND ALL READINGS WERE WITHIN THE SPECIFIED TOLERANCE. VALUES HAVE BEEN RECORDED ON A DATA SHEET AND VERIFIED BY NR INSPECTION.

THE OUT-OF-TOLERANCE CAPACITANCE MEASUREMENTS WERE ATTRIBUTED TO MOISTURE CONDENSATION WITHIN THE TEST EQUIPMENT CONNECTORS. A MORE POSITIVE GROUND STRAP HAS BEEN PROVIDED BY REPLACING THE ALLIGATOR CLIP WITH A TERMINAL LUG AND SECURING TO THE BOTTOM MOUNTING PLATE OF THE SPECIMEN.

C-19

FORM A03-G REV. 7-66

INSTRUCTIONS

STATE OBJECT OF EXPERIMENT, TEST, DESIGN, OR INVENTION AND DESCRIBE IN SUFFICIENT DETAIL TO BE UNDERSTANDABLE AND REPRODUCIBLE BY ANOTHER ENGINEER. USE SKETCHES OR MAKE REFERENCE TO DRAWINGS OR PHOTOGRAPHS, IF ANY, BY NUMBER. ALL PAGES CONTAINING SUBJECT MATTER WHICH MAY BE INVENTIVE MUST BE WITNESSED.

SIGNATURE: R.G. Schroy 7-18-1968
 WITNESSED AND UNDERSTOOD: R. Lyria 7-15-1968

C-19

North American Aviation, Inc. 

N 1997-25

DIVISION <u>SPACE (41)</u>		DATE <u>18 JULY 1968</u>	
PROJECT NO. <u>APOLLO LR 6227</u>	CONTRACT NO. <u>ATR 492117</u>		

GEN FILTER BOX ASSEMBLY

OK TO CONTINUE WITH HIGH/LOW TEMP. TEST
DR REQUIREMENTS HAVE BEEN SATISFIED

SIGNED: R.G. Schryff
LET RTC

CONCURRENCE R.M. Lykes 7/18/68 
NR INSPECTION

CONCURRENCE W.F. Klein 7/18/68
NASA

HIGH/LOW TEMP. TEST CONTINUED AT 1525 HOURS
(7-19-68)

6.4.3.1.1 FUNCTIONAL TEST RERUN, FOLLOWING APPROX.
(1500 HRS) 34 HOURS OF CONTINUOUS EXPOSURE.

INSULATION TEST AND CONTINUITY WERE TESTED
AS REQUIRED AND THE READINGS WHICH WERE
OBTAINED ARE WITHIN SPECIFIED LIMITS.
THE CAPACITANCE TEST WAS CONDUCTED AS
REQUIRED BUT 6 MEASUREMENT WERE BELOW
THE SPECIFIED LEVEL OF 5500 PICOFARADS.

MEASUREMENTS HAVE BEEN RECORDED ON A
DATA SHEET AND IDENTIFIED AS 6.4.3.1.1

FORM ASD-G REV. 7-66

INSTRUCTIONS

STATE OBJECT OF EXPERIMENT, TEST, DESIGN, OR INVENTION AND DESCRIBE IN SUFFICIENT DETAIL TO BE UNDERSTANDABLE AND REPRODUCIBLE BY ANOTHER ENGINEER. USE SKETCHES OR MAKE REFERENCE TO DRAWINGS OR PHOTOGRAPHS, IF ANY, BY NUMBER. ALL PAGES CONTAINING SUBJECT MATTER WHICH MAY BE INVENTIVE MUST BE WITNESSED.

SIGNATURE: R.G. Schryff 7-19-68

WITNESSED AND UNDERSTOOD } R.M. Lykes 7-19-68

North American Aviation, Inc. 

N 1997-26

DIVISION SPACE (41)		
PROJECT NO: APOLLO LR 6227	CONTRACT NO. ATR 992 117	DATE 19 JULY 1968

G&N FILTER BOX ASSEMBLY

DISPOSITION RECORD A 110406 HAS BEEN PREPARED BY NR INSPECTION TO RECORD THE OUT-OF-TOLERANCE CAPACITANCE READINGS NOTED ON PAGE N1997-25. APOLLO ENGINEERING, RELIABILITY AND NASA HAVE BEEN NOTIFIED.

ALTHOUGH THE OUT-OF-TOLERANCE READINGS CONSTITUTE A FAILURE, THE QUALIFICATION TEST REQUIREMENTS SHALL BE CONTINUED AS REQUIRED BY THE DR DISPOSITION

" CONTINUE TESTING - ANALYSIS TO BE CARRIED OUT AT COMPLETION OF TESTS AND RECORDING OF DATA "

SIGNED S.V. MCKEEVER, 695-412
W. JOHNSON, 695-115

OK TO CONTINUE TESTING

SIGNED R.G. Schroy 7-19-68
LET RESPONSIBLE TEST ENGR.

CONCURRENCE R. Lykes 7-19-68 
NR INSPECTION

FORM 892-B REV. 7-66

INSTRUCTIONS

STATE OBJECT OF EXPERIMENT, TEST, DESIGN, OR INVENTION AND DESCRIBE IN SUFFICIENT DETAIL TO BE UNDERSTANDABLE AND REPRODUCIBLE BY ANOTHER ENGINEER. USE SKETCHES OR MAKE REFERENCE TO DRAWINGS OR PHOTOGRAPHS, IF ANY, BY NUMBER. ALL PAGES CONTAINING SUBJECT MATTER WHICH MAY BE INVENTIVE MUST BE WITNESSED.

SIGNATURE: R.G. Schroy 7-19-68
WITNESSED AND UNDERSTOOD } R. Lykes 7-19-68

North American Aviation, Inc. 

N 1997-27

DIVISION SPACE (91)		DATE 20 JULY 1968
PROJECT NO: APOLLO LR 6227	CONTRACT NO. ATR 492117	

GEN FILTER BOX ASSEMBLY

6.4.3.1.2 FUNCTIONAL TEST FOLLOWING 48 HOURS OF TEMPERATURE EXPOSURE

THE INSULATION RESISTANCE, CONTINUITY AND CAPACITANCE TEST HAS BEEN CONDUCTED IN ACCORDANCE WITH THE TEST REQUIREMENTS. ALL MEASUREMENT READINGS HAVE BEEN RECORDED ON A DATA SHEET. ALL READINGS, EXCEPT FOR SEVEN CAPACITANCE TEST MEASUREMENTS, WERE WITHIN SPECIFIED LIMITS.

6.4.3.1.3 FUNCTIONAL TEST FOLLOWING ~~48~~ 72 HOURS OF TEMPERATURE EXPOSURE

THE CAPACITANCE, INSULATION RESISTANCE AND CONTINUITY TESTS HAVE BEEN CONDUCTED AS REQUIRED. ALL MEASUREMENTS HAVE BEEN RECORDED ON A DATA SHEET. ALL READINGS EXCEPT FOR SEVEN CAPACITANCE TEST MEASUREMENTS, WERE WITHIN SPECIFIED LIMITS.

FORM 493-G REV. 7-66

INSTRUCTIONS

STATE OBJECT OF EXPERIMENT, TEST, DESIGN, OR INVENTION AND DESCRIBE IN SUFFICIENT DETAIL TO BE UNDERSTANDABLE AND REPRODUCIBLE BY ANOTHER ENGINEER. USE SKETCHES OR MAKE REFERENCE TO DRAWINGS OR PHOTOGRAPHS, IF ANY, BY NUMBER. ALL PAGES CONTAINING SUBJECT MATTER WHICH MAY BE INVENTIVE MUST BE WITNESSED.

SIGNATURE: J.G. Schroy 7-21-68

WITNESSED AND UNDERSTOOD J. Hamaker 7/21 1968

North American Aviation, Inc. 

N 1997-28

DIVISION <i>SPACE</i>		
PROJECT NO. <i>CR 6227</i>	CONTRACT NO. <i>ATR 492117</i>	DATE <i>22 JULY 1968</i>

GEN FILTER BOX ASSEMBLY

6.4.3.1.4 FUNCTIONAL TEST FOLLOWING 96 HOURS OF TEMPERATURE (40°F)

THE INSULATION RESISTANCE, CONTINUITY AND CAPACITANCE TESTS HAVE BEEN CONDUCTED AS REQUIRED. ALL MEASUREMENTS HAVE BEEN RECORDED ON A DATA SHEET. ALL READINGS, EXCEPT FOR TWO CAPACITANCE TEST MEASUREMENTS, WERE WITHIN SPECIFIED LIMITS.

A DIELECTRIC STRENGTH TEST WAS CONDUCTED BY APPLYING 280 ± 5 VDC. NO DIELECTRIC BREAKDOWN, ARCHING OR CURRENT LEAKAGE IN EXCESS OF 2 MILLIAMPS.

AM 7-2268

6.4.3.2.1 FUNCTIONAL TEST FOLLOWING 34 HOURS OF 125°F

INSULATION RESISTANCE, CONTINUITY AND CAPACITANCE TESTS HAVE BEEN CONDUCTED AS SPECIFIED. ALL READINGS WERE WITHIN SPECIFIED LIMITS. VALUES HAVE BEEN RECORDED AND VERIFIED BY NIR/INSPECTION.

CONT N-1997-29 C 3

AM 7-2268

FORM 483-G REV. 7-66

INSTRUCTIONS
STATE OBJECT OF EXPERIMENT, TEST, DESIGN, OR INVENTION AND DESCRIBE IN SUFFICIENT DETAIL TO BE UNDERSTANDABLE AND REPRODUCIBLE BY ANOTHER ENGINEER. USE SKETCHES OR MAKE REFERENCE TO DRAWINGS OR PHOTOGRAPHS, IF ANY, BY NUMBER. ALL PAGES CONTAINING SUBJECT MATTER WHICH MAY BE INVENTIVE MUST BE WITNESSED.

SIGNATURE: *R.G. Schroyer* 723 68
 WITNESSED AND UNDERSTOOD } *[Signature]* 723 68

North American Aviation, Inc. 

N 1997-29

DIVISION SPACE (A1)		
PROJECT NO. LR 6227	CONTRACT NO. ATR 492117	DATE 24 JULY 1968

GEN FILTER BOX ASSEMBLY

6.4.3.2.2 FUNCTIONAL TEST FOLLOWING 48 HOURS OF 125°F

INSULATION RESISTANCE, CONTINUITY AND CAPACITANCE TESTS HAVE BEEN CONDUCTED AS SPECIFIED. ALL READINGS WERE WITHIN SPECIFIED LIMITS. VALUES HAVE BEEN RECORDED ON A DATA SHEET AND VERIFIED BY NR INSPECTION  7-24-68

25 JULY 1968

6.4.3.2.3 FUNCTIONAL TEST FOLLOWING 72 HOURS OF 125°F

INSULATION RESISTANCE, CONTINUITY AND CAPACITANCE TESTS HAVE BEEN CONDUCTED AS REQUIRED. ALL READINGS WERE WITHIN SPECIFIED LIMITS. VALUES HAVE BEEN RECORDED ON A DATA SHEET AND VERIFIED BY INSPECTION.

7-25-68 

26 JULY 1968
6.4.3.2.4 FUNCTIONAL TEST FOLLOWING 96 HOURS OF 125°F

INSULATION RESISTANCE, CONTINUITY AND CAPACITANCE TESTS HAVE BEEN CONDUCTED AS REQUIRED. ALL THE READINGS WERE WITHIN SPECIFIED LIMITS. VALUES HAVE BEEN RECORDED ON A DATA SHEET AND VERIFIED BY INSPECTION

CONT N-1997-30

FORM 893-G REV. 7-68

INSTRUCTIONS

STATE OBJECT OF EXPERIMENT TEST, DESIGN, OR INVENTION AND DESCRIBE IN SUFFICIENT DETAIL TO BE UNDERSTANDABLE AND REPRODUCIBLE BY ANOTHER ENGINEER. USE SKETCHES OR MAKE REFERENCE TO DRAWINGS OR PHOTOGRAPHS, IF ANY, BY NUMBER. ALL PAGES CONTAINING SUBJECT MATTER WHICH MAY BE INVENTIVE MUST BE WITNESSED.

SIGNATURE: P. G. Smith 7-26-68
 WITNESSED AND UNDERSTOOD }  7-26-68
R. L. ... 7-26-68

North American Aviation, Inc. 

N 1997-30

DIVISION SPACE		
PROJECT NO. LR 6227	CONTRACT NO. ATR 492117	DATE 7-27-68

6.4.3.2.5 FUNCTIONAL TEST FOLLOWING 120 HOURS OF 125 ° F
INSULATION RESISTANCE, CONTINUITY AND CAPACITANCE TESTS HAVE BEEN CONDUCTED AS REQUIRED ALL READINGS WERE WITHIN SPECIFIED LIMITS. VALUES HAVE BEEN RECORDED ON A DATA SHEET AND VERIFIED BY INSPECTION.  7-27-68

6.4.3.2.6 FUNCTIONAL TEST FOLLOWING 144 HOURS OF 125 ° F
INSULATION RESISTANCE, CONTINUITY, AND CAPACITANCE TESTS HAVE BEEN CONDUCTED AS REQUIRED. ALL READINGS WERE WITHIN SPECIFIED LIMITS. VALUES HAVE BEEN RECORDED ON A DATA SHEET AND VERIFIED BY INSPECTION.  7-28-68

6.4.3.2.7 FUNCTIONAL TEST FOLLOWING 168 HOURS OF 125 ° F
INSULATION RESISTANCE, CONTINUITY AND CAPACITANCE TESTS HAVE BEEN CONDUCTED AS REQUIRED. ALL READINGS WERE WITHIN SPECIFIED LIMITS. VALUES HAVE BEEN RECORDED ON A DATA SHEET AND VERIFIED BY INSPECTION.  7-30-68

CONT N - 1997 - 31

FORM 489-G REV. 7-66

INSTRUCTIONS

STATE OBJECT OF EXPERIMENT, TEST, DESIGN, OR INVENTION AND DESCRIBE IN SUFFICIENT DETAIL TO BE UNDERSTANDABLE AND REPRODUCIBLE BY ANOTHER ENGINEER. USE SKETCHES OR MAKE REFERENCE TO DRAWINGS OR PHOTOGRAPHS, IF ANY, BY NUMBER. ALL PAGES CONTAINING SUBJECT MATTER WHICH MAY BE INVENTIVE MUST BE WITNESSED.

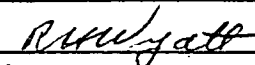
SIGNATURE:  7-29 1968

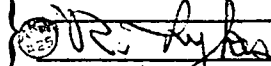
WITNESSED AND UNDERSTOOD  7-29 1968

North American Aviation, Inc. 

N 1997-31

DIVISION SPACE (41)		
PROJECT NO. LR 6227	CONTRACT NO. ATE 492117	DATE 30 JULY 1968

G & N FILTER BOX ASSY.

6.4.3.2.8 FUNCTIONAL TEST FOLLOWING 192 HOURS OF 175°F

INSULATION RESISTANCE, CONTINUITY AND CAPACITANCE HAVE BEEN CONDUCTED AS REQUIRED. ALL READINGS WERE WITHIN SPECIFIED LIMITS. VALUES HAVE BEEN RECORDED ON A DATA SHEET AND VERIFIED BY INSPECTION.

 7-30-68

6.4.3.2.9 FUNCTIONAL TEST FOLLOWING 216 HOURS OF 175°F

INSULATION RESISTANCE, CONTINUITY AND CAPACITANCE TESTS HAVE BEEN CONDUCTED AS REQUIRED. ALL READINGS WERE WITHIN SPECIFIED LIMITS. VALUES HAVE BEEN RECORDED ON A DATA SHEET AND VERIFIED BY INSPECTION.

 7-31-68

6.4.3.2.10 FUNCTIONAL TEST FOLLOWING 240 HOURS OF 125°F

INSULATION RESISTANCE, CONTINUITY AND CAPACITANCE TESTS HAVE BEEN CONDUCTED AS REQUIRED. ALL READINGS WERE WITHIN SPECIFIED LIMITS. VALUES HAVE BEEN RECORDED ON A DATA SHEET AND VERIFIED BY INSPECTION.

 1535 8-1-68 P.E. CONT N-1997-32

FORM 1050 REV. 7-66

INSTRUCTIONS

STATE OBJECT OF EXPERIMENT, TEST, DESIGN, OR INVENTION AND DESCRIBE IN SUFFICIENT DETAIL TO BE UNDERSTANDABLE AND REPRODUCIBLE BY ANOTHER ENGINEER. USE SKETCHES OR MAKE REFERENCE TO DRAWINGS OR PHOTOGRAPHS, IF ANY, BY NUMBER. ALL PAGES CONTAINING SUBJECT MATTER WHICH MAY BE INVENTIVE MUST BE WITNESSED.

SIGNATURE:  8/1 1968

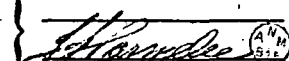
WITNESSED AND UNDERSTOOD }  8/1 1968

North American Aviation, Inc. 

N 1997-32

DIVISION SPACE (41)		
PROJECT NO. LR 6227	CONTRACT NO. ATR 492117A	DATE 8-1-68

G+N FILTER BOX ASSY.

6.4.3.2.10 (CONT.)

CONDUCTED DIELECTRIC STRENGTH TEST AT 280 VDC. CURRENT WAS LESS THAN 0.2 MA. 1535 8-1 DE

Armstrong 8/1/68 

^{DE}
6.4.3.3

CHAMBER TEMPERATURE AT 200°F AT 1600 HRS.

FUNCTIONAL TEST FOLLOWING 15 MINUTE STABILIZATION AT 200°F.

INSULATION RESISTANCE (AT 100 VDC), CONTINUITY AND CAPACITANCE AND DIELECTRIC STRENGTH TESTS AS REQUIRED HAVE BEEN CONDUCTED. ALL READINGS WERE WITHIN SPECIFIED LIMITS. VALUES HAVE BEEN RECORDED ON DATA SHEET # ^{DE} 36 AND VERIFIED BY INSPECTION 1700  8-1 DE.

DIELECTRIC STRENGTH TEST CURRENT WAS LESS THAN 0.2 MA.  8-1-68

CHAMBER TEMPERATURE STABILIZED AT AMBIENT ROOM TEMPERATURE AT 1755.

~~6.4.3.2~~ 
6.4.3.4 ^{DE}

INSULATION RESISTANCE (AT 100 VDC), CONTINUITY, CAPACITANCE AND DIELECTRIC STRENGTH TESTS (CURRENT WAS LESS THAN 0.2 MA) ^{DE} were conducted AS REQUIRED.

CONT N 1997-33 C-7

INSTRUCTIONS

STATE OBJECT OF EXPERIMENT, TEST, DESIGN, OR INVENTION AND DESCRIBE IN SUFFICIENT DETAIL TO BE UNDERSTANDABLE AND REPRODUCIBLE BY ANOTHER ENGINEER. USE SKETCHES OR MAKE REFERENCE TO DRAWINGS OR PHOTOGRAPHS IF ANY, BY NUMBER. ALL PAGES CONTAINING SUBJECT MATTER WHICH MAY BE INVENTIVE MUST BE WITNESSED.

SIGNATURE: *Paul Howard* 8-1-1968

WITNESSED AND UNDERSTOOD } *C.B. Rich*  8-1-1968

FORM 499-G REV. 7-66

North American Aviation, Inc. 

N 1997-33

DIVISION SPACE (41)		DATE 8-1-68
PROJECT NO: APOLLO LR 6227	CONTRACT NO. ATR 492117A	

CONT FROM N1997-32

CONT

~~HAVE BE~~ ALL READINGS WERE WITHIN SPECIFIED LIMITS. VALUES HAVE BEEN RECORDED ON DATA SHEET #^{VE} 37 AND VERIFIED BY INSPECTION.  8-1-68

24-HOUR TEMPERATURE SOAK AT -20°F WAS COMPLETED AT 2100 HOURS 8-2-68. THE CHAMBER TEMPERATURE WAS RAISED TO ROOM AMBIENT AT 2145. ROOM AMBIENT TEMPERATURE WAS MAINTAINED UNTIL 0155 HOURS WHILE THE VACUUM TEST CIRCUIT WAS BEING INSTALLED.

0155 FUNCTIONAL TEST FOLLOWING HIGH/LOW TEMPERATURE-LIFE TEST

INSULATION RESISTANCE, CONTINUITY, CAPACITANCE, AND DIELECTRIC STRENGTH TESTS HAVE BEEN CONDUCTED AS REQUIRED. ALL READINGS WERE WITHIN SPECIFIED LIMITS. VALUES HAVE BEEN RECORDED ON DATA SHEET #^{VE} 38 AND VERIFIED BY INSPECTION.  8-3-68

 8-3-68

VACUUM TEST

ALL VACUUM/SPACE/THERMAL TEST DATA
CONT N-1997-34

FORM 489-G REV. 7-66

INSTRUCTIONS
STATE OBJECT OF EXPERIMENT, TEST, DESIGN, OR INVENTION AND DESCRIBE IN SUFFICIENT DETAIL TO BE UNDERSTANDABLE AND REPRODUCIBLE BY ANOTHER ENGINEER. USE SKETCHES OR MAKE REFERENCE TO DRAWINGS OR PHOTOGRAPHS, IF ANY, BY NUMBER. ALL PAGES CONTAINING SUBJECT MATTER WHICH MAY BE INVENTIVE MUST BE WITNESSED.

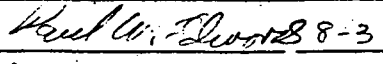
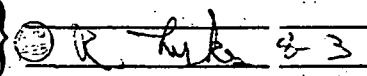
SIGNATURE:  8-3 1968
WITNESSED AND UNDERSTOOD }  8-3 1968

North American Aviation, Inc. 

N 1997-34

DIVISION SPACE 'A1)		
PROJECT NO: APOLLO LR 6227	CONTRACT NO. ATR 492117A	DATE 8-3-68

CONT FROM N 1997-33

SHALL BE RECORDED IN LABORATORY NOTE-BOOK N 2907 STARTING WITH PAGE 1-(thru 10).

6.5.1 INSULATION RESISTANCE, CONTINUITY, CAPACITANCE TESTS WERE CONDUCTED AS REQUIRED. ALL READINGS WERE WITH IN SPECIFIED LIMITS. VALUES HAVE BEEN RECORDED ON DATA SHEET #39 AND VERIFIED BY INSPECTION. ^{PE} 8-3-68

6.5.2.1 ~~PARA. 3.5.2~~ VACUUM 1×10^{-4} mm Hg @ 40 \pm 5°F for 50 \pm 5 HOURS.

PARA 6.5.2.2 START 5 CHVS 0900 8-3-68
1300 HOURS INSULATION RESISTANCE, CONTINUITY, CAPACITANCE TESTS WERE CONDUCTED AS REQUIRED. ALL READINGS WERE WITH IN SPECIFIED LIMITS. VALUES HAVE BEEN RECORDED ON DATA SHEET #40 AND VERIFIED BY INSPECTION. ^{PE} 8-3-68

ALL ELECTRICAL CIRCUITS WERE ENERGISED WITH ABOVE FUNCTION, 26 V RMS, 800 ϕ , 110 \pm 10 milliamps.

J2 Pin	VOLTS	Amps	J2 Pin	VOLTS	Amps
P	26	114 ma.	S	26	116 ma.
R		114	M		114
K		114	X		117
L		112	N		115
G		115	V		117
H		117	W		114

INSTRUCTIONS

STATE OBJECT OF EXPERIMENT, TEST, DESIGN, OR INVENTION AND DESCRIBE IN SUFFICIENT DETAIL TO BE UNDERSTANDABLE AND REPRODUCIBLE BY ANOTHER ENGINEER. USE SKETCHES OR MAKE REFERENCE TO DRAWINGS OR PHOTOGRAPHS, IF ANY, BY NUMBER. ALL PAGES CONTAINING SUBJECT MATTER WHICH MAY BE INVENTIVE MUST BE WITNESSED.

SIGNATURE: J. P. Whitted 8-3-1968
WITNESSED AND UNDERSTOOD: J. P. [Signature] 8/3 1968

FORM ASDG REV. 7-66

North American Aviation, Inc. 

N 1997-35

DIVISION SPACE (41)		
PROJECT NO: APOLLO LR6227	CONTRACT NO. ATR 492 117A	DATE 8-3-68

1000 8-4-68 PRIOR TO FUNCTIONAL TEST THE FOLLOWING CURRENT READINGS WERE NOTED

PIN	VOLTS	AMPS	PIN	VOLTS	AMPS
J2 P	26	113.4 MA	J2 S	26	118 MA
R		113	M		113
K		113	X		116
L		112	N		114
G		115	V		116
J2 H	26	116 MA	J2 W	26	112.5 MA

1100 8-9-68 24-HOUR FUNCTIONAL COMPLETE PARA 652.8

INSULATION RESISTANCE, CONTINUITY, CAPACITANCE TESTS WERE CONDUCTED AS REQUIRED. ALL READINGS WERE WITHIN SPECIFIED LIMITS. VALUES HAVE BEEN RECORDED ON DATA SHEET # ~~41~~ AND VERIFIED BY INSPECTION. ~~THE 8-7-68~~

THE AC LOAD CIRCUIT WAS ENERGIZED AND THE FOLLOWING CURRENTS RECORDED.

PIN	VOLTS	AMPS	PIN	VOLTS	AMPS
J2 P	26	114 MA	J2 S	26	117.5 MA
R		113	M		113.5
K		113	X		116
L		111.5	N		114
G		114.5	V		116
J2 H		116.5 MA	J2 W		112.5 MA

CONT. N 1997-36

FORM ASD-G REV. 7-66

INSTRUCTIONS

STATE OBJECT OF EXPERIMENT TEST DESIGN, OR INVENTION AND DESCRIBE IN SUFFICIENT DETAIL TO BE UNDERSTANDABLE AND REPRODUCIBLE BY ANOTHER ENGINEER. USE SKETCHES OR MAKE REFERENCE TO DRAWINGS OR PHOTOGRAPHS, IF ANY, BY NUMBER. ALL PAGES CONTAINING SUBJECT MATTER WHICH MAY BE INVENTIVE MUST BE WITNESSED.

SIGNATURE: Paul W. Edwards 8-9 1968
 WITNESSED AND UNDERSTOOD: [Signature] 8-4 1968

North American Aviation, Inc. 

N 1997-36

DIVISION

SPACE (41)

PROJECT NO:

APOLLO LR 6227

CONTRACT NO.

ATR 492117 A

DATE:

8-5-68

CONT. FROM N 1997-35

0810 8-^{5 DE}68 PRIOR TO FUNCTIONAL THE FOLLOWING CURRENT READINGS WERE NOTED.

J2 PIN	VOLTS	AMPS	PIN	VOLTS	AMPS
P	26	113.2 MA	S	26	116.7 MA
R		113.0	M		113.5
K		112.8	X		116
L		111.3	N		114
G		114.6	V		115.6
H	26	116.3 MA	W	26	112.5 MA

0900 8-5-68 48-HOUR FUNCTIONAL COMPLETE PARA 6.5.2.4

INSULATION RESISTANCE, CONTINUITY, CAPACITANCE TESTS WERE CONDUCTED AS REQUIRED. ALL READINGS WERE WITHIN SPECIFIED LIMITS. ~~THE~~ VALUES HAVE BEEN RECORDED ON DATA SHEET # ^{DE}42 AND VERIFIED BY INSPECTION. DE 8-5-68

THE AC LOAD CURRENT WAS RESTORED AND THE FOLLOWING CURRENTS RECORDED.

J2 PIN	VOLTS	AMPS	PIN	VOLTS	AMPS
P	26	113 MA	S	26	116.5 MA
R	26	113	M		113
K		112.5	X		116
L		111	N		114
G		114	V		116
H	26	116 MA	W	26	112 MA

CONTINUED ON N 1997-37

INSTRUCTIONS

STATE OBJECT OF EXPERIMENT, TEST, DESIGN, OR INVENTION AND DESCRIBE IN SUFFICIENT DETAIL TO BE UNDERSTANDABLE AND REPRODUCIBLE BY ANOTHER ENGINEER. USE SKETCHES OR MAKE REFERENCE TO DRAWINGS OR PHOTOGRAPHS, IF ANY, BY NUMBER. ALL PAGES CONTAINING SUBJECT MATTER WHICH MAY BE INVENTIVE MUST BE WITNESSED.

SIGNATURE: Paul D. Edwards 8-5-1968

WITNESSED AND UNDERSTOOD [Signature] 8-5-1968

FORM 403-G REV. 7-66

North American Aviation, Inc. 

N 1997-37

DIVISION

SPACE (41)

PROJECT NO:

APOLL O

LR 6227

CONTRACT NO.

ATR 992117A

DATE

8-5-68

G + N FILTER BOX

1530 8-5-68 CHAMBER REACHED 135°F AT
6.5.3.2 1330 HOURS.

PRIOR TO T + 2 ^{HR.} ²⁶ ^{AM} ⁹³ FUNCTIONAL THE FOLLOWING CURRENTS WERE NOTED.

J2 PIN	VOLTS	AMPS	PIN	VOLTS	AMPS
P	26	115 MA	J2 S	26	116 MA
R		115	M		115
K		114.5	X		118
L		113	N		116
G		116.5	V		118
J2 H	26	118 MA	J2 W	26	115 MA

1535 8-5-68 ² ^{AM} ⁹³ HOUR FUNCTIONAL COMPLETE.
PARA 6.5.3.2

INSULATION RESISTANCE, CONTINUITY, CAPACITANCE TESTS WERE CONDUCTED AS REQUIRED. ALL READINGS WERE WITHIN SPECIFIED LIMITS. VALUES HAVE BEEN RECORDED ON DATA SHEET # ²⁶ ^{AM} ⁹³ 43 AND VERIFIED BY INSPECTION. RE 8-5-68

THE AC LOAD CURRENT WAS RESTORED AND THE FOLLOWING CURRENTS WERE RECORDED.

PIN	VOLTS	AMPS	PIN	VOLTS	AMPS	PIN	VOLTS	AMPS
J2 P	26	115 MA	J2 G	26	116.5 MA	J2 X	26	118 MA
R		115 MA	H		118	N		116
K		114.5	S		116	V		118
J2 L	26	118 MA	J2 M	26	115 MA	J2 W	26	115 MA

INSTRUCTIONS

STATE OBJECT OF EXPERIMENT, TEST, DESIGN, OR INVENTION AND DESCRIBE IN SUFFICIENT DETAIL TO BE UNDERSTANDABLE AND REPRODUCIBLE BY ANOTHER ENGINEER. USE SKETCHES OR MAKE REFERENCE TO DRAWINGS OR PHOTOGRAPHS, IF ANY, BY NUMBER. ALL PAGES CONTAINING SUBJECT MATTER WHICH MAY BE INVENTIVE MUST BE WITNESSED.

SIGNATURE:

Paul W. DeWitt 8-5 1968

WITNESSED AND UNDERSTOOD

A. Parmelee 8/5 1968

FORM 489-G REV. 7-66

North American Aviation, Inc. 

N 1997-38

DIVISION

SPACE (A1)

PROJECT NO:

A POLL D

CONTRACT NO.

LR 6227 41492 117A

DATE

8-6-68

GYN FILTER BOX

1410 8-6-68 PRIOR TO T+24 HOUR FUNCTIONAL THE
6.5.3.3 FOLLOWING CURRENT READINGS WERE
NOTED:

	PIN	VOLTS	AMPS		PIN	VOLTS	AMPS
J2	P	26	115 MA	J2	S	26	119 MA
	R		114		M		115
	K		114		X		117
	L		113		N		115
	G		116		V		117
J2	H	26	118 MA	J2	W	26	114 MA

1445 8-6-68 T+24 HOUR FUNCTIONAL COMPLETE
6.5.3.3 INSULATION RESISTANCE, CONTINUITY, CAPACITANCE
TESTS WERE CONDUCTED AS REQUIRED.
ALL READINGS WERE ~~CONDUCTED~~ ^{WITHIN} SPECIFIED
LIMITS. VALUES HAVE BEEN RECORDED ON
DATA SHEET # ~~44~~ ⁴⁴ AND VERIFIED BY
INSPECTION.  8-6-68.

THE AC LOAD CURRENT WAS RESTORED
AND THE FOLLOWING CURRENTS WERE RE-
CORDED:

	DIN	VOLTS	AMPS		PIN	VOLTS	AMPS
J2	P	26	115 MA	J2	S	26	119 MA
	R		114		M		115
	K		114		X		117
	L		112		N		115
	G		116		V		116
J2	H	26	118 MA	J2	W	26	114 MA

CONT N 1997-39

INSTRUCTIONS

STATE OBJECT OF EXPERIMENT, TEST, DESIGN, OR
INVENTION AND DESCRIBE IN SUFFICIENT DETAIL TO
BE UNDERSTANDABLE AND REPRODUCIBLE BY ANOTHER
ENGINEER. USE SKETCHES OR MAKE REFERENCE TO
DRAWINGS OR PHOTOGRAPHS, IF ANY, BY NUMBER. ALL
PAGES CONTAINING SUBJECT MATTER WHICH MAY BE IN-
VENTIVE MUST BE WITNESSED.

SIGNATURE: P.W. Edwards 8-6 1968

WITNESSED AND UNDERSTOOD: [Signature] 8/6 1968

FORM 495-G REV. 7-66

North American Aviation, Inc. 

N 1997-39

DIVISION SPACE (41)		
PROJECT NO: APOLLO LK 6227	CONTRACT NO. ATR 492117A	DATE 8-7-68

G4N FILTER BOX ASSEMBLY

1450 8-7-68 PRIOR TO 48 HOUR FUNCTIONAL THE FOLLOWING CURRENT READINGS WERE RECORDED.

PIN	VOLTS	CURRENT	PIN	VOLTS	CURRENT
J2 P	26	114 MA	J2 S	26	119 MA
R		114	M		114
K		113	X		117
L		112	N		115
G		115	V		117
J2 H	26	117 MA	J2 W	26	113 MA

1530 8-7-68 ^{48 HR} TTTT HR FUNCTIONAL COMPLETE. V.I.3. & INSULATION RESISTANCE, CONTINUITY, CAPACITANCE TESTS WERE CONDUCTED AS REQUIRED. ALL READINGS WERE WITHIN SPECIFIED LIMITS. VALUES HAVE BEEN RECORDED ON DATA SHEET # ~~45~~ ²⁶ ~~193~~ AND VERIFIED BY INSPECTION. DE 8-7-68

THE AC LOAD CURRENT WAS RESTORED AND THE FOLLOWING CURRENTS RECORDED.

PIN	VOLTS	CURRENTS	PIN	VOLTS	CURRENTS
J2 P	26	114 MA	J2 S	26	118 MA
R		114	M		114
K		113	X		117
L		112	N		115
G		115	V		116
J2 H	26	117 MA	J2 W	26	112 MA

26 CONT N 1997-42

FORM 8920 REV. 7-66

INSTRUCTIONS
STATE OBJECT OF EXPERIMENT, TEST, DESIGN, OR INVENTION AND DESCRIBE IN SUFFICIENT DETAIL TO BE UNDERSTANDABLE AND REPRODUCIBLE BY ANOTHER ENGINEER. USE SKETCHES OR MAKE REFERENCE TO DRAWINGS OR PHOTOGRAPHS, IF ANY, BY NUMBER. ALL PAGES CONTAINING SUBJECT MATTER WHICH MAY BE INVENTIVE MUST BE WITNESSED.

SIGNATURE: Paul W. Edwards 8-7-68
WITNESSED AND UNDERSTOOD: [Signature] 8-7-68

North American Aviation, Inc. 

N 1997-42

DIVISION SPACE (41)		DATE 8-7-68
PROJECT NO. APOLLO LR 6227	CONTRACT NO. ATR 492 117A	

64N FILTER BOX ASSEMBLY VACUUM
CONT FROM N 1997-39 TEST
1855 8-7-68 P.M. TO 8 AMBIENT STABILIZATION
6.5.4.1 FUNCTIONAL TEST THE FOLLOWING
CURRENTS WERE READ

PIN	VOLTS	CURRENT	PIN	VOLTS	CURRENT
32 P	26	114 MA	32 S	26	118 MA
R		113	M		114
K		113	X		116
L		112	N		114
G		115	V		116
32 H	26 PE	117 MA	32 W	26 PE	113 MA

1930 8-7-68 VACUUM TEST AMBIENT/10.4 FUN-
6.5.4.1 CTIONAL COMPLETE. 8-7-68 

INSULATION RESISTANCE, CONTINUITY,
CAPACITANCE TESTS WERE CONDUCTED AS
REQUIRED. ALL READINGS WERE WITHIN
SPECIFIED LIMITS. VALUES HAVE BEEN
RECORDED ON DATA SHEET # ~~46~~ AND
VERIFIED BY INSPECTION. PE 8-7-68 

2055 8-7-68 VACUUM TEST FINAL FUNCTIONAL
6.5.4.2

INSULATION RESISTANCE, CONTINUITY,
CAPACITANCE ^{AND} DIELECTRIC STRENGTH TESTS
WERE CONDUCTED AS REQUIRED. ALL READINGS
WERE WITHIN SPECIFIED LIMITS. VALUES HAVE
BEEN RECORDED ON DATA SHEET # ~~47~~ AND
VERIFIED BY INSPECTION. PE 8-7-68 
CONT N 1997-43

FORM 492-G REV. 7-68

INSTRUCTIONS
STATE OBJECT OF EXPERIMENT, TEST, DESIGN, OR
INVENTION AND DESCRIBE IN SUFFICIENT DETAIL TO
BE UNDERSTANDABLE AND REPRODUCIBLE BY ANOTHER
ENGINEER. USE SKETCHES OR MAKE REFERENCE TO
DRAWINGS OR PHOTOGRAPHS, IF ANY, BY NUMBER. ALL
PAGES CONTAINING SUBJECT MATTER WHICH MAY BE IN-
VENTIVE MUST BE WITNESSED.

SIGNATURE: P. G. Wood 8-7 19 68
WITNESSED AND UNDERSTOOD } C. B. Rich 8-7 19 68

North American Aviation, Inc. 

N 1997-43

DIVISION <i>SPACE (41)</i>		
PROJECT NO: <i>APOLLO LR6227</i>	CONTRACT NO. <i>ATR 492 117A</i>	DATE <i>8-8-68</i>

VACUUM AND HIGH/LOW TEMPERATURE TEST EQUIPMENT LIST

1. GENERAL RADIO IMPEDANCE BRIDGE
Type 1650-A SN 5912 S009492 CAL-DUE 10-10-68
2. SENSITIVE RESEARCH MILLIAMMETER MODEL D
SN 602969 F 310151 CAL-DUE 2-13-69
3. GENERAL RADIO MEGOHM BRIDGE
Type 1644-A SN 290 N 770971 CAL-DUE 9-27-68
4. INVERTING AC PS MODEL 161A
S 011309 CAL-DUE 1-4-69
5. PERKINS DC PS MODEL TUR 040-S
S 011313 CAL-DUE 11-6-68
6. SENSITIVE RESEARCH VOLTMETER
MODEL-A SN 602279 CAL-DUE F 306 214-11-26-68
7. SIMPSON OHMMETER MODEL 269 F 302 850 CAL-DUE 9-5-68
8. ARIZONA INSULATION TESTER N 735197 CAL-DUE -12-12-68

FORM 489-G REV. 7-66

INSTRUCTIONS
STATE OBJECT OF EXPERIMENT, TEST, DESIGN, OR INVENTION AND DESCRIBE IN SUFFICIENT DETAIL TO BE UNDERSTANDABLE AND REPRODUCIBLE BY ANOTHER ENGINEER. USE SKETCHES OR MAKE REFERENCE TO DRAWINGS OR PHOTOGRAPHS, IF ANY, BY NUMBER. ALL PAGES CONTAINING SUBJECT MATTER WHICH MAY BE INVENTIVE MUST BE WITNESSED.

SIGNATURE: *Paul W. Edwards* 8-8 19 68
 WITNESSED AND UNDERSTOOD } *R. Lykes* 8-8 19 68

North American Aviation, Inc. 

N 1997-44

DIVISION SPACE (41)		
PROJECT NO. APOLLO LR627	CONTRACT NO. ATR 492117A	DATE 8-8-68

G+N FILTER BOX

1020 8-8-68 PRE ACCELERATION FUNCTIONAL TEST
PARA 6.6.1

INSULATION RESISTANCE, CONTINUITY, CAPACITANCE AND ~~DIELECTRIC STRENGTH~~ ^{ANN 193} TESTS WERE CONDUCTED AS REQUIRED. ALL READINGS WERE WITHIN SPECIFIED LIMITS. VALUES HAVE BEEN RECORDED ON DATA SHEET # ~~48~~ ⁴⁸ AND VERIFIED BY INSPECTION. ^{VE} 8-8-68

¹⁵⁵⁰ ~~1650~~ ^{ANN 193} 8-8-68 ACCELERATION TEST PER PARAGRAPH 6.6.2 ~~AND~~ COMPLETED. NO EVIDENCE OF DISCONTINUITY ~~IN~~ IN EXCESS OF 70MS WAS NOTED.

1630 8-8-68 POST-ACCELERATION FUNCTIONAL TEST COMPLETE. PAR 6.6.3

INSULATION RESISTANCE, CONTINUITY, CAPACITANCE, AND DIELECTRIC STRENGTH ~~TESTS~~ ^{ANN 193} (LESS THAN 0.2 MA.) TESTS WERE CONDUCTED AS REQUIRED. ALL READINGS WERE WITHIN SPECIFIED LIMITS. VALUES HAVE BEEN RECORDED ON DATA SHEET # ~~47~~ ⁴⁷ AND VERIFIED BY INSPECTION. ^{VE} 8-8-68

1930 8-8-68 PRE SHOCK FUNCTIONAL TEST
6.7.1.) INSULATION ~~RESISTANCE~~ RESISTANCE, CONTINUITY, CAPACITANCE AND DIELECTRIC STRENGTH TESTS WERE CONDUCTED AS REQUIRED.
CONT N 1997-45

FORM 489-G REV. 7-66

INSTRUCTIONS

STATE OBJECT OF EXPERIMENT, TEST, DESIGN, OR INVENTION AND DESCRIBE IN SUFFICIENT DETAIL TO BE UNDERSTANDABLE AND REPRODUCIBLE BY ANOTHER ENGINEER. USE SKETCHES OR MAKE REFERENCE TO DRAWINGS OR PHOTOGRAPHS, IF ANY, BY NUMBER. ALL PAGES CONTAINING SUBJECT MATTER WHICH MAY BE INVENTIVE MUST BE WITNESSED.

SIGNATURE: P.W. Edwards 8-8-1968

WITNESSED AND UNDERSTOOD: R. Lykes 8-8-1968

North American Aviation, Inc. 

N 1997-45

DIVISION SPACE (41)		DATE 8-9-68
PROJECT NO: APOLLO LR 6227	CONTRACT NO. ATR 492117A	

CONT FROM N 1997-44

1930 8-8-68 CONT

ALL READINGS WERE WITH IN SPECIFIED LIMITS. VALUES HAVE BEEN RECORDED ON DATA SHEET # ~~50~~^{PE} AND VERIFIED BY INSPECTION. PE 8-8-68. 

0000 8-9-68 POST-SHOCK FUNCTIONAL COMPLETE. PARA 6.7.7

INSULATION RESISTANCE, CONTINUITY, CAPACITANCE AND DIELECTRIC STRENGTH TESTS WERE CONDUCTED AS REQUIRED. ALL READINGS WERE WITH IN SPECIFIED LIMITS. VALUES HAVE BEEN RECORDED ON DATA SHEET # ~~51~~^{PE} AND VERIFIED BY INSPECTION. PE 8-9-68.  8-9-68

1035 8-9-68 DYNAMICS LABORATORY TEST SUPPORT DATA ~~###~~ IS REFERENCED AS FOLLOWS:

ACCELERATION LAB NOTEBOOK N5718 PAGES ^{28,29} 24-30
SHOCK LAB NOTEBOOK N5718 PAGES ²⁸ 31-33
FUNCTIONAL TEST DATA-LAB NOTE BOOK N6097 PAGES 1-6, 8-24 

1040 8-9-68 POST-QUALIFICATION TEST EXAMINATION.

NO VISIBLE EVIDENCE OF DAMAGE. THE ASSEMBLY HOUSING AND CONNECTORS ARE FREE OF CRACKS, UNUSUAL SCRATCHES OR SURFACE CONTAMINATION, INTERNA OR EXTERNAL
CONT N 1997-46

FORM 485-G REV. 7-66

INSTRUCTIONS

STATE OBJECT OF EXPERIMENT, TEST, DESIGN, OR INVENTION AND DESCRIBE IN SUFFICIENT DETAIL TO BE UNDERSTANDABLE AND REPRODUCIBLE BY ANOTHER ENGINEER. USE SKETCHES OR MAKE REFERENCE TO DRAWINGS OR PHOTOGRAPHS, IF ANY, BY NUMBER. ALL PAGES CONTAINING SUBJECT MATTER WHICH MAY BE INVENTIVE MUST BE WITNESSED.

SIGNATURE: P. W. Edwards 8-9 1968
WITNESSED AND UNDERSTOOD: R. Lykes 8-9 1968

North American Aviation, Inc. 

N 1997-46

DIVISION: SPACE (A1)		
PROJECT NO: APOLLO LR 6227	CONTRACT NO. ATR 492117A	DATE 8-9-68

G+N FILTER BOX (CONT FROM N-1997-45)

1050 8-9-68 ALL AXES OF THE SHOCK EXPOSURE WERE MONITORED FOR DISCONTINUITY ON THE SPECIFIED CIRCUITS ^(microsec) GREATER THAN 70 μs. NO DISCONTINUITY WAS NOTED. DE. S. Q. 49

CLOSING STATEMENTS:

THE PRECEDING TEST HAS BEEN CONDUCTED IN ACCORDANCE WITH THE APPROVED TEST REQUEST (ATR 492117A) AND SUPPORTING DOCUMENTS. DATA SUPPORTING THIS TEST ARE NOTED OR REFERENCED HEREIN. SPECIMEN SUBMITTED TO "BONDED STORAGE" ON (PRR # 509143) 918K No. 5000502 ^{PW 4/11} 

SIGNED Paul W. Edwards 8-9-68
LT. RESPONSIBLE TEST ENGR.

SIGNED S. U. McKee 8/14/68
APOLLO DESIGN ENGR.

VERIFIED R. M. Lykes 8-15-68 
N.R. INSPECTION

VERIFIED J. B. Johnson 8-15-68 
NASA INSPECTION

FORM 493-G REV. 7-66

INSTRUCTIONS

STATE OBJECT OF EXPERIMENT, TEST, DESIGN, OR INVENTION AND DESCRIBE IN SUFFICIENT DETAIL TO BE UNDERSTANDABLE AND REPRODUCIBLE BY ANOTHER ENGINEER. USE SKETCHES OR MAKE REFERENCE TO DRAWINGS OR PHOTOGRAPHS, IF ANY, BY NUMBER. ALL PAGES CONTAINING SUBJECT MATTER WHICH MAY BE INVENTIVE MUST BE WITNESSED.

SIGNATURE: P. W. Edwards 8-15-1968

WITNESSED AND UNDERSTOOD R. M. Lykes 8-15-68 

NORTH AMERICAN ROCKWELL CORPORATION
AEROSPACE AND SYSTEMS GROUP

N 6097-1

DIVISION

SPACE (41)

ATR 492117BA

PROJECT NO:

APOLLO

LR 6227

CONTRACT NO: G+N FILTER BOX

QUAL FUNCTIONAL TEST DATA

DATE

8-15-68

THE DATA ON PAGES N 6097-2 THRU 6 AND 8 THRU 24 IS ALL OF THE TEST (FUNCTIONAL) DATA; IE INSULATION RESISTANCE, CONTINUITY, CAPACITANCE. THIS DATA WAS COLLECTED DURING THE QUALIFICATION TESTING OF THE G+N FILTER BOX U36-442330 S/N 06362AH3858

TEST	PARAGRAPHS	TIME DATES	N6097 PAGES
INSULATION RESISTANCE	6.1.2 THRU 6.3.8.6	1505+7-10-8 / 3007+7-15-8	2 AND 3
	6.3.8.7 THRU 6.4.3.1.3	1900+7-15-8 / 1500+7-21-8	4 AND 5
	6.4.3.1.4 THRU 6.4.3.3	1510+7-22-8 / 1450+8-1-8	6 AND 5*
	6.4.3.4.1 THRU 6.6.1	2000+8-1-8 / 1030+8-7-8	9 AND 10
	6.6.3 THRU 6.7.7	1105+8-9-8 / 8000+8-9-8	11 AND 12
CONTINUITY	6.1.2 THRU 6.3.8.6	1505+7-10-8 / 10200+7-15-8	13 AND 14
	6.3.8.7 THRU 6.4.3.1.3	1900+7-15-8 / 1500+7-21-8	15 AND 16
	6.4.3.1.4 THRU 6.4.3.3	1510+7-22-8 / 1450+8-1-8	17 AND 18
	6.4.3.4.1 THRU 6.6.1	2000+8-1-8 / 1030+8-7-8	19 AND 20
	6.6.3 THRU		
	6.4.3.1.4 THRU 6.4.3.4.1	1500+7-22-8 / 5000+8-1-8	17 AND 18
6.4.3.6 THRU 6.6.7	0155+8-3-8 / 8000+8-9-8	19 AND 20	
CAPACITANCE	6.1.2 THRU 6.3.8.7	1505+7-10-8 / 1500+7-15-8	21
	6.3.8.8 THRU 6.4.3.2.1	0300+7-10-8 / 1500+7-23-8	22
	6.4.3.2.2 THRU 6.5.1	1435+7-24-8 / 0530+8-3-8	23
	6.5.2.2 THRU 6.7.7	1300+8-3-8 / 0000+8-9-8	24

G Ω = Giga ohms = 10⁹ Ω

T Ω = Tetra ohms = 10¹² Ω

* PAGE 7 VOID - NO DATA

FORM 93-C REV. 6-68

INSTRUCTIONS

STATE OBJECT OF EXPERIMENT, TEST, DESIGN, OR INVENTION AND DESCRIBE IN SUFFICIENT DETAIL TO BE UNDERSTANDABLE AND REPRODUCIBLE BY ANOTHER ENGINEER. USE SKETCHES OR MAKE REFERENCE TO DRAWINGS OR PHOTOGRAPHS, IF ANY, BY NUMBER. ALL PAGES CONTAINING SUBJECT MATTER WHICH MAY BE INVENTIVE MUST BE WITNESSED.

SIGNATURE: *Paul W. Howard* 9-15-68 19-68

WITNESSED AND UNDERSTOOD: *R. Lyman* 8-15-68 19-68

NORTH AMERICAN ROCKWELL CORPORATION
AEROSPACE AND SYSTEMS GROUP

N 6097-2

DIVISION

SPACE (41)

ATR 492117

PROJECT NO.

Apollo LR 6227

CONTRACT NO. G + N FILTER

Box: QUAL TEST

DATE

TIME	DATE	PART	RESISTANCE TEST												
			1505	0317	1100	2215	0015	0150	1990	0300	1900	0300	1900	0300	1900
30-VI-GRD/II-Q/GRD	6.12	6.21	6.21	6.21	6.31	6.33	6.33	6.35	6.37	6.38	6.38	6.38	6.38	6.38	
2	7-10-8	4.3	4.3	4.3	5.2	14.4	14.4	14.4	100T	100T	100T	100T	100T	100T	
3	7-11-8	4.0	4.0	4.0	12	13.2	13.2	100T	100T	100T	100T	100T	100T	100T	
4	7-11-8	4.1	4.1	4.1	13	11.5	11.5	100T	100T	100T	100T	100T	100T	100T	
5	7-11-8	3.8	3.8	3.8	5.7	12.0	12.0	100T	100T	100T	100T	100T	100T	100T	
6	7-11-8	3.8	3.8	3.8	5.6	13.2	13.2	100T	100T	100T	100T	100T	100T	100T	
7	7-11-8	3.9	3.9	3.9	5.8	12.6	12.6	100T	100T	100T	100T	100T	100T	100T	
8	7-11-8	3.8	3.8	3.8	6.1	19.5	19.5	100T	100T	100T	100T	100T	100T	100T	
9	7-11-8	4.05	4.05	4.05	6.5	2.1	2.1	100T	100T	100T	100T	100T	100T	100T	
10	7-11-8	4.1	4.1	4.1	6.9	2.1	2.1	100T	100T	100T	100T	100T	100T	100T	
11	7-11-8	4.4	4.4	4.4	6.9	2.1	2.1	100T	100T	100T	100T	100T	100T	100T	
12	7-11-8	4.4	4.4	4.4	7.0	2.3	2.3	100T	100T	100T	100T	100T	100T	100T	
13	7-11-8	4.3	4.3	4.3	6.8	2.3	2.3	100T	100T	100T	100T	100T	100T	100T	
14	7-11-8	4.3	4.3	4.3	6.8	2.3	2.3	100T	100T	100T	100T	100T	100T	100T	
15	7-11-8	4.3	4.3	4.3	6.8	2.5	2.5	100T	100T	100T	100T	100T	100T	100T	
16	7-11-8	4.4	4.4	4.4	7.5	3.0	3.0	100T	100T	100T	100T	100T	100T	100T	
17	7-11-8	4.4	4.4	4.4	7.5	3.0	3.0	100T	100T	100T	100T	100T	100T	100T	
18	7-11-8	4.4	4.4	4.4	7.5	3.0	3.0	100T	100T	100T	100T	100T	100T	100T	
19	7-11-8	4.4	4.4	4.4	7.5	3.0	3.0	100T	100T	100T	100T	100T	100T	100T	
20	7-11-8	4.3	4.3	4.3	7.3	2.8	2.8	1000T	1000T	1000T	1000T	1000T	1000T	1000T	
21	7-11-8	4.1	4.1	4.1	6.9	2.5	2.5	1000T	1000T	1000T	1000T	1000T	1000T	1000T	
22	7-11-8	4.1	4.1	4.1	6.8	2.5	2.5	1000T	1000T	1000T	1000T	1000T	1000T	1000T	
23	7-11-8	4.1	4.1	4.1	7.2	2.5	2.5	1000T	1000T	1000T	1000T	1000T	1000T	1000T	
30-1/3-GRD/II-H/GRD	6.12	6.21	6.21	6.21	6.0	8.7	8.7	1000T	1000T	1000T	1000T	1000T	1000T	1000T	
2	7-11-8	3.1	3.1	3.1	6.0	10	10	1000T	1000T	1000T	1000T	1000T	1000T	1000T	
3	7-11-8	3.2	3.2	3.2	6.0	11.2	11.2	1000T	1000T	1000T	1000T	1000T	1000T	1000T	

FORM 93-C REV. 6-68

INSTRUCTIONS

STATE OBJECT OF EXPERIMENT, TEST, DESIGN, OR INVENTION AND DESCRIBE IN SUFFICIENT DETAIL TO BE UNDERSTANDABLE AND REPRODUCIBLE BY ANOTHER ENGINEER. USE SKETCHES OR MAKE REFERENCE TO DRAWINGS OR PHOTOGRAPHS, IF ANY, BY NUMBER. ALL PAGES CONTAINING SUBJECT MATTER WHICH MAY BE INVENTIVE MUST BE WITNESSED.

N 6097-3

SIGNATURE: Paul W. Cleveland 8-14 1964

WITNESSED AND UNDERSTOOD: R. Lykes 8-14 1964

NORTH AMERICAN ROCKWELL CORPORATION
AEROSPACE AND SYSTEMS GROUP

N 6097-3

DIVISION <i>SPACE (41)</i>		ATR 1192117
PROJECT NO: <i>APOLLO LR 6227</i>	CONTRACT NO. <i>G+H FILTER ROX COUL TEST</i>	DATE

(G.R.) TIME DATE P.A.P.A.	INSULATION R.F.S.I.	R.F.S.I. STANDANCE												
		150S 710B 6.12	0317 710B 6.24	1100 710B 6.24	2215 711A 6.31	2150 712B 6.33	0150 712B 6.35	0720 712B 6.37	0700 713A 6.38	0300 713B 6.38	0300 714B 6.38	0300 714B 6.38		
<i>4</i>														
<i>5</i>	<i>U</i>	<i>3.09</i>	<i>6.24</i>	<i>12.26</i>										
<i>6</i>	<i>X</i>	<i>3.1</i>	<i>6.2</i>	<i>12.8</i>										
<i>7</i>	<i>M</i>	<i>3.1</i>	<i>6.2</i>	<i>13.6</i>										
<i>8</i>	<i>N</i>	<i>3.1</i>	<i>6.2</i>	<i>13.6</i>										
<i>9</i>	<i>P</i>	<i>3.2</i>	<i>6.2</i>	<i>17.</i>										
<i>10</i>	<i>R</i>	<i>3.3</i>	<i>6.3</i>	<i>18.</i>										
<i>11</i>	<i>S</i>	<i>3.3</i>	<i>6.2</i>	<i>20.</i>										
<i>12</i>	<i>I</i>	<i>3.0</i>	<i>6.4</i>	<i>20.</i>										
<i>13</i>	<i>U</i>	<i>3.0</i>	<i>6.7</i>	<i>20.</i>										
<i>14</i>	<i>V</i>	<i>3.0</i>	<i>6.3</i>	<i>20.</i>										
<i>15</i>	<i>W</i>	<i>4.1</i>	<i>6.7</i>	<i>20.</i>										
<i>16</i>	<i>X</i>	<i>3.7</i>	<i>6.5</i>	<i>24.</i>										
<i>17</i>	<i>Y</i>	<i>3.5</i>	<i>6.6</i>	<i>25.</i>										
<i>18</i>	<i>Z</i>	<i>3.4</i>	<i>6.7</i>	<i>25.</i>										
<i>19</i>	<i>AA</i>	<i>2.7</i>	<i>5.6</i>	<i>20.</i>										
<i>20</i>	<i>BB</i>	<i>3.2</i>	<i>6.4</i>	<i>22.</i>										
<i>21</i>	<i>30-20/3-GRD/JC/GRD</i>	<i>3.2</i>	<i>6.6</i>	<i>23</i>										
<i>22</i>	<i>DD</i>	<i>3.2</i>	<i>6.8</i>	<i>23</i>										
<i>23</i>	<i>EE</i>	<i>3.2</i>	<i>6.9</i>	<i>23</i>										
<i>24</i>	<i>31-1/5-GRD/JH/GRD</i>	<i>3.2</i>	<i>6.9</i>	<i>23</i>										
<i>25</i>	<i>F</i>	<i>7.4</i>	<i>13.8</i>	<i>9.7</i>										
<i>26</i>	<i>G</i>	<i>6.5</i>	<i>13.8</i>	<i>9.1</i>										
<i>27</i>	<i>H</i>	<i>6.0</i>	<i>13.8</i>	<i>8.8</i>										
<i>28</i>	<i>I</i>	<i>6.0</i>	<i>13.8</i>	<i>8.8</i>										
<i>29</i>	<i>J</i>	<i>6.0</i>	<i>13.8</i>	<i>8.8</i>										
<i>30</i>	<i>K</i>	<i>6.0</i>	<i>13.8</i>	<i>8.8</i>										

FORM 93-G REV. 6-66

INSTRUCTIONS

STATE OBJECT OF EXPERIMENT, TEST, DESIGN, OR INVENTION AND DESCRIBE IN SUFFICIENT DETAIL TO BE UNDERSTANDABLE AND REPRODUCIBLE BY ANOTHER ENGINEER. USE SKETCHES OR MAKE REFERENCE TO DRAWINGS OR PHOTOGRAPHS, IF ANY, BY NUMBER. ALL PAGES CONTAINING SUBJECT MATTER WHICH MAY BE INVENTIVE MUST BE WITNESSED.

SIGNATURE: *J. W. Edwards* 8-14 1968

WITNESSED AND UNDERSTOOD: *[Signature]* 8-14 1968

C-42

SD 68-687

NORTH AMERICAN ROCKWELL CORPORATION
AEROSPACE AND SYSTEMS GROUP

N 6097-4

DIVISION <i>SPACE (W1)</i>		ATR 492117	
PROJECT NO: <i>APOLLO LR 6227</i>	CONTRACT NO. <i>G+N FILTER BOX COOL TEST</i>	DATE	

(GR) INSULATION RESISTANCE	TIME		DATE		REMARKS
	START	STOP	START	STOP	
30-1/1-GRD/U/C/GRD.	1900	2300	7-15-8	6-38-11	
F	4.34	4.1	6-11-8	6-13-8	
G	4.1	3.6	6-11-8	6-13-8	
L	3.4	3.5	6-11-8	6-13-8	
M	2.1	2.8	6-11-8	6-13-8	
N	1.6	3.5	6-11-8	6-13-8	
P	4.1	4.2	6-11-8	6-13-8	
R	4.3	3.9	6-11-8	6-13-8	
S	4.0	4.0	6-11-8	6-13-8	
T	4.2	4.2	6-11-8	6-13-8	
U	4.2	4.1	6-11-8	6-13-8	
V	3.7	2.4	6-11-8	6-13-8	
X	4.0	2.6	6-11-8	6-13-8	
Y	2.6	2.8	6-11-8	6-13-8	
Z	2.8	2.8	6-11-8	6-13-8	
30-1/3-GRD/U/H/GRD.	1900	2300	7-15-8	6-38-11	
B	4.34	4.1	6-11-8	6-13-8	
C	4.1	3.6	6-11-8	6-13-8	
D	3.4	3.5	6-11-8	6-13-8	
E	2.1	2.8	6-11-8	6-13-8	
F	1.6	3.5	6-11-8	6-13-8	
G	4.1	4.2	6-11-8	6-13-8	
H	4.3	3.9	6-11-8	6-13-8	
I	4.0	4.0	6-11-8	6-13-8	
J	4.2	4.2	6-11-8	6-13-8	
K	4.2	4.1	6-11-8	6-13-8	

SPECIAL TEST
CHAMBER DOORS OPENED (AMBIENT)

FORM 93-G REV. 9-68

INSTRUCTIONS Cont No 97-5

STATE OBJECT OF EXPERIMENT, TEST, DESIGN, OR INVENTION AND DESCRIBE IN SUFFICIENT DETAIL TO BE UNDERSTANDABLE AND REPRODUCIBLE BY ANOTHER ENGINEER. USE SKETCHES OR MAKE REFERENCE TO DRAWINGS OR PHOTOGRAPHS, IF ANY, BY NUMBER. ALL PAGES CONTAINING SUBJECT MATTER WHICH MAY BE INVENTIVE MUST BE WITNESSED.

SIGNATURE: *P. W. Edwards* 7-19 1966

WITNESSED AND UNDERSTOOD: *R. F. [unclear]* 8/14 1968

C-43

NORTH AMERICAN ROCKWELL CORPORATION
AEROSPACE AND SYSTEMS GROUP

N 6097-6

DIVISION SPACE (41)		CONTRACT NO. G+N FILTER BOX QUAL TEST		DATE ATR 492117
PROJECT NO. APOLLO LR 6227				

TIME	R E S I S T A N C E													1450	1500	1550	1600	1650
	1500	1500	1500	1500	1500	1500	1500	1500	1500	1500	1500	1500	1500					
30-1-GRD J/C/G RD	9.36	2.66	4.06	3.46	2.76	2.76	1.96	2.06	2.36	2.56	2.56	2.36	2.36	2.56	10.6	2.16	6.4.33	
2	2.3	2.6	3.7	3.3	2.7	2.6	1.7	2.0	2.7	2.6	1.7	2.0	2.7	2.6	10.6	2.3	8-1-8	
3	2.2	2.9	6.8	3.3	2.6	2.5	1.7	1.94	2.2	2.6	1.7	2.0	2.2	2.6	10.5	2.1		
A	2.2	2.6	3.4	3.1	2.7	2.6	1.8	2.0	2.4	2.6	1.8	2.0	2.4	2.6	8.5	2.7		
5	5.0	2.7	3.4	3.1	2.8	2.7	1.9	1.96	2.5	2.6	1.9	2.0	2.5	2.6	10.	2.1		
6	5.0	2.7	3.4	3.2	2.8	2.7	1.8	2.0	2.4	2.6	1.8	2.0	2.4	2.6	9.	2.7		
7	6.3	2.6	3.5	3.0	3.0	2.9	2.0	1.97	2.6	2.7	2.0	1.97	2.6	2.7	10.	3.1		
8	6.9	2.7	3.6	3.0	3.1	3.0	2.0	1.93	2.5	2.7	2.0	1.93	2.5	2.7	12.	3.1		
9	9.8	2.7	3.8	3.0	3.3	3.3	2.0	2.1	2.8	3.0	2.0	2.1	2.8	3.0	11.	3.5		
10	3.2	2.7	3.3	3.1	3.4	3.4	2.1	2.12	2.7	3.1	2.1	2.12	2.7	3.1	15.	3.3		
11	8.0	2.8	3.3	3.1	3.5	3.4	2.3	2.3	2.6	3.2	2.3	2.3	2.6	3.2	15.	3.2		
12	11.6	2.8	3.3	3.2	3.5	3.5	2.2	2.3	2.7	3.0	2.2	2.3	2.7	3.0	15.	3.3		
13	2.9	2.8	3.3	3.2	3.4	3.4	2.1	2.4	2.6	3.0	2.1	2.4	2.6	3.0	12.	3.2		
14	2.9	2.8	3.3	3.2	3.4	3.4	2.2	2.4	5.0	3.0	2.2	2.4	5.0	3.0	13.	3.0		
15	2.9	2.8	3.3	3.2	3.4	3.4	2.1	2.4	6.0	3.0	2.1	2.4	6.0	3.0	14.	3.0		
16	3.0	2.8	3.3	3.2	3.5	3.5	2.3	2.6	10.0	3.0	2.3	2.6	10.0	3.0	16.	3.0		
17	3.1	2.8	3.3	3.2	3.5	3.5	2.3	2.7	8.5	3.1	2.3	2.7	8.5	3.1	16.	2.7		
18	3.1	2.7	3.3	3.2	3.5	3.5	2.2	2.7	8.5	3.1	2.2	2.7	8.5	3.1	15.	2.8		
19	3.1	2.9	3.3	3.1	3.5	3.5	2.1	2.7	8.5	3.0	2.1	2.7	8.5	3.0	12.	2.8		
20	3.0	2.8	3.2	3.0	3.4	3.4	2.2	2.6	13.0	2.9	2.2	2.6	13.0	2.9	17.	3.0		
21	2.9	2.8	3.1	3.0	3.4	3.4	2.2	2.7	3.0	2.9	2.2	2.7	3.0	2.9	16.	3.1		
22	2.9	2.9	3.1	3.0	3.4	3.4	2.1	2.6	3.0	2.9	2.1	2.6	3.0	2.9	13.	4.10		
23	3.2	2.9	3.3	3.0	3.5	3.5	2.4	2.6	3.0	3.0	2.4	2.6	3.0	3.0	15.	10.0		
30-1/3-GRD J/C/G RD	3.0	3.3	3.1	2.1	2.5	3.1	2.3	1.8	2.8	2.2	2.3	1.8	2.8	2.2	8.	7.00		
2	2.9	3.3	3.0	2.2	2.6	3.1	2.1	1.9	2.8	2.7	2.1	1.9	2.8	2.7	8.5	8.00		
3	2.9	3.2	3.0	2.3	2.8	3.1	2.2	2.0	2.7	2.7	2.2	2.0	2.7	2.7	8.5	1.07		

FORM 93-C REV. 6-68

INSTRUCTIONS (CONT. N 6097-6)

STATE OBJECT OF EXPERIMENT, TEST, DESIGN, OR INVENTION AND DESCRIBE IN SUFFICIENT DETAIL TO BE UNDERSTANDABLE AND REPRODUCIBLE BY ANOTHER ENGINEER. USE SKETCHES OR MAKE REFERENCE TO DRAWINGS OR PHOTOGRAPHS, IF ANY, BY NUMBER. ALL PAGES CONTAINING SUBJECT MATTER WHICH MAY BE INVENTIVE MUST BE WITNESSED.

SIGNATURE: [Signature] 8-14 1968
 WITNESSED AND UNDERSTOOD: [Signature] 8-14 1968

NORTH AMERICAN ROCKWELL CORPORATION
AEROSPACE AND SYSTEMS GROUP

N 6097-8

DIVISION SPACE (A1)		DATE ATR 492 117	
PROJECT NO: APOLLO LR 6227	CONTRACT NO. G+N FILTER BOX QUAL TEST		DATE

(GR)	TIME	DATE	PARAMETER	REFLECTION STANCE																
				1500	1500	1500	1500	1500	1500	1500	1500	1500	1500	1500	1500	1500	1500	1500	1500	1500
				2.228	2.238	7.248	7.258	7.268	7.278	7.288	7.298	7.308	7.318	7.328	7.338	7.348	7.358	7.368		
				6.4314	6.4324	6.4334	6.4344	6.4354	6.4364	6.4374	6.4384	6.4394	6.4404	6.4414	6.4424	6.4434	6.4444	6.4454		
H	↓			3.16	3.36	3.16	2.46	2.96	3.36	3.36	3.36	3.36	3.36	3.36	3.36	3.36	3.36	3.36		
5	K			3.0	3.3	3.1	2.4	2.9	3.2	3.2	3.2	3.2	3.2	3.2	3.2	3.2	3.2	3.2		
6	M			3.0	3.3	3.0	2.5	2.9	3.2	3.2	3.2	3.2	3.2	3.2	3.2	3.2	3.2	3.2		
7	N			3.1	3.3	3.0	2.6	3.1	3.2	3.2	3.2	3.2	3.2	3.2	3.2	3.2	3.2	3.2		
8	P			3.1	3.3	3.0	2.6	3.1	3.2	3.2	3.2	3.2	3.2	3.2	3.2	3.2	3.2	3.2		
9	R			3.0	3.3	2.9	2.6	3.1	3.2	3.2	3.2	3.2	3.2	3.2	3.2	3.2	3.2	3.2		
10	S			3.0	3.3	2.9	2.6	3.1	3.2	3.2	3.2	3.2	3.2	3.2	3.2	3.2	3.2	3.2		
11	T			3.0	3.4	2.9	2.6	3.1	3.2	3.2	3.2	3.2	3.2	3.2	3.2	3.2	3.2	3.2		
12	V			3.0	3.4	2.8	2.6	3.1	3.2	3.2	3.2	3.2	3.2	3.2	3.2	3.2	3.2	3.2		
13	W			3.0	3.4	2.9	2.6	3.1	3.2	3.2	3.2	3.2	3.2	3.2	3.2	3.2	3.2	3.2		
14	X			3.0	3.4	2.9	2.6	3.1	3.2	3.2	3.2	3.2	3.2	3.2	3.2	3.2	3.2	3.2		
15	Y			3.2	3.4	3.0	2.8	3.1	3.2	3.2	3.2	3.2	3.2	3.2	3.2	3.2	3.2	3.2		
16	Z			3.1	3.4	3.0	2.7	3.1	3.2	3.2	3.2	3.2	3.2	3.2	3.2	3.2	3.2	3.2		
17	AA			2.6	3.0	2.6	2.4	2.9	2.8	3.4	3.3	3.3	3.3	3.3	3.3	3.3	3.3	3.3		
18	BB			3.0	3.1	2.9	2.7	3.2	3.1	3.2	3.2	3.2	3.2	3.2	3.2	3.2	3.2	3.2		
19				3.0	3.4	2.9	2.7	3.2	3.3	3.3	3.3	3.3	3.3	3.3	3.3	3.3	3.3	3.3		
20-20/3				3.2	3.4	3.0	2.8	3.1	3.2	3.2	3.2	3.2	3.2	3.2	3.2	3.2	3.2	3.2		
21				3.1	3.4	3.0	2.7	3.2	3.3	3.3	3.3	3.3	3.3	3.3	3.3	3.3	3.3	3.3		
22				3.1	3.4	2.9	2.7	3.2	3.3	3.3	3.3	3.3	3.3	3.3	3.3	3.3	3.3	3.3		
23				3.1	3.4	2.9	2.7	3.2	3.3	3.3	3.3	3.3	3.3	3.3	3.3	3.3	3.3	3.3		
31-1				5.8	9.5	5.6	6.0	6.9	5.7	3.2	3.2	3.2	3.2	3.2	3.2	3.2	3.2	3.2		
2				5.6	8.4	5.3	5.5	6.6	5.5	3.6	3.6	5.0	5.0	5.0	5.0	5.0	5.0	5.0		
3				5.6	8.4	5.3	5.2	6.6	5.5	3.5	3.5	4.3	4.3	4.3	4.3	4.3	4.3	4.3		

INSTRUCTIONS
STATE OBJECT OF EXPERIMENT, TEST, DESIGN, OR INVENTION AND DESCRIBE IN SUFFICIENT DETAIL TO BE UNDERSTANDABLE AND REPRODUCIBLE BY ANOTHER ENGINEER. USE SKETCHES OR MAKE REFERENCE TO DRAWINGS OR PHOTOGRAPHS, IF ANY, BY NUMBER. ALL PAGES CONTAINING SUBJECT MATTER WHICH MAY BE INVENTIVE MUST BE WITNESSED.

SIGNATURE: P. W. ... 8-14 1966
WITNESSED AND UNDERSTOOD: [Signature] 8-14 1966

FORM 93-G REV. 6-66

NORTH AMERICAN ROCKWELL CORPORATION
AEROSPACE AND SYSTEMS GROUP

N 6097-9

DIVISION SPACE (A1)
 PROJECT NO: APOLLO LR 6227 CONTRACT NO. G + H FILTER BOX (QUAL TEST) DATE ATR 492117

45
37

(C.R.)	I	M	S	U	L	A	T	I	O	N	R	E	S	I	S	T	A	N	C	E		
TIME	2000	0155	0520	1300	1015	0835	1530	1430	1505	1855	2055	1030										
DATE	8-1-8	8-2-8	8-3-8	8-3-8	8-4-8	8-5-8	8-5-8	8-6-8	8-7-8	8-7-8	8-7-8	8-7-8	8-7-8	8-7-8	8-7-8	8-7-8	8-7-8	8-7-8	8-7-8	8-7-8	8-7-8	8-7-8
P.P.R.	64341	6436	651	652	652	653	653	653	653	653	654	654	654	654	654	654	654	654	654	654	654	654
30-1/1-GRD/H/C/GRD	3.06	2.36	13.16	1.66	1.60	3.6	2.46	2.36	2.46	2.36	2.36	2.36	2.36	2.36	2.36	2.36	2.36	2.36	2.36	2.36	2.36	2.36
2	3.3	2.4	14.3	1.7	6.1	3.0	9.4	2.3	2.4	2.3	2.3	2.3	2.3	2.3	2.3	2.3	2.3	2.3	2.3	2.3	2.3	2.3
3	3.0	2.4	17.2	1.7	3.9	2.9	2.3	2.2	2.4	2.2	2.2	2.2	2.2	2.2	2.2	2.2	2.2	2.2	2.2	2.2	2.2	2.2
A	3.1	2.3	12.3	1.6	2.3	2.7	2.3	2.1	2.4	2.1	2.1	2.1	2.1	2.1	2.1	2.1	2.1	2.1	2.1	2.1	2.1	2.1
S	3.3	2.7	19.1	1.8	3.6	3.0	2.5	2.3	2.5	2.3	2.3	2.3	2.3	2.3	2.3	2.3	2.3	2.3	2.3	2.3	2.3	2.3
6	3.1	2.1	9.3	1.8	2.9	2.7	2.7	2.2	2.4	2.2	2.2	2.2	2.2	2.2	2.2	2.2	2.2	2.2	2.2	2.2	2.2	2.2
7	3.1	2.4	10.1	1.76	4.0	3.0	2.8	2.4	2.6	2.4	2.4	2.4	2.4	2.4	2.4	2.4	2.4	2.4	2.4	2.4	2.4	2.4
8	3.0	2.4	6.9	1.9	6.3	3.0	3.5	2.5	2.7	2.5	2.5	2.5	2.5	2.5	2.5	2.5	2.5	2.5	2.5	2.5	2.5	2.5
9	3.4	2.2	4.0	1.7	11.0	3.2	3.1	2.7	2.9	2.7	2.7	2.7	2.7	2.7	2.7	2.7	2.7	2.7	2.7	2.7	2.7	2.7
10	3.7	3.7	20.0	2.2	9.5	4.1	3.4	2.9	3.0	2.9	2.9	2.9	2.9	2.9	2.9	2.9	2.9	2.9	2.9	2.9	2.9	2.9
11	3.6	3.7	18.0	2.2	1.7	4.1	3.5	2.9	3.1	2.9	2.9	2.9	2.9	2.9	2.9	2.9	2.9	2.9	2.9	2.9	2.9	2.9
12	3.6	3.8	17.0	2.2	1.7	3.8	3.5	3.0	3.1	3.0	3.0	3.0	3.0	3.0	3.0	3.0	3.0	3.0	3.0	3.0	3.0	3.0
13	3.3	3.8	16.0	2.2	1.7	3.8	3.4	3.0	3.1	3.0	3.0	3.0	3.0	3.0	3.0	3.0	3.0	3.0	3.0	3.0	3.0	3.0
14	3.2	3.7	15.7	2.2	1.7	3.8	3.3	2.6	3.0	2.6	2.6	2.6	2.6	2.6	2.6	2.6	2.6	2.6	2.6	2.6	2.6	2.6
15	3.4	3.6	19.4	2.2	1.7	3.8	3.4	2.8	3.0	2.8	2.8	2.8	2.8	2.8	2.8	2.8	2.8	2.8	2.8	2.8	2.8	2.8
16	3.5	3.7	14.0	2.2	1.7	4.0	3.6	3.0	3.2	3.0	3.0	3.0	3.0	3.0	3.0	3.0	3.0	3.0	3.0	3.0	3.0	3.0
17	3.7	3.7	13.9	2.2	1.7	4.0	3.6	3.0	3.2	3.0	3.0	3.0	3.0	3.0	3.0	3.0	3.0	3.0	3.0	3.0	3.0	3.0
18	3.7	3.5	13.2	2.2	9.7	4.0	3.5	2.9	3.1	2.9	2.9	2.9	2.9	2.9	2.9	2.9	2.9	2.9	2.9	2.9	2.9	2.9
19	3.7	3.5	14.1	2.1	2.0	4.0	3.5	2.9	3.1	2.9	2.9	2.9	2.9	2.9	2.9	2.9	2.9	2.9	2.9	2.9	2.9	2.9
20	3.6	3.5	14.3	2.1	2.0	4.2	3.5	2.9	3.1	2.9	2.9	2.9	2.9	2.9	2.9	2.9	2.9	2.9	2.9	2.9	2.9	2.9
21	3.5	3.3	14.2	2.0	9.3	3.7	3.3	2.8	3.0	2.8	2.8	2.8	2.8	2.8	2.8	2.8	2.8	2.8	2.8	2.8	2.8	2.8
22	3.4	2.1	3.9	1.7	5.5	3.4	3.2	2.7	3.0	2.7	2.7	2.7	2.7	2.7	2.7	2.7	2.7	2.7	2.7	2.7	2.7	2.7
23	3.7	3.0	8.5	2.0	4.6	3.8	3.5	2.8	3.1	2.8	2.8	2.8	2.8	2.8	2.8	2.8	2.8	2.8	2.8	2.8	2.8	2.8
30-1/3-GRD/H/GRD	3.2	3.0	7.5	1.7	3.3	3.4	3.3	2.9	3.1	2.9	2.9	2.9	2.9	2.9	2.9	2.9	2.9	2.9	2.9	2.9	2.9	2.9
2	3.1	3.1	7.9	1.8	3.3	3.4	3.0	2.8	2.8	2.8	2.8	2.8	2.8	2.8	2.8	2.8	2.8	2.8	2.8	2.8	2.8	2.8
3	3.1	2.7	7.6	1.6	3.1	3.2	2.9	2.7	2.8	2.7	2.7	2.7	2.7	2.7	2.7	2.7	2.7	2.7	2.7	2.7	2.7	2.7

FORM 93-C REV. 6-68

INSTRUCTIONS (CONT N 6097-10)

STATE OBJECT OF EXPERIMENT, TEST, DESIGN, OR INVENTION AND DESCRIBE IN SUFFICIENT DETAIL TO BE UNDERSTANDABLE AND REPRODUCIBLE BY ANOTHER ENGINEER. USE SKETCHES OR MAKE REFERENCE TO DRAWINGS OR PHOTOGRAPHS, IF ANY, BY NUMBER. ALL PAGES CONTAINING SUBJECT MATTER WHICH MAY BE INVENTIVE MUST BE WITNESSED.

SIGNATURE: P. W. Edwards 8-16 1968

WITNESSED AND UNDERSTOOD: [Signature] 814 18

NORTH AMERICAN ROCKWELL CORPORATION
AEROSPACE AND SYSTEMS GROUP

N 6097-10

DIVISION SPACE (A1) ATR 492117
 PROJECT NO: APD LLO LR 6227 CONTRACT NO. G+H FILTER BOX QUAL TEST DATE

(GR)	I	N	S	V	L	A	T	I	O	N	R	E	S	I	S	T	A	N	C	E
TIME	2000	0155	0530	1300	1015	0825	1530	1420	1505	1854	2055	1030								
DATE	8-18	8-31	8-28	8-31	8-48	8-58	8-58	8-68	8-78	8-78	8-78	8-8-8								
PARA.	64241	6436	151	6522	6523	6524	6522	6537	6534	6541	6542	6542								
4	3.56	3.26	10.16	1.86	3.66	3.86	3.16	2.86	2.46	2.96	3.36	3.61								
5	3.3	3.2	10.8	1.8	3.4	3.6	2.9	2.7	2.8	2.9	3.8	3.8								
6	3.4	2.7	8.5	1.7	3.2	3.2	3.2	2.6	2.7	2.6	3.0	3.0								
7	3.7	3.2	11.9	1.9	3.5	3.7	3.2	2.8	2.9	2.8	3.3	3.3								
8	3.6	3.2	13.3	1.8	3.4	3.7	3.2	2.7	2.9	2.8	3.4	3.4								
9	3.5	3.2	13.1	1.9	3.4	3.8	3.1	2.8	2.9	2.9	3.5	3.5								
10	3.4	3.3	12.7	1.9	3.4	3.5	3.3	2.7	2.8	2.9	4.0	4.0								
11	3.6	3.3	11.0	1.9	3.4	3.5	3.3	2.7	2.8	2.9	4.2	4.2								
12	3.4	3.3	10.7	1.9	3.4	3.5	3.3	2.7	2.8	2.9	4.3	4.3								
13	3.2	2.5	5.7	1.7	3.0	2.8	3.3	2.6	2.7	2.6	3.4	3.4								
14	3.3	3.1	6.4	1.8	3.3	3.5	3.2	2.7	2.8	2.9	3.8	3.8								
15	3.5	3.3	8.1	1.9	3.4	3.5	3.2	2.7	2.8	2.9	4.0	4.0								
16	3.7	3.5	10.4	2	3.6	3.8	3.4	2.8	2.9	2.8	4.0	4.0								
17	3.6	3.4	9.2	2	3.5	3.7	3.3	2.8	2.9	2.8	4.0	4.0								
18	3.0	2.6	6.8	1.7	3.0	3.1	3.3	2.4	2.5	2.5	3.5	3.5								
19	3.5	3.0	9.2	1.9	3.4	3.5	3.2	2.7	2.8	2.7	3.9	3.9								
30-20/3-GRD/11-CC/GRD	3.5	3.1	11.9	1.9	3.4	3.6	3.2	2.7	2.8	2.7	3.9	3.9								
21	3.5	3.1	12.0	1.9	3.4	3.6	3.2	2.7	2.8	2.7	3.9	3.9								
22	3.7	3.1	12.3	1.9	3.4	3.7	3.3	2.8	2.8	2.8	4.0	4.0								
23	3.7	3.1	12.7	1.9	3.5	5.9	3.3	2.7	2.8	3.0	4.0	4.0								
31-1/5-GRD/11H/GRD	8.5	8.8	11.3	7.5	11.7	12	10	8.5	6.4	6.0	6.3	6.3								
2	7.6	7.5	11.1	6.5	11.8	10.3	9	8.3	6.0	6.1	6.1	6.1								
3	8.0	7.5	10.8	6.0	13.0	10.3	9	8.0	5.8	6.0	6.4	6.4								

FORM 93-G REV. 6-66

INSTRUCTIONS CONT N 6097-11

STATE OBJECT OF EXPERIMENT, TEST, DESIGN, OR INVENTION AND DESCRIBE IN SUFFICIENT DETAIL TO BE UNDERSTANDABLE AND REPRODUCIBLE BY ANOTHER ENGINEER. USE SKETCHES OR MAKE REFERENCE TO DRAWINGS OR PHOTOGRAPHS, IF ANY, BY NUMBER. ALL PAGES CONTAINING SUBJECT MATTER WHICH MAY BE INVENTIVE MUST BE WITNESSED.

SIGNATURE: P. L. Stewart 8-14 1968
 WITNESSED AND UNDERSTOOD: [Signature] 8-14 1968

NORTH AMERICAN ROCKWELL CORPORATION
AEROSPACE AND SYSTEMS GROUP

N 6097-11

DIVISION <i>SPACE (41)</i>		ATR 492117
PROJECT NO: <i>APOLLO LR 6227</i>	CONTRACT NO. <i>G+N FILTER BOX QUAL TEST</i>	DATE —

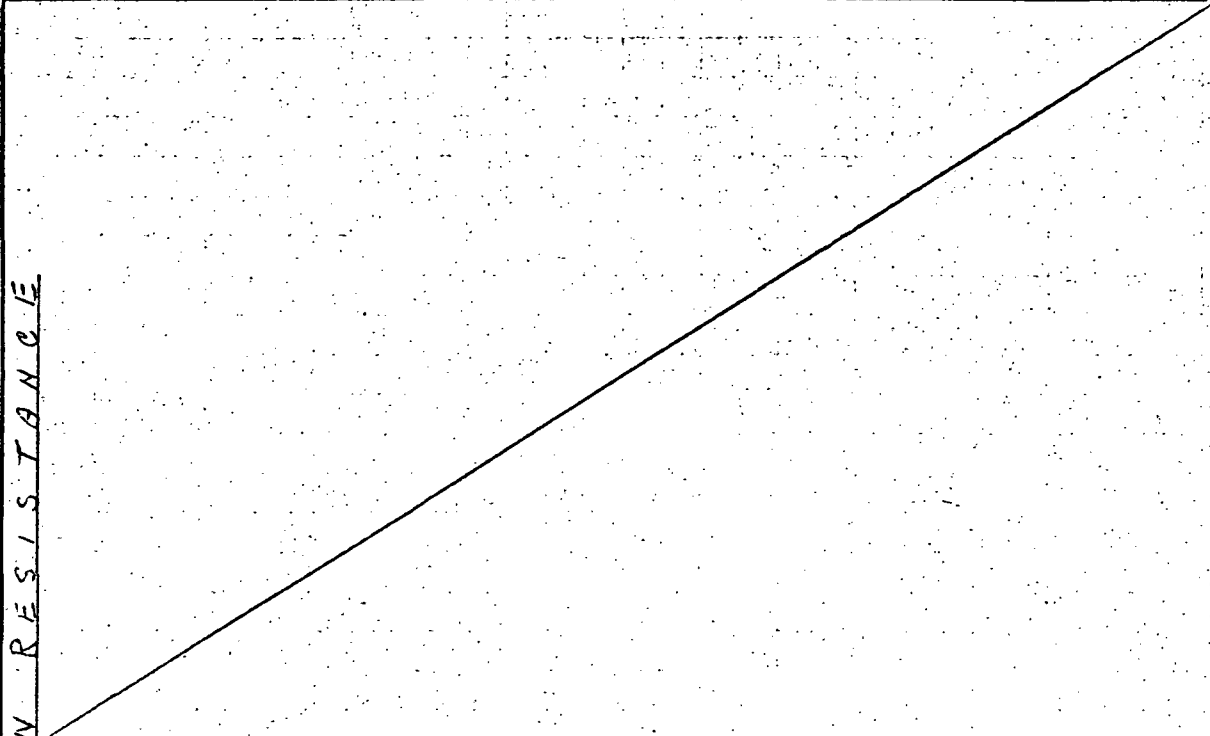

INSULATION RESISTANCE

(G.P.)	TIME	DATE	PARA.	TEST RESULTS
	1605	1905	0000	
	888	888	8.98	
	663	6711	6.77	
			30-1/1-GRD/11-C/GRD	
2			F	
3			G	
4			L	
5			M	
6			N	
7			P	
8			R	
9			S	
10			T	
11			U	
12			V	
13			X	
14			Y	
15			Z	
16			A	
17			B	
18			D	
19			E	
20			F	
21			G	
22			H	
23			I	
30-1/3-GRD/11-H/GRD			J	
2			K	
3				

FORM 93-C REV. 6-68

INSTRUCTIONS

STATE OBJECT OF EXPERIMENT, TEST, DESIGN, OR INVENTION AND DESCRIBE IN SUFFICIENT DETAIL TO BE UNDERSTANDABLE AND REPRODUCIBLE BY ANOTHER ENGINEER. USE SKETCHES OR MAKE REFERENCE TO DRAWINGS OR PHOTOGRAPHS, IF ANY, BY NUMBER. ALL PAGES CONTAINING SUBJECT MATTER WHICH MAY BE INVENTIVE MUST BE WITNESSED.

SIGNATURE: *P. L. Edwards* 8-14 1968
 WITNESSED AND UNDERSTOOD: *[Signature]* 8-14 1968

NORTH AMERICAN ROCKWELL CORPORATION
AEROSPACE AND SYSTEMS GROUP

N 6097-13

DIVISION: SPACE (HI)

PROJECT NO: APOLLO LR 6227

CONTRACT NO: G+N FILTER BOX QUAL TEST

DATE: ATR 492117

(R)	TIME	DATE	PARA.	CONTINUIT Y	
1	1505	7-10-8	6.1.2	1500	0.300
2	7-10-8	7-11-8	6.2.4	1100	0.200
3	6.1.2	6.2.4	6.2.10	0015	0.300
4	3.2	10.2	0.5R	0015	0.200
5				0015	0.200
6				0015	0.200
7				0015	0.200
8				0015	0.200
9				0015	0.200
10				0015	0.200
11				0015	0.200
12				0015	0.200
13				0015	0.200
14				0015	0.200
15				0015	0.200
16				0015	0.200
17				0015	0.200
18				0015	0.200
19				0015	0.200
20				0015	0.200
21				0015	0.200
22				0015	0.200
23				0015	0.200
24				0015	0.200
25				0015	0.200
26				0015	0.200
27				0015	0.200
28				0015	0.200
29				0015	0.200
30				0015	0.200

INSTRUCTIONS (OUT N6097-9)

STATE OBJECT OF EXPERIMENT, TEST, DESIGN, OR INVENTION AND DESCRIBE IN SUFFICIENT DETAIL TO BE UNDERSTANDABLE AND REPRODUCIBLE BY ANOTHER ENGINEER. USE SKETCHES OR MAKE REFERENCE TO DRAWINGS OR PHOTOGRAPHS, IF ANY, BY NUMBER. ALL PAGES CONTAINING SUBJECT MATTER WHICH MAY BE INVENTIVE MUST BE WITNESSED.

SIGNATURE: P. W. Stewart 8-19 1968

WITNESSED AND UNDERSTOOD: [Signature] 8-14 1968

NORTH AMERICAN ROCKWELL CORPORATION
AEROSPACE AND SYSTEMS GROUP

N 6097-14

DIVISION SPACE (A1)		ATR 492117
PROJECT NO: APOLLO LR 6227	CONTRACT NO. G+N FILTER BOX QUAL TEST	DATE

		CONTINITY											
		1505	0317	1100	1215	0015	0150	1990	0300	1900	0300	1900	0300
TIME		7:08	7:18	7:18	7:18	7:17.8	7:17.8	7:17.8	7:13.8	7:14.8	7:14.8	7:14.8	7:15.8
DATE		6.1.2	6.2.4	6.2.10	6.3.1	6.3.5	6.3.5	6.3.5	6.3.8.2	6.3.8.4	6.3.8.5	6.3.8.5	6.3.8.6
PARAM.		0.382 .40	0.02	0.522	0.02	0.02	0.02	0.02	0.02	0.02	0.02	0.02	0.02
4	K	↓	↑	↑	↑	↑	↑	↑	↑	↑	↑	↑	↑
5	M												
6	N												
7	P												
8	R												
9	S												
10	I												
11	J												
12	U												
13	V												
14	W												
15	X												
16	Y												
17	Z												
18	AA												
19	BB												
20	CC												
21	DD												
22	EE												
23	FF												
31	HH												
2	L												
3	GG												

FORM 93-C REV. 6-68

INSTRUCTIONS
STATE OBJECT OF EXPERIMENT, TEST, DESIGN, OR INVENTION, AND DESCRIBE IN SUFFICIENT DETAIL TO BE UNDERSTANDABLE AND REPRODUCIBLE BY ANOTHER ENGINEER. USE SKETCHES OR MAKE REFERENCE TO DRAWINGS OR PHOTOGRAPHS, IF ANY, BY NUMBER. ALL PAGES CONTAINING SUBJECT MATTER WHICH MAY BE INVENTIVE MUST BE WITNESSED.

SIGNATURE: P. W. Edwards 8-14 1958
WITNESSED AND UNDERSTOOD: [Signature] 8-14 1958

NORTH AMERICAN ROCKWELL CORPORATION
AEROSPACE AND SYSTEMS GROUP

N 6097-15

DIVISION		PROJECT NO.		CONTRACT NO.		DATE		
SPACE (41)		APOLLO LR 6227		G+N FILTER BOX QUAL TEST		ATR 492112		
(J2)	TIME	DATE	PARAMETER	CONTRACTIVITY	TIME	DATE	PARAMETER	
1		7158	1900	0300	1700	2110	2700	1500
2		7168	0300	1700	2110	2700	1500	1500
3		7168	0300	1700	2110	2700	1500	1500
4		7168	0300	1700	2110	2700	1500	1500
5		7168	0300	1700	2110	2700	1500	1500
6		7168	0300	1700	2110	2700	1500	1500
7		7168	0300	1700	2110	2700	1500	1500
8		7168	0300	1700	2110	2700	1500	1500
9		7168	0300	1700	2110	2700	1500	1500
10		7168	0300	1700	2110	2700	1500	1500
11		7168	0300	1700	2110	2700	1500	1500
12		7168	0300	1700	2110	2700	1500	1500
13		7168	0300	1700	2110	2700	1500	1500
14		7168	0300	1700	2110	2700	1500	1500
15		7168	0300	1700	2110	2700	1500	1500
16		7168	0300	1700	2110	2700	1500	1500
17		7168	0300	1700	2110	2700	1500	1500
18		7168	0300	1700	2110	2700	1500	1500
19		7168	0300	1700	2110	2700	1500	1500
20		7168	0300	1700	2110	2700	1500	1500
21		7168	0300	1700	2110	2700	1500	1500
22		7168	0300	1700	2110	2700	1500	1500
23		7168	0300	1700	2110	2700	1500	1500
24		7168	0300	1700	2110	2700	1500	1500
25		7168	0300	1700	2110	2700	1500	1500
26		7168	0300	1700	2110	2700	1500	1500
27		7168	0300	1700	2110	2700	1500	1500
28		7168	0300	1700	2110	2700	1500	1500
29		7168	0300	1700	2110	2700	1500	1500
30		7168	0300	1700	2110	2700	1500	1500
31		7168	0300	1700	2110	2700	1500	1500
32		7168	0300	1700	2110	2700	1500	1500
33		7168	0300	1700	2110	2700	1500	1500
34		7168	0300	1700	2110	2700	1500	1500
35		7168	0300	1700	2110	2700	1500	1500
36		7168	0300	1700	2110	2700	1500	1500
37		7168	0300	1700	2110	2700	1500	1500
38		7168	0300	1700	2110	2700	1500	1500
39		7168	0300	1700	2110	2700	1500	1500
40		7168	0300	1700	2110	2700	1500	1500
41		7168	0300	1700	2110	2700	1500	1500
42		7168	0300	1700	2110	2700	1500	1500
43		7168	0300	1700	2110	2700	1500	1500
44		7168	0300	1700	2110	2700	1500	1500
45		7168	0300	1700	2110	2700	1500	1500
46		7168	0300	1700	2110	2700	1500	1500
47		7168	0300	1700	2110	2700	1500	1500
48		7168	0300	1700	2110	2700	1500	1500
49		7168	0300	1700	2110	2700	1500	1500
50		7168	0300	1700	2110	2700	1500	1500
51		7168	0300	1700	2110	2700	1500	1500
52		7168	0300	1700	2110	2700	1500	1500
53		7168	0300	1700	2110	2700	1500	1500
54		7168	0300	1700	2110	2700	1500	1500
55		7168	0300	1700	2110	2700	1500	1500
56		7168	0300	1700	2110	2700	1500	1500
57		7168	0300	1700	2110	2700	1500	1500
58		7168	0300	1700	2110	2700	1500	1500
59		7168	0300	1700	2110	2700	1500	1500
60		7168	0300	1700	2110	2700	1500	1500
61		7168	0300	1700	2110	2700	1500	1500
62		7168	0300	1700	2110	2700	1500	1500
63		7168	0300	1700	2110	2700	1500	1500
64		7168	0300	1700	2110	2700	1500	1500
65		7168	0300	1700	2110	2700	1500	1500
66		7168	0300	1700	2110	2700	1500	1500
67		7168	0300	1700	2110	2700	1500	1500
68		7168	0300	1700	2110	2700	1500	1500
69		7168	0300	1700	2110	2700	1500	1500
70		7168	0300	1700	2110	2700	1500	1500
71		7168	0300	1700	2110	2700	1500	1500
72		7168	0300	1700	2110	2700	1500	1500
73		7168	0300	1700	2110	2700	1500	1500
74		7168	0300	1700	2110	2700	1500	1500
75		7168	0300	1700	2110	2700	1500	1500
76		7168	0300	1700	2110	2700	1500	1500
77		7168	0300	1700	2110	2700	1500	1500
78		7168	0300	1700	2110	2700	1500	1500
79		7168	0300	1700	2110	2700	1500	1500
80		7168	0300	1700	2110	2700	1500	1500
81		7168	0300	1700	2110	2700	1500	1500
82		7168	0300	1700	2110	2700	1500	1500
83		7168	0300	1700	2110	2700	1500	1500
84		7168	0300	1700	2110	2700	1500	1500
85		7168	0300	1700	2110	2700	1500	1500
86		7168	0300	1700	2110	2700	1500	1500
87		7168	0300	1700	2110	2700	1500	1500
88		7168	0300	1700	2110	2700	1500	1500
89		7168	0300	1700	2110	2700	1500	1500
90		7168	0300	1700	2110	2700	1500	1500
91		7168	0300	1700	2110	2700	1500	1500
92		7168	0300	1700	2110	2700	1500	1500
93		7168	0300	1700	2110	2700	1500	1500
94		7168	0300	1700	2110	2700	1500	1500
95		7168	0300	1700	2110	2700	1500	1500
96		7168	0300	1700	2110	2700	1500	1500
97		7168	0300	1700	2110	2700	1500	1500
98		7168	0300	1700	2110	2700	1500	1500
99		7168	0300	1700	2110	2700	1500	1500
100		7168	0300	1700	2110	2700	1500	1500

SPECIAL TEST
CHAMBER DOORS OPENED (AMBIENT)

FORM 23-G REV. 6-68

INSTRUCTIONS CONTN 6097-16

STATE OBJECT OF EXPERIMENT, TEST, DESIGN, OR INVENTION AND DESCRIBE IN SUFFICIENT DETAIL TO BE UNDERSTANDABLE AND REPRODUCIBLE BY ANOTHER ENGINEER. USE SKETCHES OR MAKE REFERENCE TO DRAWINGS OR PHOTOGRAPHS, IF ANY, BY NUMBER. ALL PAGES CONTAINING SUBJECT MATTER WHICH MAY BE INVENTIVE MUST BE WITNESSED.

SIGNATURE: [Signature] 3-14 1968

WITNESSED AND UNDERSTOOD: [Signature] 3-14 1968

NORTH AMERICAN ROCKWELL CORPORATION
AEROSPACE AND SYSTEMS GROUP

N 6097-16

DIVISION <i>SPACE (HI)</i>		DATE <i>ATR 492117</i>	
PROJECT NO: <i>APOLLO LR 6227</i>	CONTRACT NO. <i>G + H FILTER BOX QUAL TEST</i>		DATE

<i>(SR)</i>		<i>CONTINUITY</i>			
		TIME	DATE	PARA.	
4	1900	715.8	716.8	6389	↓
5	1900	716.8	716.8	6389	↑
6	1900	716.8	716.8	6389	↑
7	1900	716.8	716.8	6389	↑
8	1900	716.8	716.8	6389	↑
9	1900	716.8	716.8	6389	↑
10	1900	716.8	716.8	6389	↑
11	1900	716.8	716.8	6389	↑
12	1900	716.8	716.8	6389	↑
13	1900	716.8	716.8	6389	↑
14	1900	716.8	716.8	6389	↑
15	1900	716.8	716.8	6389	↑
16	1900	716.8	716.8	6389	↑
17	1900	716.8	716.8	6389	↑
18	1900	716.8	716.8	6389	↑
19	1900	716.8	716.8	6389	↑
20	1900	716.8	716.8	6389	↑
21	1900	716.8	716.8	6389	↑
22	1900	716.8	716.8	6389	↑
23	1900	716.8	716.8	6389	↑
24	1900	716.8	716.8	6389	↑
25	1900	716.8	716.8	6389	↑
26	1900	716.8	716.8	6389	↑
27	1900	716.8	716.8	6389	↑
28	1900	716.8	716.8	6389	↑
29	1900	716.8	716.8	6389	↑
30	1900	716.8	716.8	6389	↑
31	1900	716.8	716.8	6389	↑
32	1900	716.8	716.8	6389	↑
33	1900	716.8	716.8	6389	↑
34	1900	716.8	716.8	6389	↑
35	1900	716.8	716.8	6389	↑
36	1900	716.8	716.8	6389	↑
37	1900	716.8	716.8	6389	↑
38	1900	716.8	716.8	6389	↑
39	1900	716.8	716.8	6389	↑
40	1900	716.8	716.8	6389	↑
41	1900	716.8	716.8	6389	↑
42	1900	716.8	716.8	6389	↑
43	1900	716.8	716.8	6389	↑
44	1900	716.8	716.8	6389	↑
45	1900	716.8	716.8	6389	↑
46	1900	716.8	716.8	6389	↑
47	1900	716.8	716.8	6389	↑
48	1900	716.8	716.8	6389	↑
49	1900	716.8	716.8	6389	↑
50	1900	716.8	716.8	6389	↑
51	1900	716.8	716.8	6389	↑
52	1900	716.8	716.8	6389	↑
53	1900	716.8	716.8	6389	↑
54	1900	716.8	716.8	6389	↑
55	1900	716.8	716.8	6389	↑
56	1900	716.8	716.8	6389	↑
57	1900	716.8	716.8	6389	↑
58	1900	716.8	716.8	6389	↑
59	1900	716.8	716.8	6389	↑
60	1900	716.8	716.8	6389	↑
61	1900	716.8	716.8	6389	↑
62	1900	716.8	716.8	6389	↑
63	1900	716.8	716.8	6389	↑
64	1900	716.8	716.8	6389	↑
65	1900	716.8	716.8	6389	↑
66	1900	716.8	716.8	6389	↑
67	1900	716.8	716.8	6389	↑
68	1900	716.8	716.8	6389	↑
69	1900	716.8	716.8	6389	↑
70	1900	716.8	716.8	6389	↑
71	1900	716.8	716.8	6389	↑
72	1900	716.8	716.8	6389	↑
73	1900	716.8	716.8	6389	↑
74	1900	716.8	716.8	6389	↑
75	1900	716.8	716.8	6389	↑
76	1900	716.8	716.8	6389	↑
77	1900	716.8	716.8	6389	↑
78	1900	716.8	716.8	6389	↑
79	1900	716.8	716.8	6389	↑
80	1900	716.8	716.8	6389	↑
81	1900	716.8	716.8	6389	↑
82	1900	716.8	716.8	6389	↑
83	1900	716.8	716.8	6389	↑
84	1900	716.8	716.8	6389	↑
85	1900	716.8	716.8	6389	↑
86	1900	716.8	716.8	6389	↑
87	1900	716.8	716.8	6389	↑
88	1900	716.8	716.8	6389	↑
89	1900	716.8	716.8	6389	↑
90	1900	716.8	716.8	6389	↑
91	1900	716.8	716.8	6389	↑
92	1900	716.8	716.8	6389	↑
93	1900	716.8	716.8	6389	↑
94	1900	716.8	716.8	6389	↑
95	1900	716.8	716.8	6389	↑
96	1900	716.8	716.8	6389	↑
97	1900	716.8	716.8	6389	↑
98	1900	716.8	716.8	6389	↑
99	1900	716.8	716.8	6389	↑
100	1900	716.8	716.8	6389	↑

SPECIAL TEST
CHAMBER DOORS OPENED (AMBIENT)

FORM 93-G REV. 6-68

INSTRUCTIONS
STATE OBJECT OF EXPERIMENT, TEST, DESIGN, OR INVENTION AND DESCRIBE IN SUFFICIENT DETAIL TO BE UNDERSTANDABLE AND REPRODUCIBLE BY ANOTHER ENGINEER. USE SKETCHES OR MAKE REFERENCE TO DRAWINGS OR PHOTOGRAPHS. IF ANY, BY NUMBER. ALL PAGES CONTAINING SUBJECT MATTER WHICH MAY BE INVENTIVE MUST BE WITNESSED.

SIGNATURE: *P. L. Edward* 8-18-68
WITNESSED AND UNDERSTOOD: *[Signature]* 8-14-68

NORTH AMERICAN ROCKWELL CORPORATION
AEROSPACE AND SYSTEMS GROUP

N 6097-17

DIVISION: SPACE (411)
 PROJECT NO: APOLLO LR 6227 CONTRACT NO: G+H FILTER Box QUAL TEST DATE: ATR 492117

CONTINUITY	1500	7228	64314	0202	→		→	.20
	1500	7238	64321	0202	→		→	.20
	1435	7248	64322	0202	→		→	.20
	1500	7258	64323	0202	→		→	.20
	1500	7268	64324	0202	→		→	.20
	1500	7278	64325	0202	→		→	.20
	1500	7288	64326	0202	→		→	.20
	1300	7348	64327	0202	→		→	.2
	1500	7308	64328	0202	→		→	.20
	1500	7318	64329	0202	→		→	.20
	1450	7328	64330	0202	→		→	.20
	1655	7338	64331	0202	→		→	.20
	2000	7348	64332	0202	→		→	.20
	1500	7358	64333	0202	→		→	.20
	1500	7368	64334	0202	→		→	.20
	1500	7378	64335	0202	→		→	.20
	1500	7388	64336	0202	→		→	.20
	1500	7398	64337	0202	→		→	.20
	1500	7408	64338	0202	→		→	.20
	1500	7418	64339	0202	→		→	.20
	1500	7428	64340	0202	→		→	.20
	1500	7438	64341	0202	→		→	.20

INSTRUCTIONS *Cont N5047-13*

STATE OBJECT OF EXPERIMENT TEST DESIGN, OR INVENTION AND DESCRIBE IN SUFFICIENT DETAIL TO BE UNDERSTANDABLE AND REPRODUCIBLE BY ANOTHER ENGINEER. USE SKETCHES OR MAKE REFERENCE TO DRAWINGS OR PHOTOGRAPHS, IF ANY, BY NUMBER. ALL PAGES CONTAINING SUBJECT MATTER WHICH MAY BE INVENTIVE MUST BE WITNESSED.

SIGNATURE: P. W. Howard 8-14-1968

WITNESSED AND UNDERSTOOD: [Signature] 8-14-1968

FORM 93-C REV. 6-68

**NORTH AMERICAN ROCKWELL CORPORATION
AEROSPACE AND SYSTEMS GROUP**

N 6097-18

DIVISION SPACE (41) **ATR 492117**
PROJECT NO: APOLLO LR 6227 **CONTRACT NO. G+N FILTER**
DATE —————
Box Qual Test

TIME	DATE	PARA.				
1500	722-8	41214	.202	↑	→	.20
1500	723-8	41221	.202	↑	→	.20
1435	724-8	41222	.202	↑	→	.20
1500	725-8	41223	.202	↑	→	.20
1500	726-8	41224	.202	↑	→	.20
1500	727-8	41225	.202	↑	→	.20
1500	728-8	41226	.202	↑	→	.20
1500	729-8	41227	.202	↑	→	.20
1500	730-8	41228	.202	↑	→	.20
1500	731-8	41229	.202	↑	→	.20
1450	8-1-8	41230	.202	↑	→	.20
1655	8-1-8	41231	.202	↑	→	.20
2000	8-1-8	41232	.202	↑	→	.20

(2) **C.O.N.T.I.N.U.I.T.Y.**

30-12/3-4/11-12-14
13 14 15 16 17 18 19 20 21 22 23
31-1/5-6
3

INSTRUCTIONS
STATE OBJECT OF EXPERIMENT TEST, DESIGN, OR INVENTION AND DESCRIBE IN SUFFICIENT DETAIL TO BE UNDERSTANDABLE AND REPRODUCIBLE BY ANOTHER ENGINEER. USE SKETCHES OR MAKE REFERENCE TO DRAWINGS OR PHOTOGRAPHS, IF ANY, BY NUMBER. ALL PAGES CONTAINING SUBJECT MATTER WHICH MAY BE INVENTIVE MUST BE WITNESSED.

SIGNATURE: J. W. Edwards 5-14 1968
WITNESSED AND UNDERSTOOD: R. Lyda 8/14 1968

NORTH AMERICAN ROCKWELL CORPORATION
AEROSPACE AND SYSTEMS GROUP

N 6097-19

DIVISION

SPACE (HI)

ATR 492119

PROJECT NO:

APOLLO LR 6227

CONTRACT NO.

G + N FILTER
BOX QUAL TEST

DATE

CONTINUITY

TIME	DATE	PARA.	1	2	3	4	5	6	7	8	9	10	11	12	13	14	15	16	17	18	19	20	21	22	23	24	25	26	27	28	29	30
0155	8-28	6-426	.90R	↑																												
0530	8-28	6-51	.90R	↑																												
1300	8-28	6-522	.40R	↑																												
1015	8-28	6-522	.30R	↑																												
0825	8-28	6-522	.30R	↑																												
1520	8-28	6-532	.40R	↑																												
1420	8-28	6-533	.90R	↑																												
1505	8-28	6-534	.40R	↑																												
1855	8-28	6-544	.40R	↑																												
2055	8-28	6-544	.30R	↑																												
1030	8-28	6-61	.40R	↑																												
1605	8-28	6-63	.40R	↑																												
1905	8-28	6-71	.40R	↑																												
2000	8-28	6-72	.30R	↑																												

FORM 93-G REV. 9-66

INSTRUCTIONS

STATE OBJECT OF EXPERIMENT, TEST, DESIGN, OR INVENTION AND DESCRIBE IN SUFFICIENT DETAIL TO BE UNDERSTANDABLE AND REPRODUCIBLE BY ANOTHER ENGINEER. USE SKETCHES OR MAKE REFERENCE TO DRAWINGS OR PHOTOGRAPHS, IF ANY, BY NUMBER. ALL PAGES CONTAINING SUBJECT MATTER WHICH MAY BE INVENTIVE MUST BE WITNESSED.

SIGNATURE: P. W. Edwards 8-16-66

WITNESSED AND UNDERSTOOD: [Signature] 8/14 1966

NORTH AMERICAN ROCKWELL CORPORATION
AEROSPACE AND SYSTEMS GROUP

N 6097-20

DIVISION SPACE (A1)		HTR 49217	
PROJECT NO. APOLLO LR 6227	CONTRACT NO. G+N FILTER BOX QUAL TEST	DATE	

TIME	0155	8-7-8	6-176	6-51	.90R	→	→	.70
	1300	8-7-8	6-22	6-22	.40R	→	→	.40
DATE	0896	8-5-8	6-23	6-23	.30R	→	→	.30
PARA.	1530	8-5-8	6-32	6-32	.10R	→	→	.10
	1535	8-7-8	6-34	6-34	.40R	→	→	.40
C.O.N.T.I.N.U.I.T.Y	1540	8-7-8	6-34	6-34	.40R	→	→	.40
	1545	8-7-8	6-34	6-34	.40R	→	→	.40
4	1550	8-7-8	6-34	6-34	.30R	→	→	.30
	1555	8-7-8	6-34	6-34	.30R	→	→	.30
5	1605	8-8-8	6-61	6-61	.40R	→	→	.40
	1610	8-8-8	6-61	6-61	.40R	→	→	.40
6	1615	8-8-8	6-61	6-61	.40R	→	→	.40
	1620	8-8-8	6-61	6-61	.40R	→	→	.40
7	1625	8-7-8	6-61	6-61	.40R	→	→	.40
	1630	8-7-8	6-61	6-61	.40R	→	→	.40
8	1635	8-7-8	6-61	6-61	.40R	→	→	.40
	1640	8-7-8	6-61	6-61	.40R	→	→	.40
9	1645	8-7-8	6-61	6-61	.40R	→	→	.40
	1650	8-7-8	6-61	6-61	.40R	→	→	.40
10	1655	8-7-8	6-61	6-61	.40R	→	→	.40
	1700	8-7-8	6-61	6-61	.40R	→	→	.40
11	1705	8-7-8	6-61	6-61	.40R	→	→	.40
	1710	8-7-8	6-61	6-61	.40R	→	→	.40
12	1715	8-7-8	6-61	6-61	.40R	→	→	.40
	1720	8-7-8	6-61	6-61	.40R	→	→	.40
13	1725	8-7-8	6-61	6-61	.40R	→	→	.40
	1730	8-7-8	6-61	6-61	.40R	→	→	.40
14	1735	8-7-8	6-61	6-61	.40R	→	→	.40
	1740	8-7-8	6-61	6-61	.40R	→	→	.40
15	1745	8-7-8	6-61	6-61	.40R	→	→	.40
	1750	8-7-8	6-61	6-61	.40R	→	→	.40
16	1755	8-7-8	6-61	6-61	.40R	→	→	.40
	1800	8-7-8	6-61	6-61	.40R	→	→	.40
17	1805	8-7-8	6-61	6-61	.40R	→	→	.40
	1810	8-7-8	6-61	6-61	.40R	→	→	.40
18	1815	8-7-8	6-61	6-61	.40R	→	→	.40
	1820	8-7-8	6-61	6-61	.40R	→	→	.40
19	1825	8-7-8	6-61	6-61	.40R	→	→	.40
	1830	8-7-8	6-61	6-61	.40R	→	→	.40
20	1835	8-7-8	6-61	6-61	.40R	→	→	.40
	1840	8-7-8	6-61	6-61	.40R	→	→	.40
21	1845	8-7-8	6-61	6-61	.40R	→	→	.40
	1850	8-7-8	6-61	6-61	.40R	→	→	.40
22	1855	8-7-8	6-61	6-61	.40R	→	→	.40
	1900	8-7-8	6-61	6-61	.40R	→	→	.40
23	1905	8-7-8	6-61	6-61	.40R	→	→	.40
	1910	8-7-8	6-61	6-61	.40R	→	→	.40
24	1915	8-7-8	6-61	6-61	.40R	→	→	.40
	1920	8-7-8	6-61	6-61	.40R	→	→	.40
25	1925	8-7-8	6-61	6-61	.40R	→	→	.40
	1930	8-7-8	6-61	6-61	.40R	→	→	.40
26	1935	8-7-8	6-61	6-61	.40R	→	→	.40
	1940	8-7-8	6-61	6-61	.40R	→	→	.40
27	1945	8-7-8	6-61	6-61	.40R	→	→	.40
	1950	8-7-8	6-61	6-61	.40R	→	→	.40
28	1955	8-7-8	6-61	6-61	.40R	→	→	.40
	2000	8-7-8	6-61	6-61	.40R	→	→	.40
29	2005	8-7-8	6-61	6-61	.40R	→	→	.40
	2010	8-7-8	6-61	6-61	.40R	→	→	.40
30	2015	8-7-8	6-61	6-61	.40R	→	→	.40
	2020	8-7-8	6-61	6-61	.40R	→	→	.40
31	2025	8-7-8	6-61	6-61	.40R	→	→	.40
	2030	8-7-8	6-61	6-61	.40R	→	→	.40

FORM 93-C REV. 6-68

INSTRUCTIONS

STATE OBJECT OF EXPERIMENT, TEST, DESIGN, OR INVENTION AND DESCRIBE IN SUFFICIENT DETAIL TO BE UNDERSTANDABLE AND REPRODUCIBLE BY ANOTHER ENGINEER. USE SKETCHES OR MAKE REFERENCE TO DRAWINGS OR PHOTOGRAPHS, IF ANY, BY NUMBER. ALL PAGES CONTAINING SUBJECT MATTER WHICH MAY BE INVENTIVE MUST BE WITNESSED.

SIGNATURE: P. W. [Signature] 8-19-68

WITNESSED AND UNDERSTOOD: [Signature] 8-19-68

NORTH AMERICAN ROCKWELL CORPORATION
AEROSPACE AND SYSTEMS GROUP

N 6097-21

DIVISION SPACE (HI)		ATR 492117
PROJECT NO: APOLLO LR 622.7	CONTRACT NO. G + N FILTER Box QUBL TEST	DATE —

(PF)	C A P A C I T A N C E T E S T														
	1505	7108	6112	9500	8600	7900	8900	8100	8400	8700	8800	8500	8700	8300	8100
TIME	0317	7118	624	9000	7900	8900	8100	8400	8700	8800	8500	8700	8300	8100	8300
DATE	7-10-5	7-11-5	6-21-6	9-5-6	8-6-6	8-9-6	8-10-6	8-4-6	8-7-6	8-8-6	8-5-6	8-7-6	8-3-6	8-1-6	8-3-6
PARA	6.1.2	6.2.4	6.3.5	6.3.3	6.3.3	6.3.5	6.3.7	6.2.8.2	6.2.8.3	6.2.8.4	6.2.8.5	6.2.8.6	6.2.8.7	6.2.8.8	6.2.8.9
30-4/1-GRD/UL/GRD	9500	9000	9500	9600	8500	8800	8300	8400	8700	8800	8500	8700	8300	8100	8300
6	8600	7900	8600	8500	8500	8800	8300	8400	8700	8800	8500	8700	8300	8100	8300
7	8800	8700	8900	8800	8800	8900	8300	8400	8700	8800	8500	8700	8300	8100	8300
8	7600	6900	7700	5700	7800	7700	7600	7850	7850	7850	7850	7850	7850	7850	7850
9	8800	8100	8900	7800	8100	8100	8100	8300	8400	8700	8800	8500	8700	8300	8100
22	8100	7400	8100	8100	8100	8100	8100	8300	8400	8700	8800	8500	8700	8300	8100
23	8400	7800	8400	8400	8400	8400	8400	8300	8400	8700	8800	8500	8700	8300	8100
4/2	9400	8900	9500	9600	9400	9400	9400	9400	9400	9400	9400	9400	9400	9400	9400
6	8500	7800	8600	8500	8700	8700	8700	8700	8700	8700	8700	8700	8700	8700	8700
7	8700	8700	8800	8700	8700	8700	8700	8700	8700	8700	8700	8700	8700	8700	8700
8	7500	6700	7700	7600	7500	7500	7500	7500	7500	7500	7500	7500	7500	7500	7500
9	8700	8050	8800	8800	8700	8700	8700	8700	8700	8700	8700	8700	8700	8700	8700
22	8000	7400	8100	8100	8000	8000	8000	8000	8000	8000	8000	8000	8000	8000	8000
23	8300	7800	8300	8300	8300	8300	8300	8300	8300	8300	8300	8300	8300	8300	8300
3/3	8100	7200	8300	8200	8100	8100	8100	8100	8100	8100	8100	8100	8100	8100	8100
6	8600	7800	8800	8700	8600	8600	8600	8600	8600	8600	8600	8600	8600	8600	8600
13	8800	8000	8800	8700	8700	8700	8700	8700	8700	8700	8700	8700	8700	8700	8700
14	7900	7200	7900	7900	7800	7800	7800	7800	7800	7800	7800	7800	7800	7800	7800
15	8600	7950	8500	8500	8600	8600	8600	8600	8600	8600	8600	8600	8600	8600	8600
3/4	8000	7100	8200	8200	8100	8100	8100	8100	8100	8100	8100	8100	8100	8100	8100
6	8600	7750	8700	8600	8500	8500	8500	8500	8500	8500	8500	8500	8500	8500	8500
13	8700	8050	8800	8700	8600	8600	8600	8600	8600	8600	8600	8600	8600	8600	8600
14	7800	7100	7900	7800	7700	7700	7700	7700	7700	7700	7700	7700	7700	7700	7700
15	8500	7950	8600	8500	8400	8400	8400	8400	8400	8400	8400	8400	8400	8400	8400

FORM 93-G REV. 6-68

INSTRUCTIONS CONT N 6097-22

STATE OBJECT OF EXPERIMENT, TEST, DESIGN, OR INVENTION AND DESCRIBE IN SUFFICIENT DETAIL TO BE UNDERSTANDABLE AND REPRODUCIBLE BY ANOTHER ENGINEER. USE SKETCHES OR MAKE REFERENCE TO DRAWINGS OR PHOTOGRAPHS, IF ANY, BY NUMBER. ALL PAGES CONTAINING SUBJECT MATTER WHICH MAY BE INVENTIVE MUST BE WITNESSED.

SIGNATURE: [Signature] 8-14-68
 WITNESSED AND UNDERSTOOD: [Signature] 8-14-68

NORTH AMERICAN ROCKWELL CORPORATION
AEROSPACE AND SYSTEMS GROUP

N 6097-22

DIVISION

SPACE (HI)

ATR 492117

PROJECT NO:

APOLLO LR 627-7

CONTRACT NO.

G4N FILTER BOX QUAL TEST

DATE

TIME	DATE	PARAM	C A P A C I T A N C E T E S T														
			0300	1900	0300	1900	0300	1900	0300	1900	0300	1900	0300	1900	0300	1900	
6	7/16/68	N	7600	8100	7600	8100	7600	8100	7600	8100	7600	8100	7600	8100	7600	8100	
7	7/17/68	P	7700	8000	7700	8000	7700	8000	7700	8000	7700	8000	7700	8000	7700	8000	
8	7/18/68	R	7400	7600	7400	7600	7400	7600	7400	7600	7400	7600	7400	7600	7400	7600	
9	7/19/68	S	7800	7800	7800	7800	7800	7800	7800	7800	7800	7800	7800	7800	7800	7800	
12	7/20/68	G	7500	8100	7500	8100	7500	8100	7500	8100	7500	8100	7500	8100	7500	8100	
13	7/21/68	H	7700	8400	7700	8400	7700	8400	7700	8400	7700	8400	7700	8400	7700	8400	
4/2	7/22/68	J7-L	8900	9600	8900	9600	8900	9600	8900	9600	8900	9600	8900	9600	8900	9600	
6	7/23/68	N	7700	8400	7700	8400	7700	8400	7700	8400	7700	8400	7700	8400	7700	8400	
7	7/24/68	P	7700	8800	7700	8800	7700	8800	7700	8800	7700	8800	7700	8800	7700	8800	
8	7/25/68	R	7400	7600	7400	7600	7400	7600	7400	7600	7400	7600	7400	7600	7400	7600	
9	7/26/68	S	7800	7800	7800	7800	7800	7800	7800	7800	7800	7800	7800	7800	7800	7800	
11	7/27/68	G	7500	8100	7500	8100	7500	8100	7500	8100	7500	8100	7500	8100	7500	8100	
23	7/28/68	H	7700	8400	7700	8400	7700	8400	7700	8400	7700	8400	7700	8400	7700	8400	
3/3	7/29/68	J1-K	7900	8000	7900	8000	7900	8000	7900	8000	7900	8000	7900	8000	7900	8000	
6	7/30/68	M	8000	8900	8000	8900	8000	8900	8000	8900	8000	8900	8000	8900	8000	8900	
13	7/31/68	V	7700	8600	7700	8600	7700	8600	7700	8600	7700	8600	7700	8600	7700	8600	
14	8/1/68	W	7900	7600	7900	7600	7900	7600	7900	7600	7900	7600	7900	7600	7900	7600	
15	8/2/68	X	7600	8500	7600	8500	7600	8500	7600	8500	7600	8500	7600	8500	7600	8500	
3/4	8/3/68	J1-K	7900	8000	7900	8000	7900	8000	7900	8000	7900	8000	7900	8000	7900	8000	
6	8/4/68	M	8000	8900	8000	8900	8000	8900	8000	8900	8000	8900	8000	8900	8000	8900	
13	8/5/68	V	7700	8600	7700	8600	7700	8600	7700	8600	7700	8600	7700	8600	7700	8600	
14	8/6/68	W	7900	7600	7900	7600	7900	7600	7900	7600	7900	7600	7900	7600	7900	7600	
15	8/7/68	X	7600	8500	7600	8500	7600	8500	7600	8500	7600	8500	7600	8500	7600	8500	
3/4	8/8/68	J1-K	7900	8000	7900	8000	7900	8000	7900	8000	7900	8000	7900	8000	7900	8000	
6	8/9/68	M	8000	8900	8000	8900	8000	8900	8000	8900	8000	8900	8000	8900	8000	8900	
13	8/10/68	V	7700	8600	7700	8600	7700	8600	7700	8600	7700	8600	7700	8600	7700	8600	
14	8/11/68	W	7900	7600	7900	7600	7900	7600	7900	7600	7900	7600	7900	7600	7900	7600	
15	8/12/68	X	7600	8500	7600	8500	7600	8500	7600	8500	7600	8500	7600	8500	7600	8500	

* INDICATES BELOW TOLERANCE OR 5500 PICO FARADS

○ SPECIFIED LIMIT WAS REDUCED TO 3500 PF MINIMUM PE ATR 492117A

FORM 93-G REV. 6-68

INSTRUCTIONS (6097-23)

STATE OBJECT OF EXPERIMENT, TEST, DESIGN, OR INVENTION AND DESCRIBE IN SUFFICIENT DETAIL TO BE UNDERSTANDABLE AND REPRODUCIBLE BY ANOTHER ENGINEER. USE SKETCHES OR MAKE REFERENCE TO DRAWINGS OR PHOTOGRAPHS, IF ANY, BY NUMBER. ALL PAGES CONTAINING SUBJECT MATTER WHICH MAY BE INVENTIVE MUST BE WITNESSED.

SIGNATURE: PLB [Signature] 3-14 1968

WITNESSED AND UNDERSTOOD: [Signature] 8-14 1968

**NORTH AMERICAN ROCKWELL CORPORATION
AEROSPACE AND SYSTEMS GROUP**

N 6097-23

DIVISION **SPACE (HI)** ATR 492117
 PROJECT NO: **APOLLO LR 6247** CONTRACT NO. **G & H FILTER Box QUAL TEST** DATE _____

(PF) C H P A R I T A N C E T E S T

TIME	DATE	P.P.A.	30-4-11 - GRVIL/GAB	6	7	8	9	10	11	12	13	14	15	3/4	6	13	14	15	
1435	7-24-68	61322	64322	1500	1500	1500	1300	1500	1500	1500	1450	1655	2000	0155	0530	8400	8000	8500	8600
6	N	8400	8500	8000	8000	8000	8000	8000	8000	8000	8000	8000	8000	8000	8000	8000	8000	8000	8000
7	P	8000	8000	8000	8000	8000	8000	8000	8000	8000	8000	8000	8000	8000	8000	8000	8000	8000	8000
8	R	7600	7600	7600	7600	7600	7600	7600	7600	7600	7600	7600	7600	7600	7600	7600	7600	7600	7600
9	S	8200	8200	8200	8200	8200	8200	8200	8200	8200	8200	8200	8200	8200	8200	8200	8200	8200	8200
10	G	7800	7800	7800	7800	7800	7800	7800	7800	7800	7800	7800	7800	7800	7800	7800	7800	7800	7800
11	H	8000	8000	8000	8000	8000	8000	8000	8000	8000	8000	8000	8000	8000	8000	8000	8000	8000	8000
12	L	8400	8400	8400	8400	8400	8400	8400	8400	8400	8400	8400	8400	8400	8400	8400	8400	8400	8400
13	N	7900	7900	7900	7900	7900	7900	7900	7900	7900	7900	7900	7900	7900	7900	7900	7900	7900	7900
14	P	8000	8000	8000	8000	8000	8000	8000	8000	8000	8000	8000	8000	8000	8000	8000	8000	8000	8000
15	R	7600	7600	7600	7600	7600	7600	7600	7600	7600	7600	7600	7600	7600	7600	7600	7600	7600	7600
3/3	S	8200	8200	8200	8200	8200	8200	8200	8200	8200	8200	8200	8200	8200	8200	8200	8200	8200	8200
6	G	7700	7700	7700	7700	7700	7700	7700	7700	7700	7700	7700	7700	7700	7700	7700	7700	7700	7700
13	L	7900	7900	7900	7900	7900	7900	7900	7900	7900	7900	7900	7900	7900	7900	7900	7900	7900	7900
14	K	7400	7400	7400	7400	7400	7400	7400	7400	7400	7400	7400	7400	7400	7400	7400	7400	7400	7400
15	X	7800	7800	7800	7800	7800	7800	7800	7800	7800	7800	7800	7800	7800	7800	7800	7800	7800	7800
3/4	X	8200	8200	8200	8200	8200	8200	8200	8200	8200	8200	8200	8200	8200	8200	8200	8200	8200	8200
6	X	8300	8300	8300	8300	8300	8300	8300	8300	8300	8300	8300	8300	8300	8300	8300	8300	8300	8300
13	X	7900	7900	7900	7900	7900	7900	7900	7900	7900	7900	7900	7900	7900	7900	7900	7900	7900	7900
14	X	7400	7400	7400	7400	7400	7400	7400	7400	7400	7400	7400	7400	7400	7400	7400	7400	7400	7400
15	X	7800	7800	7800	7800	7800	7800	7800	7800	7800	7800	7800	7800	7800	7800	7800	7800	7800	7800

FORM 93-G REV. 6-68

INSTRUCTIONS CONT N6097-24

STATE OBJECT OF EXPERIMENT, TEST, DESIGN, OR INVENTION AND DESCRIBE IN SUFFICIENT DETAIL TO BE UNDERSTANDABLE AND REPRODUCIBLE BY ANOTHER ENGINEER. USE SKETCHES OR MAKE REFERENCE TO DRAWINGS OR PHOTOGRAPHS, IF ANY, BY NUMBER. ALL PAGES CONTAINING SUBJECT MATTER WHICH MAY BE INVENTIVE MUST BE WITNESSED.

SIGNATURE: P. L. Edwards 8-14 1968
 WITNESSED AND UNDERSTOOD: R. Lytle 8-14 1968

APPENDIX D

VIBRATION

North American Aviation, Inc. 

N 5778-16

DIVISION <u>SPACE-DOWNEY</u>		
PROJECT NO: <u>LR 6227</u>	CONTRACT NO. <u>ATR 492117</u>	DATE <u>7-10-68</u>

SUBJECT : QUALIFICATION TEST OF GUIDANCE AND NAVIGATIONAL FILTER BOX ASSEMBLY VIBRATION

PN V36-442330 SN 06362 AAH 3858

L&T RESPONSIBLE TEST ENGINEER R. A. SCHROFF 05717

L&T RESPONSIBLE VIBRATION ENGINEER P. W. SIMON 01246

S D ENGINEERING REQUESTER L. LUERA 01305

APPLICABLE DOCUMENTS

ATR 492 117 GUIDANCE AND NAVIGATIONAL FILTER BOX ASSY.

IL-6227-801 LABORATORIES AND TEST QUALIFICATION TEST PROCEDURE FOR GUIDANCE AND NAVIGATION FILTER BOX ASSY. V36-442330

EQUIPMENT LIST

DESCRIPTION	MFG	MODEL	NE/SD CONTROL NO.	CAL/SCR DUE DATE
VIBRATION SYSTEM	LING	40/40-1	F306 239	8-14-68
VIBRATION SYSTEM	LING	40/40-2	F300 086	8-14-68
RANDOM SYSTEM	LING	ASDE 80	J105 897	8-6-68
VTVM	BALLANTINE	321	N777 546	8-8-68
OSCILLOSCOPE	TEKTRONIX	535A	N732192	4-9-68
POWER SUPPLY	ENDEVCO	2628	S011 817	10-13-68
CHARGE AMPLIFIER	ENDEVCO	2713	S028841	8-13-68
TAPE LOOP SYSTEM	AMPEX	FR1200	S016 271	9-12-68
TAPE RECORDER SYSTEM	CLEC	GR2800	S006 357	9-12-68
ANALYZER SYSTEM	TPC	TV625	S011 440	11-7-68
X TVAA CHARGE AMP.	ENDEVCO	2713	S028 814	8-13-68
VTVM	BALLANTINE	320	F302 679	8-16-68

INSTRUCTIONS

STATE OBJECT OF EXPERIMENT, TEST, DESIGN, OR INVENTION AND DESCRIBE IN SUFFICIENT DETAIL TO BE UNDERSTANDABLE AND REPRODUCIBLE BY ANOTHER ENGINEER. USE SKETCHES OR MAKE REFERENCE TO DRAWINGS OR PHOTOGRAPHS, IF ANY, BY NUMBER. ALL PAGES CONTAINING SUBJECT MATTER WHICH MAY BE INVENTIVE MUST BE WITNESSED.

SIGNATURE: P. W. Simon 7-10-1968
 WITNESSED AND UNDERSTOOD } J. A. Petty 7-10-1968

FORM ASD-G REV. 7-66

North American Aviation, Inc. 

N 5778-17

DIVISION <i>SPACE-DOWNEY</i>		
PROJECT NO: <i>LR 6227</i>	CONTRACT NO. <i>ATR 492117</i>	DATE <i>7-10-68</i>

EQUIPMENT LIST CONTINUED!

DESCRIPTION	MFG	MODEL	NKSO CONTROL NO.	WARRANTY DUE DATE
<i>RANDOM SYSTEM</i>	<i>LING</i>	<i>ASDE 80</i>	<i>F328602</i>	<i>10-8-68</i>
<i>VTVM</i>	<i>B & K</i>	<i>2416</i>	<i>F338940</i>	<i>7-25-68</i>

ILLUSTRATION:

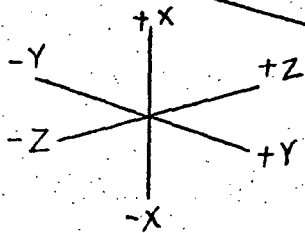
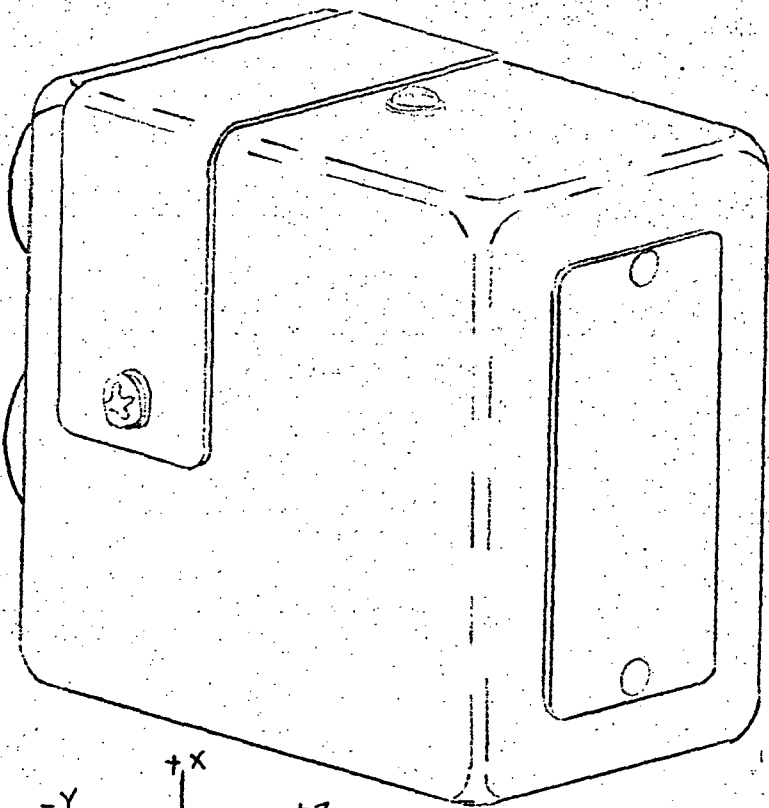

SPACE CRAFT ORIENTED

FORM 489-G REV. 7-66

INSTRUCTIONS

STATE OBJECT OF EXPERIMENT, TEST, DESIGN, OR INVENTION AND DESCRIBE IN SUFFICIENT DETAIL TO BE UNDERSTANDABLE AND REPRODUCIBLE BY ANOTHER ENGINEER. USE SKETCHES OR MAKE REFERENCE TO DRAWINGS OR PHOTOGRAPHS, IF ANY, BY NUMBER. ALL PAGES CONTAINING SUBJECT MATTER WHICH MAY BE INVENTIVE MUST BE WITNESSED.

SIGNATURE: *D.W. Lemion* 7-10 1968
 WITNESSED AND UNDERSTOOD } *J.A. Poley* 7-10 1968
 _____ 19____

North American Aviation, Inc. 

N 5778-18

DIVISION <i>SPACE DOWNEY</i>		DATE <i>7-10-68</i>
PROJECT NO: <i>LR 6227</i>	CONTRACT NO. <i>ATR 492117</i>	

PRE TEST VALIDATION: THE TEST ITEM IS EQUAL TO THAT DEFINED IN THE APPROVED TEST REQUEST ATR 492117 AND THE TEST SETUP IS ADEQUATE TO MEET THE REQUIREMENTS OF THE TEST AS DEFINED BY THE APPROVED TEST REQUEST:

L+T RESPONSIBLE TEST ENGINEER *R.G. Schroy*
 NR/SD ENGINEERING DEPARTMENT *J.S. Luera*
 NR/SD INSPECTION DEPARTMENT *J.H. Petty 7-11-68* 

RESULTS AND/OR CHRONOLOGICAL EVENTS LOG

7-10-68 VIBRATION TESTS WILL BE CONDUCTED PER REQUIREMENTS OF TR 492117. FOR EACH OF THREE AXES. AND 1K-6227-801. PARA 5.3 PAGES 6 & 7 ERROR - SHOULD BE PARA 5.4. DIE
PARA. 3.2.1: RESONANCE SEARCH (4.8.2.1) 10 MINUTES.
 10 TO 2000 CPS @ 2.0 g's (PEAK TO, -19)

PARA. 3.2.2: RANDOM VIBRATION (4.8.2.2) 2.5 MINUTES.
LEVEL A 3db/OCTAVE INCREASE - 20 TO 80 CPS
 0.067 g²/CPS CONSTANT - 80 TO 2000 CPS

PARA 3.2.2: RANDOM VIBRATION (4.8.2.2) 12.5 MINUTES.
LEVEL B 3db/OCTAVE INCREASE - 20 TO 80 CPS
 0.0039 g²/CPS. CONSTANT - 80 TO 2000 CPS.

NOTE: TEST WILL BE CONDUCTED TO RED LINED SPECIFICATION - 1K-6227-801 PAGE 7. PARA 5.4.1.3 & 5.4.1.4 - RESPONSE ACCELEROMETER NOT USED. *RHW 7-10-68*

FORM 100-0 REV. 7-68

INSTRUCTIONS

STATE OBJECT OF EXPERIMENT, TEST DESIGN, OR INVENTION AND DESCRIBE IN SUFFICIENT DETAIL TO BE UNDERSTANDABLE AND REPRODUCIBLE BY ANOTHER ENGINEER. USE SKETCHES OR MAKE REFERENCE TO DRAWINGS OR PHOTOGRAPHS, IF ANY, BY NUMBER. ALL PAGES CONTAINING SUBJECT MATTER WHICH MAY BE INVENTIVE MUST BE WITNESSED.

SIGNATURE	<u><i>D.C. Conland</i></u>	<u>7-10</u>	<u>1968</u>
WITNESSED AND UNDERSTOOD	} <u><i>J.H. Petty</i></u>	<u>7-11</u>	<u>1968</u>
			<u>19</u>

North American Aviation, Inc. 

N 5778-19

DIVISION

SPACE - DOWNEY

PROJECT NO.

LR 6227

CONTRACT NO.

TR 492117

DATE

7-10-68

RESULTS AND/OR CHRONOLOGICAL LOG OF EVENTS.

7-10-68 ACCELEROMETER CALIBRATION FOR RANDOM TESTS.

LEVEL A. 0.067g²/cps²: 3 1/6 MV/g - 100g SCALE. 2.23 VRMS.LEVEL B. 0.003g²/cps²: 100 MV/g - 10g SCALE. 707 MV.7-10-68 TEST HARDWARE MOUNTED IN X AXIS. FIXTURE BOLTS TORQUED 35 FT.LBS. - SPECIMEN BOLTS TORQUED 28 IN.LBS.7-11-68 RUN #1. SINUSOIDAL RESONANCE SEARCH. X AXIS
10 TO 2000 Hz @ 2.0g PEAK.
START TIME: 0030 STOP TIME: 0040. (10 MIN.)7-11-68 TEST HARDWARE MOUNTED IN Y AXIS - FIXTURE BOLTS
0050 TORQUED TO 35 FT.LBS. SPECIMEN BOLTS TO 28 IN.LBS.7-11-68 RUN #2. SINUSOIDAL RESONANCE SEARCH. Y AXIS
10 TO 2000 Hz @ 2.0g PEAK
START TIME: 0110 STOP TIME: 0120 (10 MIN.)7-11-68 TEST HARDWARE MOUNTED IN Z AXIS - FIXTURE BOLTS
0130 TORQUED TO 35 FT.LBS. SPECIMEN BOLTS TORQUED TO 28 IN.LBS.7-11-68 RUN #3. SINUSOIDAL RESONANCE SEARCH - Z AXIS
10 TO 2000 Hz @ 2.0g PEAK
START TIME: 0137 STOP TIME: 0147 (10 MIN.)7-11-68 TEST DATA ON THIS PAGE ARE RECORDED
ON TAPE REEL NO. 828

INSTRUCTIONS

STATE OBJECT OF EXPERIMENT, TEST, DESIGN, OR INVENTION AND DESCRIBE IN SUFFICIENT DETAIL TO BE UNDERSTANDABLE AND REPRODUCIBLE BY ANOTHER ENGINEER. USE SKETCHES OR MAKE REFERENCE TO DRAWINGS OR PHOTOGRAPHS, IF ANY, BY NUMBER. ALL PAGES CONTAINING SUBJECT MATTER WHICH MAY BE INVENTIVE MUST BE WITNESSED.

SIGNATURE: D.C. Copeland 7-11 1968WITNESSED AND UNDERSTOOD } J. Ingram 7-11 1968

FORM A93-G REV. 7-66

North American Aviation, Inc. 

N 5778-20

DIVISION

SPACE-DOWNEY

PROJECT NO.

LR 6227

CONTRACT NO.

TR 492117

DATE

7-11-68

RESULTS AND/OR CHRONOLOGICAL LOG OF EVENTS.

7-11-68 RUN#4 PERFORMED 6 SEC RANDOM EQUALIZATION WITH
0485 TEST SPECIMEN. THE EQUALIZATION IS ~~GOOD~~ ^{Z AXIS} ~~GOOD~~ ^{GOOD} OUT OF TOLERANCE

7-11-68 RUN#5 PERFORMED 5 SEC. RANDOM EQUALIZATION WITH
0503 TEST SPECIMEN. THE EQUALIZATION IS OUT OF TOLERANCE.

7-11-68 RUN#6 PERFORMED 5 SEC. RANDOM EQUALIZATION WITH
0530 TEST SPECIMEN. ^{Z AXIS} THE EQUALIZATION WAS OUT IN ONE PLACE. THE
KTE GAVE AN OK TO TEST WITH ADJUSTMENT.

7-11-68 RUN#7 PERFORMED 2 1/2 MIN. OF RANDOM VIBRATION AT LEVEL A
0625 IN THE Z AXIS

7-11-68 THE TEST SPECIMEN HAS BEEN ROTATED TO THE Y AXIS.
0640

7-11-68 RUN#8 PERFORMED 5 SEC RANDOM EQUALIZATION WITH
0643 TEST SPECIMEN IN THE Y AXIS LEVEL A. EQUALIZATION OUT OF 7-11-68
TOLERANCE.

7-11-68 RUN#9 PERFORMED 5 SEC RANDOM EQUALIZATION IN THE
0716 Y AXIS LEVEL A WITH TEST SPECIMEN. EQUALIZATION ~~GOOD~~ ^{GOOD}
IS GOOD OK TO TEST

7-11-68 RUN#10 PERFORMED 2 1/2 MIN. OF RANDOM VIBRATION AT LEVEL A
0758 IN THE Y AXIS

7-11-68 COMPLETED MOVING THE TEST SPECIMEN TO THE X AXIS
0830

FORM 493-G REV. 7-68

INSTRUCTIONS

STATE OBJECT OF EXPERIMENT, TEST, DESIGN, OR INVENTION AND DESCRIBE IN SUFFICIENT DETAIL TO BE UNDERSTANDABLE AND REPRODUCIBLE BY ANOTHER ENGINEER. USE SKETCHES OR MAKE REFERENCE TO DRAWINGS OR PHOTOGRAPHS, IF ANY, BY NUMBER. ALL PAGES CONTAINING SUBJECT MATTER WHICH MAY BE INVENTIVE MUST BE WITNESSED.

SIGNATURE:

D. W. Lerman

7-11-1968

WITNESSED AND UNDERSTOOD

J. A. Petty

7-11-1968

19

North American Aviation, Inc. 

N 5778-21

DIVISION

SPACE DOWNNEY

PROJECT NO:

LR 6227

CONTRACT NO.

ATR 492117

DATE

7-11-68

RESULTS AND/OR CHRONOLOGICAL LOG OF EVENTS

7-11-68 RUN# 11 PERFORMED 7 SEC RANDOM EQUALIZATION IN THE
0848 X AXIS LEVEL A. PLOT IS OUT OF TOLERANCE IN SEVERAL PLACES

7-11-68 RUN# 12 PERFORMED 6 SEC RANDOM EQUALIZATION IN THE
1007 X AXIS LEVEL A. THE EQUALIZATION WAS OUT OF TOLERANCE IN
TWO PLACES. THE RTE GAVE AN OK TO TEST WITH ADJUSTMENTS.

7-11-68 RUN# 13 PERFORMED 2 1/2 ^{MIN} RANDOM VIBRATION IN THE X AXIS LEVEL A
1050

7-11-68 THE RANDOM EQUALIZER (ASDEBO) HAS BEEN REPROGRAMMED
11:15 FOR LEVEL B.

7-11-68 RUN# 14 PERFORMED 6 SEC RANDOM EQUALIZATION IN THE
1320 X AXIS LEVEL B. EQUALIZATION IS OUT OF TOLERANCE

7-11-68 RUN# 15 PERFORMED 6 SEC RANDOM EQUALIZATION IN THE
1430 X AXIS LEVEL B. EQUALIZATION IS OUT OF TOLERANCE

7-11-68 RUN# 16 PERFORMED 5 SEC RANDOM EQUALIZATION IN THE
1503 X AXIS LEVEL B. SEVERAL PLACES ARE SLIGHTLY OVER THE 3dB
TOLERANCE LEVEL. THE RTE GAVE AN OK TO TEST WITH ADJUSTMENTS

7-11-68 RUN# 17 PERFORMED 12 1/2 MIN RANDOM VIBRATION IN THE
1558 X AXIS LEVEL B. ^{DATA} SAMPLES WERE TAKEN AT 1, 6, 12 MINUTES

7-11-68 2ND SHIFT.

SPECIMEN MOUNTED ON SLIP PLATE VIBRATION FIXTURE
IN THE Y AXIS.

1700 RUN# 18 6 SEC EQUALIZATION PERFORMED IN THE Y AXIS AT
LEVEL B. EQUALIZATION WAS LOW IN ONE PLACE AT APPROX 55 CPS
RTE GAVE OK TO TEST WITH ADJUSTMENTS.

INSTRUCTIONS

STATE OBJECT OF EXPERIMENT, TEST, DESIGN, OR INVENTION AND DESCRIBE IN SUFFICIENT DETAIL TO BE UNDERSTANDABLE AND REPRODUCIBLE BY ANOTHER ENGINEER. USE SKETCHES OR MAKE REFERENCE TO DRAWINGS OR PHOTOGRAPHS, IF ANY, BY NUMBER. ALL PAGES CONTAINING SUBJECT MATTER WHICH MAY BE INVENTIVE MUST BE WITNESSED.

SIGNATURE:

J.P. [Signature] 7-11-1968

WITNESSED AND UNDERSTOOD

} J.H. [Signature] 7-11-1968

19

FORM 405-0 REV. 7-66

North American Aviation, Inc. 

N 5778-22

DIVISION SPACE DIVISION		
PROJECT NO. LE6227	CONTRACT NO. ATR 492117	DATE 7-11-68

RESULTS AND/OR CHRONOLOGICAL EVENTS

7-11-68

17:50 RUN #19 PERFORMED 12.5 MINUTE RANDOM VIBRATION TEST AT LEVEL B IN THE Y AXIS. SAMPLES WERE TAKEN AND PLOTTED AT 1, 6 & 12 MINUTES. DURING RUN, BALLANTINE METER INDICATED THE RUN LEVEL WAS 2.3 G RMS.

18:45 PHOTOGRAPH TAKEN OF SPECIMEN MOUNTED ON VIBRATION FIXTURE IN THE Y AXIS.

Z-AXIS

SPECIMEN MOUNTED ON VIBRATION FIXTURE IN THE Z AXIS.

19:12 RUN #20 8 SECOND EQUALIZATION PERFORMED IN THE Z AXIS AT LEVEL B. BALLANTINE METER INDICATED THE RUN WAS AT 2.2 G RMS. PLOT HAD SEVERAL OUT OF TOLERANCE CONDITIONS IN THE LOW FREQUENCY RANGE. ANOTHER EQUALIZATION REQUIRED.

19:48 RUN #21 10 SECOND EQUALIZATION PERFORMED IN THE Z AXIS AT LEVEL B. BALLANTINE METER INDICATED THE RUN WAS AT 2.2 G RMS. AT 60 CPS THE +3db TOLERANCE WAS EXCEEDED BUT THE RTE GAVE PERMISSION TO TEST WITH ADJUSTMENTS.

21:20 RUN #22 PERFORMED 12.5 MINUTE RANDOM VIBRATION TEST AT LEVEL B IN THE Z AXIS. SAMPLES WERE TAKEN AND PLOTTED AT 1, 6 & 12 MINUTES. DURING RUN, BALLANTINE METER INDICATED THE RUN LEVEL WAS 2.2 G RMS.

21:43 TEST COMPLETE, SPECIMEN REMOVED FROM FIXTURE. NO VISUAL DEFORMATION OR DAMAGE NOTED.

FORM 493-G REV. 7-66

INSTRUCTIONS

STATE OBJECT OF EXPERIMENT TEST, DESIGN, OR INVENTION AND DESCRIBE IN SUFFICIENT DETAIL TO BE UNDERSTANDABLE AND REPRODUCIBLE BY ANOTHER ENGINEER. USE SKETCHES OR MAKE REFERENCE TO DRAWINGS OR PHOTOGRAPHS, IF ANY, BY NUMBER. ALL PAGES CONTAINING SUBJECT MATTER WHICH MAY BE INVENTIVE MUST BE WITNESSED.

SIGNATURE: J. D. Small 7-11 19 68
 WITNESSED AND UNDERSTOOD } J. H. Petty 7-11 19 68

North American Aviation, Inc. 

N 5778-23

DIVISION <i>SPACE DOWNEY</i>		
PROJECT NO: <i>LR 6227</i>	CONTRACT NO. <i>ATR 492117</i>	DATE <i>7-12-68</i>

CONCLUSION: THE GUIDANCE AND NAVIGATIONAL FILTER BOX ASSY HAS SUCCESSFULLY COMPLETED THE REQUESTED VIBRATION ENVIRONMENT. THE PRECEEDING TEST PHASE HAS BEEN CONDUCTED IN ACCORDANCE WITH THE APPROVED TEST REQUEST (TR 492117) AND SUPPORTING DOCUMENTS. DATA SUPPORTING THIS TEST ARE NOTED OR REFERENCED HERE IN.

L/T RESPONSIBLE TEST ENGINEER *R. Relyatt*

NR/SD INSPECTION DEPARTMENT *MC. Fowle* 7-12-68

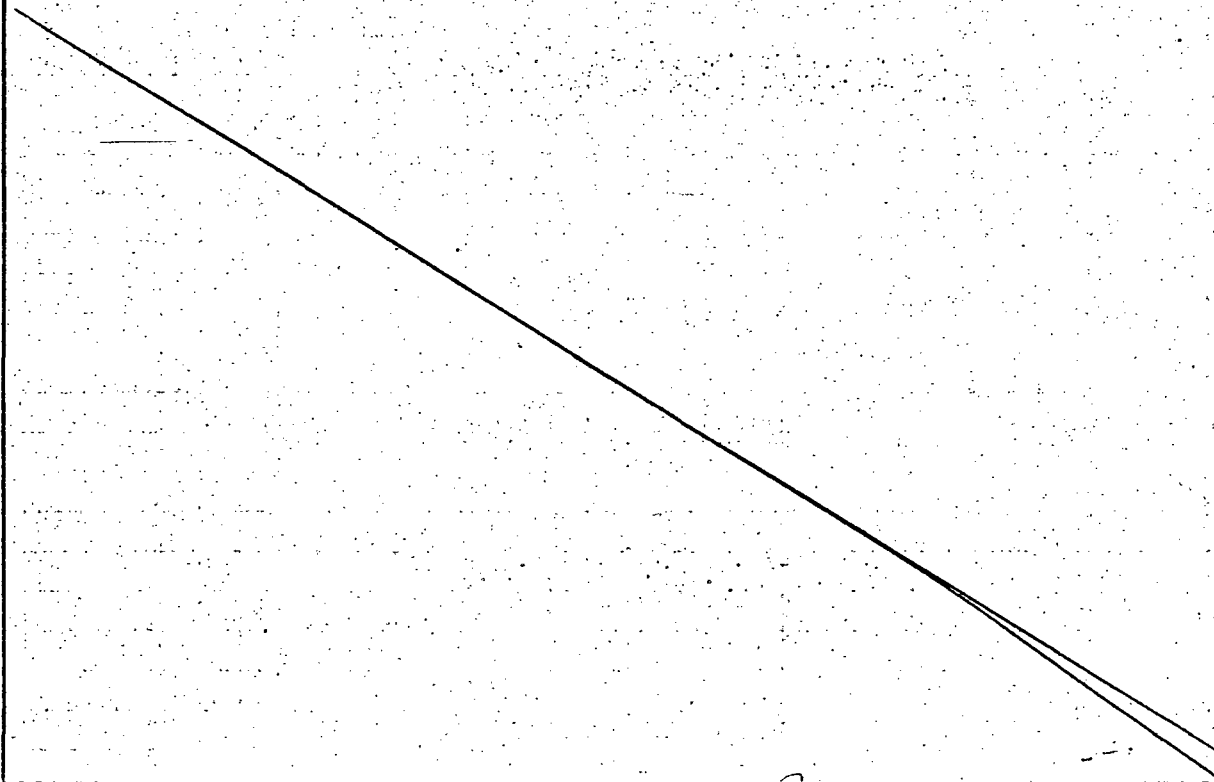

FORM 485-G REV. 7-66

INSTRUCTIONS

STATE OBJECT OF EXPERIMENT, TEST, DESIGN, OR INVENTION AND DESCRIBE IN SUFFICIENT DETAIL TO BE UNDERSTANDABLE AND REPRODUCIBLE BY ANOTHER ENGINEER. USE SKETCHES OR MAKE REFERENCE TO DRAWINGS OR PHOTOGRAPHS, IF ANY, BY NUMBER. ALL PAGES CONTAINING SUBJECT MATTER WHICH MAY BE INVENTIVE MUST BE WITNESSED.

SIGNATURE: *H. M. Lussier* 7-12 19 *68*
 WITNESSED AND UNDERSTOOD } *MC. Fowle* 7-12 19 *68*
 _____ 19 _____

SPACE DIVISION OF NORTH AMERICAN ROCKWELL CORPORATION

RANDOM

LR 6227 MEASUREMENT NUMBER LEVEL A- RUN NUMBER 2.5 MINUTES
 TR 492117 CONTROL () , RESPONSE () AXIS _____ DATE _____ 19____
 TEST TITLE G+N FILTER BOX ASSY
 OVERALL G RMS 11.5 SAMPLING _____
 FILTER BW, 5-10-20 CYCLES LOOP TIME 5 SEC
 SWEEP SPEEDS 1-2-4 SEC CROSSOVERS 100-500 CPS
 FULL SCALE 10 g/CPS AVG TIME 2.5 SEC
 OPERATOR _____ SPECIMEN P/N 436-442330
 REMARKS _____ S/N _____

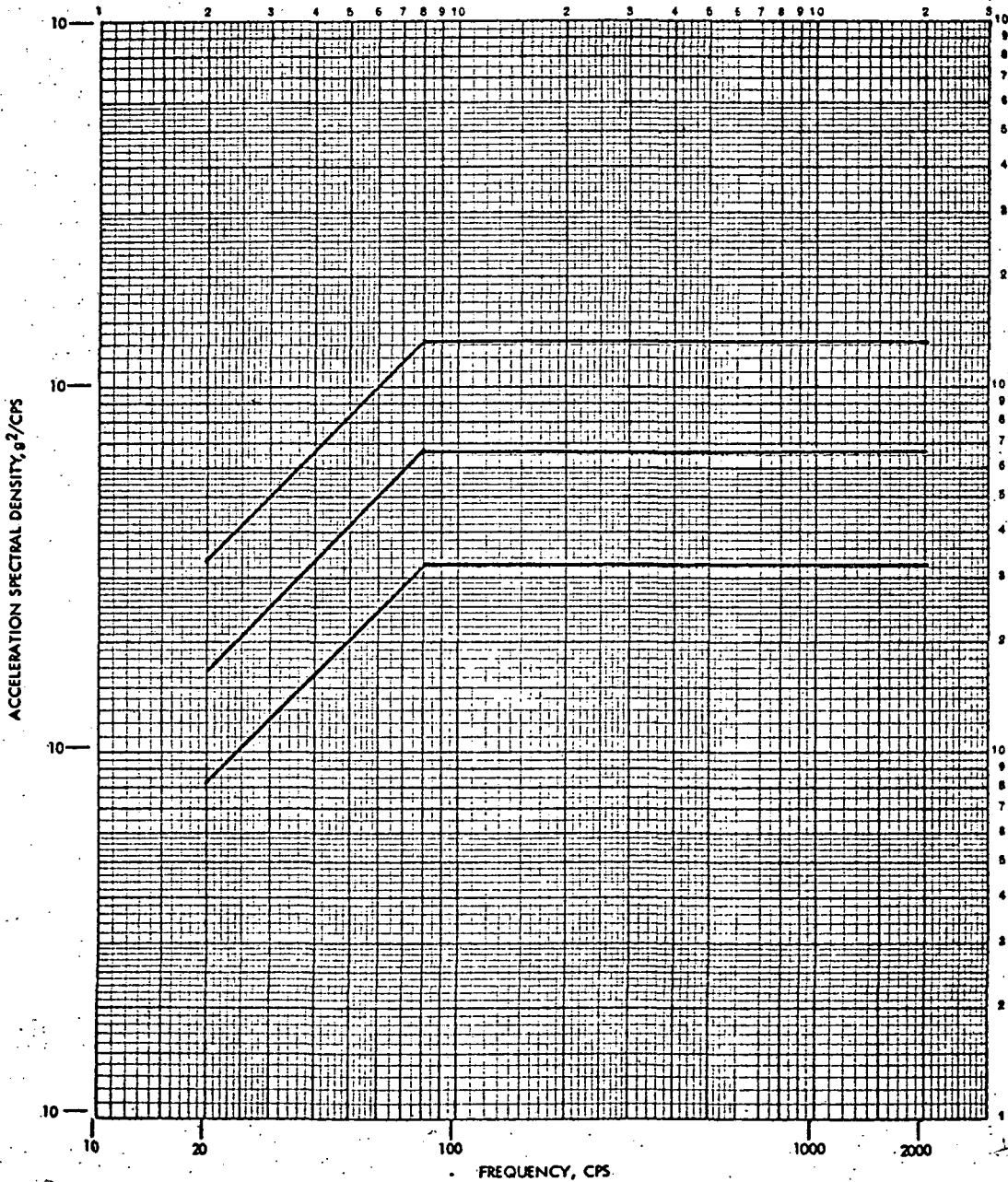

RANDOM

1215 MINUTES

LR 6227 MEASUREMENT NUMBER LEVEL B RUN NUMBER _____
 TR 492117 CONTROL (), RESPONSE () AXIS _____ DATE _____ 19____
 TEST TITLE G+N FILTER BOX ASSY
 OVERALL G RMS 2.4 SAMPLING _____
 FILTER BW, 5-10-20 CYCLES LOOP TIME 5 SEC
 SWEEP SPEEDS [REDACTED] 1-2-4 SEC CROSSOVERS 100-500 CPS
 FULL SCALE [REDACTED] .01 g/CPS AVG TIME 2.5 SEC
 OPERATOR _____ SPECIMEN P/N 136-442330
 REMARKS _____ S/N _____

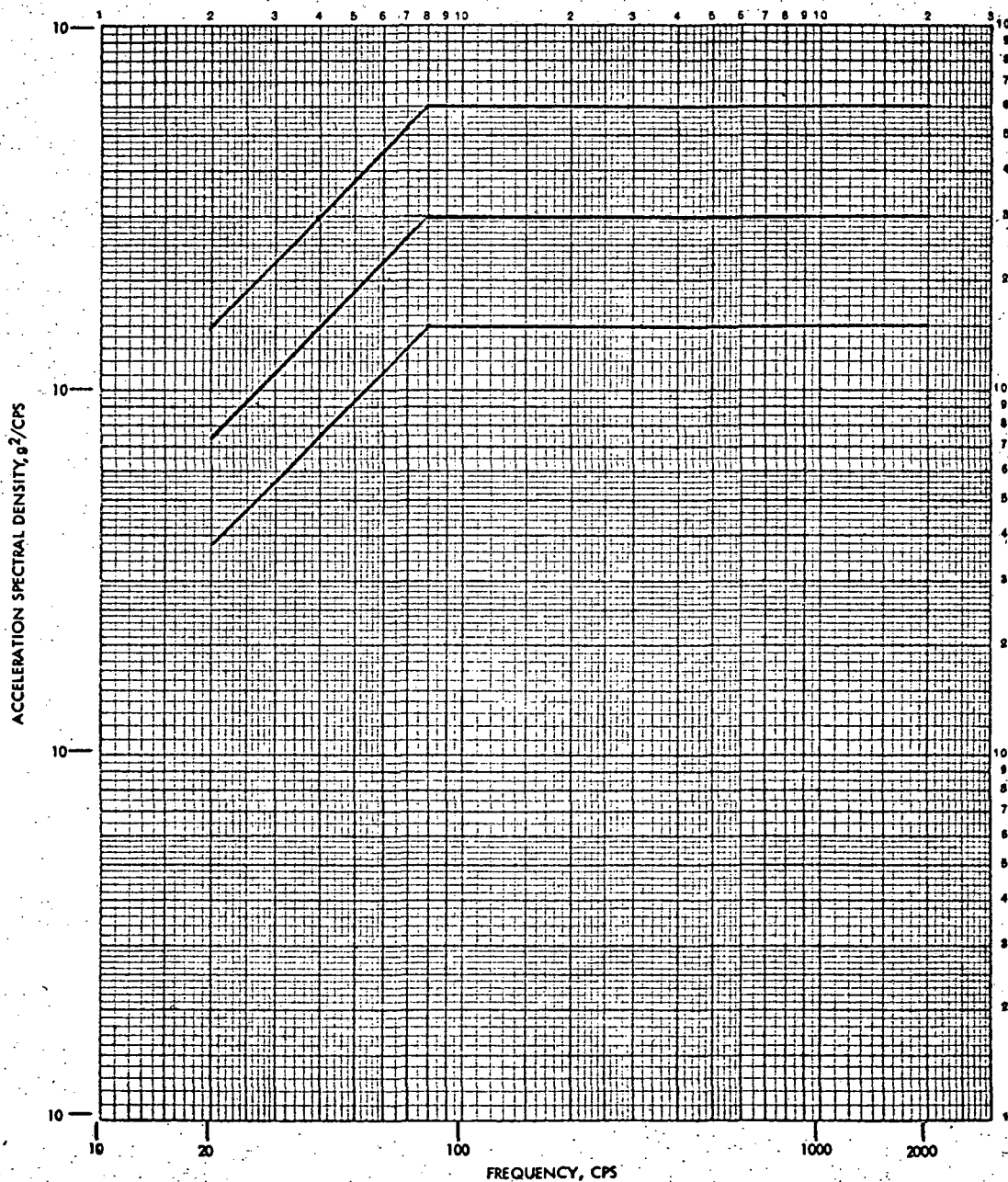

SINUSOIDAL

LR 6227 MEASUREMENT NUMBER 1 RUN NUMBER 1
 TR 492117 CONTROL (✓), RESPONSE () AXIS X DATE 7-11 19 68
 TEST TITLE C & N FILTER BOX ASSY QUAL-TEST.
 FULL SCALE 10.0 PK SWEEP: UP (✓) DOWN ()
 OPERATOR R.O.L. SPECIMEN P/N V-36-442330
 REMARKS S/N 06342 AAA 5858

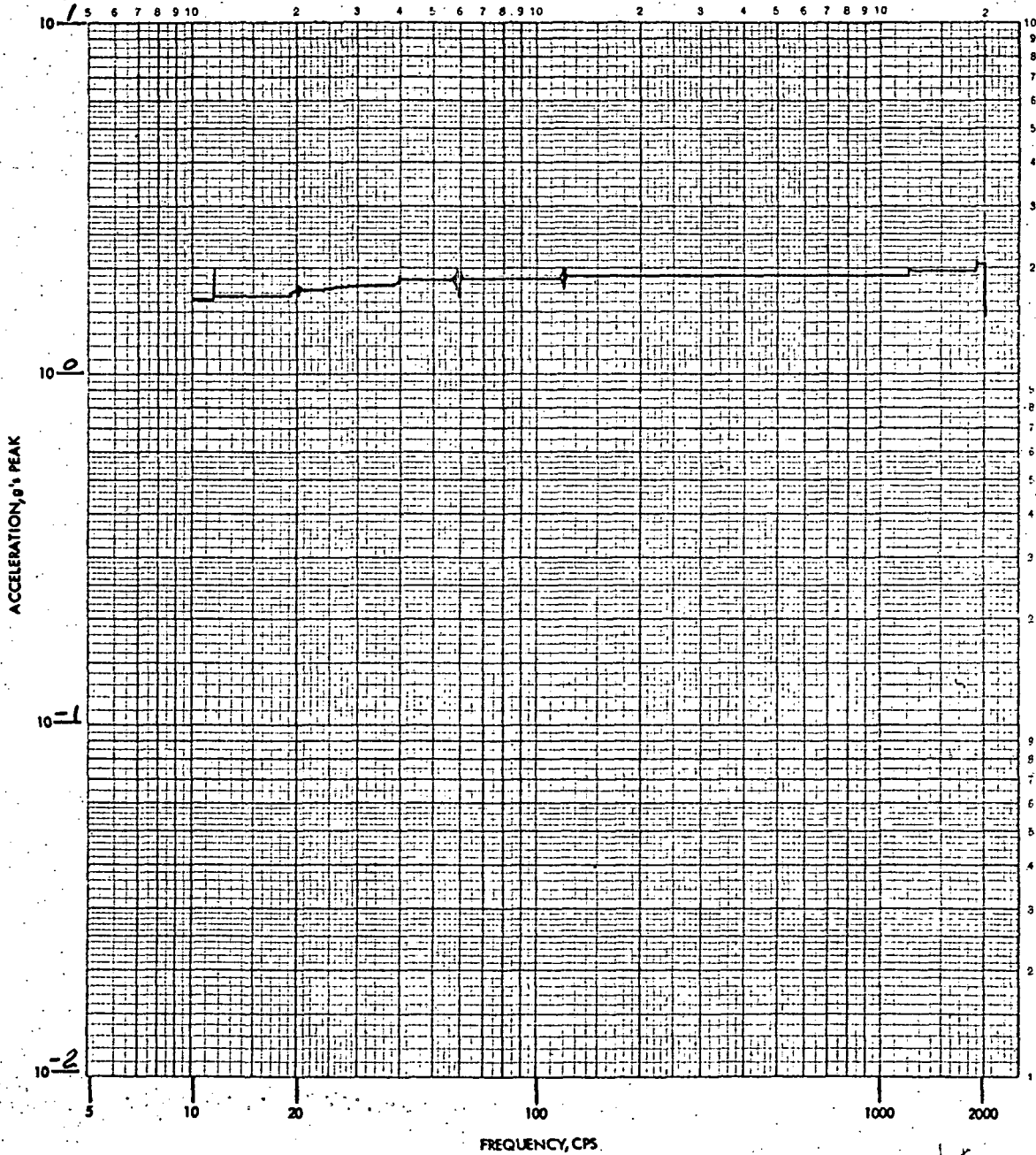

SINUSOIDAL

LR 6227 MEASUREMENT NUMBER 1 RUN NUMBER 2
 TR 492117 CONTROL (L); RESPONSE () AXIS Y DATE 7-11 19 68
 TEST TITLE G & N FILTER BOX ASSY QUAL-TEST
 FULL SCALE 10.0 gPK SWEEP: UP (L) DOWN ()
 OPERATOR R. Q. H. SPECIMEN P/N V36-442330
 REMARKS _____ S/N 06362 AAH 3858

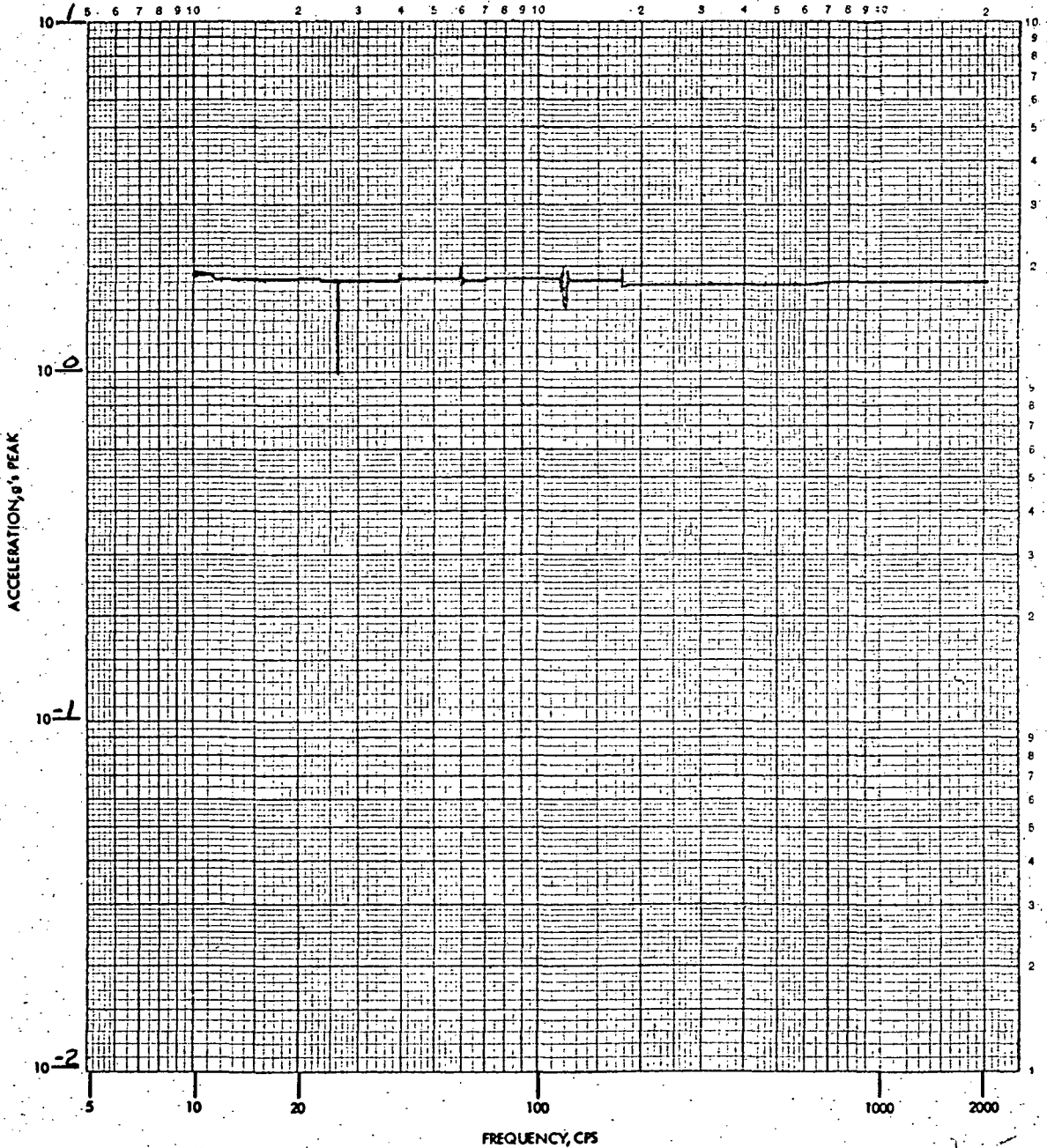

SINUSOIDAL

LR 6227 MEASUREMENT NUMBER 1 RUN NUMBER 3
 TR 49217 CONTROL (✓), RESPONSE () AXIS Z DATE 7-11 19 68
 TEST TITLE G & N FILTER BOX ASSY QUAL TEST
 FULL SCALE 10.0 gPK SWEEP: UP (✓) DOWN ()
 OPERATOR R.D.G. SPECIMEN P/N 136-442330
 REMARKS _____ S/N 06362AAH 3858

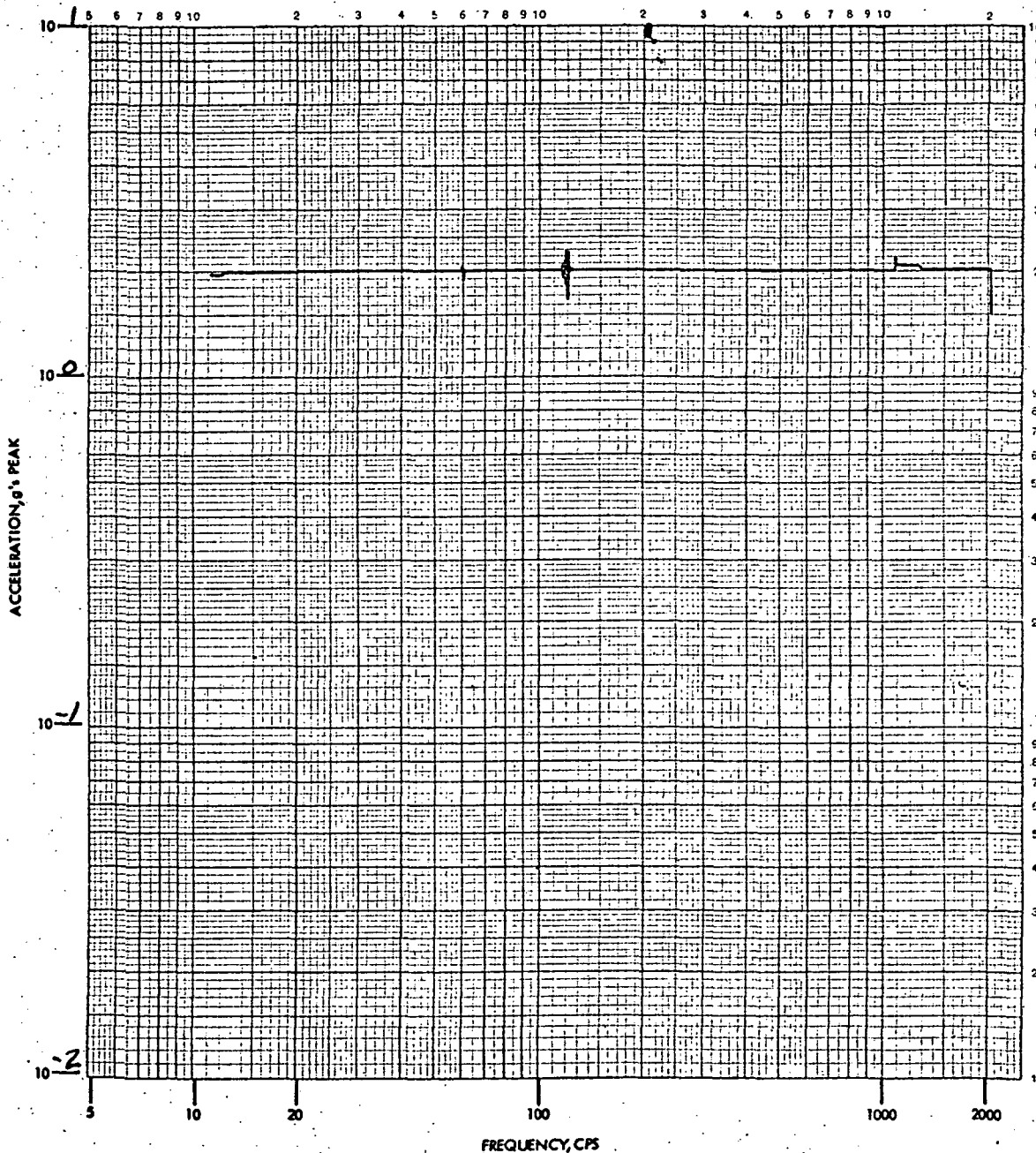

RANDOM

LR 6227 MEASUREMENT NUMBER 1-7 RUN NUMBER 4
 TR 492117 CONTROL () RESPONSE () AXIS Z DATE 7-11 19 68
 TEST TITLE GEN FILTER BOX ASSY
 OVERALL G RMS 13 SAMPLING SPEC EQUAL
 FILTER BW, 5-10-20 CYCLES LOOP TIME 5 SEC
 SWEEP SPEEDS .5-1-2 SEC CROSSOVERS 100-500 CPS
 FULL SCALE 6 g^2 /CPS AVG TIME 2.5 SEC
 OPERATOR VAI SPECIMEN P/N 436-442330
 REMARKS OUT OF SPEC. S/N 06362-AAH3858

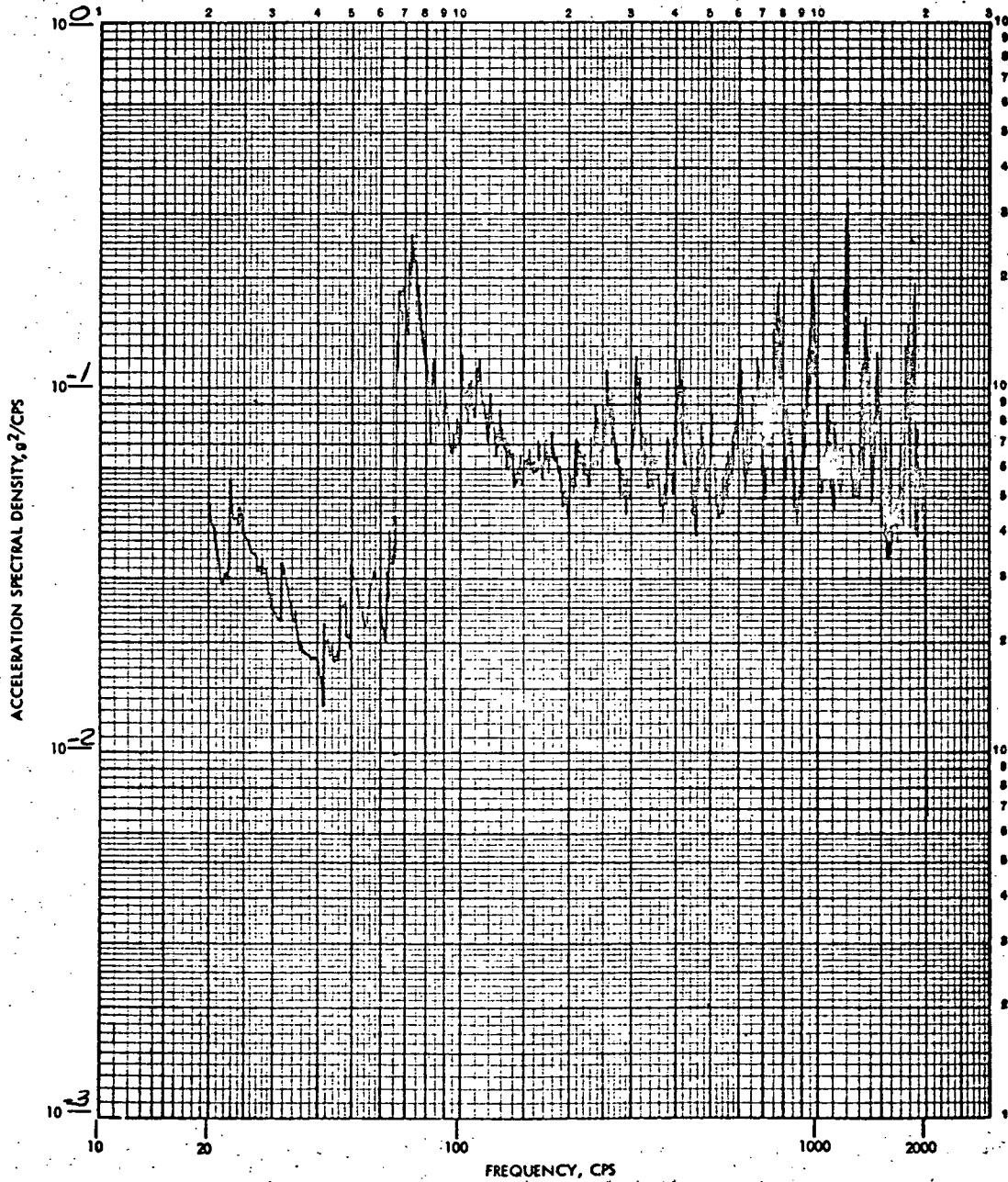

RANDOM

LR 6227 MEASUREMENT NUMBER 1-2 RUN NUMBER 5
 TR 492117 CONTROL (LY RESPONSE () AXIS Z DATE 7-11 19 68
 TEST TITLE GEN FILTER BOX ASSY
 OVERALL G RMS 14.3 SAMPLING SPEC EQUAL
 FILTER BW, 5-10-20 CYCLES LOOP TIME 5 SEC
 SWEEP SPEEDS .5-1-2 SEC CROSSOVERS 100-500 CPS
 FULL SCALE 6 g? CPS AVG TIME 2.5 SEC
 OPERATOR VAI SPECIMEN P/N V36-44230
 REMARKS OUT OF SPEC S/N 06362-AAH3858

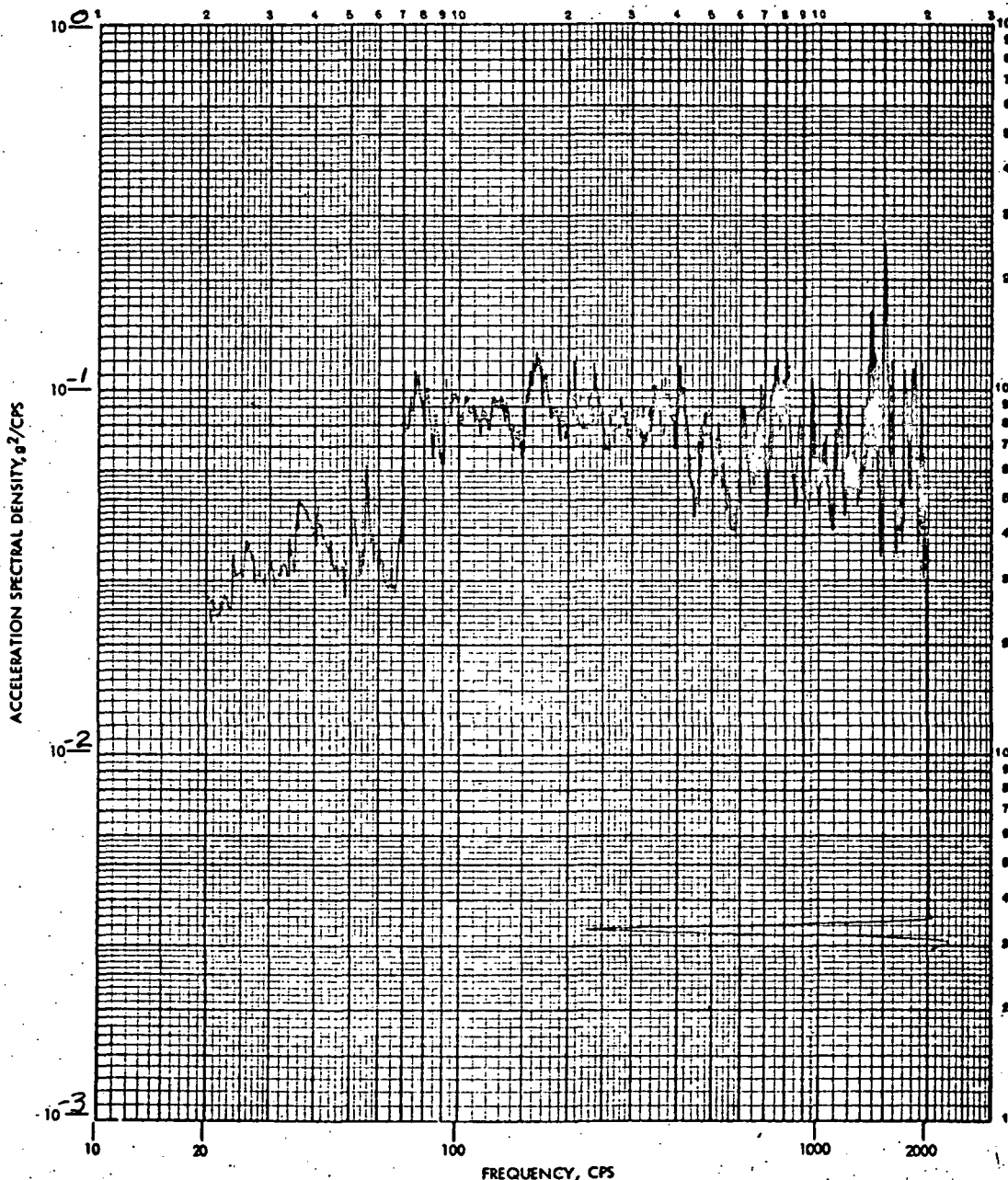

RANDOM

LR 6227 MEASUREMENT NUMBER 12 RUN NUMBER 6
 TR 492117 CONTROL (✓), RESPONSE () AXIS Z DATE 7-11 1968
 TEST TITLE G+N FILTER BOX ASSY
 OVERALL G RMS 11.3 SAMPLING EQUAL
 FILTER BW, 5, 10, 20 CYCLES LOOP TIME 5 SEC
 SWEEP SPEEDS .5, 10, 20 SEC CROSSOVERS 100-500 CPS
 FULL SCALE 1.0 g/CPS AVG TIME 2.5 SEC
 OPERATOR Alwood SPECIMEN P/N V36-442330

7-11-68 REMARKS OK TO TEST P. V. SIMON S/N 06362-AAH3858
WITH ADJUSTMENT

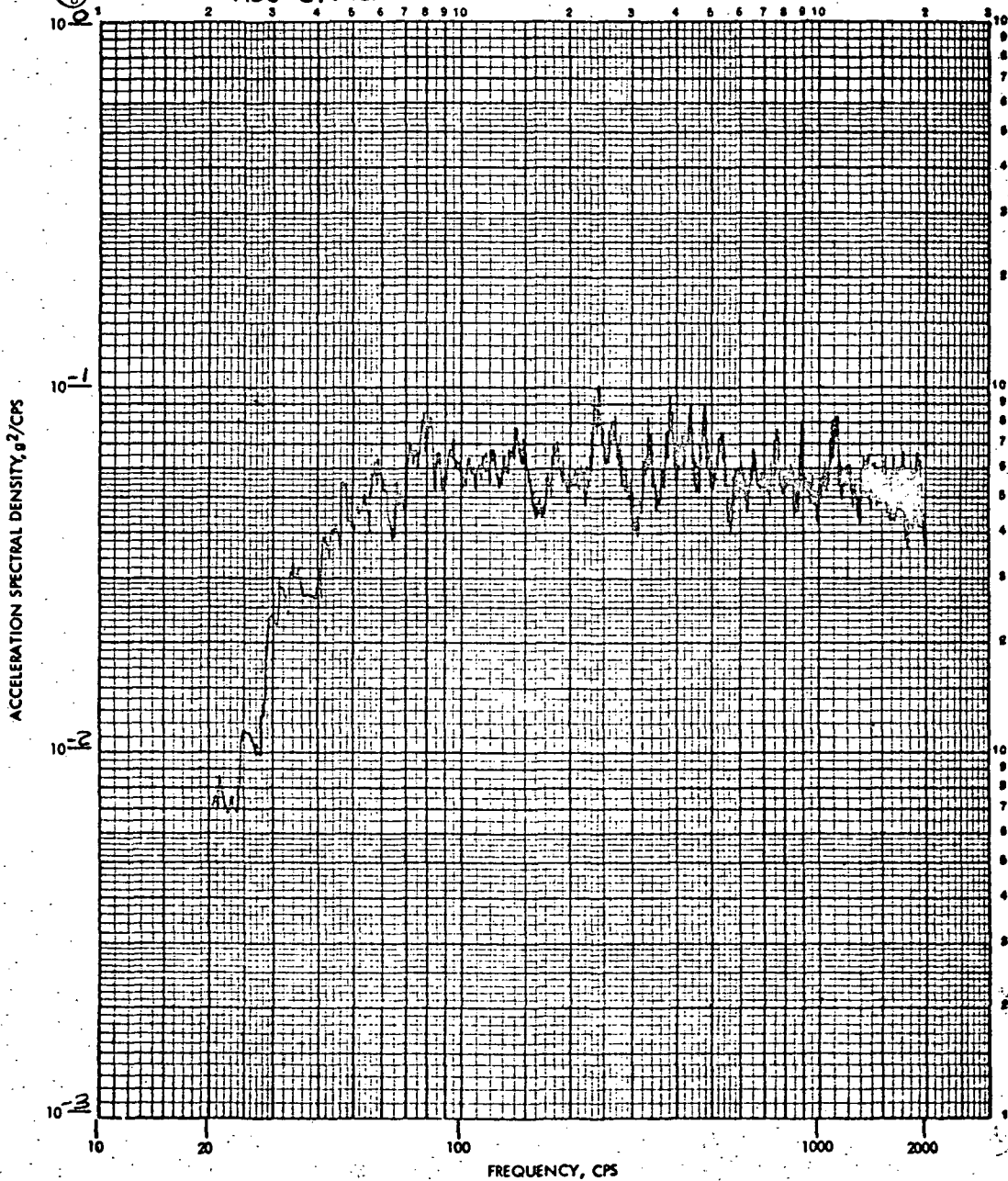

RANDOM

LR 6227 MEASUREMENT NUMBER 1-7 RUN NUMBER 7
 TR 492117 CONTROL (✓) RESPONSE () AXIS Z DATE 7-11 19 68
 TEST TITLE GEN FILTER BOX ASSY
 OVERALL G RMS 11.3 SAMPLING 2 MIN
 FILTER BW, 5-10-20 CYCLES LOOP TIME 5 SEC
 SWEEP SPEEDS 1.5-1-2 SEC CROSSOVERS 100-500 CPS
 FULL SCALE 1 g/CPS AVG TIME 2.5 SEC
 OPERATOR VAI SPECIMEN P/N V36-442330
 REMARKS _____ S/N 06362-AAH3858

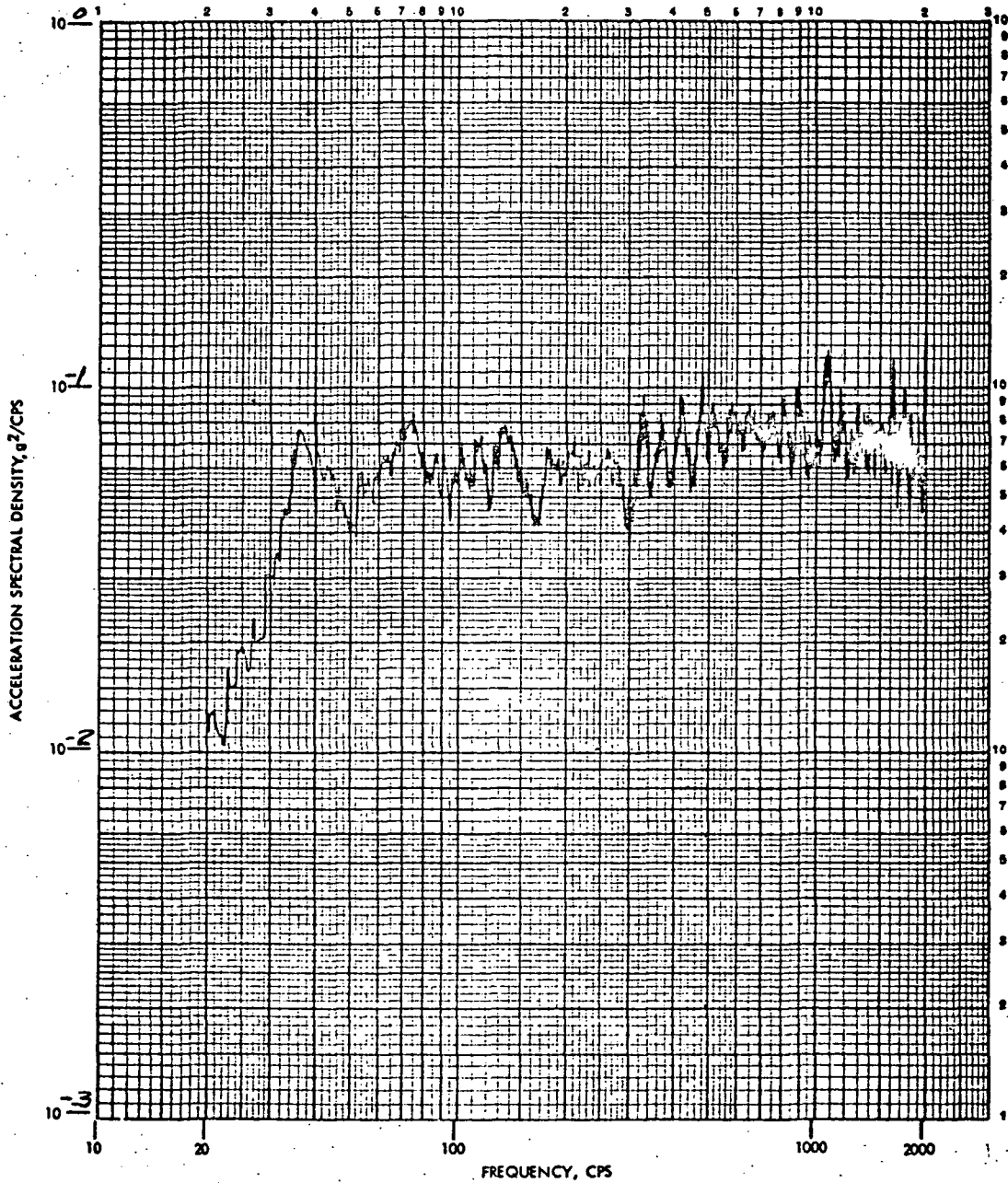

RANDOM

LR 6227 MEASUREMENT NUMBER 1Y RUN NUMBER 8
 TR 492117 CONTROL (✓), RESPONSE () AXIS Y DATE 7-11 19 68
 TEST TITLE G+N FILTER BOX ASSY
 OVERALL G RMS 11.7 SAMPLING EQUAL
 FILTER BW, 5-10-20 CYCLES LOOP TIME 5 SEC
 SWEEP SPEEDS .5-1-2 SEC CROSSOVERS 100-500 CPS
 FULL SCALE 1.0 g/CPS AVG TIME 2.5 SEC
 OPERATOR YAL SPECIMEN P/N V36-442330
 REMARKS OUT OF SPEC. S/N 06362-AAH3958

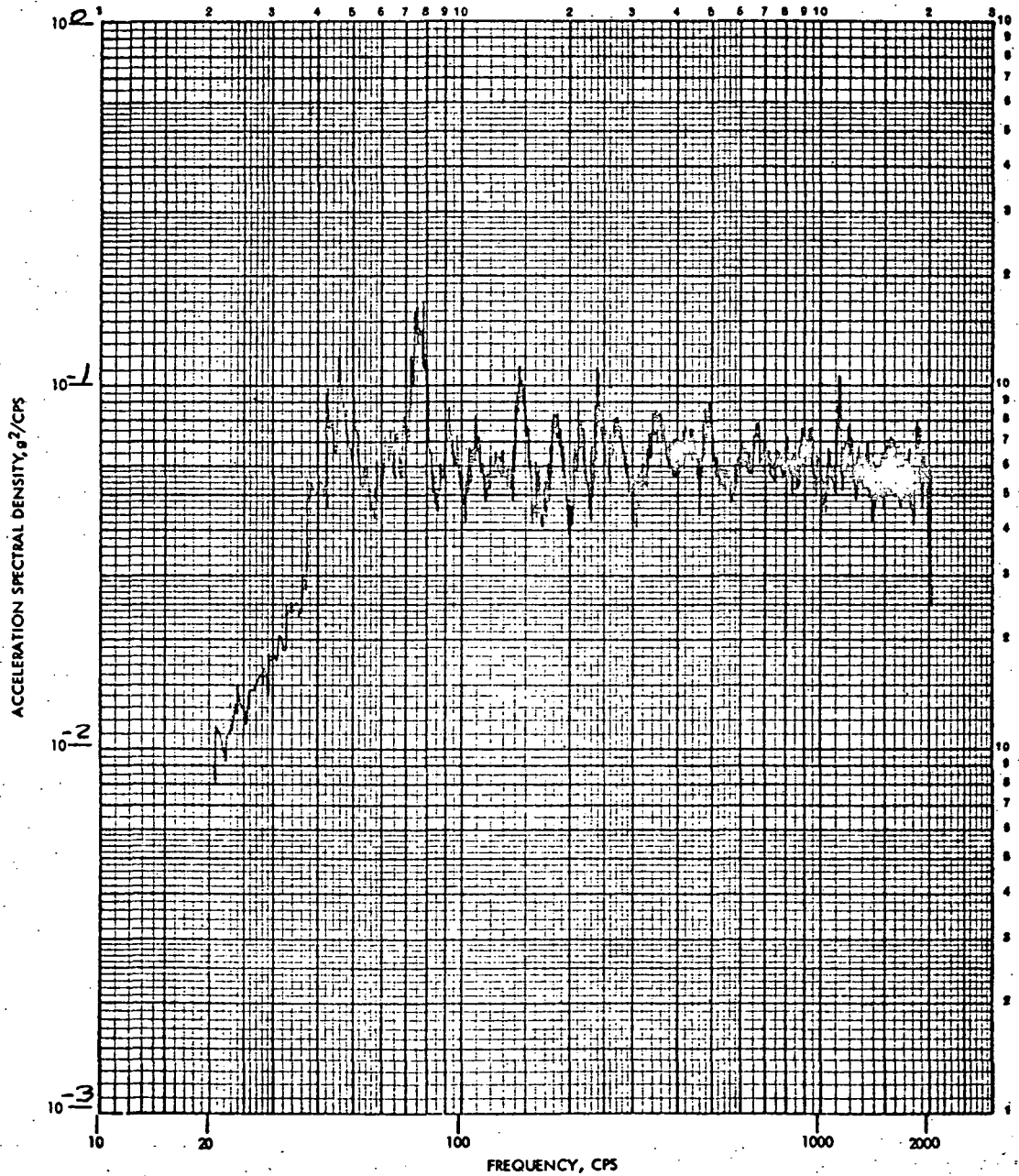

RANDOM

LR 6227 MEASUREMENT NUMBER 1Y RUN NUMBER 9
 TR 492117 CONTROL (✓), RESPONSE () AXIS Y DATE 7-11 1960
 TEST TITLE G+N FILTER BOX ASSY.
 OVERALL G RMS 11.5 SAMPLING EQUAL
 FILTER BW, 5-10-20 CYCLES LOOP TIME 5 SEC
 SWEEP SPEEDS .5-1-2 SEC CROSSOVERS 100-500 CPS
 FULL SCALE 1.0 g²/CPS AVG TIME 2.5 SEC
 OPERATOR VAL SPECIMEN P/N V36-442330
 REMARKS OK TO TEST P.W. Simon  S/N 06362-AAH3858

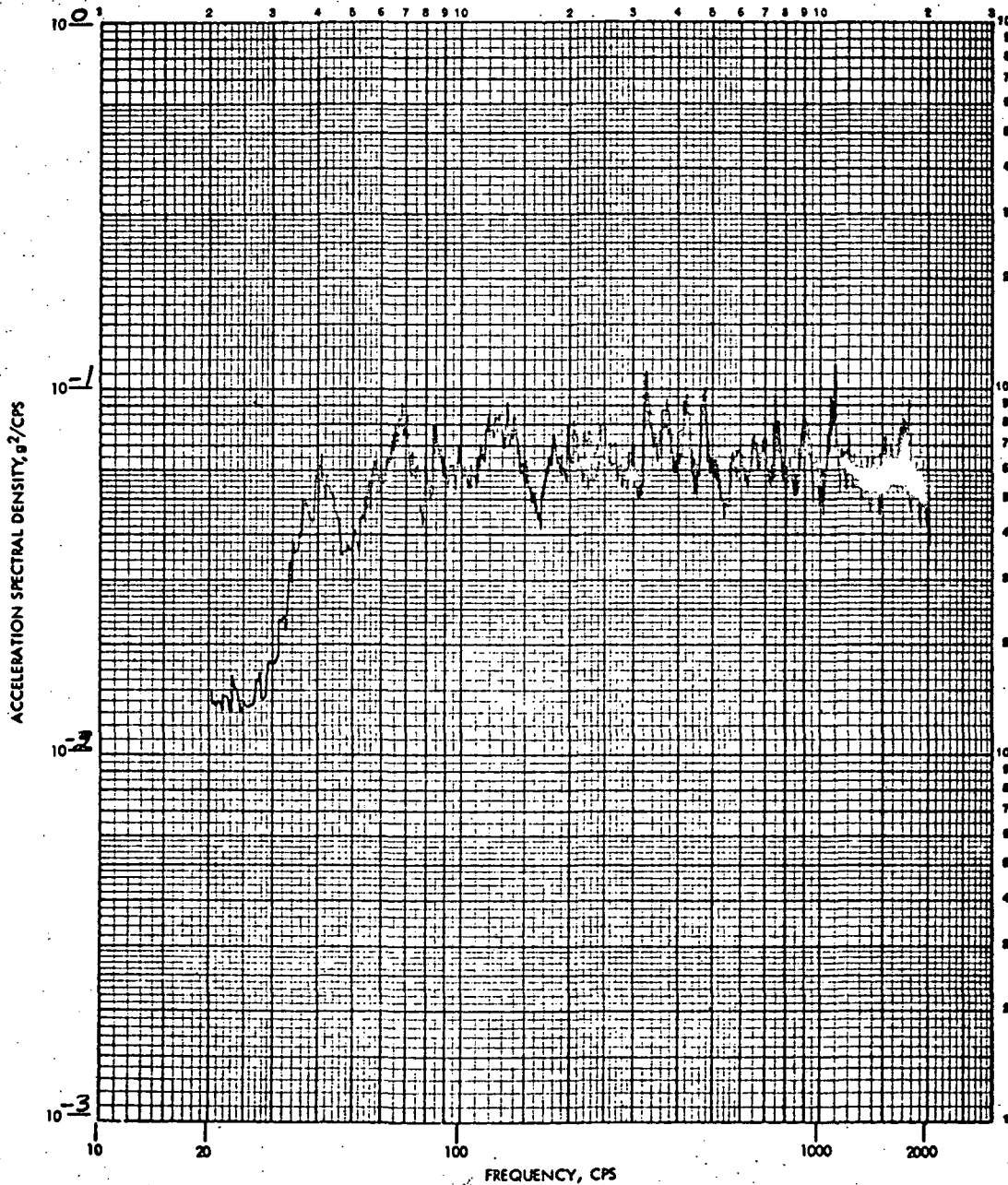

SPACE DIVISION OF NORTH AMERICAN ROCKWELL CORPORATION

RANDOM

LR 6227 MEASUREMENT NUMBER 1-V RUN NUMBER 10
 TR 492117 CONTROL (✓), RESPONSE () AXIS Y DATE 7-11 19 68
 TEST TITLE GEN FILTER BOX ASSY
 OVERALL G RMS 11.3 SAMPLING 2 MIN
 FILTER BW, 5-10-20 CYCLES LOOP TIME 5 SEC
 SWEEP SPEEDS 1.5-1-2 SEC CROSSOVERS 100-500 CPS
 FULL SCALE 1 2/CPS AVG TIME 2.5 SEC
 OPERATOR VAI SPECIMEN P/N 136-442330
 REMARKS _____ S/N 06362AAH3858

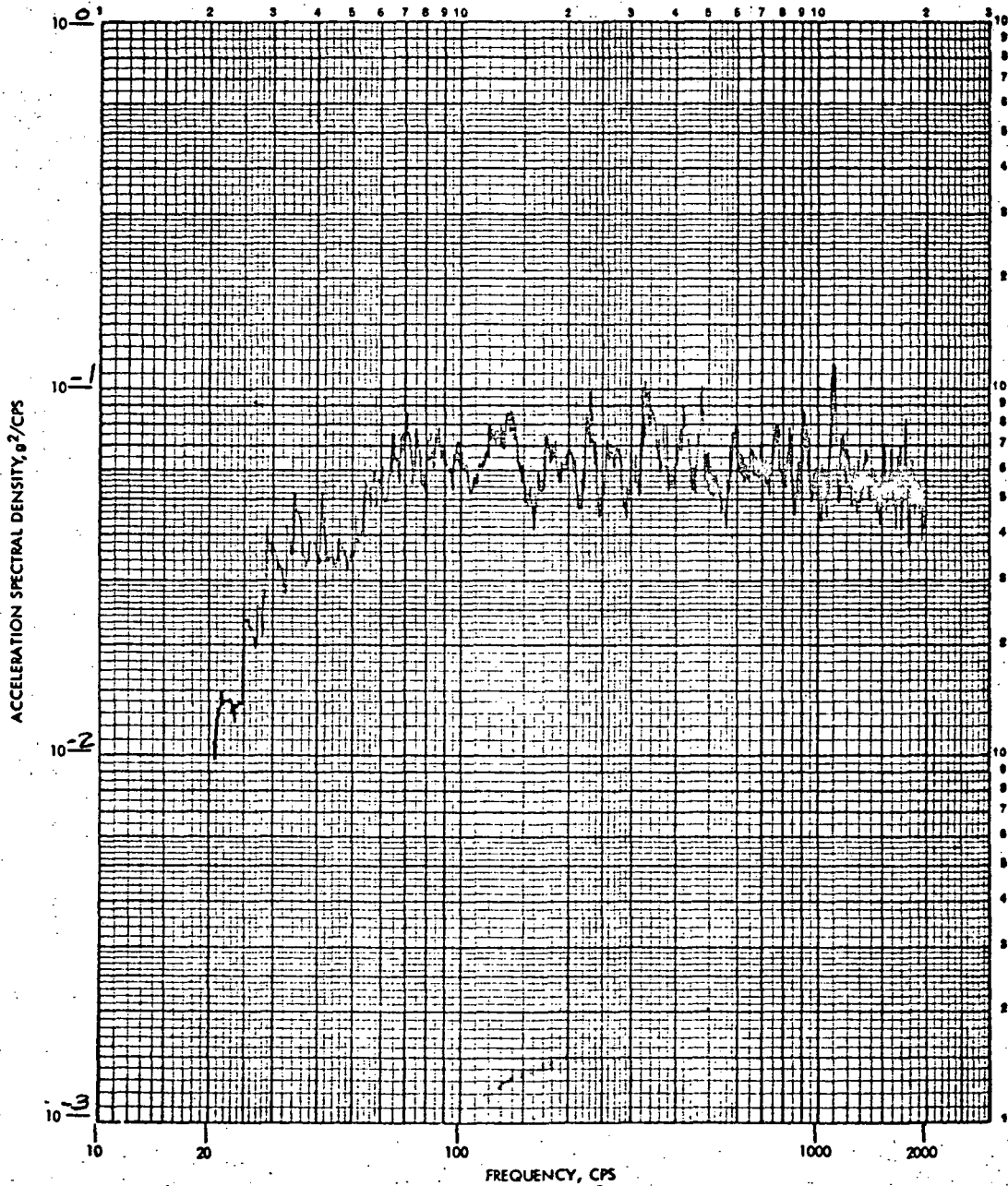

RANDOM

LR 6227 MEASUREMENT NUMBER 1-X RUN NUMBER 11
 TR 492117 CONTROL (1) RESPONSE () AXIS X DATE 7-11 1968
 TEST TITLE G+N FILTER BOX ASSY
 OVERALL G RMS 12.3 SAMPLING SPEC EQUAL
 FILTER BW, 5-10-20 CYCLES LOOP TIME 5 SEC
 SWEEP SPEEDS .5-1-2 SEC CROSSOVERS 100-500 CPS
 FULL SCALE 6 g²/CPS AVG TIME 2.5 SEC
 OPERATOR VAI SPECIMEN P/N V36-442330
 REMARKS OUT OF SPEC S/N 06362AAH3858

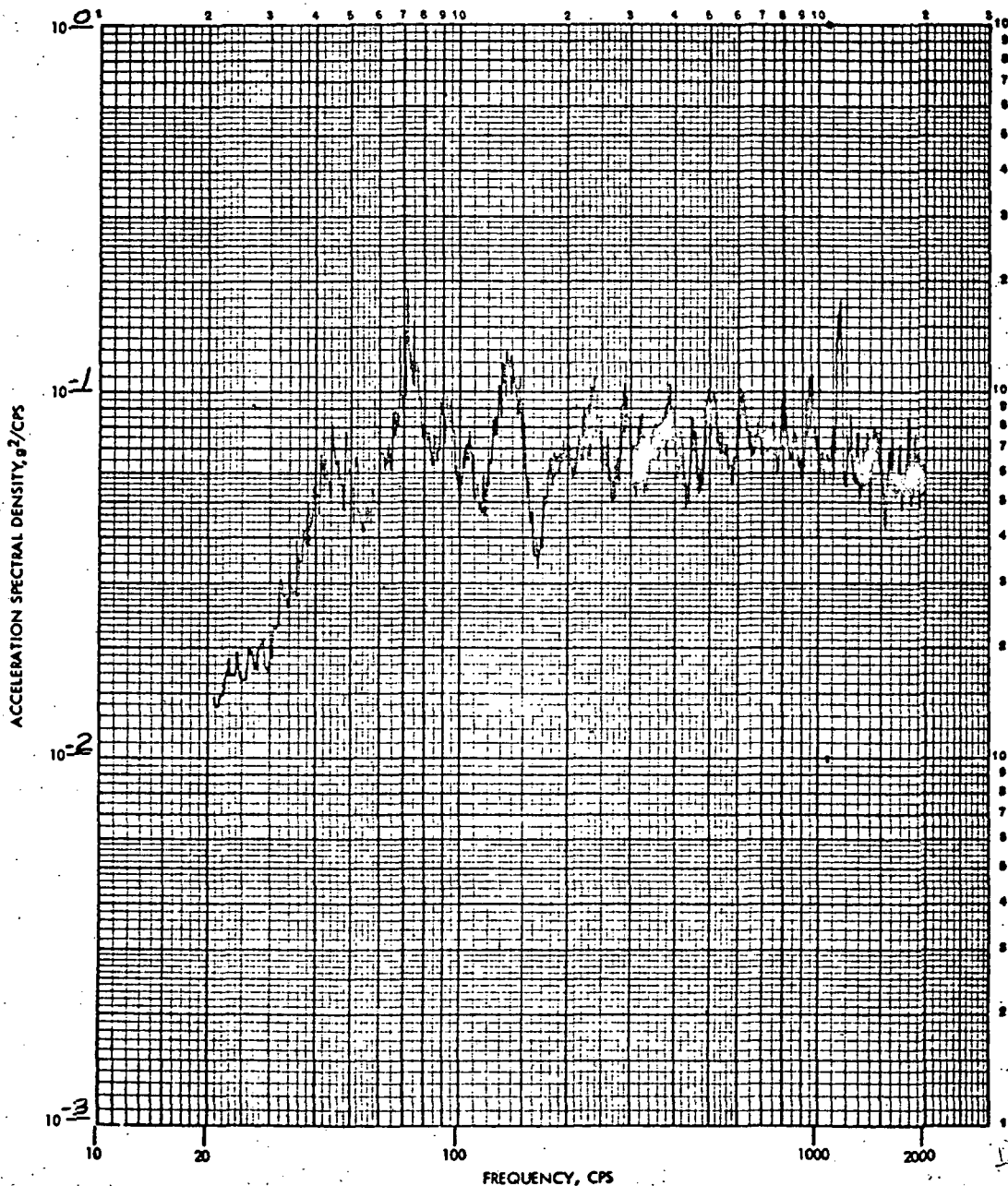

RANDOM

LR 6227 MEASUREMENT NUMBER 1-X RUN NUMBER 12
 TR 492117 CONTROL () RESPONSE () AXIS X DATE 7-11 1968
 TEST TITLE G & N FILTER BOX ASSY
 OVERALL G RMS 12.5 SAMPLING SPEC EQUAL
 FILTER BW, 5-10-20 CYCLES LOOP TIME 5 SEC
 SWEEP SPEEDS .5-1-2 SEC CROSSOVERS 100-500 CPS
 FULL SCALE 1 $\frac{1}{2}$ / CPS AVG TIME 2.5 SEC
 OPERATOR VA1 SPECIMEN P/N V36-442330
 REMARKS OK TO TEST WITH ADJUSTMENTS S/N 06362AAH3858

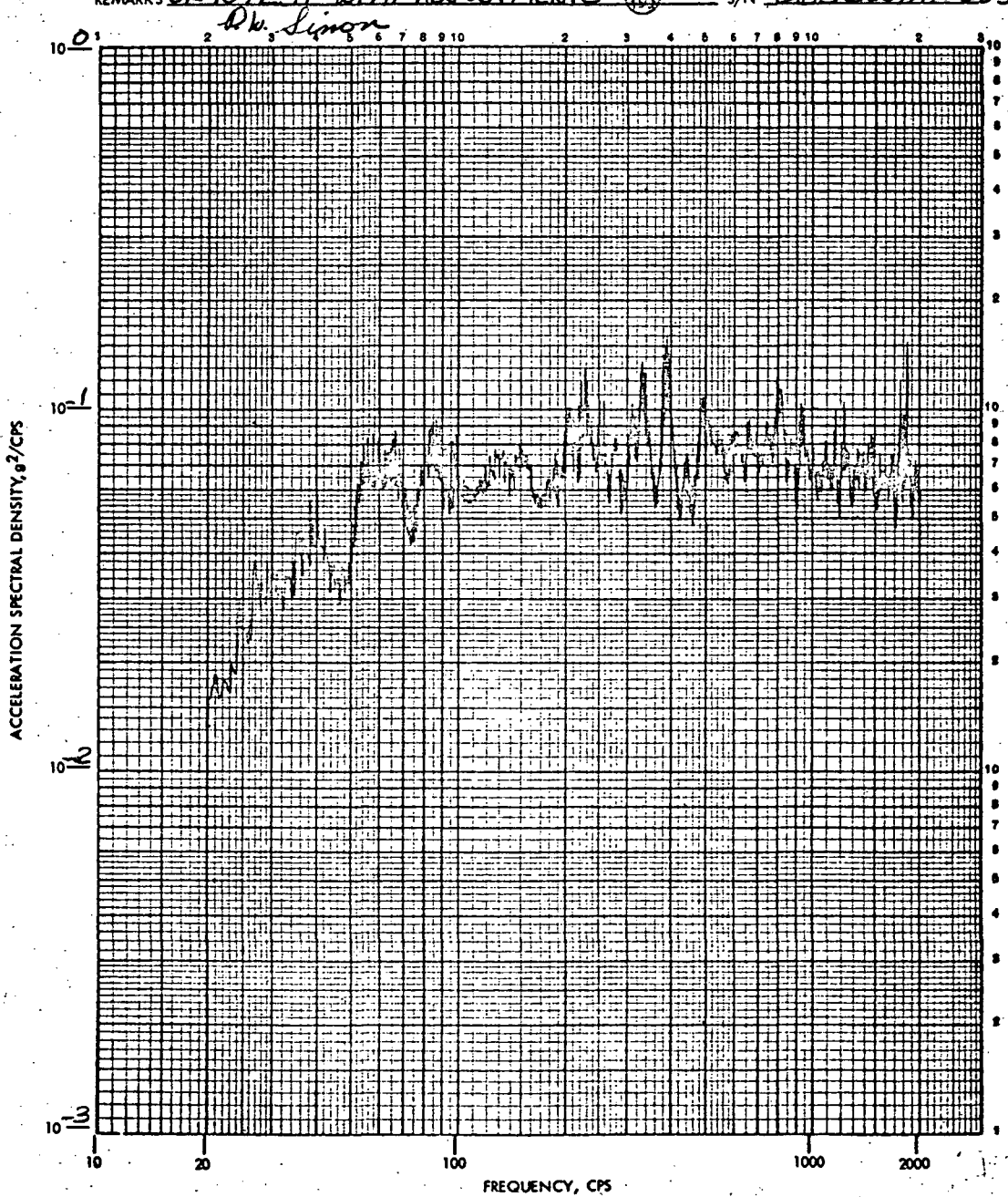

RANDOM

LR 6227 MEASUREMENT NUMBER 1-X RUN NUMBER 13
 TR 492117 CONTROL (V), RESPONSE () AXIS X DATE 7-11 19 68
 TEST TITLE GFU FILTER BOX ASSY
 OVERALL G RMS 12.3 SAMPLING 2 MIN
 FILTER BW, 5-10-20 CYCLES LOOP TIME 5 SEC
 SWEEP SPEEDS 5-1-2 SEC CROSSOVERS 100-500 CPS
 FULL SCALE 1 g/ CPS AVG TIME 2.5 SEC
 OPERATOR VAI SPECIMEN P/N 436-442330
 REMARKS _____ S/N 06362AHH3858

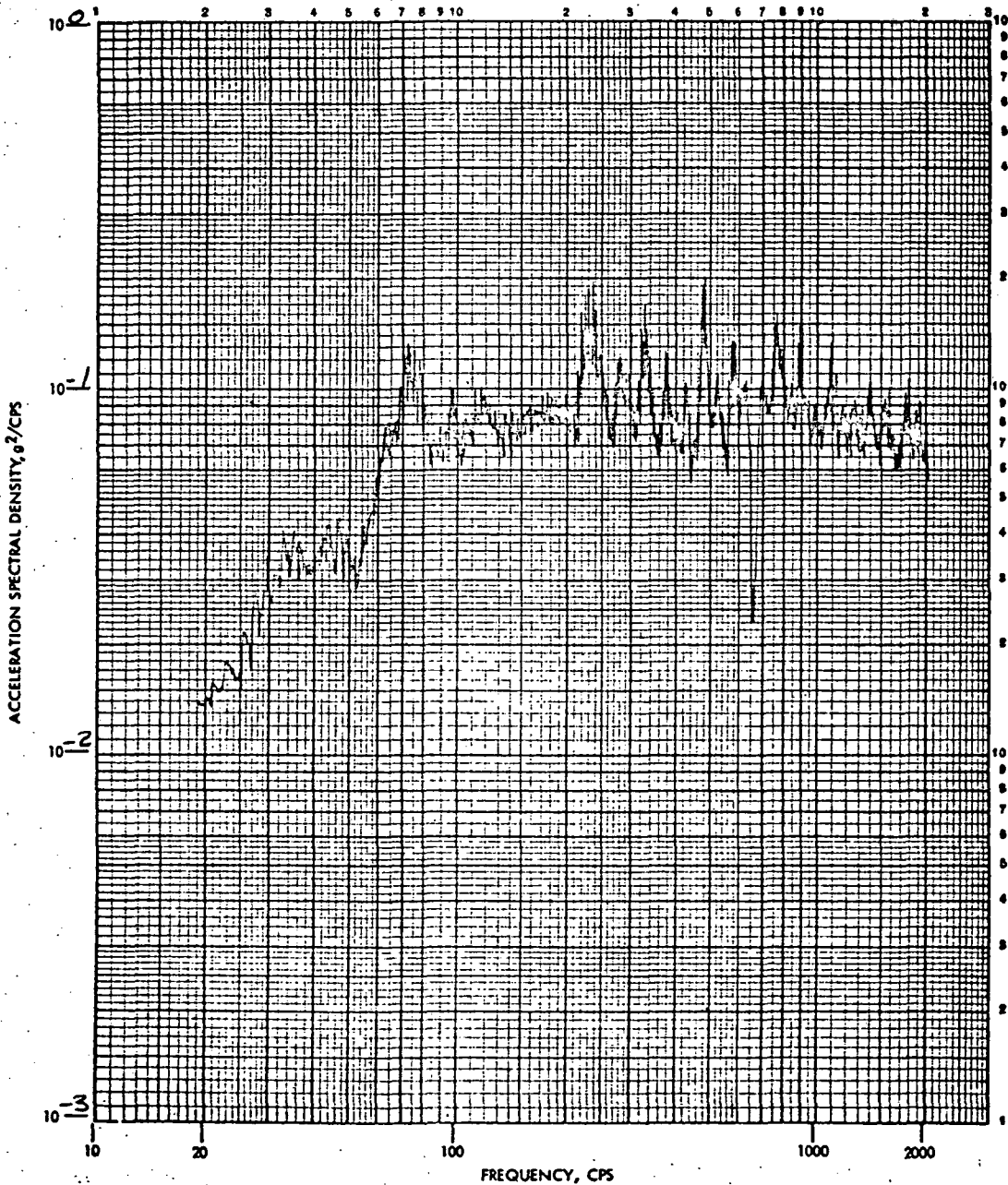

RANDOM

LR 6227 MEASUREMENT NUMBER 1-X RUN NUMBER 14
 TR 49217 CONTROL (V), RESPONSE () AXIS X DATE 7-11 1968
 TEST TITLE GEN FILTER BOX ASSY
 OVERALL G RMS 2.5 SAMPLING SPEC. EQUAL
 FILTER BW, 5-10-20 CYCLES LOOP TIME 5 SEC
 SWEEP SPEEDS .5-1-2 SEC CROSSOVERS 100-500 CPS
 FULL SCALE .01 ²/CPS AVG TIME 2.5 SEC
 OPERATOR VAI SPECIMEN P/N 136-442330
 REMARKS OUT OF SPEC. S/N 06362AAH385B

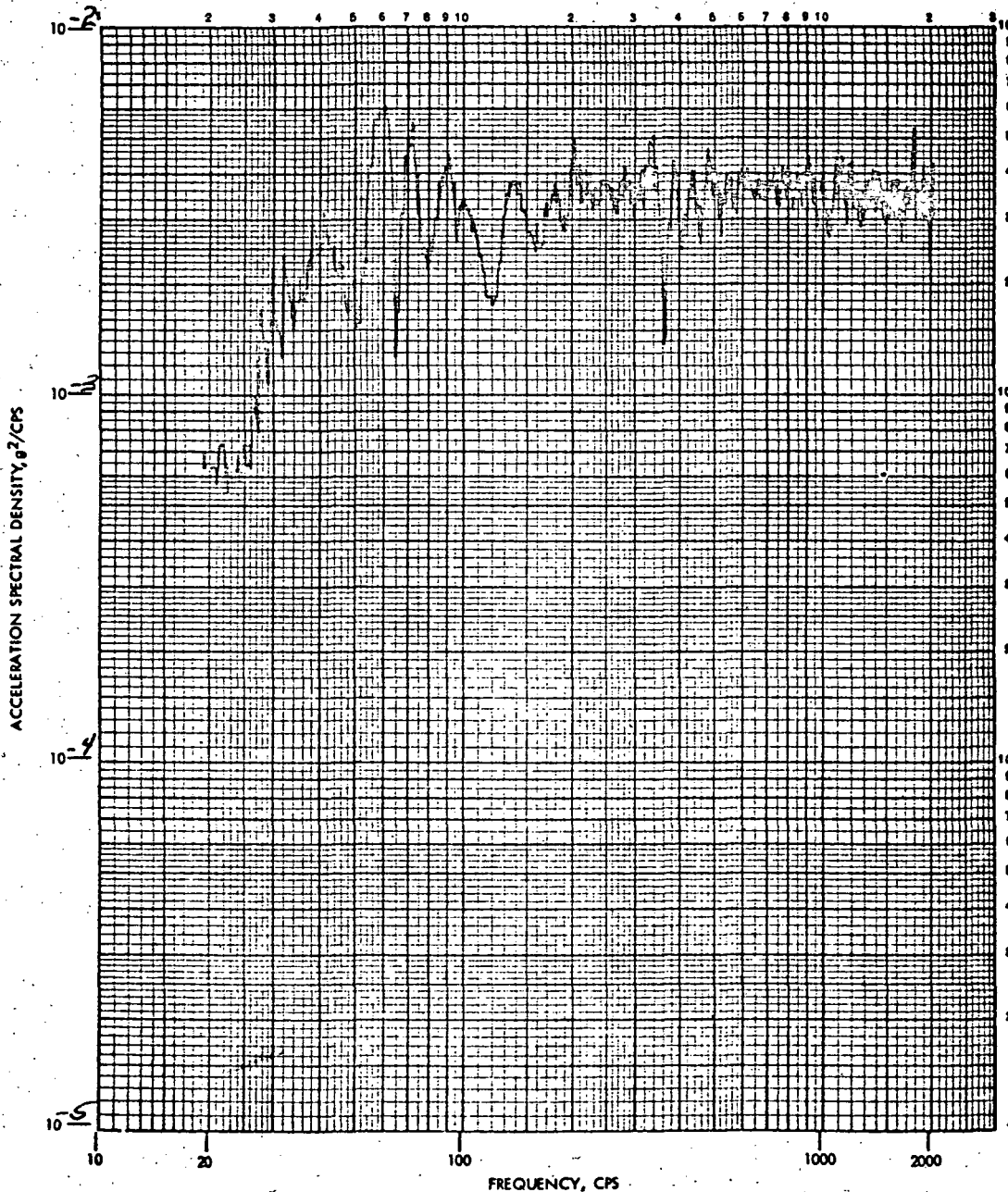

RANDOM

LR 6227 MEASUREMENT NUMBER 1-X RUN NUMBER 13
 TR 49217 CONTROL (), RESPONSE () AXIS X DATE 7-11 1968
 TEST TITLE G*N FILTER BOX ASSY
 OVERALL G RMS 2.5 SAMPLING SPEC EQUAL
 FILTER BW, 5-10-20 CYCLES LOOP TIME 5 SEC
 SWEEP SPEEDS 1.5-1-2 SEC CROSSOVERS 100-500 CPS
 FULL SCALE .01 g/cps AVG TIME 2.5 SEC
 OPERATOR VJA SPECIMEN P/N 436-442330
 REMARKS OUT OF SPEC. S/N 06362AAH3858

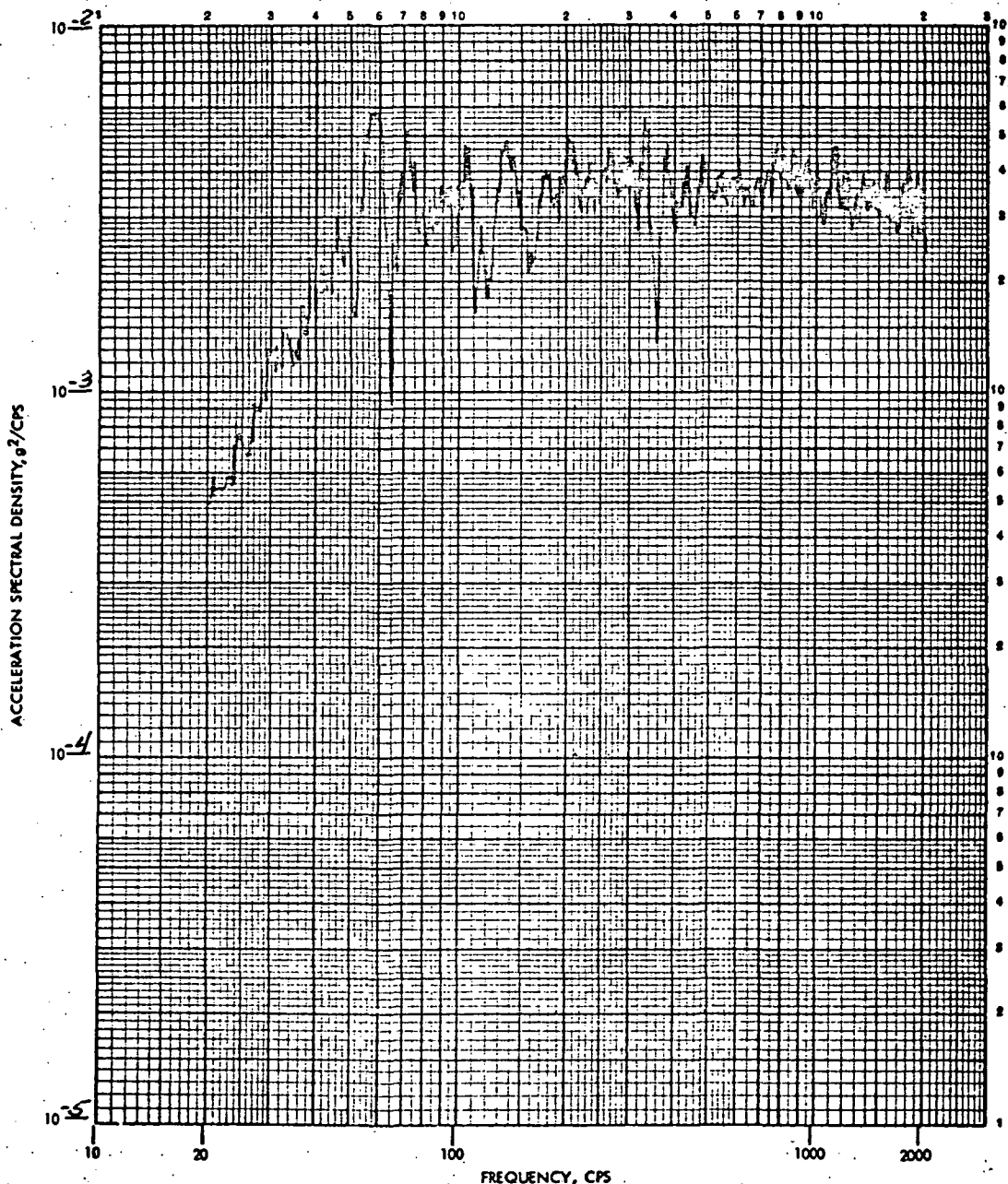

RANDOM

LR 6227 MEASUREMENT NUMBER 1-X RUN NUMBER 16
 TR 49217 CONTROL W RESPONSE () AXIS X DATE 7-11 1968
 TEST TITLE GEN FILTER BOX ASSY
 OVERALL G RMS 2.45 SAMPLING SPEC EQUAL
 FILTER BW 5-10-20 CYCLES LOOP TIME 85 SEC
 SWEEP SPEEDS .5-1-2 SEC CROSSOVERS 100-500 CPS
 FULL SCALE .01 2/CPS AVG TIME 21.5 SEC
 OPERATOR VAI SPECIMEN P/N V36-442330
 REMARKS OK TO TEST WITH ADJUSTMENTS S/N 06362AAH3858

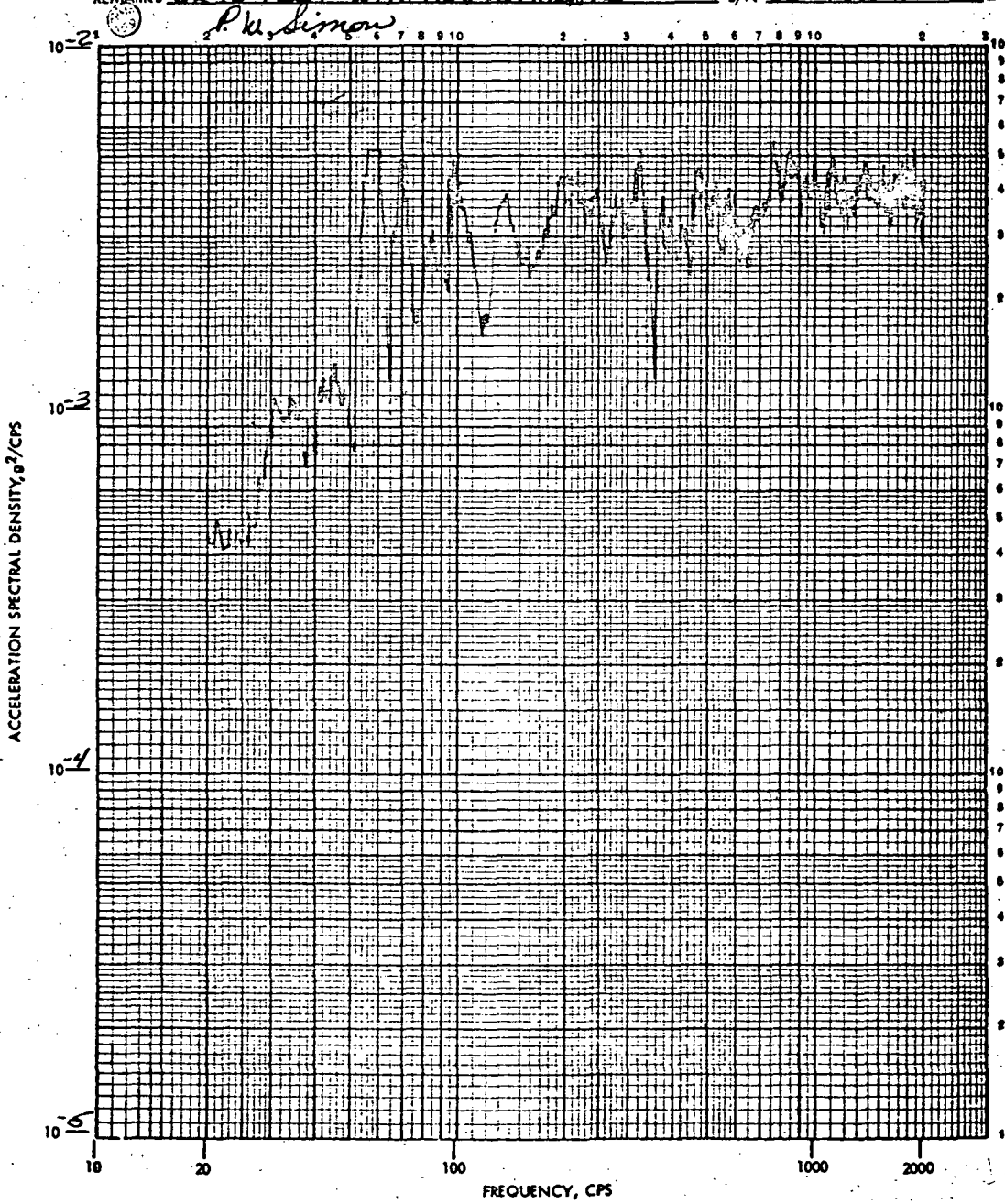

RANDOM

LR 6227 MEASUREMENT NUMBER 1-X RUN NUMBER 17
 TR 49217 CONTROL () RESPONSE () AXIS X DATE 7-11 19 68
 TEST TITLE G & N FILTER BOX ASSY
 OVERALL G RMS 2.5 SAMPLING 1 MIN
 FILTER BW 5-10-20 CYCLES LOOP TIME 5 SEC
 SWEEP SPEEDS .5-1-2 SEC CROSSOVERS 100-500 CPS
 FULL SCALE 0.1 g/CPS AVG TIME 2.5 SEC
 OPERATOR R.D.H. SPECIMEN P/N 1136-442330
 REMARKS S/N BL362APH3848

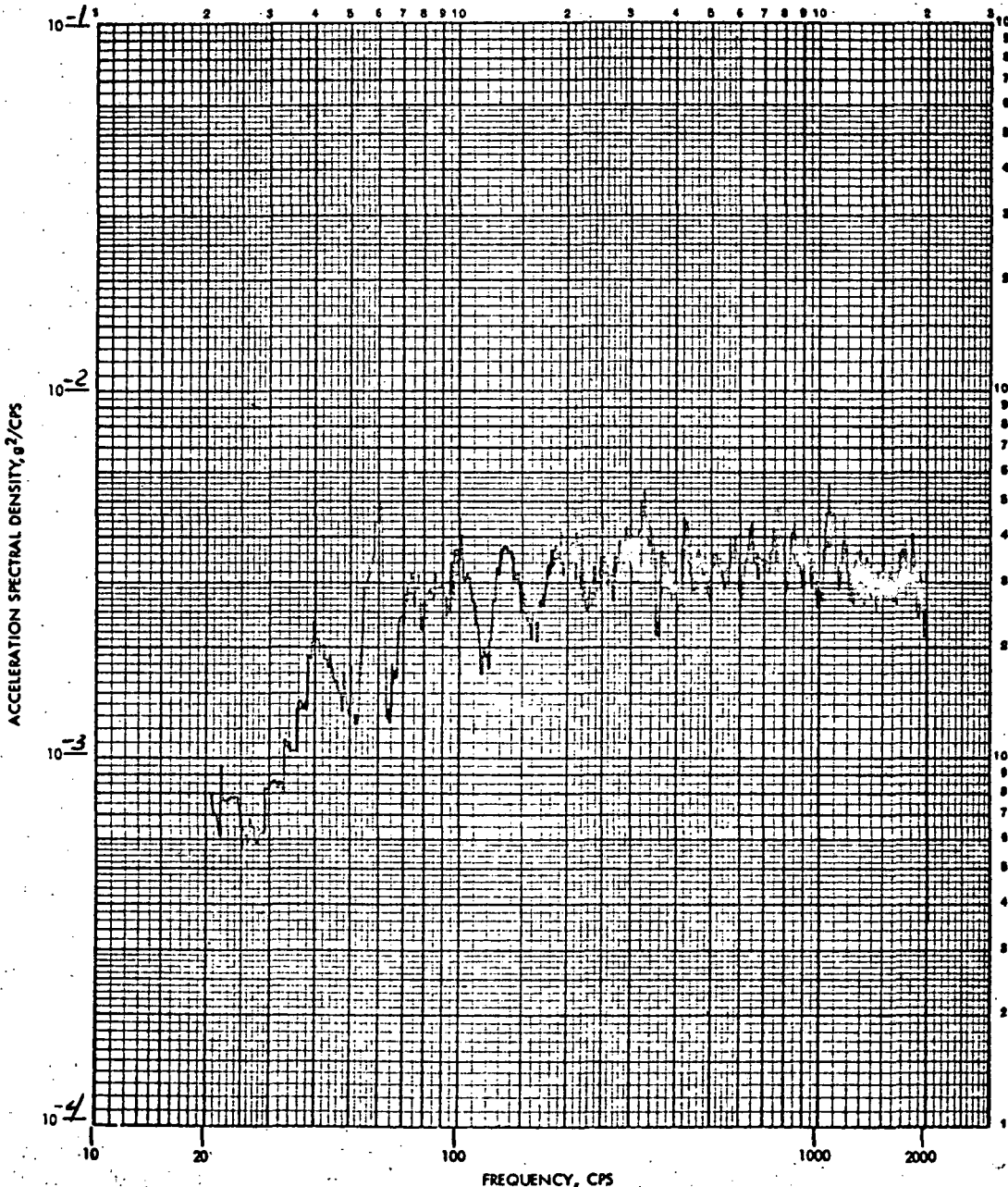

RANDOM

LR 6227 MEASUREMENT NUMBER 1-X RUN NUMBER 17
 TR 492117 CONTROL (L), RESPONSE () AXIS X DATE 7-11 1968
 TEST TITLE G&N FILTER BOX ASSY
 OVERALL G RMS 2.47 SAMPLING 6 MIN
 FILTER BW, 5-10-20 CYCLES LOOP TIME 5 SEC
 SWEEP SPEEDS .5-1-2 SEC CROSSOVERS 100-500 CPS
 FULL SCALE 0.01 2/ CPS AVG TIME 2.5 SEC
 OPERATOR R.D.H. SPECIMEN P/N V36-442330
 REMARKS _____ S/N 06362ADH3858

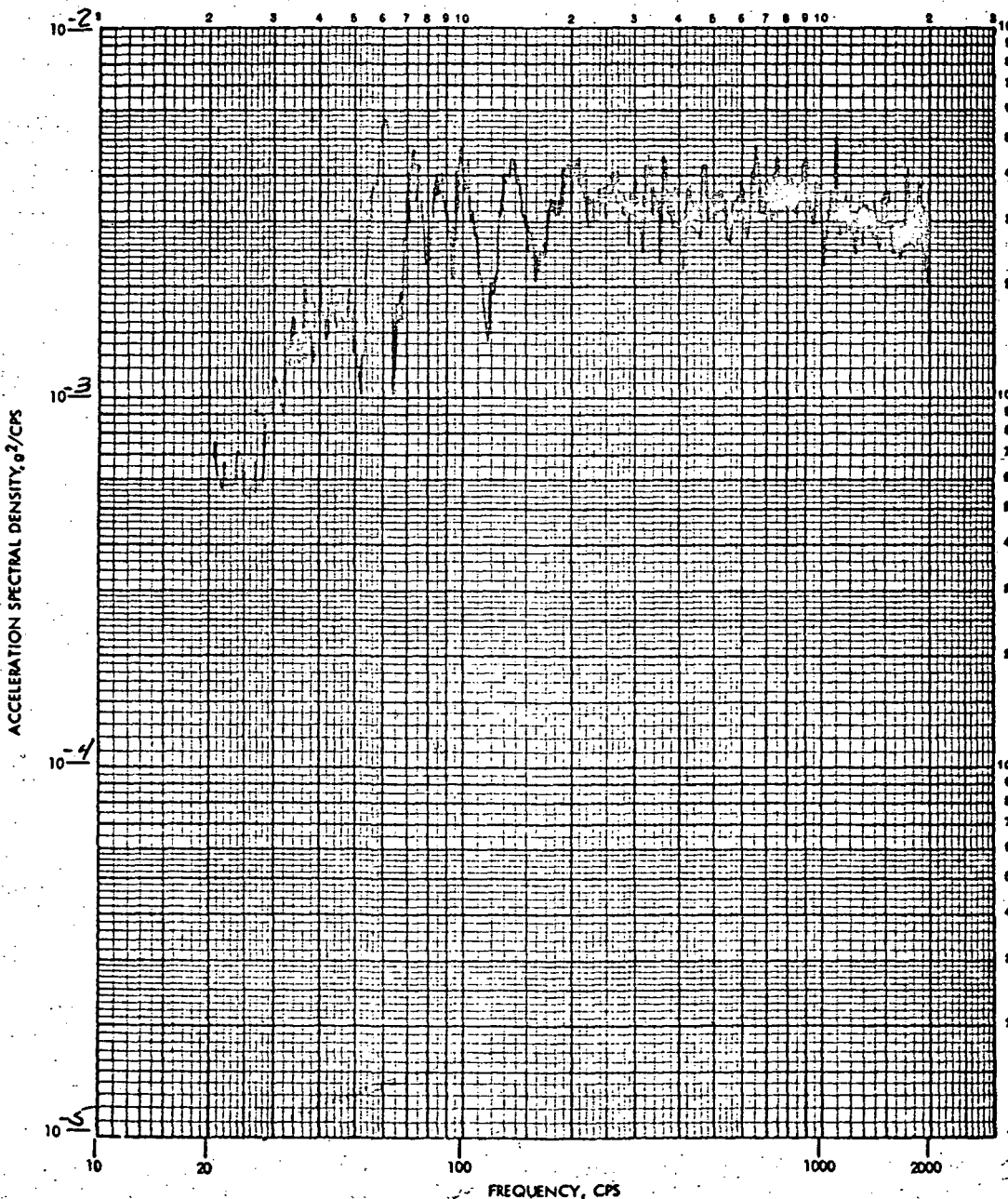

RANDOM

LR 6227 MEASUREMENT NUMBER 1-X RUN NUMBER 17
 TR 492117 CONTROL (L), RESPONSE () AXIS X DATE 7-11 19 68
 TEST TITLE G&N FILTER BOX ASSY
 OVERALL G RMS 2.49 SAMPLING 1.2 MIN
 FILTER BW, 5-10-20 CYCLES LOOP TIME 5 SEC
 SWEEP SPEEDS .5-1-2 SEC CROSSOVERS 100-500 CPS
 FULL SCALE 0.01 2/ CPS AVG TIME 2.5 SEC
 OPERATOR R.D.A. SPECIMEN P/N U36-442330
 REMARKS S/N 06362 AAH3858

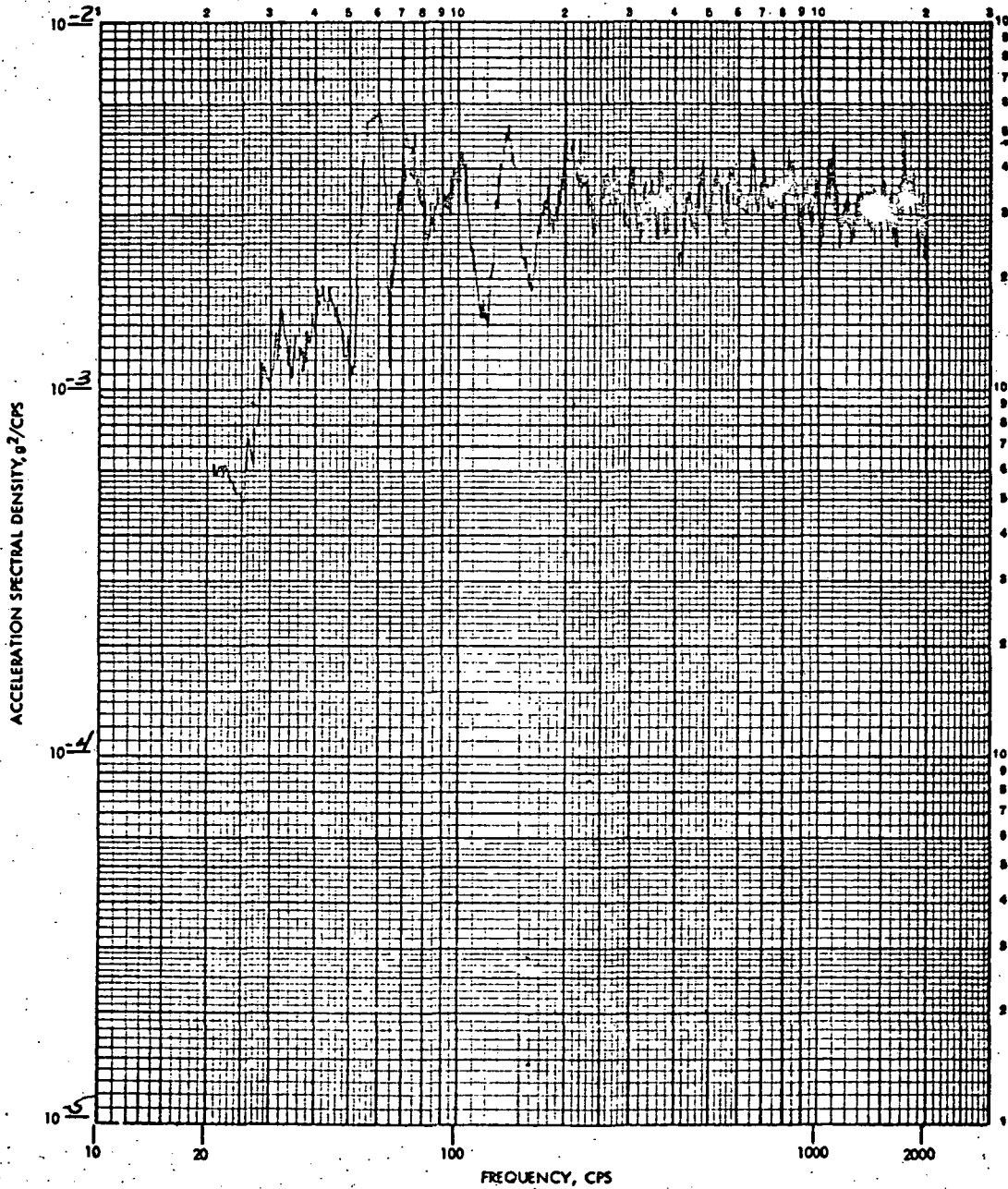

RANDOM

LR 6227 MEASUREMENT NUMBER 1-Y RUN NUMBER 18
 TR 492117 CONTROL (L), RESPONSE () AXIS Y DATE 9-11 1968
 TEST TITLE G & N FILTER BOX ASSY
 OVERALL G RMS 2.2 SAMPLING SPEC. EQUAL
 FILTER BW, 5-10-20 CYCLES LOOP TIME 5 SEC
 SWEEP SPEEDS .5-1-2 SEC CROSSOVERS 100-500 CPS
 FULL SCALE 0.01 2/CPS AVG TIME 2.5 SEC
 OPERATOR R.P.A. SPECIMEN P/N V36-442330
 REMARKS OK TO TEST WITH ADJUSTMENTS T.P. SMITH 66362 AAH3858

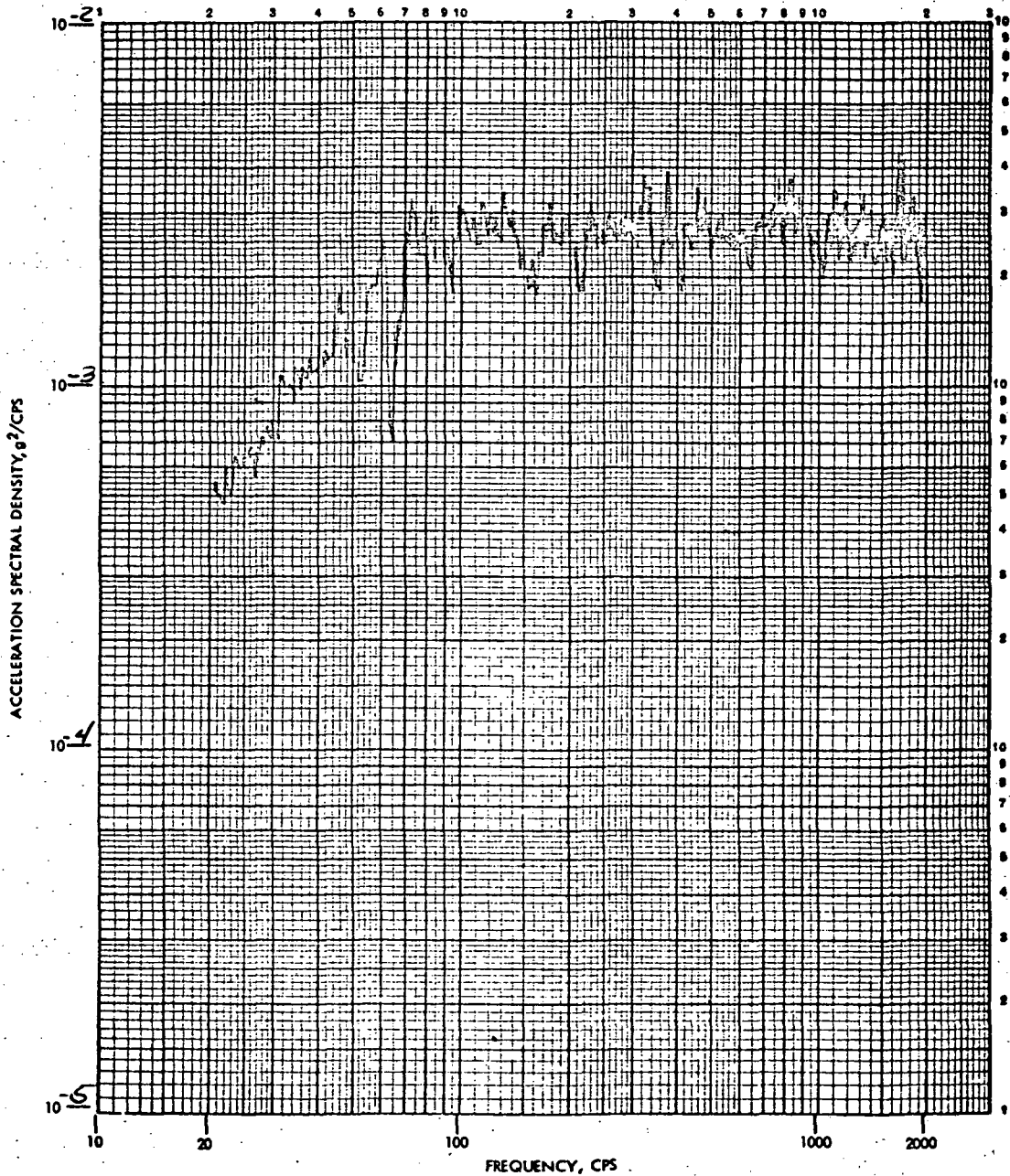

RANDOM

LR 6227 MEASUREMENT NUMBER 1-4 RUN NUMBER 19
 TR 492117 CONTROL (✓), RESPONSE () AXIS Y DATE 7-11 1968
 TEST TITLE G & N FILTER BOX ASSY
 OVERALL G RMS 2.17 SAMPLING 1 MIN.
 FILTER BW, 5-10-20 CYCLES LOOP TIME 5 SEC
 SWEEP SPEEDS .5-1-2 SEC CROSSOVERS 100-500 CPS
 FULL SCALE 0.01 g²/CPS AVG TIME 2-5 SEC
 OPERATOR R.D.S. SPECIMEN P/N V36-472330
 REMARKS _____ S/N 06362PA43858

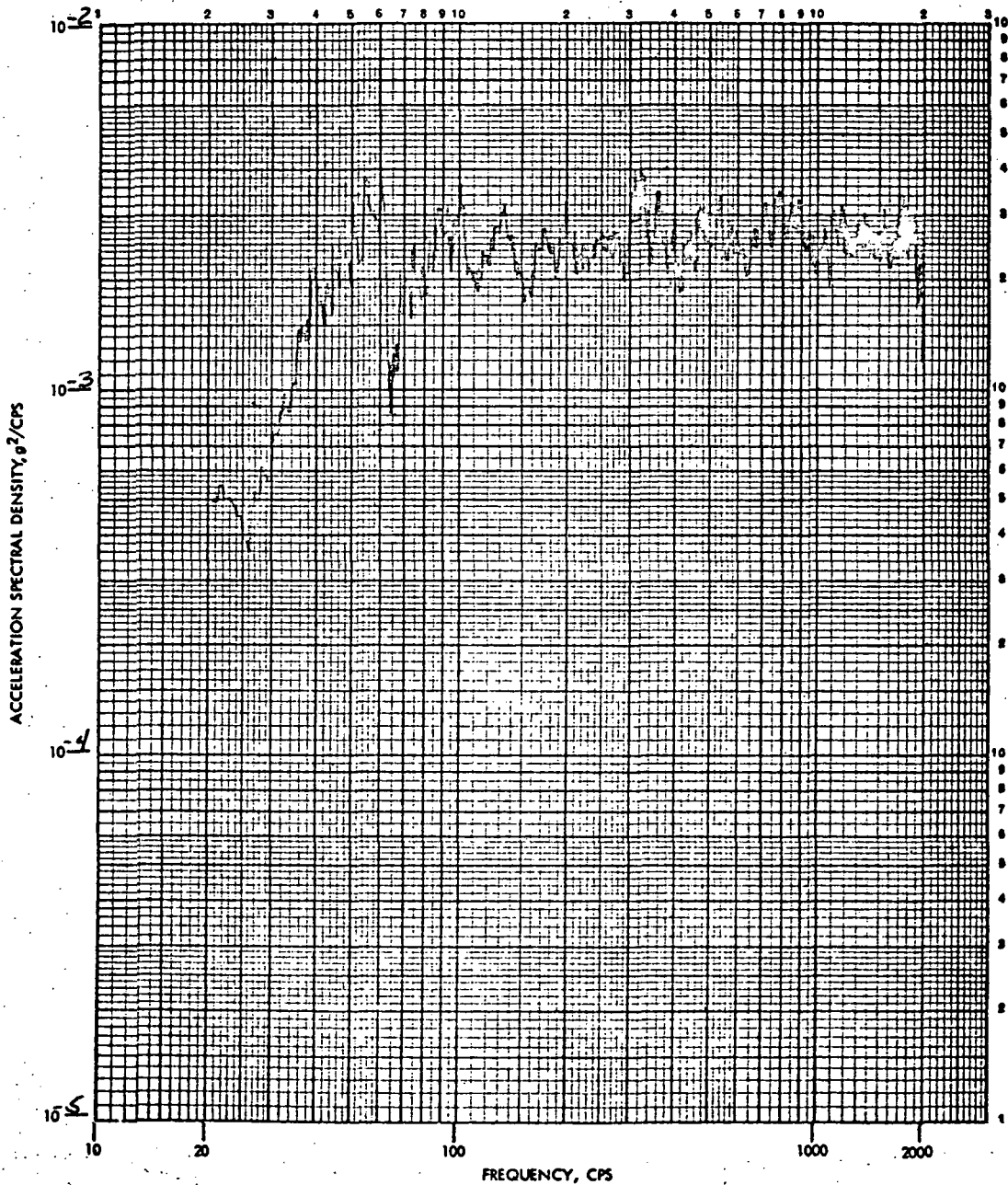

RANDOM

LR 6227 MEASUREMENT NUMBER 1-Y RUN NUMBER 19
 TR 492117 CONTROL (L), RESPONSE () AXIS Y DATE 7-11 19 68
 TEST TITLE Gd N FILTER Box ASSY
 OVERALL G RMS 2.2 SAMPLING 6 MIN
 FILTER BW, 5-10-20 CYCLES LOOP TIME 5 SEC
 SWEEP SPEEDS .5-1-2 SEC CROSSOVERS 100-500 CPS
 FULL SCALE 0.01 g/CPS AVG TIME 2-5 SEC
 OPERATOR R.O.A. SPECIMEN P/N 136-442330
 REMARKS S/N 06362 AA H3P58

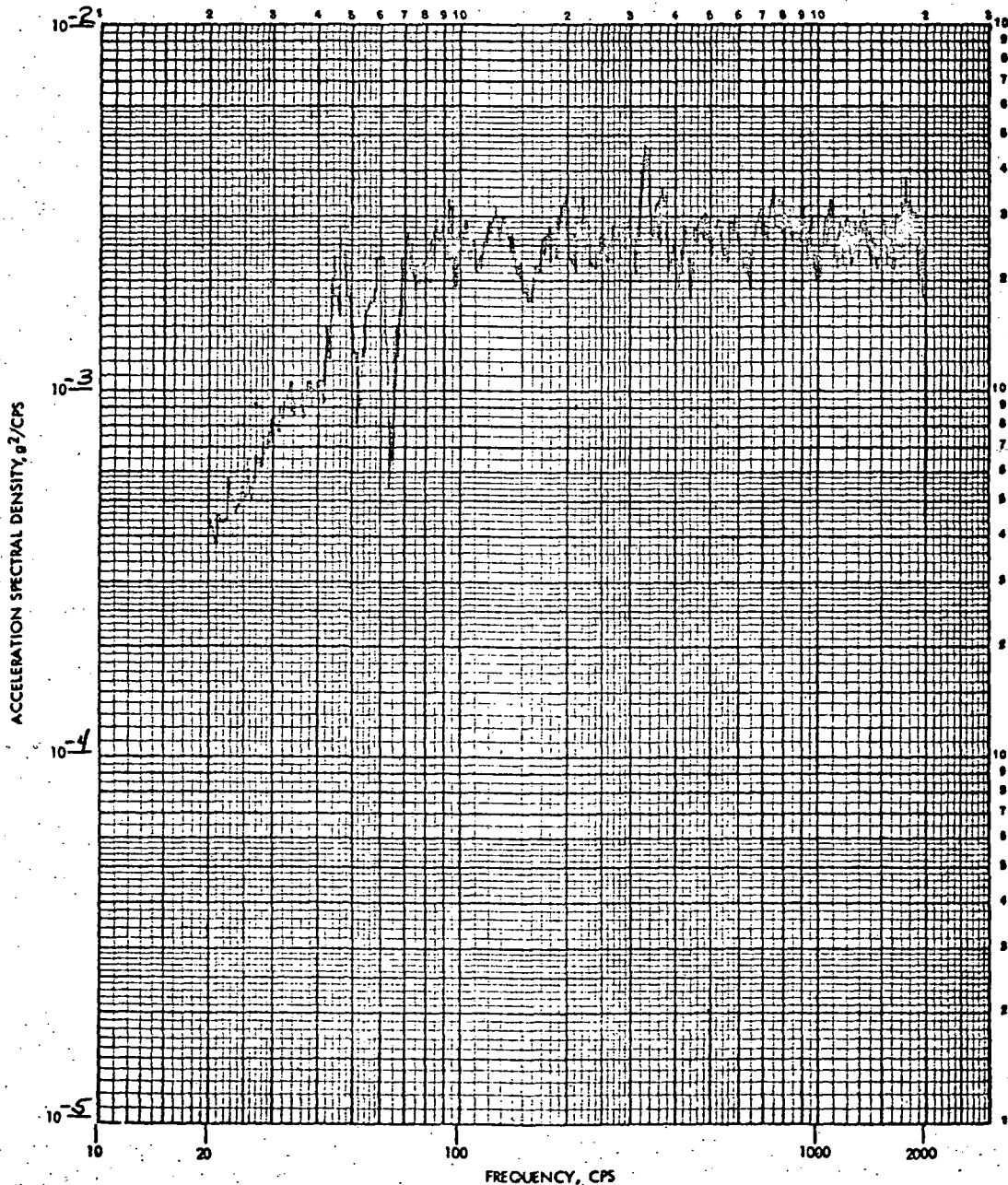

RANDOM

LR 6227 MEASUREMENT NUMBER 1-4 RUN NUMBER 19
 TR 492117 CONTROL (L), RESPONSE () AXIS Y DATE 7-11 19 68
 TEST TITLE G & N FILTER BOX ASSY
 OVERALL G RMS 2.19 SAMPLING 12 MIN
 FILTER BW, 5-10-20 CYCLES LOOP TIME 5 SEC
 SWEEP SPEEDS .5-1-2 SEC CROSSOVERS 100-500 CPS
 FULL SCALE 0.01 g^2 /CPS AVG TIME 2.5 SEC
 OPERATOR R.P.G. SPECIMEN P/N V36-442330
 REMARKS _____ S/N 06362ADH3858

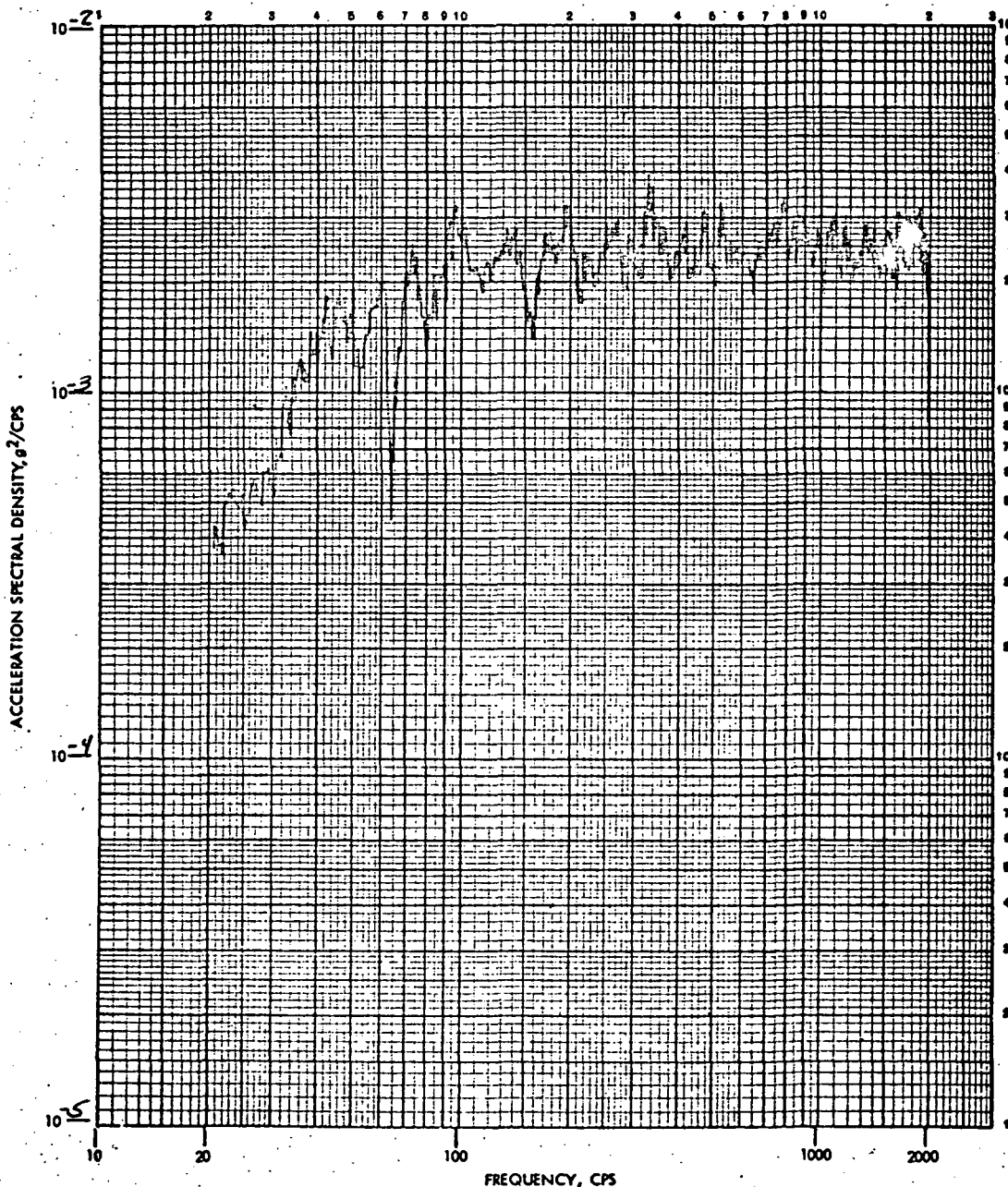

RANDOM

LR 6227 MEASUREMENT NUMBER 1-7 RUN NUMBER 20
 TR 492117 CONTROL (L), RESPONSE () AXIS Z DATE 7-11 1968
 TEST TITLE G8 N FILTER BOX ASSY
 OVERALL G RMS 2.2 SAMPLING SPR. EQUIL
 FILTER BW, 5-10-20 CYCLES LOOP TIME 5 SEC
 SWEEP SPEEDS .5-1-2 SEC CROSSOVERS 100-500 CPS
 FULL SCALE 0.01 2/ CPS AVG TIME 8.5 SEC
 OPERATOR RQG SPECIMEN P/N V36-442330
 REMARKS OUT OF SPEC S/N 06362AA/H3P5X

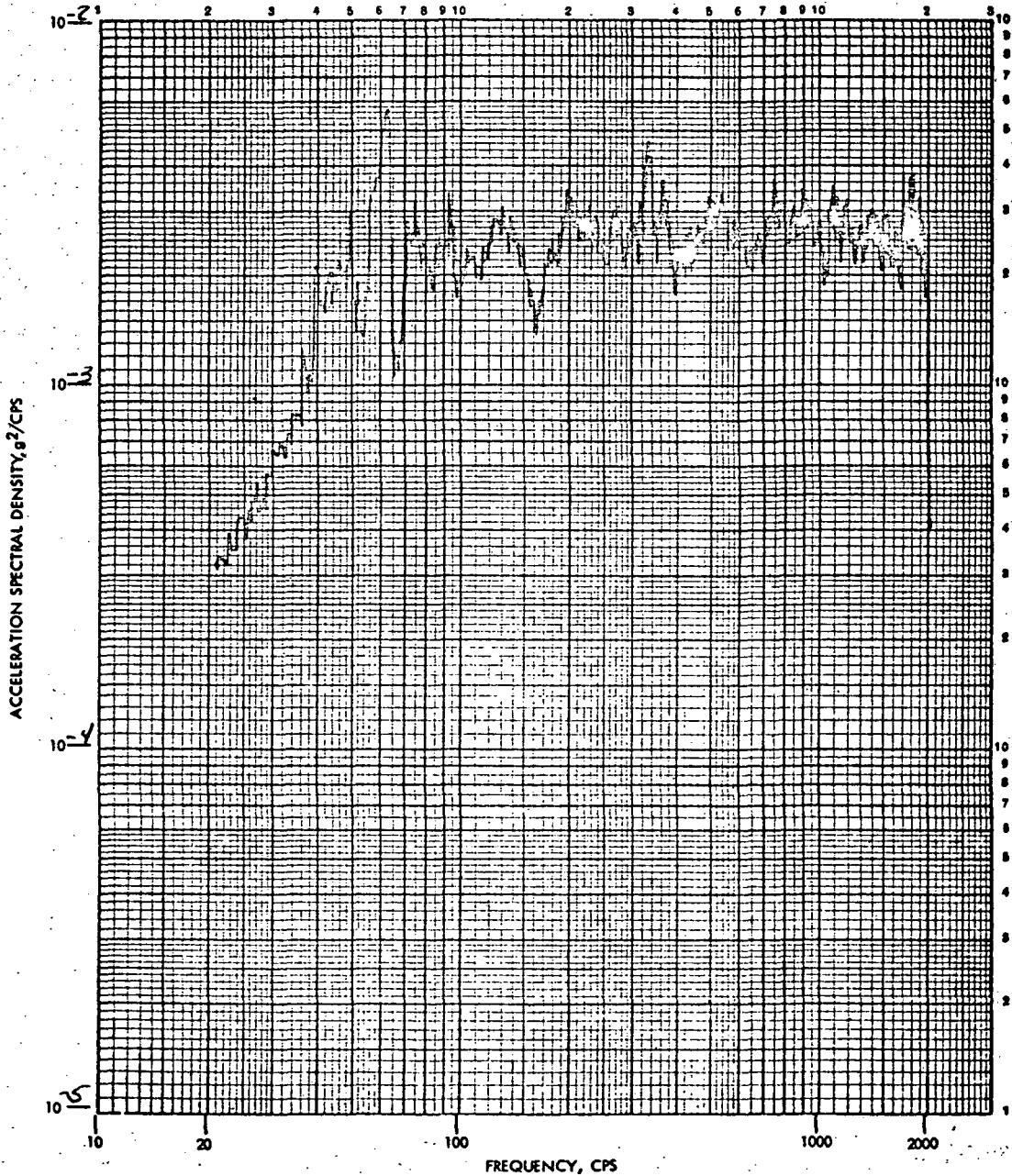

RANDOM

LR 6227 MEASUREMENT NUMBER 1-2 RUN NUMBER 21
 TR 192117 CONTROL (V), RESPONSE () AXIS Z DATE 7-11 1968
 TEST TITLE G & N FILTER BOX ASSY
 OVERALL G RMS 218 SAMPLING SPEC. EQUAL
 FILTER BW, 5-10-20 CYCLES LOOP TIME 5 SEC
 SWEEP SPEEDS .5-1-2 SEC CROSSOVERS 100-500 CPS
 FULL SCALE 0.01 G/CPS AVG TIME 2.5 SEC
 OPERATOR R.D.J. SPECIMEN P/N V36-442330
 REMARKS OK TO TEST WITH ADJUSTMENTS S/N 16362AAH3858
J.P. Smel

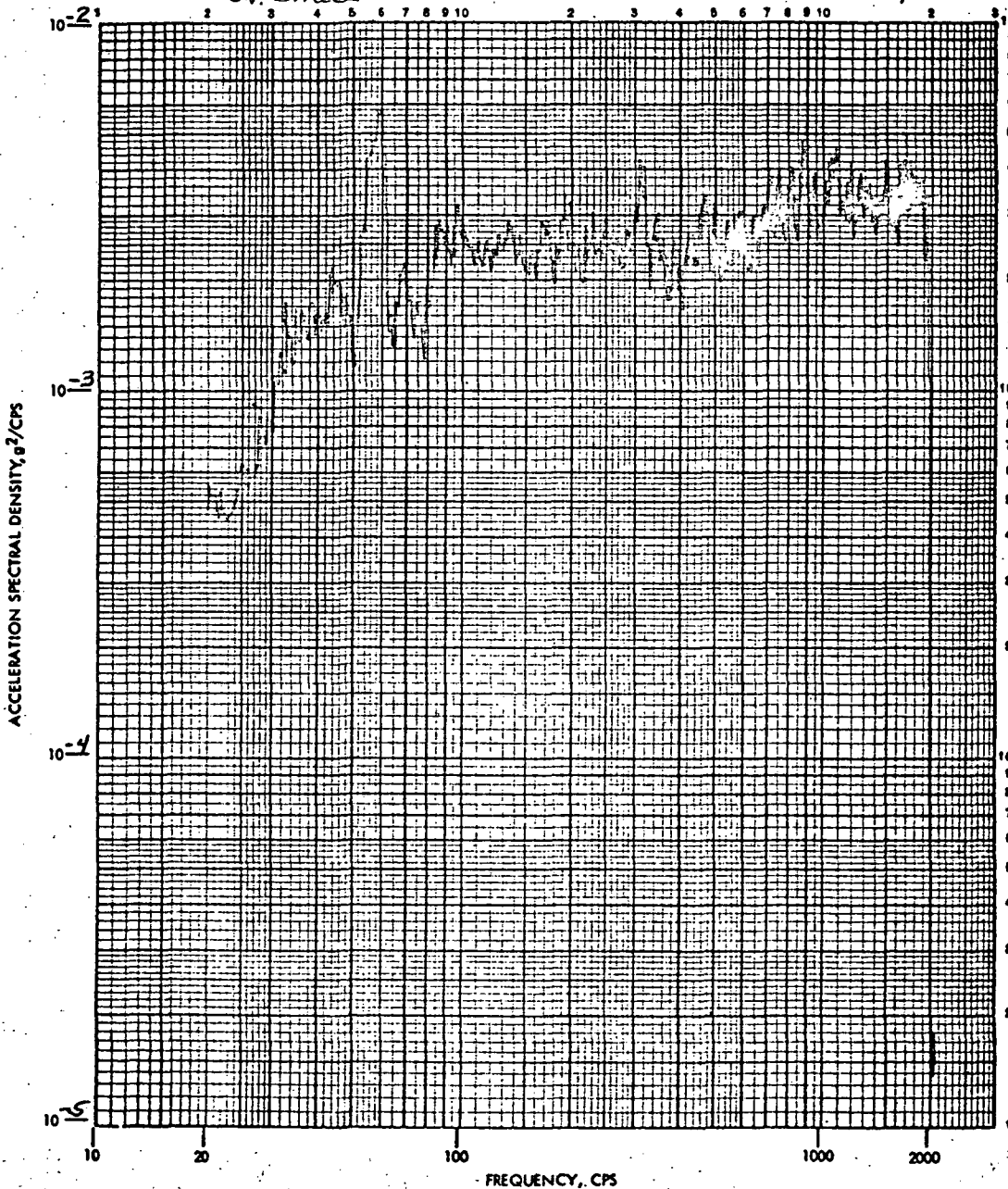

RANDOM

LR 6227 MEASUREMENT NUMBER 1-7 RUN NUMBER 22
 TR 492117 CONTROL (✓), RESPONSE () AXIS Z DATE 7-11 1968
 TEST TITLE G & N FILTER BOX ASSY
 OVERALL G RMS 2.2 SAMPLING 1 PCIA
 FILTER BW, 5-10-20 CYCLES LOOP TIME 5 SEC
 SWEEP SPEEDS .5-1-2 SEC CROSSOVERS 100-500 CPS
 FULL SCALE 0.01 g/CPS AVG TIME 2.5 SEC
 OPERATOR R.D.H SPECIMEN P/N V36-442330
 REMARKS _____ S/N 06362AAH/3858

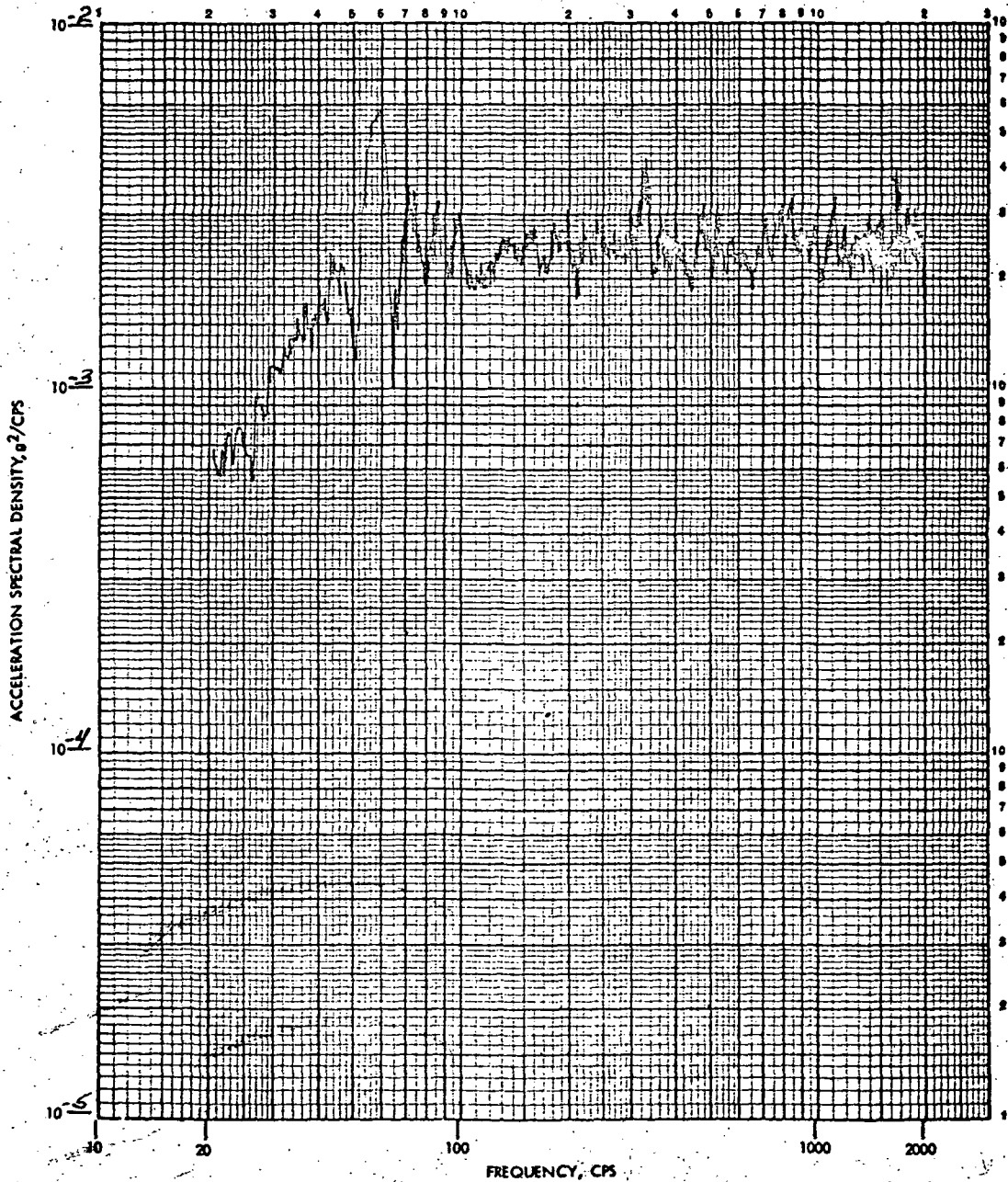

RANDOM

LR 6227 MEASUREMENT NUMBER 1-7 RUN NUMBER 22
 TR 492117 CONTROL (✓), RESPONSE () AXIS Z DATE 7-11 1968
 TEST TITLE G & N FILTER BOX ASSY
 OVERALL G RMS 2.2 SAMPLING 6 MIN
 FILTER BW, 5-10-20 CYCLES LOOP TIME 5 SEC
 SWEEP SPEEDS .5-1-2 SEC CROSSOVERS 100-500 CPS
 FULL SCALE 0.01 g/ CPS AVG TIME 2.5 SEC
 OPERATOR R.D.G. SPECIMEN P/N W36-442330
 REMARKS _____ S/N W362AAH3858

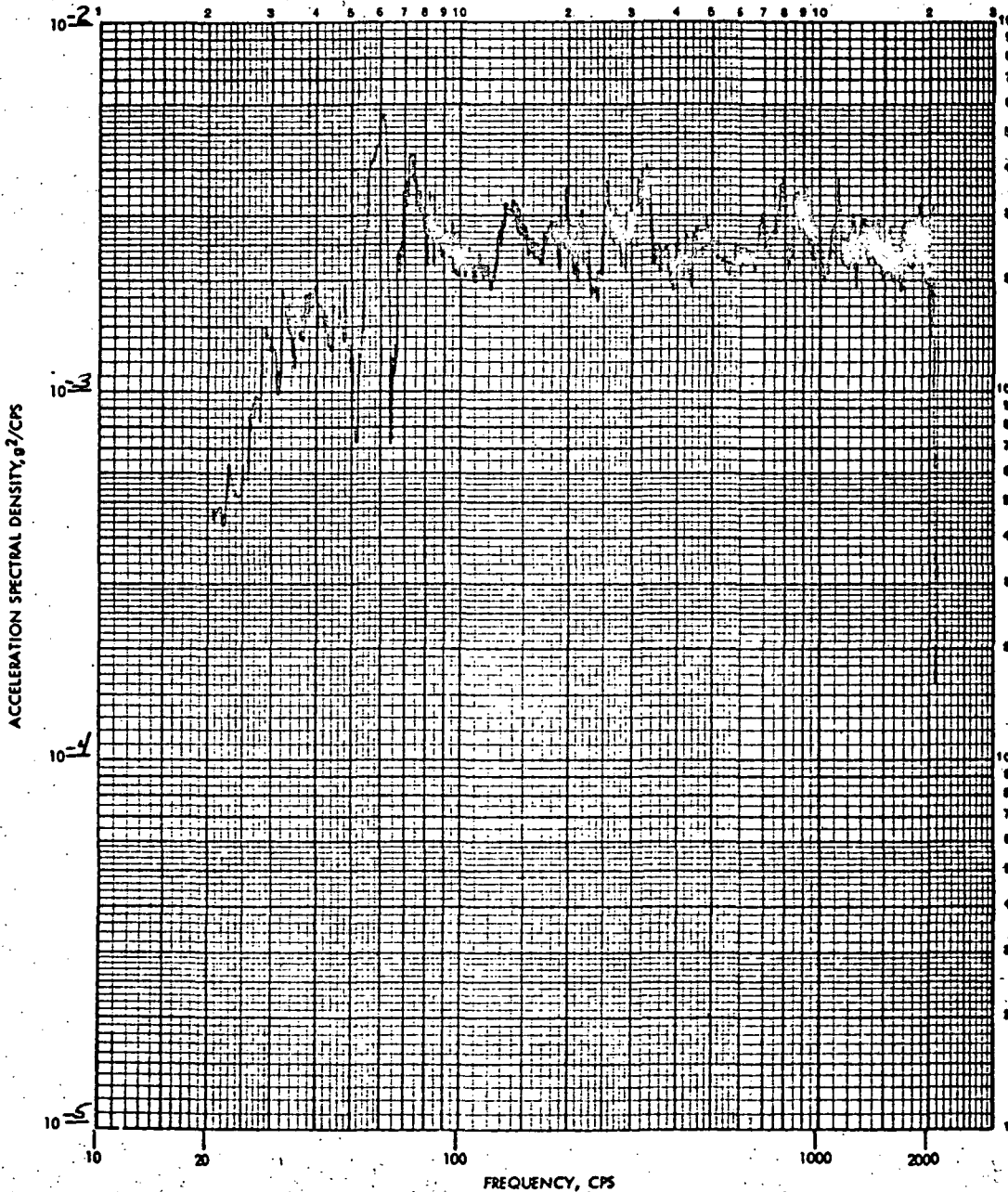

RANDOM

LR 6227 MEASUREMENT NUMBER 1-7 RUN NUMBER 22
 TR 492117 CONTROL (✓), RESPONSE () AXIS Z DATE 7-11 1968
 TEST TITLE G & N FILTER BOX ASSY
 OVERALL G RMS 2.16 SAMPLING 12 MIN.
 FILTER BW, 5-10-20 CYCLES LOOP TIME 5 SEC
 SWEEP SPEEDS .5-1-2 SEC CROSSOVERS 100-500 CPS
 FULL SCALE 0.01 g/CPS AVG TIME 2.5 SEC
 OPERATOR R.R.G. SPECIMEN P/N 1136-442330
 REMARKS _____ S/N 6362AAH3858

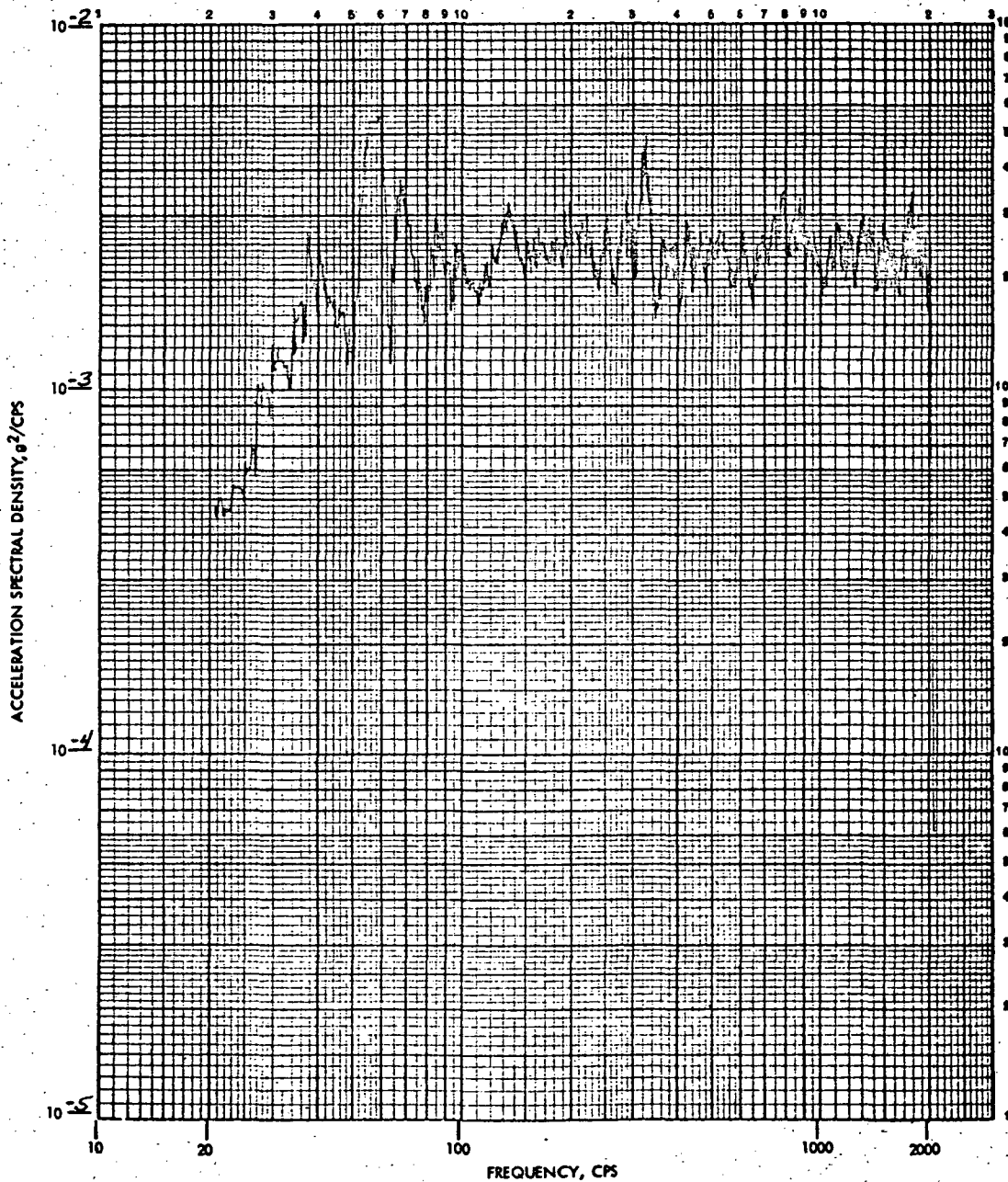

APPENDIX E

CORROSIVE-CONTAMINANTS, OXYGEN-HUMIDITY (COH)

North American Aviation, Inc. 

N 4694-29

DIVISION SPACE		
PROJECT NO: LR. 6227	CONTRACT NO. TR-492117	DATE 7-11-68

G & N FILTER BOX ASSEMBLY P/N 36-442330

TEST PHASE: HUMIDITY, OXYGEN, CORROSION CONTAMINANTS (COOH)
PHRA: 3.3 OF LR-6227 TR-492117 PAGES 5

TEST SETUP SCHEMATIC:

SALT FOG TEST SETUP

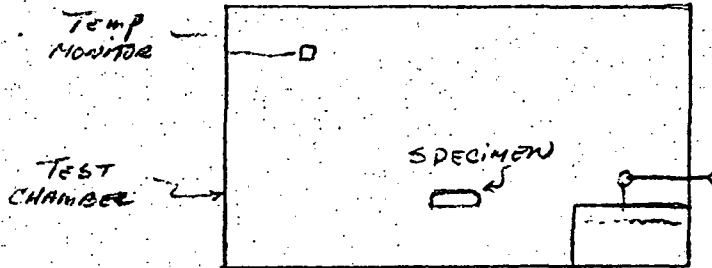

OXYGEN / HUMIDITY TEST SETUP

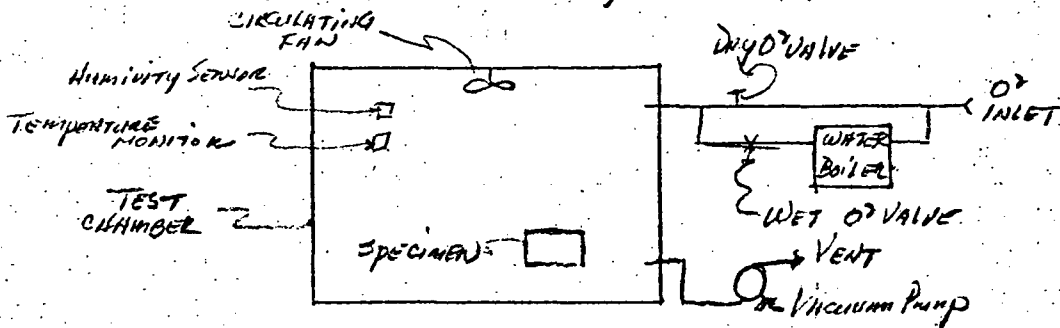

FORM ASD-G REV. 7-66

INSTRUCTIONS

STATE OBJECT OF EXPERIMENT, TEST DESIGN, OR INVENTION AND DESCRIBE IN SUFFICIENT DETAIL TO BE UNDERSTANDABLE AND REPRODUCIBLE BY ANOTHER ENGINEER. USE SKETCHES OR MAKE REFERENCE TO DRAWINGS OR PHOTOGRAPHS, IF ANY, BY NUMBER. ALL PAGES CONTAINING SUBJECT MATTER WHICH MAY BE INVENTIVE MUST BE WITNESSED.

SIGNATURE: David Gorman 7-11-68
WITNESSED AND UNDERSTOOD: G.T. Anderson 7-11-68

North American Aviation, Inc. 

N 4694-30

DIVISION <u>SPACE</u>		
PROJECT NO: <u>LR-6227</u>	CONTRACT NO. <u>TR-492117</u>	DATE <u>7-11-68</u>

CONTINUED FROM PAGE N-4694-29

SALT FOG TEST EQUIPMENT LIST

NO MENCLATURE	MANUFACTURER	PROP. NO.	MET. NO.	CALIB. DUE
SALT FOG CHAMBER	IND. FILTER & PUMP	N426934	03135	10-10-68
TEMP. RECORDER	BRISTOLS	F304137	24542	7-25-68
<u>OXYGEN / HUMIDITY TEST EQUIPMENT LIST</u>				
NO MENCLATURE	MANUFACTURER	PROP. NO.	MET. NO.	CALIB. DUE
OXYGEN CHAMBER	AUTO CONTROL LABS	5-013675	03128	10-10-68
TEMP. RECORDER	BRISTOLS	5-013676	5-513049	10-10-68
OXYGEN ANALYZER	BECKMAN'S	5012126	11418	10-10-68
ELECTRIC HUMIDIFIER	HYDRODYNAMICS	NONE	6366	9-24-68

SALT FOG CHAMBER TEMPERATURE 25°F. SALT SOLUTION SPECIFIC GRAVITY 1.0053.
SALT SOLUTION PH 6.7 SOLUTION WAS MIXED WITH 1% SALT BY WEIGHT.

THE SPECIMEN IS EQUAL TO THAT DEFINED IN THE THE APPROVED TEST REQUEST (TR-492117) AND THE TEST SETUP IS ADEQUATE TO MEET THE REQUIREMENTS OF THE COH TEST AS DEFINED IN THAT TEST REQUEST.

SIGNED R. W. Jett 7-12-68
LT. RESPONSIBLE TEST ENGINEER

VERIFIED L. B. Luce 695-412
12 July 68
NR/SU APOLLO ENGINEER

VERIFIED J. D. Williams 7/12/68
NR/SU INSPECTION

FORM 489-G REV. 7-68

INSTRUCTIONS
STATE OBJECT OF EXPERIMENT, TEST, DESIGN, OR INVENTION AND DESCRIBE IN SUFFICIENT DETAIL TO BE UNDERSTANDABLE AND REPRODUCIBLE BY ANOTHER ENGINEER. USE SKETCHES OR MAKE REFERENCE TO DRAWINGS OR PHOTOGRAPHS, IF ANY, BY NUMBER. ALL PAGES CONTAINING SUBJECT MATTER WHICH MAY BE INVENTIVE MUST BE WITNESSED.

SIGNATURE: David Carnot 7-11-68
WITNESSED AND UNDERSTOOD } J. D. Williams 7/12/68
19

North American Aviation, Inc. 

N 4694-31

DIVISION

SPACE

PROJECT NO:

LR-6227

CONTRACT NO.

TR-492117

DATE

7-11-68

CONTINUED FROM PAGE N-4694-30

SALT FOG TEST:

7-11-68-

7-11-68

THE SPECIMEN WAS PLACED IN THE SALT FOG CHAMBER. EXPOSURE STARTED AT 2315 HRS. THE TEST WAS COMPLETED AT 0015 HRS AND THE SALT FOG CHAMBER PURGE STARTED. THE SPECIMEN WAS TRANSFERRED TO THE OXYGEN/HUMIDITY CHAMBER AT 0100 HRS. SALT FOG INSPECTION REVEALED NO VISIBLE EVIDENCE OF CORROSION.  7-12-68.

7-12-68-

BEGAN CHAMBER PUMP DOWN TO 80,000 FT. AT 0200 HRS. REACHED 30,000 AT 0210 HRS AND BACK FILLED CHAMBER TO 5 PSIA AT 0220 HRS. REACHED SPECIFICATION OF 125°F TEMPERATURE, PURE OXYGEN ATMOSPHERE AND 5 PSIA AT 0800. 7-12-68. START OF 12 HR. DRY OXYGEN ATMOSPHERE EXPOSURE CYCLE. 

INSTRUCTIONS

STATE OBJECT OF EXPERIMENT, TEST, DESIGN, OR INVENTION AND DESCRIBE IN SUFFICIENT DETAIL TO BE UNDERSTANDABLE AND REPRODUCIBLE BY ANOTHER ENGINEER. USE SKETCHES OR MAKE REFERENCE TO DRAWINGS OR PHOTOGRAPHS, IF ANY, BY NUMBER. ALL PAGES CONTAINING SUBJECT MATTER WHICH MAY BE INVENTIVE MUST BE WITNESSED.

SIGNATURE

David Cromer 7-12-68

WITNESSED AND UNDERSTOOD

J. F. [unclear] 7-12-1968

19

FORM 403-G REV. 7-66

North American Aviation, Inc. 

N 4694-32

DIVISION SPACE	
PROJECT NO: LR-6227	CONTRACT NO. TR-492117
DATE 7-12-68	

CONTINUED FROM PAGE N-4694-31

DATE	TIME	CHAMBER Temp	PRESSURE PSIA	ALTITUDE FEET	Humidity %	OXYGEN %	REMARKS
7-12-68	0800*	125°	5.01	27,000	NONE	91%	* START OF 12 HR. DRY OXYGEN EXPOSURE.
	0900	125°	5.01	27,000	NONE	92%	
	1000	125°	5.01	27,000	NONE	93%	
	1100	125°	5.01	27,000	NONE	93%	
	1200	125°	5.01	27,000	NONE	93%	
7-12-68	1300	125°	5.01	27,000	-	92%	
	1400	125°	5.01	27,000	-	90%	
	1500	125°	5.01	27,000	-	92%	
	1600	125°	5.01	27,000	-	90%	
	1700	125°	5.01	27,000	-	90%	
	1800	125°	5.01	27,000	-	90%	
7-12-68	1900	125°	5.01	27,000	-	90%	
	2000	125°	5.01	27,000	-	90%	END OF DRY OXYGEN EXPOSURE
7-12-68	2100	109°	5.01	27,000	95%		PORTION OF TEST 2000
	2200	109°	5.01	27,000	90%		7-12-68 BEGIN O ₂ HUMIDITY
	2300	123°	5.01	27,000	90%		PORTION OF TEST AT 2000 7-12-68 EQD.
	2400	124°	5.01	27,000	90%		
7-13-68	0100	125°	5.01	27,000	98%		* START 2 HR. RAMP TO 125° 55' AT 2100 7-12-68
	0200	125°	5.01	27,000	96%		
	0300	125°	5.01	27,000	97%		
	0400	125°	5.01	27,000	96%		
	0500*	125°	5.01	27,000	96%		* END OF 6 HR. SOAK OF 125° START DOWN RAMP TO 60° 55'
	0600	115°	5.01	27,000	98%		
	0700	110°	5.01	27,000	98%		
	0800	105°	5.01	27,000	98%		
	0900	100°	5.01	27,000	98%		
	1000	95°	5.01	27,000	97%		
	1100	90°	5.01	27,000	96%		
	1200	85°	5.01	27,000	95%		

OXYGEN FLOW FOR REMAINDER OF TEST WILL HAVE A HUMIDITY OF 95% AT 2100

INSTRUCTIONS

STATE OBJECT OF EXPERIMENT, TEST, DESIGN, OR INVENTION AND DESCRIBE IN SUFFICIENT DETAIL TO BE UNDERSTANDABLE AND REPRODUCIBLE BY ANOTHER ENGINEER. USE SKETCHES OR MAKE REFERENCE TO DRAWINGS OR PHOTOGRAPHS, IF ANY, BY NUMBER. ALL PAGES CONTAINING SUBJECT MATTER WHICH MAY BE INVENTIVE MUST BE WITNESSED.

SIGNATURE: _____
WITNESSED AND UNDERSTOOD } _____

David Ogomori 7-13-68
J. T. Anderson 7-13-68

FORM 493-G REV. 7-66

North American Aviation, Inc. 

N 4694-33

DIVISION

SPACE

PROJECT NO.

LR. 6227

CONTRACT NO.

TR-492117

DATE

7-13-68

CONTINUED FROM PAGE N-4694-32

DATE	TIME	CHAMBER TEMP.	PRESSURE PSIA	ALTITUDE FEET	HUMIDITY %	PO2 BY	O2 %	REMARKS
7-13-68	1300	76°	5.01	27,000	95%	EJD		
7-13-68	1400	70°	5.01	27,000	90%	EJD		
7-13-68	1500	68°	5.01	27,000	96%	EJD		
7-13-68	1600	65°	5.01	27,000	92%	EJD		END 10 HR DOWN RAMP TO 60% START 6 HR SOAK AT 60% 6/13/68
7-13-68	1700	64°	5.01	27,000	90%	EJD		
7-13-68	1800	64°	5.01	27,000	92%	EJD		
7-13-68	1900	64°	5.01	27,000	95%	EJD		
7-13-68	2000	65°	5.01	27,000	95%	EJD		
7-13-68	2100	65°	5.01	27,000	98%	EJD		END OF 6 HR SOAK AT 60% START 2 HR RAMP TO 125% AT 2100 7-13-68 EJD
7-13-68	2200	110°	5.01	27,000	87%	EJD		2100-7-13-68-FINISHED
7-13-68	2300	122°	5.01	27,000	90%	EJD		
7-13-68	2400	123°	5.01	27,000	93%	EJD		
7-14-68	0100	125°	5.01	27,000	98%	DWD		
7-14-68	0200	125°	5.01	27,000	98%	DWD		
7-14-68	0300	125°	5.01	27,000	98%	DWD		
7-14-68	0400	125°	5.01	27,000	98%	DWD		
7-14-68	0500*	125°	5.01	27,000	98%	DWD		* 0500-7-14-68-START DOWN RAMP TO 60% WITHIN 10 HR
7-14-68	0600	115°	5.01	27,000	98%	DWD		
7-14-68	0700	110°	5.01	27,000	98%	DWD		
7-14-68	0800	102°	5.01	27,000	98%	DWD		
7-14-68	0900	98°	5.01	27,000	98%	DWD		
7-14-68	1000	92°	5.01	27,000	98%	DWD		
7-14-68	1100	82°	5.01	27,000	98%	DWD		
7-14-68	1200	86°	5.01	27,000	98%	DWD		
7-14-68	1300	79°	5.01	27,000	97%	EJD		
7-14-68	1400	66°	5.01	27,000	95%	EJD		
7-14-68	1500*	60°	5.01	27,000	96%	EJD		
7-14-68	1600	62°	5.01	27,000	95%	EJD		END 10 HR DOWN RAMP TO 60% START 6 HR SOAK AT 60%

INSTRUCTIONS

STATE OBJECT OF EXPERIMENT, TEST, DESIGN, OR INVENTION AND DESCRIBE IN SUFFICIENT DETAIL TO BE UNDERSTANDABLE AND REPRODUCIBLE BY ANOTHER ENGINEER. USE SKETCHES OR MAKE REFERENCE TO DRAWINGS OR PHOTOGRAPHS, IF ANY, BY NUMBER. ALL PAGES CONTAINING SUBJECT MATTER WHICH MAY BE INVENTIVE MUST BE WITNESSED.

SIGNATURE:

E.J. D... 7-14 1968

WITNESSED AND UNDERSTOOD

J. P. ... 7-14 1968

FORM 495-G REV. 7-68

North American Aviation, Inc. 

N 4694-34

DIVISION <i>SPACE</i>		
PROJECT NO. <i>LR 4227</i>	CONTRACT NO. <i>TA 492117</i>	DATE <i>7-14-68</i>
CONTINUED FROM PAGE N4694-33		

DATE	TIME	CHAMBER TEMP °	PRESSURE PSIA	ALTITUDE FT.	HUMIDITY %	O ₂ %	BY	REMARKS
7-14-68	1700	65°	5.01	27,000	98%		EJD	
	1800	66°	5.01	27,000	98%		EJD	
	1900	65°	5.01	27,000	99%		EJD	
7-14-68	2000	65°	5.01	27,000	98%		EJD	
	2100	65°	5.01	27,000	98%		EJD	END CHR SINK AT 60° START RAMP TO 125° AT 2100 7-14-68 EJD
	2200	106°	5.01	27,000	90%		EJD	ARRIVED CHAMBER OF WATER 2230 EJD
	2300	123°	5.01	27,000	90%		EJD	
7-14-68	2400	122°	5.01	27,000	98%		EJD	
7-15-68	0100	126°	5.01	27,000	98%		DUD	
7-15-68	0200	122°	5.01	27,000	98%		DUD	
7-15-68	0300	125°	5.01	27,000	96%		DUD	
7-15-68	0400	125°	5.01	27,000	93%		DUD	
7-15-68	0500	125°	5.01	27,000	97%		DUD	END OF 6 HR. 125° SOAK. START 10 HR. DOWNRAMP TO 60° RVD 7-15-68
7-15-68	0600	112°	5.01	27,000	98%		DUD	
7-15-68	0700	110°	5.01	27,000	98%		DUD	
7-15-68	0800	105°	5.01	27,000	98%		DUD	
7-15-68	0900	100°	5.01	27,000	98%		DUD	
7-15-68	1000	92°	5.01	27,000	98%		DUD	
7-15-68	1100	85°	5.01	27,000	98%		DUD	
7-15-68	1200	80°	5.01	27,000	98%		DUD	
7-15-68	1300	75°	5.01	27,000	90%		EJD	
7-15-68	1400	65°	5.01	27,000	90%		EJD	
7-15-68	1500	60°	5.01	27,000	98%		EJD	
7-15-68	1600	63°	5.01	27,000	98%		EJD	
7-15-68	1700	61°	5.01	27,000	98%		EJD	
7-15-68	1800	62°	5.01	27,000	98%		EJD	
7-15-68	1900	65°	5.01	27,000	98%		EJD	
7-15-68	2000	65°	5.01	27,000	98%		EJD	

3.12 #2

O₂ FLOW FOR REMAINDER OF TEST WILL HAVE A PURITY OF 95.5% EJD

CONTINUED ON PAGE N4694-35

FORM 488-0 REV. 7-66

INSTRUCTIONS

STATE OBJECT OF EXPERIMENT, TEST, DESIGN, OR INVENTION AND DESCRIBE IN SUFFICIENT DETAIL TO BE UNDERSTANDABLE AND REPRODUCIBLE BY ANOTHER ENGINEER. USE SKETCHES OR MAKE REFERENCE TO DRAWINGS OR PHOTOGRAPHS, IF ANY, BY NUMBER. ALL PAGES CONTAINING SUBJECT MATTER WHICH MAY BE INVENTIVE MUST BE WITNESSED.

SIGNATURE: E. J. Duffall 7-14 1968
 WITNESSED AND UNDERSTOOD: E. Kemechuk 7-15 1968

North American Aviation, Inc. 

N 4694-35

DIVISION

SPACE

PROJECT NO:

LR 4227

CONTRACT NO.

TR 492117

DATE

7-15-68

CONTINUED FROM PAGE N4694-34

CYCLE #3

DATE	TIME	TEMPERATURE	PRESSURE PSIA	ALTITUDE FT.	HUMIDITY %	O ₂ %	RECORD BY	REMARKS
7-15-68	2100*	65°	5.01	27,000	98%	90%	EJD	* END CHR SOAK AT 60°N
7-15-68	2200	98°	5.01	27,000	98%	90%	EJD	START RAMP TO 125° 50°N
7-15-68	2300	126°	5.01	27,000	96%	90%	EJD	7-15-68
7-15-68	2400	123°	5.01	27,000	98%	90%	EJD	DRAIN ED WATER FROM
7-16-68	0100	125°	5.01	27,000	98%	90%	EJD	NUMBER 2300 7-15-68 EJD
7-16-68	0200	127°	5.01	27,000	98%	90%	EJD	
7-16-68	0300	125°	5.01	27,000	98%	90%	EJD	
7-16-68	0400	127°	5.01	27,000	98%	90%	EJD	
7-16-68	0500*	125°	5.01	27,000	98%	90%	EJD	* 0500-7-16-68. END OF 6 HR 125° SOAK. START DOWN RAMP 50°N
7-16-68	0600	112°	5.01	27,000	98%	90%	EJD	
7-16-68	0700	105°	5.01	27,000	98%	90%	EJD	
7-16-68	0800	100°	5.01	27,000	98%	90%	EJD	
7-16-68	0900	95°	5.01	27,000	98%	90%	EJD	
7-16-68	1000	90°	5.01	27,000	98%	90%	EJD	
7-16-68	1100	88°	5.01	27,000	94%	90%	EJD	
7-16-68	1200	85°	5.01	27,000	96%	90%	EJD	
7-16-68	1300	75°	5.01	27,000	90%	90%	EJD	
7-16-68	1400	72°	5.01	27,000	96%	90%	EJD	
7-16-68	1500*	65°	5.01	27,000	90%	90%	EJD	* END 10 HR. DOWN RAMP TO 60°N. START CHR SOAK AT 60°N 50°N 7-16-68
7-16-68	1600	65°	5.01	27,000	90%	90%	EJD	
7-16-68	1700	65°	5.01	27,000	90%	90%	EJD	
7-16-68	1800	66°	5.01	27,000	90%	90%	EJD	
7-16-68	1900	66°	5.01	27,000	95%	90%	EJD	* END CHR SOAK AT 60°N 50°N 7-16-68
7-16-68	2000*	66°	5.01	27,000	95%	90%	EJD	START RAMP TO 125° 50°N
7-16-68	2100	66°	5.01	27,000	95%	90%	EJD	
7-16-68	2200	90°	5.01	27,000	98%	90%	EJD	
7-16-68	2300	121°	5.01	27,000	95%	90%	EJD	DRAIN ED WATER FROM
7-16-68	2400	123°	5.01	27,000	95%	90%	EJD	NUMBER 2345 EJD
7-17-68	0100	126°	5.01	27,000	98%	90%	EJD	
7-17-68	0200	127°	5.01	27,000	98%	90%	EJD	0200-7-17-68. CHR SOAK CHART

OXYGEN FLOW FOR MEMORANDUM OF TEST WILL HAVE A PURITY FLOW

FORM ASD-6 REV. 7-66

INSTRUCTIONS

STATE OBJECT OF EXPERIMENT, TEST DESIGN, OR INVENTION AND DESCRIBE IN SUFFICIENT DETAIL TO BE UNDERSTANDABLE AND REPRODUCIBLE BY ANOTHER ENGINEER. USE SKETCHES OR MAKE REFERENCE TO DRAWINGS OR PHOTOGRAPHS, IF ANY, BY NUMBER. ALL PAGES CONTAINING SUBJECT MATTER WHICH MAY BE INVENTIVE MUST BE WITNESSED.

SIGNATURE:

E. J. Duffell 7-15-1968

WITNESSED AND UNDERSTOOD

E. J. Duffell 7-15-1968

19

North American Aviation, Inc. 

N 4694-36

DIVISION SPACE		
PROJECT NO: LR-6227	CONTRACT NO: TR-492117	DATE: 7-17-68

CONTINUED FROM PAGE N-4694-35

DATE	TIME	CHAMBER TEMP. °	PRESSURE PSIA	ALTITUDE FEET	HUMIDITY %	OXYGEN %	RECORDED BY	REMARKS
7-17-68	0300	125°	5.01	27,000	98%		AWD	
7-17-68	0400	125°	5.01	27,000	98%		AWD	
7-17-68	0500*	125°	5.01	27,000	98%		AWD	*0500-7-17-68-END OF 6 HR. SOAK OF 125° START DOWN PUMP TO 60°
7-17-68	0600	116°	5.01	27,000	98%		AWD	
7-17-68	0700	105°	5.01	27,000	98%		AWD	
7-17-68	0800	100°	5.01	27,000	98%		AWD	
7-17-68	0900	95°	5.01	27,000	98%		AWD	
7-17-68	1000	90°	5.01	27,000	96%		AWD	
7-17-68	1100	87°	5.01	27,000	98%		AWD	
7-17-68	1200	85°	5.01	27,000	96%		AWD	
7-17-68	1300	78°	5.01	27,000	97%		AWD	
7-17-68	1400	76°	5.01	27,000	97%		AWD	
7-17-68	1500	67°	5.01	27,000	96%		AWD	
7-17-68	1600	65°	5.01	27,000	96%		AWD	
7-17-68	1700	65°	5.01	27,000	96%		AWD	
7-17-68	1800	66°	5.01	27,000	96%		AWD	
7-17-68	1900	66°	5.01	27,000	96%		AWD	
7-17-68	2000*	66°	5.01	27,000	96%		AWD	
7-17-68	2100	66°	5.01	27,000	96%		AWD	END TEST 7-17-68-2100 E/W

OXYGEN FLOW FOR REMINDER OF TEST WILL HAVE A PURITY AT LEAST OF 96% F 570 AND

THE RAW DATA ACCUMULATED DURING THE PRECEDING COON TEST CONSISTS OF 6 CREWER CRISTAL TEMP. CHARTS I.D. NO. 55250 MARKED T-1 THROUGH T-6 AND ONE I.D. NO 11175 MARKED S-I. E-1

FORM 493-G REV. 7-66

INSTRUCTIONS
STATE OBJECT OF EXPERIMENT, TEST, DESIGN, OR INVENTION AND DESCRIBE IN SUFFICIENT DETAIL TO BE UNDERSTANDABLE AND REPRODUCIBLE BY ANOTHER ENGINEER. USE SKETCHES OR MAKE REFERENCE TO DRAWINGS OR PHOTOGRAPHS, IF ANY, BY NUMBER. ALL PAGES CONTAINING SUBJECT MATTER WHICH MAY BE INVENTIVE MUST BE WITNESSED.

SIGNATURE: R. G. Schmitt 7-17-68
WITNESSED AND UNDERSTOOD: J. T. ... 7-17-1968

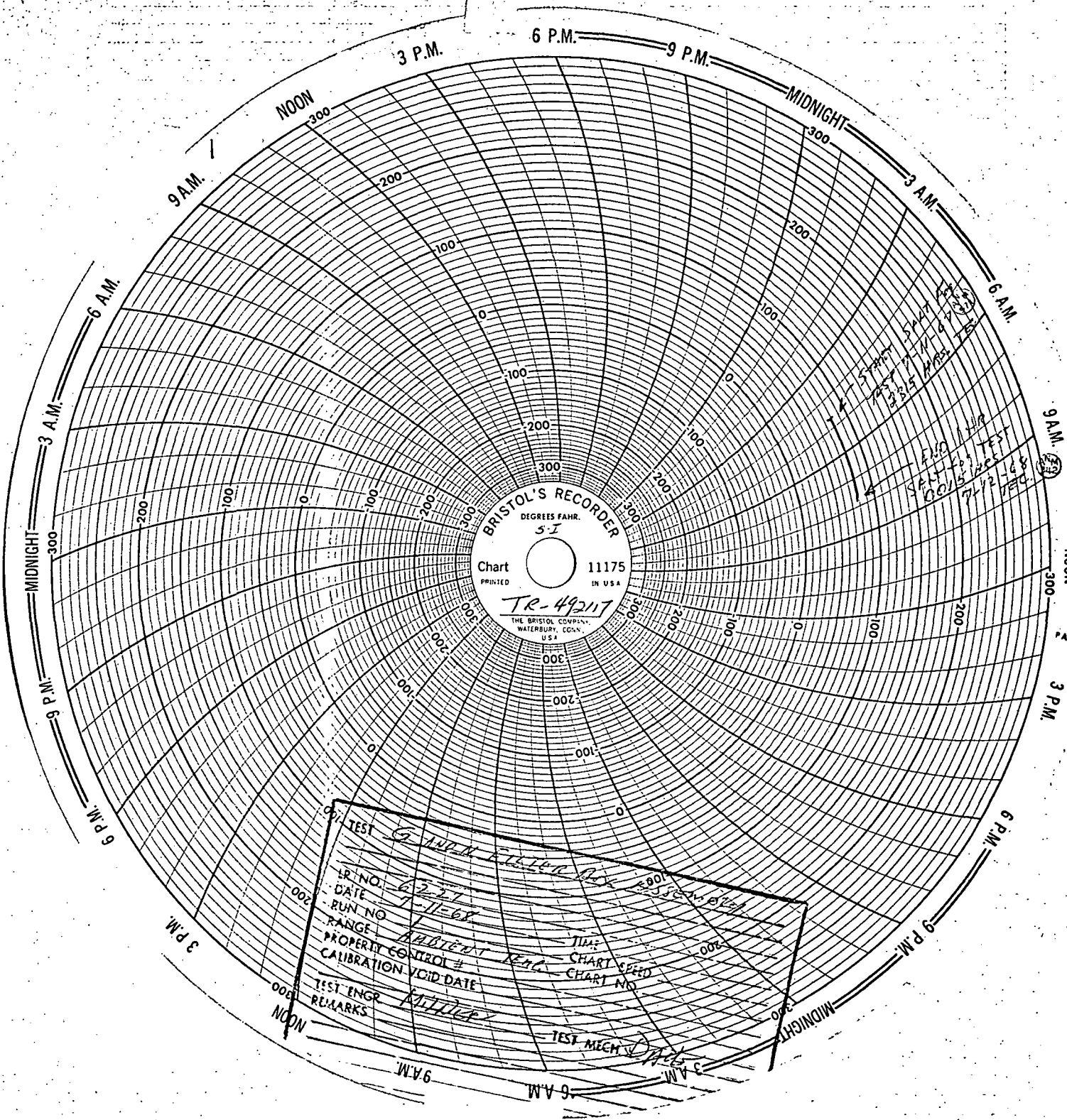

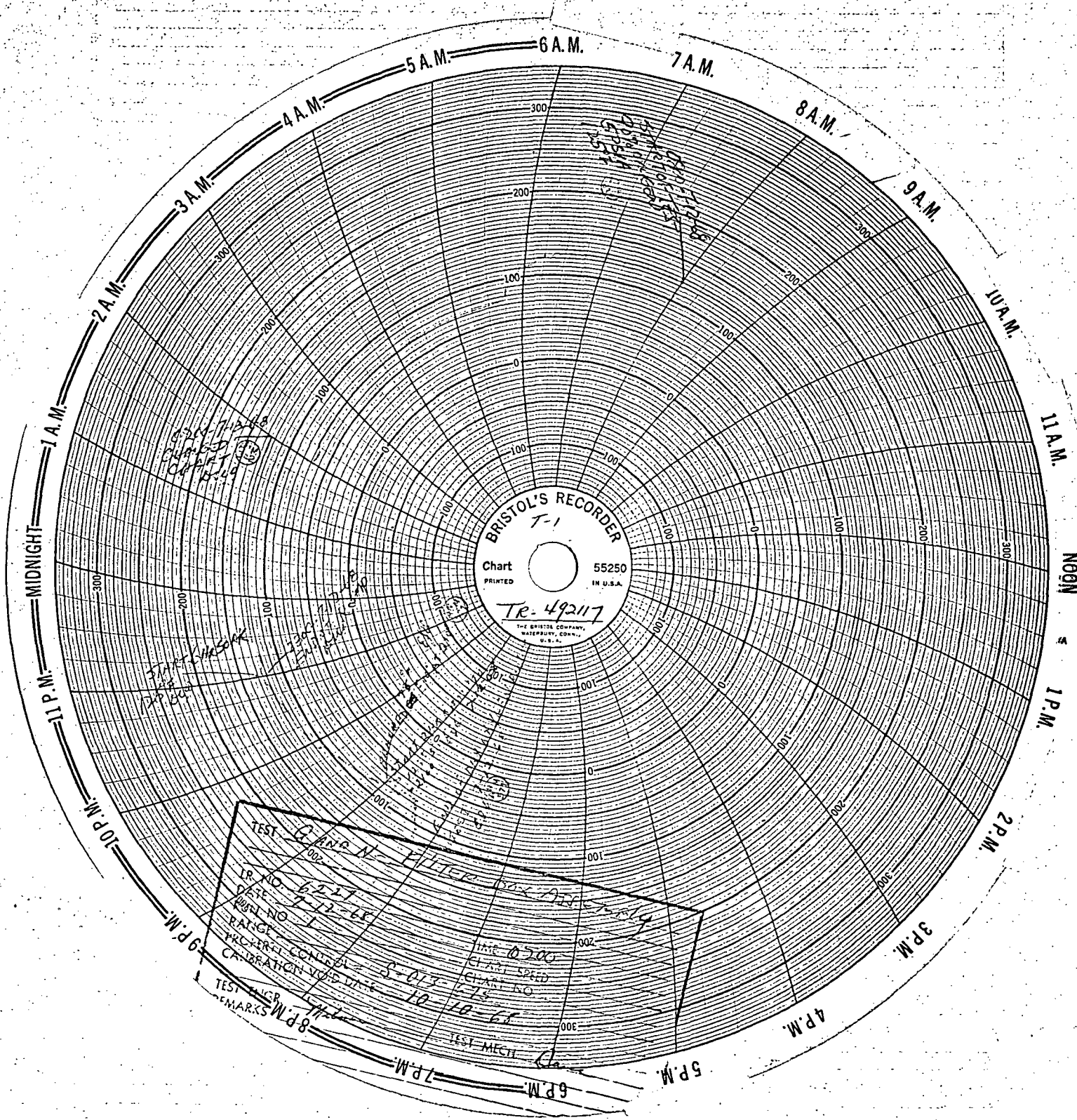

ENTER OFFICE STAMP WHEN REQUIRED

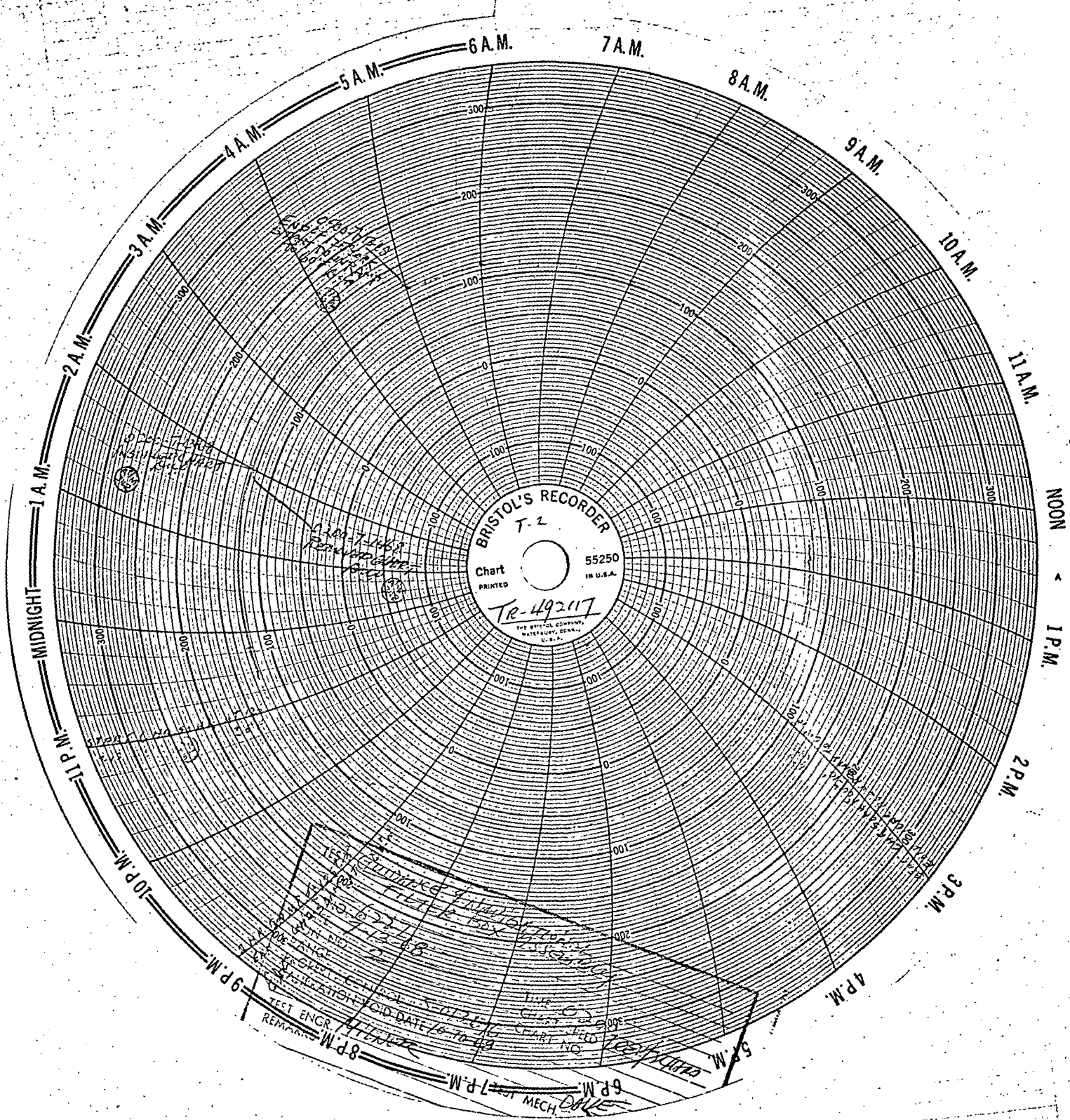

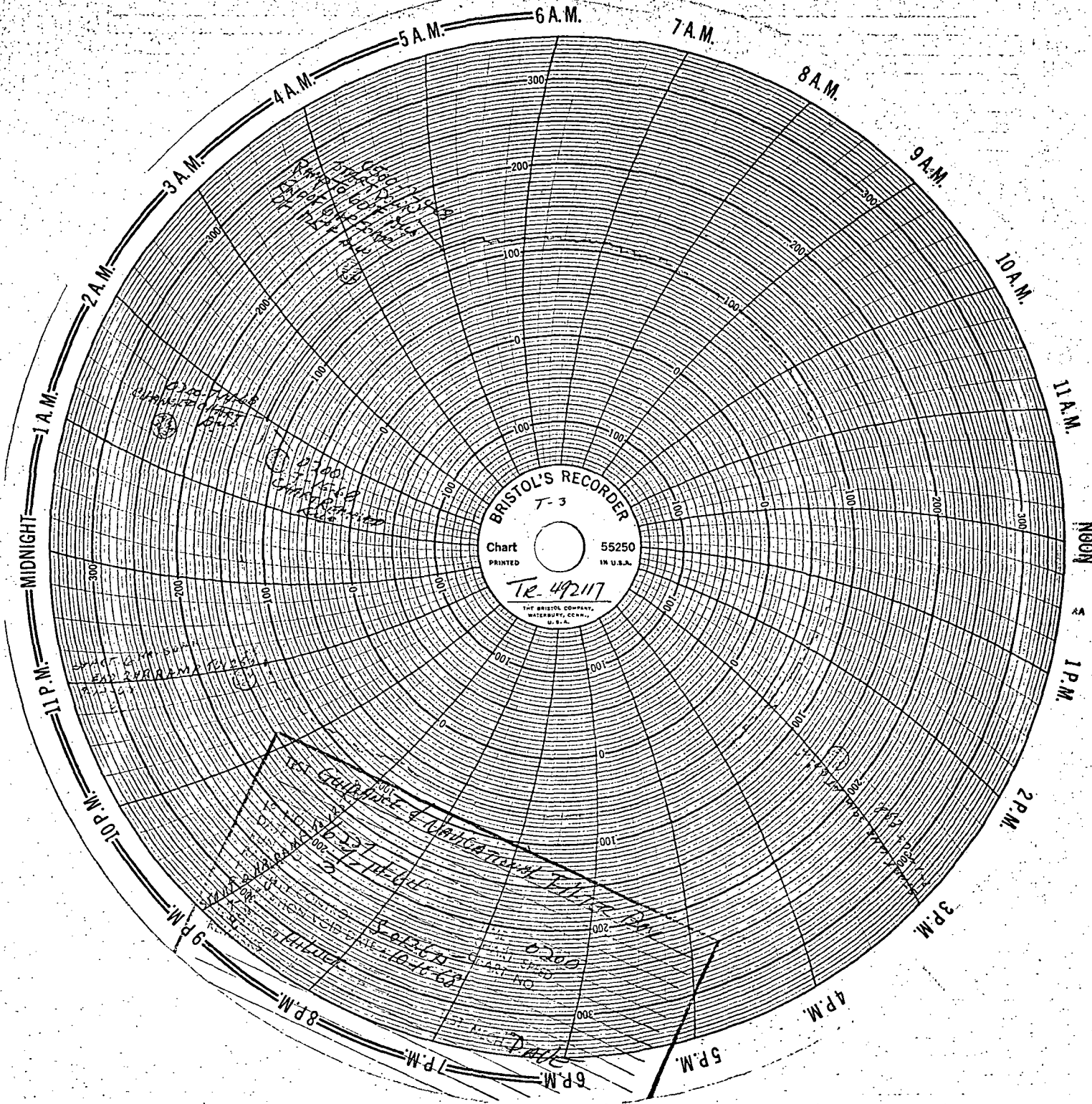

PATENT OFFICE STAMP
WHEN REQUIRED

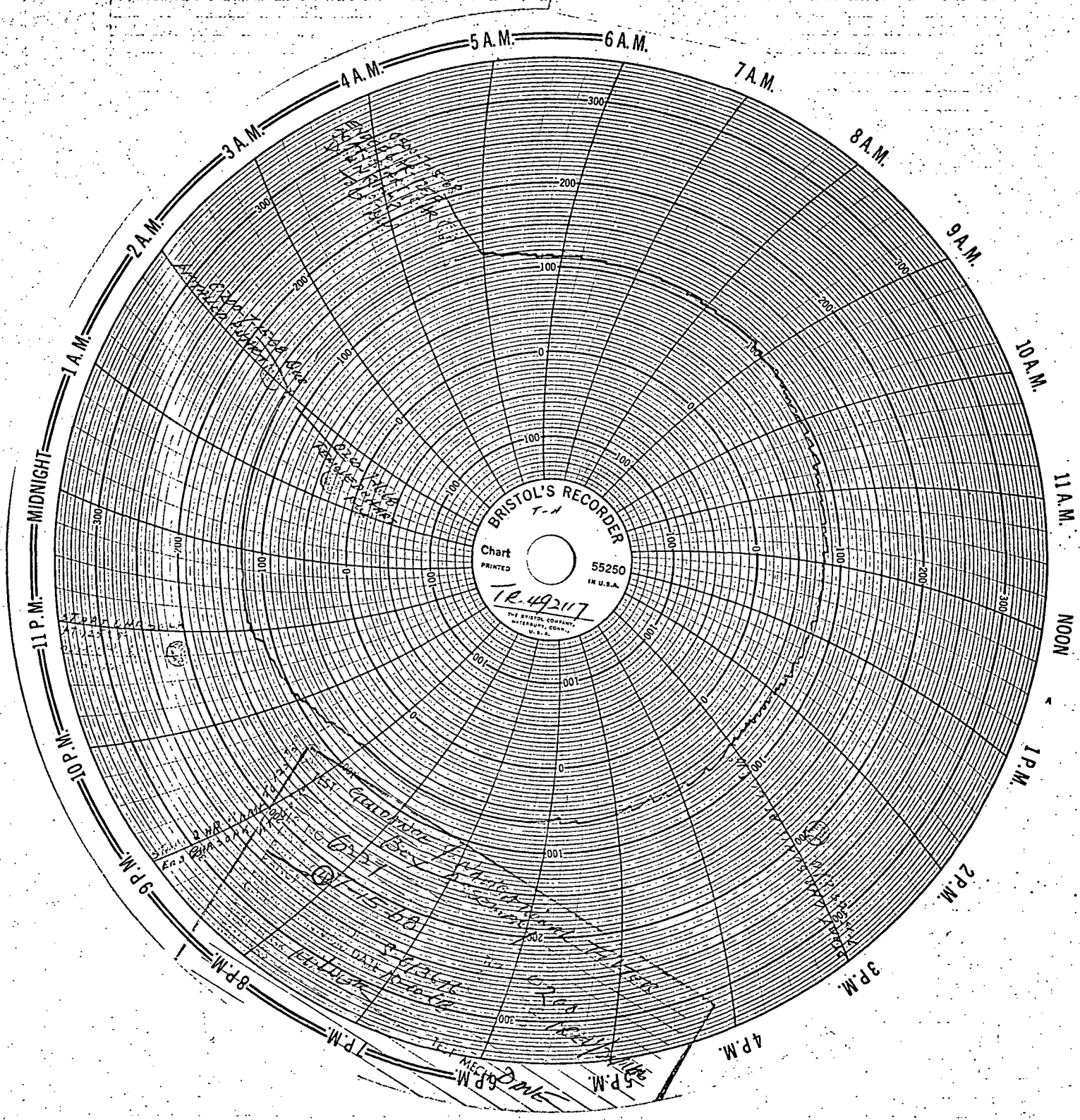

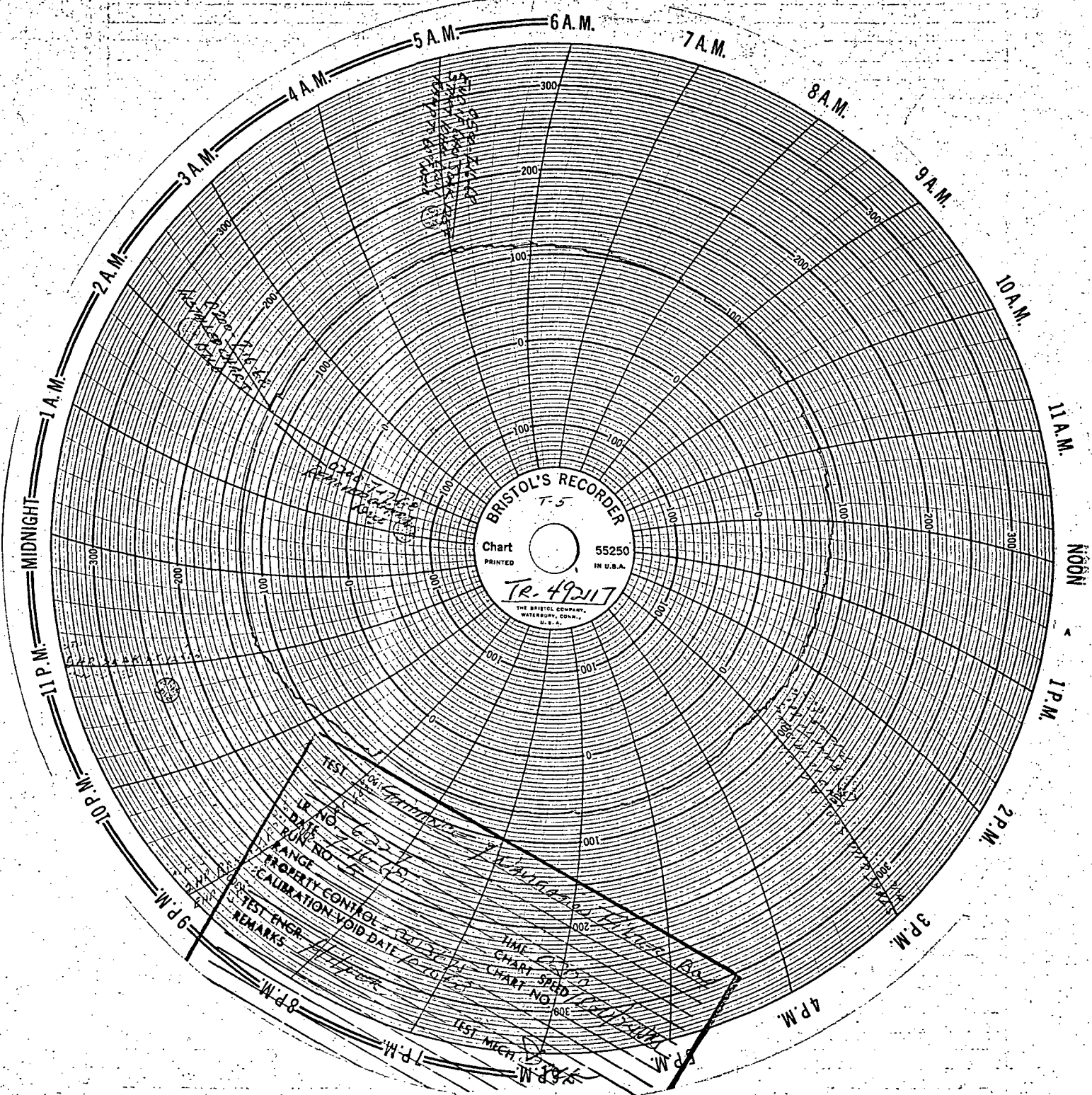

PRINTED ON RECYCLED PAPER
WHEN REQUIRED

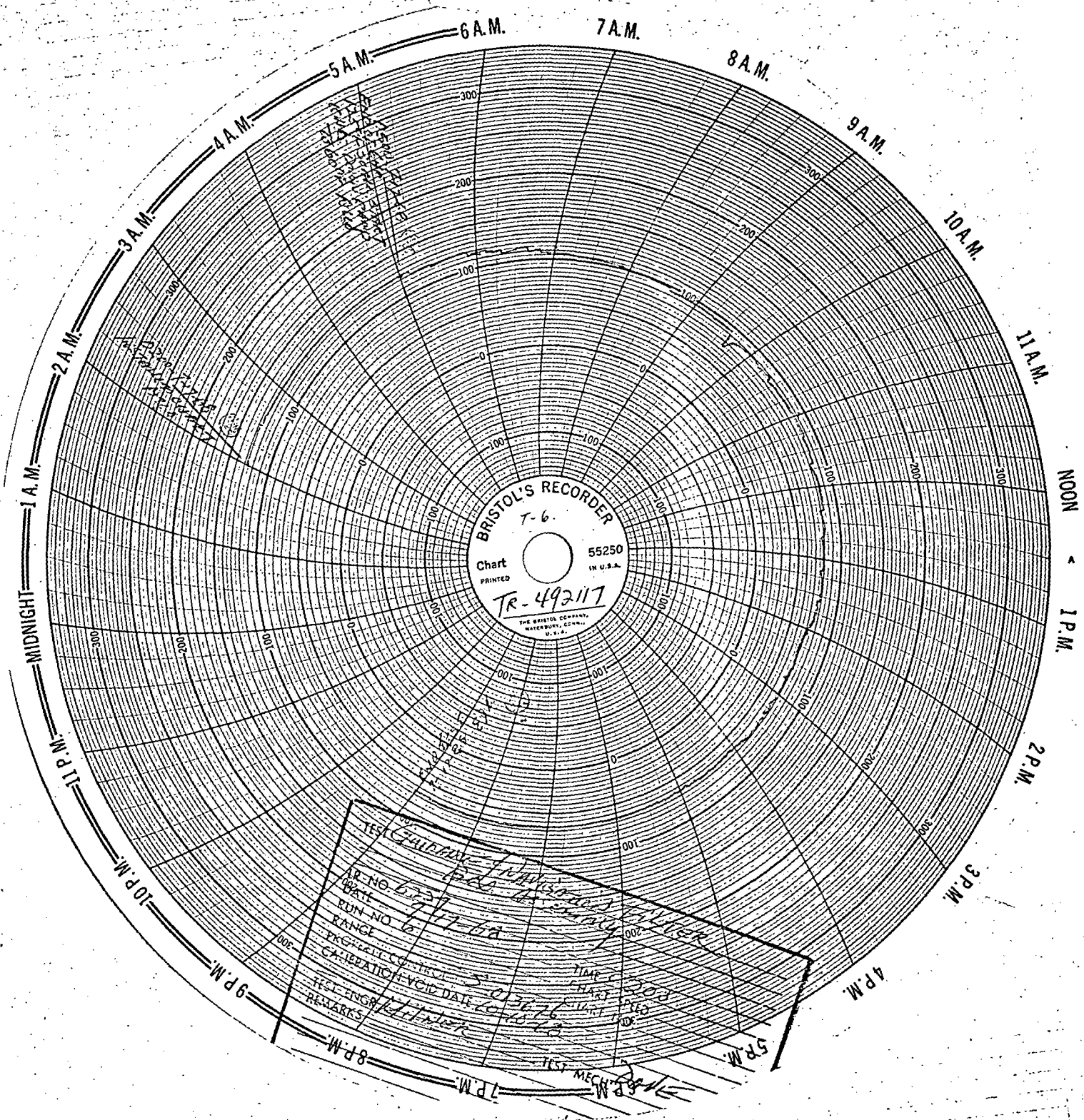

BRISTOL'S RECORDER
7-6
Chart 55250
PRINTED IN U.S.A.
TR-492117
THE BRISTOL COMPANY
WATERBURY, CONNECTICUT
U.S.A.

TEST CALIBRATION DATE	1/15/68
RANGE	0-300
CALIBRATION VOID DATE	1/15/68
REMARKS	TEST MECH

REMARKS
TEST MECH

APPENDIX F

HIGH/LOW TEMPERATURE-LIFE

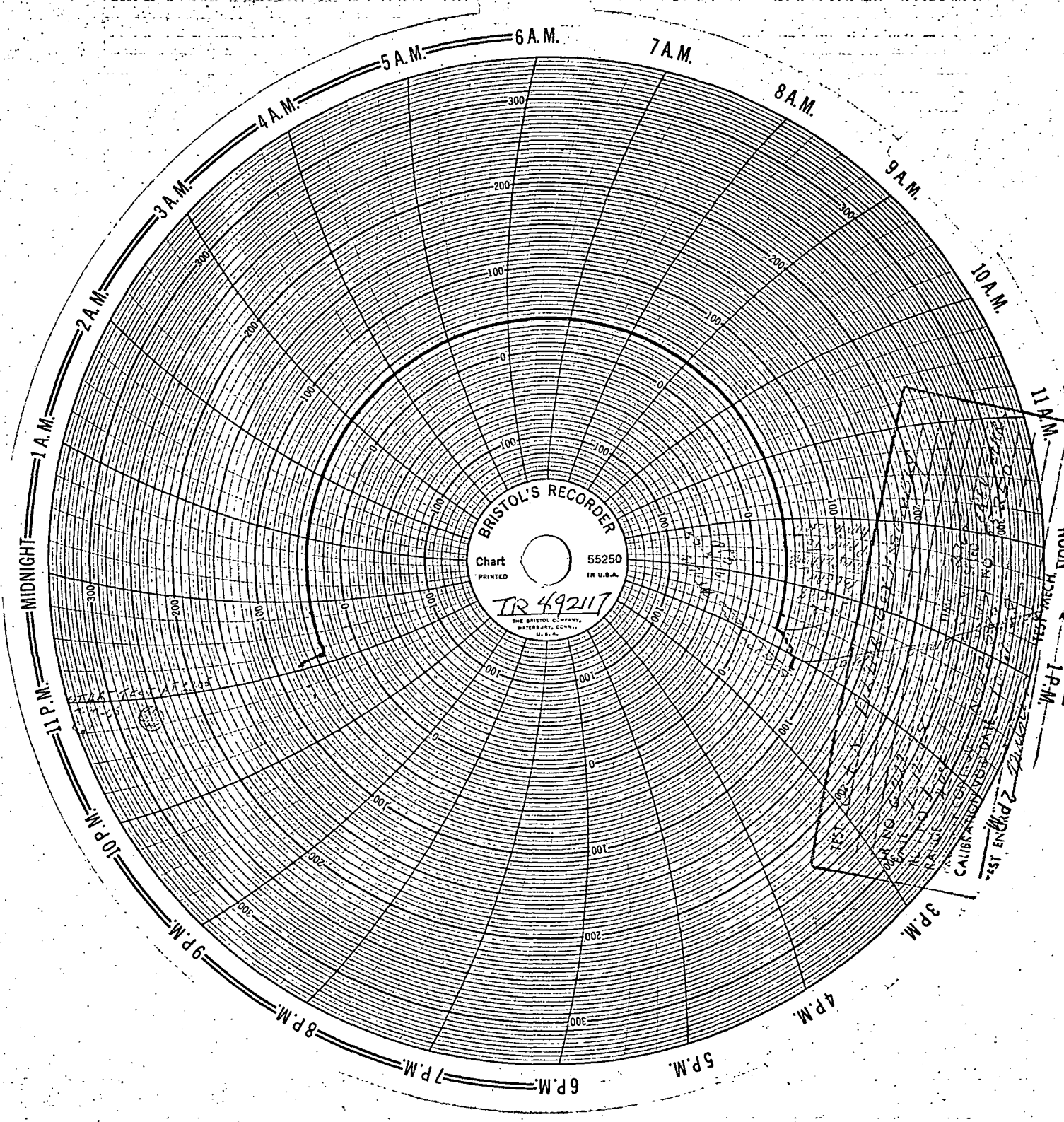

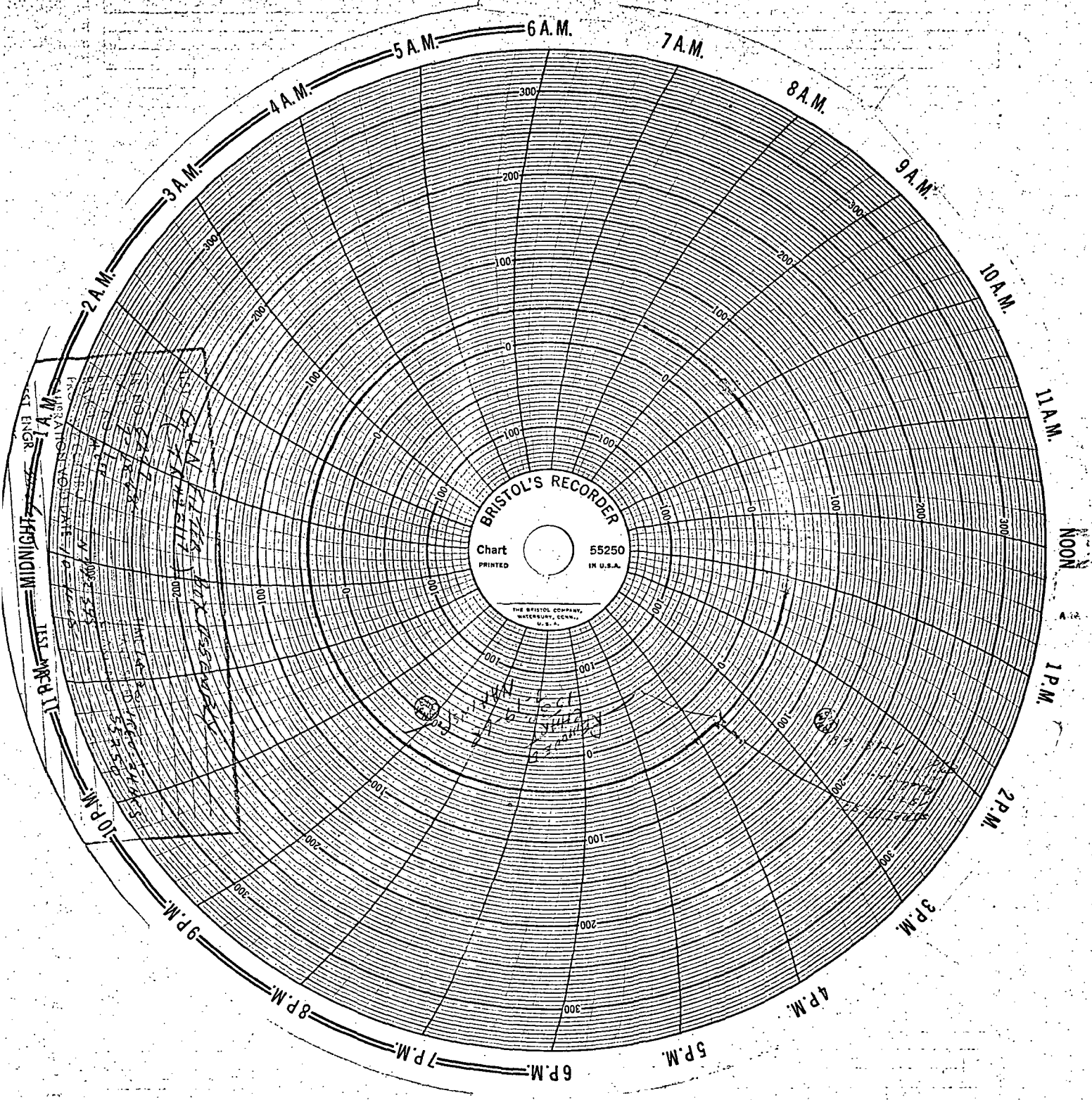

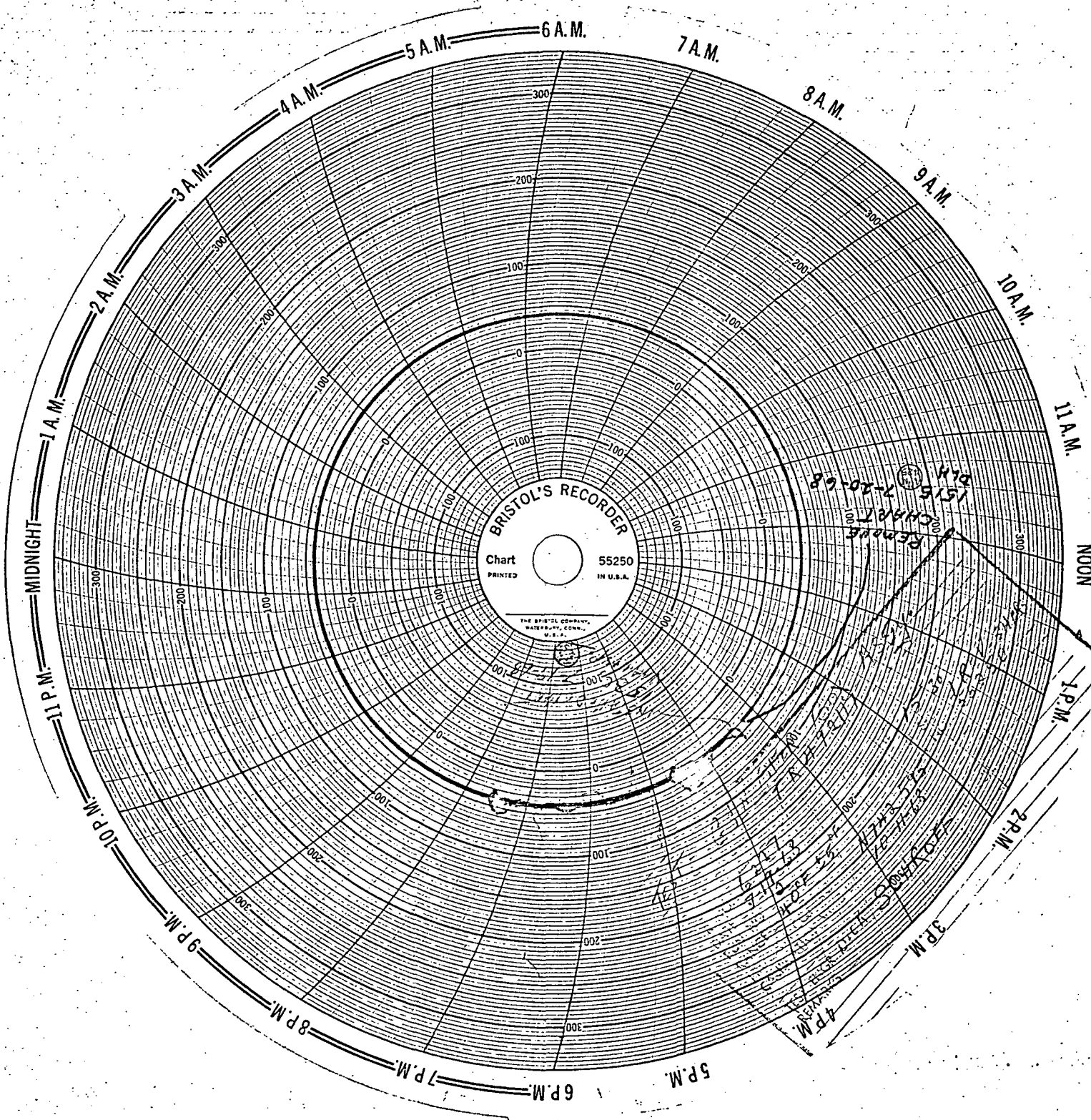

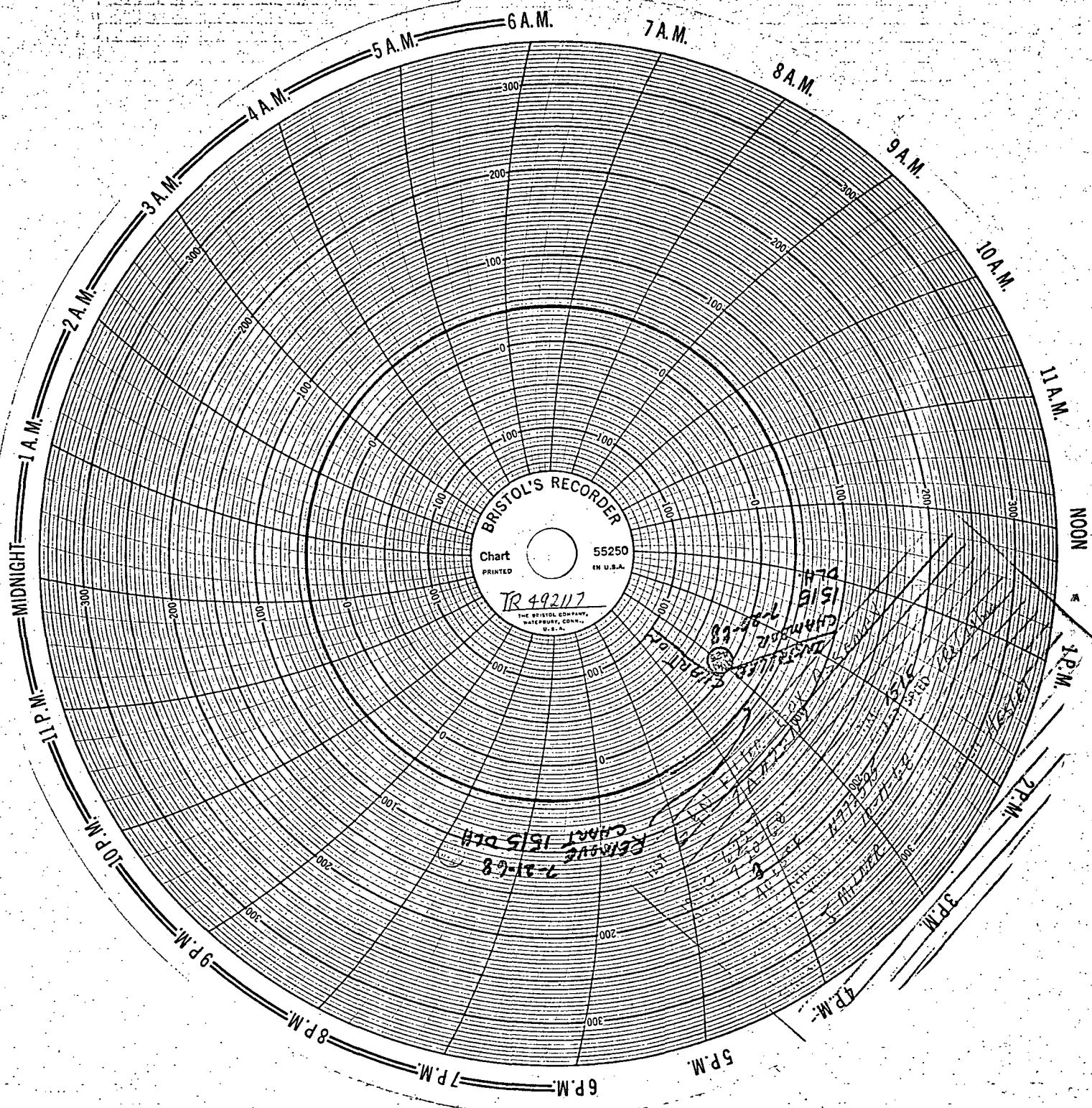

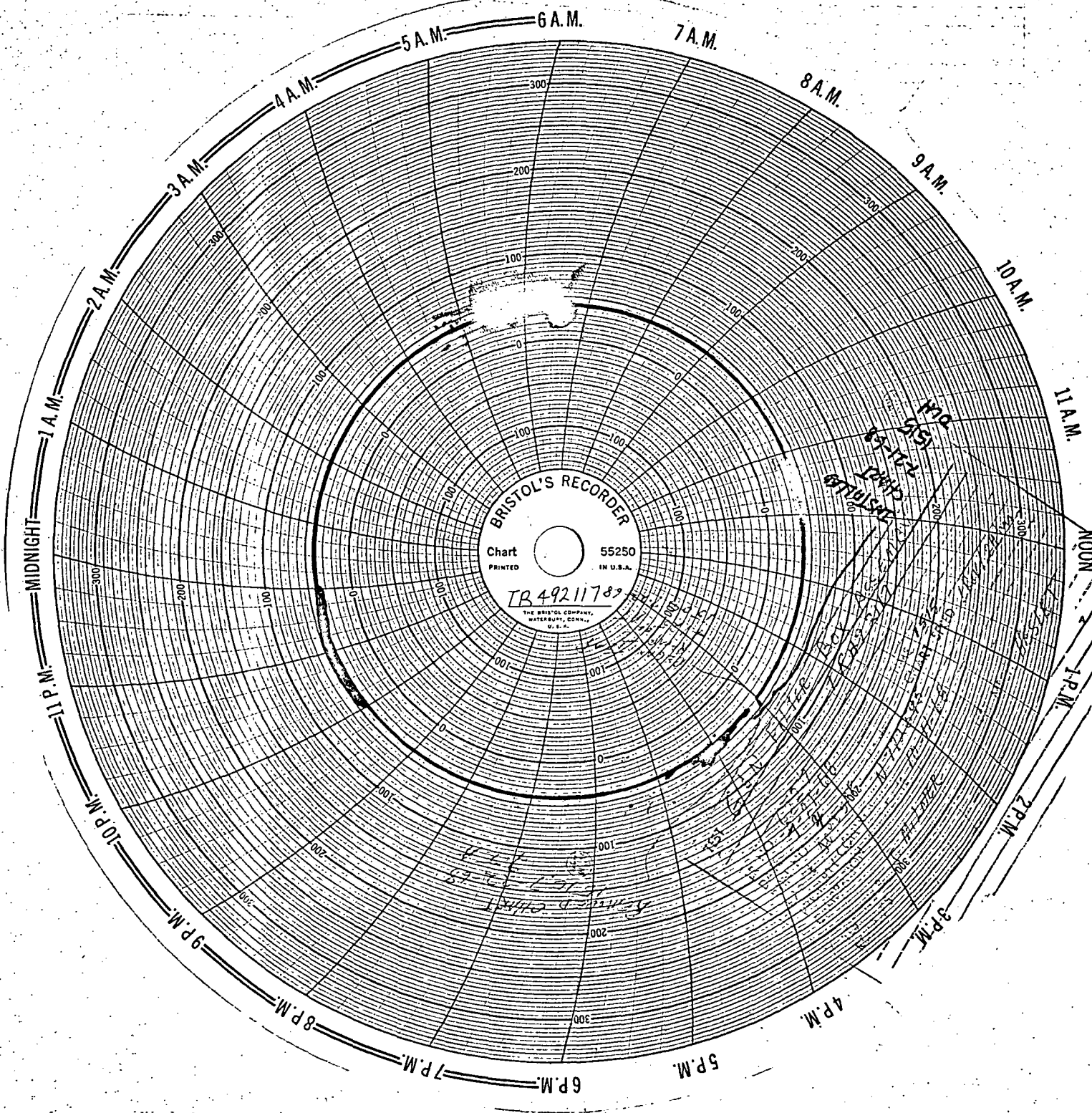

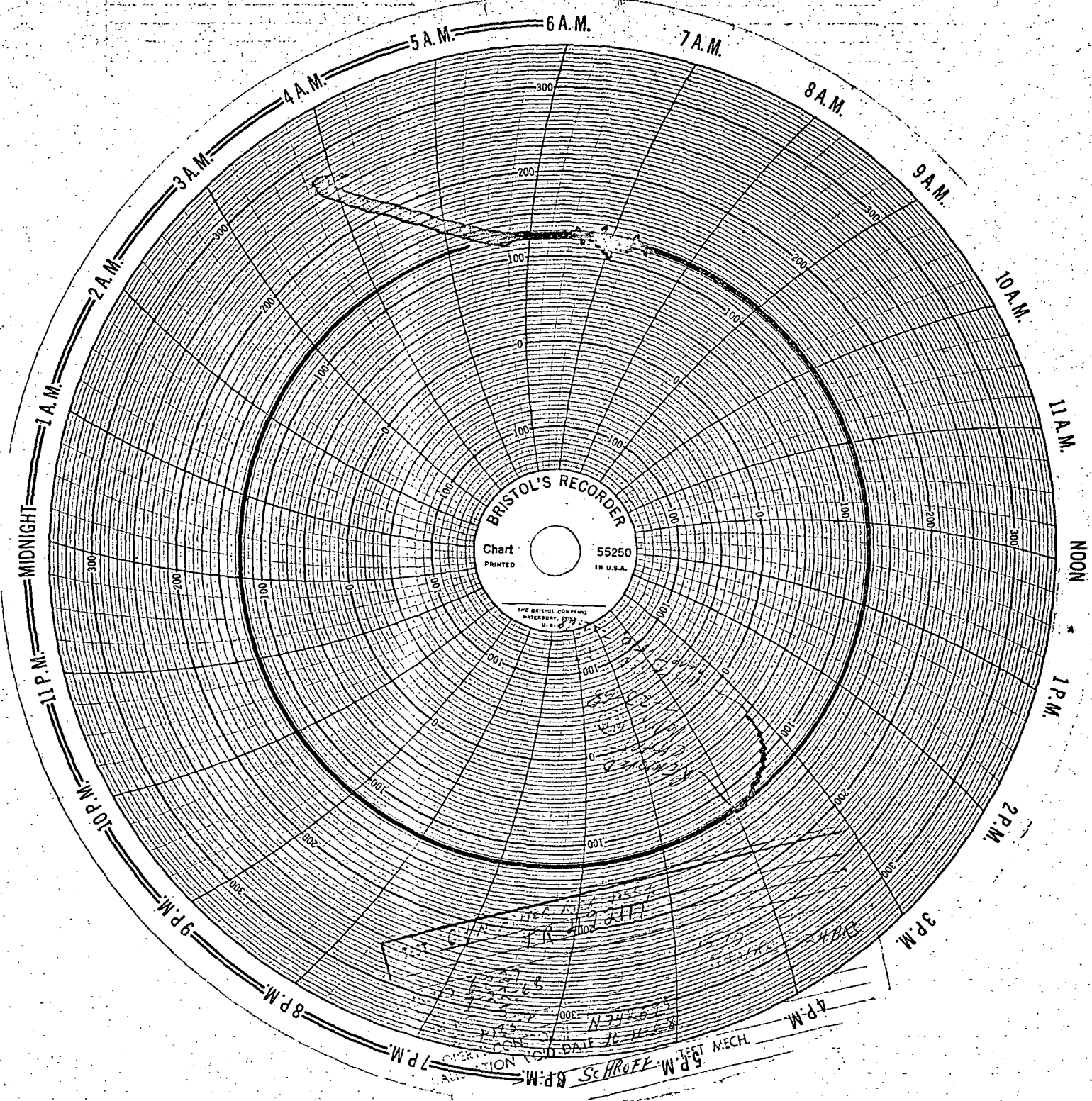

THIS IS A COPY OF THE ORIGINAL RECORD
 AND IS NOT TO BE REPRODUCED

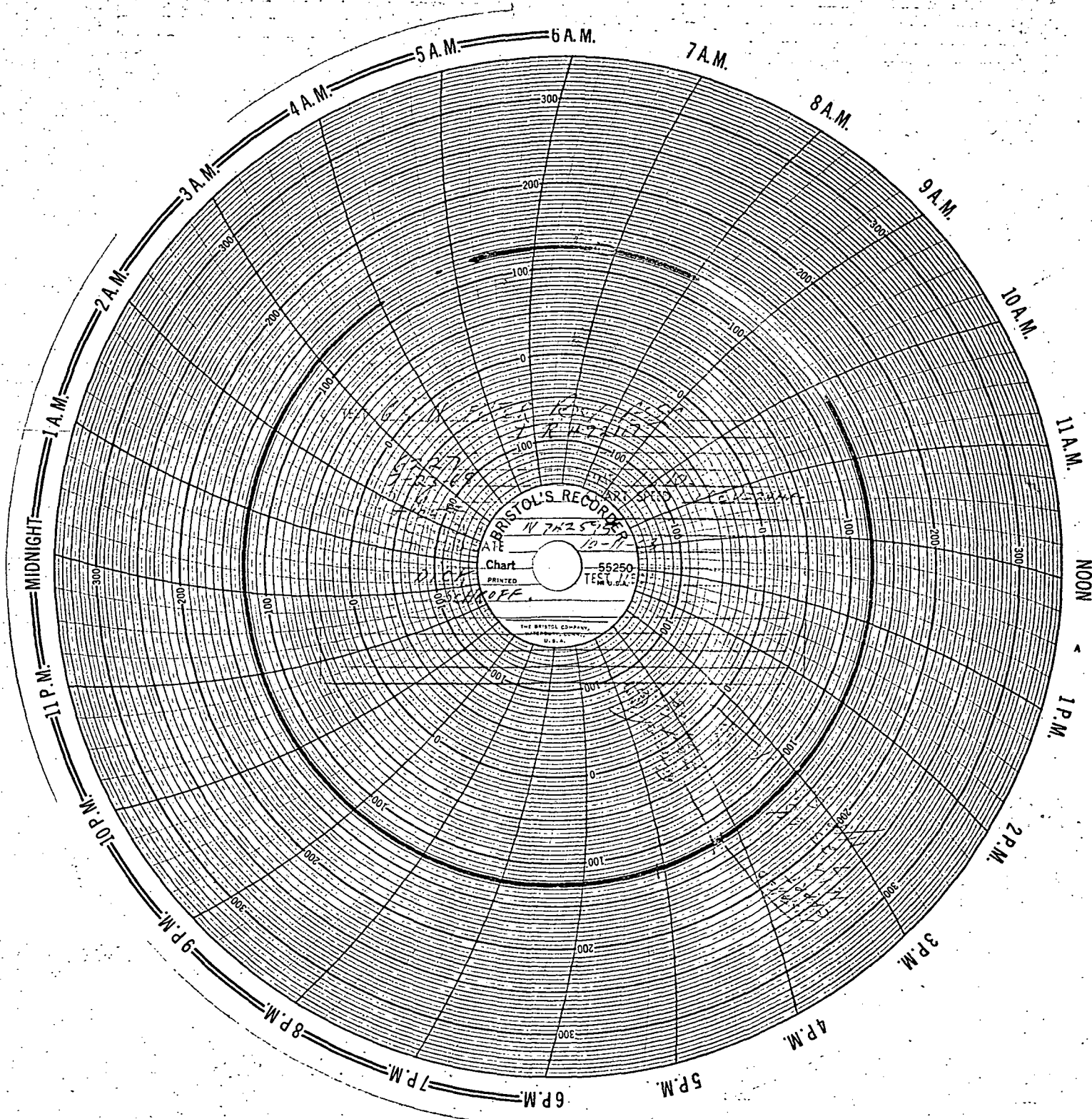

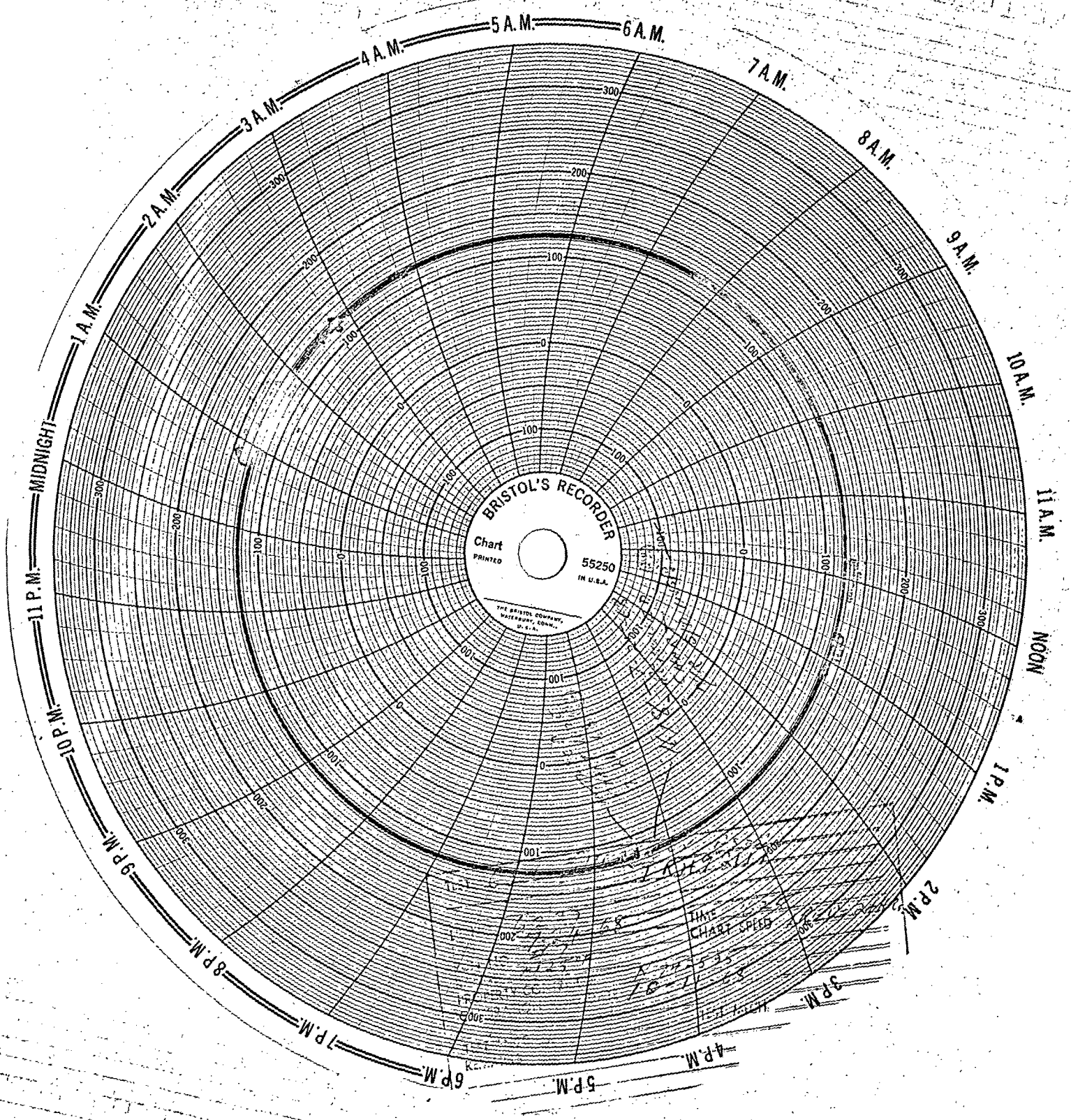

SALES REPRESENTATIVE
ORDER REQUIRED

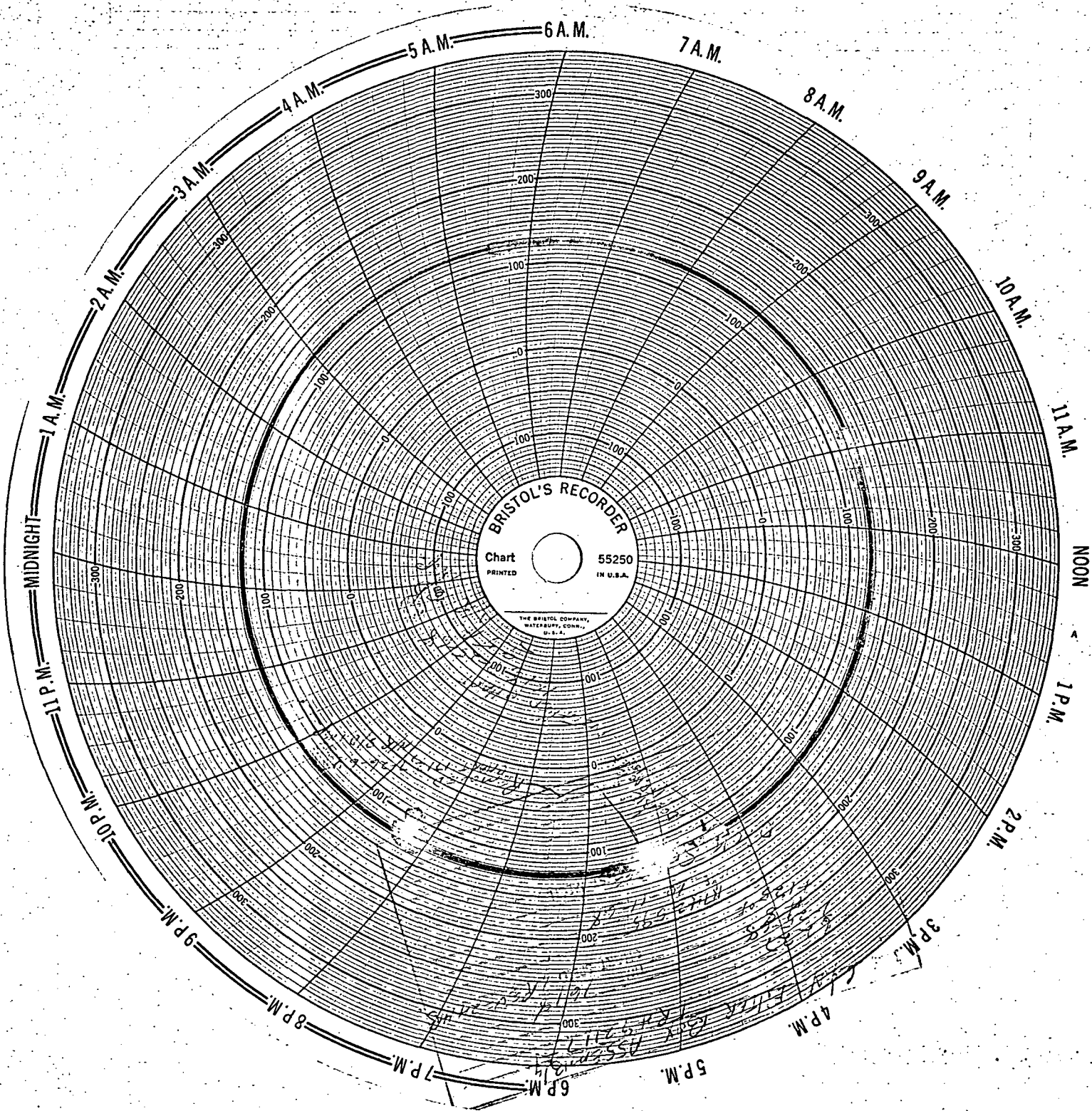

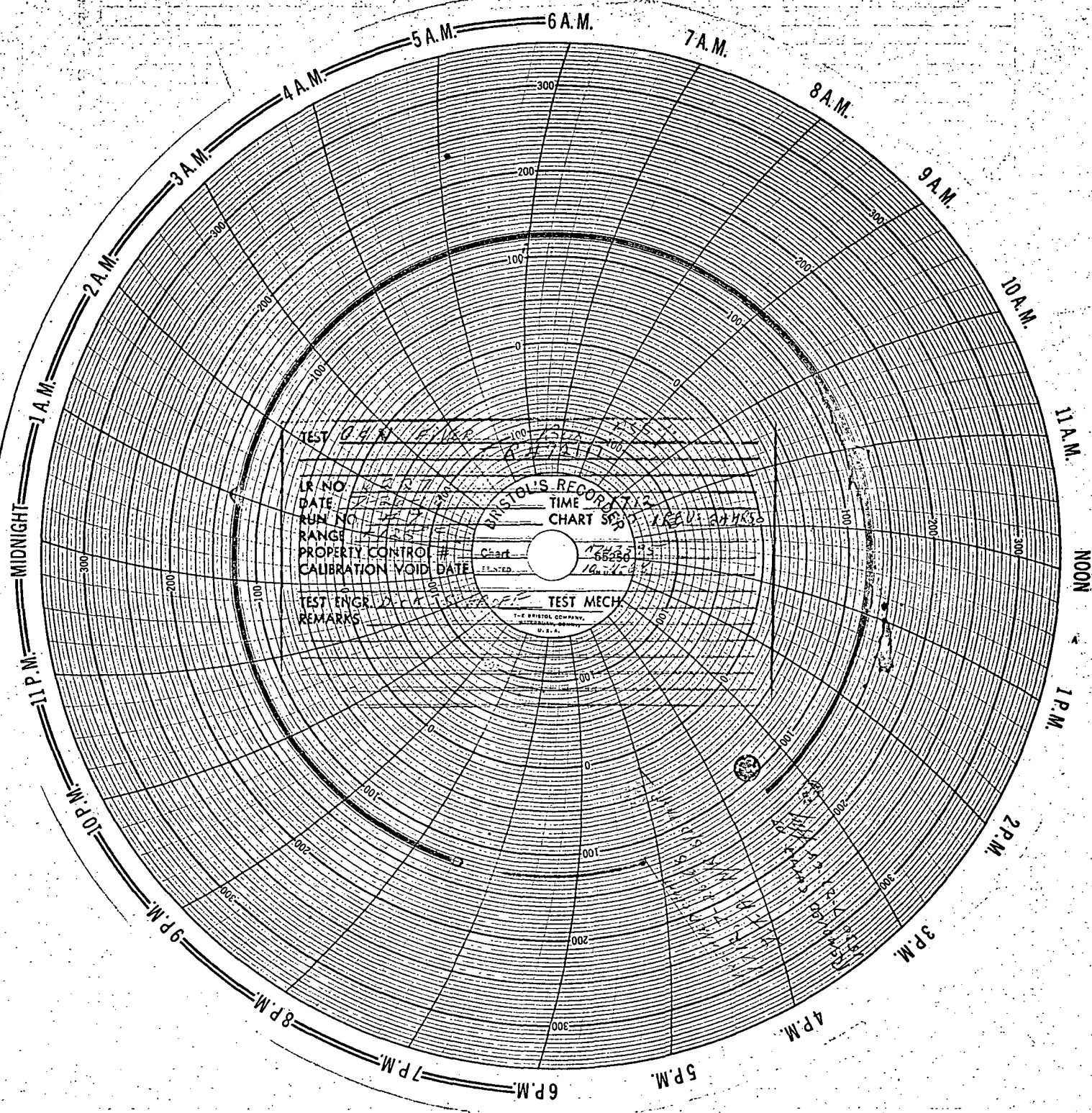

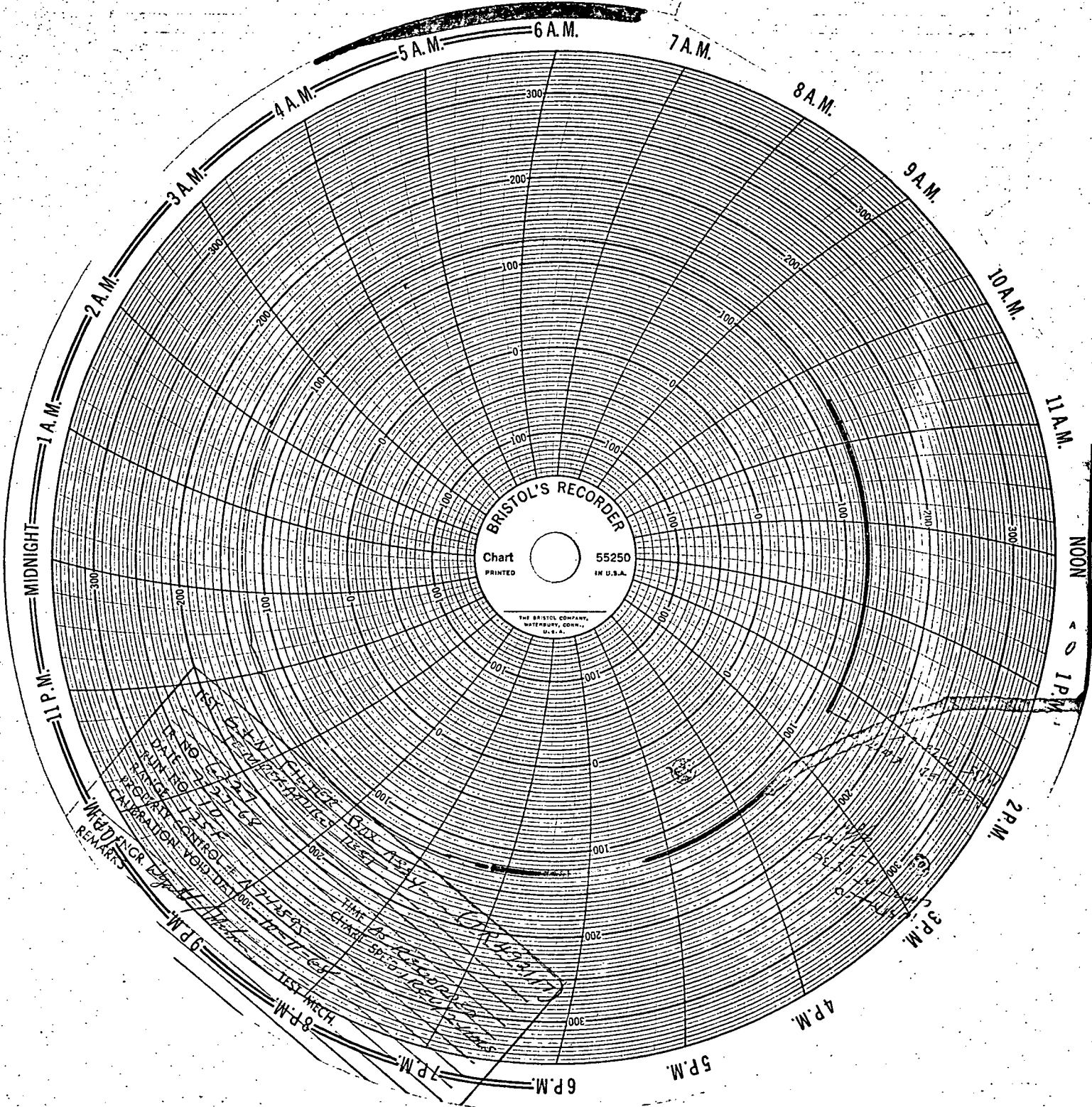

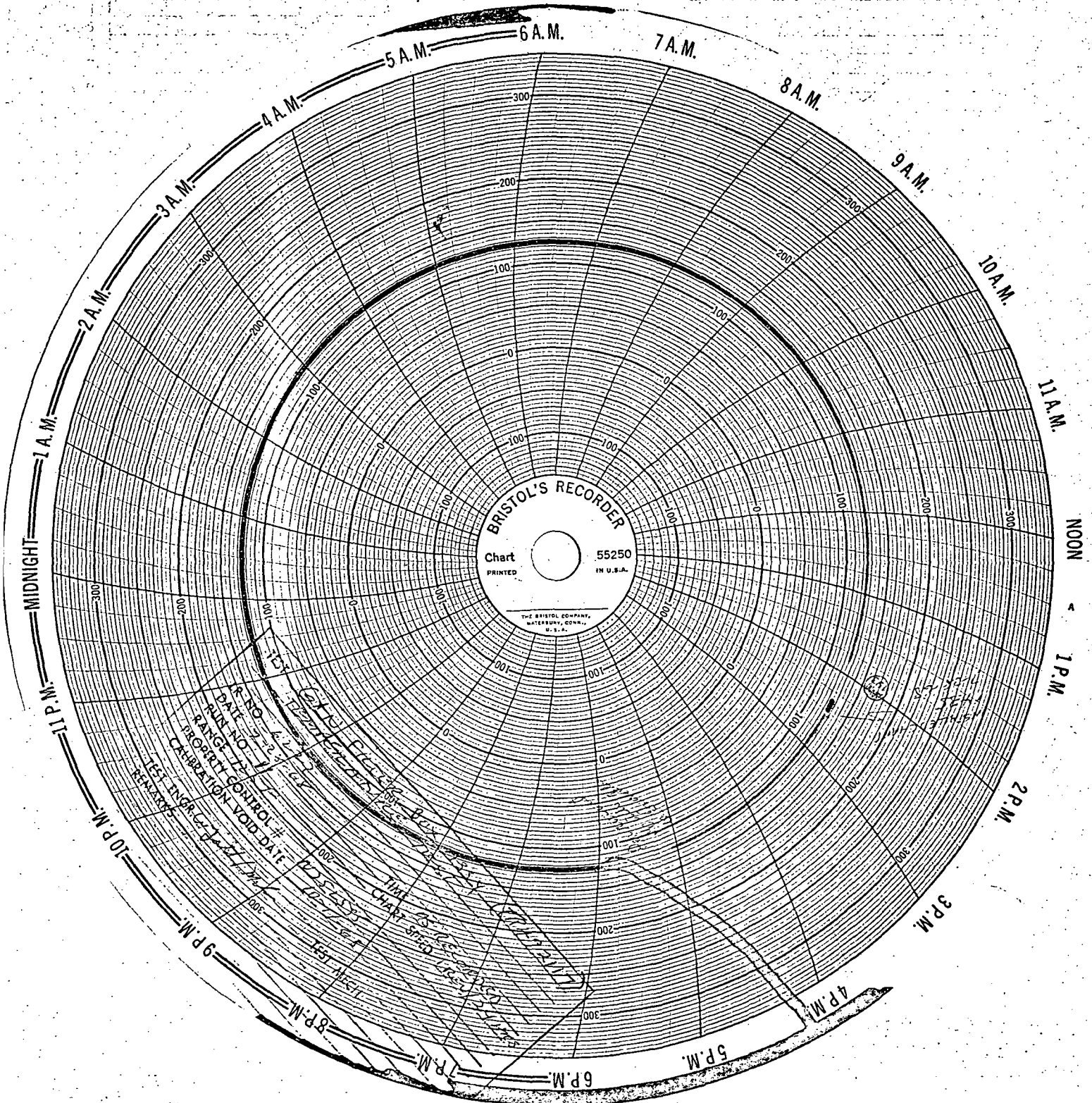

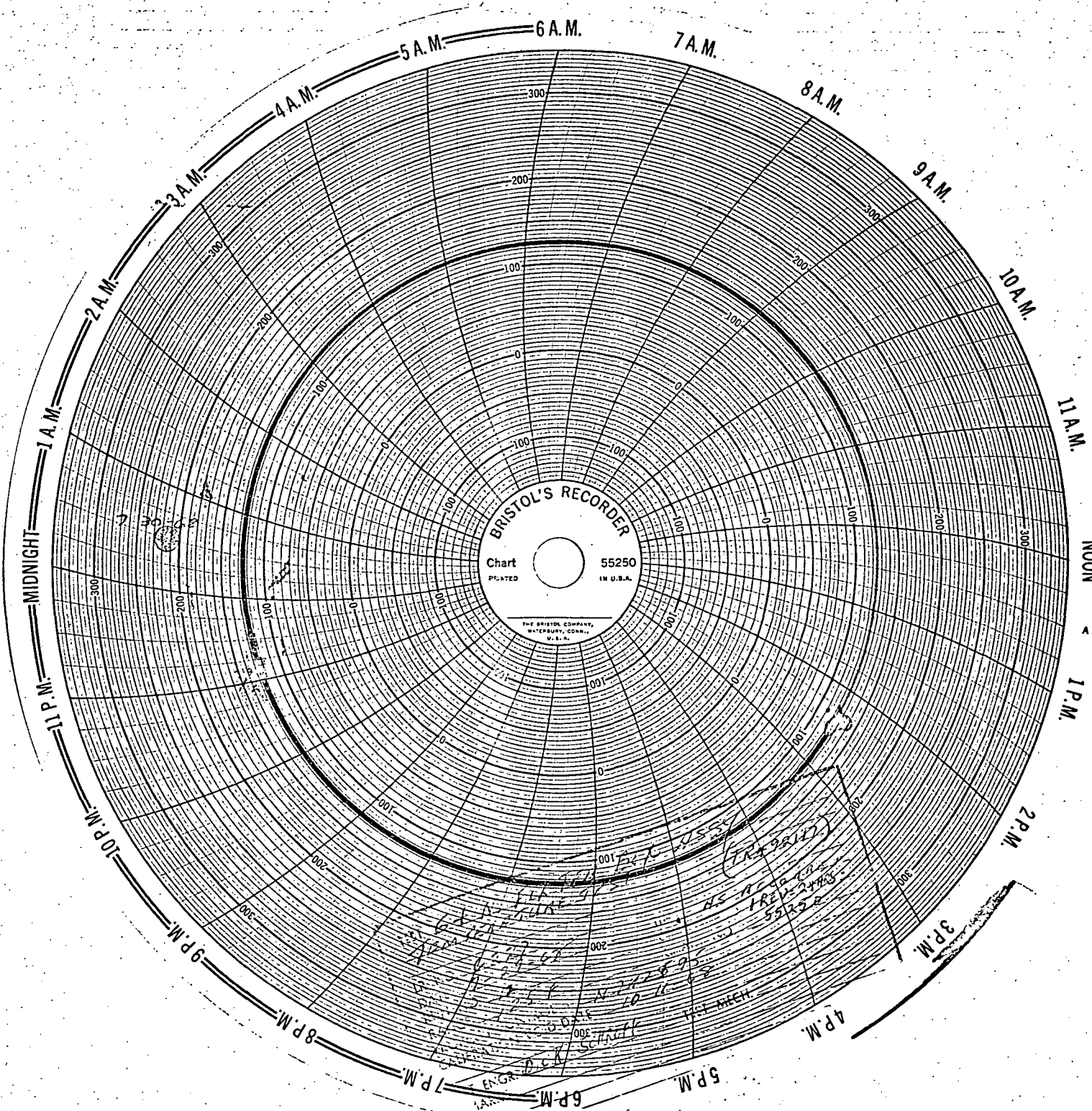

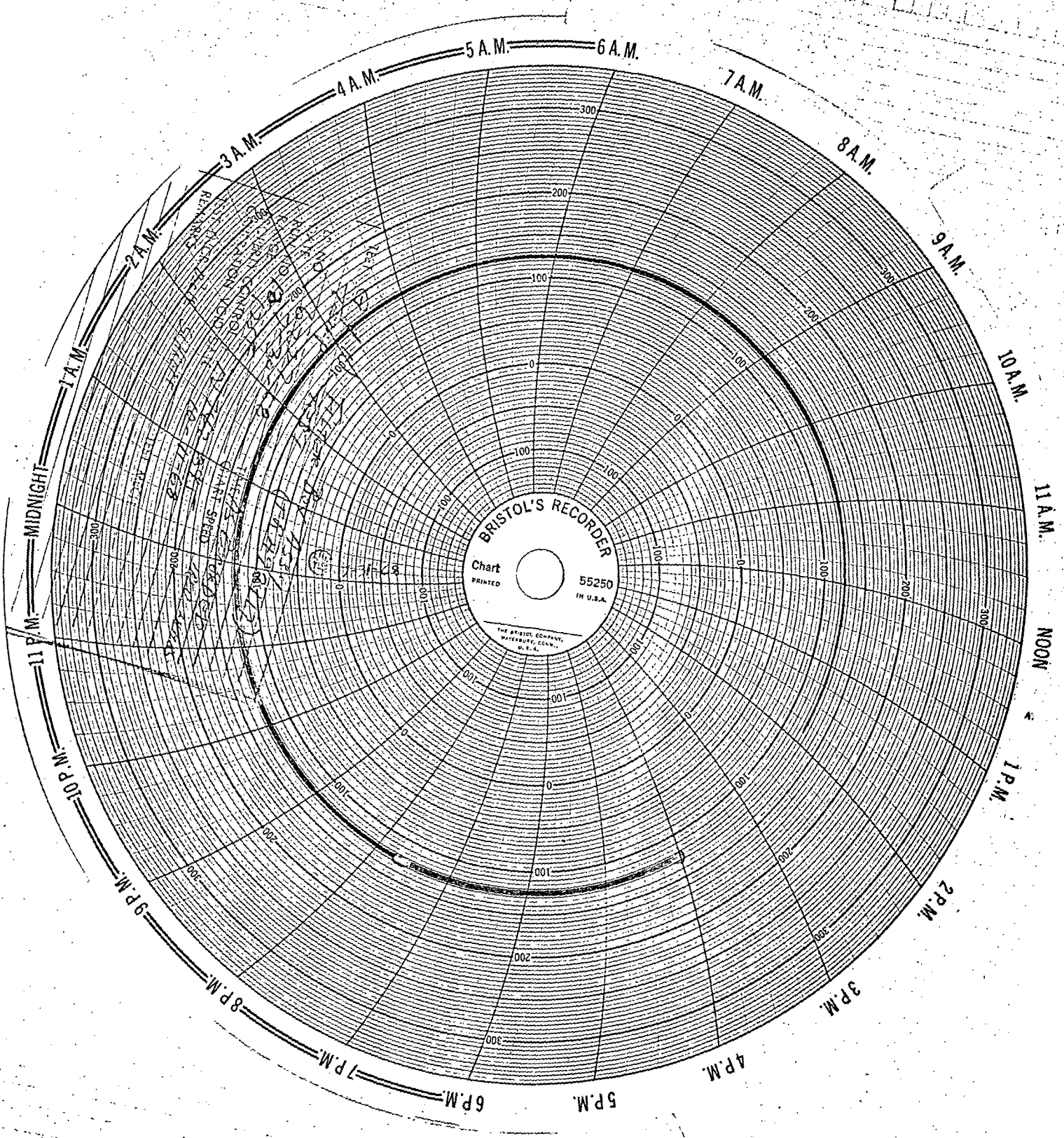

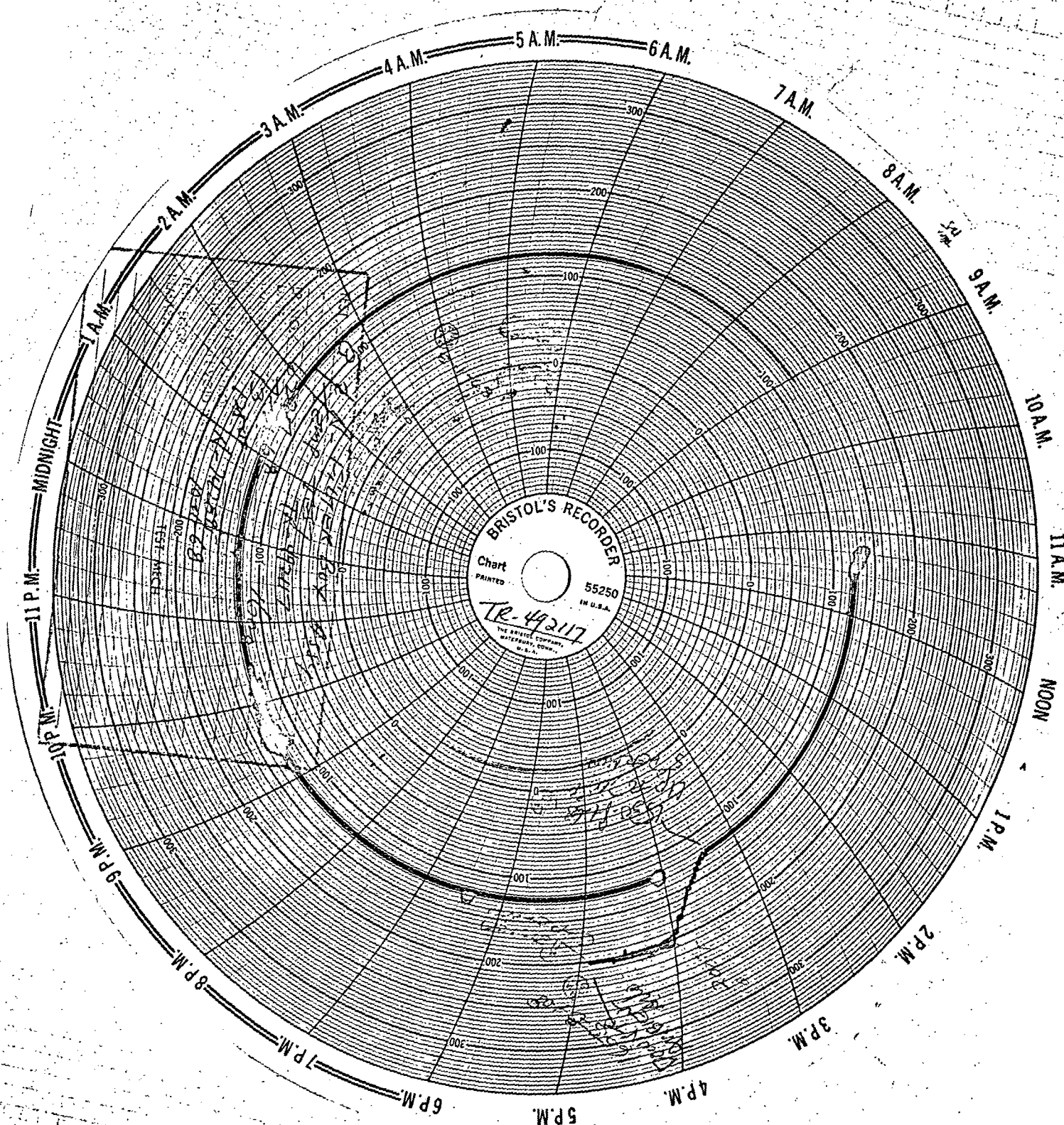

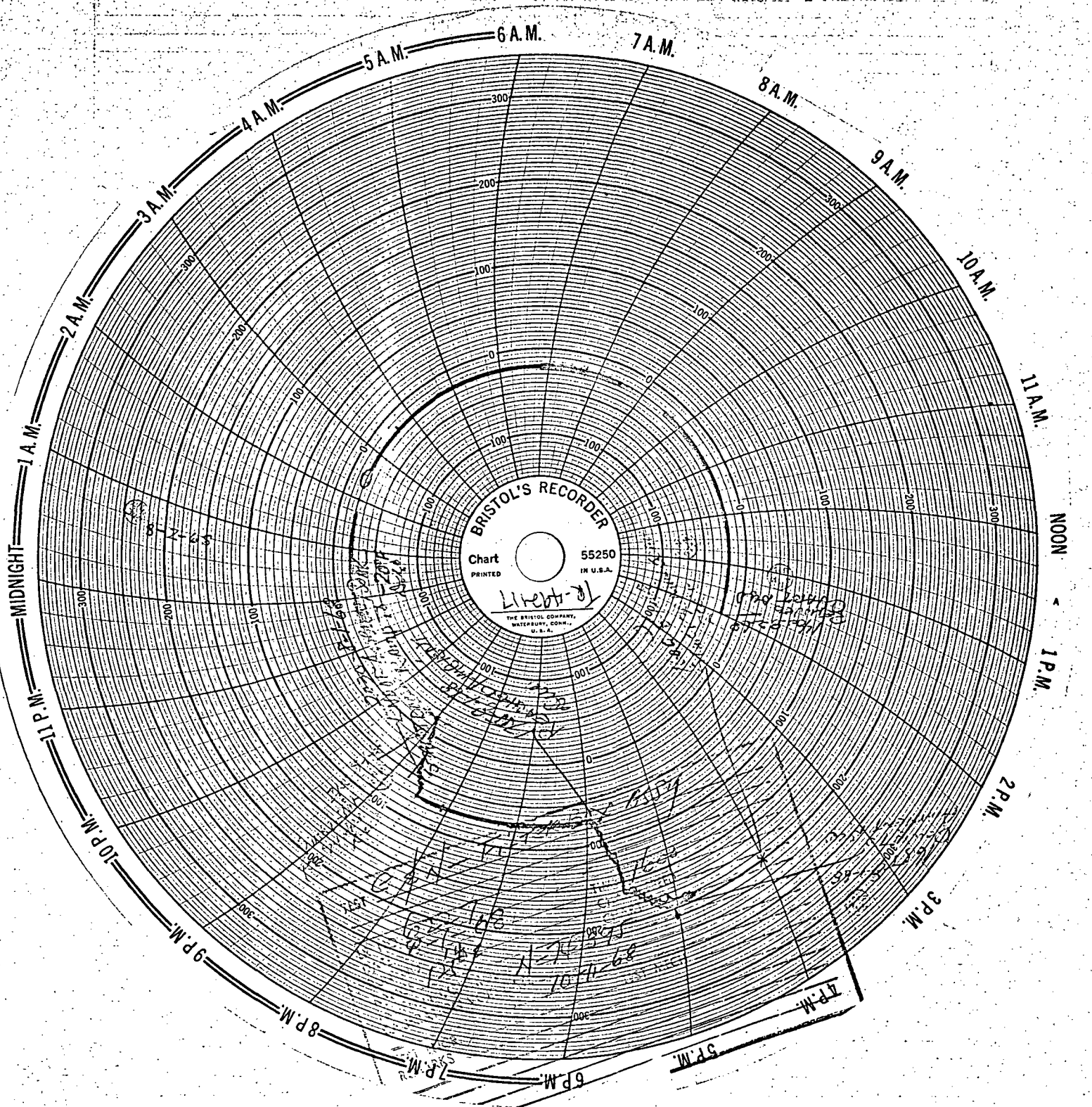

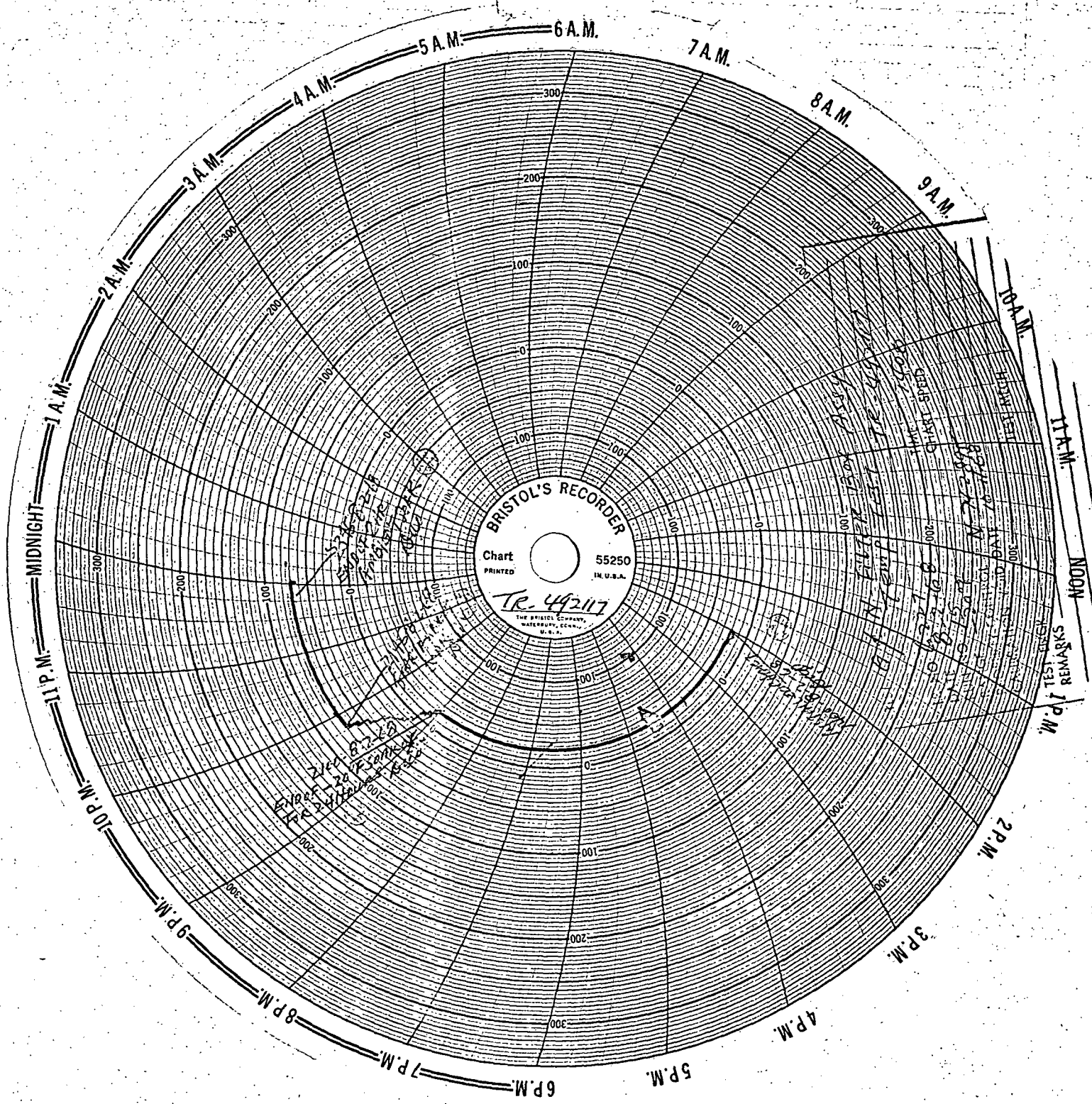

North American Aviation, Inc. 

N 1997-40

DIVISION <i>SPACE</i>		
PROJECT NO. <i>LR 6227</i>	CONTRACT NO. <i>TR 492 117</i>	DATE <i>7-17-68</i>

TEST PHASE: HIGH/LOW TEMPERATURE TEST
 PARA. 3.4.3.-1 PAGE 7 OF LR 6227 TR-492117

TEST SETUP SCHEMATIC;

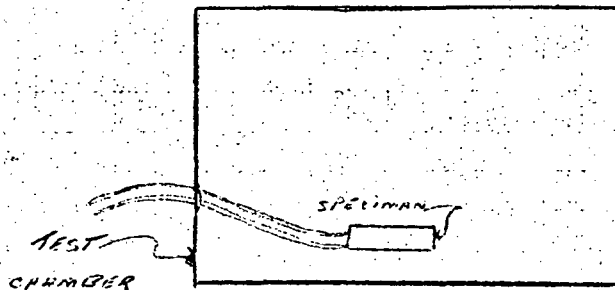

HIGH/LOW TEMPERATURE TEST EQUIPMENT LIST

DESCRIPTION	MANUFACTURE	PROP. NO.	MTG. NO.	CALIB. DUE.
ENVIRONMENTAL CHAMBER	TEMMLEY	N 742 595	03120	10-11-68
TEMPERATURE RECORDER	BRISTOL		513094	11-68
<p>7-17-68 THE SPECIMAN WAS PLACED IN THE CHAMBER AND THE DESIRED TEMP. WAS REACHED AT ²³¹³ 2305 7-17-68 (40) E&N RESTARTED TEST AT 1525 REACHED DESIRED TEMP. AT 1533-7-18-68 E&N</p>				

FORM 492-G REV. 7-66

INSTRUCTIONS

STATE OBJECT OF EXPERIMENT TEST, DESIGN, OR INVENTION AND DESCRIBE IN SUFFICIENT DETAIL TO BE UNDERSTANDABLE AND REPRODUCIBLE BY ANOTHER ENGINEER. USE SKETCHES OR MAKE REFERENCE TO DRAWINGS OR PHOTOGRAPHS, IF ANY, BY NUMBER. ALL PAGES CONTAINING SUBJECT MATTER WHICH MAY BE INVENTIVE MUST BE WITNESSED.

SIGNATURE: E. J. Butcher 7-17 1968

WITNESSED AND UNDERSTOOD: R. Lyko 7-17 1968

North American Aviation, Inc. 

N 1997-41

DIVISION <i>SPACE</i>		
PROJECT NO: <i>LR 6227</i>	CONTRACT NO. <i>TA 492117</i>	DATE <i>7-17-68</i>

CONTINUED FROM PAGE N1997-40

THE SPECIMEN IS EQUAL TO THAT DEFINED IN THE APPROVED TEST REQUEST (TA 492117) PARA. 3.4 AND THE TEST SETUP IS ADEQUATE TO MEET THE REQUIREMENTS OF THE HIGH/LOW TEMPERATURE TEST AS DEFINED IN THAT TEST REQUEST.

SIGNED *R.G. Schroy* *7-17-68*

VERIFIED *NA*

VERIFIED  *E. Jerniche* *7-17-68*

ALL TEMPERATURE DATA IS RECORDED ON TEMPERATURE CHARTS.

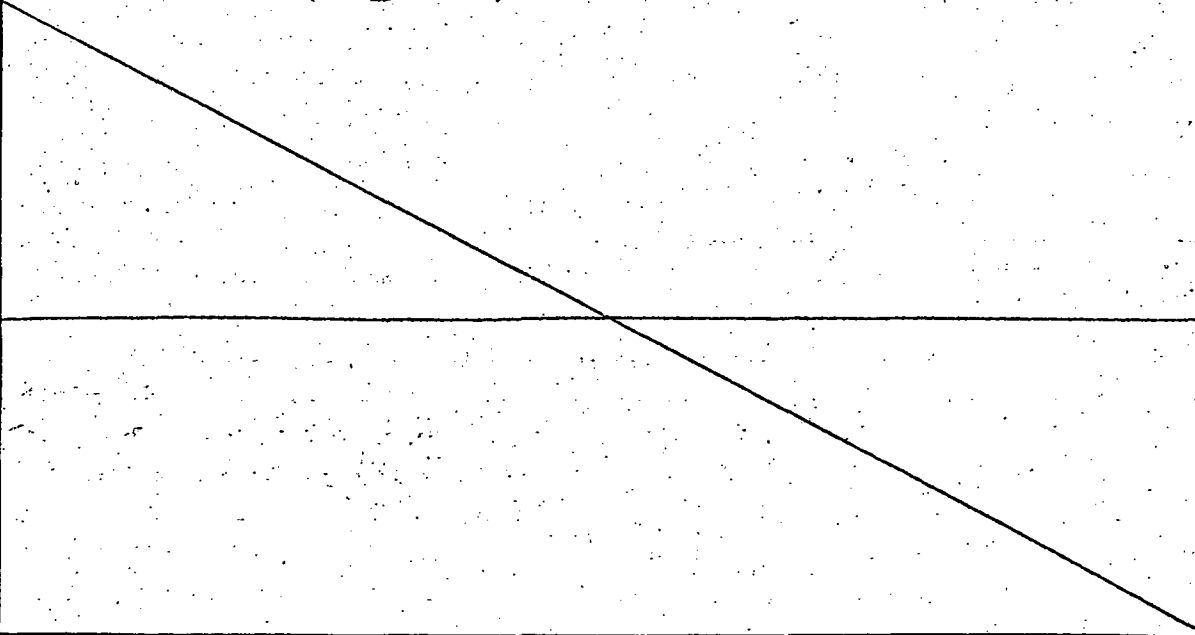

FORM 499-G REV. 7-68

INSTRUCTIONS

STATE OBJECT OF EXPERIMENT, TEST, DESIGN, OR INVENTION AND DESCRIBE IN SUFFICIENT DETAIL TO BE UNDERSTANDABLE AND REPRODUCIBLE BY ANOTHER ENGINEER. USE SKETCHES OR MAKE REFERENCE TO DRAWINGS OR PHOTOGRAPHS, IF ANY, BY NUMBER. ALL PAGES CONTAINING SUBJECT MATTER WHICH MAY BE INVENTIVE MUST BE WITNESSED.

SIGNATURE: *E. J. DuVall* *7-17 1968*

WITNESSED AND UNDERSTOOD  *R. Lykes* *7-17 1968*

APPENDIX G

VACUUM

North American Aviation, Inc. 

N 2907-1

DIVISION

41 SPACE DOWNLEY

PROJECT NO:

4R 6227

CONTRACT NO:

ATR 492117 "A"

DATE

August 3, 1968

TEST TITLE: GUIDANCE AND NAVIGATIONAL FILTER BOX
ASSEMBLY QUALIFICATION TEST

RESPONSIBLE ENGINEER. MR. P.W. EDWARDS 0/098-212
EXT 5715

APPLICABLE DOCUMENTS

NR/SD SPECIFICATIONS

MC999-0050C

GENERAL TEST REQUIREMENTS
FOR APOLLO SUB-CONTRACTORS
AND SUPPLIERS.

MAO 203-0622

SAFETY REQUIREMENTS

~~CTR 25492117~~ ~~VOID~~ WDM

NR/SD DRAWINGS

V36-44230

V36-44401

V34 945072

BOX ASSEMBLY - GEN FILTER (EDM67744)

SCHEMATIC DIAGRAM - GEN FILTER BOX
(NO EO's)

SHOULD BE V36-44401. RE ELECTRICAL SYSTEMS INSTALLATION

INSTRUCTIONS

STATE OBJECT OF EXPERIMENT, TEST, DESIGN, OR INVENTION AND DESCRIBE IN SUFFICIENT DETAIL TO BE UNDERSTANDABLE AND REPRODUCIBLE BY ANOTHER ENGINEER. USE SKETCHES OR MAKE REFERENCE TO DRAWINGS OR PHOTOGRAPHS, IF ANY, BY NUMBER. ALL PAGES CONTAINING SUBJECT MATTER WHICH MAY BE INVENTIVE MUST BE WITNESSED.

SIGNATURE: W.W. McKe 8-3-1968

WITNESSED AND UNDERSTOOD: [Signature] 8-3-1968

FORM 488-0 REV. 7-66 31

North American Aviation, Inc. 

N 2907-2

DIVISION 41 SPACE DOWNEY		
PROJECT NO: 1L-6227	CONTRACT NO. ATR 492117 "A"	DATE August 3 1968

NR/SD TEST REQUEST
ATR 492117 "A" GUIDANCE AND NAVIGATIONAL
FILTER BOX ASSEMBLY

LABORATORIES AND TEST DOCUMENTS.

1L-6227-801A

TEST INDEX.

1. THERMAL - VACUUM TEST PAGE N 2907-3
THROUGH N 2907-10

FORM 103-G REV. 7-68

INSTRUCTIONS

STATE OBJECT OF EXPERIMENT, TEST, DESIGN, OR INVENTION AND DESCRIBE IN SUFFICIENT DETAIL TO BE UNDERSTANDABLE AND REPRODUCIBLE BY ANOTHER ENGINEER. USE SKETCHES OR MAKE REFERENCE TO DRAWINGS OR PHOTOGRAPHS, IF ANY, BY NUMBER. ALL PAGES CONTAINING SUBJECT MATTER WHICH MAY BE INVENTIVE MUST BE WITNESSED.

SIGNATURE:

J. K. Black 8/3 1968

WITNESSED AND UNDERSTOOD

R. [Signature] 8-3 1968

North American Aviation, Inc. 

N 2907-3

DIVISION 41- (DOWNEY) SPACE		DATE August 3, 1968
PROJECT NO: 4A 6227	CONTRACT NO. ATR 492117A	

TEST PHASE: VACUUM ATR 492117A PAGE 8 PARA 3.5
OF AT LEAST 1×10^{-4} mm Hg AND CHAMBER WALL
TEMP. OF $40 \pm 5^\circ\text{F}$ FOR 50 ± 5 HOURS AND $135 \pm 5^\circ\text{F}$
FOR 50 ± 5 HOURS.

TEST SETUP SCHEMATIC

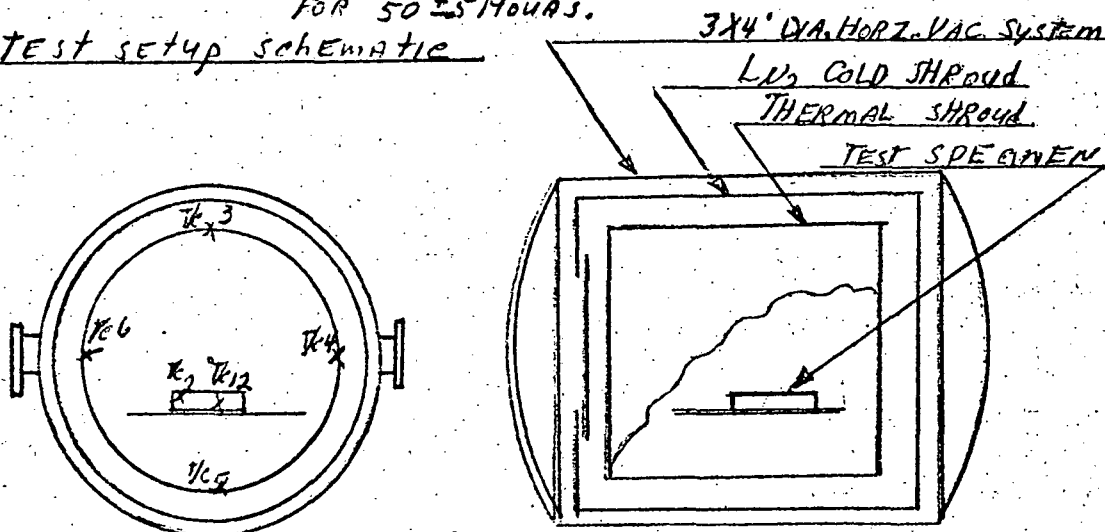

THERMOCOUPLE LOCATION

- T2 ON TOP SIDE OF SPECIMEN
- T12 ON TOP SIDE OF SPECIMEN
- T3, T4, T5, T6 LOCATE IN EACH QUADRANT OF THE THERMAL SHROUD.

TEST EQUIPMENT LIST:

NOMENCLATURE	MFG	PROPERTY NUMBER	METROLOGY NUMBER	CALIBRATION DUE DATE
RECORDER TEMPERATURE	BARBER COLMAN	5020488	16053	11-24-68
RECORDER PRESSURE	BARBER COLMAN	5019866	24246	10-23-68
IONIZATION GAUGE CONTROL	HERRMANN ASE	5019097	07699	11-22-68
THERMIC TEMP CONTROLLER	RESEARCH INDUSTRIES CONSOLIDATED	N78294	24267	1-14-68
VACUUM SYSTEM	UAC. CORP	5013297	N/A	N/A

INSTRUCTIONS

STATE OBJECT OF EXPERIMENT, TEST DESIGN, OR INVENTION AND DESCRIBE IN SUFFICIENT DETAIL TO BE UNDERSTANDABLE AND REPRODUCIBLE BY ANOTHER ENGINEER. USE SKETCHES OR MAKE REFERENCE TO DRAWINGS OR PHOTOGRAPHS, IF ANY, BY NUMBER. ALL PAGES CONTAINING SUBJECT MATTER WHICH MAY BE INVENTIVE MUST BE WITNESSED.

SIGNATURE: W.D. McKee 8-3-68

WITNESSED AND UNDERSTOOD: E. Tomahol 8-3-68

FORM 102-G REV. 7-66

North American Aviation, Inc. 

N 2907-4

DIVISION 41 SPACE DOWNEY		DATE August 3 1968
PROJECT NO. 4R 6227	CONTRACT NO. ATR 492117 "A"	

THE SPECIMEN IS EQUAL TO THAT DEFINED IN THE APPROVED TEST REQUEST (TR 492117 "A") AND THE TEST SET UP IS ADEQUATE TO MEET THE REQUIREMENTS OF THE TEST AS DEFINED IN THAT TEST REQUEST.

OK TO TEST Paul W. Downey
LET RESPONSIBLE TEST ENGINEER

VERIFIED E. J. Hemench 8-3-68
NA/SD INSPECTION DEPT.

THE GUIDANCE & NAVIGATIONAL FILTER BOX ASSEMBLY WAS PLACED IN THE VACUUM SYSTEM AND THE INSTRUMENTATION WAS CONNECTED BY 1/8" O.D. TUBING. TWO THERMO COUPLES WERE BONDDED BY USING ALUMINUM ADHESIVE TO SECURE THE T/C IN PLACE. START A PRETEST FUNCTIONAL, PARA. 3.5.1 AS SPECIFIED IN PARA 2.5 AT ROOM AMBIENT CONDITION. 0530 COMPLETED PRETEST FUNCTIONAL, CLOSED THE CHAMBER DOOR AND STARTED ROUGHING SYSTEM. 8-3-68
THE INSULATION RESISTANCE, CONTINUITY, CAPACITANCE TEST RESULTS ARE RECORDED AND NOTED IN LABORATORY NOTE BOOK N1997-34

0630 CHAMBER PRESSURE 140 MICRONS ALL T/C'S
75°F ± 3

TEST DATA SEE PAGE N2907-5

FORM 100-G REV. 7-66

INSTRUCTIONS

STATE OBJECT OF EXPERIMENT TEST, DESIGN, OR INVENTION AND DESCRIBE IN SUFFICIENT DETAIL TO BE UNDERSTANDABLE AND REPRODUCIBLE BY ANOTHER ENGINEER. USE SKETCHES OR MAKE REFERENCE TO DRAWINGS OR PHOTOGRAPHS, IF ANY, BY NUMBER. ALL PAGES CONTAINING SUBJECT MATTER WHICH MAY BE INVENTIVE MUST BE WITNESSED.

SIGNATURE: W.D. McKee 8-3-68

WITNESSED AND UNDERSTOOD: E. J. Hemench 8-3-68

North American Aviation, Inc. 

N 2907-5

DIVISION 41 SPACE Downey		
PROJECT NO: 4R 6227	CONTRACT NO: ATR 492117 A	DATE: August 3 1968

CONTINUED FROM PAGE N 2907-4

DATE OR TIME	DATA Point	CHAMBER PRESSURE mm Hg	TEMPERATURES						REMARKS
			SPEC MIN T_e 2	T_e 12	T_e 3	T_e 4	T_e 5	T_e 6	
0630	1	130.4	70	74	75	55	75	75	
0650	2	4.5×10^{-5}							START LN2
0700	3	3.9×10^{-6}	77	75	75	82	100	-300	OPEN LEAD ON T_e #6
0730	4	2.2×10^{-6}	64	58	45	55	89	59	8-2-8 
0800	5	1.4×10^{-6}	43	44	25	35	72	39	
0900	6	1.0×10^{-6}	42	43	33	39	77	36	
10:00	7	6.9×10^{-7}	40	40	44	54	94	53	
11:00	8	6.2×10^{-7}	39	38	37	55	95	55	
12:00	9	6.0×10^{-7}	37	41	49	59	100	61	FUNCTIONAL AT temp.
1300	10	6.0×10^{-7}	43	45	45	59	102	60	AND VACUUM PER
1400	11	5.6×10^{-7}	43	43	47	57	96	58	PAPA 3.5.2
1500	12	5.8×10^{-7}	40	43	47	58	100	58	
1600	13	5.7×10^{-7}	38	38	47	57	93	57	
1700	14	5.6×10^{-7}	38	38	46	57	98	58	
1800	15	5.3×10^{-7}	40	43	47	58	99	54	
1900	16	4.8×10^{-7}	43	43	48	57	100	59	
2000	17	4.8×10^{-7}	40	40	50	55	101	61	
2100	18	4.6×10^{-7}	41	42	48	58	100	64	
2200	19	4.5×10^{-7}	43	44	52	60	105	60	
2300	20	4.2×10^{-7}	40	40	43	58	98	54	
2359	21	4.1×10^{-7}	38	42	44	52	94	58	
00:58	22	4.0×10^{-7}	38	39	44	54	95	55	W_{Dm}
01:08	23	4.0×10^{-7}	42	42	50	61	101	61	
02:58	24	4.0×10^{-7}	39	43	46	56	98	56	
03:57	25	3.9×10^{-7}	41	43	50	58	100	55	
04:58	26	3.9×10^{-7}	41	44	50	55	100	56	
05:59	27	3.9×10^{-7}	39	42	50	55	98	55	6-5
06:59	28	4.0×10^{-7}	39	38	50	56	95	56	

TEST DATA CONTINUED ON PAGE N 2907-6

INSTRUCTIONS

STATE OBJECT OF EXPERIMENT, TEST, DESIGN, OR INVENTION AND DESCRIBE IN SUFFICIENT DETAIL TO BE UNDERSTANDABLE AND REPRODUCIBLE BY ANOTHER ENGINEER. USE SKETCHES OR MAKE REFERENCE TO DRAWINGS OR PHOTOGRAPHS, IF ANY, BY NUMBER. ALL PAGES CONTAINING SUBJECT MATTER WHICH MAY BE INVENTIVE MUST BE WITNESSED.

SIGNATURE: W.D. Miller 1862

WITNESSED AND UNDERSTOOD: E. Henschel 8-4-68

FORM 482-G REV. 7-66

North American Aviation, Inc. 

N 2907-6

DIVISION

41 SPACE DOWNEY

PROJECT NO:

4P 6227-801

CONTRACT NO.

ATA 492117 'A'

DATE

August 4 1968

CONTINUED FROM PAGE N2907-5

DATE OR TIME	DATA Pint	CHAMBER PRESSURE Torr	TEMPERATURES						REMARKS
			SPECIMEN T ₁	SPECIMEN T ₂	THERMAL T ₃	SHROUD T ₄	T ₅	T ₆	
8:45-8:50	29	4.0 x 10 ⁻⁷	43	40	44	55	97	55	
0901	30	3.8 x 10 ⁻⁷	38	39	43	54	96	56	
10:00	31	3.6 x 10 ⁻⁷	41	42	44	54	97	55	
START REPEAT FUNCTION TEST AT 24 hours DATA OBTAINED IN LABORATORY / ENGINEERING NOTEBOOK N1997-									
11:01	32	3.6 x 10 ⁻⁷	39	39	44	54	94	59	
1200	33	3.7 x 10 ⁻⁷	41	43	44	54	88	57	
1300	34	3.8 x 10 ⁻⁷	37	40	42	51	94	53	
1402	35	3.9 x 10 ⁻⁷	36	37	41	51	94	52	
1500	36	4.1 x 10 ⁻⁷	36	37	43	51	95	54	
1601	37	3.9 x 10 ⁻⁷	37	37	43	53	95	54	
1700	38	4.0 x 10 ⁻⁷	40	38	45	55	100	55	
1800	39	3.9 x 10 ⁻⁷	39	40	46	58	99	56	
1900	40	3.5 x 10 ⁻⁷	41	40	50	56	100	56	
2001	41	3.7 x 10 ⁻⁷	39	36	43	56	103	55	
2100	42	3.7 x 10 ⁻⁷	39	38	45	54	101	53	
2206	43	3.7 x 10 ⁻⁷	43	43	48	60	103	61	
2302	44	3.6 x 10 ⁻⁷	43	39	44	55	101	55	
2359	45	3.5 x 10 ⁻⁷	41	43	46	54	99	60	
00:05	46	3.4 x 10 ⁻⁷	42	42	48	59	101	60	
01:59	47	3.4 x 10 ⁻⁷	42	42	49	59	103	62	8-5-68
03:02	48	3.3 x 10 ⁻⁷	42	42	45	54	94	56	
0400	49	3.3 x 10 ⁻⁷	42	41	50	57	100	68	
0600	50	3.3 x 10 ⁻⁷	43	40	50	60	100	68	
0700	51	3.3 x 10 ⁻⁷	40	39	45	54	96	55	
0802	52	3.2 x 10 ⁻⁷	42	40	46	54	100	57	
0830	START REPEAT THE FUNCTIONAL TEST Post 50 hours								
0905	53	3.2 x 10 ⁻⁷	39	39	46	50	96	52	

INSTRUCTIONS

STATE OBJECT OF EXPERIMENT, TEST, DESIGN, OR INVENTION AND DESCRIBE IN SUFFICIENT DETAIL TO BE UNDERSTANDABLE AND REPRODUCIBLE BY ANOTHER ENGINEER. USE SKETCHES OR MAKE REFERENCE TO DRAWINGS OR PHOTOGRAPHS, IF ANY, BY NUMBER. ALL PAGES CONTAINING SUBJECT MATTER WHICH MAY BE INVENTIVE MUST BE WITNESSED.

SIGNATURE

WJ MPA 8-5-68

WITNESSED AND UNDERSTOOD

[Signature] 19 8/5 1968

FORM 495-G REV. 7-68

North American Aviation, Inc. 

N 2907-7

DIVISION **41 SPACE DOWNEY**

PROJECT NO: **1/4 6227** CONTRACT NO. **ATR 492117 "A"**

DATE **AUGUST 5, 1968**

TEST DATA CONTINUED FROM PAGE N 2907-6

DATE OR TIME	DATA POINT	CHAMBER PRESS. TORR.	TEMPERATURES						REMARKS
			SPECIMEN			THERMAL SHROUD			
			1/2 2	1/2 12	1/2 3	1/2 4	1/2 5	1/2 6	
09:59	54	3.2 x 10 ⁻⁷	42	39	39	54	93	57	
10:55	54	TRANSITION FROM				40	25		135 ± 5°F
10:55	55	Sheet of LM2 Cold				54			SHROUD.
11:00	55	3.0 x 10 ⁻⁶	52	55	69	72	125	79	
12:00	56	1.0 x 10 ⁻⁴	63	65	85	90	130	113	
13:00	57	1.8 x 10 ⁻⁴	127	130	165	178	195	174	
13:30	58	7.8 x 10 ⁻⁵	137	137	148	157	170	143	START SONS AT 135°F
14:00	59	3.3 x 10 ⁻⁵	134	135	120	125	137	118	AT 1330 HRS.
15:01	60	3.8 x 10 ⁻⁵	138	137	153	158	168	153	
16:04	61	1.7 x 10 ⁻⁵	140	137	137	141	145	125	Spec. to be Re-adjusted
17:00	62	1.2 x 10 ⁻⁵	128	137	123	136	140	127	to Re-adj 135°F ± 10°
18:00	63	1.2 x 10 ⁻⁵	133	135	143	150	157	140	
19:03	64	1.0 x 10 ⁻⁵	140	135	146	147	160	140	
20:00	65	8.7 x 10 ⁻⁶	123	138	132	145	160	132	
21:00	66	7.5 x 10 ⁻⁶	135	135	133	145	154	134	
22:00	67	7.4 x 10 ⁻⁶	134	135	145	155	163	142	
23:00	68	6.2 x 10 ⁻⁶	139	142	137	144	154	131	
23:59	69	5.5 x 10 ⁻⁶	138	140	142	146	161	142	
00:59	70	5.4 x 10 ⁻⁶	138	137	140	148	160	143	8-6-68.
01:58	71	4.9 x 10 ⁻⁶	137	137	141	145	162	142	
03:00	72	4.6 x 10 ⁻⁶	135	135	139	144	162	137	
03:58	73	4.4 x 10 ⁻⁶	135	137	138	145	160	137	
05:00	74	3.8 x 10 ⁻⁶	134	132	136	142	154	134	
05:59	75	4.4 x 10 ⁻⁶	138	137	144	149	166	150	
07:00	76	3.8 x 10 ⁻⁶	136	136	136	144	158	136	
07:58	77	3.7 x 10 ⁻⁶	134	134	137	144	157	136	
09:00	78	3.7 x 10 ⁻⁶	136	136	137	145	159	139	
10:02	79	3.5 x 10 ⁻⁶	134	134	135	145	158	135	

TEST DATA CONTINUED ON PAGE N 2907-8

INSTRUCTIONS

STATE OBJECT OF EXPERIMENT, TEST, DESIGN, OR INVENTION AND DESCRIBE IN SUFFICIENT DETAIL TO BE UNDERSTANDABLE AND REPRODUCIBLE BY ANOTHER ENGINEER. USE SKETCHES OR MAKE REFERENCE TO DRAWINGS OR PHOTOGRAPHS, IF ANY, BY NUMBER. ALL PAGES CONTAINING SUBJECT MATTER WHICH MAY BE INVENTIVE MUST BE WITNESSED.

SIGNATURE *W. J. Miller 8-6-68*

WITNESSED AND UNDERSTOOD *[Signature]* 19 *68*

FORM 488-G REV. 7-66

North American Aviation, Inc. 

N 2907- 8

DIVISION 41 SPACE - DOWNNEY	
PROJECT NO. 4R 6227	CONTRACT NO. ATR 492117 "A"
DATE AUGUST 6 1968	

TEST DATA CONTINUED FROM PAGE N2907-7

DATE OR TIME	DATA POINT	CHAMBER PRESSURE TORR	TEMPERATURES						REMARKS		
			SPECIMEN			THERMAL SHROUD					
			1/2	2 1/2	12	12	3 1/2	4 1/2	5 1/2	6	
11:00	80	3.7x10 ⁻⁶	134	135	138	144	163	136			
12:01	81	3.7x10 ⁻⁶	135	138	137	144	157	136			
13:00	82	3.7x10 ⁻⁶	132	133	133	137	152	132			
14:00	83	3.8x10 ⁻⁶	131	131	133	139	151	134			
15:00	84	3.8x10 ⁻⁶	133	132	134	140	155	134			
16:00	85	3.9x10 ⁻⁶	132	136	135	140	153	134			
17:00	86	3.8x10 ⁻⁶	132	132	135	140	153	133			
18:00	87	3.6x10 ⁻⁶	132	132	135	139	153	134			
19:02	88	3.4x10 ⁻⁶	134	137	137	142	155	136			
20:00	89	3.2x10 ⁻⁶	135	139	138	144	156	137			
21:04	90	3.0x10 ⁻⁶	133	135	139	144	159	137			
22:05	91	3.0x10 ⁻⁶	138	138	143	149	162	142			
23:01	92	2.8x10 ⁻⁶	138	137	138	145	157	137			
23:58	93	2.7x10 ⁻⁶	137	136	138	145	157	138			8-6-68.
00:02	94	2.7x10 ⁻⁶	137	140	140	144	160	140			
01:00	95	2.5x10 ⁻⁶	137	137	139	144	158	139			
02:59	96	2.4x10 ⁻⁶	135	135	136	139	155	138			
03:35	NOTICED THAT THE RECORDER 5020488 (TEMPERATURE) HAD STOPPED PRINTING. THE CHART WAS PULLED AND MEASURED; (DISTANCE 22 INCHES CHART SPEED 2"/MIN) 22 MINUTES TOTAL TIME OF NO TEMPERATURE RECORD CHART MARKED AND STAMPED FOR 0324 STOPPED.										
04:00	97	2.5x10 ⁻⁶	135	135	140	146	158	140			8-7-68
05:00	98	2.4x10 ⁻⁶	134	136	138	144	157	140			
06:01	99	2.4x10 ⁻⁶	134	136	138	142	160	140			
07:00	100	2.3x10 ⁻⁶	133	136	136	140	160	140			
08:00	101	2.2x10 ⁻⁶	132	135	136	140	160	135			
09:00	102	2.2x10 ⁻⁶	136	138	135	139	158	139			

FORM 493-G REV. 7-68

INSTRUCTIONS

STATE OBJECT OF EXPERIMENT, TEST, DESIGN, OR INVENTION AND DESCRIBE IN SUFFICIENT DETAIL TO BE UNDERSTANDABLE AND REPRODUCIBLE BY ANOTHER ENGINEER. USE SKETCHES OR MAKE REFERENCE TO DRAWINGS OR PHOTOGRAPHS IF ANY. BY NUMBER. ALL PAGES CONTAINING SUBJECT MATTER WHICH MAY BE INVENTIVE MUST BE WITNESSED.

SIGNATURE: W J McNeil 8-7-68
 WITNESSED AND UNDERSTOOD: [Signature] 8/7/68

North American Aviation, Inc. 

N 2907-9

DIVISION H1 SPACE DOWNEY

PROJECT NO: 4/R 6227 CONTRACT NO: ATR 492117 "A" DATE: August 7 1968

DATA CONTINUED FROM PAGE N2907-8

DATE OR TIME	DATA POINT	CHAMBER PRESSURE TORR	TEMPERATURES						REMARKS
			SPEARMEN			SHPOUD			
			% 2	% 12	% 3	% 4	% 5	% 6	
10:02	103	2.1 x 10 ⁻⁶	135	135	133	141	156	136	
11:00	104	2.1 x 10 ⁻⁶	135	134	137	141	155	140	
12:00	105	2.1 x 10 ⁻⁶	131	131	133	137	152	132	
13:00	106	2.0 x 10 ⁻⁶	131	130	130	135	146	130	
14:02	107	2.1 x 10 ⁻⁶	130	130	132	139	152	133	
15:00	108	2.3 x 10 ⁻⁶	131	131	135	141	155	136	
15:35 15:35	109	2.2 x 10 ⁻⁶	130	132	131	136	150	130	END 50 HR. SOAK
16:30	110	5.6 x 10 ⁻⁷	84	86	19	25	83	23	AT 1350°F ± 100
17:35 17:35	111	1.3 x 10 ⁻⁶	51	49	51	50	55	56	AT 1535 HRS.
17:50	112	1.0 x 10 ⁻⁶	68	68	112	115	121	124	START 1 hr. soak
18:25	113	1.0 x 10 ⁻⁶	82	80	97	99	110	97	AT ambient temp. at 1750 hrs.
18:50	114	1.0 x 10 ⁻⁶	84	84	88	89	97	89	1535 HRS.  8-7-68
19:30	115	1.0 x 10 ⁻⁶	86	80	82	86	84	84	END OF TEST.

INSTRUCTIONS

STATE OBJECT OF EXPERIMENT, TEST, DESIGN, OR INVENTION AND DESCRIBE IN SUFFICIENT DETAIL TO BE UNDERSTANDABLE AND REPRODUCIBLE BY ANOTHER ENGINEER. USE SKETCHES OR MAKE REFERENCE TO DRAWINGS OR PHOTOGRAPHS, IF ANY, BY NUMBER. ALL PAGES CONTAINING SUBJECT MATTER WHICH MAY BE INVENTIVE MUST BE WITNESSED.

SIGNATURE: L. K. Fairbank 8-7 1968

WITNESSED AND UNDERSTOOD } CB Rich  8-7 1968

FORM 482-G REV. 7-66

North American Aviation, Inc. 

N 2907-10

DIVISION

41 SPACE DOWNNEY

PROJECT NO:

4R 6227

CONTRACT NO.

ATR 492117 "A"

DATE

August 8 1968

THE PRECEDING VACUUM & THERMAL TEST HAS BEEN CONDUCTED IN ACCORDANCE WITH THE TEST REQUEST (TR 492117 "A" CHANGE PARA 3.5) AND SUPPORTING DOCUMENTS. DATA SUPPORTING THIS TEST ARE NOTED OR REFERENCED HERE-IN AS NOTED IN LABORATORY/ENGINEERING NOTE BOOK N 2907- PAGES 5 THRU 9

SIGNED Paul W. Edwards

Laboratory & Test RESPONSIBLE TEST ENG.

J. J. Pamela  8/8/68

VERIFIED

N/R/SD inspection

FORM 493-G REV. 7-66

INSTRUCTIONS

STATE OBJECT OF EXPERIMENT, TEST, DESIGN, OR INVENTION AND DESCRIBE IN SUFFICIENT DETAIL TO BE UNDERSTANDABLE AND REPRODUCIBLE BY ANOTHER ENGINEER. USE SKETCHES OR MAKE REFERENCE TO DRAWINGS OR PHOTOGRAPHS, IF ANY, BY NUMBER. ALL PAGES CONTAINING SUBJECT MATTER WHICH MAY BE INVENTIVE MUST BE WITNESSED.

SIGNATURE:

W. D. Miele  1968

WITNESSED AND UNDERSTOOD

J. J. Pamela  8/8 1968

APPENDIX H
ACCELERATION

North American Aviation, Inc. 

N 5778-28

DIVISION

SPACE - DOWNEY

PROJECT NO:

LR 6227

CONTRACT NO.

ATR 492117

DATE

8-7-68

SUBJECT: QUALIFICATION TEST OF GUIDANCE AND NAVIGATIONAL FILTER BOX ASSEMBLY ACCELERATION TEST

PN 436-442330 SN 06362AAH3858

P. W. EDWARDS

L&T RESPONSIBLE TEST ENGINEER R. A. SCHROFF

L&T RESPONSIBLE TASK ENGINEER P. W. SIMON

SD ENGINEERING REQUESTER L. LUERA

APPLICABLE DOCUMENTS:

ATR 492117 GUIDANCE AND NAVIGATIONAL FILTER BOX ASSY.

IL-6227-801 LABORATORIES AND TEST QUALIFICATION TEST PROCEDURE FOR GUIDANCE AND NAVIGATIONAL FILTER BOX ASSY 436-442330

EQUIPMENT LIST

DESCRIPTION	MFG	MODEL	NR/SD CONTROL NO.	CAL/ SER DUE DATE
ACCELERATOR	GENISCO	50159	MET. # 3078	20 AUG. 1968
COUNTER	C/H	420R	" 10370	6 JAN. 1969
H-1				

INSTRUCTIONS

STATE OBJECT OF EXPERIMENT, TEST, DESIGN, OR INVENTION AND DESCRIBE IN SUFFICIENT DETAIL TO BE UNDERSTANDABLE AND REPRODUCIBLE BY ANOTHER ENGINEER. USE SKETCHES OR MAKE REFERENCE TO DRAWINGS OR PHOTOGRAPHS, IF ANY, BY NUMBER. ALL PAGES CONTAINING SUBJECT MATTER WHICH MAY BE INVENTIVE MUST BE WITNESSED.

SIGNATURE: P. W. Simon 8-7-1968

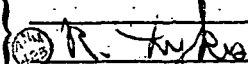
WITNESSED AND UNDERSTOOD  8-8-1968

FORM 1025-G REV. 7-68

North American Aviation, Inc. 

N 5778-29

DIVISION <i>SPACE DOWNEY</i>		
PROJECT NO: <i>LR 6227</i>	CONTRACT NO. <i>ATR 492117</i>	DATE <i>8-7-68</i>

ILLUSTRATION:

REFER TO LABORATORY NOTEBOOK PAGE N.5778-17

PRE TEST VALIDATION FOR ACCELERATION:

THE TEST ITEM IS EQUAL TO THAT DEFINED IN THE APPROVED TEST REQUEST ATR 492117A AND THE TEST SETUP IS ADEQUATE TO MEET THE REQUIREMENTS OF THE TEST AS DEFINED BY THE APPROVED TEST REQUEST.

LTT RESPONSIBLE TEST ENGINEER P. W. Edwards
 NR/SD ENGINEERING DEPARTMENT L. S. Luera ⁶⁹⁵⁻⁴¹² _{8 Aug 68}
 NR/SD INSPECTION DEPARTMENT R. Lykes ⁸⁸⁻⁸ ₁₉₆₈

RESULTS AND/OR CHRONOLOGICAL EVENTS LOG

<i>8-8-68</i> <i>1256</i>	<i>ACCELERATION, 5 MIN IN THE -Y DIRECTION @ 20g R=38" (137 RPM)</i>
<i>8-8-68</i> <i>1301</i>	<i>END OF ACCELERATION TEST IN -Y DIRECTION; NO MALFUNCTIONS</i>
<i>8-8-68</i> <i>1312</i>	<i>ACCELERATION, -Z DIRECTION @ 20g (R=38" RPM=137), 5 MIN.</i>
<i>8-8-68</i> <i>1317</i>	<i>END OF ACCELERATION TEST IN -Z DIRECTION. NO CHATTER.</i>

INSTRUCTIONS

STATE OBJECT OF EXPERIMENT, TEST, DESIGN, OR INVENTION AND DESCRIBE IN SUFFICIENT DETAIL TO BE UNDERSTANDABLE AND REPRODUCIBLE BY ANOTHER ENGINEER. USE SKETCHES OR MAKE REFERENCE TO DRAWINGS OR PHOTOGRAPHS, IF ANY, BY NUMBER. ALL PAGES CONTAINING SUBJECT MATTER WHICH MAY BE INVENTIVE MUST BE WITNESSED.

SIGNATURE: P. W. Luera *88* 19 *68*

WITNESSED AND UNDERSTOOD  R. Lykes *88* 19 *68*

FORM 485-G REV. 7-66

North American Aviation, Inc. 

N 5778-30

DIVISION <i>SPACE DOWNNEY (41)</i>		
PROJECT NO. <i>LR-6227</i>	CONTRACT NO. <i>ATR 492117</i>	DATE <i>8-8-68</i>

RESULTS AND/OR CHRONOLOGICAL EVENTS LOG.

- 8-8-68 1341 STARTED 5 MIN. ACCELERATION TEST IN +Y DIRECTION @ 20g's*
- 8-8-68 1346 END OF 5 MIN. ACCELERATION TEST IN +Y DIRECTION; NO CHATTER*
- 8-8-68 1353 STARTED 5 MIN. ACCELERATION TEST IN +Z DIRECTION @ 20g's*
- 8-8-68 1358 END OF 5 MIN. ACCELERATION TEST IN +Z DIRECTION; NO CHATTER*
- 8-8-68 1512 STARTED 5 MIN ACCELERATION TEST IN -X DIRECTION @ 20G'S (R#43.5" RPM 128)*
- 8-8-68 1517.5 END OF 5 MIN. ACCELERATION TEST IN -X DIRECTION; NO CHATTER*
- 8-8-68 1537 STARTED 5 MIN. ACCELERATION TEST IN +X DIRECTION @ 20G'S (R 35 RPM 142)*
- 8-8-68 1542 END OF ~~STARTED~~ 5 MIN. ACCELERATION TEST IN +X DIRECTION; NO CHATTER*

CONCLUSION:

THE TEST SPECIMEN SUCCESSFULLY MET THE REQUIREMENTS OF THE TEST. THE PROCEEDING TEST PHASE HAS BEEN CONDUCTED IN ACCORDANCE WITH THE APPROVED TEST REQUEST TR492117, AND SUPPORTING DOCUMENTS.

FORM 893-G REV. 7-68

INSTRUCTIONS

STATE OBJECT OF EXPERIMENT, TEST, DESIGN, OR INVENTION AND DESCRIBE IN SUFFICIENT DETAIL TO BE UNDERSTANDABLE AND REPRODUCIBLE BY ANOTHER ENGINEER. USE SKETCHES OR MAKE REFERENCE TO DRAWINGS OR PHOTOGRAPHS, IF ANY, BY NUMBER. ALL PAGES CONTAINING SUBJECT MATTER WHICH MAY BE INVENTIVE MUST BE WITNESSED.

SIGNATURE: *P. N. Simon* 8-8 1968

WITNESSED AND UNDERSTOOD  *R. Lykes* 8-8 1968

APPENDIX I

SHOCK

North American Aviation, Inc. 

N 5778-31

DIVISION **SPACE DIVISION**

PROJECT NO. **L.R. 6227**

CONTRACT NO. **ATR 492117**

DATE **8-8-68**

**SHOCK TEST OF G. LN FILTER BOX
ASSEMBLY PER PARAGRAPH 3.7,
TR 492117A. P/N 136-442330
S/N 06362 MAH 3858**

EQUIPMENT -

DESCRIPTION	MFG.	MODEL	NR/SD CONTROL NO.	CAL/SERVICE DUE DATE
SIRCK MACHINE	AVCO	020	N740739	1-26-69
ACC.	ENDEVCO	2246	JA16	10-3-68
CHARGE AMP	"	2713	5028787	8-9-68
CHARGEAMP RACK	"	2628	5011 933	8-22-68
MEMO SCOPE	TEKTRONIX	564	F332961	9-17-68
DUAL TRACE AMA	"	3A1	002800	7-17-68
TIME BASE	"	3B3	000848	7-17-68

ILLUSTRATION: REFER TO LABORATORY ~~57~~
NOTEBOOK PAGE N5778-17

PRE-TEST VALIDATION FOR SHOCK -

THE TEST ITEM IS EQUAL TO THAT DEFINED IN
THE APPROVED TEST REQUEST ATR 492117A AND THE
TEST SETUP IS ADEQUATE TO MEET THE REQUIRE
MENTS OF THE TEST AS DEFINED BY THE
APPROVED TEST REQUEST -

L & T RESPONSIBLE TEST ENGINEER P. W. Edwards 8-8-68

NR/SD INSPECTION DEPT. C.B. Rich 8-8-68

INSTRUCTIONS

STATE OBJECT OF EXPERIMENT, TEST, DESIGN, OR
INVENTION AND DESCRIBE IN SUFFICIENT DETAIL TO
BE UNDERSTANDABLE AND REPRODUCIBLE BY ANOTHER
ENGINEER. USE SKETCHES OR MAKE REFERENCE TO
DRAWINGS OR PHOTOGRAPHS, IF ANY, BY NUMBER. ALL
PAGES CONTAINING SUBJECT MATTER WHICH MAY BE IN-
VENTIVE MUST BE WITNESSED.

SIGNATURE: R. A. Mulholland 8-8 1968

WITNESSED AND UNDERSTOOD } C.B. Rich (AN 571) 8-8 1968

FORM 492-G REV. 7-66

North American Aviation, Inc. 

N 5778-32

DIVISION <u>SPACE-DOWNEY</u>		
PROJECT NO. <u>L.R. 6227</u>	CONTRACT NO. <u>A.T.R. 492117</u>	DATE <u>8-8-68</u>

RESULTS AND CHRONOLOGICAL LOG

IY AXIS

18:20	RUN #1	CALIBRATION - WITHOUT TEST
8-8-68	HEIGHT 26"	SPECIMEN - 14MSEC 35g
18:25	RUN #2	CALIBRATION - IY AXIS WITHOUT
8-8-68	HEIGHT 26"	TEST SPECIMEN - 4MSEC 35g
18:30	RUN #3	CALIBRATION - IY AXIS WITHOUT
8-8-68	HEIGHT 26"	TEST SPECIMEN - 14MSEC 35g
19:45	RUN #4	SHOCK TEST +Y AXIS - WITH
8-8-68	HEIGHT 26"	TEST SPECIMEN. SPECIMEN AND
	<u>NO SPECIMEN</u>	PLATE WERE MOUNTED TO
	<u>MALFUNCTION</u>	SCOOP FIXTURE. BOLT TORQUE 35FF LBS.
		14MSEC 3Ag
19:55	RUN #5	SPECIMEN AND PLATE WERE
8-8-68	HEIGHT 26"	MOUNTED TO SCOOP FIXTURE
	<u>NO SPECIMEN</u>	IN - Y AXIS. BOLT TORQUE 35FF LBS.
	<u>MALFUNCTION</u>	SHOCK TEST - 14MSEC 3Ag
21:50	RUN #6	CALIBRATION - WITHOUT TEST
8-8-68	HEIGHT 16"	SPECIMEN - -X AXIS 15MSEC 20g
21:53	RUN #7	CALIBRATION - WITHOUT TEST
8-8-68	HEIGHT 16"	SPECIMEN - -X AXIS 15MSEC 21g
21:58	RUN #8	CALIBRATION - WITHOUT TEST
8-8-68	HEIGHT 16"	SPECIMEN - -X AXIS 15MSEC 21g
22:15	RUN #9	SPECIMEN MOUNTED IN -X
8-8-68	HEIGHT 16"	AXIS IN BOX FIXTURE - BOLTS
	<u>NO SPECIMEN</u>	TORQUED TO 35FF LBS. FOR FIXTURE
	<u>MALFUNCTION</u>	MOUNTING. SHOCK TEST - 15MSEC 20g
22:40	RUN #10	CALIBRATION - WITHOUT TEST
8-8-68	HEIGHT 55"	SPECIMEN - +X AXIS 12MSEC 78g
22:45	RUN #11	CALIBRATION - WITHOUT TEST
8-8-68	HEIGHT 55"	SPECIMEN - +X AXIS - 12MSEC 78g

INSTRUCTIONS

STATE OBJECT OF EXPERIMENT, TEST, DESIGN, OR INVENTION AND DESCRIBE IN SUFFICIENT DETAIL TO BE UNDERSTANDABLE AND REPRODUCIBLE BY ANOTHER ENGINEER. USE SKETCHES OR MAKE REFERENCE TO DRAWINGS OR PHOTOGRAPHS, IF ANY, BY NUMBER. ALL PAGES CONTAINING SUBJECT MATTER WHICH MAY BE INVENTIVE MUST BE WITNESSED.

SIGNATURE: R.A. Muller 8-8-68
 WITNESSED AND UNDERSTOOD } C.B. Rich 8-8-68

FORM 493-G REV. 7-66

North American Aviation, Inc. 

N 5778-33

DIVISION SPACE - DOWNEY		
PROJECT NO: 6227	CONTRACT NO. ATR 492117	DATE 8-8-68

RESULTS AND CHRONOLOGICAL LOG (CONT.)

22:46 8-8-68	RUN #12 HEIGHT 55"	CALIBRATION - WITHOUT TEST SPECIMEN - + X AXIS - 80g
22:50 8-8-68	RUN #13 HEIGHT 55"	SPECIMEN MOUNTED IN +X AXIS ON BOX FIXTURE - MOUNTING BOLTS TORQUED TO 35 ft-lbs ^{FOR FIXTURE} SHOCK TEST -
23:22 8-8-68	RUN #14 HEIGHT 56"	CALIBRATION - ± Z AXIS - WITHOUT TEST SPECIMEN - 72g 12ms
23:25 8-8-68	RUN #15 HEIGHT 56"	CALIBRATION - ± Z AXIS 72g WITHOUT TEST SPECIMEN 12ms
23:27 8-8-68	RUN #16 HEIGHT 60"	CALIBRATION - ± Z AXIS WITHOUT TEST SPECIMEN 80g 12ms
23:32 8-8-68	RUN #17 HEIGHT 60"	CALIBRATION - ± Z AXIS WITHOUT TEST SPECIMEN 80g 12ms
23:34 8-8-68	RUN #18 HEIGHT 60"	CALIBRATION - ± Z AXIS WITHOUT TEST SPECIMEN 80g 12ms
23:45 8-8-68	RUN #19 HEIGHT 60"	SPECIMEN MOUNTED IN -Z AXIS - SPECIMEN BOLTED TO FIXTURE - 30 in lbs. FIXTURE BOLTED TO SCOOP 35 ft lbs, 12 msec 79g
23:52 8-8-68	RUN #20 HEIGHT 60"	SPECIMEN MOUNTED IN +Z AXIS - SPECIMEN TORQUE 30 in lbs FIXTURE TORQUE 35 ft lbs 12 msec 81g

CONCLUSION - THE TEST SPECIMEN SUCCESSFULLY MET THE REQUIREMENTS OF THE SHOCK TEST PER PARAGRAPH 3.7, ATR 492117A. THE PRECEDING TEST HAS BEEN CONDUCTED IN ACCORDANCE TO THE ATR 492117A AND SUPPORTING DOCUMENTS. ALL DATA IS STATED OR REFERENCED ~~HEREIN~~ ^{HEREIN}.

INSTRUCTIONS

STATE OBJECT OF EXPERIMENT, TEST, DESIGN, OR INVENTION AND DESCRIBE IN SUFFICIENT DETAIL TO BE UNDERSTANDABLE AND REPRODUCIBLE BY ANOTHER ENGINEER. USE SKETCHES OR MAKE REFERENCE TO DRAWINGS OR PHOTOGRAPHS, IF ANY, BY NUMBER. ALL PAGES CONTAINING SUBJECT MATTER WHICH MAY BE INVENTIVE MUST BE WITNESSED.

SIGNATURE: R. A. Mallick 8-8-68

WITNESSED AND UNDERSTOOD } C. B. Rich 8-8-68

FORM 482-G REV. 7-68

SHOCK IMPULSE DATA

Run No.	Calibration or Specimen	Axis	Volt (mv/cm)	Time (msec/cm)	Vertical Sensor (g/cm)	Duration (msec)	Rise Time (msec)	Decay Time (msec)	Acceleration (g)
1	Calibration	+Y	500	2	10	14	13	1	35
2	Calibration	+Y	500	2	10	14	13	1	35
3	Calibration	+Y	500	2	10	14	13	1	35
4	Specimen	+Y	500	2	10	14	13	1	34
5	Specimen	-Y	500	2	10	14	13	1	34
6	Calibration	-X	500	2	10	15	14	1	20
7	Calibration	-X	500	2	10	15	14	1	21
8	Calibration	-X	500	2	10	15	14	1	21
9	Specimen	-X	500	2	10	15	14	1	20
10	Calibration	+X	1000	2	20	13	12	1	78
11	Calibration	+X	1000	2	20	13	12	1	78
12	Calibration	+X	1000	2	20	13	12	1	80
13	Specimen	+X	1000	2	20	13	12	1	80
14	Calibration	±Z	1000	2	20	12	11	1	72
15	Calibration	±Z	1000	2	20	12	11	1	72
16	Calibration	±Z	1000	2	20	12	11	1	80
17	Calibration	±Z	1000	2	20	12	11	1	80
18	Calibration	±Z	1000	2	20	12	11	1	80
19	Specimen	-Z	1000	2	20	12	11	1	79
20	Specimen	+Z	1000	2	20	12	11	1	81

SHOCK IMPULSES

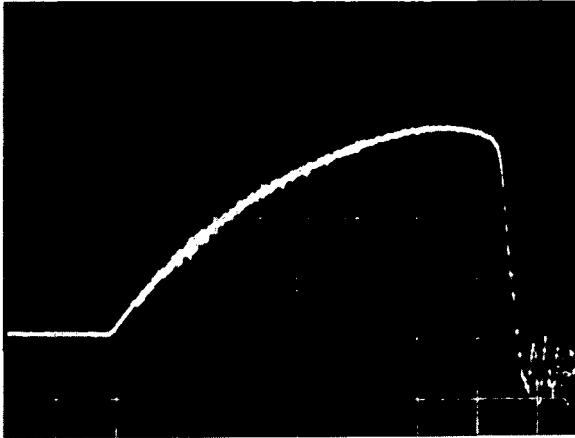

RUN 1

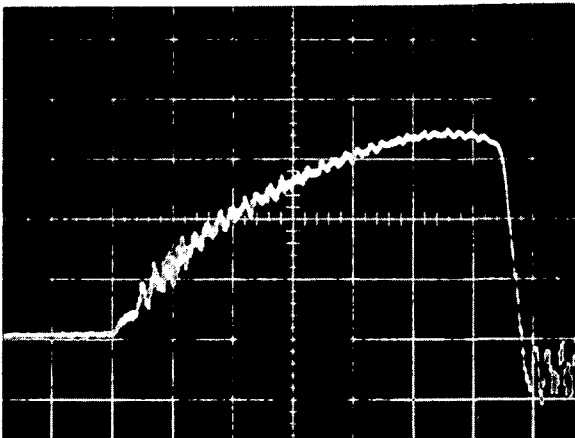

RUN 2

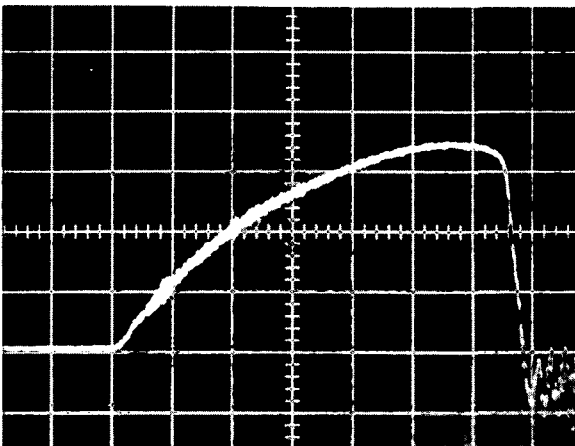

RUN 3

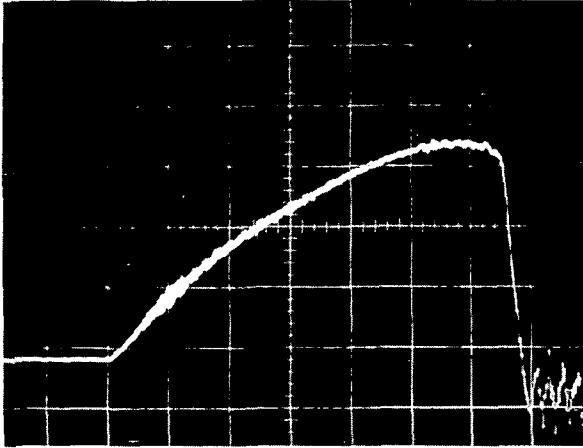

RUN 4

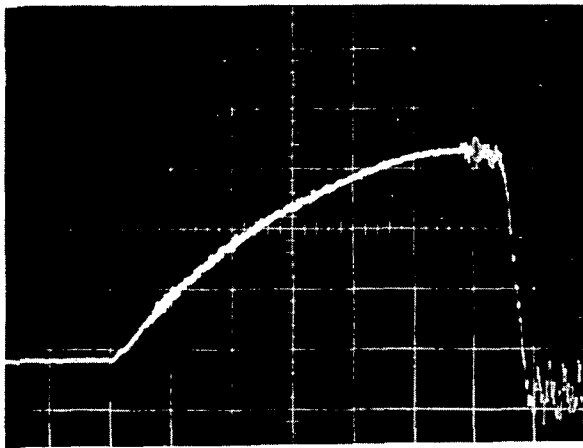

RUN 5

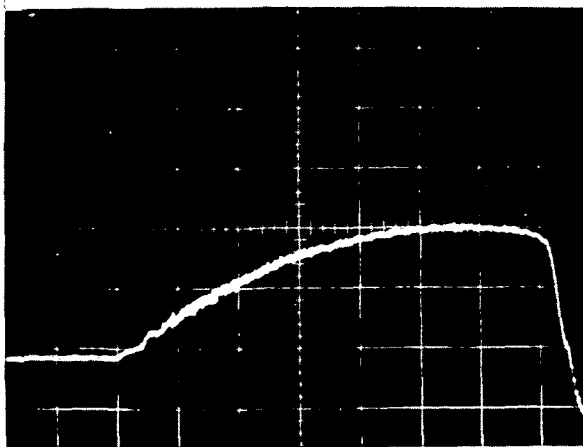

RUN 6

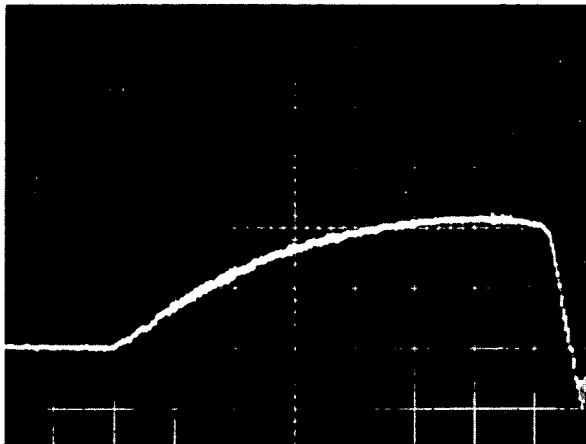

RUN 7

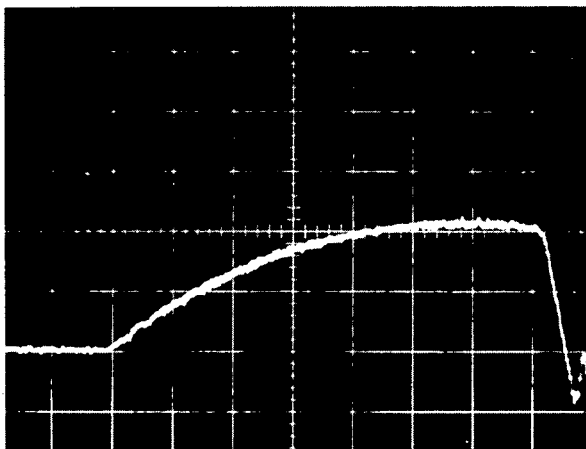

RUN 8

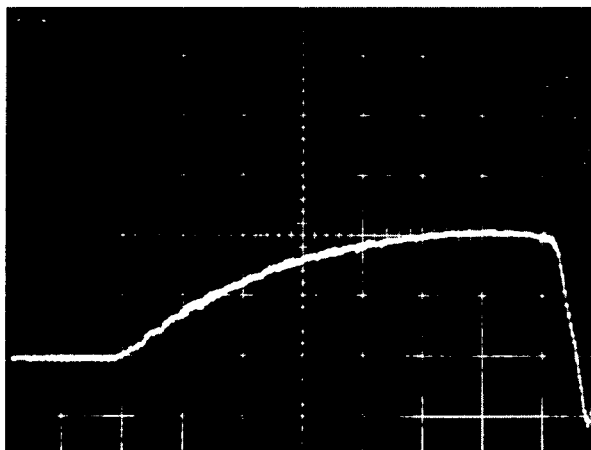

RUN 9

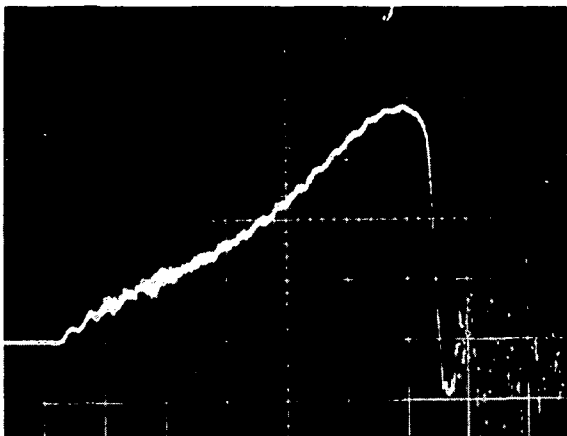

RUN 10

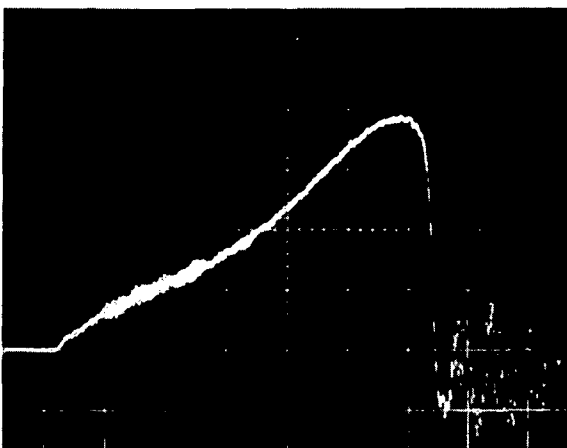

RUN 11

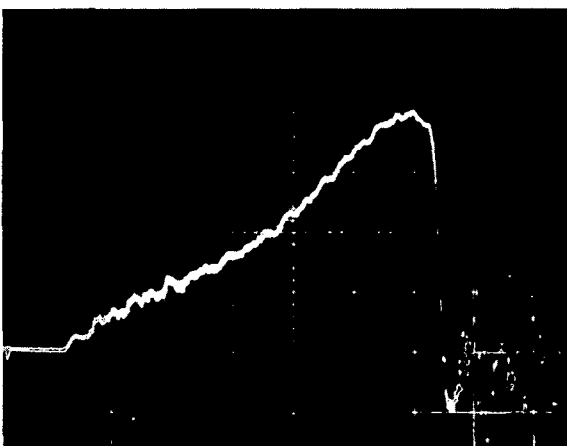

RUN 12

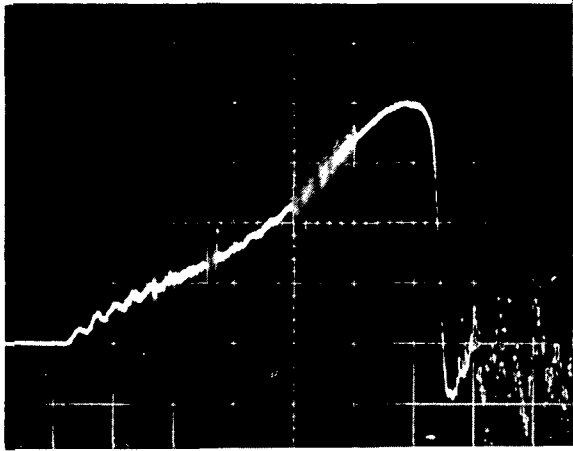

RUN 13

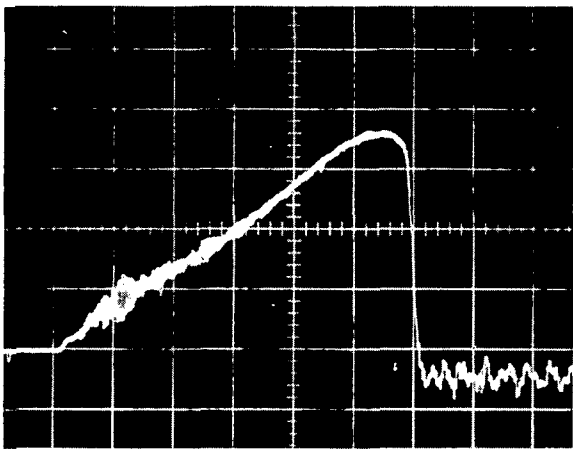

RUN 14

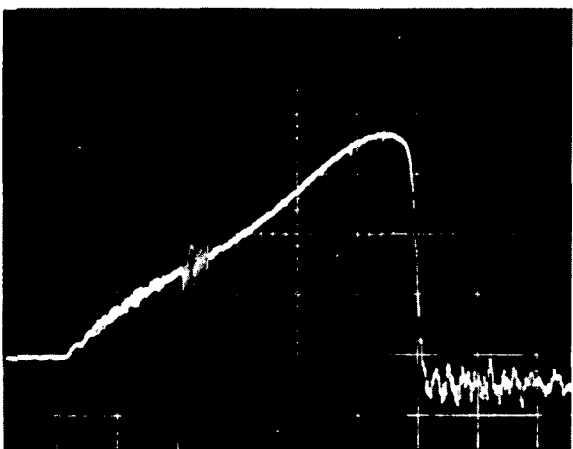

RUN 15

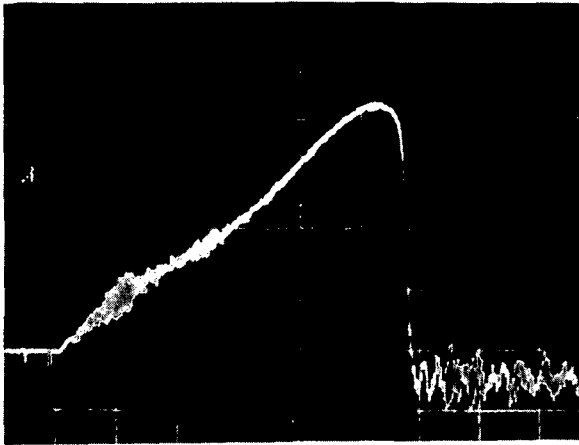

RUN 16

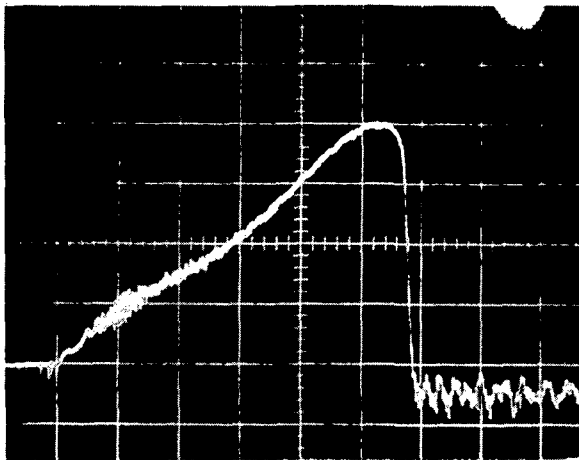

RUN 17

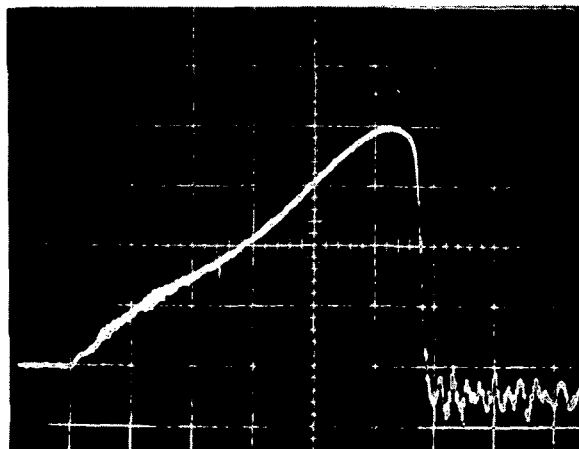

RUN 18

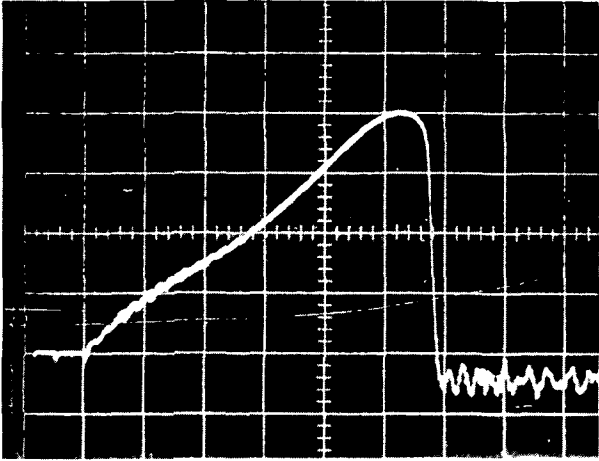

RUN 19

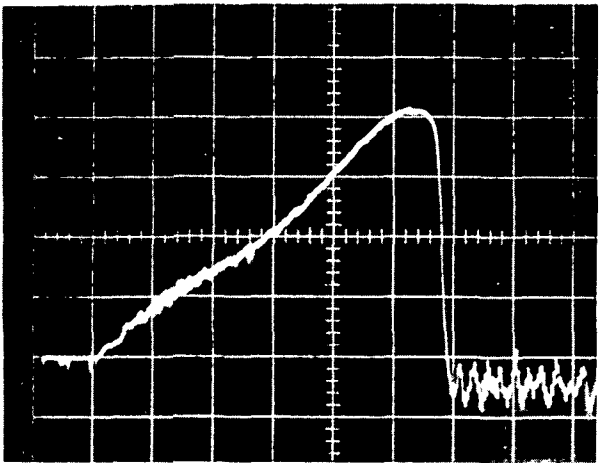

RUN 20

APPENDIX J

SUPPLEMENTARY DOCUMENTS

SPACE DIVISION OF NORTH AMERICAN ROCKWELL CORPORATION

SPACE DIVISION
NORTH AMERICAN ROCKWELL CORPORATION
14 LANWOOD BOULEVARD - DOWNEY, CALIFORNIA

IF THIS IS A CONTINUATION
A 96675

DISPOSITION RECORD

PAGE 1 OF 1 PAGES

CROSS OUT THIS NO. IF THIS IS A CONTINUATION

ENTER ORIGINAL D.R. NO.

PART NAME: EVIDENCE & NAVIGATION FILTER BOX	PART NUMBER: JK492117	SERIAL NUMBER: 06362-ADH 3858	NEXT ASSY PART NUMBER: QUAL TEST
SUPPLIER: N.R.	END ITEM MODEL: QUAL TEST	REF. DOC. NO.: 12-6227-801	TIME CYCLES IN USE: CAUSE

DISPOSITION: INSP.	ZONE: TEST	SYSTEM C.W.P. & NAME: TEST	OCC. DUR.: TEST	SYMPTOM: TEST	TYPE: TEST	UNIT/QTY: 1
ITEM NO.:	NONCONFORMANCE					

2 REF. PARA. 6.4.3.1.1 OF 12-6227-801
14 OUT OF 14 CAPACITANCE TEST MEASUREMENTS WERE UNDER 5500 PICO FARADS, THE MINIMUM REQUIREMENT FOR THIS TEST. (REF. SPEC. M00203-0622 N/C PARA. 4.1.3)

NOTIFIED PAA AT DISO, MR. BLANE, LOF NO. 6418

INITIATOR'S SIGNATURE: R. Lyra	DEPT: 4680	SERIAL NO.: 146-A06302	LOCATION: BLDM 238, D/097	DATE: 7-18-68
---------------------------------------	-------------------	-------------------------------	----------------------------------	----------------------

MR ACTION REQ'D: <input checked="" type="checkbox"/> YES <input type="checkbox"/> NO	PROCEDURES ANALYSIS REQ'D: <input type="checkbox"/> YES <input checked="" type="checkbox"/> NO	CONTINUATION SHEET REQUIRED: <input type="checkbox"/> YES <input checked="" type="checkbox"/> NO	PRR/SCRAP TAG NO.:	REPLACEMENT PART NO.:	SERIAL NO.:
SYSTEM RETEST REQUIRED: <input checked="" type="checkbox"/> YES <input type="checkbox"/> NO	FAILURE ANALYSIS REQUIRED: <input type="checkbox"/> YES <input checked="" type="checkbox"/> NO	OTHER SYSTEMS AFFECTED:	RETEST ACCEPTED DATE: 7-18-68	COMPANY: Q25	CUSTOMER: 51A

ITEM NO.	DISPOSITION	ITEM REWORK MECH AND/OR LEAD	ITEM ACCEPTANCE	
			COMPANY INSPECT	CUST. INSPECT
2.1	SUSPECT MOISTURE IN MATING CONNECTORS - REMOVE AND CLEAN INTERNAL SURFACES AND PINS. INSTALL SEALING PLUGS WHERE REQUIRED. L.S. Luera 695-412 18 July 1968	702 402	Q25	51A
2.2	CONDUCT CAPACITANCE TEST TO SPECIFIED REQUIREMENTS AND RECORD ON DATA SHEETS. L.S. Luera 695-412 18 July 1968	702 402	Q25	51A
2.3	IF READINGS ARE WITHIN THE SPECIFIED TOLERANCE OF 5500 PICO FARADS MINIMUM, CONTINUE WITH THE HIGH/LOW TEMPERATURE TEST. STARTING WITH TIME ZERO. L.S. Luera 695-412 18 July 1968	702 402	Q25	51A

APPROVALS: INSP.	MATERIAL REVIEW: <input type="checkbox"/>	TEST CONDUCT: <input type="checkbox"/>	ENG'R DISPOSITION: <input checked="" type="checkbox"/>	FINAL ACCEPTANCE: <input type="checkbox"/>
COMPANY: L.S. Luera	ORG/N/DATE: 18 July 1968	CUSTOMER: W. A. H. H.	ORG/N/DATE: 7/18/68	DATE: 7/18/68

FORM 39 2 REV. 68 ORIGINAL A 96675

SPACE DIVISION
NORTH AMERICAN ROCKWELL CORPORATION
14 LAKEWOOD BOULEVARD • DOWNEY, CALIFORNIA

IF THIS IS A CONTINUATION
A110406

DISPOSITION RECORD

PAGE 1 OF 1 PAGES

CROSS OUT THIS NO. IF THIS IS A CONTINUATION

ENTER ORIGINAL D.R. NO.

PART NAME GUIDANCE & NAVIGATION FILTER BOX	PART NUMBER Y36-442330	SERIAL NUMBER 06360-ASH3850	NEXT ASSY PART NUMBER QUAL. TEST
SUPPLIER N.R.	FINI ITEM MODEL SERIAL QUAL. TEST	REF. DOC. NO. 11-6227-801	TIME CYCLES IN USE
DISPOSITION INSTR.	ZONE	SYSTEM CUID & NAME TEST	OCC. DUR. TEST
SYMPTOM	TYPE	UNIT/QTY	CAUSE

NONCONFORMANCE

3 REF PARA. 6.4.3.1.1 OF 11-6227-801: (RETEST)
3.1 OUT OF 24 CAPACITANCE TEST MEASUREMENTS WERE
UNDER 5500 PICO FARADS, THE MINIMUM REQUIREMENT FOR
THIS TEST. (REF. SPEC. MAD203-0622 W/C PARA. 4.1.3)

NOTIFIED PATENTS, MR. HAAS, LOG NO. 6462

INITIATOR'S SIGNATURE/DEPT SERIAL NO. R. Lyria, 146-406302	LOCATION BDR 258, D/098	DATE 7-19-68
---	----------------------------	-----------------

DISPOSITION

MR ACTION REQ'D <input type="checkbox"/> YES <input checked="" type="checkbox"/> NO	PROCEDURES ANALYSIS REQ'D <input type="checkbox"/> YES <input checked="" type="checkbox"/> NO	CONTINUATION SHEET REQUIRED <input type="checkbox"/> YES <input checked="" type="checkbox"/> NO	PRE-SCRAP TAG NO.	REPLACEMENT PART NO.	SERIAL NO.
SYSTEM RETEST REQUIRED <input type="checkbox"/> YES <input checked="" type="checkbox"/> NO	FAILURE ANALYSIS REQUIRED <input type="checkbox"/> YES <input checked="" type="checkbox"/> NO	OTHER SYSTEMS AFFECTED	RETEST ACCORD	DATE	COMPANY

DISPOSITION

ITEM NO.	DISPOSITION	ITEM REWORK MECH AND/OR LEAD	ITEM ACCEPTANCE COMPANY INSPECT	CUST. INSPECT
3.1	CONTINUE TESTING - ANALYSIS TO BE CARRIED OUT AT COMPLETION OF TESTS AND RECORDING OF DATA.	N/R 7/19/68	7/19/68	

S. V. McKeever, 695-412,
7/19/68
Johnson 695-115 (Reliability)
7/19/68

APPROVALS	MATERIAL REVIEW	TEST CONDUCT	ENGR'S DISPOSITION	FINAL ACCEPTANCE
COMPANY R. Lyria	DATE 7/19/68	COMPANY S. V. McKeever	ORG/DATE 695-412, 7/19/68	CUSTOMER Johnson

FORM 3951

REV. 1-68

(ORIGINAL)

A110406

SPACE DIVISION OF NORTH AMERICAN ROCKWELL CORPORATION

SPACE DIVISION
 NORTH AMERICAN ROCKWELL CORPORATION
 114 LAKEWOOD BOULEVARD • DOWNEY, CALIFORNIA

IF THIS IS A CONTINUATION

A110403

DISPOSITION RECORD

PAGE 1 OF 1 PAGES

CROSS OUT THIS NO.

CATEGORY

IF THIS IS A CONTINUATION

ENTER ORIGINAL D.R. NO.

PART NAME <i>Navigation Unit</i>	PART NUMBER <i>Y36-442930</i>	SERIAL NUMBER <i>0258A NNN 3858</i>	NEXT ASSY PART NUMBER <i>Blank Test</i>
SUPPLIER <i>N/R</i>	END ITEM MODEL SERIAL <i>Qual Test</i>	REF. DOC. NO. <i>ATR 492117</i>	TIME CYCLES IN USE <i>N/R</i>
CAUSE <i>N/R</i>	CONDITION <i>N/R</i>		

DISPOSITION <i>Test</i>	ZONE	SYSTEM <i>N/R</i>	OCC. DUR. <i>Test</i>	SYMPTOM <i>N/R</i>	TYPE	UNIT QTY <i>1</i>
----------------------------	------	----------------------	--------------------------	-----------------------	------	----------------------

NONCONFORMANCE

PAR. 3.3.2.3.4 Requires a chamber temp. of 120°F after cycle #4 to complete 120min. test time. The chamber temp has been elevated to 120°F & 5 cycles have been completed. Ref PAR 3.3.2.3.1 then 3.3.2.4 of ATR 492117

INITIATOR SIGNATURE DEPT/SERIAL NO. LOCATION DATE

[Signature] 176 202230 D/OER 8/288 7/17/68

DISPOSITION

MR ACTION REQ'D YES NO PROCEDURES ANALYSIS REQ'D YES NO CONTINUATION SHEET REQUIRED YES NO PRE-SCRAP TAG NO. REPLACEMENT PART NO. SERIAL NO.

SYSTEM RE-TEST REQUIRED YES NO FAILURE ANALYSIS REQUIRED YES NO OTHER SYSTEMS AFFECTED TEST ACCEPTED DATE COMPANY CUSTOMER

DISPOSITION

ITEM NO.	DISPOSITION	ITEM REWORK MECH AND/OR LEAD	ITEM ACCEPTANCE COMPANY INSPECT CJST. INSPECT
<i>11</i>	<i>OK as is - NO TEST ANOMALY OCCURRED. A.V. McKinnon 695-412 & Richly 68-45 7/17/68</i>		<i>[Signature]</i> <i>7-17-68</i>

APPROVALS

<input checked="" type="checkbox"/> MATERIAL REVIEW	<input type="checkbox"/> TEST CONDUCT	<input type="checkbox"/> ENG'R DISPOSITION	FINAL ACCEPTANCE
COMPANY <i>[Signature]</i> 7-17-68	ORG'N/DATE <i>N/R</i> 7-17-68	CUSTOMER <i>[Signature]</i> 7-17-68	<i>[Signature]</i> 7-17-68

FORM 3916 REV. 1-58 ORIGINAL A110403

INTERNAL LETTER
North American Aviation, Inc.

TO N. R. Sanders
Address D/098-212
41 AB93

Date August 16, 1968
SD/AD/68-055

FROM J. R. West, Jr.
Address D/099-220
41 AB95

Phone 6771, 2, 3

Subject Qualification Test of G&N Filter Box Assembly
(P/N V36-442330, S/N 06362AAH3858)

Reference: Test Request No. 492117

Because of the simple, rigid construction of the vibration fixture, which was used for G&N filter box assy. qualification test, the fixture need not be subjected to the evaluation specified by specification MC999-0050C.

Response accelerometers on the filter assembly are not required. Input accelerometers (monitoring the vibration input to the assy.) will be sufficient to demonstrate the assy. can successfully sustain the specified vibration environment.

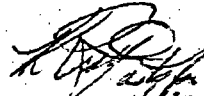

J. R. West, Jr.
Supervisor
Apollo CSM Dynamics

AEC:sal

cc: R. F. Nicholas
S. V. McKeever

695-570
695-412

AB97
FB72