

JUL 11 1969

FM

Internal Note No. 69-FM-197



NATIONAL AERONAUTICS AND SPACE ADMINISTRATION

MSC INTERNAL NOTE NO. 69-FM-197

July 3, 1969

FEB 10 1970

FEB 9 1978

Technical Library, Bellcomm, Inc.

REVISION 1 TO
VIEWS FROM THE CM AND LM
DURING THE FLIGHT OF APOLLO 11
(MISSION G)

(NASA-TM-X-69921) VIEWS FROM THE CM AND
LM DURING THE FLIGHT OF APOLLO 11
(MISSION G) (NASA) 303 P

N74-71189

00/99 Unclas
16164

Flight Analysis Branch

MISSION PLANNING AND ANALYSIS DIVISION

MANNED SPACECRAFT CENTER
HOUSTON, TEXAS



PROJECT APOLLO

REVISION 1 TO VIEWS FROM THE CM AND LM
DURING THE FLIGHT OF APOLLO 11 (MISSION G)

By Alfred N. Lunde
Flight Analysis Branch

July 3, 1969

MISSION PLANNING AND ANALYSIS DIVISION
NATIONAL AERONAUTICS AND SPACE ADMINISTRATION
MANNED SPACECRAFT CENTER
HOUSTON, TEXAS

Approved:

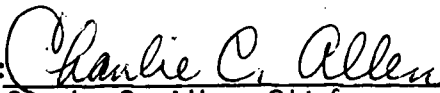

Charlie C. Allen, Chief
Flight Analysis Branch

Approved:

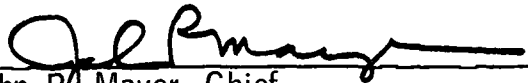

John P. Mayer, Chief
Mission Planning and Analysis Division

CONTENTS

Section		Page
1.0	SUMMARY AND INTRODUCTION	5
	1.1 Summary	5
	1.2 Introduction	5
2.0	SYMBOLS AND NOMENCLATURE	9
3.0	DISCUSSION OF DATA	13
	3.1 General Information	13
	3.2 Mission Geometry	14
	3.3 TLI Burn	14
	3.4 Translunar Coast	15
	3.5 Views from the CSM During LOI Burn	15
	3.6 Views from the LM During Descent	15
	3.7 Views from the LM During Ascent Phase	16
	3.8 TEI Burn	16
	3.9 Post-TEI	16
	3.10 Transearth Coast	16
	3.11 Views from the CM During Entry Phase	16
	3.12 Views Through the Scanning Telescope	17
	3.13 View through the Alinement Optical Telescope	18
4.0	MISSION GEOMETRY	23
5.0	VIEWS FROM CSM DURING TRANSLUNAR PHASE	31
	5.1 TLI Burn	33

Section	Page
5.2 Translunar Coast	39
5.2.1 Earth Views	41
5.2.2 Moon Views	69
6.0 VIEWS FROM CSM AND LM DURING LUNAR ORBIT PHASE	89
6.1 Views from CSM During LOI Burn	91
6.2 Views from LM During Descent Phase	101
6.2.1 DOI burn	110
6.2.2 PDI burn	113
6.3 Views from LM During Ascent Phase	141
6.3.1 Ascent burn	141
6.3.2 CSI maneuver	169
6.3.3 CDH maneuver	173
6.3.4 TPI maneuver	177
7.0 VIEWS FROM CSM DURING TRANSEARTH PHASE	183
7.1 TEI Burn	185
7.2 Post-TEI	191
7.3 Transearth Coast	195
7.3.1 Moon views	197
7.3.2 Earth views	213
8.0 VIEWS FROM CM DURING ENTRY PHASE	231
9.0 VIEWS THROUGH SCANNING TELESCOPE	243
9.1 Earth Parking Orbit Phase	249
9.2 Translunar Coast Phase	253
9.3 Lunar Orbit Coast Phase	265
9.4 Transearth Coast Phase	277

Section		Page
10.0	VIEWS THROUGH ALINEMENT OPTICAL TELESCOPE	285
11.0	STAR IDENTIFICATION CATALOGUE	291
12.0	REFERENCES	299
	APPENDIX - MAJOR APOLLO F AND G MILESTONES FOR THE CONTINGENCY ANALYSIS SECTION	303

FIGURES

Figure		Page
4.0-1	Illustration of lunar orbit plane in year 1969	25
4.0-2	Sun-centered inertial geometry of Apollo 11 (Mission G)	26
4.0-3	Location of the sun and moon at major phases of Apollo 11 (Mission G)	27
4.0-4	A schematic of the maneuver attitude and lighting conditions for Apollo 11 (Mission G)	28
4.0-5	Flight of Apollo 11 (Mission G) projected on a map of the celestial sphere	29
5.1-1	Translunar injection burn	
	(a) Begin TLI burn	35
	(b) Middle of TLI burn	36
	(c) End of TLI burn	37
5.2.1-1	Translunar coast - constant field of view (earth)	
	(a) g.e.t. = 10 hours	43
	(b) g.e.t. = 20 hours	44
	(c) g.e.t. = 30 hours	45
	(d) g.e.t. = 40 hours	46
	(e) g.e.t. = 50 hours	47
	(f) g.e.t. = 60 hours	48
	(g) g.e.t. = 70 hours	49
5.2.1-2	Translunar coast - variable field of view (earth)	
	(a) g.e.t. = 3 hours	50
	(b) g.e.t. = 4 hours	50
	(c) g.e.t. = 5 hours	50
	(d) g.e.t. = 6 hours	50
	(e) g.e.t. = 7 hours	51
	(f) g.e.t. = 8 hours	51
	(g) g.e.t. = 9 hours	51
	(h) g.e.t. = 10 hours	51
	(i) g.e.t. = 11 hours	52

(j)	g.e.t. = 12 hours	52
(k)	g.e.t. = 13 hours	52
(l)	g.e.t. = 14 hours	52
(m)	g.e.t. = 15 hours	53
(n)	g.e.t. = 16 hours	53
(o)	g.e.t. = 17 hours	53
(p)	g.e.t. = 18 hours	53
(q)	g.e.t. = 19 hours	54
(r)	g.e.t. = 20 hours	54
(s)	g.e.t. = 21 hours	54
(t)	g.e.t. = 22 hours	54
(u)	g.e.t. = 23 hours	55
(v)	g.e.t. = 24 hours	55
(w)	g.e.t. = 25 hours	55
(x)	g.e.t. = 26 hours	55
(y)	g.e.t. = 27 hours	56
(z)	g.e.t. = 28 hours	56
(aa)	g.e.t. = 29 hours	56
(bb)	g.e.t. = 30 hours	56
(cc)	g.e.t. = 31 hours	57
(dd)	g.e.t. = 32 hours	57
(ee)	g.e.t. = 33 hours	57
(ff)	g.e.t. = 34 hours	57
(gg)	g.e.t. = 35 hours	58
(hh)	g.e.t. = 36 hours	58
(ii)	g.e.t. = 37 hours	58
(jj)	g.e.t. = 38 hours	58
(kk)	g.e.t. = 39 hours	59
(ll)	g.e.t. = 40 hours	59
(mm)	g.e.t. = 41 hours	59
(nn)	g.e.t. = 42 hours	59
(oo)	g.e.t. = 43 hours	60
(pp)	g.e.t. = 44 hours	60
(qq)	g.e.t. = 45 hours	60
(rr)	g.e.t. = 46 hours	60
(ss)	g.e.t. = 47 hours	61
(tt)	g.e.t. = 48 hours	61
(uu)	g.e.t. = 49 hours	61
(vv)	g.e.t. = 50 hours	61
(ww)	g.e.t. = 51 hours	62
(xx)	g.e.t. = 52 hours	62
(yy)	g.e.t. = 53 hours	62
(zz)	g.e.t. = 54 hours	62
(aaa)	g.e.t. = 55 hours	63
(bbb)	g.e.t. = 56 hours	63
(ccc)	g.e.t. = 57 hours	63

(ddd)	g.e.t. = 58 hours	63
(eee)	g.e.t. = 59 hours	64
(fff)	g.e.t. = 60 hours	64
(ggg)	g.e.t. = 61 hours	64
(hhh)	g.e.t. = 62 hours	64
(iii)	g.e.t. = 63 hours	65
(jjj)	g.e.t. = 64 hours	65
(kkk)	g.e.t. = 65 hours	65
(lll)	g.e.t. = 66 hours	65
(mmm)	g.e.t. = 67 hours	66
(nnn)	g.e.t. = 68 hours	66
(ooo)	g.e.t. = 69 hours	66
(ppp)	g.e.t. = 70 hours	66
(qqq)	g.e.t. = 71 hours	67
(rrr)	g.e.t. = 72 hours	67
(sss)	g.e.t. = 73 hours	67
(ttt)	g.e.t. = 74 hours	67

5.2.2-1

Translunar coast - constant field of view (moon)

(a)	g.e.t. = 10 hours	71
(b)	g.e.t. = 20 hours	72
(c)	g.e.t. = 30 hours	73
(d)	g.e.t. = 40 hours	74
(e)	g.e.t. = 50 hours	75
(f)	g.e.t. = 60 hours	76
(g)	g.e.t. = 65 hours	77
(h)	g.e.t. = 70 hours	78
(i)	g.e.t. = 71 hours	79
(j)	g.e.t. = 72 hours	80
(k)	g.e.t. = 73 hours	81
(l)	g.e.t. = 74 hours	82
(m)	g.e.t. = 75 hours	83

5.2.2-2

Translunar coast - variable field of view (moon)

(a)	g.e.t. = 10 hours	84
(b)	g.e.t. = 20 hours	84
(c)	g.e.t. = 30 hours	84
(d)	g.e.t. = 40 hours	84
(e)	g.e.t. = 50 hours	85
(f)	g.e.t. = 60 hours	85

Figure	Page
6.0-1 LM/CSM docked orientation	91
6.1-1 Lunar orbit insertion burn	
(a) Begin of LOI burn (g.e.t. = 75:55:02.8)	95
(b) Middle of LOI burn (g.e.t. = 75:58:02.8)	96
(c) End of LOI burn (g.e.t. = 76:01:08.2)	97
6.2.0-1 Descent phase	
(a) LM descent phase geometry	101
(b) Powered descent profile	103
6.2.0-2 LM groundtracked during descent and ascent	105
6.2.1-1 LM window and body axes geometry	109
6.2.1-2 DOI burn (g.e.t. = 101:38:48)	110
6.2.2-1 PDI burn	
(a) Begin descent burn	113
(b) 26 seconds into descent burn	114
(c) 1 minute 6 seconds into descent burn	115
(d) 1 minute 46 seconds into descent burn	116
(e) 2 minutes 6 seconds into descent burn	117
(f) 2 minutes 26 seconds into descent burn	118
(g) 2 minutes 46 seconds into descent burn	119
(h) 3 minutes 6 seconds into descent burn	120
(i) 3 minutes 46 seconds into descent burn	121
(j) 5 minutes 26 seconds into descent burn	122
(k) 6 minutes 6 seconds into descent burn	123
(l) 6 minutes 26 seconds into descent burn	124
(m) 6 minutes 46 seconds into descent burn	125
(n) 7 minutes 6 seconds into descent burn	126
(o) 7 minutes 46 seconds into descent burn	127
(p) 8 minutes 6 seconds into descent burn	128
(q) 8 minutes 26 seconds into descent burn	129
(r) 8 minutes 46 seconds into descent burn	130
(s) 9 minutes 6 seconds into descent burn	131
(t) 9 minutes 46 seconds into descent burn	132
(u) 10 minutes 6 seconds into descent burn	133
(v) 10 minutes 46 seconds into descent burn	134
(w) 11 minutes 6 seconds into descent burn	135
(x) 11 minutes 26 seconds into descent burn	136
(y) 11 minutes 46 seconds into descent burn	137
(z) End of descent burn	138

Figure	Page	
6.3.0-1	Ascent phase	
	(a) LM ascent phase geometry	141
	(b) Vertical rise phase	142
6.3.0-2	LM groundtrack during descent and ascent	143
6.3.1-1	Ascent burn	
	(a) Begin ascent burn	147
	(b) 1 minute 0 seconds into ascent burn	148
	(c) 1 minute 20 seconds into ascent burn	149
	(d) 2 minutes 0 seconds into ascent burn	150
	(e) 2 minutes 20 seconds into ascent burn	151
	(f) 2 minutes 40 seconds into ascent burn	152
	(g) 3 minutes 0 seconds into ascent burn	153
	(h) 3 minutes 20 seconds into ascent burn	154
	(i) 3 minutes 40 seconds into ascent burn	155
	(j) 4 minutes 0 seconds into ascent burn	156
	(k) 4 minutes 20 seconds into ascent burn	157
	(l) 4 minutes 40 seconds into ascent burn	158
	(m) 5 minutes 20 seconds into ascent burn	159
	(n) 5 minutes 40 seconds into ascent burn	160
	(o) 6 minutes 0 seconds into ascent burn	161
	(p) 6 minutes 20 seconds into ascent burn	162
	(q) 6 minutes 40 seconds into ascent burn	163
	(r) 7 minutes 0 seconds into ascent burn	164
	(s) End ascent burn	165
6.3.2-1	CSI burn (g.e.t. = 125:21:20)	169
6.3.3-1	CDH burn (g.e.t. = 126:19:40)	173
6.3.4-1	TPI burn (g.e.t. = 126:58:26)	177
7.1-1	Transearch injection burn	
	(a) Begin TEI burn (g.e.t. = 135:24:34)	185
	(b) Middle of TEI burn (g.e.t. = 135:25:43.7)	186
	(c) End TEI burn (g.e.t. = 135:27:03)	187
7.2-1	Post TEI	
	(a) g.e.t. = 135:35:27	191
	(b) g.e.t. = 135:36:03	191

Figure		Page
7.3.1-1	Transearth coast - constant field of view (moon)	
	(a) g.e.t. = 140 hours	197
	(b) g.e.t. = 150 hours	198
	(c) g.e.t. = 160 hours	199
	(d) g.e.t. = 170 hours	200
	(e) g.e.t. = 180 hours	201
	(f) g.e.t. = 190 hours	202
7.3.1-2	Transearth coast - variable field of view (moon)	
	(a) g.e.t. = 140 hours	203
	(b) g.e.t. = 150 hours	203
	(c) g.e.t. = 160 hours	203
	(d) g.e.t. = 170 hours	203
	(e) g.e.t. = 180 hours	204
7.3.2-1	Transearth coast - constant field of view (moon)	
	(a) g.e.t. = 140 hours	207
	(b) g.e.t. = 150 hours	208
	(c) g.e.t. = 160 hours	209
	(d) g.e.t. = 170 hours	210
	(e) g.e.t. = 180 hours	211
	(f) g.e.t. = 190 hours	212
7.3.2-2	Transearth coast - variable field of view (earth)	
	(a) g.e.t. = 136 hours	213
	(b) g.e.t. = 137 hours	213
	(c) g.e.t. = 138 hours	213
	(d) g.e.t. = 139 hours	213
	(e) g.e.t. = 140 hours	214
	(f) g.e.t. = 141 hours	214
	(g) g.e.t. = 142 hours	214
	(h) g.e.t. = 143 hours	214
	(i) g.e.t. = 144 hours	215
	(j) g.e.t. = 145 hours	215
	(k) g.e.t. = 146 hours	215
	(l) g.e.t. = 147 hours	215
	(m) g.e.t. = 148 hours	216
	(n) g.e.t. = 149 hours	216
	(o) g.e.t. = 150 hours	216
	(p) g.e.t. = 151 hours	216
	(q) g.e.t. = 152 hours	217

(r)	g.e.t. = 153 hours	217
(s)	g.e.t. = 154 hours	217
(t)	g.e.t. = 155 hours	217
(u)	g.e.t. = 156 hours	218
(v)	g.e.t. = 157 hours	218
(w)	g.e.t. = 158 hours	218
(x)	g.e.t. = 159 hours	218
(y)	g.e.t. = 160 hours	219
(z)	g.e.t. = 161 hours	219
(aa)	g.e.t. = 162 hours	219
(bb)	g.e.t. = 163 hours	219
(cc)	g.e.t. = 164 hours	220
(dd)	g.e.t. = 165 hours	220
(ee)	g.e.t. = 166 hours	220
(ff)	g.e.t. = 167 hours	220
(gg)	g.e.t. = 168 hours	221
(hh)	g.e.t. = 169 hours	221
(ii)	g.e.t. = 170 hours	221
(jj)	g.e.t. = 171 hours	221
(kk)	g.e.t. = 172 hours	222
(ll)	g.e.t. = 173 hours	222
(mm)	g.e.t. = 174 hours	222
(nn)	g.e.t. = 175 hours	222
(oo)	g.e.t. = 176 hours	223
(pp)	g.e.t. = 177 hours	223
(qq)	g.e.t. = 178 hours	223
(rr)	g.e.t. = 179 hours	223
(ss)	g.e.t. = 180 hours	224
(tt)	g.e.t. = 181 hours	224
(uu)	g.e.t. = 182 hours	224
(vv)	g.e.t. = 183 hours	224
(ww)	g.e.t. = 184 hours	225
(xx)	g.e.t. = 185 hours	225
(yy)	g.e.t. = 186 hours	225
(zz)	g.e.t. = 187 hours	225
(aaa)	g.e.t. = 188 hours	226
(bbb)	g.e.t. = 189 hours	226
(ccc)	g.e.t. = 190 hours	226
(ddd)	g.e.t. = 191 hours	226
(eee)	g.e.t. = 192 hours	227
(fff)	g.e.t. = 193 hours	227
(ggg)	g.e.t. = 194 hours	227

Figure		Page
8.0-1	Entry phase	
	(a) 15 minutes prior to entry (g.e.t. = 194:46:12)	231
	(b) 13 minutes prior to entry (g.e.t. = 194:48:12)	232
	(c) 11 minutes prior to entry (g.e.t. = 194:50:12)	233
	(d) 9 minutes prior to entry (g.e.t. = 194:52:12)	234
	(e) 7 minutes prior to entry (g.e.t. = 194:54:12)	235
	(f) 5 minutes prior to entry (g.e.t. = 194:56:12)	236
	(g) 3 minutes prior to entry (g.e.t. = 194:58:12)	237
	(h) 1 minute prior to entry (g.e.t. = 195:00:12)	238
	(i) Entry interface (g.e.t. = 195:01:12)	239
9.0-1	Approximate location of scanning telescope sighting	243
9.0-2	General CM optics field of coverage	244
9.0-3	PTC modes	245
9.1-1	Scanning telescope - earth parking orbit - rev 1	
	(a) g.e.t. = 00:45:00	249
	(b) g.e.t. = 01:00:00	249
	(c) g.e.t. = 01:15:00	249
9.2-1	Scanning telescope - evasive maneuver attitude - (g.e.t. = 05:30:00)	
	(a) Evasive maneuver roll	253
	(b) Evasive maneuver roll + 60°	253
	(c) Evasive maneuver roll + 120°	253
	(d) Evasive maneuver roll + 180°	253
	(e) Evasive maneuver roll + 240°	253
	(f) Evasive maneuver roll + 300°	253

9.2-2	Scanning telescope - translunar coast - (g.e.t. = 11:00:00)	
	(a) Roll = 0°	254
	(b) Roll = 60°	254
	(c) Roll = 120°	254
	(d) Roll = 180°	254
	(e) Roll = 240°	254
	(f) Roll = 300°	254
9.2-3	Scanning telescope - PTC attitude - (g.e.t. = 12:00:00)	
	(a) Roll = 0°	255
	(b) Roll = 60°	255
	(c) Roll = 120°	255
	(d) Roll = 180°	255
	(e) Roll = 240°	255
	(f) Roll = 300°	255
9.2-4	Scanning telescope - PTC attitude - (g.e.t. = 23:00:00)	
	(a) Roll = 0°	256
	(b) Roll = 60°	256
	(c) Roll = 120°	256
	(d) Roll = 180°	256
	(e) Roll = 240°	256
	(f) Roll = 300°	256
9.2-5	Scanning telescope - PTC attitude - (g.e.t. = 26:00:00)	
	(a) Roll = 0°	257
	(b) Roll = 60°	257
	(c) Roll = 120°	257
	(d) Roll = 180°	257
	(e) Roll = 240°	257
	(f) Roll = 300°	257
9.2-6	Scanning telescope - PTC attitude - (g.e.t. = 53:00:00)	
	(a) Roll = 0°	258
	(b) Roll = 60°	258

Figure

Page

(c) Roll = 120°	258
(d) Roll = 180°	258
(e) Roll = 240°	258
(f) Roll = 300°	258

9.2-7 Scanning telescope - PTC attitude -
(g.e.t. = 70:00:00)

(a) Roll = 0°	259
(b) Roll = 60°	259
(c) Roll = 120°	259
(d) Roll = 180°	259
(e) Roll = 240°	259
(f) Roll = 300°	259

9.2-8 Scanning telescope - LOI burn attitude -
(g.e.t. = 73:00:00)

(a) Burn attitude roll	260
(b) Burn attitude roll + 60°	260
(c) Burn attitude roll + 120°	260
(d) Burn attitude roll + 180°	260
(e) Burn attitude roll + 240°	260
(f) Burn attitude roll + 300°	260

9.2-9 Scanning telescope - LOI burn attitude -
(g.e.t. = 74:30:00)

(a) Burn attitude roll	261
(b) Burn attitude roll + 60°	261
(c) Burn attitude roll + 120°	261
(d) Burn attitude roll + 180°	261
(e) Burn attitude roll + 240°	261
(f) Burn attitude roll + 300°	261

9.3-1 Scanning telescope - rev 1

(a) g.e.t. = 77:00:00	265
(b) g.e.t. = 77:25:00	265
(c) g.e.t. = 77:45:00	265

9.3-2 Scanning telescope - rev 2

(a) g.e.t. = 79:15:00	266
(b) g.e.t. = 79:35:00	266
(c) g.e.t. = 79:55:00	266

Figure	Page
9.3-3	Scanning telescope - rev 4
	(a) g.e.t. = 83:10:00 267
	(b) g.e.t. = 83:30:00 267
	(c) g.e.t. = 83:50:00 267
9.3-4	Scanning telescope - rev 10
	(a) g.e.t. = 95:05:00 268
	(b) g.e.t. = 95:25:00 268
	(c) g.e.t. = 95:40:00 268
9.3-5	Scanning telescope - rev 12
	(a) g.e.t. = 99:00:00 269
	(b) g.e.t. = 99:20:00 269
	(c) g.e.t. = 99:40:00 269
9.3-6	Scanning telescope - rev 13
	(a) g.e.t. = 101:00:00 270
	(b) g.e.t. = 101:20:00 270
	(c) g.e.t. = 101:35:00 270
9.3-7	Scanning telescope - rev 14
	(a) g.e.t. = 103:00:00 271
	(b) g.e.t. = 103:15:00 271
	(c) g.e.t. = 103:30:00 271
9.3-8	Scanning telescope - rev 30
	(a) g.e.t. = 124:40:00 272
	(b) g.e.t. = 125:00:00 272
	(c) g.e.t. = 125:15:00 272
9.3-9	Scanning telescope - rev 30
	(a) g.e.t. = 134:35:00 273
	(b) g.e.t. = 134:55:00 273
	(c) g.e.t. = 135:10:00 273
9.4-2	Scanning telescope - PTC attitude (g.e.t. = 148:00:00)
	(a) Roll = 0° 277

Figure		Page
	(b) Roll = 60°	277
	(c) Roll = 120°	277
	(d) Roll = 180°	277
	(e) Roll = 240°	277
	(f) Roll = 300°	277
9.4-3	Scanning telescope - PTC attitude (g.e.t. = 172:00:00)	
	(a) Roll = 0°	278
	(b) Roll = 60°	278
	(c) Roll = 120°	278
	(d) Roll = 180°	278
	(e) Roll = 240°	278
	(f) Roll = 300°	278
9.4-4	Scanning telescope - EI - 4 hours (g.e.t. = 191:15:00)	
	(a) Roll = 0°	279
	(b) Roll = 60°	279
	(c) Roll = 120°	279
	(d) Roll = 180°	279
	(e) Roll = 240°	279
	(f) Roll = 300°	279
9.4-5	Scanning telescope - EI - 1.5 hours (g.e.t. = 193:30:00)	
	(a) Roll = 0°	280
	(b) Roll = 60°	280
	(c) Roll = 120°	280
	(d) Roll = 180°	280
	(e) Roll = 240°	280
	(f) Roll = 300°	280
10.0-1	Attitude constraint geometry of AOT viewing positions	285
10.0-2	AOT views 2 hours after lunar landing	
	(a) AOT front detent position	286
	(b) AOT left front detent position	286
	(c) AOT left rear detent position	286
	(d) AOT rear detent position	286
	(e) AOT right detent position	286
	(f) AOT right front detent position	286

10.0-3

AOT views 2 hours prior to lunar lift-off

(a)	AOT front detent position	287
(b)	AOT left front detent position	287
(c)	AOT left rear detent position	287
(d)	AOT rear detent position	287
(e)	AOT right rear detent position	287
(f)	AOT right front detent position	287

1.0 SUMMARY AND INTRODUCTION

2.0 SYMBOLS AND NOMENCLATURE

3.0 DISCUSSION OF DATA

4.0 MISSION GEOMETRY

5.0 VIEWS FROM CSM DURING
TRANSLUNAR PHASE

5.1 TLI BURN

5.2 TRANSLUNAR COAST

5.2.1 EARTH VIEWS

5.2.2 MOON VIEWS

"Page missing from available version"

Page intentionally left blank

VIEWS FROM THE CM AND IM DURING THE FLIGHT

OF APOLLO 11 (MISSION G) - REVISION 1

By Alfred N. Lunde

1.0 SUMMARY AND INTRODUCTION

1.1 Summary

This report supersedes MSC IN 69-FM-168, Views from the CSM and LM During the Flight of Apollo 11 (Mission G) (ref. 1). The data presented in this report is identical to the above mentioned report up to a ground elapsed time of 99 hours. Due to the recently added revolution prior to DOI, the g.e.t. changes by about 2 hours. This report reflects all changes that have been made to date, and conforms with the latest nominal mission profile.

The purpose of this report is to visually depict various aspects of the Apollo 11 (Mission G) lunar landing mission. Out-the-window views are shown for most critical maneuvers executed by the CSM and by the LM. Detailed views of the earth and the moon are shown for the translunar and transearth coast phases of the flight. Views through the scanning telescope are presented for earth parking orbit, translunar coast, moon parking orbit, and transearth coast. Views through the alinement optical telescope are presented for the lunar surface stay.

These views will prove valuable to the crew as onboard data and for simulation purposes in preparation for the flight. Some of the data presented in this report are a result of crew requests and will be incorporated into the crew flight plan.

1.2 Introduction

Because of the complex geometry associated with a lunar mission, it is difficult to visualize the various aspects of such a mission. The objective of this document is to depict what the crew will see during maneuvers and coast periods during the flight of Apollo 11 (Mission G).

Because this mission is the first lunar landing mission, considerable attention has been given to LM maneuvers while in lunar orbit. Views

through the LM commander's front and docking windows have been shown for most major LM burns.

All critical CSM maneuvers have been depicted. The CM left rendezvous window has been superimposed on these views to indicate the view available to the commander while he is in a restrained couch position during a burn.

For the translunar and transearth coast periods, views are shown of the earth and the moon. Most of these are close-up views of the two celestial bodies. These views should prove useful for photography purposes.

The sections that concern views through the scanning telescope and alinement optical telescope have been added at the request of the crew.

The sequence of major events are listed in table I, and the mission REFSMMAT's are presented in table II.

The major analytical tool used to produce this report was developed by Mr. G. B. Roush of the Computation and Analysis Division.

This document and its relation to other Apollo 11 (Mission G) milestones for the Contingency Analysis Section are shown in the appendix.

The apparent motion of the earth terminator relative to the spacecraft view is caused by the assumed attitude of the spacecraft. This attitude assumes the spacecraft is pitched down 90° from the local horizontal in a plane defined by the radius vector to the spacecraft and the inertial velocity vector relative to the body being observed. As the spacecraft approaches the moon, the trajectory is warped by the moon and causes the effect depicted. The crew will not necessarily have the spacecraft oriented as stated previously. The x in the center of each view merely centers the view, except for CSM critical maneuver views where the x also denotes the projection of the CM X-axis. All X and Y scales are referenced from the center of the view, and their only purpose is to indicate the field of view. This XY coordinate system is not necessarily parallel to the CSM- or LM-body axis.

This report has the following additions or changes to MSC IN 69-FM-168:

1. New descent and ascent burn views with craters are shown.
2. Updated DOI, CSI, CDH, TPI, TEI, and post-TEI burn views are shown.
3. Transearth coast views, scanning telescope views in lunar orbit after 99 hours g.e.t., and alinement optical telescope views while on lunar surface have been updated.

Page intentionally left blank

2.0 SYMBOLS

AOT	alinement optical telescope
c.g.	center of gravity
CDH	constant delta height
CM	command module
CSI	concentric sequencing initiation
CSM	command and service modules
DOI	descent orbit insertion
EI	entry interface
g.e.t.	ground elapsed time
h_E	altitude above earth's surface
h_M	altitude above moon's surface
LOI	lunar orbit insertion
LM	lunar module
PDI	powered descent initiation
PTC	passive thermal control
R_E	radius from center of earth
R_M	radius from center of moon
SCT	scanning telescope
SEQ	star identification number
SM	service module

TEC transearth coast
TEI transearth injection
TLC translunar coast
TLI translunar injection
TPI terminal phase initiation
 V_i inertial velocity

3.0 DISCUSSION OF DATA

Page intentionally left blank

3.0 DISCUSSION OF DATA

3.1 General Information

For a better understanding of the data presented in this report, a brief explanation follows.

All the views of the critical maneuvers have a field of view of 100°, although the crew does not have such a large field of view.

All navigation stars, four of the largest planets (Venus, Mars, Jupiter, and Saturn), the sun, moon, and earth are named on all views where they appear. Other stars with a magnitude of +3 have been shown but are not named on the views. In views for some of the critical maneuvers and in various other views, all of the stars can be identified by the number on top of the view. The star name and location can be found in the star catalogue.

To show a close-up view of the earth and moon during the translunar and transearth coast phases, the field of view has been varied.

The CM window configuration data were obtained from the command module manufacturer and from reference 1. The LM window configuration data were obtained from reference 2.

The field of view is indicated on all views. The velocity in fps and mph as well as the radius in n. mi. and altitude in stat. mi. are indicated on many of the views.

During the descent and ascent burn phases, the outline of both the LM front windows are shown projected on the lunar surface or on the celestial sphere. Only the portion within the window outline is visible to the crew at the particular time indicated, although areas outside the window are also shown. Due to a combination of the extremely wide field of view used and the mathematical model involved, the surface of the moon appears to take on a fish-eye view in some cases. However, the distortion in these big fields of view is very minimal. The smallest craters depicted in this report have a size of 1 minute of arc (1658 ft).

3.2 Mission Geometry

The relationship of the ecliptic, equatorial, and lunar planes as they appear in the year 1969 are shown in figure 4.0-1.

The position of the earth's equatorial plane in the ecliptic plane for the month of July is shown in figure 4.0-2. The location of the sun and the moon during the major phases of the mission is depicted in figure 4.0-3.

A schematic diagram of the maneuver attitude and lighting conditions at TLI, LOI, and TEI is presented in figure 4.0-4. The Apollo 11 (Mission G) trajectory has been plotted on a map of the celestial sphere and shows the inertial position of the spacecraft with respect to the stars, sun, and moon (fig. 4.0-5).

For a comparison of the mission geometry for the two previous lunar missions, refer to references 3 and 4.

3.3 TLI Burn

The beginning, middle, and end of the TLI burn are shown in figure 5.1-1. The horizon is dark until shortly before the end of the burn, at which time the terminator can be seen.

3.4 Translunar Coast

Views of the earth and the moon during the translunar coast phase of the mission are presented in figures 5.2.1 and 5.2.2. In figure 5.2.1-1, the earth is shown as it would appear as the spacecraft recedes from it on the lunar trajectory. To show details of the earth such as continents and the terminator, the view has been enlarged in figure 5.2.1-2. These views are shown every hour during the coast period and should be helpful to determine which part of the world can be seen from the spacecraft. In figure 5.2.2-1, the moon is shown as it appears to the crew at various times on the translunar trajectory. Note that the moon is almost totally dark and that the sun is occulted by the moon for a period of time during the coast. In figure 5.2.2-2, a few enlarged views of the moon are shown. Vectors used were obtained from reference 5.

3.5 Views From the CSM During LOI Burn

The beginning, middle, and end of the LOI burn are depicted in figure 6.1-1. Because of the obstruction caused by the docked LM, the views from the rendezvous windows are severely limited. The crewmen are in the heads-down position during this burn, and the burn is performed in a retrograde attitude to brake the trajectory speed so that a lunar orbit may be achieved. (See page 99 for orientation.)

3.6 Views from the LM During Descent

The geometry associated with the LM descent phase is presented in figure 6.2.0-1. Initiation of the DOI burn is shown in figure 6.2.1-1. The docking window is mostly covered by the dark moon. However, note that the horizon of the moon can be monitored on the scribe on the window. (See page 102.)

The powered descent burn is shown in figure 6.2.2-1. The lighted lunar surface and horizon can be monitored through either the **front** windows or the docking window for the first 180 seconds of the burn. After completing the yaw maneuver, the crew loses sight of the moon until about 444 seconds into the PDI burn. After the lunar horizon is visible through the front windows, very few craters are visible because of the flatness of the approach area to landing site 2 and because of the oblique look angle to the horizon. It is of interest to note the apparent motion of the sun through the docking window. At the end of the burn, both the earth and Saturn are visible through the docking window.

3.7 Views from the LM During Ascent Phase

The geometry of the ascent phase is shown in figure 6.3.0-1. The ascent burn is depicted in figure 6.3.1-1. Again, shortly after leaving landing site 2, very few craters are visible due to the scarcity of large craters close to the landing site. However, due to the LM attitude during the ascent phase, the lunar surface and horizon can be monitored through the front windows and docking window, respectively.

3.8 TEI Burn

The beginning, middle, and end of the TEI burn are shown in the correct burn attitude in figure 7.1-1. This maneuver is a posigrade burn designed to free the spacecraft from the lunar gravitational attraction.

3.9 Post-TEI

The two post-TEI views (figs. 7.2-1 and 7.2-2) depict the view from the spacecraft as the earth comes into view after the TEI maneuver. At this time, the crew are looking at the middle of the Pacific Ocean.

3.10 Transearth Coast

As with the translunar coast, the views of the earth and moon are shown at various times during the transearth coast period (figs. 7.3.1-1, 7.3.1-2, 7.3.2-1, and 7.3.2-2). The moon is nearly three-quarters full as seen by the crew, and half of the earth facing the crew is in darkness.

3.11 Views from the CM During Entry Phase

The entry phase is shown in figure 8.0-1. The SM is jettisoned at approximately 15 minutes prior to entry interface, and the CM is in a heatshield-forward attitude. The angle between the spacecraft X-axis and the earth horizon is held at $+31.7^\circ$, which can be monitored on the 31.7° scribe on the window. The entry is made in darkness, and the moon is visible during part of the entry phase. The gimbals angles used for the entry phase were obtained from reference 6.

3.12 Views Through the Scanning Telescope

The times and location of the SCT sightings in this report are shown in figure 9.0-1. The SCT location and its field of view are shown in figure 9.0-2. The view along the CM X-axis during the PTC mode is shown in figure 9.0-3. The x in the middle of the view denotes the spacecraft X-axis projected on the star field background. The CM left rendezvous window outline is shown for a zero roll attitude.

In figure 9.1-1, the view is presented as seen through the SCT approximately at the beginning, middle, and end of the darkness period during earth parking orbit. The spacecraft is in a heads-down position with pitch 0° , yaw 0° , roll 180° with respect to the local horizontal.

The SCT views at indicated g.e.t. times during the translunar coast are shown in figures 9.2-1 through 9.2-9. In each case, a view as seen through the SCT is presented at a roll increment of 60° , while pitch and yaw remain at their initial value.

The SCT view from the evasive maneuver attitude is presented in figure 9.2-1. Because no attitude was available and because PTC was not started at a g.e.t. of 11 hours, an initial attitude of $0^\circ, 0^\circ, 0^\circ$ was used for the inner, middle, and outer gimbal angles.

The next five figures assume a PTC attitude with an initial attitude of $+90^\circ, 0^\circ, 0^\circ$ for the inner middle and outer gimbal angles. A LOI-1 attitude is assumed in figures 9.2-8 and 9.2-9.

The SCT views during lunar orbit are shown in figures 9.3-1 through 9.3-12. All of these views are shown at the beginning, middle, and end of the darkness period in the revolution indicated. The REFSMMAT and the gimbal angles used are stated on each view. The gimbal angles were obtained from reference 7.

The view through the SCT during the transearth phase of the mission is shown in figures 9.4-1 through 9.4-5. Again, the views are presented at a roll increment of 60° .

All times for the SCT were obtained from reference 8.

3.13 View Through Alinement Optical Telescope (AOT)

The attitude constraint geometry of the AOT is shown in figure 10.0-1. The various detent positions are shown as well as the location of the AOT (ref. 8).

The views through the AOT and the six detent positions at 2 hours after lunar landing and 2 hours prior to lunar lift-off are shown in figures 10.0-2 and 10.0-3, respectively. The quarter-moon shape in each view is an obstruction to the sightings. The lunar surface can be seen at the extreme center bottom of each of the views.

TABLE I.- SEQUENCE OF MAJOR EVENTS

Event	Time, hr:min:sec, g.e.t.	Burn duration, sec
Earth parking orbit	00:11:24	--
Translunar injection	02:44:18	321.0
Lunar orbit insertion	75:55:03	365.4
DOI	101:38:48	28.4
PDI	102:35:40	692.0
Ascent	124:23:21	
CSI	125:21:20	44.8
CDH	126:19:40	2.0
TPI	126:58:26	22.3
TEI	135:24:34	149.2
Entry interface	195:05:03	--

TABLE II.- MISSION REFSMMATS^a(a) Launch pad REFSMMAT^b

-.87505508	.40084951	.27128990
-.0067739375	.55029242	-.83494452
-.48397589	-.73246016	-.47882088

(b) PTC REFSMMAT^c

.866025404	-.45872739	-.19892002
-.5000000	-.79453916	-.34453958
0.00000	.39784004	-.91745480

(c) Lunar landing site REFSMMAT^b

.78005170	.57655390	.24311512
.00374215	-.39283134	.91960294
.62570309	-.71642806	-.30858630

(d) CSM preferred plane change REFSMMAT^b

.002798289	-.39330923	.9194020
-.65180536	-.69797995	-.29660368
.75838113	-.59844117	-.25831421

(e) Lunar lift-off REFSMMAT^b

.63482512	.71274759	.29830852
.00595964	-.39058739	.92054658
.77263288	-.58260827	-.25220240

^aAll REFSMMAT's are listed in the following format

xx	xy	xz
yx	yy	yz
zx	zy	zz

^bRef. 10.

^cRef. 11.

(f) Entry REFSMMAT^b

.00541143	.76825450	.64012164
-.07168836	.63878201	-.76604068
-.99741240	-.04174389	.05853164

^aAll REFSMMAT's are listed in the following format.

xx	xy	xz
yx	yy	yz
zx	zy	zz

^bRef. 10.

^cRef. 11.

Page intentionally left blank

4.0 MISSION GEOMETRY

Page intentionally left blank

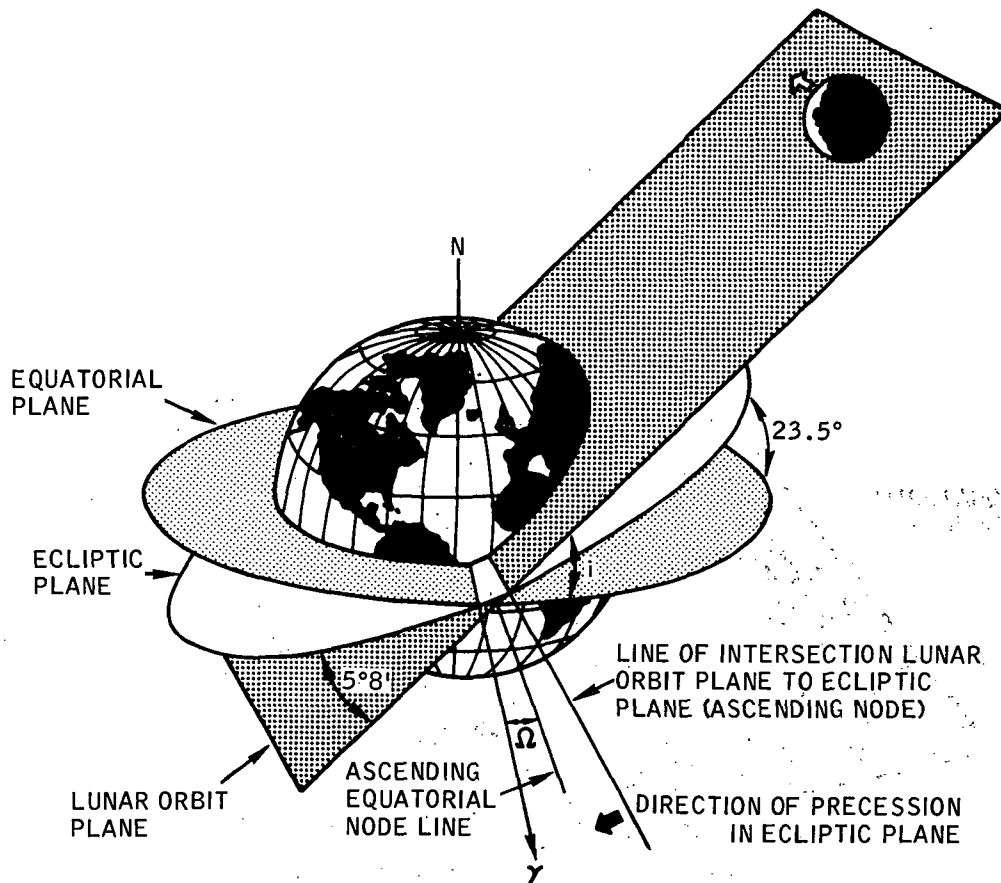

Figure 4.0-1. - Illustration of lunar orbit plane in year 1969 - inclination angle (i) $\approx 28^\circ$, right ascension of ascending equatorial node (Ω) $\approx 5^\circ$.

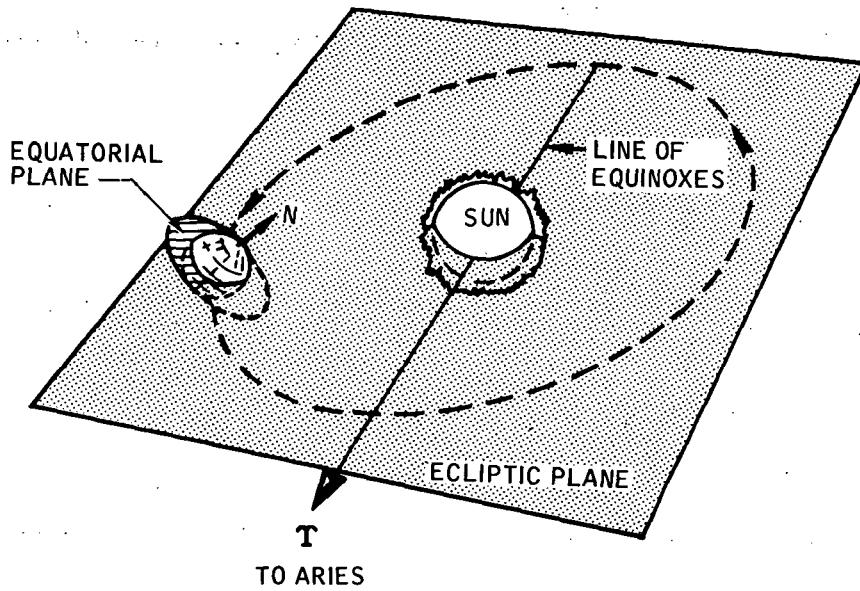

Figure 4.0-2.- Sun-centered inertial geometry of Apollo 11 (Mission G).

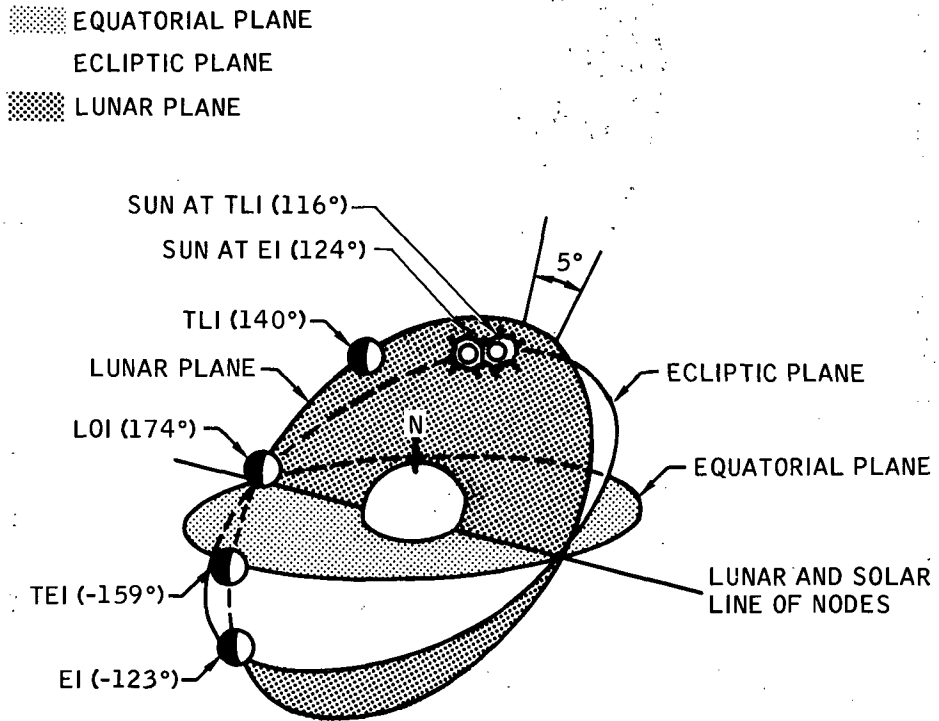

Figure 4.0-3.- Location of the sun and moon at major phases of Apollo (Mission G).

NOTE: For all maneuvers crew in heads-down position relative to the earth or moon

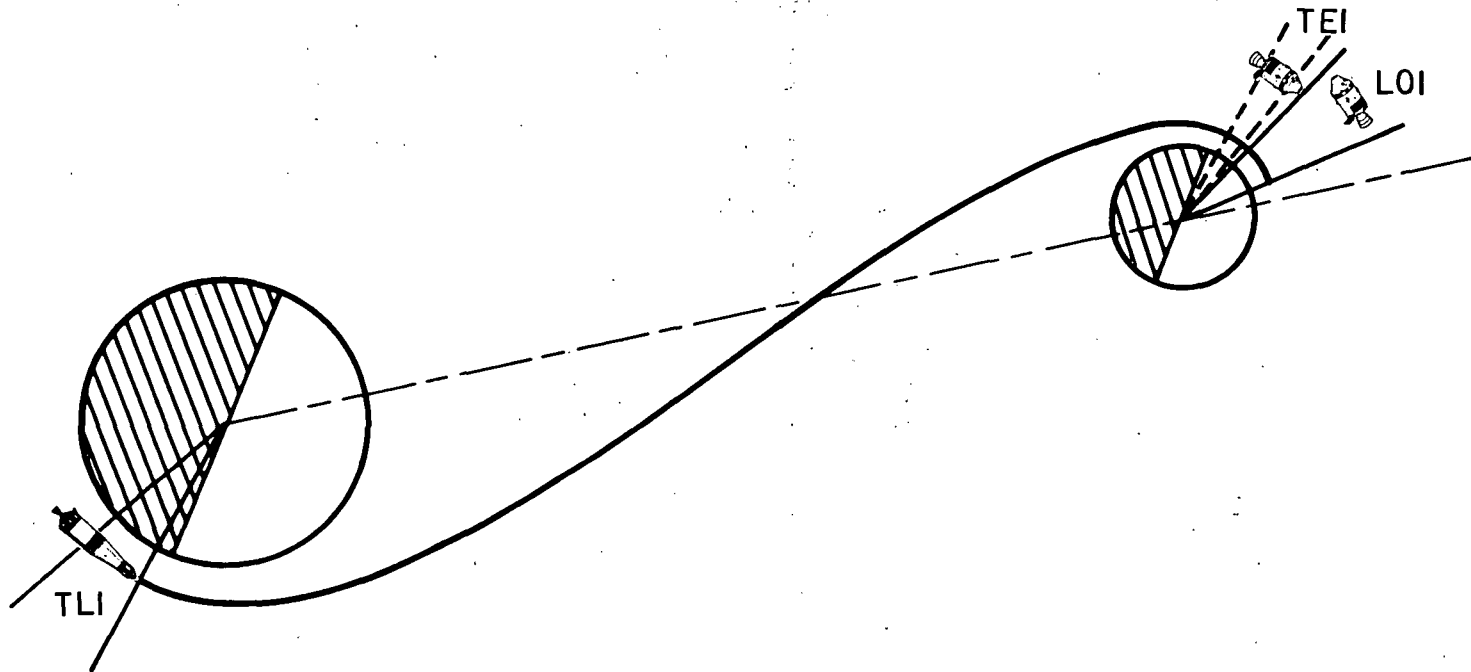

Figure 4.0-4.- A schematic of the maneuver attitudes and lighting conditions for the nominal Apollo 11 (Mission G).

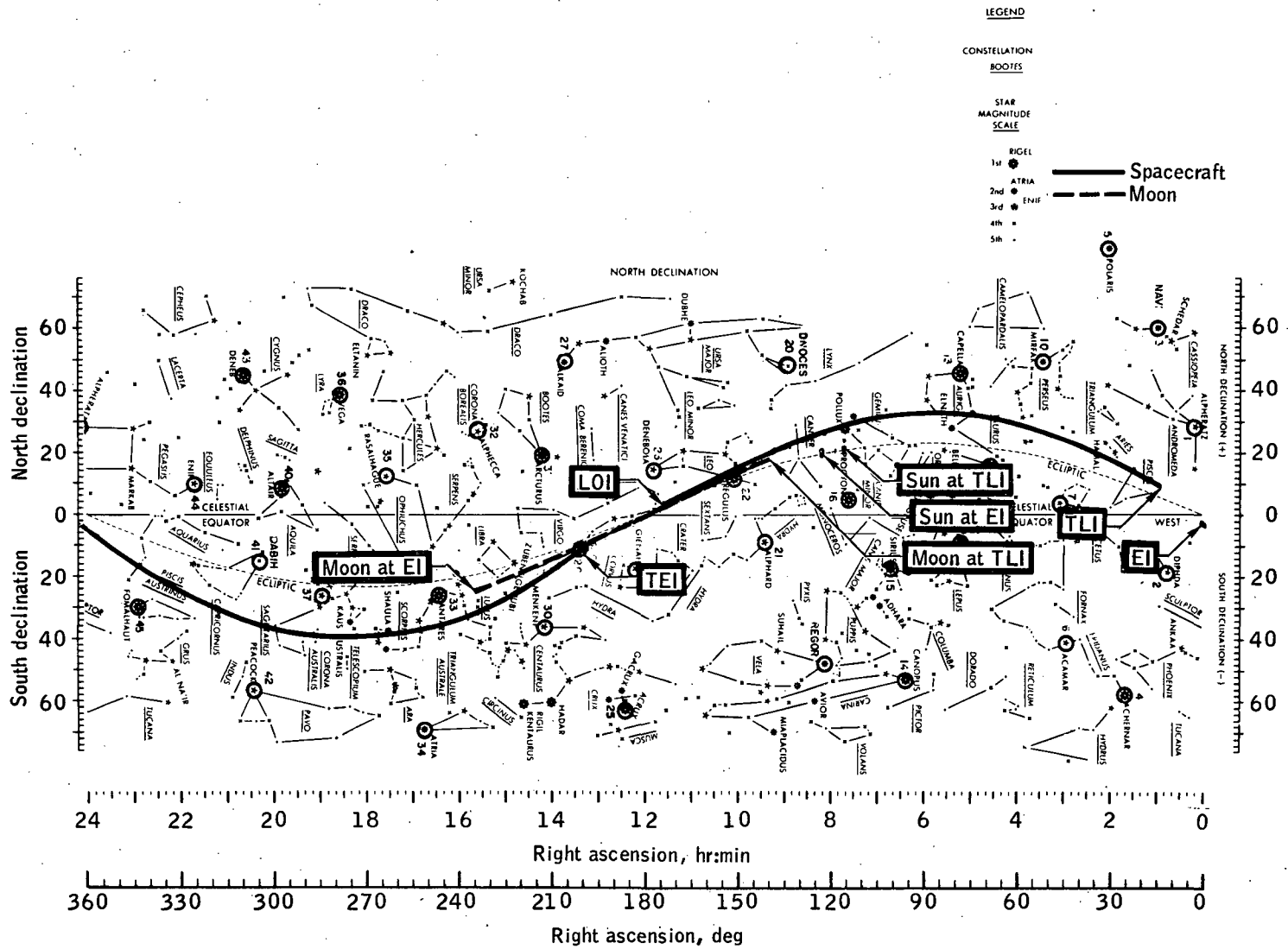

Figure 4.0-5. - Flight of Apollo 11 (Mission G) projected on a map of the celestial sphere.

Page intentionally left blank

5.0 VIEWS FROM CSM DURING
TRANSLUNAR PHASE

Page intentionally left blank

5.1 TLI BURN

Page intentionally left blank

SEQ	1	4	3	7	8	9	10	11	38	45	47	48
X	-5	-4	21	-9	11	-7	-20	6	2	-12	-12	-1
Y	-2	-20	-11	-18	-7	-5	-2	1	-20	4	0	1
SEQ	49	50	64	66	67	68	69	70	82	88	89	90
X	-16	-17	24	11	11	-16	-21	6	21	20	2	-1
Y	1	1	-13	-21	-15	0	2	5	-14	-10	-22	-9
SEQ	93	91	92	94	97	98	100					
X	0	1	5	-18	-19	-5	2					
Y	-1	-8	-6	-2	0	2	5					

$R_E = 3550$ n. mi.

$h_E = 122$ stat. mi.

$V_i = 25\,564$ fps

$V_i = 17\,430$ mph

Field of view = 100°

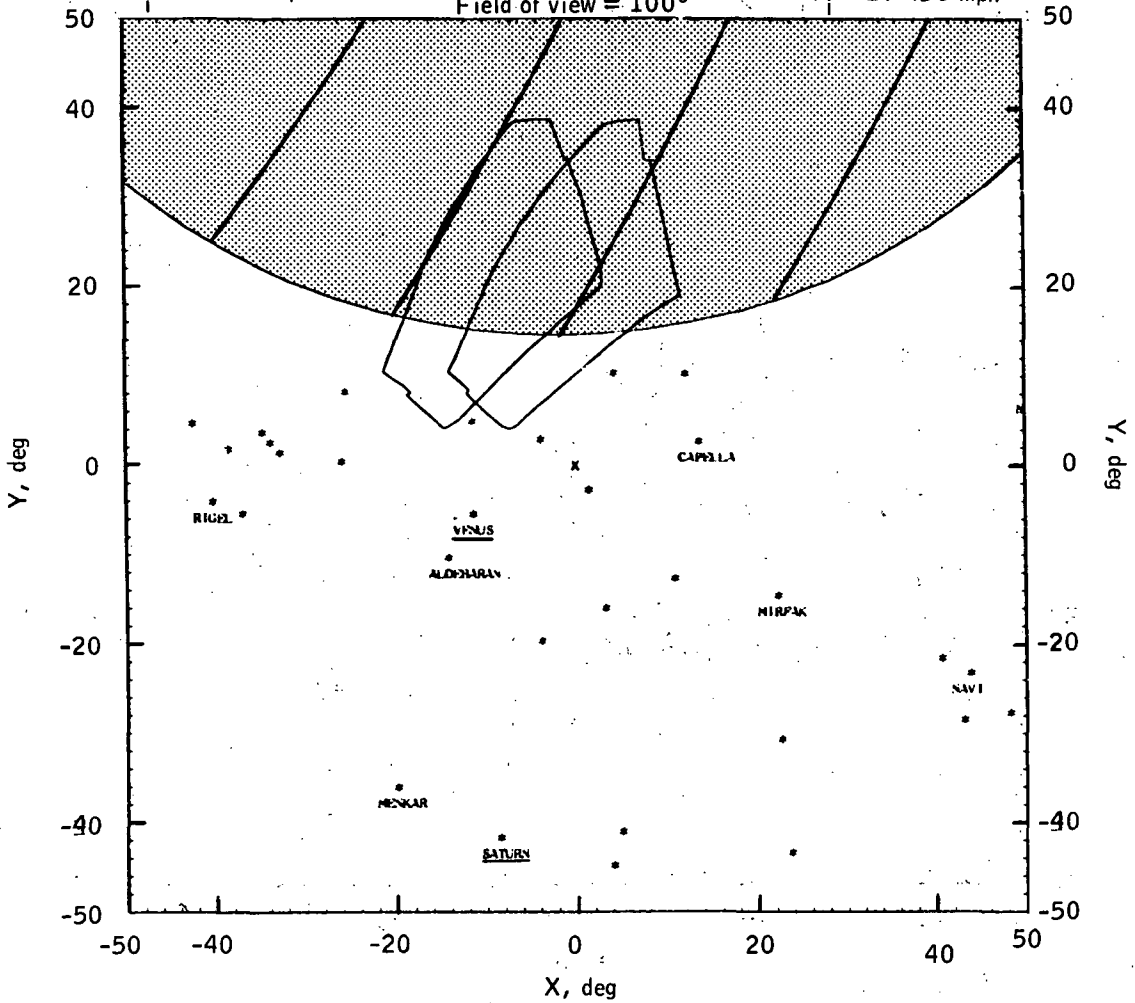

(a) Begin TLI burn (g. e. t. = 2:44:11).

Figure 5.1-1.- Translunar injection burn.

SEQ	1	3	7	8	9	10	11	13	45	47	48	49
X	-3	24	-8	13	-5	-18	9	-22	-10	-10	0	-14
Y	-8	-16	-23	-12	-11	-7	-4	4	-1	-5	-4	-4

SEQ	50	51	52	67	68	69	70	82	88	90	91	92
X	-15	-23	-6	13	-14	-19	8	24	23	0	3	7
Y	-3	1	3	-21	-4	-2	0	-19	-15	-15	-13	-12

SEQ	93	94	95	96	97	98	100
X	2	-16	-24	-23	-17	-3	4
Y	-7	-7	-5	-4	-4	-3	0

$R_E = 3555$ n. mi.

$h_E = 127$ stat. mi.

$V_i = 29\ 531$ fps

$V_i = 20\ 135$ mph

Field of view = 100°

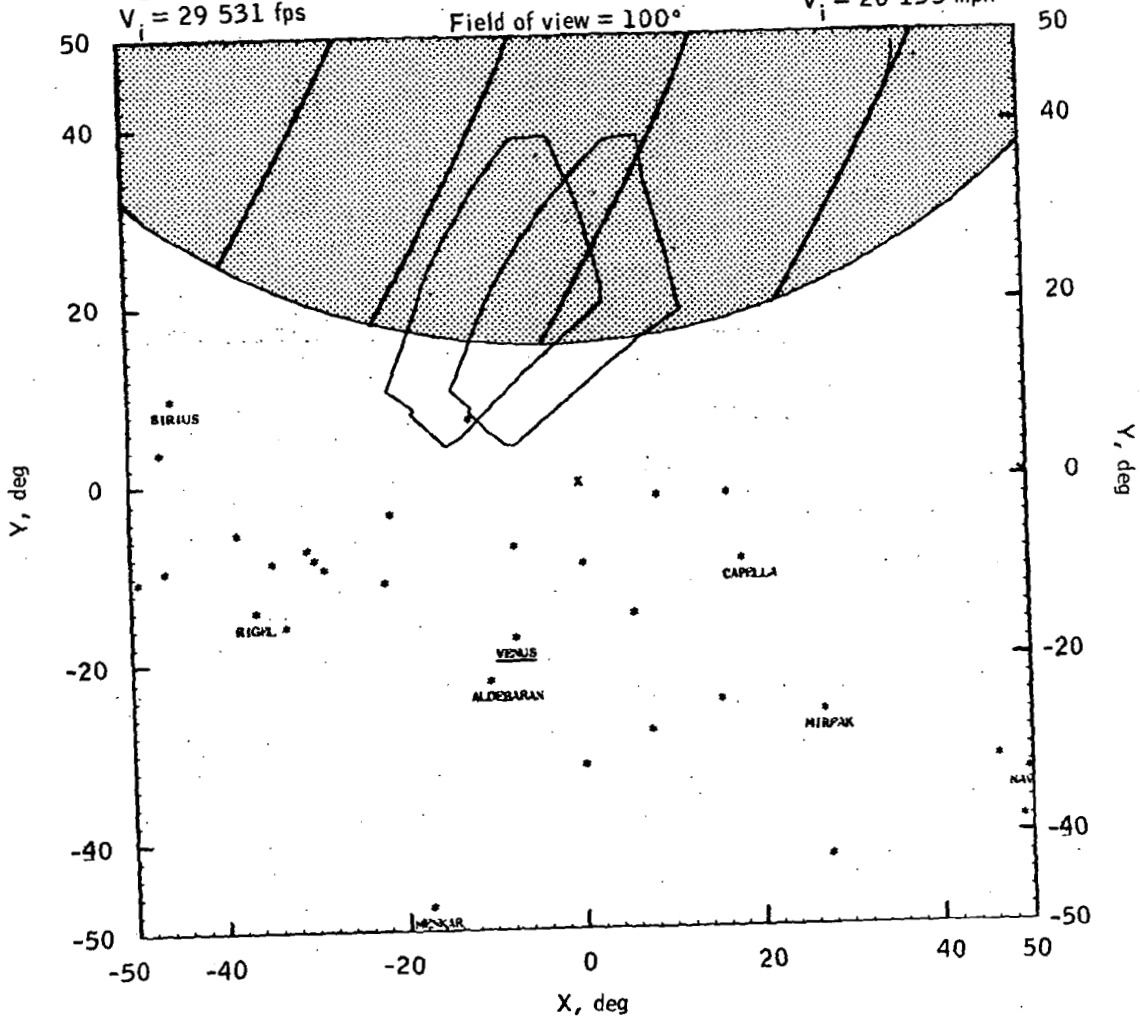

(b) Middle TLI burn (g.e.t. = 2:47:06).

Figure 5.1-1.- Continued.

SEQ	1	8	9	10	11	13	14	16	40	45	47	48
X	1	15	-3	-16	11	-20	8	14	3	-8	-9	2
Y	13	-17	-15	-10	-9	1	7	9	5	-5	-9	-9
SEQ	49	50	51	52	54	55	68	69	70	90	91	92
X	-12	-13	-21	-3	-24	4	-12	-17	10	1	5	9
Y	-8	-7	-1	0	4	4	-8	-6	-5	-20	-18	-17
SEQ	93	94	95	96	97	98	100					
X	4	-14	-22	-21	-15	-1	6					
Y	-12	-11	-8	-7	-8	-8	-5					

$R_E = 3610$ n. mi.

$h_E = 192$ stat. mi.

$V_i = 35\ 613$ fps

$V_i = 24\ 282$ mph

Field of view = 100°

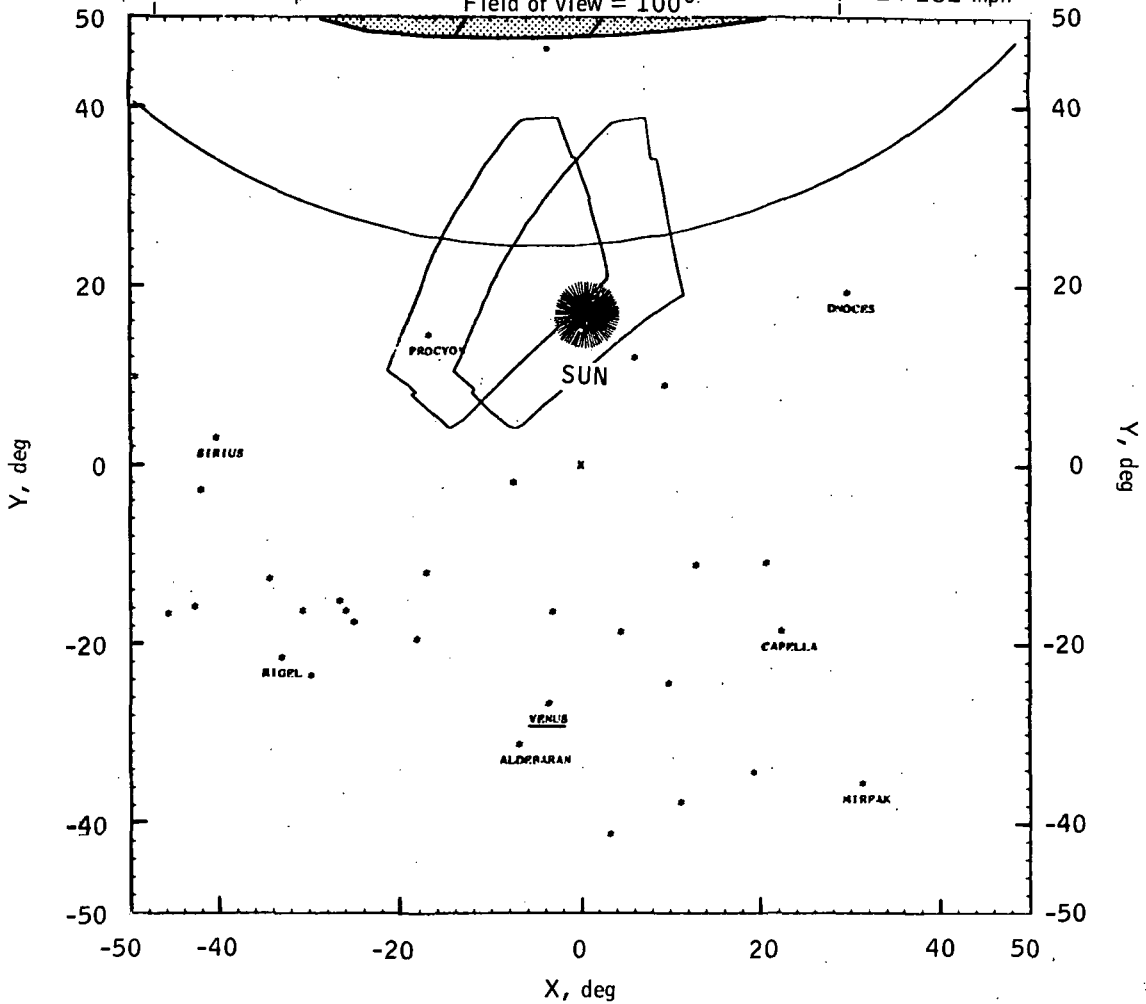

(c) End TLI burn (g.e.t. = 2:50:02).

Figure 5.1-1.- Concluded.

Page intentionally left blank

5.2 TRANSLUNAR COAST

Page intentionally left blank

5.2.1 EARTH VIEWS

Page intentionally left blank

SLQ	2	36	37	145	148
X	22	-24	18	-1	-19
Y	-22	0	4	12	-19

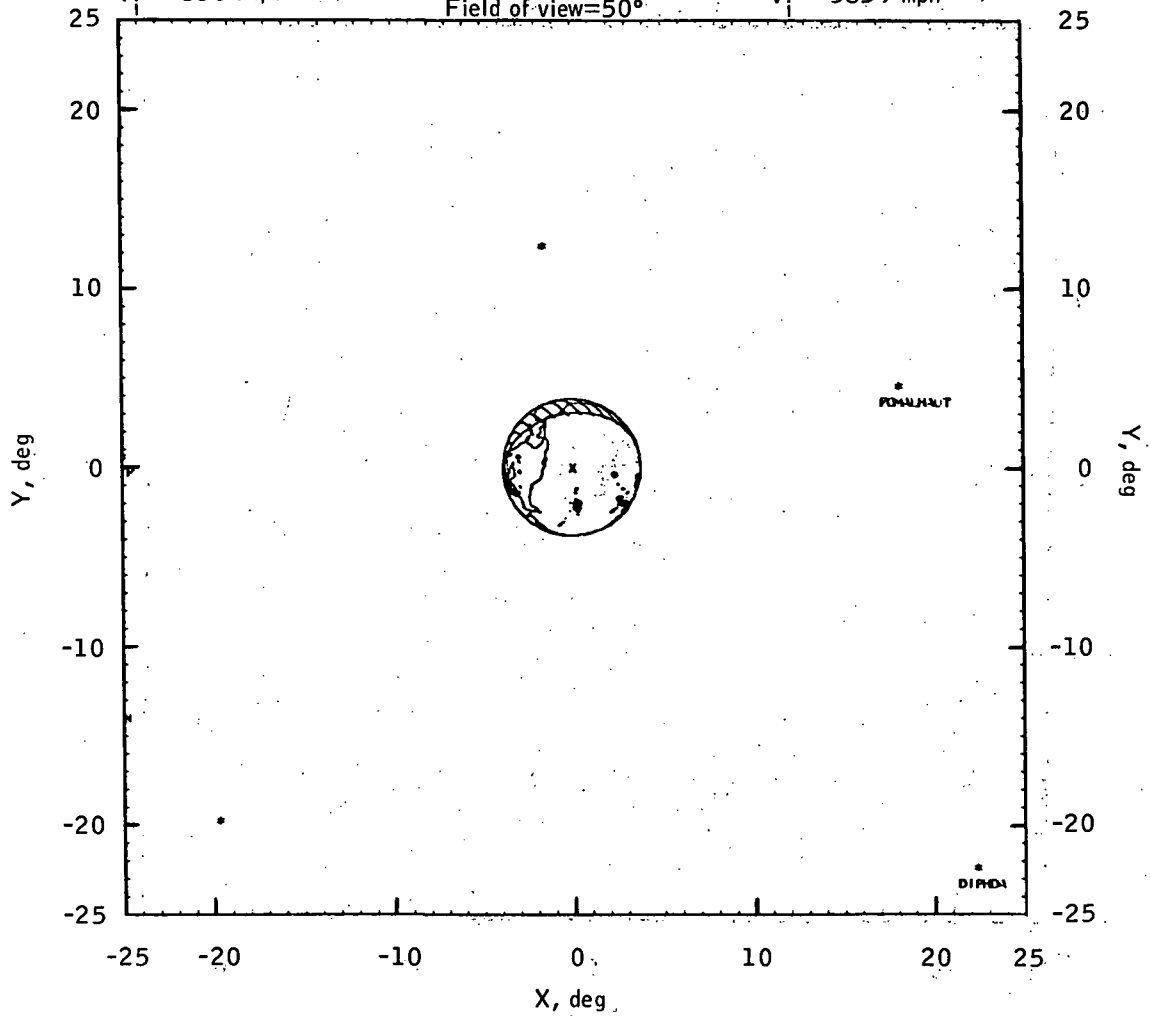
 $R_E = 51\,850 \text{ n. mi.}$
 $V_i = 8564 \text{ fps}$
 $h_E = 55\,704 \text{ stat. mi.}$
 $V_i = 5839 \text{ mph}$
Field of view = 50° 

(a) g.e.t. = 10 hours.

Figure 5.2.1-1.- Translunar coast-constant field of view (earth).

SEQ	2	37	145	148
X	21	18	-1	-19
Y	-14	13	21	-11

$R_E = 91\,747$ n. mi.

$h_E = 101\,617$ stat. mi.

$V_i = 5875$ fps

$V_i = 4006$ mph

Field of view = 50°

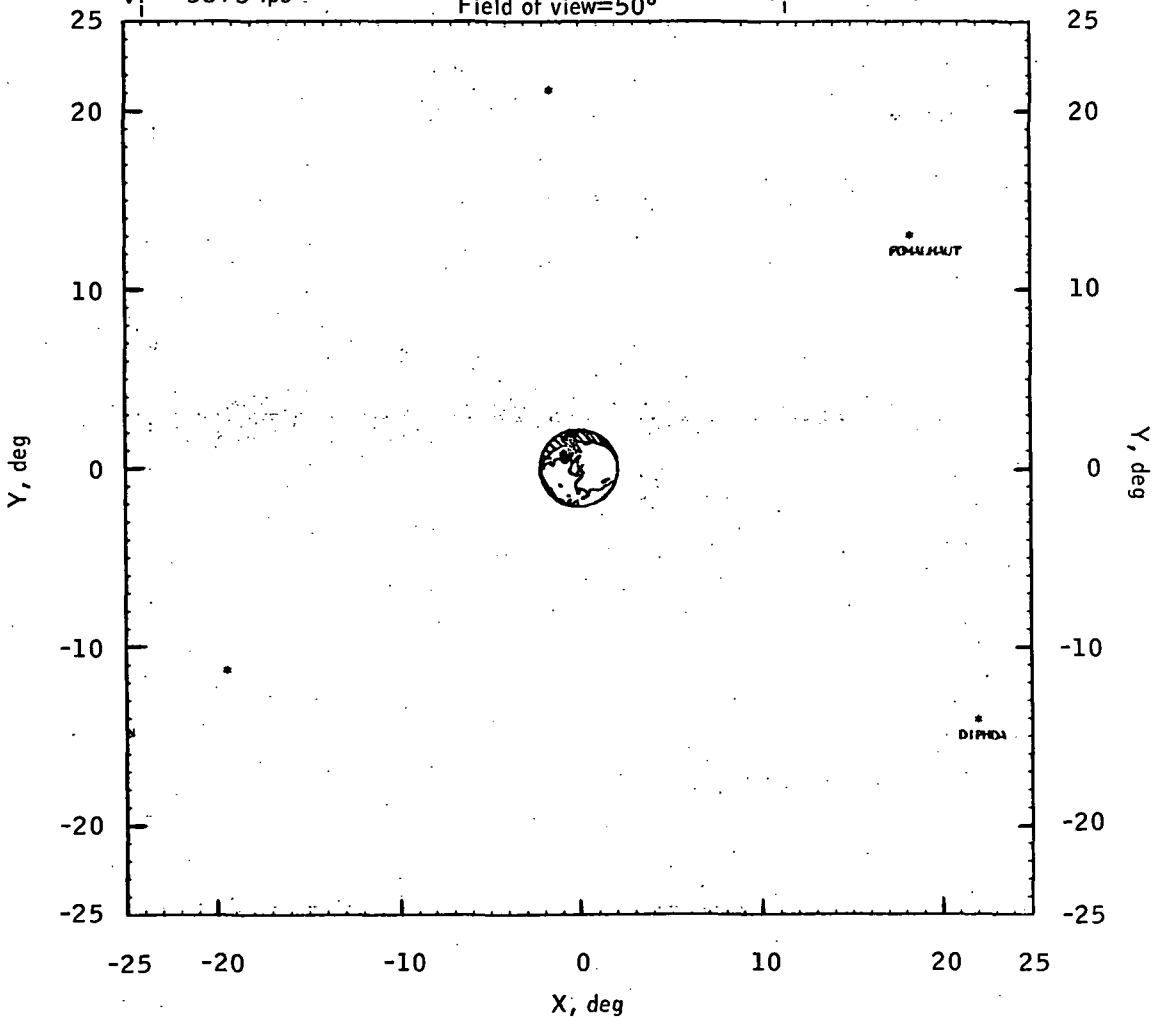

(b) g.e.t. = 20 hours.

Figure 5.2.1-1.- Continued.

SEQ	2	37	86	145	148
X	21	18	-10	-1	-19
Y	-10	16	-22	24	-7

 $R_E = 121.920 \text{ n. mi.}$
 $h_E = 136.339 \text{ stat. mi.}$
 $V_i = 4697 \text{ fps}$

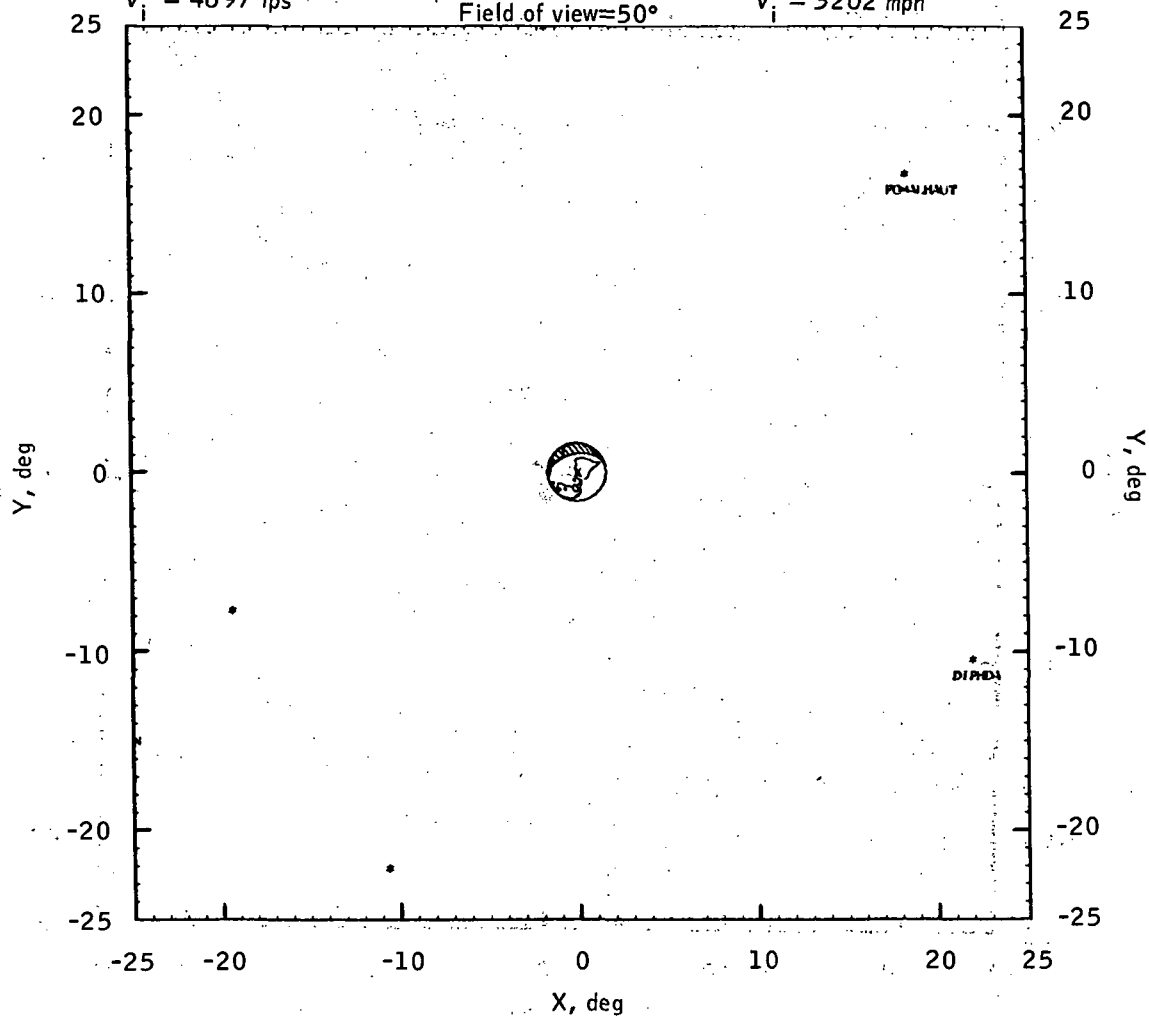
 Field of view = 50°
 $V_i = 3202 \text{ mph}$

(c) g.e.t. = 30 hours.

Figure 5.2.1-1: -Continued.

SEQ	2	37	86	148
X	21	18	-10	-19
Y	-8	18	-19	-5

$R_E = 146\,817$ n. mi.

$V_i = 3961$ fps

$h_E = 164\,990$ stat. mi.

$V_i = 2701$ mph

Field of view = 50°

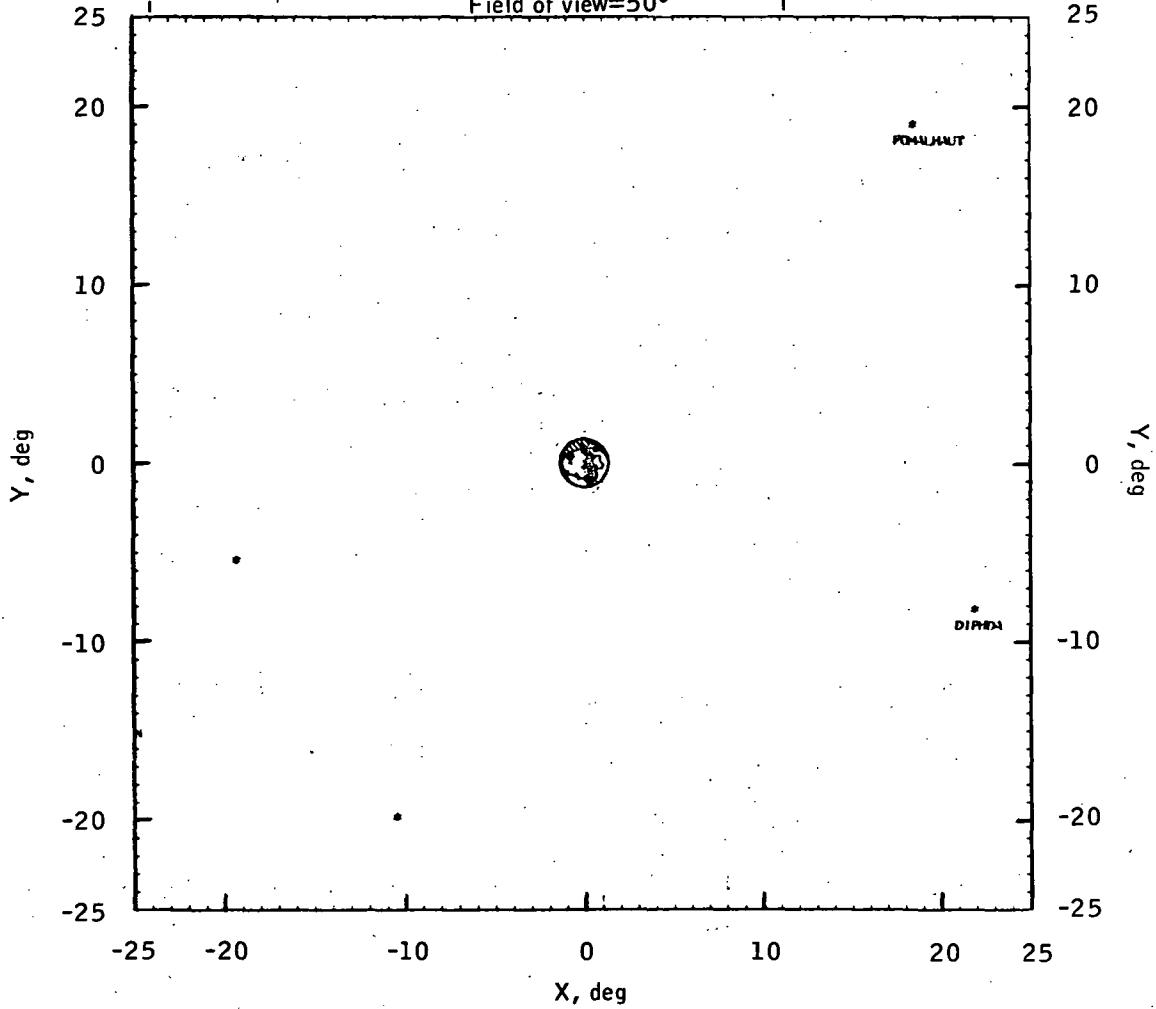

(d) g.e.t. = 40 hours.

Figure 5.2:1-1.- Continued.

SEQ	1	2	37	86	148
X	-23	21	18	-10	-19
Y	-24	-6	20	-18	-3

$R_E = 168\,146$ n. mi.

$h_E = 189\,534$ stat. mi.

$V_i = 3434$ fps

$V_i = 2341$ mph

Field of view = 50°

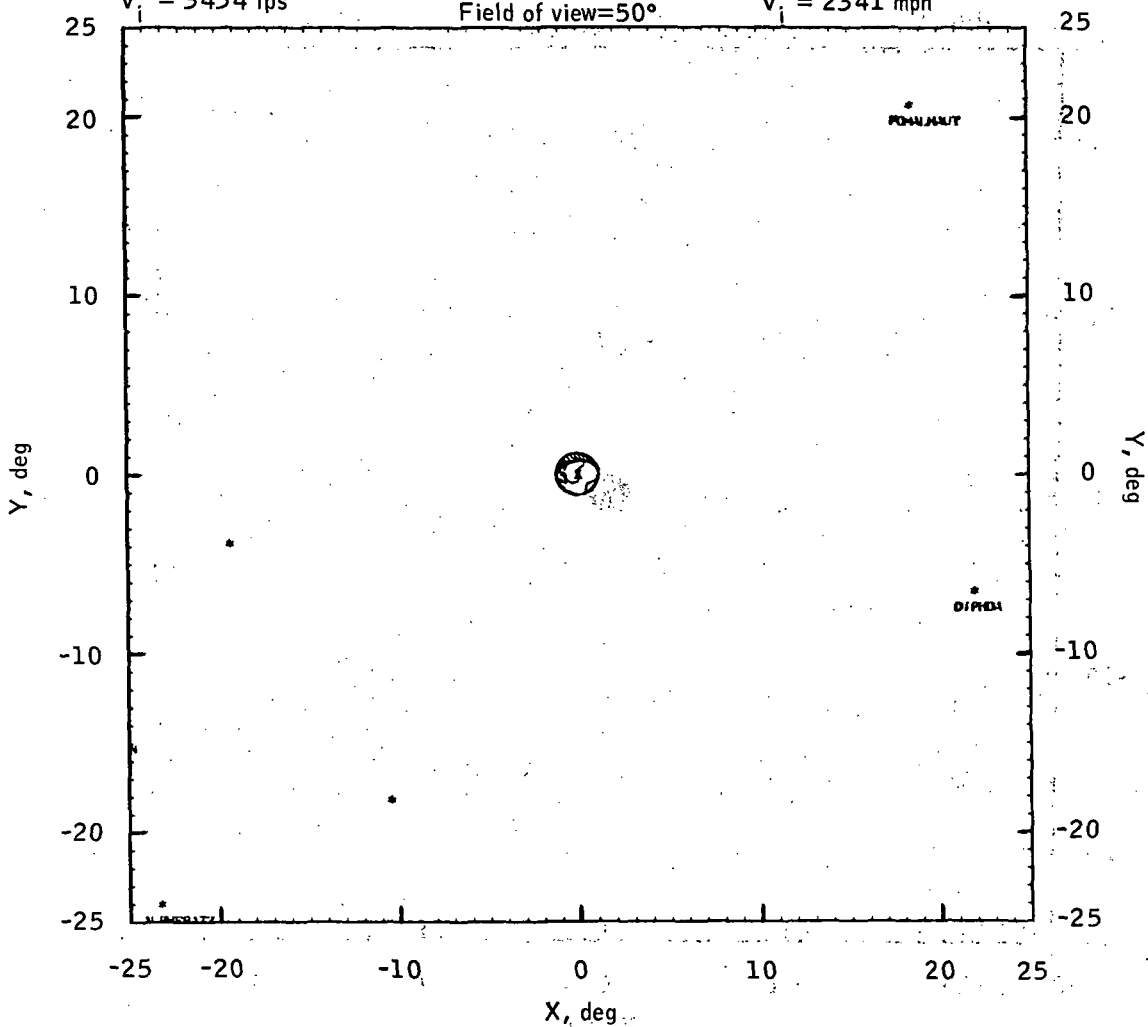

(e)g.e.t. = 50 hours..

Figure 5.2.1-1.- Continued..

SEQ	1	2	37	86	148
X	-22	21	18	-10	-19
Y	-23	-5	21	-17	-2

$R_E = 186\,861$ n. mi.

$h_E = 211\,071$ stat. mi.

$V_i = 3040$ fps

$V_i = 2073$ mph

Field of view = 50°

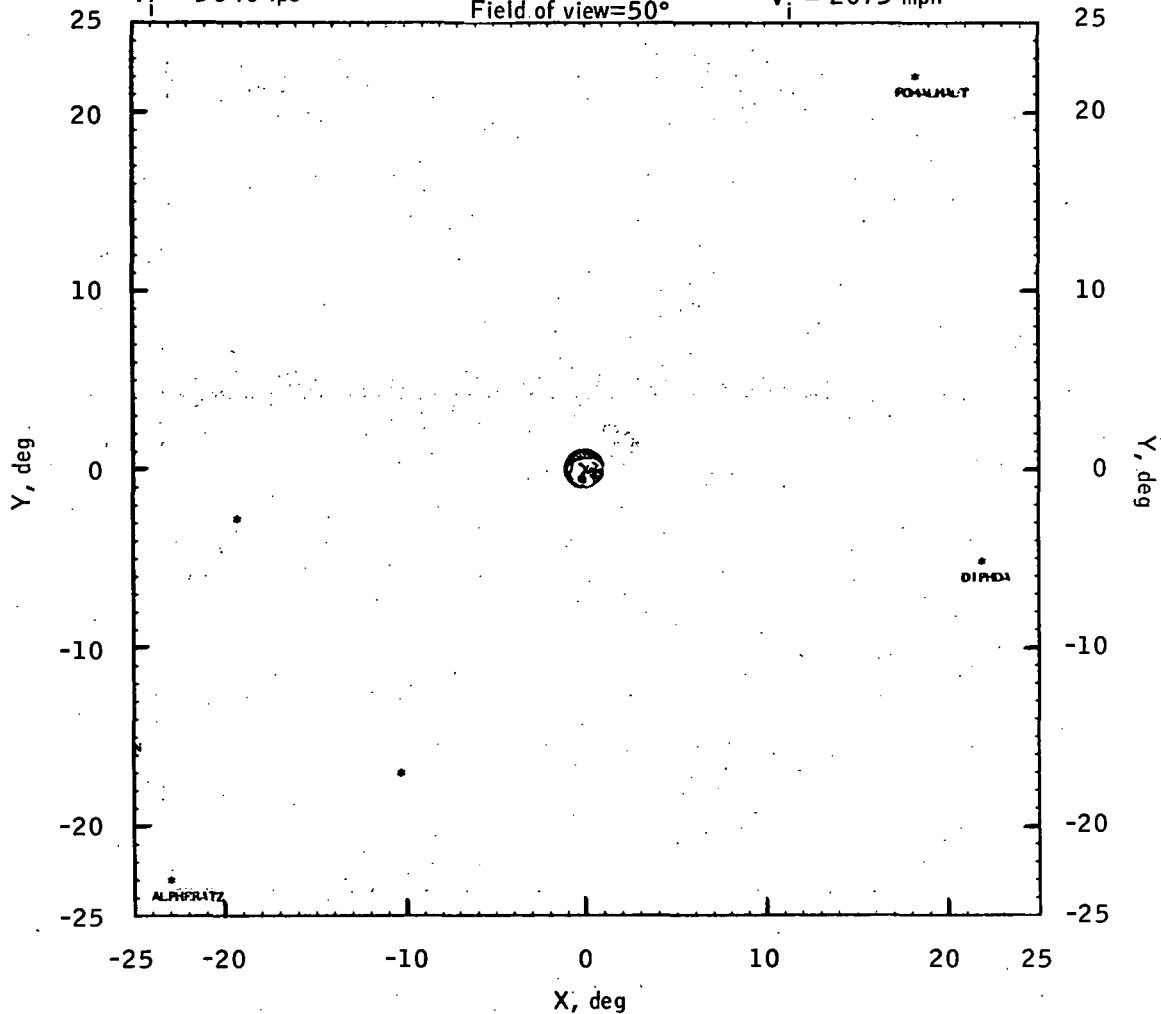

(f) g.e.t. = 60 hours.

Figure 5.2.1-1.- Continued.

SEQ	1	2	37	86	198
X	-21	22	17	-9	-19
Y	-23	-3	23	-16	-2

$R_M = 16\,000$ n. mi.

$h_M = 17\,332$ stat. mi.

$V_M = 4006$ fps

$V_i = 2731$ mph

Field of view = 50°

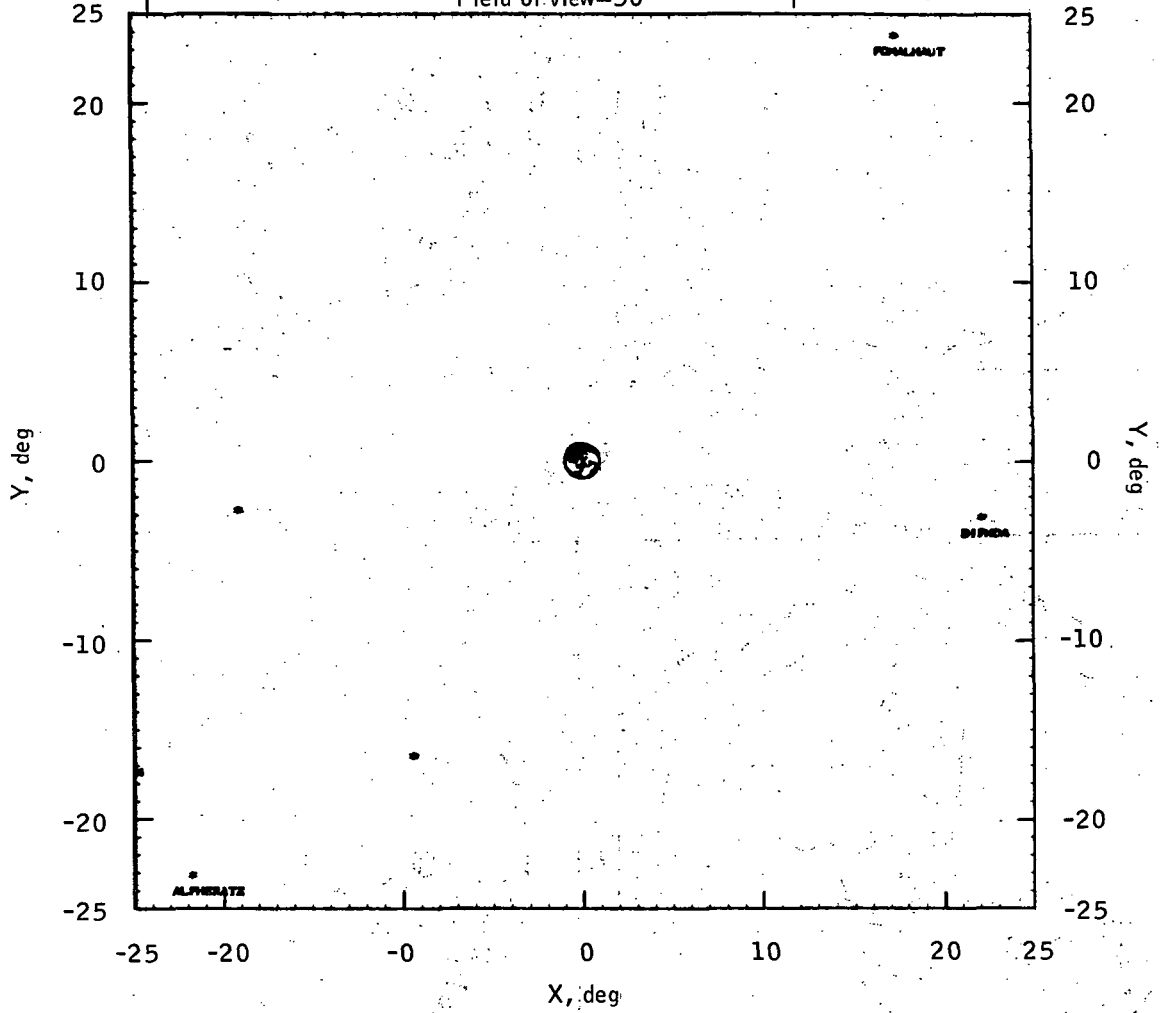

(g) g.e.t. = 70 hours.

Figure 5.2.1-1.- Concluded.

$R_E = 4727$ n. mi.
 $V_i = 31\ 059$ fps

$h_E = 1480$ stat. mi.
 $V_i = 21\ 177$ mph

Field of view = 100°

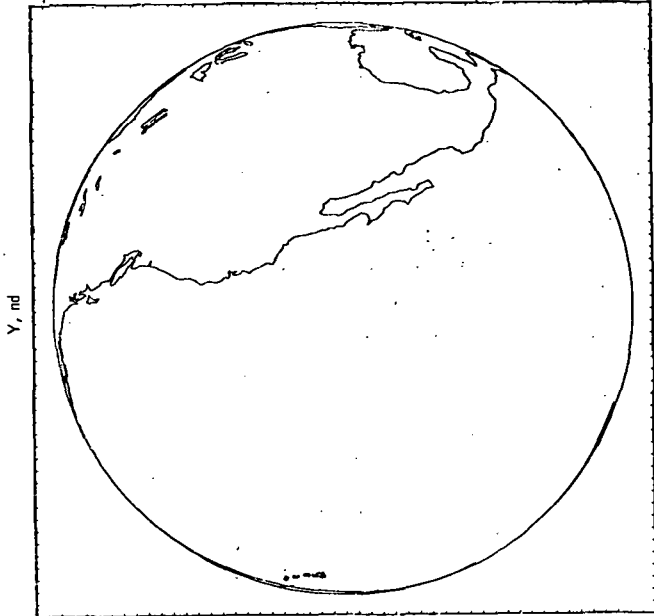

X, nd

(a) g.e.t. = 3 hours.

$R_E = 14\ 566$ n. mi.
 $V_i = 17\ 392$ fps

$h_E = 12\ 801$ stat. mi.
 $V_i = 11\ 858$ mph

Field of view = 30°

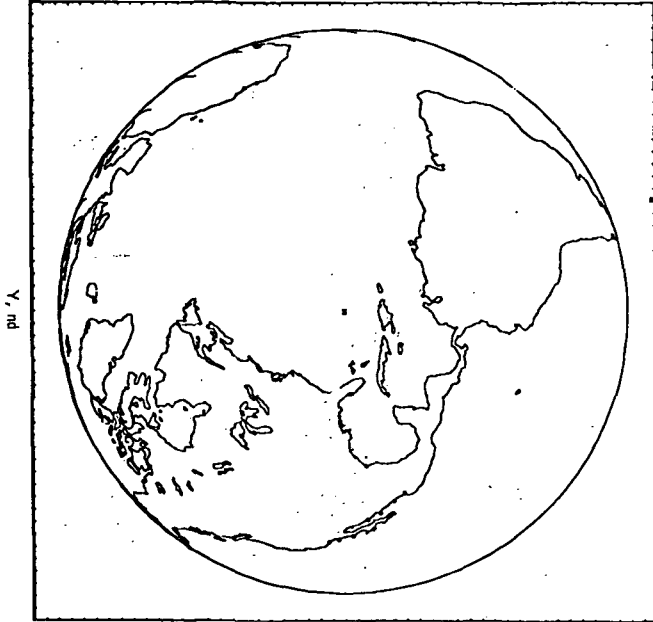

X, nd

(b) g.e.t. = 4 hours.

$R_E = 22\ 654$ n. mi.
 $V_i = 13\ 729$ fps

$h_E = 22\ 107$ stat. mi.
 $V_i = 9361$ mph

Field of view = 20°

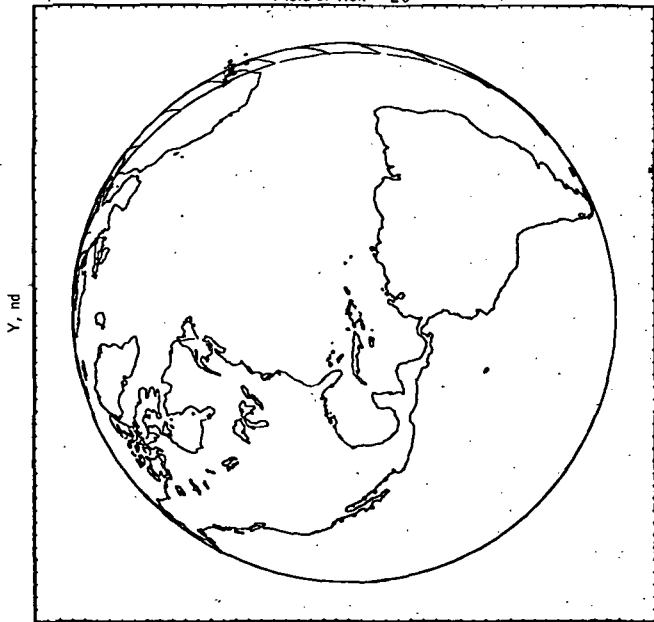

X, nd

(c) g.e.t. = 5 hours.

$R_E = 29\ 601$ n. mi.
 $V_i = 11\ 853$ fps

$h_E = 30\ 102$ stat. mi.
 $V_i = 8082$ mph

Field of view = 16°

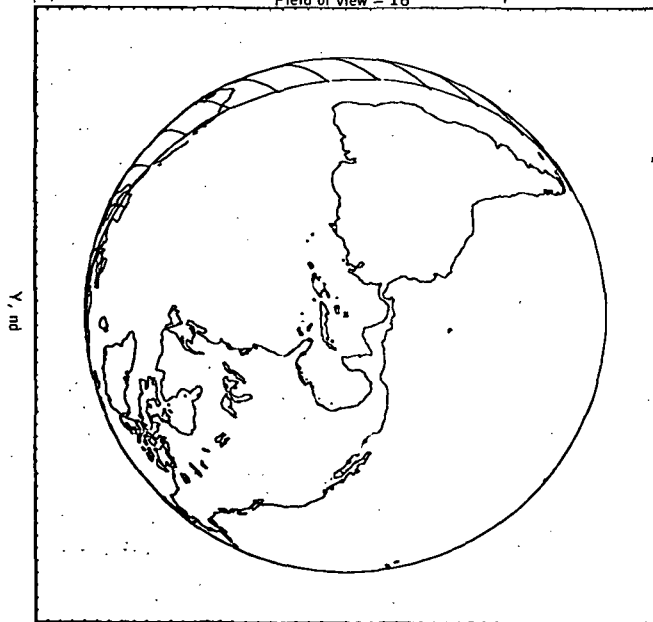

X, nd

(d) g.e.t. = 6 hours.

Figure 5.2.1-2.- Translunar coast-variable field of view (earth).

$R_E = 35\,827$ n. mi.
 $V_i = 10\,644$ fps

$h_E = 37\,265$ stat. mi.
 $V_i = 7257$ mph

Field of view = 12°

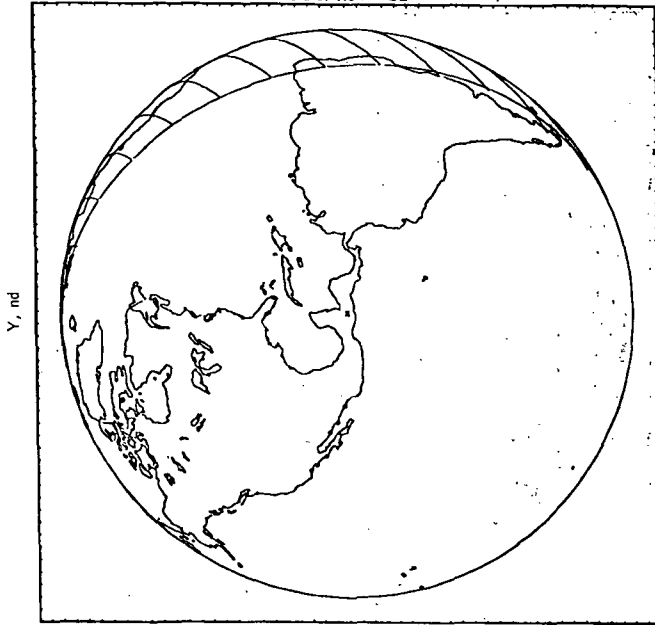

X, nd

(e) g.e.t. = 7 hours.

$R_E = 41\,536$ n. mi.
 $V_i = 9773$ fps

$h_E = 43\,836$ stat. mi.
 $V_i = 6663$ mph

Field of view = 12°

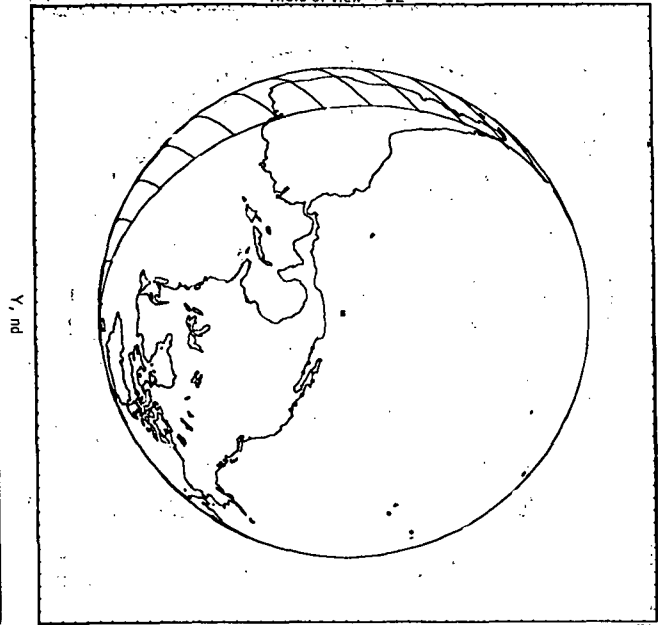

X, nd

(f) g.e.t. = 8 hours.

$R_E = 46\,851$ n. mi.
 $V_i = 9103$ fps

$h_E = 49\,953$ stat. mi.
 $V_i = 6207$ mph

Field of view = 10°

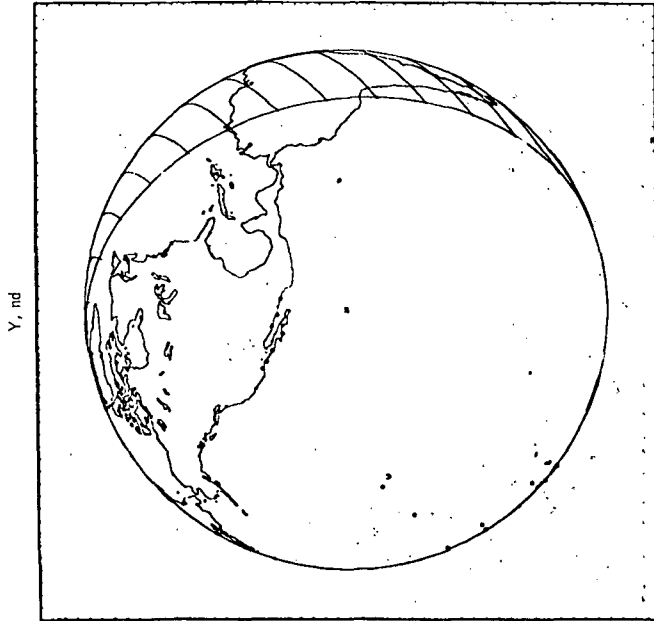

X, nd

(g) g.e.t. = 9 hours.

$R_E = 51\,850$ n. mi.
 $V_i = 8564$ fps

$h_E = 55\,704$ stat. mi.
 $V_i = 5839$ mph

Field of view = 10°

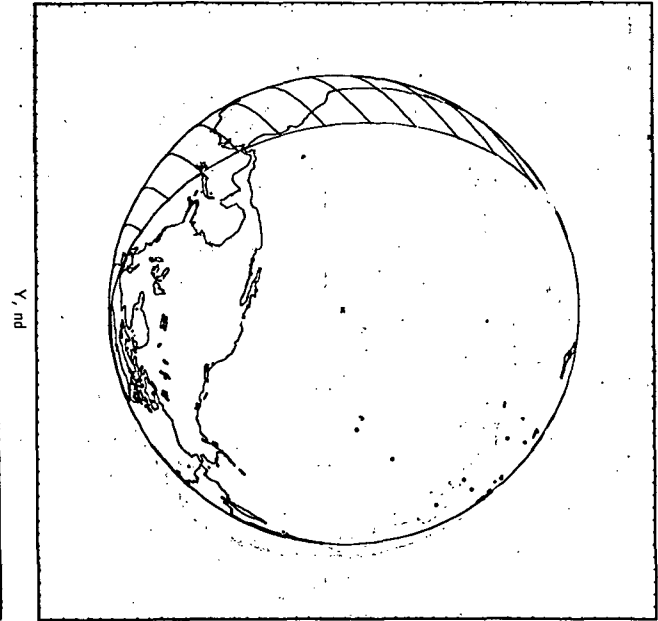

X, nd

(h) g.e.t. = 10 hours.

Figure 5.2.1-2. Continued.

$R_E = 56\,586$ n. mi.
 $V_i = 8115$ fps

$h_E = 61\,154$ stat. mi.
 $V_i = 5533$ mph

Field of view = 8°

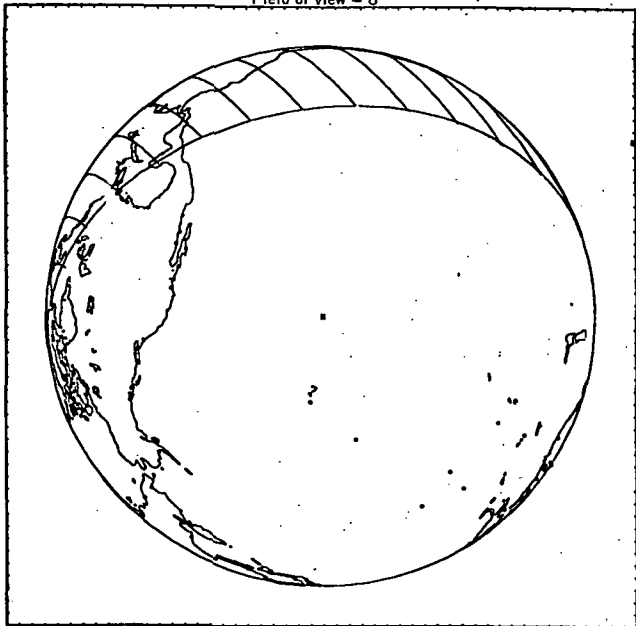

X, nd

(i) g.e.t. = 11 hours.

$R_E = 61\,098$ n. mi.
 $V_i = 7734$ fps

$h_E = 66\,348$ stat. mi.
 $V_i = 5273$ mph

Field of view = 7°

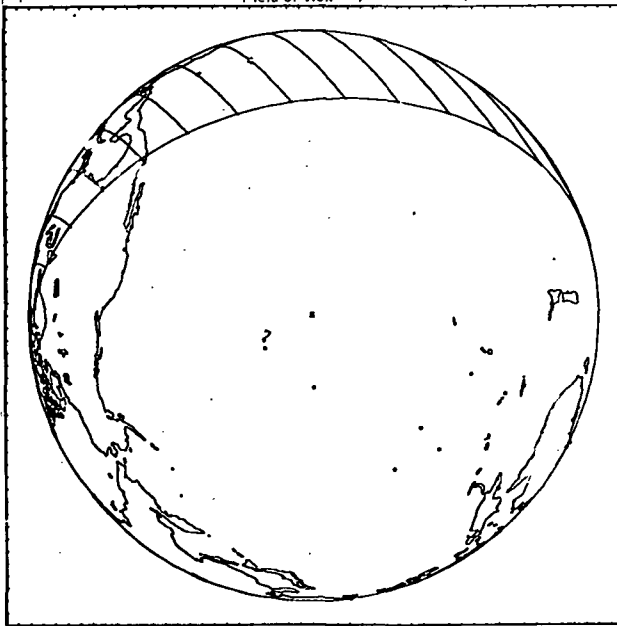

X, nd

(j) g.e.t. = 12 hours.

$R_E = 65\,418$ n. mi.
 $V_i = 7403$ fps

$h_E = 71\,319$ stat. mi.
 $V_i = 5047$ mph

Field of view = 8°

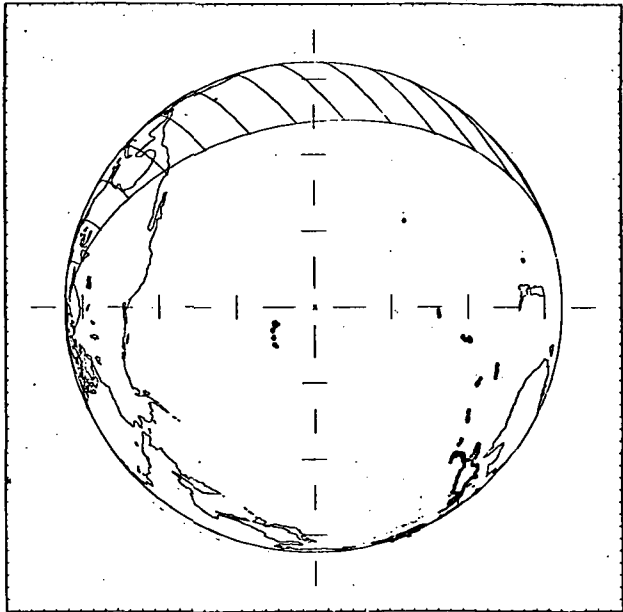

X, nd

(k) g.e.t. = 13 hours.

$R_E = 69\,568$ n. mi.
 $V_i = 7112$ fps

$h_E = 76\,094$ stat. mi.
 $V_i = 4849$ mph

Field of view = 6°

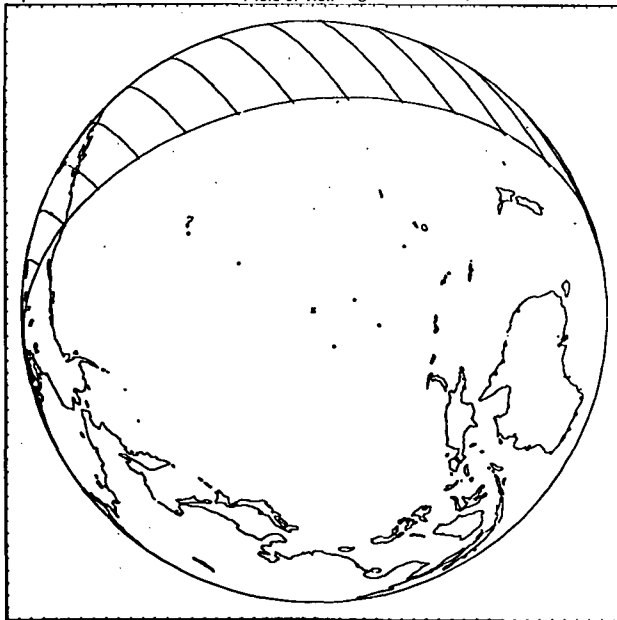

X, nd

(l) g.e.t. = 14 hours.

Figure 5.2.1-2.- Continued.

$R_E = 73\ 567$ n. mi.
 $V_i = 6854$ fps

$h_E = 80\ 696$ stat. mi.
 $V_i = 4673$ mph

Field of view = 6°

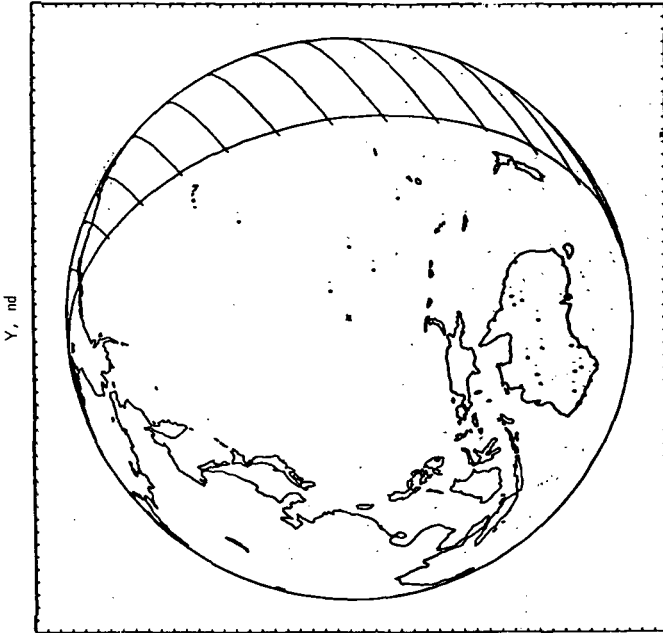

X, nd

(m) g.e.t. = 15 hours.

$R_E = 77\ 430$ n. mi.
 $V_i = 6621$ fps

$h_E = 85\ 141$ stat. mi.
 $V_i = 4514$ mph

Field of view = 6°

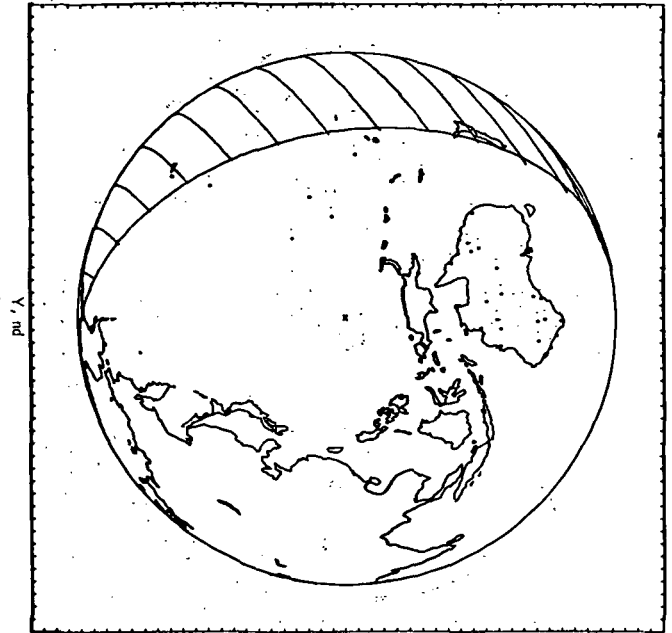

X, nd

(n) g.e.t. = 16 hours.

$R_E = 81\ 169$ n. mi.
 $V_i = 6410$ fps

$h_E = 89\ 445$ stat. mi.
 $V_i = 4370$ mph

Field of view = 5°

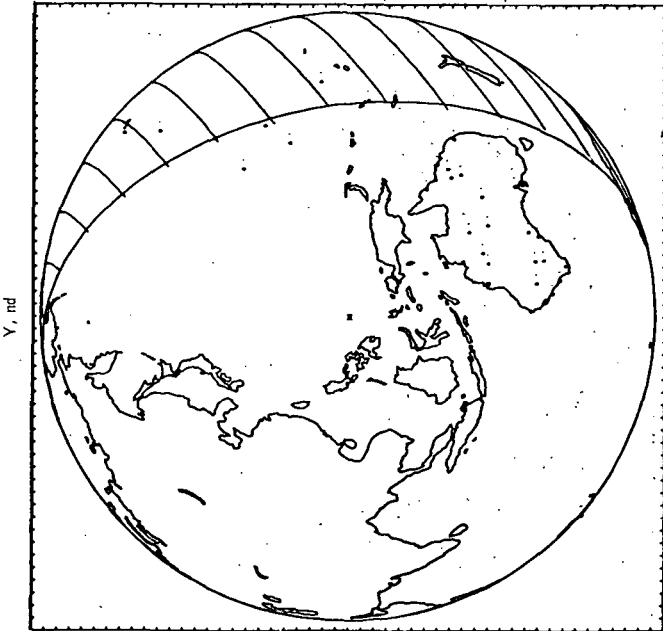

X, nd

(o) g.e.t. = 17 hours.

$R_E = 84\ 796$ n. mi.
 $V_i = 6216$ fps

$h_E = 93\ 618$ stat. mi.
 $V_i = 4238$ mph

Field of view = 5°

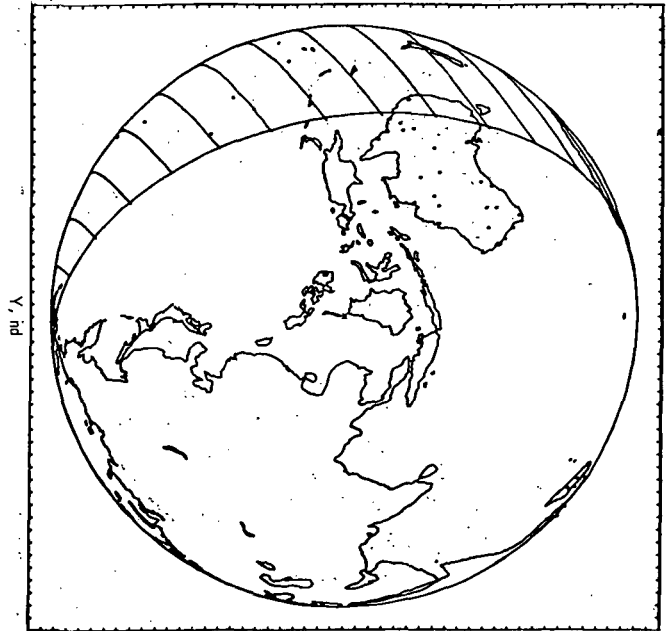

X, nd

(p) g.e.t. = 18 hours.

$R_E = 88\,320$ n. mi.
 $V_i = 6039$ fps

$h_E = 97\,673$ stat. mi.
 $V_i = 4117$ mph

Field of view = 5°

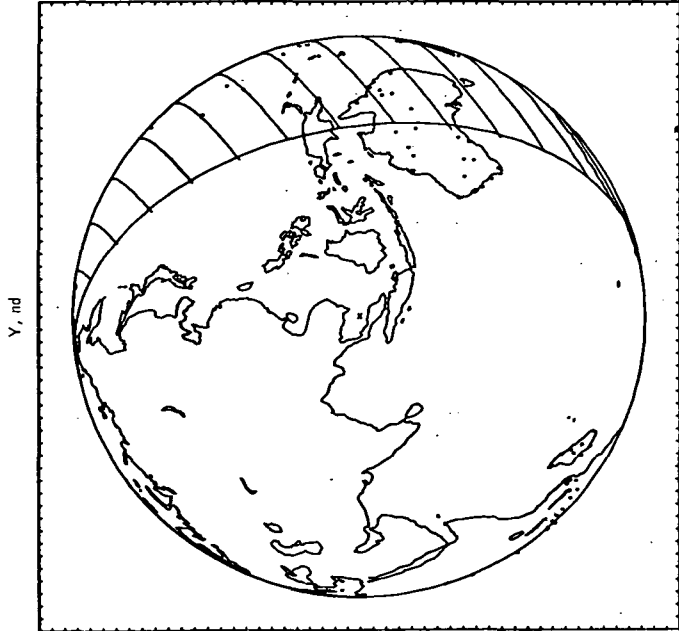

X, nd

(a) g.e.t. = 19 hours.

$R_E = 91\,747$ n. mi.
 $V_i = 5875$ fps

$h_E = 101\,617$ stat. mi.
 $V_i = 4006$ mph

Field of view = 5°

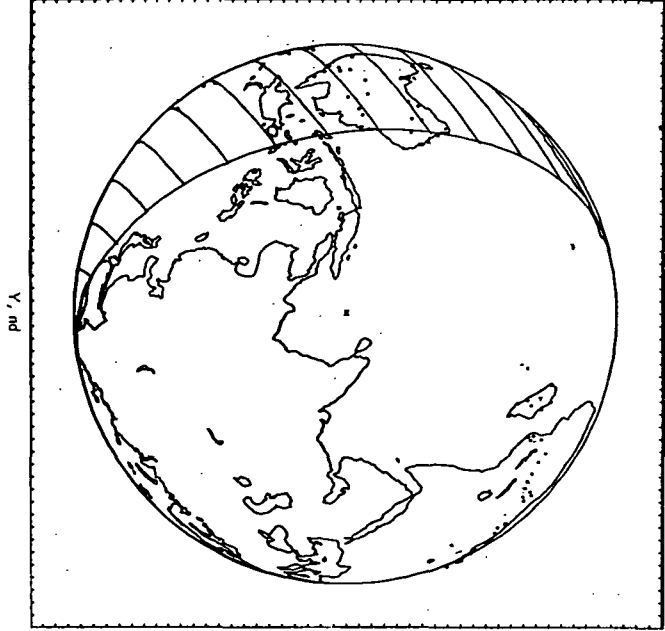

X, nd

(r) g.e.t. = 20 hours.

$R_E = 95\,086$ n. mi.
 $V_i = 5722$ fps

$h_E = 105\,459$ stat. mi.
 $V_i = 3901$ mph

Field of view = 5°

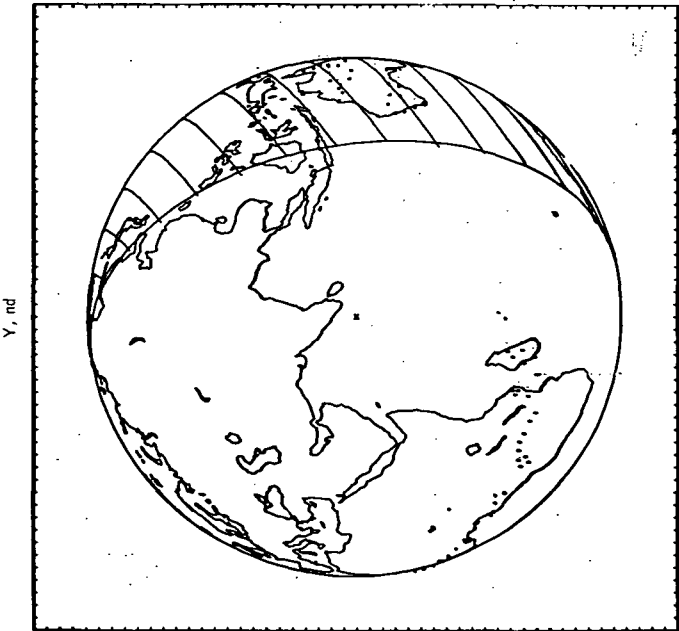

X, nd

(s) g.e.t. = 21 hours.

$R_E = 98\,341$ n. mi.
 $V_i = 5580$ fps

$h_E = 109\,205$ stat. mi.
 $V_i = 3805$ mph

Field of view = 5°

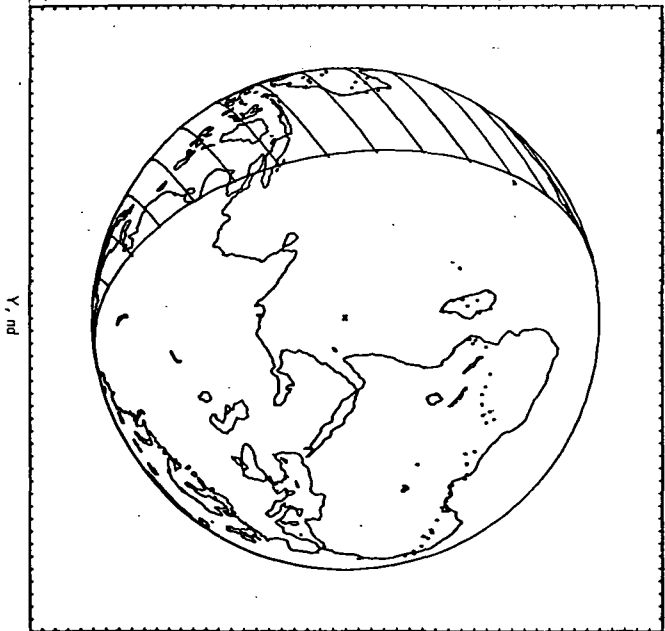

X, nd

(t) g.e.t. = 22 hours.

$R_E = 101\,519$ n. mi.
 $V_i = 5446$ fps

$h_E = 112\,862$ stat. mi.
 $V_i = 3713$ mph

Field of view = 4°

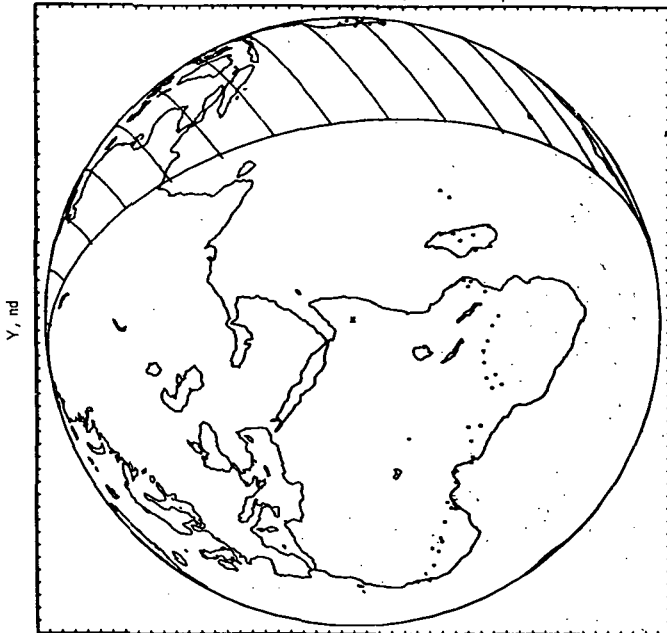

(u) g.e.t. = 23 hours.

$R_E = 104\,623$ n. mi.
 $V_i = 5321$ fps

$h_E = 116\,434$ stat. mi.
 $V_i = 3628$ mph

Field of view = 4°



(v) g.e.t. = 24 hours.

$R_E = 107\,659$ n. mi.
 $V_i = 5203$ fps

$h_E = 119\,928$ stat. mi.
 $V_i = 3547$ mph

Field of view = 4°

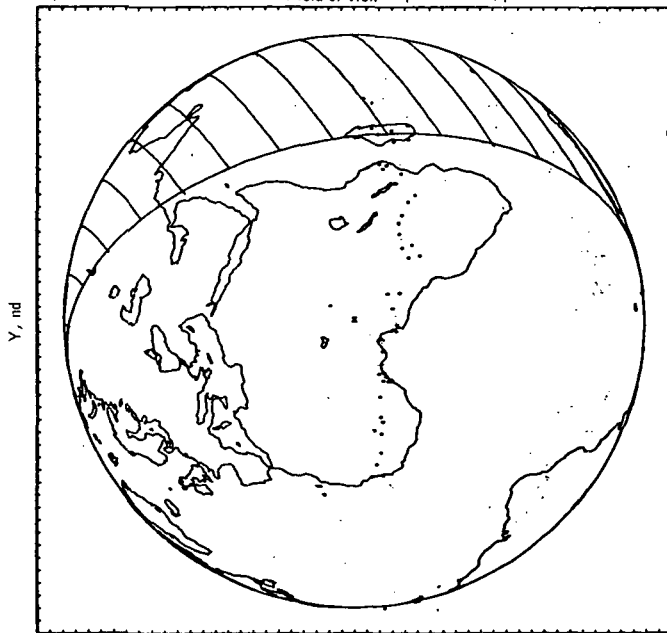

(w) g.e.f. = 25 hours.

$R_E = 110\,629$ n. mi.
 $V_i = 5091$ fps

$h_E = 123\,345$ stat. mi.
 $V_i = 3471$ mph

Field of view = 4°

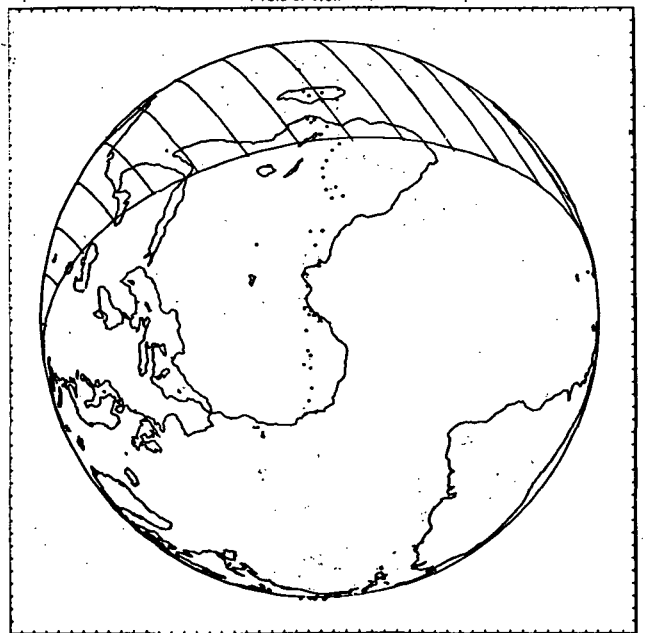

(x) g.e.t. = 26 hours.

Figure 5.2.1-2.- Continued.

$R_E = 113\,537$ n. mi.
 $V_i = 4985$ fps

$h_E = 126\,692$ stat. mi.
 $V_i = 3399$ mph

Field of view = 4°

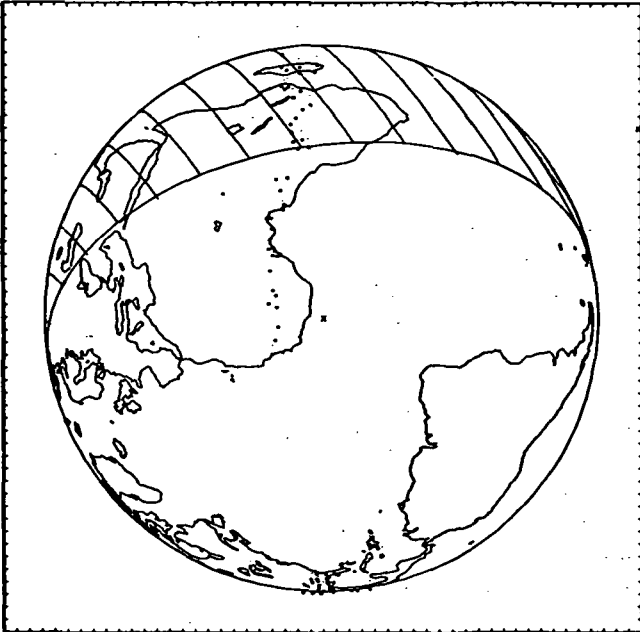

X, nd

(y) g.e.t. = 27 hours.

$R_E = 116\,387$ n. mi.
 $V_i = 4884$ fps

$h_E = 129\,972$ stat. mi.
 $V_i = 3330$ mph

Field of view = 4°

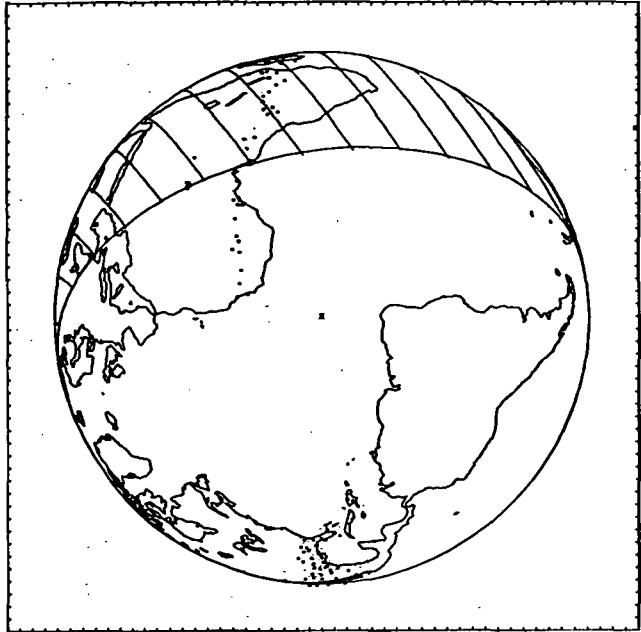

X, nd

(z) g.e.t. = 28 hours.

$R_E = 119\,180$ n. mi.
 $V_i = 4789$ fps

$h_E = 133\,186$ stat. mi.
 $V_i = 3265$ mph

Field of view = 4°

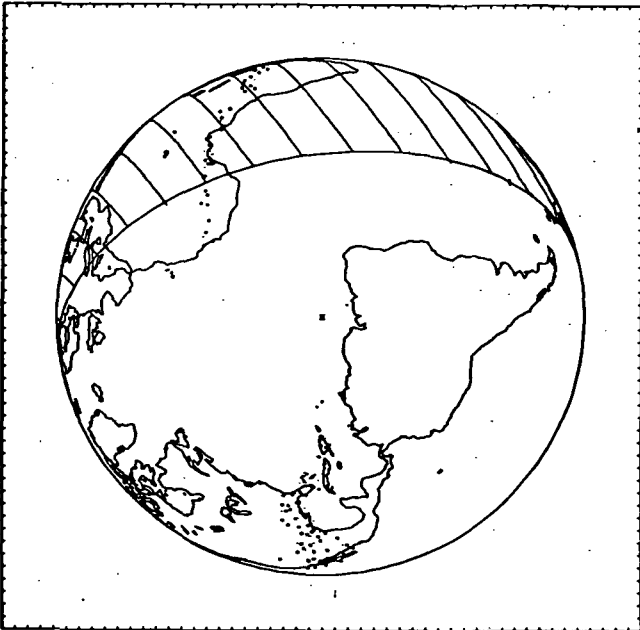

X, nd

(aa) g.e.t. = 29 hours.

$R_E = 121\,920$ n. mi.
 $V_i = 4697$ fps

$h_E = 136\,339$ stat. mi.
 $V_i = 3202$ mph

Field of view = 4°

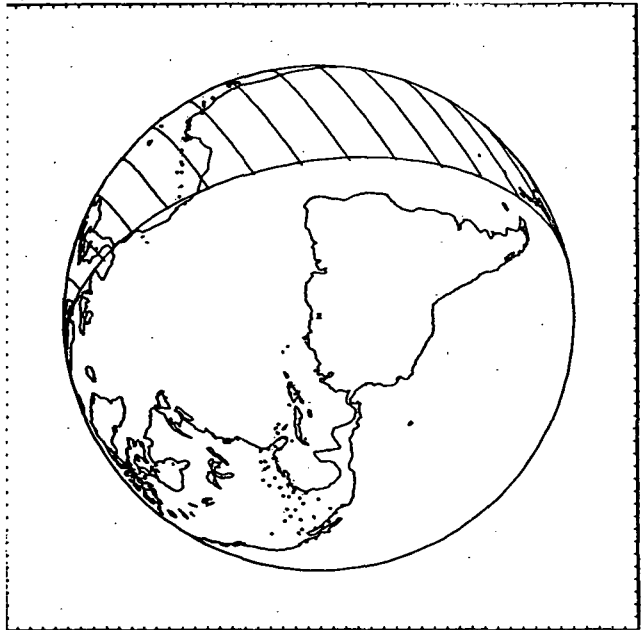

X, nd

(bb) g.e.t. = 30 hours.

$R_E = 124\,609$ n. mi.
 $V_i = 4610$ fps

$h_E = 139\,433$ stat. mi.
 $V_i = 3143$ mph

Field of view = 4°

Y, nd

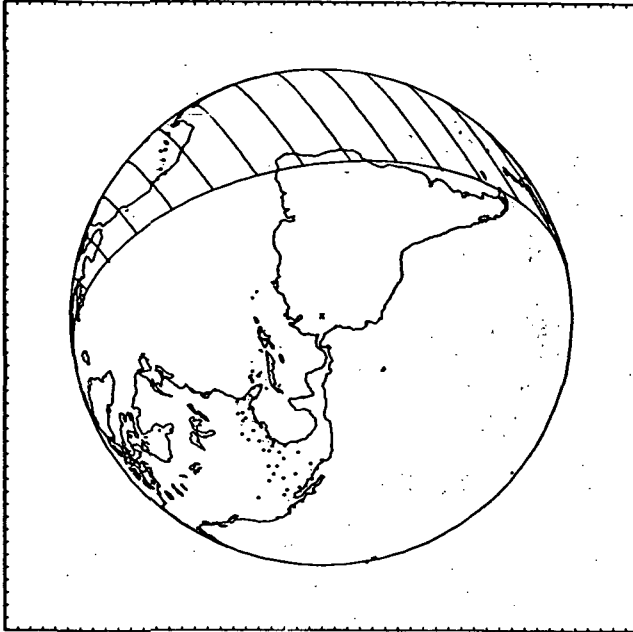

X, nd

(cc) g.e.t. = 31 hours.

57

$R_E = 127\,248$ n. mi.
 $V_i = 4526$ fps

$h_E = 142\,471$ stat. mi.
 $V_i = 3085$ mph

Field of view = 4°

Y, nd

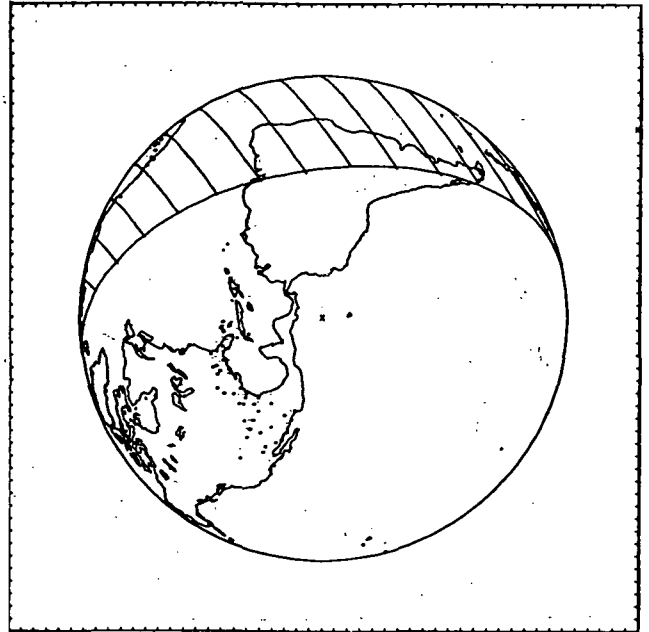

X, nd

(dd) g.e.t. = 32 hours.

$R_E = 129\,841$ n. mi.
 $V_i = 4445$ fps

$h_E = 145\,455$ stat. mi.
 $V_i = 3031$ mph

Field of view = 4°

Y, nd

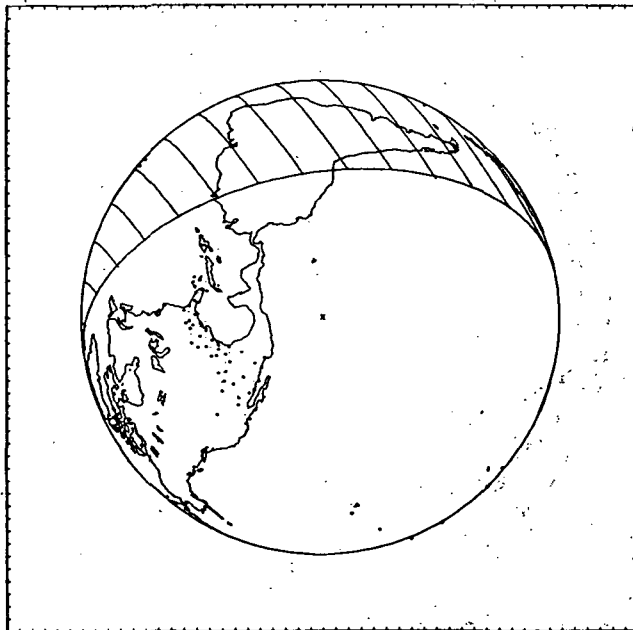

X, nd

(ee) g.e.t. = 33 hours.

$R_E = 132\,389$ n. mi.
 $V_i = 4368$ fps

$h_E = 148\,386$ stat. mi.
 $V_i = 2978$ mph

Field of view = 4°

Y, nd

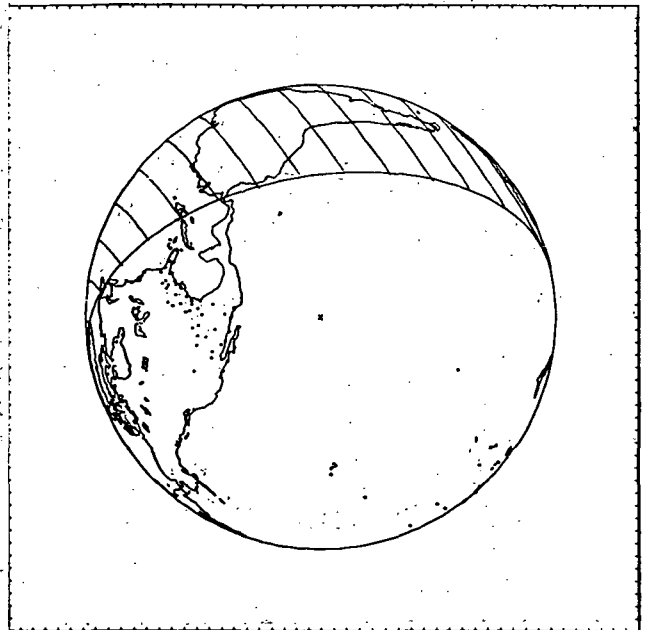

X, nd

(ff) g.e.t. = 34 hours.

Figure 5.2.1-2.- Continued.

$R_E = 134\ 893$ n. mi.
 $V_i = 4294$ fps

$h_E = 151\ 269$ stat. mi.
 $V_i = 2928$ mph

Field of view = 4°

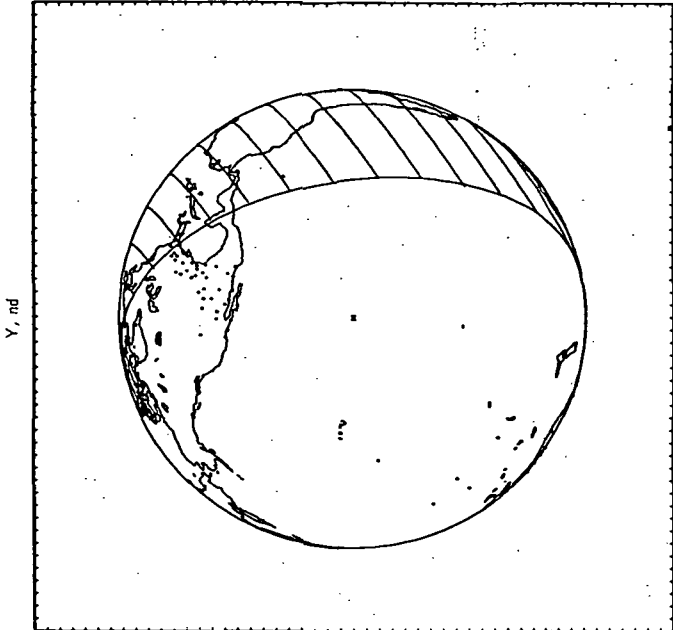

X, nd

(gg) g.e.t. = 35 hours.

$R_E = 137\ 356$ n. mi.
 $V_i = 4222$ fps

$h_E = 154\ 102$ stat. mi.
 $V_i = 2879$ mph

Field of view = 4°

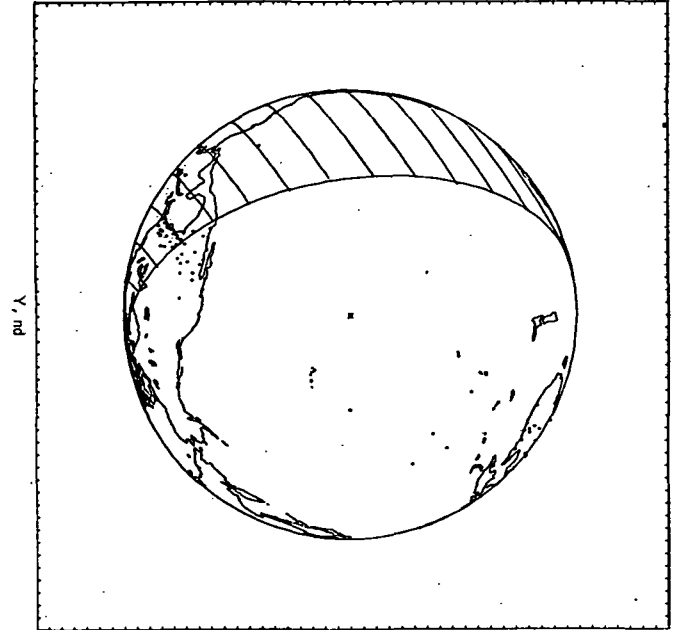

X, nd

(hh) g.e.t. = 36 hours.

$R_E = 139\ 778$ n. mi.
 $V_i = 4154$ fps

$h_E = 156\ 889$ stat. mi.
 $V_i = 2832$ mph

Field of view = 4°

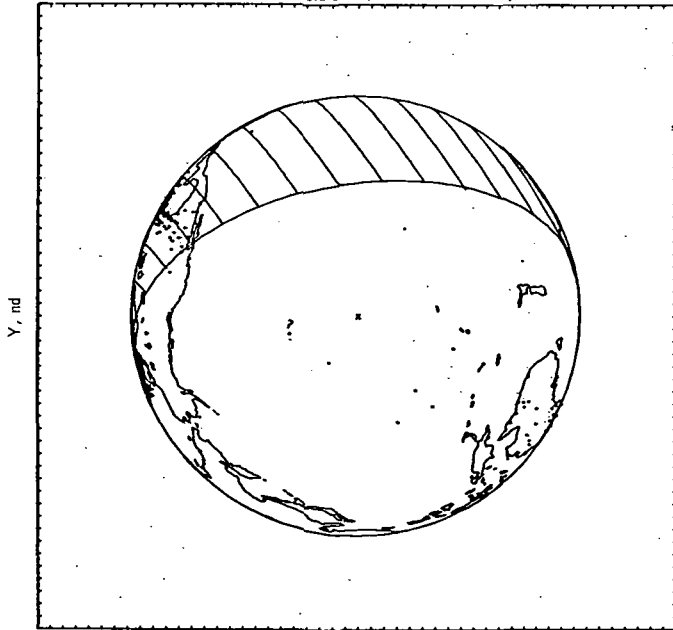

X, nd

(ii) g.e.t. = 37 hours.

$R_E = 142\ 162$ n. mi.
 $V_i = 4087$ fps

$h_E = 159\ 633$ stat. mi.
 $V_i = 2787$ mph

Field of view = 3°

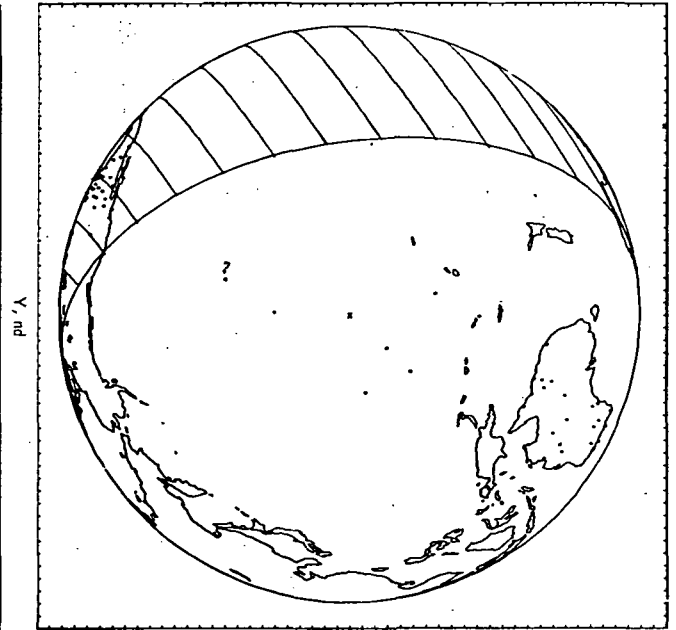

X, nd

(jj) g.e.t. = 38 hours.

Figure 5.2.1-2.- Continued.

$R_E = 144\ 508$ n. mi.
 $V_i = 4023$ fps

$h_E = 162\ 332$ stat. mi.
 $V_i = 2743$ mph

Field of view = 3°

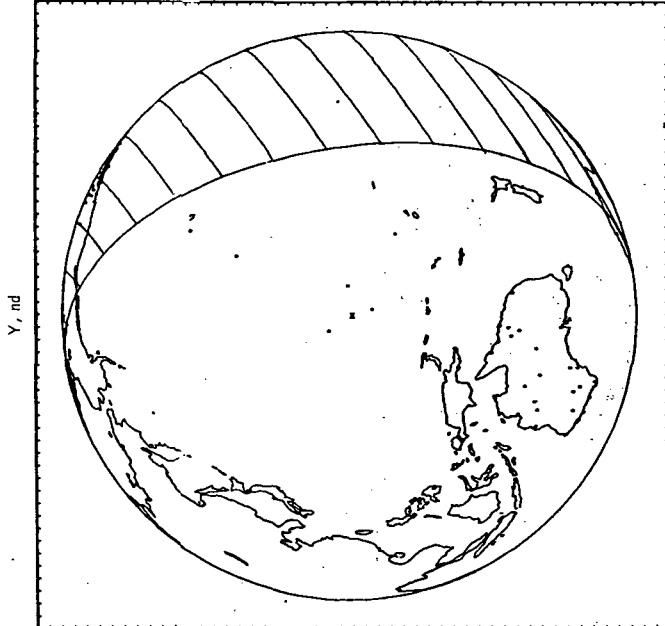

X, nd

(kk) g.e.t. = 39 hours.

$R_E = 146\ 817$ n. mi.
 $V_i = 3961$ fps

$h_E = 164\ 990$ stat. mi.
 $V_i = 2701$ mph

Field of view = 3°

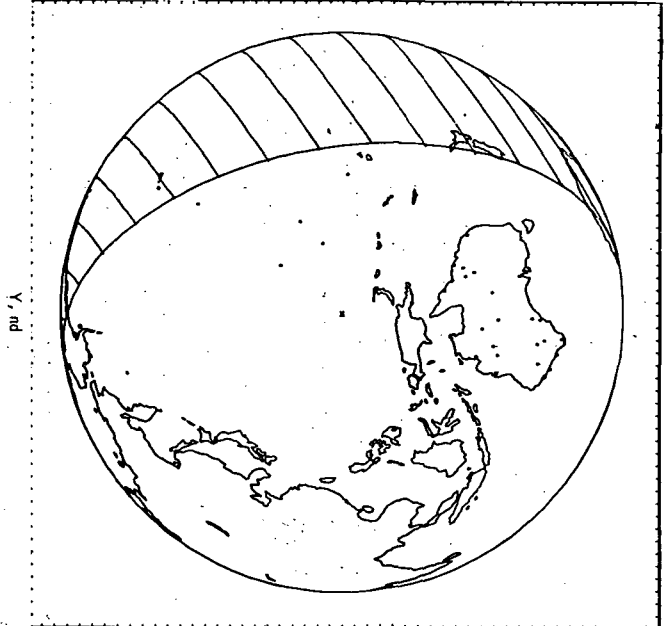

X, nd

(ll) g.e.t. = 40 hours.

$R_E = 149\ 091$ n. mi.
 $V_i = 3900$ fps

$h_E = 167\ 608$ stat. mi.
 $V_i = 2659$ mph

Field of view = 3°

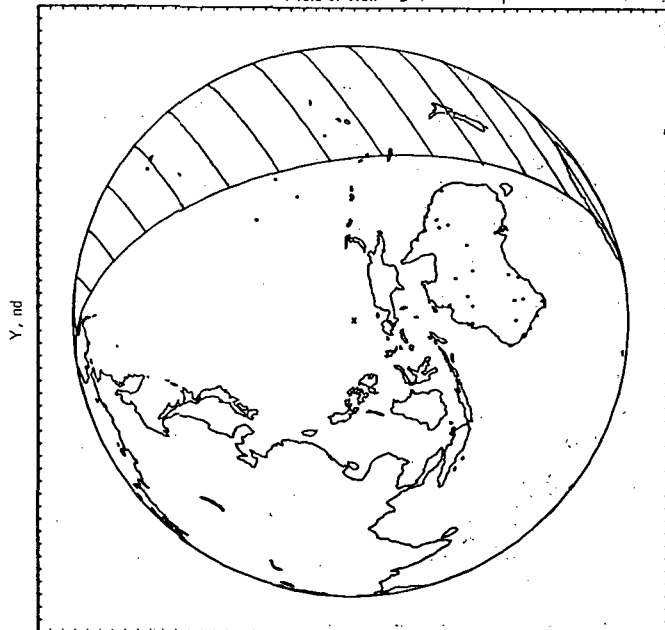

X, nd

(mm) g.e.t. = 41 hours.

$R_E = 151\ 332$ n. mi.
 $V_i = 3842$ fps

$h_E = 170\ 185$ stat. mi.
 $V_i = 2620$ mph

Field of view = 3°

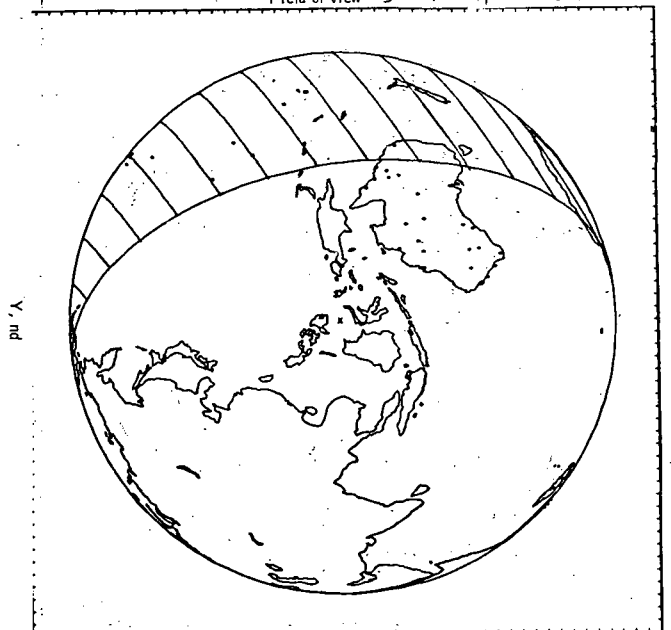

X, nd

(nn) g.e.t. = 42 hours.

Figure 5.2.1-2.- Continued.

$R_E = 153\,539$ n. mi.
 $V_i = 3786$ fps

$h_E = 172\,725$ stat. mi.
 $V_i = 2581$ mph

Field of view = 3°

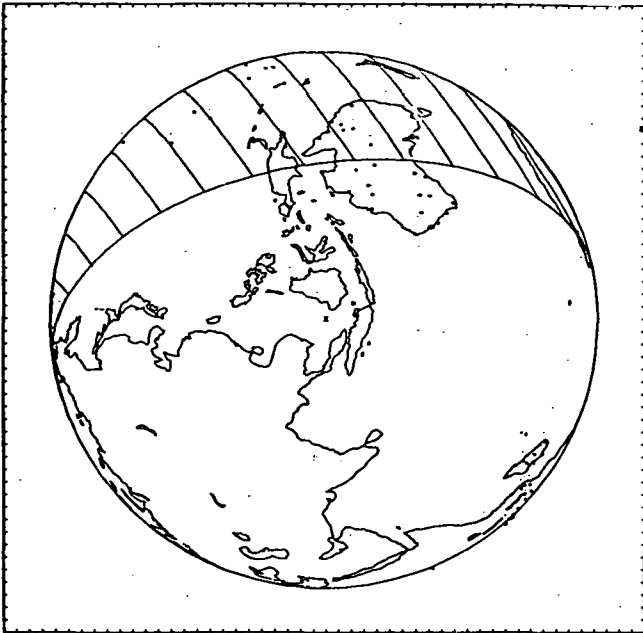

X, nd

(oo) g.e.t. = 43 hours.

$R_E = 155\,714$ n. mi.
 $V_i = 3731$ fps

$h_E = 175\,229$ stat. mi.
 $V_i = 2544$ mph

Field of view = 3°

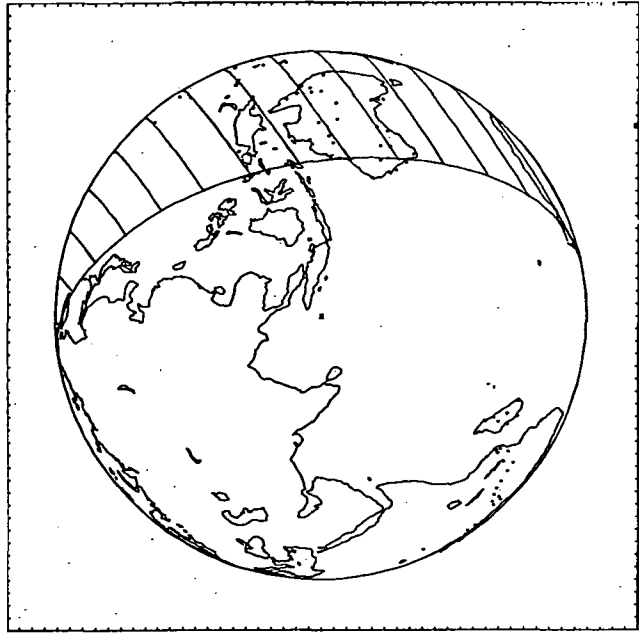

X, nd

(pp) g.e.t. = 44 hours.

$R_E = 157\,859$ n. mi.
 $V_i = 3678$ fps

$h_E = 177\,696$ stat. mi.
 $V_i = 2508$ mph

Field of view = 3°

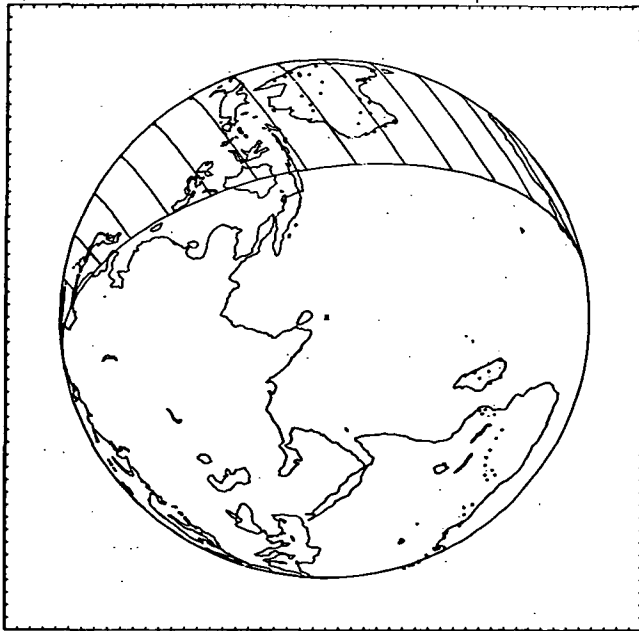

X, nd

(qq) g.e.t. = 45 hours.

$R_E = 159\,973$ n. mi.
 $V_i = 3626$ fps

$h_E = 180\,129$ stat. mi.
 $V_i = 2472$ mph

Field of view = 3°

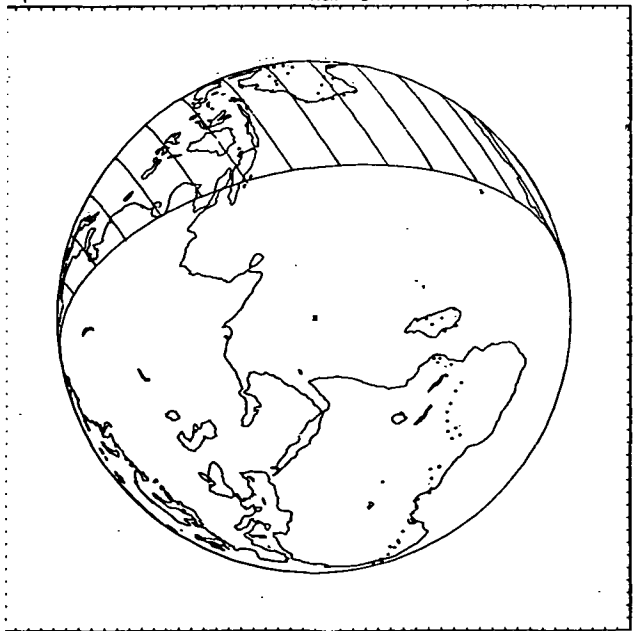

X, nd

(rr) g.e.t. = 46 hours.

Figure 5.2.1-2.- Continued.

$R_E = 162\ 058$ n. mi.
 $V_i = 3576$ fps

Field of view = 3°

$h_E = 182\ 528$ stat. mi.
 $V_i = 2438$ mph

$R_E = 164\ 115$ n. mi.
 $V_i = 3527$ fps

Field of view = 3°

$h_E = 184\ 896$ stat. mi.
 $V_i = 2405$ mph

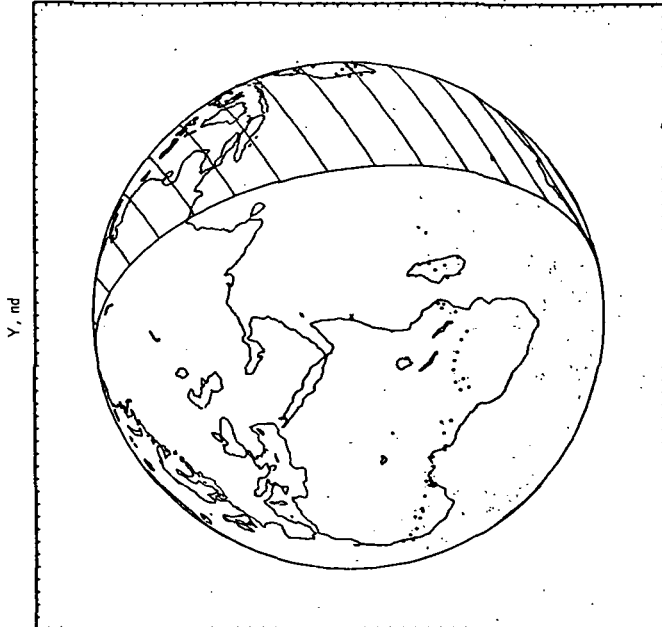

(ss) g.e.t. = 47 hours.

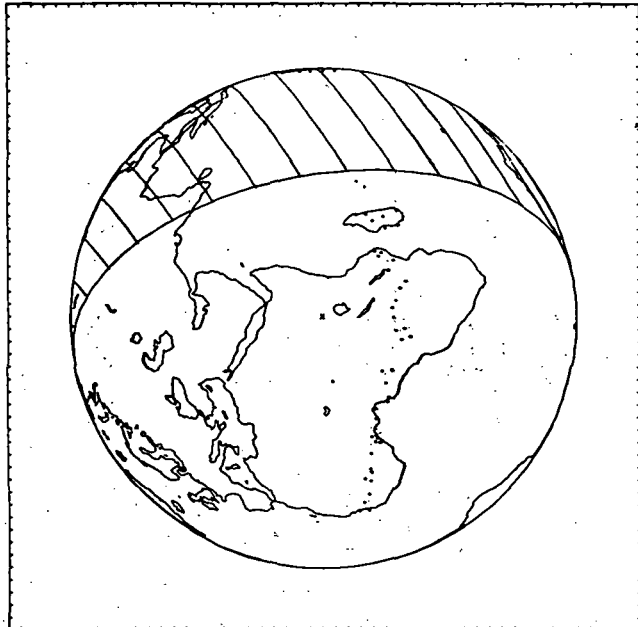

(tt) g.e.t. = 48 hours.

$R_E = 166\ 144$ n. mi.
 $V_i = 3480$ fps

Field of view = 3°

$h_E = 187\ 196$ stat. mi.
 $V_i = 2373$ mph

$R_E = 168\ 146$ n. mi.
 $V_i = 3434$ fps

Field of view = 3°

$h_E = 189\ 534$ stat. mi.
 $V_i = 2341$ mph

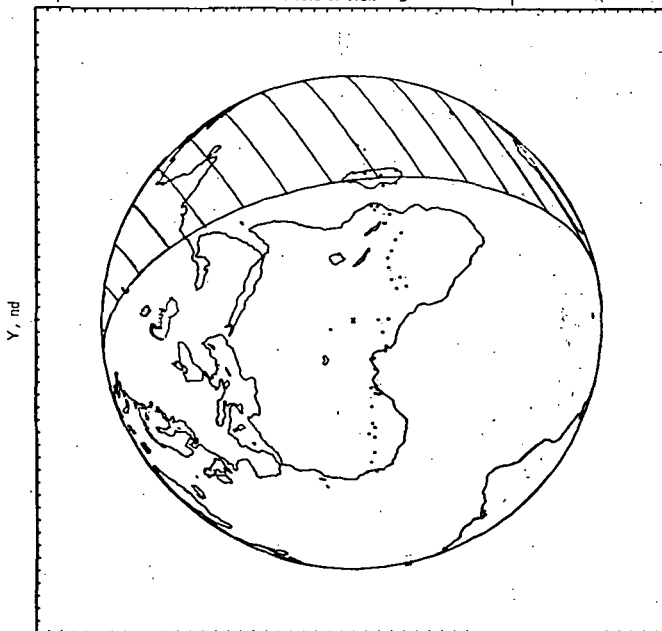

(uu) g.e.t. = 49 hours.

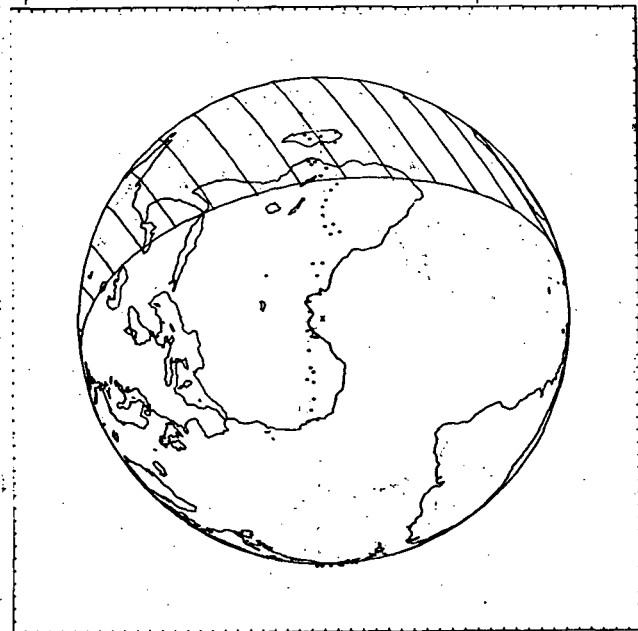

(vv) g.e.t. = 50 hours.

Figure 5.2.1-2.- Continued.

$R_E = 170\,122$ n. mi.
 $V_i = 3389$ fps

$h_E = 191\,809$ stat. mi.
 $V_i = 2311$ mph

Field of view = 3°

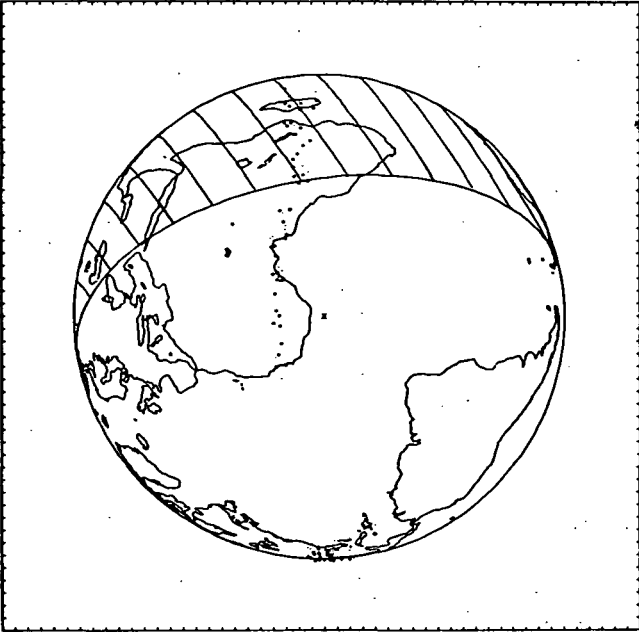

X, nd

(ww) g.e.t. = 51 hours.

$R_E = 172\,074$ n. mi.
 $V_i = 3345$ fps

$h_E = 194\,055$ stat. mi.
 $V_i = 2281$ mph

Field of view = 3°

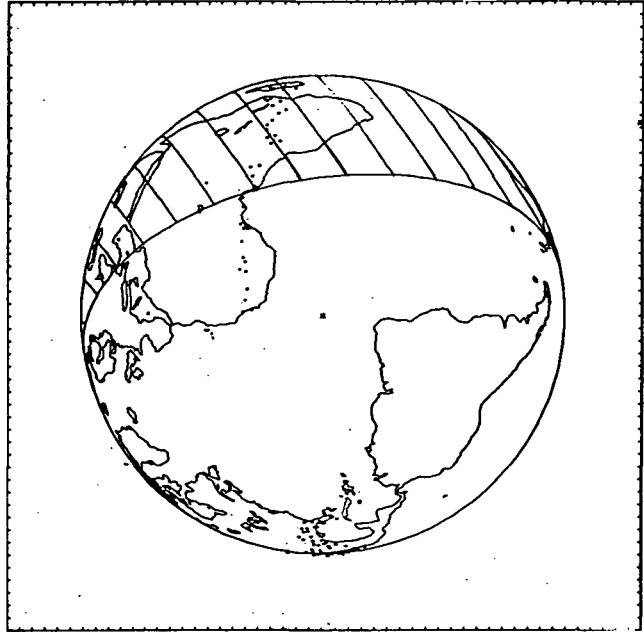

X, nd

(xx) g.e.t. = 52 hours.

$R_E = 174\,000$ n. mi.
 $V_i = 3303$ fps

$h_E = 196\,271$ stat. mi.
 $V_i = 2252$ mph

Field of view = 3°

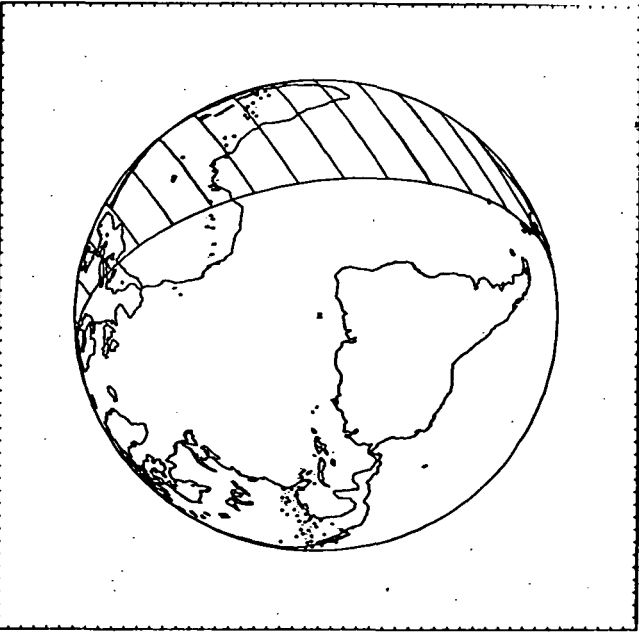

X, nd

(yy) g.e.t. = 53 hours.

$R_E = 175\,903$ n. mi.
 $V_i = 3262$ fps

$h_E = 198\,461$ stat. mi.
 $V_i = 2224$ mph

Field of view = 3°

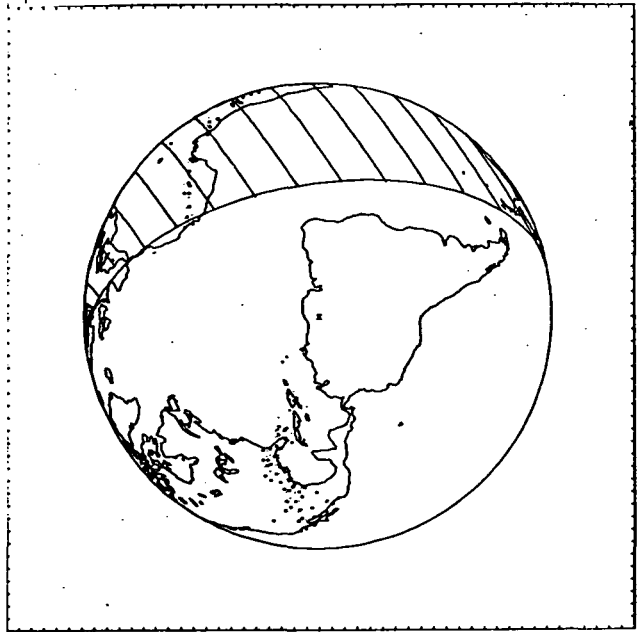

X, nd

(zz) g.e.t. = 54 hours.

Figure 5.2.1-2.- Continued.

$R_E = 177\,783$ n. mi.
 $V_i = 3222$ fps

$h_E = 200\,624$ stat. mi.
 $V_i = 2197$ mph

Field of view = 3°

Y, nd

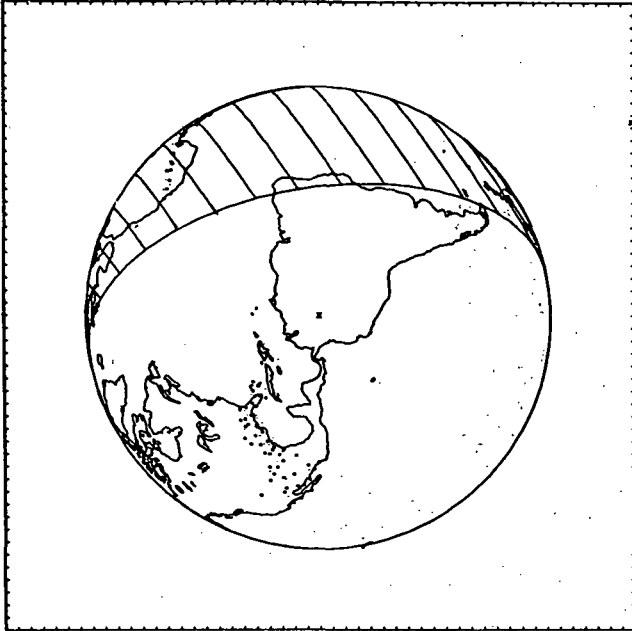

X, nd

(aaa) g.e.t. = 55 hours.

$R_E = 179\,640$ n. mi.
 $V_i = 3183$ fps

$h_E = 202\,761$ stat. mi.
 $V_i = 2170$ mph

Field of view = 3°

Y, nd

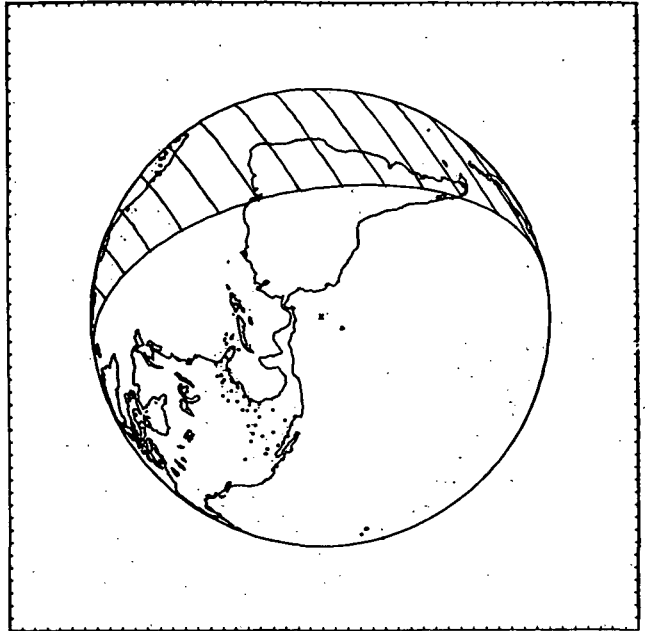

X, nd

(bbb) g.e.t. = 56 hours.

$R_E = 181\,476$ n. mi.
 $V_i = 3146$ fps

$h_E = 204\,874$ stat. mi.
 $V_i = 2145$ mph

Field of view = 3°

Y, nd

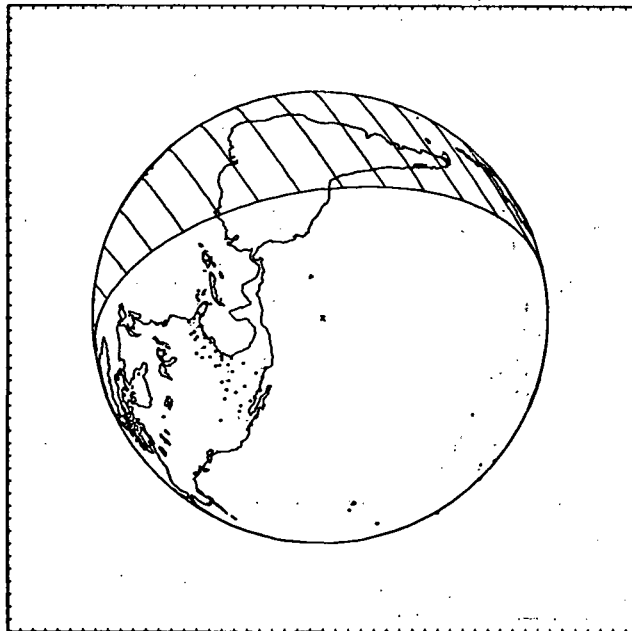

X, nd

(ccc) g.e.t. = 57 hours.

$R_E = 183\,291$ n. mi.
 $V_i = 3109$ fps

$h_E = 206\,963$ stat. mi.
 $V_i = 2120$ mph

Field of view = 3°

Y, nd

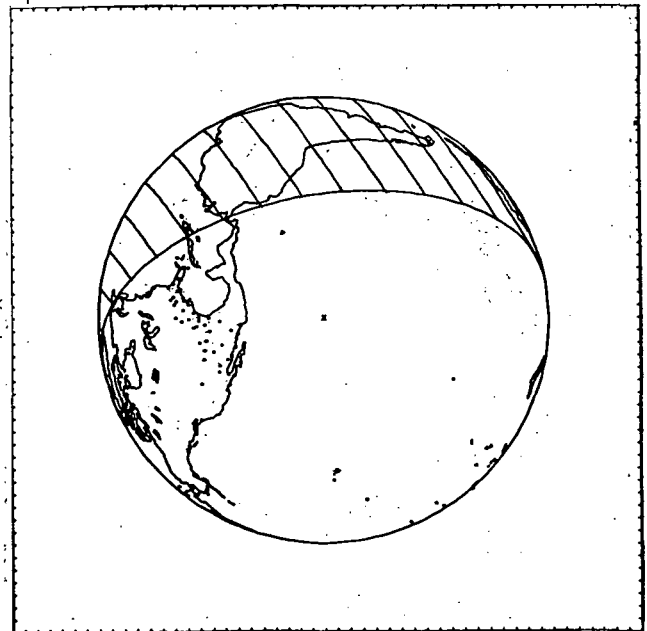

X, nd

(ddd) g.e.t. = 58 hours.

$R_E = 185\ 085$ n. mi.
 $V_i = 3074$ fps

$h_E = 209\ 027$ stat. mi.
 $V_i = 2096$ mph

Field of view = 3°

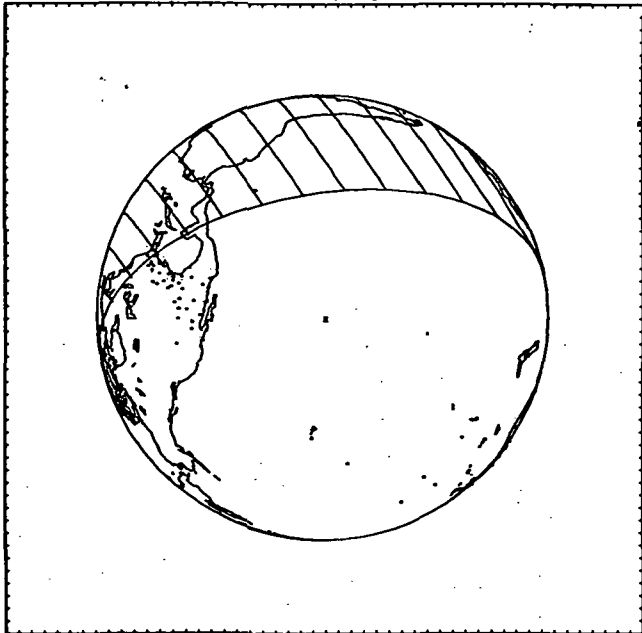

X, nd

(eee) g.e.t. = 59 hours.

$R_E = 186\ 861$ n. mi.
 $V_i = 3040$ fps

$h_E = 211\ 071$ stat. mi.
 $V_i = 2073$ mph

Field of view = 3°

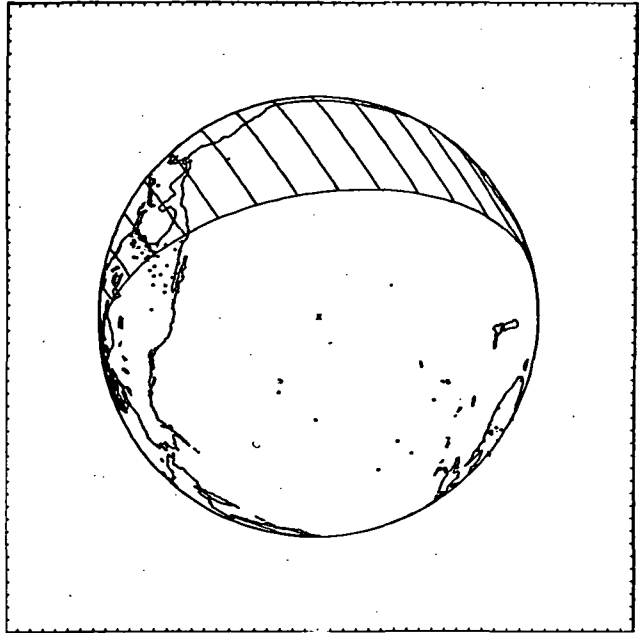

X, nd

(fff) g.e.t. = 60 hours.

$R_E = 188\ 618$ n. mi.
 $V_i = 3007$ fps

$h_E = 213\ 094$ stat. mi.
 $V_i = 2050$ mph

Field of view = 3°

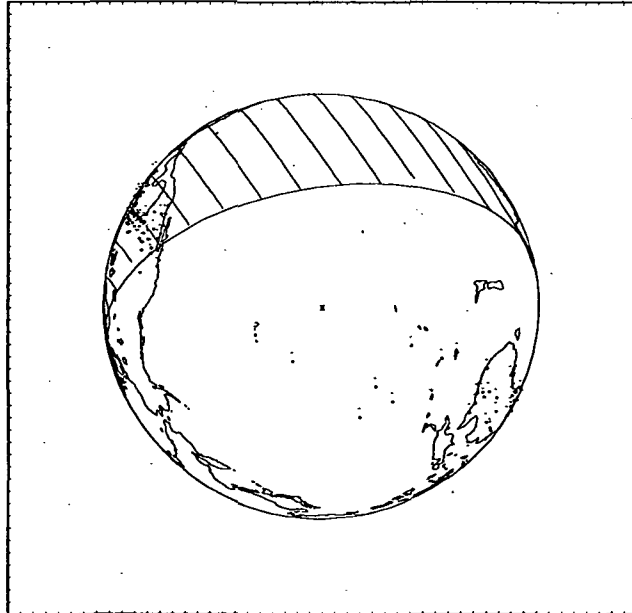

X, nd

(ggg) g.e.t. = 61 hours.

$R_E = 190\ 358$ n. mi.
 $V_i = 2976$ fps

$h_E = 215\ 095$ stat. mi.
 $V_i = 2029$ mph

Field of view = 3°

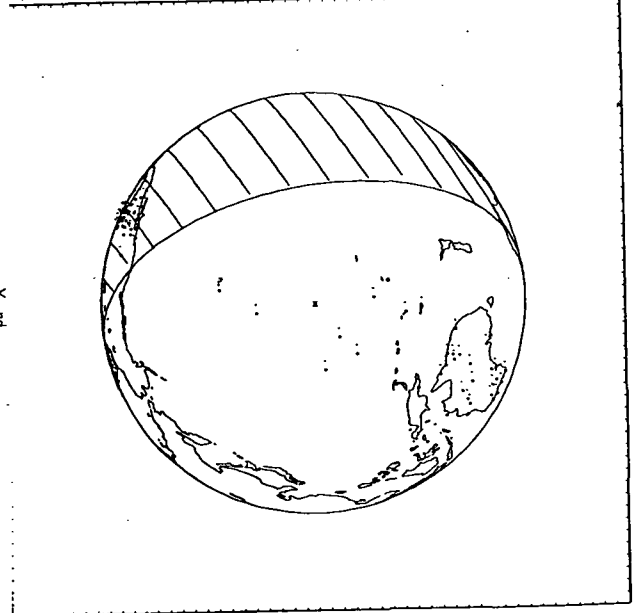

X, nd

(hhh) g.e.t. = 62 hours.

Figure 5.2.1-2.- Continued.

$R_M = 31\,974$ n. mi.
 $V_i = 3790$ fps

$h_M = 38\,261$ stat. mi.
 $V_i = 2584$ mph

Field of view = 3°

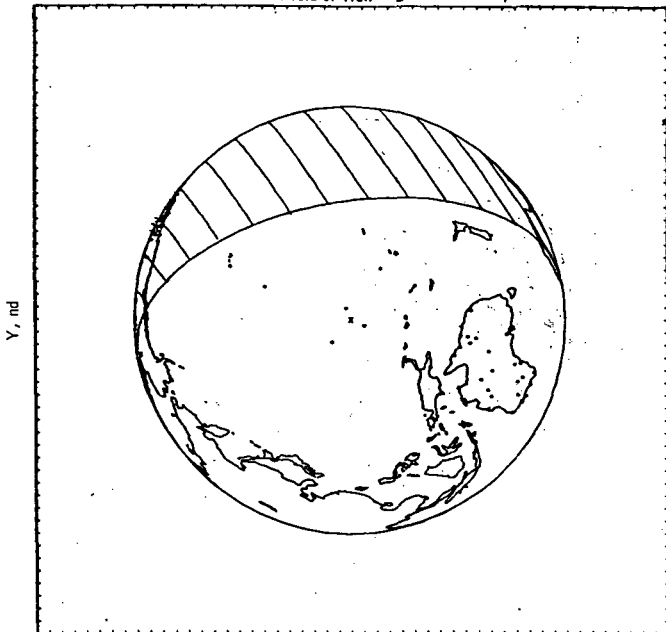

(iii) g.e.t. = 63 hours.

$R_M = 29\,731$ n. mi.
 $V_i = 3805$ fps

$h_M = 33\,134$ stat. mi.
 $V_i = 2594$ mph

Field of view = 3°

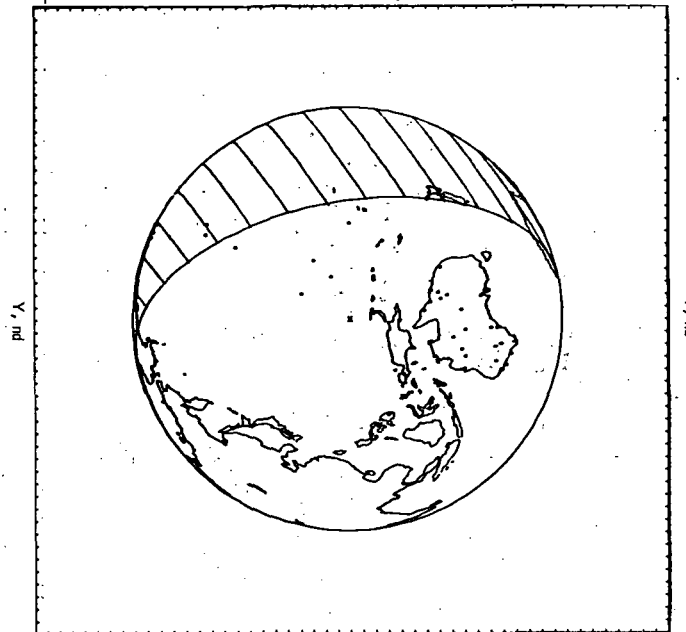

(jjj) g.e.t. = 64 hours.

$R_M = 27\,480$ n. mi.
 $V_i = 3823$ fps

$h_M = 30\,543$ stat. mi.
 $V_i = 2607$ mph

Field of view = 3°

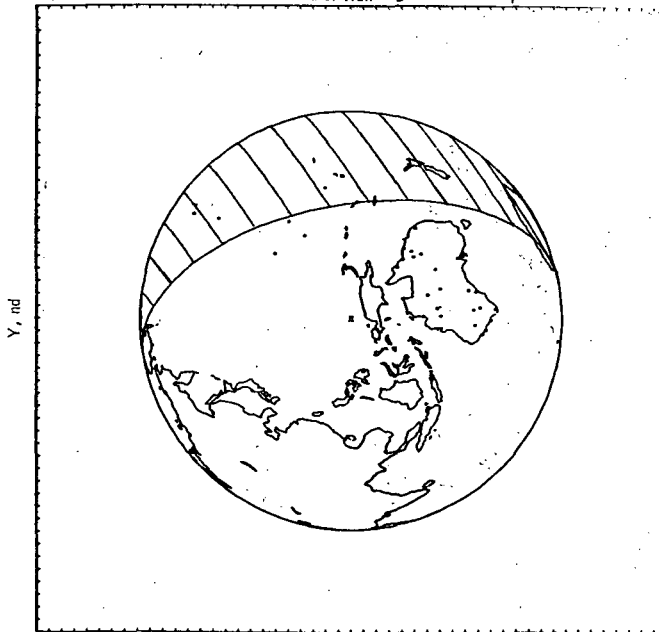

(kkk) g.e.t. = 65 hours.

$R_M = 25\,217$ n. mi.
 $V_i = 3845$ fps

$h_M = 27\,940$ stat. mi.
 $V_i = 2622$ mph

Field of view = 3°

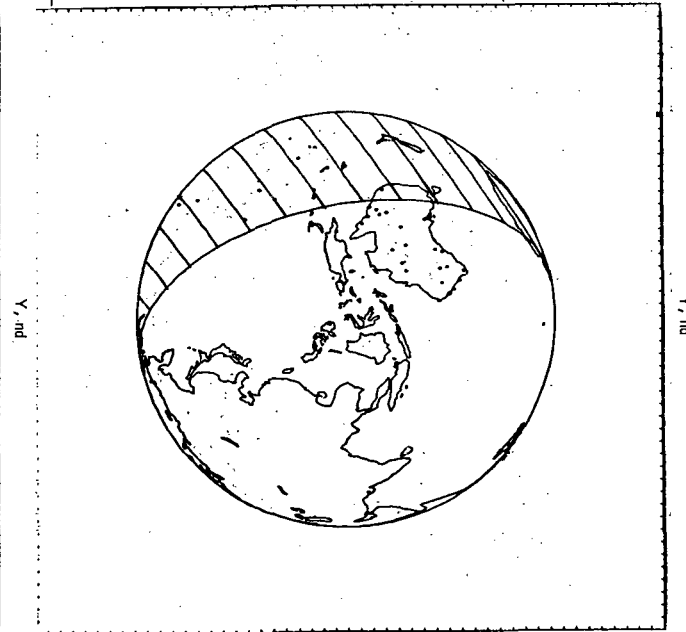

(lll) g.e.t. = 66 hours.

$R_M = 22\,942$ n. mi.
 $V_i = 3872$ fps

$h_M = 25\,320$ stat. mi.
 $V_i = 2640$ mph

Field of view = 3°

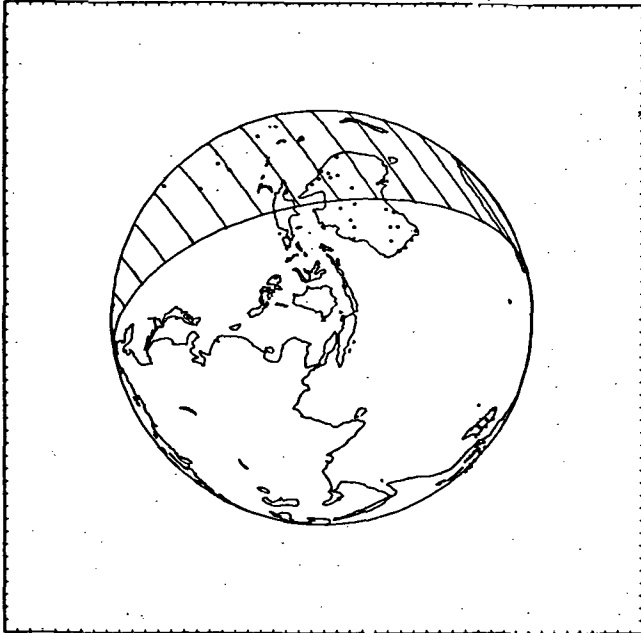

X, nd

(mmm) g.e.t. = 67 hours.

$R_M = 20\,649$ n. mi.
 $V_i = 3907$ fps

$h_M = 22\,683$ stat. mi.
 $V_i = 2664$ mph

Field of view = 3°

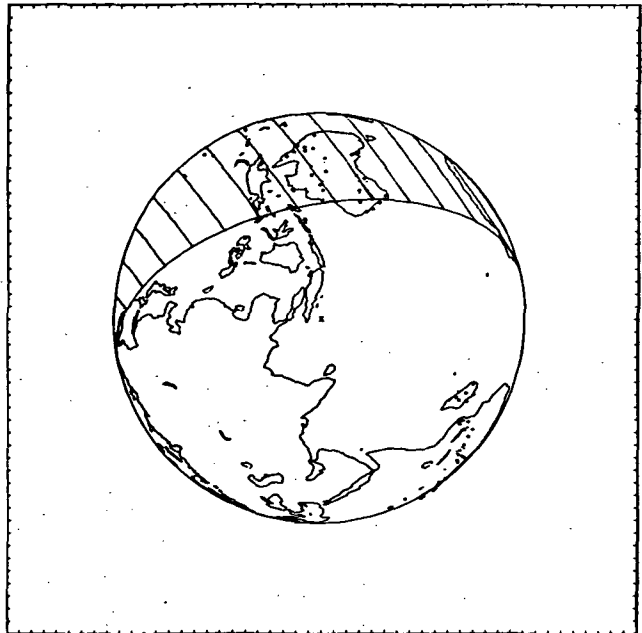

X, nd

(nnn) g.e.t. = 68 hours.

$R_M = 18\,337$ n. mi.
 $V_i = 3950$ fps

$h_M = 20\,349$ stat. mi.
 $V_i = 2693$ mph

Field of view = 3°

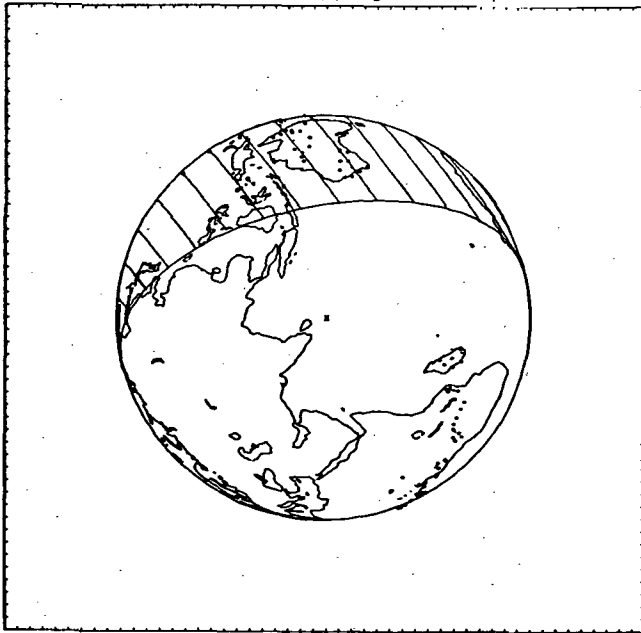

X, nd

(ooo) g.e.t. = 69 hours.

$R_M = 16\,000$ n. mi.
 $V_i = 4006$ fps

$h_M = 17\,332$ stat. mi.
 $V_i = 2731$ mph

Field of view = 3°

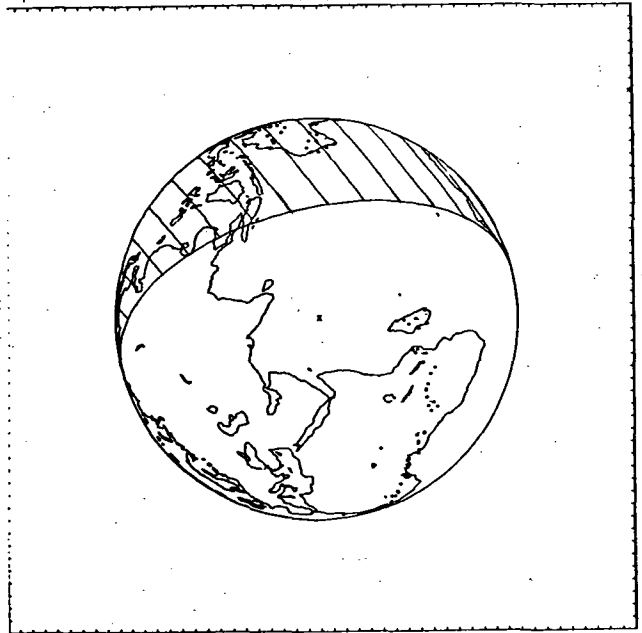

X, nd

(ppp) g.e.t. = 70 hours.

Figure 5.2.1-2.- Continued.

$R_M = 13\,629$ n. mi.
 $V_i = 4082$ fps

Field of view = 3°

$h_M = 14\,603$ stat. mi.
 $V_i = 2783$ mph

⁶⁷ $R_M = 11\,213$ n. mi.
 $V_i = 4190$ fps

Field of view = 3°

$h_M = 11\,824$ stat. mi.
 $V_i = 2857$ mph

Y, nd

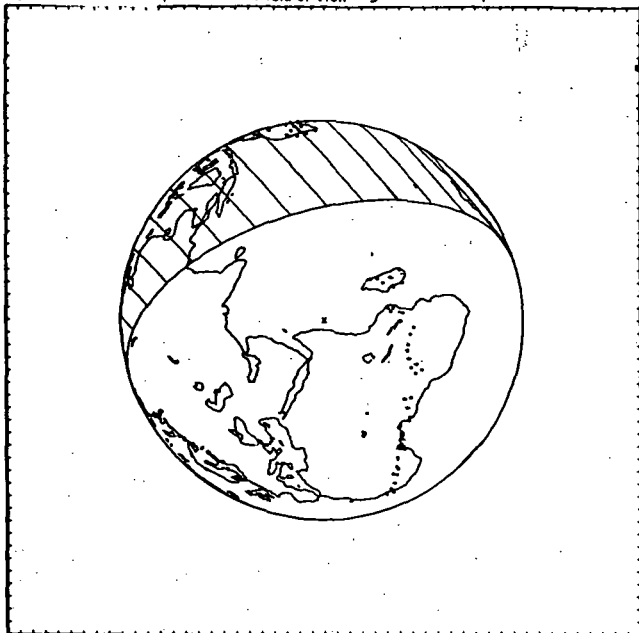

X, nd

(qqq) g.e.t. = 71 hours.

Y, nd

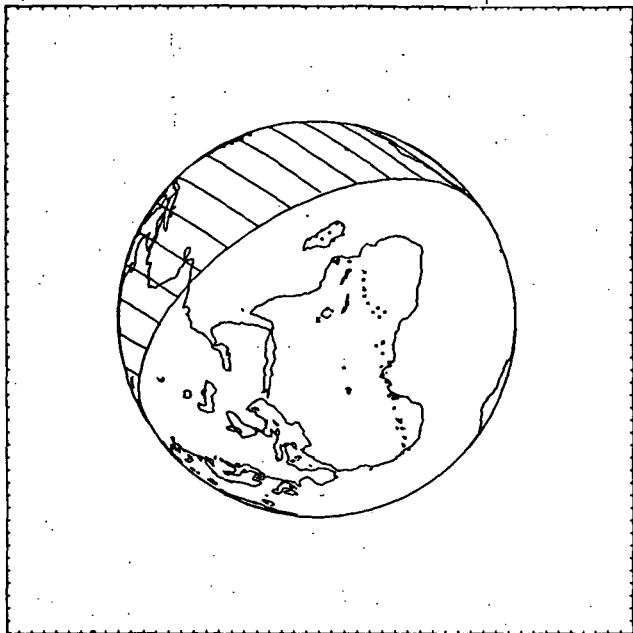

X, nd

(rrr) g.e.t. = 72 hours.

Y, nd

$R_M = 8734$ n. mi.
 $V_i = 4359$ m

Field of view = 3°

$h_M = 8971$ stat. mi.
 $V_i = 8971$ mph

$R_M = 6158$ n. mi.
 $V_i = 4662$ fps

Field of view = 3°

$h_M = 6007$ stat. mi.
 $V_i = 3179$ mph

Y, nd

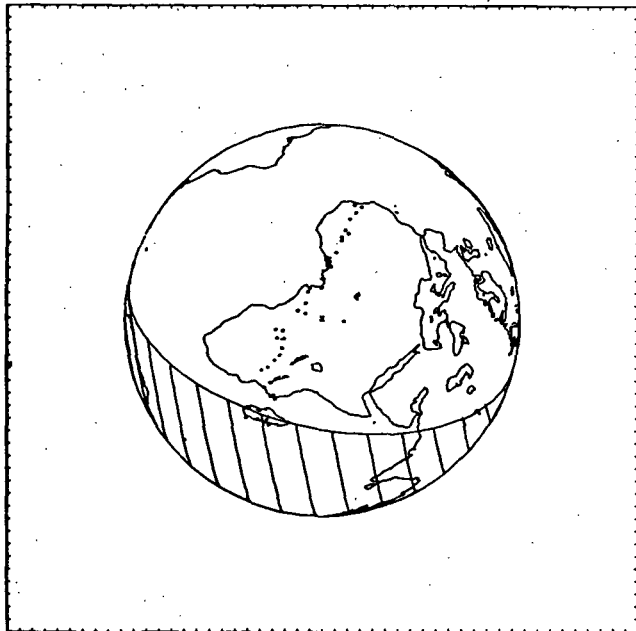

X, nd

(sss) g.e.t. = 73 hours.

Y, nd

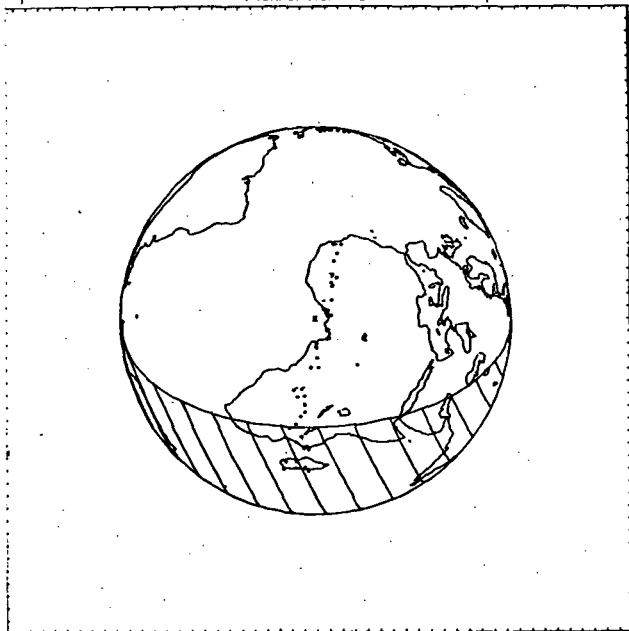

X, nd

(ttt) g.e.t. = 74 hours.

Y, nd

Figure 5.2.1-2. - Concluded.

Page intentionally left blank

5.2.2 MOON VIEWS

Page intentionally left blank

SEQ	14	17	18	40	105	107
X	-19	-24	-1	3	0	13
Y	-19	11	13	-22	13	24

$R_E = 51\,850$ n. mi.

$h_E = 55\,704$ stat. mi.

$V_i = 8564$ fps

$V_i = 5839$ mph

Field of view=50°

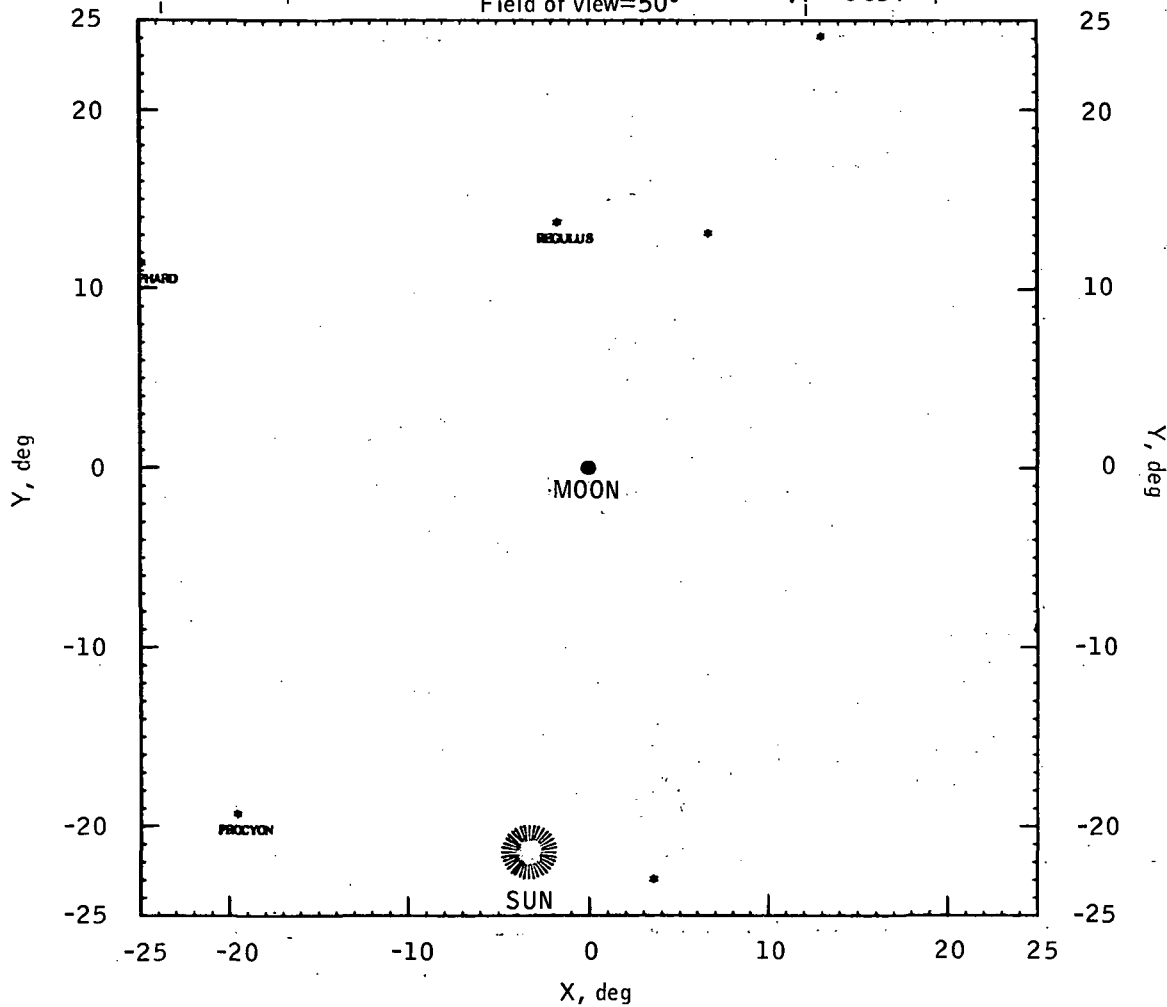

(a) g.e.t. = 10 hours.

Figure 5.2.2-1.- Translunar coast - constant field of view (moon).

SEC	14	17	19	40	55	105
X	-17	-24	-1	3	6	6
Y	-15	14	12	-19	-22	16

$R_E = 91\,747$ n. mi.

$h_E = 101\,617$ stat. mi.

$V_i = 5875$ fps

$V_i = 4006$ mph

Field of view = 50°

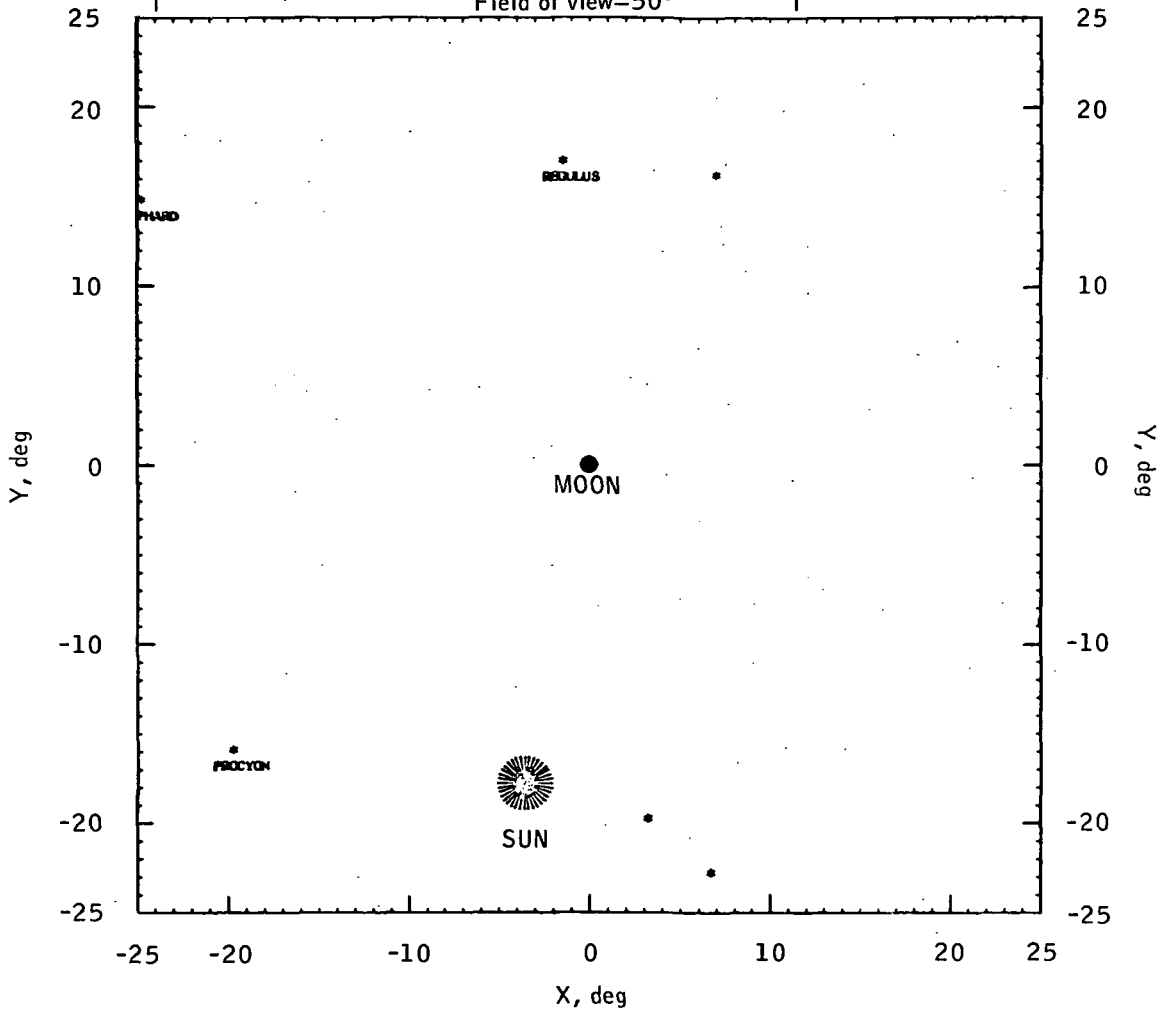

(b) g.e.t. = 20 hours.

Figure 5.2.2-1.- Continued.

SEQ	14	17	18	40	55	105
X	-19	-24	-1	3	6	6
Y	-13	17	17	-17	-20	18

$R_E = 121\,920$ n. mi.

$V_i = 4697$ fps

$h_E = 136\,339$ stat. mi.

$V_i = 3202$ mph

Field of view = 50°

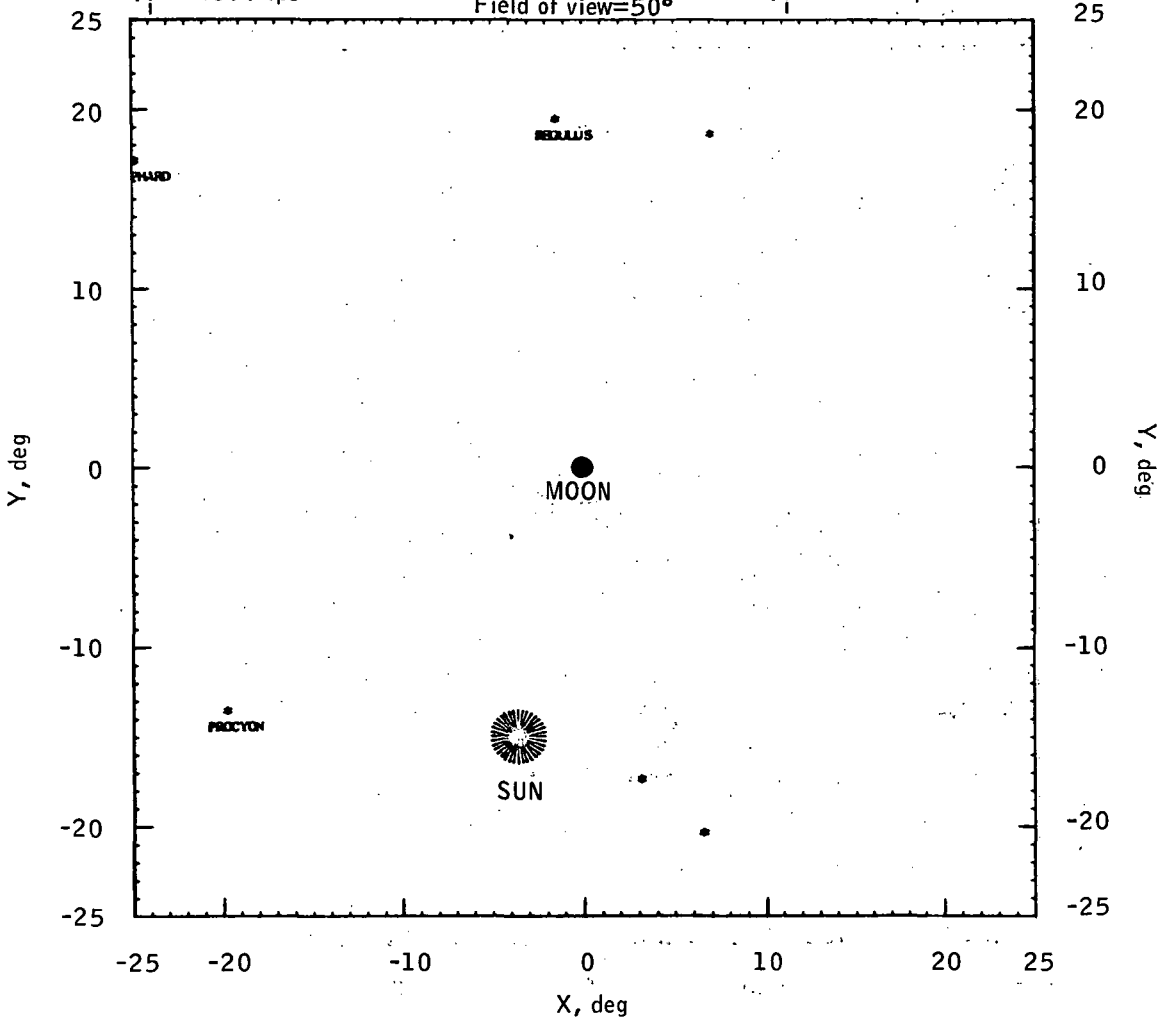

(c) g.e.t. = 30 hours.

Figure 5.2.2-1.- Continued.

SEQ	14	17	13	40	55	105
X	-19	-24	-1	3	6	7
Y	-11	18	21	-15	-18	20

$R_E = 146\,817$ n. mi.

$h_E = 164\,990$ stat. mi.

$V_i = 3961$ fps

$V_i = 2701$ mph

Field of view=50°

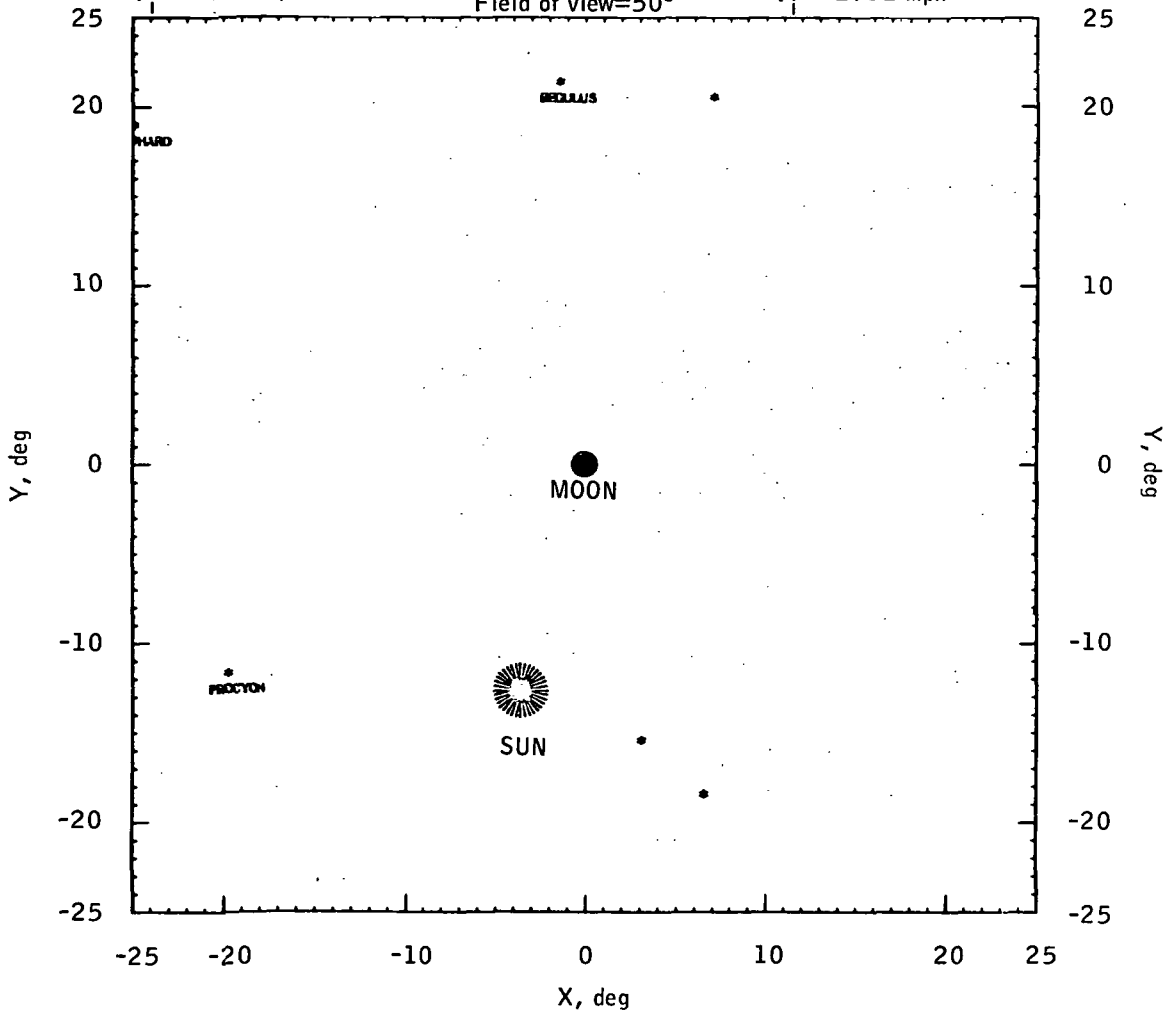

(d) g.e.t. = 40 hours.

Figure 5.2.2-1.- Continued.

SEQ	14	18	40	55	105
X	-19	-1	3	6	7
Y	-9	23	-13	-16	22

$R_E = 168\,146$ n. mi.

$h_E = 189\,534$ stat. mi.

$V_i = 3434$ fps

$V_i = 2341$ mph

Field of view = 50°

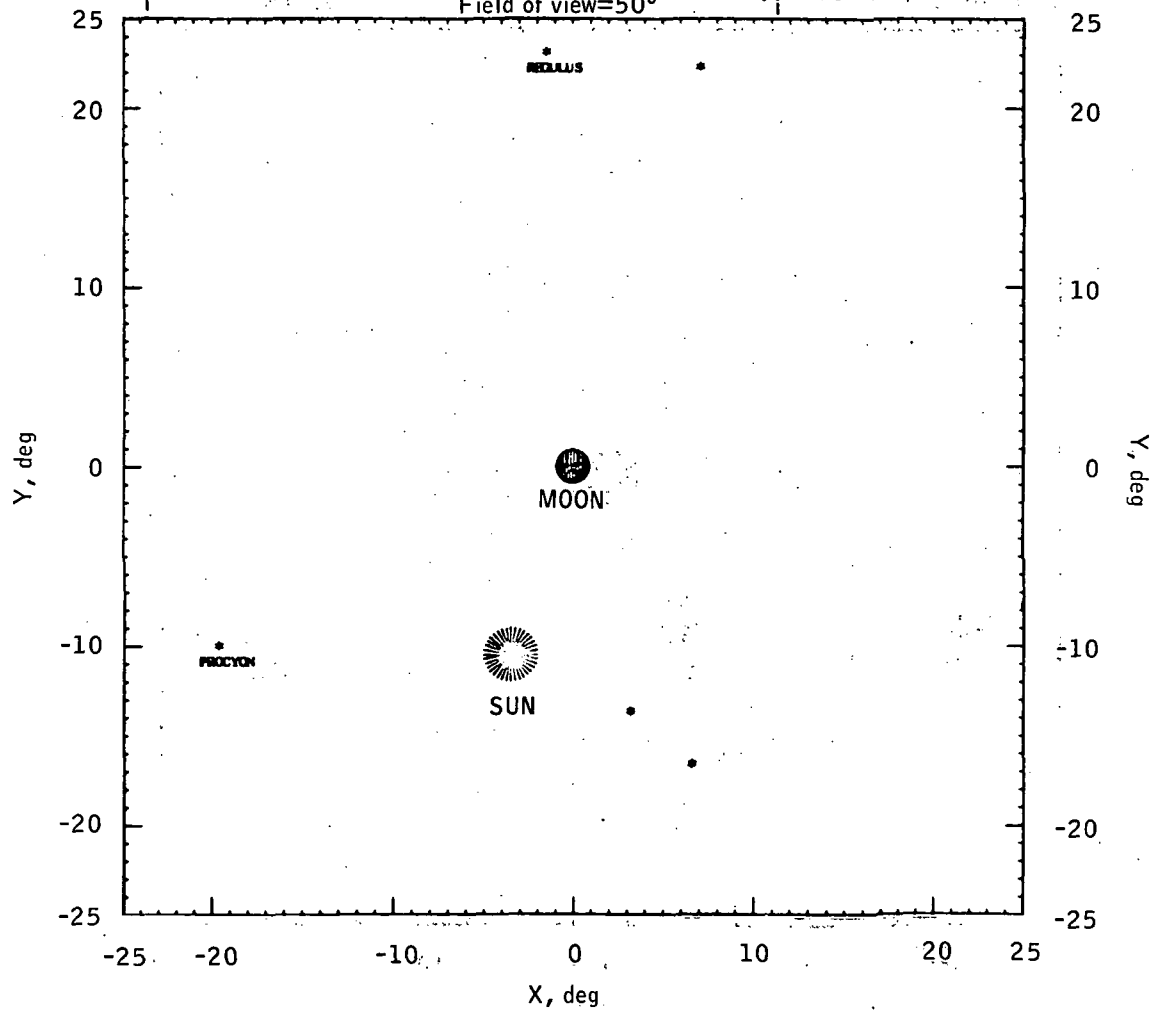

(e) g.e.t. = 50 hours.

Figure 5.2.2-1, - Continued.

SEQ	14	40	52	55	105
X	-17	3	-10	6	6
Y	-7	-11	-24	-14	27

 $R_E = 186\,861 \text{ n. mi.}$
 $h_E = 211\,071 \text{ stat. mi.}$
 $V_i = 3040 \text{ fps}$
 $V_i = 2073 \text{ mph}$

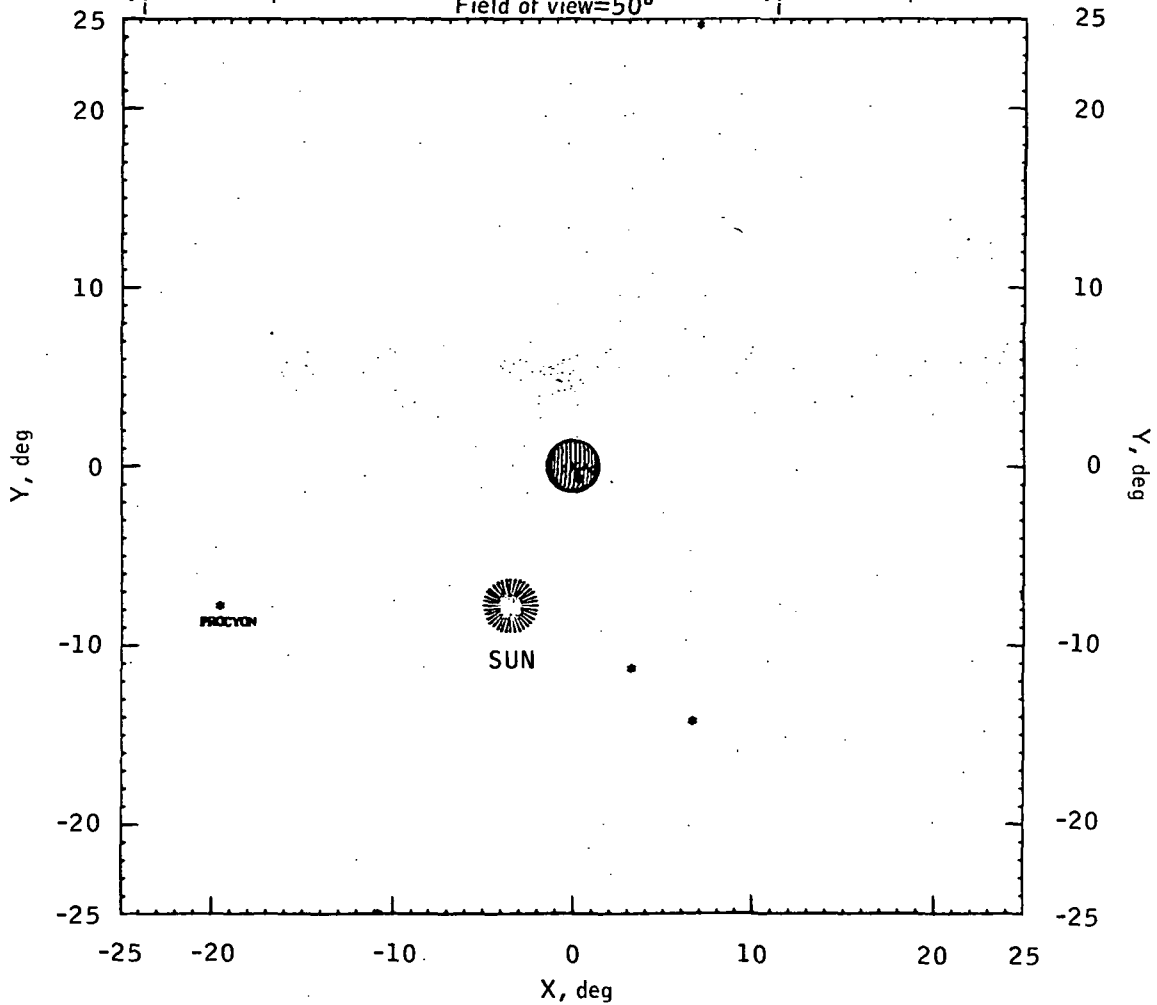
 Field of view = 50°

(f) g.e.t. = 60 hours.

Figure 5.2.2-1.- Continued.

SEQ	14	40	52	55
X	-19	3	-10	6
Y	-5	-9	-22	-12

 $R_M = 27\,480$ n. mi.

 $h_M = 30\,543$ stat. mi.

 $V_i = 3823$ fps

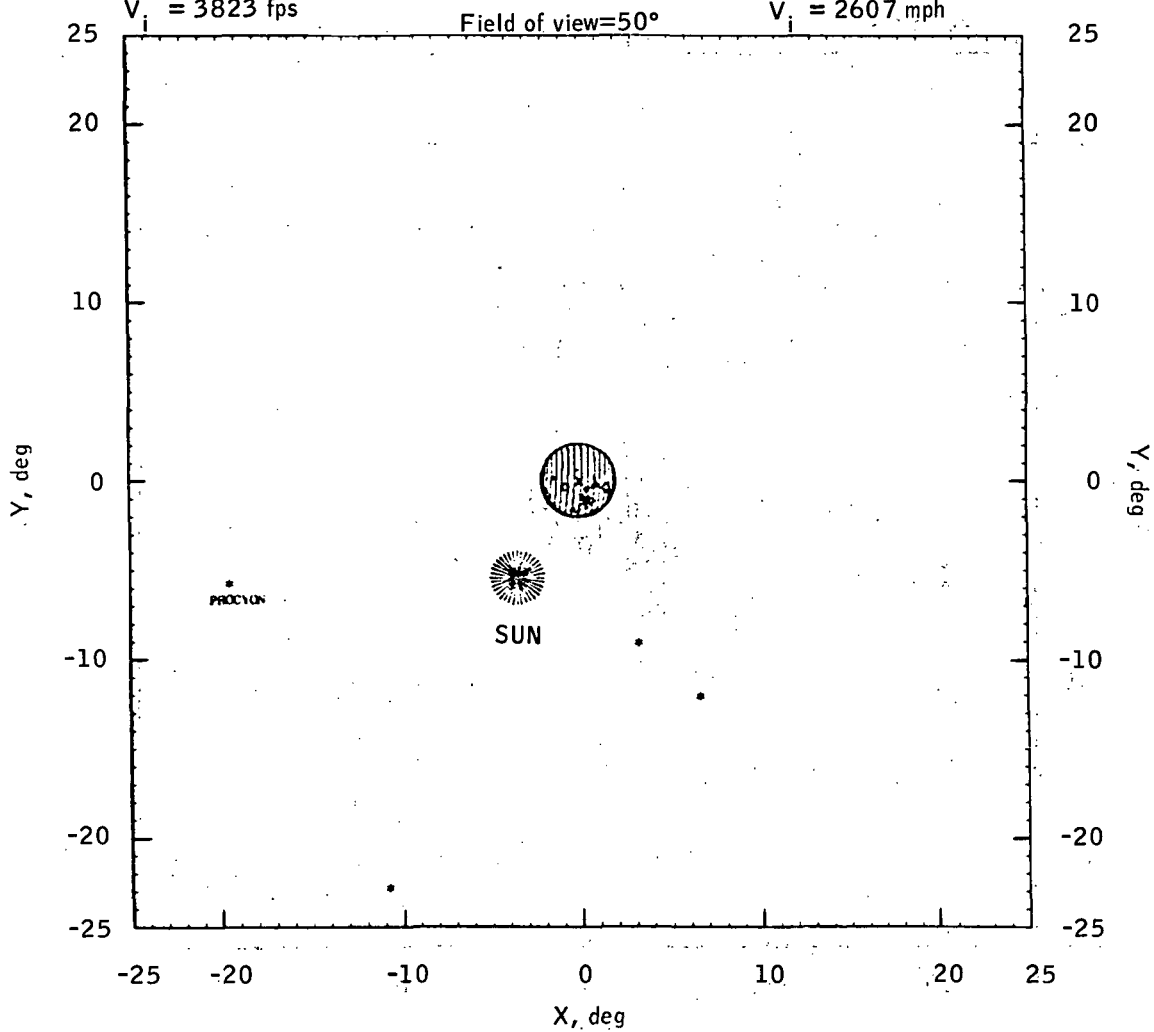
 $V_i = 2607$ mph

(g) g.e.t. = 65 hours.

Figure 5.2.2-1.- Continued.

SEQ	14	40	52	55
X	-19	2	-11	6
Y	-3	-7	-20	-10

 $R_E = 16\,000$ n. mi.

 $h_E = 17\,332$ stat. mi.

 $V_i = 4006$ fps

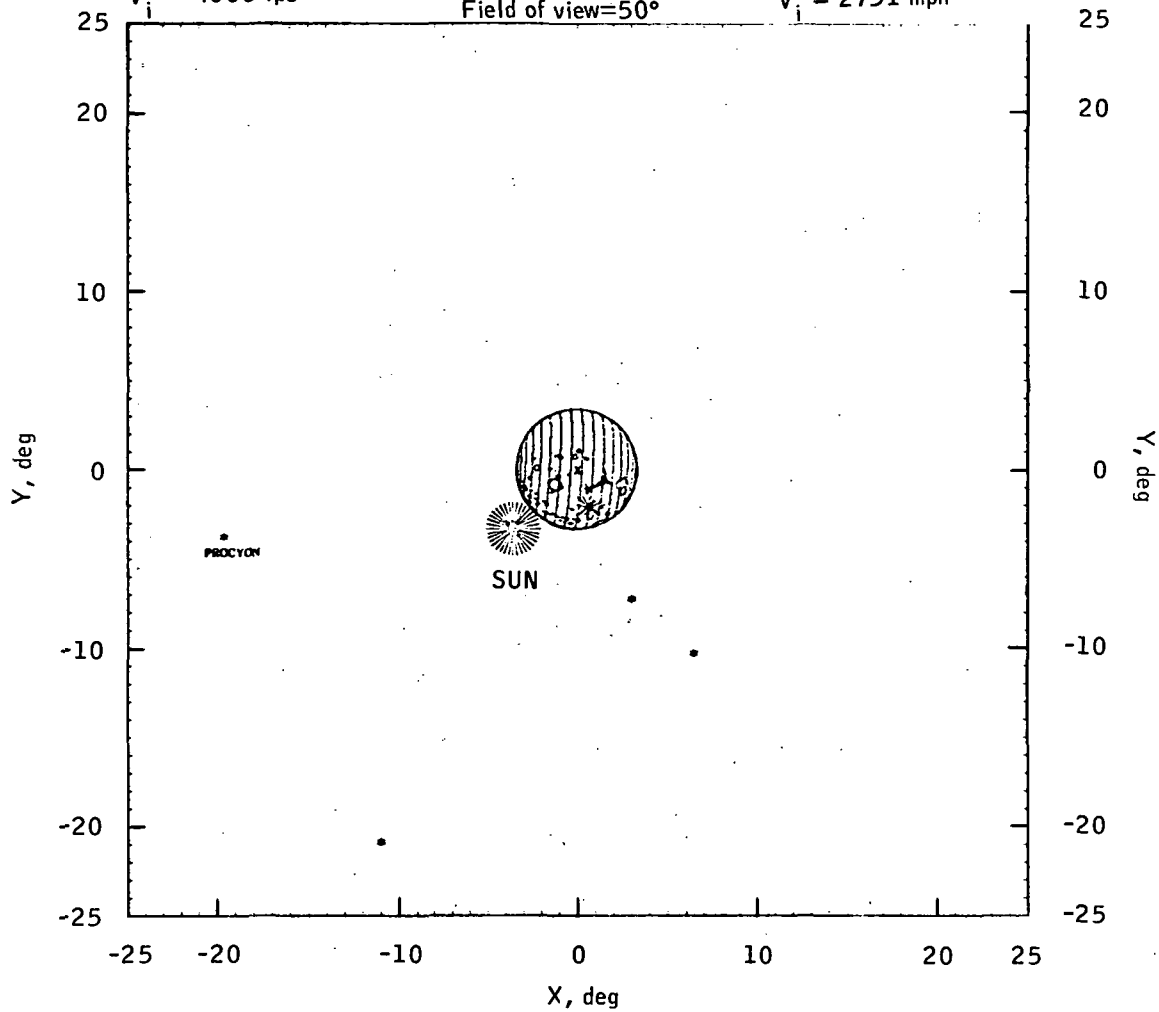
 $V_i = 2731$ mph
Field of view = 50° 

(h) g.e.t. = 70 hours.

Figure 5.2.2-1.- Continued.

SEQ	14	40	52	55
λ	-14	2	-10	8
γ	-2	-5	-19	-9

 $R_E = 13\,629$ n. mi.

 $h_E = 14\,603$ stat. mi.

 $V_i = 4082$ fps

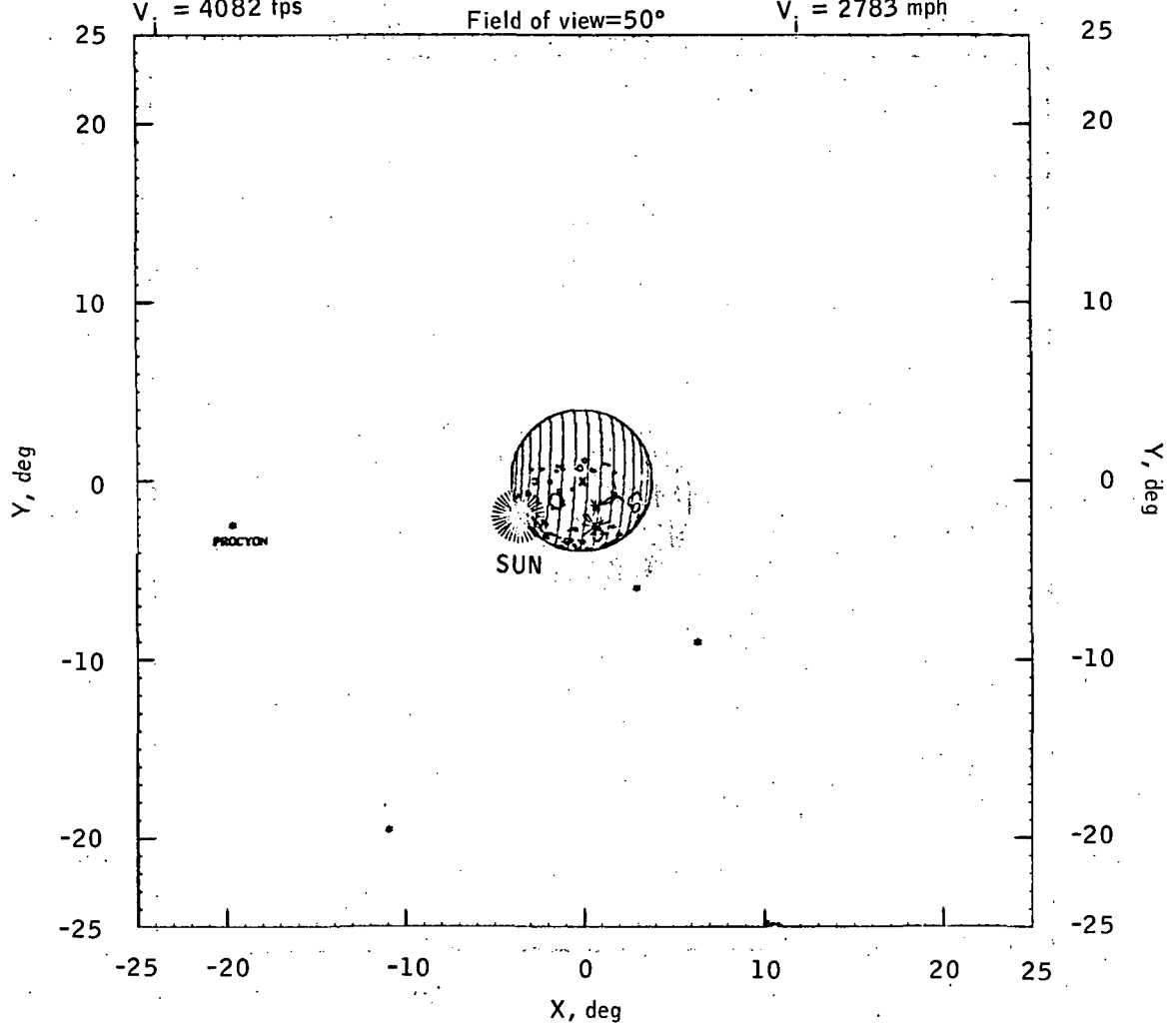
 $V_i = 2783$ mph

(i) g.e.t. = 71 hours.

Figure 5.2.2-1.- Continued.

SEQ	14	40	52	55
λ	-19	2	-10	6
γ	0	-4	-17	-7

$R_E = 11\,213$ n. mi.

$h_E = 11\,824$ stat. mi.

$V_i = 4190$ fps

$V_i = 2857$ mph

Field of view = 50°

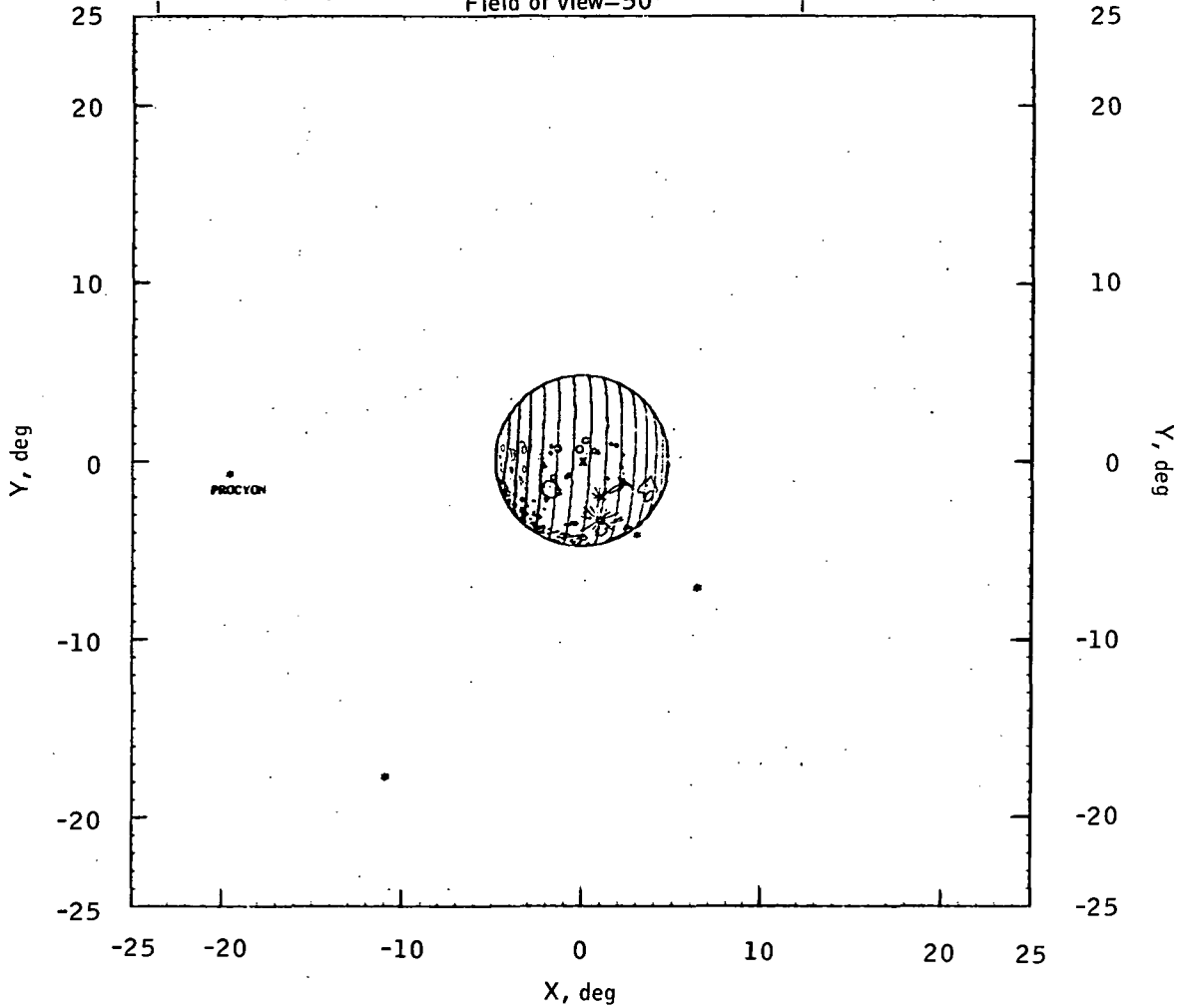

(j) g.e.t. = 72 hours.

Figure 5.2.2-1.- Continued.

SEQ	14	45	52	55	70	100
X	-14	-20	-10	6	17	9
Y	2	-24	-14	-4	-23	-24

 $R_E = 8734 \text{ n. mi.}$
 $h_E = 8971 \text{ stat. mi.}$
 $V_i = 4359 \text{ fps}$

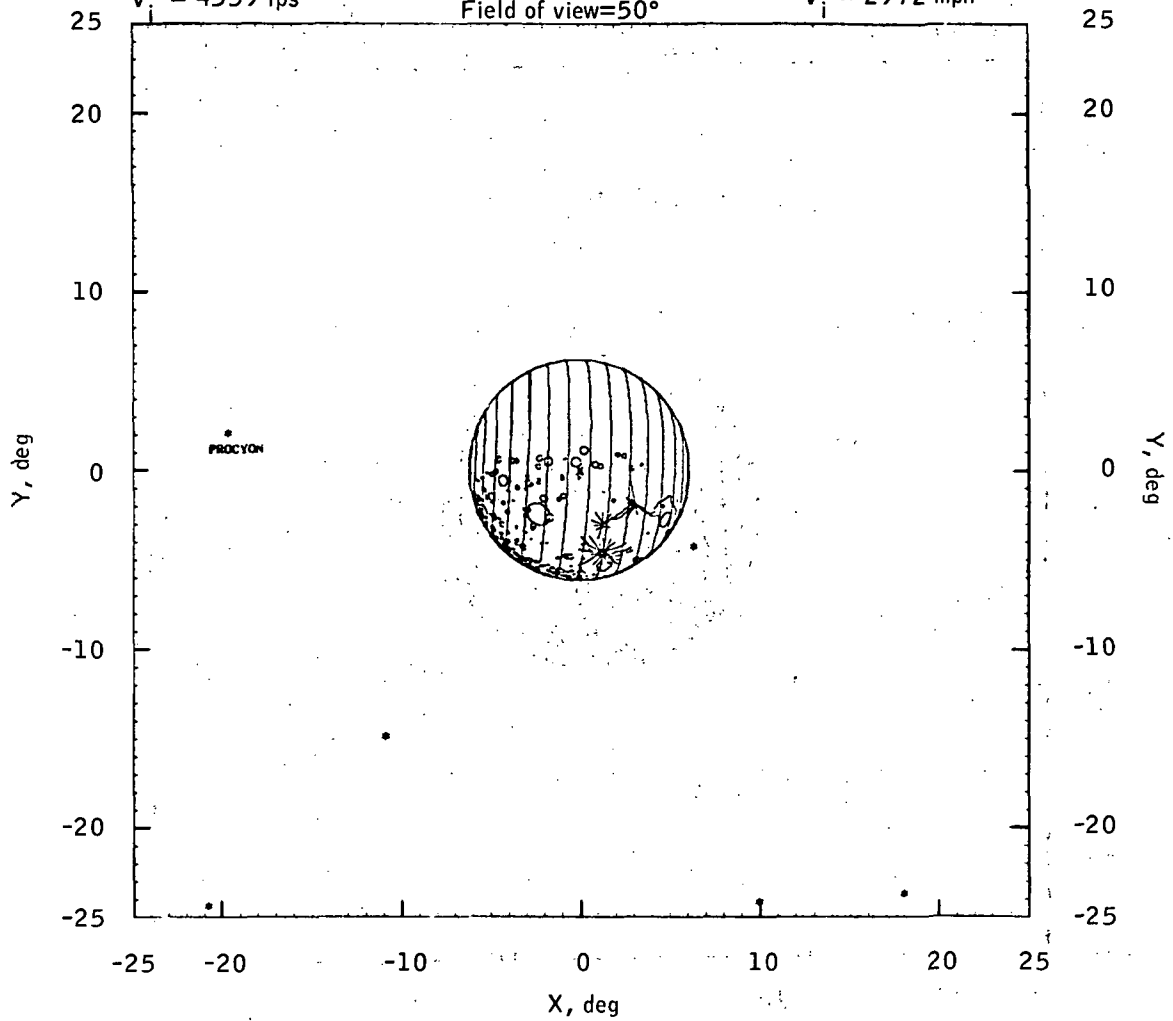
 Field of view = 50°
 $V_i = 2972 \text{ mph}$

(k) g.e.t. = 73 hours.

Figure 5.2.2-1.- Continued.

SEQ	14	45	52	70	98	100
X	-19	-20	-10	17	-6	-9
Y	7	-19	-9	-18	-24	-18

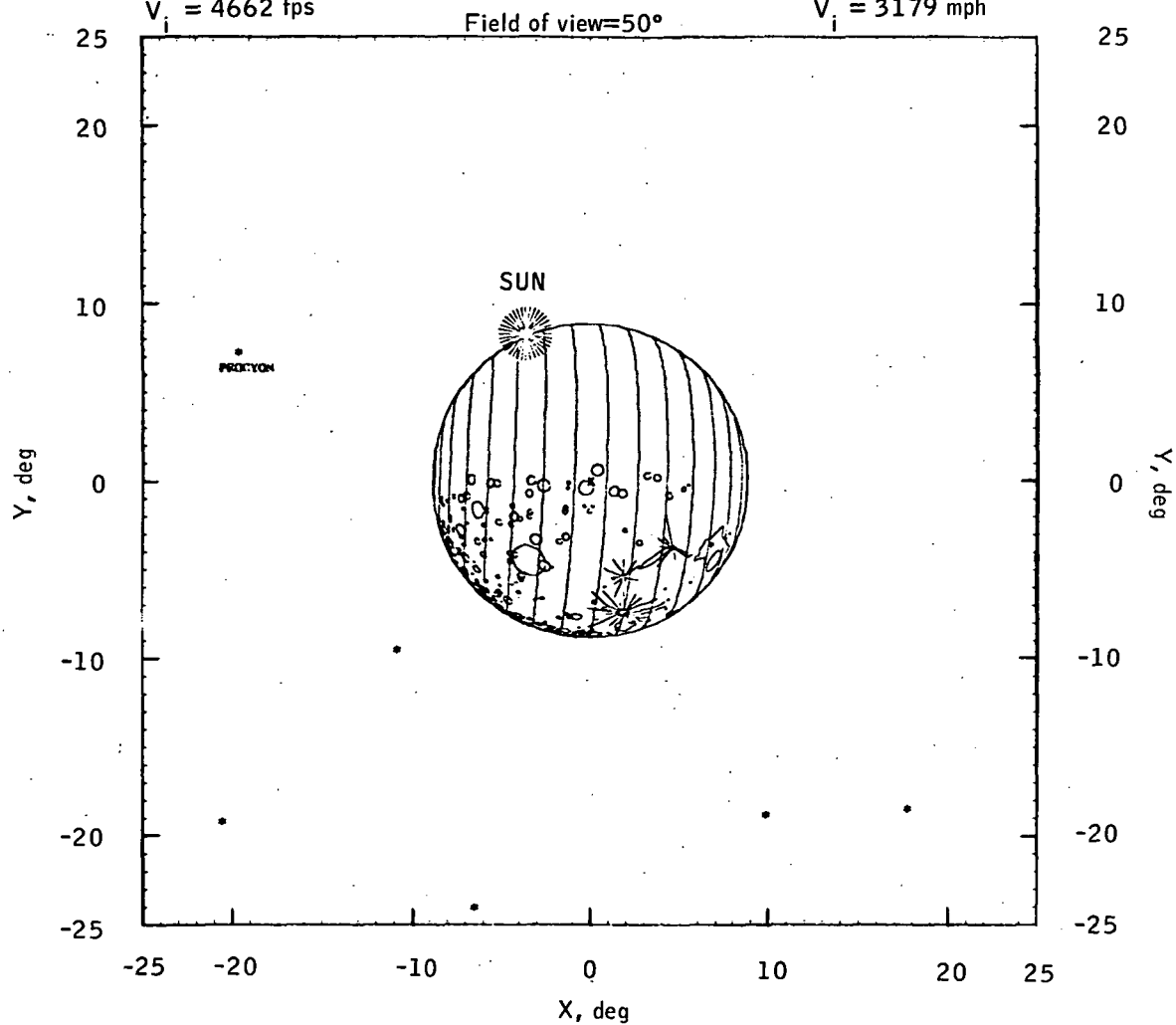
 $R_E = 6158 \text{ n. mi.}$
 $V_i = 4662 \text{ fps}$
 $h_E = 6007 \text{ stat. mi.}$
 $V_i = 3179 \text{ mph}$

(1) g.e.t. = 74 hours.

Figure 5.2.2-1.- Continued.

SEQ	11	14	40	45	47	70	93	1
X	18	-20	3	-20	-21	17	6	-6
Y	-12	20	17	-6	-13	-5	-18	-20

$R_E = 3418$ n. mi.

$h_E = 2853$ stat. mi.

$V_i = 5399$ fps

$V_i = 3681$ mph

Field of view = 50°

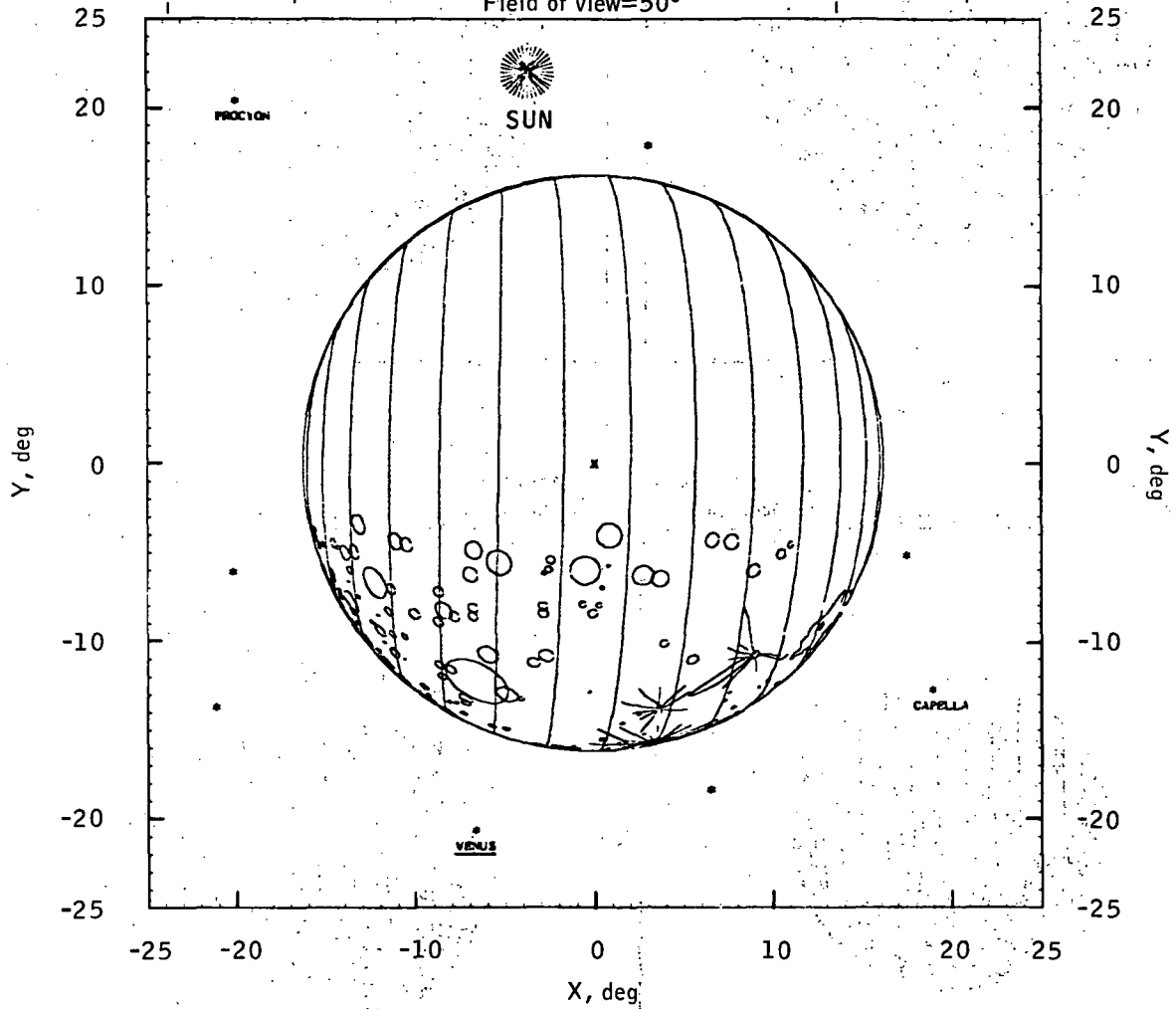

(m) g.e.t. = 75 hours.

Figure 5.2.2-1.- Concluded.

$R_E = 51\,850$ n. mi.
 $V_i = 8564$ fps

$h_E = 55\,704$ stat. mi.
 $V_i = 5839$ mph

Field of view = 1°

Y, nd

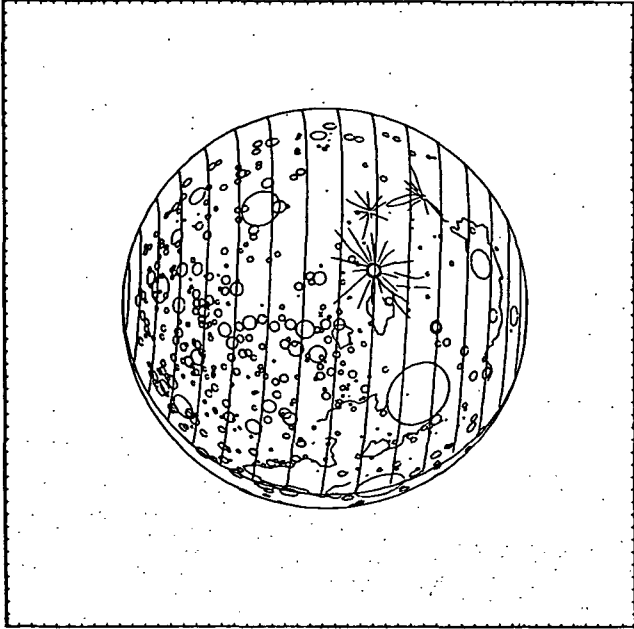

X, nd

(a) g.e.t. = 10 hours.

84

$R_E = 91\,747$ n. mi.
 $V_i = 5875$ fps

$h_E = 101\,617$ stat. mi.
 $V_i = 4006$ mph

Field of view = 1°

Y, nd

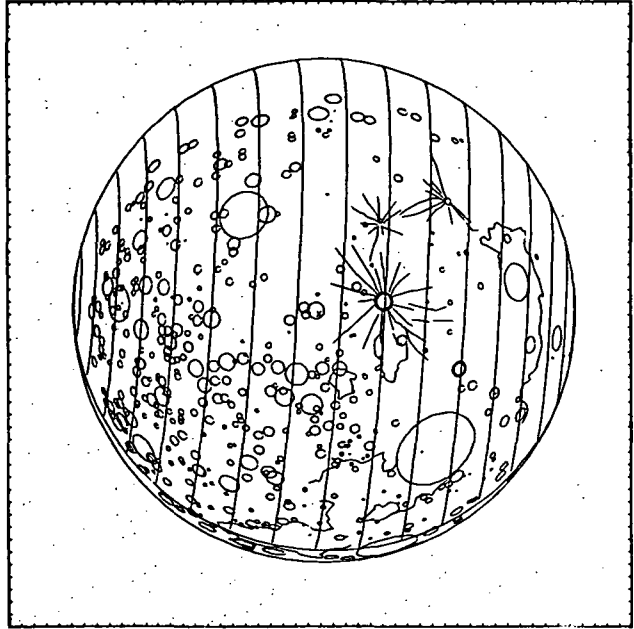

X, nd

(b) g.e.t. = 20 hours.

Y, nd

$R_E = 121\,920$ n. mi.
 $V_i = 4697$ fps

$h_E = 136\,339$ stat. mi.
 $V_i = 3202$ mph

Field of view = 2°

Y, nd

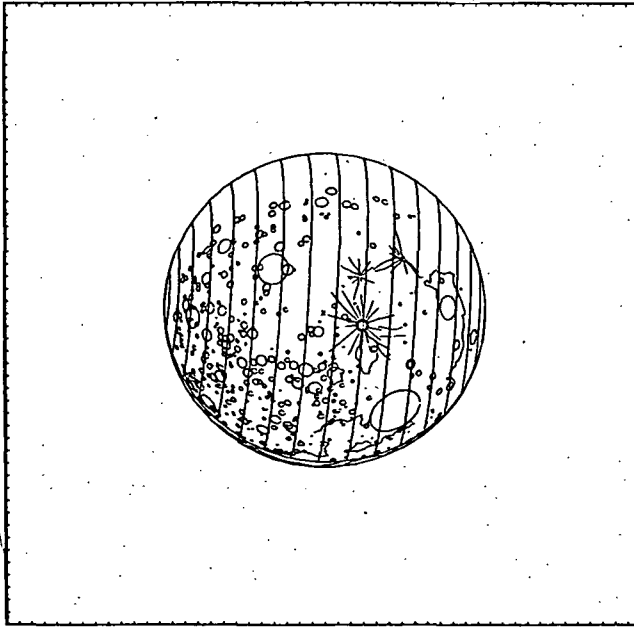

X, nd

(c) g.e.t. = 30 hours.

$R_E = 146\,817$ n. mi.
 $V_i = 3961$ fps

$h_E = 164\,990$ stat. mi.
 $V_i = 2701$ mph

Field of view = 2°

Y, nd

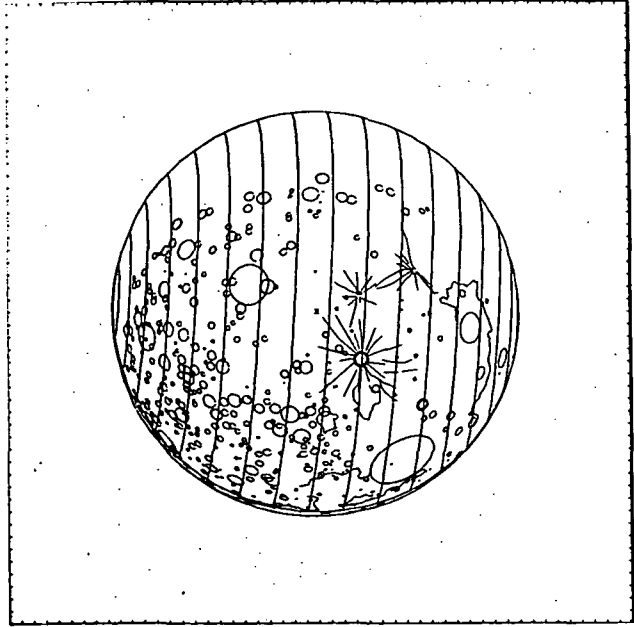

X, nd

(d) g.e.t. = 40 hours.

Y, nd

Figure 5.2.2-2.- Translunar coast - variable field of view (moon).

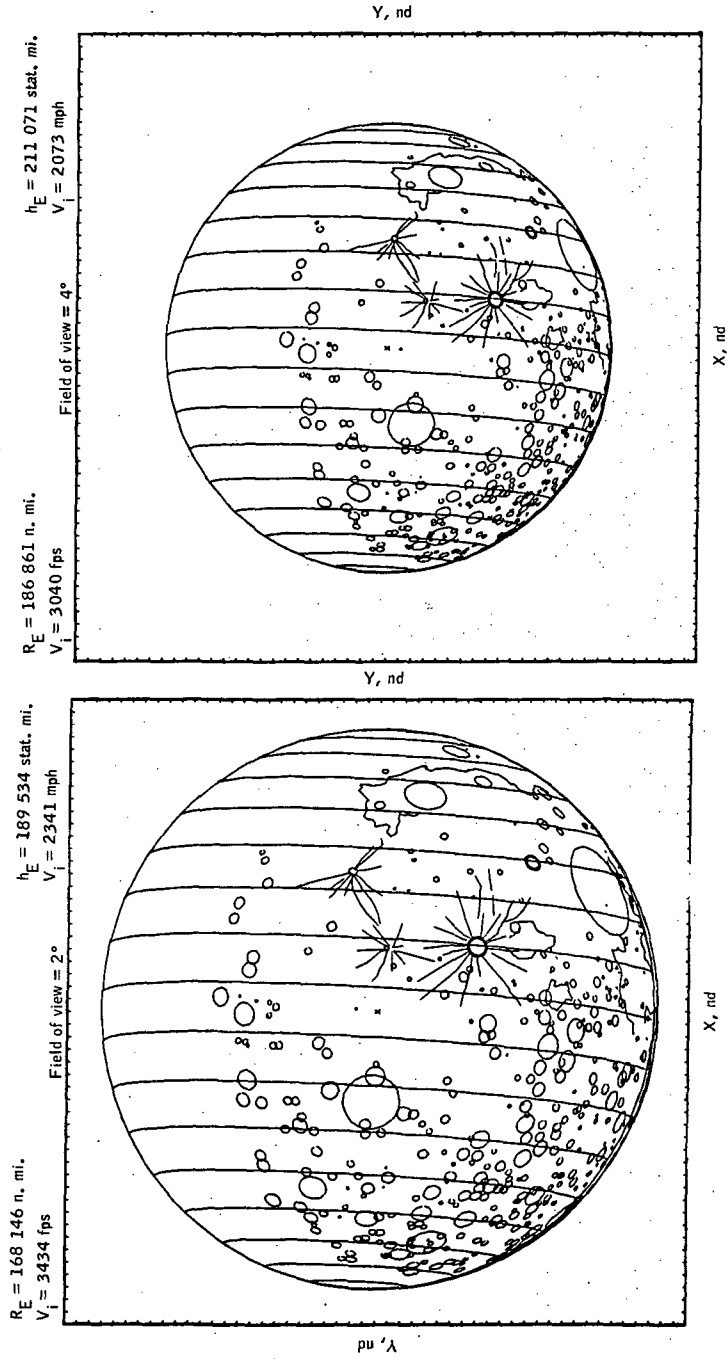

(f) g.e.t. = 60 hours.

Figure 5.2.2-2.- Concluded.

(e) g.e.t. = 50 hours.

Page intentionally left blank

6.0 VIEWS FROM CSM AND LM DURING
LUNAR ORBIT PHASE

6.1 VIEWS FROM CSM DURING LOI BURN

6.2 VIEWS FROM LM DURING
DESCENT PHASE

6.2.1 DOI BURN

6.2.2 PDI BURN

6.3 VIEWS FROM LM DURING
ASCENT PHASE

6.3.1 ASCENT BURN

6.3.2 CSI MANEUVER

6.3.3 CDH MANEUVER

6.3.4 TPI MANEUVER

Page intentionally left blank

6.0 VIEWS FROM CSM AND LM DURING
LUNAR ORBIT PHASE

Page intentionally left blank

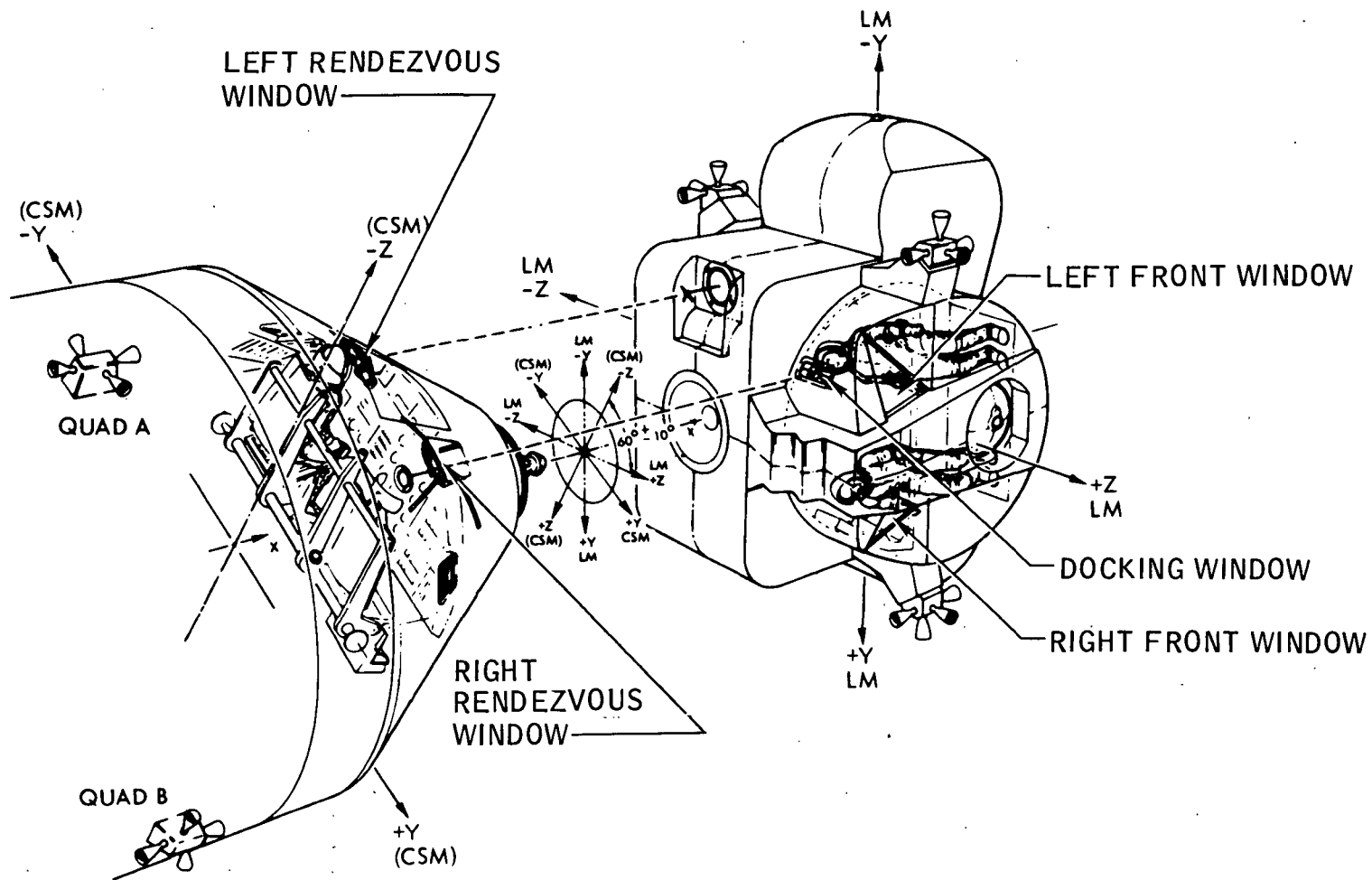

Figure 6.0-1.- LM/CSM docked orientation.

Page intentionally left blank

6.1 VIEWS FROM CSM DURING LOI BURN

Page intentionally left blank

SEG	24	26	29	32	34	43	44	113	114	117	118
X	-14	21	14	12	-21	-24	-24	-16	-23	-16	-18
Y	-20	-15	0	16	12	-22	-10	-24	-16	-16	-14
SEG	119	120	121	122	123	124	128	131	133	135	142
X	21	-2	-15	2	13	10	19	24	-19	-16	13
Y	-22	-19	-14	-17	-11	-14	-9	-7	0	0	15

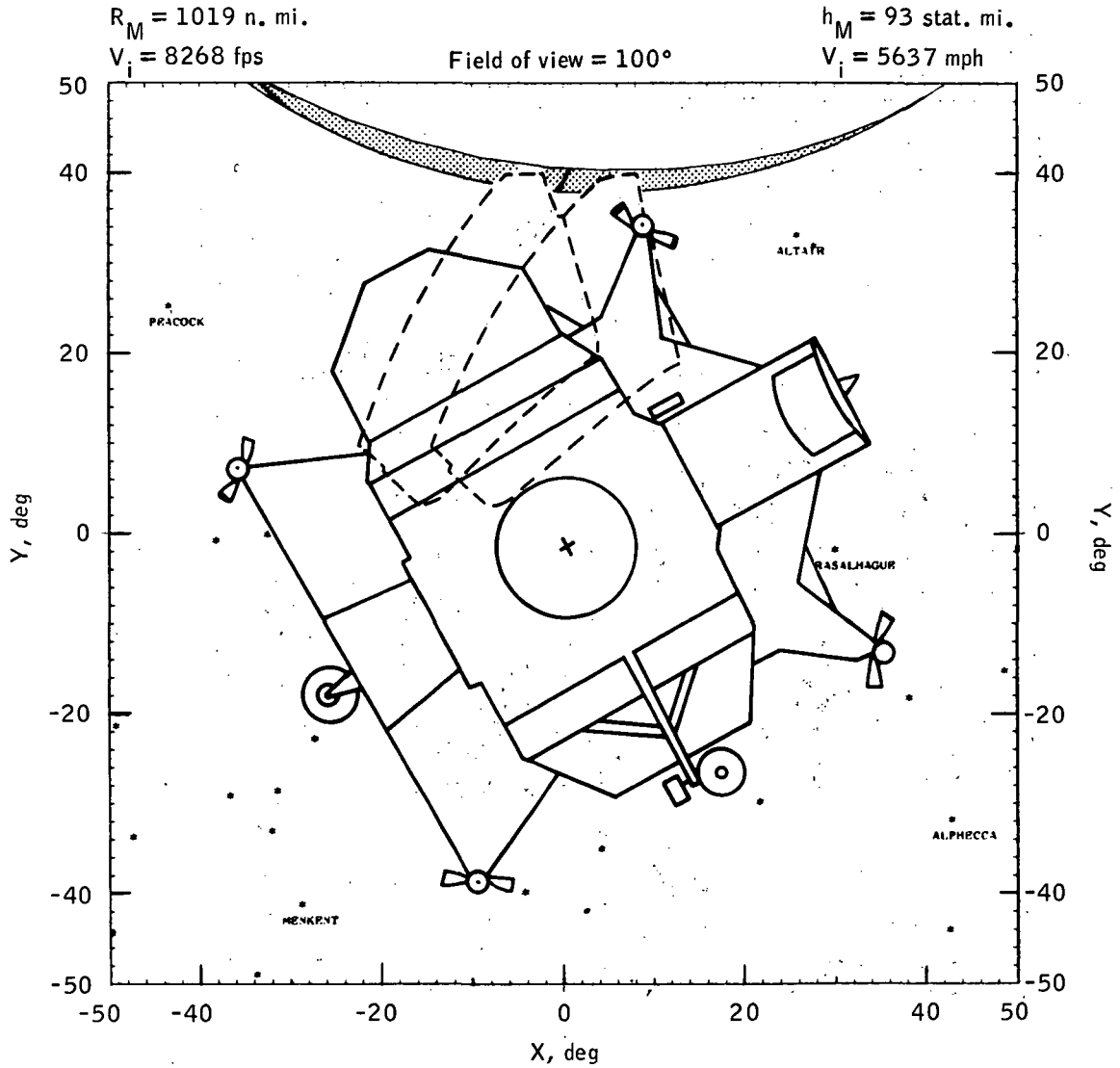

(a) Begin of LOI burn (g.e.t. = 75:55:02.8).

Figure 6.1-1. - Lunar orbit insertion burn.

SEQ	24	26	113	117	118	119	121	122	123	124
X	-16	19	-19	-18	-20	18	-17	0	-15	8
Y	-20	-16	-24	-16	-14	-22	-13	-17	-11	-15

SEQ	128	131	133	135
X	16	22	-21	-18
Y	-9	-8	0	0

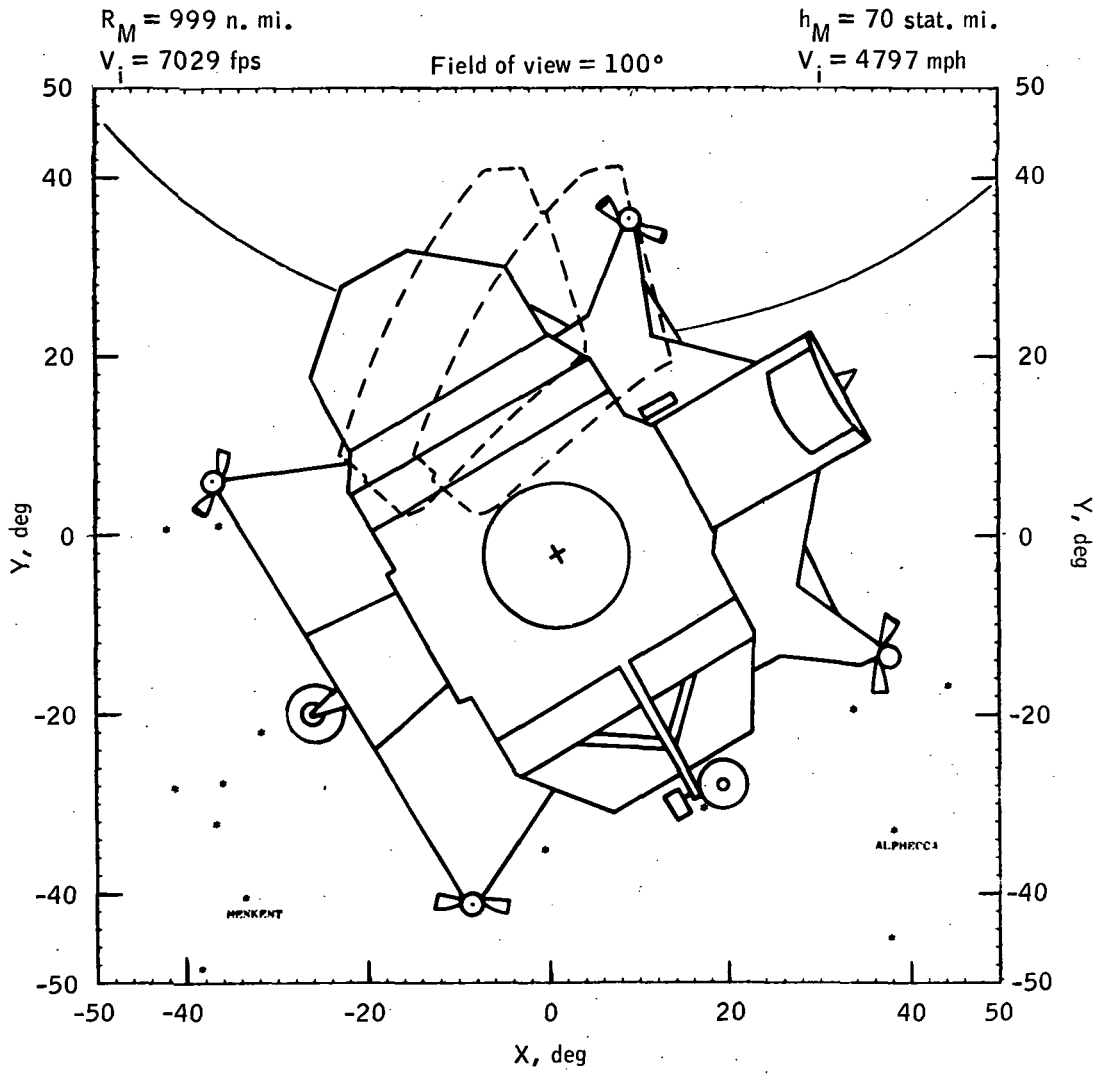

(b) Middle of LOI burn (g.e.t. = 75:58:02.8).

Figure 6.1-1.- Continued.

SEG	24	26	30	61	63	85	113	116	117	118	119
X	-20	15	23	-14	-12	-13	-22	22	-21	-23	15
Y	-20	-17	3	0	5	-4	-24	-23	-15	-13	-22

SEG	120	121	123	124	125	126	128	131	133	135
X	-7	-21	-19	3	-11	-7	13	18	-23	-20
Y	-19	-13	-10	-15	-10	-10	-10	-9	1	1

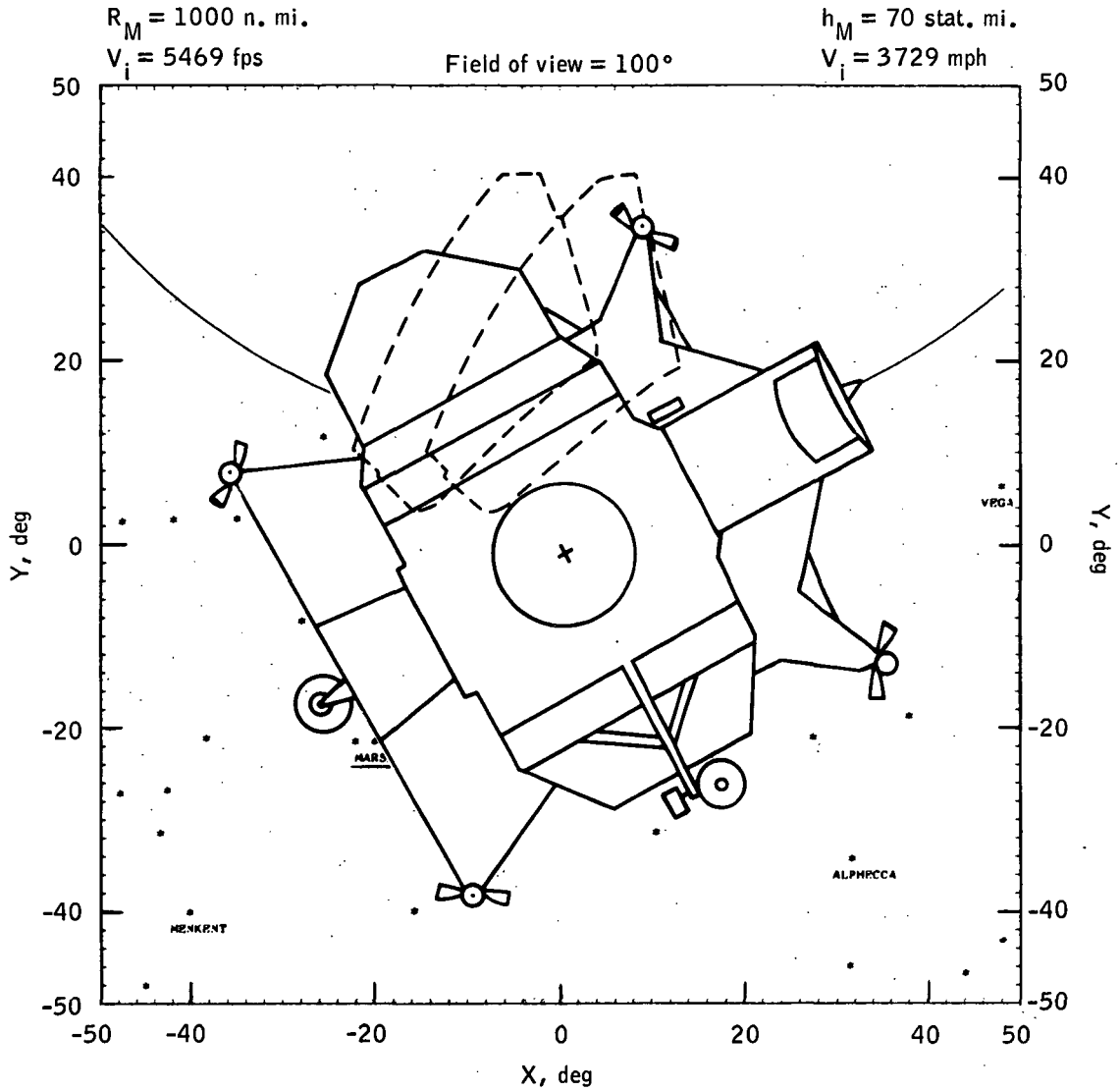

(c) End of LOI burn (g.e.t. = 76:01:08.2).

Figure 6.1-1.- Concluded.

Page intentionally left blank

6.2 VIEWS FROM LM DURING
DESCENT PHASE

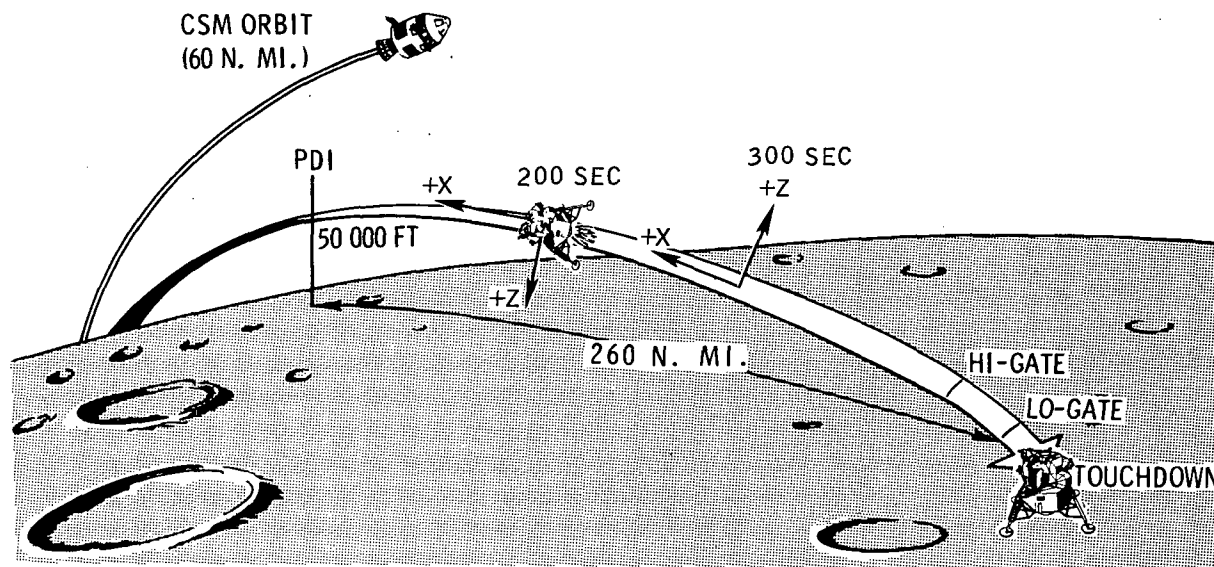

DESIGN CRITERIA

- BRAKING PHASE (PDI TO HI-GATE) - EFFICIENT REDUCTION OF ORBITAL VELOCITY
- FINAL APPROACH PHASE (HI-GATE TO LO-GATE) - CREW VISIBILITY (SAFETY OF FLIGHT AND SITE ASSESSMENT)
- LANDING PHASE (LO-GATE TO TOUCHDOWN) - MANUAL CONTROL TAKEOVER

(b) Operational phases of powered descent.

Figure 6.2.0-1.- Concluded.

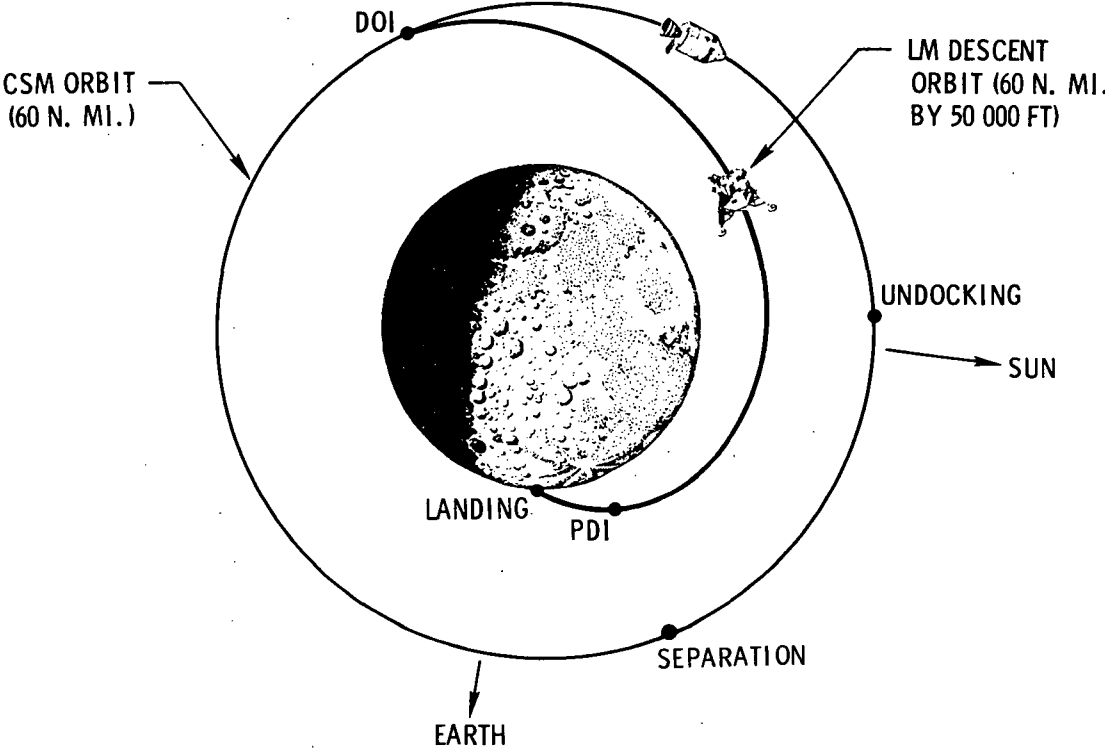

(a) LM descent phase geometry.

Figure 6.2.0-1.- Descent phase.

Page intentionally left blank

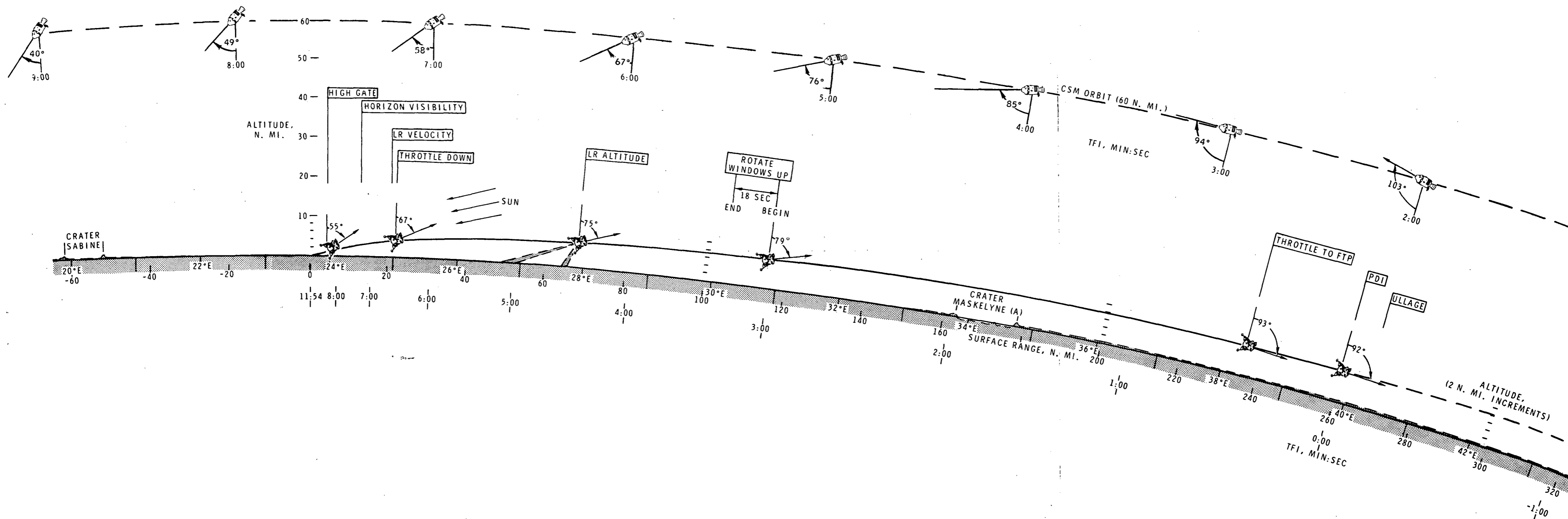

(b) Powered descent profile.

Figure 6.2.0-1. - Concluded.

Page intentionally left blank

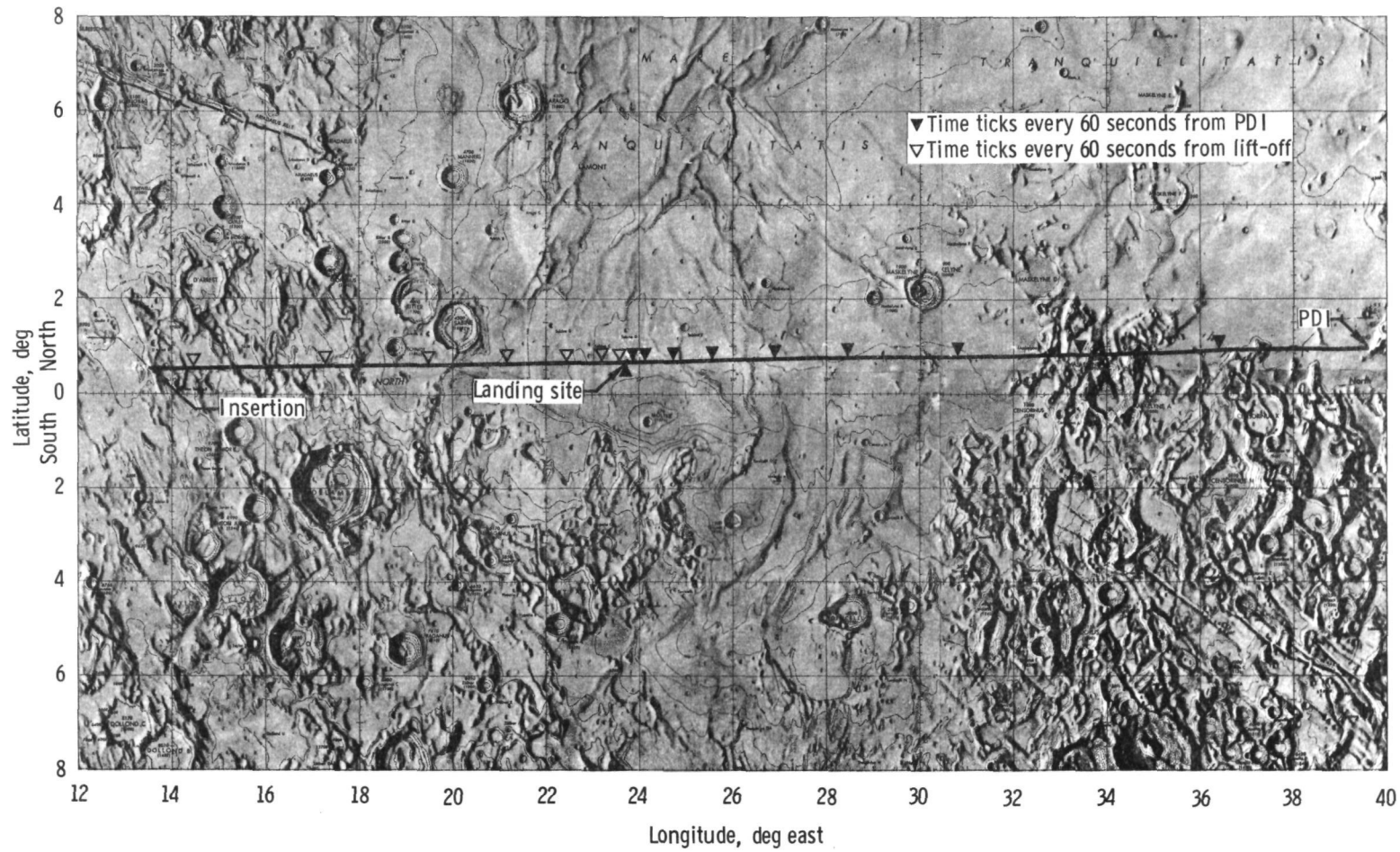

Figure 6.2.0-2. - LM groundtrack during descent and ascent.

Page intentionally left blank

6.2.1 DOI BURN

Page intentionally left blank

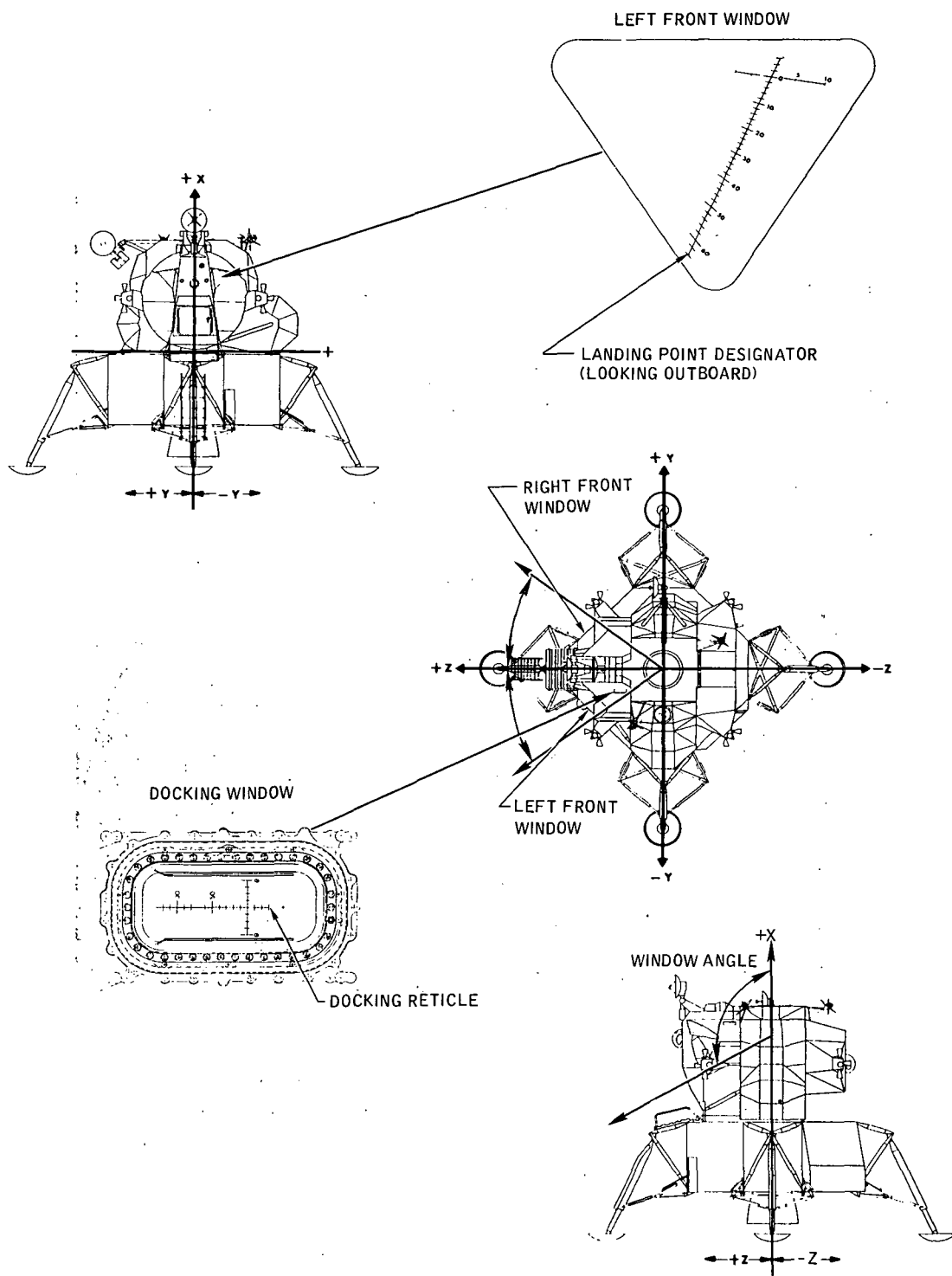

Figure 6.2.1-1.- LM window and body axes geometry.

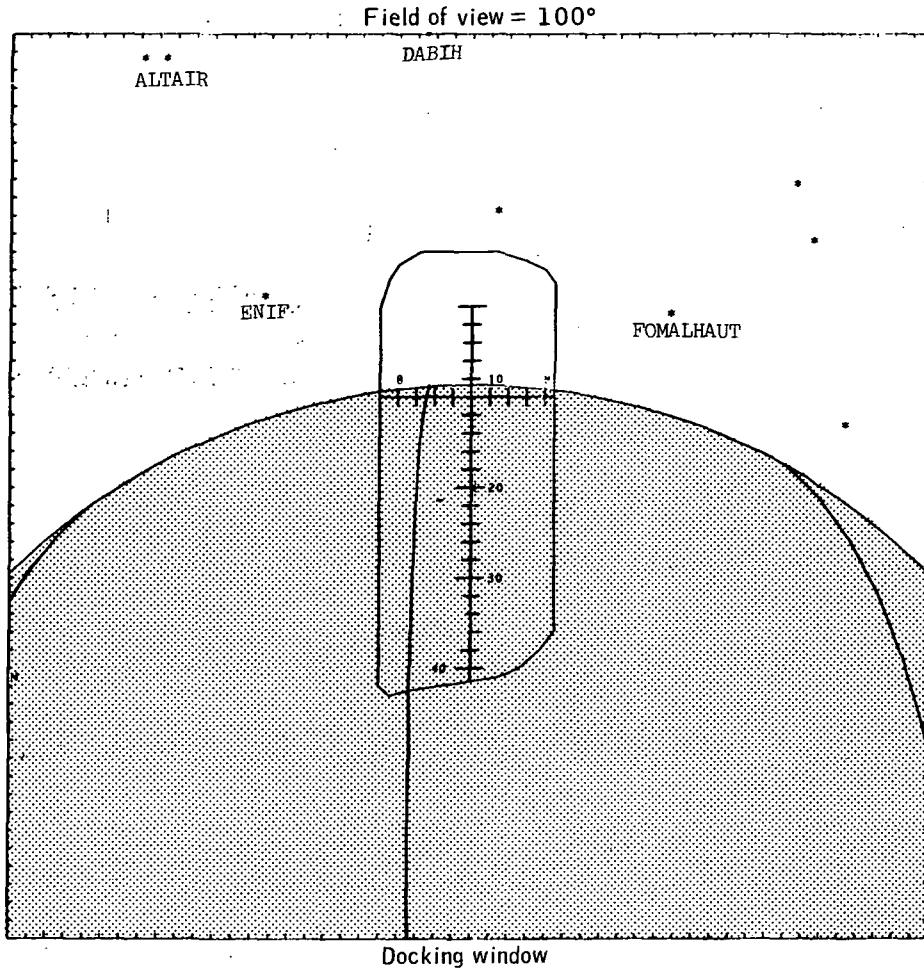
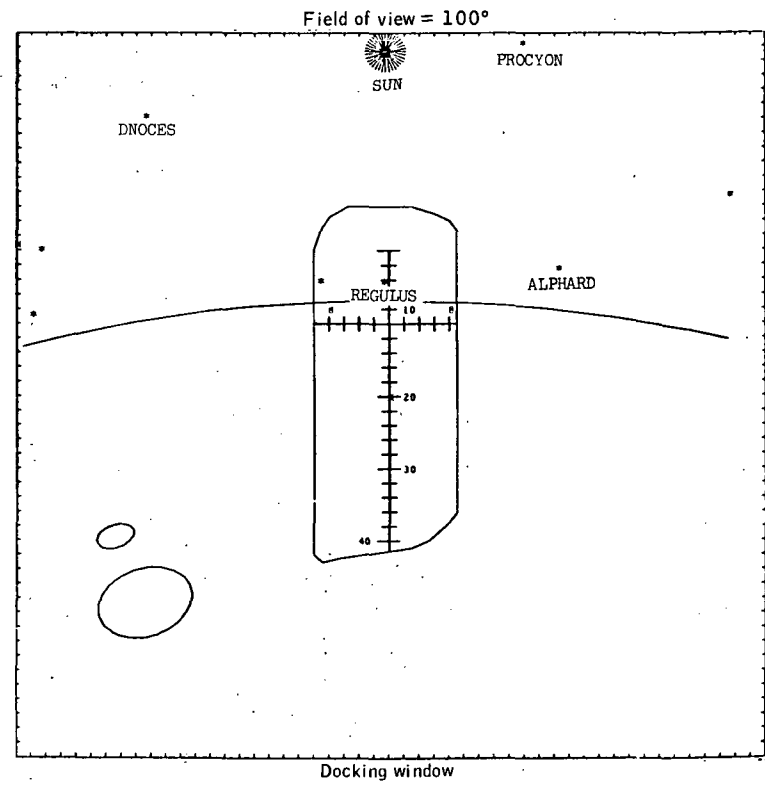
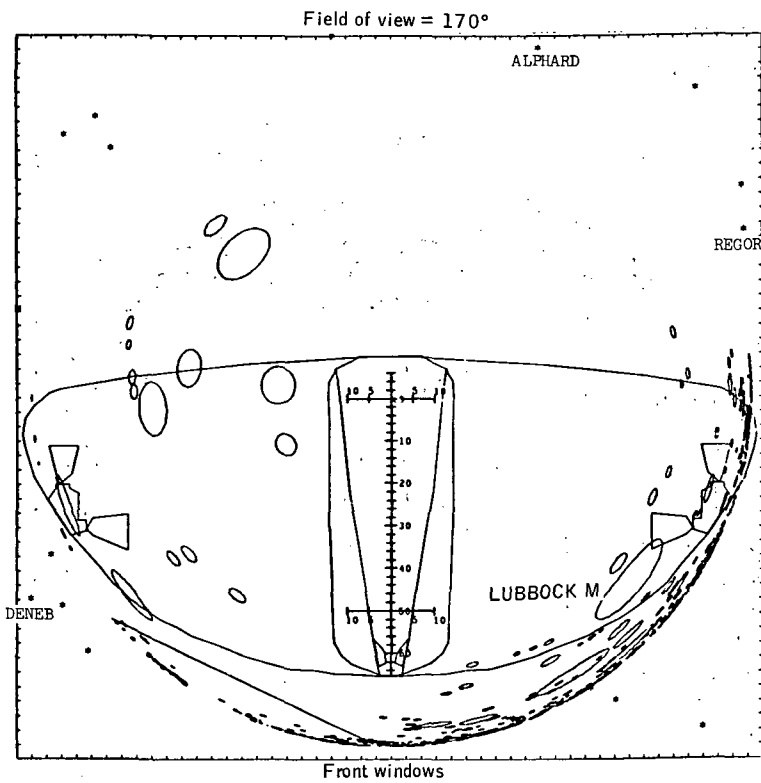

Figure 6.2.1-2.- DOI burn (g.e.t. = 101:38:48).

6.2.2 PDI BURN

Page intentionally left blank



(a) Begin descent burn.

Figure 6.2.2-1. - PDI bum.

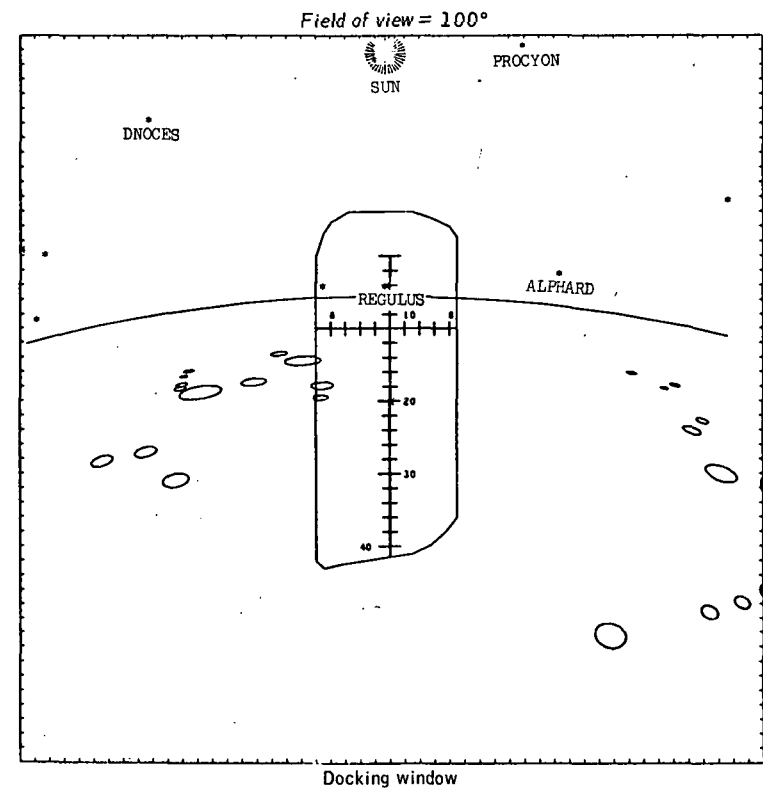
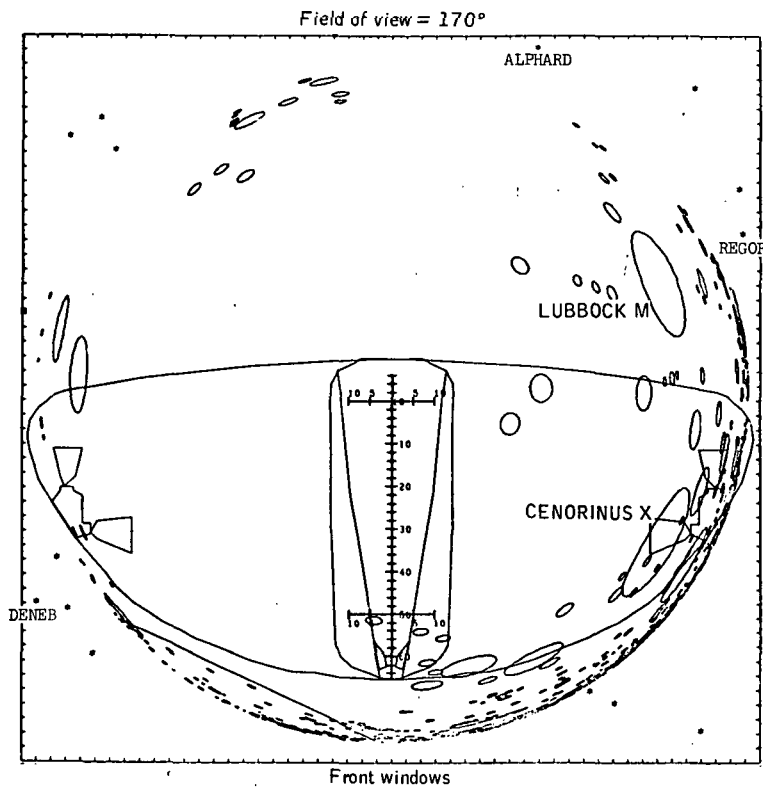

(b) 26 seconds into descent burn.

Figure 6.2.2-1. - Continued.

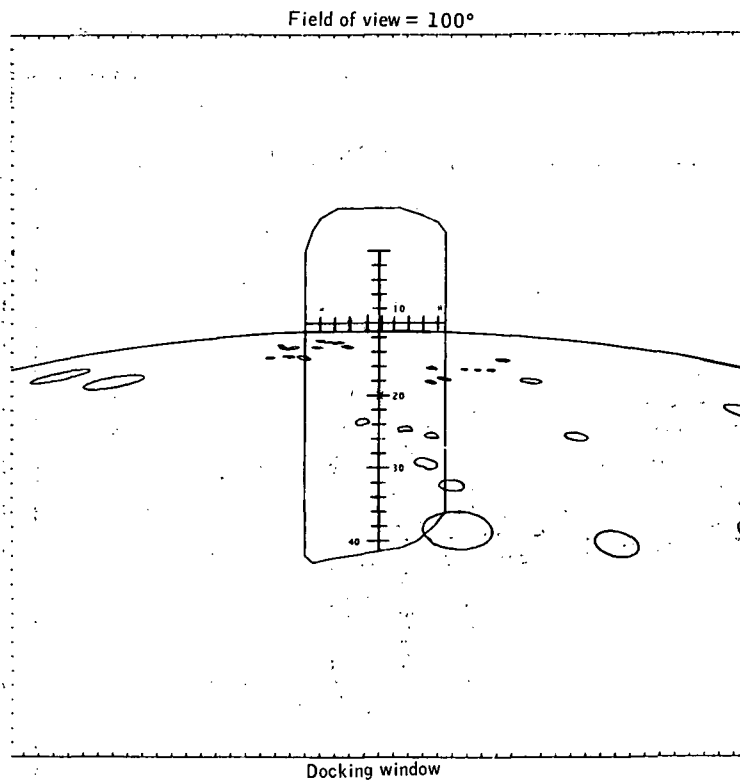
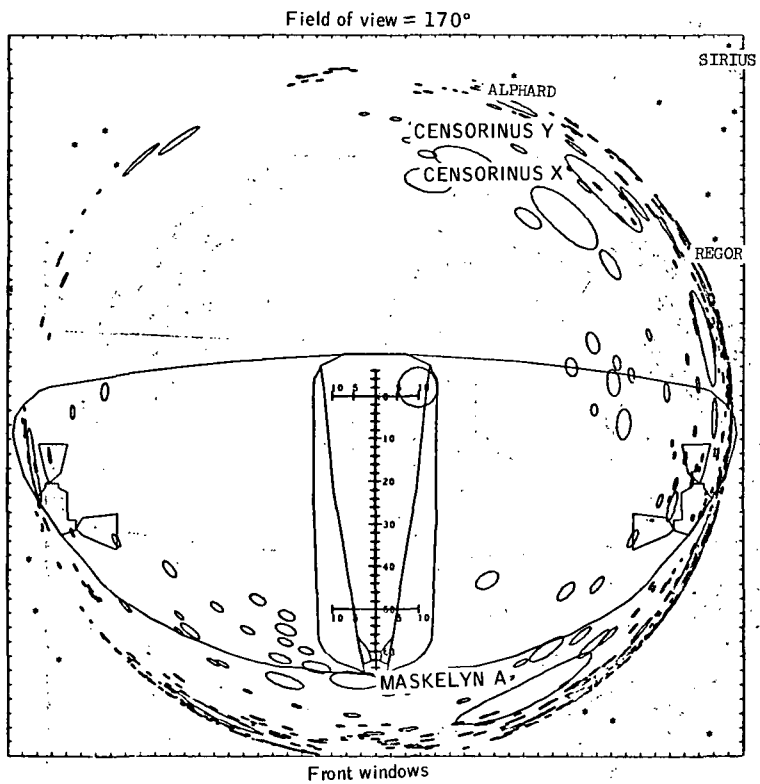

(c) 1 minute 6 seconds into descent burn.

Figure 6.2.2-1.- Continued.

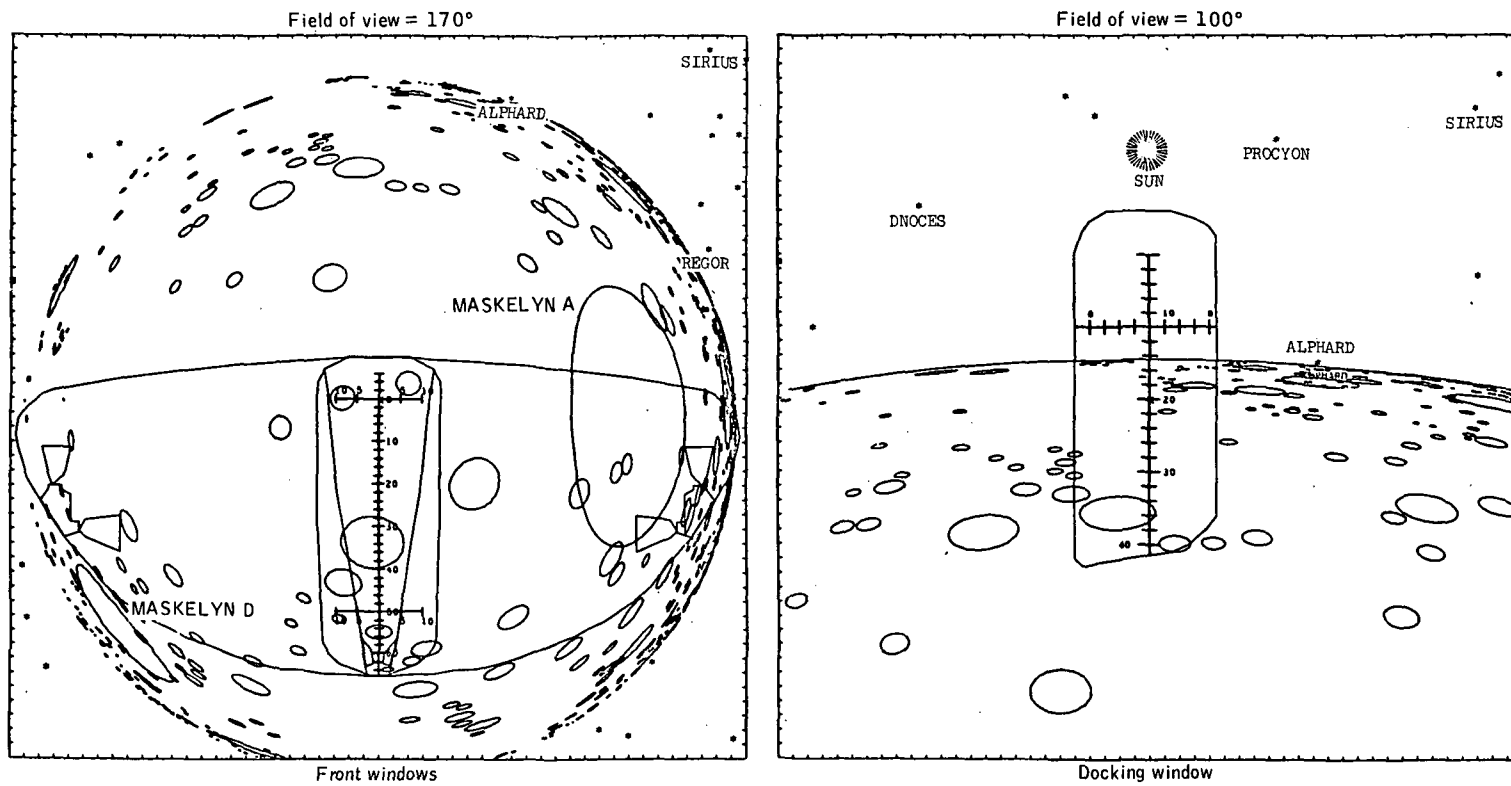

(d) 1 minute 46 seconds into descent burn.

Figure 6.2.2-1.- Continued.

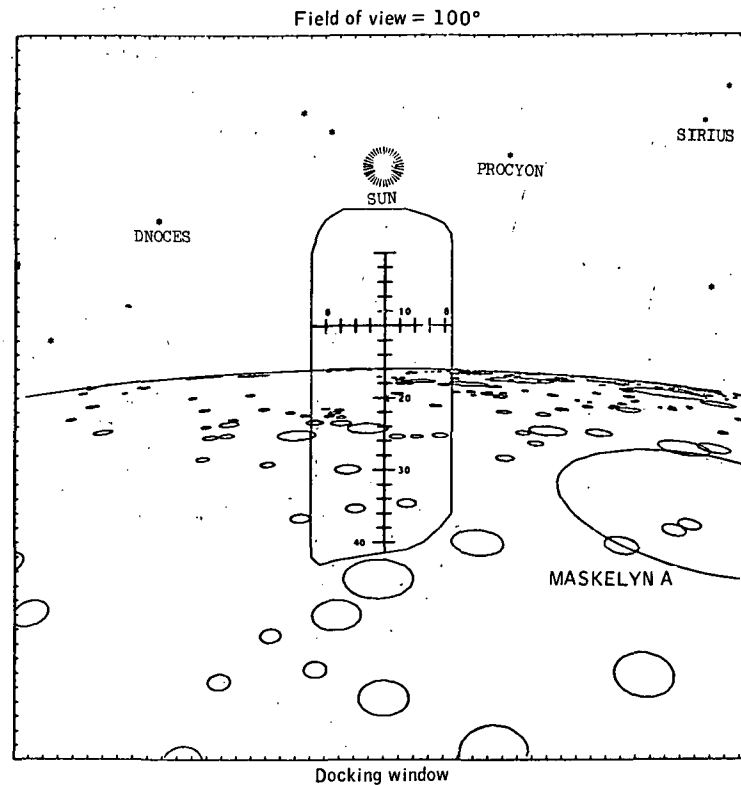
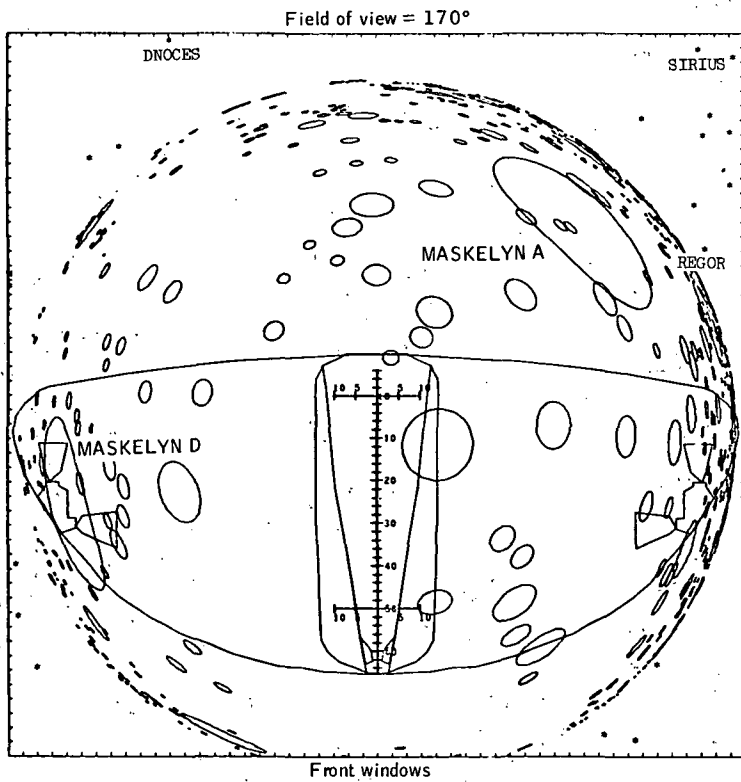

(e) 2 minutes 6 seconds into descent burn.

Figure 6.2.2-1. - Continued.

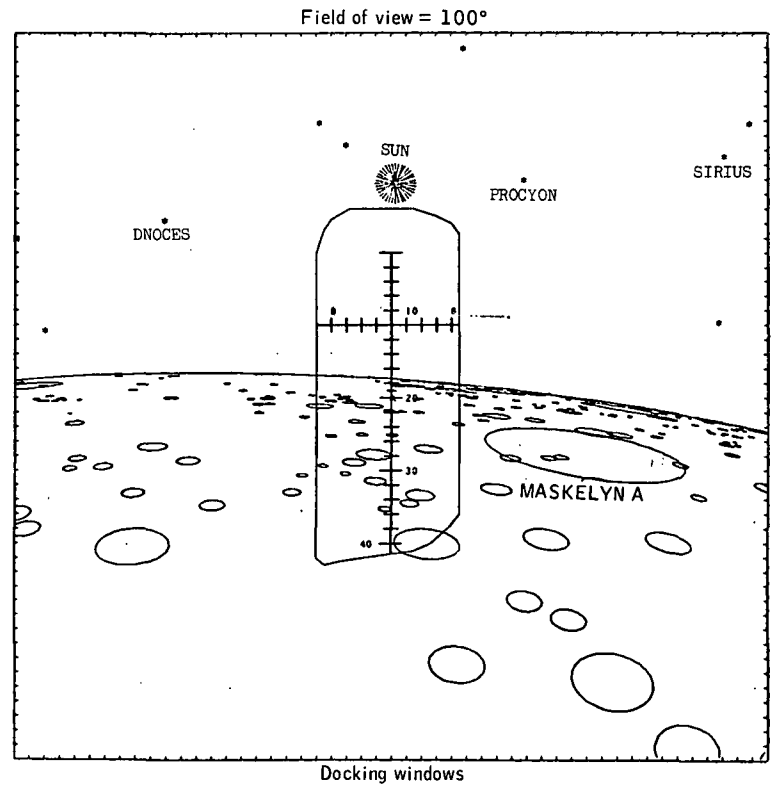
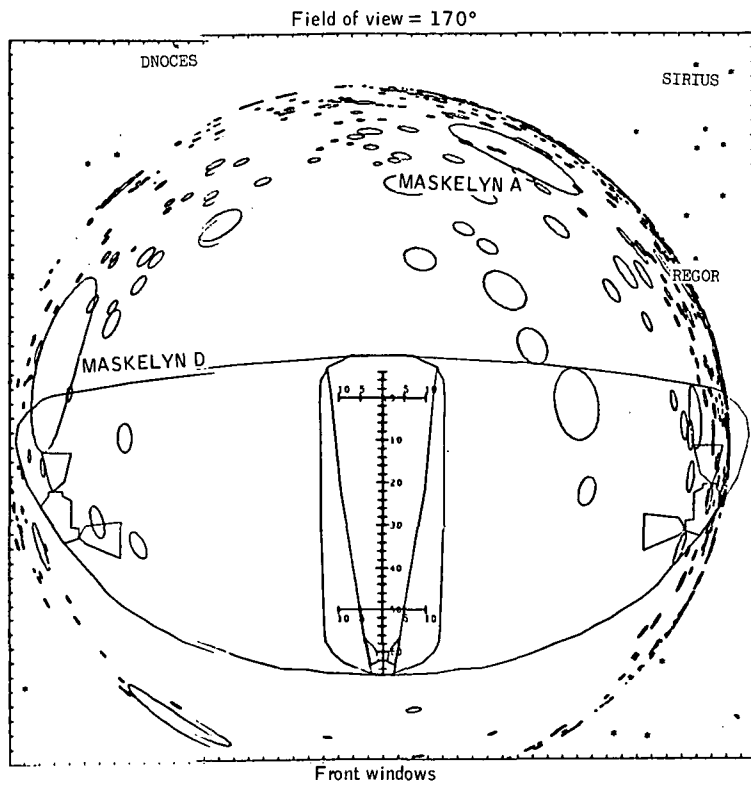

(f) 2 minutes 26 seconds into descent burn.

Figure 6.2.2-1.- Continued.

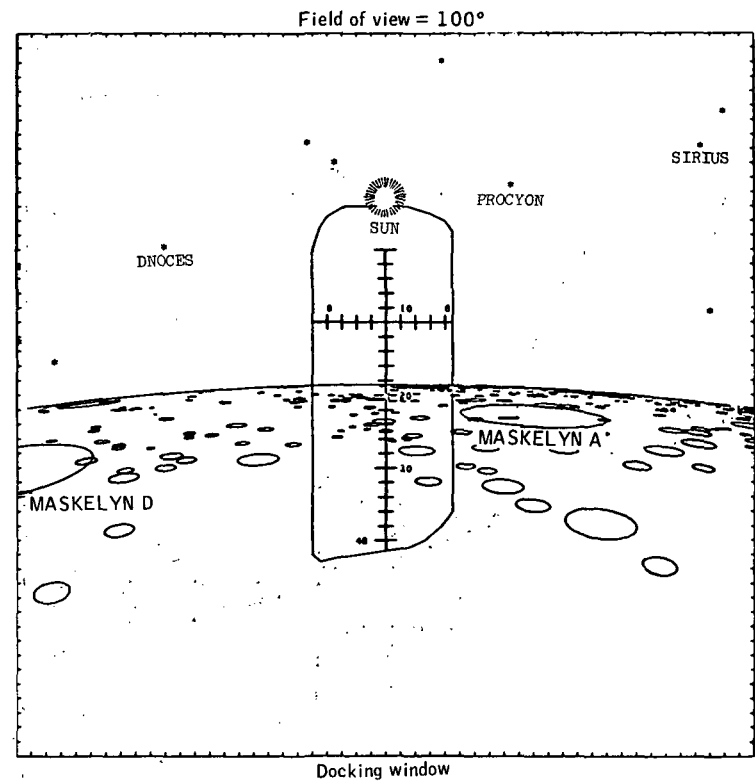
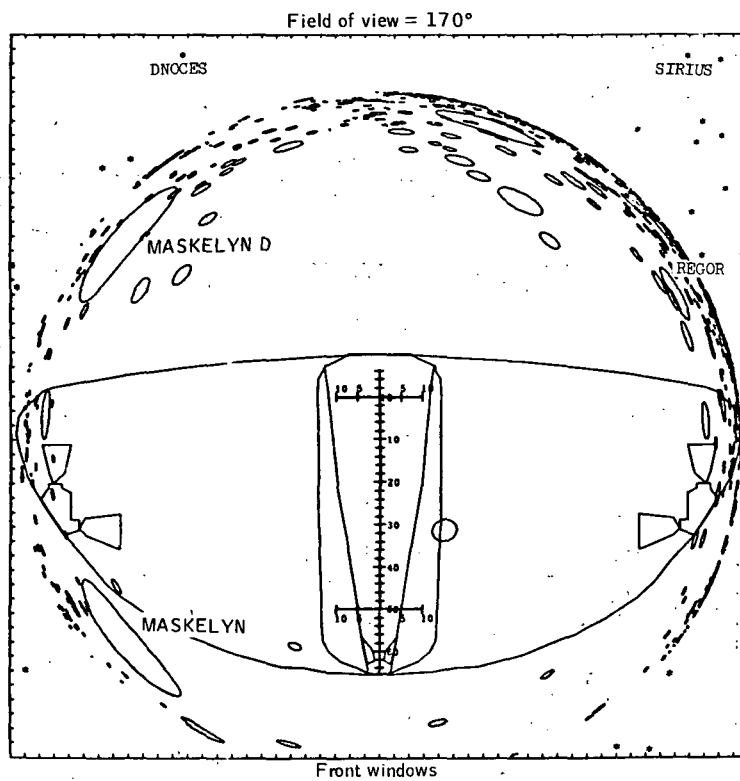

(g) 2 minutes 46 seconds into descent burn.

Figure 6.2.2-1.- Continued.

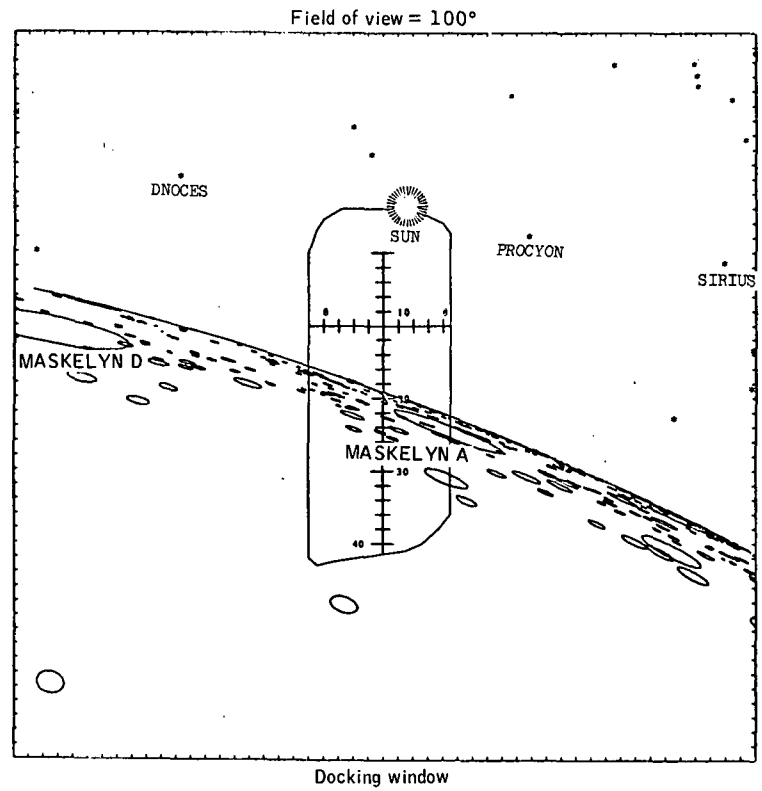
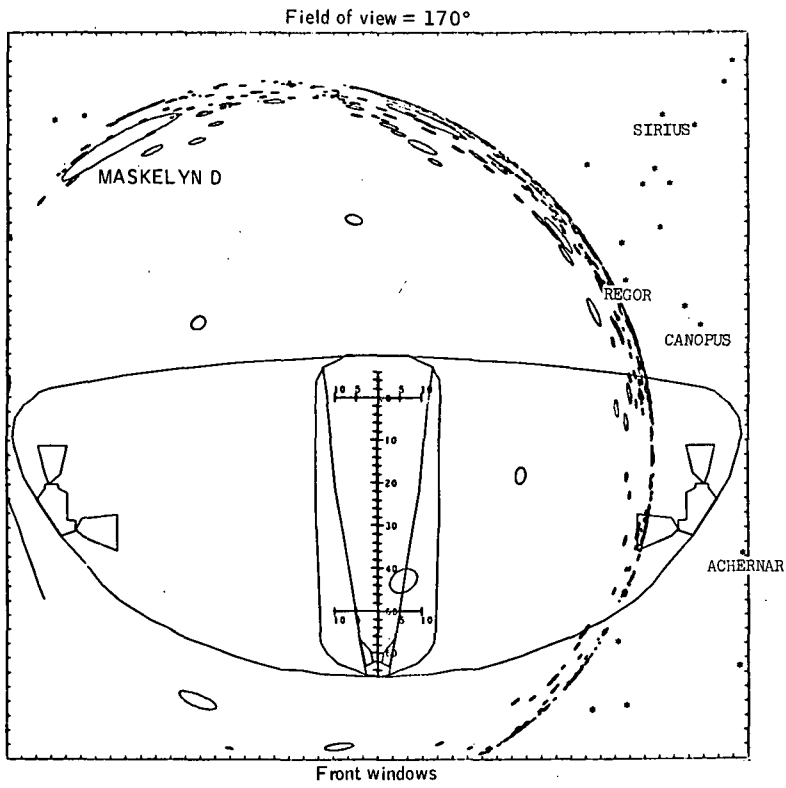

(h) 3 minutes 6 seconds into descent burn:

Figure 6.2.2-1.- Continued.

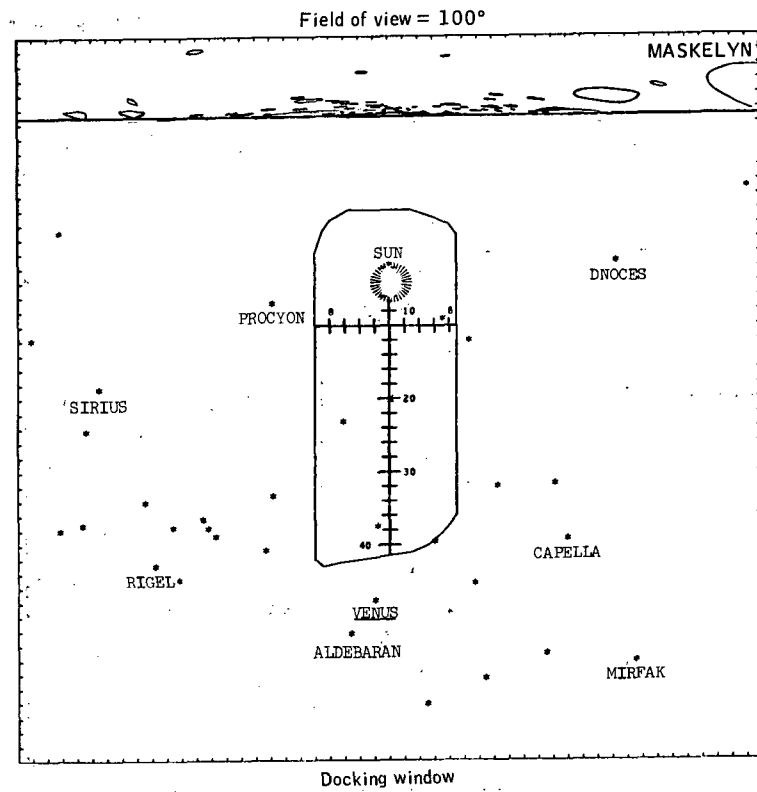
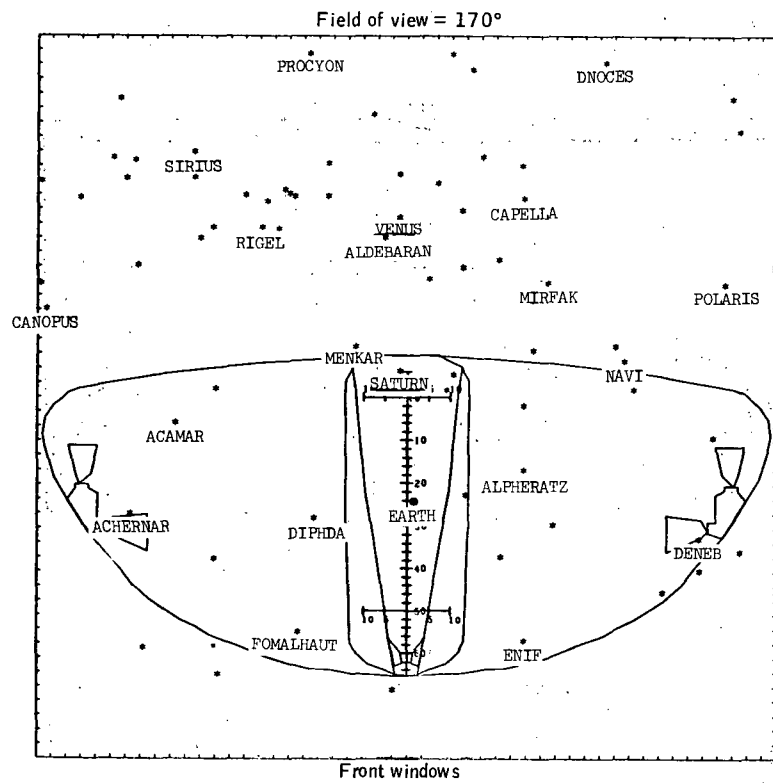

(i) 3-minutes 46 seconds into descent burn.

Figure 6.2.2-1.- Continued.

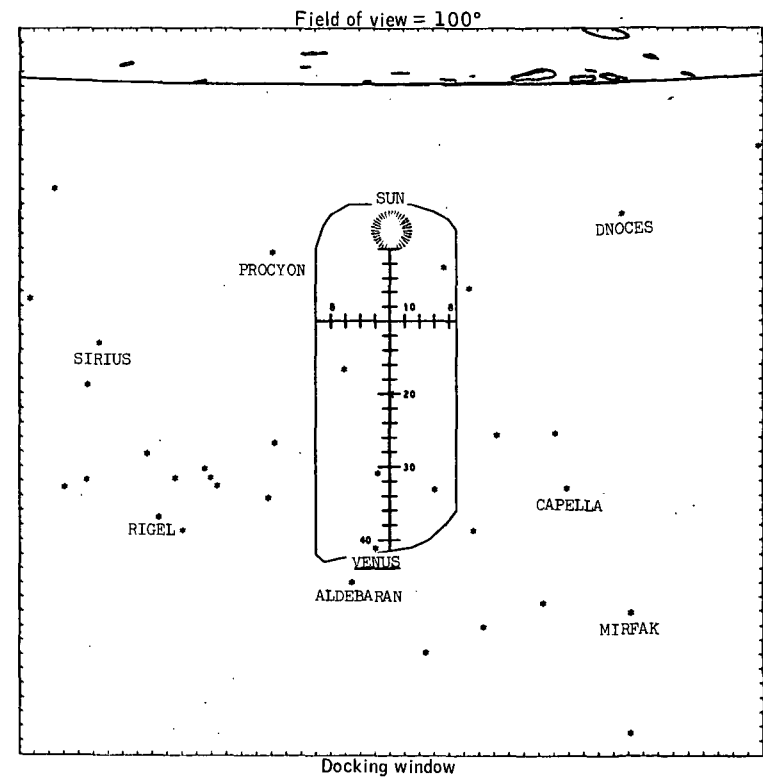
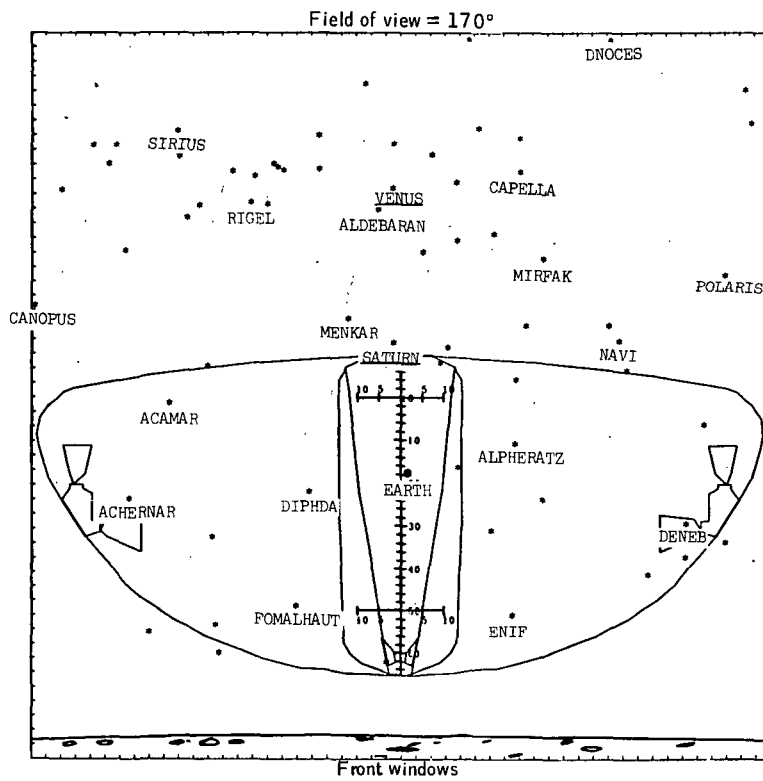

(i) 5 minutes 26 seconds into descent burn.

Figure 6.2.2-1.- Continued.

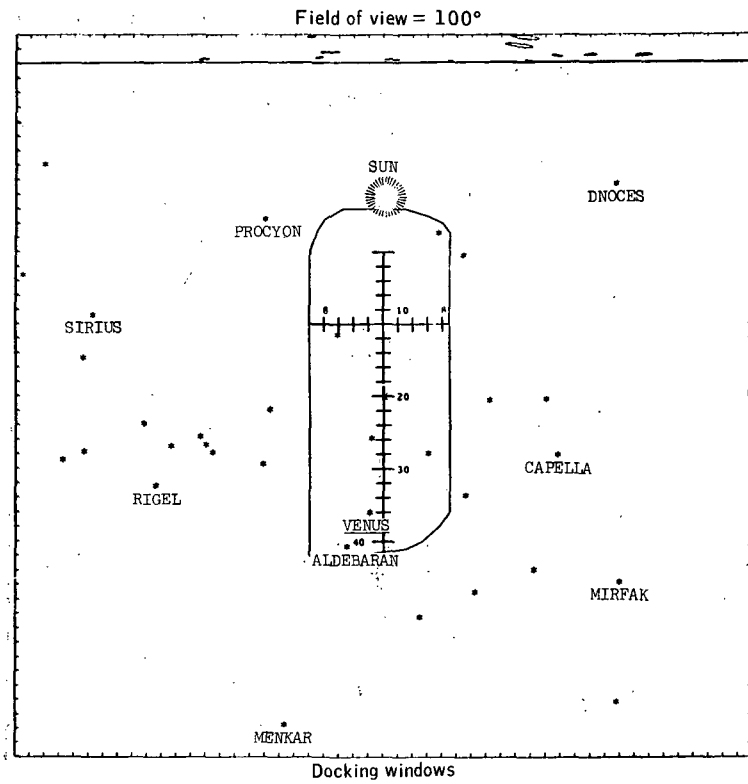
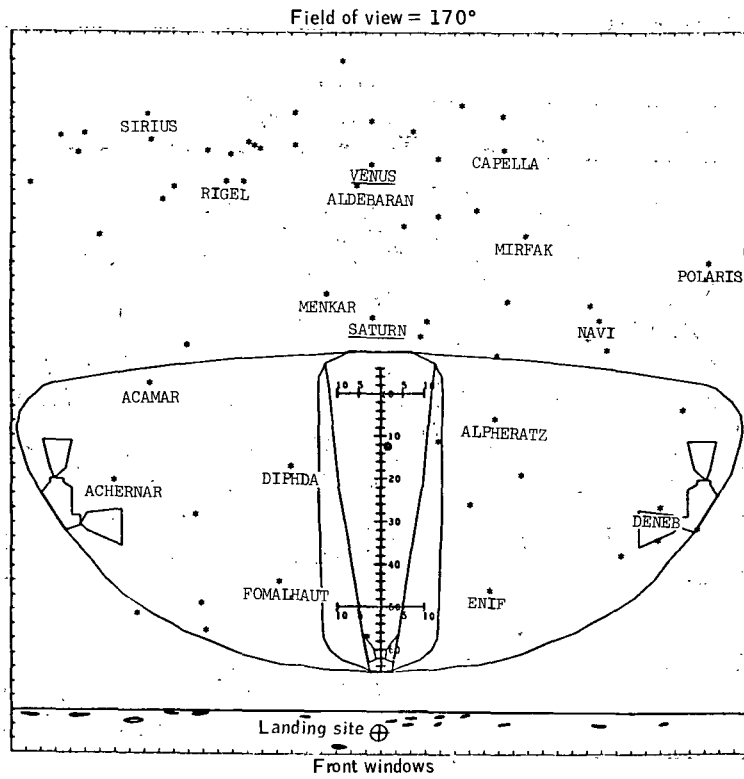

(k) 6 minutes 6 seconds into descent burn.

Figure 6.2.2-1.- Continued.

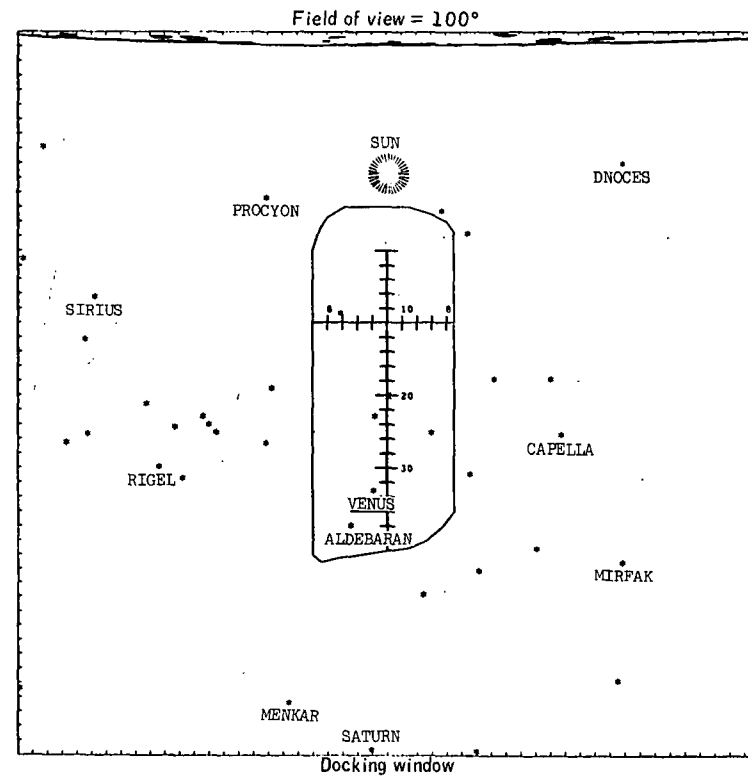
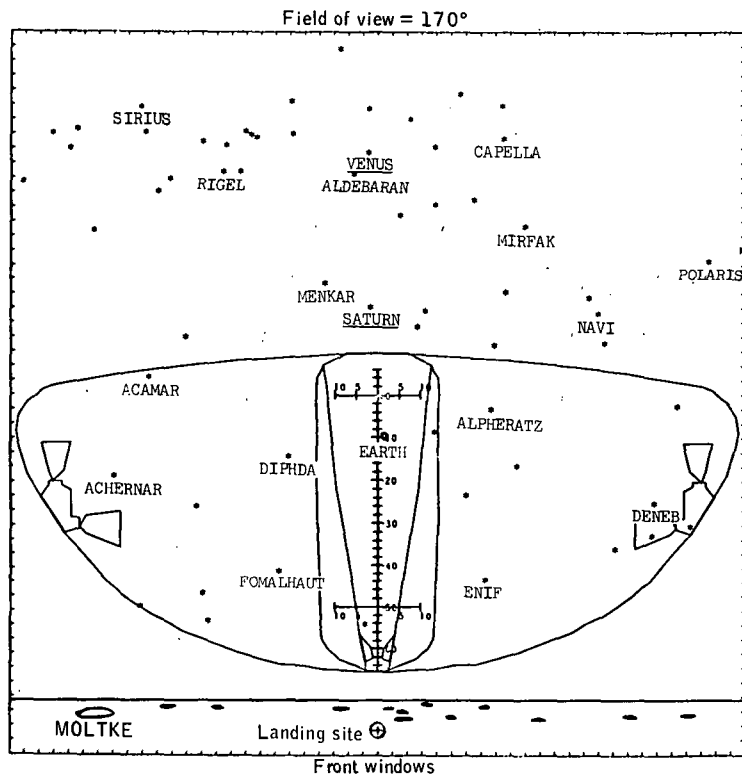

(I) 6 minutes 26 seconds into descent burn.

Figure 6.2.2-1. - Continued.

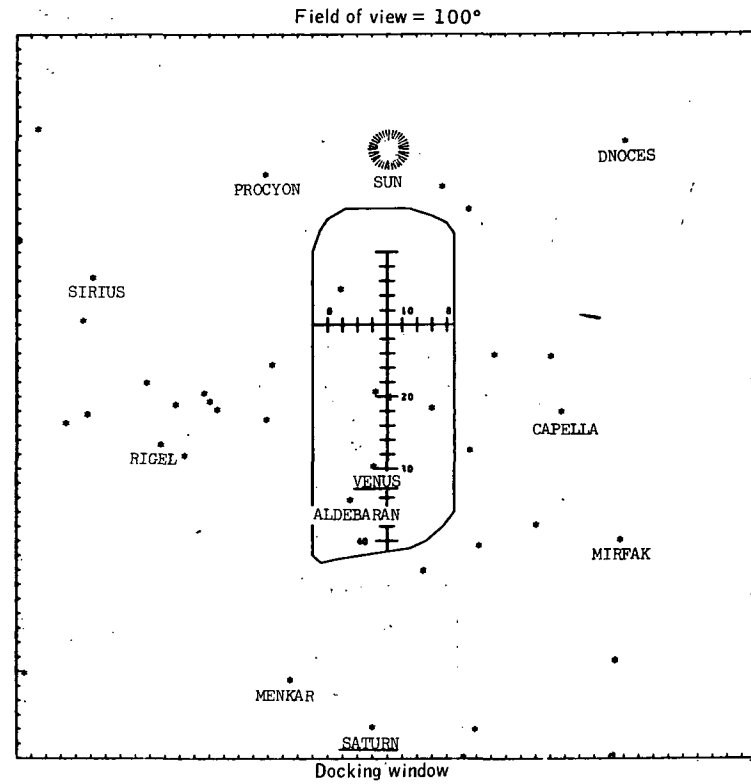
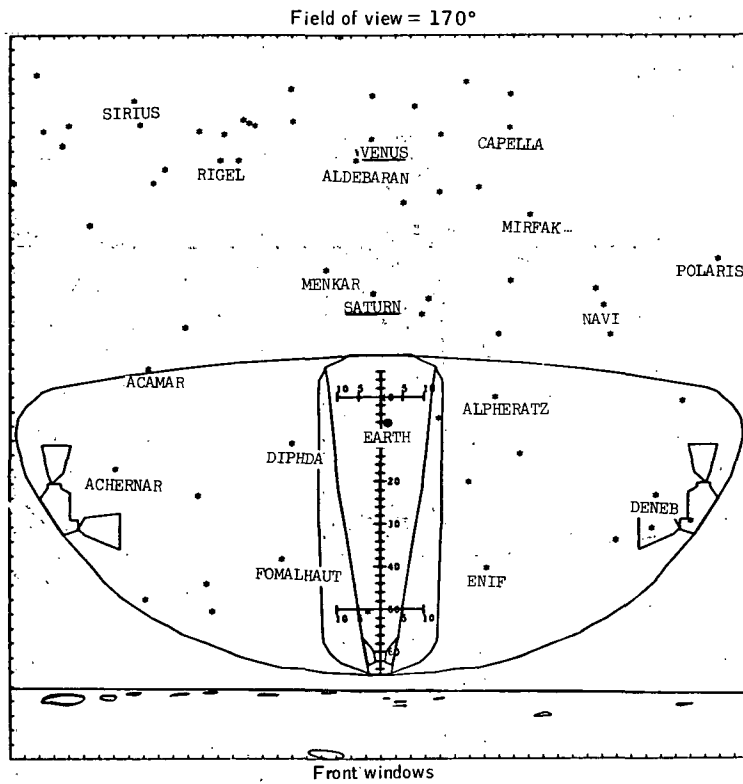

(m) 6 minutes 46 seconds into descent burn.

Figure 6.2.2-1.- Continued.

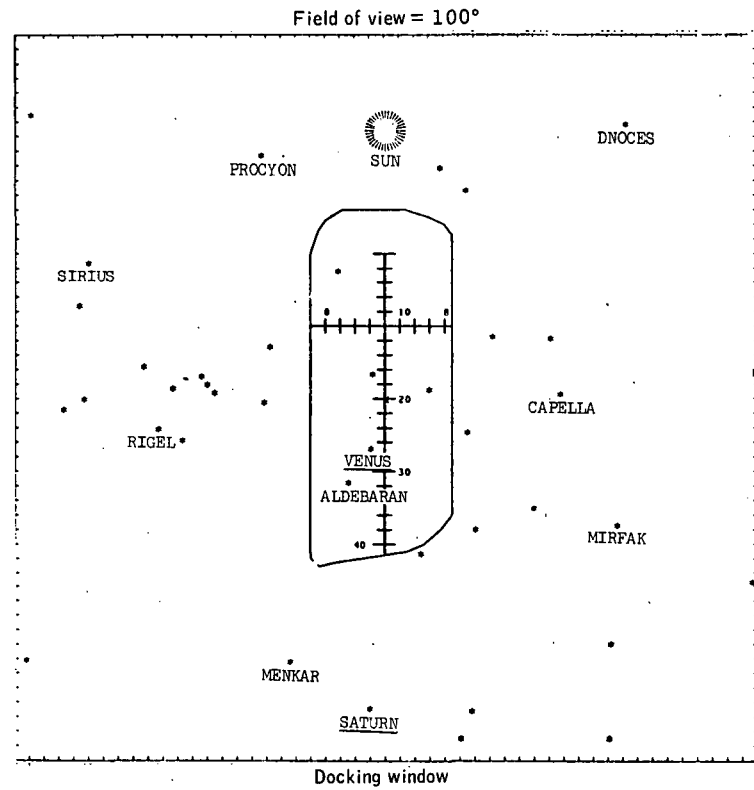
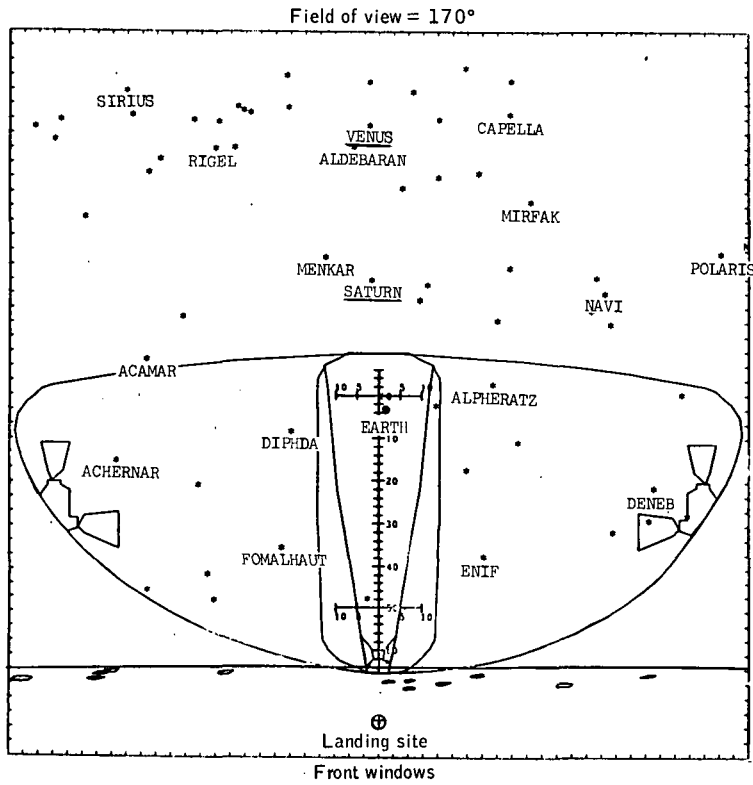

(n) 7 minutes 6 seconds into descent burn.

Figure 6.2.2-1. - Continued.

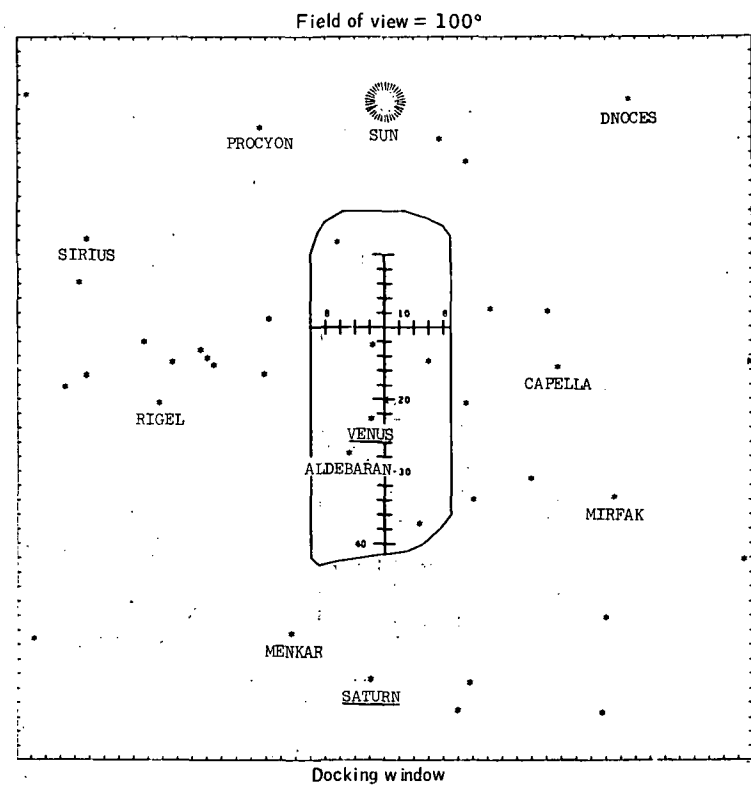
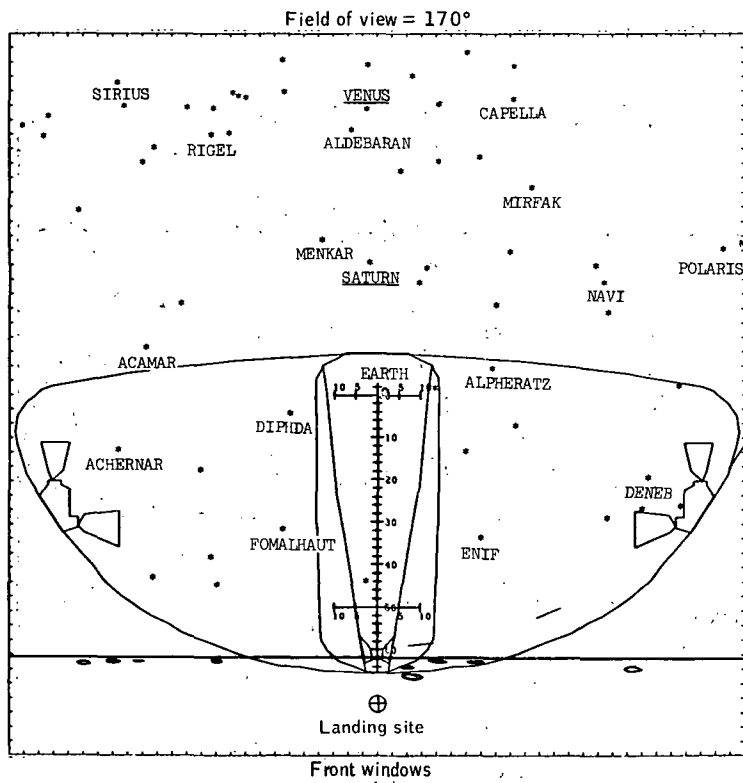

(a) 7 minutes 46 seconds into descent burn.

Figure 6.2.2-1. - Continued.

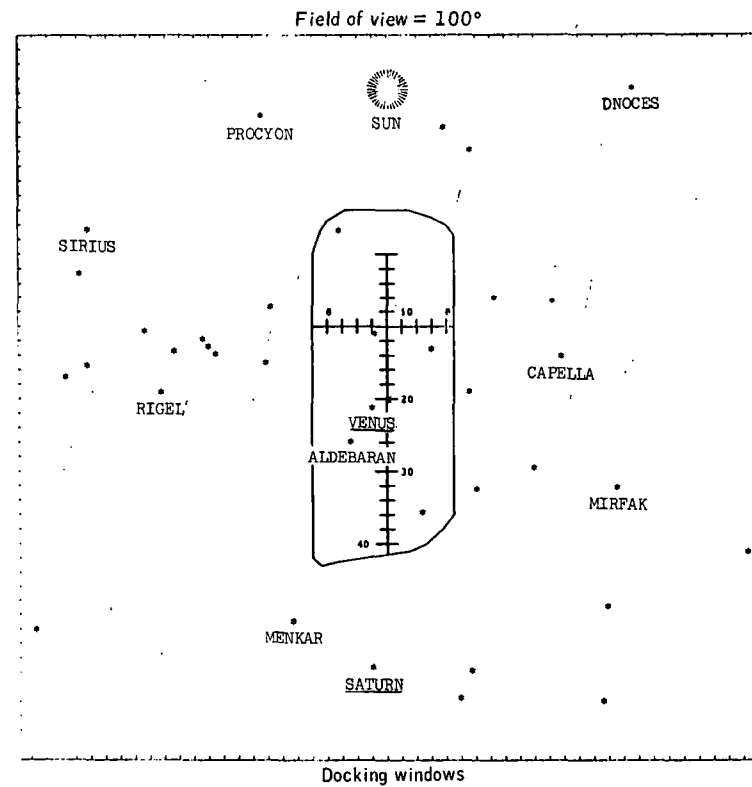
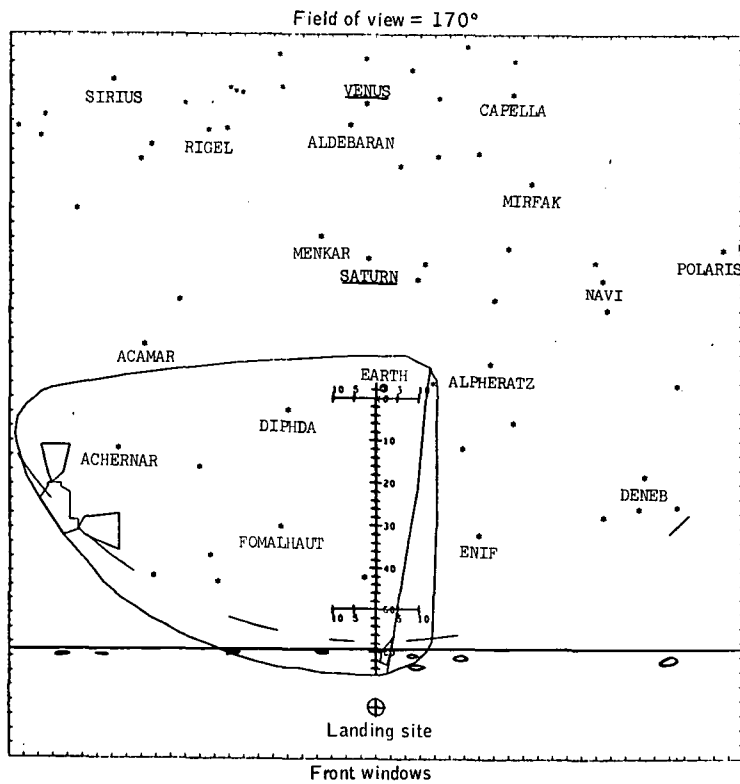

(p) 8 minutes 6 seconds into descent burn.

Figure 6.2.2-1. - Continued.

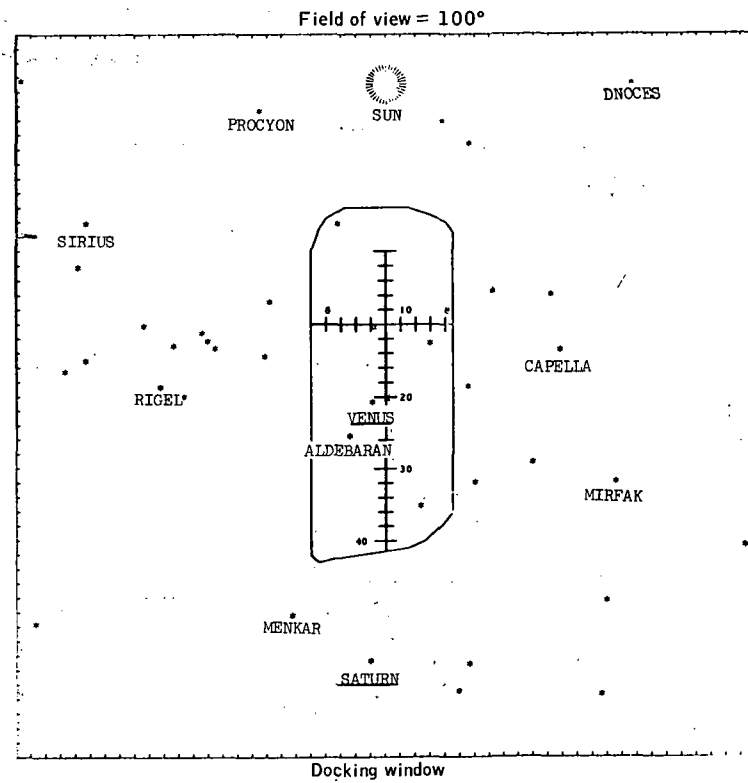
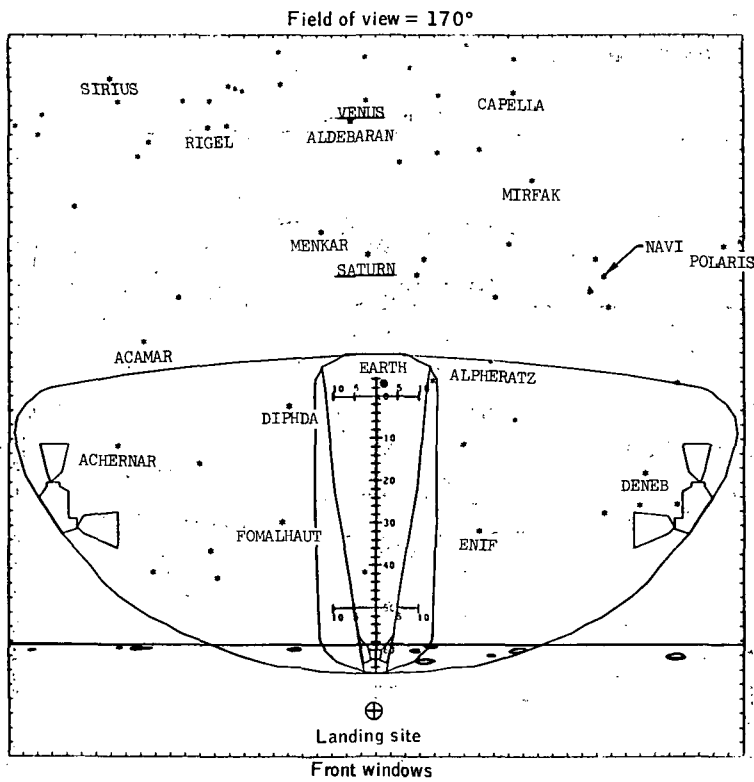

(q) 8 minutes 26 seconds into descent burn.

Figure 6.2.2-1. - Continued.

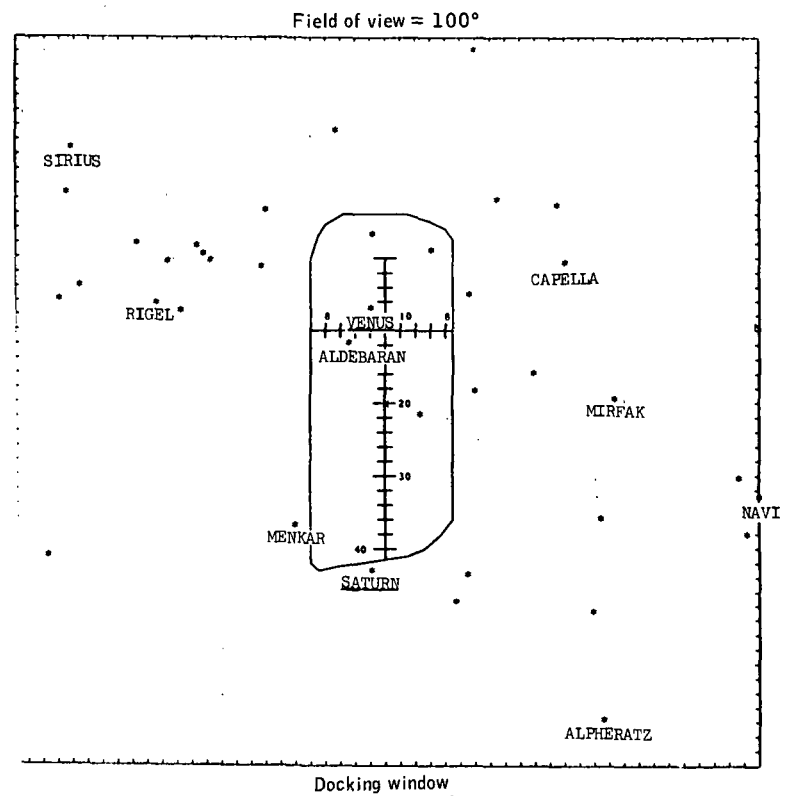
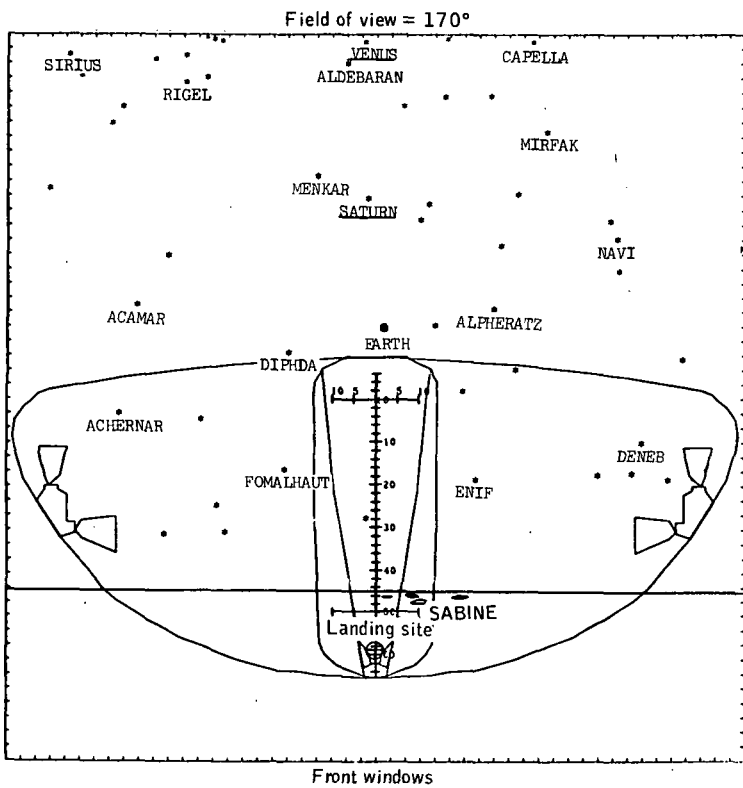

(r) 8 minutes 46 seconds into descent burn.

Figure 6.2.2-1. - Continued.

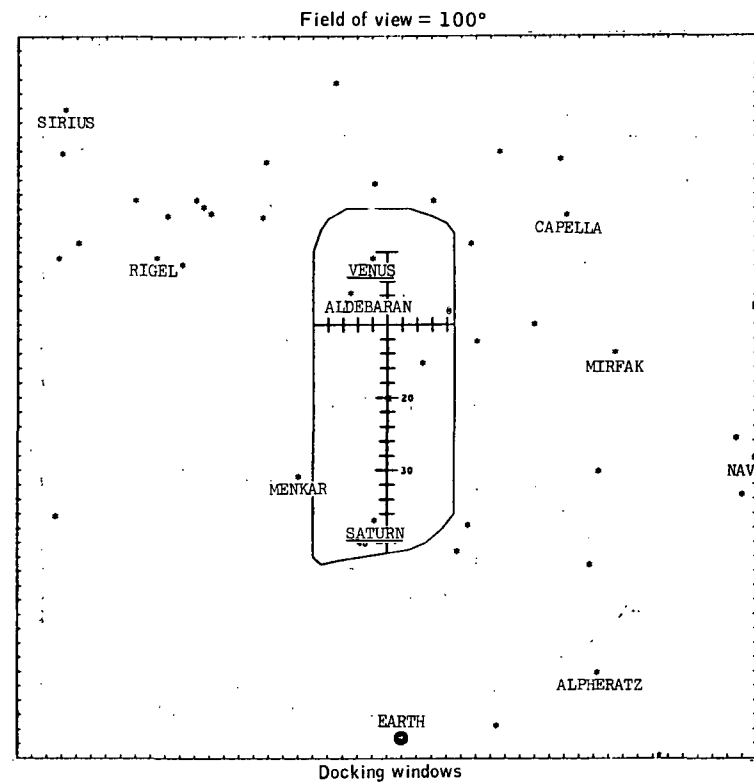
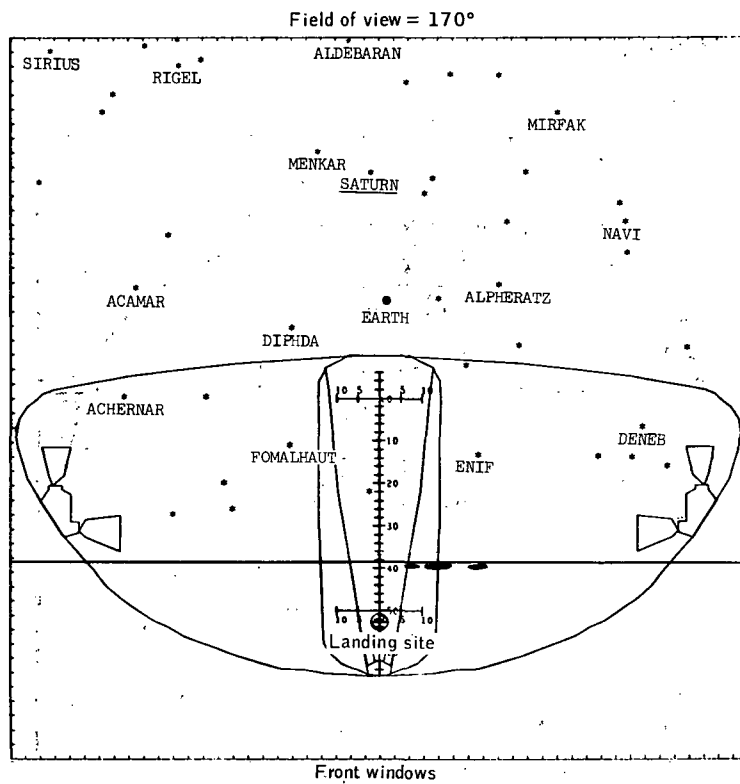

(s) 9 minutes 6 seconds into descent burn.

Figure 6.2.2-1.- Continued.

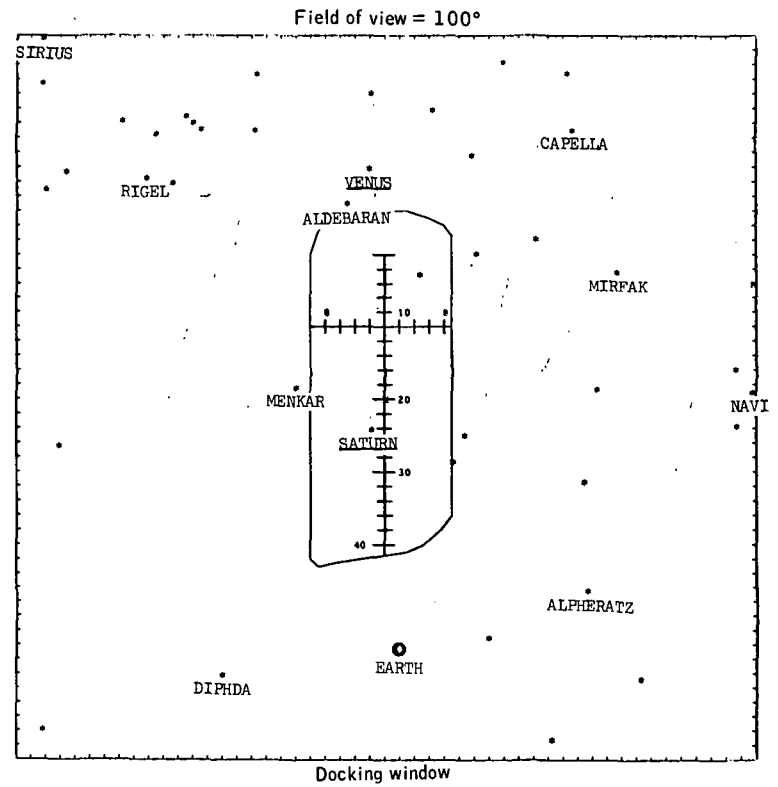
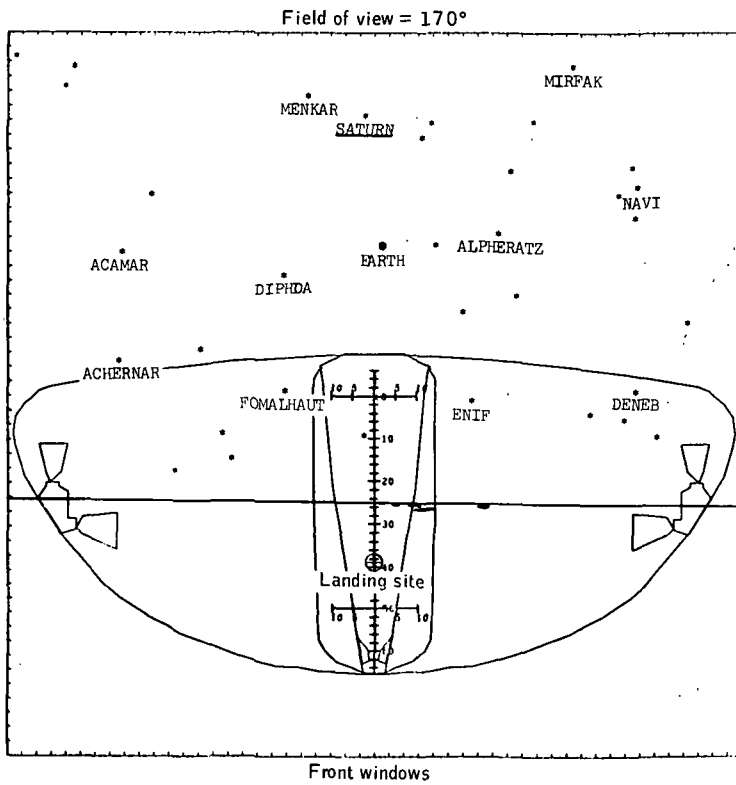

(t) 9 minutes 46 seconds into descent burn.

Figure 6.2.2-1. - Continued.

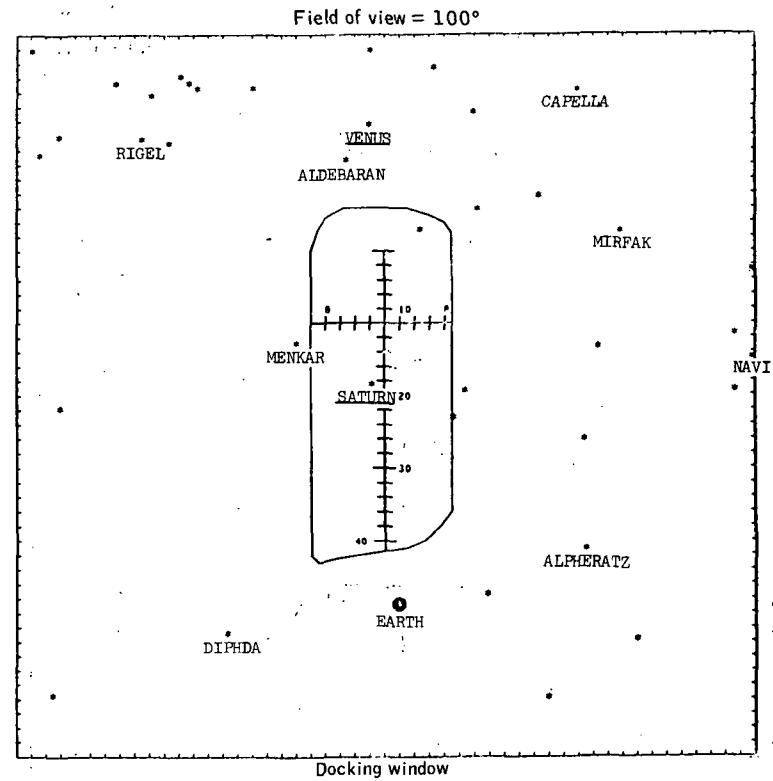
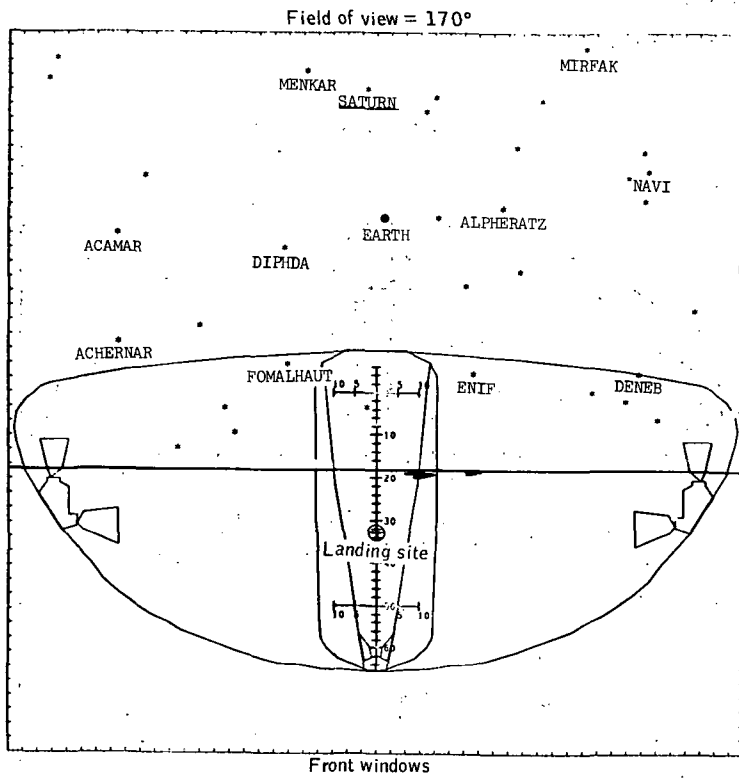

(u) 10 minutes 6 seconds into descent burn.

Figure 6.2.2-1.- Continued.

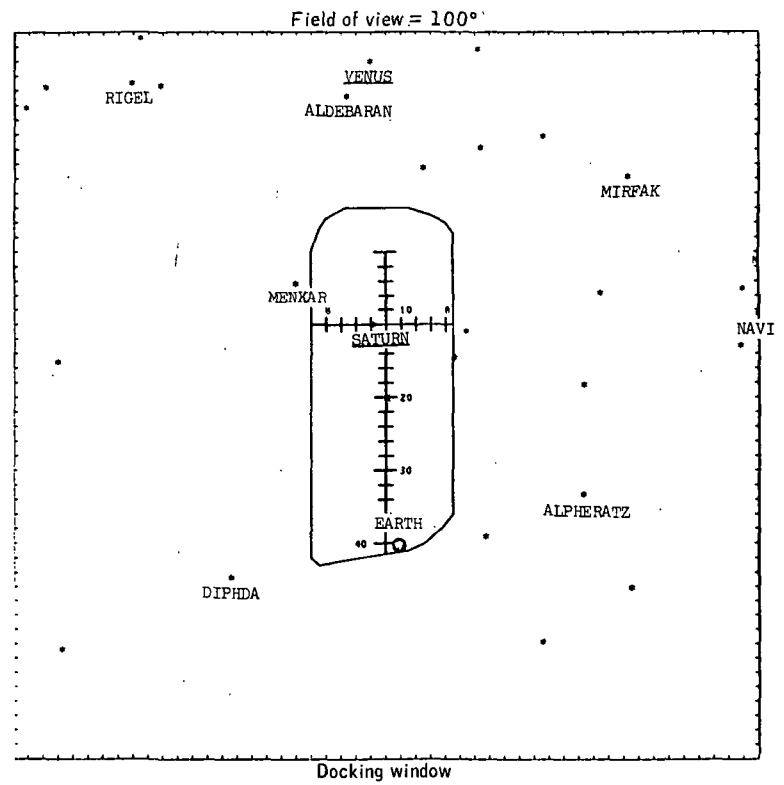
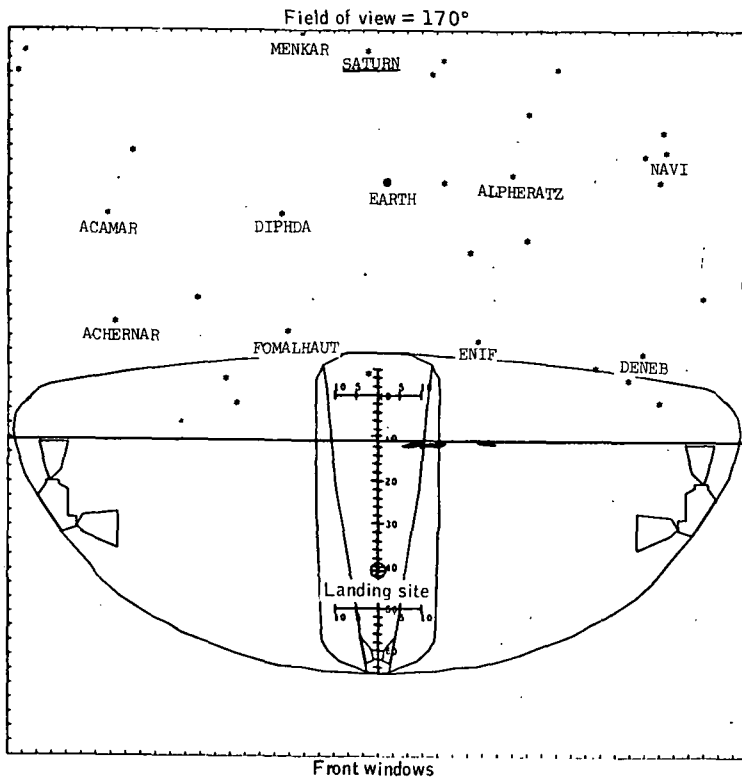

(v) 10 minutes 46 seconds into descent burn.

Figure 6.2.2-1. - Continued.

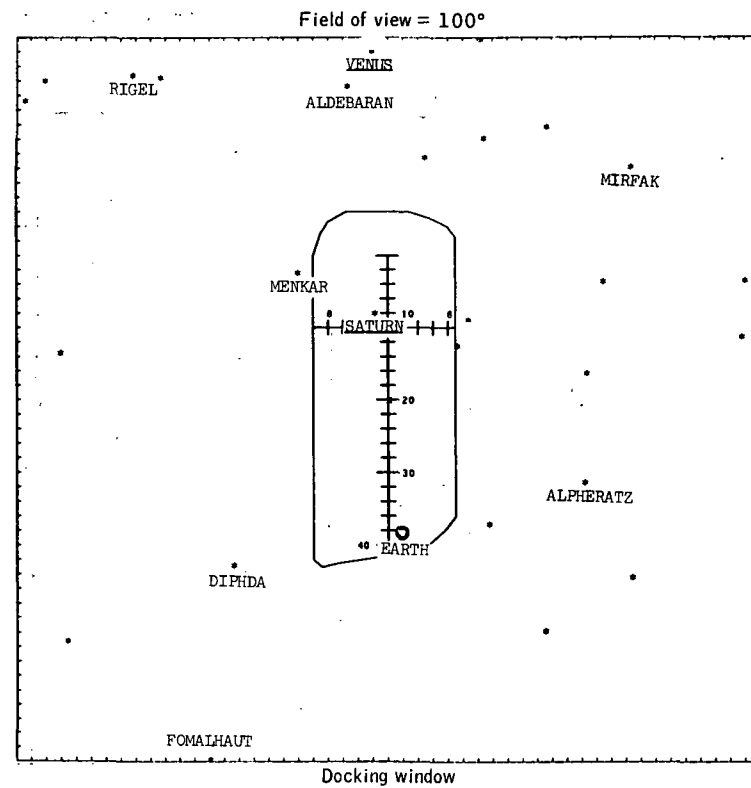
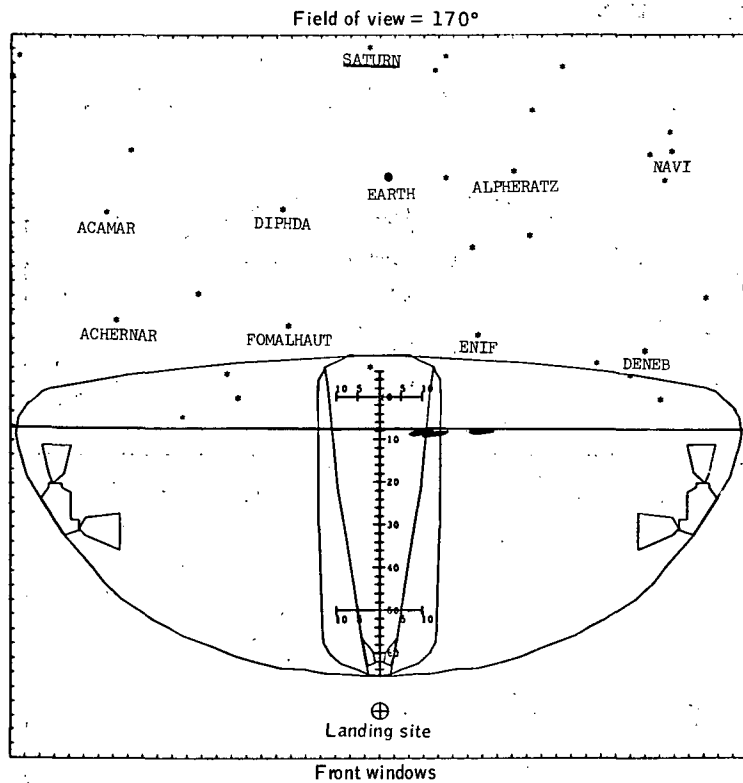

(w) 11 minutes 6 seconds into descent burn.

Figure 6.2.2-1. - Continued.

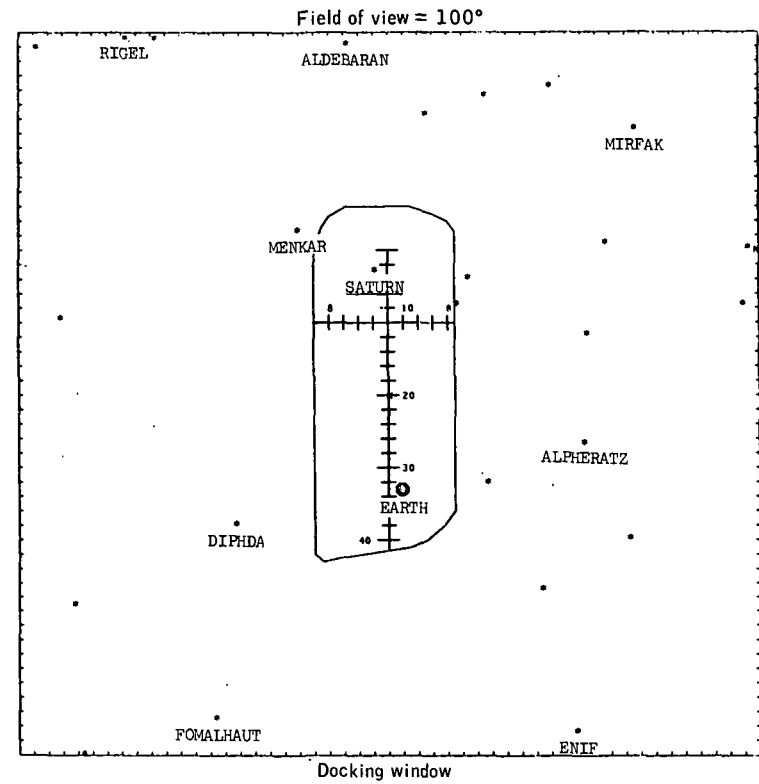
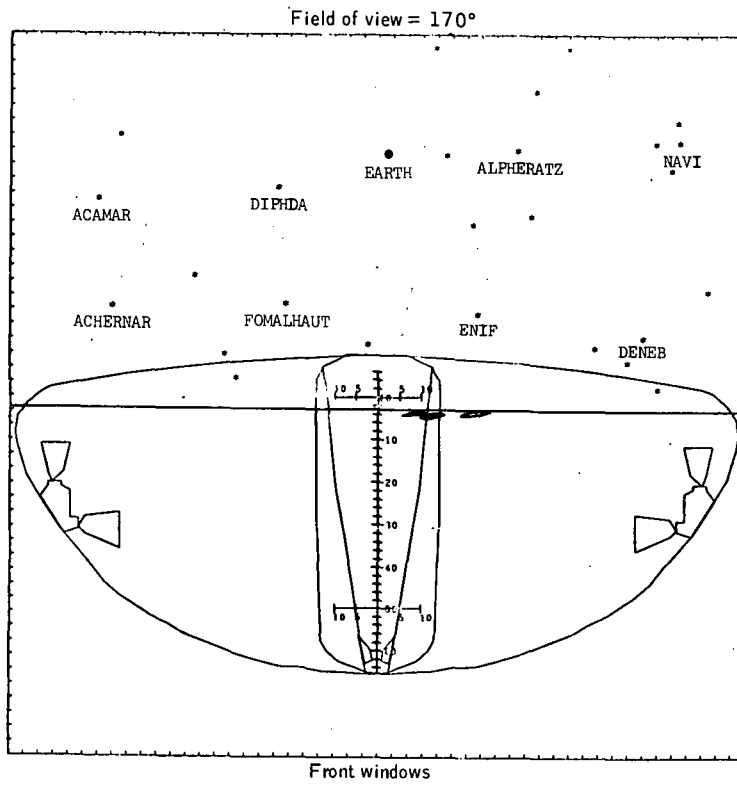

(x) 11 minutes 26 seconds into descent burn.

Figure 6.2.2-1.- Continued.

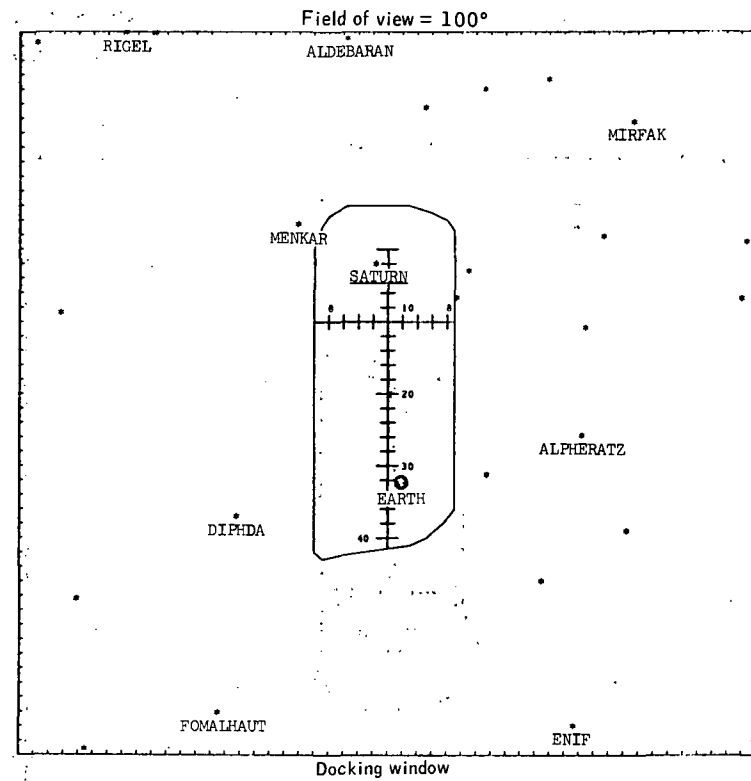
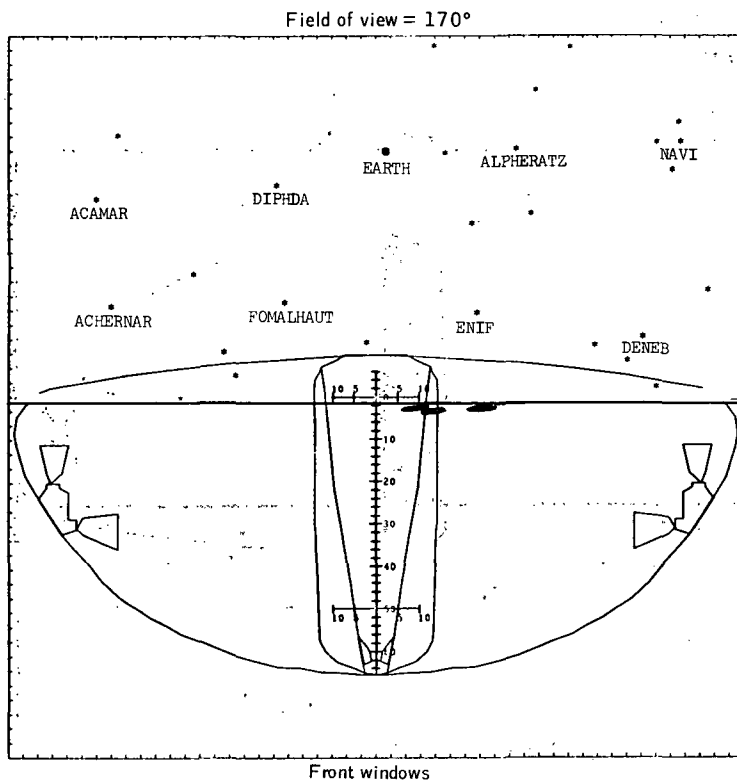

(y) 11 minutes 46 seconds into descent burn.

Figure 6.2.2-1. - Continued.

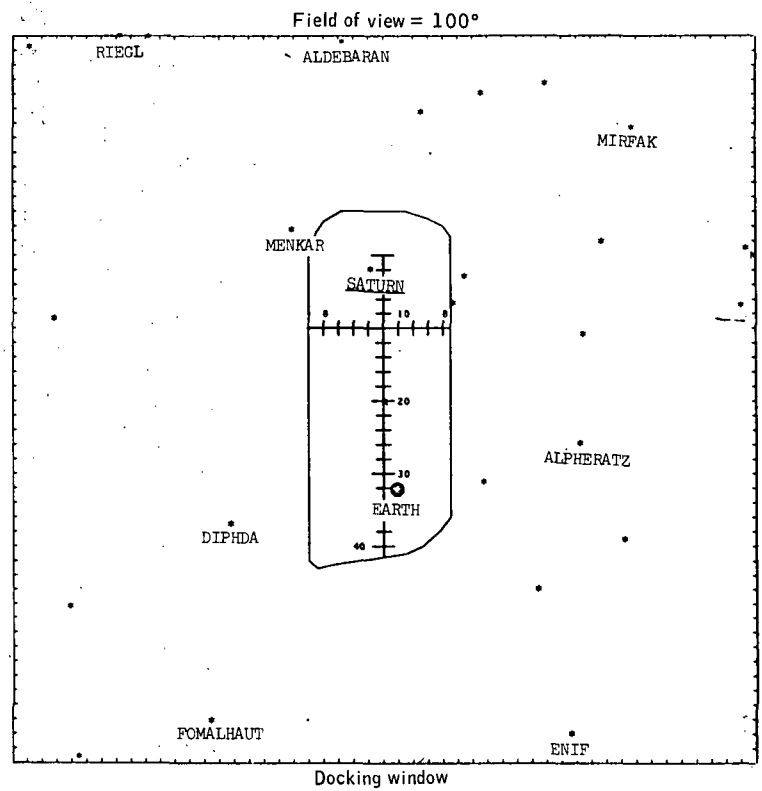
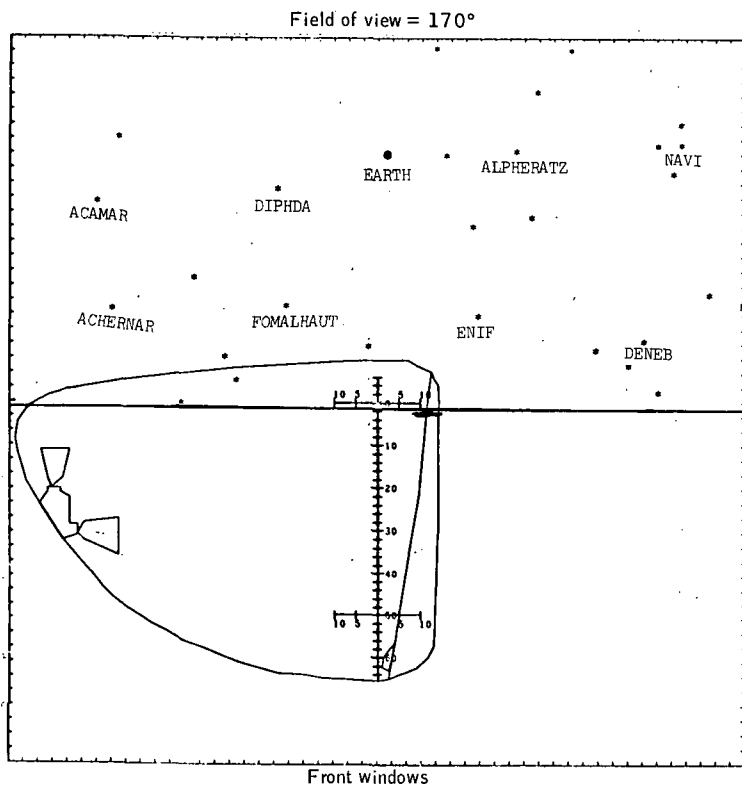

(z) End of descent bum.
 Figure 6.2.2-1.- Concluded.

6.3 VIEWS FROM LM DURING
ASCENT PHASE

Page intentionally left blank

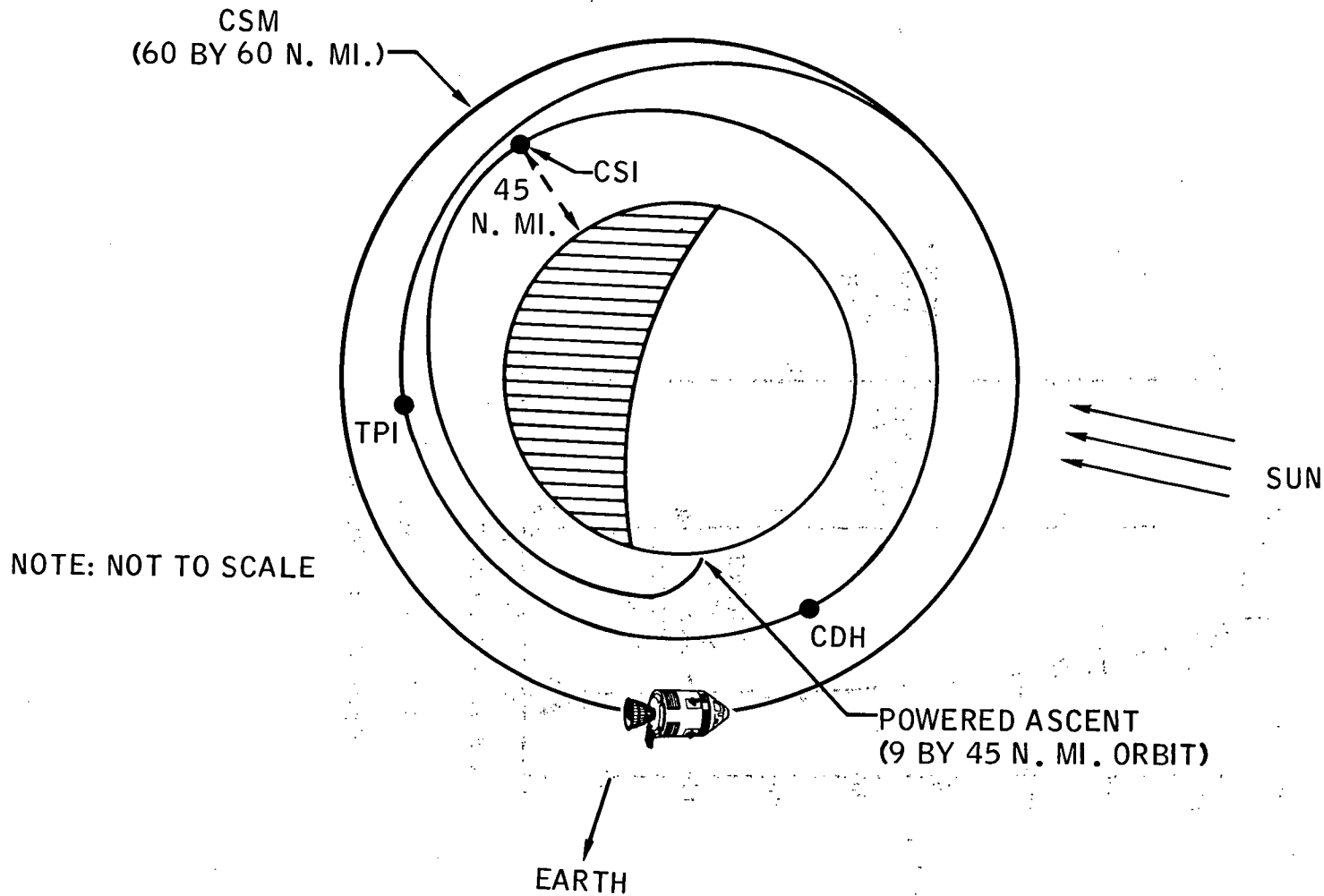

(a) LM ascent phase geometry.

Figure 6.3.0-1. - Ascent phase.

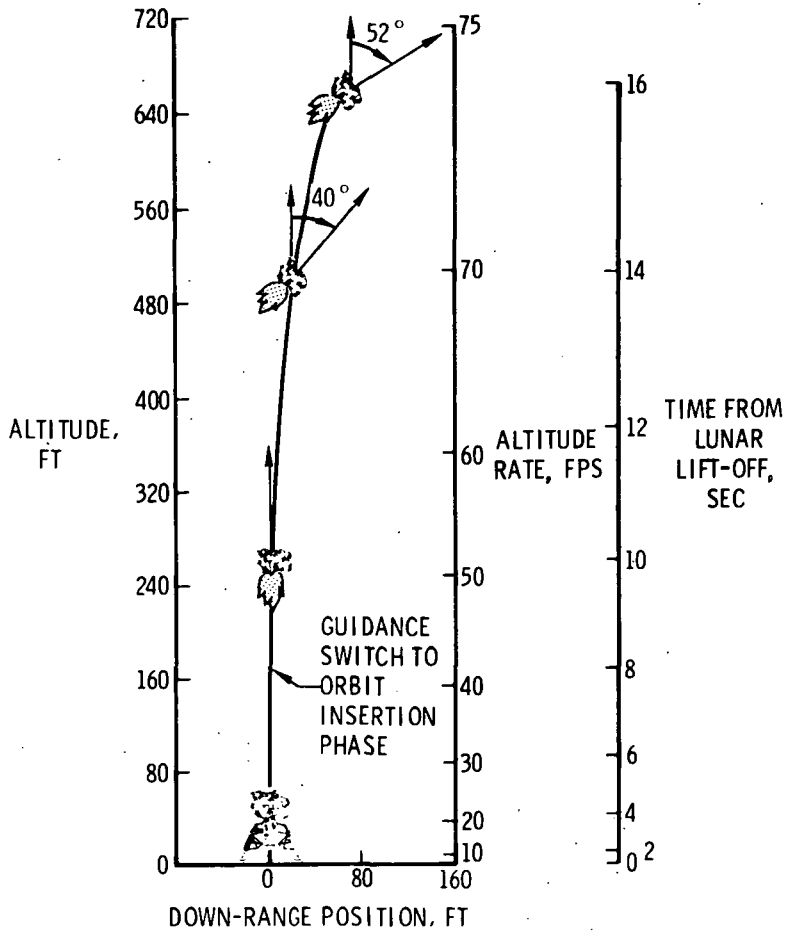

(b) Vertical rise phase.

Figure 6.3.0-1.- Concluded.

Page intentionally left blank

6.3.1 ASCENT BURN

Page intentionally left blank

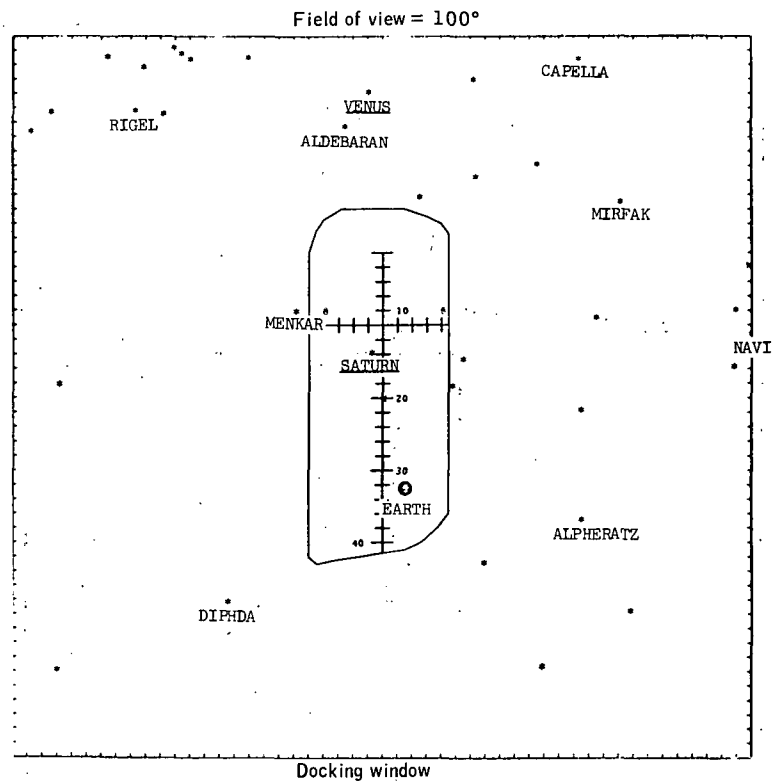
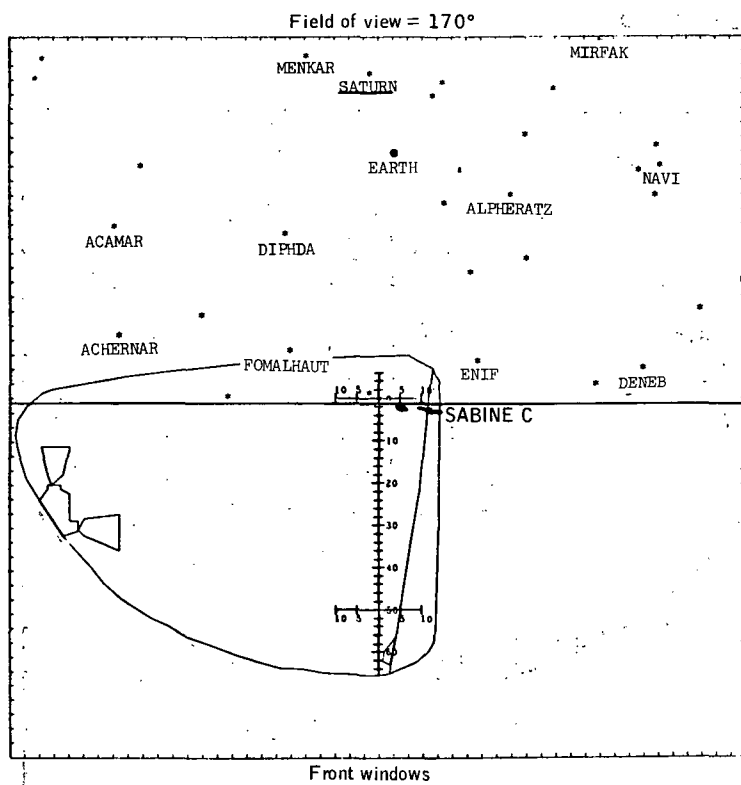

(a) Begin ascent burn.

Figure 6.3.1-1.- Ascent burn.

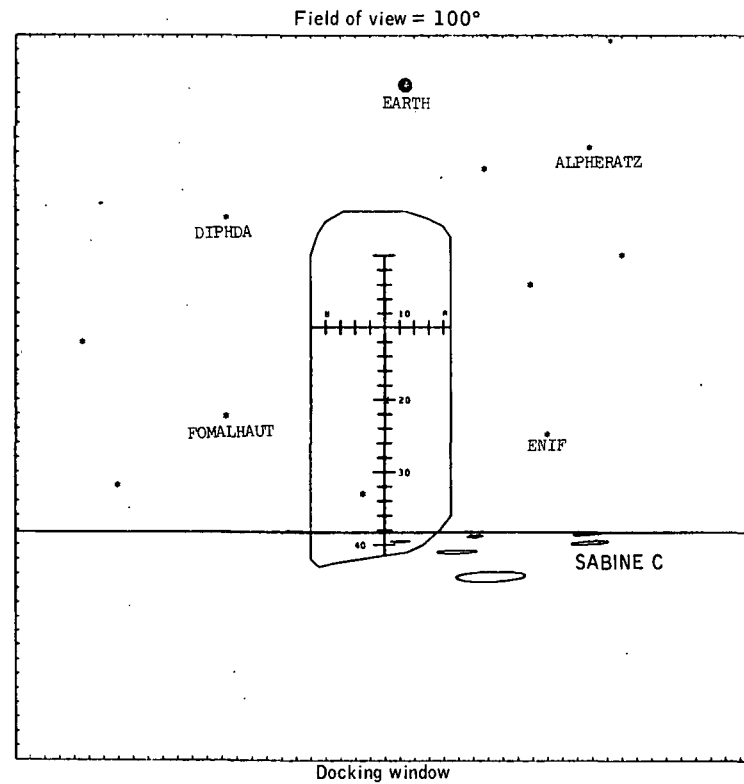
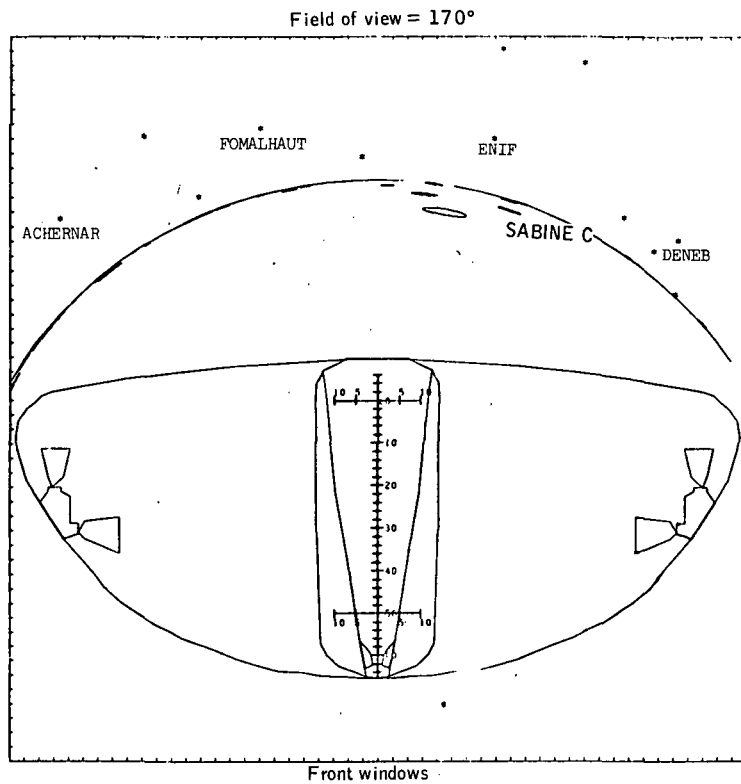

(b) 1 minute 0 seconds into ascent burn.

Figure 6.3.1-1.-Continued.

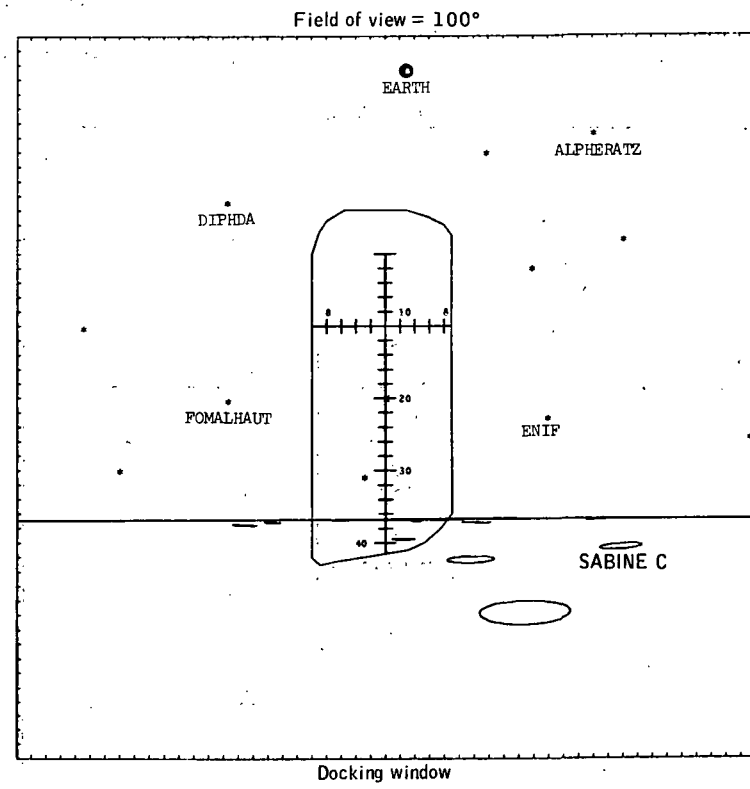
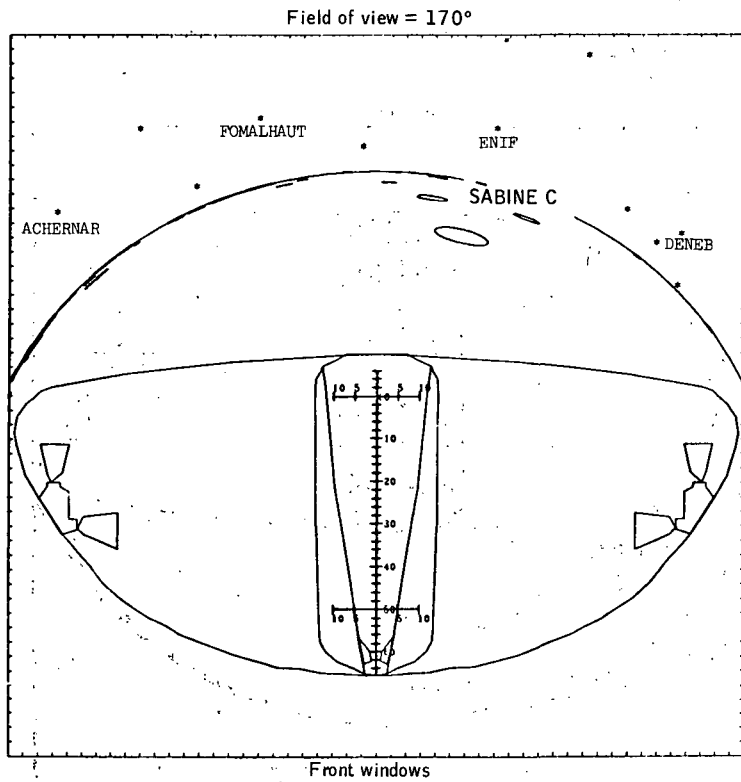

(c) 1 minute 20 seconds into ascent burn.

Figure 6.3.1-1. - Continued.

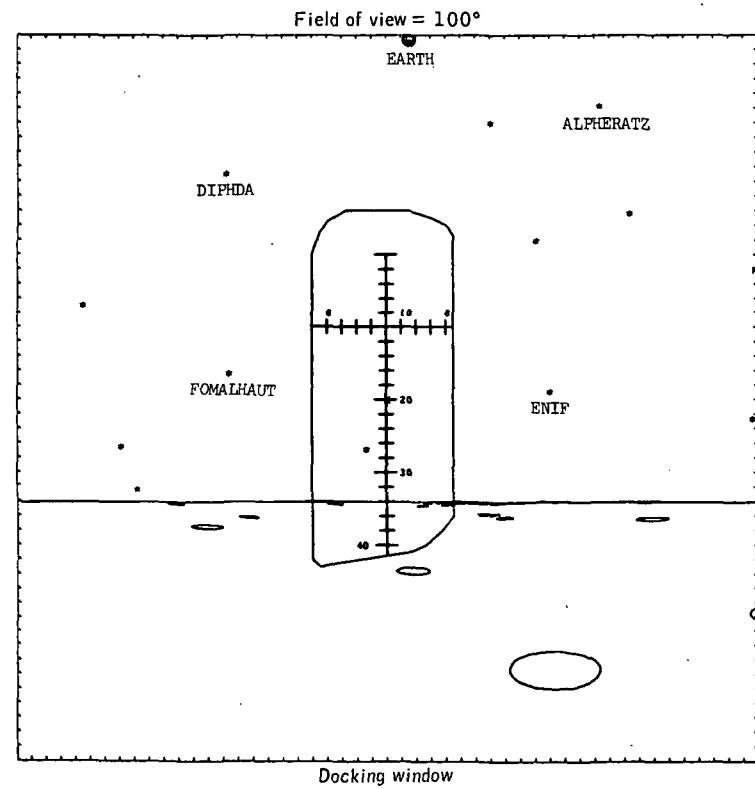
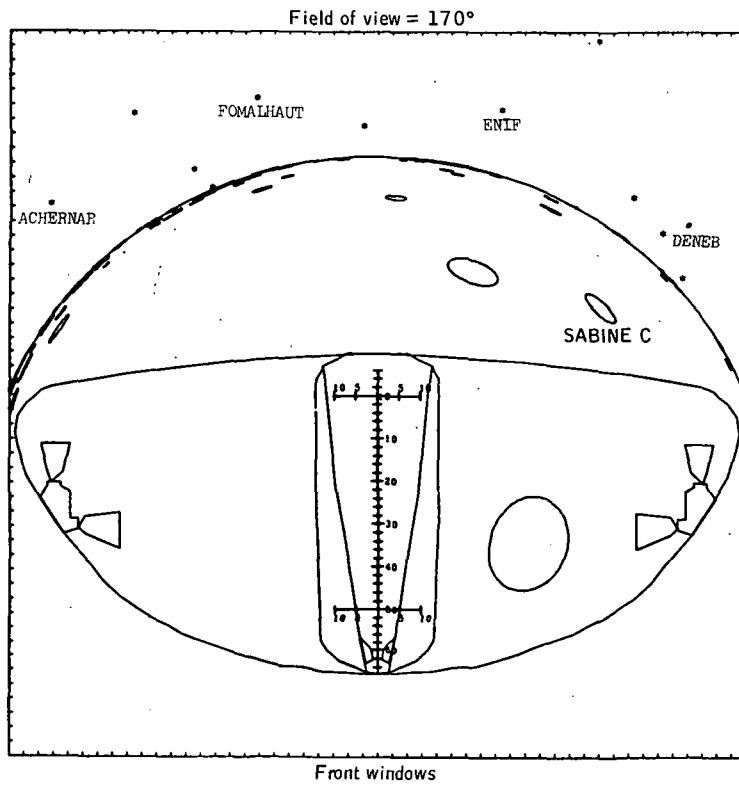

(d) 2 minutes 0 seconds into ascent burn.

Figure 6.3.1-1.- Continued.

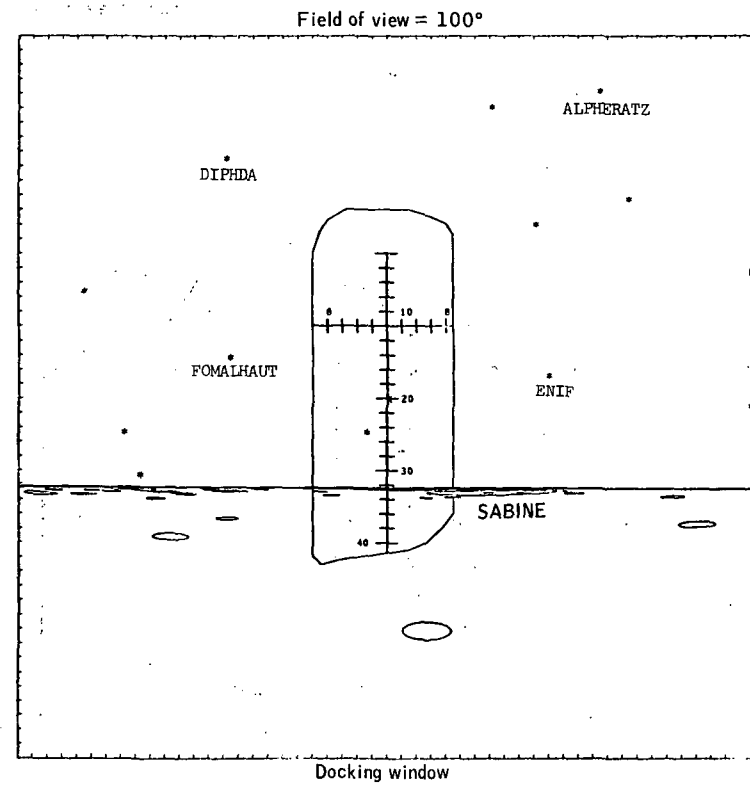
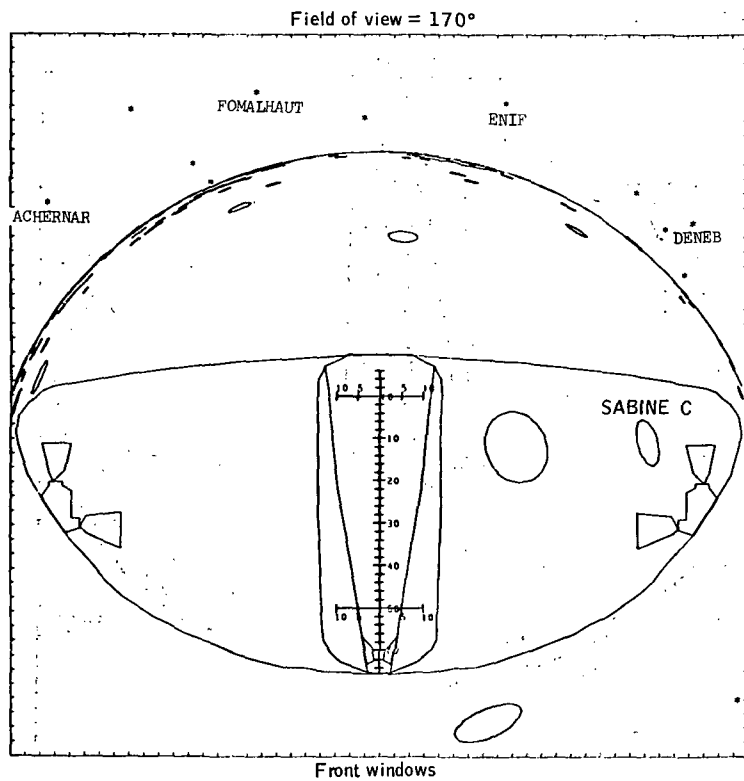

(e) 2 minutes 20 seconds into ascent burn.

Figure 6.3.1-1.- Continued.

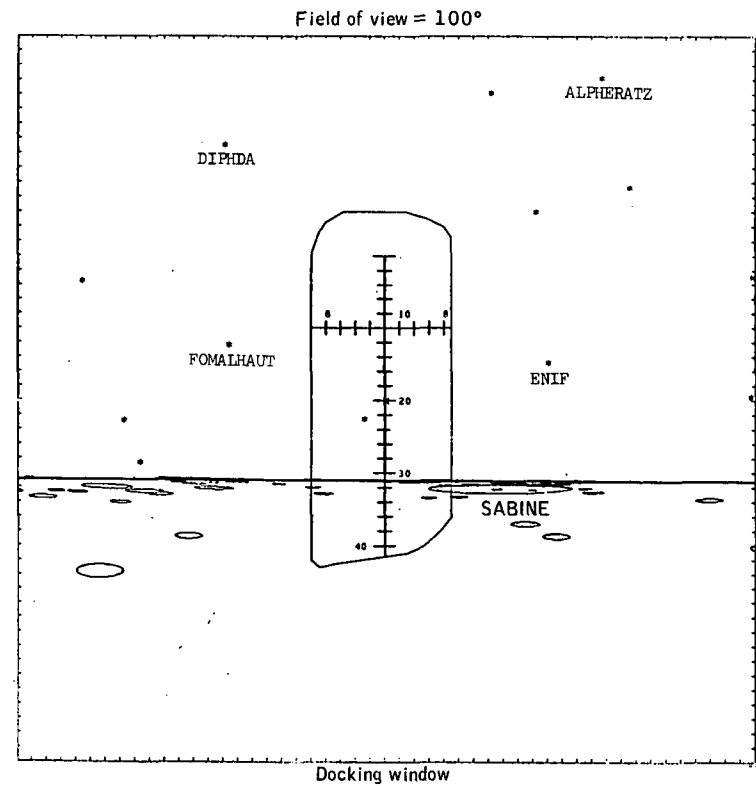
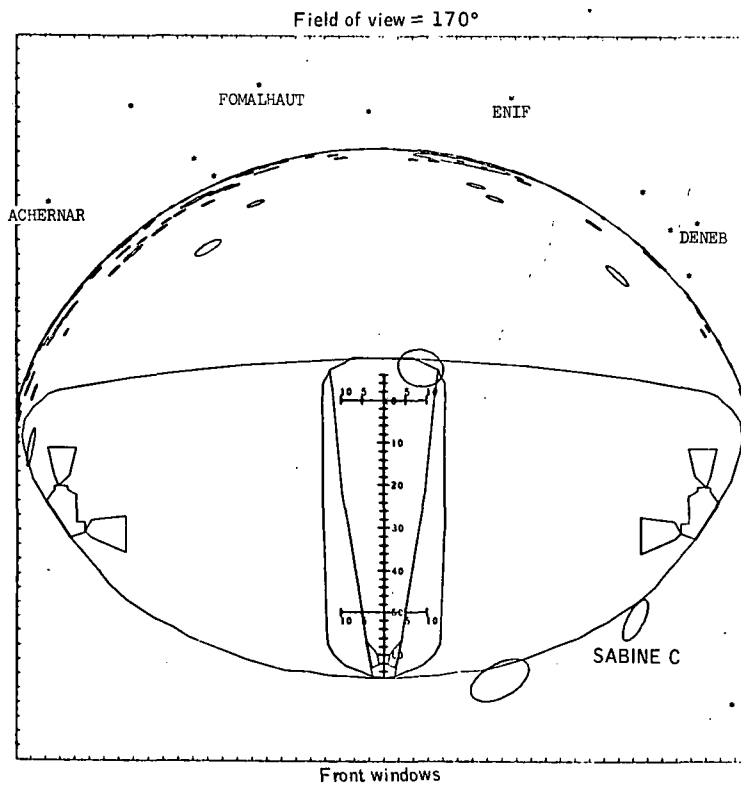

(f) 2 minutes 40 seconds into ascent burn.

Figure 6.3.1-1. - Continued.

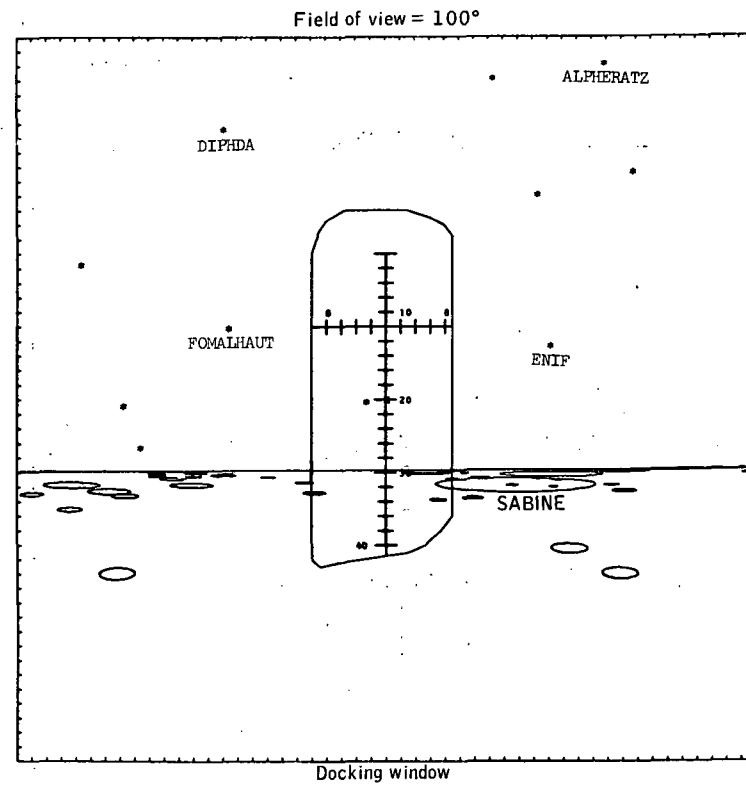
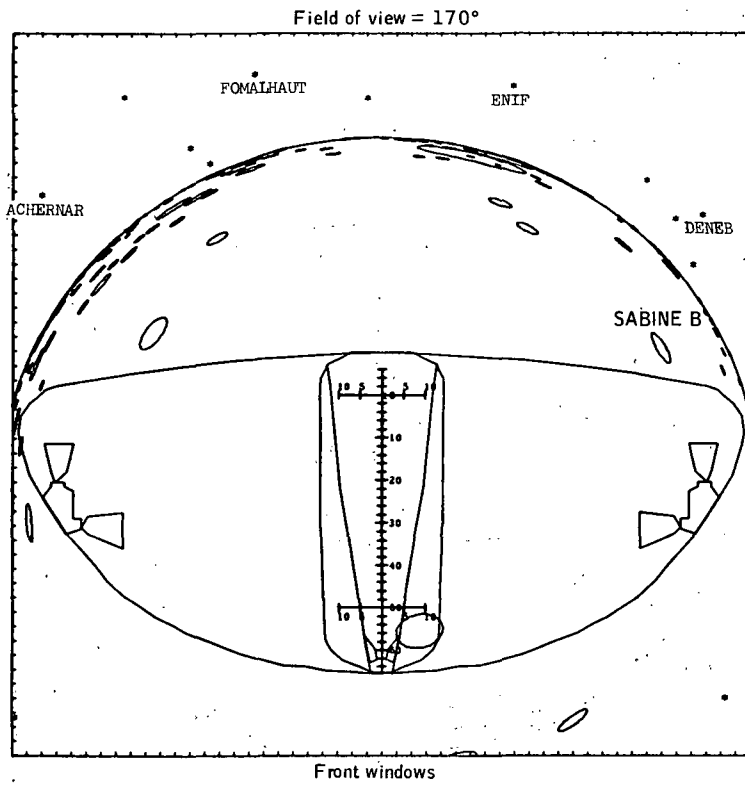

(g) 3 minutes 0 seconds into ascent burn.

Figure 6.3.1-1.- Continued.

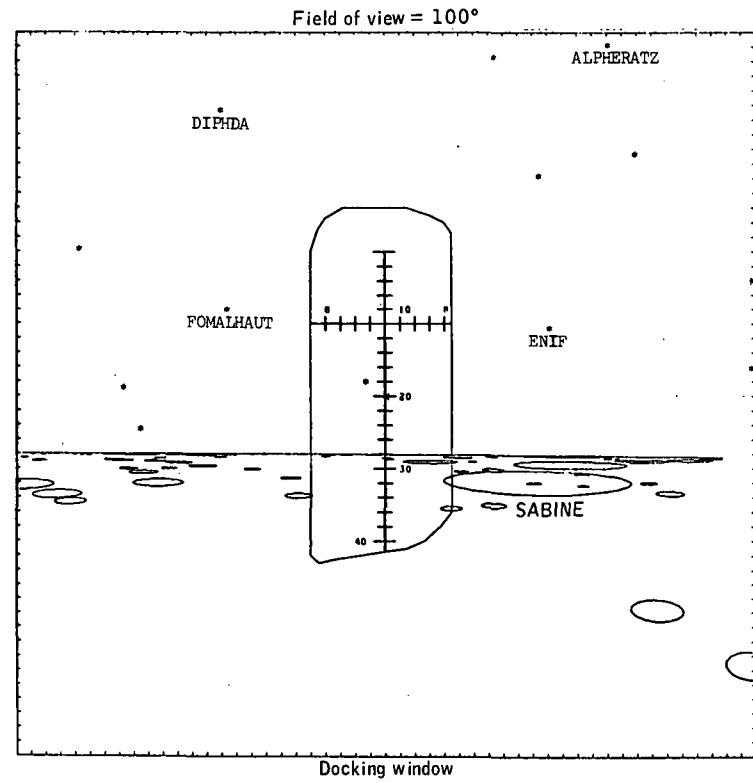
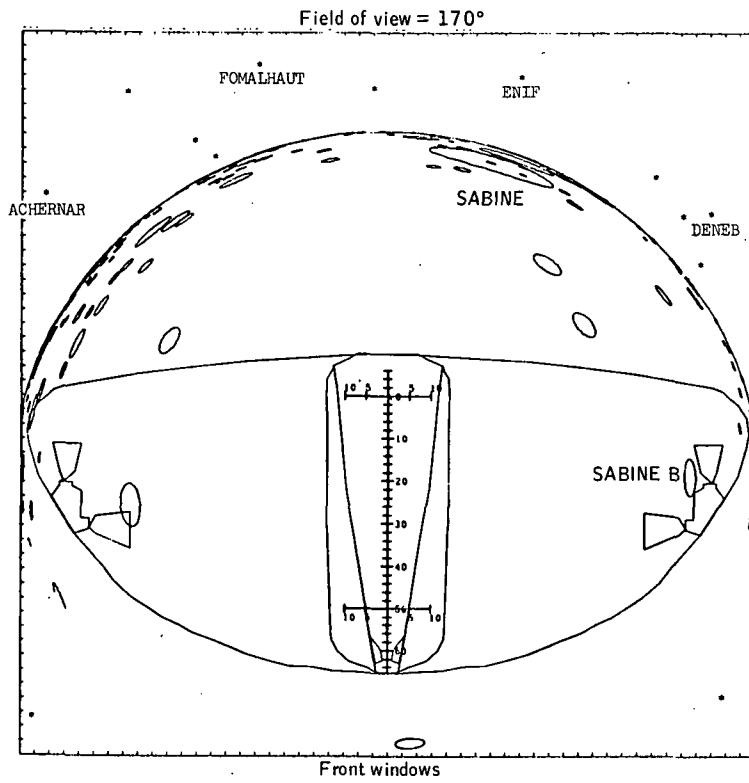

(h) 3 minutes 20 seconds into ascent burn.

Figure 6.3.1-1. - Continued.

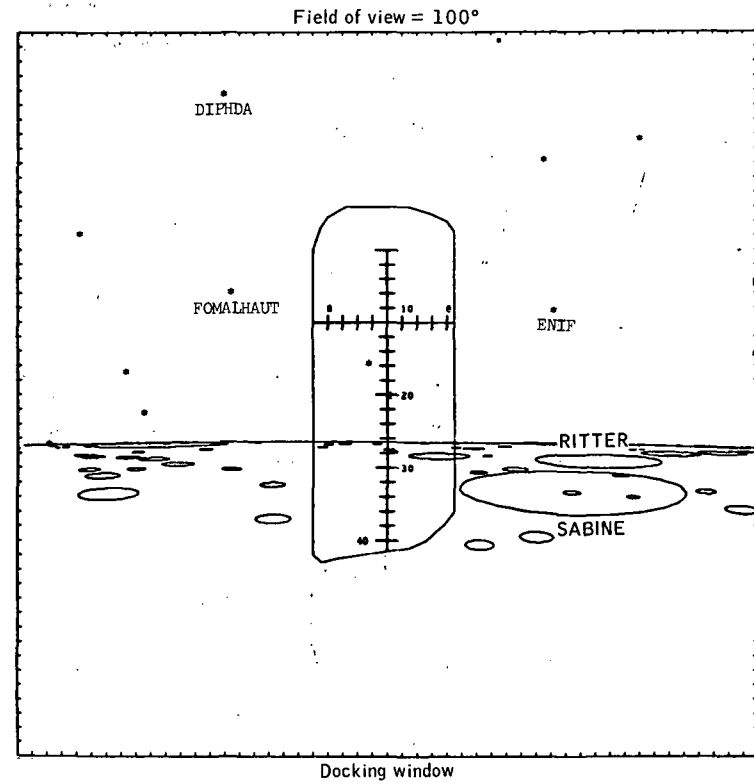
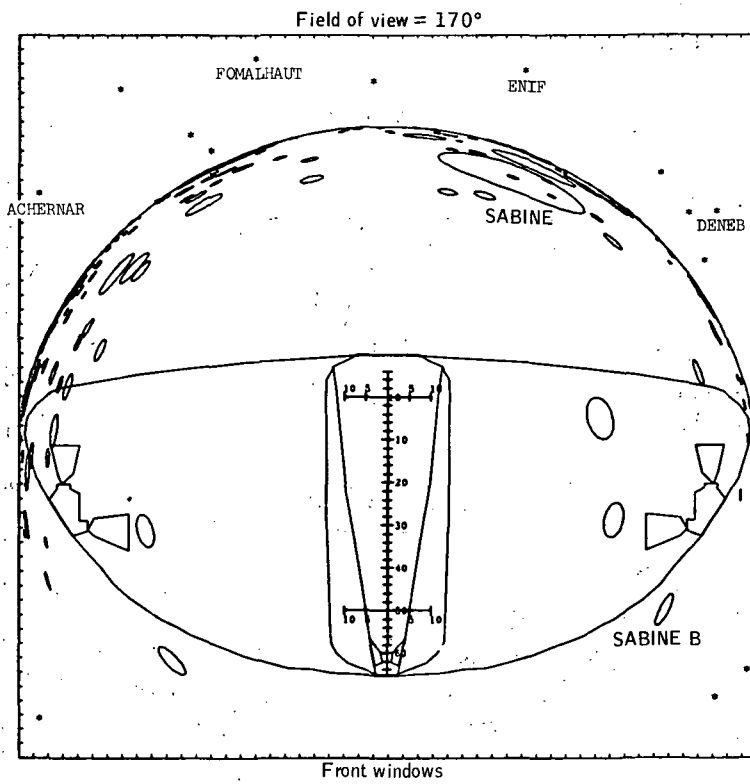

(i) 3 minutes 40 seconds into ascent burn.

Figure 6.3.1-1. - Continued.

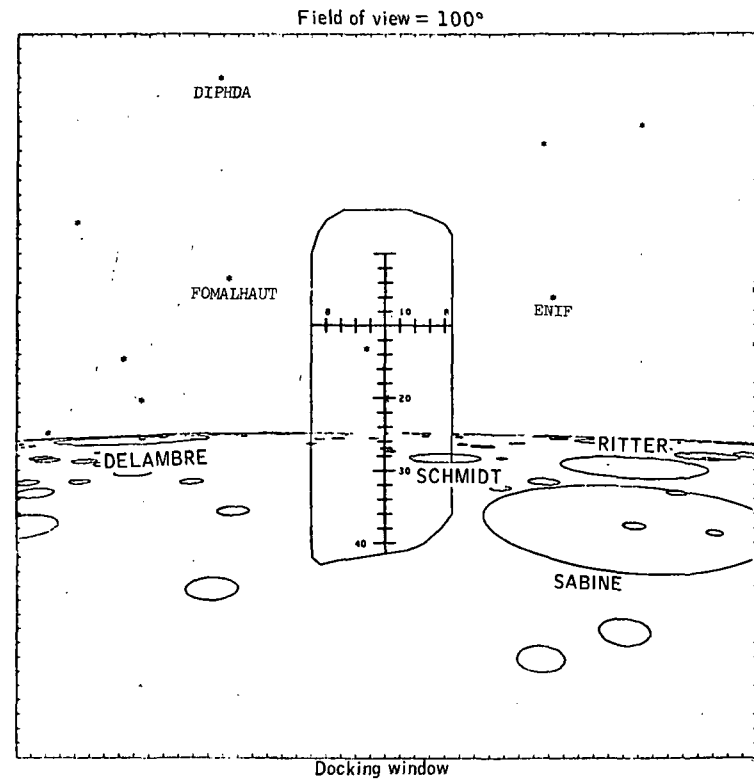
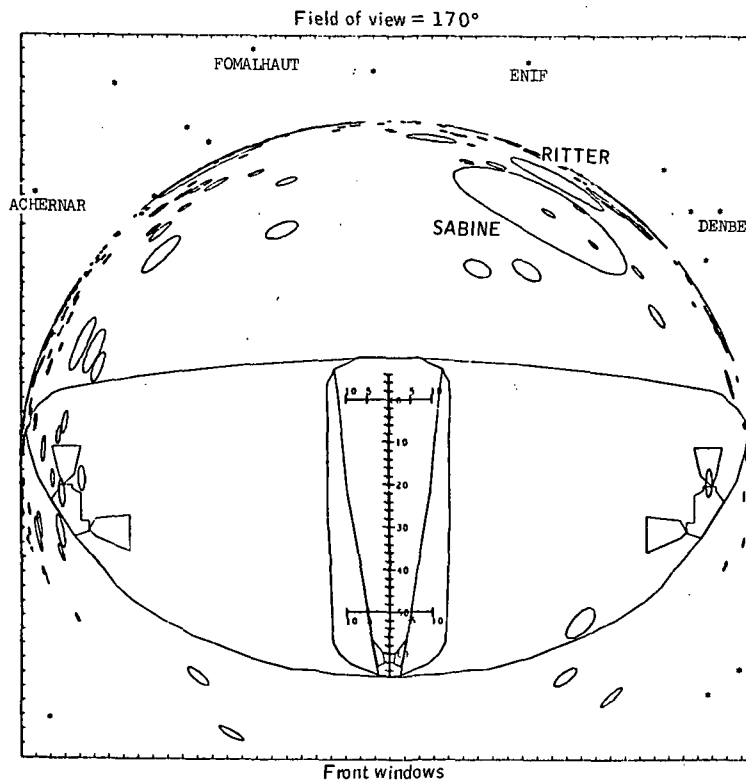

(i) 4 minutes 0 seconds into ascent burn.

Figure 6.3.1-1. - Continued.

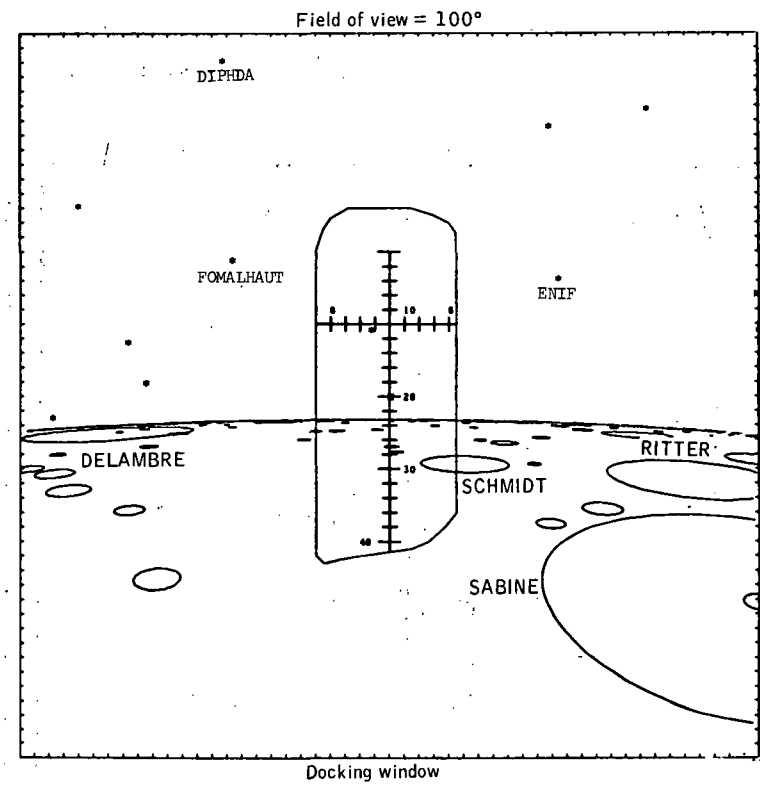
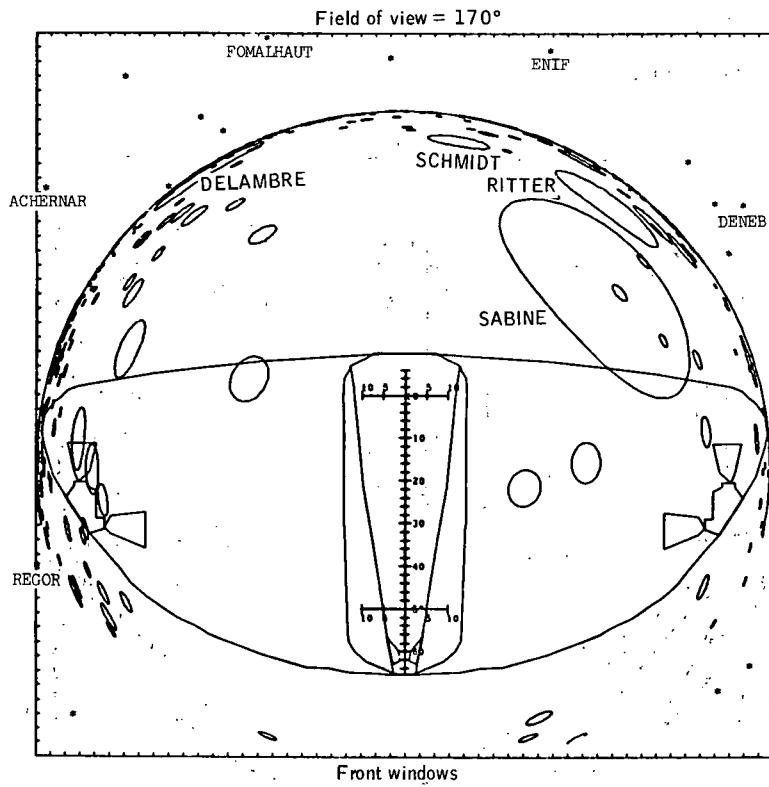

(k) 4 minutes 20 seconds into ascent burn.

Figure 6.3.1-1.- Continued.

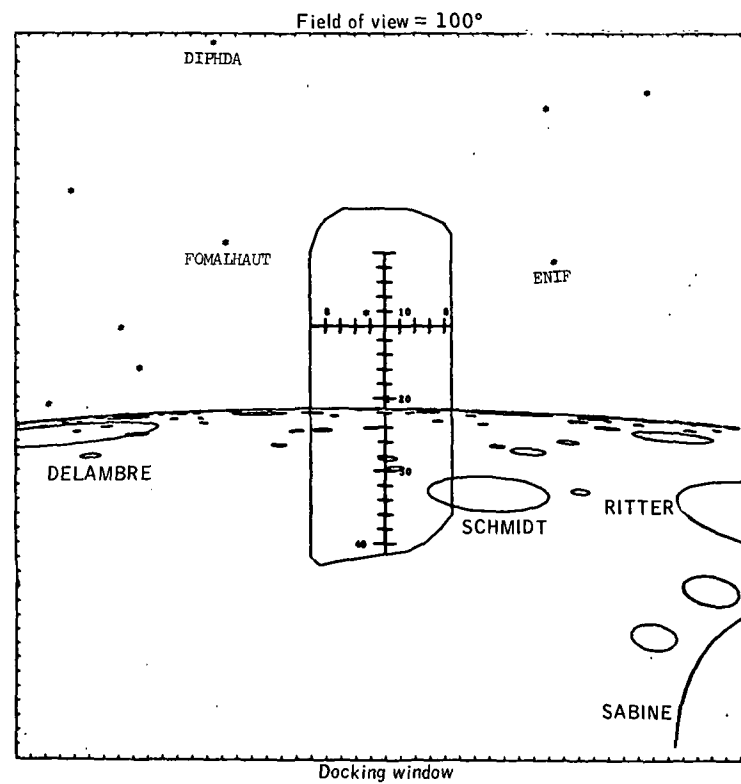
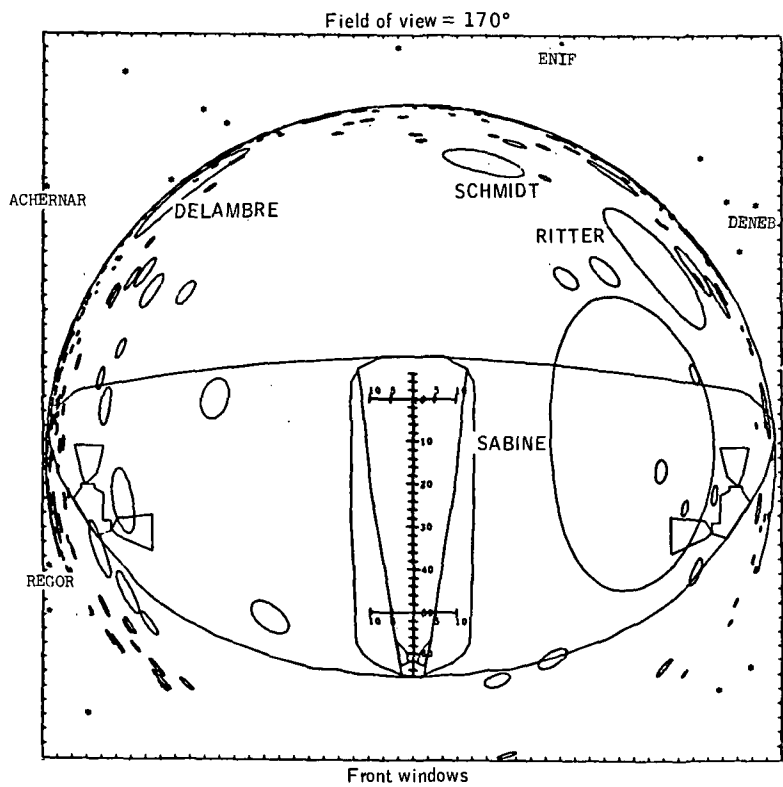

(I) 4 minutes 40 seconds into ascent burn.

Figure 6.3.1-1.- Continued.

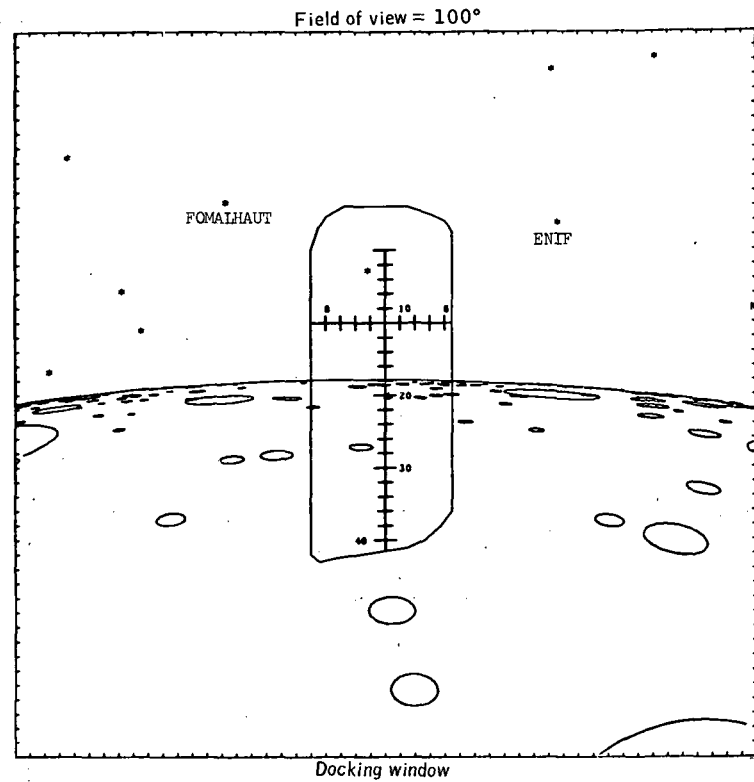
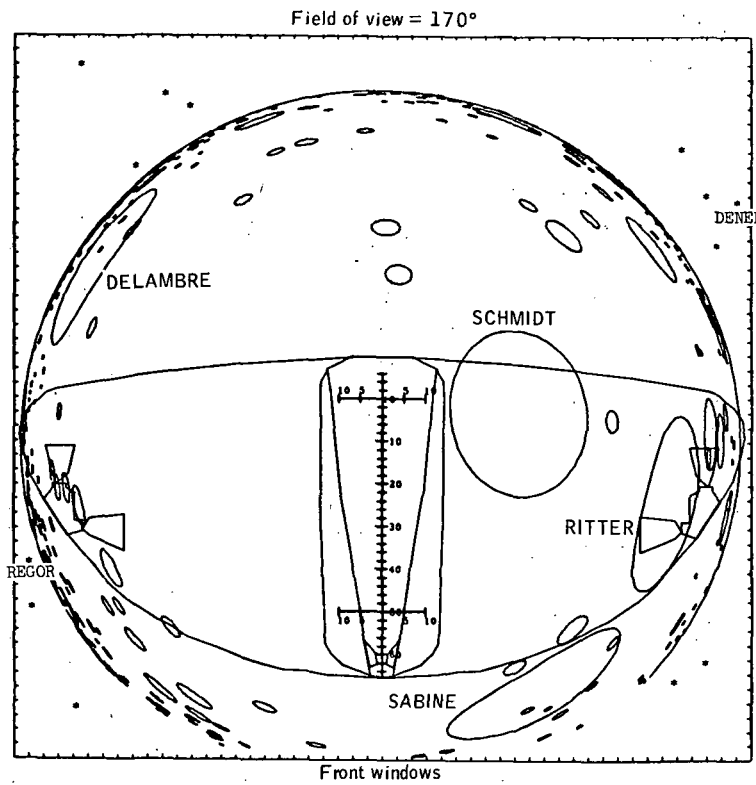

(m) 5 minutes 20 seconds into ascent burn.

Figure 6.3.1-1.- Continued.

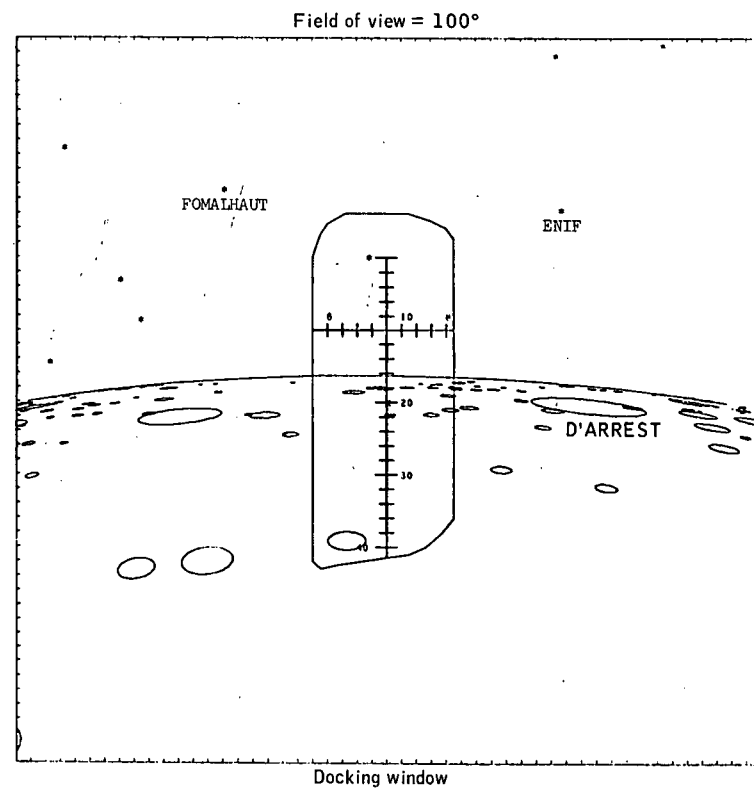
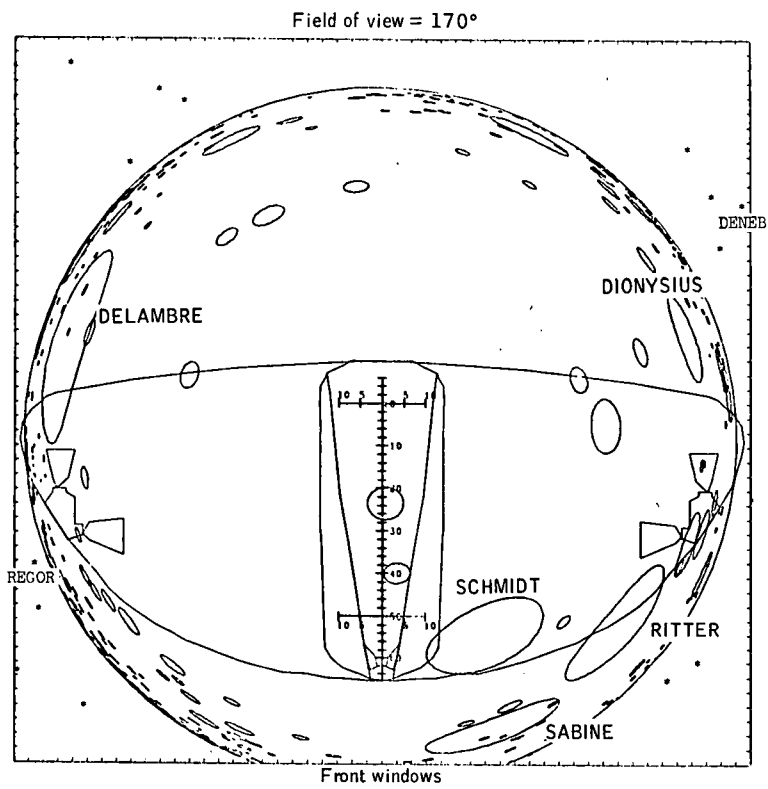

(n) 5 minutes 40 seconds into ascent burn.

Figure 6.3.1-1.- Continued.

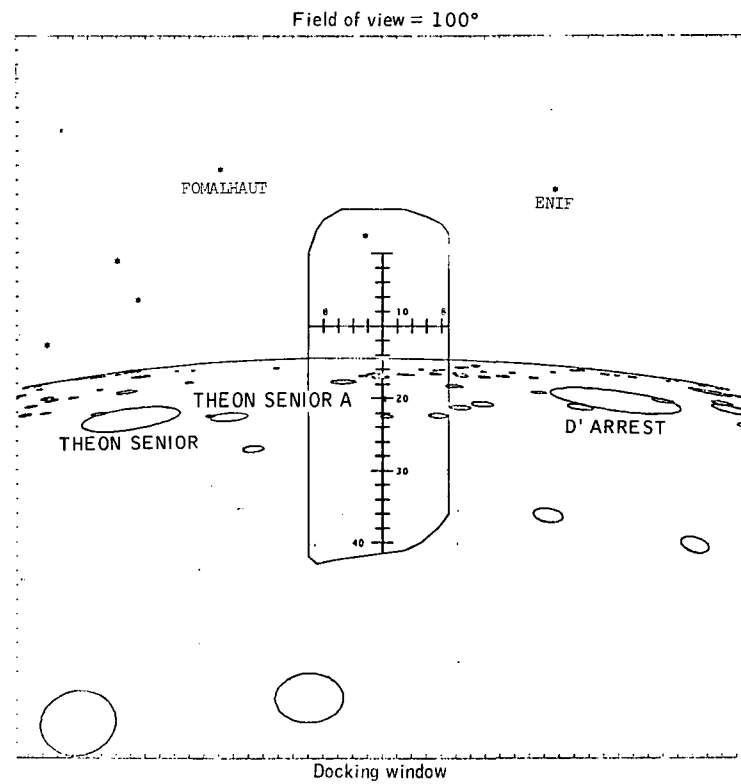
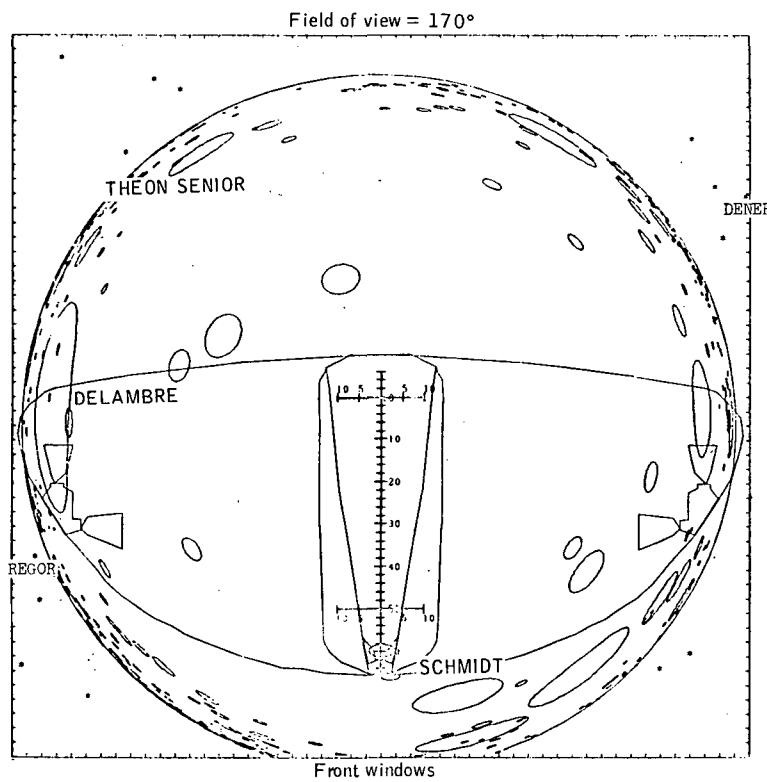

(o) 6 minutes 0 seconds into ascent burn.

Figure 6.3.1-1. - Continued.

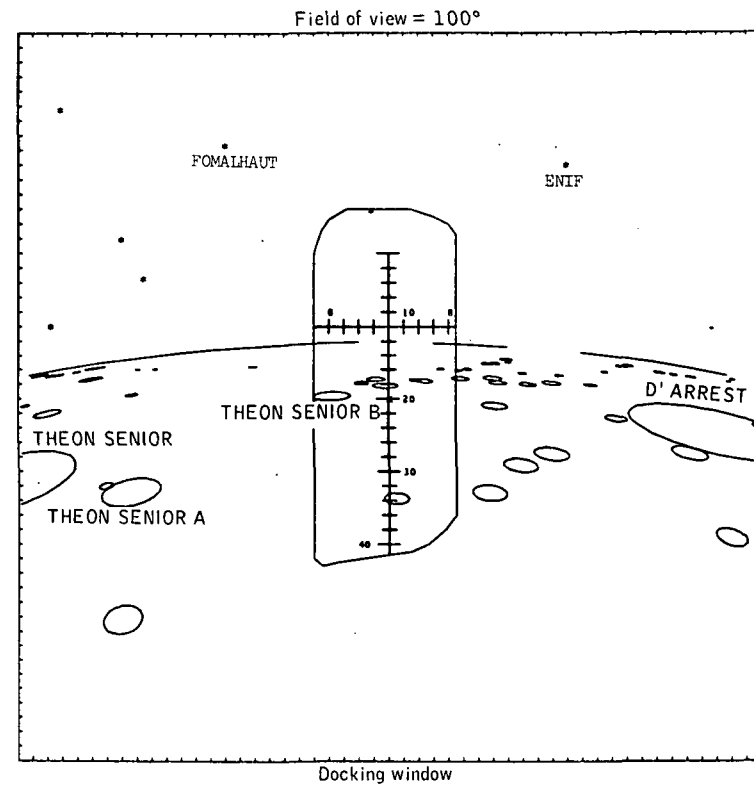
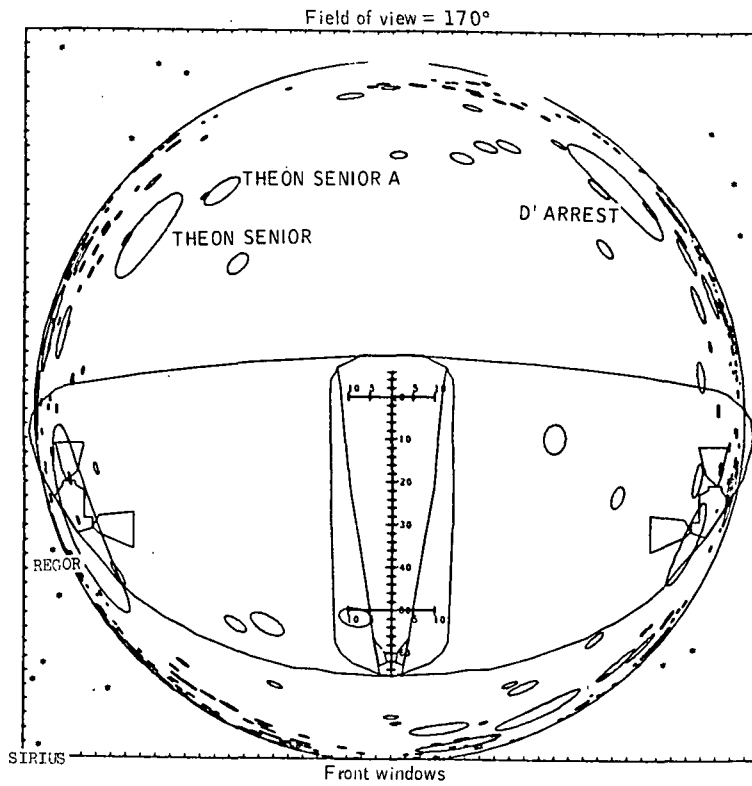

(p) 6 minutes 20 seconds into ascent burn.

Figure 6.3.1-1. - Continued.

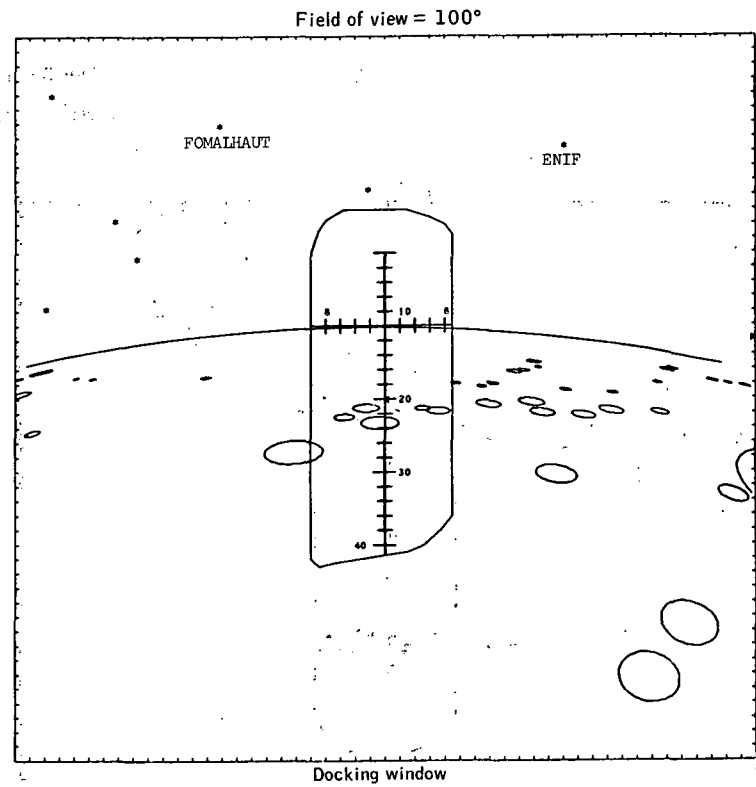
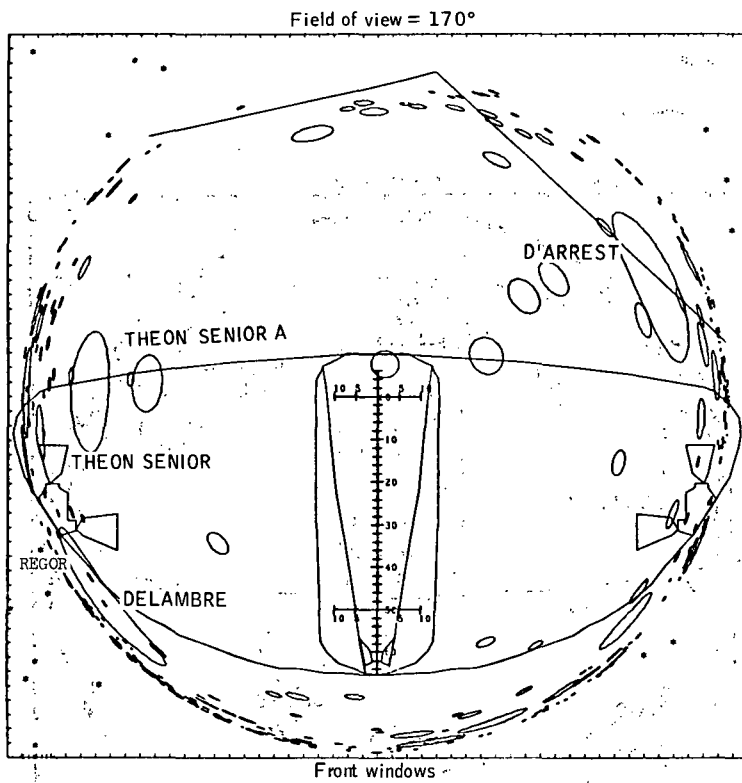

(q) 6 minutes 40 seconds into ascent burn.

Figure 6.3.1-1. - Continued.

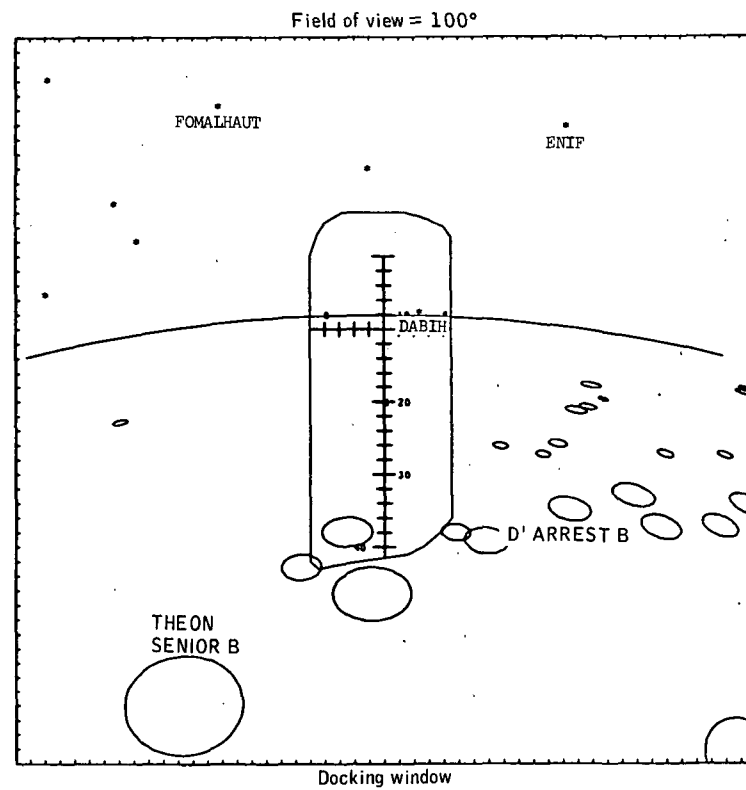
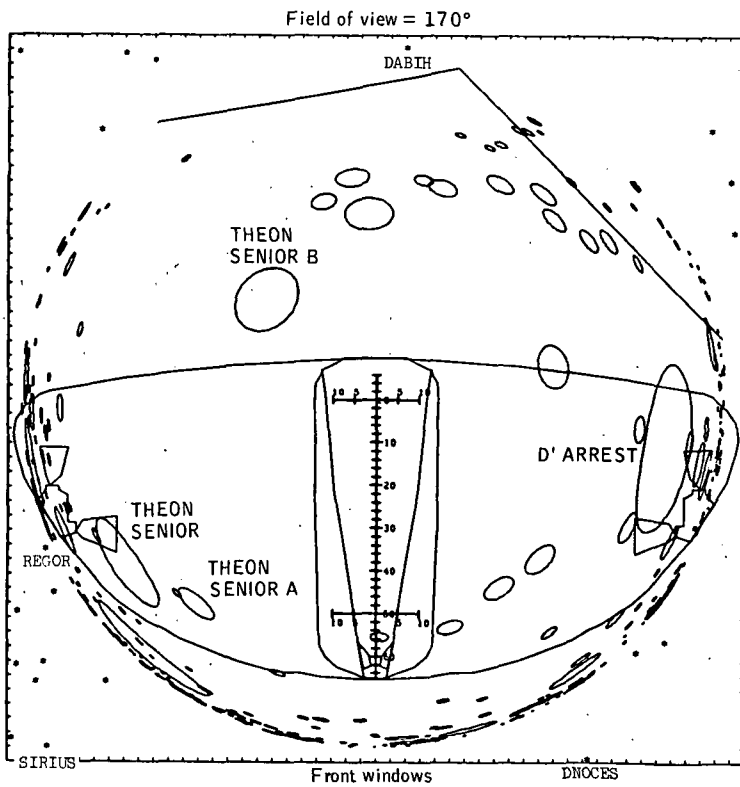

(r) 7 minutes 0 seconds into ascent burn.

Figure 6.3.1-1.- Continued.

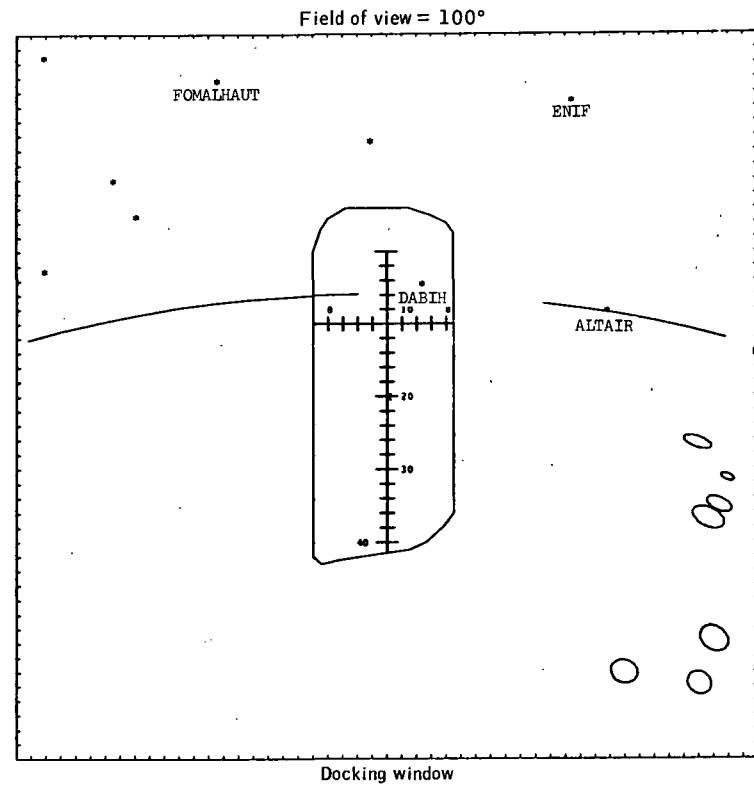
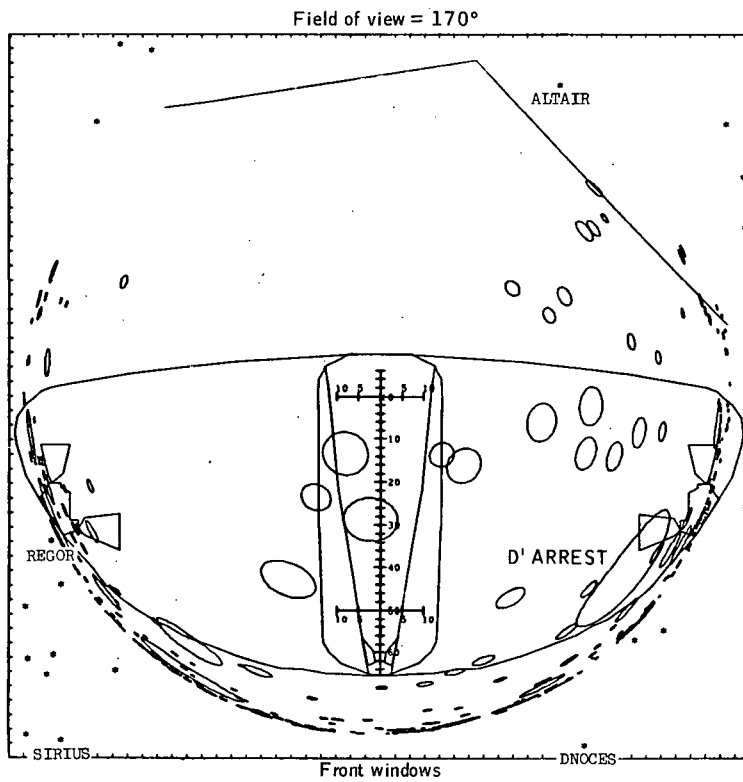

(s) End ascent burn.

Figure 6.3.1-1.- Concluded.

Page intentionally left blank

6.3.2 CSI MANEUVER

Page intentionally left blank

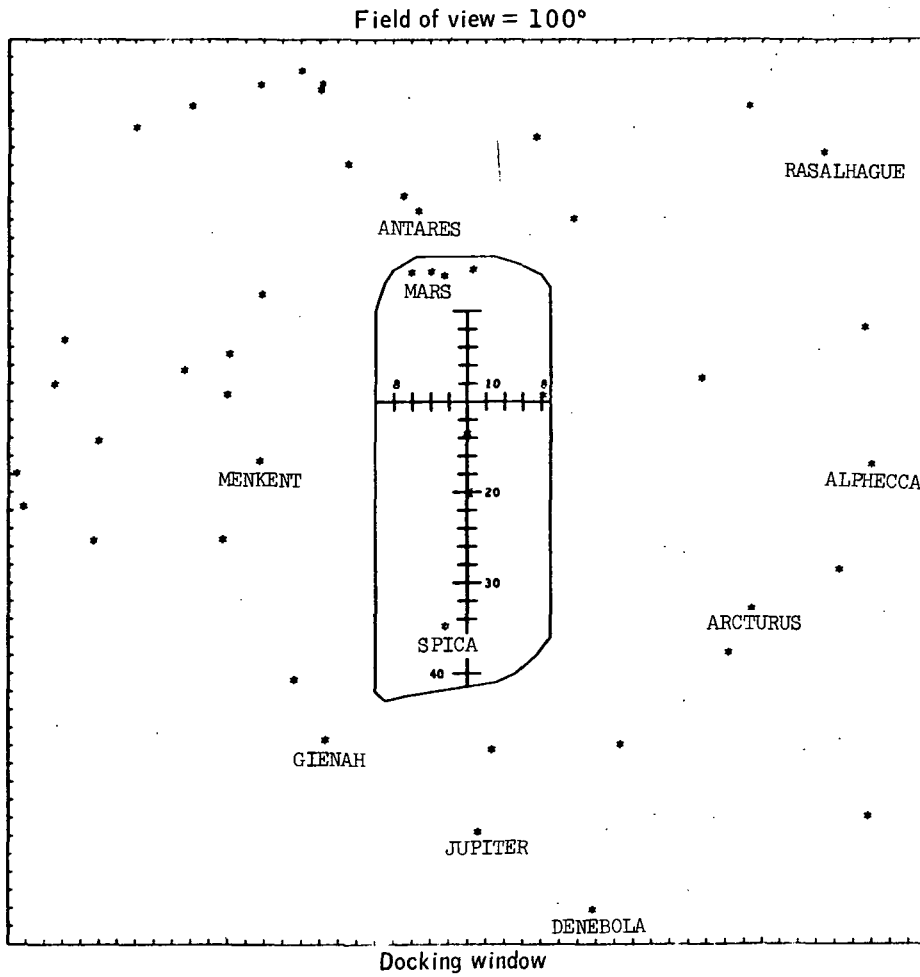

Figure 6.3.2-1.- CSI burn (g.e.t. = 125:21:20).

Page intentionally left blank

6.3.3 CDH MANEUVER

Page intentionally left blank

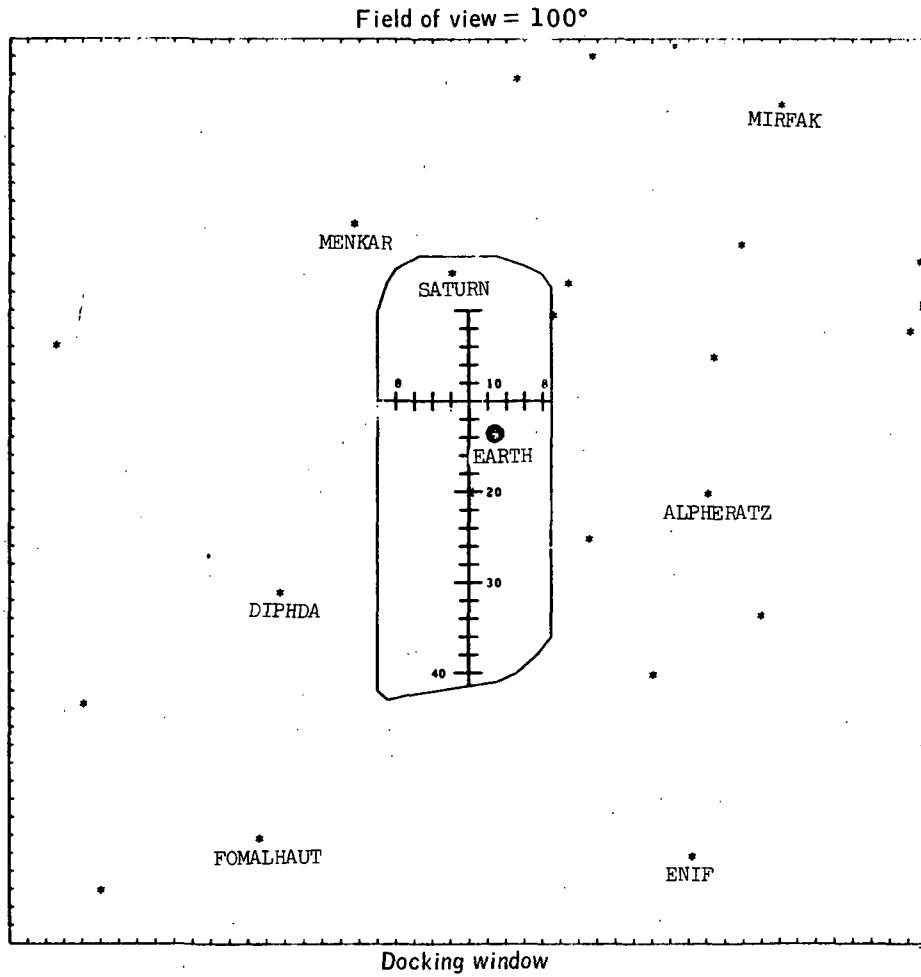

Figure 6.3.3-1.- CDH burn (g.e.t. = 126:19:40).

Page intentionally left blank

6.3.4 TPI MANEUVER

Page intentionally left blank

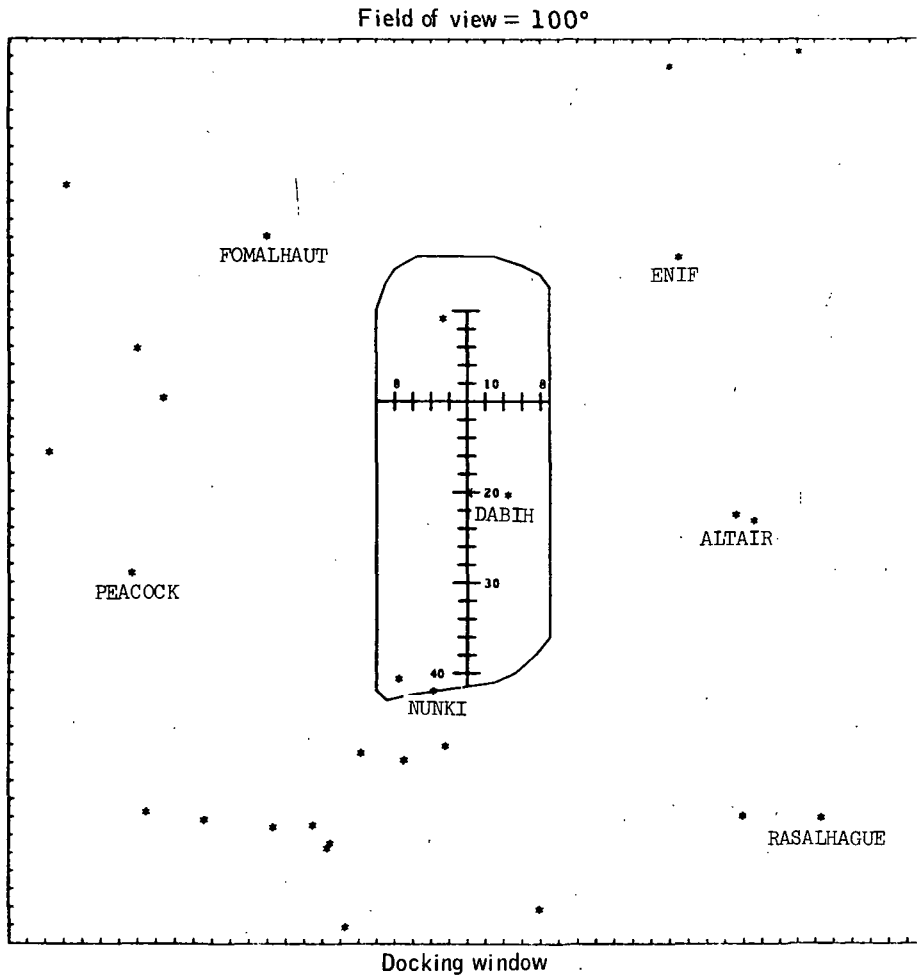

Figure 6.3.4-1.- TPI burn (g.e.t. = 126:58:26).

Page intentionally left blank

7.0 VIEWS FROM CSM DURING
TRANSEARTH PHASE

7.1 TEI BURN

7.2 POST TEI

7.3 TRANSEARTH COAST

7.3.1 MOON VIEWS

7.3.2 EARTH VIEWS

8.0 VIEWS FROM CM DURING
ENTRY PHASE

9.0 VIEWS THROUGH SCANNING
TELESCOPE

9.1 EARTH PARKING ORBIT PHASE

9.2 TRANSLUNAR COAST PHASE

9.3 LUNAR ORBIT COAST PHASE

9.4 TRANSEARTH COAST PHASE

Page intentionally left blank

7.0 VIEWS FROM CSM DURING
TRANSEARTH PHASE

Page intentionally left blank

7.1 TEI BURN

Page intentionally left blank

SEQ	14	16	17	18	40	42	45	52	55	60	69	70	75
X	14	-8	18	6	3	-19	13	9	1	-24	22	-4	-17
Y	-6	-9	-21	-24	-5	-12	7	1	-4	-18	8	5	-14

SEQ	83	100	105
X	-19	0	1
Y	-18	5	-23

$R_M = 996$ n. mi.

$h_M = 66$ stat. mi.

$V_i = 5349$ fps

Field of view = 100°

$V_i = 3646$ mph

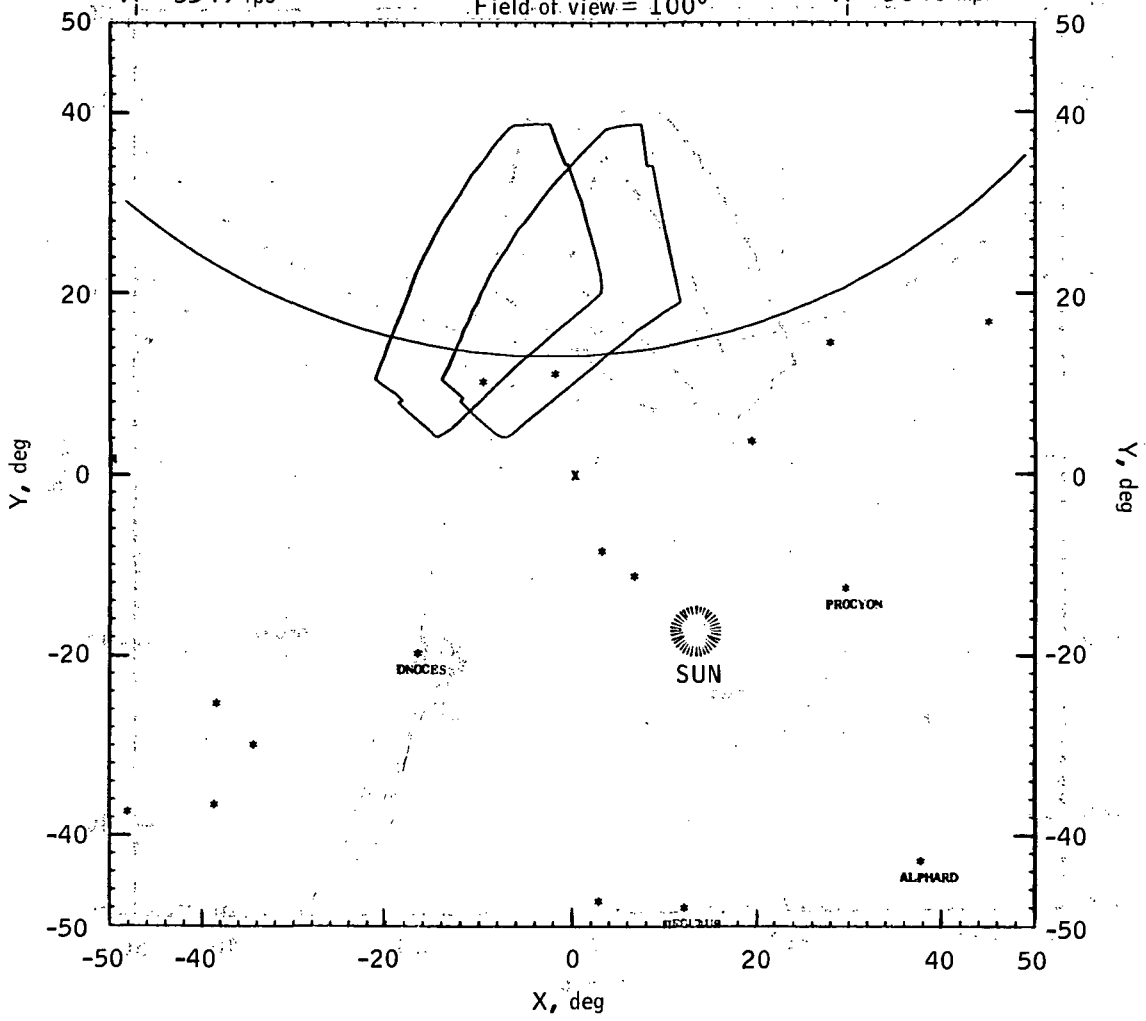

(a) Begin TEI burn (g.e.t. = 135:24:34).

Figure 7.1-1.- Transearth injection burn.

SEQ	14	16	17	40	42	45	49	50	52	55	60	69	70
X	16	-6	20	5	-17	15	19	20	11	3	-23	24	-2
Y	-8	-12	-23	-8	-14	5	7	7	0	-6	-19	6	2

SEQ	75	83	97	98	100
X	-15	-18	22	8	0
Y	-16	-19	8	6	3

$R_M = 996$ n. mi.

$h_M = 66$ stat. mi.

$V_i = 6736$ fps

$V_i = 4592$ mph

Field of view = 100°

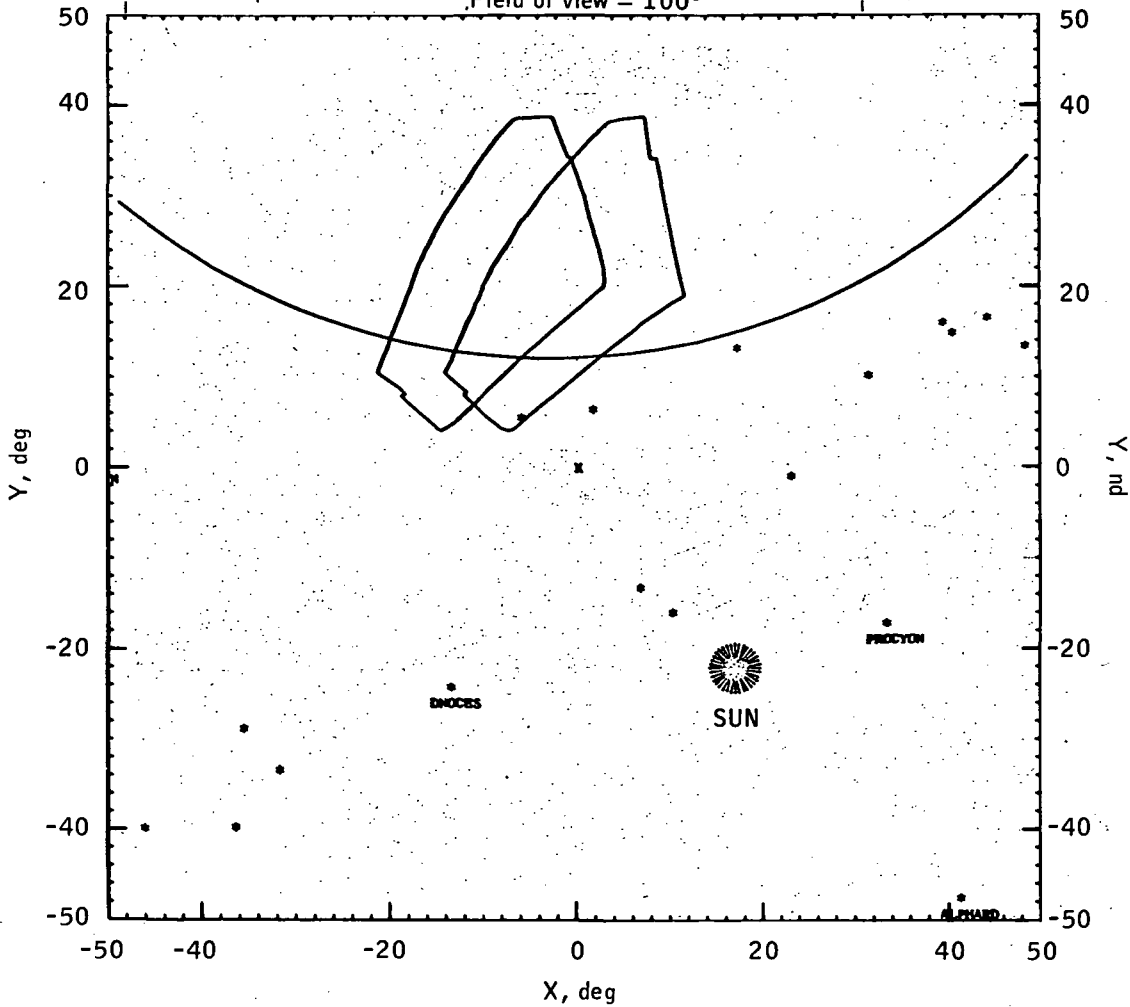

(b) Middle of TEI bum (g.e.t. = 135:25:43.7).

Figure 7.1-1.- Continued.

SEQ	5	10	11	14	16	40	42	45	47	48	49	50
X	-23	23	-2	17	-5	6	-17	16	16	5	20	21
Y	-1	8	3	-11	-14	-10	-16	2	6	4	5	4

SEQ	52	55	60	68	70	75	83	97	98	100
X	12	4	-23	20	-1	-15	-18	23	9	2
Y	-3	-9	-21	5	0	-18	-21	5	3	0

$R_M = 1000$ n. mi.

$h_M = 71$ stat. mi.

$V_i = 8577$ fps

$V_i = 5847$ mph

Field of view = 100°

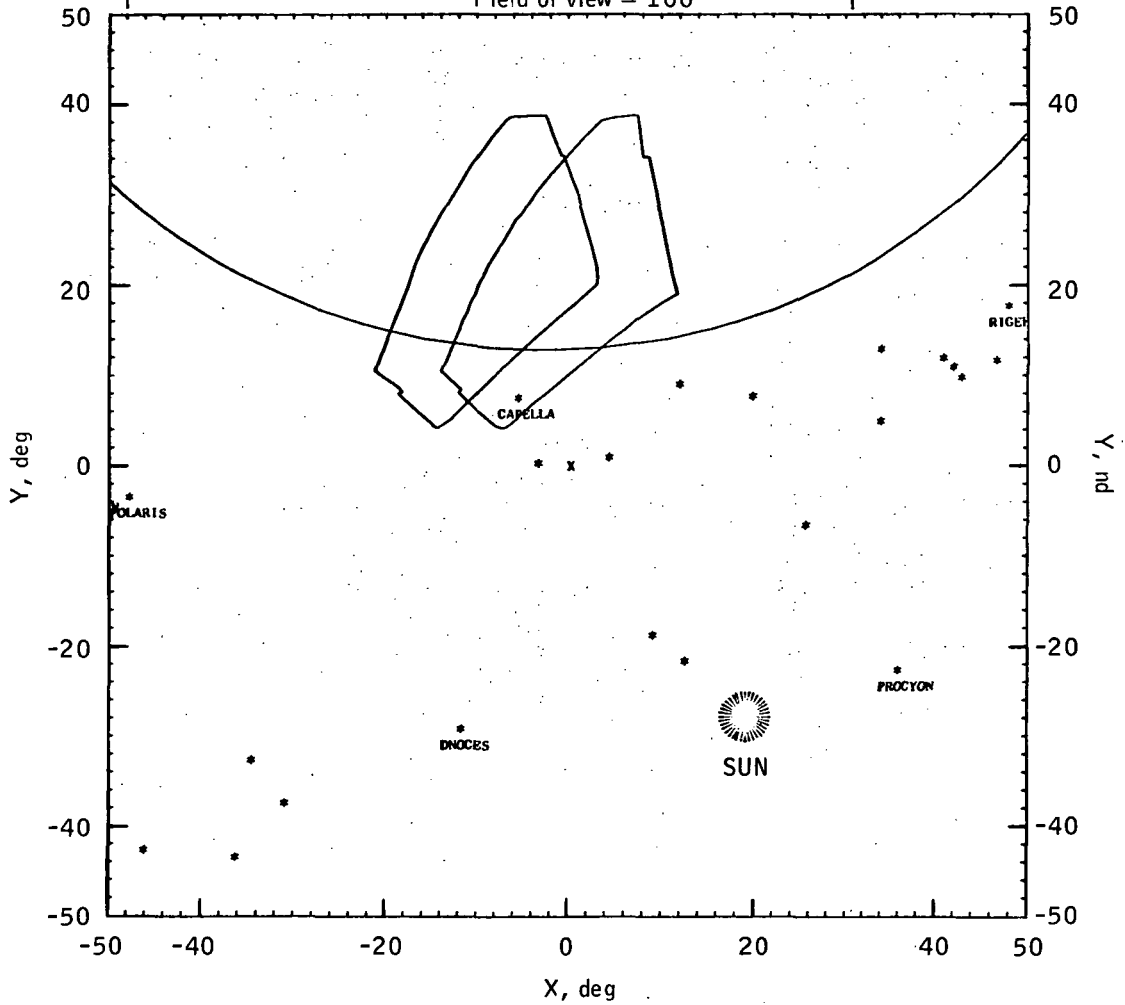

(c) End TEI burn (g.e.t. = 135:27:03).

Figure 7.1-1.- Concluded.

Page intentionally left blank

7.2 POST TEI

Page intentionally left blank

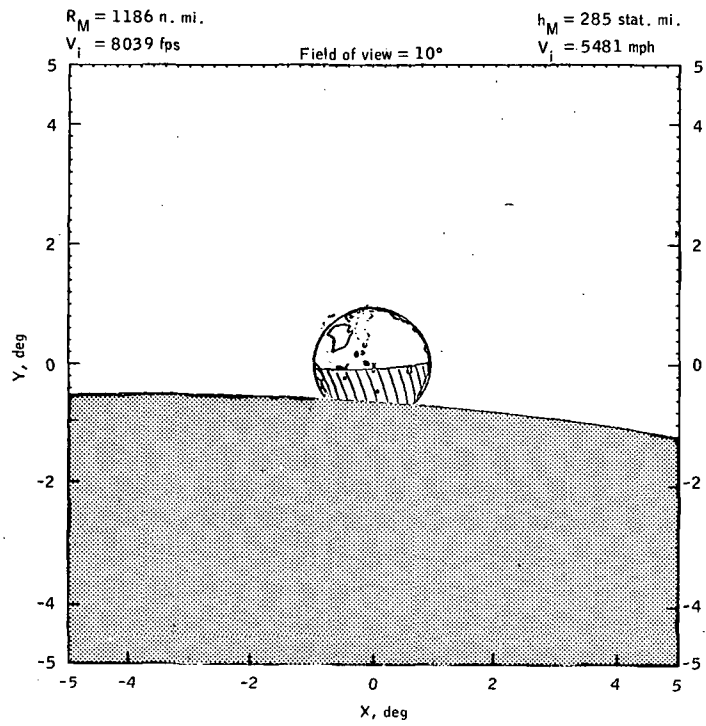

(a) g.e.t. = 135:35:27.

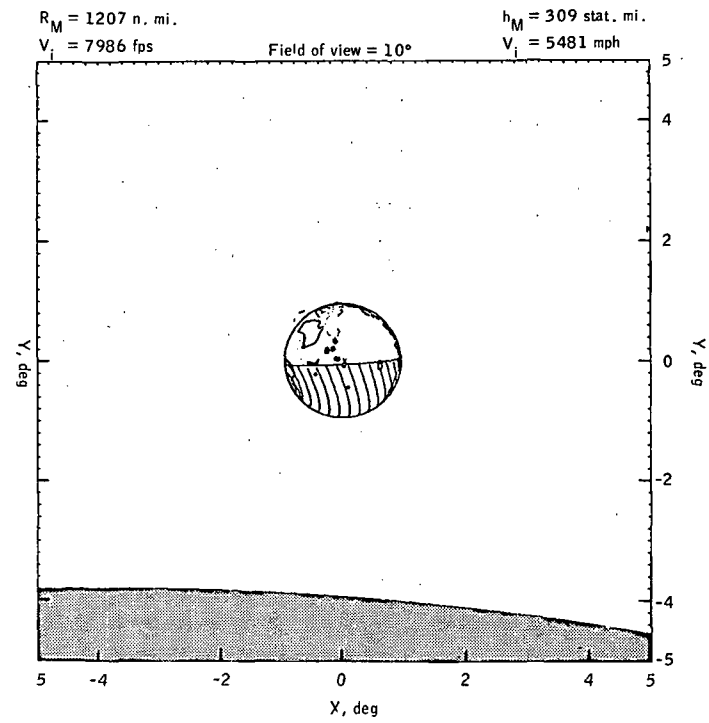

(b) g.e.t. = 135:36:03.

Figure 7.2-1.- Post TEI.

Page intentionally left blank

7.3 TRANSEARTH COAST

Page intentionally left blank

7.3.1 MOON VIEWS

Page intentionally left blank

SEQ	27	61	62	63	84	85	87	117	121	122	123	125
X	-1	-9	-15	-7	0	-8	-11	-24	-23	10	-18	-2
Y	-3	11	12	22	-10	2	13	-19	-15	-24	-10	-9

SEQ	126	129	130	132	134	135	138	139	2
X	3	-2	14	10	-10	-22	-2	2	0
Y	-10	-1	-4	4	11	12	21	23	-9

$R_M = 13\,718$ n. mi.

$h_M = 14\,706$ stat. mi.

$V_i = 4\,555$ fps

$V_i = 3\,106$ mph

Field of view = 50°

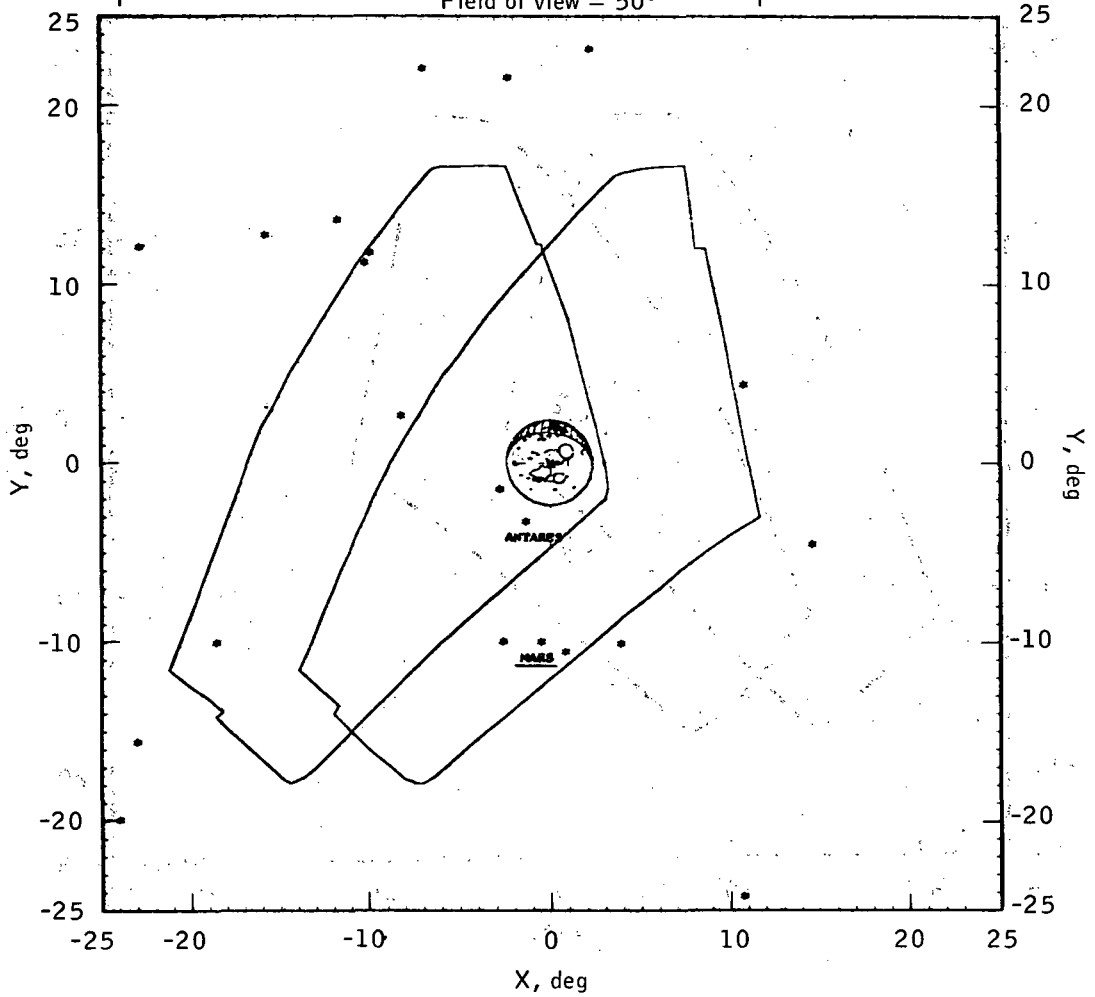

(a) g.e.t. = 140 hours

Figure 7.3.1-1.- Transearth coast - constant field of view (moon).

SEQ	X	Y	X	Y	X	Y	X	Y	X	Y	X	Y
27	61	62	63	84	85	87	117	121	122	123	125	
-1	-10	-16	-7	0	-8	-12	-23	-22	11	-18	-2	
0	14	15	24	-7	5	16	-17	-13	-20	-7	-6	

SEQ	X	Y	X	Y	X	Y	X	Y
126	129	130	132	134	135	138	2	
3	-2	14	10	-10	-23	-2	0	
-6	1	-1	7	13	14	24	-6	

$R_E = 173\,780$ n. mi.

$h_E = 196\,019$ stat. mi.

$V_i = 4\,052$ fps

$V_i = 2\,763$ mph

Field of view = 50°

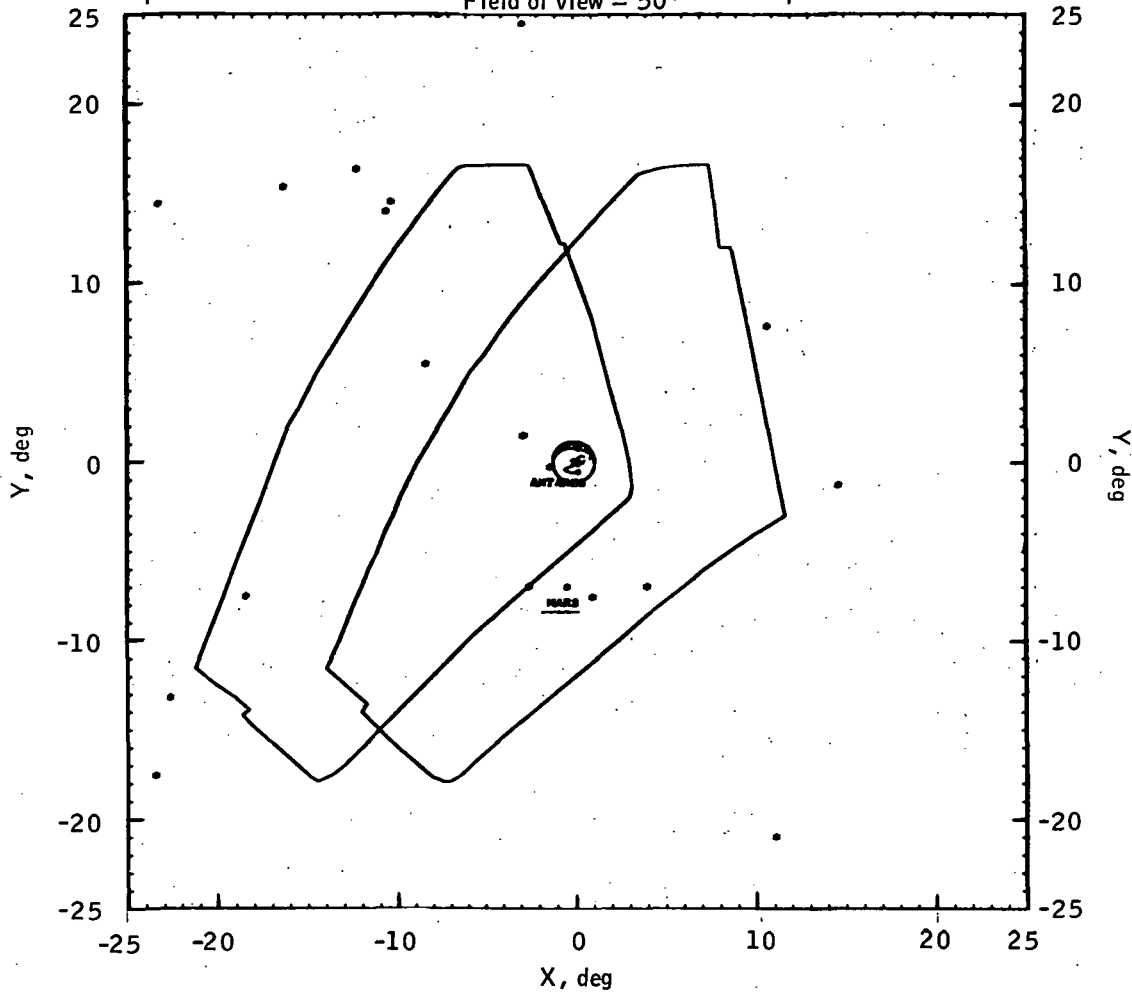

(b) g.e.t. = 150 hours.

Figure 7.3.1-1.- Continued.

SEQ	24	27	61	62	84	85	87	117	120	121	122	123
X	-19	-1	-10	-16	1	-8	-12	-22	3	-22	11	-18
Y	-24	1	15	16	-5	6	17	-16	-23	-12	-18	-6

SEQ	125	126	129	130	132	134	135	2
X	-2	4	-2	14	10	-11	-23	0
Y	-5	-5	3	0	9	15	15	-5

$R_E = 148\ 825$ n. mi.

$h_E = 167\ 301$ stat. mi.

$V_i = 4\ 537$ fps

$V_i = 3\ 093$ mph

Field of view = 50°

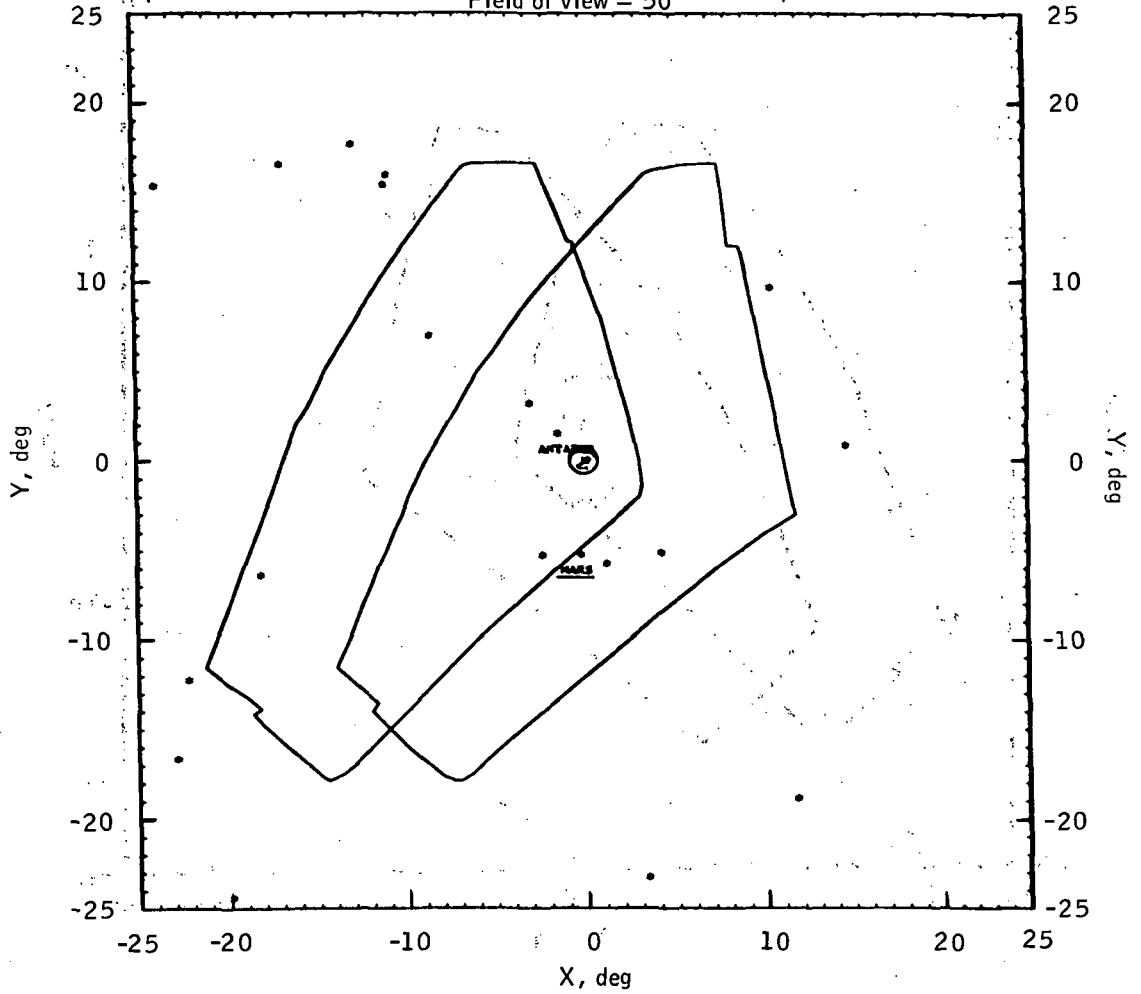

(c) g.e.t. = 160 hours.

Figure 7.3.1-1.- Continued.

SEQ	24	27	61	62	84	85	87	117	120	121	122	123	125
X	-19	-1	-11	-17	1	-8	-13	-22	3	-21	12	-17	-2
Y	-23	3	17	17	-3	8	19	-15	-21	-11	-16	-5	-3

SEQ							
X	126	129	130	132	134	135	2
Y	4	-3	14	10	-11	-24	0
	-3	4	3	11	16	16	-3

$R_E = 120\,459$ n. mi.

$h_E = 134\,659$ stat. mi.

$V_i = 5\,270$ fps

$V_i = 3\,593$ mph

Field of view = 50°

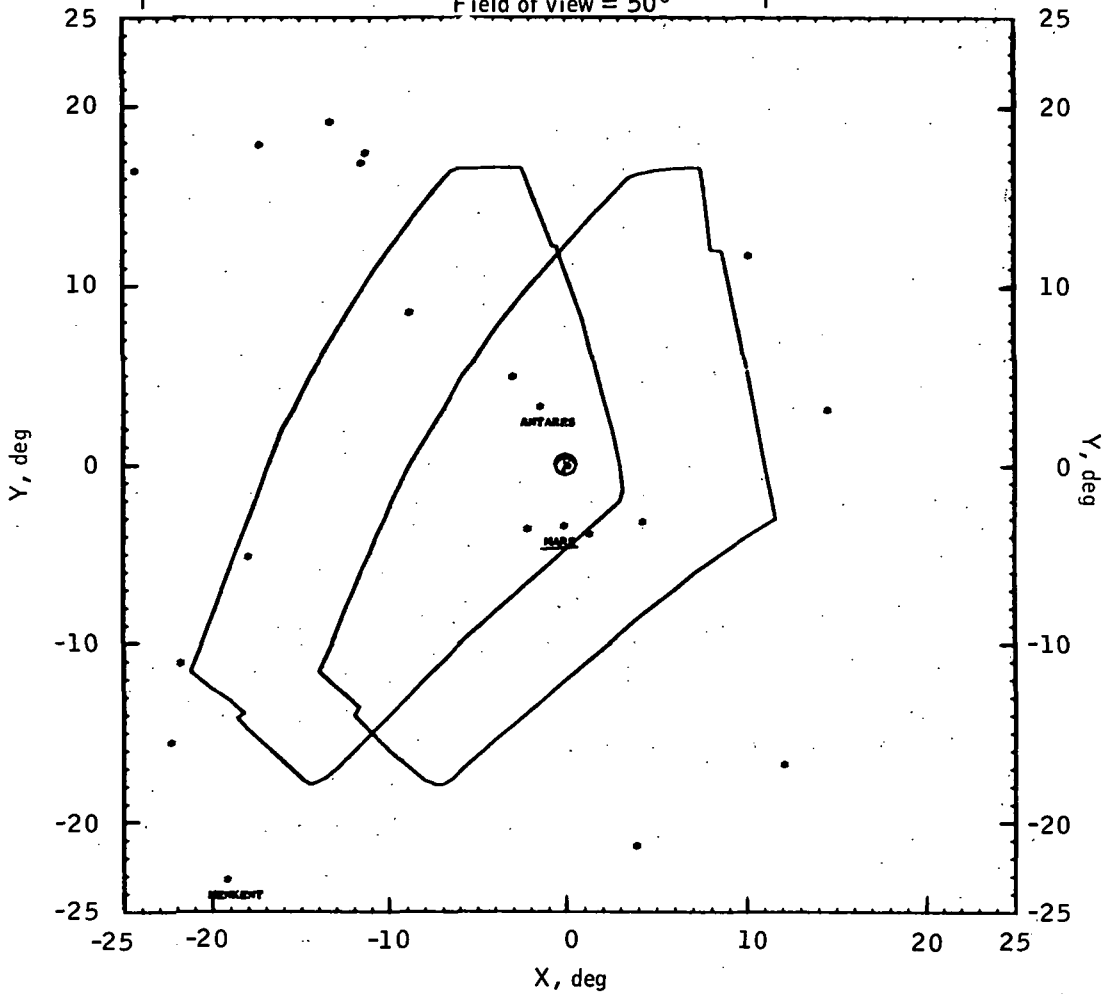

(d) g.e.t. = 170 hours.

Figure 7.3.1-1.- Continued.

SEQ	X	Y	X	Y	X	Y	X	Y	X	Y	X	Y
	24	-18	27	-1	61	-11	62	-17	84	1	85	-9
		-21		5		19		19		-1		10
											21	-13
											-13	-18
											4	-21
											12	-17
											-9	-14
											-3	-3

SEQ	X	Y	X	Y	X	Y	X	Y
	125	-2	126	4	129	-3	130	14
		-1		0		7		5
								14
								18
								17

$R_E = 86\,662$ n. mi.

$h_E = 95\,766$ stat. mi.

$V_i = 6\,534$ fps

$V_i = 4\,455$ mph

Field of view = 50°

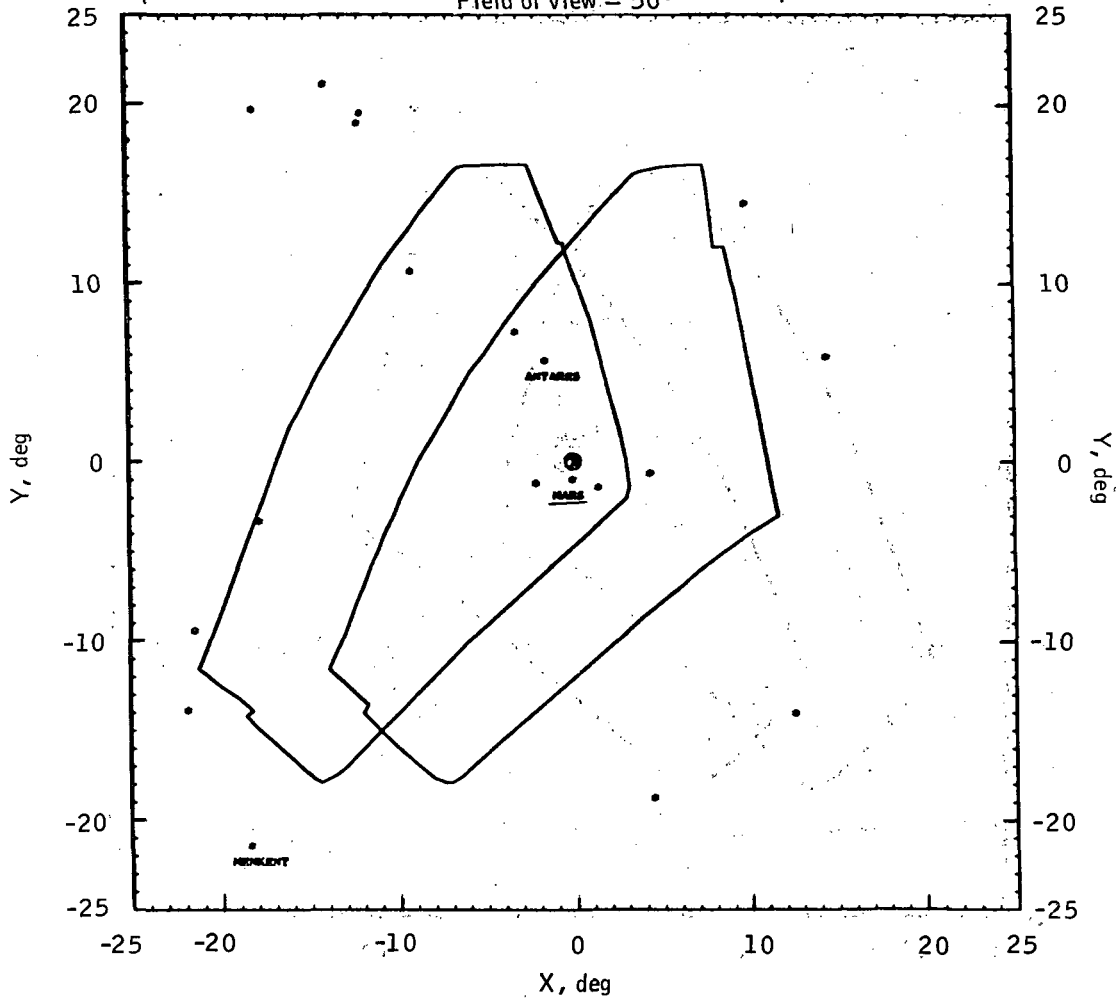

(e) g.e.t. = 180 hours.

Figure 7.3.1-1.- Continued.

SEQ	X	24	27	61	62	84	85	87	117	120	121	122	123
Y	-16	-2	-13	-19	1	-10	-15	-20	5	-20	13	-17	
	-19	9	21	21	2	13	23	-12	-14	-7	-9	-1	

SEQ	X	125	126	129	130	132	134
Y	-2	4	-4	13	8	-13	
	2	3	10	10	18	21	

$R_E = 41\ 589\ n.\ mi.$

$h_E = 43\ 898\ stat.\ mi.$

$V_i = 10\ 030\ fps$

$V_i = 6\ 839\ mph$

Field of view = 50°

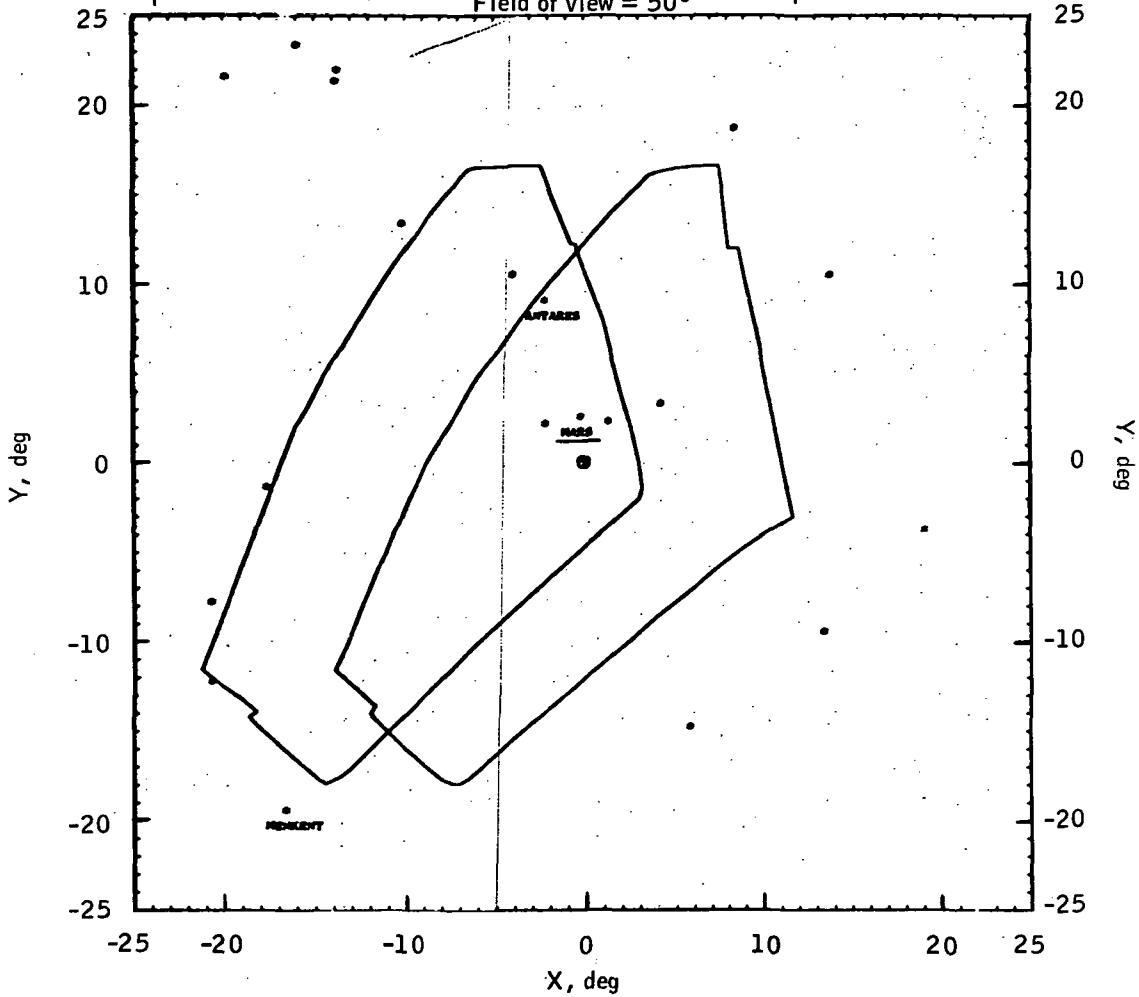

(f) g.e.t. = 190 hours.

Figure 7.3.1-1.- Concluded.

$R_M = 13\ 718$ n. mi.
 $V_I = 4\ 555$ fps

$h_M = 14\ 706$ stat. mi.
 $V_I = 3\ 106$ mph

Field of view = 8°

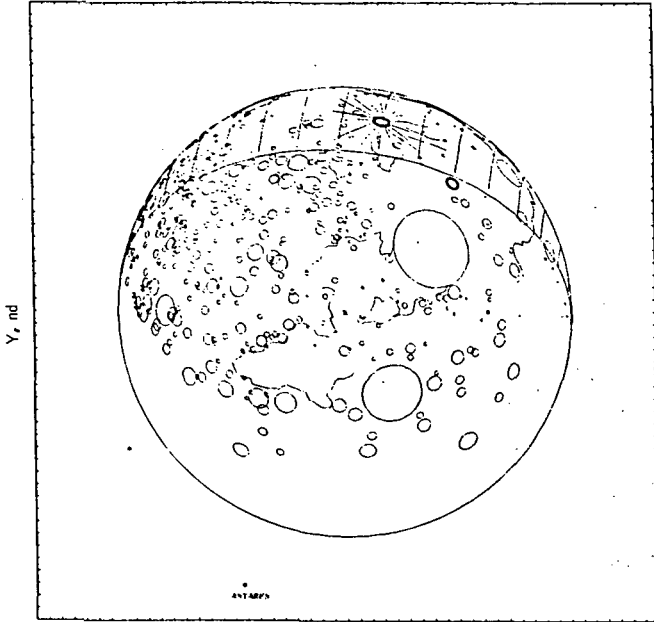

(a) g.e.t. = 140 hours.

$R_E = 173\ 780$ n. mi.
 $V_I = 4\ 052$ fps

$h_E = 196\ 019$ stat. mi.
 $V_I = 2\ 763$ mph

Field of view = 4°

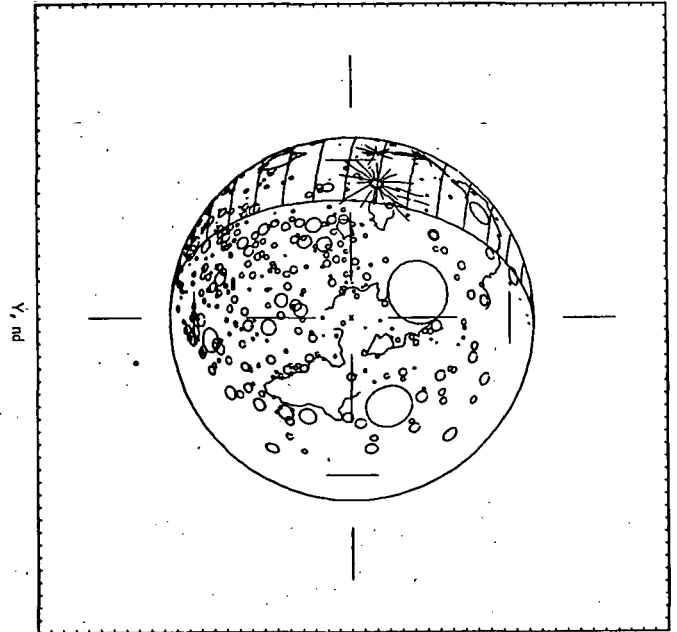

(b) g.e.t. = 150 hours.

$R_E = 148\ 825$ n. mi.
 $V_I = 4\ 537$ fps

$h_E = 167\ 301$ stat. mi.
 $V_I = 3\ 093$ mph

Field of view = 2°

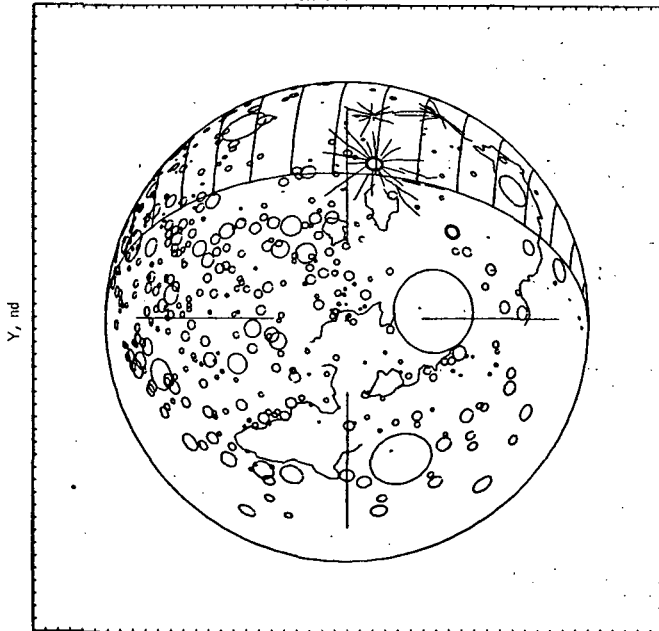

(c) g.e.t. = 160 hours.

$R_E = 120\ 459$ n. mi.
 $V_I = 5\ 270$ fps

$h_E = 134\ 659$ stat. mi.
 $V_I = 3\ 593$ mph

Field of view = 2°

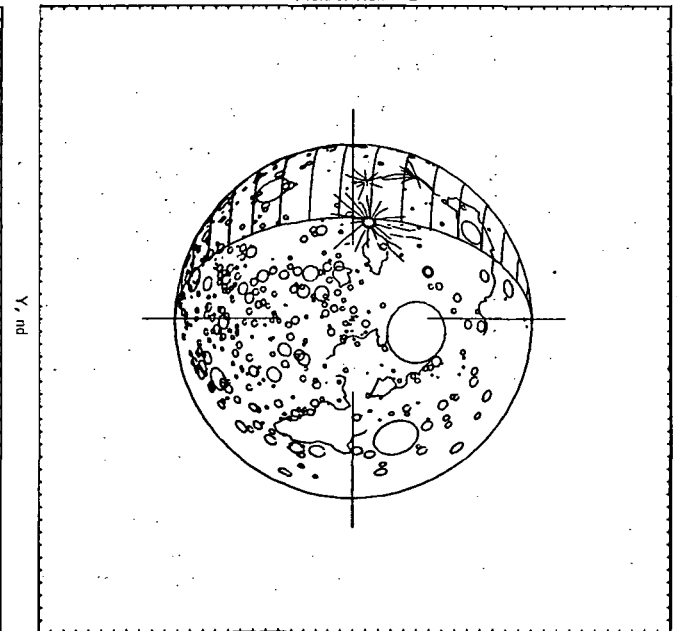

(d) g.e.t. = 170 hours.

Figure 7.3.1-2.- Transearth coast - variable field of view (moon).

$R_E = 86\,662$ n. mi.

$V_i = 6\,534$ fps

$h_E = 95\,766$ stat. mi.

$V_i = 4\,455$ mph

Field of view = 1°

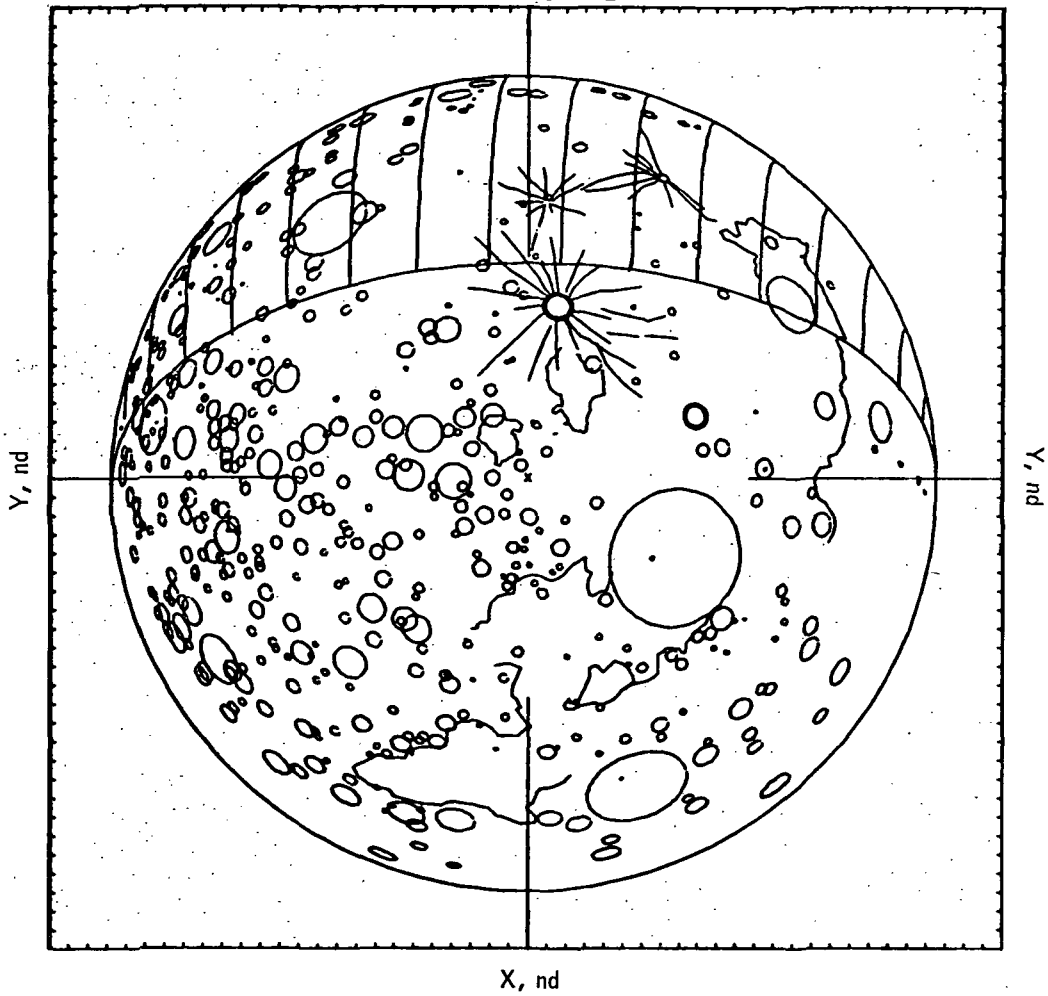

(e) g.e.t. = 180 hours.

Figure 7.3.1-2.- Concluded.

Page intentionally left blank

7.3.2 EARTH VIEWS

SE0	4	7	41	63	75	80	108	1082
X	-24	-14	-19	-1	-2	20	21	9
Y	0	10	-13	-11	-15	0	-13	-11

$R_M = 13\ 718$ n. mi.

$h_M = 14\ 706$ stat. mi.

$V_i = 4\ 555$ fps

$V_i = 3\ 106$ mph

Field of view = 50°

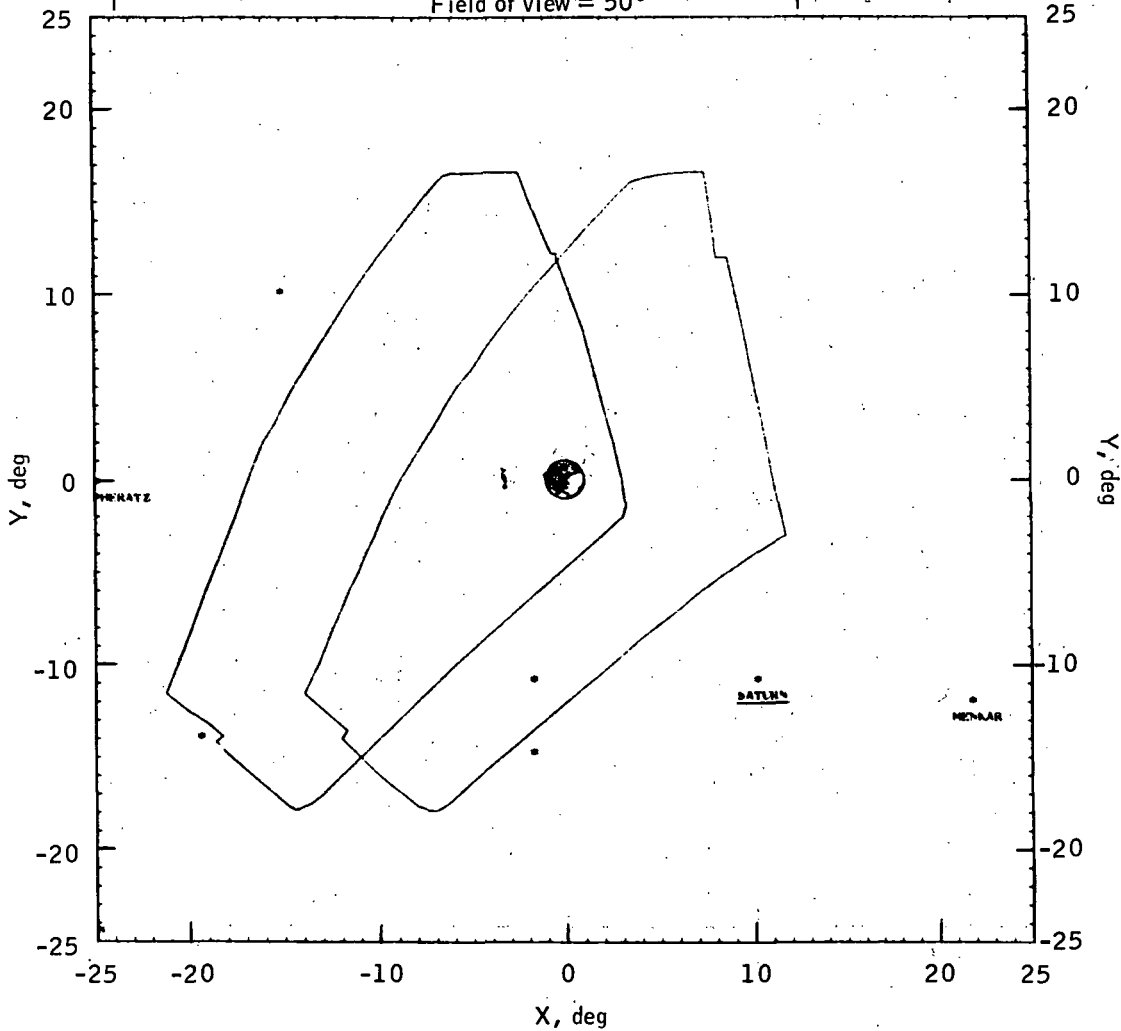

(a) g.e.t. = 140 hours.

Figure 7.3.2-1.- Transearth coast - constant field of view (earth).

SEQ	1	7	38	66	67	86	89	4
X	-24	20	-2	-20	-18	-14	-2	9
Y	3	-12	-13	-11	-23	12	-9	-10

$R_E = 173\,780$ n. mi.

$h_E = 196\,019$ stat. mi.

$V_i = 4\,052$ fps

$V_i = 2\,763$ mph

Field of view = 50°

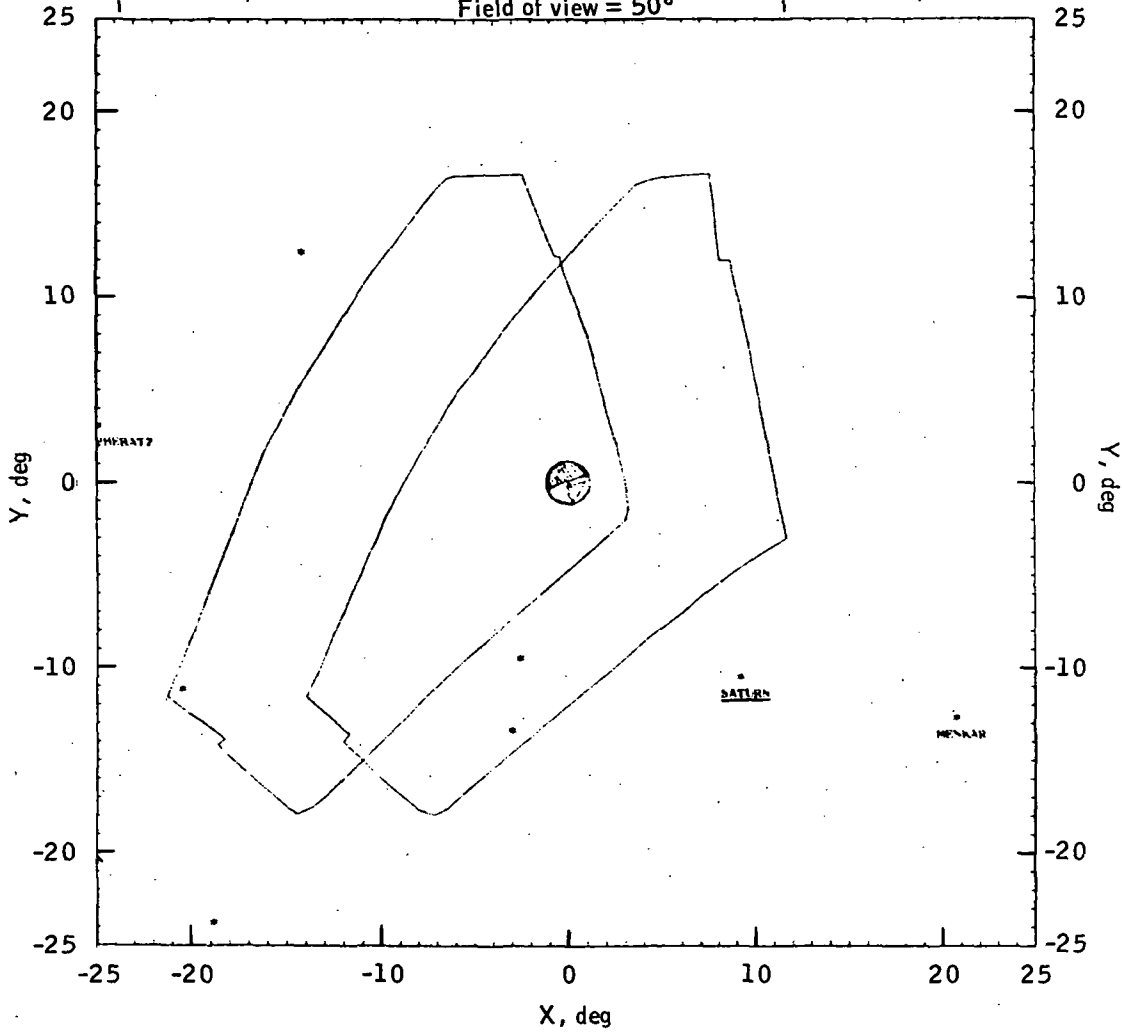

(b) g. e. t. = 150 hours.

Figure 7.3.2-1.- Continued.

SEQ	1	7	38	66	67	86	89	4
X	-24	20	-3	-20	-19	-13	-2	9
Y	4	-11	-11	-9	-21	14	-7	-9

 $R_E = 148\,825$ n. mi.

 $h_E = 167\,301$ stat. mi.

 $V_i = 4\,537$ fps

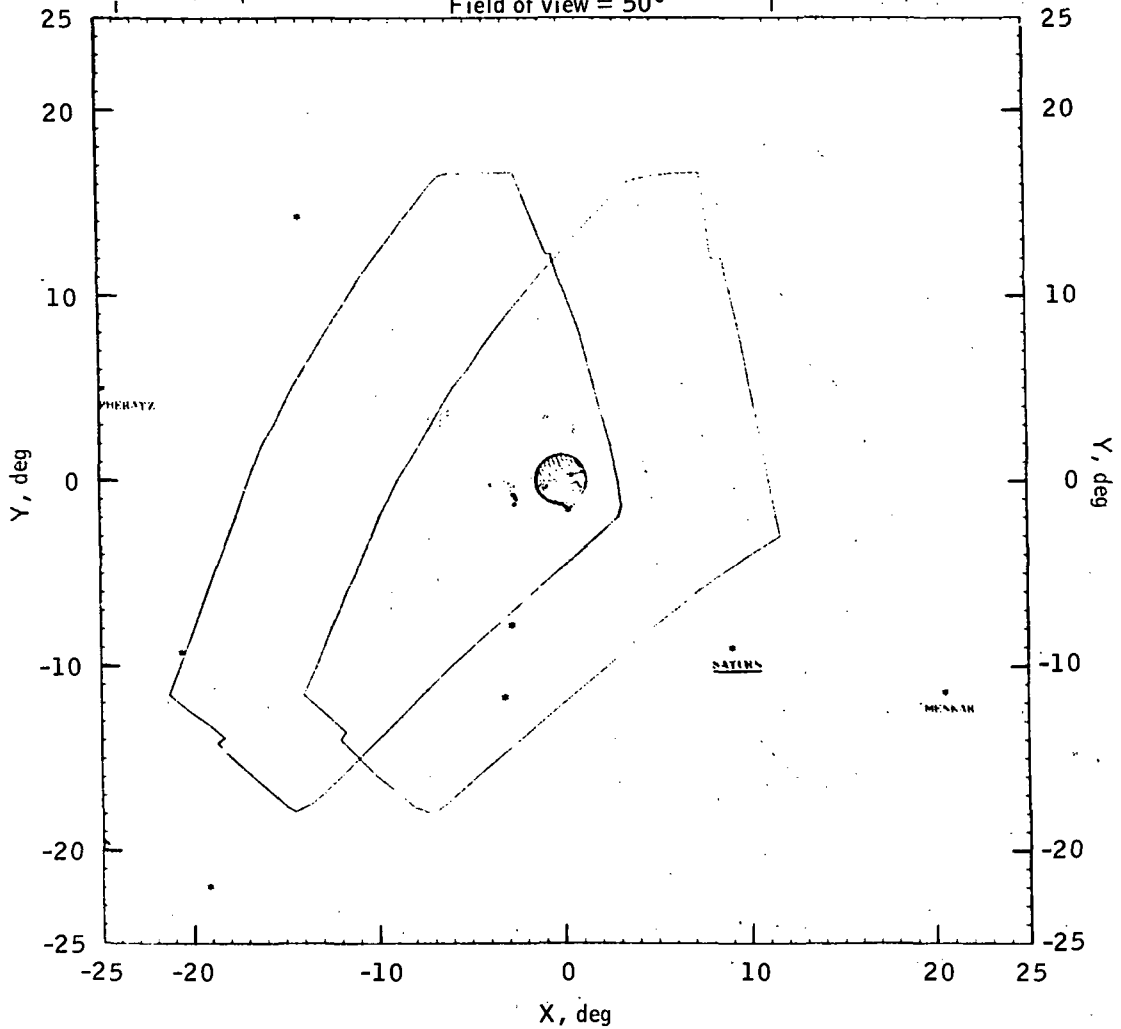
 Field of view = 50°
 $V_i = 3\,093$ mph

(c) g.e.t. = 160 hours.

Figure 7.3.2-1.- Continued.

SEQ	1	7	38	66	67	86	89	4
X	-24	20	-3	-20	-19	-13	-2	9
Y	7	-9	-9	-6	-19	16	-5	-6

$R_E = 120\,459$ n. mi.

$V_i = 5\,270$ fps

$h_E = 134\,659$ stat. mi.

$V_i = 3\,593$ mph

Field of view = 50°

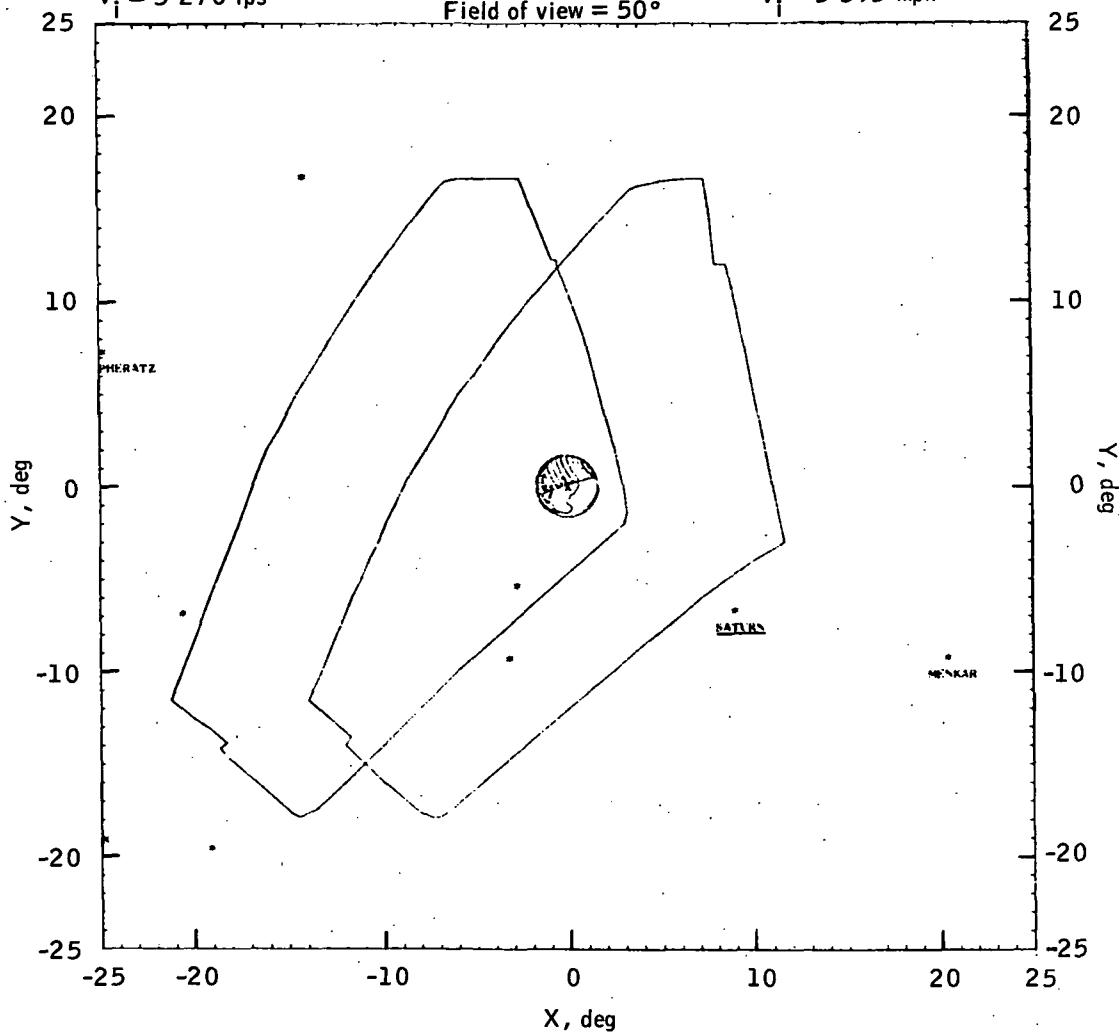

(d) g.e.t. = 170 hours.

Figure 7.3.2-1.- Continued.

SEQ	1	7	38	66	67	86	89	4
X	-24	20	-3	-20	-18	-14	-2	9
Y	11	-5	-5	-2	-15	20	-1	-2

$R_E = 86\,662$ n. mi.

$h_E = 95\,766$ stat. mi.

$V_i = 6\,534$ fps

$V_i = 4\,455$ mph

Field of view = 50°

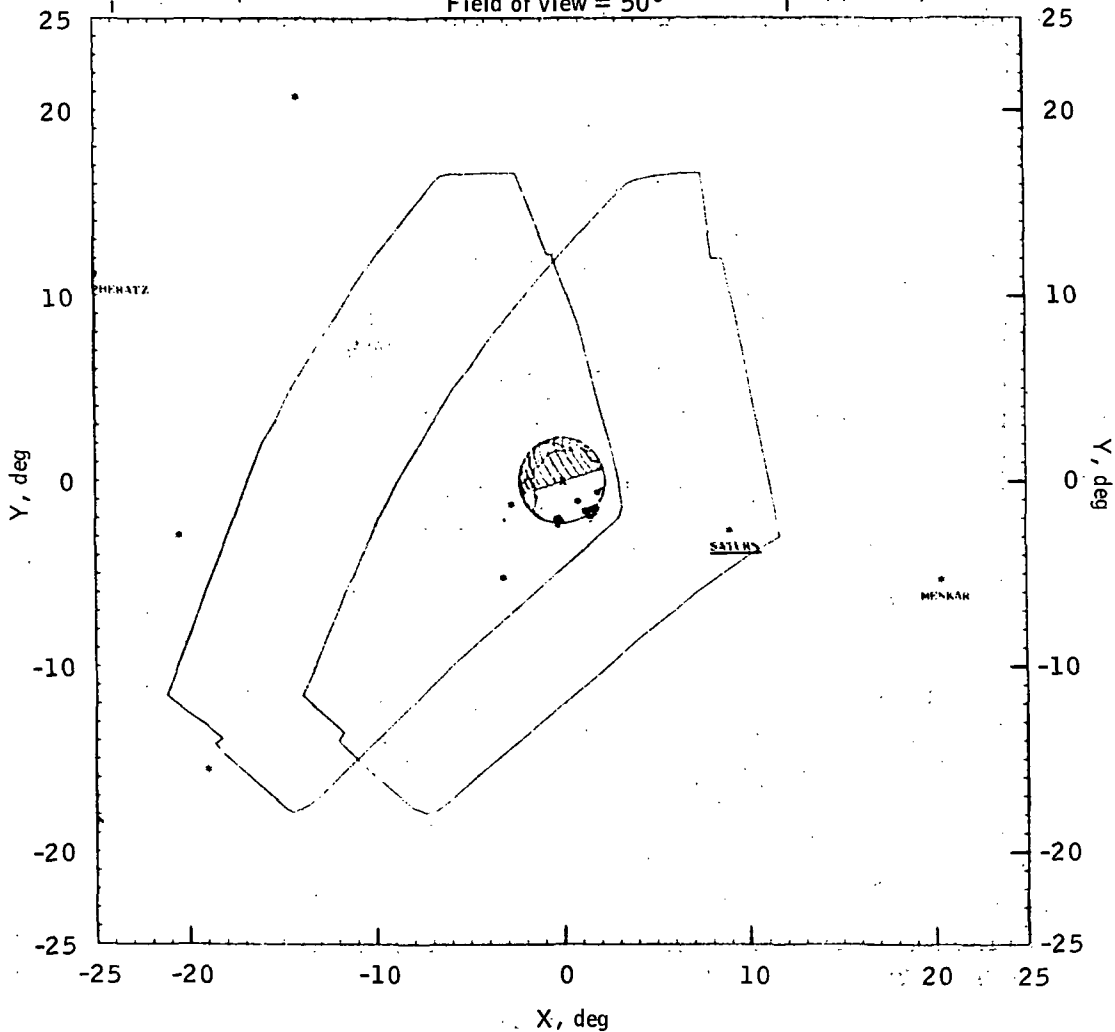

(e) g. e. t. = 180 hours.

Figure 7.3.2-1.- Continued.

SEQ	7	8	9	38	66	67	89	90	91	92	4
X	20	-17	19	-3	-20	-18	-2	7	1	-5	9
Y	5	-20	-20	6	8	-4	10	-13	-18	-22	8

$R_E = 41\,589$ n. mi.

$V_i = 10\,030$ fps

$h_E = 43\,898$ stat. mi.

$V_i = 6\,839$ mph

Field of view = 50°

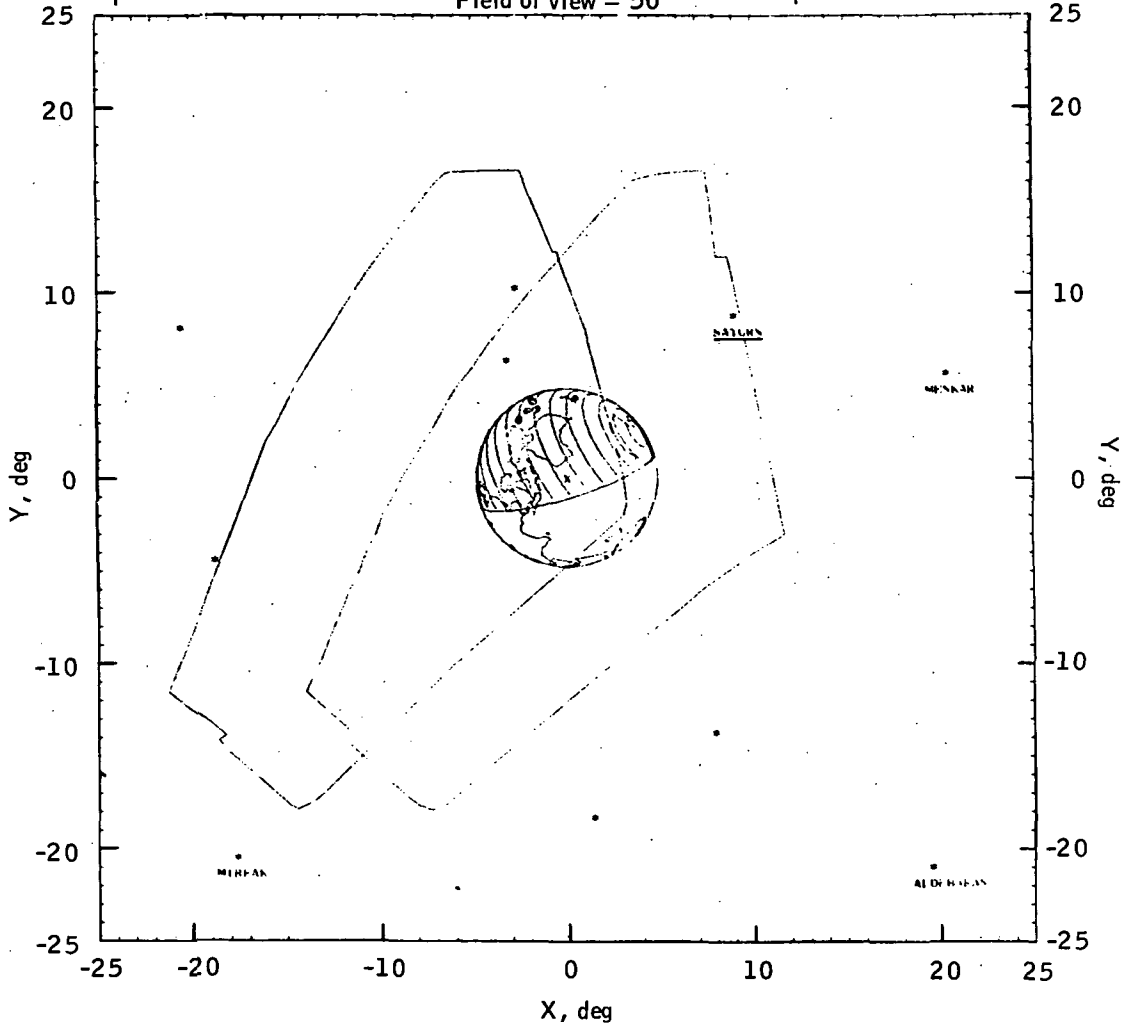

(f) g.e.t. = 190 hours.

Figure 7.3.2-1.- Concluded.

$R_M = 2\,354$ n. mi.
 $V_i = 6\,386$ fps

$h_M = 1\,628$ stat. mi.
 $V_i = 4\,354$ mph

Field of view = 3°

Y, nd

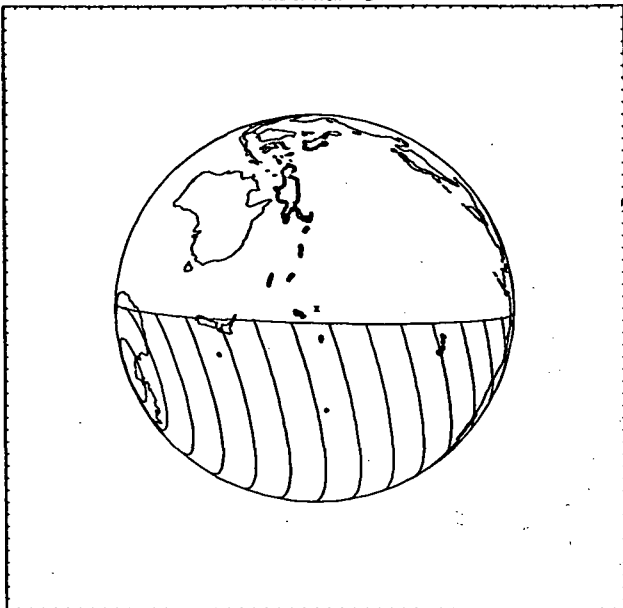

X, nd

(a) g.e.t. = 136 hours.

$R_M = 5\,394$ n. mi.
 $V_i = 5\,210$ fps

$h_M = 5\,127$ stat. mi.
 $V_i = 3\,552$ mph

Field of view = 3°

pu, Y

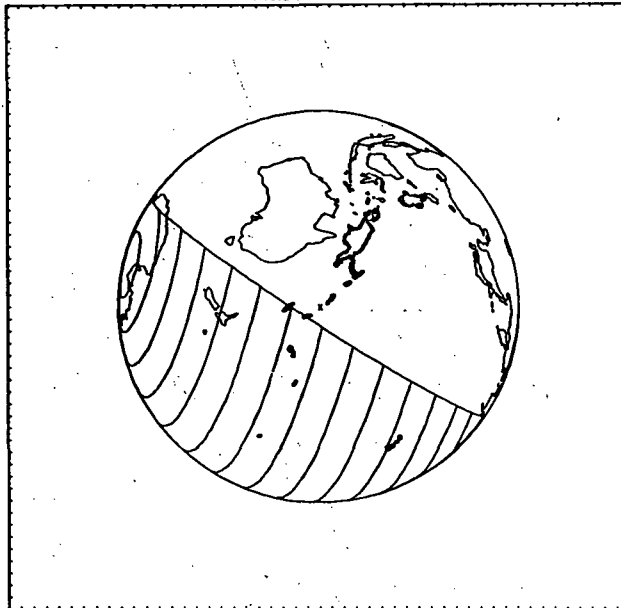

X, nd

(b) g.e.t. = 137 hours.

$R_M = 8\,259$ n. mi.
 $V_i = 4\,845$ fps

$h_M = 8\,425$ stat. mi.
 $V_i = 3\,303$ mph

Field of view = 3°

Y, nd

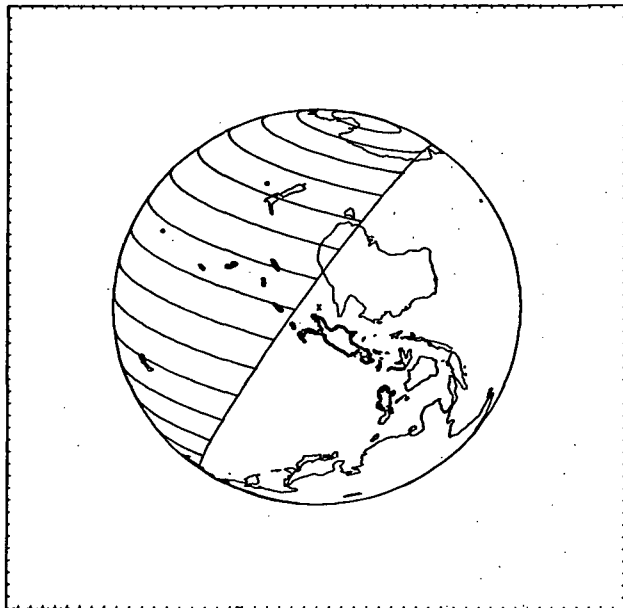

X, nd

(c) g.e.t. = 138 hours.

$R_M = 11\,021$ n. mi.
 $V_i = 4\,664$ fps

$h_M = 11\,602$ stat. mi.
 $V_i = 3\,180$ mph

Field of view = 3°

pu, Y

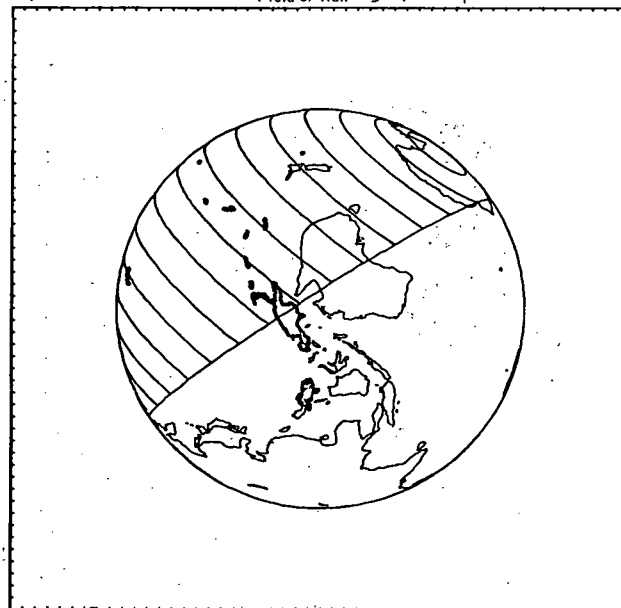

X, nd

(d) g.e.t. = 139 hours.

Figure 7.3.2-2.- Transearth coast - variable field of view (earth).

$R_M = 13\,718$ n. mi.
 $V_i = 4\,555$ fps

$h_M = 14\,706$ stat. mi.
 $V_i = 3\,106$ mph

Field of view = 3°

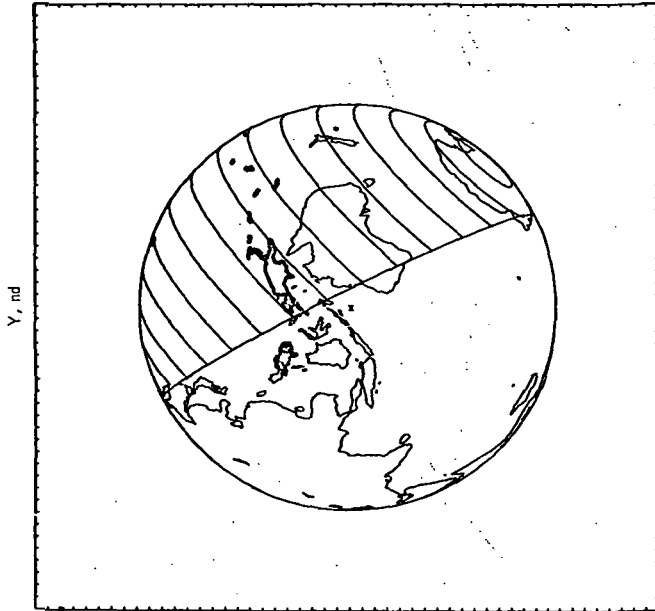

(e) g.e.t. = 140 hours.

$R_M = 16\,372$ n. mi.
 $V_i = 4\,482$ fps

$h_M = 17\,760$ stat. mi.
 $V_i = 3\,056$ mph

Field of view = 3°

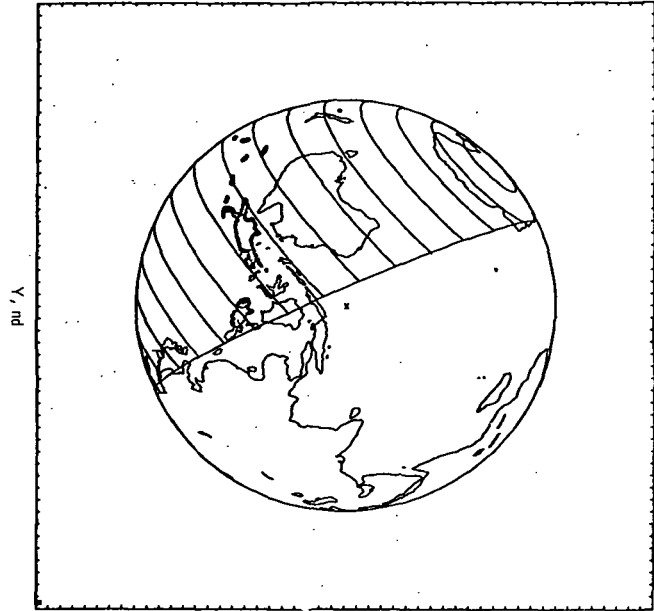

(f) g.e.t. = 141 hours.

$R_M = 18\,995$ n. mi.
 $V_i = 4\,430$ fps

$h_M = 20\,778$ stat. mi.
 $V_i = 3\,020$ mph

Field of view = 3°

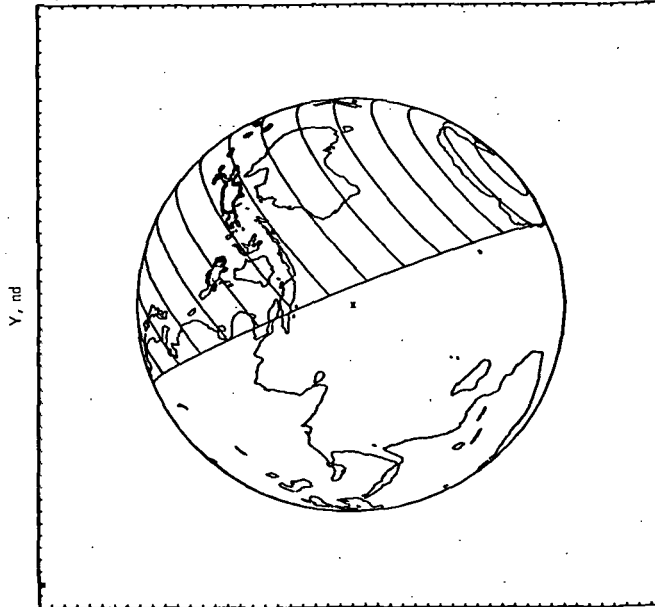

(g) g.e.t. = 142 hours.

$R_M = 21\,595$ n. mi.
 $V_i = 4\,392$ fps

$h_M = 23\,770$ stat. mi.
 $V_i = 2\,995$ mph

Field of view = 3°

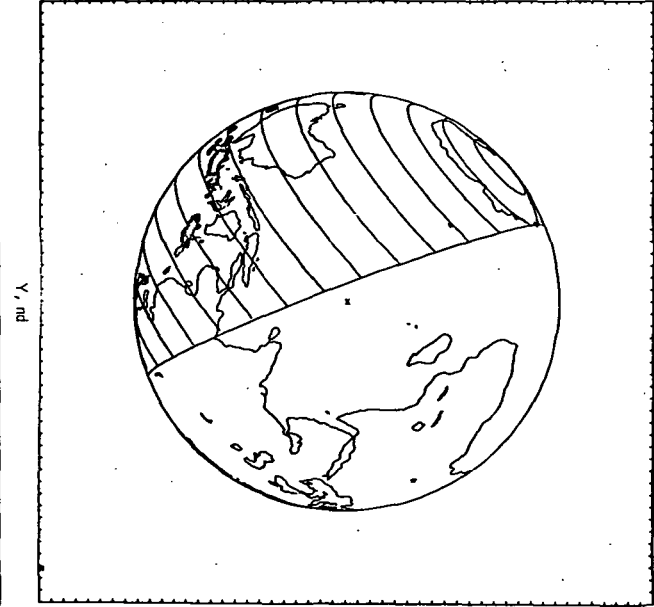

(h) g.e.t. = 143 hours.

$R_M = 24\ 177$ n. mi.
 $V_i = 4\ 363$ fps

$h_M = 26\ 743$ stat. mi.
 $V_i = 2\ 975$ mph

Field of view = 3°

Y, nd

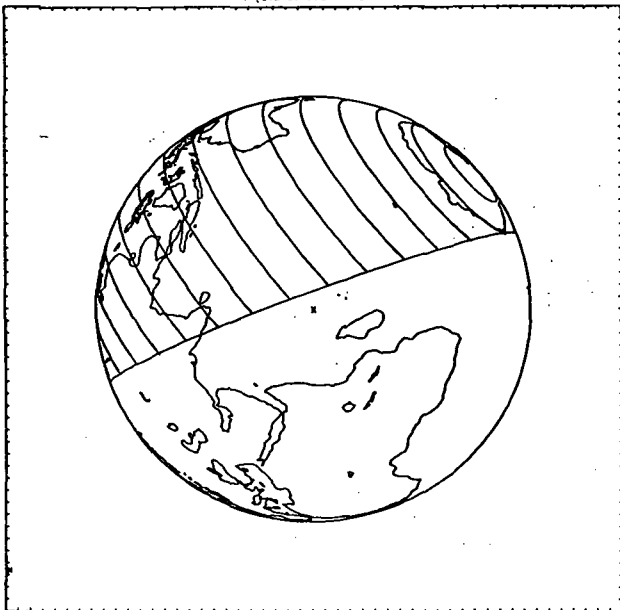

X, nd

(i) g.e.t. = 144 hours.

$R_M = 26\ 746$ n. mi.
 $V_i = 4\ 340$ fps

$h_M = 29\ 699$ stat. mi.
 $V_i = 2\ 959$ mph

Field of view = 3°

pu, Y

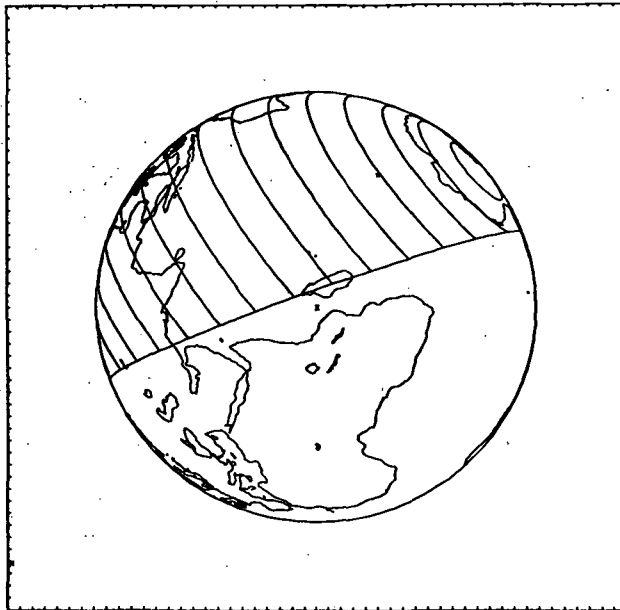

X, nd

(j) g.e.t. = 145 hours.

$R_M = 29\ 305$ n. mi.
 $V_i = 4\ 323$ fps

$h_M = 32\ 644$ stat. mi.
 $V_i = 2\ 947$ mph

Field of view = 3°

Y, nd

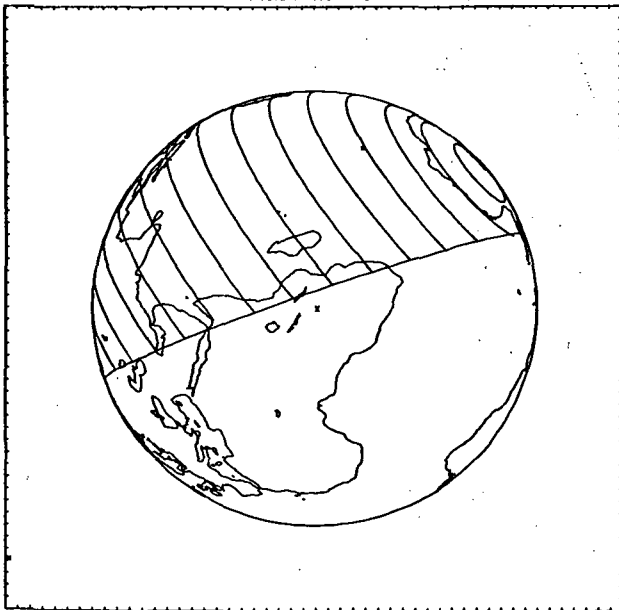

X, nd

(k) g.e.t. = 146 hours.

$R_M = 31\ 855$ n. mi.
 $V_i = 4\ 310$ fps

$h_M = 35\ 578$ stat. mi.
 $V_i = 2\ 939$ mph

Field of view = 3°

pu, Y

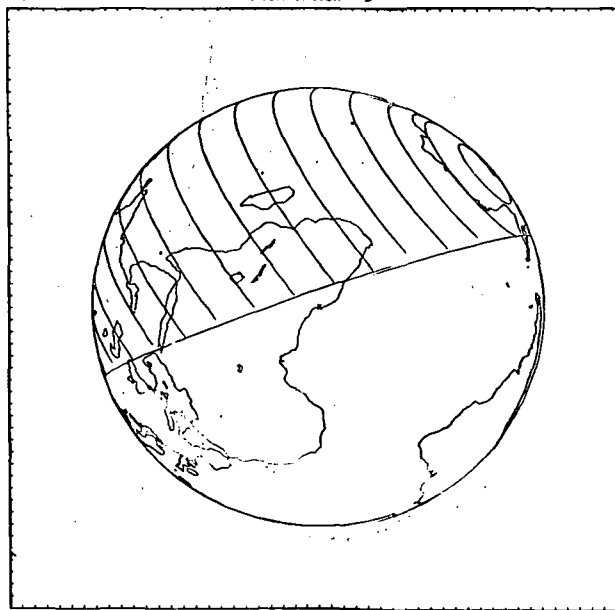

X, nd

(l) g.e.t. = 147 hours.

Figure 7.3.2-2.- Continued.

$R_M = 34\,400$ n. mi.
 $V_i = 4\,300$ fps

$h_M = 38\,506$ stat. mi.
 $V_i = 2\,932$ mph

Field of view = 3°

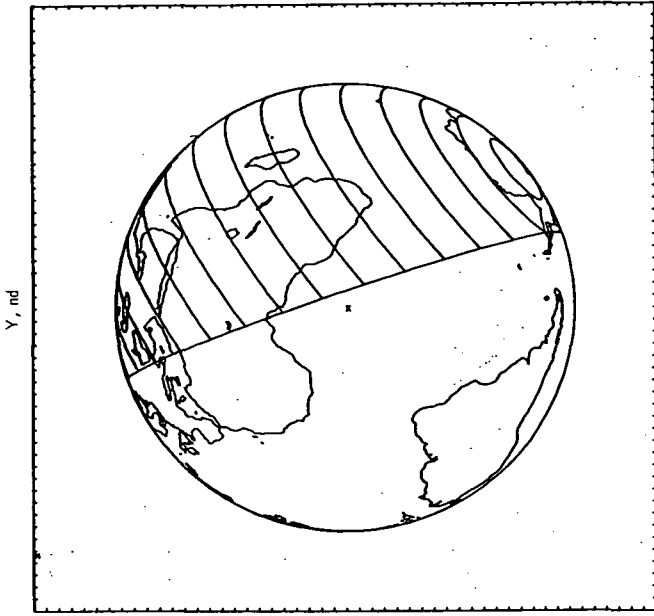

(m) g.e.t. = 148 hours.

$R_E = 176\,138$ n. mi.
 $V_i = 4\,015$ fps

$h_E = 198\,731$ stat. mi.
 $V_i = 2\,737$ mph

Field of view = 3°

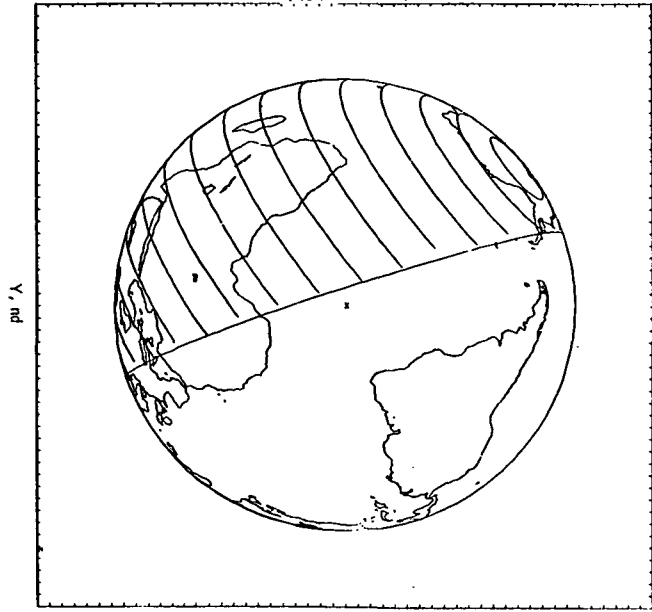

(n) g.e.t. = 149 hours.

$R_E = 173\,780$ n. mi.
 $V_i = 4\,052$ fps

$h_E = 196\,019$ stat. mi.
 $V_i = 2\,763$ mph

Field of view = 3°

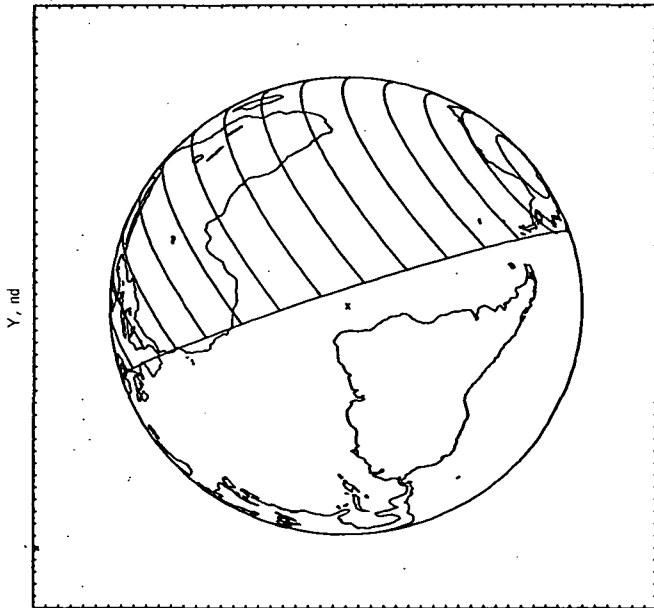

(o) g.e.t. = 150 hours.

$R_E = 171\,401$ n. mi.
 $V_i = 4\,092$ fps

$h_M = 193\,281$ stat. mi.
 $V_i = 2\,790$ mph

Field of view = 3°

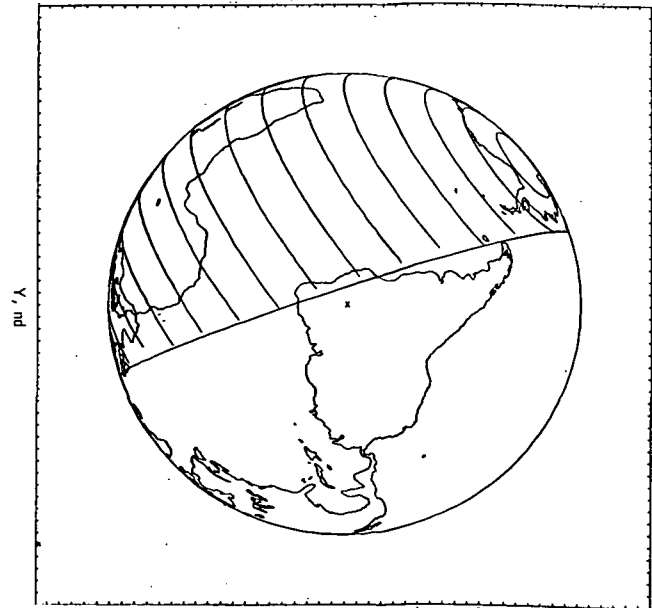

(p) g.e.t. = 151 hours.

$R_E = 168\,997$ n. mi.
 $V_i = 4\,134$ fps

$h_E = 190\,526$ stat. mi.
 $V_i = 2\,819$ mph

Field of view = 3°

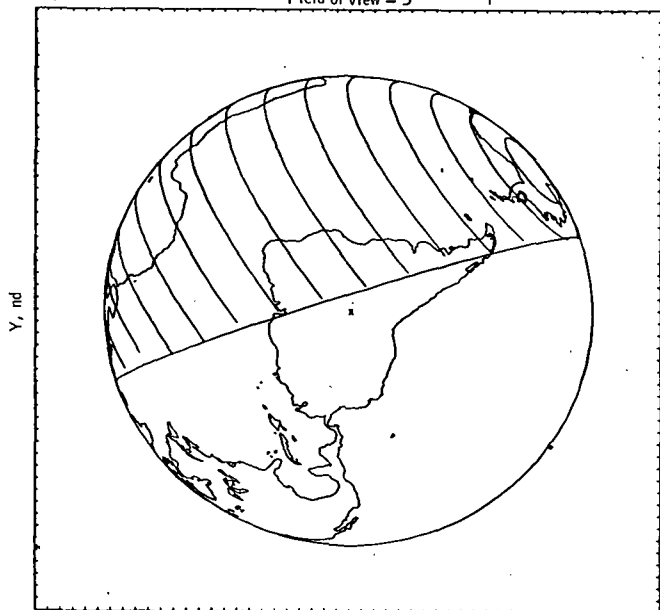

(q) g.e.t. = 152 hours.

$R_E = 166\,574$ n. mi.
 $V_i = 4\,177$ fps

$h_E = 187\,726$ stat. mi.
 $V_i = 2\,848$ mph

Field of view = 3°

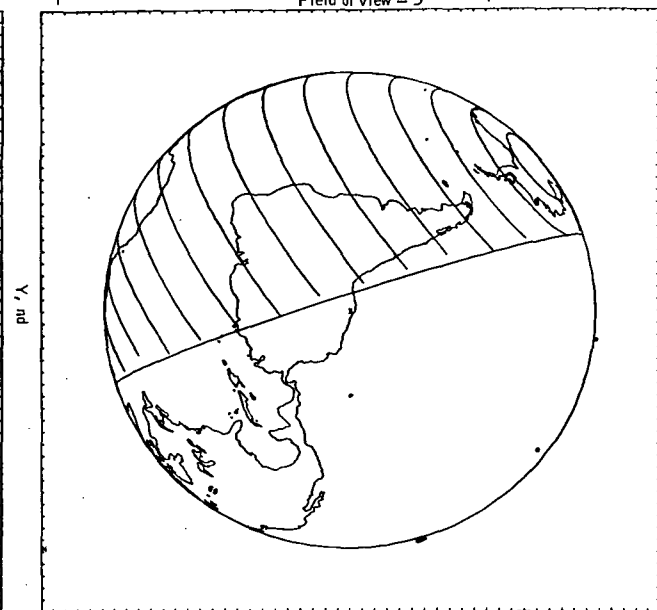

(r) g.e.t. = 153 hours.

$R_E = 164\,123$ n. mi.
 $V_i = 4\,222$ fps

$h_E = 184\,906$ stat. mi.
 $V_i = 2\,879$ mph

Field of view = 3°

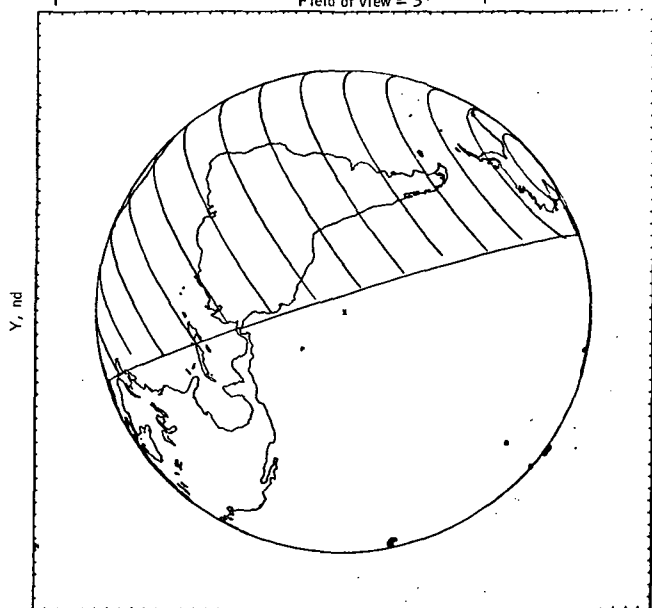

(s) g.e.t. = 154 hours.

$R_E = 161\,646$ n. mi.
 $V_i = 4\,270$ fps

$h_E = 182\,055$ stat. mi.
 $V_i = 2\,911$ mph

Field of view = 3°

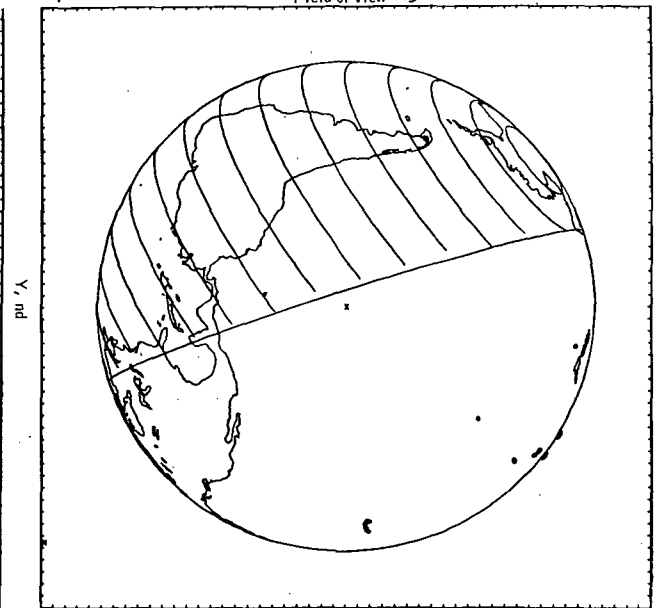

(t) g.e.t. = 155 hours.

$R_E = 159\,141$ n. mi.
 $V_i = 4\,319$ fps

$h_E = 179\,173$ stat. mi.
 $V_i = 2\,945$ mph

Field of view = 3°

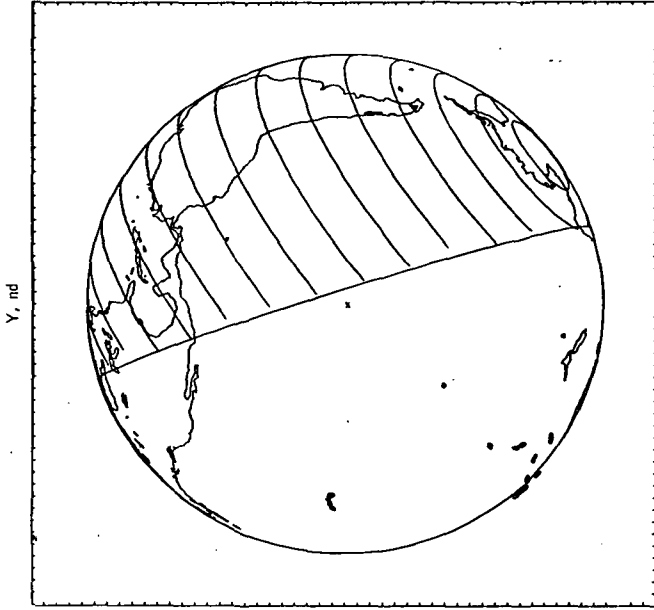

(u) g.e.t. = 156 hours.

$R_E = 156\,608$ n. mi.
 $V_i = 4\,370$ fps

$h_E = 176\,258$ stat. mi.
 $V_i = 2\,980$ mph

Field of view = 3°

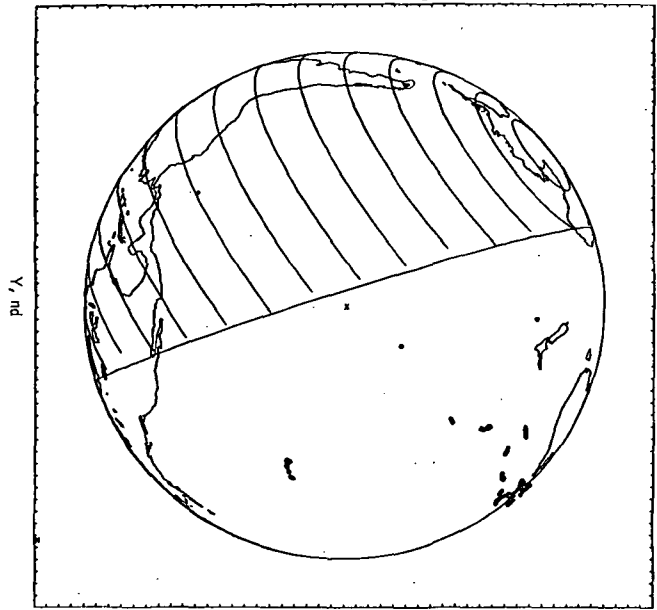

(v) g.e.t. = 157 hours.

$R_E = 154\,045$ n. mi.
 $V_i = 4\,424$ fps

$h_E = 173\,308$ stat. mi.
 $V_i = 3\,016$ mph

Field of view = 3°

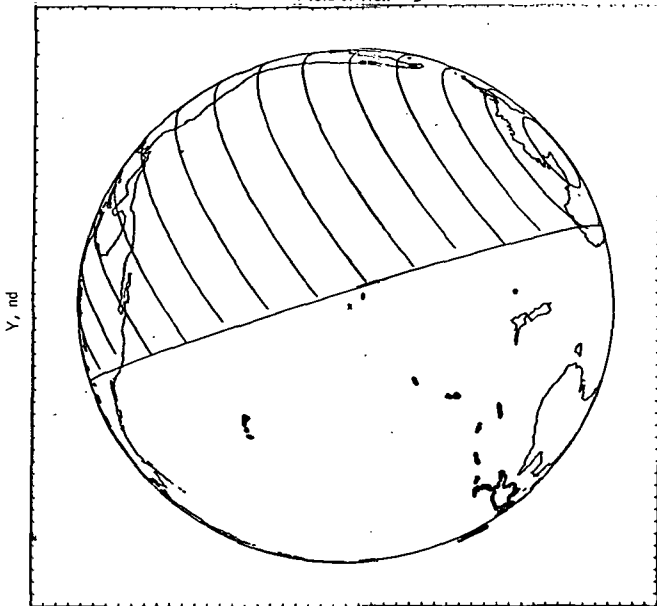

(w) g.e.t. = 158 hours.

$R_E = 151\,451$ n. mi.
 $V_i = 4\,479$ fps

$h_E = 170\,323$ stat. mi.
 $V_i = 3\,054$ mph

Field of view = 3°

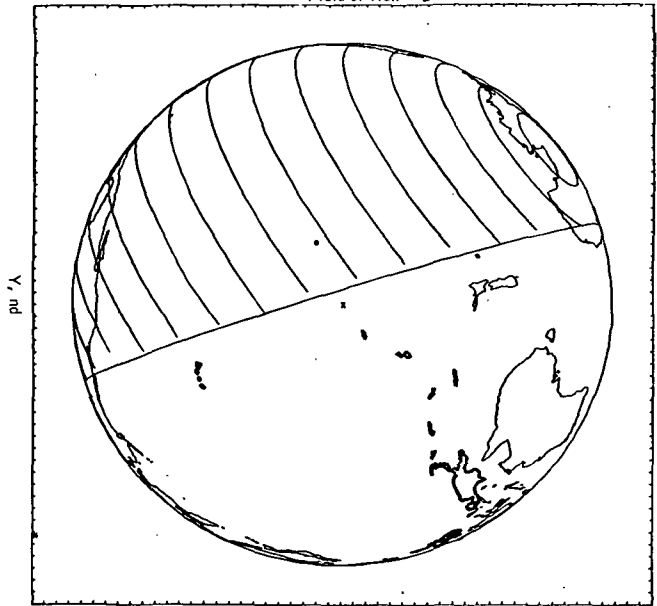

(x) g.e.t. = 159 hours.

$R_E = 148\,825$ n. mi.
 $V_i = 4\,537$ fps

$h_E = 167\,301$ stat. mi.
 $V_i = 3\,093$ mph

Field of view = 3°

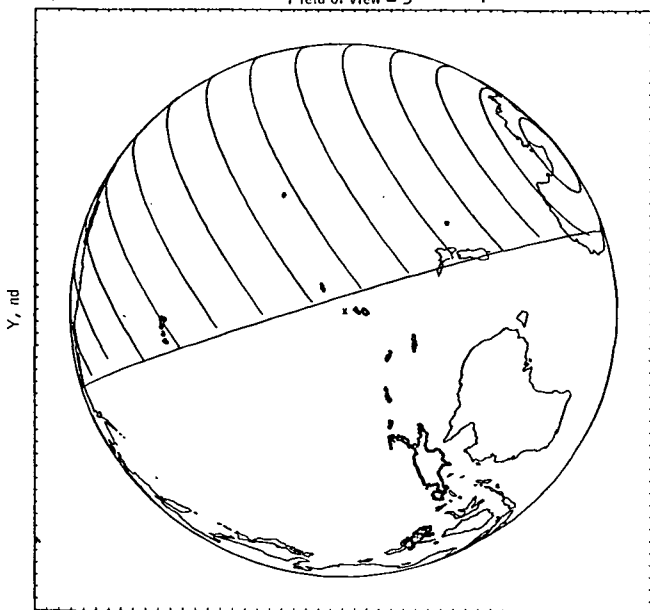

(y) g.e.t. = 160 hours.

$R_E = 146\,165$ n. mi.
 $V_i = 4\,597$ fps

$h_E = 164\,240$ stat. mi.
 $V_i = 3\,134$ mph

Field of view = 3°

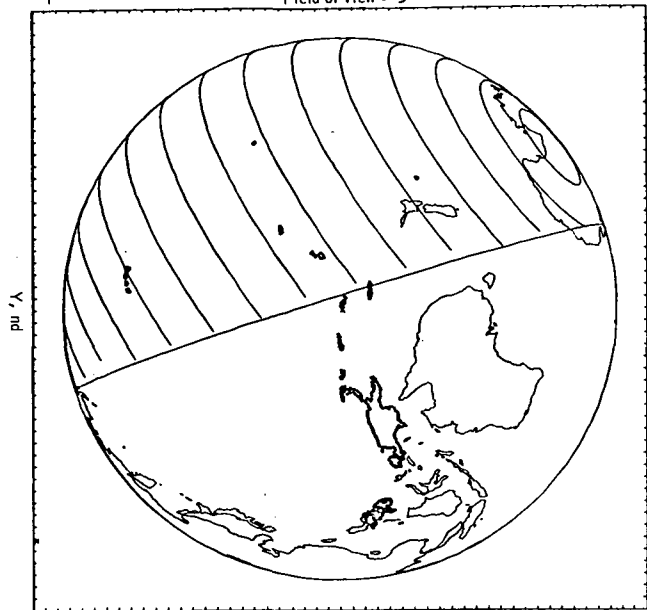

(z) g.e.t. = 161 hours.

$R_E = 143\,470$ n. mi.
 $V_i = 4\,659$ fps

$h_E = 161\,139$ stat. mi.
 $V_i = 3\,177$ mph

Field of view = 3°

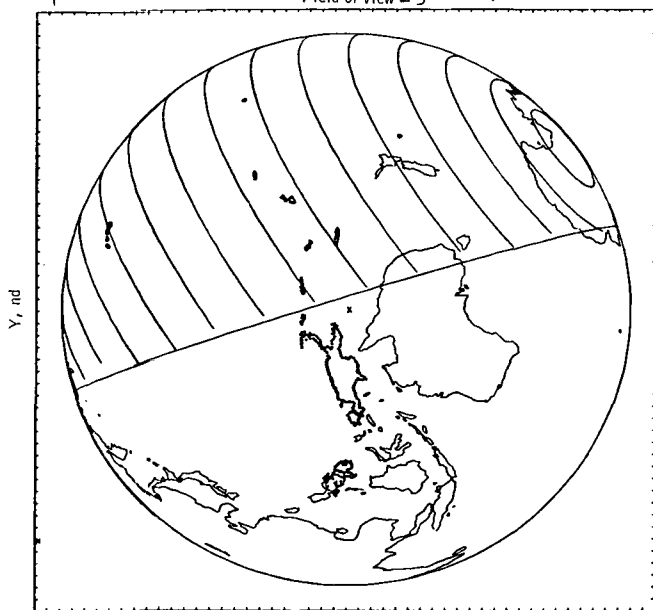

(aa) g.e.t. = 162 hours.

$R_E = 140\,739$ n. mi.
 $V_i = 4\,724$ fps

$h_E = 157\,996$ stat. mi.
 $V_i = 3\,221$ mph

Field of view = 4°

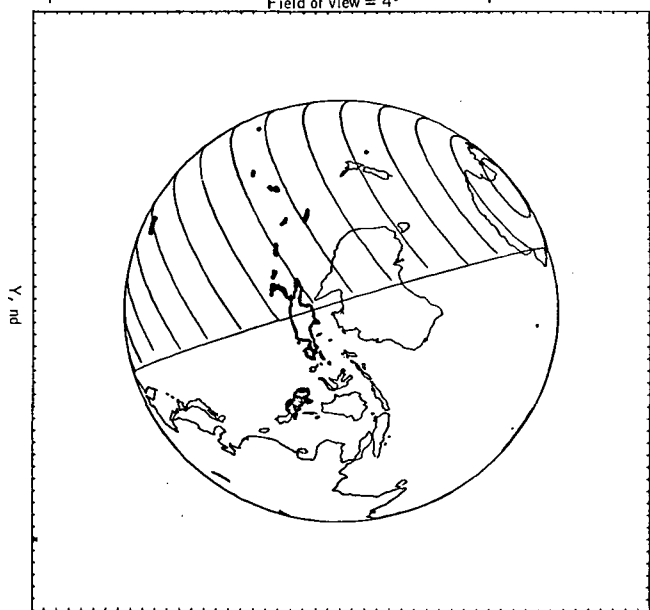

(bb) g.e.t. = 163 hours.

Figure 7.3.2-2.- Continued.

$R_E = 137\,970$ n. mi.
 $V_i = 4\,792$ fps

$h_E = 154\,810$ stat. mi.
 $V_i = 3\,267$ mph

Field of view = 4°

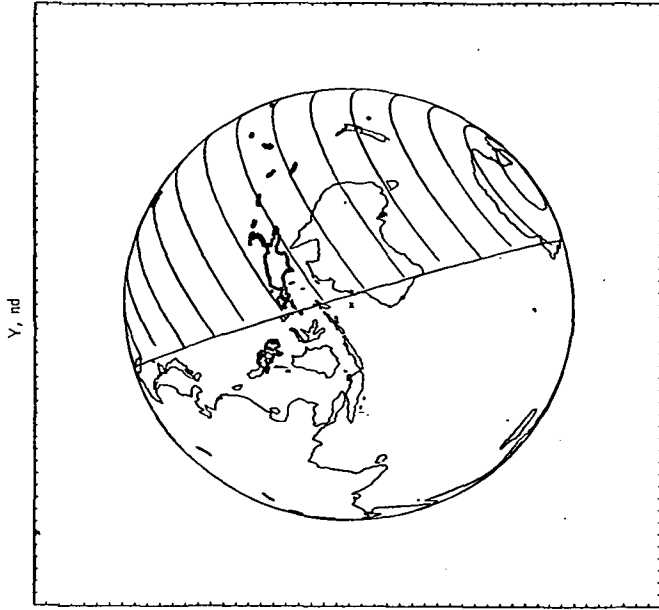

(cc) g.e.t. = 164 hours.

$R_E = 135\,161$ n. mi.
 $V_i = 4\,863$ fps

$h_E = 151\,577$ stat. mi.
 $V_i = 3\,316$ mph

Field of view = 4°

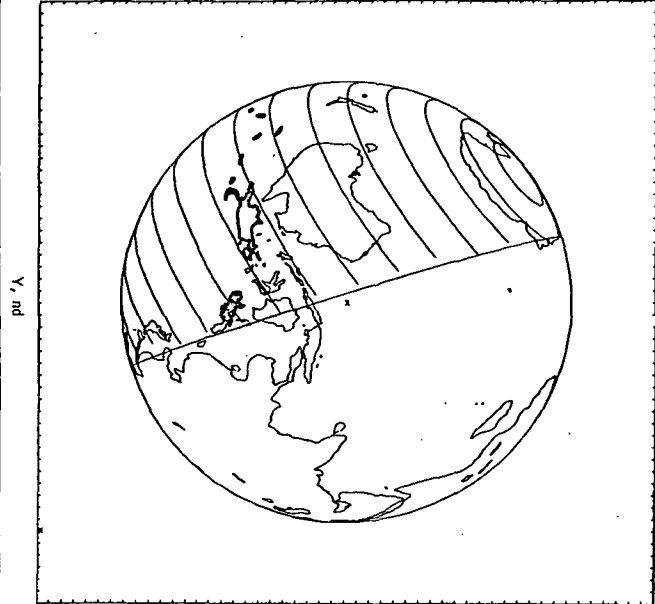

(dd) g.e.t. = 165 hours.

$R_E = 132\,311$ n. mi.
 $V_i = 4\,937$ fps

$h_E = 148\,298$ stat. mi.
 $V_i = 3\,366$ mph

Field of view = 4°

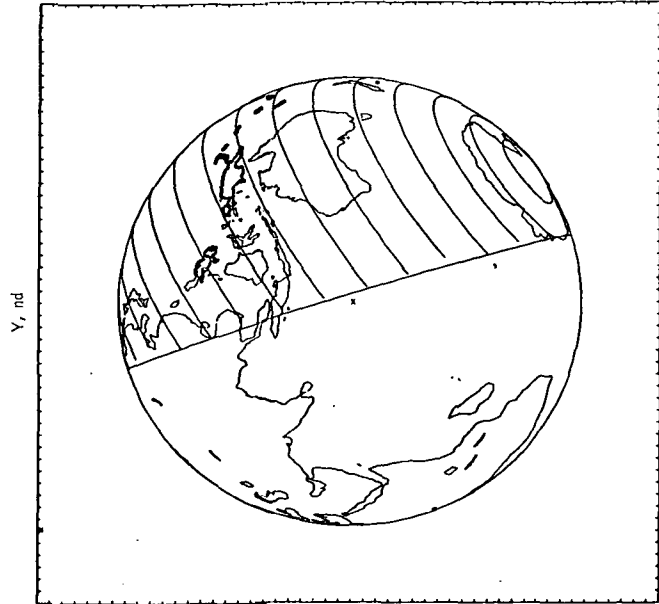

(ee) g.e.t. = 166 hours.

$R_E = 129\,418$ n. mi.
 $V_i = 5\,014$ fps

$h_E = 144\,968$ stat. mi.
 $V_i = 3\,419$ mph

Field of view = 4°

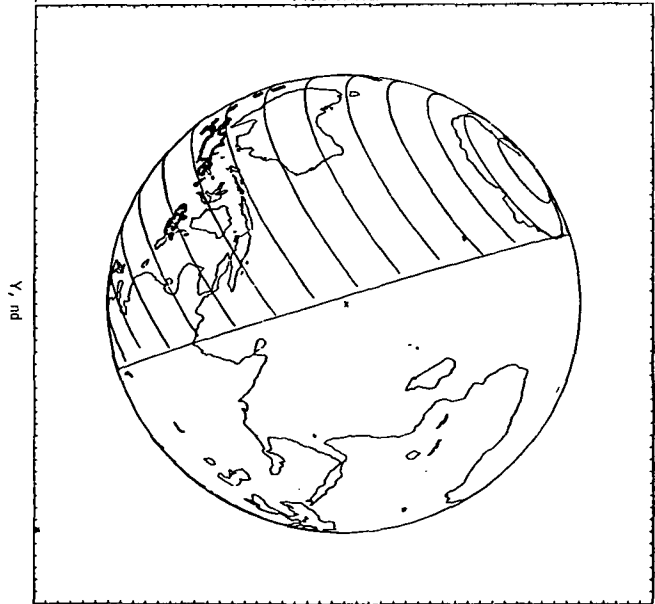

(ff) g.e.t. = 167 hours.

Figure 7.3.2-2.- Continued.

$R_E = 126\,480$ n. mi.
 $V_i = 5\,095$ fps

$h_E = 141\,587$ stat. mi.
 $V_i = 3\,474$ mph

Field of view = 4°

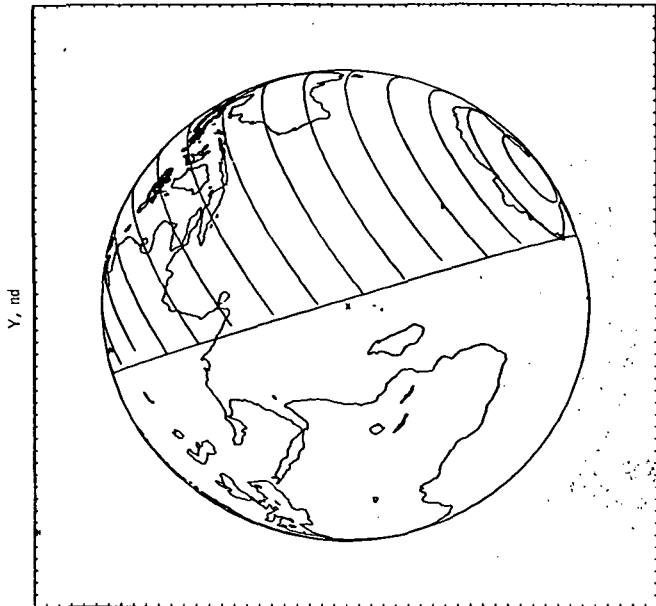

(gg) g.e.t. = 168 hours.

$R_E = 123\,494$ n. mi.
 $V_i = 5\,181$ fps

$h_E = 138\,151$ stat. mi.
 $V_i = 3\,532$ mph

Field of view = 4°

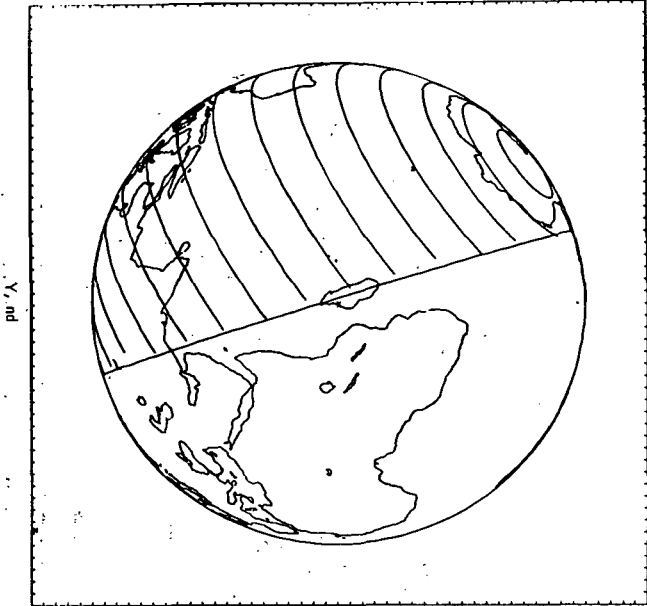

(hh) g.e.t. = 169 hours.

$R_E = 120\,459$ n. mi.
 $V_i = 5\,270$ fps

$h_E = 134\,659$ stat. mi.
 $V_i = 3\,593$ mph

Field of view = 4°

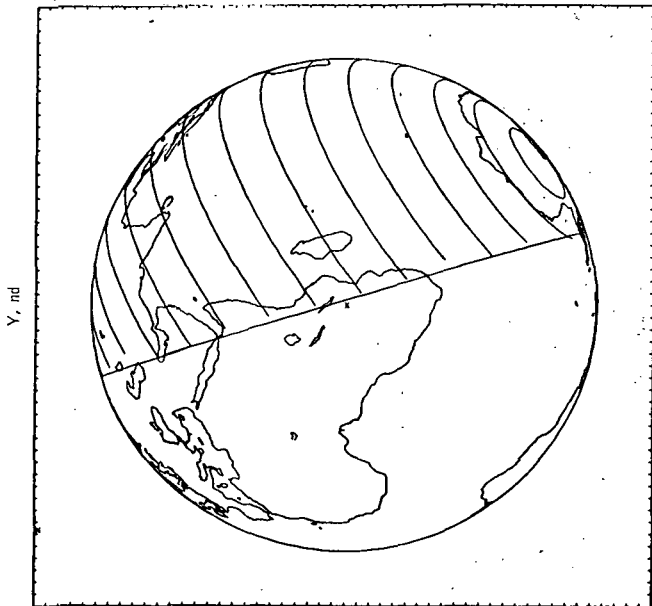

(ii) g.e.t. = 170 hours.

$R_E = 117\,371$ n. mi.
 $V_i = 5\,364$ fps

$h_E = 131\,105$ stat. mi.
 $V_i = 3\,657$ mph

Field of view = 4°

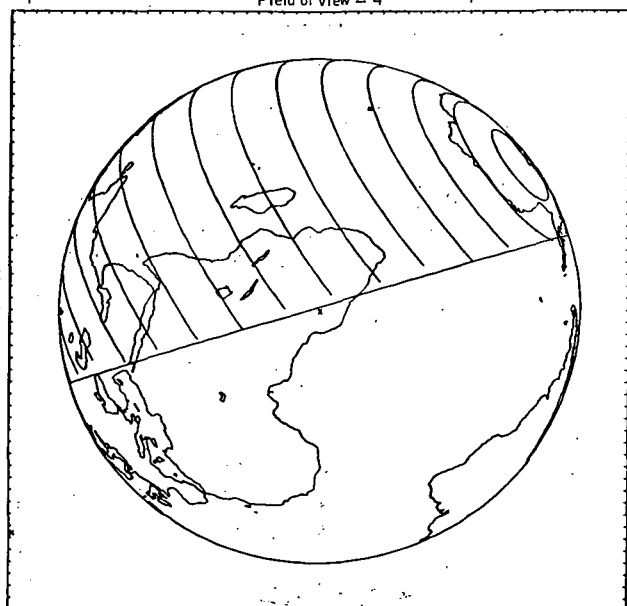

(jj) g.e.t. = 171 hours.

$R_E = 114\,229$ n. mi.
 $V_i = 5\,464$ fps

$h_E = 127\,489$ stat. mi.
 $V_i = 3\,725$ mph

Field of view = 4°

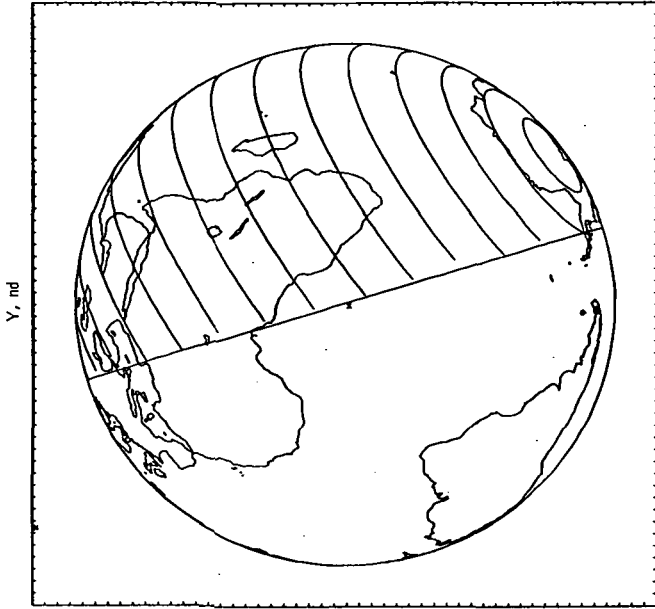

X, nd

(kk) g.e.t. = 172 hours.

$R_E = 111\,028$ n. mi.
 $V_i = 5\,569$ fps

$h_E = 123\,806$ stat. mi.
 $V_i = 3\,797$ mph

Field of view = 4°

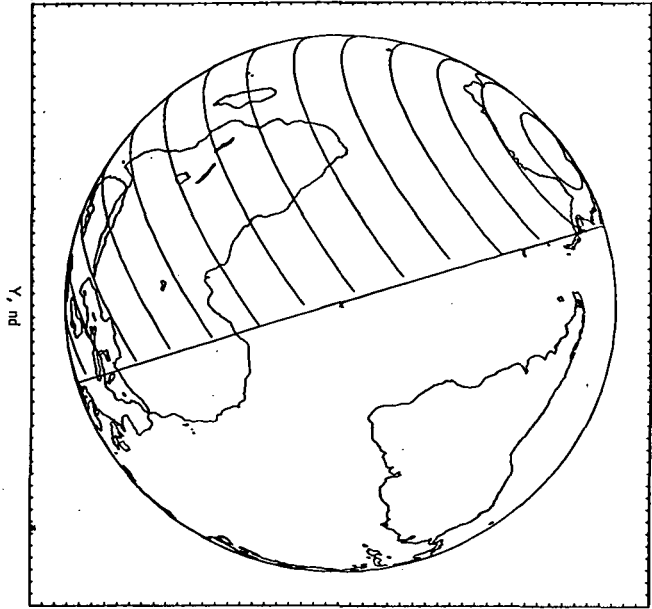

X, nd

(ll) g.e.t. = 173 hours.

$R_E = 107\,766$ n. mi.
 $V_i = 5\,681$ fps

$h_E = 120\,052$ stat. mi.
 $V_i = 3\,873$ mph

Field of view = 4°

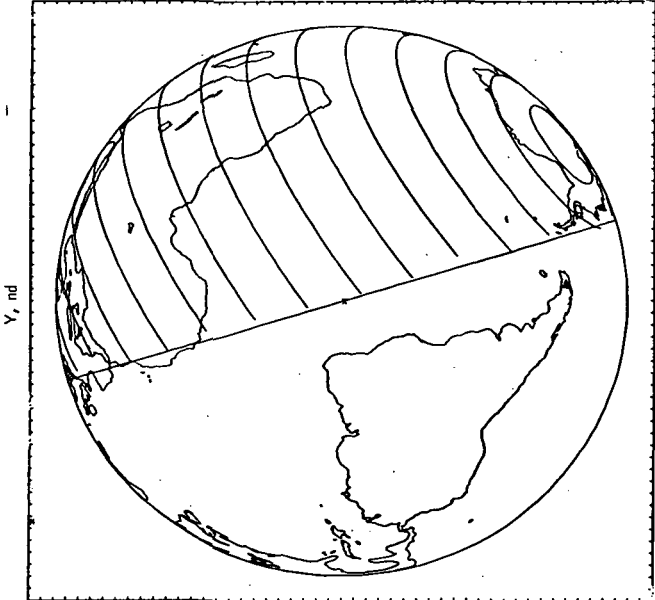

X, nd

(mm) g.e.t. = 174 hours.

$R_E = 104\,439$ n. mi.
 $V_i = 5\,799$ fps

$h_E = 116\,223$ stat. mi.
 $V_i = 3\,954$ mph

Field of view = 4°

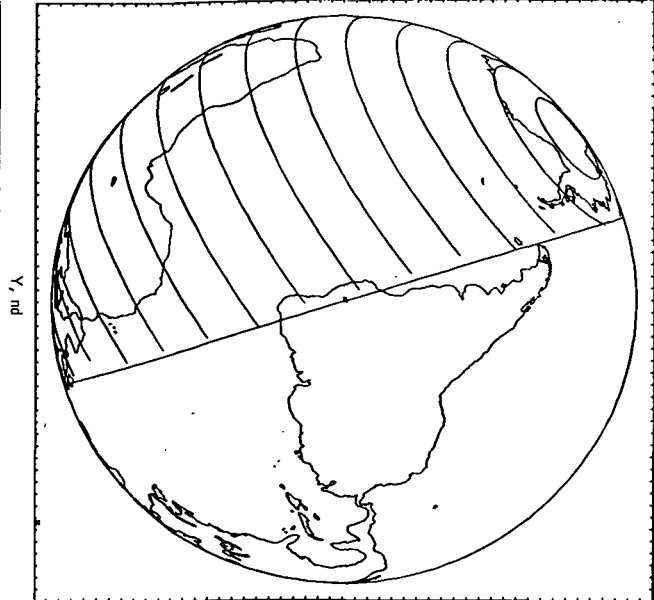

X, nd

(nn) g.e.t. = 175 hours.

$R_E = 101\ 042$ n. mi.
 $V_i = 5\ 926$ fps

$h_E = 112\ 314$ stat. mi.
 $V_i = 4\ 027$ mph

Field of view = 4°

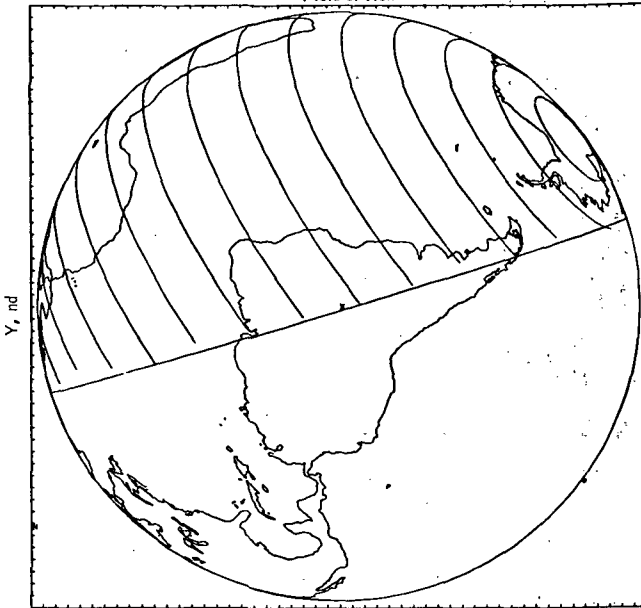

X, nd

(oo) g.e.t. = 176 hours.

$R_E = 97\ 572$ n. mi.
 $V_i = 6\ 061$ fps

$h_E = 108\ 320$ stat. mi.
 $V_i = 4\ 132$ mph

Field of view = 4°

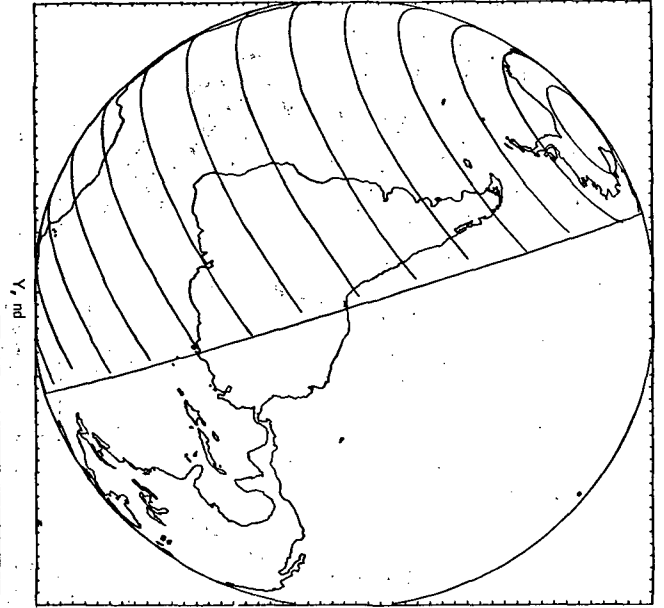

X, nd

(pp) g.e.t. = 177 hours.

$R_E = 94\ 023$ n. mi.
 $V_i = 6\ 207$ fps

$h_E = 104\ 237$ stat. mi.
 $V_i = 4\ 232$ mph

Field of view = 5°

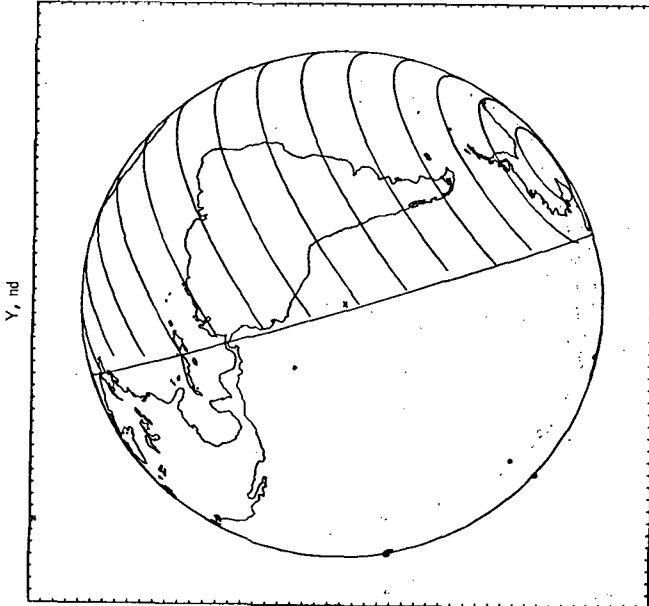

X, nd

(qq) g.e.t. = 178 hours.

$R_E = 90\ 388$ n. mi.
 $V_i = 6\ 364$ fps

$h_E = 100\ 054$ stat. mi.
 $V_i = 4\ 339$ mph

Field of view = 5°

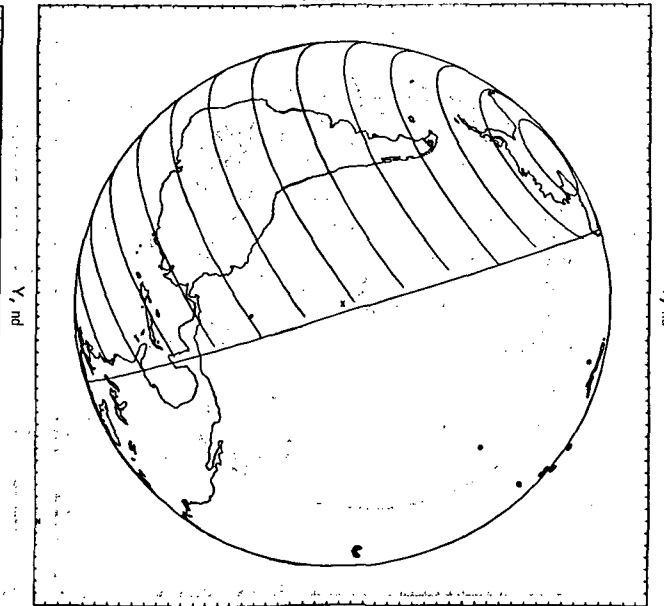

X, nd

(rr) g.e.t. = 179 hours.

$R_E = 86\ 662$ n. mi.
 $V_I = 6\ 534$ fps

$h_E = 95\ 766$ stat. mi.
 $V_I = 4\ 455$ mph

Field of view = 5°

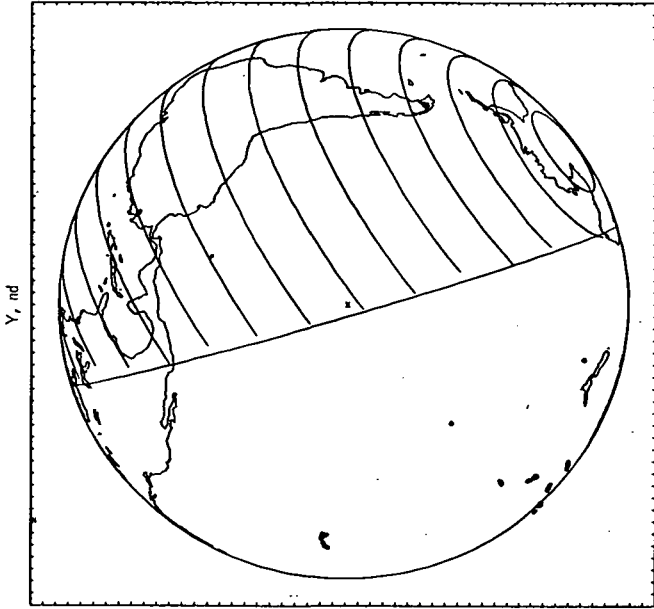

X, nd

(ss) g.e.t. = 180 hours.

$R_E = 82\ 836$ n. mi.
 $V_I = 6\ 720$ fps

$h_E = 91\ 364$ stat. mi.
 $V_I = 4\ 582$ mph

Field of view = 5°

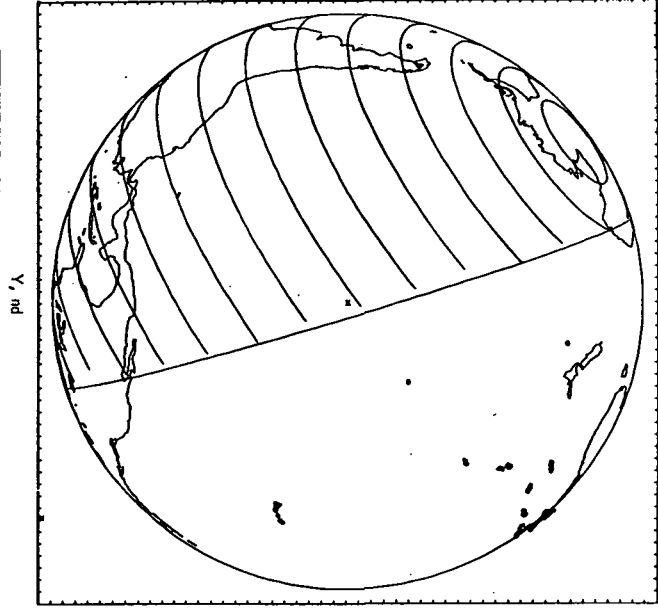

X, nd

(tt) g.e.t. = 181 hours.

$R_E = 78\ 902$ n. mi.
 $V_I = 6\ 924$ fps

$h_E = 86\ 836$ stat. mi.
 $V_I = 4\ 721$ mph

Field of view = 7°

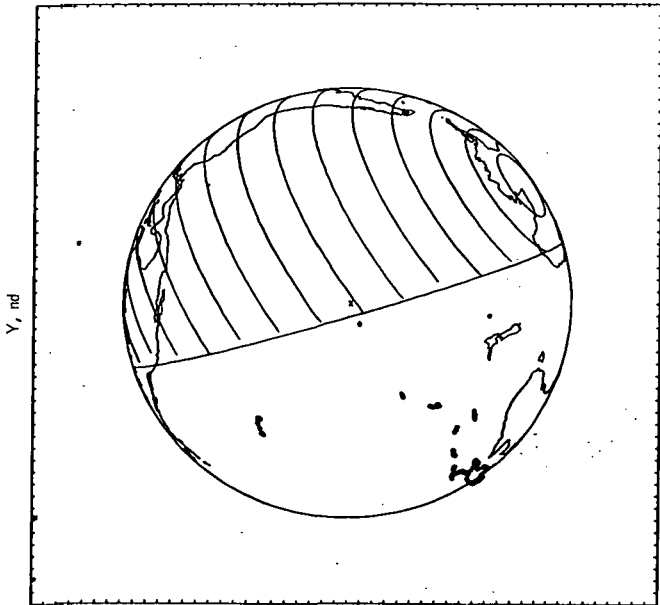

X, nd

(uu) g.e.t. = 182 hours.

$R_E = 74\ 849$ n. mi.
 $V_I = 7\ 150$ fps

$h_E = 82\ 172$ stat. mi.
 $V_I = 4\ 875$ mph

Field of view = 7°

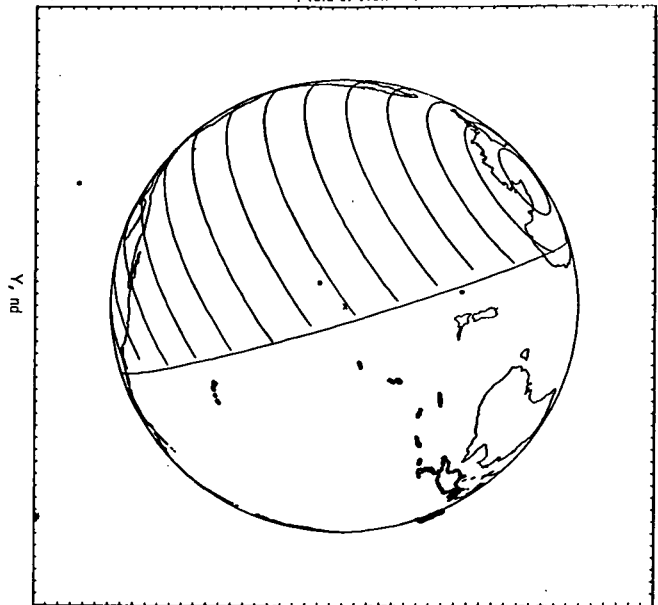

X, nd

(vv) g.e.t. = 183 hours.

Figure 7.3.2-2.- Continued.

$R_E = 70\,664$ n. mi.
 $V_i = 7\,402$ fps

$h_E = 77\,356$ stat. mi.
 $V_i = 5\,047$ mph

Field of view = 7°

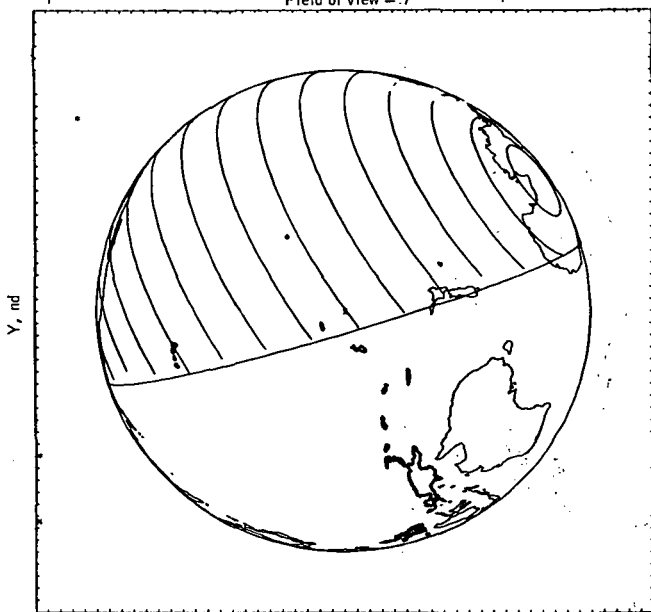

(ww) g.e.t. = 184 hours.

$R_E = 66\,331$ n. mi.
 $V_i = 7\,685$ fps

$h_E = 72\,371$ stat. mi.
 $V_i = 5\,240$ mph

Field of view = 7°

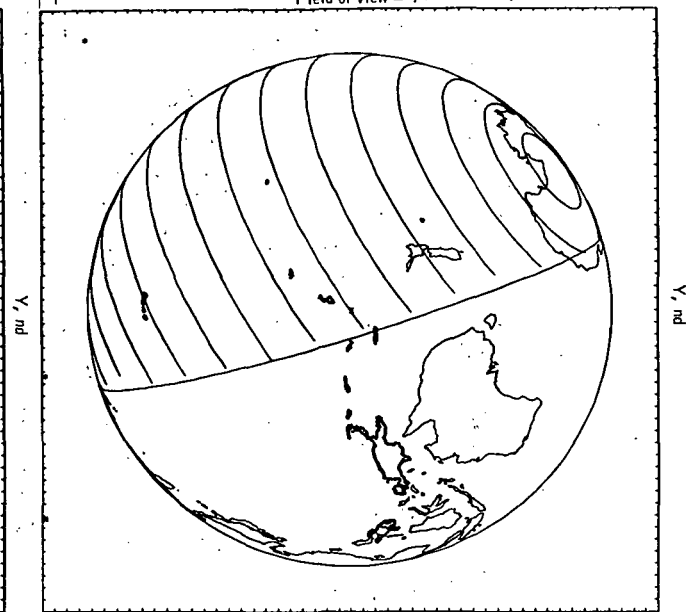

(xx) g.e.t. = 185 hours.

$R_E = 61\,833$ n. mi.
 $V_i = 8\,009$ fps

$h_E = 67\,195$ stat. mi.
 $V_i = 5\,461$ mph

Field of view = 8°

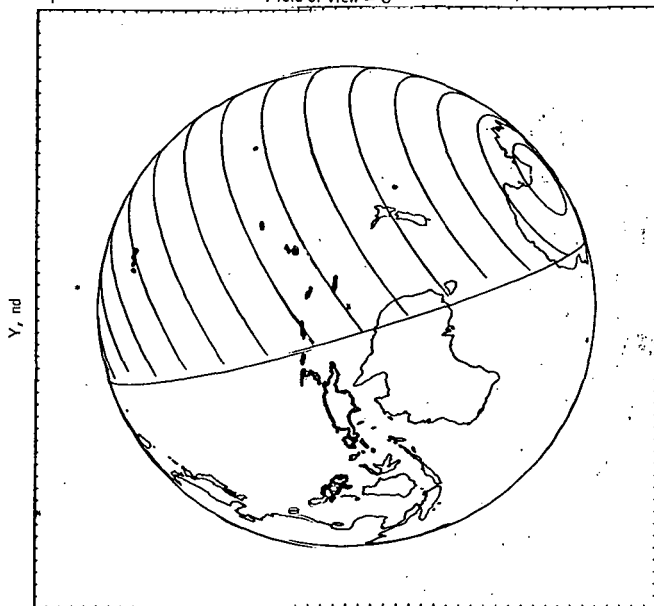

(yy) g.e.t. = 186 hours.

$R_E = 57\,146$ n. mi.
 $V_i = 8\,383$ fps

$h_E = 61\,800$ stat. mi.
 $V_i = 5\,716$ mph

Field of view = 8°

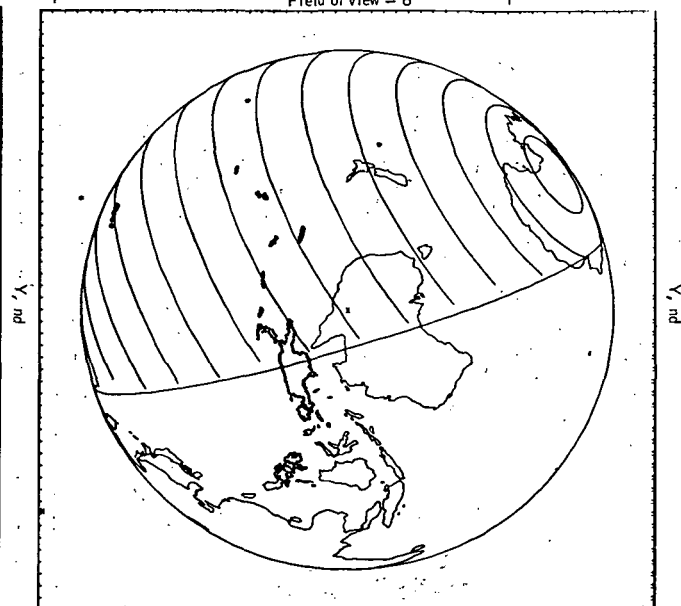

(zz) g.e.t. = 187 hours.

Figure 7.3.2-2. Continued.

$R_E = 52\,238$ n. mi.
 $V_i = 8\,826$ fps

$h_E = 56\,153$ stat. mi.
 $V_i = 6\,018$ mph

Field of view = 8°

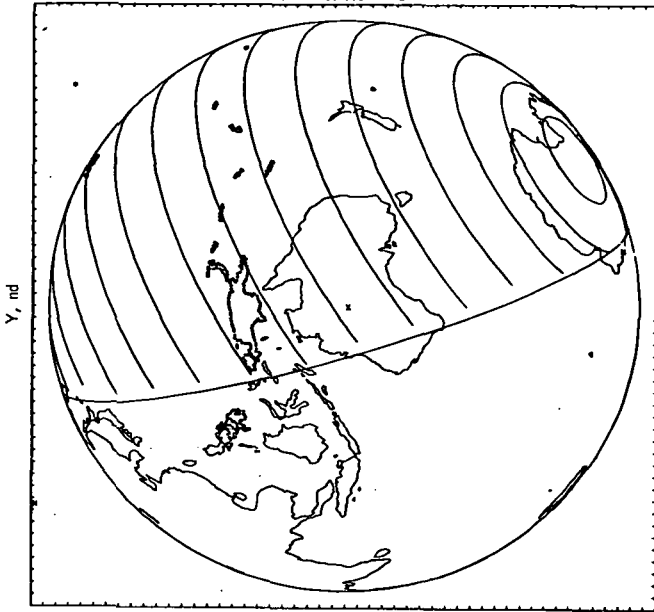

(aaa) g.e.t. = 188 hours.

$R_E = 47\,071$ n. mi.
 $V_i = 9\,361$ fps

Field of view = 10°

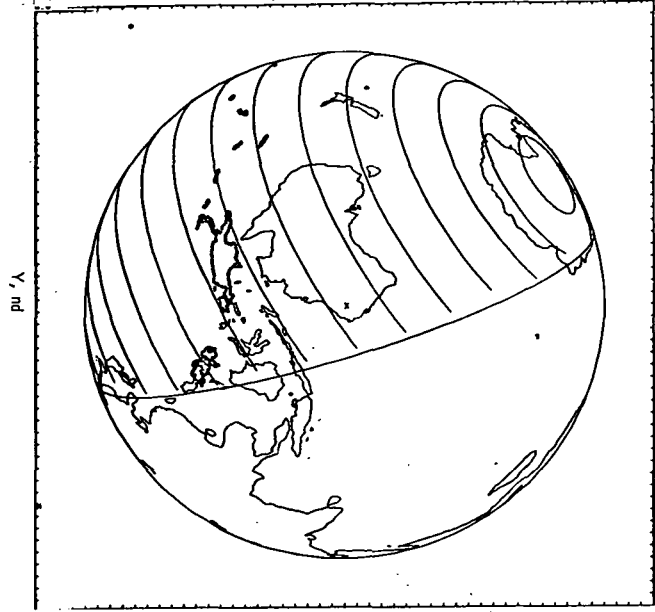

(bbb) g.e.t. = 189 hours.

$R_E = 41\,589$ n. mi.
 $V_i = 10\,030$ fps

$h_E = 43\,898$ stat. mi.
 $V_i = 6\,839$ mph

Field of view = 10°

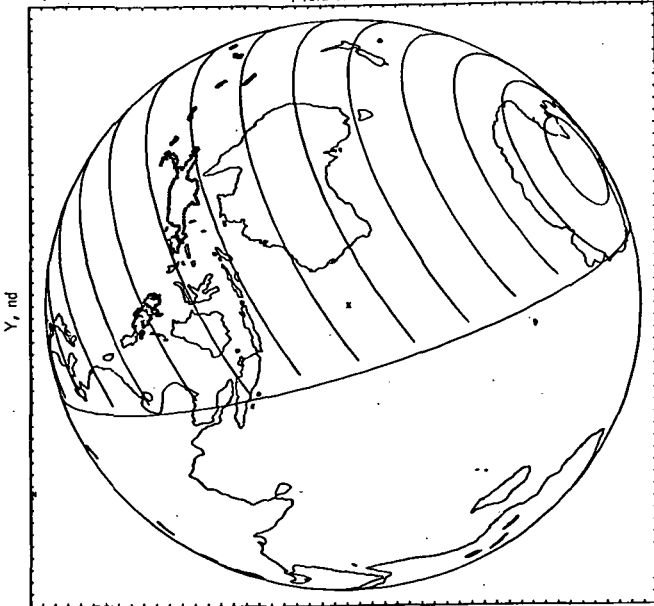

(ccc) g.e.t. = 190 hours.

$R_E = 35\,103$ n. mi.
 $V_i = 10\,906$ fps

Field of view = 12°

$h_E = 37\,133$ stat. mi.
 $V_i = 7\,436$ mph

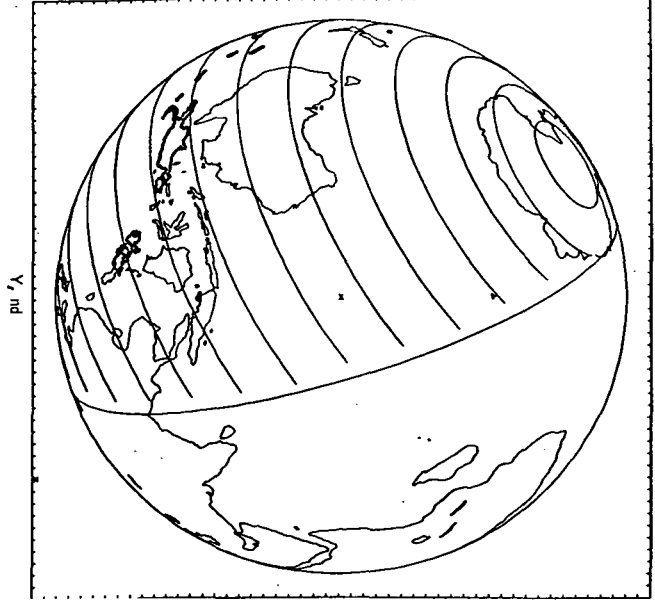

(ddd) g.e.t. = 191 hours.

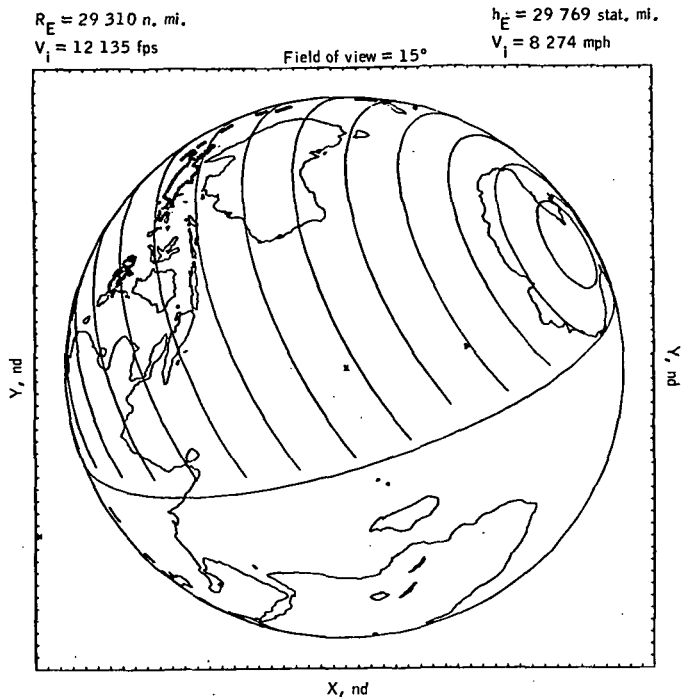

(eee) g.e.t. = 192 hours.

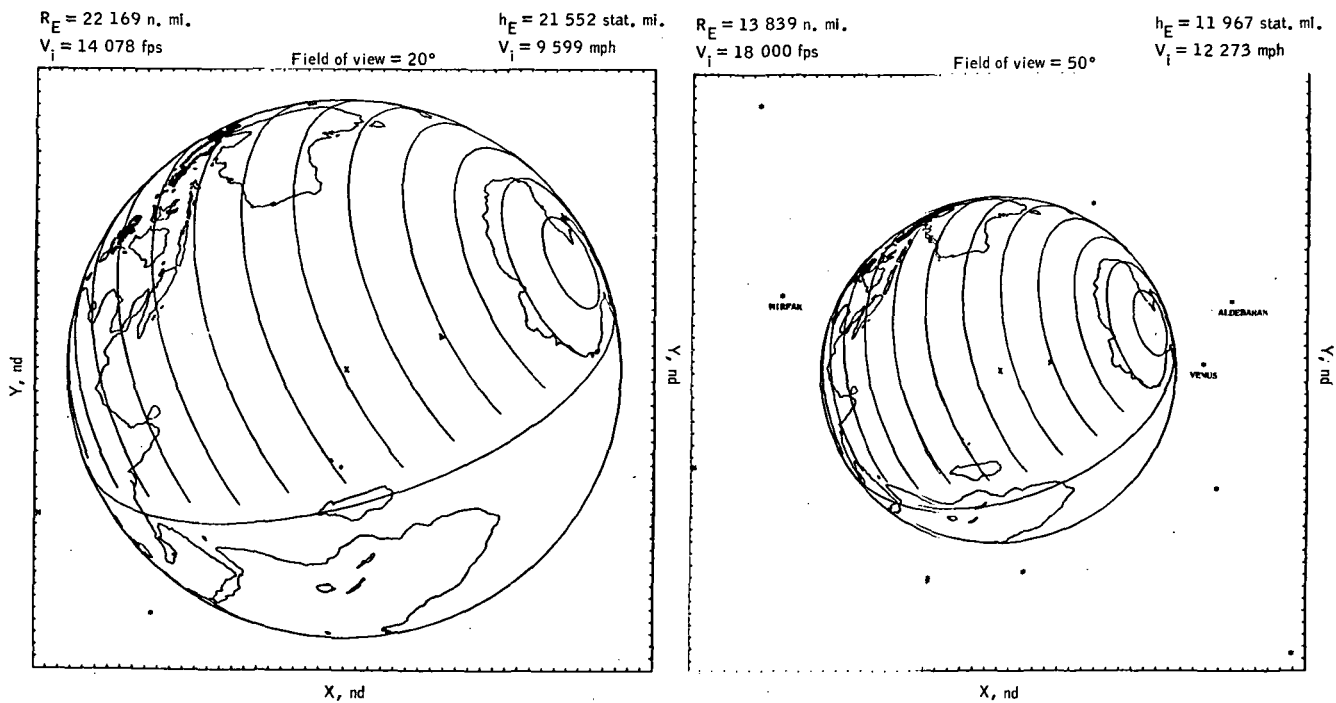

(fff) g.e.t. = 193 hours.

(ggg) g.e.t. = 194 hours.

Figure 7.3.2-2.- Concluded.

Page intentionally left blank

8.0 VIEWS FROM CM DURING
ENTRY PHASE

Page intentionally left blank

SEQ	17	19	20	21	22	24	25	27	43	44	46	58	59
X	18	-2	7	22	0	6	-16	-5	17	16	17	20	20
Y	19	15	2	-14	-2	-13	2	-24	-10	-21	-19	-12	-14
SEQ	60	84	106	108	109	110	111	112	113	114	115	116	
X	-24	-5	24	8	24	0	-17	-7	9	15	-14	-24	
Y	21	-20	-4	-1	-17	5	16	7	-9	-15	4	8	
SEQ	117	118	119	120	121	122	123	124	125	126	130	2	3
X	7	-10	-21	-4	7	-9	4	-17	-3	-7	-13	-5	1
Y	-17	-18	2	-11	-19	-12	-22	-10	-21	-20	-21	-21	9

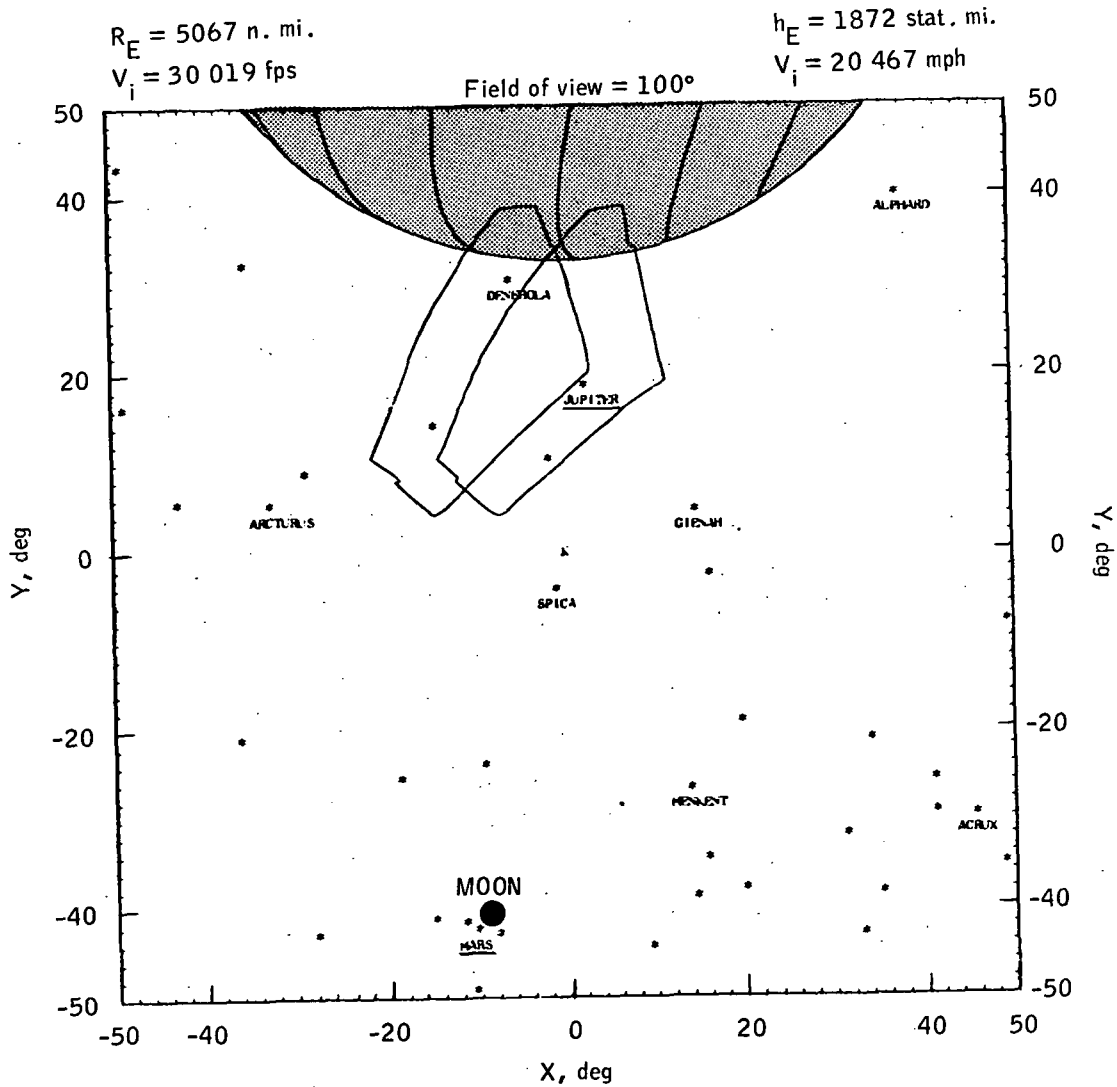

(b) 13 minutes prior to entry (g.e.t. = 194:48:12).

Figure 8.0-1.- Continued.

SEQ	20	21	22	24	25	27	28	43	44	46	58	59	84
X	7	22	0	6	-16	-5	17	16	15	16	20	20	-5
Y	7	-11	2	-8	7	-19	-24	-6	-17	-14	-8	-10	-15
SEQ	85	106	108	109	110	112	113	114	115	116	117	118	119
X	-1	24	8	23	0	-7	9	15	-14	-24	7	9	-21
Y	-23	0	3	-13	10	11	-4	-11	8	11	-12	-14	6
SEQ	120	121	122	123	124	125	126	129	130	132	137	2	3
X	-4	7	-9	4	-17	-3	-7	-4	-13	-12	-24	-4	1
Y	-7	-14	-7	-17	-6	-16	-15	-20	-16	-21	-19	-16	14

$R_E = 4742$ n. mi.

$V_i = 31\ 045$ fps

$h_E = 1497$ stat. mi.

$V_i = 21\ 167$ mph

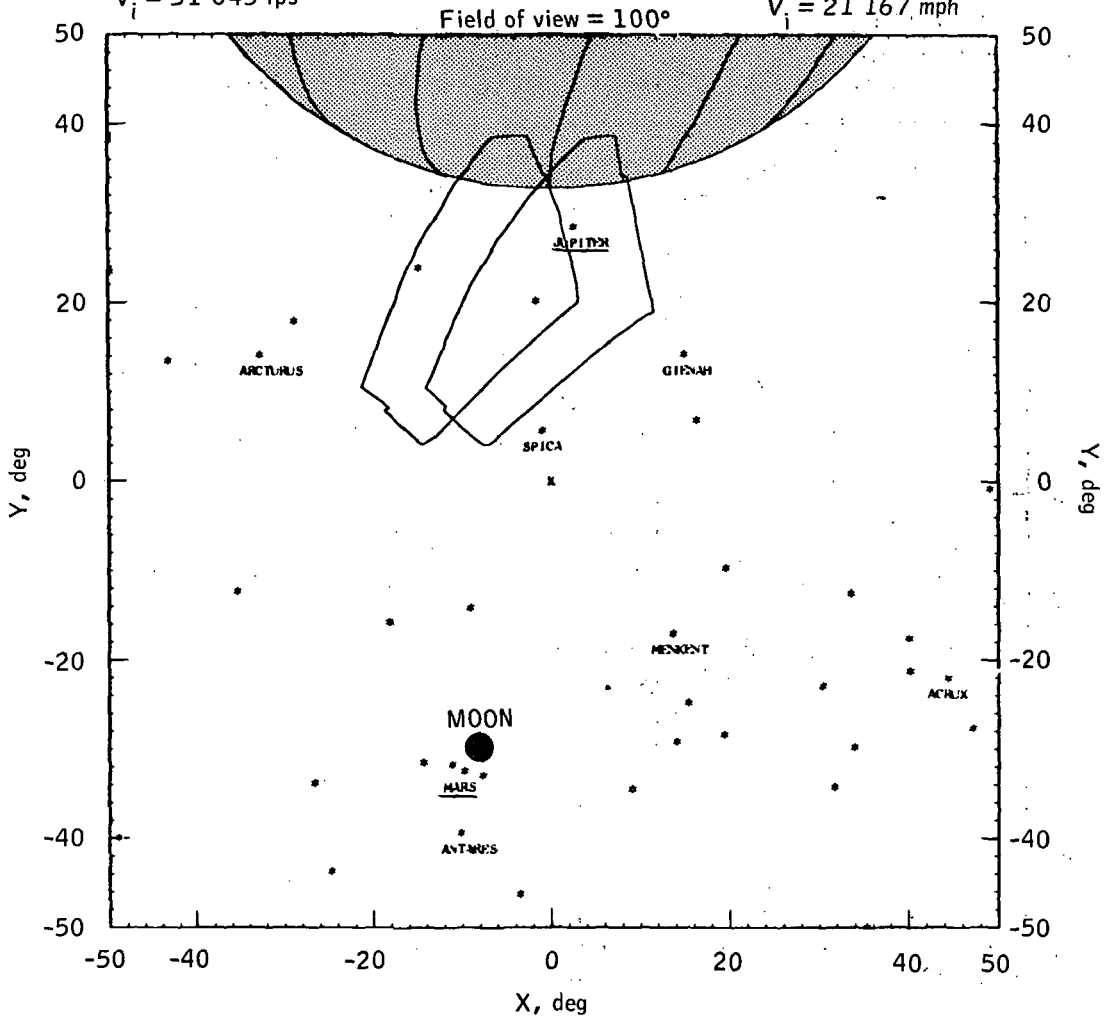

(c) 11 minutes prior to entry (g.e.t. = 194:50:12).

SEQ	20	21	22	24	25	27	28	43	44	46	58	59	61	62
X	7	21	0	6	-16	-4	16	16	15	16	19	19	-1	2
Y	12	-6	8	-3	11	-14	-20	-1	-12	-10	-4	-6	-22	-23
SEQ	84	85	87	106	108	109	110	113	114	115	117	118	119	120
X	-5	-1	0	24	8	22	0	9	14	-14	7	9	-21	-4
Y	-10	-17	-23	3	8	-9	15	0	-6	13	-7	-9	10	-1
SEQ	121	122	123	124	125	126	129	130	132	133	134	135	137	2
X	6	-8	4	-17	-3	-7	-4	-12	-11	9	-1	5	-23	-4
Y	-9	-2	-12	-1	-11	-10	-15	-12	-16	-22	-22	-22	-16	-11

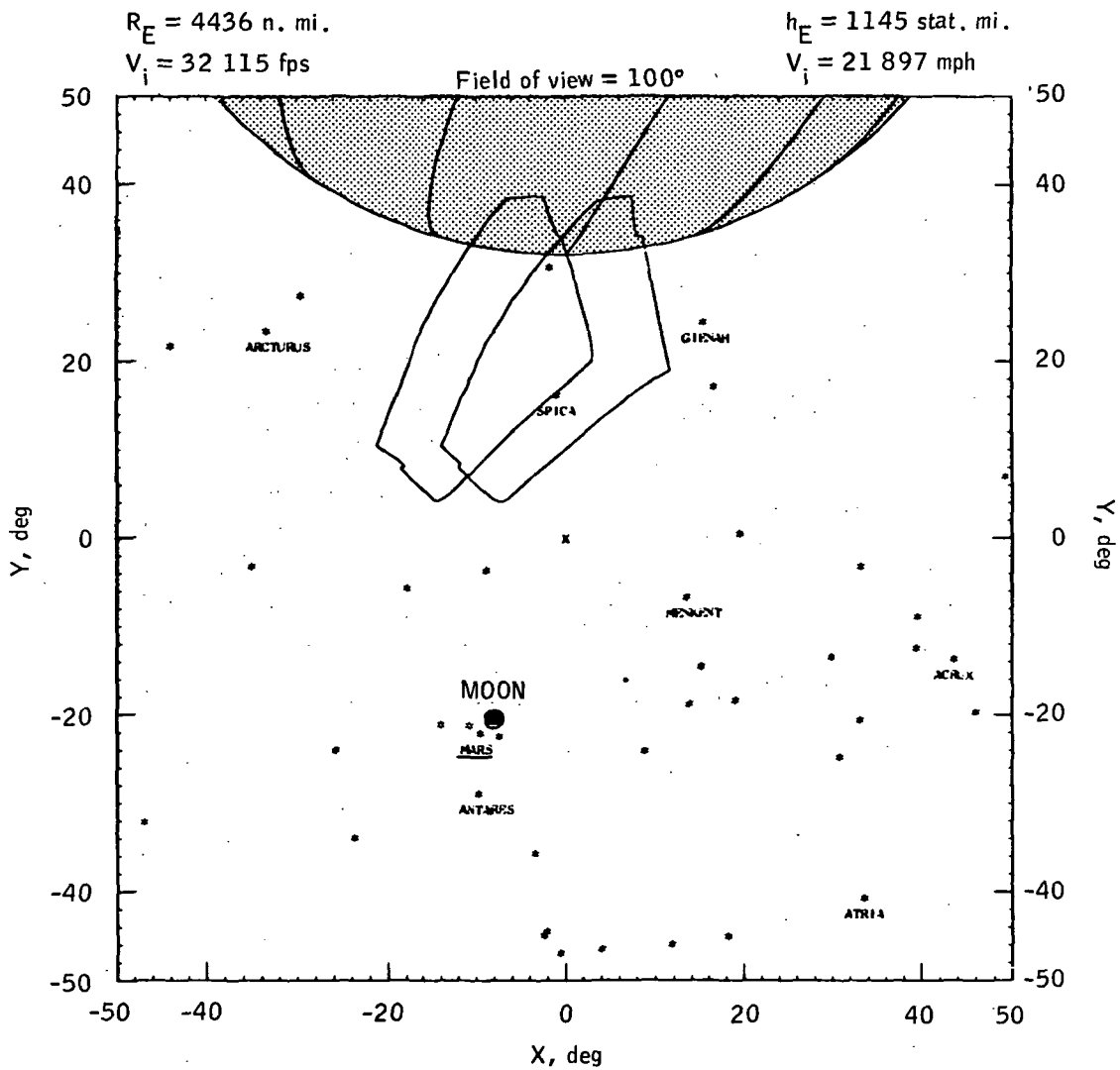

(d) 9 minutes prior to entry (g.e.t. = 194:52:12).

SEQ	21	22	24	25	27	28	31	43	44	46	58	59
X	21	0	6	-17	-4	15	-7	16	14	16	19	19
Y	-1	14	3	-17	-8	-14	-24	4	-6	-4	0	0

SEQ	61	62	63	84	85	87	108	109	113	114	117	118
X	-1	1	-3	-5	-1	0	8	22	9	14	7	9
Y	-15	-16	-20	-4	-11	-16	14	-4	-6	0	0	-2

SEQ	119	120	121	122	123	124	125	126	129	130	132	133
X	-22	-4	6	-8	4	-17	-3	-6	-4	-12	-11	8
Y	16	4	-3	3	-5	4	-4	-4	-9	-5	-10	-16

SEQ	134	135	137	138	139	140	2
X	0	5	-22	-5	-7	-5	-4
Y	-15	-16	-11	-20	-20	-24	-4

$R_M = 4154$ n. mi.

$h_E = 821$ stat. mi.

$V_i = 33\,199$ fps

$V_i = 22\,636$ mph

Field of view = 100°

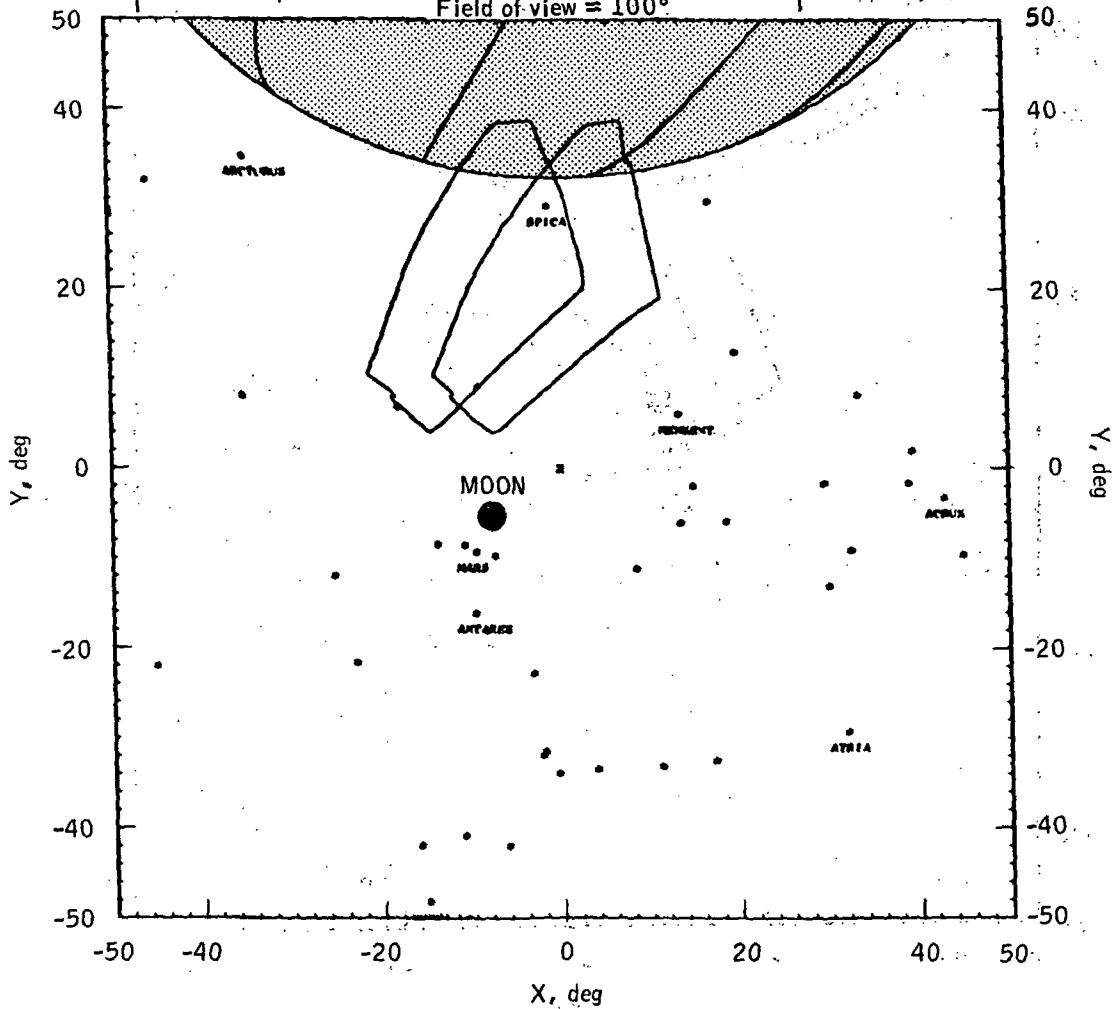

(e) 7 minutes prior to entry (g.e.t. = 194:54:12)

Figure 8.0-1.- Continued.

21	24	27	28	31	34	43	44	46	58	59	67
21	6	-4	15	-7	10	17	14	16	19	19	-1
4	10	0	-8	-17	-21	10	0	1	7	5	-8
62	63	84	85	87	109	113	114	117	118	120	121
1	-2	-5	-1	0	22	10	14	7	9	-4	6
-9	-13	2	-4	-9	0	13	5	6	4	11	4
122	123	124	125	126	129	130	132	133	134	135	137
-9	4	-17	-3	-6	-4	-12	-11	8	0	5	-22
10	1	10	2	2	-1	0	-3	-9	-8	-9	-5
138	139	140	2								
-5	-7	-5	-4								
-13	-13	-17	2								

$R_E \approx 3907$ n. mi.

$V_i = 34\,246$ fps

$h_E \approx 535$ stat. mi.

$V_i = 23\,350$ mph

Field of view = 100°

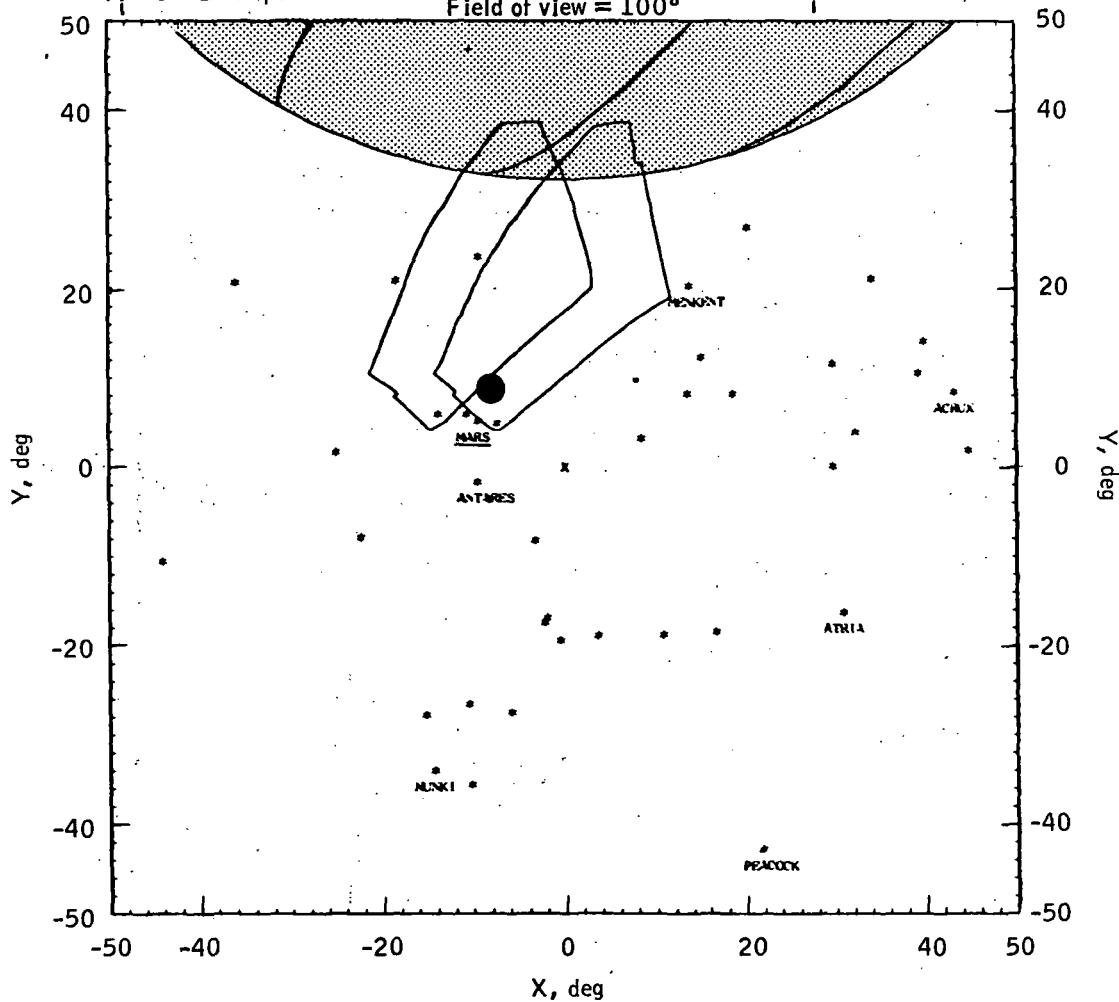

(f) 5 minutes prior to entry (g.e.t. = 194:56:12).

Figure 8.0-1.-Continued.

SEQ	21	27	28	31	32	33	34	44	46	58	59	61	62
X	22	-4	15	-6	-24	-11	10	15	16	20	20	21	1
Y	10	7	0	-8	-16	19	-13	7	9	14	12	0	-1

SEQ	63	80	81	84	85	87	109	114	117	118	121	123	125
X	-2	10	12	-5	-1	0	22	15	7	9	6	4	-3
Y	-5	-22	-24	11	4	-1	7	13	14	12	12	10	10

SEQ	126	129	130	132	133	134	135	137	138	139	140	146	2
X	-7	-4	-12	-11	8	0	5	-21	-5	-7	24	16	-4
Y	11	6	8	4	0	0	-1	1	-4	-5	29	-17	10

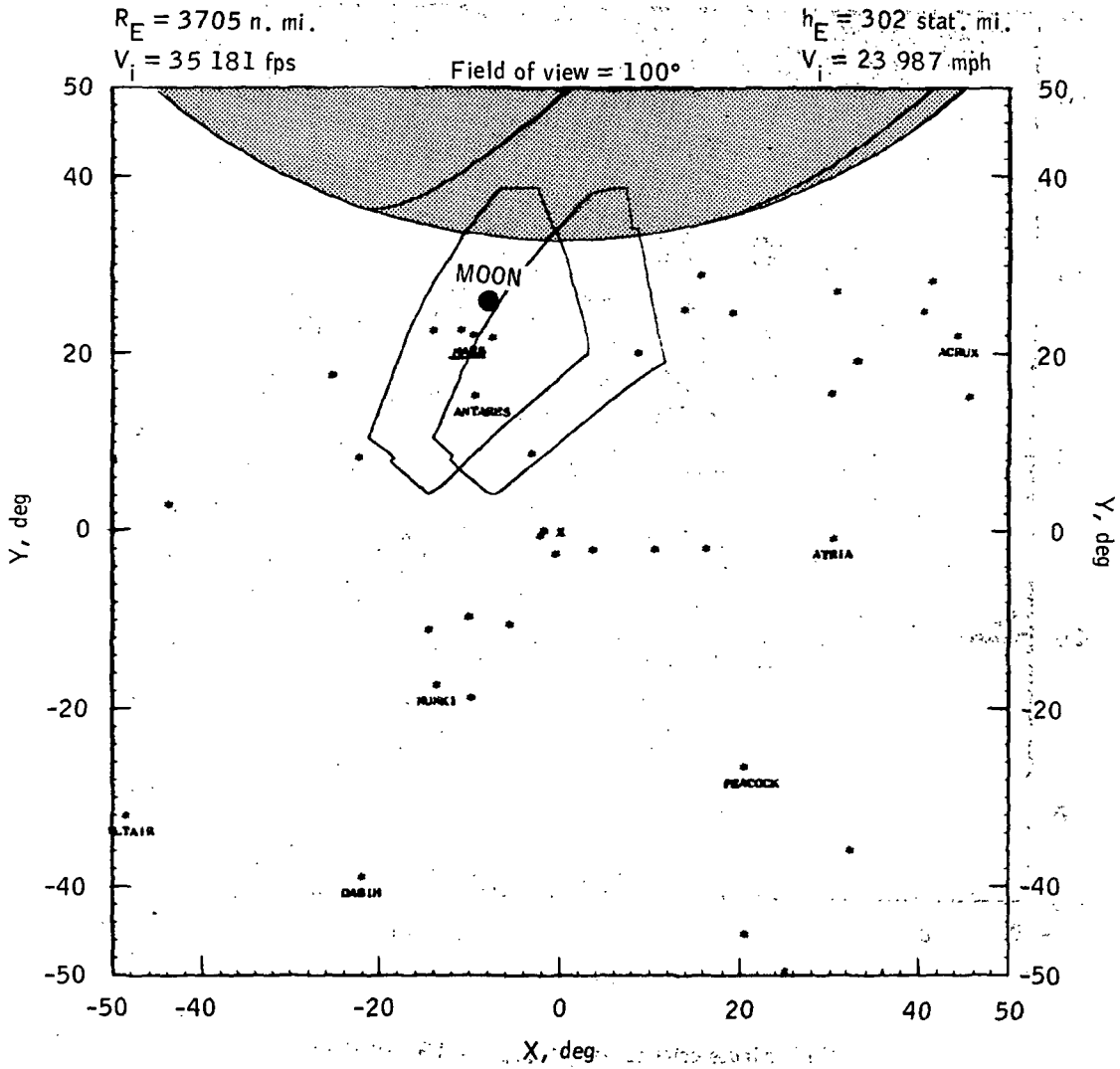

(g) 3 minutes prior to entry (g.e.t. = 194:58:12).

Figure 8.0-1. - Continued.

SEQ	28	31	32	33	34	36	37	61	62	63	65	80	81	85
X	15	-6	-23	-10	9	-18	5	-1	1	-2	17	9	11	-1
Y	7	0	-9	-11	-4	-24	-23	8	7	3	-23	-14	-16	13

SEQ	87	109	129	132	133	134	135	137	138	139	140	142	145	146
X	0	23	-4	-11	8	0	5	-22	-5	-7	-4	-24	-5	15
Y	7	14	15	12	7	8	7	8	3	2	0	18	-20	-10

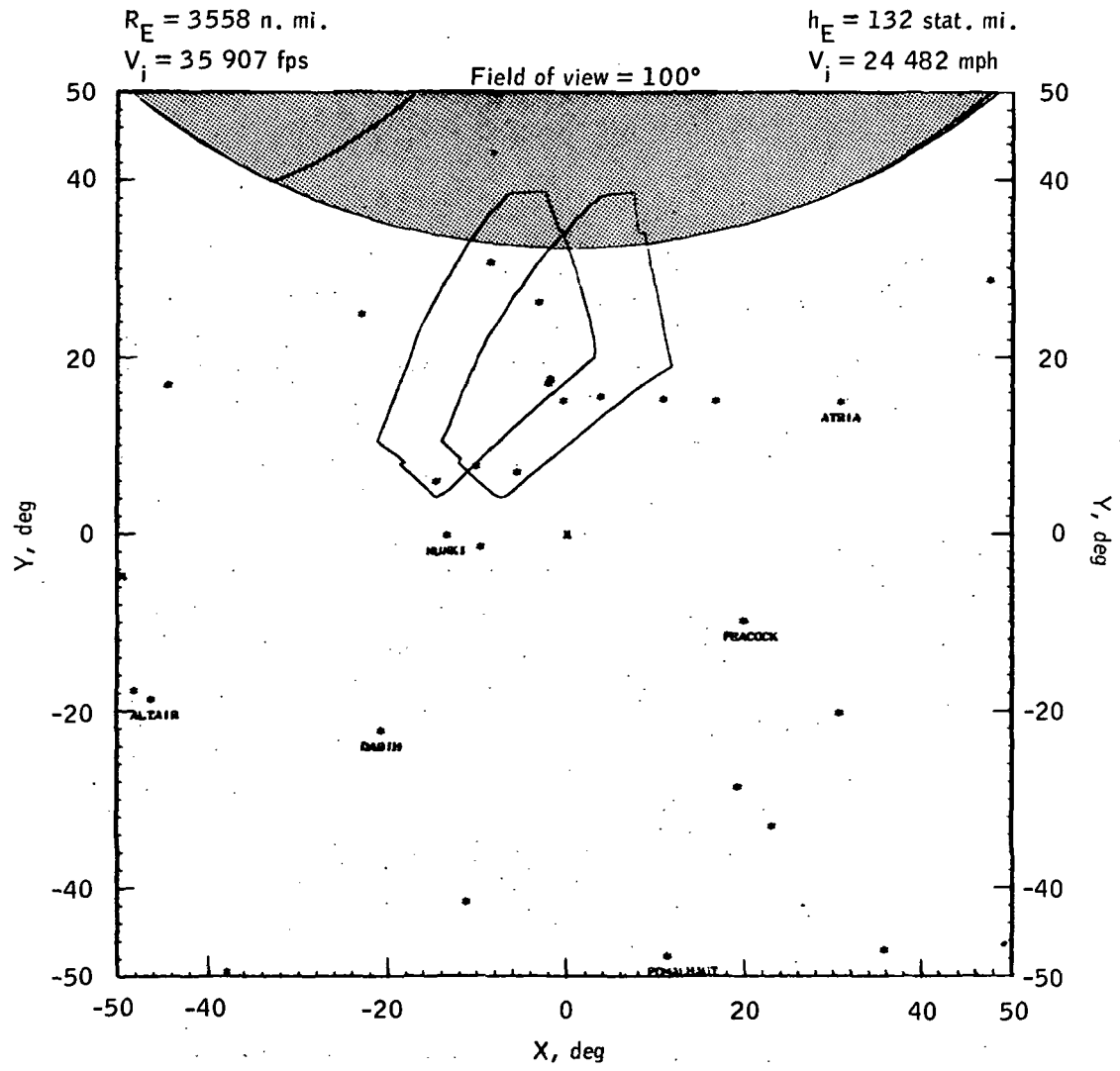

(h) 1 minute prior to entry (g.e.t. = 195:00:12).

Figure 8.0-1.- Continued.

SEQ	28	31	32	33	34	36	37	61	62	63	65	80
X	15	-6	-22	-10	9	-18	5	-1	1	-2	17	9
Y	11	4	-5	-6	0	-20	-15	13	12	7	-19	-9

SEQ	81	87	133	134	135	137	138	139	140	142	145	146
X	11	0	8	0	5	-22	-5	-7	-4	-23	-5	15
Y	-14	12	11	13	12	11	8	7	3	-5	-16	-6

$R_E = 3509$ n. mi.

$V_i = 36\ 160$ fps

$h_E = 76$ stat. mi.

$V_i = 24\ 655$ mph

Field of view = 100°

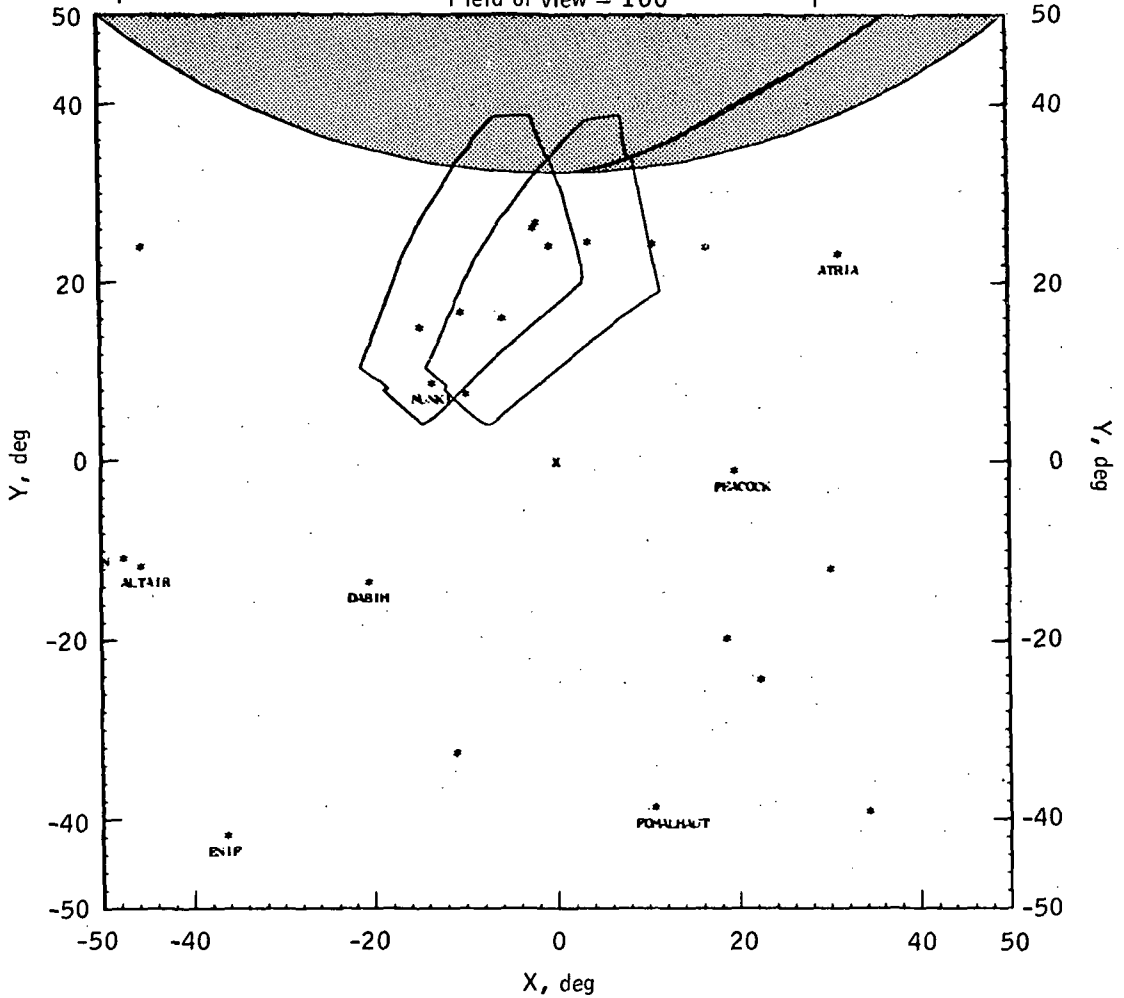

(i) Entry interface (g.e.t. = 195:01:12).

Figure 8.0-1.- Concluded.

Page intentionally left blank

9.0 VIEWS THROUGH SCANNING
TELESCOPE

Page intentionally left blank

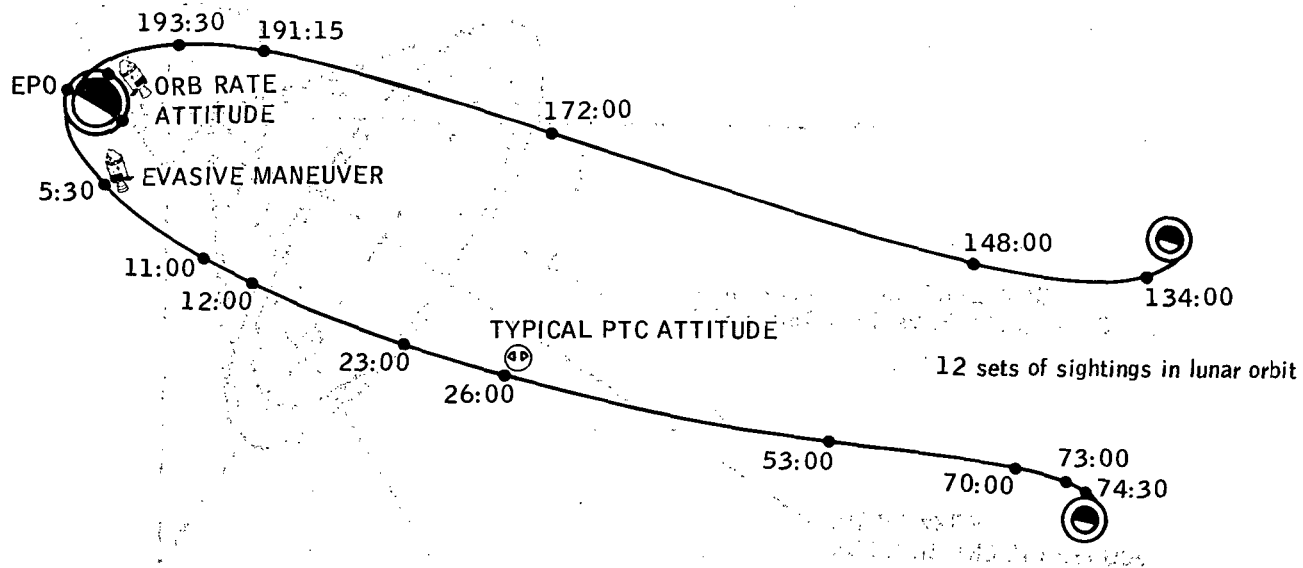

243

Figure 9.0-1.- Approximate location of scanning telescope sightings.

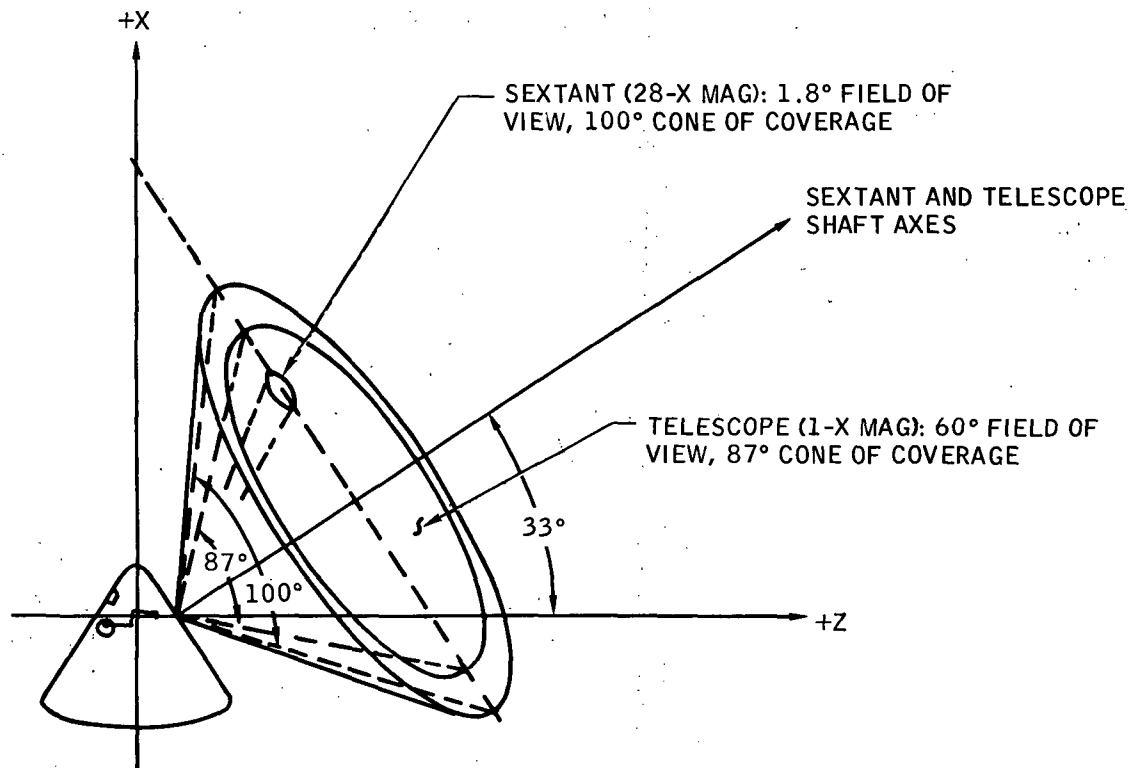

Figure 9.0-2. - General CM optics field of coverage.

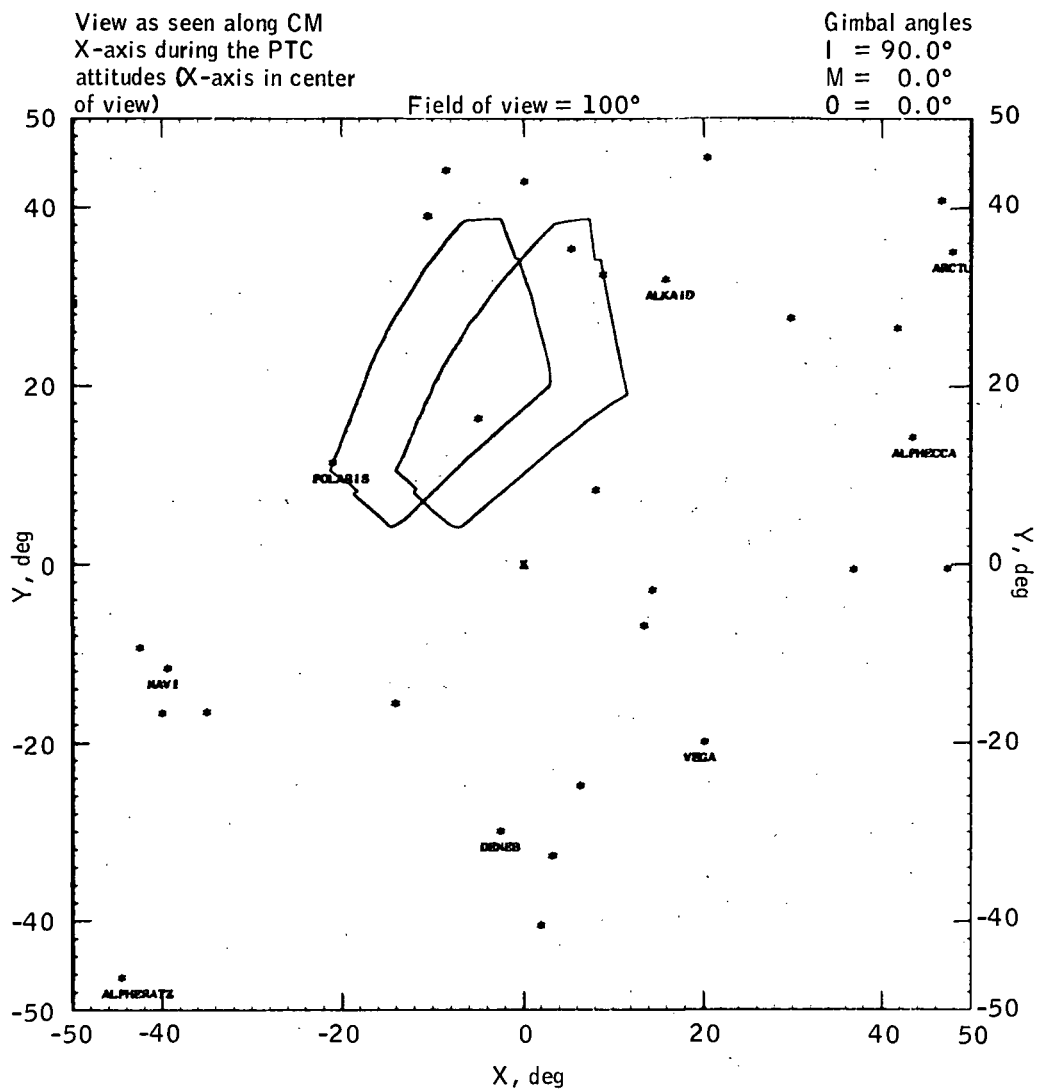
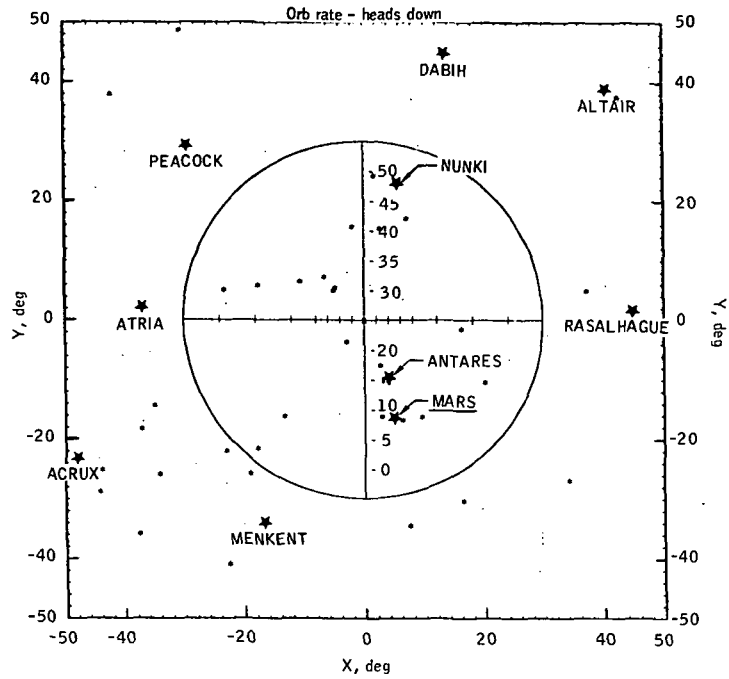

Figure 9.0-3.- PTC mode.

Page intentionally left blank

9.1 EARTH PARKING ORBIT PHASE

Page intentionally left blank



(a) g.e.t. = 00:45:00.

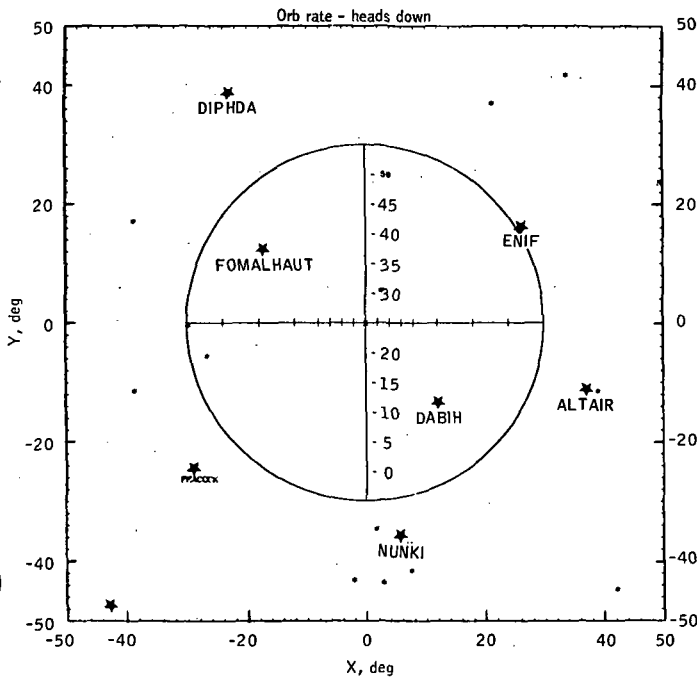

(b) g.e.t. = 01:00:00.

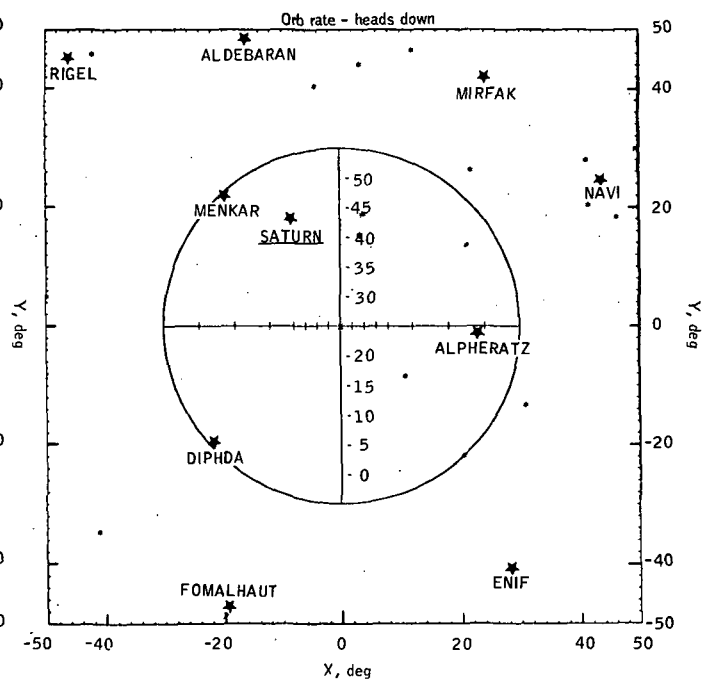

(c) g.e.t. = 01:15:00.

Figure 9.1-1.- Scanning telescope - earth parking orbit - rev 1.

Page intentionally left blank

9.2 TRANSLUNAR COAST PHASE

Page intentionally left blank

Local horizontal attitude
 $P = -75^\circ$
 $Y = 0^\circ$
 $R = 55^\circ$

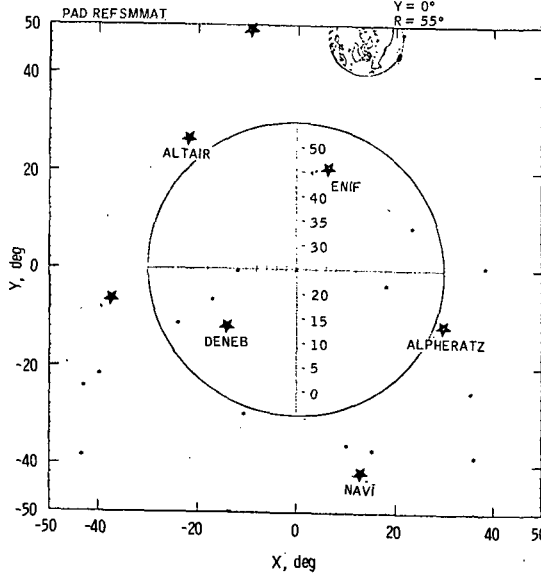

(a) Evasive maneuver roll.

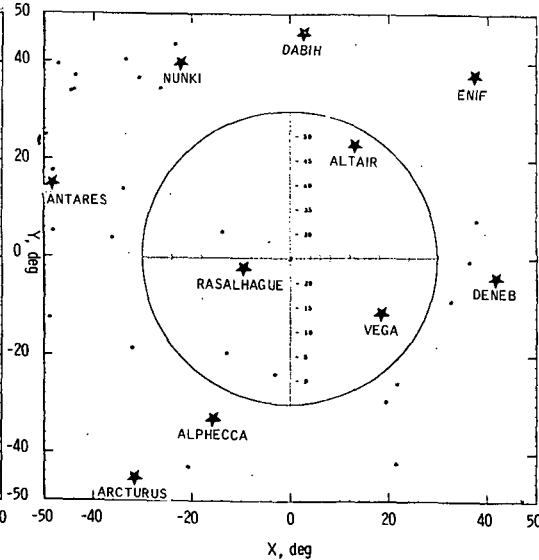

(b) Evasive maneuver roll + 60°.

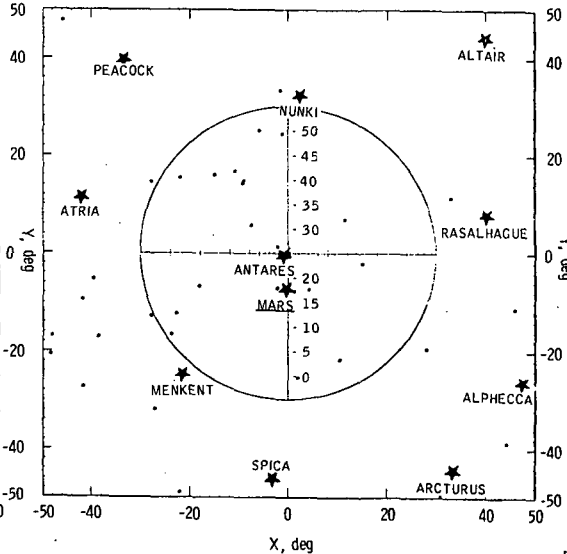

(c) Evasive maneuver roll + 120°.

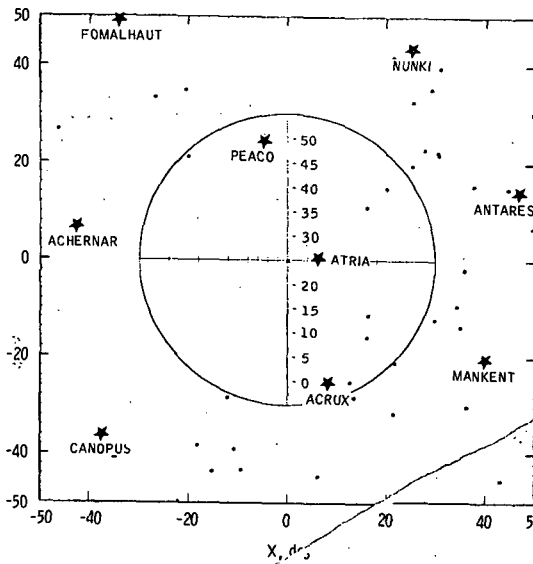

(d) Evasive maneuver roll + 180°.

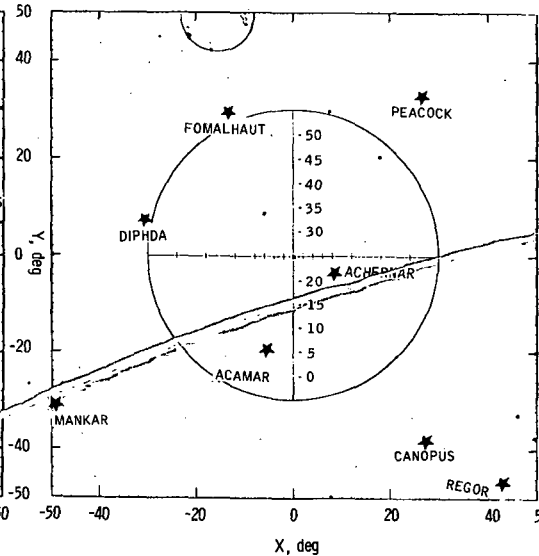

(e) Evasive maneuver roll + 240°.

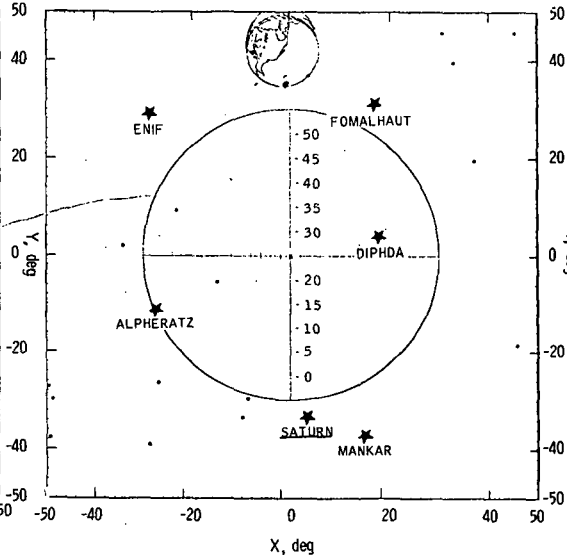

(f) Evasive maneuver roll + 300°.

Figure 9.2-1. - Scanning telescope - evasive maneuver attitude - (g. e. t. = 05:30:00).

Gimbal angles
 $I = 0^\circ$
 $M = 0^\circ$
 $O = 0^\circ$

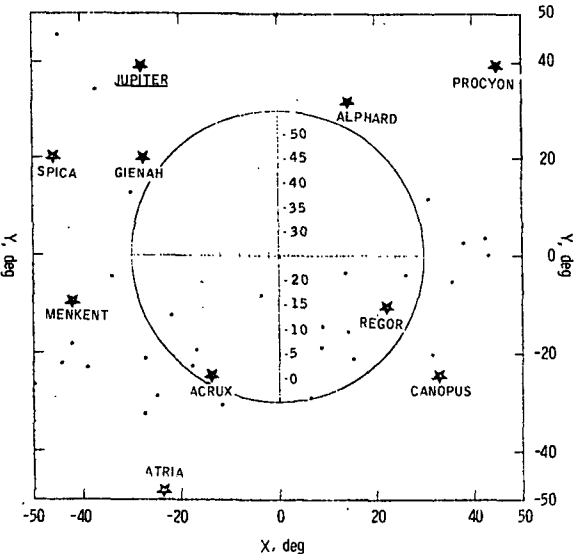
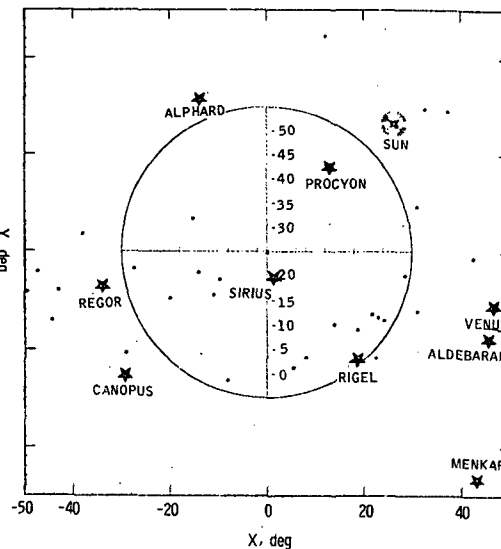
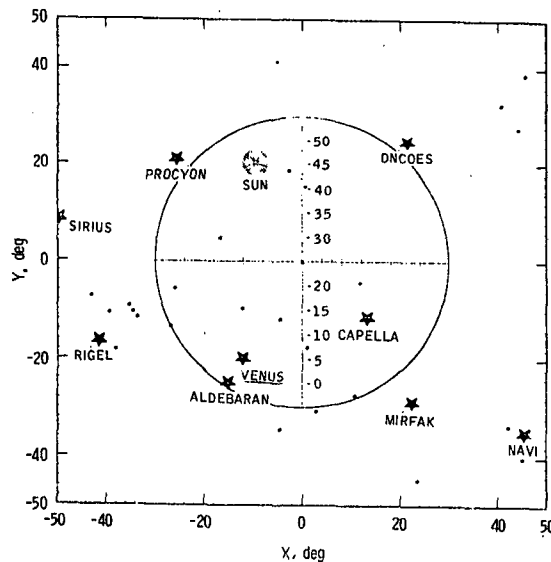
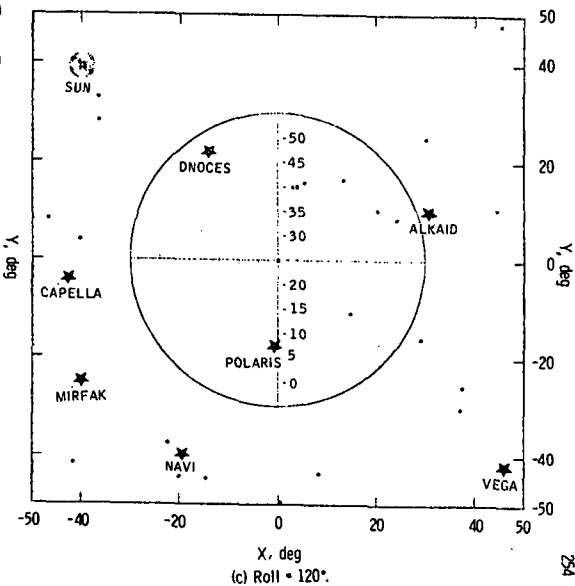
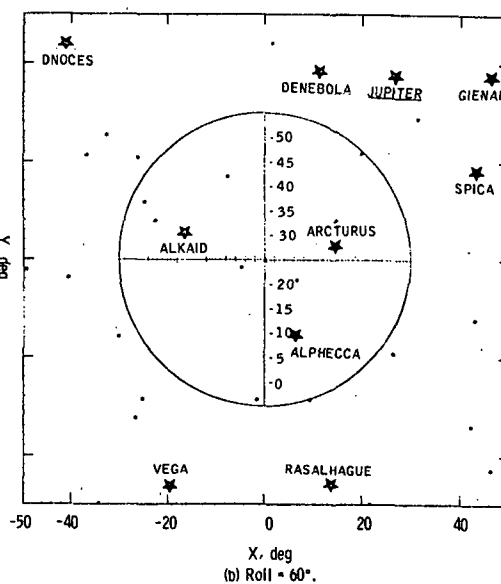
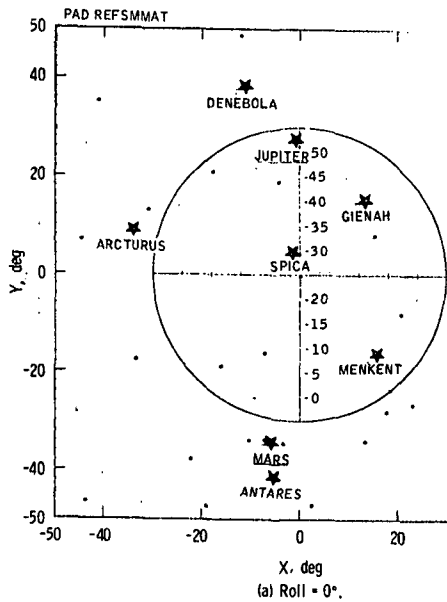

Figure 9.2-2. - Scanning telescope - translunar coast - (g. e. t. = 11:00:00).

Gimbal angles
 $I = 90.0^\circ$
 $M = 0.0^\circ$
 $O = 0.0^\circ$

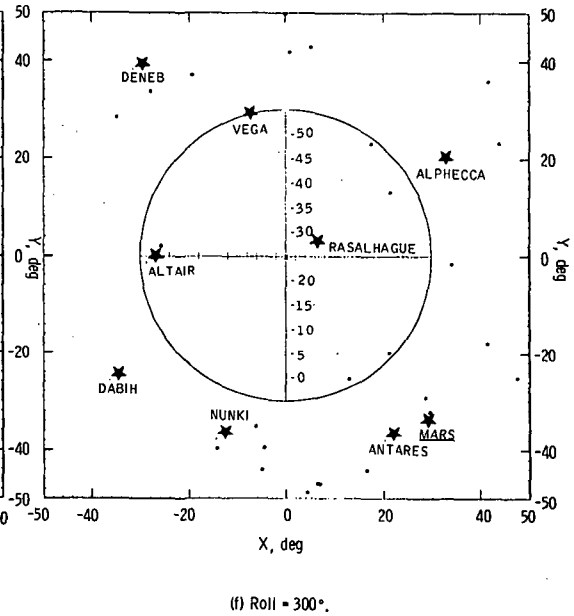
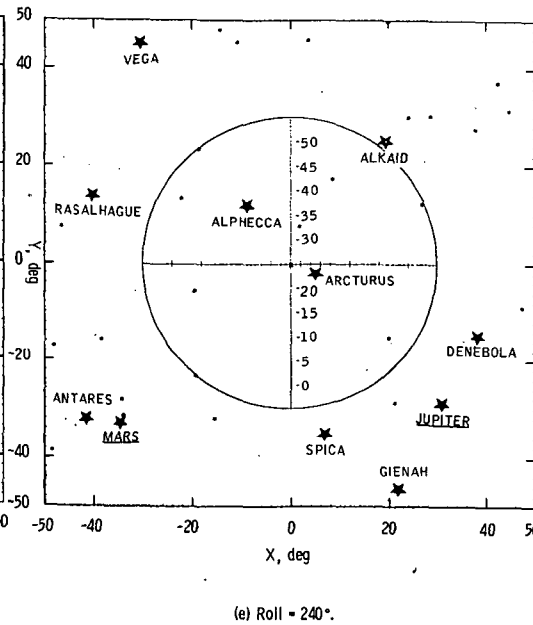
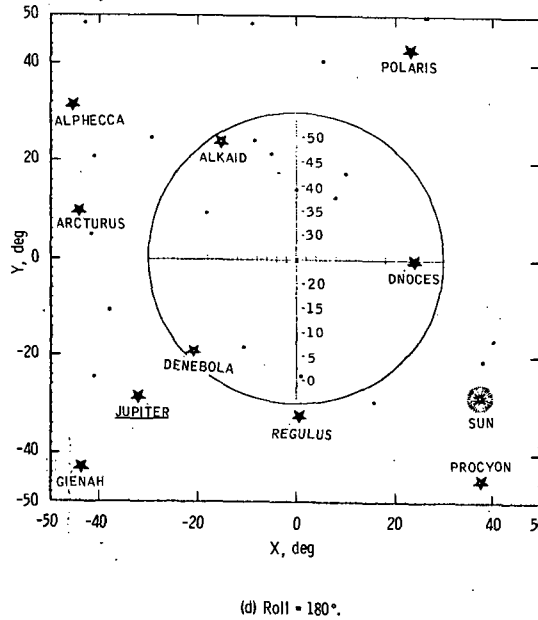
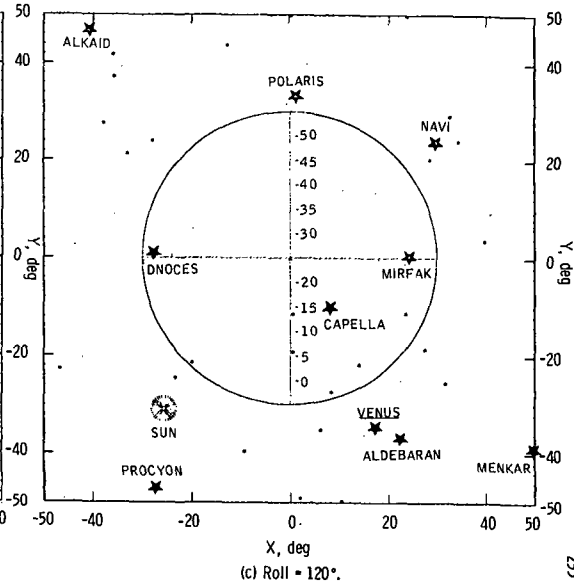
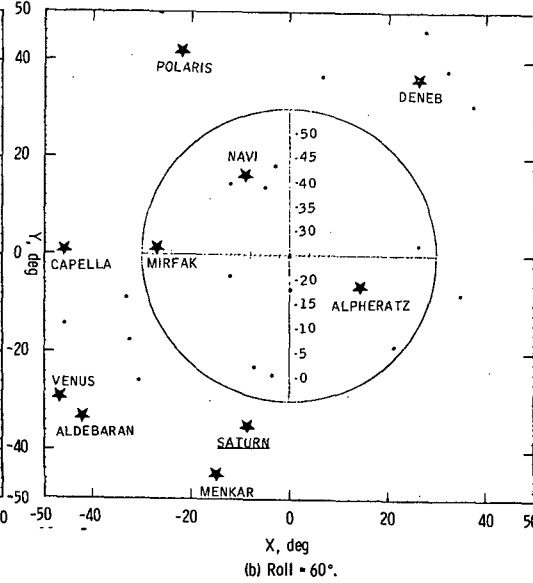
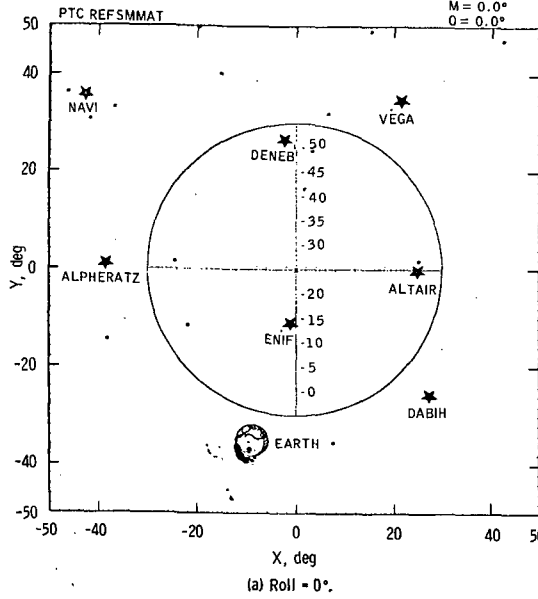

Figure 9.2-3. - Scanning telescope - PTC attitude - (g. e. t. = 12:00:00).

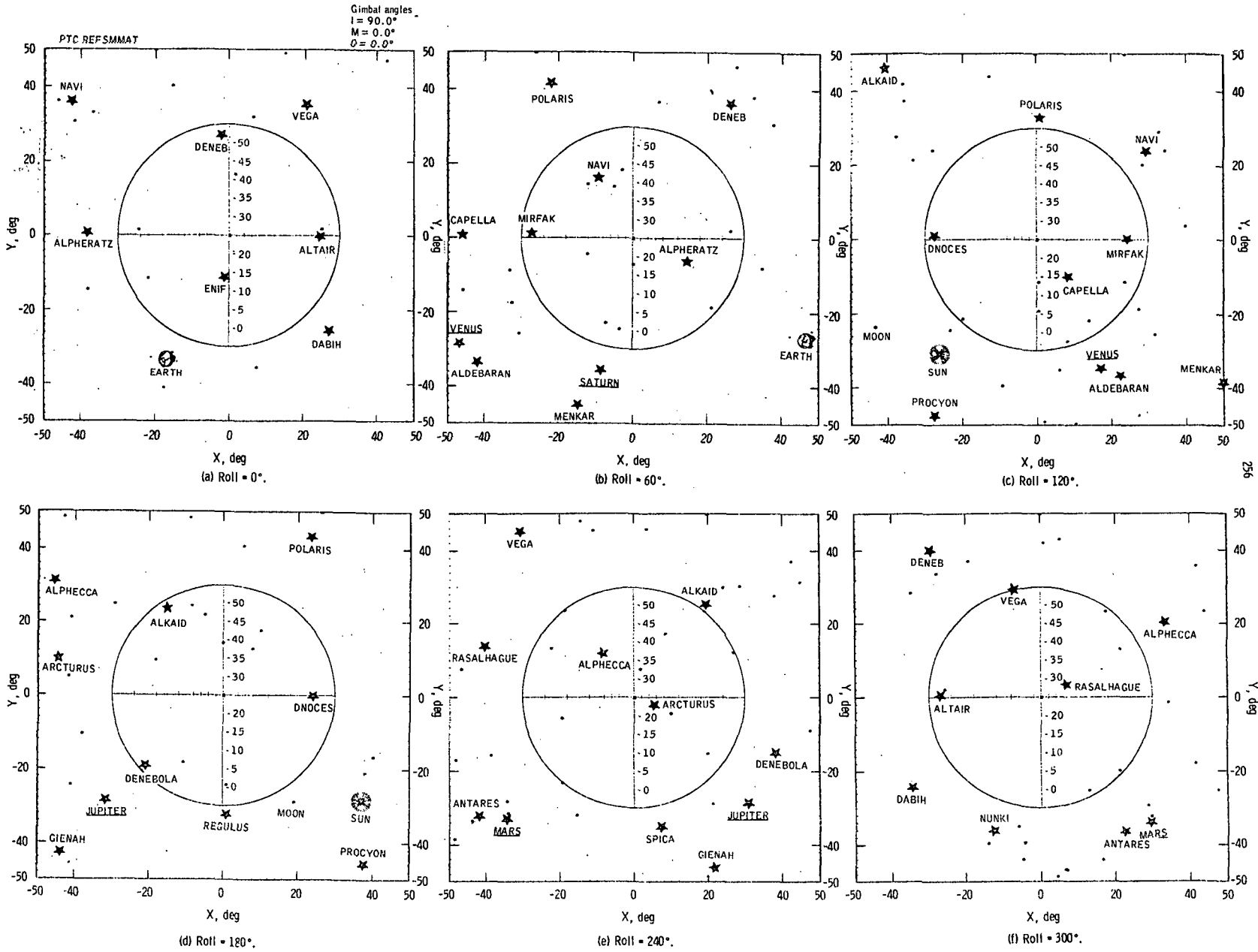
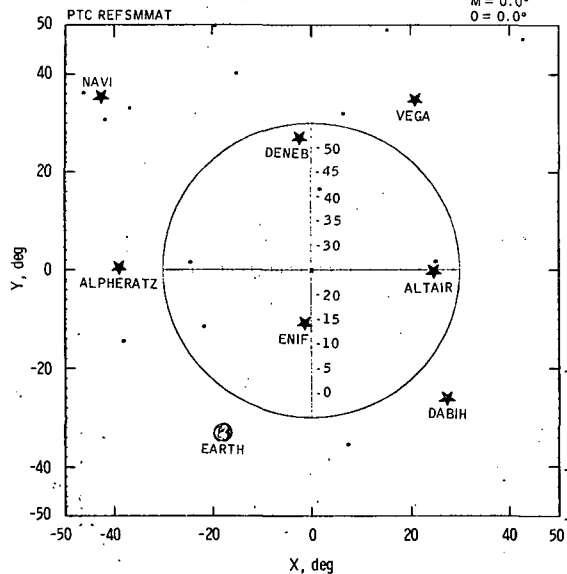
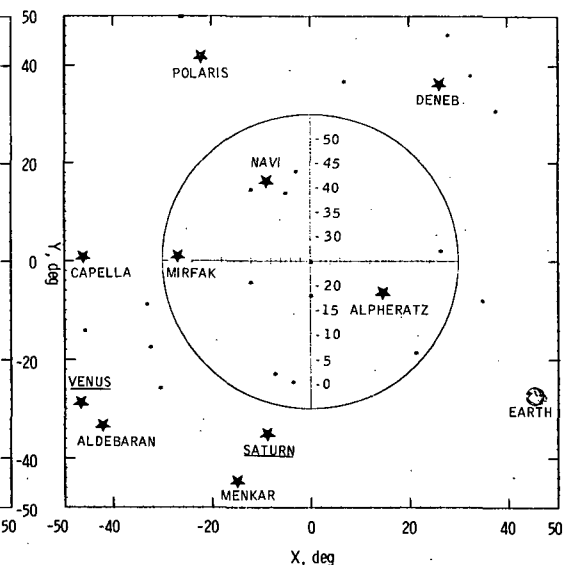

Figure 9.2-4. - Scanning telescope - PTC attitude - (g. c. t. = 23:00:00).

Gimbal angles
 $I = 90.0^\circ$
 $M = 0.0^\circ$
 $O = 0.0^\circ$



(a) Roll = 0° .



(b) Roll = 60° .

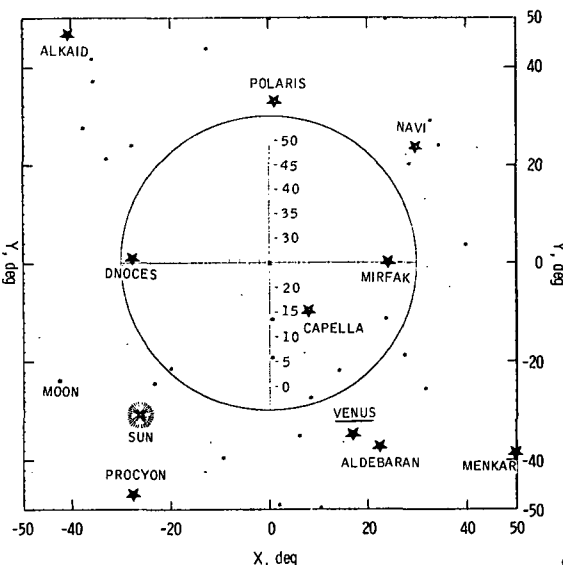

(c) Roll = 120° .

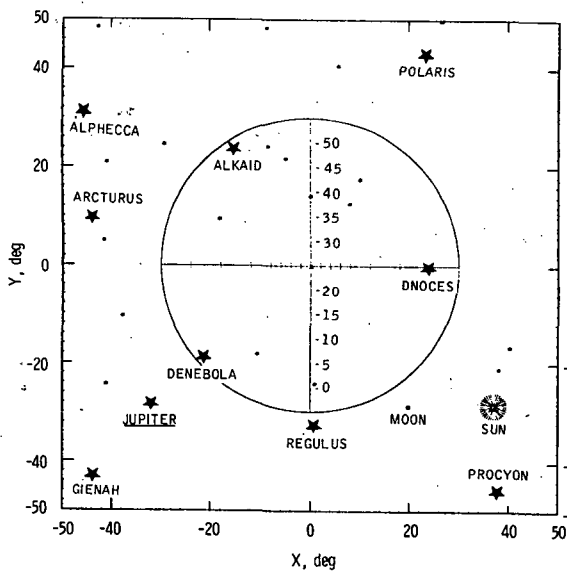

(d) Roll = 180° .

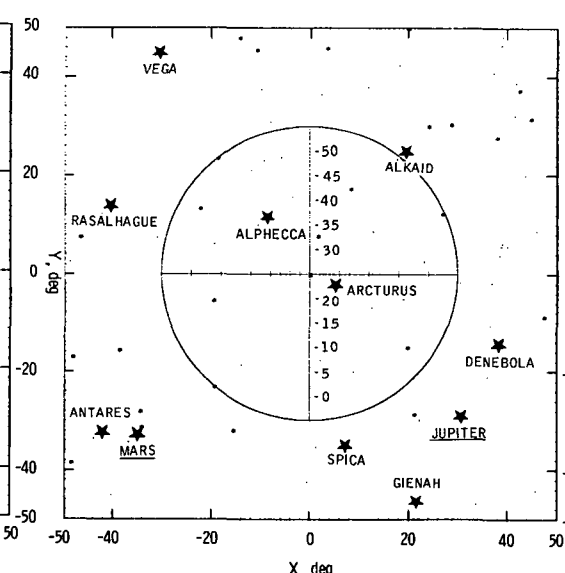

(e) Roll = 240° .

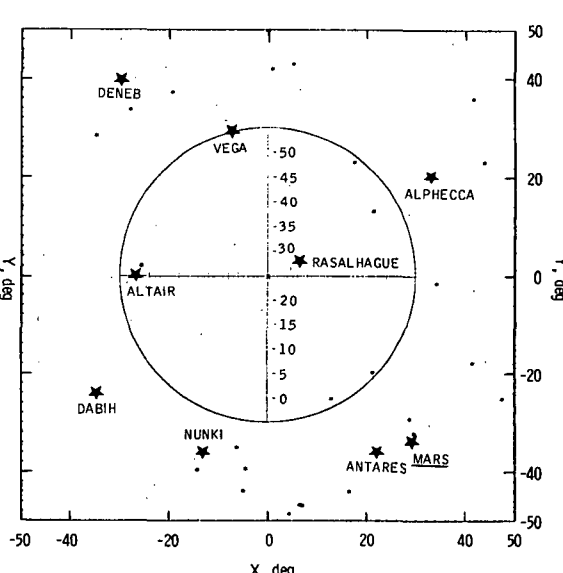

(f) Roll = 300° .

Figure 9.2-5. - Scanning telescope - PTC attitude - (g. e. t. = 26:00:00).

Gimbal angles
 $I = 90.0^\circ$
 $M = 0.0^\circ$
 $O = 0.0^\circ$

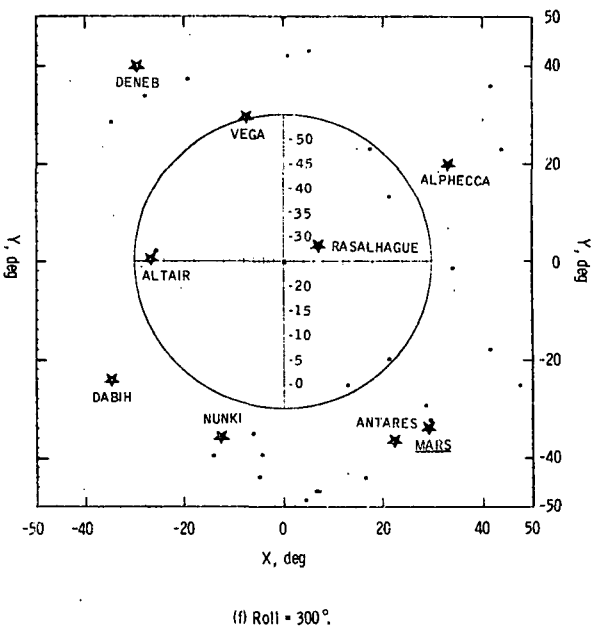
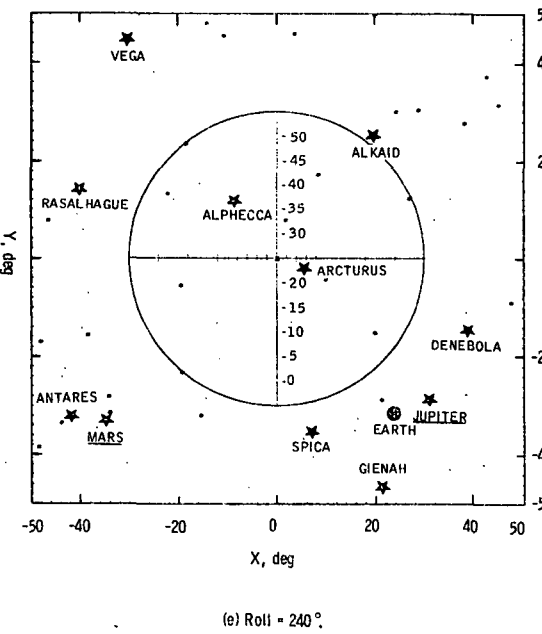
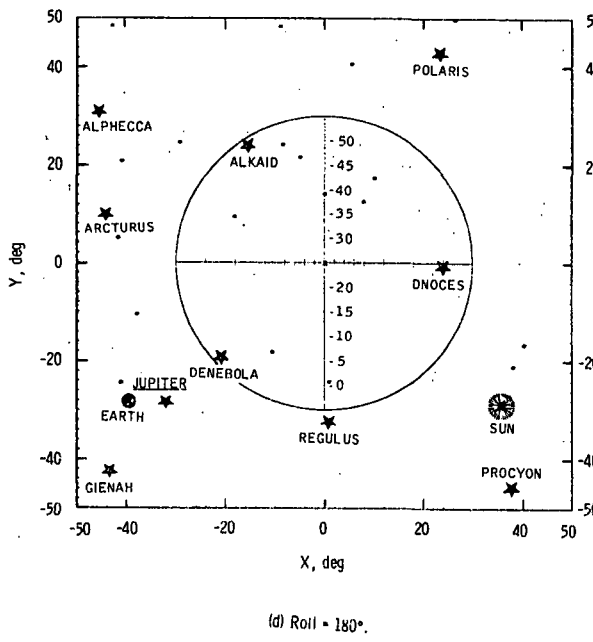
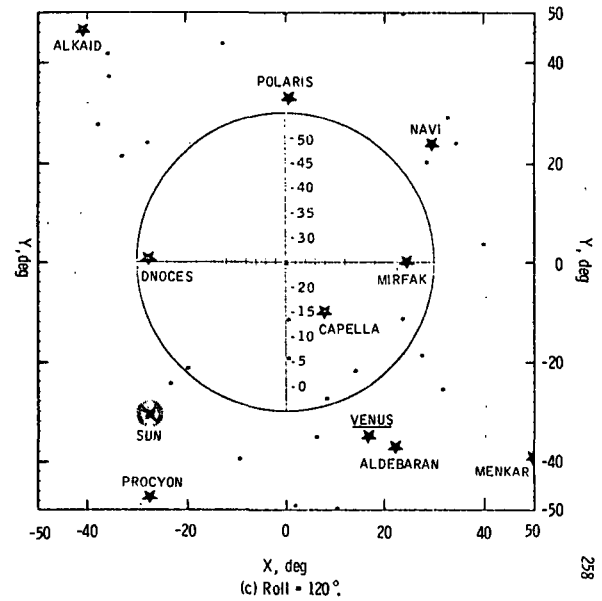
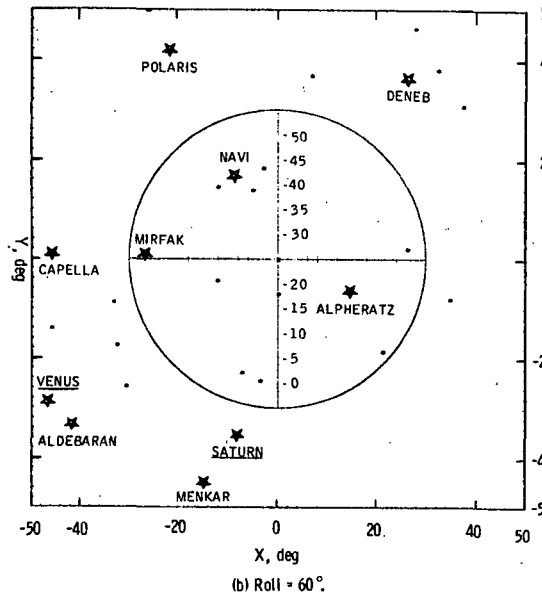
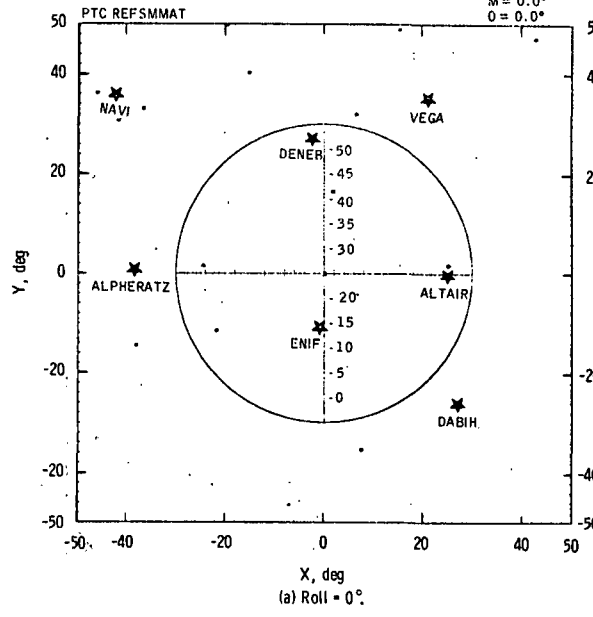

258

Figure 9.2-6. - Scanning telescope - PTC attitude - (g. e. t. = 53:00:00).

Gimbal angles
 $I = 90^\circ$
 $M = 0^\circ$
 $O = 0^\circ$

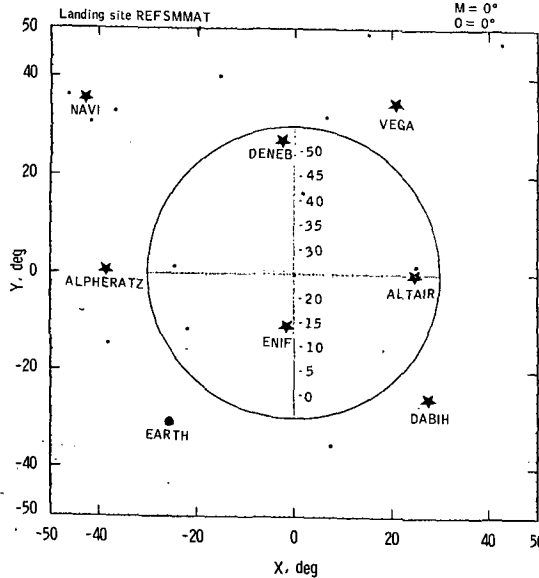

(a) Roll = 0° .

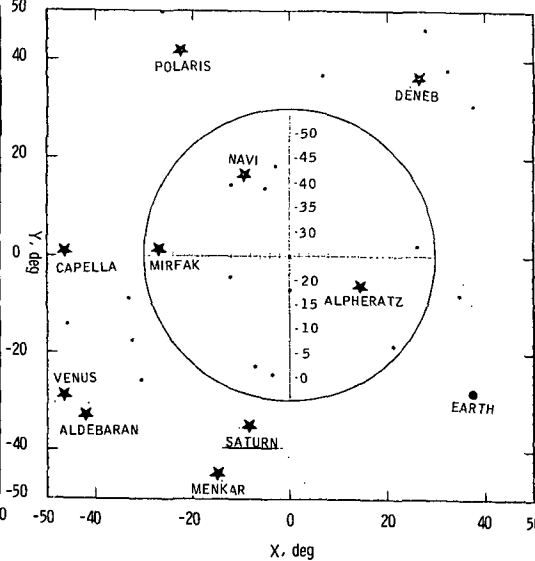

(b) Roll = 60° .

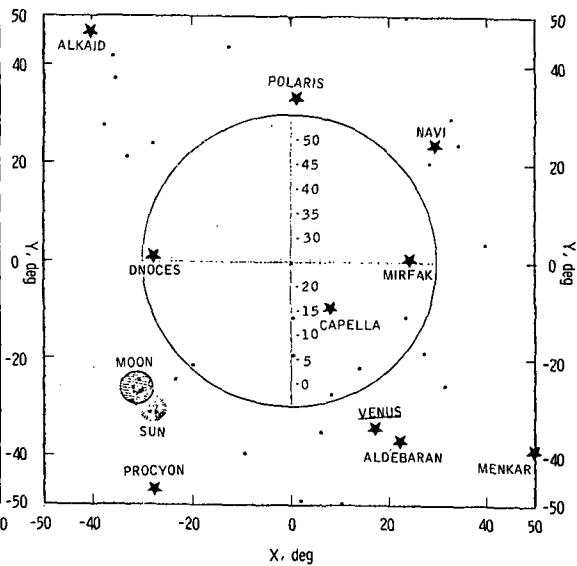

(c) Roll = 120° .

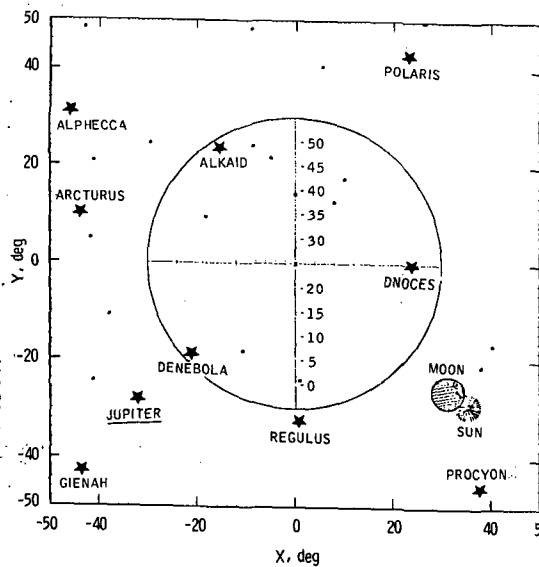

(d) Roll = 180° .

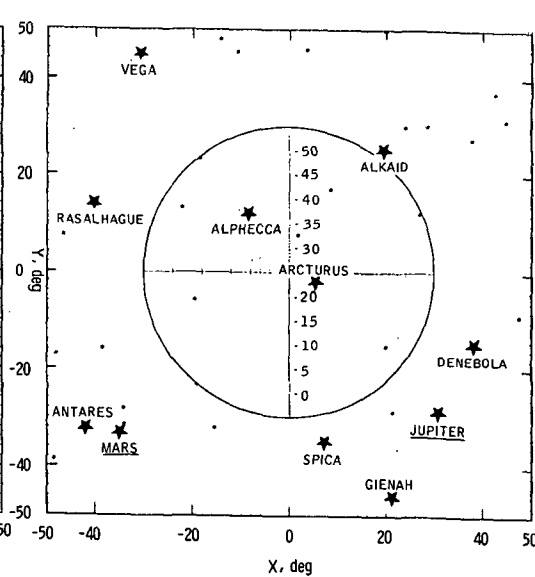

(e) Roll = 240° .

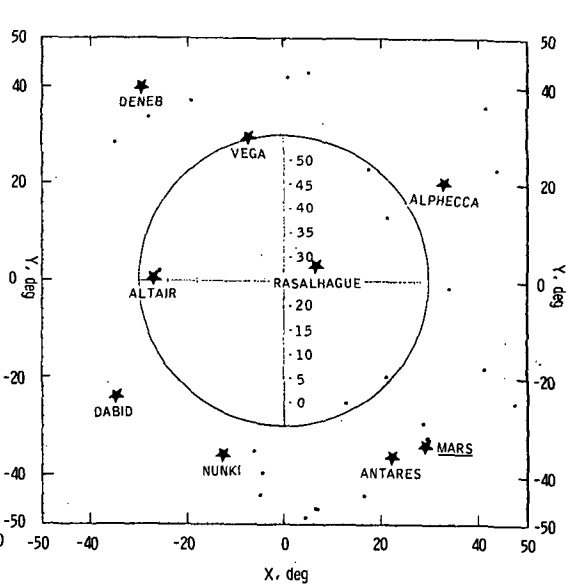

(f) Roll = 300° .

Figure 9.2-7. - Scanning telescope - PTC attitude - (g. e. t. = 70:00:00).

Gimbal angles
 I = -132.95
 M = -14.85
 O = -2.06

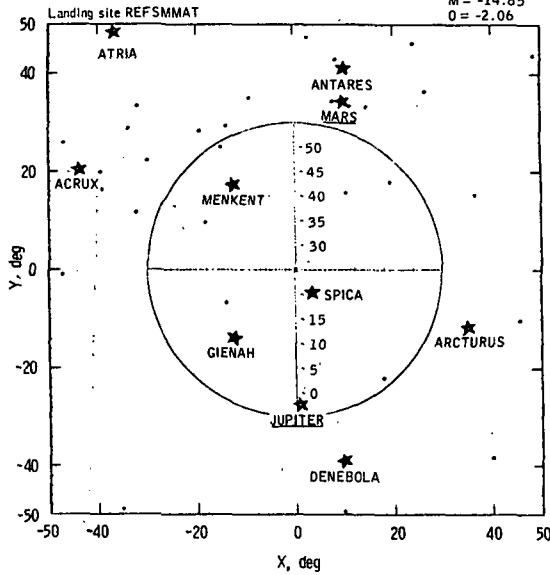

(a) Burn attitude roll.

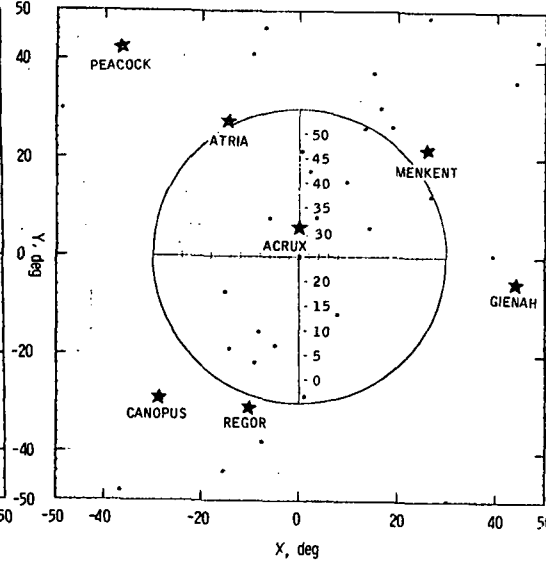

(b) Burn attitude roll + 60°.

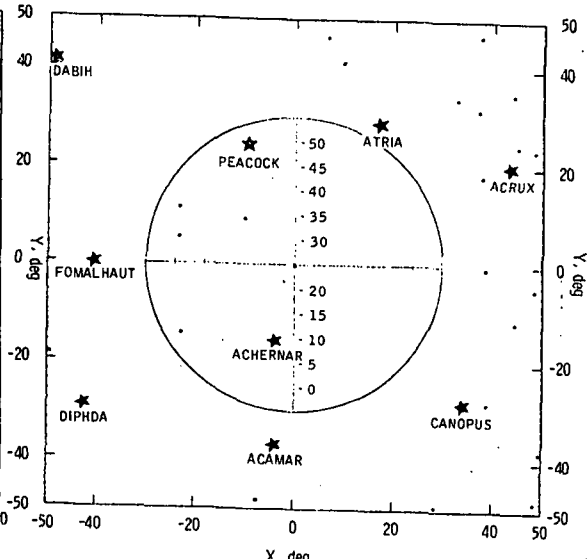

(c) Burn attitude roll + 120°.

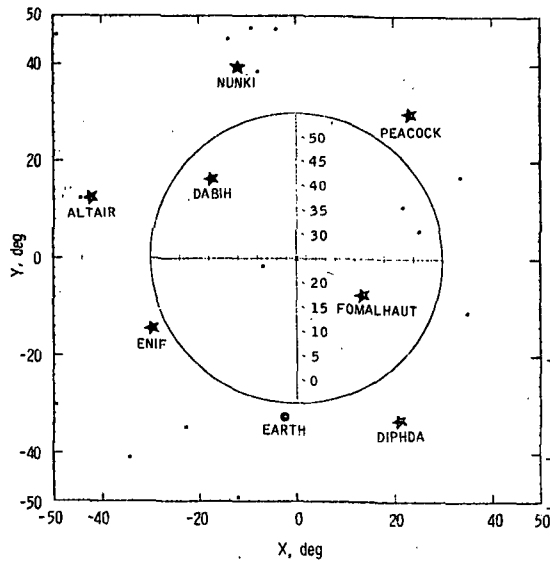

(d) Burn attitude roll + 180°.

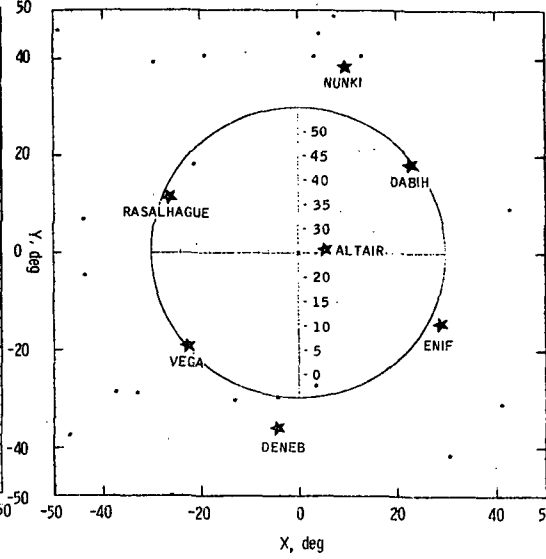

(e) Burn attitude roll + 240°.

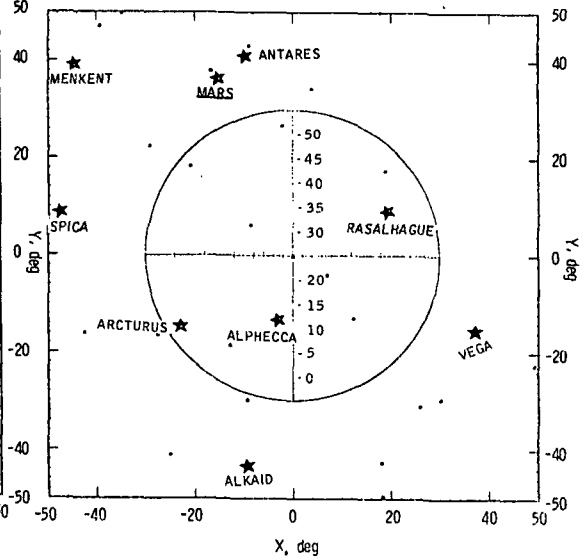

(f) Burn attitude roll + 300°.

Figure 9.2-8. - Scanning telescope - LOI burn attitude - (g. e. t. = 73:00:00).

Gimbal angles
 $I = -132.95^\circ$
 $M = -14.85^\circ$
 $O = -2.06^\circ$

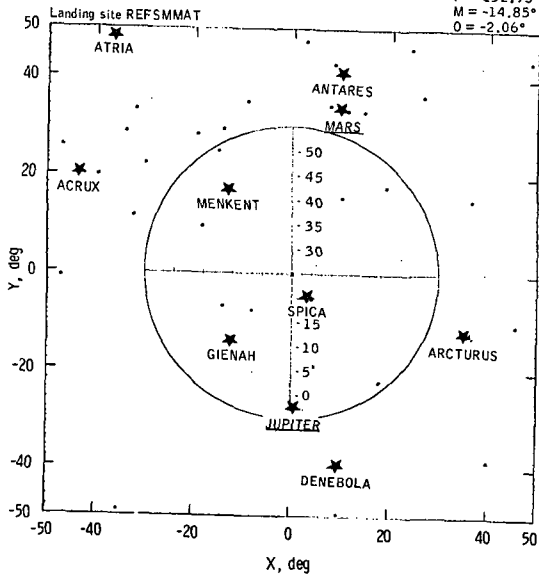

(a) Burn attitude roll.

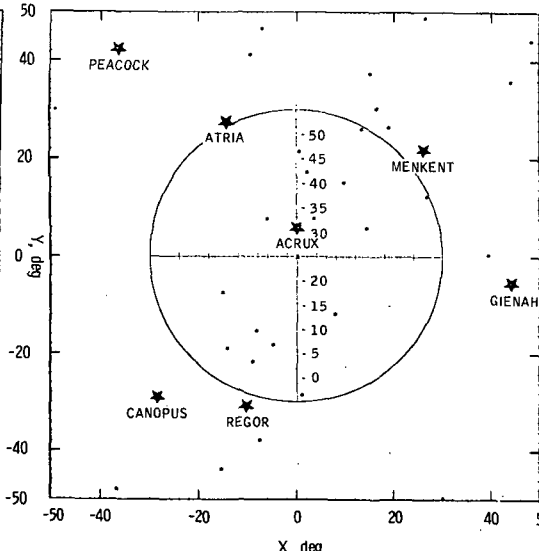

(b) Burn attitude roll + 60°.

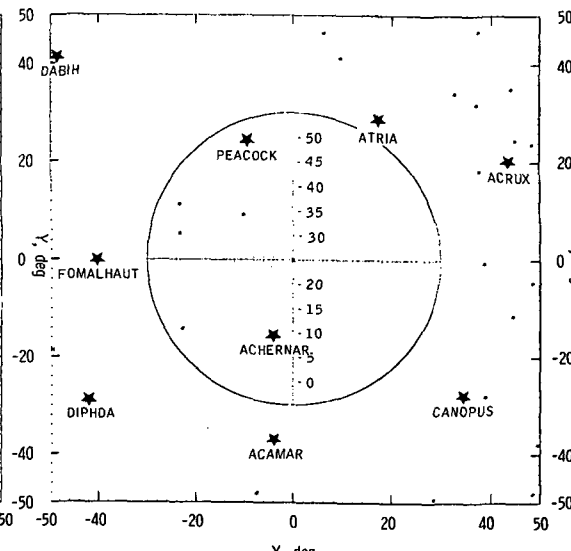

(c) Burn attitude roll + 120°.

261

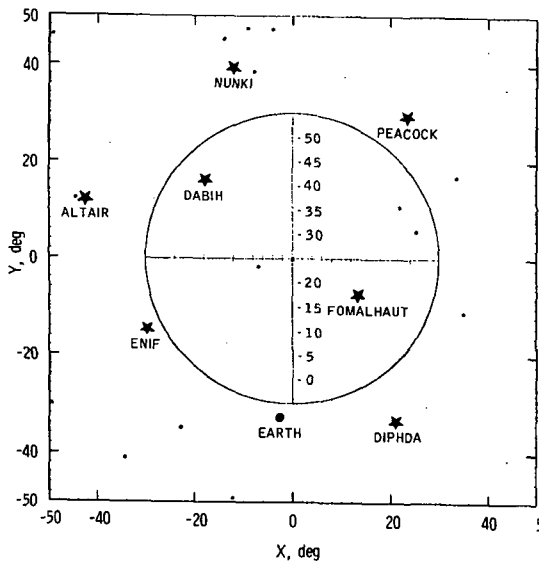

(d) Burn attitude roll + 180°.

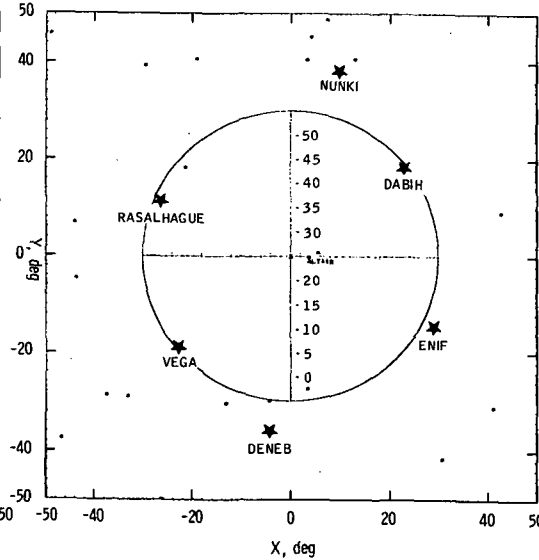

(e) Burn attitude roll + 240°.

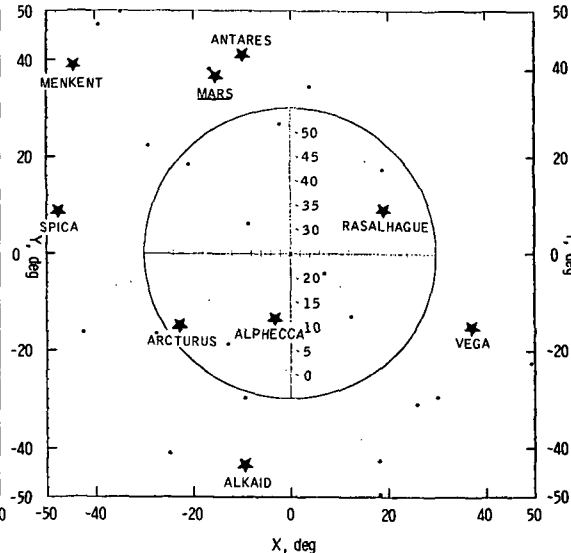

(f) Burn attitude roll + 300°.

Figure 9.2-9. - Scanning telescope - LOI burn attitude - (g. e. t. = 74:30:00).

Page intentionally left blank

Page intentionally left blank

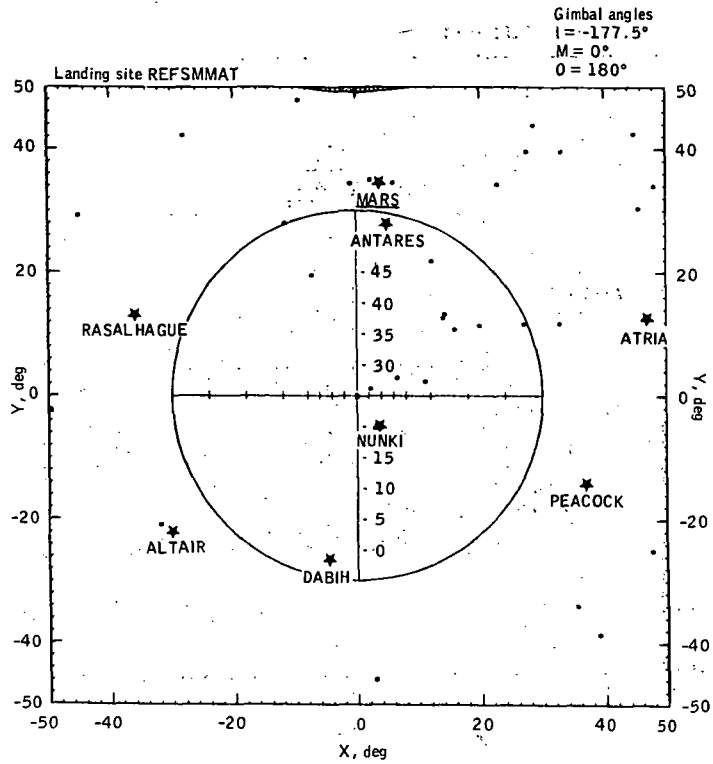

(a) g.e.t. = 77:00:00.

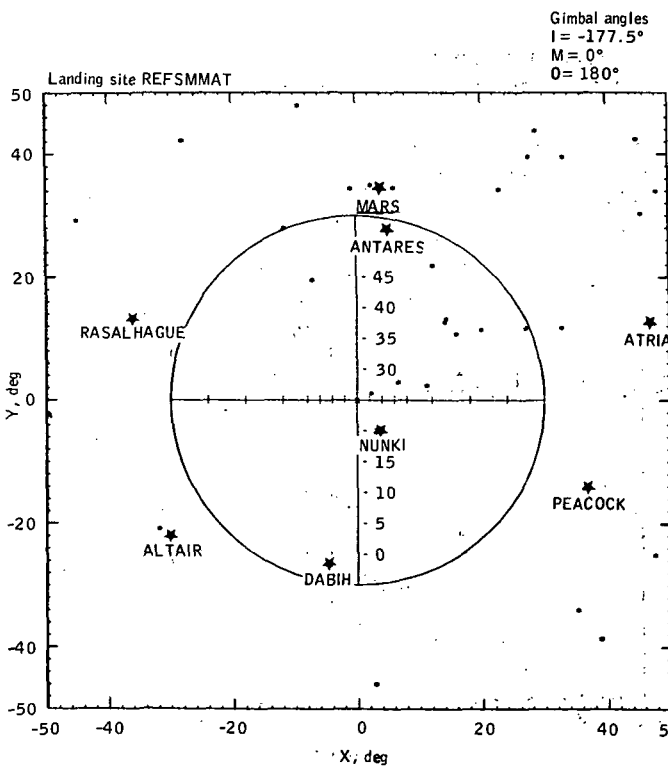

(b) g.e.t. = 77:25:00.

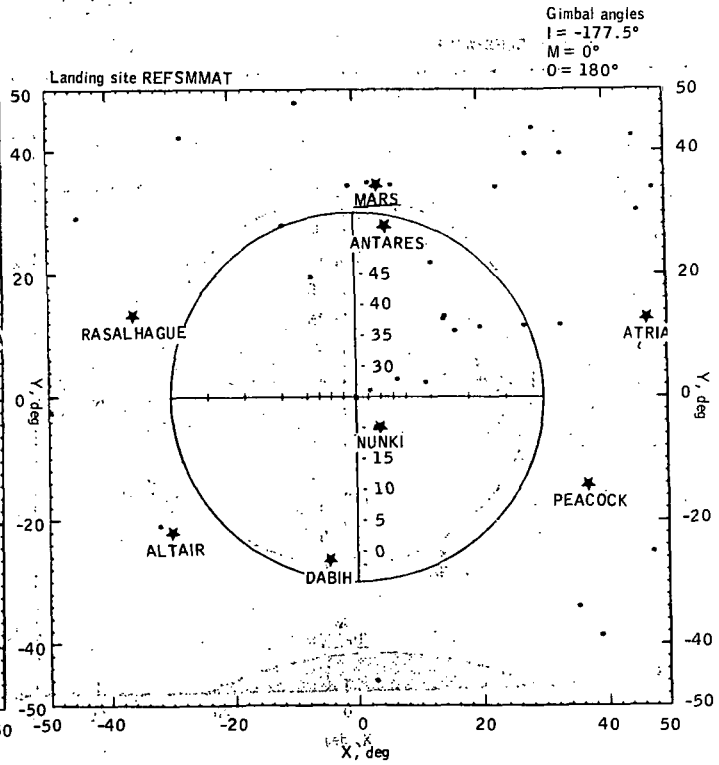

(c) g.e.t. = 77:45:00.

Figure 9.3-1. - Scanning telescope - rev 1.

Gimbal angles
I = -176.1°
M = 0°
O = 180°

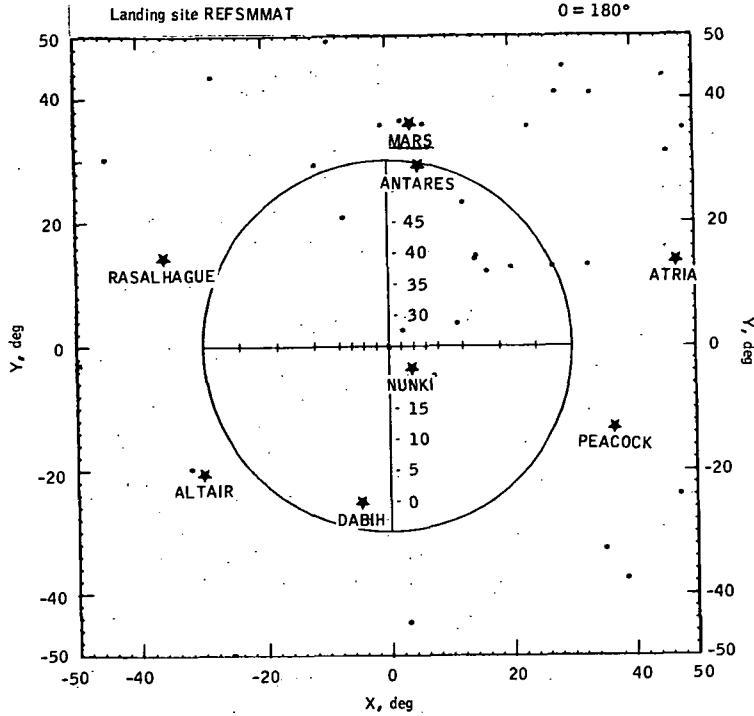

(a) g.e.t. = 79:15:00.

Gimbal angles
I = -120.7°
M = -2.4°
O = 0.1°

Gimbal angles
I = -120.7°
M = -2.4°
O = 0.1°

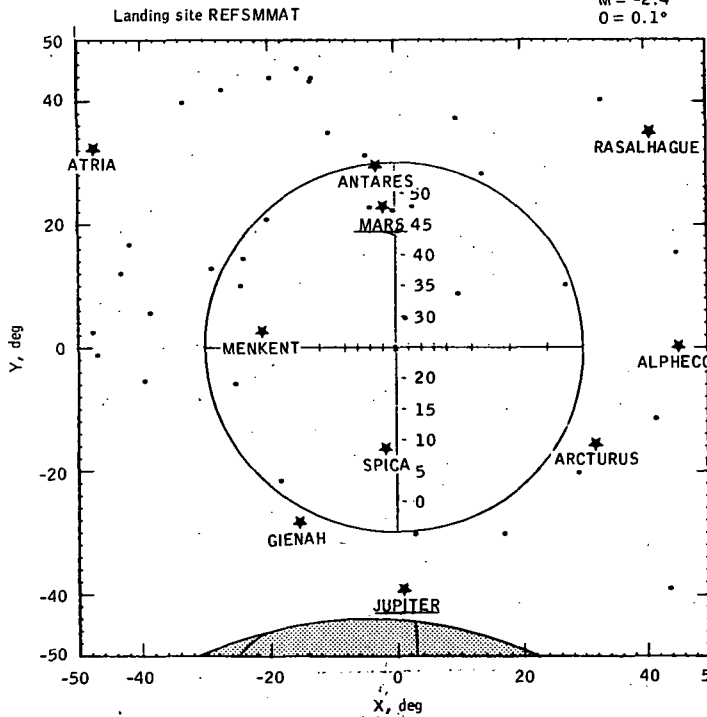

(b) g.e.t. = 79:35:00.

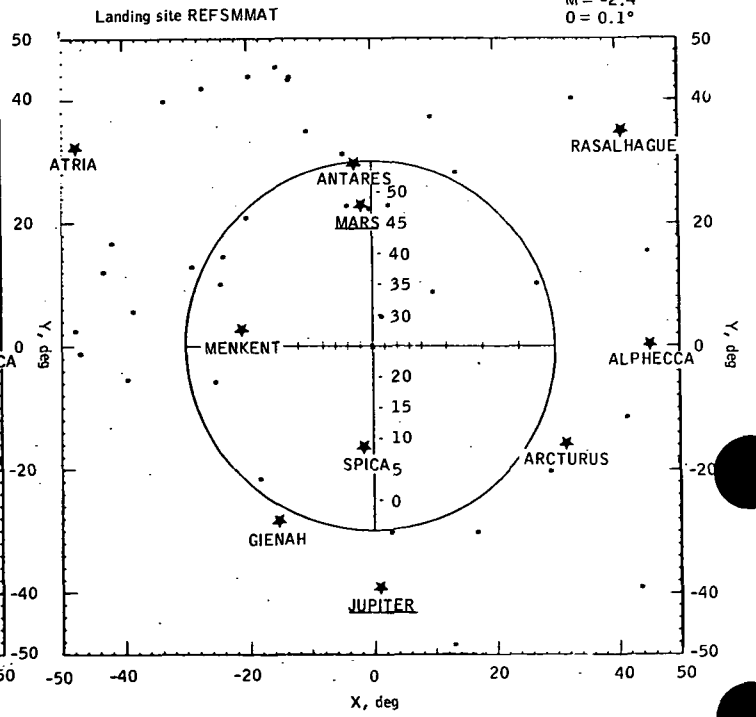

(c) g.e.t. = 79:55:00.

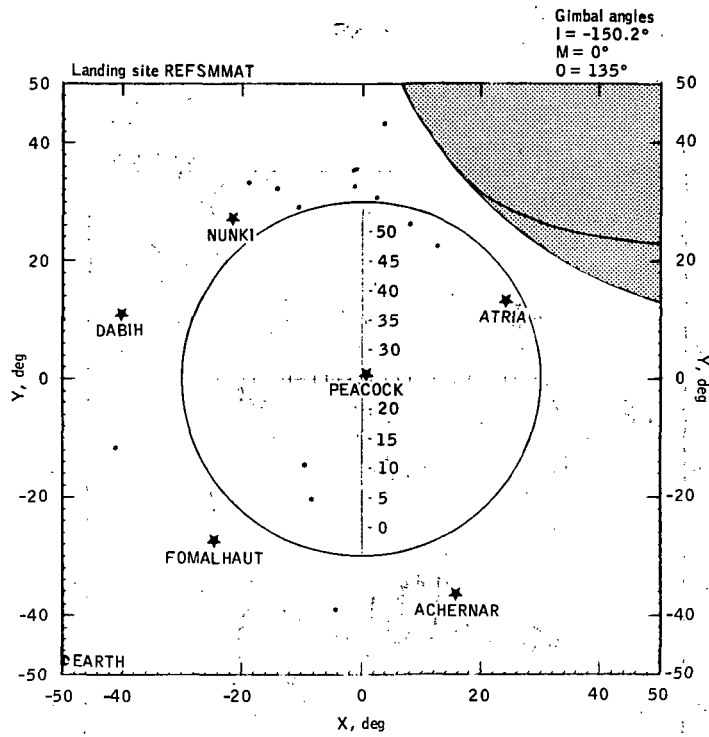

(a) g.e.t. = 83:10:00.

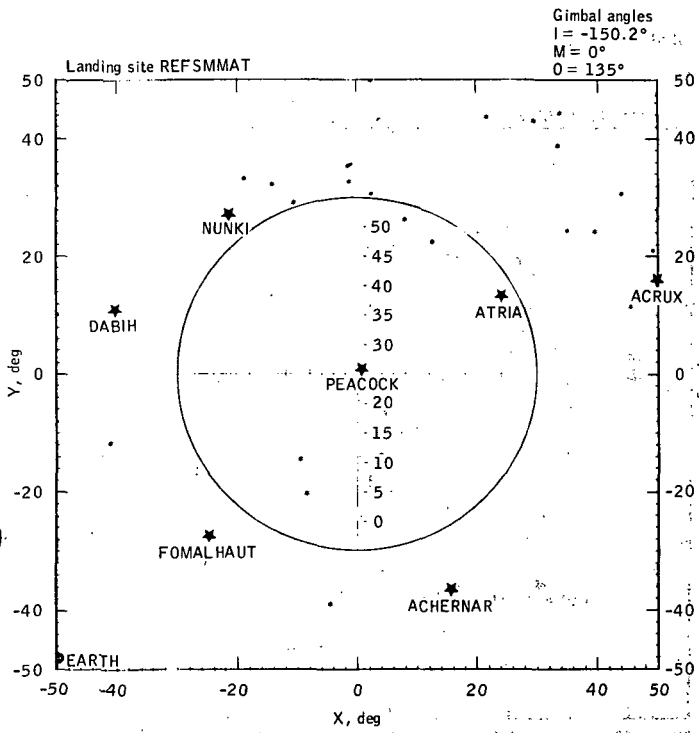

(b) g.e.t. = 83:30:00.

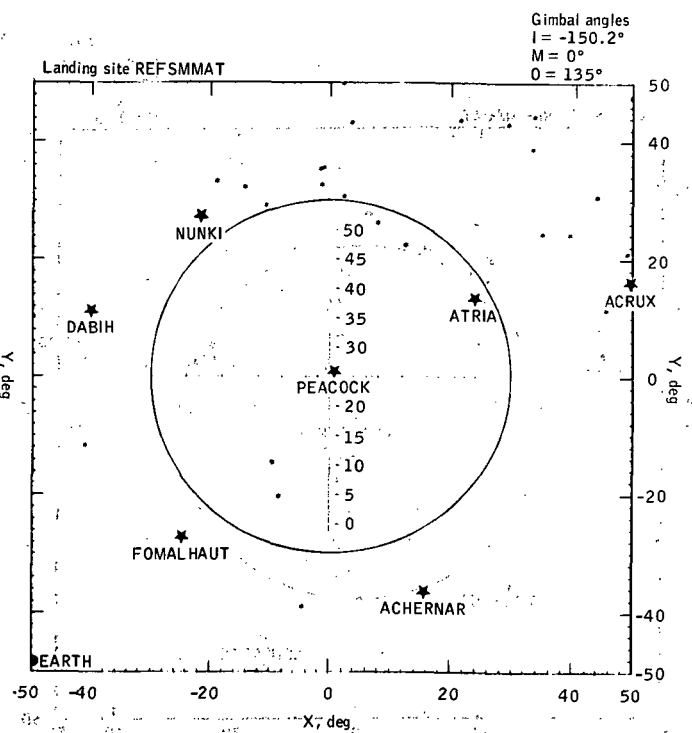

(c) g.e.t. = 83:50:00.

Figure 9.3-3 - Scanning telescope - rev 4.

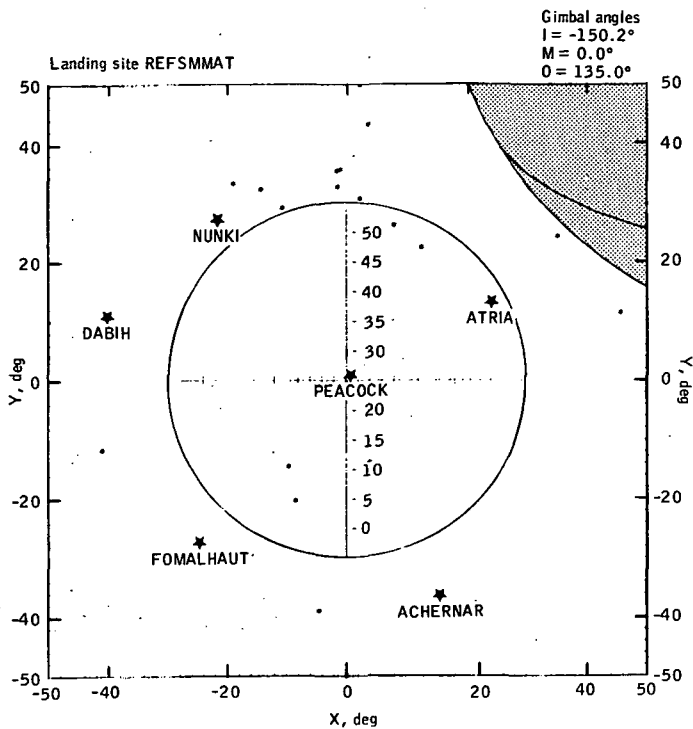

(a) g.e.t. = 95:05:00.

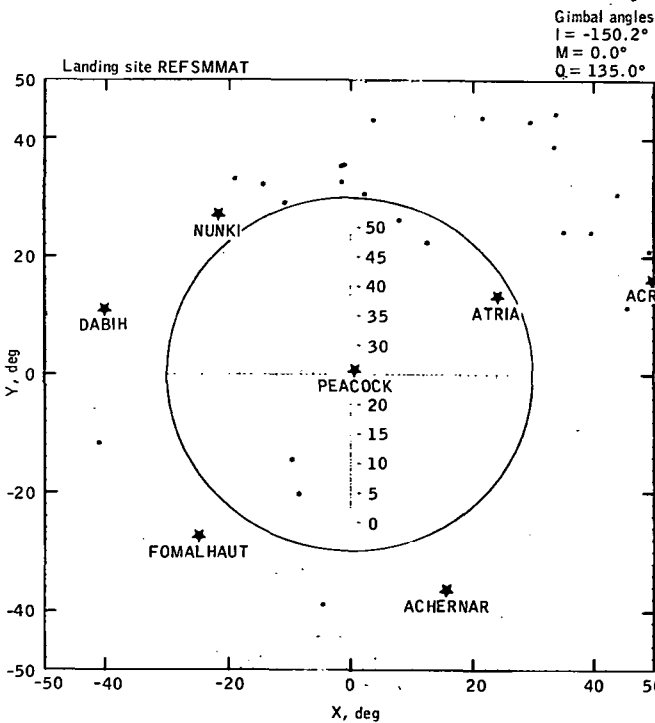

(b) g.e.t. = 95:25:00.

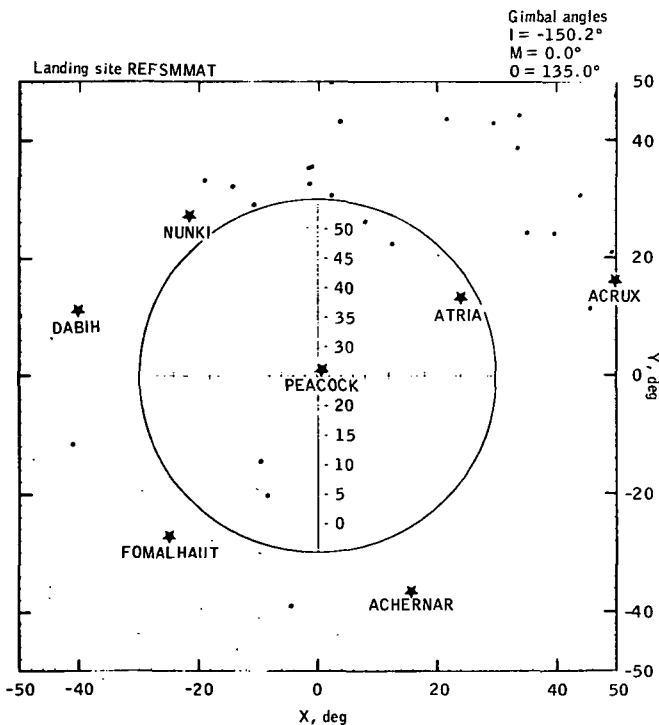

(c) g.e.t. = 95:40:00.

Figure 9.3-4. - Scanning telescope - rev 10.

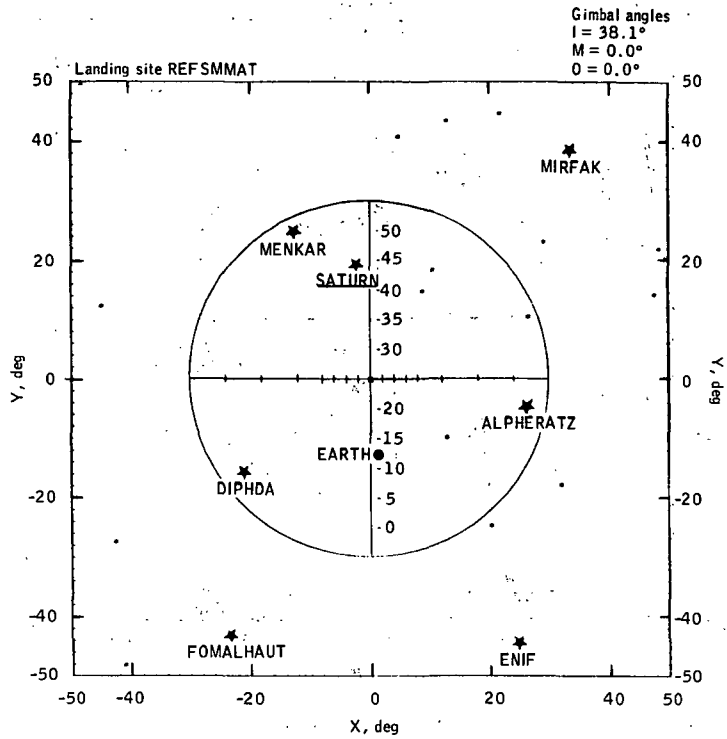

(a) g.e.t. = 99:00:00.

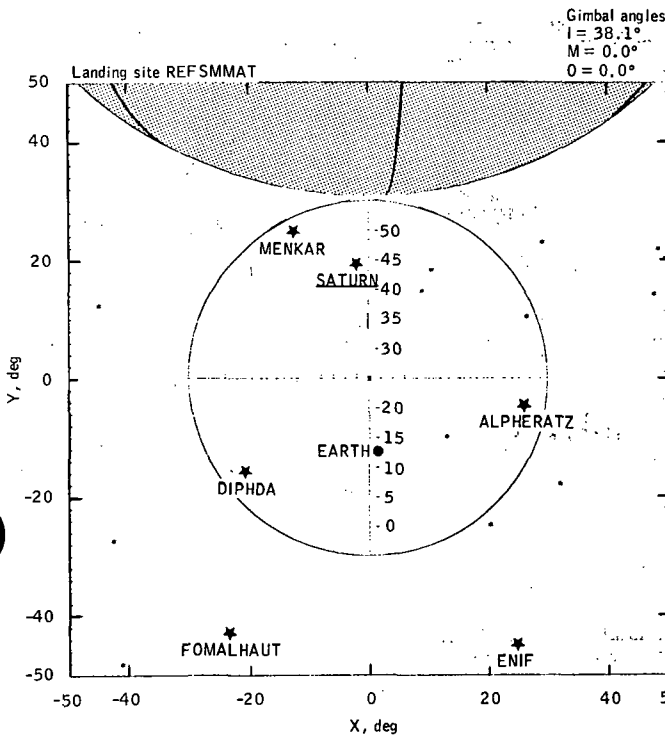

(b) g.e.t. = 99:20:00.

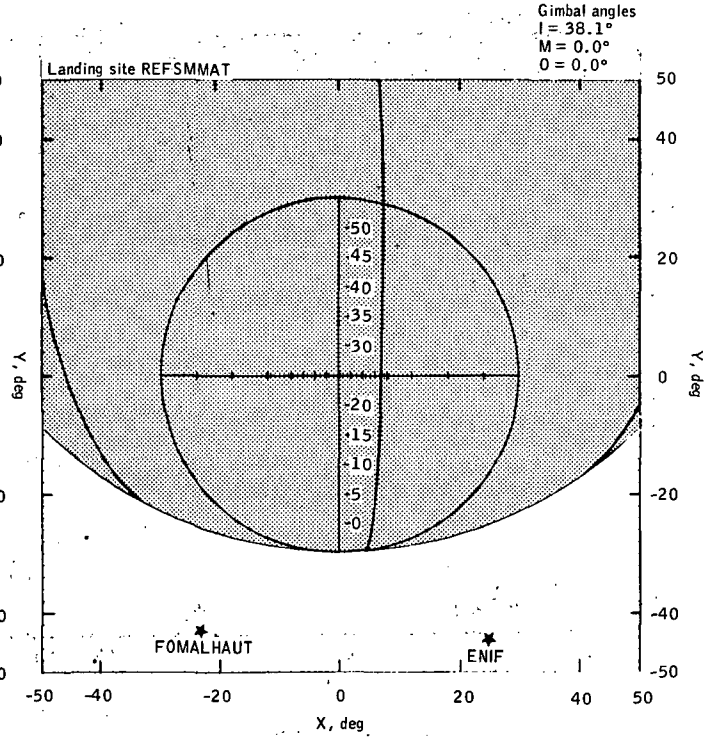

(c) g.e.t. = 99:40:00.

Figure 9.3-5.- Scanning telescope - rev 12.

Gimbal angles
I = 37.6°
M = 0.0°
O = 0.0°

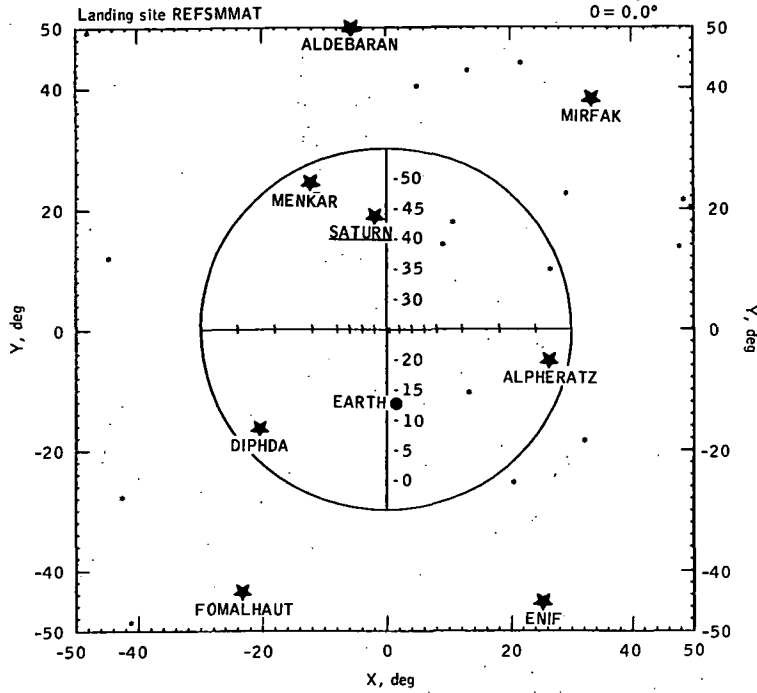

(a) g.e.t. = 101:00:00.

Gimbal angles
I = 37.6°
M = 0.0°
O = 0.0°

Gimbal angles
I = -33.0°
M = 0.0°
O = 0.0°

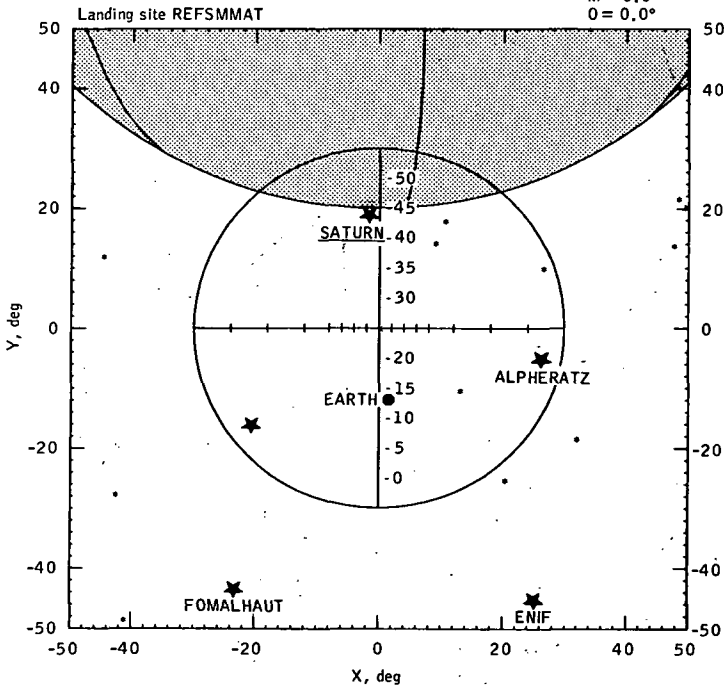

(b) g.e.t. = 101:20:00.

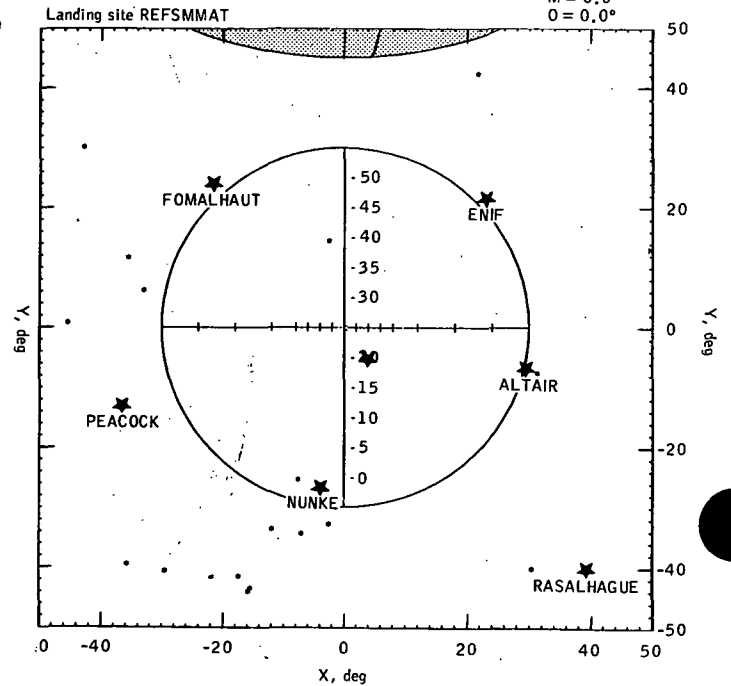

(c) g.e.t. = 101:35:00.

Figure 9.3-6.- Scanning telescope - rev 13.

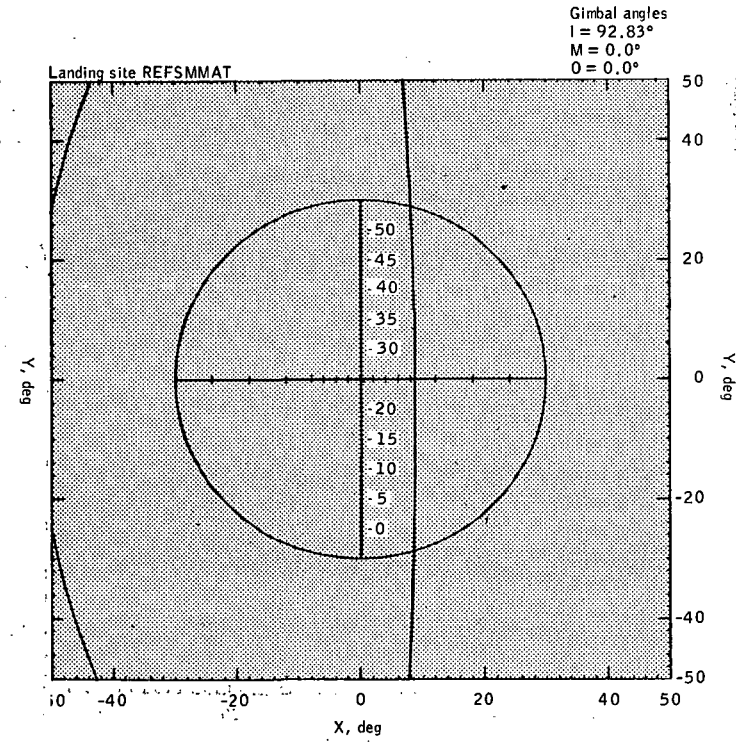
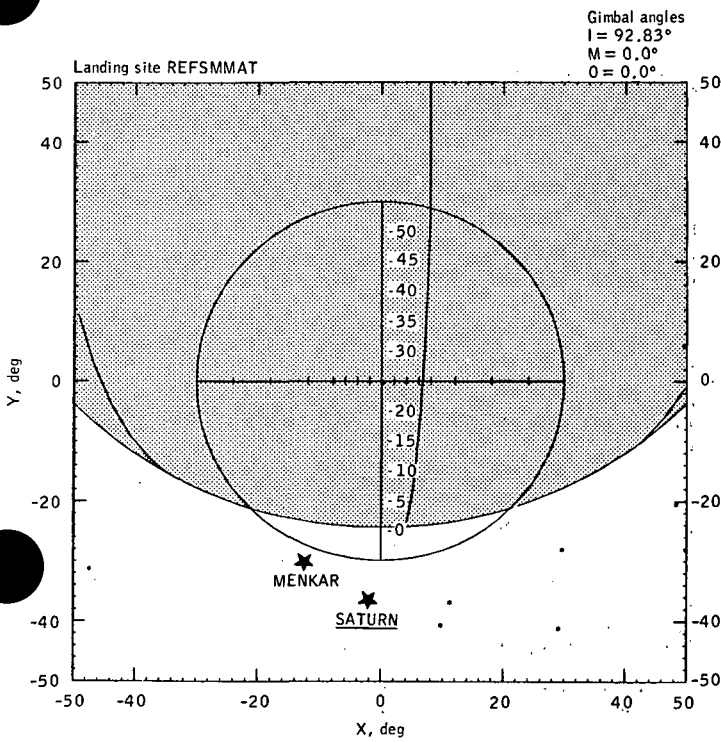
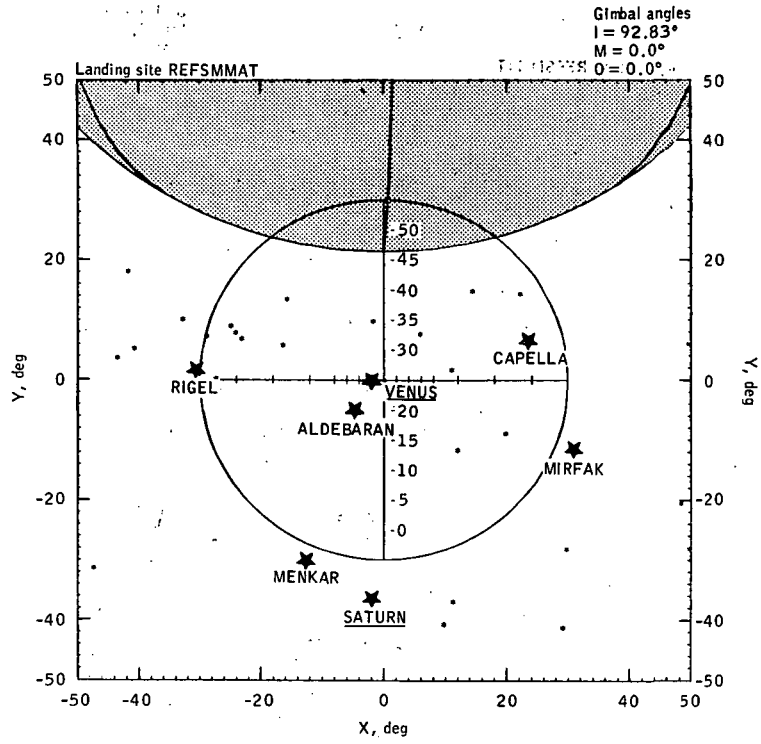
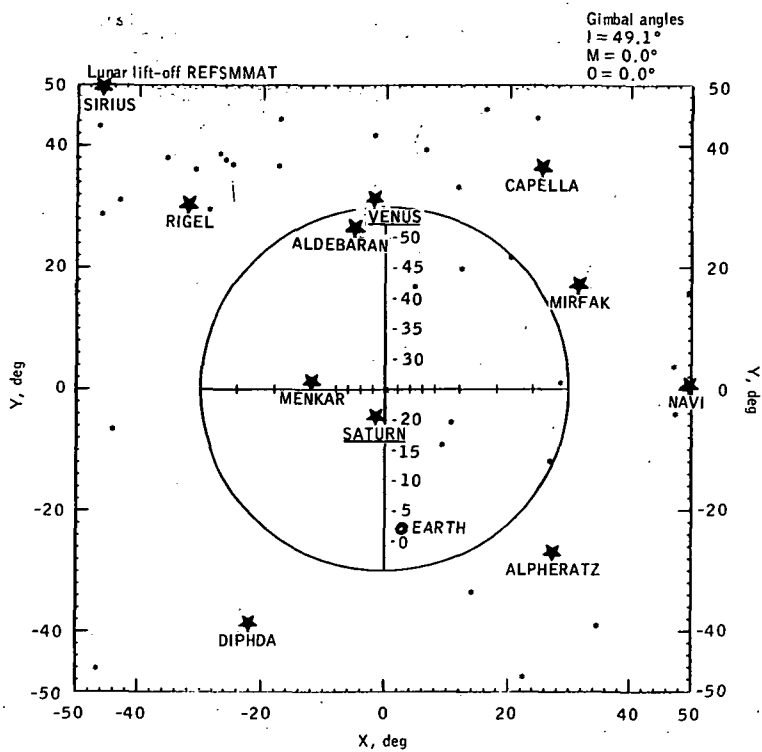
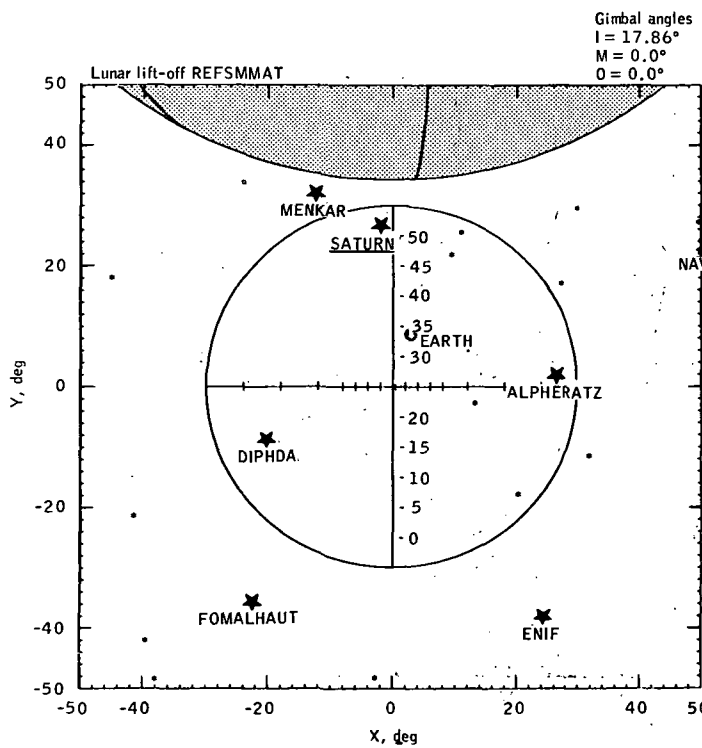

Figure 9.3-7.- Scanning telescope - rev. 14.



(a) g.e.t. = 124:40:00.



(b) g.e.t. = 125:00:00.

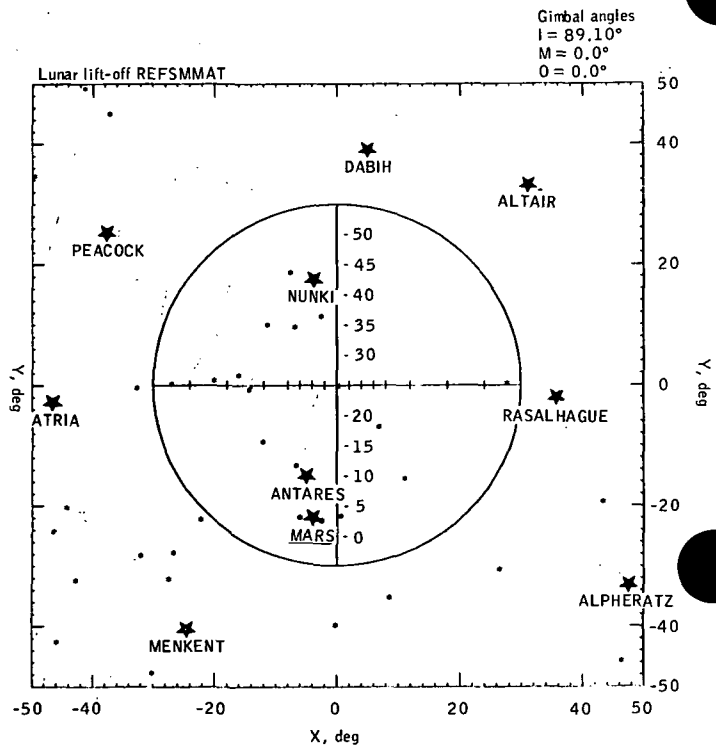

(c) g.e.t. = 125:15:00.

Figure 9.3-8.- Scanning telescope - rev 30.

Gimbal angles
 $I = 53.5^\circ$
 $M = 13.7^\circ$
 $O = 1.1^\circ$

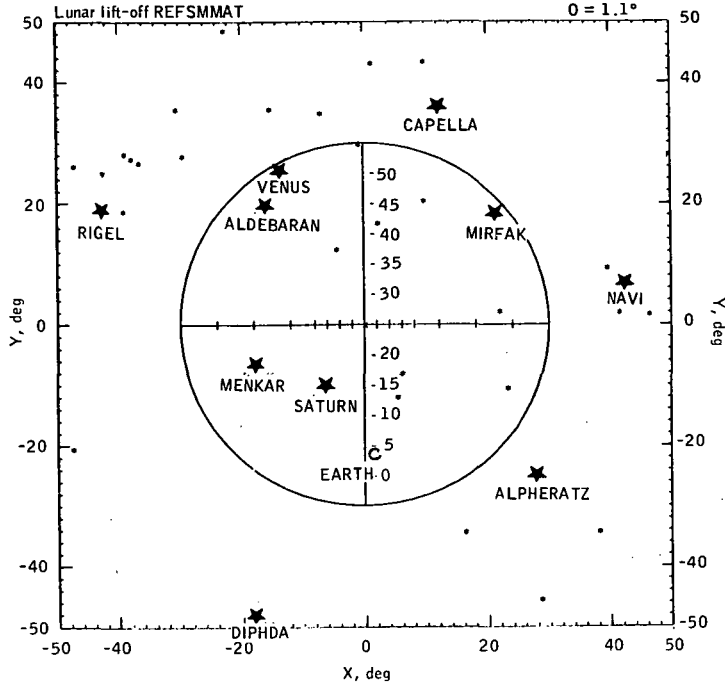

(a) g.e.t. = 134:35:00.

Gimbal angles
 $I = 53.5^\circ$
 $M = 13.7^\circ$
 $O = 1.1^\circ$

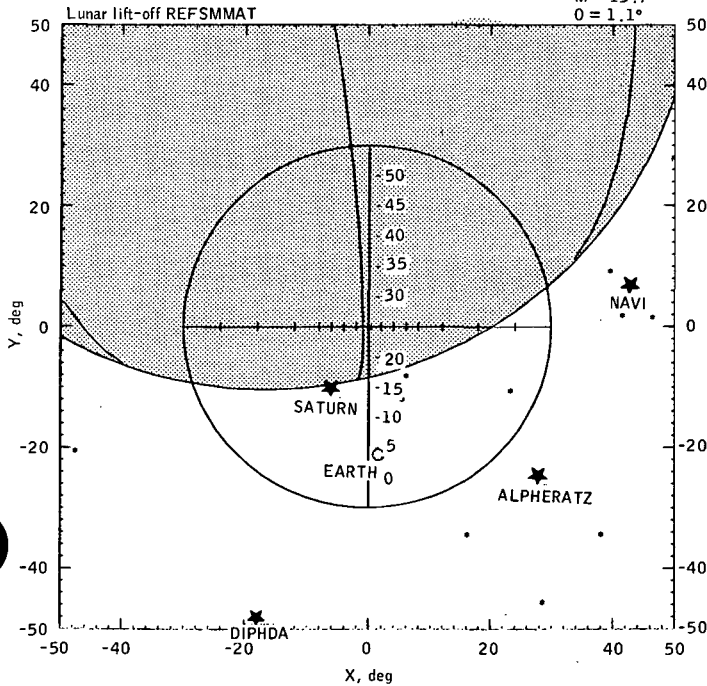

(b) g.e.t. = 134:55:00.

Gimbal angles
 $I = 53.5^\circ$
 $M = 13.7^\circ$
 $O = 1.1^\circ$

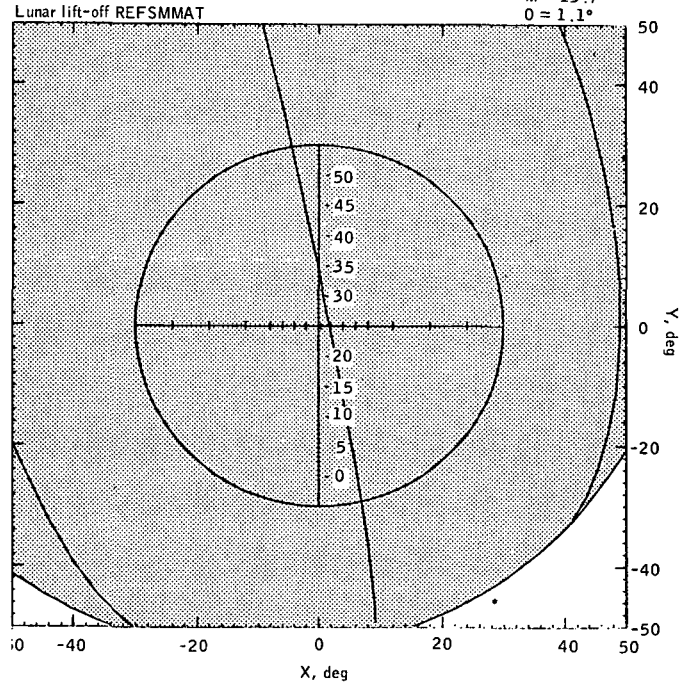

(c) g.e.t. = 135:10:00.

Figure 9.3-9. - Scanning telescope - rev 30.

Page intentionally left blank

Page intentionally left blank

Gimbal angles
 $I = 90.0^\circ$
 $M = 0.0^\circ$
 $O = 0.0^\circ$

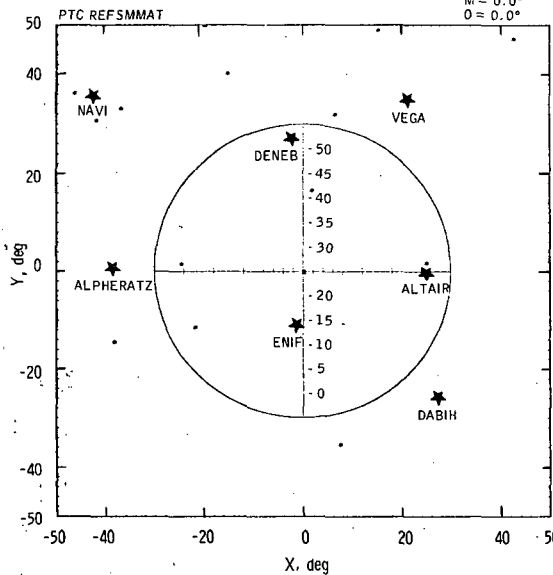

(a) Roll = 0° .

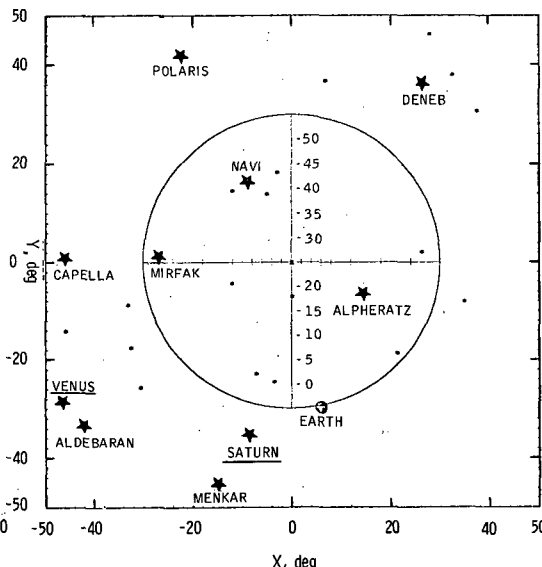

(b) Roll = 60° .

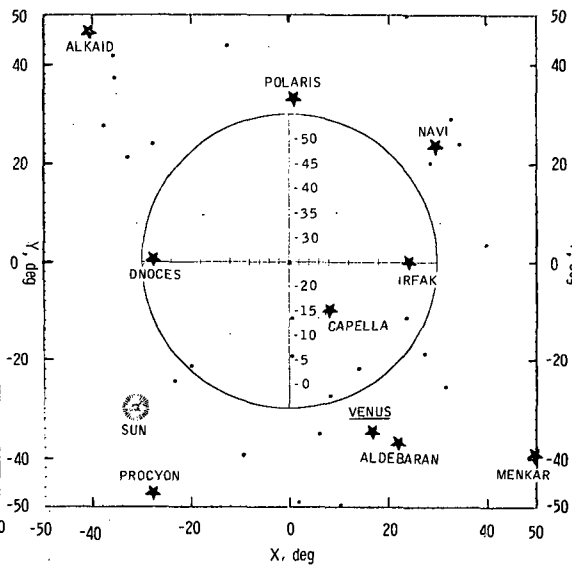

(c) Roll = 120° .

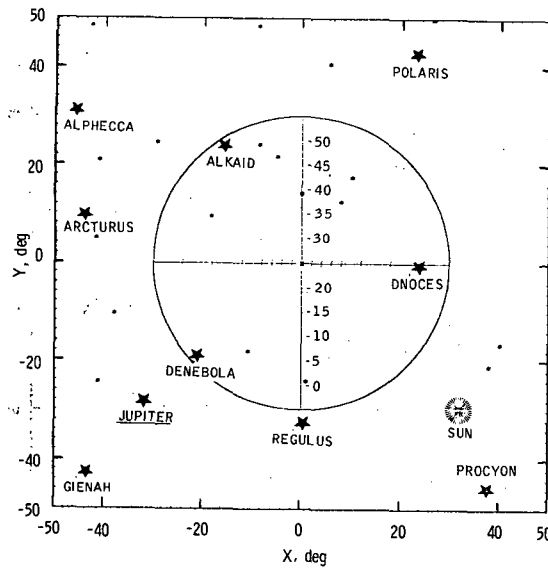

(d) Roll = 180° .

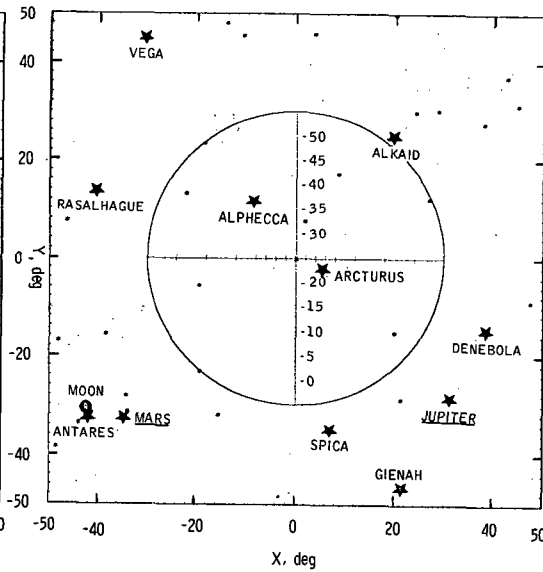

(e) Roll = 240° .

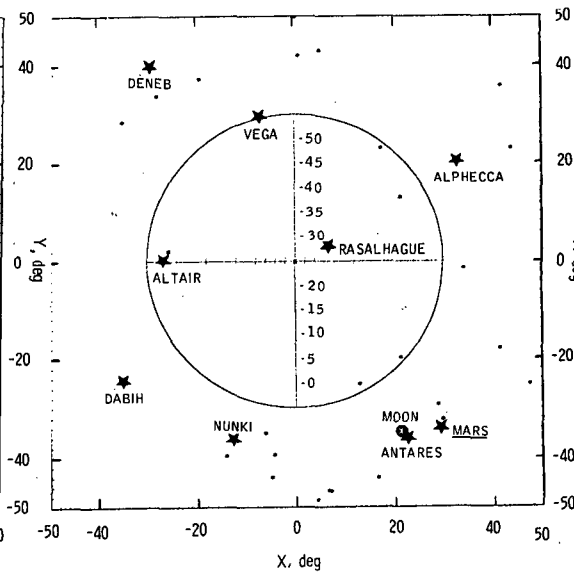

(f) Roll = 300° .

Figure 9.4-2. - Scanning telescope - PTC attitude (g. e. t. = 148:00:00).

Gimbal angles
 $I = 90.0^\circ$
 $M = 0.0^\circ$
 $O = 0.0^\circ$

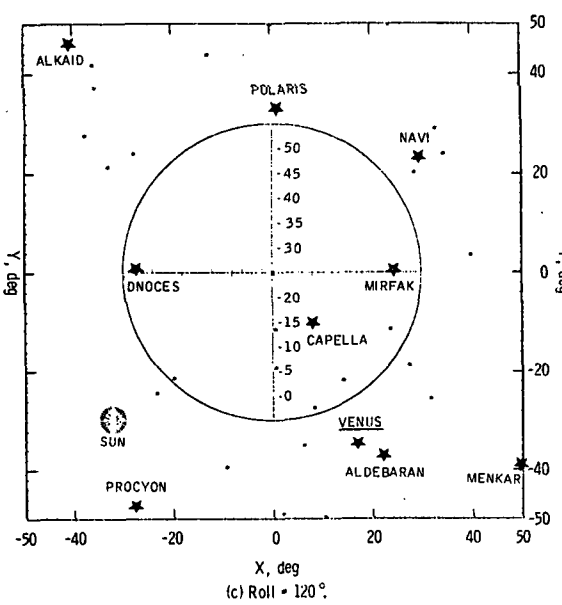
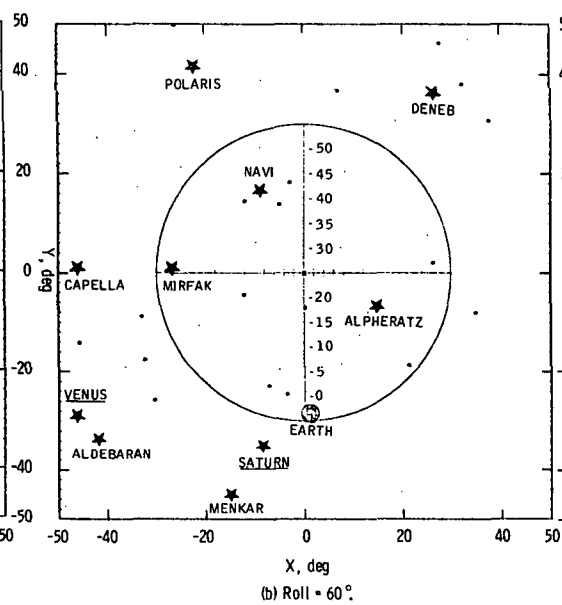
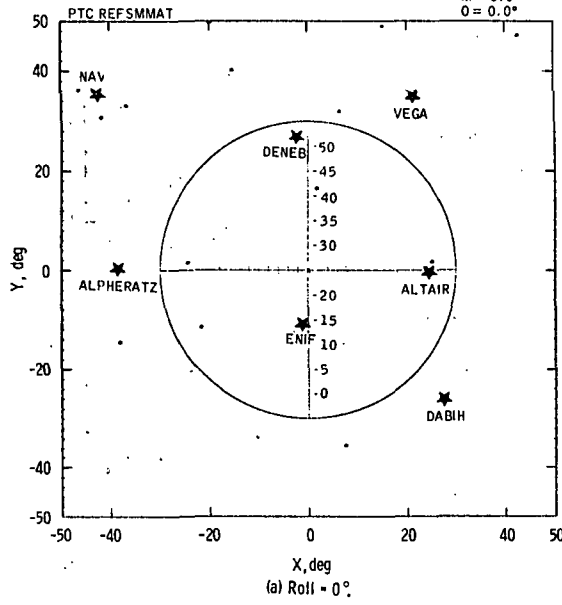

278

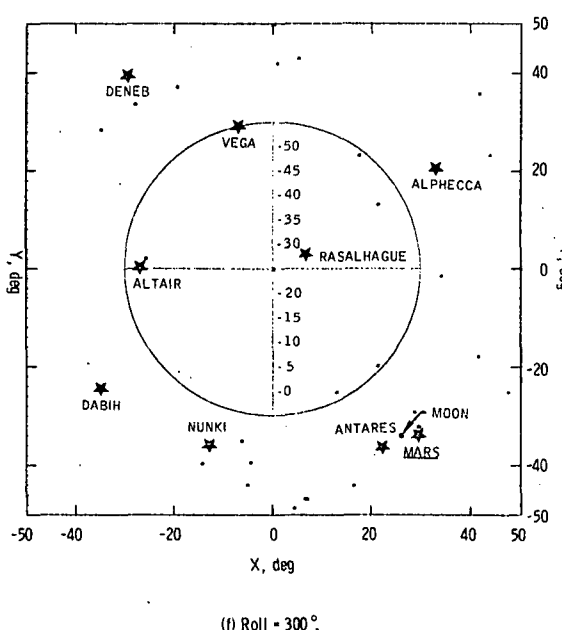
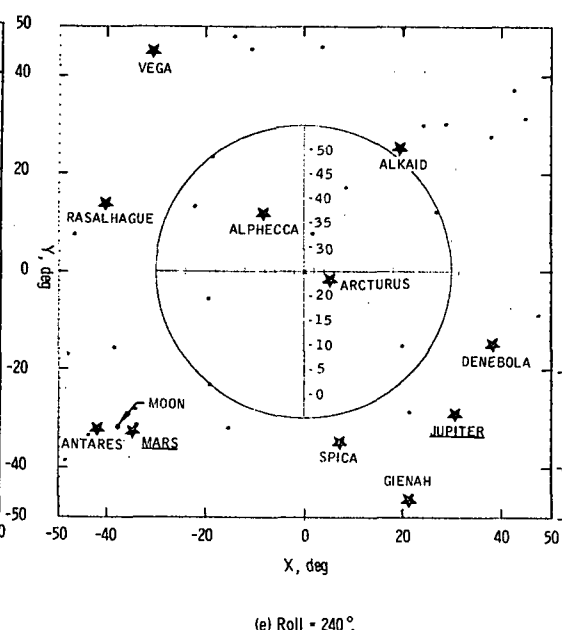
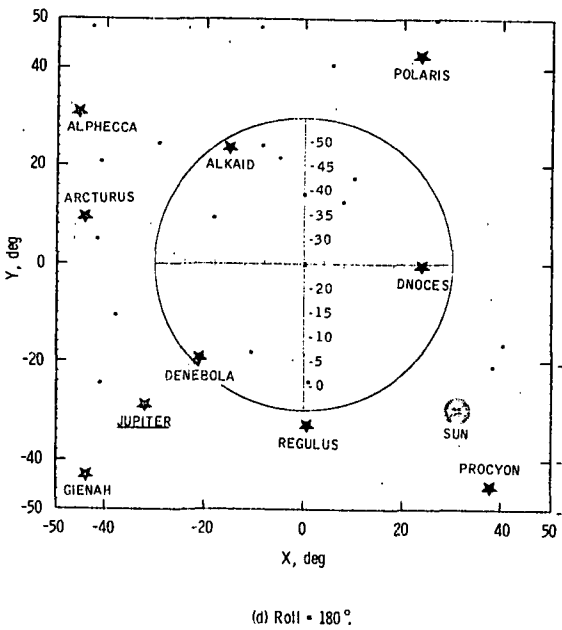

Figure 9.4-3. - Scanning telescope - PTC attitude (g. e. t. = 172:00:00).

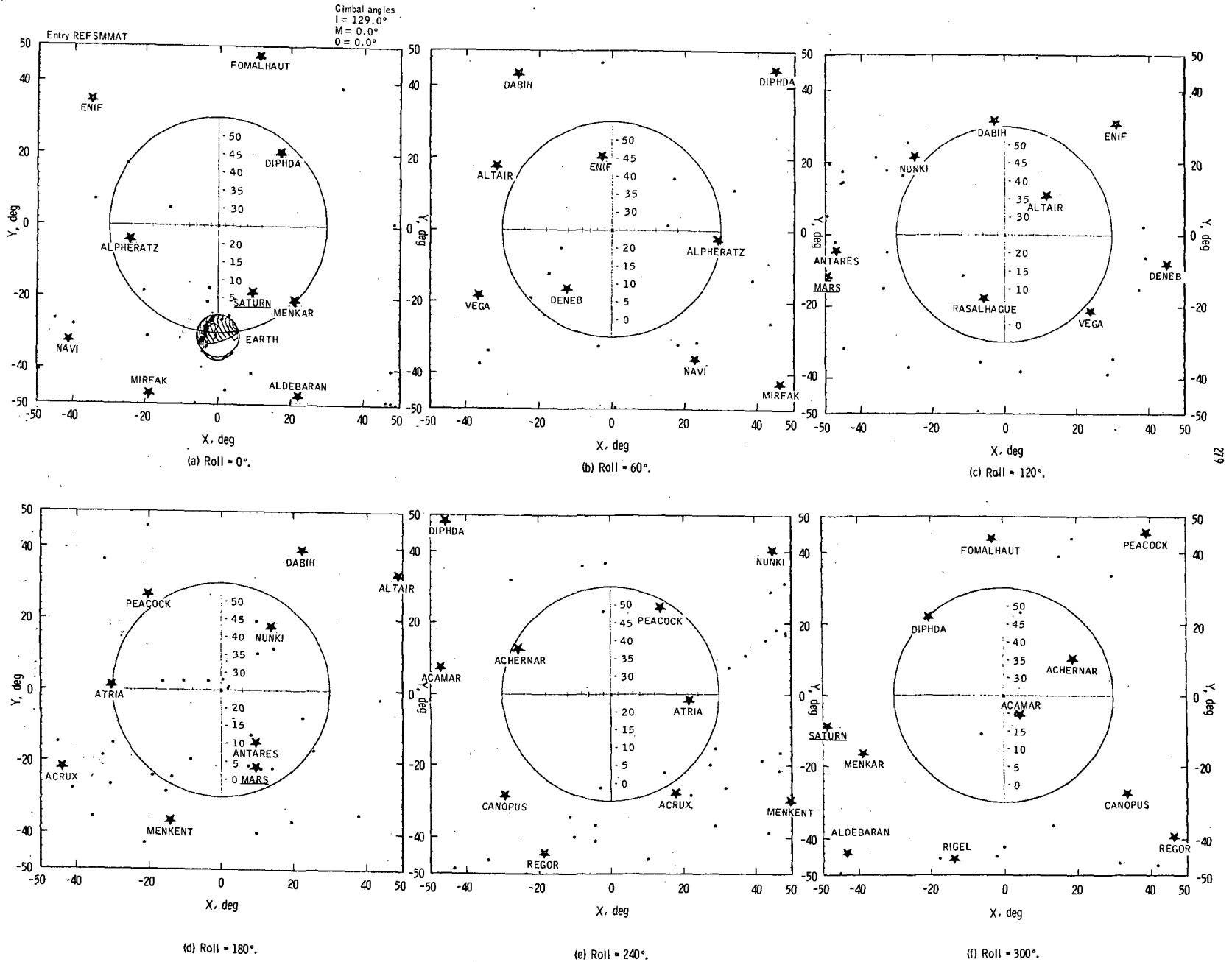

Figure 9.4-4. - Scanning telescope - E1 - \approx 4 hours (g. e. t. = 191:15:00).

Gimbal angles
 $I = 153.0^\circ$
 $M = 0.0^\circ$
 $O = 0.0^\circ$

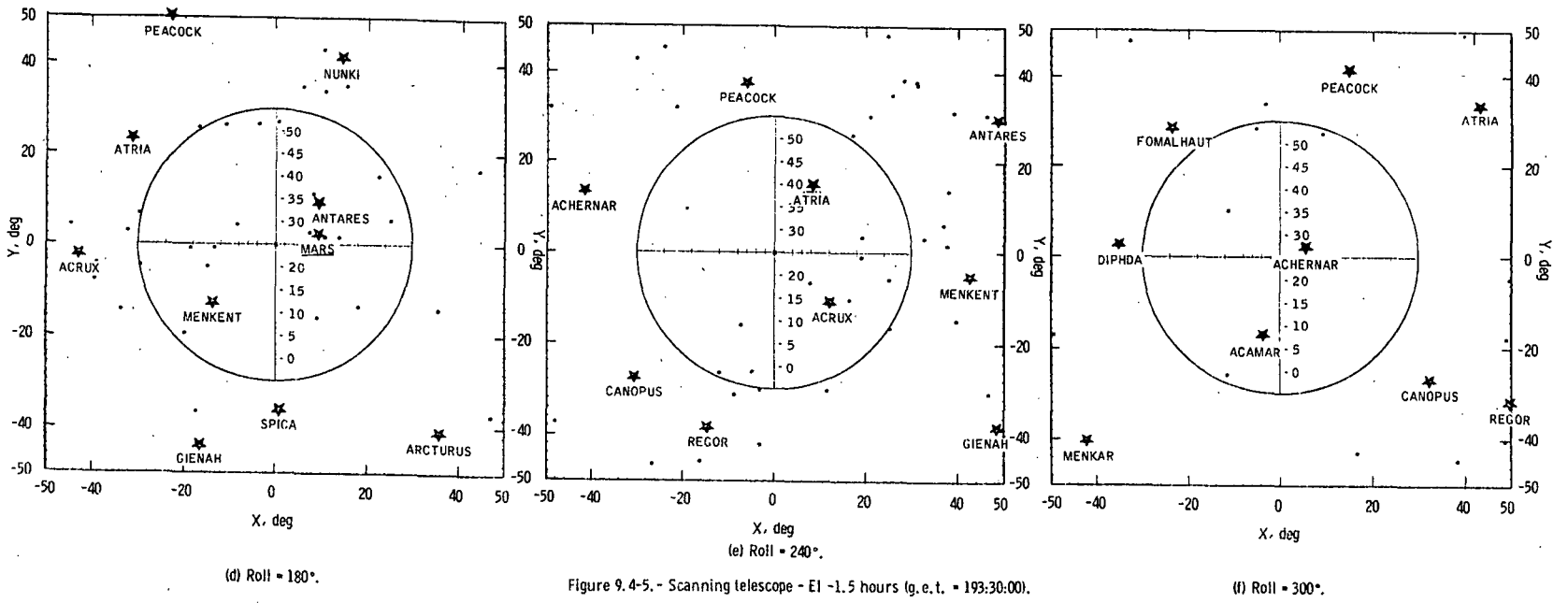
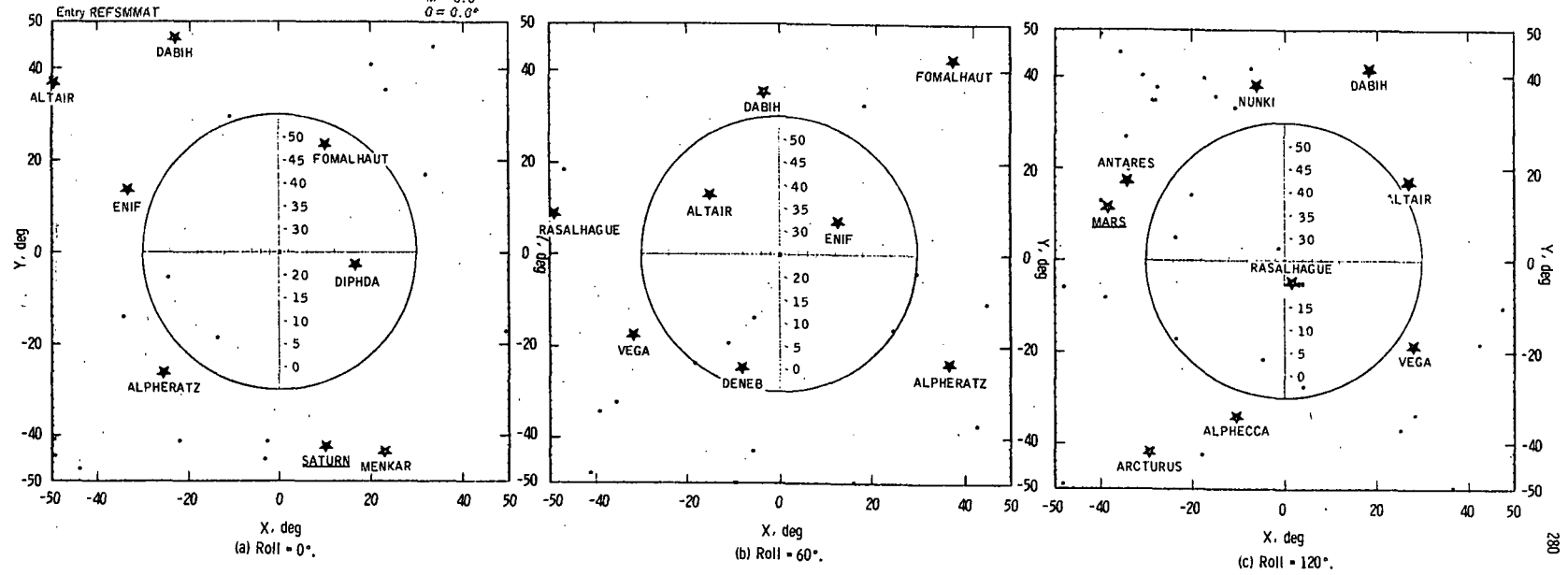

Figure 9.4-5. - Scanning telescope - E1 -1.5 hours (g. e. t. = 193:30:00).

Page intentionally left blank

10.0 VIEWS THROUGH ALINEMENT
OPTICAL TELESCOPE

11.0 STAR IDENTIFICATION CATALOGUE

12.0 REFERENCES

10.0 VIEWS THROUGH ALINEMENT
OPTICAL TELESCOPE

Page intentionally left blank

NOTE: 3 ADDITIONAL REAR DETENT VIEWING POSITIONS ARE AVAILABLE WHEN UNDOCKED.

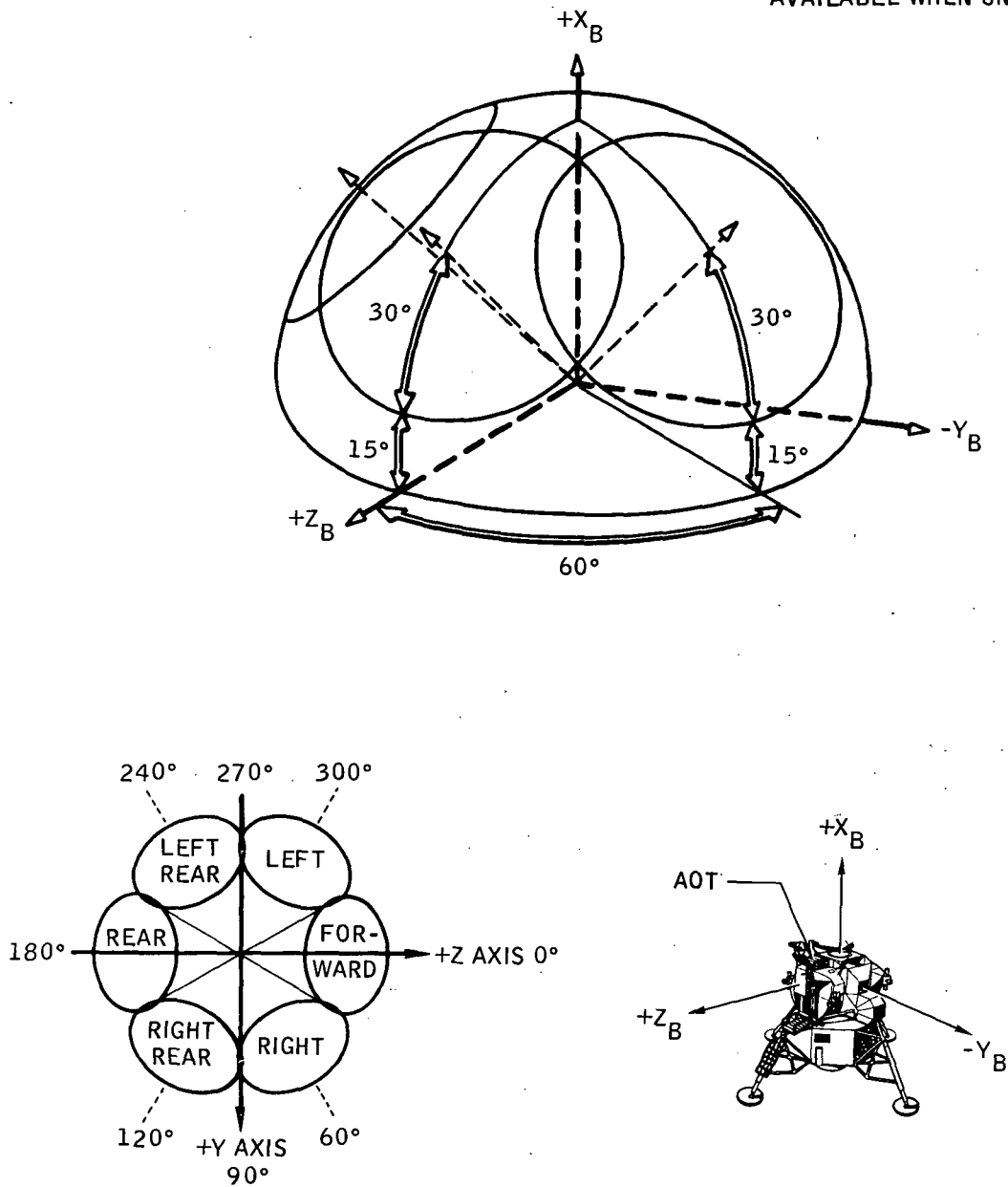
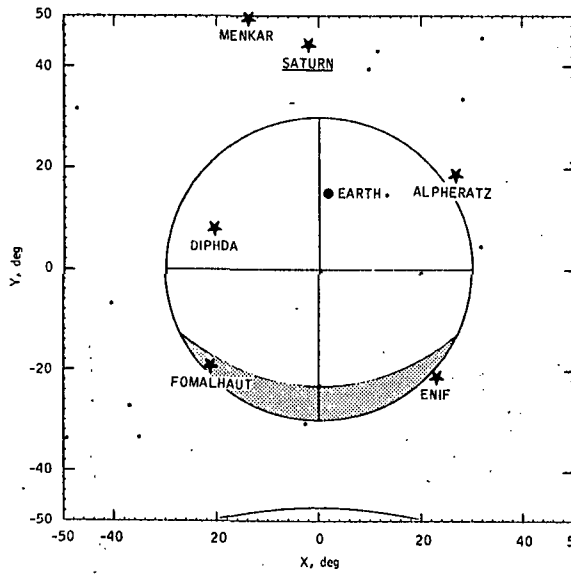
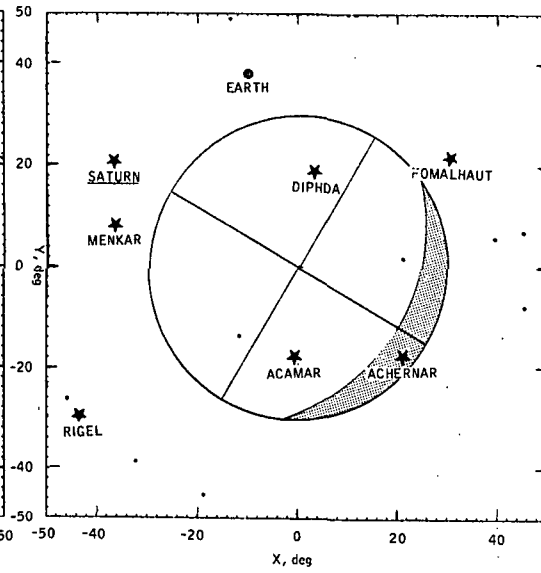

Figure 10.0-1.- Attitude constraint geometry of AOT viewing positions.



(a) AOT front detent position.



(b) AOT left front detent position.

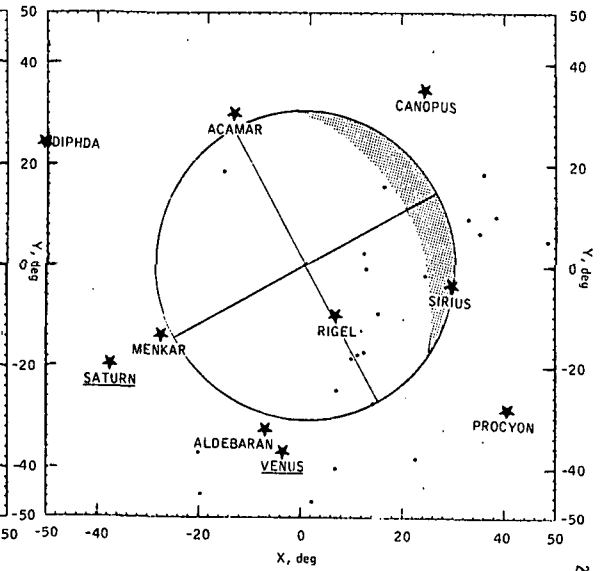

(c) AOT left rear detent position.

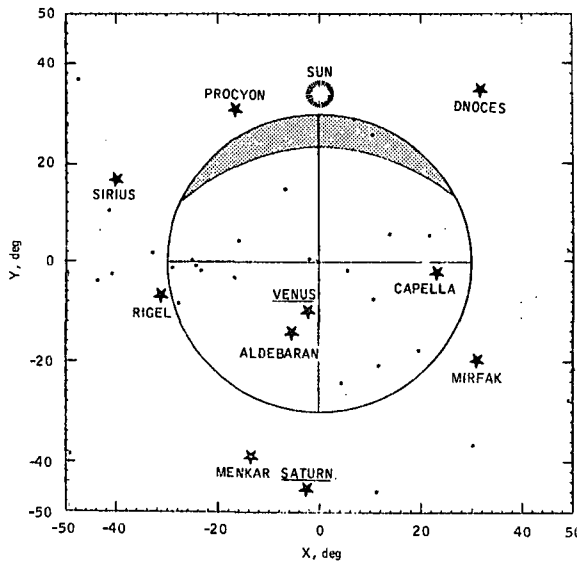

(d) AOT rear detent position.

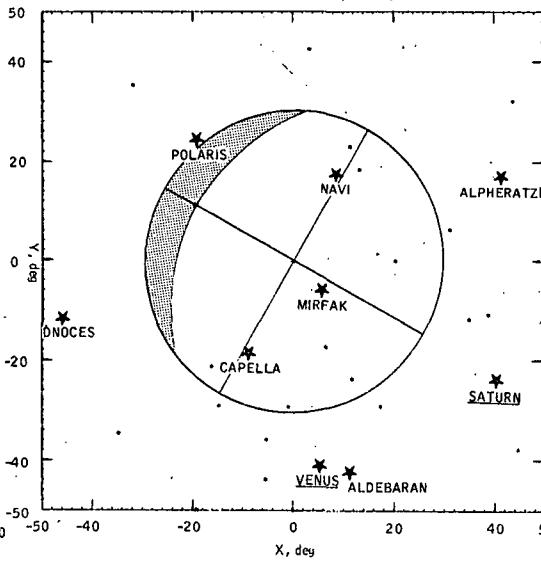

(e) AOT right rear detent position.

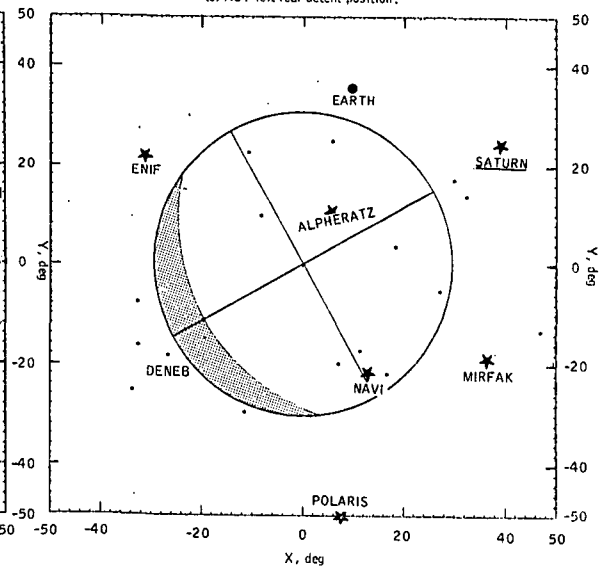

(f) AOT right front detent position.

Figure 10.0-2.- AOT views 2 hours after lunar landing.

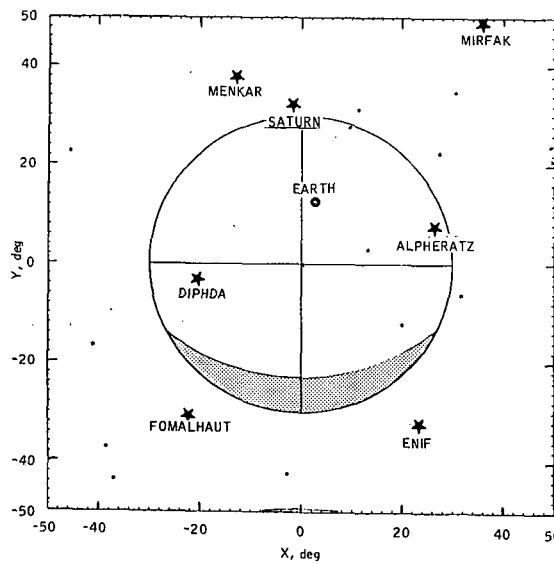

(a) AOT front detent position.

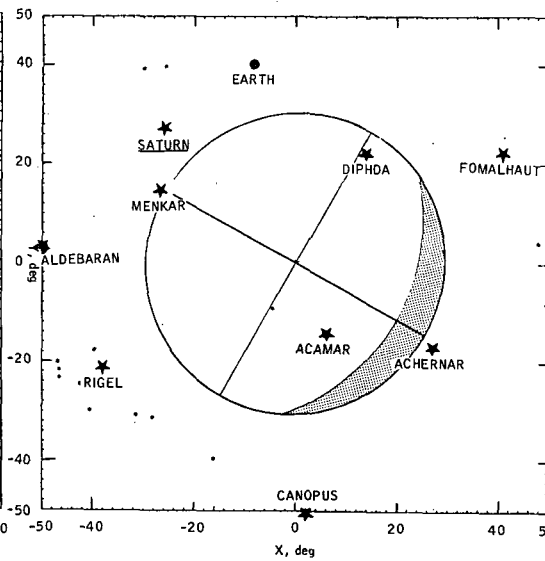

(b) AOT left front detent position.

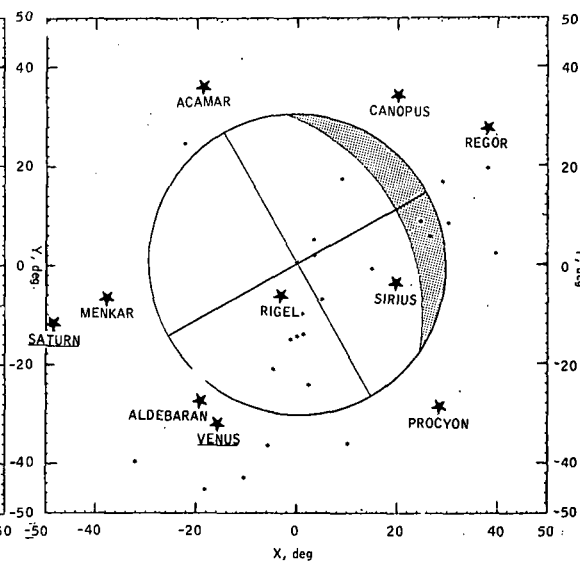

(c) AOT left rear detent position.

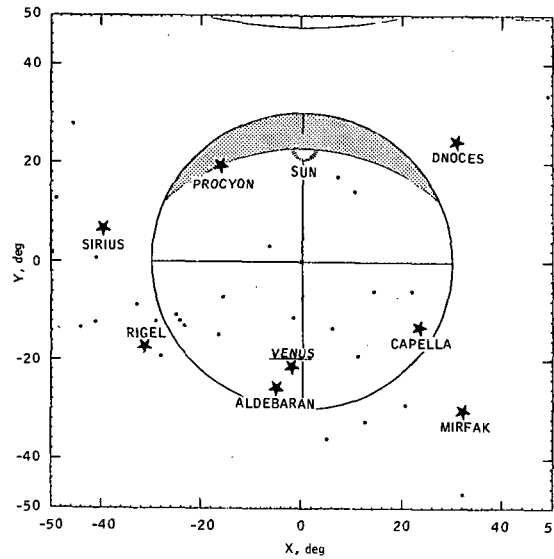

(d) AOT rear detent position.

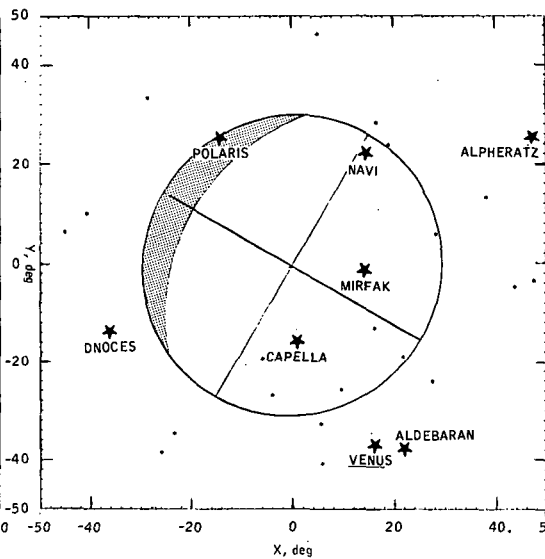

(e) AOT right rear detent position.

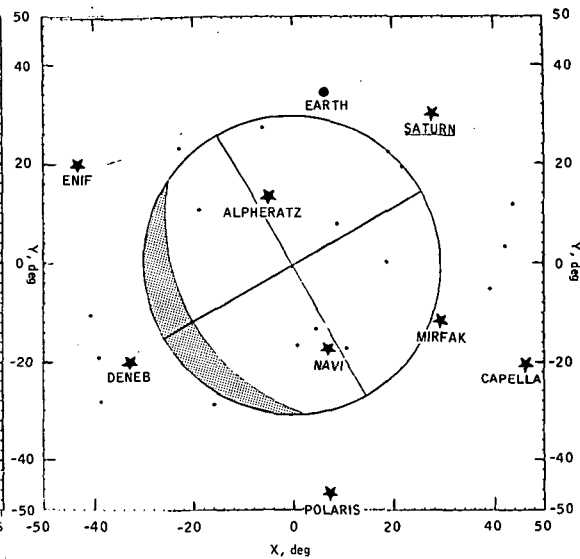

(f) AOT right front detent position.

Figure 10.0-3. - AOT views 2 hours prior to lunar lift-off.

Page intentionally left blank

11.0 STAR IDENTIFICATION CATALOGUE

Page intentionally left blank

STAR AND PLANET CATALOGUE

(a) RTCC star catalogue for Besselian year 1970

Star no.	Name				Right ascension, hr:min:sec	Declination, deg:min:sec	Magnitude
	IAU designation	Relative brightness and constellation ^a	Common name				
1	α And	α Andromedae	Alpheratz	0:06:49.9	+28:55:29	2.1	
2	β Cet	β Ceti	Diphda	0:42:05.0	-18:09:04	2.2	
3	γ Cas	γ Casseopeiae	--	0:54:53.0	+60:33:17	Varies	
4	α Eri	α Eridani	Acnurnar	1:36:35.9	-57:23:20	0.6	
5	α UMi	α Ursae Minoris	Polaris	2:03:18.9	+89:07:34	2.1	
6	θ Eri	θ Eridani	Acamar	2:57:07.4	-40:25:27	3.4	
7	α Cet	α Ceti	Menkar	3:00:42.5	+3:58:23	2.8	
8	α Per	α Percei	Mirfak	3:22:10.3	+49:45:21	1.9	
9	α Tau	α Tauri	Aldebaran	4:34:11.8	+16:27:01	1.1	
10	β Ori	β Orionis	Rigel	5:13:05.7	-8:14:06	0.3	
11	α Aur	α Aurigae	Capella	5:14:28.2	+45:58:10	0.2	
12	α Car	α Carinae	Canopus	6:23:17.1	-52:40:44	-0.9	
13	α CMa	α Canis Majoris	Sirius	6:43:49.6	-16:40:25	-1.6	
14	α CMi	α Canis Minoris	Procyon	7:37:43.9	+5:18:11	0.5	
15	γ ² Vel	γ ² Velorum	--	8:08:36.4	-47:14:51	1.9	
16	ι UMa	ι Ursae Majoris	--	8:57:09.7	+48:09:38	3.1	
17	α Hya	α Hydrae	Alphard	9:26:06.8	-8:31:40	2.2	
18	α Leo	α Leois	Regulus	10:06:46.5	+12:06:52	1.3	
19	β Leo	β Leois	Denebola	11:47:31.8	+14:44:23	2.2	
20	γ Crv	γ Corvi	--	12:14:15.6	-17:22:32	2.8	
21	α ¹ Cru	α ¹ Crucis	Acrux	12:24:59.4	-62:55:59	1.0	
22	α Vir	α Virginis	Spica	13:23:36.6	-11:00:19	1.2	
23	η UMa	η Ursae Majoris	Alkaid	13:46:21.6	+49:27:45	1.9	
24	θ Cen	θ Centauri	Menkent	14:04:54.6	-36:13:23	2.3	
25	α Boo	α Boötis	Arcturus	14:14:17.5	+19:20:16	0.2	
26	α CrB	α Coronae Borealis	Alphecca	15:33:25.0	+26:48:53	2.3	
27	α Sco	α Scorpii	Antares	16:27:33.9	-26:22:01	1.2	
28	α TrA	α Trianguli Australis	Atria	16:45:28.3	-68:58:31	1.9	
29	α Oph	α Ophiuchi	Rasalague	17:33:32.4	+12:34:50	2.1	
30	α Lyr	α Lyrae	Vega	18:35:55.3	+38:45:17	0.1	
31	σ Sgr	σ Sagittarii	Nunki	18:53:24.3	-26:20:08	2.1	
32	α Aql	α Aquilae	Altair	19:49:19.1	+8:47:16	0.9	
33	β Cap	β Capricorni	--	20:19:19.6	-14:52:38	3.2	
34	α Pav	α Pavonis	Peacock	20:23:17.0	-56:49:58	2.1	
35	α Cyg	α Cygni	Deneb	20:40:24.4	+45:10:21	1.3	

^aThe earlier Greek letters are assigned to the stars roughly in order of brightness; there are exceptions. Magnitudes should be used for mission planning.

TABLE STAR AND PLANET CATALOGUE - Continued

(a) RTCC star catalogue for Besselian year 1970 - Continued

Star no.	Name			Right ascension, hr:min:sec	Declination, deg:min:sec	Magnitude
	IAU designation	Relative brightness and constellation ^a	Common name			
36	ε Peg	ε Pegasi	Enif	21:42:42.7	+9:44:12	2.5
37	α PsA	α Piscis Austrini	Formalhaut	22:55:59.7	-29:46:54	1.3
38	α Ari	α Arietis	Hamal	2:05:28.6	+23:19:17	2.2
39	α For	α Fornacis	--	3:10:47.7	-29:06:16	3.9
40	β Gem	β Geminorum	Pollux	7:43:29.0	+28:06:00	1.2
41	β Car	β Carinae	Miaplacidus	9:12:52.8	-69:35:37	1.8
42	α U Ma	α Ursae Majoris	Dubhe	11:01:53.4	+61:54:48	1.9
43	γ Cen	γ Centauri	--	12:39:51.2	-48:47:43	2.4
44	α Cen	α Centauri	Rigel Kent	14:37:32.9	-60:42:46	0.1
45	α Ori	α Orionis	Betelgeuse	5:53:32.8	+7:24:10	0 to 1.
46	β Cen	β Centauri	Hadar	14:01:41.4	-60:13:45	0.9
47	γ Ori	γ Orionis	Bellatrix	5:23:31.2	+6:19:26	1.7
48	β Tau	β Tauri	El Nath	5:24:23.6	+28:35:01	1.8
49	ε Ori	ε Orionis	Alni Lam	5:34:41.4	-1:13:11	1.7
50	ζ Ori	ζ Orionis	Alnitak	5:39:14.6	-1:57:26	2.0
51	β CMa	β Canis Majoris	Murzim	6:21:22.7	-17:56:24	2.0
52	γ Gem	γ Geminorum	Alhena	6:35:58.8	+16:25:35	1.9
53	ε CMa	ε Canis Majoris	Adhera	6:57:26.8	-28:55:49	1.6
54	δ CMa	δ Canis Majoris	Al Wazor	7:07:10.3	-26:20:40	2.0
55	α Gem	α Geminorum	Castor	7:32:41.2	+31:57:19	1.6
56	ε Car	ε Carinae	Avior	8:21:54.0	-59:24:45	1.7
57	δ Vel	δ Velorum	--	8:43:52.5	-54:35:53	2.0
58	γ Cru	γ Crucis	Gacrux	12:29:29.4	-56:56:44	1.6
59	β Cru	β Crucis	Becrux	12:45:57.3	-59:31:30	1.5
60	ε UMa	ε Ursae Majoris	Alioth	12:52:42.8	+56:07:20	1.7
61	λ Sco	λ Scorpii	Shaula	17:31:34.1	-37:05:01	1.7
62	θ Sco	θ Scorpii	--	17:35:09.6	-42:58:50	2.0
63	ε Sgr	ε Sagittarii	Kaus Aust	18:22:10.8	-34:24:02	1.9
64	β Cas	β Cassiopeiae	Caph	0:07:33.9	+58:59:04	2.4
65	α Phe	α Phoenicis	Ankaa	0:24:48.2	-42:28:08	2.4
66	β And	β Andromedae	Mirach	1:08:02.7	+35:27:43	2.4
67	γ ¹ And	γ ¹ Andromedae	Almach	2:02:03.0	+42:11:12	2.3
68	δ Ori	δ Orionis	Mintaka	5:30:28.4	-0:19:12	2.5
69	κ Ori	κ Orionis	Saiph	5:46:20.0	-9:40:45	2.2
70	β Aur	β Aurigae	Menkalinan	5:57:19.7	+44:56:47	2.1

^aThe earlier Greek letters are assigned to the stars roughly in order of brightness; there are exceptions. Magnitudes should be used for mission planning.

STAR AND PLANET CATALOGUE - Continued

(a) RTCC star catalogue for Besselian year 1970 - Continued

Star no.	Name			Common name	Right ascension, hr:min:sec	Declination, deg:min:sec	Magnitude
	IAU designation	Relative brightness and constellation ^a					
71	η CMa	η Canis Majoris	Aludra	7:22:54.5	-29:14:37	2.4	
72	ζ Pup	ζ Puppis	--	8:02:31.8	-39:55:04	2.3	
73	λ Vel	λ Velorum	Suhail	9:06:53.5	-43:18:39	2.2	
74	ι Car	ι Carinae	--	9:16:17.3	-59:08:57	2.2	
75	β UMa	β Ursae Majoris	Merak	11:00:02.5	+56:32:37	2.4	
76	ζ UMa	ζ Ursae Majoris	Mizar	13:22:43.2	+55:04:53	2.4	
77	β UMi	β Ursae Minoris	Kochab	14:50:46.5	+74:16:41	2.2	
78	γ Dra	γ Draconis	Eltanin	17:55:54.5	+51:29:30	2.4	
79	γ Cyg	γ Cygni	Sadr	20:21:09.0	+40:09:35	2.3	
80	α Gru	α Gruis	Al Na'ir	22:06:20.9	-47:06:26	2.2	
81	β Gru	β Gruis	--	22:40:52.9	-47:02:32	2.2	
82	α Cas	α Cassiopeiae	Schedar	0:38:47.6	+56:22:23	2.3	
83	γ UMa	γ Ursae Majoris	Phecda	11:52:15.6	+53:51:41	2.5	
84	δ Sco	δ Scorpii	--	15:58:33.3	-22:32:16	2.5	
85	ε Sco	ε Scorpii	--	16:48:13.0	-34:14:25	2.4	
86	γ Peg	γ Pegasi	--	0:11:41.3	+15:01:01	2.9	
87	κ Sco	κ Scorpii	--	17:40:24.5	-39:00:59	2.5	
88	δ Cas	δ Cassiopeiae	--	1:23:50.2	+60:04:48	2.8	
89	β Ari	β Arietis	--	1:52:58.7	+20:39:43	2.7	
90	η Tau	η Tauri	--	3:45:41.8	+24:00:49	3.0	
91	ζ Per	ζ Persei	--	3:52:14.5	+31:47:45	2.9	
92	ε Per	ε Persei	--	3:55:50.1	+39:55:30	3.0	
93	ι Aur	ι Aurigae	--	4:55:02.2	+33:07:13	2.9	
94	β Eri	β Eridani	--	5:06:22.4	-5:07:26	2.9	
95	β Lep	β Leporis	--	5:26:57.6	-20:46:56	3.0	
96	α Lep	α Leporis	--	5:31:24.4	-17:50:33	2.7	
97	ι Ori	ι Orionis	--	5:33:57.9	-5:55:42	2.9	
98	ζ Tau	ζ Tauri	--	5:35:51.0	+21:07:33	3.0	
99	α Col	α Columbae	--	5:38:33.7	-34:05:21	2.7	
100	θ Aur	θ Aurigae	--	5:57:40.5	+37:12:44	2.7	
101	τ Pup	τ Puppis	--	6:49:11.4	-50:34:42	2.8	
102	π Pup	π Puppis	--	7:16:05.0	-37:02:34	2.7	
103	ρ Pup	ρ Puppis	--	8:06:15.9	-24:13:01	2.9	
104	κ Vel	κ Velorum	--	9:21:11.0	-54:52:56	2.6	
105	γ ¹ Leo	γ ¹ Leonis	--	10:18:19.3	+19:59:38	2.6	
106	μ Vel	μ Velorum	--	10:45:28.5	-49:15:41	2.8	

^aThe earlier Greek letters are assigned to the stars roughly in order of brightness; there are exceptions. Magnitudes should be used for mission planning.

STAR AND PLANET CATALOGUE - Continued

(a) RTCC star catalogue for Besselian year 1970 - Continued

Star no.	Name			Common name	Right ascension, hr:min:sec	Declination, deg:min:sec	Magnitude
	IAU designation	Relative brightness and constellation ^a					
107	δ Leo	δ Leois	--		11:12:30.9	+20:41:18	2.6
108	β Crv	β Corvi	--		12:32:48.4	-23:13:52	2.8
109	α Mus	α Muscae	--		12:35:22.6	-68:58:14	2.9
110	γ Vir	γ Virgo	--		12:40:08.3	-1:17:07	2.9
111	α ² CVn	α ² Canes Venatici	--		12:54:37.6	+38:28:48	2.9
112	ε Vir	ε Virginis	--		13:00:41.0	+11:07:12	2.9
113	ι Cen	ι Centauri	--		13:18:54.2	-36:33:17	2.9
114	ε Cen	ε Centauri	--		13:37:58.5	-53:18:52	2.6
115	η Boo	η Boötis	--		13:53:15.3	+18:32:51	2.8
116	γ Boo	γ Boötis	--		14:30:52.2	+38:26:19	3.0
117	η Cen	η Centauri	--		14:33:35.6	-42:01:37	2.6
118	α Lup	α Luporis	--		14:39:55.5	-47:15:38	2.9
119	ε Boo	ε Boötis	--		14:43:40.6	+27:11:59	2.7
120	α ² Lib	α ² Librae	Zuben'ubi		14:49:12.9	-15:55:05	2.9
121	β Lup	β Lupi	--		14:56:33.5	-43:00:52	2.8
122	β Lib	β Librae	--		15:15:23.3	-9:16:24	2.7
123	γ Lup	γ Lupi	--		15:33:08.0	-41:04:02	2.9
124	α Ser	α Serpentis	--		15:42:47.3	+6:31:08	2.7
125	π Sco	π Scorpii	--		15:57:01.9	-26:01:45	3.0
126	β ¹ Sco	β ¹ Scorpii	--		16:03:41.3	-19:43:29	2.9
127	η Dra	η Draconis	--		16:23:34.8	+61:34:54	2.9
128	β Her	β Herculis	--		16:28:55.7	+21:33:14	2.8
129	τ Sco	τ Scorpii	--		16:34:00.6	-28:09:19	2.9
130	ζ Oph	ζ Ophiuchi	--		16:35:30.2	-10:30:28	2.7
131	ζ Her	ζ Herculis	--		16:40:09.3	+31:39:22	3.0
132	η Oph	η Ophiuchi	Sabik		17:08:39.3	-15:41:22	2.6
133	β Ara	β Arae	--		17:22:48.0	-55:30:13	2.8
134	ν Sco	ν Scorpii	--		17:28:43.3	-37:16:25	2.8
135	α Ara	α Arae	--		17:29:31.1	-49:51:16	3.0
136	β Dra	β Draconis	--		17:29:45.2	+52:19:22	3.0
137	β Oph	β Ophiuchi	--		17:41:59.3	+4:34:42	2.9
138	δ Sgr	δ Sagittarii	--		18:19:04.4	-29:50:33	2.8
139	λ Sgr	λ Sagittarii	--		18:26:07.1	-25:26:24	2.9
140	ζ Sgr	ζ Sagittarii	--		19:00:42.2	-29:55:29	2.7
141	δ Cyg	δ Cygni	--		19:44:02.1	+45:03:24	3.0
142	γ Aql	γ Aquilae	--		19:44:49.9	+10:32:20	2.8

^aThe earlier Greek letters are assigned to the stars roughly in order of brightness; there are exceptions. Magnitudes should be used for mission planning.

STAR AND PLANET CATALOGUE - Concluded

(a) RTCC star catalogue for Besselian year 1970 - Concluded

Star no.	IAU designation	Name		Right ascension, hr:min:sec	Declination, deg:min:sec	Magnitude
		^a Relative brightness and constellation	Common name			
143	ε Cyg	ε Cygni	--	20:44:59.7	+33:51:25	2.6
144	α Cep	α Cephei	--	21:17:51.8	+62:27:29	2.6
145	δ Cap	δ Capricorni	--	21:45:23.2	-16:15:51	3.0
146	α Tuc	α Tucanae	--	22:16:27.6	-60:24:36	2.9
147	β Peg	β Pegasi	--	23:02:19.0	+27:55:11	2.6
148	α Peg	α Pegasi	Markab	23:03:15.8	+15:02:36	2.6

(b) Planets

No.	Name	Right ascension, hr:min:sec	Declination, hr:min:sec
1	Venus	4:52:16.98	20:01:45.2
2	Mars	15:59:22.95	-24:01:01.5
3	Jupiter	12:04:13.881	0:52:22.31
4	Saturn	2:25:56.208	11:54:00.30

^aThe earlier Greek letters are assigned to the stars roughly in order of brightness; there are exceptions. Magnitudes should be used for mission planning.

Page intentionally left blank

Page intentionally left blank

12.0 REFERENCES

Page intentionally left blank

Page intentionally left blank

APPENDIX
MAJOR APOLLO F AND G MILESTONES
FOR THE CONTINGENCY ANALYSIS SECTION

Page intentionally left blank

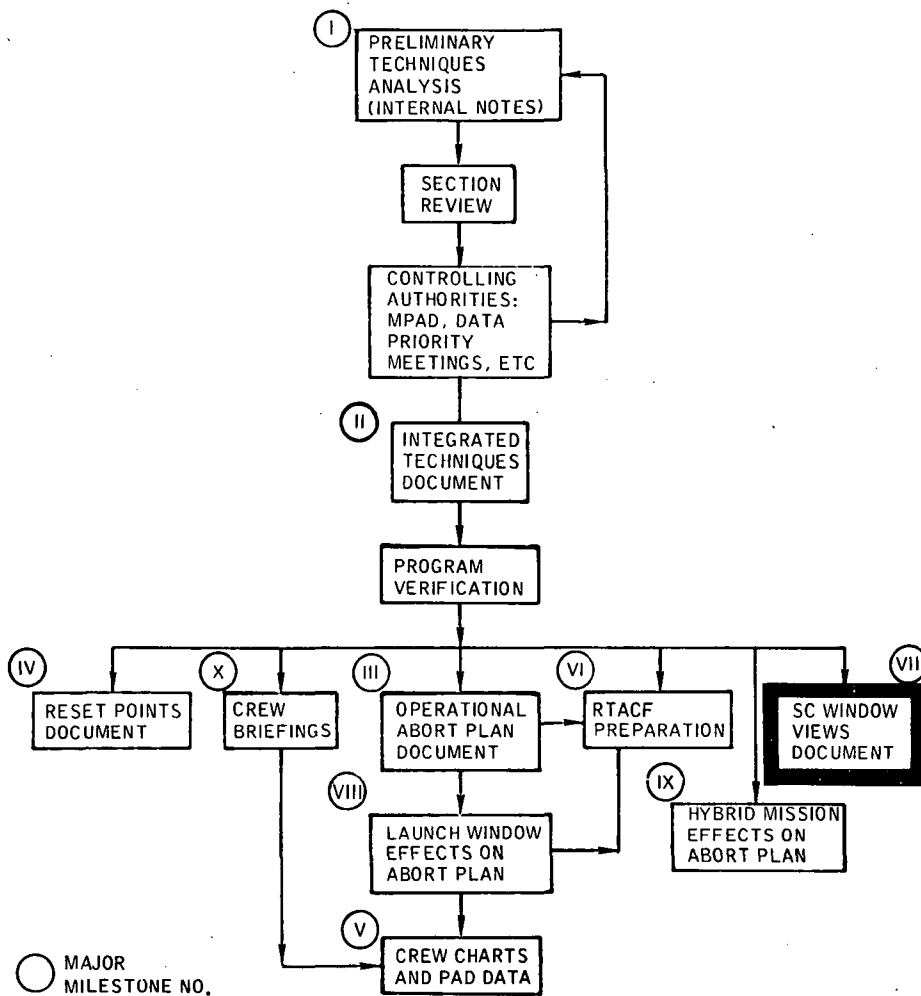

MAJOR MILESTONES

- I. PRELIMINARY CONTINGENCY TECHNIQUES
(PRELIMINARY PROCEDURES TO BE FOLLOWED BY CREW AND GROUND)
- II. INTEGRATED CONTINGENCY (ABORT) TECHNIQUES DOCUMENT
(DEFINES DETAILED PROCEDURES TO BE FOLLOWED BY CREW AND GROUND)
- III. OPERATIONAL ABORT PLAN DOCUMENT
(PROVIDES DETAILED ABORT SOLUTIONS AND ASSOCIATED DATA FOR THE PRIMARY LAUNCH OPPORTUNITY)
- IV. RESET POINTS DOCUMENT
(INSURES CREW/RTCC SIMULATION OF ABORTS ARE COMPATIBLE AND PROVIDES DRIVER FOR SIMULATION)
- V. CREW CHARTS AND PAD DATA
(PROVIDES FINAL PLOTS AND CHARTS CREW NEEDS TO CARRY OUT OPERATIONAL ABORT PLAN; INCLUDES LAUNCH, TLI MONITOR, TLI + 10 MIN ABORT AND LOI 15 MIN ABORT CHARTS)
- VI. RTACF PREPARATION
(INSURES REAL TIME OPERATIONAL COMPUTER SUPPORT REQUIREMENTS WILL BE MET)
- VII. SC WINDOW VIEWS DOCUMENT
(PROVIDES STARFIELD, EARTH-MOON TERMINATOR, AND HORIZON SCHEMATICS FOR CREW FAMILIARIZATION AND INDEPENDENT MANEUVER ATTITUDE CHECKS)
- VIII. LAUNCH WINDOW EFFECTS ON THE OPERATIONAL ABORT PLAN (DOCUMENT)
(INSURES ADEQUACY OF ABORT PLAN FOR LAUNCH WINDOW VARIATIONS)
- IX. HYBRID MISSION EFFECTS ON THE OPERATIONAL ABORT PLAN
(SUPPLEMENTS ABORT PLAN FOR TRAJECTORY AND PROCEDURE CHANGES DUE TO A HYBRID PROFILE)
- X. CREW BRIEFINGS
(EXPLANATION OF PROCEDURES AND ONBOARD ABORT CHARTS)

Flow chart 1. - Major Apollo F and G milestones for the Contingency Analysis Section.