

235.

MAR 29 1966

RVS

MSC IN 66-FM-26

RVS  
WGH  
202 (2  
FM file

R. V. SPERRY  
G. HEFFRON  
G. NIEDFELD

MSC INTERNAL NOTE NO. 66-FM-26

PROJECT APOLLO

AS-202 REENTRY GUIDANCE AND NAVIGATION EQUATIONS  
AND FLOW LOGIC

Prepared by: Oliver Hill  
Mission Analysis Branch

MISSION PLANNING AND ANALYSIS DIVISION  
NATIONAL AERONAUTICS AND SPACE ADMINISTRATION  
MANNED SPACECRAFT CENTER  
HOUSTON, TEXAS

March 18, 1966

(NASA-TM-X-72203) AS-202 REENTRY GUIDANCE  
AND NAVIGATION EQUATIONS AND FLOW LOGIC  
(NASA) 32 p

N75-70854

Unclas  
00/98 17606

BELLCOMM, INC.  
355 L'Enfant Place  
Washington

JAN 22 1966

MSC INTERNAL NOTE NO. 66-FM-26

---

PROJECT APOLLO  
AS-202 REENTRY GUIDANCE AND NAVIGATION EQUATIONS  
AND FLOW LOGIC

Prepared by: Oliver Hill  
Mission Analysis Branch

---

March 18, 1966

MISSION PLANNING AND ANALYSIS DIVISION  
NATIONAL AERONAUTICS AND SPACE ADMINISTRATION  
MANNED SPACECRAFT CENTER  
HOUSTON, TEXAS

Approved: 

\_\_\_\_\_  
M. P. Frank, Chief  
Mission Analysis Branch

Approved: 

\_\_\_\_\_  
John P. Mayer, Chief  
Mission Planning and Analysis Division

## CONTENTS

Section	Page
SUMMARY AND INTRODUCTION . . . . .	1
REAL TIME PROGRAM REQUIREMENTS . . . . .	1
Initialization Computations . . . . .	1
Targets and Nominal Flight Time . . . . .	2
SCS Routine and Gimbal Angles . . . . .	2
Reentry Backup Mode . . . . .	3
APPENDIX—SCS-IBM AND GIMBAL ANGLE ROUTINE . . . . .	21
REFERENCES . . . . .	28

## FIGURES

Figure		Page
1	Reentry Steering . . . . .	8
2	Navigation $\Delta V$ Computation . . . . .	9
3	Initialization . . . . .	10
4	Targeting . . . . .	11
5	Initial Roll . . . . .	12
6	Huntest . . . . .	13
7	Range Prediction . . . . .	14
8	Constant Drag . . . . .	15
9	Upcontrol . . . . .	16
10	Kepler . . . . .	17
11	Predict 3 . . . . .	18
12	G Limiter . . . . .	19
13	Lateral Control . . . . .	20

# AS-202 REENTRY GUIDANCE AND NAVIGATION EQUATIONS

## AND FLOW LOGIC

By Oliver Hill

### SUMMARY AND INTRODUCTION

A general description of the Reentry Guidance and Navigation (G & N) Program has been documented in "Apollo Reentry Guidance and Navigation Equations and Flow Logic." This document (reference 1) presents the flow logic and equations which should apply to all Apollo missions. Definition of guidance gains, constants, and minor additions or changes to the G & N logic will be necessary for individual missions. This internal note defines the guidance gains, constants, and the additions and changes to reference 1 required to define the reentry guidance for the real time program for the AS-202 mission. This note also presents an evaluation of the stability and control system (SCS) developed by MIT and IBM.

### REAL TIME PROGRAM REQUIREMENTS

The symbols and values of the guidance gains and constants necessary for the reentry G & N program simulations for the AS-202 mission are presented in table I. The contents of table II are identical to table III of reference 1. The column headings of table II have been changed to make them compatible with the variable names used in calculating the reference trajectory in the predict 3 control phase.

The AS-202 G & N logic is presented in figures 1 through 13 and supersedes that in reference 1.

### Initialization Computations

The complete AS-202 reentry guidance presented in reference 1 includes the initialization phase logic, which had not previously been documented. The purpose of this phase is to compute initial values for the variables THETA, K2ROLL, and  $\bar{U}RTO$ , which are necessary to start reentry guidance. The variables are defined as the inertial range to target (THETA), parameter to control the direction of the command module (CM) initial roll (K2ROLL), and the unit target vector ( $\bar{U}RTO$ ).

The initial target vector,  $\bar{RTINT}$ , used in the calculation of THETA and K2ROLL in the initialization sequence, is obtained by evaluating

$$\bar{RTINT} = \bar{URTO} + \bar{UTR} (\cos WT_N - 1) + \bar{RTE} \sin WT_N$$

at the nominal flight time corresponding to the selected target,  $\bar{UTRO}$ , which is either the Atlantic or Pacific target. Nominal flight time,  $T_N$ , is the predicted flight time from guidance reference release to an altitude of 25 000 ft above the target.

### Targets and Nominal Flight Times

The unit target vectors for the Atlantic and Pacific targets and their respective nominal flight times are to be entered in the real time program in the following manner: The Atlantic abort target and its nominal flight time are to be written into the real time program. The program must have the capability of receiving a manual entry device (MED) update of the target and its nominal flight time only if an abort is imminent. The Pacific target and its nominal flight time, which require a MED update capability also, are to be read into the real time program on a constants tape prior to launch.

The Pacific target and any update to the Atlantic target are to be read into the real time program in geodetic latitude and longitude, referred to the Fischer ellipsoid of 1960, and the geocentric radius. The nominal flight times will be input in hours, minutes, and seconds. The targets are then to be transformed into unit target vectors referred to the geocentric inertial frame at guidance release. The real time program must be capable of reading out all targets and nominal flight times to allow verification of the input quantities.

In essence, the Atlantic abort target and its nominal flight time can be updated any time before the spacecraft has been committed to the Pacific target. The Pacific target and its nominal flight time can be updated only after the spacecraft has been committed to the Pacific target.

### SCS Routine and Gimbal Angles

A one-degree-of-freedom simulation of the SCS is desirable for obtaining a measure of the CM reaction control system (RCS) fuel consumption for reentry control maneuvers. The Mission Analysis Branch's Reentry Studies Section and IBM are presently coordinating regarding this simulation for the real time program. The Reentry Studies Section has developed a gimbal angle routine for accurately determining the vehicle attitude.

This routine is an integral part of the SCS routine.

An evaluation of the SCS-IBM and the SCS-294 (MIT) routines revealed no basic differences between the accuracy of the two. The SCS-IBM requires less computer time and is therefore more desirable. It was necessary to alter the SCS-IBM in order to achieve the desired simulation and make the SCS-IBM compatible with the gimbal angle routine. This modification was initiated and performed by the Reentry Studies Section. The recommended values of gains, constants, and initial flag settings to be used in the SCS-IBM routine are given in table I. The SCS logic is given in the appendix.

It is requested that the SCS-IBM containing the gimbal angle routine be included in the real time program. This routine provides a means for accurately determining the attitude and lift-vector orientation of the CM. The platform will be aligned as specified in reference 2, and no realignment will occur during the flights. Thus, the platform alignment will be the same at reentry as at guidance reference release. The platform is aligned with the X PIPA input axis held to the local geopotential (1960 Fischer ellipsoid) vertical (up), the Z PIPA axis pointing down range at an azimuth of  $104.9901^{\circ}$  east of true North, and the Y PIPA axis completing the orthogonal system.

#### Reentry Backup Mode

Nominal trajectory computations will reflect the type of reentry specified by the letters Z, M, or B, which are defined as follows:

Z - A zero lift reentry trajectory (rolling reentry with a roll rate of 17 deg/sec about the velocity vector) will be generated. The CM will fly with lift vector down until 0.05 gs at which time rolling will be initiated.

M - A maximum lift vector will be generated.

B - A reentry trajectory will be generated based upon a constant bank angle and the latest target stored in the computer. The CM will fly a constant bank angle from guidance initiation, 0.05 g, to the target.

TABLE I.-GUIDANCE GAINS AND CONSTANTS

	<u>Symbol</u>	<u>Value</u>
Constant drag gain (on drag)	C16	0.1 1/fps/sec
Constant drag gain (on RDOT)	C17	0.00497 1/fps
Lead velocity for upcontrol start	C18	500 fps
Minimum constant drag	C19	40 fps/sec
Minimum D for lift-up	C20	175 fps/sec
Factor in AHOOK computation	CHOOK	0.25 n.d.
Factor in GAMMAL computation	CH1	0.75 n.d.
G-limit	GMAX	10 g
Minimum drag for lift-up if down	KA	0.2 g
Upcontrol gain, optimized	KB2	0.0034 1/fps
Upcontrol gain, optimized	KB1	3.4 n.d.
Factor in V1 computation	KC1	0.8 n.d.
Factor in A0 computation	KC2	0.7 n.d.
Lateral switch gain	KLAT	0.0075 n. mi.
Normalization factor, acceleration	GS	32.2 fps/sec
Factor in L/D computation for final phase	K13P	4 n.d.
Increment to Q7 to end kepler	KDMIN	0.5 fps/sec
Time of flight calculation gain	KTETA	1000 sec
MAX L/D	LAD	0.3 n.d.
Lateral switch bias term	LATBIAS	0.4 n.mi.
LAD COS (15°)	L/DCMINR	0.2895 n.d.
Upcontrol L/D	LEWD	0.2 n.d.
Final phase L/D	LOD	0.18 n.d.
Acceptable tolerance to stop range iteration	25NM	25 n. mi.
Final phase range -(23 500 Q3)	Q2	-1002 n. mi.
Final phase dR/dV	Q3	0.07 n. mi./fps
Final phase initial velocity	Q4	23 500 fps
Final phase dR/dRDOT	Q5	0.3 n. mi./fps



TABLE I.-GUIDANCE GAINS AND CONSTANTS - Continued

	<u>Symbol</u>	<u>Value</u>
Final phase initial RDOT	Q6	820 fps
Minimum drag for upcontrol	Q7F	6 fps/sec
Factor in PREDANG 3 computation	Q8	0 n.d.
Limit value of VCORR	VCORLIM	1000 fps
Minimum RDOT to close loop	VRCONTRL	700 fps
Velocity to switch to relative velocity	VMIN	12 883 fps
Minimum VL	VLMIN	18 000 fps
Velocity to stop steering	VQUIT	1000 fps
MAX drag for constant drag phase	DOMAX	500 fps/sec
Earth equatorial rate vector	$\bar{W}E = W \bar{U}Z$	7.292 115 05 x $10^{-5}$ rad/sec
Earth sidereal rate X time	WT = W T	----
Earth sidereal rate	W	7.292 115 05 x $10^{-5}$ rad/sec
Normalization factor, velocity	VSAT	25 766.197 fps
Nominal earth's radius (entry only)	RE	21 202 900 ft
Atmosphere scale height	HS	28 500 ft
Range angle to nautical mile factor	ATK	3437.7468 n. mi./rad
Gravity potential harmonic coefficient	J	1.623 45 x $10^{-3}$ n.d.
Earth's gravitation constant	MUE	3.986 032 233 x $10^{14}$ meters <sup>3</sup> /sec <sup>2</sup>
Acceleration about x-body axis	BACC	9.07 deg/sec <sup>2</sup>
Acceleration about x-stability axis	SACC	BACC/cos 22° deg/sec <sup>2</sup>
MAX roll rate	----	17.2 deg/sec
Rate command limiter	E	1.9 deg/sec
Dead band 2	A	0.2 deg/sec
Dead band 1	B	A-.007 deg/sec
Rate gain	GR	0.1 n.d.
Attitude error gain	GA	0.2/sec

TABLE I.-GUIDANCE GAINS AND CONSTANTS - Concluded

	<u>Symbol</u>	<u>Value</u>
Attitude error dead band	D	4.0 deg
Trim angle of attack	----	22.0 deg
Pacific target nominal flight time	$T_N$	5243 sec
Atlantic target nominal flight time	$T_N$	1420 sec
Initial unit target vector at lift-off	$\bar{U}_{RTO}$	----
	HIND	0 n.d.
	HUNTIND	0 n.d.
	GONEPAST	0 n.d.
	EGSW	0 n.d.
	STARTER	0 n.d.
	KLROLL	0 n.d.
	RELVELSW	0 n.d.
	LATSW	0 n.d.

TABLE II. --FINAL PHASE REFERENCE TRAJECTORY

<u>N</u>	<u>VREF</u>	<u>RDTR</u>	<u>AREF</u>	<u>FRDT</u>	<u>FA</u>	<u>RTOGO</u>	<u>PP</u>
--	----	<u>RDOTREF</u>	----	<u>DR/DRDOT</u>	<u>DR/DA</u>	----	<u>DR/DL/D</u>
16	FPS	FPS	FPSS	NM/FPSS	NM/FPSS	NM	NM
15	0	-331	34.1	0	- .026 95	0	1
14	337	-331	34.1	0	- .026 95	0	1
13	1080	-693	42.6	.002 591	- .036 29	2.7	6.44 x 2
12	2103	-719	60.0	.003 582	- .055 51	8.9	10.91 x 2
11	3922	-694	81.5	.007 039	- .090 34	22.1	21.64 x 2
10	6295	-609	93.9	.014 46	- .1410	46.3	48.35 x 2
9	8531	-493	98.5	.024 79	- .1978	75.4	93.72 x 2
8	10 101	-416	102.3	.033 91	- .2372	99.9	141.1 x 2
7	14 014	-352	118.7	.061 39	- .3305	170.9	329.4
6	15 951	-416	125.2	.076 83	- .3605	210.3	465.5
5	18 357	-566	120.4	.099 82	- .4956	266.8	682.7
4	20 829	-781	95.4	.1335	- .6483	344.3	980.5
3	23 090	-927	28.1	.2175	-2.021	504.8	1385
2	23 500	-820	6.4	.3046	-7.569	643.0	1508
1	35 000	-820	6.4	.3046	-7.569	643.0	1508

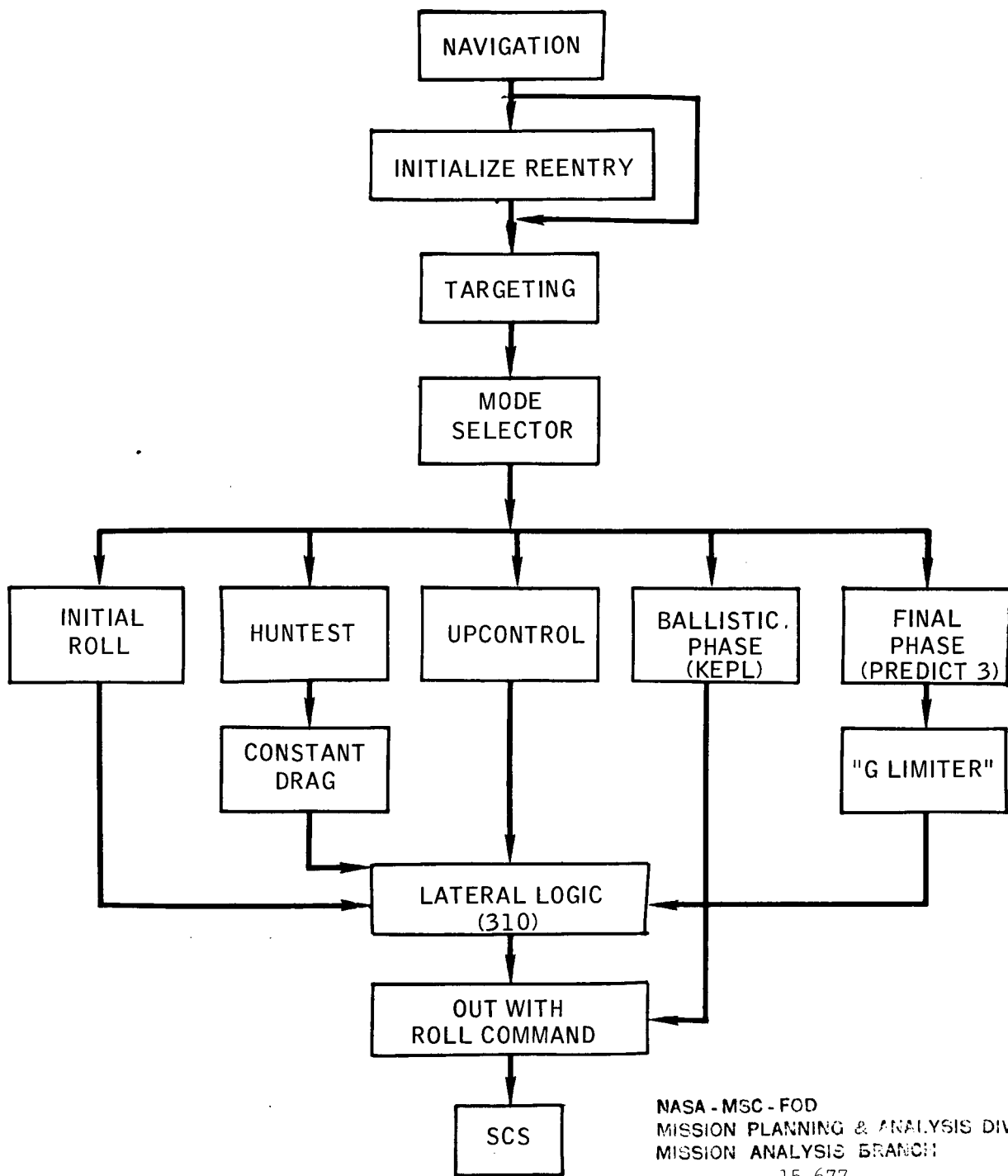

NASA - MSC - FOD  
 MISSION PLANNING & ANALYSIS DIVISION  
 MISSION ANALYSIS BRANCH  
 Plot No. 15,677  
 Date 3-18-66 G. Hunt/O. Hill

FIGURE 1.- REENTRY STEERING

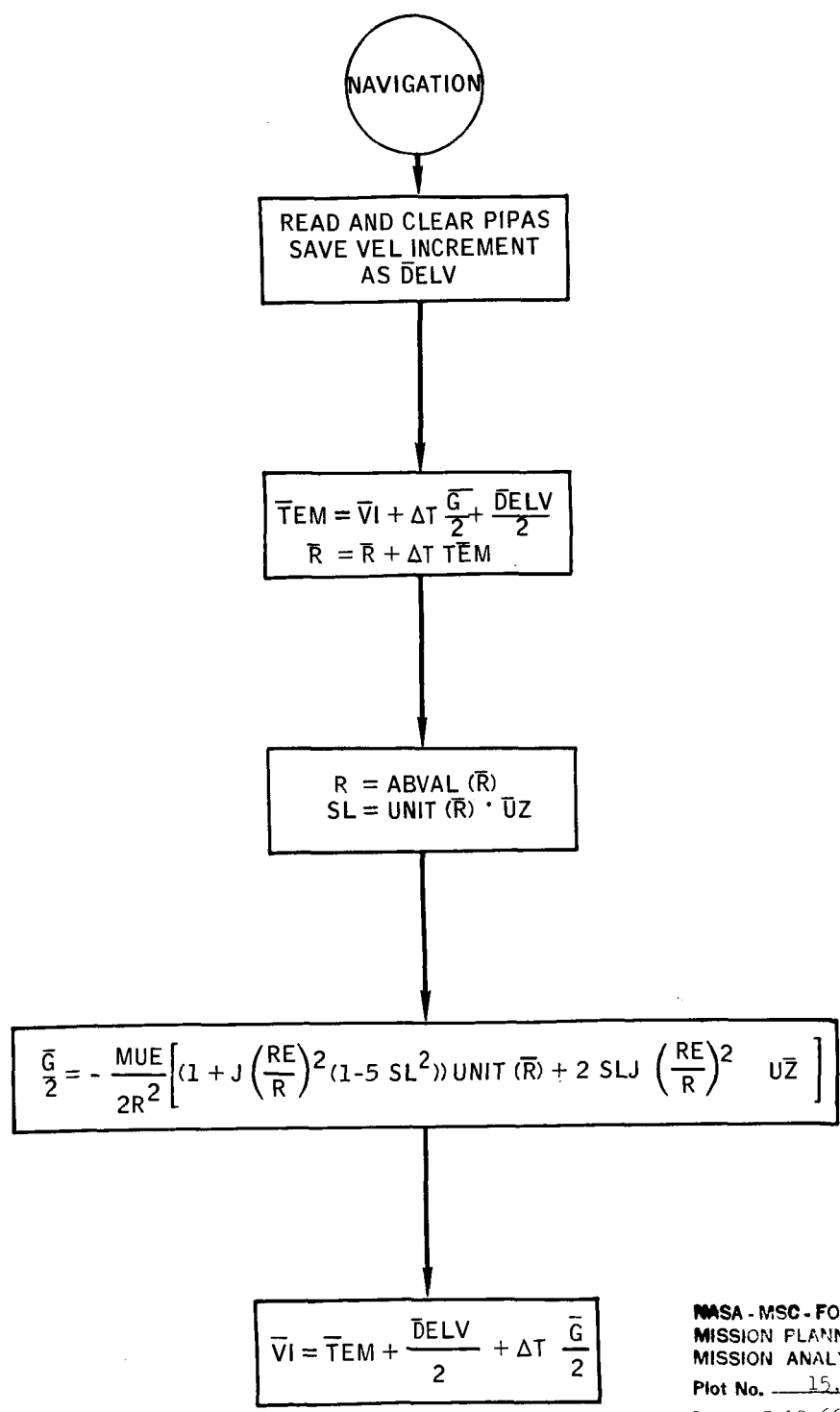

NASA - MSC - FOD  
 MISSION PLANNING & ANALYSIS DIVISION  
 MISSION ANALYSIS BRANCH  
 Plot No. 15,678  
 Date 3-18-66 G. Hunt/O. Hill

FIGURE 2.- NAVIGATION ΔV COMPUTATION.

PARA-MFC-FOD  
 MISSION PLANNING & ANALYSIS DIVISION  
 MISSION ANALYSIS BRANCH  
 Report No. 15,675  
 Date 5-18-66 O. Hill

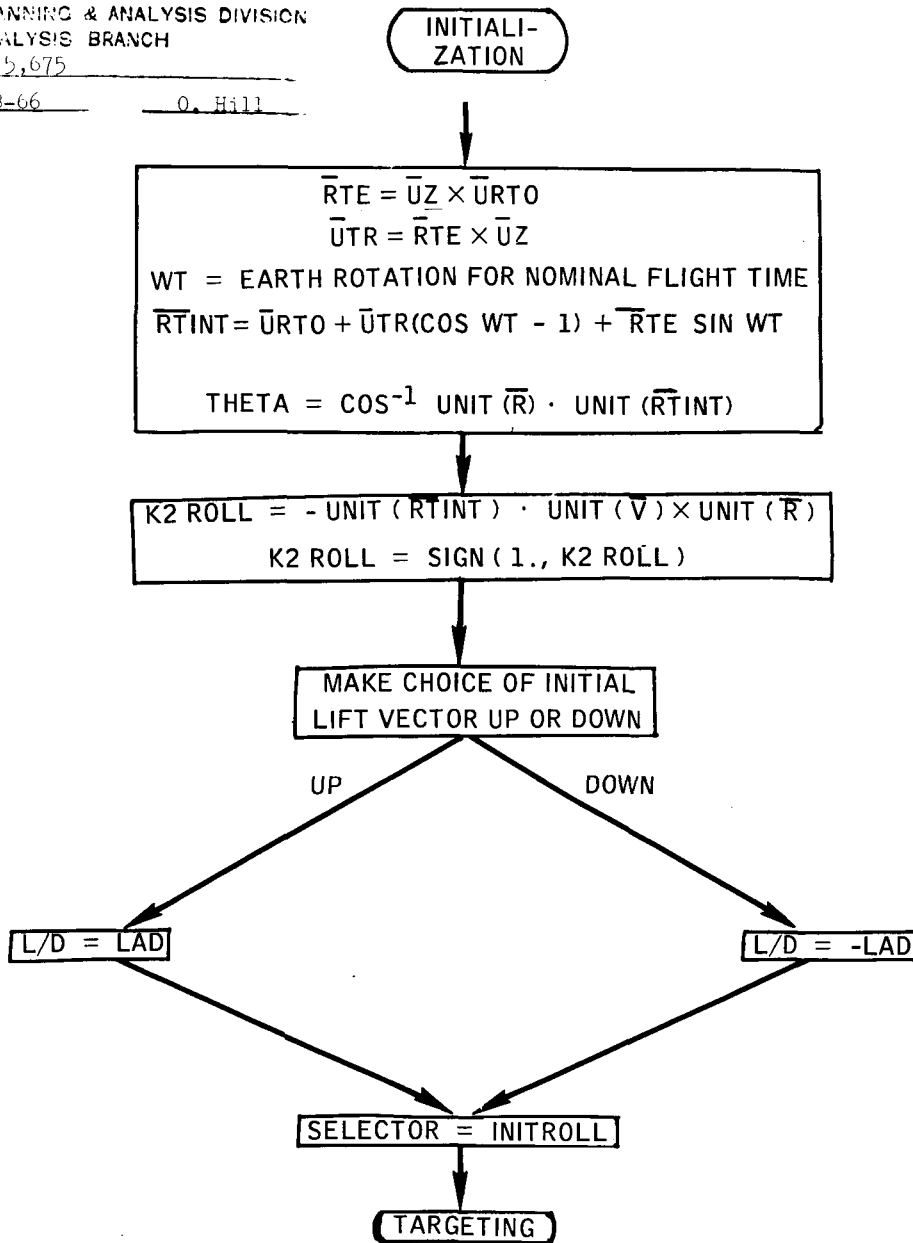

NOTE :  $\pm$  LAD FOUND IN SOME BRANCH LOGIC INDICATES THAT  
 THE SIGN ASSOCIATED WITH THE CALCULATED VALUE OF L/D IS TO BE ATTACHED TO LAD

FIGURE 3.- INITIALIZATION.

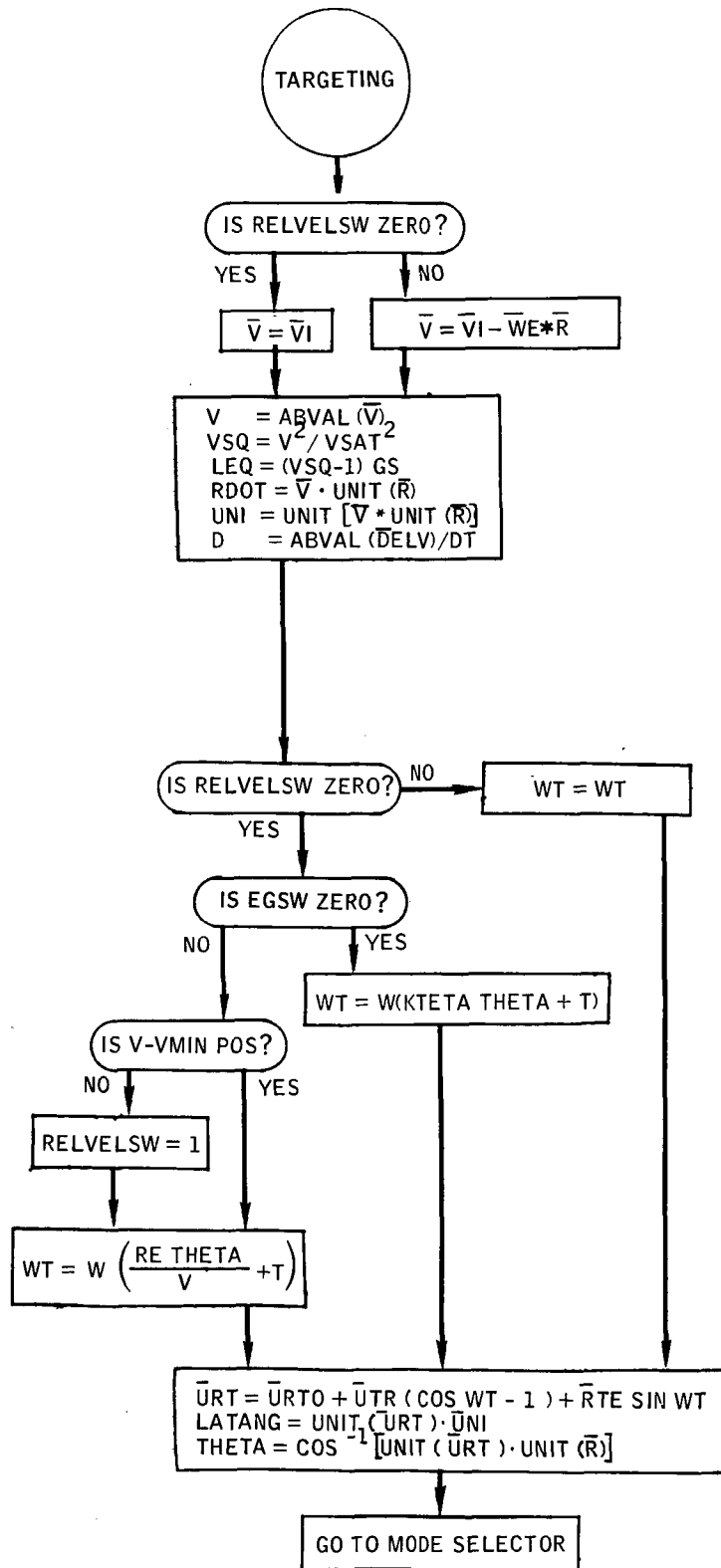

NASA - MSC - FOD  
MISSION PLANNING & ANALYSIS DIVISION  
MISSION ANALYSIS BRANCH

Plot No. 15,679

Date 3-18-66 G. Hunt/O. Hill

FIGURE 4.- TARGETING

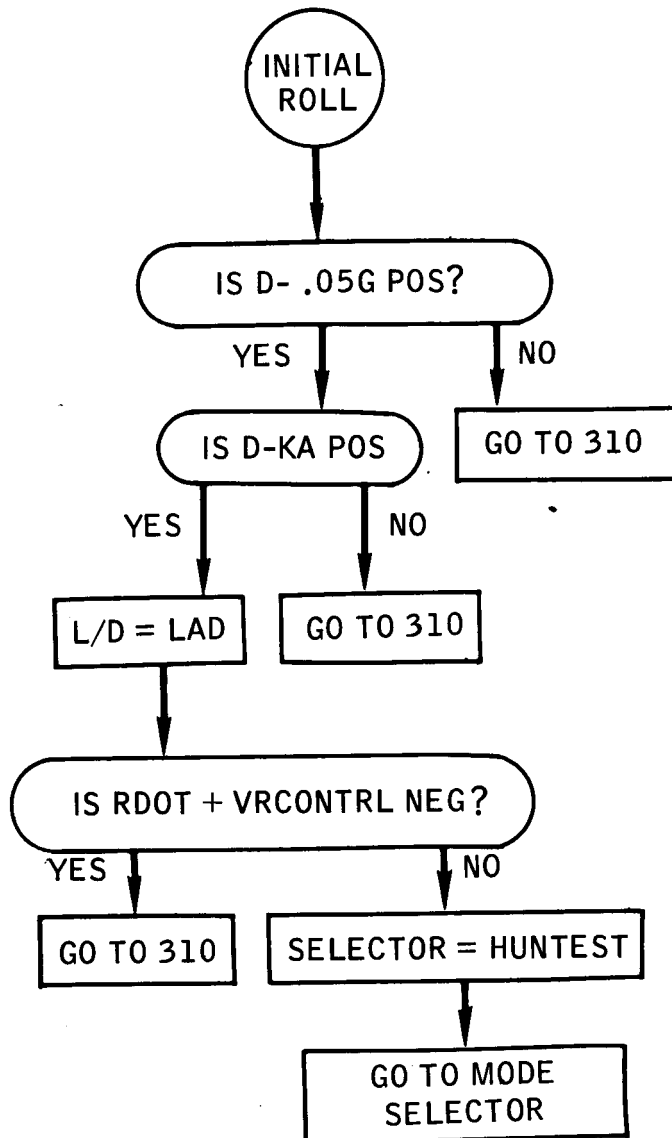

FIGURE 5.- INITIAL ROLL

NASA - MSC - FOD  
 MISSION PLANNING & ANALYSIS DIVISION  
 MISSION ANALYSIS BRANCH

Plot No. 15,632

Date 12/13/65 G. Hunt



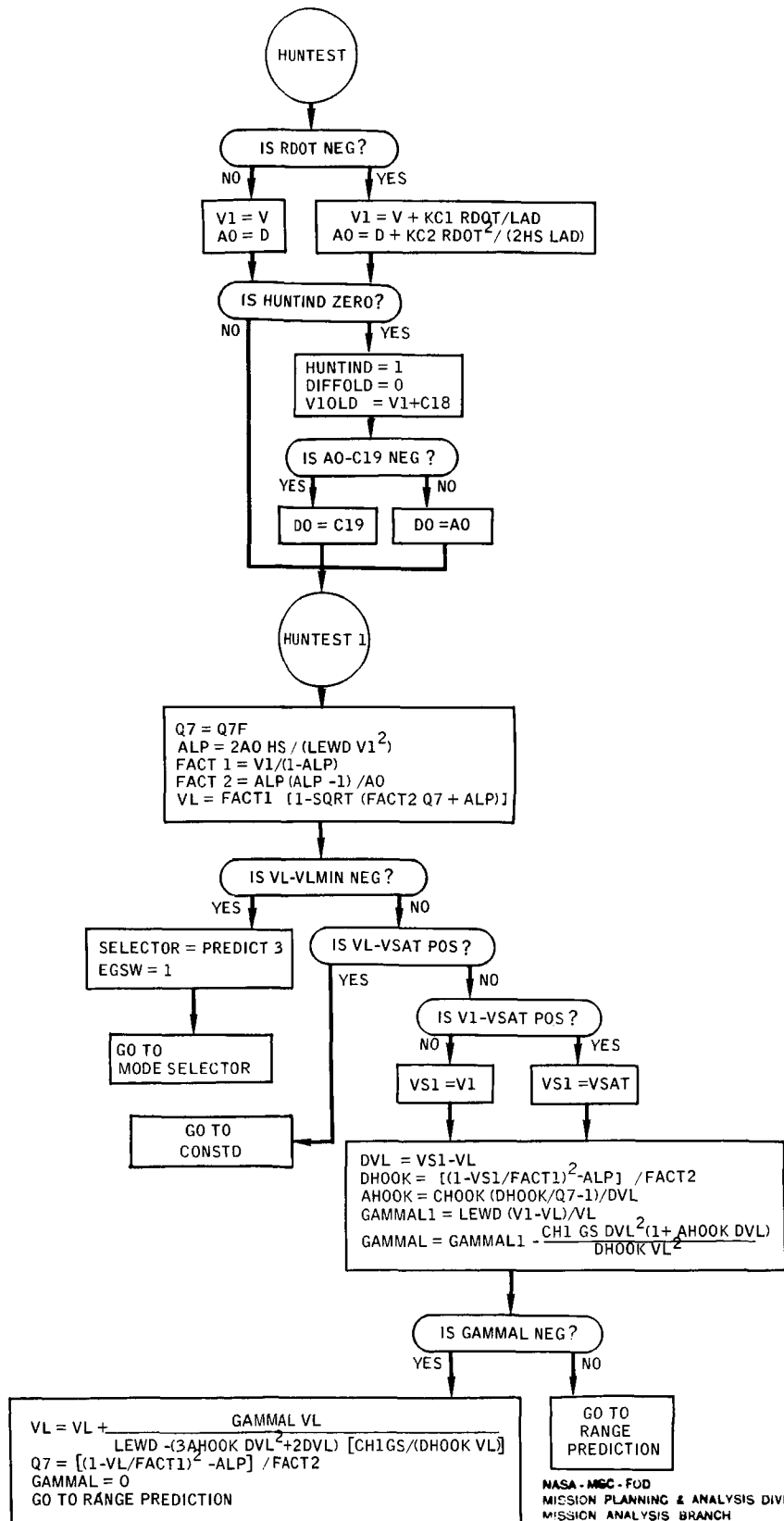

NASA - MSC - FOD  
MISSION PLANNING & ANALYSIS DIVISION  
MISSION ANALYSIS BRANCH  
Plot No. 15,833  
Date 12/13/67 G. Hunt

FIGURE 6. - HUNTEST

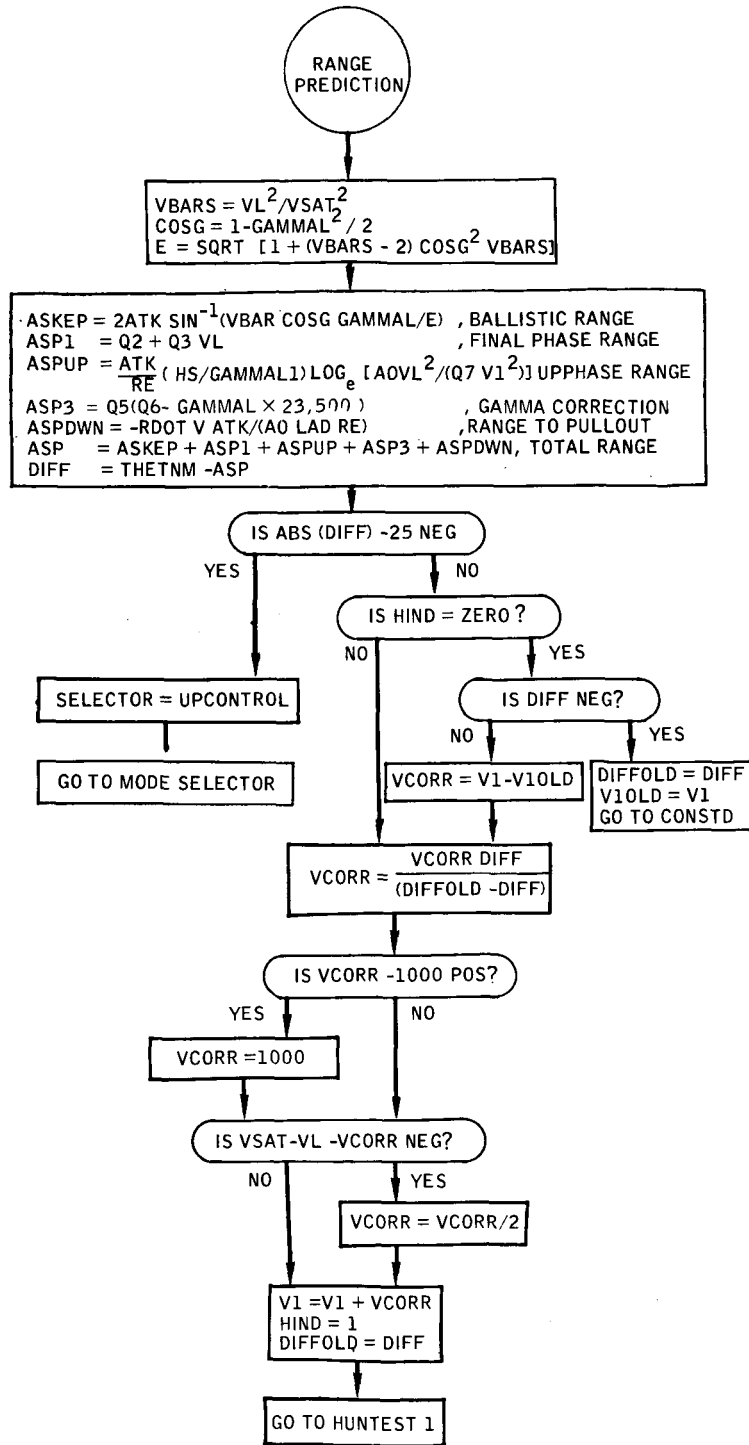

FIGURE 7.- RANGE PREDICTION

NASA-MSC-FOO  
MISSION PLANNING & ANALYSIS DIVISION  
MISSION ANALYSIS BRANCH  
Pict No. 17,800  
Date 4-18-60

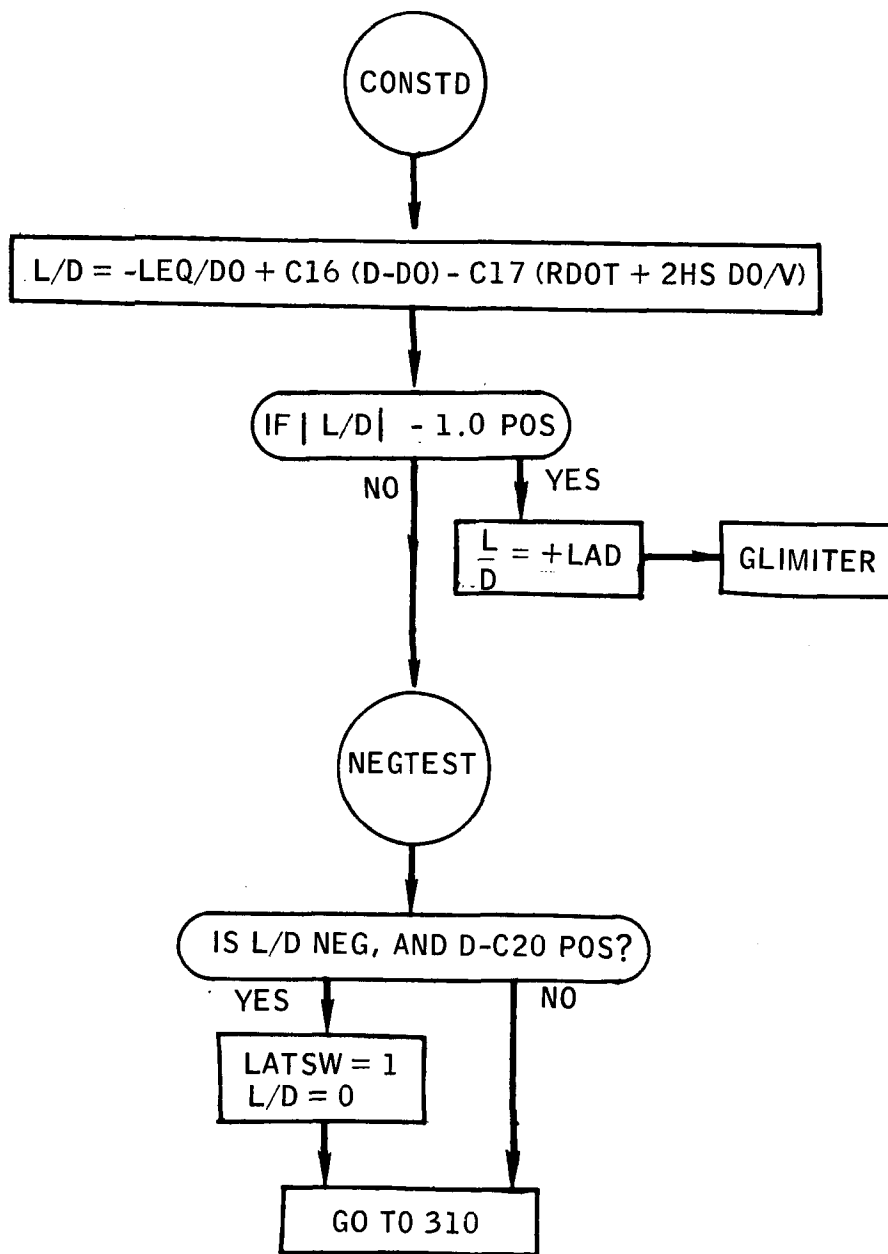
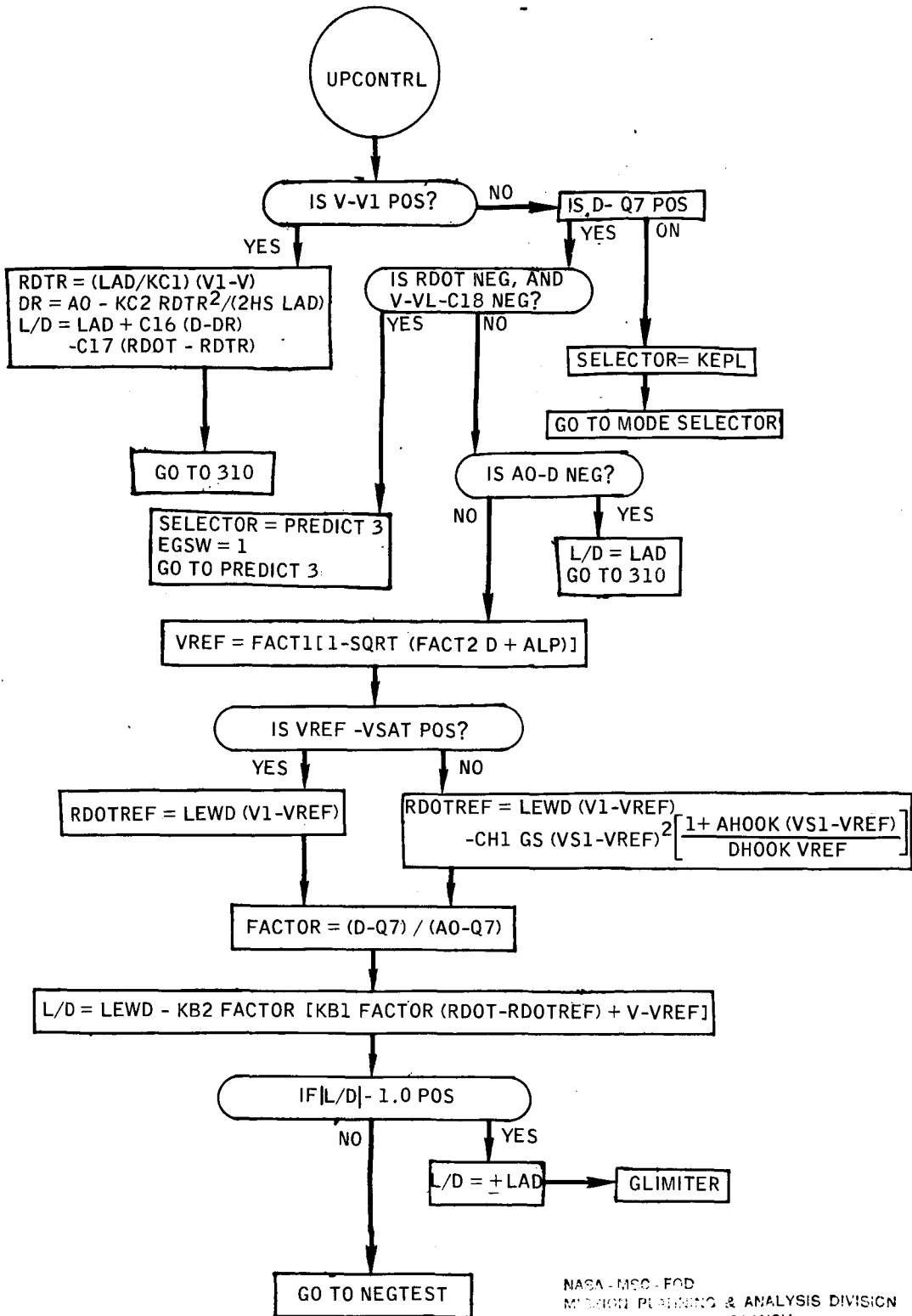

FIGURE 8.- CONSTANT DRAG

NASA - MCC - FOD  
MISSION PLANNING & ANALYSIS DIVISION  
MISSION ANALYSIS BRANCH

Plot No. 15,681

Date 3-18-66 G. Hunt/O. Hill



NASA-MSC-FOD  
MISSION PERFORMANCE & ANALYSIS DIVISION  
MISSION ANALYSIS BRANCH  
Plot No. 15,682  
Date 3-18-66 G. Hunt/O. Hill

FIGURE 9.- UPCONTROL

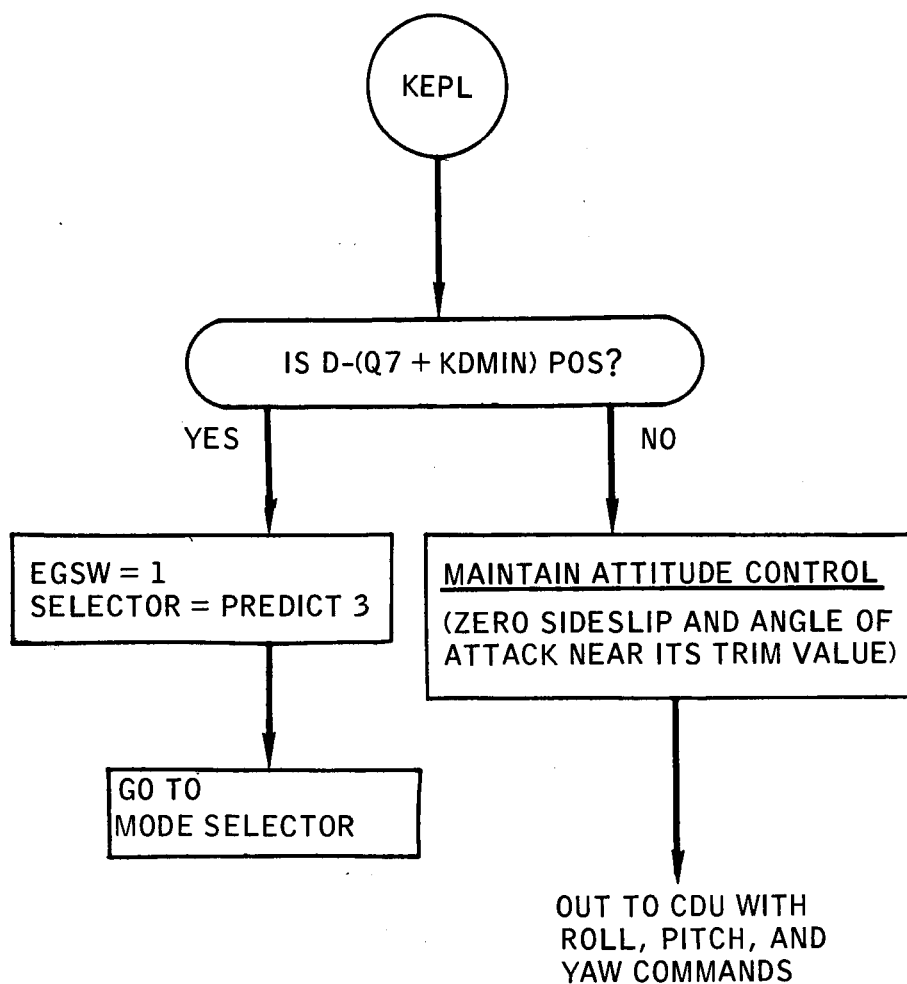

FIGURE 10.- KEPLER

NASA - MSC - FOD  
MISSION PLANNING & ANALYSIS DIVISION  
MISSION ANALYSIS BRANCH

Plot No. 15,637

Date 12/13/65

G. Hunt

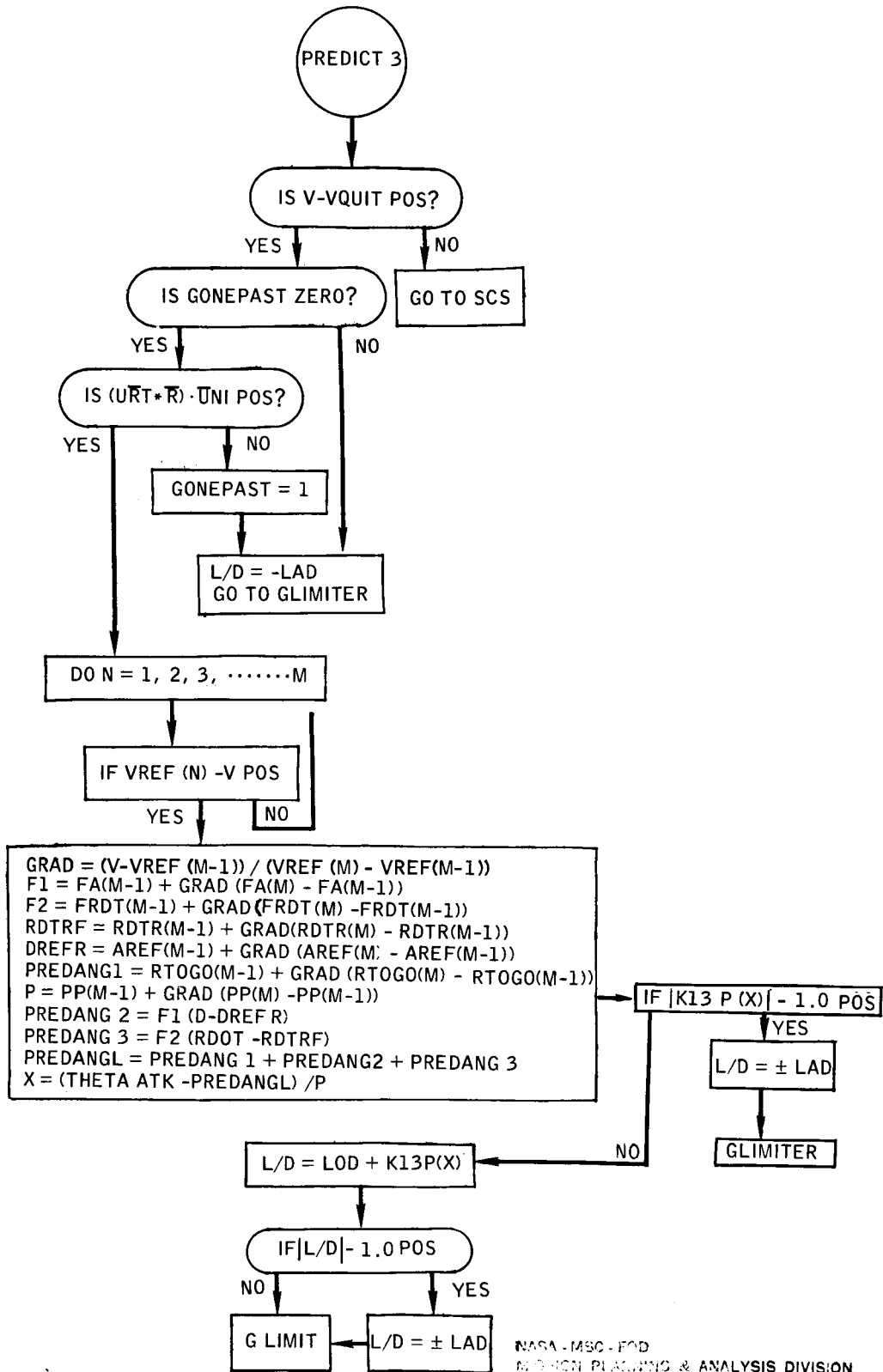

NASA-MSC-FOD  
 MISSION PLANNING & ANALYSIS DIVISION  
 MODELLING ANALYSIS BRANCH  
 Plot No. 15,683  
 Date 3-18-66 G. Hunt/O. Hill

FIGURE 11.- PREDICT 3

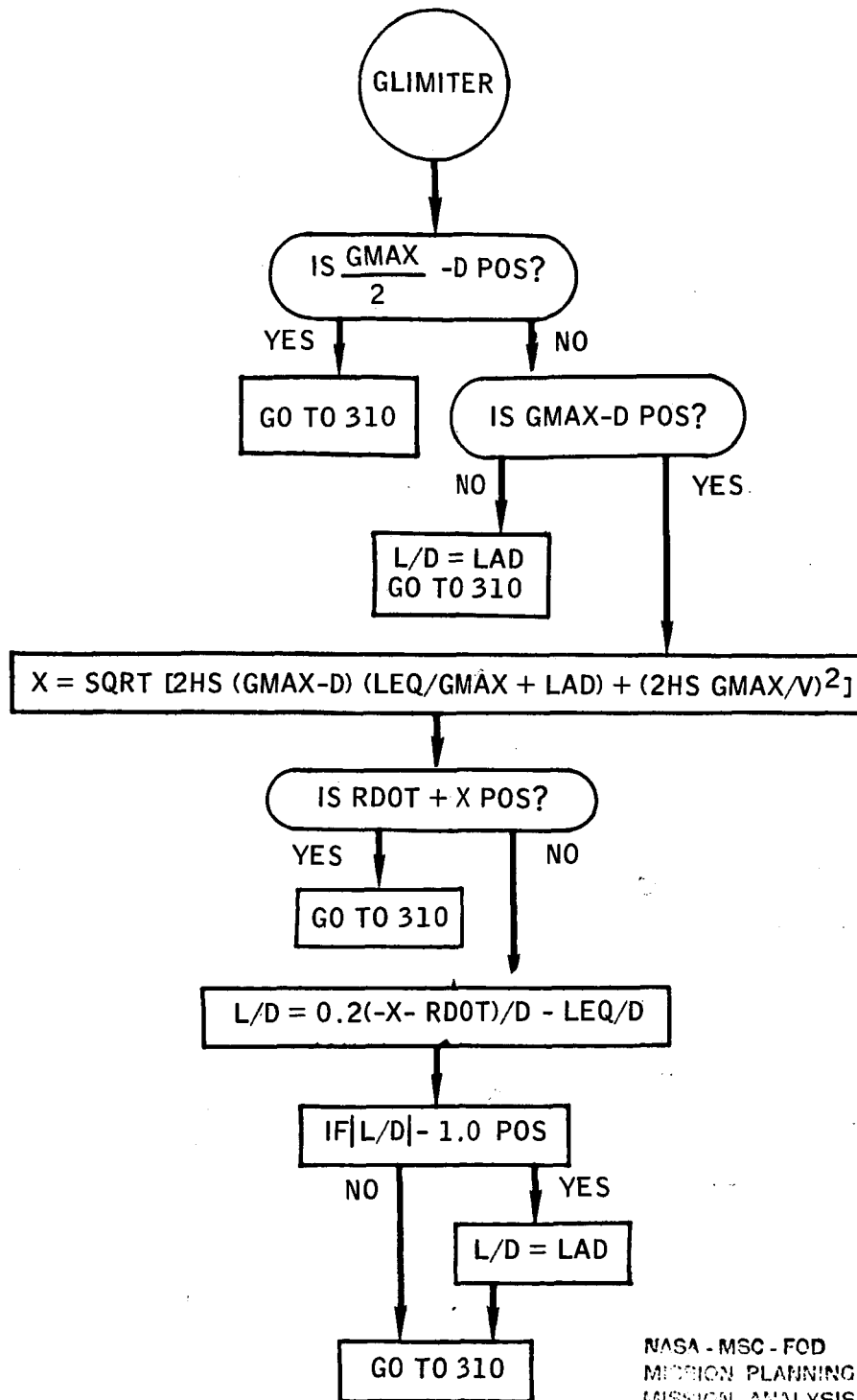

NASA - MSC - FOD  
MISSION PLANNING & ANALYSIS DIVISION  
MISSION ANALYSIS BRANCH

Plot No. 15,684

Date 3-18-66 G. Hunt/O. Hill

FIGURE 12.- G LIMITER

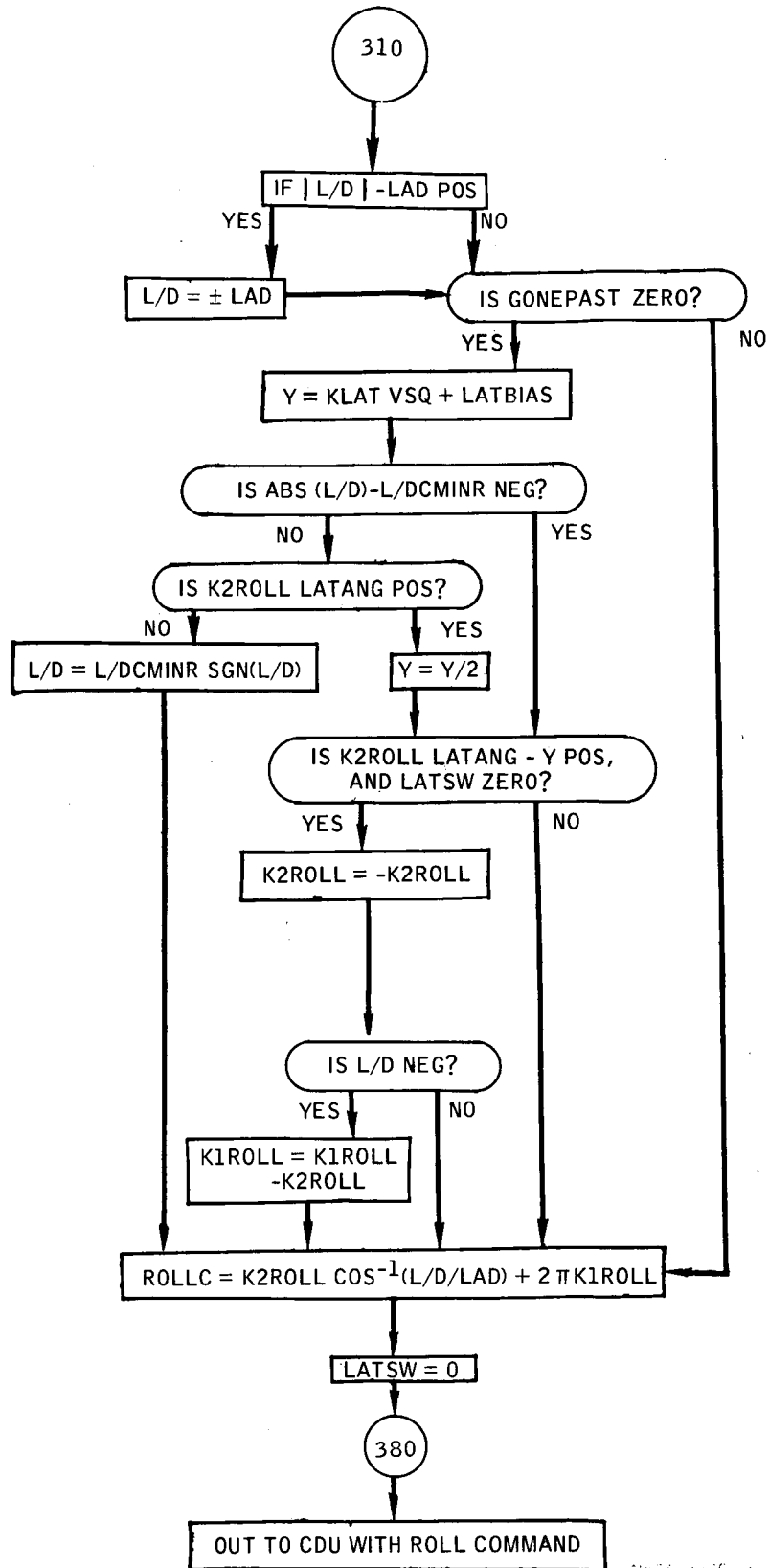

PROVISED BY  
MISSION PLANNING & ANALYSIS DIVISION  
MISSION ANALYSIS BRANCH  
Plot No. 15,685  
Date 3-18-66 G. Hunt/O. Hill

FIGURE 13.- LATERAL CONTROL



## APPENDIX

## SCS-IBM AND GIMBAL ANGLE ROUTINE

Flow logic for the SCS-IBM routine is presented in its final form in figures 1 through 4 of this appendix. The gains and constants are given in table I. The following transformation matrices required to determine the navigation base, body, and stability axes were developed for a right-hand system. Unit vectors  $\hat{V}_R$ ,  $\hat{H}$ , and  $\hat{N}$  are defined in figure 5. Subscripts B, N, and S indicate the respective body, navigation base, and stability axes.

$$\begin{bmatrix} \hat{X}_S \\ \hat{Y}_S \\ \hat{Z}_S \end{bmatrix} = \begin{bmatrix} -1 & 0 & 0 \\ 0 & -\cos \beta & \sin \beta \\ 0 & \sin \beta & \cos \beta \end{bmatrix} \begin{bmatrix} \hat{V}_R \\ \hat{H} \\ \hat{N} \end{bmatrix}$$

$$\begin{bmatrix} \hat{X}_B \\ \hat{Y}_B \\ \hat{Z}_B \end{bmatrix} = \begin{bmatrix} \cos \alpha & 0 & \sin \alpha \\ 0 & 1 & 0 \\ -\sin \alpha & 0 & \cos \alpha \end{bmatrix} \begin{bmatrix} \hat{X}_S \\ \hat{Y}_S \\ \hat{Z}_S \end{bmatrix}$$

$$\begin{bmatrix} \hat{X}_N \\ \hat{Y}_N \\ \hat{Z}_N \end{bmatrix} = \begin{bmatrix} \cos \eta & 0 & -\sin \eta \\ 0 & 1 & 0 \\ \sin \eta & 0 & \cos \eta \end{bmatrix} \begin{bmatrix} \hat{X}_S \\ \hat{Y}_S \\ \hat{Z}_S \end{bmatrix}$$

$\alpha = 22^\circ$  - angle of attack (angle between x-body axis and x-stability axis)

$\eta = 11^\circ$  - angle between x-navigation base and x-stability axis

The roll gimbal angle  $R(2)$  is obtained from the equation

$$R(2) = \tan^{-1} \left( \frac{-\hat{Z}_N \cdot \hat{Y}_P}{\hat{Y}_N \cdot \hat{Y}_P} \right)$$

where  $\hat{Y}_P$  is the platform unit Y-axis

The fuel consumption during reentry is computed from the jet-on time and a scaled fuel flow rate,  $\bar{F}$ . The rate  $\bar{F}$  was obtained from a six-degree-of-freedom reentry simulation and includes the fuel consumed in the roll, pitch, and yaw RCS jets.

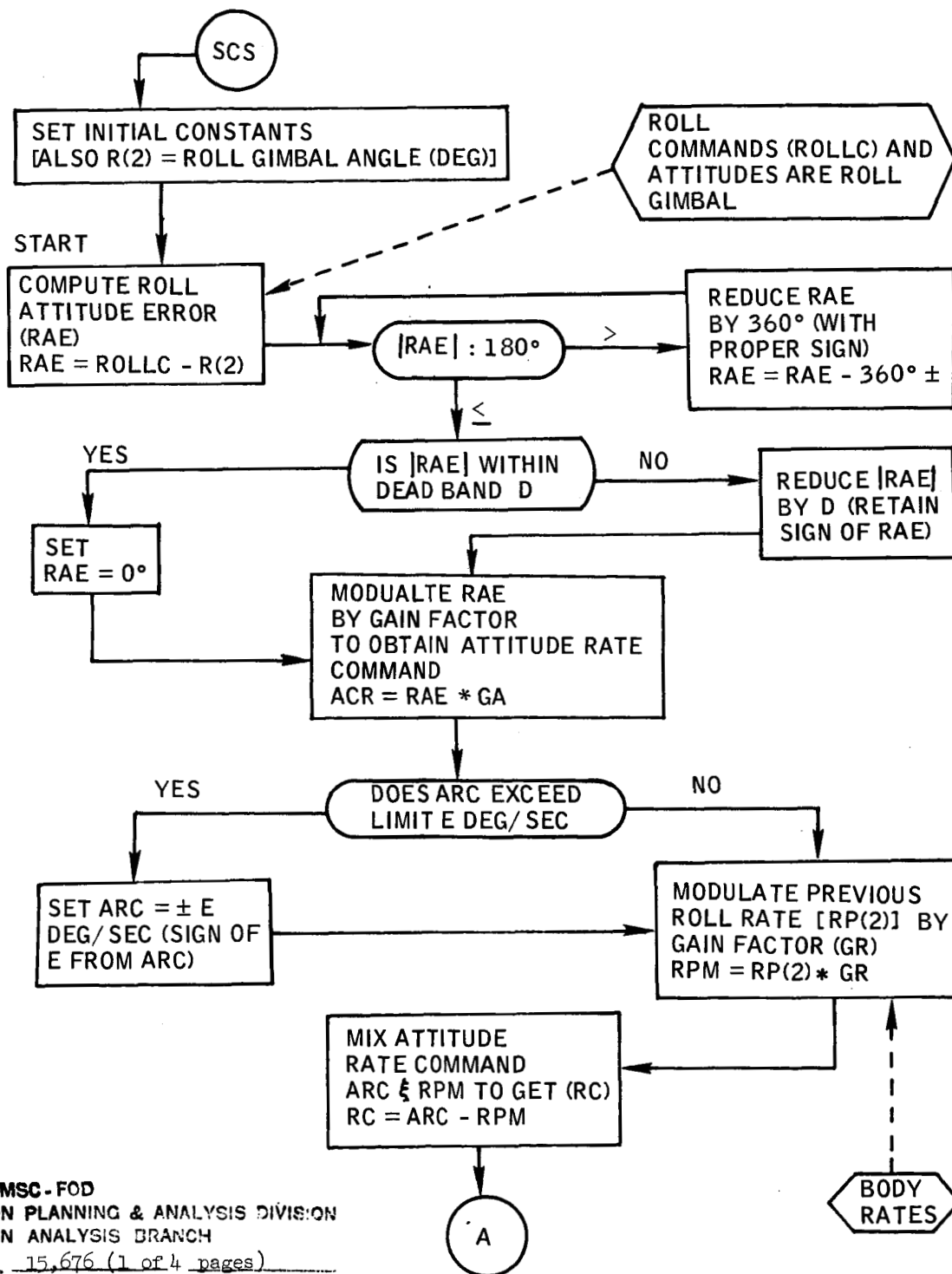

NASA - MSC - FOD  
 MISSION PLANNING & ANALYSIS DIVISION  
 MISSION ANALYSIS BRANCH  
 Plot No. 15,676 (1 of 4 pages)  
 Date 3/18/66 O. Hill

FIGURE 1.- SCS - IBM.

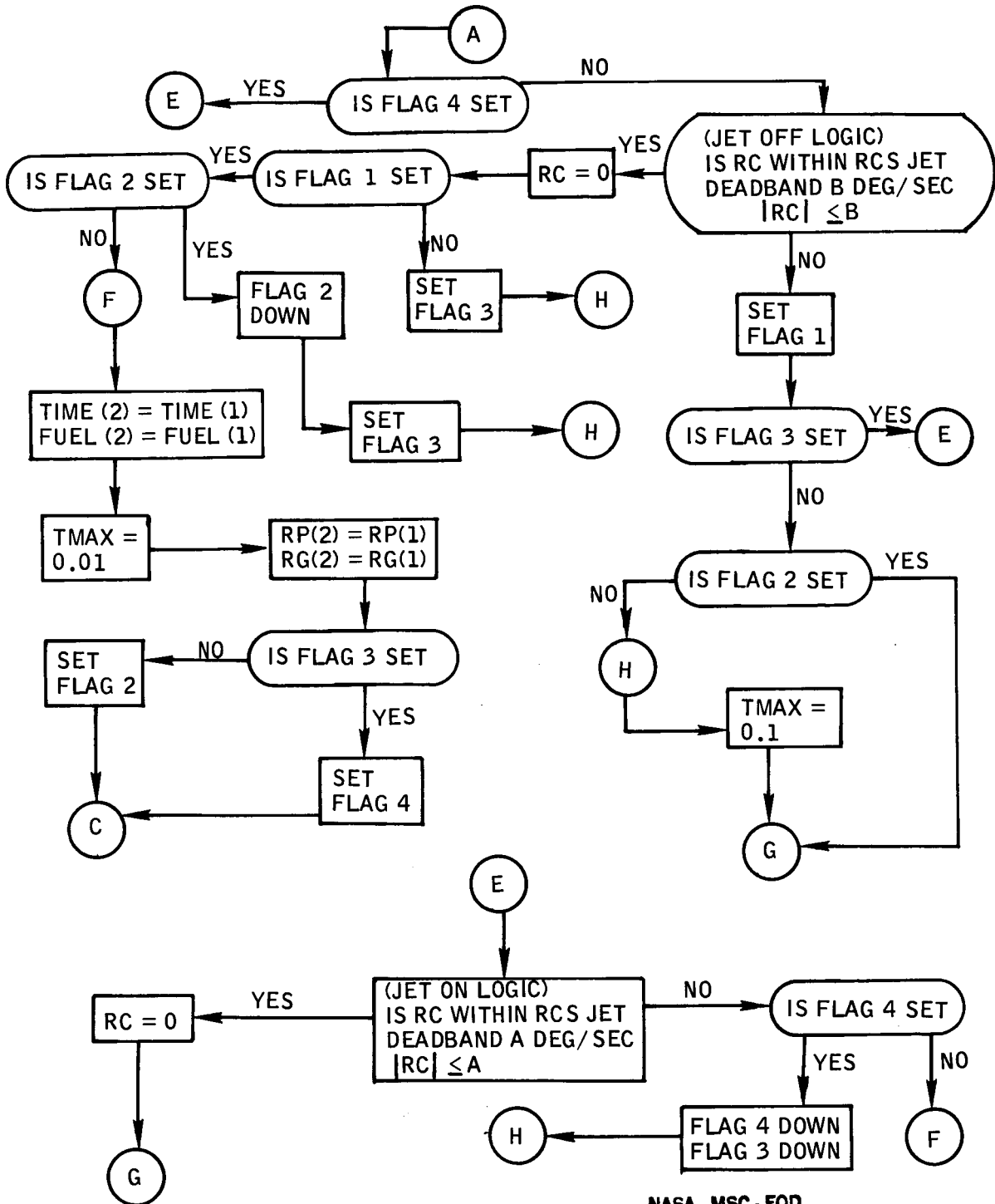

FIGURE 1.- CONTINUED.

NASA - MSC - FOD  
MISSION PLANNING & ANALYSIS DIVISION  
MISSION ANALYSIS BRANCH  
Plot No. 15,676 (2 of 4 pages)  
Date 3/18/66 O. Hill

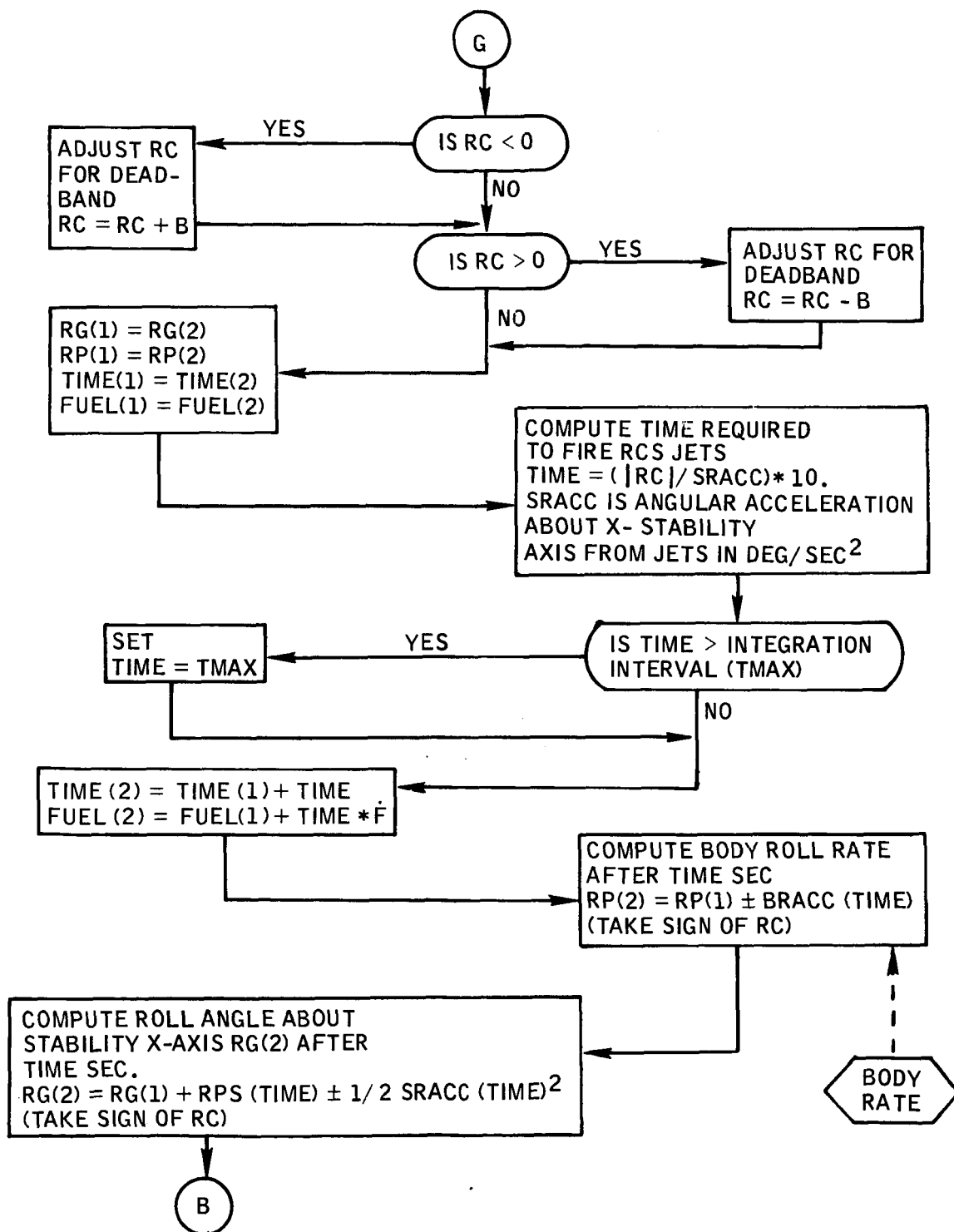

FIGURE 1.- CONTINUED.

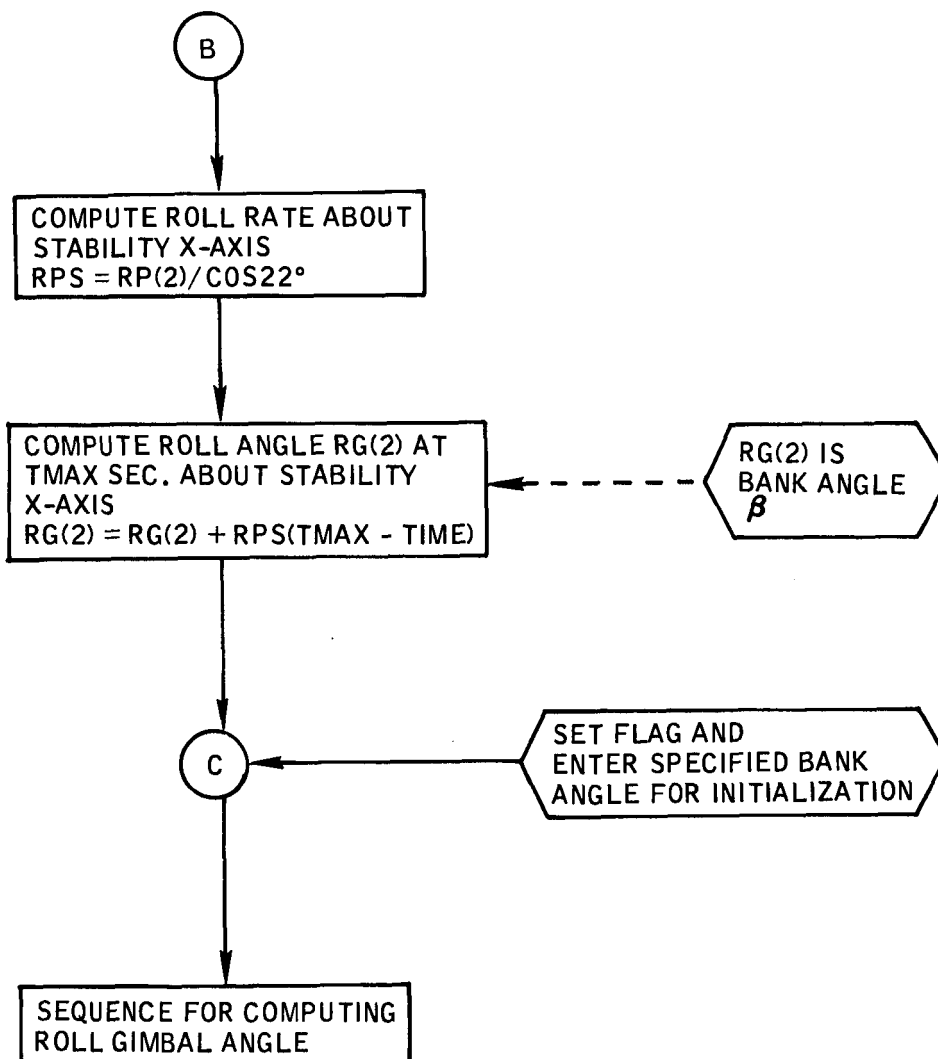
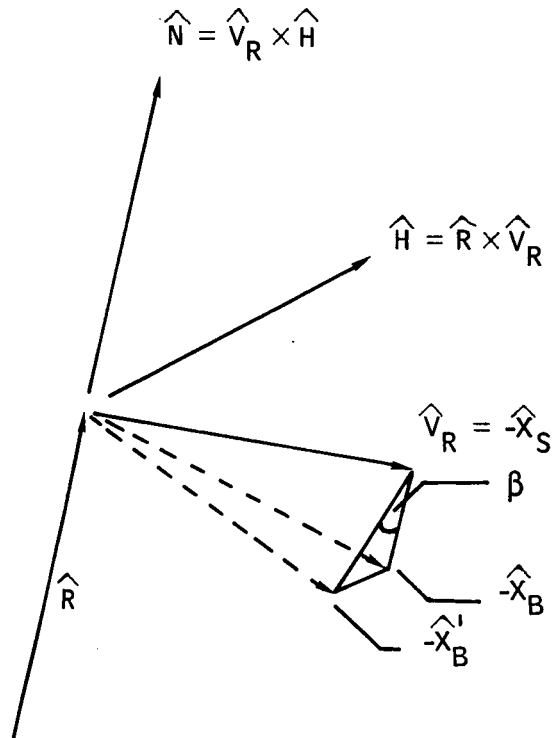

FIGURE 1. - CONCLUDED.

NASA - MSC - FOD  
 MISSION PLANNING & ANALYSIS DIVISION  
 MISSION ANALYSIS BRANCH  
 Plot No. 15,677  
 Date 3/18/66 O. Hill



- $\hat{X}_S$  = UNIT X- STABILITY AXIS
- $\hat{X}_B$  = UNIT X- BODY AXIS AT ZERO BANK ANGLE
- $\hat{X}_B'$  = UNIT X- BODY AXIS AT BANK ANGLE  $\beta$
- $\hat{R}$  = UNIT POSITION VECTOR OF SPACE CRAFT
- $\hat{V}_R$  = UNIT VELOCITY VECTOR OF SPACE CRAFT
- $\beta$  = BANK ANGLE

FIGURE 2.- ORTHOGONAL SET REFERENCED TO THE OSCULATING PLANE.

## REFERENCES

1. Hunt, Gerald L.: Apollo Reentry Guidance and Navigation Equations and Flow Logic. NASA TN 65-FM-157, 1965.
2. Dahlen, J.; Kosmala, A.; Lickly, D.; Morth, R.; Shillingford, J.; and Sokkappa, B.: Guidance and Navigation System Operations Plan, Apollo Mission 202, Revision 2. NASA CR R-477, 1965. Confidential.