

68-FM-170



NATIONAL AERONAUTICS AND SPACE ADMINISTRATION

MSC INTERNAL NOTE NO. 68-FM-170

July 19, 1968

Technical Library, Bellcomm, Inc.

061 301589

SPACECRAFT  
OPERATIONAL ABORT PLAN  
FOR APOLLO 7 (MISSION C)  
VOLUME II - CSM LAUNCH ABORTS

By Edward M. Henderson,  
Flight Analysis Branch,  
and

J. V. Butler,

Mission Operational Section, TRW Systems Group

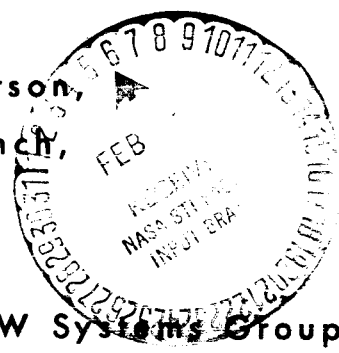

MISSION PLANNING AND ANALYSIS DIVISION



MANNED SPACECRAFT CENTER  
HOUSTON, TEXAS

(NASA-TM-X-69694) SPACECRAFT OPERATIONAL  
ABORT PLAN FOR APOLLO 7 (MISSION C).  
VOLUME 2: CSM LAUNCH ABORTS (NASA)  
86 p

N74-70892

00/99 Unclass  
16373

MSC INTERNAL NOTE NO. 68-FM-170

---

PROJECT APOLLO

SPACECRAFT OPERATIONAL ABORT PLAN FOR APOLLO 7  
(MISSION C) VOLUME II-CSM LAUNCH ABORTS

By Edward M. Henderson, Flight Analysis Branch,  
and J. V. Butler, Mission Operational Section, TRW Systems Group

---

July 19, 1968

MISSION PLANNING AND ANALYSIS DIVISION  
NATIONAL AERONAUTICS AND SPACE ADMINISTRATION  
MANNED SPACECRAFT CENTER  
HOUSTON, TEXAS

Approved: Charlie C. Allen  
for Claiborne R. Hicks, Jr., Chief  
Flight Analysis Branch

Approved: Carl R. Huser  
for John P. Mayer, Chief  
Mission Planning and Analysis Division

## CONTENTS

Section	Page
1.0 SUMMARY . . . . .	1
2.0 INTRODUCTION . . . . .	1
3.0 INPUT DATA . . . . .	3
4.0 ABORT MODES . . . . .	5
4.1 General Trajectory Data . . . . .	7
4.2 Mode II . . . . .	8
4.3 Mode III . . . . .	9
4.4 Fixed- $\Delta V$ Mode . . . . .	10
4.5 Mode IV . . . . .	11
4.6 SPS Failures . . . . .	13
5.0 LAUNCH MONITORING DISPLAYS . . . . .	14
5.1 Flight Dynamics Displays . . . . .	14
5.2 Onboard Crew Displays . . . . .	17
6.0 CONCLUDING REMARKS . . . . .	19
7.0 REFERENCES . . . . .	78

## TABLES

Table		Page
I	COMMAND MODULE AERODYNAMIC CHARACTERISTICS AT THE BEGINNING OF MISSION C . . . . .	21
II	S-IVB THRUST AND WEIGHT FLOW TAILOFF MULTIPLIERS . . . . .	22
III	MISSION C/CSM-101 LAUNCH VEHICLE OPERATIONAL TRAJECTORY SEQUENCE OF EVENTS . . . . .	23
IV	SEQUENCE OF EVENTS FOR MODE II LAUNCH ABORT SIMULATIONS . . . . .	24
V	HIGH ALTITUDE CHARACTERISTICS OF MODE II ABORTS FROM THE NOMINAL LAUNCH TRAJECTORY . . . . .	25
VI	LOW ALTITUDE CHARACTERISTICS OF MODE II ABORTS FROM THE NOMINAL LAUNCH TRAJECTORY . . . . .	27
VII	SEQUENCE OF EVENTS FOR MODE III LAUNCH ABORT . . . . .	29
VIII	CHARACTERISTICS OF MODE III ABORTS FROM THE NOMINAL TRAJECTORY . . . . .	30
IX	SEQUENCE OF EVENTS FOR FIXED $\Delta V$ MODE LAUNCH ABORT SIMULATIONS . . . . .	31
X	FIXED $\Delta V$ MODE ABORT DATA . . . . .	32
XI	SEQUENCE OF EVENTS FOR CONTINGENCY ORBIT INSERTIONS . . . . .	33
XII	SPS BURN DURATION, SPS $\Delta V$ , AND RESULTANT APOGEE ALTITUDE FOR MODE IV ABORTS FROM THE NOMINAL TRAJECTORY . . . . .	34
XIII	TYPICAL DSKY PARAMETER VALUES DURING LAUNCH . . . . .	35

## FIGURES

Figure		Page
1	Command service module orientation at SPS ignition for mode III, fixed $\Delta V$ , and mode IV launch aborts . .	37
2	Nominal launch trajectory inertial flight-path angle versus inertial velocity . . . . .	38
3	Nominal launch trajectory altitude versus range . . .	39
4	Nominal spacecraft inertial measurement unit pitch, yaw, and roll platform gimbal angle readouts versus ground elapsed time of abort . . . . .	40
5	Nominal launch abort regions and inertial velocity versus ground elapsed time from launch . . . . .	41
6	Groundtrack and full-lift landing point trace . . . .	42
7	Full-lift landing range following mode II abort from the nominal trajectory . . . . .	43
8	Geodetic latitude and longitude of landing after mode II aborts from the nominal launch trajectory . .	44
9	S-band communication blackout following mode II aborts from the nominal trajectory . . . . .	45
10	Time of free fall to 300,000 feet and maximum entry load factor following mode II aborts from the nominal trajectory . . . . .	46
11	Time of free fall and maximum entry load factor limit lines for mode II aborts . . . . .	47
12	Variation of landing range for mode II aborts . . . .	48
13	Command service module local pitch attitude at SPS ignition for mode III aborts . . . . .	49
14	Sensed velocity change required to land at the Atlantic Discrete Recovery Area . . . . .	50
15	SPS sensed velocity change and CSM weight versus SPS burn duration . . . . .	51

Figure		Page
16	Time of free fall to an altitude of 300,000 feet and maximum entry load factor following mode III aborts from the nominal trajectory . . . . .	52
17	S-band communication blackout following mode III aborts from the nominal trajectory . . . . .	53
18	SPS burn time required to land at the ADRA for mode III aborts from the nominal trajectory . . . . .	54
19	Fixed $\Delta V$ abort mode region . . . . .	55
20	Ground elapsed time of SPS ignition for fixed $\Delta V$ aborts from the nominal trajectory . . . . .	56
21	Time of free fall to an altitude of 300,000 feet and maximum entry load factor for fixed $\Delta V$ aborts from the nominal trajectory . . . . .	57
22	S-band communication blackout interval versus ground elapsed time of a fixed $\Delta V$ abort from the nominal trajectory . . . . .	58
23	Boundaries, SPS $\Delta V$ required, and contingency orbit size for mode IV aborts . . . . .	59
24	Mode IV apogee kick region . . . . .	60
25	SPS burn duration and $\Delta V$ required for COI from the nominal trajectory . . . . .	61
26	Mode IV local pitch attitude versus altitude at SPS ignition . . . . .	62
27	Near insertion abort mode overlap . . . . .	63
28	Landing range control for aborts with no SPS burn . . .	64
29	Landing location for aborts at off-nominal flight-path angles with SPS failure at ignition . . . . .	65
30	Landing location for mode III aborts with SPS failure during the SPS burn . . . . .	66
31	Landing location resulting from SPS failure during a mode IV abort . . . . .	67

Figure		Page
32	Inertial flight-path angle versus inertial velocity ( $\gamma - V$ ) . . . . .	68
33	Inertial flight-path angle at entry interface versus inertial velocity at entry interface ( $\gamma_{EI} - V_{EI}$ ) . . .	69
34	Time of free fall to entry interface versus range to predicted impact point ( $T_{ff} - R_{ip}$ ) . . . . .	70
35	Geodetic latitude versus longitude ( $\phi - \gamma$ ) . . . . .	71
36	Inertial flight-path angle versus inertial velocity (AGC dynamic status) ( $\gamma_i - V_i$ ) . . . . .	72
37	Inertial flight-path angle versus velocity to go to achieve a 75-nautical mile perigee orbit ( $\gamma - V_s$ ) . . .	73
38	Altitude versus range ( $h - d$ ) . . . . .	74
39	DSKY panel layout and display switching pattern . . . .	75
40	Onboard crew chart 1 . . . . .	76
41	Onboard crew chart 2 . . . . .	77

# SPACECRAFT OPERATIONAL ABORT PLAN FOR APOLLO 7 (MISSION C)

## VOLUME II - CSM LAUNCH ABORTS

By Edward M. Henderson, Flight Analysis Branch,  
and J. V. Butler, Mission Operational Section, TRW Systems Group

### 1.0 SUMMARY

The Apollo 7 spacecraft operational abort plan is divided into three volumes: Volume I contains the mode I abort trajectory data, and Volume III contains the associated trajectory data for contingency deorbits. In this volume, Volume II, the results of detailed abort trajectory studies for the Mission C launch phase from launch escape tower (LET) jettison until insertion in earth orbit is presented. A complete abort analysis was conducted for mode II, mode III, and fixed- $\Delta V$  aborts, and for the mode IV contingency orbit insertion maneuvers.

The data enclosed can be used to determine when the limiting flight dynamic conditions for safe abort are reached, to determine which abort mode or technique is required, to provide the basic information needed to perform an abort, and to determine information on the abort result. The flight dynamics display facsimiles and the recommended crew charts for launch monitoring are included. Consideration of the expected dispersions and consumables is discussed.

The primary conclusion is that continuous abort capability exists throughout the launch, should contingencies demand it.

### 2.0 INTRODUCTION

The operational abort studies for Apollo 7 (Mission C) were conducted for command and service modules (CSM) 101 and the Saturn 205 launch vehicle. The abort plan is divided into three volumes: Volume I contains the mode I or the launch escape vehicle abort trajectory data, Volume II contains the remaining launch abort trajectory data pertaining to the CSM, and Volume III contains the associated trajectory data for contingency deorbits. Since mode I abort and contingency deorbit studies are still in progress, these volumes will be published separately and only brief mention of them is included here. In this volume, Volume II, the results of detailed abort trajectory studies for Mission C launch phase from launch escape



tower jettison until insertion in earth orbit is presented.

The primary requirement for launch abort planning is to provide techniques that insure safe recovery of the crew and spacecraft for contingencies that could occur during the launch phase. It is assumed that the launch vehicle performance can vary over a wide range of conditions during launch. Therefore, these conditions must be bounded by limits that would allow sufficient reaction time by the crew and spacecraft systems operations to perform a safe abort. Abort action would be initiated if the launch vehicle violates these limits to prevent flight with unsafe conditions. To avoid aborting a successful launch, the limit lines are defined for the least restrictive conditions which will allow a safe abort.

During launch the velocity, altitude, atmosphere, and launch configuration change drastically; therefore, several abort modes, each adapted to a portion of the launch trajectory, are required. Mode I aborts protect the spacecraft and crew while the launch vehicle is on the pad and during atmospheric flight. They utilize the launch escape system for safe separation, and the aborts result in a suborbital trajectory with landings in the Atlantic Continuous Recovery Area (ACRA). Mode II abort capability begins once the LET has been jettisoned and continues until the contingency orbit insertions capability begins or until the resulting landings threaten the African coast. Mode II aborts consist of a manual CSM separation from the launch vehicle, CM/SM separation, an entry orientation maneuver, and an open loop full lift entry. These aborts result in a suborbital trajectory with landings in the ACRA also. The mode III abort capability begins once the mode II landings threaten the African coast and continues until nominal insertion. The mode III aborts consist of a manual CSM separation, a fixed attitude service propulsion system (SPS) retrograde burn, CM/SM separation, an entry orientation maneuver, and an open loop, bank-left  $55^\circ$  entry. These abort maneuvers result in a suborbital trajectory with landings at the Atlantic Discrete Recovery Area (ADRA). The fixed- $\Delta V$  abort capability exists only near nominal insertion. This procedure is the same as mode III except the SPS retrograde burn results in landings in the Indian Ocean Recovery Area (IORA). The mode IV, or contingency orbit insertion (COI) capability, begins once the SPS can be used to insert the CSM into a safe orbit and continues until the launch vehicle has obtained a safe orbit. The COI maneuver consists of a manual CSM separation, a fixed-attitude, SPS prograde burn resulting in a 75-n. mi. perigee altitude, and subsequent SPS deorbit to a planned landing area. These maneuvers result in a safe orbital trajectory from which an alternate mission or an immediate deorbit can be planned.

The following lists the basic abort requirements for each mode:

1. Mode I aborts are required to provide rapid separation from the launch vehicle during atmospheric flight.

2. Mode II aborts are required to assure sufficient entry sequencing time prior to atmospheric capture and/or to avoid excessive entry loads.

3. Mode III and fixed- $\Delta V$  aborts are required to provide safe water landings for spacecraft systems malfunctions and extremely dispersed cutoffs conditions near insertion.

4. Mode IV, or contingency orbit insertion, is required to achieve a safe orbit following premature S-IVB cutoffs.

The data presented in this report are used to determine when the limiting flight dynamic conditions for a safe abort are reached, to determine which abort mode is required, and to provide the basic information needed to perform an abort and information concerning the abort result.

Reference 1 is a recent comprehensive study of the effects of dispersions on launch phase aborts. This reference can be used to supplement this document for dispersion type information. The sensitivities of the various abort parameters for variations in weight, altitude, burn attitude, and other parameters are discussed and graphically displayed. The launch vehicle trajectory variations for off nominal performance are summarized in reference 2. This reference is good to determine the expected deviations in altitude, range, and flight path angle for the initial abort conditions. Another document that should be used to supplement this document is reference 3. This reference presents the launch phase abort techniques and data flow for Mission C. It contains the flow charts and accompanying rationale for the abort cues, decisions, and data flow for each of the abort modes.

Spacecraft tumbling could occur for aborts when the launch vehicle failures result in high rates. These type of aborts could require an SPS burn to damp the rates. (approximately a 2-second burn is considered sufficient). However, this additional sequence has a negligible effect on the resulting abort procedures and trajectories. Therefore the tumbling abort simulations have not been included in these studies. This technique is listed in the crew procedures and described in reference 4.

The procedures defined in this document require far less consumables than the nominal mission plan, reference 5. Therefore, a specific consumable analysis has not been conducted for this abort plan.

### 3.0 INPUT DATA

The information presented in the following list was used to generate the data presented in this report.

1. Aerodynamic data.- Tables of coefficient of drag ( $C_D$ ) versus

Mach number and lift-to-drag ratio (L/D) versus Mach number for the CM were taken from table I of reference 6. These data are reproduced in table I of this report. These data are valid at the beginning of Mission C for a command module weight of 12 647 lb, which differs from the weight used in these abort studies by 8 lb. Linear interpolation was used between table entries.

2. Central body constants.- Earth model constants were taken from reference 7. The launch pad location was taken from reference 8. The entry interface altitude is 400 000 ft, and the reference altitude for time-of-free-fall calculation is 300 000 ft.

3. Horizon monitor attitudes.- A scribe mark has been positioned on the command pilot's window along the loci of points where the angle between the command pilot's line of sight and the CSM X-body axis is 0.553269373 radian, or  $31.7^\circ$  (reference 9). By maneuvering the CSM to superimpose this scribe mark and the horizon of the earth the command pilot obtains the attitudes illustrated in figure 1.

4. Nominal launch trajectory.- The nominal trajectory computer printout, obtained from reference 10, was used as the basis for the abort studies. Event times were taken from reference 11, since none were explicit in the launch trajectory printout. Event times from reference 11 are consistent with thrust and weight change events in the trajectory printout. Since the last data point of reference 10 is at 10 minutes 3.0 seconds, that time is treated as insertion in this report instead of 10 minutes and 3.6 seconds from reference 11.

5. S-IVB tailoff.- S-IVB thrust and weight flow tailoffs were simulated by multiplying the full thrust values at cutoff initiation by the multipliers given in table II. Tailoff is complete at 1.85 seconds after cutoff is initiated.

6. Tracking ship.- From reference 5 the location of the insertion ship Vanguard used for these studies is  $48.0^\circ$  W longitude and  $32.7^\circ$  N geodetic latitude.

7. Trajectory simulation.- The computer program documented in reference 12 was used to simulate flights. Multi-vehicle N-stage (MVNS) has the capability to simulate both powered and coasting flight in vacuum and in an atmosphere. For these studies vehicle rotational dynamics do not have any significant consequences and were not investigated.

During an SPS burn the thrust axis is aligned through the center of gravity to eliminate rotational moments. Because of the locations of the engine and center of gravity this thrust axis is about  $3^\circ$  from the X-body axis (reference 6).

However, for these studies, the SPS thrust has been assumed to be parallel to the X-body axis. Since the resultant thrust misalignment angle is small, the effect on the data presented in this report is negligible. For example, the sensed velocity change error is approximately 0.14 of 1 percent.

The CSM/S-IVB separation burn during an abort was simulated at the same inertial altitude as the vehicle has on the nominal trajectory at the time of abort initiation. If an abort is necessary during the mission the separation burn will be performed at whatever altitude the vehicle has when separation occurs. The change in flight dynamic parameters due to the separation RCS burn is small so that even a retrograde separation has only a small effect on the accuracy of the data presented in this report.

The sequences of events used for simulations are not exactly identical to those presented in reference 4. However, all of the events having significant effect on flight dynamics have been simulated. Detailed abort procedures are presented in reference 4.

All of the data, except the crew charts in Section 5.2, were generated under the assumption that the altitude at abort equals the altitude on the nominal trajectory at the time of abort. As discussed in Section 5.1 certain plotboard data is calculated using the current vehicle altitude therefore deviations from nominal altitude can be taken into account by flight controllers during the mission. Digital readout data calculated on the basis of current altitude are also available to flight controllers during the mission.

8. Weights, weight flow rates, thrust.- Reference 13 is the source used for the CSM weight (32 389 lb) and SPS usable propellant (8378 lb) at separation from the S-IVB during an abort. The CM weight at entry interface altitude, 400 000 ft, was assumed to be the same as its weight at launch (12 659 lb). The CM reaction control system (RCS) propellant expended after separation of the CM from the SM during an abort is neglected.

The SPS thrust is 20 000 lb, and the weight flow rate is 63.8 lb/sec according to reference 14. From reference 13 the resultant plus-X SM RCS thrust using four jets is 393.2 lb, and the corresponding weight flow rate is 1.444 lb/sec.

#### 4.0 ABORT MODES

The Mission C launch is divided into abort mode regions which are selected depending upon (a) spacecraft propulsion and performance capabilities,

(b) trajectory conditions at abort initiation, and (c) status of life support systems. Consequently the following abort modes have been defined for selection:

1. Mode I.- The mode I abort procedures are designed to protect the crew and spacecraft for contingencies that could occur while the launch vehicle is on the pad, in the sensible atmosphere, at S-IB/S-IVB staging, and during approximately the first 15 seconds of S-IVB powered flight. Contingencies occurring in this region of flight require an escape system that will insure rapid detection of the malfunction, provide adequate separation from the launch vehicle in the event of impending conflagration, and to provide sufficient activation of the spacecraft's earth landing systems. Therefore, the mode I abort is selected when the launch escape vehicle is required to insure a safe procedure. (See Volume I for the mode I trajectory details.)

2. Mode II.- The mode II abort procedures are designed for contingencies occurring after the launch escape tower jettison until a safe orbit can be achieved with the SPS or until the resulting landings threaten the west coast of Africa. Because the aborts initiated in this region can result in very high entry loads (g's) and/or time-critical entries, no range control maneuvers are considered. A full-lift entry is used to minimize g's, and a simple separation technique is established for rapid entry orientation. The mode II procedure requires at least 100 seconds from S-IVB cutoff to 300 000 ft altitude to orient to proper atmospheric capture attitude. This sometimes, for low launch trajectories, requires extending the mode I region or delaying tower jettison until sufficient free-fall time is available to perform the mode II abort. Caution should be employed here to avoid delaying tower jettison too long because the launch vehicle would go unstable in approximately 40 seconds (ref. 15).

3. Mode III.- The mode III abort procedures are for contingencies occurring beyond mode II when a safe orbit cannot be achieved or when spacecraft systems malfunctions require immediate landings. The first mode III requirement is unlikely because of the large COI region and the S-IVB cutoff conditions would have to be greatly dispersed from the nominal launch trajectory. The second is unlikely because if such a malfunction had occurred during launch, the abort would be initiated before entering mode III; and failures occurring after entering mode III (approximately the last 22 seconds of the launch) would be almost impossible to confirm in sufficient time to recommend a mode III.

4. Fixed- $\Delta V$ .- The fixed- $\Delta V$  abort mode is selected when S-IVB cutoff occurs very near nominal and spacecraft system malfunctions dictate immediate landings (same as mode III). For these near nominal cutoffs, the S-IVB has either inserted the spacecraft into a safe orbit or a region requiring only a small COI maneuver. If time permitted, continuing the flight until the first recovery area in the second revolution (2-1) would be the safest procedure. Mode III abort capability exists in this region

also, but the fixed- $\Delta V$  procedure would be used for such contingencies when a safe solution is computed. This is because the fixed- $\Delta V$  procedure requires much less  $\Delta V$ , does not walk the landing trace back across Africa, and usually allows the crew more burn preparation time than mode III. The problem is being able to identify and confirm the malfunction in sufficient time to perform a fixed- $\Delta V$  abort.

The major concern would be a systems failure that required immediate return to the earth's environment to relieve the life support systems. If the spacecraft systems malfunction is not time-critical, the safest procedure would be to achieve a safe orbit and deorbit to the first recovery area in the second revolution (2-1). (See Volume III for trajectory details.) None of these spacecraft systems malfunctions has yet been identified that would require using the mode III or fixed- $\Delta V$  for that purpose. Therefore, the chances of the crew having to perform a mode III or fixed- $\Delta V$  abort is very small compared to the other abort modes.

5. Mode IV.- This COI procedure is selected for contingencies occurring once the SPS can insert the spacecraft into a safe orbit (perigee altitude  $> 75$  n. mi.) and deorbit from any place in the resulting orbit. This technique is the prime selection because it is safest. It allows the ground and crew ample time in earth orbit to determine the spacecraft's trajectory and system status, and the ground can compute a precise deorbit maneuver for a planned landing area. It may also provide a bonus, depending on the propellant available after COI, to perform an alternate mission and obtain many of the planned test objectives (ref. 16). The COI maneuver will be performed at a fixed time after S-IVB cutoff or, if possible, delayed until apogee (apogee kick). The apogee kick maneuver has the following significant advantages over the fixed-time procedure: requires less  $\Delta V$ , results in smaller apogees, and gives the crew additional burn preparation time. Therefore, apogee kick will be selected whenever the apogee is located favorably for the COI maneuver.

To summarize, the abort mode selection criteria is based on the safest procedure available. The mode I abort region would be extended until a safe mode II abort could be achieved. Mode I, mode II, or deorbiting at 2-1 would be best procedure for spacecraft systems malfunctions that require terminating the mission. Mode IV, or COI, is the primary technique for adverse trajectory conditions at S-IVB cutoff.

#### 4.1 General Trajectory Data

The nominal launch sequence of events, condensed from reference 11, is shown in table III. For a nominal launch, the launch vehicle inserts the spacecraft into an earth orbit having approximately a 120-n. mi. perigee altitude and a 150-n. mi. apogee altitude. The relatively high insertion altitude (123 n. mi.) and the total weight placed in orbit require a steep

ascent trajectory and nearly the maximum capability of the launch vehicle.

Figures 2, 3, 4, and 5 show nominal Mission C launch trajectory parameters. Thrust and weight flow begin decreasing rapidly at a guidance cutoff, and insertion occurs exactly 10 seconds after guidance cutoff. Figure 4 shows the gimbal angle readouts of the spacecraft onboard inertial measurement unit (IMU) for the nominal trajectory. Figure 5 shows when the various launch abort modes can be used for an abort from the nominal trajectory. Figure 6 shows the nominal groundtrack and the landing point trace for aborts from the nominal trajectory using the mode II sequence of events. If a situation develops during launch which requires an abort, but which is not time critical, then the abort will be delayed until one of the fixed abort times. These fixed times are 1 minute 40 seconds, 2 minutes 40 seconds, 6 minutes, and 9 minutes. The first two times are in the mode I region, and the mode I procedure would normally be used. Therefore, the landing points for these two times are not shown.

The ACRA extends from Cape Kennedy to the ADRA which is 3200 n. mi. from Cape Kennedy.

#### 4.2 Mode II

The sequence of events for a mode II abort is listed in table IV. Mode II coverage begins when the LET is jettisoned and ends when the landing point, resulting from the sequence listed in table IV, is past the ADRA. Nominally, tower jettison occurs at 2 minutes 43.6 seconds after lift-off. From figure 7, the end of mode II coverage for an abort from the nominal trajectory occurs at 9 minutes 32 seconds after lift-off. Figure 8 shows the landing location for a mode II abort. Fixed-time aborts at 6 minutes and at 9 minutes from lift-off are in the mode II region. Figure 9 shows the S-band communication blackout interval. During this interval there is no communication with the CM since other channels used for Mission C are more sensitive to ionization blackout than is S-band. Figure 10 shows the time of free fall to 300 000 ft and the maximum entry load factor, or deceleration. From about 6 minutes 45 seconds g.e.t. to 7 minutes 40 seconds g.e.t., a mode II abort from the nominal trajectory results in a maximum entry load factor exceeding 16g's. A brief 16g load has been considered the most that a man can tolerate without injury. Consequently, abort limit lines have been defined for the conditions at abort which result in 16g loads during the subsequent entry. Upon reaching these conditions an abort would be initiated. As shown by figure 11, a 16g boundary crossed the nominal Mission C trajectory. Reshaping of the trajectory could eliminate the high g region. However, Mission C is limited by launch vehicle capability, and the needed reshaping would produce an orbit unacceptable for performing a rendezvous. With the concurrence (ref. 17) of the Medical Research and Operations

Directorate and the Structures and Mechanics Division of the Manned Spacecraft Center, the maximum load factor limit has been raised to 18g's where necessary for Mission C. The maximum load factor abort limit line, shown in figures 11 and 12, was arbitrarily faired between 16 and 18g's.

At mode II abort initiation the flight crew needs a minimum of 100 seconds of free fall to prepare for entry. Because of the steepness of the Mission C trajectory, a 100-second limit line allows trajectory deviations into low flight-path angle conditions where an abort would produce excessive g loads during entry. Also a 100-second limit line permits trajectory deviations so large that there is little chance of reaching an acceptable orbit. Therefore, the time-of-free-fall abort limit line, shown in figures 11 and 12, has been defined for the conditions at abort which result in 140 seconds of free fall to 300 000 ft. The 140-second time-of-free-fall limit was adopted by the Apollo Abort Working Group, as reported in reference 18.

Tables V and VI list pertinent characteristics of mode II aborts from the nominal trajectory. All of the mode II data were generated under the assumption that the altitude at abort equals the altitude on the nominal trajectory at the time of abort.

#### 4.3 Mode III

The sequence of events for a mode III abort is listed in table VII. As for the other abort modes, the RCS plus-X translation burn beginning at 3 seconds after abort initiation is performed at the same inertial attitude as the vehicle has on the nominal trajectory at the time of abort initiation. The retrograde horizon monitor attitude, illustrated in figure 1, is used during the RCS ullage, which begins at 110 seconds after abort initiation. This attitude is altitude dependent, as shown in figure 13. During the second RCS burn, the CSM, if viewed in an inertial reference system, will be rotating at the orbital rate. During the SPS burn, however, the stabilization and control system (SCS) will maintain the CSM in the inertial attitude which corresponds to its horizon monitor attitude at SPS ignition. The bank angle used from 0.2g deceleration to drogue deployment is  $55^\circ$  south to be consistent with the end of mission backup entry procedure. Also,  $55^\circ$  bank maximizes cross-range travel which further reduces a low CM/SM recontact probability.

Mode III abort capability begins when the mode II landing range exceeds 3200 n. mi. On the nominal trajectory, mode III coverage begins 32 seconds prior to insertion. Mode III ends beyond nominal insertion when SPS propellant capacity or time-of-free-fall restrictions will not allow sufficient SPS burn to land in the ADRA. The landing location for a mode III abort, the ADRA, is 3200 n. mi. downrange from the launch site. The landing target is at longitude  $20.28^\circ$  W and geodetic latitude  $25.55^\circ$  N.



Because a mode III abort employs a partial-lift entry as opposed to a full-lift entry for a mode II abort, early abort times in the mode III region require no SPS burn and will land short of the ADRA. This region corresponds to the shaded area of figure 14. The nominal trajectory leaves this region at 9 minutes 34 seconds g.e.t. In the same figures the SPS total-sensed velocity change ( $\Delta V$ )<sup>a</sup> required to land at the ADRA can be determined by interpolating between the lines of constant  $\Delta V$ . The SPS burn duration which corresponds to a given  $\Delta V$  can be determined from figure 15. The relationship between burn duration and total sensed velocity change, which is the basis for figure 15, is not dependent on burn attitude; therefore, figure 15 is also valid for mode IV and fixed- $\Delta V$  SPS burns. Figure 16 shows the time of free fall to 300 000 ft after SPS cutoff and the maximum entry g's for mode III aborts from the nominal trajectory. Both of these quantities are well within the limits established for Mission C. The discontinuity in time of free fall at 9 minutes 34 seconds g.e.t. corresponds to the first time an SPS burn is required to land at the ADRA. Figure 17 shows the S-band communications blackout region for mode III aborts from the nominal trajectory. The blackout duration is approximately 2 minutes. Figure 18 shows the SPS retrograde burn required to land at the ADRA after an abort from the nominal launch trajectory. SPS failures at ignition or during the retrograde burn are discussed in section 4.6.

#### 4.4 Fixed- $\Delta V$ Mode

Several characteristics of a mode III abort near the nominal insertion point or after insertion are undesirable. In this area long SPS burns, over a minute in duration, are required to land at the ADRA. Also, the instantaneous landing point during the SPS burn sweeps westward across Africa so that a premature SPS cutoff can result in a land landing. The fixed- $\Delta V$  mode, defined in table IX, has been designed to provide capability for quick return to earth without the long burns or the land landing possibility associated with a mode III abort. The fixed- $\Delta V$  mode also has the advantage of long coast times, from 2 to over 30 minutes in duration, preceding SPS ignition. However, some disadvantages to this abort mode are significant. Fixed- $\Delta V$  mode capability exists only for S-IVB cutoffs very near nominal insertion, between approximately 2 seconds of underspeed and 3 seconds of overspeed. Also, the landing area, IORA, will be covered only by aircraft and ships of opportunity.

In the fixed- $\Delta V$  abort region, the range from the SPS initiation point to the desired CM landing point, the IORA, is variable. The fixed- $\Delta V$

---

<sup>a</sup>The vector component of sensed velocity change along the plus-X axis of the CM is calculated onboard. Since the thrust axis is displaced approximately 3.0° from the plus-X axis, the plus-X component equals approximately 99.86 percent of the total sensed velocity change.

abort consists of a fixed retrograde SPS burn ( $\Delta V = 600$  fps) at a fixed attitude (figure 1) and a half-lift entry (bank left  $55^\circ$ ), which results in a fixed landing range of 8800-n. mi. downrange from the launch pad. The timing of SPS ignition provides the necessary landing range control just as a variable SPS burn duration provides landing range control for mode III. In figure 19 lines of constant ground elapsed time of SPS ignition required to land at the IORA are shown.

The boundaries of the fixed- $\Delta V$  region of figure 19 are defined by the lines for maximum time delay, minimum time delay, and perigee altitude of 35 n. mi. The maximum-time-delay line is the locus of S-IVB cutoff conditions that stipulate the first time the fixed- $\Delta V$  procedure can be used, the landing target be achieved, and still have 100 seconds of free-fall time after the burn. It defines the longest time the SPS burn can be delayed from S-IVB cutoff. S-IVB cutoffs to the left of this line would require delays too far in the suborbital trajectory to maintain the 100-second free-fall time. The minimum-time-delay line defines the locus of S-IVB overspeed conditions that require the SPS burn to be performed in 2 minutes 5 seconds to achieve the desired abort parameters. S-IVB overspeed beyond this line would require SPS ignitions sooner than 2 minutes 5 seconds from S-IVB cutoff, which is less than the minimum crew abort burn preparation time. The 35-n. mi. perigee altitude line defines the S-IVB cutoff conditions which would produce a 35-n. mi. perigee altitude after the fixed- $\Delta V$  maneuver. S-IVB cutoffs beyond this line would result in higher perigees for the fixed- $\Delta V$  aborts and would be extremely sensitive to the smallest dispersion. See reference 1.

Figure 20 shows the ground elapsed time of SPS ignition for aborts from the nominal trajectory. Figure 21 shows the time of free fall to 300 000 ft after SPS cutoff and the maximum load factor experienced during atmospheric entry for aborts from the nominal. The time of free fall increases very rapidly as the fixed- $\Delta V$  region is entered. Along the nominal trajectory the time of free fall is about 60 seconds for an abort at 9 minutes 51 seconds g.e.t. At 9 minutes 52 seconds the time of free fall is over 5 minutes. Figure 22 shows the ground elapsed time of entering and exiting the S-band ionization blackout region for aborts from the nominal trajectory. Table X lists pertinent characteristics of fixed- $\Delta V$  aborts from the nominal trajectory.

#### 4.5 Mode IV

The sequence of events for a mode IV abort is given in table XI. A mode IV abort is a COI using the SPS. The perigee altitude must be at least 75 n. mi., and the apogee must be low enough to permit a deorbit from any point on the orbit. Current SPS propellant loading allows a total sensed velocity increment of 3030 ft/sec. Of this amount, 230 ft/sec is allotted to arresting attitude rates and maintaining pitch attitude,

and a minimum of 600 ft/sec is reserved for deorbit from the contingency orbit. This leaves a maximum SPS  $\Delta V$  capability of 2200 ft/sec for use in attaining COI.

Figure 23 presents constant SPS  $\Delta V$  lines from 0 to 2200 ft/sec at 200 ft/sec intervals on a plot of inertial flight-path angle versus inertial velocity. These lines indicate the sensed velocity change necessary to achieve an orbit with a 75-n. mi. perigee. Constant apogee lines displayed on figure 23 show the dimensions of the orbit (perigee equals 75 n. mi.) which can be expected as a result of the COI. The GO - NO-GO line indicates conditions at abort resulting in an orbit with a 75-n. mi. perigee. On or to the right of this line, the mode IV  $\Delta V$  is zero. The two segments of the mode IV boundary define the region in which the total  $\Delta V$  required for COI and the subsequent deorbit is equal to or less than the 2800 ft/sec allotted for these maneuvers. The left side of the mode IV region is bounded by the 2200 ft/sec COI  $\Delta V$  line, since this is more constraining than the 2800 ft/sec limit for COI and deorbit combined.

In practice the COI burn will usually be padded, or extended to obtain an extra 100 ft/sec of  $\Delta V$ . This pad is intended to insure achieving a 75-n. mi. perigee despite small pitch, altitude, or other dispersions. As discussed in reference 1, there exist flight mechanical limits beyond which no amount of SPS burn, at the attitude shown in figure 1, will raise perigee to 75 n. mi. Near these flight mechanical limits COI capability can be lost by padding the burn. For Mission C, SPS propellant limitations establish the COI region inside of the flight mechanical limits so that padding the SPS burn 100 ft/sec should not adversely affect the resultant perigee altitude.

A modified mode IV procedure, called apogee kick, can be used to advantage for some positive flight-path angle contingency situations near insertion. The SPS burn to raise perigee and the RCS ullage immediately preceding the SPS burn are delayed until the CSM coasts to apogee. Compared to the standard mode IV sequence, apogee kick allows the crew more time to prepare for the SPS burn and requires a smaller  $\Delta V$  to achieve a 75-n. mi. perigee. Apogee kick also has the advantage of a smaller increase in apogee altitude during the SPS burn. A lower apogee requires less retrograde burn for a deorbit maneuver performed near perigee. Mission rules require that Canary Island acquisition occurs no later than apogee if an apogee kick is to be performed. The area to the right of the apogee kick line in figure 27 defines the region where the resulting apogee, following an S-IVB cutoff, occurs after the Canary Island tracking station has acquired the spacecraft. (Acquisition occurs at an elevation angle of  $3^\circ$ .) In this zone any spacecraft burn to be performed at apogee can be relayed to the crew via the Canary Island station. Constant times from abort to apogee and constant  $\Delta V$ 's required for apogee kick are shown in the apogee kick region.

The burn duration and sensed velocity change required for COI are

presented in figure 25 as functions of ground elapsed time of abort. Table XII contains SPS burn duration, SPS sensed velocity change, and the resulting apogee altitude for mode IV aborts from the nominal trajectory. The pitch attitude at SPS ignition in the local coordinate system is shown in figure 26 as a function of altitude. This attitude is illustrated in figure 1. Positive pitch is measured upward from the projection of the velocity vector on the local horizontal plane.

The aborts discussed are summarized on figure 27. On this figure the abort mode overlap is obvious and the abort mode priorities are as discussed in section 4.0. Once the S-IVB has crossed the GO - NO-GO line, no abort action will be required unless for SC system malfunctions.

#### 4.6 SPS Failures

As discussed in the preceding sections, a continuous abort capability exists throughout the launch. This is true, only, if the SPS is operational. There are two regions during launch, the mode III and fixed- $\Delta V$  abort, and the mode IV burns where SPS failures could produce unsafe orbital or landing conditions. An unsafe orbit is defined as one with perigee altitudes (HP) greater than 35 n. mi. but less than 75 n. mi., and an unsafe landing is defined as African landings which exist for landing ranges between 3500 n. mi. and 7100 n. mi. Neither of these two conditions can be obtained in the mode II abort region, and therefore this mode will not be discussed here.

Figure 28 shows the landing trace as it crosses Africa for different CM lift profiles. From this figure the times of abort along the nominal launch trajectory that corresponds to the landing footprint being completely on Africa for no SPS burns can be obtained. The last abort time, a bank- $90^\circ$  entry, could result in an Atlantic Ocean landing is 9 minutes 39 seconds g.e.t., and the first time a full lift landing would result in an Indian Ocean landing is 9 minutes 50 seconds g.e.t. Using this entry technique results in a dwell time of 11 seconds along the nominal trajectory, where aborts with no SPS ignitions would result in African landings. The use of the SM RCS to decrease this dwell time was not investigated; but, from previous studies such as reference 19, this time could be reduced several seconds by burning the SM RCS, retrograde for Atlantic landings and prograde for Indian Ocean landings. The high flight altitudes for this mission in this region would allow ample free-fall time to perform such a maneuver.

Figure 29 summarizes this information for off-nominal flight-path angles and indicates where S-IVB cutoffs would result in unsafe conditions without remedial SPS or SM RCS maneuvers. The procedures for handling unsafe orbits in real time are defined in the mission rules and will be discussed in Volume III of this document. Incidentally, the 35-n. mi. perigee altitude line closely corresponds to the skipout line for the entry corridor.

The SPS burns for the mode III abort or the mode IV COI maneuver are subject to the same unsafe conditions. That is, partial SPS burns for these maneuvers could result in an African landing or in an unsafe orbit. These are summarized for aborts from the nominal launch trajectory as a function of SPS failure time on figures 30 and 31. As shown on these figures, the dwell times are greatly increased for the SPS burns across Africa as compared to the S-IVB burn.

## 5.0 LAUNCH MONITORING DISPLAYS

### 5.1 Flight Dynamics Displays

The flight dynamics displays are the visual aids which are available for the flight dynamics, retrofire, and guidance offices for trajectory monitoring during the launch. They are launch digitals and projection plotters displayed on cathode ray tubes and analog plotboards to be used to determine the trajectory status and to command abort action if necessary. The displays are driven by real-time computer computations based on the actual flight data received from the Manned Space Flight Network (MSFN).

The background plots that will be used to monitor the trajectory traces are shown in figures 32 through 39. These figures are the ones currently being used in simulations as defined in reference 20. These displays will be updated prior to the actual launch to reflect the latest spacecraft and trajectory data.

Figure 32 is the primary display for monitoring the launch trajectory. The lines shown on this display, except for the structural breakup line, were computed assuming the altitudes, corresponding to the inertial velocities along the nominal launch trajectory, remain constant for the flight-path angles investigated. The nominal launch profile is shown for easy detection of launch deviations.

The structural breakup line defines the region where structural failure is assured. Structural failures above this line are protected by the emergency detection system, (EDS). This line is used to protect against slow drifting trajectories which will not be covered by the EDS, and it is the only line on this display that will be used to command abort action and is biased 8 seconds for data and reaction delays. The line is only valid when all eight engines are thrusting during S-IB flight. The maximum load factor line is only used to indicate an impending abort. The actual abort action will be taken on figure 33. The time-of-free-fall line is also used only as an indication, and abort action will be taken when the time-of-free-fall digital equals 140 seconds and is decreasing.

The mode IV capability line is biased 3.5 seconds to show that the spacecraft has achieved COI capability when the scribe reached the line. This crossing will be used for the ground to report to the crew that

mode IV status has been achieved. The actual mode IV capability is determined by the mode IV computed  $\Delta V$  ( $\Delta V_{INS}$ ) after S-IVB cutoff and is displayed on the launch digitals for the selected tracking source. A mode IV can be recommended if the  $\Delta V_{INS} \leq 2200$  fps. The bias is obtained by moving the plotboard line to the left at an increment equal to the change in velocity occurring during the 3.5 seconds of flight on the nominal trajectory just prior to achieving mode IV capability. The biased line will erroneously indicate that mode IV capability has been achieved if the S-IVB cutoff occurs during the 3.5 seconds prior to actually achieving mode IV capability, if the trajectory is off-nominal in altitude or intersects the biased line at a shallow angle.

The apogee kick line indicates when S-IVB cutoff conditions would require an apogee kick. This line defines when the S-IVB cutoff trajectory conditions would result in apogee occurring at Canary Island tracking acquisition (based on  $3^\circ$  elevation angle). A combination of displays will be used to make this decision in real time. The GO - NO-GO line is determined by trajectory parameters which define a 75-n. mi. perigee altitude for the nominal insertion altitude. The GO - NO-GO decision will be based on the digital displays for the selected tracking source after S-IVB cutoff.

A potential abort limit that may be added to this display is an exit heating limit. This limit will protect against flight conditions which would cause heating damage to the spacecraft during launch. This limit is currently under investigation by North American Rockwell, and its exact use will depend upon the results of these studies.

The time of free fall and the maximum entry load factor limit lines in figure 32 were generated using the altitude on the nominal trajectory corresponding to the velocity at abort initiation. These lines will be inaccurate at off-nominal altitudes. To avoid making an abort decision on an inaccurate boundary, the flight controllers will switch to one of the plotboards shown in figures 33 and 34, if the maximum entry load factor or time-of-free-fall limits in figure 32 are approached. The plotboard on figure 33 displays the trace of the actual entry conditions at 400 000 ft altitude, and the one on figure 34 displays the trace of free-fall time and full-lift landing range. These parameters are computed almost instantaneously by the real-time program from the actual position and velocity vectors extracted from the flight data. Therefore, the lines shown on these displays are not subjected to the altitude assumptions as the ones of figure 32.

Figure 33 will be used to initiate abort action for trajectory violations that result in excessive maximum entry load factors (g's). Figure 34 illustrates the nominal full-lift landing range variation with free-fall time. This plot shows the free-fall time abort limit, but abort action will be taken on the digital value of free-fall time of 140 seconds and decreasing. Full-lift landing ranges corresponding to the range from the

pad to the ADRA, east coast of Africa (7300 n. mi.), and IORA are also shown. This display can be used to indicate when the mode II ends and when the full landing range is clear of Africa.

Figure 35 shows the geodetic latitude versus longitude plotboard, which is used to record the predicted mode II landing point of the CM. When the full-lift landing point marker crosses the "Mode II Landing Range Equals 3200 Nautical Miles" line, mode II capability ends. The last time an Atlantic landing can be obtained without a retrograde burn is when the full-lift landing trace crosses the "Bank 90 Degree Range Equals 3400 Nautical Miles" line. This line and the east coast of Africa line on figure 34 defines when the landing footprint is completely on Africa. Figure 35 also shows the acquisition ellipses for the Canary Island, Bermuda, and Vanguard tracking locations. These ellipses are based on a constant 100-n. mi. altitude and a  $0^\circ$  elevation angle.

Figure 36 is the Apollo guidance computer (AGC) Dynamic Status display. This display will be used to compare the trajectory from the AGC tracking data with that of other sources. The mode IV capability line is also shown to indicate when the AGC data would compute a valid COI maneuver ( $\Delta V_{INS} \leq 2200$  fps). This display along with other data is used to indicate that the AGC is navigating properly.

Figure 37 displays the inertial flight-path angle and velocity-to-go ( $V_S$ ) to achieve a 75-n. mi. perigee orbit as computed in real time. When the trace crosses the  $V_S = 0$  line a GO orbit is achieved. The primary use of this display will be to monitor the COI maneuver. This display will indicate when the COI burn has achieved a safe orbit. Consideration is being given to adding mode IV or COI capability lines for various altitudes. This would enable defining COI capability for anytime during coasting flight and not just at 125 seconds after S-IVB cutoff. Also for delayed burns, it would show for the altitudes considered when COI capability is lost.

The altitude-versus-range profile is shown on figure 38. This display would show when the altitude history deviates significantly from the planned profile. The display can be used in conjunction with figure 32 to help determine the validity of those altitude-dependent lines. The mode IV mark is a biased 100 000-ft altitude line which defines the first time the crew can perform the high altitude mode I abort procedure. The actual ground report to the crew will be based on the corresponding digital value of altitude. The 75-n. mi. altitude line shows the smallest altitude for which a COI maneuver can be computed.

The flight dynamics displays and the Real-Time Computer Complex (RTCC) computations are designed to account for off-nominal flight-path angles and altitudes for abort conditions where possible. But, because much of

the information data shown on the displays is computed premission, a nominal altitude history has been assumed. For this reason, to back up the RTCC computations, and as a cross check, the abort burn  $\Delta V$  parameters are being generated for several different altitudes. These will be flight controller console plots which can be used in simulations or during the mission to compare solutions.

## 5.2 Onboard Crew Displays

During the launch the crew has program 11 and its corresponding display keyboard (DSKY) displays to facilitate trajectory monitoring (figure 39). This program is automatically initiated upon lift-off and is available until the ground or crew commands program 00. Normally the ground Mission Control Center (MCC) will inform the crew of their trajectory status, but, if voice communications were lost during the launch, the crew would have to depend on the DSKY for this information. Table XIII shows the values of the parameters for a nominal launch, which were computed with the guidance equations (ref. 21) and the launch parameters from reference 11. During the launch, these parameters are updated every two seconds and displayed to the crew. Any time the MCC would rule the spacecraft guidance NO GO - from the displays like figure 36 - the computer will be commanded to program 00 and these DSKY displays would no longer be available. (See ref. 3 for procedure.)

In conjunction with the DSKY displays in program 11, two onboard charts are proposed for use in the event of voice communications loss during the launch, figures 40 and 41. These charts have been tentatively agreed upon with the crew and are designed specifically to be uncomplicated with as few lines as possible. The apogee kick and fixed- $\Delta V$  procedures have been ruled out as alternatives when voice communications are lost to further simplify no-voice decisions.

The basic display for launch monitoring are the inertial velocity, altitude rate, and altitude parameters. Therefore, these are the parameters used to govern the charts. The charts with the DSKY are to be used to help determine when abort action is necessary and what action is required. These functions would normally be conducted by the MCC when voice communications exist. Once the abort decision has been made, the crew would use the DSKY parameters to monitor the abort burn. The following list defines the action required for each mode:

1. Mode I.- Mode I aborts use the launch escape vehicle and no DSKY parameters will be required.
2. Mode II.- Mode II aborts require no SPS burns, but V16N50E displays are recommended. These parameters will indicate the free-fall time (TFF) remaining for entry orientation and can be used to estimate



their landing range by adjusting SPLERROR<sup>a</sup> for the full lift entry.

3. Mode III.- Mode III aborts do require an SPS burn and VI6N50E is the necessary display. After achieving the proper burn attitude (fig. 1) the crew would burn the SPS until SPLERROR is equal to zero. This would satisfy the desired landing coordinates for a mode III entry.

4. Mode IV.- Mode IV or contingency orbit insertion also requires a burn and VI6N50E is the recommended display. After achieving the proper burn attitude (fig. 1) the crew would burn the SPS until perigee altitude is equal to 75-n. mi.-plus-5-seconds. This procedure would insure achieving a safe orbit. Caution should be employed here, if anytime during the burn the perigee altitude starts decreasing the burn should be terminated; and, for these terminated burns with perigee altitude less than 75 n. mi., a mode III abort should be initiated.

5. GO Orbit.- A GO orbit is defined to exist anytime the cutoff conditions result in perigee altitude greater than 75 n. mi. and no other action be required. VI6N44E can be called to display insertion parameters.

Figure 40 shows the nominal-altitude-rate-versus-velocity trace and the current abort trajectory limits. Should the actual flight trace violate the booster breakup line or the maximum-entry-load-limit line, an abort is required. If the trace approaches the time-of-free-fall-limit line, VI6N50E should be called and abort action be taken when time of free fall equals 140 seconds and is decreasing. Note that if even voice communications were lost, the MCC might still have command capability; then MCC would light the abort lite for trajectory limit violations. Using the chart to initiate aborts on the maximum entry load limit for off-nominal altitudes would be an invalid cue. Therefore, for higher than nominal altitudes aborts should be initiated sooner, and for lower than nominal altitudes aborts could be initiated later than would be indicated. See reference 1 for this limit sensitivity with altitude.

Figure 41 shows the nominal-altitude-rate-versus-velocity trace for approximately the last 30 seconds of the launch. This plot expands the region in which abort capability starts varying rapidly. The primary use of this chart is to show for what S-IVB cutoff conditions COI capability exists. Therefore, the COI boundary is defined for different altitudes. The altitude being fairly static near insertion, the crew could choose the appropriate COI boundary and determine when the S-IVB trace crosses into the COI capability region. The remaining lines on this figure are for information only and to facilitate crew training. The other abort capabilities can be determined directly from the DSKY. Once tower jettison has occurred, mode II capability extends until SPLERROR ( $\Delta R$ ) becomes

<sup>a</sup>SPLERROR is the difference between the half-lift landing point as computed by the AGC and the desired ADRA target coordinates. This computation is based on the current position and velocity of the spacecraft.

greater than -167 n. mi. corresponding to a full-lift landing at 3200 n. mi. Mode III capability extends from  $\Delta R$  greater than -167 n. mi. until a nominal insertion is achieved. A GO orbit is achieved when perigee altitude is greater than or equal to 75 n. mi.

Note whenever the time of free fall is pegged at 59 minutes 59 seconds, the  $\Delta R$  computation is invalid. This is true once the perigee altitude becomes greater than 300 000 ft. If a mode III burn is required in this region,  $\Delta R$  will become valid when the burn has progressed enough to decrease perigee below 300 000 ft.

## 6.0 CONCLUDING REMARKS

The data presented here illustrates that continuous abort capability exist for contingencies that could occur between LET jettison up to nominal insertion. For very low launch trajectories tower jettison may need delaying until mode II capability is achieved. Where possible, mode II aborts should be delayed until entry g's are reduced. Mode IV, or COI, is the primary procedure once the capability is achieved. The COI maneuver may need adjusting during the burn to correct for pitch alignment errors. The mode III and IV SPS burns require a lighted horizon to confirm proper burn attitude.

Other studies, outside this document, have been conducted which show that sun-in-the-window and separation for the abort procedures defined present no problem. These are documented in references 22 and 23, respectively.

The flight dynamics displays, crew charts, and console plots will be updated as required before launch. Other revisions will be incorporated as an update to this document if necessary to reflect significant changes in the abort trajectory data. The fixed-time aborts and apogee kick capability has changed since the data for this document has been generated. The new fixed time of aborts are 1 minute 40 seconds, 2 minutes 40 seconds, 4 minutes 40 seconds, and 8 minutes 30 seconds (ref. 24). The apogee kick capability is defined as when S-IVB cutoffs for positive flight path angles and inertial velocities greater than the 23 500 fps result in apogees later than three minutes from cutoff with mode IV SPS burns greater than 100 fps.

An attempt to investigate all the reasonable flight-path angle and altitude variations for this type launch has been made. This document does not show all these results; however, much of this type data can be obtained directly from references 1 and 2. Also some consideration has been given to off-nominal performance and the effects of atmospheric variations.

These studies showed that one of the most sensitive parameters, that could not be computed in real time, was the pitch attitude the crew uses for the COI burn. Therefore, as discussed in section 4.5, a part of the total SPS propellant is held in reserve for when COI burns with off-nominal pitch attitudes require more burn. This means the COI maneuver computed and passed from the MCC might need adjusting during the burn to account for misalignments.

A specific consumable analysis has not been conducted for this abort plan. All of the procedures defined in this document require far less consumables than the nominal mission plan. The only requirement for consumable analysis would be on the alternate missions considered after an COI had been performed, and these are discussed in reference 16. The SPS propellant available is the only critical consumable that influences these abort plans, and this value was obtained from reference 13.

Table I. Command Module Aerodynamic Characteristics  
at the Beginning of Mission C

---

<u>Mach No.</u>	<u>Drag (<math>C_D</math>)</u>	<u>Lift-to-drag Ratio (L/D)</u>
0.00	0.82706	0.27359
0.20	0.82706	0.27359
0.40	0.85592	0.26518
0.70	0.99119	0.25373
0.90	1.07330	0.28468
1.10	1.18650	0.39687
1.20	1.17160	0.39148
1.35	1.29310	0.41764
1.65	1.28040	0.41723
2.00	1.29550	0.40182
2.40	1.26630	0.39003
3.00	1.24300	0.37503
4.00	1.23610	0.34628
6.00	1.31000	0.28444
25.00	1.31000	0.28444

---

Command Module Weight = 12,647 lb  
X Center of Gravity = 1041.22 in.  
Y Center of Gravity = -0.4 in.  
Z Center of Gravity = 5.65 in.

Table II. S-IVB Thrust and Weight Flow Tailoff Multipliers

---

<u>Time Elapsed Since Cutoff (sec)</u>	<u>Thrust or Flow Rate Multiplier</u>
0.00	1.000
0.10	0.993
0.20	0.503
0.30	0.137
0.40	0.086
0.60	0.060
0.80	0.036
1.00	0.026
1.20	0.018
1.40	0.012
1.70	0.004
1.85	0.000

---

Table III. Mission C/CSM-101 Launch Vehicle Operational Trajectory Sequence of Events

---

<u>Ground Elapsed Time</u> (min:sec)	<u>Event</u>
-0:05.0	Guidance Reference Release (GRR)
0:00.0	First motion
0:00.2	Lift-off signal; initiate Time Base 1.
0:10.2	Initiate pitch and roll maneuvers.
1:16.0	Maximum dynamic pressure
2:14.5	Tilt arrest
2:17.4	Level sensor activation, initiate Time Base 2.
2:20.6	Inboard engine cutoff
2:23.6	Outboard engine cutoff; initiate Time Base 3.
2:24.9	Separation signal
2:25.0	S-IB/S-IVB physical separation
2:26.3	J-2 engine start command
2:28.7	Ullage burn out
2:29.9	90 percent J-2 thrust level
2:36.9	Jettison ullage rocket motors
2:43.6	Jettison launch escape tower
2:48.6	Command IGM initiation
9:53.6	Guidance cutoff signal
9:53.9	Initiate Time Base 4 (reflects an approximate 0.2 second systems delay).
10:03.6	Orbital insertion

---

Table IV. Sequence of Events for Mode II Launch Abort Simulations

---

<u>Controlling Condition</u>	<u>Value of Controlling Condition</u>	<u>Event</u>
Time Since Abort Initiated (sec)	0.0	S-IVB thrust tailoff begins. Service module RCS ullage begins. (4 SM RCS jets in plus X direction).
	1.85	Thrust and weight flow equals zero.
	3.0	S-IVB and CSM separate.
	24.0	Ullage burn terminates. Coast begins. Crew begins maneuvers to separate CM from SM and to orient for entry
Altitude (ft)	400,000	Atmospheric entry Bank angle equals zero.
	24,000	Apex cover jettison
Time Since Apex Cover Jettison (sec)	2.0	Drogue parachute deploys.
Altitude (ft)	10,000	Main parachute deploys.
	0	Landing in Atlantic Continuous Recovery Area

---

Table V. High Altitude Characteristics of Mode II Aborts from the Nominal Launch Trajectory

Ground Elapsed Time of Abort (min:sec)	Predicted Time of Free Fall from Abort to 300,000 Feet (min:sec)	Ground Elapsed Time at 400,000 Feet (min:sec)	Inertial Velocity at 400,000 Feet (ft/sec)	Inertial Flight-path Angle at 400,000 Feet (deg)	Ground Elapsed Time at 300,000 Feet (min:sec)	Ground Elapsed Time at S-band Blackout Entry (min:sec)	Ground Elapsed Time at S-band Blackout Exit (min:sec)
2:43.91*	3:20.00	3:46.69	7,197.42	-10.02	6:05:02	--	--
2:50	3:21.00	3:43.03	7,361.56	-11.33	6:11.88	--	--
3:00	3:23.21	3:38.52	7,627.04	-13.17	6:24.09	--	--
3:10	3:25.68	5:57.32	7,888.43	-14.68	6:36.52	--	--
3:20	3:27.80	6:11.93	8,149.38	-15.76	6:48.62	--	--
3:30	3:29.62	6:25.70	8,411.59	-16.56	7:00.42	--	--
3:40	3:31.19	6:38.83	8,675.90	-17.16	7:11.97	--	--
3:50	3:32.55	6:51.48	8,941.23	-17.61	7:23.32	--	--
4:00	3:33.76	7:03.76	9,210.70	-17.92	7:34.51	--	--
4:10	3:34.81	7:15.72	9,483.96	-18.12	7:45.55	--	--
4:20	3:35.77	7:27.45	9,759.99	-18.23	7:56.50	--	--
4:30	3:36.65	7:38.98	10,042.45	-18.26	8:07.37	--	--
4:40	3:37.45	7:50.34	10,330.88	-18.22	8:18.16	--	--
4:50	3:38.21	8:01.57	10,624.42	-18.12	8:28.91	--	--
5:00	3:38.96	8:12.73	10,925.44	-17.96	8:39.64	--	--
5:10	3:39.69	8:23.80	11,234.97	-17.76	8:50.37	--	--
5:20	3:40.42	8:34.81	11,551.83	-17.51	9:01.09	--	--
5:30	3:41.19	8:45.81	11,876.18	-17.23	9:11.85	--	--
5:40	3:42.04	8:56.82	12,210.85	-16.92	9:22.68	--	--
5:50	3:42.94	9:07.85	12,556.89	-16.57	9:33.57	--	--
6:00	3:43.93	9:18.92	12,914.02	-16.19	9:44.55	--	--
6:10	3:45.06	9:30.08	13,281.56	-15.79	9:55.67	10:35	10:38
6:20	3:46.35	9:41.36	13,662.07	-15.37	10:06.94	10:44	10:51
6:30	3:47.86	9:52.80	14,056.50	-14.92	10:18.43	10:55	11:03
6:40	3:49.60	10:04.43	14,466.94	-14.45	10:30.15	11:05	11:16
6:50	3:51.65	10:16.31	14,893.60	-13.96	10:42.18	11:16	11:29
7:00	3:54.03	10:28.47	15,335.38	-13.46	10:54.54	11:28	11:42
7:10	3:56.86	10:40.99	15,794.87	-12.94	11:07.33	11:40	11:56
7:20	4:00.22	10:53.99	16,273.43	-12.41	11:20.65	11:52	12:10
7:30	4:04.25	11:07.56	16,773.41	-11.86	11:34.64	12:06	12:25
7:40	4:09.13	11:21.88	17,297.26	-11.29	11:49.46	12:20	12:42
7:50	4:15.02	11:37.08	17,844.57	-10.70	12:05.28	12:35	12:59

\* Launch Escape Tower Jettison



Table V. High Altitude Characteristics of Mode II Aborts from the Nominal Launch Trajectory (Continued)

Ground Elapsed Time of Abort (min:sec)	Predicted Time of Free Fall from Abort to 300,000 Feet (min:sec)	Ground Elapsed Time at 400,000 Feet (min:sec)	Inertial Velocity at 400,000 Feet (ft/sec)	Inertial Flight-path Angle at 400,000 Feet (deg)	Ground Elapsed Time at 300,000 Feet (min:sec)	Ground Elapsed Time at S-band Blackout Entry (min:sec)	Ground Elapsed Time at S-band Blackout Exit (min:sec)
8:00	4:21.53	11:52.79	18,395.73	-10.12	12:21.71	12:51	13:17
8:10	4:28.42	12:08.72	18,950.46	-9.54	12:38.49	13:07	13:36
8:20	4:36.09	12:25.25	19,513.29	-8.96	12:56.04	13:24	13:56
8:23	4:38.63	12:30.40	19,684.72	-8.78	13:01.53	13:30	14:02
8:31	4:46.11	12:44.72	20,148.60	-8.30	13:16.88	13:45	14:20
8:41	4:57.46	13:04.31	20,743.79	-7.69	13:38.02	14:06	14:44
8:51	5:12.15	13:26.75	21,356.91	-7.05	14:02.42	14:31	15:13
9:01	5:31.88	13:56.60	22,039.48	-6.34	14:35.04	15:04	15:51
9:11	5:59.67	14:31.10	22,705.29	-5.62	15:13.12	15:42	16:37
9:21	6:41.59	15:18.16	23,405.22	-4.83	16:05.53	16:36	17:40
9:31	7:52.99	16:31.00	24,144.72	-3.92	17:27.90	18:02	19:21

Table VI. Low Altitude Characteristics of Mode II Aborts from the Nominal Launch Trajectory

Ground Elapsed Time of Abort (min:sec)	Ground Elapsed Time at Drogue Chute Deployment (min:sec)	Ground Elapsed Time at Main Chute Deployment (min:sec)	Ground Elapsed Time at Landing (min:sec)	Geodetic Latitude at Landing (deg north)	Longitude at Landing (deg west)	Range at Landing (n mi)
2:43.91*	8:56.12	9:42.12	14:25.12	29.94	74.85	311.42
2:50	9:02.35	9:48.35	14:31.35	29.98	74.65	322.38
3:00	9:13.42	9:59.42	14:42.42	30.05	74.30	341.18
3:10	9:24.85	10:10.85	14:53.85	30.12	73.93	360.57
3:20	9:36.32	10:22.32	15:05.32	30.19	73.56	380.53
3:30	9:47.78	10:33.78	15:16.78	30.26	73.17	401.07
3:40	9:59.29	10:45.29	15:28.29	30.33	72.77	422.24
3:50	10:10.82	10:56.82	15:39.82	30.39	72.36	443.98
4:00	10:22.44	11:08.44	15:51.44	30.46	71.93	466.47
4:10	10:34.11	11:20.11	16:03.11	30.53	71.49	489.69
4:20	10:45.87	11:31.87	16:14.87	30.60	71.03	513.61
4:30	10:57.77	11:43.77	16:26.77	30.67	70.56	538.44
4:40	11:09.79	11:55.79	16:38.79	30.74	70.07	564.17
4:50	11:21.94	12:07.94	16:50.94	30.80	69.56	590.79
5:00	11:34.28	12:20.28	17:03.28	30.87	69.03	618.45
5:10	11:46.81	12:32.81	17:15.81	30.94	68.48	647.24
5:20	11:59.53	12:45.53	17:28.53	31.01	67.90	677.13
5:30	12:12.51	12:58.51	17:41.51	31.08	67.31	708.22
5:40	12:25.74	13:11.74	17:54.74	31.14	66.68	740.71
5:50	12:39.32	13:25.32	18:08.32	31.21	66.02	774.71
6:00	12:53.22	13:39.22	18:22.22	31.27	65.34	810.29
6:10	13:07.51	13:53.51	18:36.51	31.34	64.61	847.56
6:20	13:22.24	14:08.24	18:51.24	31.40	63.85	886.78
6:30	13:37.49	14:23.49	19:06.49	31.46	63.05	928.18

\*Launch escape tower jettison

Table VI. Low Altitude Characteristics of Mode II Aborts from the Nominal Launch Trajectory (Continued)

Ground Elapsed Time of Abort (min:sec)	Ground Elapsed Time at Drogue Chute Deployment (min:sec)	Ground Elapsed Time at Main Chute Deployment (min:sec)	Ground Elapsed Time at Landing (min:sec)	Geodetic Latitude at Landing (deg north)	Longitude at Landing (deg west)	Range at Landing (n mi)
6:40	13:53.33	14:39.33	19:22.33	31.51	62.20	972.06
6:50	14:09.81	14:55.81	19:38.81	31.57	61.29	1018.69
7:00	14:26.99	15:12.99	19:55.99	31.61	60.32	1068.26
7:10	14:45.03	15:31.03	20:14.03	31.66	59.29	1121.33
7:20	15:04.07	15:50.07	20:33.07	31.69	58.17	1178.47
7:30	15:24.34	16:10.34	20:53.34	31.72	56.96	1240.50
7:40	15:46.09	16:32.09	21:15.09	31.73	55.63	1308.40
7:50	16:09.56	16:55.56	21:38.56	31.73	54.17	1383.21
8:00	16:34.19	17:20.19	22:03.19	31.71	52.61	1463.24
8:10	16:59.88	17:45.88	22:28.88	31.66	50.94	1548.44
8:20	17:27.23	18:13.23	22:56.23	31.59	49.14	1640.80
8:23	17:35.87	18:21.87	23:04.87	31.56	48.57	1670.34
8:31	18:00.19	18:46.19	23:29.19	31.45	46.94	1754.21
8:41	18:33.92	19:19.92	24:02.92	31.27	44.65	1872.27
8:51	19:12.88	19:58.88	24:41.88	31.00	41.98	2010.66
9:01	20:04.17	20:50.17	25:33.17	30.55	38.44	2195.44
9:11	21:03.98	21:49.98	26:32.98	29.88	34.29	2414.99
9:21	22:24.90	23:10.90	27:53.90	28.72	28.68	2716.97
9:31**	24:28.30	25:14.30	29:57.30	26.43	20.28	3200.00

\*\* End of Mode II

Table VII. Sequence of Events for Mode III Launch Abort

<u>Controlling Condition</u>	<u>Value of Controlling Condition</u>	<u>Event</u>
Time Since Abort Initiated (sec)	0.0	S-IVB thrust tailoff begins. SM RCS ullage begins.
	1.85	Thrust and weight flow equal zero.
	3.0	S-IVB and CSM separate.
	24.0	Separation burn terminates. Crew begins orienting CSM for retrograde horizon monitor burn with heads up.
	110.0	Service module RCS ullage begins using 4 jets in the plus X direction.
	125.0	SPS engine ignites.
	126.0	RCS ullage terminates.
Predicted Half Lift Landing Range (n mi)	3,200	SPS burn terminates. Crew begins maneuvers to separate CM from SM and orient CM with heat shield forward for entry.
Altitude (ft)	400,000	Atmospheric entry Bank angle equals zero.
Deceleration (g's)	0.2	Change bank angle to 55 degrees South.
Altitude (ft)	24,000	Apex cover jettison
Time Since Apex Cover Jettison (sec)	2.0	Drogue parachute deploys.
Altitude (ft)	10,000	Main parachute deploys.
	0	Landing in Atlantic Continuous Recovery Area

Table VIII. Characteristics of Mode III Aborts from the Nominal Trajectory

Ground Elapsed Time of Abort (min:sec)	SPS Burn Time (min:sec)	SPS $\Delta V$ (ft/sec)	Predicted Time of Free Fall from SPS Cutoff to 300,000 Feet (min:sec)	Ground Elapsed Time at 400,000 Feet (min:sec)	Inertial Velocity at 400,000 Feet (ft/min:sec)	Inertial Flight-Path Angle at 400,000 Feet (deg)	Ground Elapsed Time at 300,000 Feet (min:sec)	Ground Elapsed Time at Drogue Chute Deployment (min:sec)	Ground Elapsed Time at Main Chute Deployment (min:sec)	Ground Elapsed Time at Landing (min:sec)
9:31	-0-*	-0.*	7:53	16:31	24,144	-3.92	17:28	22:40	23:26	28:54
9:33	-0-	-0-	8:13	16:51	24,297	-3.72	17:51	23:11	23:57	29:26
9:35	0:03.23	64.4	6:19	17:01	24,406	-3.60	17:02	23:28	24:14	29:43
9:37	0:10.31	206.8	6:06	16:57	24,469	-3.58	17:58	23:27	24:13	29:42
9:39	0:17.49	353.3	5:54	16:53	24,532	-3.57	17:55	23:25	24:11	29:40
9:41	0:24.15	491.0	5:41	16:49	24,604	-3.56	17:51	23:23	24:09	29:38
9:43	0:31.72	650.8	5:28	16:47	24,665	-3.57	17:48	23:21	24:07	29:36
9:45	0:39.11	807.7	5:16	16:44	24,730	-3.59	17:45	23:19	24:05	29:34
9:47	0:46.69	972.0	5:04	16:42	24,794	-3.63	17:43	23:17	24:03	29:32
9:49	0:54.45	1142.9	4:52	16:41	24,857	-3.67	17:40	23:15	24:01	29:30
9:51	1:04.22	1322.1	4:40	16:40	24,918	-3.73	17:39	23:13	23:59	29:28
9:53.47**	1:12.64	1555.4	4:26	16:40	24,991	-3.82	17:37	23:11	23:57	29:26
9:55	1:12.98	1563.5	4:25	16:40	24,988	-3.83	17:38	23:10	23:56	29:25
9:57	1:13.44	1574.1	4:23	16:41	24,982	-3.85	17:38	23:10	23:56	29:25
9:59	1:13.90	1584.9	4:21	16:42	24,976	-3.87	17:39	23:10	23:56	29:25
10:01	1:14.37	1595.6	4:19	16:43	24,971	-3.89	17:39	23:10	23:56	29:25
10:03***	1:14.82	1606.1	4:17	16:44	24,965	-3.91	17:40	23:10	23:56	29:25

\* No SPS burn required; landing range is less than 3200 nautical miles.

\*\* Guidance cutoff signal

\*\*\* Insertion

Note: The landing target for a Mode III abort is the Atlantic Discrete Recovery Area, located 3200 nautical miles downrange from the launch site.

Table IX. Sequence of Events for Fixed  $\Delta V$  Mode Launch Abort Simulations

<u>Controlling Condition</u>	<u>Value of Controlling Condition</u>	<u>Event</u>
Time Since Abort Initiated (sec)	0.0	S-IVB thrust tailoff begins. SM RCS direct ullage starts.
↓	1.85	Thrust and weight flow equal zero.
	3.0	S-IVB and CSM separate.
	24.0	Ullage burn terminates; Crew begins orienting CSM for heads up, retrograde, horizon monitor burn.
	Calculated Ground Elapsed Time (min:sec)	Variable (Ignition minus 15 sec)
	Variable	SPS engine ignites.
	Variable (Ignition plus 1 sec)	RCS ullage terminates.
Sensed Velocity Change (ft/sec)	600	SPS burn terminates; Crew begins maneuvers to separate CM from SM and orient CM with heat shield forward for entry.
Altitude (ft)	400,000	Atmospheric entry Bank angle equals zero.
Deceleration (g's)	0.2	Change bank angle to 55 degrees South.
Altitude (ft)	24,000	Apex cover jettison
Time Since Apex Cover Jettison (sec)	2.0	Drogue parachute deploys.
Altitude (ft)	10,000	Main parachute deploys.
↓	0	Landing in Atlantic Continuous Recovery Area

Table X. Fixed  $\Delta V$  Mode Abort Data

Ground Elapsed Time of Abort (min:sec)	Predicted Time of Free Fall from SPS Cutoff to 300,000 Feet (min:sec)	Ground Elapsed Time of SPS Ignition (min:sec)	Ground Elapsed Time at 400,000 Feet (min:sec)	Inertial Velocity at 400,000 Feet (ft/sec)	Inertial Flight-path Angle at 400,000 Feet (deg)	Ground Elapsed Time at 300,000 Feet (min:sec)	Ground Elapsed Time at Drogue Chute Deployment (min:sec)	Ground Elapsed Time at Main Chute Deployment (min:sec)	Ground Elapsed Time at Landing (min:sec)
9:52	6:25	31:40	38:04	25,421	-1.83	40:03	49:04	49:50	55:19
9:53	7:56	31:51	38:04	25,456	-1.84	40:56	47:33	48:19	53:48
9:53.47 <sup>c</sup>	13:05	26:23	38:01	25,562	-1.84	39:49	47:30	48:16	53:45
9:55	13:08	26:22	37:53	25,563	-1.80	39:48	47:31	48:17	53:46
9:57	13:09	26:21	37:52	25,564	-1.80	39:48	47:32	48:18	53:47
9:59	13:10	26:20	37:52	25,564	-1.80	39:48	47:32	48:18	53:47
10:01	13:11	26:19	37:51	25,564	-1.80	39:48	47:32	48:18	53:47
10:03**	13:12	26:18	37:51	25,565	-1.80	39:48	47:33	48:19	53:48

<sup>a</sup> Guidance cutoff signal as insertion

Note:  $\Delta V = 600$  ft/sec  
IORA target range = 8800 n mi

Table XI. Sequence of Events for Contingency Orbit Insertions

<u>Controlling Condition</u>	<u>Value of Controlling Condition</u>	<u>Event</u>	
Time Since Abort Initiated (sec)	0.0	S-IVB thrust tailoff begins. SM RCS direct ullage begins.	
↓	1.85	Thrust and weight flow equal zero.	
	3.0	S-IVB and CSM separate.	
	24.00	Ullage burn terminates; Crew begins maneuvers to orient CSM for contingency orbit insertion burn.	
	110.0	Service module RCS ullage begins using 4 jets in a plus X direction.	
	125	SPS engine ignites.	
	126	RCS ullage terminates.	
	Predicted Perigee Altitude (n mi)	75	SPS burn terminates; Orbital coast begins.



Table XII. SPS Burn Duration, SPS  $\Delta V$ , and Resultant Apogee Altitude for Mode IV Aborts from the Nominal Trajectory

<u>Ground Elapsed Time of Abort (min:sec)</u>	<u>SPS Burn Time (min:sec)</u>	<u>SPS <math>\Delta V</math>* (ft/sec)</u>	<u>Apogee Altitude at SPS Cutoff (n mi)</u>
9:26.11	1:39.74	2200.00	113.35
9:27	1:36.79	2130.61	113.66
9:29	1:29.99	1965.34	114.40
9:31	1:23.03	1798.87	115.17
9:33	1:15.90	1631.20	115.96
9:35	1:08.60	1462.29	116.76
9:37	1:01.12	1292.13	117.56
9:39	0:53.45	1120.74	118.35
9:41	0:45.60	948.17	119.12
9:43	0:37.56	774.41	119.86
9:45	0:29.33	599.43	120.57
9:47	0:20.89	423.21	121.22
9:49	0:12.24	245.75	121.83
9:51	0:03.37	67.03	122.40
9:51.75	0:00.00	0.00	122.61

\*The SPS  $\Delta V$  listed will result in a 75-nautical mile perigee altitude. In practice a pad of 100 feet per second will be added to these  $\Delta V$  values.

Table XIII. Typical DSKY Parameter Values During Launch

Ground Elapsed Time (min:sec)	Inertial Velocity (ft/sec)	Altitude (n mi)	Altitude Rate (ft/sec)	SPLERROR (n mi)	Predicted Perigee (n mi)	Predicted Apogee (n mi)	Predicted Time of Free Fall to 300,000 ft (min:sec)
00:00	1,342	0.0	0	-3188.6*	-3436.7	0.0	-59:59**
00:20	1,360	0.3	202	-3188.6*	-3436.7	0.4	-59:59**
00:40	1,511	1.5	518	-3188.6*	-3436.1	2.2	-59:59**
01:00	1,927	3.9	939	-3188.8*	-3434.1	6.1	-59:59**
01:20	2,631	7.7	1400	-3189.2*	-3428.6	12.7	-59:59**
01:40	3,738	13.2	1972	-3188.6*	-3415.3	23.3	-59:59**
02:00	5,290	20.8	2640	-3183.9*	-3386.3	39.3	-59:59**
02:20	7,393	30.6	3378	-2895.6	-3325.6	62.5	-3:09
02:40	7,718	41.5	3110	-2873.2	-3305.7	69.1	-3:20
03:00	7,980	51.2	2823	-2840.3	-3288.3	74.2	-3:19
03:20	8,278	60.1	2589	-2801.6	-3269.8	79.8	-3:24
03:40	8,620	68.3	2362	-2759.1	-3248.6	84.9	-3:28
04:00	9,005	75.7	2145	-2714.5	-3224.6	89.6	-3:30
04:20	9,434	82.4	1939	-2667.0	-3197.1	94.0	-3:32
04:40	9,911	88.4	1741	-2616.1	-3165.4	98.0	-3:34
05:00	10,433	93.9	1553	-2516.5	-3128.9	101.7	-3:36
05:20	11,007	98.7	1378	-2502.4	-3086.5	105.0	-3:37
05:40	11,630	103.0	1214	-2438.4	-3037.3	108.0	-3:39
06:00	12,311	106.7	1056	-2367.7	-2979.4	110.6	-3:41
06:20	13,048	109.9	910	-2291.4	-2911.4	113.0	-3:43
06:40	13,853	112.7	778	-2205.4	-2830.2	115.0	-3:46
07:00	14,729	115.1	655	-2108.5	-2732.6	116.8	-3:51
07:20	15,681	117.0	547	-1997.3	-2614.2	118.3	-3:57

\* SPLERROR = RTO-GO (distance from current position to target - apogee less than 300,000 feet)

\*\* Time of free fall = POSMAX (-59:59) - apogee less than 300,000 feet

Note: Velocity, altitude, and altitude rate are the nominal booster monitor displays.

Table XIII. Typical DSKY Parameter Values During Launch (Continued)

Ground Elapsed Time (min:sec)	Inertial Velocity (ft/sec)	Altitude (n. mi)	Altitude Rate (ft/sec)	SPLERROR (n mi)	Predicted Perigee (n mi)	Predicted Apogee (n mi)	Predicted Time of Free Fall to 300,000 ft (min:sec)
07:40	11,725	118.7	455	-1865.9	-2467.8	119.7	-4:06
08:00	17,845	120.0	371	-1709.4	-2287.9	120.8	-4:19
08:20	18,985	121.1	275	-1529.8	-2076.1	121.6	-4:33
08:40	20,180	121.8	176	-1307.5	-1817.0	122.1	-4:53
09:00	21,450	122.3	97	-1033.9	-1489.7	122.4	-5:27
09:20	22,835	122.5	44	-589.4	-1055.0	122.5	-5:29
09:40	24,375	122.6	0	564.5	-441.8	122.6	-10:05
09:53.6	25,522	122.6	0	-2274.0*	122.0	138.4	-59:59**
10:03.6	25,549	122.6	-2	-2239.0*	122.6	152.6	-59:59**

\* SPLERROR = R<sub>TO-GO</sub> (distance from current position to target - perigee greater than 300,000 feet)

\*\* Time of free fall = POSMAX (-59:59) - perigee greater than 300,000 feet

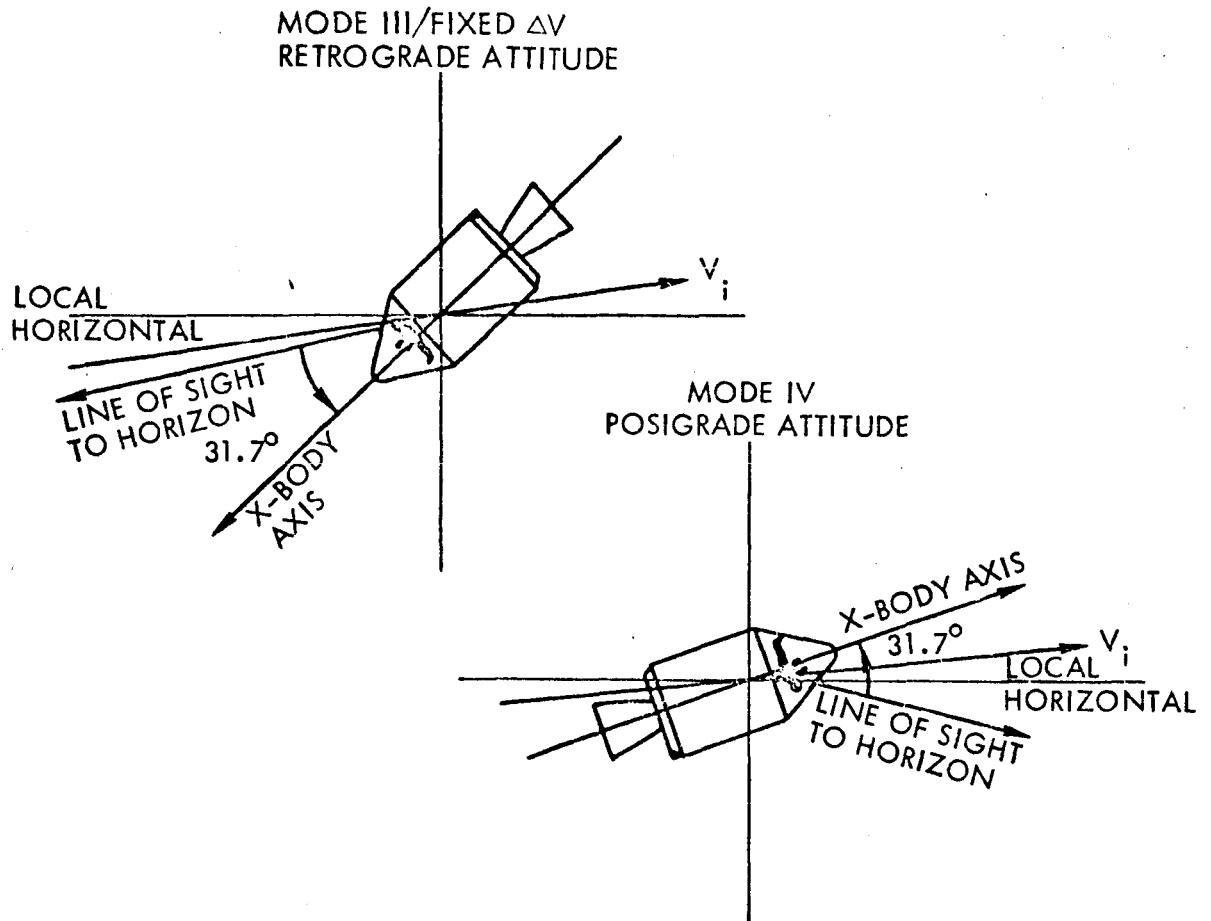

NOTE: SPS RETROGRADE AND POSIGRADE MANEUVERS WILL NORMALLY BE INITIATED AT BOOSTER CUTOFF PLUS 125 SECONDS FOR ALL LAUNCH ABORTS REQUIRING SPS MANEUVERS. THE ATTITUDES PRESENTED ABOVE ARE THE REQUIRED SPACECRAFT ORIENTATIONS AT SPS IGNITION. THE SUBSEQUENT ABORT MANEUVER WILL BE CONTROLLED VIA THE SCS; WHEREBY, THE SCS SHALL MAINTAIN THE INERTIAL ATTITUDE WHICH CORRESPONDS TO THE RELATIVE ATTITUDE AT SPS IGNITION.

Figure 1. Command Service Module Orientation at SPS Ignition for Mode III, Fixed  $\Delta V$ , and Mode IV Launch Aborts

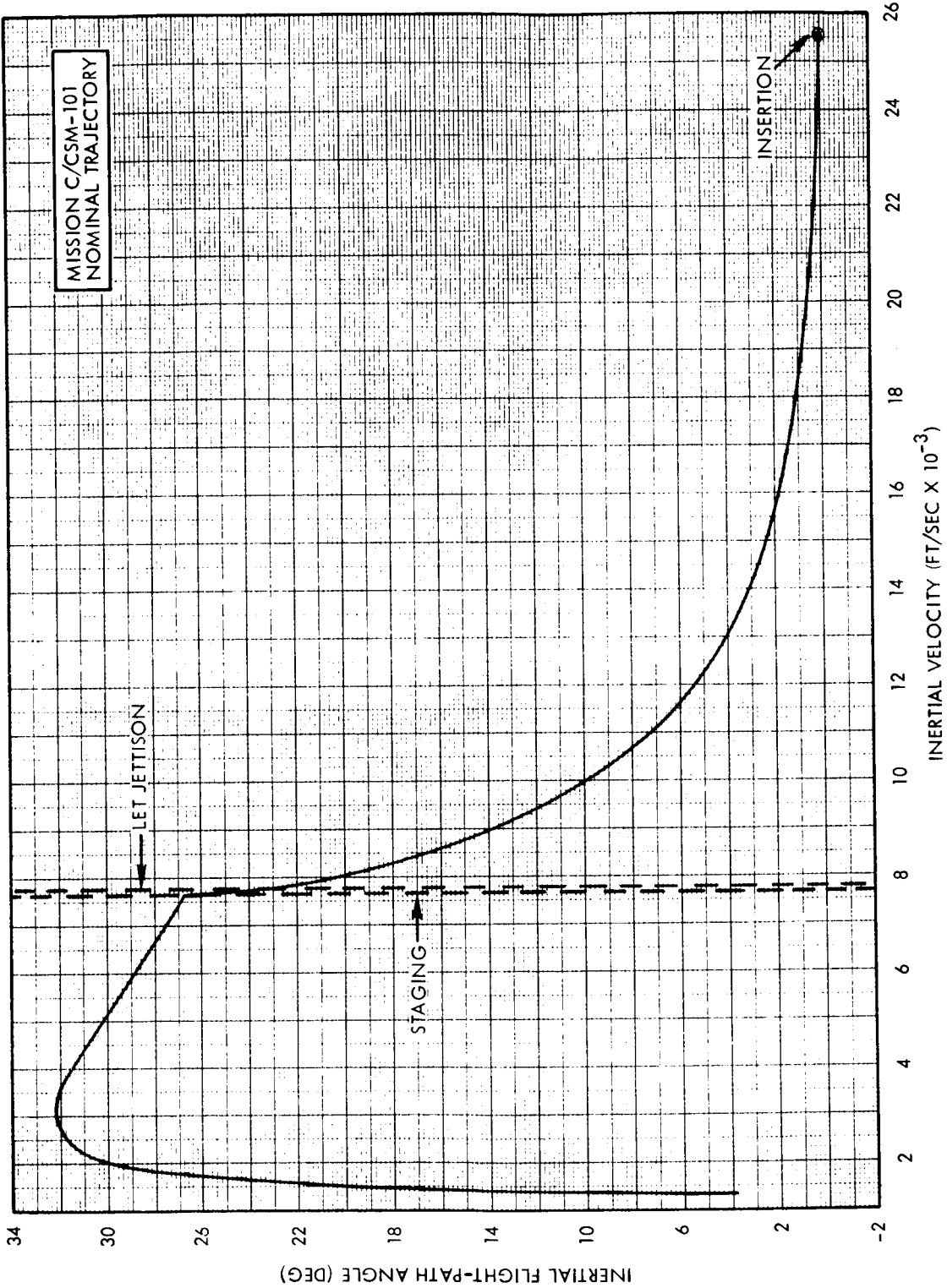

Figure 2. Nominal Launch Trajectory Inertial Flight-path Angle versus Inertial Velocity

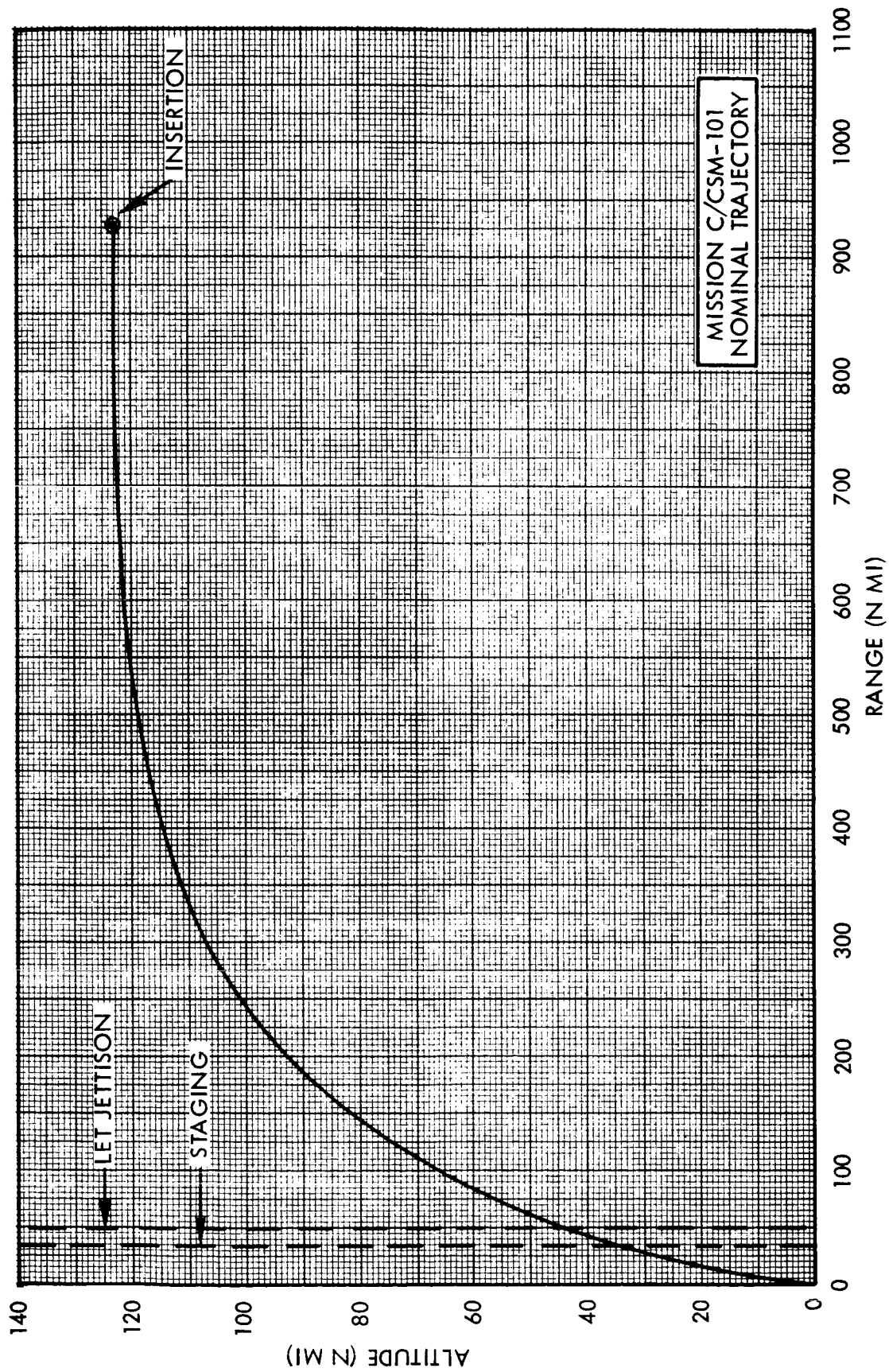

Figure 3. Nominal Launch Trajectory Altitude versus Range

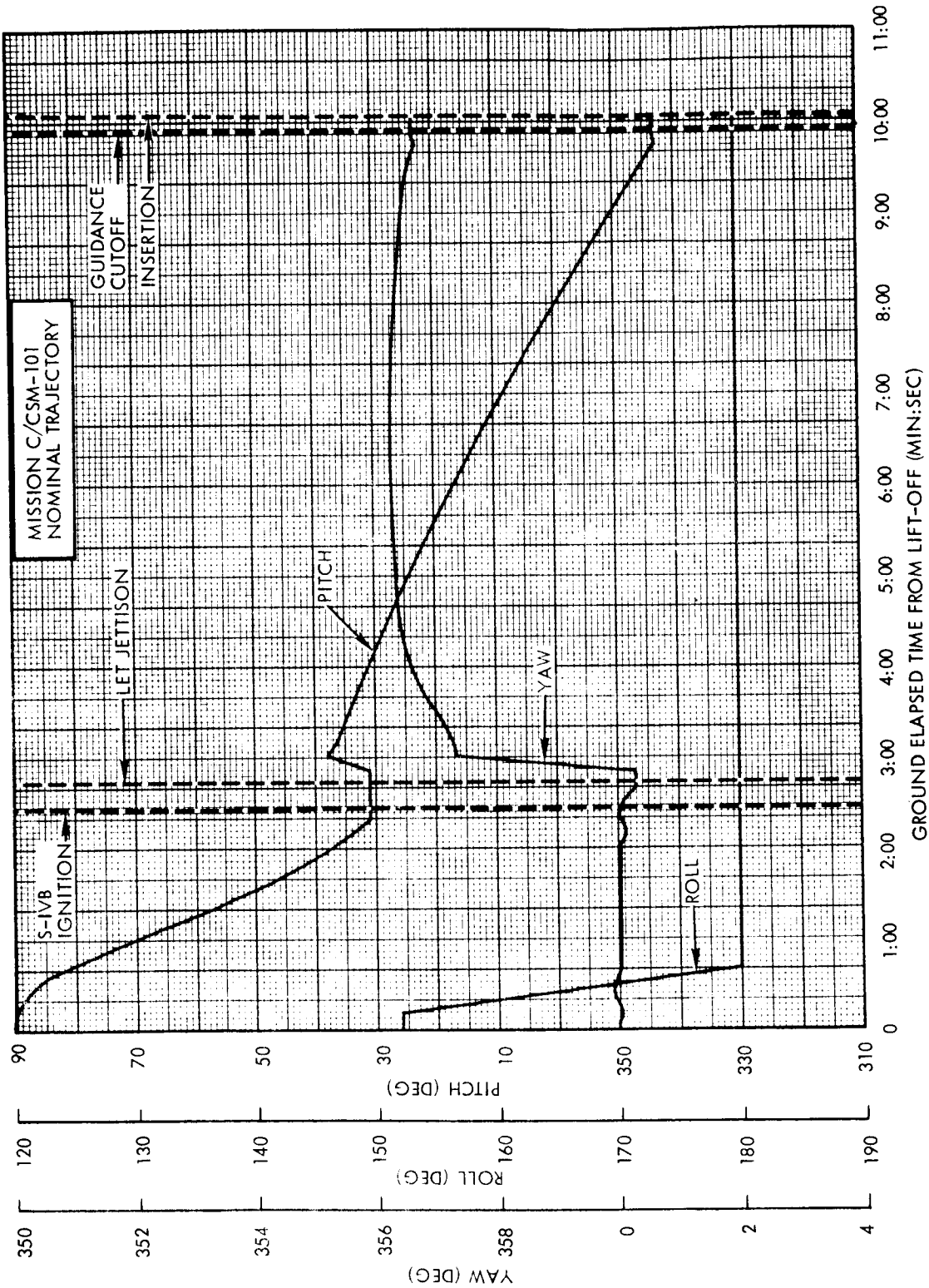

Figure 4. Nominal Spacecraft Inertial Measurement Unit Pitch, Yaw, and Roll Platform Gimbal Angle Readouts versus Ground Elapsed Time of Abort

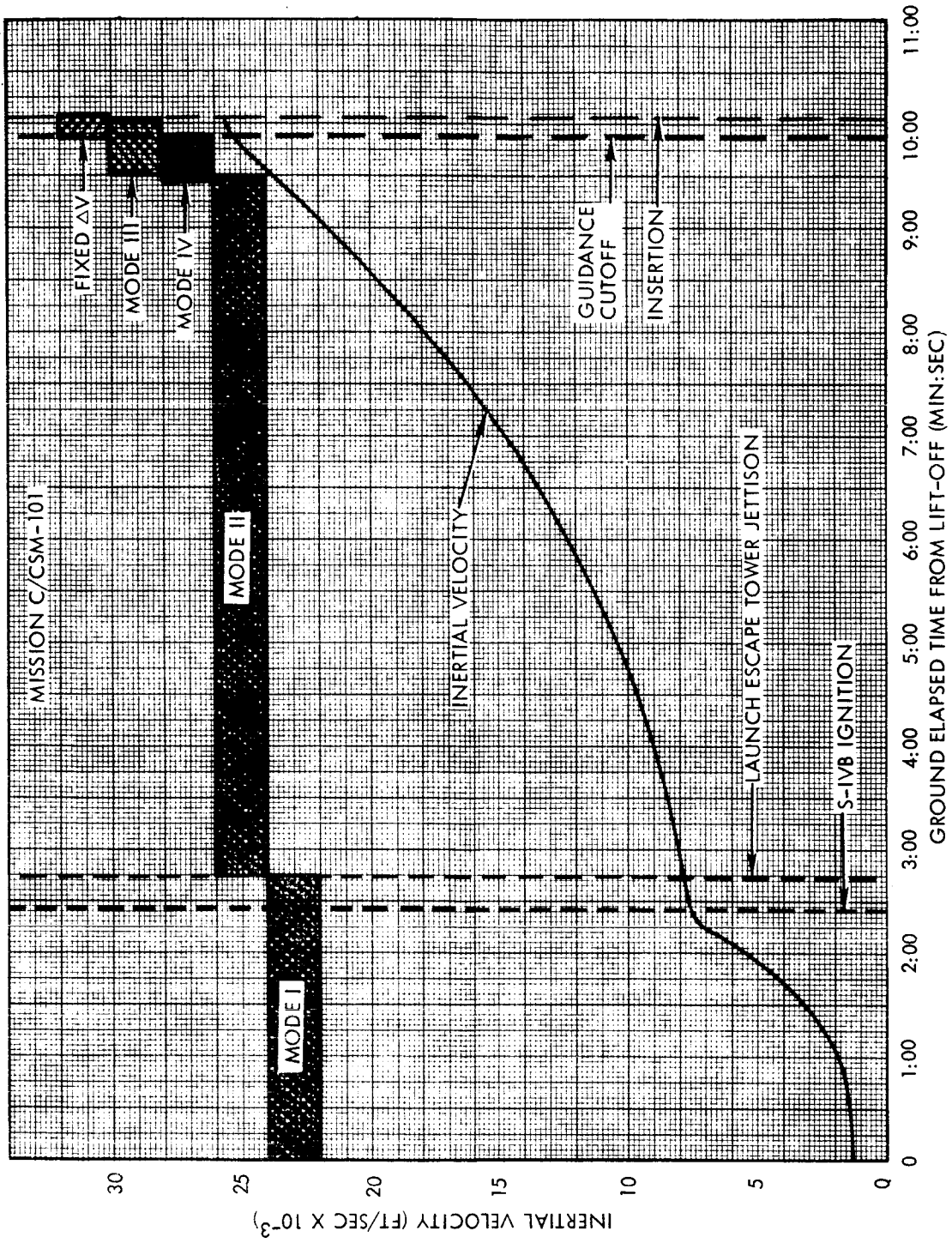

Figure 5. Nominal Launch Abort Regions and Inertial Velocity versus Ground Elapsed Time from Launch



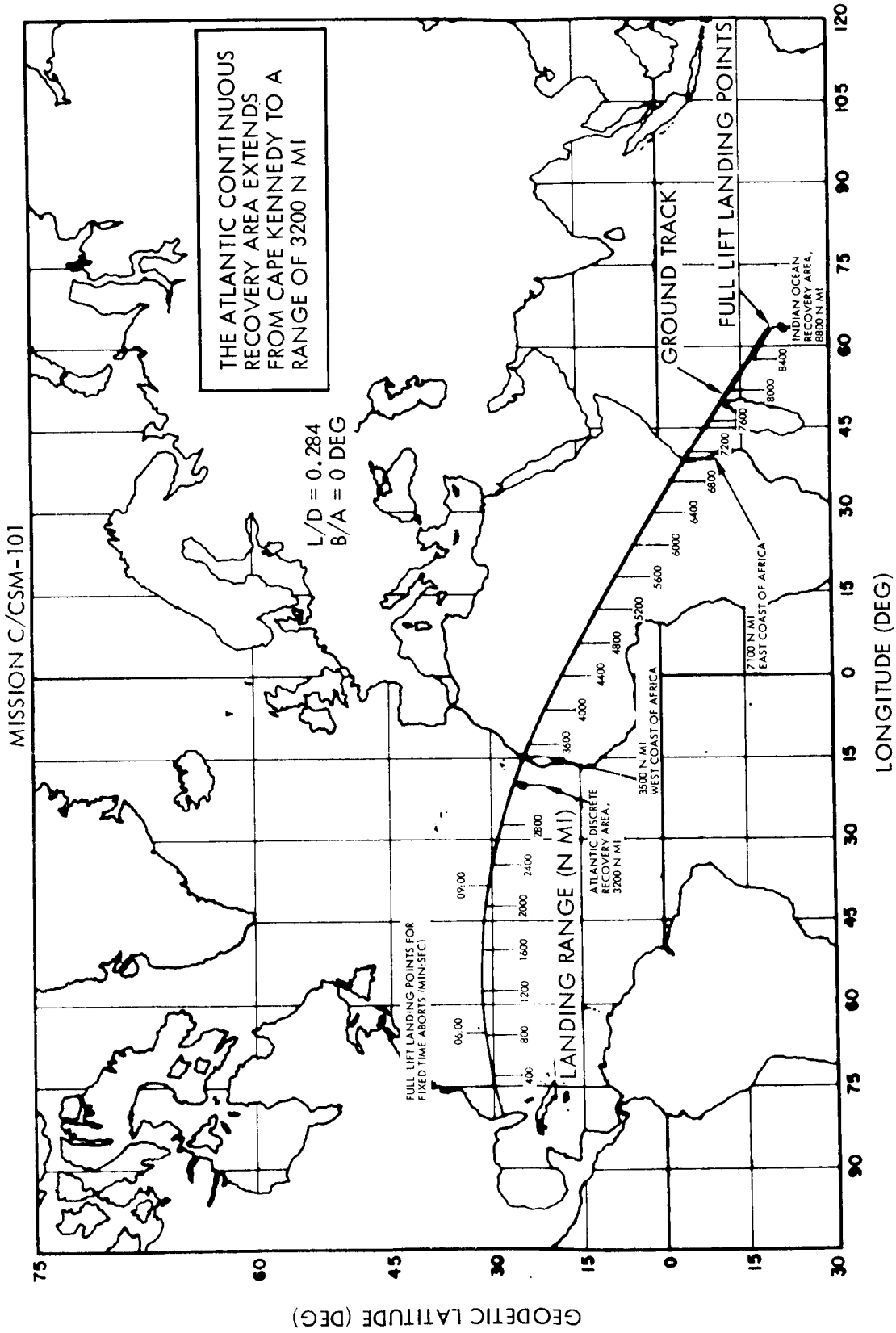

Figure 6. Groundtrack and Full-lift Landing Point Trace

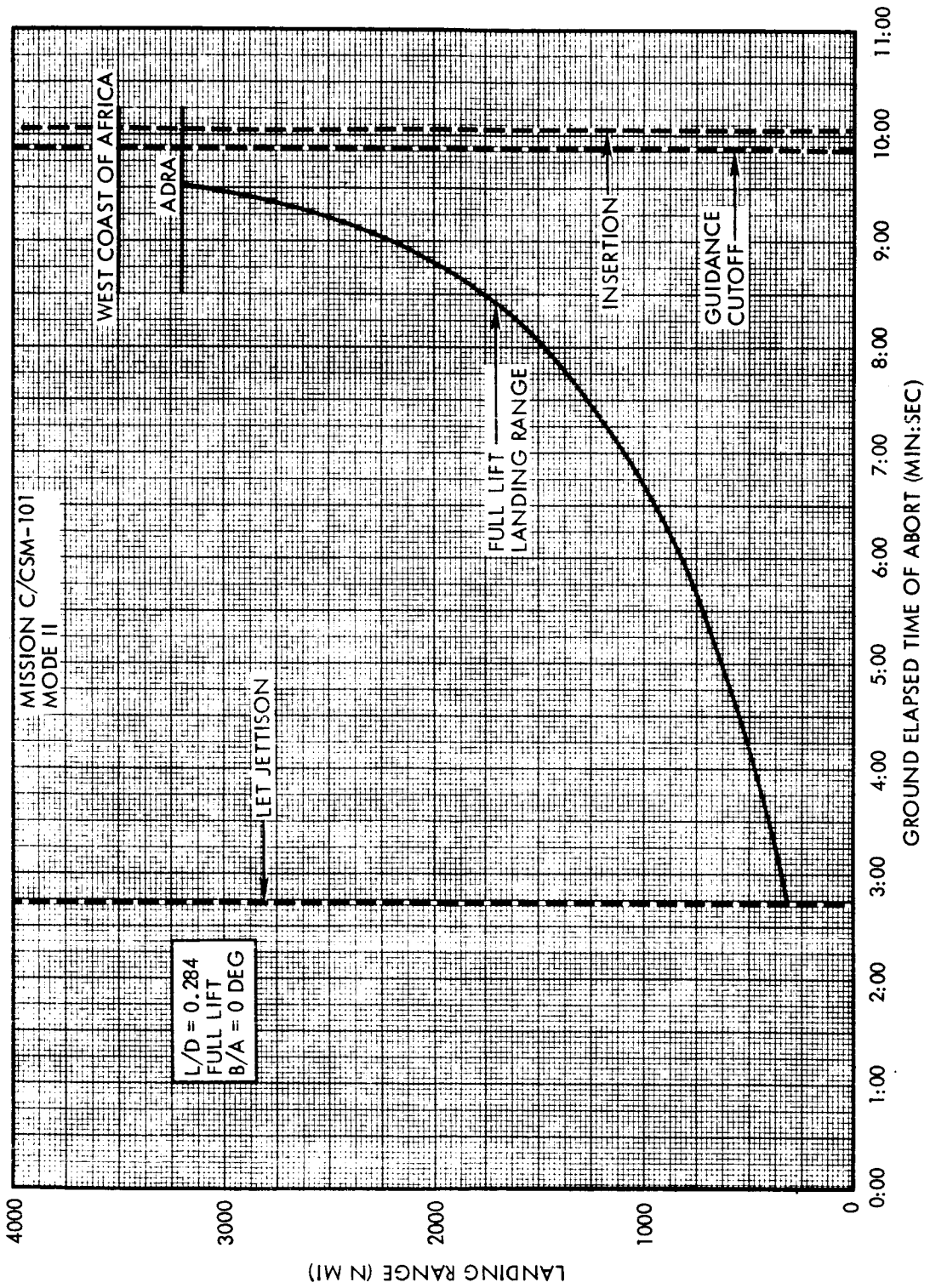

Figure 7. Full-lift Landing Range Following Mode II Abort from the Nominal Trajectory

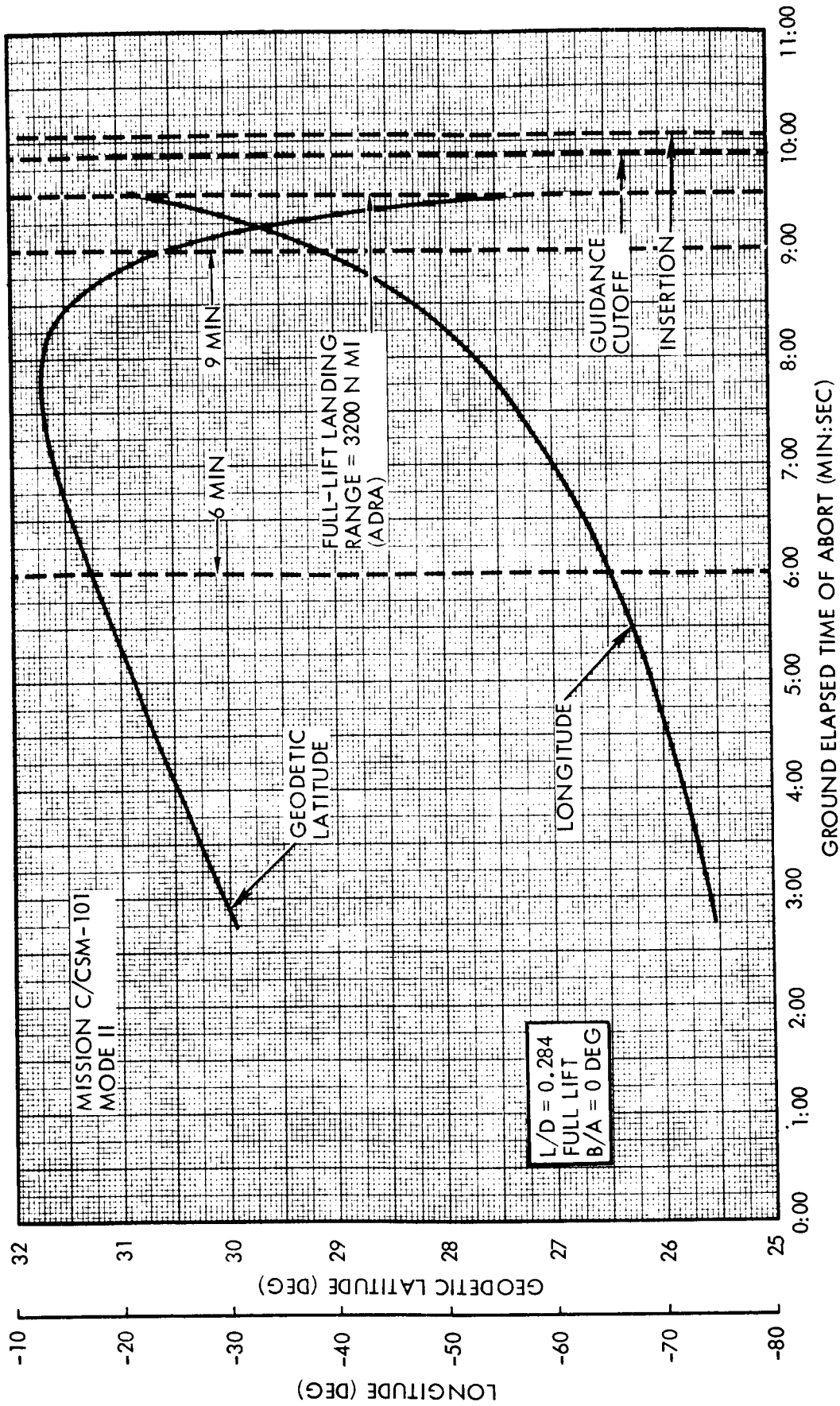

Figure 8. Geodetic Latitude and Longitude of Landing After Mode II Aborts from the Nominal Launch Trajectory

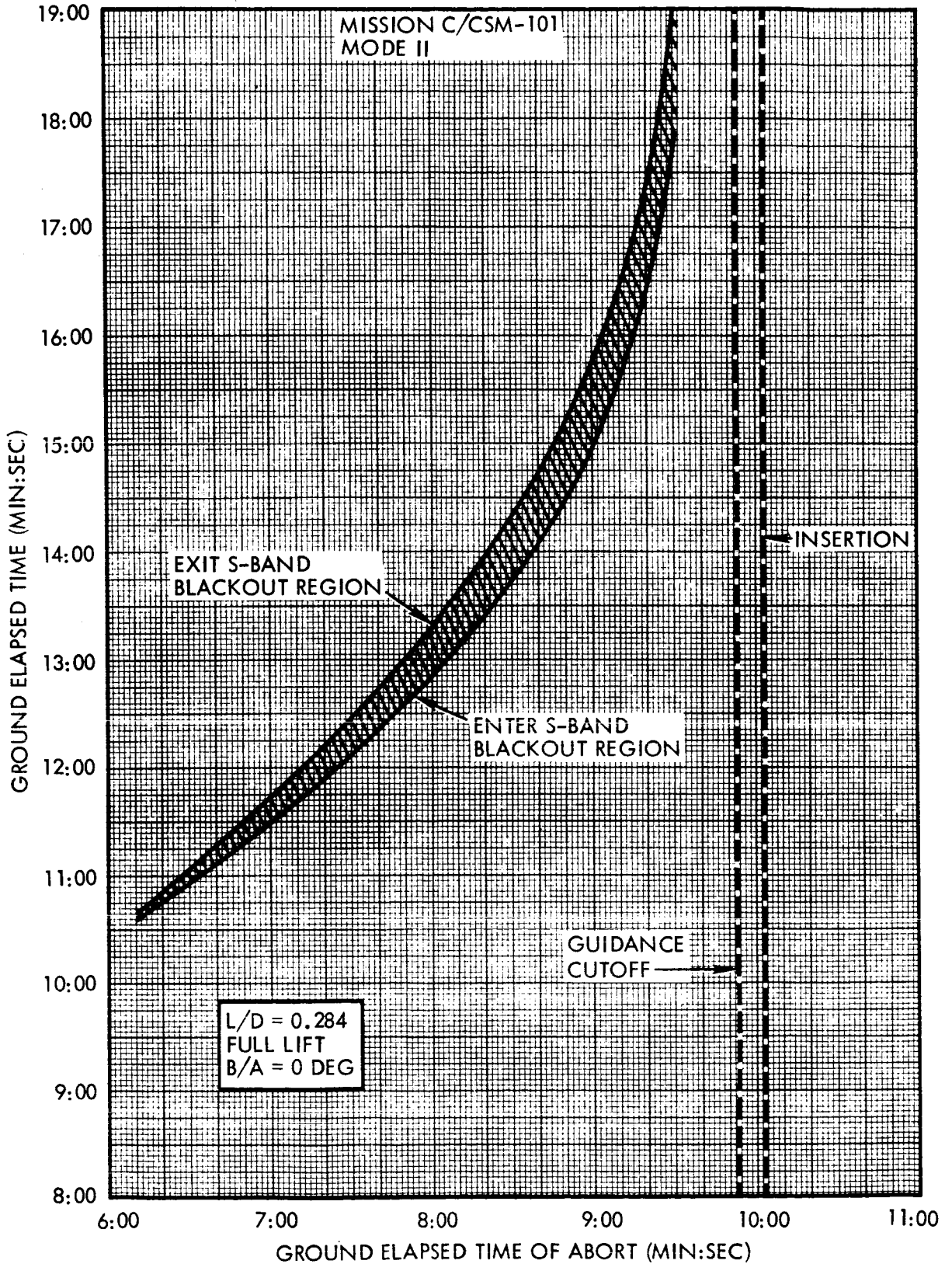

Figure 9. S-band Communication Blackout Following Mode II Aborts from the Nominal Trajectory

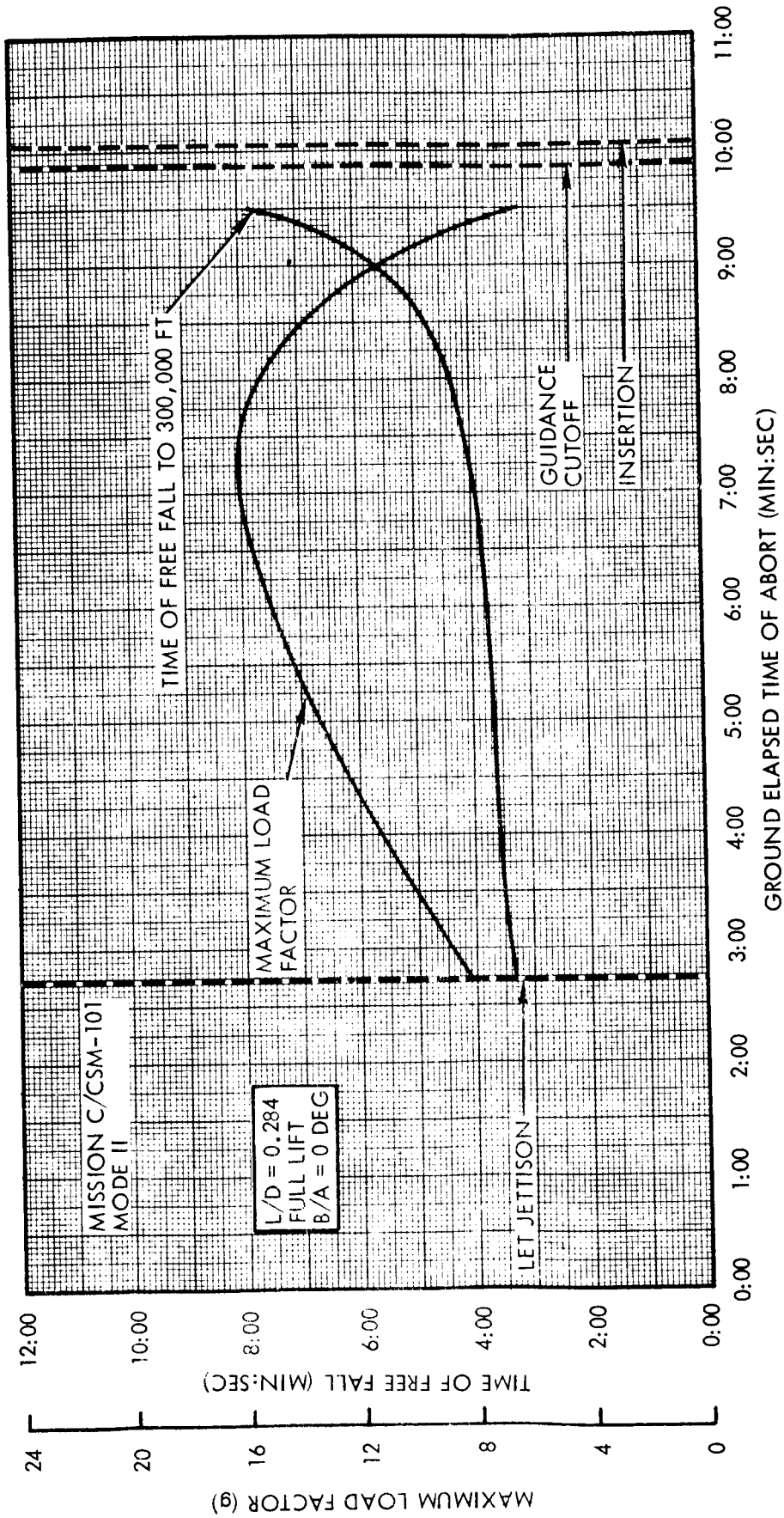

Figure 10. Time of Free Fall to 300,000 Feet and Maximum Entry Load Factor Following Mode II Aborts from the Nominal Trajectory

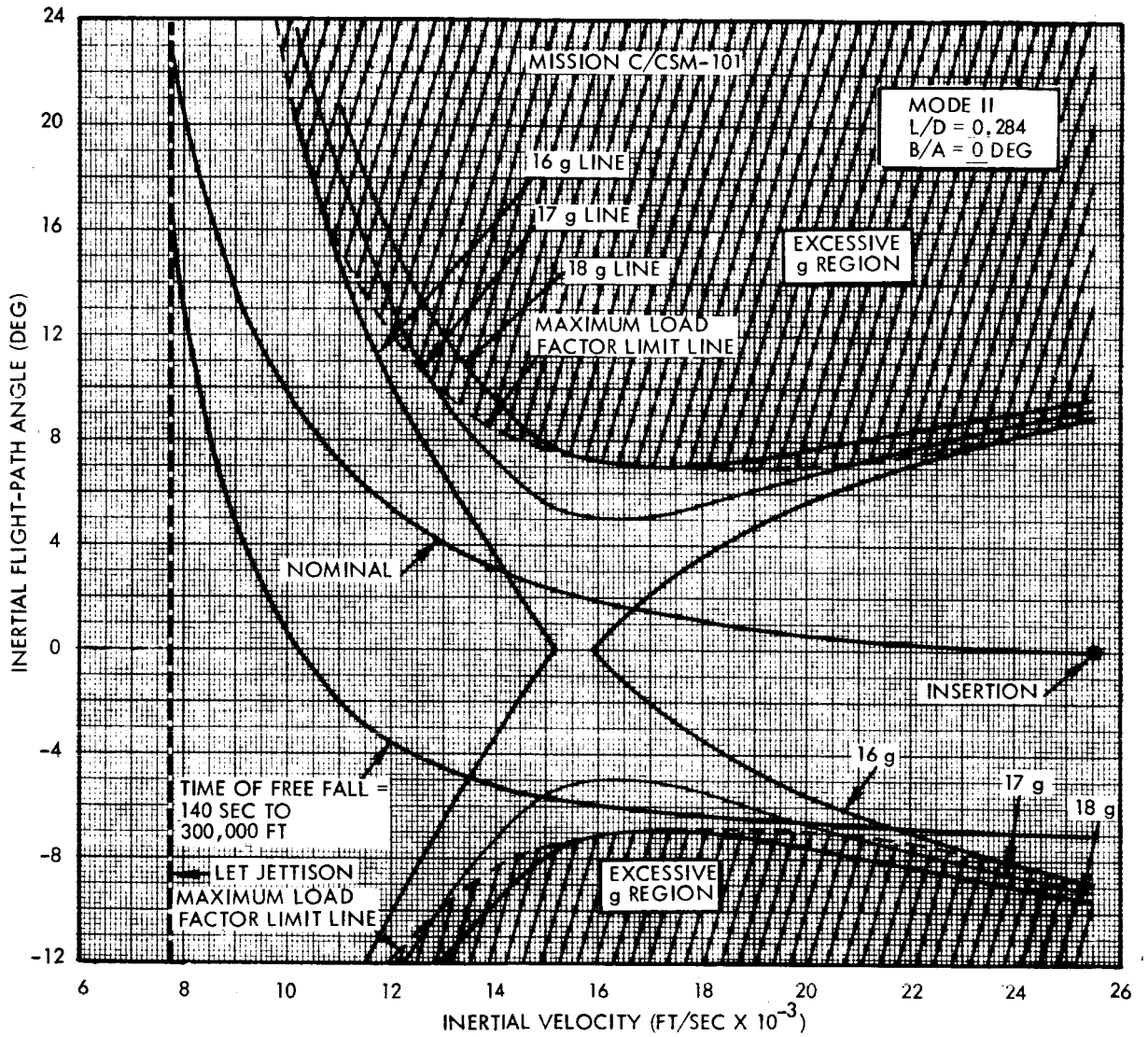

Figure 11. Time of Free Fall and Maximum Entry Load Factor Limit Lines for Mode II Aborts

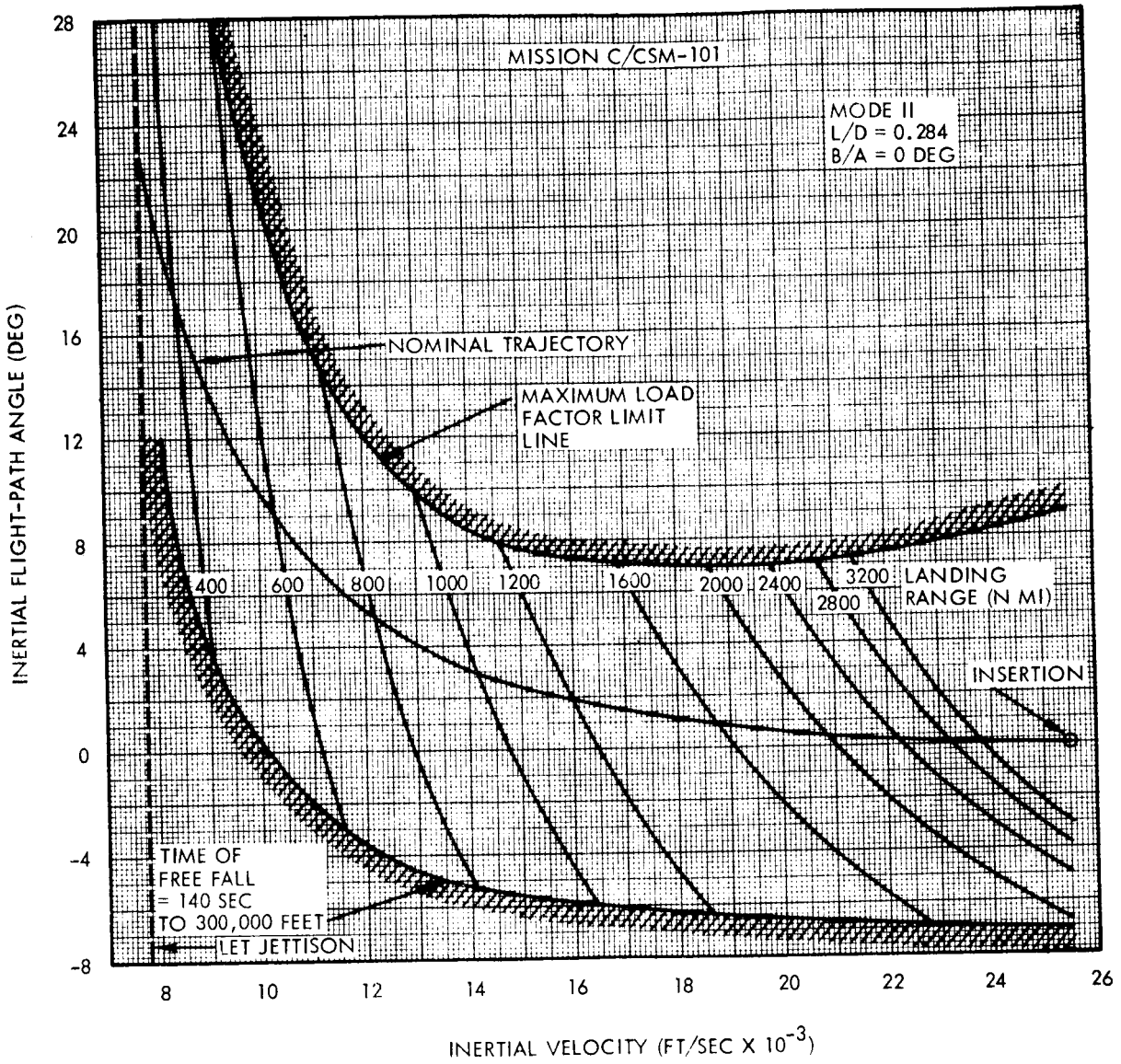

Figure 12. Variation of Landing Range for Mode II Aborts

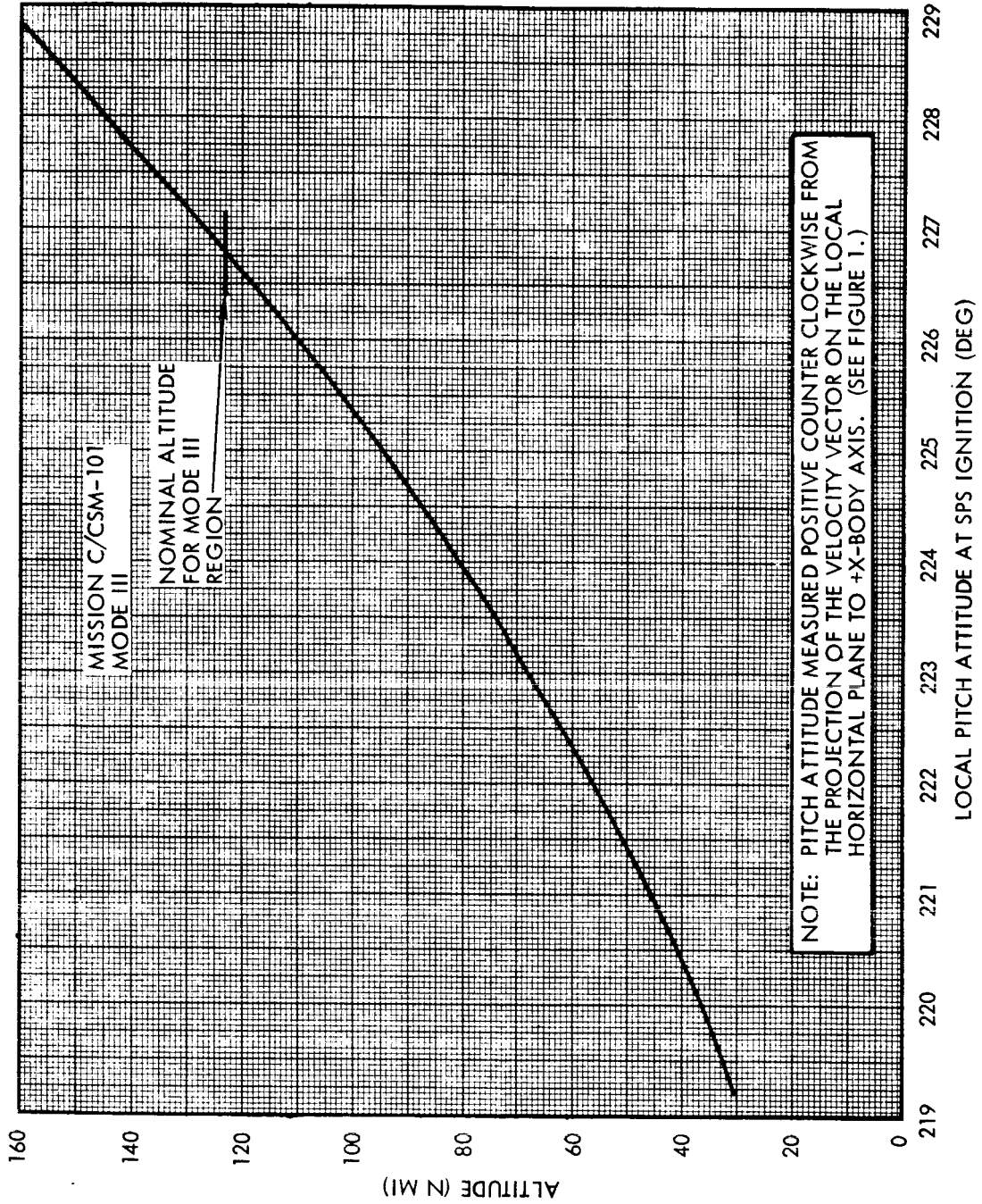

Figure 13. Command Service Module Local Pitch Attitude at SPS Ignition for Mode III Aborts



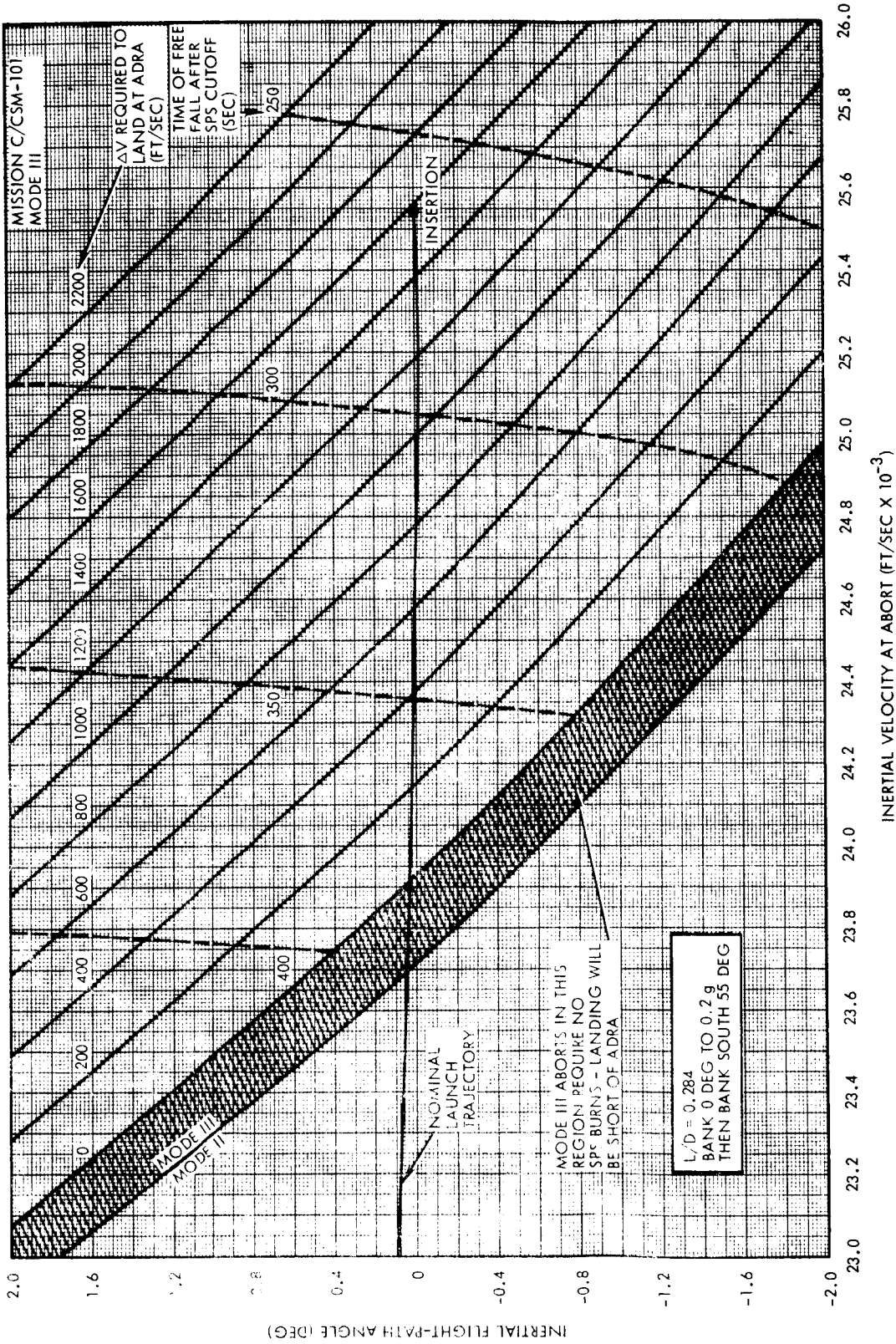

Figure 14. Sensed Velocity Change Required to Land at the Atlantic Discrete Recovery Area

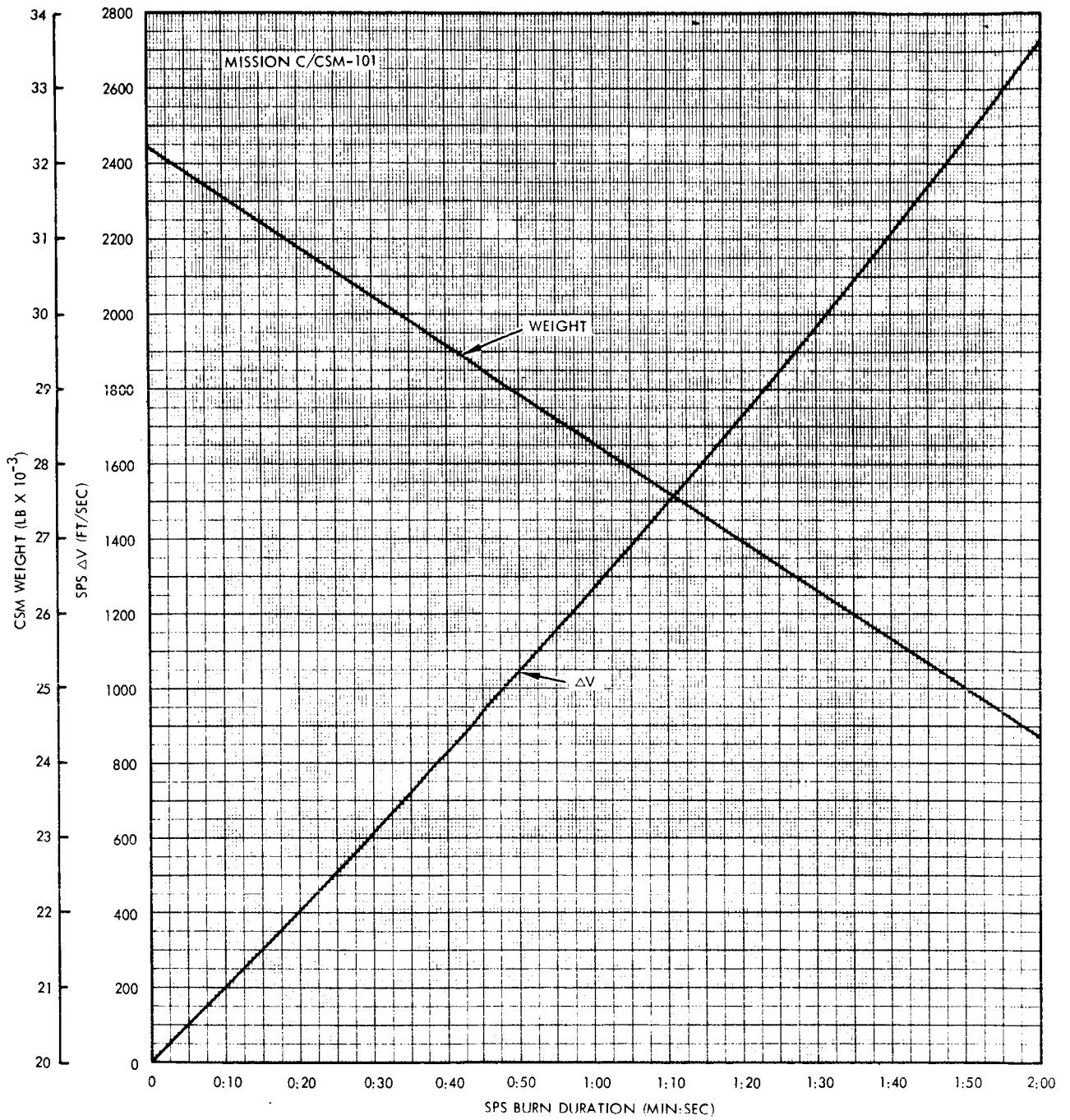

Figure 15. SPS Sensed Velocity Change and CSM Weight versus SPS Burn Duration

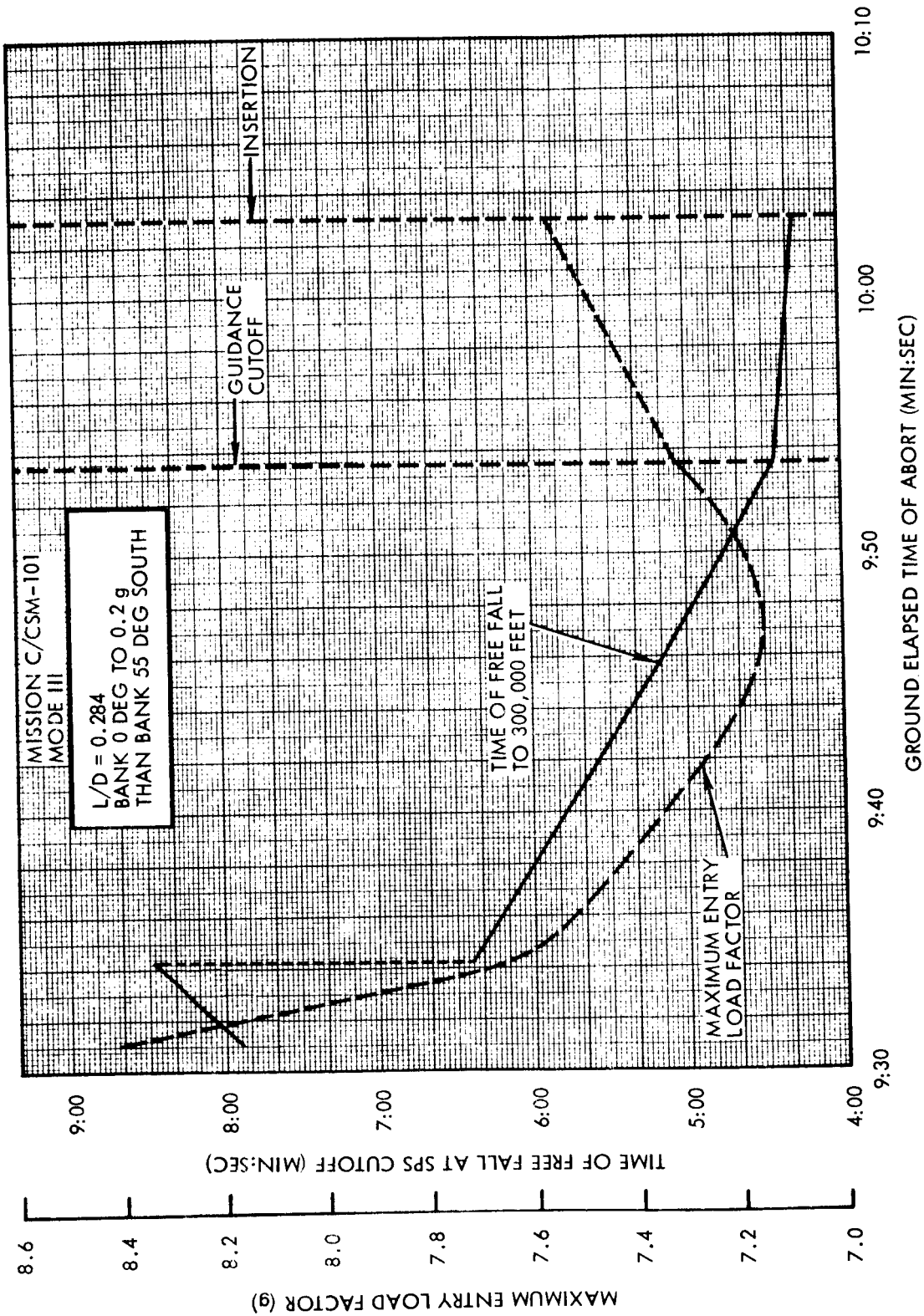

Figure 16. Time of Free Fall to an Altitude of 300,000 Feet and Maximum Entry Load Factor Following Mode III Aborts from the Nominal Trajectory

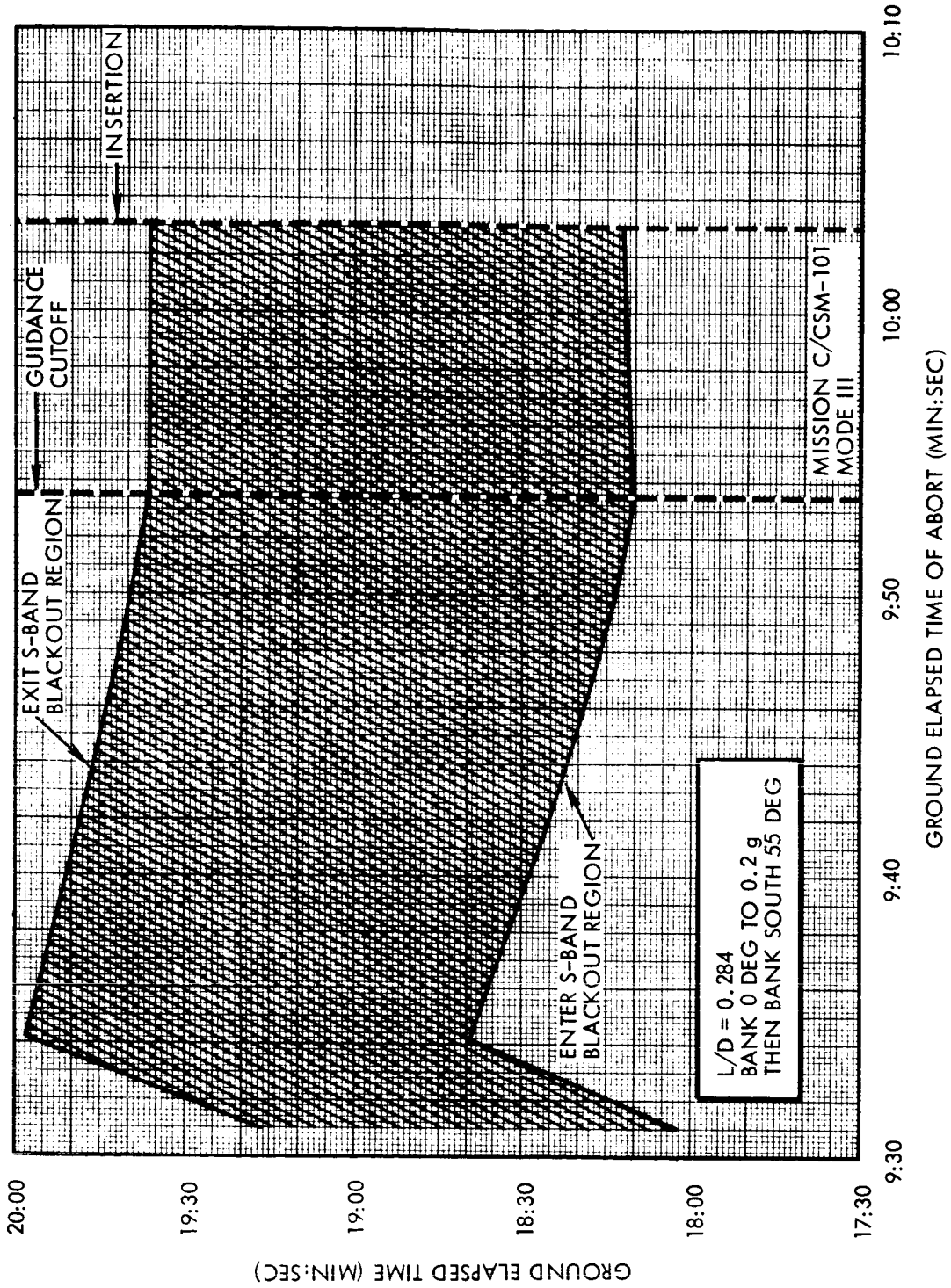

Figure 17. S-band Communication Blackout Following Mode III Aborts from the Nominal Trajectory

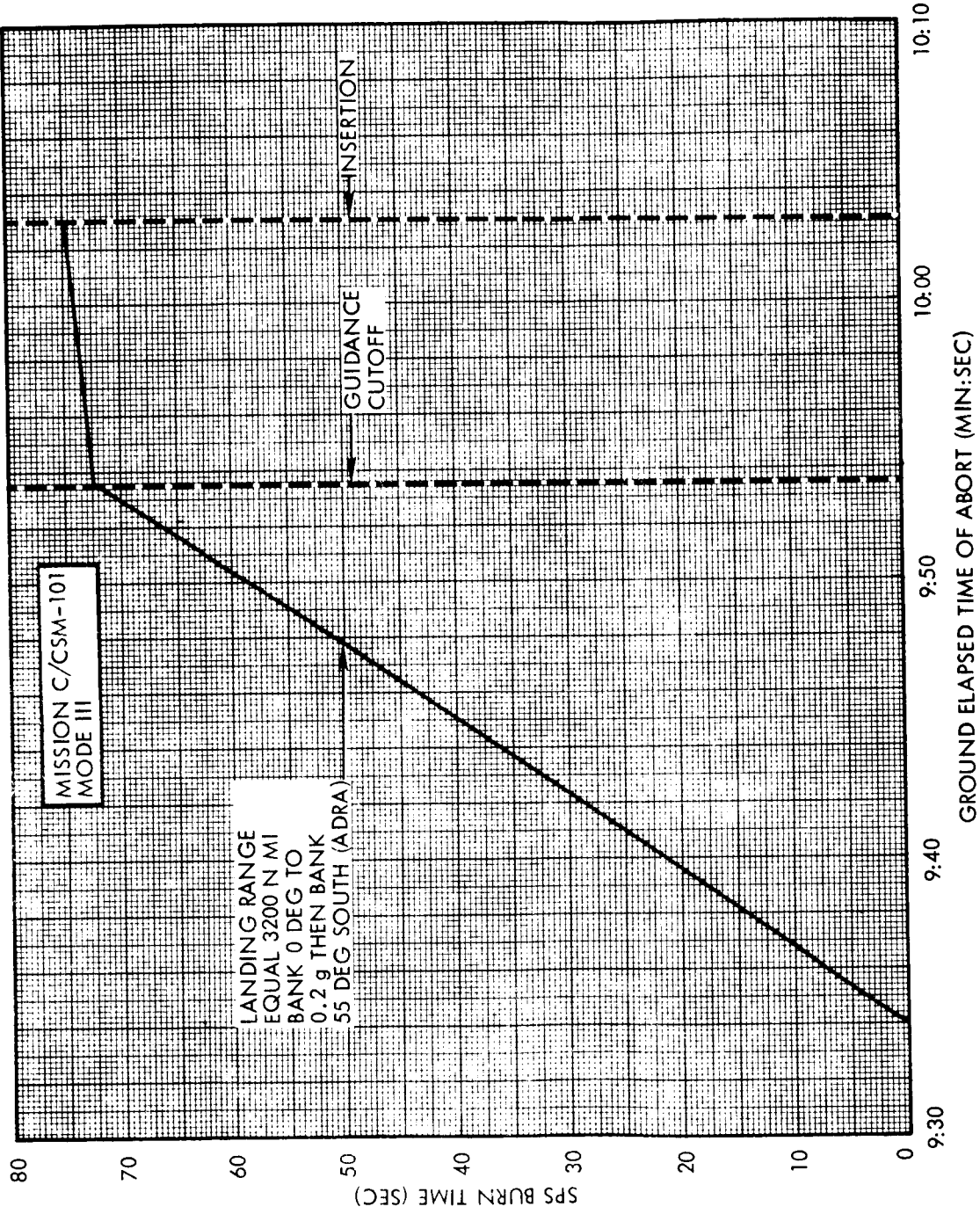

Figure 18. SPS Burn Time Required to Land at the ADRA for Mode III Aborts from the Nominal Trajectory

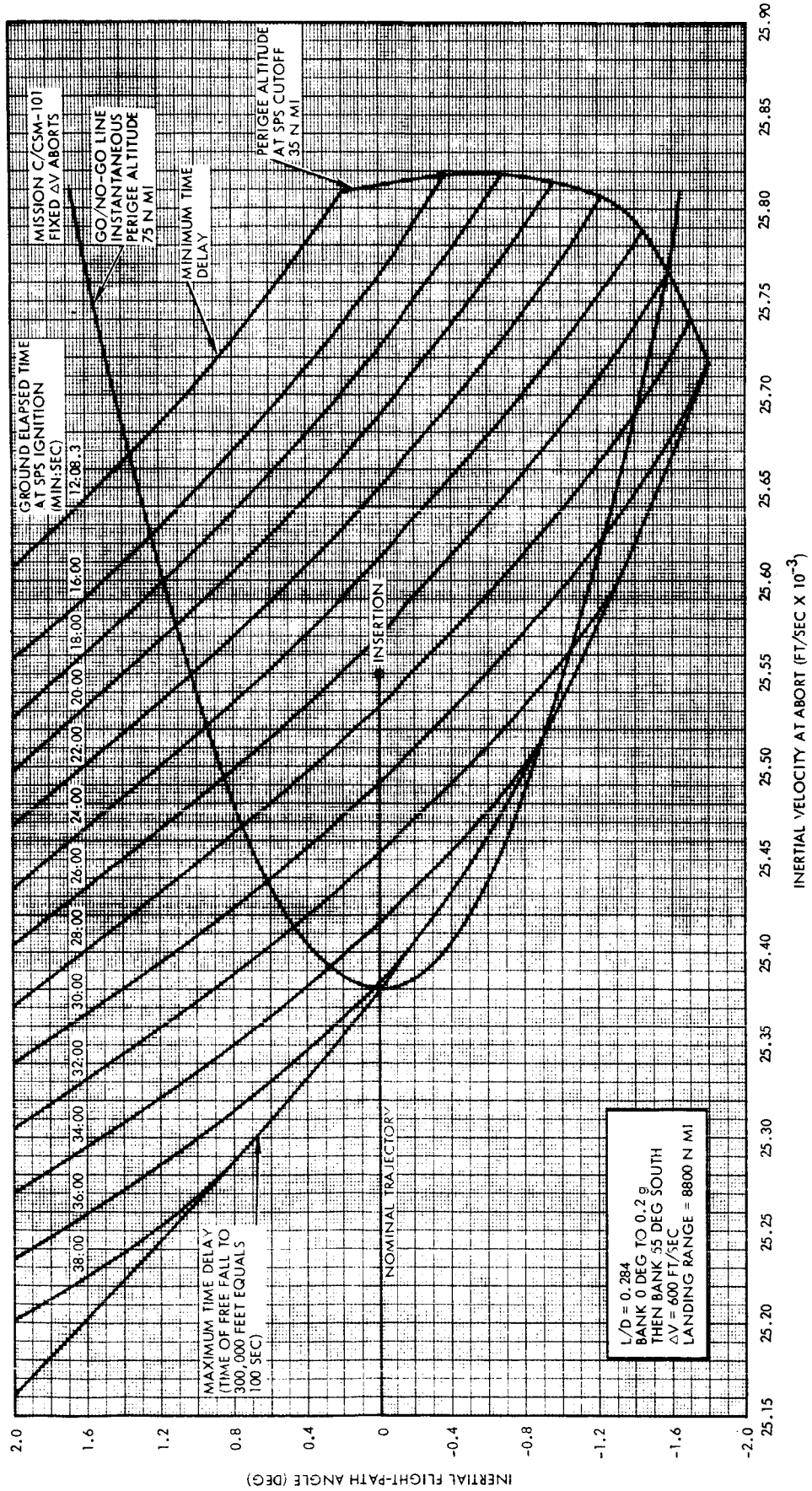

Figure 19. Fixed  $\Delta V$  Abort Mode Region

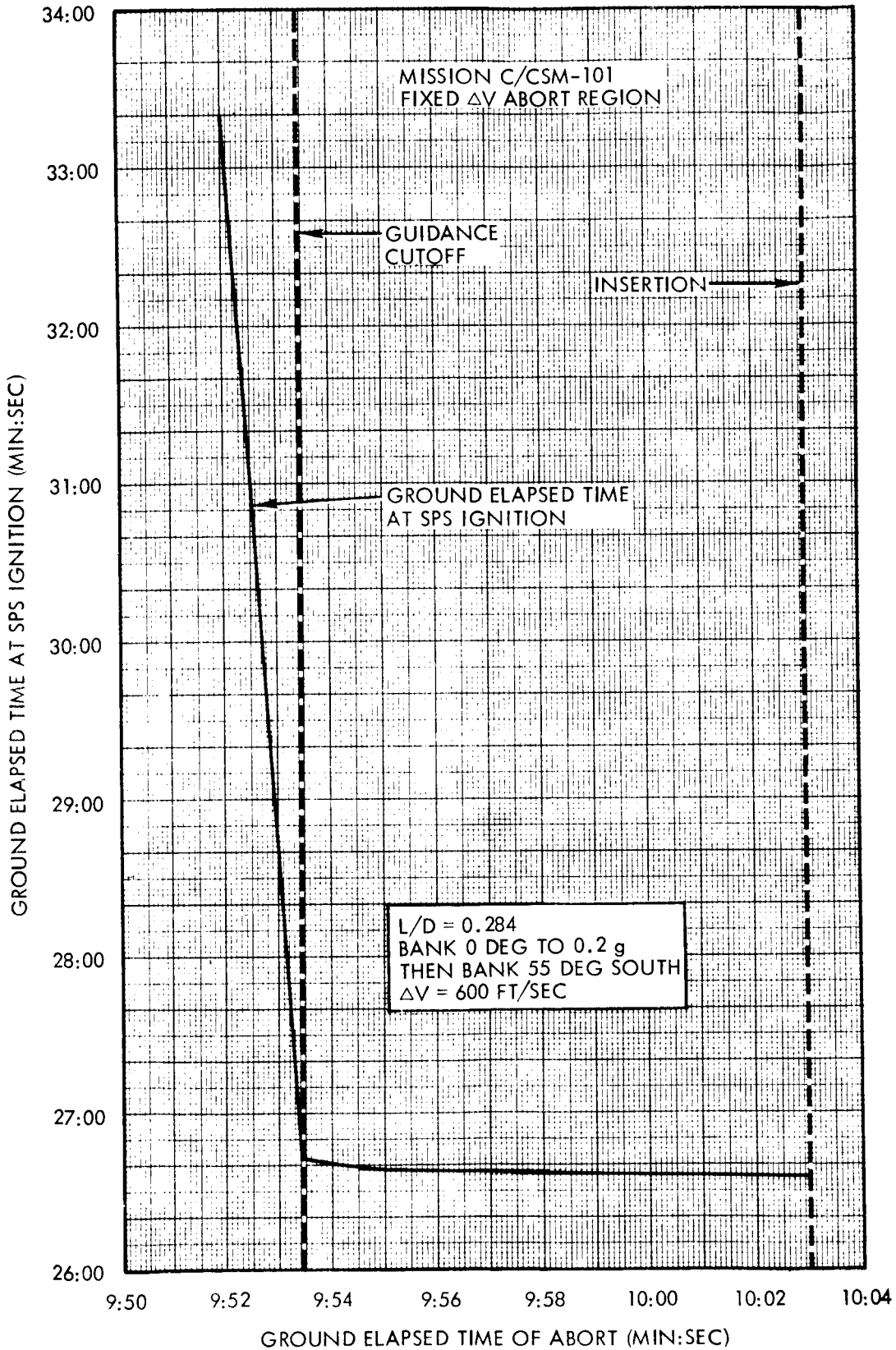

Figure 20. Ground Elapsed Time of SPS Ignition for Fixed  $\Delta V$  Aborts from the Nominal Trajectory

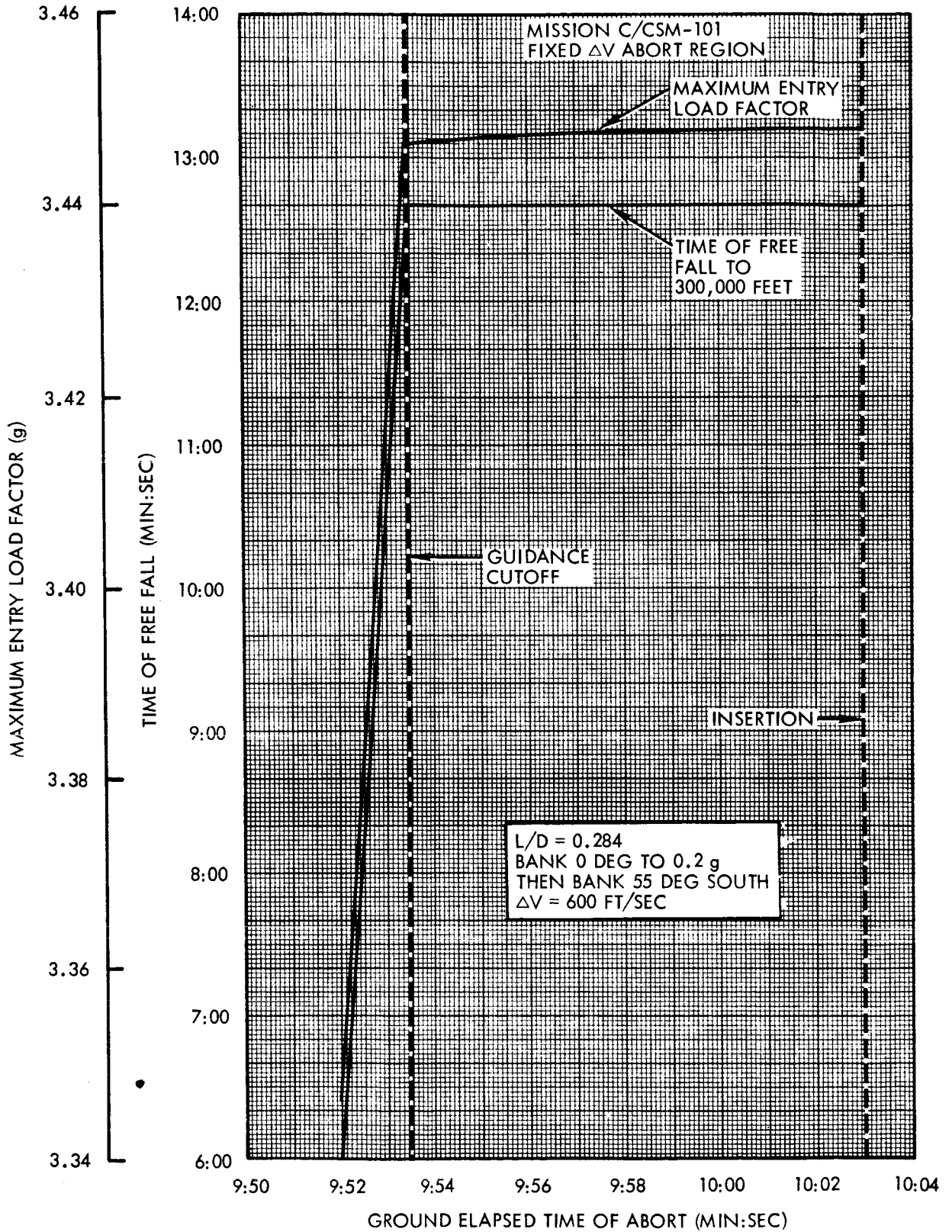

Figure 21. Time of Free Fall to an Altitude of 300,000 Feet and Maximum Entry Load Factor for Fixed  $\Delta V$  Aborts from the Nominal Trajectory



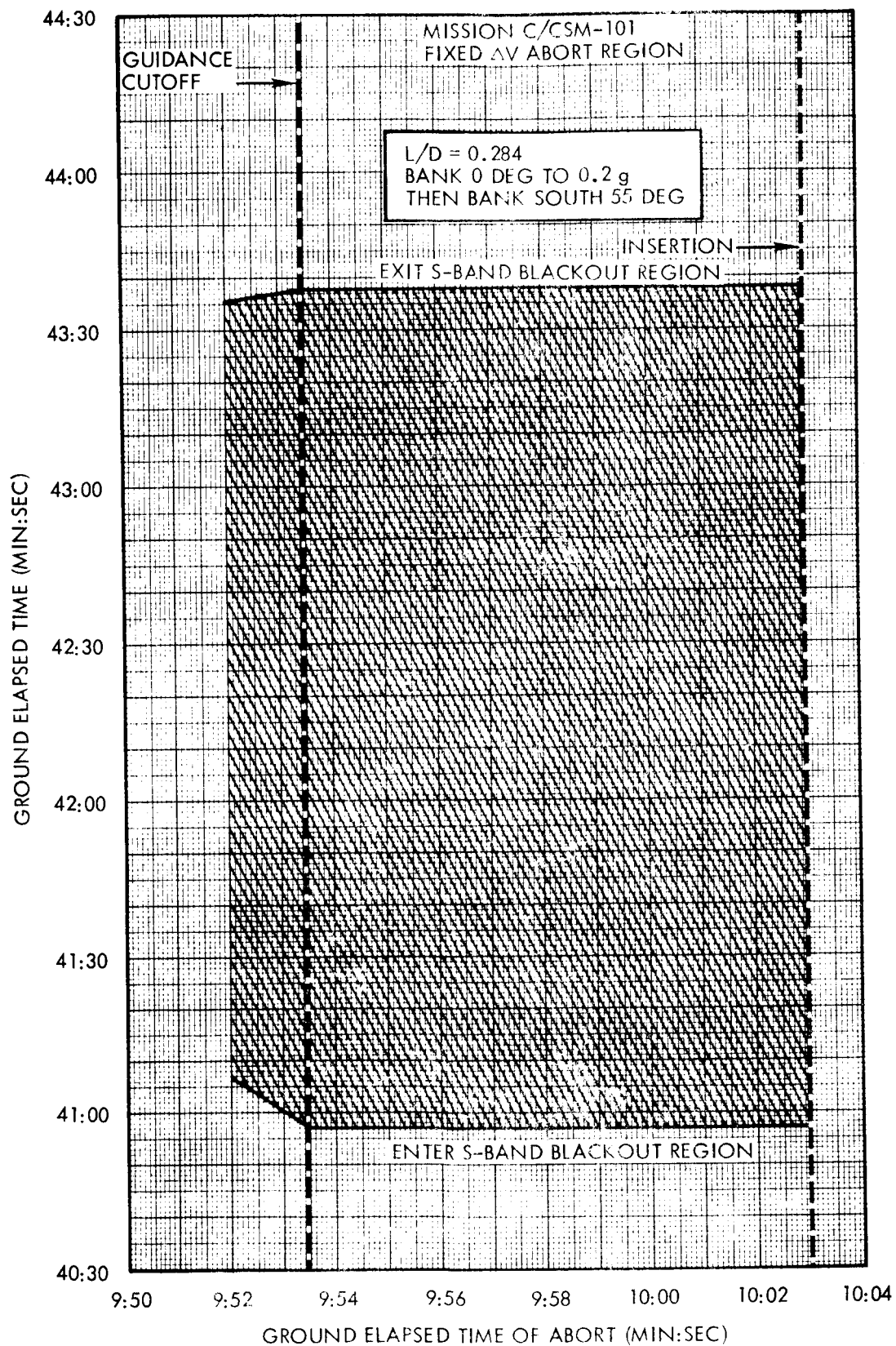

Figure 22. S-band Communication Blackout Interval versus Ground Elapsed Time of a Fixed  $\Delta V$  Abort from the Nominal Trajectory

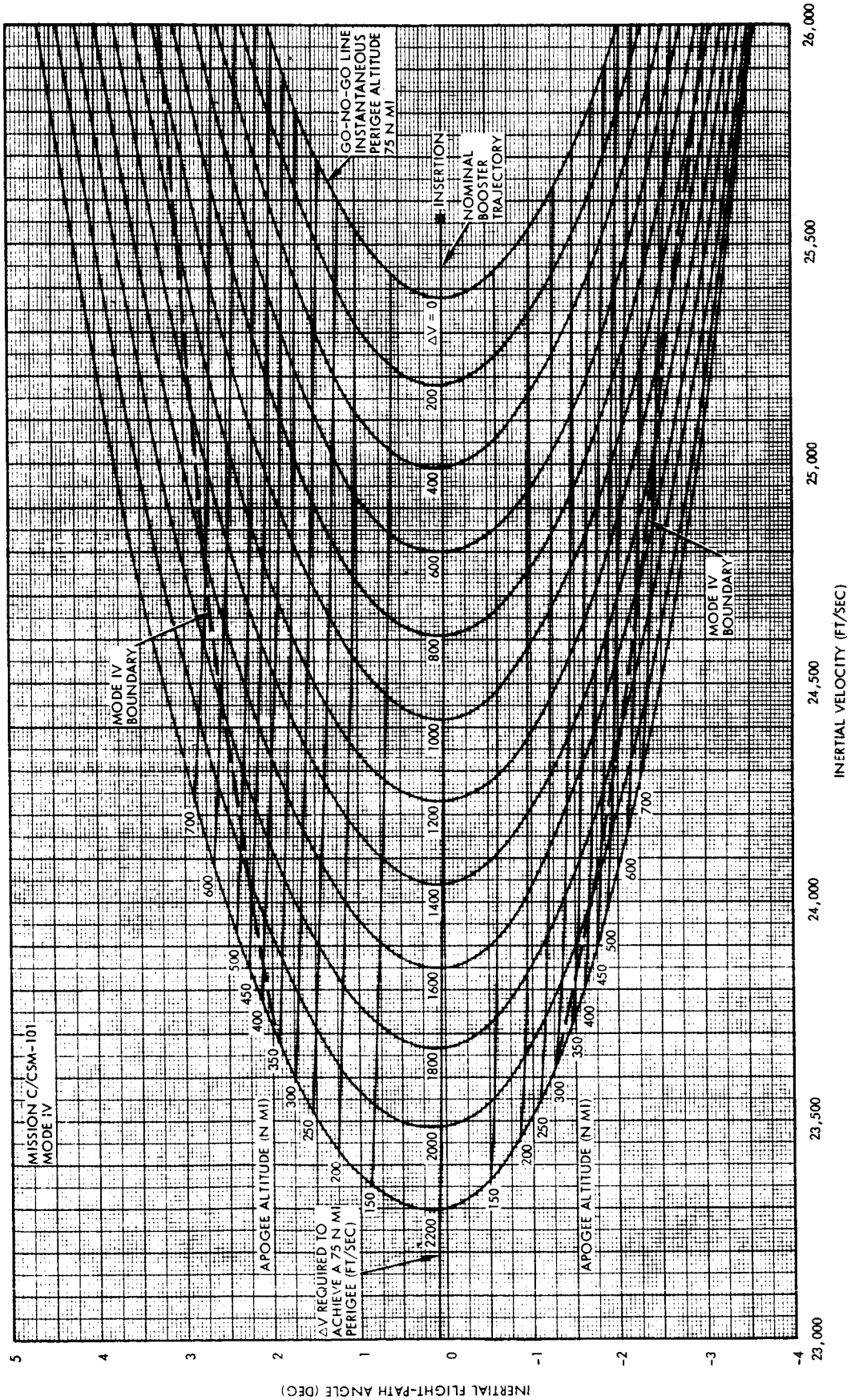

Figure 23. Boundaries, SPS  $\Delta V$  Required, and Contingency Orbit Size for Mode IV Aborts

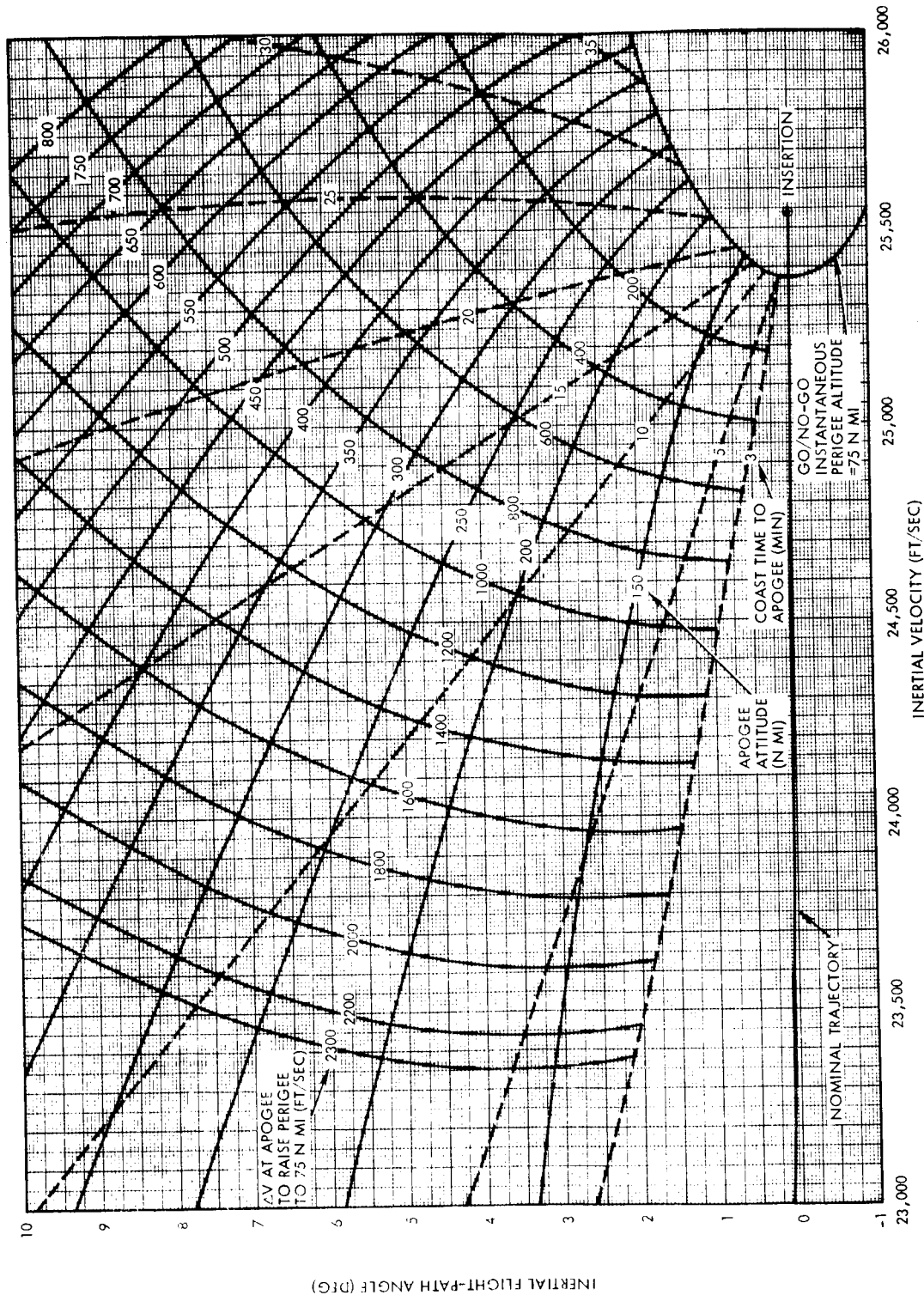

Figure 24. Mode IV Apogee Kick Region

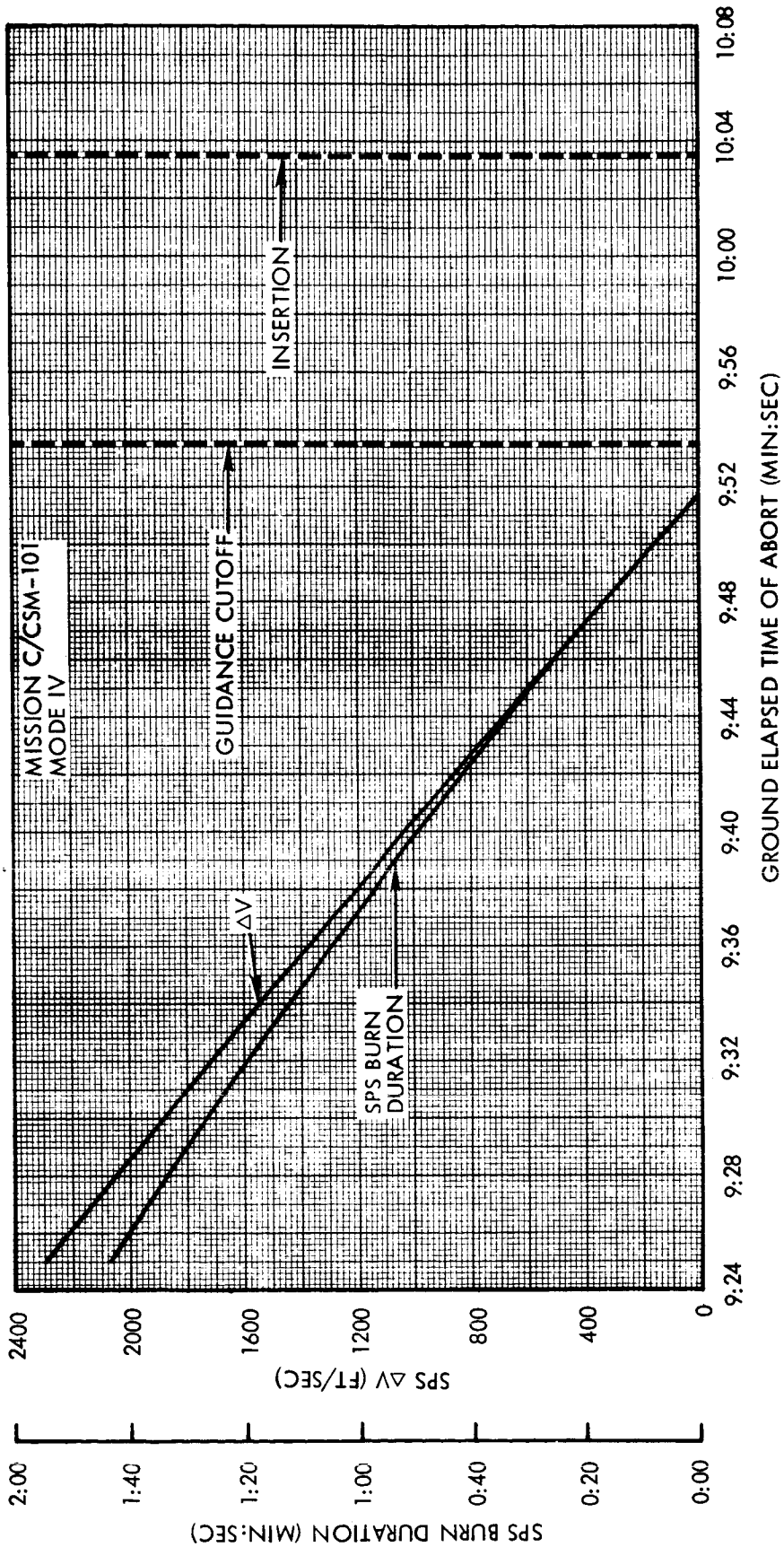

Figure 25. SPS Burn Duration and ΔV Required for COI from the Nominal Trajectory

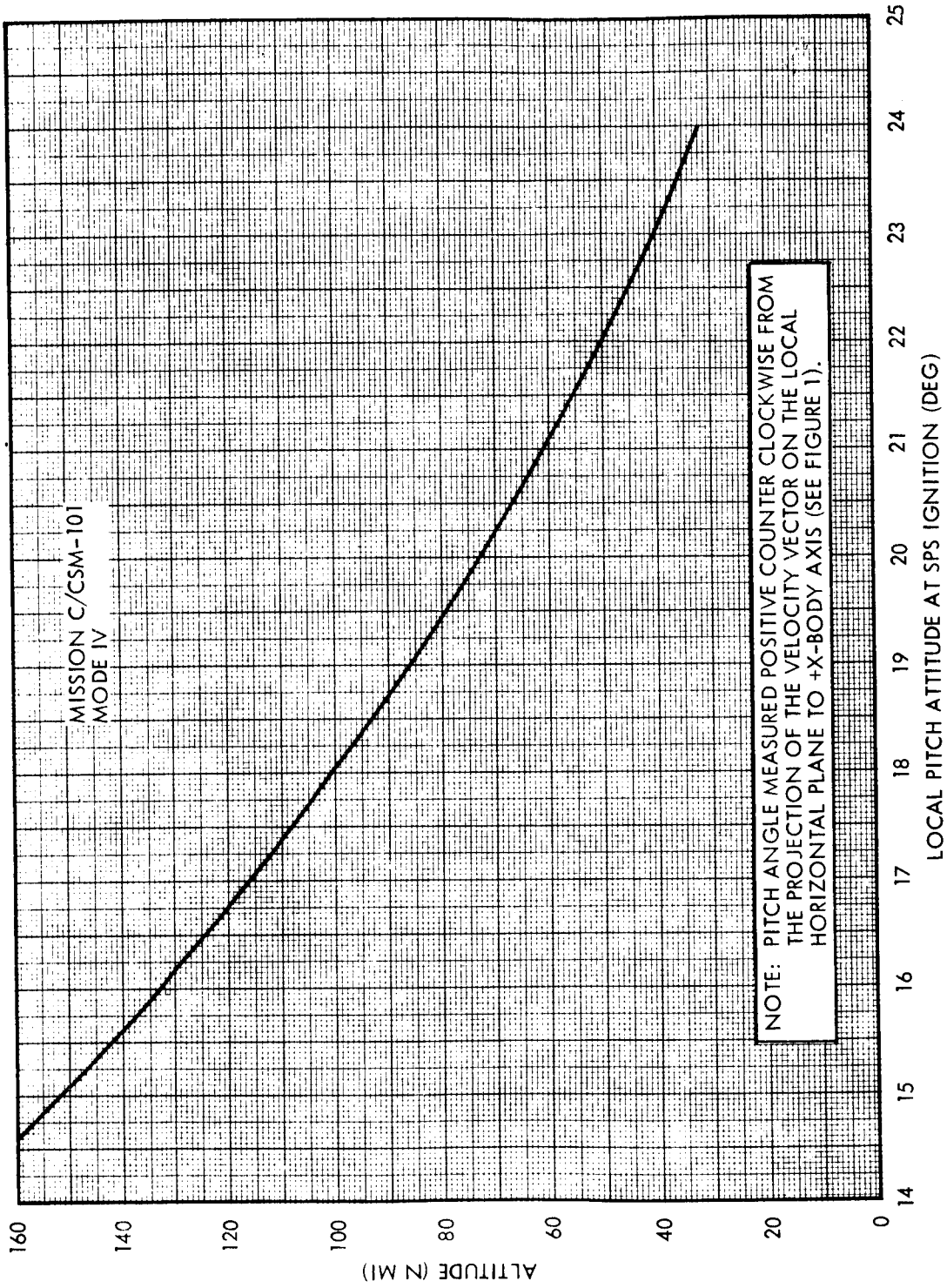

Figure 26. Mode IV Local Pitch Attitude versus Altitude at SPS Ignition

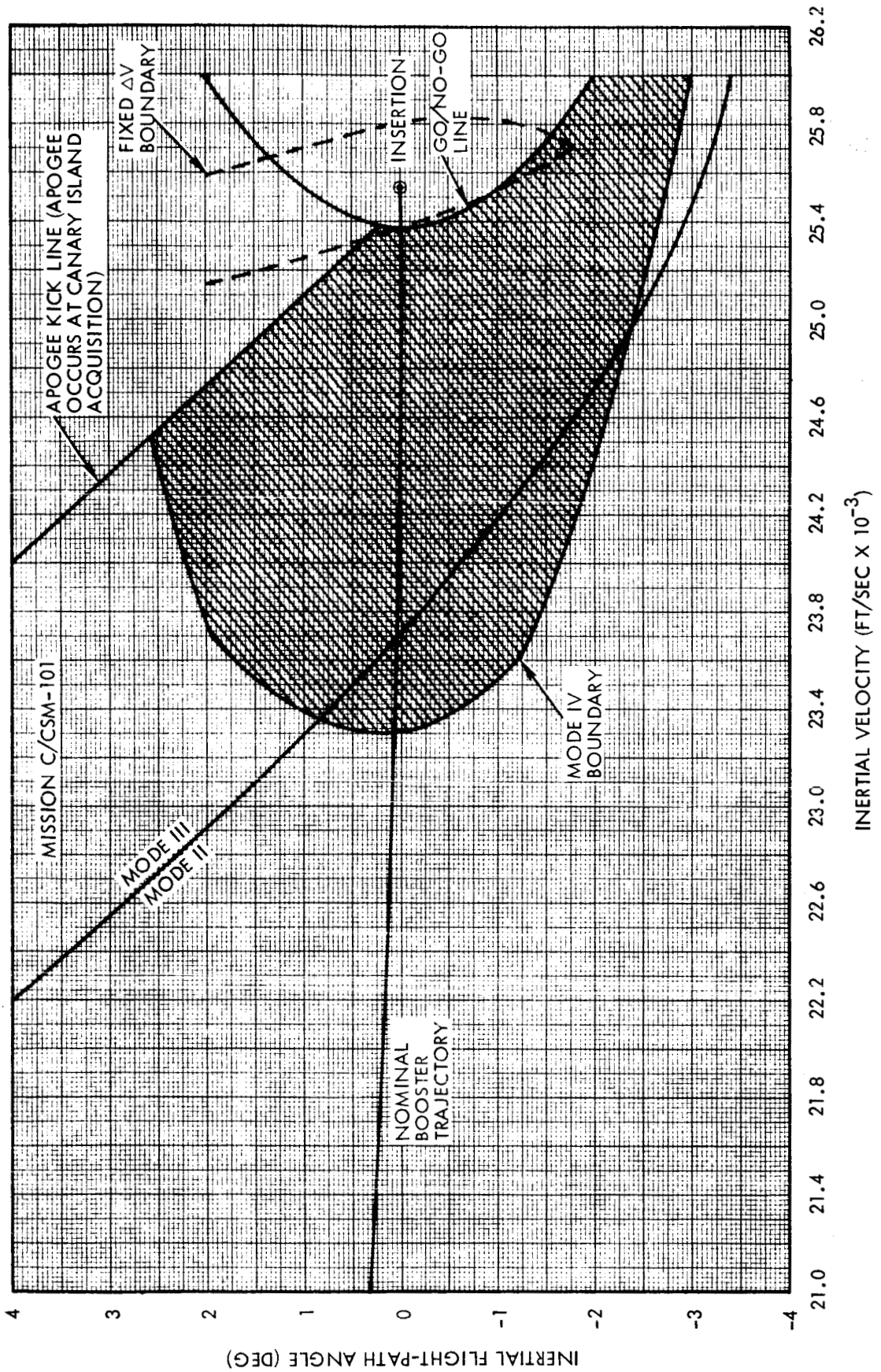

Figure 27. Near Insertion Abort Mode Overlap

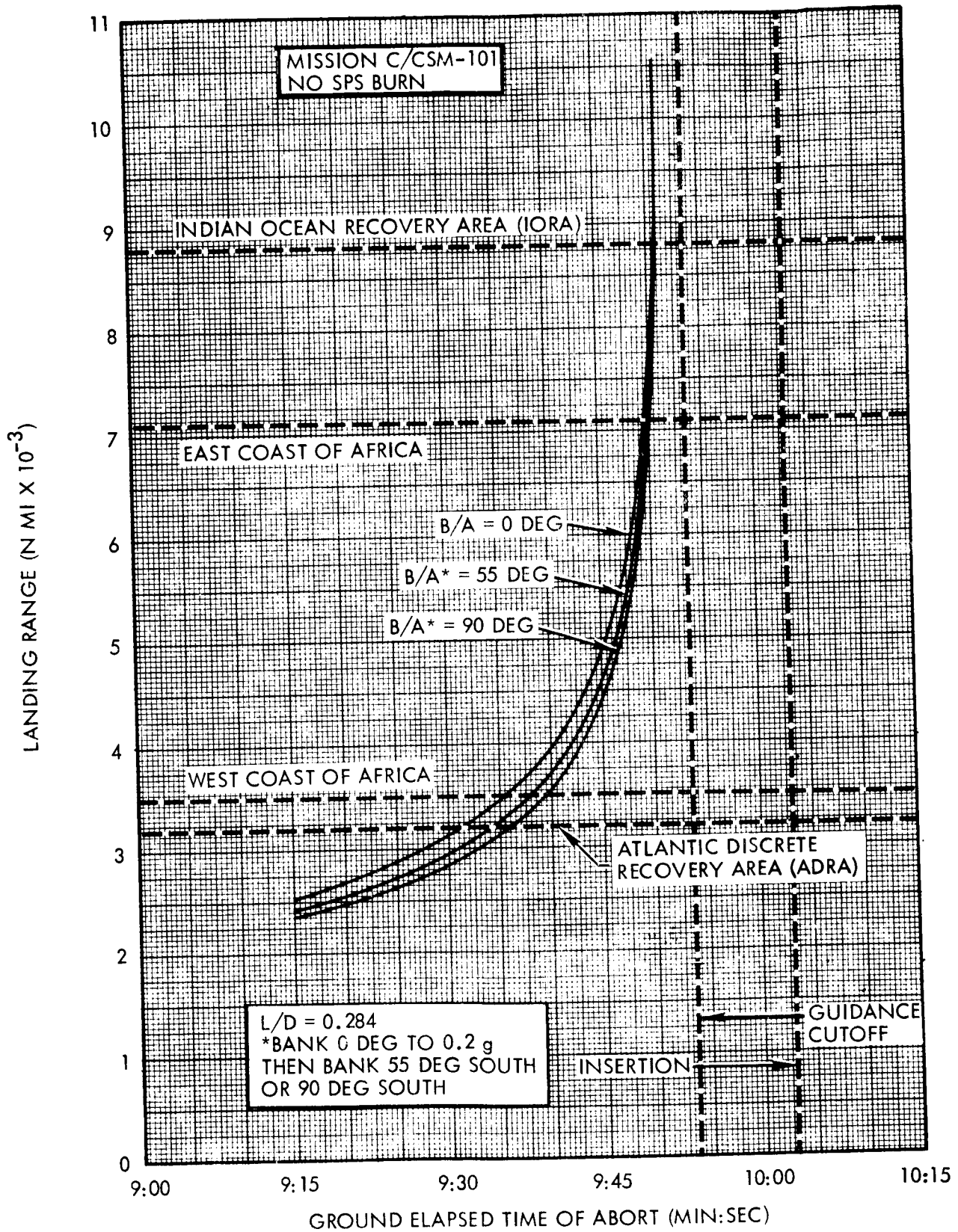

Figure 28. Landing Range Control for Aborts with No SPS Burn

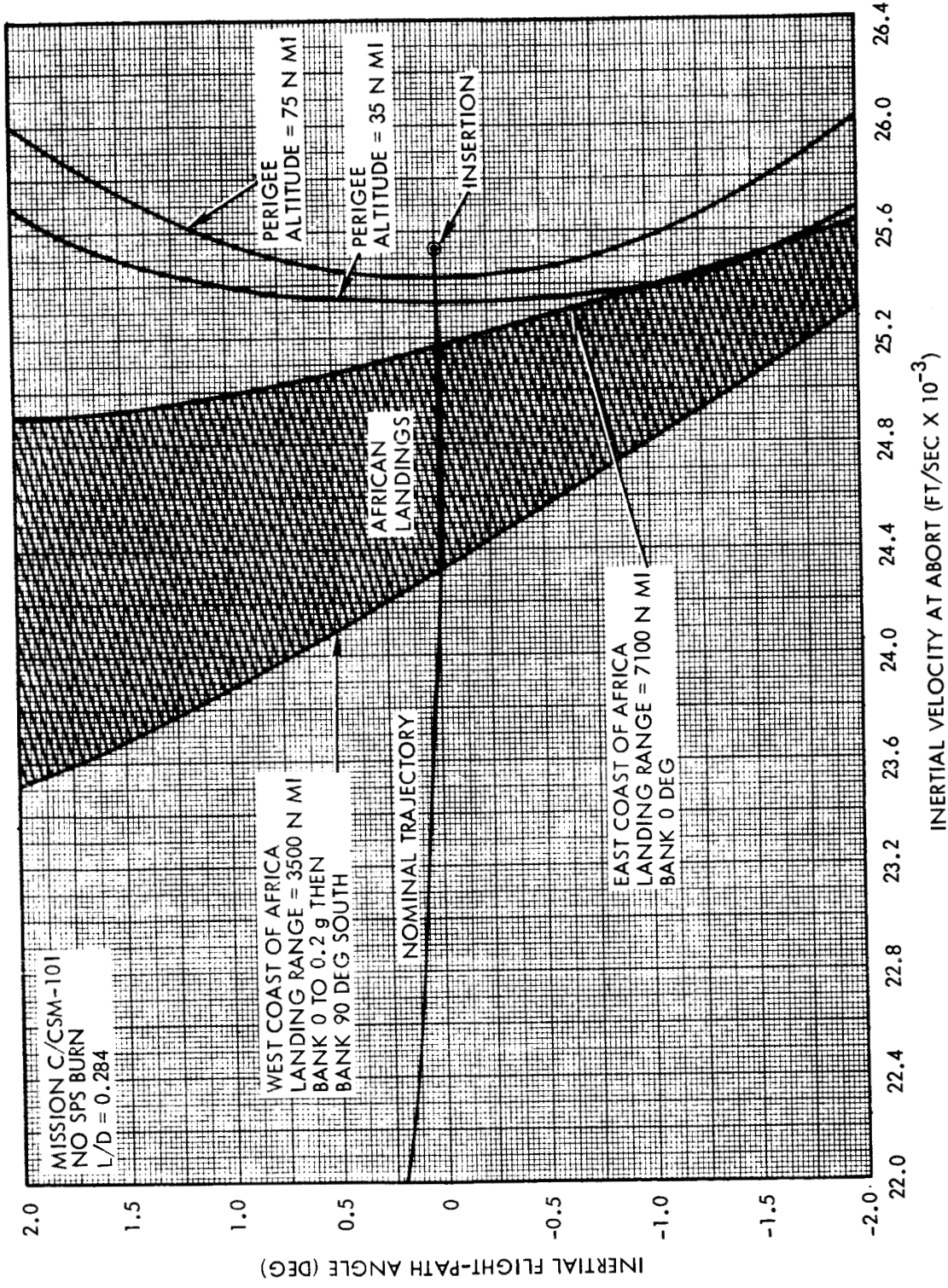

Figure 29. Landing Location for Aborts at Off-nominal Flight-path Angles with SPS Failure at Ignition



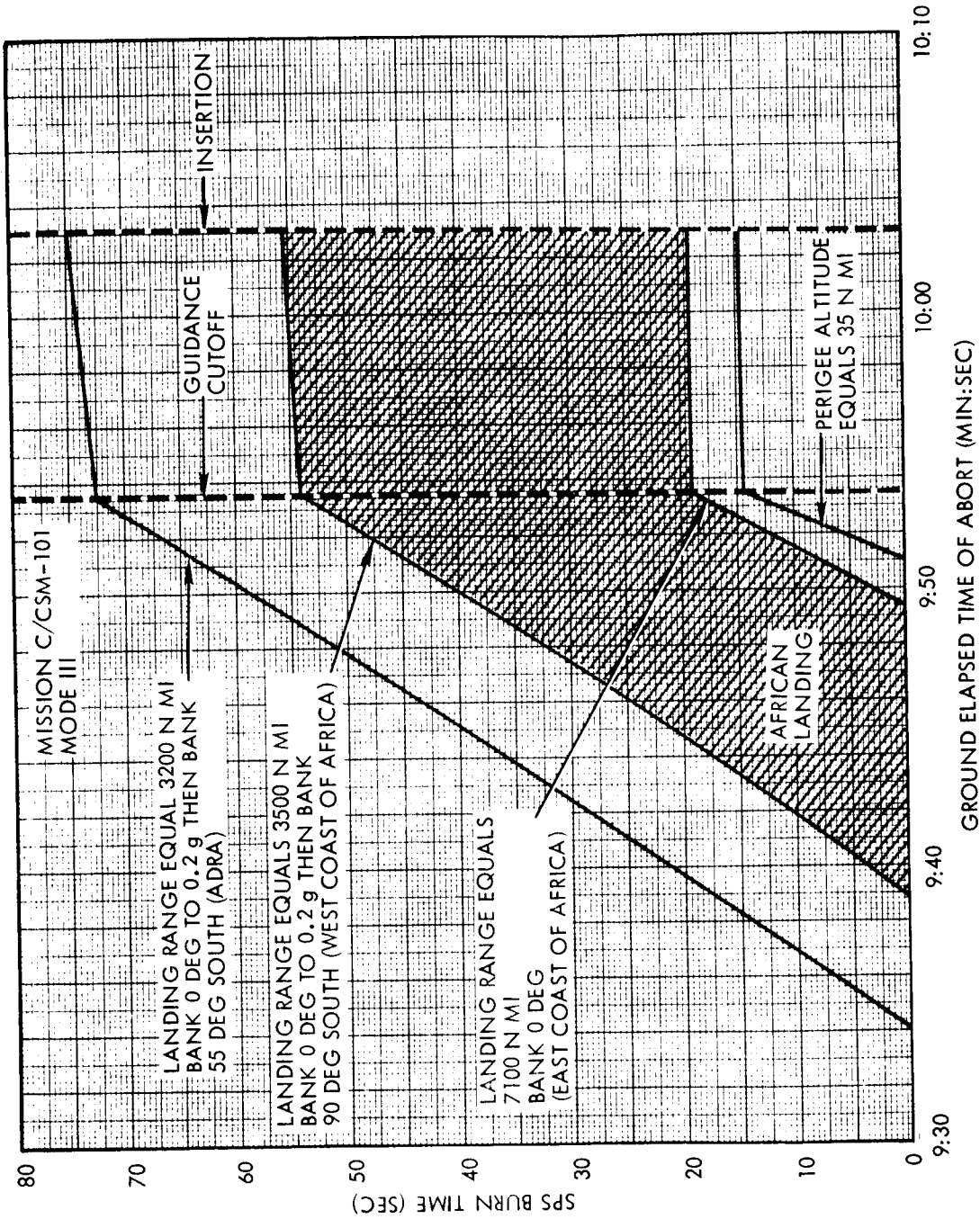

Figure 30. Landing Location for Mode III Aborts with SPS Failure During the SPS Burn

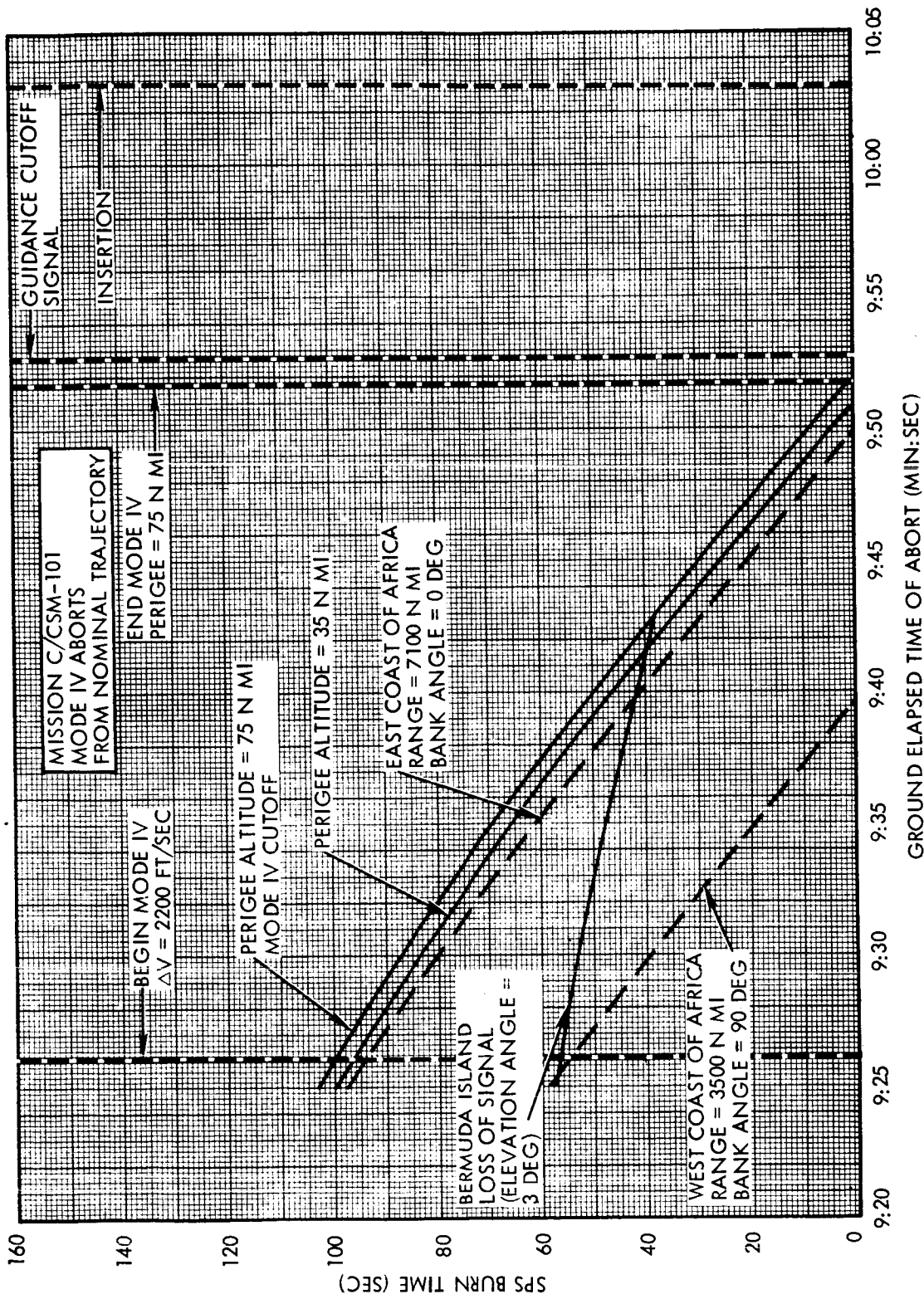

Figure 31. Landing Location Resulting from SPS Failure During a Mode IV Abort

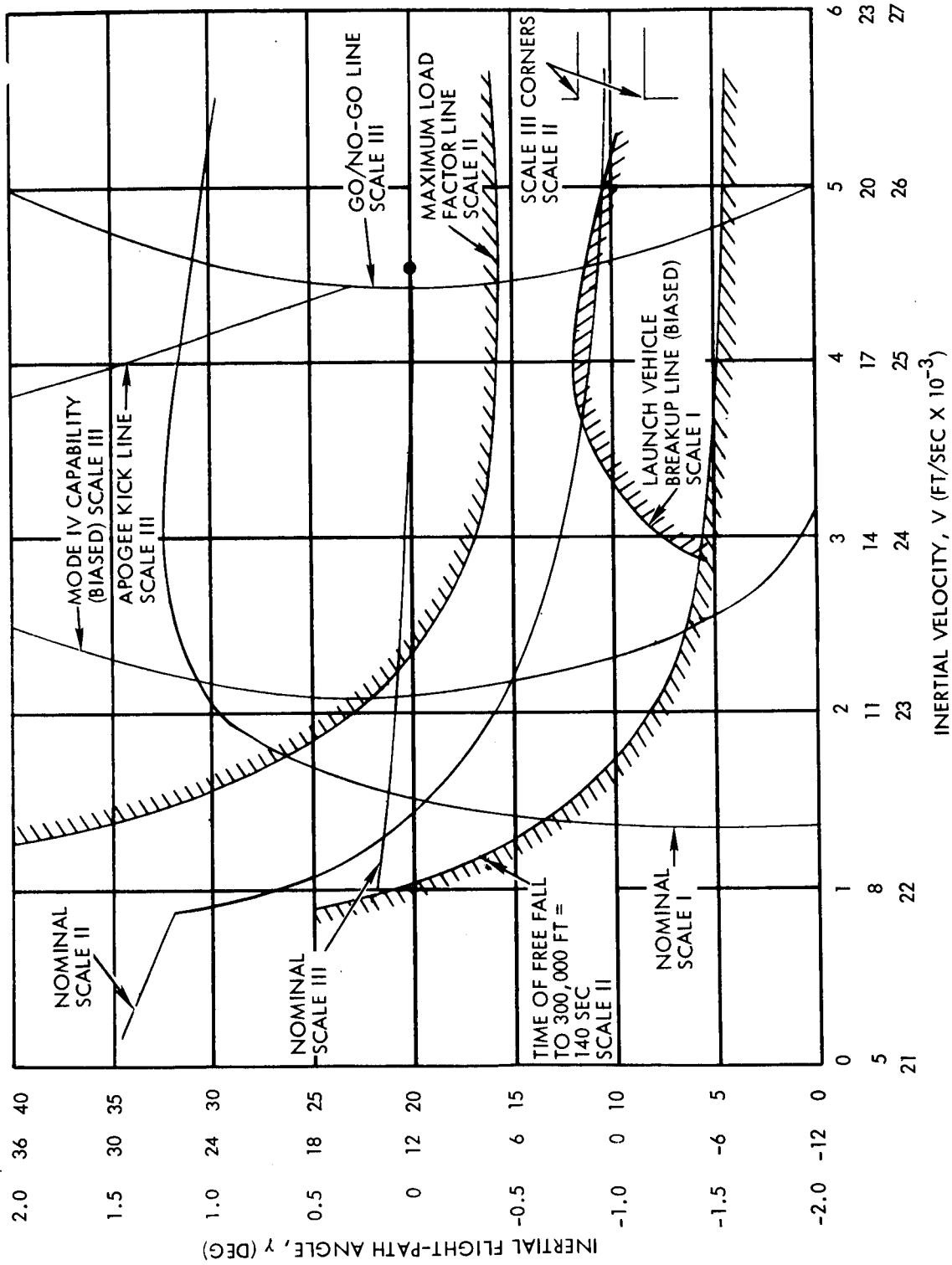

Figure 32. Inertial Flight-path Angle versus Inertial Velocity ( $\gamma - V$ )

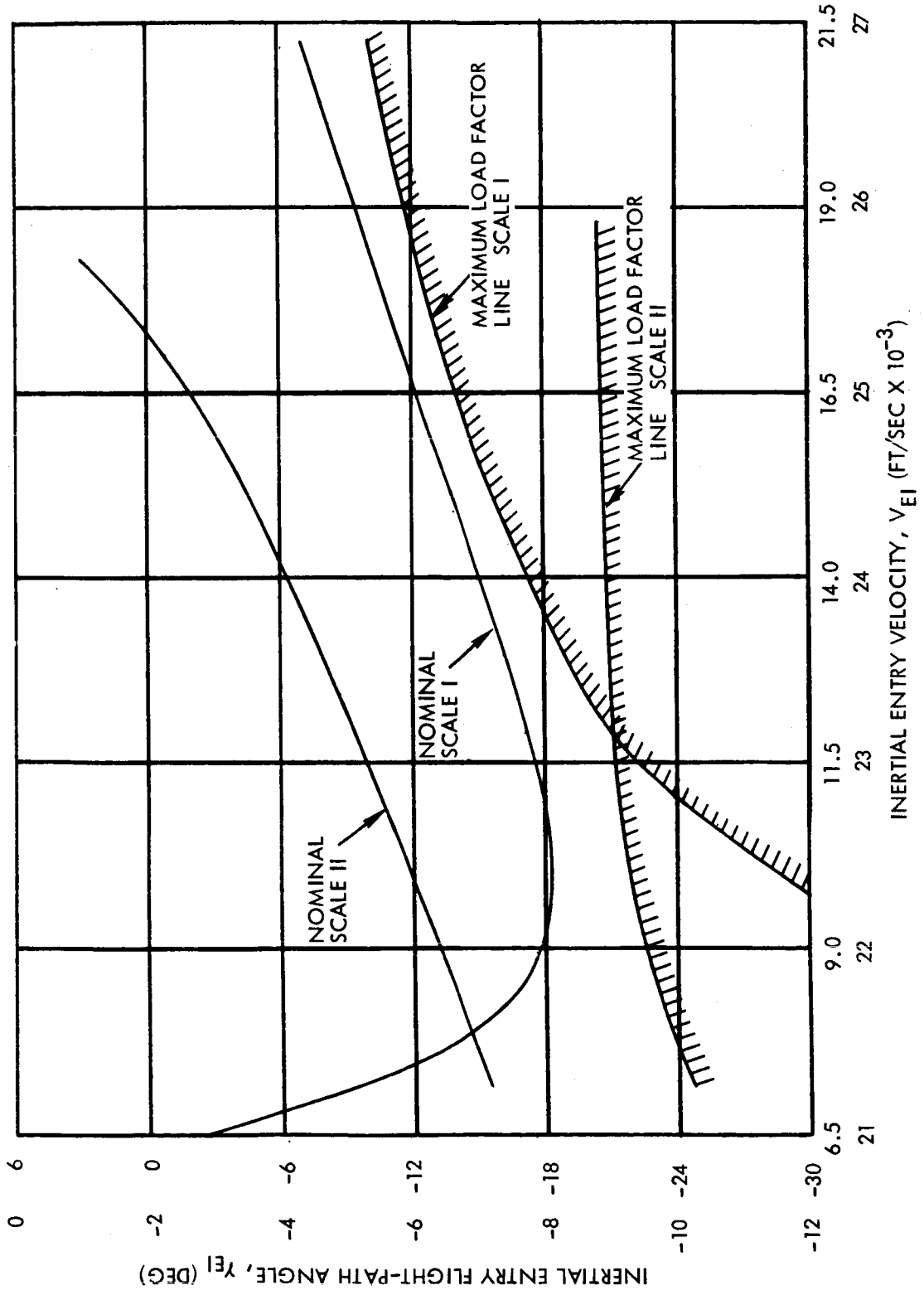

Figure 33. Inertial Flight-path Angle at Entry Interface versus Inertial Velocity at Entry Interface ( $\gamma_{EI} - V_{EI}$ )

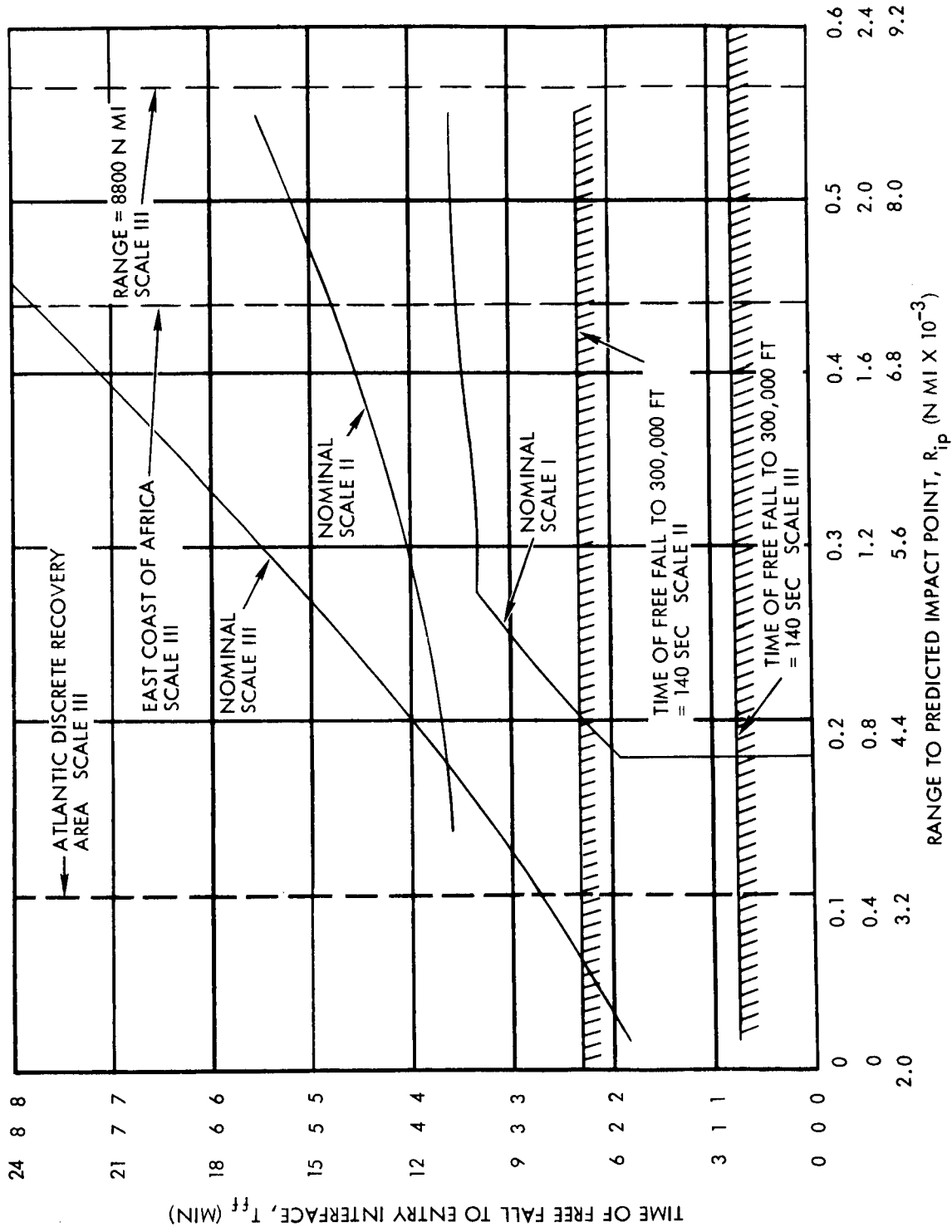

Figure 34. Time of Free Fall to Entry Interface versus Range to Predicted Impact Point ( $T_{ff} - R_{ip}$ )

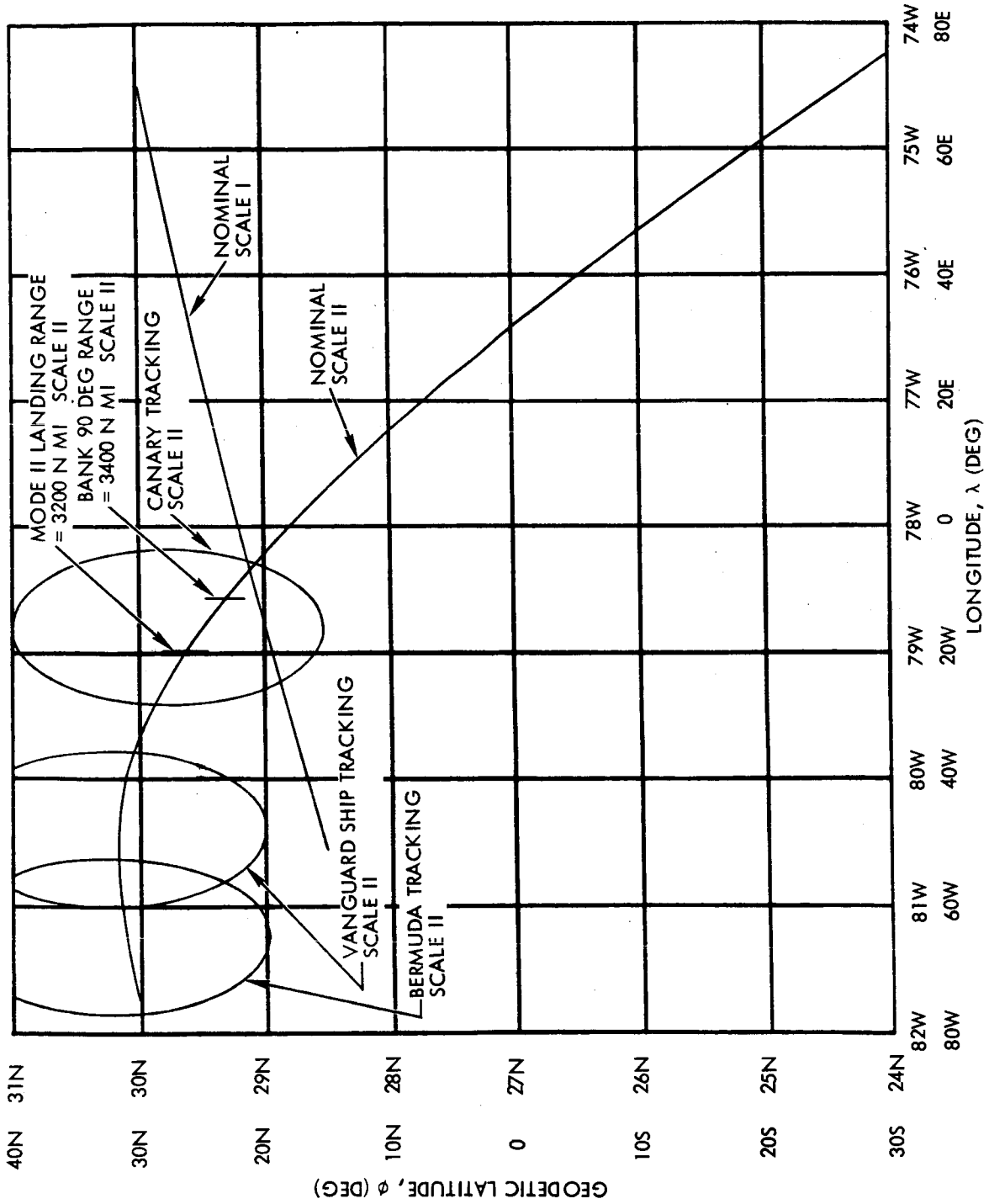

Figure 35. Geodetic Latitude versus Longitude ( $\phi - \lambda$ )

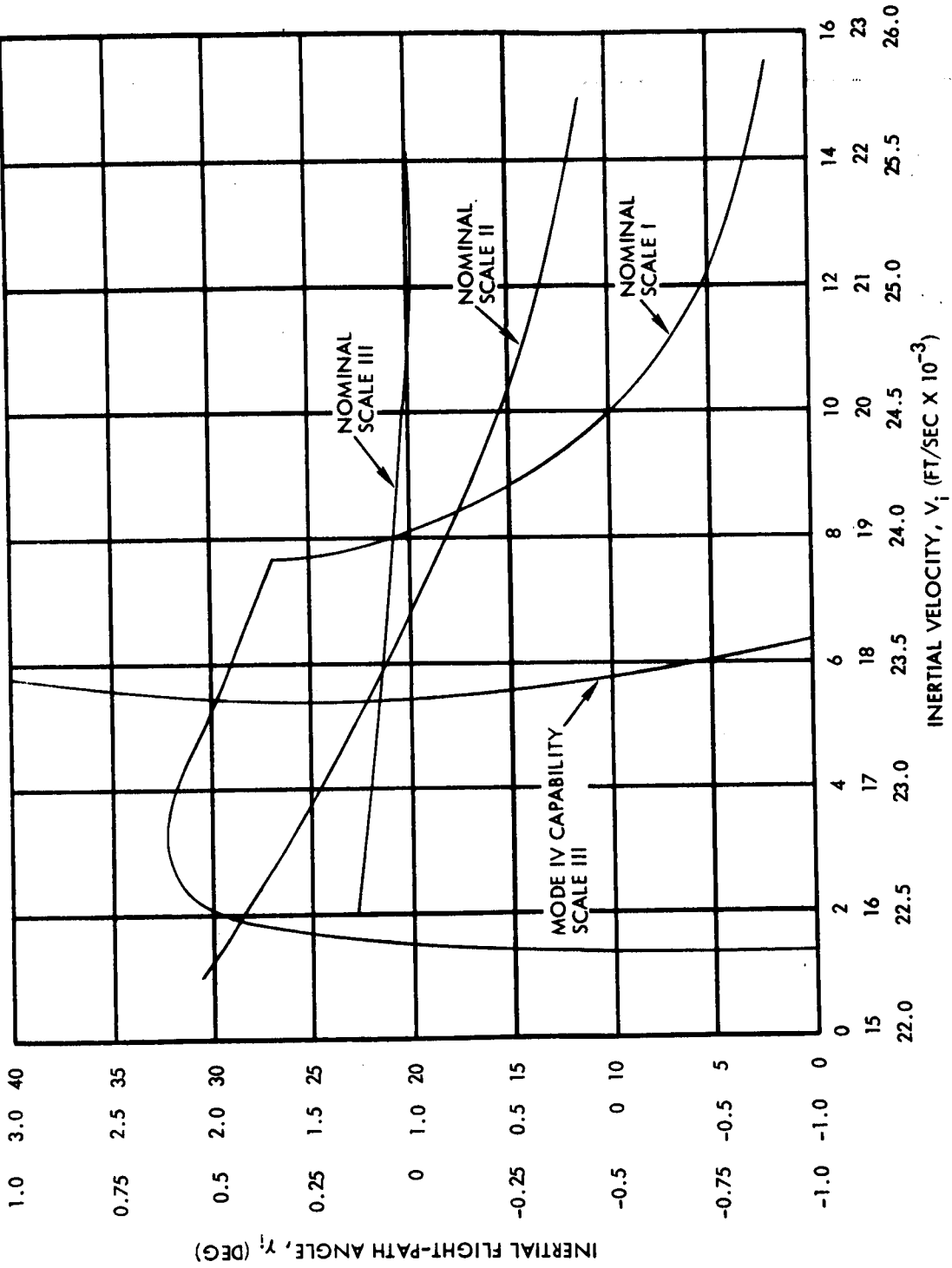

Figure 36. Inertial Flight-path Angle versus Inertial Velocity (AGC Dynamic Status) ( $y_i - V_i$ )

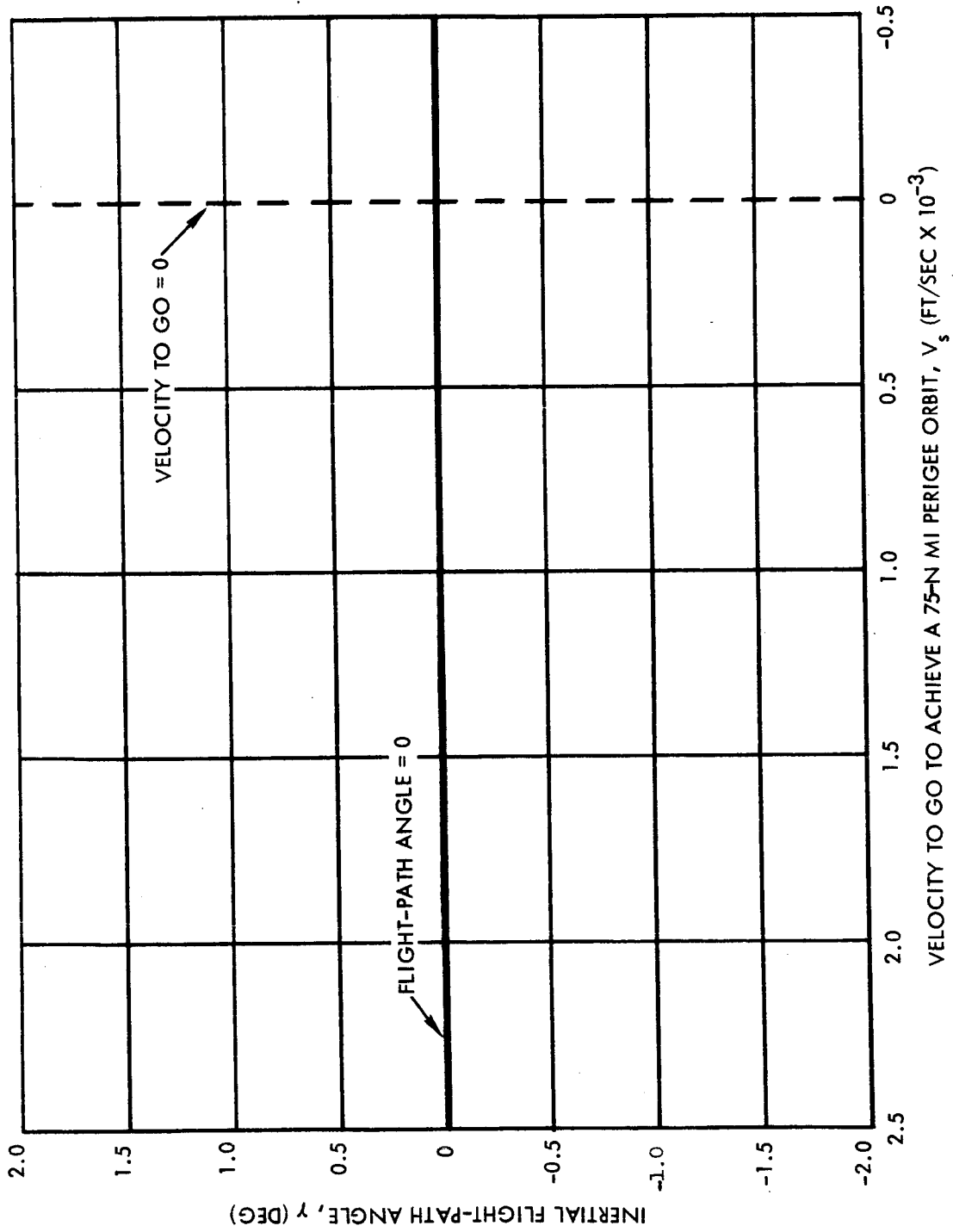

Figure 37. Inertial Flight-path Angle versus Velocity To Go To Achieve a 75-Nautical Mile Perigee Orbit ( $\gamma - V_s$ )



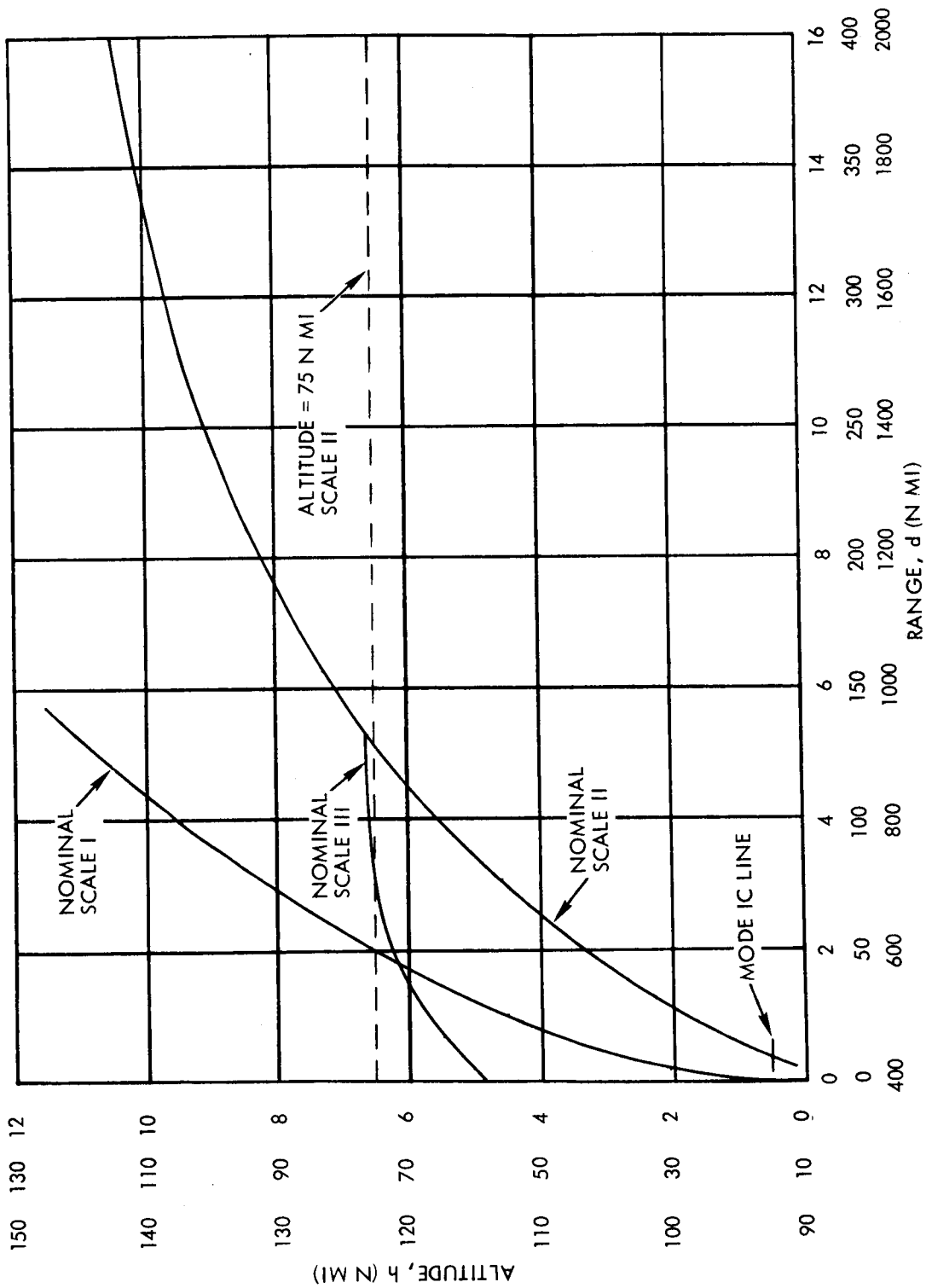

Figure 38. Altitude versus Range ( $h - d$ )

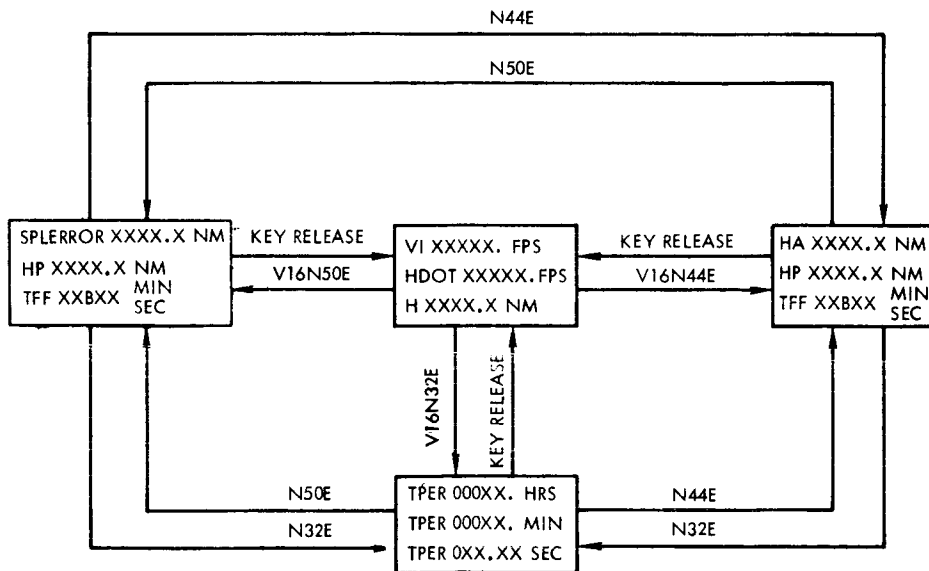
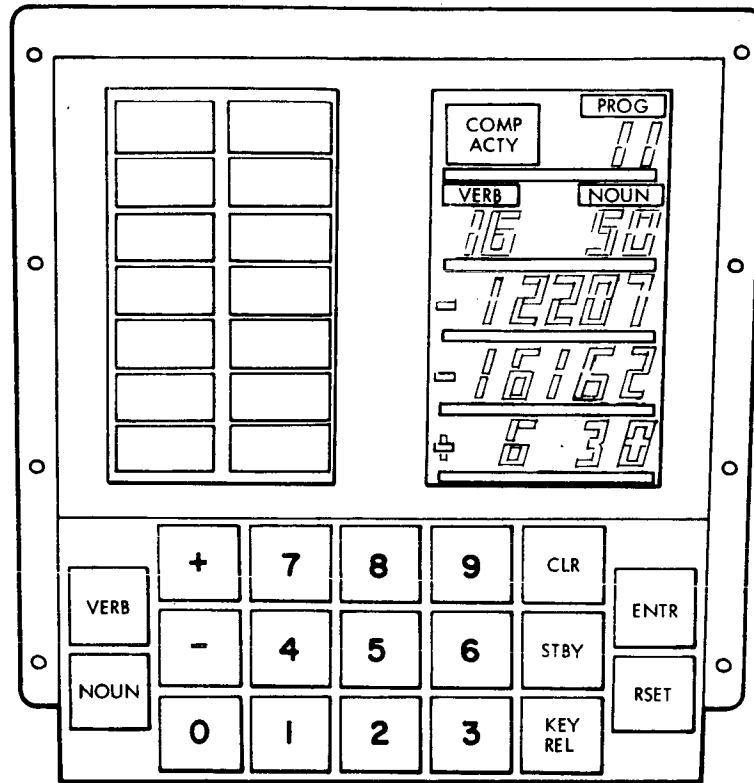

Figure 39. DSKY Panel Layout and Display Switching Pattern

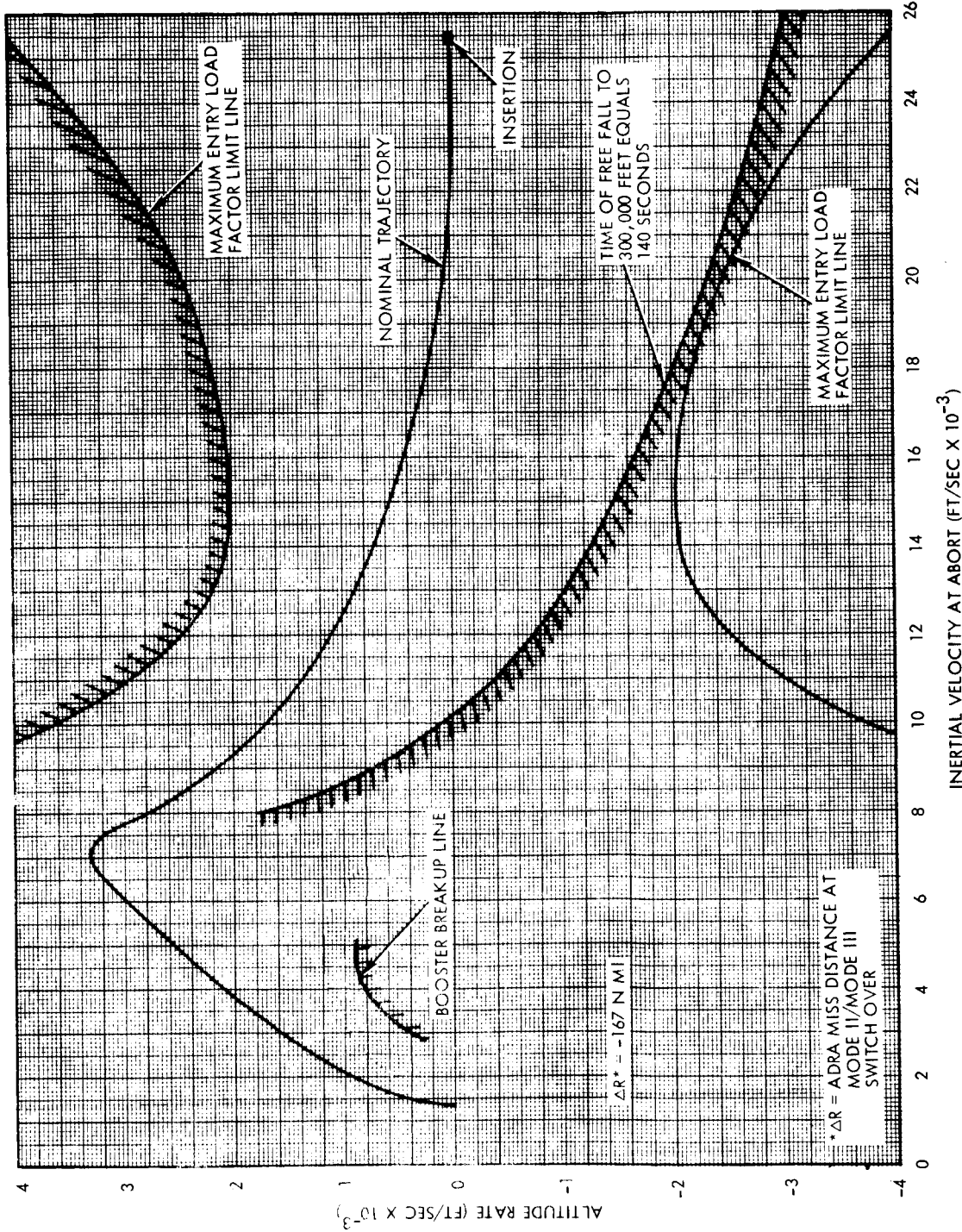

Figure 40. Onboard Crew Chart 1

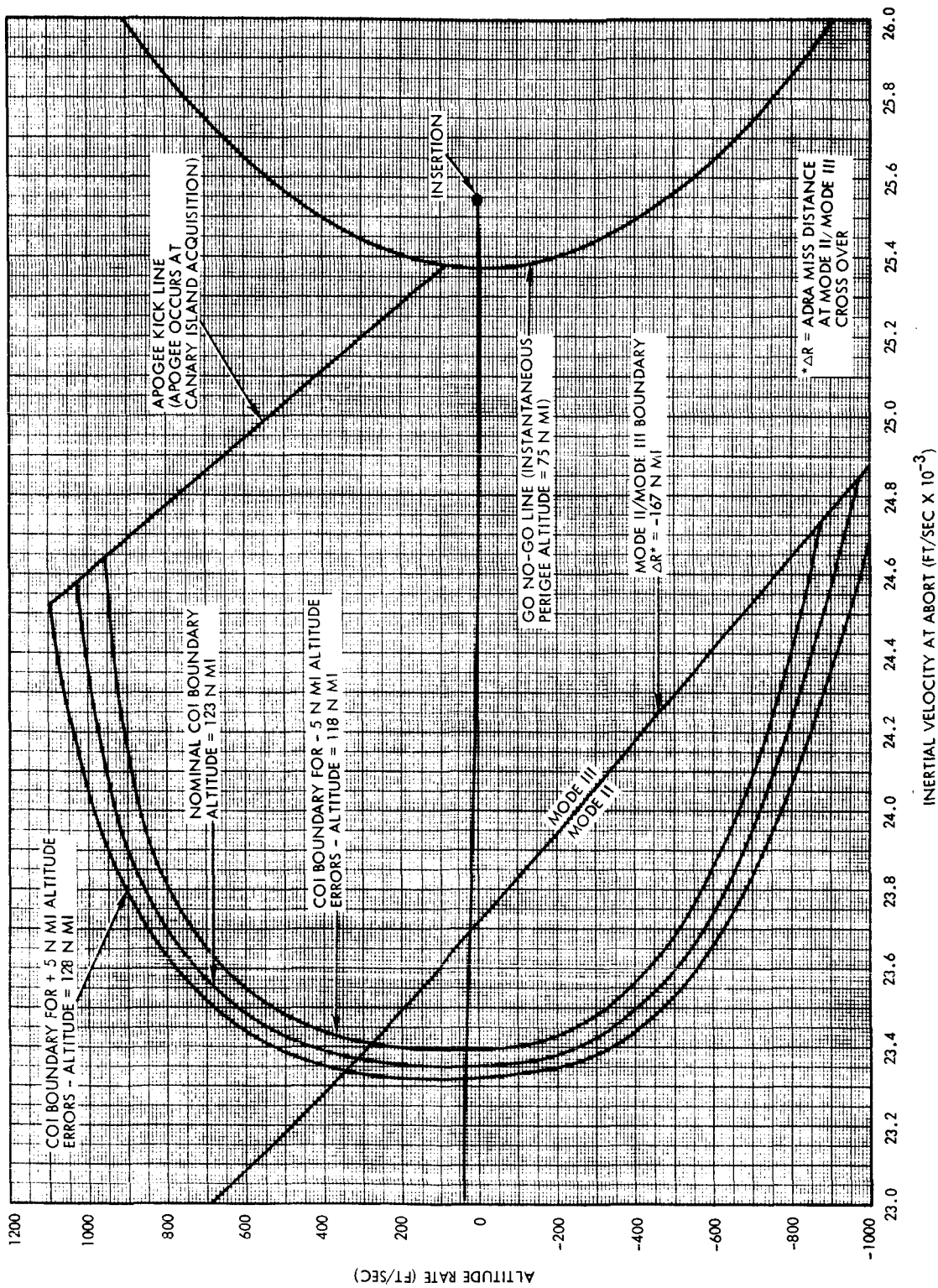

Figure 41. Onboard Crew Chart 2

## 7.0 REFERENCES

1. TRW: Apollo Saturn LB Earth Launch Phase Abort Study. TRW Note 68-FMT-629, May 1968.
2. TRW: An Investigation of S-LB Abort Criteria Based on Booster Performance Capabilities. TRW Note 68-FMT-654, May 28, 1968.
3. Apollo Mission Techniques Apollo 7 Spacecraft Launch Phase Aborts. MSC Internal Note, to be published.
4. Apollo Abort Summary Document, Mission 205/101, Final. MSC IN MSC-CF-P-68-15, April 15, 1968.
5. Griffith, David J.; Miller, Samuel L.; and Jensen, Fred C., OMAB; and Heath, David W., IMAB: Apollo 7 Spacecraft Operational Trajectory Volume I - Mission Profile. MSC IN 68-FM-110, May 22, 1968.
6. CSM/IM Spacecraft Operational Data Book, Volume III - Mass Properties. MSC Report, SNA-8-D-027, March 1968.
7. Apollo Missions and Navigation Systems Characteristics. Goddard Space Flight Center Technical Report No. AN-1.3, December 15, 1967.
8. Directory of Standard Geodetic and Geophysical Constants for Gemini and Apollo. MSC NASA General Working Paper 10020B, April 6, 1966.
9. Results of the Sixteenth Apollo Abort Working Group (AAWG) Meeting (205/101) Held on September 21, 1967. MSC Memorandum 67-FM36-391, October 11, 1967.
10. B7 tape for unbiased Mission C operational trajectory transmitted with letter number R-AERO-FMR-46-68 to John McAnulty of MSC from Range Safety Section of MSFC. February 26, 1968.
11. AS-205/CSM-101 Launch Vehicle Operational Trajectory. MSFC Operational Trajectory Data Report, May 15, 1968.
12. TRW Systems Multi-Vehicle N-Stage (MVNS) Digital Computer Program. CDRC Report 9830.4-23, August 2, 1965.
13. CSM/IM Spacecraft Operational Data Book, Volume I, CSM Data Book. MSC Report SNA-8-D-027, May 1968.

14. Performance Data Supplement to Mission Modular Data Book Block II Earth Orbital Mission. North American Aviation Report SID 66-15-10A Part 3 issued as United States Government Memorandum FM3/M-189/67, Revised March 15, 1967.
15. Final Document of the Twelfth Flight Limits Subpanel. Joint MSFC and MSC Document, to be published.
16. Benney, Alexie H., Jr., and Miller, Samuel L.: Apollo 7 (Mission C) Operational Alternate Mission Plan. MSC IN 68-FM-163, July 10, 1968.
17. Results of the Twenty-Seventh Apollo Abort Working Group (AAWG) Meeting Held on January 16, 1968 on the AS-205/101 Mission. MSC Memorandum 68-FM36-59, February 8, 1968.
18. Results of the Thirty-Second Apollo Abort Working Group Meeting on AS-205/101 Held March 26, 1968. MSC Memorandum 68-FM36-189, April 22, 1968.
19. Spacecraft Operational Abort and Alternate Mission Studies for AS-204A, Volume I - Abort Studies. MSC IN 66-FM-113, October 28, 1966.
20. Launch Phase Flight Dynamics Displays for Mission C/CSM-101 Simulations. MSC Memorandum 68-FM36-210, May 8, 1968.
21. Guidance System Operations Plan for Manned CM Earth Orbital Missions using Program Sundisk, Section 5 - Guidance Equations (Rev. 2). MIT/IL Document, March 1968.
22. Prah1, Robert E.: Sun-In-The-Window Analysis for the Apollo 7 Nominal Launch Phase and the Mode III, Fixed- $\Delta V$ , and Mode IV Aborts. MSC IN 68-FM-169, July 16, 1968.
23. Apollo 7 (Mission C) Separation and Recontact Analysis Summary Document. MSC IN 68-FM-176 to be published.
24. Fixed Time Aborts (FTA) for AS-205/101. MSC Memorandum to FA/Director of Flight Operations from FC/Acting Chief, Flight Control Division, June 20, 1968.