

ГЛАВНЫЙ ПУЛЬТ ИНДИКАЦИИ
MAIN DISPLAY CONSOLE

ПАНЕЛЬ 9

УПРАВЛЕНИЕ РТС

ПАНЕЛЬ 8

PANEL 9

TELECOM CONTROLS

УПРАВЛЕНИЕ ОСВЕЩЕНИЕМ
АЗЦ ЭЛЕКТРОПИТАНИЯ

PANEL 8

LIGHTING CONTROLS
POWER CIRCUIT BREAKERS

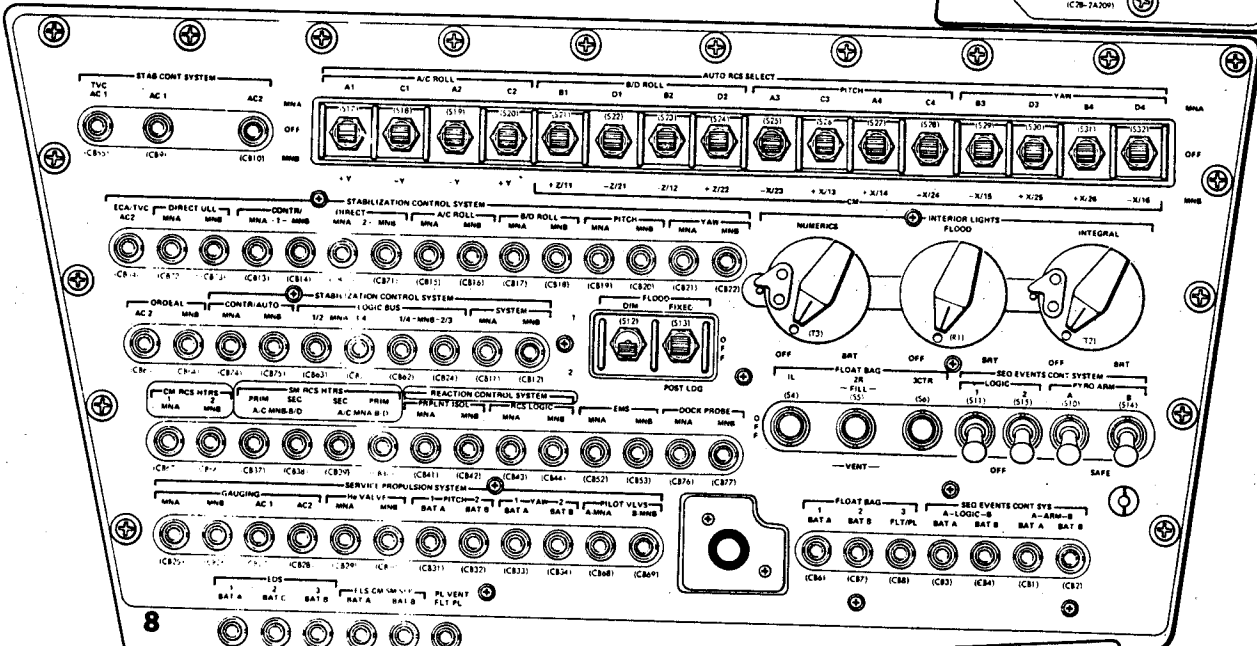
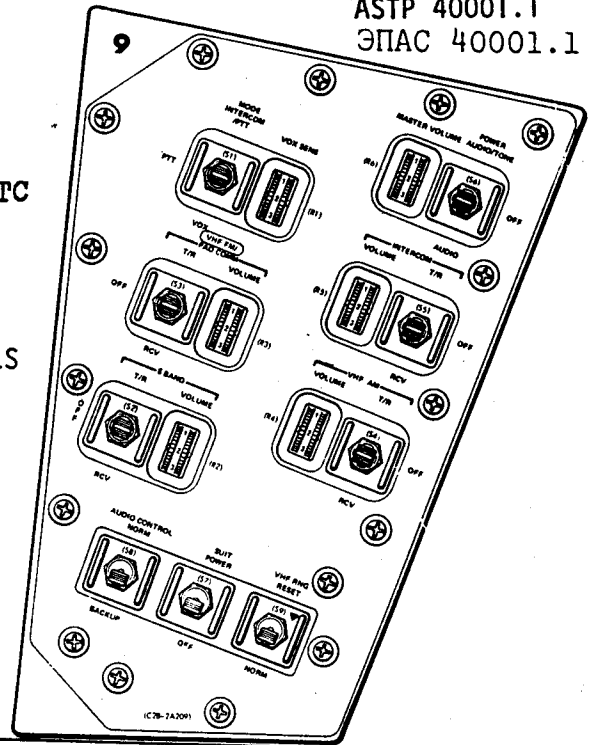

ПАНЕЛЬ 7

ПЕРЕКЛЮЧАТЕЛИ
ЭЛЕКТРОПИТАНИЯ СУС

PANEL 7

SCS POWER SWITCHES

РИС 4-14 ПУЛЬТ УПРАВЛЕНИЯ И ИНДИКАЦИИ КСМ 111 ЛИСТ 6 ИЗ 15

FIGURE 4-14 CSM 111 DISPLAYS AND CONTROLS PANELS (SHEET 6 OF 15)

ГЛАВНЫЙ ПУЛЬТ ИНДИКАЦИИ
MAIN DISPLAY CONSOLE

ASTP 40001.1
ЭПАС 40001.1

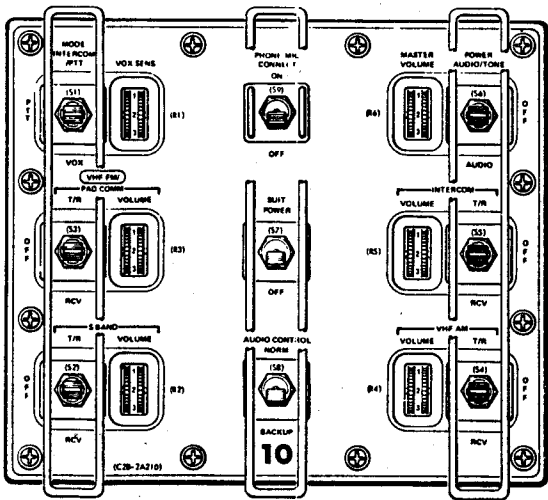

ПАНЕЛЬ 10

PANEL 10

УПРАВЛЕНИЕ РТС

TELECOM CONTROLS

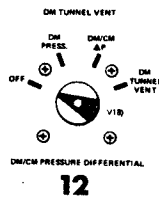

ПАНЕЛЬ 12

PANEL 12

ОТДУШИНА ТОННЕЛЯ СМ

DM TUNNEL VENT

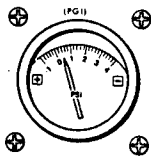

ПАНЕЛЬ 13

PANEL 13

УПРАВЛЕНИЕ
ОРИТАЛЬНОЙ
СКОРОСТЬЮ

ORBITAL RATE CONTROL

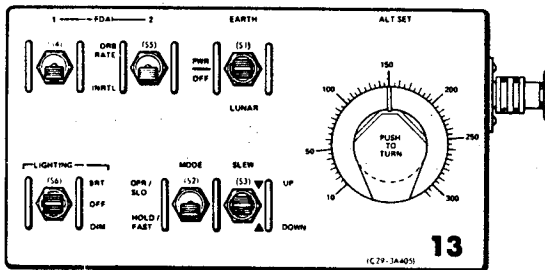

ПАНЕЛЬ 15

PANEL 15

УПРАВЛЕНИЕ СИСТЕМАМИ
ПОСЛЕПРИЗЕМЛЕНИЯ
ПИТАНИЕ ОБЩЕГО
НАЗНАЧЕНИЯ

POSTLANDING CONTROLS
UTILITY POWER OUTLET

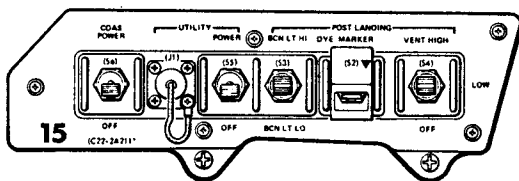

ПАНЕЛЬ 16

PANEL 16

ПИТАНИЕ ОБЩЕГО
НАЗНАЧЕНИЯ

UTILITY POWER OUTLET

РИС 4-14 ПУЛЬТ УПРАВЛЕНИЯ И ИНДИКАЦИИ КСМ 111 ЛИСТ 7 ИЗ 15

FIGURE 4-14 CSM 111 DISPLAYS AND CONTROLS PANELS (SHEET 7 OF 15)

ПАНЕЛЬ 100

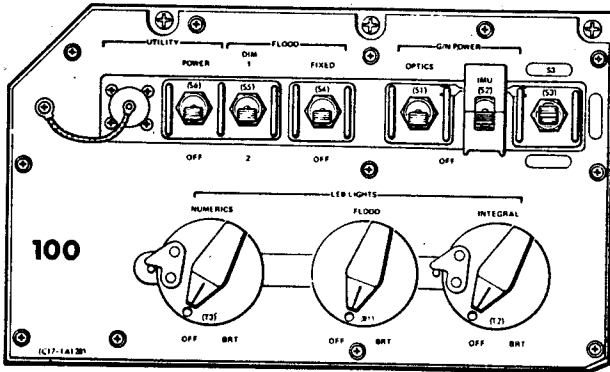

УПРАВЛЕНИЕ ОСВЕЩЕНИЕМ
ПИТАНИЕ ОБЩЕГО НАЗНАЧЕНИЯ
ПЕРЕКЛЮЧАТЕЛЬ ПИТАНИЯ СНН

PANEL 100

LIGHTING CONTROLS
UTILITY POWER OUTLET
G & N POWER SWITCHES

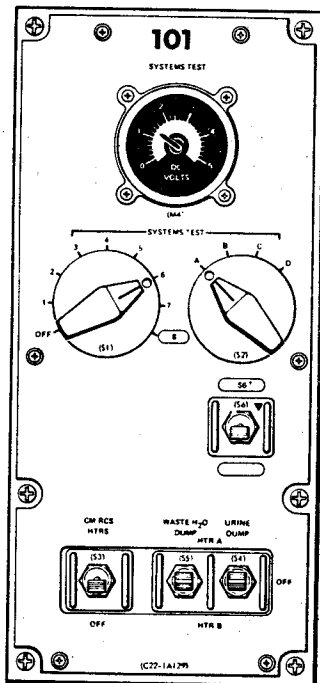

ПАНЕЛЬ 101

УКАЗАТЕЛЬ ПРОВЕРКИ СИСТЕМ
УПРАВЛЕНИЕ СБРОСА ВОДЫ

PANEL 101

SYSTEMS TEST METER
WATER DUMP CONTROLS

РИС 4-14 ПУЛЬТ УПРАВЛЕНИЯ И ИНДИКАЦИИ КСМ 111 ЛИСТ 8 ИЗ 15

FIGURE 4-14 CSM 111 DISPLAYS AND CONTROLS PANELS (SHEET 8 OF 15)

НИЖНИЙ ОТСЕК ДЛЯ ОБОРУДОВАНИЯ
LOWER EQUIPMENT BAY

ASTP 40001.1
ЭПАС 40001.1

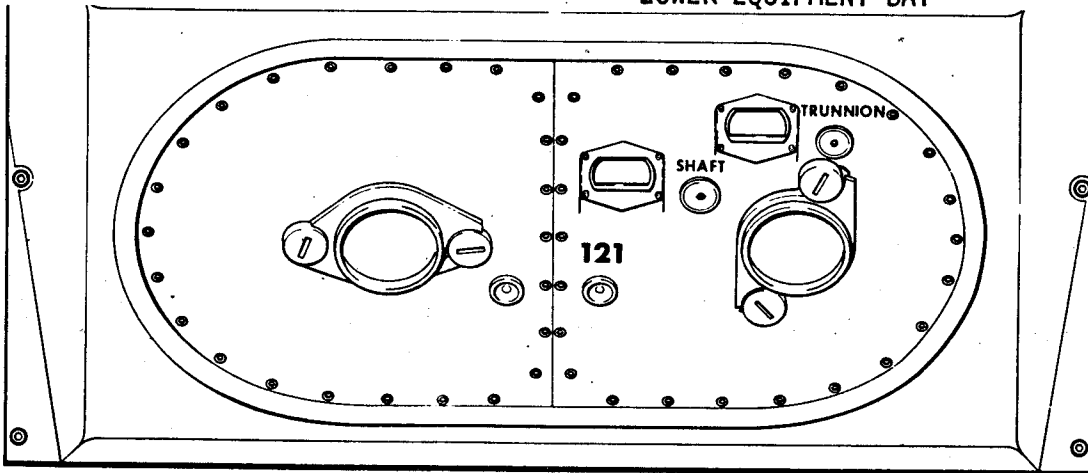

ПАНЕЛЬ 121
ПАНЕЛЬ 122

ОПТИКА И
УПРАВЛЕНИЕ СНИ

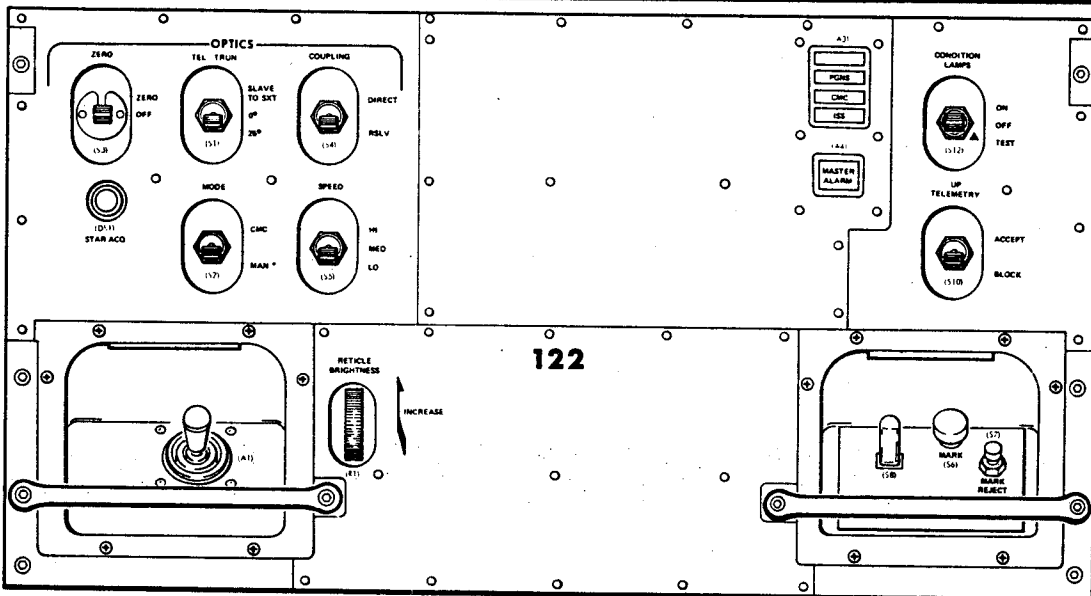

PANEL 121
PANEL 122

G & N OPTICS AND
CONTROLS

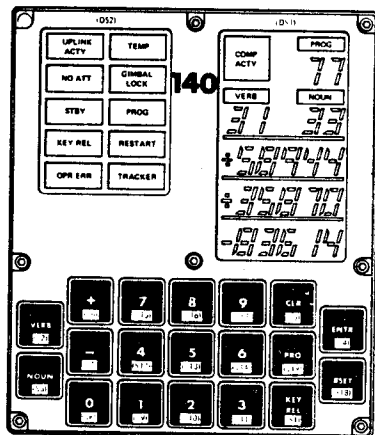

ПАНЕЛЬ 140

КЛАВИШИ КОМПЬЮТЕРА СНИ

PANEL 140

G & N COMPUTER KEYBOARD

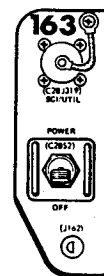

ПАНЕЛЬ 163

ПИТАНИЕ НАУЧНЫХ
ЭКСПЕРИМЕНТОВ

PANEL 163

SCIENTIFIC EXPERIMENT
POWER OUTLET

РИС 4-14 ПУЛЬТ УПРАВЛЕНИЯ И ИНДИКАЦИИ КСМ 111 ЛИСТ 9 ИЗ 15

FIGURE 4-14 CSM 111 DISPLAYS AND CONTROLS PANELS (SHEET 9 OF 15)

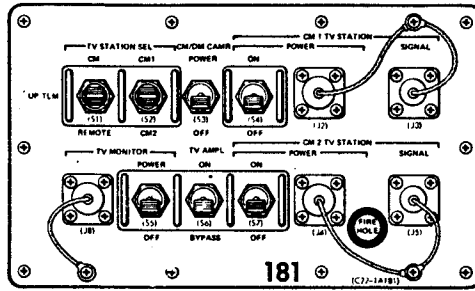

PANEL 181
TV POWER AND SIGNAL OUTLETS

ПАНЕЛЬ 181
ВЫВОДЫ СИГНАЛЬНОЙ СИСТЕМЫ
И ТВ ПИТАНИЯ

ПРАВЫЙ ОТСЕК ДЛЯ ОБОРУДОВАНИЯ
RIGHT HAND EQUIPMENT BAY

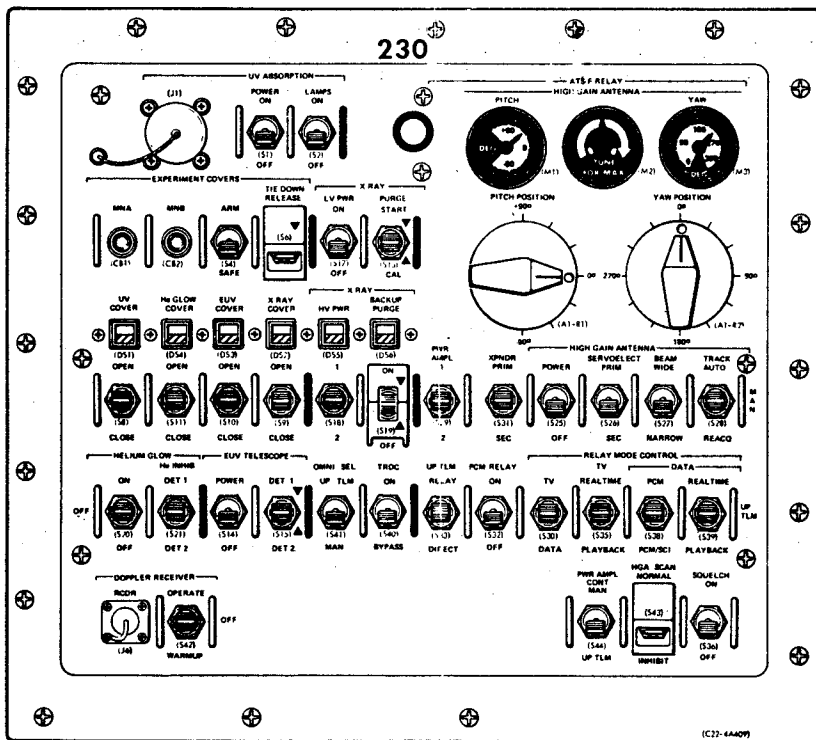

PANEL 230
ATS-6 SATELLITE COMMUNICATION
RELAY AND EXPERIMENT CONTROLS

ПАНЕЛЬ 230
Управление связью со
спутником ATS -6 и
экспериментами

РИС 4-14 ПУЛЬТ УПРАВЛЕНИЯ И ИНДИКАЦИИ КСМ 111 ЛИСТ 9А ИЗ 15

FIGURE 4-14 CSM 111 DISPLAYS AND CONTROLS PANELS (SHEET 9A OF 15)

ПРАВЫЙ ОТСЕК ДЛЯ ОБОРУДОВАНИЯ
RIGHT HAND EQUIPMENT BAY

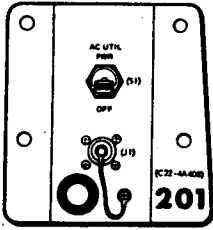

ПАНЕЛЬ 201

ПИТАНИЕ ОБЩЕГО НАЗНАЧЕНИЯ
ПЕРЕМЕННЫМ ТОКОМ

PANEL 201

AC UTILITY POWER OUTLET

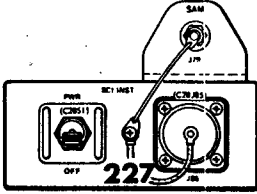

ПАНЕЛЬ 227

ПИТАНИЕ НАУЧНЫХ
ЭКСПЕРИМЕНТОВ

PANEL 227

UTILITY POWER OUTLET

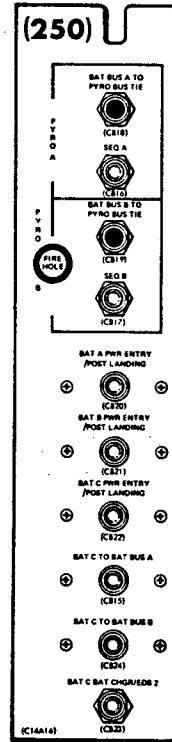
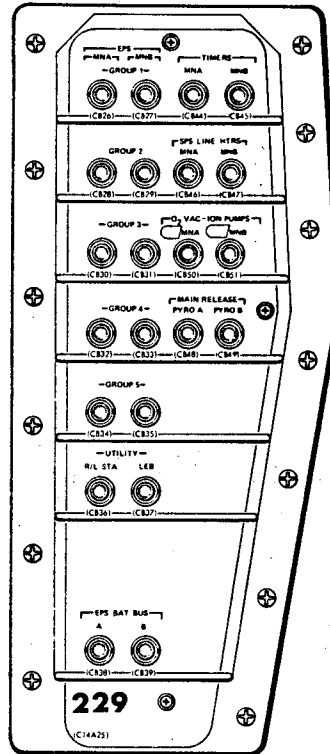
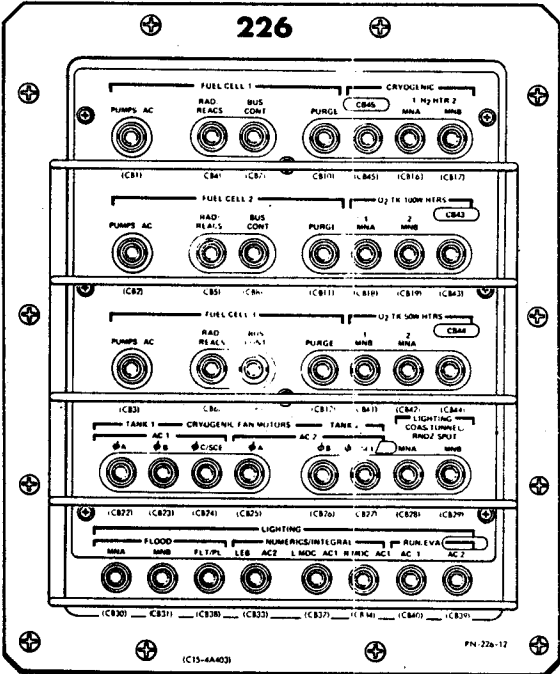
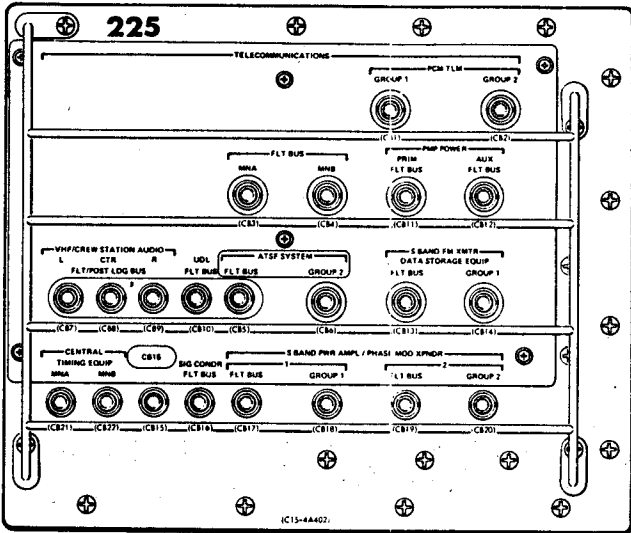

ПАНЕЛЬ 225
ПАНЕЛЬ 226
ПАНЕЛЬ 229
ПАНЕЛЬ 250

PANEL 225
PANEL 226
PANEL 229
PANEL 250

АЗС ЭЛЕКТРОПИТАНИЯ

POWER CIRCUIT BREAKERS

РИС 4-14 ПУЛЬТ УПРАВЛЕНИЯ И ИНДИКАЦИИ КСМ 111 ЛИСТ 10 ИЗ 15

FIGURE 4-14 CSM 111 DISPLAYS AND CONTROLS PANELS (SHEET 10 OF 15)

ПРАВЫЙ ОТСЕК ДЛЯ ОБОРУДОВАНИЯ
RIGHT HAND EQUIPMENT BAY

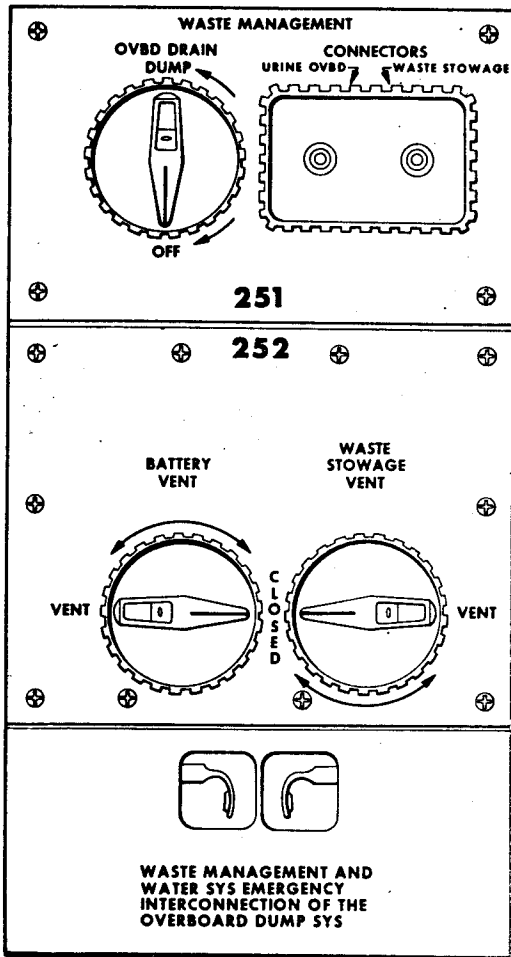

ПАНЕЛЬ 251
ПАНЕЛЬ 252

УПРАВЛЕНИЕ СИСТЕМОЙ СБРОСА.

PANEL 251
PANEL 252

WASTE MANAGEMENT CONTROLS

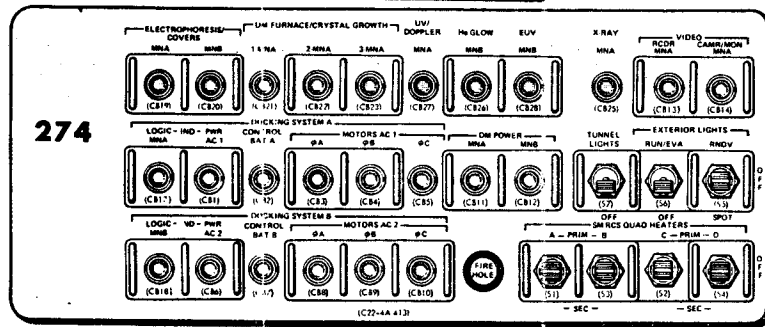

ПАНЕЛЬ 274
ПАНЕЛЬ 275
ПАНЕЛЬ 276
ПАНЕЛЬ 277
ПАНЕЛЬ 278

АЗЦ ЭЛЕКТРОПИТАНИЯ

PANEL 274
PANEL 275
PANEL 276
PANEL 277
PANEL 278

POWER CIRCUIT BREAKERS



РИС 4-14 ПУЛЬТ УПРАВЛЕНИЯ И ИНДИКАЦИИ КСМ 111 ЛИСТ 11 ИЗ 15

FIGURE 4-14 CSM 111 DISPLAYS AND CONTROLS PANELS (SHEET 11 OF 15)

ЛЕВЫЙ ОТСЕК ДЛЯ ОБОРУДОВАНИЯ
LEFT HAND EQUIPMENT BAY

ASTP 40001.1
ЭПАС 40001.1

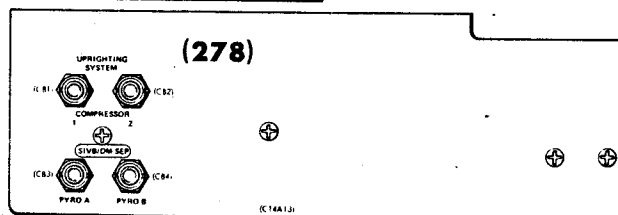
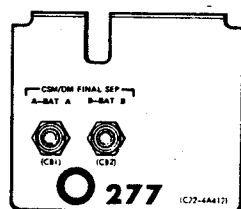
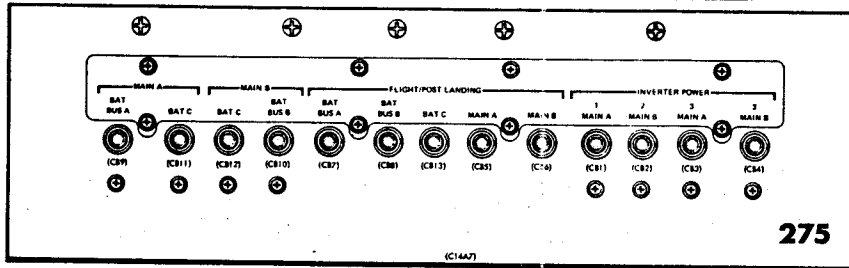
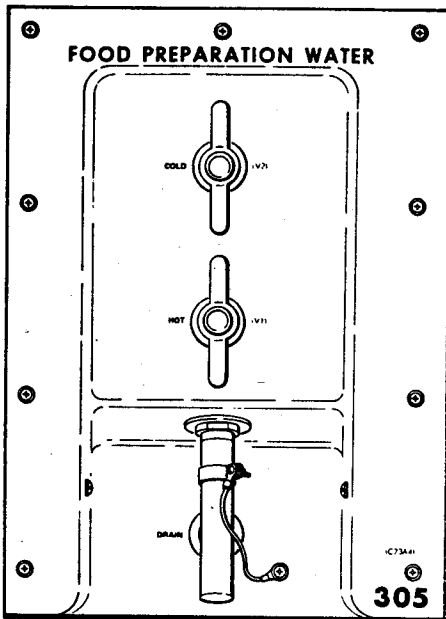

ПАНЕЛЬ 304
РЕГУЛЯТОР
ПИТЬЕВОЙ ВОДЫ

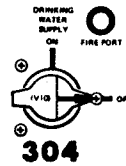

PANEL 304
DRINKING WATER
CONTROL

ПАНЕЛЬ 305
СНАБЖЕНИЕ ГОРЯЧЕЙ И
ХОЛОДНОЙ ВОДОЙ

PANEL 305
HOT AND COLD
WATER SUPPLY

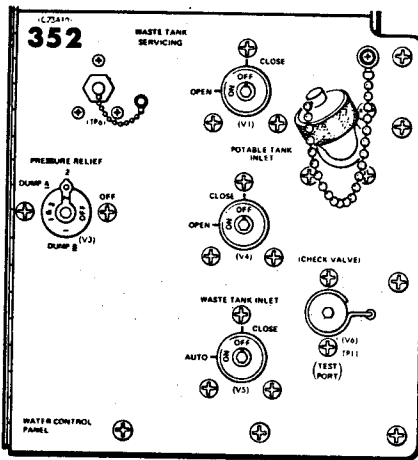

ПАНЕЛЬ 352
УПРАВЛЕНИЕ БАКАМИ
ВОДОСНАБЖЕНИЯ

PANEL 352
WATER TANK CONTROLS

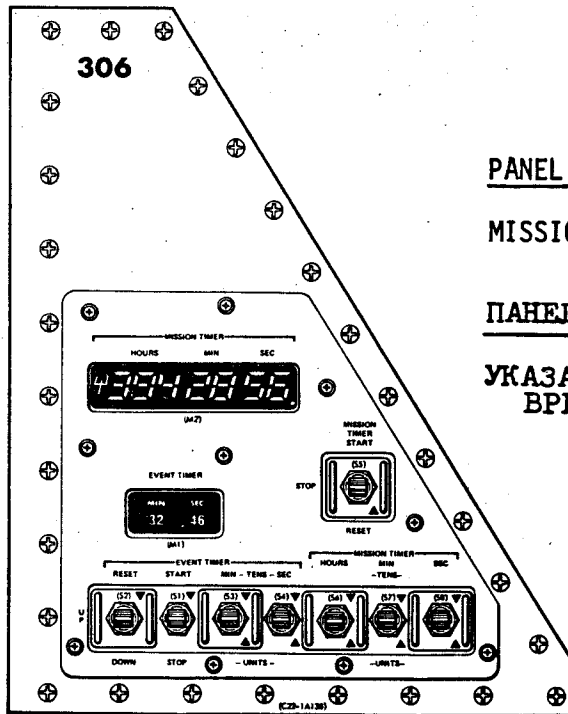

PANEL 306
MISSION TIMER

ПАНЕЛЬ 306
УКАЗАТЕЛЬ
ВРЕМЕНИ ПОЛЕТА

РИС 4-14 ПУЛЬТ УПРАВЛЕНИЯ И ИНДИКАЦИИ КСМ 111 ЛИСТ 13 ИЗ 15

FIGURE 4-14 CSM 111 DISPLAYS AND CONTROLS PANELS (SHEET 13 OF 15)

ЛЕВЫЙ ОТСЕК ДЛЯ ОБОРУДОВАНИЯ
LEFT HAND EQUIPMENT BAY

ASTP 40001.1
ЭПАС 40001.1

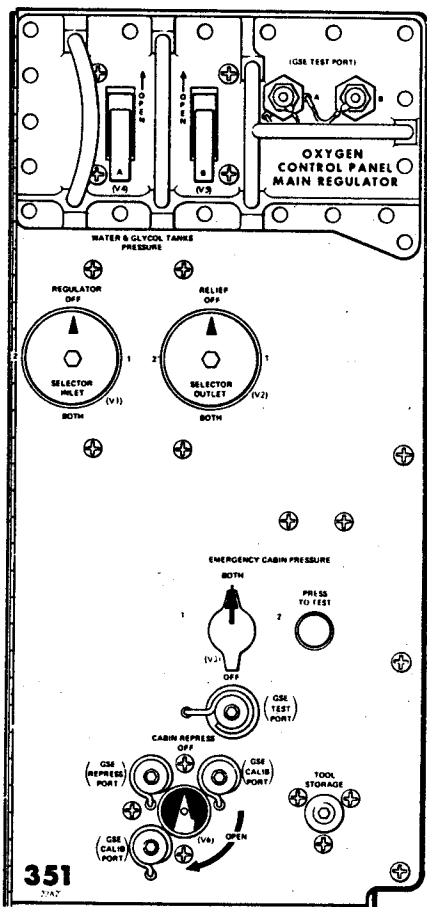
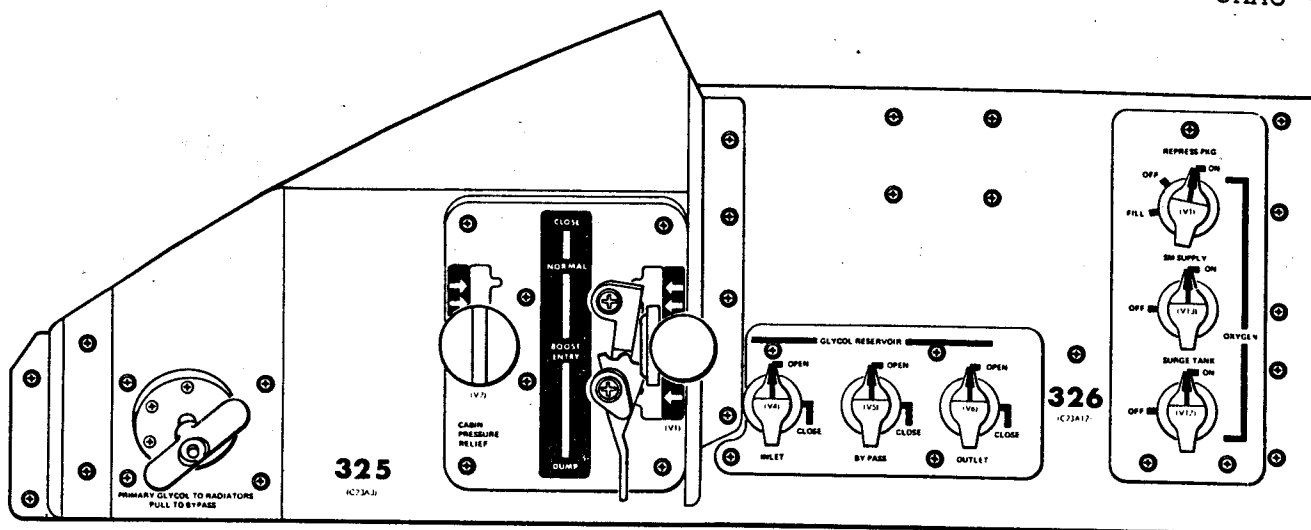

ПАНЕЛЬ 325

ОБХОД РАДИАТОРА
КЛАПАН СБОРА
ДАВЛЕНИЯ В КМ

PANEL 325

RADIATOR BYPASS
CM PRESSURE RELIEF VALVE

ПАНЕЛЬ 326

УПРАВЛЕНИЕ
КИСЛОРОДОМ
УПРАВЛЕНИЕ
ОХЛАЖДЕНИЕМ

PANEL 326

COOLANT CONTROLS
OXYGEN CONTROLS

ПАНЕЛЬ 351

УПРАВЛЕНИЕ
КИСЛОРОДОМ

PANEL 351

OXYGEN CONTROLS

РИС 4-14 ПУЛЬТ УПРАВЛЕНИЯ И ИНДИКАЦИИ КСМ 111 ЛИСТ 14 ИЗ 15

FIGURE 4-14 CSM 111 DISPLAYS AND CONTROLS PANELS (SHEET 14 OF 15)

ЛЕВЫЙ ОТСЕК ДЛЯ ОБОРУДОВАНИЯ
LEFT HAND EQUIPMENT BAY

ASTP 40001.1
ЭПАС 40001.1

ПАНЕЛЬ 377
ПАНЕЛЬ 378
ПАНЕЛЬ 379
ПАНЕЛЬ 382

PANEL 377
PANEL 378
PANEL 379
PANEL 382

УПРАВЛЕНИЕ
ОХЛАЖДЕНИЕМ

COOLANT CONTROLS

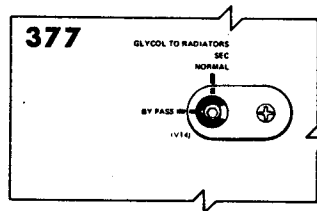
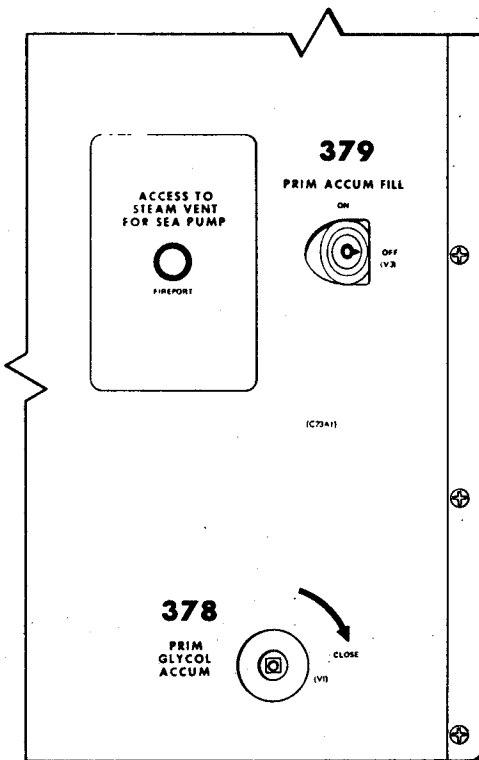
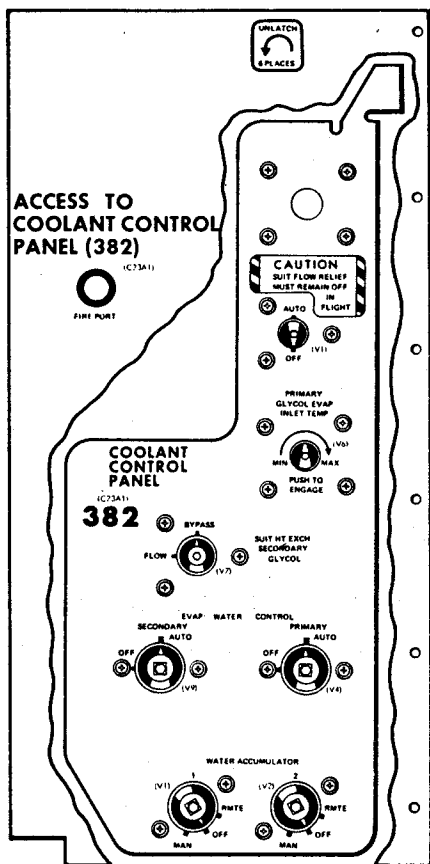

ПАНЕЛЬ 375

сравливание давления из баллона с O₂

PANEL 375

OXYGEN SURGE TANK
PRESSURE RELIEF



РИС 4-14 ПУЛЬТ УПРАВЛЕНИЯ И ИНДИКАЦИИ КСМ 111 ЛИСТ 14А ИЗ 15

FIGURE 4-14 CSM 111 DISPLAYS AND CONTROLS PANELS (SHEET 14 A OF 15)

НИЖНИЙ ОТСЕК ДЛЯ ОБОРУДОВАНИЯ
LOWER EQUIPMENT BAY

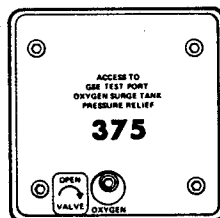
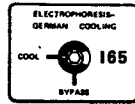

ПАНЕЛЬ 165

PANEL 165

EXPERIMENT COOLING CONTROL

управление системой охлаждения
для эксперимента

ПАНЕЛЬ 400

УПРАВЛЕНИЕ ВИДЕО
ЛЕНТОЧНЫМ МАГНИТОФОНОМ

PANEL 400

VIDEO TAPE RECORDER

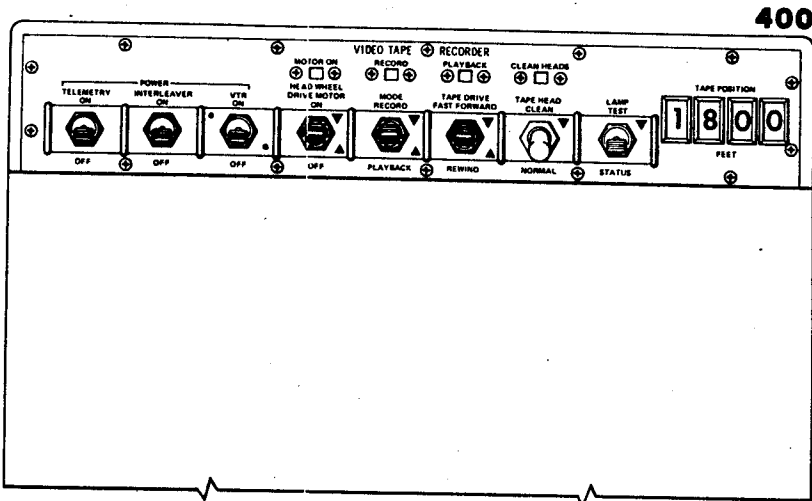

ВЕРХНИЙ ОТСЕК ДЛЯ ОБОРУДОВАНИЯ
UPPER EQUIPMENT BAY

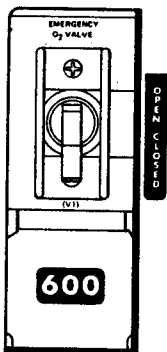

OXYGEN
REPRESS
PRESSURE
GAGE



ПАНЕЛЬ 600

ПАНЕЛЬ 601

ПАНЕЛЬ 602

УПРАВЛЕНИЕ НАДУВОМ СМ

PANEL 600

PANEL 601

PANEL 602

DM PRESSURIZATION CONTROLS



РИС 4-14 ПУЛЬТ УПРАВЛЕНИЯ И ИНДИКАЦИИ КСМ 111 ЛИСТ 15 ИЗ 15

FIGURE 4-14 CSM 111 DISPLAYS AND CONTROLS PANELS (SHEET 15 OF 15)

110

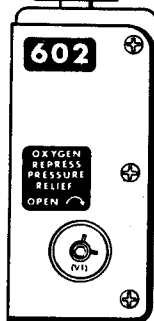
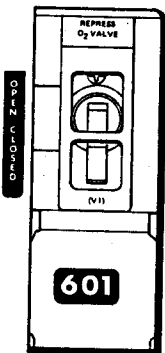

РИС 4-15 **КОНФИГУРАЦИЯ СТЫКОВОЧНОГО МОДУЛЯ**

FIGURE 4-15 DOCKING MODULE CONFIGURATION

АСТР 40001.1
ЭПАС 40001.1

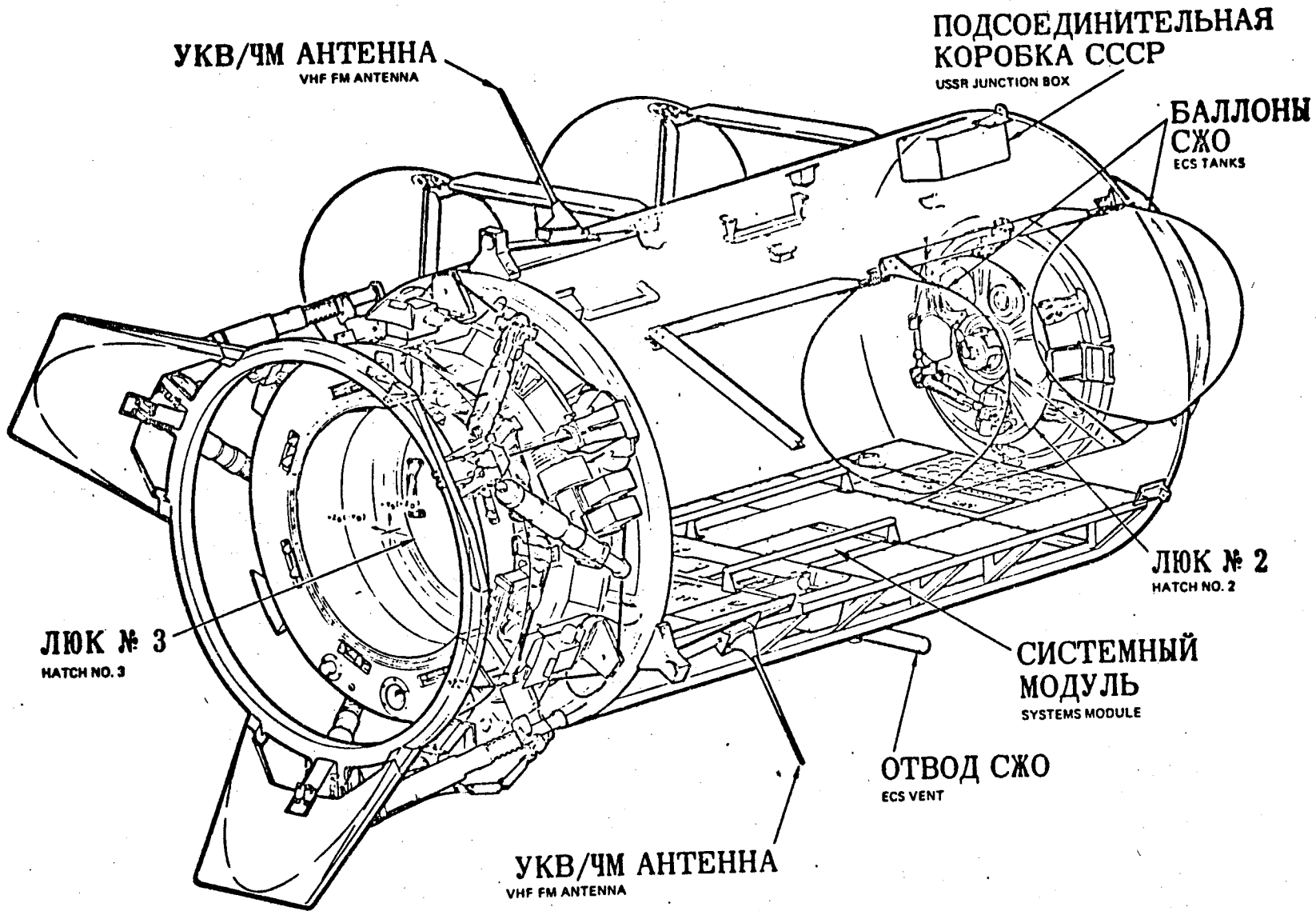

РИС 4-16 **СТЫКОВОЧНЫЙ МОДУЛЬ-ВНУТРЕННЯЯ КОМПОНОВКА**

FIGURE 4-16 DM INTERNAL CONFIGURATION

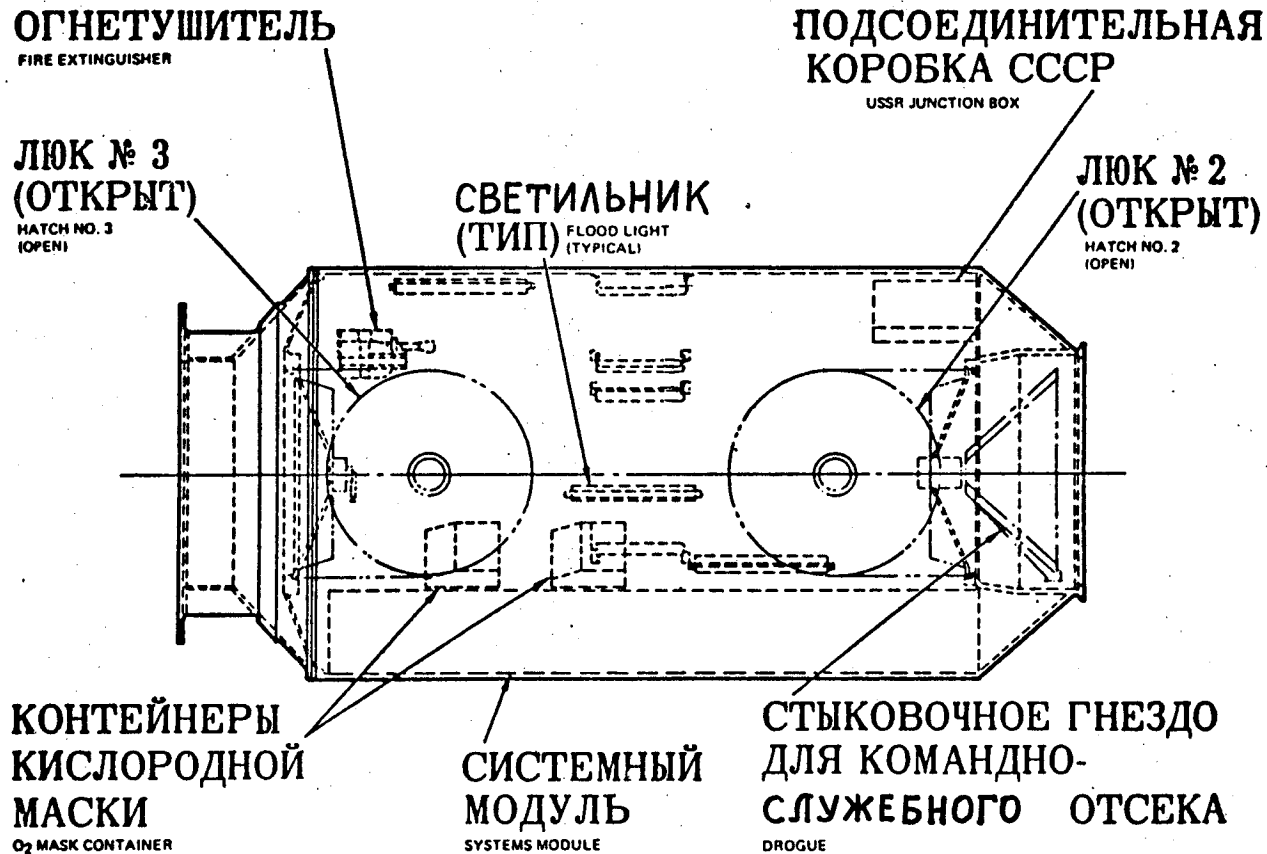

РИС 4-17 **СТЫКОВОЧНЫЙ МОДУЛЬ-ВНУТРЕННЯЯ КОМПОНОВКА**

FIGURE 4-17 DM INTERNAL CONFIGURATION

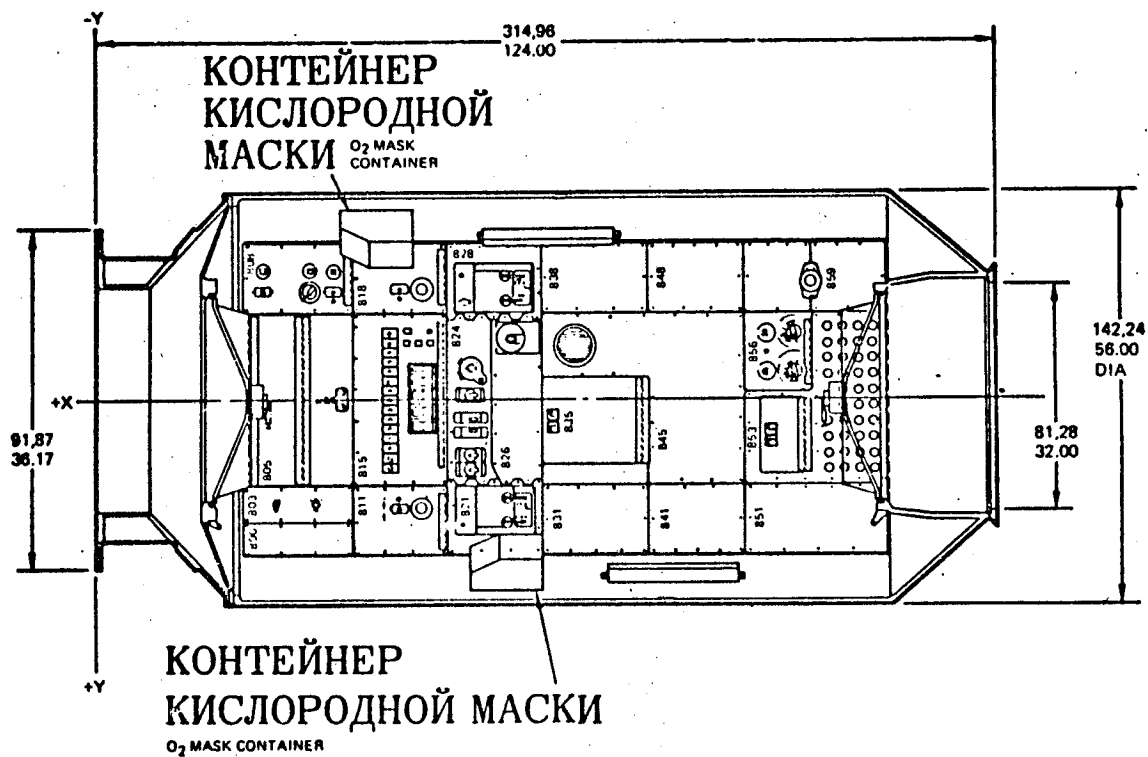
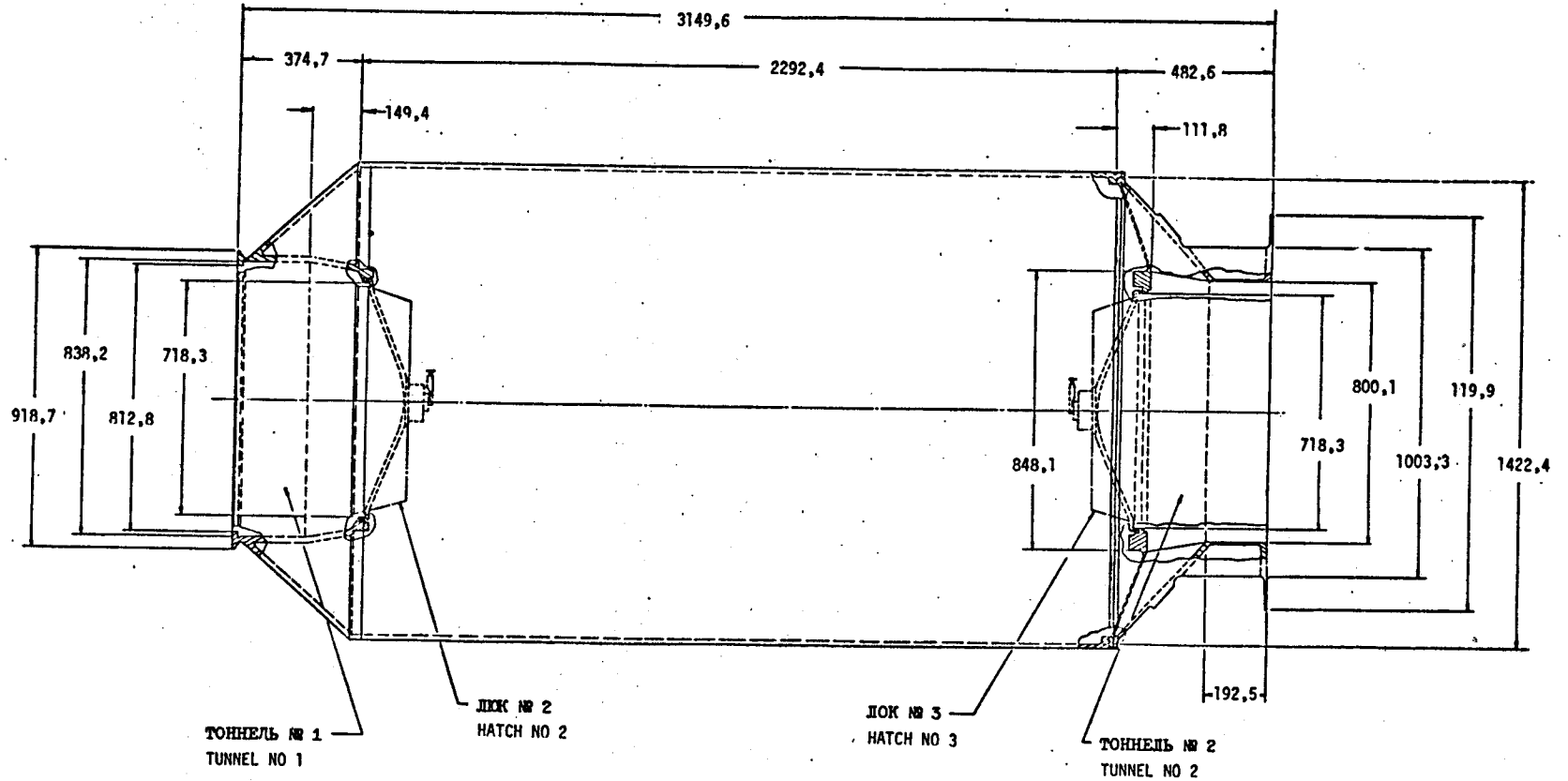

ПРИМЕЧАНИЕ: ВСЕ РАЗМЕРЫ В МИЛЛИМЕТРАХ
 NOTE: ALL DIMENSIONS IN MM

РИС 4-18 СТЫКОВОЧНЫЙ МОДУЛЬ, ОБЩИЕ РАЗМЕРЫ
 FIGURE 4-18 DOCKING MODULE, OVERALL DIMENSIONS

РИС 4-20

СТЫКОВОЧНЫЙ МОДУЛЬ МЕСТОПОЛОЖЕНИЕ

ТВ КАМЕР

FIGURE 4-20

DOCKING MODULE TV CAMERA LOCATIONS

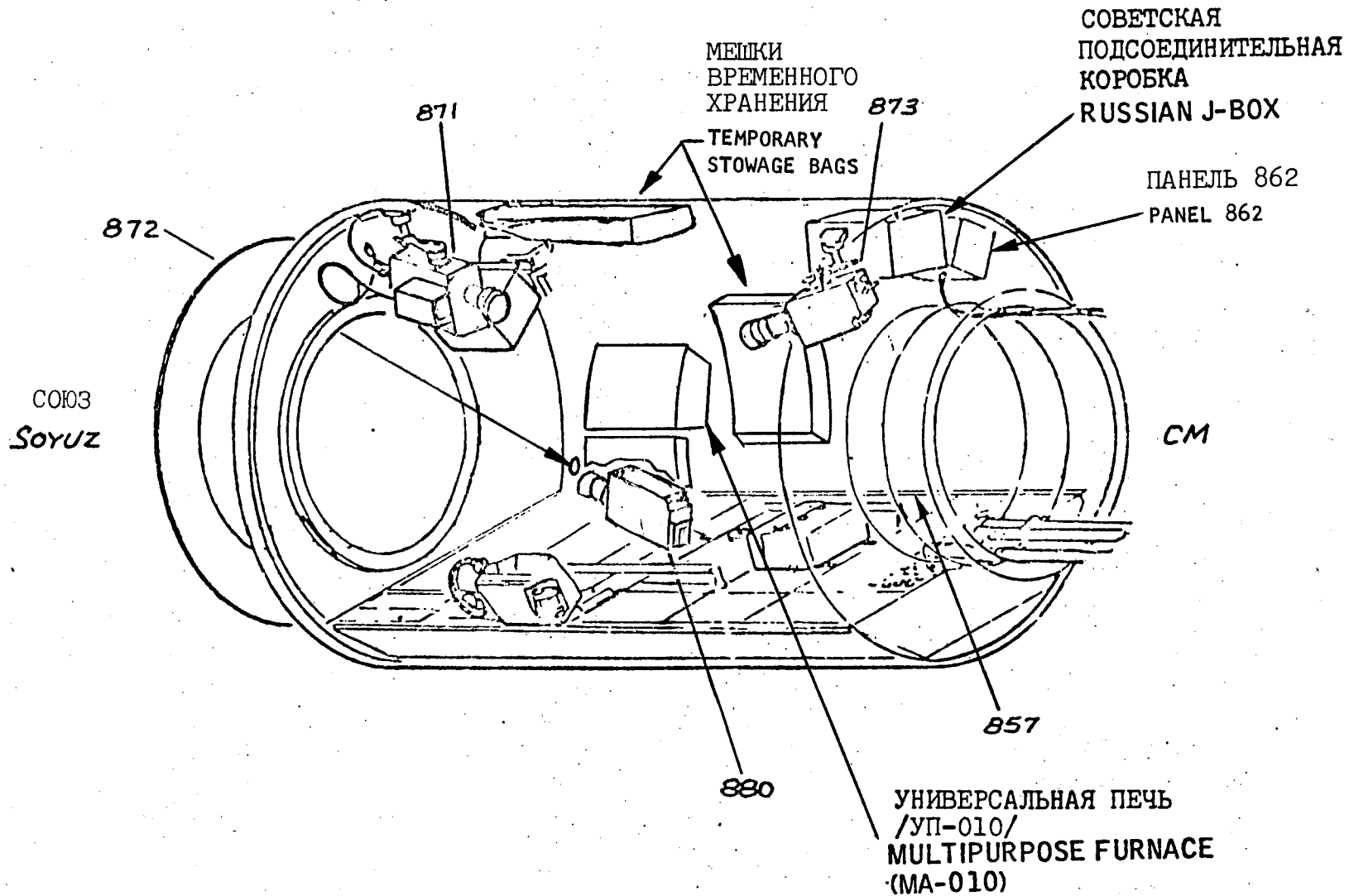

117

АСТР 40001.1
ЭПАС 40001.1



РИС 4-21

**СТЫКОВОЧНЫЙ МОДУЛЬ
РАСПОЛОЖЕНИЕ СВЕТИЛЬНИКОВ.**

FIGURE 4-21 DOCKING MODULE FLOODLIGHT ARRANGEMENT

SIDEWALL LIGHT
светильник у боковой стены

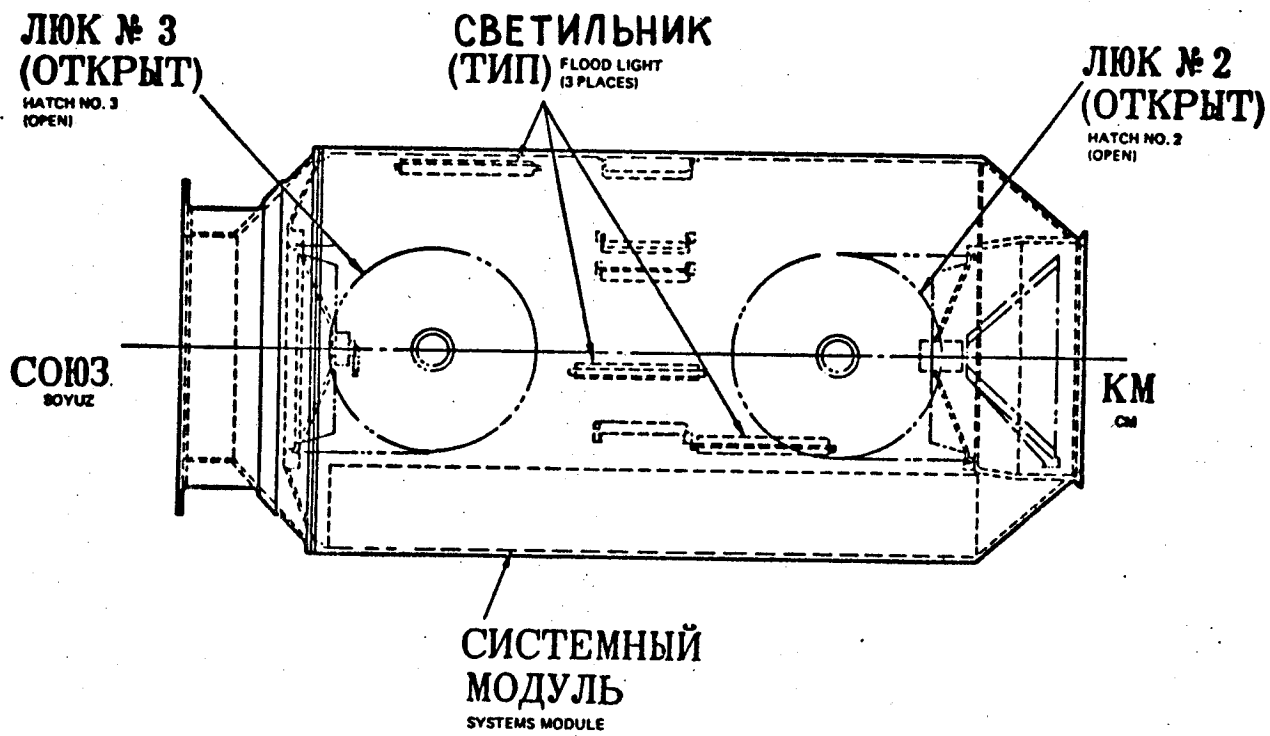
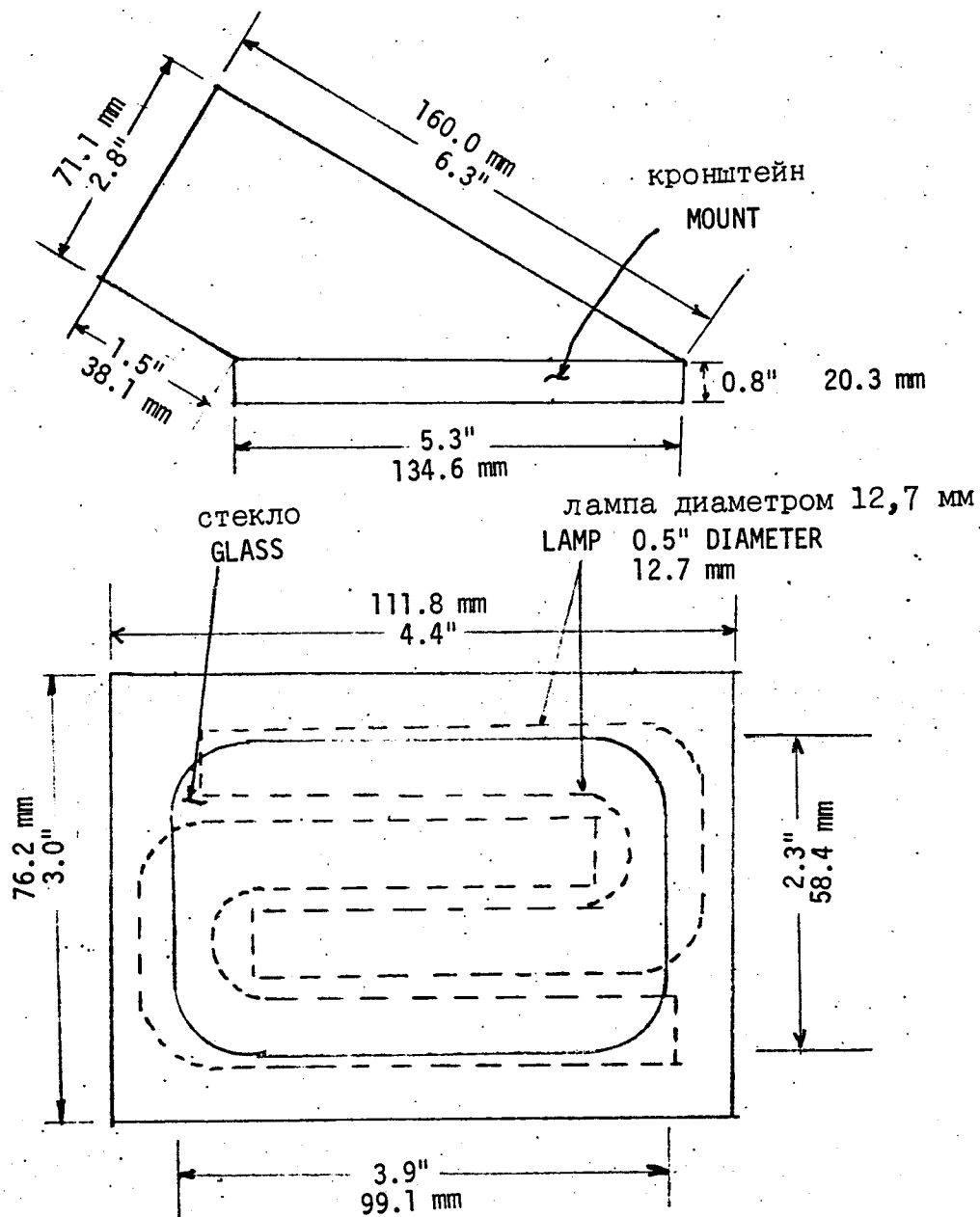

ширина луча половинной мощности

HALF-POWER BEAM WIDTH:

100° WIDTH

ширина 100°

100° LENGTH

длина 100°

РИС 4-22
Figure 4-22

COUCH LIGHT
светильник у кресла

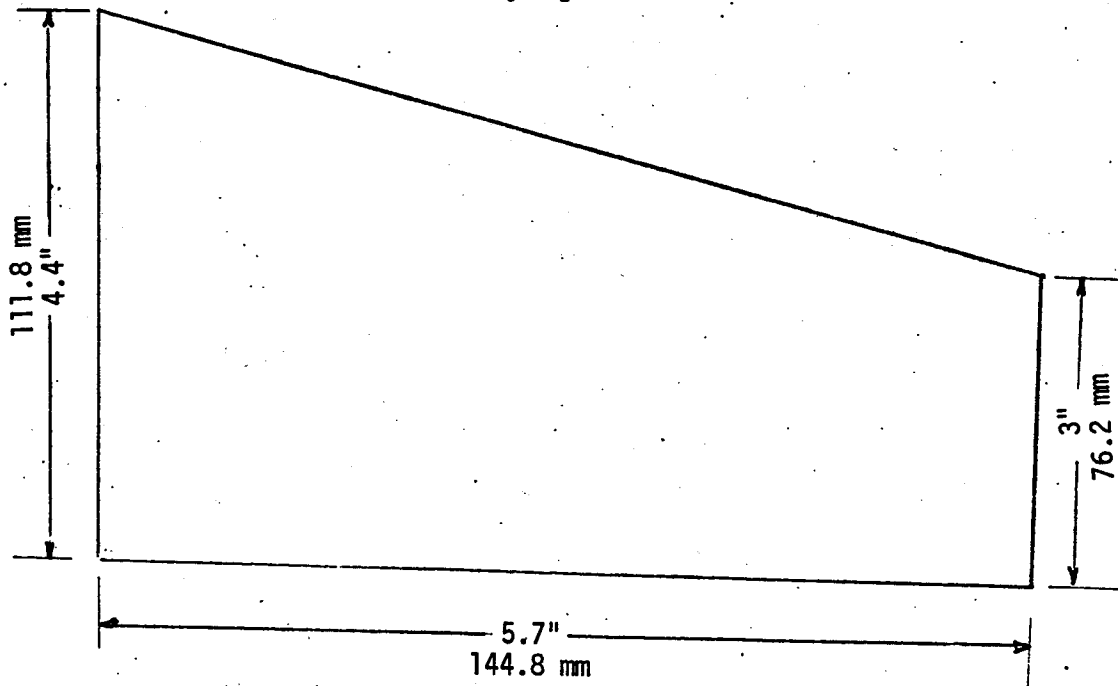

лампа диаметром 12,7 мм

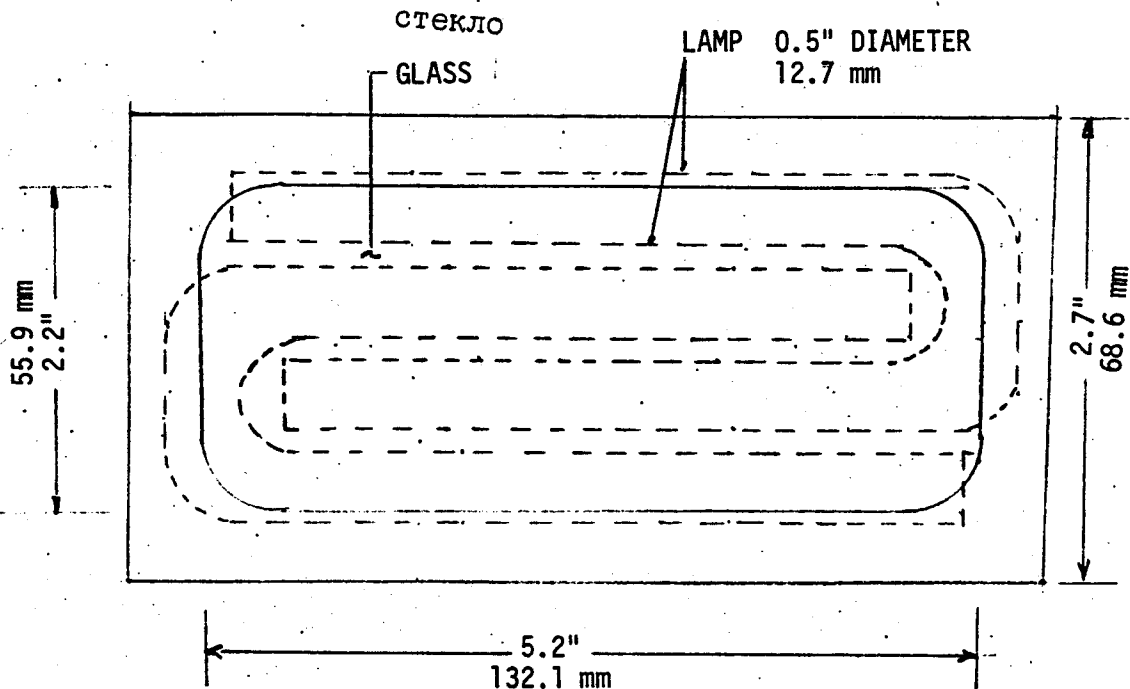

HALF-POWER BEAM WIDTH:

100° WIDTH
100° LENGTH

ширина луча, половинной мощности

ширина 100°

длина 100°

COUCH STRUT LIGHT
светильник на стойке кресла

HALF-POWER BEAM WIDTH: ширина луча половинной мощности
120° WIDTH ширина 120°
110° LENGTH длина 110°



РИС 4-24
Figure 4-24

FIGURE 4-26 APOLLO PORTABLE LIGHT
 РИСУНОК 4-26 ПЕРЕНОСНОЙ СВЕТИЛЬНИК АПОЛЛОНА
 (ALL DIMENSIONS IN MM)
 /ВСЕ РАЗМЕРЫ ДАНЫ В ММ/

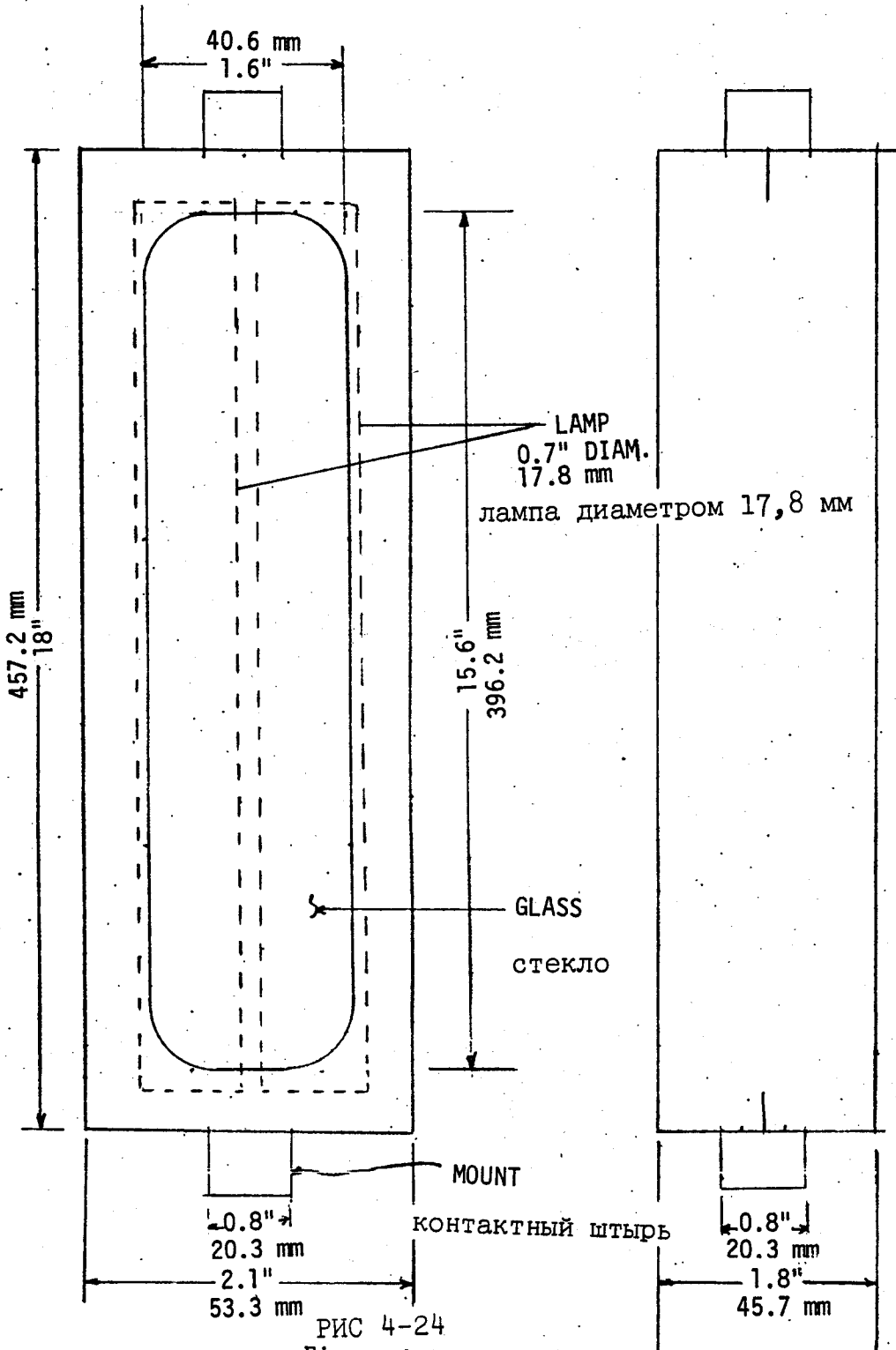
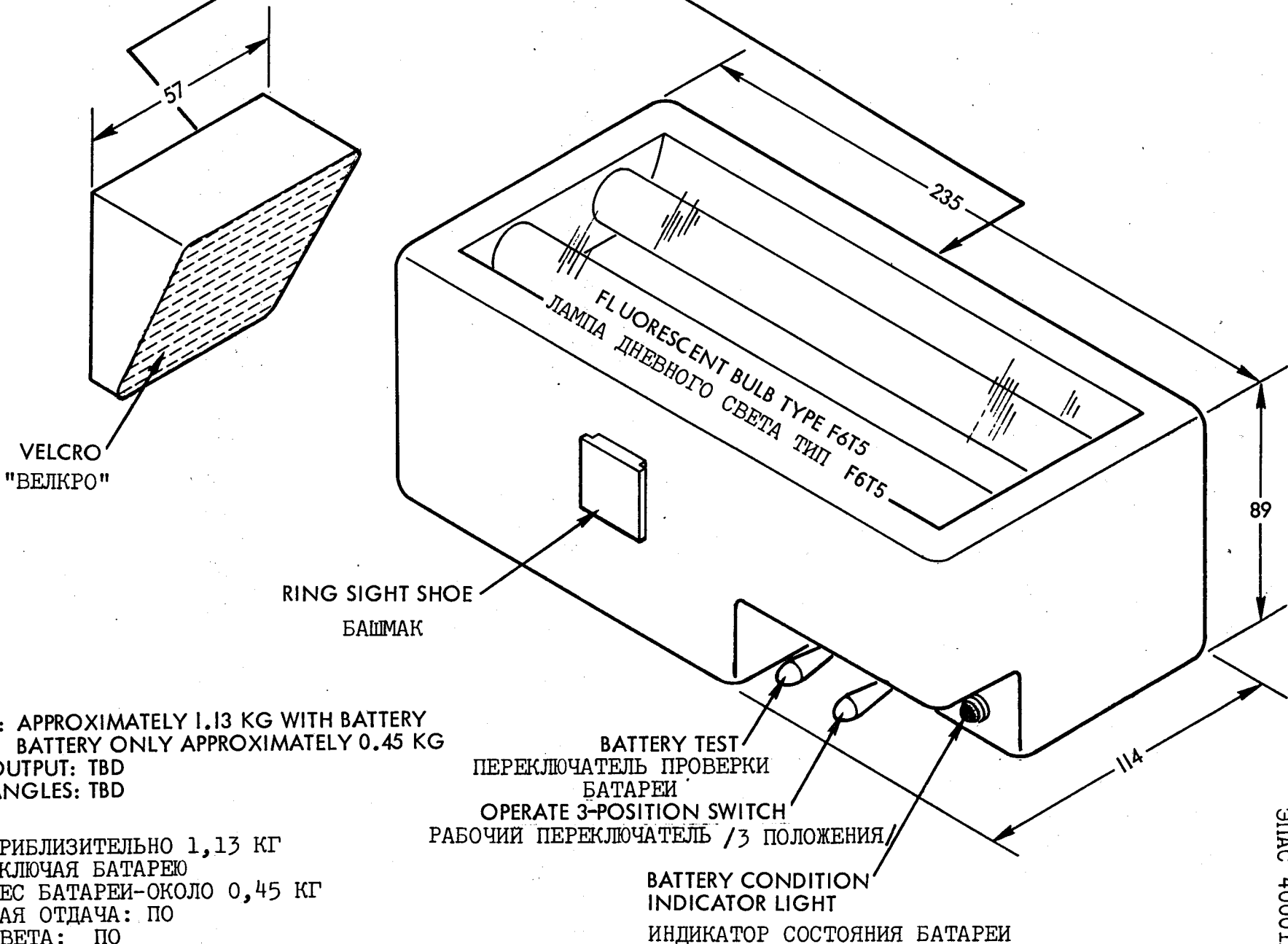

WEIGHT: APPROXIMATELY 1.13 KG WITH BATTERY
 BATTERY ONLY APPROXIMATELY 0.45 KG
 LIGHT OUTPUT: TBD
 LIGHT ANGLES: TBD

ВЕС: ПРИБЛИЗИТЕЛЬНО 1,13 КГ
 ВКЛЮЧАЯ БАТАРЕЮ
 ВЕС БАТАРЕИ-ОКОЛО 0,45 КГ
 СВЕТОВАЯ ОТДАЧА: ПО
 УГОЛ СВЕТА: ПО

NASA TECHNICAL TRANSLATION

A BRIEF DESCRIPTION OF THE RADAR APPROACH
EQUIPMENT OF THE SOYUZ-TYPE SPACECRAFT

Translation of "Kratkoye opisaniye radioapparatury
sblizheniya kosmicheskikh korabley tipa
Soyuz."

NATIONAL AERONAUTICS AND SPACE ADMINISTRATION
WASHINGTON, D. C. 20546 NOVEMBER 1970

A BRIEF DESCRIPTION OF THE RADAR APPROACH
EQUIPMENT OF THE SOYUZ-TYPE SPACECRAFT

ABSTRACT: Radar approach equipment of Soyuz-type spacecraft is described and presented in computational form.

Radar equipment is used to measure the parameters of the relative movement of the Soyuz spacecraft, and provides

/1*

- mutual search and detection of the spacecraft;
- measurement of the angular position of the sighting line relative to the coordinate system for the body of the spacecraft;
- measurement of the relative distance between the spacecraft;
- measurement of the radial component of the the relative speed of the spacecraft;
- measurement of the angular velocity of the movement of the sighting line in an inertial coordinate system;
- measurement of the mutual roll angle between the spacecraft.

These functions are provided for by the equipment on both linked spacecraft: on the "active" spacecraft, where delivery of all the compiled information is carried out, there is an interrogator device, and on the "passive" spacecraft, there is a responder which in addition to retranslating the signals in the approach zone, also measures the angular coordinates of the sighting line in order to orient the "passive" spacecraft.

The operation of the electronic linkup system is completely automatic, i.e., not connected with any ground electronic or other type of instruments. The initial conditions for the operation of the system at a relative distance and relative velocity are determined by the accuracy of the orbit of the linked spacecraft when their attitude with respect to the sighting line is arbitrary.

/2

* Numbers in the margin indicate pagination in the foreign text.

These initial conditions are provided for by means of a corresponding orbit correction using ordinary navigational equipment.

It is also essential that the system be designed so that its operation does not require preliminary target destination for the mutual angular position of the spacecraft. When a system is constructed in this way, it is more universal in the sense that it can be used in different types of spacecraft and that different ballistic systems of detection and long-range approach.

MUTUAL SEARCH

The mutual search and detection channel includes two transmitting antennas mounted on the "passive" spacecraft and which provide omnidirectional scanning of the whole of space. In this case, the transmitting device of the responder operates in a noncoherent regime with continuous scanning.

The signals from the responder ("beacon"), i.e., the "passive" spacecraft are picked up by the antenna system of the "active" spacecraft which is also made up of two antennas which circularly scan the whole of space. The receiving device of the "active" spacecraft also emits control signals as it turns with respect to the sighting line. As the "active" spacecraft turns, the "passive" spacecraft remains stabilized in the inertial coordinate system. L3

The sequence of the mutual orientation of the spacecraft assumed for the system is shown in Figure 1.

Lock-on of the "target", i.e., "passive" spacecraft occurs when the "active" spacecraft completes its revolution by the narrow beam antenna system of the homing attachment, and further orientation of the "active" spacecraft relative to the sighting line is carried out by the information received from the angle gauges, located in the Cardan suspension of the homing attachment. The interrogator signal is transmitted by this same narrow beam antenna system and is picked up by the antennas of the circular scanner of the "passive" spacecraft. These antennas as well as the equipment for generating the orientation control signals on both spacecraft are analog type.

After the "passive" spacecraft completes its revolution relative to the sighting line, its responder is switched to the coherent-fractional retranslation zone for the interrogator signal through the narrow beam antenna which is rigidly connected to the body of the spacecraft. From this point, all the information necessary for the approach is fed into the control system of the "active" spacecraft.

MEASUREMENT OF THE MUTUAL DISTANCE AND RADIAL SPEED

Figure 2 gives a functional diagram of the gauge for the relative distance between the spacecraft ρ and the rate of measurement $\dot{\rho}$. The device uses the phase method of measuring distance, whereby, information on the relative distance yields the magnitude of the phase lag of the continuous answer signal with respect to the phase of the interrogator signal emitted by the transmitter of the "active" spacecraft. The interrogator includes a modulation frequency shaper for the distance, a modulator, a transmitter, and a receiver which separates the continuous answer signal, and a phase meter which produces a constant voltage proportional to the measured distance value. The type of modulation is amplitude modulation with continuous emission. Decoupling the transmitter from the receiver is accomplished by a corresponding frequency shift. /4

The responder separates the constant modulation frequency and transfers it to a new carrier. Modulation here is also of the amplitude type (see diagram of responder also inserted in Figure 2). In order to eliminate ambiguity to obtain the necessary measurement accuracy over short distances, there are several interchangeable distance scales on board the vehicle which correspond to the amount of modulation frequencies. The magnitudes of the initial phase lags in the responder, interrogator, and the feed lines from the transceiver to the antennas are fixed and allowed for in the phase meter.

The method described enables measurement of the distance until the spacecraft is mechanically coupled.

In order to measure the magnitude of $\dot{\rho}$, the same signal is used as is used for retranslation of the distance signals as seen in Figure 2.

The method of measurement is based on determination of the Doppler displacements of the frequency carrier for the coherent-fractional retranslation of the interrogator signal. This method enables us to measure $\dot{\rho}$ with an accuracy which guarantees normal operation of the docking unit. /5

MEASUREMENT OF THE ANGULAR COORDINATES

As has already been mentioned, the interrogator system includes a homing unit which automatically tracks the "passive" spacecraft, or more precisely, the antenna-retranslator mounted on it. In order to increase the measurement accuracy of the angular velocity of the shift of the sighting line, the antenna of the homing unit is mounted on a gyrostabilized platform which eliminates the effect of stabilization fluctuations of the target about its center of mass.

The Cardan suspension in which the gyrostabilized platform with antenna is located, has the following angles of roll:

in the pitching plane

to the side of the docking unit - 10 degrees,

to the side of the cruising engine -190 degrees;

in the perpendicular plane (internal frame of the Cardan suspension) ± 10 degrees.

The functional diagram of the angular measurement channel is given in Figure 3 which shows the receiver which separates the error signal, resolved into two orthogonal components of pitch and yaw.

The error signals obtained in this manner are fed into the controls of the gyrostabilized platform; in addition, these same signals are fed into the approach control system, since in the established zone, they are proportional to the angular speeds of the movement of the sighting line ω_{ζ} and ω_{η} . In order to decrease the effect of reflections from the body of the spacecraft on the measurement of the angular speeds, special reflector plates were provided and mounted on the body of the spacecraft, and by means of which there was a considerable reduction in the reflected signals at the antenna of the homing unit. The receiver of the angular measurement channel also includes a shaping diagram for the error signal with respect to the roll which is also /6

fed into the control system in the docking zone. The input cascades and the first intermediate frequency amplifier of the receiver are joint, both for the goniometric channel as well as for the ρ and $\dot{\rho}$ measurement channel.

SPECIAL FEATURES OF THE RADAR SYSTEM OVER SHORT DISTANCES

When the method of coherent-fractional retranslation of the interrogator signal is used, the operation of the ρ and $\dot{\rho}$ gauges in the docking zone does not differ in principle from its operation over great distances. As regards the function of the goniometric channel, it is necessary to take into account several special structural features for short distance values. It would be appropriate here to define "short distances" as those distances between the spacecraft which are commensurate with the geometric dimensions of the spacecraft themselves.

Figure 4 shows a conventional diagram of the arrangement of the antennas of the electronic docking system on both spacecraft. At large distances (up to the docking zone) the connecting line is formed as follows: the signal from the interrogator is transmitted from the antenna of the homing unit on the "active" spacecraft, is fixed by the circular sweep antenna of the anterior hemisphere of the "passive" spacecraft, is retranslated by the narrow beam antenna rigidly fastened to the body of the "passive" spacecraft and fixed by the antenna of the homing unit. /7

From Figure 4, we can see that when the distance is reduced, the "passive" spacecraft will orient itself along the sighting line with an angular error which is conditioned by the increasing movement of the sighting line from the longitudinal axis of the spacecraft. This error is eliminated by installing a supplementary antenna on the "active" spacecraft, located at the "reflecting" point of the circular sweep direction-finding antenna of the "passive" spacecraft. The interrogator signal is transmitted over this antenna in the docking zone.

Measurement of the angular coordinates in this arrangement is possible until the spacecraft makes mechanical contact, since in this case, there is still some distance between the corresponding antennas of the spacecraft so that the alignment diagrams retain their shape.

STAGES OF MUTUAL ORIENTATION

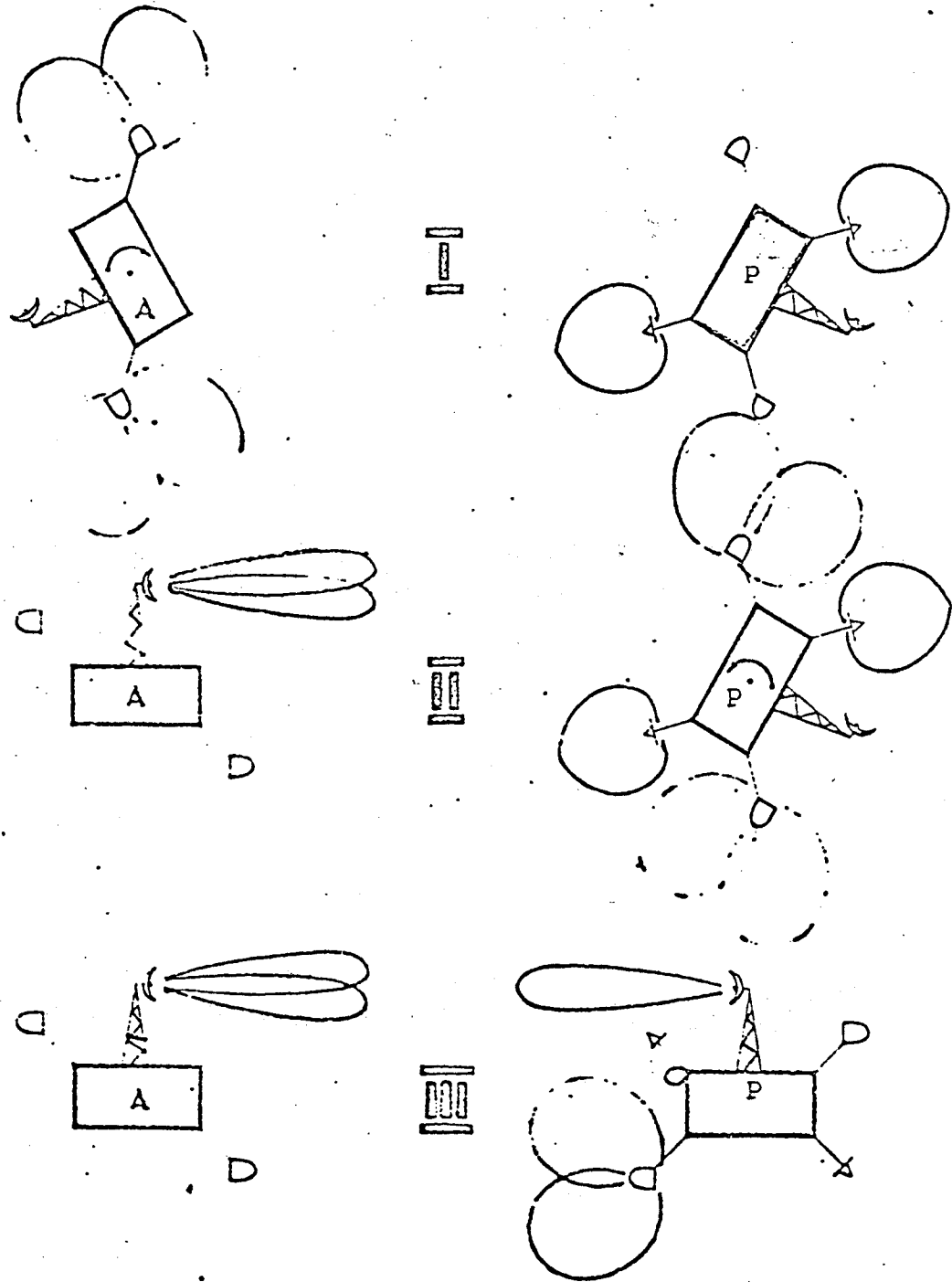

Figure 1

R and R MEASUREMENT

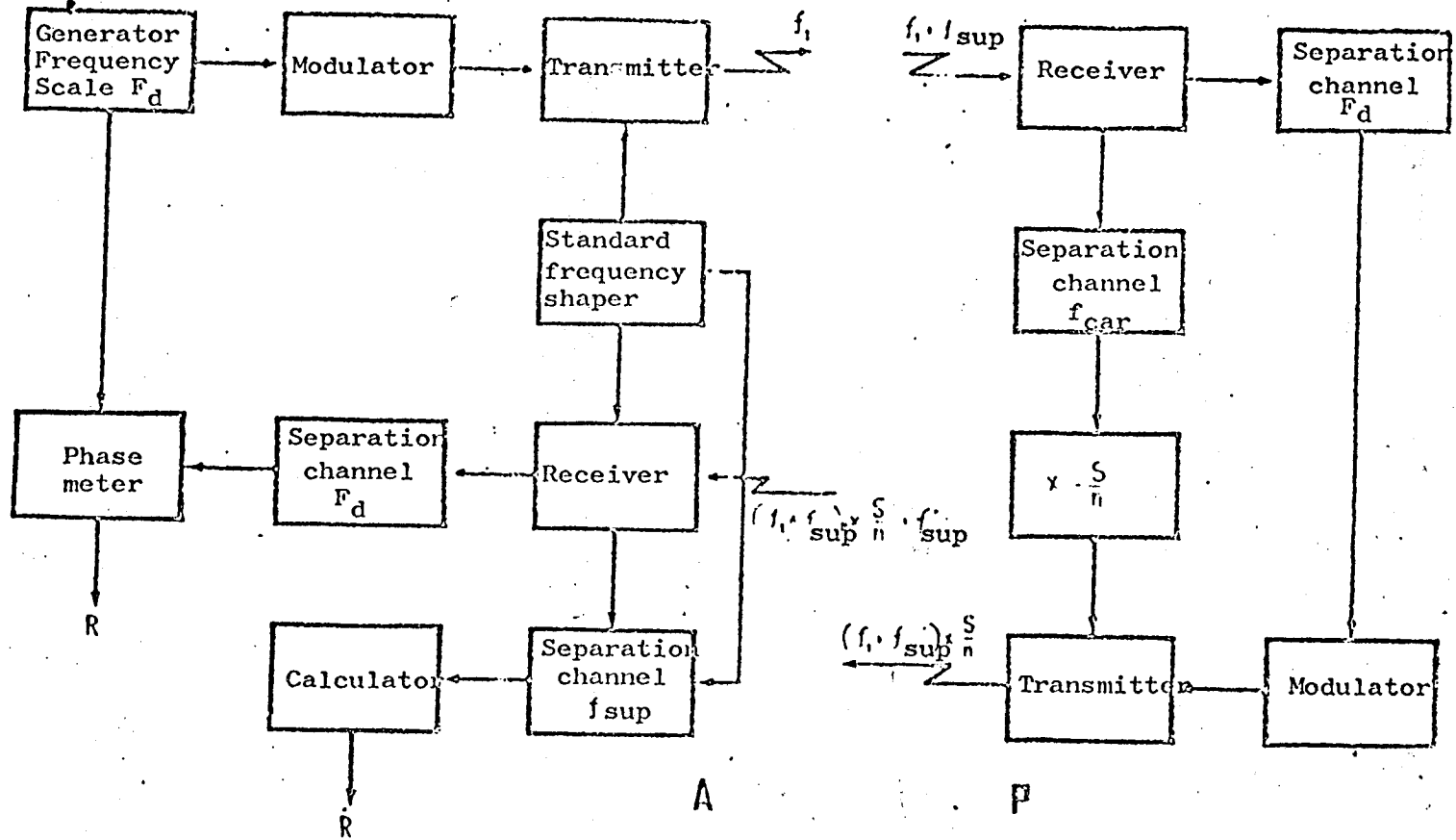

Figure 2.

MEASUREMENT OF ANGULAR COORDINATES

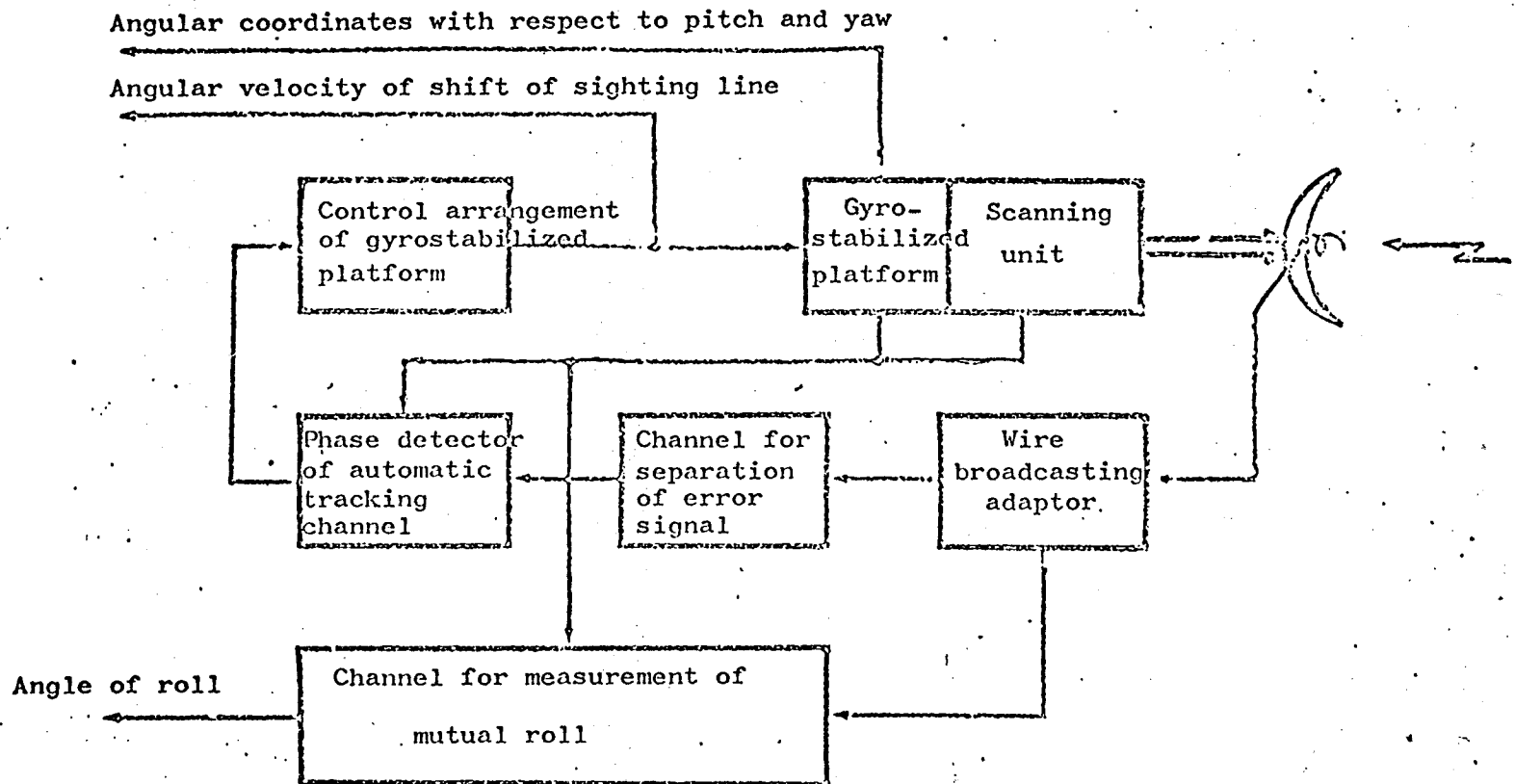

Figure 3.

DIAGRAM OF THE POSITION OF THE ANTENNA ASSEMBLIES

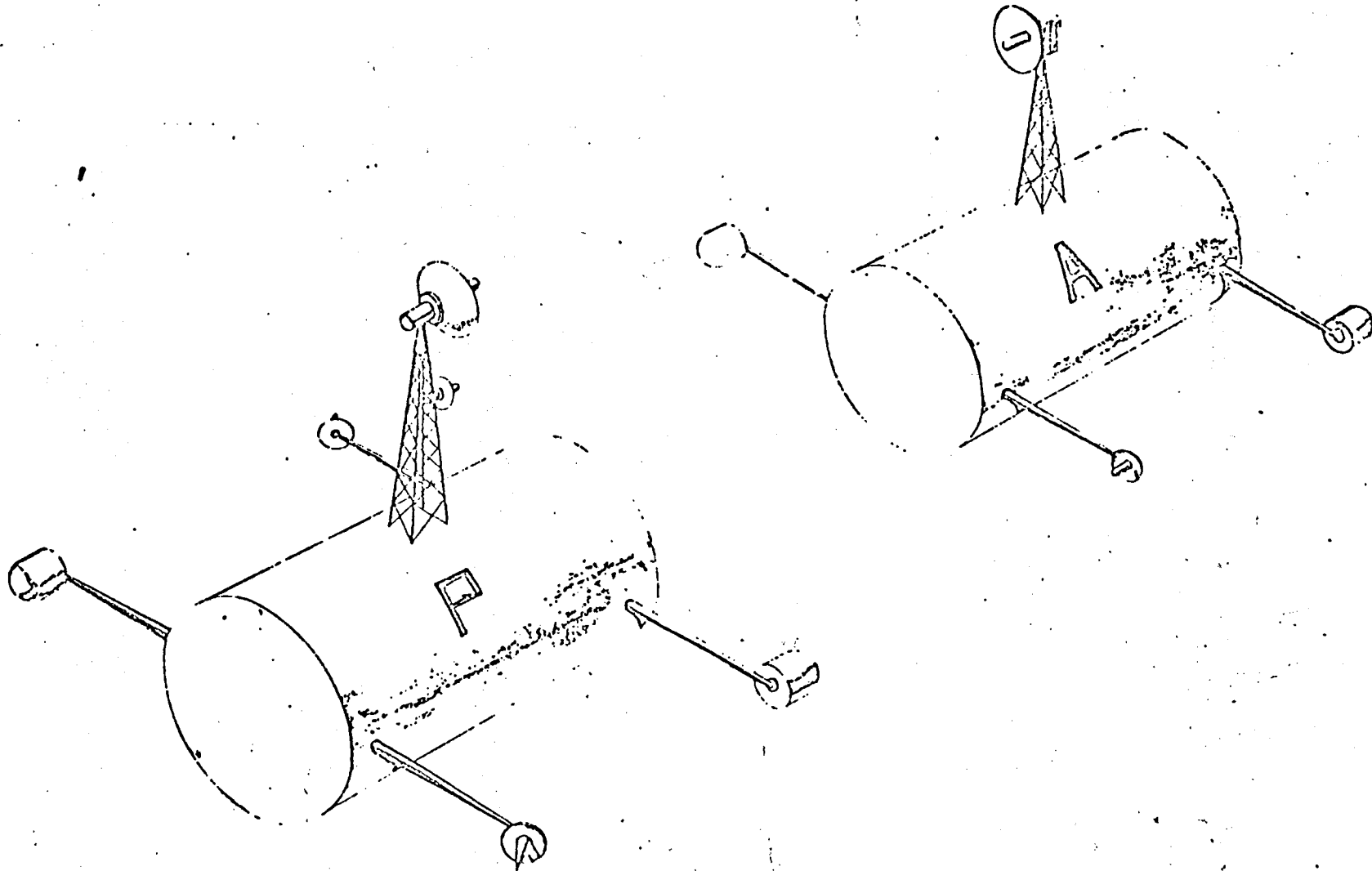
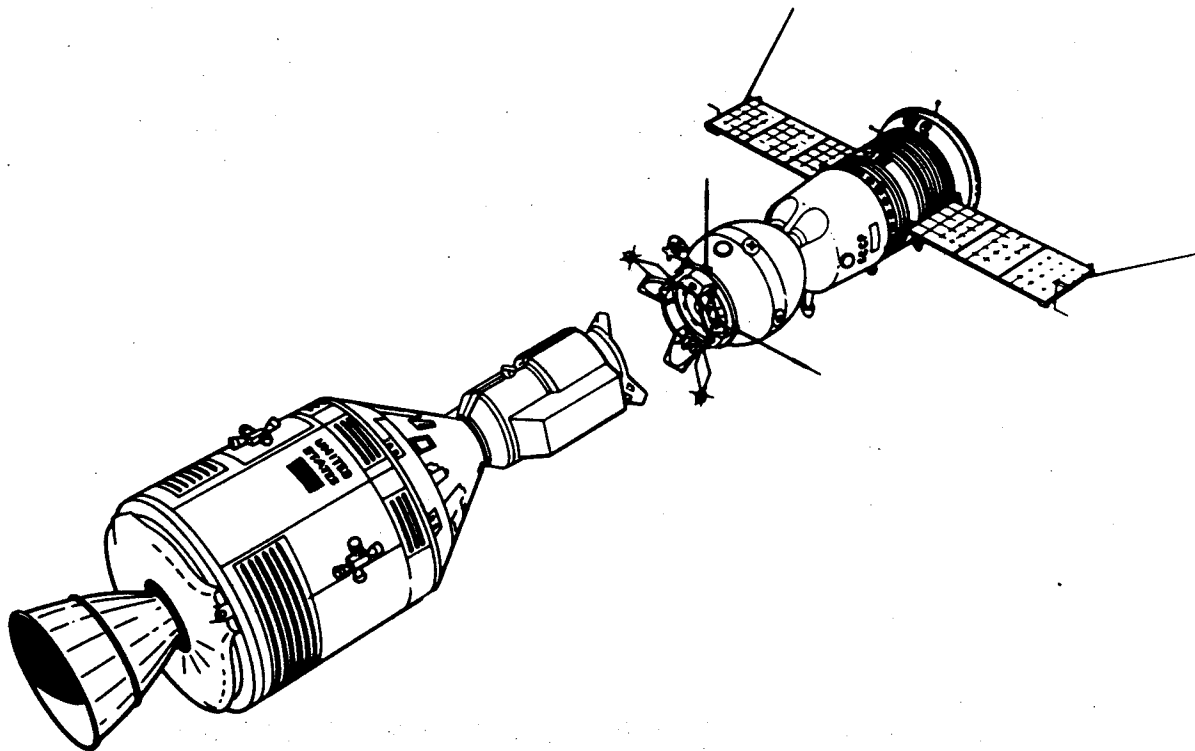

Fig. 4

ASTP 20202
APRIL 30, 1974

APOLLO SOYUZ TEST PROJECT



SAFETY ASSESSMENT REPORT FOR SOYUZ PROPULSION AND CONTROL SYSTEMS

USA - USSR

ORIGINAL	USA	<i>Ross H. Lavroff</i>	<i>H. E. Smith</i>	<i>S. S. Lunney 5/3/74</i>	
		R. Lavroff	H. E. Smith	G. S. Lunney	
ОРИГИНАЛ	СССР	<i>Бабуков</i>	<i>Софорова</i>	<i>Бушуев №. 24</i>	
		O. Babkov	E. Safonova	V. Legostayev	
REISSUE NO.	COUNTRY	PREPARED	TRANSLATION VERIFIED	WORKING GROUP CHAIRMAN	DIRECTOR
№ РЕДАКЦИИ	СТРАНА	ИСПОЛНИТЕЛЬ	ПЕРЕВОД СВЕРИЛ	РУКОВОДИТЕЛЬ РАБОЧЕЙ ГРУППЫ	ДИРЕКТОР

TITLE

SAFETY ASSESSMENT REPORT FOR SOYUZ
PROPULSION AND CONTROL SYSTEMS

ЗАГЛАВИЕ

ОТЧЕТ ПО ОЦЕНКЕ БЕЗОПАСНОСТИ СИСТЕМЫ
ОРИЕНТАЦИИ И УПРАВЛЕНИЯ ДВИЖЕНИЕМ
КОРАБЛЯ "СОЮЗ"

APOLLO/SOYUZ

"АПОЛЛОН-СОЮЗ"

TEST PROJECT

ЭКСПЕРИМЕНТАЛЬНЫЙ ПОЛЕТ

SCALE
МАСШТАБDOC. NO.
№ ДОКУМЕНТАSHEET 1 OF 54

ЛИСТ _____ ИЗ _____

REVISION LOG

REVISION NUMBER	CHANGE SUMMARY NO.	DESCRIPTION OF CHANGE	COUNTRY	DATE APPROVED

CONTENTS

Section		Page
	CONTENTS	3
	LIST OF FIGURES	6
	LIST OF ABBREVIATIONS	7
1.0	INTRODUCTION	9
2.0	THE PURPOSE AND CONSTITUENTS OF THE ATTITUDE AND TRANSLATION CONTROL OF THE SOYUZ SPACECRAFT	10
2.1	COMMAND SENSORS	11
2.1.1	<u>Infrared Vertical Sensor</u>	11
2.1.2	<u>Ionic Sensor</u>	11
2.1.3	<u>Sun Sensor</u>	12
2.1.4	<u>Gyro System</u>	12
2.1.5	<u>Integrating accelerometer</u>	13
2.1.6	<u>Sensor Unit of Angular Rates</u>	13
2.2	CONVERTERS AND SWITCHING LOGIC INSTRUMENTS	14
2.2.1	<u>Control Assembly of the Docking and Orientation Engines</u>	14
2.2.2	<u>Stabilization Assembly</u>	15
2.2.3	<u>Ionic Sensors Switching Unit</u>	15
2.2.4	<u>Program Timing Device</u>	15
2.2.5	<u>Switching Logic Instrument</u>	16

Section	PAGE
2.3	16
VISUAL ORIENTATION INSTRUMENT AND HAND CONTROLLERS	
2.3.1	16
<u>The Right Control Knob (Rotational Hand Controller)</u>	
2.3.2	17
<u>The Left Control Knob (Translation Hand Controller)</u>	
2.3.3	18
<u>Sighting Device (Periscope)</u>	
2.3.4	19
<u>Shade Gauge</u>	
2.4	19
COSMONAUT CONTROL PANEL	
2.4.1	19
<u>Command-Signal Device</u>	
2.4.2	21
<u>Instrument Panel</u>	
2.4.2.1	21
<u>Combined electronic instrument.-</u>	
2.4.2.2	22
<u>The program monitoring display.-</u>	
2.4.2.3	22
<u>Digital display unit.-</u>	
2.5	22
DOCKING AND ORIENTATION ENGINES	
2.6	24
DESCENT VEHICLE ORIENTATION ENGINES	
2.7	25
MAIN AND BACKUP CORRECTIVE ENGINES	
3.0	25
OPERATIONAL MODES OF THE CONTROL SYSTEM (SOUD)	
3.1	26
AUTOMATIC CONTROL MODES	
3.1.1	26
<u>Orbital Orientation</u>	
3.1.2	26
<u>Attitude Hold</u>	
3.1.3	28
<u>Program Attitude Maneuvers</u>	
3.1.4	29
<u>Sun Orientation of the Spacecraft</u>	

Section	PAGE
3.1.5	
	29
3.2	
	30
3.2.1	
	30
3.2.2	
	31
3.2.3	
	31
3.2.4	
	32
3.2.5	
	32
3.2.6	
	33
3.3	
	33
4.0	
	34

LIST OF FIGURES

Figure		PAGE
1	Block diagram of the attitude and translation control system.	35
2	Control knobs (rotational and translational hand controllers).	36
3	Screen of sighting device (periscope reticule).	37
4	Command-signal devices.	38
5	Display windows of command signal system (KSU).	39
6	Instrument panel.	49
7	Electroluminescent indicator.	50
8	Program monitoring display.	51
9	Digital display unit.	52
10	Gas and fuel feed system schematics of the approach and orientation engines (SIO).	53
11	Critical commands unit.	54

LIST OF ABBREVIATIONS

BVDPO	The control assembly of the docking and orientation engines
BDUS	The sensor unit of angular rates
BKID	Ionic sensors switching unit
BS	The stabilization assembly
BTsI	The digital display unit
DO	Orientation engines (1 kg)
DKD	Backup corrective engine
DPO	Docking and orientation engines (10 kg)
ID	Ionic sensor
IKV	Infrared vertical sensor
IKP	Program monitoring display
IRO	Manual pulse orientation
IU	Integrating accelerometer
K	Roll
T	Pitch
R	Yaw
KSU	Command signal device
KEI	Combined electronic instrument
KLP	Switching-logic instrument
PVU	Program timing device
PD	Instrument panel
PK	Cosmonaut Control Panel
RO	Manual orientation
RUL	Left control knob (translation hand controller)

RUP	Right control knob (rotational hand controller)
SD	Sun sensor
SIO	Docking and orientation engine system
SKD	Main corrective engine
SKDU	Main and backup corrective engine system (SKD and DKD)
SOUD	Attitude and motion control system
SUS	Control system for descent
TE	Shade gauge
URD	Control thruster
ELS	Electroluminescent Indicator

INTRODUCTION

1.0 This report gives a brief description of the attitude and translation control system of the Soyuz spacecraft and its associated instruments. The following are represented:

1. A block diagram of the system.
2. Interfaces inside the system.
3. Attitude and translation control system modes.

The objective of this report is to provide the necessary information on the adequacy of the control system design to assure its flight safety.

2.0

THE PURPOSE AND CONSTITUENTS OF THE ATTITUDE AND TRANSLATION CONTROL SYSTEM OF THE SOYUZ SPACECRAFT

The attitude and translation control system (SOUD) is designed to perform the following functions:

1. The modes of attitude maneuvering and attitude hold of the Soyuz spacecraft.
2. The stabilization of the spacecraft when using the main and backup corrective engine system (SKDU).
3. Control during docking.

The SOUD hardware consists of command sensors, converters, switching logic instruments, attitude reference displays, and control knobs (hand controllers), the docking and orientation engine system, and the main and backup corrective engine system. The block diagram of the SOUD of the Soyuz spacecraft is given in Figure 1. Command sensors provide input information on attitude and angular rate in automatic modes. The output signals of these instruments are sent to the control assembly of the docking and orientation engines (BVDPO). In this assembly the signals from sensors are summed and are converted into the commands to the docking and orientation engines (SIO). Attitude control of the spacecraft is provided by the operation of the SIO control thrusters.

In manual control modes, the information on the spacecraft angular position is provided to the crew through the visual monitoring equipment, and the crew generates signals via the rotational and translational controllers (knobs) to the SIO control thrusters.

2.1 COMMAND SENSORS

2.1.1 Infrared Vertical Sensor

The infrared vertical sensor (IKV) is an optical electronic instrument, which measures the angular misalignment of the spacecraft $-OY_{C4}$ axis and the local vertical.

The IKV uses the earth's and earth atmosphere's infrared radiation and converts it into command signals along the pitch and roll channels.

The crew visually checks attitude by means of optical devices and if necessary switches on the mode of manual orientation from the PK and performs orbital attitude manually.

2.1.2 Ionic Sensor

The Ionic sensor (ID) is an electronic device, which measures the misalignment of the Soyuz spacecraft OX_{C4} axis from the orbital velocity vector. The ID uses the incident ion flow on the spacecraft and converts it into command signals along the pitch and yaw channels. Three ionic sensors are installed in the spacecraft: two along $+X_{C4}$ axis and one along $-X_{C4}$ axis.

The selection of an ionic sensor and its control switching are accomplished by a command from the ground or cosmonaut control panel (PK).

The sensor selected is tested in that SQUAD mode using ionic sensors. The test results either confirm the selected sensor's operational readiness or provide for automatic switching to the other sensor.

During the flight in the docked configuration the ionic sensors are not used for control.

2.1.3 Sun Sensor

The sun sensor (SD) is an optical-electronic instrument, producing a signal of the solar attitude misalignment of the spacecraft $+0Y_{C4}$ axis. The central zone of the sensor generates a signal indicating that the sun is within $\pm 6^\circ$ of the sensor line-of-sight axis. The crew monitors the attitude by means of the shade gauge. If the sensor fails, solar orientation is performed manually.

2.1.4 Gyro System

The gyro system consists of two free gyros, each gyro with two gimbals. Both gyros are used simultaneously. The gyro system provides for selected inertial attitude hold of the spacecraft and performs attitude maneuvers about the roll and yaw axes from 0° to 360° . Attitude change maneuvers are performed consecutively about the roll and yaw axes.

The maximum allowable angular deviation of the spacecraft relative to the reference value about any axis (including the pitch axis) is $\pm 8^\circ$.

During gyro system operation, attitude rate signals supplied by the angular rate sensor unit (BDUS) are used. The gyro system does not contain additional angular rate sensors. If the angular deflection with gyro system operation exceeds $\pm 8^\circ$, an "emergency" signal is generated which automatically disables the Soud. Gyro system functions are duplicated by the rate gyros in the angular rate integration mode (see 2.1.6).

2.1.5 Integrating Accelerometer

The integrating accelerometer measures the velocity increment projection onto the $-X_{C4}$ axis. It is used with main and backup corrective engine system (SKDU) operation. The preset velocity increment (settings) is fed into the integrating accelerometer prior to the engine firing. Upon achieving the preset incremental velocity, the engine is automatically shut off.

The integrating accelerometer is tripled and works by voting. The incremental velocities are displayed on the digital display unit (BTsI).

2.1.6 Sensor Unit of Angular Rates

The angular rate sensor unit (BDUS) is an electronic gyroscopic instrument, which contains three rate gyros and forms the signals, proportional to the projections of the spacecraft angular rate vector on the OX_{C4} , OY_{C4} , and OZ_{C4} axes. On command from the cosmonaut control panel (PK), the BDUS can be switched into a mode which, in addition to the rate signals, also forms signals proportional to the integral of the respective angular rates. In this mode, the BDUS provides the inertial or orbital attitude hold of the spacecraft and makes it possible to implement programmed maneuvers about the roll, pitch, and yaw axes. Also, it generates an "emergency" signal if the magnitude of the angular deviation of the spacecraft from the reference direction in any of the three axes exceeds $\pm 6^\circ$. In this case, the subsequent activity is defined in Section 3.1.2.

Two BDUS systems are installed in the spacecraft; one in the instrument module and the other in the orbital module. During SOUD operation, one BDUS is operational and the other is powered off and on standby. It takes less than 1 minute for the BDUS to become operational. Switchover of the sets is performed by a command from the ground or from the PK. BDUS malfunctioning is identified by the loss of spacecraft attitude hold and a "emergency" light on the PK. The "emergency" signal is also telemetered to the ground station.

2.2 CONVERTERS AND SWITCHING LOGIC INSTRUMENTS

2.2.1 Control Assembly of the Docking and Orientation Engines

The control assembly of the docking and orientation engine (BVDPO) is an electronic device, located in the instrument module, which performs the summation of the signals of command sensors, amplifies them, and converts them into commands which fire the SIO control thrusters.

The BVDPO also switches the signals from command sensors and the hand controllers and forms the pulse train commands. For each of the X, Y, Z control axes in BVDPO there are three identical electronic units which generate "switch-on" commands of SIO thrusters by voting. These three units are powered by three independent buses through separate circuit breakers, switching off the corresponding bus in case of a current overload.

The firing of any DO thrusters (1 kg.) illuminates the light "DO thrusters" on the electroluminescent indicator (ELS) (fig 7) for

the time of firing. Firing of any DPO thrusters illuminates the light "DPO thrusters" on the ELS for the time of firing.

Minimum pulses for deflection of the RUP are generated by a separate device in the BVDPO. This device is tripled and operates by voting. This device is powered from the same buses that are used for the above mentioned primary electronic units of the BVDPO.

2.2.2 Stabilization Assembly

The stabilization assembly (BS) is an electronic device, located in the instrument module of the spacecraft, which sums the signals from the gyro system and from the BDUS, amplifies them and forms control commands to the drivers of the backup corrective engine (DKD). The function of the DKD drivers is to provide linear control of special thrusters located near the SKDU and generating the spacecraft stabilization control torques.

2.2.3 Ionic Sensors Switching Unit

The ionic sensors switching unit (BKID) analyzes the condition of the active ionic sensor in control and if failures occur, switches to the backup ID.

2.2.4 Program Timing Device

To perform any SQUAD mode (for example, orientation, attitude change maneuver, orbit correction), it is necessary to follow a particular operation sequence (on and off switching of equipment, preparatory operations such as warmup or gyro runup, initialization of attitude change maneuvers, SKDU on and off switching, etc.). All of these

operations can be accomplished from the PK, if desired; however, to reduce the cosmonaut's work load, it is possible to perform a particular set of such sequences ("fixed programs") on command from the PK or the ground. These functions are performed by the program timing device (PVU).

The PVU is redundant in such a way that a single failure of any element does not cause any malfunction. The crew is also able to switch off the PVU by issuing a command through the command signal device (KSU) and issue all the necessary commands manually.

2.2.5 Switching Logic Instrument

The switching logic instrument (KLP) processes the commands, which enter through a radiocommunication line, from the PVU, and the PK and distributes them to the appropriate equipment. The KLP is redundant in such a way that a single failure of any element does not cause any malfunction.

2.3 VISUAL ORIENTATION INSTRUMENTS AND HAND CONTROLLERS

2.3.1 The Right Control Knob (Rotational Hand Controller)

The right control knob (RUP) makes it possible for crew to perform attitude maneuvers around any axis of the spacecraft in a proportional rate command mode and in a pulse mode. The RUP has three degrees of freedom (Figure 2), corresponding to the "roll", "yaw", and "pitch" (K, R, T) control channels. The control stick grip is returned by springs to the neutral position. This position is fixed. The characteristic of the output signal of the stick along each axis is piecewise-linear. The force on the stick is expressed by the same relationship. At the break point of the output curve,

the force necessary to deflect the stick increases, acting as a "soft detent". Furthermore, at full displacement of the stick along each axis there are contacts. In the pulse control mode the closing of the end contacts generates a single SIO thruster pulse of a fixed time interval.

The signal, from the stick in the "soft detent" position, corresponds to a rate command of 0.5 degrees/second in the pitch and roll axes, and 1 degrees/second in the yaw axis. The rate achieved by the spacecraft with hard detent position of the stick is 3 degrees/second in all three control channels. Power to the RUP is applied by calling the manual orientation control mode on the PK.

The Right Control knob (RUP) can be used in two operational modes - for orientation and for manual approach. In the mode of manual approach, in contrast to Figure 2, the roll and yaw channels are interchanged due to the 90° rotation of the periscope head. This RUP switching is automatic with on and off switching of the SQUAD "manual approach" mode.

In the modes when the RUP is not used, it is powered down and does not generate any signals to the control system.

2.3.2 The Left Control Knob (Translational Hand Controller)

The left control knob (RUL) controls the translation of the spacecraft's center of mass. It permits the crew to perform translations of the spacecraft along the Y_{C4} and Z_{C4} axes. The toggle switch on the RUL commands thrusters on and off to provide translation along the $\pm X_{C4}$ axis. RUL contacts close at the end of

RUL travel. In the modes when the RUL is not used, it is powered down and does not generate any signals to the control system.

2.3.3 Sighting Device (Periscope)

The sighting device is an optical device, arranged in the descent vehicle, for viewing the earth and/or for viewing the other spacecraft during docking. The sighting device has central and peripheral fields of vision. The central field provides a view in the direction of the optical axis of the instrument with a field of view of $\pm 7.5^\circ$. The peripheral field makes it possible to view objects, arranged in a zone from 71° to 84° from the axis of the instrument. The images of the central and peripheral optical systems are projected onto a common screen (Figure 3). The sighting device is equipped with a rotary periscopical head. During the docking of the spacecraft it is possible to rotate the central optical system through an angle of 90° so that the line-of-sight axis would coincide with the longitudinal axis of the spacecraft. This rotation is performed by command from the KSU. With the sighting device, the crew can orient the spacecraft $-OY_{C4}$ axis along the local vertical, and the OX_{C4} axis along the desired course angle. Orientation to the local vertical is performed while observing the local horizon in the peripheral field of view. During the orientation of the spacecraft along the local vertical the horizon is symmetric relative to the center of the screen. Course orientation is performed by a viewing the movement of the earth's landmarks on the screen of the sighting device. A reticule on the screen of the central field of sight makes it possible to monitor a course angle, and

also to determine angular dimensions and the relative location of the other spacecraft.

2.3.4 Shade Gauge

Shade gauges (TI) are located outside the descent vehicle at the right and left windows. The TI makes it possible for a cosmonaut to perform a rough visual check of the orientation of the spacecraft with respect to the sun. The gauge is a translucent screen with a rod mounted in the center of the screen. With the spacecraft oriented toward the sun, the shadow of the rod is minimal. A circle is drawn on the screen concentric with the rod mounting point. When the shadow of the rod falls within the circle, the spacecraft $+OY_{C4}$ axis is aimed at the sun within $\pm 10^\circ$.

2.4 COSMONAUT CONTROL PANEL

The cosmonaut control panels (PK) are used for the display of information and for control of the spacecraft systems. During the operation of the attitude and translation control system, the consoles of the two command-signal devices (KSU) and the instrument panel (PD) of the descent vehicle are used. The control panels contain command instrumentation, displays of information, warning displays, and communication controls.

2.4.1 Command Signal Devices

The command signal devices (KSU) are intended for the control of spacecraft systems and units, the confirming the execution of commands, and monitoring the condition of units and systems. The KSU consists of a left and a right command signal device

(see Figures 4 and 5). Switching on of the left KSU panel, the right KSU panel, or of both simultaneously, and also their switching off is done from the instrument panel (Figure 11). On the panel of the KSU are:

1. Sixteen keys for the selection of systems or modes with associated titles.
2. A display with 16 electroluminescent windows.
3. Twenty-four numbered command keys for on and off switching.

The selection of appropriate SQUAD matrices in the display windows: Orientation Modes, Prep. for Descent Orientation, Settings, Programs, Reserve System, Combined Electronic Instrument (KEI), is performed by depressing the appropriate keys. The selection of the Reserve System Mode (fuel systems for the SIO and SKDU) can be switched on only after overriding the interlock on the PD. After the indicated commands appear in the front window panel of the displays, the required function is switched on by depressing the "ON" key located beside them. The execution of the command is confirmed by the illumination of an electroluminescent indicator. The display indicates execution of a command regardless of its source (from the ground through the radio communication link, from the PK through the KSU, and the PVU). For the switching off of a unit, the appropriate "OFF" key is depressed. The selection keys of a system or mode, as well as the "ON" and "OFF" switching keys, have mechanical interlocks, which prevent simultaneous depressing of more than one key.

2.4.2 The Instrument Panel

The instrument panel (PD) of the descent vehicle is intended to provide the crew with the information on the operation of the spacecraft primary systems. The instrument panel (PD, see Figure 6) is composed of: the program monitoring indicator (IKP), the digital display unit (BTsI), combined electronic instrument (KEI), the electroluminescent indicator (ELS), (Figure 7), and the critical command unit (Figure 11).

2.4.2.1 Combined Electronic Instrument

The combined electronic instrument (KEI) is used for the monitoring of the SOUD analog parameters and of other spacecraft systems. In manual control system operation the KEI functions in two modes. In the television mode, the instrument makes it possible to observe another spacecraft during rendezvous and docking. In an "unrastered" mode of the instrument (CRT), the KEI displays the signals of the ionic sensor. The position of the longitudinal axis of the spacecraft relative to the direction of the incident ionic flow is depicted as a luminous spot on the face. The deflection of the spot from the center of the screen is proportional to the displacement angle. The displacement of the spot along a vertical axis corresponds to an angular deviation with respect to the pitch channel. Displacement along the abscissa corresponds to deviation with respect to the yaw channel. A displacement at the edge of the screen corresponds to OX_{C4} deviation from the direction of the incident ionic flow of $\pm 9^\circ$. The KEI can also monitor pressure in the SIO.

2.4.2.2 Program Monitoring Display

The program monitoring display (IKP, see Figure 8), monitors the progress of a program called for by the onboard program-time system (PVU).

IKP makes it possible to determine the content of the monitored program, elapsed program time in a monitored program on a time scale, and the time of command execution indicated by extinguishing of light indices.

2.4.2.3 Digital Display Unit

The digital display unit (BTsI, Figure 9) serves for the manual input and the monitoring of automatic settings into the SOUD, for monitoring the remaining propellant of the SKDU, and the spacecraft incremental velocity due to thrusting.

The BTsI is a system of electromechanical counter enabling the cosmonaut to monitor and introduce angular settings (α_x , α_y , α_z) and a velocity increment value ("impulse"). The register "RESOURCE" indicates the amount of remaining SKDU propellant at a given moment. Input of automatic settings is monitored through the digital data of the BTsI.

On the BTsI, there is a light "DKD" which lights up when the DKD is selected.

2.5 DOCKING AND ORIENTATION ENGINE SYSTEM

The docking and orientation engine system (SIO), utilized during orientation and translation of the center of mass, includes the control thrusters operating on hydrogen peroxide. There are two

sets of thrusters: orientation engines (DO) with 1 kg thrust, and the docking and orientation engines (DPO) with a 10 kg thrust. The latter are utilized in the high torque modes: stabilization during operation of the main corrective engine (SKD), for the translation of the spacecraft during docking, and also in other modes of control. DO and DPO are not used simultaneously. There are no thermal constraints for SIO operation.

The pressure and fuel feed components of the SIO (Figure 10) system are:

1. A pressure feed system (primary and backup)
2. A fuel feed system (primary and backup)
3. Control thrusters (URD)

During the preparation of the SIO for operation, the electrically operated valves of the gas supply of the pressurization system and the electrically operated valve of a fuel feed are opened. Electrically operated valves in the mains of the pressurization and fuel systems have backup pyrotechnic valves. Gas from a spherical tank is supplied to a pressure regulator and pressurizes the fuel. On command of the BVDPO, the electrically operated valves of the control thrusters (URD) feed fuel into the control thrusters. At the end of an orientation mode, the electrically operated gas supply valve of the pressurization system and the electrically operated fuel feed valve are shut off. After depletion of propellant from the primary tanks, switchover to a reserve fuel tank is performed. The switchover from of the fuel tanks can be commanded from either the ground or from the PK. It is possible to feed from both

tanks simultaneously. In the case of a pressure leak of one of the pressurization system, fuel pressurization is provided by the other system. For this case, the pressure crossfeed is opened and the failed pressurization system is isolated.

When selecting engines D0 and DPO the electrically operated fuel feed valve for the corresponding fuel system is opened. The mains, connecting the fuel systems, are normally opened. Pyrotechnic valves allow separate operation of the DPO off the main fuel system and the D0 off the backup system. Maximum working pressure in the fuel system is 15.5 kg/cm^2 . Test pressure is 18.5 kg/cm^2 .

URD operation is telemetered. Firings of the URD are displayed on a signal panel in the form of the signals: ("СОПЛА Д0") and ("СОПЛА ДПО") Gas pressure in the pressurization system, and the temperature of the primary elements of the SIO are monitored on the combined electronic instrument (KEI) and by telemetry.

If any of the thrusters fails-on, it is necessary to switch over from the D0 system (1 kg) to the DPO system (10 kg) or vice versa by command from the PK or ground station.

2.6

DESCENT VEHICLE ORIENTATION ENGINES

In the descent vehicle there is an additional system of orientation thrusters, which operates on the commands of the descent control system (SUS). The switching on of the SIO SUS is inhibited until the commands to separate the spacecraft modules is given. During orbital flight of the spacecraft, the primary SIO SUS parameters are monitored on the combined electronic instrument (KEI) and by telemetry.

2.7 MAIN AND BACKUP CORRECTIVE ENGINES

The main and backup corrective engine system (SKDU) of the Soyuz spacecraft consists of two engines:

- the single chamber (main) corrective engine (SKD);
- the dual chamber (backup) corrective engine (DKD).

The switching of either SKDU engine is performed by the spacecraft automatic equipment in accordance with the corresponding PVU program upon receipt of a go ahead signal from the control system (SOUD).

The crew can also cancel the program and fire the engine manually from the control panel (PK) using the following sequence:

- the depression of the command key "БЛОК ВЫКЛ";
- the removal of mechanical interlock from the button "SKDU ON";
- command input to the "SKDU ON" (Figure 11).

Monitoring of the switching on of the SKDU is provided by the "SKDU ON" light on the ELS (Figure 7). Simultaneously with the SKD, only the DPO engines are used.

3.0 OPERATIONAL MODES OF THE CONTROL SYSTEM (SOUD)

Attitude control of spacecraft can be performed in automatic or manual modes. The crew has the capability of selecting the mode of control from the KSU console.

The switching and operation of the automatic mode is performed by starting the program timing device (PVU) through the command signal system (KSU) or by radiocommunication command. It can also be accomplished by sequential crew inputs commands from the KSU. The manual modes of spacecraft attitude control are turned on by KSU commands.

3.1 AUTOMATIC CONTROL MODES

In automatic control modes; the following functions are performed:

- orbital orientation;
- orbital or inertial attitude hold;
- program attitude maneuvers;
- orientation to the sun;
- stabilization during the SKDU operation.

3.1.3 Orbital Orientation

The mode of orbital orientation is performed using an ionic and the infrared vertical sensors. The following instruments are used in this mode: ID, IKV, BDUS, BVDPO, and DO SIO.

The IKV is used to orientate the $-OY_{C4}$ spacecraft axis to the center of the earth and provides analog signals of angular errors in the pitch and roll channels. The orientation in the yaw channel is provided by the ionic sensor, by means of analog signals of angular errors. The pitch channel is provided a rate command input to compensate for orbital rotation.

Deadbands of the SIO thruster ignition in this mode are 1 to 2 degrees in angle and 0.07 degrees/second in angular rate.

3.1.2 Attitude Hold

The inertial attitude hold mode is performed in two versions: with or without the use of the gyros. In the first case, the attitude signals are generated by the gyro system and angular rates are generated by the BDUS. In the second case, the attitude signals and angular rate signals are generated by BDUS.

The following instruments are also used in this mode: BVDP0 and SIO thrusters. The SOUD provides inertial orientation in all three axes with angular deviations not more than 1° .

Whenever the spacecraft attitude while in an inertial attitude hold mode (including program attitude maneuvers) deviates in any axis by an angle greater than 6° from the reference attitude using the BDUS, or 8° using the gyros, an emergency signal "АВАРИЯ" is generated.

In case of the "Emergency" command from the gyro system the SOUD is switched off and the light "Modes OFF" on KSU comes on. If the gyro system fails there is still a capability of reestablishing the reference for orbital and inertial attitude hold modes, maneuvers and stabilization during the SKDU operation both automatically and manually. In this case it takes less than 15 minutes to establish the orbital orientation. If necessary this time should be extended for the time needed for the maneuvers with a rate of $+0.45^\circ$ per sec.

In case of the "Emergency" command when BDUS is used, the light "АВАРИЯ" on ELS and on audio signal comes on. If as a result of disturbances, the attitude is changed by more than 7.5° relative to the original reference system, the original reference system is lost. After rate damping, the control system will maintain the new inertial reference system which is determined by the magnitude of the disturbance.

When a BDUS package fails there still remains a capability of all the automatic and manual SOUD modes.

To perform inertial attitude hold the following instruments are used: IKV, BDUS with the integration of an angular rate for the yaw channel, or using the BDUS with the integration of angular rates for all channels.

In both cases, the pitch channel supplies a rate input to the BDUS to compensate for orbital velocity.

The orbital attitude hold is switched on after aligning to the orbital orientation using the IKV and ID sensors or manual modes. To monitor the accuracy of the orbital orientation, the ionic sensor is turned on in the indicator mode and angular information from it is displayed on the KEI. The correction of the errors of the orbital orientation, caused by the drift of the BDUS, is accomplished by periodic reestablishment of the initial orbital orientation.

3.1.3 Program Attitude Maneuvers

In an inertial attitude hold mode, the Soyuz spacecraft can perform attitude maneuvers. This mode can be performed when using either the gyros or the BDUS operating in an angular rate integration mode. Using the gyros the program maneuvers are performed through roll and yaw at angles from 0° to 360° at a maneuver rate of -0.66 degrees/second in roll and $+0.66$ degrees/second in yaw.

Using the BDUS, the maneuvers can be performed in all three axes at angles from 0 to 360° with a maneuver rate of $+0.45$ degrees/second.

The maneuver angles are preset either by a radiocommunication command or by the crew through the BTsI and the maneuver sequence is initiated either through inputs from the PVU or cosmonaut commands to the KSU. Also the maneuver angles can be input from a radiocommunication command.

3.1.4 Sun Orientation of the Spacecraft

In the sun orientation mode the sun sensor (SD), BDUS, BVDPO, and DO SIO are used. Sun acquisition is automatic by maneuvering the spacecraft about the pitch axis. After the sun appears in the SD field of view, the spacecraft is maneuvered until the sun is in the central zone of the sensor.

After the alignment of the OY_{C4} axis in the direction of the sun, the SQUAD can maintain this orientation with an angular deflection not more than $\pm 6^\circ$. Alternately, a rotation can be performed around the OY_{C4} axis at a rate of 2.5 degrees/second, which ensures the gyro spin stabilization of the OY_{C4} axis in the direction of the sun to recharge the batteries with the control system (SQUAD) switched off. These modes are initiated either through inputs from the PVU or cosmonaut commands to the KSU.

3.1.5 Stabilization using the Main or Backup Corrective Engines (SKDU)

The inertial attitude stabilization with SKD operation is performed using the BDUS, BVDPO, DPO SIO, and with the gyros or without them (obtaining the angular signals from the BDUS).

In the operation of the backup corrective engine (DKD), the angles and angular rate signals are input to the stabilization assembly (BS), where control commands to the drivers of the DKD are generated. The setting, which defines the magnitude of the corrective or retro impulse, is inserted into the integrating accelerometer either from the PK or from radio link command. The switching on of the stabilization mode is performed by initiating an automatic program

either by a radio communication command or the cosmonaut via the PK. The selection of an engine and sensors (BDUS or gyros), which provide angle information, is performed by a preset input command on the PK or by a radiocommunication command.

Just as for other automatic modes, this mode can be implemented by a set of commands from the PK.

3.2 MANUAL CONTROL MODES

In the manual control modes, the SOUD provides:

- damping any initial angular rates;
- the orientation of spacecraft in an orbital coordinate system (local vertical with a given course angle);
- stabilization with SKD operation;
- single axis orientation to the sun;
- docking.

3.2.1 Manual Orientation Mode

In the manual orientation mode (RO) using the BDUS, the cosmonaut determines the magnitude and direction of the angular deviation from the desired orientation by means of the visual monitoring instrument (periscope or shade gauge) from TV data or ID data, and moves the right control knob (RUP). The RUP inputs enter the angular rates sensor unit (BDUS) and displace the sensor "null position" by a corresponding angular rate value. The thrusters fire until the control signals become less than the deadband. After this the thrusters are switched off, and the spacecraft continues to rotate at a constant rate. After the angular deviation is reduced to zero, the cosmonaut returns the control knob to the neutral

position, and the thrusters damp the angular rate below the rate deadband of the BVDPO. The RO mode is switched on by pressing buttons "K" and "5" on the KSU. The "RO" display is lighted.

3.2.2 Manual Pulse Orientation Mode

The manual pulse orientation mode (IRO) is implemented without the angular rate sensors. The cosmonaut moves the RUP to the stop and closes the contacts. On the closing of the contacts the BVDPO generates a command to the control thrusters for a fixed time interval.

Angular rate increments from a single pulse about the appropriate axis in IRO modes:

	1 kg Thrust	10 kg Thrust
roll	0.03 deg/sec	0.077 deg/sec
pitch	0.007 deg/sec	0.06 deg/sec
yaw	0.006 deg/sec	0.06 deg/sec

In order to generate repeated pulses, the control knob must be returned into the neutral position and deflected again. The IRO mode is switched on by pressing the buttons "K" and "7" on the KSU. The "IMPULSE RO" display lights up.

3.2.3 Orbital Orientation

Orbital orientation is established with the aid of the cosmonaut's sighting device. Generally, orientation is attained by searching for the earth by means of a roll channel (K) rotation. Following the first rotation, a maneuver is performed about the pitch channel (T) for the local vertical orientation. The position of the visible

horizon in the peripheral field of the sighting device indicates to the cosmonaut the orientation of the spacecraft in the roll and pitch axes.

For proper local vertical orientation, the earth's horizon should appear symmetric in the peripheral zone relative to the center of the periscope screen.

The third rotation is performed in the yaw channel (R) until the direction of motion of the earth's surface in the central field of the sighting device coincides with a given course. Afterwards the cosmonaut can maintain orbital orientation either with or without the use of the BDUS. To establish orientation along the X or Y axes in the R0 mode, the ionic sensor or infrared sensor, respectively, can also be used.

3.2.4 Single-Axis Sun Orientation

Single-Axis orientation to the sun is performed in the R0 mode. The cosmonaut receives visual data on the sun location from the shade gauge.

3.2.5 Manual Docking Control

Manual control for docking is used to perform a rendezvous from a range (200-300 m) until mechanical contact in the sunlit portion of the orbit. The initial relative velocity in this case must not exceed $\pm 1-2$ m/sec. To accomplish docking a target is installed on the passive spacecraft and is observed through the sighting device during the docking portion of the flight.

During manual control of docking the cosmonaut orients the spacecraft along his line of sight, commanding angular rates using the right control knob (RUP), while sighting the target of the passive vehicle through the sighting device. In this case the optical axis of the sighting device is aligned with the Ox_{C4} axis. The lateral motion of the center of mass is controlled by the cosmonaut using the left control knob (RUL), and longitudinal motion is controlled using the toggle switch located on the RUL to fire the DPO SIO thrusters. Manual docking control at contact insures maintenance of the docking parameters within the limits for normal functioning of the docking assembly.

3.2.6 Manual Stabilization

For manual stabilization during SKD operation, the cosmonaut maintains attitude control using the right control (RUP) and with the aid of the sighting device. Control in this case differs from the orbital manual mode only by the necessity to compensate for the disturbance torques produced by the SKD.

3.3 OPERATIONAL MODES FOR THE DOCKED CONFIGURATION

For nominal joint mission operations, the Soyuz control system is switched off on capture (on signal from the contact sensors on the docking mechanism). The contact sensors generating the signal to switch off the Soud are tripled and work in series. In the docked configuration contingency situations can arise which are related to crew safety and require that control of the docked spacecraft

be transferred to the Soyuz. In this case, the Soyuz SOUD can be reactivated through crew or ground commands. The required modes of SOUD operation in the docked configuration and the SOUD's capability to perform these operations are to be determined.

4.0

SAFETY ASSESSMENT OF THE CONTROL SYSTEM

The safety of the mission during the operation of the attitude and translation control system is assured by:

- by the redundancy of the SOUD modes;
- by arranging the most important instruments of the SOUD in a configuration yielding reliable performance (BVDPO, for example, is triply redundant); and by the redundancy of command sensors (BDUS - two complete sets, ID - two complete sets), of the SIO thrusters (DO and DPO), and of the corrective engines (SKD and DKD). The switching of these instruments and assemblies is implemented either from the PK or on a radio-link.
- by monitoring on the PK and telemetry the condition of the SKDU, SIO and operation of its engines, and also by the monitoring of the performance of the commands and programs;
- by the selection of the sequence of commands and operations, which eliminate any spurious inputs of commands affecting flight safety.



РИСУНОК I. БЛОК-СХЕМА СИСТЕМЫ ОРИЕНТАЦИИ И УПРАВЛЕНИЯ ДВИЖЕНИЕМ

Figure 1. - Block diagram of RCS & Motion Control.



РИСУНОК 2. РУЧКИ УПРАВЛЕНИЯ
Figure 2. - Hand Controllers

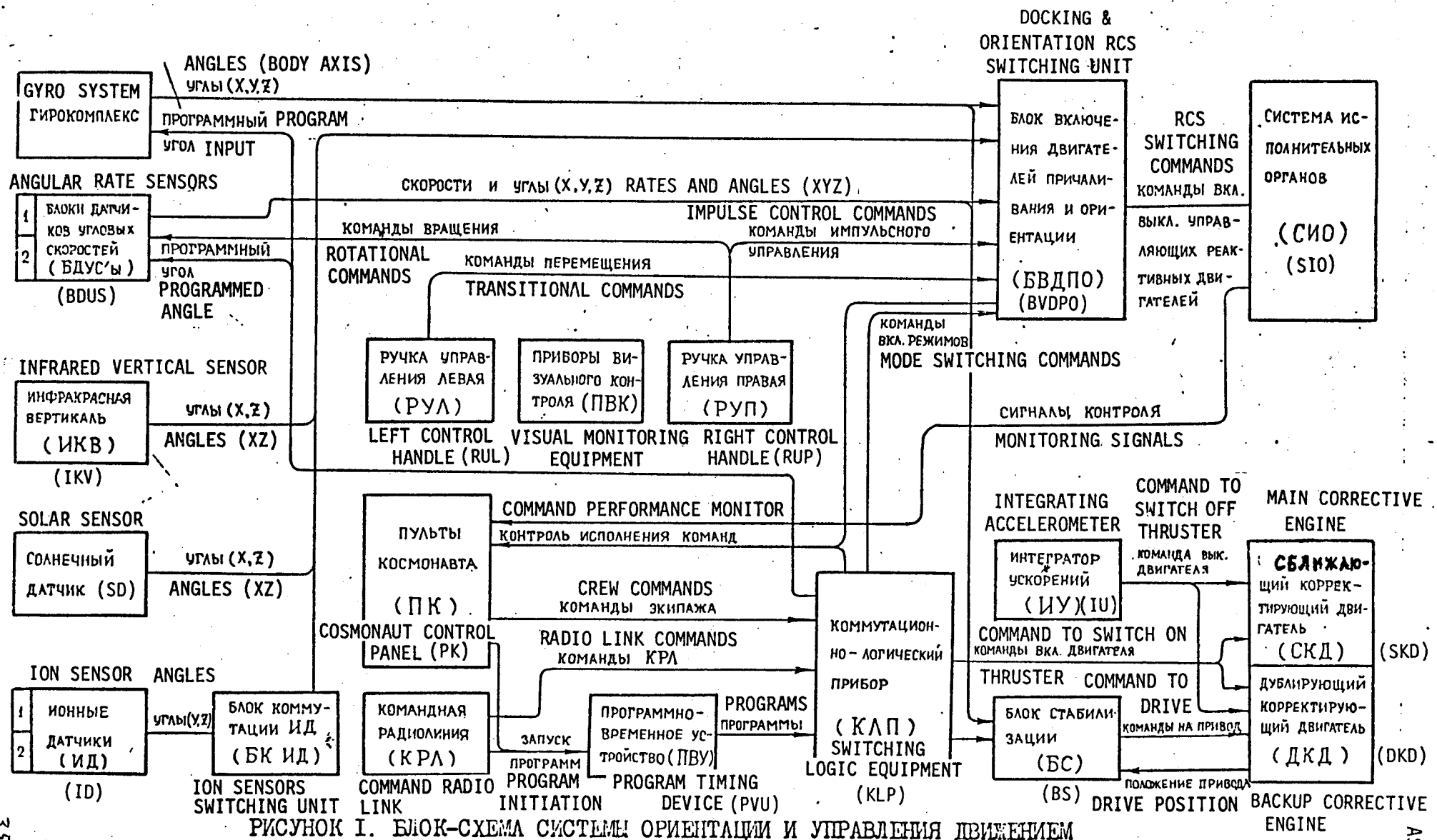

CENTRAL FIELD OF VIEW
центральное поле зрения
PERIPHERAL FIELD OF VIEW
периферийное поле зрения

РИСУНОК 3. ЭКРАН ВИЗИРА

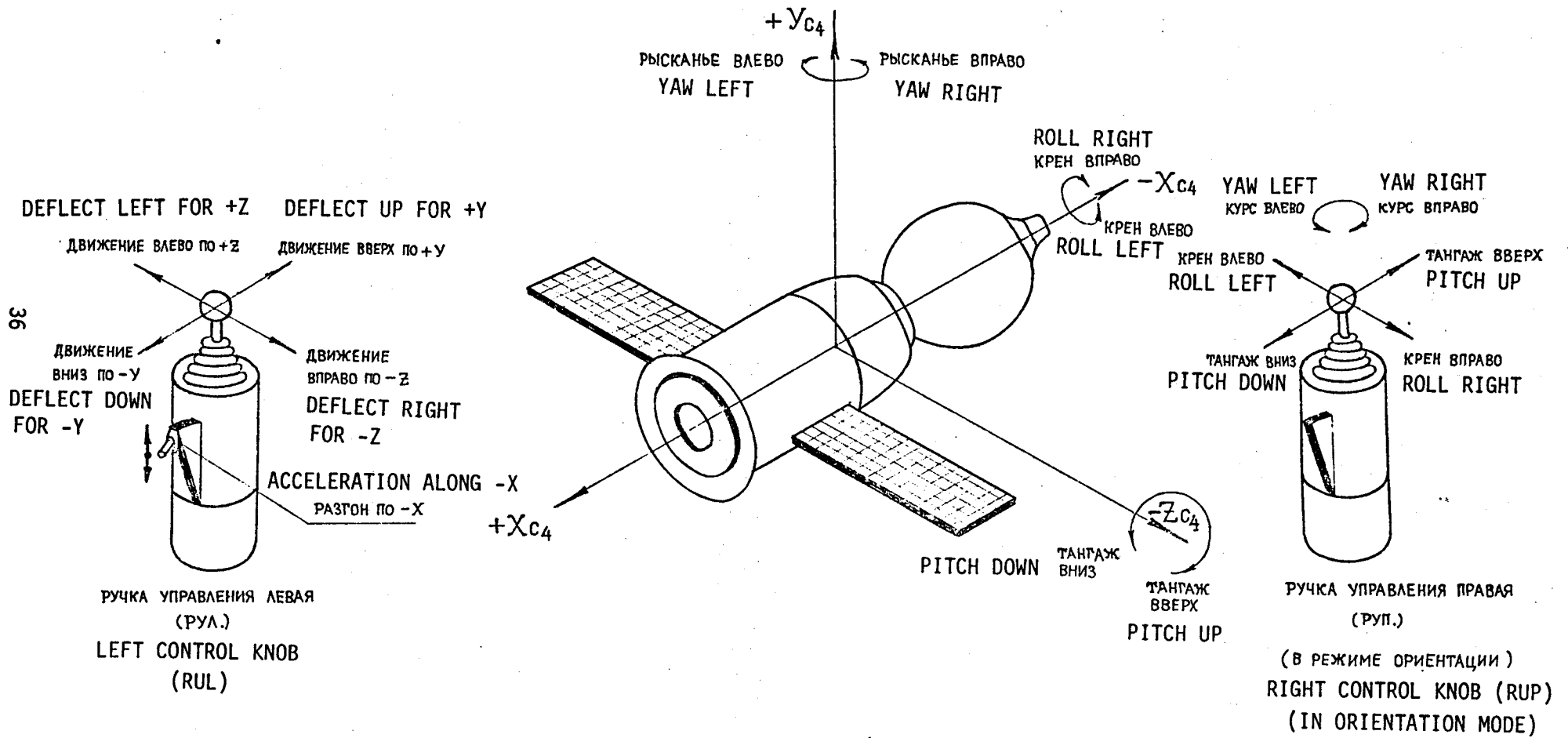
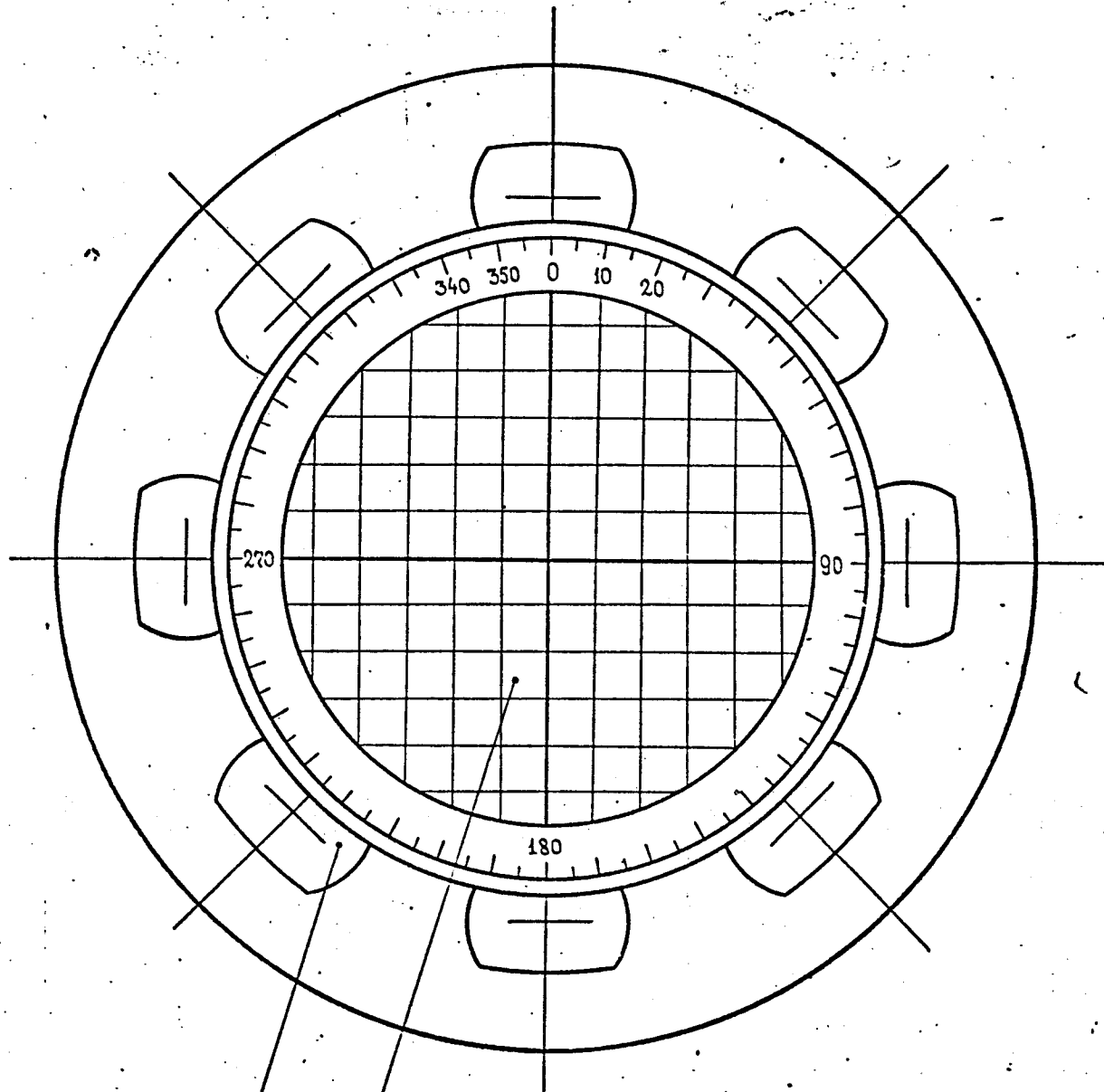
Figure 3. - Screen of sighting device (periscope reticule).

CSD-L КСУ-Л

CSD-R КСУ-П



РИСУНОК 4. - КСУ-Л КСУ-П.

Figure 4. - CSD-L CSD-R.

	А	В	С	Д	Е	Ж	И	К	Л	М	Н	П	Р	С	Т			
	А	Б.	В	Г	Д	Е	Ж	И	К	Л	М	Н	П	Р	С	Т		
1	СВЯЗЬ РЕЖИМЫ	СВЯЗЬ ВСПОМ.	ПОСАДКА	СОЖ СА	СОЖ ОМ, ПО	СПГ КСД	СБОРКА	ПОДГОТ. ОРИЕНТ. СПУСК.	ОРИЕНТ. РЕЖИМЫ	УСТАВКИ	ПРОГР.	РЕЗЕРВ. ИСПОЛН. ОРГАИ.	РЕЗЕРВ. СИСТЕМ	РТС, РКО КИ, СЭП	АПСС. СКГС	КЭИ		
2	ПОДГОТ. УКВ ПРД I	РАЗДЕЛ КАНАЛОО СВЯЗИ	АСП	ТЕЛЕВ. ОСВЕЩ.			ВЕНДИЖ КОЛЬЦА	ВЫБОР ДПО	ВЫКЛ. РЕЖИМОВ	РУЧНОЙ ВВОД	ВЫКЛ. ПРОГР.	РЕЗЕРВ. СИО	ПОСТОЯН. СИСТЕМЫ	НП РТС	ПИТАНИЕ АПСС	КЭИ	ВКЛ. ВЫКЛ.	1 2
3		ОТСТРЕЛ АНТЕНСА	ВЕНТ ДЫХАТ.	РАБОЧЕЕ ОСВЕЩ. I	ТК ОМ	РАЗРЕШ. СРОСА ДАВЛЕН. ИЗ ОМ	ОТР. ЗАЩЕЛОК	ВЫБОР ДО	ДУС	ПОДГОТ. α, γ ДУС	ЗАПРЕТ МЕТОК СОУД (ГР-Т)	РАЗДЕЛ ТОПА МАГИСТР		АНТЕННЫ I ГР	ЗАКР. ЗАЩЕЛОК	СОСТАВ ВОЗДУХА		3 4
4	УКВ-ПРМ СИМЛП		ВЕНТ. СА СКА Ф I	РАБОЧЕЕ ОСВЕЩ. II		СБРОС ДАВЛЕН. ОМ	РУЧНОЕ ПРИЧАЛ.	ВЫБОР НАПРАВЛ. Р. Т	РО	ПОДГОТ. α, γ ДУС	СВЯЗЬ	ПОДАЧА ДО	ДАТЧИК УГЛА Д	АНТЕННЫ В ГР	СТЯЖИВ.	НЕПЕРМЕТ.		5 6
5	УКВ-ПРМ ДУПЛ	МИКРОФОН	НАСОС КВО		ВЕНТ ПО	КОНТРОЛЬ НЕПЕРМЕТ.	ПЕРЕПЕЧА. КРАН «А»	ВЫБОР Т. ДАТЧ. 2	ИМПУЛЬС РО	ПОДГОТ. α, γ ДУС	СПУСК II	ОБЪЕДИН. НАДДУВ.		МАТРИЦА I ОТКЛ.	ЗАКР. КРЮКОВ	ТАНГАЖ РЫСКАЯ		7 8
6	ПОДГОТ. КВ ПРД I	СИМЛП	ОТСТРЕЛ СТРЕЛКИ	ГАЗО-АНАЛИЗ	КОНДИЦ. ОМ	РЕЖИМ КИРМЛ.	ТЕЛЕКАМ. РЕПОРТАЖ	ТАНГАЖ ВПЕРЕД	ОРИЕНТ. ПО X	ИСКЛЮЧ. УСТАВОК	СПУСК С РО	ПОДАЧА ДПО	ФИЛЬТР ДУС	МАТРИЦА I ОТКЛ.	РАСТЯЖ.			9 10
7	ПОДГОТ. КВ ПРД I	ДУПЛ	ОТСТРЕЛ СТРЕЛКИ II	ПОПЛОХ СО ₂	ЗНА КИР ВМ 2 1	ДИАГНОЗ АВН БОМБ.	ТЕЛЕКАМ. НАРУЖ.	ТАНГАЖ НАЗАД	ОРИЕНТ. ПО Y	ИМПУЛЬС СКД	АВТОМ. МАНЕВР	РЕЗЕРВ. НАДДУВА	КОМПЛЕКТ ДУС 2	БКИП ОТКЛ.	НАДДУВ СТЫКА	ДАВЛЕНИЕ СИО		11 12
8		ТЛГ		ТК СА	ЗНА КИР НМ 2 1	ТЕЛЕКАМ. ОМ	ОБЪЕКТЫВ. ТЕЛЕКАМ. НАРУЖ. ТЛК. ВЕНТ.	ВИЗИР ОРИЕНТ.	ЗАПРОС ОРИЕНТ. ПО X	α, γ И ПОДГОТОВ.	МАНЕВР С РО	ДКД	ГЕНЕРАТ. УСТАВОК 2 1	СОЛНЕЧН. БАТАРЕЯ ОТКЛ.	КОНТРОЛЬ ПЕРМЕТ. СТЫКА			13 14
9	КВ ПРМ ДУПЛ	РЕЗЕРВ. УКВ ПРД II	СВЕТОВ. АЛМАК	ВЕНТ. СА	ЗНА КИР О 2 1		ФИЛЬТР. ТЕЛЕКАМ. НАРУЖ. ВЫКЛ. СВЯЗ.	ИНЕРЦ. ОРИЕНТ.	ПОДГОТ. ИНЕРЦ. I		ОРИЕНТ. НА СОЛНЦЕ		ОРИЕНТ. СТАБИЛ. Р	РКО	КВД			15 16
10	КВ ПРМ СИМЛП	РЕЗЕРВ. АЛМАК	ВЕНТ. СА СКАФ. 2		РАБОЧЕЕ ОСВЕЩ.	КОНТР. ДАВЛЕН. СТР. ПО	ВИЗИР ПРИЧАЛ.		ПОДГОТ. ИНЕРЦ. II	РАЗРЕШ. ПРОГР. РАЗВОР.			ОРИЕНТ. СТАБИЛ. Т		КОНТРОЛЬ ТОННЕЛЯ	ДАВЛЕНИЕ СИО		17 18
11	ТЛФ РЕЖИМ	ДУПЛ. ВПУ	СЛИВ I		КИНО-КАМЕРА	КОНТР. ДАВЛЕН. КИР. КИНО	ОТР. КРЮКОВ	ПРИЗНАК СПУСК	ИНТЕГР.	ПОДГОТ. СТАБИЛ. ДУС			БКИП 2	КОНТР. ДАВЛЕНИЯ СТЫКА	ПОДГОТ. ВЫРАВИ.	НАДДУВ ДВИГАТЕЛЯ		19 20
12	АКУСТИКА ПОДКЛ.	ПОДГОТ. УКВ ПРД II	СЛИВ II	КОНДИЦ. СА	ОБНОВСЕТ	НАДДУВ ОМ	РАЗРЕШ. РАСТЯЖ.	ВЫБОР ТРЕКОС. ОРИЕНТ.	СЛОЛАЗ. СПУСК		СО				БЛОКИР. АПСС СНЯТА			21 22
13	ЧАСТОТА КВ ПРД I	УКВ. АЛМАК	АВТОМАТИКА КСС		ВАХИР. БАЛЛОН ОТКРЫТ		РЕЗЕРВ. СТР. ПАС. АПСС	ТЕМПО-ДАТЧИКИ ОТКЛ.	РАЗРЕШ. ОЧЕНУ.			АВАРИЙН. НАДДУВ СКДУ			КСД ТОННЕЛЯ			23 24
14	ЧАСТОТА I		РАЗДЕЛЕНИЕ		РЕГУЛИР. РАССОДА ОТКРЫТ	ЛОК-ЛАЗ ОТКРЫТ 1	ПЕРЕХОД. ЛОК. ЗАКРЫТ.	РАЗВОРОТ α, γ	СНТ						КОЛЫШО ВЫРАВИ.			25
15	ЧАСТОТА II		АВТОМЕРА		РЕГУЛИР. РАССОДА ЗАКРЫТ	ЛОК-ЛАЗ ОТКРЫТ 2	АКТИВ. ГОТОВ. АПСС	РАЗВОРОТ α, γ	НАДДУВ СКДУ						СЫЛКА			26
16	ЧАСТОТА III			ШТОРКА Т.К. ОТКРЫТА	ШТОРКА Т.К. ОТКРЫТА	ЛОК-ЛАЗ ОТКРЫТ 3		РАЗВОРОТ α, γ	ЗОНА Н						СТЫК СОВМЕЩ.			27
17	ЧАСТОТА IV			ШТОРКА Т.К. ЗАКРЫТА	ШТОРКА Т.К. ЗАКРЫТА		ПАССИВ. ГОТОВ. АПСС								СТЫК ОБЖАТ			28

РИСУНОК 5. Транспаранты КСУ
Figure 5. - CSD Control Lights.

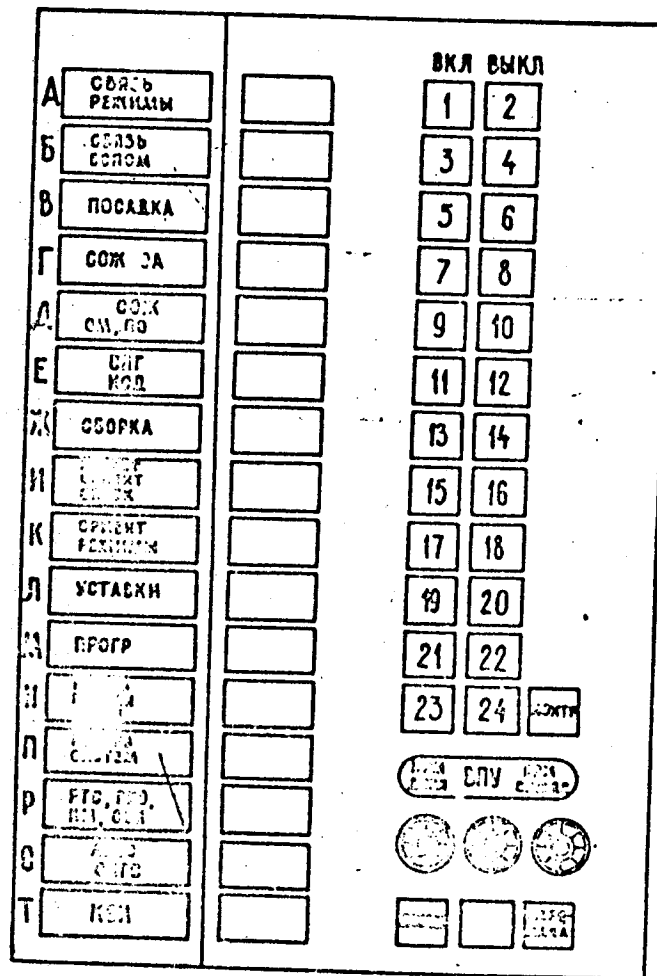
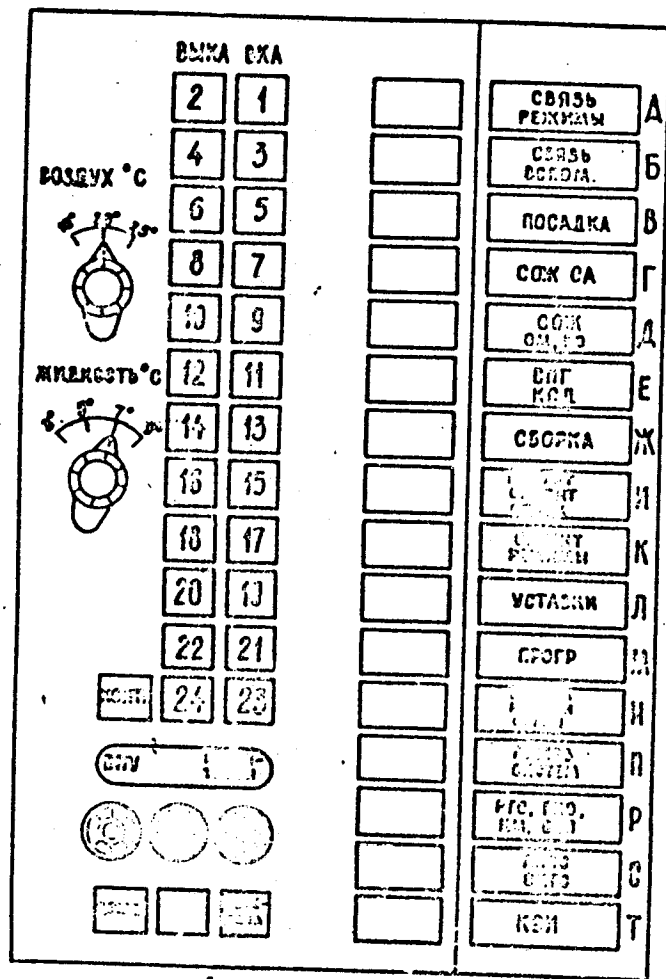
FIGURE 5* (CONT)

1-A	COMMUNICATION MODEL
2-A	PREP, VHF XMTR I
4-A	VHF SIMPLEX RCVR
5-A	VHF DUPLEX RCVD
6-A	PREP, VHF XMTR II
7-A	PREP, VHF XMTR I
9-A	DUPLEX VHF RCVR
10-A	SIMPLEX VHF RCVR
11-A	TELEPHONE MODE
12-A	CONNTCT ACOUSTICS
13-A	VHF XMTR I FREQUENCY
14-A	FREQUENCY I
15-A	FREQUENCY II
16-A	FREQUENCY III
17-A	FREQUENCY IV
1-B	AUXILIARY COMMUNICATION
2-B	COMMUNICATION CABLE SEPARATION
3-B	DESCENT VEHICLE ANTENNA JETTISON
5-B	MICROPHONE
6-B	SIMPLEX
7-B	DUPLEX
8-B	TELEGRAPH
9-B	BACKUP VHF XMTR II
10-B	BACKUP ACOUSTICS
11-B	DUPLEX INTERCOM

*THIS LIST CONTAINS A PARTIAL TRANSLATION OF THE COMMAND SIGNAL DEVICE SWITCHES SHOWN IN FIGURE 5.

12-B PREP. VHF XMTR II
13-B VHF BEACON
1-C LANDING
2-C
3-C RESPIRATORY VENT.
4-C DESCENT VEHICLE VENT. SPACE SUIT I
5-C
6-C
7-C
9-C LIGHT BEACON
10-C DESCENT VEHICLE VENT SPACE SUIT II
11-C
12-C
13-C
14-C SEPARATION
15-C ATMOSPHERE
1-D DESCENT VEHICLE LIFE SUPPORT SYSTEM
2-D TELEV. LIGHT.
3-D OPERATION LIGHT I
4-D OPERATION LIGHT II
6-D GAS - ANALYSIS
7-D CO₂ CONSUMP.
8-D
9-D DESCENT VEHICLE VENT.
12-D DESCENT VEHICLE AIR-CONDITIONING
16-D
17-D

1-E OM, EM LIFE SUPPORT SYSTEM
3-E
5-E EM VENT.
6-E OM CONDITIONING
7-E
8-E
9-E
10-E OPERATION LIGHT
11-E MOVIE CAMERA
12-E MOVIE LIGHT
13-E SHUT OFF VALVE OPEN
14-E FLOW REGULATOR OPEN
15-E FLOW REGULATOR CLOSED
16-E
17-E
1-F
3-F PERMISSION FOR PRESSURE DUMPING FROM OM
4-F OM PRESSURE DUMPING
5-F PRESSURE INTEGRITY MONITORING
6-F MEASURING MODE
7-F
8-F OM TV CAMERA
10-F
11-F
12-F OM PRESSURIZATION
14-F HATCH I OPEN

15-F HATCH 2 OPEN
16-F HATCH 3 OPEN
1-G ASSEMBLY
2-G RING EXTENSION
3-G CAPTURE LATCHES OPENING
4-G MANUAL APPROACH
5-G
6-G TV CAMERA REPORTING
7-G EXTERIOR TV CAMERA
8-G EXTERIOR TV CAMERA LENS, NARROW WIDE
9-G
10-G APPROACH SIGHTING DEVICE
11-G HOOKS OPENING
12-G PERMISSION FOR BACKUP UNDOCKING
13-G BACKUP PASSIVE HOOKS OPENING
14-G TRANSFER HATCH CLOSED
15-G
17-G

1-H PREPARATION FOR DESCENT ORIENTATION
 2-H SELECT 10 KG THRUSTERS
 3-H SELECT 1 KG THRUSTERS
 4-H SELECT DIRECTION (YAW, PITCH)
 5-H SELECT ION SENSOR (2 - 1)
 6-H PITCH FORWARD
 7-H PITCH BACKWARD
 8-H ORIENT PERISCOPE
 9-H INERTIAL ORIENTATION
 11-H DESCENT CONDITIONER
 12-H SELECT 3-AXIS ORIENTATION
 12-H THERMAL SENSOR SWITCH OFF
 14-H α_Z MANEUVER
 15-H α_Y MANEUVER
 16-H α_X MANEUVER
 1-I ATTITUDE MODES
 2-I MODES SWITCH OFF
 3-I RATE GYRO
 4-I MANUAL ORIENTATION
 5-I MINIMUM IMPULSE MANUAL ORIENTATION
 6-I ORBIT ORIENTATION ALONG X
 7-I ORBIT ORIENTATION ALONG Y
 8-I TEST ORIENTATION ALONG X
 9-I PREPARATION FOR INERTIAL I
 10-I PREPARATION FOR INERTIAL II
 11-I INTEGRATING ACCELEROMETER
 12-I SLIP MANEUVERS

13-I PERMISSION FOR INERTIAL ORIENTATION
 14-I ION CURRENT
 15-I PRESSURIZE CORRECTIVE ENGINES
 16-I ZONE H
 1-J SETTINGS
 2-J MANUAL SETTINGS
 3-J PREPARATION OF α_Z - RATE GYRO
 4-J PREPARATION OF α_Y - RATE GYRO
 5-J PREPARATION OF α_X - RATE GYRO
 6-J INITIAL CONFIGURATION
 7-J IMPULSIVE MAIN CORRECTIVE ENGINE
 8-J α_X AND PREPARATION OF α_Y
 10-J PERMISSION FOR PROGRAMMED TURN
 11-J PREPARE RATE GYROS
 1-K PROGRAMS
 2-K PROGRAM OFF
 3-K PROHIBIT COMMANDS TO THE CONTROL SYSTEM FROM THE TIMER
 4-K COMMUNICATION
 5-K DESCENT II
 6-K DESCENT WITH MANUAL ORIENTATION
 7-K AUTOMATIC MANEUVERS
 8-K MANEUVERS WITH MANUAL ORIENTATION
 9-K ORIENTATION AT THE SUN
 1-L RESERVE SYSTEM
 2-L RESERVE RCS
 3-L FUEL SUPPLY ISOLATION PYROVALVE
 4-L DO FUEL SUPPLY PYROVALVE
 5-L JOINT PRESSURIZATION PYROVALVE

6-L DPO FUEL SUPPLY PYROVALVE
7-L RESERVE PRESSURE PYROVALVE
8-L BACKUP CORRECTIVE ENGINE
13-L BACKUP PRESSURIZATION OF CORRECTIVE ENGINES
1-M RESERVE SYSTEM
2-M PERMANENT SYSTEM
4-M GYRO ASSEMBLY (RATE, FREE GYRO)
6-M BDUS FILTER
7-M BDUS COMPLEX (2 - 1)
8-M PULSE GENERATOR SETUP
9-M ORIENTATION STABILIZATION - X FORWARD
10-M ORIENTATION STABILIZATION - X BACKWARD

1-N

2-N

3-N

4-N

5-N I DEVIATION MATRIX

6-N II DEVIATION MATRIX

7-N

8-N

8-N

11-N DOCKING PRESSURE CONTROL

1-0

2-0

3-0 LATCHES CLOSING

4-0 RETRACTION

5-0 CLOSING HOOKS

6-0 UNDOCKING

7-0 DOCKING PRESSURIZATION

8-0 DOCKING INTERFACE PRESSURE INTEGRITY MONITORING

9-0

10-0 TUNNEL PRESSURE INTEGRITY MONITORING
11-0 PREPARATION FOR ALIGNMENT
12-0
13-0 TUNNEL PRESSURE RELIEF VALVE
14-0 GUIDE RING
15-0 CAPTURE
16-0 STRUCTURAL RING CONTACT
17-0 STRUCTURAL RING LATCHES PRELOADED
1-P
2-P
3-P ATMOSPHERE COMPOSITION
4-P LEAKAGE
5-P PITCH YAW
7-P
10-P
11-P PROPULSION SYSTEM PRESSURIZATION

ELECTROLUMINESCENT

INDICATOR

ЭЛЕКТРОЛЮМИНЕСЦЕНТНЫЙ СИГНАЛИЗАТОР (ЭЛС)



РИСУНОК 7. - ЭЛЕКТРОЛЮМИНЕСЦЕНТНЫЙ СИГНАЛИЗАТОР/ЭЛС/

Figure 7. - Electroluminescent Indicator.

PROGRAM MONITORING INDICATOR

ИНАДИКАТОР КОНТРОЛЯ ПРОГРАММ ИКП-С

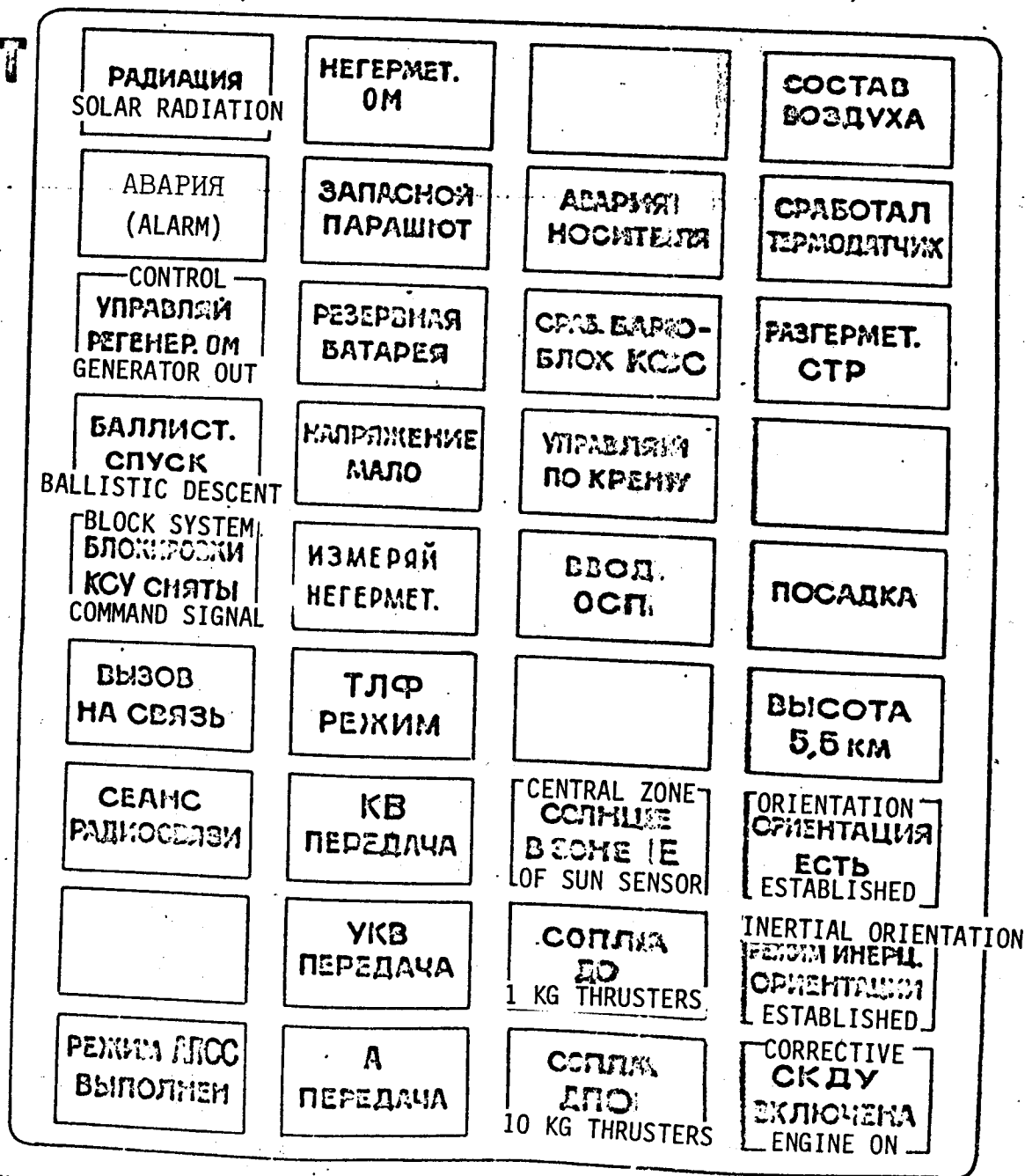
51

РИСУНОК 8. - ИНДИКАТОР КОНТРОЛЯ ПРОГРАММ ИКП-С

Figure 8. - Program Monitoring Indicator.

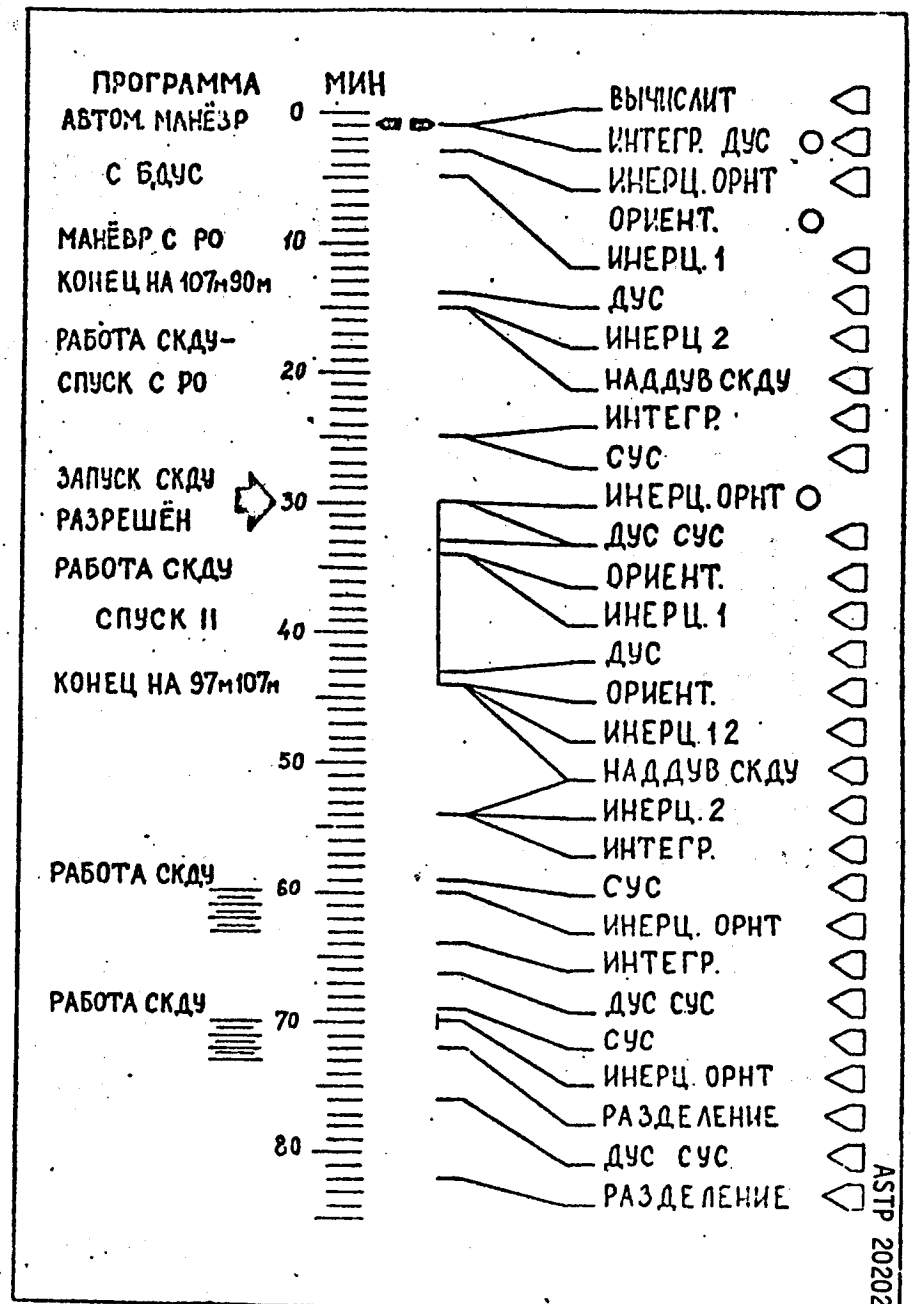

DIGITAL DISPLAY UNIT

БЛОК ЦИФРОВОЙ ИНДИКАЦИИ БЦИ2-



РИСУНОК 9. - БЛОК ЦИФРОВОЙ ИНДИКАЦИИ БЦИ2-М

Figure 9. - Digital Display Unit.

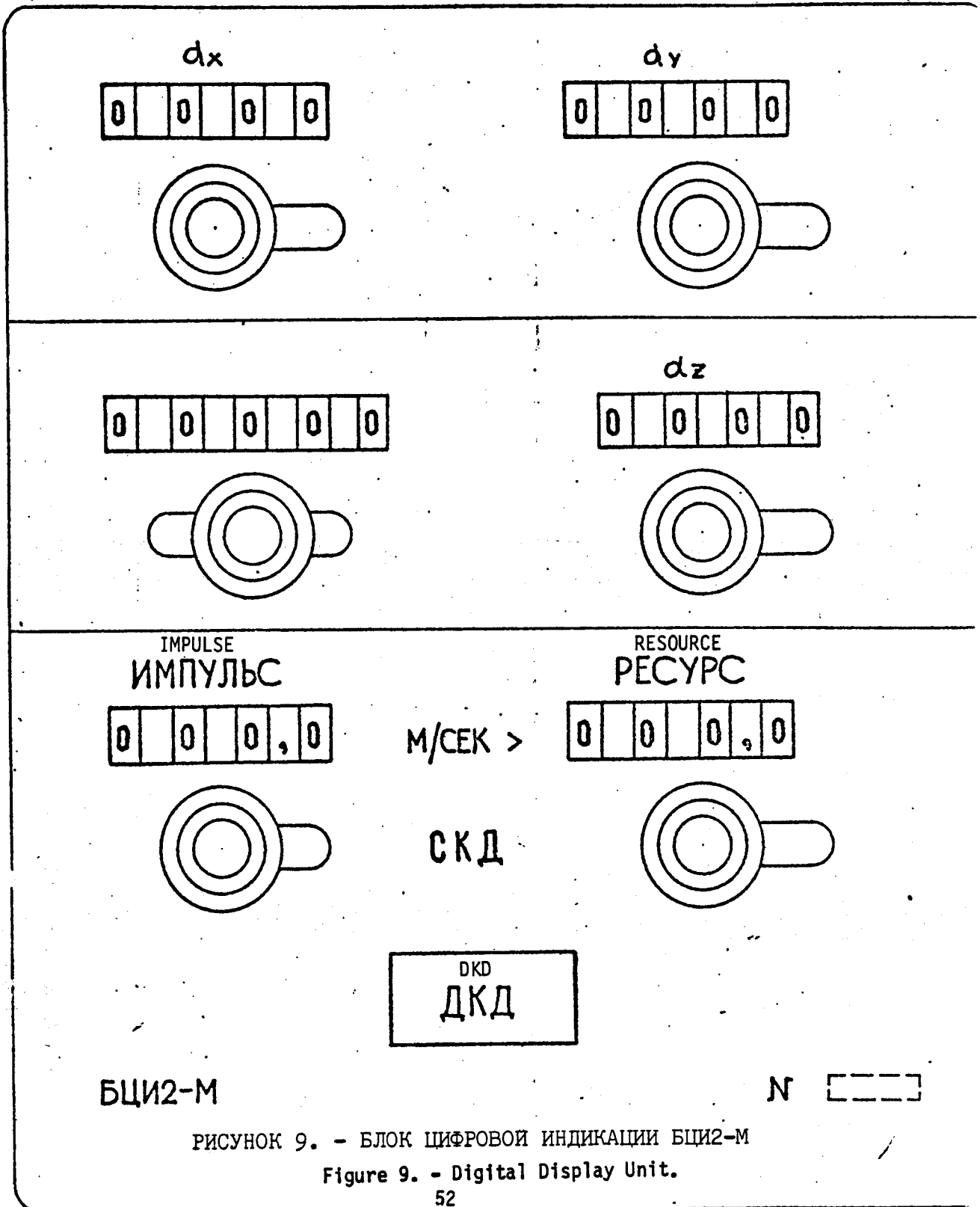
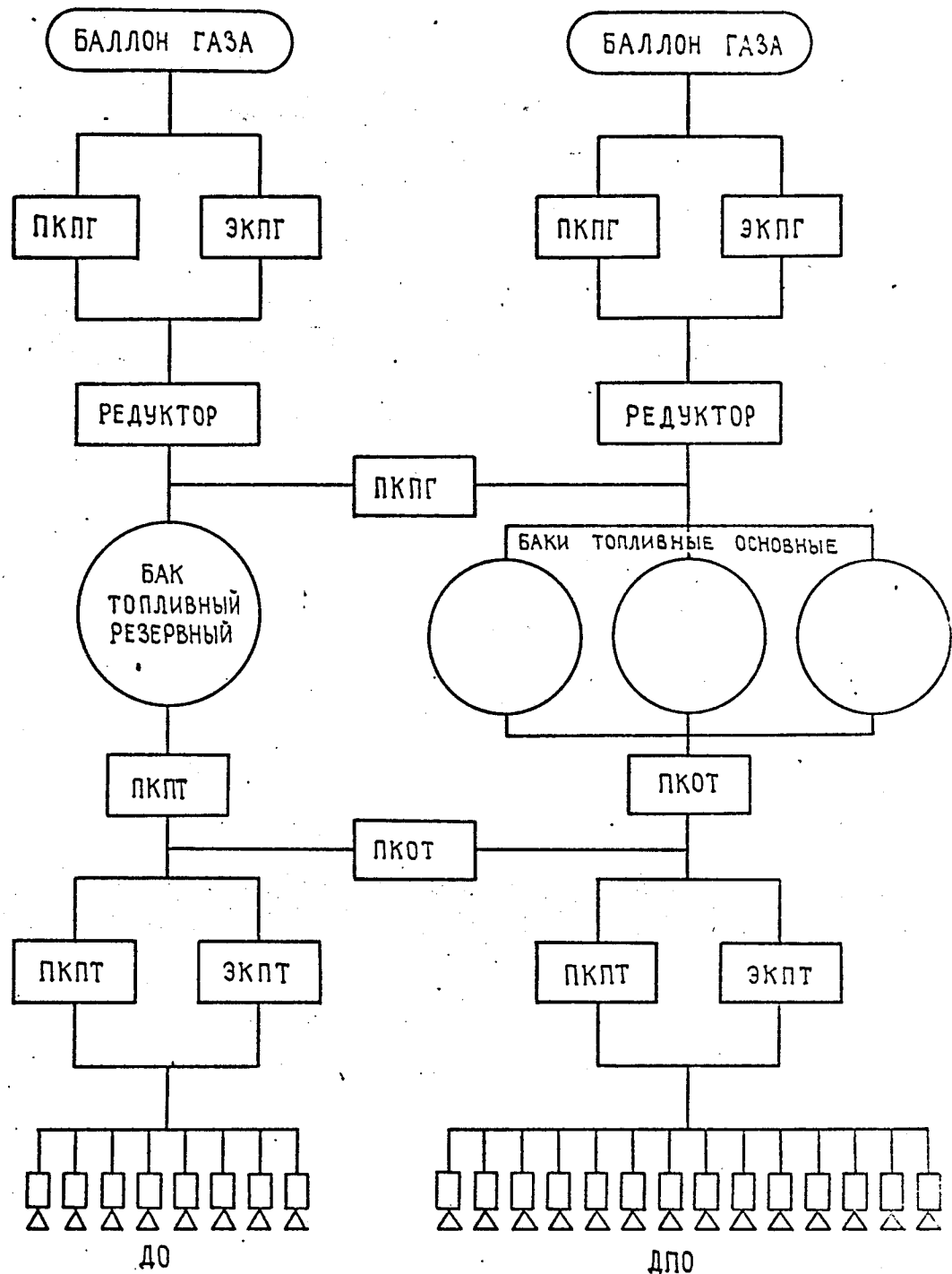

- ПКПГ - gas supply pyrovalve
- ЭКПГ - gas supply electrovalve
- ЭКПТ - fuel supply electrovalve
- ПКПТ - fuel supply pyrovalve
- ПКОТ - fuel cutoff electrovalve

РИСУНОК 10 Пневмогидравлическая схема СМО
 Figure 10. - Pneumohydraulic Diagram For

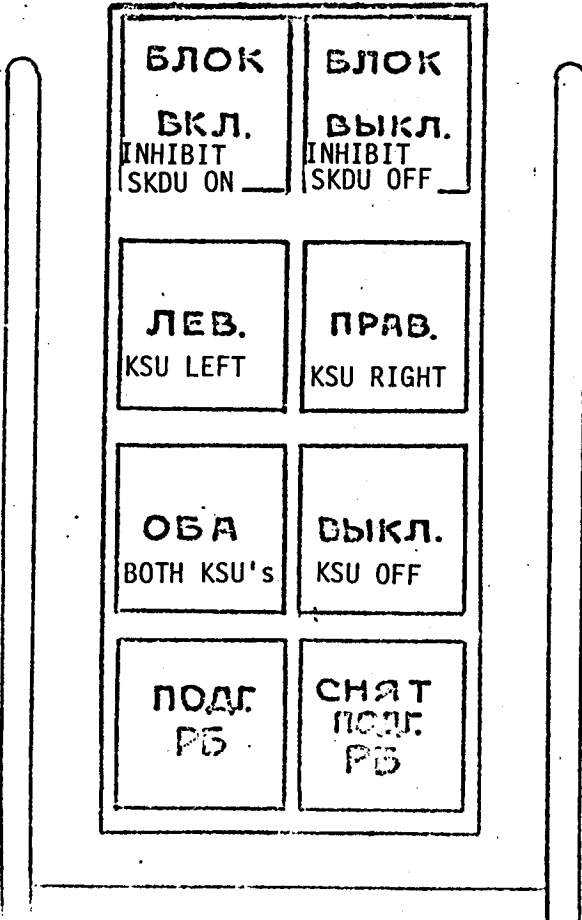
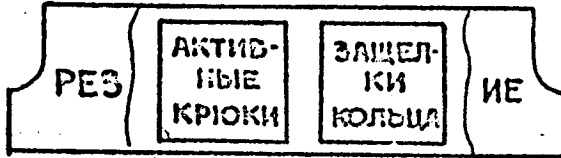

CRITICAL COMMANDS UNIT

БЛОК ОСОБО ВАЖНЫХ КОМАНД

РИСУНОК 11. - БЛОК ОСОБО ВАЖНЫХ КОМАНД

Figure 11. - Critical Commands Unit.

ГЛАВНЫЙ ПУЛЬТ ИНДИКАЦИИ
MAIN DISPLAY CONSOLE

ПАНЕЛЬ 2

УКАЗАТЕЛЬ ПОЛОЖЕНИЯ
КЛАВИШИ КОМПЬЮТЕРА
ИНДИКАТОРЫ СИСТЕМЫ ПРЕДУПРЕЖДЕНИЯ
УПРАВЛЕНИЕ СТЫКОВОЧНЫМ АГРЕГАТОМ
УПРАВЛЕНИЕ РСУ
УПРАВЛЕНИЕ СОЖ
УКАЗАТЕЛЬ ВРЕМЕНИ ПОЛЕТА

PANEL 2

ATTITUDE INDICATOR
COMPUTER KEYBOARD
C & W INDICATORS
DOCKING SYSTEM CONTROLS
RCS CONTROLS
ECS CONTROLS
MISSION TIMER

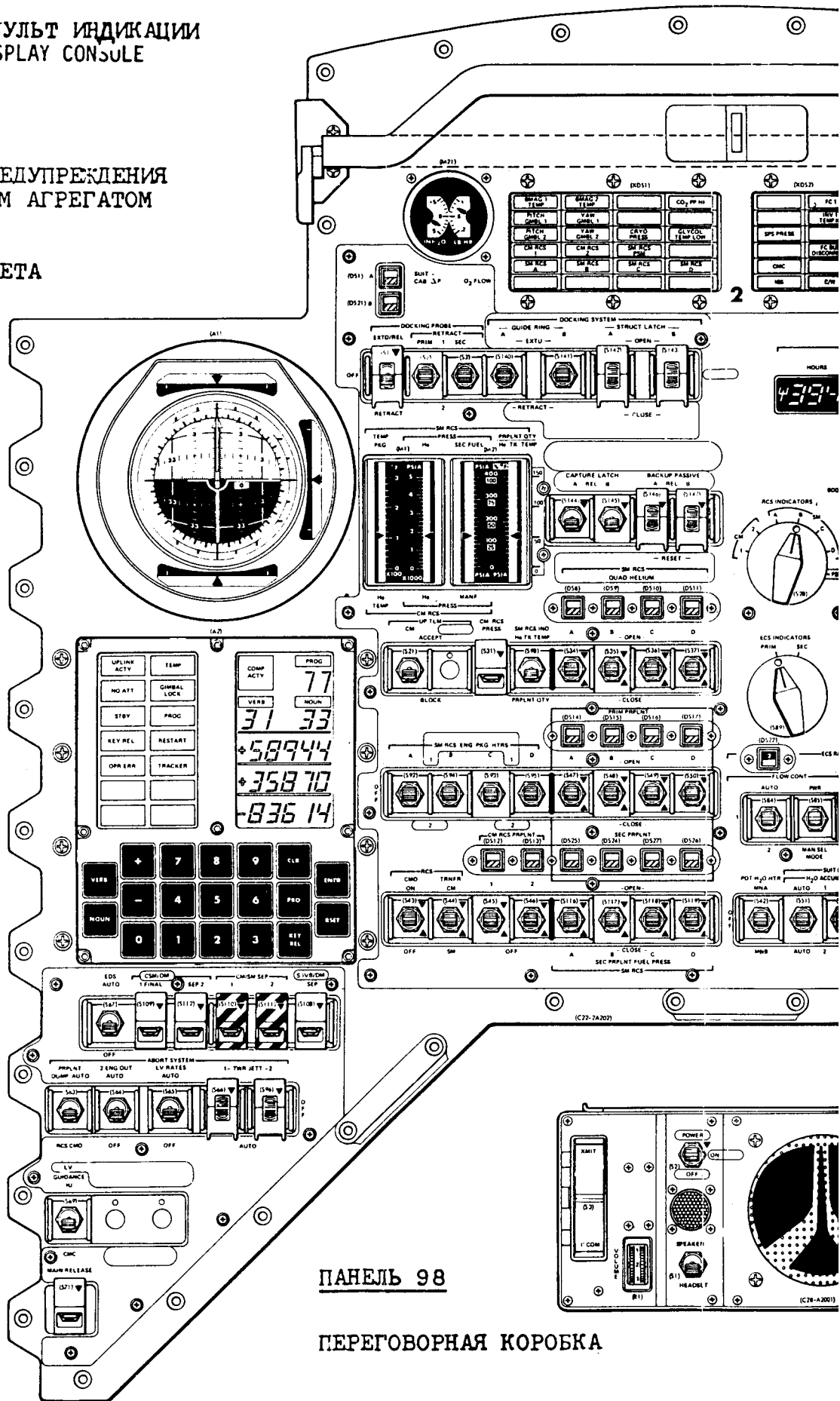

ПАНЕЛЬ 98

ПЕРЕГОВОРНАЯ КОРОБКА

РИС 4-14 ПУЛЬТ УПРАВЛЕНИЯ И ИНДИКАЦИИ

FIGURE 4-14 CSM 111 DISPLAYS AND CONTROLS

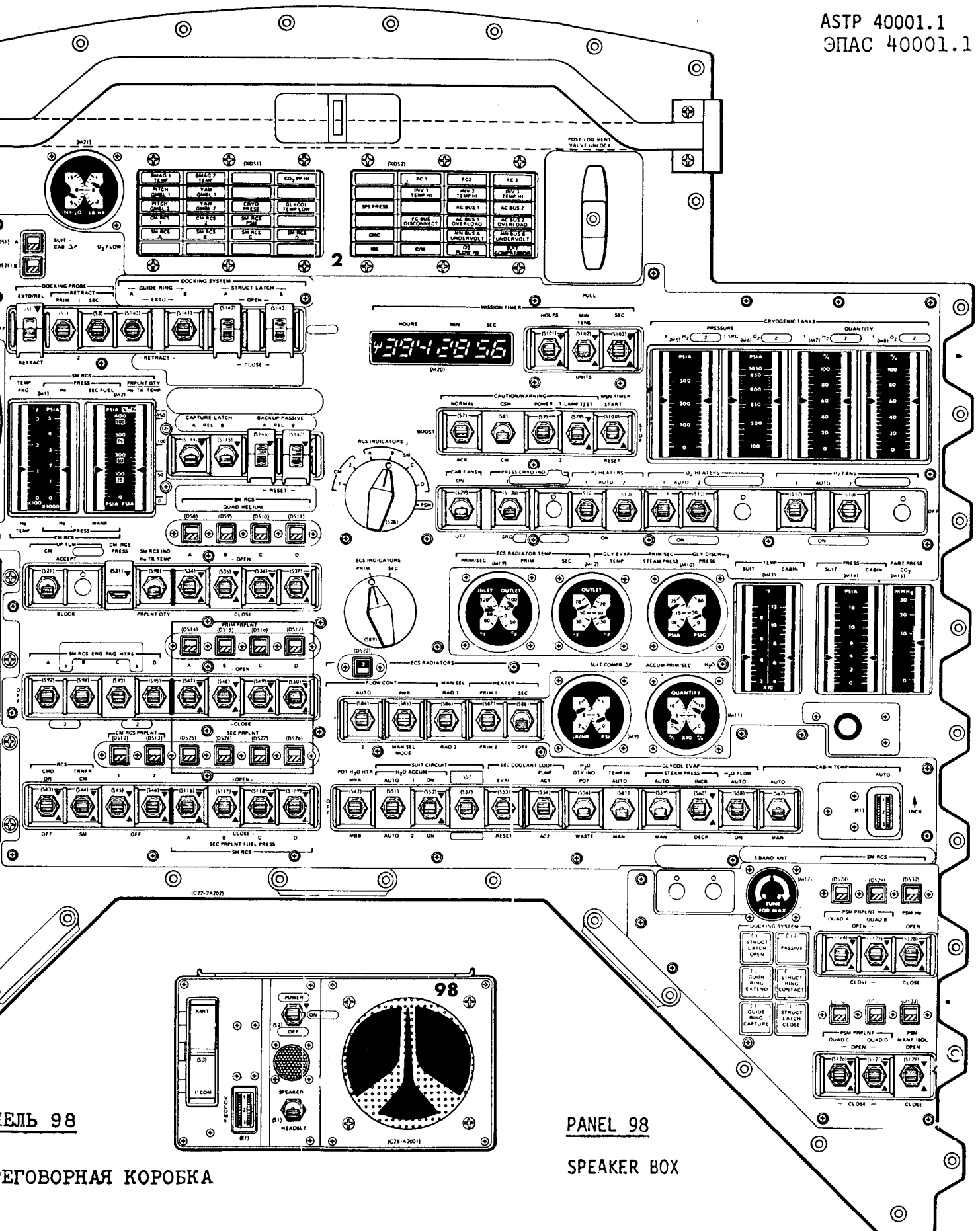

ПАНЕЛЬ 98

PANEL 98

РАЗГОВОРНАЯ КОРОБКА

SPEAKER BOX

РИС 4-14 ПУЛЬТ УПРАВЛЕНИЯ И ИНДИКАЦИИ КСМ 111 ЛИСТ 3 ИЗ 15

FIGURE 4-14 CSM 111 DISPLAYS AND CONTROLS PANELS (SHEET 3 OF 15)

DOCKING MODULE

СТЫКОВОЧНЫЙ МОДУЛЬ

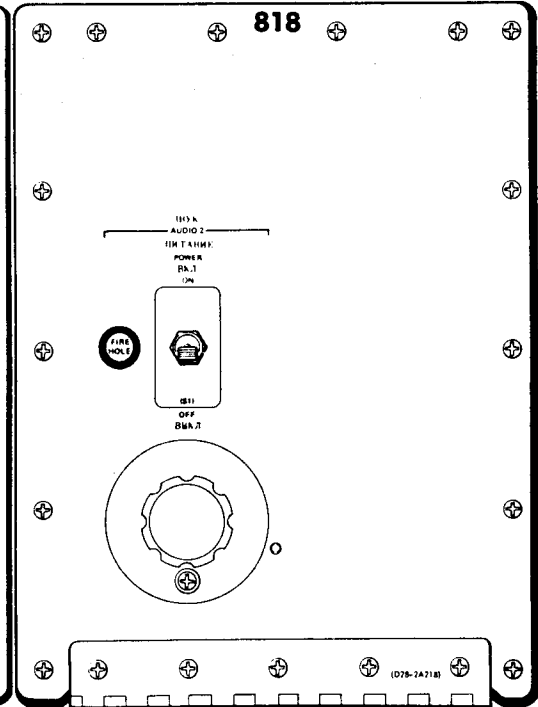
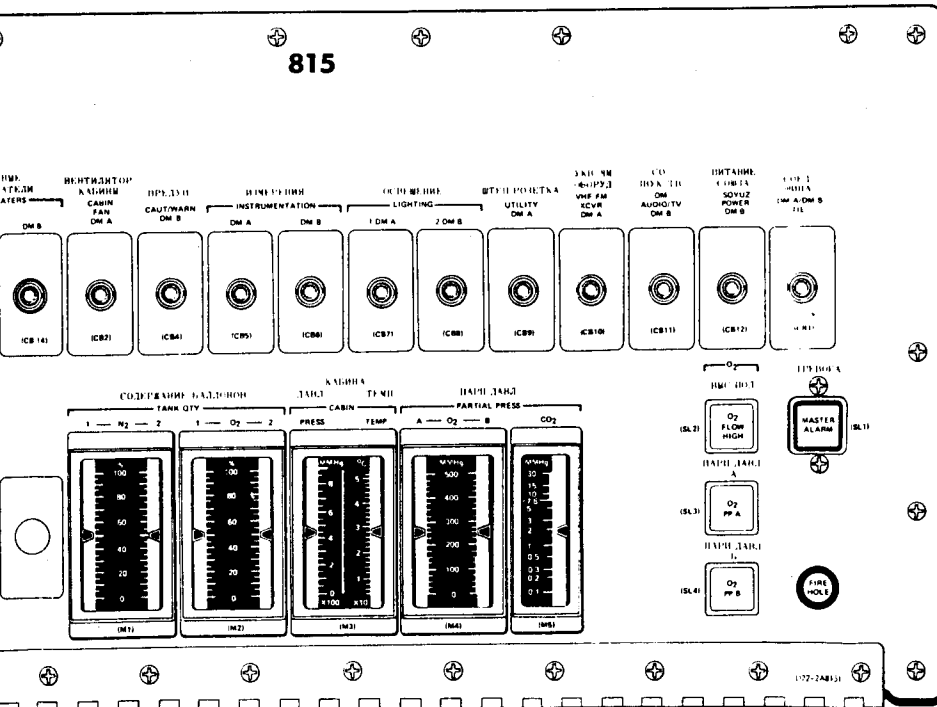
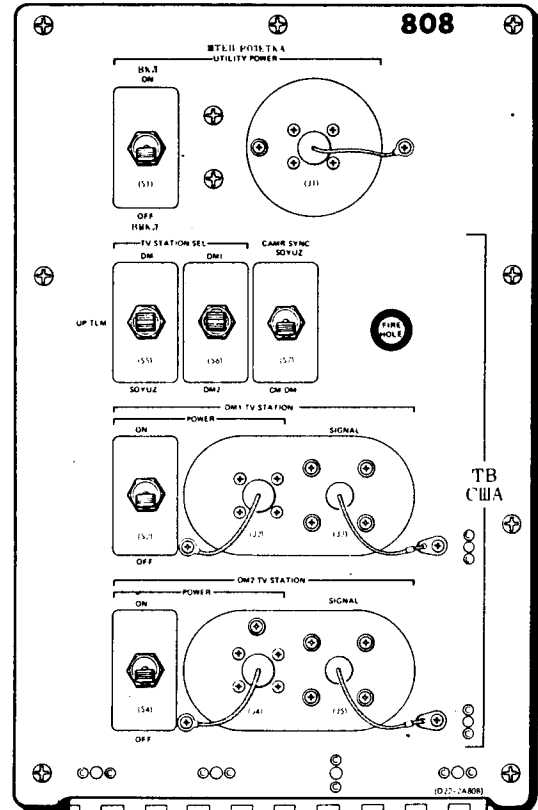
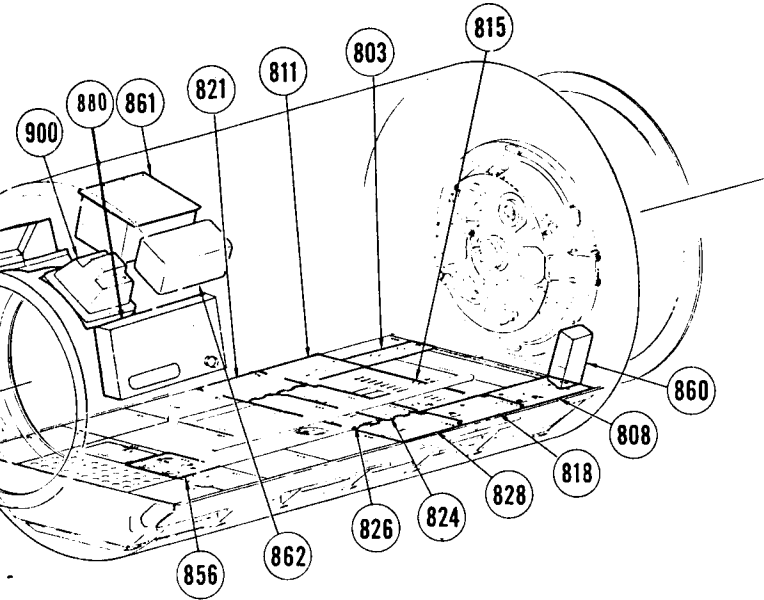
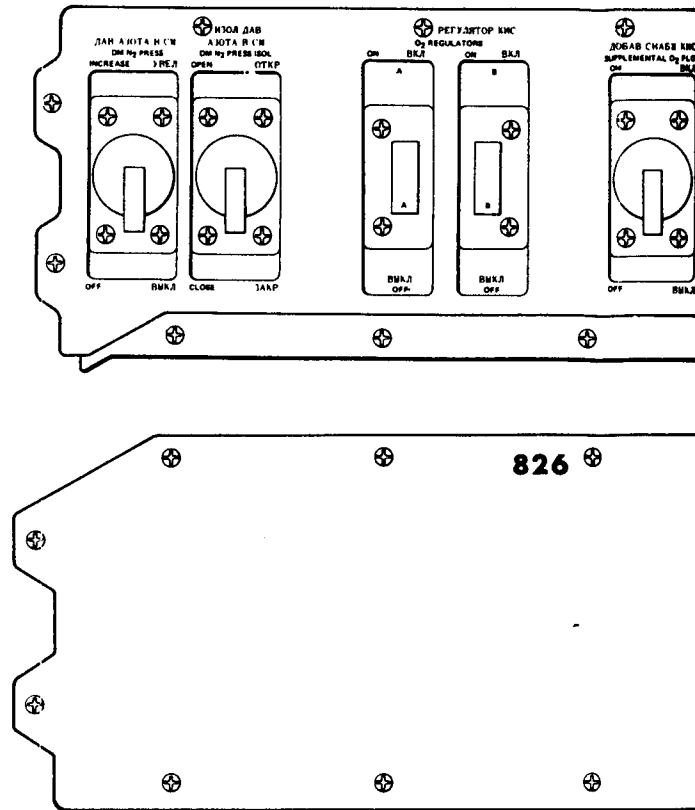
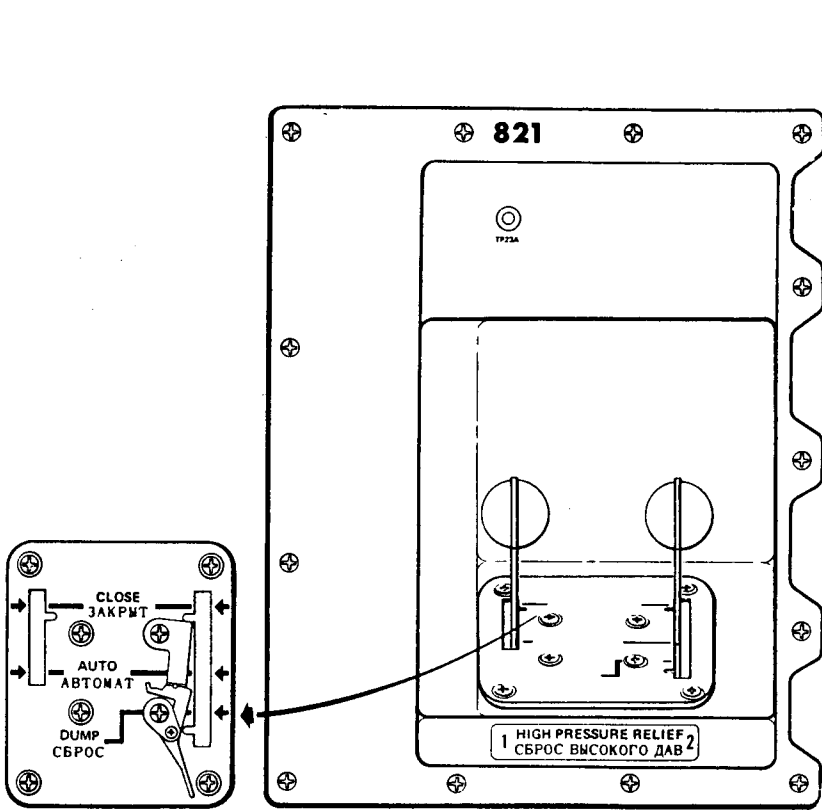

FIGURE 4-19 - Docking module display and control panels - sheet 1 of 3

РИС. 4-19 - Панели индикации и управления стыковочного модуля - Лист 1 из 3



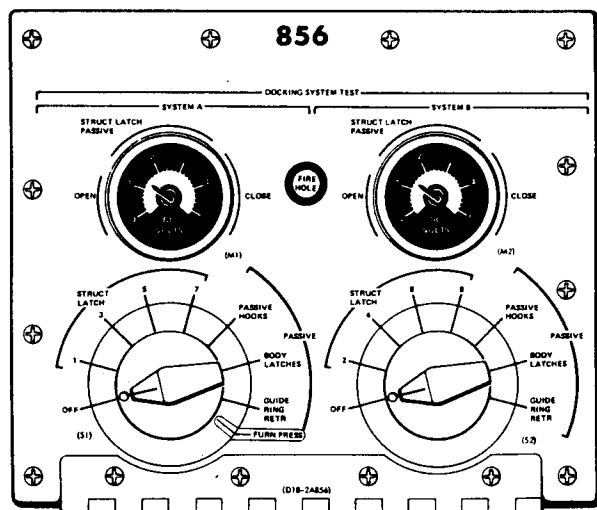
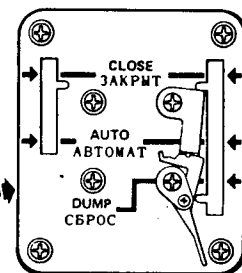
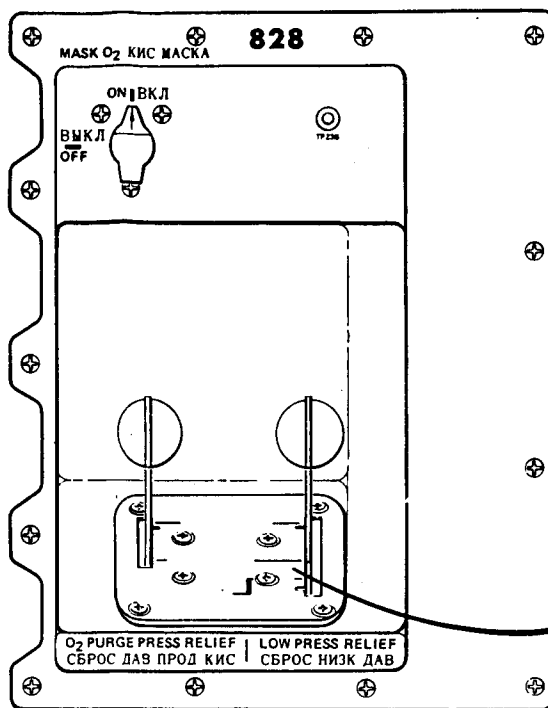
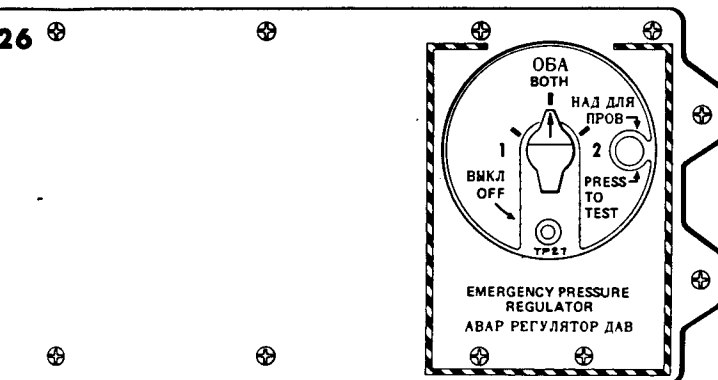
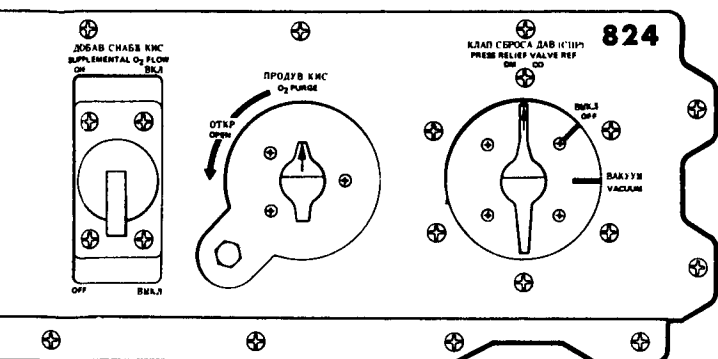

FIGURE 4-19 DOCKING MODULE DISPLAY AND CONTROL PANELS - sheet 2 of 3

РИС 4-19 - Панели индикации и управления стыковочного модуля - Лист 2 из 3

