

D5-15555-4C

FACILITY FORM 602

N69-77219 (THRU)

338 (PAGES)

CR# 15824 (NASA CR OR TMX OR AD NUMBER)

(CODE)

(CATEGORY)

SATURN V LAUNCH VEHICLE
EMERGENCY DETECTION SYSTEM ANALYSIS,
SA-504

JANUARY 28, 1969

THE **BOEING** COMPANY ■ SPACE DIVISION

DOCUMENT NO. D5-15555-4C

TITLE SATURN V LAUNCH VEHICLE EMERGENCY DETECTION SYSTEM
ANALYSIS, SA-504

MODEL NO. SATURN V CONTRACT NO. NAS8-5608, SCHEDULE II,
PART IIA, EXHIBIT CC,
TASK 8.1.5, DRL 049,
ITEM 151

PREPARED BY:
SATURN V FLIGHT SYSTEMS ANALYSIS

ORIGINAL RELEASE - JUNE 17, 1968
REVISION C - JANUARY 28, 1969



S. C. Krausse

S. C. KRAUSSE
SECTION MANAGER
FLIGHT SYSTEMS ANALYSIS

ISSUE NO. H-110

ISSUED TO *NASA Scientific &
Tech. Information Facility*

REVISIONS

REV. SYM	DESCRIPTION	DATE	APPROVED
A	<p>Incorporated revisions, additions and corrections on chi-freeze schedule, loss of inertial velocity, S-II single engine out, S-IC dual engine out, P.U. malfunctions, RCS illustration, T_{2j}, Reference 23, Pages: Title Page, ii, iv, v, xii, xiii, xiv, 1-10, 1-11, 1-12, 1-13, 1-14, 1-15, 1-16, 1-17, 1-18, 1-19, 1-20, 1-21, 1-22, 1-23, 1-24, 2-17, 2-67, 2-78, 2-82, 2-92, 2-93, 2-96, 2-97, 2-148, 2-151, 2-152, 2-153, 2-193</p>	9/13/68 For	 S. C. Krausse
B	<p>Complete revision that incorporated updated data including operational trajectory, 2° S-IC engine cant, structural capability, spacecraft structural dynamic characteristics, aerodynamic flow separation, S-II aerodynamics, TOPS engine shut-down. Added early staging analysis.</p>	1/13/69	 S. C. Krausse
C	<p>Revised EDS abort cues, malfunction summary, contingency plan, event times in S-II dual engine failure analysis, and pad fallback and tower collision analysis. Also add ft/sec scale to FDO plots. Pages: Title Page, ii, viii, ix, 1-5, 1-7, 1-9, 1-11, 1-12, 1-14, 1-16, 1-19, 1-20, 1-21, 1-23, 1-24, 1-25, 2-6, 2-53, 2-54, 2-55, 2-57, 2-58, 2-60, 2-62, 2-63, 2-64, 2-65, 2-66, 2-68, 2-102, 2-103, 2-104, 2-107, 2-125, 2-126, 2-129, 2-130, 2-133, 2-135, 2-136, 2-142, 2-145, 2-148, 2-152, 2-173, 2-190, 2-213, 2-214, 2-217, 2-236, 2-237,</p>	1/28/69	 S. C. Krausse

REVISIONS

REV. SYM	DESCRIPTION	DATE	APPROVED
C	2-238, 2-244, 2-245, 2-246, 2-247, 2-255, 2-272, 2-273, 2-274, 2-275. Added pages: ii.1, 2-192.1, 2-192.2.		

ABSTRACT AND LIST OF KEY WORDS

This report presents the Emergency Detection System (EDS) study results and recommendations for the Saturn V (SA-504) launch vehicle. The results include an assessment of the vehicle flight dynamics and structural integrity for malfunctions during S-IC, S-II, and S-IVB burns.

Vehicle loss is assessed for various types of malfunction and inflight wind conditions. EDS sensors and limit settings are defined for manual and automatic abort modes. Crew safety is assessed for these EDS limits.

KEY WORDS

Saturn V/Apollo Vehicle
Emergency Detection System
Abort
Flight Dynamics
Malfunctions
Structural Integrity
Vehicle Loss
Crew Safety

TABLE OF CONTENTS

PARAGRAPH		PAGE
	REVISIONS	ii
	ABSTRACT AND LIST OF KEY WORDS	iii
	TABLE OF CONTENTS	iv
	ILLUSTRATIONS	v
	REFERENCES	xiii
	SOURCE DATA PAGE	xv
	 SECTION 1 - SUMMARY	 1-1
1.0	INTRODUCTION	1-1
1.1	SUMMARY OF EDS LIMITS	1-3
1.2	MALFUNCTION FLIGHT CAPABILITY	1-3
1.3	EDS EFFECTIVENESS SUMMARY	1-4
1.4	RECOMMENDATIONS - S-IC FLIGHT	1-15
1.5	RECOMMENDATIONS - S-II FLIGHT	1-19
1.6	RECOMMENDATIONS - S-IVB FLIGHT	1-23
	 SECTION 2 - ANALYSIS	 2-1
2.0	INTRODUCTION	2-1
2.1	CRITERIA	2-2
2.2	PARAMETERS	2-10
2.3	MALFUNCTION DESCRIPTION	2-18
2.4	MODES OF VEHICLE LOSS	2-42
2.5	CONTINGENCY PLAN	2-48
2.6	EVALUATION OF THE BASELINE VEHICLE	2-69
2.7	EDS LIMIT SETTINGS	2-238
2.8	EDS EFFECTIVENESS	2-255
2.9	FLIGHT DYNAMICS OFFICER DATA FOR MALFUNCTION FLIGHT	2-261
	 APPENDIX A - SIMULATION DESCRIPTION	 A-1

ILLUSTRATIONS

FIGURE		PAGE
1-1	S-IC Malfunction Summary	1-7
1-2	S-II Malfunction Summary	1-9
1-3	S-IVB Malfunction Summary	1-11
1-4	S-IC Malfunctions Causing Possible Crew Loss	1-14
1-5	Recommended S-IC EDS Parameters and Limit Settings	1-16
1-6	Recommended S-II EDS Parameters and Limit Settings	1-20
1-7	Recommended S-IVB EDS Parameters and Limit Settings	1-24
2-1	LEV Initial Angle-of-Attack Limit	2-4
2-2	Abort Lead Time Requirements	2-6
2-3	Command Module and Launch Vehicle Trajectories Following Abort	2-7
2-4	Saturn V AS-504 S-IC/S-II Staging Limits - Dynamic Perturbations	2-8
2-5	Saturn V AS-504 S-IC/S-II Staging Limits - Trajectory Perturbations	2-9
2-6	Percentiles of 10-14 KM Head and Tail Wind Components (Non-Bias Months)	2-11
2-7	Percentiles of 10-14 KM Right and Left Cross Wind Components (Non-Bias Months)	2-12
2-8	Percentiles of 10-14 KM Right and Left Cross Wind Components (Wind Bias Months)	2-13
2-9	Percentiles of 10-14 KM Head and Tail Wind Components (Wind Bias Months)	2-14
2-10	Cases Evaluated for EDS Wind Criteria	2-17
2-11	Saturn V Guidance and Control Failure Modes	2-19
2-12	Thrust at Thrust OK Pressure Switch (TOPS) Dropout	2-20
2-13	Predicted F-1 Engine Thrust Decay Following TOPS Dropout	2-21
2-14	S-II Predicted J-2 Engine Thrust Decay	2-23
2-15	S-IVB Predicted J-2 Engine Thrust Decay	2-24
2-16	AS-504 Present and Suggested Chi Freeze Schedules for Engine Failures During S-IC Flight	2-25
2-17	Effect of Abort Delay on Angle of Attack at CM/SM Separation	2-45
2-18	Typical Pitch Attitude for Guidance Failure	2-46
2-19	Typical Height - Velocity for Guidance Failure	2-47
2-20	Engine Cant	2-73
2-21	Time History of Dynamic Variables for Actuator Hardover	2-74

ILLUSTRATIONS

FIGURE		PAGE
2-22	Actuator Hardover Control Capability - Short Throw	2-75
2-23	Actuator Hardover Control Capability - Long Throw	2-76
2-24	Control Capability - No. 1 Actuator Hardover (+ $\beta P1$)	2-77
2-25	Control Capability - No. 1 Actuator Hardover (- $\beta P1$)	2-78
2-26	Control Capability - No. 1 Actuator Hardover (+ $\beta Y1$)	2-79
2-27	Control Capability - No. 1 Actuator Hardover (- $\beta Y1$)	2-80
2-28	Control Capability - No. 2 Actuator Hardover (+ $\beta P2$)	2-81
2-29	Control Capability - No. 2 Actuator Hardover (- $\beta P2$)	2-82
2-30	Control Capability - No. 2 Actuator Hardover (+ $\beta Y2$)	2-83
2-31	Control Capability - No. 2 Actuator Hardover (- $\beta Y2$)	2-84
2-32	Control Capability - No. 3 Actuator Hardover (+ $\beta P3$)	2-85
2-33	Control Capability - No. 3 Actuator Hardover (- $\beta P3$)	2-86
2-34	Control Capability - No. 3 Actuator Hardover(+ $\beta Y3$)	2-87
2-35	Control Capability - No. 3 Actuator Hardover (- $\beta Y3$)	2-88
2-36	Control Capability - No. 4 Actuator Hardover (+ $\beta P4$)	2-89
2-37	Control Capability - No. 4 Actuator Hardover (- $\beta P4$)	2-90
2-38	Control Capability - No. 4 Actuator Hardover (+ $\beta Y4$)	2-91
2-39	Control Capability - No. 4 Actuator Hardover (- $\beta Y4$)	2-92
2-40	Pitch Actuator Response to An S-II Actuator Hardover	2-94
2-41	Effect of Platform Malfunction "B" at 170 Seconds	2-99
2-42	Time History of Dynamic Variables for Saturated Control Signal	2-101
2-43	Vehicle Pitch Rate Vs. Time with Saturated Control System in S-II and S-IVB	2-104
2-44	Vehicle Pitch Rate Vs. Time with Saturated Control System in S-II and S-IVB	2-104

ILLUSTRATIONS

FIGURE		PAGE
2-45	Time History of Dynamic Variables for a Single Engine Out	2-108
2-46	Engine-Out Control Capability	2-109
2-47	No. 1 Engine-Out Capability During S-IC Flight	2-110
2-48	No. 2 Engine-Out Capability During S-IC Flight	2-111
2-49	No. 3 Engine-Out Capability During S-IC Flight	2-112
2-50	No. 4 Engine-Out Capability During S-IC Flight	2-113
2-51	CSM Joint Load Envelope Due to S-IC Control Engine Out	2-114
2-52	CSM Joint Bending Moment Time History	2-115
2-53	Envelope of Spacecraft Loads - Engine Out No Loss of Control	2-118
2-54	Envelope of Combined Tensile Loads with a Single Engine Out - No Loss of Control	2-119
2-55	Envelope of Combined Compressive Loads with a Single Engine Out - No Loss of Control	2-120
2-56	Envelope of Resultant Bending Moment with a Single Engine Out - No Loss of Control	2-121
2-57	Pitch Command for S-II Single Engine Failure	2-124
2-58	Payload at POI Vs. S-IC/S-II Early Staging Time	2-125
2-59	FDO Plotboard for S-IC/S-II Staging at 100 Seconds	2-129
2-60	Pitch Attitude for S-IC/S-II Staging at 100 Seconds	2-130
2-61	Critical Regions for S-II Simultaneous Dual Engine Malfunction	2-133
2-62	S-IVB Commanded Attitude After S-II Dual Engine Out	2-135
2-63	Pitch Rate Histories for Controllable and Non-Controllable Dual S-II Engine Failures	2-136
2-64	Typical Commanded Attitude History for Loss of Control Subsequent to a Dual S-II Engine Malfunction	2-138
2-65	Typical Attitude History for Loss of Control Subsequent to S-II Dual Engine Malfunction	2-139
2-66	Attitude History Plot Showing Deviation Between Actual and Commanded Attitudes for Loss of Control	2-140

ILLUSTRATIONS

FIGURE		PAGE
2-67	Engine Yaw Deflection After S-II Dual Engine Out	2-141
2-68	Flight Path Angle for S-IVB Guidance Failure After S-II Engine Failures	2-142
2-69	Typical Divergence of Time to go (T_{3j}) for S-IVB Guidance Subsequent to a Dual S-II Engine Failure	2-143
2-70	Critical Regions for S-II Sequential Dual Engine Malfunction	2-145
2-71	Effect of Sequential Engines Out on Guidance Profile	2-146
2-72	Effect of Sequential Engine Out on Pitch Attitude	2-147
2-73	Typical Loss of Control Effect on Flight Path Angle	2-148
2-74	Effect of Sequential S-II Engines Out on Height - Velocity	2-149
2-75	S-IVB Pitch Command After S-II Sequential Dual Engine Out	2-150
2-76	S-IVB Pitch Attitude After S-II Sequential Dual Engine Out	2-151
2-77	Flight Path Angle - Velocity for S-II Sequential Dual Engine Out	2-152
2-78	Height - Velocity for S-II Sequential Dual Engine Out	2-153
2-79	Pitch Rate Recovery Transient - Early S-II/S-IVB Staging Resulting in Loss of Control	2-157
2-80	Pitch Error Recovery Transient - Early S-II/S-IVB Staging Resulting in Loss of Control	2-158
2-81	Pitch Attitude and Command - Early S-II/S-IVB Staging Resulting in Loss of Control	2-159
2-82	S-IVB Pitch Actuator Response - Early S-II/S-IVB Staging Resulting in Loss of Control	2-160
2-83	Pitch Attitude and Command - Early S-II/S-IVB Staging Regaining Control	2-161
2-84	S-IVB Actuator Response - Early S-II/S-IVB Staging Regaining Control	2-162
2-85	Pitch Error Recovery Transient - Early S-II/S-IVB Staging Regaining Control	2-163
2-86	Pitch Rate Recovery Transient - Early S-II/S-IVB Staging Regaining Control	2-164

ILLUSTRATIONS

FIGURE		PAGE
2-87	S-IVB Yaw Actuator Response - Early S-II/S-IVB Staging Resulting in Loss of Control	2-165
2-88	Yaw Error Recovery Transient - Early S-II/S-IVB Staging Resulting in Loss of Control	2-166
2-89	Yaw Attitude and Command - Early S-II/S-IVB Staging Resulting in Loss of Control	2-167
2-90	Yaw Rate Recovery Transient - Early S-II/S-IVB Staging Resulting in Loss of Control	2-168
2-91	Yaw Attitude and Command - Early S-II/S-IVB Staging Regaining Control	2-169
2-92	S-IVB Yaw Actuator Response - Early S-II/S-IVB Staging Regaining Control	2-170
2-93	Yaw Error Recovery Transient - Early S-II/S-IVB Staging Regaining Control	2-171
2-94	Yaw Rate Recovery Transient - Early S-II/S-IVB Staging Regaining Control	2-172
2-95	Tension Load at Sta. 1564 (Actuator Hardover)	2-173
2-96	Tension Load at Sta. 1760 (Actuator Hardover)	2-174
2-97	Tension Load at Sta. 2746 (Actuator Hardover)	2-175
2-98	Tension Load at Sta. 2832 Aft (Actuator Hardover)	2-176
2-99	Tension Load at Station 1564 (Single Engine Out)	2-177
2-100	Tension Load at Station 1760 (Single Engine Out)	2-178
2-101	Tension Load at Station 2746 (Single Engine Out)	2-179
2-102	Tension Load at Station 2832 Aft (Single Engine Out)	2-180
2-103	Tension Load at Station 1564 (Saturated Control Signal)	2-181
2-104	Tension Load at Station 1760 (Saturated Control Signal)	2-182
2-105	Tension Load at Station 2746 (Saturated Control Signal)	2-183
2-106	Tension Load at Station 2832 Aft (Saturated Control Signal)	2-184
2-107	S-II and S-IVB Worst Case Abort Tension Loads Summary	2-187
2-107.1	Summary of Malfunctions Requiring Near-Pad Abort	2-192.1

ILLUSTRATIONS

FIGURE		PAGE
2-108	Vehicle Response to No. 1 or No. 2 Engine Out Prior to 5.25 Seconds with 95 Percentile, 180° Wind	2-194
2-109	Time from Single Engine Failure to Collision	2-195
2-110	Collision with Hold Down Posts Due to Engine No. 2 Out	2-196
2-111	Pitch Phase Plane Plot for No. 2 Engine Out at .97 Seconds	2-197
2-112	Yaw Phase Plane Plot for No. 2 Engine Out at .97 Seconds	2-198
2-113	Roll Phase Plane Plot for No. 2 Engine Out at .97 Seconds	2-199
2-114	Vehicle Response to No. 2 Yaw Actuator Failure Prior to 2.7 Seconds with 95 Percentile, 180° Wind	2-200
2-115	Time from Single Actuator Failure to Collision	2-201
2-116	Yaw Phase Plane Plot for No. 2 Actuator Hardover (+ Yaw) at 0.59 Seconds	2-202
2-117	Roll Phase Plane Plot for No. 2 Actuator Hardover (+ Yaw) at 0.59 Seconds	2-203
2-118	Pitch Phase Plane Plot for Saturated Control Signal (+ Yaw) at 1.2 Seconds	2-204
2-119	Yaw Phase Plane Plot for Saturated Control Signal (+ Yaw) at 1.2 Seconds	2-205
2-120	Roll Phase Plane Plot for Saturated Control Signal (+ Yaw) at 1.2 Seconds	2-206
2-121	Pitch Phase Plane Plot for Saturated Control Signal (+ Pitch) at 5.9 Seconds	2-207
2-122	Yaw Phase Plane Plot for Saturated Control Signal (+ Pitch) at 5.9 Seconds	2-208
2-123	Roll Phase Plane Plot for Saturated Control Signal (+ Pitch) at 5.9 Seconds	2-209
2-124	Time History of Dynamic Variables for a Loss of Attitude Error at 75 Seconds	2-211
2-125	S-II Loss of Pitch Rate Signal	2-214
2-126	S-II Loss of Roll Rate Signal	2-215
2-127	S-IVB Loss of Pitch Rate Signal	2-217
2-128	S-IVB Pitch (Yaw) First Bending Mode Gain Margin (LET Jettison Failure)	2-219
2-129	Separation Clearance During S-IC/S-II Staging	2-224
2-130	S-II Separation Distance Histories	2-225
2-131	Effect of No Retro Rocket Fire on S-II/S-IVB Separation at Staging	2-227

ILLUSTRATIONS

FIGURE		PAGE
2-132	Separation Clearance During S-II/S-IVB Staging	2-228
2-133	S-IVB Attitude Errors During Loss of One APS Module in Parking Orbit	2-232
2-134	Time History of Dynamic Variables for Actuator Hardover with AS-501 T-0 Wind	2-235
2-135	Time History of Dynamic Variables for Actuator Hardover with AS-502 T-0 Wind	2-236
2-136	Time History of Dynamic Variables for Actuator Hardover with AS-503 T-11 Wind	2-237
2-137	O-Ball Pressure for S-IC Flight	2-240
2-138	Attitude Rate Envelopes for S-IC Flight	2-241
2-139	Attitude Error Envelopes for S-IC Flight	2-242
2-140	Typical $\Delta P\alpha$ History for an Early Engine Out	2-243
2-141	S-II Cross Plot of Yaw Error vs. Yaw Rate	2-245
2-142	S-IVB First Burn Cross Plot of Yaw Error Vs. Yaw Rate	2-246
2-143	S-IVB Second Burn Cross Plot of Yaw Error Vs. Yaw Rate	2-247
2-144	S-II False Abort Factor - Attitude	2-248
2-145	S-II False Abort Factor - Rate	2-249
2-146	S-IVB False Abort Factor - Attitude	2-250
2-147	S-IVB False Abort Factor - Rate	2-251
2-148	S-II Body Rates for Malfunctions	2-253
2-149	S-IVB Body Rates for Malfunction	2-254
2-150	Lead Times for Abort After an Engine Out	2-256
2-151	Lead Times for Abort After an Actuator Hardover	2-257
2-152	Lead Times for Abort After a Saturated Control Signal	2-258
2-153	Minimum Time from Malfunction to Abort - Upper Stages	2-260
2-154	FDO Plotboard for S-IC Engine Malfunctions	2-272
2-155	FDO Plotboard Display for S-II Engine Malfunctions	2-273
2-156	FDO Plotboard for S-II Malfunctions	2-274
A-1	Coordinate Systems	A-9

TABLES

		PAGE
1-I	AS-504 EDS Manual Abort Cues and Limits Summary	1-5
1-II	AS-504 EDS Automatic Abort Cues and Limit Summary	1-6
2-I	Contingency Plan	2-49
2-II	Differences Between SA-503 C' and SA-504 D	2-70
2-III	Recommended Abort Cues for Loss of Platform	2-96
2-IV	Sudden Peak Launch Vehicle Loads for Single Engine-Out - No Loss of Control	2-116
2-V	AS-504 Spacecraft Loads Resulting from Single S-IC Control Engine-Out	2-117
2-VI	Results of Early Staging in 90 to 110 Second Time Span	2-127
2-VII	AS-503 C' and AS-504 D Mass Differences	2-134
2-VIII	Sudden Breakup After Abort	2-173
2-IX	Coefficients for SA-504 Predictions for Latest Times of Collision	2-192
2-X	Summary of Near Pad Malfunctions	2-193
2-XI	FDO Limits for Malfunction Flight	2-263
2-XII	Malfunction Trajectory Data	2-275

REFERENCES

1. Boeing Document D5-15705-3, "Saturn V Launch Vehicle Emergency Detection System Analysis AS-503," dated June 1, 1967.
2. Boeing Document D5-15555-3D, "Saturn V Launch Vehicle Emergency Detection System Analysis, SA-503," dated November 15, 1968.
3. Boeing Document D5-15705-4, "Saturn V/Apollo Requirements for S-IC Emergency Detection System, SA-504," dated June 30, 1967.
4. MSFC Memo R-ASTR-F-67-260, "Launch Vehicle Implementation to Continue Flight After ST-124 Platform Failure Detection," dated December 21, 1967.
5. MSC Memorandum ET 253/6810-170-B, "Required Lead Times, Saturn V," dated October 3, 1968.
6. S&ID Document 64-396, "Apollo Range Safety Destruct Time Delay Study," dated March 25, 1963.
7. Boeing Memorandum 5-9450-H-073, "SSR-220, Saturn V S-IC/S-II Staging Limits," dated August 30, 1968.
8. Boeing Memorandum 5-9450-H-161, "SSR-222, S-IC Engine-Out Pitch Guidance," dated November 23, 1968.
9. Boeing Memorandum 5-9650-H-67, "SSR-164, Backup Accelerometer Implementation Study," dated January 15, 1968.
10. Boeing Memorandum 5-9600-H-191, "Preliminary Report AS-504D Launch Vehicle Operational Abort and Alternate Mission Trajectories," dated January 6, 1969.
11. MSFC Letter R-AERO-FF, C. Hagood to J. Gelzer, Untitled, dated September 3, 1968.
12. Boeing Memorandum 5-9600-H-149, "Preliminary Report, AS-503C' Launch Vehicle Operational Abort and Alternate Mission Trajectories," dated November 5, 1968.
13. MSFC Memorandum R-P&VE-DIR-68-755, "S-IC Control Engine Out," dated December 2, 1968.
14. North American Aviation Letter 67MS2216, "Contract NAS7-200, "Collision Boundary and Probability of Collision During Second Plane Separation, Action Item 96, Ninth Dynamics and Control Working Group Meeting," dated June 19, 1967.

REFERENCES (Continued)

15. Boeing Coordination Sheet EDS-H-161A, "S-II Dual E/O Analysis," dated September 19, 1968.
16. Boeing Memorandum, "AS-504 LET-on Stability Analysis," to be released (DRL-049, LI 32).
17. NAR Memorandum 68M52589, "Review Revision 1 AS-503, AS-504 Flight Mission Rule Document," dated August 16, 1968.
18. Boeing Coordination Sheet G&C-H-061, "S-IC/S-II Staging Without Retrorockets," dated June 14, 1967.
19. MSFC Memorandum R-AERO-FF-76-68, Untitled, dated July 22, 1968.
20. MSC Memorandum ET 255/6811-232-B, "Saturn V Malfunction Trajectory Data for AS-503 and AS-504," dated November 26, 1968.

SOURCE DATA PAGE

The following listed government furnished documentation was used in the preparation of this document release:

<u>EXHIBIT FF & DRL LINE ITEM NUMBERS</u>	<u>GFD TITLE</u>	<u>DATE OF ISSUE</u>	<u>REVISION DATE</u>
0140 0141 0142	NASA TMX 53517, "Static Aero- dynamic Characteristics of the Apollo-Saturn V Vehicle."	Sept. 16, 1966	
	NASA TMX 53599, "Range Safety Aerodynamic Characteristics of the Apollo/Saturn V Vehicle."	April 21, 1967	
	MSFC Memo R-AERO-AD- 68-35, "Effects of Flow Separation on Apollo Saturn V First Stage Aerodynamics."	June 10, 1968	
0147	Boeing Document D5-15580-4B, "SA-504 Operational Structural Dynamic Characteristics."	April 1, 1968	
	MSFC Memo R-AERO-DD- 7-66, "Saturn V Design Sloshing Data."	February 24, 1966	
0148	Boeing Document D5-15509(F)-3A, "Saturn V Launch Vehicle Flight Dynamics Analysis, AS-503."	Sept. 11, 1968	
	Boeing Memo 5-9450- H-073, "SSR-220, Saturn V S-IC/S-II Staging Limits."	August 30, 1968	

SOURCE DATA PAGE (Continued)

<u>EXHIBIT FF & DRL LINE ITEM NUMBERS</u>	<u>GFD TITLE</u>	<u>DATE OF ISSUE</u>	<u>REVISION DATE</u>
0149	MSFC Memo R-AERO-P-251-67, "Final Documentation of the Ninth Flight Limits Sub-Panel Meeting."	June 6, 1967	
0151	NASA Support Manual SM2A-02, "Apollo Spacecraft Familiarization."	December 1, 1966	
0152	NASA TMX 53328, "Terrestrial Environment (Climatic) Criteria Guidelines for Use in Space Vehicle Development." (1966 Revision)	May 1, 1966	
0153	NASA R-AERO-Y-66-65, "Redefinition of the Saturn IB/V Synthetic Wind Profiles."	Sept. 10, 1965	
	MSFC Memo R-AERO-Y-118-66, "Cape Kennedy Wind Component Statistics (0 - 60 km. Alt.), for all Flight Azimuths for Monthly and Annual Reference Periods."	October 25, 1966	
0154	NASA TMX 53139, "Reference Atmosphere for Patrick AFB 1963 Rev."	Sept. 23, 1964	
	NASA M-DE 8020.08B, SE 015-001-1, "Natural Environment and Physical Standards for the Apollo Programs."	April, 1965	

SOURCE DATA PAGE (Continued)

<u>EXHIBIT FF & DRL LINE ITEM NUMBERS</u>	<u>GFD TITLE</u>	<u>DATE OF ISSUE</u>	<u>REVISION DATE</u>
0386	MSFC Memo R-AERO-FMT- 251-68, "AS-504 D Presettings."	Nov. 27, 1968	
	P&VE Memo R-P&VE-PA- 68-M-586, "F-1 Engine Malfunction Curves for S-IC Engine Out Condition."	July 29, 1968	
	Boeing Memo 5-9450- H-161, SSR-222, "S-IC Engine Out Pitch Guidance."	Nov. 23, 1968	
0184	MSFC R-ASTR-NFS- 134-66, "The Linear Equations and Nonlinear Models for the Saturn V Vehicle Thrust Vector Control System."	April 1, 1966	
	MSFC R-ASTR-BV- 858-67, "Minutes of the S-II Stage Vehicle Dynamics and Control Working Group Splinter Meeting."	May 31, 1967	
0187	MSFC Drawing 10M30792, "Failure Effects Analysis and Criticality Determination Reports, Vol. I-Vol. VII."	Aug. 10, 1967	
	MSFC Drawing 10M30803, "Reliability Analysis Model Summary, SA-503."	April 5, 1968	
	MSFC Memo R-ASTR-S- 66-46, "Failure Modes of the Saturn V Vehicle, Action Item 13.7."	Aug. 26, 1966	

SOURCE DATA PAGE (Continued)

<u>EXHIBIT FF & DRL LINE ITEM NUMBERS</u>	<u>GFD TITLE</u>	<u>DATE OF ISSUE</u>	<u>REVISION DATE</u>
0188	Technical Manual MSFC No. 111-5-509-7, "Apollo-Saturn Emergency Detection System Description."	Aug. 1, 1966	July 1, 1967
0189 0190	MSFC Memo R-ASTR-F- 68-164R, "Control Gains, Shaping Networks and Frequency Responses, AS-501 through AS-508, S-IC, S-II, and S-IVB Stages."	Nov. 4, 1968	
0192	MSFC No. III-4-423-10, "LVDC Equation Defining Document for the AS-503 Flight Program."	Nov. 21, 1966	
0193	MSFC Drawing No. 40M33624, "Interface Control Document Definition of Saturn SA-504 Flight Sequence Program."	Jan. 16, 1967	
0232	Boeing Coord Sheet ST-H-68-22, "Saturn V Launch Vehicle Propellant Tank Ullage and Venting Pressures."	March 18, 1968	
0241	Boeing Document D5-15579-4A, "Saturn V Operational Structural Capability, SA-504."	June 3, 1968	
0244	MSFC Memo R-P&VE-VAW- 68-154, "Saturn V/AS-504 Final Predicted Operational Mass Characteristics, Depletion Cutoff, Mission D."	Nov. 13, 1968	

SOURCE DATA PAGE (Continued)

<u>EXHIBIT FF & DRL LINE ITEM NUMBERS</u>	<u>GFD TITLE</u>	<u>DATE OF ISSUE</u>	<u>REVISION DATE</u>
0275	MSFC Drawing No. 10M30524B, "Saturn V/ SA-504 Flight Sequence."	Dec. 28, 1966	
0341	Boeing Document D5-15580-4B, "SA-504 Operational Structural Dynamic Characteristics."	April 1, 1968	

SECTION 1 - SUMMARY

1.0 INTRODUCTION

This report presents an analysis of the Emergency Detection System (EDS) of the Saturn V/Apollo SA-504 launch vehicle for the AS-504 D mission and the capability of the vehicle to continue flight after malfunction. The baseline vehicle for this study is described in documents listed in the Source Data list. EDS limit settings are derived for automatic and manual abort during boost flight.

This report complements results reported in Reference 3. This reference evaluated vehicle changes for S-IC flight to improve malfunction flight capability for the SA-504 vehicle. This document is based on the SA-503 EDS analysis of Reference 2. Differences between SA-503 and SA-504 results will be noted and analyzed by considering vehicle differences.

The major differences between the SA-503 C' and the SA-504 D launch vehicles affecting S-IC flight are:

- a. 4 percent reduction in thrust-to-weight ratio at liftoff.
- b. 8 percent reduction in maximum dynamic pressure (Max-q).
- c. 5.5 second later occurrence of max-q.

The significant upper stage baseline vehicle changes from SA-503 C' to SA-504 D are:

- a. The SA-504 S-II stage at S-II ignition is 2.6% heavier.
- b. The Flight Program presettings (AS-504 operational trajectory) allow for a 0.4% less S-IVB performance.

The evaluations of this report cover vehicle and crew loss probabilities, interpretation of Launch Escape Vehicle (LEV) escape requirements utilizing launch vehicle explosion information, preliminary Flight Dynamics Officer (FDO) plotboard limits exceeded in malfunctioned flight and contingency plan data. Malfunction coverage includes the following:

- a. Loss of inertial attitude.
- b. Loss of inertial velocity.
- c. Loss of attitude error signal.
- d. Attitude error signal saturated.
- e. Loss of attitude command signal.
- f. Attitude rate signal saturated.

1.0 (Continued)

- g. Loss of attitude rate signal.
- h. One actuator fully deflected.
- i. One actuator inoperative (null position).
- j. Loss of both APS modules.
- k. Loss of one APS module.
- l. Loss of thrust, engine failure.
- m. Sequence or staging malfunctions.
- n. Failure to jettison launch escape tower.
- o. P.U. System malfunctions.

The above malfunctions are described in more detail in Section 2.3.

1.1 SUMMARY OF EDS LIMITS

EDS abort parameter and limit recommendations for this report are summarized in Tables 1-I and 1-II.

1.2 MALFUNCTION FLIGHT CAPABILITY

Figures 1-1, 1-2, and 1-3 show, for S-IC, S-II, and S-IVB respectively, times of powered flight for which the listed malfunctions may cause vehicle loss. Malfunction occurrence probabilities shown are totals across the stages noted. Not all malfunctions occurring in the indicated time span will cause vehicle loss due to the capability of the vehicle to sustain safe flight under most malfunctions. Probabilities of vehicle loss shown account for both this fact and the time span where vehicle loss can result.

The following vehicle loss cases are considered:

- a. Structural failure resulting directly from malfunction dynamics.
- b. Loss of control followed by consequent tumbling and possible structural failure.
- c. Structural failure because vehicle tension load is increased by engine shutdown at abort.
- d. Unsuccessful staging. This results when the malfunction causes stage collision, or loss of control in the following stage.
- e. Tower collision or pad fallback because of early failures. Included is interference with ground support equipment at liftoff.
- f. Guidance failures causing slow divergence from nominal trajectory.

Spacecraft loads after engine-out were evaluated for vehicle failure resulting directly from malfunction-induced dynamics response (no loss of control). Maximum bending moment for an engine out with 95 percentile wind is 4.8×10^6 in-lb at Station 1010. The structural capability at this station from Reference 13 is 5×10^6 in-lbs.

1.3 EDS EFFECTIVENESS SUMMARY

Crew loss may occur if the launch vehicle explodes before the launch escape vehicle (LEV) achieves a safe separation distance by abort action, or if the LEV angle-of-attack (LEV- α) limit is exceeded prior to abort, making safe abort improbable. This analysis makes the conservative assumption that explosion results immediately when structural limits are exceeded or when collision with the tower or ground equipment occurs.

Malfunction conditions leading to possible crew loss are summarized in Figure 1-4. Crew loss situations have been reduced by improved malfunction flight capability described in References 1 and 3. This improvement is due to:

- a. Increase in tension load capability.
- b. Bias the pitch program to minimize angle-of-attack for winds expected during the launch month.
- c. Redesign of the tilt attitude freeze schedule.
- d. Canting the outboard engines.

TABLE 1-I AS-504 EDS MANUAL ABORT CUES AND LIMITS SUMMARY

STAGE	FLIGHT TIME (SEC)	PARAMETER	LIMIT
S-IC	Near Pad 0 < t < 50	Engine Status Light	Abort at 50 sec
		Voice	
		Abort Request Light Guidance Failure Light and L/V Rate Light	
S-II and S-IVB	High-q* 50 < t < 100	Engine Status Light	± 5 deg 3.2 PSID (100%) Abort Immediately
		Attitude Error Q-Ball ΔP	
		Guidance Failure Light and L/V Rate Light	
S-II and S-IVB	Post High-q 100 < t < t _{OBECO}	Engine Status Light	± 20 deg/sec ± 4 deg/sec Abort Request Light
		L/V Rate Light	
		S/C Rate Indicator - Roll Pitch or Yaw Guidance Failure Light	
S-II and S-IVB	All Phases	Roll Rate	± 20 deg/sec ± 9 deg/sec ** Limit Exceeded ± 20 deg
		Pitch or Yaw Rate	
		FDO Display Attitude Deviation	

* This period will be delayed for engine out prior to this time.
 ** Overtime light will be lighted at 9.2 ± 0.8 deg/sec.

TABLE 1-II AS-504 EDS AUTOMATIC ABORT CUES AND LIMIT SUMMARY

STAGE	FLIGHT TIME (SEC)	PARAMETER	LIMIT
S-IC	$0 \leq t \leq 120$	Pitch or Yaw Rate Roll Rate Thrust OK Switch (80% of Rated Thrust)	± 4 deg/sec ± 20 deg/sec Two or More Eng. Out.
S-IC, S-II and S-IVB	$t \geq 120$	AUTOMATIC ABORT NOT REQUIRED	

MALFUNCTION (UNRELIABILITY) (β) POSSIBLE HAZARD ABORT CUES
 =CN

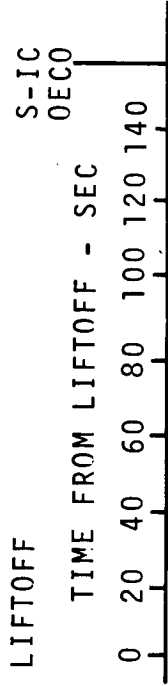

Loss of Attitude Rate Signal (40). (1)=40	TC CNTRL SEP	All Phases Pitch or yaw rate = ±4°/sec Roll rate = ±20°/sec ΔP = 3.2 psid (High-q).
Control Feedback Signal Saturated (230). (1)=230	TC CNTRL SEP	All Phases Pitch or yaw rate = ±4°/sec Roll rate = ±20°/sec
Loss of Thrust Two Engines (<1). (1)=<1	TC CNTRL SEP	All Phases Eng. Status Lights Pitch or yaw rate = ±4°/sec
Loss of Attitude Error Signal (70). (1)=70	TC CNTRL SEP	All Phases Pitch or yaw error = ±5° ΔP = 3.2 psid Pitch or yaw rate = ±4°/sec
One Actuator Inoperative (750). (<10-3)=<1	NO VEHICLE LOSSES	
Loss of Inertial Velocity (1935). (10-4)=<1	No Effect on S-IC Flight Possible sub-nominal orbit and partial mission loss	

FIGURE I-1 S-IC MALFUNCTION SUMMARY (CONTINUED)

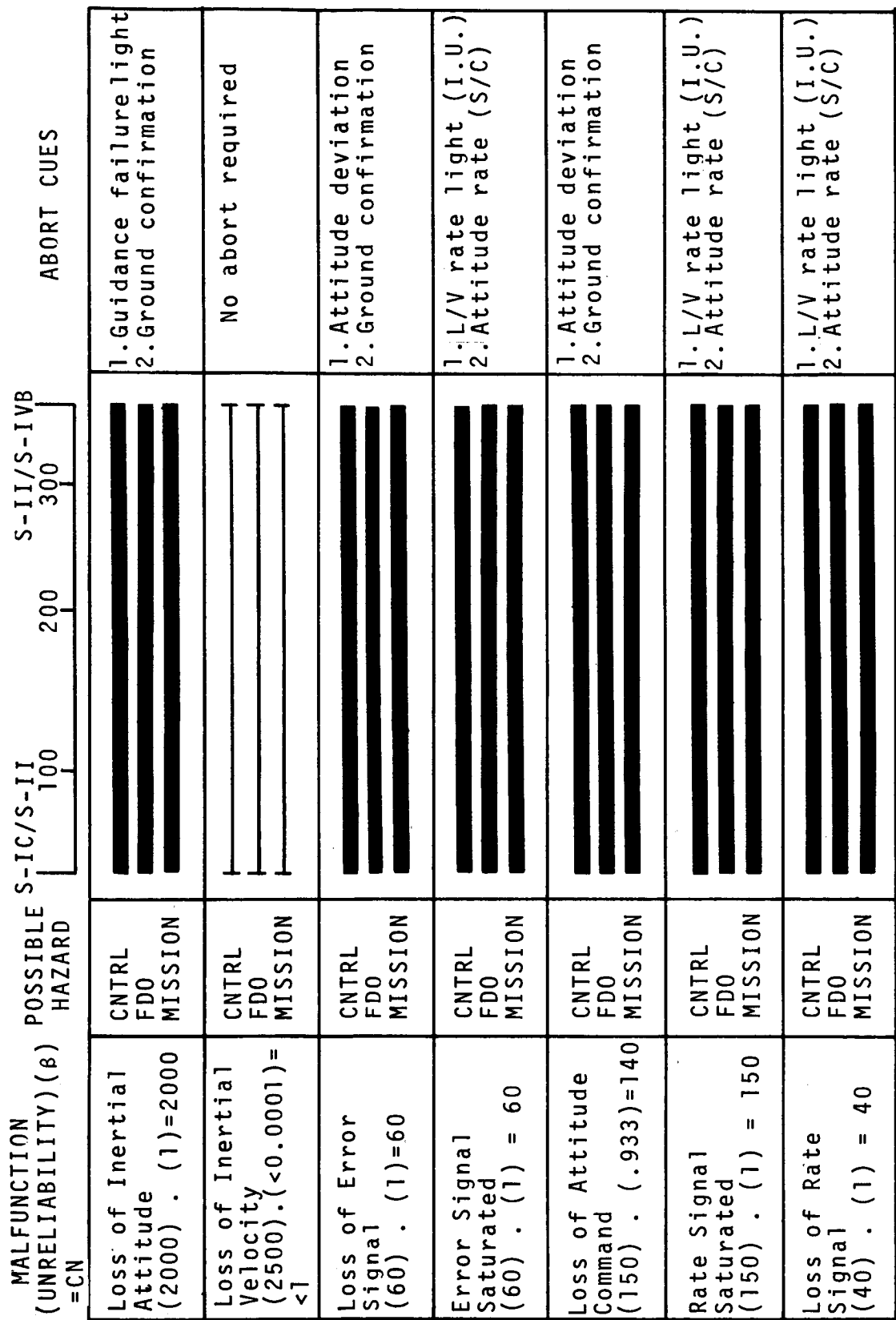

LEGEND PROBABLE LOSS POSSIBLE LOSS NO LOSS
FIGURE 1-2 S-II MALFUNCTION SUMMARY

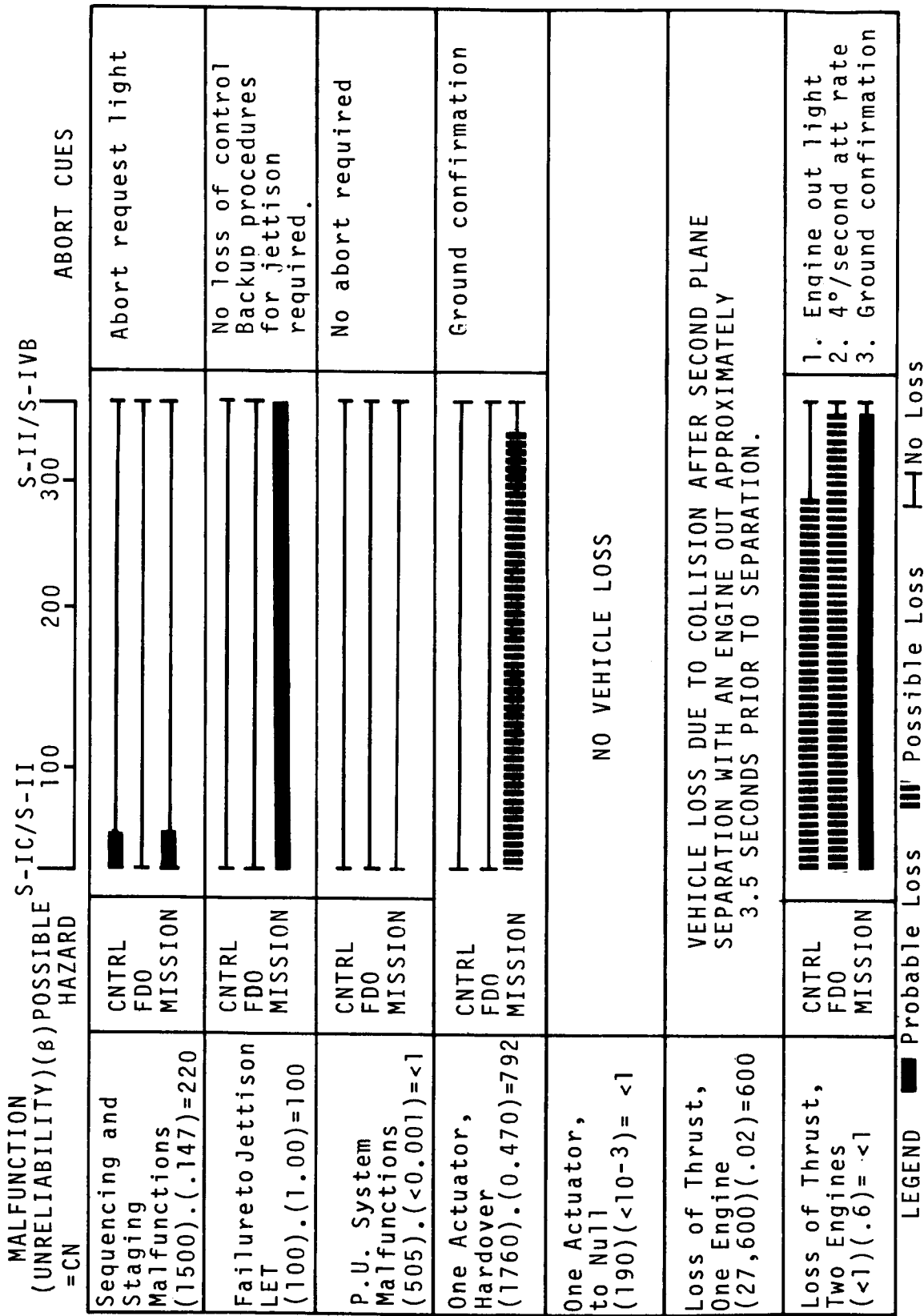

LEGEND Probable Loss Possible Loss No Loss

FIGURE 1-2 S-II MALFUNCTION SUMMARY (CONTINUED)

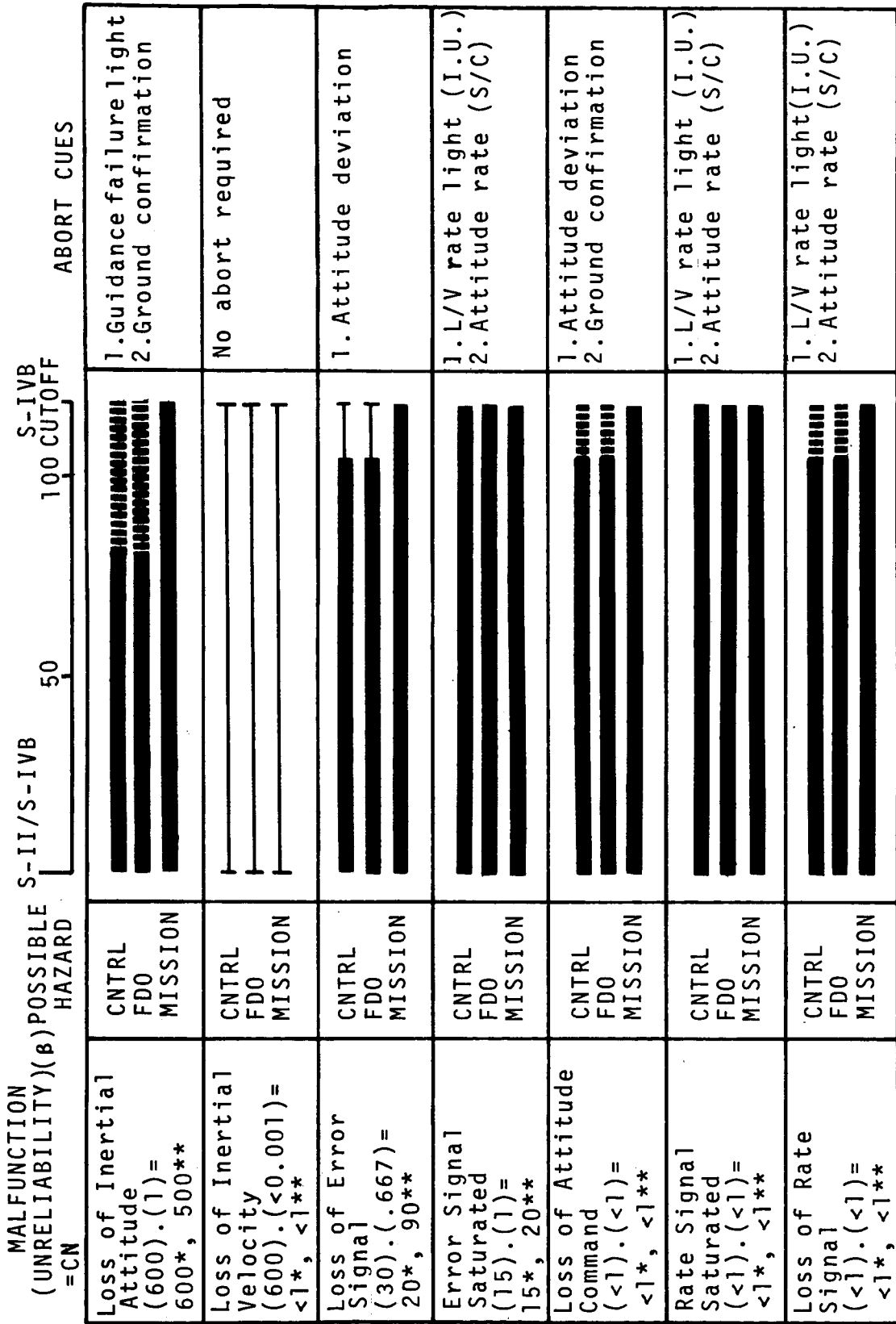

LEGEND

Probable Loss Possible Loss No Loss

* FIRST BURN
** COAST

FIGURE 1-3 S-IVB MALFUNCTION SUMMARY

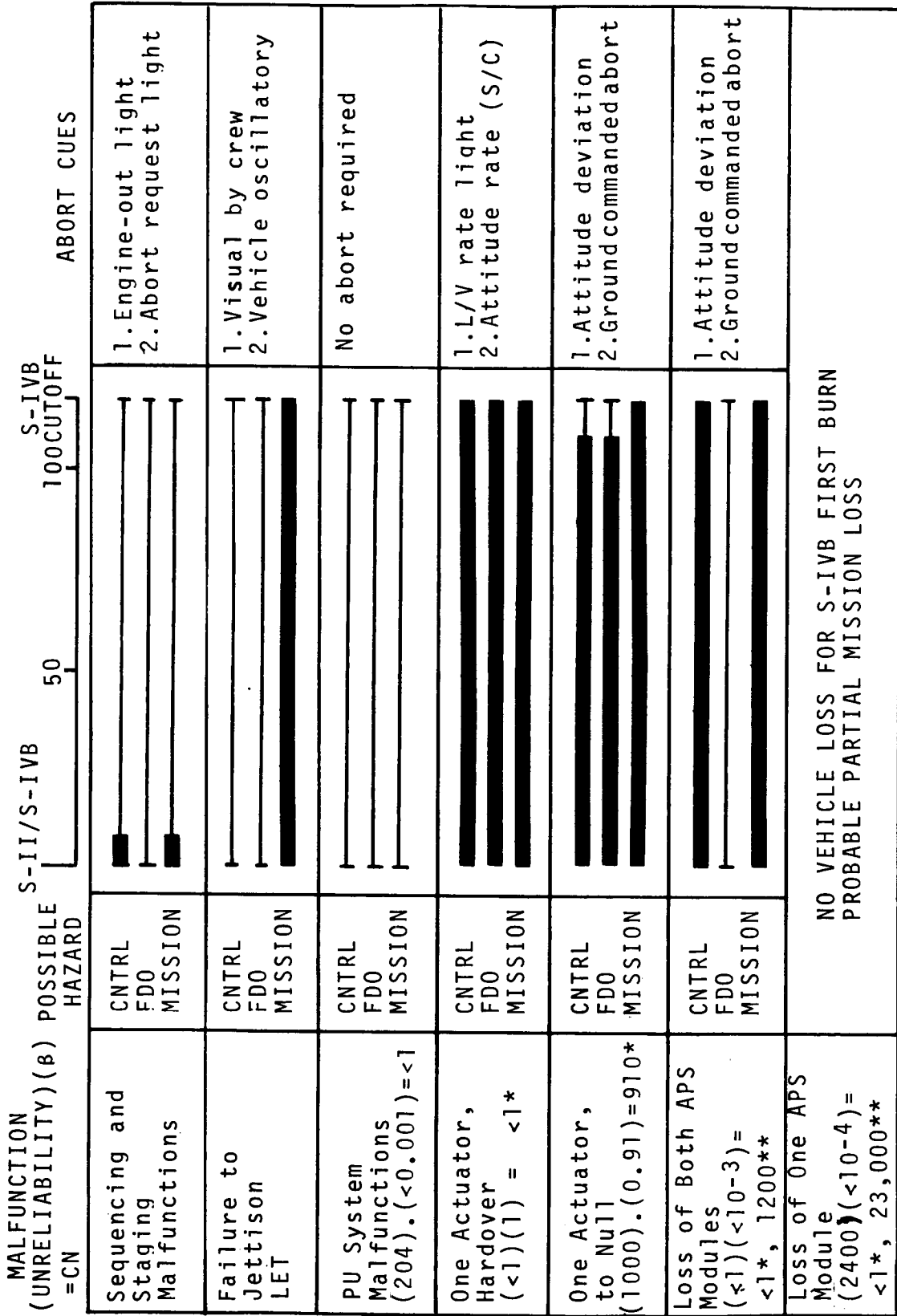

LEGEND Probable Loss Possible Loss No Loss * FIRST BURN ** COAST

FIGURE 1-3 S-IVB MALFUNCTION SUMMARY (CONTINUED)

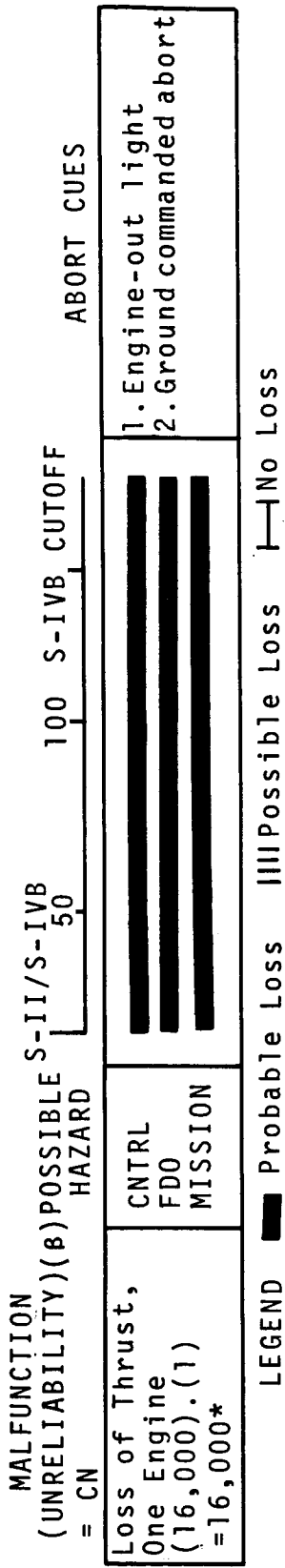
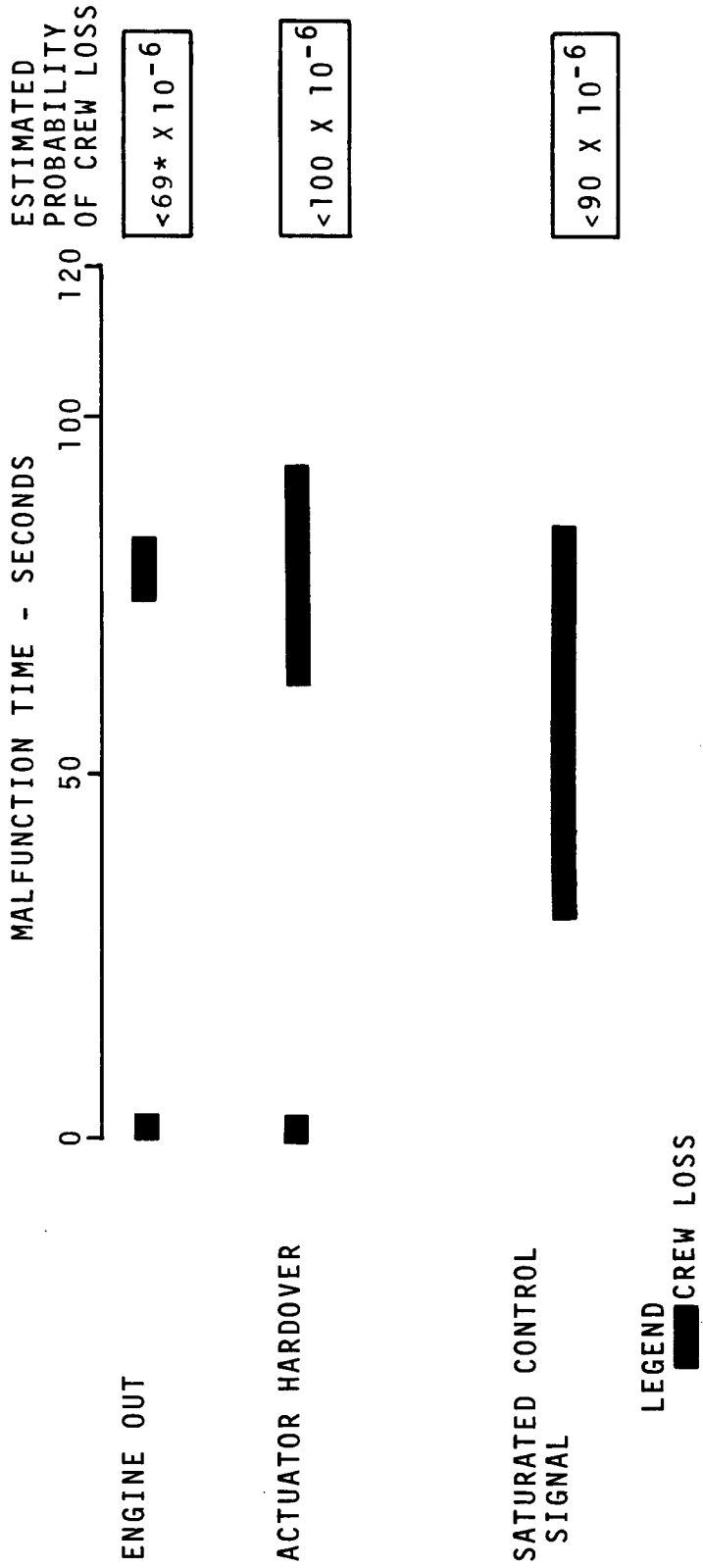

FIGURE 1-3 S-IVB MALFUNCTION: SUMMARY (CONTINUED)



* INCLUDES 61×10^{-6} FOR CATASTROPHIC ENGINE FAILURE

FIGURE 1-4 S-IC MALFUNCTIONS CAUSING POSSIBLE CREW LOSS

1.4 RECOMMENDATIONS - S-IC FLIGHT

1.4.1 EDS Limits

Figure 1-5 shows the recommended EDS abort parameters and limits during S-IC flight. These limits will provide for abort prior to structural failure. Safe abort is not guaranteed since structural limits are exceeded in some cases within 0.5 second after abort.

Automatic abort may be deactivated at 120 seconds flight time for two engines out and angular overrate. Manual abort provides sufficient warning time after 120 seconds. The manual abort cues to be used are

- a. Two engine-out lights, and angular overrate light
- b. Angular overrate indicated by the attitude rate indicator and the overrate light.

Further discussion of abort parameters and limits is presented in Section 2.7.

1.4.2 Platform Backup

The platform backup system proposed in Reference 4 will not be used for SA-504. The system is still under consideration for subsequent vehicles.

In order to provide safe abort on two cues, the overrate light is used as a redundant guidance failure light during the time that automatic abort is active. After 100 seconds, attitude divergence is slow and FDO displays may be used to indicate a platform failure. The crew should abort on the guidance failure light and the abort request light.

MALFUNCTION	AUTOMATIC ABORT		MANUAL ABORT		
	PARAMETER	LIMIT	1ST CUE PARAMETER	LIMIT	2ND CUE PARAMETER
Single Engine-Out	Attitude Rate	4 DEG/SEC	Engine-Out light	Thrust OK Switch Setting	After 50 seconds: Q-Ball Pressure
					3.2 PSI
Dual Engine-Out	Thrust OK Switch Setting	2 or more switches	Two engine out lights (t>120 sec.)	Thrust OK Switch Setting	Abort request light (near pad)
					L/V overrate light
Actuator Hardover	Attitude Rate	4 DEG/SEC	Roll Attitude Error	5 DEG	After 50 secs. Q-Ball Pressure
					3.2 PSI
Actuator to Null	No Abort Required				

FIGURE 1-5 RECOMMENDED S-IC EDS PARAMETERS AND LIMIT SETTINGS

MALFUNCTION	AUTOMATIC ABORT		MANUAL ABORT			
	PARAMETER	LIMIT	1ST CUE PARAMETER	LIMIT	2ND CUE PARAMETER	LIMIT
Loss of Inertial Attitude	Attitude Rate	4 DEG/SEC	Guidance Failure Light	Platform Reasonableness Test	0-50 abort at 50 seconds with overrate light	Guidance Reasonableness Test
					50-100 L/V overrate light	
Loss of Attitude Error	Attitude Rate	4 DEG/SEC	Attitude Error	5 DEG	After 50 seconds Q-Ball pressure	3.2 PSI
Loss of Attitude Rate	Attitude Rate	4 DEG/SEC	Attitude Error	5 DEG	After 50 seconds Q-Ball pressure	3.2 PSI

FIGURE 1-5 RECOMMENDED S-IC EDS PARAMETERS AND LIMIT SETTINGS (CONTINUED)

MALFUNCTION	AUTOMATIC ABORT		MANUAL ABORT		
	PARAMETER	LIMIT	1ST CUE PARAMETER	LIMIT	2ND CUE PARAMETER
Loss of Attitude Command Signal	Attitude Rate	4 DEG/SEC	Attitude Error	5 DEG	After 50 seconds Q-Ball pressure
					3.2 PSI
Saturated Signal to Control System	Pitch or Yaw Attitude Rate	4 DEG/SEC	L/V Overtime Light		S/C pitch or yaw rate indication
	Roll Attitude Rate	20 DEG/SEC			

FIGURE 1-5 RECOMMENDED S-IC EDS PARAMETERS AND LIMIT SETTINGS (CONTINUED)

1.5 RECOMMENDATIONS - S-II FLIGHT

Figure 1-6 summarizes the abort parameters and limit settings recommended for S-II flight. The recommended manual abort second cue is a $\pm 10^\circ/\text{second}$ ($\pm 4^\circ/\text{second}$ for S-II dual engine-out) vehicle attitude rate (spacecraft indication) in pitch or yaw or FDO limits. For rapidly diverging failures, the first cue is the launch vehicle rate light (Instrument Unit source). The L/V rate light comes on at 9.2 ± 0.8 degrees per second. The vehicle did not have any cases of structural failure for any simulated malfunctions investigated in this report. Consequently, abort timing is not as critical as in S-IC flight. These recommendations provide sufficient warning time before the vehicle has progressed into gross loss-of-control.

The rapidly diverging malfunctions use attitude rate for both first and second cue. However, the first cue is from the Instrument Unit (I.U.), and the second cue is from the Spacecraft (S/C) System. Since there are two separate sources, they may be used for abort.

For the slowly diverging malfunctions that use an attitude deviation of $\pm 20^\circ$ for a first cue, the crew must depend heavily on ground instrumentation and communication because the attitude deviation parameter will be displayed on the Flight Director Attitude Indicator (FDAI) and will be difficult to interpret as a malfunction condition. Guidance deviations caused by malfunctions that do not require abort will appear as attitude deviations on the FDAI. Also, the FDAI ball will be difficult to read to close tolerances. For these reasons, it is recommended that for slowly diverging malfunctions, using attitude deviations as a first cue, emphasis should be placed on the second cue of ground commanded abort based on ground instrumentation (FDO limits, Section 2.9). The first cue for inertial platform failure is the guidance failure light which is based on the LVDC reasonableness test.

The first cue for S-II dual engine failure is the engine out lights. The recommended second abort cue for the S-II dual engine failure is $\pm 4^\circ/\text{second}$ attitude rate. Ground commanded early staging to the S-IVB at chi-freeze plus 5 seconds is recommended for cases that maintain control but will not achieve orbit due to guidance problems. Early S-II/S-IVB staging is not recommended for S-II loss of control cases because discrimination of necessity for early staging and reaction time could result in early staging with body rates in excess of $3.5^\circ/\text{second}$ which could cause guidance failure and S-IVB loss of control.

S-II MALFUNCTION	MANUAL ABORT		
	1st CUE PARAMETER	LIMIT	2nd CUE PARAMETER
Loss of Inertial Attitude	Guidance Failure Light	Platform Reasonableness Test	Ground Confirmation
			FDO limits or prior to exceeding 90*deg. yaw attitude.
Loss of Inertial Velocity	NO ABORT REQUIRED		
Loss of Attitude Error Commands	Attitude Deviation	20 DEG	Ground Confirmation
			FDO limits or prior to exceeding 90*deg. yaw attitude
Attitude Error Signal Saturated	L/V Rate Light (I.U.)	9 DEG/SEC	Attitude Rate (S/C)
			10 DEG/SEC
Loss of Attitude Command Signal	Attitude Deviation	20 DEG	Ground Confirmation
			FDO limits or prior to exceeding 90*deg. yaw attitude
Attitude Rate Signal Saturated	L/V Rate Light (I.U.)	9 DEG/SEC	Attitude Rate (S/C)
			10 DEG/SEC

* S/C Platform Limit

FIGURE 1-6 RECOMMENDED S-II EDS PARAMETERS AND LIMIT SETTINGS

S-II MALFUNCTION	MANUAL ABORT		
	1st CUE PARAMETER	LIMIT	2nd CUE PARAMETER
Loss of Attitude Rate Signal	L/V Rate Light (I.U.)	9 DEG/SEC	Attitude Rate (S/C)
One Actuator Fully Deflected		OUTBOARD - NO ABORT REQUIRED INBOARD - GROUND CONFIRMATION	10 DEG/SEC
One Actuator Inoperative (Null)		NO ABORT REQUIRED	
Loss of Thrust, One Engine		NO ABORT REQUIRED	
Loss of Thrust, Two Engines	Engine Out Lights	Thrust OK Switch Setting	attitude rate
No S-II Control Gain Change		NO ABORT REQUIRED	4 DEG/SEC

FIGURE I-6 RECOMMENDED S-II EDS PARAMETERS AND LIMIT SETTINGS (Continued)

1.5 (Continued)

The time span for which a dual engine failure in S-II results in loss of control is greater for 504 than for 503C'. This is the case for both simultaneous and sequential dual engine failures. The increase in loss of control region is a direct result of the vehicle mass and loadings (See Table 2-VII). The S-II stage dry mass is less, but the fuel and LOX loadings are greater. The net result is that the 504 vehicle CG is farther aft than for 503C'. The greater vehicle mass also results in larger moments of inertia, so even though the rates do not build up as fast for 504 as for 503 the forces required to null the rates are greater. These are the major contributing factors causing the increased loss of control region for 504. The major factor contributing to the increased region of failure to achieve orbit is the decrease of the presetting of T_{2j} (second phase IGM burn time) from 81.5 seconds for AS-503C' to 79.5 seconds for AS-504D.

An S-II actuator hardover inboard will not cause loss of control but may cause overheating in the engine area. The overheating may lead to fire and/or explosion and a need to abort. Since no onboard EDS limits are exceeded, the S-II actuator hardover inboard malfunction will be treated as a special case. This malfunction will cause a roll rate greater than 2.5 degrees/second for a short time before the vehicle recovers. Because the crew may not detect the roll rate above 2.5 degrees/second and there is no indication of whether the actuator went inboard or outboard, it is felt that the roll rate can not be used as an abort cue. Therefore, the only recommended abort cue for an S-II actuator hardover inboard is a ground commanded abort.

Using the AS-504 D Initial Operational Trajectory, it is found that the worst case of S-IC single engine out exceeds the 100 second free flight to reentry FDO limit (300,000 feet) as late as 140 seconds into S-II flight. However, the vehicle is in this unsafe abort region for only a small part (approximately 280-300 seconds from liftoff) of S-II flight.

1.6 RECOMMENDATIONS - S-IVB FLIGHT

Figure 1-7 summarizes the abort parameters and limit settings recommended for S-IVB flight. For the single-engine case, actuator hardover and saturated control error and rate signals produce equivalent results with rapid buildup of attitude rate and error. Actuator at null and loss of attitude error signal produce gradual loss of control and departure from planned trajectory. Manual abort based on a $\pm 10^\circ/\text{second}$ vehicle attitude rate (S/C) or FDO limits is recommended. Attitude rate signal (I.U.) can be used as a first abort cue for the faster malfunctions. For actuator at null and loss of attitude error signal where rate buildup is slow, a first cue of a ± 20 degree attitude deviation is required. The first cue for inertial platform failure is the guidance failure light. Abort must be initiated before the spacecraft platform tumble limit is reached.

S-IVB loss of thrust, since it is total loss of propulsion, will require staging to the spacecraft (CM/SM). An EDS abort situation is not produced. Trajectory aspects of this staging situation are covered by Reference 10. Cues for loss of propulsion include engine-out light and acceleration.

Loss of the Auxiliary Propulsion System in powered flight roll control is considered as an S-IVB malfunction. Simulation results indicate that excessive roll rates do not build up as long as no driving disturbance in roll occurs.

During S-II/S-IVB early staging the S-IVB may exceed the EDS limit of 10 degrees/second during the recovery from a large attitude error. Early staging from an S-II malfunction condition which causes body rates in excess of $4^\circ/\text{second}$ in pitch and $3.5^\circ/\text{second}$ in yaw at separation will result either in subsequent loss of control and/or failure of gimbal reasonableness tests. Possibility of loss of control exists after excessive coast period in early staging sequence. It is therefore recommended that early staging not be relied upon as a means of recovery from an out of control vehicle, but rather as a means of avoiding inherent guidance problems resulting from severe malfunctions which do not cause loss of control.

S-IVB MALFUNCTION	MANUAL ABORT			LIMIT
	1st CUE PARAMETER	2nd CUE PARAMETER	LIMIT	
Loss of Inertial Attitude	Guidance Failure Light	Ground Confirmation	Platform Reasonableness Test	FDO limits or prior to exceeding 90*deg. yaw attitude
Loss of Inertial Velocity	NO ABORT REQUIRED			
Loss of Attitude Error Commands	Attitude Deviation	Ground Confirmation	20 DEG	FDO limits or prior to exceeding 90*deg. yaw attitude
Attitude Error Signal Saturated	L/V Rate Light (I.U.)	Attitude Rate (S/C)	9 DEG/SEC	10 DEG/SEC
Loss of Attitude Command Signal	Attitude Deviation	Ground Confirmation	20 DEG	FDO limits or prior to exceeding 90*deg. yaw attitude
Attitude Rate Signal Saturated	L/V Rate Light (I.U.)	Attitude Rate (S/C)	9 DEG/SEC	10 DEG/SEC

* S/C Platform Limit

FIGURE 1-7 RECOMMENDED S-IVB EDS PARAMETERS AND LIMIT SETTINGS

S-IVB MALFUNCTION	MANUAL ABORT			LIMIT
	1st CUE PARAMETER	2nd CUE PARAMETER	LIMIT	
Loss of Attitude Rate Signal	L/V Rate Light (I.U.)	Attitude Rate (S/C)	9 DEG/SEC	10 DEG/SEC
One Actuator Fully Deflected	L/V Rate Light (I.U.)	Attitude Rate (S/C)	9 DEG/SEC	10 DEG/SEC
One Actuator Inoperative (Null)	Attitude Deviation	Ground Confirmation	20 DEG	FDO limits or prior to exceeding 90*deg. yaw attitude
Loss of One APS Module	Attitude Deviation	Ground Confirmation	20 DEG	FDO limits or prior to exceeding 90*deg. yaw attitude
Loss of Both APS Modules	Attitude Deviation	Ground Confirmation	20 DEG	FDO limits or prior to exceeding 90*deg. yaw attitude
Loss of Thrust	Engine Out Light	Ground Confirmation	Thrust OK Switch Setting	FDO limits or prior to exceeding 90*deg. yaw attitude

* S/C Platform Limit

FIGURE 1-7 RECOMMENDED S-IVB EDS PARAMETERS AND LIMIT SETTINGS (Continued)

SECTION 2 - ANALYSIS

2.0 INTRODUCTION

Digital and hybrid computer simulations were used to analyze malfunction dynamics and evaluate the recommended changes. The digital simulation was used to obtain detailed flight dynamics and loads for final recommendations and the hybrid was used to determine parametric data and the relative effects of vehicle changes in S-IC.

A six degrees of freedom digital tower clearance program was used to evaluate tower clearance and pad fallback. It had dynamics models similar to the digital program above with the exception of distributed mass. A dual six degrees of freedom rigid body staging program (digital) was used to analyze staging malfunctions and stage sever after abort.

Appendix A describes the features of the hybrid and digital programs in more detail.

2.1 CRITERIA

The criteria used to evaluate the baseline vehicle are:

- a. Controllability.
- b. Structural integrity.
- c. Abort limits.
- d. Minimum warning time.
- e. Staging limits.
- f. Tower collision.
- g. Liftoff interference.
- h. Pad fallback.

2.1.1 Controllability

Controllability is defined as the ability to prevent excessive divergence of the attitude error, i.e., tumbling.

2.1.2 Structural Integrity

Structural integrity is defined in terms of vehicle loads exceeding the vehicle structural capability. The baseline structural capability values for the Saturn V Apollo vehicle are presented in the source data. These capability values serve as a tool for predicting relative structural integrity of the Saturn V Apollo subject to various malfunction loading conditions.

To facilitate the rapid analysis of a large number of malfunction flight load conditions, a simplified structural failure criteria has been used. The following formulae define the criteria:

a. Compression

$$FS = \frac{N_C}{\frac{M}{\pi R^2} + \frac{P}{2\pi R} - \left[\frac{(\Delta P)R}{2} \right]} \quad (\text{Use minimum differential pressure})$$

2.1.2 (Continued)

b. Tension

$$FS = \frac{N_T}{\frac{M}{\pi R^2} - \frac{P}{2\pi R} + \left[\frac{(\Delta P)R}{2} \right]} \quad \text{(Use maximum differential, tank, inter-tank, and interstage pressure)}$$

- where
- FS = factor of safety
 - NC = ultimate compression capability - lb/in
 - NT = ultimate tension capability - lb/in
 - R = vehicle radius - in
 - M = external moment - in-lb
 - P = total axial load - lb
 - ΔP = scheduled differential operating pressure - psi

A FS < 1.0 indicates failure of the vehicle for a given malfunction loading condition. A FS > 1.0 indicates survival of the vehicle for a given malfunction loading condition.

This criterion is subjected to additional analysis. Failure of the vehicle structure could occur for FS > 1.0 if the vehicle is subjected to elevated temperatures or is exposed to large differential pressures causing either collapse or burst. Other factors such as duration of loading could cause failure not predicted by the above criteria. Temperature and differential pressure factors have been considered in the vehicle loss analysis of this report.

2.1.3 Abort Limits

Abort limits for S-IC flight are described in terms of a Launch Escape Vehicle angle-of-attack limit (LEV-α) at the altitude at which abort occurs. The assumed limit for this study is shown by Figure 2-1. The constraint is due to the limiting over-pressures on the command module after separation from the launch vehicle. For the upper stage, SPS mode II aborts, the constraints are the S/C platform tumble limits (90° yaw), the 16 g re-entry limit, and free fall 100 seconds before reaching 300,000 feet altitude.

2.1.4 EDS Warning Time

For S-IC flight, warning time is defined as the time from abort to exceeding the vehicle structural capability. This is to allow for the following typical sequence.

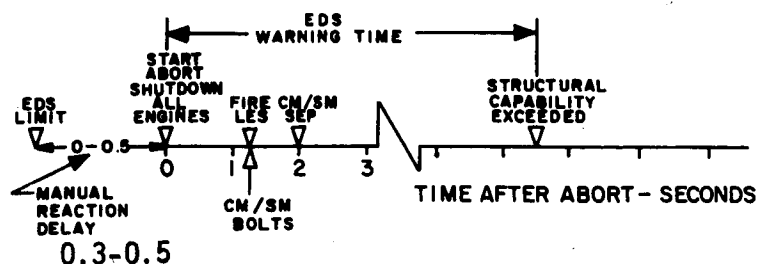

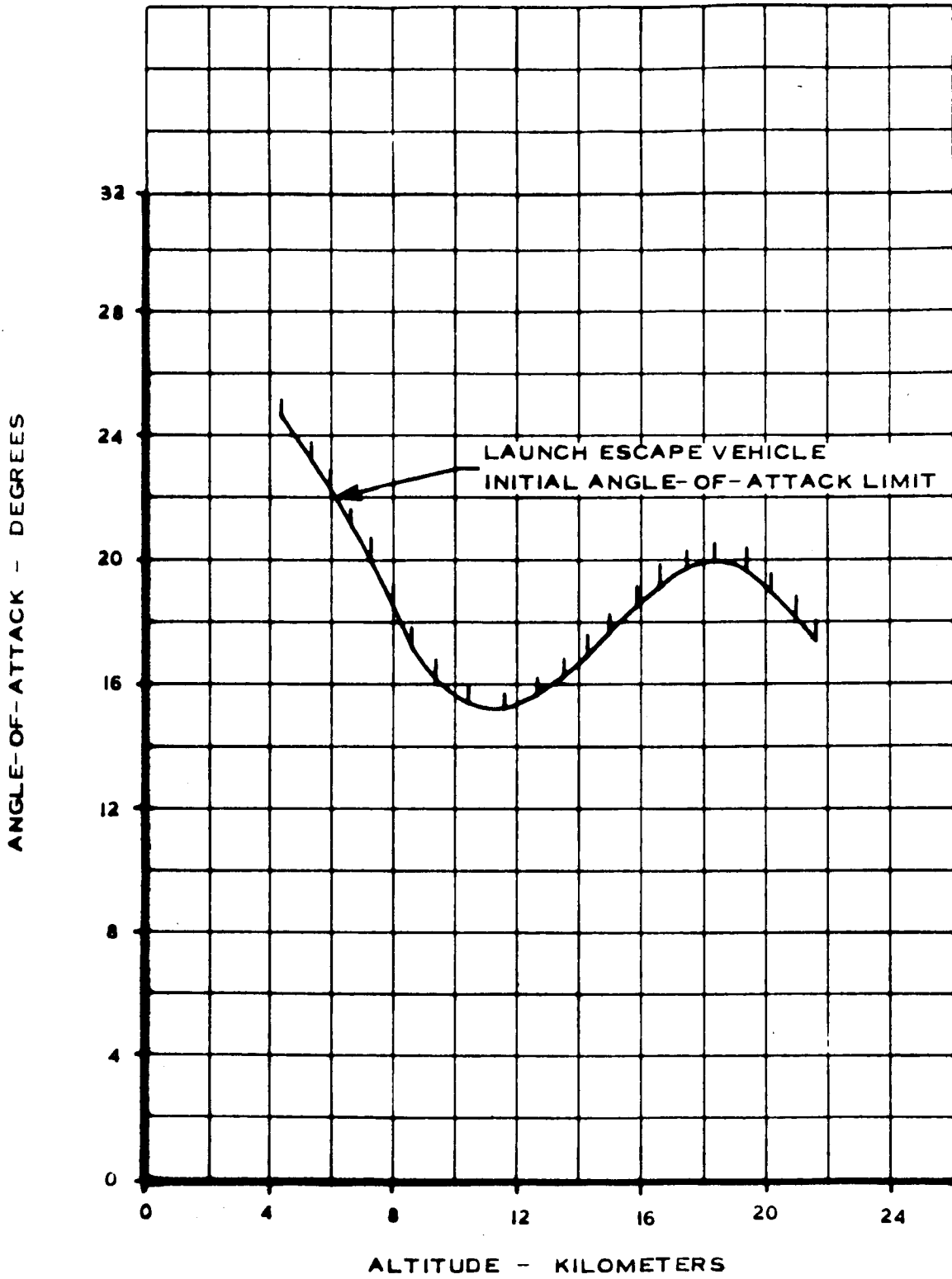

FIGURE 2-1 LEV INITIAL ANGLE-OF-ATTACK LIMIT

2.1.5 Safe Abort Lead Times for Saturn V Explosions

An explosion during the flight of AS-504 will require that abort occur at some time in advance of the explosion. This section defines the time prior to explosion at which the abort vehicle must initiate escape to prevent damage to the Command Module due to overpressure at the high-q region of flight.

The lead time required to assure a safe abort for all combinations of propellant mixing may be obtained in detail from Reference 5. Figure 2-2 shows the lead time required to insure structural integrity for the "worst" case conditions during S-IC flight.

The Command Module and Launch Vehicle Trajectories following an abort at 40,000 feet are shown in Figure 2-3. Reference 6 gives in detail the buildup of the curves shown in Figure 2-3.

2.1.6 S-IC/S-II Staging Limits

Staging limits used in this study to determine successful S-IC/S-II first plane separation are from Reference 7 and are shown by Figures 2-4 and 2-5. These limits were not exceeded for regions shown as "no vehicle loss" in this report.

2.1.7 S-II/S-IVB Staging Limits

The S-IVB vehicle constraints during S-II/S-IVB staging are ± 15.3 degrees attitude error, ± 10 degrees attitude rate, and ± 7 degrees engine deflection.

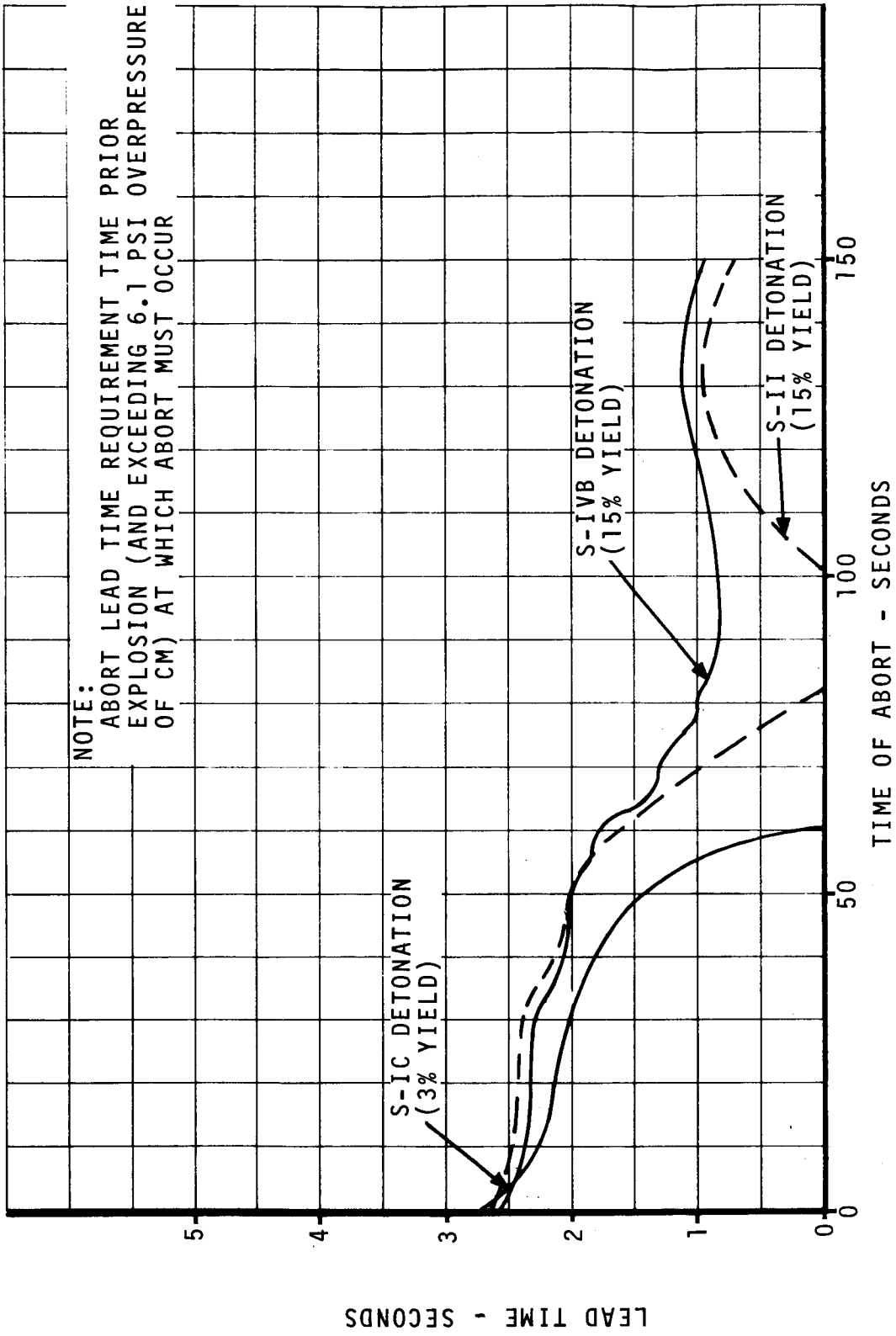

FIGURE 2-2 ABORT LEAD TIME REQUIREMENTS

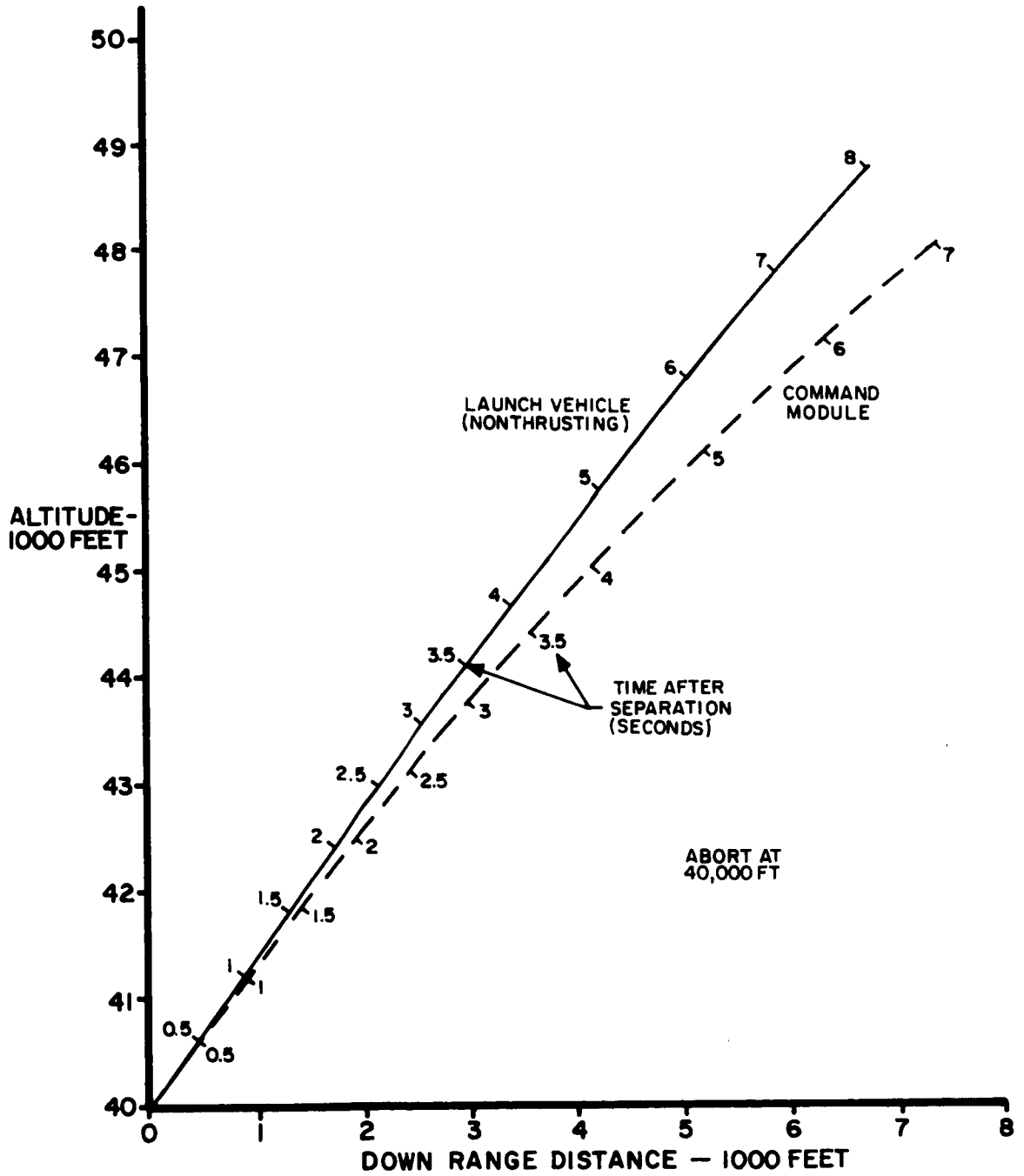

FIGURE 2-3 COMMAND MODULE AND LAUNCH VEHICLE TRAJECTORIES FOLLOWING ABORT

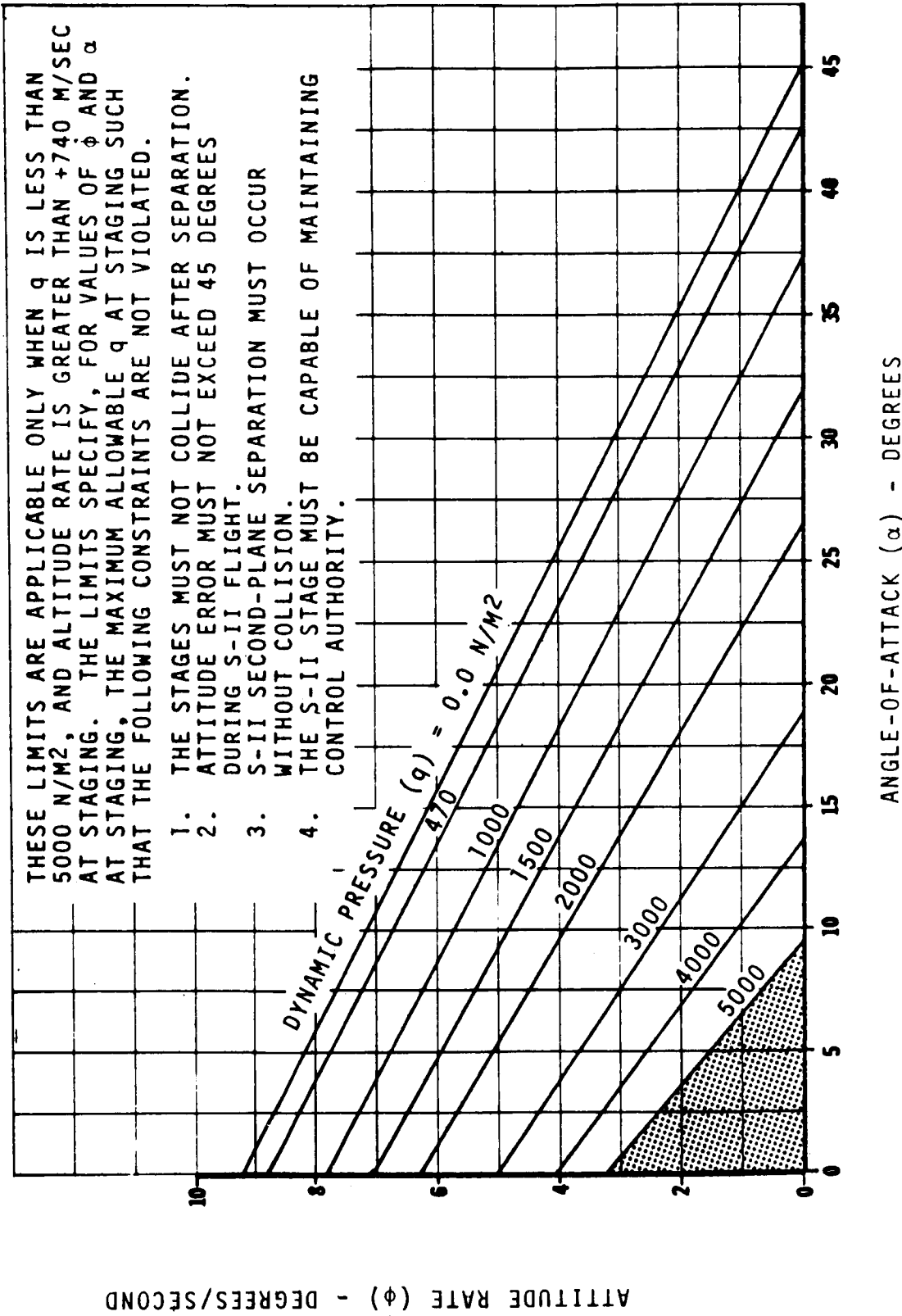

FIGURE 2-4 SATURN V AS-504 S-IC/S-II STAGING LIMITS - DYNAMIC PERTURBATIONS

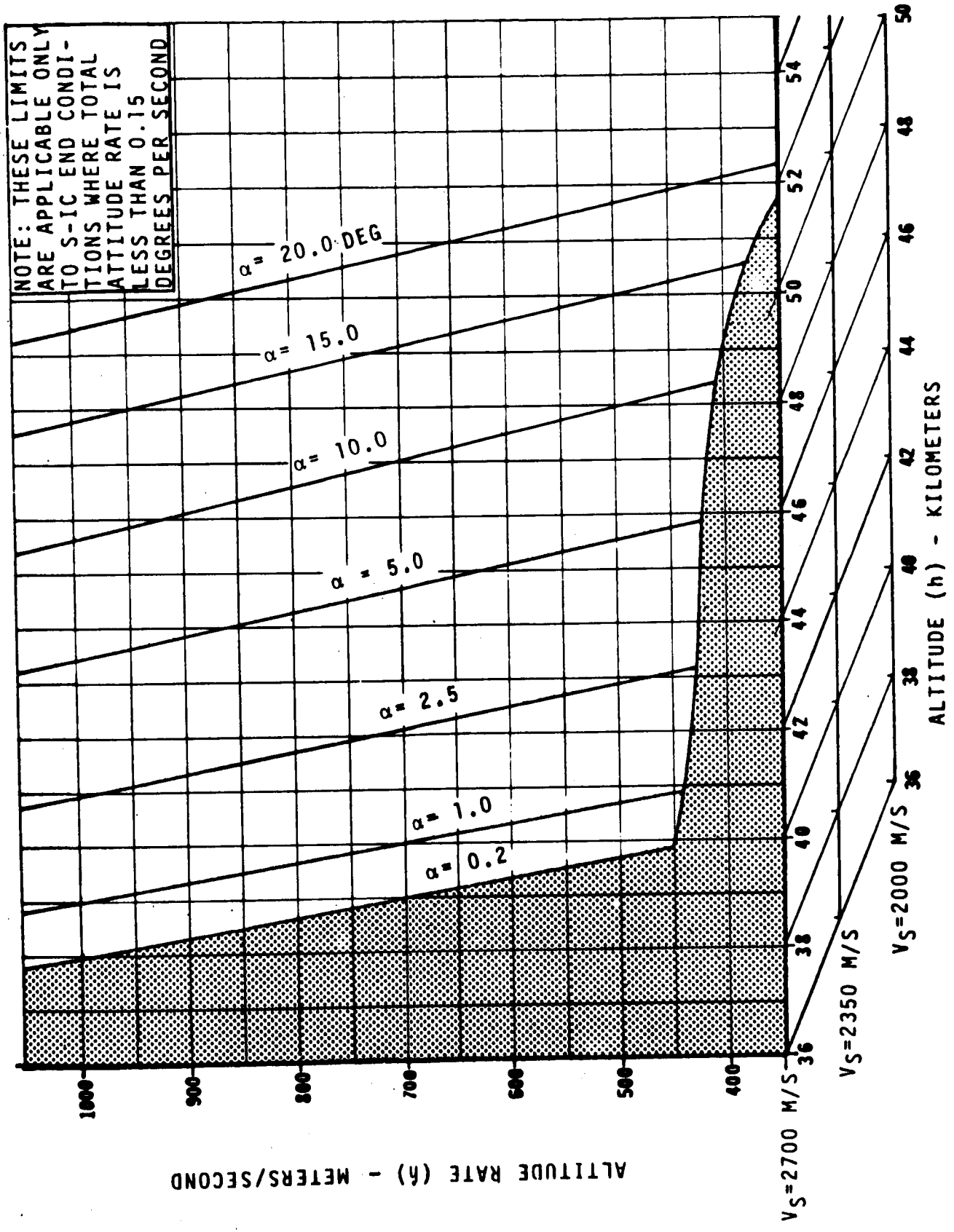

FIGURE 2-5 SATURN V AS-504 S-IC/S-II STAGING LIMITS - TRAJECTORY PERTURBATIONS

2.2 PARAMETERS

The parameters which were varied in the analysis are discussed below.

2.2.1 Malfunctions

Malfunction type is varied as a parameter. For engine-out malfunctions this is described by engine number. For actuator hardover it is described by axis (pitch or yaw) and direction (up or down, right or left) of malfunction. Other malfunctions are described by reference to a vehicle axis (pitch, yaw or roll). Detailed malfunction descriptions are presented in Section 2.3.

Time of malfunction is varied as a parameter. This time is defined as the time of initiation of the malfunction effect, e.g., initiation of thrust decay for engine-out or initiation of actuator velocity toward the hardover position.

2.2.2 Winds

Wind direction and magnitude are varied as a parameter. Figures 2-6 through 2-9 present monthly wind velocity versus probability percentile for both wind-biased and non-wind biased trajectories as used in this document. These curves can be used to relate wind velocity used in subsequent analysis sections to percentile, for evaluating loss probabilities.

For example, if December is the launch month, the 5th percentile head and tail wind component from Figure 2-9 is 0 m/sec. From the same figure, the 95th percentile head and tail wind component is 61 m/sec. The 5th and 95th percentile crosswind components are found from Figure 2-8 to be 33 m/sec and 14 m/sec, respectively. By integrating the regions of vehicle loss within these limits, the probability of vehicle loss can be found.

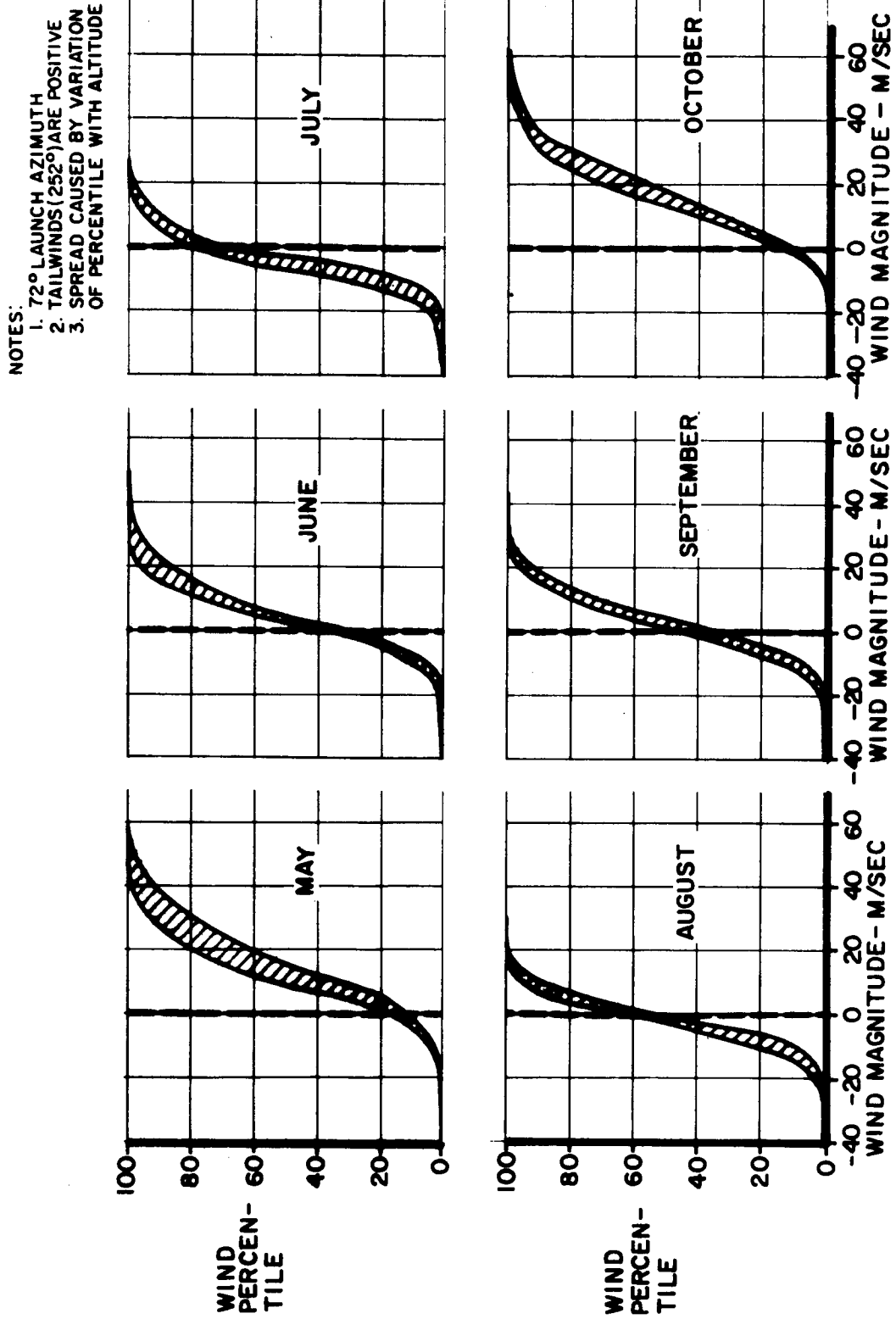

FIGURE 2-6 PERCENTILES OF 10-14KM HEAD AND TAIL WIND COMPONENTS (NON-BIAS MONTHS)

- NOTES:
 1. 72° LAUNCH AZIMUTH
 2. RIGHT CROSSWINDS (162°)
 ARE POSITIVE
 3. SPREAD CAUSED BY VARIATION
 OF PERCENTILE WITH ALTITUDE

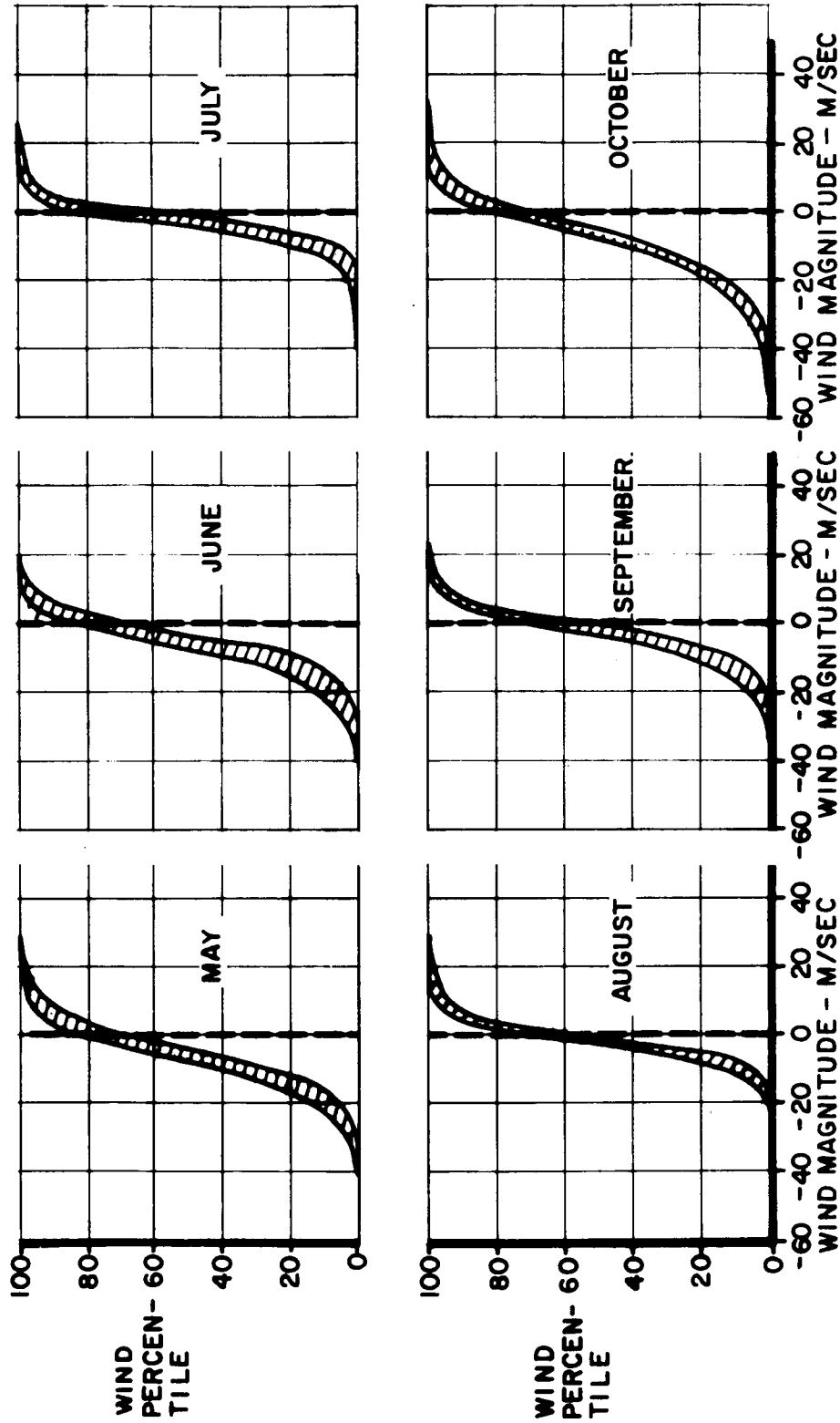

FIGURE 2-7 PERCENTILES OF 10-14 KM RIGHT AND LEFT CROSS WIND COMPONENTS (NON-BIAS MONTHS)

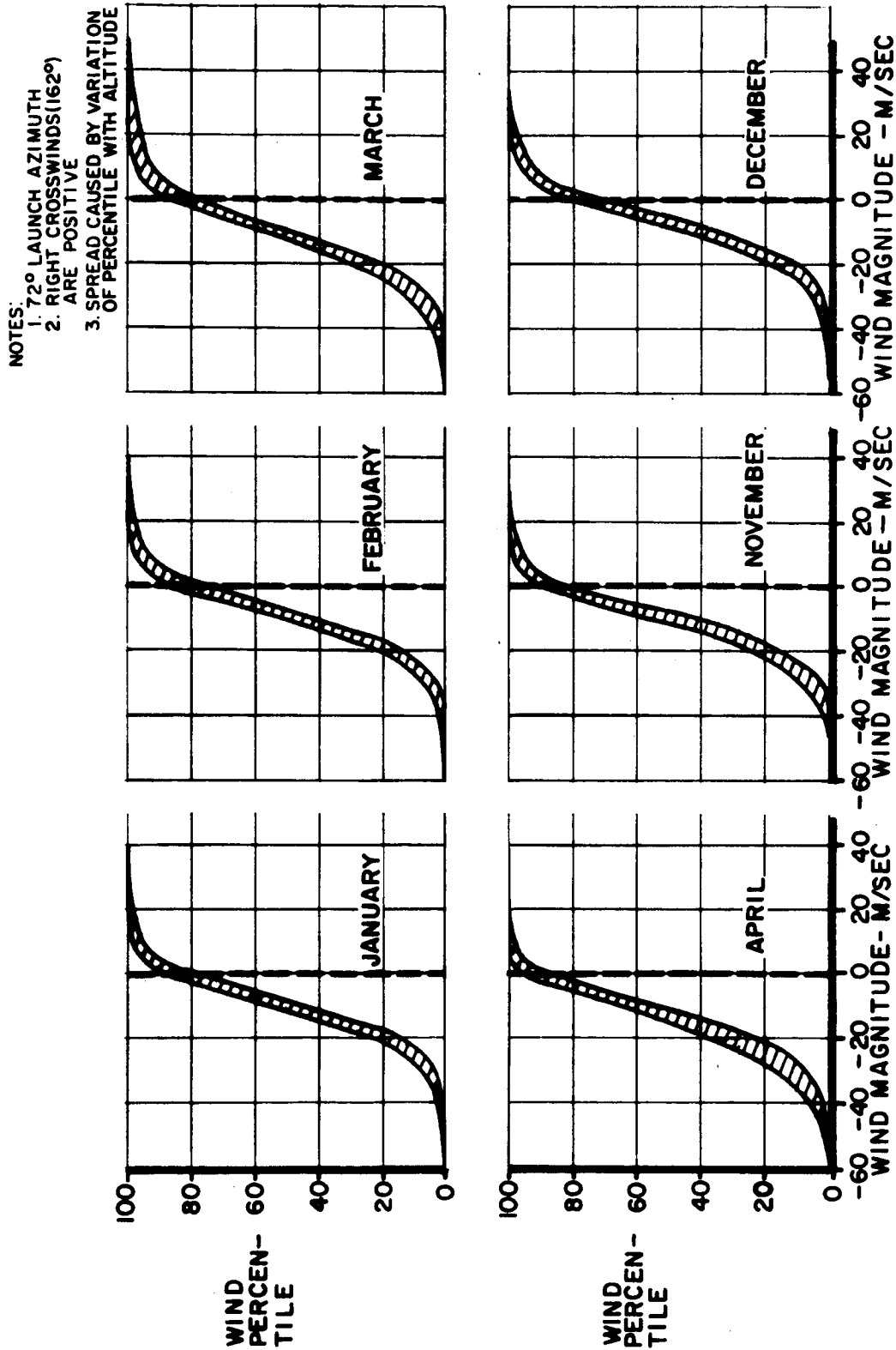

FIGURE 2-8 PERCENTILES OF 10-14 KM RIGHT AND LEFT CROSS WIND COMPONENTS (WIND BIAS MONTHS)

- NOTES:
1. 72° LAUNCH AZIMUTH
 2. TAILWIND (252°) ARE POSITIVE
 3. SPREAD CAUSED BY VARIATION OF PERCENTILE WITH ALTITUDE

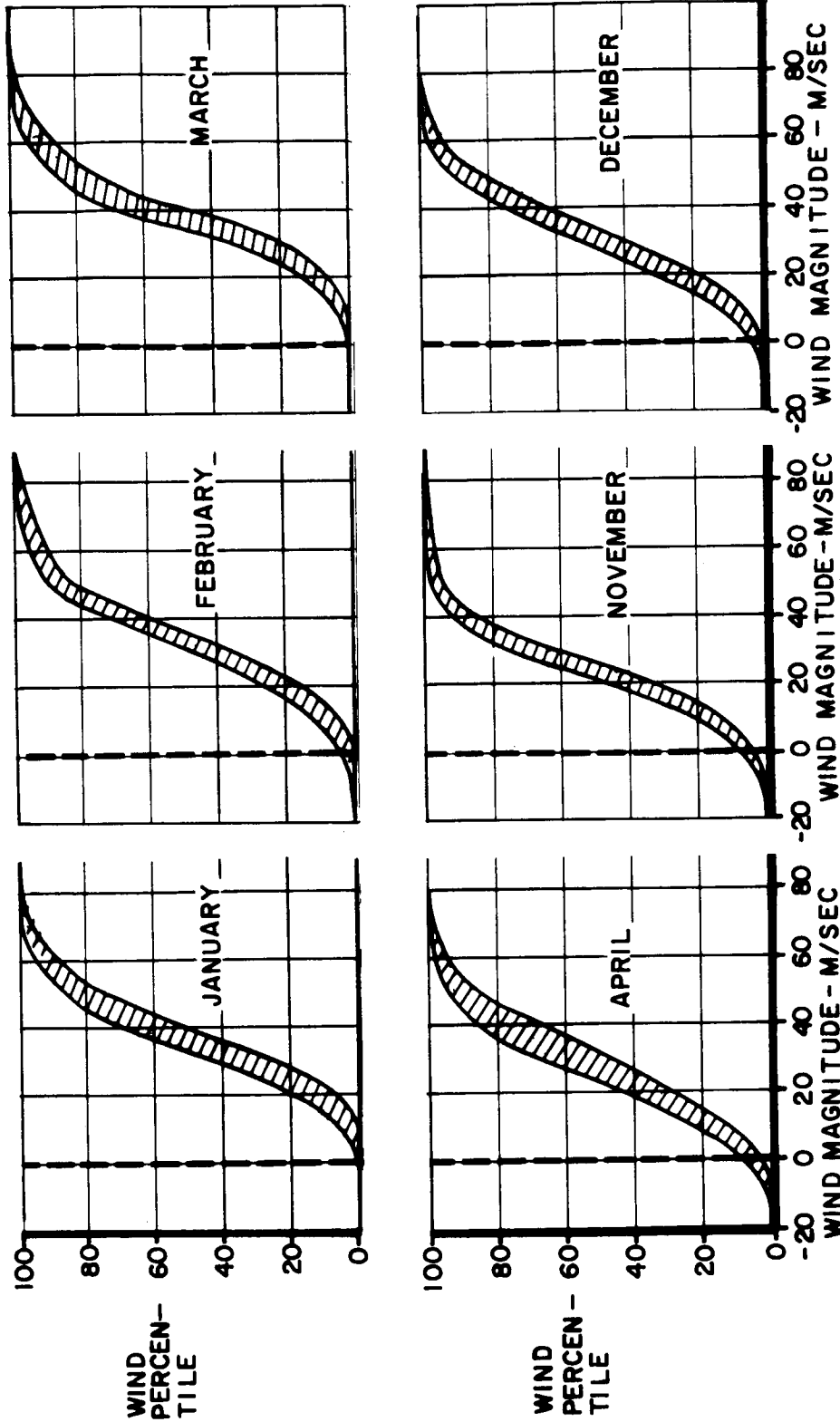
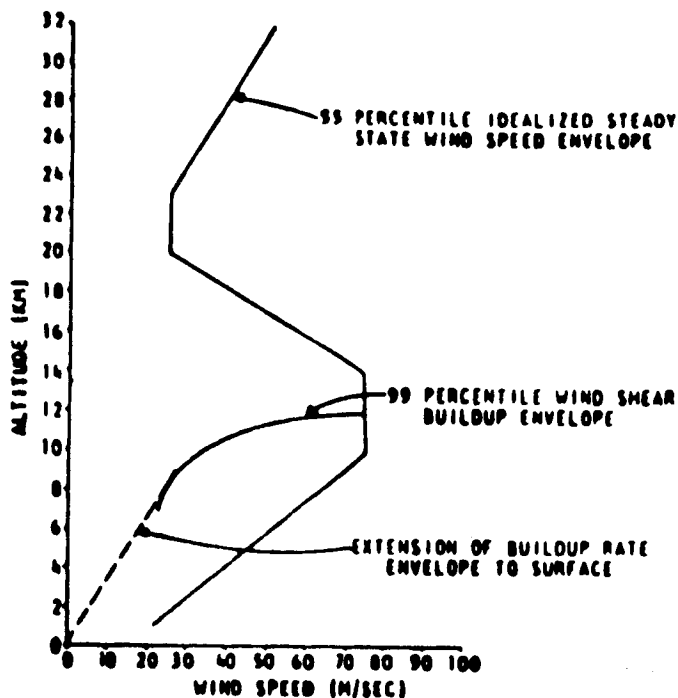

FIGURE 2-9 PERCENTILES OF 10-14 KM HEAD AND TAIL WIND COMPONENTS (WIND BIAS MONTHS)

2.2.2 (Continued)

An example of the construction of synthetic wind profiles, as a function of altitude without the gust superimposed is shown below:



Example of Synthetic Wind Profile Construction

A gust is superimposed on the above quasi-steady-state wind profile to account for the high frequency component of the wind. The gust which is used for this purpose is shown below.

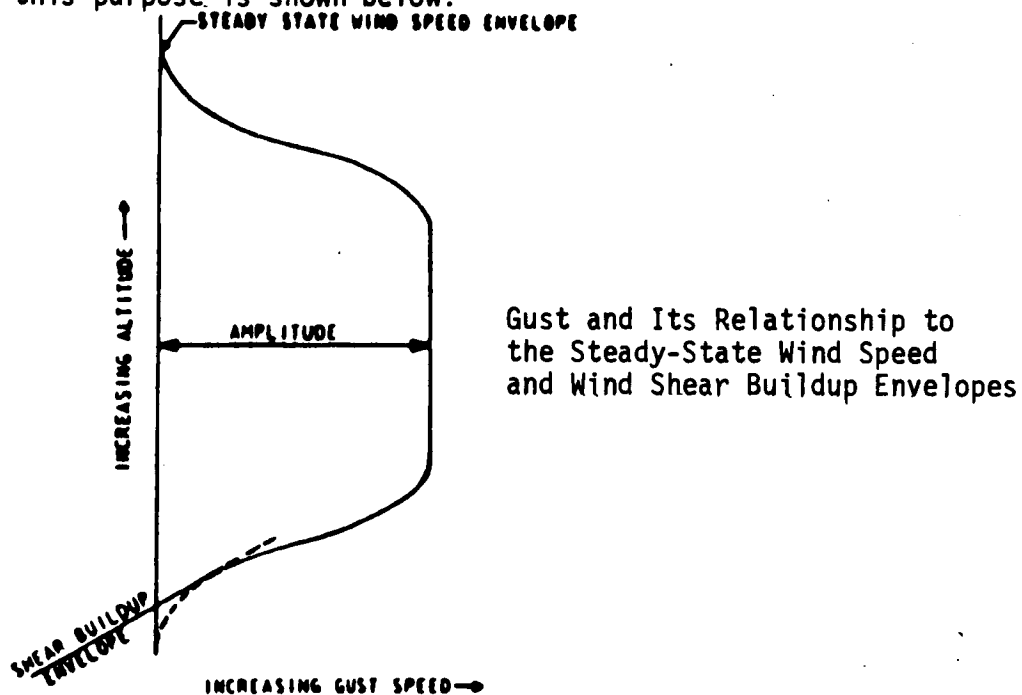

Gust and Its Relationship to the Steady-State Wind Speed and Wind Shear Buildup Envelopes

2.2.2 (Continued)

To obtain the worst condition of loads and controllability for engine and actuator malfunctions, the wind types in Figure 2-10 are evaluated. For malfunctions after 40 seconds of flight time, it is determined that maximum loads and minimum controllability occurred when a gust is initiated at the time of the malfunction. For malfunction prior to 40 seconds, a gust in the region of maximum dynamic pressure produces a more critical case. Critical phasing of the gust and malfunction is used throughout this study.

2.2.3 Vehicle Tolerances

Operating vehicle tolerances were considered in this analysis. The tolerances used are listed below:

<u>PARAMETER</u>	<u>TOLERANCE</u>
a. S-IC	
Center of Pressure	± 0.2 calibers
Pitch/Yaw Control Gains	±10%
Normal Force Coefficient	± 6%
Thrust Misalignment	
Pitch/Yaw	± 0.34°/engine
Roll	± 0.4°/control engine
b. S-II	
Center of Pressure	± 0.2 calibers
Pitch/Yaw Control Gains	±10%
Normal Force Coefficient	± 6%
Thrust Misalignment	
Pitch/Yaw	± 0.34°/Engine
Roll	± 0.40°/Control engine
c. S-IVB	
Control Gains	±10%
Thrust Misalignment	
Pitch/Yaw	± 1.01°

Regions of vehicle loss and EDS effectiveness shown in this report include the above tolerances.

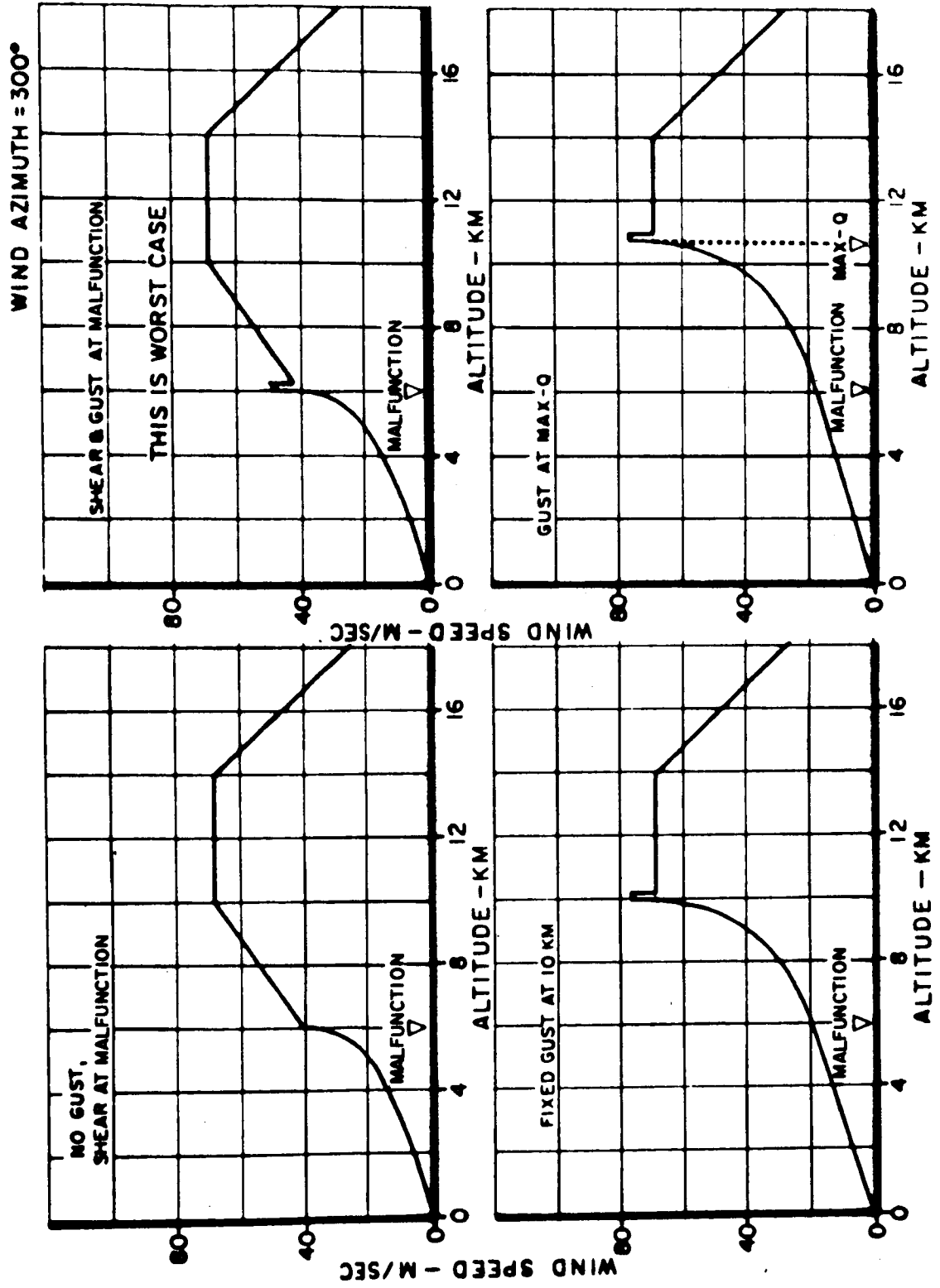

FIGURE 2-10 CASES EVALUATED FOR EDS WIND CRITERIA

2.3 MALFUNCTION DESCRIPTION

The following paragraphs document description of malfunction modes and subsequent subsystem dynamics considered by this study. Subsequent effects on vehicle and flight dynamics for each critical failure mode for the various phases of powered and coast flight are described in following subsections of the report. Based on information in other subsections, estimates for resulting vehicle loss factor are also given for the stages indicated. These factors do not reflect primary mission loss β -factors, which are in general, equal to or larger than the vehicle loss factor. The criteria and parameters described in the previous subsections are used for each of the representative critical failure modes shown in Figure 2-11. Vehicle loss factors are based on POI only.

a. Loss of Thrust

Loss of thrust for the study is the thrust decay resulting from any component malfunction which causes dropout of the thrust OK pressure switch (TOPS). Figure 2-12 shows the band of the F-1 engine thrust that corresponds to TOPS dropout for the applicable fuel injection pressure. The band of J-2 engine thrust applicable to TOPS dropout is similar with the only difference being level of thrust. All TOPS dropout thrust decays were initiated for the worst control and load conditions which correspond to TOPS dropout at the maximum value of 1070 psi. No specific decay data is available for the time from component failure to TOPS dropout, since the rate of thrust loss is dependent on the component failure and is not fully predictable. However, constant thrust decay rates for 25 secs. and 20 secs. were assumed for the F-1 and J-2 engines, respectively, since these rates prevent significant effects in vehicle dynamics. Engine data has indicated that thrust decay, after thrust OK sensor de-activation, is a function of the normal cutoff thrust decay* and flight time at which the malfunction takes place. Thrust variations for normal cutoff and TOPS dropout can be represented by 3 sigma limits and are due to dispersions in valve closing time and in the absolute value of thrust. These thrust values and dispersion can be normalized and statistically combined to show that for the worst possible loads, the rate of thrust decay for the normal cutoff and after thrust OK sensor de-activation are nearly coincidental. Therefore, the rate of thrust decay for an engine out would follow the -3 sigma curve because this portion of the 3 sigma band has the greatest probability of causing loss of vehicle control.

Loss of thrust due to major explosions (explosion that leads to structural integrity reduction and/or loss of thrust in another engine) is near instantaneous thrust loss, as shown in Figure 2-13.

*See Page 2-22

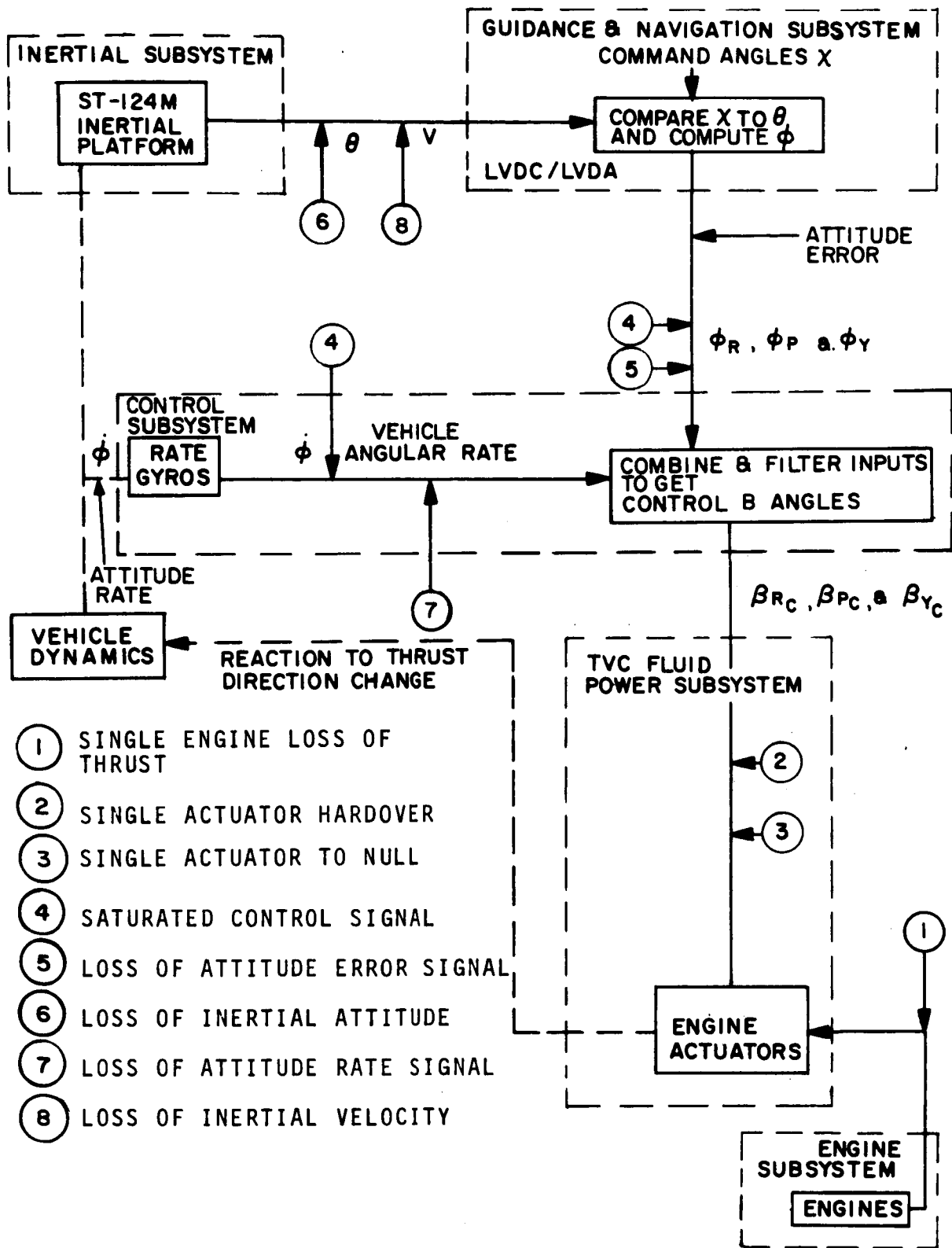

FIGURE 2-11 SATURN V GUIDANCE AND CONTROL FAILURE MODES

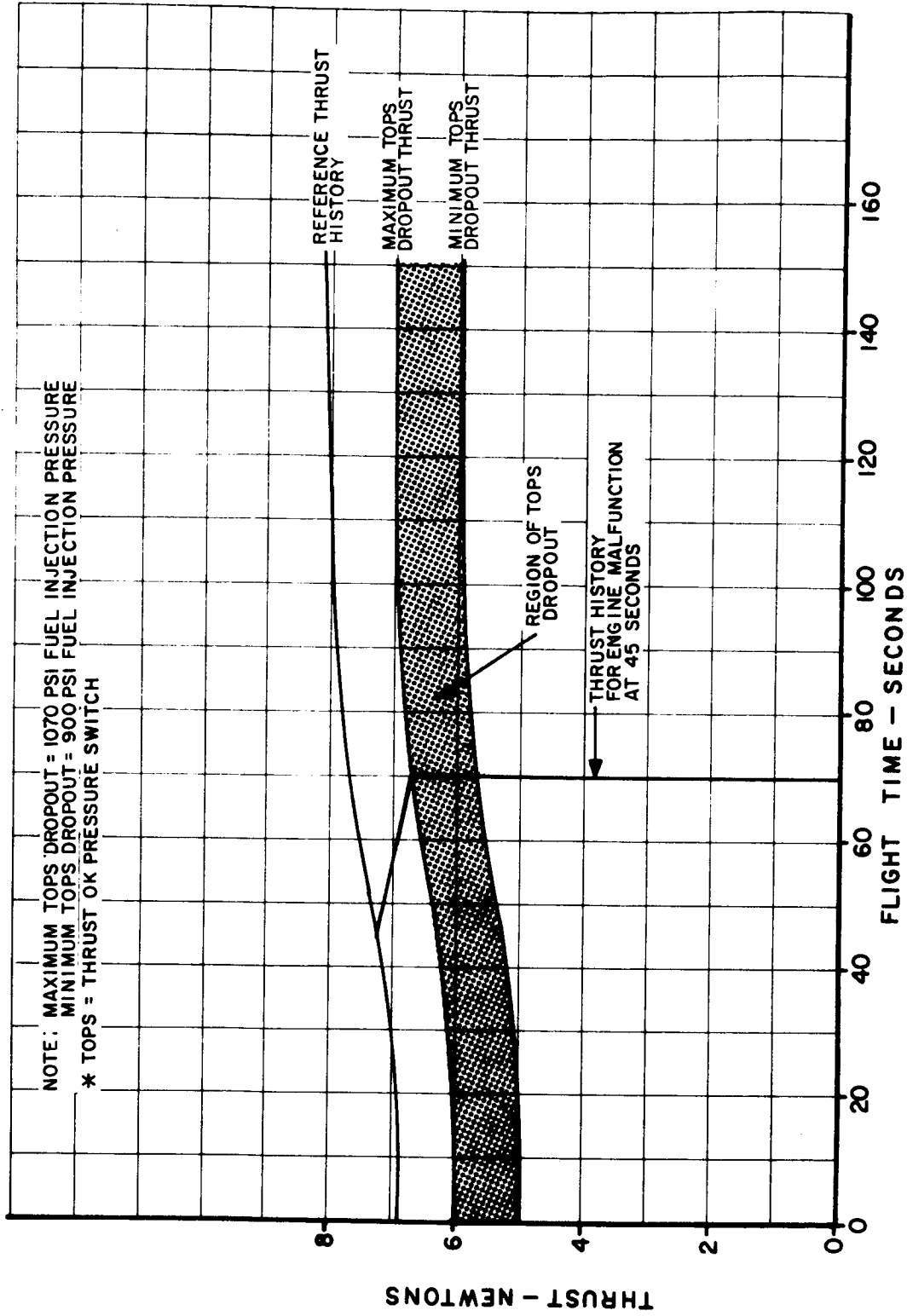

FIGURE 2-12 THRUST AT THRUST OK PRESSURE SWITCH (TOPS) DROPOUT

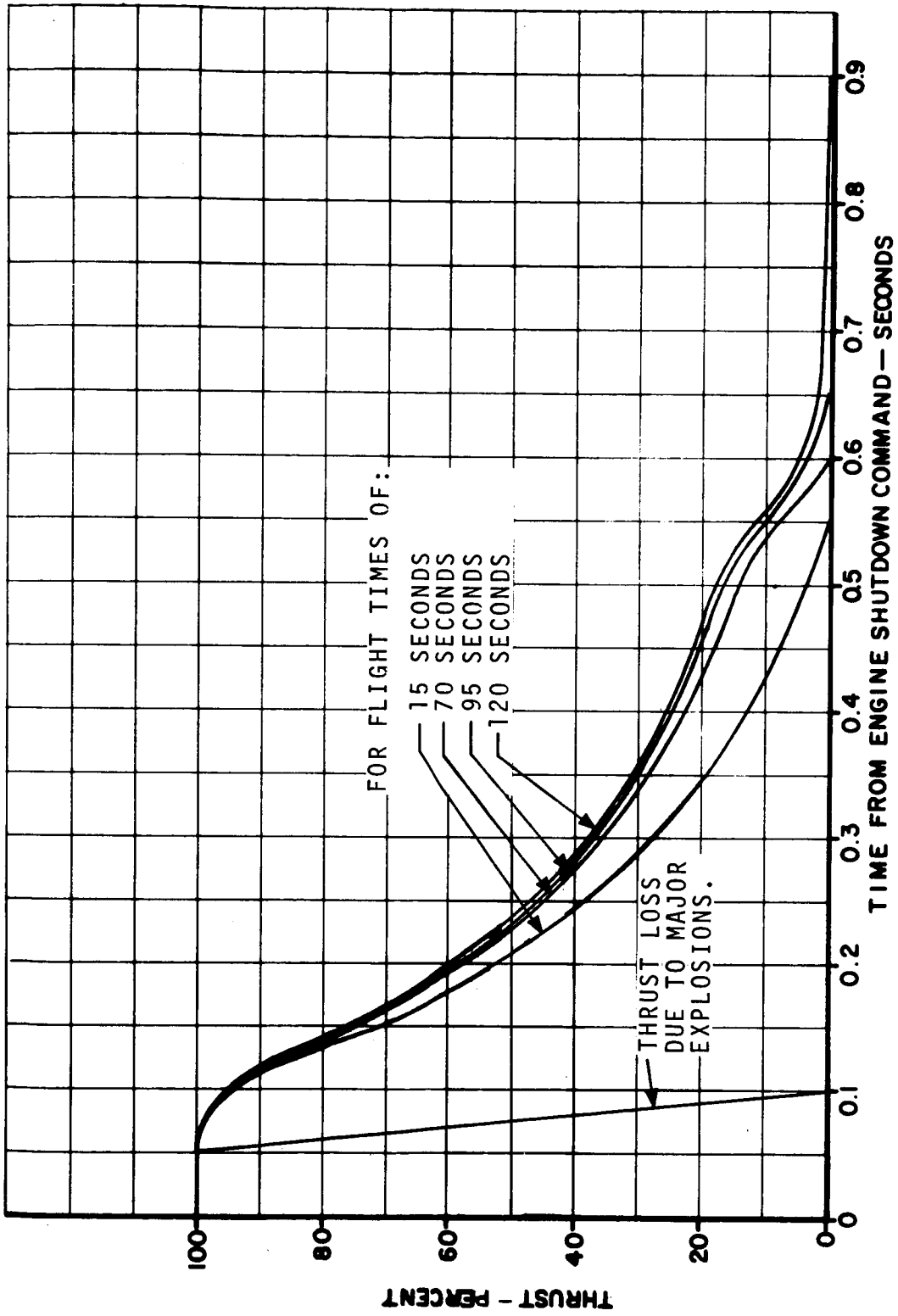

FIGURE 2-13 PREDICTED F-1 ENGINE THRUST DECAY FOLLOWING TOPS DROPOUT

2.3 (Continued)

Simulation of loss of thrust (Figures 2-13, 2-14, 2-15) was implemented by the following sequence:

1. Failed engine begins loss of thrust at a constant rate.
2. Engine thrust decays at this rate until the thrust reaches a level low enough to cause dropout of TOPS at fuel injection pressure of 1070 psi.
3. At TOPS dropout engine shutdown to zero thrust along -3 sigma curves dependent on flight times. (Linear interpolation is used to approximate curve for other flight times not shown in graphs.)
4. At TOPS dropout the LVDC updates tilt arrest by the length of the Chi-freeze. The Chi-freeze schedule used in this study is shown in Figure 2-16. This Chi-freeze was recommended in Reference 8.

*Engine shutdown as a result of an electrical command (abort sequence, CECO, OECO, etc.) begins immediate loss of thrust on the curve applicable to that shutdown time shown in Figure 2-13.

	VEHICLE LOSS FACTOR		
	S-IC	S-II	S-IVB
1. LOSS OF THRUST - ONE ENGINE A failure as above which affects only one engine, either a control or a center engine (S-IC and S-II). A center engine affects vehicle performance but does not require abort.	0.023 **1.00	0.02	1.00
2. LOSS OF THRUST - TWO ENGINES Failures as above which affect two engines.	1.00	0.6	N/A
3. LOSS OF THRUST - ALL ENGINES A failure which affects all engines. Not considered due to low probability of occurrence.	1.00	1.00	1.00
4. FAILURE TO START - ONE ENGINE A failure which results in not reaching full thrust as indicated by the thrust OK switch and subsequent engine shutdown. Failure to start is included in the above one engine failure cases.	0.00	0.00	1.00

** Engine failure as a result of major explosion.

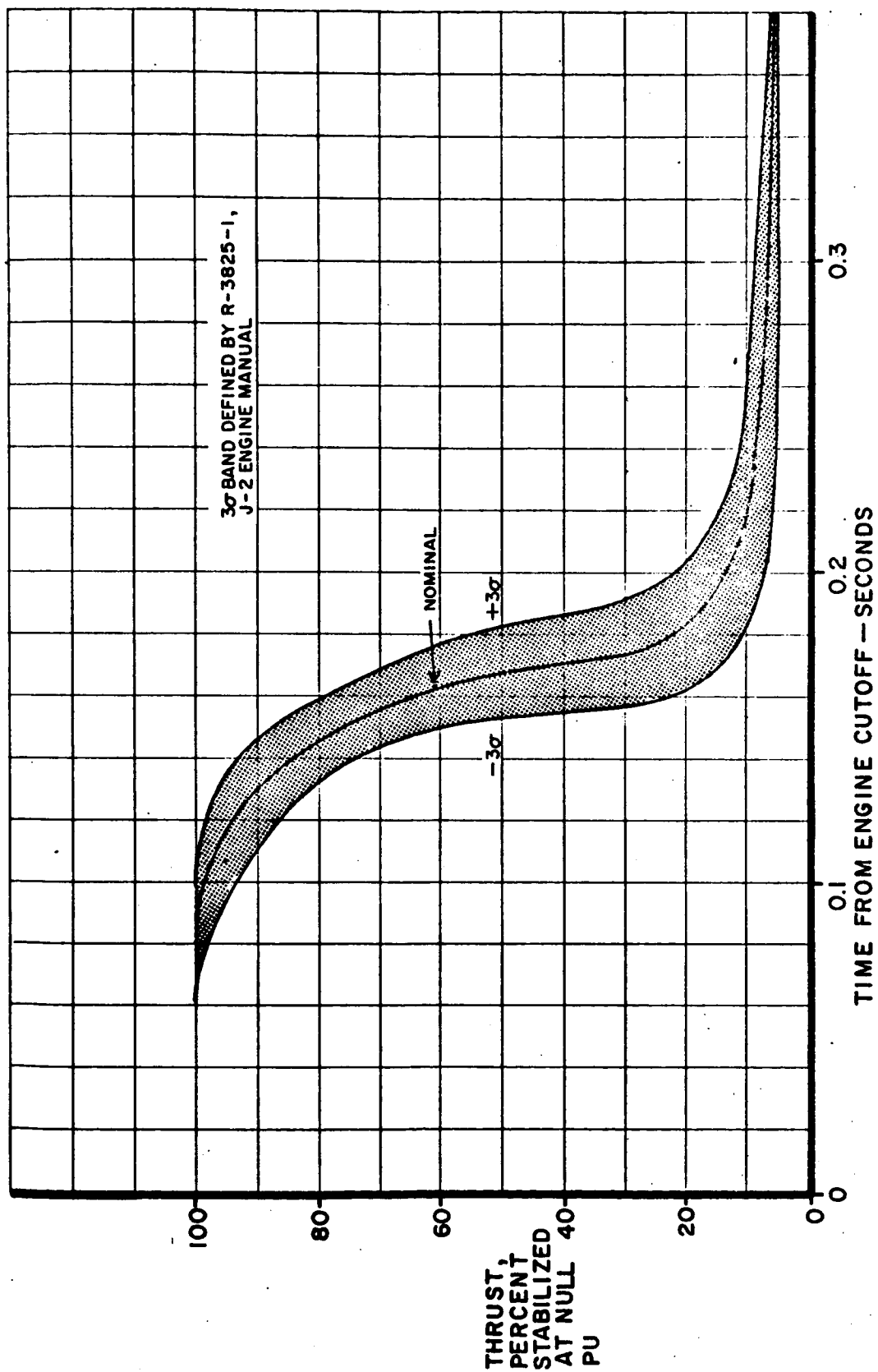

FIGURE 2-14 S-II PREDICTED J-2 ENGINE THRUST DECAY

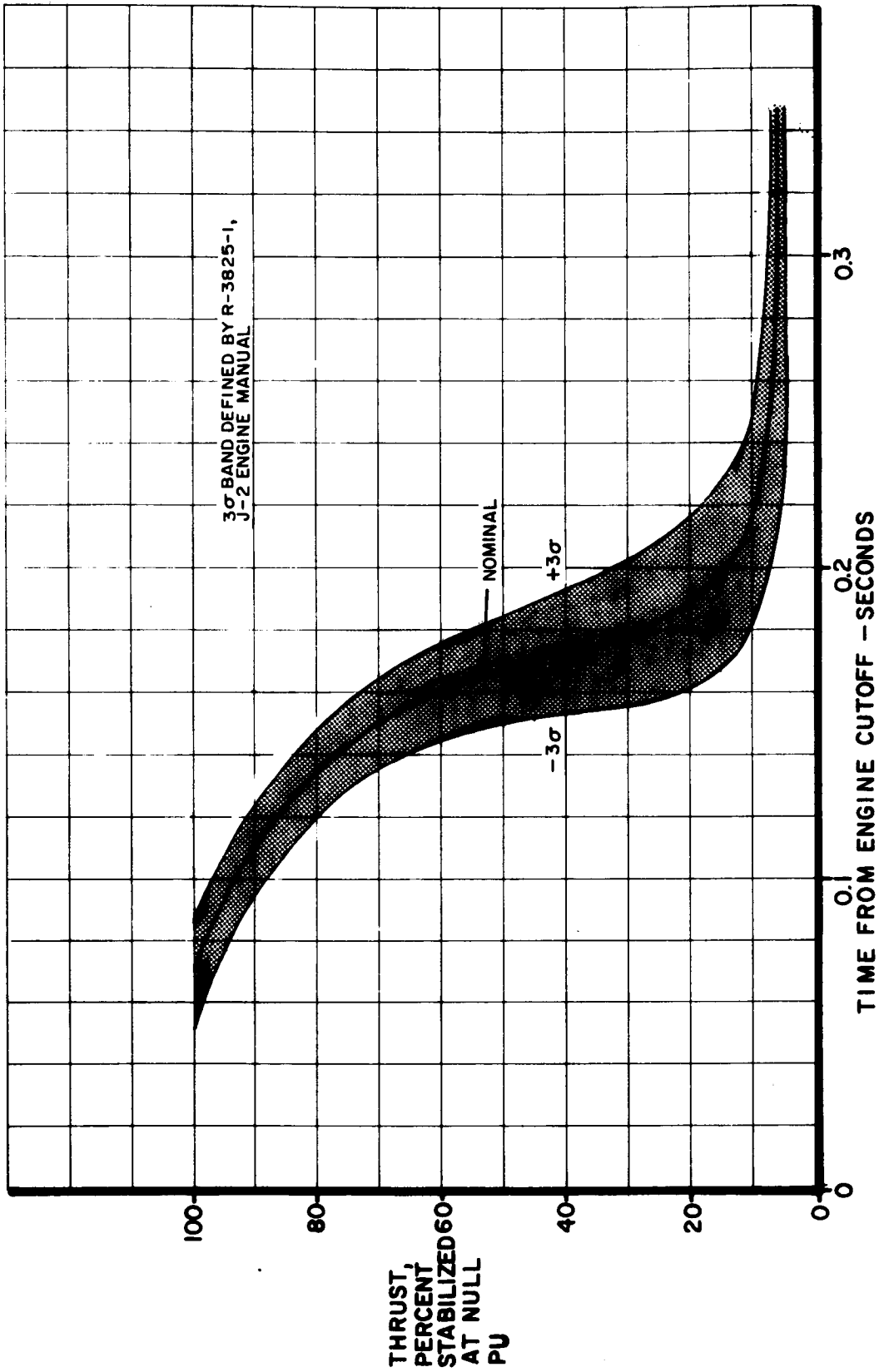

FIGURE 2-15 S-IVB PREDICTED J-2 ENGINE THRUST DECAY

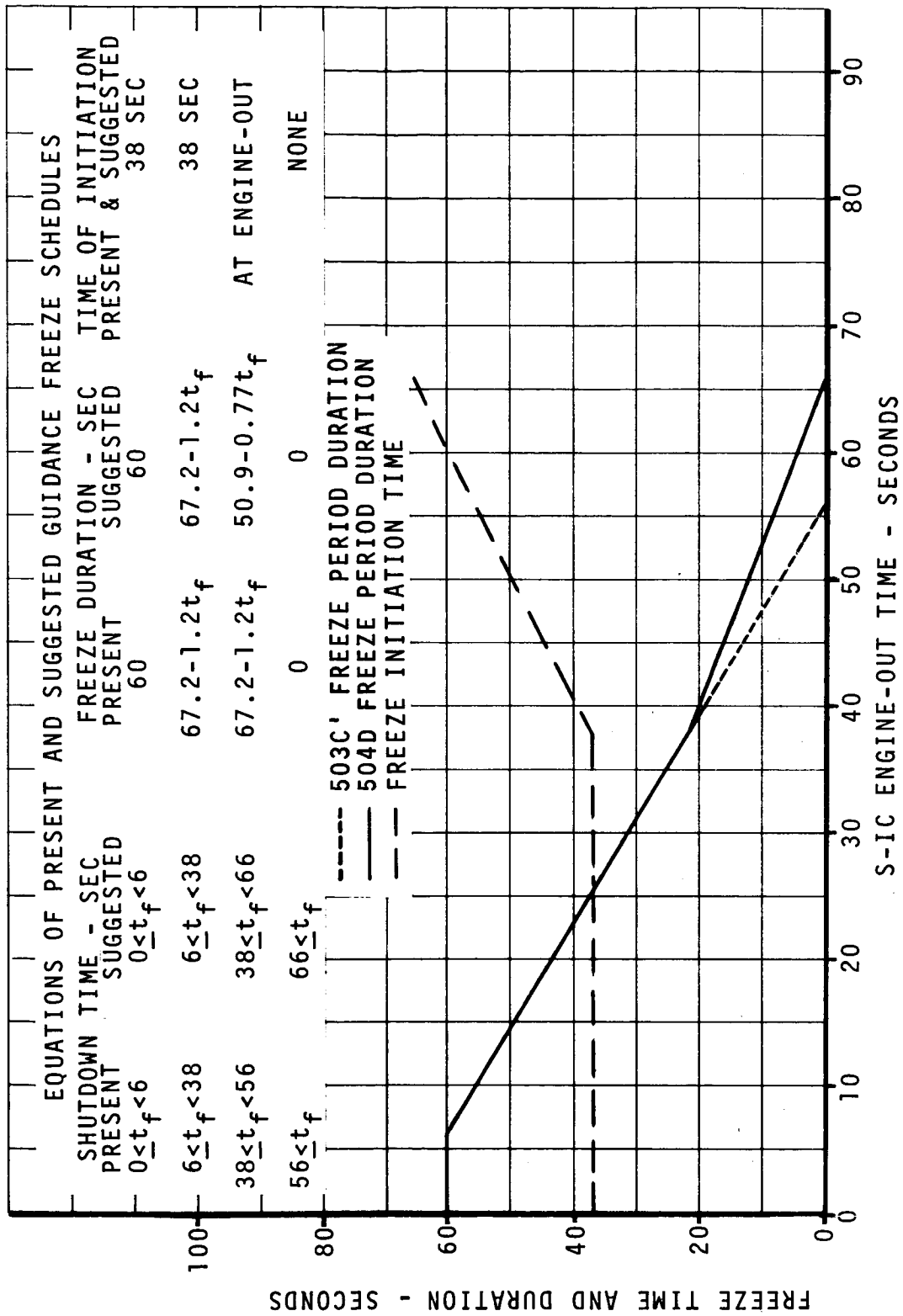

FIGURE 2-16 AS-504 PRESENT AND SUGGESTED CHI FREEZE SCHEDULES FOR ENGINE FAILURES DURING S-IC FLIGHT

2.3 (Continued)		VEHICLE LOSS FACTOR		
		S-IC	S-II	S-IVB
5.	FAILURE TO START - ALL ENGINES Any malfunction resulting in termination of the startup sequence for all engines of a stage. Stage startup failures do not produce an immediate EDS problem and are not considered here. Direct staging and alternate mission aspects are covered by Reference 10.	0.00	1.00	1.00
b.	SERVO ACTUATOR FAILURES Failures included in this category are those which cause a single engine to be positioned incorrectly or controlled in an undesirable manner.			
1.	ONE ACTUATOR FULLY DEFLECTED (Hardover) This malfunction mode is the result of a thrust vector control (TVC) component failure that causes a force to be applied to a control engine actuator, causing a fully extended or retracted position in the plane of the failure. This type of failure mode can occur regardless of the β command issued by the control computer. The rate of an actuator hardover and its corresponding engine is dependent upon the prevailing load conditions at the time of failure. Maximum loads throughout flight can be calculated from the range of max S/C gibal moments (excluding aerodynamic) and SA-504 aerodynamic gibal hinge moments. Assuming the dynamic pressure at the time of malfunction is approximately equal to the equivalent of the SA-504 OT, the max gibal moments are an addition of both types of gibal moments. Since the total moment is applied in the actuator plane, the max actuator loading can be calculated for each time of flight. Based on the above results of a max constant actuator	0.024	.001	1.00

2.3 (Continued)

VEHICLE LOSS FACTOR		
S-IC	S-II	S-IVB

1. load of 75,000 lbs., extreme values of actuator rate limit can be calculated. Results indicated the engine rate limit was between 6 and 16.6 degrees/sec. with a nominal value of 12.3 degrees/sec. The rate of 6 degrees/sec. was for the load opposing the actuator command and the rate of 16.6 degrees/sec. was calculated for the load moving in the direction of the actuator command. Rate of 12.3 degrees/sec. was determined for no load.

The rate of actuator hardover for S-II engines and S-IVB engines have been determined to be 9.6 degrees/sec. and 8.0 degrees/sec., respectively. The rate was determined using only a first order servo system since the bending coupling is not an input to the TVC system.

Simulation of the actuator hardover malfunction was implemented in the S-IC engines by using the extreme engine rate limits of 6 degrees/sec. and 16.6 degrees/sec. Rate of actuator hardover in the S-II and S-IVB stages were simulated with the rates described above.

- | | | | | |
|----|--|-------|-------|------|
| 2. | ONE ACTUATOR INOPERATIVE (NULL POSITION)
Any failure which causes a single actuator to remain at null regardless of commands issued by Control Computer or external forces placed on the actuator by the engine. Does not require abort except during S-IVB flight. This malfunction is simulated by commanding the failed actuator to null position at the above maximum rate. | <.001 | <.001 | 1.00 |
| 3. | ONE ACTUATOR OSCILLATORY
Any failure which causes the actuator position to be modulated about the desired commanded position. The oscillation (modulation) may include | - | - | 1.00 |

2.3 (Continued)

	VEHICLE LOSS FACTOR		
	S-IC	S-II	S-IVB
3. those which are low in frequency (drifts). This malfunction has been covered in previous analyses and does not result in need for S-IC or S-II abort. In S-IVB, loss of control results.	-	-	1.00
4. ONE ACTUATOR FAILS TO HOLD Any failure which allows the actuator position to be modulated by external loads. Limiting cases for this malfunction are bounded by actuator-to-null cases (where actuator remains near center) and by actuator hardover cases (where actuator is forced against stops), hence separate analyses are not supplied. In S-IVB, loss-of-control may result.	-	-	-
5. ONE ACTUATOR RATE LIMITED Any failure which causes the rate of change (velocity) of position capability to be velocity limited below the desirable capability. This malfunction is bounded by the above cases and separate analyses are not included. Abort is not required in S-IC or S-II. Loss of control may result in S-IVB.	-	-	-
6. BOTH ACTUATORS, SAME ENGINE, INOPERATIVE Any single failure which affects both actuators of single engine such as to cause any of the same problems described for single actuator above. Dual actuator failures are not considered in this analysis.	-	-	1.00
c. LOSS OF INERTIAL VELOCITY INFORMATION Failures included here are those which cause the velocity reasonableness test to be failed (velocity reasonableness failures due to inertial platform attitude errors are	-	0.00	0.00 (with Reference 9 changes, perigee > 60 NM)

2.3 (Continued)

VEHICLE LOSS FACTOR
S-IC S-II S-IVB

c. not to be included here).

The velocity reasonableness test is performed in the Accelerometer Processing Loop of the LVDC on the change in velocity (ΔV) since last test (a period which may vary from 0.6 to 2.1 seconds). The reasonableness test is failed when:
a) the velocity change is zero for five successive samples in the X-channel;
b) the velocity change is zero for five successive samples in the Z-channel after $t_0 + 10$ seconds; c) the velocity change does not satisfy the following:

$$0.5(\Delta V_c) - RTC \leq \Delta V \leq 1.5 \Delta V_c + RTC$$

where:

ΔV = measured change in velocity

ΔV_c = calculated expected change based on last used platform acceleration value resolved through present gimbal angles.

RTC = reasonableness test constant
TIME RTC_x RTC_y RTC_z

S-IC Burn	6	6	6
During Staging & T7 to end of mission	50	6	50
S-II & S-IVB burn	6	1.5	6
T3 + 4.7 to T4 (with one S-II engine out)	20	20	20

2.3 (Continued)

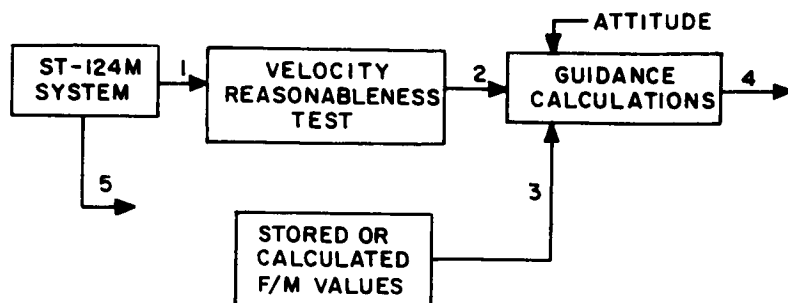
VEHICLE LOSS FACTOR
S-IC S-II S-IVB

1. Measured velocity
2. Measured velocity after test
3. Calculated velocity from stored values
4. Attitude correction command to control computer
5. Attitude angle information from platform

Loss occurs when velocity reasonableness is failed and item 3 is substituted.

The attitude angles at 5 are not degraded by failure.

There are four failure categories:

- a) x body axis
- b) y body axis
- c) z body axis
- d) Two or more axes

The primary contributor to this system failure is an "Accelerometer Servo Loop Failure" which is primarily caused by an accelerometer failure or a PEA failure.

The above problem does not affect first-stage flight; however, failures during S-IC flight affect navigation, which may change initial conditions for S-II IGM turn-on. Analysis is presented in Reference 10.

2.3 (Continued)

VEHICLE LOSS FACTOR
S-IC S-II S-IVBd. LOSS OF INERTIAL ATTITUDE
(Platform Failure)

This malfunction happens as a result of the failure of ST-124 Inertial Platform which provides attitude reference. The outputs of the platform are monitored by the LVDC and tested for reasonableness. If the reasonableness test is failed, the LVDC permanently substitutes the last good signal for error feedback.

The (RT) is performed in the LVDC minor loop once every 40 milliseconds on each axis. An indicated attitude change greater than 0.4 degrees in 40 milliseconds or a non-explainable zero reading causes the (RT) to fail and the last "good" reading is used to provide attitude error commands to the Control Computer. Three (RT) failures during a major loop will cause the coarse resolver to be switched in at the next minor loop and utilized throughout remaining mission. After switching to the coarse resolver, the (RT) increment becomes 0.6 degrees. Each (RT) failure after switching in the coarse resolver increments a counter which is compared at end of major loop with 15 times the nominal major loop time. If the (RT) failure counter is larger the guidance failure discrete is set but further processing of that axis occurs. The attitude error command to the Control Computer is "frozen" to last good value. If the RT count was less, then the counter is reset to zero and normal processing is continued into next major loop. Depending on when the malfunction occurred during the major loop and the major loop cycle time, the time between malfunction and guidance failure discrete may be a maximum of 1.72 secs. in pre-IGM flight and 2.68 secs. in IGM

2.3 (Continued)

VEHICLE LOSS FACTOR
S-IC S-II S-IVB

- d. flight. The minimum delay will be .76 secs. in pre-IGM.

The primary contributors to this system failure is a "Gyro Servo Loop Failure" which is primarily caused by: a) gyro torque motor failure, b) battery D10 failures, c) PEA failures, d) gas bearing supply failure, e) Platform AC Power Supply, f) 56 volt power supply failure, g) miscellaneous small contributors.

1. LOSS OF INERTIAL ATTITUDE REFERENCE (VELOCITY NOT AFFECTED)
Failures which cause attitude reason- 1.00 1.00 1.00
ableness test to be failed but do
not lead to a platform stable element
reorientation causing erroneous
velocity information.



1. Measured attitude (vehicle to inertial reference)
2. Attitude error or correction command

"Loss" occurs when the reasonable-ness test is failed such as to freeze the attitude error signal as described above. The following categories of failures can occur:

- a. Pitch axis only
- b. Yaw axis only
- c. Roll axis only
- d. Two or more axes (from a single failure, whether simultaneously or not)

The final consequence of all of the above cases will be freezing of attitude error signals in the axis or axes affected.

2.3 (Continued)

VEHICLE LOSS FACTOR
S-IC S-II S-IVB

2. LOSS OF INERTIAL ATTITUDE REFERENCE WITH VELOCITY INFORMATION DEGRADED
Failure which results in stable element reorientation such as to cause the attitude reasonableness test to be failed.

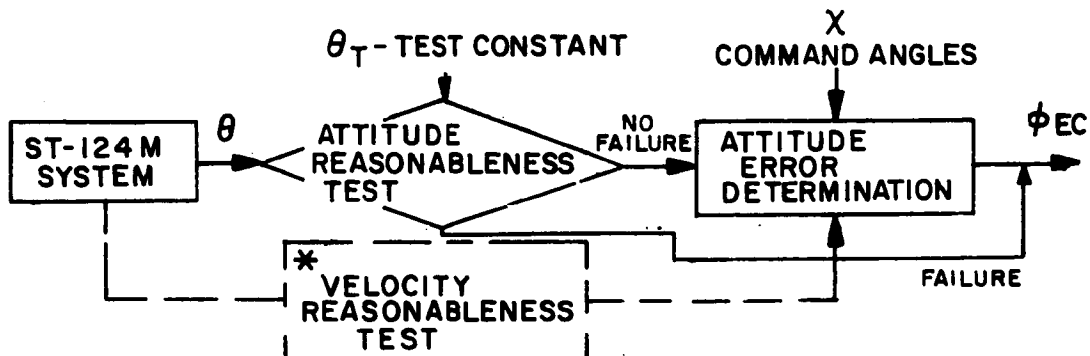

- θ - Measured attitude (vehicle to inertial reference)
- θ_T - LVDC test constant utilized for LVDC major and minor loop
- ϕ_{EC} - Attitude error signal or correction command to the Control Computer.

*Eventually the velocity reasonableness test may also be failed, resulting in loss of inertial velocity information.

"Loss" occurs when the Attitude Reasonableness Test is failed such as to result in freezing (ϕ_{EC}) to the value current at final test failure. This is demonstrated in the following procedure.

ATTITUDE REASONABLENESS TEST PROCEDURE
Test platform gimbal angle readings for pitch/yaw attitude rate greater than 10 degrees/second.

First Fine Resolver Reading Fails Test:

$$\Delta^\circ < \left| \theta_{FINE} - \theta_{OLD} \right|$$

\uparrow 0.4 deg. \uparrow fine gimbal angle reading \uparrow gimbal reading from previous minor loop

2.3 (Continued)

VEHICLE LOSS FACTOR
S-IC S-II S-IVB

2. Retain last good value of attitude error sent to flight control computer. If three consecutive readings fail as shown above, then -
Switch to coarse resolver.
Accept first coarse resolver if change is less than 18.5 degrees.
Change test constant to 15 degrees/second. If any 15 coarse resolver readings fail during major loop cycle - Guidance failure discrete signal is sent to guidance fail lights in spacecraft.
Attitude error signal freezes.

$\phi_{EC} = \theta - \chi$
↑
freezes

There are four failure categories:

- a. Pitch axis only
- b. Yaw axis only
- c. Roll axis only
- d. Two or more axes - perhaps not simultaneously but from a single failure.

All of the above cases result in freezing the attitude error signal in the affected axis. This malfunction is simulated in the same way as the preceding loss of platform without velocity failure. An additional critical malfunction which fits in any of the above four failure categories is a failure of a gyro torque motor which results in an open servo loop. Subsystem effects of this malfunction is an unstable inner gimbal platform. Results give rotation of this platform at a constant rate of 1 rad/sec. (57.3°/sec). This malfunction is simulated in a similar way to the above malfunctions except the attitude error signal freezes with a possible input step function of ± 0.48 degrees every 3.14 secs.

2.3 (Continued)

VEHICLE LOSS FACTOR		
S-IC	S-II	S-IVB
1.00	0.667*	0.533*

- e. **LOSS OF ATTITUDE ERROR SIGNAL**
 A failure which causes a "Loss of Attitude Error Signal" is defined as one for which the desired command is not being received by the Control Computer Summing Amplifier (i.e., changes in desired command could not cause changes in signal utilized by Summing Amplifier where rate and attitude error are combined. (Degraded signals are not to be included here). The failure does not preclude rate feedback control (i.e., it does not saturate the Summing Amplifier).

The failure would occur somewhere between the LVDA ladder output and the summing amplifier input and would be such as to open or block the attitude error signal path.

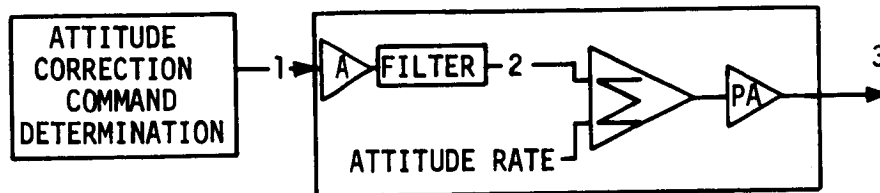

1. Attitude Error Correction Command - Single Axis
2. Conditioned Error Command
3. Actuator β commands

* Assume roll failure will not cause vehicle loss.

2.3 (Continued)

VEHICLE LOSS FACTOR
S-IC S-II S-IVB

- e. "Loss" is any failure which results in signal at 2 not following command at 1 (i.e., the path has opened or has been blocked) and the resultant signal at 2 is not sufficient to saturate the summing amplifier (thus is still varied by rate feedback).

There are four failure categories:

- a. Pitch axis only
- b. Yaw axis only
- c. Roll axis only
- d. Two or more axes

Loss of the attitude error signal is simulated by setting this signal zero at the time of malfunction. This results in loss of dynamic attitude feedback to the control computer and introduces an initial transient. Only single axis failures are considered.

- | | | | | |
|----|--------------------------|-----|--------|--------|
| f. | LOSS OF ATTITUDE COMMAND | 1.0 | 0.667* | 0.567* |
|----|--------------------------|-----|--------|--------|
- The major contributors of this failure are: a) LVDC memory failure, b) LVDC logic failure, c) LVDA power supply failure, d) LVDA logic failure. Failure categories include:
- a. Failure to the current command value.
 - b. Failure to zero or a large offset value.

The former case results in flying with a premature tilt arrest and might use manual control as a backup. The latter case has results equivalent to a saturated attitude error control signal. This is principally a pitch plane problem.

- | | | | | |
|----|-----------------------------------|------|------|-------|
| g. | LOSS OF ATTITUDE RATE INFORMATION | 1.00 | 1.00 | 0.733 |
|----|-----------------------------------|------|------|-------|
- A failure which causes a "loss" is one which precludes any useful rate information being supplied to the Control Computer Summing Amplifier.

* Assume roll failure will not cause vehicle loss.

2.3 (Continued)

VEHICLE LOSS FACTOR
S-IC S-II S-IVB

- g. (Degraded rate information is not to be included here.)
The failure does not preclude attitude feedback control (i.e., it does not saturate Summing Amplifier). Diagram is same as above with attitude error and attitude rate interchanged.

The major contributors of this system failure are: a) control computer rate channel circuitry, b) control rate gyros and control signal processor. The expected consequence of this malfunction is divergent vehicle attitude oscillation. Failure categories include:

- a. Failure in pitch axis
- b. Failure in yaw axis
- c. Failure in roll axis
- d. Failure in 2 or more axes from the same malfunction.

- h. SATURATED CONTROL SYSTEM 1.00 1.00 1.00
Any failure which saturates Summing Amplifier (thus precluding any rate or attitude feedback) or causes all actuators of single plane to go hardover.

Major contributors of this failure are: a) flight control computer failure in rate or attitude error channel which saturates summing amplifier, or a summing amp (mag. amp) failure, or an output stage failure which commands actuators hardover.

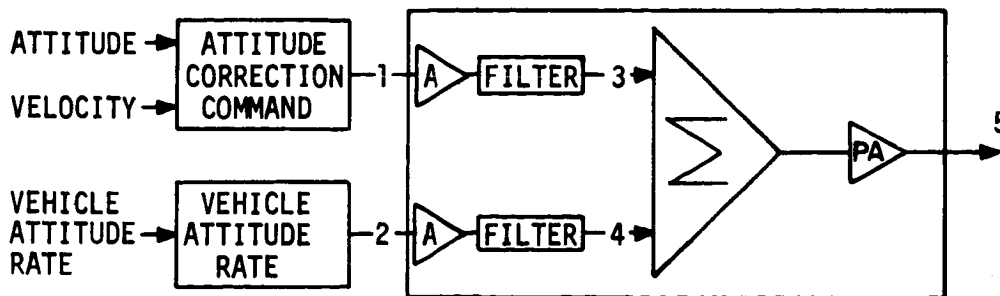

2.3 (Continued)

VEHICLE LOSS FACTOR
S-IC S-II S-IVB

- h. 1. Attitude Error command
2. Measured vehicle rate
3. Conditioned attitude error command
4. Conditioned measured rate signal
5. β command to actuators

Saturated Control System is the result of failures which cause the summing amplifier to saturate such that the command at 5 is no longer a function of either rate or attitude.

The failure can fall into four categories:

- a. Pitch axis only
b. Yaw axis only
c. Roll axis only
d. Two or more axes

NOTE: Saturated Control System covers both "Attitude Error Command Saturated" and "Attitude Rate Signal Saturated."

A saturated control signal is simulated by a step function corresponding to 15.3 degrees of the pitch attitude error signal to the control computer. The same result is obtained by a step input of the maximum pitch rate signal to the control computer. This results in all control engines gimbaling to the hardover position and rapid vehicle divergence.

- | | | | | |
|----|--|------|------|------|
| i. | NULL CONTROL SYSTEM
Any failure which removes attitude and rate control in any plane results in the command (to actuators) in that plane going to "near zero." "Near zero" is defined as within 10% of null position. | 1.00 | 1.00 | 1.00 |
|----|--|------|------|------|

Major contributor to this system failure mode is the Flight Control Computer causing a signal

2.3 (Continued)

VEHICLE LOSS FACTOR		
S-IC	S-II	S-IVB

- i. failure from Summing Amplifier to output which results in a residual signal within 10% of null.
- j. SEQUENCING FAILURES
There are several "sequences of events" which are determined by the mode selected. The mode selection and initiation is accomplished through one of three actions: The successful completion of a previous mode, computer switching to a new mode based on real time, or an event occurrence. In addition to these internal mode selections which the Astrionics system makes, mode switching is accomplished by the I.U. Command System, or the Apollo Spacecraft.

Changes in modes and flight sequences are made by changing the instructions and programs in the LVDC memory. Thus flight sequences may vary for each flight.

Sequencing malfunctions are, therefore, defined as any malfunction which causes an erroneous sequence to occur, or a sequence which occurs at the wrong time. The sequences for a 504 launch are defined in Document 10M30524B.

The hardware involved are: LVDC, LVDA, I.U. Command Receiver, Control Distributor, Auxiliary Power Distributor, and Switch Selector and Stage Control Circuitry of each stage.

Some specific sequencing malfunctions resulting from failure of Switch Selector outputs are:

- a. fails to give sequence command
- b. gives command in error (random time during launch)

2.3 (Continued)

VEHICLE LOSS FACTOR	
S-IC	S-II S-IVB

- c. generates multiple erroneous outputs to relays in control distributor
- d. loss of all outputs.

Sequence failures (other than those for staging covered below) simulated for this analysis consist of those affecting control system gain switching. Specific cases include:

- a. Early gain switching
 - b. Late (or no) gain switching
- k. STAGING MALFUNCTIONS - 0.9 0.8
- Staging malfunctions are defined as any malfunction which causes premature staging, lack of staging or complications during staging.

Items which are included follow:

1. Lack of down stage retrorocket firing
2. Lack of S-IC first plane separation
3. Lack of S-II second plane separation
4. Partial S-II second plane separation
5. Lack of S-II/S-IVB plane separation
6. Partial S-II/S-IVB plane separation.

Separation device failures are covered under the contingency and analysis section of this report.

1. PROPELLANT UTILIZATION SYSTEM MALFUNCTIONS
- Propellant Utilization (PU) system malfunctions are defined as those causing the PU valve in S-II or S-IVB to assume some position other than that determined by propellant tank loadings. Principal causes are failures in the PU valve servo or bridge-balancing servos. Failure categories are:

2.3 (Continued)

VEHICLE LOSS FACTOR
S-IC S-II S-IVB

1. a. PU valve to null position
- b. PU valve to upper limit
(no second MR shift)
- c. PU valve to lower limit
- d. Early MR shift
- e. Late MR shift.

The range of thrust variation covered by the PU valve travel does not result in any immediate vehicle dynamics problem and these malfunctions are not analyzed by this report. Trajectory effects of some of the above failures are covered in the analysis section.

m. APS SYSTEM FAILURES

Any failure in APS system which causes loss of control of the S-IVB stage. Failures prior to control computer output are not considered here.

- | | | | | |
|----|--|---|---|------------|
| 1. | LOSS OF ONE APS NOZZLE
"Loss" is defined as any failure which prevents turning on of one APS nozzle in a module. Remaining nozzles are not affected. | - | - | 0.33 |
| 2. | LOSS OF ONE APS MODULE
"Loss" is defined as the result of a failure which results in problems in turning on any reaction jet of one APS module when desired. | - | - | $<10^{-4}$ |
| 3. | LOSS OF BOTH APS MODULES
"Loss" is defined as above except here both APS modules are affected. | - | - | $<10^{-3}$ |
| 4. | APS ULLAGING FAILURE
APS ullaging failures are defined as malfunctions resulting in failure to turn on an APS ullaging nozzle. Only single failures are considered. | | | |

2.4 MODES OF VEHICLE LOSS

The following types of vehicle loss transients are encountered in simulating the malfunctions described in Section 2.3. Wind effects as described in Section 2.2 are included in the S-IC simulations:

- a. Structural failure resulting directly from malfunction-dynamics.
- b. Loss-of-control, followed by consequent tumbling and structural failure.
- c. Structural failure resulting from vehicle tension load increase due to engine shutdown at abort.
- d. Unsuccessful staging. This results when the malfunction causes the vehicle to exceed staging limits.
- e. Tower collision or pad fallback because of early failures. Included is interference with ground support equipment.
- f. Guidance failures causing slow divergence from the nominal trajectory.

These vehicle failures and the events leading to them are described in more detail in the following paragraphs. Separate analyses are not included for malfunctions not producing significantly differing results (a saturated attitude rate signal, for example, has consequences similar to a saturated attitude error signal).

2.4.1 Sudden Vehicle Breakup Resulting from Malfunction Dynamics

This mode of vehicle failure is an engine-out problem and results directly from dynamic responses driven by the malfunction. Sudden breakup has been eliminated by wind biasing, increased load capability, and engine cant.

2.4.2 Vehicle Loss-of-Control After Malfunction

Figure 2-21 illustrates a typical loss-of-control sequence following a malfunction at high-q. Inability of the vehicle to recover results from the malfunction moment in combination with winds.

In loss-of-control cases, vehicle tumbling and structural failure will occur and abort is required. Consequently, in the subsequent vehicle evaluation sections, vehicle loss is indicated for all loss-of-control regions.

2.4.3 Abort-Induced Tension Breakup

For abort after 30 seconds of flight shutdown of the mainstage engines is performed as part of the abort sequence. Consequently, engine compressive forces are suddenly removed. In cases requiring abort, this sequence rapidly increases the vehicle tension loading and may produce sudden failure.

The following is the typical abort sequence of events associated with the tension breakup problem.

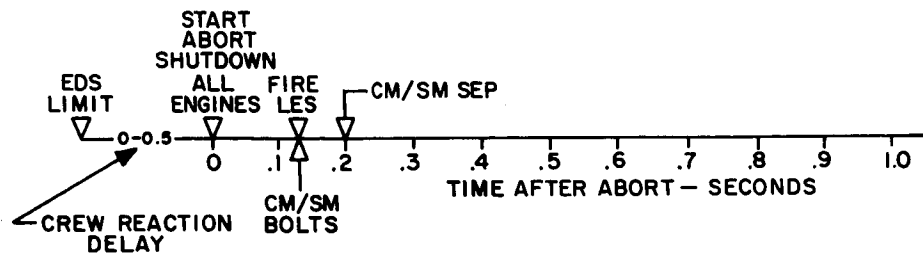

At high- q , the vehicle is in a state of high moment loading due to angle of attack (including winds), slosh, flexibility and control engine forces. Moments are further increased if a malfunction exists such as outboard engine failure, actuator hardover or control/guidance failure. With engines thrusting, the loads on the tension side of the vehicle are reduced by the compressive thrust forces. At abort initiation +.03 second, shutdown of the mainstage engines is initiated to provide faster abort vehicle separation. Subsequent decay of thrust forces results in rapidly increasing load on the tension side of the vehicle with structural failure occurring in as little as 0.5 second after the abort signal. Due to this sudden breakup after abort, the abort vehicle may not be at a safe separation distance at the time of propellant explosion.

Figure 2-95 illustrates a typical sequence of events during an abort tension breakup transient. The transient shown was initiated by a high- q engine out; however, abort tension breakup cases can result for any of the malfunctions listed in Section 2.3 requiring high- q abort. The malfunction here occurred at 80 seconds of S-IC flight time, resulting in the vehicle exceeding an abort cue with abort occurring at 86.2 seconds. The rapid buildup of tension load causes structural failure at 0.44 seconds after abort.

2.4.4 Staging Requirements

Improved vehicle malfunction flight capability allows successful completion of stage flight in many malfunction cases. In some cases, however, subsequent recovery of vehicle attitude is not sufficient to allow successful staging. S-IC/S-II staging requirements applied for this study are shown by Figure 2-4. In addition the limits of $\pm 10^\circ/\text{second}$ attitude rate, $\pm 15.3^\circ$ attitude error and $\pm 7^\circ$ engine deflection were applied for S-II/S-IVB staging. These limits were not exceeded for regions shown as "no vehicle loss" in this report.

2.4.5 Tower Collision and Pad Fallback

Engine malfunctions, actuator malfunctions or saturated control system occurring shortly after liftoff can result in launch vehicle collision with the tower or ground equipment (hold down arms). In addition, engine malfunctions can cause hovering or fallback in the launch site area. This study examines these malfunction conditions to derive flight parameters which might be useful to indicate the need for abort action. Regions of failure for these malfunctions are shown in the following vehicle evaluation sections.

2.4.6 Launch Vehicle Angle-of-Attack ($LEV-\alpha$) Limit

The vehicle angle-of-attack from which the LEV can successfully abort is limited as indicated in Figure 2-1, particularly for aborts in the high-q region. In the subsequent analysis, crew loss is noted for regions where this requirement is not met. As indicated in Figure 2-17 the $LEV-\alpha$ capability shown in Figure 2-1 is sufficient for all malfunctions.

2.4.7 Guidance Failures

Guidance failures, which include any malfunction that causes an incorrect or no attitude error signal to be sent to the Control Computer, require an abort. These failures do not result in rapid rates or divergence and are not critical with regard to warning time in most cases. However, the slow divergence, as shown in Figures 2-18 and 2-19, makes this type of malfunction difficult to detect. Guidance failures prohibit successful parking orbit insertion unless the malfunction occurs just before (within 15 seconds) parking orbit insertion.

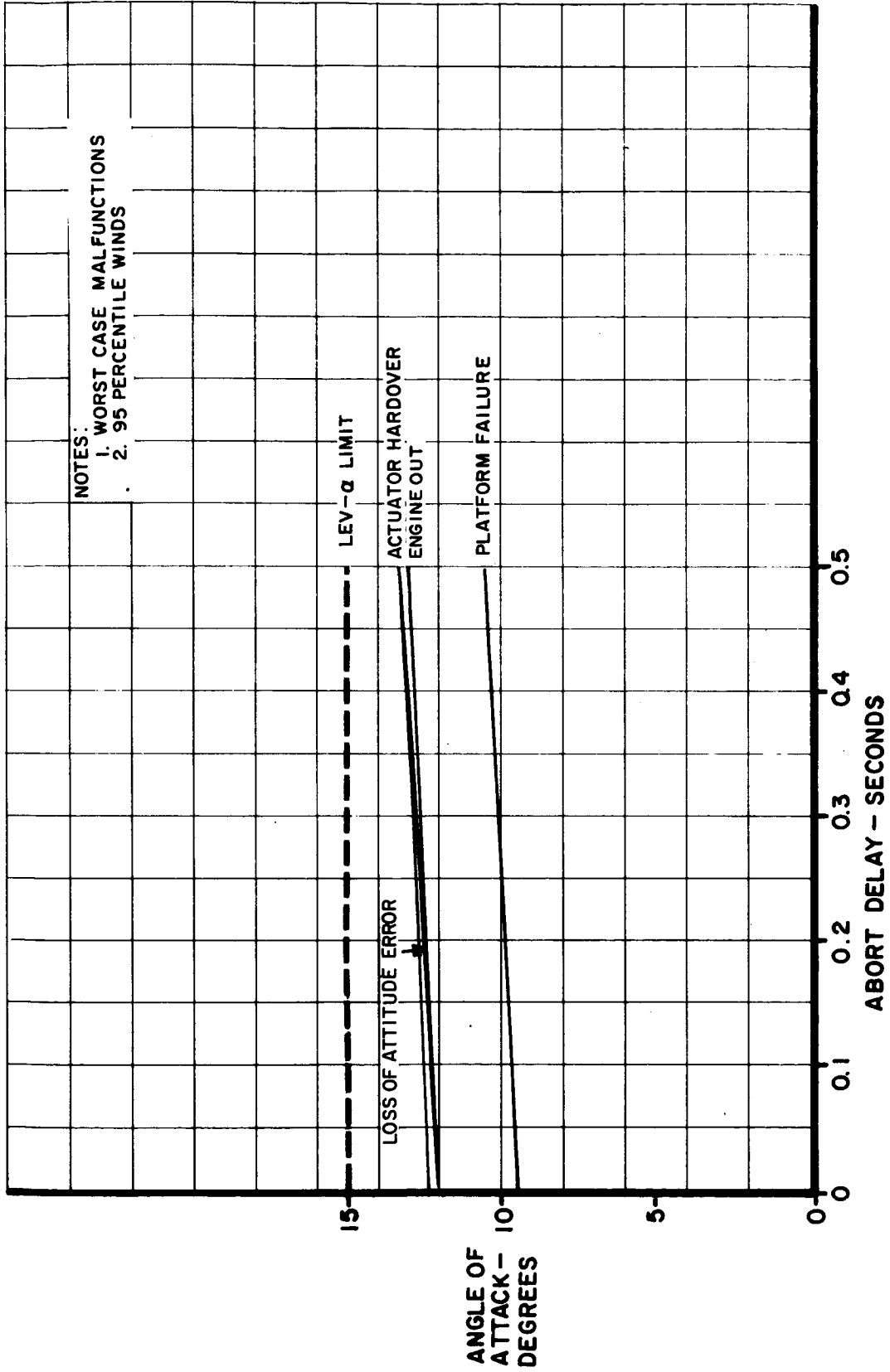

FIGURE 2-17 EFFECT OF ABORT DELAY ON ANGLE OF ATTACK AT CM/SM SEPARATION

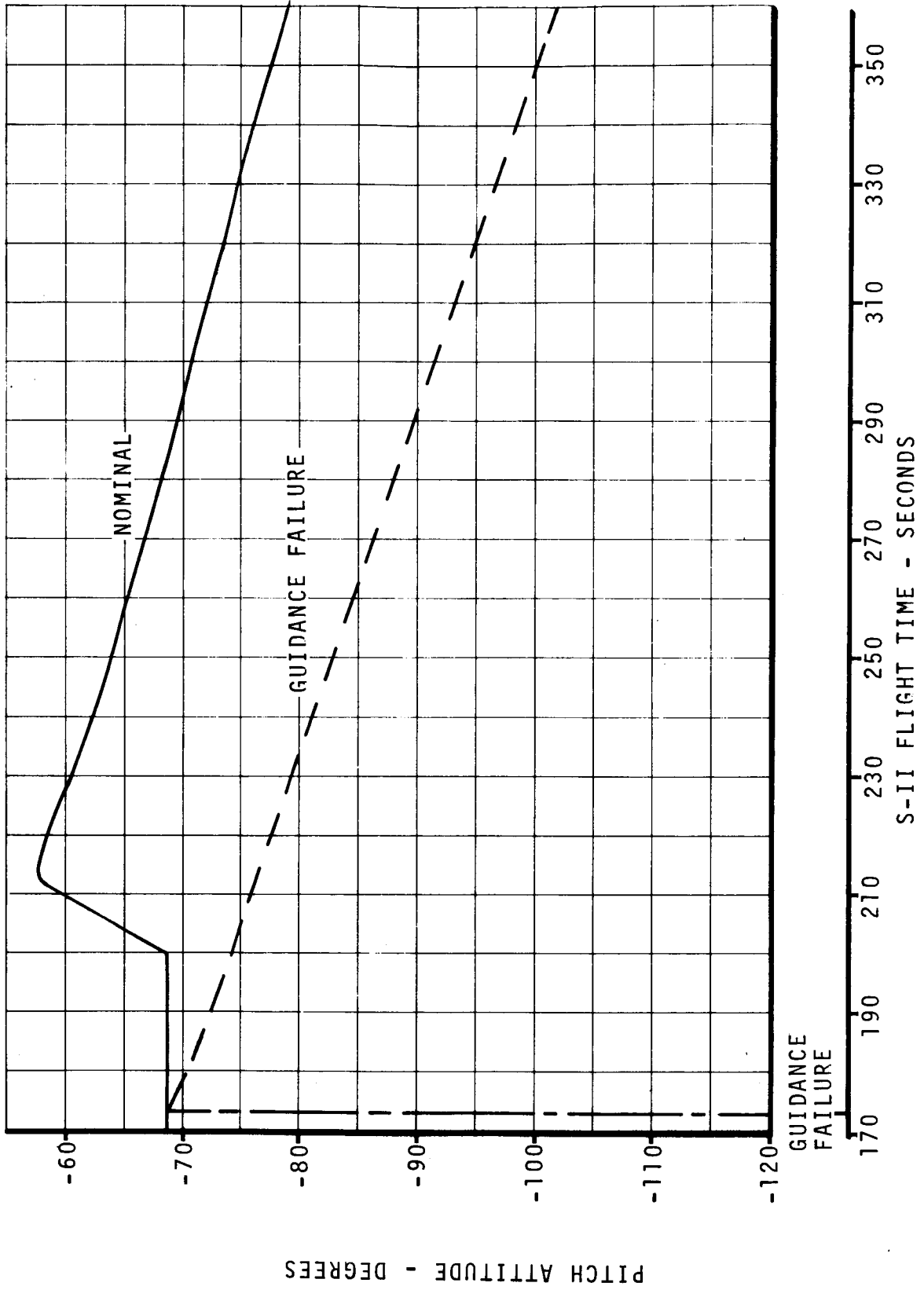

FIGURE 2-18 TYPICAL PITCH ATTITUDE FOR GUIDANCE FAILURE

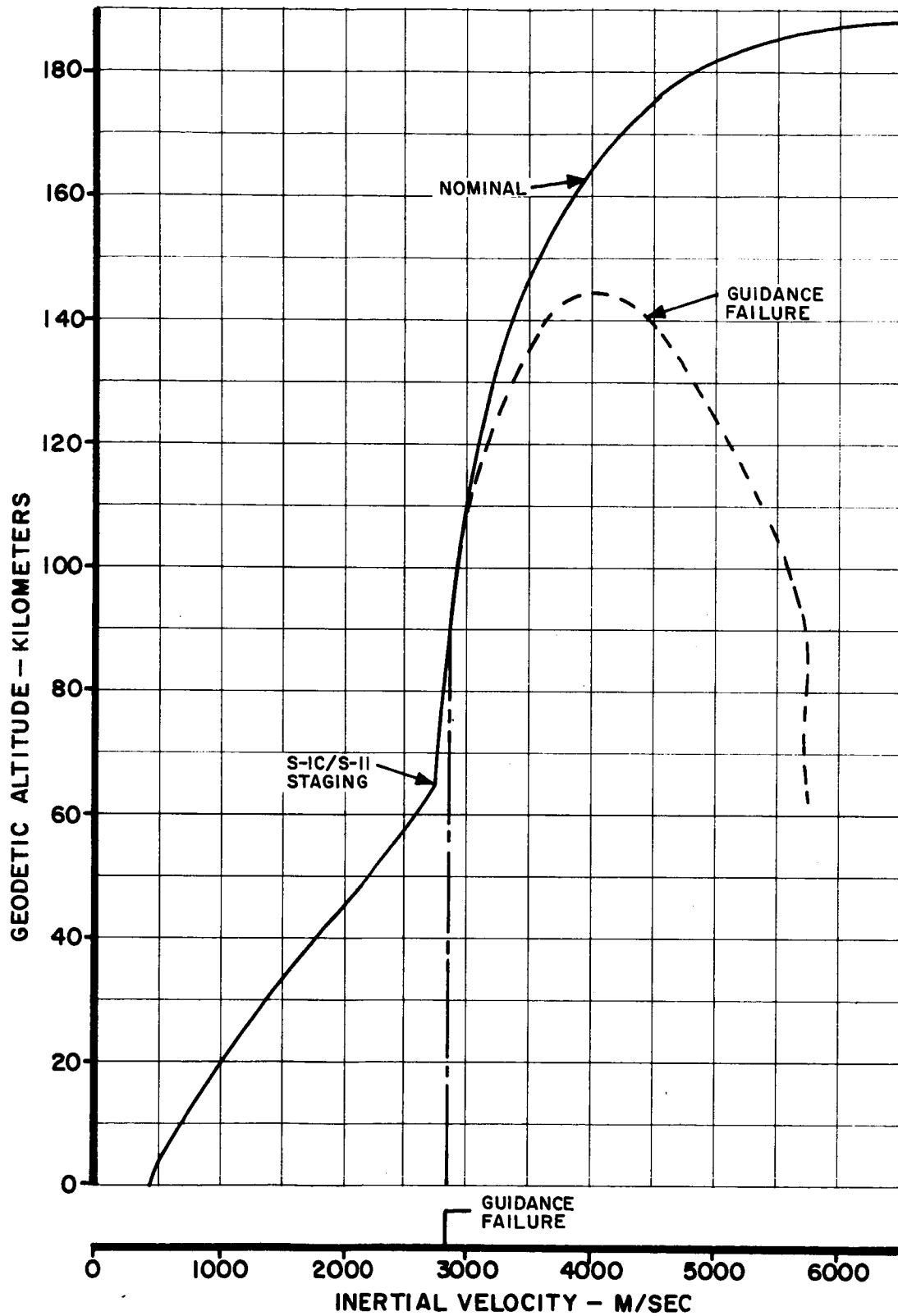

FIGURE 2-19 TYPICAL HEIGHT-VELOCITY FOR GUIDANCE FAILURE

2.5 CONTINGENCY PLAN

This section outlines the contingencies in tabular form. The bases for the contingencies shown in this section are analyzed in detail in other sections. The Mission Rule Data column of these tables is shown as a general guideline only and further information may be obtained from the "Abort and Alternate Mission Plan" Reference 10. The "Flight Mission Rules Final" for AS-504 (NASA documentation to be issued) will be the governing document for the Mission Rules Data.

TABLE 2-I CONTINGENCY PLAN

CONTINGENCY	FLIGHT TIME SECONDS	EFFECT	SENSORS OR DISPLAYS	MISSION RULE DATA
Loss of thrust for single control engine	0 - .97	Collision with hold-down post	Crew 1. Thrust OK light 2. Physiological 3. Abort request light Ground 1. Thrust OK light 2. Thrust chamber pressure 3. Longitudinal acceleration 4. Visual	No automatic abort Manual abort by LES with two cues 1. Thrust OK light 2. Physiological 3. Visual by ground
Loss of thrust for any single engine	0 -.17	Pad fallback	Crew 1. Thrust OK light 2. Physiological 3. Abort request light Ground 1. Thrust OK light 2. Thrust chamber pressure 3. Longitudinal acceleration 4. Visual	No automatic abort Manual abort by LES with two cues 1. Thrust OK light 2. Physiological 3. Visual by ground

TABLE 2-I CONTINGENCY PLAN (CONT'D)

CONTINGENCY	FLIGHT TIME SECONDS	EFFECT	SENSORS OR DISPLAYS	MISSION RULE DATA
Loss of thrust for any single tower side engine (#1 or #2)	.97-5.3	Tower collision	Crew 1. Thrust OK light 2. Abort request light Ground 1. Thrust OK light 2. Thrust chamber pressure 3. Longitudinal acceleration 4. Visual	No automatic abort available. Manual abort by LES with two cues 1. Thrust OK light 2. Physiological 3. Visual by ground
Loss of thrust for single control engine	0 - 50	Possible false abort if not covered by above contingencies.	Crew 1. Thrust OK light 2. Q-Ball may exceed 3.2 psi 3. Physiological Ground 1. Thrust OK light 2. Thrust chamber pressure 3. Longitudinal acceleration 4. Visual	Recommendation required to assure no false abort

TABLE 2-1 CONTINGENCY PLAN (CONT'D)

CONTINGENCY	FLIGHT TIME SECONDS	EFFECT	SENSORS OR DISPLAYS	MISSION RULE DATA
Loss of thrust any single engine	50 - 73	No effects	Crew 1. Thrust OK light 2. Physiological Ground 1. Thrust OK light 2. Thrust chamber pressure 3. Longitudinal acceleration 4. Visual	No abort required
Loss of thrust any single control engine	73 - 83	Possible loss of control of vehicle resulting in structural breakup within 0.5 seconds after malfunction	Crew 1. Attitude rate exceeds 4°/second 2. Thrust OK light 3. Q-Ball exceeds 3.2 psi Ground 1. Thrust OK light 2. Thrust chamber pressure 3. Longitudinal acceleration	Automatic abort when attitude rate is exceeded. Manual abort by LES with two cues 1. Thrust OK light 2. Q-Ball limits exceeded

TABLE 2-I CONTINGENCY PLAN (CONT'D)

CONTINGENCY	FLIGHT TIME SECONDS	EFFECT	SENSORS OR DISPLAYS	MISSION RULE DATA
Loss of thrust any single engine	83 - 161	No effect	Crew 1. Thrust OK light 2. Physiological Ground 1. Thrust OK light 2. Thrust Chamber pressure 3. Longitudinal acceleration	No abort required
	161 - 534	No effect	Crew 1. Thrust OK light 2. Physiological Ground 1. Thrust OK light 2. Thrust chamber pressure 3. Longitudinal acceleration	No abort required
	S-IVB Burn	Complete loss of thrust	Crew 1. Thrust OK light 2. Physiological Ground 1. Thrust OK light 2. Thrust chamber pressure 3. Longitudinal acceleration	Abort by SPS

TABLE 2-I CONTINGENCY PLAN (CONT'D)

CONTINGENCY	FLIGHT TIME SECONDS	EFFECT	SENSORS OR DISPLAYS	MISSION RULE DATA
Loss of thrust any two adjacent control engines	0 - 161	Loss of control resulting in structural breakup	Crew 1. Thrust OK lights 2. Physiological (if shutdown occurs for 2 or more engines at the same time the effects may be the same as a single engine shut down) Ground 1. Thrust OK light 2. Thrust chamber pressure 3. Longitudinal acceleration	Automatic abort by LES with loss of thrust for any two engines prior to 120 second. Manual abort after 120 seconds with two cues. 1. 2 engine out lights 2. Overrate light

TABLE 2-I CONTINGENCY PLAN (CONTINUED)

CONTINGENCY	FLIGHT TIME SECONDS	EFFECT	SENSORS OR DISPLAYS	MISSION RULE DATA
Loss of thrust 2 Adjacent Control Engines	161-512	Possible Loss of control during S-II flight	Crew 1. Thrust OK lights 2. Attitude rate exceeds 4°/second prior to 512 seconds 3. Physiological Ground 1. Thrust OK lights 2. Thrust chamber pressure - zero 3. Longitudinal acceleration 4. Attitude rate	No automatic abort. Manual abort by LES prior to tower jettison and by SPS after tower jettison with two cues 1. Thrust OK lights 2. Attitude rate exceeded prior to 512 seconds 3. Physiological
	512-550	Possible loss of IGM in S-IVB		Early stage at chi freeze +5.0 seconds.
	550-Staging	No effect		Continue mission

TABLE 2-I CONTINGENCY PLAN (CONT'D)

CONTINGENCY	FLIGHT TIME SECONDS	EFFECT	SENSORS OR DISPLAYS	MISSION RULE DATA
Loss of thrust 2 diametrically opposing or center and one control engine	161-200	Possible fuel depletion prior to orbit	Crew 1. Thrust OK lights 2. Attitude rate exceeds 4°/second prior to 512 seconds 3. Physiological Ground 1. Thrust OK lights 2. Thrust chamber pressure - zero 3. Longitudinal acceleration 4. Attitude rate	Same as 161 - 512 above
	200-215	No effect		Continue mission
	215-550	Possible loss of IGM in S-IVB flight		Early stage at chi freeze + 5.0 seconds
	550-Staging	No effect		Continue mission

NOTE:

S-IC/S-II staging @ 160.4
 S-II/S-IVB staging @ 535.0 Nominal
 S-II/S-IVB staging with 4 engines throughout S-II @ 630.15
 S-II dual engine out data reflects worst case sequential failures.

TABLE 2-I CONTINGENCY PLAN (CONT'D)

CONTINGENCY	FLIGHT TIME SECONDS	EFFECT	SENSORS OR DISPLAYS	MISSION RULE DATA
One actuator inoperative (null position)	S-IVB boost	Loss of control	Crew 1. No defined cues Ground 1. FDO limits exceeded	No automatic abort. Manual abort by SPS when FDO limits exceeded
Any single actuator hardover (pitch or yaw)	0 - .6	Collision with hold-down post.	Crew 1. Roll rate exceeds 5°/second 2. Abort request light 3. Physiological Ground 1. Visual 2. Loss of hydraulic pressure 3. Engine position	No automatic abort. Manual abort upon contact with hold-down posts.
Any single actuator hardover (yaw positive only)	0 - 2.7	Tower collision	Crew 1. Roll rate exceeds 5°/second 2. Abort request light 3. Physiological Ground 1. Actuator position 2. Loss of hydraulic pressure 3. Visual	No automatic abort. Manual abort by LES with two cues 1. Engine position by ground 2. Roll rate limit exceeded 3. Visual by ground

TABLE 2-I CONTINGENCY PLAN (CONT'D)

CONTINGENCY	FLIGHT TIME SECONDS	EFFECT	SENSORS OR DISPLAYS	MISSION RULE DATA
Any single actuator hardover (pitch or yaw)	0 - 65	No effect unless covered by above	Crew 1. Roll rate 5°/sec. Ground 1. Actuator position 2. Loss of hydraulic pressure 3. Visual	No abort required.
Any single actuator hardover (pitch or yaw)	65 - 95	Possible loss of control resulting in structural breakup	Crew 1. Attitude rate exceeds 4°/second 2. Attitude error exceeds 5° 3. Q-Ball exceeds 3.2 psi Ground 1. Actuator position 2. Loss of hydraulic pressure	Automatic abort by LES when attitude rate limit is exceeded. Manual abort by LES with two cues 1. Roll attitude limit exceeded 2. Q-Ball limits exceeded 3. Engine position by ground

TABLE 2-I CONTINGENCY PLAN (CONT'D)

CONTINGENCY	FLIGHT TIME SECONDS	EFFECT	SENSORS OR DISPLAYS	MISSION RULE DATA
Any single actuator hardover	95-161	No effect	Crew 1. Roll Rate exceeds 5°/second Ground 1. Actuator position 2. Loss of hydraulic pressure	No abort required
	161 - 534	Possible overheating in the engine area leading to fire and/or explosion	Crew 1. No defined cues Ground 1. Actuator position 2. Loss of hydraulic pressure 3. Engine area temperature	Ground commanded abort.
	S-IVB Burn Phase	Loss of control	Crew 1. Attitude rate exceeds 10°/second 2. L/V overrate light Ground 1. Actuator position 2. Loss of hydraulic pressure	No automatic abort. Manual abort by SPS with two cues 1. Attitude rate limit is exceeded 2. L/V overrate light 3. Engine position (ground)

TABLE 2-I CONTINGENCY PLAN (CONT'D)

CONTINGENCY	FLIGHT TIME SECONDS	EFFECT	SENSORS OR DISPLAYS	MISSION RULE DATA
Engine Hardover	S-IVB Restart	Loss of control if restarted. Lead thrust would cause vehicle rotation	Crew 1. No defined cues Ground 1. Engine position 2. Loss of hydraulic pressure	No automatic abort. Manual abort by SPS. Do not attempt restart.
Loss of both actuators for same engine	0 - 161	Loss of control resulting in structural breakup if engine goes to roll corner	Crew 1. Roll rate exceeds 20°/second 2. Q-Ball exceeds 3.2 psi Ground 1. Engine position 2. Loss of hydraulic pressure 3. Roll rate	Automatic abort by LES when roll rate limit is exceeded prior to 120 seconds. Manual abort by LES with two cues 1. Q-Ball limit exceeded (50 - 110 seconds) 2. Engine position (ground cue)
	161-534	No effect	Crew 1. No defined cues Ground 1. Engine position 2. Loss of hydraulic pressure	No abort required.

TABLE 2-I CONTINGENCY PLAN (CONT'D)

CONTINGENCY	FLIGHT TIME SECONDS	EFFECT	SENSORS OR DISPLAYS	MISSION RULE DATA
Loss of both actuators for same engine (Continued)	S-IVB Burn Phase	Loss of control	Crew 1. Attitude rate exceeds 10°/second 2. L/V overrate light Ground 1. Engine position 2. Loss of hydraulic pressure	No automatic abort. Manual abort by SPS with two cues 1. Attitude rate limit is exceeded 2. L/V overrate light 3. Engine position (ground)
Loss of Inertial attitude	0 - 90	Loss of guidance control resulting in structural breakup.	Crew 1. Attitude rate exceeds 4°/second 2. Guidance failure light 3. Q-Ball exceeds 3.2 psi (50 - 90 seconds) Ground 1. Guidance failure light	Automatic abort by LES when attitude rate limit is exceeded. Manual abort with two cues: 1. Guidance failure light 2. Q-Ball limit exceeded

TABLE 2-I CONTINGENCY PLAN (CONT'D)

CONTINGENCY	FLIGHT TIME SECONDS	EFFECT	SENSORS OR DISPLAYS	MISSION RULE DATA
Loss of Inertial attitude (continued)	90 - 161	Loss of guidance with no structural failures.	<p>Crew</p> <ol style="list-style-type: none"> 1. Attitude rate exceeds 4°/second 2. Guidance failure light 3. Q-Ball exceeds 3.2 psi (90 - 110 seconds) 	<p>Automatic abort by LES when attitude rate limit is exceeded. Manual abort by LES with two cues (without backup control)</p> <ol style="list-style-type: none"> 1. Guidance failure light 2. Q-Ball limits exceeded 3. Attitude error limit exceeded
	161 -534	Loss of guidance	<p>Crew</p> <ol style="list-style-type: none"> 1. Guidance failure light <p>Ground</p> <ol style="list-style-type: none"> 1. FDO limits exceeded 	<p>No automatic abort. Manual abort by LES prior to tower jettison or by SPS after tower jettison with a single cue</p> <ol style="list-style-type: none"> 1. Guidance failure light 2. FDO limits exceeded

TABLE 2-I CONTINGENCY PLAN (CONT'D)

CONTINGENCY	FLIGHT TIME SECONDS	EFFECT	SENSORS OR DISPLAYS	MISSION RULE DATA
Loss of inertial attitude	S-IVB Burn Phase	Loss of guidance	Crew 1. Guidance failure light Ground 1. FDO limits exceeded	No automatic abort Manual abort by SPS with single cue 1. Guidance failure light 2. FDO limits exceeded
Loss of inertial velocity	All Stages	No effect (see Reference 9)		No abort required
Loss of attitude error commands	All Stages	Loss of control	Crew 1. Attitude rate exceeds 4°/second for S-IC 2. Attitude rate exceeds 10°/second for S-II and S-IVB Ground 1. FDO limits exceeded	Automatic abort by LES prior to 120 seconds when attitude rate limit is exceeded. Manual abort by LES prior to tower jettison and SPS after tower jettison with a single cue 1. FDO limits exceeded (all stages)

TABLE 2-I CONTINGENCY PLAN (CONT'D)

CONTINGENCY	FLIGHT TIME SECONDS	EFFECT	SENSORS OR DISPLAYS	MISSION RULE DATA
Attitude error command saturated	All stages	Loss of control	<p>Crew</p> <ol style="list-style-type: none"> 1. Attitude rate exceeds 4°/second in pitch or yaw or 20°/second in roll for S-IC 2. Attitude rate exceeds 10°/second for S-II and S-IVB in pitch or yaw or 20°/second in roll for S-II and S-IVB 3. L/V overrate light <p>Ground</p> <ol style="list-style-type: none"> 1. Guidance failure light 2. FDO limits exceeded 	<p>Automatic abort by LES prior to 120 seconds when attitude rate limit is exceeded.</p> <p>Manual abort by LES prior to tower jettison and SPS after tower jettison with two cues</p> <ol style="list-style-type: none"> 1. L/V overrate light 2. Attitude rate indicator 3. FDO limits exceeded

TABLE 2-1 CONTINGENCY PLAN (CONT'D)

CONTINGENCY	FLIGHT TIME SECONDS	EFFECT	SENSORS OR DISPLAYS	MISSION RULE DATA
Loss of attitude command signal	All stages	Loss of guidance	<p>Crew</p> <ol style="list-style-type: none"> 1. Attitude rate exceeds 4°/second for S-IC in pitch or yaw 2. Attitude rate exceeds 10°/second for S-II and S-IVB in pitch and yaw <p>Ground</p> <ol style="list-style-type: none"> 1. FDO limits exceeded 	<p>Automatic abort by LES prior to 120 seconds when attitude rate limit is exceeded.</p> <p>Manual abort by LES prior to tower jettison and SPS after tower jettison with a single cue</p> <ol style="list-style-type: none"> 1. Attitude rate limits exceeded 2. FDO limits exceeded

TABLE 2-I CONTINGENCY PLAN (CONT'D)

CONTINGENCY	FLIGHT TIME SECONDS	EFFECT	SENSORS OR DISPLAYS	MISSION RULE DATA
Attitude rate signal saturated	All stages	Loss of control	<p>Crew</p> <ol style="list-style-type: none"> 1. Attitude rate exceeds 4°/second in pitch or yaw or 20°/second in roll for S-IC 2. Attitude rate exceeds 10°/second for S-II and S-IVB in pitch or yaw or 20°/second in roll for S-II and S-IVB 3. L/V overrate light <p>Ground</p> <ol style="list-style-type: none"> 1. Guidance failure light 2. FDO limits exceeded 	<p>Automatic abort by LES prior to 120 seconds when attitude rate limit is exceeded.</p> <p>Manual abort by LES prior to tower jettison and SPS after tower jettison with two cues</p> <ol style="list-style-type: none"> 1. L/V overrate light 2. Attitude rate indicator 3. FDO limits exceeded

TABLE 2-I CONTINGENCY PLAN (CONT'D)

CONTINGENCY	FLIGHT TIME SECONDS	EFFECT	SENSORS OR DISPLAYS	MISSION RULE DATA
Loss of attitude rate signal	All stages	Loss of control	<p>Crew</p> <ol style="list-style-type: none"> 1. Attitude rate exceeds 4°/second in pitch or yaw or 20°/second in roll for S-IC 2. Attitude rate exceeds 10°/second for S-II and S-IVB in pitch or yaw or 20°/second in roll for S-II and S-IVB 3. L/V overrate light <p>Ground</p> <ol style="list-style-type: none"> 1. Guidance failure light 2. FDO limits exceeded 	<p>Automatic abort by LES prior to 120 seconds when attitude rate limit is exceeded.</p> <p>Manual abort by LES prior to tower jettison and SPS after tower jettison with two cues</p> <ol style="list-style-type: none"> 1. L/V overrate light 2. Attitude rate indicator 3. FDO limits exceeded
Lack of S-IC first plane separation	161	No S-II ignition possible	Lack of S-II thrust	Early S-IVB staging or abort by crew (orbit not possible)

TABLE 2-I CONTINGENCY PLAN (CONT'D)

CONTINGENCY	FLIGHT TIME SECONDS	EFFECT	SENSORS OR DISPLAYS	MISSION RULE DATA
Lack of S-II second plane separation (includes partial separation)	179	Probable subsequent loss of vehicle due to excessive temperature	Second plane separation indicator (redundant indication)	Shutdown prior to overheat and early S-IVB staging required by crew only, limited time between normal jettison time and excessive temperature may preclude ground information backup
Lack of S-II/S-IVB plane separation (includes partial)	534	No S-IVB ignition	Lack of S-IVB thrust	SPS abort required
Loss of both APS modules, S-IVB	S-IVB burn phases	Lack of roll control	Crew 1. Roll attitude may be excessive Ground 1. Roll attitude	Manual control by crew with RCS when roll attitude is excessive

TABLE 2-I CONTINGENCY PLAN (CONT'D)

CONTINGENCY	FLIGHT TIME SECONDS	EFFECT	SENSORS OR DISPLAYS	MISSION RULE DATA
Loss of one APS module, S-IVB	S-IVB burn phases	Negligible	Crew 1. No indication	Manual control by crew with RCS when roll attitude is excessive
LET fails to jettison	185	No effect during Earth to parking orbit flight.	Crew 1. Visual by crew Ground 1. Tower off indication	Crew to use emergency procedures for removal of LET after orbit is achieved.

2.6 EVALUATION OF THE BASELINE VEHICLE

Table 2-II compares the SA-503 vehicle as analyzed in Reference 2 and the SA-504 vehicle that is the baseline vehicle for this analysis. The effects of the differences are summarized in Table 2-II and discussed in more detail in the following sections. Characteristics that are not in the tables do not cause significant differences between the SA-503 and SA-504 EDS Analysis results.

TABLE 2-II DIFFERENCES BETWEEN SA-503 C' AND SA-504 D

CHARACTERISTIC	503C'	504	Δ	EFFECT				CONCLUSION
				LATEST TIME OF MALFUNCTION CAUSING COLLISION (SEC)				
				PAD FALLBACK	LIFTOFF INTERFERENCE	TOWER COLLISION		
Thrust-to-Weight Ratio at Liftoff				503C'	504D	503C'	504D	
Actuator Hardover	1.25	1.20	-0.05	None	0.34	0.59	2.0	2.7
Saturated Control Signal	1.25	1.20	-0.05	>30	1.0	1.2	2.3	2.8
Single Engine Out	1.00	.96	-0.04	None	.165	0.72	4.5	5.25
Two Engines Out	0.75	.72	-0.03	>30	>30	1.4	1.55	6.8
Maximum Dynamic Pressure (max-q)	35.6 x 10 ³ Nt/M ²	32.9 x 10 ³ Nt/M ²	-2.7 x 10 ³ Nt/M ²	Regions of vehicle loss are smaller for single engine out and single actuator hardover near max-q				
Time of max-q	75.75 Sec.	81.25 Sec.	+5.5 Sec.	Vehicle loss regions occur about 5.0 seconds later for single engine out and actuator hardover near max-q				

TABLE 2-II DIFFERENCES BETWEEN SA-503 C' AND SA-504 D (Continued)

CHARACTERISTIC	503C'	504D	Δ	EFFECT
S-II TOTAL MASS (KG)	635,721.3	652,464.6	+ 2.63%	Shifts C. G. and extends S-II dual engine-out loss of control region (~ 20 seconds).
TRAJECTORY PRESETTINGS				
VEX 1	4169.1205	4155.7503	- .32%	Contributing factors to decreased capability to obtain orbit after S-II dual engine out and P.U. system malfunctions.
VEX 2	4237.6003	4193.3576	- 1.04%	
VEX 3	4163.7846	4176.7404	- 0.31%	
τ_2	321.95309	285.80	- 11.23%	
τ_3	661.53587	654.96	- 1.00%	
T_{2i}	81.5	79.50	- 2.45 Sec	
\dot{M}_1	14316.19	13784.785	- 3.71%	
\dot{M}_2	1226.524	1212.8138	- 1.12%	
\dot{M}_{2s}	1218.3948	1232.9053	+ 1.19%	
\dot{M}_3	955.6354	1003.3504	+ 4.99%	
\dot{M}_{3s}	990.4009	1022.3931	+ 3.23%	
\dot{M}_4	218.6125	239.0204	+ 9.335%	

2.6.1 Actuator Hardover Capability - S-IC

For winds between the 5th and 95th percentile, single actuator hardover produces loss of control only during the maximum dynamic pressure (max-q) region. Both long and short throw malfunctions as defined in Figure 2-20 can cause loss of control. Figure 2-21 shows the typical dynamic responses that result from a single long throw actuator hardover in the max-q region.

Loss of control regions for actuator hardover are shown on Figures 2-22 through 2-39. Each polar plot of Figure 2-22 is a composite loss of control plot for all short throw malfunctions occurring at that flight time. Shaded regions denote loss of control. The wind rose on each time plot represents the 5th to 95th percentile winds of February for the nominal altitude corresponding to that flight time. Therefore, total blackened regions represent winds between the 5th and 95th percentile that cause loss of control. Figure 2-23 presents identical information for all long throw actuator malfunctions.

Staging problems as defined in Reference 7 do not occur for single actuator hardover.

LEV- α limit is not exceeded prior to abort for this malfunction.

Figures 2-95 through 2-98 show tension loads resulting from an actuator hardover that requires a high-q abort. Sudden vehicle tension loads that result from mainstage engine shutdown at abort may cause structural failure for actuator hardover malfunction between 70 and 93 seconds flight time.

The recommended EDS limit settings for this malfunction are:
(1) 4 degrees/second attitude rate for automatic abort, and
(2) 5 degrees roll attitude error (first abort cue) and 3.2 psi q-ball pressure after 50 seconds (second abort cue) for manual abort. Manual abort cues occur prior to exceeding automatic abort limits for most high-q malfunctions.

The probability of vehicle loss due to an actuator hardover in the high-q region is 100×10^{-6} . The probability of crew loss after these malfunctions is 100×10^{-6} .

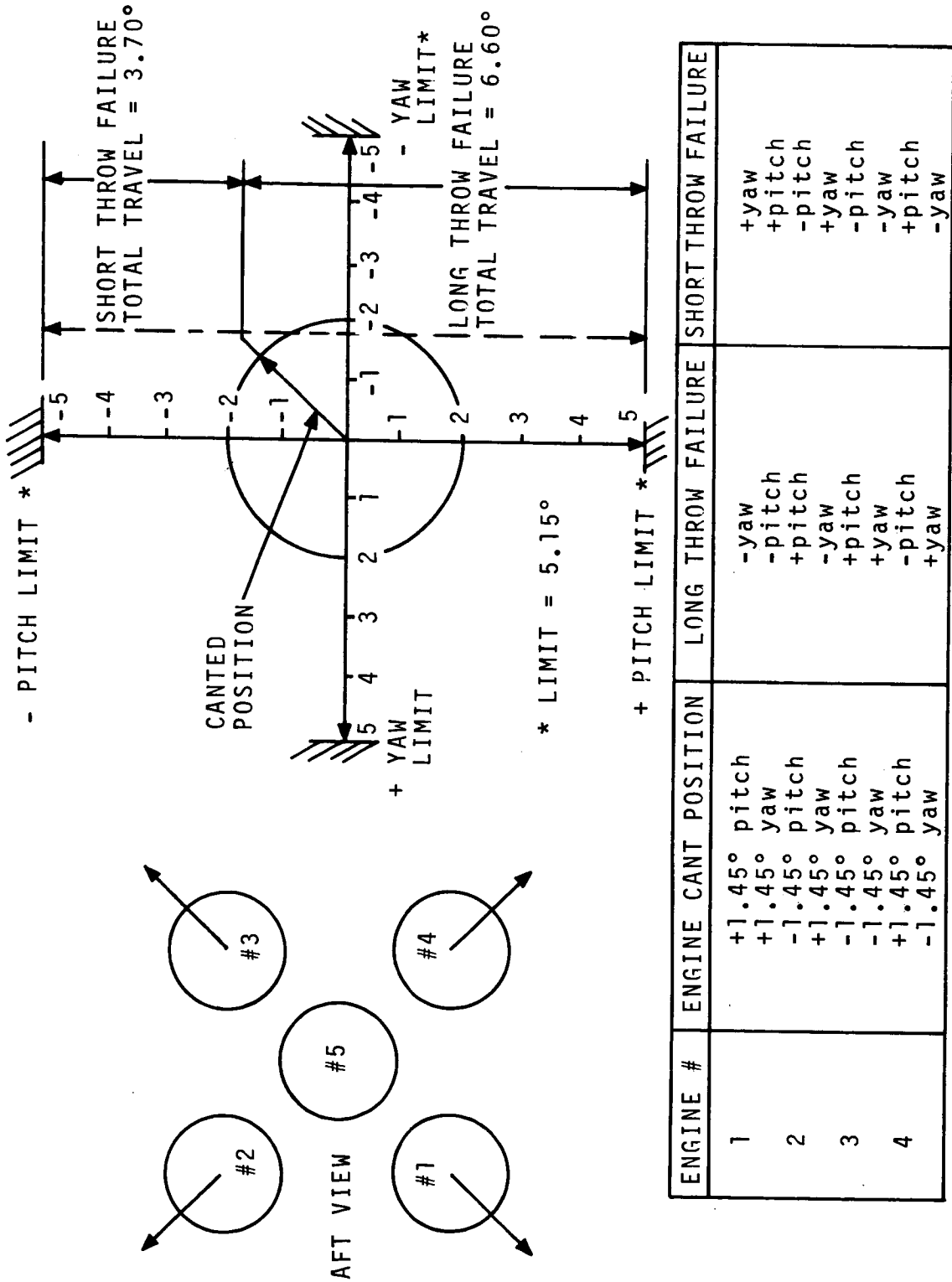

FIGURE 2-20 ENGINE CANT

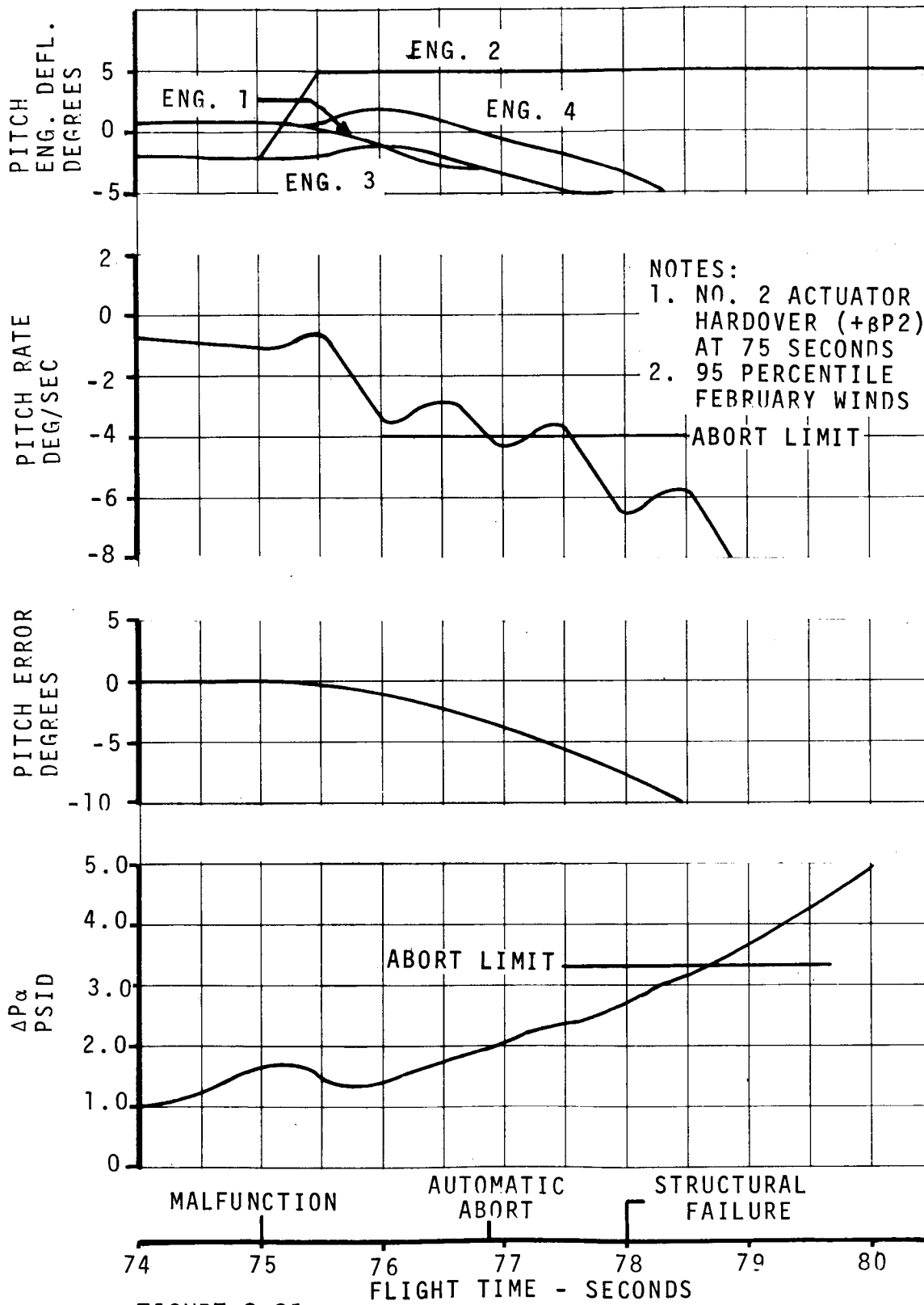
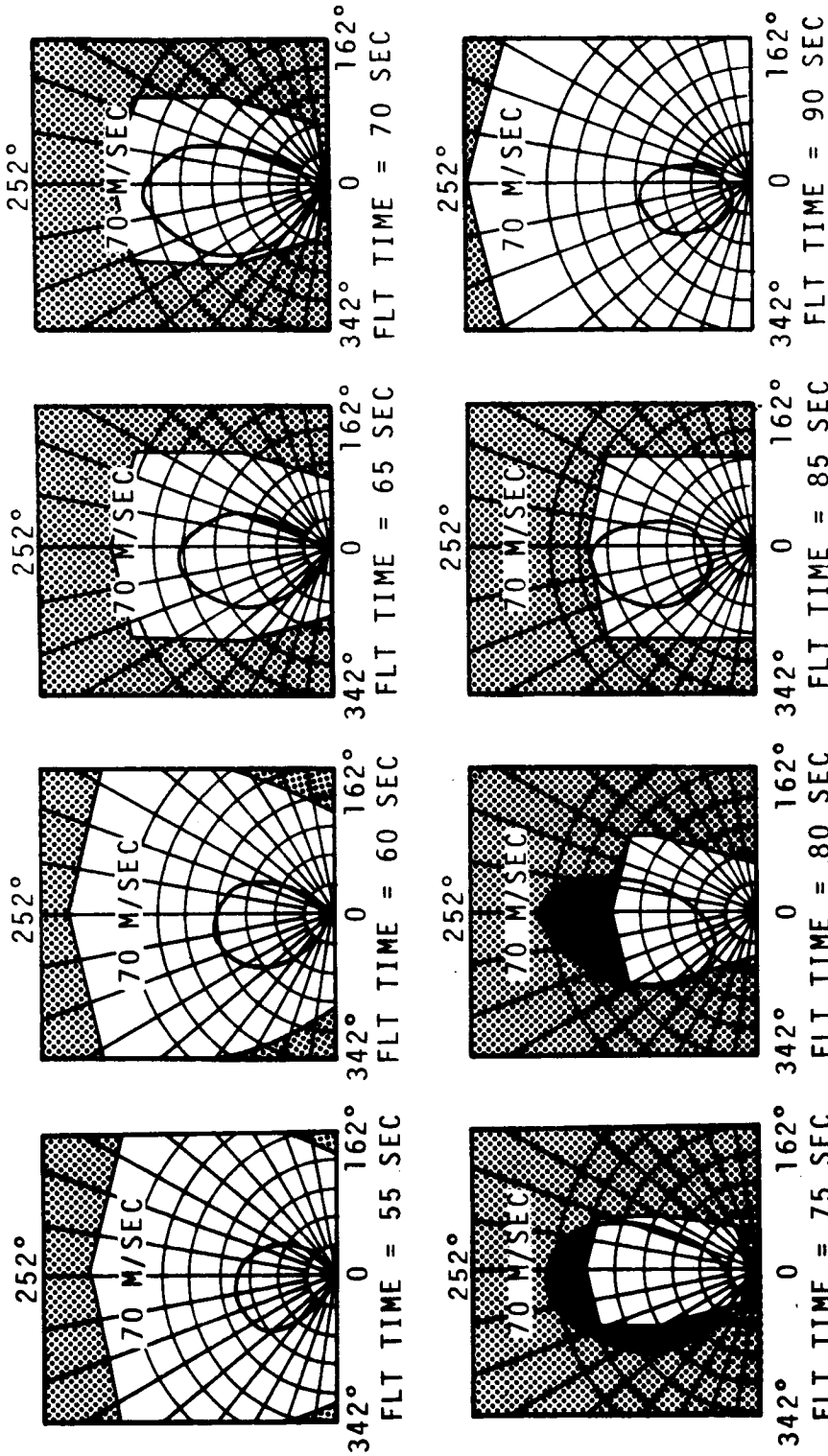

FIGURE 2-21 TIME HISTORY OF DYNAMIC VARIABLES FOR ACTUATOR HARDOVER



LEGEND:

- ▨ WINDS THAT CAUSE LOSS OF CONTROL
- WINDS LESS THAN FEBRUARY 95 PERCENTILE THAT CAUSE LOSS OF CONTROL

NOTES:

- 72° LAUNCH AZIMUTH
- 95 PERCENTILE SHEAR AND GUST REDUCED BY 15%
- SHORT THROW MALFUNCTION

FIGURE 2-22 ACTUATOR HARDOVER CONTROL CAPABILITY - SHORT THROW

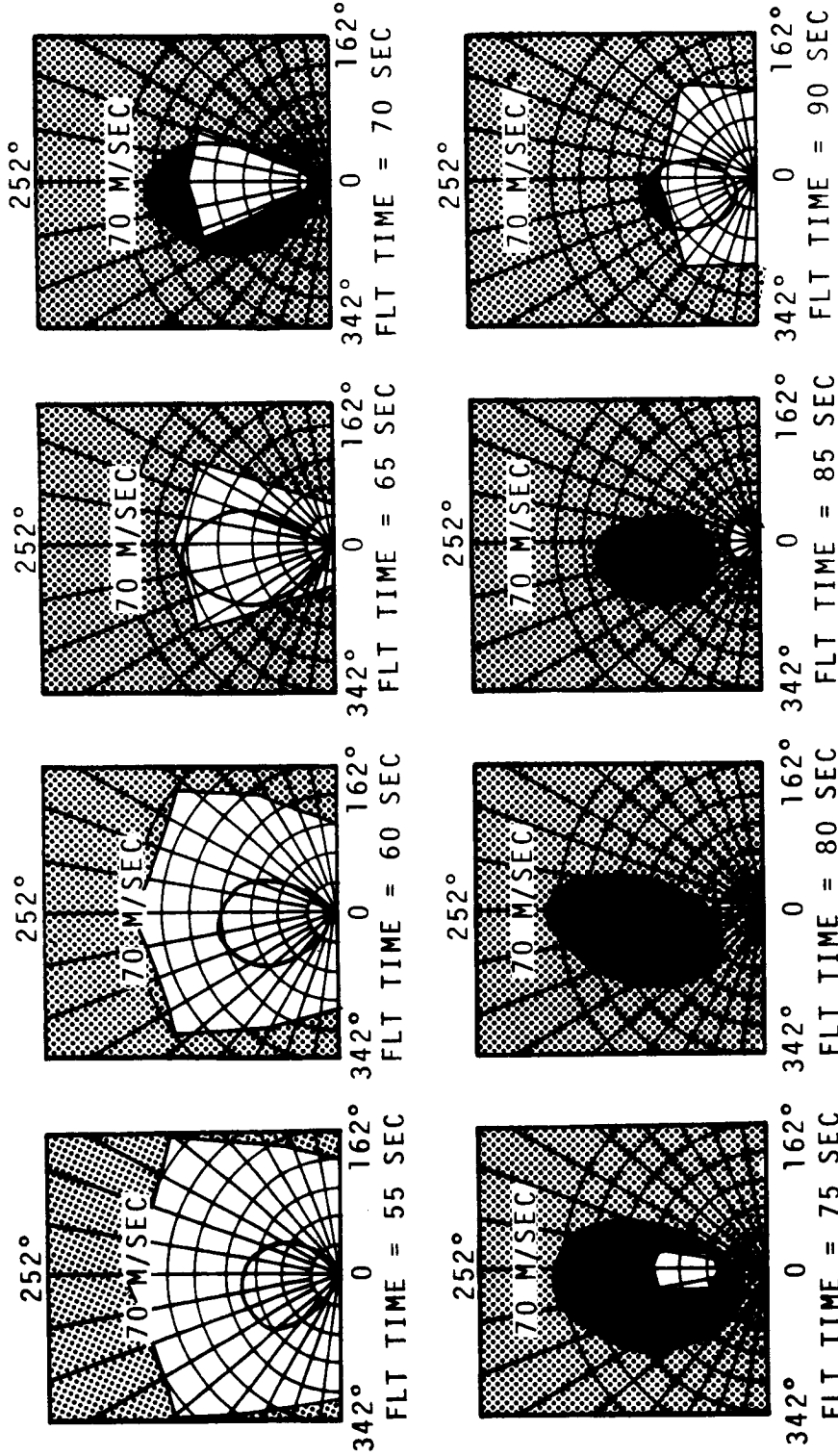

LEGEND:

- ▒ WINDS THAT CAUSE LOSS OF CONTROL
- WINDS LESS THAN FEBRUARY 95 PERCENTILE THAT CAUSE LOSS OF CONTROL

NOTES:

- 72° LAUNCH AZIMUTH
- 95 PERCENTILE SHEAR AND GUST REDUCED BY 15%
- LONG THROW MALFUNCTION

FIGURE 2-23 ACTUATOR HARDOVER CONTROL CAPABILITY - LONG THROW

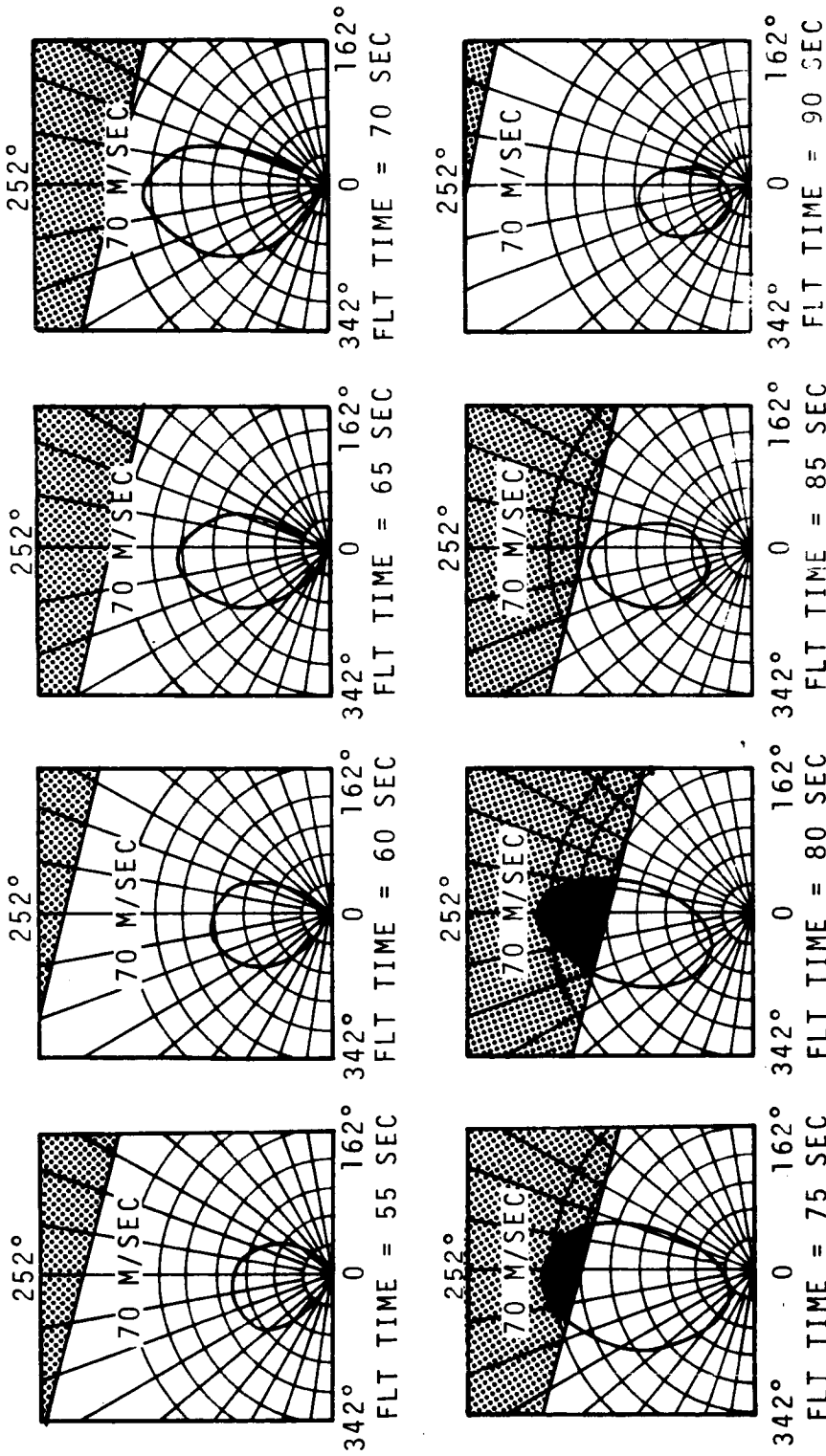

LEGEND:

▨ WINDS THAT CAUSE LOSS OF CONTROL

■ WINDS LESS THAN FEBRUARY 95 PERCENTILE THAT CAUSE LOSS OF CONTROL

NOTES:

- 72° LAUNCH AZIMUTH
- 95 PERCENTILE SHEAR AND GUST REDUCED BY 15%
- SHORT THROW MALFUNCTION

FIGURE 2-24 CONTROL CAPABILITY - NO. 1 ACTUATOR HARDOVER (+8PI)

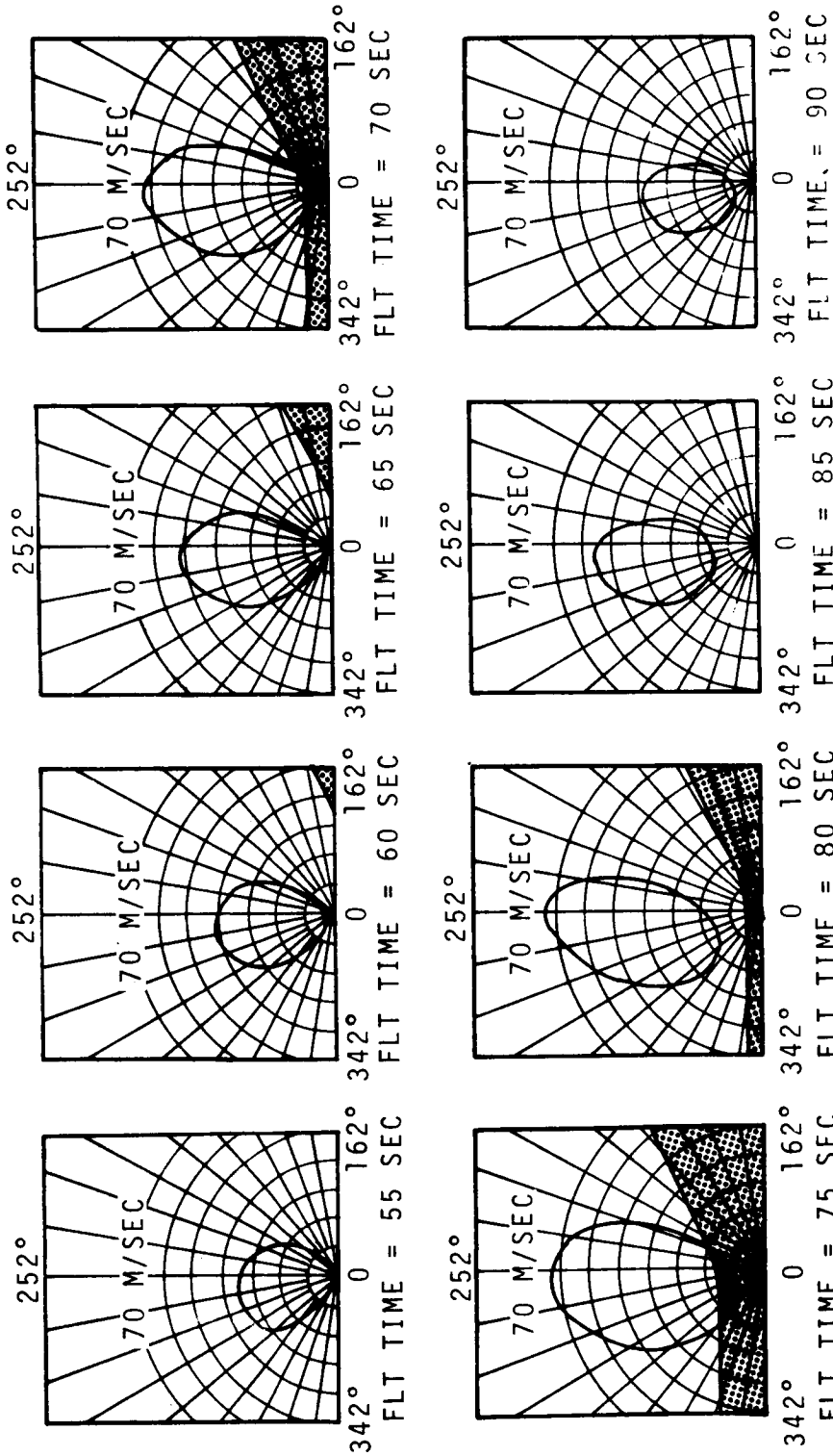

LEGEND:

▨ WINDS THAT CAUSE LOSS OF CONTROL

■ WINDS LESS THAN FEBRUARY 95 PERCENTILE THAT CAUSE LOSS OF CONTROL

NOTES:

- 72° LAUNCH AZIMUTH
- 95 PERCENTILE SHEAR AND GUST REDUCED BY 15%
- LONG THROW MALFUNCTION

FIGURE 2-25 CONTROL CAPABILITY - NO. 1 ACTUATOR HARDOVER (-8PI)

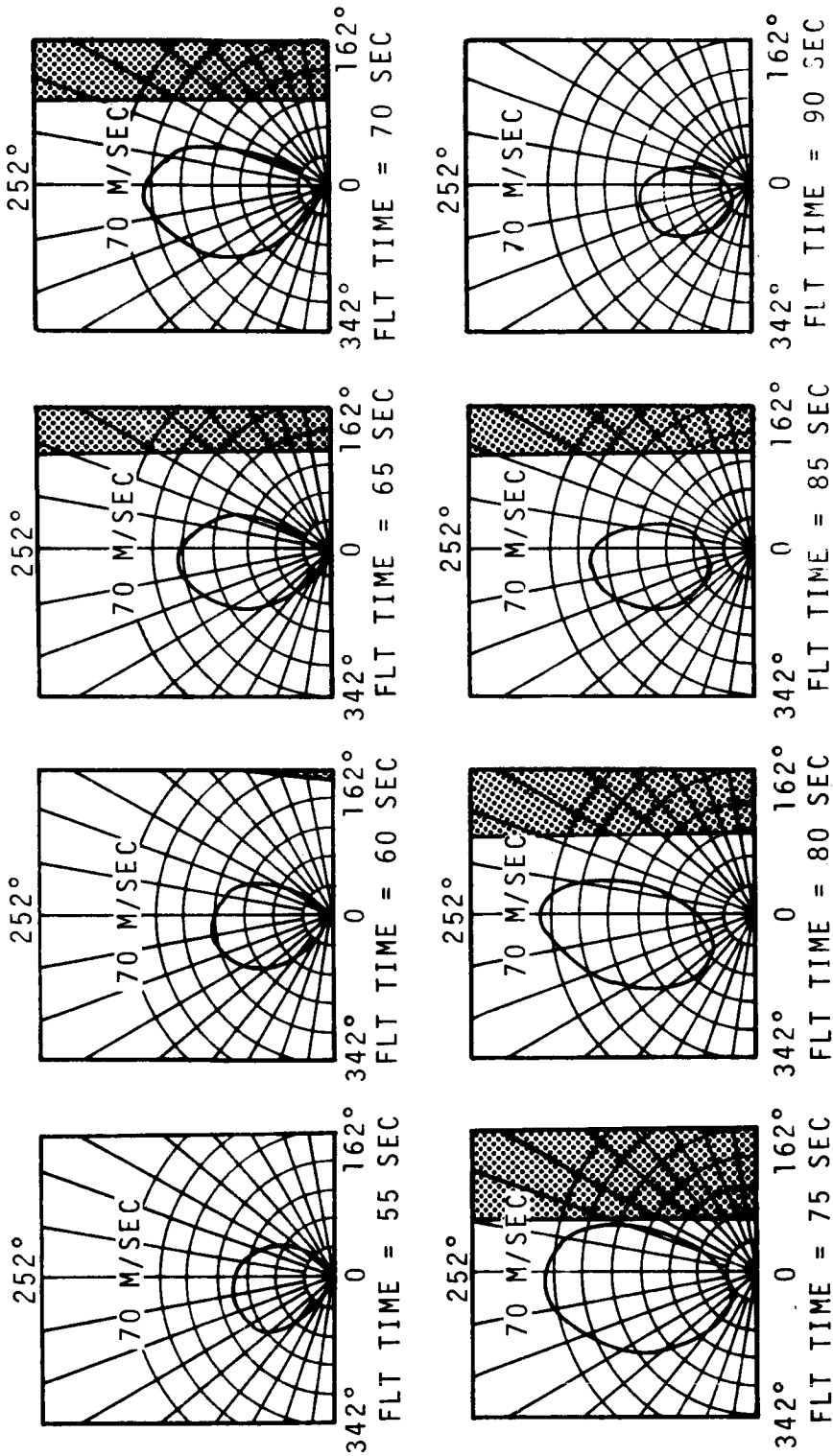
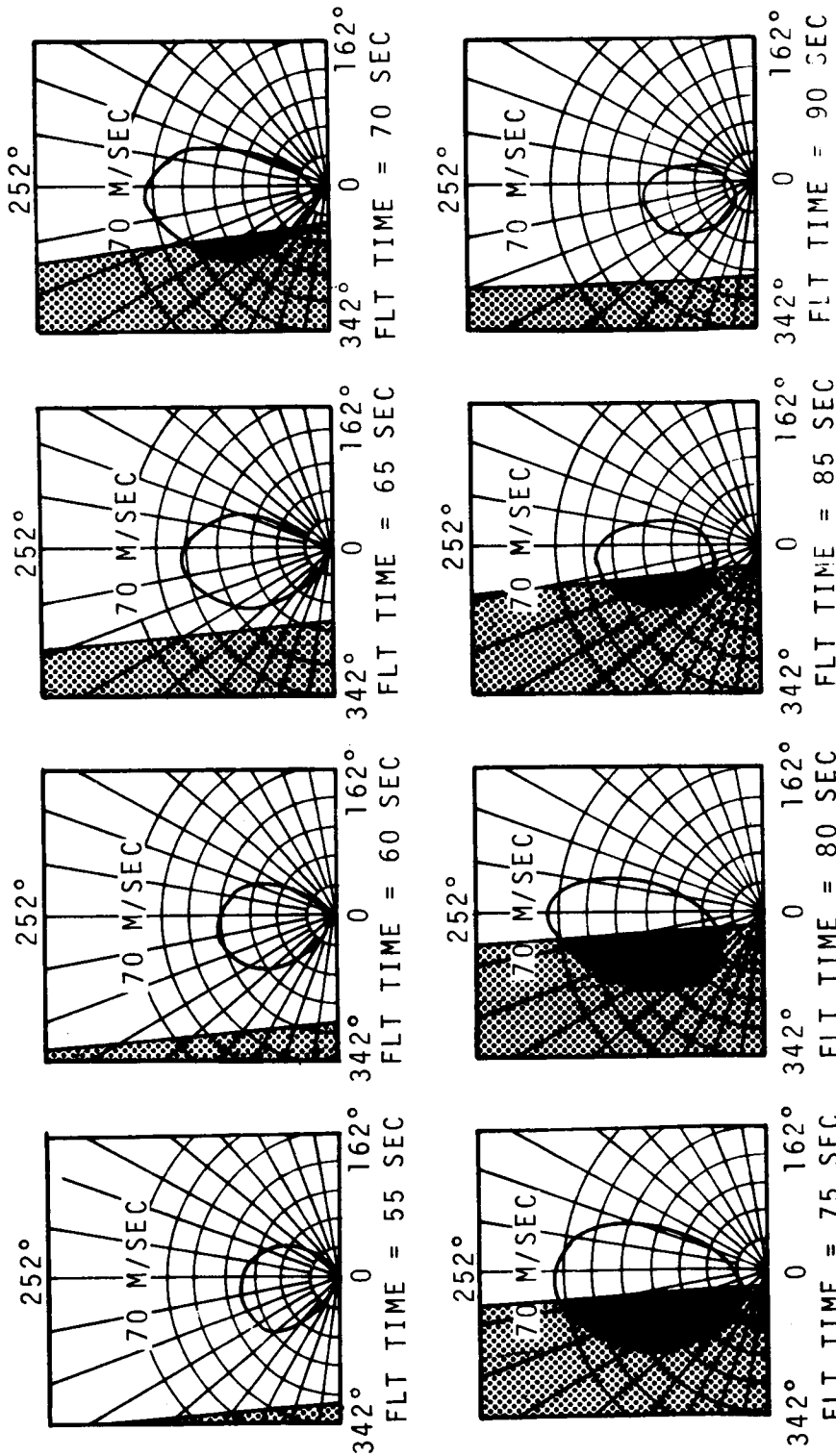

FIGURE 2-26 CONTROL CAPABILITY - NO. 1 ACTUATOR HARDOVER (+BY1)



LEGEND:

☐ WINDS THAT CAUSE LOSS OF CONTROL

■ WINDS LESS THAN FEBRUARY 95 PERCENTILE THAT CAUSE LOSS OF CONTROL

NOTES:

- 72° LAUNCH AZIMUTH
- 95 PERCENTILE SHEAR AND GUST REDUCED BY 15%
- LONG THROW MALFUNCTION

FIGURE 2-27 CONTROL CAPABILITY - NO. 1 ACTUATOR HARDOVER (-βY1)

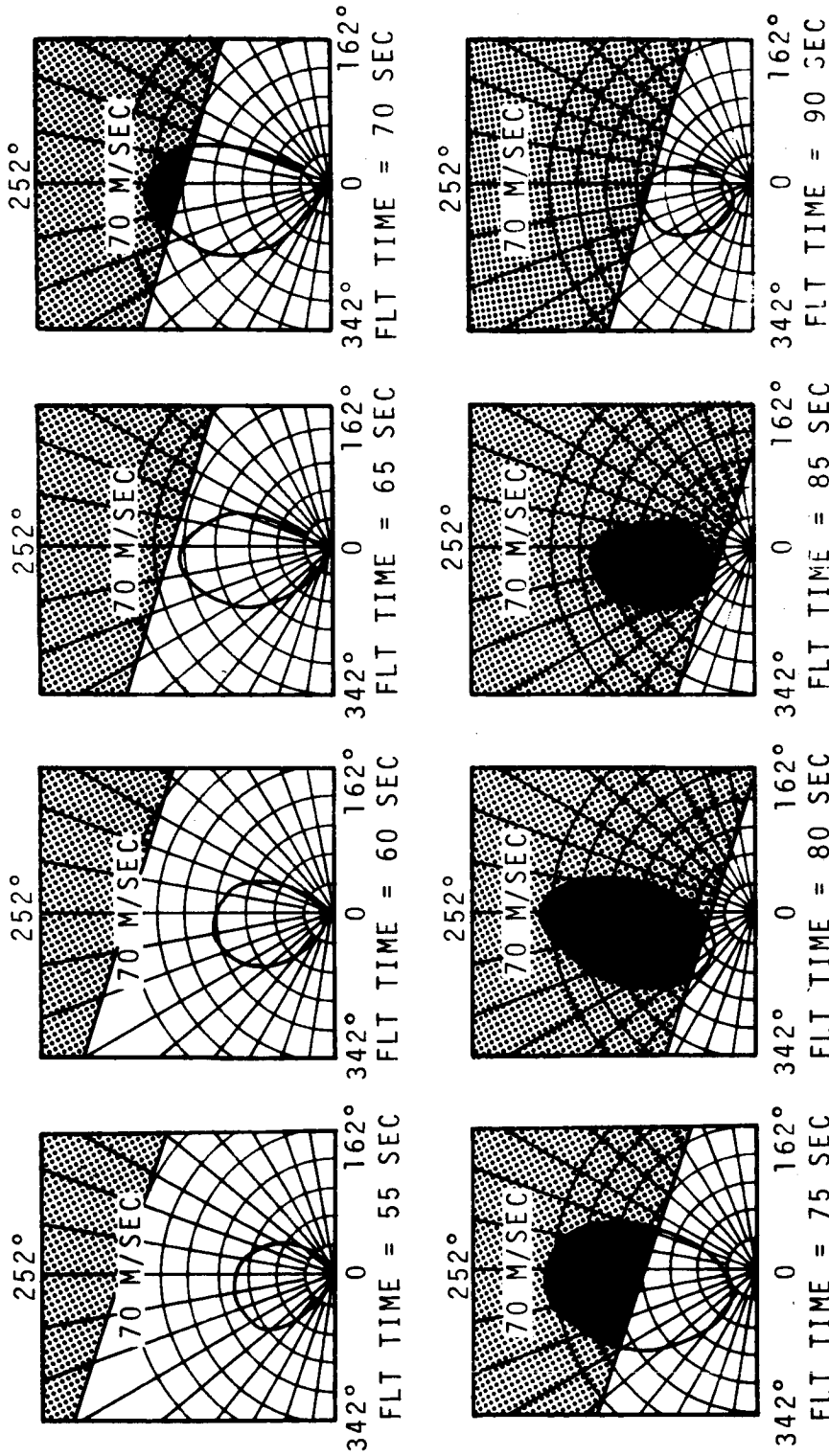

■ WINDS THAT CAUSE LOSS OF CONTROL
 ■ WINDS LESS THAN FEBRUARY 95 PERCENTILE THAT CAUSE LOSS OF CONTROL
 NOTES:
 72° LAUNCH AZIMUTH
 95 PERCENTILE SHEAR AND GUST REDUCED BY 15%
 LONG THROW MALFUNCTION

FIGURE 2-28 CONTROL CAPABILITY - NO. 2 ACTUATOR HARDOVER (+BP2)

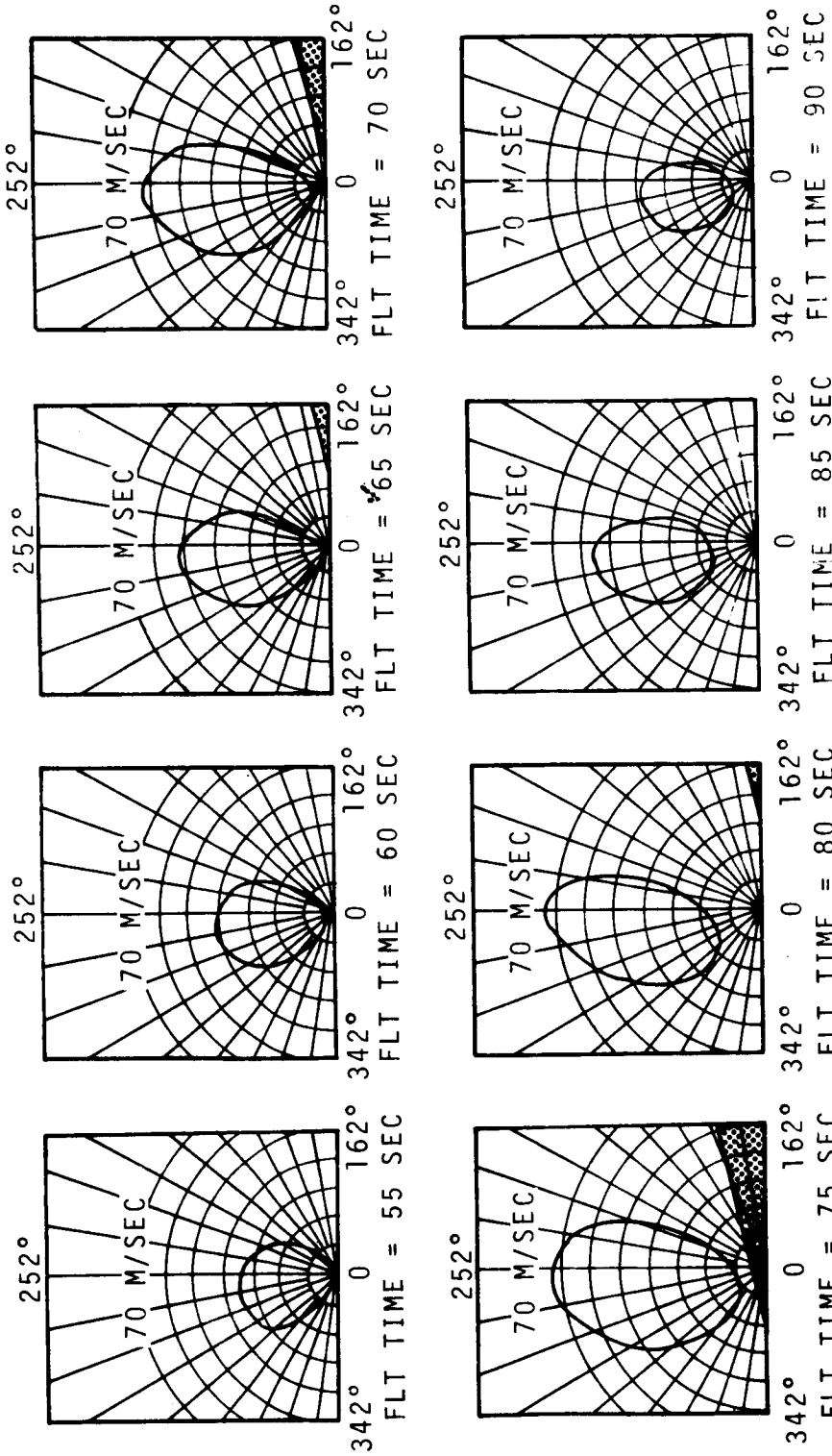

LEGEND:

- ▨ WINDS THAT CAUSE LOSS OF CONTROL
 - WINDS LESS THAN FEBRUARY 95 PERCENTILE THAT CAUSE LOSS OF CONTROL
- NOTES:

72° LAUNCH AZIMUTH
95 PERCENTILE SHEAR AND GUST REDUCED BY 15%
SHORT THROW MALFUNCTION

FIGURE 2-29 CONTROL CAPABILITY - NO. 2 ACTUATOR HARDOVER (-6P2)

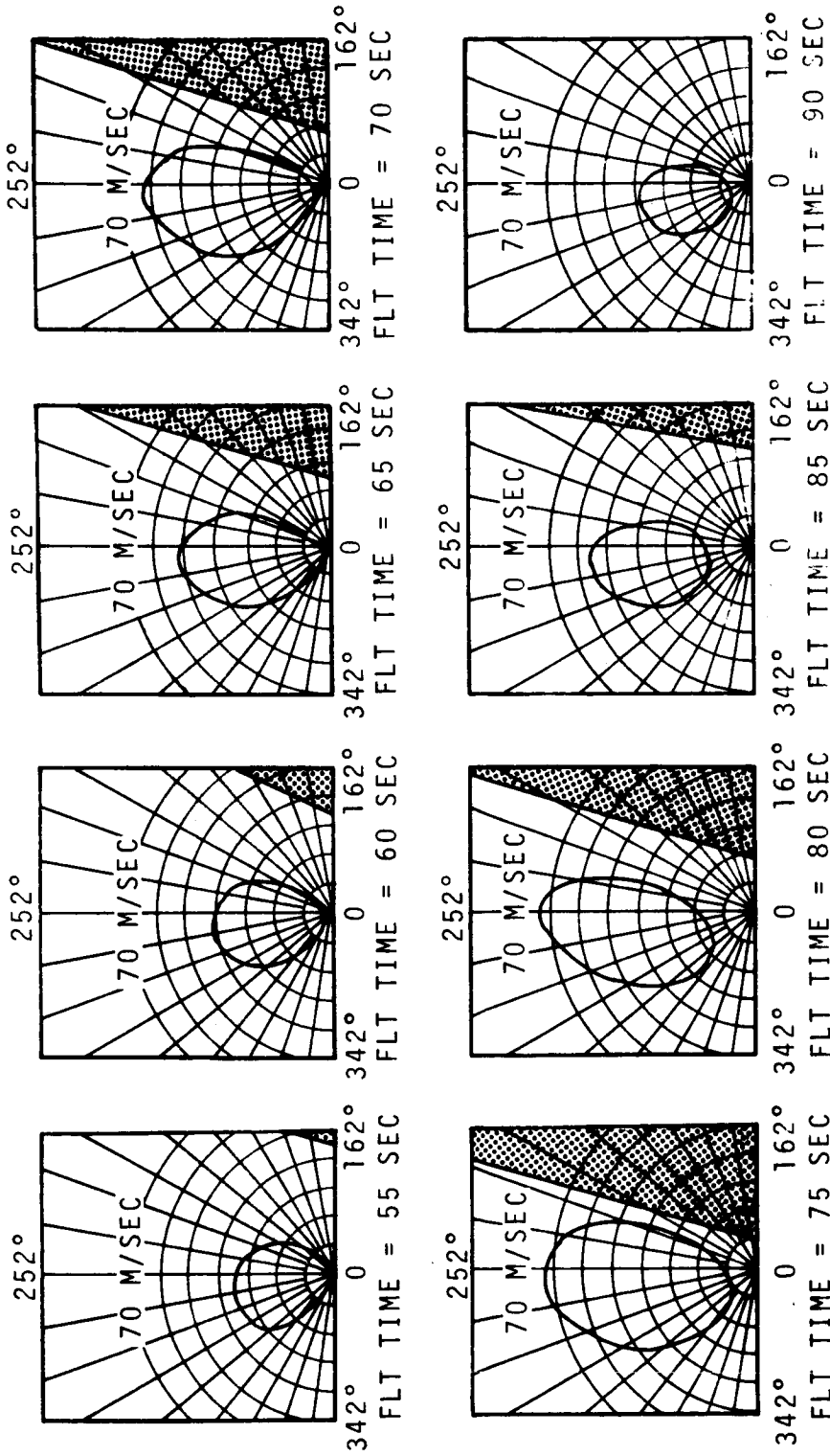

LEGEND:

- ▨ WINDS THAT CAUSE LOSS OF CONTROL
- WINDS LESS THAN FEBRUARY 95 PERCENTILE THAT CAUSE LOSS OF CONTROL

NOTES:

72° LAUNCH AZIMUTH
 95 PERCENTILE SHEAR AND GUST REDUCED BY 15%
 SHORT THROW MALFUNCTION

FIGURE 2-30 CONTROL CAPABILITY - NO. 2 ACTUATOR HARDOVER (+BY2)

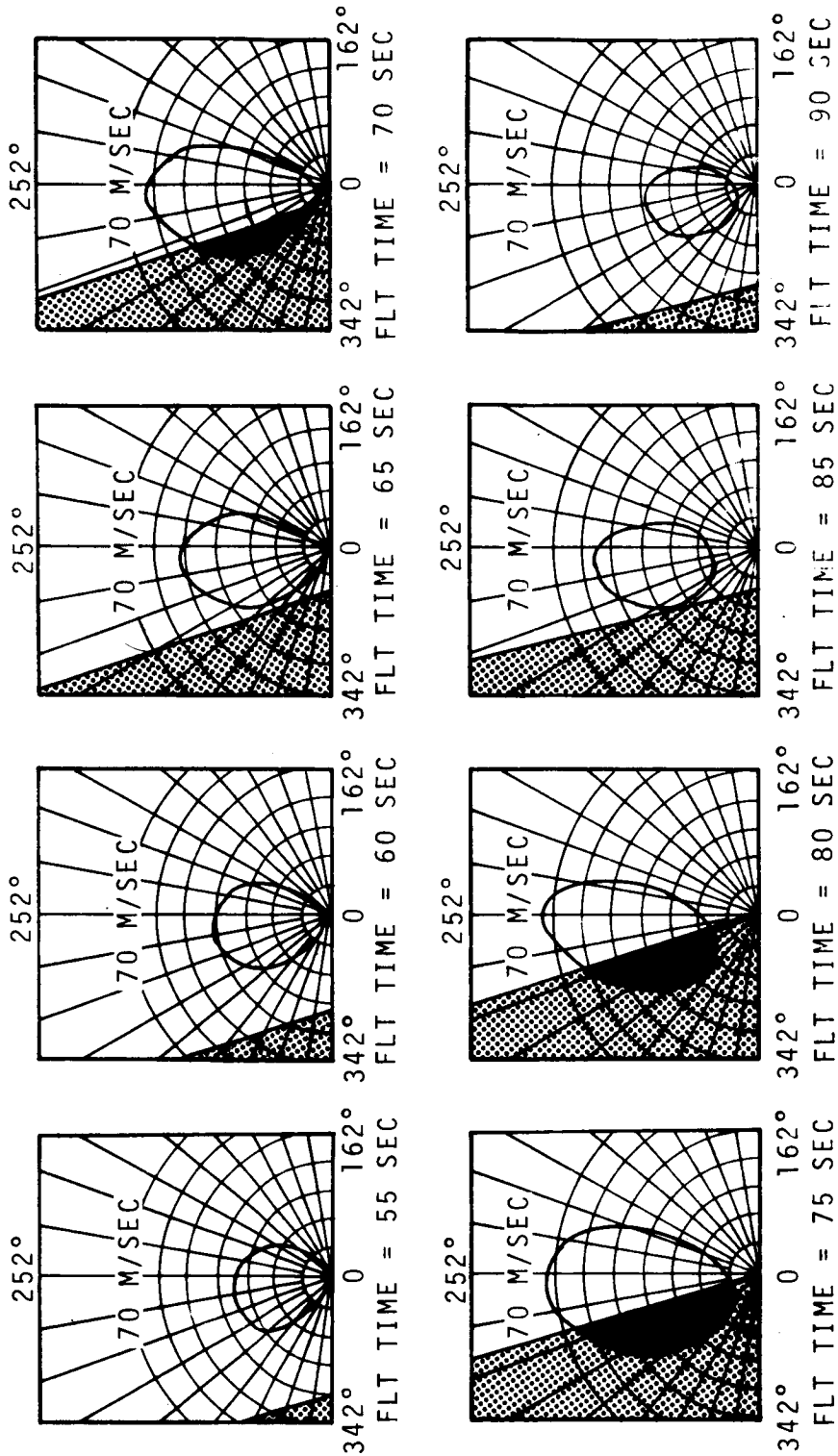

LEGEND:

▨ WINDS THAT CAUSE LOSS OF CONTROL

■ WINDS LESS THAN FEBRUARY 95 PERCENTILE THAT CAUSE LOSS OF CONTROL

NOTES:

- 72° LAUNCH AZIMUTH
- 95 PERCENTILE SHEAR AND GUST REDUCED BY 15%
- LONG THROW MALFUNCTION

FIGURE 2-31 CONTROL CAPABILITY - NO. 2 ACTUATOR HARDOVER (-8Y2)

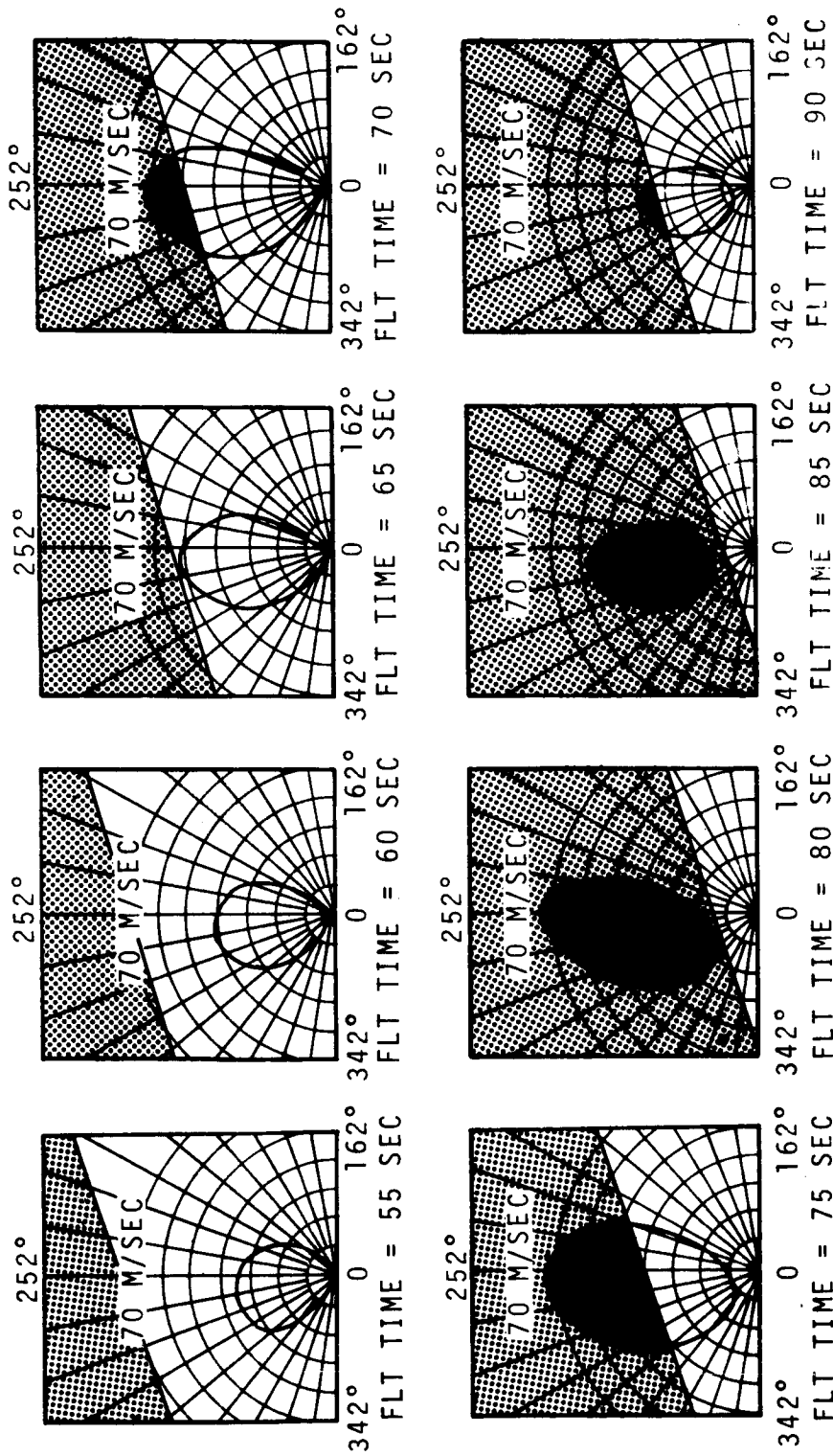

LEGEND:

- ▤ WINDS THAT CAUSE LOSS OF CONTROL
- WINDS LESS THAN FEBRUARY 95 PERCENTILE THAT CAUSE LOSS OF CONTROL

NOTES:

- 72° LAUNCH AZIMUTH
- 95 PERCENTILE SHEAR AND GUST REDUCED BY 15%
- LONG THROW MALFUNCTION

FIGURE 2-32 CONTROL CAPABILITY - NO. 3 ACTUATOR HARDOVER (+BP3)

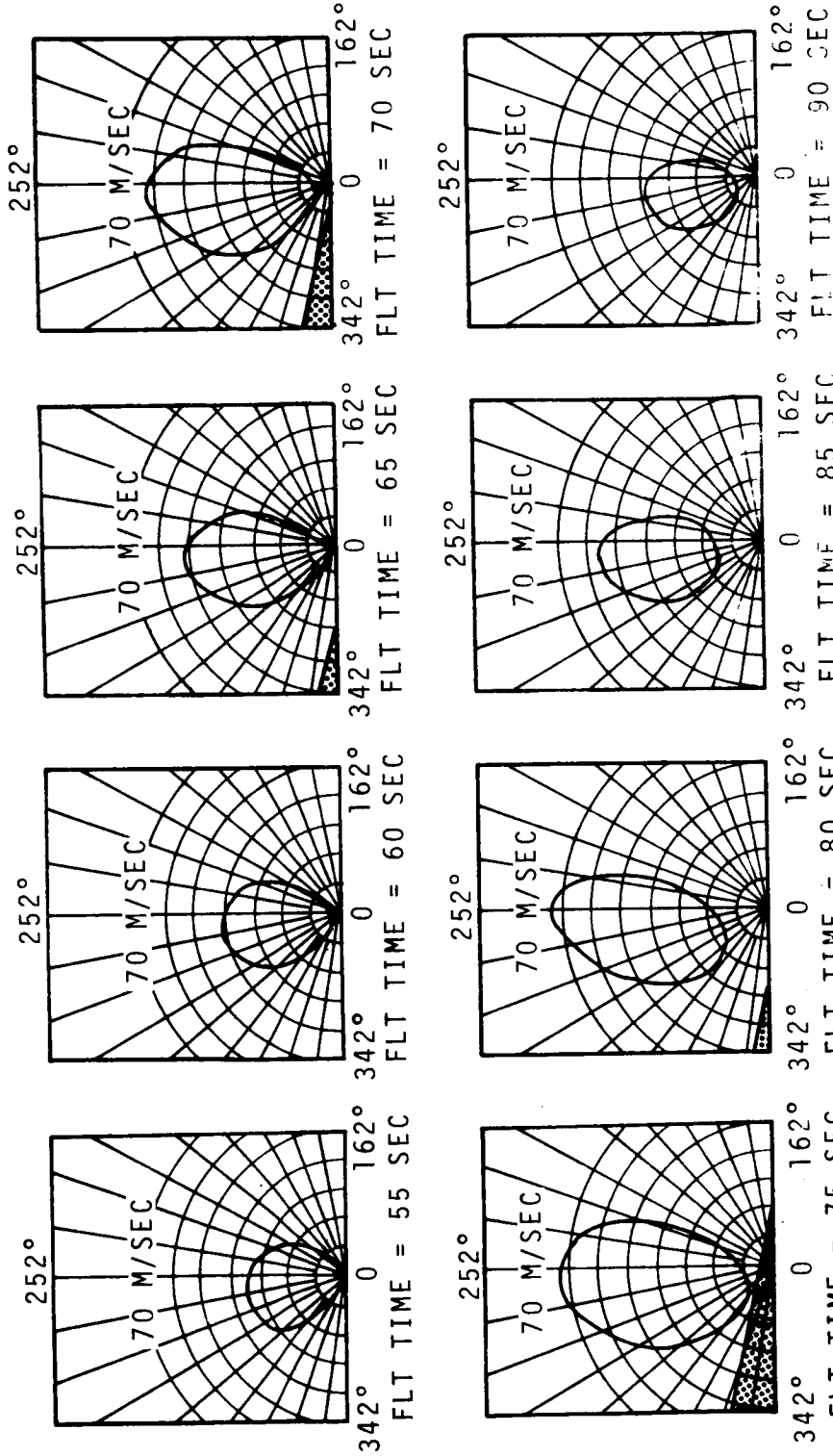

LEGEND:

▨ WINDS THAT CAUSE LOSS OF CONTROL

■ WINDS LESS THAN FEBRUARY 95 PERCENTILE THAT CAUSE LOSS OF CONTROL

NOTES:

- 72° LAUNCH AZIMUTH
- 95 PERCENTILE SHEAR AND GUST REDUCED BY 15%
- SHORT THROW MALFUNCTION

FIGURE 2-33 CONTROL CAPABILITY - NO. 3 ACTUATOR HARDOVER (-8P3)

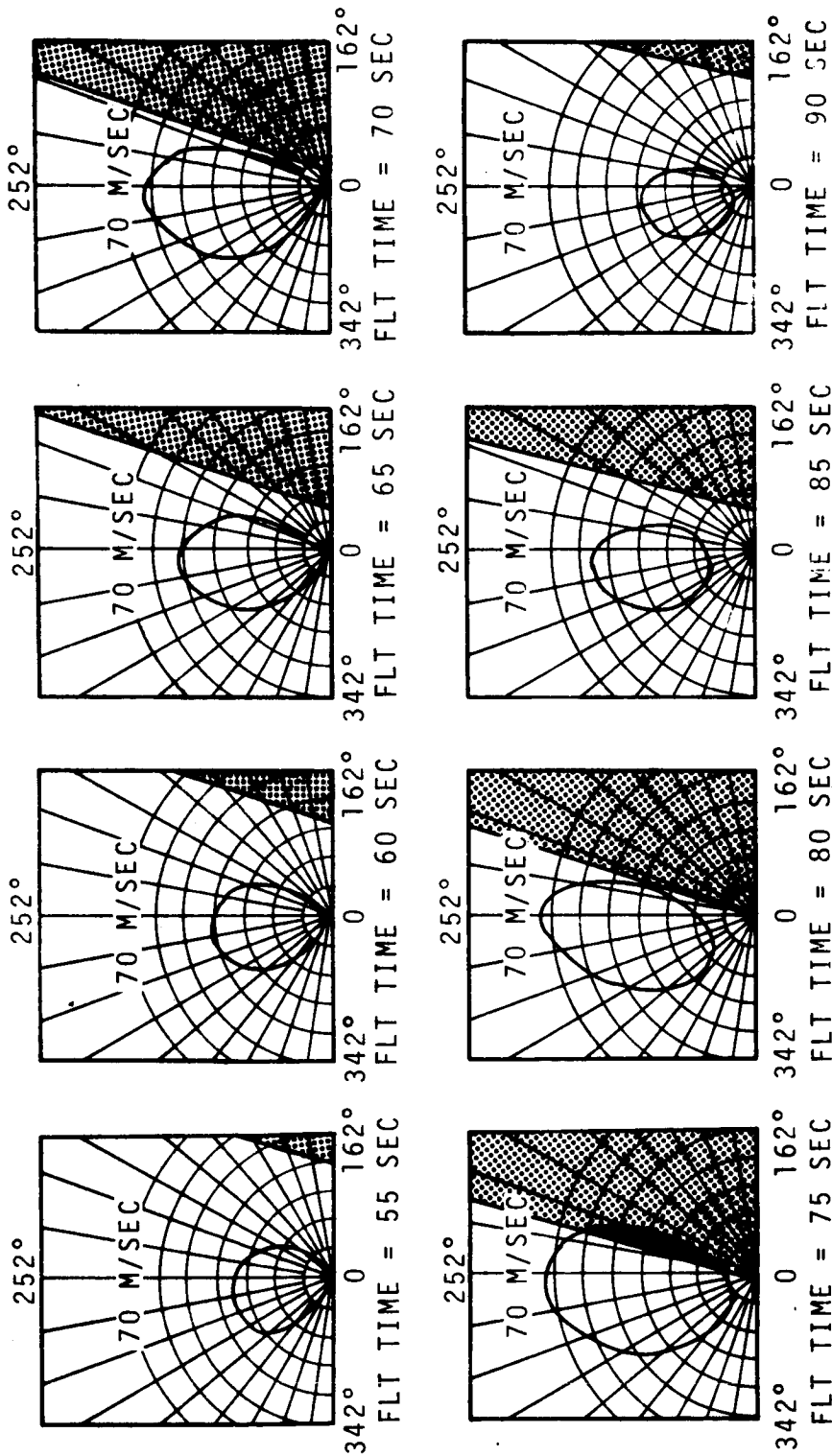

LEGEND:

- ▨ WINDS THAT CAUSE LOSS OF CONTROL
- WINDS LESS THAN FEBRUARY 95 PERCENTILE THAT CAUSE LOSS OF CONTROL

NOTES:

- 72° LAUNCH AZIMUTH
- 95 PERCENTILE SHEAR AND GUST REDUCED BY 15%
- LONG THROW MALFUNCTION

FIGURE 2-34 CONTROL CAPABILITY - NO. 3 ACTUATOR HARDOVER (+BY3)

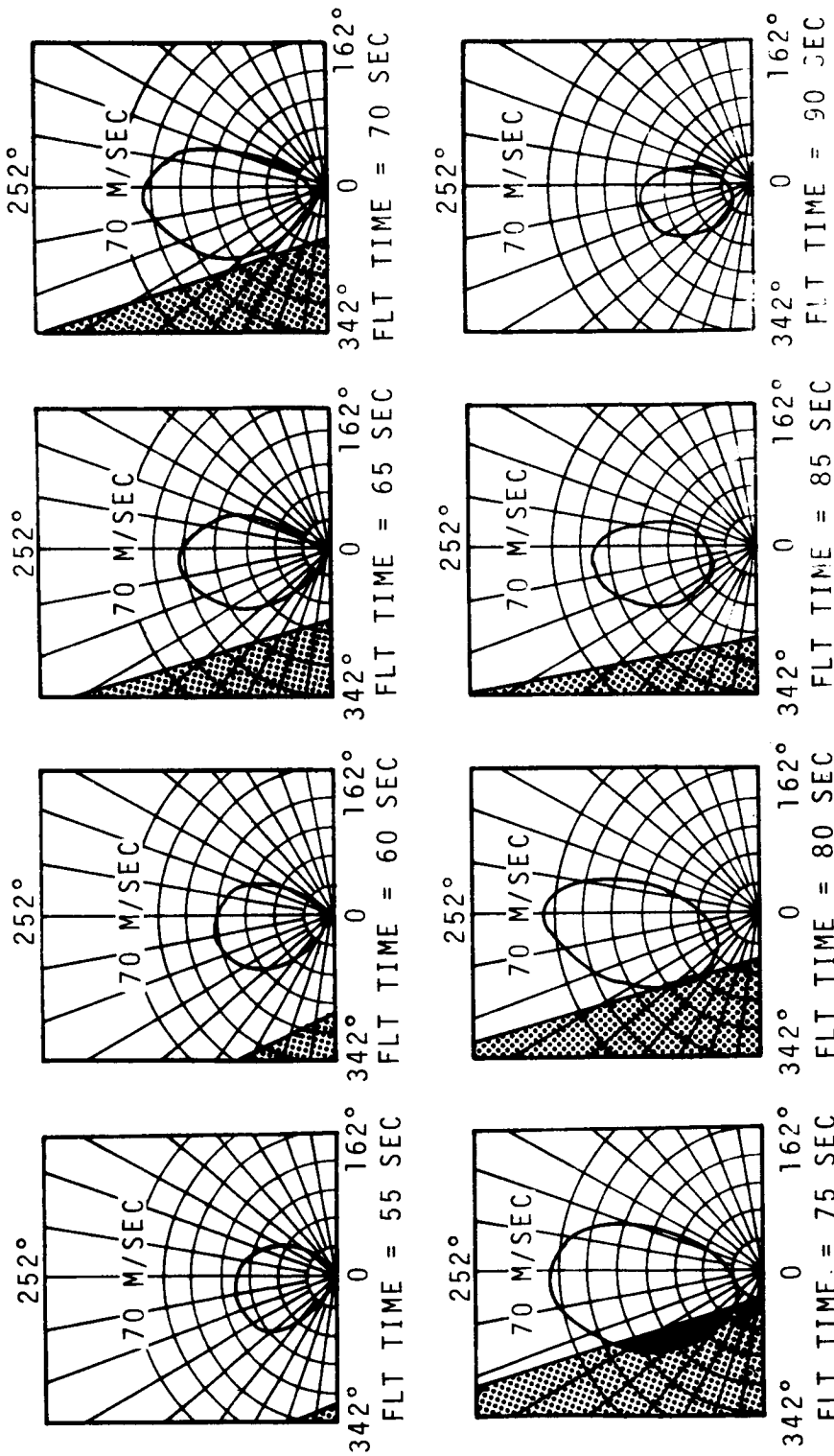

LEGEND:

▨ WINDS THAT CAUSE LOSS OF CONTROL

■ WINDS LESS THAN FEBRUARY 95 PERCENTILE THAT CAUSE LOSS OF CONTROL

NOTES:

- 72° LAUNCH AZIMUTH
- 95 PERCENTILE SHEAR AND GUST REDUCED BY 15%
- SHORT THROW MALFUNCTION

FIGURE 2-35 CONTROL CAPABILITY - NO. 3 ACTUATOR HARDOVER (-BY3)

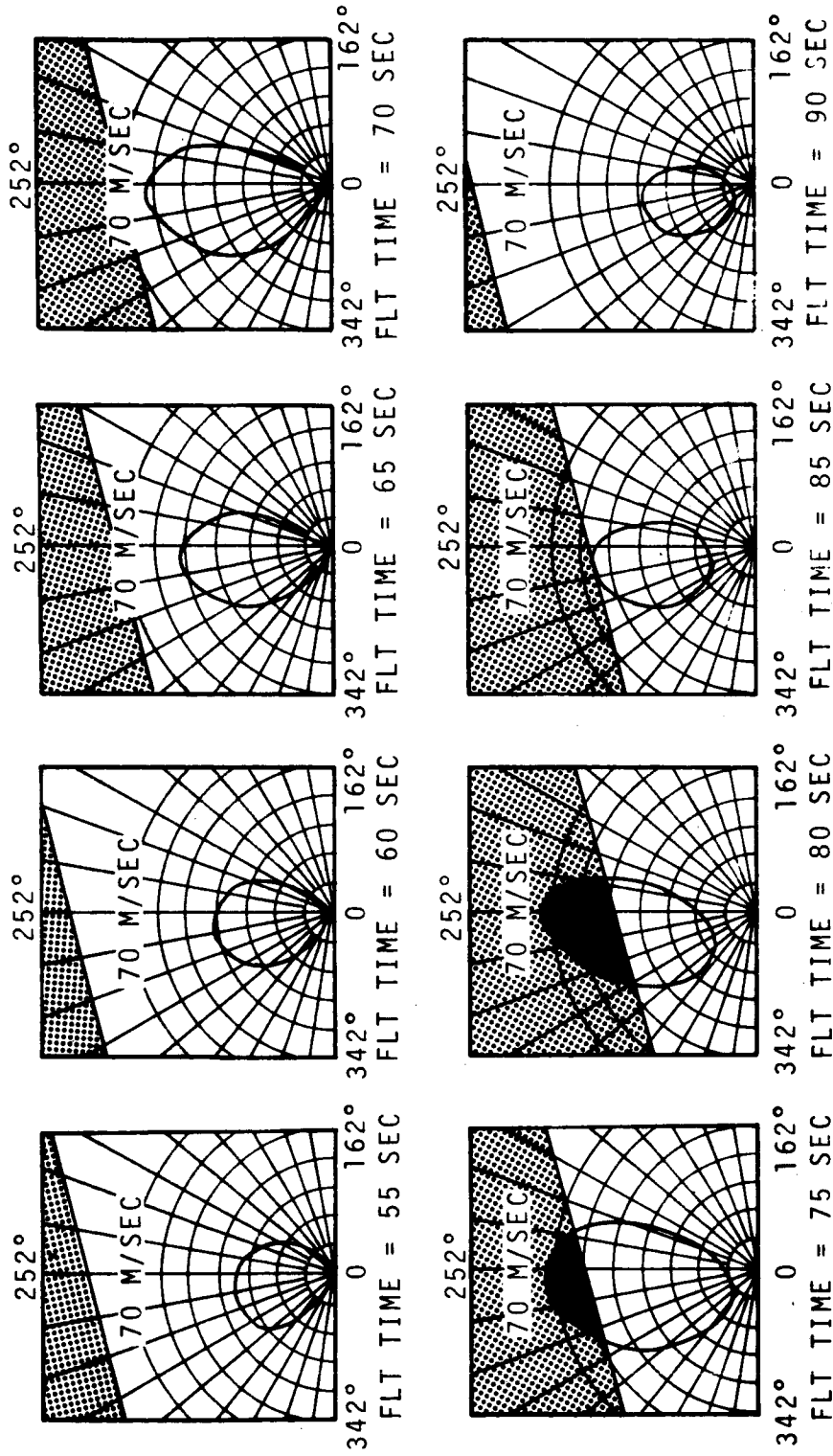

LEGEND:

- ▨ WINDS THAT CAUSE LOSS OF CONTROL
- WINDS LESS THAN FEBRUARY 95 PERCENTILE THAT CAUSE LOSS OF CONTROL

NOTES:

- 72° LAUNCH AZIMUTH
- 95 PERCENTILE SHEAR AND GUST REDUCED BY 15%
- SHORT THROW MALFUNCTION

FIGURE 2-36 CONTROL CAPABILITY - NO. 4 ACTUATOR HARDOVER (+8P4)

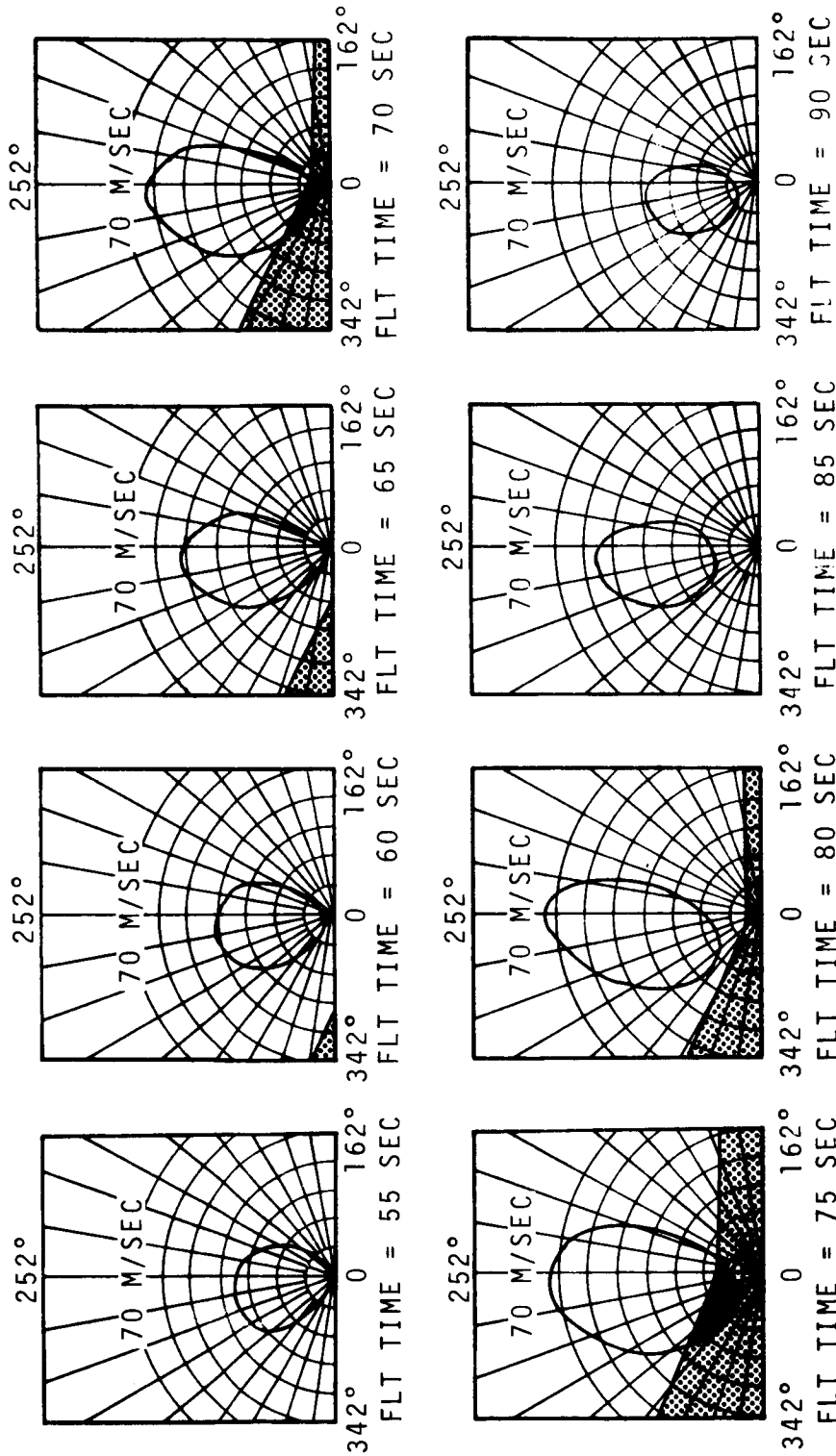

LEGEND:

▨ WINDS THAT CAUSE LOSS OF CONTROL

■ WINDS LESS THAN FEBRUARY 95 PERCENTILE THAT CAUSE LOSS OF CONTROL

NOTES:

- 72° LAUNCH AZIMUTH
- 95 PERCENTILE SHEAR AND GUST REDUCED BY 15%
- LONG THROW MALFUNCTION

FIGURE 2-37 CONTROL CAPABILITY - NO. 4 ACTUATOR HARDOVER (-8P4)

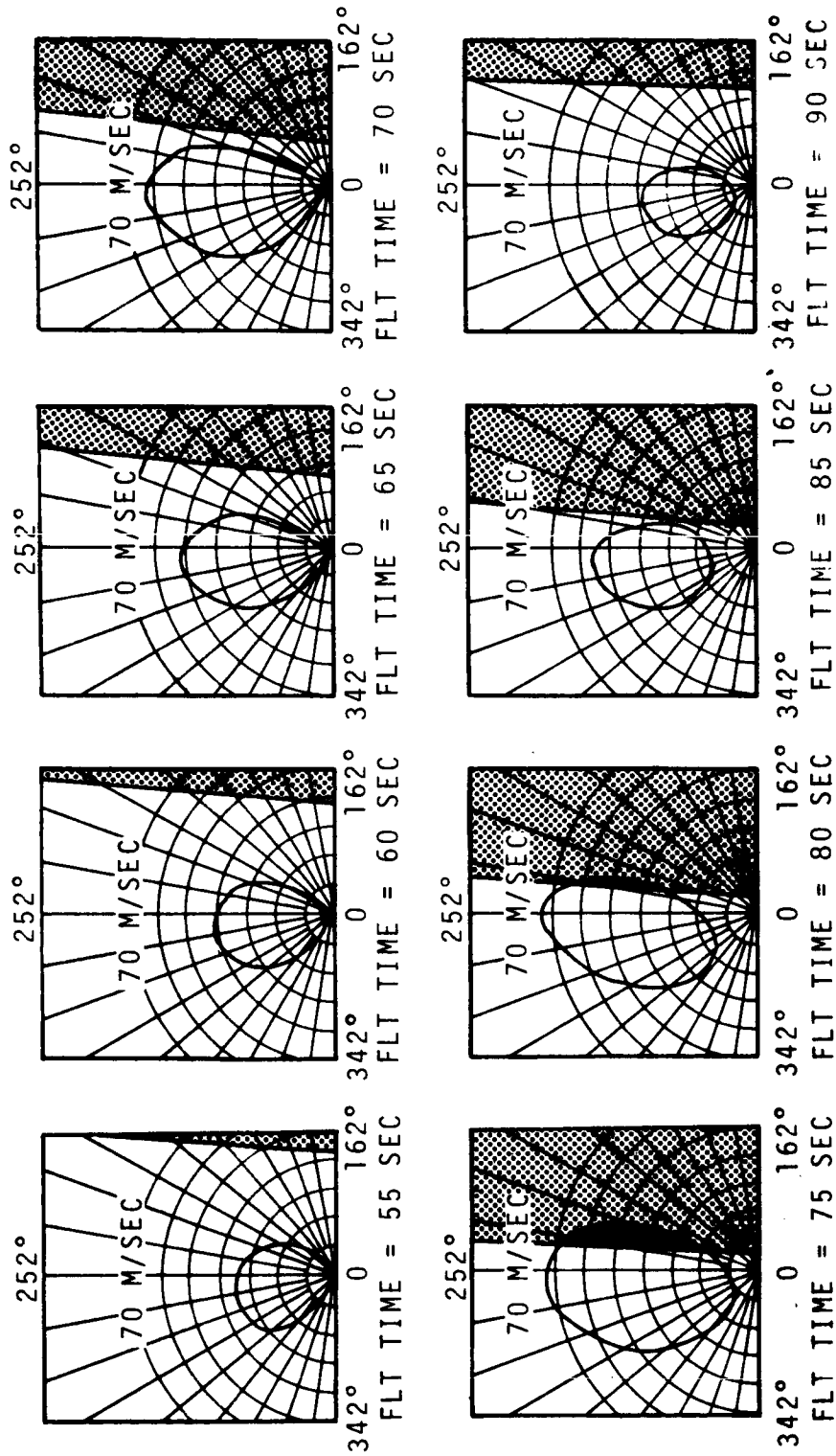

LEGEND:

- ▨ WINDS THAT CAUSE LOSS OF CONTROL
- WINDS LESS THAN FEBRUARY 95 PERCENTILE THAT CAUSE LOSS OF CONTROL

NOTES:

72° LAUNCH AZIMUTH
 95 PERCENTILE SHEAR AND GUST REDUCED BY 15%
 LONG THROW MALFUNCTION

FIGURE 2-38 CONTROL CAPABILITY - NO. 4 ACTUATOR HARDOVER (+BY4)

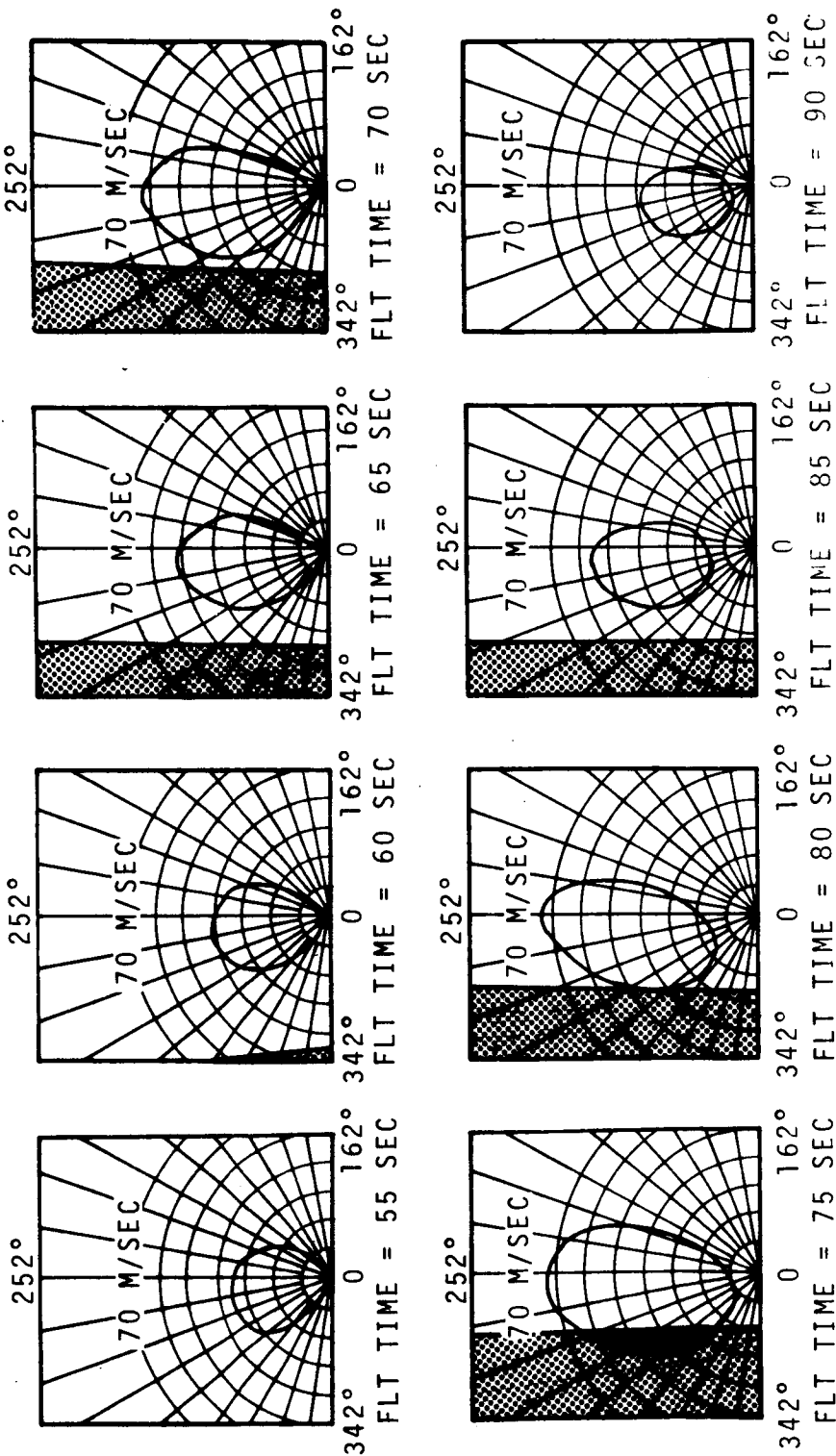

LEGEND:

☼ WINDS THAT CAUSE LOSS OF CONTROL

■ WINDS LESS THAN FEBRUARY 95 PERCENTILE THAT CAUSE LOSS OF CONTROL

NOTES:

- 72° LAUNCH AZIMUTH
- 95 PERCENTILE SHEAR AND GUST REDUCED BY 15%
- SHORT THROW MALFUNCTION

FIGURE 2-39 CONTROL CAPABILITY - NO. 4 ACTUATOR HARDOVER (-8Y4)

2.6.2 Actuator Hardover Capability - S-II

No vehicle losses resulted from simulation of single actuator failures during S-II flight. In addition, no cases exceeding FDO limits were encountered. Near nominal parking orbit insertion was attained in all simulations of actuator hardover during S-II flight. The maximum rates in pitch and roll, respectively, were: 2.6 deg/sec and 3.6 deg/sec. Maximum yaw rate was less than 1 deg/sec. Maximum attitude errors were: pitch 4.1, yaw <1, roll 4.5. Yaw actuator hardover results are symmetric to those of pitch actuator hardover cases.

A single actuator hardover inboard causes a large inboard deflection of another control engine, as shown in Figure 2-40. This deflection of two control engines will expose the base of the S-II vehicle to excessive radiation from the engine plumes. Presently available information indicates the following potential results for this malfunction:

1. Collapse of thrust structure due to induced thermal stress.
2. Loss of engine thrust and/or S-II/S-IVB separation capability due to wiring harness damage.

The damage to the S-II thrust structure may occur within 15 to 25 seconds from failure of the flexible curtain portion of the base heat shield. These consequences of excessive inboard engine deflections may cause abort or early staging. Abort cues would necessarily be ground initiated, since there is presently no onboard display which violates EDS limits as a result of this malfunction.

2.6.3 Actuator Hardover Capability - S-IVB

S-IVB actuator hardover produces immediate loss of control. Since results are identical to S-IVB saturated control, these cases are covered by the saturated control discussion.

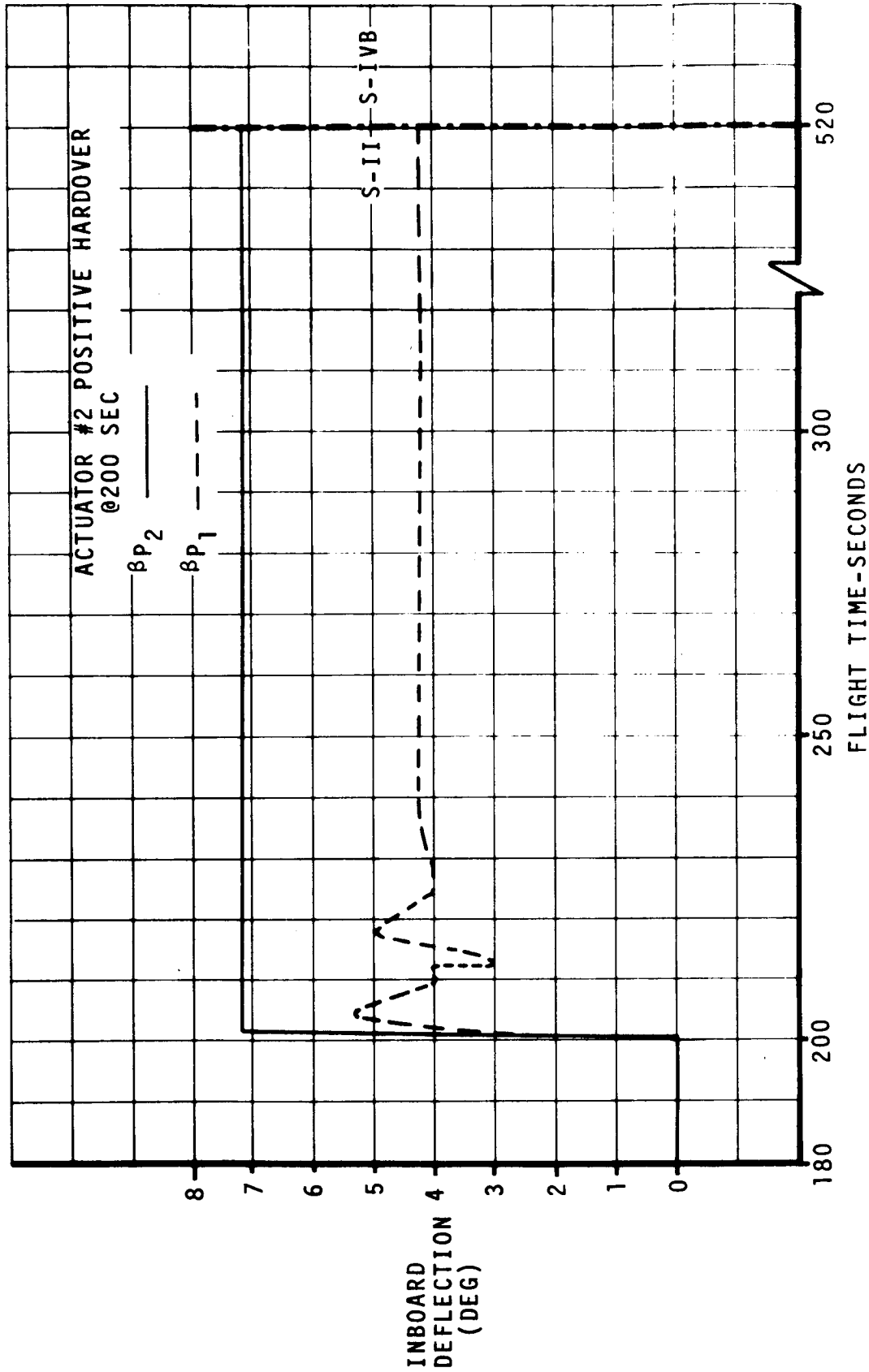

FIGURE 2-40 PITCH ACTUATOR RESPONSE TO AN S-II ACTUATOR HARDOVER

2.6.4 S-IVB Restart with Actuator Hardover

The following are considered in analyzing S-IVB capability to restart with an actuator in the hardover position:

- a. Ability of APS to control attitude with torque resulting from J-2 lead thrust during restart preparation.
- b. Ability of APS to recover attitude control after the J-2 burn is terminated. Recovery must be to a rate from which a successful abort to the SM or spacecraft can be made.

Assuming ~900 pounds J-2 lead thrust, J-2 restart preparation will develop about 3900 newton-meters torque when hardover. Since pitch APS develops about 4470 newton-meters, pitch attitude control is marginal. With two APS nozzles available in yaw, yaw attitude control can be maintained with about 43% APS duty cycle during the 8.0 seconds of restart preparation where lead thrust is developed. This will consume 0.6 percent of APS fuel in addition to the 70 percent (approximately) used for powered flight roll control, orbital attitude control and APS ullaging.

For recovery after termination of the J-2 burn, APS must operate for 240 seconds for each second of J-2 full-thrust burn with a pitch hardover, or 120 seconds for a yaw hardover. For a 2 second J-2 burn, 9.7°/second rate (about 10°/second, allowing for thrust buildup and decay) would be generated. This would require 500 seconds in pitch or 250 seconds in yaw for full recovery by APS. About 45 percent APS fuel would be consumed in either case. Even in yaw, where recovery is more rapid, the vehicle would complete 3-1/2 revolutions before recovery, hence spacecraft platform tumble limits (assumed to be 90°) would be exceeded. Consequently, S-IVB restart for even two to three seconds would have to be terminated by abort to SPS. Consequently, it is recommended that S-IVB restart not be attempted after actuator hardover has been detected in parking orbit.

2.6.5 Inertial Platform Failure - S-IC

Loss of inertial attitude reference in S-IC flight caused by rapid tumbling of the stable platform described in Reference 11 results in the consecutive failure of the attitude reasonableness test. This malfunction can create steps in the attitude error signal of 0.48 degrees each 3.14 seconds. Rapid divergence of vehicle attitude causes loss of control for this malfunction at any time during S-IC flight. This rapid divergence results in tumbling in the high-q region, leading to structural failure for all winds.

The recommended EDS manual abort cues for loss of inertial attitude reference are listed in Table 2-III.

TABLE 2-III RECOMMENDED ABORT CUES FOR LOSS OF PLATFORM

TIME OF FAILURE	ABORT RULE	ABORT CUE
0 - 50 seconds	Abort at 50 seconds	Guidance failure light and L/V overrate light
50 - 100 seconds	Abort at abort cue	Guidance failure light and L/V overrate light
100 - OECO	Abort at abort cue	Guidance failure light and abort request light

The recommended EDS automatic abort limit is 4 degrees/second pitch or yaw rate. Manual abort cues occur prior to exceeding automatic abort limits for all times of flight.

The probability of vehicle loss due to this malfunction is 2100×10^{-6} ; however, safe abort can be accomplished throughout flight.

2.6.6 Inertial Platform Failure - S-II

Loss of inertial attitude in S-II flight results in failure of the attitude reasonableness test and subsequent freeze of the attitude error signal. There are two categories of inertial platform failures:

FAILURE CATEGORY A - failures which do not result in a reorientation of the platform stable element.

FAILURE CATEGORY B - failures which will result in a reorientation of the platform stable element (tumbling).

Vehicle loss occurs for all S-II flight times since guidance to orbit is not possible. Structural failure will not occur immediately following the malfunction due to negligible aerodynamic forces in the nominal S-II trajectory region.

Failure category "A" simulates gimbal angle resolver failures and platform power supply and electronics assembly (PEA) failures which produce large step inputs for gimbal angle readings. Also included in this category are those failures which produce incorrect gimbal angle readings of zero. Zero failures during intervals of flight when the commanded attitude in the particular plane is less than 0.06° will not be detected by the reasonableness test. This will occur for the roll axis throughout S-II flight and for the yaw axis until IGM turn-on at approximately 200 seconds of flight time. The results of those zero failures which are not detected by the reasonableness test are similar to results for loss of error signal. For the roll axis failure, parking orbit insertion may be achieved, but off-nominal roll disturbances of any magnitude could result in vehicle loss. For those zero failures detected and for the other failures in this category, the result is an immediate and permanent freeze of the attitude error at the last correctly calculated value. In most cases this produces a gradual divergence from the nominal trajectory and an attitude eventually requiring abort. However, during periods of flight where high attitude error signals nominally occur, such as after IGM turn-on in S-II, S-II 2nd mixture ratio shift, and IGM turn-on in S-IVB, rapid divergence can occur.

Failure category "B" simulates a failure in which the stable platform begins to physically tumble. The primary contributor to this type malfunction is a "Gyro Servo Loop Failure." This

2.6.6 (Continued)

is the more severe of the two types of failures, the primary reasons being:

- a. Accumulation of a large attitude error signal prior to failure of the attitude reasonableness test.
- b. The large reasonableness test constant (RTC) used for switchover from fine to coarse resolver which contributes to an even larger attitude error signal after the first reasonableness test failures.
- c. The continued use of the attitude reasonableness test after the guidance failure discrete is issued which allows changes in what should be a frozen attitude error signal.

A more detailed explanation of each of these may be found in Section 2.3.

Figure 2-41 gives two cases of platform failure type "B". The slowly accelerating platform tumble malfunctions, those with an acceleration less than approximately $30^\circ/\text{second}^2$, are the more rapidly diverging since they accumulate a large attitude error signal before the failure of the attitude reasonableness test. The changes in direction of pitch attitude for the rapidly accelerating platform tumble are due to reason "C" given above.

Safe abort should be obtained with both types of platform malfunctions if the guidance failure light, 20° attitude deviation limit, and exceeding of FDO limits are used for abort cues. The guidance failure light should be used for the first abort cue and exceeding of FDO limits as the second cue.

2.6.7 Inertial Platform Failure - S-IVB

Consequences of this malfunction in S-IVB flight are similar to those in S-II flight. If failure category "A" occurs within approximately the last 50 seconds of S-IVB flight, the vehicle may be inserted into parking orbit. As in S-II flight, parking orbit insertion may be achieved for zero failures of the roll axis if off-nominal roll disturbances are not present. However, all cases will probably result in ultimate abort after POI due to tumbling.

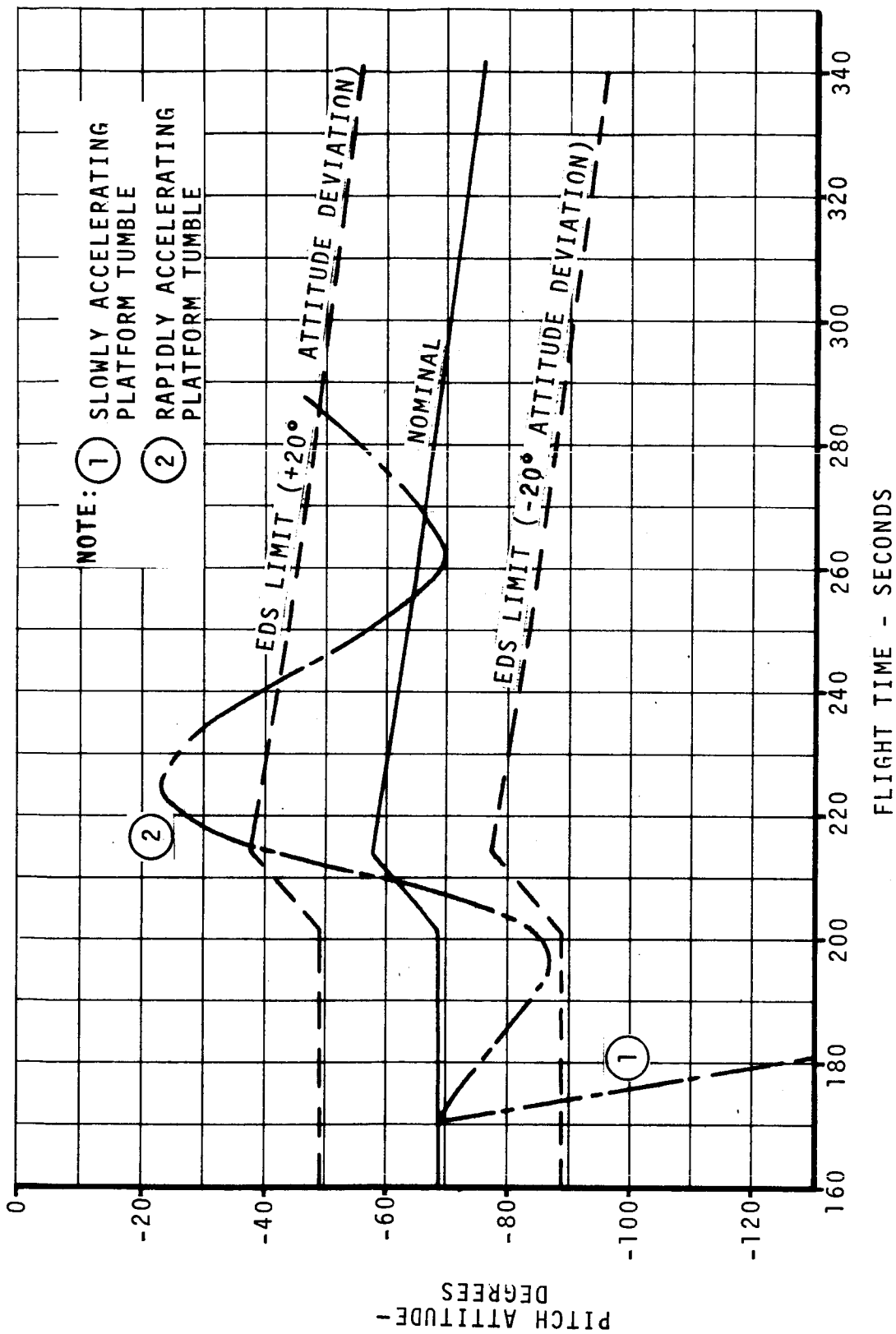

FIGURE 2-41 EFFECT OF PLATFORM MALFUNCTION "B" AT 170 SECONDS

2.6.8 Saturated Control System - S-IC

Saturated control system causes all actuators in the affected plane to go hardover and results in rapid tumbling as illustrated in Figure 2-42 . Loss of control occurs at all flight times for all winds.

An example of the tension loads that result for a saturated control system in the high-q region is shown in Figures 2-103 through 2-106 .

The recommended EDS automatic abort limit settings are: (1) 4 degrees/second pitch or yaw attitude rate and (2) 20 degrees/second roll attitude rate. After automatic abort is deactivated, the recommended manual abort cues are (1) launch vehicle overrate light, and (2) spacecraft rate indication exceeding above rate limits.

For saturated control signal automatic abort can be deactivated at 120 seconds. As with dual engine out, this time was selected on the basis of launch vehicle loads only.

The probability of vehicle loss due to a saturated control signal is 230×10^{-6} . The probability of crew loss after these malfunctions is 90×10^{-6} .

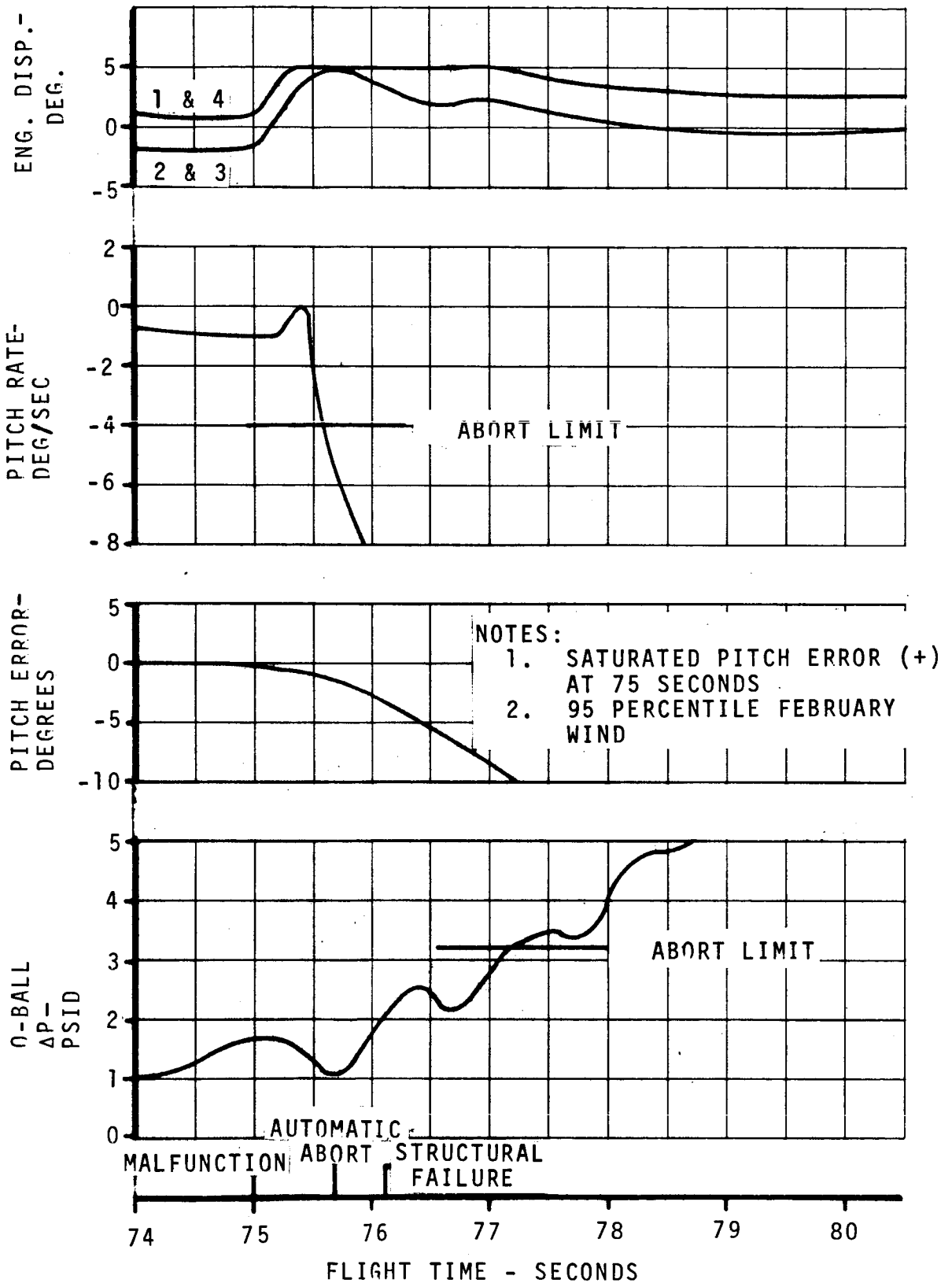

FIGURE 2-42 TIME HISTORY OF DYNAMIC VARIABLES FOR SATURATED CONTROL SIGNAL

2.6.9 Saturated Control System - S-II

a) Saturated Error Signal

Saturation of pitch or yaw error signal in S-II causes actuators hardover in the affected plane; actuators hardover causes the vehicle attitude rate to increase so that the control equation ($\beta = a_0\psi + a_1\dot{\phi}$) will become balanced; when the equation becomes balanced, the actuators will be near the null position; the attitude rate will reach maximum value and remain at that value balancing the equation. Shown below are the values used to calculate the maximum rate for S-II saturated error signal for the first set of S-II gains (Typical S-II Case):

$$0 = (1.12)(15.3) + (1.89) \dot{\phi}_{MAX}$$

$$\dot{\phi}_{MAX} = -9.1 \text{ deg/sec.}$$

This maximum vehicle rate does not violate the EDS rate limit of $10^\circ/\text{second}$; the EDS error limit of 20 degrees, however, is exceeded within 5 seconds after time of malfunction. Saturated roll error signal causes a large engine deflection in both pitch and yaw planes; as in pitch and yaw, the vehicle rate reaches a value which stabilizes the control equation; this value is calculated below:

$$0 = (.25)(15.3) + (.2) \dot{\phi}_{RMAX}$$

$$\dot{\phi}_{RMAX} = -19 \text{ deg/sec}$$

b) Saturated Rate Signal

Saturated pitch or yaw rate signal in S-II causes the actuator in the affected plane to go hardover. The attitude error then increases until it reaches the limit of 15.3 degrees. The maximum value of the error requires the actuator be hardover in order to balance the control equation; the figures below show that during S-II the actuator must remain positive hardover to balance a saturated rate signal.

$$\beta = (1.12)(-15.3) + (1.89)(20.0)$$

$$\beta = 20.7 \text{ (limited to 6.0)}$$

2.6.9 (Continued)

b) (Continued)

Saturated roll rate signal in S-II results in large deflections of both pitch and yaw engines. For the same reason described above for saturated pitch and yaw signals, the control engines are forced to maintain large deflections. Figure 2-43 presents a time history of vehicle rates for saturated rate signal and saturated error signal in S-II.

2.6.10 Saturated Control System - S-IVB

a) Saturated Error Signal

Saturated Error Signal in S-IVB produces the same effects as those described above for S-II. Because of the difference in control gains a_0 and a_1 , however, the EDS rate limit of 10 deg/sec is exceeded for pitch and yaw malfunctions.

$$0 = (.81)(15.3) + (.97) \dot{\phi}_{MAX} \text{ (pitch and yaw)}$$

$$\dot{\phi}_{MAX} = -12.8 \text{ deg/sec}$$

$$0 = 15.3 + \dot{\phi}_{MAX} \text{ (Roll)}$$

$$\dot{\phi}_{MAX} \text{ (Roll)} = 15.3 \text{ deg/sec}$$

b) Saturated Rate Signal

Saturated rate signal in S-IVB is similar to S-II saturated rate signal. A sample calculation of the required engine deflection is given below:

$$\beta = (.81)(-15.3) + (.97)(20.0)$$

$$\beta = 7.0$$

Figure 2-44 presents a time history of vehicle rates for saturated rate signal and saturated error signal in S-IVB.

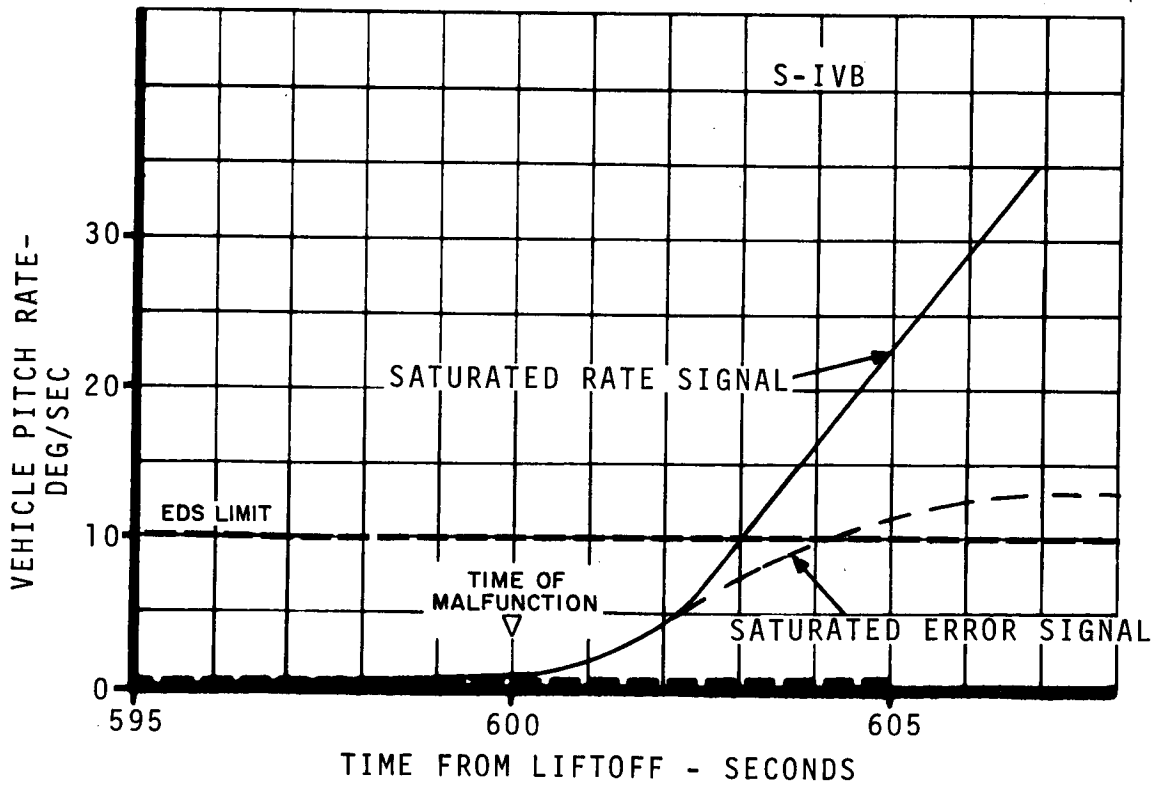
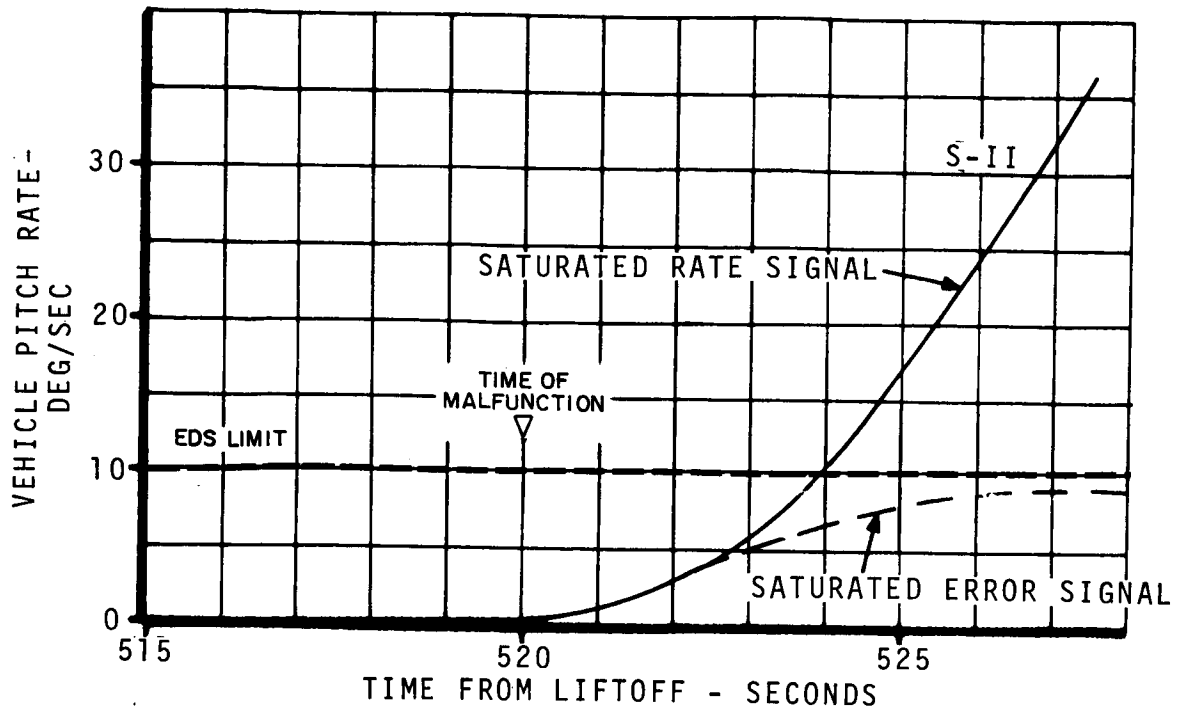

FIGURES 2-43 (TOP) AND 2-44 VEHICLE PITCH RATE VS. TIME WITH SATURATED CONTROL SYSTEM IN S-II AND S-IVB

2.6.11 Loss of Inertial Velocity

Failure of the accelerometer reasonableness test will follow the loss of inertial velocity malfunction, with the result that the LVDC flight program will revert to pre-stored thrust and mass flow rate profiles. This malfunction can occur in all stages but will produce trajectory deviations only during S-II and S-IVB flight since velocity information is not used in S-IC guidance. However, failures in S-IC can produce navigator errors which may result in even greater trajectory deviations in S-II and S-IVB flight.

Loss of inertial velocity malfunction in S-II and S-IVB flight will result in a higher than nominal trajectory since the pre-stored constants used for the backup F/M calculation yield a 3-sigma low value. During S-IC, the loss of inertial velocity may result in a sub-nominal trajectory because the pre-stored values for the backup F/M calculation do not take into account thrust force variation due to atmospheric pressure decrease with increased altitude. Further analyses of the S-IC type failures are presented in References 9 and 10.

The loss of inertial velocity malfunction does not result in loss of vehicle or an abort situation. It may affect mission objectives since it does produce off-nominal parking orbit insertion conditions. Reference 12 shows that reignition after an X or Z accelerometer failure during boost to parking orbit may result in atmospheric reentry. Therefore, the EDS recommendation is that reignition not be attempted after an accelerometer failure in boost to parking orbit flight.

2.6.12 Single Engine Out Capability - S-IC

For winds between the 5th and 95th percentile, single engine out produces loss of control only during the max-q region. Figure 2-45 shows the typical dynamic responses that result from a single engine out in this region.

Loss of control regions for single engine out are shown on Figures 2-46 through 2-50. Each polar plot of Figure 2-44 is a composite loss of control plot for all single engine outs at that flight time. Shaded regions denote loss of control. The wind rose on each time plot represents the 5th to 95th percentile winds of February for the nominal altitude corresponding to that flight time. Loss of control does not occur for winds in the 5th to 95th percentile regions. Figure 2-16 shows the chi-freeze equation used for this analysis.

Staging problems as defined in Reference 7 do not occur for single engine out.

LEV- α limit is not exceeded prior to abort for this malfunction.

For single engines out before 50 seconds, high q-ball pressure is present, however, no loss of control results. A false abort will result if 3.2 psid is used as an abort cue. Figure 2-140 shows a typical example of this malfunction.

Results of an analysis to determine loads at the Command Module/Service Module (CSM) joint resulting from an S-IC single engine out are shown in Figure 2-51. Figure 2-52 presents a typical time history of bending moment at the CSM joint after an engine out. The rapid buildup of bending moment is due to structural dynamics resulting from the malfunction.

A tabulation of vehicle loads for the launch vehicle is presented in Table 2-IV. Spacecraft loads are presented in Table 2-V. These tabulations give the peak vehicle loads which can occur within 1.0 second following a single engine out that does not lose control. Envelope curves of vehicle and spacecraft loads, tabulated in Tables 2-IV and 2-V, are presented in Figures 2-53 through 2-56.

Figures 2-99 through 2-102 show tension loads resulting from a single engine out that requires a high-q abort. Sudden vehicle tension loads that result from mainstage engine shutdown at abort may cause sudden structural failure for single engine out.

2.6.12 (Continued)

The recommended EDS automatic abort limit setting for this malfunction is 4 degrees/second attitude rate. Recommended manual abort cues for engine out after 50 seconds are: (1) engine out light and (2) 3.2 psi q-ball pressure. Manual abort cues occur prior to exceeding automatic abort limits for most high-q malfunctions.

The probability of vehicle loss due to an engine shutdown in the high-q region is 1×10^{-6} . The probability of crew loss after these malfunctions is $< 1 \times 10^{-6}$.

The probability of vehicle loss due to catastrophic engine failure is 61×10^{-6} . This is also the probability of crew loss for this malfunction, since catastrophic engine failure results in spacecraft breakup at all times of flight.

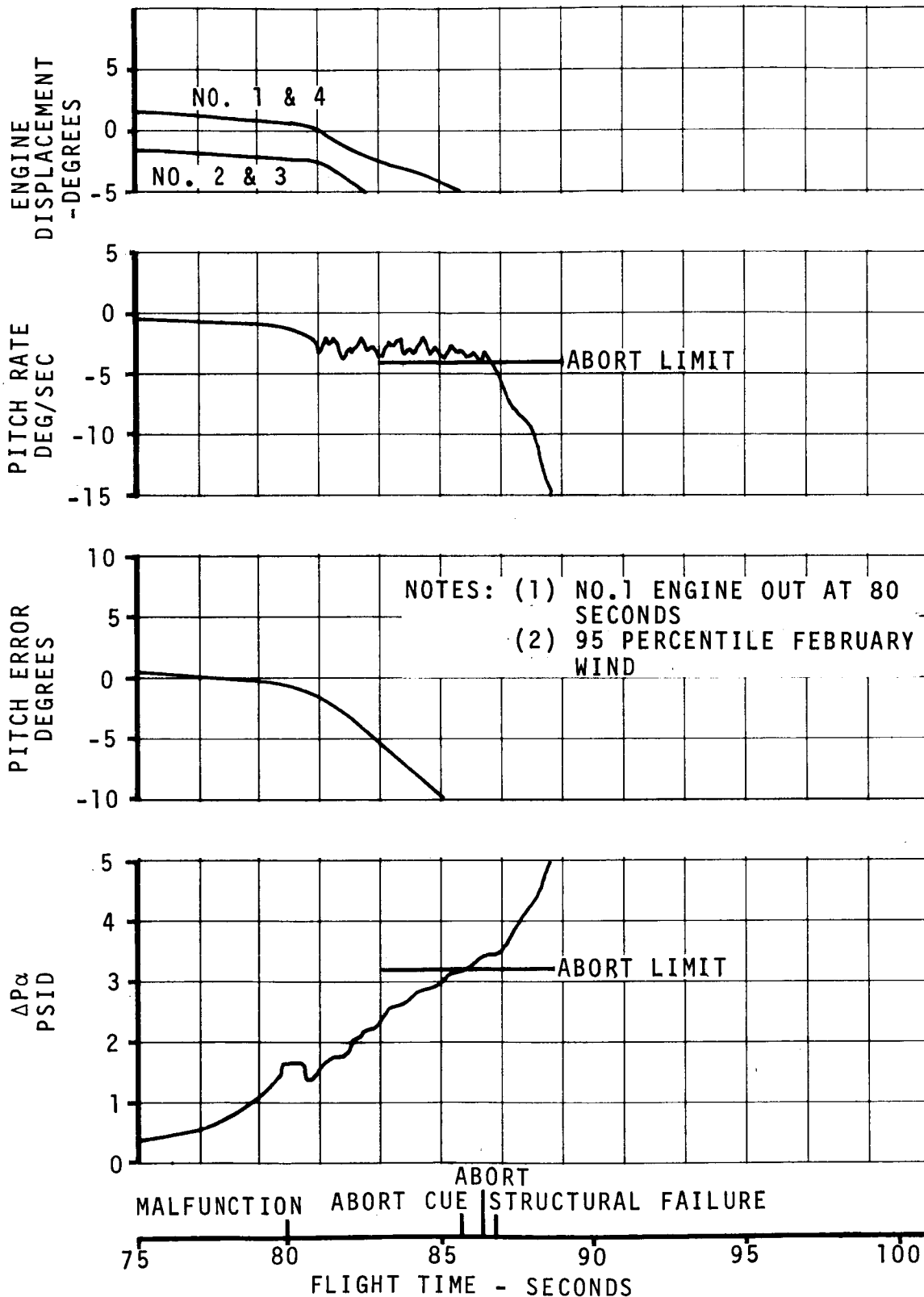
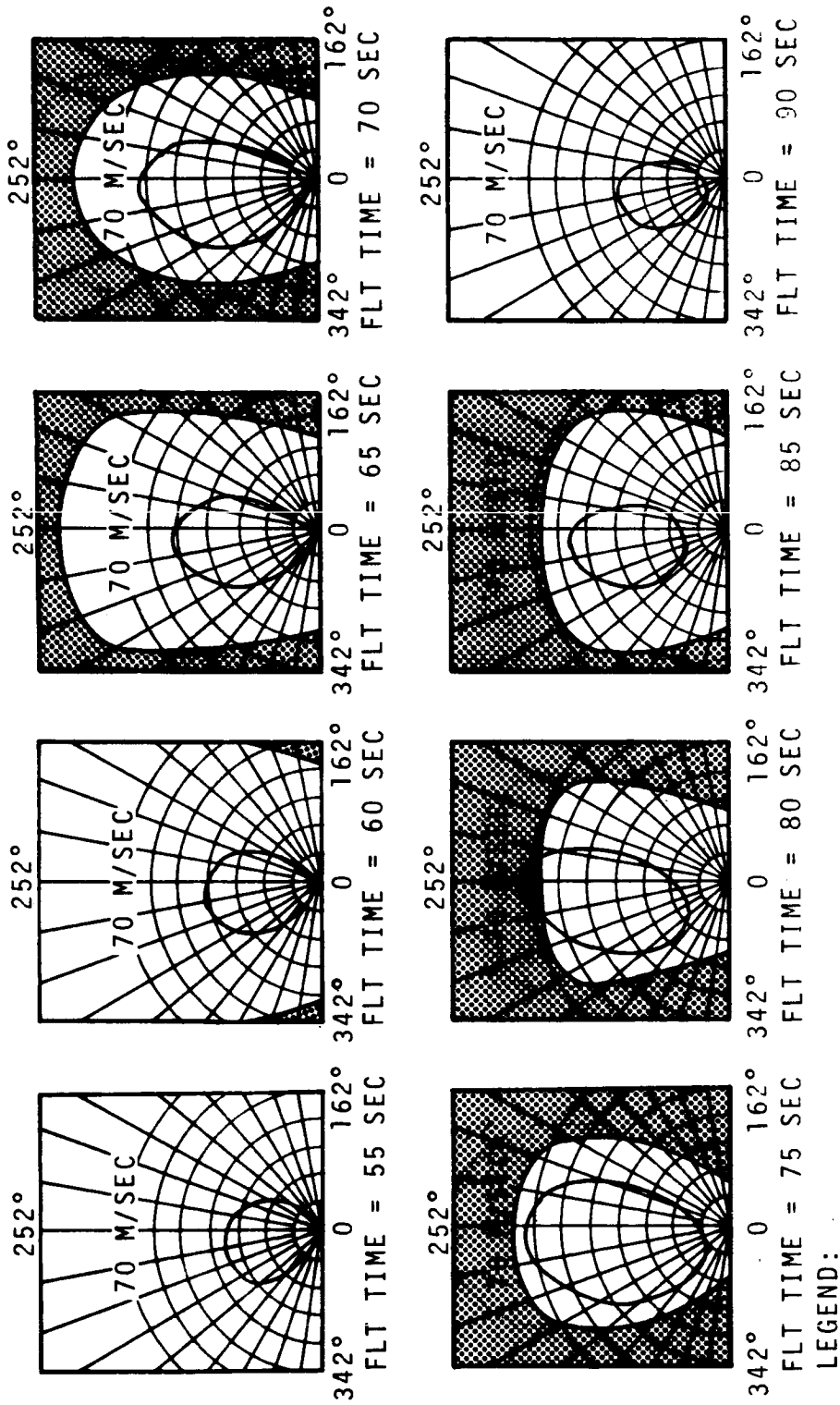
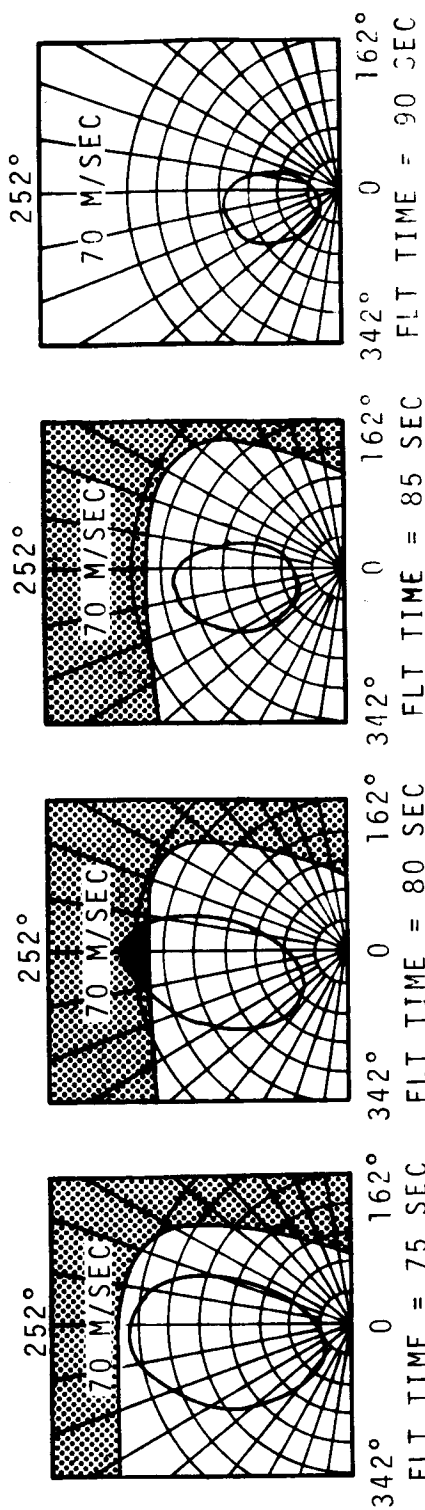
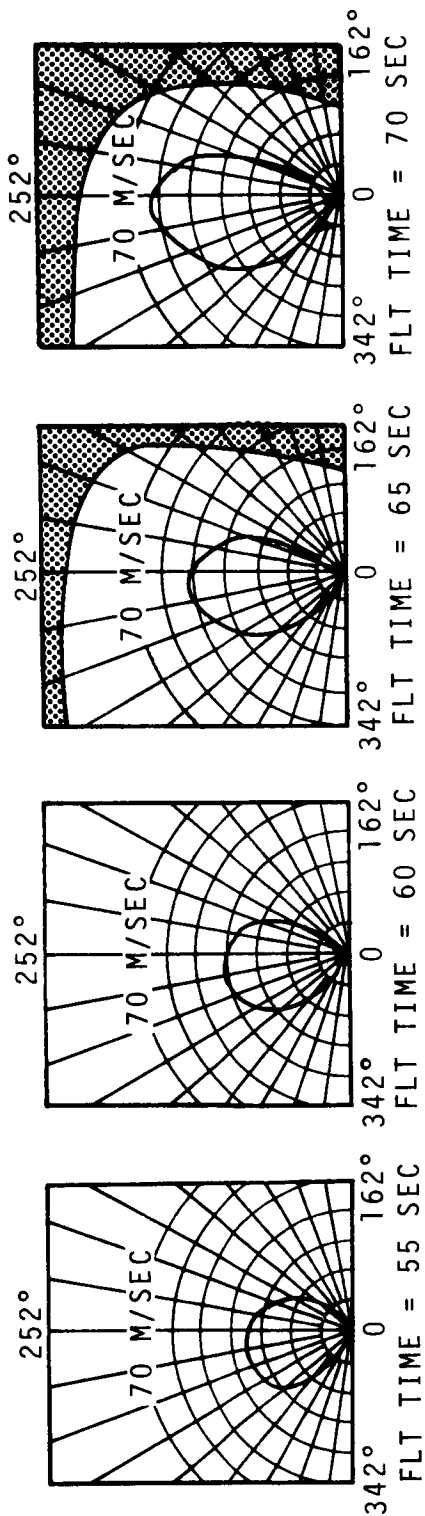

FIGURE 2-45 TIME HISTORY OF DYNAMIC VARIABLES FOR A SINGLE ENGINE OUT



■ WINDS THAT CAUSE LOSS OF CONTROL
 ■ WINDS LESS THAN FEBRUARY 95 PERCENTILE THAT CAUSE LOSS OF CONTROL
 NOTES:
 72° LAUNCH AZIMUTH
 95 PERCENTILE SHEAR AND GUST REDUCED BY 15%

FIGURE 2-46 ENGINE-OUT CONTROL CAPABILITY



LEGEND:

- ▨ WINDS THAT CAUSE LOSS OF CONTROL
- WINDS LESS THAN FEBRUARY 95 PERCENTILE THAT CAUSE LOSS OF CONTROL

NOTES:
72° LAUNCH AZIMUTH
95 PERCENTILE SHEAR AND GUST REDUCED BY 15%

FIGURE 2-47 NO. 1 ENGINE-OUT CAPABILITY DURING S-IC FLIGHT

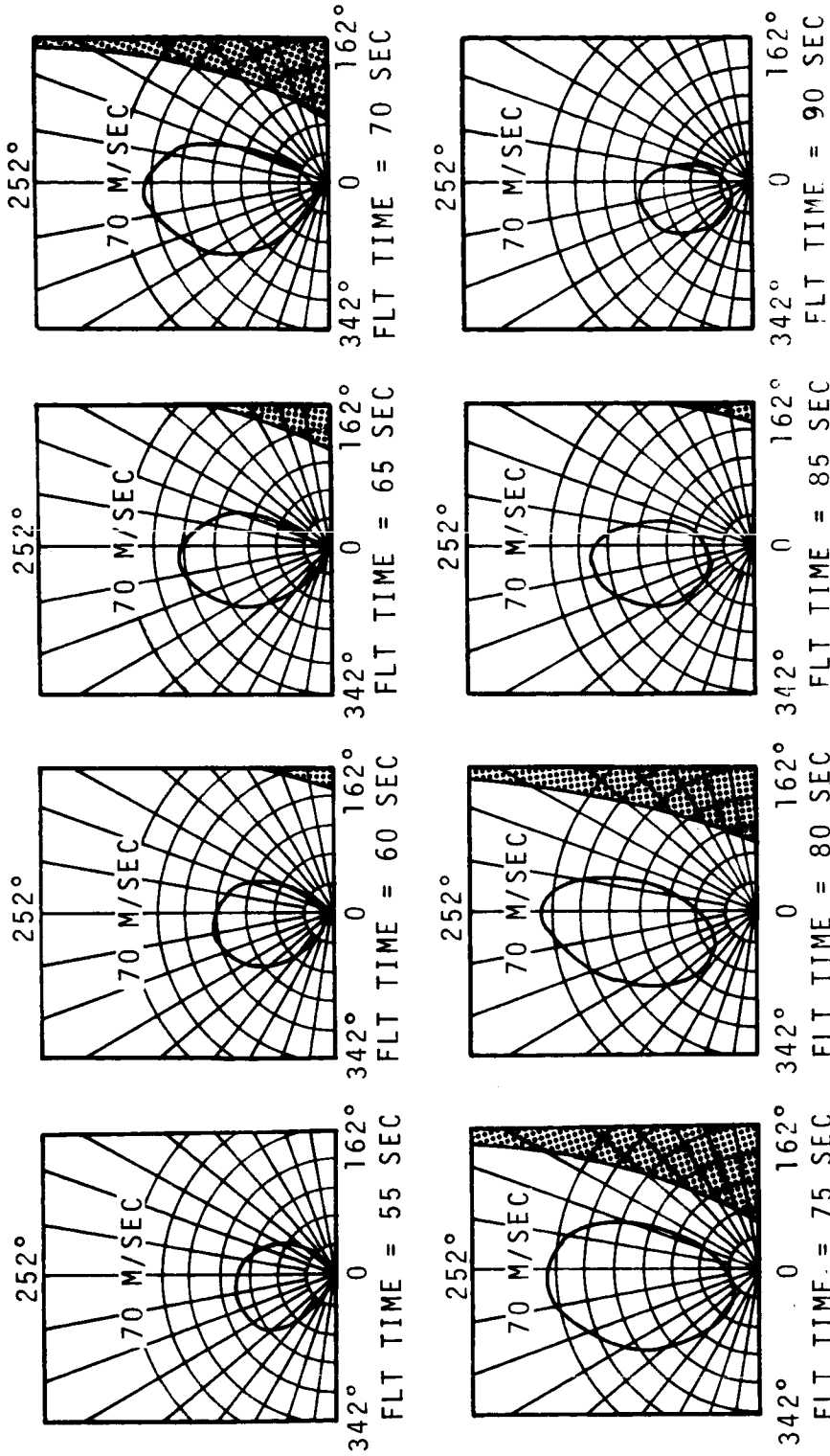

LEGEND:

▨ WINDS THAT CAUSE LOSS OF CONTROL

■ WINDS LESS THAN FEBRUARY 95 PERCENTILE THAT CAUSE LOSS OF CONTROL

NOTES:

- 72° LAUNCH AZIMUTH
- 95 PERCENTILE SHEAR AND GUST REDUCED BY 15%

FIGURE 2-48 NO. 2 ENGINE-OUT CAPABILITY DURING S-IC FLIGHT

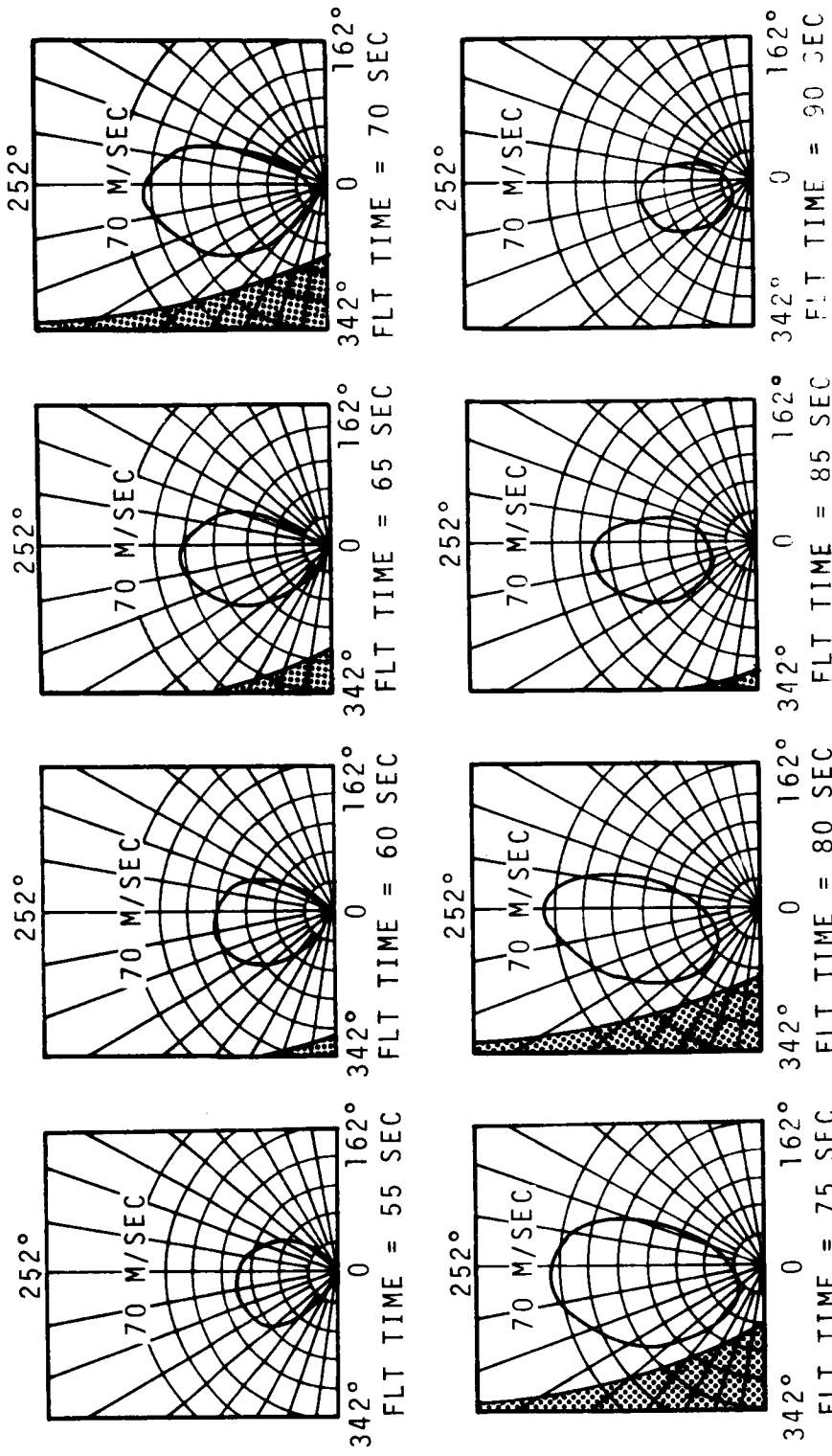

LEGEND:
 [Cross-hatched box] WINDS THAT CAUSE LOSS OF CONTROL
 [Solid black box] WINDS LESS THAN FEBRUARY 95 PERCENTILE THAT CAUSE LOSS OF CONTROL

NOTES:
 72° LAUNCH AZIMUTH
 95 PERCENTILE SHEAR AND GUST REDUCED BY 15%

FIGURE 2-49 NO. 3 ENGINE-OUT CAPABILITY DURING S-IC FLIGHT

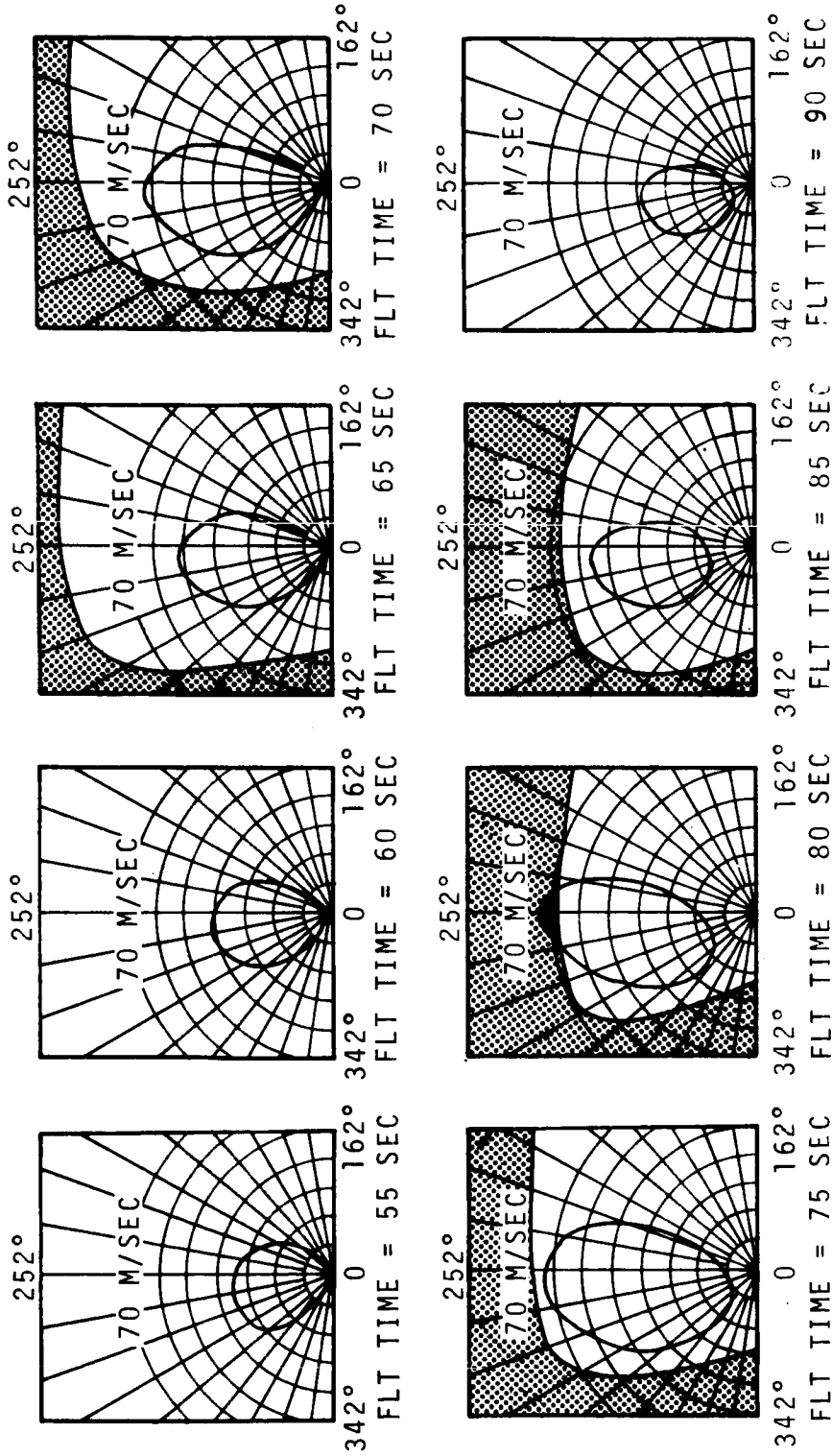

LEGEND:

- WINDS THAT CAUSE LOSS OF CONTROL
- WINDS LESS THAN FEBRUARY 95 PERCENTILE THAT CAUSE LOSS OF CONTROL

NOTES:

- 72° LAUNCH AZIMUTH
- 95 PERCENTILE SHEAR AND GUST REDUCED BY 15%

FIGURE 2-50 NO. 4 ENGINE-OUT CAPABILITY DURING S-IC FLIGHT

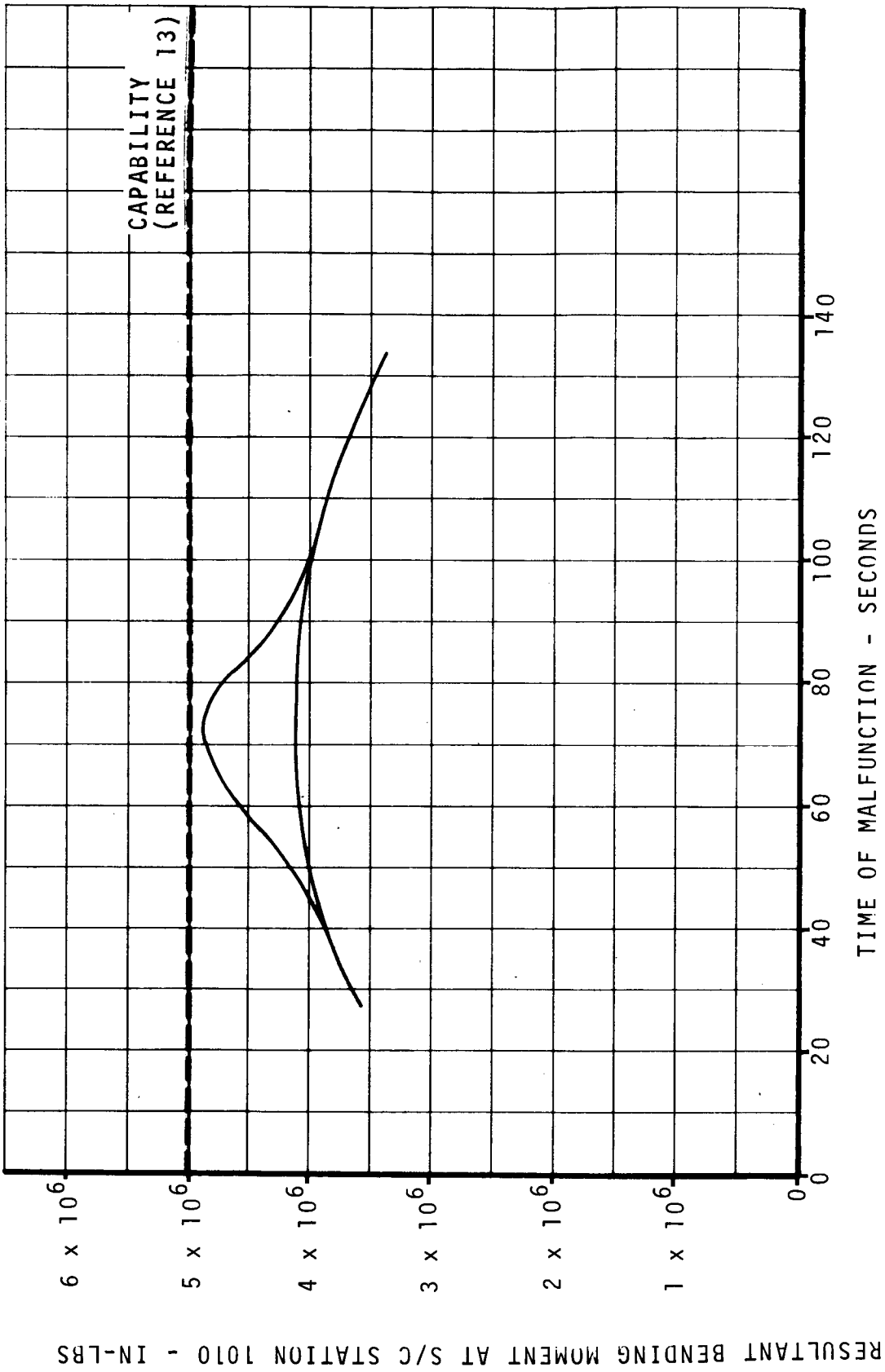

FIGURE 2-51 CSM JOINT LOAD ENVELOPE DUE TO S-IC CONTROL ENGINE OUT

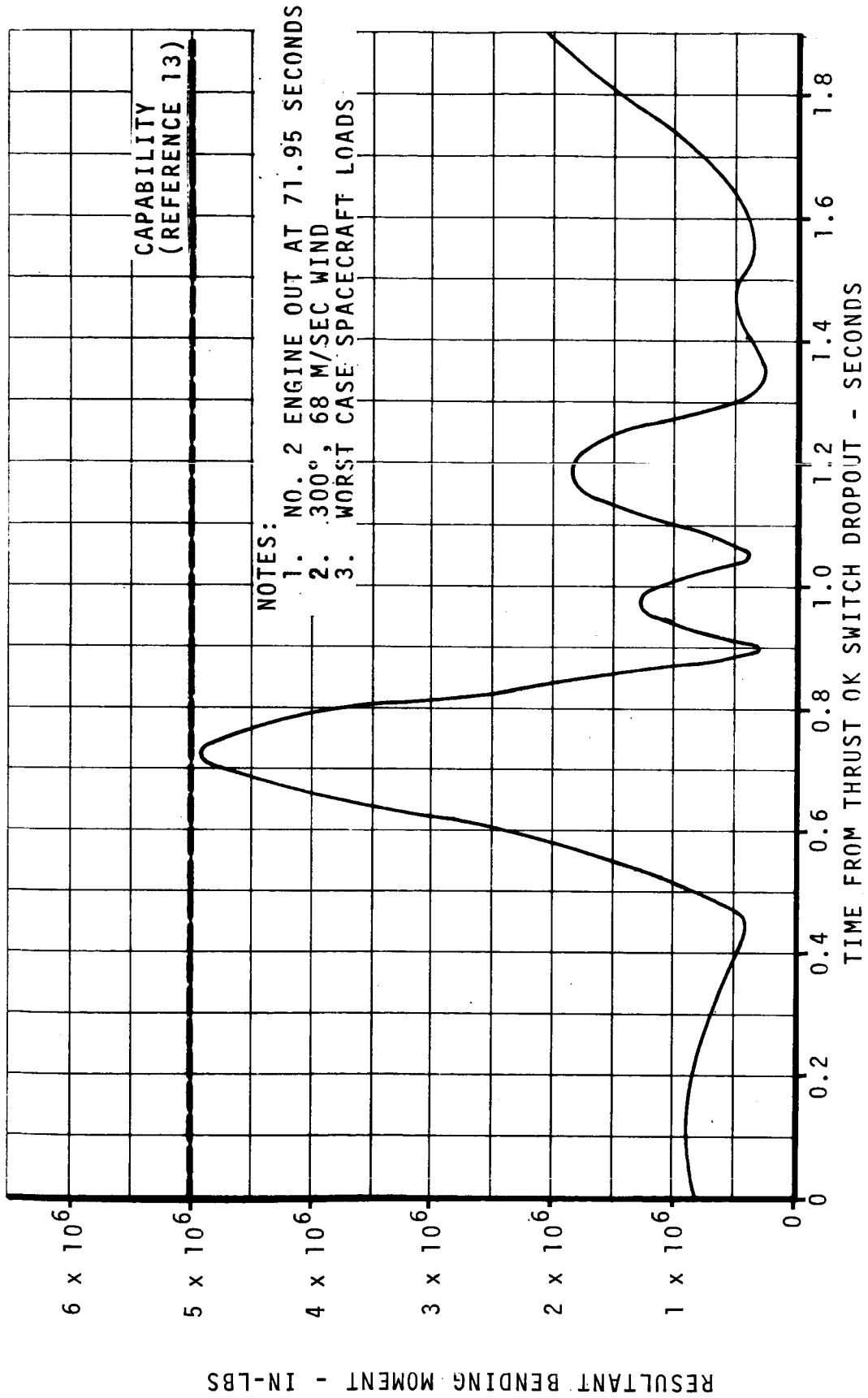

FIGURE 2-52CSM JOINT BENDING MOMENT TIME HISTORY

TABLE 2-IV SUDDEN PEAK LAUNCH VEHICLE LOADS FOR A SINGLE ENGINE-OUT - NO LOSS OF CONTROL

STATION (IN)	RESULTANT BENDING LOAD $M/\pi R^2$ (LB/IN)	AXIAL LOAD $P/2\pi R$ (LB/IN)	ULLAGE LOAD COMPRESSION $\frac{P_{u\min}}{2}$ (LB/IN)	ULLAGE LOAD TENSION $\frac{P_{u\max}}{2}$ (LB/IN)	COMPRESSIVE LIMIT LOAD (LB/IN)	TENSILE LIMIT LOAD (LB/IN)
3258.536	710.7	280.0	0.0	0.0	990.64	430.71
3222.552	778.35	288.61	0.0	0.0	1067.0	489.7
3100.545F	1035.60	296.1	0.0	0.0	1331.7	739.5
3100.545A	1035.60	298.2	1555.0	1948.8	-	2686.2
2832.002F	1651.7	315.23	1555.0	1948.8	411.9	3285.2
2832.002A	1666.4	776.0	0.0	184.90	2442.0	1074.0
2746.490	1808.2	785.31	0.0	184.90	2593.0	1207.7
2519.010	1008.8	620.1	0.0	281.66	1629.0	670.3
2387.003F	1193.6	629.4	0.0	281.66	1823.0	845.9
2387.003A	1193.6	633.0	2721.8	2919.8	-	3480.4
2117.476	1654.1	646.2	2721.8	2919.8	-	3927.7
1847.988F	2151.7	664.1	2721.8	2919.8	93.93	4407.3
1847.988A	2157.5	1901.3	0.0	0.0	4060.8	258.3
1759.996	2242.6	1957.9	0.0	0.0	4200.5	284.7
1540.981	2472.3	1976.5	0.0	0.0	4448.8	495.8
1400.981F	2675.5	1989.2	0.0	0.0	4664.7	686.3
1400.981A	2675.5	1989.2	1385.3	2535.5	3279.4	3221.7
1156.494	3027.0	2013.2	1385.3	2535.5	3654.9	3549.3
912.006F	3171.5	2037.7	1385.3	2535.5	3823.9	3669.2
912.006A	3197.0	4173.3	0.0	0.0	7370.3	-
602.007F	3024.2	4207.7	0.0	0.0	7231.9	-
602.007A	3024.2	4213.1	1533.7	3067.9	5703.5	1879.0
365.000F	2864.1	4272.1	1533.7	3067.9	5602.5	1659.9
365.000A	2874.1	5214.0	0.0	0.0	8088.1	-

TABLE 2-V AS-504 SPACECRAFT LOADS RESULTING FROM SINGLE S-IC CONTROL ENGINE-OUT

SPACECRAFT STATION (INCHES)	RESULTANT BENDING MOMENT (IN-LBS)	RESULTANT SHEAR (LBS)	AXIAL FORCE (LBS)
1084	3.44×10^6	13.6×10^3	17.2×10^3
1010	4.83×10^6	33.3×10^3	78.2×10^3
838	12.97×10^6	55.9×10^3	156.7×10^3
584F	29.10×10^6	80.4×10^3	175.7×10^3
584A	29.20×10^6	81.4×10^3	224.8×10^3
502	37.70×10^6	94.6×10^3	231.7×10^3

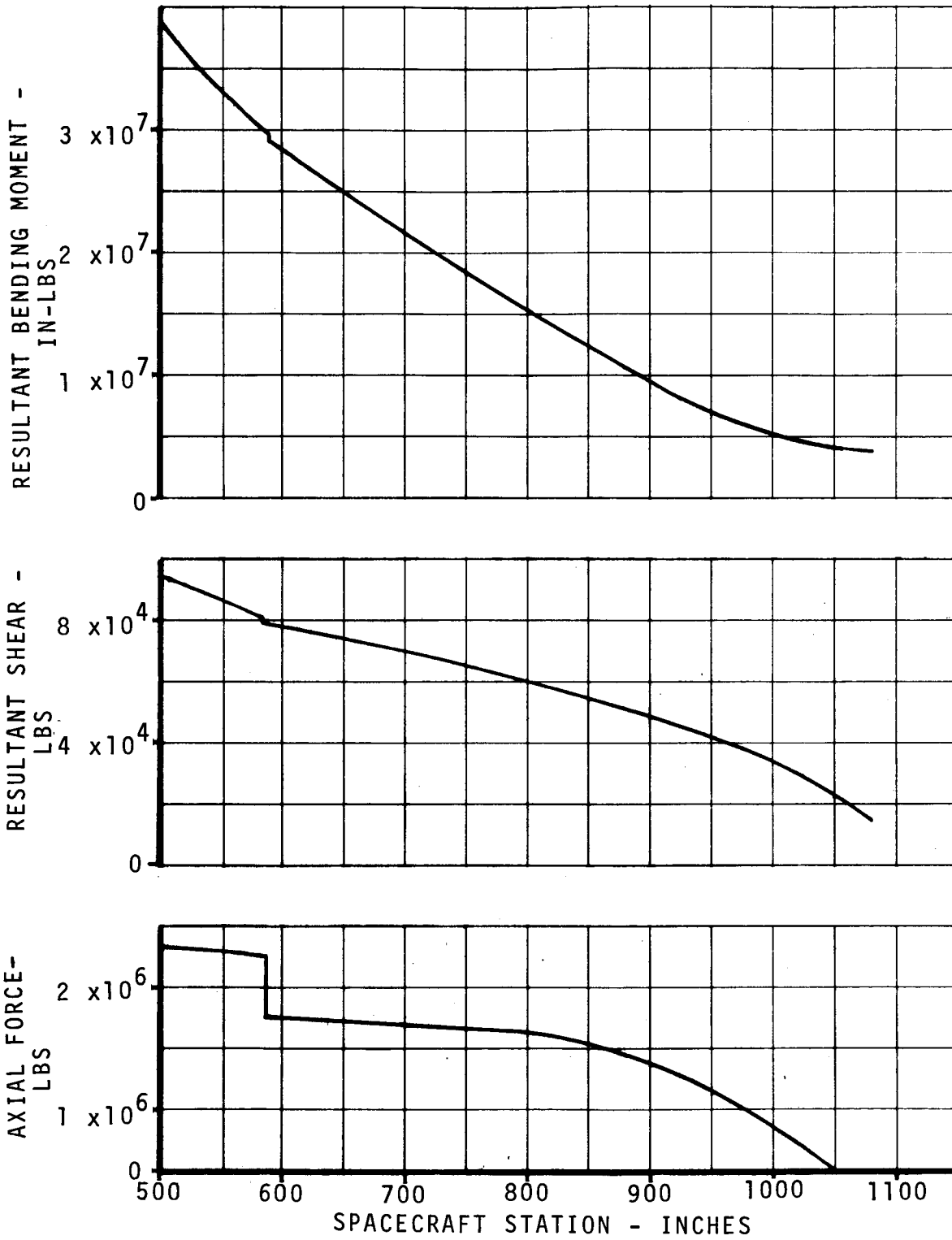

FIGURE 2-53 ENVELOPE OF SPACECRAFT LOADS - ENGINE OUT
NO LOSS OF CONTROL

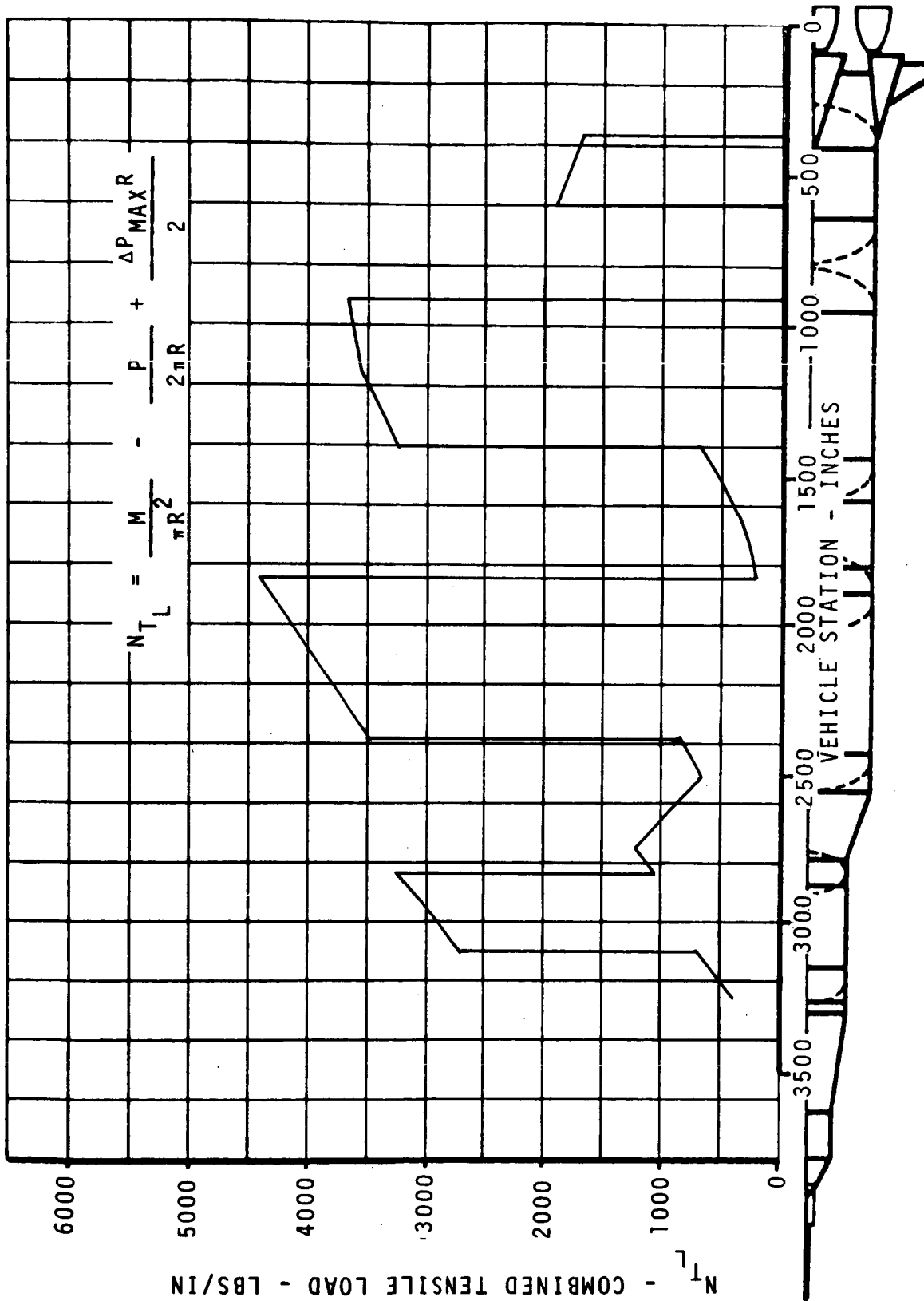

FIGURE 2-54 ENVELOPE OF COMBINED TENSILE LOADS WITH A SINGLE ENGINE OUT
- NO LOSS OF CONTROL

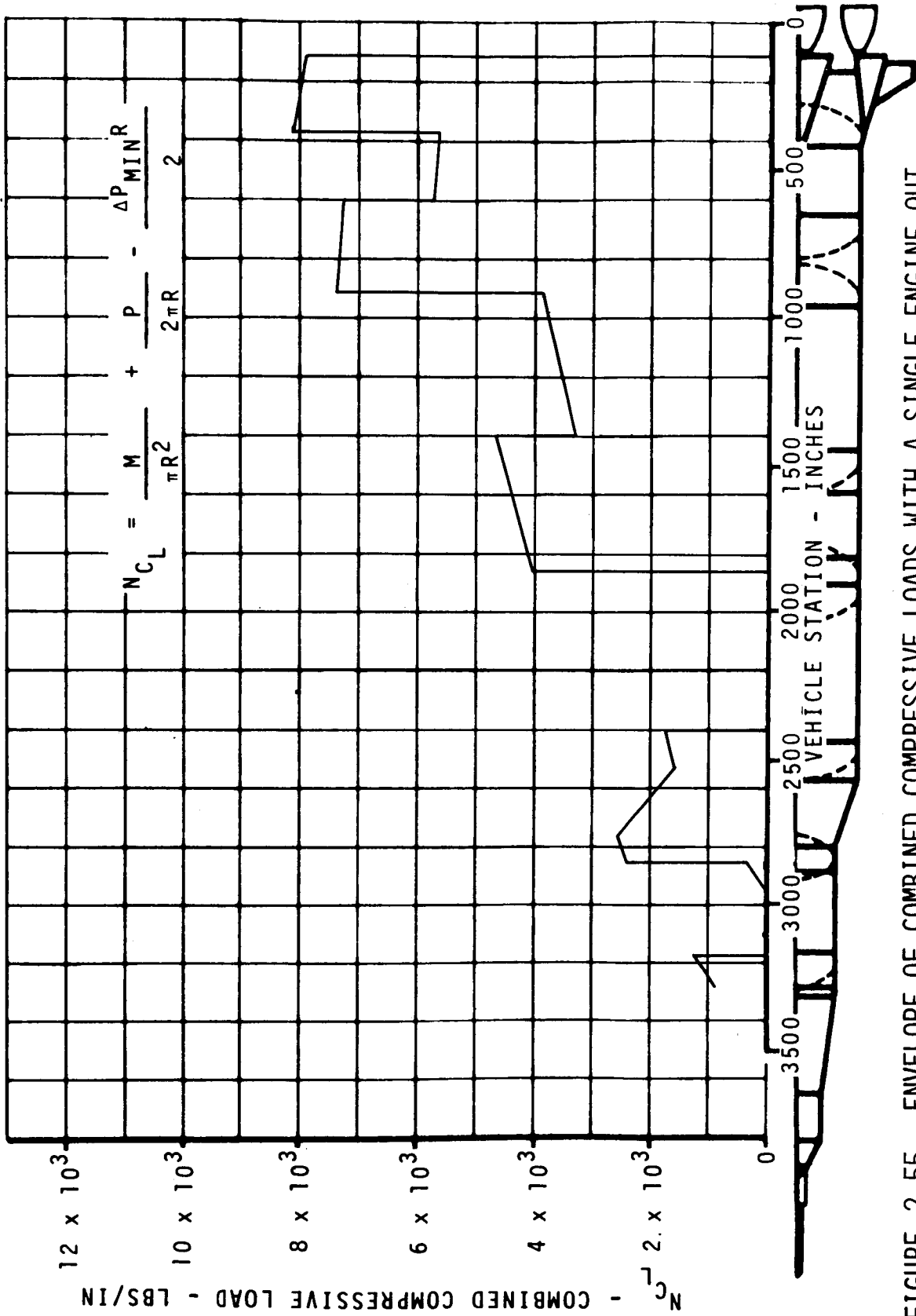

FIGURE 2-55 ENVELOPE OF COMBINED COMPRESSIVE LOADS WITH A SINGLE ENGINE OUT
 - NO LOSS OF CONTROL

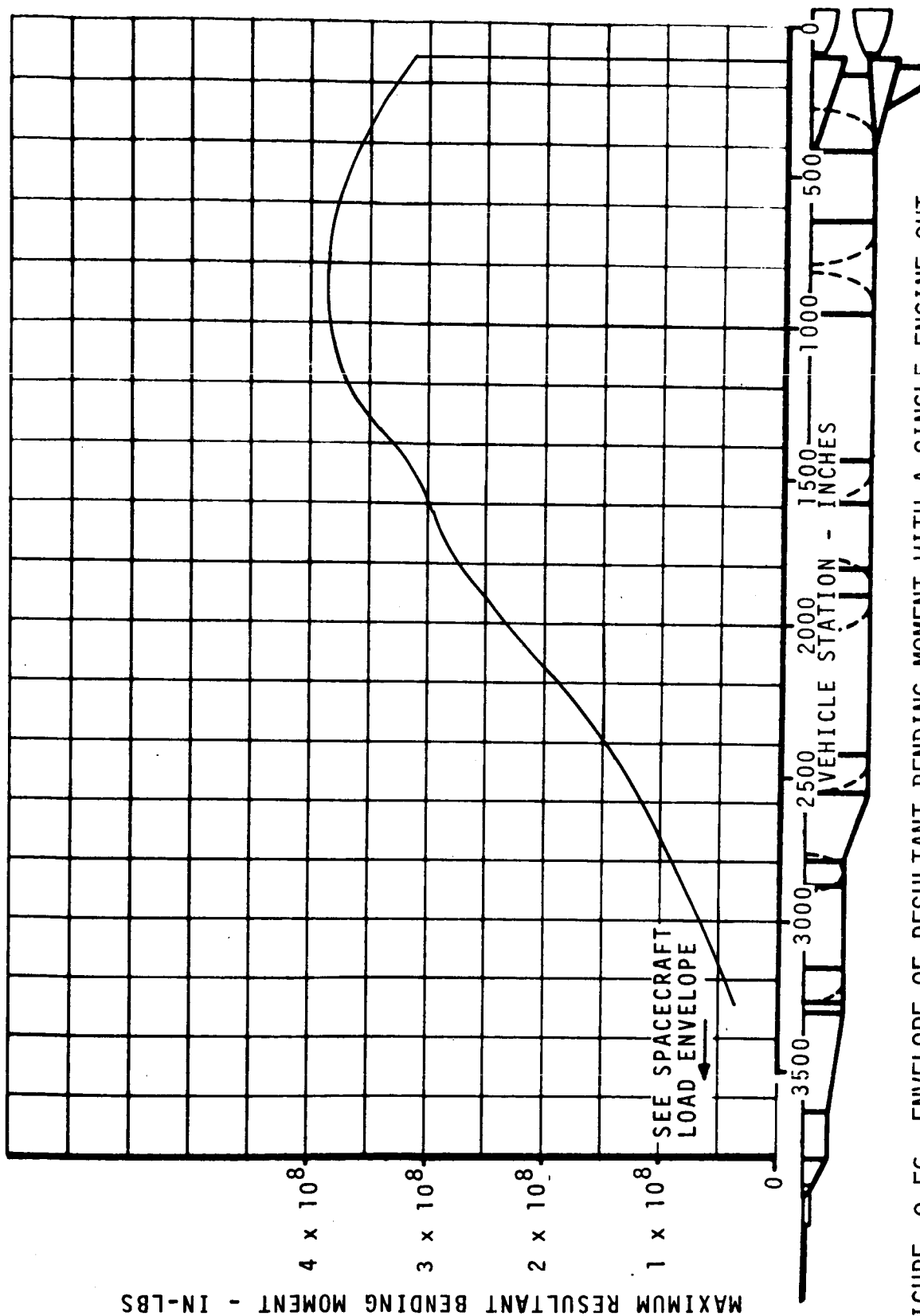

FIGURE 2-56 ENVELOPE OF RESULTANT BENDING MOMENT WITH A SINGLE ENGINE OUT
- NO LOSS OF CONTROL

2.6.13 S-II Single Engine Malfunction

Parking orbit was successfully achieved for all cases where a single S-II engine malfunctioned. Simulations were performed at the following critical times:

1. S-II ignition
2. Loss of thrust at IGM initiation
3. Loss of thrust during the period of PU valve activity
4. Loss of thrust near end of S-II burn.

For this study two types of engine thrust decay profiles were used; a TOPS shutdown which simulates a gradual drop in thrust until the thrust OK switch issues a cutoff signal, and a regular shutdown which simulates an electrically commanded shutdown.

The TOPS shutdown produces less severe dynamics transients than the regular shutdown, since it has a gradual initial decay, until the engine is commanded to cut off by the thrust OK switch.

The following chart shows the maximum body rates, engine angles, and error signals for single engine out early in S-II (190 seconds) and late in S-II (500 seconds).

MALF.	BODY RATES (DEG/SEC)			ENGINE ANGLES (DEG)		ERROR SIGNAL (DEG)		
	$\dot{\phi}_p$	$\dot{\phi}_y$	$\dot{\phi}_r$	β_p	β_y	ψ_p	ψ_y	ψ_r
Eng. #1 @190*	1.2	0.4	0.4	3.8	3.4	2.2	2.4	0.4
Eng. #1 @500	1.2	1.1	0.6	2.3	1.8	2.2	1.8	0.4

* Maximum values occurred after IGM turn-on following the malfunction.

This analysis indicated that for all cases considered for a single S-II engine failure, IGM logic always detected mixture ratio shift at the time MRS occurred. In the previous analysis it was found that an engine malfunction could cause IGM to be unable to detect a mixture ratio shift. The original 504 study duration of decreasing thrust due to mixture ratio change was about 15 seconds less than the 504 update duration (Operational

2.6.13 (Continued)

Trajectory thrust data). With the longer period of decreasing thrust the mixture ratio detector has time to reinitialize after an engine malfunction has zeroed the detector coefficients. It should be noted that the possibility of a failure to detect mixture ratio shift exists if the period of decreasing thrust is less than 15 seconds. The result of such a failure is operation of IGM in an artificial tau mode during phase two IGM, and also an early initiation of the chi-freeze during the S-II/S-IVB staging period. This extension of the chi-freeze period amounts to approximately 25% of the T_{2j} presetting. The consequence of this extended chi-freeze is a larger than nominal deviation in the IGM attitude command when IGM is activated again after S-IVB ignition.

Figure 2-57 shows a pitch command envelope for single engine malfunction in S-II. In each case considered for single engine failure in S-II, restart capability exists as shown in Reference 10.

Structural failure was not encountered for S-II single engine out. The minimum load indicator is 1.51.

An S-II single control engine malfunction 2 to 4 seconds prior to second plane separation will cause a collision between the interstage and a J-2 engine bell. A detailed report of this problem is presented in Reference 14. No S-II/S-IVB staging problems were encountered for an S-II single control engine malfunction just before S-II/S-IVB staging. The maximum body rates, errors, and engine angles were well below the staging limits.

2.6.14 S-IVB Engine Malfunction

S-IVB engine failure produces total loss of thrust but no structural failure. Subsequent attitude control can be maintained by the APS.

Staging to the SPS is required for abort. CSM insertion using SPS is possible after approximately 600 seconds of flight time (Assume SPS $\Delta V = 500$ meters/second).

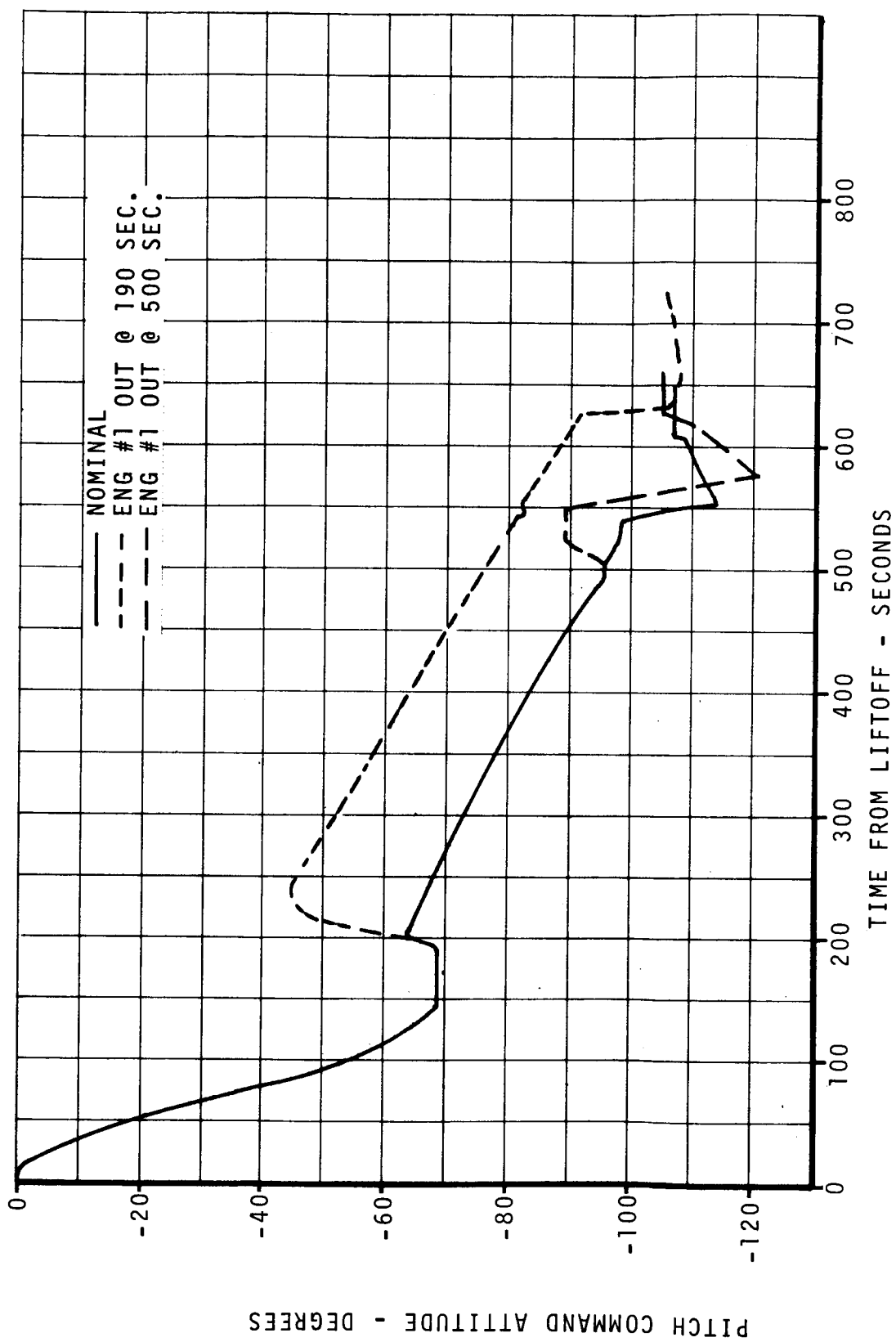

FIGURE 2-57 PITCH COMMAND FOR S-II SINGLE ENGINE FAILURE

2.6.15 Early S-IC/S-II Staging Capability*

The upper-stage hybrid flight simulator described in Appendix A was used to perform the study of early S-IC/S-II staging capability. All cases studied that achieved staging without loss of control reached parking orbit insertion, indicating adequate performance in guidance. Premature S-IVB shutdown will occur due to depletion if staging is attempted earlier than approximately 85 seconds of flight time. Figure 2-58 gives the terminal payload possible with each early staging time.

Early staging was commanded in approximately 10 second increments from 90 to 150 seconds during S-IC flight time. All cases prior to 100 seconds failed to successfully complete staging; all cases after 110 seconds did successfully complete staging. The 100 to 110 second region is considered one of possible successful staging, since the 100 second cases included both successes and failures. Table 2-VI provides more detail on the results of early staging during the 90 to 110 second time span.

Since the 100 second and 110 second cases were borderline cases, the effects of winds were studied for these cases. 95 percentile nose, tail, quartering, and crosswinds with gusts for the month of February, and an average of the 50 percentile winds for February and March, referred to as the nominal wind, were considered. All 110 second cases flew with the worst wind case causing an increase in maximum angle of attack of approximately 2 degrees. For the 100 second staging time, the additional aerodynamic moment created by the tail, quartering tail, and crosswinds caused these cases to lose control, but the quartering headwind, headwind, no wind, and nominal wind cases did not cause loss of control.

All unsuccessful staging cases were caused by loss of control in S-II flight shortly after S-IC/S-II separation. These cases occurred during the region of S-IC flight where the dynamic pressure was still high. This resulted in a large aerodynamic moment which exceeded the S-II control moment, causing a rapidly increasing attitude rate and attitude divergence in the affected axis. For no wind, nominal wind, and tailwind cases, the divergence occurs primarily in the pitch plane; for quartering and crosswinds the divergence occurs primarily in the yaw plane.

* Does not currently exist but above analysis could be used as a guideline if capability were available.

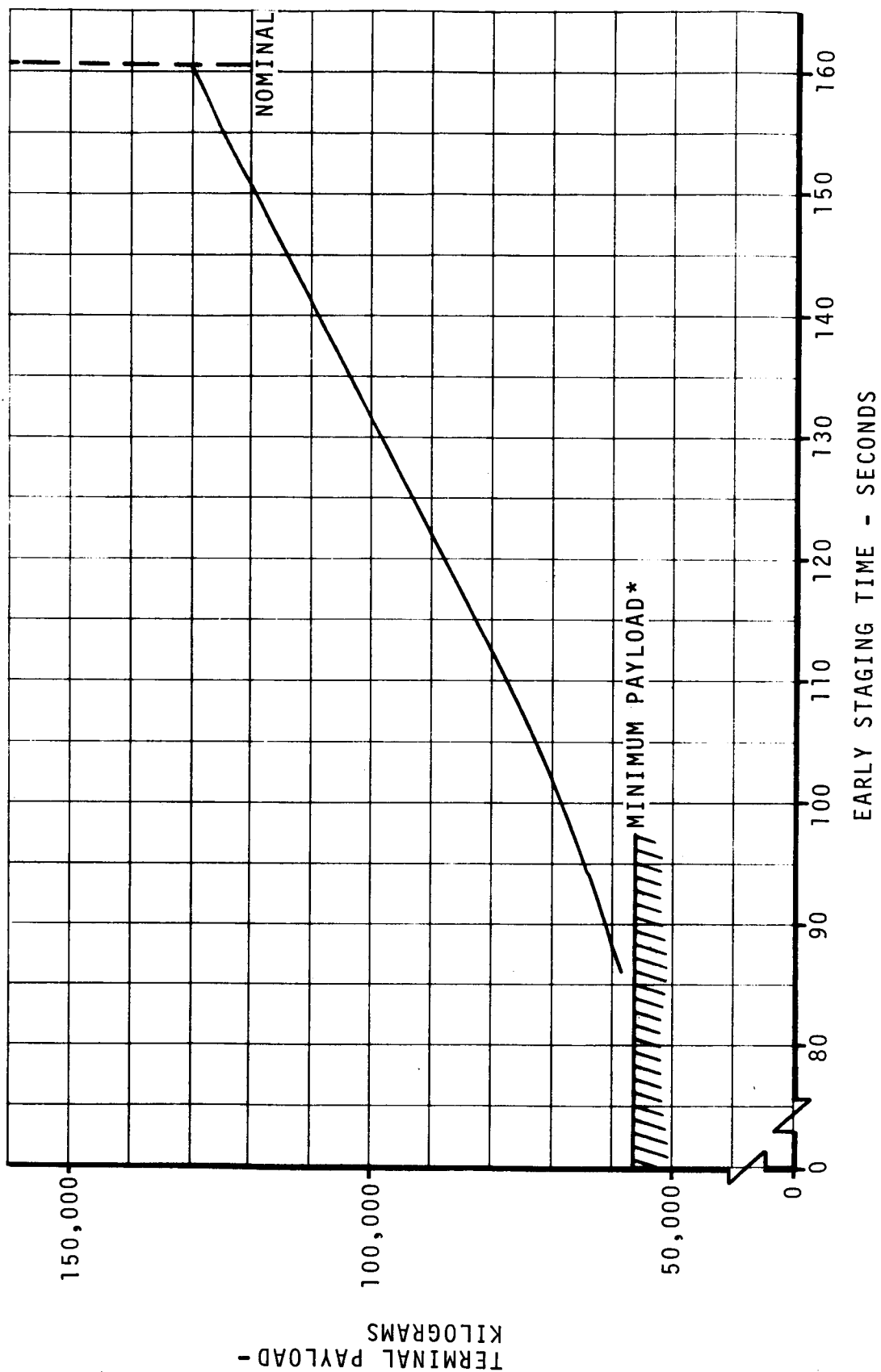

* Includes S-IVB dry mass.

FIGURE 2-58 PAYLOAD AT POI VS. S-IC/S-II EARLY STAGING TIME

TERMINAL PAYLOAD -
KILOGRAMS

TABLE 2-VI RESULTS OF EARLY STAGING IN 90 TO 110 SECOND TIME SPAN

WIND TYPE	S-IC/S-II EARLY STAGING TIME (SECONDS)		
	90	100	110
Nominal Wind	L/C	POI	POI
No Wind	L/C	POI	POI
95% Headwind	L/C	POI	POI
95% Quartering Headwind	L/C	POI	POI
95% Crosswind	L/C	L/C	POI
95% Quartering Tailwind	L/C	L/C	POI
95% Tailwind	L/C	L/C	POI

L/C - Loss of Control Case

POI - Parking Orbit Insertion

2.6.15 (Continued)

To summarize, the earliest time that staging capability exists for all cases is 110 seconds. However, the possibility of successful staging still exists from 100 to 110 seconds, but is highly dependent upon the atmospheric conditions encountered. If winds of large magnitude are present, then successful staging during this time is unlikely due to the additional aerodynamic moment created by the winds. Any early staging attempt prior to 100 seconds should result in loss of control shortly after S-IC/S-II separation.

For the loss of control cases, the EDS rate limits are exceeded in from 4 to 8 seconds after separation. None of the cases that successfully completed staging exceeded EDS or FDO limits. For reference, an FDO plotboard is presented in Figure 2-59, for the 100 second nominal wind case. Figure 2-60 shows the response of the vehicle to the command pitch attitude for this case.

It should be noted that there were assumed to be no constraints upon the issuance of early S-IC/S-II staging during the time interval of the study. Tilt arrest was begun with the shutdown of the S-IC engines. All S-IC engines were commanded to shut down simultaneously. The sequence of events, as referenced to S-IC/S-II separation, remained the same after staging as the nominal, except for events connected with the guidance shutdown of the S-IVB engine.

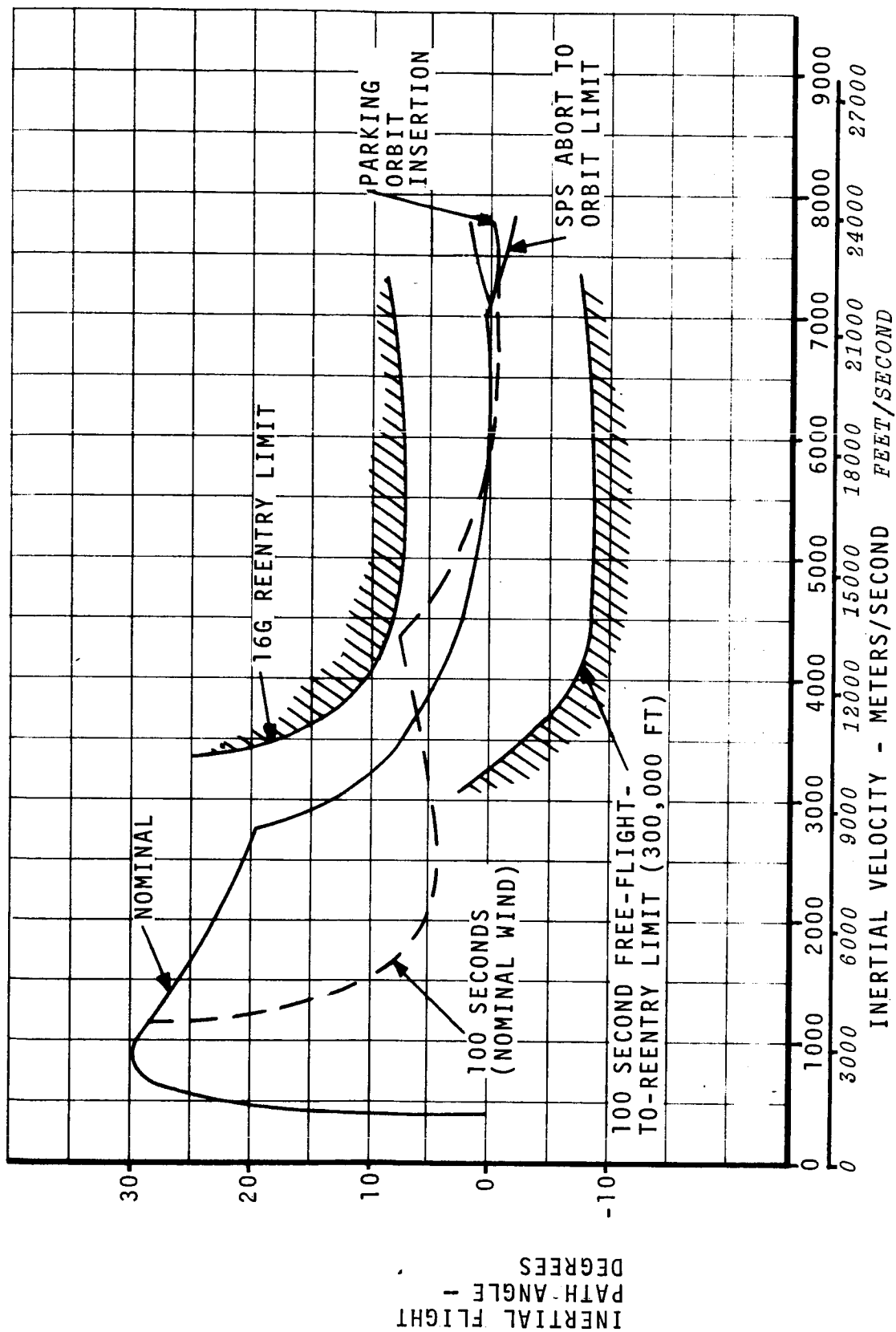

FIGURE 2-59 FDO PLOTBOARD FOR S-IC/S-II STAGING AT 100 SECONDS

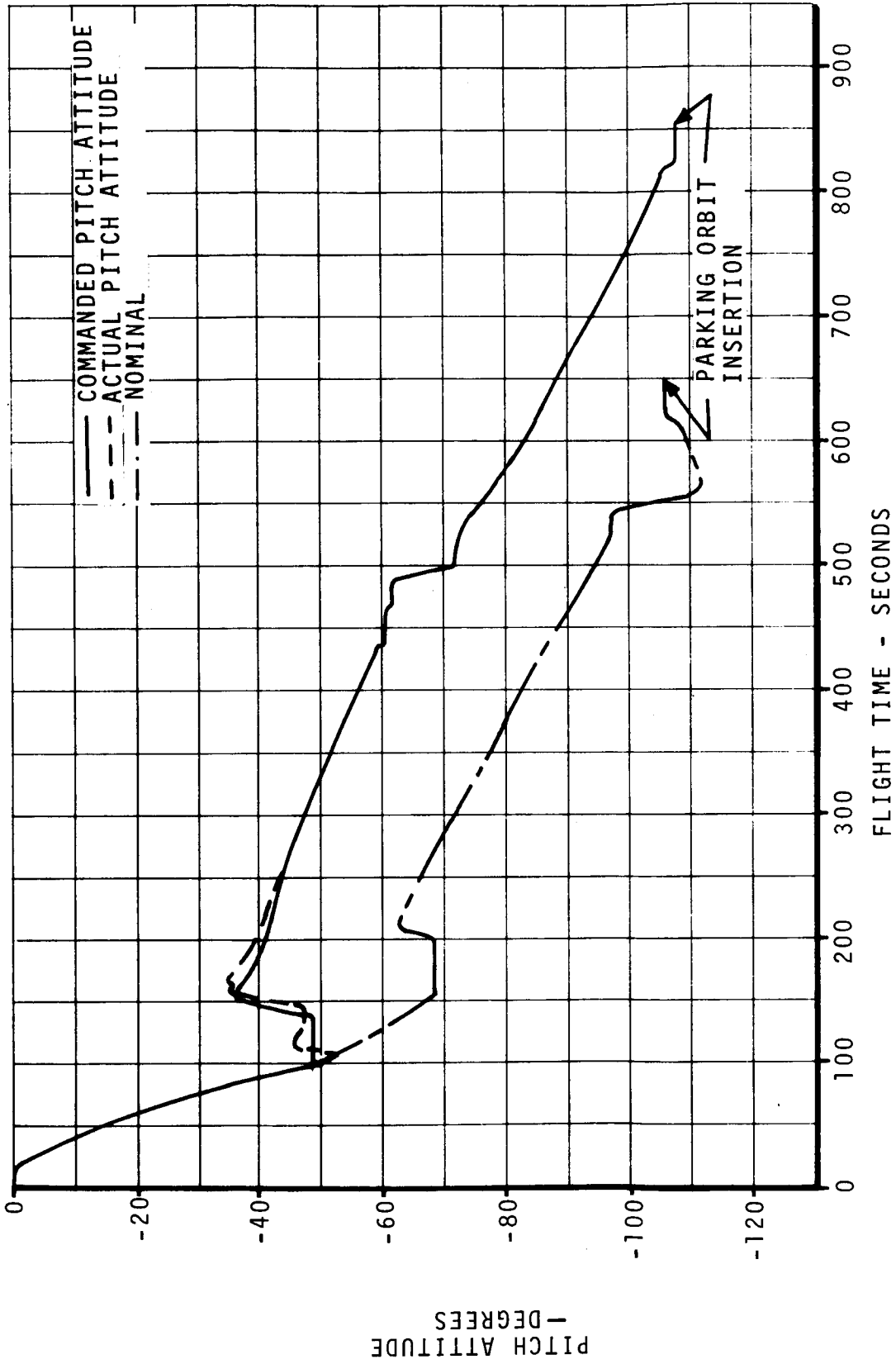
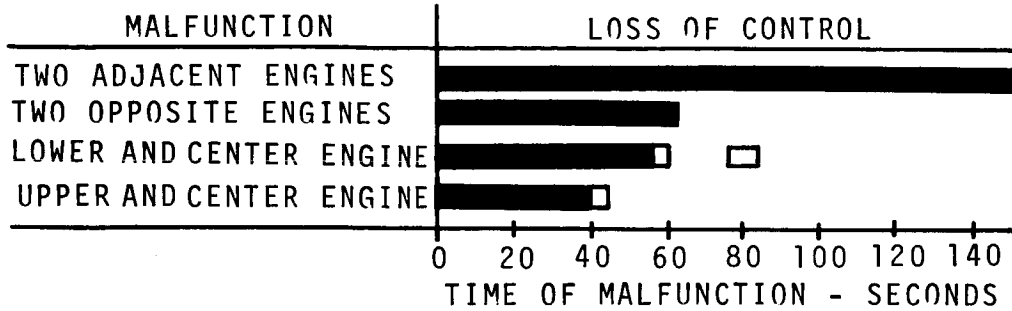

FIGURE 2-60 PITCH ATTITUDE FOR S-IC/S-II STAGING AT 100 SECONDS

2.6.16 Dual Engine Out - S-IC

Loss of thrust on two engines causes loss of control at the times indicated on the bar chart below.



□ POSSIBLE LOSS OF CONTROL ■ CERTAIN LOSS OF CONTROL

The region of loss for center engine and one control engine out between 78 and 83 seconds flight time is identical to the single engine out loss of control region.

Automatic abort will be initiated if the thrust OK pressure switches on two engines drop out. These switches drop out if the thrust on the associated engine falls below 80 percent of the nominal thrust. Automatic abort on two engines out may be inhibited manually by the crew. The recommended time to inhibit automatic abort is 120 seconds. Automatic abort deactivation time was selected on the basis of launch vehicle loads only.

2.6.17 S-II Simultaneous Dual Engine Failure

This section presents the results of the AS-504 simultaneous dual S-II engine out analysis. Figure 2-61 indicates the capability to achieve orbit after failure of various engine combinations. The cases that fail to achieve orbit are separated into three categories:

- a. Fuel depletion - this category covers the cases which would have made at least a 75 N. mile orbit if additional propellant were available.
- b. Loss of control - this category includes cases in which the actuators are against the limits and the vehicle continues to diverge from its commanded attitude.
- c. Failure to achieve a 75 N. mile orbit - this category includes cases in which cutoff criteria for IGM are not met and no guidance commanded shutdown occurs.

The analysis reveals that the capability to attain orbit after a dual engine malfunction in S-II is much less than indicated in the previous analyses of AS-503 C' and AS-504. The increase in the regions of loss of control for AS-504 is typical of the response of a heavier vehicle. Table 2-VII gives a comparison of dry mass and propellant loadings. The extensions of the regions of S-IVB guidance problem are caused predominantly by the presetting for T_{2j} , second phase IGM burn time. This presetting is presently 79.5 seconds, which is about 8.5 seconds less than for the previous 504 analysis, and 2.0 seconds less than for AS-503 C'. The effect of this smaller presetting is an earlier freeze between S-II and S-IVB. Entering this freeze period earlier means arresting the attitude in a slightly more nose up position. The result of these two effects is that the commanded pitch attitude rides the limit longer when IGM is initiated in S-IVB. This is shown in Figure 2-62 .

The region in which a dual engine failure causes fuel depletion is reduced because the S-II stage for the 504 has more propellant on board than the 503. This additional propellant increases the burn time approximately 14 seconds for the nominal case. This increase in S-II performance gives the vehicle enough additional velocity so that the S-IVB can meet cutoff conditions prior to S-IVB fuel depletion.

Figure 2-63 shows typical pitch rate histories for dual engine failures causing loss of control and a case in which control is regained in S-II. Figure 2-64 shows the pitch command for a dual engine

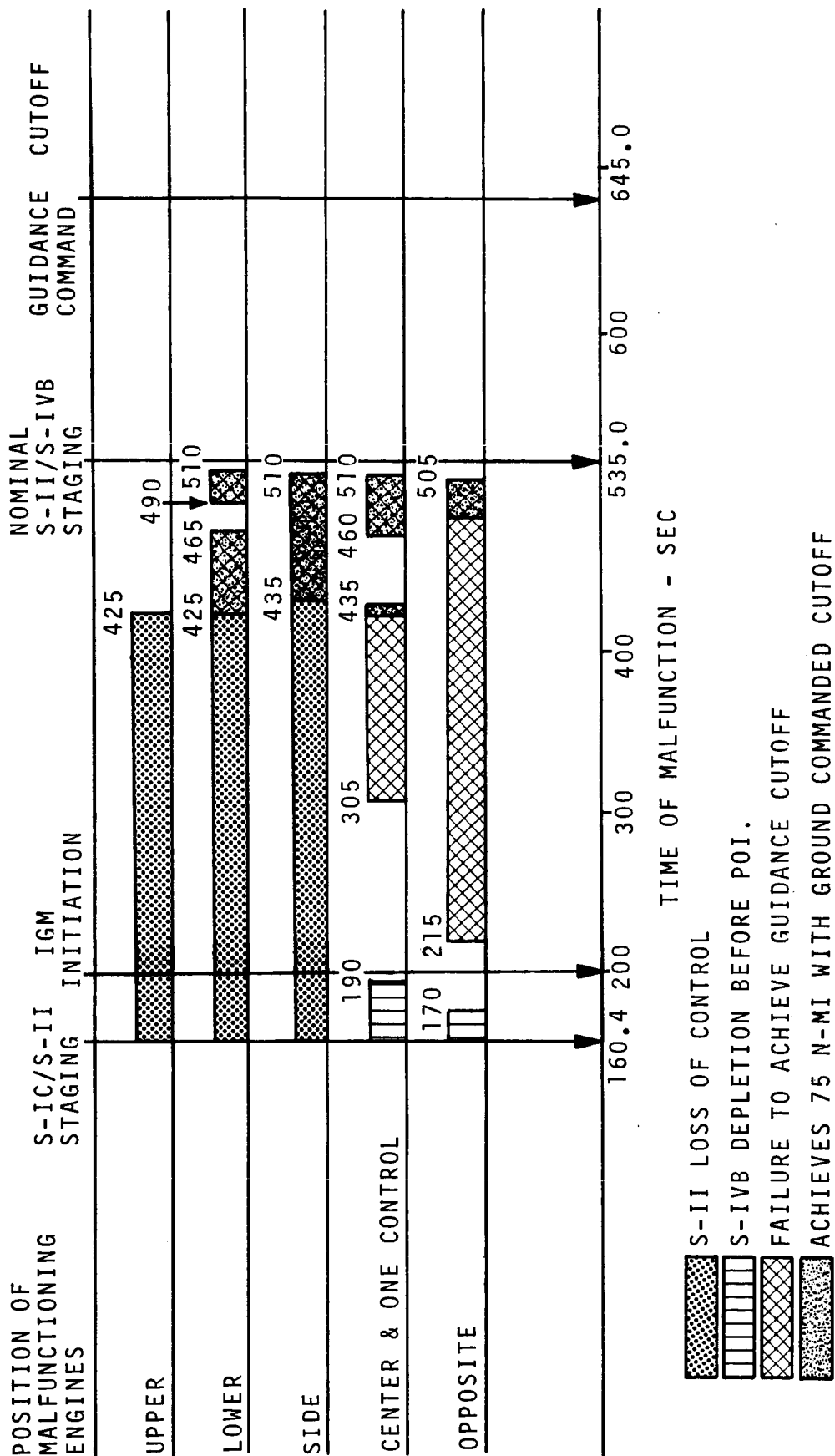

FIGURE 2-61 CRITICAL REGIONS FOR S-II SIMULTANEOUS DUAL ENGINE MALFUNCTION

TABLE 2-VII AS-503C' AND AS-504D MASS DIFFERENCES

	AS-503 C'	AS-504 D
S-IC Dry Mass	146025.00	138008.50
S-II Dry Mass	465380.00	42475.30
Adapt Dry Mass	4445.00	4060.60
LES Dry Mass	4026.00	4023.40
S-IVB Dry Mass	15889.00	14007.80
S/C *	39780.00	43091.20
S-IC Fuel	615023.00	646201.20
S-IC LOX	1411209.00	1499714.80
S-II Fuel	69542.00	71516.50
S-II LOX	358738.00	374427.90
Total S-IVB Fuel	18336.00	19731.20
Total S-IVB LOX	86642.00	85154.20

* Includes fuels, LEM, etc.

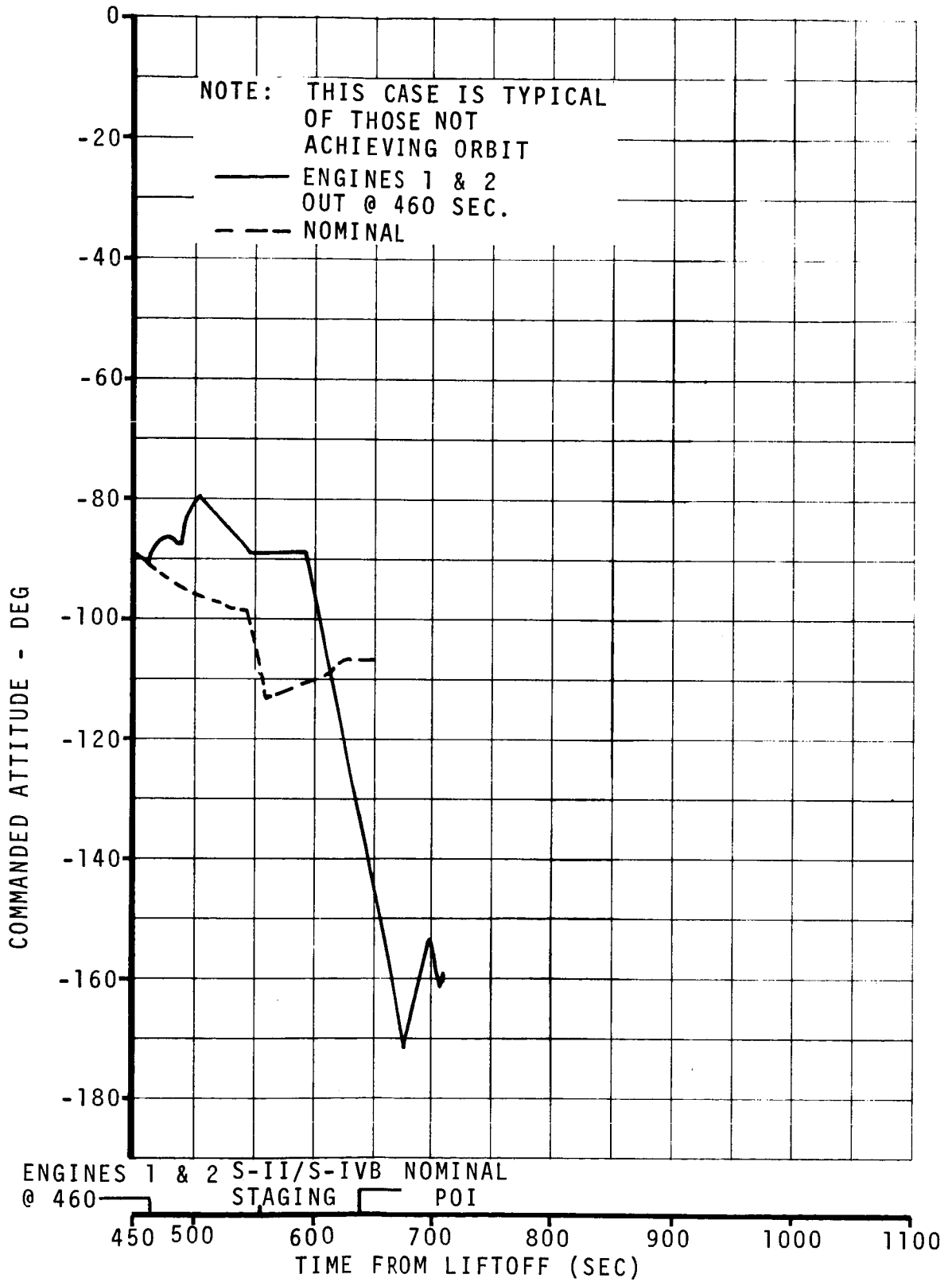

FIGURE 2-62 S-IVB COMMANDED ATTITUDE AFTER S-II DUAL ENGINE OUT

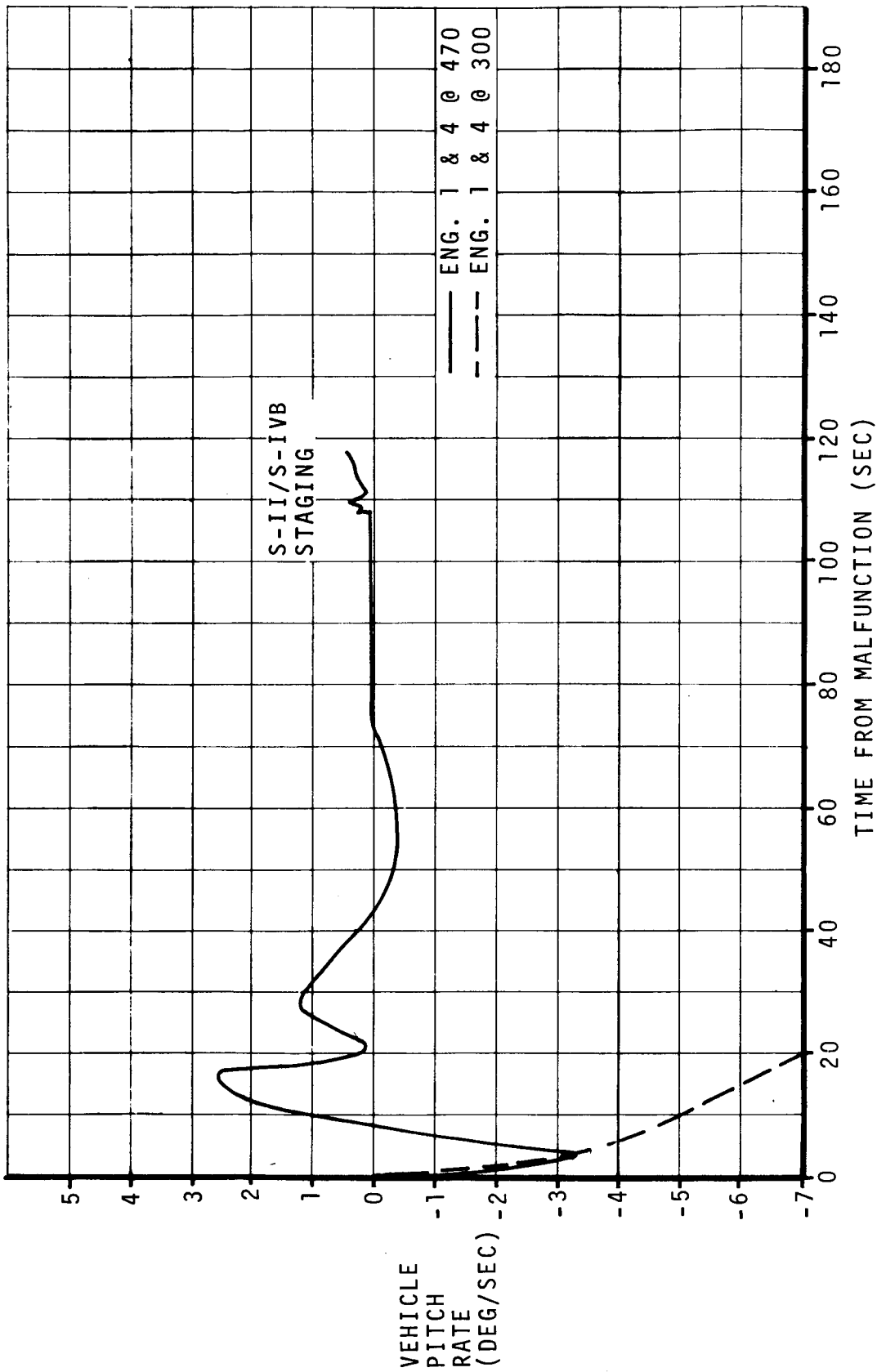
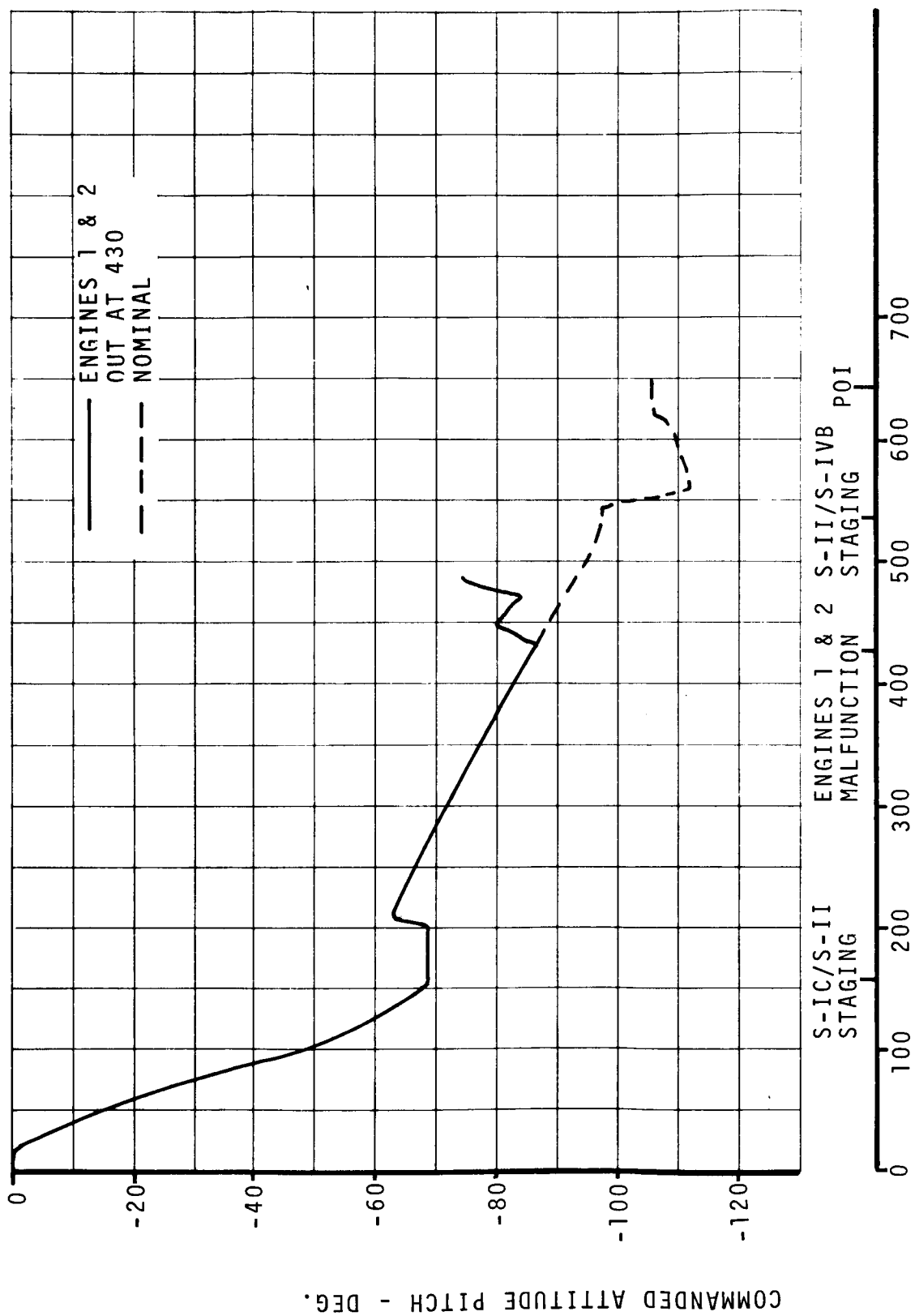

FIGURE 2-63 PITCH RATE HISTORIES FOR CONTROLLABLE AND NON-CONTROLLABLE DUAL S-II ENGINE FAILURES

2.6.17 (Continued)

failure in the loss of control region. Figure 2-65 shows the actual attitude for this same case. The divergence between actual and commanded attitude for this case is shown in Figure 2-66 . Figure 2-67 gives a time history of the engine actuator displacement for a dual engine failure which regains control. Figure 2-68 shows the flight path angle for a case in which IGM was unable to steer the S-IVB into parking orbit. The divergence in T3i, third phase IGM burn time, for this case is shown in Figure 2-69 . Also for the same case the S-IVB guidance commands are shown in Figure 2-62 .



COMMANDED ATTITUDE PITCH - DEG.

S-IC/S-II STAGING ENGINES 1 & 2 MALFUNCTION S-II/S-IVB STAGING POI

TIME FROM LIFTOFF - SEC.

FIGURE 2-64 TYPICAL COMMANDED ATTITUDE HISTORY FOR LOSS OF CONTROL SUBSEQUENT TO A DUAL S-II ENGINE MALFUNCTION

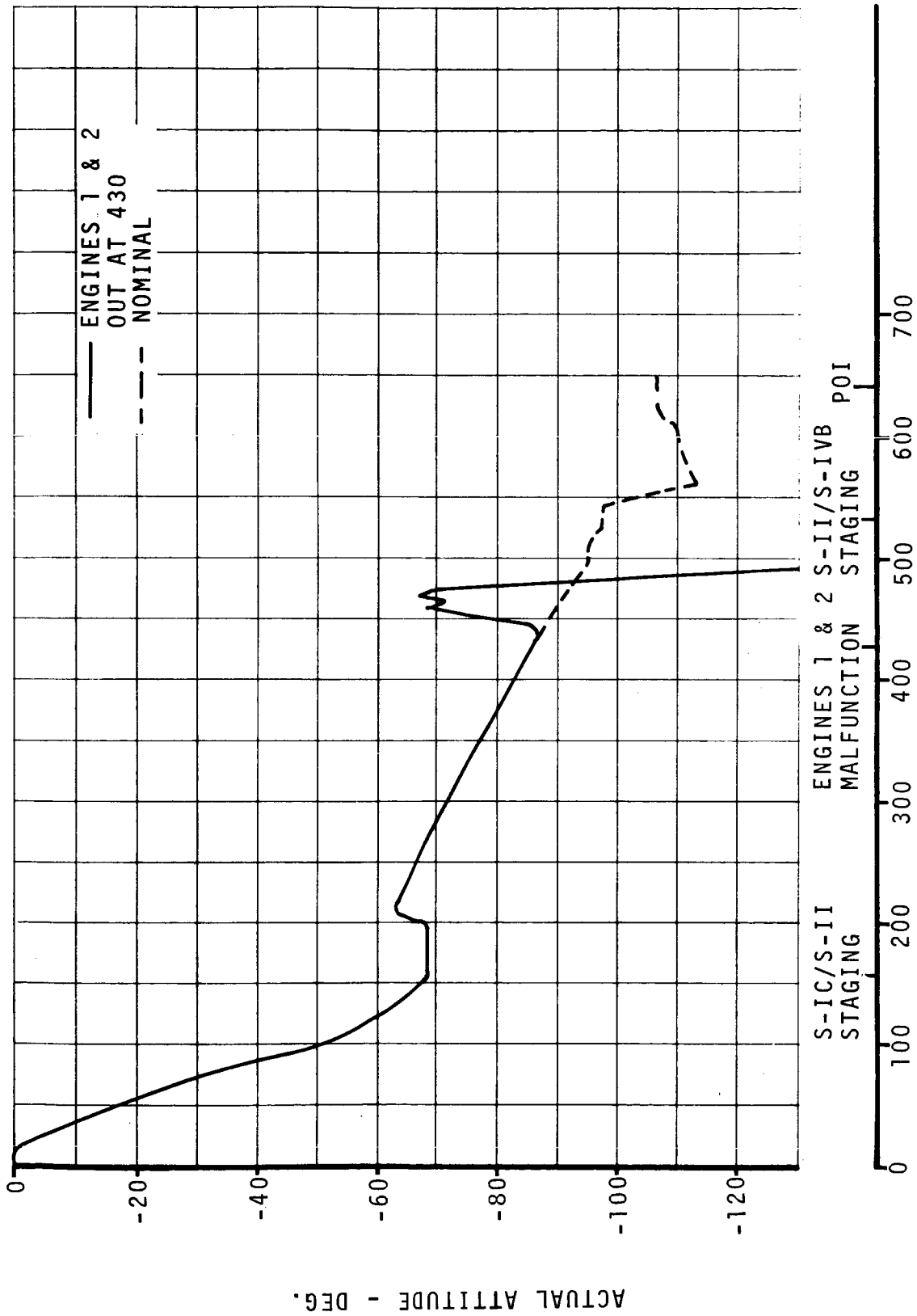

FIGURE 2-65 TYPICAL ATTITUDE HISTORY FOR LOSS OF CONTROL SUBSEQUENT TO S-II DUAL ENGINE MALFUNCTION

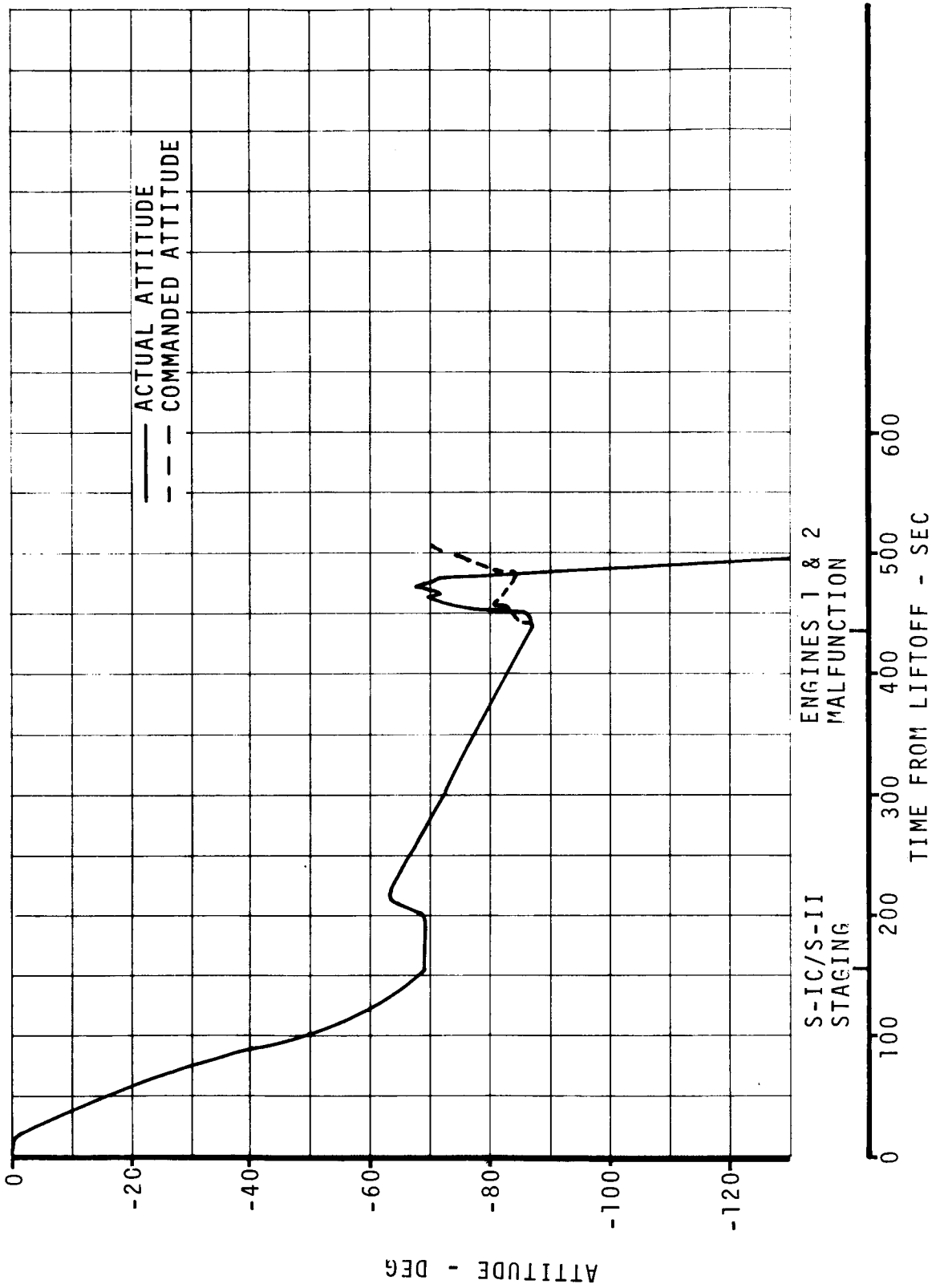

FIGURE 2-66 ATTITUDE HISTORY PLOT SHOWING DEVIATION BETWEEN ACTUAL AND COMMANDED ATTITUDES FOR LOSS OF CONTROL

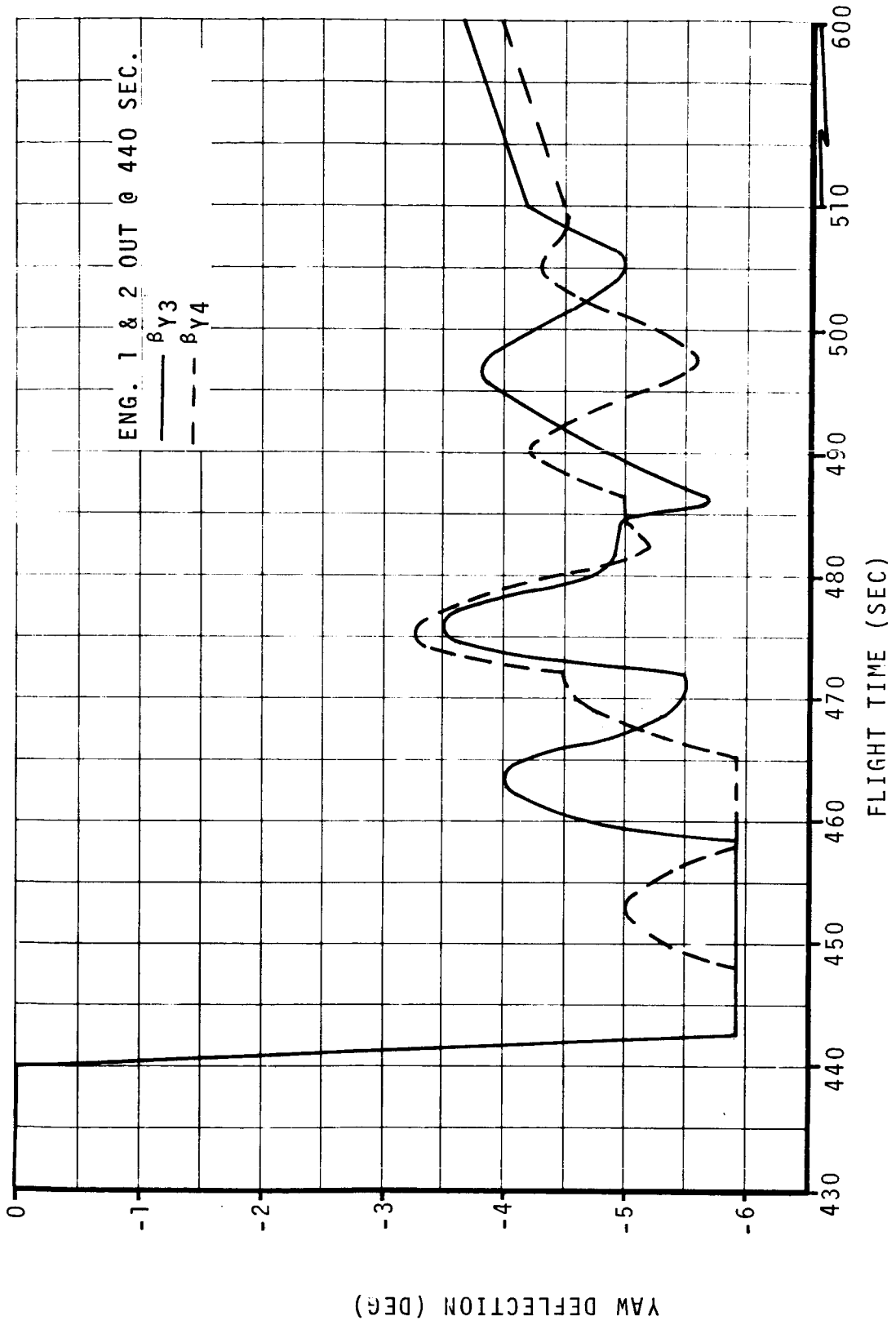

FIGURE 2-67 ENGINE YAW DEFLECTION AFTER S-II DUAL ENGINE OUT

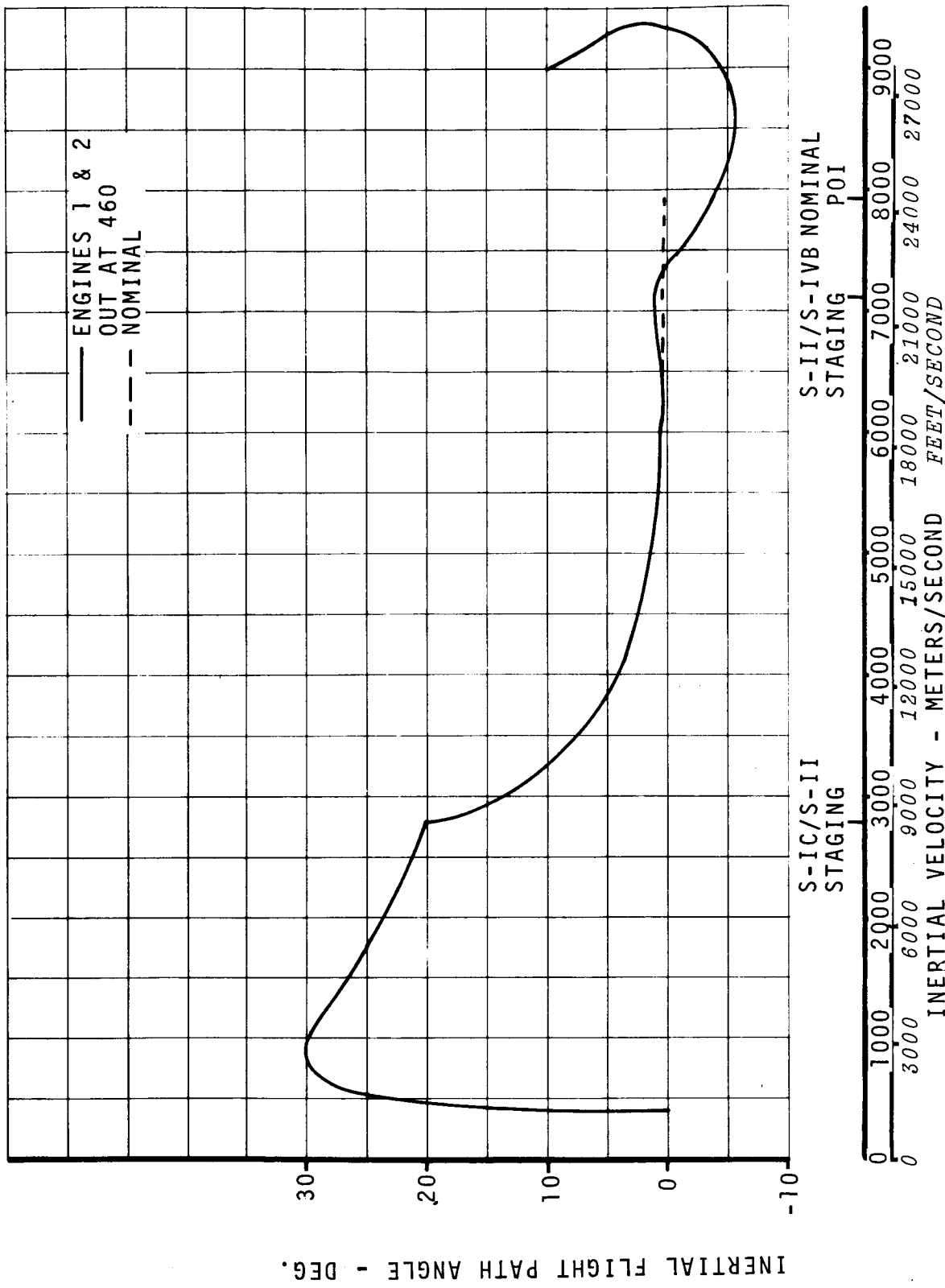

FIGURE 2-68 FLIGHT PATH ANGLE FOR S-IVB GUIDANCE FAILURE AFTER S-II ENGINE FAILURES

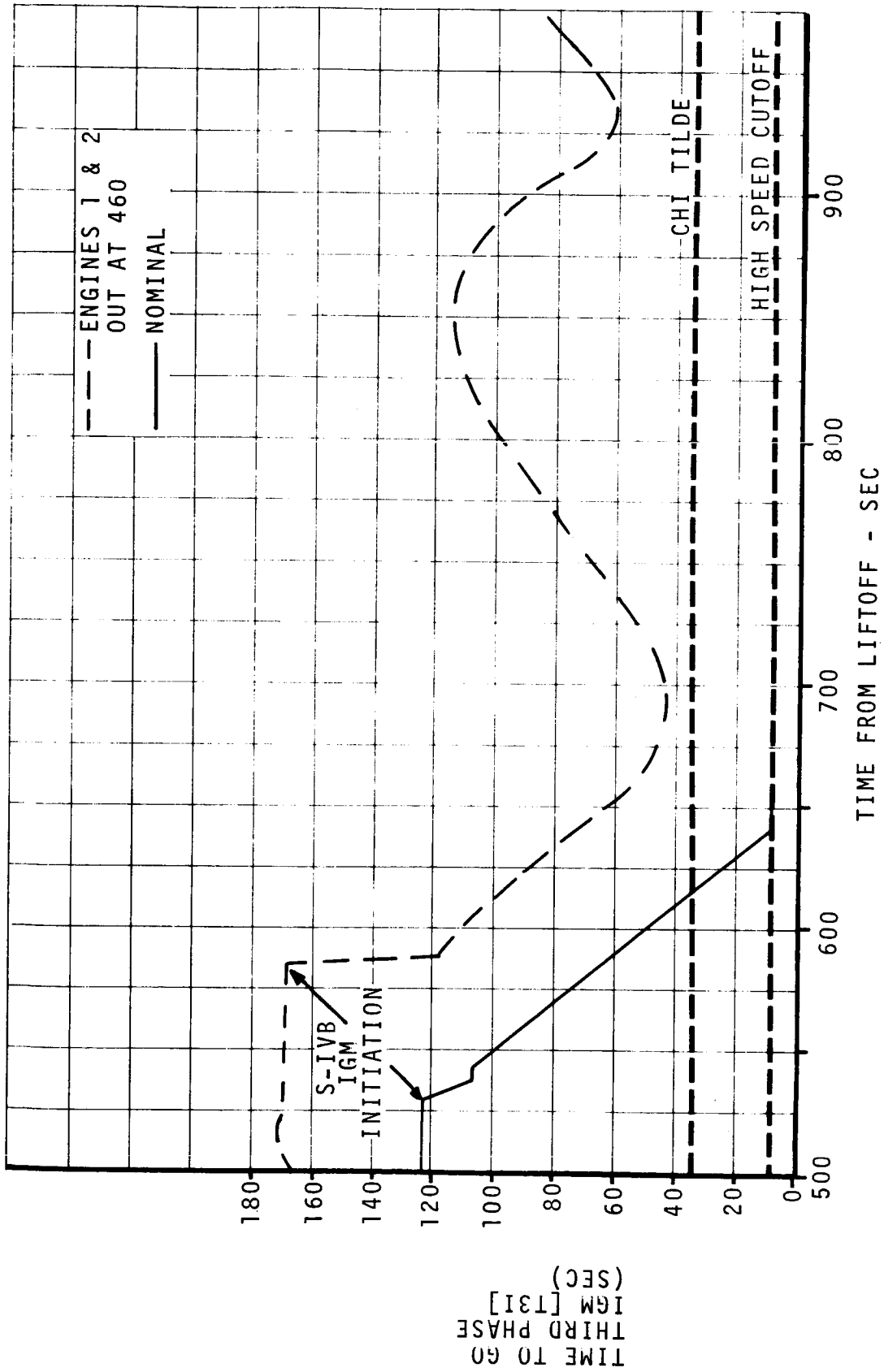

FIGURE 2-69 TYPICAL DIVERGENCE OF TIME TO GO (T₃₁) FOR S-IVB GUIDANCE SUBSEQUENT TO A DUAL S-II ENGINE FAILURE

2.6.18 S-II Sequential Dual Engine Failure

The vehicle response to a dual sequential engine failure is similar to the response of simultaneous dual engine failures. Figure 2-70 defines the regions of loss of control, fuel depletion, and failure to achieve a 75 NM orbit. These categories are defined in Section 2.6.17. Because of the vast number of cases possible, the following method for establishing the bounds of the problem areas was used. For all sequential engine failures the first engine failed at 165 seconds from liftoff and the second engine failure time was varied to find the regional bounds. The region of loss of control for sequential engine failure can be extended from 50 to 80 seconds beyond the region of control loss for simultaneous dual engine failures, depending on the particular engine which malfunctioned.

Since the location of the CG is a major factor in the controllability of the vehicle, it follows that the reduced flowrate resulting from an engine failure impedes the forward progression of the CG as propellant is expended. The retarded CG motion extends the period during which a second engine failure could cause loss of control. Thus the overall loss of control region is extended.

The region for failure to achieve a 75 N mile orbit is larger than previous AS-503 and AS-504 failure regions because T_{2i} , IGM second phase burn time, is reduced. Figures 2-71 through 2-74 show guidance profile, actual attitude, flight path angle, and trajectory response for loss of control subsequent to the second engine failure in S-II. Figures 2-75 through 2-78 give the guidance profile, vehicle response, flight path angle, and trajectory deviation for an S-II sequential engine failure resulting in failure to cut off in S-IVB.

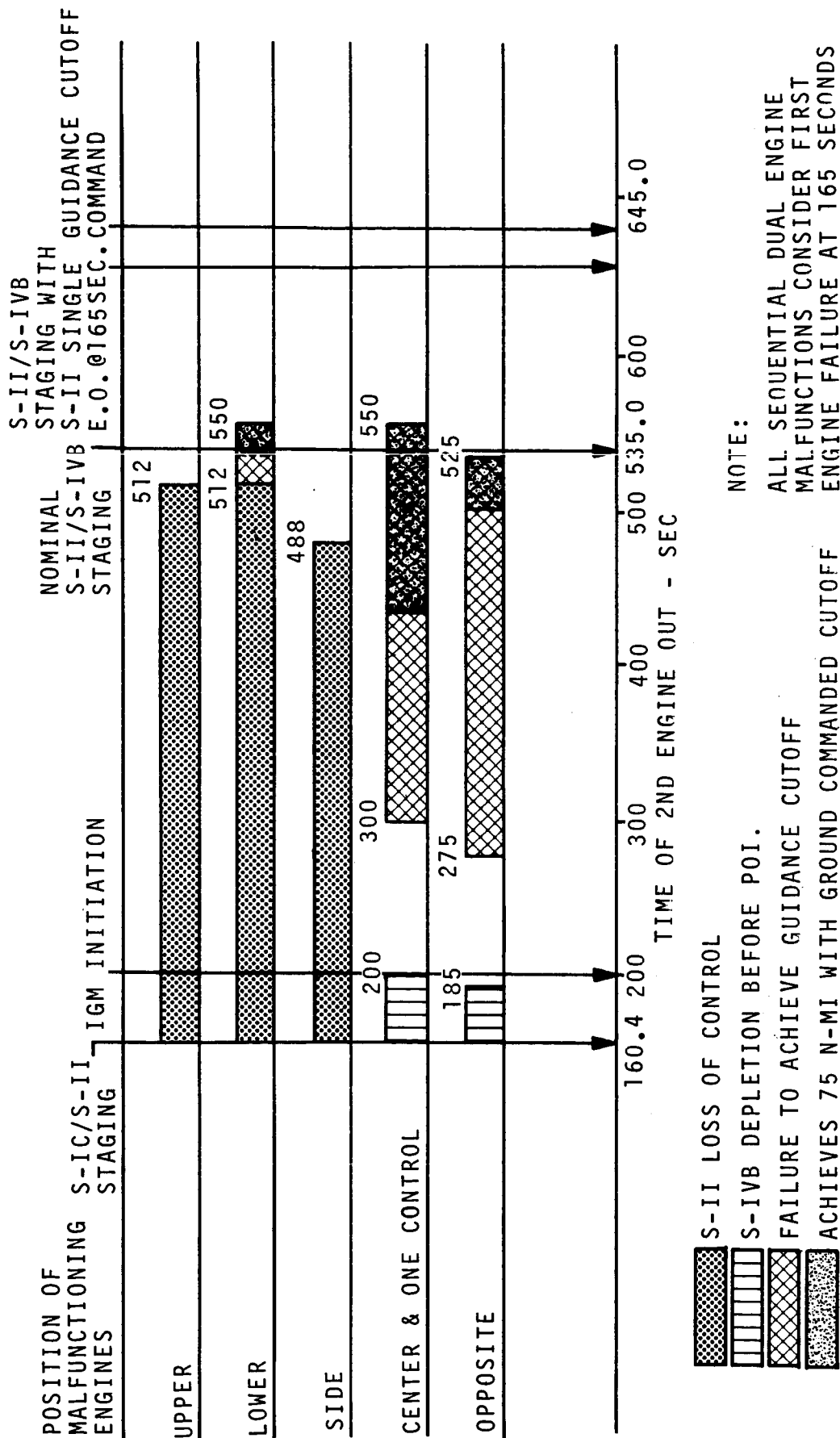

FIGURE 2-70 CRITICAL REGIONS FOR S-II SEQUENTIAL DUAL ENGINE MALFUNCTION

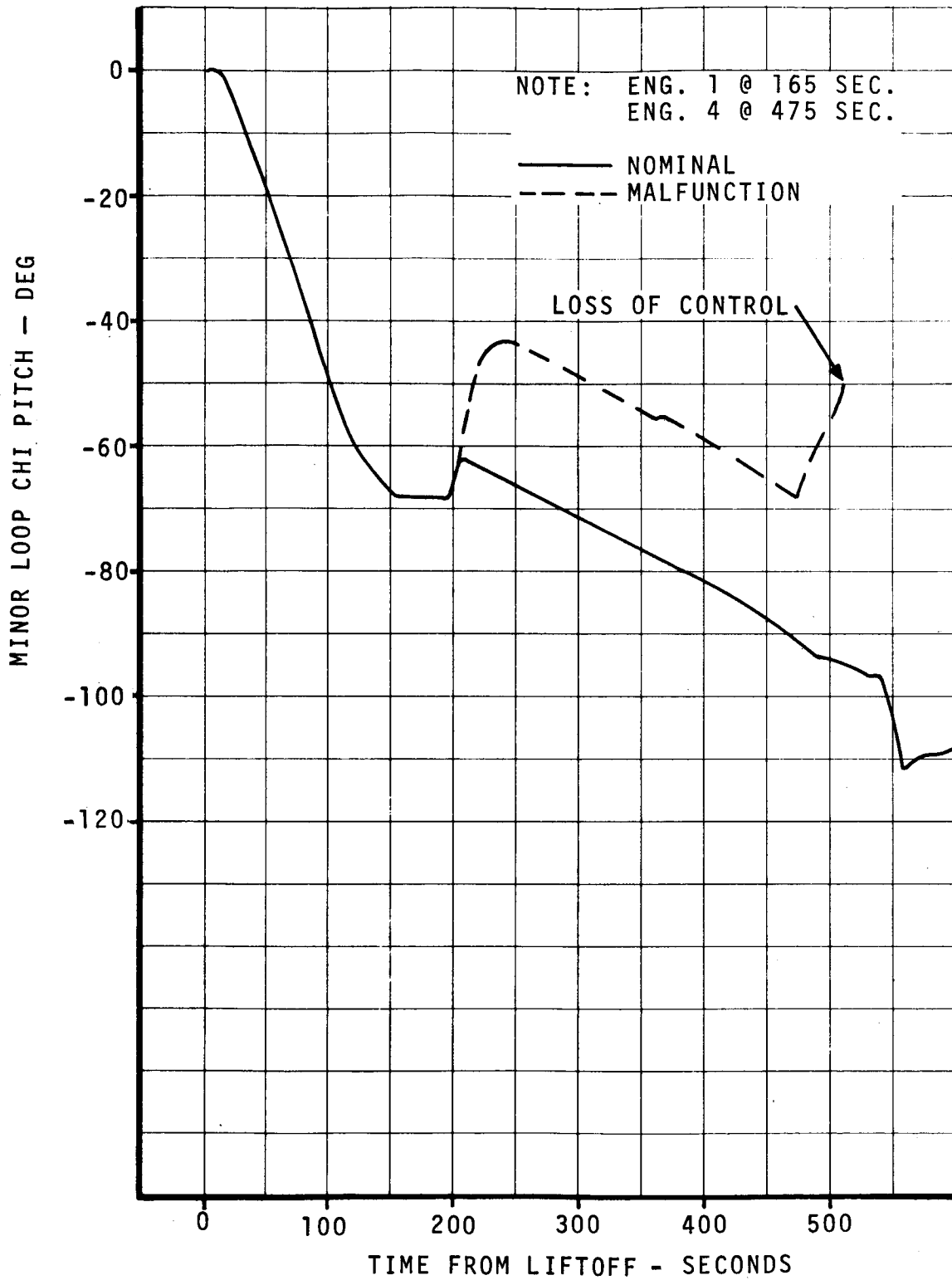

FIGURE 2-71 EFFECT OF SEQUENTIAL ENGINES OUT ON GUIDANCE PROFILE

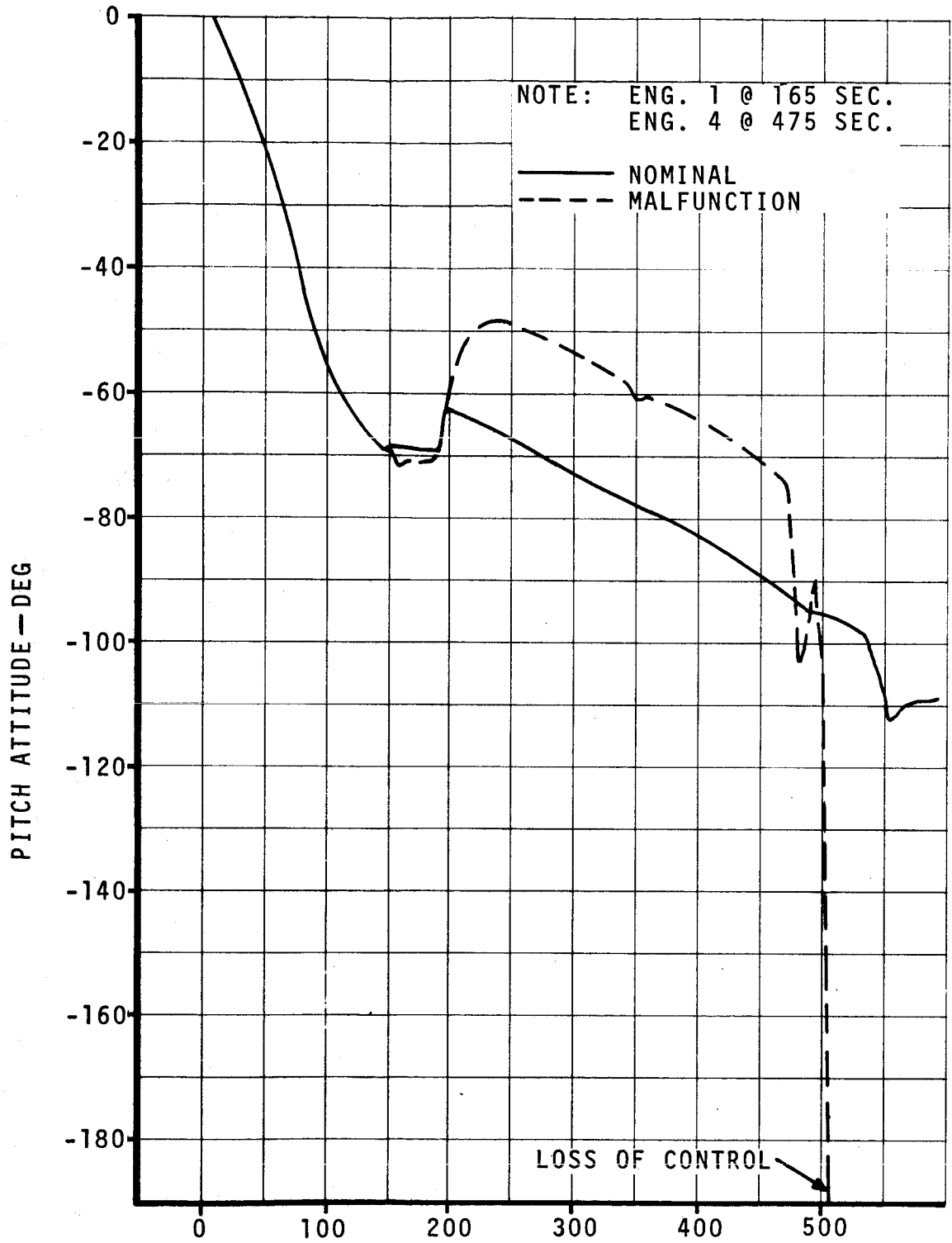

FIGURE 2-72 EFFECT OF SEQUENTIAL ENGINE OUT ON PITCH ATTITUDE

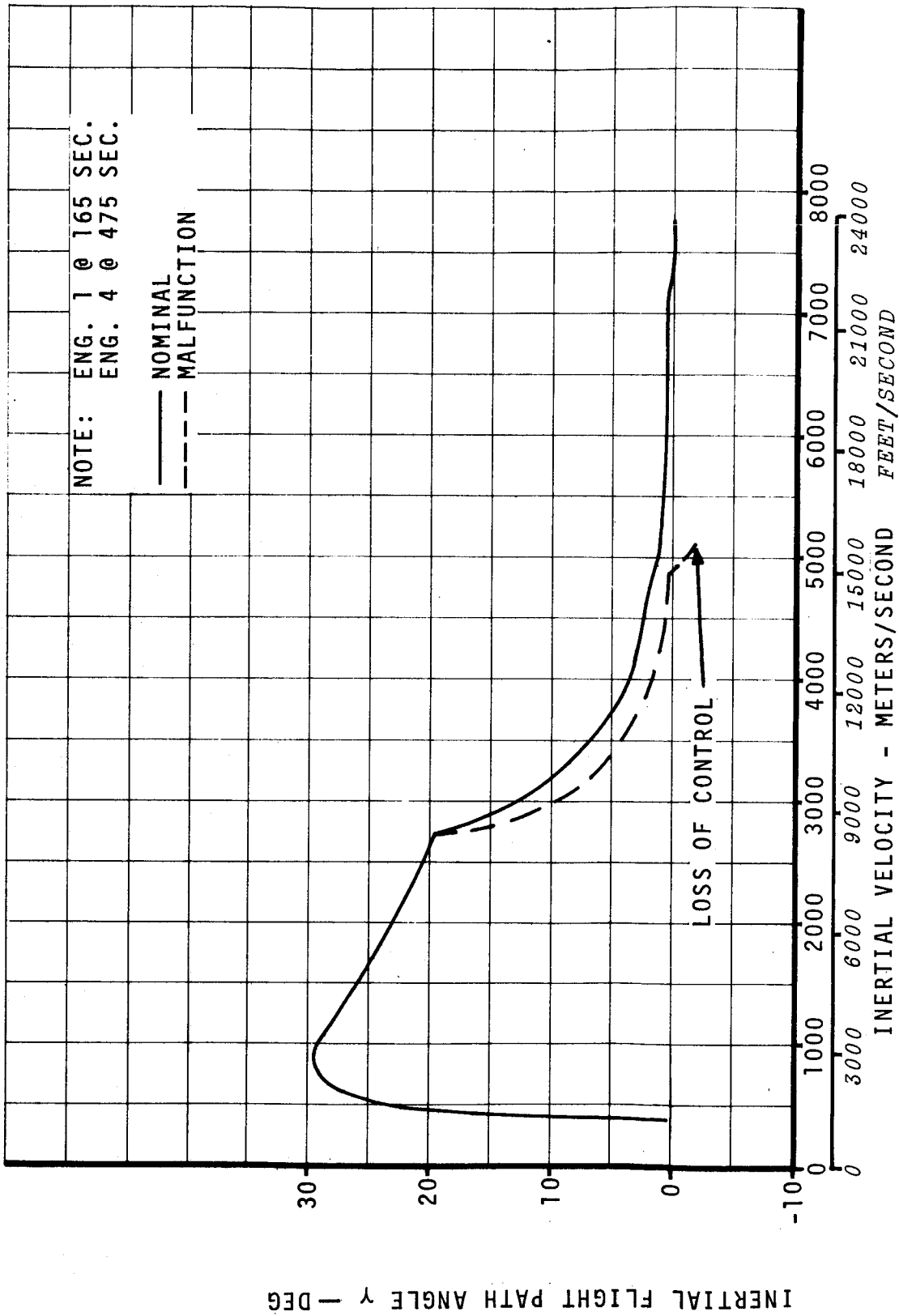

FIGURE 2-73 TYPICAL LOSS OF CONTROL EFFECT ON FLIGHT PATH ANGLE

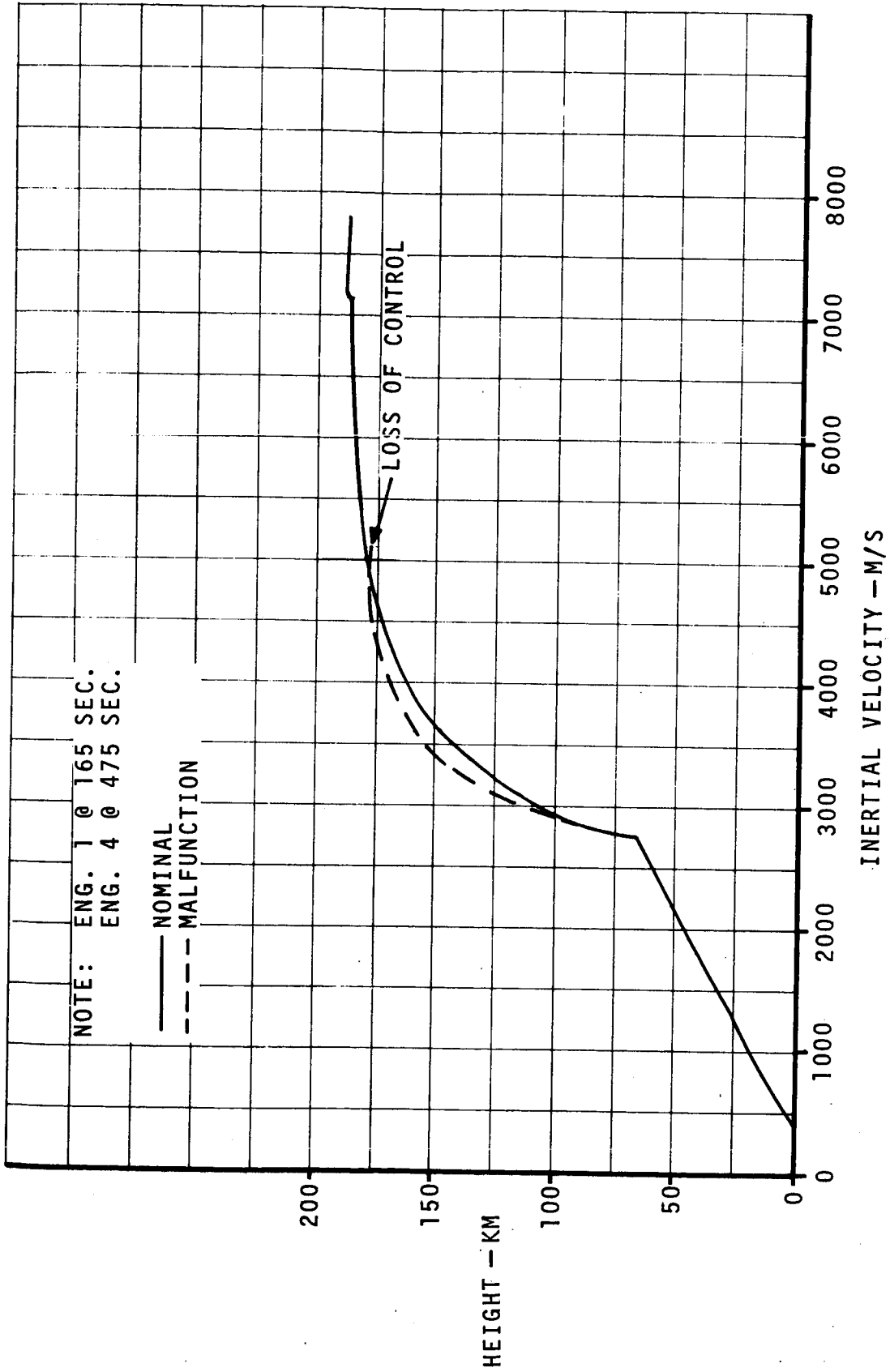

FIGURE 2-74 EFFECT OF SEQUENTIAL S-II ENGINES OUT ON HEIGHT-VELOCITY

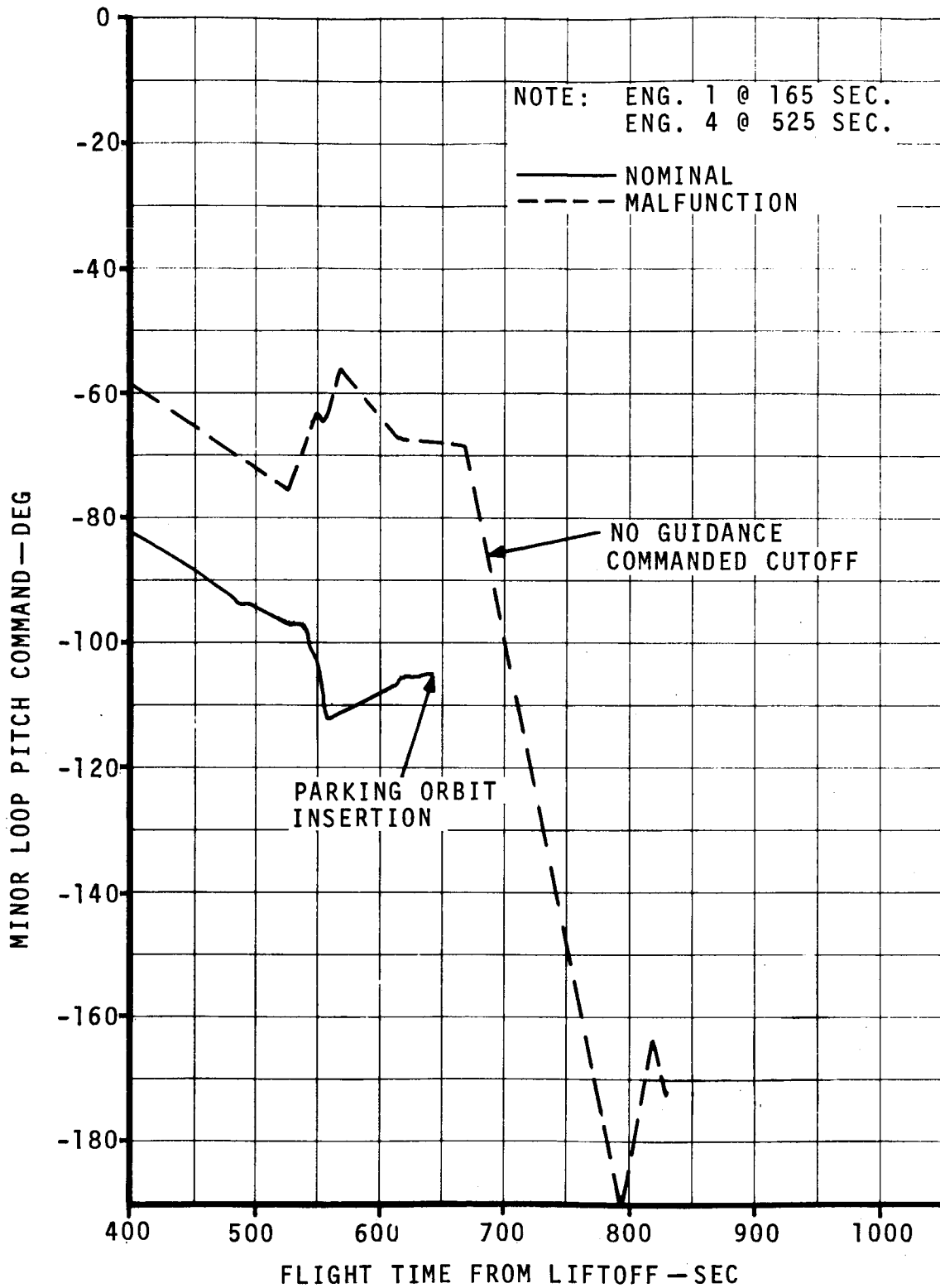

FIGURE 2-75 S-IVB PITCH COMMAND AFTER S-II SEQUENTIAL DUAL ENGINE OUT

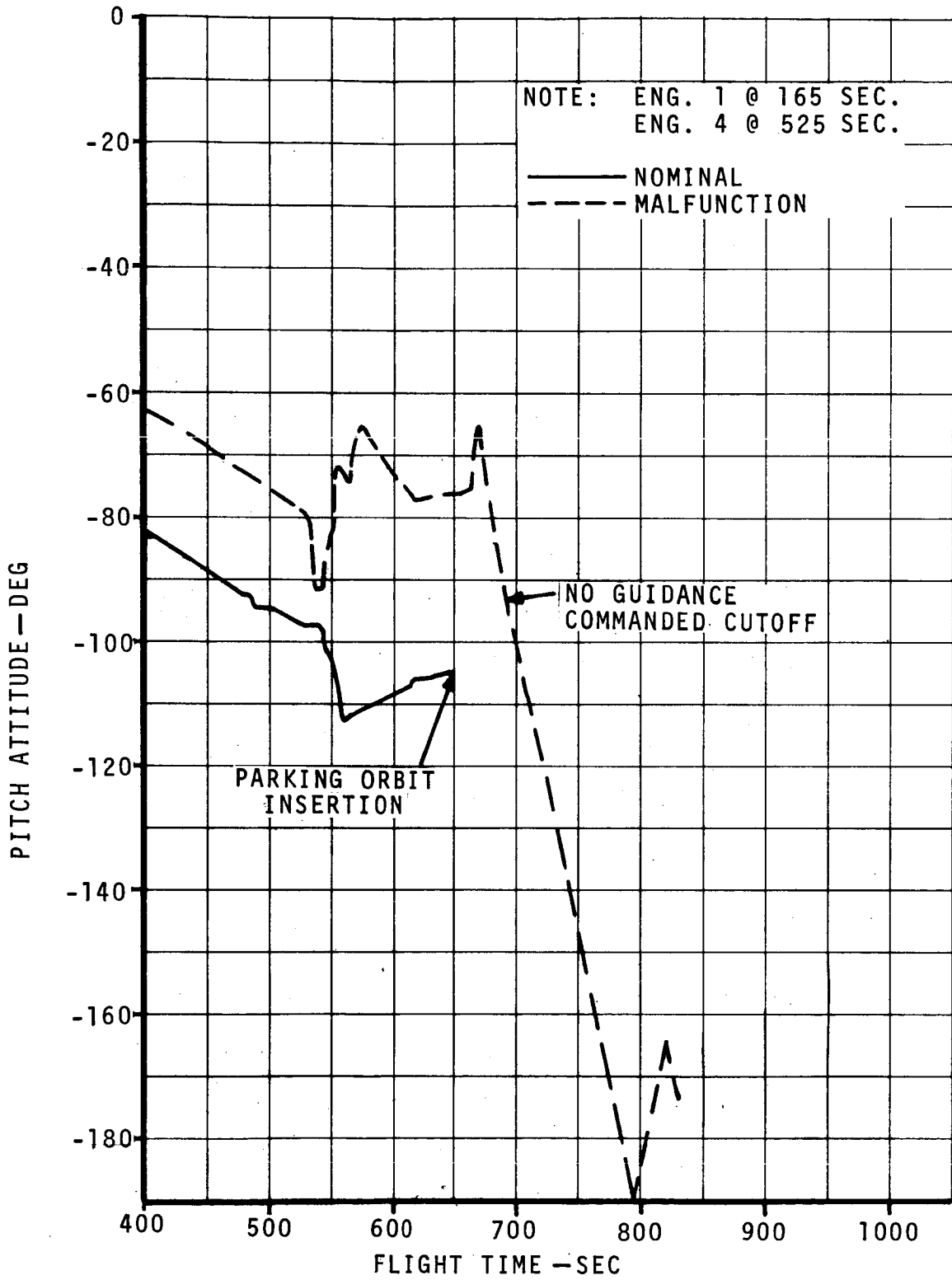

FIGURE 2-76 S-IVB PITCH ATTITUDE AFTER S-II SEQUENTIAL DUAL ENGINE OUT

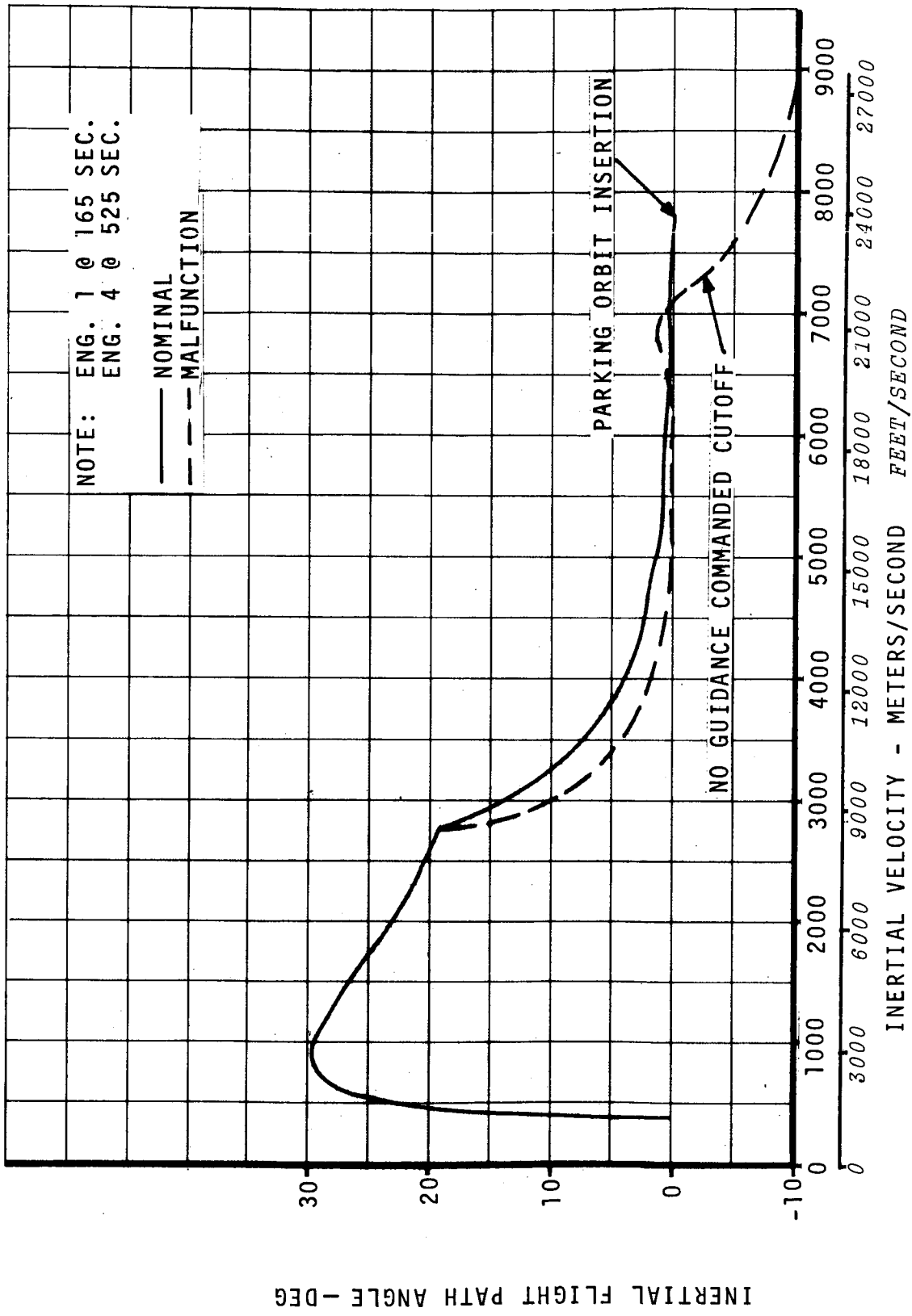

FIGURE 2-77 FLIGHT PATH ANGLE-VELOCITY FOR S-II SEQUENTIAL DUAL ENGINE OUT

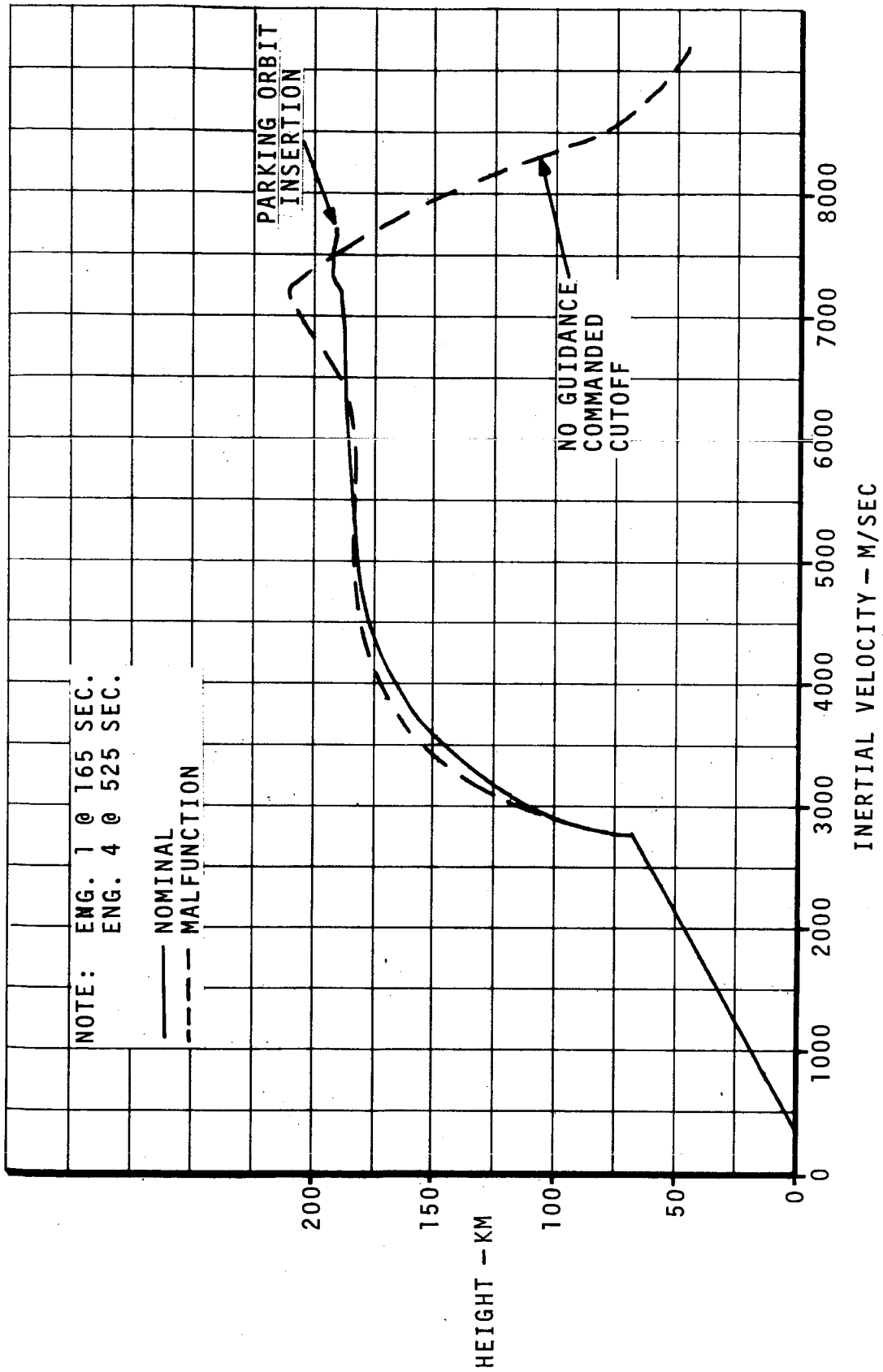

FIGURE 2-78 HEIGHT-VELOCITY FOR S-II SEQUENTIAL DUAL ENGINE OUT

2.6.19 S-II/S-IVB Early Staging

The SA-504 S-IVB performance analysis in Reference 10 indicates that the S-IVB can achieve parking orbit from early staging at 360 seconds flight time (with an SPS burn, as early as 310 seconds).

For malfunctions which cause rapid loss of control, such as dual adjacent engine malfunctions, approximately 3 seconds are available to initiate early staging. Staging later than three seconds after malfunction can cause loss of control in S-IVB. In cases of dual engine malfunction, the first cue will be engine out lights. Additional cues and limits that may be used are attitude rate greater than 3 deg/sec., roll attitude error greater than 20 degrees, and FDO limits. Since dual engine malfunctions do not in all cases cause loss of control, the available cues must be used to discriminate between cases of engine failure resulting in loss of control and engine failures causing guidance problems in S-IVB flight. Malfunction cases that do not cause loss of control but exhibit guidance problems in the S-IVB stage, preventing satisfaction of cutoff conditions, can make nominal parking orbit by early staging at 5 seconds after start of the freeze period between S-II and S-IVB. Absence of dual engine out logic in the flight program results in an inadequate update of T_{1i} and T_{2i} , first and second phase IGM burn times. This results in initiating chi freeze as much as 50 seconds early. During this extended freeze period trajectory deviations develop which can cause failure to meet cutoff conditions. Staging at chi freeze plus 5 seconds degrades performance but enables the S-IVB to achieve parking orbit. Further analysis of this problem can be found in Reference 15.

For dual adjacent control engine malfunctions resulting in gradual loss of control, the abort cues to initiate immediate S-II/S-IVB staging must satisfy the two cue requirements normally used for abort. No reliable second cue is available which will provide sufficient warning time before body rates become large enough to prevent staging.

The problem of S-IVB control recovery after early staging subsequent to a dual engine failure in S-II was investigated as early as 300 seconds flight time. Body rotational rates as large as 5.5 deg/sec at S-II/S-IVB separation were used to determine recovery transients and effects on the gimbal reasonableness test in both pitch and yaw planes.

For the case of staging with a body rate of 5.5 deg/sec, a pitch rate recovery transient of more than 15 deg/sec was encountered. This was sufficient to fail the fine resolver

2.6.19 (Continued)

limit of 10 deg/sec, and the coarse resolver limit of 15 deg/sec, setting the guidance failure discrete and causing loss of control.

Staging with a yaw rate of 4 deg/sec caused failure of the fine gimbal resolver, and failure of the coarse gimbal resolver, setting the guidance failure discrete and causing loss of control. The rate from which successful S-IVB recovery can be anticipated after early staging should not exceed 3 deg/sec. The maximum pitch rate recovery transient after early staging from a rate of 3 deg/sec is 11 deg/sec in pitch and 12 deg/sec in yaw. This is sufficient to cause permanent switchover to the coarse gimbal resolver and degradation of attitude information but not large enough to cause a guidance failure, or loss of control.

The largest body rate from which early staging can be initiated and not fail the fine gimbal resolver test is approximately 2 deg/sec.

Since the buildup of body rates after a dual S-II engine failure is rapid, early staging from a malfunction condition which will result in loss of control is not recommended. For the cases studied, body rates exceeded 2°/second within 1.25 seconds of dual engine malfunction. Discrimination between dual engine failures which require early staging and those which do not will probably require more than 1.25 seconds. Under these conditions, early staging could result in a loss of S-IVB control, guidance failure indication, or some compromise of the mission.

Figures 2-79 through 2-82 give the results of the worst case in which early staging was initiated with a body rate of 5.5 deg/sec. Figure 2-79 shows the body rates about the pitch axis. It can be seen that rates large enough to fail the coarse resolver limit of 15 deg/sec occurred during the S-IVB recovery period. Figure 2-82 shows pitch actuator deflection. Figure 2-80 shows the pitch attitude error, and Figure 2-81 shows a comparison between actual and commanded attitudes.

Figures 2-83 through 2-86 show early staging data with a pitch rate of 4 deg/sec at S-II/S-IVB separation. Figure 2-86 shows a recovery transient of 11.8 deg/sec with no resulting guidance failure. Figures 2-84, 2-85 and 2-83 show pitch actuator deflection, pitch attitude error, and actual and commanded attitudes respectively.

2.6.19 (Continued)

Figures 2-87 through 2-90 show data for early staging with initial rates of $4.4^\circ/\text{second}$ in the yaw plane. Figure 2-90 shows yaw rate. It is seen that the recovery transient well exceeds the 15 deg/sec limit for the coarse gimbal resolver. Figure 2-87 shows the S-IVB actuator going hardover for an extended period causing loss of control. Figure 2-88 shows attitude error, and Figure 2-89 compares actual and commanded attitudes.

The next case also presents data for early staging rates of the yaw plane. Figure 2-94 shows yaw rate. The recovery transient does not exceed the coarse resolver limit. Figures 2-91 through 2-93 show actuator deflection, yaw attitude error, and a comparison of commanded and actual attitude.

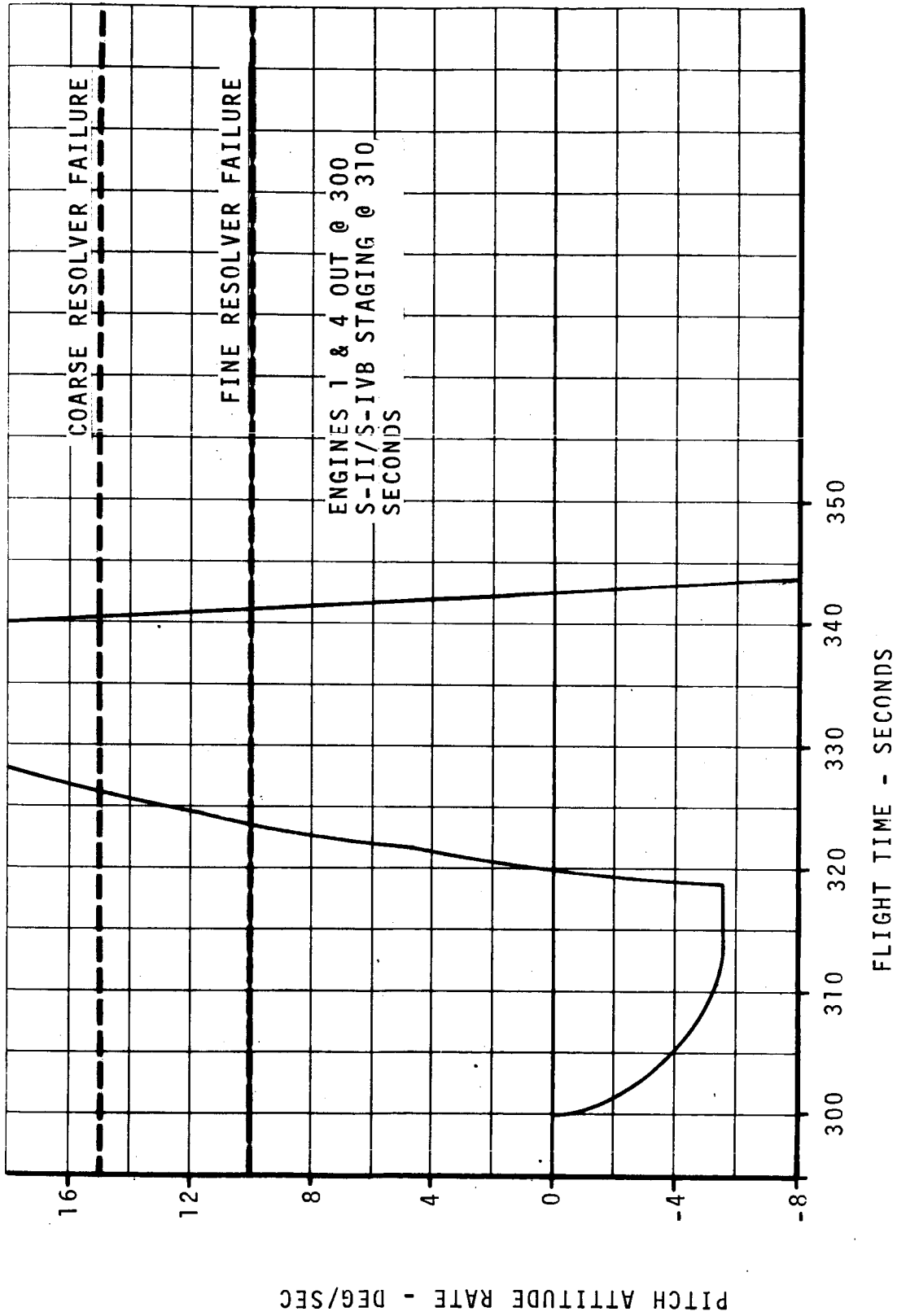

FIGURE 2-79 PITCH RATE RECOVERY TRANSIENT - EARLY S-II/S-IVB STAGING RESULTING IN LOSS OF CONTROL

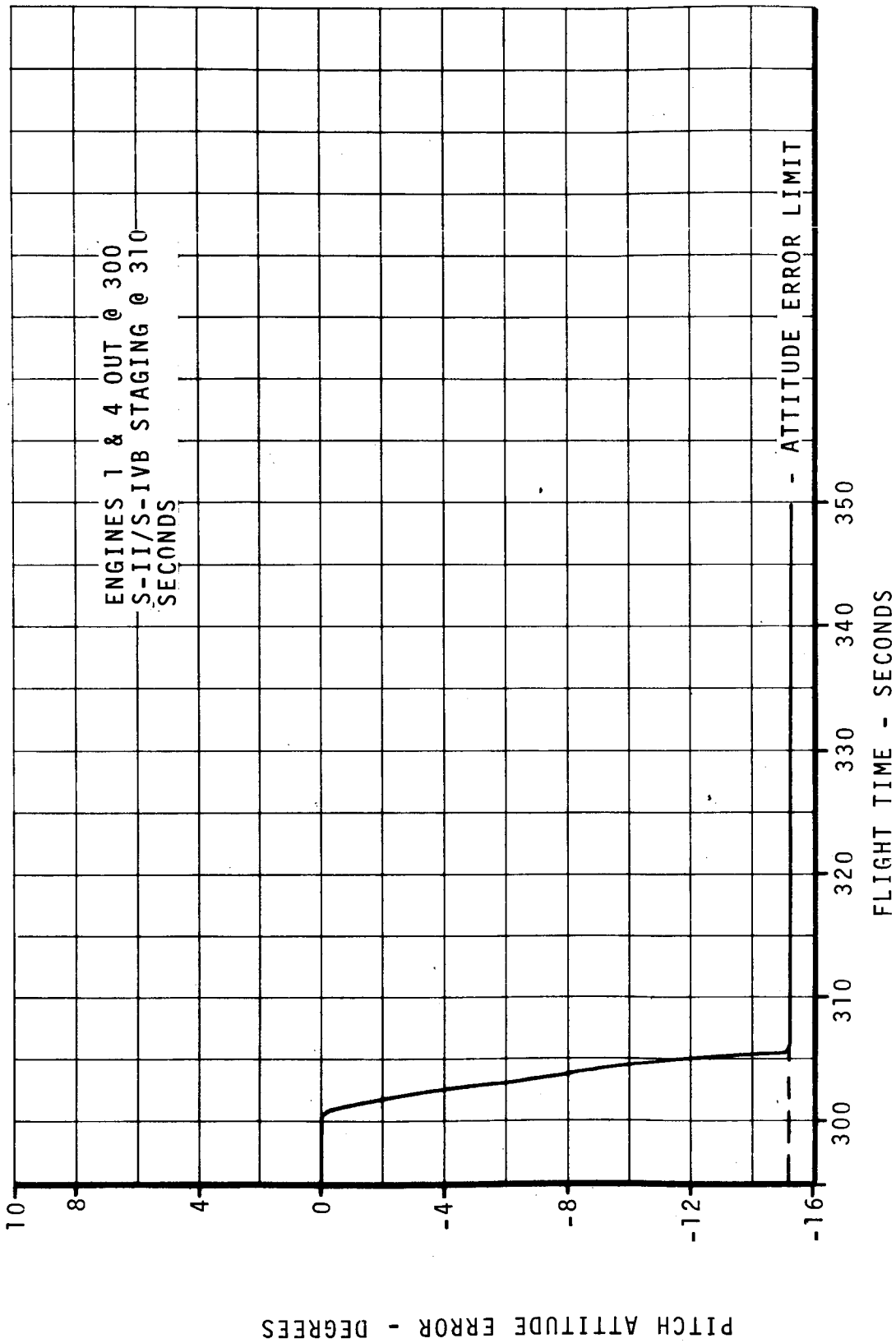

FIGURE 2-80 PITCH ERROR RECOVERY TRANSIENT - EARLY S-II/S-IVB STAGING RESULTING IN LOSS OF CONTROL

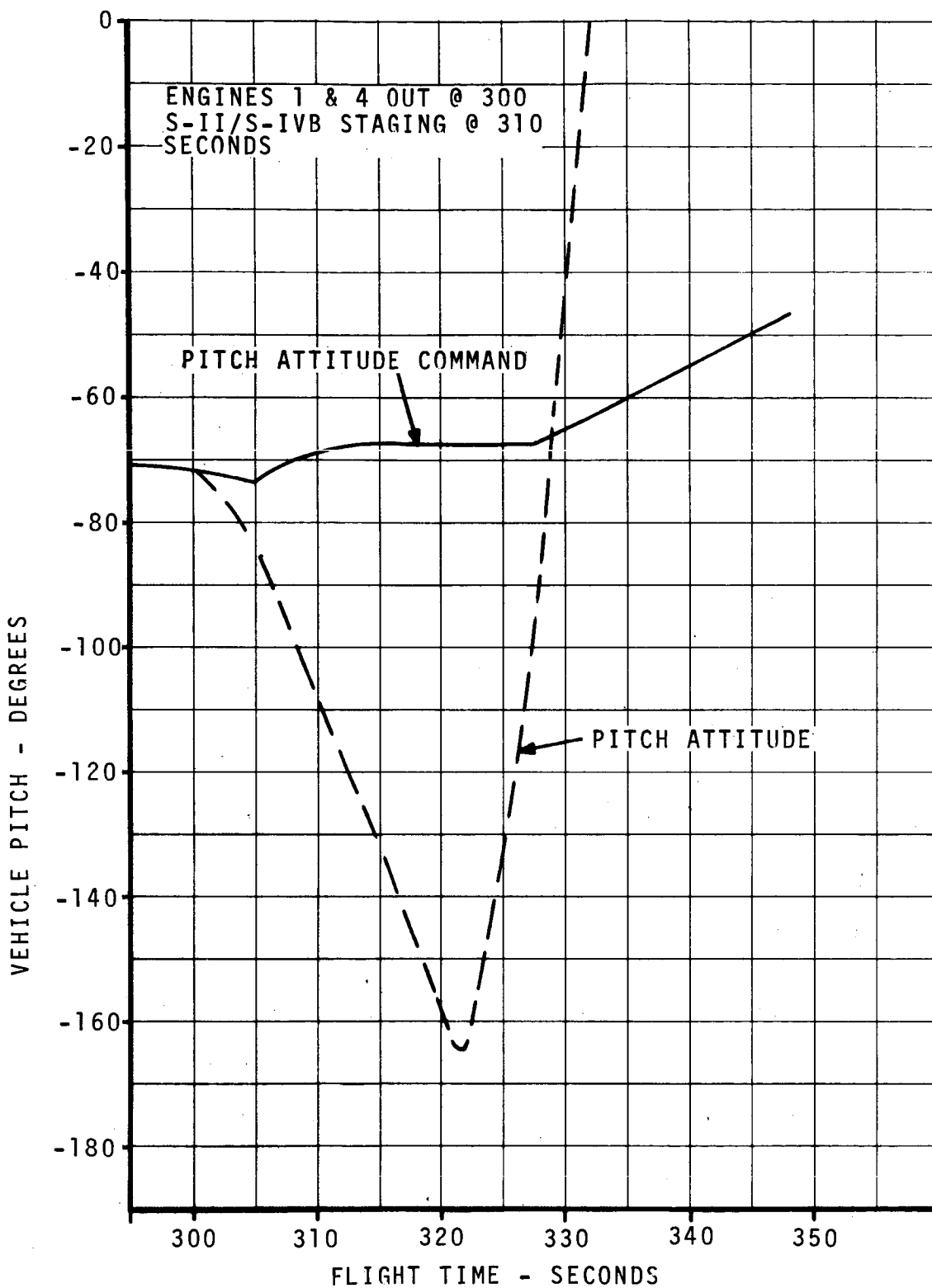

FIGURE 2-81 PITCH ATTITUDE AND COMMAND - EARLY S-II/S-IVB STAGING RESULTING IN LOSS OF CONTROL

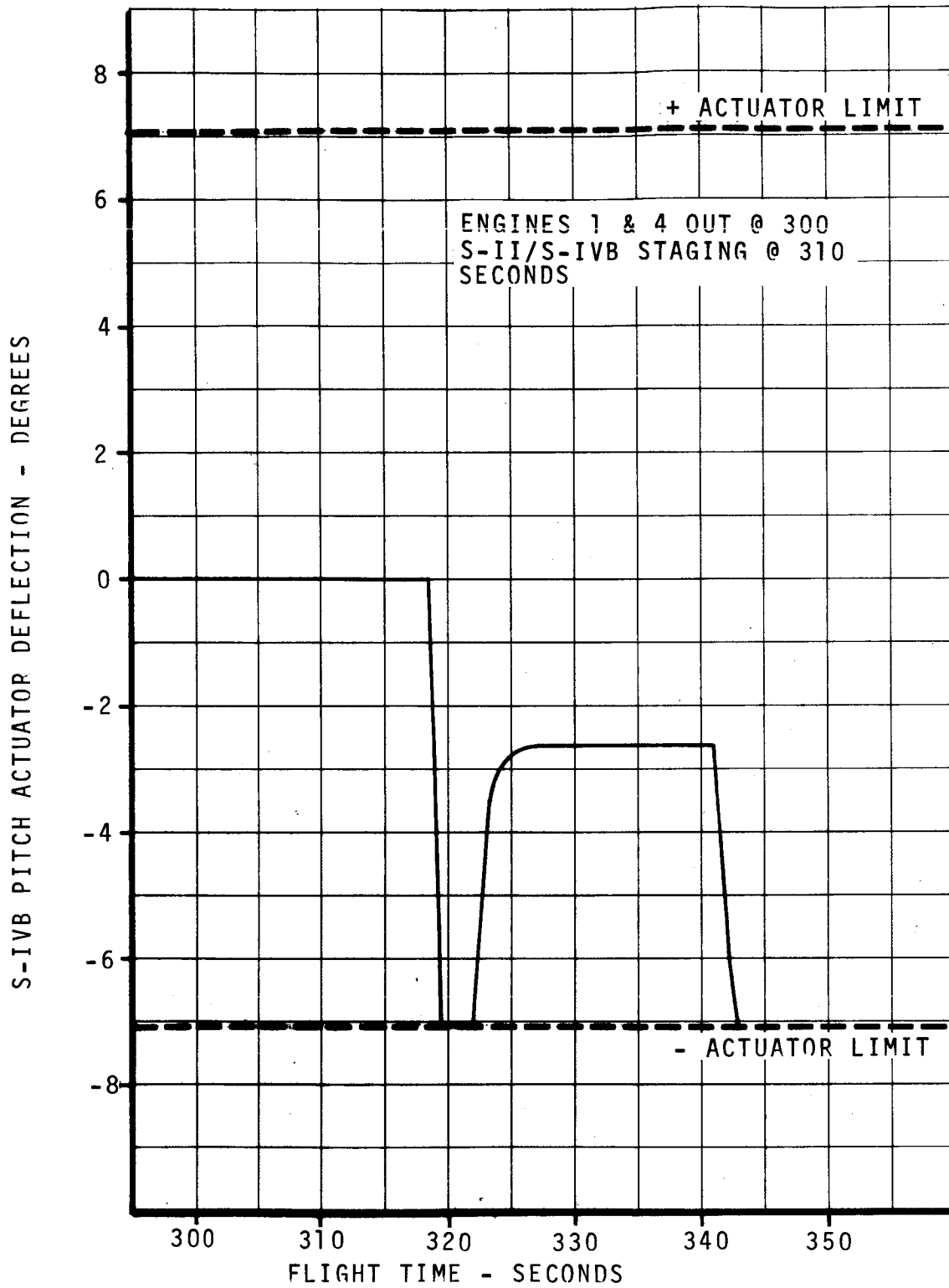

FIGURE 2-82 S-IVB PITCH ACTUATOR RESPONSE - EARLY S-II/S-IVB STAGING RESULTING IN LOSS OF CONTROL

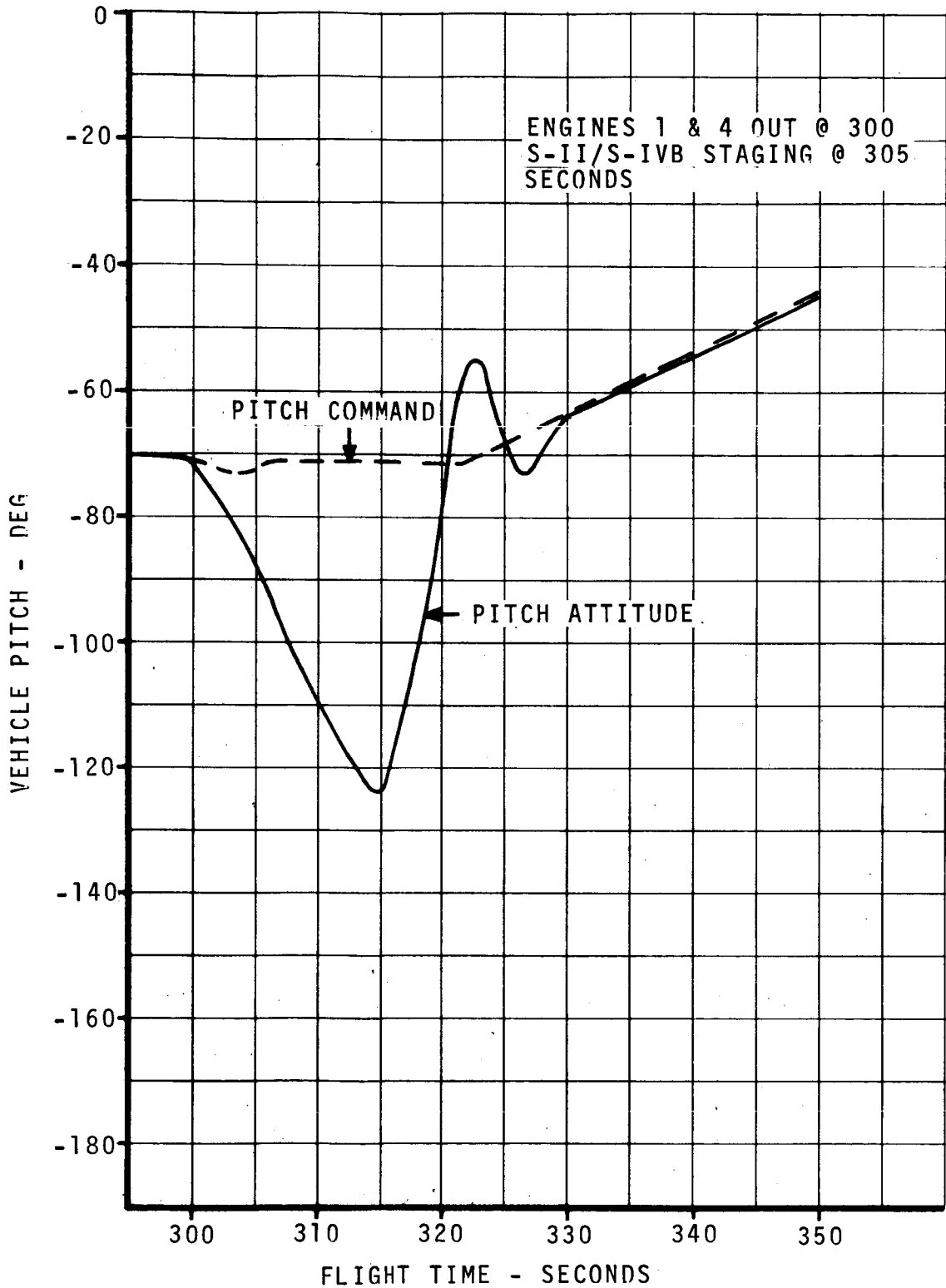

FIGURE 2-83 PITCH ATTITUDE AND COMMAND - EARLY S-II/S-IVB STAGING REGAINING CONTROL

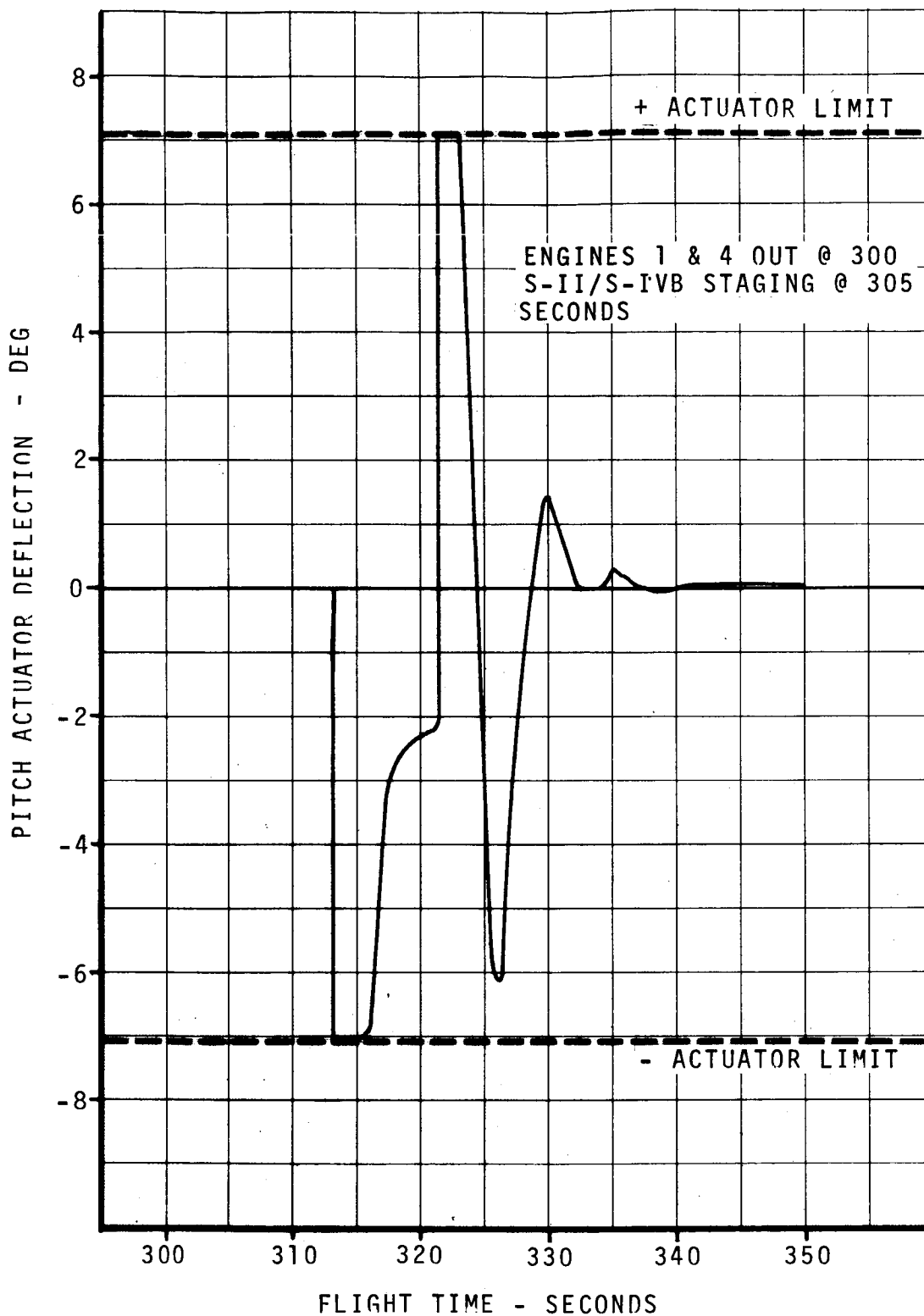

FIGURE 2-84 S-IVB ACTUATOR RESPONSE - EARLY S-II/S-IVB STAGING REGAINING CONTROL

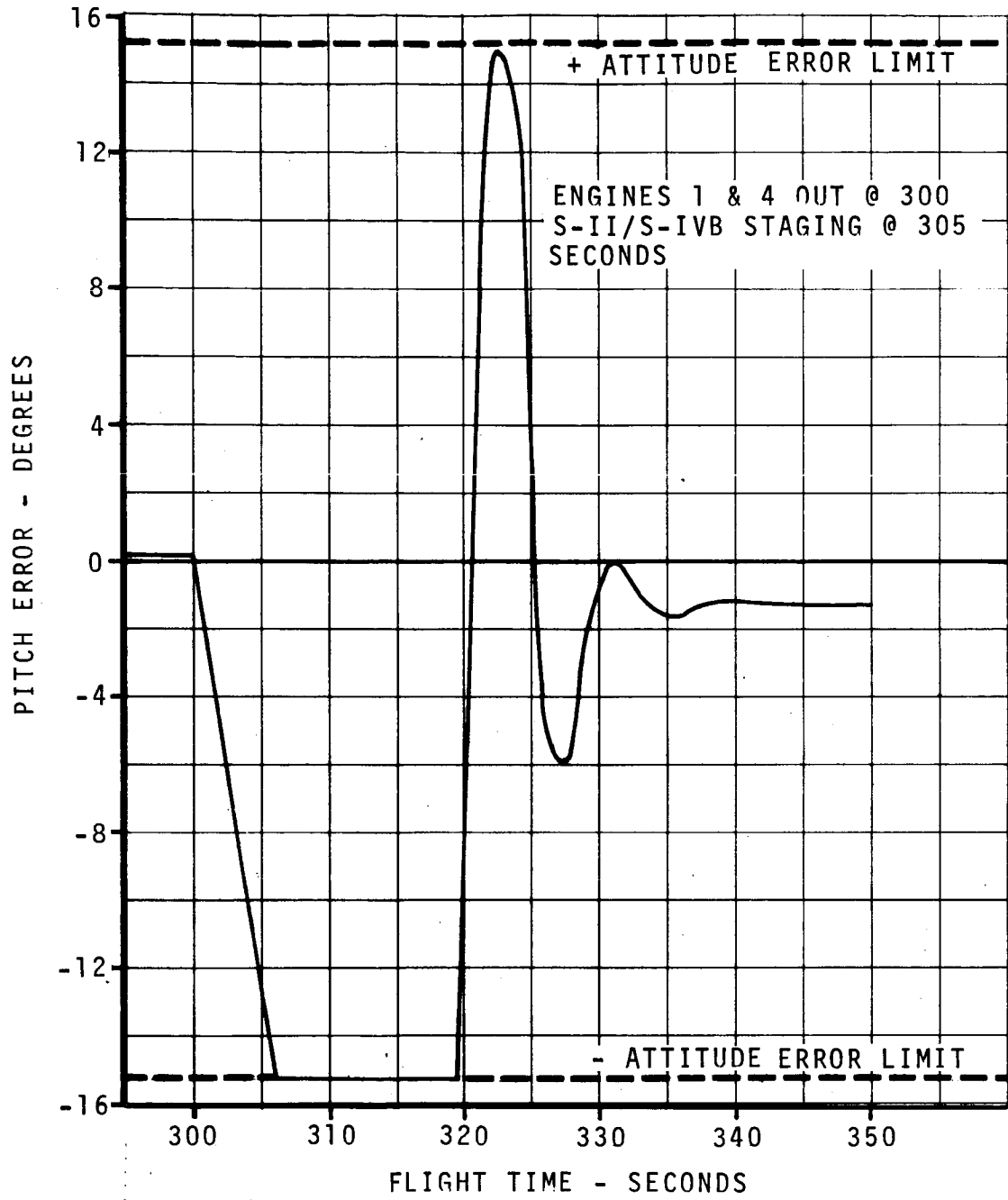

FIGURE 2-85 PITCH ERROR RECOVERY TRANSIENT - EARLY S-II/S-IVB STAGING REGAINING CONTROL

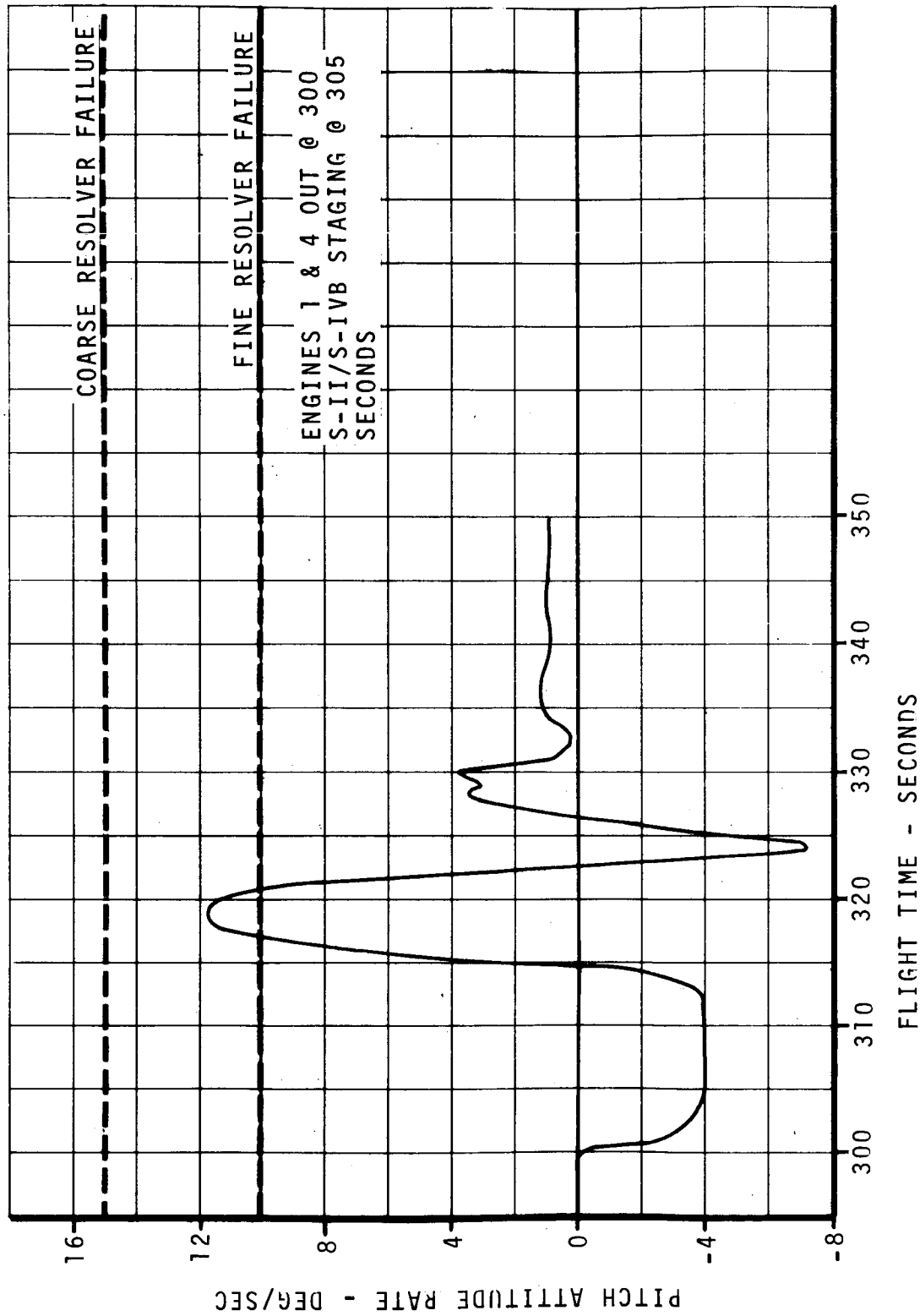

FIGURE 2-86 PITCH RATE RECOVERY TRANSIENT - EARLY S-II/S-IVB STAGING REGAINING CONTROL

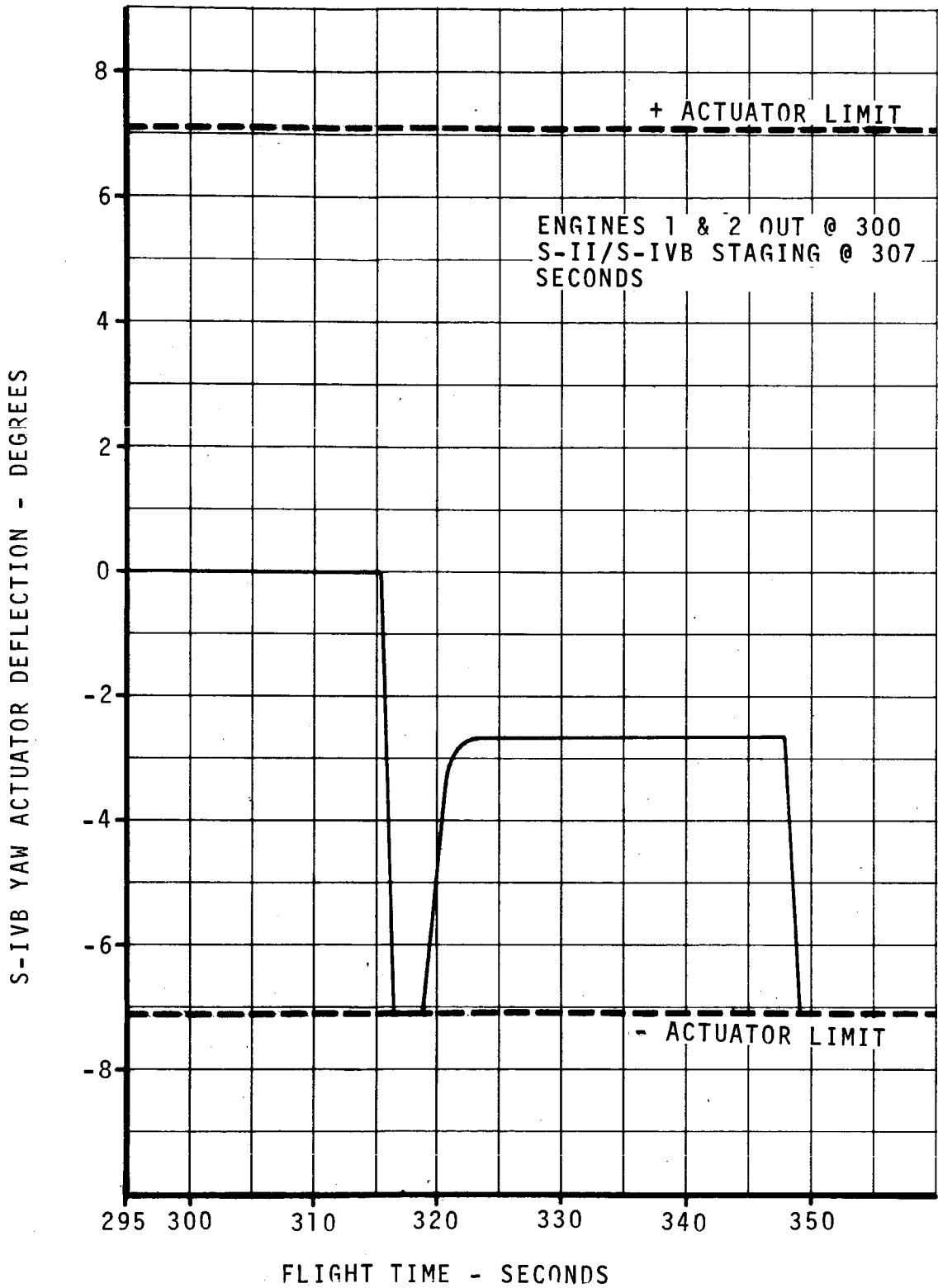

FIGURE 2-87 S-IVB YAW ACTUATOR RESPONSE - EARLY S-II/S-IVB STAGING RESULTING IN LOSS OF CONTROL

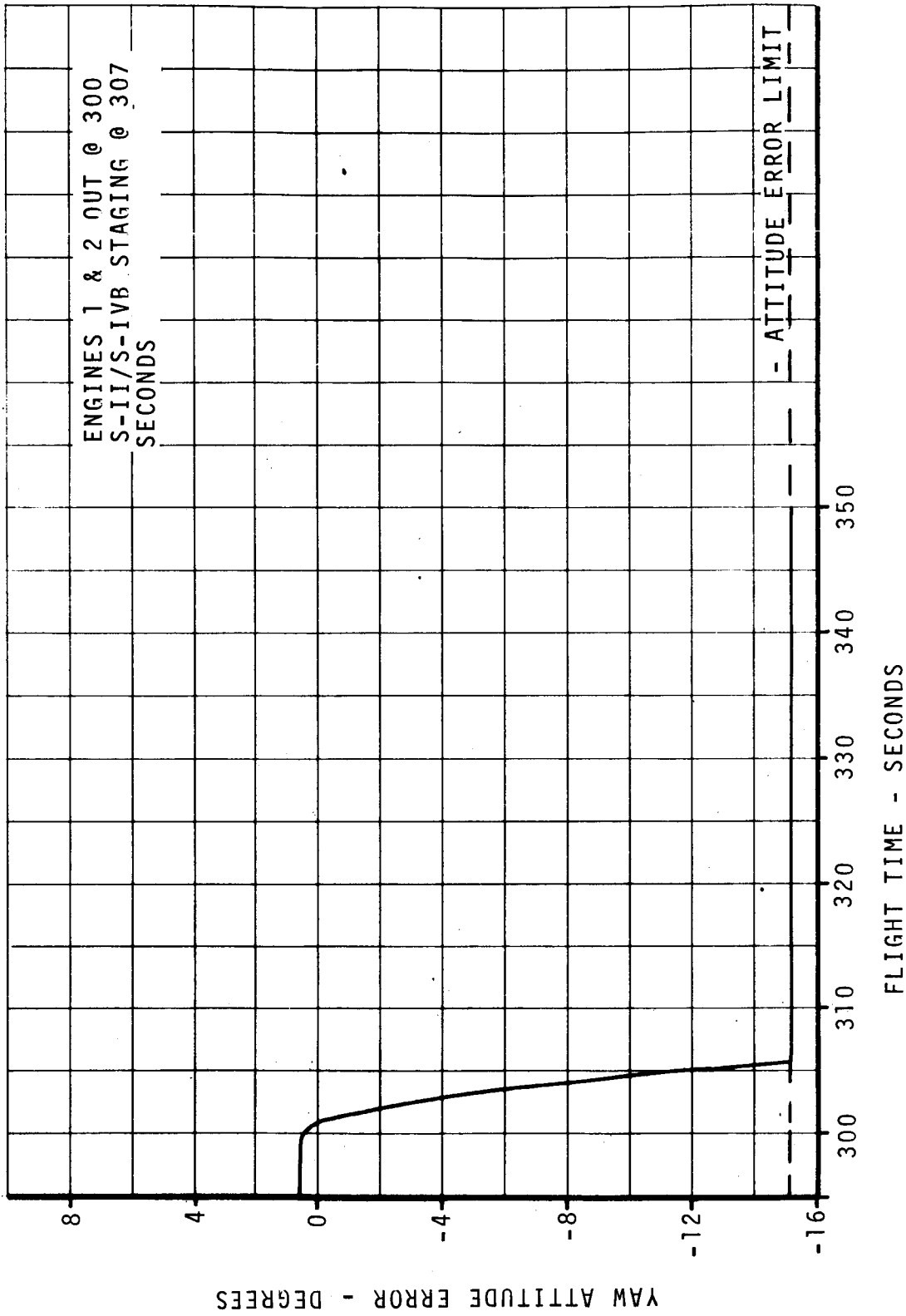

FIGURE 2-88 YAW ERROR RECOVERY TRANSIENT - EARLY S-II/S-IVB STAGING RESULTING IN LOSS OF CONTROL

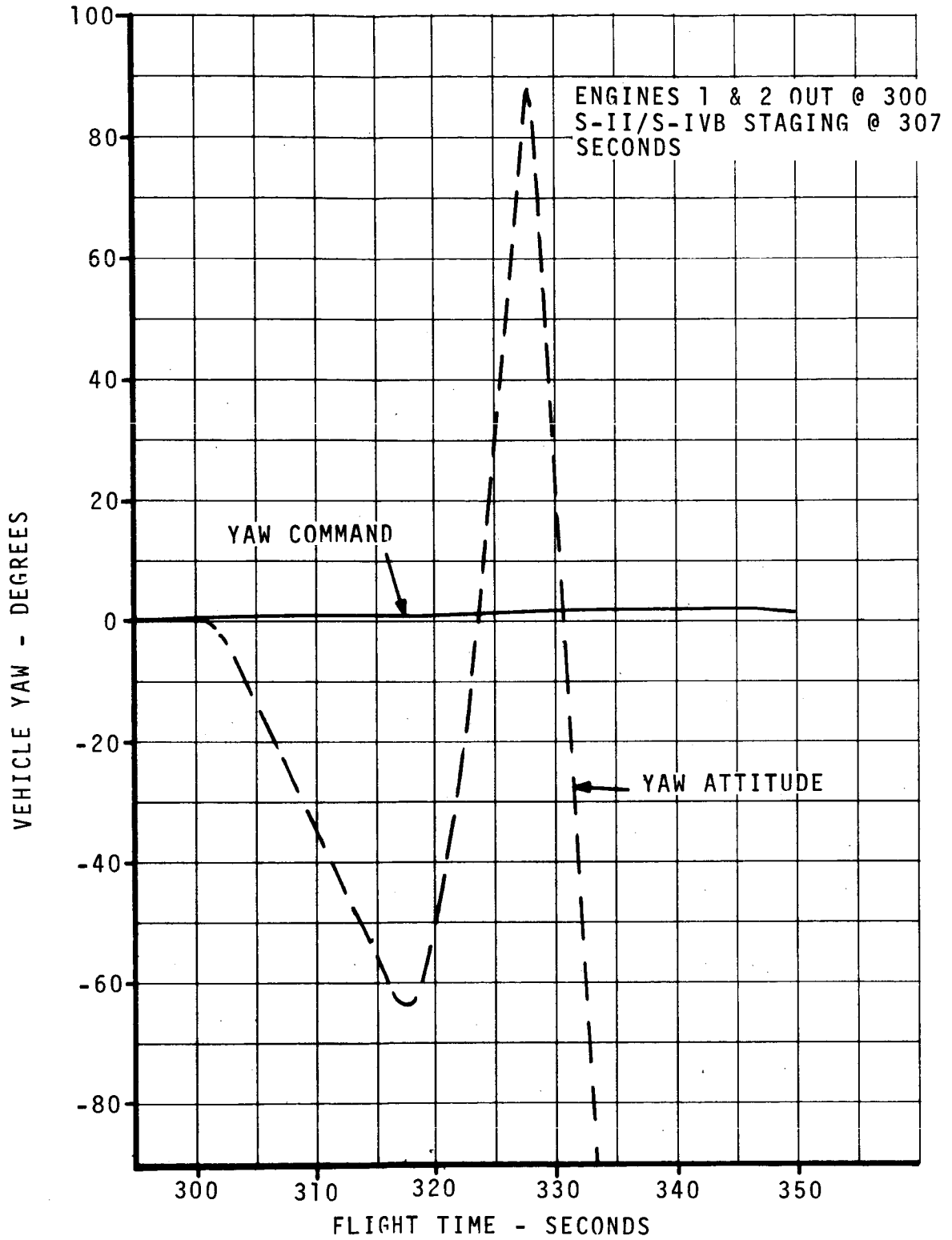

FIGURE 2-89 YAW ATTITUDE AND COMMAND - EARLY S-II/S-IVB STAGING RESULTING IN LOSS OF CONTROL

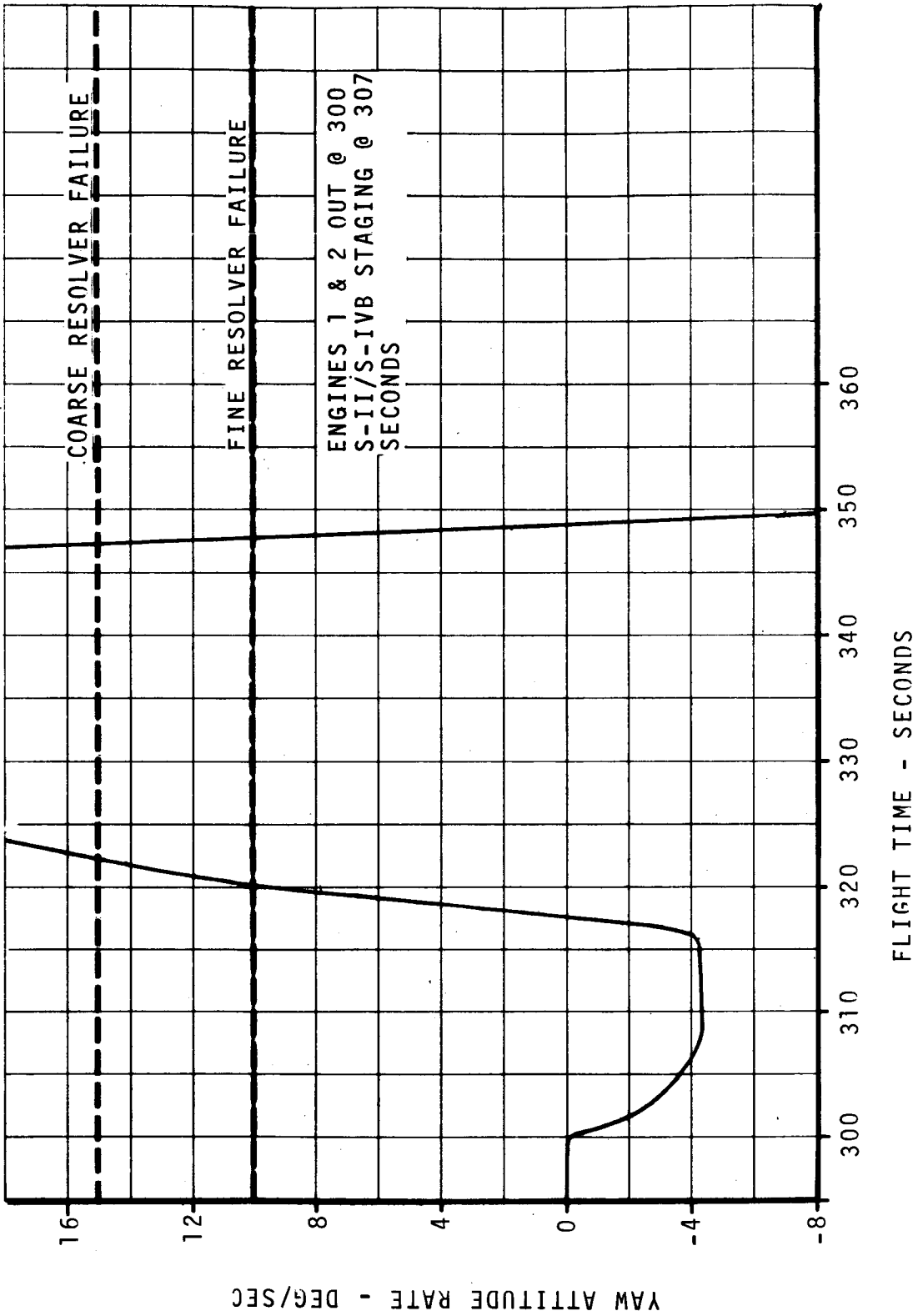

FIGURE 2-90 YAW RATE RECOVERY TRANSIENT - EARLY S-II/S-IVB STAGING RESULTING IN LOSS OF CONTROL

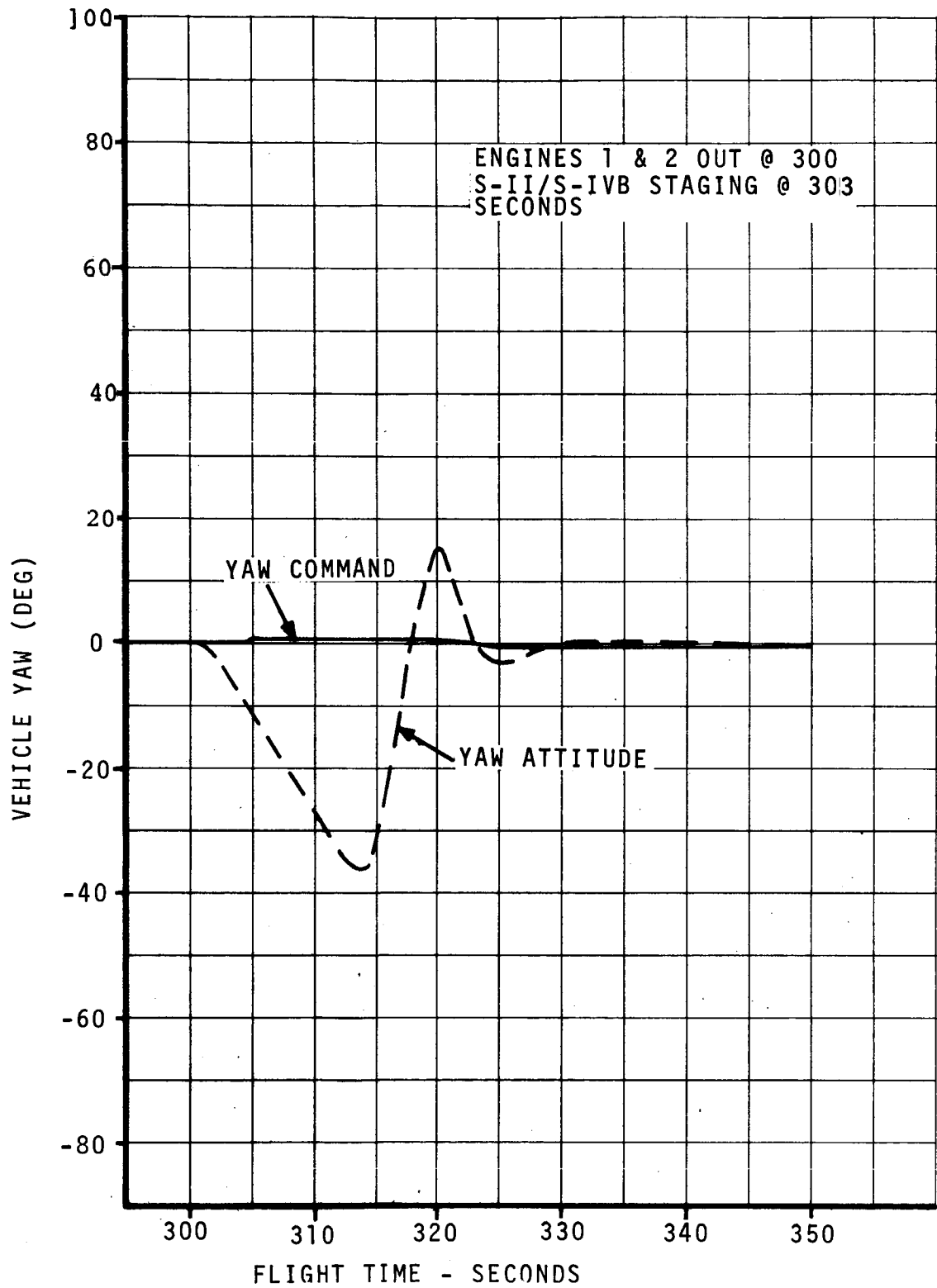

FIGURE 2-91 YAW ATTITUDE AND COMMAND - EARLY S-II/S-IVB STAGING REGAINING CONTROL

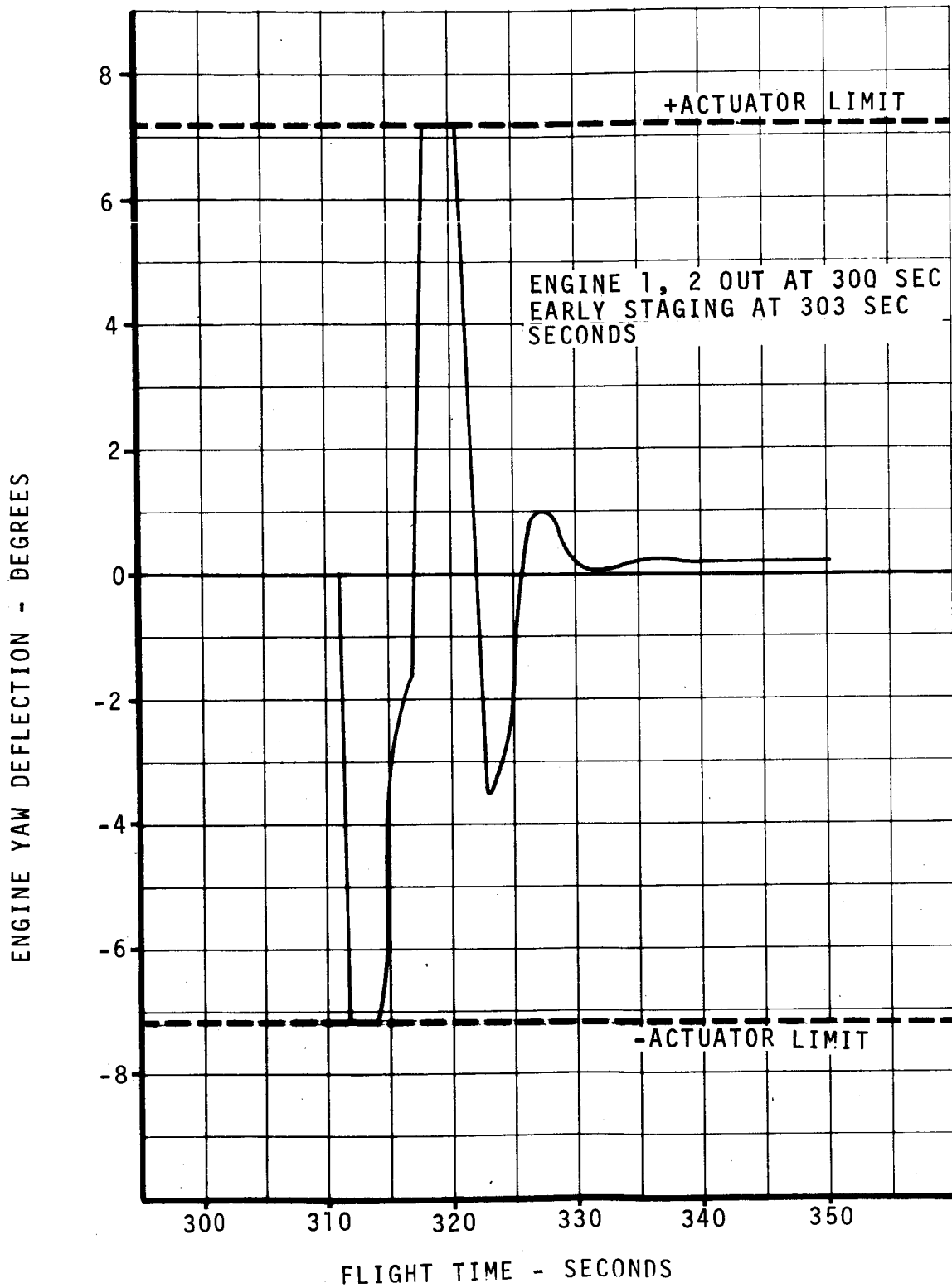

FIGURE 2-92 S-IVB YAW ACTUATOR RESPONSE - EARLY S-II/S-IVB STAGING REGAINING CONTROL

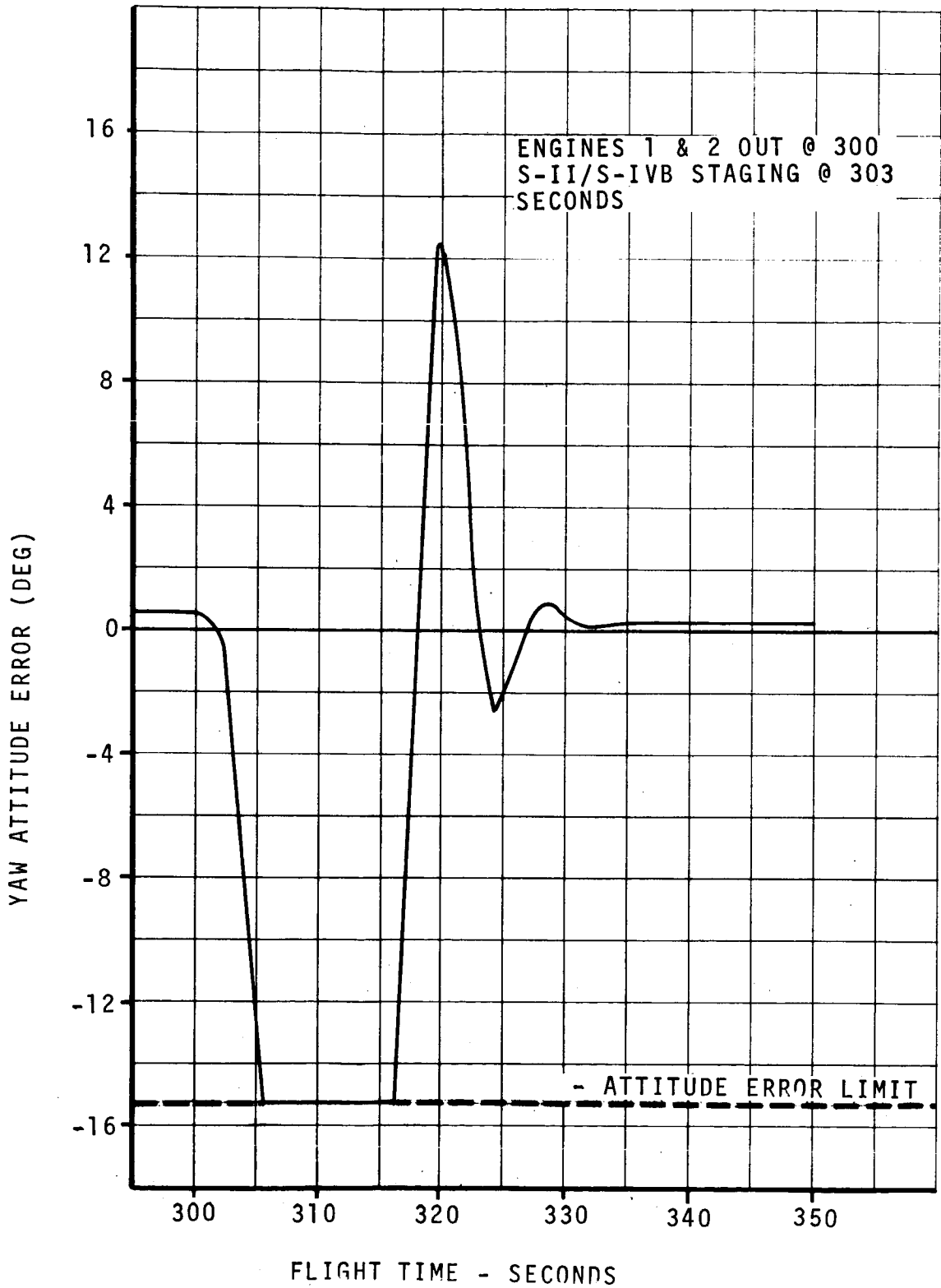

FIGURE 2-93 YAW ERROR RECOVERY TRANSIENT - EARLY S-II/S-IVB STAGING REGAINING CONTROL

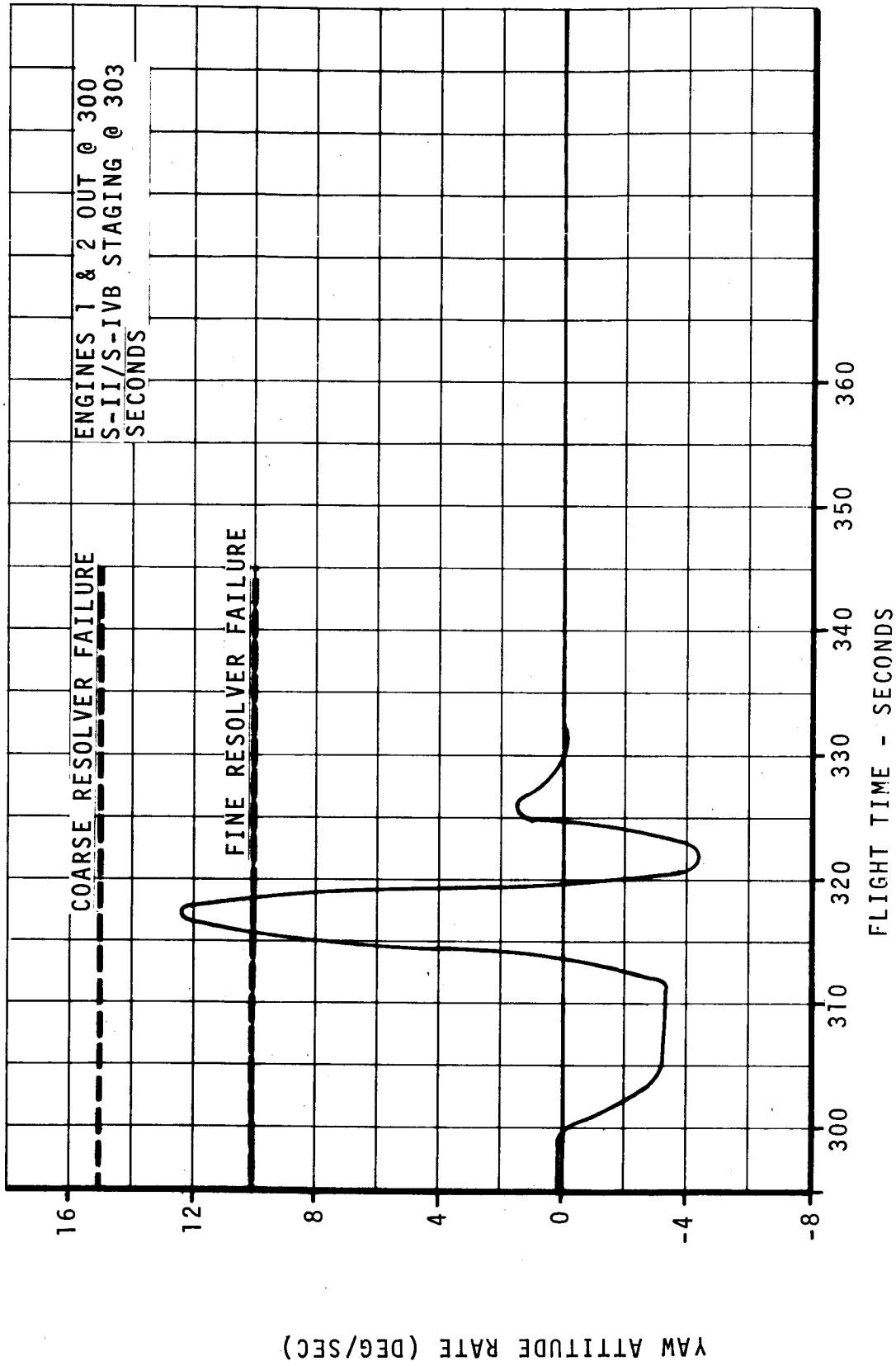
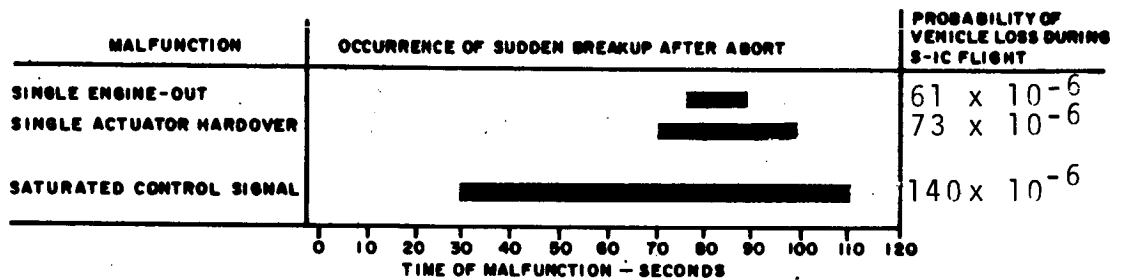

FIGURE 2-94 YAW RATE RECOVERY TRANSIENT - EARLY S-II/S-IVB STAGING REGAINING CONTROL

2.6.20 Abort Tension Loads - S-IC

The abort tension breakup problem is described by 2.4.3 under the vehicle modes of failure section. Examples of this form of vehicle structural failure are shown in Figures 2-95 through 2-106. Termination of engine compressive forces due to mainstage engine shutdown at abort suddenly increases tension forces. The vehicle is already stressed by the malfunction dynamics transient. Sudden structural failure can result after abort, without sufficient time to gain safe LEV escape distance. This may occur for any S-IC malfunction requiring abort in the high-q region. The bar chart below indicates flight times in which a sudden tension breakup can follow abort due to the noted malfunction.



The following table summarizes worst-case time-to-breakup simulation results for higher probability S-IC malfunctions. These results reflect test results of critical joint structural capability.

TABLE 2-VIII SUDDEN BREAKUP AFTER ABORT

STATION	MINIMUM TIME FROM ABORT INITIATION TO BREAKUP - SECONDS		
	ENGINE-OUT	ACTUATOR HARDOVER	SATURATED CONTROL
2832	.83	1.18	.46
2746	.94	1.11	.48
1760	.44	.95	.47
1564	.44	.65	.48

No sudden breakup after abort from nominal flight is encountered with winds up to 95th percentile.

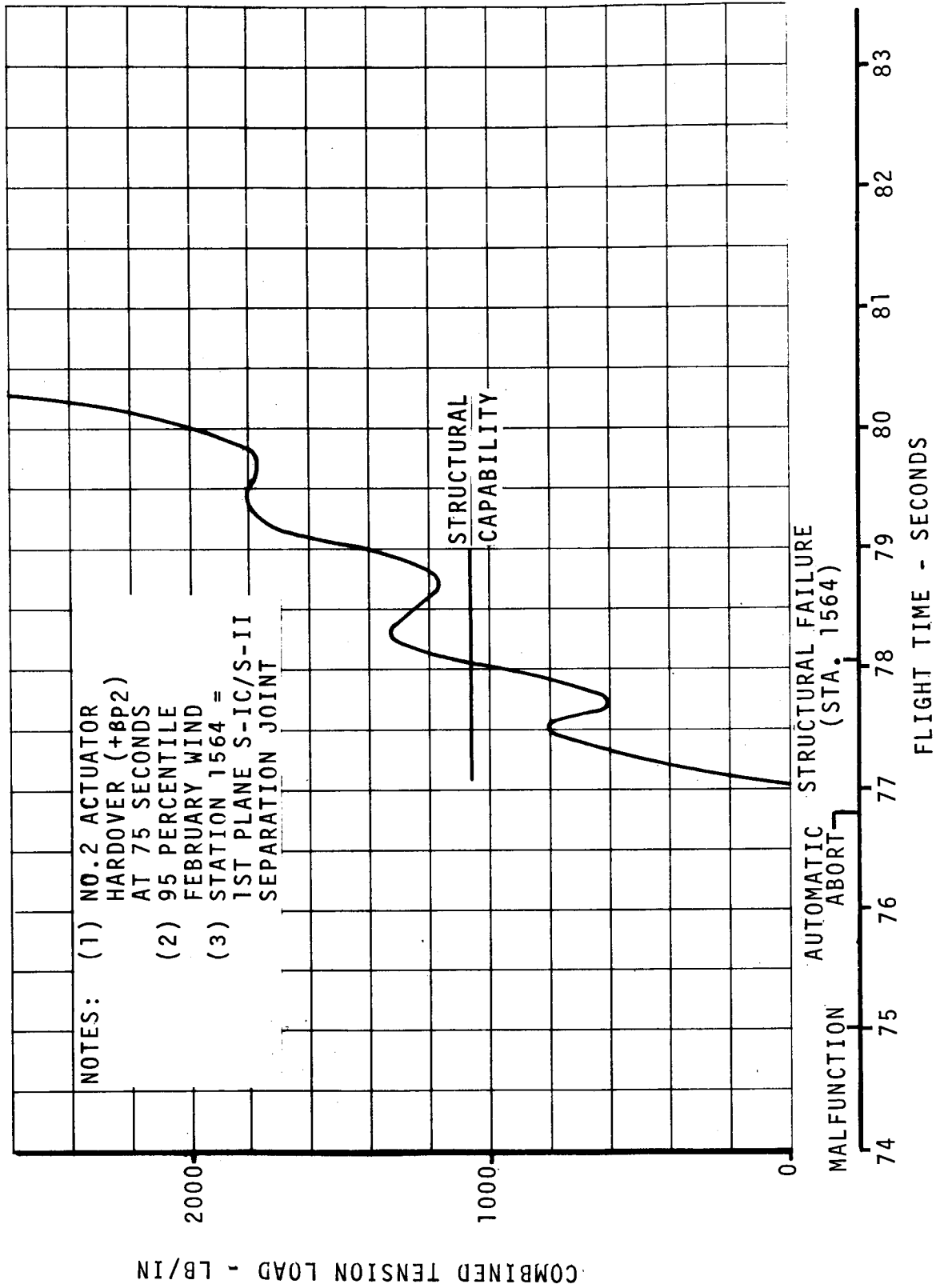
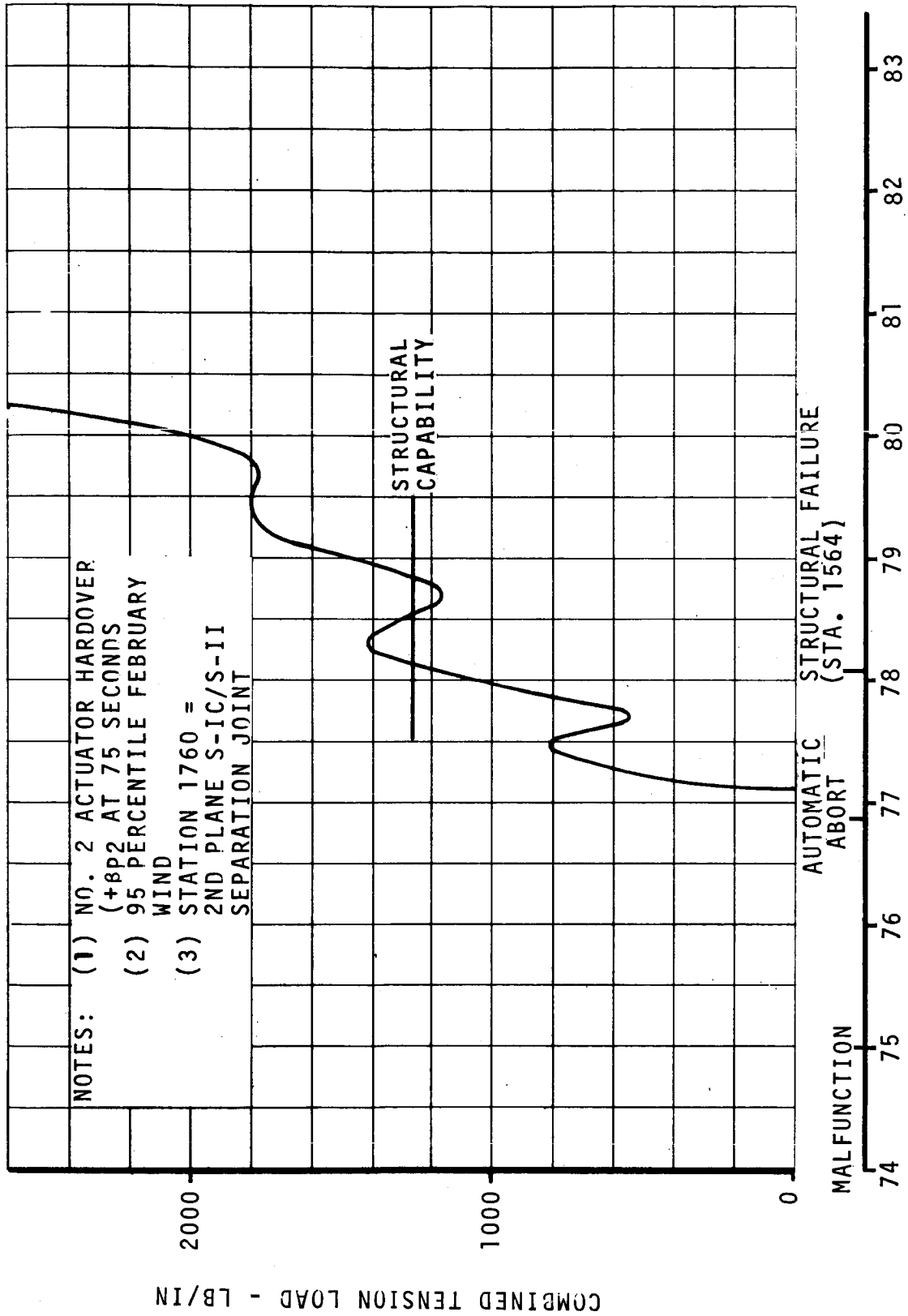

FIGURE 2-95 TENSION LOAD AT STA. 1564 (ACTUATOR HARDOVER)



NOTES: (1) NO. 2 ACTUATOR HARDOVER (+8p2 AT 75 SECONDS)
 (2) 95 PERCENTILE FEBRUARY WIND
 (3) STATION 1760 = 2ND PLANE S-IC/S-II SEPARATION JOINT

STRUCTURAL CAPABILITY

AUTOMATIC ABORT
 STRUCTURAL FAILURE (STA. 1564)

FLIGHT TIME - SECONDS

FIGURE 2-96 TENSION LOAD AT STA. 1760 (ACTUATOR HARDOVER)

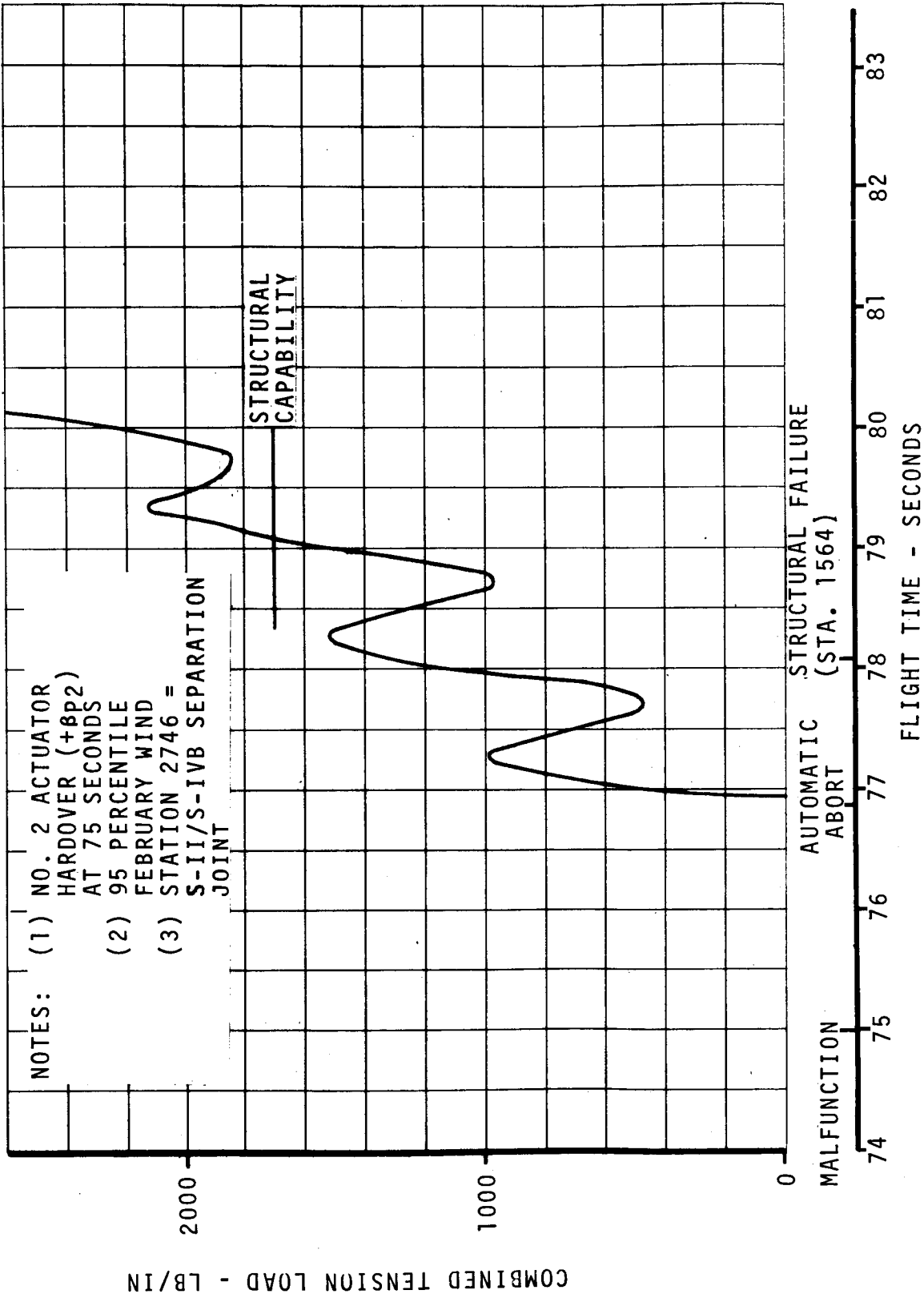

FIGURE 2-97 TENSION LOAD AT STA. 2746 (ACTUATOR HARDOVER)

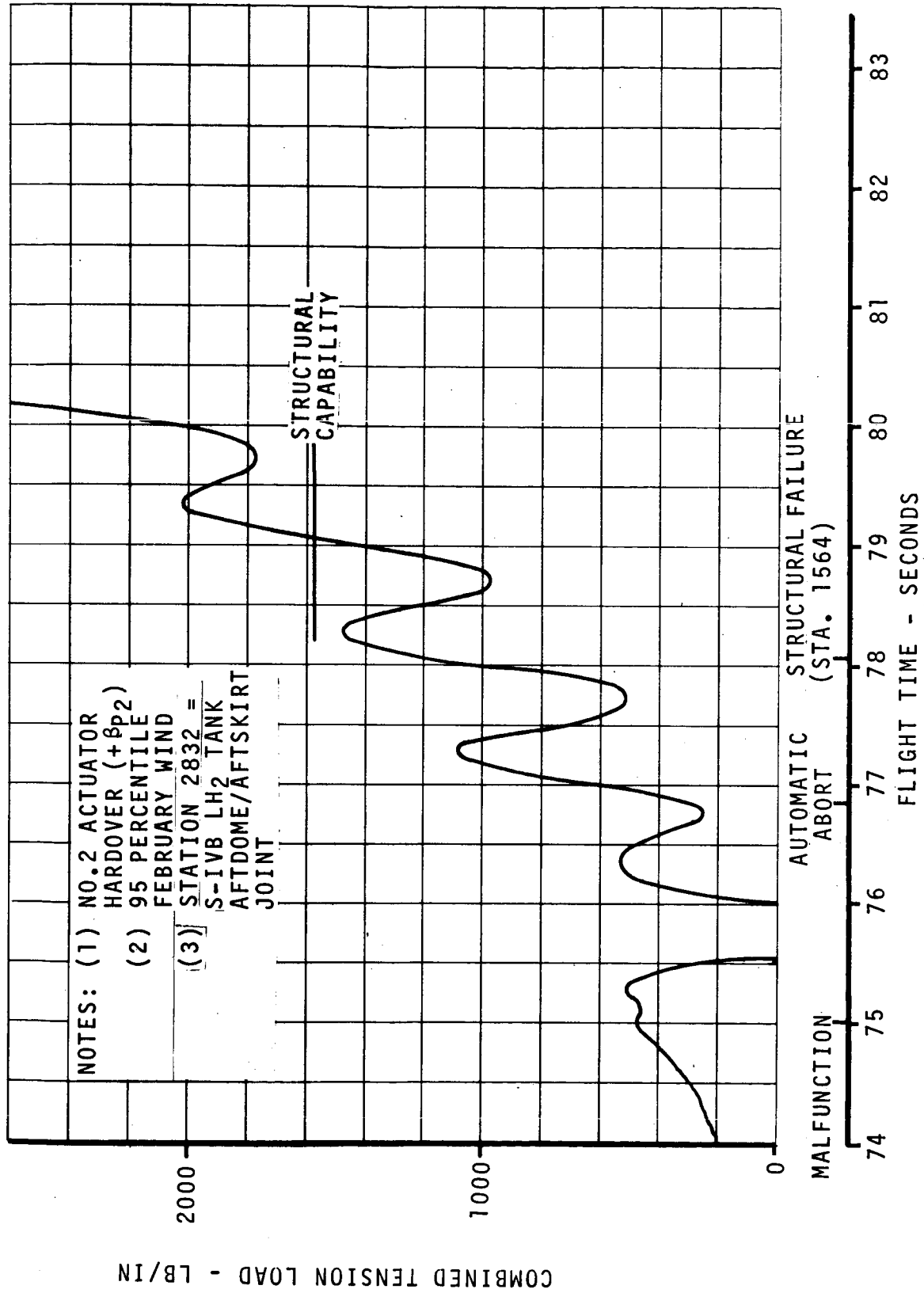

FIGURE 2-98 TENSION LOAD AT STA. 2832 AFT (ACTUATOR HARDOVER)

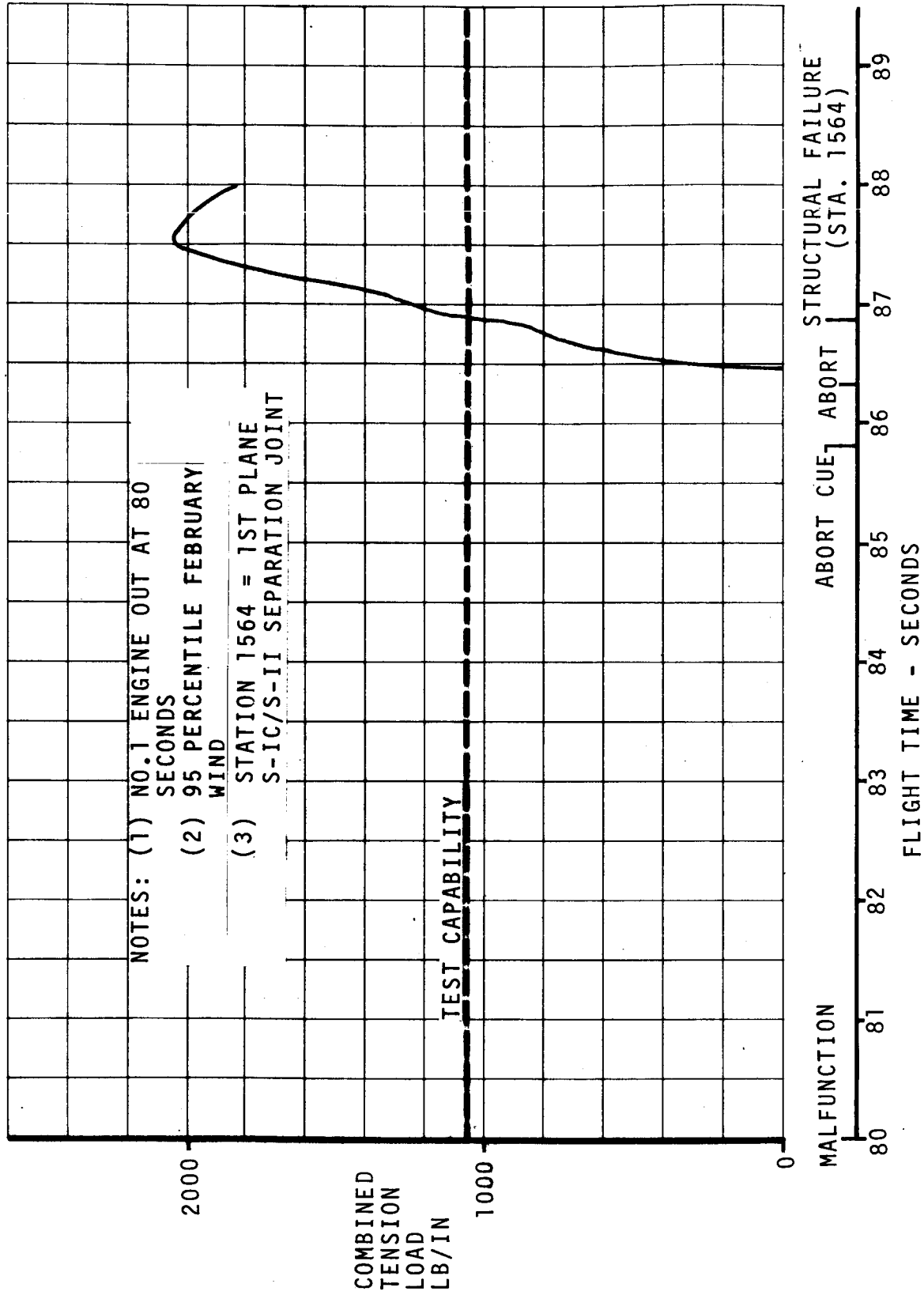

FIGURE 2-99 TENSION LOAD AT STATION 1564 (SINGLE ENGINE OUT)

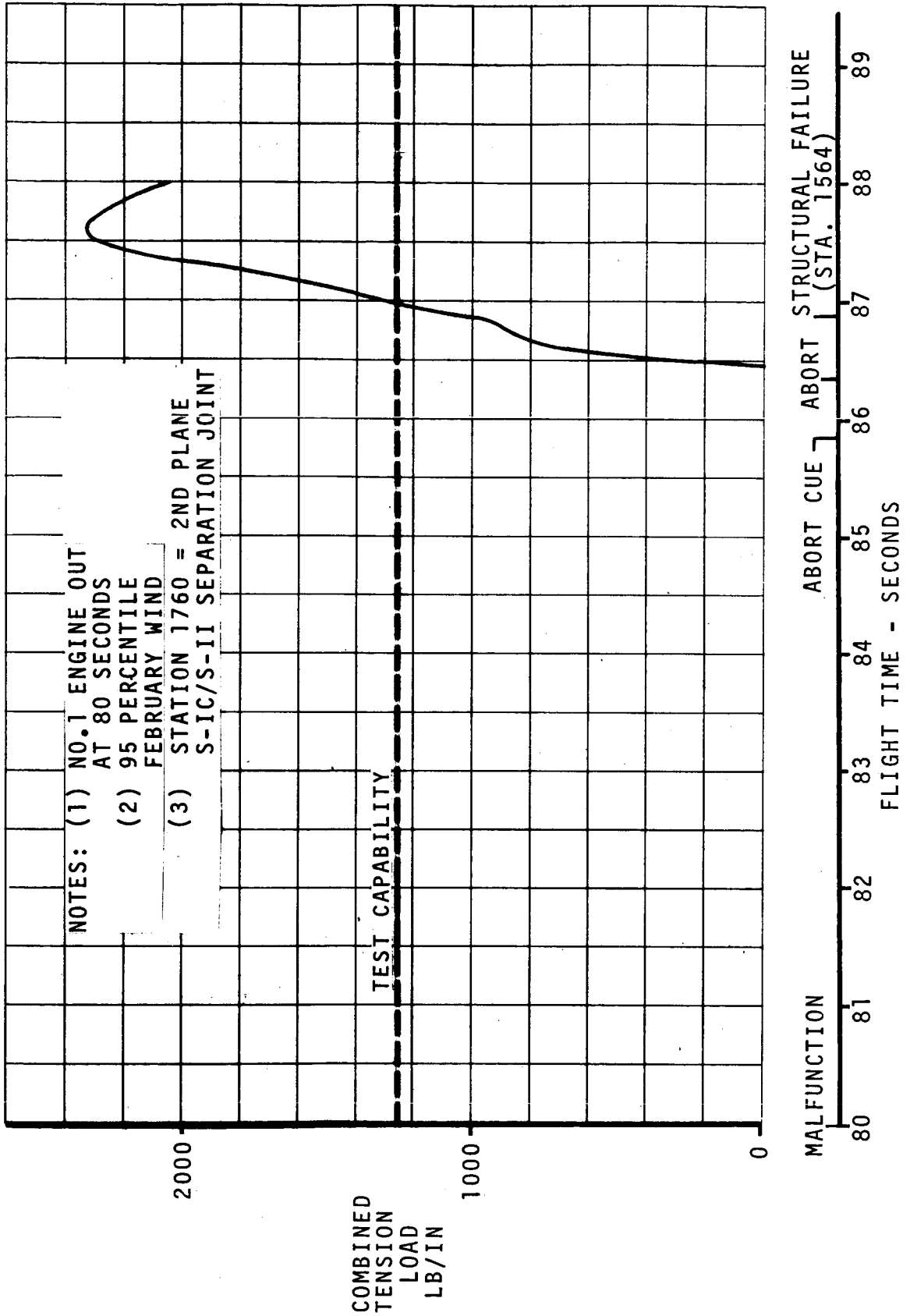

FIGURE 2-100 TENSION LOAD AT STATION 1760 (SINGLE ENGINE OUT)

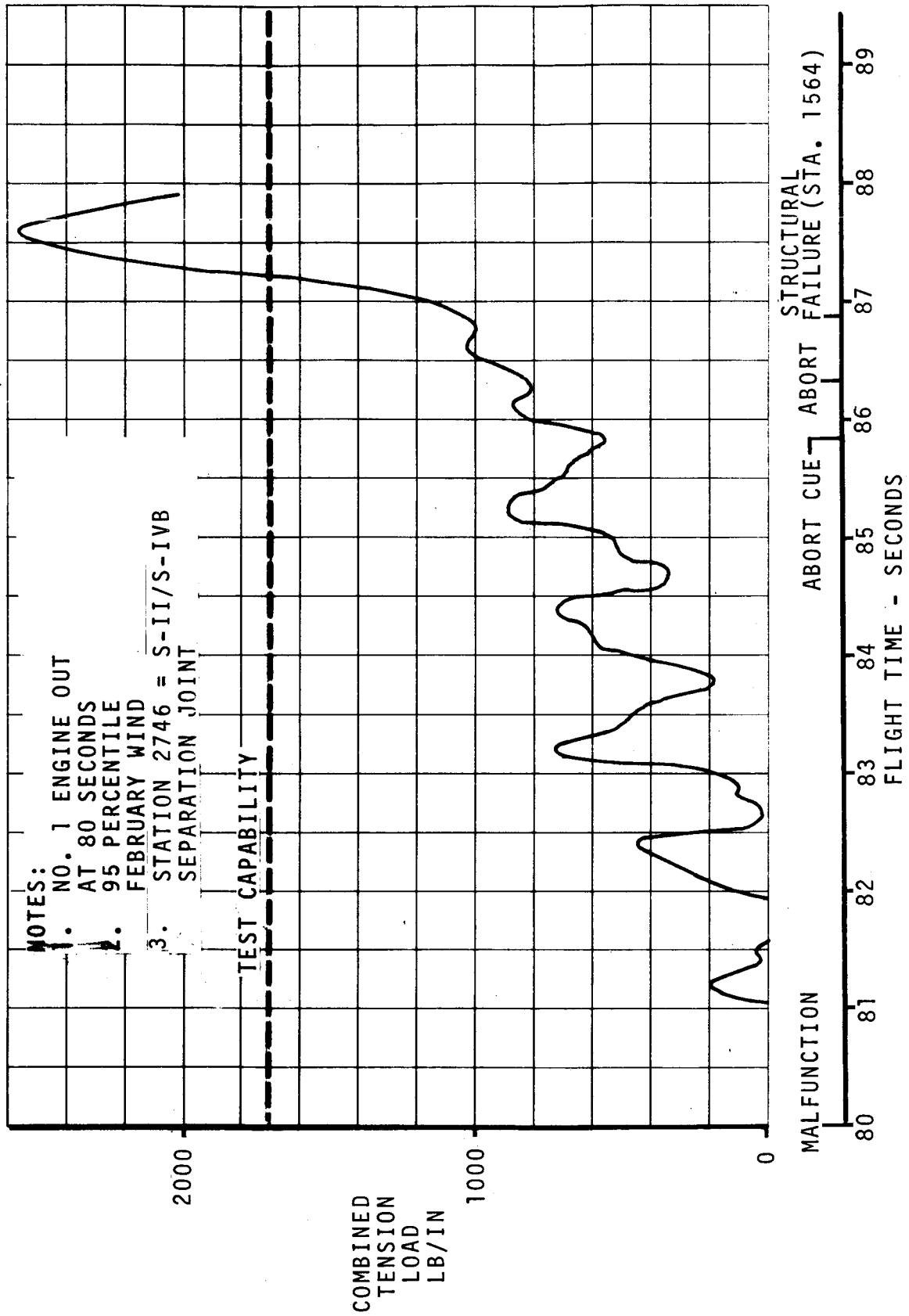

FIGURE 2-101 TENSION LOAD AT STATION 2746 (SINGLE ENGINE OUT)

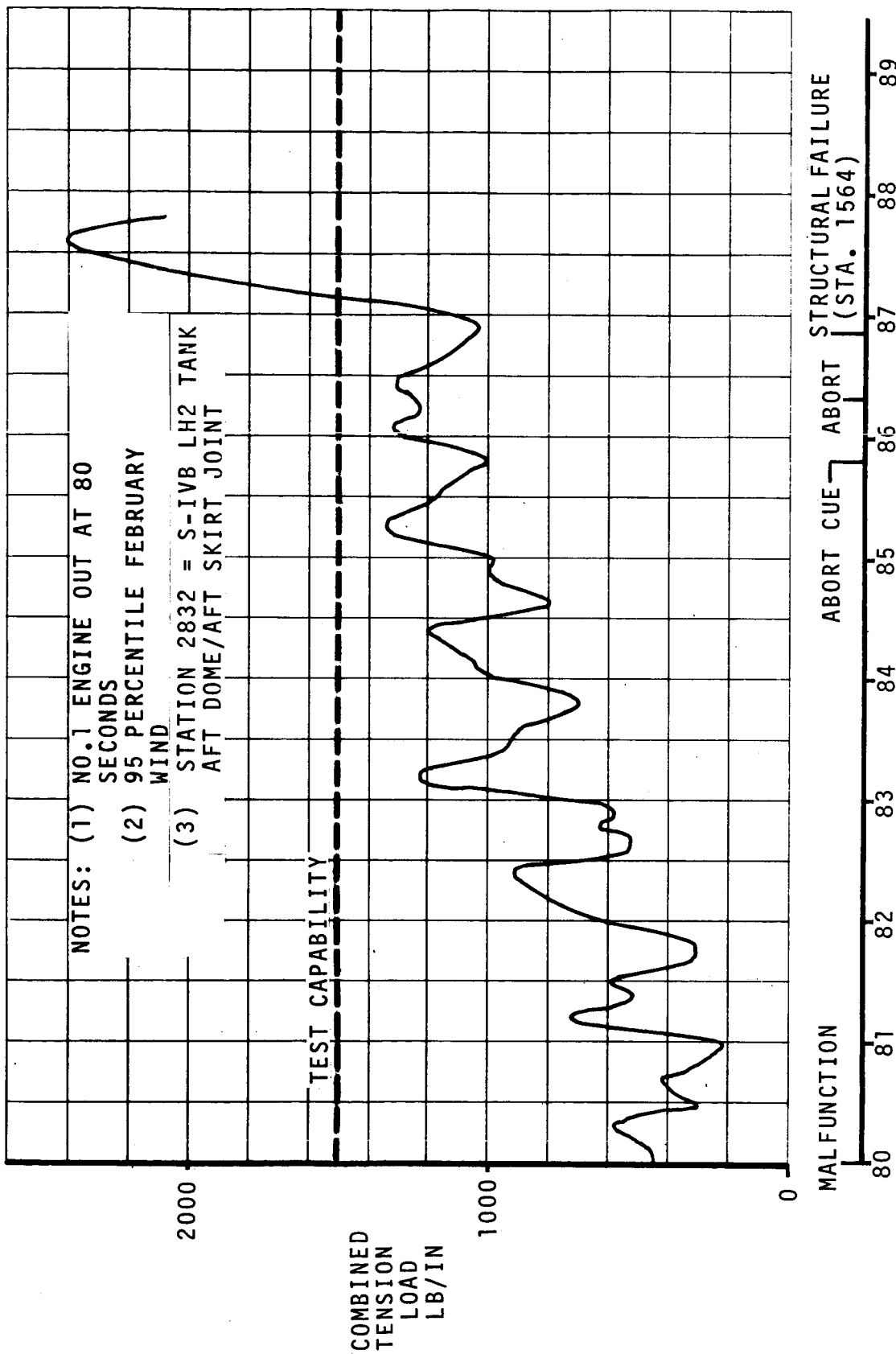

FIGURE 2-102 TENSION LOAD AT STATION 2832 AFT (SINGLE ENGINE OUT)

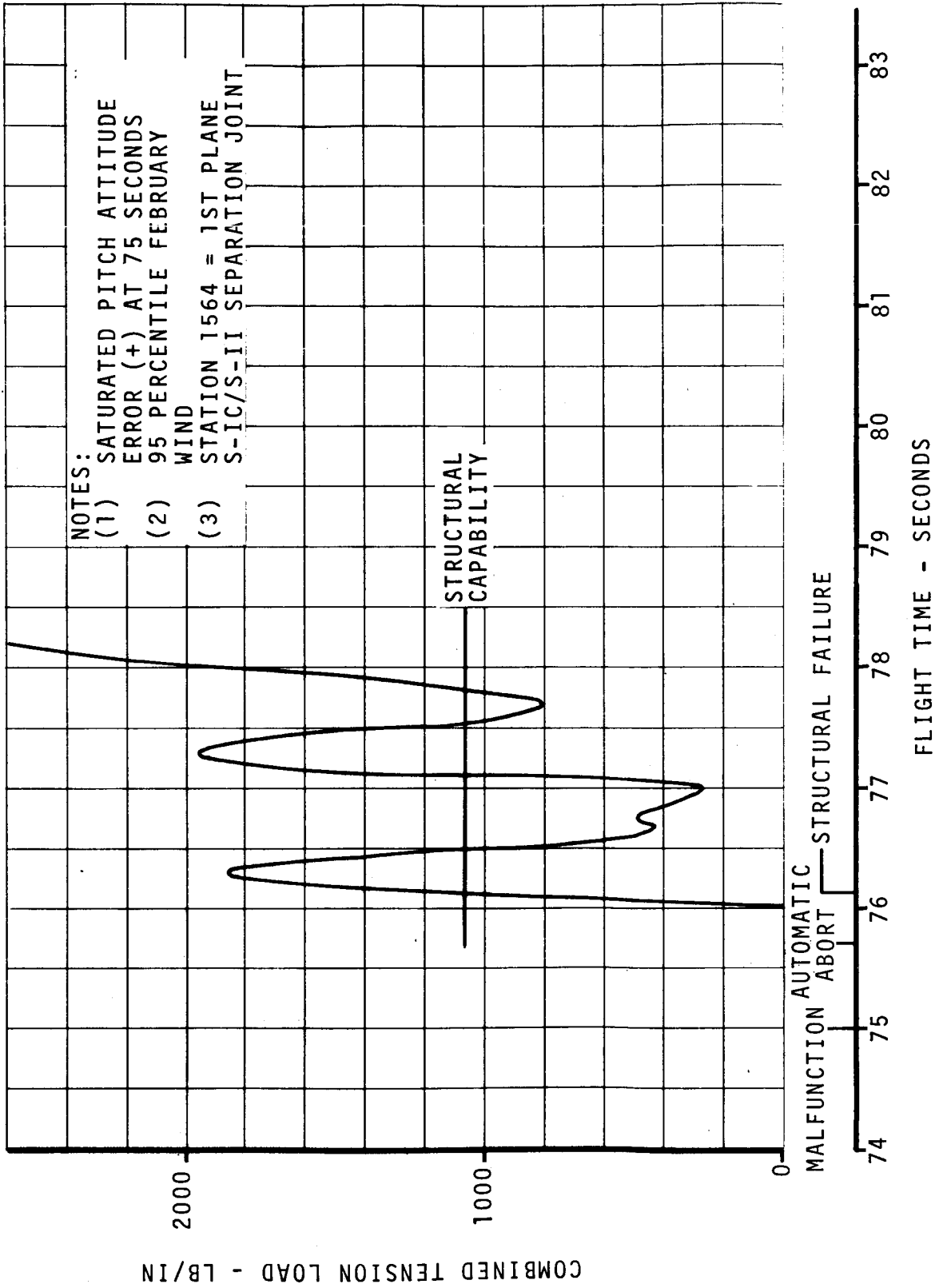

FIGURE 2-103 TENSION LOAD AT STATION 1564 (SATURATED CONTROL SIGNAL)

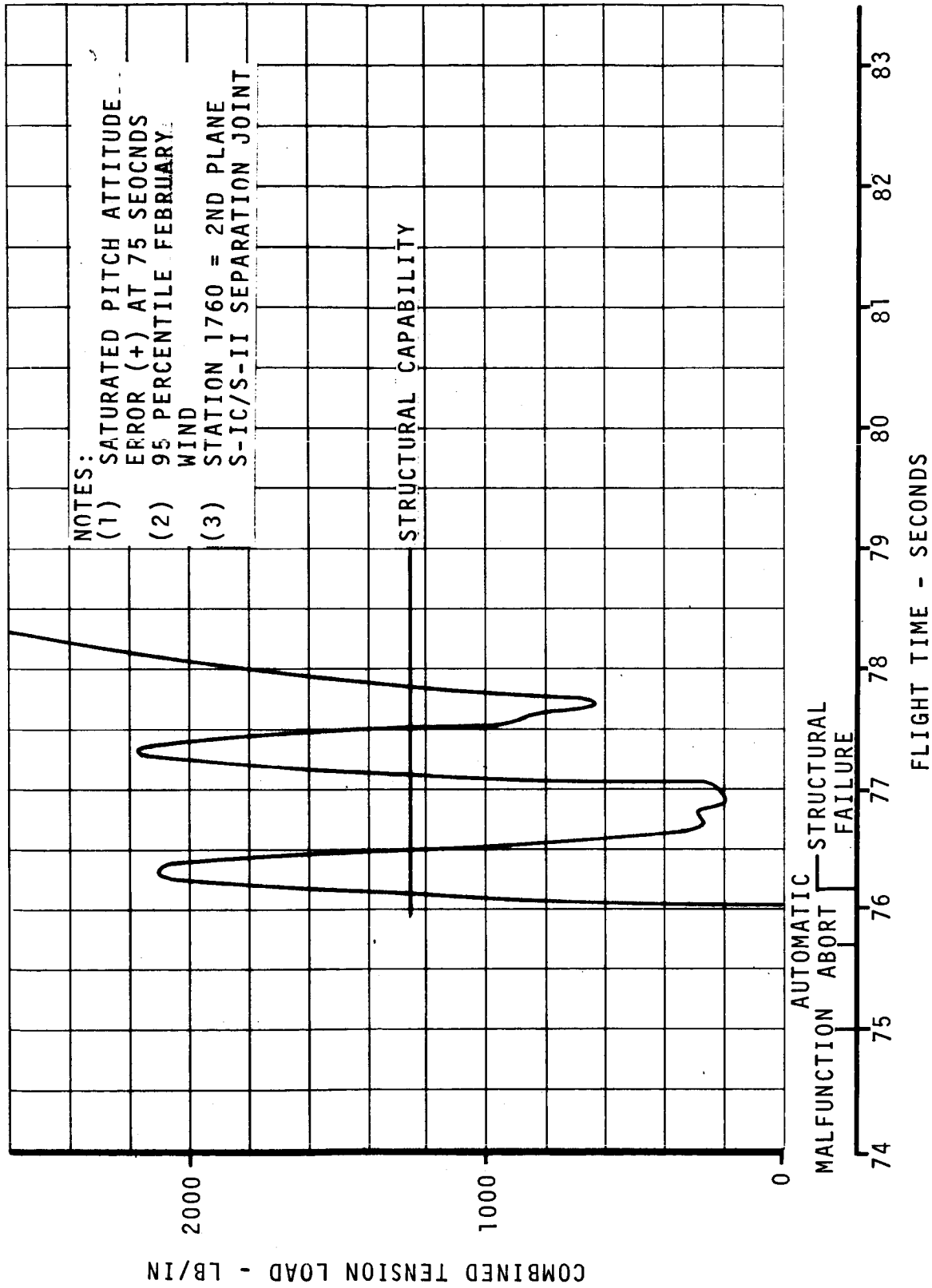

FIGURE 2-104 TENSION LOAD AT STATION 1760 (SATURATED CONTROL SIGNAL)

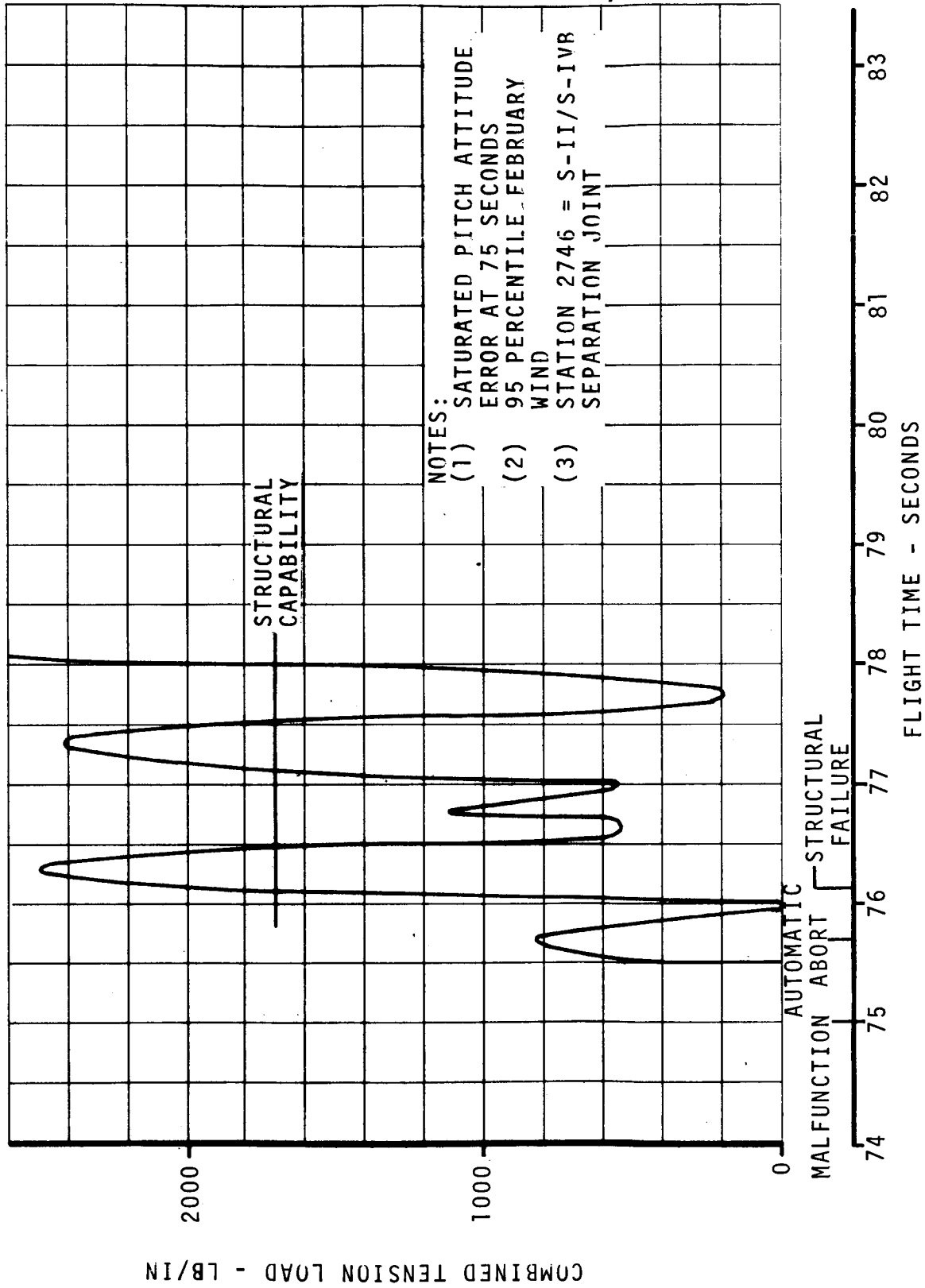

FIGURE 2-105 TENSION LOAD AT STATION 2746 (SATURATED CONTROL SIGNAL)

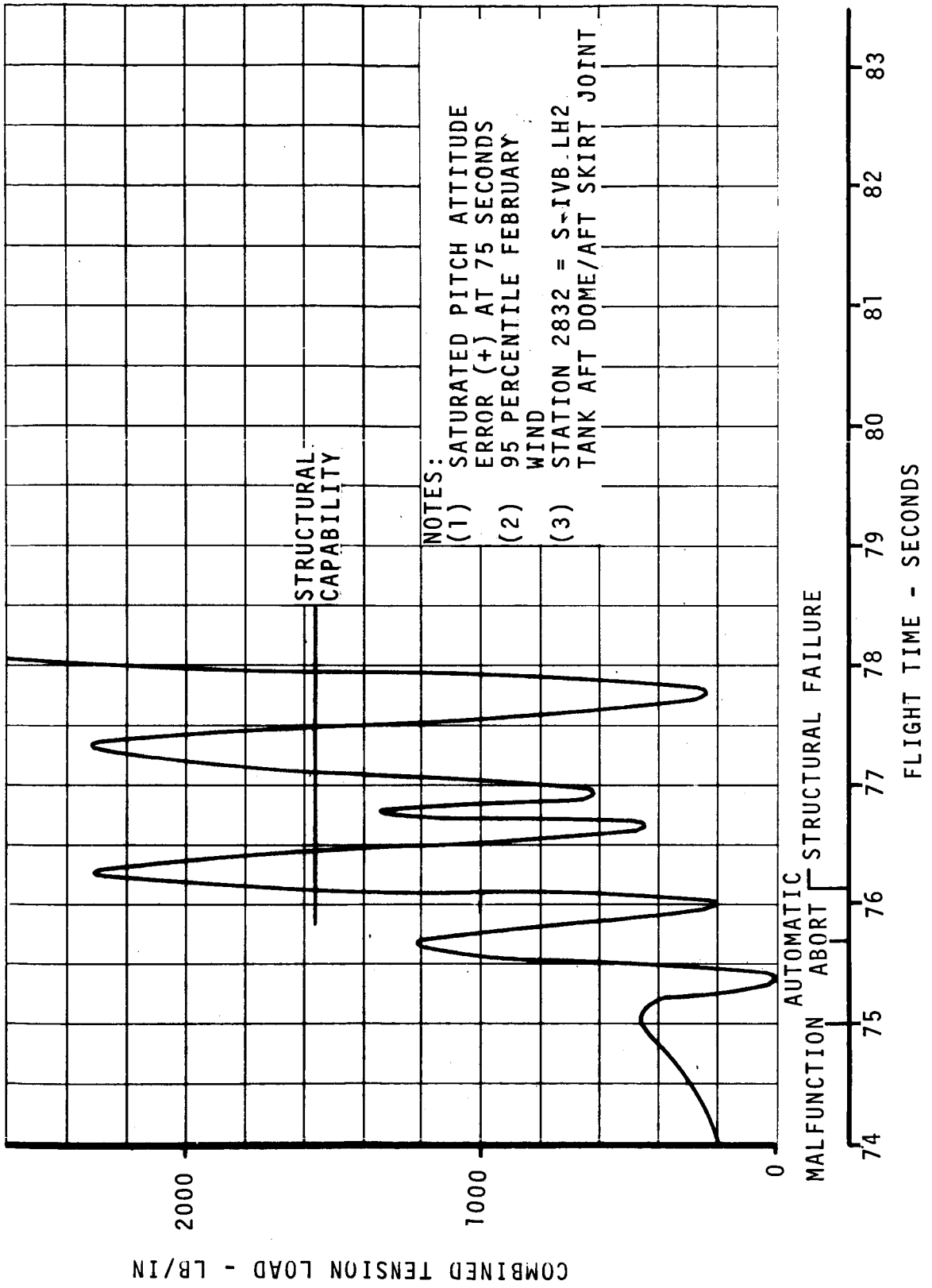

FIGURE 2-106 TENSION LOAD AT STATION 2832 AFT (SATURATED CONTROL SIGNAL)

2.6.21 Abort Tension Loads - S-II

No abort tension structural failures result from simulation of any S-II malfunctions covered in this report. Lowest load indicators result from the saturated control system and dual adjacent control engine-out malfunctions. In all cases, these were greater than 1.4. A summary of worst-case S-II loads is presented in Figure 2-107.

2.6.22 Abort Tension Loads - S-IVB

No cases of abort tension structural failure resulted from simulation of S-IVB malfunctions covered in this report. Lowest load indicator obtained was 1.87 for any S-IVB malfunction. (See Figure 2-107).

MALFUNCTION	TIME SINCE L/O (SEC)	ABORT TIME (ALL ENGINES) SHUTDOWN (SEC)	MINIMUM LOAD INDICATOR	STATION (IN)	TIME MLI (SEC)	REMARKS
Engine 1 Out	200	205	1.58 (T)	2387A	205.28	No Breakup
1 & 4 Engine-Out	200	206.56	1.56 (T)	2387A	205.04	No Breakup
1 & 4 Engine-Out	400	403.00	1.58 (T)	2387A	403.24	No Breakup
Saturated Control Signal	200	203.00	1.71 (T)	2387A	202.04	No Breakup
Saturated Control Signal	575	578	1.87 (T)	3100A	579.24	No Breakup

FIGURE 2-107 S-11 AND S-1VB WORST CASE ABORT TENSION LOADS SUMMARY

2.6.23 Pad Fallback and Tower Collision

Malfunctions occurring at liftoff or when the vehicle is in the pad area can cause pad fallback, collision with the holddown posts, or collision with the launch tower. Since several analyses have been made on each vehicle and only small changes have occurred in the times to collision, an attempt was made to derive a set of equations to predict these times for various malfunctions.

By assuming the partial differential equations are linear, the following general equation can be applied for various malfunctions:

$$T = T_{RC} + \frac{\partial TC_1}{\partial M} \Delta M + \frac{\partial TC_2}{\partial T} \Delta T + \frac{\partial TC_3}{\partial NR} \Delta NR$$

- T = the predicted time of collision for some malfunction.
- T_{RC} = time of collision of the reference.
- TC_1 = change in time of collision for variable mass.
- TC_2 = change in time of collision for variable thrust.
- TC_3 = change in time of collision for variable number of slow release rods.
- ΔM = change in mass between the reference and new vehicle.
- ΔT = change in thrust between the reference and new vehicle.
- ΔNR = change in number of slow release rods between the reference and new vehicle.
- MR = mass of the reference (2.782×10^6 kilograms).
- TR = thrust of the reference (6.8018×10^6 newtons/engine).
- NR_R = number of slow release rods for the reference (Twelve slow release rods were used for all cases except pad fallback for a single engine out. For pad fallback 16 rods were used).
- M = variation in mass for reference (latest times of collision were determined for the reference +5000 kg. and reference -5000 kg.).

2.6.23 (Continued)

T = variation in thrust for reference (Thrust was raised 1% and lowered 1%).

N_R = variation in number of slow release rods for reference. (Same as above except 8, 12, and 16 S.R. rods were used).

The reference referred to above was the 503 C prime vehicle. An example of the above equation is given below for a single engine malfunction. The predicted time will be the latest time of holddown post collision.

$$T_{L/O} = .72 + \frac{.02}{10,000} (M - M_R) - \frac{.07}{2} \frac{(T - T_R)}{T_R} 100 + \frac{.09}{8} (N_R - N_{RR})$$

$$T_{L/O} = .72 + 2 \times 10^{-6} (M - M_R) - 3.50 \left(\frac{T - T_R}{T_R} \right) + .01125 (N_R - N_{RR})$$

Hence the coefficients are:

$$\frac{\partial T_{C1}}{\partial M} = 2 \times 10^{-6}$$

$$\frac{\partial T_{C2}}{\partial T} = 3.50 \quad \text{and}$$

$$\frac{\partial T_{C3}}{\partial N_R} = 1.125 \times 10^{-2}$$

By substituting known values into the equation for the variables we have:

$$T_{L/O} = .72 + 2 \times 10^{-6} (2.9033 \times 10^6 - 2.782 \times 10^6) - 3.50 \left(\frac{6.8679 \times 10^6 - 6.8018 \times 10^6}{6.8016 \times 10^6} \right) + .01125(8-12)$$

2.6.23 (Continued)

$T_{L/O} = .8826$, the predicted latest time of liftoff interference for a single engine out.

Table 2-IX contains the coefficient for each malfunction and each collision that might occur. Table 2-X presents the results for the reference (503 C prime), the predicted 504 results, and the actual 504 results. Figure 2-107.1 shows the probability of vehicle loss for early malfunctions.

Figure 2-108 shows expected envelopes of typical dynamics for a No. 1 or No. 2 engine out prior to 5.25 seconds, the latest time of collision for this malfunction. The dynamics shown are yaw attitude, yaw rate, yaw lateral displacement, and yaw engine deflection.

Figure 2-109 presents the time to collision for a single engine failure. No collision occurs with the holddown posts after .97 seconds or with the tower after 5.25 seconds. Figure 2-110 shows the vehicle motion due to a single engine failure.

Figures 2-111 through 2-113 are the phase plane plots for a No. 2 engine out at .97 seconds, the latest engine out time which causes the engine bell to collide with the holddown posts for a single engine failure.

Some expected envelopes of typical dynamics are presented in Figure 2-114, for a No. 2 actuator hardover in the positive yaw direction prior to 2.7 seconds. This is the latest time this malfunction causes the fin tip to collide with the tower. The dynamics presented are the same as those presented for the corresponding engine out figure. Figure 2-115 shows the time to collision for a single actuator hardover. If a malfunction occurs after .59 seconds the vehicle does not collide with the holddown posts. If the malfunction occurs after 2.7 seconds, the vehicle will clear the tower with no collision.

Figures 2-116 through 2-117 show the phase plane plots for a No. 2 actuator hardover in the positive yaw direction at .59 seconds, the latest time of liftoff interference for this malfunction.

Figures 2-118 through 2-123 present the phase plane plots for two saturated control signal cases. The first case, presented in Figures 2-118 through 2-120, is a saturated control signal in the positive yaw direction at 1.2 seconds. After 1.2 seconds no collision with the holddown posts occurs for this malfunction. The second case is a saturated control signal in the positive

2.6.23 (Continued)

pitch direction at 5.9 seconds. This data, representing worst case phase plane relationship, is useful to align the pitch control motor on the launch escape tower. Figures 2-121 through 2-123 present this case.

TABLE 2-IX COEFFICIENTS FOR SA-504 PREDICTIONS FOR LATEST TIMES OF COLLISION

MALFUNCTION	$\frac{\partial T_{C1}}{\partial M}$	$\frac{\partial T_{C2}}{\partial T}$	$\frac{\partial T_{C3}}{\partial NR}$
Single Engine Out			
Pad Fallback	1.5×10^{-6}	4.50	1.44×10^{-2}
Liftoff Interference	2×10^{-6}	3.50	1.125×10^{-2}
Tower Collision	1×10^{-5}	17.5	2.5×10^{-2}
Actuator Hardover			
Liftoff Interference	3×10^{-6}	2.0	1.375×10^{-2}
Tower Collision	1×10^{-5}	15.0	1.875×10^{-2}
Saturated Control Signal (+ Yaw)			
Liftoff Interference	2.5×10^{-5}	6.0	1.88×10^{-2}
Tower Collision	1×10^{-5}	15.0	1.875×10^{-2}
Saturated Control Signal (- Yaw)			
Tower Collision	1×10^{-5}	15	2.50×10^{-2}

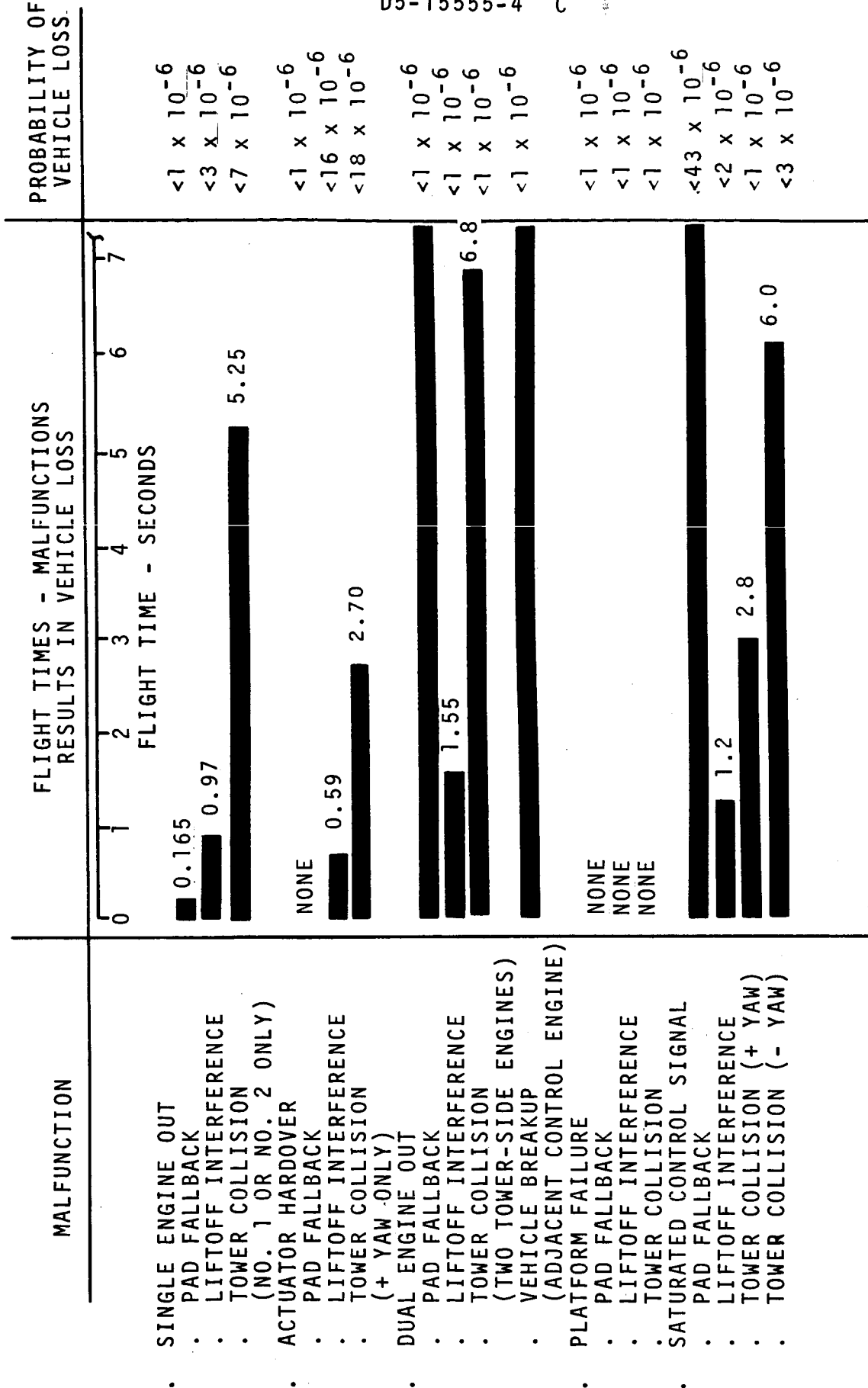

FIGURE 2-107.1 SUMMARY OF MALFUNCTIONS REQUIRING NEAR-PAD ABORT

THIS PAGE INTENTIONALLY LEFT BLANK.

TABLE 2-X SUMMARY OF NEAR PAD MALFUNCTIONS

TYPE OF COLLISION	LATEST TIMES OF COLLISION		
	SA-503C' TIME-SEC	SA-504 PREDICTED TIME-SEC	SA-504 ACTUAL TIME-SEC
SINGLE ENGINE OUT			
PAD FALLBACK	None	0.137	.165
LIFTOFF INTERFERENCE	0.72	0.88	0.97
TOWER COLLISION (NO. 1 OR NO.2 ONLY)	4.50	5.40	5.25
ACTUATOR HARDOVER			
PAD FALLBACK	None	None	None
LIFTOFF INTERFERENCE	0.34	0.63	0.59
TOWER COLLISION (+ YAW ONLY)	2.00	3.00	2.70
SATURATED CONTROL SIGNAL			
PAD FALLBACK	>30	>30	>30
LIFTOFF INTERFERENCE	1.00	1.17	1.20
TOWER COLLISION (+ YAW)	2.30	3.28	2.80
TOWER COLLISION (- YAW)	5.40	6.36	6.00

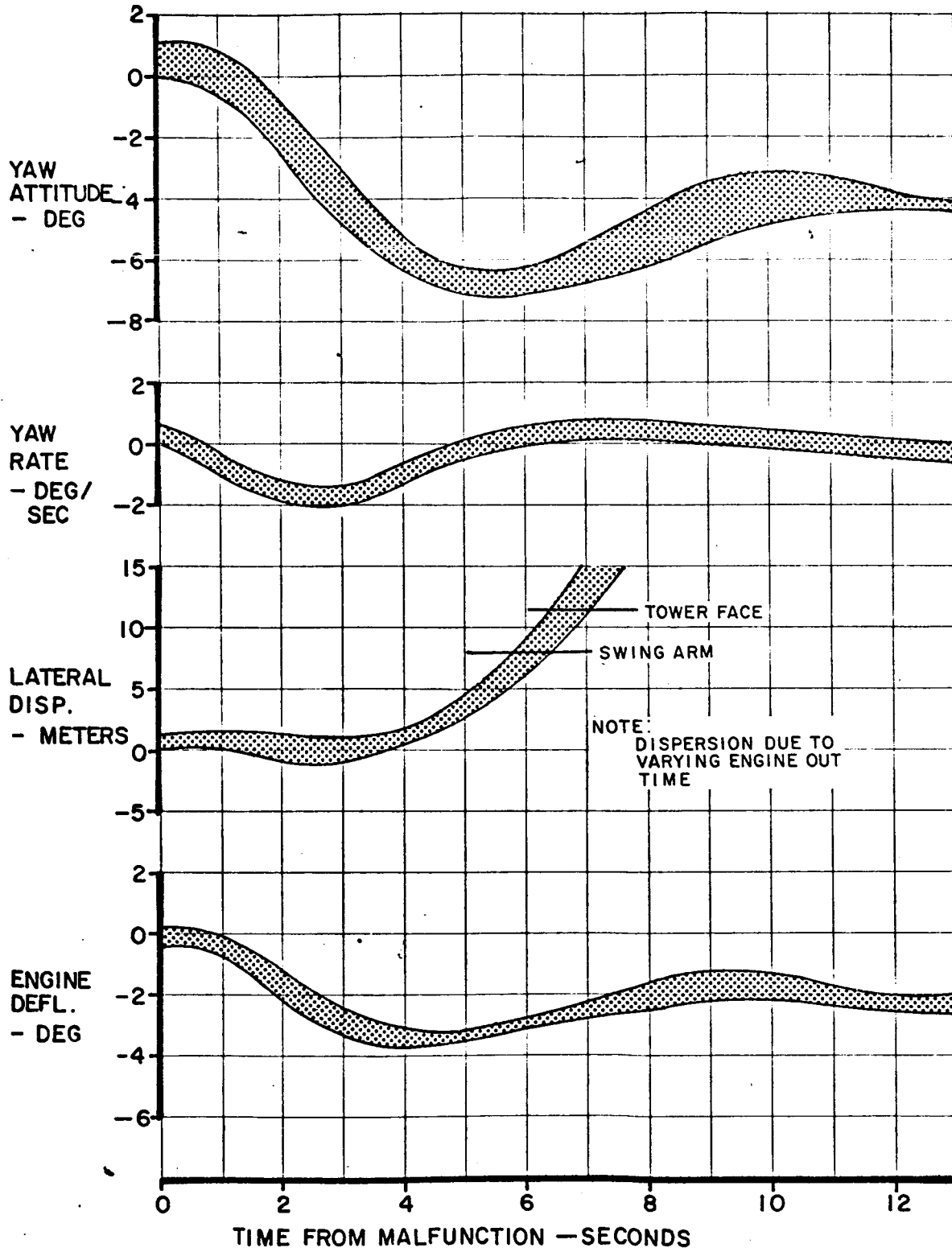

FIGURE 2-108 VEHICLE RESPONSE TO NO.1 OR NO.2 ENGINE OUT PRIOR TO 5.25 SECONDS WITH 95 PERCENTILE, 180° WIND

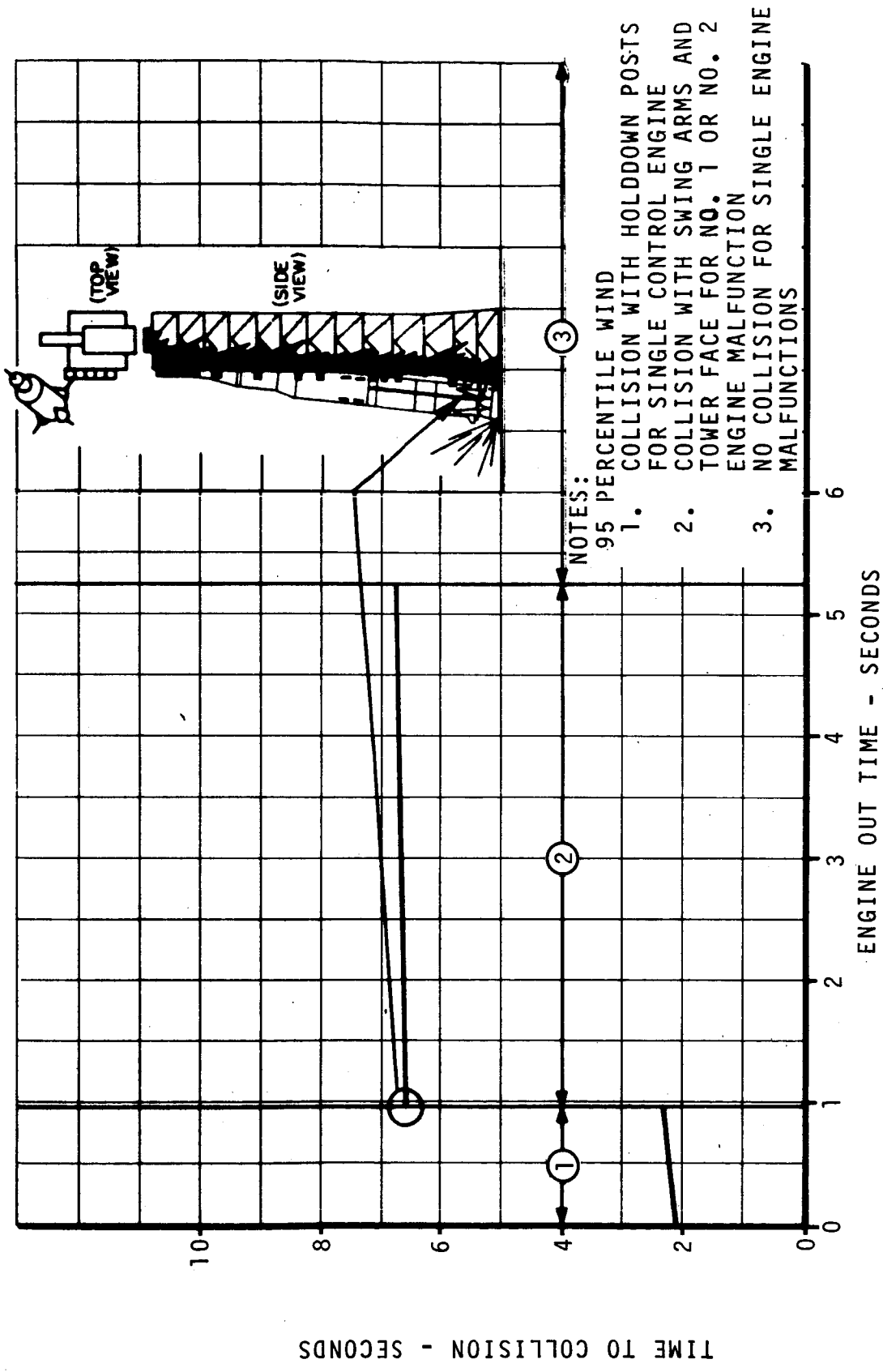

FIGURE 2-109 TIME FROM SINGLE ENGINE FAILURE TO COLLISION

NOTE:
COLLISION OCCURS FOR ANY
OUTBOARD ENGINE MALFUNCTION
PRIOR TO .97 SECONDS

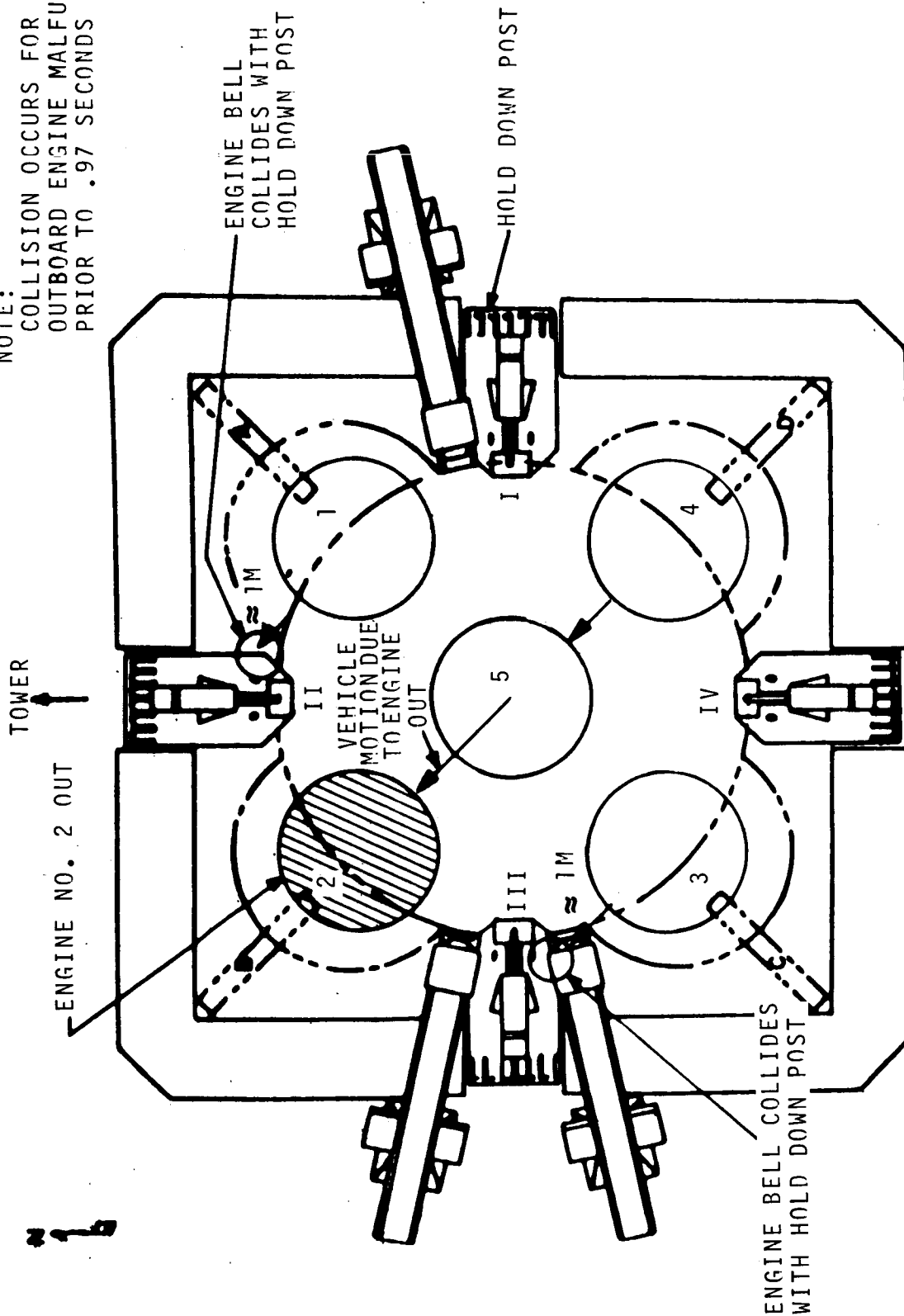

FIGURE 2-110 COLLISION WITH HOLD DOWN POSTS DUE TO ENGINE NO. 2 OUT

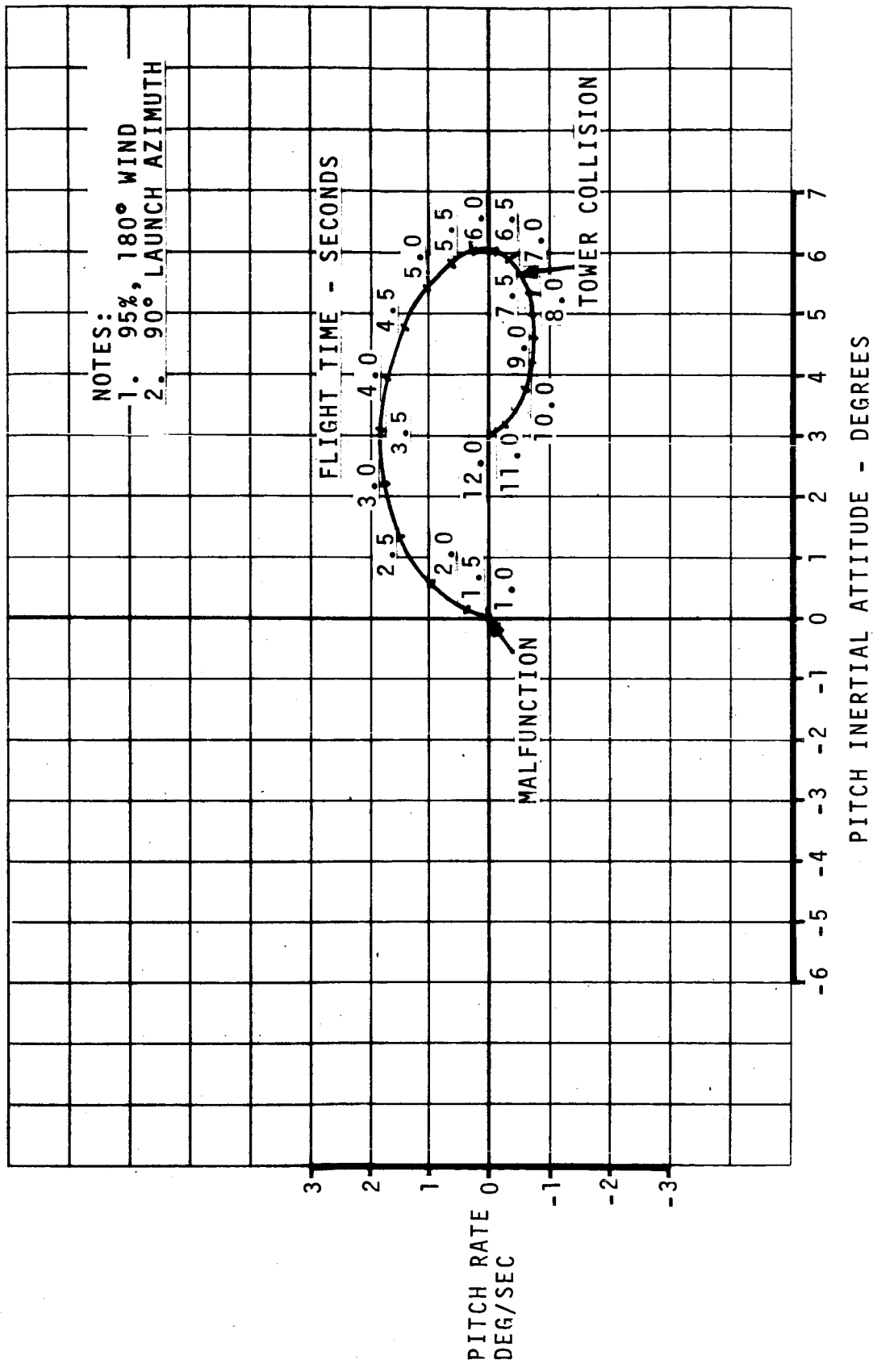

FIGURE 2-111 PITCH PHASE PLANE PLOT FOR NO. 2 ENGINE OUT AT .97 SECONDS

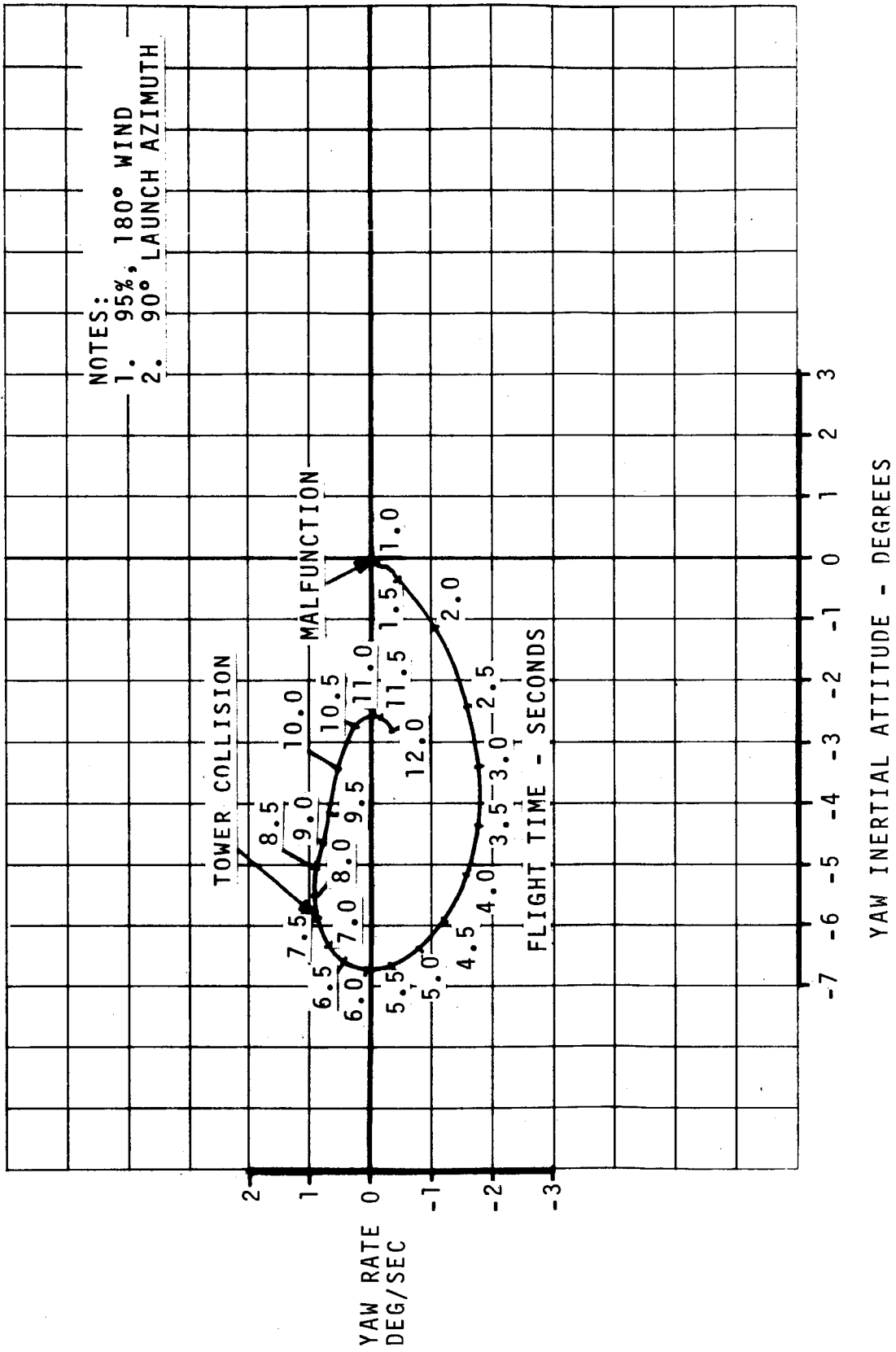

FIGURE 2-112 YAW PHASE PLANE PLOT FOR NO. 2 ENGINE OUT AT .97 SECONDS

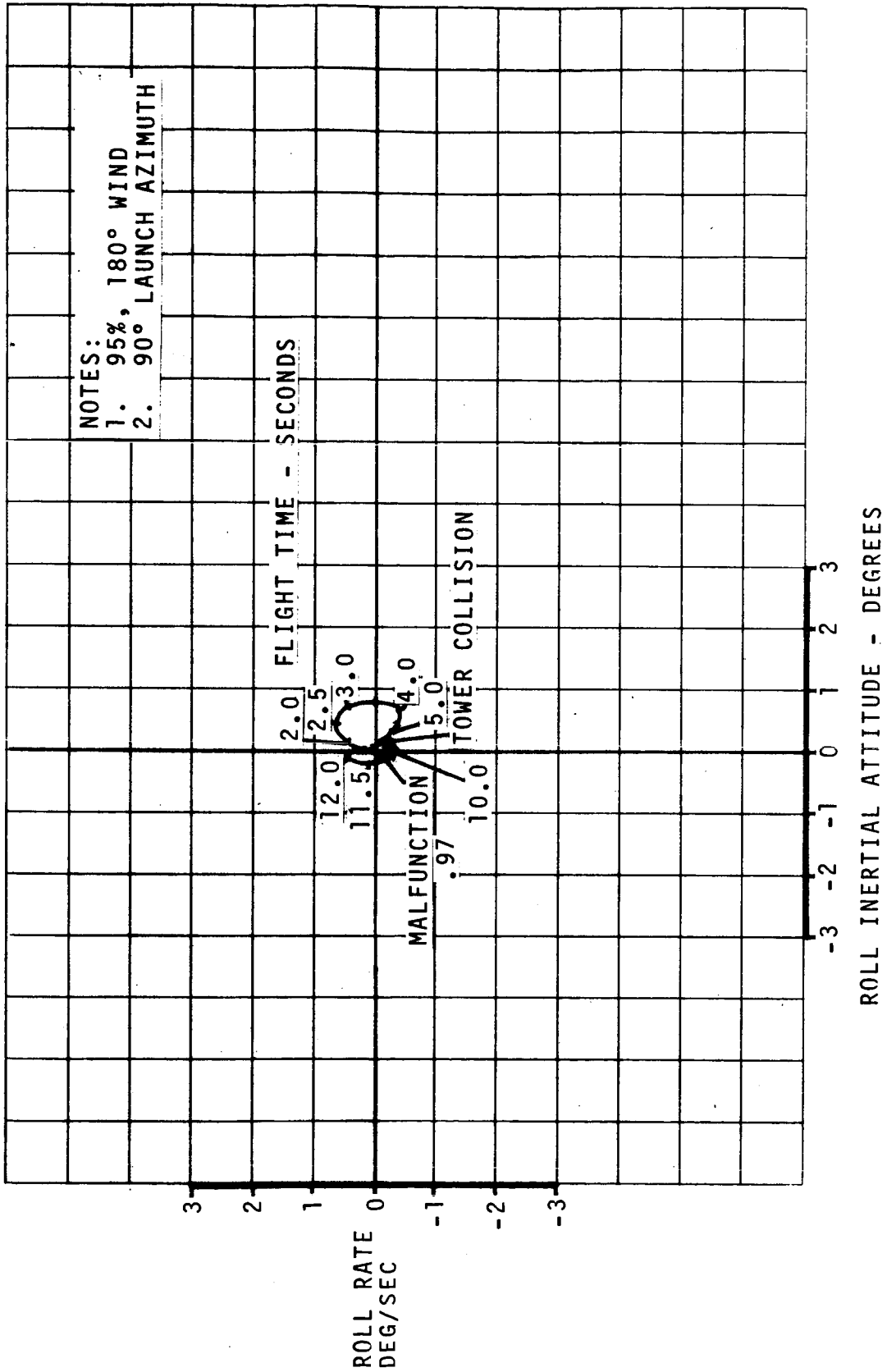

FIGURE 2-113 ROLL PHASE PLANE PLOT FOR NO. 2 ENGINE OUT AT .97 SECONDS

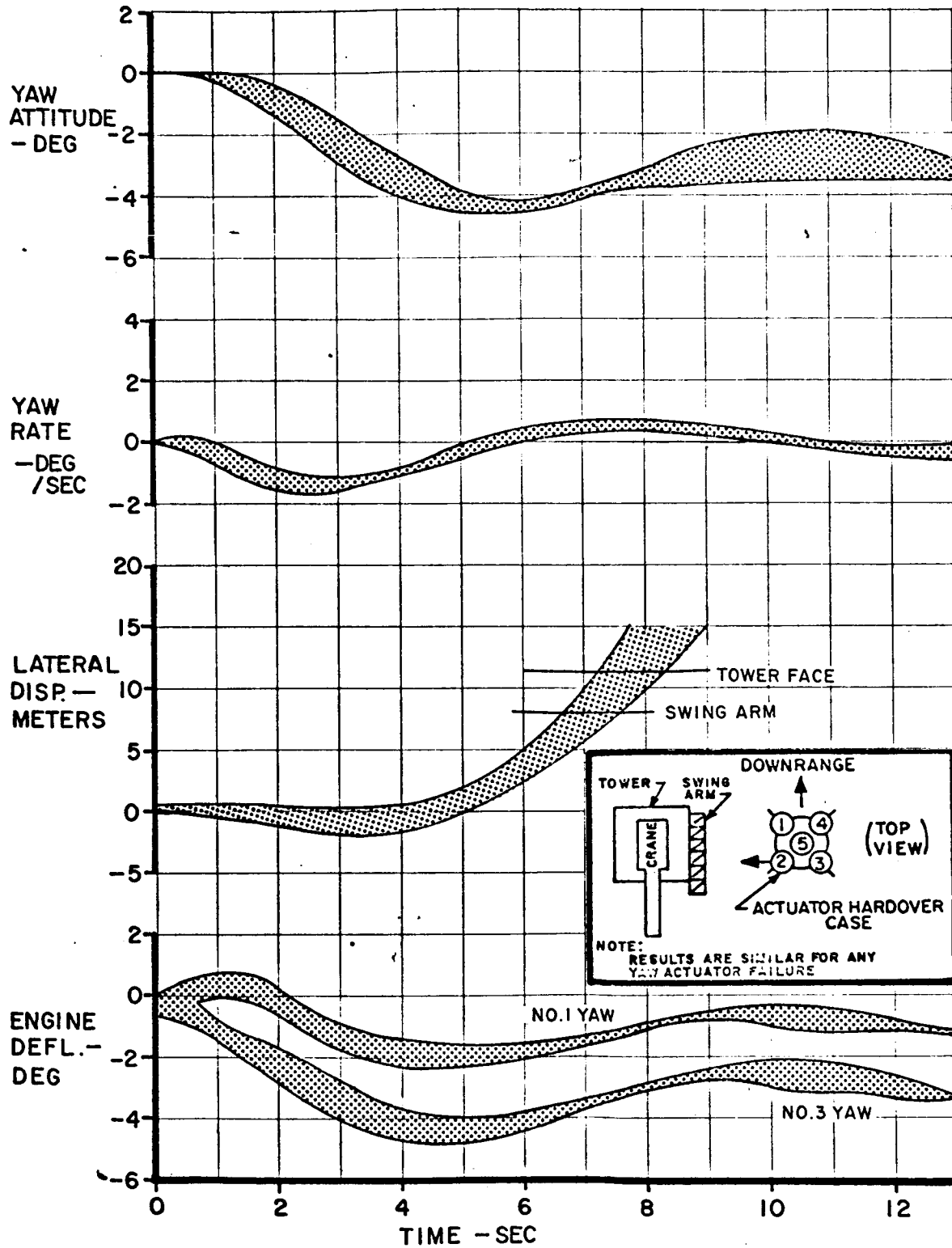

FIGURE 2-114 VEHICLE RESPONSE TO NO. 2 YAW ACTUATOR FAILURE PRIOR TO 2.7 SECONDS WITH 95 PER-CENTILE, 180° WIND

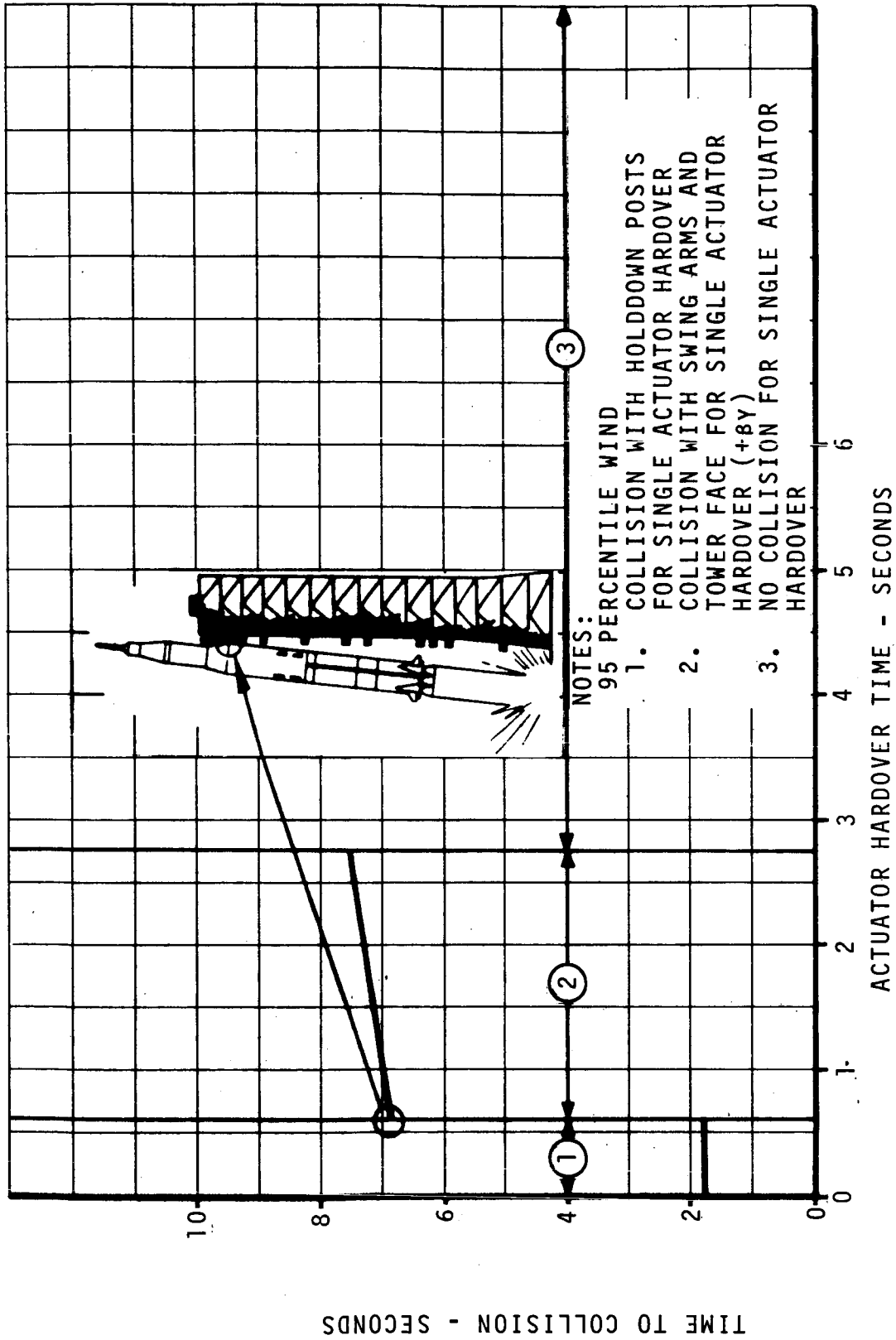

FIGURE 2-115 TIME FROM SINGLE ACTUATOR FAILURE TO COLLISION

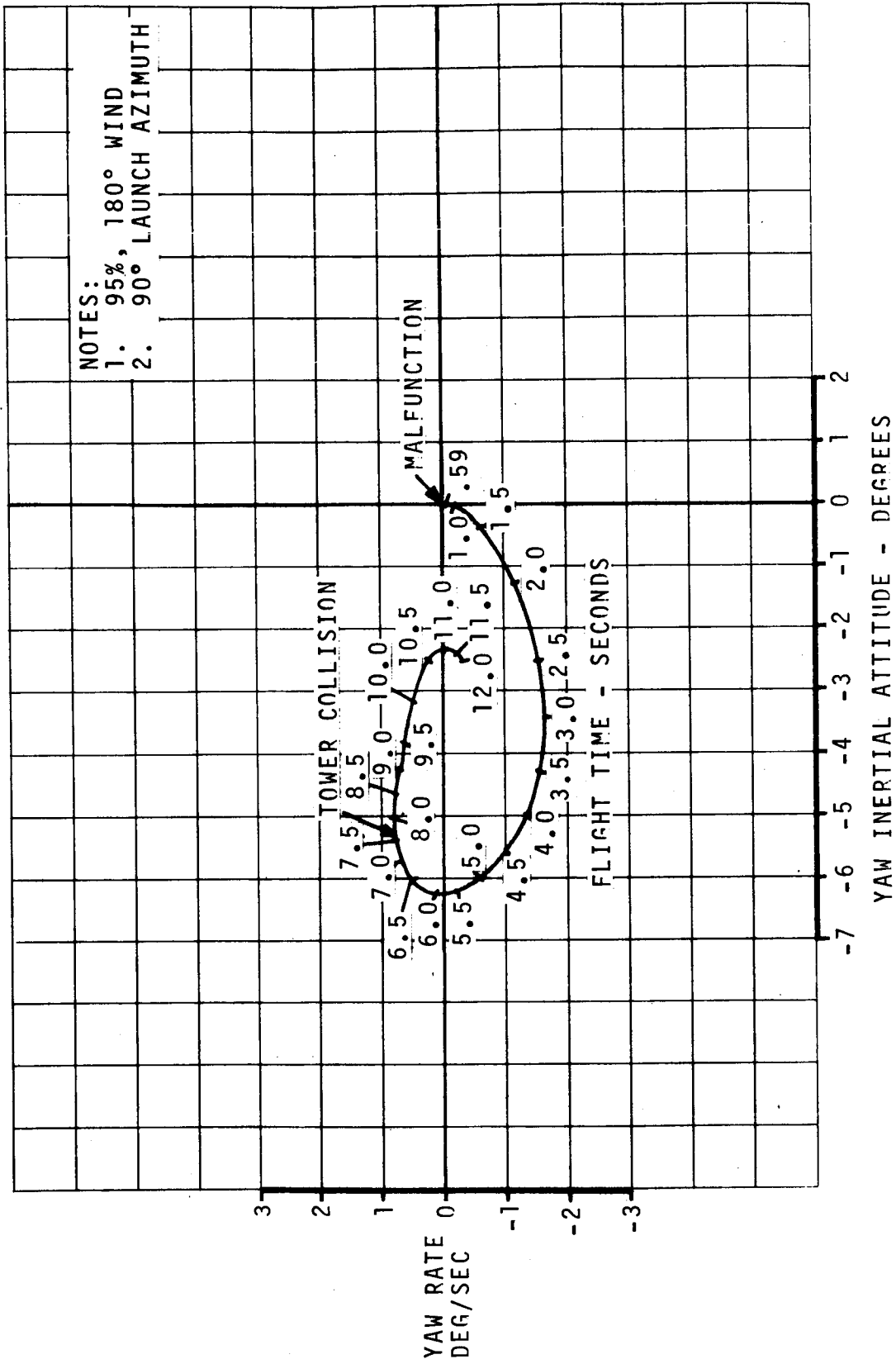

FIGURE 2-116 YAW PHASE PLANE PLOT FOR NO. 2 ACTUATOR HARDOVER (+ YAW) AT 0.59 SECONDS

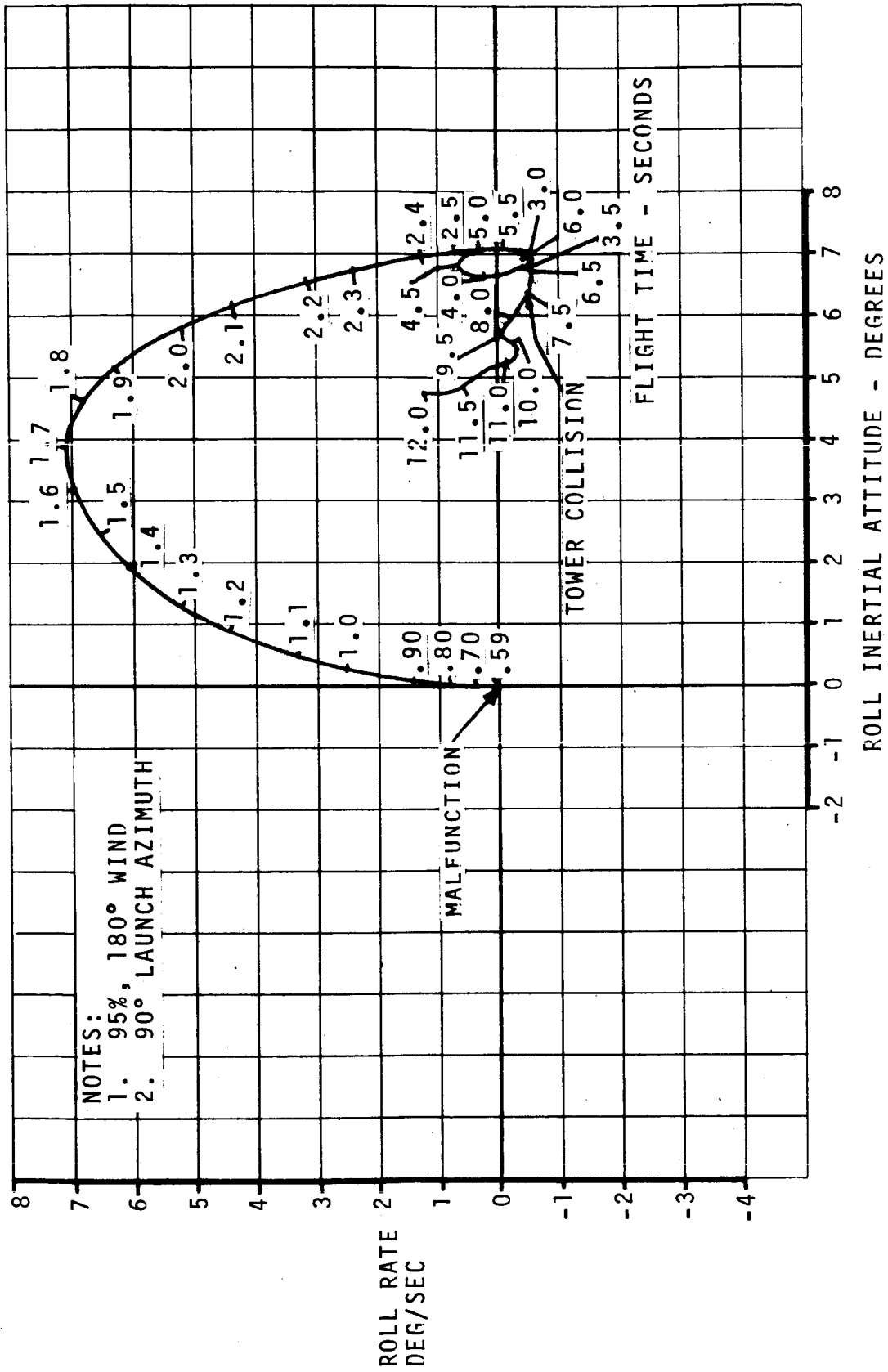

FIGURE 2-117 ROLL PHASE PLANE PLOT FOR NO. 2 ACTUATOR HARDOVER (+ YAW) AT 0.59 SECONDS

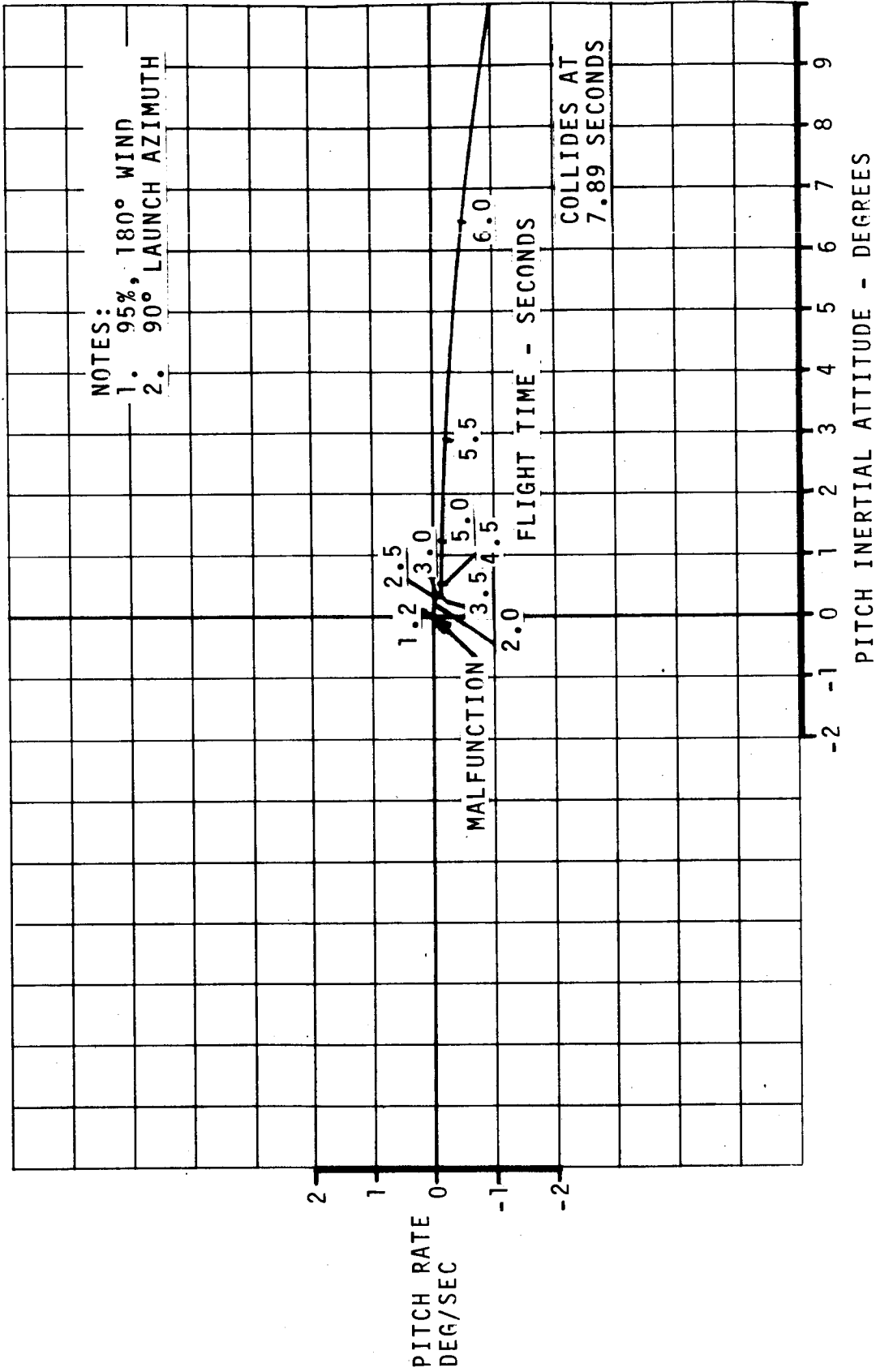

FIGURE 2-118 PITCH PHASE PLANE PLOT FOR SATURATED CONTROL SIGNAL (+ YAW) AT 1.2 SECONDS

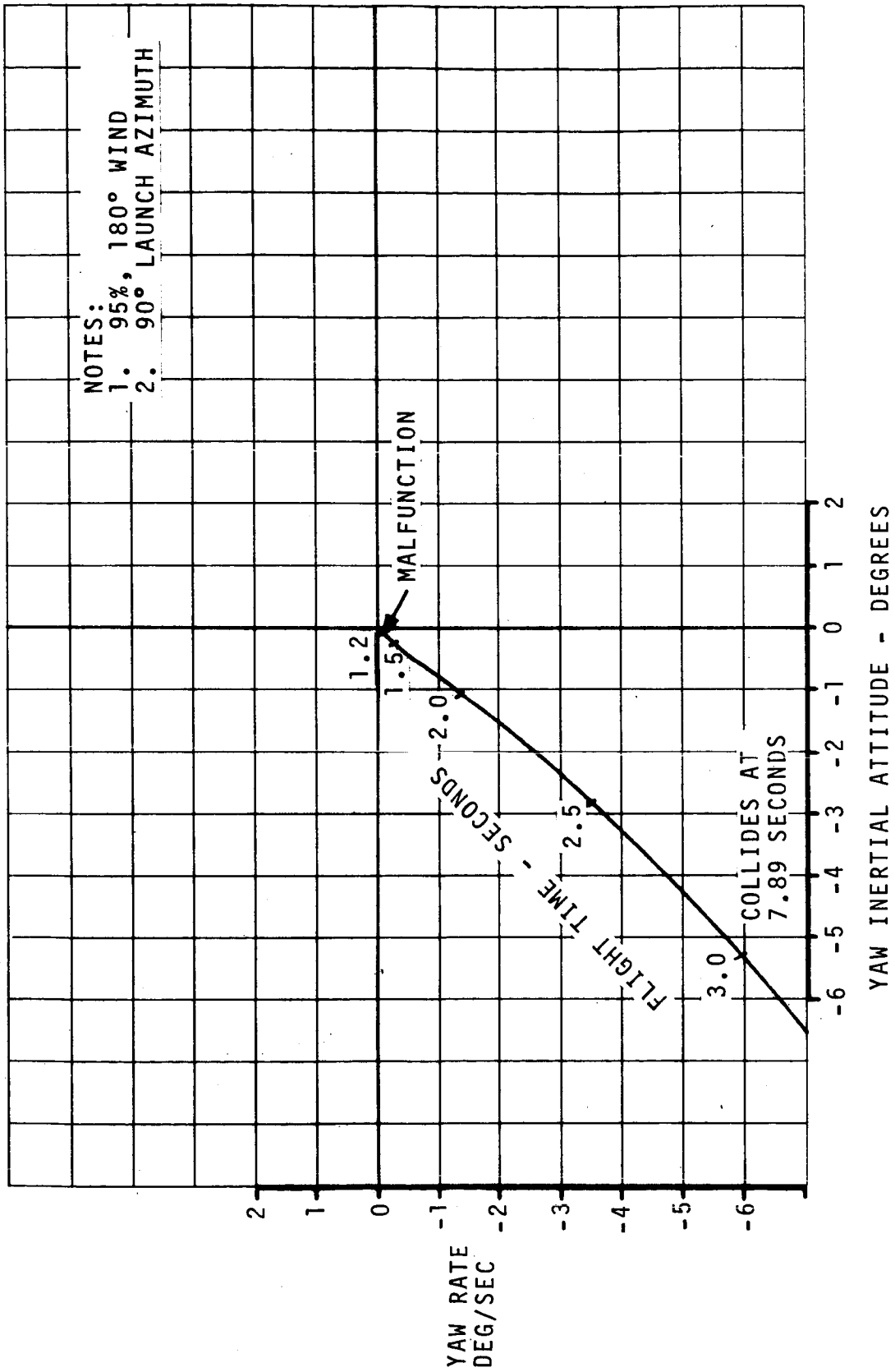

FIGURE 2-119 YAW PHASE PLANE PLOT FOR SATURATED CONTROL SIGNAL (+ YAW) AT 1.2 SECONDS

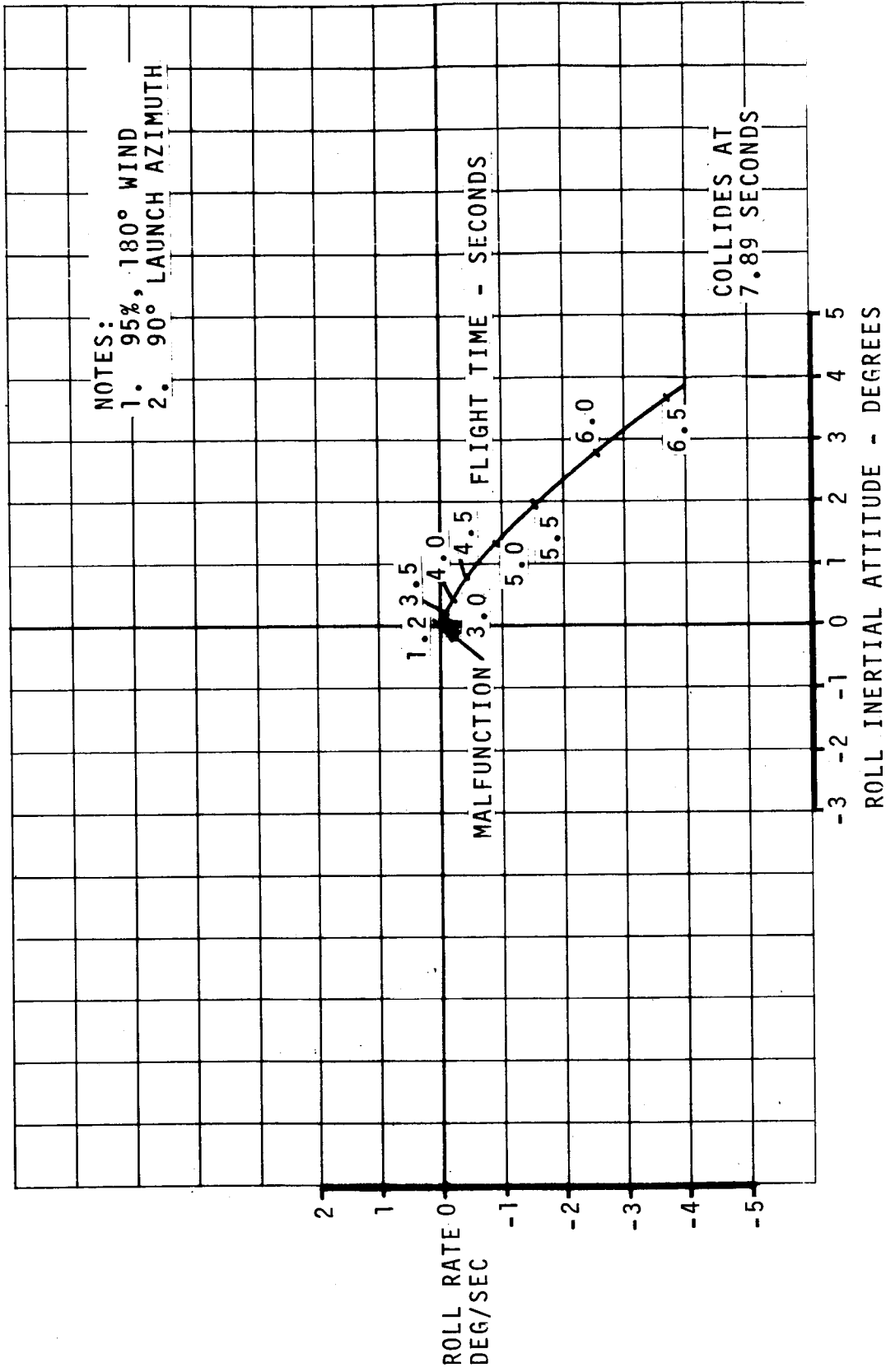

FIGURE 2-120 ROLL PHASE PLANE PLOT FOR SATURATED CONTROL SIGNAL (+ YAW) AT 1.2 SECONDS

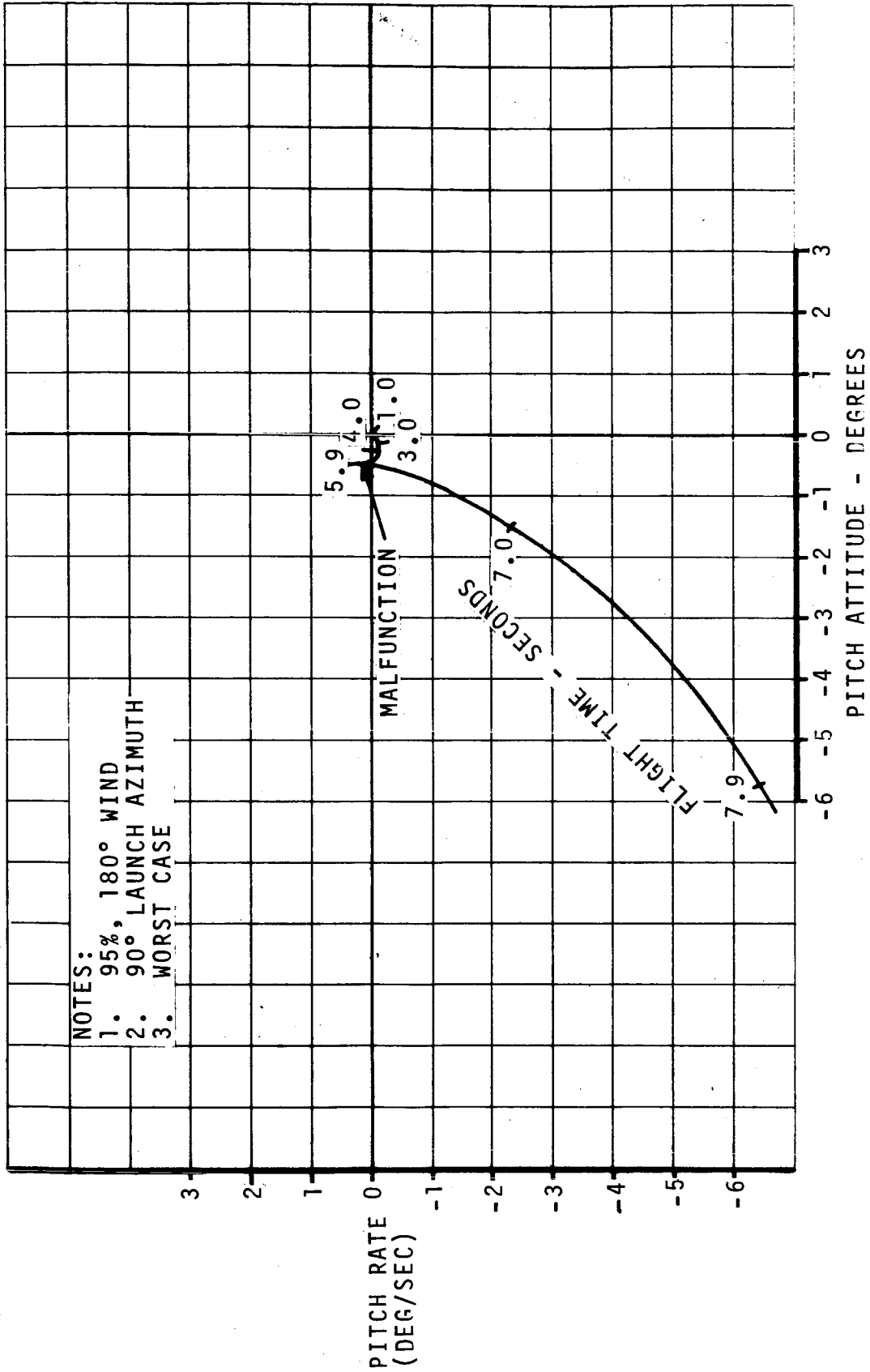

FIGURE 2-121 PITCH PHASE PLANE PLOT FOR SATURATED CONTROL SIGNAL (+ PITCH) AT 5.9 SECONDS

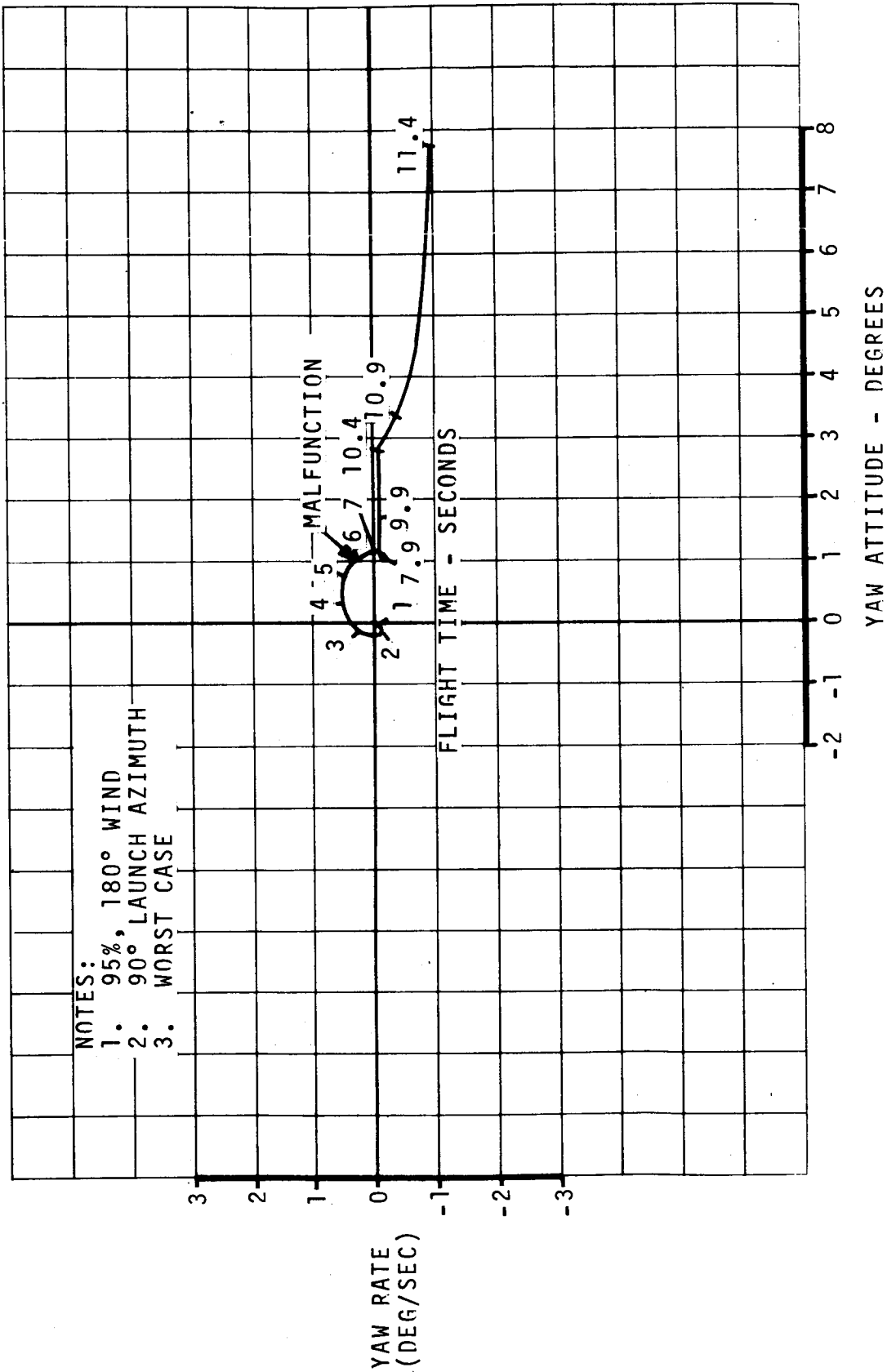

FIGURE 2-122 YAW PHASE PLANE PLOT FOR SATURATED CONTROL SIGNAL (+ PITCH) AT 5.9 SECONDS

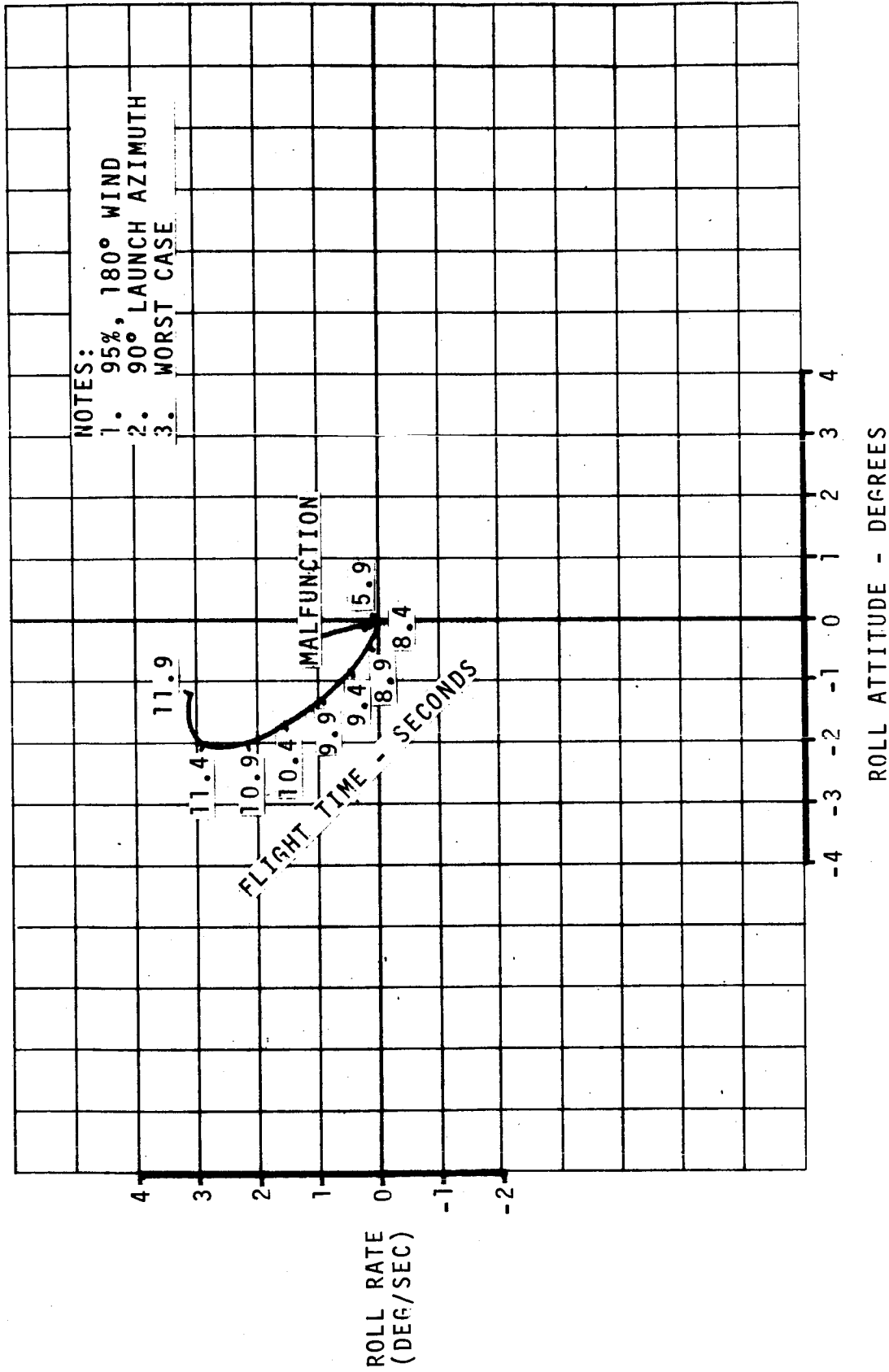

FIGURE 2-123 ROLL PHASE PLANE PLOT FOR SATURATED CONTROL SIGNAL (+ PITCH) AT 5.9 SECONDS

2.6.24 Loss of Attitude Error - S-IC

Loss of attitude error causes exponential divergence of vehicle attitude for failures throughout S-IC flight. Figure 2-124 shows typical dynamics for loss of attitude error at 75 seconds.

In the high-q region, structural failure occurs within 0.63 seconds after abort.

The recommended EDS limit settings for this malfunction are:
(1) 4 degrees/second attitude rate for automatic abort,
(2) 5 degrees attitude error (first abort cue) and 3.2 psi q-ball pressure after 50 seconds (second abort cue) for manual abort.

In the high-q region, manual abort cues occur before the automatic abort limit is exceeded. After the high-q region, the abort request light may be used as a second cue.

The probability of vehicle loss due to this malfunction is 70×10^{-6} .

2.6.25 Loss of Attitude Error Signal - S-II

Loss of pitch or yaw attitude error signal in S-II flight results in slow divergence from the nominal vehicle flight path and an attitude eventually requiring abort. Due to center of gravity offset and engine misalignment the rate for the failed axis does not approach zero as expected but stabilizes at a small rate. For the pitch axis this value can vary from 0.015 to 0.04 deg/sec depending upon the attitude rate gain being used at the time. For the yaw axis the value can vary from -0.04 to -0.13 deg/sec.

Loss of roll attitude error does not result in an abort. For all cases studied the vehicle was placed into parking orbit with the roll attitude error not exceeding 13.5 deg at insertion for the worst case.

2.6.26 Loss of Attitude Error Signal - S-IVB

Results of loss of pitch or yaw attitude error signal in S-IVB are similar to S-II results. If the malfunction occurs within the last 30 seconds of S-IVB flight, orbital insertion can be obtained.

As in S-II flight, loss of roll attitude error in S-IVB does not result in abort. In all cases studied the vehicle was placed into parking orbit.

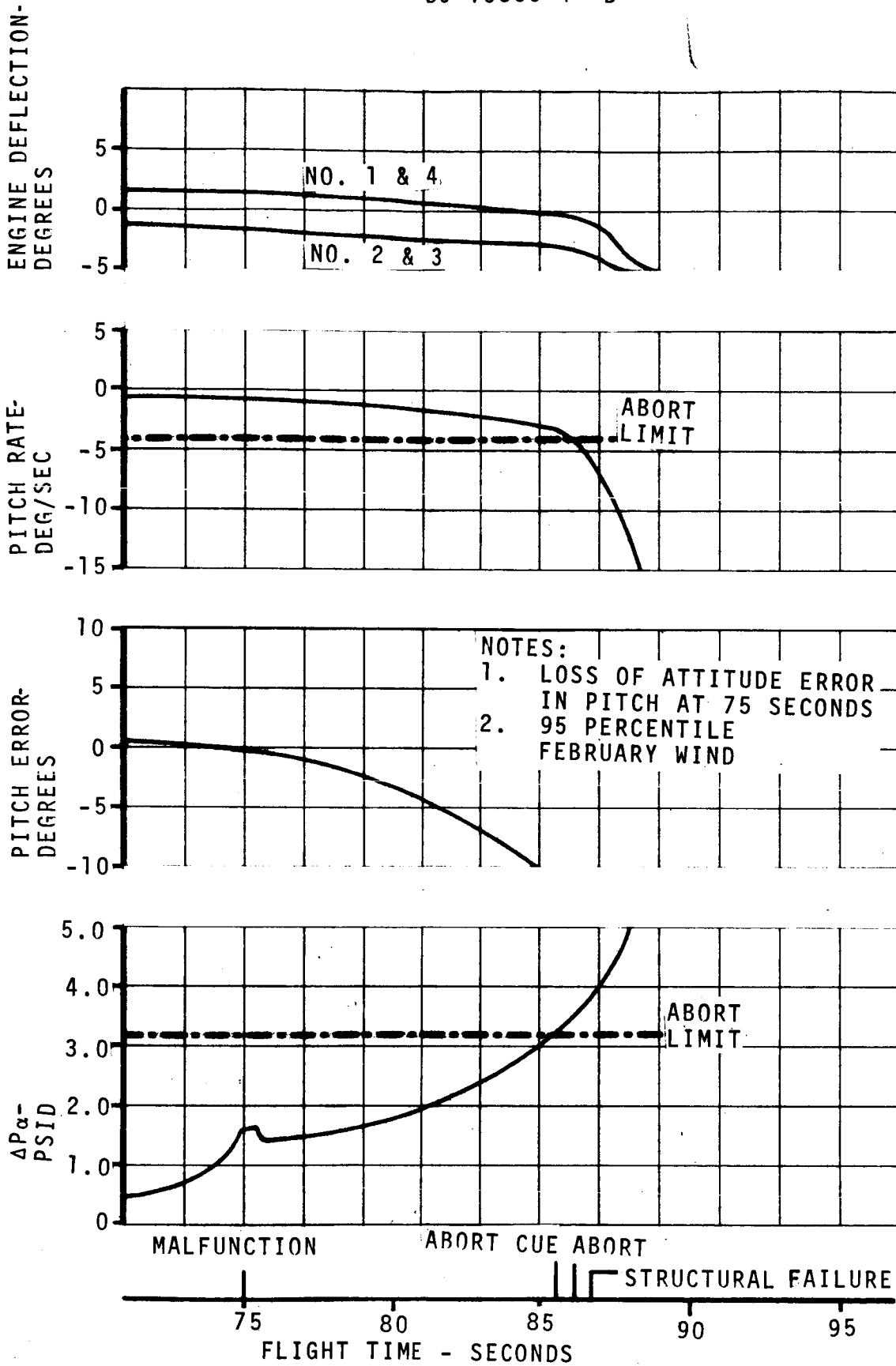

FIGURE 2-124 TIME HISTORY OF DYNAMIC VARIABLES FOR A LOSS OF ATTITUDE ERROR AT 75 SECONDS

2.6.27 Loss of Rate Signal - S-IC

Loss of rate signal causes oscillatory divergence of vehicle attitude for failures throughout S-IC flight.

In the high-q region structural failure occurs within 0.90 seconds after abort.

The recommended EDS limit setting for this malfunction is 4 degrees/second attitude rate for automatic abort. The automatic abort limit is exceeded prior to the q-ball pressure limit in the high-q region. After automatic abort is inhibited the recommended manual abort cues are (1) launch vehicle overrate light, and (2) spacecraft rate indication of 4 degrees/second.

The probability of vehicle loss for this malfunction is 40×10^{-6} .

2.6.28 Loss of Rate Signal - S-II

Loss of the pitch, yaw or roll rate feedback signals during S-II flight produces vehicle instability in the axis affected. Divergent attitude oscillations result which can be used as a first cue for abort. Frequency of oscillation varies from approximately 0.08 Hertz early in S-II flight to approximately 0.13 Hertz late in S-II flight in the pitch and yaw axes. Since atmospheric perturbations to drive the oscillation are absent in S-II, divergence is not as rapid as in S-IC.

Oscillations in the pitch plane reach EDS limit values earlier than in yaw. This appears to result from larger driving disturbance due to pitch attitude commands and does not reflect any greater oscillatory instability in pitch than for the corresponding malfunction in yaw. Simulator results in Figure 2-125 give a worst-case amplitude doubling time in pitch of approximately 13 seconds. This occurs with the initiation of IGM early in S-II flight. Time to reach the abort cue will vary with time of flight and driving disturbances (mainly guidance commands) but may be as short as 20 seconds after malfunction if phased with a large change in guidance command. Structural failure does not occur prior to abort and manual abort actuation with engine shutdown initiated at a $10^\circ/\text{second}$ attitude rate provides safe abort. Assuming no further rate buildup after engine shutdown, this would be the worst rate from which a subsequent SPS abort would be initiated.

If loss of rate signal occurs within 40 seconds of staging, S-II/S-IVB staging should be reached before abort. Rates at staging in pitch or yaw may be as high as 9° per second but successful staging should follow, assuming a 10° per second staging limit. It is probable, however, that the malfunction will persist into the S-IVB burn and abort will occur, at best, shortly after S-IVB IGM turn-on. (See following S-IVB analysis).

As noted, yaw axis results are similar, except that times to reach EDS limits are longer due to reduced disturbances from guidance attitude commands. In roll, loss of rate signal produces divergent oscillations with a typical frequency of about 0.25 Hertz in S-II and time to double amplitude as short as 4 seconds. In the simulator results of Figure 2-126, time to reach the EDS limit was 43 seconds, but this resulted from the small magnitude of driving disturbances (roll attitude commands). Any roll disturbance of appreciable magnitude might reduce this by as much as 15 seconds.

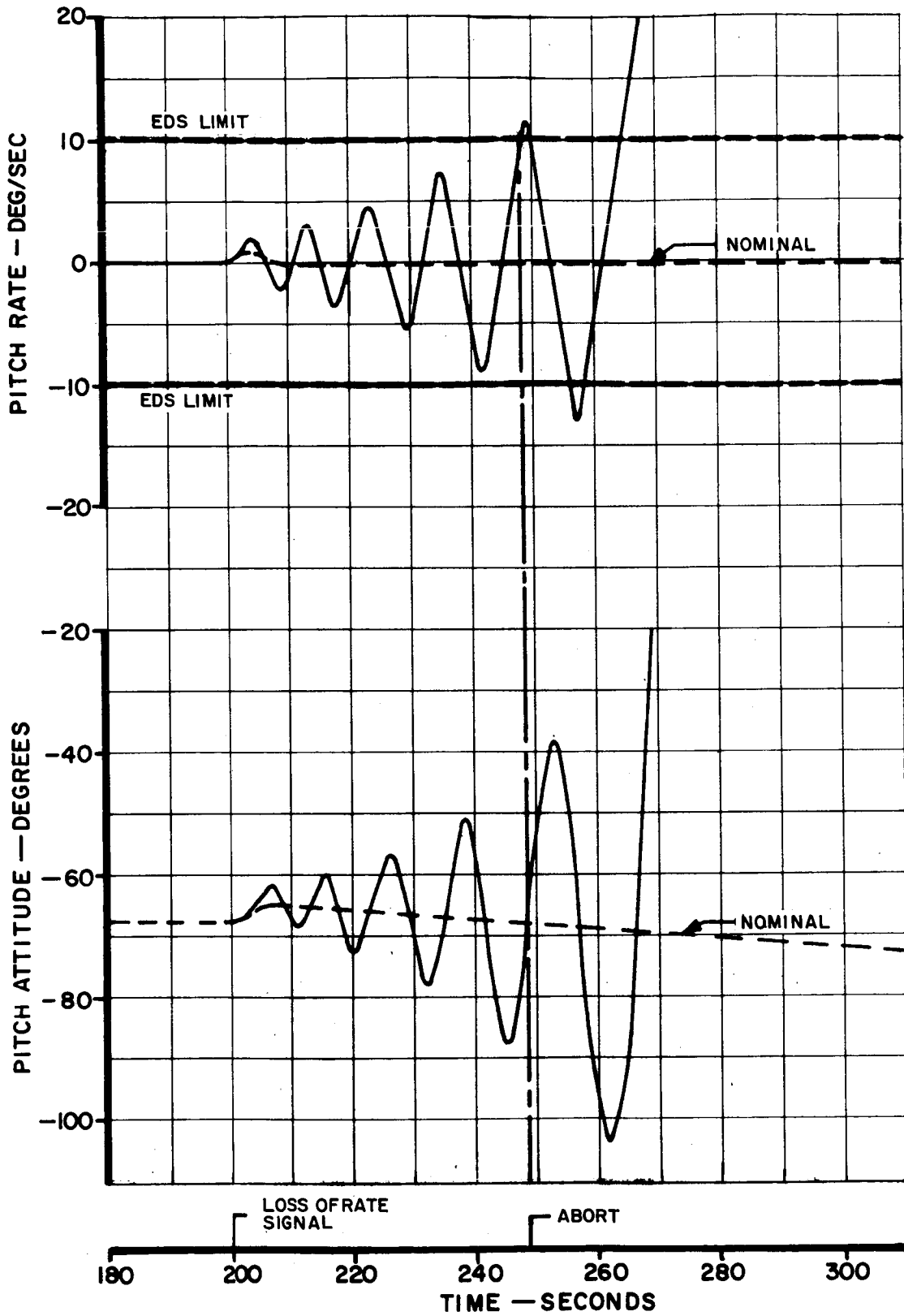

FIGURE 2-125 S-11 LOSS OF PITCH RATE SIGNAL

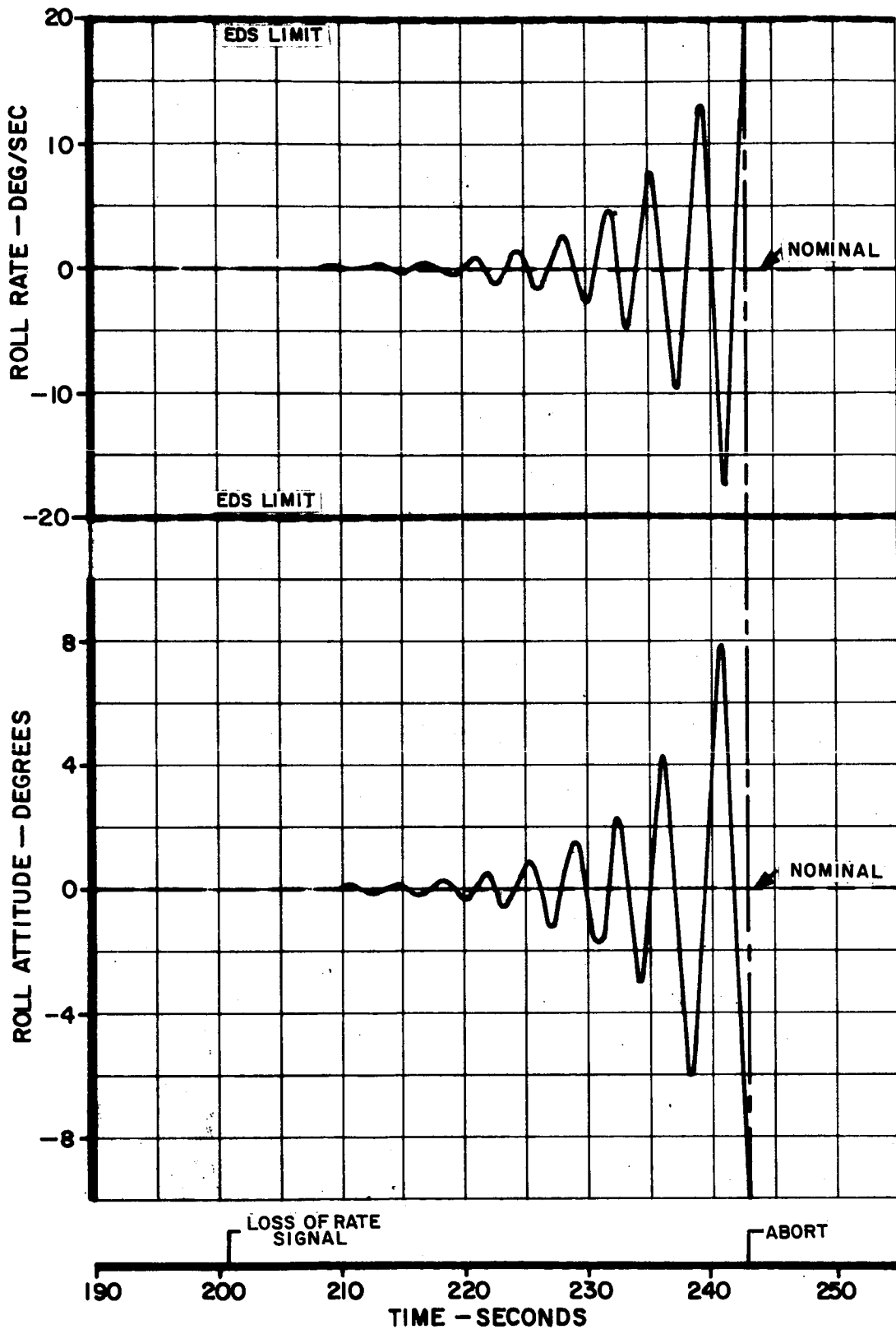

FIGURE 2-126 S-II LOSS OF ROLL RATE SIGNAL

2.6.29 Loss of Rate Signal - S-IVB

As in S-II, loss of rate signal produces vehicle instability with divergent attitude oscillations in the affected axis. The average frequency of the pitch attitude oscillations during S-IVB flight is approximately 0.13 Hertz with divergence more rapid early in flight. In pitch, where the oscillations are usually initiated by changes in guidance attitude command, an EDS limit can be reached in as little as 27 seconds.

For loss of rate signal as late as 45 seconds before S-IVB first shutdown, parking orbit insertion may be reached with residual pitch or yaw rates less than 10° per second. Even though orbit is obtained, it is expected that, at best, SPS will be initiated shortly after insertion since the loss of rate signal malfunction persists into orbit with APS control. Typical simulation results of this malfunction with parking orbit insertion are given in Figure 2-127.

Since APS is used for S-IVB powered flight roll control, a separate roll axis analysis is not presented.

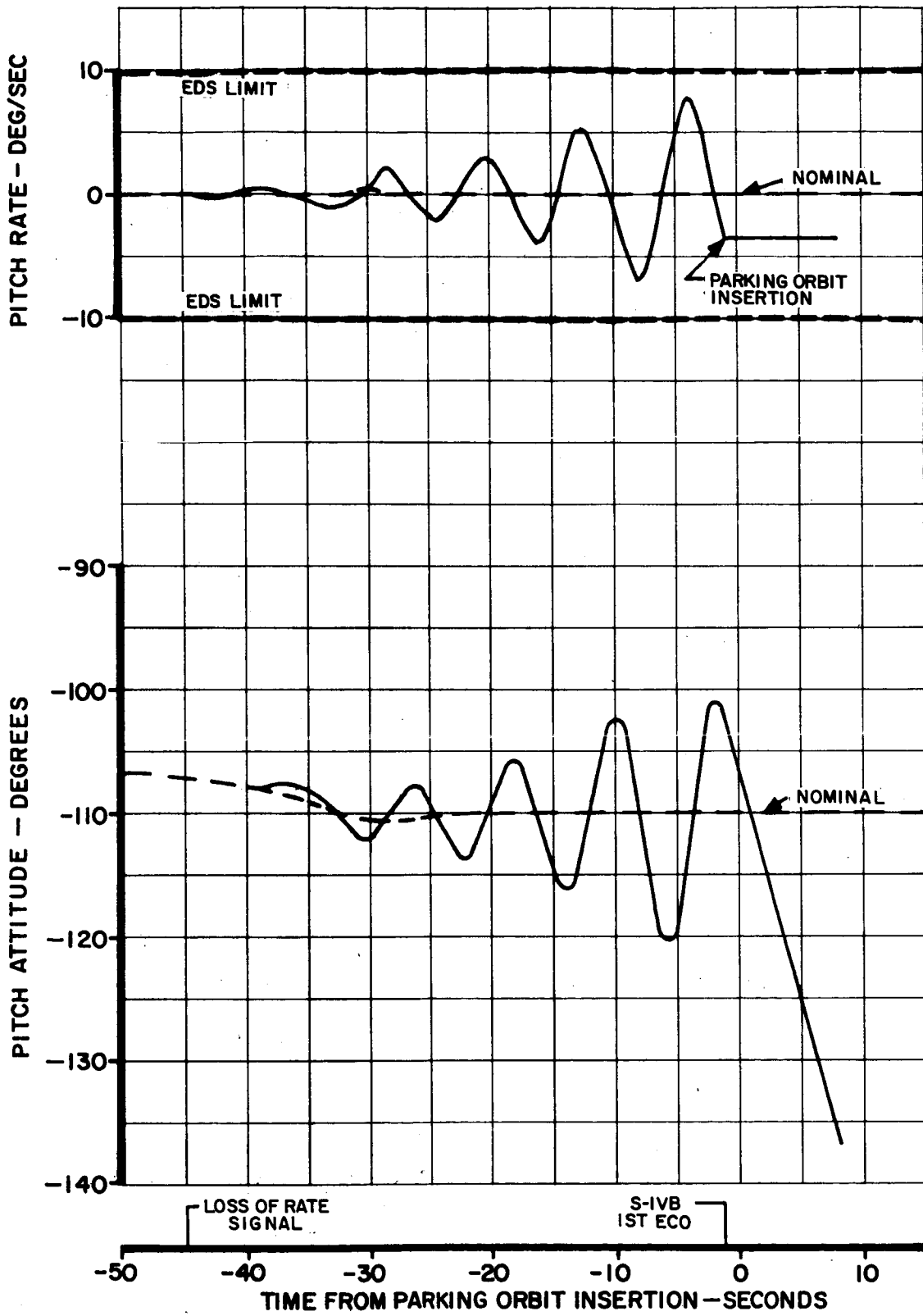

FIGURE 2-127 S-IVB LOSS OF PITCH RATE SIGNAL

2.6.30 Failure to Jettison Launch Escape Tower

The following analysis was performed to obtain best available estimate of SA-504 stability for the launch escape tower (LET) failure to jettison condition. Vehicle mass, center of gravity, and flexibility characteristics for the tower-on condition were used.

Results of the analysis show no stability problem during S-II and S-IVB flight. The worst degradation of stability margin occurs during S-IVB flight, Figure 2-128 . Using the latest available S-IVB data, Reference 16 , the first bending mode gain margin for the tower-on condition is reduced to 9.5 db at the worst time point. Application of 3σ scatter reduces this gain margin to 1.4 db.

Reentry cannot be attempted with the LET and boost protective cover preventing deployment of the drogue and main parachutes. Emergency procedures are required to allow the crew to remove the LET and boost protective cover during earth parking orbit.

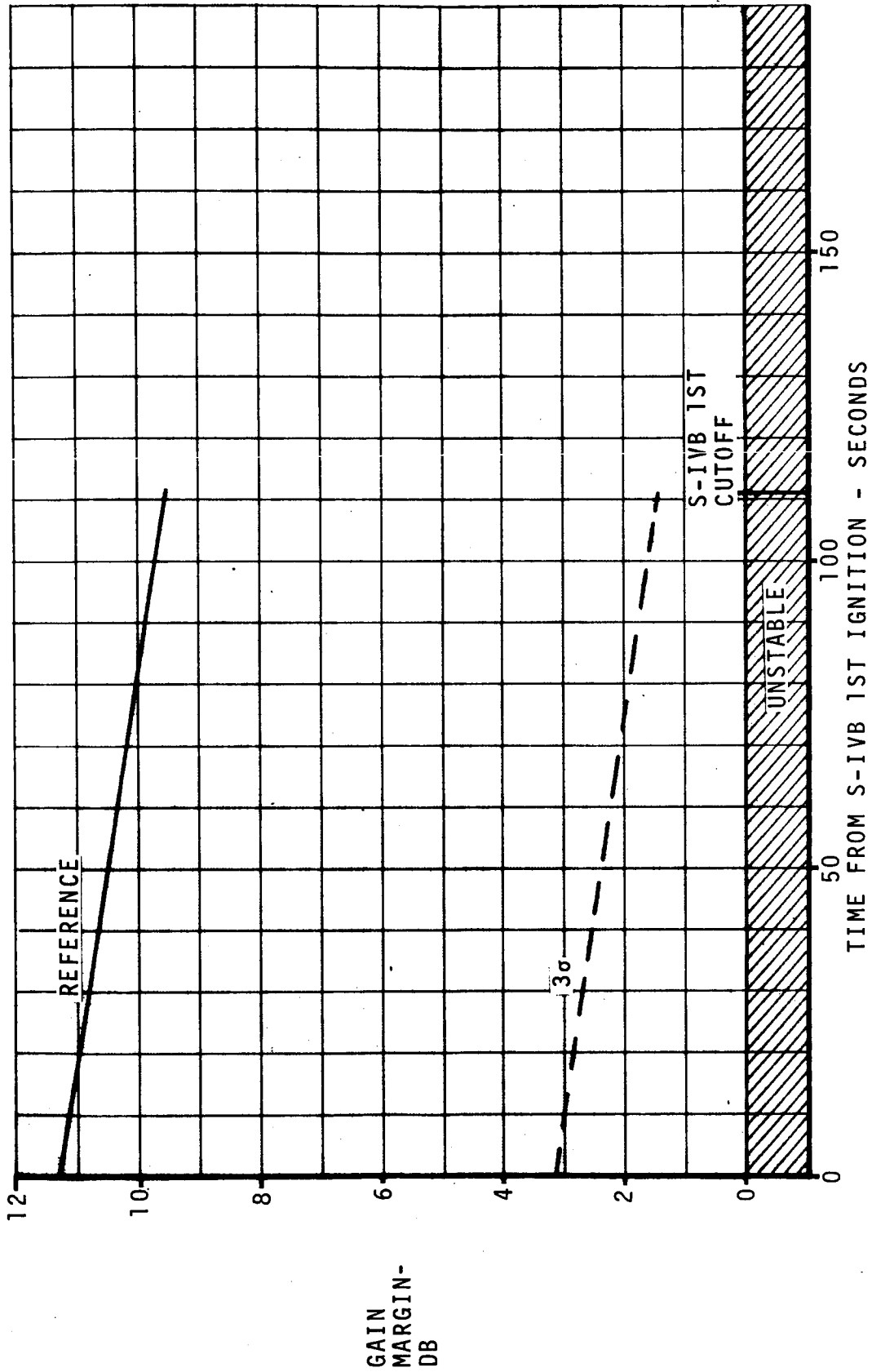

FIGURE 2-128 S-IVB PITCH (YAW) FIRST BEIDING MODE GAIN MARGIN (LET JETTISON FAILURE)

2.6.31 Failure to Jettison S-IC/S-II Interstage

Sequencing failures or severe device malfunctions causing failure to jettison the S-IC/S-II interstage will lead to exceeding the thermal environment limits in the S-II boattail area.

No recommendations are made to eliminate this problem. Engine shutdown and abort are required prior to generation of excessive temperatures. Due to the short time between nominal interstage jettison and exceeding temperature limits, the mission rule is to abort at TB3 + 46 seconds, Reference 17 .

2.6.32 Sequencing Failures - S-IC

a. Early Gain Change

A sequencing failure which causes a gain change prior to 85 seconds will cause vehicle loss because the vehicle attitude is unstable in the max-q region with low gains.

The first cue for this malfunction is 5° attitude error. If an abort is initiated at a $\Delta P\alpha$ of 3.2 psi, sudden breakup at abort occurs for the baseline vehicle.

b. Late Gain Change

A sequencing failure which produces a late gain change does not require abort even if no gain change occurs during S-IC flight. The attitude is unstable because of slosh, but more than 50 seconds is required to cause loss of control from this instability.

c. Early CECO

Early center engine cutoff does not require abort during S-IC flight. Staging parameters are within limits in Figure 2-4 for the worst case.

2.6.33 Sequencing Failures - S-II

a. Early Gain Change

A sequencing failure which causes early gain change does not cause an abort even if the second gain change occurs before S-II ignition.

b. Late Gain Change

A sequencing failure which produces a late control gain change does not require abort even if no gain change occurs during S-II flight.

c. Early CECO

Early center engine cutoff does not require abort during S-II flight. Staging parameters are within limits.

d. Failure to Start - All Engines

Since failure of all S-II engines to start prevents the S-IVB from achieving parking orbit (Reference 10), an LES abort is recommended.

2.6.34 Sequencing Failures - S-IVB

Gain change and early CECO are not applicable to S-IVB flight.
An S-IVB failure to start will cause an abort.

2.6.35 Retrorocket Failures at S-IC/S-II Staging

One retrorocket out will not cause a requirement to abort. Figure 2-129 shows that successful staging will occur for one retro failure. Sequencing malfunctions resulting in not issuing firing commands for the S-IC retrograde rockets will produce delayed stage separation and a possible period of local deformation where the stages remain in contact after the sever ordnance is fired. Thrust tailoff forces of the F-1 engines will tend to keep the stages in contact and precise structural consequences are not known. Analyses presented in Reference 18 which may be applied to SA-504 show that stage contact is maintained for approximately 2.5 seconds after OBECO, or 1.8 seconds after nominal firing of separation ordnance. Approximately one additional second is needed for the 0.4 meter (16 inch) separation required for the J-2 engine bell plane to clear the S-IC separation plane. This event occurs in about 0.4 second for normal separation. These results are shown in Figure 2-130. Clearance between the center J-2 engine bell and the top bulkhead of the S-IC LOX tank is only 0.178 meter (7.00 inches). Any extensive local deformation or relative side motion during the period of contact might allow these components to interfere.

In addition, the following result from slow separation stages:

- a. J-2 chilldown propellant might be trapped in the interstage and create an explosion hazard at J-2 ignition.
- b. Only about one-half meter separation will exist at J-2 ignition. Approximately 7 meters minimum has been estimated as a requirement for S-IC LOX tank dome integrity.

No concrete recommendations are available in the above situation. The following are suggested for feasibility evaluation:

- a. Investigate making firing of separation ordnance dependent on detected retro firing. This would prevent interstage "grinding" in case of no retrofire. Ordnance might be fired at a still later time (~ 3 seconds) after more complete F-1 thrust tailoff, with J-2 startup further delayed. (No J-2 startup would be allowed if separation ordnance is not fired). Gradual stage separation will follow without thrust assistance (but interference is more probable). The nominal flight reliability of such a system should be carefully considered, since a failure might inhibit separation ordnance firing and result in wasted retro thrust.
- b. Investigate delay of J-2 startup by a separation wire approximately nine meters in length. If this wire is not broken in approximately 3 seconds after OBECO, a further J-2 ignition delay of 8 to 10 seconds would be applied to prevent exceeding S-IC LOX tank dome environmental limits. This system should not affect normal staging. Nominal flight reliability again should be carefully considered.

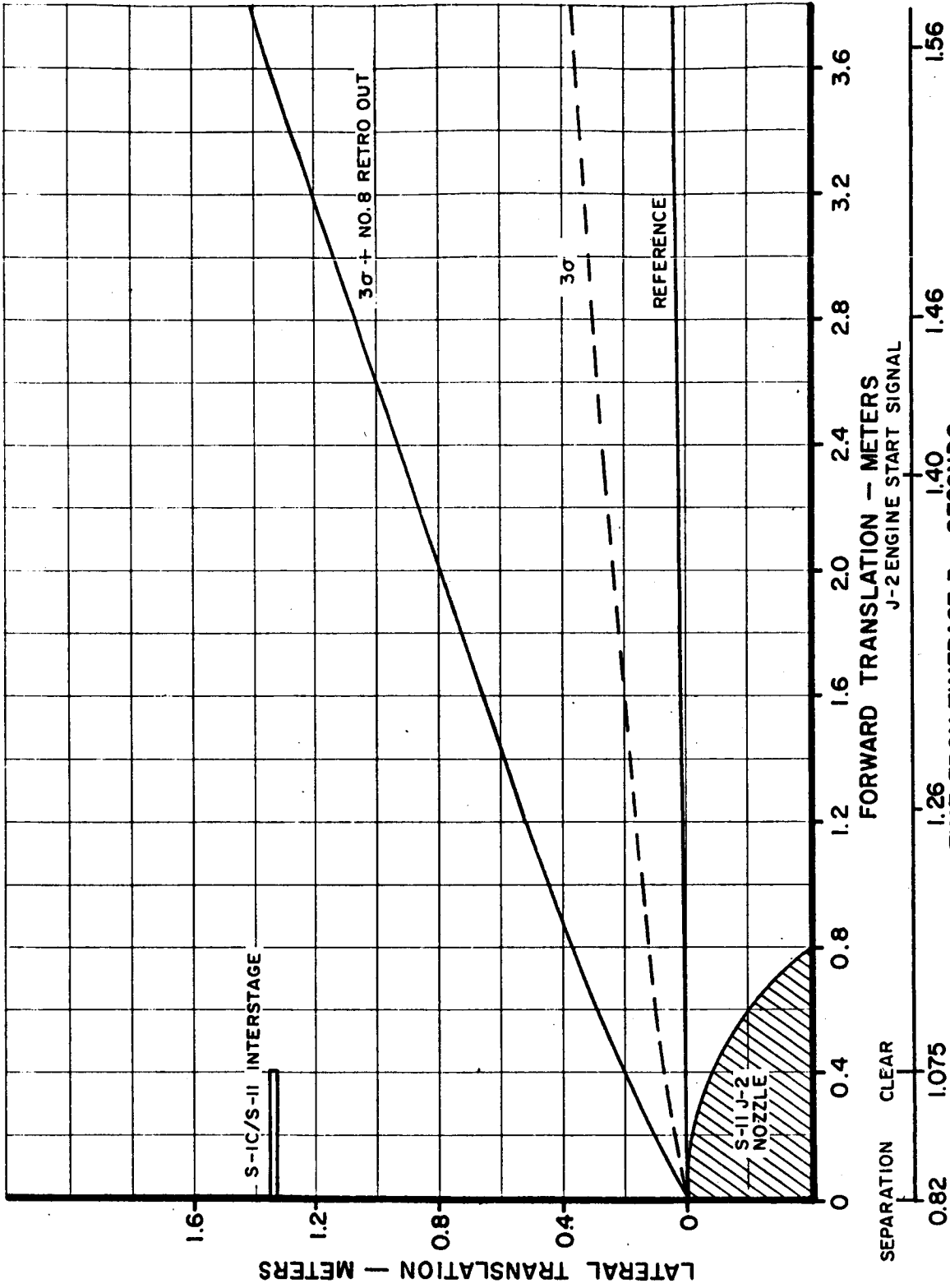

FIGURE 2-129 SEPARATION CLEARANCE DURING S-IC/S-II STAGING

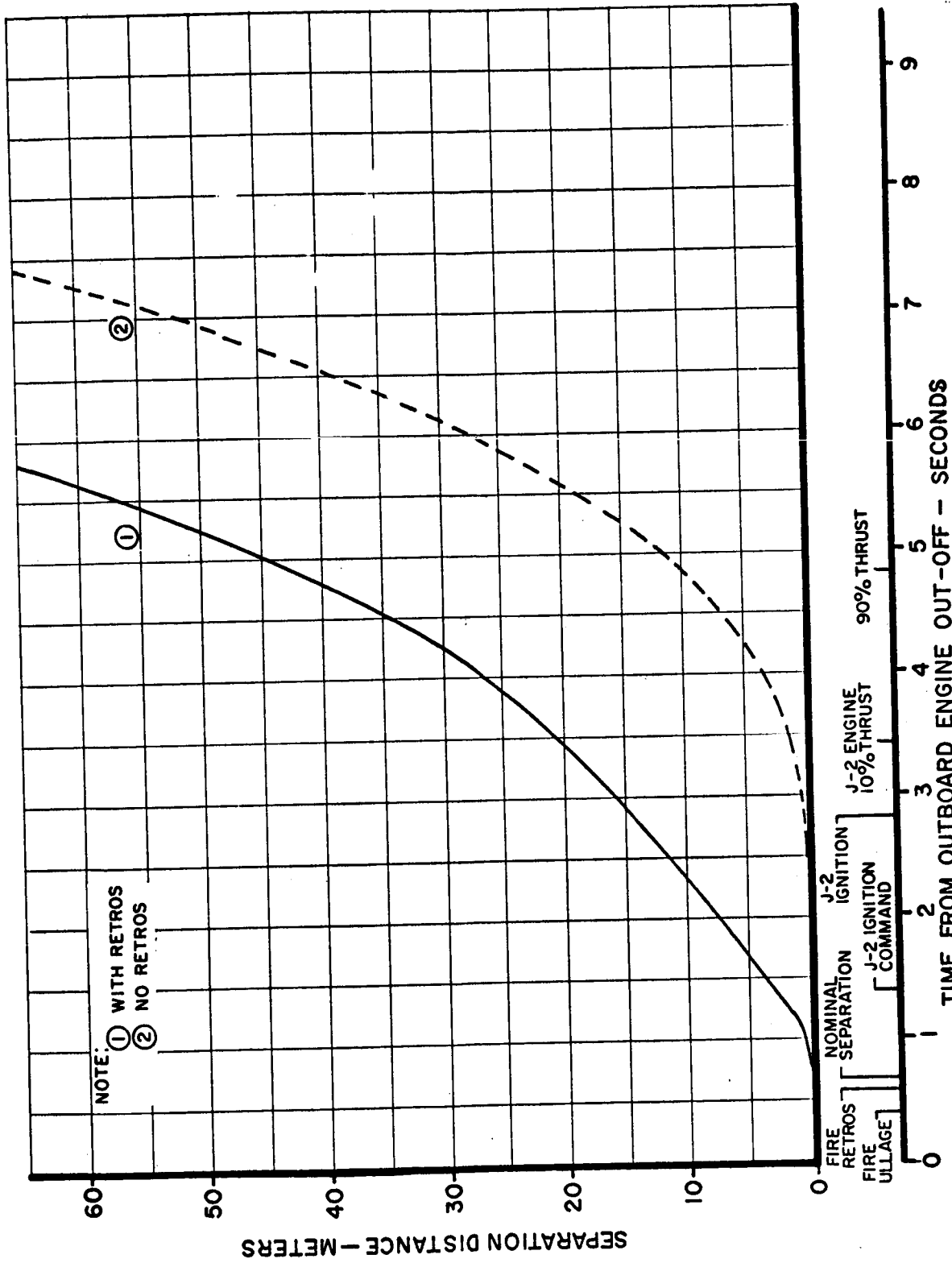

FIGURE 2-130 S-II SEPARATION DISTANCE HISTORIES

2.6.35 (Continued)

In case of retrofire failure, J-2 startup delays caused by the suggested system would cause considerable loss of payload into orbit. Propellant reserve depletion might prevent completion of the out-of-orbit mission.

2.6.36 Retrorocket Failures at S-II/S-IVB Staging

Sequencing malfunctions resulting in not issuing firing commands for the S-II retrograde rockets have similar consequences to the corresponding S-IC malfunction and separate discussion is not included here. Separation distance information for this case is shown in Figure 2-131. Figure 2-132 shows that successful staging occurs for one retrorocket failure.

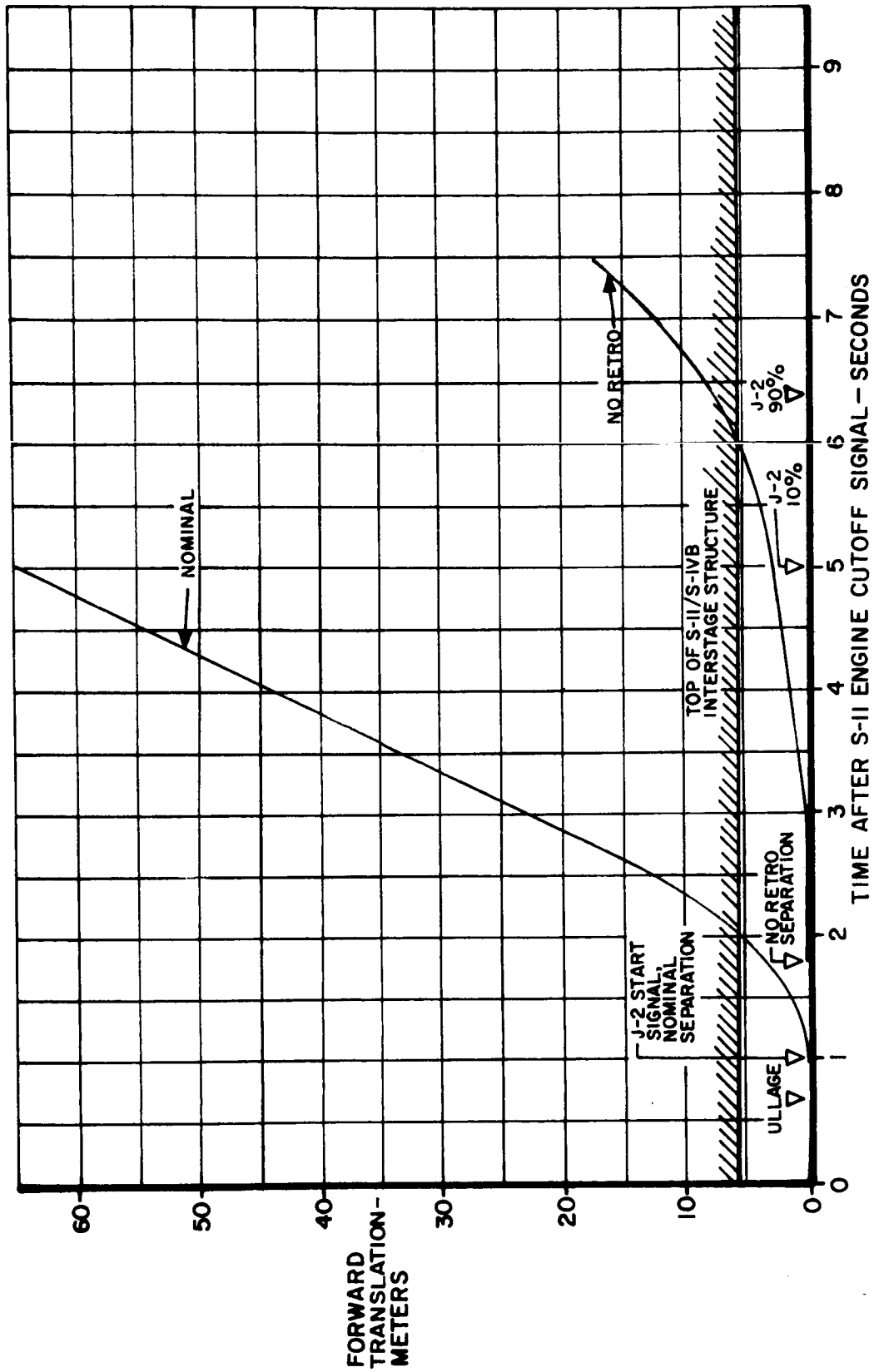

FIGURE 2-131 EFFECT OF NO RETRO ROCKET FIRE ON S-II-S-IVB SEPARATION AT STAGING

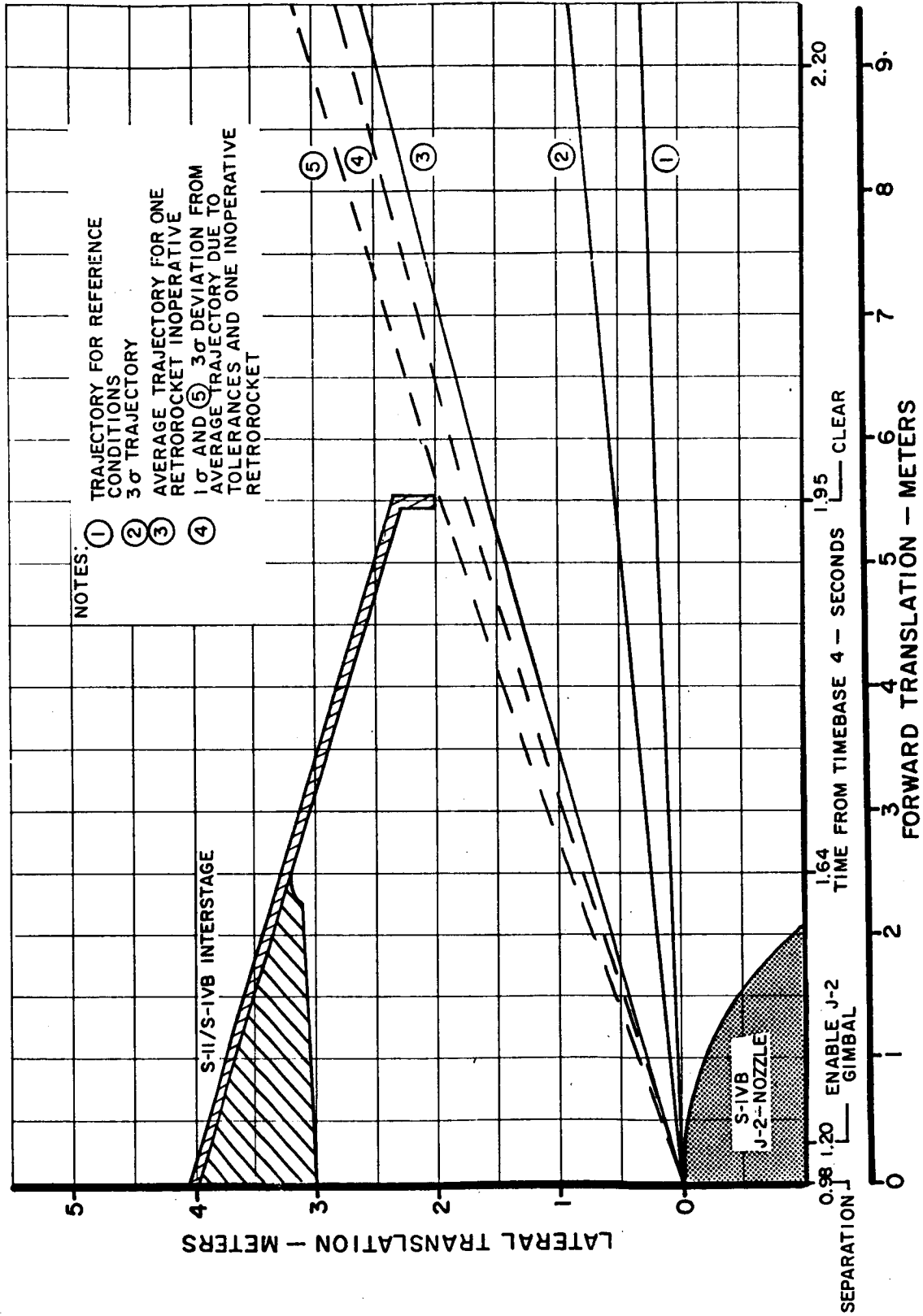

FIGURE 2-132 SEPARATION CLEARANCE DURING S-II/S-IVB STAGING

2.6.37 Propellant Utilization System Malfunctions

The following investigation of Propellant Utilization (P.U.) System failures and variations on IGM performance was made to determine if any possible EDS abort situations result.

During most of S-II and S-IVB first burn flight, the propellant utilization (P.U.) system is placed "against stops" by the selected propellant loadings and variations are not possible without malfunction. Some variation in time of MR shift is expected and trajectory consequences are covered in the Saturn V dispersion analyses. Malfunctions consisting of (a) failure of P.U. valve to null position, (b) failure of P.U. valve to lower stop and (c) failure of P.U. valve to upper stop are presented. These failures will be investigated in detail for trajectory deviations in the Reference 10 series of documents.

None of the S-II P.U. malfunctions studied required an abort of the vehicle, nor did any of the cases exceed EDS parameter limits. Therefore, it is not expected that any abort will be required for a P.U. malfunction or that a false abort signal will be issued. The primary effects of S-II P.U. malfunctions are trajectory deviations requiring extra S-IVB burn time and off-nominal parking orbit insertion conditions. Parking orbit insertion (POI) can be obtained with all S-II P.U. system malfunctions, but off-nominal vehicle performance may result in guidance being unable to reach its cutoff conditions for the worse cases (P.U. null at unlock).

Failure of S-II 2nd mixture ratio shift to occur (failure of P.U. to upper limit) does not cause the extra S-IVB burn time experienced in the other two types of P.U. malfunctions. It does give slightly off-nominal parking orbit insertion conditions.

S-IVB P.U. malfunctions are less severe than those in the S-II stage causing very little deviation from the nominal trajectory. No excessive S-IVB 1st burn is experienced with P.U. malfunctions in that stage. As in the S-II stage, none of the malfunctions considered exceeded any EDS limits; therefore, no false abort is expected.

2.6.38 Auxiliary Propulsion System Failures

The following failures in the Auxiliary Propulsion System (APS) were considered:

- a. Loss of one APS yaw thruster, one APS module and both APS modules in S-IVB powered flight roll control.
- b. Loss of one APS yaw nozzle and one APS module in parking orbit coast.
- c. Loss of one APS ullaging thruster in parking orbit coast.

An analysis of these malfunction situations follows:

- a. Loss of one APS yaw thruster during S-IVB powered flight produces very small deviations from nominal flight with no disturbances present. With the introduction of a 5.6 degree roll error, recovery was accomplished in 13 seconds. A further discussion on the effects of loss of a single yaw thruster in orbit is presented in part (b) of this section.

Loss of one complete APS module (with roll forcing as above) produces the same recovery rate as one yaw thruster. The introduction of a one degree roll error into the simulation at the time of malfunction produced very little change in vehicle rates; a near-nominal parking orbit insertion followed. The loss of one APS yaw thruster or one APS module in S-IVB powered flight will not cause an abort. The S-IVB has sufficient control with either malfunction to recover from small roll perturbations and achieve near-nominal parking orbit insertion.

Loss of both APS modules in S-IVB powered flight produces total loss of roll control. Simulation results do not show buildup of excessive roll error; however, in-flight disturbances that might contribute to roll rate are not present in the simulation. To represent these unknown effects and to determine permissible roll deviation, a roll error of one degree was introduced into the simulation at the time of the malfunction. Guidance disturbances were encountered when roll attitude deviation reached 90 degrees. This disturbance does not result from stable platform tumbling but instead appears to be due to limitations in the flight program inertial-body axis transformations.

2.6.38 (Continued)

- b. Loss of a single APS thruster in orbit causes eventual loss of control. With thruster #3 failed in the diagram below, it can be seen that any attempt to move the vehicle in the negative yaw direction by firing thrusters 3 and 4 will induce a motion about the roll axis; this roll motion will become large enough to cause thrusters 3 and 6 to be commanded to fire, with thruster 4 being commanded to shut off. Thruster 6 will fire until the roll motion has been reduced sufficiently to allow the yaw error to become the controlling factor; thrusters 3 and 4 are again commanded to fire; this process continues, the yaw attitude diverging with each cycle.

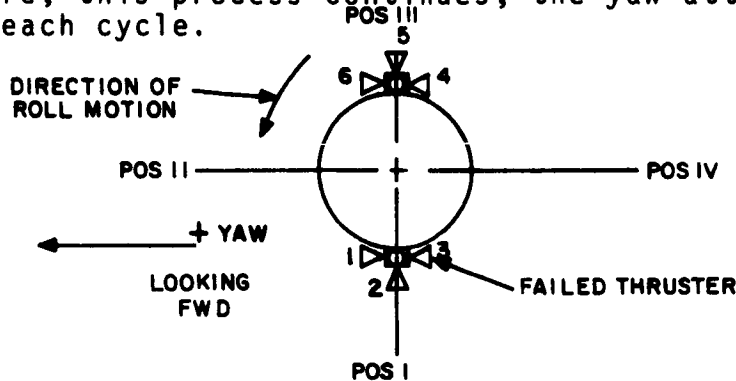

The loss of one APS module in orbit produces the transients shown in Figure 2-133. For both pitch and roll perturbances the vehicle slowly rotated about the pitch axis and slowly diverged in yaw and roll during parking orbit coast. The pitch rotation cannot be stopped because one APS module has pitch torque in only one direction. Yaw and roll are coupled because one module's yaw thruster produces both yaw and roll torque. The loss of one APS module will cause an abort in parking orbit.

Total loss of APS is not considered here.

- c. Two 70 pound force (311 N) APS ullaging motors are mounted as shown below. These motors are fired just after parking orbit insertion and during restart preparation to settle S-IVB propellants in their tanks.

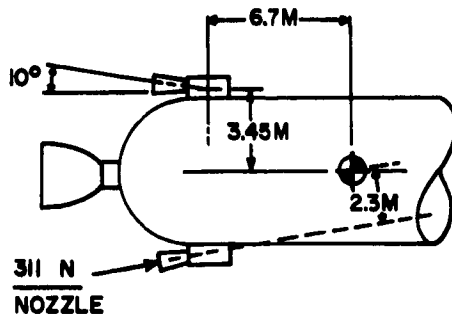

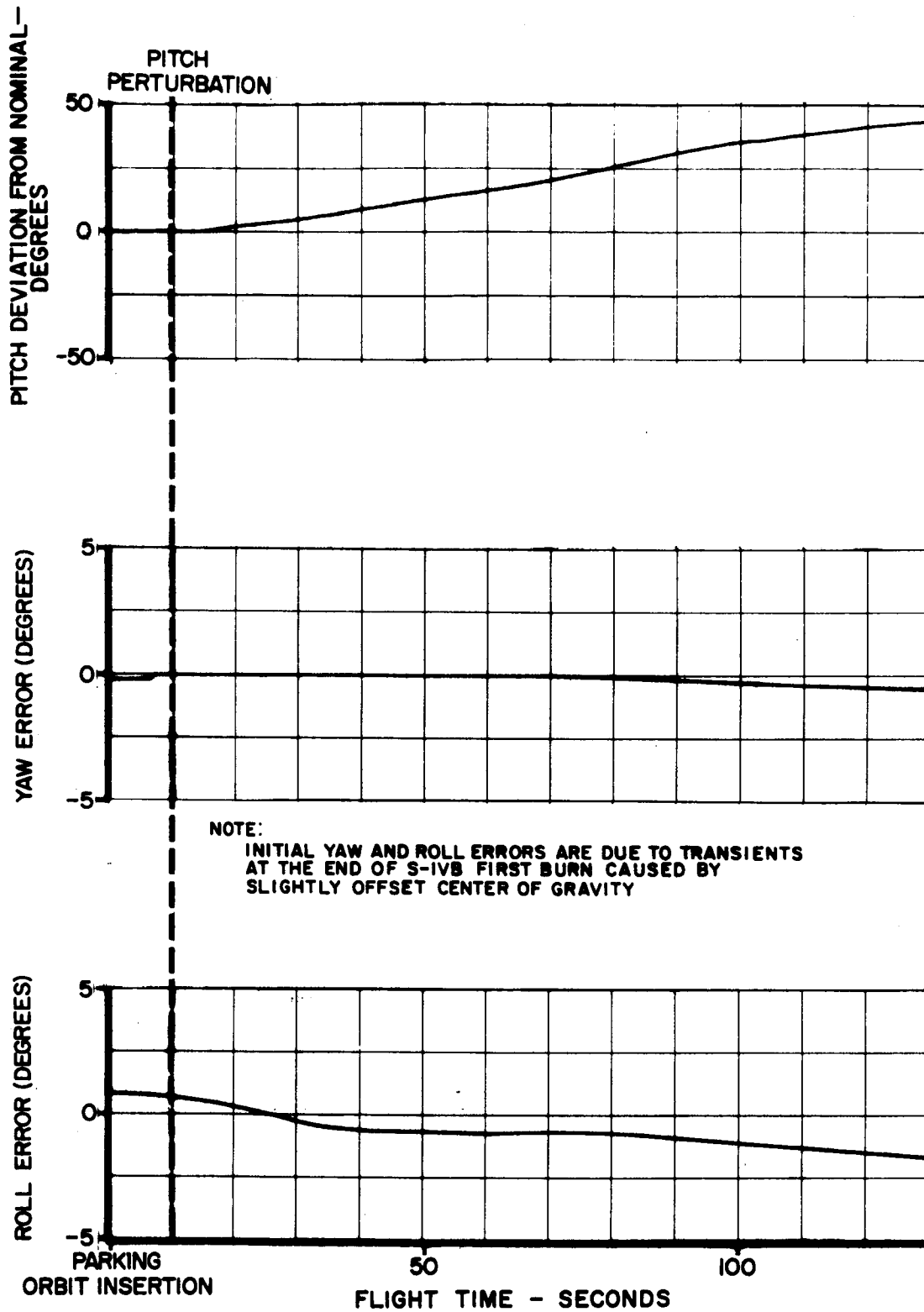

FIGURE 2-133 S-IVB ATTITUDE ERRORS DURING LOSS OF ONE APS MODULE IN PARKING ORBIT

2.6.38 (Continued)

Failure of one ullaging motor creates a torque that must be cancelled by APS pitch control. The above moment balance indicates that 15 percent duty cycle is required for the APS pitch motor. The ullage motor fires for 88 seconds at POI and 327 seconds at restart preparation. Consequently, additional pitch motor operation during these periods will consume an additional 11 percent APS fuel from the affected module (or 5.5 percent of total APS fuel). The opposite APS module will save 34 percent of its fuel due to no ullaging. If the ullaging burn times are extended to compensate for reduced thrust, the above APS fuel consumption is increased proportionally. The S-IVB pitch error was -1.1 degrees (-0.9 degrees nominal) and the pitch rate was near-nominal during loss of one ullage motor in parking orbit. Loss of one APS ullage motor in parking orbit will not cause an abort due to loss of control.

2.6.39 Malfunction Flight with Inflight Measured Winds

To develop a typical performance result for malfunction under a real-wind situation, the SA-504 flight simulation was flown with SA-501, SA-502, and SA-503 winds. The actuator hardover malfunction was chosen to be worst-case for the prevailing wind direction at the failure altitude. Simulation results are presented in Figures 2-134, 2-135, and 2-136.

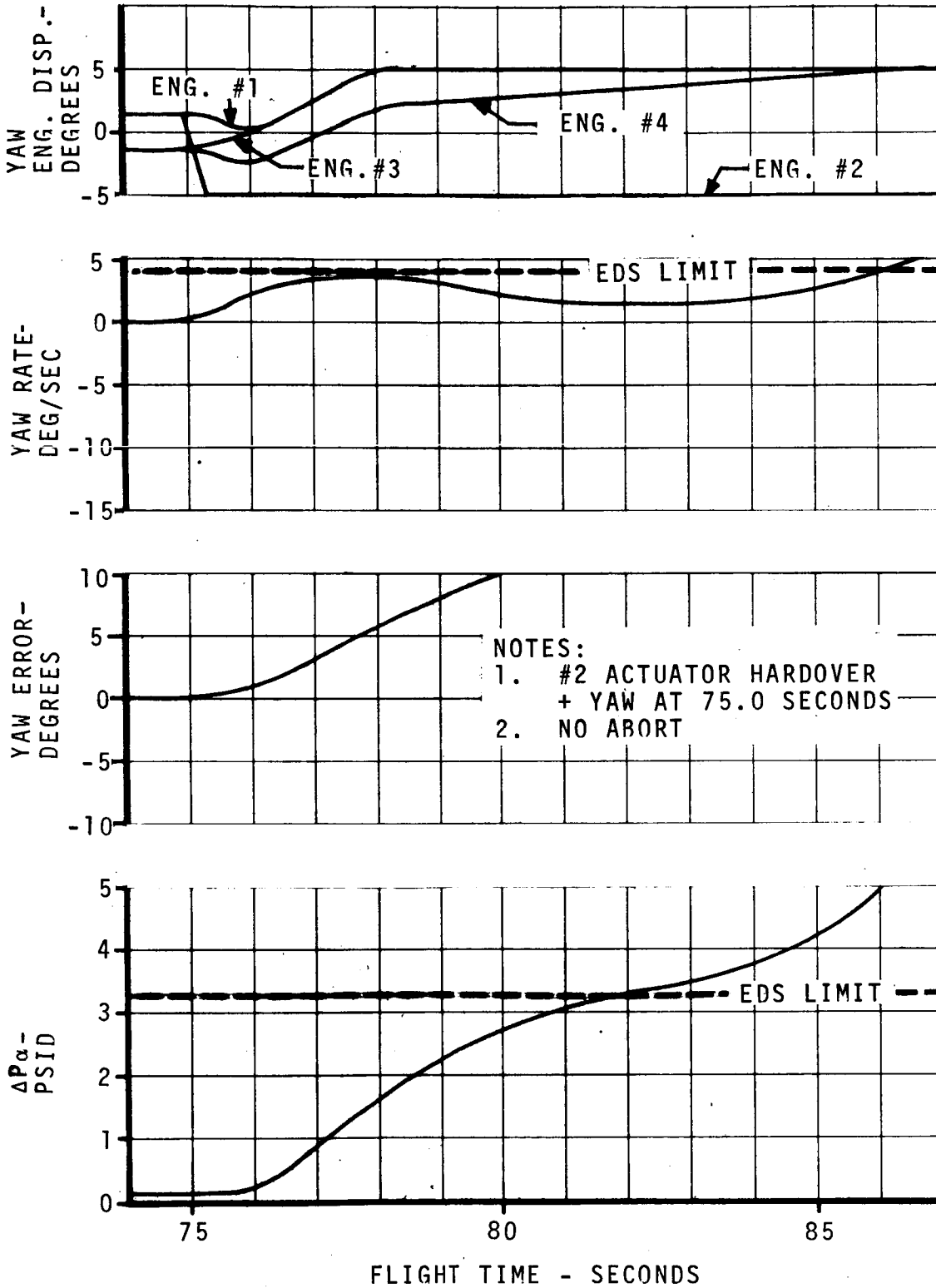

FIGURE 2-134 TIME HISTORY OF DYNAMIC VARIABLES FOR ACTUATOR HARDOVER WITH AS-501 T-O WIND

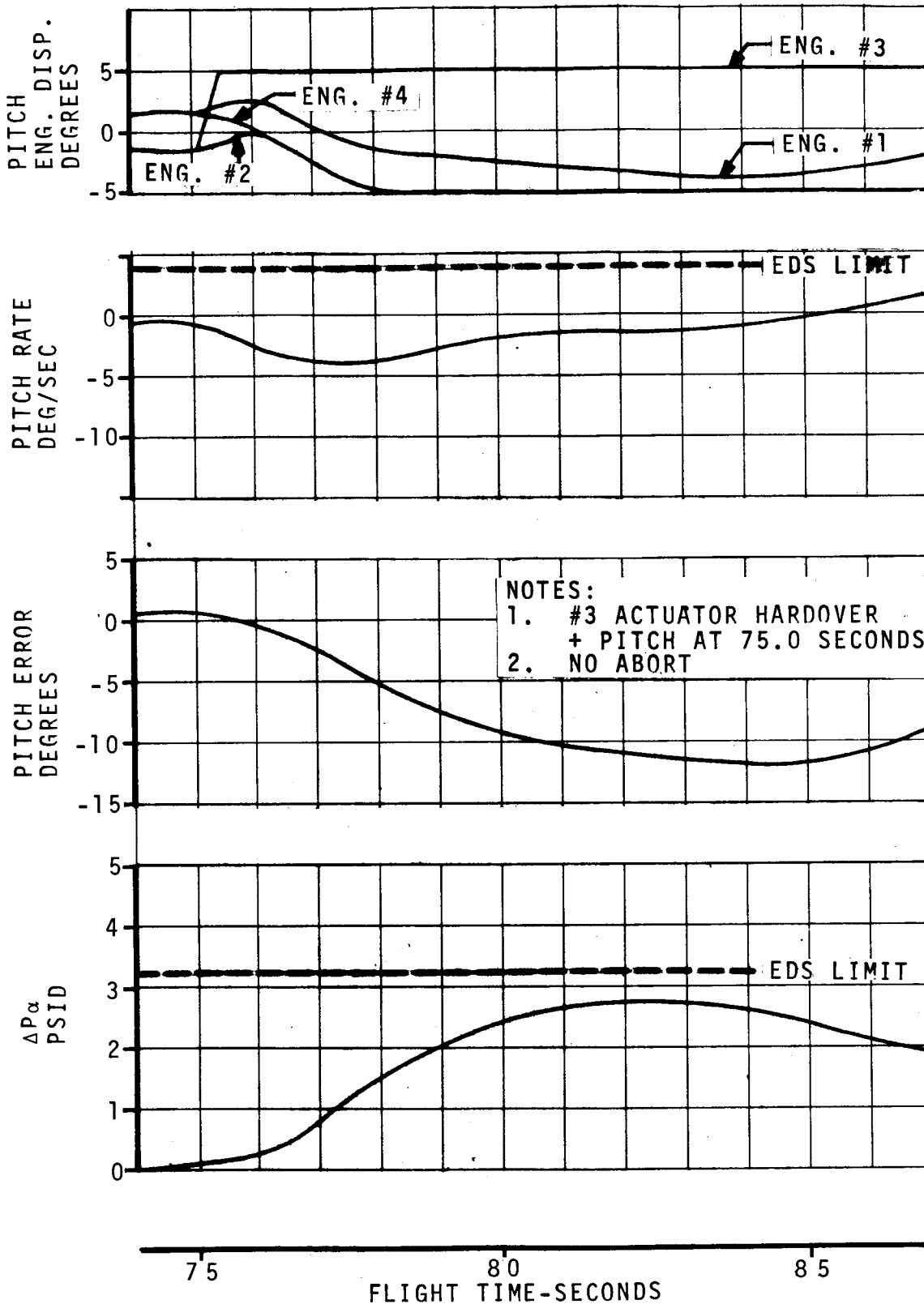

FIGURE 2-135 TIME HISTORY OF DYNAMIC VARIABLES FOR ACTUATOR HARDOVER WITH AS-502 T-0 WIND

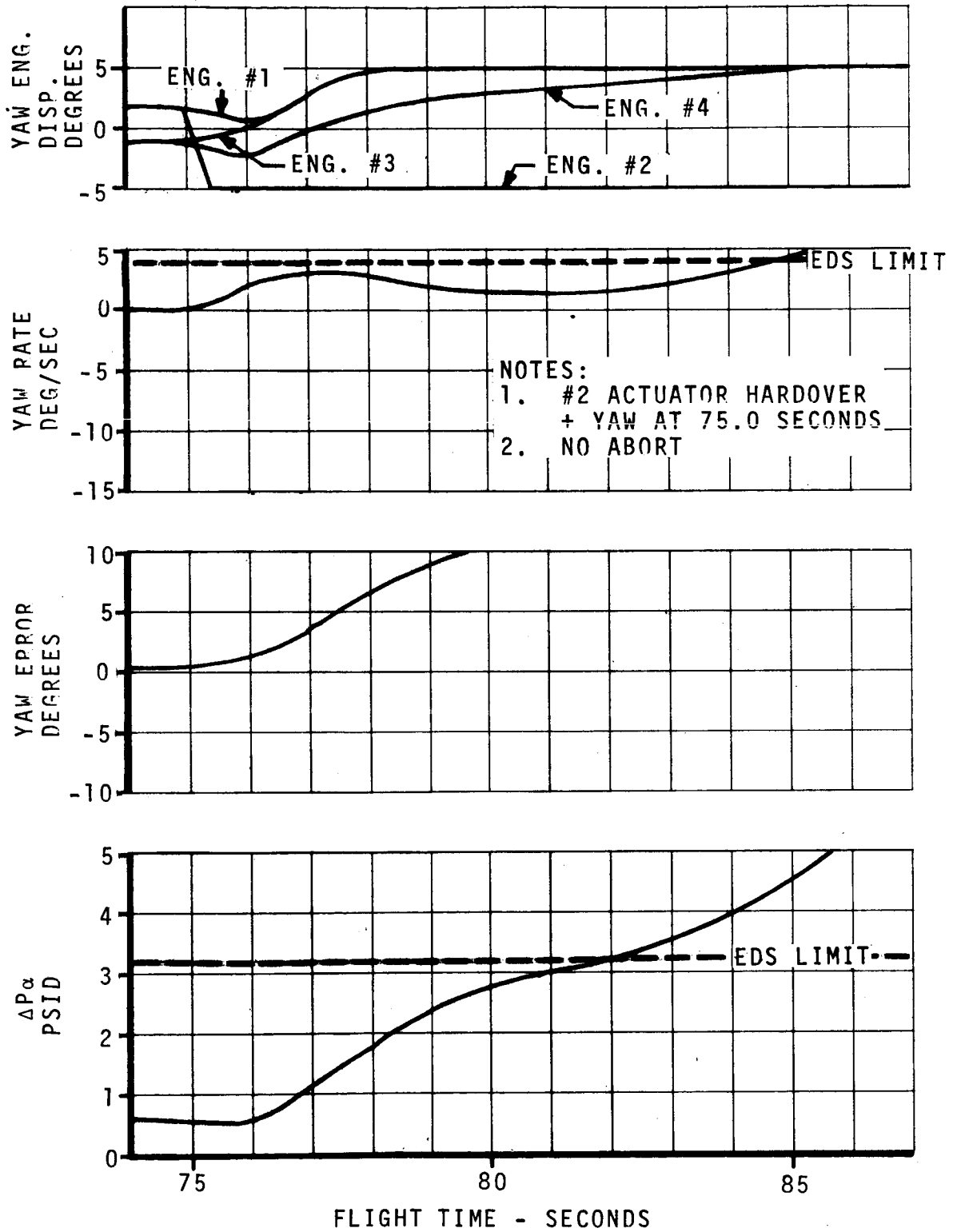

FIGURE 2-136 TIME HISTORY OF DYNAMIC VARIABLES FOR ACTUATOR HARDOVER WITH AS-503 T-11 WIND

2.7 EDS LIMIT SETTINGS

2.7.1 S-IC EDS Limits

S-IC abort limits are shown in Table 1-I. These limits guarantee abort prior to launch vehicle structural failure. Safe abort is not guaranteed, however, because tension loads after abort may cause breakup and explosion before the Launch Escape Vehicle can reach a safe distance.

Automatic abort will be initiated by an overrate measured by two of the three rate gyros in each axis or by two engines below 89 percent thrust as indicated by two of the three "thrust-OK" pressure switches on each engine. An overrate is an angular rate of 4° per second in pitch or yaw or 20° per second in roll.

Manual abort will be initiated by the crew. Two independent cues measured and indicated by separate systems are necessary to prevent false aborts. First cues are

- a. Pitch, yaw, and roll attitude errors.
- b. Engine out lights.
- c. Guidance failure lights.

Second cues are

- a. Q-ball differential pressure (ΔP_α).
- b. Abort request light.

Automatic abort may be turned off at 120 seconds. After that time, the crew will initiate abort using

- a. Two engine out lights.
- b. Angular overrate light and angular rate indicator.

The angular overrate light and angular rate indicator are separate systems. The angular overrate light is turned on by the rate gyros in the Instrument Unit. The angular rate indicator is operated by the spacecraft rate gyros.

2.7.2 Selection of EDS Limits

EDS limits were selected to insure abort prior to structural failure or exceeding LEV- α abort limits, and to minimize

2.7.2 (Continued)

false aborts. False aborts are:

- a. Abort without malfunction due to nominal flight sensor readings, and
- b. Abort with malfunction, but where the vehicle is capable of sustaining safe flight.

To prevent false abort of the first type, EDS limits should be set above nominal flight dispersion envelopes. These envelopes were generated by simulating flight of a nominal vehicle with 3σ operating tolerances under varying wind conditions. Sensor measurement errors are added. The envelopes are shown by Figures 2-137 through 2-139 .

Preventing false aborts of the latter type (b) requires more refined discrimination. Since many of the malfunctions do not result in vehicle loss, EDS limits must be chosen to discriminate between vehicle-loss and non-vehicle-loss malfunctions. Previous evaluation of sensor limits from the standpoint of maximum warning time for malfunction cases requiring abort and minimum false abort cues for malfunctions not requiring abort has resulted in current limits used. Statistical data has been compiled on past studies to yield a quantitative measure of abort and false abort percentages for S-IC malfunctions which support the proposed limit settings.

Crew procedure will prevent engine-out false aborts after early engine out cases (prior to 50 seconds). For these, the ΔP_α abort limit is exceeded early in flight without loss of control or structural failure. Because of the steepness of the chi-freeze trajectory and the reduced thrust, ΔP_α peaks well before high q and the vehicle recovers in all cases. This sequence of events is illustrated in Figure 2-140. To prevent false abort, ΔP_α should not be used as an abort cue for engine failures prior to 50 seconds.

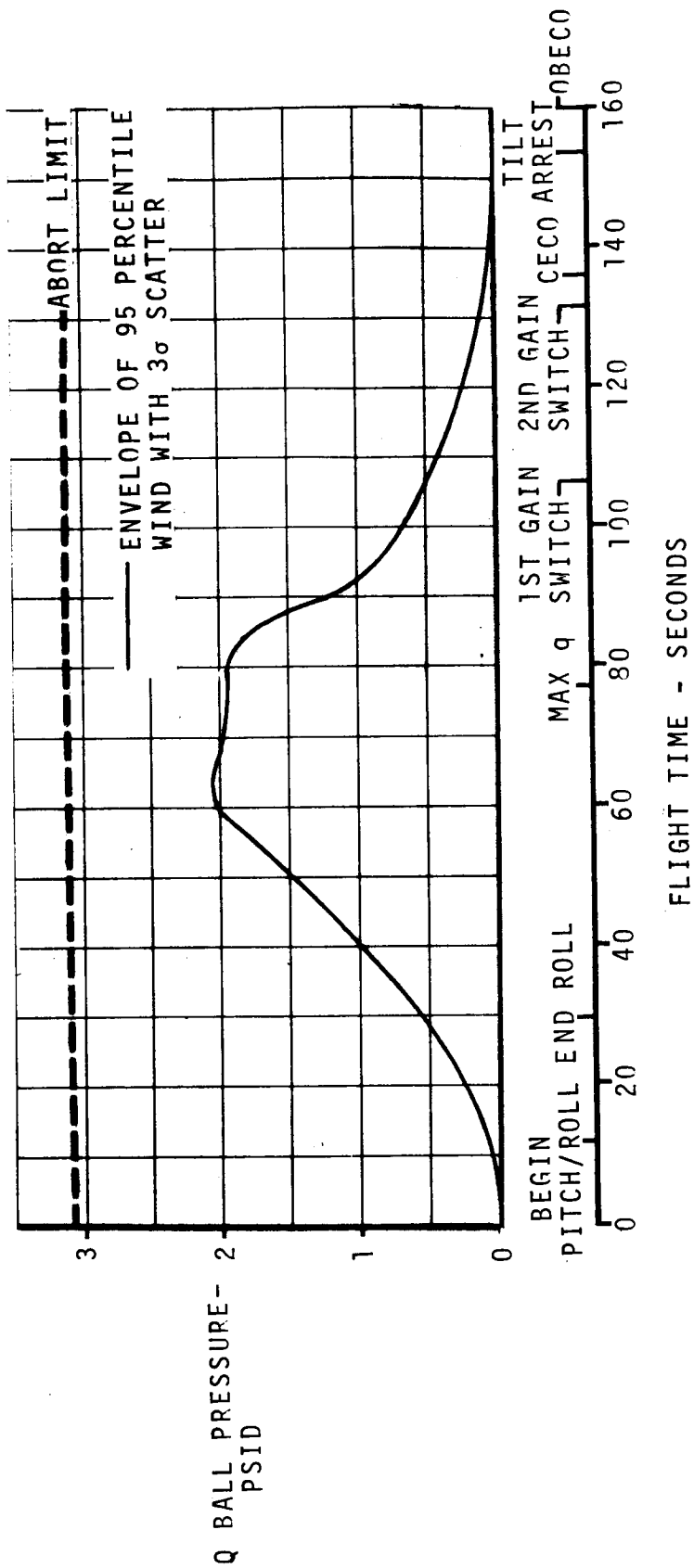

FIGURE 2-137 Q-BALL PRESSURE FOR S-IC FLIGHT

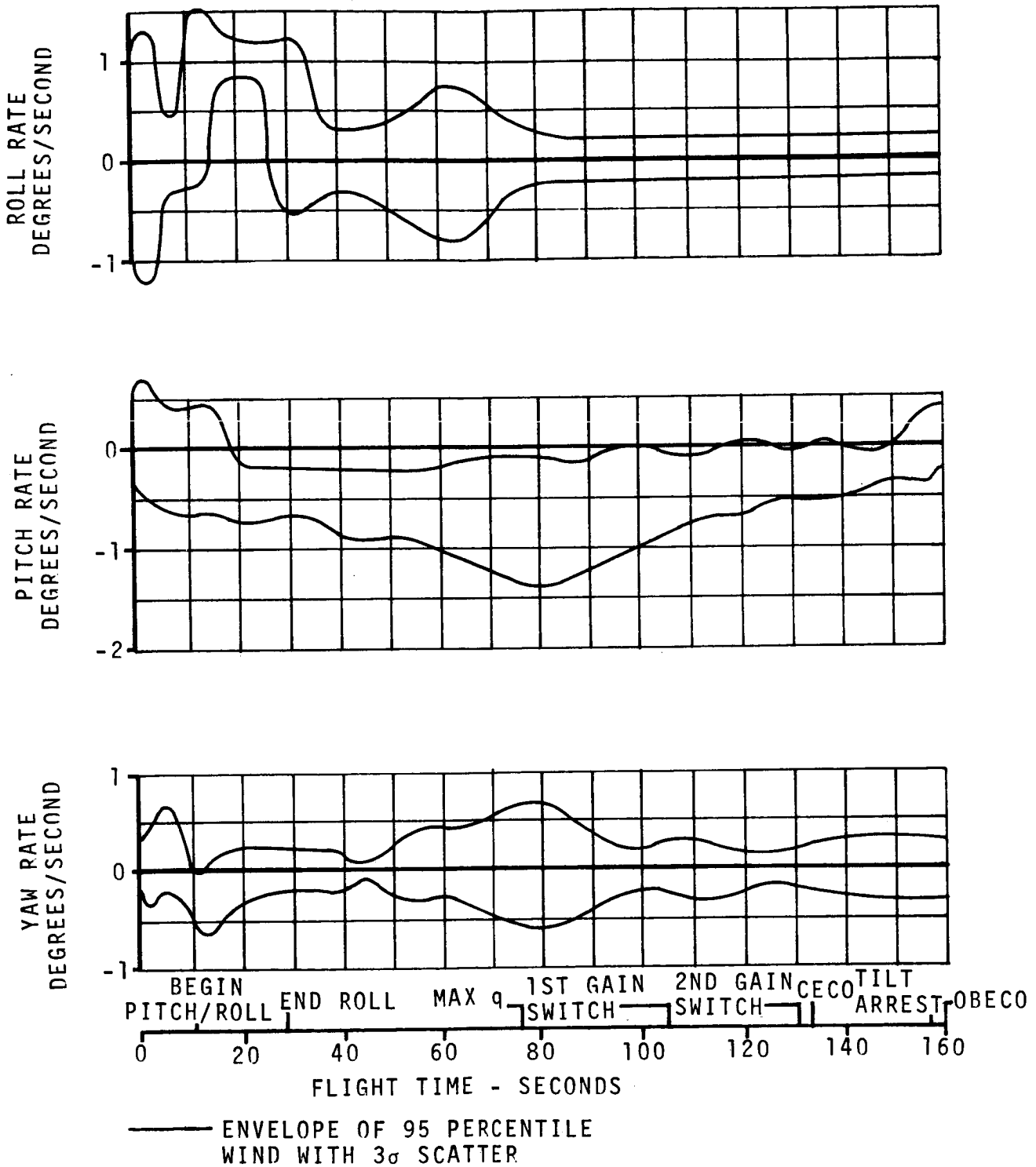

FIGURE 2-138 ATTITUDE RATE ENVELOPES FOR S-IC FLIGHT

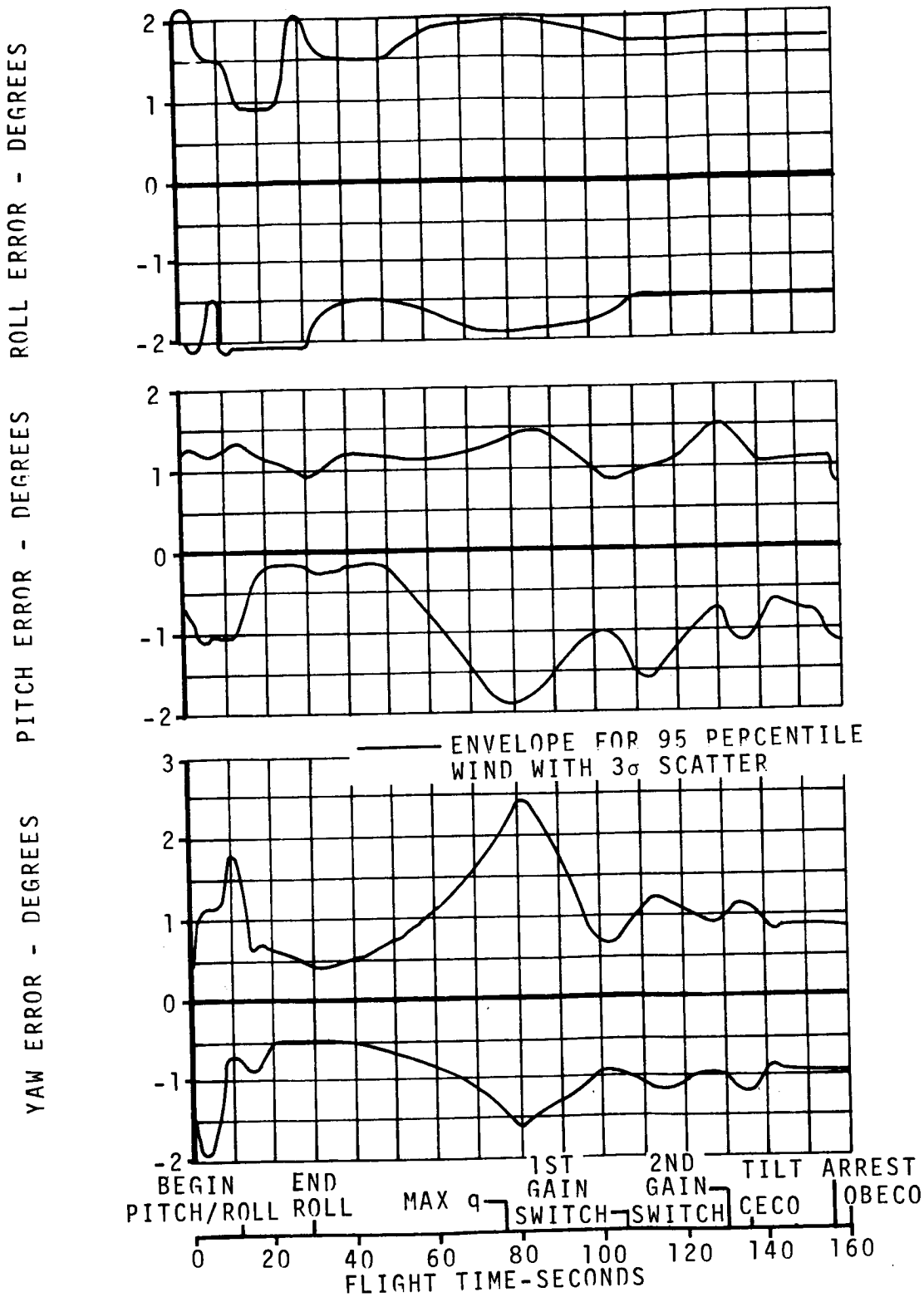

FIGURE 2-139 ATTITUDE ERROR ENVELOPES FOR S-IC FLIGHT

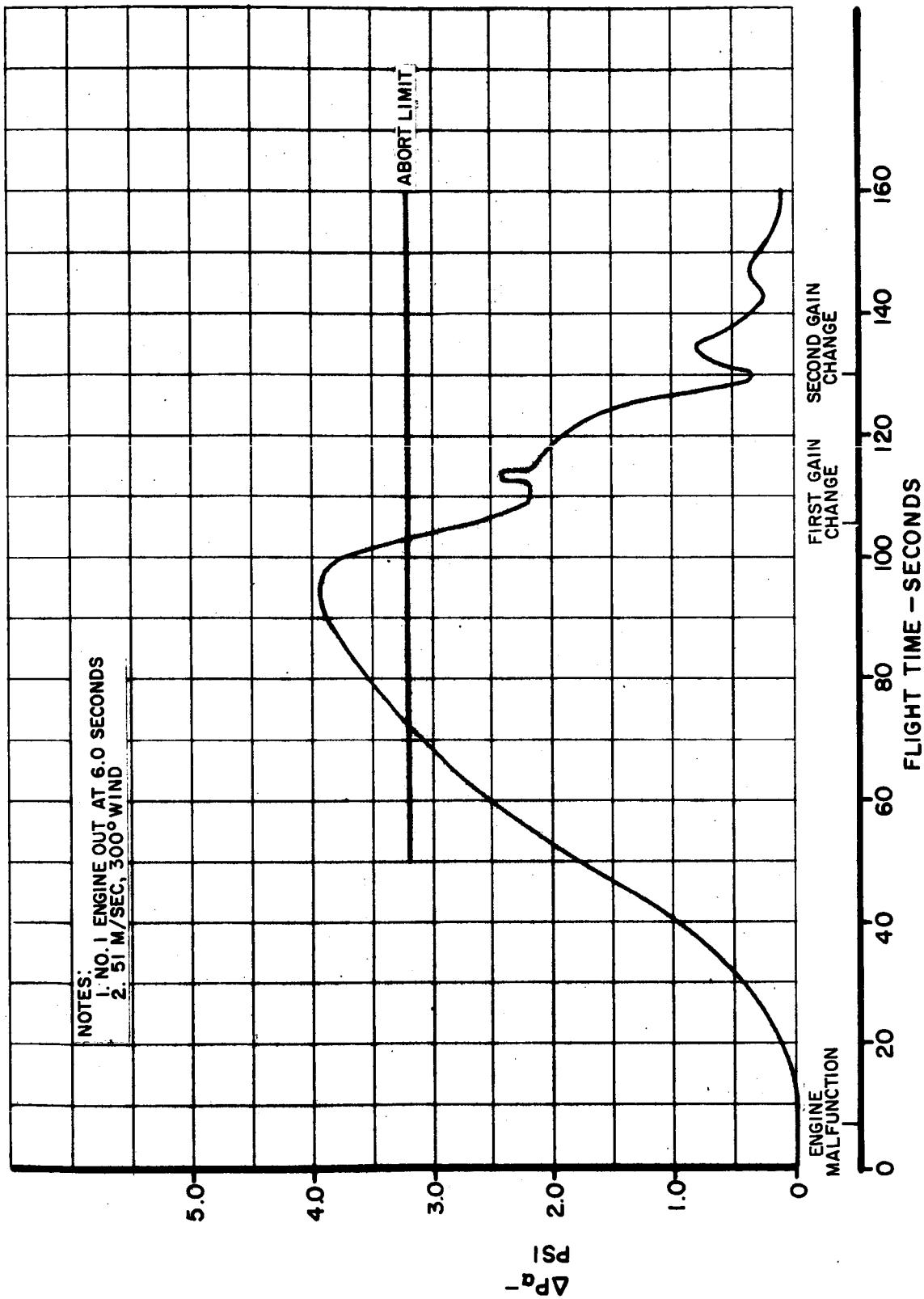

FIGURE 2-140 TYPICAL ΔP_{a1} HISTORY FOR AN EARLY ENGINE OUT

2.7.3 S-II and S-IVB EDS Limits

The recommended EDS abort limit is 10 degrees per second attitude (pitch or yaw) rate indicator (signal from spacecraft system). The first cue is the L/V rate light (signal from L/V EDS). FDO limits are used as EDS limits for slowly diverging vehicle failures.

Automatic abort is not provided in S-II and S-IVB since lack of atmospheric effects alleviate fast response time requirements. Q-ball ΔP readings are also not available, however, so that other manual abort cues must be relied on to obtain a two-cue abort sequence. Depending on the type of malfunction, a final abort cue of attitude rate (S/C signal) or FDO limits are used with one or more of the following initial cues:

- a. Pitch, yaw or roll attitude rates. (L/V EDS signal).
- b. Pitch, yaw or roll attitude deviation.
- c. Engine-out lights.
- d. Guidance failure lights.

2.8.4 Selection of S-II and S-IVB Limits

In addition to the requirements stated for S-IC, selected abort limits for S-II and S-IVB must also

- a. Provide safe re-entry and recovery conditions as defined by Flight Dynamics Officer plotboard limits.
- b. Not allow attitudes to exceed spacecraft platform tumble limits during abort recovery by SPS. (90° in yaw).

Flight Dynamics Officer plotboard limits are covered in Section 2.9. In Figures 2-141 to 2-143, a limit line is shown for spacecraft platform tumble, as defined by rates and attitudes of the launch vehicle at the time of abort. Also shown are results for typical malfunctions in S-II and S-IVB.

Figures 2-144 through 2-147 summarize false abort discrimination for all S-II and S-IVB malfunctions examined. Any settings larger than 10 degrees attitude deviation or 4 degrees per second rate provide complete discrimination for S-II and S-IVB. Extent of settings above this point are limited primarily by the capability of the CM/SM to recover after SPS abort before the S/C platform tumble limit is reached. This is specified as a yaw limit but is applied here in pitch and yaw. The reason for this high level of discrimination is the small level of nominal flight deviations encountered for flight outside the atmosphere.

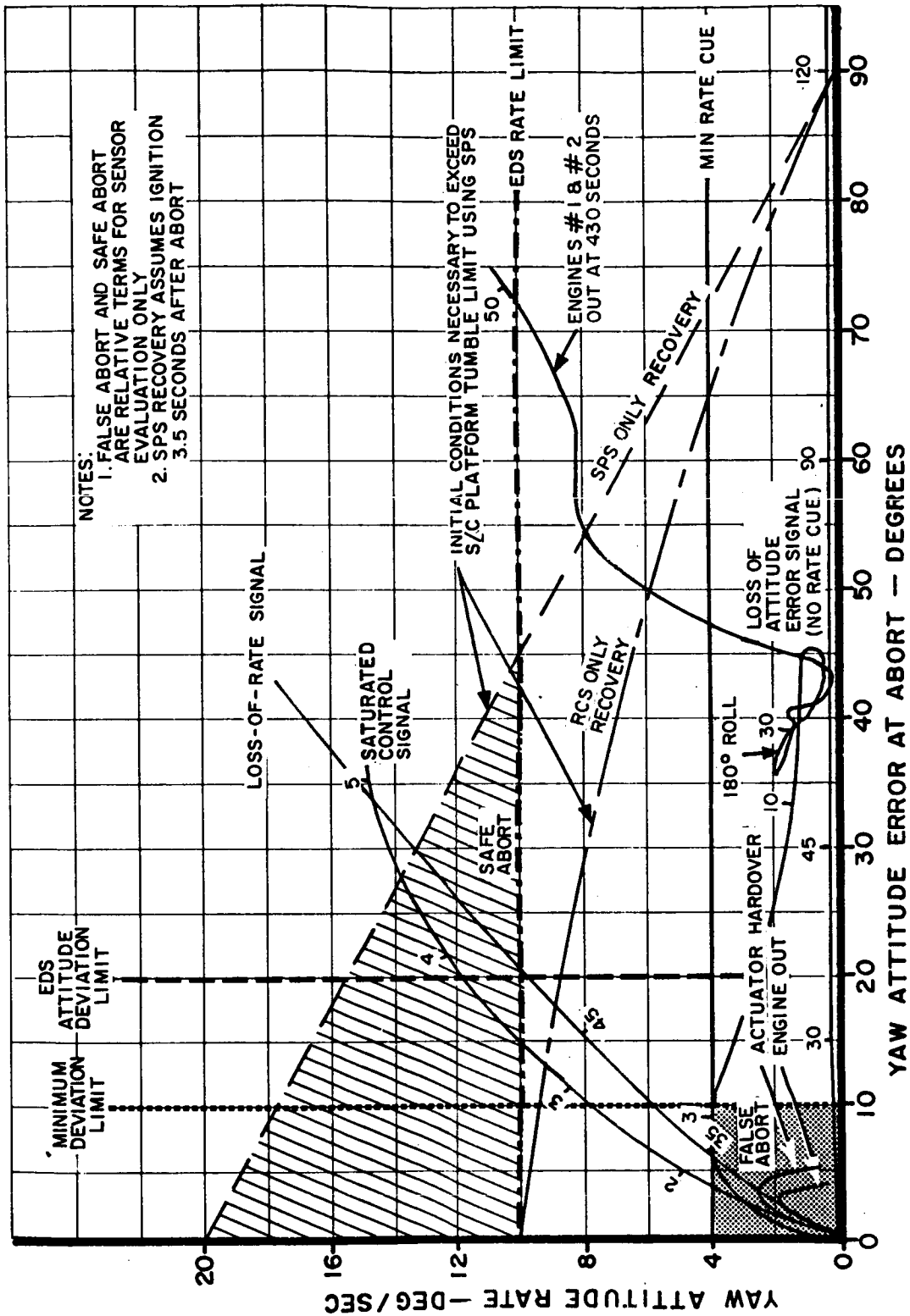

FIGURE 2-141 S-II CROSS PLOT OF YAW ERROR VS. YAW RATE

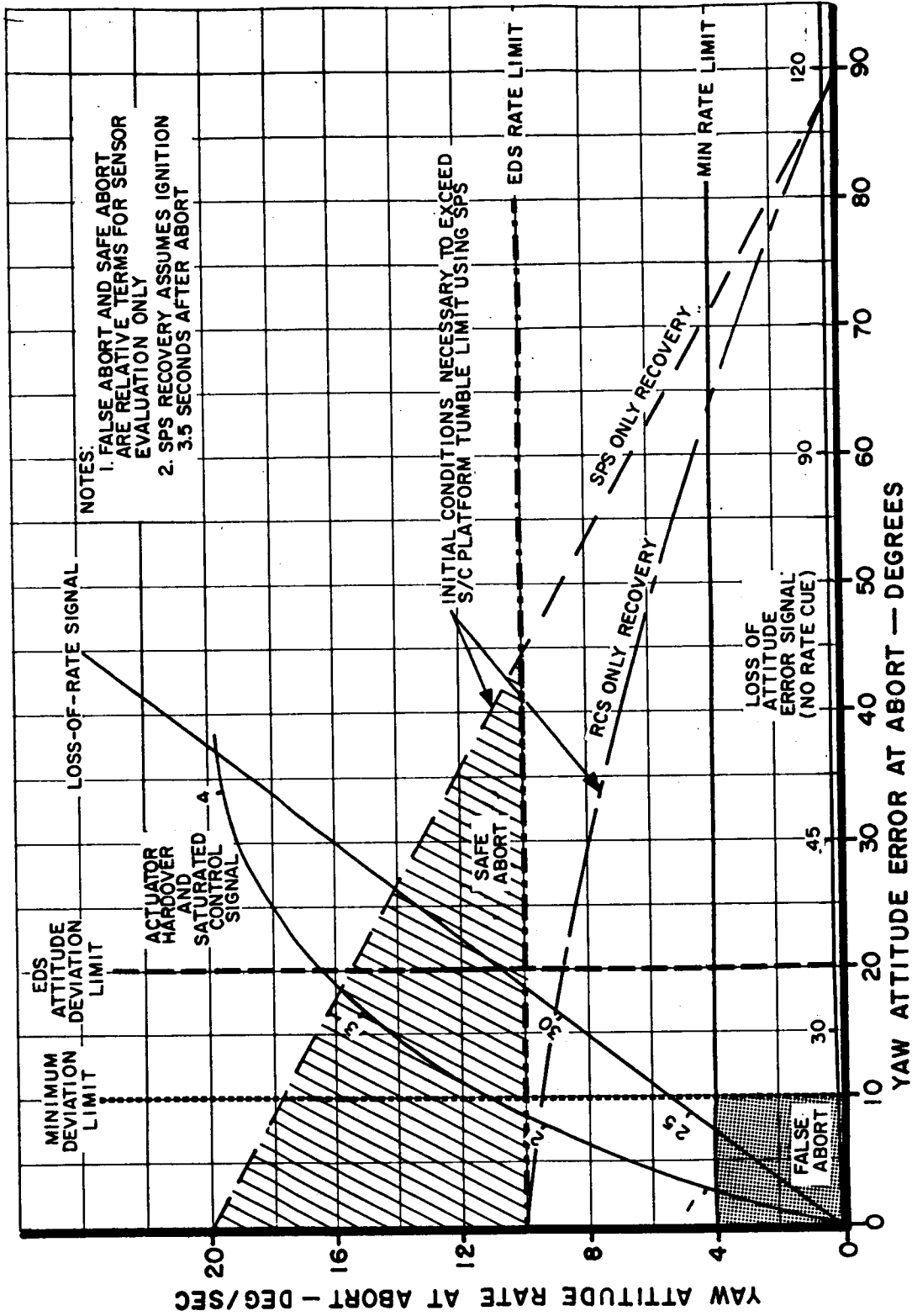
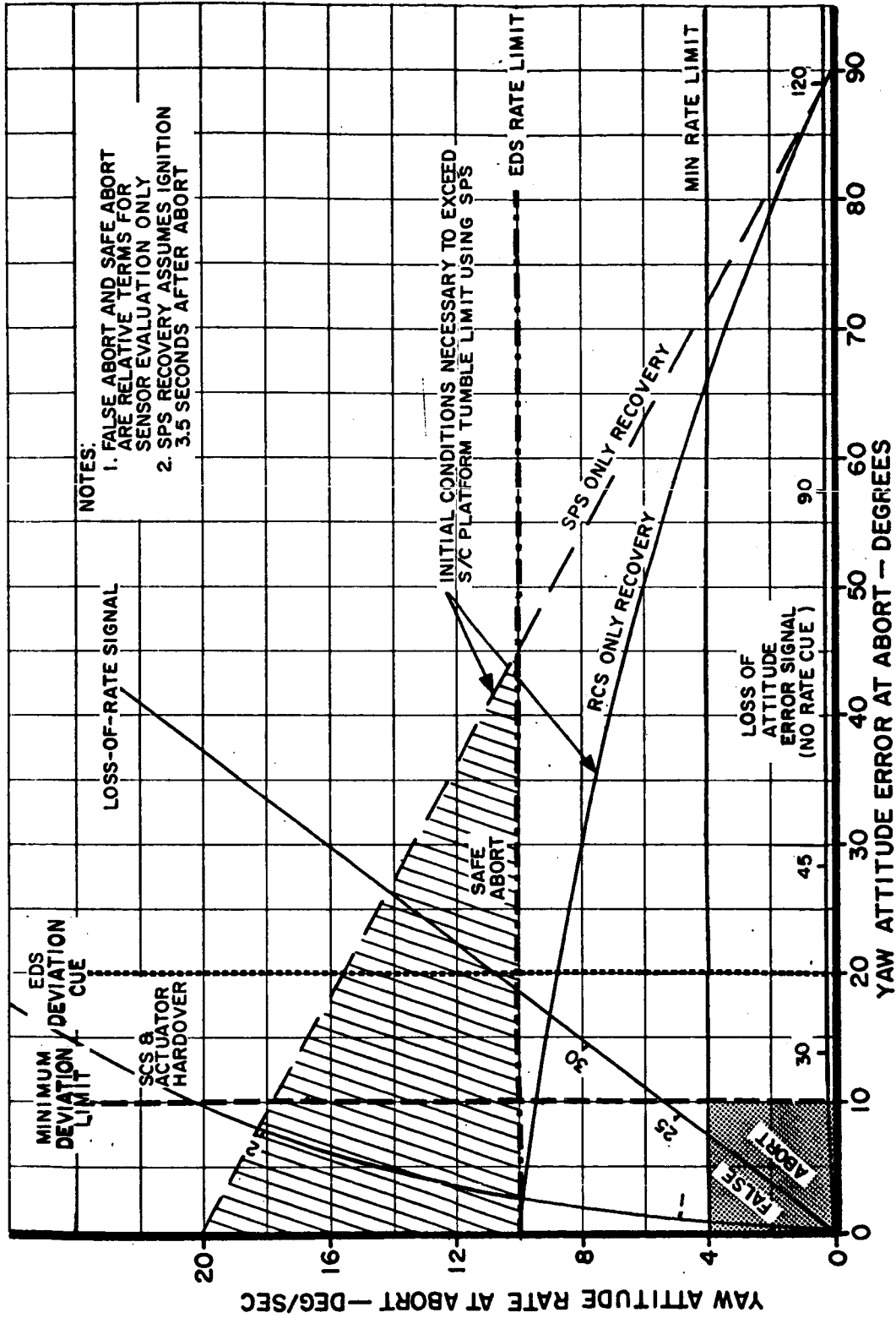

FIGURE 2-142 S-IVB FIRST BURN-CROSS PLOT OF YAW ERROR VS. YAW RATE



NOTES:
 1. FALSE ABORT AND SAFE ABORT ARE RELATIVE TERMS FOR SENSOR EVALUATION ONLY
 2. SPS RECOVERY ASSUMES IGNITION 3.5 SECONDS AFTER ABORT

FIGURE 2-143 S-1VB SECOND BURN CROSS PLOT OF YAW ERROR VS. YAW RATE

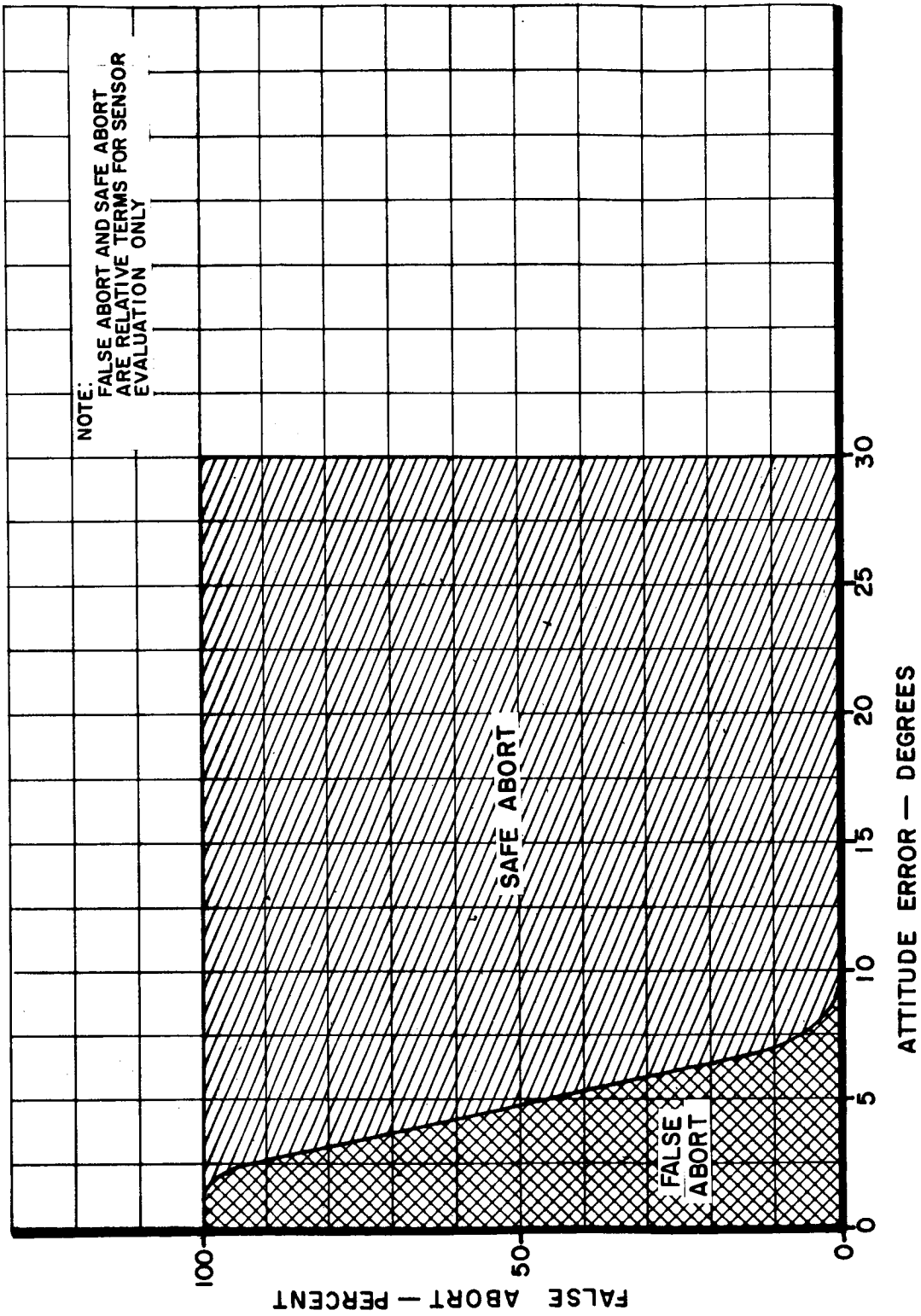

FIGURE 2-144 S-11 FALSE ABORT FACTOR - ATTITUDE

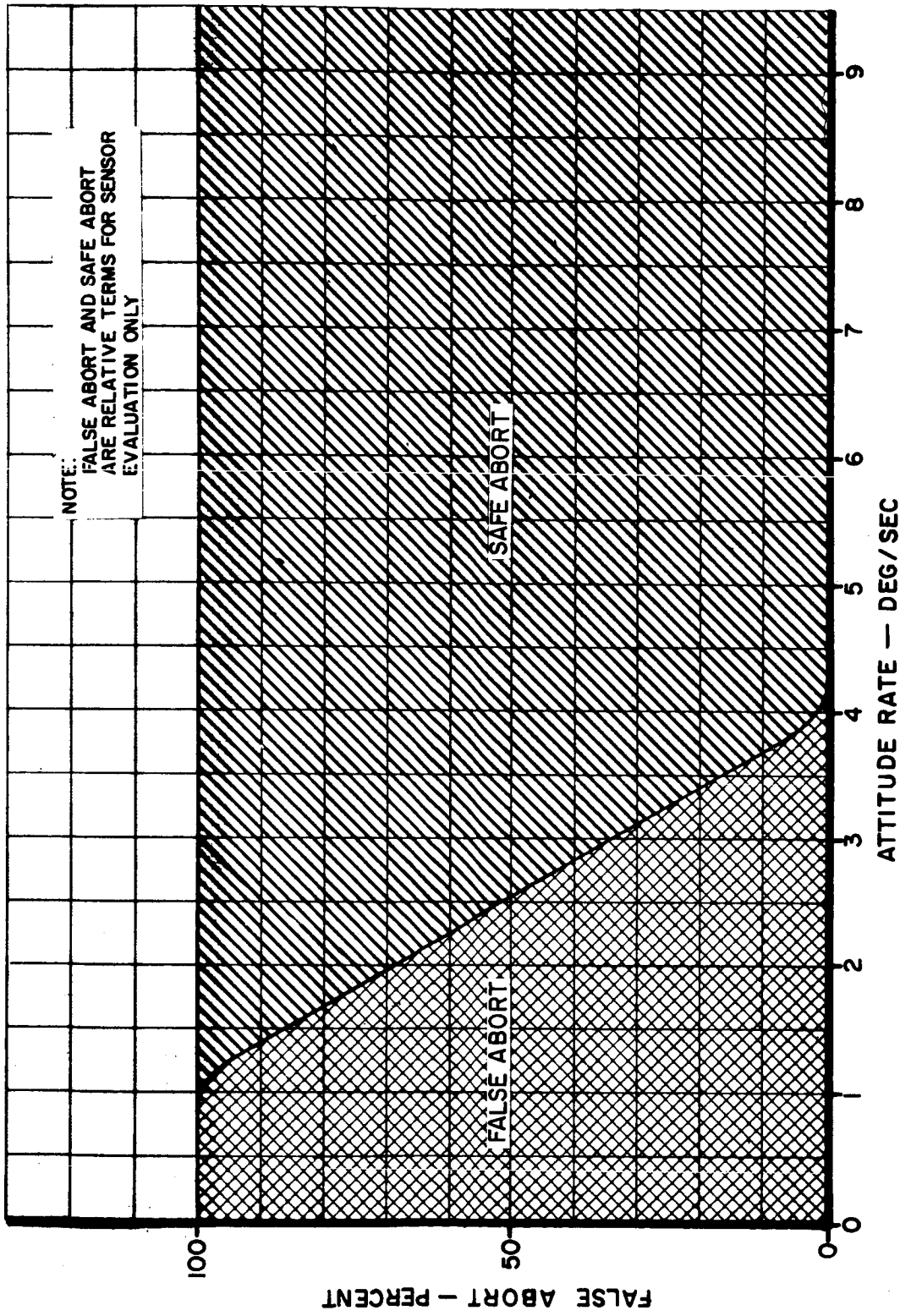

FIGURE 2-145 S-11 FALSE ABORT FACTOR - RATE

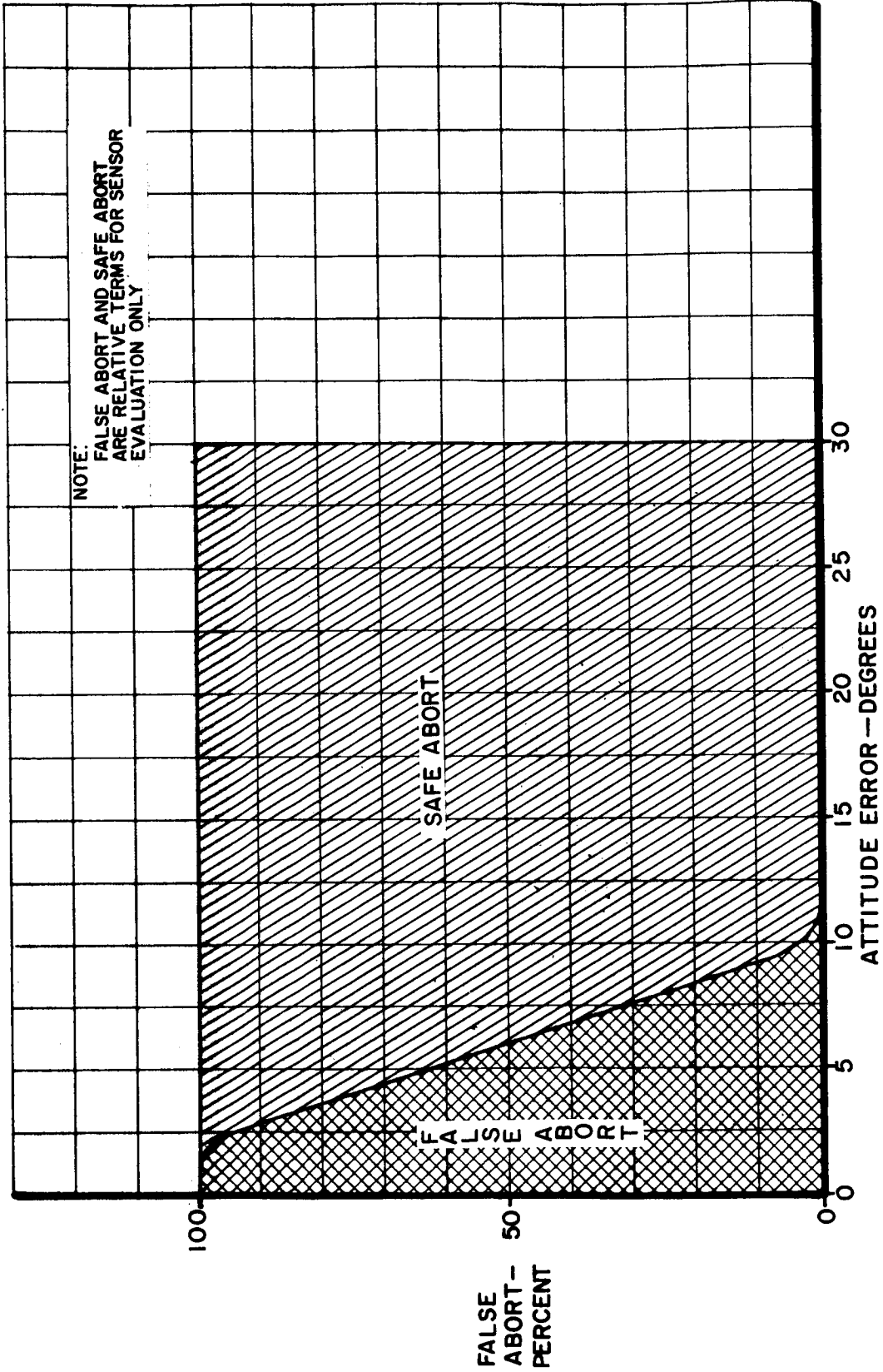

FIGURE 2-I46 S-1VB FALSE ABORT FACTOR - ATTITUDE

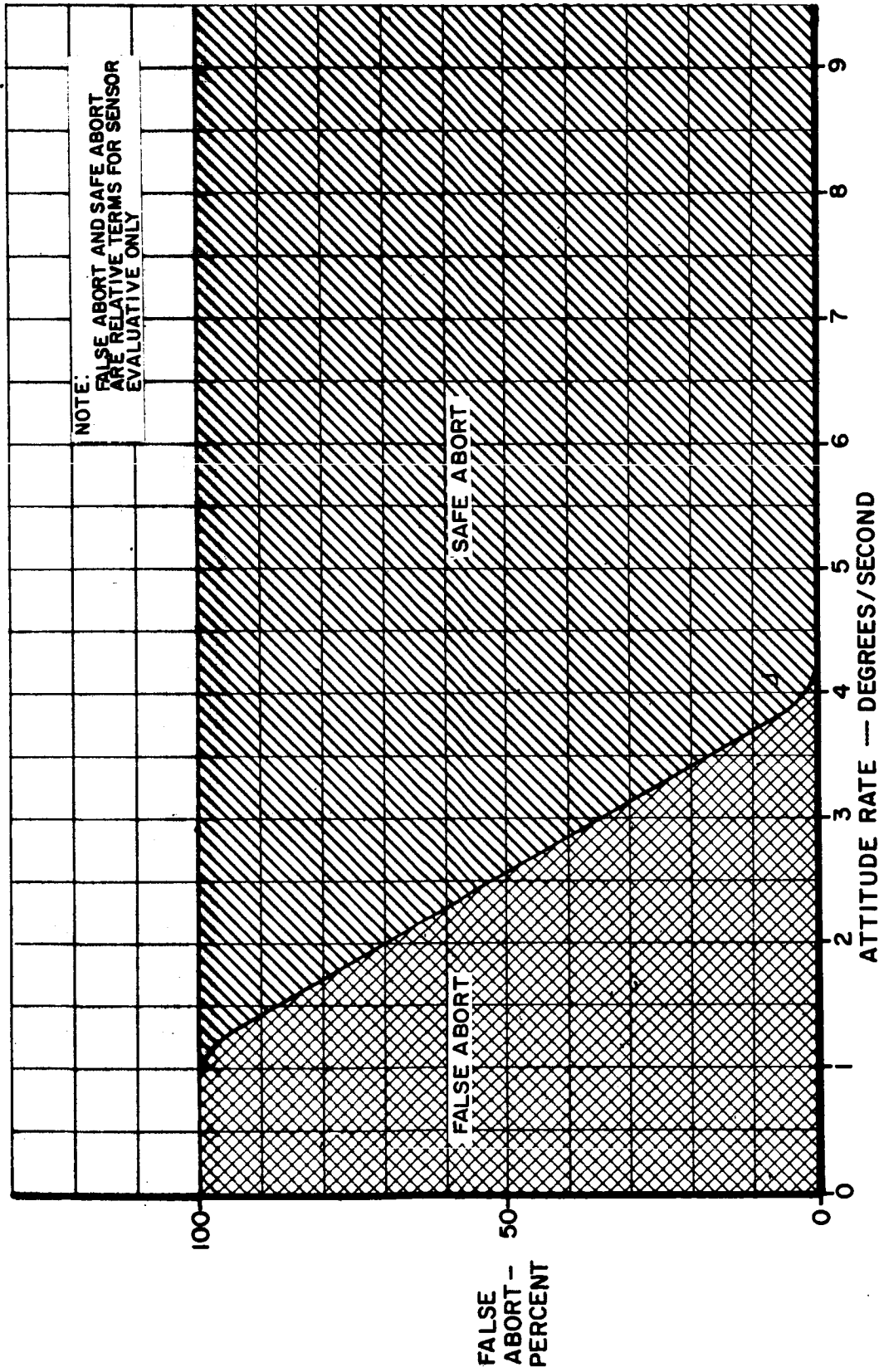

FIGURE 2-147 S-IVB FALSE ABORT FACTOR - RATE

2.7.3 (Continued)

Figure 2-148 and 2-149 summarize attitudes and rates for malfunctions. Using these cues in combination with limit levels as follows:

	RATE LIMIT RANGE	ATTITUDE LIMIT RANGE
S-II	4-15 deg/sec	10-45 deg
S-IVB	4-15 deg/sec	10-45 deg

will provide correct discrimination with no false aborts for all faster-diverging malfunctions. EDS limit settings can be varied through the range shown without changing this result.

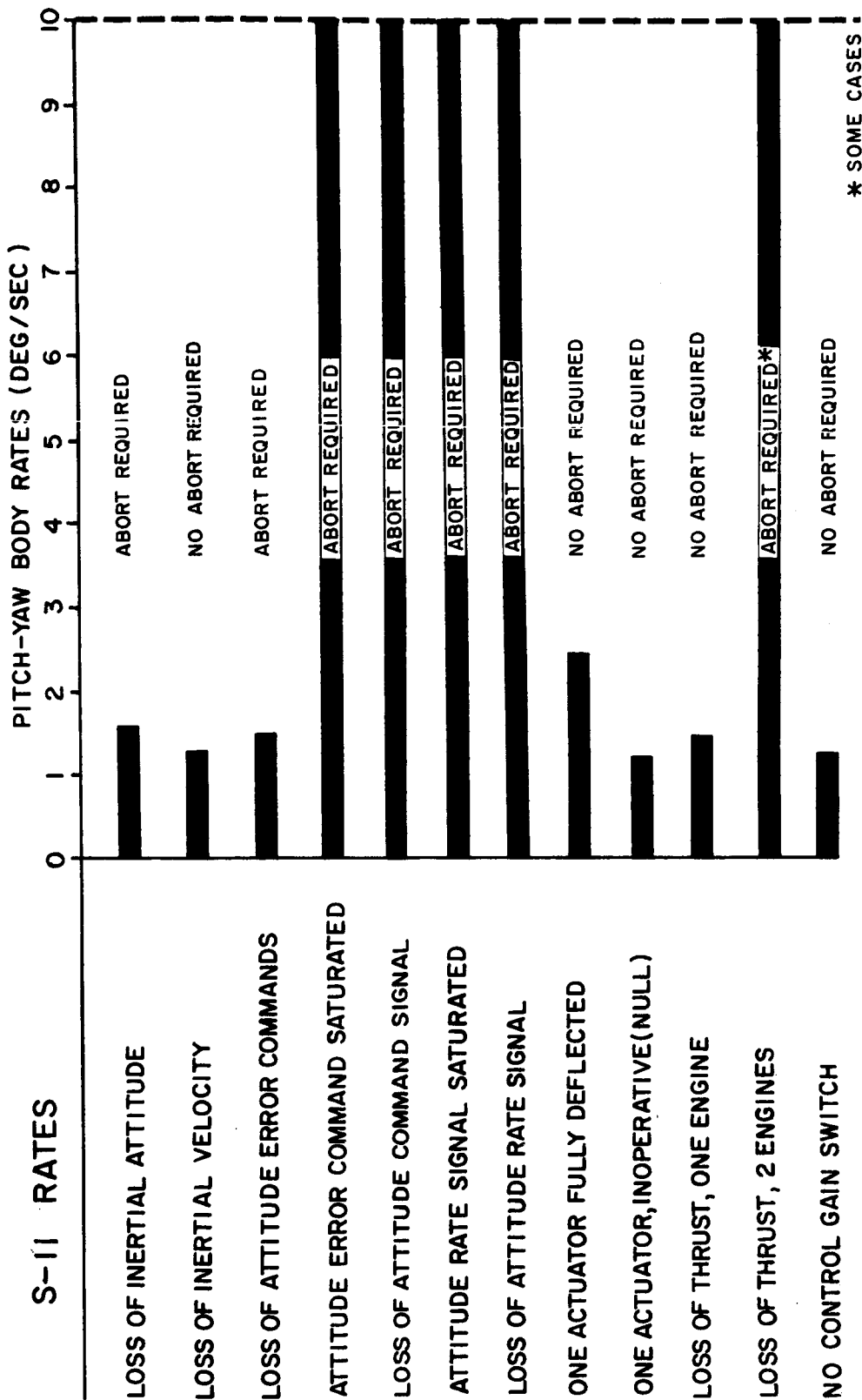

FIGURE 2-148 S-II BODY RATES FOR MALFUNCTIONS

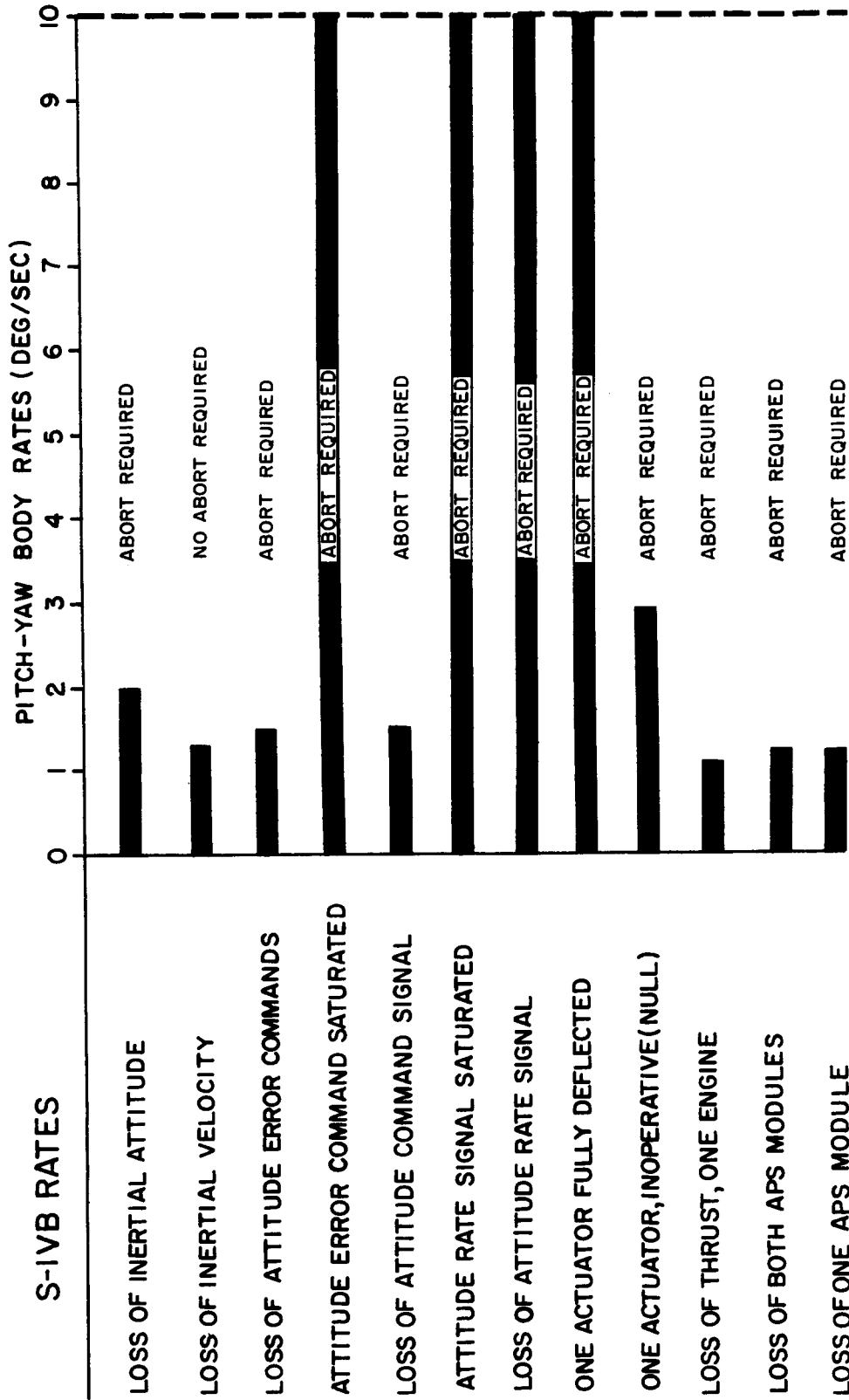

FIGURE 2-149 S-IVB BODY RATES FOR MALFUNCTION

2.8 EDS EFFECTIVENESS

2.8.1 S-IC EDS Effectiveness

Probability of vehicle loss for all S-IC malfunctions considered is 2600×10^{-6} . Probability of crew loss for these malfunctions is 350×10^{-6} . It is assumed that the crew is lost if the abort lead time is less than the required lead time. All catastrophic engine failures are crew losses because of spacecraft loads. Figures 2-150 through 2-152 compare abort lead times to required lead times for three critical malfunctions.

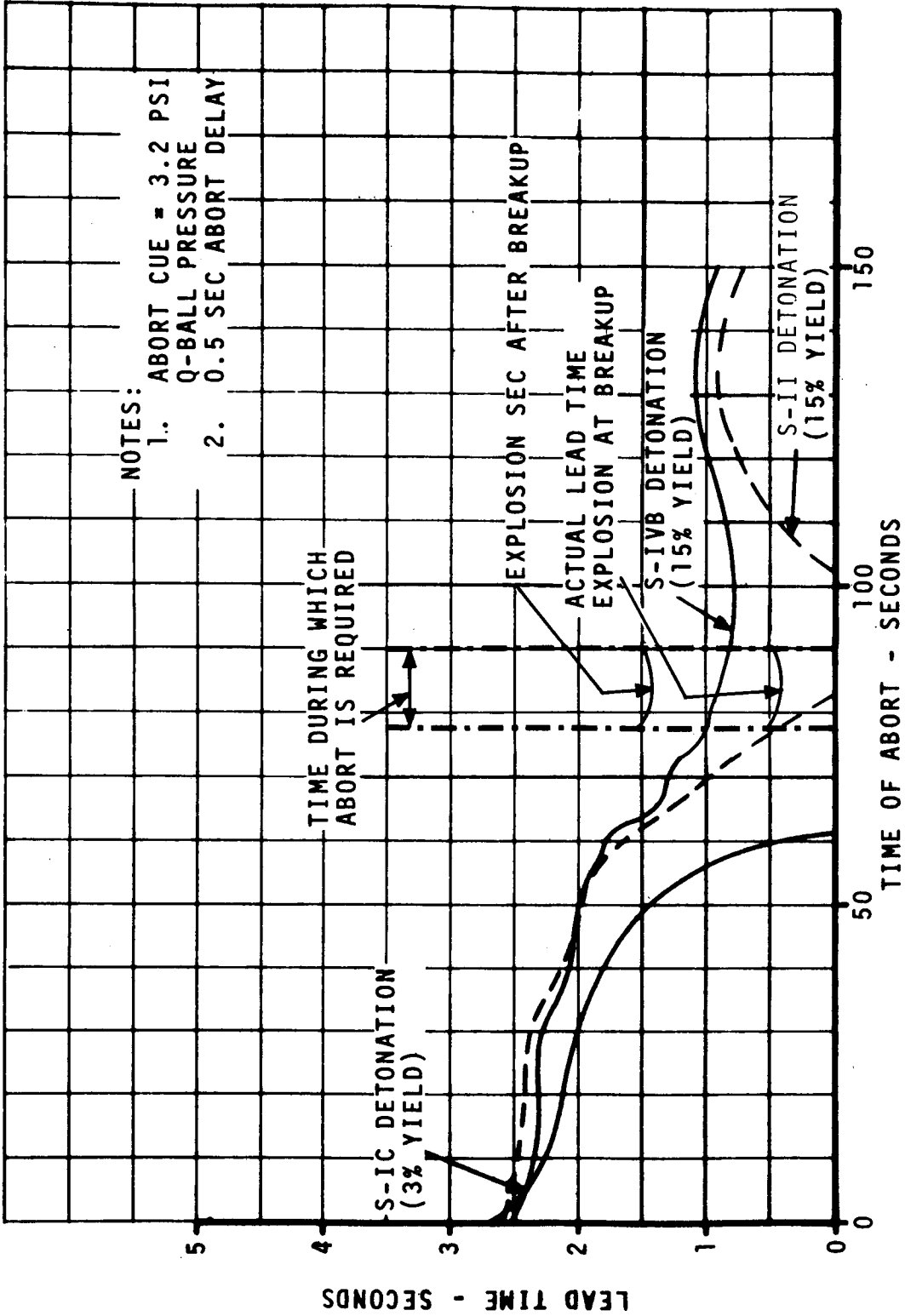
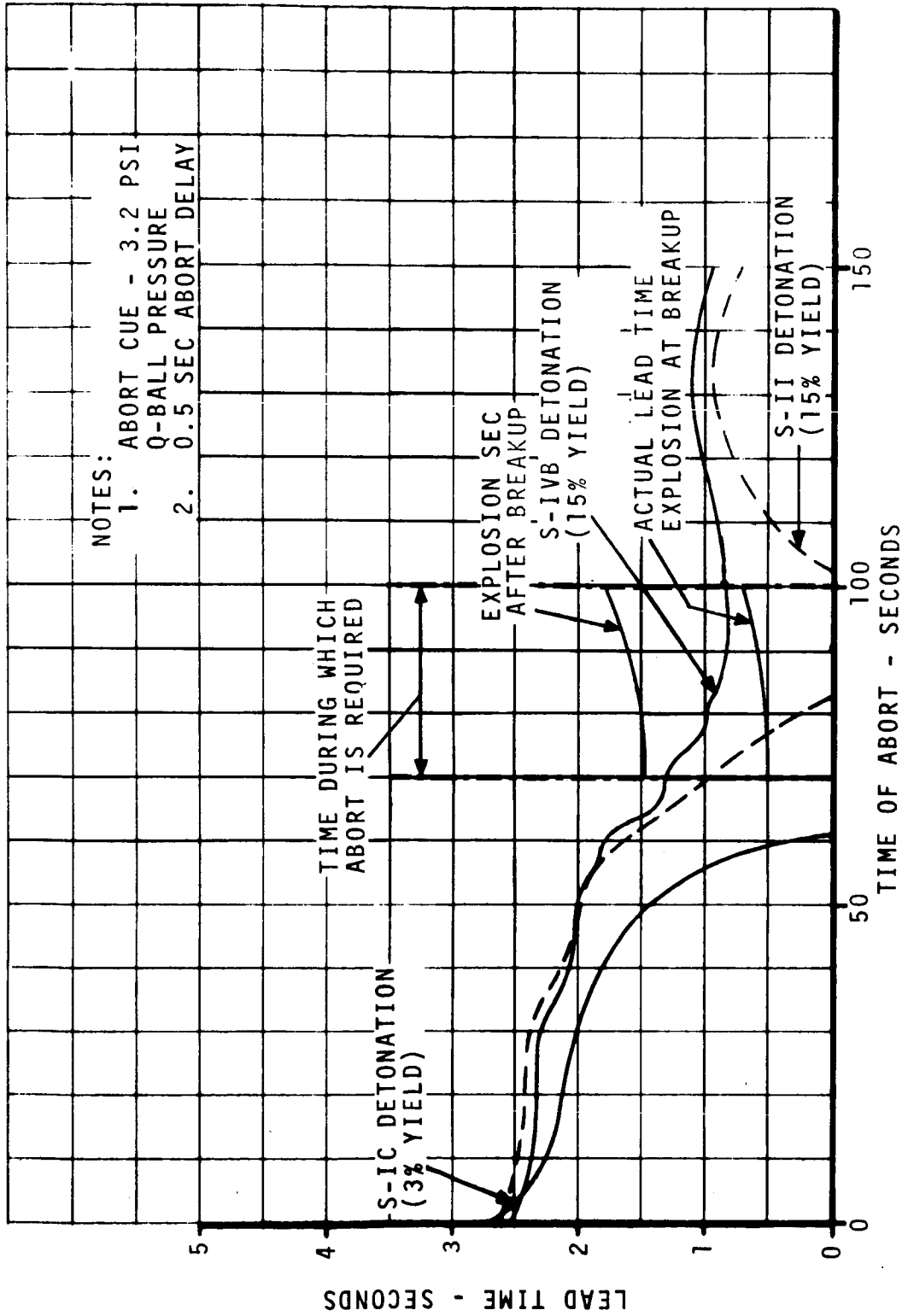

FIGURE 2-150 LEAD TIMES FOR ABORT AFTER AN ENGINE OUT



NOTES:
1. ABORT CUE - 3.2 PSI Q-BALL PRESSURE
2. 0.5 SEC ABORT DELAY

FIGURE 2-151 LEAD TIMES FOR ABORT AFTER AN ACTUATOR HARDOVER

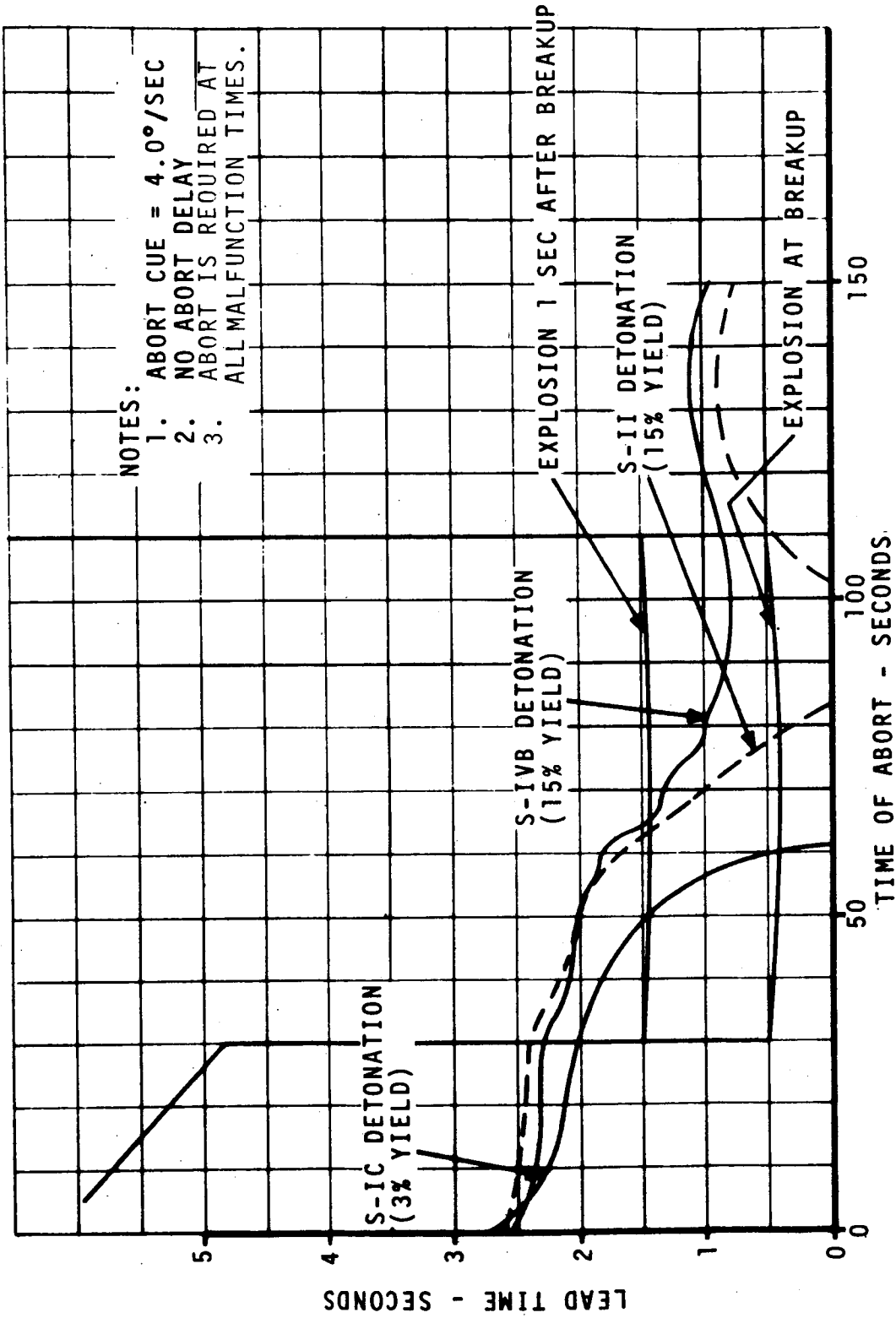

FIGURE 2-152 LEAD TIMES FOR ABORT AFTER A SATURATED CONTROL SIGNAL

2.8.2 S-II and S-IVB EDS Effectiveness

Due to lack of atmospheric forces, abort timing is less restricted in the upper stages and vehicle structural failure does not occur for the malfunctions examined. S-II/S-IVB direct staging can be employed for S-II malfunctions where staging limits are not exceeded. In other cases, and in aborts from S-IVB, SPS abort can be accomplished. Restrictions in the latter case are:

- a. Abort conditions must allow attitude recovery prior to exceeding the spacecraft platform tumble limits.
- b. To provide safe re-entry and recovery, Flight Dynamics Officer (FDO) plotboard limits must not be exceeded.

Analyses of this document show that manual abort can be fully effective in meeting these requirements. Figure 2-153 indicates available time from malfunction to abort for the malfunctions examined. For slow diverging malfunctions reaching FDO limits prior to final abort cue, ground commanded abort may be employed.

This document outlines further proposals to improve malfunction flight capability in S-II and S-IVB. Backup for the inertial platform is recommended, but must be a system of sufficient accuracy to obtain successful orbit. Proposals to improve S-II dual engine-out flight capability are also made but must be evaluated in light of the low probability of this malfunction. In both cases, extended mission flight time is an objective, and crew loss is not expected.

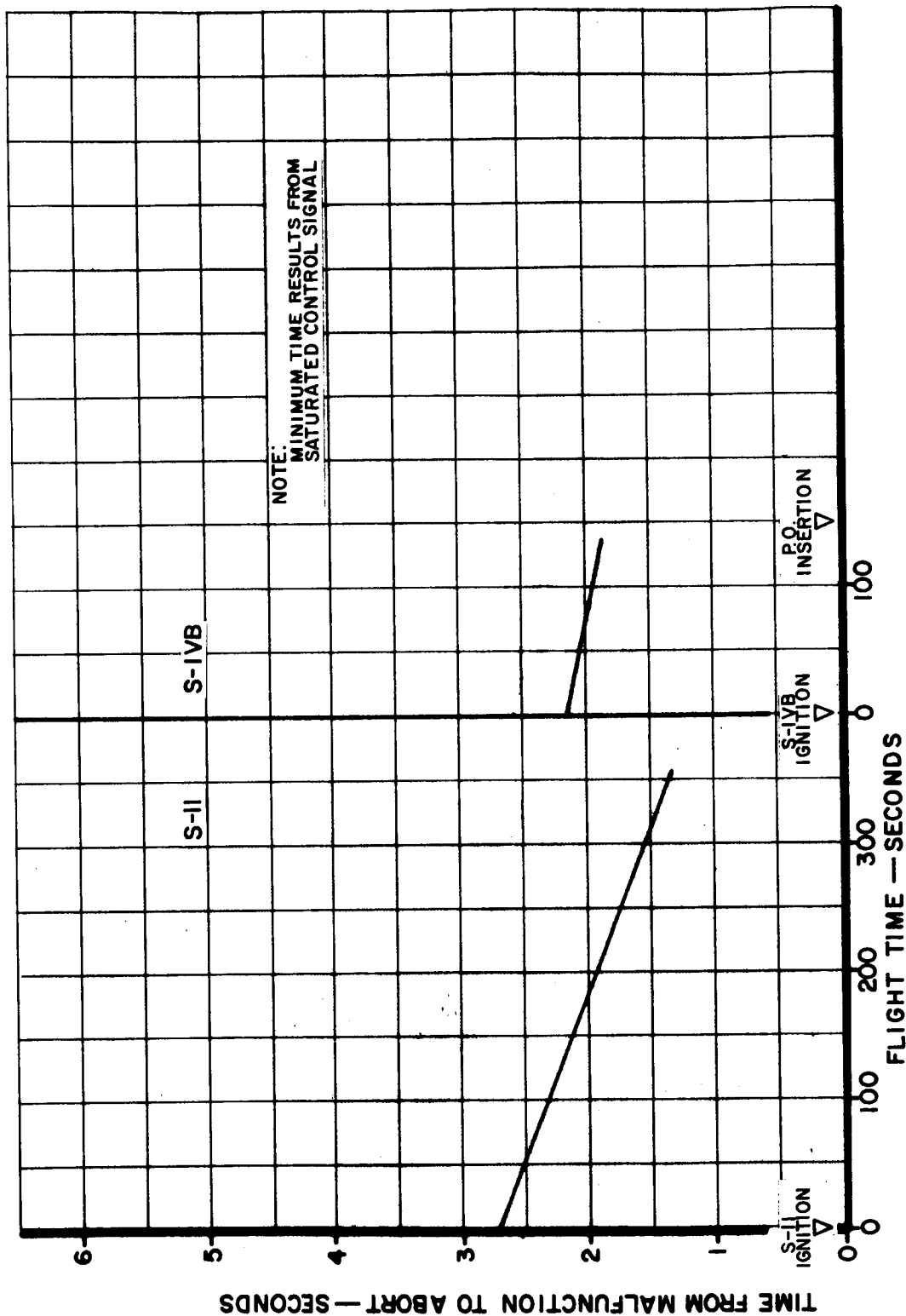

NOTE:
MINIMUM TIME RESULTS FROM
SATURATED CONTROL SIGNAL

FIGURE 2-153 MINIMUM TIME FROM MALFUNCTION TO ABORT - UPPER STAGES

2.9 FLIGHT DYNAMICS OFFICER DATA FOR MALFUNCTION FLIGHT

2.9.1 FDO Displays

The following summarizes the results of an investigation of malfunctions that might cause boost phase termination by exceeding Flight Dynamics Officer plotboard limits. The following limits (Reference T9) were considered:

a. Inertial Flight Path Angle vs. Inertial Velocity

1. SPS Abort to Orbit Limit - this envelope represents conditions under which SPS may be utilized to obtain a 75 nautical mile perigee orbit.
2. Structural Load Limit of 16-g - this limit represents the condition at the time of abort that will produce a 16-g load factor during entry.
3. 100 Second Free-Flight to Reentry Limit (300,000 feet) - this is the condition at abort that will give a time of free fall to 300,000 feet of 100 seconds. This limit assumes adequate time for separation and orientation before entry.

b. Altitude vs. Range

This plotboard presents altitude above an oblate earth as a function of the range referenced to pad.

1. Altitude equal to 300,000 feet.

c. Latitude of Present Position vs. Longitude of Present Position

This plotboard shows geodetic latitude of present position as a function of longitude of present position.

S-IC malfunctions producing vehicle breakup are not shown, since it is assumed that destruction of the vehicle has already taken place before Flight Dynamics Officer limits are reached. Instead, borderline cases producing large trajectory deviations but not structural failure are used. In S-II and S-IVB, breakup does not result for the malfunctions examined, hence results shown cover all malfunctions investigated. Table 2-XI summarizes results, including malfunction, malfunction time, flight dynamics limit and time exceeded. Figures 2-154 - 2-156 show typical trajectory results obtained for the malfunctions investigated.

2.9.1 (Continued)

The requirement for no negative flight path angle in S-IC is met for all malfunctions simulated.

The 100 second free-flight to reentry line in the following charts is based on Reference 19.

TABLE 2-XI FDO LIMITS FOR MALFUNCTION FLIGHT

TIME REF. TO LIFTOFF	MALFUNCTION	TIME SPAN	LIMIT EXCEEDED	TIME RANGE	COMMENTS
	Lower Engine Out between 8 sec. and 43 sec. with no wind	S-IC Stage	100 second free flight to reentry limit (300,000 ft.)	Until 140 sec. in S-II	Early S-IC engine out results in an extended burn time in S-IVB in order to achieve cutoff conditions. This extended burn time depletes enough propellant to violate the 120,000 kg terminal payload requirement.
	Lower Engine Out between 43 sec. and 53 sec. with no wind	S-IC Stage	100 second free flight to reentry limit (300,000 ft.)	Until 85 sec. in S-II	POI - No restart capability.
	Lower Engine Out after 53 sec. with no wind	S-IC Stage	None		Achieves POI. All lower engine out cases after 95 seconds also have restart capability.

TABLE 2-XI FDO LIMITS FOR MALFUNCTION FLIGHT (CONT'D)

TIME REF. TO LIFTOFF	MALFUNCTION	TIME SPAN	LIMIT EXCEEDED	TIME RANGE	COMMENTS
	Lower Engine Out between 8 sec. and 43 sec. with tail winds	S-IC Stage	100 second free flight to reentry limit (300,000 ft.)	Until 140 sec. in S-II	All lower engine out cases in this category were able to achieve parking orbit insertion but no restart capability exists due to extended burn time in S-IVB stage
	Lower Engine Out between 43 sec. and 53 sec. with tail wind	S-IC Stage	100 second free flight to reentry limit (300,000 ft.)	Until 105 sec. in S-II	POI but no restart capability
	Lower Engine Out between 53 sec. and 100 sec. with tail wind	S-IC Stage	None		These cases will achieve parking orbit insertion but no restart capability
	Lower Engine Out after 100 sec. with tail wind	S-IC Stage	None		Achieve parking orbit insertion and have restart capability

TABLE 2-XI FDO LIMITS FOR MALFUNCTION FLIGHT (CONT'D)

TIME REF. TO LIFTOFF	MALFUNCTION	TIME SPAN	LIMIT EXCEEDED	TIME RANGE	COMMENTS
	Lower Engine Out between 8 sec. and 60 sec. with head wind	S-IC	100 second free flight to reentry limit (300,000 ft.)	Until 140 sec. in S-II	Parking orbit insertion but no restart capability
	Lower Engine Out between 60 sec. and 67 sec. with head wind	S-IC	100 second free flight to reentry limit (300,000 ft.)	Until 85 sec. in S-II	POI but no restart capability
	Lower Engine Out between 67 and 100 sec. with head wind	S-IC	None		Parking orbit insertion but no restart capability
	Lower Engine Out after 100 sec with head wind	S-IC	None		Parking orbit insertion and restart capability

TABLE 2-XI FDO LIMITS FOR MALFUNCTION FLIGHT (CONT'D)

TIME REF. TO LIFTOFF	MALFUNCTION	TIME SPAN	LIMIT EXCEEDED	TIME RANGE	COMMENTS
	Upper Engine Out between 8 sec and 27 sec with no wind	S-IC Stage	None		These cases achieve parking orbit insertion but do not have restart capability
	Upper Engine Out between 27 sec and 65 sec with no wind	S-IC Stage	None		Achieve parking orbit and has restart capability
	Upper Engine Out between 65 sec. and 78 sec. with no wind	S-IC Stage	None		POI but no restart capability
	Upper Engine Out after 78 sec. with no wind	S-IC Stage	None		Achieve parking orbit and has restart capability

TABLE 2-XI FDO LIMITS FOR MALFUNCTION FLIGHT (CONT'D)

TIME REF. TO LIFTOFF	MALFUNCTION	TIME SPAN	LIMIT EXCEEDED	TIME RANGE	COMMENTS
	Upper Engine Out between 8 sec and 25 sec with head wind	S-IC Stage	None		Achieve parking orbit insertion but no restart capability
	Upper Engine Out between 25 sec and 65 sec with head wind	S-IC Stage	None		Achieves parking orbit and has restart capability
	Upper Engine Out between 65 sec and 75 sec with head wind	S-IC Stage	None		POI but no restart capability
	Upper Engine Out after 75 sec with head wind	S-IC Stage	None		Achieves parking orbit insertion and has restart capability

TABLE 2-XI FDO LIMITS FOR MALFUNCTION FLIGHT (CONT'D)

TIME REF. TO LIFTOFF	MALFUNCTION	TIME SPAN	LIMIT EXCEEDED	TIME RANGE	COMMENTS
	Upper Engine Out between 8 sec and 27 sec with tail wind	S-IC Stage	None		Achieves parking orbit but has no restart capability
	Upper Engine Out after 27 sec with tail wind	S-IC Stage	None		Achieves parking orbit and has restart capability
	ψ p Freeze				Loss of vehicle for ψ p. Freeze in all stages.
	Actuator negative hardover in S-IC	S-IC Stage	100 second free flight to reentry limit (300,000 ft.)	Until 135 sec in S-II	Achieves parking orbit and has restart capability

TABLE 2-XI FDO LIMITS FOR MALFUNCTION FLIGHT (CONT'D)

TIME REF. TO
S-II IGNITION

MALFUNCTION	TIME SPAN	LIMIT EXCEEDED	TIME RANGE	COMMENTS
Lower Engine Out in S-II before 255 seconds	Until end of S-II burn	None		No limits were exceeded and parking orbit insertion and restart capability exist.
Lower Engine Out in S-II after 255 seconds	Until end of S-II burn	None		Full mission capability
Upper engine malfunction in S-II	Until end of S-II burn	None		In all cases these malfunctions were less severe than lower engine out.

TABLE 2-XI FDO LIMITS FOR MALFUNCTION FLIGHT (CONT'D)

TIME REF. TO S-II IGNITION	MALFUNCTION	TIME SPAN	LIMIT EXCEEDED	TIME RANGE	COMMENTS
Actuator hardover in S-II	None	Until end of S-II burn	Full mission capability.		

TABLE 2-XI FDO LIMITS FOR MALFUNCTION FLIGHT (CONT'D)

TIME REF. TO S-IVB IGNITION	MALFUNCTION	TIME SPAN	LIMIT EXCEEDED	TIME RANGE	COMMENTS
	Actuator hardover in S-IVB	S-IVB	None		Loss of vehicle before FDO limits are reached.
	S-IVB engine out before 110 seconds	S-IVB			Does not achieve parking orbit insertion.
	S-IVB Engine Out after 110 seconds	S-IVB			Possible to achieve a 75 N.M. perigee orbit.

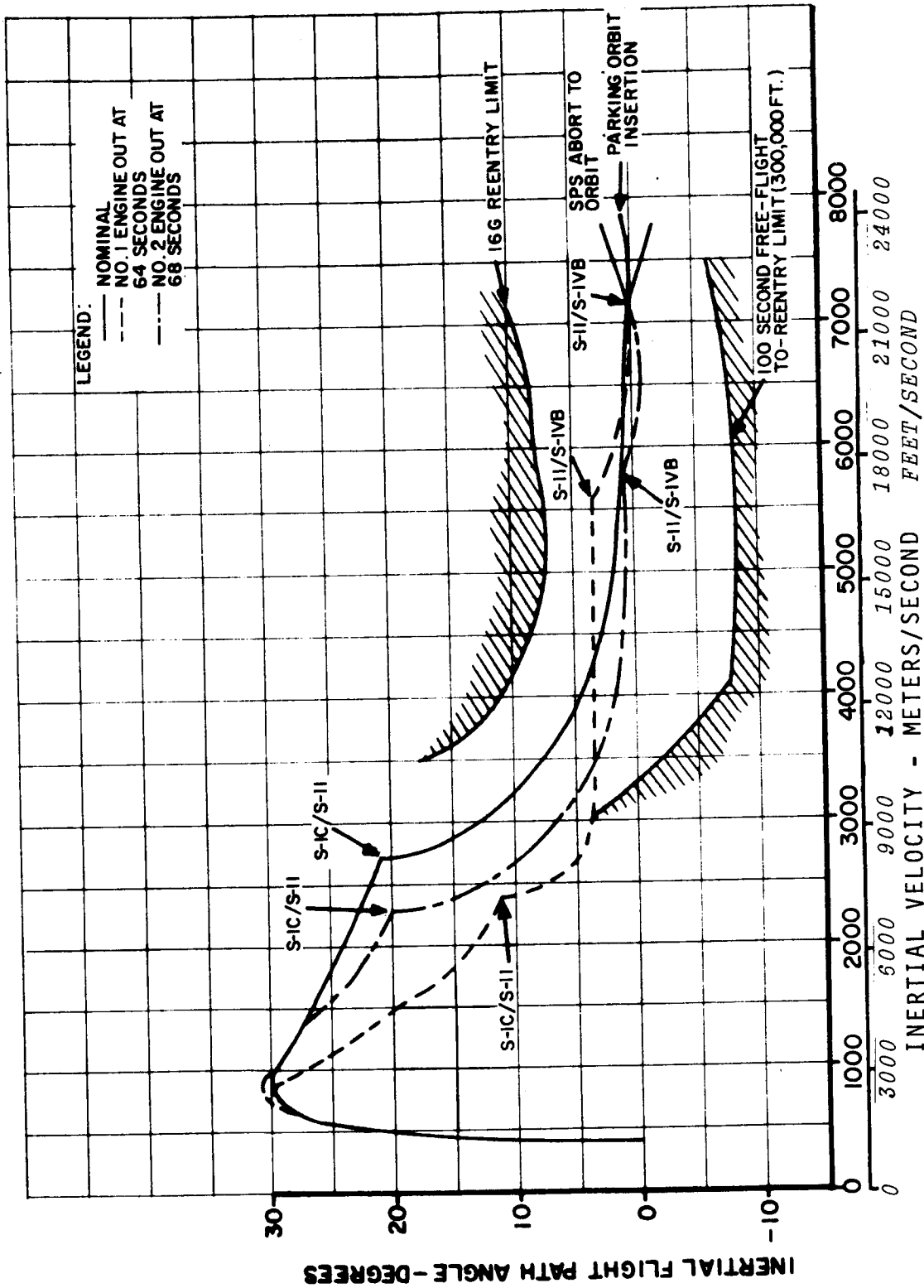

FIGURE 2-154 FDO PLOTBOARD FOR S-IC ENGINE MALFUNCTIONS

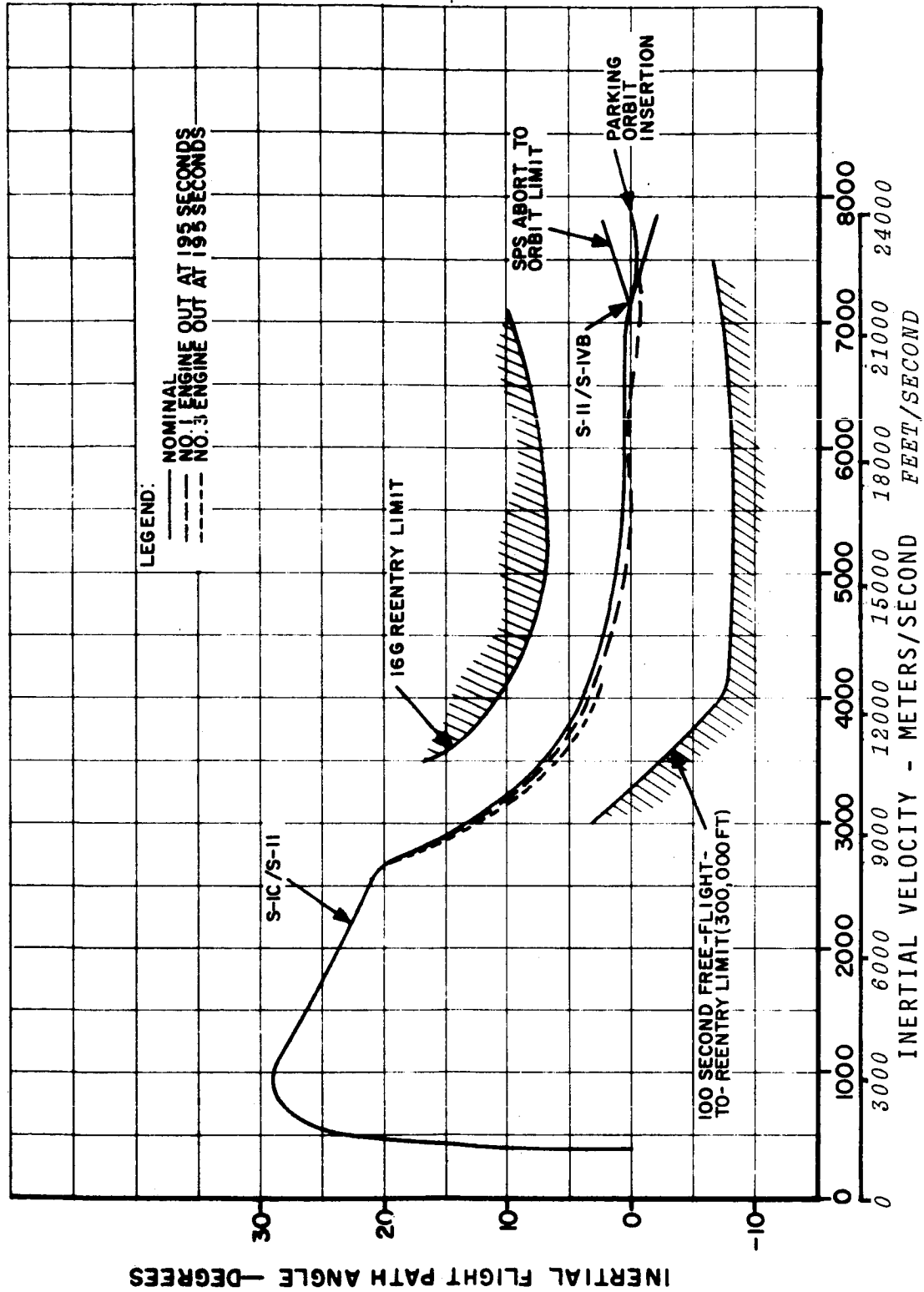

FIGURE 2-155 FDO PLOTBOARD DISPLAY FOR S-II ENGINE MALFUNCTIONS

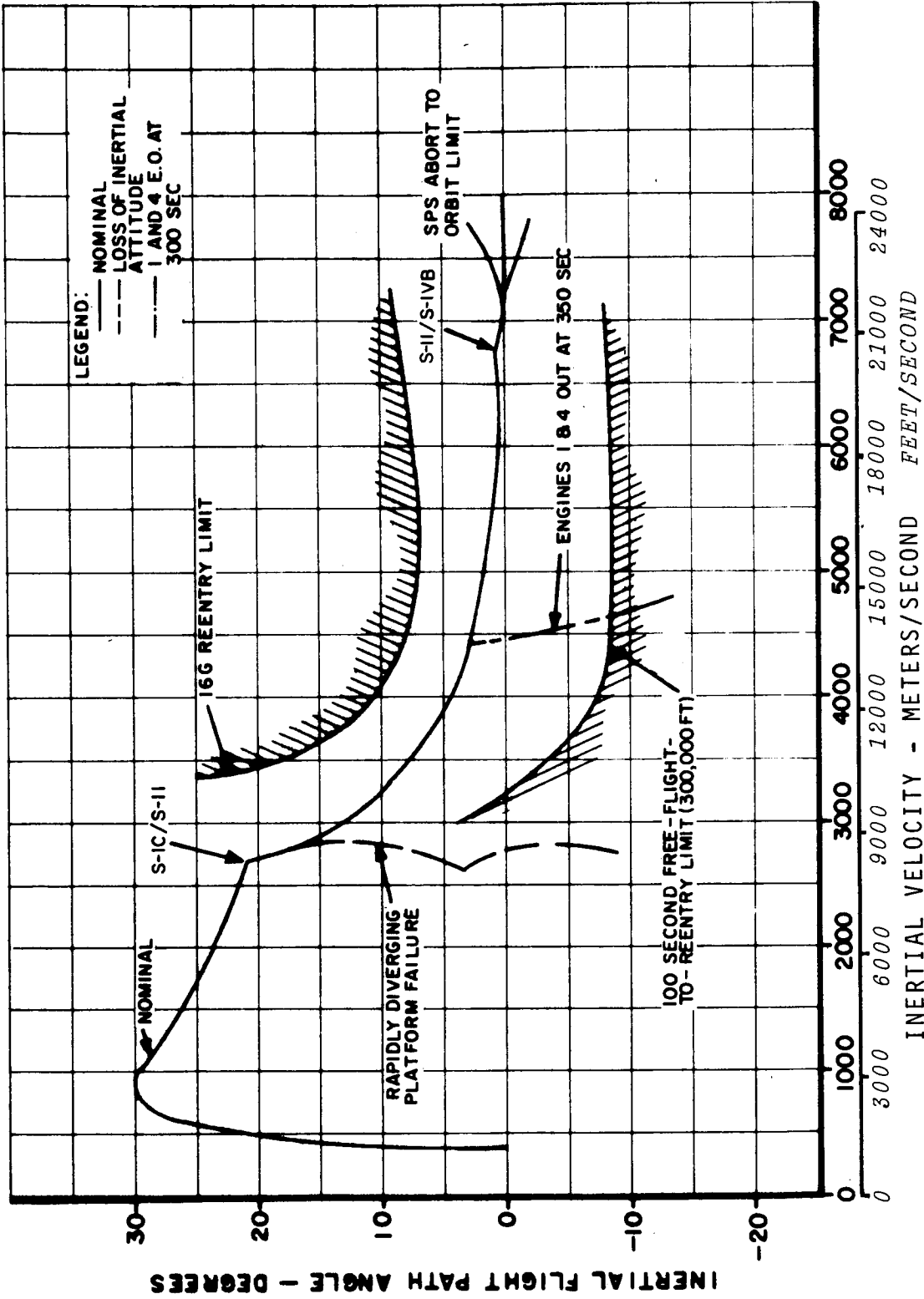

FIGURE 2-156 FDO PLOTBOARD FOR S-II MALFUNCTIONS

2.9.2 Trajectory Data for Malfunctions Resulting in Abort

Malfunction trajectory data requested for AS-504 study in Reference 20 is as follows:

TABLE 2-XII MALFUNCTION TRAJECTORY DATA

MALFUNCTION		SATURATED NEGATIVE PITCH RATE@ 95 SEC.	SATURATED NEGATIVE PITCH RATE @ 185 SEC.	LOSS OF PITCH ERROR @ 110 SEC.
Time of Abort (Sec from L/O)		98	188	190
FDO Limits Exceeded (Yes/No)		No	No	No
EDS Limit Exceeded		10 deg/sec rate	10 deg/sec rate	20 deg.att. deviation
Altitude at Time of Abort (km)		21.15	92.21	104.91
Body Rates at Abort	$\dot{\phi}_P$	15.43	10.05	.009
	$\dot{\phi}_Y$.16	.004	-.0007
	$\dot{\phi}_R$	-.54	.09	.0009
Attitudes at Abort	θ_P	-30.68	-52.56	-47.47
	θ_Y	.14	.11	.18
	θ_R	-.28	-.57	-.037
Velocity at Abort (m/sec)		1089.9	2908.9	2821.2
Flight Path Angle at Abort (deg)		29.1	15.4	22.3

THIS PAGE INTENTIONALLY LEFT BLANK.

APPENDIX A

SIMULATION DESCRIPTION

A.0 SIMULATION TOOLS

The following simulations are the tools used to provide the data for EDS Analysis:

1. BHA-0100 Space Vehicle Systems Simulation (hybrid)
2. BHA-0097 6D 1st Stage Flight Dynamics (hybrid)
3. BHA-0072 6D Lift-off Dynamics (hybrid)
4. BHA-0045 Staging Dynamics (hybrid)
5. BHA-0030 6D 1st Stage Dynamics (digital)
6. BHA-0170 Flight Loads Post Processor (digital)

Each of the above simulations is a specialized tool designed and developed for detailed study of particular mission objectives of the Saturn V/Apollo launch vehicle. Various degrees of sophistication and detail exist in the math models of the above simulations to best fulfill the particular objectives of the simulation. The following is a verbal description of each simulation to make the reader cognizant of the general capabilities and limitations of each simulation, as well as the reason why several simulations must be used to perform the studies necessary for a comprehensive EDS Analysis.

A.0.1 BHA-0100 Space Vehicle Systems Simulation

- a. Simulation Objective - to study the phase of the Saturn V/ Apollo launch vehicle flight from guidance reference release to lunar orbit insertion in real time, with particular emphasis on upper stage dynamics.
- b. Mathematical Models and Capabilities

Gravity - Fischer ellipsoidal, fundamental and 3 harmonics

Mass - lumped mass at center of gravity

Aerodynamics - lumped, non-linear aerodynamics in all stages of flight

Winds - variable profiles at fixed or variable azimuth

Propellant Slosh - all six propellant tanks in both pitch and yaw, with closed loop propulsion coupling through propellant utilization, and slosh induced center of gravity offset.

APPENDIX A (Continued)

A.O.1 (Continued)

- Bending - upper stages only. Three bending modes acting at vehicle center of gravity.
- Propulsion - optional closed or open loop models
- (1) Open loop P&VE propulsion tape data on thrusts, fuel and lox flowrates per engine
 - (2) Closed loop propulsion polynomial curve fits of thrust, fuel and lox flowrates per engine, with analog implementation of propellant utilization to control lox bypass valve position.
- Integration - trapezoidal integration with gravity predictor during powered boost phases. Runge-Kutta-Gill 4 pass integrator during orbital phases.
- LVDC - detailed simulation of launch vehicle digital computer program incorporating the following features: variable computation cycle, minor loop interrupt, discrete backups, accelerometer processing, boost navigator, guidance selector, pre-IGM for S-IC flight, iterative guidance in upper stages, minor loop support, orbital guidance, and orbital processor and navigation.
- Auxiliary Propulsion System - analog APS implementation with roll control only during S-IVB powered flight, roll, pitch and yaw control during coast phases, with 50 MS minimum pulse duration.
- Flight Control Computer - analog implementation of control rate and error signal filters in pitch, yaw, and roll, with separate filters for each stage of flight, and S-IC engine cants.
- TVC System - analog implementation of first order actuators with non-symmetrical limits. Separate actuators for each engine, in each stage, in both pitch and yaw.
- Inertial Platform Model - detailed platform model incorporating I.U.-C.G. correction, and provisions for accelerometer and gimbal error and failure modes.
- Structural Loads - upper stage output for the BHA-0170 Flight Loads Post Processor on an optional basis.
- Output Capability - real time monitoring output on hard copy, strip charts and X-Y plotters of significant vehicle dynamic and trajectory data. Detailed post processor output of 500 significant variables from equations of motion, slosh, bending, propulsion, platform,

APPENDIX A (Continued)

A.0.1 (Continued)

Output capability - (Continued)

and LVDC models, for time response histories and EDS analysis.

Malfunction Capability - provisions are made in the simulation for malfunctions in the propulsion, propellant utilization, flight control computer, thrust vector control, and auxiliary propulsion models. Simulation of LVDC-LVDA hardware malfunctions is also possible in the LVDC and platform models. Dispersion capabilities for parametric studies are available to a limited extent.

A.0.2 BHA-0097 6D 1st Stage Flight Dynamics

a. Simulation Objective - to provide detailed dynamics of the Saturn V/Apollo launch vehicle in real time S-IC flight.

b. Mathematical Models and Capabilities

Gravity - Fischer ellipsoid, fundamental and 1st harmonic.

Mass - distributed mass over 5 panels.

Aerodynamics - non-linear aerodynamics distributed over 5 panels.

Winds - variable wind profiles at fixed or variable azimuth.

Propellant Slosh - S-IC propellant tanks in both pitch and yaw, coupling into rate gyros.

Bending - primary bending mode in five bending panels, with moments computed at four stations in both pitch and yaw planes. Local bending effects at platform and rate gyros are included.

Propulsion - closed loop propulsion polynomial curve fits of thrust, fuel and lox flowrates per engine.

Integration - trapezoidal with linear predictor and corrector.

LVDC - table lookup guidance with minor loop calculation of attitude error commands.

Flight Control Computer - analog implementation of control rate and error filters in pitch, yaw and roll and S-IC engine cants.

TVC System - analog implementation of first order actuators with non-symmetrical limits.

Platform Model - ideal platform is assumed.

APPENDIX A (Continued)

A.0.2 (Continued)

- Structural Loads - bending moments and loads at 4 stations are computed in real time during S-IC flight.
- Output Capability - real time output on strip charts, X-Y plotters and hard copy of 10 variables. Post processor output of 200 variables for detailed analysis.
- Malfunction Capability - provisions are made for malfunctions of the propulsion system, flight control computer, thrust vector control, and LVDC systems. Dispersion capabilities are also available for parametric studies.

A.0.3 BHA-0072 6D Lift-off Dynamics

- a. Simulation Objective - to provide detailed dynamics of the Saturn V/Apollo launch vehicle in the near pad region of S-IC flight. Soft release and lift-off sequences are simulated in detail. Tower and platform to vehicle clearances are calculated.
- b. Mathematical Models and Capabilities
 - Gravity - constant magnitude and direction.
 - Mass - lumped mass at center of gravity.
 - Aerodynamics - non-linear aerodynamics, distributed over 19 panels.
 - Winds - variable profiles at fixed or variable azimuth.
 - Propellant Slosh - none.
 - Bending - four bending modes acting at center of gravity.
 - Propulsion - optional closed or open loop models.
 - (1) preset tabular propulsion thrust data
 - (2) closed loop propulsion thrust polynomial
 - Integration - trapezoidal with linear predictor and corrector.
 - LVDC - open loop tabular guidance data.
 - Flight Control Computer - analog implementation of control rate and error signal filters in pitch, yaw and roll, and S-IC engine cants. Bending coupling into control system included.
 - TVC System - analog implementation of first order actuators with non-symmetrical limits.
 - Structural Loads - none.

APPENDIX A (Continued)

A.0.3 (Continued)

- Liftoff Release - soft release model of the vehicle liftoff sequence.
- Tower Clearance - detailed calculations of tower and platform to vehicle clearances at 8 distinct points.
- Output Capability - real time or 10 times real time output of strip charts, X-Y plotters and hard copy of 10 variables. Post processor of 200 variables for detailed analysis.
- Malfunction Capability - provisions are made for malfunctions of propulsion system, flight control computer, and thrust vector control systems. Dispersion capabilities also available for parametric studies.

A.0.4 BHA-0045 Two Body 6D Staging Dynamics

- a. Simulation Objective - to provide detailed separation and staging dynamics for the S-IC-S-II and S-II-S-IVB separation.
- b. Mathematical Models and Capabilities

- Gravity - Fischer ellipsoid with 3 harmonics.
- Mass - lumped mass at center of gravity.
- Aerodynamics - lumped, non-linear aerodynamics for mainstage, continuing stage, and dropped stage.
- Winds - variable profiles at fixed or variable azimuth.
- Propellant Slosh - none.
- Bending - none.
- Propulsion - open loop tabular thrust data for individual main engines, retro rockets, and ullage motors.
- Integration - trapezoidal integration.
- LVDC - open loop tabular guidance with minor loop calculation of attitude error commands.
- Flight Control Computer - digital Z-transform implementation of control rate and error signal filters for each stage.
- TVC System - digital Z-transform implementation of first order engine actuators in pitch and yaw, for each engine, in each stage.
- Staging Clearances - detailed calculation of dropped and continuing stage clearances at centers of gravity and four points on the separation plane.
- Output Capability - real time or 10 times real time output of strip charts, X-Y plotters and hard copy of significant vehicle dynamic and trajectory data. Post processor output of 500 variables from mainstage, continuing stage, dropped

APPENDIX A (Continued)

A.0.4 (Continued)

Output Capability - (Continued)

stage, and body clearance equations.
Malfunction Capability - provisions are made in the simulation for malfunctions in main propulsion, retro rockets, ullage motors, flight control computer, and thrust vector control system. Dispersion capabilities for parametric studies are also available.

A.0.5 BHA-0030 6D 1st Stage Flight Dynamics

a. Simulation Objective - to provide detailed flight dynamics and structural dynamics of the Saturn V/Apollo launch vehicle during S-IC flight.

b. Mathematical Models and Capabilities

Gravity - Fischer ellipsoid; fundamental and 3 harmonics.

Mass - distributed mass model made up of 45 discrete mass panels, for the purpose of computing detailed flight loads.

Aerodynamics - non-linear aerodynamics distributed over 19 panels.

Winds - variable wind profiles at fixed or variable azimuth.

Propellant slosh - all six propellant tanks in both pitch and yaw, in the first slosh mode, are simulated.

Bending - four bending modes are simulated in pitch and yaw planes, with no cross-plane coupling. Bending moments are calculated at 22 specific stations. Bending moments computed include effects of beam-column and appreciable cantilevered masses.

Propulsion - closed loop propulsion polynomial curve fits of thrust, fuel and lox flowrates per engine.

Integration - 4 pass Runge-Kutta-Gill with .05 second integration interval.

LVDC - table lookup guidance with minor loop calculation of attitude error commands.

Flight Control Computer - digital Z-transform implementation of attitude error and rate filters, and S-IC engine cants.

Thrust Vector Control - Digital Z-transform implementation of engine actuators. Ideal, first, or third order servo actuators are available on optional basis.

APPENDIX A (Continued)

A.0.5 (Continued)

Platform Model - ideal platform is assumed.

Structural Loads - differential equations used to simulate elastic body motion make use of the concept of normal modes. Some structural damping is assumed so that the equations can be expressed as damped quadratics. Loads can be calculated on as many as 30 body stations.

Output Capability - hard copy output of vehicle dynamic variables, bending moments, loads, and load indicators.

Malfunction Capability - provisions are made for malfunctions of propulsion system, flight control computer, and thrust vector control system. Dispersion capabilities for parametric studies are also available.

A.0.6 BHA-0170 Flight Loads Post Processor

a. Simulation Objective - to provide a capability for detailed analysis of bending moments and structural loads, for large hybrid simulations which have computation time restriction due to real-time.

b. Simulation Capability

Bending Moments - optional calculations are available for up to 6 bending modes.

Structural Capabilities - tabular data of vehicle structural characteristics.

Loads Calculations - detailed loads analysis is available for 27 body stations distributed as follows:

S-IC	-	11 stations
S-II	-	7 stations
S-IVB	-	6 stations
I.U.	-	1 station
S/C	-	2 stations

Output Capability - hard copy output of vehicle bending moments, loads, and load indicators, as well as Benson-Lehrner plots, available from post processor. Real time print and strip chart output of load indicators.

APPENDIX A (Continued)

A.1 Coordinate Systems

Three coordinate systems, chosen primarily for their compatibility with the Project Apollo Coordinate Systems Standards (PACSS), are used to describe the motion of the vehicle relative to an oblate rotating earth with a noncentral force field. A description of these coordinate systems shown in Figure A-1 is given below.

a. Geocentric Inertial Coordinate System (PACSS No. 4)

The axes of this system are defined by unit vectors I_f , J_f , and K_f . The origin of this system is the center of the earth. The I_f axis is directed through the Prime Meridian at the mean vernal equinox. The K_f axis is directed along the Earth's mean rotational axis and the J_f completes the orthogonal, right hand system.

b. Vehicle Body Fixed Coordinate System (PACSS No. 8b)

The origin of this system is located at the vehicle's instantaneous center of mass. The X-axis is parallel to the vehicle's longitudinal centerline with positive direction toward the vehicle nose. The Y-axis is to the "right" and the Z-axis is "down". At liftoff the Z-axis points due East and the Y-axis points due South thus completing the orthogonal, right hand system.

c. Launch Vehicle Navigation Coordinate System (PACSS No. 13)

The axes of this system are defined by unit vectors e_x , e_y , and e_z . It is a space fixed system with its origin at the Earth's center at the time of first motion. The e_x axis is co-linear with the gravity gradient at the launch site and opposite in sense. The e_z axis is normal to the e_x axis at an angle (launch azimuth) from the North. The e_y axis completes the orthogonal, right hand system.

A.2 Combined Loads

The vehicle bending moments are combined with axial loads using linear elastic theory to yield circumferential shell loads. The combined limit and ultimate loads are computed using the equations below:

$$N_c = \text{F.S.} \left(\frac{P}{2\pi R_x} + \frac{M}{\pi R_x^2} - \frac{\Delta P_{\text{MIN}} R_x}{2} \right)$$

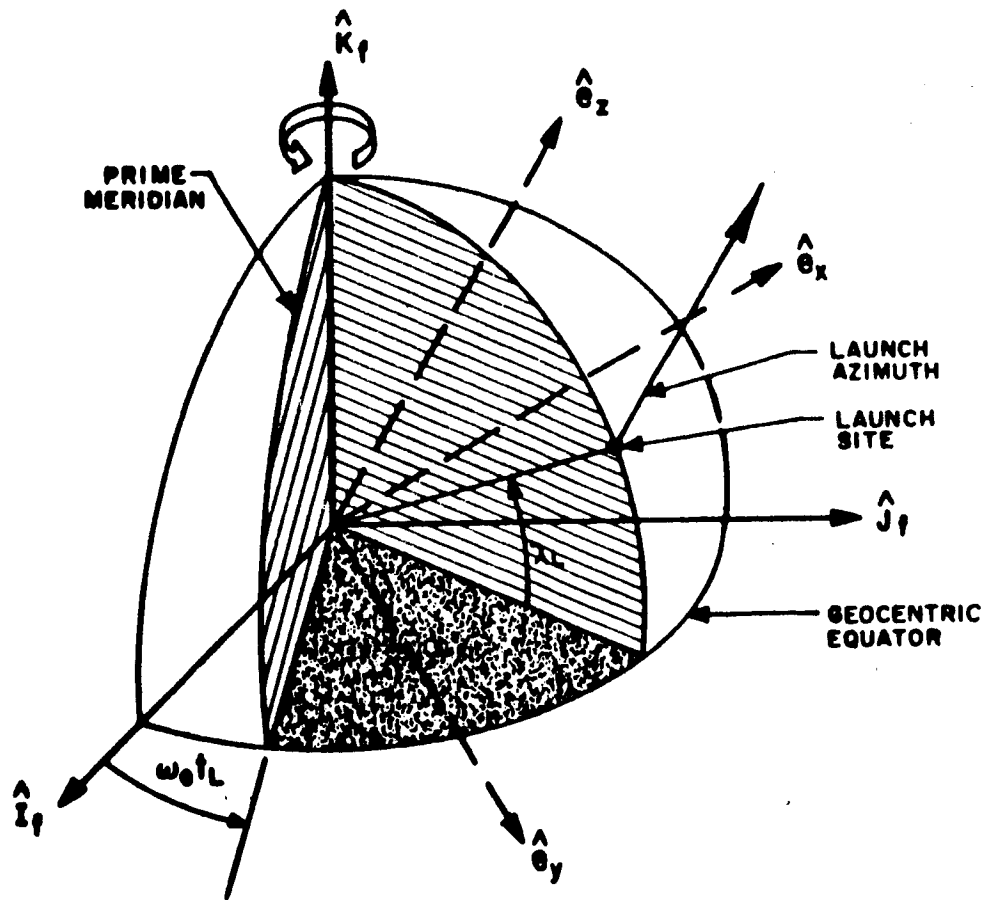
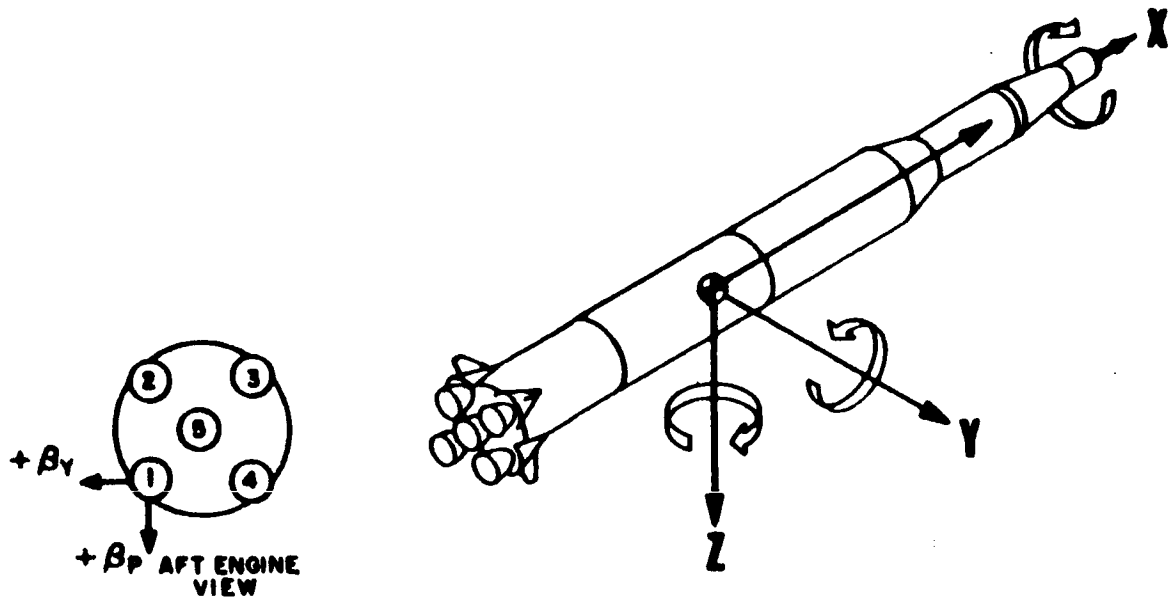

FIGURE A-1 COORDINATE SYSTEMS

APPENDIX A (Continued)

A.2 (Continued)

$$N_t = \text{F.S.} \left(\frac{P}{2\pi R_x} - \frac{M}{\pi R_x^2} - \frac{\Delta P_{\text{MAX}} R_x}{2} \right)$$

Using a factor of safety of 1.0, a comparison of limit loads and vehicle ultimate capability is made to determine the relative criticality of the vehicle loads.