

12-75

[CHANGE SHEET

FOR

MSC INTERNAL NOTE 70-FM-141 DATED SEPTEMBER 25, 1970;

SPACECRAFT OPERATIONAL TRAJECTORY FOR APOLLO 14

(MISSION H-3) LAUNCHED JANUARY 31, 1971,

VOLUME I - MISSION PROFILE]

By Landing Analysis Branch, Orbital Mission Analysis Branch,
and Lunar Mission Analysis Branch

Change 1

December 11, 1970

Floyd Bennett

Floyd W. Bennett, Chief
Landing Analysis Branch

Edgar C. Lineberry

Edgar C. Lineberry, Chief
Orbital Mission Analysis Branch

Ronald L. Berry

Ronald L. Berry, Chief
Lunar Mission Analysis Branch

John F. Mayer

John F. Mayer, Chief
Mission Planning and Analysis Division

Page 1 of
(with enclosures)

NOTE: A black bar in the margin indicates the area of change.

After the attached enclosures, which are replacement pages, have been inserted, place this CHANGE SHEET between the cover and title page and write on the cover, "CHANGE 1 inserted."

1. Replace page iii.
2. Add page iiiia.

INDEXING DATA

| DATE | OPR | # | T | PGM | SUBJECT | SIGNATOR | LOC |
|----------|-----|---|---|-----|---------|----------|--------|
| 12-11-70 | MSC | | R | MPA | [] | MSC | 079-55 |

CHANGE HISTORY FOR 70-FM-141

| Change | Date | Description |
|--------|----------|--------------------------------------------------------------|
| 1 | 12/11/70 | Replace page iii and add page iiia: addition to foreword. |

FOREWORD

The trajectory for the Apollo 14 mission was computed without taking into account the weight increase caused by the addition of a third oxygen tank and a battery in the service module. These modifications are being made as a result of the Apollo 13 accident.

For all previous Apollo missions, the spacecraft operational trajectory document has been revised 2 months before launch. This permitted the flight crews and flight controllers to train on the latest available trajectory data. However, it has been determined, as recorded in MSC memorandum 70-FM-H-55, that the real-time changes have been equal to those occurring from updating the trajectory. Therefore, it is inadvisable to train to specific mission-dependent numbers. In addition, a technique for updating the ground elapsed time has been devised for Apollo 14. This will allow the ground elapsed time of the mission to match that of the flight plan, eliminating the need for extensive flight plan updates in real time. Based on these facts and because no major changes have occurred since the operational trajectory document was published, the decision has been made not to generate a revised trajectory.

The following is a list of the changes that have been identified to date.

- a. CSM weight increase of ≈ 660 pounds.- This change resulted from adding the third oxygen tank, battery, and associated hardware.
- b. Three-minute change in lift-off time from 20:20 G.m.t. to 20:23 G.m.t. - This change occurred because the operational trajectory was generated before the official lift-off time was determined by MSFC. In the past, this time difference was less than a minute. New procedures are being implemented that will permit using the official lift-off time in the operational trajectory.
- c. LM descent targeted for desired landing point
- d. Preferred REFSMMAT for TEI rather than ascent REFSMMAT
- e. The CSM separation maneuver prior to landing using four jets rather than two jets
- f. S-IVB impact point moved

g. The CSM separation maneuver attitude, prior to LM ascent stage impact, changed

The decision not to revise the operational trajectory means that the following additional documents will not be revised.

Simulator Data Pack

Flight Planning Data

Updates will be made to the consumables crew charts and to any other charts that are sensitive to the changes listed previously.



NATIONAL AERONAUTICS AND SPACE ADMINISTRATION

*Apollo-14
a-58*

~~LA-10~~
MSC-02629

VOLUME I

MSC INTERNAL NOTE NO. 70-FM-141

September 25, 1970

**THE SPACECRAFT OPERATIONAL
TRAJECTORY FOR APOLLO 14**

(MISSION H-3)

LAUNCHED JANUARY 31, 1971

VOLUME I - MISSION PROFILE

**Lunar Mission Analysis Branch,
Orbital Mission Analysis Branch,
and
Landing Analysis Branch**

MISSION PLANNING AND ANALYSIS DIVISION

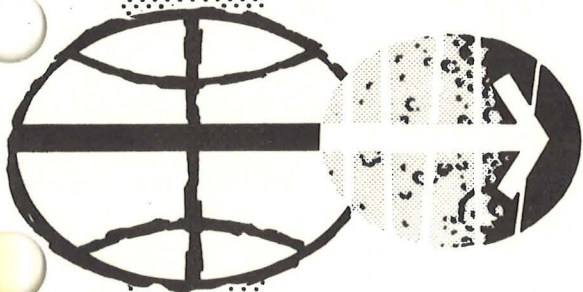

**MANNED SPACECRAFT CENTER
HOUSTON, TEXAS**

MSC INTERNAL NOTE NO. 70-FM-141

PROJECT APOLLO

THE SPACECRAFT OPERATIONAL TRAJECTORY FOR APOLLO 14
(MISSION H-3) LAUNCHED JANUARY 31, 1971
VOLUME I - MISSION PROFILE

By Lunar Mission Analysis Branch, Orbital Mission Analysis Branch,
and Landing Analysis Branch

September 25, 1970

MISSION PLANNING AND ANALYSIS DIVISION
NATIONAL AERONAUTICS AND SPACE ADMINISTRATION
MANNED SPACECRAFT CENTER
HOUSTON, TEXAS

Approved: Ronald L. Berry
Ronald L. Berry, Chief
Lunar Mission Analysis Branch

Approved: Edgar C. Lineberry
Edgar C. Lineberry, Chief
Orbital Mission Analysis Branch

Approved: Floyd Bennett
Floyd V. Bennett, Chief
Landing Analysis Branch

Approved: John P. Mayer
John P. Mayer, Chief
Mission Planning and Analysis Division

FOREWORD

The trajectory for the Apollo 14 mission was computed without taking into account the weight increase caused by the addition of a third oxygen tank and a battery in the service module. These modifications are being made as a result of the Apollo 13 accident. The weight of these modifications is approximately 754 pounds and was not incorporated into the computations because the input was frozen on July 13 and this weight was not defined for the Mission Planning and Analysis Division until August 18. A revision to this trajectory is scheduled for publication on December 1, and it will incorporate this weight change and any other changes that might occur between now and the input freeze date of October 1, 1970.

The time of day of the launch as given in this document is approximate only and will be defined exactly in the Marshall Space Flight Center Operational Launch Trajectory. The difference between the two times should not exceed 5 minutes.

CONTENTS

| Section | Page |
|------------------------------------------------------------------|------|
| 1.0 SUMMARY AND INTRODUCTION | 1-3 |
| 1.1 Summary | 1-5 |
| 1.2 Introduction | 1-6 |
| 2.0 SYMBOLS AND NOMENCLATURE | 2-3 |
| 3.0 PRIMARY GUIDELINES AND CONSTRAINTS | 3-3 |
| 4.0 MISSION SUMMARY | 4-3 |
| 4.1 Earth Launch | 4-7 |
| 4.2 Earth Parking Orbit | 4-11 |
| 4.3 Translunar Injection (TLI) | 4-15 |
| 4.4 Free-return Circumlunar Trajectory | 4-19 |
| 4.5 Posttranslunar Injection Events | 4-23 |
| 4.6 Translunar Coast | 4-31 |
| 4.7 Lunar Orbit Insertion (LOI) | 4-41 |
| 4.8 Descent Orbit Insertion (DOI) | 4-49 |
| 4.9 CSM/LM Coast From LOI to Undock | 4-53 |
| 4.10 CSM/LM Undock to Landing | 4-57 |
| 4.10.1 CSM/LM undock and separation | 4-57 |
| 4.10.2 CSM circularization | 4-57 |
| 4.10.3 Powered descent | 4-58 |
| 4.10.4 Ullage and trim phases | 4-58 |
| 4.10.5 Braking phase | 4-58 |
| 4.10.6 Approach phase | 4-58 |
| 4.10.7 Landing phase | 4-58 |
| 4.10.8 Graphical description of the powered descent | 4-59 |

| Section | Page |
|----------------------------------------------------------------------|-------|
| 4.11 CSM Lunar Orbit Plane Change | 4-85 |
| 4.12 LM Ascent | 4-89 |
| 4.13 Rendezvous Sequence | 4-105 |
| 4.13.1 Sequence summary | 4-105 |
| 4.13.2 Tweak maneuver | 4-105 |
| 4.13.3 TPI | 4-106 |
| 4.13.4 Midcourse corrections and TPF | 4-107 |
| 4.14 LM Jettison and Separation to Transearth Injection | 4-123 |
| 4.15 Transearth Injection | 4-131 |
| 4.16 Transearth Coast | 4-139 |
| 4.17 Entry | 4-147 |
| 5.0 INPUT DATA | 5-3 |
| 6.0 REFERENCES | 6-3 |

TABLES

| Table | Page |
|---------|--------------------------------------------------------------------------------------------|
| 1.1-I | SEQUENCE OF MAJOR EVENTS 1-8 |
| 1.1-II | LUNAR ORBIT ACTIVITIES 1-14 |
| 1.1-III | LAUNCH WINDOW SUMMARY 1-16 |
| 1.1-IV | TIMETABLE OF MISSION EVENTS 1-17 |
| 1.1-V | MISSION RADAR TIMELINE |
| (a) | CSM acquisition and termination during rendezvous - 0° minimum elevation 1-19 |
| (b) | LM acquisition and termination during descent - 0° minimum elevation 1-66 |
| (c) | LM acquisition and termination during ascent - 0° minimum elevation 1-69 |
| (d) | LM acquisition and termination during rendezvous - 0° minimum elevation 1-70 |
| (e) | CSM acquisition and termination during rendezvous - 3° minimum elevation 1-78 |
| (f) | LM acquisition and termination during descent - 3° minimum elevation 1-123 |
| (g) | LM acquisition and termination during ascent - 3° minimum elevation 1-126 |
| (h) | LM acquisition and termination during rendezvous - 3° minimum elevation 1-127 |
| 1.1-VI | MISSION SHADOW TIMELINE |
| (a) | CSM 1-135 |
| (b) | LM descent 1-150 |
| (c) | LM rendezvous 1-151 |
| 4.5-I | SUMMARY OF EVENTS FROM TLI CUTOFF THROUGH LOX DUMP 4-24 |
| 4.6-I | TARGET LOAD FOR RELAXED FREE-RETURN MANEUVER |
| (a) | Target 4-33 |
| (b) | REFSMMAT 4-33 |
| (c) | Gimbal angles at t_{IG} 4-33 |

| Table | Page |
|----------|---------------------------------------------------|
| 4.7-I | TARGET LOAD FOR LOI MANEUVER |
| | (a) Target 4-42 |
| | (b) REFSMMAT 4-42 |
| | (c) Gimbal angles at t_{IG} 4-42 |
| 4.8-I | TARGET LOAD FOR LOI-2 MANEUVER |
| | (a) Target 4-50 |
| | (b) REFSMMAT 4-50 |
| | (c) Gimbal angles at t_{IG} 4-50 |
| 4.10-I | DATA FOR MANUAL CSM SEPARATION MANEUVER |
| | (a) Desired ΔV 's 4-61 |
| | (b) CSM REFSMMAT 4-61 |
| | (c) CSM gimbal angles at t_{IG} 4-61 |
| 4.10-II | TARGET LOAD FOR CSM CIRCULARIZATION MANEUVER |
| | (a) Target 4-62 |
| | (b) REFSMMAT 4-62 |
| | (c) Gimbal angles at t_{IG} 4-62 |
| 4.10-III | TARGET LOAD FOR LM POWERED DESCENT MANEUVER |
| | (a) Ignition targets for PDI (P63) 4-63 |
| | (b) Braking phase targets 4-64 |
| | (c) Approach phase targets (P64) 4-65 |
| | (d) Vertical descent targets (P66) 4-65 |
| 4.11-I | TARGET LOAD FOR LUNAR ORBIT PLANE CHANGE MANEUVER |
| | (a) Target 4-86 |
| | (b) REFSMMAT 4-86 |
| | (c) Gimbal angles at t_{IG} 4-86 |
| 4.12-I | LM ASCENT WEIGHT SUMMARY 4-90 |
| 4.12-II | TARGET LOAD FOR LM ASCENT |
| | (a) Target 4-91 |
| | (b) REFSMMAT 4-91 |
| | (c) Gimbal angles at t_{IG} 4-91 |

| Table | Page |
|-------------------------------------------------------------------------|-------|
| 4.12-III LM ASCENT PROPULSION PERFORMANCE SUMMARY | 4-92 |
| 4.13-I RENDEZVOUS MANEUVER SUMMARY | 4-108 |
| 4.13-II MSFN TRACKING AND SHADOW TIMELINE | 4-109 |
| 4.13-III TARGET LOADS FOR TPI MANEUVER | |
| (a) Target | 4-110 |
| (b) REFSMMAT | 4-110 |
| (c) Gimbal angles at t_{IG} | 4-110 |
| 4.14-I TARGET LOAD FOR CSM SEPARATION MANEUVER FOLLOWING LM JETTISON | |
| (a) Target | 4-124 |
| (b) REFSMMAT | 4-124 |
| (c) Gimbal angles at t_{IG} | 4-124 |
| 4.14-II LM DEORBIT SUMMARY | 4-125 |
| 4.14-III TARGET LOAD FOR LM DEORBIT | |
| (a) Target | 4-126 |
| (b) REFSMMAT | 4-126 |
| (c) Gimbal angles at t_{IG} | 4-126 |
| 4.15-I TARGET LOAD FOR TEI MANEUVER | |
| (a) Target | 4-132 |
| (b) REFSMMAT | 4-132 |
| (c) Gimbal angles at t_{IG} | 4-132 |
| 4.17-I ENTRY EVENTS SEQUENCE | 4-149 |
| 4.17-II COMMAND MODULE MASS PROPERTIES | 4-150 |
| 4.17-III CONDITIONS AT ENTRY INTERFACE AND TARGET POINT | 4-151 |
| 5-I LAUNCH PAD REFSMMAT | |
| (a) Applicable maneuvers | 5-4 |
| (b) Definition of REFSMMAT | 5-4 |
| (c) REFSMMAT components | 5-4 |

| Table | Page | |
|--------|-----------------------------------------------------------|------|
| 5-II | PTC REFSMMAT | |
| | (a) Applicable maneuvers | 5-5 |
| | (b) Definition of REFSMMAT | 5-5 |
| | (c) REFSMMAT components | 5-5 |
| 5-III | LANDING SITE REFSMMAT | |
| | (a) Applicable maneuvers | 5-6 |
| | (b) Definition of REFSMMAT | 5-6 |
| | (c) REFSMMAT components | 5-6 |
| 5-IV | PREFERRED (LOPC) REFSMMAT | |
| | (a) Applicable maneuver | 5-7 |
| | (b) Definition of REFSMMAT | 5-7 |
| | (c) REFSMMAT components | 5-7 |
| 5-V | LM ASCENT REFSMMAT | |
| | (a) Applicable maneuvers | 5-8 |
| | (b) Definition of REFSMMAT | 5-8 |
| | (c) REFSMMAT components | 5-8 |
| 5-VI | ENTRY REFSMMAT | |
| | (a) Applicable maneuvers | 5-9 |
| | (b) Definition of REFSMMAT | 5-9 |
| | (c) REFSMMAT components | 5-9 |
| 5-VII | SPACECRAFT WEIGHT SUMMARY | 5-10 |
| 5-VIII | ASSUMED MISSION-INDEPENDENT EXPENDABLES | 5-11 |
| 5-IX | SERVICE MODULE PROPULSION PERFORMANCE SUMMARY | 5-12 |
| 5-X | LUNAR MODULE PROPULSION PERFORMANCE SUMMARY | 5-13 |
| 5-XI | COMMAND MODULE AERODYNAMIC COEFFICIENTS | 5-14 |
| 5-XII | LUNAR LANDING AND PHOTOGRAPHY SITE POSITIONS | 5-15 |
| 5-XIII | IMU ALINEMENT CRITERIA AND REFSMMAT DEFINITIONS | 5-16 |

| Table | | Page |
|-------|-------------------------------------------------------------------|------|
| 5-XIV | LM BRAKING SCHEDULE DURING TERMINAL RENDEZVOUS PHASE | 5-17 |
| 5-XV | MSFN STATION CHARACTERISTICS | 5-18 |
| 5-XVI | MSFN STATION IDENTIFICATION | 5-19 |

FIGURES

| Figure | | Page |
|--------|-------------------------------------------------------------------------------------------------|------|
| 1.1-1 | Schematic of the hybrid mission profile | 1-7 |
| 4.2-1 | Earth parking orbit groundtrack | 4-12 |
| 4.3-1 | TLI geometry | 4-16 |
| 4.5-1 | Motion of the S-IVB relative to the spacecraft for the S-IVB evasive maneuver of Apollo 14 | |
| | (a) Range versus time | 4-25 |
| | (b) Cross range versus horizontal displacement | 4-26 |
| | (c) Vertical displacement versus horizontal displacement | 4-29 |
| 4.6-1 | Translunar coast groundtrack | 4-34 |
| 4.6-2 | Time history of altitude for first 10 hours of translunar coast | 4-35 |
| 4.6-3 | Time history of true anomaly for first 10 hours of translunar coast | 4-36 |
| 4.6-4 | Altitude time history from translunar injection to lunar orbit insertion | 4-37 |
| 4.6-5 | Time history of altitude 10 hours prior to LOI ignition | 4-38 |
| 4.7-1 | LOI geometry | 4-43 |
| 4.7-2 | Lunar orbit groundtracks from LOI to LM landing | 4-44 |
| 4.7-3 | Time history of trajectory parameters for LOI | |
| | (a) Velocity, flight-path angle, and altitude versus time from LOI burn initiation | 4-45 |
| | (b) Local horizontal pitch and yaw versus time from LOI burn initiation | 4-46 |
| 4.10-1 | LM and CSM events from undocking to landing | 4-66 |

| Figure | Page |
|---------|-------------------------------------------------------------------------------------------------|
| 4.10-2 | Time history of LM and LM-CSM trajectory parameters from undocking to landing |
| (a) | LM total velocity, altitude above landing site, and flight-path angle 4-67 |
| (b) | LM-CSM range, range rate, and phase angle 4-68 |
| 4.10-3 | LM-CSM relative motion from undocking to landing (curvilinear coordinate system) 4-69 |
| 4.10-4 | Powered descent profile 4-70 |
| 4.10-5 | LM powered descent groundtrack 4-71 |
| 4.10-6 | Time histories of LM and LM-CSM trajectory parameters from PDI to landing |
| (a) | LM velocity, altitude, and flight-path angle . . . 4-72 |
| (b) | LM-CSM range, range rate, and phase angle 4-73 |
| (c) | FDAI pitch angle and thrust angle from local vertical 4-74 |
| (d) | LM thrust magnitude 4-75 |
| 4.10-7 | Altitude above landing site versus altitude rate 4-76 |
| 4.10-8 | S-band gimbal angle profile 4-77 |
| 4.10-9 | Terrain altitude 4-78 |
| 4.10-10 | Approach phase summary 4-79 |
| 4.10-11 | Topography around the landing site Fra Mauro 4-80 |
| 4.10-12 | Landing phase summary 4-81 |
| 4.12-1 | LM ascent 4-93 |
| 4.12-2 | Vertical rise phase 4-94 |
| 4.12-3 | Orbit insertion phase 4-95 |
| 4.12-4 | LM and CSM groundtracks 4-96 |

| Figure | Page |
|--------|-------------------------------------------------------------------------------------------------------------------------------------------------|
| 4.12-5 | Time histories of LM trajectory parameters from lunar lift-off to LM insertion |
| | (a) LM altitude, inertial velocity, and inertial flight-path angle 4-97 |
| | (b) LM thrust angle and FDAI angles 4-98 |
| 4.12-6 | LM altitude versus altitude rate during powered ascent 4-99 |
| 4.12-7 | LM-CSM phase angle, range, and range rate versus time from lift-off and vertical range versus horizontal range (CSM referenced) 4-100 |
| 4.12-8 | LM-CSM range versus LM-CSM range rate during powered ascent 4-101 |
| 4.12-9 | S-band gimbal angle profile during powered ascent 4-102 |
| 4.13-1 | Orbital schematic of ascent through docking 4-111 |
| 4.13-2 | Parameters from LM orbit insertion through terminal rendezvous |
| | (a) LM-CSM elevation angle versus time from LM orbit insertion 4-112 |
| | (b) CSM-LM-sun angle versus time from LM orbit insertion 4-113 |
| | (c) CSM lead angle versus time from LM orbit insertion 4-114 |
| | (d) LM-CSM range versus time from LM orbit insertion 4-115 |
| | (e) LM-CSM range rate versus time from LM orbit insertion 4-116 |
| | (f) Vertical relative range versus horizontal relative range 4-117 |
| 4.13-3 | Mission events and tracking summaries for LM-active rendezvous 4-118 |
| 4.13-4 | LM-CSM relative geometry at TPI 4-119 |
| 4.14-1 | Groundtrack from LOPC to TEI 4-127 |

| Figure | Page |
|--------|----------------------------------------------------------------------------------------------------|
| 4.15-1 | Time history of trajectory parameters for transearth injection |
| | (a) Velocity, flight-path angle, and altitude versus time from TEI burn initiation 4-133 |
| | (b) Local horizontal pitch and yaw versus time from TEI burn initiation 4-134 |
| 4.15-2 | TEI geometry 4-135 |
| 4.16-1 | Transearth coast groundtrack 4-140 |
| 4.16-2 | Altitude time history during the first 10 hours of transearth coast 4-141 |
| 4.16-3 | Altitude time history from transearth injection to entry interface 4-142 |
| 4.16-4 | Altitude time history 10 hours prior to entry interface 4-143 |
| 4.17-1 | Entry corridor 4-152 |
| 4.17-2 | Maneuver footprint and nominal groundtrack 4-153 |
| 4.17-3 | Geodetic altitude versus range-to-go 4-154 |
| 4.17-4 | CMC commanded bank angle, altitude, and altitude rate time histories 4-155 |
| 4.17-5 | Total aerodynamic heating rate and heat load time histories 4-156 |
| 4.17-6 | Time histories of velocity and flight-path angle for entry |
| | (a) Relative and inertial velocity 4-157 |
| | (b) Relative and inertial flight-path angle 4-157 |
| 4.17-7 | Total propellant consumed from CSM separation 4-158 |
| 4.17-8 | Communications blackout 4-159 |
| 4.17-9 | Primary DSKY display VERB 06 NOUN 74 4-160 |

| Figure | Page |
|-------------------------------------------------------------------------------------------------------------------|-------|
| 4.17-10 DSKY displays (final phase) VERB 06 NOUN 66 | 4-161 |
| 4.17-11 Relative velocity and relative flight-path angle time histories from drogue parachute deployment . . . | 4-162 |
| 4.17-12 Geodetic altitude and load factor time histories from drogue parachute deployment | 4-163 |
| 4.17-13 EMS parameters | |
| (a) Load factor versus inertial velocity | 4-164 |
| (b) CMC commanded bank angle and EMS range-to-go versus inertial velocity | 4-164 |

1.0 SUMMARY AND INTRODUCTION

2.0 SYMBOLS AND NOMENCLATURE

3.0 PRIMARY GUIDELINES AND CONSTRAINTS

4.0 MISSION SUMMARY

4.1 EARTH LAUNCH

4.2 EARTH PARKING ORBIT

4.3 TRANSLUNAR INJECTION

4.4 FREE-RETURN CIRCUMLUNAR

4.5 POST-TRANSLUNAR INJECTION EVENTS

4.6 TRANSLUNAR COAST

4.7 LUNAR ORBIT INSERTION

4.8 DESCENT ORBIT INSERTION

4.9 CSM/LM COAST FROM LOI TO UNDOCK

4.10 CSM/LM UNDOCK TO LANDING

4.11 CSM PLANE CHANGE

4.12 LM ASCENT

4.13 RENDEZVOUS SEQUENCE

4.14 LM JETTISON AND SEPARATION TO TEI

4.15 TRANSEARTH INJECTION

4.16 TRANSEARTH COAST

4.17 ENTRY

5.0 INPUT DATA

6.0 REFERENCES

THE SPACECRAFT OPERATIONAL TRAJECTORY FOR

APOLLO 14 (MISSION H-3)

LAUNCHED JANUARY 31, 1971

VOLUME I - MISSION PROFILE

By Lunar Mission Analysis Branch, Orbital Mission Analysis Branch,
and Landing Analysis Branch

1.0 SUMMARY AND INTRODUCTION

1.1 Summary

In volumes I and II of the Spacecraft Operational Trajectory, a detailed description of the hybrid mission profile for Apollo 14 is presented. The nominal launch date of January 31, 1971 was used for this trajectory simulation.

Translunar injection places the spacecraft on a free-return trajectory with a high perilune altitude. The evasive maneuver is performed by the S-IVB prior to the blowdown as was done on Apollo 13. The S-IVB blowdown maneuver will place the discarded S-IVB on a lunar impact trajectory. Twenty-eight hours after TLI, an SPS transfer maneuver is performed to lower perilune to 57 n. mi. After the maneuver, the spacecraft is on a relaxed-free-return trajectory which is restricted such that an earth return would be within the DPS docked ΔV capability if an SPS failure should occur at LOI ignition.

The lunar orbit time line is similar to that of Apollo 12 but does not include a plane change after LM jettison to gain photographic coverage of selected prime sites for future landing missions. After LM jettison, there is a LM ascent stage deorbit maneuver which results in a lunar impact as was done on Apollo 12. TEI occurs at the start of revolution 35.

For the nominal mission, the launch time is 14^h20^m c.s.t., and the flight azimuth is $\sim 72^\circ$. Translunar injection occurs during the second revolution over the Pacific Ocean.

The mission duration is approximately 9 days. The translunar flight time is $80^{\text{h}}02^{\text{m}}$. The time spent in lunar orbit is approximately $66^{\text{h}}31^{\text{m}}$, and the transearth flight time is $67^{\text{h}}10^{\text{m}}$. An inertial plot of the basic profile is shown in figure 1.1-1.

The nominal mission is summarized in the following tables.

- a. Table 1.1-I.- Sequence of major events
- b. Table 1.1-II.- Lunar orbit activities
- c. Table 1.1-III.- Launch window summary
- d. Table 1.1-IV.- Timetable of mission events
- e. Table 1.1-V.- Radar timeline
- f. Table 1.1-VI.- Shadow timeline

1.2 Introduction

The operational trajectory document is divided into numbered sections with index tabs. The symbols and nomenclature are presented in section 2.0, and a list of the primary mission guidelines and constraints is presented in section 3.0.

The main body of the document is section 4.0. This section is divided into subsections according to mission phases, and each subsection contains the text, tables, and figures related to the particular mission phase. In general, the information in each subsection includes a tracking timeline summary, a shadow timeline summary, target parameters, and a sequence of events table with a standard set of parameters. The propellant consumption predictions in section 4.0 are approximate and are included for completeness. The official predictions will be published in the operational consumables document.

The input data that were used to generate the operational trajectory are presented in section 5.0, which also contains the REFSMMAT's. Almost all of the input data are tabulated; however, for some data, only the source is identified. The references are listed in section 6.0.

The mission tracking timeline, shadow timeline, and more detailed trajectory data are contained in volume II of the operational trajectory document (ref. 1).

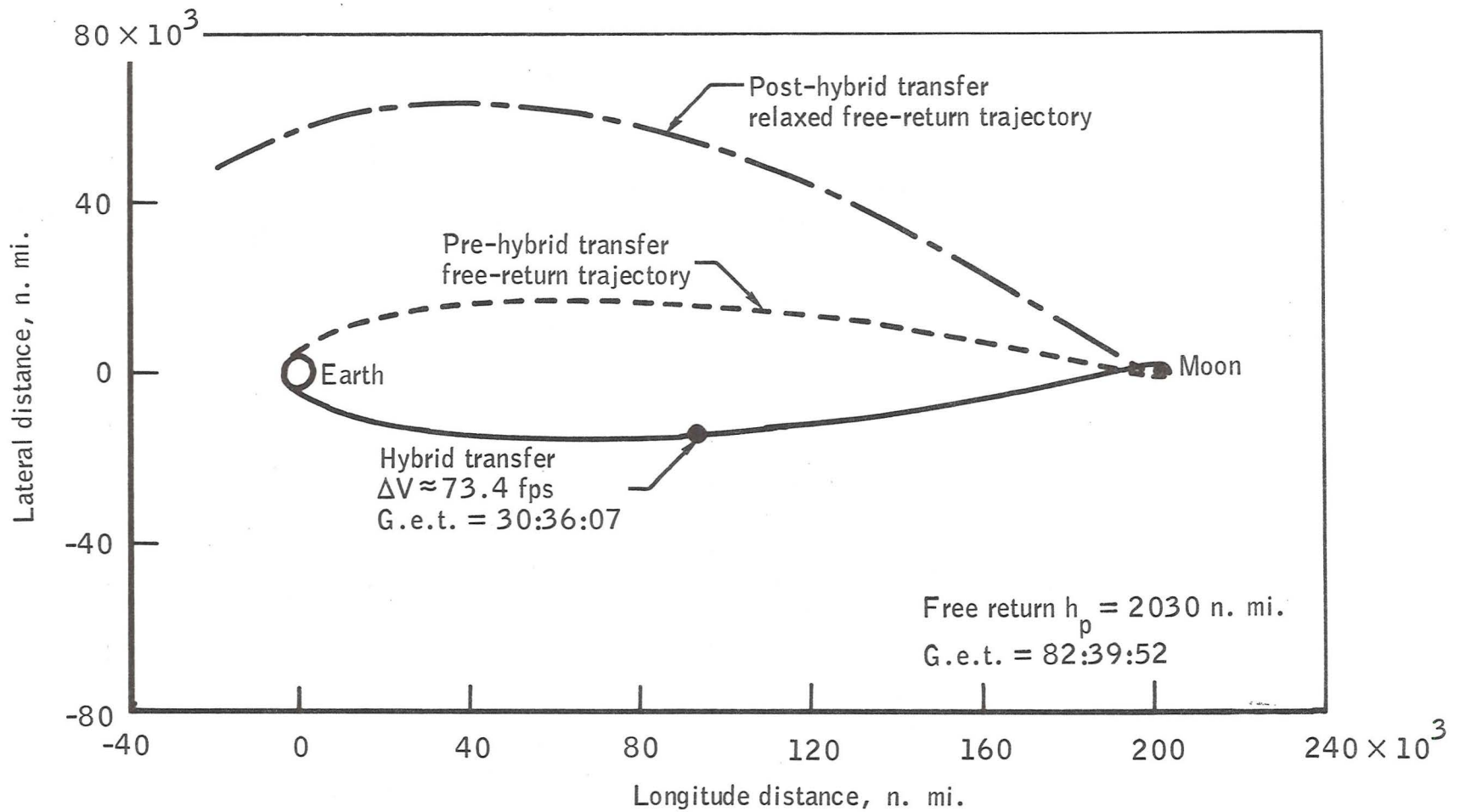

Figure 1.1-1.- Schematic of the hybrid mission profile.

TABLE 1.1-I.- SEQUENCE OF MAJOR EVENTS^a

| Event | Time, hr:min:sec, g.e.t | Time, hr:min:sec, c.s.t | Data summary |
|--------------------------------------------------------------|-------------------------------|-------------------------------|------------------------------------------------------------------------------------------------------------------------------------------------------------------------------------------------------------------------------------------|
| Launch | 00:00:00 | Jan. 31, 1971 14:20:00 | Flight azimuth, deg 72 Launch complex 39A |
| EPO insertion | 00:11:39.6 | 14:31:39.6 | Geodetic latitude, deg 32.7 Longitude, deg -53.3 Geodetic altitude, n. mi. 103.3 Velocity, fps 25 567.7 |
| Translunar injection Burn initiation | 02:30:42.4 | 16:50:42.4 | Geodetic latitude, deg -29.0 Longitude, deg 124.4 Velocity, fps 25 593.6 Apogee altitude, n. mi. 104.7 Geodetic altitude, n. mi. 99.4 |
| Burn termination | 02:36:06.8 | 16:56:06.8 | Geodetic latitude, deg -19.1 Longitude, deg 149.9 Burn duration, sec 324.4 Plane change, deg 0.3 Apogee altitude, n. mi. 250 173 Geodetic altitude, n. mi. 162.3 |
| Post-TLI events CSM/S-IVB separation | 02:51:06.8 | 17:11:06.8 | |
| Docking | 03:11:06.8 | 17:31:06.8 | |
| CSM/LM ejection | 03:56:06.8 | 18:16:06.8 | |
| Evasive maneuver (performed by S-IVB) | 04:19:06.8 | 18:39:06.8 | ΔV , fps ≈ 10 |
| Translunar coast, midcourse correction maneuvers MCC-1 | TLI plus 9 hr | Feb. 1, 1971 01:56:06.8 | Geodetic altitude, n. mi. $\approx 56\ 000$ |
| MCC-2 (hybrid transfer) | 30:36:06.8 | 20:56:06.8 | Geodetic altitude, n. mi. 118 344.5 ΔV , fps 73.4 Burn duration, sec 11.1 SPS propellant used, lb 705.7 Plane change, deg 0.2 |
| MCC-3 | LOI minus 22 hr | Feb. 3, 1971 02:58:13.6 | Geodetic altitude, n. mi. $\approx 174\ 600$ |
| MCC-4 | LOI minus 5 hr | 19:58:13.6 | Altitude above mean lunar radius, n. mi. $\approx 12\ 600$ |
| Lunar orbit insertion (LOI) Burn initiation | 82:38:13.6 | Feb. 4, 1971 00:58:13.6 | Mass, lb 96 377.7 Altitude above LLS, n. mi. 76.4 Selenographic latitude, deg 2.2 Selenographic longitude, deg -178.2 Perilune altitude above LLS, n. mi. 57.1 Selenographic inclination, deg 3.2 Velocity, fps 8094.4 |

^aData shown for launch vehicle events (e.g., launch, EPO insertion, TLI, etc.) are based on MSC simulations and should be considered unofficial and approximate only. Official launch vehicle data are contained in the launch vehicle Operational Trajectory published by the Marshall Space Flight Center.

TABLE 1.1-I.- SEQUENCE OF MAJOR EVENTS^a - Continued

| Event | Time, hr:min:sec, g.e.t. | Time, hr:min:sec, c.s.t. | Data summary |
|--------------------------------------------------|--------------------------------|--------------------------------|-------------------------------------------------------------------------------------------------------------------------------------------------------------------------------------------------------------------------------------------------------------------------------------------------------------------------------------------------------------------------------------------------------------------------------------------------------|
| Burn termination | 82:44:20.2 | Feb. 4, 1971 01:04:20.2 | Altitude above LLS, n. mi. 57.7 Selenographic latitude, deg -0.7 Selenographic longitude, deg 158.2 Selenographic inclination, deg 14.1 Burn duration, sec 366.6 Inertial burn arc, deg 23.7 Plane change, deg -11.2 ΔV, fps 2986.0 SPS propellant used, lb 24 695.2 Velocity, fps 5490.6 Orbital period, hr:min:sec 02:08:29.3 Perilune altitude above LLS, n. mi. 57.1 Apolune altitude above LLS, n. mi. 170.0 |
| S-IVB predicted lunar impact | TBD | TBD | Selenographic latitude, deg -1.7 Selenographic longitude, deg -33.25 |
| Descent orbit insertion (DOI) Burn initiation | 86:56:57.6 | 05:16:57.6 | Mass, lb 71 642.6 Altitude above LLS, n. mi. 57.3 Selenographic latitude, deg 2.4 Selenographic longitude, deg 168.6 Perilune altitude above LLS, n. mi. 57.1 Apolune altitude above LLS, n. mi. 170.0 Velocity, fps 5492.7 |
| Burn termination | 86:57:18.9 | 05:17:18.9 | Altitude above LLS, n. mi. 57.2 Selenographic latitude, deg 2.2 Selenographic longitude, deg 167.5 Selenographic inclination, deg 14.1 Burn duration, sec 21.4 Inertial burn arc, deg 1.1 Plane change, deg 0.0 ΔV, fps 206.6 Velocity, fps 5287.7 SPS propellant used, lb 1452.2 Orbital period, hr:min:sec 01:54:12.0 Perilune altitude above LLS, n. mi. 9.8 Apolune altitude above LLS, n. mi. 58.4 |
| First pass over Descartes | 89:38:51.0 | 07:58:51.0 | |
| Descent CSM/LM undock and SEP | 104:27:30.7 | 22:47:30.7 | Revolution number 12 |
| Circularization (CSM) Burn initiation | 105:46:48.5 | Feb. 5, 1971 00:06:48.5 | Mass, lb 35 937.7 Selenographic latitude, deg 9.7 Selenographic longitude, deg -168.2 Selenographic inclination, deg 14.2 Altitude above LLS, n. mi. 58.6 Perilune altitude above LLS, n. mi. 8.8 Velocity, fps 5280.1 Revolution number 12 |

^aData shown for launch vehicle events (e.g., launch, EPO insertion, TLI, etc.) are based on MSC simulations and should be considered unofficial and approximate only. Official launch vehicle data are contained in the launch vehicle Operational Trajectory published by Marshall Space Flight Center.

TABLE 1.1-I.- SEQUENCE OF MAJOR EVENTS^a- Continued

| Event | Time, hr:min:sec, g.e.t. | Time, hr:min:sec, c.s.t. | Data summary |
|-------------------------------------|--------------------------------|--------------------------------|----------------------------------------------------------------------------------------------------------------------------------------------------------------------------------------------------------------------------------------------------------------------------------------------------------------------------------------------------------------------------------------------------|
| Burn termination | 105:46:52.3 | 00:06:52.3 | ΔV, fps 72.5 Burn duration, sec 3.8 Altitude above LLS, n. mi. 58.6 Perilune altitude above LLS, n. mi. 56.0 Apolune altitude above LLS, n. mi. 63.5 Velocity, fps 5351.0 SPS propellant consumed, lb 257.2 Burn arc, deg 0.2 Period, hr:min:sec 01:58:45.2 |
| PDI (DPS ignition time) | 108:42:01.1 | 03:02:01.1 | Altitude above LLS, ft 50 026.6 Velocity, fps 5574.5 Revolution number 14 |
| High gate (P63 to P64) | 108:50:35.1 | 03:10:35.1 | Altitude above LLS, ft 7496.3 Velocity, fps 464.0 |
| Low gate | 108:52:13.1 | 03:12:13.1 | Altitude above LLS, ft 682.8 Velocity, fps 84.5 |
| Vertical descent (P64 to P65) | 108:53:01.1 | 03:13:01.1 | Altitude above LLS, ft 125.1 Velocity, fps 6.7 |
| LM landing | 108:53:32.6 | 03:13:32.6 | ΔV, fps 6637.6 Burn duration, min:sec 11:31.5 DPS propellant consumed, lb 16 801.2 Revolution number 14 |
| CSM first pass over LLS | 108:54:18.2 | 03:14:18.2 | Revolution number 14 |
| CSM plane change Burn initiation | 118:09:40.2 | 12:29:40.2 | Mass, lb 35 585.0 Selenographic latitude, deg -10.9 Selenographic longitude, deg 93.7 Altitude above LLS, n. mi. 61.7 Perilune altitude above LLS, n. mi. 57.4 Apolune altitude above LLS, n. mi. 61.7 Velocity, fps 5333.8 Revolution number 19 |
| Burn termination | 118:09:58.5 | 12:29:58.5 | SPS propellant consumed, lb 1249.8 ΔV, fps 360.7 Burn duration, sec 18.4 Selenographic latitude, deg -11.0 Selenographic longitude, deg 92.7 Altitude above LLS, n. mi. 61.7 Perilune altitude above LLS, n. mi. 57.4 Apolune altitude above LLS, n. mi. 61.7 Plane change, deg 3.9 Selenographic inclination, deg 12.1 Velocity, fps 5333.8 Revolution number 19 |

^aData shown for launch vehicle events (e.g., launch, EPO insertion, TLI, etc.) are based on MSC simulations and should be considered unofficial and approximate only. Official launch vehicle data are contained in the launch vehicle Operational Trajectory published by Marshall Space Flight Center.

TABLE 1.1-I.- SEQUENCE OF MAJOR EVENTS^a- Continued

| Event | Time, hr:min:sec, g.e.t. | Time, hr:min:sec, c.s.t. | Data summary |
|--------------------------------------|--------------------------------|--------------------------------|-------------------------------------------------------------------------------------------------------------------------------------------------------------------------------------------------------------------------------------------------------------------|
| Second pass over Descartes | 134:21:30.6 | Feb. 6, 1971 04:41:30.6 | Revolution number 27 |
| Ascent | | | |
| LM lift-off | 142:24:29.2 | 12:44:29.2 | Mass, lb 10 747.0 Selenographic latitude, deg -3.7 Selenographic longitude, deg -17.5 Revolution number 31 |
| LM insertion | 142:31:39.9 | 12:51:39.9 | Mass, lb 5831.5 ΔV , fps 6053.4 Burn duration, sec 430.7 Latitude, deg -1.6 Longitude, deg -27.3 Altitude above LLS, ft 59 932.7 Perilune altitude above LLS, ft 55 511.9 Apolune altitude above LLS, ft 309 656.4 |
| Rendezvous TPI | 143:09:39.9 | 13:29:39.9 | Burn duration, sec 4.0 ΔV , fps 77.8 Propellant used, lb 45.3 Resultant h_a/h_p , n. mi. 61.0/44.6 Range at cutoff, n. mi. 32.5 Range rate at cutoff, fps -134.3 Propulsion system AFS Revolution number 31 |
| Braking | 143:50:32.8 | 14:10:32.8 | Burn duration, sec 29.2 ΔV , fps 32.6 Propellant used, lb 20.8 Range at final braking, n. mi. 0.02 Range rate at final braking, fps -0.23 h_a/h_p at final braking, n. mi. 60.3/58.7 Propulsion system LM RCS Revolution number 32 |
| Docking | 144:10:00.0 | 14:30:00.0 | |
| LM jettison | 146:23:30.5 | 16:43:30.5 | Selenographic latitude, deg -3.3 Selenographic longitude, deg -21.1 |
| CSM/LM separation Burn initiation | 146:28:30.6 | 16:48:30.6 | |

^aData shown for launch vehicle events (e.g., launch, EPO insertion, TLI, etc.) are based on MSC simulations and should be considered unofficial and approximate only. Official launch vehicle data are contained in the launch vehicle Operational Trajectory published by Marshall Space Flight Center.

TABLE 1.1-I.- SEQUENCE OF MAJOR EVENTS^a- Continued

| Event | Time, hr:min:sec, g.e.t. | Time, hr:min:sec, c.s.t. | Data summary |
|-----------------------------------------|--------------------------------|--------------------------------|--------------------------------------------------------------------------------------------------------------------------------------------------------------------------------------------------------------------------------------------------------------------------------------------------------------------------------------------------------------------------------|
| Burn termination | 146:28:36.5 | 16:48:36.5 | Mass, lb 34 570.7 ΔV, fps 1.0 Burn duration, sec 5.9 Selenographic latitude, deg -0.1 Selenographic longitude, deg -36.3 Altitude above LLS, n. mi. 59.5 Perilune altitude above LLS, n. mi. 58.3 Apolune altitude above LLS, n. mi. 60.2 Plane change, deg 0.0 Selenographic inclination, deg 12.2 Velocity, fps 5344.7 Revolution number 33 |
| LM deorbit | 147:52:58.9 | 18:12:58.9 | Mass, lb 5277.2 ΔV, fps 183.7 Burn duration, sec 77.0 Selenographic latitude, deg -11.8 Selenographic longitude, deg 67.4 |
| LM impact | 148:20:58.1 | 18:40:58.1 | Mass, lb 5171.1 Selenographic latitude, deg -3.5 Selenographic longitude, deg -19.3 Velocity, fps 5505.9 CSM revolution number 34 |
| Transearth injection Burn initiation | 149:14:50.1 | 19:34:50.1 | Mass, lb 34 515.7 Altitude above LLS, n. mi. 59.3 Selenographic latitude, deg 7.1 Selenographic longitude, deg 177.3 Perilune altitude above LLS, n. mi. 58.1 Selenographic inclination, deg 12.2 Velocity, fps 5346.4 Revolution number 35 |
| Burn termination | 149:17:17.3 | 19:37:17.3 | Altitude above LLS, n. mi. 66.4 Selenographic latitude, deg 6.5 Selenographic longitude, deg 167.8 Perilune altitude above LLS, n. mi. 57.5 Selenographic inclination, deg 6.5 Burn duration, sec 147.1 Inertial burn arc, deg 9.4 Plane change, deg 11.0 ΔV, fps 3449.5 SPS propellant used, lb 9995.7 Velocity, fps 8503.6 |

^aData shown for launch vehicle events (e.g., launch, EPO insertion, TLI, etc.) are based on MSC simulations and should be considered unofficial and approximate only. Official launch vehicle data are contained in the launch vehicle Operational Trajectory published by Marshall Space Flight Center.

TABLE 1.1-I.- SEQUENCE OF MAJOR EVENTS^a - Concluded

| Events | Time, hr:min:sec, g.e.t. | Time, hr:min:sec, c.s.t. | Data summary |
|-----------------------------------------------------|--------------------------------|--------------------------------|----------------------------------------------------------------------------------------------------------------------------------------------------------------------------------------------------------------------------------------------------------------------------------------------------------------------------------------------------------------------------------------------------------------------------------------------------|
| Transearch coast, midcourse correction maneuvers | | | |
| MCC-5 | TEI plus 17 hr | Feb. 7, 1971 12:37:17.3 | Geodetic altitude, n. mi. ≈ 175 500 |
| MCC-6 | EI minus 22 hr | Feb. 8, 1971 16:46:58.7 | Geodetic altitude, n. mi. ≈ 105 400 |
| MCC-7 | EI minus 3 hr | Feb. 9, 1971 11:46:58.7 | Geodetic altitude, n. mi. ≈ 24 800 |
| CM/SM sep | EI minus 15 min | 14:31:58.7 | Geodetic altitude, n. mi. 1961.9 |
| Entry interface | 216:26:58.7 | 14:46:58.7 | Transearch coast time, hr 67.2 Inertial velocity, fps 36 170.1 Geodetic altitude, n. mi. (ft) 65.9(400 249) Inertial flight-path angle, deg -6.5 Geodetic latitude, deg -36.3 Longitude, deg 166.4 Equatorial inclination (ascending), deg 40 |
| CM landing | 216:40:53.1 | 15:00:53.1 | Geodetic latitude, deg -27.241 Longitude, deg -171.53 |

^aData shown for launch vehicle events (e.g., launch, EPO insertion, TLI, etc.) are based on MSC simulations and should be considered unofficial and approximate only. Official launch vehicle data are contained in the launch vehicle Operational Trajectory published by Marshall Space Flight Center.

TABLE 1.1-II.- LUNAR ORBIT ACTIVITIES

| Activity | Revolution number | Time, hr:min:, g.e.t. |
|-------------------------------------|----------------------|--------------------------|
| LOI | Beginning of 1 | 82:38 |
| DOI | Beginning of 3 | 86:57 |
| Low-altitude surface observation | 3 | 87:50 |
| Descartes photograph | 4 | 89:35 |
| Begin rest period | 5 | 91:00 |
| End rest period | 9 | 99:30 |
| Begin IVT to LM | 10 | 101:50 |
| Undocking and separation | 12 | 104:28 |
| CSM circularization | 12 | 105:47 |
| PDI | 14 | 108:42 |
| Landing | 14 | 108:54 |
| Begin first EVA | 16 | 113:30 |
| Terminate first EVA | 18 | 117:45 |
| CSM plane change | 19 | 118:10 |
| Begin second EVA | 27 | 134:12 |
| Descartes photograph | 27 | 134:22 |
| Terminate second EVA | 29 | 138:30 |
| LM ascent | 31 | 142:24 |

TABLE 1.1-II- LUNAR ORBIT ACTIVITIES - Concluded

| Activity | Revolution number | Time, hr:min:, g.e.t. |
|-----------------|----------------------|--------------------------|
| Docking | 32 | 144:10 |
| LM jettison | 34 | 146:23 |
| CSM separation | 33 | 146:29 |
| LM deorbit burn | 34 | 147:53 |
| LM lunar impact | 34 | 148:21 |
| TEI | Beginning of 35 | 149:17 |

TABLE 1.1-III.- LAUNCH WINDOW SUMMARY

| | |
|----------------------------------------------------|------------------|
| Launch date | January 31, 1971 |
| Site | Fra Mauro |
| Flight azimuth, deg ^a | 72 to 96 |
| Launch time, hr:min, c.s.t. ^a | 14:20 to 18:10 |
| Free-return h _p , n. mi. | 2030 to 1075 |
| Hybrid transfer ΔV , fps | 73.4 to 45.0 |
| Translunar flight time, hr:min | 80:02 to 74:50 |
| Lunar orbit inclination, deg | 14.1 |
| Approach azimuth at landing, deg | -76.31 |
| Sun elevation at landing, deg | 10.3 |
| Goldstone landing coverage, hr:min | 1:30 |
| Lunar surface stay time, hr | 34 |
| Photo site | Descartes |
| Total lunar orbit stay time | 67 hr, 34 revs |
| Transearth flight time, hr | 67 |
| Total mission time, hr | 216:41 to 212:51 |

^aThe parameters for this phase are approximate and are presented for information only. The official source for this phase is the MSFC LV operational trajectory (ref. 2).

| Event | Launch | EOI | TLI initiation | TLI cutoff | Evasive maneuver (S-IVB) | Hybrid transfer | LOI initiation | LOI cutoff | DOI | Descartes photo pass 1 | CSM undock and separation | CSM circularization | PDI | LM landing | CSM first pass over LLS | CSM plane change 1 | Descartes photo pass 2 | LM lift-off | TPI | Braking | Docking |
|------------------------------|-----------|-----------|----------------|------------|--------------------------|-----------------|----------------|------------|-----------|------------------------|---------------------------|---------------------|-----------|------------|-------------------------|--------------------|------------------------|-------------|----------|----------|----------|
| Launch | | | | | | | | | | | | | | | | | | | | | |
| EOI | 0:11:40 | | | | | | | | | | | | | | | | | | | | |
| TLI initiation | 2:30:42 | 02:19:03 | | | | | | | | | | | | | | | | | | | |
| TLI cutoff | 2:36:07 | 02:24:27 | 00:05:24 | | | | | | | | | | | | | | | | | | |
| Evasive maneuver (S-IVB) | 4:19:07 | 04:07:27 | 01:48:24 | 01:43:00 | | | | | | | | | | | | | | | | | |
| Hybrid transfer | 30:36:07 | 30:24:27 | 28:05:24 | 28:00:00 | 26:17:00 | | | | | | | | | | | | | | | | |
| LOI initiation | 82:38:14 | 82:26:34 | 80:07:31 | 80:02:07 | 78:19:07 | 52:02:07 | | | | | | | | | | | | | | | |
| LOI cutoff | 82:44:20 | 82:32:41 | 80:13:38 | 80:08:13 | 78:25:13 | 52:08:13 | 00:06:07 | | | | | | | | | | | | | | |
| DOI | 86:56:58 | 86:45:18 | 84:26:15 | 84:20:51 | 82:37:51 | 56:20:51 | 04:18:44 | 04:12:37 | | | | | | | | | | | | | |
| Descartes photo pass 1 | 89:38:51 | 89:27:11 | 87:08:09 | 87:02:44 | 85:19:44 | 59:02:44 | 07:00:37 | 06:54:31 | 02:41:53 | | | | | | | | | | | | |
| CSM/LM undock and separation | 104:27:31 | 104:15:51 | 101:56:48 | 101:51:24 | 100:08:24 | 73:51:24 | 21:49:17 | 21:43:11 | 17:30:33 | 14:48:40 | | | | | | | | | | | |
| CSM circularization | 105:46:48 | 105:35:09 | 103:16:06 | 103:10:42 | 101:27:42 | 75:10:42 | 23:08:35 | 23:02:28 | 18:49:51 | 16:07:57 | 01:19:18 | | | | | | | | | | |
| PDI | 108:42:01 | 108:30:21 | 106:11:19 | 106:05:54 | 104:22:54 | 78:05:54 | 26:03:47 | 25:57:41 | 21:45:03 | 19:03:10 | 04:14:30 | 02:55:13 | | | | | | | | | |
| LM landing | 108:53:33 | 108:41:53 | 106:22:50 | 106:17:26 | 104:34:26 | 78:17:26 | 26:15:19 | 26:09:12 | 21:56:35 | 19:14:42 | 04:26:02 | 03:06:44 | 00:11:32 | | | | | | | | |
| CSM first pass over LLS | 108:54:18 | 108:42:39 | 106:23:36 | 106:18:11 | 104:35:11 | 78:18:11 | 26:16:05 | 26:09:58 | 21:57:21 | 19:15:27 | 04:26:47 | 03:07:30 | 00:12:17 | 00:00:46 | | | | | | | |
| CSM plane change 1 | 118:09:40 | 117:58:01 | 115:38:58 | 115:33:33 | 113:50:33 | 87:33:33 | 35:31:27 | 35:25:20 | 31:12:43 | 28:30:49 | 13:42:10 | 12:22:52 | 09:27:39 | 09:16:08 | 09:15:22 | | | | | | |
| Descartes photo pass 2 | 134:21:31 | 134:09:51 | 131:50:48 | 131:45:24 | 130:02:24 | 103:45:24 | 51:43:17 | 51:37:10 | 47:24:33 | 44:42:40 | 29:54:00 | 28:34:42 | 25:39:29 | 25:27:58 | 25:27:12 | 16:11:50 | | | | | |
| LM lift-off | 142:25:42 | 142:14:03 | 139:55:00 | 139:49:36 | 138:06:36 | 111:49:36 | 59:47:29 | 59:41:22 | 55:28:45 | 52:46:51 | 37:58:12 | 36:38:54 | 33:43:41 | 33:32:10 | 33:31:24 | 24:16:02 | 08:04:12 | | | | |
| TPI | 143:09:40 | 142:58:00 | 140:38:57 | 140:33:33 | 138:50:33 | 112:33:33 | 60:31:26 | 60:25:20 | 56:12:42 | 53:30:49 | 38:42:09 | 37:22:51 | 34:27:39 | 34:16:07 | 34:15:22 | 25:00:00 | 08:48:09 | 00:43:57 | | | |
| Braking | 143:50:33 | 143:38:53 | 141:19:50 | 141:14:26 | 139:31:26 | 113:14:26 | 61:12:19 | 61:06:13 | 56:53:35 | 54:11:42 | 39:23:02 | 38:03:44 | 35:08:32 | 34:57:00 | 34:56:15 | 25:40:53 | 09:29:02 | 01:24:50 | 00:40:53 | | |
| Docking | 144:10:00 | 143:58:20 | 141:39:18 | 141:33:53 | 139:50:53 | 113:33:53 | 61:31:46 | 61:25:40 | 57:13:02 | 54:31:09 | 39:42:29 | 38:23:11 | 35:27:59 | 35:16:27 | 35:15:42 | 26:00:20 | 09:48:29 | 01:44:18 | 01:00:20 | 00:19:27 | |
| LM jettison | 146:23:30 | 146:11:51 | 143:52:48 | 143:47:24 | 142:04:24 | 115:47:24 | 63:45:17 | 63:39:10 | 59:26:33 | 56:44:39 | 41:56:00 | 40:36:42 | 37:41:29 | 37:29:58 | 37:29:12 | 28:13:50 | 12:02:00 | 03:57:48 | 03:13:51 | 02:32:58 | 02:13:30 |
| CSM separation | 146:28:31 | 146:16:51 | 143:57:48 | 143:52:24 | 142:09:24 | 115:52:24 | 63:50:17 | 63:44:10 | 59:31:33 | 56:49:40 | 42:01:00 | 40:41:42 | 37:46:29 | 37:34:58 | 37:34:12 | 28:18:50 | 12:07:00 | 04:02:48 | 03:18:51 | 02:37:58 | 02:18:31 |
| LM deorbit | 147:52:59 | 147:41:19 | 145:22:16 | 145:16:52 | 143:33:52 | 117:16:52 | 65:14:45 | 65:08:39 | 60:56:01 | 58:14:08 | 43:25:28 | 42:06:10 | 39:10:58 | 38:59:26 | 38:58:41 | 29:43:19 | 13:31:28 | 05:27:16 | 04:43:19 | 04:02:26 | 03:42:59 |
| LM lunar impact | 148:20:58 | 148:09:18 | 145:50:16 | 145:44:51 | 144:01:51 | 117:44:51 | 65:42:44 | 65:36:38 | 61:24:00 | 58:42:07 | 43:53:27 | 42:34:10 | 39:38:57 | 39:27:25 | 39:26:40 | 30:11:18 | 13:59:27 | 05:55:16 | 05:11:18 | 04:30:25 | 04:10:58 |
| TEI initiation | 149:14:50 | 149:03:10 | 146:44:08 | 146:38:43 | 144:55:43 | 118:38:43 | 66:36:36 | 66:30:30 | 62:17:52 | 59:35:59 | 44:47:19 | 43:28:02 | 40:32:49 | 40:21:17 | 40:20:32 | 31:05:10 | 14:53:19 | 06:49:08 | 06:05:10 | 05:24:17 | 05:04:50 |
| TEI cutoff | 149:17:17 | 149:05:38 | 146:46:35 | 146:41:10 | 144:58:10 | 118:41:10 | 66:39:04 | 66:32:57 | 62:20:20 | 59:38:26 | 44:49:47 | 43:30:29 | 40:35:16 | 40:23:45 | 40:22:59 | 31:07:37 | 14:55:47 | 06:51:35 | 06:07:37 | 05:26:44 | 05:07:17 |
| Entry interface | 216:26:59 | 216:15:19 | 213:56:16 | 213:50:52 | 212:07:52 | 185:50:52 | 133:48:45 | 133:42:38 | 129:30:01 | 126:48:08 | 111:59:28 | 110:40:10 | 107:44:58 | 107:33:26 | 107:32:40 | 98:17:18 | 82:05:28 | 74:01:16 | 73:17:19 | 72:36:26 | 72:16:59 |
| Landing | 216:40:59 | 216:29:19 | 214:10:17 | 214:04:52 | 212:21:52 | 186:04:52 | 134:02:45 | 133:56:39 | 129:44:01 | 127:02:08 | 112:13:28 | 110:54:11 | 107:58:58 | 107:47:26 | 107:46:41 | 98:31:19 | 82:19:28 | 74:15:17 | 73:31:19 | 72:50:26 | 72:30:59 |

TABLE 1.1-IV.- TIMETABLE OF MISSION EVENTS

| cutoff | Evasive maneuver (S-IVB) | Hybrid transfer | LOI initiation | LOI cutoff | DOI | Descartes photo pass 1 | CSM undock and separation | CSM circularization | PDI | LM landing | CSM first pass over LLS | CSM plane change 1 | Descartes photo pass 2 | LM lift-off | TPI | Braking | Docking | LM jettison | CSM separation | LM deorbit | LM lunar impact | TEI initiation | TEI cutoff | Entry interface | |
|--------|--------------------------|-----------------|----------------|------------|-----------|------------------------|---------------------------|---------------------|-----------|------------|-------------------------|--------------------|------------------------|-------------|----------|----------|----------|-------------|----------------|------------|-----------------|----------------|------------|-----------------|--|
| :43:00 | | | | | | | | | | | | | | | | | | | | | | | | | |
| :00:00 | 26:17:00 | | | | | | | | | | | | | | | | | | | | | | | | |
| :02:07 | 78:19:07 | 52:02:07 | | | | | | | | | | | | | | | | | | | | | | | |
| :08:13 | 78:25:13 | 52:08:13 | 00:06:07 | | | | | | | | | | | | | | | | | | | | | | |
| :20:51 | 82:37:51 | 56:20:51 | 04:18:44 | 04:12:37 | | | | | | | | | | | | | | | | | | | | | |
| :02:44 | 85:19:44 | 59:02:44 | 07:00:37 | 06:54:31 | 02:41:53 | | | | | | | | | | | | | | | | | | | | |
| :51:24 | 100:08:24 | 73:51:24 | 21:49:17 | 21:43:11 | 17:30:33 | 14:48:40 | | | | | | | | | | | | | | | | | | | |
| :10:42 | 101:27:42 | 75:10:42 | 23:08:35 | 23:02:28 | 18:49:51 | 16:07:57 | 01:19:18 | | | | | | | | | | | | | | | | | | |
| :05:54 | 104:22:54 | 78:05:54 | 26:03:47 | 25:57:41 | 21:45:03 | 19:03:10 | 04:14:30 | 02:55:13 | | | | | | | | | | | | | | | | | |
| :17:26 | 104:34:26 | 78:17:26 | 26:15:19 | 26:09:12 | 21:56:35 | 19:14:42 | 04:26:02 | 03:06:44 | 00:11:32 | | | | | | | | | | | | | | | | |
| :18:11 | 104:35:11 | 78:18:11 | 26:16:05 | 26:09:58 | 21:57:21 | 19:15:27 | 04:26:47 | 03:07:30 | 00:12:17 | 00:00:46 | | | | | | | | | | | | | | | |
| :33:33 | 113:50:33 | 87:33:33 | 35:31:27 | 35:25:20 | 31:12:43 | 28:30:49 | 13:42:10 | 12:22:52 | 09:27:39 | 09:16:08 | 09:15:22 | | | | | | | | | | | | | | |
| :45:24 | 130:02:24 | 103:45:24 | 51:43:17 | 51:37:10 | 47:24:33 | 44:42:40 | 29:54:00 | 28:34:42 | 25:39:29 | 25:27:58 | 25:27:12 | 16:11:50 | | | | | | | | | | | | | |
| :49:36 | 138:06:36 | 111:49:36 | 59:47:29 | 59:41:22 | 55:28:45 | 52:46:51 | 37:58:12 | 36:38:54 | 33:43:41 | 33:32:10 | 33:31:24 | 24:16:02 | 08:04:12 | | | | | | | | | | | | |
| :33:33 | 138:50:33 | 112:33:33 | 60:31:26 | 60:25:20 | 56:12:42 | 53:30:49 | 38:42:09 | 37:22:51 | 34:27:39 | 34:16:07 | 34:15:22 | 25:00:00 | 08:48:09 | 00:43:57 | | | | | | | | | | | |
| :14:26 | 139:31:26 | 113:14:26 | 61:12:19 | 61:06:13 | 56:53:35 | 54:11:42 | 39:23:02 | 38:03:44 | 35:08:32 | 34:57:00 | 34:56:15 | 25:40:53 | 09:29:02 | 01:24:50 | 00:40:53 | | | | | | | | | | |
| :33:53 | 139:50:53 | 113:33:53 | 61:31:46 | 61:25:40 | 57:13:02 | 54:31:09 | 39:42:29 | 38:23:11 | 35:27:59 | 35:16:27 | 35:15:42 | 26:00:20 | 09:48:29 | 01:44:18 | 01:00:20 | 00:19:27 | | | | | | | | | |
| :47:24 | 142:04:24 | 115:47:24 | 63:45:17 | 63:39:10 | 59:26:33 | 56:44:39 | 41:56:00 | 40:36:42 | 37:41:29 | 37:29:58 | 37:29:12 | 28:13:50 | 12:02:00 | 03:57:48 | 03:13:51 | 02:32:58 | 02:13:30 | | | | | | | | |
| :52:24 | 142:09:24 | 115:52:24 | 63:50:17 | 63:44:10 | 59:31:33 | 56:49:40 | 42:01:00 | 40:41:42 | 37:46:29 | 37:34:58 | 37:34:12 | 28:18:50 | 12:07:00 | 04:02:48 | 03:18:51 | 02:37:58 | 02:18:31 | 00:05:00 | | | | | | | |
| :16:52 | 143:33:52 | 117:16:52 | 65:14:45 | 65:08:39 | 60:56:01 | 58:14:08 | 43:25:28 | 42:06:10 | 39:10:58 | 38:59:26 | 38:58:41 | 29:43:19 | 13:31:28 | 05:27:16 | 04:43:19 | 04:02:26 | 03:42:59 | 01:29:28 | 01:24:28 | | | | | | |
| :44:51 | 144:01:51 | 117:44:51 | 65:42:44 | 65:36:38 | 61:24:00 | 58:42:07 | 43:53:27 | 42:34:10 | 39:38:57 | 39:27:25 | 39:26:40 | 30:11:18 | 13:59:27 | 05:55:16 | 05:11:18 | 04:30:25 | 04:10:58 | 01:57:28 | 01:52:28 | 00:27:59 | | | | | |
| :38:43 | 144:55:43 | 118:38:43 | 66:36:36 | 66:30:30 | 62:17:52 | 59:35:59 | 44:47:19 | 43:28:02 | 40:32:49 | 40:21:17 | 40:20:32 | 31:05:10 | 14:53:19 | 06:49:08 | 06:05:10 | 05:24:17 | 05:04:50 | 02:51:20 | 02:46:20 | 01:21:51 | 00:53:52 | | | | |
| :41:10 | 144:58:10 | 118:41:10 | 66:39:04 | 66:32:57 | 62:20:20 | 59:38:26 | 44:49:47 | 43:30:29 | 40:35:16 | 40:23:45 | 40:22:59 | 31:07:37 | 14:55:47 | 06:51:35 | 06:07:37 | 05:26:44 | 05:07:17 | 02:53:47 | 02:48:47 | 01:24:18 | 00:56:19 | 00:02:27 | | | |
| :50:52 | 212:07:52 | 185:50:52 | 133:48:45 | 133:42:38 | 129:30:01 | 126:48:08 | 111:59:28 | 110:40:10 | 107:44:58 | 107:33:26 | 107:32:40 | 98:17:18 | 82:05:28 | 74:01:16 | 73:17:19 | 72:36:26 | 72:16:59 | 70:03:28 | 69:58:28 | 68:34:00 | 68:06:01 | 67:12:09 | 67:09:41 | | |
| :04:52 | 212:21:52 | 186:04:52 | 134:02:45 | 133:56:39 | 129:44:01 | 127:02:08 | 112:13:28 | 110:54:11 | 107:58:58 | 107:47:26 | 107:46:41 | 98:31:19 | 82:19:28 | 74:15:17 | 73:31:19 | 72:50:26 | 72:30:59 | 70:17:29 | 70:12:29 | 68:48:00 | 68:20:01 | 67:26:09 | 67:23:42 | 00:14:00 | |

TABLE 1.1-V.- MISSION RADAR TIMELINE

(a) CSM acquisition and termination during rendezvous - 0° minimum elevation

| | | 31 JAN 71 EOI TO TLI IGNITION | | | | | | | | | | | | LAZ 72.1 | | | | | | | | | | | | |
|----------------------|-------------|-------------------------------|-----|-----|--------------------------|-----|-----|-----|-----|------|----|-----|-----|----------|--------------------------|-----|-----|-----|------|-----|-----|----|-----|-----|-----|-------|
| VEHICLE | RADAR TABLE | TRACKING TIME | | | STATION ACQUISITION DATA | | | | | | | | | | STATION TERMINATION DATA | | | | | | | | | | | |
| | | HRS | MIN | SEC | DAY | HRS | MIN | SEC | RA | DEC | AZ | ELV | X | Y | RANGE | DAY | HRS | MIN | SEC | RA | DEC | AZ | ELV | X | Y | RANGE |
| | | BDA-02 X-Y USB-30 | 0 | 1 | 7 | 0 | 0 | 11 | 40 | 102 | 7 | 85 | 5 | 85 | 5 | 592 | 0 | 0 | 12 | 46 | 107 | 5 | 84 | 0 | 90 | 6 |
| SHIP 1 INSERTION | 0 | 4 | 20 | 0 | 0 | 11 | 40 | -76 | 52 | -38 | 13 | -70 | 51 | 379 | 0 | 0 | 15 | 60 | 129 | 16 | 72 | 0 | 90 | 18 | 846 | |
| CYI-04 X-Y USB-30 | 0 | 7 | 6 | 0 | 0 | 16 | 34 | -34 | 15 | -73 | 0 | -90 | 17 | 847 | 0 | 0 | 23 | 40 | 145 | -20 | 113 | 0 | 90 | -23 | 840 | |
| TAN-22 A-E FPS-16 | 0 | 5 | 33 | 0 | 0 | 37 | 5 | 84 | 63 | -20 | 0 | -90 | 70 | 824 | 0 | 0 | 42 | 38 | -138 | 3 | 87 | 0 | 90 | 3 | 827 | |
| CRO-08 X-Y USB-30 | 0 | 5 | 50 | 0 | 0 | 52 | 17 | 98 | -28 | -121 | 0 | -90 | -31 | 833 | 0 | 0 | 58 | 7 | -49 | -32 | 126 | 0 | 90 | -36 | 833 | |
| HSK-25 X-Y USB-85 | 0 | 6 | 2 | 0 | 0 | 59 | 35 | 156 | 10 | -78 | 0 | -90 | -78 | 832 | 0 | 1 | 5 | 37 | -62 | 37 | 42 | 0 | -90 | 42 | 826 | |
| GYM-14 X-Y USB-30 | 0 | 7 | 3 | 0 | 1 | 28 | 19 | -89 | -25 | -118 | 0 | -90 | -28 | 839 | 0 | 1 | 35 | 22 | 85 | 13 | 76 | 0 | 90 | 14 | 846 | |
| GDS-28 X-Y USB-85 | 0 | 4 | 41 | 0 | 1 | 29 | 0 | -47 | -51 | -163 | 0 | 90 | -17 | 840 | 0 | 1 | 33 | 41 | 58 | -19 | 114 | 0 | 90 | 66 | 847 | |
| TEX-16 X-Y USB-30 | 0 | 7 | 3 | 0 | 1 | 31 | 12 | -87 | -4 | -95 | 0 | -90 | -5 | 844 | 0 | 1 | 38 | 15 | 104 | 21 | 67 | 0 | 90 | 23 | 850 | |
| MIL-71 X-Y USB-30 | 0 | 6 | 53 | 0 | 1 | 35 | 5 | -77 | 10 | -79 | 0 | -90 | 11 | 848 | 0 | 1 | 41 | 58 | 120 | 18 | 70 | 0 | 90 | 20 | 847 | |

1-19

2
1
0
9
8
7
6

VEHICLE 1 RADAR TABLE

TRACKING TIME

STATION ACQUISITION DATA

STATION TERMINATION DATA

HRS MIN SEC

DAY HRS MIN SEC RA DEC AZ ELV X Y RANGE

DAY HRS MIN SEC RA DEC AZ ELV X Y RANGE

GBM-41 0 6 30 0 1 35 49 -79 19 -69 0 -90 21 847 0 1 42 19 126 25 62 0 90 28 848
X-Y USB-30

BDA-02 0 7 9 0 1 38 31 -57 4 -85 0 -90 5 850 0 1 45 40 124 -4 95 0 90 -5 846
X-Y USB-30

GTI-51 0 4 17 0 1 38 37 -88 49 -36 0 -90 54 849 0 1 42 54 145 47 38 0 90 52 849
A-E TPQ-18

SHIP 1 0 7 5 0 1 42 12 -49 19 -68 0 -90 22 850 0 1 49 17 141 -6 96 0 90 -6 844
INSERTION

CYI-04 0 5 18 0 1 50 7 2 -10 -101 0 -90 -11 843 0 1 55 25 125 -57 161 0 90 -71 834
X-Y USB-30

PRE-76 0 3 6 0 2 8 2 151 63 7 0 90 83 824 0 2 11 8 -148 27 60 0 90 30 826
A-E MPS-25

TAN-22 0 6 50 0 2 9 11 70 15 -74 0 -90 16 827 0 2 16 2 -99 -35 127 0 90 -37 826
A-E FPS-16

CRD-08 0 5 18 0 2 25 25 118 -33 -127 0 -90 -37 833 0 2 30 42 -35 -24 115 4 86 -25 639
X-Y USB-30

31 JAN 71 TLI TO NFR IGNITION LAZ 72.1

HSK-25 0 0 51 0 2 36 7 -91 54 3 1 -89 3 1021 0 2 36 58 -72 52 15 0 -90 15 1197
X-Y USB-85

HAW-12 12 47 58 0 2 42 34 -114 -40 -133 0 -90 -43 2344 0 15 30 32 46 30 -58 0 -90 32 75532
X-Y USB-30

1-20

VEHICLE 1 RADAR TABLE

TRACKING TIME

STATION ACQUISITION DATA

STATION TERMINATION DATA

| | HRS MIN SEC | | | DAY | HRS MIN SEC | | | RA | DEC | AZ | ELV | X | Y | RANGE | DAY | HRS MIN SEC | | | RA | DEC | AZ | ELV | X | Y | RANGE |
|----------------------|-------------|----|----|-----|-------------|----|----|-----|-----|------|-----|-----|-----|-------|-----|-------------|----|----|----|-----|-----|-----|-----|-----|-------|
| GMM-24 X-Y USB-30 | 0 | 4 | 16 | 0 | 2 | 44 | 23 | -12 | -15 | 105 | 0 | 90 | -15 | 2748 | 0 | 2 | 48 | 39 | -8 | -1 | 91 | 0 | 90 | -1 | 3692 |
| STN-00 A-E USB150 | 10 | 53 | 30 | 0 | 2 | 49 | 23 | -79 | -19 | -114 | 0 | -90 | -24 | 3850 | 0 | 13 | 42 | 53 | 44 | 29 | -52 | 0 | -90 | 38 | 68583 |
| GDS-28 X-Y USB-85 | 10 | 21 | 12 | 0 | 2 | 50 | 12 | -78 | -14 | -108 | 0 | 90 | -72 | 4030 | 0 | 13 | 11 | 24 | 43 | 29 | -53 | 0 | -90 | -53 | 66459 |
| GYM-14 X-Y USB-30 | 9 | 26 | 15 | 0 | 2 | 51 | 8 | -79 | -7 | -97 | 0 | -90 | -7 | 4232 | 0 | 12 | 17 | 23 | 42 | 30 | -56 | 0 | -90 | 34 | 62706 |
| TEX-16 X-Y USB-30 | 8 | 22 | 12 | 0 | 2 | 54 | 48 | -69 | 1 | -89 | 0 | -90 | 1 | 5011 | 0 | 11 | 16 | 60 | 40 | 30 | -56 | 0 | -90 | 34 | 58334 |
| MIL-71 X-Y USB-30 | 7 | 2 | 57 | 0 | 3 | 0 | 59 | -54 | 8 | -81 | 0 | -90 | 9 | 6273 | 0 | 10 | 3 | 56 | 38 | 30 | -55 | 0 | -90 | 35 | 52754 |
| GBM-41 X-Y USB-30 | 6 | 43 | 27 | 0 | 3 | 2 | 18 | -52 | 10 | -79 | 0 | -90 | 11 | 6534 | 0 | 9 | 45 | 46 | 37 | 30 | -56 | 0 | -90 | 34 | 51310 |
| GTI-51 A-E TPQ-18 | 2 | 2 | 38 | 0 | 3 | 7 | 5 | -45 | 16 | -73 | 0 | -90 | 17 | 7457 | 0 | 5 | 9 | 43 | 16 | 32 | -64 | 31 | -56 | 22 | 23400 |
| BDA-02 X-Y USB-30 | 5 | 53 | 60 | 0 | 3 | 8 | 58 | -40 | 13 | -75 | 0 | -90 | 15 | 7815 | 0 | 9 | 2 | 58 | 36 | 30 | -54 | 0 | -90 | 36 | 47811 |
| ANG-91 X-Y USB-30 | 4 | 35 | 33 | 0 | 3 | 15 | 50 | -34 | 22 | -67 | 0 | -90 | 23 | 9069 | 0 | 7 | 51 | 23 | 31 | 31 | -58 | 0 | -90 | 32 | 41594 |

1-21

12
11
10
9
8
7
6
5

VEHICLE 1 RADAR TABLE

TRACKING TIME

STATION ACQUISITION DATA

STATION TERMINATION DATA

HRS MIN SEC

DAY HRS MIN SEC RA DEC AZ ELV X Y RANGE

DAY HRS MIN SEC RA DEC AZ ELV X Y RANGE

SHIP 1 1 38 20 0 3 24 20 -24 20 -67 0 -90 23 10553 0 5 2 40 14 30 -64 15 -73 25 23392
 INSERTION

GWM-24 14 12 24 0 4 48 35 31 31 58 0 90 32 22557 0 19 0 58 48 30 -59 0 -90 31 87969
 X-Y USB-30

HSK-25 8 31 27 0 7 47 2 40 36 44 0 -90 44 41190 0 16 18 29 47 33 -49 0 -90 -49 78480
 X-Y USB-85

CRO-08 9 56 36 0 9 33 29 45 34 52 0 90 38 50310 0 19 30 5 49 31 -55 0 -90 35 89581
 X-Y USB-30

MAD-23 15 57 59 0 14 38 7 50 29 50 0 -90 50 72208 1 6 36 7 55 28 -52 0 -90 -52 121732
 X-Y USB-85

CYI-04 14 21 37 0 16 14 29 51 29 56 0 90 34 78248 1 6 36 7 54 28 -58 1 -89 32 121699
 X-Y USB-30

ACN-75 11 24 10 0 17 42 55 53 31 59 0 90 31 83509 1 5 7 5 54 30 -60 0 -90 30 117888
 X-Y USB-30

BDA-02 11 12 2 0 19 24 5 53 29 55 0 90 35 89258 1 6 36 7 55 29 -78 42 -47 9 119460
 X-Y USB-30

ANG-91 10 38 46 0 19 57 20 54 30 59 0 90 31 91084 1 6 36 7 54 29 -66 35 -53 20 119803
 X-Y USB-30

GBM-41 9 57 28 0 20 38 39 54 29 57 0 90 33 93318 1 6 36 7 55 29 -76 52 -37 9 119039
 X-Y USB-30

1-22

12
11
10
9
8
7
6
5
4
3
2

VEHICLE 1 RADAR TABLE

TRACKING TIME

STATION ACQUISITION DATA

STATION TERMINATION DATA

HRS MIN SEC

DAY HRS MIN SEC

RA DEC AZ ELV X Y RANGE

DAY HRS MIN SEC

RA DEC AZ ELV X Y RANGE

| | | | | | |
|----------------------|---------|------------|----------------------------|-----------|----------------------------|
| MIL-71 X-Y USB-30 | 9 53 4 | 0 20 43 3 | 54 29 56 0 90 34 93554 | 1 6 36 7 | 55 29 -79 55 -34 6 118949 |
| TEX-16 X-Y USB-30 | 8 41 22 | 0 21 54 45 | 54 29 57 0 90 33 97323 | 1 6 36 7 | 55 29 -80 70 -20 3 118551 |
| GYM-14 X-Y USB-30 | 7 47 24 | 0 22 48 43 | 55 29 57 0 90 33 100086 | 1 6 36 7 | 56 29 -78 82 -8 2 118379 |
| GDS-28 X-Y USB-85 | 7 46 42 | 0 22 49 25 | 55 29 54 0 -90 54 100123 | 1 6 36 7 | 56 29 -158 83 6 -3 118367 |
| STN-00 A-E USB150 | 7 32 40 | 0 23 3 26 | 55 29 53 0 90 37 100830 | 1 6 36 7 | 56 29 165 81 2 -8 118382 |
| HAW-12 X-Y USB-30 | 4 9 38 | 1 2 26 28 | 56 29 59 0 90 31 110641 | 1 6 36 7 | 57 29 70 52 36 12 119039 |
| GWM-24 X-Y USB-30 | 0 0 32 | 1 6 35 34 | 58 29 60 0 90 30 121717 | 1 6 36 7 | 58 29 60 0 90 30 121733 |
| | | 31 JAN 71 | NFR TO LOI IGNITION | LAZ 72.1 | |
| MAD-23 X-Y USB-85 | 0 1 11 | 1 6 36 18 | 55 28 -52 0 -90 -52 121742 | 1 6 37 29 | 55 28 -52 0 -90 -52 121801 |
| CYI-04 X-Y USB-30 | 0 3 41 | 1 6 36 18 | 54 28 -58 1 -89 32 121709 | 1 6 39 59 | 54 28 -57 0 -90 33 121904 |
| ANG-91 X-Y USB-30 | 2 42 38 | 1 6 36 18 | 54 29 -66 34 -53 20 119813 | 1 9 18 55 | 55 29 -60 0 -90 30 128369 |

I-23

2
1
0
1
8
7
0

VEHICLE TRACKING TABLE

TRACKING TIME

STATION ACQUISITION DATA

STATION TERMINATION DATA

HRS MIN SEC

DAY HRS MIN SEC RA DEC AZ ELV X Y RANGE

DAY HRS MIN SEC RA DEC AZ ELV X Y RANGE

| | | | | | | | |
|----------------------|----------|-----------|------------------|-----------|------------|-----------------|------------|
| BDA-02 X-Y USB-30 | 3 37 1 | 1 6 36 18 | 55 29 -78 42 -47 | 9 119469 | 1 10 13 18 | 56 28 -56 0 -90 | 34 130508 |
| GBM-41 X-Y USB-30 | 4 14 44 | 1 6 36 18 | 55 29 -76 52 -37 | 9 119048 | 1 10 51 2 | 56 28 -58 0 -90 | 32 131966 |
| MIL-71 X-Y USB-30 | 4 30 16 | 1 6 36 18 | 55 29 -79 55 -34 | 6 118958 | 1 11 6 34 | 56 28 -57 0 -90 | 33 132564 |
| TEX-16 X-Y USB-30 | 5 35 25 | 1 6 36 18 | 55 29 -80 70 -20 | 3 118559 | 1 12 11 43 | 56 28 -58 0 -90 | 32 135033 |
| GYM-14 X-Y USB-30 | 6 30 24 | 1 6 36 18 | 56 29 -78 82 -8 | 2 118387 | 1 13 6 42 | 56 28 -58 0 -90 | 32 137079 |
| GDS-28 X-Y USB-85 | 7 18 27 | 1 6 36 18 | 56 29 -157 83 6 | -3 118375 | 1 13 54 45 | 57 28 -55 0 -90 | -55 138838 |
| STN-00 A-E USB150 | 7 47 16 | 1 6 36 18 | 56 29 165 81 2 | -8 118390 | 1 14 23 33 | 57 28 -54 0 -90 | 36 139880 |
| HAW-12 X-Y USB-30 | 9 32 41 | 1 6 36 18 | 57 29 70 53 36 | 12 119045 | 1 16 8 59 | 57 28 -59 0 -90 | 31 143618 |
| GMM-24 X-Y USB-30 | 12 56 15 | 1 6 36 18 | 58 29 60 0 90 | 30 121738 | 1 19 32 33 | 58 28 -61 0 -90 | 29 150517 |
| HSK-25 X-Y USB-85 | 8 43 34 | 1 8 27 9 | 58 30 52 0 -90 | 52 126291 | 1 17 10 43 | 58 29 -53 0 -90 | -53 145743 |

12
11
10
9
8
7
6
5
4
3
2

VEHICLE 1 RADAR TABLE

TRACKING TIME

STATION ACQUISITION DATA

STATION TERMINATION DATA

HRS MIN SEC

DAY HRS MIN SEC RA DEC AZ ELV X Y RANGE

DAY HRS MIN SEC RA DEC AZ ELV X Y RANGE

| | | | | | |
|----------------------|----------|------------|--------------------------|------------|----------------------------|
| CRO-08 X-Y USB-30 | 9 54 60 | 1 10 13 47 | 59 30 57 0 90 33 130517 | 1 20 8 47 | 58 29 -58 0 -90 32 151696 |
| MAD-23 X-Y USB-85 | 15 29 48 | 1 15 20 15 | 59 28 52 0 -90 52 141905 | 2 6 50 3 | 60 27 -53 0 -90 -53 170857 |
| CYI-04 X-Y USB-30 | 14 5 27 | 1 16 49 37 | 60 28 58 0 90 32 145028 | 2 6 55 3 | 60 27 -59 0 -90 31 170992 |
| ACN-75 X-Y USB-30 | 11 20 19 | 1 18 8 12 | 60 29 61 0 90 29 147703 | 2 5 28 31 | 60 28 -62 0 -90 28 168594 |
| BDA-02 X-Y USB-30 | 14 30 55 | 1 19 54 27 | 60 28 57 0 90 33 151237 | 2 10 25 22 | 61 27 -58 0 -90 32 176589 |
| ANG-91 X-Y USB-30 | 13 9 52 | 1 20 23 59 | 61 28 61 0 90 29 152197 | 2 9 33 51 | 60 27 -61 0 -90 29 175245 |
| GBM-41 X-Y USB-30 | 13 57 43 | 1 21 6 6 | 61 28 59 0 90 31 153558 | 2 11 3 50 | 61 27 -59 0 -90 31 177580 |
| MIL-71 X-Y USB-30 | 14 7 54 | 1 21 10 47 | 61 28 58 0 90 32 153708 | 2 11 18 41 | 61 27 -59 0 -90 31 177960 |
| TEX-16 X-Y USB-30 | 14 2 34 | 1 22 20 49 | 61 28 58 0 90 32 155926 | 2 12 23 23 | 61 27 -59 0 -90 31 179599 |
| GYM-14 X-Y USB-30 | 14 4 4 | 1 23 13 47 | 61 28 58 0 90 32 157578 | 2 13 17 51 | 61 27 -59 0 -90 31 180960 |

1-25

12
11
10
9
8
7
6
5

VEHICLE 1 RADAR TABLE

TRACKING TIME

STATION ACQUISITION DATA

STATION TERMINATION DATA

| HRS MIN SEC | | | | DAY | HRS MIN SEC | | | | RA | DEC | AZ | ELV | X | Y | RANGE | DAY | HRS | MIN | SEC | RA | DEC | AZ | ELV | X | Y | RANGE | |
|-------------|----|----|----|-----|-------------|----|----|----|----|-----|----|-----|----|--------|-------|-----|-----|-----|-----|----|-----|----|-----|-----|--------|-------|--|
| GDS-28 | 14 | 48 | 32 | 1 | 23 | 15 | 60 | 61 | 27 | 56 | 0 | -90 | 56 | 157647 | 2 | 14 | 4 | 31 | 61 | 27 | -56 | 0 | -90 | -56 | 182112 | | |
| X-Y USB-85 | | | | | | | | | | | | | | | | | | | | | | | | | | | |
| STN-00 | 15 | 2 | 36 | 1 | 23 | 30 | 10 | 61 | 27 | 55 | 0 | 90 | 35 | 158085 | 2 | 14 | 32 | 45 | 61 | 27 | -55 | 0 | -90 | 35 | 182802 | | |
| A-E USB150 | | | | | | | | | | | | | | | | | | | | | | | | | | | |
| HAW-12 | 13 | 32 | 27 | 2 | 2 | 46 | 59 | 62 | 28 | 60 | 0 | 90 | 30 | 163983 | 2 | 16 | 19 | 26 | 61 | 27 | -61 | 0 | -90 | 29 | 185363 | | |
| X-Y USB-30 | | | | | | | | | | | | | | | | | | | | | | | | | | | |
| GWM-24 | 12 | 51 | 1 | 2 | 6 | 51 | 57 | 62 | 28 | 62 | 0 | 90 | 28 | 170905 | 2 | 19 | 42 | 58 | 62 | 27 | -62 | 0 | -90 | 28 | 190131 | | |
| X-Y USB-30 | | | | | | | | | | | | | | | | | | | | | | | | | | | |
| HSK-25 | 8 | 54 | 33 | 2 | 8 | 34 | 14 | 62 | 29 | 54 | 0 | -90 | 54 | 173659 | 2 | 17 | 28 | 48 | 62 | 28 | -55 | 0 | -90 | -55 | 186986 | | |
| X-Y USB-85 | | | | | | | | | | | | | | | | | | | | | | | | | | | |
| CRO-08 | 10 | 0 | 59 | 2 | 10 | 22 | 38 | 63 | 28 | 59 | 0 | 90 | 31 | 176510 | 2 | 20 | 23 | 37 | 62 | 28 | -59 | 0 | -90 | 31 | 191065 | | |
| X-Y USB-30 | | | | | | | | | | | | | | | | | | | | | | | | | | | |
| MAD-23 | 15 | 16 | 6 | 2 | 15 | 35 | 55 | 63 | 27 | 54 | 0 | -90 | 54 | 184329 | 3 | 6 | 52 | 1 | 63 | 26 | -55 | 0 | -90 | -55 | 204362 | | |
| X-Y USB-85 | | | | | | | | | | | | | | | | | | | | | | | | | | | |
| CYI-04 | 13 | 55 | 58 | 2 | 17 | 2 | 35 | 64 | 27 | 59 | 0 | 90 | 31 | 186383 | 3 | 6 | 58 | 33 | 63 | 26 | -60 | 0 | -90 | 30 | 204474 | | |
| X-Y USB-30 | | | | | | | | | | | | | | | | | | | | | | | | | | | |
| ACN-75 | 11 | 18 | 43 | 2 | 18 | 17 | 32 | 64 | 27 | 62 | 0 | 90 | 28 | 188250 | 3 | 5 | 36 | 15 | 62 | 27 | -63 | 0 | -90 | 27 | 202752 | | |
| X-Y USB-30 | | | | | | | | | | | | | | | | | | | | | | | | | | | |
| BDA-02 | 14 | 15 | 60 | 2 | 20 | 7 | 24 | 64 | 27 | 58 | 0 | 90 | 32 | 190719 | 3 | 10 | 23 | 23 | 62 | 26 | -59 | 0 | -90 | 31 | 208596 | | |
| X-Y USB-30 | | | | | | | | | | | | | | | | | | | | | | | | | | | |

VEHICLE 1 RADAR TABLE

TRACKING TIME

STATION ACQUISITION DATA

STATION TERMINATION DATA

| | HRS | MIN | SEC | DAY | HRS | MIN | SEC | RA | DEC | AZ | ELV | X | Y | RANGE | DAY | HRS | MIN | SEC | RA | DEC | AZ | ELV | X | Y | RANGE |
|----------------------|-----|-----|-----|-----|-----|-----|-----|----|-----|----|-----|-----|----|--------|-----|-----|-----|-----|----|-----|-----|-----|-----|-----|--------|
| ANG-91 X-Y USB-30 | 13 | 1 | 24 | 2 | 20 | 34 | 17 | 64 | 27 | 62 | 0 | 90 | 28 | 191245 | 3 | 9 | 35 | 41 | 62 | 26 | -63 | 0 | -90 | 27 | 207720 |
| GBM-41 X-Y USB-30 | 13 | 7 | 24 | 2 | 21 | 17 | 21 | 64 | 27 | 60 | 0 | 90 | 30 | 192217 | 3 | 10 | 24 | 45 | 62 | 26 | -65 | 8 | -82 | 25 | 208163 |
| MIL-71 X=Y USB=30 | 13 | 1 | 59 | 2 | 21 | 22 | 47 | 64 | 27 | 59 | 0 | 90 | 31 | 192394 | 3 | 10 | 24 | 46 | 62 | 26 | -66 | 10 | -79 | 24 | 207999 |
| TEX-16 X-Y USB-30 | 11 | 53 | 9 | 2 | 22 | 31 | 35 | 64 | 27 | 60 | 0 | 90 | 30 | 193853 | 3 | 10 | 24 | 45 | 62 | 26 | -72 | 24 | -65 | 17 | 207228 |
| GYM-14 X-Y USB-30 | 10 | 59 | 54 | 2 | 23 | 24 | 49 | 64 | 27 | 60 | 0 | 90 | 30 | 195041 | 3 | 10 | 24 | 43 | 62 | 26 | -76 | 35 | -54 | 11 | 206630 |
| GDS-28 X-Y USB-85 | 10 | 57 | 5 | 2 | 23 | 27 | 37 | 64 | 26 | 57 | 0 | -90 | 57 | 195090 | 3 | 10 | 24 | 42 | 62 | 26 | -85 | 42 | -6 | -48 | 206330 |
| STN-00 A-E USB150 | 10 | 42 | 34 | 2 | 23 | 42 | 6 | 64 | 26 | 56 | 0 | 90 | 34 | 195405 | 3 | 10 | 24 | 40 | 62 | 26 | -90 | 46 | -44 | 0 | 206141 |
| HAW-12 X-Y USB=30 | 7 | 28 | 41 | 3 | 2 | 55 | 52 | 64 | 26 | 61 | 0 | 90 | 29 | 199492 | 3 | 10 | 24 | 33 | 63 | 26 | -67 | 78 | -11 | 5 | 205263 |
| GWM-24 X-Y USB-30 | 3 | 26 | 26 | 3 | 6 | 57 | 54 | 65 | 26 | 63 | 0 | 90 | 27 | 204460 | 3 | 10 | 24 | 20 | 64 | 26 | 65 | 47 | 41 | 17 | 206107 |
| MSK-25 X-Y USB-85 | 1 | 51 | 54 | 3 | 8 | 32 | 27 | 64 | 27 | 56 | 0 | -90 | 56 | 206394 | 3 | 10 | 24 | 21 | 64 | 27 | 36 | 17 | -69 | 35 | 207589 |

1-27

12
11
10
9
8
7
6
5

VEHICLE 1 RADAR TABLE

| | TRACKING TIME | | | STATION ACQUISITION DATA | | | | | | | | STATION TERMINATION DATA | | | | | | | | | | | | | | |
|----------------------|---------------|-----|-----|--------------------------|-----|-----|-----|---------------------|-----|-----|-----|--------------------------|-----|--------|-----|-----|-----|-----|----|-----|-----|-----|-----|-----|--------|--|
| | HRS | MIN | SEC | DAY | HRS | MIN | SEC | RA | DEC | AZ | ELV | X | Y | RANGE | DAY | HRS | MIN | SEC | RA | DEC | AZ | ELV | X | Y | RANGE | |
| CRJ-08 X-Y USB-30 | 0 | 4 | 12 | 3 | 10 | 20 | 4 | 64 | 27 | 60 | 0 | 90 | 30 | 208549 | 3 | 10 | 24 | 16 | 64 | 27 | 60 | 1 | 89 | 30 | 208542 | |
| | | | | 31 JAN 71 | | | | LOI TO DOI IGNITION | | | | LAZ 72.1 | | | | | | | | | | | | | | |
| CRD-08 X-Y USB-30 | 1 | 24 | 20 | 3 | 10 | 56 | 52 | 64 | 27 | 56 | 7 | 81 | 34 | 207538 | 3 | 12 | 21 | 12 | 65 | 27 | 44 | 21 | 61 | 42 | 206942 | |
| HSK-25 X-Y USB-85 | 1 | 24 | 24 | 3 | 10 | 56 | 57 | 63 | 27 | 30 | 21 | -66 | 27 | 206753 | 3 | 12 | 21 | 20 | 64 | 27 | 11 | 26 | -63 | 10 | 206664 | |
| GWM-24 X-Y USB-30 | 1 | 24 | 24 | 3 | 10 | 56 | 60 | 63 | 26 | 63 | 54 | 33 | 15 | 205203 | 3 | 12 | 21 | 24 | 64 | 27 | 45 | 70 | 14 | 14 | 204971 | |
| HAW-12 X-Y USB-30 | 1 | 24 | 28 | 3 | 10 | 57 | 15 | 62 | 26 | -73 | 70 | -19 | 5 | 204747 | 3 | 12 | 21 | 43 | 63 | 27 | -75 | 52 | -37 | 9 | 204400 | |
| STN-00 A-E USB150 | 1 | 24 | 27 | 3 | 10 | 57 | 24 | 62 | 26 | -85 | 39 | -51 | 4 | 205787 | 3 | 12 | 21 | 52 | 63 | 26 | -74 | 24 | -65 | 14 | 206823 | |
| GDS-28 X-Y USB-85 | 1 | 24 | 28 | 3 | 10 | 57 | 24 | 62 | 26 | -81 | 35 | -13 | -54 | 206002 | 3 | 12 | 21 | 52 | 63 | 26 | -71 | 19 | -43 | -63 | 207086 | |
| GYM-14 X-Y USB-30 | 1 | 24 | 27 | 3 | 10 | 57 | 26 | 62 | 26 | -74 | 28 | -61 | 14 | 206347 | 3 | 12 | 21 | 53 | 63 | 26 | -66 | 12 | -77 | 23 | 207524 | |
| GBM-41 X-Y USB-30 | 0 | 3 | 48 | 3 | 10 | 57 | 26 | 62 | 26 | -61 | 1 | -89 | 29 | 207914 | 3 | 11 | 1 | 14 | 62 | 26 | -61 | 0 | -90 | 29 | 207772 | |
| MIL-71 X-Y USB-30 | 0 | 19 | 11 | 3 | 10 | 57 | 27 | 62 | 26 | -62 | 4 | -86 | 28 | 207745 | 3 | 11 | 16 | 39 | 62 | 26 | -60 | 0 | -90 | 30 | 207026 | |

1-28

VEHICLE 1 RADAR TABLE

| | TRACKING TIME | | | STATION ACQUISITION DATA | | | | | | | | | | STATION TERMINATION DATA | | | | | | | | | | | |
|----------------------|---------------|-----|-----|----------------------------------|-----|-----|-----|----|-----|-----|-----|-----|-----|--------------------------|-----|-----|-----|-----|----|-----|-----|-----|-----|-----|--------|
| | HRS | MIN | SEC | DAY | HRS | MIN | SEC | RA | DEC | AZ | ELV | X | Y | RANGE | DAY | HRS | MIN | SEC | RA | DEC | AZ | ELV | X | Y | RANGE |
| TEX-16 X-Y USB-30 | 1 | 24 | 25 | 3 | 10 | 57 | 27 | 62 | 26 | -69 | 17 | -72 | 20 | 206973 | 3 | 12 | 21 | 52 | 63 | 26 | -61 | 1 | -89 | 29 | 208163 |
| CRO-08 X-Y USB-30 | 1 | 24 | 29 | 3 | 13 | 5 | 1 | 65 | 27 | 36 | 28 | 48 | 46 | 206592 | 3 | 14 | 29 | 29 | 66 | 28 | 17 | 35 | 22 | 51 | 206411 |
| HSK-25 X-Y USB-85 | 1 | 24 | 30 | 3 | 13 | 5 | 7 | 64 | 27 | 0 | 27 | -63 | 0 | 206609 | 3 | 14 | 29 | 36 | 65 | 28 | -20 | 24 | -65 | -18 | 207006 |
| GWM-24 X-Y USB-30 | 1 | 24 | 29 | 3 | 13 | 5 | 11 | 64 | 27 | 16 | 76 | 4 | 13 | 204864 | 3 | 14 | 29 | 40 | 65 | 27 | -45 | 70 | -15 | 14 | 205208 |
| HAW-12 X-Y USB-30 | 1 | 24 | 28 | 3 | 13 | 5 | 23 | 63 | 26 | -74 | 42 | -46 | 12 | 205859 | 3 | 14 | 29 | 51 | 64 | 27 | -70 | 25 | -64 | 18 | 206979 |
| GYM-14 X-Y USB-30 | 0 | 14 | 51 | 3 | 13 | 5 | 28 | 63 | 26 | -62 | 3 | -87 | 28 | 208002 | 3 | 13 | 20 | 19 | 63 | 26 | -60 | 0 | -90 | 30 | 207428 |
| STN-00 A-E USB150 | 1 | 24 | 24 | 3 | 13 | 5 | 28 | 63 | 26 | -69 | 16 | -73 | 20 | 207250 | 3 | 14 | 29 | 52 | 65 | 26 | -58 | 2 | -88 | 32 | 208329 |
| GDS-28 X-Y USB-85 | 1 | 5 | 26 | 3 | 13 | 5 | 29 | 63 | 26 | -66 | 11 | -65 | -64 | 207527 | 3 | 14 | 10 | 55 | 64 | 26 | -57 | 0 | -90 | -57 | 207470 |
| | | | | 31 JAN 71 DCI TO LM SEP IGNITION | | | | | | | | | | LAZ 72-1 | | | | | | | | | | | |
| CRO-08 X-Y USB-30 | 1 | 5 | 6 | 3 | 15 | 15 | 7 | 65 | 27 | 4 | 38 | 6 | 52 | 206200 | 3 | 16 | 20 | 13 | 66 | 28 | -13 | 36 | -17 | 52 | 206361 |
| HSK-25 X-Y USB-85 | 1 | 5 | 5 | 3 | 15 | 15 | 15 | 65 | 27 | -30 | 20 | -67 | -28 | 207096 | 3 | 16 | 20 | 20 | 66 | 28 | -42 | 13 | -73 | -41 | 207638 |

1-29

VEHICLE 1 RADAR TABLE

| TRACKING TIME | | | | STATION ACQUISITION DATA | | | | | | | | | STATION TERMINATION DATA | | | | | | | | | | | | |
|---------------|--------|-----|----|--------------------------|-----|-----|-----|----|-----|-----|-----|-----|--------------------------|--------|-----|-----|-----|-----|----|-----|-----|-----|-----|-----|--------|
| HRS | MIN | SEC | | DAY | HRS | MIN | SEC | RA | DEC | AZ | ELV | X | Y | RANGE | DAY | HRS | MIN | SEC | RA | DEC | AZ | ELV | X | Y | RANGE |
| GWM-24 | 1 | 5 | 6 | 3 | 15 | 15 | 20 | 65 | 27 | -88 | 61 | -25 | 15 | 205301 | 3 | 16 | 20 | 26 | 66 | 27 | -64 | 48 | -39 | 17 | 205880 |
| X-Y | USB-20 | | | | | | | | | | | | | | | | | | | | | | | | |
| HAW-12 | 1 | 5 | 2 | 3 | 15 | 15 | 29 | 64 | 26 | -67 | 15 | -74 | 22 | 207397 | 3 | 16 | 20 | 31 | 66 | 27 | -62 | 2 | 07 | 28 | 208277 |
| X-Y | USB-30 | | | | | | | | | | | | | | | | | | | | | | | | |
| MAD-23 | 0 | 21 | 31 | 3 | 15 | 48 | 37 | 67 | 26 | 55 | 0 | -90 | 55 | 207138 | 3 | 16 | 20 | 8 | 67 | 26 | 59 | 5 | -81 | 58 | 208111 |
| X-Y | USB-85 | | | | | | | | | | | | | | | | | | | | | | | | |
| MAD-23 | 1 | 4 | 56 | 3 | 17 | 8 | 41 | 67 | 26 | 66 | 13 | -60 | 63 | 207730 | 3 | 18 | 13 | 37 | 68 | 27 | 75 | 24 | -31 | 62 | 207164 |
| X-Y | USB-85 | | | | | | | | | | | | | | | | | | | | | | | | |
| CRO-08 | 1 | 4 | 53 | 3 | 17 | 8 | 60 | 66 | 28 | -25 | 33 | -34 | 49 | 206619 | 3 | 18 | 13 | 52 | 67 | 28 | -38 | 25 | -53 | 45 | 207101 |
| X-Y | USB-30 | | | | | | | | | | | | | | | | | | | | | | | | |
| HSK-25 | 0 | 36 | 20 | 3 | 17 | 9 | 8 | 66 | 27 | -50 | 6 | -81 | -50 | 208130 | 3 | 17 | 45 | 28 | 66 | 28 | -55 | 0 | -90 | -55 | 207335 |
| X-Y | USB-85 | | | | | | | | | | | | | | | | | | | | | | | | |
| GWM-24 | 1 | 4 | 48 | 3 | 17 | 9 | 15 | 66 | 27 | -66 | 37 | -51 | 19 | 206424 | 3 | 18 | 14 | 3 | 67 | 27 | -66 | 23 | -65 | 22 | 207235 |
| X-Y | USB-30 | | | | | | | | | | | | | | | | | | | | | | | | |
| CYI-04 | 0 | 57 | 53 | 3 | 17 | 15 | 42 | 67 | 26 | 60 | 0 | 90 | 30 | 208134 | 3 | 18 | 13 | 35 | 69 | 27 | 65 | 11 | 78 | 24 | 207923 |
| X-Y | USB-30 | | | | | | | | | | | | | | | | | | | | | | | | |
| ACN-75 | 1 | 4 | 43 | 3 | 19 | 2 | 37 | 69 | 27 | 61 | 7 | 82 | 28 | 208265 | 3 | 20 | 7 | 20 | 70 | 27 | 57 | 20 | 67 | 31 | 207583 |
| X-Y | USB-30 | | | | | | | | | | | | | | | | | | | | | | | | |
| CYI-04 | 1 | 4 | 42 | 3 | 19 | 2 | 44 | 69 | 27 | 70 | 21 | 68 | 19 | 207450 | 3 | 20 | 7 | 26 | 70 | 27 | 75 | 34 | 55 | 13 | 206842 |
| X-Y | USB-30 | | | | | | | | | | | | | | | | | | | | | | | | |

VEHICLE 1 RADAR TABLE

TRACKING TIME

HRS MIN SEC

STATION ACQUISITION DATA

DAY HRS MIN SEC RA DEC AZ ELV X Y RANGE

STATION TERMINATION DATA

DAY HRS MIN SEC RA DEC AZ ELV X Y RANGE

| | | | | | | | |
|----------------------|---------|------------|------------------|-----------|-----------|-----------------|-------------|
| MAD-23 X-Y USB-85 | 1 4 48 | 3 19 2 47 | 68 26 82 33 -12 | 56 206787 | 3 20 7 34 | 69 27 91 45 | 1 45 206331 |
| CRC-08 X-Y USB-30 | 1 4 55 | 3 19 3 5 | 67 28 -47 18 -66 | 41 207598 | 3 20 7 60 | 68 28 -55 7 -82 | 35 208354 |
| GWM-24 X-Y USB-30 | 0 59 42 | 3 19 3 14 | 67 27 -65 12 -77 | 24 207923 | 3 20 2 56 | 68 27 -62 0 -90 | 28 208493 |
| ACN-75 X-Y USB-30 | 1 5 2 | 3 20 56 20 | 70 27 52 30 54 | 32 207157 | 3 22 1 22 | 71 28 42 41 38 | 34 206700 |
| ANG-91 X-Y USB-30 | 1 5 1 | 3 20 56 20 | 70 27 62 1 89 | 28 208824 | 3 22 1 22 | 71 27 65 14 75 | 24 208125 |
| BDA-02 X-Y USB-30 | 1 5 1 | 3 20 56 23 | 70 27 62 5 84 | 28 208530 | 3 22 1 24 | 71 27 69 17 72 | 20 207921 |
| CYI-04 X-Y USB-30 | 1 5 1 | 3 20 56 23 | 70 27 78 44 45 | 8 206462 | 3 22 1 24 | 71 27 82 58 32 | 4 206044 |
| MAD-23 X-Y USB-85 | 1 5 3 | 3 20 56 28 | 69 27 100 54 7 | 35 206073 | 3 22 1 31 | 70 27 115 66 11 | 22 205829 |
| GRM-41 X-Y USB-30 | 0 21 50 | 3 21 39 34 | 71 27 60 0 90 | 30 207866 | 3 22 1 24 | 71 27 62 4 85 | 28 208695 |
| MIL-71 X-Y USB-30 | 0 16 37 | 3 21 44 46 | 71 27 59 0 90 | 31 208062 | 3 22 1 23 | 71 27 61 3 87 | 29 208755 |

VEHICLE 1 RADAR TABLE

| | TRACKING TIME | | | STATION ACQUISITION DATA | | | | | | | | STATION TERMINATION DATA | | | | | | | | | | | | | |
|----------------------|---------------|-----|-----|--------------------------|-----|-----|-----|----|-----|-----|-----|--------------------------|----|--------|-----|-----|-----|-----|----|-----|------|-----|-----|----|--------|
| | HRS | MIN | SEC | DAY | HRS | MIN | SEC | RA | DEC | AZ | ELV | X | Y | RANGE | DAY | HRS | MIN | SEC | RA | DEC | AZ | ELV | X | Y | RANGE |
| GBM-41 X-Y USB-30 | 1 | 4 | 57 | 3 | 22 | 49 | 56 | 71 | 27 | 67 | 14 | 75 | 23 | 208231 | 3 | 23 | 54 | 53 | 72 | 27 | 71 | 27 | 62 | 17 | 207561 |
| ANG-91 X-Y USB-30 | 1 | 4 | 54 | 3 | 22 | 49 | 56 | 71 | 27 | 67 | 24 | 64 | 20 | 207635 | 3 | 23 | 54 | 52 | 72 | 27 | 68 | 38 | 50 | 17 | 206992 |
| MIL-71 X-Y USB-30 | 1 | 4 | 57 | 3 | 22 | 49 | 58 | 71 | 27 | 66 | 13 | 76 | 23 | 208302 | 3 | 23 | 54 | 54 | 72 | 27 | 71 | 25 | 64 | 17 | 207641 |
| BDA-02 X-Y USB-30 | 1 | 4 | 55 | 3 | 22 | 50 | 0 | 71 | 27 | 74 | 27 | 62 | 14 | 207493 | 3 | 23 | 54 | 55 | 72 | 27 | 80 | 40 | 50 | 8 | 206915 |
| ACN-75 X-Y USB-30 | 1 | 4 | 57 | 3 | 22 | 50 | 2 | 70 | 28 | 31 | 48 | 25 | 35 | 206495 | 3 | 23 | 54 | 59 | 71 | 28 | 11 | 53 | 8 | 36 | 206351 |
| CYI-04 X-Y USB-30 | 1 | 4 | 52 | 3 | 22 | 50 | 10 | 70 | 27 | 86 | 69 | 21 | 1 | 205857 | 3 | 23 | 55 | 2 | 71 | 27 | 91 | 82 | 8 | 0 | 205719 |
| MAD-23 X-Y USB-85 | 1 | 4 | 53 | 3 | 22 | 50 | 16 | 70 | 27 | 139 | 73 | 13 | 11 | 205765 | 3 | 23 | 55 | 9 | 71 | 27 | -169 | 77 | 13 | -3 | 205786 |
| TEX-16 X-Y USB-30 | 1 | 0 | 14 | 3 | 22 | 54 | 40 | 71 | 27 | 60 | 0 | 90 | 30 | 208812 | 3 | 23 | 54 | 54 | 72 | 27 | 65 | 11 | 78 | 24 | 208439 |
| GYM-14 X-Y USB-30 | 0 | 3 | 57 | 3 | 23 | 50 | 56 | 72 | 27 | 59 | 0 | 90 | 31 | 208883 | 3 | 23 | 54 | 53 | 72 | 27 | 60 | 1 | 89 | 30 | 209055 |
| GDS-28 X-Y USB-85 | 0 | 1 | 8 | 3 | 23 | 53 | 50 | 72 | 27 | 56 | 0 | -90 | 56 | 209045 | 3 | 23 | 54 | 58 | 72 | 27 | 57 | 0 | -90 | 57 | 209093 |

VEHICLE I RADAR TABLE

TRACKING TIME

HRS MIN SEC

STATION ACQUISITION DATA

DAY HRS MIN SEC RA DEC AZ ELV X Y RANGE

STATION TERMINATION DATA

DAY HRS MIN SEC RA DEC AZ ELV X Y RANGE

| | | | | | | | | | | | | | | | | | | | | | | | | | |
|----------------------|---|---|----|---|---|----|----|----|----|-----|----|-----|----|--------|---|---|----|----|----|----|-----|----|-----|----|--------|
| TEX-16 X-Y USB-30 | 1 | 4 | 41 | 4 | 0 | 44 | 3 | 72 | 27 | 70 | 21 | 68 | 19 | 207973 | 4 | 1 | 48 | 45 | 73 | 27 | 74 | 34 | 55 | 13 | 207359 |
| GYM-14 X-Y USB-30 | 1 | 4 | 38 | 4 | 0 | 44 | 4 | 72 | 27 | 65 | 10 | 79 | 25 | 208596 | 4 | 1 | 48 | 42 | 73 | 27 | 70 | 23 | 66 | 18 | 207946 |
| GDS-28 X-Y USB-85 | 1 | 4 | 44 | 4 | 0 | 44 | 5 | 72 | 27 | 63 | 9 | -71 | 62 | 208685 | 4 | 1 | 48 | 49 | 73 | 27 | 71 | 20 | -42 | 62 | 208090 |
| MIL-71 X-Y USB-30 | 1 | 4 | 43 | 4 | 0 | 44 | 6 | 72 | 27 | 76 | 36 | 54 | 12 | 207216 | 4 | 1 | 48 | 49 | 73 | 27 | 80 | 49 | 41 | 7 | 206708 |
| GBM-41 X-Y USB-30 | 1 | 4 | 42 | 4 | 0 | 44 | 6 | 72 | 27 | 75 | 37 | 52 | 12 | 207137 | 4 | 1 | 48 | 48 | 73 | 27 | 78 | 51 | 39 | 7 | 206637 |
| ANG-91 X-Y USB-30 | 1 | 4 | 42 | 4 | 0 | 44 | 7 | 72 | 27 | 68 | 49 | 39 | 14 | 206627 | 4 | 1 | 48 | 48 | 73 | 28 | 63 | 62 | 25 | 12 | 206254 |
| BDA-02 X-Y USB-30 | 1 | 4 | 45 | 4 | 0 | 44 | 7 | 72 | 27 | 85 | 50 | 40 | 3 | 206587 | 4 | 1 | 48 | 52 | 73 | 27 | 93 | 63 | 27 | -1 | 206236 |
| STN-00 A-E USB150 | 1 | 4 | 41 | 4 | 0 | 44 | 8 | 72 | 27 | 61 | 6 | 83 | 29 | 208850 | 4 | 1 | 48 | 49 | 73 | 27 | 69 | 17 | 72 | 20 | 208277 |
| ACN-75 X-Y USB-30 | 1 | 4 | 51 | 4 | 0 | 44 | 14 | 71 | 28 | -8 | 54 | -6 | 36 | 206435 | 4 | 1 | 49 | 6 | 72 | 28 | -28 | 49 | -22 | 35 | 206708 |
| CYI-04 X-Y USB-30 | 1 | 4 | 53 | 4 | 0 | 44 | 21 | 71 | 27 | -98 | 87 | -3 | 0 | 205787 | 4 | 1 | 49 | 14 | 72 | 27 | -87 | 73 | -17 | 1 | 206032 |

VEHICLE I RADAR TABLE

| TRACKING TIME | | | | STATION ACQUISITION DATA | | | | | | | | STATION TERMINATION DATA | | | | | | | | | | | | | | |
|---------------|-----|-----|----|--------------------------|-----|-----|-----|----|-----|----|------|--------------------------|-----|-------|--------|-----|-----|-----|----|-----|----|------|----|-----|-------|--------|
| HRS | MIN | SEC | | DAY | HRS | MIN | SEC | RA | DEC | AZ | ELV | X | Y | RANGE | DAY | HRS | MIN | SEC | RA | DEC | AZ | ELV | X | Y | RANGE | |
| MAD-23 | 1 | 4 | 51 | | 4 | 0 | 44 | 23 | 71 | 27 | -132 | 71 | 13 | -14 | 205955 | 4 | 1 | 49 | 14 | 72 | 27 | -108 | 61 | 10 | -27 | 206296 |
| X-Y USB-85 | | | | | | | | | | | | | | | | | | | | | | | | | | |
| GYM-14 | 1 | 5 | 3 | | 4 | 2 | 37 | 42 | 73 | 27 | 74 | 33 | 56 | 13 | 207521 | 4 | 3 | 42 | 45 | 74 | 27 | 76 | 46 | 43 | 8 | 206992 |
| X-Y USB-30 | | | | | | | | | | | | | | | | | | | | | | | | | | |
| GDS-28 | 1 | 5 | 0 | | 4 | 2 | 37 | 43 | 73 | 27 | 76 | 30 | -22 | 57 | 207686 | 4 | 3 | 42 | 43 | 74 | 27 | 83 | 42 | -7 | 47 | 207164 |
| X-Y USB-8E | | | | | | | | | | | | | | | | | | | | | | | | | | |
| STN-CO | 1 | 5 | 1 | | 4 | 2 | 37 | 44 | 73 | 27 | 75 | 26 | 63 | 13 | 207878 | 4 | 3 | 42 | 44 | 74 | 27 | 82 | 38 | 52 | 6 | 207349 |
| A-E USB150 | | | | | | | | | | | | | | | | | | | | | | | | | | |
| TEX-16 | 1 | 5 | 0 | | 4 | 2 | 37 | 45 | 73 | 27 | 78 | 45 | 45 | 8 | 206986 | 4 | 3 | 42 | 45 | 74 | 28 | 82 | 58 | 32 | 4 | 206567 |
| X-Y USB-30 | | | | | | | | | | | | | | | | | | | | | | | | | | |
| GRM-41 | 1 | 5 | 3 | | 4 | 2 | 37 | 46 | 73 | 27 | 81 | 62 | 28 | 4 | 206389 | 4 | 3 | 42 | 49 | 74 | 28 | 83 | 75 | 15 | 2 | 206170 |
| X-Y USB-30 | | | | | | | | | | | | | | | | | | | | | | | | | | |
| MIL-71 | 1 | 5 | 2 | | 4 | 2 | 37 | 47 | 73 | 27 | 84 | 60 | 30 | 3 | 206444 | 4 | 3 | 42 | 49 | 74 | 28 | 89 | 73 | 17 | 0 | 206204 |
| X-Y USB-30 | | | | | | | | | | | | | | | | | | | | | | | | | | |
| ANG-91 | 1 | 5 | 5 | | 4 | 2 | 37 | 48 | 72 | 28 | 51 | 72 | 14 | 11 | 206135 | 4 | 3 | 42 | 53 | 73 | 28 | 0 | 79 | 0 | 11 | 206118 |
| X-Y USB-30 | | | | | | | | | | | | | | | | | | | | | | | | | | |
| BDA-02 | 1 | 5 | 1 | | 4 | 2 | 37 | 50 | 72 | 27 | 103 | 73 | 16 | -4 | 206115 | 4 | 3 | 42 | 51 | 73 | 28 | 152 | 85 | 3 | -5 | 206073 |
| X-Y USB-30 | | | | | | | | | | | | | | | | | | | | | | | | | | |
| ACN-75 | 1 | 5 | 4 | | 4 | 2 | 37 | 58 | 72 | 28 | -40 | 42 | -36 | 34 | 207084 | 4 | 3 | 43 | 3 | 73 | 28 | -50 | 31 | -52 | 33 | 207705 |
| X-Y USB-30 | | | | | | | | | | | | | | | | | | | | | | | | | | |

13-1

VEHICLE 1 RADAR TABLE

TRACKING TIME

STATION ACQUISITION DATA

STATION TERMINATION DATA

HRS MIN SEC

DAY HRS MIN SEC RA DEC AZ ELV X Y RANGE

DAY HRS MIN SEC RA DEC AZ ELV X Y RANGE

CYI-04 1 5 2 4 2 38 2 72 27 -83 62 -28 3 206360
X-Y USB-30

4 3 43 4 73 27 -79 49 -41 7 206912

MAD-23 1 5 3 4 2 38 4 72 27 -97 52 5 -38 206677
X-Y USB-85

4 3 43 7 73 27 -87 41 -4 -49 207255

HAW-12 0 13 18 4 3 29 23 74 27 60 0 90 30 208748
X-Y USB-30

4 3 42 41 74 27 62 3 87 28 209312

HAW-12 1 4 54 4 4 31 19 74 27 66 13 76 24 208832
X-Y USB-30

4 5 36 13 75 27 69 26 63 19 208135

GDS-28 1 4 54 4 4 31 27 74 27 90 52 0 38 206873
X-Y USB-85

4 5 36 21 75 27 100 65 5 25 206538

GYM-14 1 4 53 4 4 31 29 74 27 82 57 33 4 206707
X-Y USB-30

4 5 36 22 75 28 86 71 19 1 206409

STN-00 1 4 53 4 4 31 29 74 27 89 48 42 0 207035
A-E USB150

4 5 36 22 75 27 100 60 29 -5 206666

TEX-16 1 4 57 4 4 31 31 74 27 85 69 21 2 206386
X-Y USB-30

4 5 36 28 75 28 88 83 7 0 206250

GBM-41 1 4 52 4 4 31 40 73 27 77 86 4 1 206161
X-Y USB-30

4 5 36 32 74 28 -81 80 -10 1 206276

MIL-71 1 4 51 4 4 31 41 73 27 99 84 6 -1 206171
X-Y USB-30

4 5 36 32 74 28 -94 82 -8 -1 206255

I-35

VEHICLE 1 RADAR TABLE

TRACKING TIME

STATION ACQUISITION DATA

STATION TERMINATION DATA

HRS MIN SEC

DAY HRS MIN SEC RA DEC AZ ELV X Y RANGE

DAY HRS MIN SEC RA DEC AZ ELV X Y RANGE

| | | | | | | | | | | | | | | | | | | | | | | | | | |
|----------------------|---|---|----|---|---|----|----|----|----|------|----|-----|-----|--------|---|---|----|----|----|----|-----|----|-----|-----|--------|
| BDA-02 X-Y USB-30 | 1 | 4 | 53 | 4 | 4 | 31 | 43 | 73 | 27 | -119 | 80 | -9 | -5 | 206199 | 4 | 5 | 36 | 36 | 74 | 28 | -96 | 68 | -22 | -2 | 206476 |
| ANG-91 X-Y USB-30 | 1 | 4 | 49 | 4 | 4 | 31 | 46 | 73 | 28 | -45 | 74 | -11 | 11 | 206274 | 4 | 5 | 36 | 35 | 74 | 28 | -62 | 62 | -25 | 13 | 206620 |
| ACN-75 X-Y USB-30 | 1 | 4 | 47 | 4 | 4 | 31 | 59 | 72 | 28 | -56 | 21 | -65 | 31 | 208300 | 4 | 5 | 36 | 46 | 74 | 28 | -60 | 9 | -80 | 30 | 209137 |
| MAD-23 X-Y USB-85 | 1 | 4 | 46 | 4 | 4 | 31 | 60 | 73 | 27 | -80 | 31 | -17 | -57 | 207776 | 4 | 5 | 36 | 45 | 74 | 27 | -71 | 20 | -41 | -63 | 208469 |
| CYI-04 X-Y USB-30 | 1 | 4 | 46 | 4 | 4 | 32 | 1 | 73 | 27 | -76 | 38 | -51 | 11 | 207446 | 4 | 5 | 36 | 47 | 74 | 27 | -71 | 25 | -64 | 17 | 208198 |
| HAW-12 X-Y USB-30 | 1 | 4 | 44 | 4 | 6 | 25 | 24 | 75 | 27 | 71 | 37 | 52 | 15 | 207703 | 4 | 7 | 30 | 8 | 76 | 28 | 73 | 50 | 39 | 11 | 207180 |
| GYM-14 X-Y USB-30 | 1 | 4 | 55 | 4 | 6 | 25 | 34 | 75 | 28 | 91 | 82 | 8 | 0 | 206358 | 4 | 7 | 30 | 28 | 76 | 28 | -91 | 85 | -5 | 0 | 206419 |
| GDS-28 X-Y USR-85 | 1 | 4 | 53 | 4 | 6 | 25 | 35 | 75 | 27 | 117 | 75 | 7 | 14 | 206443 | 4 | 7 | 30 | 28 | 76 | 28 | 178 | 82 | 8 | 0 | 206435 |
| STN-00 A-E USB150 | 1 | 4 | 49 | 4 | 6 | 25 | 35 | 75 | 27 | 114 | 70 | 19 | -8 | 206531 | 4 | 7 | 30 | 24 | 76 | 28 | 152 | 79 | 5 | -10 | 206463 |
| TEX-16 X-Y USB-30 | 1 | 4 | 51 | 4 | 6 | 25 | 40 | 74 | 28 | -91 | 86 | -4 | 0 | 206324 | 4 | 7 | 30 | 31 | 75 | 28 | -85 | 73 | -17 | 1 | 206560 |

VEHICLE 1 RADAR TABLE

TRACKING TIME

STATION ACQUISITION DATA

STATION TERMINATION DATA

HRS MIN SEC

DAY HRS MIN SEC RA DEC AZ ELV X Y RANGE

DAY HRS MIN SEC RA DEC AZ ELV X Y RANGE

| | | | | | | | | | | | | | | | | | | | | | | | | | |
|----------------------|---|---|----|---|---|----|----|----|----|------|----|-----|-----|--------|---|---|----|----|----|----|------|----|-----|-----|--------|
| MIL-71 X-Y USB-30 | 1 | 4 | 55 | 4 | 6 | 25 | 43 | 74 | 27 | -88 | 71 | -19 | 1 | 206493 | 4 | 7 | 30 | 38 | 75 | 28 | -83 | 58 | -32 | 4 | 206931 |
| GBM-41 X-Y USB-30 | 1 | 5 | 0 | 4 | 6 | 25 | 44 | 74 | 28 | -82 | 69 | -21 | 3 | 206540 | 4 | 7 | 30 | 45 | 75 | 28 | -79 | 55 | -34 | 6 | 207018 |
| BDA-02 X-Y USB-30 | 1 | 4 | 57 | 4 | 6 | 25 | 48 | 74 | 27 | -89 | 57 | -33 | 1 | 206848 | 4 | 7 | 30 | 45 | 75 | 28 | -82 | 45 | -45 | 6 | 207434 |
| ANG-91 X-Y USB-30 | 1 | 4 | 58 | 4 | 6 | 25 | 49 | 74 | 28 | -67 | 51 | -36 | 14 | 207055 | 4 | 7 | 30 | 47 | 75 | 28 | -68 | 38 | -50 | 17 | 207737 |
| MAD-23 X-Y USB-85 | 1 | 5 | 3 | 4 | 6 | 25 | 53 | 74 | 27 | -64 | 11 | -65 | -62 | 209046 | 4 | 7 | 30 | 56 | 75 | 27 | -55 | 2 | -87 | -55 | 209754 |
| CYI-04 X-Y USB-30 | 1 | 4 | 58 | 4 | 6 | 25 | 56 | 74 | 27 | -67 | 15 | -74 | 22 | 208842 | 4 | 7 | 30 | 54 | 75 | 27 | -61 | 3 | -87 | 29 | 209672 |
| GWM-24 X-Y USB-30 | 0 | 8 | 33 | 4 | 8 | 18 | 58 | 77 | 27 | 64 | 8 | 81 | 26 | 209437 | 4 | 8 | 27 | 31 | 77 | 27 | 64 | 10 | 79 | 26 | 208890 |
| HAW-12 X-Y USB-30 | 0 | 8 | 25 | 4 | 8 | 19 | 6 | 76 | 28 | 73 | 61 | 28 | 8 | 206930 | 4 | 8 | 27 | 31 | 76 | 28 | 72 | 63 | 26 | 8 | 206446 |
| STN-00 A-E USB150 | 0 | 8 | 16 | 4 | 8 | 19 | 14 | 76 | 27 | -148 | 79 | -6 | -10 | 206569 | 4 | 8 | 27 | 31 | 76 | 27 | -141 | 78 | -8 | -10 | 206155 |
| GDS-28 X-Y USB-85 | 0 | 8 | 15 | 4 | 8 | 19 | 15 | 75 | 27 | -124 | 77 | 7 | -11 | 206587 | 4 | 8 | 27 | 31 | 75 | 27 | -119 | 76 | 7 | -13 | 206182 |

VEHICLE 1 RADAR TABLE

TRACKING TIME

STATION ACQUISITION DATA

STATION TERMINATION DATA

HRS MIN SEC

DAY HRS MIN SEC RA DEC AZ ELV X Y RANGE

DAY HRS MIN SEC RA DEC AZ ELV X Y RANGE

GYM-14 0 8 13 4 8 19 17 75 28 -87 74 -16 1 206635
X-Y USB-30

4 8 27 31 75 28 -86 72 -18 1 206243

TEX-16 0 8 11 4 8 19 20 75 28 -83 62 -28 3 206901
X-Y USB-30

4 8 27 31 75 28 -82 60 -30 4 206531

MIL-71 0 8 8 4 8 19 23 75 27 -79 47 -42 7 207402
X-Y USB-30

4 8 27 31 75 27 -79 45 -44 8 207054

GBM-41 0 8 5 4 8 19 26 75 27 -77 45 -45 9 207505
X-Y USB-30

4 8 27 31 75 27 -76 43 -46 10 207163

BDA-02 0 8 5 4 8 19 26 75 27 -77 34 -55 11 207981
X-Y USB-30

4 8 27 31 75 27 -76 33 -57 12 207646

ANG-91 0 8 3 4 8 19 28 75 28 -67 27 -61 20 208356
X-Y USB-30

4 8 27 31 75 27 -67 25 -63 21 208035

31 JAN 71

LM SEP TO CIR IGNITION

LAZ 72.1

GWM-24 0 56 28 4 8 27 37 77 27 64 10 79 26 208883
X-Y USB-30

4 9 24 5 78 28 65 22 66 23 208726

HAW-12 0 56 36 4 8 27 37 76 28 72 63 26 8 206441
X-Y USB-30

4 9 24 13 77 28 65 74 14 6 206705

STN-00 0 56 44 4 8 27 37 76 27 -141 78 -8 -10 206149
A-E USB150

4 9 24 21 77 28 -111 69 -20 -8 206812

GDS-28 0 56 47 4 8 27 37 75 27 -119 76 7 -13 206177
X-Y USB-85

4 9 24 24 76 28 -101 65 5 -24 206897

VEHICLE 1 RADAR TABLE

TRACKING TIME

STATION ACQUISITION DATA

STATION TERMINATION DATA

HRS MIN SEC

DAY HRS MIN SEC RA DEC AZ ELV X Y RANGE

DAY HRS MIN SEC RA DEC AZ ELV X Y RANGE

| | | | | | | | |
|----------------------|---------|-----------|------------------|-----------|-----------|------------------|-----------|
| GVM-14 X-Y USB-30 | 0 56 49 | 4 8 27 37 | 75 28 -86 72 -18 | 1 206238 | 4 9 24 26 | 76 28 -82 60 -30 | 4 207039 |
| TEX-16 X-Y USB-30 | 0 56 51 | 4 8 27 37 | 75 28 -82 60 -30 | 4 206527 | 4 9 24 28 | 76 28 -78 48 -41 | 8 207451 |
| MIL-71 X-Y USB-30 | 0 56 54 | 4 8 27 37 | 75 27 -79 45 -44 | 8 207050 | 4 9 24 31 | 76 28 -74 34 -55 | 13 208091 |
| GBM-41 X-Y USB-30 | 0 56 54 | 4 8 27 37 | 75 27 -76 43 -46 | 10 207159 | 4 9 24 31 | 76 28 -73 31 -57 | 15 208223 |
| ANG-91 X-Y USB-30 | 0 56 55 | 4 8 27 37 | 75 27 -67 25 -63 | 21 208030 | 4 9 24 32 | 76 28 -65 14 -75 | 24 209205 |
| BDA-02 X-Y USB-30 | 0 56 57 | 4 8 27 37 | 75 27 -76 33 -57 | 12 207642 | 4 9 24 34 | 76 27 -71 22 -67 | 18 208733 |

31 JAN 71

CIR TO LOPCI IGNITION

LAZ 72.1

| | | | | | | | |
|----------------------|---------|------------|--------------------|-----------|------------|---------------------|-----------|
| GVM-24 X-Y USB-30 | 1 11 46 | 4 10 11 42 | 78 28 65 32 55 21 | 208327 | 4 11 23 28 | 79 28 63 47 40 | 18 207716 |
| HOK-25 X-Y USB-85 | 1 11 46 | 4 10 11 42 | 77 28 47 7 -79 | 47 209718 | 4 11 23 28 | 79 29 35 16 -71 | 33 209265 |
| HAM-12 X-Y USB-30 | 1 11 54 | 4 10 11 56 | 77 28 30 83 3 6 | 206755 | 4 11 23 49 | 78 28 -62 77 -12 | 6 206919 |
| GDS-28 X-Y USB-85 | 1 11 59 | 4 10 12 4 | 76 27 -92 55 1 -35 | 207324 | 4 11 24 3 | 77 28 -83 42 -8 -48 | 207977 |

1-39

12
11
10
9
8
7
6
5

VEHICLE 1 RADAR TABLE

TRACKING TIME

STATION ACQUISITION DATA

STATION TERMINATION DATA

HRS MIN SEC

DAY HRS MIN SEC

RA DEC

AZ ELV

X

Y

RANGE

DAY HRS MIN SEC

RA DEC

AZ ELV

X

Y

RANGE

| | | | | | | | | | | | | | | | | | | | | | | | | | |
|----------------------|---|----|----|---|----|----|----|----|----|-----|----|-----|----|--------|---|----|----|----|----|----|-----|----|-----|----|--------|
| STN-00 A-E USB150 | 1 | 11 | 54 | 4 | 10 | 12 | 5 | 76 | 27 | -99 | 60 | -30 | -5 | 207193 | 4 | 11 | 23 | 59 | 77 | 28 | -88 | 46 | -44 | 2 | 207781 |
| GYM-14 X-Y USB-30 | 1 | 11 | 57 | 4 | 10 | 12 | 6 | 76 | 28 | -79 | 50 | -40 | 7 | 207536 | 4 | 11 | 24 | 3 | 77 | 28 | -74 | 35 | -54 | 13 | 208289 |
| TEX-16 X-Y USB-30 | 1 | 11 | 56 | 4 | 10 | 12 | 10 | 76 | 27 | -75 | 38 | -51 | 11 | 208036 | 4 | 11 | 24 | 6 | 77 | 28 | -70 | 24 | -65 | 18 | 208885 |
| BDA-02 X-Y USB-30 | 1 | 11 | 51 | 4 | 10 | 12 | 12 | 76 | 27 | -66 | 12 | -76 | 24 | 209399 | 4 | 11 | 24 | 3 | 77 | 27 | -57 | 0 | -90 | 33 | 210254 |
| GBM-41 X-Y USB-30 | 1 | 11 | 55 | 4 | 10 | 12 | 13 | 76 | 27 | -69 | 21 | -67 | 19 | 208896 | 4 | 11 | 24 | 8 | 77 | 27 | -63 | 7 | -82 | 27 | 209812 |
| MIL-71 X-Y USB-30 | 1 | 11 | 51 | 4 | 10 | 12 | 13 | 76 | 27 | -71 | 24 | -65 | 18 | 208746 | 4 | 11 | 24 | 5 | 77 | 27 | -64 | 10 | -79 | 25 | 209644 |
| ANG-91 X-Y USB-30 | 0 | 15 | 56 | 4 | 10 | 12 | 14 | 76 | 27 | -62 | 3 | -86 | 28 | 209941 | 4 | 10 | 28 | 10 | 76 | 27 | -61 | 0 | -90 | 29 | 209348 |
| CRO-08 X-Y USB-30 | 0 | 3 | 48 | 4 | 11 | 19 | 34 | 79 | 28 | 59 | 0 | 90 | 31 | 210012 | 4 | 11 | 23 | 22 | 79 | 28 | 58 | 1 | 89 | 32 | 210171 |
| CRO-08 X-Y USB-30 | 1 | 11 | 42 | 4 | 12 | 10 | 1 | 79 | 28 | 53 | 10 | 78 | 37 | 209762 | 4 | 13 | 21 | 43 | 80 | 29 | 42 | 21 | 61 | 44 | 209180 |
| HSK-25 X-Y USB-85 | 1 | 11 | 42 | 4 | 12 | 10 | 9 | 78 | 29 | 25 | 21 | -67 | 24 | 209093 | 4 | 13 | 21 | 51 | 79 | 29 | 10 | 25 | -65 | 9 | 208947 |

1-10

12
11
10
9
8
7
6
5
4
3
2

VEHICLE 1 RADAR TABLE

TRACKING TIME

STATION ACQUISITION DATA

STATION TERMINATION DATA

HRS MIN SEC

DAY HRS MIN SEC RA DEC AZ ELV X Y RANGE

DAY HRS MIN SEC RA DEC AZ ELV X Y RANGE

| | | | | | | | |
|----------------------|---------|------------|----------------------|--------|------------|----------------------|--------|
| GWM-24 X-Y USB-30 | 1 11 40 | 4 12 10 12 | 79 28 59 57 29 16 | 207453 | 4 13 21 52 | 80 28 40 70 13 15 | 207197 |
| HAW-12 X-Y USB-30 | 1 11 40 | 4 12 10 29 | 78 28 -71 66 -22 7 | 207184 | 4 13 22 10 | 79 28 -73 52 -37 11 | 207744 |
| GDS-28 X-Y USB-85 | 1 11 37 | 4 12 10 37 | 77 27 -77 32 -19 -56 | 208489 | 4 13 22 13 | 78 27 -69 19 -45 -62 | 209305 |
| STN-00 A-E USB150 | 1 11 35 | 4 12 10 38 | 77 27 -81 37 -53 7 | 208262 | 4 13 22 13 | 78 27 -73 24 -65 16 | 209041 |
| GYM-14 X-Y USB-30 | 1 11 34 | 4 12 10 39 | 77 27 -71 25 -64 17 | 208861 | 4 13 22 12 | 78 27 -65 11 -77 25 | 209750 |
| TEX-16 X-Y USB-30 | 1 11 35 | 4 12 10 40 | 77 27 -66 14 -75 23 | 209489 | 4 13 22 15 | 78 27 -59 1 -89 31 | 210383 |
| MIL-71 X-Y USB-30 | 0 6 0 | 4 12 10 41 | 77 27 -59 1 -89 31 | 210244 | 4 12 16 41 | 77 27 -59 0 -90 31 | 210007 |
| CRO-08 X-Y USB-30 | 1 11 54 | 4 14 8 26 | 80 28 34 27 47 48 | 208921 | 4 15 20 20 | 81 29 18 34 25 52 | 208662 |
| HSK-25 X-Y USB-85 | 1 11 57 | 4 14 8 34 | 79 29 -2 26 -64 -2 | 209002 | 4 15 20 31 | 80 29 -18 23 -66 -17 | 209231 |
| GWM-24 X-Y USB-30 | 1 10 10 | 4 14 8 35 | 79 28 8 75 2 15 | 207201 | 4 15 18 45 | 80 28 -40 70 -13 15 | 207293 |

14-1

12
11
10
9
8
7
6
5

VEHICLE 1 RADAR TABLE

TRACKING TIME

STATION ACQUISITION DATA

STATION TERMINATION DATA

HRS MIN SEC

DAY HRS MIN SEC RA DEC AZ ELV X Y RANGE

DAY HRS MIN SEC RA DEC AZ ELV X Y RANGE

| | | | | | | | |
|----------------------|---------|------------|----------------------|--------|------------|----------------------|--------|
| HAW-12 X-Y USB-30 | 1 11 60 | 4 14 8 48 | 78 28 -72 41 -48 14 | 208247 | 4 15 20 48 | 80 28 -69 26 -62 19 | 209099 |
| GYM-14 X-Y USB-30 | 0 11 13 | 4 14 8 51 | 78 27 -60 2 -88 30 | 210370 | 4 14 20 4 | 78 27 -59 0 -90 31 | 209928 |
| STN-00 A-E USB150 | 1 11 58 | 4 14 8 51 | 78 27 -67 15 -74 22 | 209608 | 4 15 20 50 | 80 27 -58 3 -86 32 | 210428 |
| GDS-28 X-Y USB-85 | 1 2 50 | 4 14 8 51 | 78 27 -64 10 -68 -62 | 209886 | 4 15 11 42 | 80 27 -56 0 -90 -56 | 210129 |
| CRO-08 X-Y USB-30 | 1 11 40 | 4 16 6 57 | 80 29 5 36 7 53 | 208641 | 4 17 18 37 | 81 29 -13 35 -18 53 | 208779 |
| HSK-25 X-Y USB-85 | 1 11 41 | 4 16 7 4 | 80 29 -29 20 -68 -27 | 209514 | 4 17 18 45 | 81 29 -42 12 -75 -40 | 210068 |
| GWM-24 X=Y USB=30 | 1 11 38 | 4 16 7 11 | 80 28 -55 61 -24 16 | 207673 | 4 17 18 49 | 81 28 -63 47 -40 18 | 208272 |
| HAW-12 X-Y USB-30 | 1 11 36 | 4 16 7 21 | 79 28 -66 16 -73 23 | 209710 | 4 17 18 56 | 81 28 -61 2 -87 29 | 210645 |
| MAD-23 X-Y USB-85 | 0 39 6 | 4 16 39 22 | 82 27 53 0 -90 53 | 209416 | 4 17 18 28 | 82 27 59 6 -79 58 | 210412 |
| MAD-23 X-Y USB-85 | 1 11 54 | 4 18 5 7 | 82 27 66 14 -59 62 | 210051 | 4 19 17 1 | 84 27 75 26 -28 60 | 209451 |

1-42

12
11
10
9
8
7
6
5
4
3
2

VEHICLE 1 RADAR TABLE

TRACKING TIME

STATION ACQUISITION DATA

STATION TERMINATION DATA

| | HRS | MIN | SEC | DAY | HRS | MIN | SEC | RA | DEC | AZ | ELV | X | Y | RANGE | DAY | HRS | MIN | SEC | RA | DEC | AZ | ELV | X | Y | RANGE |
|----------------------|-----|-----|-----|-----|-----|-----|-----|----|-----|-----|-----|-----|-----|--------|-----|-----|-----|-----|----|-----|-----|-----|-----|-----|--------|
| CRO-08 X-Y USB-30 | 1 | 11 | 59 | 4 | 18 | 5 | 20 | 81 | 29 | -25 | 32 | -34 | 50 | 209034 | 4 | 19 | 17 | 19 | 82 | 29 | -39 | 24 | -55 | 45 | 209576 |
| HSK-25 X-Y USB-85 | 0 | 32 | 5 | 4 | 18 | 5 | 24 | 81 | 28 | -50 | 5 | -83 | -49 | 210547 | 4 | 18 | 37 | 29 | 81 | 28 | -54 | 0 | -90 | -54 | 209580 |
| GWM-24 X-Y USB-30 | 1 | 11 | 59 | 4 | 18 | 5 | 28 | 81 | 28 | -65 | 36 | -51 | 20 | 208804 | 4 | 19 | 17 | 26 | 82 | 28 | -65 | 22 | -66 | 23 | 209698 |
| CYI-04 X-Y USB-30 | 1 | 8 | 7 | 4 | 18 | 8 | 53 | 82 | 27 | 59 | 0 | 90 | 31 | 210676 | 4 | 19 | 16 | 60 | 84 | 28 | 65 | 12 | 76 | 24 | 210203 |
| ACN-75 X-Y USB-30 | 1 | 11 | 42 | 4 | 20 | 3 | 25 | 84 | 28 | 60 | 8 | 81 | 30 | 210583 | 4 | 21 | 15 | 7 | 85 | 28 | 55 | 22 | 64 | 32 | 209832 |
| CYI-04 X-Y USB-30 | 1 | 11 | 39 | 4 | 20 | 3 | 31 | 84 | 28 | 70 | 22 | 67 | 19 | 209745 | 4 | 21 | 15 | 10 | 85 | 28 | 75 | 36 | 53 | 12 | 209075 |
| MAD-23 X-Y USB-85 | 1 | 11 | 42 | 4 | 20 | 3 | 34 | 83 | 27 | 82 | 35 | -12 | 55 | 209087 | 4 | 21 | 15 | 15 | 85 | 28 | 92 | 47 | 1 | 43 | 208585 |
| CRO-08 X-Y USB-30 | 1 | 11 | 43 | 4 | 20 | 3 | 54 | 82 | 28 | -47 | 16 | -68 | 41 | 210040 | 4 | 21 | 15 | 37 | 83 | 28 | -56 | 4 | -85 | 34 | 210854 |
| GWM-24 X-Y USB-30 | 0 | 55 | 57 | 4 | 20 | 3 | 59 | 82 | 28 | -64 | 11 | -78 | 26 | 210341 | 4 | 20 | 59 | 56 | 83 | 28 | -61 | 0 | -90 | 29 | 210296 |
| ACN-75 X-Y USB-30 | 0 | 8 | 4 | 4 | 22 | 1 | 36 | 85 | 28 | 50 | 31 | 52 | 33 | 209444 | 4 | 22 | 9 | 40 | 85 | 28 | 49 | 32 | 50 | 34 | 208962 |

1-43

12
11
10
9
8
7
6
5

VEHICLE 1 RADAR TABLE

TRACKING TIME

STATION ACQUISITION DATA

STATION TERMINATION DATA

HRS MIN SEC

DAY HRS MIN SEC RA DEC AZ ELV X Y RANGE

DAY HRS MIN SEC RA DEC AZ ELV X Y RANGE

ANG-91 0 8 2 4 22 1 38 85 28 62 3 87 28 211051 4 22 9 40 85 28 63 4 85 27 210548
X-Y USB-30

BDA-02 0 8 2 4 22 1 38 85 27 62 8 82 27 210763 4 22 9 40 85 27 63 9 80 26 210272
X-Y USB-30

CYI-04 0 7 58 4 22 1 42 85 28 78 46 43 8 208727 4 22 9 40 85 28 79 48 41 8 208258
X-Y USB-30

MAD-23 0 7 55 4 22 1 45 84 28 101 56 7 33 208357 4 22 9 40 84 28 102 58 8 31 207912
X-Y USB=85

31 JAN 71

LOPCI TO LM JETT IGNITION

LAZ 72.1

ANG-91 1 3 40 4 22 9 59 85 28 63 4 85 27 210528 4 23 13 39 86 28 65 17 71 23 210263
X-Y USB-30

BDA-02 1 3 46 4 22 9 59 85 27 63 9 80 26 210253 4 23 13 44 86 28 70 21 68 19 210082
X-Y USB-30

ACN-75 1 3 47 4 22 9 59 85 28 49 33 50 34 208944 4 23 13 45 86 28 39 43 34 35 208960
X-Y USB-30

CYI-04 1 3 50 4 22 9 59 85 28 79 48 41 8 208240 4 23 13 48 86 28 82 61 29 4 208292
X-Y USB-30

MAD-23 1 3 52 4 22 9 59 84 28 102 58 8 31 207895 4 23 13 50 85 28 120 69 11 18 208109
X-Y USB=85

GBM-41 0 40 44 4 22 32 58 85 27 59 0 90 31 209949 4 23 13 42 86 28 63 7 82 27 210835
X-Y USB-30

111

12
11
10
9
8
7
6
5
4
3
2

VEHICLE 1 RADAR TABLE

TRACKING TIME

STATION ACQUISITION DATA

STATION TERMINATION DATA

HRS MIN SEC

DAY HRS MIN SEC

RA DEC

AZ ELV

X

Y

RANGE

DAY HRS MIN SEC

RA DEC

AZ ELV

X

Y

RANGE

| | | | | | | | | | | | |
|----------------------|---------|-----------|-------|--------|-------|--------|------------|-------|---------|-------|--------|
| MIL-71 X-Y USB-30 | 0 35 36 | 4 22 38 8 | 85 27 | 58 0 | 90 32 | 209918 | 4 23 13 44 | 86 27 | 62 6 | 83 28 | 210908 |
| ANG-91 X-Y USB-30 | 1 11 37 | 5 0 0 13 | 86 28 | 67 27 | 61 20 | 209790 | 5 1 11 50 | 87 28 | 67 42 | 45 16 | 209131 |
| MIL-71 X-Y USB-30 | 1 11 36 | 5 0 0 14 | 86 27 | 67 16 | 73 22 | 210446 | 5 1 11 50 | 87 28 | 73 30 | 59 15 | 209750 |
| TEX-16 X-Y USB-30 | 1 11 32 | 5 0 0 15 | 86 27 | 60 2 | 88 30 | 211248 | 5 1 11 47 | 87 28 | 67 15 | 73 23 | 210530 |
| GBM-41 X-Y USB-30 | 1 11 31 | 5 0 0 17 | 86 27 | 67 17 | 72 22 | 210370 | 5 1 11 47 | 87 28 | 72 31 | 58 15 | 209670 |
| BDA-02 X-Y USB-30 | 1 11 33 | 5 0 0 18 | 86 27 | 75 30 | 59 13 | 209652 | 5 1 11 51 | 87 28 | 81 44 | 46 6 | 209062 |
| ACN-75 X-Y USB-30 | 1 11 37 | 5 0 0 21 | 85 28 | 27 49 | 21 36 | 208771 | 5 1 11 58 | 86 28 | 4 54 | 3 36 | 208690 |
| CYI-04 X-Y USB-30 | 1 11 37 | 5 0 0 25 | 85 28 | 85 72 | 18 2 | 208117 | 5 1 12 2 | 86 28 | 87 87 | 3 0 | 208038 |
| MAD-23 X-Y USB-85 | 1 11 38 | 5 0 0 28 | 85 28 | 147 75 | 13 8 | 208056 | 5 1 12 5 | 86 28 | -150 76 | 13 -7 | 208141 |
| GYM-14 X-Y USB-30 | 0 26 48 | 5 0 44 58 | 87 27 | 59 0 | 90 31 | 210201 | 5 1 11 47 | 87 27 | 61 5 | 85 29 | 211149 |

I-45

12
11
10
9
8
7
6
5

VEHICLE 1 RADAR TABLE

TRACKING TIME

STATION ACQUISITION DATA

STATION TERMINATION DATA

HRS MIN SEC

DAY HRS MIN SEC

RA DEC

AZ ELV X Y RANGE

DAY HRS MIN SEC

RA DEC

AZ ELV X Y RANGE

| | | | | | | | |
|----------------------|---------|-----------|-----------------|-----------|-----------|-----------------|-----------|
| GDS-28 X-Y USB-85 | 0 24 20 | 5 0 47 30 | 87 27 56 0 -90 | 56 210275 | 5 1 11 50 | 87 27 59 4 -82 | 59 211205 |
| STN-00 A-E USB150 | 0 9 20 | 5 1 2 33 | 87 27 55 0 90 | 35 210948 | 5 1 11 53 | 87 27 56 1 88 | 34 211357 |
| GYM-14 X-Y USB-30 | 1 12 1 | 5 1 58 23 | 87 27 66 14 75 | 23 210708 | 5 3 10 24 | 88 28 72 28 61 | 16 210006 |
| TEX-16 X-Y USB-30 | 1 11 59 | 5 1 58 23 | 87 27 71 25 64 | 17 210093 | 5 3 10 22 | 88 28 76 39 50 | 11 209443 |
| GBM-41 X-Y USB-30 | 1 12 1 | 5 1 58 25 | 87 28 76 41 48 | 11 209287 | 5 3 10 26 | 88 28 79 56 33 | 6 208784 |
| MIL-71 X-Y USB-30 | 1 12 0 | 5 1 58 25 | 87 28 76 40 50 | 10 209362 | 5 3 10 26 | 88 28 81 54 35 | 5 208847 |
| GDS-28 X-Y USB-85 | 1 11 58 | 5 1 58 26 | 87 27 65 12 -62 | 62 210807 | 5 3 10 24 | 88 27 73 25 -32 | 60 210156 |
| STN-00 A-E USB150 | 1 11 58 | 5 1 58 26 | 87 27 63 9 79 | 27 210981 | 5 3 10 24 | 88 27 71 22 67 | 17 210346 |
| BDA-02 X-Y USB-30 | 1 12 2 | 5 1 58 27 | 87 28 86 54 36 | 2 208776 | 5 3 10 29 | 88 28 96 68 22 | -2 208447 |
| ANG-91 X-Y USB-30 | 1 11 60 | 5 1 58 28 | 87 28 66 53 35 | 14 208814 | 5 3 10 27 | 88 28 57 67 19 | 12 208470 |

194-T

12
11
10
9
8
7
6
5
4
3
2

VEHICLE 1 RADAR TABLE

| TRACKING TIME | | | | STATION ACQUISITION DATA | | | | | | | | | STATION TERMINATION DATA | | | | | | | | | | | | | | |
|---------------|-----|-----|----|--------------------------|-----|-----|-----|----|-----|------|-----|-----|--------------------------|--------|-----|-----|-----|-----|----|-----|------|-----|-----|-----|--------|--|--|
| HRS | MIN | SEC | | DAY | HRS | MIN | SEC | RA | DEC | AZ | ELV | X | Y | RANGE | DAY | HRS | MIN | SEC | RA | DEC | AZ | ELV | X | Y | RANGE | | |
| ACN-75 | 1 | 12 | 1 | 5 | 1 | 58 | 37 | 86 | 28 | -14 | 53 | -11 | 36 | 208813 | 5 | 3 | 10 | 38 | 87 | 28 | -34 | 45 | -29 | 35 | 209186 | | |
| X-Y USB-30 | | | | | | | | | | | | | | | | | | | | | | | | | | | |
| CYI-04 | 1 | 12 | 2 | 5 | 1 | 58 | 37 | 86 | 28 | -88 | 83 | -7 | 0 | 208146 | 5 | 3 | 10 | 39 | 87 | 28 | -84 | 68 | -22 | 2 | 208471 | | |
| X-Y USB-30 | | | | | | | | | | | | | | | | | | | | | | | | | | | |
| MAD-23 | 1 | 12 | 0 | 5 | 1 | 58 | 40 | 86 | 28 | -122 | 69 | 11 | -18 | 208338 | 5 | 3 | 10 | 40 | 87 | 28 | -101 | 57 | 7 | -32 | 208760 | | |
| X-Y USB-85 | | | | | | | | | | | | | | | | | | | | | | | | | | | |
| STN-00 | 1 | 11 | 40 | 5 | 3 | 56 | 55 | 88 | 27 | 77 | 31 | 59 | 11 | 209949 | 5 | 5 | 8 | 34 | 89 | 28 | 86 | 44 | 46 | 3 | 209391 | | |
| A-E USB150 | | | | | | | | | | | | | | | | | | | | | | | | | | | |
| GDS-28 | 1 | 11 | 38 | 5 | 3 | 56 | 55 | 88 | 27 | 79 | 35 | -16 | 54 | 209758 | 5 | 5 | 8 | 34 | 89 | 28 | 87 | 48 | -3 | 42 | 209218 | | |
| X-Y USB-85 | | | | | | | | | | | | | | | | | | | | | | | | | | | |
| GYM-14 | 1 | 11 | 42 | 5 | 3 | 56 | 56 | 88 | 28 | 76 | 38 | 51 | 11 | 209589 | 5 | 5 | 8 | 38 | 89 | 28 | 80 | 53 | 37 | 6 | 209054 | | |
| X-Y USB-30 | | | | | | | | | | | | | | | | | | | | | | | | | | | |
| TEX-16 | 1 | 11 | 41 | 5 | 3 | 56 | 58 | 88 | 28 | 79 | 50 | 40 | 7 | 209093 | 5 | 5 | 8 | 38 | 89 | 28 | 83 | 65 | 25 | 3 | 208691 | | |
| X-Y USB-30 | | | | | | | | | | | | | | | | | | | | | | | | | | | |
| GBM-41 | 1 | 11 | 41 | 5 | 3 | 57 | 1 | 88 | 28 | 81 | 67 | 23 | 3 | 208563 | 5 | 5 | 8 | 42 | 89 | 28 | 80 | 82 | 8 | 2 | 208401 | | |
| X-Y USB-30 | | | | | | | | | | | | | | | | | | | | | | | | | | | |
| MIL-71 | 1 | 11 | 44 | 5 | 3 | 57 | 1 | 88 | 28 | 85 | 65 | 25 | 2 | 208611 | 5 | 5 | 8 | 45 | 89 | 28 | 91 | 80 | 10 | 0 | 208423 | | |
| X-Y USB-30 | | | | | | | | | | | | | | | | | | | | | | | | | | | |
| BDA-02 | 1 | 11 | 44 | 5 | 3 | 57 | 4 | 88 | 28 | 110 | 78 | 11 | -4 | 208353 | 5 | 5 | 8 | 48 | 89 | 28 | -139 | 84 | -4 | -5 | 208387 | | |
| X-Y USB-30 | | | | | | | | | | | | | | | | | | | | | | | | | | | |

1-17

2
1
0
9
8
7
6

VEHICLE I RADAR TABLE

TRACKING TIME

STATION ACQUISITION DATA

STATION TERMINATION DATA

HRS MIN SEC

DAY HPS MIN SEC RA DEC AZ ELV X Y RANGE

DAY HRS MIN SEC RA DEC AZ ELV X Y RANGE

| | | | | | | | |
|----------------------|---------|-----------|--------------|---------------|----------|--------------|----------------|
| ANG-9I X-Y USB-30 | 1 11 45 | 5 3 57 6 | 88 28 37 76 | 9 11 208381 | 5 5 8 51 | 89 28 -31 77 | -7 11 208456 |
| ACN-75 X-Y USB-30 | 1 11 45 | 5 3 57 16 | 87 28 -44 38 | -42 34 209572 | 5 5 9 1 | 88 28 -54 25 | -60 32 210323 |
| CYI-04 X-Y USB-30 | 1 11 46 | 5 3 57 17 | 87 28 -81 57 | -33 5 208814 | 5 5 9 3 | 88 28 -77 42 | -47 10 209487 |
| MAD-23 X-Y USB-85 | 1 11 43 | 5 3 57 20 | 87 27 -92 48 | 2 -42 209138 | 5 5 9 3 | 88 27 -82 35 | -11 -54 209819 |
| HAW-12 X-Y USB-30 | 0 45 20 | 5 4 23 12 | 89 27 60 0 | 90 30 210540 | 5 5 8 32 | 90 28 64 9 | 80 26 211257 |
| HAW-12 X-Y USB-30 | 1 11 53 | 5 5 55 5 | 90 27 67 19 | 70 22 210790 | 5 7 6 58 | 91 28 71 33 | 55 16 210069 |
| STN-00 A-E USB150 | 1 11 54 | 5 5 55 11 | 89 27 93 53 | 36 -2 209125 | 5 7 7 5 | 90 28 108 67 | 22 -7 208806 |
| GYM-14 X-Y USB-30 | 1 11 55 | 5 5 55 12 | 89 28 83 63 | 27 3 208824 | 5 7 7 7 | 90 28 88 78 | 12 0 208606 |
| GDS-28 X-Y USB-85 | 1 11 53 | 5 5 55 12 | 89 28 94 58 | 2 32 208975 | 5 7 7 5 | 90 28 109 72 | 6 17 208705 |
| TEX-16 X-Y USB-30 | 1 11 55 | 5 5 55 17 | 89 28 86 75 | 15 1 208569 | 5 7 7 12 | 90 28 -40 90 | 0 0 208537 |

84-1

12
11
10
9
8
7
6
5
4
3
2

VEHICLE 1 RADAR TABLE

TRACKING TIME

STATION ACQUISITION DATA

STATION TERMINATION DATA

| | HRS | MIN | SEC | DAY | HRS | MIN | SEC | RA | DEC | AZ | ELV | X | Y | RANGE | DAY | HRS | MIN | SEC | RA | DEC | AZ | ELV | X | Y | RANGE |
|----------------------|-----|-----|-----|-----|-----|-----|-----|----|-----|------|-----|-----|-----|--------|-----|-----|-----|-----|----|-----|------|-----|-----|-----|--------|
| MIL-71 X-Y USB-30 | 1 | 11 | 53 | 5 | 5 | 55 | 24 | 89 | 28 | -175 | 89 | 0 | -1 | 208449 | 5 | 7 | 7 | 17 | 90 | 28 | -89 | 75 | -15 | 0 | 208658 |
| GBM-41 X-Y USB-30 | 1 | 11 | 52 | 5 | 5 | 55 | 25 | 89 | 28 | -64 | 87 | -2 | 1 | 208450 | 5 | 7 | 7 | 17 | 90 | 28 | -82 | 73 | -17 | 2 | 208697 |
| BDA-02 X-Y USB-30 | 1 | 11 | 52 | 5 | 5 | 55 | 28 | 88 | 28 | -104 | 75 | -14 | -4 | 208560 | 5 | 7 | 7 | 20 | 89 | 28 | -90 | 61 | -29 | 0 | 208974 |
| ANG-91 X-Y USB-30 | 1 | 11 | 52 | 5 | 5 | 55 | 28 | 88 | 28 | -55 | 69 | -17 | 12 | 208667 | 5 | 7 | 7 | 21 | 89 | 28 | -66 | 55 | -33 | 14 | 209164 |
| CYI-04 X-Y USB-30 | 1 | 11 | 48 | 5 | 5 | 55 | 40 | 88 | 27 | -73 | 32 | -57 | 14 | 210023 | 5 | 7 | 7 | 28 | 89 | 27 | -68 | 18 | -70 | 21 | 210895 |
| MAD-23 X-Y USB-85 | 1 | 11 | 47 | 5 | 5 | 55 | 41 | 88 | 27 | -76 | 26 | -27 | -60 | 210329 | 5 | 7 | 7 | 27 | 89 | 27 | -66 | 14 | -58 | -62 | 211119 |
| ACN-75 X-Y USB-30 | 1 | 11 | 46 | 5 | 5 | 55 | 42 | 88 | 28 | -58 | 16 | -72 | 31 | 210917 | 5 | 7 | 7 | 28 | 89 | 28 | -62 | 1 | -89 | 28 | 211885 |
| HAW-12 X-Y USB-30 | 1 | 11 | 47 | 5 | 7 | 53 | 37 | 91 | 28 | 72 | 44 | 45 | 13 | 209670 | 5 | 9 | 5 | 25 | 92 | 28 | 73 | 59 | 30 | 9 | 209187 |
| STN-00 A-E USB150 | 1 | 11 | 47 | 5 | 7 | 53 | 49 | 90 | 27 | 128 | 75 | 12 | -9 | 208717 | 5 | 9 | 5 | 35 | 91 | 28 | -160 | 80 | -4 | -10 | 208754 |
| GDS-28 X-Y USB-85 | 1 | 11 | 51 | 5 | 7 | 53 | 46 | 90 | 28 | 138 | 80 | 8 | 7 | 208658 | 5 | 9 | 5 | 39 | 91 | 28 | -132 | 79 | 7 | -8 | 208765 |

64-1

VEHICLE 1 FAFAR TABLE

TRACKING TIME

STATION ACQUISITION DATA

STATION TERMINATION DATA

| | HRS | MIN | SEC | DAY | HRS | MIN | SEC | RA | DEC | AZ | ELV | X | Y | RANGE | DAY | HRS | MIN | SEC | RA | DEC | AZ | ELV | X | Y | RANGE |
|----------------------|-----|-----|-----|-----|-----|-----|-----|----|-----|-----|-----|-----|-----|--------|-----|-----|-----|-----|----|-----|-----|-----|-----|-----|--------|
| GYM-14 X-Y USB-30 | 1 | 11 | 56 | 5 | 7 | 53 | 50 | 90 | 28 | 103 | 83 | 1 | 0 | 208604 | 5 | 9 | 5 | 46 | 91 | 28 | -87 | 76 | -14 | 1 | 208806 |
| TEX-16 X-Y USB-30 | 1 | 11 | 54 | 5 | 7 | 53 | 53 | 90 | 28 | -87 | 79 | -11 | 1 | 208661 | 5 | 9 | 5 | 47 | 91 | 28 | -83 | 64 | -26 | 3 | 209045 |
| GBM-41 X-Y USB-30 | 1 | 11 | 55 | 5 | 7 | 53 | 57 | 89 | 28 | -81 | 62 | -28 | 4 | 208997 | 5 | 9 | 5 | 52 | 90 | 28 | -77 | 47 | -42 | 9 | 209623 |
| MIL-71 X-Y USB-30 | 1 | 11 | 54 | 5 | 7 | 53 | 57 | 89 | 28 | -85 | 64 | -26 | 2 | 208932 | 5 | 9 | 5 | 51 | 90 | 28 | -80 | 50 | -40 | 7 | 209522 |
| BDA-02 X-Y USB-30 | 1 | 11 | 56 | 5 | 7 | 53 | 58 | 89 | 27 | -85 | 51 | -39 | 3 | 209365 | 5 | 9 | 5 | 55 | 90 | 27 | -78 | 37 | -53 | 10 | 210090 |
| ANG-91 X-Y USB-30 | 1 | 11 | 58 | 5 | 7 | 54 | 1 | 89 | 28 | -68 | 44 | -43 | 16 | 209618 | 5 | 9 | 5 | 59 | 90 | 28 | -67 | 29 | -59 | 20 | 210454 |
| MAD-23 X-Y USB-85 | 0 | 42 | 31 | 5 | 7 | 54 | 2 | 89 | 27 | -59 | 6 | -78 | -59 | 211640 | 5 | 8 | 36 | 33 | 90 | 27 | -53 | 0 | -90 | -53 | 210822 |
| CYI-04 X-Y USB-30 | 0 | 47 | 54 | 5 | 7 | 54 | 4 | 89 | 27 | -64 | 9 | -80 | 26 | 211497 | 5 | 8 | 41 | 58 | 90 | 27 | -59 | 0 | -90 | 31 | 210964 |
| GWM-24 X-Y USB-30 | 0 | 28 | 43 | 5 | 8 | 36 | 35 | 92 | 27 | 62 | 0 | 90 | 28 | 210821 | 5 | 9 | 5 | 18 | 92 | 28 | 63 | 6 | 83 | 27 | 211751 |
| GWM-24 X-Y USB-30 | 1 | 11 | 45 | 5 | 9 | 51 | 50 | 92 | 27 | 65 | 16 | 72 | 24 | 211246 | 5 | 11 | 3 | 35 | 93 | 28 | 66 | 31 | 57 | 21 | 210494 |

1-50

VEHICLE 1 RADAR TABLE

| | TRACKING TIME | | | STATION ACQUISITION DATA | | | | | | | | | STATION TERMINATION DATA | | | | | | | | | | | | |
|----------------------|---------------|-----|-----|--------------------------|-----|-----|-----|----|-----|------|-----|-----|--------------------------|--------|-----|-----|-----|-----|----|-----|------|-----|-----|-----|--------|
| | HRS | MIN | SEC | DAY | HRS | MIN | SEC | RA | DEC | AZ | ELV | X | Y | RANGE | DAY | HRS | MIN | SEC | RA | DEC | AZ | ELV | X | Y | RANGE |
| HAW-12 X-Y USB-30 | 1 | 11 | 46 | 5 | 9 | 52 | 3 | 91 | 28 | 70 | 69 | 20 | 7 | 208997 | 5 | 11 | 3 | 49 | 92 | 28 | 39 | 83 | 5 | 6 | 208883 |
| STN-00 A-E USB150 | 1 | 11 | 44 | 5 | 9 | 52 | 15 | 91 | 27 | -122 | 73 | -14 | -9 | 208906 | 5 | 11 | 3 | 58 | 92 | 27 | -100 | 61 | -29 | -5 | 209296 |
| GDS-28 X-Y USB-85 | 1 | 11 | 45 | 5 | 9 | 52 | 15 | 91 | 27 | -108 | 70 | 6 | -19 | 208962 | 5 | 11 | 4 | 1 | 92 | 27 | -93 | 57 | 2 | -33 | 209423 |
| GYM-14 X-Y USB-30 | 1 | 11 | 44 | 5 | 9 | 52 | 18 | 91 | 28 | -84 | 66 | -24 | 2 | 209062 | 5 | 11 | 4 | 3 | 92 | 28 | -80 | 51 | -39 | 6 | 209629 |
| TEX-16 X-Y USB-30 | 1 | 11 | 44 | 5 | 9 | 52 | 20 | 90 | 28 | -80 | 54 | -36 | 6 | 209416 | 5 | 11 | 4 | 4 | 91 | 27 | -76 | 39 | -50 | 11 | 210123 |
| GBM-41 X-Y USB-30 | 1 | 11 | 44 | 5 | 9 | 52 | 24 | 90 | 27 | -74 | 37 | -52 | 12 | 210123 | 5 | 11 | 4 | 8 | 91 | 27 | -70 | 22 | -66 | 19 | 210979 |
| MIL-71 X-Y USB-30 | 1 | 11 | 41 | 5 | 9 | 52 | 24 | 90 | 27 | -77 | 39 | -50 | 10 | 210001 | 5 | 11 | 4 | 6 | 91 | 27 | -71 | 25 | -64 | 17 | 210830 |
| BDA-02 X-Y USB-30 | 1 | 11 | 40 | 5 | 9 | 52 | 26 | 90 | 27 | -73 | 27 | -62 | 15 | 210623 | 5 | 11 | 4 | 6 | 91 | 27 | -66 | 14 | -75 | 23 | 211483 |
| ANG-91 X-Y USB-30 | 1 | 11 | 38 | 5 | 9 | 52 | 29 | 90 | 27 | -66 | 19 | -69 | 23 | 211054 | 5 | 11 | 4 | 7 | 91 | 27 | -63 | 4 | -85 | 27 | 212018 |
| HSK-25 X-Y USB-85 | 0 | 43 | 27 | 5 | 10 | 20 | 9 | 92 | 28 | 54 | 0 | -90 | 54 | 210972 | 5 | 11 | 3 | 36 | 93 | 28 | 48 | 6 | -81 | 48 | 211871 |

1-51

12
11
10
9
8
7
6
5

VEHICLE 1 RADAR TABLE

TRACKING TIME

STATION ACQUISITION DATA

STATION TERMINATION DATA

HRS MIN SEC

DAY HRS MIN SEC RA DEC AZ ELV X Y RANGE

DAY HRS MIN SEC RA DEC AZ ELV X Y RANGE

| | | | | | | | | | |
|----------------------|---------|------------|-------|------------|------------|------------|-------|------------|------------|
| HSK-25 X-Y USB-85 | 1 11 55 | 5 11 50 18 | 93 28 | 40 13 -73 | 39 211559 | 5 13 2 13 | 94 28 | 27 21 -67 | 25 211207 |
| GWM-24 X-Y USB-30 | 1 11 54 | 5 11 50 18 | 93 28 | 65 42 46 | 19 210079 | 5 13 2 11 | 94 28 | 60 56 30 | 16 209586 |
| HAW-12 X-Y USB-30 | 1 12 4 | 5 11 50 30 | 92 28 | -47 82 -6 | 6 208960 | 5 13 2 34 | 93 28 | -71 68 -21 | 7 209289 |
| STN-00 A-E USB150 | 1 12 1 | 5 11 50 37 | 92 27 | -92 51 -39 | -1 209668 | 5 13 2 38 | 93 27 | -82 38 -52 | 6 210356 |
| GDS-28 X-Y USB-85 | 1 11 60 | 5 11 50 39 | 91 27 | -86 47 -3 | -43 209835 | 5 13 2 39 | 93 27 | -78 33 -17 | -55 210580 |
| TEX-16 X-Y USB-30 | 1 12 1 | 5 11 50 42 | 91 27 | -72 29 -60 | 15 210673 | 5 13 2 43 | 93 27 | -67 15 -74 | 22 211575 |
| GYN-14 X-Y USB-30 | 1 11 60 | 5 11 50 42 | 91 27 | -77 41 -49 | 10 210107 | 5 13 2 42 | 93 27 | -71 26 -63 | 17 210948 |
| BDA-02 X-Y USB-30 | 0 26 34 | 5 11 50 43 | 91 27 | -61 5 -85 | 29 212061 | 5 12 17 17 | 92 27 | -58 0 -90 | 32 211168 |
| GBM-41 X-Y USB-30 | 1 8 10 | 5 11 50 43 | 91 27 | -66 13 -76 | 24 211584 | 5 12 58 54 | 93 27 | -59 0 -90 | 31 212262 |
| MIL-71 X-Y USB-30 | 1 11 58 | 5 11 50 45 | 91 27 | -67 15 -73 | 22 211423 | 5 13 2 43 | 93 27 | -60 2 -88 | 30 212335 |

VEHICLE 1 RADAR TABLE

TRACKING TIME

STATION ACQUISITION DATA

STATION TERMINATION DATA

| | HRS | MIN | SEC | DAY | HRS | MIN | SEC | RA | DEC | AZ | ELV | X | Y | RANGE | DAY | HRS | MIN | SEC | RA | DEC | AZ | ELV | X | Y | RANGE |
|----------------------|-----|-----|-----|-----|-----|-----|-----|----|-----|-----|-----|-----|-----|--------|-----|-----|-----|-----|----|-----|-----|-----|-----|-----|--------|
| CRO-08 K-Y USB-30 | 0 | 49 | 50 | 5 | 12 | 12 | 15 | 93 | 28 | 59 | 0 | 90 | 31 | 211308 | 5 | 13 | 2 | 5 | 94 | 28 | 53 | 9 | 79 | 36 | 211898 |
| CRD-08 K-Y USB-30 | 1 | 11 | 40 | 5 | 13 | 48 | 40 | 94 | 28 | 47 | 17 | 67 | 41 | 211500 | 5 | 15 | 0 | 20 | 95 | 28 | 35 | 27 | 48 | 47 | 211015 |
| GWN-24 K-Y USB-30 | 1 | 11 | 42 | 5 | 13 | 48 | 48 | 94 | 28 | 50 | 66 | 19 | 15 | 209384 | 5 | 15 | 0 | 30 | 95 | 28 | 13 | 75 | 4 | 14 | 209283 |
| MSK-25 K-Y USB-85 | 1 | 11 | 42 | 5 | 13 | 48 | 48 | 94 | 28 | 16 | 24 | -65 | 14 | 211081 | 5 | 15 | 0 | 30 | 95 | 28 | 0 | 26 | -64 | 0 | 211066 |
| HAW-12 X-Y USB-30 | 1 | 11 | 42 | 5 | 13 | 49 | 4 | 93 | 27 | -73 | 57 | -32 | 9 | 209614 | 5 | 15 | 0 | 46 | 94 | 27 | -72 | 42 | -46 | 13 | 210298 |
| GDS-28 K-Y USB-85 | 1 | 11 | 39 | 5 | 13 | 49 | 11 | 92 | 27 | -73 | 24 | -34 | -61 | 211101 | 5 | 15 | 0 | 50 | 94 | 27 | -65 | 11 | -65 | -63 | 211066 |
| TEX-16 K-Y USB-30 | 0 | 30 | 3 | 5 | 13 | 49 | 12 | 92 | 27 | -62 | 5 | -84 | 28 | 212158 | 5 | 14 | 19 | 15 | 93 | 27 | -59 | 0 | -90 | 31 | 211258 |
| STM-20 I-E USB150 | 1 | 11 | 38 | 5 | 13 | 49 | 12 | 93 | 27 | -76 | 29 | -61 | 12 | 210849 | 5 | 15 | 0 | 49 | 94 | 27 | -68 | 16 | -73 | 21 | 211669 |
| GWN-14 I-E USB-30 | 1 | 11 | 38 | 5 | 13 | 49 | 12 | 92 | 27 | -68 | 16 | -72 | 22 | 211520 | 5 | 15 | 0 | 50 | 94 | 27 | -61 | 3 | -87 | 29 | 212425 |
| CRD-08 K-Y USB-30 | 1 | 12 | 2 | 5 | 15 | 46 | 60 | 95 | 28 | 25 | 32 | 33 | 50 | 210818 | 5 | 16 | 59 | 2 | 96 | 28 | 7 | 37 | 9 | 53 | 210702 |

I-53

2
1
0
9
8
7
6
5

VEHICLE I RADAR TABLE

TRACKING TIME

STATION ACQUISITION DATA

STATION TERMINATION DATA

HRS MIN SEC

DAY HRS MIN SEC

PA DEC

AZ ELV

X

Y

RANGE

DAY HRS MIN SEC

RA DEC

AZ ELV

X

Y

RANGE

| | | | | | | | | | | | |
|----------------------|---------|------------|-------|------------|-----|--------|------------|-------|------------|-----|--------|
| HSK-25 X-Y USB-85 | 1 12 1 | 5 15 47 7 | 94 28 | -12 25 -64 | -11 | 211189 | 5 16 59 8 | 95 28 | -28 20 -67 | -26 | 211548 |
| GWM-24 X-Y USB-30 | 1 12 0 | 5 15 47 9 | 94 28 | -27 74 -7 | 14 | 209376 | 5 16 59 9 | 95 28 | -55 62 -23 | 15 | 209727 |
| HAW-12 X-Y USB-30 | 1 11 59 | 5 15 47 18 | 94 27 | -71 32 -57 | 16 | 210846 | 5 16 59 17 | 95 27 | -67 17 -71 | 22 | 211754 |
| STN-00 A-E USB150 | 0 46 21 | 5 15 47 20 | 94 27 | -62 7 -82 | 28 | 212216 | 5 16 33 41 | 95 27 | -56 0 -90 | 34 | 211549 |
| GDS-28 X-Y USB-85 | 0 15 15 | 5 15 47 21 | 94 27 | -59 3 -85 | -58 | 212499 | 5 16 2 36 | 94 27 | -57 0 -90 | -57 | 211892 |
| MAD-23 X-Y USB-85 | 1 11 31 | 5 17 45 30 | 96 27 | 55 1 -88 | 55 | 212737 | 5 18 57 1 | 98 27 | 65 12 -62 | 63 | 212153 |
| CRO-08 X-Y USB-30 | 1 11 37 | 5 17 45 41 | 96 28 | -6 37 -8 | 53 | 210743 | 5 18 57 18 | 97 28 | -24 33 -32 | 50 | 211036 |
| HSK-25 X-Y USB-85 | 1 11 37 | 5 17 45 49 | 95 28 | -37 15 -71 | -36 | 211877 | 5 18 57 26 | 96 28 | -49 6 -81 | -49 | 212537 |
| GWM-24 X-Y USB-30 | 1 11 40 | 5 17 45 52 | 95 27 | -62 53 -34 | 17 | 210079 | 5 18 57 32 | 96 27 | -66 38 -50 | 19 | 210816 |
| HAW-12 X-Y USB-30 | 0 37 16 | 5 17 45 58 | 95 27 | -64 7 -82 | 26 | 212365 | 5 18 23 14 | 95 27 | -61 0 -90 | 29 | 211540 |

1-54

12
11
10
9
8
7
6
5
4
3
2

VEHICLE 1 RADAR TABLE

| | TRACKING TIME | | | STATION ACQUISITION DATA | | | | | | | | | | STATION TERMINATION DATA | | | | | | | | | | | |
|----------------------|---------------|-----|-----|--------------------------|-----|-----|-----|----|-----|-----|-----|-----|----|--------------------------|-----|-----|-----|-----|-----|-----|-----|-----|-----|----|--------|
| | HRS | MIN | SEC | DAY | HRS | MIN | SEC | RA | DEC | AZ | ELV | X | Y | RANGE | DAY | HRS | MIN | SEC | RA | DEC | AZ | ELV | X | Y | RANGE |
| CYI-04 X-Y USB-30 | 1 | 11 | 59 | 5 | 19 | 43 | 31 | 98 | 27 | 63 | 7 | 82 | 26 | 212561 | 5 | 20 | 55 | 30 | 99 | 27 | 70 | 21 | 68 | 19 | 211836 |
| MAD-23 X-Y USB-85 | 1 | 11 | 58 | 5 | 19 | 43 | 33 | 98 | 27 | 72 | 21 | -39 | 63 | 211767 | 5 | 20 | 55 | 31 | 99 | 27 | 81 | 33 | -13 | 56 | 211174 |
| CRO-08 X-Y USB-30 | 1 | 12 | 2 | 5 | 19 | 43 | 52 | 96 | 28 | -35 | 28 | -47 | 47 | 211369 | 5 | 20 | 55 | 53 | 97 | 28 | -47 | 18 | -66 | 41 | 212020 |
| GMM-24 X-Y USB-30 | 1 | 11 | 56 | 5 | 19 | 44 | 2 | 96 | 27 | -66 | 27 | -61 | 21 | 211391 | 5 | 20 | 55 | 58 | 97 | 27 | -65 | 12 | -76 | 25 | 212343 |
| ACN-75 X-Y USB-30 | 0 | 32 | 10 | 5 | 20 | 23 | 17 | 99 | 27 | 62 | 0 | 90 | 28 | 211704 | 5 | 20 | 55 | 27 | 99 | 27 | 61 | 7 | 83 | 29 | 212650 |
| ACN-75 X-Y USB-30 | 1 | 11 | 41 | 5 | 21 | 42 | 4 | 99 | 27 | 58 | 17 | 71 | 30 | 212132 | 5 | 22 | 53 | 45 | 100 | 27 | 52 | 30 | 53 | 32 | 211453 |
| CYI-04 X-Y USB-30 | 1 | 11 | 40 | 5 | 21 | 42 | 7 | 99 | 27 | 74 | 31 | 58 | 14 | 211374 | 5 | 22 | 53 | 47 | 100 | 27 | 79 | 45 | 44 | 8 | 210766 |
| MAD-23 X-Y USB-85 | 1 | 11 | 43 | 5 | 21 | 42 | 11 | 99 | 27 | 89 | 42 | -1 | 48 | 210820 | 5 | 22 | 53 | 53 | 100 | 27 | 101 | 55 | 7 | 34 | 210397 |
| CRO-08 X-Y USB-30 | 0 | 53 | 52 | 5 | 21 | 42 | 33 | 97 | 28 | -54 | 9 | -78 | 36 | 212530 | 5 | 22 | 36 | 25 | 98 | 27 | -59 | 0 | -90 | 31 | 212289 |
| GMM-24 X-Y USB-30 | 0 | 8 | 57 | 5 | 21 | 42 | 36 | 97 | 27 | -63 | 2 | -88 | 27 | 212985 | 5 | 21 | 51 | 33 | 97 | 27 | -62 | 0 | -90 | 28 | 212644 |

VEHICLE I RACAR TABLE

TRACKING TIME

STATION ACQUISITION DATA

STATION TERMINATION DATA

HRS MIN SEC

DAY HRS MIN SEC RA DEC AZ ELV X Y RANGE

DAY HRS MIN SEC RA DEC AZ ELV X Y RANGE

| | | | | | |
|----------------------|---------|------------|---------------------------|------------|---------------------------|
| BDA-02 X-Y USB-30 | 0 36 8 | 5 22 17 39 | 99 26 58 0 90 32 211844 | 5 22 53 47 | 100 27 62 6 83 27 212826 |
| ANG-91 X-Y USB-30 | 0 6 47 | 5 22 46 56 | 100 27 62 0 90 28 212829 | 5 22 53 42 | 100 27 62 1 88 28 213108 |
| BDA-02 X-Y USB-30 | 1 11 48 | 5 23 40 17 | 100 26 68 15 74 21 212386 | 6 0 52 6 | 101 27 75 29 61 13 211701 |
| ANG-91 X-Y USB-30 | 1 11 48 | 5 23 40 18 | 100 27 65 11 77 24 212599 | 6 0 52 6 | 101 27 68 26 62 20 211825 |
| GBM-41 X-Y USB-30 | 1 11 47 | 5 23 40 19 | 100 26 61 2 88 29 213162 | 6 0 52 7 | 101 27 68 16 73 21 212425 |
| MIL-71 X-Y USB-30 | 1 11 45 | 5 23 40 21 | 100 26 60 1 89 30 213220 | 6 0 52 5 | 101 27 67 14 75 22 212500 |
| ACN-75 X-Y USB-30 | 1 11 48 | 5 23 40 25 | 100 27 44 39 41 34 211105 | 6 0 52 13 | 101 27 29 49 22 35 210747 |
| CYI-04 X-Y USB-30 | 1 11 46 | 5 23 40 29 | 100 27 82 56 34 4 210452 | 6 0 52 15 | 101 27 88 71 19 1 210130 |
| MAD-23 X-Y USB-85 | 1 11 44 | 5 23 40 33 | 99 27 113 64 11 24 210206 | 6 0 52 17 | 100 27 145 74 13 9 210071 |
| TEX-16 X-Y USB-30 | 0 3 35 | 6 0 48 31 | 101 26 60 0 90 30 213160 | 6 0 52 7 | 101 26 60 1 89 30 213308 |

1-56

12
11
10
9
8
7
6
5
4
3
2

VEHICLE 1 RADAR TABLE

TRACKING TIME

STATION ACQUISITION DATA

STATION TERMINATION DATA

HRS MIN SEC

DAY HRS MIN SEC RA DEC AZ ELV X Y RANGE

DAY HRS MIN SEC RA DEC AZ ELV X Y RANGE

| | | | | | | | | | | | |
|----------------------|---------|-----------|--------|---------|--------|--------|-----------|--------|---------|--------|--------|
| GBM-41 X-Y USB-30 | 0 49 44 | 6 1 38 46 | 101 27 | 72 25 | 63 16 | 211947 | 6 2 28 31 | 102 27 | 75 35 | 54 12 | 210417 |
| MIL-71 X-Y USB-30 | 0 49 44 | 6 1 38 47 | 101 26 | 72 24 | 65 17 | 212027 | 6 2 28 31 | 102 27 | 76 34 | 55 12 | 210498 |
| ANG-91 X-Y USB-30 | 0 49 43 | 6 1 38 47 | 101 27 | 69 37 | 51 17 | 211364 | 6 2 28 31 | 102 27 | 69 47 | 41 14 | 209888 |
| TEX-16 X-Y USB-30 | 0 49 43 | 6 1 38 47 | 101 26 | 65 10 | 79 24 | 212830 | 6 2 28 31 | 102 26 | 70 19 | 69 19 | 211265 |
| BDA-02 X-Y USB-30 | 0 49 42 | 6 1 38 48 | 101 27 | 80 38 | 51 8 | 211290 | 6 2 28 31 | 102 27 | 85 48 | 42 3 | 209852 |
| CYI-04 X-Y USB-30 | 0 49 33 | 6 1 38 57 | 100 27 | 94 81 | 9 -1 | 210038 | 6 2 28 31 | 101 27 | -123 88 | -2 -1 | 208989 |
| ACN-75 X-Y USB-30 | 0 49 33 | 6 1 38 58 | 100 27 | 13 54 | 9 35 | 210649 | 6 2 28 31 | 101 27 | -5 55 | -3 35 | 209609 |
| MAD-23 X-Y USB-85 | 0 49 31 | 6 1 38 60 | 100 27 | -173 76 | 14 -2 | 210095 | 6 2 28 31 | 101 27 | -137 72 | 13 -12 | 209149 |
| GYM-14 X-Y USB-30 | 0 47 36 | 6 1 40 55 | 101 26 | 60 0 | 90 30 | 213322 | 6 2 28 31 | 102 26 | 65 9 | 81 25 | 211892 |
| GDS-28 X-Y USB-85 | 0 44 0 | 6 1 44 30 | 101 26 | 57 0 | -90 57 | 213140 | 6 2 28 31 | 102 26 | 63 7 | -75 62 | 211979 |

1-57

12
11
10
9
8
7
6

VEHICLE 1 RADAR TABLE

TRACKING TIME

STATION ACQUISITION DATA

STATION TERMINATION DATA

HRS MIN SEC

DAY HRS MIN SEC RA DEC AZ ELV X Y RANGE

DAY HRS MIN SEC RA DEC AZ ELV X Y RANGE

| | | | | | |
|----------------------|---------|-----------|---------------------------|-----------|----------------------------|
| STN-00 A-E USB150 | 0 28 30 | 6 2 0 1 | 101 26 56 0 90 34 212416 | 6 2 28 31 | 102 26 60 4 85 30 212144 |
| | | 31 JAN 71 | LM JETT TO TEI IGNITION | LAZ 72.1 | |
| GYM-14 X-Y USB-30 | 0 21 56 | 6 2 28 36 | 102 26 65 9 81 25 211894 | 6 2 50 32 | 102 26 67 13 76 23 212734 |
| TEX-16 X-Y USB-30 | 0 21 56 | 6 2 28 36 | 102 26 70 19 69 19 211267 | 6 2 50 32 | 102 26 71 24 65 17 212111 |
| GDS-28 X-Y USB-85 | 0 21 58 | 6 2 28 36 | 102 26 63 7 -75 62 211981 | 6 2 50 35 | 102 26 66 11 -65 63 212843 |
| GBM-41 X-Y USB-30 | 0 21 58 | 6 2 28 36 | 102 27 75 35 54 12 210419 | 6 2 50 35 | 102 27 77 40 49 10 211293 |
| STN-00 A-E USB150 | 0 21 58 | 6 2 28 36 | 102 26 60 4 85 30 212147 | 6 2 50 35 | 102 26 63 8 81 27 213018 |
| MIL-71 X-Y USB-30 | 0 21 59 | 6 2 28 36 | 102 27 76 34 55 12 210500 | 6 2 50 35 | 102 27 77 38 51 10 211373 |
| ANG-91 X-Y USB-30 | 0 22 0 | 6 2 28 36 | 102 27 69 47 41 14 209891 | 6 2 50 37 | 102 27 68 52 36 13 210800 |
| BDA-02 X-Y USB-30 | 0 22 4 | 6 2 28 36 | 102 27 85 48 42 3 209855 | 6 2 50 41 | 102 27 88 53 37 1 210780 |
| ACN-75 X-Y USB-30 | 0 22 18 | 6 2 28 36 | 101 27 -5 55 -3 35 209612 | 6 2 50 54 | 101 27 -13 54 -9 35 210746 |

158

VEHICLE 1 RADAR TABLE

| | TRACKING TIME | | | STATION ACQUISITION DATA | | | | | | | | | STATION TERMINATION DATA | | | | | | | | | | | | |
|----------------------|---------------|-----|-----|--------------------------|-----|-----|-----|-----|-----|------|-----|-----|--------------------------|--------|-----|-----|-----|-----|-----|-----|------|-----|-----|-----|--------|
| | HRS | MIN | SEC | DAY | HRS | MIN | SEC | RA | DEC | AZ | ELV | X | Y | RANGE | DAY | HRS | MIN | SEC | RA | DEC | AZ | ELV | X | Y | RANGE |
| CYI-04 X-Y USB-30 | 0 | 22 | 18 | 6 | 2 | 28 | 36 | 101 | 27 | -122 | 88 | -2 | -1 | 208992 | 6 | 2 | 50 | 54 | 101 | 27 | -98 | 84 | -6 | -1 | 210117 |
| MAD-23 X-Y USB-85 | 0 | 22 | 22 | 6 | 2 | 28 | 36 | 101 | 27 | -137 | 72 | 13 | -12 | 209153 | 6 | 2 | 50 | 59 | 101 | 27 | -126 | 69 | 13 | -17 | 210322 |
| GYM-14 X-Y USB-30 | 1 | 11 | 40 | 6 | 3 | 37 | 6 | 102 | 26 | 71 | 23 | 66 | 17 | 212257 | 6 | 4 | 48 | 45 | 103 | 26 | 77 | 37 | 52 | 11 | 211587 |
| GDS-23 X-Y USB-85 | 1 | 11 | 37 | 6 | 3 | 37 | 8 | 102 | 26 | 71 | 20 | -41 | 63 | 212401 | 6 | 4 | 48 | 45 | 103 | 26 | 79 | 33 | -16 | 55 | 211765 |
| TEX-16 X-Y USB-30 | 1 | 11 | 36 | 6 | 3 | 37 | 8 | 102 | 26 | 75 | 34 | 55 | 12 | 211661 | 6 | 4 | 48 | 45 | 103 | 26 | 80 | 48 | 41 | 6 | 211078 |
| STN-00 A-E USB150 | 1 | 11 | 36 | 6 | 3 | 37 | 9 | 102 | 26 | 69 | 17 | 72 | 20 | 212591 | 6 | 4 | 48 | 44 | 103 | 26 | 78 | 29 | 60 | 10 | 211960 |
| MIL-71 X-Y USB-30 | 1 | 11 | 39 | 6 | 3 | 37 | 10 | 102 | 26 | 81 | 49 | 41 | 6 | 211002 | 6 | 4 | 48 | 49 | 103 | 27 | 87 | 63 | 27 | 1 | 210586 |
| GBM-41 X-Y USB-30 | 1 | 11 | 39 | 6 | 3 | 37 | 11 | 102 | 27 | 80 | 50 | 39 | 7 | 210929 | 6 | 4 | 48 | 49 | 103 | 27 | 84 | 65 | 24 | 3 | 210534 |
| ANG-91 X-Y USB-30 | 1 | 11 | 39 | 6 | 3 | 37 | 13 | 102 | 27 | 64 | 62 | 25 | 11 | 210531 | 6 | 4 | 48 | 52 | 103 | 27 | 44 | 76 | 10 | 10 | 210328 |
| BDA-02 X-Y USB-30 | 1 | 11 | 41 | 6 | 3 | 37 | 14 | 102 | 26 | 94 | 63 | 27 | -2 | 210524 | 6 | 4 | 48 | 55 | 103 | 26 | 113 | 77 | 12 | -5 | 210321 |

1-59

VEHICLE 1 RADAR TABLE

TRACKING TIME

STATION ACQUISITION DATA

STATION TERMINATION DATA

| HRS MIN SEC | | | DAY | HRS | MIN | SEC | RA | DEC | AZ | ELV | X | Y | RANGE | DAY | HRS | MIN | SEC | RA | DEC | AZ | ELV | X | Y | RANGE | | |
|-----------------------------------------------------|----|----|-----|-----|-----|-----|----|-----|----|------|----|-----|-------|--------|-----|-----|-----|----|-----|----|-----|----|-----|-------|--------|--|
| ACN-75 | 1 | 11 | 39 | 6 | 3 | 37 | 28 | 101 | 27 | -29 | 50 | -22 | 35 | 210938 | 6 | 4 | 49 | 7 | 102 | 27 | -45 | 40 | -40 | 33 | 211469 | |
| X-Y USB-30 | | | | | | | | | | | | | | | | | | | | | | | | | | |
| CYI-C4 | 1 | 11 | 39 | 6 | 3 | 37 | 29 | 101 | 27 | -89 | 73 | -17 | 0 | 210283 | 6 | 4 | 49 | 8 | 102 | 26 | -84 | 58 | -32 | 3 | 210758 | |
| X-Y USB-30 | | | | | | | | | | | | | | | | | | | | | | | | | | |
| MAD-23 | 1 | 11 | 37 | 6 | 3 | 37 | 31 | 101 | 26 | -109 | 61 | 10 | -27 | 210559 | 6 | 4 | 49 | 8 | 102 | 26 | -95 | 48 | 4 | -41 | 211100 | |
| X-Y USB-85 | | | | | | | | | | | | | | | | | | | | | | | | | | |
| 31 JAN 71 TEI TO ENTRY INTERFACE LAZ 72.1 | | | | | | | | | | | | | | | | | | | | | | | | | | |
| HAW-12 | 13 | 16 | 12 | 6 | 5 | 25 | 22 | 103 | 26 | 62 | 1 | 89 | 28 | 214047 | 6 | 18 | 41 | 34 | 102 | 25 | -62 | 0 | -90 | 28 | 187404 | |
| X-Y USB-30 | | | | | | | | | | | | | | | | | | | | | | | | | | |
| STN-00 | 11 | 26 | 54 | 6 | 5 | 25 | 24 | 103 | 26 | 83 | 37 | 53 | 6 | 212064 | 6 | 16 | 52 | 18 | 102 | 25 | -57 | 0 | -90 | 33 | 191064 | |
| A-E USB150 | | | | | | | | | | | | | | | | | | | | | | | | | | |
| GYM-14 | 10 | 14 | 22 | 6 | 5 | 25 | 25 | 103 | 26 | 80 | 45 | 45 | 7 | 211692 | 6 | 15 | 39 | 47 | 101 | 26 | -61 | 0 | -90 | 29 | 193473 | |
| X-Y USB-30 | | | | | | | | | | | | | | | | | | | | | | | | | | |
| GDS-28 | 10 | 59 | 16 | 6 | 5 | 25 | 25 | 103 | 26 | 84 | 41 | -7 | 49 | 211875 | 6 | 16 | 24 | 41 | 102 | 25 | -58 | 0 | -90 | -58 | 191988 | |
| X-Y USB-85 | | | | | | | | | | | | | | | | | | | | | | | | | | |
| TEX-16 | 9 | 20 | 34 | 6 | 5 | 25 | 27 | 103 | 26 | 83 | 57 | 33 | 4 | 211250 | 6 | 14 | 46 | 0 | 102 | 26 | -61 | 0 | -90 | 29 | 195230 | |
| X-Y USB-30 | | | | | | | | | | | | | | | | | | | | | | | | | | |
| MIL-71 | 8 | 16 | 11 | 6 | 5 | 25 | 29 | 103 | 26 | 91 | 72 | 18 | 0 | 210865 | 6 | 13 | 41 | 40 | 101 | 26 | -61 | 0 | -90 | 29 | 197334 | |
| X-Y USB-30 | | | | | | | | | | | | | | | | | | | | | | | | | | |
| GBM-41 | 8 | 1 | 37 | 6 | 5 | 25 | 29 | 103 | 27 | 86 | 74 | 16 | 1 | 210826 | 6 | 13 | 27 | 6 | 101 | 26 | -61 | 0 | -90 | 29 | 197811 | |
| X-Y USB-30 | | | | | | | | | | | | | | | | | | | | | | | | | | |

09-1

VEHICLE 1 RADAR TABLE

TRACKING TIME

STATION ACQUISITION DATA

STATION TERMINATION DATA

HRS MIN SEC

DAY

HRS MIN SEC

RA DEC

AZ ELV

X

Y

RANGE

DAY

HRS MIN SEC

RA DEC

AZ ELV

X

Y

RANGE

| | | | | | | | | | | | | | | |
|----------------------|----------|---|----------|--------|--------|-----|-----|--------|---|----------|--------|-----|-------|------------|
| ANG-91 X-Y USB-30 | 6 33 32 | 6 | 5 25 32 | 102 27 | 7 80 | 1 | 10 | 210740 | 6 | 11 59 4 | 101 26 | -63 | 0 -90 | 27 200684 |
| BDA-02 X-Y USB-30 | 7 22 11 | 6 | 5 25 32 | 102 26 | 147 83 | 4 | -6 | 210717 | 6 | 12 47 43 | 101 26 | -59 | 0 -90 | 31 199104 |
| MAD-23 X-Y USB-85 | 3 46 54 | 6 | 5 25 38 | 102 26 | -89 41 | -2 | -49 | 211852 | 6 | 9 12 32 | 101 26 | -55 | 0 -90 | -55 206131 |
| CYI-04 X-Y USB-30 | 3 53 53 | 6 | 5 25 38 | 102 26 | -81 50 | -40 | 6 | 211496 | 6 | 9 19 32 | 101 26 | -60 | 0 -90 | 30 205898 |
| ACN-75 X-Y USB-30 | 2 33 23 | 6 | 5 25 40 | 102 27 | -51 33 | -50 | 32 | 212248 | 6 | 7 59 3 | 101 27 | -63 | 0 -90 | 27 208574 |
| GWM-24 X-Y USB-30 | 12 45 41 | 6 | 9 19 56 | 103 26 | 63 0 | 90 | 27 | 205887 | 6 | 22 5 37 | 102 25 | -64 | 0 -90 | 26 180405 |
| HSK-25 X-Y USB-85 | 9 5 48 | 6 | 10 54 9 | 103 27 | 56 0 | -90 | 56 | 202797 | 6 | 19 59 57 | 102 26 | -57 | 0 -90 | -57 184733 |
| CRO-08 X-Y USB-30 | 10 6 56 | 6 | 12 44 58 | 103 27 | 60 0 | 90 | 30 | 199181 | 6 | 22 51 54 | 102 26 | -61 | 0 -90 | 29 178780 |
| PKS-96 H-D USB210 | 0 26 18 | 6 | 15 14 47 | 103 27 | 4 30 | 7 | 60 | 192555 | 6 | 15 41 6 | 103 27 | -3 | 30 -5 | 60 191676 |
| MAD-23 X-Y USB-85 | 15 0 47 | 6 | 18 8 1 | 104 25 | 56 0 | -90 | 56 | 188534 | 7 | 9 8 48 | 104 24 | -58 | 0 -90 | -58 155841 |

19-T

12
11
10
9
8
7
6
5

VEHICLE I RADAR TABLE

| VEHICLE | TRACKING TIME | | | STATION ACQUISITION DATA | | | | | | | | STATION TERMINATION DATA | | | | | | | | | | | | | |
|----------------------|---------------|-----|-----|--------------------------|-----|-----|-----|-----|-----|----|-----|--------------------------|----|--------|-----|-----|-----|-----|-----|-----|-----|-----|-----|-----|--------|
| | HRS | MIN | SEC | DAY | HRS | MIN | SEC | RA | DEC | AZ | ELV | X | Y | RANGE | DAY | HRS | MIN | SEC | RA | DEC | AZ | ELV | X | Y | RANGE |
| CYI-04 X-Y USB-30 | 13 | 47 | 58 | 6 | 19 | 31 | 54 | 104 | 25 | 61 | 0 | 90 | 29 | 185699 | 7 | 9 | 19 | 51 | 103 | 24 | -63 | 0 | -90 | 27 | 155403 |
| ACN-75 X-Y USB-30 | 11 | 23 | 18 | 6 | 20 | 40 | 42 | 104 | 26 | 64 | 0 | 90 | 26 | 183341 | 7 | 8 | 4 | 1 | 103 | 25 | -65 | 0 | -90 | 25 | 158380 |
| BDA-02 X-Y USB-30 | 14 | 9 | 46 | 6 | 22 | 37 | 46 | 104 | 25 | 60 | 0 | 90 | 30 | 179284 | 7 | 12 | 47 | 32 | 104 | 24 | -62 | 0 | -90 | 28 | 146977 |
| ANG-91 X-Y USB-30 | 12 | 59 | 36 | 6 | 23 | 2 | 18 | 104 | 25 | 64 | 0 | 90 | 26 | 178421 | 7 | 12 | 1 | 54 | 104 | 24 | -65 | 0 | -90 | 25 | 148861 |
| GBM-41 X-Y USB-30 | 13 | 41 | 4 | 6 | 23 | 47 | 15 | 104 | 25 | 62 | 0 | 90 | 28 | 176835 | 7 | 13 | 28 | 19 | 104 | 24 | -63 | 0 | -90 | 27 | 145275 |
| MIL-71 X-Y USB-30 | 13 | 49 | 52 | 6 | 23 | 52 | 31 | 104 | 25 | 61 | 0 | 90 | 29 | 176649 | 7 | 13 | 42 | 23 | 104 | 24 | -63 | 0 | -90 | 27 | 144683 |
| TEX-16 X-Y USB-30 | 13 | 45 | 21 | 7 | 1 | 2 | 4 | 105 | 25 | 62 | 0 | 90 | 28 | 174166 | 7 | 14 | 47 | 25 | 104 | 23 | -63 | 0 | -90 | 27 | 141926 |
| GYM-14 X-Y USB-30 | 13 | 46 | 24 | 7 | 1 | 55 | 11 | 105 | 25 | 62 | 0 | 90 | 28 | 172250 | 7 | 15 | 41 | 35 | 104 | 23 | -63 | 0 | -90 | 27 | 139594 |
| GDS-28 X-Y USB-85 | 14 | 24 | 18 | 7 | 2 | 0 | 15 | 105 | 25 | 59 | 0 | -90 | 59 | 172066 | 7 | 16 | 24 | 33 | 105 | 23 | -61 | 0 | -90 | -61 | 137725 |
| STN-00 A-E USB150 | 14 | 36 | 1 | 7 | 2 | 15 | 29 | 105 | 25 | 58 | 0 | 90 | 32 | 171512 | 7 | 16 | 51 | 30 | 105 | 23 | -61 | 0 | -90 | 29 | 136541 |

1-62

VEHICLE 1 RADAR TABLE

TRACKING TIME

STATION ACQUISITION DATA

STATION TERMINATION DATA

HRS MIN SEC

DAY HRS MIN SEC

RA DEC

AZ ELV

X

Y

RANGE

DAY HRS MIN SEC

RA DEC

AZ ELV

X

Y

RANGE

| | | | | | | | | | | | |
|----------------------|----------|------------|--------|----------|----|--------|------------|------------|--------|-----|--------|
| HAW-12 X-Y USB-30 | 13 19 9 | 7 5 26 35 | 105 25 | 63 0 90 | 27 | 164427 | 7 18 45 44 | 105 23 -65 | 0 -90 | 25 | 131426 |
| GWM-24 X-Y USB-30 | 12 43 21 | 7 9 29 35 | 106 24 | 65 0 90 | 25 | 155015 | 7 22 12 56 | 105 23 -67 | 0 -90 | 23 | 121735 |
| HSK-25 X-Y USB-85 | 9 20 55 | 7 10 56 27 | 106 25 | 58 0 -90 | 58 | 151523 | 7 20 17 21 | 105 24 -59 | 0 -90 | -59 | 127203 |
| CRO-C8 X-Y USB-30 | 10 18 32 | 7 12 49 48 | 106 25 | 62 0 90 | 28 | 146875 | 7 23 8 21 | 106 24 -64 | 0 -90 | 26 | 119039 |
| PKS-96 H-D USB210 | 1 59 46 | 7 14 39 49 | 106 25 | 15 30 25 | 57 | 140528 | 7 16 39 35 | 106 25 -16 | 30 -26 | 56 | 135342 |
| MAD-23 X-Y USB-85 | 14 37 2 | 7 18 30 58 | 107 23 | 60 0 -90 | 60 | 132098 | 8 9 7 60 | 109 19 -64 | 0 -90 | -64 | 86436 |
| CYI-04 X-Y USB-30 | 13 35 45 | 7 19 51 20 | 108 23 | 64 0 90 | 26 | 128420 | 8 9 27 5 | 109 19 -68 | 0 -90 | 22 | 85265 |
| ACN-75 X-Y USB-30 | 11 30 54 | 7 20 52 55 | 109 24 | 66 0 90 | 24 | 125541 | 8 8 23 49 | 108 21 -69 | 0 -90 | 21 | 89101 |
| BDA-02 X-Y USB-30 | 13 51 56 | 7 23 1 38 | 109 22 | 64 0 90 | 26 | 119375 | 8 12 53 35 | 111 18 -69 | 0 -90 | 21 | 71873 |
| ANG-91 X-Y USB-30 | 12 54 38 | 7 23 21 48 | 109 22 | 66 0 90 | 24 | 118384 | 8 12 16 26 | 110 19 -70 | 0 -90 | 20 | 74388 |

1-63

12
11
10
9
8
7

VEHICLE I RADAR TABLE

TRACKING TIME

STATION ACQUISITION DATA

STATION TERMINATION DATA

HRS MIN SEC

DAY HRS MIN SEC RA DEC AZ ELV X Y RANGE

DAY HRS MIN SEC RA DEC AZ ELV X Y RANGE

| | | | | | |
|----------------------|----------|------------|---------------------------|------------|----------------------------|
| GBM-41 X-Y USB-30 | 13 28 10 | 8 0 10 28 | 109 22 65 0 90 25 115974 | 8 13 38 38 | 111 17 -70 0 -90 20 68743 |
| MIL-71 X-Y USB-30 | 13 35 18 | 8 0 16 27 | 109 22 65 0 90 25 115676 | 8 13 51 44 | 111 17 -70 0 -90 20 67818 |
| TEX-16 X-Y USB-30 | 13 31 11 | 8 1 26 57 | 110 22 65 0 90 25 112110 | 8 14 58 8 | 112 17 -71 0 -90 19 63006 |
| GYM-14 X-Y USB-30 | 13 31 35 | 8 2 21 19 | 110 22 65 0 90 25 109303 | 8 15 52 55 | 113 16 -72 0 -90 18 58867 |
| GDS-28 X-Y USB-85 | 13 59 38 | 8 2 29 43 | 110 21 64 0 -90 64 108866 | 8 16 29 21 | 114 15 -72 0 -90 -72 56021 |
| STN-00 A-E USB150 | 14 7 41 | 8 2 46 23 | 110 21 63 0 90 27 107993 | 8 16 54 4 | 114 14 -72 0 -90 18 54042 |
| HAW-12 X-Y USB-30 | 13 11 7 | 8 5 55 33 | 112 21 67 0 90 23 97708 | 8 19 6 40 | 116 12 -77 0 -90 13 42628 |
| GWM-24 X-Y USB-30 | 13 3 30 | 8 10 2 44 | 114 20 70 0 90 20 83048 | 8 23 6 15 | 126 -3 -93 0 -90 -3 15757 |
| HSK-25 X-Y USB-85 | 10 55 32 | 8 11 11 42 | 114 22 63 0 -90 63 78650 | 8 22 7 14 | 123 11 -76 0 -90 -76 23665 |
| CRO-08 X-Y USB-30 | 11 8 37 | 8 13 14 7 | 116 20 68 0 90 22 70451 | 9 0 22 44 | -45 -38 132 0 90 -42 1666 |

VEHICLE 1 RADAR TABLE

TRACKING TIME

STATION ACQUISITION DATA

STATION TERMINATION DATA

| | HRS | MIN | SEC | DAY | HRS | MIN | SEC | RA | DEC | AZ | ELV | X | Y | RANGE | DAY | HRS | MIN | SEC | RA | DEC | AZ | ELV | X | Y | RANGE |
|----------------------|-----|-----|-----|-----|-----|-----|-----|-----|-----|-----|-----|-----|-----|-------|-----|-----|-----|-----|------|-----|-----|-----|-----|-----|-------|
| PKS-96 H-D USB210 | 4 | 9 | 28 | 8 | 14 | 22 | 19 | 116 | 21 | 30 | 30 | 41 | 48 | 63919 | 8 | 18 | 31 | 47 | 117 | 18 | -37 | 30 | -46 | 44 | 44082 |
| MAD-23 X-Y USB-85 | 2 | 15 | 56 | 8 | 20 | 55 | 46 | 130 | 7 | 81 | 0 | -90 | 81 | 31847 | 8 | 23 | 11 | 42 | 149 | -10 | 103 | 0 | 90 | 77 | 14945 |
| TAN-22 A-E FPS-16 | 2 | 23 | 14 | 8 | 21 | 50 | 13 | 133 | 11 | 50 | 45 | 37 | 27 | 23398 | 9 | 0 | 13 | 27 | -126 | -25 | 117 | 0 | 90 | -27 | 3837 |
| PRE-76 A-E MPS-25 | 2 | 11 | 52 | 8 | 21 | 57 | 16 | 135 | 11 | 61 | 26 | 60 | 26 | 23400 | 9 | 0 | 9 | 8 | -148 | -15 | 107 | 0 | 90 | -17 | 4792 |
| HSK-25 X-Y USB-85 | 0 | 25 | 50 | 9 | 0 | 0 | 48 | 140 | -5 | -96 | 0 | 90 | -84 | 6523 | 9 | 0 | 26 | 38 | -24 | -9 | 101 | 0 | 90 | 79 | 749 |

TABLE 1.1-V.- MISSION RADAR TIMELINE - Continued

(b) LM acquisition and termination during descent - 0° minimum elevation

31 JAN 71 LM FROM UNDOCK TO LANDING

| VEHICLE | RADAR TABLE | | | STATION ACQUISITION DATA | | | | | | | | | | | STATION TERMINATION DATA | | | | | | | | | | |
|-----------------------|---------------|-----|-----|--------------------------|-----|-----|-----|----|-----|------|-----|-----|-----|--------|--------------------------|-----|-----|-----|----|-----|------|-----|-----|-----|--------|
| | TRACKING TIME | | | DAY | HRS | MIN | SEC | RA | DEC | AZ | ELV | X | Y | RANGE | DAY | HRS | MIN | SEC | RA | DEC | AZ | ELV | X | Y | RANGE |
| | HRS | MIN | SEC | | | | | | | | | | | | | | | | | | | | | | |
| GWM-24 X-Y USB-30 | 0 | 56 | 33 | 4 | 8 | 27 | 31 | 77 | 27 | 64 | 10 | 79 | 26 | 208890 | 4 | 9 | 24 | 4 | 78 | 28 | 65 | 22 | 68 | 23 | 208724 |
| HAW-12 X-Y USB-30 | 0 | 56 | 43 | 4 | 8 | 27 | 31 | 76 | 28 | 72 | 63 | 26 | 8 | 206446 | 4 | 9 | 24 | 13 | 77 | 28 | 65 | 74 | 14 | 6 | 206704 |
| GYM-14 X-Y USB-30 | 0 | 56 | 50 | 4 | 8 | 27 | 31 | 75 | 28 | -8A | 72 | -18 | 1 | 206243 | 4 | 9 | 24 | 21 | 76 | 28 | -82 | 60 | -30 | 4 | 207034 |
| STN-00 A-E USB-150 | 0 | 56 | 51 | 4 | 8 | 27 | 31 | 76 | 27 | -141 | 78 | -8 | -10 | 206155 | 4 | 9 | 24 | 22 | 77 | 28 | -111 | 69 | -20 | -8 | 206812 |
| GDS-28 X-Y USB-85 | 0 | 56 | 54 | 4 | 8 | 27 | 31 | 75 | 27 | -119 | 76 | 7 | -13 | 206182 | 4 | 9 | 24 | 24 | 76 | 28 | -101 | 65 | 5 | -24 | 206896 |
| TEX-16 X-Y USB-30 | 0 | 56 | 57 | 4 | 8 | 27 | 31 | 75 | 28 | -82 | 60 | -30 | 4 | 206531 | 4 | 9 | 24 | 28 | 76 | 28 | -78 | 48 | -41 | 8 | 207450 |
| GBM-41 X-Y USB-30 | 0 | 56 | 58 | 4 | 8 | 27 | 31 | 75 | 27 | -76 | 43 | -46 | 10 | 207163 | 4 | 9 | 24 | 29 | 76 | 28 | -73 | 31 | -57 | 15 | 208220 |
| MIL-71 X-Y USB-30 | 0 | 56 | 59 | 4 | 8 | 27 | 31 | 75 | 27 | -79 | 45 | -44 | 8 | 207054 | 4 | 9 | 24 | 30 | 76 | 28 | -74 | 34 | -55 | 13 | 208088 |
| ANG-91 X-Y USB-30 | 0 | 57 | 1 | 4 | 8 | 27 | 31 | 75 | 27 | -67 | 25 | -63 | 21 | 208035 | 4 | 9 | 24 | 32 | 76 | 28 | -65 | 14 | -75 | 24 | 209203 |
| BDA-02 X-Y USB-30 | 0 | 57 | 1 | 4 | 8 | 27 | 31 | 75 | 27 | -76 | 33 | -57 | 12 | 207646 | 4 | 9 | 24 | 32 | 76 | 27 | -71 | 22 | -67 | 18 | 208731 |

1-66

| VEHICLE | RADAR TABLE | | | | | | | | | | | | | | | | | | | | | | | | |
|----------------------|---------------|-----|-----|--------------------------|-----|-----|-----|----|-----|-----|--------------------------|-----|-----|--------|-----|-----|-----|-----|----|-----|-----|-----|-----|-----|--------|
| | TRACKING TIME | | | STATION ACQUISITION DATA | | | | | | | STATION TERMINATION DATA | | | | | | | | | | | | | | |
| | HRS | MIN | SEC | DAY | HRS | MIN | SEC | RA | DEC | AZ | ELV | X | Y | RANGE | DAY | HRS | MIN | SEC | RA | DEC | AZ | ELV | X | Y | RANGE |
| GMH-24 X-Y USB-30 | 1 | 5 | 6 | 4 | 10 | 12 | 33 | 78 | 28 | 65 | 32 | 55 | 21 | 208277 | 4 | 11 | 17 | 39 | 79 | 28 | 63 | 46 | 41 | 18 | 207688 |
| MSK-25 X-Y USB-85 | 1 | 5 | 5 | 4 | 10 | 12 | 33 | 78 | 28 | 47 | 7 | -79 | 47 | 209670 | 4 | 11 | 17 | 38 | 79 | 29 | 36 | 15 | -71 | 35 | 209223 |
| HAW-12 X-Y USB-30 | 1 | 4 | 57 | 4 | 10 | 12 | 55 | 77 | 28 | 29 | 84 | 3 | 6 | 204705 | 4 | 11 | 17 | 53 | 78 | 28 | -59 | 78 | -10 | 6 | 206818 |
| STN-00 A-E USB150 | 1 | 4 | 59 | 4 | 10 | 13 | 7 | 76 | 27 | -99 | 59 | -30 | -4 | 207147 | 4 | 11 | 18 | 5 | 77 | 28 | -88 | 47 | -43 | 1 | 207651 |
| GDS-28 X-Y USB-85 | 1 | 4 | 52 | 4 | 10 | 13 | 12 | 76 | 27 | -92 | 55 | 1 | -35 | 207274 | 4 | 11 | 18 | 4 | 77 | 28 | -83 | 43 | -7 | -47 | 207837 |
| GYM-14 X-Y USB-30 | 1 | 4 | 54 | 4 | 10 | 13 | 14 | 76 | 28 | -79 | 49 | -40 | 7 | 207487 | 4 | 11 | 18 | 8 | 77 | 28 | -75 | 36 | -53 | 12 | 208144 |
| BDA-02 X-Y USB-30 | 1 | 4 | 53 | 4 | 10 | 13 | 16 | 76 | 27 | -65 | 12 | -77 | 24 | 209356 | 4 | 11 | 18 | 10 | 77 | 27 | -58 | 1 | -89 | 32 | 210110 |
| GBM-41 X-Y USB-30 | 1 | 4 | 53 | 4 | 10 | 13 | 18 | 76 | 27 | -69 | 21 | -68 | 20 | 20A852 | 4 | 11 | 18 | 11 | 77 | 27 | -64 | 2 | -80 | 26 | 209658 |
| TEX-16 X-Y USB-30 | 1 | 4 | 51 | 4 | 10 | 13 | 19 | 76 | 27 | -75 | 38 | -51 | 12 | 207989 | 4 | 11 | 18 | 9 | 77 | 28 | -71 | 25 | -64 | 18 | 208734 |
| MIL-71 X-Y USB-30 | 1 | 4 | 50 | 4 | 10 | 13 | 21 | 76 | 27 | -71 | 24 | -65 | 18 | 20A701 | 4 | 11 | 18 | 10 | 77 | 27 | -65 | 11 | -77 | 25 | 209493 |

1-67

VEHICLE RADAR TABLE

| VEHICLE | TRACKING TIME | | | STATION ACQUISITION DATA | | | | | | | | STATION TERMINATION DATA | | | | | | | | | | | | | |
|----------------------|---------------|-----|-----|--------------------------|-----|-----|-----|----|-----|-----|-----|--------------------------|-----|--------|-----|-----|-----|-----|----|-----|-----|-----|-----|-----|--------|
| | HRS | MIN | SEC | DAY | HRS | MIN | SEC | RA | DEC | AZ | ELV | X | Y | RANGE | DAY | HRS | MIN | SEC | RA | DEC | AZ | ELV | X | Y | RANGE |
| ANG-91 X-Y USB-30 | 0 | 14 | 53 | 4 | 10 | 13 | 22 | 76 | 27 | -62 | 3 | -87 | 28 | 209897 | 4 | 10 | 28 | 15 | 76 | 27 | -61 | 0 | -90 | 29 | 209333 |
| CRO-08 X-Y USB-30 | 0 | 35 | 20 | 4 | 12 | 6 | 41 | 79 | 28 | 53 | 9 | 79 | 36 | 209726 | 4 | 12 | 42 | 1 | 79 | 28 | 48 | 15 | 71 | 40 | 208218 |
| MSK-25 X-Y USB-85 | 0 | 35 | 13 | 4 | 12 | 6 | 48 | 78 | 29 | 26 | 21 | -67 | 24 | 209038 | 4 | 12 | 42 | 1 | 79 | 29 | 19 | 23 | -66 | 17 | 207735 |
| GWM-24 X-Y USB-30 | 0 | 35 | 12 | 4 | 12 | 6 | 49 | 78 | 28 | 59 | 57 | 29 | 16 | 207406 | 4 | 12 | 42 | 1 | 79 | 28 | 53 | 63 | 22 | 16 | 206043 |
| HAW-12 X-Y USB-30 | 0 | 34 | 53 | 4 | 12 | 7 | 8 | 78 | 28 | -71 | 67 | -22 | 7 | 207097 | 4 | 12 | 42 | 1 | 78 | 28 | -72 | 60 | -29 | 9 | 206138 |
| STN-00 A-E USB150 | 0 | 34 | 45 | 4 | 12 | 7 | 16 | 77 | 27 | -82 | 37 | -52 | 7 | 208162 | 4 | 12 | 42 | 1 | 78 | 27 | -78 | 31 | -58 | 11 | 207330 |
| GDS-28 X-Y USB-85 | 0 | 34 | 44 | 4 | 12 | 7 | 17 | 77 | 27 | -78 | 33 | -18 | -55 | 208386 | 4 | 12 | 42 | 1 | 78 | 27 | -74 | 26 | -29 | -59 | 207575 |
| GYM-14 X-Y USB-30 | 0 | 34 | 44 | 4 | 12 | 7 | 17 | 77 | 27 | -71 | 26 | -63 | 17 | 208755 | 4 | 12 | 42 | 1 | 78 | 27 | -68 | 19 | -70 | 20 | 207983 |
| TEX-16 X-Y USB-30 | 0 | 34 | 42 | 4 | 12 | 7 | 19 | 77 | 27 | -66 | 15 | -74 | 23 | 209380 | 4 | 12 | 42 | 1 | 78 | 27 | -63 | 8 | -81 | 26 | 208618 |
| MIL-71 X-Y USB-30 | 0 | 9 | 26 | 4 | 12 | 7 | 20 | 77 | 27 | -60 | 2 | -88 | 30 | 210137 | 4 | 12 | 16 | 46 | 77 | 27 | -59 | 0 | -90 | 31 | 209758 |

89-1

152

1.1-V (c)

TABLE 1.1-V.- MISSION RADAR TIMELINE - Continued

(c) LM acquisition and termination during ascent - 0° minimum elevation

31 JAN 71 LM ASCENT TO INSERTION

| VEHICLE | RADAR TABLE | | | STATION ACQUISITION DATA | | | | | | | | | | STATION TERMINATION DATA | | | | | | | | | | | |
|----------------------|---------------|---|----|--------------------------|-----|-----|-----|-----|-----|-----|-----|-----|----|--------------------------|-----|-----|-----|-----|-----|-----|-----|-----|-----|----|--------|
| | TRACKING TIME | | | DAY | HRS | MIN | SEC | RA | DEC | AZ | ELV | X | Y | RANGE | DAY | HRS | MIN | SEC | RA | DEC | AZ | ELV | X | Y | RANGE |
| HAB-23 R-Y USB-85 | 0 | 7 | 11 | 5 | 22 | 24 | 29 | 99 | 27 | 95 | 50 | 4 | 40 | 209365 | 5 | 22 | 31 | 40 | 99 | 27 | 97 | 51 | 5 | 39 | 209401 |
| BDA-02 R-Y USB-30 | 0 | 7 | 11 | 5 | 22 | 24 | 29 | 100 | 26 | 59 | 1 | 89 | 31 | 211913 | 5 | 22 | 31 | 40 | 100 | 26 | 60 | 2 | 87 | 30 | 211923 |
| CVI-04 R-Y USB-30 | 0 | 7 | 11 | 5 | 22 | 24 | 29 | 99 | 27 | 77 | 39 | 50 | 10 | 209814 | 5 | 22 | 31 | 40 | 100 | 27 | 77 | 41 | 49 | 10 | 209831 |
| ACH-75 R-Y USB-30 | 0 | 7 | 11 | 5 | 22 | 24 | 29 | 100 | 27 | 55 | 25 | 40 | 32 | 210524 | 5 | 22 | 31 | 40 | 100 | 27 | 59 | 26 | 59 | 32 | 210537 |
| CRO-08 R-Y USB-30 | 0 | 7 | 11 | 5 | 22 | 24 | 29 | 98 | 27 | -58 | 2 | -87 | 32 | 211842 | 5 | 22 | 31 | 40 | 98 | 27 | -59 | 1 | -89 | 31 | 212009 |

TABLE 1.1-V.- MISSION RADAR TIMELINE - Continued

(d) LM acquisition and termination during rendezvous - 0° minimum elevation

COAST TO RENDEZVOUS RADAR TRACKING PRIOR TO TPI

VEHICLE 2 RADAR TABLE

| VEHICLE | 2 | TRACKING TIME | | | STATION ACQUISITION DATA | | | | | | | | STATION TERMINATION DATA | | | | | | | | | | | | | | |
|----------------------------------------|---|---------------|-----|-----|--------------------------|-----|-----|-----|----|-----|----|-----|--------------------------|--------|-------|-----|-----|-----|-----|----|-----|----|-----|----|--------|-------|--|
| | | HRS | MIN | SEC | DAY | HRS | MIN | SEC | RA | DEC | AZ | ELV | X | Y | RANGE | DAY | HRS | MIN | SEC | RA | DEC | AZ | ELV | X | Y | RANGE | |
| CRO-08 X-Y USB-30 | 0 | 4 | 37 | 5 | 22 | 31 | 40 | 98 | 27 | -59 | 1 | -89 | 31 | 211999 | 5 | 22 | 36 | 17 | 98 | 27 | -59 | 0 | -90 | 31 | 212218 | | |
| MAD-23 X-Y USB-85 | 0 | 9 | 60 | 5 | 22 | 31 | 40 | 99 | 27 | 97 | 51 | 5 | 39 | 209395 | 5 | 22 | 41 | 40 | 100 | 27 | 98 | 53 | 6 | 37 | 209751 | | |
| BDA-02 X-Y USB-30 | 0 | 9 | 60 | 5 | 22 | 31 | 40 | 100 | 26 | 60 | 2 | 87 | 30 | 211918 | 5 | 22 | 41 | 40 | 100 | 27 | 61 | 4 | 85 | 29 | 212236 | | |
| CYI-04 X-Y USB-30 | 0 | 9 | 60 | 5 | 22 | 31 | 40 | 100 | 27 | 77 | 41 | 49 | 10 | 209825 | 5 | 22 | 41 | 40 | 100 | 27 | 78 | 43 | 47 | 9 | 210156 | | |
| ACN-75 X-Y USB-30 | 0 | 9 | 60 | 5 | 22 | 31 | 40 | 100 | 27 | 54 | 26 | 59 | 32 | 210531 | 5 | 22 | 41 | 40 | 100 | 27 | 53 | 28 | 56 | 32 | 210854 | | |
| RENDEZVOUS RADAR TRACKING PRIOR TO TPI | | | | | | | | | | | | | | | | | | | | | | | | | | | |
| ACN-75 X-Y USB-30 | 0 | 11 | 21 | 5 | 22 | 41 | 40 | 100 | 27 | 53 | 28 | 56 | 32 | 210854 | 5 | 22 | 53 | 1 | 100 | 27 | 52 | 30 | 53 | 32 | 211358 | | |
| BDA-02 X-Y USB-30 | 0 | 11 | 22 | 5 | 22 | 41 | 40 | 100 | 27 | 61 | 4 | 85 | 29 | 212236 | 5 | 22 | 53 | 2 | 100 | 27 | 62 | 6 | 83 | 28 | 212732 | | |
| CYI-04 X-Y USB-30 | 0 | 11 | 23 | 5 | 22 | 41 | 40 | 100 | 27 | 78 | 43 | 47 | 9 | 210156 | 5 | 22 | 53 | 3 | 100 | 27 | 79 | 45 | 44 | 8 | 210671 | | |
| MAD-23 X-Y USB-85 | 0 | 11 | 27 | 5 | 22 | 41 | 40 | 100 | 27 | 98 | 53 | 6 | 37 | 209751 | 5 | 22 | 53 | 7 | 100 | 27 | 101 | 55 | 7 | 34 | 210299 | | |
| ANG-91 X-Y USB-30 | 0 | 6 | 6 | 5 | 22 | 46 | 53 | 100 | 27 | 62 | 0 | 90 | 28 | 212755 | 5 | 22 | 52 | 59 | 100 | 27 | 62 | 1 | 89 | 28 | 213016 | | |

COAST TO TPI

ULLAGE FOR TPI

TPI

1-70

COAST TO 1ST BRAKING GATE

VEHICLE 2 RADAR TABLE

TRACKING TIME

STATION ACQUISITION DATA

STATION TERMINATION DATA

| VEHICLE | TRACKING TIME | | | STATION ACQUISITION DATA | | | | | | | | | | STATION TERMINATION DATA | | | | | | | | | | | |
|----------------------|---------------|-----|-----|--------------------------|-----|-----|-----|-----|-----|-----|-----|----|----|--------------------------|-----|-----|-----|-----|-----|-----|-----|-----|----|----|--------|
| | HRS | MIN | SEC | DAY | HRS | MIN | SEC | RA | DEC | AZ | ELV | X | Y | RANGE | DAY | HRS | MIN | SEC | RA | DEC | AZ | ELV | X | Y | RANGE |
| ANG-91 X-Y USB-30 | 0 | 8 | 20 | 5 | 23 | 40 | 24 | 100 | 27 | 65 | 12 | 77 | 24 | 212586 | 5 | 23 | 48 | 44 | 100 | 27 | 66 | 13 | 75 | 24 | 212060 |
| BDA-02 X-Y USB-30 | 0 | 8 | 15 | 5 | 23 | 40 | 28 | 100 | 26 | 68 | 15 | 74 | 21 | 212369 | 5 | 23 | 48 | 44 | 100 | 26 | 69 | 17 | 72 | 20 | 211860 |
| MIL-71 X-Y USB-30 | 0 | 8 | 15 | 5 | 23 | 40 | 29 | 100 | 26 | 60 | 1 | 89 | 30 | 213206 | 5 | 23 | 48 | 44 | 100 | 26 | 61 | 3 | 87 | 29 | 212695 |
| GBM-41 X-Y USB-30 | 0 | 8 | 15 | 5 | 23 | 40 | 29 | 100 | 26 | 61 | 2 | 88 | 29 | 213146 | 5 | 23 | 48 | 44 | 100 | 26 | 62 | 4 | 86 | 28 | 212634 |
| ACN-75 X-Y USB-30 | 0 | 8 | 13 | 5 | 23 | 40 | 31 | 100 | 27 | 44 | 39 | 41 | 34 | 211093 | 5 | 23 | 48 | 44 | 100 | 27 | 43 | 41 | 38 | 34 | 210613 |
| CYT-04 X-Y USB-30 | 0 | 8 | 12 | 5 | 23 | 40 | 32 | 100 | 27 | 82 | 56 | 34 | 4 | 210444 | 5 | 23 | 48 | 44 | 100 | 27 | 83 | 57 | 32 | 4 | 209970 |
| MAD-23 X-Y USB-85 | 0 | 8 | 10 | 5 | 23 | 40 | 34 | 99 | 27 | 113 | 64 | 11 | 24 | 210200 | 5 | 23 | 48 | 44 | 99 | 27 | 116 | 65 | 11 | 22 | 209751 |

COAST TO 2ND BRAKING GATE

| | | | | | | | | | | | | | | | | | | | | | | | | | |
|----------------------|---|---|----|---|----|----|----|-----|----|-----|----|----|----|--------|---|----|----|----|-----|----|-----|----|----|----|--------|
| MAD-23 X-Y USB-85 | 0 | 1 | 49 | 5 | 23 | 48 | 44 | 99 | 27 | 116 | 65 | 11 | 22 | 209751 | 5 | 23 | 50 | 33 | 99 | 27 | 116 | 65 | 12 | 22 | 209651 |
| MIL-71 X-Y USB-30 | 0 | 1 | 49 | 5 | 23 | 48 | 44 | 100 | 26 | 61 | 3 | 87 | 29 | 212695 | 5 | 23 | 50 | 33 | 100 | 26 | 61 | 3 | 87 | 29 | 212583 |
| GBM-41 X-Y USB-30 | 0 | 1 | 49 | 5 | 23 | 48 | 44 | 100 | 26 | 62 | 4 | 86 | 28 | 212634 | 5 | 23 | 50 | 33 | 100 | 26 | 62 | 4 | 85 | 28 | 212521 |

VEHICLE 2 RADAR TABLE

TRACKING TIME

STATION ACQUISITION DATA

STATION TERMINATION DATA

| | HRS | MIN | SEC | DAY | HRS | MIN | SEC | RA | DEC | AZ | ELV | X | Y | RANGE | DAY | HRS | MIN | SEC | RA | DEC | AZ | ELV | X | Y | RANGE | |
|------------------------|-----|-----|-----|-----|-----|-----|-----|-----|-----|-----|----------------|----|----|--------|-----|-----|-----|-----|-----|-----|-----|----------------|----|----|--------|--|
| BDA-02 X-Y USB-30 | 0 | 1 | 49 | 5 | 23 | 48 | 44 | 100 | 26 | 69 | 17 | 72 | 20 | 211860 | 5 | 23 | 50 | 33 | 100 | 26 | 69 | 17 | 72 | 20 | 211748 | |
| ANG-91 X-Y USB-30 | 0 | 1 | 49 | 5 | 23 | 48 | 44 | 100 | 27 | 66 | 13 | 75 | 24 | 212060 | 5 | 23 | 50 | 33 | 100 | 27 | 66 | 14 | 75 | 23 | 211946 | |
| CYI-04 X-Y USB-30 | 0 | 1 | 49 | 5 | 23 | 48 | 44 | 100 | 27 | 83 | 57 | 32 | 4 | 209970 | 5 | 23 | 50 | 33 | 100 | 27 | 83 | 58 | 32 | 4 | 209865 | |
| ACN-75 X-Y USB-30 | 0 | 1 | 49 | 5 | 23 | 48 | 44 | 100 | 27 | 43 | 41 | 38 | 34 | 210613 | 5 | 23 | 50 | 33 | 100 | 27 | 43 | 41 | 38 | 34 | 210507 | |
| 1ST BRAKING MANEUVER * | | | | | | | | | | | | | | | | | | | | | | | | | | |
| MAD-23 X-Y USB-85 | 0 | 0 | 12 | 5 | 23 | 50 | 33 | 99 | 27 | 116 | 6 ⁵ | 12 | 22 | 209651 | 5 | 23 | 50 | 45 | 99 | 27 | 116 | 6 ⁵ | 12 | 22 | 209640 | |
| MIL-71 X-Y USB-30 | 0 | 0 | 12 | 5 | 23 | 50 | 33 | 100 | 26 | 61 | 3 | 87 | 29 | 212583 | 5 | 23 | 50 | 45 | 100 | 26 | 61 | 3 | 87 | 29 | 212571 | |
| GBM-41 X-Y USB-30 | 0 | 0 | 12 | 5 | 23 | 50 | 33 | 100 | 26 | 62 | 4 | 85 | 28 | 212521 | 5 | 23 | 50 | 45 | 100 | 26 | 62 | 4 | 85 | 28 | 212508 | |
| BDA-02 X-Y USB-30 | 0 | 0 | 12 | 5 | 23 | 50 | 33 | 100 | 26 | 69 | 17 | 72 | 20 | 211748 | 5 | 23 | 50 | 45 | 100 | 26 | 69 | 17 | 72 | 20 | 211735 | |
| ANG-91 X-Y USB-30 | 0 | 0 | 12 | 5 | 23 | 50 | 33 | 100 | 27 | 66 | 14 | 75 | 23 | 211946 | 5 | 23 | 50 | 45 | 100 | 27 | 66 | 14 | 75 | 23 | 211933 | |
| CYI-04 X-Y USB-30 | 0 | 0 | 12 | 5 | 23 | 50 | 33 | 100 | 27 | 83 | 58 | 32 | 4 | 209865 | 5 | 23 | 50 | 45 | 100 | 27 | 83 | 58 | 32 | 4 | 209854 | |

1-72

VEHICLE 2 RADAR TABLE

TRACKING TIME

STATION ACQUISITION DATA

STATION TERMINATION DATA

| | HRS | MIN | SEC | DAY | HRS | MIN | SEC | RA | DEC | AZ | ELV | X | Y | RANGE | DAY | HRS | MIN | SEC | RA | DEC | AZ | ELV | X | Y | RANGE | |
|---------------------------|-----|-----|-----|-----|-----|-----|-----|-----|-----|-----|-----|----|----|--------|-----|-----|-----|-----|-----|-----|-----|-----|----|----|--------|--|
| ACN-78 X-Y USB-30 | 0 | 0 | 12 | 5 | 23 | 50 | 33 | 100 | 27 | 43 | 41 | 38 | 34 | 210507 | 5 | 23 | 50 | 45 | 100 | 27 | 43 | 41 | 38 | 34 | 210496 | |
| COAST TO 3RD BRAKING GATE | | | | | | | | | | | | | | | | | | | | | | | | | | |
| MAD-23 X-Y USB-85 | 0 | 1 | 1 | 5 | 23 | 50 | 45 | 99 | 27 | 116 | 65 | 12 | 22 | 209640 | 5 | 23 | 51 | 46 | 99 | 27 | 117 | 66 | 12 | 22 | 209585 | |
| MIL-71 X-Y USB-30 | 0 | 1 | 1 | 5 | 23 | 50 | 45 | 100 | 26 | 61 | 3 | 87 | 29 | 212571 | 5 | 23 | 51 | 46 | 100 | 26 | 62 | 3 | 86 | 28 | 212509 | |
| GBM-41 X-Y USB-30 | 0 | 1 | 1 | 5 | 23 | 50 | 45 | 100 | 26 | 62 | 4 | 85 | 28 | 212508 | 5 | 23 | 51 | 46 | 100 | 26 | 62 | 4 | 85 | 27 | 212446 | |
| BDA-02 X-Y USB-30 | 0 | 1 | 1 | 5 | 23 | 50 | 45 | 100 | 26 | 69 | 17 | 72 | 20 | 211735 | 5 | 23 | 51 | 46 | 100 | 26 | 69 | 17 | 71 | 20 | 211673 | |
| ANG-91 X-Y USB-30 | 0 | 1 | 1 | 5 | 23 | 50 | 45 | 100 | 27 | 66 | 14 | 75 | 23 | 211933 | 5 | 23 | 51 | 46 | 100 | 27 | 66 | 14 | 75 | 23 | 211876 | |
| GYI-04 X-Y USB-30 | 0 | 1 | 1 | 5 | 23 | 50 | 45 | 100 | 27 | 83 | 58 | 32 | 4 | 209854 | 5 | 23 | 51 | 46 | 100 | 27 | 83 | 58 | 32 | 4 | 209796 | |
| ACN-75 X-Y USB-30 | 0 | 1 | 1 | 5 | 23 | 50 | 45 | 100 | 27 | 43 | 41 | 38 | 34 | 210496 | 5 | 23 | 51 | 46 | 100 | 27 | 42 | 41 | 38 | 34 | 210437 | |
| 2ND BRAKING MANEUVER * | | | | | | | | | | | | | | | | | | | | | | | | | | |
| MAD-23 X-Y USB-85 | 0 | 0 | 9 | 5 | 23 | 51 | 46 | 99 | 27 | 117 | 66 | 12 | 22 | 209585 | 5 | 23 | 51 | 54 | 99 | 27 | 117 | 66 | 12 | 22 | 209577 | |
| MIL-71 X-Y USB-30 | 0 | 0 | 9 | 5 | 23 | 51 | 46 | 100 | 26 | 62 | 3 | 86 | 28 | 212509 | 5 | 23 | 51 | 54 | 100 | 26 | 62 | 3 | 86 | 28 | 212506 | |

1-731

VEHICLE 2 RADAR TABLE

| | TRACKING TIME | | | STATION ACQUISITION DATA | | | | | | | | | | STATION TERMINATION DATA | | | | | | | | | | | | | |
|---------------------------|---------------|-----|-----|--------------------------|-----|-----|-----|-----|-----|-----|-----|----|----|--------------------------|-----|-----|-----|-----|-----|-----|-----|-----|----|----|--------|--|--|
| | HRS | MIN | SEC | DAY | HRS | MIN | SEC | RA | DEC | AZ | ELV | X | Y | RANGE | DAY | HRS | MIN | SEC | RA | DEC | AZ | ELV | X | Y | RANGE | | |
| GBM-41 X-Y USB-30 | 0 | 0 | 9 | 5 | 23 | 51 | 46 | 100 | 26 | 62 | 4 | 85 | 27 | 212446 | 5 | 23 | 51 | 54 | 100 | 26 | 62 | 4 | 85 | 27 | 212437 | | |
| BDA-02 X-Y USB-30 | 0 | 0 | 9 | 5 | 23 | 51 | 46 | 100 | 26 | 69 | 17 | 71 | 20 | 211673 | 5 | 23 | 51 | 54 | 100 | 26 | 69 | 17 | 71 | 20 | 211665 | | |
| ANG-91 X-Y USB-30 | 0 | 0 | 9 | 5 | 23 | 51 | 46 | 100 | 27 | 66 | 14 | 75 | 23 | 211870 | 5 | 23 | 51 | 54 | 100 | 27 | 66 | 14 | 75 | 23 | 211861 | | |
| CYI-04 X-Y USB-30 | 0 | 0 | 9 | 5 | 23 | 51 | 46 | 100 | 27 | 83 | 58 | 32 | 4 | 209796 | 5 | 23 | 51 | 54 | 100 | 27 | 83 | 58 | 32 | 4 | 209788 | | |
| ACN-75 X-Y USB-30 | 0 | 0 | 9 | 5 | 23 | 51 | 46 | 100 | 27 | 42 | 41 | 38 | 34 | 210437 | 5 | 23 | 51 | 54 | 100 | 27 | 42 | 41 | 38 | 34 | 210429 | | |
| CCAST TO 4TH BRAKING GATE | | | | | | | | | | | | | | | | | | | | | | | | | | | |
| MAD-23 X-Y USB-85 | 0 | 1 | 30 | 5 | 23 | 51 | 54 | 99 | 27 | 117 | 66 | 12 | 22 | 209577 | 5 | 23 | 53 | 24 | 100 | 27 | 117 | 66 | 12 | 21 | 209498 | | |
| MIL-71 X-Y USB-30 | 0 | 1 | 30 | 5 | 23 | 51 | 54 | 100 | 26 | 62 | 3 | 86 | 28 | 212500 | 5 | 23 | 53 | 24 | 100 | 26 | 62 | 3 | 86 | 28 | 212410 | | |
| GBM-41 X-Y USB-30 | 0 | 1 | 30 | 5 | 23 | 51 | 54 | 100 | 26 | 62 | 4 | 85 | 27 | 212437 | 5 | 23 | 53 | 24 | 100 | 26 | 63 | 5 | 85 | 27 | 212347 | | |
| BDA-02 X-Y USB-30 | 0 | 1 | 30 | 5 | 23 | 51 | 54 | 100 | 26 | 69 | 17 | 71 | 20 | 211665 | 5 | 23 | 53 | 24 | 100 | 26 | 69 | 18 | 71 | 20 | 211575 | | |
| ANG-91 X-Y USB-30 | 0 | 1 | 30 | 5 | 23 | 51 | 54 | 100 | 27 | 66 | 14 | 75 | 23 | 211861 | 5 | 23 | 53 | 24 | 100 | 27 | 66 | 14 | 74 | 23 | 211770 | | |

1-74

VEHICLE 2 RADAR TABLE

TRACKING TIME

HRS MIN SEC

STATION ACQUISITION DATA

DAY HRS MIN SEC RA DEC AZ ELV X Y RANGE

STATION TERMINATION DATA

DAY HRS MIN SEC RA DEC AZ ELV X Y RANGE

GYI-04 0 1 30
X-Y USB-30

5 23 51 24 100 27 83 58 32 4 209788

5 23 53 24 100 27 83 58 31 4 209704

ACN-75 0 1 30
X-Y USB-30

5 23 51 24 100 27 42 41 38 34 210429

5 23 53 24 100 27 42 41 37 34 210345

JRC BRAKING MANEUVER *

MAD-23 0 0 4
X-Y USB-85

5 23 53 24 100 27 117 66 12 21 209498

5 23 53 28 100 27 117 66 12 21 209494

MIL-71 0 0 4
X-Y USB-30

5 23 53 24 100 26 62 3 86 28 212410

5 23 53 28 100 26 62 3 86 28 212406

GBM-41 0 0 4
X-Y USB-30

5 23 53 24 100 26 63 5 85 27 212347

5 23 53 28 100 26 63 5 85 27 212342

BDA-02 0 0 4
X-Y USB-30

5 23 53 24 100 26 69 18 71 20 211575

5 23 53 28 100 26 69 18 71 20 211571

ANG-91 0 0 4
X-Y USB-30

5 23 53 24 100 27 66 14 74 23 211770

5 23 53 28 100 27 66 14 74 23 211765

GYI-04 0 0 4
X-Y USB-30

5 23 53 24 100 27 83 58 31 4 209704

5 23 53 28 100 27 83 58 31 4 209701

ACN-75 0 0 4
X-Y USB-30

5 23 53 24 100 27 42 41 37 34 210345

5 23 53 28 100 27 42 41 37 34 210341

CCAST TO 5TH BRAKING GATE

MAD-23 0 1 15
X-Y USB-85

5 23 53 28 100 27 117 66 12 21 209494

5 23 54 44 100 27 118 66 12 21 209429

11-75

VEHICLE 2 RADAR TABLE

| | TRACKING TIME | | | STATION ACQUISITION DATA | | | | | | | | | | STATION TERMINATION DATA | | | | | | | | | | | | | |
|----------------------|---------------|-----|-----|--------------------------|-----|-----|-----|-----|-----|-----|-----|----|----|--------------------------|-----|-----|-----|-----|-----|-----|-----|-----|----|----|--------|--|--|
| | HRS | MIN | SEC | DAY | HRS | MIN | SEC | RA | DEC | AZ | ELV | X | Y | RANGE | DAY | HRS | MIN | SEC | RA | DEC | AZ | ELV | X | Y | RANGE | | |
| MIL-71 X-Y USB-30 | 0 | 1 | 15 | 5 | 23 | 53 | 28 | 100 | 26 | 62 | 3 | 86 | 28 | 212406 | 5 | 23 | 54 | 44 | 100 | 26 | 62 | 4 | 86 | 28 | 212332 | | |
| GBM-41 X-Y USB-30 | 0 | 1 | 15 | 5 | 23 | 53 | 28 | 100 | 26 | 63 | 5 | 85 | 27 | 212342 | 5 | 23 | 54 | 44 | 100 | 26 | 63 | 5 | 85 | 27 | 212268 | | |
| BDA-02 X-Y USB-30 | 0 | 1 | 15 | 5 | 23 | 53 | 28 | 100 | 26 | 69 | 18 | 71 | 20 | 211571 | 5 | 23 | 54 | 44 | 100 | 26 | 70 | 18 | 71 | 19 | 211498 | | |
| ANG-91 X-Y USB-30 | 0 | 1 | 15 | 5 | 23 | 53 | 28 | 100 | 27 | 66 | 14 | 74 | 23 | 211765 | 5 | 23 | 54 | 44 | 100 | 27 | 66 | 15 | 74 | 23 | 211690 | | |
| CYI-04 X-Y USB-30 | 0 | 1 | 15 | 5 | 23 | 53 | 28 | 100 | 27 | 83 | 58 | 31 | 4 | 209701 | 5 | 23 | 54 | 44 | 100 | 27 | 83 | 59 | 31 | 3 | 209632 | | |
| ACN-75 X-Y USB-30 | 0 | 1 | 15 | 5 | 23 | 53 | 28 | 100 | 27 | 42 | 41 | 37 | 34 | 210341 | 5 | 23 | 54 | 44 | 100 | 27 | 42 | 42 | 37 | 34 | 210272 | | |
| 4TH BRAKING MANEUVER | | | | | | | | | | | | | | | | | | | | | | | | | | | |
| MAD-23 X-Y USB-85 | 0 | 0 | 4 | 5 | 23 | 54 | 44 | 100 | 27 | 118 | 66 | 12 | 21 | 209429 | 5 | 23 | 54 | 48 | 100 | 27 | 118 | 66 | 12 | 21 | 209425 | | |
| MIL-71 X-Y USB-30 | 0 | 0 | 4 | 5 | 23 | 54 | 44 | 100 | 26 | 62 | 4 | 86 | 28 | 212332 | 5 | 23 | 54 | 48 | 100 | 26 | 62 | 4 | 86 | 28 | 212328 | | |
| GBM-41 X-Y USB-30 | 0 | 0 | 4 | 5 | 23 | 54 | 44 | 100 | 26 | 63 | 5 | 85 | 27 | 212268 | 5 | 23 | 54 | 48 | 100 | 26 | 63 | 5 | 85 | 27 | 212264 | | |
| BDA-02 X-Y USB-30 | 0 | 0 | 4 | 5 | 23 | 54 | 44 | 100 | 26 | 70 | 18 | 71 | 19 | 211498 | 5 | 23 | 54 | 48 | 100 | 26 | 70 | 18 | 71 | 19 | 211494 | | |

VEHICLE 2 RADAR TABLE

| | TRACKING TIME | | | STATION ACQUISITION DATA | | | | | | | | | | STATION TERMINATION DATA | | | | | | | | | | | | | |
|----------------------|---------------|-----|-----|--------------------------|-----|-----|-----|-----|-----|-----|-----|----|----|--------------------------|-----|-----|-----|-----|-----|-----|-----|-----|----|----|--------|--|--|
| | HRS | MIN | SEC | DAY | HRS | MIN | SEC | RA | DEC | AZ | ELV | X | Y | RANGE | DAY | HRS | MIN | SEC | RA | DEC | AZ | ELV | X | Y | RANGE | | |
| ANG-91 X-Y USB=30 | 0 | 0 | 4 | 5 | 23 | 54 | 44 | 100 | 27 | 66 | 15 | 74 | 23 | 211690 | 5 | 23 | 54 | 48 | 100 | 27 | 66 | 15 | 74 | 23 | 211686 | | |
| GYI-04 X-Y USB=30 | 0 | 0 | 4 | 5 | 23 | 54 | 44 | 100 | 27 | 83 | 59 | 31 | 3 | 209632 | 5 | 23 | 54 | 48 | 100 | 27 | 83 | 59 | 31 | 3 | 209629 | | |
| ACN-75 X-Y USB=30 | 0 | 0 | 4 | 5 | 23 | 54 | 44 | 100 | 27 | 42 | 42 | 37 | 34 | 210272 | 5 | 23 | 54 | 48 | 100 | 27 | 42 | 42 | 37 | 34 | 210268 | | |
| COAST TO DOCKING | | | | | | | | | | | | | | | | | | | | | | | | | | | |
| MAD-23 X-Y USB=85 | 0 | 4 | 22 | 5 | 23 | 54 | 48 | 100 | 27 | 118 | 66 | 12 | 21 | 209425 | 5 | 23 | 59 | 10 | 100 | 27 | 119 | 67 | 12 | 20 | 209216 | | |
| MIL-71 X-Y USB=30 | 0 | 4 | 22 | 5 | 23 | 54 | 48 | 100 | 26 | 62 | 4 | 86 | 28 | 212328 | 5 | 23 | 59 | 10 | 100 | 26 | 62 | 5 | 85 | 28 | 212087 | | |
| GBM-41 X-Y USB=30 | 0 | 4 | 22 | 5 | 23 | 54 | 48 | 100 | 26 | 63 | 5 | 85 | 27 | 212264 | 5 | 23 | 59 | 10 | 100 | 26 | 63 | 6 | 84 | 27 | 212023 | | |
| BDA-02 X-Y USB=30 | 0 | 4 | 22 | 5 | 23 | 54 | 48 | 100 | 26 | 70 | 18 | 71 | 19 | 211494 | 5 | 23 | 59 | 10 | 100 | 26 | 70 | 19 | 70 | 19 | 211254 | | |
| ANG-91 X-Y USB=30 | 0 | 4 | 22 | 5 | 23 | 54 | 48 | 100 | 27 | 66 | 15 | 74 | 23 | 211686 | 5 | 23 | 59 | 10 | 100 | 27 | 66 | 15 | 73 | 23 | 211441 | | |
| GYI-04 X-Y USB=30 | 0 | 4 | 22 | 5 | 23 | 54 | 48 | 100 | 27 | 83 | 59 | 31 | 3 | 209629 | 5 | 23 | 59 | 10 | 100 | 27 | 84 | 60 | 30 | 3 | 209408 | | |
| ACN-75 X-Y USB=30 | 0 | 4 | 22 | 5 | 23 | 54 | 48 | 100 | 27 | 42 | 42 | 37 | 34 | 210268 | 5 | 23 | 59 | 10 | 100 | 27 | 41 | 42 | 36 | 34 | 210045 | | |

1-77

TABLE 1.1-V.- MISSION RADAR TIMELINE - Continued

(e) CSM acquisition and termination during rendezvous - 3° minimum elevation

| | | 31 JAN 71 EOI TO TLI IGNITION | | | | | | | | | | | | LAZ 72.1 | | | | | | | | | | | | |
|----------------------|---------------|-------------------------------|-----|-----|--------------------------|-----|-----|-----|-----|------|----|-----|-----|----------|--------------------------|-----|-----|-----|------|-----|-----|----|-----|-----|-----|-------|
| VEHICLE | 1 RADAR TABLE | TRACKING TIME | | | STATION ACQUISITION DATA | | | | | | | | | | STATION TERMINATION DATA | | | | | | | | | | | |
| | | HRS | MIN | SEC | DAY | HRS | MIN | SEC | RA | DEC | AZ | ELV | X | Y | RANGE | DAY | HRS | MIN | SEC | RA | DEC | AZ | ELV | X | Y | RANGE |
| | | BDA-02 X-Y USB-30 | 0 | 0 | 25 | 0 | 0 | 11 | 40 | 102 | 7 | 85 | 5 | 85 | 5 | 592 | 0 | 0 | 12 | 5 | 104 | 6 | 85 | 3 | 87 | 5 |
| SHIP 1 INSERTION | 0 | 3 | 35 | 0 | 0 | 11 | 40 | -76 | 52 | -38 | 13 | -70 | 51 | 379 | 0 | 0 | 15 | 15 | 129 | 22 | 67 | 3 | 87 | 23 | 687 | |
| CYI-04 X-Y USB-30 | 0 | 5 | 44 | 0 | 0 | 17 | 15 | -31 | 16 | -73 | 3 | -87 | 17 | 686 | 0 | 0 | 22 | 59 | 141 | -19 | 113 | 3 | 87 | -23 | 680 | |
| TAN-22 A-E FPS-15 | 0 | 3 | 41 | 0 | 0 | 38 | 1 | 112 | 67 | -8 | 3 | -69 | 82 | 664 | 0 | 0 | 41 | 42 | -145 | 13 | 75 | 3 | 87 | 15 | 666 | |
| CRO-08 X-Y USB-30 | 0 | 4 | 2 | 0 | 0 | 53 | 11 | 95 | -38 | -131 | 3 | -86 | -41 | 673 | 0 | 0 | 57 | 13 | -46 | -43 | 137 | 3 | 86 | -47 | 673 | |
| HSK-25 X-Y USB-85 | 0 | 4 | 22 | 0 | 1 | 0 | 25 | 164 | 15 | -69 | 3 | -82 | -69 | 671 | 0 | 1 | 4 | 47 | -73 | 40 | 33 | 3 | -86 | 33 | 667 | |
| GYM-14 X-Y USB-30 | 0 | 5 | 40 | 0 | 1 | 29 | 1 | -85 | -24 | -120 | 3 | -87 | -30 | 680 | 0 | 1 | 34 | 41 | 82 | 13 | 77 | 3 | 87 | 13 | 686 | |
| GDS-28 X-Y USB-85 | 0 | 1 | 58 | 0 | 1 | 30 | 21 | -12 | -51 | 176 | 3 | 87 | 4 | 679 | 0 | 1 | 32 | 19 | 39 | -33 | 135 | 3 | 86 | 45 | 682 | |
| TEX-16 X-Y USB-30 | 0 | 5 | 38 | 0 | 1 | 31 | 54 | -85 | -1 | -93 | 3 | -87 | -3 | 684 | 0 | 1 | 37 | 33 | 102 | 24 | 64 | 3 | 87 | 26 | 688 | |
| MIL-71 X-Y USB-30 | 0 | 5 | 25 | 0 | 1 | 35 | 50 | -76 | 15 | -74 | 3 | -87 | 15 | 686 | 0 | 1 | 41 | 14 | 120 | 23 | 65 | 3 | 87 | 24 | 689 | |

1-78

12
11
10
9
8
7
6
5
4
3
2

VEHICLE 1 RADAR TABLE

TRACKING TIME

STATION ACQUISITION DATA

STATION TERMINATION DATA

HRS MIN SEC

DAY HRS MIN SEC

RA DEC

AZ ELV

X

Y

RANGE

DAY HRS MIN SEC

RA DEC

AZ ELV

X

Y

RANGE

| | | | | | | | | | | | | | |
|----------------------|----------|-----------|---------------------|------|-------|-----|------|------------|----------|-------|---------|-------|--|
| GBM-41 X-Y USB-30 | 0 4 55 | 0 1 36 36 | -79 27 | -62 | 3 -87 | 28 | 688 | 0 1 41 31 | 127 32 | 55 3 | 86 34 | 688 | |
| BDA-02 X-Y USB-30 | 0 5 47 | 0 1 39 13 | -54 6 | -85 | 3 -87 | 5 | 689 | 0 1 44 60 | 122 -3 | 95 3 | 87 -5 | 687 | |
| SHIP 1 INSERTION | 0 5 40 | 0 1 42 54 | -47 23 | -66 | 3 -87 | 24 | 688 | 0 1 48 35 | 139 -2 | 94 3 | 87 -4 | 684 | |
| CYI-04 X-Y USB-30 | 0 3 15 | 0 1 51 10 | 13 -20 | -115 | 3 -87 | -25 | 681 | 0 1 54 24 | 97 -59 | 175 3 | 57 -84 | 676 | |
| TAN-22 A-E FPS-16 | 0 5 26 | 0 2 9 54 | 72 11 | -77 | 3 -87 | 13 | 666 | 0 2 15 20 | -102 -38 | 130 3 | 86 -40 | 668 | |
| CRD-08 X-Y USB-30 | 0 4 30 | 0 2 26 13 | 116 -41 | -135 | 3 -86 | -45 | 673 | 0 2 30 42 | -35 -24 | 115 4 | 86 -25 | 639 | |
| | | 31 JAN 71 | TLI TO NFR IGNITION | | | | | LAZ 72.1 | | | | | |
| HAW-12 X-Y USB-30 | 12 31 19 | 0 2 43 2 | -110 -39 | -134 | 3 -86 | -44 | 2271 | 0 15 14 22 | 45 30 | -59 3 | -86 31 | 74337 | |
| STN-00 A-E USB150 | 10 32 22 | 0 2 50 7 | -77 -17 | -114 | 3 -87 | -24 | 3835 | 0 13 22 29 | 44 29 | -55 3 | -86 35 | 67031 | |
| GDS-28 X-Y USB-85 | 10 0 39 | 0 2 50 59 | -76 -13 | -108 | 3 80 | -72 | 4021 | 0 12 51 38 | 43 29 | -55 3 | -85 -55 | 64922 | |
| GYM-14 X-Y USB-30 | 9 7 24 | 0 2 51 58 | -76 -5 | -97 | 3 -87 | -7 | 4235 | 0 11 59 23 | 41 30 | -57 3 | -86 32 | 61242 | |

I-79

12
11
10
9
8
7
6
5

VEHICLE I RADAR TABLE

| VEHICLE | TRACKING TIME | | | STATION ACQUISITION DATA | | | | | | | | | STATION TERMINATION DATA | | | | | | | | | | | | |
|----------------------|---------------|-----|-----|--------------------------|-----|-----|-----|-----|-----|-----|-----|-----|--------------------------|-------|-----|-----|-----|-----|----|-----|-----|-----|-----|-----|-------|
| | HRS | MIN | SEC | DAY | HRS | MIN | SEC | RA | DEC | AZ | ELV | X | Y | RANGE | DAY | HRS | MIN | SEC | RA | DEC | AZ | ELV | X | Y | RANGE |
| TEX-16 X-Y USB-30 | 8 | 2 | 48 | 0 | 2 | 55 | 53 | -66 | 3 | -89 | 3 | -87 | 1 | 5058 | 0 | 10 | 58 | 41 | 40 | 30 | -57 | 3 | -86 | 32 | 56786 |
| MIL-71 X-Y USB-30 | 6 | 42 | 17 | 0 | 3 | 2 | 34 | -51 | 10 | -80 | 3 | -87 | 10 | 6409 | 0 | 9 | 44 | 51 | 37 | 30 | -57 | 3 | -86 | 33 | 51057 |
| GBM-41 X-Y USB-30 | 6 | 22 | 47 | 0 | 3 | 4 | 1 | -49 | 12 | -78 | 3 | -87 | 12 | 6692 | 0 | 9 | 26 | 48 | 36 | 30 | -58 | 3 | -86 | 32 | 49597 |
| GTI-51 A=E TPQ=18 | 2 | 0 | 23 | 0 | 3 | 9 | 20 | -42 | 18 | -72 | 3 | -87 | 18 | 7706 | 0 | 5 | 9 | 43 | 16 | 32 | -64 | 31 | -56 | 22 | 23400 |
| BDA-02 X-Y USB-30 | 5 | 30 | 30 | 0 | 3 | 11 | 24 | -37 | 14 | -75 | 3 | -87 | 15 | 8090 | 0 | 8 | 41 | 55 | 35 | 30 | -56 | 3 | -86 | 34 | 45854 |
| ANG-91 X-Y USB-30 | 4 | 12 | 20 | 0 | 3 | 19 | 22 | -30 | 23 | -67 | 3 | -87 | 23 | 9517 | 0 | 7 | 31 | 42 | 30 | 31 | -58 | 3 | -86 | 32 | 39613 |
| SHIP 1 INSERTION | 1 | 33 | 16 | 0 | 3 | 29 | 23 | -20 | 22 | -67 | 3 | -87 | 23 | 11220 | 0 | 5 | 2 | 40 | 14 | 30 | -64 | 15 | -73 | 25 | 23392 |
| GWM-24 X-Y USB-30 | 13 | 34 | 15 | 0 | 5 | 11 | 48 | 33 | 31 | 59 | 3 | 86 | 31 | 25171 | 0 | 18 | 46 | 3 | 48 | 30 | -60 | 3 | -87 | 30 | 86950 |
| HSK-25 X=Y USB=85 | 7 | 45 | 45 | 0 | 8 | 11 | 11 | 41 | 36 | 41 | 3 | -86 | 41 | 43172 | 0 | 15 | 56 | 56 | 47 | 33 | -45 | 3 | -86 | -45 | 76982 |
| CRO-08 X-Y USB-30 | 9 | 20 | 48 | 0 | 9 | 51 | 57 | 45 | 34 | 50 | 3 | 86 | 40 | 51614 | 0 | 19 | 12 | 45 | 49 | 32 | -53 | 3 | -86 | 37 | 88439 |

1-80

VEHICLE 1 RADAR TABLE

TRACKING TIME

STATION ACQUISITION DATA

STATION TERMINATION DATA

| | HRS | MIN | SEC | DAY | HRS | MIN | SEC | RA | DEC | AZ | ELV | X | Y | RANGE | DAY | HRS | MIN | SEC | RA | DEC | AZ | ELV | X | Y | RANGE |
|----------------------|-----|-----|-----|-----|-----|-----|-----|----|-----|----|-----|-----|----|--------|-----|-----|-----|-----|----|-----|------|-----|-----|-----|--------|
| MAD-23 X-Y USB-85 | 15 | 17 | 60 | 0 | 14 | 59 | 28 | 50 | 29 | 53 | 3 | -85 | 53 | 73394 | 1 | 6 | 17 | 27 | 55 | 28 | -55 | 3 | -85 | -55 | 120767 |
| CYI-04 X-Y USB-30 | 13 | 52 | 13 | 0 | 16 | 31 | 28 | 52 | 30 | 58 | 3 | 86 | 32 | 79098 | 1 | 6 | 23 | 41 | 54 | 29 | -59 | 3 | -86 | 31 | 121031 |
| ACN-75 X-Y USB-30 | 10 | 55 | 8 | 0 | 17 | 57 | 36 | 53 | 31 | 58 | 3 | 86 | 32 | 84181 | 1 | 4 | 52 | 44 | 54 | 30 | -59 | 3 | -87 | 31 | 117077 |
| BDA-02 X-Y USB-30 | 10 | 54 | 24 | 0 | 19 | 41 | 42 | 53 | 29 | 57 | 3 | 86 | 33 | 90052 | 1 | 6 | 36 | 7 | 55 | 29 | -78 | 42 | -47 | 9 | 119460 |
| ANG-91 X-Y USB-30 | 10 | 23 | 48 | 0 | 20 | 12 | 19 | 54 | 30 | 60 | 3 | 87 | 30 | 91718 | 1 | 6 | 36 | 7 | 54 | 29 | -66 | 35 | -53 | 20 | 119803 |
| GBM-41 X-Y USB-30 | 9 | 40 | 58 | 0 | 20 | 55 | 8 | 54 | 29 | 59 | 3 | 86 | 31 | 94016 | 1 | 6 | 36 | 7 | 55 | 29 | -76 | 52 | -37 | 9 | 119039 |
| MIL-71 X-Y USB-30 | 9 | 36 | 13 | 0 | 20 | 59 | 53 | 54 | 29 | 58 | 3 | 86 | 32 | 94269 | 1 | 6 | 36 | 7 | 55 | 29 | -79 | 55 | -34 | 6 | 118949 |
| TEX-16 X-Y USB-30 | 8 | 24 | 58 | 0 | 22 | 11 | 8 | 55 | 29 | 59 | 3 | 86 | 31 | 97990 | 1 | 6 | 36 | 7 | 55 | 29 | -80 | 70 | -20 | 3 | 118551 |
| GVM-14 X-Y USB-30 | 7 | 30 | 52 | 0 | 23 | 5 | 15 | 55 | 29 | 59 | 3 | 86 | 31 | 100740 | 1 | 6 | 36 | 7 | 56 | 29 | -78 | 82 | -8 | 2 | 118379 |
| GDS-28 X-Y USB-85 | 7 | 28 | 17 | 0 | 23 | 7 | 50 | 55 | 29 | 56 | 3 | -85 | 56 | 100871 | 1 | 6 | 36 | 7 | 56 | 29 | -158 | 83 | 6 | -3 | 118367 |

1-81

2
1
0
9
8
7
6

VEHICLE 1 RADAR TABLE

| | TRACKING TIME | | | STATION ACQUISITION DATA | | | | | | | | | | STATION TERMINATION DATA | | | | | | | | | | | |
|----------------------|---------------|-----|-----|-------------------------------|-----|-----|-----|----|-----|------|-----|-----|----|--------------------------|-----|-----|-----|-----|----|-----|-----|-----|-----|-----|--------|
| | HRS | MIN | SEC | DAY | HRS | MIN | SEC | RA | DEC | AZ | ELV | X | Y | RANGE | DAY | HRS | MIN | SEC | RA | DEC | AZ | ELV | X | Y | RANGE |
| STN-00 A-E USB150 | 7 | 13 | 28 | 0 | 23 | 22 | 39 | 55 | 29 | 56 | 3 | 86 | 34 | 101612 | 1 | 6 | 36 | 7 | 56 | 29 | 165 | 81 | 2 | -8 | 118382 |
| HAW-12 X-Y USB-30 | 3 | 54 | 21 | 1 | 2 | 41 | 46 | 56 | 29 | 60 | 3 | 87 | 30 | 111170 | 1 | 6 | 36 | 7 | 57 | 29 | 70 | 52 | 36 | 12 | 119039 |
| | | | | 31 JAN 71 NFR TO LOI IGNITION | | | | | | | | | | LAZ 72.1 | | | | | | | | | | | |
| ANG-91 X-Y USB-30 | 2 | 28 | 1 | 1 | 6 | 36 | 18 | 54 | 29 | -66 | 34 | -53 | 20 | 119813 | 1 | 9 | 4 | 19 | 55 | 29 | -61 | 3 | -87 | 29 | 127609 |
| BDA-02 X-Y USB-30 | 3 | 19 | 50 | 1 | 6 | 36 | 18 | 55 | 29 | -78 | 42 | -47 | 9 | 119469 | 1 | 9 | 56 | 8 | 56 | 28 | -58 | 3 | -86 | 32 | 129657 |
| GBM-41 X-Y USB-30 | 3 | 58 | 59 | 1 | 6 | 36 | 18 | 55 | 29 | -76 | 52 | -37 | 9 | 119048 | 1 | 10 | 35 | 17 | 56 | 28 | -60 | 3 | -87 | 30 | 131180 |
| MIL-71 X-Y USB-30 | 4 | 13 | 54 | 1 | 6 | 36 | 18 | 55 | 29 | -79 | 55 | -34 | 6 | 118958 | 1 | 10 | 50 | 12 | 56 | 28 | -59 | 3 | -86 | 31 | 131755 |
| TEX-16 X-Y USB-30 | 5 | 19 | 19 | 1 | 6 | 36 | 18 | 55 | 29 | -80 | 70 | -20 | 3 | 118559 | 1 | 11 | 55 | 36 | 56 | 28 | -60 | 3 | -87 | 30 | 134247 |
| GYM-14 X-Y USB-30 | 6 | 14 | 11 | 1 | 6 | 36 | 18 | 56 | 29 | -78 | 82 | -8 | 2 | 118387 | 1 | 12 | 50 | 29 | 56 | 28 | -60 | 3 | -86 | 30 | 136298 |
| GDS-28 X-Y USB-85 | 7 | 0 | 41 | 1 | 6 | 36 | 18 | 56 | 29 | -157 | 83 | 6 | -3 | 118375 | 1 | 13 | 36 | 59 | 57 | 28 | -57 | 3 | -84 | -57 | 138011 |
| STN-00 A-E USB150 | 7 | 28 | 52 | 1 | 6 | 36 | 18 | 56 | 29 | 165 | 81 | 2 | -8 | 118390 | 1 | 14 | 5 | 10 | 57 | 28 | -57 | 3 | -86 | 33 | 139037 |

1-82

VEHICLE 1 RADAR TABLE

TRACKING TIME

STATION ACQUISITION DATA

STATION TERMINATION DATA

HRS MIN SEC

DAY HRS MIN SEC

RA DEC

AZ ELV

X

Y

RANGE

DAY HRS MIN SEC

RA DEC

AZ ELV

X

Y

RANGE

| | | | | | | | | | | | | | | |
|----------------------|----------|------------|-------|-------|-----|----|--------|------------|-------|-----|---|-----|-----|--------|
| HAW-12 X-Y USB-30 | 9 17 31 | 1 6 36 18 | 57 29 | 70 53 | 36 | 12 | 119045 | 1 15 53 49 | 57 28 | -61 | 3 | -87 | 29 | 142906 |
| GWM-24 X-Y USB-30 | 12 28 18 | 1 6 50 1 | 58 29 | 61 3 | 87 | 29 | 122139 | 1 19 18 20 | 58 28 | -62 | 3 | -87 | 28 | 149867 |
| HSK-25 X-Y USB-85 | 8 5 19 | 1 8 46 26 | 58 30 | 49 3 | -85 | 49 | 126886 | 1 16 51 44 | 58 30 | -50 | 3 | -85 | -50 | 144913 |
| CRO-08 X-Y USB-30 | 9 22 57 | 1 10 29 54 | 59 30 | 55 3 | 86 | 35 | 130963 | 1 19 52 51 | 58 29 | -56 | 3 | -86 | 34 | 150997 |
| MAD-23 X-Y USB-85 | 14 51 1 | 1 15 39 50 | 60 28 | 55 3 | -85 | 55 | 142418 | 2 6 30 51 | 60 27 | -56 | 3 | -85 | -56 | 170151 |
| CYI-04 X-Y USB-30 | 13 33 50 | 1 17 5 31 | 60 28 | 60 3 | 87 | 30 | 145396 | 2 6 39 21 | 60 27 | -61 | 3 | -87 | 29 | 170383 |
| ACN-75 X-Y USB-30 | 10 52 25 | 1 18 22 10 | 60 29 | 60 3 | 87 | 30 | 147993 | 2 5 14 35 | 60 28 | -61 | 3 | -87 | 29 | 168024 |
| BDA-02 X-Y USB-30 | 13 57 24 | 1 20 11 21 | 61 28 | 59 3 | 86 | 31 | 151609 | 2 10 8 45 | 61 27 | -60 | 3 | -87 | 30 | 175978 |
| ANG-91 X-Y USB-30 | 12 41 5 | 1 20 38 24 | 61 28 | 62 3 | 87 | 28 | 152484 | 2 9 19 29 | 60 27 | -62 | 3 | -87 | 28 | 174686 |
| GBM-41 X-Y USB-30 | 13 26 16 | 1 21 21 58 | 61 28 | 60 3 | 87 | 30 | 153883 | 2 10 48 13 | 61 27 | -61 | 3 | -87 | 29 | 176998 |

1-83

12
11
10
9
8
7
6
5

VEHICLE 1 RADAR TABLE

| | TRACKING TIME | | | STATION ACQUISITION DATA | | | | | | | | | | STATION TERMINATION DATA | | | | | | | | | | | |
|----------------------|---------------|-----|-----|--------------------------|-----|-----|-----|----|-----|----|-----|-----|----|--------------------------|-----|-----|-----|-----|----|-----|-----|-----|-----|-----|--------|
| | HRS | MIN | SEC | DAY | HRS | MIN | SEC | RA | DEC | AZ | ELV | X | Y | RANGE | DAY | HRS | MIN | SEC | RA | DEC | AZ | ELV | X | Y | RANGE |
| MIL-71 X-Y USB-30 | 13 | 35 | 59 | 1 | 21 | 26 | 55 | 61 | 28 | 60 | 3 | 87 | 30 | 154042 | 2 | 11 | 2 | 54 | 61 | 27 | -61 | 3 | -87 | 29 | 177377 |
| TEX-16 X-Y USB-30 | 13 | 31 | 12 | 1 | 22 | 36 | 35 | 61 | 28 | 60 | 3 | 87 | 30 | 156241 | 2 | 12 | 7 | 47 | 61 | 27 | -61 | 3 | -87 | 29 | 179027 |
| GYM-14 X-Y USB-30 | 13 | 32 | 26 | 1 | 23 | 29 | 44 | 61 | 28 | 60 | 3 | 87 | 30 | 157890 | 2 | 13 | 2 | 10 | 61 | 27 | -61 | 3 | -87 | 29 | 180391 |
| GDS-28 X-Y USB-85 | 14 | 13 | 19 | 1 | 23 | 33 | 40 | 61 | 27 | 58 | 3 | -84 | 58 | 158012 | 2 | 13 | 46 | 59 | 61 | 27 | -59 | 3 | -84 | -59 | 181500 |
| STN-00 A-E USB150 | 14 | 25 | 56 | 1 | 23 | 48 | 41 | 61 | 27 | 57 | 3 | 86 | 33 | 158473 | 2 | 14 | 14 | 37 | 61 | 27 | -58 | 3 | -86 | 32 | 182179 |
| HAW-12 X-Y USB-30 | 13 | 2 | 48 | 2 | 3 | 1 | 54 | 62 | 28 | 61 | 3 | 87 | 29 | 164238 | 2 | 16 | 4 | 42 | 61 | 27 | -62 | 3 | -87 | 28 | 184833 |
| GWM-24 X-Y USB-30 | 12 | 23 | 2 | 2 | 7 | 5 | 57 | 62 | 28 | 62 | 3 | 87 | 28 | 171108 | 2 | 19 | 28 | 59 | 62 | 27 | -63 | 3 | -87 | 27 | 189628 |
| HSK-25 X-Y USB-85 | 8 | 17 | 35 | 2 | 8 | 52 | 37 | 62 | 29 | 51 | 3 | -85 | 51 | 173969 | 2 | 17 | 10 | 13 | 62 | 28 | -52 | 3 | -85 | -52 | 186371 |
| CRO-08 X-Y USB-30 | 9 | 29 | 35 | 2 | 10 | 38 | 26 | 63 | 28 | 57 | 3 | 86 | 33 | 176737 | 2 | 20 | 8 | 0 | 62 | 28 | -57 | 3 | -86 | 33 | 190539 |
| MAD-23 X-Y USB-85 | 14 | 37 | 9 | 2 | 15 | 55 | 19 | 63 | 27 | 57 | 3 | -84 | 57 | 184611 | 3 | 6 | 32 | 29 | 63 | 26 | -58 | 3 | -84 | -58 | 203745 |

18-1

VEHICLE 1 RADAR TABLE

| | TRACKING TIME | | | STATION ACQUISITION DATA | | | | | | | | | | STATION TERMINATION DATA | | | | | | | | | | | |
|----------------------|---------------|-----|-----|--------------------------|-----|-----|-----|----|-----|----|-----|-----|----|--------------------------|-----|-----|-----|-----|----|-----|-----|-----|-----|-----|--------|
| | HRS | MIN | SEC | DAY | HRS | MIN | SEC | RA | DEC | AZ | ELV | X | Y | RANGE | DAY | HRS | MIN | SEC | RA | DEC | AZ | ELV | X | Y | RANGE |
| CVI-04 X-Y USB-30 | 13 | 24 | 46 | 2 | 17 | 18 | 22 | 64 | 27 | 61 | 3 | 87 | 29 | 186572 | 3 | 6 | 43 | 8 | 63 | 26 | -62 | 3 | -87 | 28 | 203978 |
| ACN-75 X-Y USB-30 | 10 | 52 | 28 | 2 | 18 | 30 | 41 | 64 | 27 | 62 | 3 | 87 | 28 | 188282 | 3 | 5 | 23 | 9 | 63 | 27 | -62 | 3 | -87 | 28 | 202351 |
| BDA-02 X-Y USB-30 | 13 | 43 | 43 | 2 | 20 | 23 | 59 | 64 | 27 | 60 | 3 | 87 | 30 | 190901 | 3 | 10 | 7 | 42 | 62 | 26 | -61 | 3 | -87 | 29 | 208183 |
| ANG-91 X-Y USB-30 | 12 | 33 | 21 | 2 | 20 | 48 | 31 | 64 | 27 | 63 | 3 | 87 | 27 | 191388 | 3 | 9 | 21 | 51 | 62 | 26 | -63 | 3 | -87 | 26 | 207255 |
| GBM-41 X-Y USB-30 | 12 | 51 | 57 | 2 | 21 | 32 | 48 | 64 | 27 | 62 | 3 | 87 | 28 | 192376 | 3 | 10 | 24 | 45 | 62 | 26 | -65 | 8 | -82 | 25 | 208163 |
| MIL-71 X-Y USB-30 | 12 | 46 | 13 | 2 | 21 | 38 | 33 | 64 | 27 | 61 | 3 | 87 | 29 | 192556 | 3 | 10 | 24 | 46 | 62 | 26 | -66 | 10 | -79 | 24 | 207999 |
| TEX-16 X-Y USB-30 | 11 | 37 | 32 | 2 | 22 | 47 | 12 | 64 | 27 | 61 | 3 | 87 | 29 | 194008 | 3 | 10 | 24 | 45 | 62 | 26 | -72 | 24 | -65 | 17 | 207228 |
| GYM-14 X-Y USB-30 | 10 | 44 | 15 | 2 | 23 | 40 | 28 | 64 | 27 | 61 | 3 | 87 | 29 | 195194 | 3 | 10 | 24 | 43 | 62 | 26 | -76 | 35 | -54 | 11 | 206630 |
| GDS-28 X-Y USB-85 | 10 | 39 | 42 | 2 | 23 | 45 | 0 | 64 | 26 | 59 | 3 | -84 | 59 | 195270 | 3 | 10 | 24 | 42 | 62 | 26 | -85 | 42 | -6 | -48 | 206330 |
| STN-00 A-E USB150 | 10 | 24 | 33 | 3 | 0 | 0 | 7 | 64 | 26 | 59 | 3 | 87 | 31 | 195593 | 3 | 10 | 24 | 40 | 62 | 26 | -90 | 46 | -44 | 0 | 206141 |

1-85

VEHICLE 1 RADAR TABLE

TRACKING TIME

STATION ACQUISITION DATA

STATION TERMINATION DATA

HRS MIN SEC

DAY HRS MIN SEC

RA DEC

AZ ELV

X

Y

RANGE

DAY HRS MIN SEC

RA DEC

AZ ELV

X

Y

RANGE

HAW-12 7 13 58 3 3 10 35 64 27 63 3 87 27 199619 3 10 24 33 63 26 -67 78 -11 5 205263
X-Y USB-30

GWM-24 3 12 36 3 7 11 43 65 26 64 3 87 26 204567 3 10 24 20 64 26 65 47 41 17 206107
X-Y USB-30

HSK-25 1 34 2 3 8 50 18 64 27 53 3 -85 53 206579 3 10 24 21 64 27 36 17 -69 35 207589
X-Y USB-85

31 JAN 71

LOI TO DOI IGNITION

LAZ 72.1

CRO-08 1 24 20 3 10 56 52 64 27 56 7 81 34 207538 3 12 21 12 65 27 44 21 61 42 206942
X-Y USB-30

HSK-25 1 24 24 3 10 56 57 63 27 30 21 -66 27 206753 3 12 21 20 64 27 11 26 -63 10 206664
X-Y USB-85

GWM-24 1 24 24 3 10 56 60 63 26 63 54 33 15 205203 3 12 21 24 64 27 45 70 14 14 204971
X-Y USB-30

HAW-12 1 24 28 3 10 57 15 62 26 -73 70 -19 5 204747 3 12 21 43 63 27 -75 52 -37 9 205490
X-Y USB-30

STN-00 1 24 27 3 10 57 24 62 26 -85 39 -51 4 205787 3 12 21 52 63 26 -74 24 -65 14 206823
A-E USB150

GDS-28 1 24 28 3 10 57 24 62 26 -81 35 -13 -54 206002 3 12 21 52 63 26 -71 19 -43 -63 207086
X-Y USB-85

GYM-14 1 24 27 3 10 57 26 62 26 -74 28 -61 14 206347 3 12 21 53 63 26 -66 12 -77 23 207524
X-Y USB-30

1-86

12
11
10
9
8
7
6
5
4
3
2

VEHICLE 1 RADAR TABLE

TRACKING TIME

STATION ACQUISITION DATA

STATION TERMINATION DATA

HRS MIN SEC

DAY HRS MIN SEC RA DEC AZ ELV X Y RANGE

DAY HRS MIN SEC RA DEC AZ ELV X Y RANGE

MIL-71 0 2 47 3 10 57 27 62 26 -62 4 -86 28 207745 3 11 0 14 62 26 -62 3 -87 28 207642
X-Y USB-30

TEX-16 1 13 16 3 10 57 27 62 26 -69 17 -72 20 206973 3 12 10 43 63 26 -62 3 -87 28 207470
X-Y USB-30

CRO-08 1 24 29 3 13 5 1 65 27 36 28 48 46 206592 3 14 29 29 66 28 17 35 22 51 206411
X-Y USB-30

HSK-25 1 24 30 3 13 5 7 64 27 0 27 -63 0 206609 3 14 29 36 65 28 -20 24 -65 -18 207006
X-Y USB-85

GWM-24 1 24 29 3 13 5 11 64 27 16 76 4 13 204864 3 14 29 40 65 27 -45 70 -15 14 205208
X-Y USB-30

HAW-12 1 24 28 3 13 5 23 63 26 -74 42 -46 12 205859 3 14 29 51 64 27 -70 25 -64 18 206979
X-Y USB-30

STN-00 1 16 6 3 13 5 28 63 26 -69 16 -73 20 207250 3 14 21 34 65 26 -59 3 -86 31 207827
A-E USB150

GDS-28 0 46 21 3 13 5 29 63 26 -66 11 -65 -64 207527 3 13 51 50 64 26 -60 3 -84 -60 206648
X-Y USB-85

31 JAN 71

DOI TO LM SEP IGNITION

LAZ 72.1

CRO-08 1 5 6 3 15 15 7 65 27 4 38 6 52 206200 3 16 20 13 66 28 -13 36 -17 52 206361
X-Y USB-30

HSK-25 1 5 5 3 15 15 15 65 27 -30 20 -67 -28 207096 3 16 20 20 66 28 -42 13 -73 -41 207638
X-Y USB-85

1-87

12
11
10
9
8
7
6

VEHICLE 1 RADAR TABLE

| | TRACKING TIME | | | STATION ACQUISITION DATA | | | | | | | | | | STATION TERMINATION DATA | | | | | | | | | | | |
|----------------------|---------------|-----|-----|--------------------------|-----|-----|-----|----|-----|-----|-----|-----|-----|--------------------------|-----|-----|-----|-----|----|-----|-----|-----|-----|-----|--------|
| | HRS | MIN | SEC | DAY | HRS | MIN | SEC | RA | DEC | AZ | ELV | X | Y | RANGE | DAY | HRS | MIN | SEC | RA | DEC | AZ | ELV | X | Y | RANGE |
| GWM-24 X-Y USB-30 | 1 | 5 | 6 | 3 | 15 | 15 | 20 | 65 | 27 | -58 | 61 | -25 | 15 | 205301 | 3 | 16 | 20 | 26 | 66 | 27 | -64 | 48 | -39 | 17 | 205880 |
| HAW-12 X-Y USB-30 | 1 | 1 | 20 | 3 | 15 | 15 | 29 | 64 | 26 | -67 | 15 | -74 | 22 | 207397 | 3 | 16 | 16 | 49 | 66 | 27 | -63 | 3 | -87 | 27 | 208032 |
| MAD-23 X-Y USB-85 | 0 | 11 | 19 | 3 | 16 | 8 | 49 | 67 | 26 | 57 | 3 | -84 | 57 | 207602 | 3 | 16 | 20 | 8 | 67 | 26 | 59 | 5 | -81 | 59 | 208111 |
| MAD-23 X-Y USB-85 | 1 | 4 | 56 | 3 | 17 | 8 | 41 | 67 | 26 | 66 | 13 | -60 | 63 | 207730 | 3 | 18 | 13 | 37 | 68 | 27 | 75 | 24 | -31 | 62 | 207164 |
| CRO-08 X-Y USB-30 | 1 | 4 | 53 | 3 | 17 | 8 | 60 | 66 | 28 | -25 | 33 | -34 | 49 | 206619 | 3 | 18 | 13 | 52 | 67 | 28 | -38 | 25 | -53 | 45 | 207101 |
| HSK-25 X-Y USB-85 | 0 | 16 | 46 | 3 | 17 | 9 | 8 | 66 | 27 | -50 | 6 | -81 | -50 | 208130 | 3 | 17 | 25 | 54 | 66 | 27 | -53 | 3 | -85 | -53 | 207458 |
| GWM-24 X-Y USB-30 | 1 | 4 | 48 | 3 | 17 | 9 | 15 | 66 | 27 | -66 | 37 | -51 | 19 | 206424 | 3 | 18 | 14 | 3 | 67 | 27 | -66 | 23 | -65 | 22 | 207235 |
| CYI-04 X-Y USB-30 | 0 | 41 | 20 | 3 | 17 | 32 | 15 | 68 | 26 | 62 | 3 | 87 | 28 | 207258 | 3 | 18 | 13 | 35 | 69 | 27 | 65 | 11 | 78 | 24 | 207923 |
| ACN-75 X-Y USB-30 | 1 | 4 | 43 | 3 | 19 | 2 | 37 | 69 | 27 | 61 | 7 | 82 | 28 | 208265 | 3 | 20 | 7 | 20 | 70 | 27 | 57 | 20 | 67 | 31 | 207583 |
| CYI-04 X-Y USB-30 | 1 | 4 | 42 | 3 | 19 | 2 | 44 | 69 | 27 | 70 | 21 | 68 | 19 | 207450 | 3 | 20 | 7 | 26 | 70 | 27 | 75 | 34 | 55 | 13 | 206842 |

1-88

VEHICLE 1 RADAR TABLE

TRACKING TIME

STATION ACQUISITION DATA

STATION TERMINATION DATA

HRS MIN SEC

DAY HRS MIN SEC RA DEC AZ ELV X Y RANGE

DAY HRS MIN SEC RA DEC AZ ELV X Y RANGE

| | | | | | | | |
|----------------------|---------|------------|---------------------|--------|-----------|--------------------|--------|
| MAD-23 X-Y USB-85 | 1 4 48 | 3 19 2 47 | 68 26 82 33 -12 56 | 206787 | 3 20 7 34 | 69 27 91 45 1 45 | 206331 |
| CRO-08 X-Y USB-30 | 1 4 55 | 3 19 3 5 | 67 28 -47 18 -66 41 | 207598 | 3 20 7 60 | 68 28 -55 7 -82 35 | 208354 |
| GWM-24 X-Y USB-30 | 0 44 48 | 3 19 3 14 | 67 27 -65 12 -77 24 | 207923 | 3 19 48 3 | 68 27 -63 3 -87 27 | 207577 |
| ACN-75 X-Y USB-30 | 1 5 2 | 3 20 56 20 | 70 27 52 30 54 32 | 207157 | 3 22 1 22 | 71 28 42 41 38 34 | 206700 |
| BDA-02 X-Y USB-30 | 1 5 1 | 3 20 56 23 | 70 27 62 5 84 28 | 208530 | 3 22 1 24 | 71 27 69 17 72 20 | 207921 |
| CYI-04 X-Y USB-30 | 1 5 1 | 3 20 56 23 | 70 27 78 44 45 8 | 206462 | 3 22 1 24 | 71 27 82 58 32 4 | 206044 |
| MAD-23 X-Y USB-85 | 1 5 3 | 3 20 56 28 | 69 27 100 54 7 35 | 206073 | 3 22 1 31 | 70 27 115 66 11 22 | 205829 |
| ANG-91 X-Y USB-30 | 0 53 0 | 3 21 8 21 | 70 27 63 3 87 27 | 208063 | 3 22 1 22 | 71 27 65 14 75 24 | 208125 |
| GBM-41 X-Y USB-30 | 0 5 29 | 3 21 55 55 | 71 27 61 3 87 29 | 208453 | 3 22 1 24 | 71 27 62 4 85 28 | 208695 |
| MIL-71 X-Y USB-30 | 0 0 9 | 3 22 1 14 | 71 27 61 3 87 29 | 208749 | 3 22 1 23 | 71 27 61 3 87 29 | 208755 |

1-89

12
11
10
9
8
7
6

VEHICLE 1 RADAR TABLE

TRACKING TIME

STATION ACQUISITION DATA

STATION TERMINATION DATA

| HRS MIN SEC | | | DAY | HRS | MIN | SEC | RA | DEC | AZ | ELV | X | Y | RANGE | DAY | HRS | MIN | SEC | RA | DEC | AZ | ELV | X | Y | RANGE | |
|-------------|---|----|-----|-----|-----|-----|----|-----|----|-----|----|----|-------|--------|-----|-----|-----|----|-----|----|------|----|----|-------|--------|
| GBM-41 | 1 | 4 | 57 | 3 | 22 | 49 | 56 | 71 | 27 | 67 | 14 | 75 | 23 | 208231 | 3 | 23 | 54 | 53 | 72 | 27 | 71 | 27 | 62 | 17 | 207561 |
| X-Y USB-30 | | | | | | | | | | | | | | | | | | | | | | | | | |
| ANG-91 | 1 | 4 | 54 | 3 | 22 | 49 | 58 | 71 | 27 | 67 | 24 | 64 | 20 | 207635 | 3 | 23 | 54 | 52 | 72 | 27 | 68 | 38 | 50 | 17 | 206992 |
| X-Y USB-30 | | | | | | | | | | | | | | | | | | | | | | | | | |
| MIL-71 | 1 | 4 | 57 | 3 | 22 | 49 | 58 | 71 | 27 | 66 | 13 | 76 | 23 | 208302 | 3 | 23 | 54 | 54 | 72 | 27 | 71 | 25 | 64 | 17 | 207641 |
| X-Y USB-30 | | | | | | | | | | | | | | | | | | | | | | | | | |
| BDA-02 | 1 | 4 | 55 | 3 | 22 | 50 | 0 | 71 | 27 | 74 | 27 | 62 | 14 | 207493 | 3 | 23 | 54 | 55 | 72 | 27 | 80 | 40 | 50 | 8 | 206915 |
| X-Y USB-30 | | | | | | | | | | | | | | | | | | | | | | | | | |
| ACN-75 | 1 | 4 | 57 | 3 | 22 | 50 | 2 | 70 | 28 | 31 | 48 | 25 | 35 | 206495 | 3 | 23 | 54 | 59 | 71 | 28 | 11 | 53 | 8 | 36 | 206351 |
| X-Y USB-30 | | | | | | | | | | | | | | | | | | | | | | | | | |
| CYI-04 | 1 | 4 | 52 | 3 | 22 | 50 | 10 | 70 | 27 | 86 | 69 | 21 | 1 | 205857 | 3 | 23 | 55 | 2 | 71 | 27 | 91 | 82 | 8 | 0 | 205719 |
| X-Y USB-30 | | | | | | | | | | | | | | | | | | | | | | | | | |
| MAD-23 | 1 | 4 | 53 | 3 | 22 | 50 | 16 | 70 | 27 | 139 | 73 | 13 | 11 | 205765 | 3 | 23 | 55 | 9 | 71 | 27 | -169 | 77 | 13 | -3 | 205786 |
| X-Y USB-85 | | | | | | | | | | | | | | | | | | | | | | | | | |
| TEX-16 | 0 | 43 | 43 | 3 | 23 | 11 | 11 | 71 | 27 | 61 | 3 | 87 | 29 | 207874 | 3 | 23 | 54 | 54 | 72 | 27 | 65 | 11 | 78 | 24 | 208439 |
| X-Y USB-30 | | | | | | | | | | | | | | | | | | | | | | | | | |
| TEX-16 | 1 | 4 | 41 | 4 | 0 | 44 | 3 | 72 | 27 | 70 | 21 | 68 | 19 | 207973 | 4 | 1 | 48 | 45 | 73 | 27 | 74 | 34 | 55 | 13 | 207359 |
| X-Y USB-30 | | | | | | | | | | | | | | | | | | | | | | | | | |
| GYM-14 | 1 | 4 | 38 | 4 | 0 | 44 | 4 | 72 | 27 | 65 | 10 | 79 | 25 | 208596 | 4 | 1 | 48 | 42 | 73 | 27 | 70 | 23 | 66 | 18 | 207946 |
| X-Y USB-30 | | | | | | | | | | | | | | | | | | | | | | | | | |

06-1

12
11
10
9
8
7
6
5
4
3
2

VEHICLE 1 RADAR TABLE

TRACKING TIME

STATION ACQUISITION DATA

STATION TERMINATION DATA

HRS MIN SEC

DAY HRS MIN SEC RA DEC AZ ELV X Y RANGE

DAY HRS MIN SEC RA DEC AZ ELV X Y RANGE

| | | | | | | | | | | | | | | | | | | | | | | | | | |
|----------------------|---|---|----|---|---|----|----|----|----|------|----|-----|-----|--------|---|---|----|----|----|----|------|----|-----|-----|--------|
| GDS-28 X-Y USB-85 | 1 | 4 | 44 | 4 | 0 | 44 | 5 | 72 | 27 | 63 | 9 | -71 | 62 | 208685 | 4 | 1 | 48 | 49 | 73 | 27 | 71 | 20 | -42 | 62 | 208090 |
| NIL-71 X-Y USB-30 | 1 | 4 | 43 | 4 | 0 | 44 | 6 | 72 | 27 | 76 | 36 | 54 | 12 | 207216 | 4 | 1 | 48 | 49 | 73 | 27 | 80 | 49 | 41 | 7 | 206708 |
| GBM-41 X-Y USB-30 | 1 | 4 | 42 | 4 | 0 | 44 | 6 | 72 | 27 | 75 | 37 | 52 | 12 | 207137 | 4 | 1 | 48 | 48 | 73 | 27 | 78 | 51 | 39 | 7 | 206637 |
| ANG-91 X-Y USB-30 | 1 | 4 | 42 | 4 | 0 | 44 | 7 | 72 | 27 | 68 | 49 | 39 | 14 | 206627 | 4 | 1 | 48 | 48 | 73 | 28 | 63 | 62 | 25 | 12 | 206254 |
| BDA-02 X-Y USB-30 | 1 | 4 | 45 | 4 | 0 | 44 | 7 | 72 | 27 | 85 | 50 | 40 | 3 | 206587 | 4 | 1 | 48 | 52 | 73 | 27 | 93 | 63 | 27 | -1 | 206236 |
| STN-00 A-E USB150 | 1 | 4 | 41 | 4 | 0 | 44 | 8 | 72 | 27 | 61 | 6 | 83 | 29 | 208850 | 4 | 1 | 48 | 49 | 73 | 27 | 69 | 17 | 72 | 20 | 208277 |
| ACN-75 X-Y USB-30 | 1 | 4 | 51 | 4 | 0 | 44 | 14 | 71 | 28 | -8 | 54 | -6 | 36 | 206435 | 4 | 1 | 49 | 6 | 72 | 28 | -28 | 49 | -22 | 35 | 206708 |
| CYI-04 X-Y USB-30 | 1 | 4 | 53 | 4 | 0 | 44 | 21 | 71 | 27 | -98 | 87 | -3 | 0 | 205787 | 4 | 1 | 49 | 14 | 72 | 27 | -87 | 73 | -17 | 1 | 206032 |
| MAD-23 X-Y USB-85 | 1 | 4 | 51 | 4 | 0 | 44 | 23 | 71 | 27 | -132 | 71 | 13 | -14 | 205955 | 4 | 1 | 49 | 14 | 72 | 27 | -108 | 61 | 10 | -27 | 206296 |
| GYM-14 X-Y USB-30 | 1 | 5 | 3 | 4 | 2 | 37 | 42 | 73 | 27 | 74 | 33 | 56 | 13 | 207521 | 4 | 3 | 42 | 45 | 74 | 27 | 78 | 46 | 43 | 8 | 206992 |

116-1

12
11
10
9
8
7
6

VEHICLE 1 RADAR TABLE

| | TRACKING TIME | | | STATION ACQUISITION DATA | | | | | | | | STATION TERMINATION DATA | | | | | | | | | | | | | |
|----------------------|---------------|-----|-----|--------------------------|-----|-----|-----|----|-----|-----|-----|--------------------------|-----|--------|-----|-----|-----|-----|----|-----|-----|-----|-----|-----|--------|
| | HRS | MIN | SEC | DAY | HRS | MIN | SEC | RA | DEC | AZ | ELV | X | Y | RANGE | DAY | HRS | MIN | SEC | RA | DEC | AZ | ELV | X | Y | RANGE |
| GDS-28 X-Y USB-85 | 1 | 5 | 0 | 4 | 2 | 37 | 43 | 73 | 27 | 76 | 30 | -22 | 57 | 207686 | 4 | 3 | 42 | 43 | 74 | 27 | 83 | 42 | -7 | 47 | 207164 |
| STN-00 A-E USB150 | 1 | 5 | 1 | 4 | 2 | 37 | 44 | 73 | 27 | 75 | 26 | 63 | 13 | 207878 | 4 | 3 | 42 | 44 | 74 | 27 | 82 | 38 | 52 | 6 | 207349 |
| TEX-16 X-Y USB-30 | 1 | 5 | 0 | 4 | 2 | 37 | 45 | 73 | 27 | 78 | 45 | 45 | 8 | 206986 | 4 | 3 | 42 | 45 | 74 | 28 | 82 | 58 | 32 | 4 | 206567 |
| GBM-41 X-Y USB-30 | 1 | 5 | 3 | 4 | 2 | 37 | 46 | 73 | 27 | 81 | 62 | 28 | 4 | 206389 | 4 | 3 | 42 | 49 | 74 | 28 | 83 | 75 | 15 | 2 | 206170 |
| MIL-71 X-Y USB-30 | 1 | 5 | 2 | 4 | 2 | 37 | 47 | 73 | 27 | 84 | 60 | 30 | 3 | 206444 | 4 | 3 | 42 | 49 | 74 | 28 | 89 | 73 | 17 | 0 | 206204 |
| ANG-91 X-Y USB-30 | 1 | 5 | 5 | 4 | 2 | 37 | 48 | 72 | 28 | 51 | 72 | 14 | 11 | 206135 | 4 | 3 | 42 | 53 | 73 | 28 | 0 | 79 | 0 | 11 | 206118 |
| BDA-02 X-Y USB-30 | 1 | 5 | 1 | 4 | 2 | 37 | 50 | 72 | 27 | 103 | 73 | 16 | -4 | 206115 | 4 | 3 | 42 | 51 | 73 | 28 | 152 | 85 | 3 | -5 | 206073 |
| ACN-75 X-Y USB-30 | 1 | 5 | 4 | 4 | 2 | 37 | 58 | 72 | 28 | -40 | 42 | -36 | 34 | 207084 | 4 | 3 | 43 | 3 | 73 | 28 | -50 | 31 | -52 | 33 | 207705 |
| CYI-04 X-Y USB-30 | 1 | 5 | 2 | 4 | 2 | 38 | 2 | 72 | 27 | -83 | 62 | -28 | 3 | 206360 | 4 | 3 | 43 | 4 | 73 | 27 | -79 | 49 | -41 | 7 | 206912 |
| MAD-23 X-Y USB-85 | 1 | 5 | 3 | 4 | 2 | 38 | 4 | 72 | 27 | -97 | 52 | 5 | -38 | 206677 | 4 | 3 | 43 | 7 | 73 | 27 | -87 | 41 | -4 | -49 | 207255 |

1-92

12
11
10
9
8
7
6
5
4
3
2

VEHICLE 1 RADAR TABLE

TRACKING TIME

STATION ACQUISITION DATA

STATION TERMINATION DATA

HRS MIN SEC

DAY HRS MIN SEC

RA DEC

AZ ELV

X

Y

RANGE

DAY HRS MIN SEC

RA DEC

AZ ELV

X

Y

RANGE

| | | | | | | | | | | | | | | | | | | | | | | | | | |
|----------------------|---|---|----|---|---|----|----|----|----|------|----|-----|----|--------|---|---|----|----|----|----|-----|----|-----|----|--------|
| NAM-12 X-Y USB-30 | 1 | 4 | 54 | 4 | 4 | 31 | 19 | 74 | 27 | 66 | 13 | 76 | 24 | 208832 | 4 | 5 | 36 | 13 | 75 | 27 | 69 | 26 | 63 | 19 | 208135 |
| GDS-28 X-Y USB-85 | 1 | 4 | 54 | 4 | 4 | 31 | 27 | 74 | 27 | 90 | 52 | 0 | 38 | 206873 | 4 | 5 | 36 | 21 | 75 | 27 | 100 | 65 | 5 | 25 | 206538 |
| GYM-14 X-Y USB-30 | 1 | 4 | 53 | 4 | 4 | 31 | 29 | 74 | 27 | 82 | 57 | 33 | 4 | 206707 | 4 | 5 | 36 | 22 | 75 | 28 | 86 | 71 | 19 | 1 | 206409 |
| STN-00 A-E USB150 | 1 | 4 | 53 | 4 | 4 | 31 | 29 | 74 | 27 | 89 | 48 | 42 | 0 | 207035 | 4 | 5 | 36 | 22 | 75 | 27 | 100 | 60 | 29 | -5 | 206666 |
| TEX-16 X-Y USB-30 | 1 | 4 | 57 | 4 | 4 | 31 | 31 | 74 | 27 | 85 | 69 | 21 | 2 | 206386 | 4 | 5 | 36 | 28 | 75 | 28 | 88 | 83 | 7 | 0 | 206250 |
| GBM-41 X-Y USB-30 | 1 | 4 | 52 | 4 | 4 | 31 | 40 | 73 | 27 | 77 | 86 | 4 | 1 | 206161 | 4 | 5 | 36 | 32 | 74 | 28 | -81 | 80 | -10 | 1 | 206276 |
| MIL-71 X-Y USB-30 | 1 | 4 | 51 | 4 | 4 | 31 | 41 | 73 | 27 | 99 | 84 | 6 | -1 | 206171 | 4 | 5 | 36 | 32 | 74 | 28 | -94 | 82 | -8 | -1 | 206255 |
| BDA-02 X-Y USB-30 | 1 | 4 | 53 | 4 | 4 | 31 | 43 | 73 | 27 | -119 | 80 | -9 | -5 | 206199 | 4 | 5 | 36 | 36 | 74 | 28 | -96 | 68 | -22 | -2 | 206476 |
| ANG-91 X-Y USB-30 | 1 | 4 | 49 | 4 | 4 | 31 | 46 | 73 | 28 | -45 | 74 | -11 | 11 | 206274 | 4 | 5 | 36 | 35 | 74 | 28 | -62 | 62 | -25 | 13 | 206620 |
| ACN-75 X-Y USB-30 | 1 | 4 | 47 | 4 | 4 | 31 | 59 | 72 | 28 | -56 | 21 | -65 | 31 | 208300 | 4 | 5 | 36 | 46 | 74 | 28 | -60 | 9 | -80 | 30 | 209137 |

1-93

12
11
10
9
8
7
6

VEHICLE 1 RADAR TABLE

TRACKING TIME

STATION ACQUISITION DATA

STATION TERMINATION DATA

HRS MIN SEC

DAY HRS MIN SEC RA DEC AZ ELV X Y RANGE

DAY HRS MIN SEC RA DEC AZ ELV X Y RANGE

| | | | | | | | | | | | | | | | | | | | | | | | | | |
|----------------------|---|---|----|---|---|----|----|----|----|-----|----|-----|-----|--------|---|---|----|----|----|----|-----|----|-----|-----|--------|
| MAD-23 X-Y USB-85 | 1 | 4 | 46 | 4 | 4 | 31 | 60 | 73 | 27 | -80 | 31 | -17 | -57 | 207776 | 4 | 5 | 36 | 45 | 74 | 27 | -71 | 20 | -41 | -63 | 208469 |
| CYI-04 X-Y USB-30 | 1 | 4 | 46 | 4 | 4 | 32 | 1 | 73 | 27 | -76 | 38 | -51 | 11 | 207446 | 4 | 5 | 36 | 47 | 74 | 27 | -71 | 25 | -64 | 17 | 208198 |
| HAW-12 X-Y USB-30 | 1 | 4 | 44 | 4 | 6 | 25 | 24 | 75 | 27 | 71 | 37 | 52 | 15 | 207703 | 4 | 7 | 30 | 8 | 76 | 28 | 73 | 50 | 39 | 11 | 207180 |
| GYM-14 X-Y USB-30 | 1 | 4 | 55 | 4 | 6 | 25 | 34 | 75 | 28 | 91 | 82 | 8 | 0 | 206358 | 4 | 7 | 30 | 28 | 76 | 28 | -91 | 85 | -5 | 0 | 206419 |
| GDS-28 X-Y USB-85 | 1 | 4 | 53 | 4 | 6 | 25 | 35 | 75 | 27 | 117 | 75 | 7 | 14 | 206443 | 4 | 7 | 30 | 28 | 76 | 28 | 178 | 82 | 8 | 0 | 206435 |
| STN-00 A-E USB150 | 1 | 4 | 49 | 4 | 6 | 25 | 35 | 75 | 27 | 114 | 70 | 19 | -8 | 206531 | 4 | 7 | 30 | 24 | 76 | 28 | 152 | 79 | 5 | -10 | 206463 |
| TEX-16 X-Y USB-30 | 1 | 4 | 51 | 4 | 6 | 25 | 40 | 74 | 28 | -91 | 86 | -4 | 0 | 206324 | 4 | 7 | 30 | 31 | 75 | 28 | -85 | 73 | -17 | 1 | 206560 |
| MIL-71 X-Y USB-30 | 1 | 4 | 55 | 4 | 6 | 25 | 43 | 74 | 27 | -88 | 71 | -19 | 1 | 206493 | 4 | 7 | 30 | 38 | 75 | 28 | -83 | 58 | -32 | 4 | 206931 |
| GBM-41 X-Y USB-30 | 1 | 5 | 0 | 4 | 6 | 25 | 44 | 74 | 28 | -82 | 69 | -21 | 3 | 206540 | 4 | 7 | 30 | 45 | 75 | 28 | -79 | 55 | -34 | 6 | 207018 |
| BDA-02 X-Y USB-30 | 1 | 4 | 57 | 4 | 6 | 25 | 48 | 74 | 27 | -89 | 57 | -33 | 1 | 206848 | 4 | 7 | 30 | 45 | 75 | 28 | -82 | 45 | -45 | 6 | 207434 |

46-1

VEHICLE 1 RADAR TABLE

TRACKING TIME

STATION ACQUISITION DATA

STATION TERMINATION DATA

HRS MIN SEC

DAY HRS MIN SEC

RA DEC AZ ELV X Y RANGE

DAY HRS MIN SEC

RA DEC AZ ELV X Y RANGE

| | | | | | |
|----------------------|---------|-----------|-----------------------------|-----------|-----------------------------|
| ANG-91 X-Y USB-30 | 1 4 58 | 4 6 25 49 | 74 28 -67 51 -36 14 207055 | 4 7 30 47 | 75 28 -68 38 -50 17 207737 |
| MAD-23 X-Y USB-85 | 0 55 37 | 4 6 25 53 | 74 27 -64 11 -65 -62 209046 | 4 7 21 30 | 75 27 -56 3 -85 -56 209155 |
| CYI-04 X-Y USB-30 | 1 4 21 | 4 6 25 56 | 74 27 -67 15 -74 22 208842 | 4 7 30 18 | 75 27 -61 3 -87 29 209633 |
| GWN-24 X-Y USB-30 | 0 8 33 | 4 8 18 58 | 77 27 64 8 81 26 209437 | 4 8 27 31 | 77 27 64 10 79 26 208890 |
| HAW-12 X-Y USB-30 | 0 8 25 | 4 8 19 6 | 76 28 73 61 28 8 206930 | 4 8 27 31 | 76 28 72 63 26 8 206446 |
| STN-00 A-E USB150 | 0 8 16 | 4 8 19 14 | 76 27 -148 79 -6 -10 206569 | 4 8 27 31 | 76 27 -141 78 -8 -10 206155 |
| GDS-28 X-Y USB-85 | 0 8 15 | 4 8 19 15 | 75 27 -124 77 7 -11 206587 | 4 8 27 31 | 75 27 -119 76 7 -13 206182 |
| GYM-14 X-Y USB-30 | 0 8 13 | 4 8 19 17 | 75 28 -87 74 -16 1 206635 | 4 8 27 31 | 75 28 -86 72 -18 1 206243 |
| TEX-16 X-Y USB-30 | 0 8 11 | 4 8 19 20 | 75 28 -83 62 -28 3 206901 | 4 8 27 31 | 75 28 -82 60 -30 4 206531 |
| MIL-71 X-Y USB-30 | 0 8 8 | 4 8 19 23 | 75 27 -79 47 -42 7 207402 | 4 8 27 31 | 75 27 -79 45 -44 8 207054 |

1-95

12
11
10
9
8
7
6

VEHICLE 1 RADAR TABLE

TRACKING TIME

STATION ACQUISITION DATA

STATION TERMINATION DATA

HRS MIN SEC

DAY HRS MIN SEC

RA DEC

AZ ELV

X

Y

RANGE

DAY HRS MIN SEC

RA DEC

AZ ELV

X

Y

RANGE

GBM-41 0 8 5 4 8 19 26 75 27 -77 45 -45 9 207505 4 8 27 31 75 27 -76 43 -46 10 207163
X-Y USB-30

BDA-02 0 8 5 4 8 19 26 75 27 -77 34 -55 11 207981 4 8 27 31 75 27 -76 33 -57 12 207646
X-Y USB-30

ANG-91 0 8 3 4 8 19 28 75 28 -67 27 -61 20 208356 4 8 27 31 75 27 -67 25 -63 21 208035
X-Y USB-30

31 JAN 71

LM SEP TO CIR IGNITION

LAZ 72.1

GWM-24 0 56 28 4 8 27 37 77 27 64 10 79 26 208883 4 9 24 5 78 28 65 22 66 23 208726
X-Y USB-30

HAW-12 0 56 36 4 8 27 37 76 28 72 63 26 8 206441 4 9 24 13 77 28 65 74 14 6 206705
X-Y USB-30

STN-00 0 56 44 4 8 27 37 76 27 -141 78 -8 -10 206149 4 9 24 21 77 28 -111 69 -20 -8 206812
A-E USB150

GDS-28 0 56 47 4 8 27 37 75 27 -119 76 7 -13 206177 4 9 24 24 76 28 -101 65 5 -24 206897
X-Y USB-85

GYM-14 0 56 49 4 8 27 37 75 28 -86 72 -18 1 206238 4 9 24 26 76 28 -82 60 -30 4 207039
X-Y USB-30

TEX-16 0 56 51 4 8 27 37 75 28 -82 60 -30 4 206527 4 9 24 28 76 28 -78 48 -41 8 207451
X-Y USB-30

MIL-71 0 56 54 4 8 27 37 75 27 -79 45 -44 8 207050 4 9 24 31 76 28 -74 34 -55 13 208091
X-Y USB-30

1-96

VEHICLE 1 RADAR TABLE

TRACKING TIME

STATION ACQUISITION DATA

STATION TERMINATION DATA

| | HRS | MIN | SEC | DAY | HRS | MIN | SEC | RA | DEC | AZ | ELV | X | Y | RANGE | DAY | HRS | MIN | SEC | RA | DEC | AZ | ELV | X | Y | RANGE |
|----------------------|-----|-----|-----|-----|-----|-----|-----|-----|-----|-------|----------|-----|-----|--------|-----|------|-----|-----|----|-----|-----|-----|-----|-----|--------|
| GBM-41 X-Y USB-30 | 0 | 56 | 54 | 4 | 8 | 27 | 37 | 75 | 27 | -76 | 43 | -46 | 10 | 207159 | 4 | 9 | 24 | 31 | 76 | 28 | -73 | 31 | -57 | 15 | 208223 |
| ANG-91 X-Y USB-30 | 0 | 56 | 55 | 4 | 8 | 27 | 37 | 75 | 27 | -67 | 25 | -63 | 21 | 208030 | 4 | 9 | 24 | 32 | 76 | 28 | -65 | 14 | -75 | 24 | 209205 |
| BDA-02 X-Y USB-30 | 0 | 56 | 57 | 4 | 8 | 27 | 37 | 75 | 27 | -76 | 33 | -57 | 12 | 207642 | 4 | 9 | 24 | 34 | 76 | 27 | -71 | 22 | -67 | 18 | 208733 |
| | | | | 31 | JAN | 71 | | CIR | TO | LOPC1 | IGNITION | | | | LAZ | 72.1 | | | | | | | | | |
| GWM-24 X-Y USB-30 | 1 | 11 | 46 | 4 | 10 | 11 | 42 | 78 | 28 | 65 | 32 | 55 | 21 | 208327 | 4 | 11 | 23 | 28 | 79 | 28 | 63 | 47 | 40 | 18 | 207716 |
| MSK-25 X-Y USB-85 | 1 | 11 | 46 | 4 | 10 | 11 | 42 | 77 | 28 | 47 | 7 | -79 | 47 | 209718 | 4 | 11 | 23 | 28 | 79 | 29 | 35 | 16 | -71 | 33 | 209265 |
| HAW-12 X-Y USB-30 | 1 | 11 | 54 | 4 | 10 | 11 | 56 | 77 | 28 | 30 | 83 | 3 | 6 | 206755 | 4 | 11 | 23 | 49 | 78 | 28 | -62 | 77 | -12 | 6 | 206919 |
| GDS-28 X-Y USB-85 | 1 | 11 | 59 | 4 | 10 | 12 | 4 | 76 | 27 | -92 | 55 | 1 | -35 | 207324 | 4 | 11 | 24 | 3 | 77 | 28 | -83 | 42 | -8 | -48 | 207977 |
| STN-00 A-E USB150 | 1 | 11 | 54 | 4 | 10 | 12 | 5 | 76 | 27 | -99 | 60 | -30 | -5 | 207193 | 4 | 11 | 23 | 59 | 77 | 28 | -88 | 46 | -44 | 2 | 207781 |
| GYM-14 X-Y USB-30 | 1 | 11 | 57 | 4 | 10 | 12 | 6 | 76 | 28 | -79 | 50 | -40 | 7 | 207536 | 4 | 11 | 24 | 3 | 77 | 28 | -74 | 35 | -54 | 13 | 208289 |
| TEX-16 X-Y USB-30 | 1 | 11 | 56 | 4 | 10 | 12 | 10 | 76 | 27 | -75 | 38 | -51 | 11 | 208036 | 4 | 11 | 24 | 6 | 77 | 28 | -70 | 24 | -65 | 18 | 208885 |

1-97

12
11
10
9
8
7

VEHICLE 1 RADAR TABLE

| | TRACKING TIME | | | STATION ACQUISITION DATA | | | | | | | STATION TERMINATION DATA | | | | | | | | | | | | | | |
|----------------------|---------------|-----|-----|--------------------------|-----|-----|-----|----|-----|-----|--------------------------|-----|-----|--------|-----|-----|-----|-----|----|-----|-----|-----|-----|-----|--------|
| | HRS | MIN | SEC | DAY | HRS | MIN | SEC | RA | DEC | AZ | ELV | X | Y | RANGE | DAY | HRS | MIN | SEC | RA | DEC | AZ | ELV | X | Y | RANGE |
| BDA-02 X-Y USB-30 | 0 | 54 | 42 | 4 | 10 | 12 | 12 | 76 | 27 | -66 | 12 | -76 | 24 | 209399 | 4 | 11 | 6 | 54 | 77 | 27 | -59 | 3 | -86 | 31 | 209181 |
| GBM-41 X-Y USB-30 | 1 | 11 | 55 | 4 | 10 | 12 | 13 | 76 | 27 | -69 | 21 | -67 | 19 | 208896 | 4 | 11 | 24 | 8 | 77 | 27 | -63 | 7 | -82 | 27 | 209812 |
| MIL-71 X-Y USB-30 | 1 | 11 | 51 | 4 | 10 | 12 | 13 | 76 | 27 | -71 | 24 | -65 | 18 | 208746 | 4 | 11 | 24 | 5 | 77 | 27 | -64 | 10 | -79 | 25 | 209644 |
| ANG-91 X-Y USB-30 | 0 | 1 | 2 | 4 | 10 | 12 | 14 | 76 | 27 | -62 | 3 | -86 | 28 | 209941 | 4 | 10 | 13 | 16 | 76 | 27 | -62 | 3 | -87 | 28 | 209906 |
| CRO-08 X-Y USB-30 | 1 | 11 | 42 | 4 | 12 | 10 | 1 | 79 | 28 | 53 | 10 | 78 | 37 | 209762 | 4 | 13 | 21 | 43 | 80 | 29 | 42 | 21 | 61 | 44 | 209180 |
| HSK-25 X-Y USB-85 | 1 | 11 | 42 | 4 | 12 | 10 | 9 | 78 | 29 | 25 | 21 | -67 | 24 | 209093 | 4 | 13 | 21 | 51 | 79 | 29 | 10 | 25 | -65 | 9 | 208947 |
| GWM-24 X-Y USB-30 | 1 | 11 | 40 | 4 | 12 | 10 | 12 | 79 | 28 | 59 | 57 | 29 | 16 | 207453 | 4 | 13 | 21 | 52 | 80 | 28 | 40 | 70 | 13 | 15 | 207197 |
| HAW-12 X-Y USB-30 | 1 | 11 | 40 | 4 | 12 | 10 | 29 | 78 | 28 | -71 | 66 | -22 | 7 | 207184 | 4 | 13 | 22 | 10 | 79 | 28 | -73 | 52 | -37 | 11 | 207744 |
| GDS-28 X-Y USB-85 | 1 | 11 | 37 | 4 | 12 | 10 | 37 | 77 | 27 | -77 | 32 | -19 | -56 | 208489 | 4 | 13 | 22 | 13 | 78 | 27 | -69 | 19 | -45 | -62 | 209305 |
| STN-00 A-E USB150 | 1 | 11 | 35 | 4 | 12 | 10 | 38 | 77 | 27 | -81 | 37 | -53 | 7 | 208262 | 4 | 13 | 22 | 13 | 78 | 27 | -73 | 24 | -65 | 16 | 209041 |

1-98

VEHICLE 1 RADAR TABLE

| | TRACKING TIME | | | STATION ACQUISITION DATA | | | | | | | | | | STATION TERMINATION DATA | | | | | | | | | | | |
|----------------------|---------------|-----|-----|--------------------------|-----|-----|-----|----|-----|-----|-----|-----|-----|--------------------------|-----|-----|-----|-----|----|-----|-----|-----|-----|-----|--------|
| | HRS | MIN | SEC | DAY | HRS | MIN | SEC | RA | DEC | AZ | ELV | X | Y | RANGE | DAY | HRS | MIN | SEC | RA | DEC | AZ | ELV | X | Y | RANGE |
| GYM-14 X-Y USB-30 | 1 | 11 | 34 | 4 | 12 | 10 | 39 | 77 | 27 | -71 | 25 | -64 | 17 | 208861 | 4 | 13 | 22 | 12 | 78 | 27 | -65 | 11 | -77 | 25 | 209750 |
| TEX-16 X-Y USB-30 | 0 | 59 | 28 | 4 | 12 | 10 | 40 | 77 | 27 | -66 | 14 | -75 | 23 | 209489 | 4 | 13 | 10 | 8 | 78 | 27 | -60 | 3 | -87 | 29 | 209601 |
| CRO-08 X-Y USB-30 | 1 | 11 | 54 | 4 | 14 | 8 | 26 | 80 | 28 | 34 | 27 | 47 | 48 | 208921 | 4 | 15 | 20 | 20 | 81 | 29 | 18 | 34 | 25 | 52 | 208662 |
| MSK-25 X-Y USB-85 | 1 | 11 | 57 | 4 | 14 | 8 | 34 | 79 | 29 | -2 | 26 | -64 | -2 | 209002 | 4 | 15 | 20 | 31 | 80 | 29 | -18 | 23 | -66 | -17 | 209231 |
| GWM-24 X-Y USB-30 | 1 | 10 | 10 | 4 | 14 | 8 | 35 | 79 | 28 | 8 | 75 | 2 | 15 | 207201 | 4 | 15 | 18 | 45 | 80 | 28 | -40 | 70 | -13 | 15 | 207293 |
| HAW-12 X-Y USB-30 | 1 | 11 | 60 | 4 | 14 | 8 | 48 | 78 | 28 | -72 | 41 | -48 | 14 | 208247 | 4 | 15 | 20 | 48 | 80 | 28 | -69 | 26 | -62 | 19 | 209099 |
| STN-00 A-E USB150 | 1 | 11 | 58 | 4 | 14 | 8 | 51 | 78 | 27 | -67 | 15 | -74 | 22 | 209608 | 4 | 15 | 20 | 50 | 80 | 27 | -58 | 3 | -86 | 32 | 210428 |
| GDS-28 X-Y USB-85 | 0 | 43 | 41 | 4 | 14 | 8 | 51 | 78 | 27 | -64 | 10 | -68 | -62 | 209886 | 4 | 14 | 52 | 32 | 79 | 27 | -58 | 3 | -84 | -58 | 209143 |
| CRO-08 X-Y USB-30 | 1 | 11 | 40 | 4 | 16 | 6 | 57 | 80 | 29 | 5 | 36 | 7 | 53 | 208641 | 4 | 17 | 18 | 37 | 81 | 29 | -13 | 35 | -18 | 53 | 208779 |
| MSK-25 X-Y USB-85 | 1 | 11 | 41 | 4 | 16 | 7 | 4 | 80 | 29 | -29 | 20 | -68 | -27 | 209514 | 4 | 17 | 18 | 45 | 81 | 29 | -42 | 12 | -75 | -40 | 210068 |

66-T

12
11
10
9
8
7
6
5
4

VEHICLE 1 RADAR TABLE

TRACKING TIME

STATION ACQUISITION DATA

STATION TERMINATION DATA

| | HRS | MIN | SEC | DAY | HRS | MIN | SEC | RA | DEC | AZ | ELV | X | Y | RANGE | DAY | HRS | MIN | SEC | RA | DEC | AZ | ELV | X | Y | RANGE |
|----------------------|-----|-----|-----|-----|-----|-----|-----|----|-----|-----|-----|-----|-----|--------|-----|-----|-----|-----|----|-----|-----|-----|-----|-----|--------|
| GWM-24 X-Y USB-30 | 1 | 11 | 38 | 4 | 16 | 7 | 11 | 80 | 28 | -55 | 61 | -24 | 16 | 207673 | 4 | 17 | 18 | 49 | 81 | 28 | -63 | 47 | -40 | 18 | 208272 |
| HAW-12 X-Y USB-30 | 1 | 7 | 46 | 4 | 16 | 7 | 21 | 79 | 28 | -66 | 16 | -73 | 23 | 209710 | 4 | 17 | 15 | 7 | 81 | 28 | -61 | 3 | -87 | 29 | 210397 |
| MAD-23 X-Y USB-85 | 0 | 18 | 11 | 4 | 17 | 0 | 17 | 82 | 27 | 56 | 3 | -85 | 56 | 209639 | 4 | 17 | 18 | 28 | 82 | 27 | 59 | 6 | -79 | 58 | 210412 |
| MAD-23 X-Y USB-85 | 1 | 11 | 54 | 4 | 18 | 5 | 7 | 82 | 27 | 66 | 14 | -59 | 62 | 210051 | 4 | 19 | 17 | 1 | 84 | 27 | 75 | 26 | -28 | 60 | 209451 |
| CRO-08 X-Y USB-30 | 1 | 11 | 59 | 4 | 18 | 5 | 20 | 81 | 29 | -25 | 32 | -34 | 50 | 209034 | 4 | 19 | 17 | 19 | 82 | 29 | -39 | 24 | -55 | 45 | 209576 |
| HSK-25 X-Y USB-85 | 0 | 12 | 6 | 4 | 18 | 5 | 24 | 81 | 28 | -50 | 5 | -83 | -49 | 210547 | 4 | 18 | 17 | 30 | 81 | 28 | -51 | 3 | -85 | -51 | 210051 |
| GWM-24 X-Y USB-30 | 1 | 11 | 59 | 4 | 18 | 5 | 28 | 81 | 28 | -65 | 36 | -51 | 20 | 208804 | 4 | 19 | 17 | 26 | 82 | 28 | -65 | 22 | -66 | 23 | 209698 |
| CYI-04 X-Y USB-30 | 0 | 51 | 29 | 4 | 18 | 25 | 31 | 83 | 27 | 61 | 3 | 87 | 29 | 209709 | 4 | 19 | 16 | 60 | 84 | 28 | 65 | 12 | 76 | 24 | 210203 |
| ACN-75 X-Y USB-30 | 1 | 11 | 42 | 4 | 20 | 3 | 25 | 84 | 28 | 60 | 8 | 81 | 30 | 210583 | 4 | 21 | 15 | 7 | 85 | 28 | 55 | 22 | 64 | 32 | 209832 |
| CYI-04 X-Y USB-30 | 1 | 11 | 39 | 4 | 20 | 3 | 31 | 84 | 28 | 70 | 22 | 67 | 19 | 209745 | 4 | 21 | 15 | 10 | 85 | 28 | 75 | 36 | 53 | 12 | 209075 |

1-100

VEHICLE 1 RADAR TABLE

TRACKING TIME

STATION ACQUISITION DATA

STATION TERMINATION DATA

HRS MIN SEC

DAY HRS MIN SEC

RA DEC

AZ ELV X Y RANGE

DAY HRS MIN SEC

RA DEC

AZ ELV X Y RANGE

MAD-23 1 11 42 4 20 3 34 83 27 82 35 -12 55 209087 4 21 15 15 85 28 92 47 1 43 208585
X-Y USB-85

CRO-08 1 11 43 4 20 3 54 82 28 -47 16 -68 41 210040 4 21 15 37 83 28 -56 4 -85 34 210854
X-Y USB-30

GWM-24 0 40 36 4 20 3 59 82 28 -64 11 -78 26 210341 4 20 44 35 82 28 -62 3 -87 28 209605
X-Y USB-30

ACN-75 0 8 4 4 22 1 36 85 28 50 31 52 33 209444 4 22 9 40 85 28 49 32 50 34 208962
X-Y USB-30

BDA-02 0 8 2 4 22 1 38 85 27 62 8 82 27 210763 4 22 9 40 85 27 63 9 80 26 210272
X-Y USB-30

CYI-04 0 7 58 4 22 1 42 85 28 78 46 43 8 208727 4 22 9 40 85 28 79 48 41 8 208258
X-Y USB-30

MAD-23 0 7 55 4 22 1 45 84 28 101 56 7 33 208357 4 22 9 40 84 28 102 58 8 31 207912
X-Y USB-85

ANG-91 0 6 28 4 22 3 12 85 28 62 3 87 28 210959 4 22 9 40 85 28 63 4 85 27 210548
X-Y USB-30

31 JAN 71

LOPC1 TO LM JETT IGNITION

LAZ 72.1

ANG-91 1 3 40 4 22 9 59 85 28 63 4 85 27 210528 4 23 13 39 86 28 65 17 71 23 210263
X-Y USB-30

BDA-02 1 3 46 4 22 9 59 85 27 63 9 80 26 210253 4 23 13 44 86 28 70 21 68 19 210082
X-Y USB-30

1-101

12
11
10
9
8
7
6
5

VEHICLE 1 RADAR TABLE

| VEHICLE | TRACKING TIME | | | STATION ACQUISITION DATA | | | | | | | | | | STATION TERMINATION DATA | | | | | | | | | | | |
|----------------------|---------------|-----|-----|--------------------------|-----|-----|-----|----|-----|-----|-----|----|----|--------------------------|-----|-----|-----|-----|----|-----|-----|-----|----|----|--------|
| | HRS | MIN | SEC | DAY | HRS | MIN | SEC | RA | DEC | AZ | ELV | X | Y | RANGE | DAY | HRS | MIN | SEC | RA | DEC | AZ | ELV | X | Y | RANGE |
| ACN-75 X-Y USB-30 | 1 | 3 | 47 | 4 | 22 | 9 | 59 | 85 | 28 | 49 | 33 | 50 | 34 | 208944 | 4 | 23 | 13 | 45 | 86 | 28 | 39 | 43 | 34 | 35 | 208960 |
| CYI-04 X-Y USB-30 | 1 | 3 | 50 | 4 | 22 | 9 | 59 | 85 | 28 | 79 | 48 | 41 | 8 | 208240 | 4 | 23 | 13 | 48 | 86 | 28 | 82 | 61 | 29 | 4 | 208292 |
| MAD-23 X-Y USB-85 | 1 | 3 | 52 | 4 | 22 | 9 | 59 | 84 | 28 | 102 | 58 | 8 | 31 | 207895 | 4 | 23 | 13 | 50 | 85 | 28 | 120 | 69 | 11 | 18 | 208109 |
| GBM-41 X-Y USB-30 | 0 | 23 | 41 | 4 | 22 | 50 | 1 | 86 | 27 | 61 | 3 | 87 | 29 | 209948 | 4 | 23 | 13 | 42 | 86 | 28 | 63 | 7 | 82 | 27 | 210835 |
| MIL-71 X-Y USB-30 | 0 | 18 | 17 | 4 | 22 | 55 | 27 | 86 | 27 | 60 | 3 | 87 | 30 | 210162 | 4 | 23 | 13 | 44 | 86 | 27 | 62 | 6 | 83 | 28 | 210908 |
| ANG-91 X-Y USB-30 | 1 | 11 | 37 | 5 | 0 | 0 | 13 | 86 | 28 | 67 | 27 | 61 | 20 | 209790 | 5 | 1 | 11 | 50 | 87 | 28 | 67 | 42 | 45 | 16 | 209131 |
| MIL-71 X-Y USB-30 | 1 | 11 | 36 | 5 | 0 | 0 | 14 | 86 | 27 | 67 | 16 | 73 | 22 | 210446 | 5 | 1 | 11 | 50 | 87 | 28 | 73 | 30 | 59 | 15 | 209750 |
| GBM-41 X-Y USB-30 | 1 | 11 | 31 | 5 | 0 | 0 | 17 | 86 | 27 | 67 | 17 | 72 | 22 | 210370 | 5 | 1 | 11 | 47 | 87 | 28 | 72 | 31 | 58 | 15 | 209670 |
| BDA-02 X-Y USB-30 | 1 | 11 | 33 | 5 | 0 | 0 | 18 | 86 | 27 | 75 | 30 | 59 | 13 | 209652 | 5 | 1 | 11 | 51 | 87 | 28 | 81 | 44 | 46 | 6 | 209062 |
| ACN-75 X-Y USB-30 | 1 | 11 | 37 | 5 | 0 | 0 | 21 | 85 | 28 | 27 | 49 | 21 | 36 | 208771 | 5 | 1 | 11 | 58 | 86 | 28 | 4 | 54 | 3 | 36 | 208690 |

1-102

VEHICLE 1 RADAR TABLE

TRACKING TIME

STATION ACQUISITION DATA

STATION TERMINATION DATA

HRS MIN SEC

DAY HRS MIN SEC

RA DEC

AZ ELV

X

Y

RANGE

DAY HRS MIN SEC

RA DEC

AZ ELV

X

Y

RANGE

CYI-04 1 11 37 5 0 0 25 85 28 85 72 18 2 208117

X-Y USB-30

5 1 12 2 86 28 87 87 3 0 208038

MAD-23 1 11 38 5 0 0 28 85 28 147 75 13 8 208056

X-Y USB-85

5 1 12 5 86 28 -150 76 13 -7 208141

TEX-16 1 6 39 5 0 5 8 86 27 61 3 87 29 210947

X-Y USB-30

5 1 11 47 87 28 67 15 73 23 210530

GYM-14 0 9 52 5 1 1 54 87 27 60 3 87 30 210725

X-Y USB-30

5 1 11 47 87 27 61 5 85 29 211149

GDS-28 0 5 42 5 1 6 8 87 27 58 3 -84 58 210954

X-Y USB-85

5 1 11 50 87 27 59 4 -82 59 211205

GYM-14 1 12 1 5 1 58 23 87 27 66 14 75 23 210708

X-Y USB-30

5 3 10 24 88 28 72 28 61 16 210006

TEX-16 1 11 59 5 1 58 23 87 27 71 25 64 17 210093

X-Y USB-30

5 3 10 22 88 28 76 39 50 11 209443

GBM-41 1 12 1 5 1 58 25 87 28 76 41 48 11 209287

X-Y USB-30

5 3 10 26 88 28 79 56 33 6 208784

MIL-71 1 12 0 5 1 58 25 87 28 76 40 50 10 209362

X-Y USB-30

5 3 10 26 88 28 81 54 35 5 208847

GDS-28 1 11 58 5 1 58 26 87 27 65 12 -62 62 210807

X-Y USB-85

5 3 10 24 88 27 73 25 -32 60 210156

1-103

12
11
10
9
8
7
6

VEHICLE 1 RADAR TABLE

| VEHICLE | TRACKING TIME | | | STATION ACQUISITION DATA | | | | | | | | | | STATION TERMINATION DATA | | | | | | | | | | | |
|----------------------|---------------|-----|-----|--------------------------|-----|-----|-----|----|-----|------|-----|-----|-----|--------------------------|-----|-----|-----|-----|----|-----|------|-----|-----|-----|--------|
| | HRS | MIN | SEC | DAY | HRS | MIN | SEC | RA | DEC | AZ | ELV | X | Y | RANGE | DAY | HRS | MIN | SEC | RA | DEC | AZ | ELV | X | Y | RANGE |
| STN=00 A-E USB150 | 1 | 11 | 58 | 5 | 1 | 58 | 26 | 87 | 27 | 63 | 9 | 79 | 27 | 210981 | 5 | 3 | 10 | 24 | 88 | 27 | 71 | 22 | 67 | 17 | 210346 |
| BDA-02 X-Y USB=30 | 1 | 12 | 2 | 5 | 1 | 58 | 27 | 87 | 28 | 86 | 54 | 36 | 2 | 208776 | 5 | 3 | 10 | 29 | 88 | 28 | 96 | 68 | 22 | -2 | 208447 |
| ANG-91 X-Y USB-30 | 1 | 11 | 60 | 5 | 1 | 58 | 28 | 87 | 28 | 66 | 53 | 35 | 14 | 208814 | 5 | 3 | 10 | 27 | 88 | 28 | 57 | 67 | 19 | 12 | 208470 |
| ACN-75 X-Y USB-30 | 1 | 12 | 1 | 5 | 1 | 58 | 37 | 86 | 28 | -14 | 53 | -11 | 36 | 208813 | 5 | 3 | 10 | 38 | 87 | 28 | -34 | 45 | -29 | 35 | 209186 |
| CYI-04 X-Y USB-30 | 1 | 12 | 2 | 5 | 1 | 58 | 37 | 86 | 28 | -88 | 83 | -7 | 0 | 208146 | 5 | 3 | 10 | 39 | 87 | 28 | -84 | 68 | -22 | 2 | 208471 |
| MAD-23 X-Y USB-85 | 1 | 12 | 0 | 5 | 1 | 58 | 40 | 86 | 28 | -122 | 69 | 11 | -18 | 208338 | 5 | 3 | 10 | 40 | 87 | 28 | -101 | 57 | 7 | -32 | 208760 |
| STN=00 A-E USB150 | 1 | 11 | 40 | 5 | 3 | 56 | 55 | 88 | 27 | 77 | 31 | 59 | 11 | 209949 | 5 | 5 | 8 | 34 | 89 | 28 | 86 | 44 | 46 | 3 | 209391 |
| GDS-28 X-Y USB=85 | 1 | 11 | 38 | 5 | 3 | 56 | 55 | 88 | 27 | 79 | 35 | -16 | 54 | 209758 | 5 | 5 | 8 | 34 | 89 | 28 | 87 | 48 | -3 | 42 | 209218 |
| GYM-14 X-Y USB-30 | 1 | 11 | 42 | 5 | 3 | 56 | 56 | 88 | 28 | 76 | 38 | 51 | 11 | 209589 | 5 | 5 | 8 | 38 | 89 | 28 | 80 | 53 | 37 | 6 | 209054 |
| TEX-16 X-Y USB-30 | 1 | 11 | 41 | 5 | 3 | 56 | 58 | 88 | 28 | 79 | 50 | 40 | 7 | 209093 | 5 | 5 | 8 | 38 | 89 | 28 | 83 | 65 | 25 | 3 | 208691 |

I-104

VEHICLE 1 RADAR TABLE

TRACKING TIME

STATION ACQUISITION DATA

STATION TERMINATION DATA

| | HRS MIN SEC | | | DAY | HRS MIN SEC | | | | RA DEC | | | | AZ ELV | | | | X | Y | RANGE | DAY | HRS MIN SEC | | | | RA DEC | | | | AZ ELV | | | | X | Y | RANGE |
|----------------------|-------------|-----|-----|-----|-------------|-----|-----|----|--------|-----|-----|-----|--------|--------|-----|-----|---|----|-------|-----|-------------|----|-----|-----|--------|---|---|-------|--------|--|--|--|---|---|-------|
| | HRS | MIN | SEC | | HRS | MIN | SEC | RA | DEC | AZ | ELV | X | Y | RANGE | HRS | MIN | | | | | SEC | RA | DEC | AZ | ELV | X | Y | RANGE | | | | | | | |
| GBM-41 X-Y USB-30 | 1 | 11 | 41 | 5 | 3 | 57 | 1 | 88 | 28 | 81 | 67 | 23 | 3 | 208563 | 5 | 5 | 8 | 42 | 89 | 28 | 80 | 82 | 8 | 2 | 208401 | | | | | | | | | | |
| MIL-71 X-Y USB-30 | 1 | 11 | 44 | 5 | 3 | 57 | 1 | 88 | 28 | 85 | 65 | 25 | 2 | 208611 | 5 | 5 | 8 | 45 | 89 | 28 | 91 | 80 | 10 | 0 | 208423 | | | | | | | | | | |
| BDA-02 X-Y USB-30 | 1 | 11 | 44 | 5 | 3 | 57 | 4 | 88 | 28 | 110 | 78 | 11 | -4 | 208353 | 5 | 5 | 8 | 48 | 89 | 28 | -139 | 84 | -4 | -5 | 208387 | | | | | | | | | | |
| ANG-91 X-Y USB-30 | 1 | 11 | 45 | 5 | 3 | 57 | 6 | 88 | 28 | 37 | 76 | 9 | 11 | 208381 | 5 | 5 | 8 | 51 | 89 | 28 | -31 | 77 | -7 | 11 | 208456 | | | | | | | | | | |
| ACN-75 X-Y USB-30 | 1 | 11 | 45 | 5 | 3 | 57 | 16 | 87 | 28 | -44 | 38 | -42 | 34 | 209572 | 5 | 5 | 9 | 1 | 88 | 28 | -54 | 25 | -60 | 32 | 210323 | | | | | | | | | | |
| CYI-04 X-Y USB-30 | 1 | 11 | 46 | 5 | 3 | 57 | 17 | 87 | 28 | -81 | 57 | -33 | 5 | 208814 | 5 | 5 | 9 | 3 | 88 | 28 | -77 | 42 | -47 | 10 | 209487 | | | | | | | | | | |
| MAD-23 X-Y USB-85 | 1 | 11 | 43 | 5 | 3 | 57 | 20 | 87 | 27 | -92 | 48 | 2 | -42 | 209138 | 5 | 5 | 9 | 3 | 88 | 27 | -82 | 35 | -11 | -54 | 209819 | | | | | | | | | | |
| HAW-12 X-Y USB-30 | 0 | 28 | 59 | 5 | 4 | 39 | 33 | 89 | 27 | 62 | 3 | 87 | 28 | 210303 | 5 | 5 | 8 | 32 | 90 | 28 | 64 | 9 | 80 | 26 | 211257 | | | | | | | | | | |
| HAW-12 X-Y USB-30 | 1 | 11 | 53 | 5 | 5 | 55 | 5 | 90 | 27 | 67 | 19 | 70 | 22 | 210790 | 5 | 7 | 6 | 58 | 91 | 28 | 71 | 33 | 55 | 16 | 210069 | | | | | | | | | | |
| STN-00 A-E USB150 | 1 | 11 | 54 | 5 | 5 | 55 | 11 | 89 | 27 | 93 | 53 | 36 | -2 | 209125 | 5 | 7 | 7 | 5 | 90 | 28 | 108 | 67 | 22 | -7 | 208806 | | | | | | | | | | |

I-1015

VEHICLE 1 RADAR TABLE

| | TRACKING TIME | | | STATION ACQUISITION DATA | | | | | | | | STATION TERMINATION DATA | | | | | | | | | | | | | |
|----------------------|---------------|-----|-----|--------------------------|-----|-----|-----|----|-----|------|-----|--------------------------|-----|--------|-----|-----|-----|-----|----|-----|-----|-----|-----|-----|--------|
| | HRS | MIN | SEC | DAY | HRS | MIN | SEC | RA | DEC | AZ | ELV | X | Y | RANGE | DAY | HRS | MIN | SEC | RA | DEC | AZ | ELV | X | Y | RANGE |
| GYM-14 X-Y USB-30 | 1 | 11 | 55 | 5 | 5 | 55 | 12 | 89 | 28 | 83 | 63 | 27 | 3 | 208824 | 5 | 7 | 7 | 7 | 90 | 28 | 88 | 78 | 12 | 0 | 208606 |
| GDS-28 X-Y USB-85 | 1 | 11 | 53 | 5 | 5 | 55 | 12 | 89 | 28 | 94 | 58 | 2 | 32 | 208975 | 5 | 7 | 7 | 5 | 90 | 28 | 109 | 72 | 6 | 17 | 208705 |
| TEX-16 X-Y USB-30 | 1 | 11 | 55 | 5 | 5 | 55 | 17 | 89 | 28 | 86 | 75 | 15 | 1 | 208569 | 5 | 7 | 7 | 12 | 90 | 28 | -40 | 90 | 0 | 0 | 208537 |
| MIL-71 X-Y USB-30 | 1 | 11 | 53 | 5 | 5 | 55 | 24 | 89 | 28 | -175 | 89 | 0 | -1 | 208449 | 5 | 7 | 7 | 17 | 90 | 28 | -89 | 75 | -15 | 0 | 208658 |
| GBM-41 X-Y USB-30 | 1 | 11 | 52 | 5 | 5 | 55 | 25 | 89 | 28 | -64 | 87 | -2 | 1 | 208450 | 5 | 7 | 7 | 17 | 90 | 28 | -82 | 73 | -17 | 2 | 208697 |
| BDA-02 X-Y USB-30 | 1 | 11 | 52 | 5 | 5 | 55 | 28 | 88 | 28 | -104 | 75 | -14 | -4 | 208560 | 5 | 7 | 7 | 20 | 89 | 28 | -90 | 61 | -29 | 0 | 208974 |
| ANG-91 X-Y USB-30 | 1 | 11 | 52 | 5 | 5 | 55 | 28 | 88 | 28 | -55 | 69 | -17 | 12 | 208667 | 5 | 7 | 7 | 21 | 89 | 28 | -66 | 55 | -33 | 14 | 209164 |
| CYI-04 X-Y USB-30 | 1 | 11 | 48 | 5 | 5 | 55 | 40 | 88 | 27 | -73 | 32 | -57 | 14 | 210023 | 5 | 7 | 7 | 28 | 89 | 27 | -68 | 18 | -70 | 21 | 210895 |
| MAD-23 X-Y USB-85 | 1 | 11 | 47 | 5 | 5 | 55 | 41 | 88 | 27 | -76 | 26 | -27 | -60 | 210329 | 5 | 7 | 7 | 27 | 89 | 27 | -66 | 14 | -58 | -62 | 211119 |
| ACN-75 X-Y USB-30 | 1 | 3 | 32 | 5 | 5 | 55 | 42 | 88 | 28 | -58 | 16 | -72 | 31 | 210917 | 5 | 6 | 59 | 14 | 89 | 28 | -61 | 3 | -87 | 29 | 211341 |

1-106

VEHICLE 1 RADAR TABLE

TRACKING TIME

STATION ACQUISITION DATA

STATION TERMINATION DATA

HRS MIN SEC

DAY HRS MIN SEC

RA DEC

AZ ELV

X

Y

RANGE

DAY HRS MIN SEC

RA DEC

AZ ELV

X

Y

RANGE

| | | | | | | | | | | | |
|----------------------|---------|-----------|-------|--------|---------|--------|----------|-------|---------|---------|--------|
| HAW-12 X-Y USB-30 | 1 11 47 | 5 7 53 37 | 91 28 | 72 44 | 45 13 | 209670 | 5 9 5 25 | 92 28 | 73 59 | 30 9 | 209187 |
| STN-00 A-E USB150 | 1 11 47 | 5 7 53 49 | 90 27 | 128 75 | 12 -9 | 208717 | 5 9 5 35 | 91 28 | -160 80 | -4 -10 | 208754 |
| GDS-28 X-Y USB-85 | 1 11 51 | 5 7 53 49 | 90 28 | 138 80 | 8 7 | 208658 | 5 9 5 39 | 91 28 | -132 79 | 7 -8 | 208765 |
| GYM-14 X-Y USB-30 | 1 11 56 | 5 7 53 50 | 90 28 | 103 89 | 1 0 | 208604 | 5 9 5 46 | 91 28 | -87 76 | -14 1 | 208806 |
| TEX-16 X-Y USB-30 | 1 11 54 | 5 7 53 53 | 90 28 | -87 79 | -11 1 | 208661 | 5 9 5 47 | 91 28 | -83 64 | -26 3 | 209045 |
| GDM-41 X-Y USB-30 | 1 11 55 | 5 7 53 57 | 89 28 | -81 62 | -28 4 | 208997 | 5 9 5 52 | 90 28 | -77 47 | -42 9 | 209623 |
| MIL-71 X-Y USB-30 | 1 11 54 | 5 7 53 57 | 89 28 | -85 64 | -26 2 | 208932 | 5 9 5 51 | 90 28 | -80 50 | -40 7 | 209522 |
| BDA-02 X-Y USB-30 | 1 11 56 | 5 7 53 58 | 89 27 | -85 51 | -39 3 | 209365 | 5 9 5 55 | 90 27 | -78 37 | -53 10 | 210090 |
| ANG-91 X-Y USB-30 | 1 11 58 | 5 7 54 1 | 89 28 | -68 44 | -43 16 | 209618 | 5 9 5 59 | 90 28 | -67 25 | -59 20 | 210454 |
| MAD-23 X-Y USB-85 | 0 20 60 | 5 7 54 2 | 89 27 | -59 6 | -78 -59 | 211640 | 5 8 15 2 | 89 27 | -56 3 | -85 -56 | 210837 |

1-107

12
11
10
9
8
7
6
5

VEHICLE 1 RADAR TABLE

| | TRACKING TIME | | | STATION ACQUISITION DATA | | | | | | | | STATION TERMINATION DATA | | | | | | | | | | | | | |
|----------------------|---------------|-----|-----|--------------------------|-----|-----|-----|----|-----|------|-----|--------------------------|-----|--------|-----|-----|-----|-----|----|-----|------|-----|-----|-----|--------|
| | HRS | MIN | SEC | DAY | HRS | MIN | SEC | RA | DEC | AZ | ELV | X | Y | RANGE | DAY | HRS | MIN | SEC | RA | DEC | AZ | ELV | X | Y | RANGE |
| CYI-04 X-Y USB-30 | 0 | 30 | 24 | 5 | 7 | 54 | 4 | 89 | 27 | -64 | 9 | -80 | 26 | 211497 | 5 | 8 | 24 | 28 | 89 | 27 | -61 | 3 | -87 | 29 | 210595 |
| GWM-24 X-Y USB-30 | 0 | 13 | 34 | 5 | 8 | 51 | 43 | 92 | 28 | 62 | 3 | 87 | 28 | 211203 | 5 | 9 | 5 | 18 | 92 | 28 | 63 | 6 | 83 | 27 | 211751 |
| GWM-24 X-Y USB-30 | 1 | 11 | 45 | 5 | 9 | 51 | 50 | 92 | 27 | 65 | 16 | 72 | 24 | 211246 | 5 | 11 | 3 | 35 | 93 | 28 | 66 | 31 | 57 | 21 | 210494 |
| HAW-12 X-Y USB-30 | 1 | 11 | 46 | 5 | 9 | 52 | 3 | 91 | 28 | 70 | 69 | 20 | 7 | 208997 | 5 | 11 | 3 | 49 | 92 | 28 | 39 | 83 | 5 | 6 | 208883 |
| STN-00 A-E USB150 | 1 | 11 | 44 | 5 | 9 | 52 | 15 | 91 | 27 | -122 | 73 | -14 | -9 | 208906 | 5 | 11 | 3 | 58 | 92 | 27 | -100 | 61 | -29 | -5 | 209296 |
| GDS-28 X-Y USB-85 | 1 | 11 | 45 | 5 | 9 | 52 | 15 | 91 | 27 | -108 | 70 | 6 | -19 | 208962 | 5 | 11 | 4 | 1 | 92 | 27 | -93 | 57 | 2 | -33 | 209423 |
| GYM-14 X-Y USB-30 | 1 | 11 | 44 | 5 | 9 | 52 | 18 | 91 | 28 | -84 | 66 | -24 | 2 | 209062 | 5 | 11 | 4 | 3 | 92 | 28 | -80 | 51 | -39 | 6 | 209629 |
| TEX-16 X-Y USB-30 | 1 | 11 | 44 | 5 | 9 | 52 | 20 | 90 | 28 | -80 | 54 | -36 | 6 | 209416 | 5 | 11 | 4 | 4 | 91 | 27 | -76 | 39 | -50 | 11 | 210123 |
| GBM-41 X-Y USB-30 | 1 | 11 | 44 | 5 | 9 | 52 | 24 | 90 | 27 | -74 | 37 | -52 | 12 | 210123 | 5 | 11 | 4 | 8 | 91 | 27 | -70 | 22 | -66 | 19 | 210979 |
| MIL-71 X-Y USB-30 | 1 | 11 | 41 | 5 | 9 | 52 | 24 | 90 | 27 | -77 | 39 | -50 | 10 | 210001 | 5 | 11 | 4 | 6 | 91 | 27 | -71 | 25 | -64 | 17 | 210830 |

VEHICLE 1 RADAR TABLE

TRACKING TIME

STATION ACQUISITION DATA

STATION TERMINATION DATA

| | HRS | MIN | SEC | DAY | HRS | MIN | SEC | RA | DEC | AZ | ELV | X | Y | RANGE | DAY | HRS | MIN | SEC | RA | DEC | AZ | ELV | X | Y | RANGE |
|----------------------|-----|-----|-----|-----|-----|-----|-----|----|-----|-----|-----|-----|-----|--------|-----|-----|-----|-----|----|-----|-----|-----|-----|-----|--------|
| BDA-02 X-Y USB-30 | 1 | 11 | 40 | 5 | 9 | 52 | 26 | 90 | 27 | -73 | 27 | -62 | 15 | 210623 | 5 | 11 | 4 | 6 | 91 | 27 | -66 | 14 | -75 | 23 | 211483 |
| ANG-91 X-Y USB-30 | 1 | 11 | 38 | 5 | 9 | 52 | 29 | 90 | 27 | -66 | 19 | -69 | 23 | 211054 | 5 | 11 | 4 | 7 | 91 | 27 | -63 | 4 | -85 | 27 | 212018 |
| HSK-25 X-Y USB-85 | 0 | 22 | 51 | 5 | 10 | 40 | 46 | 93 | 28 | 52 | 3 | -85 | 52 | 210953 | 5 | 11 | 3 | 36 | 93 | 28 | 48 | 6 | -81 | 48 | 211871 |
| HSK-25 X-Y USB-85 | 1 | 11 | 55 | 5 | 11 | 50 | 18 | 93 | 28 | 40 | 13 | -73 | 39 | 211559 | 5 | 13 | 2 | 13 | 94 | 28 | 27 | 21 | -67 | 25 | 211207 |
| GWM-24 X-Y USB-30 | 1 | 11 | 54 | 5 | 11 | 50 | 18 | 93 | 28 | 65 | 42 | 46 | 19 | 210079 | 5 | 13 | 2 | 11 | 94 | 28 | 60 | 56 | 30 | 16 | 209586 |
| HAW-12 X-Y USB-30 | 1 | 12 | 4 | 5 | 11 | 50 | 30 | 92 | 28 | -47 | 82 | -6 | 6 | 208960 | 5 | 13 | 2 | 34 | 93 | 28 | -71 | 68 | -21 | 7 | 209289 |
| STN-00 A-E USB150 | 1 | 12 | 1 | 5 | 11 | 50 | 37 | 92 | 27 | -92 | 51 | -39 | -1 | 209668 | 5 | 13 | 2 | 38 | 93 | 27 | -82 | 38 | -52 | 6 | 210356 |
| GDS-28 X-Y USB-85 | 1 | 11 | 60 | 5 | 11 | 50 | 39 | 91 | 27 | -86 | 47 | -3 | -43 | 209835 | 5 | 13 | 2 | 39 | 93 | 27 | -78 | 33 | -17 | -55 | 210580 |
| TEX-16 X-Y USB-30 | 1 | 12 | 1 | 5 | 11 | 50 | 42 | 91 | 27 | -72 | 29 | -60 | 15 | 210673 | 5 | 13 | 2 | 43 | 93 | 27 | -67 | 15 | -74 | 22 | 211575 |
| GYM-14 X-Y USB-30 | 1 | 11 | 60 | 5 | 11 | 50 | 42 | 91 | 27 | -77 | 41 | -49 | 10 | 210107 | 5 | 13 | 2 | 42 | 93 | 27 | -71 | 26 | -63 | 17 | 210948 |

1601-1

12
11
10
9
8
7
6
5

VEHICLE 1 RADAR TABLE

| | TRACKING TIME | | | STATION ACQUISITION DATA | | | | | | | | STATION TERMINATION DATA | | | | | | | | | | | | | |
|----------------------|---------------|-----|-----|--------------------------|-----|-----|-----|----|-----|-----|-----|--------------------------|-----|--------|-----|-----|-----|-----|----|-----|-----|-----|-----|-----|--------|
| | HRS | MIN | SEC | DAY | HRS | MIN | SEC | RA | DEC | AZ | ELV | X | Y | RANGE | DAY | HRS | MIN | SEC | RA | DEC | AZ | ELV | X | Y | RANGE |
| BDA-02 X-Y USB-30 | 0 | 8 | 39 | 5 | 11 | 50 | 43 | 91 | 27 | -61 | 5 | -85 | 29 | 212061 | 5 | 11 | 59 | 21 | 91 | 27 | -60 | 3 | -87 | 30 | 211716 |
| GBM-41 X-Y USB-30 | 0 | 51 | 48 | 5 | 11 | 50 | 43 | 91 | 27 | -66 | 13 | -76 | 24 | 211584 | 5 | 12 | 42 | 32 | 92 | 27 | -61 | 3 | -87 | 29 | 211249 |
| MIL-71 X-Y USB-30 | 1 | 7 | 13 | 5 | 11 | 50 | 45 | 91 | 27 | -67 | 15 | -73 | 22 | 211423 | 5 | 12 | 57 | 57 | 92 | 27 | -61 | 3 | -87 | 29 | 212028 |
| CRO-08 X-Y USB-30 | 0 | 32 | 30 | 5 | 12 | 29 | 35 | 94 | 28 | 57 | 3 | 86 | 33 | 210897 | 5 | 13 | 2 | 5 | 94 | 28 | 53 | 9 | 79 | 36 | 211898 |
| CRO-08 X-Y USB-30 | 1 | 11 | 40 | 5 | 13 | 48 | 40 | 94 | 28 | 47 | 17 | 67 | 41 | 211500 | 5 | 15 | 0 | 20 | 95 | 28 | 35 | 27 | 48 | 47 | 211015 |
| GWM-24 X-Y USB-30 | 1 | 11 | 42 | 5 | 13 | 48 | 48 | 94 | 28 | 50 | 66 | 19 | 15 | 209384 | 5 | 15 | 0 | 30 | 95 | 28 | 13 | 75 | 4 | 14 | 209283 |
| HSK-25 X-Y USB-85 | 1 | 11 | 42 | 5 | 13 | 48 | 48 | 94 | 28 | 16 | 24 | -65 | 14 | 211081 | 5 | 15 | 0 | 30 | 95 | 28 | 0 | 26 | -64 | 0 | 211066 |
| HAW-12 X-Y USB-30 | 1 | 11 | 42 | 5 | 13 | 49 | 4 | 93 | 27 | -73 | 57 | -32 | 9 | 209614 | 5 | 15 | 0 | 46 | 94 | 27 | -72 | 42 | -46 | 13 | 210298 |
| GDS-28 X-Y USB-85 | 1 | 11 | 39 | 5 | 13 | 49 | 11 | 92 | 27 | -73 | 24 | -34 | -61 | 211101 | 5 | 15 | 0 | 50 | 94 | 27 | -65 | 11 | -65 | -63 | 211946 |
| TEX-16 X-Y USB-30 | 0 | 13 | 1 | 5 | 13 | 49 | 12 | 92 | 27 | -62 | 5 | -84 | 28 | 212158 | 5 | 14 | 2 | 13 | 93 | 27 | -61 | 3 | -87 | 29 | 211646 |

I-110

2
3
4
5
6
7
8
9
10
11
12

VEHICLE 1 RADAR TABLE

TRACKING TIME

STATION ACQUISITION DATA

STATION TERMINATION DATA

| | HRS MIN SEC | | | DAY HRS MIN SEC | | | | RA DEC AZ ELV X Y RANGE | | | | DAY HRS MIN SEC | | | | RA DEC AZ ELV X Y RANGE | | | | | | | | | |
|----------------------|-------------|----|----|-----------------|----|----|----|-------------------------|----|-----|----|-----------------|-----|--------|---|-------------------------|----|----|----|----|-----|----|-----|-----|--------|
| STN-00 A-E USB150 | 1 | 11 | 38 | 5 | 13 | 49 | 12 | 93 | 27 | -76 | 29 | -61 | 12 | 210849 | 5 | 15 | 0 | 49 | 94 | 27 | -68 | 16 | -73 | 21 | 211669 |
| GYM-14 X-Y USB-30 | 1 | 11 | 38 | 5 | 13 | 49 | 12 | 92 | 27 | -68 | 16 | -72 | 22 | 211520 | 5 | 15 | 0 | 50 | 94 | 27 | -61 | 3 | -87 | 29 | 212425 |
| CRO-08 X-Y USB-30 | 1 | 12 | 2 | 5 | 15 | 46 | 60 | 95 | 28 | 25 | 32 | 33 | 50 | 210818 | 5 | 16 | 59 | 2 | 96 | 28 | 7 | 37 | 9 | 53 | 210702 |
| HSK-25 X-Y USB-85 | 1 | 12 | 1 | 5 | 15 | 47 | 7 | 94 | 28 | -12 | 25 | -64 | -11 | 211189 | 5 | 16 | 59 | 8 | 95 | 28 | -28 | 20 | -67 | -26 | 211548 |
| GWM-24 X-Y USB-30 | 1 | 12 | 0 | 5 | 15 | 47 | 9 | 94 | 28 | -27 | 74 | -7 | 14 | 209376 | 5 | 16 | 59 | 9 | 95 | 28 | -55 | 62 | -23 | 15 | 209727 |
| HAW-12 X-Y USB-30 | 1 | 11 | 59 | 5 | 15 | 47 | 18 | 94 | 27 | -71 | 32 | -57 | 16 | 210846 | 5 | 16 | 59 | 17 | 95 | 27 | -67 | 17 | -71 | 22 | 211754 |
| STN-00 A-E USB150 | 0 | 26 | 15 | 5 | 15 | 47 | 20 | 94 | 27 | -62 | 7 | -82 | 28 | 212216 | 5 | 16 | 13 | 35 | 94 | 27 | -58 | 3 | -86 | 32 | 211312 |
| CRO-08 X-Y USB-30 | 1 | 11 | 37 | 5 | 17 | 45 | 41 | 96 | 28 | -6 | 37 | -8 | 53 | 210743 | 5 | 18 | 57 | 18 | 97 | 28 | -24 | 33 | -32 | 50 | 211036 |
| HSK-25 X-Y USB-85 | 1 | 11 | 37 | 5 | 17 | 45 | 49 | 95 | 28 | -37 | 15 | -71 | -36 | 211877 | 5 | 18 | 57 | 26 | 96 | 28 | -49 | 6 | -81 | -49 | 212537 |
| GWM-24 X-Y USB-30 | 1 | 11 | 40 | 5 | 17 | 45 | 52 | 95 | 27 | -62 | 53 | -34 | 17 | 210079 | 5 | 18 | 57 | 32 | 96 | 27 | -66 | 38 | -50 | 19 | 210816 |

1111

VEHICLE 1 RADAR TABLE

| | TRACKING TIME | | | STATION ACQUISITION DATA | | | | | | | | STATION TERMINATION DATA | | | | | | | | | | | | | |
|----------------------|---------------|-----|-----|--------------------------|-----|-----|-----|----|-----|-----|-----|--------------------------|----|--------|-----|-----|-----|-----|-----|-----|-----|-----|-----|----|--------|
| | HRS | MIN | SEC | DAY | HRS | MIN | SEC | RA | DEC | AZ | ELV | X | Y | RANGE | DAY | HRS | MIN | SEC | RA | DEC | AZ | ELV | X | Y | RANGE |
| HAW-12 X-Y USB-30 | 0 | 20 | 58 | 5 | 17 | 45 | 58 | 95 | 27 | -64 | 7 | -82 | 26 | 212365 | 5 | 18 | 6 | 56 | 95 | 27 | -62 | 3 | -87 | 28 | 211617 |
| MAD-23 X-Y USB-85 | 1 | 0 | 46 | 5 | 17 | 56 | 15 | 96 | 27 | 57 | 3 | -85 | 57 | 212094 | 5 | 18 | 57 | 1 | 98 | 27 | 65 | 12 | -62 | 63 | 212153 |
| CYI-04 X-Y USB-30 | 1 | 11 | 59 | 5 | 19 | 43 | 31 | 98 | 27 | 63 | 7 | 82 | 26 | 212561 | 5 | 20 | 55 | 30 | 99 | 27 | 70 | 21 | 68 | 19 | 211936 |
| MAD-23 X-Y USB-85 | 1 | 11 | 58 | 5 | 19 | 43 | 33 | 98 | 27 | 72 | 21 | -39 | 63 | 211767 | 5 | 20 | 55 | 31 | 99 | 27 | 61 | 33 | -13 | 56 | 211174 |
| CRO-08 X-Y USB-30 | 1 | 12 | 2 | 5 | 19 | 43 | 52 | 96 | 28 | -35 | 28 | -47 | 47 | 211369 | 5 | 20 | 55 | 53 | 97 | 28 | -47 | 18 | -66 | 41 | 212020 |
| GWM-24 X-Y USB-30 | 1 | 11 | 56 | 5 | 19 | 44 | 2 | 96 | 27 | -66 | 27 | -61 | 21 | 211391 | 5 | 20 | 55 | 58 | 97 | 27 | -65 | 12 | -76 | 25 | 212243 |
| ACN-75 X-Y USB-30 | 0 | 17 | 9 | 5 | 20 | 38 | 18 | 99 | 27 | 62 | 3 | 87 | 28 | 211971 | 5 | 20 | 55 | 21 | 99 | 27 | 61 | 7 | 65 | 29 | 212650 |
| ACN-75 X-Y USB-30 | 1 | 11 | 41 | 5 | 21 | 42 | 4 | 99 | 27 | 58 | 17 | 71 | 30 | 212132 | 5 | 22 | 53 | 45 | 100 | 27 | 67 | 20 | 63 | 32 | 211451 |
| CYI-04 X-Y USB-30 | 1 | 11 | 40 | 5 | 21 | 42 | 7 | 99 | 27 | 74 | 31 | 58 | 14 | 211374 | 5 | 22 | 53 | 47 | 100 | 27 | 72 | 45 | 41 | 78 | 210761 |
| MAD-23 X-Y USB-85 | 1 | 11 | 43 | 5 | 21 | 42 | 11 | 99 | 27 | 89 | 42 | -1 | 48 | 210820 | 5 | 22 | 53 | 53 | 100 | 27 | 70 | 55 | 7 | 34 | 210397 |

1-110

VEHICLE 1 RADAR TABLE

| | TRACKING TIME | | | STATION ACQUISITION DATA | | | | | | | | STATION TERMINATION DATA | | | | | | | | | | | | | |
|----------------------|---------------|-----|-----|--------------------------|-----|-----|-----|-----|-----|-----|-----|--------------------------|----|--------|-----|-----|-----|-----|-----|-----|-----|-----|-----|----|--------|
| | HRS | MIN | SEC | DAY | HRS | MIN | SEC | RA | DEC | AZ | ELV | X | Y | RANGE | DAY | HRS | MIN | SEC | RA | DEC | AZ | ELV | X | Y | RANGE |
| CRO-08 X-Y USB-30 | 0 | 36 | 52 | 5 | 21 | 42 | 33 | 97 | 28 | -54 | 9 | -78 | 36 | 212530 | 5 | 22 | 19 | 25 | 98 | 27 | -58 | 3 | -86 | 32 | 211653 |
| BDA-02 X-Y USB-30 | 0 | 18 | 1 | 5 | 22 | 35 | 46 | 100 | 26 | 60 | 3 | 87 | 30 | 212088 | 5 | 22 | 53 | 47 | 100 | 27 | 62 | 6 | 83 | 27 | 212826 |
| BDA-02 X-Y USB-30 | 1 | 11 | 48 | 5 | 23 | 40 | 17 | 100 | 26 | 68 | 15 | 74 | 21 | 212386 | 6 | 0 | 52 | 6 | 101 | 27 | 75 | 29 | 61 | 13 | 211701 |
| ANG-91 X-Y USB-30 | 1 | 11 | 48 | 5 | 23 | 40 | 18 | 100 | 27 | 65 | 11 | 77 | 24 | 212599 | 6 | 0 | 52 | 6 | 101 | 27 | 68 | 26 | 62 | 20 | 211825 |
| ACN-75 X-Y USB-30 | 1 | 11 | 48 | 5 | 23 | 40 | 25 | 100 | 27 | 44 | 39 | 41 | 34 | 211105 | 6 | 0 | 52 | 13 | 101 | 27 | 29 | 49 | 22 | 35 | 210747 |
| CYI-04 X-Y USB-30 | 1 | 11 | 46 | 5 | 23 | 40 | 29 | 100 | 27 | 82 | 56 | 34 | 4 | 210452 | 6 | 0 | 52 | 15 | 101 | 27 | 88 | 71 | 19 | 1 | 210130 |
| MAD-23 X-Y USB-85 | 1 | 11 | 44 | 5 | 23 | 40 | 33 | 99 | 27 | 113 | 64 | 11 | 24 | 210206 | 6 | 0 | 52 | 17 | 100 | 27 | 145 | 74 | 13 | 9 | 210071 |
| GBM-41 X-Y USB-30 | 1 | 6 | 50 | 5 | 23 | 45 | 17 | 100 | 26 | 62 | 3 | 87 | 28 | 212854 | 6 | 0 | 52 | 7 | 101 | 27 | 68 | 16 | 73 | 21 | 212425 |
| MIL-71 X-Y USB-30 | 1 | 1 | 19 | 5 | 23 | 50 | 47 | 100 | 26 | 61 | 3 | 87 | 29 | 212570 | 6 | 0 | 52 | 5 | 101 | 27 | 67 | 14 | 75 | 22 | 212500 |
| GBM-41 X-Y USB-30 | 0 | 49 | 44 | 6 | 1 | 38 | 46 | 101 | 27 | 72 | 25 | 63 | 16 | 211947 | 6 | 2 | 28 | 31 | 102 | 27 | 75 | 35 | 54 | 12 | 210417 |

I-113

2
1
0
9
8
7
6

VEHICLE 1 RADAR TABLE

| | TRACKING TIME | | | STATION ACQUISITION DATA | | | | | | | | STATION TERMINATION DATA | | | | | | | | | | | | | |
|----------------------|---------------|-----|-----|--------------------------|-----|-----|-----|-----|-----|------|-----|--------------------------|----|--------|-----|-----|-----|-----|-----|-----|------|-----|-----|-----|--------|
| | HRS | MIN | SEC | DAY | HRS | MIN | SEC | RA | DEC | AZ | ELV | X | Y | RANGE | DAY | HRS | MIN | SEC | RA | DEC | AZ | ELV | X | Y | RANGE |
| MIL-71 X-Y USB-30 | 0 | 49 | 44 | 6 | 1 | 38 | 47 | 101 | 26 | 72 | 24 | 65 | 17 | 212027 | 6 | 2 | 28 | 31 | 102 | 27 | 76 | 34 | 55 | 12 | 210498 |
| ANG-91 X-Y USB-30 | 0 | 49 | 43 | 6 | 1 | 38 | 47 | 101 | 27 | 69 | 37 | 51 | 17 | 211364 | 6 | 2 | 28 | 31 | 102 | 27 | 69 | 47 | 41 | 14 | 209888 |
| TEX-16 X-Y USB-30 | 0 | 49 | 43 | 6 | 1 | 38 | 47 | 101 | 26 | 65 | 10 | 79 | 24 | 212830 | 6 | 2 | 28 | 31 | 102 | 26 | 70 | 19 | 69 | 19 | 211265 |
| BDA-02 X-Y USB-30 | 0 | 49 | 42 | 6 | 1 | 38 | 48 | 101 | 27 | 80 | 38 | 51 | 8 | 211290 | 6 | 2 | 28 | 31 | 102 | 27 | 85 | 48 | 42 | 3 | 209852 |
| CYI-04 X-Y USB-30 | 0 | 49 | 33 | 6 | 1 | 38 | 57 | 100 | 27 | 94 | 81 | 9 | -1 | 210038 | 6 | 2 | 28 | 31 | 101 | 27 | -123 | 88 | -2 | -1 | 208989 |
| ACN-75 X-Y USB-30 | 0 | 49 | 33 | 6 | 1 | 38 | 58 | 100 | 27 | 13 | 54 | 9 | 35 | 210649 | 6 | 2 | 28 | 31 | 101 | 27 | -5 | 55 | -3 | 35 | 209609 |
| MAD-23 X-Y USB-85 | 0 | 49 | 31 | 6 | 1 | 38 | 60 | 100 | 27 | -173 | 76 | 14 | -2 | 210095 | 6 | 2 | 28 | 31 | 101 | 27 | -137 | 72 | 13 | -12 | 209149 |
| GYM-14 X-Y USB-30 | 0 | 31 | 9 | 6 | 1 | 57 | 22 | 101 | 26 | 62 | 3 | 87 | 28 | 212335 | 6 | 2 | 28 | 31 | 102 | 26 | 65 | 9 | 81 | 25 | 211892 |
| GDS-28 X-Y USB-85 | 0 | 25 | 29 | 6 | 2 | 3 | 1 | 101 | 26 | 60 | 3 | -84 | 60 | 212136 | 6 | 2 | 28 | 31 | 102 | 26 | 63 | 7 | -75 | 62 | 211979 |
| STN-00 A-E USB150 | 0 | 8 | 44 | 6 | 2 | 19 | 46 | 102 | 26 | 59 | 3 | 87 | 31 | 211999 | 6 | 2 | 28 | 31 | 102 | 26 | 60 | 4 | 85 | 30 | 212144 |

1-11-71

31 JAN 71

LM JETT TO TEI IGNITION

LAZ 72.1

VEHICLE 1 RADAR TABLE

TRACKING TIME

STATION ACQUISITION DATA

STATION TERMINATION DATA

| | HRS | MIN | SEC | DAY | HRS | MIN | SEC | RA | DEC | AZ | ELV | X | Y | RANGE | DAY | HRS | MIN | SEC | RA | DEC | AZ | ELV | X | Y | RANGE |
|----------------------|-----|-----|-----|-----|-----|-----|-----|-----|-----|------|-----|-----|----|--------|-----|-----|-----|-----|-----|-----|-----|-----|-----|----|--------|
| GYM-14 X-Y USB-30 | 0 | 21 | 56 | 6 | 2 | 28 | 36 | 102 | 26 | 65 | 9 | 81 | 25 | 211894 | 6 | 2 | 50 | 32 | 102 | 26 | 67 | 13 | 76 | 23 | 212734 |
| TEX-16 X-Y USB-30 | 0 | 21 | 56 | 6 | 2 | 28 | 36 | 102 | 26 | 70 | 19 | 69 | 19 | 211267 | 6 | 2 | 50 | 32 | 102 | 26 | 71 | 24 | 65 | 17 | 212111 |
| GDS-28 X-Y USB-85 | 0 | 21 | 58 | 6 | 2 | 28 | 36 | 102 | 26 | 63 | 7 | -75 | 62 | 211981 | 6 | 2 | 50 | 35 | 102 | 26 | 66 | 11 | -65 | 63 | 212843 |
| GBM-41 X-Y USB-30 | 0 | 21 | 58 | 6 | 2 | 28 | 36 | 102 | 27 | 75 | 35 | 54 | 12 | 210419 | 6 | 2 | 50 | 35 | 102 | 27 | 77 | 40 | 49 | 10 | 211293 |
| STN-00 A-E USB150 | 0 | 21 | 58 | 6 | 2 | 28 | 36 | 102 | 26 | 60 | 4 | 85 | 30 | 212147 | 6 | 2 | 50 | 35 | 102 | 26 | 63 | 8 | 81 | 27 | 213018 |
| MIL-71 X-Y USB-30 | 0 | 21 | 59 | 6 | 2 | 28 | 36 | 102 | 27 | 76 | 34 | 55 | 12 | 210500 | 6 | 2 | 50 | 35 | 102 | 27 | 77 | 38 | 51 | 10 | 211373 |
| ANG-91 X-Y USB-30 | 0 | 22 | 0 | 6 | 2 | 28 | 36 | 102 | 27 | 69 | 47 | 41 | 14 | 209891 | 6 | 2 | 50 | 37 | 102 | 27 | 68 | 52 | 36 | 13 | 210800 |
| BDA-02 X-Y USB-30 | 0 | 22 | 4 | 6 | 2 | 28 | 36 | 102 | 27 | 85 | 48 | 42 | 3 | 209855 | 6 | 2 | 50 | 41 | 102 | 27 | 88 | 53 | 37 | 1 | 210780 |
| ACN-75 X-Y USB-30 | 0 | 22 | 18 | 6 | 2 | 28 | 36 | 101 | 27 | -5 | 55 | -3 | 35 | 209612 | 6 | 2 | 50 | 54 | 101 | 27 | -13 | 54 | -9 | 35 | 210746 |
| CYI-04 X-Y USB-30 | 0 | 22 | 18 | 6 | 2 | 28 | 36 | 101 | 27 | -122 | 88 | -2 | -1 | 208992 | 6 | 2 | 50 | 54 | 101 | 27 | -98 | 84 | -6 | -1 | 210117 |

1-115

VEHICLE 1 RADAR TABLE

| | TRACKING TIME | | | STATION ACQUISITION DATA | | | | | | | | | | STATION TERMINATION DATA | | | | | | | | | | | |
|----------------------|---------------|-----|-----|--------------------------|-----|-----|-----|-----|-----|------|-----|-----|-----|--------------------------|-----|-----|-----|-----|-----|-----|------|-----|-----|-----|--------|
| | HRS | MIN | SEC | DAY | HRS | MIN | SEC | RA | DEC | AZ | ELV | X | Y | RANGE | DAY | HRS | MIN | SEC | RA | DEC | AZ | ELV | X | Y | RANGE |
| MAD-23 X-Y USB-85 | 0 | 22 | 22 | 6 | 2 | 28 | 36 | 101 | 27 | -137 | 72 | 13 | -12 | 209153 | 6 | 2 | 50 | 59 | 101 | 27 | -126 | 69 | 13 | -17 | 210322 |
| GYM-14 X-Y USB-30 | 1 | 11 | 40 | 6 | 3 | 37 | 6 | 102 | 26 | 71 | 23 | 66 | 17 | 212257 | 6 | 4 | 48 | 45 | 103 | 26 | 77 | 37 | 52 | 11 | 211587 |
| GDS-28 X-Y USB-85 | 1 | 11 | 37 | 6 | 3 | 37 | 8 | 102 | 26 | 71 | 20 | -41 | 63 | 212401 | 6 | 4 | 48 | 45 | 103 | 26 | 79 | 33 | -16 | 55 | 211765 |
| TEX-16 X-Y USB-30 | 1 | 11 | 36 | 6 | 3 | 37 | 8 | 102 | 26 | 75 | 34 | 55 | 12 | 211661 | 6 | 4 | 48 | 45 | 103 | 26 | 80 | 48 | 41 | 6 | 211078 |
| STN-00 A-E USB150 | 1 | 11 | 36 | 6 | 3 | 37 | 9 | 102 | 26 | 69 | 17 | 72 | 20 | 212591 | 6 | 4 | 48 | 44 | 103 | 26 | 78 | 29 | 60 | 10 | 211960 |
| MIL-71 X-Y USB-30 | 1 | 11 | 39 | 6 | 3 | 37 | 10 | 102 | 26 | 81 | 49 | 41 | 6 | 211002 | 6 | 4 | 48 | 49 | 103 | 27 | 87 | 63 | 27 | 1 | 210586 |
| GBM-41 X-Y USB-30 | 1 | 11 | 39 | 6 | 3 | 37 | 11 | 102 | 27 | 80 | 50 | 39 | 7 | 210929 | 6 | 4 | 48 | 49 | 103 | 27 | 84 | 65 | 24 | 3 | 210534 |
| ANG-91 X-Y USB-30 | 1 | 11 | 39 | 6 | 3 | 37 | 13 | 102 | 27 | 64 | 62 | 25 | 11 | 210531 | 6 | 4 | 48 | 52 | 103 | 27 | 44 | 76 | 10 | 10 | 210328 |
| BDA-02 X-Y USB=30 | 1 | 11 | 41 | 6 | 3 | 37 | 14 | 102 | 26 | 94 | 63 | 27 | -2 | 210524 | 6 | 4 | 48 | 55 | 103 | 26 | 113 | 77 | 12 | -5 | 210321 |
| ACN-75 X-Y USB-30 | 1 | 11 | 39 | 6 | 3 | 37 | 28 | 101 | 27 | -29 | 50 | -22 | 35 | 210938 | 6 | 4 | 49 | 7 | 102 | 27 | -45 | 40 | -40 | 33 | 211469 |

1-116

VEHICLE 1 RADAR TABLE

TRACKING TIME

STATION ACQUISITION DATA

STATION TERMINATION DATA

HRS MIN SEC

DAY HRS MIN SEC RA DEC AZ ELV X Y RANGE

DAY HRS MIN SEC RA DEC AZ ELV X Y RANGE

CYI-04 1 11 39 6 3 37 29 101 27 -89 73 -17 0 210283 6 4 49 8 102 26 -84 58 -32 3 210758
X-Y USB-30

MAD-23 1 11 37 6 3 37 31 101 26 -109 61 10 -27 210559 6 4 49 8 102 26 -95 48 4 -41 211100
X-Y USB-85

31 JAN 71 TEI TO ENTRY INTERFACE LAZ 72.1

STN-00 11 9 15 6 5 25 24 103 26 83 37 53 6 212064 6 16 34 39 102 25 -60 3 -86 30 191464
A-E USB150

GYM-14 9 58 57 6 5 25 25 103 26 80 45 45 7 211692 6 15 24 21 101 26 -63 3 -87 27 193801
X-Y USB-30

GDS-28 10 42 14 6 5 25 25 103 26 84 41 -7 49 211875 6 16 7 39 102 25 -61 3 -84 -61 192367
X-Y USB-85

TEX-16 9 5 12 6 5 25 27 103 26 83 57 33 4 211250 6 14 30 39 101 26 -63 3 -87 27 195553
X-Y USB-30

MIL-71 8 0 41 6 5 25 29 103 26 91 72 18 0 210865 6 13 26 9 101 26 -62 3 -87 28 197660
X-Y USB-30

GBM-41 7 46 25 6 5 25 29 103 27 86 74 16 1 210826 6 13 11 54 101 26 -63 3 -87 27 198127
X-Y USB-30

ANG-91 6 19 28 6 5 25 32 102 27 7 80 1 10 210740 6 11 44 60 101 26 -64 3 -87 26 200963
X-Y USB-30

BDA-02 7 5 55 6 5 25 32 102 26 147 83 4 -6 210717 6 12 31 27 101 26 -61 3 -87 29 199453
X-Y USB-30

1-117

14
13
10
9
8
7
6
5
4

VEHICLE 1 RADAR TABLE

| VEHICLE | TRACKING TIME | | | STATION ACQUISITION DATA | | | | | | | | | | STATION TERMINATION DATA | | | | | | | | | | | |
|----------------------|---------------|-----|-----|--------------------------|-----|-----|-----|-----|-----|-----|-----|-----|-----|--------------------------|-----|-----|-----|-----|-----|-----|-----|-----|-----|-----|--------|
| | HRS | MIN | SEC | DAY | HRS | MIN | SEC | RA | DEC | AZ | ELV | X | Y | RANGE | DAY | HRS | MIN | SEC | RA | DEC | AZ | ELV | X | Y | RANGE |
| MAD-23 X-Y USB-85 | 3 | 27 | 43 | 6 | 5 | 25 | 38 | 102 | 26 | -89 | 41 | -2 | -49 | 211852 | 6 | 8 | 53 | 21 | 101 | 26 | -58 | 3 | -84 | -58 | 206586 |
| CYI-04 X-Y USB-30 | 3 | 38 | 29 | 6 | 5 | 25 | 38 | 102 | 26 | -81 | 50 | -40 | 6 | 211496 | 6 | 9 | 4 | 7 | 101 | 26 | -62 | 3 | -87 | 28 | 206225 |
| ACN-75 X-Y USB-30 | 2 | 19 | 46 | 6 | 5 | 25 | 40 | 102 | 27 | -51 | 33 | -50 | 32 | 212248 | 6 | 7 | 45 | 26 | 101 | 27 | -63 | 3 | -87 | 27 | 208855 |
| HAW-12 X-Y USB-30 | 12 | 53 | 7 | 6 | 5 | 33 | 59 | 103 | 26 | 63 | 3 | 87 | 27 | 213631 | 6 | 18 | 27 | 6 | 102 | 25 | -64 | 3 | -87 | 26 | 187712 |
| GWM-24 X-Y USB-30 | 12 | 17 | 57 | 6 | 9 | 33 | 58 | 103 | 26 | 64 | 3 | 87 | 26 | 205242 | 6 | 21 | 51 | 55 | 102 | 25 | -65 | 3 | -87 | 25 | 180702 |
| HSK-25 X-Y USB-85 | 8 | 29 | 25 | 6 | 11 | 12 | 37 | 103 | 27 | 53 | 3 | -85 | 53 | 202006 | 6 | 19 | 42 | 2 | 102 | 27 | -54 | 3 | -85 | -54 | 185165 |
| CRO-08 X-Y USB-30 | 9 | 36 | 19 | 6 | 13 | 0 | 18 | 103 | 27 | 59 | 3 | 86 | 31 | 198501 | 6 | 22 | 36 | 38 | 102 | 26 | -59 | 3 | -87 | 31 | 179136 |
| PKS-96 H-D USB210 | 0 | 26 | 18 | 6 | 15 | 14 | 47 | 103 | 27 | 4 | 30 | 7 | 60 | 192555 | 6 | 15 | 41 | 6 | 103 | 27 | -3 | 30 | -5 | 60 | 191676 |
| MAD-23 X-Y USB-85 | 14 | 23 | 46 | 6 | 18 | 26 | 53 | 104 | 25 | 59 | 3 | -84 | 59 | 187722 | 7 | 8 | 50 | 38 | 104 | 24 | -61 | 3 | -84 | -61 | 156379 |
| CYI-04 X-Y USB-30 | 13 | 17 | 16 | 6 | 19 | 47 | 22 | 104 | 25 | 63 | 3 | 87 | 27 | 184992 | 7 | 9 | 4 | 38 | 103 | 24 | -64 | 3 | -87 | 26 | 155825 |

VEHICLE 1 RADAR TABLE

TRACKING TIME

STATION ACQUISITION DATA

STATION TERMINATION DATA

| | HRS | MIN | SEC | DAY | HRS | MIN | SEC | RA | DEC | AZ | ELV | X | Y | RANGE | DAY | HRS | MIN | SEC | RA | DEC | AZ | ELV | X | Y | RANGE |
|----------------------|-----|-----|-----|-----|-----|-----|-----|-----|-----|----|-----|-----|----|--------|-----|-----|-----|-----|-----|-----|-----|-----|-----|-----|--------|
| ACN-75 X-Y USB-30 | 10 | 56 | 10 | 6 | 20 | 54 | 19 | 104 | 26 | 63 | 3 | 87 | 27 | 182692 | 7 | 7 | 50 | 29 | 103 | 25 | -64 | 3 | -87 | 26 | 158727 |
| BDA-02 X-Y USB-30 | 13 | 37 | 31 | 6 | 22 | 54 | 2 | 104 | 25 | 62 | 3 | 87 | 28 | 178535 | 7 | 12 | 31 | 33 | 104 | 24 | -64 | 3 | -87 | 26 | 147460 |
| ANG-91 X-Y USB-30 | 12 | 31 | 40 | 6 | 23 | 16 | 22 | 104 | 25 | 65 | 3 | 87 | 25 | 177746 | 7 | 11 | 48 | 2 | 104 | 24 | -66 | 3 | -87 | 24 | 149250 |
| GBM-41 X-Y USB-30 | 13 | 10 | 48 | 7 | 0 | 2 | 30 | 104 | 25 | 63 | 3 | 87 | 26 | 176114 | 7 | 13 | 13 | 18 | 104 | 24 | -65 | 3 | -87 | 25 | 145723 |
| MIL-71 X-Y USB-30 | 13 | 19 | 2 | 7 | 0 | 8 | 12 | 104 | 25 | 63 | 3 | 87 | 27 | 175911 | 7 | 13 | 27 | 13 | 104 | 24 | -65 | 3 | -87 | 25 | 145141 |
| TEX-16 X-Y USB-30 | 13 | 14 | 50 | 7 | 1 | 17 | 28 | 105 | 25 | 63 | 3 | 87 | 27 | 173432 | 7 | 14 | 32 | 19 | 104 | 24 | -65 | 3 | -87 | 25 | 142390 |
| GYM-14 X-Y USB-30 | 13 | 15 | 48 | 7 | 2 | 10 | 44 | 105 | 25 | 63 | 3 | 87 | 27 | 171503 | 7 | 15 | 26 | 33 | 104 | 23 | -65 | 3 | -87 | 25 | 140065 |
| GDS-28 X-Y USB-85 | 13 | 50 | 29 | 7 | 2 | 17 | 22 | 105 | 25 | 62 | 3 | -84 | 62 | 171264 | 7 | 16 | 7 | 51 | 105 | 23 | -64 | 3 | -83 | -63 | 138273 |
| STN-00 A-E USB150 | 14 | 1 | 8 | 7 | 2 | 33 | 10 | 105 | 25 | 61 | 3 | 87 | 29 | 170687 | 7 | 16 | 34 | 19 | 105 | 23 | -63 | 3 | -87 | 27 | 137116 |
| HAW-12 X-Y USB-30 | 12 | 50 | 14 | 7 | 5 | 41 | 13 | 105 | 25 | 65 | 3 | 87 | 25 | 163692 | 7 | 18 | 31 | 27 | 105 | 23 | -66 | 3 | -87 | 24 | 131894 |

1-119

VEHICLE 1 RADAR TABLE

| | TRACKING TIME | | | STATION ACQUISITION DATA | | | | | | | | | | STATION TERMINATION DATA | | | | | | | | | | | |
|----------------------|---------------|-----|-----|--------------------------|-----|-----|-----|-----|-----|----|-----|-----|----|--------------------------|-----|-----|-----|-----|-----|-----|-----|-----|-----|-----|--------|
| | HRS | MIN | SEC | DAY | HRS | MIN | SEC | RA | DEC | AZ | ELV | X | Y | RANGE | DAY | HRS | MIN | SEC | RA | DEC | AZ | ELV | X | Y | RANGE |
| GWM-24 X-Y USB-30 | 12 | 16 | 7 | 7 | 9 | 43 | 20 | 106 | 24 | 66 | 3 | 87 | 24 | 154287 | 7 | 21 | 59 | 27 | 105 | 23 | -67 | 3 | -87 | 23 | 122203 |
| HSK-25 X-Y USB-85 | 8 | 45 | 36 | 7 | 11 | 14 | 2 | 106 | 25 | 56 | 3 | -85 | 55 | 150631 | 7 | 19 | 59 | 38 | 105 | 25 | -57 | 3 | -85 | -57 | 127846 |
| CRD-08 X-Y USB-30 | 9 | 48 | 11 | 7 | 13 | 4 | 56 | 107 | 25 | 61 | 3 | 87 | 29 | 146065 | 7 | 22 | 53 | 7 | 106 | 24 | -62 | 3 | -87 | 28 | 119602 |
| PKS-96 H=D USB210 | 1 | 59 | 46 | 7 | 14 | 39 | 49 | 106 | 25 | 15 | 30 | 25 | 57 | 140528 | 7 | 16 | 39 | 35 | 106 | 25 | -16 | 30 | -26 | 56 | 135342 |
| MAD-23 X-Y USB-85 | 14 | 1 | 24 | 7 | 18 | 49 | 25 | 108 | 23 | 62 | 3 | -84 | 62 | 131081 | 8 | 8 | 50 | 49 | 109 | 19 | -67 | 3 | -82 | -67 | 87301 |
| CYI-04 X-Y USB-30 | 13 | 5 | 38 | 7 | 20 | 6 | 41 | 108 | 23 | 66 | 3 | 87 | 24 | 127527 | 8 | 9 | 12 | 19 | 109 | 20 | -69 | 3 | -87 | 21 | 85990 |
| ACN-75 X-Y USB-30 | 11 | 4 | 5 | 7 | 21 | 6 | 22 | 109 | 24 | 66 | 3 | 87 | 24 | 124727 | 8 | 8 | 10 | 27 | 108 | 21 | -68 | 3 | -87 | 22 | 89718 |
| BDA-02 X-Y USB-30 | 13 | 20 | 28 | 7 | 23 | 17 | 47 | 109 | 22 | 66 | 3 | 87 | 24 | 118404 | 8 | 12 | 38 | 15 | 111 | 18 | -71 | 3 | -87 | 19 | 72737 |
| ANG-91 X-Y USB-30 | 12 | 27 | 6 | 7 | 23 | 35 | 47 | 109 | 22 | 67 | 3 | 87 | 23 | 117515 | 8 | 12 | 2 | 53 | 110 | 19 | -71 | 3 | -87 | 19 | 75114 |
| GBM-41 X-Y USB-30 | 12 | 58 | 50 | 8 | 0 | 25 | 27 | 109 | 22 | 67 | 3 | 87 | 23 | 115045 | 8 | 13 | 24 | 17 | 111 | 18 | -72 | 3 | -87 | 18 | 69569 |

1-120

VEHICLE 1 RADAR TABLE

TRACKING TIME

STATION ACQUISITION DATA

STATION TERMINATION DATA

HRS MIN SEC

DAY HRS MIN SEC

RA DEC

AZ ELV

X

Y

RANGE

DAY HRS MIN SEC

RA DEC

AZ ELV

X

Y

RANGE

| | | | | | | | | | | | |
|----------------------|----------|------------|--------|-------|--------|--------|------------|---------|--------|---------|-------|
| MIL-71 X-Y USB-30 | 13 5 14 | 8 0 31 50 | 109 22 | 67 3 | 87 23 | 114725 | 8 13 37 3 | 111 17 | -72 3 | -87 18 | 68674 |
| TEX-16 X-Y USB-30 | 13 1 21 | 8 1 42 16 | 110 22 | 67 3 | 87 23 | 111143 | 8 14 43 37 | 112 17 | -73 3 | -87 17 | 63895 |
| GYM-14 X-Y USB-30 | 13 1 42 | 8 2 36 41 | 110 22 | 67 3 | 87 23 | 108320 | 8 15 38 23 | 113 16 | -73 3 | -87 17 | 59800 |
| GDS-28 X-Y USB-85 | 13 27 14 | 8 2 46 34 | 110 21 | 66 3 | -83 66 | 107802 | 8 16 13 48 | 113 15 | -73 3 | -80 -73 | 57065 |
| STN-00 A-E USB150 | 13 34 24 | 8 3 3 47 | 110 21 | 66 3 | 87 24 | 106896 | 8 16 38 10 | 114 15 | -74 3 | -87 16 | 55138 |
| HAW-12 X-Y USB-30 | 12 42 46 | 8 6 10 6 | 112 21 | 69 3 | 87 21 | 96705 | 8 18 52 52 | 116 13 | -77 3 | -87 13 | 43709 |
| GWM-24 X-Y USB-30 | 12 34 39 | 8 10 16 30 | 114 20 | 70 3 | 87 20 | 82004 | 8 22 51 9 | 125 -1 | -91 3 | -87 -1 | 17744 |
| MSK-25 X-Y USB-85 | 10 13 50 | 8 11 28 55 | 114 21 | 61 3 | -84 61 | 77349 | 8 21 42 45 | 122 13 | -72 3 | -80 -72 | 26420 |
| CRO-08 X-Y USB-30 | 10 53 12 | 8 13 29 8 | 116 20 | 66 3 | 87 24 | 69224 | 9 0 22 20 | -47 -41 | 134 3 | 86 -44 | 1590 |
| PKS-96 H-D USB210 | 4 9 28 | 8 14 22 19 | 116 21 | 30 30 | 41 48 | 63919 | 8 18 31 47 | 117 18 | -37 30 | -46 44 | 44082 |

1-121

12
11
10
9
8
7
6
5

VEHICLE 1 RADAR TABLE

| | TRACKING TIME | | | STATION ACQUISITION DATA | | | | | | | | | | STATION TERMINATION DATA | | | | | | | | | | | |
|----------------------|---------------|-----|-----|--------------------------|-----|-----|-----|-----|-----|-----|-----|-----|-----|--------------------------|-----|-----|-----|-----|------|-----|-----|-----|----|-----|-------|
| | HRS | MIN | SEC | DAY | HRS | MIN | SEC | RA | DEC | AZ | ELV | X | Y | RANGE | DAY | HRS | MIN | SEC | RA | DEC | AZ | ELV | X | Y | RANGE |
| MAD-23 X-Y USB-85 | 1 | 25 | 19 | 8 | 21 | 29 | 58 | 132 | 4 | 87 | 3 | -48 | 86 | 27899 | 8 | 22 | 55 | 17 | 145 | -6 | 101 | 3 | 74 | 79 | 17163 |
| TAN-22 A-E FPS-16 | 2 | 22 | 28 | 8 | 21 | 50 | 13 | 133 | 11 | 50 | 45 | 37 | 27 | 23398 | 9 | 0 | 12 | 41 | -129 | -25 | 116 | 3 | 87 | -26 | 3833 |
| PRE-76 A-E MPS-25 | 2 | 10 | 37 | 8 | 21 | 57 | 16 | 135 | 11 | 61 | 26 | 60 | 26 | 23400 | 9 | 0 | 7 | 53 | -152 | -14 | 105 | 3 | 87 | -15 | 4882 |
| HSK-25 X-Y USB-85 | 0 | 19 | 4 | 9 | 0 | 7 | 16 | 143 | -8 | -98 | 3 | 69 | -82 | 5014 | 9 | 0 | 26 | 20 | -25 | -13 | 104 | 3 | 77 | 76 | 656 |

1-122

12
11
10
9
8
7
6
5
4
3
2

TABLE 1.1-V.- MISSION RADAR TIMELINE - Continued

(f) LM acquisition and termination during descent - 3° minimum elevation

31 JAN 71 LM FROM UNDOCK TO LANDING

| VEHICLE | RADAR TABLE | | STATION ACQUISITION DATA | | | | | | | | | | | | STATION TERMINATION DATA | | | | | | | | | | |
|----------------------|---------------|-----|--------------------------|-----|-----|-----|-----|----|-----|------|-----|-----|-----|--------|--------------------------|-----|-----|-----|----|-----|------|-----|-----|-----|--------|
| | TRACKING TIME | | | | | | | | | | | | | | | | | | | | | | | | |
| | HRS | MIN | SEC | DAY | HRS | MIN | SEC | RA | DEC | AZ | ELV | X | Y | RANGE | DAY | HRS | MIN | SEC | RA | DEC | AZ | ELV | X | Y | RANGE |
| GWM-24 X-Y USB-30 | 0 | 56 | 38 | 4 | 8 | 27 | 31 | 77 | 27 | 64 | 10 | 79 | 26 | 208890 | 4 | 9 | 24 | 8 | 78 | 28 | 65 | 22 | 66 | 23 | 208721 |
| HAW-12 X-Y USB-30 | 0 | 56 | 50 | 4 | 8 | 27 | 31 | 76 | 28 | 72 | 63 | 26 | 8 | 206446 | 4 | 9 | 24 | 21 | 77 | 28 | 65 | 74 | 14 | 6 | 206705 |
| STN-00 A-E USB150 | 0 | 57 | 3 | 4 | 8 | 27 | 31 | 76 | 27 | -141 | 78 | -8 | -10 | 206155 | 4 | 9 | 24 | 34 | 77 | 28 | -111 | 69 | -20 | -8 | 206819 |
| GDS-28 X-Y USB-85 | 0 | 57 | 5 | 4 | 8 | 27 | 31 | 75 | 27 | -119 | 76 | 7 | -13 | 206182 | 4 | 9 | 24 | 36 | 76 | 28 | -101 | 65 | 5 | -24 | 206903 |
| GYM-14 X-Y USB-30 | 0 | 57 | 7 | 4 | 8 | 27 | 31 | 75 | 28 | -86 | 72 | -18 | 1 | 206243 | 4 | 9 | 24 | 38 | 76 | 28 | -82 | 60 | -30 | 4 | 207046 |
| TEX-16 X-Y USB-30 | 0 | 57 | 13 | 4 | 8 | 27 | 31 | 75 | 28 | -82 | 60 | -30 | 4 | 206531 | 4 | 9 | 24 | 43 | 76 | 28 | -78 | 48 | -41 | 8 | 207463 |
| MIL-71 X-Y USB-30 | 0 | 57 | 13 | 4 | 8 | 27 | 31 | 75 | 27 | -79 | 45 | -44 | 8 | 207054 | 4 | 9 | 24 | 43 | 76 | 28 | -74 | 34 | -55 | 13 | 208108 |
| GBM-41 X-Y USB-30 | 0 | 57 | 13 | 4 | 8 | 27 | 31 | 75 | 27 | -76 | 43 | -46 | 10 | 207163 | 4 | 9 | 24 | 43 | 76 | 28 | -73 | 31 | -57 | 15 | 208233 |
| BDA-02 X-Y USB-30 | 0 | 57 | 14 | 4 | 8 | 27 | 31 | 75 | 27 | -76 | 33 | -57 | 12 | 207646 | 4 | 9 | 24 | 45 | 76 | 27 | -71 | 22 | -67 | 18 | 208742 |
| ANG-91 X-Y USB-30 | 0 | 57 | 16 | 4 | 8 | 27 | 31 | 75 | 27 | -67 | 25 | -63 | 21 | 208035 | 4 | 9 | 24 | 46 | 76 | 28 | -65 | 14 | -75 | 24 | 209217 |

1-123

| VEHICLE | RADAR TABLE | | | STATION ACQUISITION DATA | | | | | | | | | | STATION TERMINATION DATA | | | | | | | | | | | |
|----------------------|---------------|----|----|--------------------------|-----|-----|-----|----|-----|-----|-----|-----|-----|--------------------------|-----|-----|-----|-----|----|-----|-----|-----|-----|-----|--------|
| | TRACKING TIME | | | DAY | HRS | MIN | SEC | RA | DEC | AZ | ELV | X | Y | RANGE | DAY | HRS | MIN | SEC | RA | DEC | AZ | ELV | X | Y | RANGE |
| HSK-25 X-Y USB-85 | 1 | 5 | 26 | 4 | 10 | 12 | 32 | 77 | 28 | 47 | 7 | -79 | 47 | 209666 | 4 | 11 | 17 | 58 | 79 | 29 | 36 | 15 | -71 | 35 | 209235 |
| GWM-24 X-Y USB-30 | 1 | 5 | 26 | 4 | 10 | 12 | 32 | 78 | 28 | 65 | 32 | 55 | 21 | 208273 | 4 | 11 | 17 | 59 | 79 | 28 | 63 | 46 | 41 | 18 | 207698 |
| HAW-12 X-Y USB-30 | 1 | 5 | 26 | 4 | 10 | 12 | 50 | 77 | 28 | 29 | 84 | 3 | 6 | 206706 | 4 | 11 | 18 | 16 | 78 | 28 | -59 | 78 | -11 | 6 | 206837 |
| STN-00 A-E USB150 | 1 | 5 | 28 | 4 | 10 | 12 | 59 | 76 | 27 | -99 | 59 | -30 | -4 | 207149 | 4 | 11 | 18 | 27 | 77 | 28 | -88 | 47 | -43 | 1 | 207672 |
| GDS-28 X-Y USB-85 | 1 | 5 | 24 | 4 | 10 | 13 | 0 | 76 | 27 | -92 | 55 | 1 | -35 | 207280 | 4 | 11 | 18 | 24 | 77 | 28 | -83 | 43 | -7 | -47 | 207856 |
| GYM-14 X-Y USB-30 | 1 | 5 | 26 | 4 | 10 | 13 | 2 | 76 | 28 | -79 | 49 | -40 | 7 | 207493 | 4 | 11 | 18 | 27 | 77 | 28 | -75 | 36 | -53 | 12 | 208164 |
| GBM-41 X-Y USB-30 | 1 | 5 | 24 | 4 | 10 | 13 | 7 | 76 | 27 | -69 | 21 | -68 | 20 | 208857 | 4 | 11 | 18 | 32 | 77 | 27 | -64 | 9 | -80 | 26 | 209679 |
| TEX-16 X-Y USB-30 | 1 | 5 | 25 | 4 | 10 | 13 | 7 | 76 | 27 | -75 | 38 | -51 | 12 | 207994 | 4 | 11 | 18 | 32 | 77 | 28 | -71 | 25 | -64 | 18 | 208757 |
| BDA-02 X-Y USB-30 | 0 | 53 | 52 | 4 | 10 | 13 | 8 | 76 | 27 | -65 | 12 | -77 | 24 | 209359 | 4 | 11 | 7 | 0 | 77 | 27 | -59 | 3 | -87 | 31 | 209387 |
| MIL-71 X-Y USB-30 | 1 | 5 | 23 | 4 | 10 | 13 | 9 | 76 | 27 | -71 | 24 | -65 | 18 | 208706 | 4 | 11 | 18 | 32 | 77 | 27 | -65 | 11 | -77 | 25 | 209515 |

1-121

| VEHICLE | RADAR TABLE | | | | | | | | | | | | | | | | | | | | | | | | |
|----------------------|---------------|-----|-----|--------------------------|-----|-----|-----|----|-----|-----|-----|-----|-----|--------------------------|-----|-----|-----|-----|----|-----|-----|-----|-----|-----|--------|
| | TRACKING TIME | | | STATION ACQUISITION DATA | | | | | | | | | | STATION TERMINATION DATA | | | | | | | | | | | |
| | HRS | MIN | SEC | DAY | HRS | MIN | SEC | RA | DEC | AZ | ELV | X | Y | RANGE | DAY | HRS | MIN | SEC | RA | DEC | AZ | ELV | X | Y | RANGE |
| ANG-91 X-Y USB-30 | 0 | 0 | 8 | 4 | 10 | 13 | 10 | 76 | 27 | -62 | 3 | -87 | 28 | 209902 | 4 | 10 | 13 | 17 | 76 | 27 | -62 | 3 | -87 | 28 | 209897 |
| CRO-08 X-Y USB-30 | 0 | 35 | 39 | 4 | 12 | 6 | 22 | 79 | 28 | 53 | 9 | 79 | 36 | 209742 | 4 | 12 | 42 | 1 | 79 | 28 | 48 | 15 | 71 | 40 | 208218 |
| GWM-24 X-Y USB-30 | 0 | 35 | 32 | 4 | 12 | 6 | 29 | 78 | 28 | 59 | 57 | 29 | 16 | 207423 | 4 | 12 | 42 | 1 | 79 | 28 | 53 | 63 | 22 | 16 | 206543 |
| HSK-25 X-Y USB-85 | 0 | 35 | 31 | 4 | 12 | 6 | 30 | 78 | 29 | 26 | 21 | -67 | 24 | 209052 | 4 | 12 | 42 | 1 | 79 | 29 | 19 | 23 | -66 | 17 | 207735 |
| HAW-12 X-Y USB-30 | 0 | 35 | 11 | 4 | 12 | 6 | 50 | 78 | 28 | -71 | 67 | -22 | 7 | 207108 | 4 | 12 | 42 | 1 | 78 | 28 | -72 | 60 | -29 | 9 | 206138 |
| STN-00 A-E USB150 | 0 | 35 | 6 | 4 | 12 | 6 | 55 | 77 | 27 | -82 | 37 | -52 | 7 | 208175 | 4 | 12 | 42 | 1 | 78 | 27 | -78 | 31 | -58 | 11 | 207336 |
| GDS-28 X-Y USB-85 | 0 | 35 | 3 | 4 | 12 | 6 | 58 | 77 | 27 | -78 | 33 | -18 | -55 | 208398 | 4 | 12 | 42 | 1 | 78 | 27 | -74 | 26 | -29 | -59 | 207575 |
| GYM-14 X-Y USB-30 | 0 | 35 | 2 | 4 | 12 | 6 | 59 | 77 | 27 | -71 | 26 | -63 | 17 | 208766 | 4 | 12 | 42 | 1 | 78 | 27 | -68 | 19 | -70 | 20 | 207983 |
| TEX-16 X-Y USB-30 | 0 | 35 | 0 | 4 | 12 | 7 | 1 | 77 | 27 | -66 | 15 | -74 | 23 | 209391 | 4 | 12 | 42 | 1 | 78 | 27 | -63 | 8 | -81 | 26 | 208618 |

1-125

TABLE 1.1-V.- MISSION RADAR TIMELINE - Continued

(g) LM acquisition and termination during ascent - 3° minimum elevation

31 JAN 71 LM ASCENT TO INSERTION

VEHICLE RADAR TABLE

TRACKING TIME

STATION ACQUISITION DATA

STATION TERMINATION DATA

HRS MIN SEC

DAY HRS MIN SEC RA DEC AZ ELV X Y RANGE

DAY HRS MIN SEC RA DEC AZ ELV X Y RANGE

MAD-23 0 7 11
X-Y USB-05

5 22 24 29 99 27 95 50 4 40 209365

5 22 31 40 99 27 97 51 5 39 209401

CYI-04 0 7 11
X-Y USB-30

5 22 24 29 99 27 77 39 50 10 209814

5 22 31 40 100 27 77 41 49 10 209831

ACN-75 0 7 11
X-Y USB-30

5 22 24 29 100 27 55 25 60 32 210526

5 22 31 40 100 27 54 26 59 32 210537

TABLE 1.1-V.- MISSION RADAR TIMELINE - Concluded

(h) LM acquisition and termination during rendezvous - 3° minimum elevation

COAST TO RENDEZVOUS RADAR TRACKING PRIOR TO TPI

VEHICLE 2 RADAR TABLE

| VEHICLE | TRACKING TIME | | | STATION ACQUISITION DATA | | | | | | | STATION TERMINATION DATA | | | | | | | | | | | | | | |
|----------------------|---------------|-----|-----|--------------------------|-----|-----|-----|-----|-----|----|--------------------------|----|----|--------|-----|-----|-----|-----|-----|-----|----|-----|----|----|--------|
| | HRS | MIN | SEC | DAY | HRS | MIN | SEC | RA | DEC | AZ | ELV | X | Y | RANGE | DAY | HRS | MIN | SEC | RA | DEC | AZ | ELV | X | Y | RANGE |
| MAD-23 X-Y USB-85 | 0 | 9 | 60 | 5 | 22 | 31 | 40 | 99 | 27 | 97 | 51 | 5 | 39 | 209395 | 5 | 22 | 41 | 40 | 100 | 27 | 98 | 53 | 6 | 37 | 209751 |
| CYI-04 X-Y USB-30 | 0 | 9 | 60 | 5 | 22 | 31 | 40 | 100 | 27 | 77 | 41 | 49 | 10 | 209825 | 5 | 22 | 41 | 40 | 100 | 27 | 78 | 43 | 47 | 9 | 210156 |
| ACN-75 X-Y USB-30 | 0 | 9 | 60 | 5 | 22 | 31 | 40 | 100 | 27 | 54 | 26 | 59 | 32 | 210531 | 5 | 22 | 41 | 40 | 100 | 27 | 53 | 28 | 56 | 32 | 210854 |
| BDA-02 X-Y USB-30 | 0 | 6 | 2 | 5 | 22 | 35 | 38 | 100 | 26 | 60 | 3 | 87 | 30 | 212021 | 5 | 22 | 41 | 40 | 100 | 27 | 61 | 4 | 85 | 29 | 212236 |

RENDEZVOUS RADAR TRACKING PRIOR TO TPI

| | | | | | | | | | | | | | | | | | | | | | | | | | |
|----------------------|---|----|----|---|----|----|----|-----|----|----|----|----|----|--------|---|----|----|---|-----|----|-----|----|----|----|--------|
| ACN-75 X-Y USB-30 | 0 | 11 | 21 | 5 | 22 | 41 | 40 | 100 | 27 | 53 | 28 | 56 | 32 | 210854 | 5 | 22 | 53 | 1 | 100 | 27 | 52 | 30 | 53 | 32 | 211358 |
| BDA-02 X-Y USB-30 | 0 | 11 | 22 | 5 | 22 | 41 | 40 | 100 | 27 | 61 | 4 | 85 | 29 | 212236 | 5 | 22 | 53 | 2 | 100 | 27 | 62 | 6 | 83 | 28 | 212732 |
| CYI-04 X-Y USB-30 | 0 | 11 | 23 | 5 | 22 | 41 | 40 | 100 | 27 | 78 | 43 | 47 | 9 | 210156 | 5 | 22 | 53 | 3 | 100 | 27 | 79 | 45 | 44 | 8 | 210671 |
| MAD-23 X-Y USB-85 | 0 | 11 | 27 | 5 | 22 | 41 | 40 | 100 | 27 | 98 | 53 | 6 | 37 | 209751 | 5 | 22 | 53 | 7 | 100 | 27 | 101 | 55 | 7 | 34 | 210299 |

COAST TO TPI

ULLAGE FOR TPI

TPI

COAST TO 1ST BRAKING GATE

| | | | | | | | | | | | | | | | | | | | | | | | | | |
|----------------------|---|---|----|---|----|----|----|-----|----|----|----|----|----|--------|---|----|----|----|-----|----|----|----|----|----|--------|
| ANG-91 X-Y USB-30 | 0 | 8 | 20 | 5 | 23 | 40 | 24 | 100 | 27 | 65 | 12 | 77 | 24 | 212586 | 5 | 23 | 48 | 44 | 100 | 27 | 66 | 13 | 75 | 24 | 212060 |
| BDA-02 X-Y USB-30 | 0 | 8 | 15 | 5 | 23 | 40 | 28 | 100 | 26 | 68 | 15 | 74 | 21 | 212369 | 5 | 23 | 48 | 44 | 100 | 26 | 69 | 17 | 72 | 20 | 211860 |

1-1127

VEHICLE 2 RADAR TABLE

| TRACKING TIME | | | | STATION ACQUISITION DATA | | | | | | | | | | STATION TERMINATION DATA | | | | | | | | | | | | | |
|---------------------------|-----|-----|----|--------------------------|-----|-----|-----|----|-----|----|-----|----|----|--------------------------|--------|-----|-----|-----|----|-----|----|-----|----|----|-------|--------|--|
| HRS | MIN | SEC | | DAY | HRS | MIN | SEC | RA | DEC | AZ | ELV | X | Y | RANGE | DAY | HRS | MIN | SEC | RA | DEC | AZ | ELV | X | Y | RANGE | | |
| ACN-75 | 0 | 8 | 13 | | 5 | 23 | 40 | 31 | 100 | 27 | 44 | 39 | 41 | 34 | 211093 | 5 | 23 | 48 | 44 | 100 | 27 | 43 | 41 | 38 | 34 | 210613 | |
| X-Y USB-30 | | | | | | | | | | | | | | | | | | | | | | | | | | | |
| CYI-04 | 0 | 8 | 12 | | 5 | 23 | 40 | 32 | 100 | 27 | 82 | 56 | 34 | 4 | 210444 | 5 | 23 | 48 | 44 | 100 | 27 | 83 | 57 | 32 | 4 | 209970 | |
| X-Y USB-30 | | | | | | | | | | | | | | | | | | | | | | | | | | | |
| MAD-23 | 0 | 8 | 10 | | 5 | 23 | 40 | 34 | 99 | 27 | 113 | 64 | 11 | 24 | 210200 | 5 | 23 | 48 | 44 | 99 | 27 | 116 | 65 | 11 | 22 | 209951 | |
| X-Y USB-85 | | | | | | | | | | | | | | | | | | | | | | | | | | | |
| GBM-41 | 0 | 3 | 27 | | 5 | 23 | 45 | 17 | 100 | 26 | 62 | 3 | 87 | 28 | 212851 | 5 | 23 | 48 | 44 | 100 | 26 | 62 | 4 | 86 | 28 | 212634 | |
| X-Y USB-30 | | | | | | | | | | | | | | | | | | | | | | | | | | | |
| COAST TO 2ND BRAKING GATE | | | | | | | | | | | | | | | | | | | | | | | | | | | |
| MAD-23 | 0 | 1 | 49 | | 5 | 23 | 48 | 44 | 99 | 27 | 116 | 65 | 11 | 22 | 209751 | 5 | 23 | 50 | 33 | 99 | 27 | 116 | 65 | 12 | 22 | 209651 | |
| X-Y USB-85 | | | | | | | | | | | | | | | | | | | | | | | | | | | |
| GBM-41 | 0 | 1 | 49 | | 5 | 23 | 48 | 44 | 100 | 26 | 62 | 4 | 86 | 28 | 212634 | 5 | 23 | 50 | 33 | 100 | 26 | 62 | 4 | 86 | 28 | 212521 | |
| X-Y USB-30 | | | | | | | | | | | | | | | | | | | | | | | | | | | |
| BDA-02 | 0 | 1 | 49 | | 5 | 23 | 48 | 44 | 100 | 26 | 69 | 17 | 72 | 20 | 211860 | 5 | 23 | 50 | 33 | 100 | 26 | 69 | 17 | 72 | 20 | 211748 | |
| X-Y USB-30 | | | | | | | | | | | | | | | | | | | | | | | | | | | |
| ANG-91 | 0 | 1 | 49 | | 5 | 23 | 48 | 44 | 100 | 27 | 66 | 13 | 75 | 24 | 212060 | 5 | 23 | 50 | 33 | 100 | 27 | 66 | 13 | 75 | 23 | 211946 | |
| X-Y USB-30 | | | | | | | | | | | | | | | | | | | | | | | | | | | |
| CYI-04 | 0 | 1 | 49 | | 5 | 23 | 48 | 44 | 100 | 27 | 83 | 57 | 32 | 4 | 209970 | 5 | 23 | 50 | 33 | 100 | 27 | 83 | 58 | 32 | 4 | 209865 | |
| X-Y USB-30 | | | | | | | | | | | | | | | | | | | | | | | | | | | |
| ACN-75 | 0 | 1 | 49 | | 5 | 23 | 48 | 44 | 100 | 27 | 43 | 41 | 38 | 34 | 210613 | 5 | 23 | 50 | 33 | 100 | 27 | 43 | 41 | 38 | 34 | 210507 | |
| X-Y USB-30 | | | | | | | | | | | | | | | | | | | | | | | | | | | |

1-109

1ST BRAKING MANEUVER *

VEHICLE 2 RADAR TABLE

| | TRACKING TIME | | | STATION ACQUISITION DATA | | | | | | | | STATION TERMINATION DATA | | | | | | | | | | | | | | |
|---------------------------|---------------|-----|-----|--------------------------|-----|-----|-----|-----|-----|-----|-----|--------------------------|----|--------|-----|-----|-----|-----|-----|-----|-----|-----|----|----|--------|--|
| | HRS | MIN | SEC | DAY | HRS | MIN | SEC | RA | DEC | AZ | ELV | X | Y | RANGE | DAY | HRS | MIN | SEC | RA | DEC | AZ | ELV | X | Y | RANGE | |
| MAD-23 X-Y USB-85 | 0 | 0 | 12 | 5 | 23 | 50 | 33 | 99 | 27 | 116 | 65 | 12 | 22 | 209651 | 5 | 23 | 50 | 45 | 99 | 27 | 116 | 65 | 12 | 22 | 209640 | |
| GBM-41 X-Y USB-30 | 0 | 0 | 12 | 5 | 23 | 50 | 33 | 100 | 26 | 62 | 4 | 85 | 28 | 212521 | 5 | 23 | 50 | 45 | 100 | 26 | 62 | 4 | 85 | 28 | 212508 | |
| BDA-02 X-Y USB-30 | 0 | 0 | 12 | 5 | 23 | 50 | 33 | 100 | 26 | 69 | 17 | 72 | 20 | 211748 | 5 | 23 | 50 | 45 | 100 | 26 | 69 | 17 | 72 | 20 | 211735 | |
| ANG-91 X-Y USB-30 | 0 | 0 | 12 | 5 | 23 | 50 | 33 | 100 | 27 | 66 | 14 | 75 | 23 | 211946 | 5 | 23 | 50 | 45 | 100 | 27 | 66 | 14 | 75 | 23 | 211933 | |
| CYI-04 X-Y USB-30 | 0 | 0 | 12 | 5 | 23 | 50 | 33 | 100 | 27 | 83 | 58 | 32 | 4 | 209865 | 5 | 23 | 50 | 45 | 100 | 27 | 83 | 58 | 32 | 4 | 209854 | |
| ACN-75 X-Y USB-30 | 0 | 0 | 12 | 5 | 23 | 50 | 33 | 100 | 27 | 43 | 41 | 38 | 34 | 210507 | 5 | 23 | 50 | 45 | 100 | 27 | 43 | 41 | 38 | 34 | 210496 | |
| COAST TO 3RD BRAKING GATE | | | | | | | | | | | | | | | | | | | | | | | | | | |
| MAD-23 X-Y USB-85 | 0 | 1 | 1 | 5 | 23 | 50 | 45 | 99 | 27 | 116 | 65 | 12 | 22 | 209640 | 5 | 23 | 51 | 46 | 99 | 27 | 117 | 66 | 12 | 22 | 209585 | |
| GBM-41 X-Y USB-30 | 0 | 1 | 1 | 5 | 23 | 50 | 45 | 100 | 26 | 62 | 4 | 85 | 28 | 212508 | 5 | 23 | 51 | 46 | 100 | 26 | 62 | 4 | 85 | 27 | 212446 | |
| BDA-02 X-Y USB-30 | 0 | 1 | 1 | 5 | 23 | 50 | 45 | 100 | 26 | 69 | 17 | 72 | 20 | 211735 | 5 | 23 | 51 | 46 | 100 | 26 | 69 | 17 | 71 | 20 | 211673 | |
| ANG-91 X-Y USB-30 | 0 | 1 | 1 | 5 | 23 | 50 | 45 | 100 | 27 | 66 | 14 | 75 | 23 | 211933 | 5 | 23 | 51 | 46 | 100 | 27 | 66 | 14 | 75 | 23 | 211870 | |

L-129

VEHICLE 2 RADAR TABLE

| TRACKING TIME | | | | STATION ACQUISITION DATA | | | | | | | | | | STATION TERMINATION DATA | | | | | | | | | | | | | |
|------------------------|-----|-----|----|--------------------------|-----|-----|-----|-----|-----|-----|-----|----|----|--------------------------|-----|-----|-----|-----|-----|-----|-----|-----|----|----|--------|--|--|
| HRS | MIN | SEC | | DAY | HRS | MIN | SEC | RA | DEC | AZ | ELV | X | Y | RANGE | DAY | HRS | MIN | SEC | RA | DEC | AZ | ELV | X | Y | RANGE | | |
| CYI-04 | 0 | 1 | 1 | 5 | 23 | 50 | 45 | 100 | 27 | 83 | 58 | 32 | 4 | 209854 | 5 | 23 | 51 | 46 | 100 | 27 | 83 | 58 | 32 | 4 | 209796 | | |
| X-Y USB-30 | | | | | | | | | | | | | | | | | | | | | | | | | | | |
| ACN-75 | 0 | 1 | 1 | 5 | 23 | 50 | 45 | 100 | 27 | 43 | 41 | 38 | 34 | 210496 | 5 | 23 | 51 | 46 | 100 | 27 | 42 | 41 | 38 | 34 | 210437 | | |
| X-Y USB-30 | | | | | | | | | | | | | | | | | | | | | | | | | | | |
| MIL-71 | 0 | 0 | 59 | 5 | 23 | 50 | 47 | 100 | 26 | 61 | 3 | 87 | 29 | 212570 | 5 | 23 | 51 | 46 | 100 | 26 | 62 | 3 | 86 | 28 | 212500 | | |
| X-Y USB-30 | | | | | | | | | | | | | | | | | | | | | | | | | | | |
| 2ND BRAKING MANEUVER * | | | | | | | | | | | | | | | | | | | | | | | | | | | |
| MAD-23 | 0 | 0 | 9 | 5 | 23 | 51 | 46 | 99 | 27 | 117 | 66 | 12 | 22 | 209585 | 5 | 23 | 51 | 54 | 99 | 27 | 117 | 66 | 12 | 22 | 209577 | | |
| X-Y USB-85 | | | | | | | | | | | | | | | | | | | | | | | | | | | |
| MIL-71 | 0 | 0 | 9 | 5 | 23 | 51 | 46 | 100 | 26 | 62 | 3 | 86 | 28 | 212509 | 5 | 23 | 51 | 54 | 100 | 26 | 62 | 3 | 86 | 28 | 212500 | | |
| X-Y USB-30 | | | | | | | | | | | | | | | | | | | | | | | | | | | |
| GBM-41 | 0 | 0 | 9 | 5 | 23 | 51 | 46 | 100 | 26 | 62 | 4 | 85 | 27 | 212446 | 5 | 23 | 51 | 54 | 100 | 26 | 62 | 4 | 85 | 27 | 212437 | | |
| X-Y USB-30 | | | | | | | | | | | | | | | | | | | | | | | | | | | |
| BDA-02 | 0 | 0 | 9 | 5 | 23 | 51 | 46 | 100 | 26 | 69 | 17 | 71 | 20 | 211673 | 5 | 23 | 51 | 54 | 100 | 26 | 69 | 17 | 71 | 20 | 211665 | | |
| X-Y USB-30 | | | | | | | | | | | | | | | | | | | | | | | | | | | |
| ANG-91 | 0 | 0 | 9 | 5 | 23 | 51 | 46 | 100 | 27 | 66 | 14 | 75 | 23 | 211870 | 5 | 23 | 51 | 54 | 100 | 27 | 66 | 14 | 75 | 23 | 211861 | | |
| X-Y USB-30 | | | | | | | | | | | | | | | | | | | | | | | | | | | |
| CYI-04 | 0 | 0 | 9 | 5 | 23 | 51 | 46 | 100 | 27 | 83 | 58 | 32 | 4 | 209796 | 5 | 23 | 51 | 54 | 100 | 27 | 83 | 58 | 32 | 4 | 209788 | | |
| X-Y USB-30 | | | | | | | | | | | | | | | | | | | | | | | | | | | |
| ACN-75 | 0 | 0 | 9 | 5 | 23 | 51 | 46 | 100 | 27 | 42 | 41 | 38 | 34 | 210437 | 5 | 23 | 51 | 54 | 100 | 27 | 42 | 41 | 38 | 34 | 210429 | | |
| X-Y USB-30 | | | | | | | | | | | | | | | | | | | | | | | | | | | |

COAST TO 4TH BRAKING GATE

VEHICLE 2 RADAR TABLE

| VEHICLE | TRACKING TIME | | | STATION ACQUISITION DATA | | | | | | | | | STATION TERMINATION DATA | | | | | | | | | | | | | | |
|------------------------|---------------|-----|-----|--------------------------|-----|-----|-----|-----|-----|-----|-----|----|--------------------------|--------|-----|-----|-----|-----|-----|-----|-----|-----|----|----|--------|--|--|
| | HRS | MIN | SEC | DAY | HRS | MIN | SEC | RA | DEC | AZ | ELV | X | Y | RANGE | DAY | HRS | MIN | SEC | RA | DEC | AZ | ELV | X | Y | RANGE | | |
| MAD-23 X-Y USB-85 | 0 | 1 | 30 | 5 | 23 | 51 | 54 | 99 | 27 | 117 | 66 | 12 | 22 | 209577 | 5 | 23 | 53 | 24 | 100 | 27 | 117 | 66 | 12 | 21 | 209498 | | |
| MIL-71 X-Y USB-30 | 0 | 1 | 30 | 5 | 23 | 51 | 54 | 100 | 26 | 62 | 3 | 86 | 28 | 212500 | 5 | 23 | 53 | 24 | 100 | 26 | 62 | 3 | 86 | 28 | 212410 | | |
| GBM-41 X-Y USB-30 | 0 | 1 | 30 | 5 | 23 | 51 | 54 | 100 | 26 | 62 | 4 | 85 | 27 | 212437 | 5 | 23 | 53 | 24 | 100 | 26 | 63 | 5 | 85 | 27 | 212347 | | |
| BDA-02 X-Y USB-30 | 0 | 1 | 30 | 5 | 23 | 51 | 54 | 100 | 26 | 69 | 17 | 71 | 20 | 211665 | 5 | 23 | 53 | 24 | 100 | 26 | 69 | 18 | 71 | 20 | 211575 | | |
| ANG-91 X-Y USB-30 | 0 | 1 | 30 | 5 | 23 | 51 | 54 | 100 | 27 | 66 | 14 | 75 | 23 | 211861 | 5 | 23 | 53 | 24 | 100 | 27 | 66 | 14 | 74 | 23 | 211770 | | |
| CY1-04 X-Y USB-30 | 0 | 1 | 30 | 5 | 23 | 51 | 54 | 100 | 27 | 83 | 58 | 32 | 4 | 209788 | 5 | 23 | 53 | 24 | 100 | 27 | 83 | 58 | 31 | 4 | 209704 | | |
| ACH-75 X-Y USB-30 | 0 | 1 | 30 | 5 | 23 | 51 | 54 | 100 | 27 | 42 | 41 | 38 | 34 | 210429 | 5 | 23 | 53 | 24 | 100 | 27 | 42 | 41 | 37 | 34 | 210345 | | |
| 3RD BRAKING MANEUVER * | | | | | | | | | | | | | | | | | | | | | | | | | | | |
| MAD-23 X-Y USB-85 | 0 | 0 | 4 | 5 | 23 | 53 | 24 | 100 | 27 | 117 | 66 | 12 | 21 | 209498 | 5 | 23 | 53 | 28 | 100 | 27 | 117 | 66 | 12 | 21 | 209494 | | |
| MIL-71 X-Y USB-30 | 0 | 0 | 4 | 5 | 23 | 53 | 24 | 100 | 26 | 62 | 3 | 86 | 28 | 212410 | 5 | 23 | 53 | 28 | 100 | 26 | 62 | 3 | 86 | 28 | 212406 | | |
| GBM-41 X-Y USB-30 | 0 | 0 | 4 | 5 | 23 | 53 | 24 | 100 | 26 | 63 | 5 | 85 | 27 | 212347 | 5 | 23 | 53 | 28 | 100 | 26 | 63 | 5 | 85 | 27 | 212342 | | |

VEHICLE 2 RADAR TABLE

| | TRACKING TIME | | | STATION ACQUISITION DATA | | | | | | | | | | STATION TERMINATION DATA | | | | | | | | | | | | | |
|---------------------------|---------------|-----|-----|--------------------------|-----|-----|-----|-----|-----|-----|-----|----|----|--------------------------|-----|-----|-----|-----|-----|-----|-----|-----|----|----|--------|--|--|
| | HRS | MIN | SEC | DAY | HRS | MIN | SEC | RA | DEC | AZ | ELV | X | Y | RANGE | DAY | HRS | MIN | SEC | RA | DEC | AZ | ELV | X | Y | RANGE | | |
| BDA-02 X-Y USB-30 | 0 | 0 | 4 | 5 | 23 | 53 | 24 | 100 | 26 | 69 | 18 | 71 | 20 | 211575 | 5 | 23 | 53 | 28 | 100 | 26 | 69 | 18 | 71 | 20 | 211571 | | |
| ANG-91 X-Y USB-30 | 0 | 0 | 4 | 5 | 23 | 53 | 24 | 100 | 27 | 66 | 14 | 74 | 23 | 211770 | 5 | 23 | 53 | 28 | 100 | 27 | 66 | 14 | 74 | 23 | 211765 | | |
| CYI-04 X-Y USB-30 | 0 | 0 | 4 | 5 | 23 | 53 | 24 | 100 | 27 | 83 | 58 | 31 | 4 | 209704 | 5 | 23 | 53 | 28 | 100 | 27 | 83 | 58 | 31 | 4 | 209701 | | |
| ACN-75 X-Y USB-30 | 0 | 0 | 4 | 5 | 23 | 53 | 24 | 100 | 27 | 42 | 41 | 37 | 34 | 210345 | 5 | 23 | 53 | 28 | 100 | 27 | 42 | 41 | 37 | 34 | 210341 | | |
| COAST TO 5TH BRAKING GATE | | | | | | | | | | | | | | | | | | | | | | | | | | | |
| MAD-23 X-Y USB-85 | 0 | 1 | 15 | 5 | 23 | 53 | 28 | 100 | 27 | 117 | 66 | 12 | 21 | 209494 | 5 | 23 | 54 | 44 | 100 | 27 | 118 | 66 | 12 | 21 | 209429 | | |
| MIL-71 X-Y USB-30 | 0 | 1 | 15 | 5 | 23 | 53 | 28 | 100 | 26 | 62 | 3 | 86 | 28 | 212406 | 5 | 23 | 54 | 44 | 100 | 26 | 62 | 4 | 86 | 28 | 212332 | | |
| GBM-41 X-Y USB-30 | 0 | 1 | 15 | 5 | 23 | 53 | 28 | 100 | 26 | 63 | 5 | 85 | 27 | 212342 | 5 | 23 | 54 | 44 | 100 | 26 | 63 | 5 | 85 | 27 | 212268 | | |
| BDA-02 X-Y USB-30 | 0 | 1 | 15 | 5 | 23 | 53 | 28 | 100 | 26 | 69 | 18 | 71 | 20 | 211571 | 5 | 23 | 54 | 44 | 100 | 26 | 70 | 18 | 71 | 19 | 211498 | | |
| ANG-91 X-Y USB-30 | 0 | 1 | 15 | 5 | 23 | 53 | 28 | 100 | 27 | 66 | 14 | 74 | 23 | 211765 | 5 | 23 | 54 | 44 | 100 | 27 | 66 | 15 | 74 | 23 | 211690 | | |
| CYI-04 X-Y USB-30 | 0 | 1 | 15 | 5 | 23 | 53 | 28 | 100 | 27 | 83 | 58 | 31 | 4 | 209701 | 5 | 23 | 54 | 44 | 100 | 27 | 83 | 59 | 31 | 3 | 209632 | | |

1-132

VEHICLE 2 RADAR TABLE

| TRACKING TIME | | | | STATION ACQUISITION DATA | | | | | | | | STATION TERMINATION DATA | | | | | | | | | | | | | | | |
|----------------------|-----|-----|----|--------------------------|-----|-----|-----|----|-----|----|-----|--------------------------|----|-------|--------|-----|-----|-----|----|-----|----|-----|----|----|-------|--------|--|
| HRS | MIN | SEC | | DAY | HRS | MIN | SEC | RA | DEC | AZ | ELV | X | Y | RANGE | DAY | HRS | MIN | SEC | RA | DEC | AZ | ELV | X | Y | RANGE | | |
| ACN-75 | 0 | 1 | 15 | | 5 | 23 | 53 | 28 | 100 | 27 | 42 | 41 | 37 | 34 | 210341 | 5 | 23 | 54 | 44 | 100 | 27 | 42 | 42 | 37 | 34 | 210272 | |
| X-Y USB-30 | | | | | | | | | | | | | | | | | | | | | | | | | | | |
| 4TH BRAKING MANEUVER | | | | | | | | | | | | | | | | | | | | | | | | | | | |
| MAD-23 | 0 | 0 | 4 | | 5 | 23 | 54 | 44 | 100 | 27 | 118 | 66 | 12 | 21 | 209429 | 5 | 23 | 54 | 48 | 100 | 27 | 118 | 66 | 12 | 21 | 209425 | |
| X-Y USB-85 | | | | | | | | | | | | | | | | | | | | | | | | | | | |
| MIL-71 | 0 | 0 | 4 | | 5 | 23 | 54 | 44 | 100 | 26 | 62 | 4 | 86 | 28 | 212332 | 5 | 23 | 54 | 48 | 100 | 26 | 62 | 4 | 86 | 28 | 212328 | |
| X-Y USB-30 | | | | | | | | | | | | | | | | | | | | | | | | | | | |
| GBM-41 | 0 | 0 | 4 | | 5 | 23 | 54 | 44 | 100 | 26 | 63 | 5 | 85 | 27 | 212268 | 5 | 23 | 54 | 48 | 100 | 26 | 63 | 5 | 85 | 27 | 212264 | |
| X-Y USB-30 | | | | | | | | | | | | | | | | | | | | | | | | | | | |
| BDA-02 | 0 | 0 | 4 | | 5 | 23 | 54 | 44 | 100 | 26 | 70 | 18 | 71 | 19 | 211498 | 5 | 23 | 54 | 48 | 100 | 26 | 70 | 18 | 71 | 19 | 211494 | |
| X-Y USB-30 | | | | | | | | | | | | | | | | | | | | | | | | | | | |
| ANG-91 | 0 | 0 | 4 | | 5 | 23 | 54 | 44 | 100 | 27 | 66 | 15 | 74 | 23 | 211690 | 5 | 23 | 54 | 48 | 100 | 27 | 66 | 15 | 74 | 23 | 211686 | |
| X-Y USB-30 | | | | | | | | | | | | | | | | | | | | | | | | | | | |
| CYI-04 | 0 | 0 | 4 | | 5 | 23 | 54 | 44 | 100 | 27 | 83 | 59 | 31 | 3 | 209632 | 5 | 23 | 54 | 48 | 100 | 27 | 83 | 59 | 31 | 3 | 209629 | |
| X-Y USB-30 | | | | | | | | | | | | | | | | | | | | | | | | | | | |
| ACN-75 | 0 | 0 | 4 | | 5 | 23 | 54 | 44 | 100 | 27 | 42 | 42 | 37 | 34 | 210272 | 5 | 23 | 54 | 48 | 100 | 27 | 42 | 42 | 37 | 34 | 210268 | |
| X-Y USB-30 | | | | | | | | | | | | | | | | | | | | | | | | | | | |
| COAST TO DOCKING | | | | | | | | | | | | | | | | | | | | | | | | | | | |
| MAD-23 | 0 | 4 | 22 | | 5 | 23 | 54 | 48 | 100 | 27 | 118 | 66 | 12 | 21 | 209425 | 5 | 23 | 59 | 10 | 100 | 27 | 119 | 67 | 12 | 20 | 209216 | |
| X-Y USB-85 | | | | | | | | | | | | | | | | | | | | | | | | | | | |
| MIL-71 | 0 | 4 | 22 | | 5 | 23 | 54 | 48 | 100 | 26 | 62 | 4 | 86 | 28 | 212328 | 5 | 23 | 59 | 10 | 100 | 26 | 62 | 5 | 85 | 28 | 212087 | |
| X-Y USB-30 | | | | | | | | | | | | | | | | | | | | | | | | | | | |

VEHICLE 2 RADAR TABLE

| TRACKING TIME | | | | STATION ACQUISITION DATA | | | | | | | | STATION TERMINATION DATA | | | | | | | | | | | | | | | |
|---------------|-----|-----|----|--------------------------|-----|-----|-----|----|-----|----|-----|--------------------------|----|-------|--------|-----|-----|-----|----|-----|----|-----|----|----|-------|--------|--|
| HRS | MIN | SEC | | DAY | HRS | MIN | SEC | RA | DEC | Az | ELV | X | Y | RANGE | DAY | HRS | MIN | SEC | RA | DEC | Az | ELV | X | Y | RANGE | | |
| GBM-41 | 0 | 4 | 22 | | 5 | 23 | 54 | 48 | 100 | 26 | 63 | 5 | 85 | 27 | 212264 | 5 | 23 | 59 | 10 | 100 | 26 | 63 | 6 | 84 | 27 | 212023 | |
| X-Y USB-30 | | | | | | | | | | | | | | | | | | | | | | | | | | | |
| BDA-02 | 0 | 4 | 22 | | 5 | 23 | 54 | 48 | 100 | 26 | 70 | 18 | 71 | 19 | 211494 | 5 | 23 | 59 | 10 | 100 | 26 | 70 | 19 | 70 | 19 | 211254 | |
| X-Y USB-30 | | | | | | | | | | | | | | | | | | | | | | | | | | | |
| ANG-91 | 0 | 4 | 22 | | 5 | 23 | 54 | 48 | 100 | 27 | 66 | 15 | 74 | 23 | 211686 | 5 | 23 | 59 | 10 | 100 | 27 | 66 | 15 | 73 | 23 | 211441 | |
| X-Y USB-30 | | | | | | | | | | | | | | | | | | | | | | | | | | | |
| CYI-04 | 0 | 4 | 22 | | 5 | 23 | 54 | 48 | 100 | 27 | 83 | 59 | 31 | 3 | 209629 | 5 | 23 | 59 | 10 | 100 | 27 | 84 | 60 | 30 | 3 | 209408 | |
| X-Y USB-30 | | | | | | | | | | | | | | | | | | | | | | | | | | | |
| ACN-75 | 0 | 4 | 22 | | 5 | 23 | 54 | 48 | 100 | 27 | 42 | 42 | 37 | 34 | 210268 | 5 | 23 | 59 | 10 | 100 | 27 | 41 | 42 | 36 | 34 | 210045 | |
| X-Y USB-30 | | | | | | | | | | | | | | | | | | | | | | | | | | | |

TABLE 1.1-VI.- MISSION SHADOW TIMELINE

(a) CSM

31 JAN 71

EOI TO TLI IGNITION

LAZ 72.1

VEH IN SUNLIGHT

AT PHASE INITIATION

| | DAYS HRS MINS SECS | | | | TIME SPENT IN REGION | | | |
|-----------------------------|--------------------|-----|------|------|----------------------|-----|------|------|
| | DAYS | HRS | MINS | SECS | DAYS | HRS | MINS | SECS |
| VEH ENTERING EARTH PENUMBRA | 0 | 0 | 16 | 45.1 | | | | |
| | | | | | 0 | 0 | 0 | 8.7 |
| VEH ENTERING EARTH UMBRA | 0 | 0 | 16 | 53.8 | | | | |
| | | | | | 0 | 0 | 36 | 37.6 |
| VEH ENTERING EARTH PENUMBRA | 0 | 0 | 53 | 31.5 | | | | |
| | | | | | 0 | 0 | 0 | 8.3 |
| VEH ENTERING SUNLIGHT | 0 | 0 | 53 | 39.7 | | | | |
| | | | | | 0 | 0 | 51 | 13.0 |
| VEH ENTERING EARTH PENUMBRA | 0 | 1 | 44 | 52.7 | | | | |
| | | | | | 0 | 0 | 0 | 8.7 |
| VEH ENTERING EARTH UMBRA | 0 | 1 | 45 | 1.4 | | | | |
| | | | | | 0 | 0 | 36 | 36.8 |
| VEH ENTERING EARTH PENUMBRA | 0 | 2 | 21 | 38.1 | | | | |
| | | | | | 0 | 0 | 0 | 8.3 |
| VEH ENTERING SUNLIGHT | 0 | 2 | 21 | 46.4 | | | | |

I-135

12
11
10
9
8
7
6

LIGHTING CONDITION FOR VEH 1

| DATE | EVENT | LAZ | TIME SPENT IN REGION | | | |
|-----------------|---------------------|------|----------------------|-----|------|------|
| 31 JAN 71 | TLI TO NFR IGNITION | 72.1 | DAYS | HRS | MINS | SECS |
| VEH IN SUNLIGHT | AT PHASE INITIATION | | | | | |

| DATE | EVENT | LAZ | TIME SPENT IN REGION | | | |
|-----------------|---------------------|------|----------------------|-----|------|------|
| 31 JAN 71 | NFR TO LOI IGNITION | 72.1 | DAYS | HRS | MINS | SECS |
| VEH IN SUNLIGHT | AT PHASE INITIATION | | | | | |

| EVENT | DAYS | HRS | MINS | SECS | DAYS | HRS | MINS | SECS |
|-----------------------------|------|-----|------|------|------|-----|------|------|
| VEH ENTERING LUNAR PENUMBRA | 3 | 9 | 39 | 16.4 | 0 | 0 | 0 | 54.2 |
| VEH ENTERING LUNAR UMBRA | 3 | 9 | 40 | 10.6 | 0 | 0 | 55 | 27.1 |
| VEH ENTERING LUNAR PENUMBRA | 3 | 10 | 35 | 37.7 | 0 | 0 | 0 | 13.3 |
| VEH ENTERING SUNLIGHT | 3 | 10 | 35 | 51.0 | | | | |

I-136

12
11
10
9
8
7
6
5
4
3
2

LIGHTING CONDITION FOR VEH 1

31 JAN 71 LOI TO DOI IGNITION LAZ 72.1

VEH IN SUNLIGHT AT PHASE INITIATION

| | DAYS HRS MINS SECS | | | | TIME SPENT IN REGION | | | |
|-----------------------------|--------------------|-----|------|------|----------------------|-----|------|------|
| | DAYS | HRS | MINS | SECS | DAYS | HRS | MINS | SECS |
| VEH ENTERING LUNAR PENUMBRA | 3 | 11 | 58 | 43.6 | | | | |
| | | | | | 0 | 0 | 0 | 13.8 |
| VEH ENTERING LUNAR UMBRA | 3 | 11 | 58 | 57.4 | | | | |
| | | | | | 0 | 0 | 44 | 44.0 |
| VEH ENTERING LUNAR PENUMBRA | 3 | 12 | 43 | 41.4 | | | | |
| | | | | | 0 | 0 | 0 | 15.7 |
| VEH ENTERING SUNLIGHT | 3 | 12 | 43 | 57.0 | | | | |
| | | | | | 0 | 1 | 23 | 10.1 |
| VEH ENTERING LUNAR PENUMBRA | 3 | 14 | 7 | 7.1 | | | | |
| | | | | | 0 | 0 | 0 | 11.3 |
| VEH ENTERING LUNAR UMBRA | 3 | 14 | 7 | 18.5 | | | | |
| | | | | | 0 | 0 | 44 | 48.1 |
| VEH ENTERING LUNAR PENUMBRA | 3 | 14 | 52 | 6.6 | | | | |
| | | | | | 0 | 0 | 0 | 5.1 |
| VEH ENTERING SUNLIGHT | 3 | 14 | 52 | 11.7 | | | | |

1-1137

12
11
10
9
8
7
6

LIGHTING CONDITION FOR VEH 1

31 JAN 71 DCI TO LM SEP IGNITION LAZ 72.1

VEH IN SUNLIGHT AT PHASE INITIATION

| | DAYS HRS MINS SECS | | | | TIME SPENT IN REGION | | | |
|-----------------------------|--------------------|-----|------|------|----------------------|-----|------|------|
| | DAYS | HRS | MINS | SECS | DAYS | HRS | MINS | SECS |
| VEH ENTERING LUNAR PENUMBRA | 3 | 15 | 57 | 37.4 | 0 | 0 | 0 | 6.8 |
| VEH ENTERING LUNAR UMBRA | 3 | 15 | 57 | 44.3 | 0 | 0 | 48 | 18.4 |
| VEH ENTERING LUNAR PENUMBRA | 3 | 16 | 46 | 2.7 | 0 | 0 | 0 | 14.3 |
| VEH ENTERING SUNLIGHT | 3 | 16 | 46 | 17.1 | 0 | 1 | 5 | 35.5 |
| VEH ENTERING LUNAR PENUMBRA | 3 | 17 | 51 | 52.5 | 0 | 0 | 0 | 14.1 |
| VEH ENTERING LUNAR UMBRA | 3 | 17 | 52 | 6.7 | 0 | 0 | 48 | .8 |
| VEH ENTERING LUNAR PENUMBRA | 3 | 18 | 40 | 7.5 | 0 | 0 | 0 | 11.7 |
| VEH ENTERING SUNLIGHT | 3 | 18 | 40 | 19.1 | 0 | 1 | 5 | 31.9 |
| VEH ENTERING LUNAR PENUMBRA | 3 | 19 | 45 | 51.0 | 0 | 0 | 0 | 17.1 |
| VEH ENTERING LUNAR UMBRA | 3 | 19 | 46 | 8.2 | 0 | 0 | 48 | 12.1 |
| VEH ENTERING LUNAR PENUMBRA | 3 | 20 | 34 | 20.2 | | | | |

1-138

LIGHTING CONDITION FOR VEH 1

| | DAYS HRS MINS SECS | | | | TIME SPENT IN REGION | | | |
|-----------------------------|--------------------|-----|------|------|----------------------|-----|------|------|
| | DAYS | HRS | MINS | SECS | DAYS | HRS | MINS | SECS |
| | | | | | 0 | 0 | 0 | 9.2 |
| VEH ENTERING SUNLIGHT | 3 | 20 | 34 | 29.5 | | | | |
| | | | | | 0 | 1 | 5 | 28.6 |
| VEH ENTERING LUNAR PENUMBRA | 3 | 21 | 39 | 58.0 | | | | |
| | | | | | 0 | 0 | 0 | 12.0 |
| VEH ENTERING LUNAR UMBRA | 3 | 21 | 40 | 10.0 | | | | |
| | | | | | 0 | 0 | 48 | 7.2 |
| VEH ENTERING LUNAR PENUMBRA | 3 | 22 | 28 | 17.2 | | | | |
| | | | | | 0 | 0 | 0 | 11.7 |
| VEH ENTERING SUNLIGHT | 3 | 22 | 28 | 28.9 | | | | |
| | | | | | 0 | 1 | 5 | 26.3 |
| VEH ENTERING LUNAR PENUMBRA | 3 | 23 | 33 | 55.1 | | | | |
| | | | | | 0 | 0 | 48 | 30.7 |
| VEH ENTERING LUNAR PENUMBRA | 4 | 0 | 22 | 25.9 | | | | |
| | | | | | 0 | 0 | 0 | 11.3 |
| VEH ENTERING SUNLIGHT | 4 | 0 | 22 | 37.1 | | | | |
| | | | | | 0 | 1 | 5 | 31.6 |
| VEH ENTERING LUNAR PENUMBRA | 4 | 1 | 28 | 8.7 | | | | |
| | | | | | 0 | 0 | 0 | 10.7 |
| VEH ENTERING LUNAR UMBRA | 4 | 1 | 28 | 19.4 | | | | |
| | | | | | 0 | 0 | 48 | 8.7 |
| VEH ENTERING LUNAR PENUMBRA | 4 | 2 | 16 | 28.0 | | | | |

1-139

12
11
10
9
8
7
6
5

LIGHTING CONDITION FOR VEH 1

| | DAYS HRS MINS SECS | | | | TIME SPENT IN REGION | | | |
|-----------------------------|--------------------|-----|------|------|----------------------|-----|------|------|
| | DAYS | HRS | MINS | SECS | DAYS | HRS | MINS | SECS |
| | | | | | 0 | 0 | 0 | 11.1 |
| VEH ENTERING SUNLIGHT | 4 | 2 | 16 | 39.2 | | | | |
| | | | | | 0 | 1 | 5 | 48.0 |
| VEH ENTERING LUNAR PENUMBRA | 4 | 3 | 22 | 27.2 | | | | |
| | | | | | 0 | 0 | 0 | 16.6 |
| VEH ENTERING LUNAR UMBRA | 4 | 3 | 22 | 43.8 | | | | |
| | | | | | 0 | 0 | 47 | 52.6 |
| VEH ENTERING LUNAR PENUMBRA | 4 | 4 | 10 | 36.4 | | | | |
| | | | | | 0 | 0 | 0 | 11.5 |
| VEH ENTERING SUNLIGHT | 4 | 4 | 10 | 47.9 | | | | |
| | | | | | 0 | 1 | 5 | 29.2 |
| VEH ENTERING LUNAR PENUMBRA | 4 | 5 | 16 | 17.2 | | | | |
| | | | | | 0 | 0 | 0 | 6.8 |
| VEH ENTERING LUNAR UMBRA | 4 | 5 | 16 | 24.0 | | | | |
| | | | | | 0 | 0 | 48 | 19.0 |
| VEH ENTERING LUNAR PENUMBRA | 4 | 6 | 4 | 43.0 | | | | |
| | | | | | 0 | 0 | 0 | 11.1 |
| VEH ENTERING SUNLIGHT | 4 | 6 | 4 | 54.1 | | | | |
| | | | | | 0 | 1 | 5 | 33.2 |
| VEH ENTERING LUNAR PENUMBRA | 4 | 7 | 10 | 27.2 | | | | |
| | | | | | 0 | 0 | 0 | 13.6 |
| VEH ENTERING LUNAR UMBRA | 4 | 7 | 10 | 40.9 | | | | |
| | | | | | 0 | 0 | 48 | 5.4 |
| VEH ENTERING LUNAR PENUMBRA | 4 | 7 | 58 | 46.3 | | | | |
| | | | | | 0 | 0 | 0 | 11.7 |
| VEH ENTERING SUNLIGHT | 4 | 7 | 58 | 58.0 | | | | |

071-1

31 JAN 71

4M SEP TO CIR IGNITION

LAZ 72

VEH IN SUNLIGHT

AT PHASE INITIATION

LIGHTING CONDITION FOR VEH 1

31 JAN 71

CIR TO LOPC1 IGNITION

LAZ 72.1

VEH IN LUNAR UMBRA

AT PHASE INITIATION

| | DAYS HRS MINS SECS | | | | TIME SPENT IN REGION | | | |
|-----------------------------|--------------------|-----|------|------|----------------------|-----|------|------|
| | DAYS | HRS | MINS | SECS | DAYS | HRS | MINS | SECS |
| VEH ENTERING LUNAR PENUMBRA | 4 | 9 | 52 | 46.0 | 0 | 0 | 0 | 11.2 |
| VEH ENTERING SUNLIGHT | 4 | 9 | 52 | 57.2 | 0 | 1 | 12 | 39.3 |
| VEH ENTERING LUNAR PENUMBRA | 4 | 11 | 5 | 36.5 | 0 | 0 | 0 | 9.0 |
| VEH ENTERING LUNAR UMBRA | 4 | 11 | 5 | 45.5 | 0 | 0 | 45 | 36.9 |
| VEH ENTERING LUNAR PENUMBRA | 4 | 11 | 51 | 22.4 | 0 | 0 | 0 | 11.2 |
| VEH ENTERING SUNLIGHT | 4 | 11 | 51 | 33.6 | 0 | 1 | 12 | 42.7 |
| VEH ENTERING LUNAR PENUMBRA | 4 | 13 | 4 | 16.3 | 0 | 0 | 0 | 11.4 |
| VEH ENTERING LUNAR UMBRA | 4 | 13 | 4 | 27.7 | 0 | 0 | 45 | 42.1 |
| VEH ENTERING LUNAR PENUMBRA | 4 | 13 | 50 | 9.8 | 0 | 0 | 0 | 9.0 |
| VEH ENTERING SUNLIGHT | 4 | 13 | 50 | 18.8 | 0 | 1 | 12 | 34.1 |
| VEH ENTERING LUNAR PENUMBRA | 4 | 15 | 2 | 52.9 | | | | |

1711-1

12
11
10
9
8
7
6

LIGHTING CONDITION FOR VEH 1

| | DAYS HRS MINS SECS | | | | TIME SPENT IN REGION | | | |
|-----------------------------|--------------------|-----|------|------|----------------------|-----|------|------|
| | DAYS | HRS | MINS | SECS | DAYS | HRS | MINS | SECS |
| | | | | | 0 | 0 | 0 | 11.0 |
| VEH ENTERING LUNAR UMBRA | 4 | 15 | 3 | 3.9 | | | | |
| | | | | | 0 | 0 | 45 | 38.9 |
| VEH ENTERING LUNAR PENUMBRA | 4 | 15 | 48 | 42.8 | | | | |
| | | | | | 0 | 0 | 0 | 11.3 |
| VEH ENTERING SUNLIGHT | 4 | 15 | 48 | 54.1 | | | | |
| | | | | | 0 | 1 | 12 | 32.5 |
| VEH ENTERING LUNAR PENUMBRA | 4 | 17 | 1 | 26.6 | | | | |
| | | | | | 0 | 0 | 0 | 14.2 |
| VEH ENTERING LUNAR UMBRA | 4 | 17 | 1 | 40.8 | | | | |
| | | | | | 0 | 0 | 45 | 38.9 |
| VEH ENTERING LUNAR PENUMBRA | 4 | 17 | 47 | 19.7 | | | | |
| | | | | | 0 | 0 | 0 | 10.9 |
| VEH ENTERING SUNLIGHT | 4 | 17 | 47 | 30.7 | | | | |
| | | | | | 0 | 1 | 12 | 41.2 |
| VEH ENTERING LUNAR PENUMBRA | 4 | 19 | 0 | 11.8 | | | | |
| | | | | | 0 | 0 | 0 | 11.4 |
| VEH ENTERING LUNAR UMBRA | 4 | 19 | 0 | 23.2 | | | | |
| | | | | | 0 | 0 | 45 | 38.9 |
| VEH ENTERING LUNAR PENUMBRA | 4 | 19 | 46 | 2.1 | | | | |
| | | | | | 0 | 0 | 0 | 10.9 |
| VEH ENTERING SUNLIGHT | 4 | 19 | 46 | 13.0 | | | | |

1-142

LIGHTING CONDITION FOR VEH 1

| | DAYS HRS MINS SECS | | | | TIME SPENT IN REGION | | | |
|-----------------------------|--------------------|-----|------|------|----------------------|-----|------|------|
| | DAYS | HRS | MINS | SECS | DAYS | HRS | MINS | SECS |
| | | | | | 0 | 1 | 12 | 36.3 |
| VEH ENTERING LUNAR PENUMBRA | 4 | 20 | 58 | 49.2 | | | | |
| | | | | | 0 | 0 | 0 | 10.9 |
| VEH ENTERING LUNAR UMBRA | 4 | 20 | 59 | .1 | | | | |
| | | | | | 0 | 0 | 45 | 39.4 |
| VEH ENTERING LUNAR PENUMBRA | 4 | 21 | 44 | 39.5 | | | | |
| | | | | | 0 | 0 | 0 | 11.4 |
| VEH ENTERING SUNLIGHT | 4 | 21 | 44 | 50.9 | | | | |

1-113

12
11
10
9
8
7
6
5

LIGHTING CONDITION FOR VEH 1

31 JAN 71 LOPCI TO LM JETT IGNITION LAZ 72.1

VEH IN SUNLIGHT AT PHASE INITIATION

| | DAYS HRS MINS SECS | | | | TIME SPENT IN REGION | | | |
|-----------------------------|--------------------|-----|------|------|----------------------|-----|------|------|
| | DAYS | HRS | MINS | SECS | DAYS | HRS | MINS | SECS |
| VEH ENTERING LUNAR PENUMBRA | 4 | 22 | 57 | 41.6 | 0 | 0 | 0 | 11.2 |
| VEH ENTERING LUNAR UMBRA | 4 | 22 | 57 | 52.9 | 0 | 0 | 45 | 45.7 |
| VEH ENTERING LUNAR PENUMBRA | 4 | 23 | 43 | 38.6 | 0 | 0 | 0 | 11.3 |
| VEH ENTERING SUNLIGHT | 4 | 23 | 43 | 49.9 | 0 | 1 | 12 | 27.8 |
| VEH ENTERING LUNAR PENUMBRA | 5 | 0 | 56 | 17.7 | 0 | 0 | 0 | 11.1 |
| VEH ENTERING LUNAR UMBRA | 5 | 0 | 56 | 28.8 | 0 | 0 | 45 | 48.7 |
| VEH ENTERING LUNAR PENUMBRA | 5 | 1 | 42 | 17.5 | 0 | 0 | 0 | 11.0 |
| VEH ENTERING SUNLIGHT | 5 | 1 | 42 | 28.6 | 0 | 1 | 12 | 28.8 |
| VEH ENTERING LUNAR PENUMBRA | 5 | 2 | 54 | 57.4 | 0 | 0 | 0 | 9.1 |
| VEH ENTERING LUNAR UMBRA | 5 | 2 | 55 | 6.5 | 0 | 0 | 45 | 47.5 |
| VEH ENTERING LUNAR PENUMBRA | 5 | 3 | 40 | 54.0 | | | | |

441-1

LIGHTING CONDITION FOR VEH 1

| | DAYS HRS MINS SECS | | | | TIME SPENT IN REGION | | | |
|-----------------------------|--------------------|-----|------|------|----------------------|-----|------|------|
| | DAYS | HRS | MINS | SECS | DAYS | HRS | MINS | SECS |
| | | | | | 0 | 0 | 0 | 11.3 |
| VEH ENTERING SUNLIGHT | 5 | 3 | 41 | 5.3 | | | | |
| | | | | | 0 | 1 | 12 | 32.2 |
| VEH ENTERING LUNAR PENUMBRA | 5 | 4 | 53 | 37.5 | | | | |
| | | | | | 0 | 0 | 0 | 11.3 |
| VEH ENTERING LUNAR UMBRA | 5 | 4 | 53 | 48.9 | | | | |
| | | | | | 0 | 0 | 45 | 50.8 |
| VEH ENTERING LUNAR PENUMBRA | 5 | 5 | 39 | 39.7 | | | | |
| | | | | | 0 | 0 | 0 | 8.8 |
| VEH ENTERING SUNLIGHT | 5 | 5 | 39 | 48.6 | | | | |
| | | | | | 0 | 1 | 12 | 25.7 |
| VEH ENTERING LUNAR PENUMBRA | 5 | 6 | 52 | 14.2 | | | | |
| | | | | | 0 | 0 | 0 | 10.9 |
| VEH ENTERING LUNAR UMBRA | 5 | 6 | 52 | 25.2 | | | | |
| | | | | | 0 | 0 | 45 | 49.8 |
| VEH ENTERING LUNAR PENUMBRA | 5 | 7 | 38 | 15.0 | | | | |
| | | | | | 0 | 0 | 0 | 11.2 |
| VEH ENTERING SUNLIGHT | 5 | 7 | 38 | 26.2 | | | | |
| | | | | | 0 | 1 | 12 | 22.0 |
| VEH ENTERING LUNAR PENUMBRA | 5 | 8 | 50 | 48.2 | | | | |
| | | | | | 0 | 0 | 0 | 14.2 |
| VEH ENTERING LUNAR UMBRA | 5 | 8 | 51 | 2.3 | | | | |

541-1

12
11
10
9
8
7
6
5

LIGHTING CONDITION FOR VEH 1

| | DAYS HRS MINS SECS | | | | TIME SPENT IN REGION | | | |
|-----------------------------|--------------------|-----|------|------|----------------------|-----|------|------|
| | DAYS | HRS | MINS | SECS | DAYS | HRS | MINS | SECS |
| | | | | | 0 | 0 | 45 | 49.3 |
| VEH ENTERING LUNAR PENUMBRA | 5 | 9 | 36 | 51.6 | | | | |
| | | | | | 0 | 0 | 0 | 11.1 |
| VEH ENTERING SUNLIGHT | 5 | 9 | 37 | 2.7 | | | | |
| | | | | | 0 | 1 | 12 | 30.8 |
| VEH ENTERING LUNAR PENUMBRA | 5 | 10 | 49 | 33.5 | | | | |
| | | | | | 0 | 0 | 0 | 11.3 |
| VEH ENTERING LUNAR UMBRA | 5 | 10 | 49 | 44.9 | | | | |
| | | | | | 0 | 0 | 45 | 49.4 |
| VEH ENTERING LUNAR PENUMBRA | 5 | 11 | 35 | 34.2 | | | | |
| | | | | | 0 | 0 | 0 | 15.4 |
| VEH ENTERING SUNLIGHT | 5 | 11 | 35 | 49.6 | | | | |
| | | | | | 0 | 1 | 12 | 21.5 |
| VEH ENTERING LUNAR PENUMBRA | 5 | 12 | 48 | 11.1 | | | | |
| | | | | | 0 | 0 | 0 | 10.8 |
| VEH ENTERING LUNAR UMBRA | 5 | 12 | 48 | 21.9 | | | | |
| | | | | | 0 | 0 | 45 | 50.4 |
| VEH ENTERING LUNAR PENUMBRA | 5 | 13 | 34 | 12.3 | | | | |
| | | | | | 0 | 0 | 0 | 11.3 |
| VEH ENTERING SUNLIGHT | 5 | 13 | 34 | 23.7 | | | | |
| | | | | | 0 | 1 | 12 | 29.7 |
| VEH ENTERING LUNAR PENUMBRA | 5 | 14 | 46 | 53.4 | | | | |

97E-1

LIGHTING CONDITION FOR VEH 1

| | DAYS HRS MINS SECS | | | | TIME SPENT IN REGION | | | |
|-----------------------------|--------------------|-----|------|------|----------------------|-----|------|------|
| | DAYS | HRS | MINS | SECS | DAYS | HRS | MINS | SECS |
| | | | | | 0 | 0 | 0 | 10.8 |
| VEH ENTERING LUNAR UMBRA | 5 | 14 | 47 | 4.2 | | | | |
| | | | | | 0 | 0 | 45 | 45.6 |
| VEH ENTERING LUNAR PENUMBRA | 5 | 15 | 32 | 49.8 | | | | |
| | | | | | 0 | 0 | 0 | 10.7 |
| VEH ENTERING SUNLIGHT | 5 | 15 | 33 | .5 | | | | |
| | | | | | 0 | 1 | 12 | 29.2 |
| VEH ENTERING LUNAR PENUMBRA | 5 | 16 | 45 | 29.7 | | | | |
| | | | | | 0 | 0 | 0 | 11.3 |
| VEH ENTERING LUNAR UMBRA | 5 | 16 | 45 | 41.0 | | | | |
| | | | | | 0 | 0 | 45 | 51.3 |
| VEH ENTERING LUNAR PENUMBRA | 5 | 17 | 31 | 32.3 | | | | |
| | | | | | 0 | 0 | 0 | 10.9 |
| VEH ENTERING SUNLIGHT | 5 | 17 | 31 | 43.2 | | | | |
| | | | | | 0 | 1 | 12 | 21.0 |
| VEH ENTERING LUNAR PENUMBRA | 5 | 18 | 44 | 4.2 | | | | |
| | | | | | 0 | 0 | 0 | 9.0 |
| VEH ENTERING LUNAR UMBRA | 5 | 18 | 44 | 13.2 | | | | |
| | | | | | 0 | 0 | 45 | 56.5 |
| VEH ENTERING LUNAR PENUMBRA | 5 | 19 | 30 | 9.7 | | | | |
| | | | | | 0 | 0 | 0 | 11.4 |
| VEH ENTERING SUNLIGHT | 5 | 19 | 30 | 21.1 | | | | |

1-1147

12
11
10
9
8
7
6
5

LIGHTING CONDITION FOR VEH 1

| | DAYS HRS MINS SECS | | | | TIME SPENT IN REGION | | | |
|-----------------------------|--------------------|-----|------|------|----------------------|-----|------|------|
| | DAYS | HRS | MINS | SECS | DAYS | HRS | MINS | SECS |
| | | | | | 0 | 1 | 12 | 28.9 |
| VEH ENTERING LUNAR PENUMBRA | 5 | 20 | 42 | 50.0 | | | | |
| | | | | | 0 | 0 | 0 | 11.2 |
| VEH ENTERING LUNAR UMBRA | 5 | 20 | 43 | 1.2 | | | | |
| | | | | | 0 | 0 | 45 | 50.9 |
| VEH ENTERING LUNAR PENUMBRA | 5 | 21 | 28 | 52.1 | | | | |
| | | | | | 0 | 0 | 0 | 14.3 |
| VEH ENTERING SUNLIGHT | 5 | 21 | 29 | 6.4 | | | | |
| | | | | | 0 | 1 | 12 | 19.8 |
| VEH ENTERING LUNAR PENUMBRA | 5 | 22 | 41 | 26.2 | | | | |
| | | | | | 0 | 0 | 0 | 11.2 |
| VEH ENTERING LUNAR UMBRA | 5 | 22 | 41 | 37.4 | | | | |
| | | | | | 0 | 0 | 45 | 52.9 |
| VEH ENTERING LUNAR PENUMBRA | 5 | 23 | 27 | 30.3 | | | | |
| | | | | | 0 | 0 | 0 | 11.0 |
| VEH ENTERING SUNLIGHT | 5 | 23 | 27 | 41.3 | | | | |
| | | | | | 0 | 1 | 12 | 23.3 |
| VEH ENTERING LUNAR PENUMBRA | 6 | 0 | 40 | 4.6 | | | | |
| | | | | | 0 | 0 | 0 | 8.8 |
| VEH ENTERING LUNAR UMBRA | 6 | 0 | 40 | 13.4 | | | | |
| | | | | | 0 | 0 | 45 | 53.7 |
| VEH ENTERING LUNAR PENUMBRA | 6 | 1 | 26 | 7.1 | | | | |
| | | | | | 0 | 0 | 0 | 11.4 |
| VEH ENTERING SUNLIGHT | 6 | 1 | 26 | 18.5 | | | | |

8411-1

LIGHTING CONDITION FOR VEH 1

31 JAN 71 LM JETT TO TEI IGNITION LAZ 72.1

VEH IN SUNLIGHT AT PHASE INITIATION

| | DAYS HRS MINS SECS | | | | TIME SPENT IN REGION | | | |
|-----------------------------|--------------------|-----|------|------|----------------------|-----|------|------|
| | DAYS | HRS | MINS | SECS | DAYS | HRS | MINS | SECS |
| VEH ENTERING LUNAR PENUMBRA | 6 | 2 | 38 | 46.6 | 0 | 0 | 0 | 11.3 |
| VEH ENTERING LUNAR UMBRA | 6 | 2 | 38 | 57.9 | 0 | 0 | 45 | 51.3 |
| VEH ENTERING LUNAR PENUMBRA | 6 | 3 | 24 | 49.2 | 0 | 0 | 0 | 13.2 |
| VEH ENTERING SUNLIGHT | 6 | 3 | 25 | 2.4 | 0 | 1 | 12 | 16.5 |
| VEH ENTERING LUNAR PENUMBRA | 6 | 4 | 37 | 19.0 | 0 | 0 | 0 | 11.1 |
| VEH ENTERING LUNAR UMBRA | 6 | 4 | 37 | 30.1 | | | | |

31 JAN 71 TEI TO ENTRY INTERFACE LAZ 72.1

VEH IN LUNAR UMBRA AT PHASE INITIATION

| | DAYS HRS MINS SECS | | | | TIME SPENT IN REGION | | | |
|-----------------------------|--------------------|-----|------|------|----------------------|-----|------|------|
| | DAYS | HRS | MINS | SECS | DAYS | HRS | MINS | SECS |
| VEH ENTERING LUNAR PENUMBRA | 6 | 5 | 19 | 34.8 | 0 | 0 | 0 | 4.9 |
| VEH ENTERING SUNLIGHT | 6 | 5 | 19 | 39.7 | | | | |

164111

12
11
10
9
8
7
6
5

TABLE I.1-VI.- MISSION SHADOW TIMELINE - Continued

(b) LM descent
LIGHTING CONDITION FOR VEH I

31 JAN 71 LM FROM UNDCCK TO LANDING

VEH IN SUNLIGHT AT PHASE INITIATION

| | DAYS HRS MINS SECS | | | | TIME SPENT IN REGION | | | |
|-----------------------------|--------------------|-----|------|------|----------------------|-----|------|------|
| | DAYS | HRS | MINS | SECS | DAYS | HRS | MINS | SECS |
| VEH ENTERING LUNAR PENUMBRA | 4 | 9 | 4 | 34.2 | 0 | 0 | 0 | 11.7 |
| VEH ENTERING LUNAR UMBRA | 4 | 9 | 4 | 45.9 | 0 | 0 | 48 | 7.0 |
| VEH ENTERING LUNAR PENUMBRA | 4 | 9 | 52 | 52.9 | 0 | 0 | 0 | 11.8 |
| VEH ENTERING SUNLIGHT | 4 | 9 | 53 | 4.7 | 0 | 1 | 5 | 35.5 |
| VEH ENTERING LUNAR PENUMBRA | 4 | 10 | 58 | 40.2 | 0 | 0 | 0 | 10.6 |
| VEH ENTERING LUNAR UMBRA | 4 | 10 | 58 | 50.8 | 0 | 0 | 48 | 8.2 |
| VEH ENTERING LUNAR PENUMBRA | 4 | 11 | 46 | 59.0 | 0 | 0 | 0 | 10.7 |
| VEH ENTERING SUNLIGHT | 4 | 11 | 47 | 9.7 | | | | |

I-150

TABLE 1.1-VI.- MISSION SHADOW TIMELINE - Concluded

(c) LM rendezvous

LIGHTING CONDITION FOR VEH 2

COAST TO RENDEZVOUS RADAR TRACKING PRIOR TO TPI

VEH IN PENUMBRA @@@@@ AT PHASE INITIATION

| | DAYS HRS MINS SECS | | | | TIME SPENT IN REGION | | | |
|--------------------------|--------------------|-----|------|------|----------------------|-----|------|------|
| | DAYS | HRS | MINS | SECS | DAYS | HRS | MINS | SECS |
| VEH ENTERING LUNAR UMBRA | 5 | 22 | 40 | 9.9 | | | | |

COAST TO 1ST BRAKING GATE

VEH IN PENUMBRA @@@@@ AT PHASE INITIATION

| | DAYS HRS MINS SECS | | | | TIME SPENT IN REGION | | | |
|-----------------------|--------------------|-----|------|------|----------------------|-----|------|------|
| | DAYS | HRS | MINS | SECS | DAYS | HRS | MINS | SECS |
| VEH ENTERING SUNLIGHT | 5 | 23 | 28 | 21.3 | | | | |

2.0 SYMBOLS AND NOMENCLATURE

| | |
|--------|--------------------------------------|
| AGS | abort guidance system |
| AOS | acquisition of signal |
| APS | ascent propulsion system |
| C | cross-product steering gain constant |
| CDH | constant delta height |
| CDR | commander |
| CM | command module |
| CMC | command module computer |
| CMP | command module pilot |
| CSI | coelliptic sequence initiation |
| CSM | command and service modules |
| c.g. | center of gravity |
| DOI | descent orbit insertion |
| DPS | descent propulsion system |
| DSKY | display keyboard |
| ECI | earth centered inertial |
| EI | entry interface |
| EMS | entry monitor system |
| EPO | earth parking orbit |
| FTP | fixed throttle point |
| g.e.t. | ground elapsed time |
| h_a | apogee altitude |
| h_p | perigee altitude |

IGA inner gimbal angle
IMU inertial measurement unit
IVT intravehicular transfer
Jerk time derivative of acceleration
L/D lift-to-drag ratio
LGC LM guidance computer
LLM lunar landing mission
LLS lunar landing site
LM lunar module
LMP lunar module pilot
LOI lunar orbit insertion
LOS loss of signal
LPO lunar parking orbit
LOX liquid oxygen
LV launch vehicle
MC LM midcourse correction
MCC midcourse correction
MCI moon centered inertial
MGA middle gimbal angle
MNBY mean nearest Besselian year
MSFC Marshall Space Flight Center
MSFN Manned Space Flight Network
OGA outer gimbal angle
OPS oxygen purge system
PC plane change

PDI powered descent initiation

PGNCS primary guidance and navigation control subsystem

PTC passive thermal control

RDG position target for LM powered descent

RCS reaction control system

REFSMMAT transformation matrix from the basic reference coordinate system to the stable member (IMU) coordinate system

RR rendezvous radar

RT target vector for Lambert guidance scheme

SC spacecraft

SPS service propulsion system

TB7 time elapsed since TLI engine cutoff

T&D transposition and docking

TD&E transposition and docking and extraction

TEI transearth injection

t_{IG} time at ignition

TLI translunar injection

Tf Δt from ignition time (t_{IG}) to Lambert target vector (RT)

TPF terminal phase finalization

TPI terminal phase initiation

VHF very high frequency

ΔV change in velocity caused by thrusting

Δt change in time

| | | |
|--------------|---|-----------------------------------------------------------------------------|
| ΔV_X | } | components of velocity to be gained in the local vertical coordinate system |
| ΔV_Y | | |
| ΔV_Z | | |
| X_I | } | components of unit vector in inertial coordinate system |
| Y_I | | |
| Z_I | | |
| X_{SM} | } | components of unit vector in vehicle stable member system |
| Y_{SM} | | |
| Z_{SM} | | |

3.0 PRIMARY GUIDELINES AND CONSTRAINTS

3.0 PRIMARY GUIDELINES AND CONSTRAINTS

The design of the mission and the monthly and daily launch windows were based on the guidelines and constraints listed below.

- a. The primary lunar landing site is Fra Mauro. There is no backup site.
- b. Daylight launch is highly desirable.
- c. The launch windows and profiles will be designed to achieve favorable lunar lighting at the lunar landing sites. The sun elevation range of 7° to 14° is highly desirable; a range of 18° to 20° is acceptable with proper landing site approach azimuths.
- d. The flight azimuth range following launch is limited to 72° to 96° .
- e. The mission will be designed for a translunar injection over the Pacific Ocean.
- f. Two TLI opportunities will be targeted: the first on the second revolution and the second on the third revolution.
- g. TLI will be targeted to provide a free-return circumlunar trajectory.
- h. The S-IVB will perform an evasive maneuver prior to the blow-down. The blowdown will be targeted to achieve an S-IVB lunar impact.
- i. A hybrid profile will be used where necessary to provide a Pacific injection, optimum lunar lighting, 210-foot dish coverage of lunar landing, or a preferred lunar groundtrack.
- j. The hybrid transfer maneuver will be planned for TLI plus 28 hours. After the maneuver, the SC will be on a relaxed-free-return trajectory which will be restricted such that, in the case of an SPS failure at LOI ignition, an earth return is within the DPS docked ΔV capability.
- k. An even integer number of days of flight time to the moon is highly desirable because of the crew work/rest cycle.
- l. The LOI maneuver will result in a 57- by 170-n. mi. elliptical orbit. DOI will be performed with the SPS after two revs in the 57- by 170-n. mi. orbit established by LOI. The targeting will be biased to place the spacecraft in a 50 000-foot by 60-n. mi. orbit at the time of PDI on rev 14.

m. The lunar surface stay time will be approximately 34 hours. The CSM lunar orbit orientation will be restricted to permit an any-orbit LM lift-off.

n. A CSM plane change will be made approximately 4.75 revolutions after LM landing to place the landing site in the orbital plane at the planned time of lift-off and to allow photography of Descartes on revolution 27.

o. The LM ascent stage will be deorbited for lunar impact.

p. The lunar orbit will be designed within the SPS capability to return to earth from any orbit including the cryogenic tank failure situation.

q. The TEI maneuver will be targeted to return as soon as possible to the prime recovery area within the available ΔV capability and without exceeding a return inclination of 40° .

r. The earth relative entry range will be 1250 n. mi.

4.0 MISSION SUMMARY

4.0 MISSION SUMMARY

In this section, a mission profile is summarized for a mission launched January 31, 1971. Major events, spacecraft performance characteristics, and significant trajectory parameters are described in detail for each phase.

In the design of the spacecraft operational mission, the LV mission phases were simulated independently of the exact LV operational trajectory (ref. 2). The trajectory data presented here for the LV mission phases were simulated with data received from the MSFC for the Apollo 14 mission. No attempt was made to duplicate exactly the LV operational mission, and the information for the LV phases will differ from information that will be presented in the official MSFC trajectory document.

4.1 EARTH LAUNCH

4.1 Earth Launch^a

The launch time for this mission was determined to provide an optimized injected payload to support two injection opportunities. The launch is summarized as follows.

| | |
|------------------------------------------|------------------|
| Date, month, day, year | January 31, 1971 |
| Time, hr:min, c.s.t. | 14:20 |
| Azimuth, deg | ~ 72 |
| Location (Cape Kennedy, complex 39A) | |
| Geodetic latitude, deg:min:sec | 28°36'30.32" |
| Longitude, deg:min:sec | 279°23'45.12" |

The CSM launch pad REFSMMAT is presented in table 5-I.

^aThe parameters for this phase are approximate and are presented for information only. The official source for this phase is the MSFC LV operational trajectory (ref. 2).

4.2 EARTH PARKING ORBIT

4.2 Earth Parking Orbit^a (EPO)

The EPO insertion conditions are as follows.

| | |
|------------------------------------|------------|
| Time, hr:min:sec, g.e.t. | 00:11:39.6 |
| Geodetic latitude, deg | 32.7 |
| Longitude, deg | -53.3 |
| Altitude, n. mi. | 103.3 |
| Inclination, deg | 32.5 |

The insertion ship positioned at 28°N latitude and 49°W longitude tracks the vehicle for approximately 3 minutes after insertion for a minimum elevation angle of 5°.

The LV maintains local horizontal attitude throughout the EPO phase except for an inertial hold of approximately 10 seconds immediately after EPO insertion. The total time spent in EPO is 2^h29^m2.8^s. The EPO ground-track from insertion through translunar injection is shown in figure 4.2-1.

^aThe parameters for this phase are approximate and are presented for information only. The official source for this phase is the MSFC LV operational trajectory (ref. 2).

4.3 TRANSLUNAR INJECTION

4.3 Translunar Injection^a (TLI)

The TLI burn is initiated over Australia on the second revolution in earth orbit, and the burn is totally in sunlight. Four ARIA support the burn. The TLI ships are not used for this mission. The TLI burn geometry is shown in figure 4.3-1.

The TLI burn places the spacecraft on a free-return trajectory with a high perilune altitude (2030 n. mi.). The evasive maneuver after CSM/LM ejection is made with the S-IVB APS rather than with the SM SPS. The characteristics of the TLI burn are as follows.

Burn initiation

| | |
|------------------------------------------------------|------------|
| Time, hr:min:sec, g.e.t. | 02:30:42.4 |
| Geodetic latitude, deg | -29.0 |
| Longitude, deg | 124.4 |
| Velocity, fps | 25 593.6 |
| Apogee altitude above mean radius, n. mi. | 104.7 |

Burn cutoff

| | |
|------------------------------------------------------|------------|
| Time, hr:min:sec, g.e.t. | 02:36:06.8 |
| Geodetic latitude, deg | -19.1 |
| Longitude, deg | 149.9 |
| Velocity, fps | 35 598.6 |
| Burn duration, sec | 324.4 |
| S-IVB propellant used, lb | 157 289 |
| Plane change, deg | 0.3 |
| Inclination to earth-moon plane, deg | 28.1 |
| Apogee altitude above mean radius, n. mi. | 250 173 |

^aThe parameters for this phase are approximate and are presented for information only. The official source for this phase is the MSFC LV operational trajectory (ref. 2).

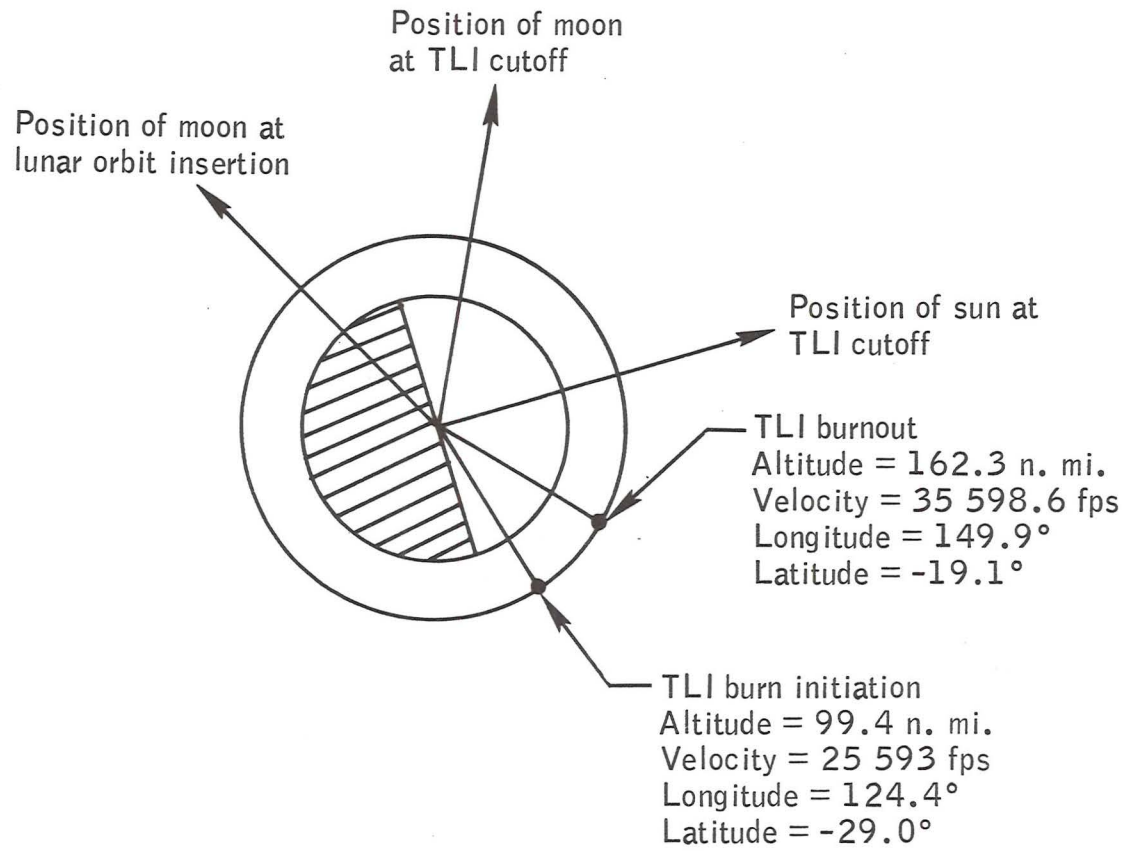

Figure 4.3-1.- TLI geometry.

4.4 FREE-RETURN CIRCUMLUNAR

4.4 Free-Return Circumlunar Trajectory

The free-return trajectory of the hybrid profile, shown in figure 1.1-1, is plotted in an inertial reference frame anchored at the time of perilune. The characteristics of the trajectory are the following.

Perilune

| | |
|----------------------------------------|------------|
| Time, hr:min:sec, g.e.t. | 82:39:52.2 |
| Altitude above LLS, n. mi. | 2030.9 |
| Selenographic latitude, deg | 6.6 |
| Selenographic longitude, deg | -172.7 |

| | |
|------------------------------------------------|------|
| Return vacuum perigee altitude, n. mi. | 20.6 |
|------------------------------------------------|------|

Transit time from TLI

| | |
|--------------------------------------------------|-----------|
| Burnout to entry interface, hr:min:sec | 166:51:14 |
|--------------------------------------------------|-----------|

Earth entry interface

| | |
|------------------------------------|-----------|
| Time, hr:min:sec, g.e.t. | 169:27:21 |
| Altitude, n. mi. | 65.8 |
| Geodetic latitude, deg | -30.0 |
| Longitude, deg | 117.5 |
| Inclination, deg | 31.0 |

Landing

| | |
|----------------------------------------|-----------|
| Time, hr:min:sec, g.e.t. | 169:41:21 |
| Geodetic latitude, deg | -24.6 |
| Longitude, deg | 140.2 |
| Time prior to sunset, hr:min | 11:30 |

4.5 POST-TRANSLUNAR INJECTION EVENTS

4.5 Posttranslunar Injection Events

The summary of the major events from TLI cutoff through S-IVB LOX blowdown is given in table 4.5-I. To determine the separation attitude maneuver (TB7 plus 900 sec), the sun was constrained to between 32° and 90° of the LV +X-axis. This constraint provides over-the-shoulder lighting and avoids any CSM shadow on the S-IVB for the docking phase.

Upon ground command, the S-IVB performs an APS evasive maneuver approximately 23 minutes after CSM/LM separation. The S-IVB attitude for this maneuver will be the same as the separation attitude except that the sign of the middle gimbal angle (yaw gimbal) will be reversed. The APS burn will be 10.0 fps.

The S-IVB performs a LOX dump 21 minutes 20 seconds after the APS evasive maneuver. The preliminary local horizontal attitude for this dump is pitch 183° , yaw -5° , roll 180° .

The LOX dump maneuver is designed to reduce the probability of SC recontact with the S-IVB and also to achieve an S-IVB impact with the moon. Nominally, an S-IVB APS lunar impact burn will be executed after the APS evasive and LOX dump maneuvers (g.e.t. of approximately 6 hours) to target the S-IVB for a lunar impact at 33°W and 20°S which is near the Apollo 12 landing site.

The relative motion between the S-IVB and SC for this post-T, D, and E phase is shown in figure 4.5-1.

TABLE 4.5-I.- SUMMARY OF EVENTS FROM TLI

CUTOFF THROUGH LOX DUMP

| Time from TB7, hr:min:sec | Event | ΔV , fps | Comments |
|------------------------------|------------------------------------------|---------------------|------------------------------------------------------------------------------------------------------------|
| 00:00:00 | Hold cutoff attitude | | |
| 00:00:20 | Command and hold local horizontal | | |
| 00:15:00 | Initiate maneuver to separation attitude | | Local horizontal attitude Pitch = 120° Yaw = -40° Roll = 180° 0.8 deg/sec |
| 00:20:00 | Freeze separation attitude inertially | | Latest time for maneuver to be completed |
| 00:25:00 | Begin SC separation/SLA jettison | 0.5 | |
| 00:25:15 | AUTO maneuver to docking attitude | | 2.0 deg/sec |
| | Null rates and translation | | |
| | Initiate 0.7-fps closing rate | | 4-sec RCS +X |
| | Null 0.7-fps closing rate | 0.7 | -X RCS |
| 00:35:00 | Begin dock | | |
| 01:20:00 | LM/CSM undock from S-IVB | 1.1 | Spring ejection and 3-sec -X RCS |
| 01:43:00 | S-IVB APS | 9.4 | Start TB8 |
| 02:04:20 | S-IVB LOX | | Local horizontal attitude Pitch = 183° Yaw = -5° Roll = 180° |

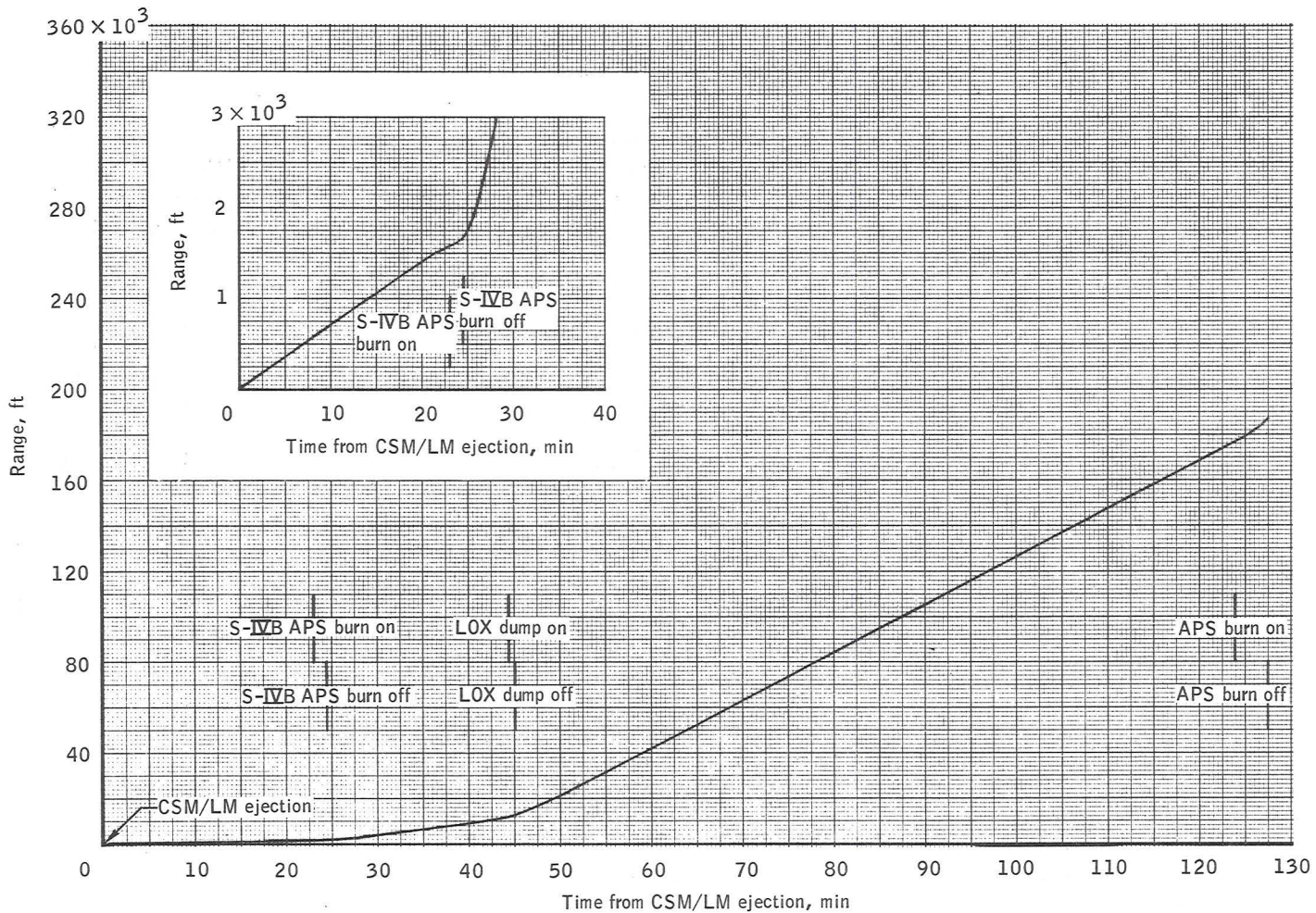

(a) Range versus time.

Figure 4.5-1.- Motion of the S-IVB relative to the spacecraft for the S-IVB evasive maneuver on Apollo 14.

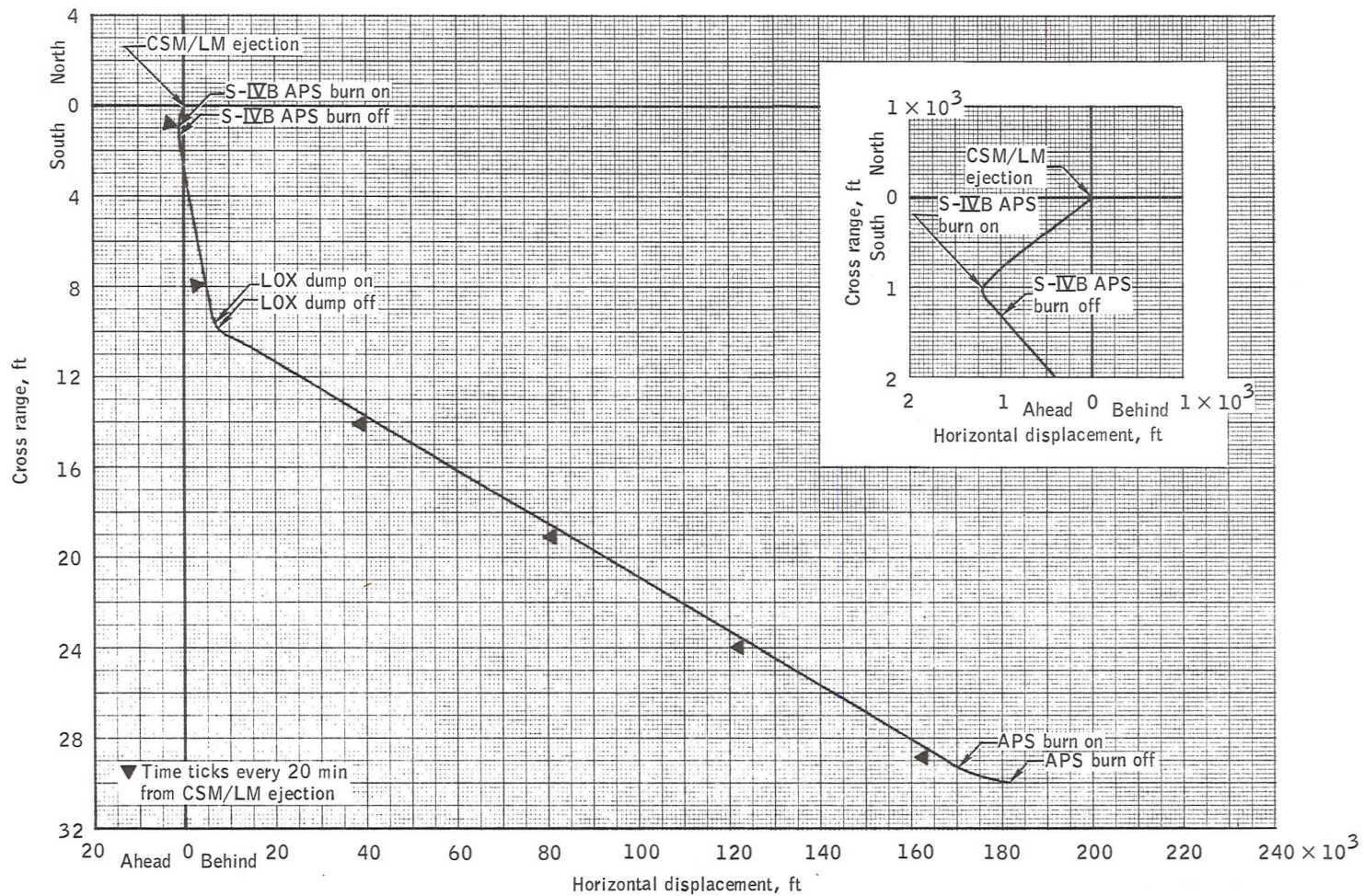

(b) Cross range versus horizontal displacement.

Figure 4.5-1.- Continued.

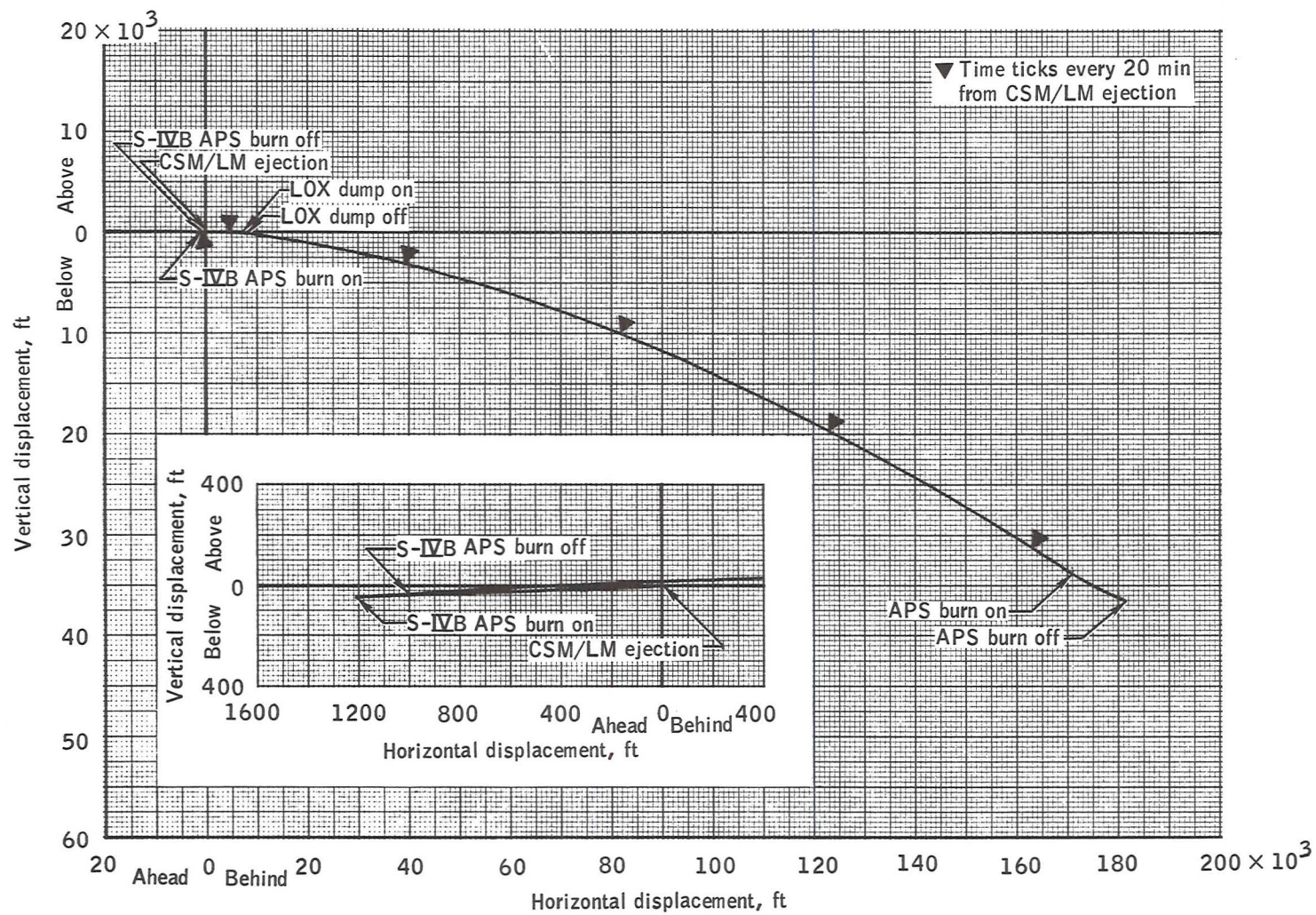

(c) Vertical displacement versus horizontal displacement.

Figure 4.5-1.- Concluded.

4.6 TRANSLUNAR COAST

4.6 Translunar Coast

A groundtrack of the translunar coast phase is shown in figure 4.6-1. Time histories of altitude and true anomaly for the first 10 hours of translunar coast are provided in figures 4.6-2 and 4.6-3.

After TLI, the spacecraft is on a free-return circumlunar trajectory with a perilune altitude of 2030 n. mi. At TLI plus 28 hours, a transfer maneuver is performed which results in a relaxed-free-return translunar trajectory with a 57.1-n. mi. perilune altitude. The transfer trajectory is restricted such that, in the event an SPS maneuver could not be made, an earth return would be possible within the DPS docked ΔV capability. It is assumed that the LM maneuver could be made at a minimum of 2 hours after perilune. The target load for this maneuver is presented in table 4.6-I.

The transfer maneuver is GNCS controlled, and external ΔV guidance and the PTC REFSMMAT are used. The characteristics of the burn are the following.

| | |
|------------------------------------|----------|
| Time, hr:min:sec, g.e.t. | 30:36:07 |
| Geodetic altitude, n. mi. | 118 345 |
| ΔV , fps | 73.4 |
| Burn time, sec | 11.1 |
| SPS propellant used, lb | 705.7 |
| Plane change, deg | 0.2 |

Passive thermal control attitude will be maintained during most of the translunar coast phase. The PTC REFSMMAT is given in table 5-II.

Four midcourse correction maneuver points have been defined at the following times.

- a. TLI plus 9 hours (MCC-1)
- b. TLI plus 28 hours (MCC-2) (the transfer maneuver)
- c. LOI minus 22 hours (MCC-3)
- d. LOI minus 5 hours (MCC-4)

The midcourse correction strategy has been defined and documented through the Apollo Data Priority Coordination Office. The maneuvers are GNCS controlled, and external ΔV guidance is used. The PTC REFSMMAT (table 5-II) will be used for MCC-1, MCC-2, MCC-3, and MCC-4. The alignment criteria are presented in section 5.0.

The SC enters the lunar umbra approximately 53 minutes prior to LOI ignition but is back in sunlight 2 minutes before the time of ignition. Hawaii acquires approximately 6 minutes after TLI cutoff, and there is continual MSFN coverage until lunar occultation.

The duration of the translunar coast phase is 80 hours 2 minutes. Note that this duration violates the highly desirable ground rule of an even integer number of days for translunar flight to provide a more favorable crew work/rest cycle. However, a thorough review of mission design scans indicated that no even-integer day was possible without violation of other mandatory ground rules.

Geodetic altitude from translunar injection to LOI is shown in figure 4.6-4. Altitude above the lunar surface during the last 10 hours of translunar coast is shown in figure 4.6-5.

TABLE 4.6-I.- TARGET LOAD FOR RELAXED-FREE-RETURN MANEUVER

[Propulsion system: SPS; guidance: external ΔV]

(a) Target

| | |
|-----------------------------------------|----------|
| t_{IG} , hr:min:sec, g.e.t. | 30:36:07 |
| ΔV_X , fps | -5.3 |
| ΔV_Y , fps | 4.0 |
| ΔV_Z , fps | 73.1 |
| Mass, lb | 97 228.8 |

(b) REFSMMAT

Refer to table 5-II

(c) Gimbal angles at t_{IG}

| | |
|--------------------|-------|
| IGA, deg | -12.8 |
| MGA, deg | -43.8 |
| OGA, deg | 73.0 |

APOLLO TRACKING NETWORK

All stations operational May 1968

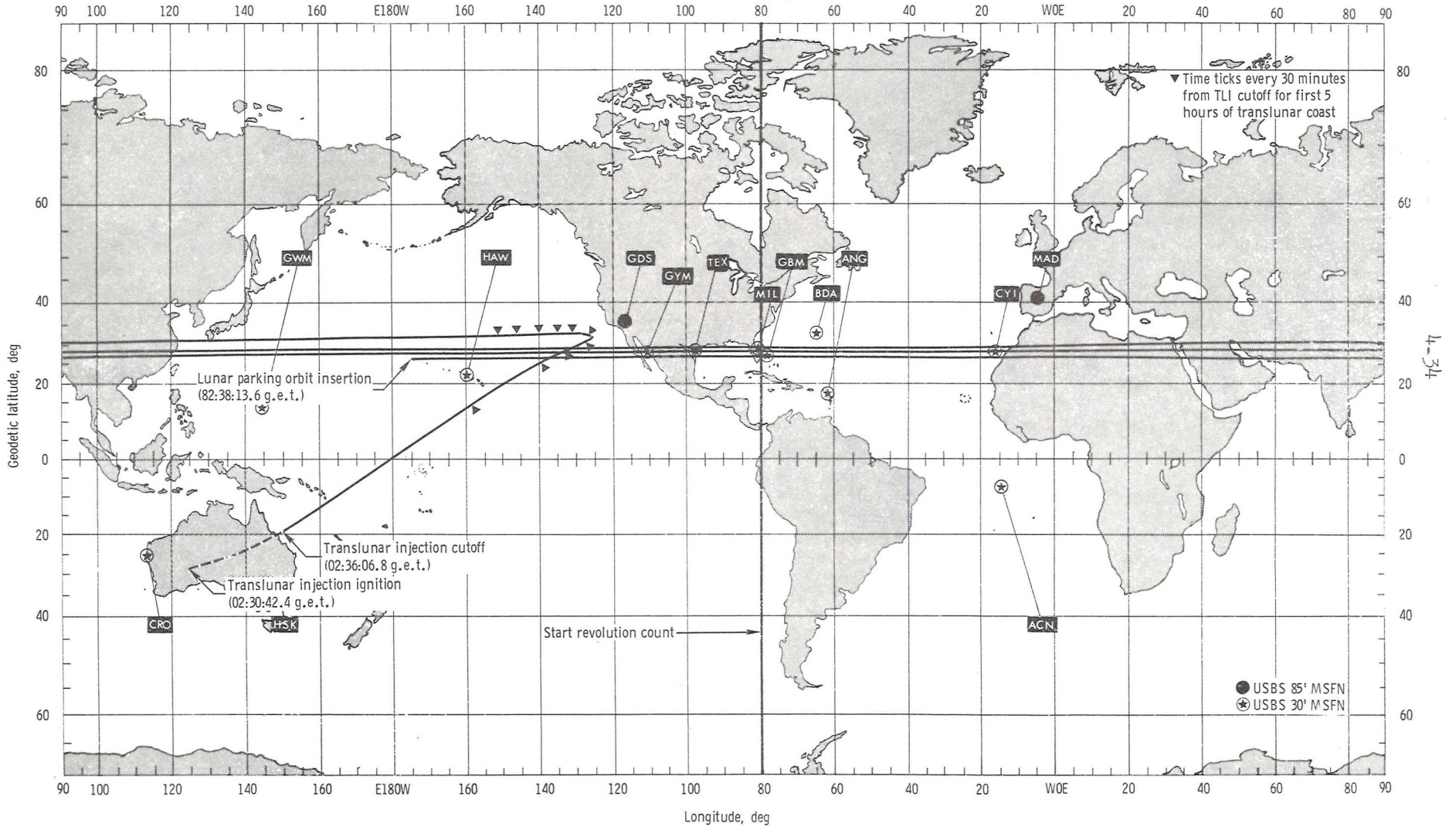

Figure 4.6-1. - Translunar coast groundtrack.

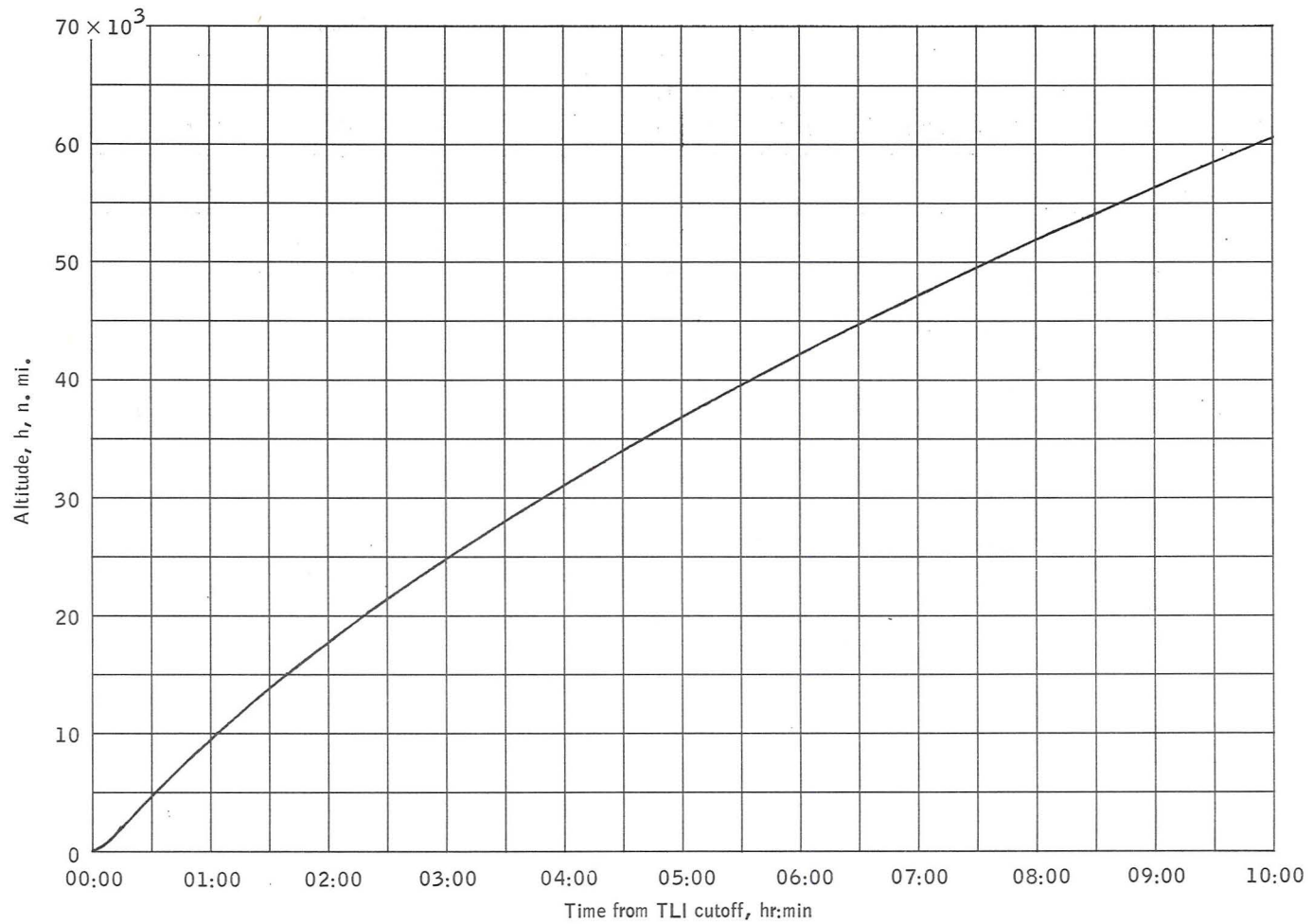

Figure 4.6-2.- Time history of altitude for first 10 hours of translunar coast.

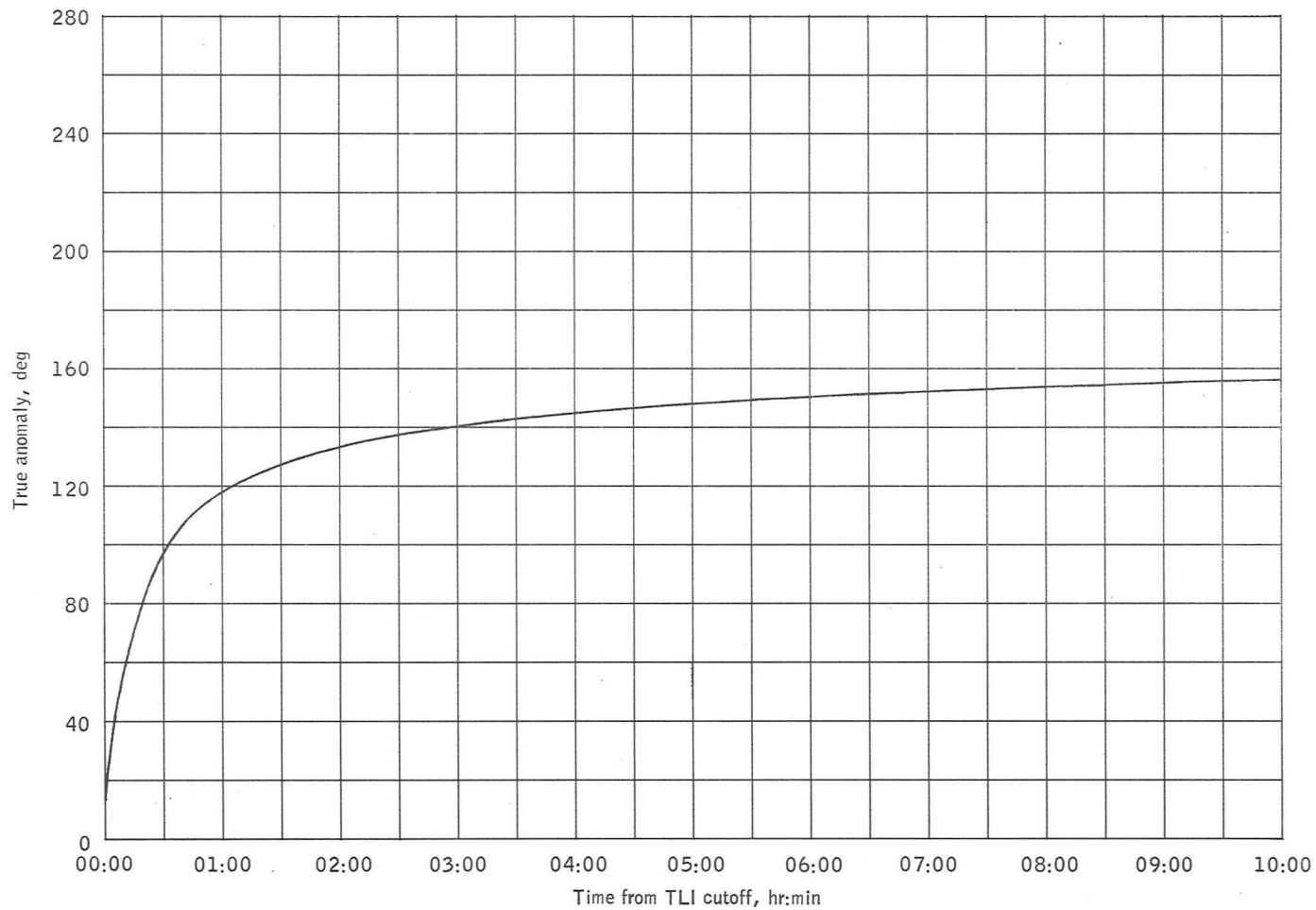

Figure 4.6-3.- Time history of true anomaly for first 10 hours of translunar coast.

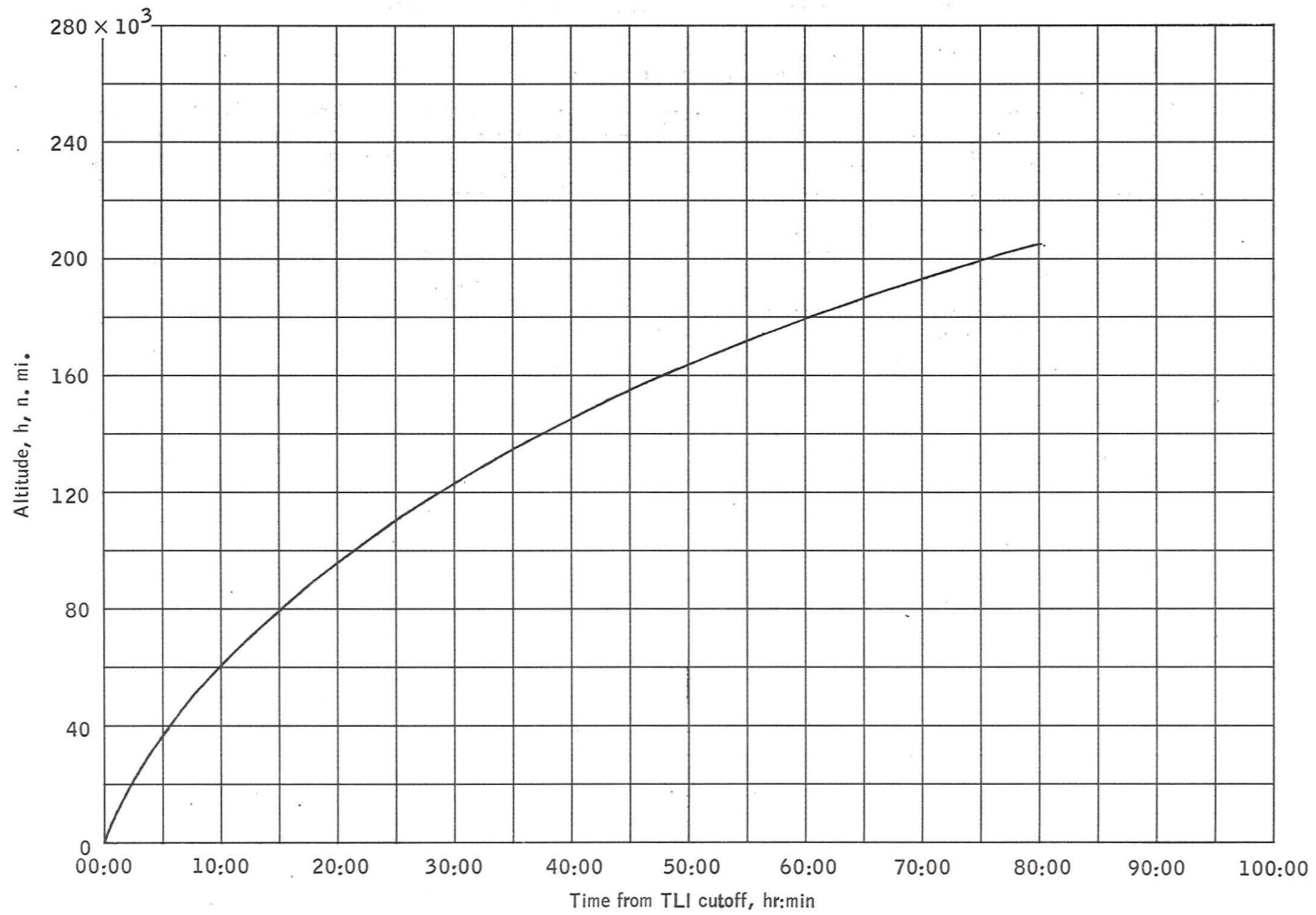

Figure 4.6-4.- Altitude time history from translunar injection to lunar orbit insertion.

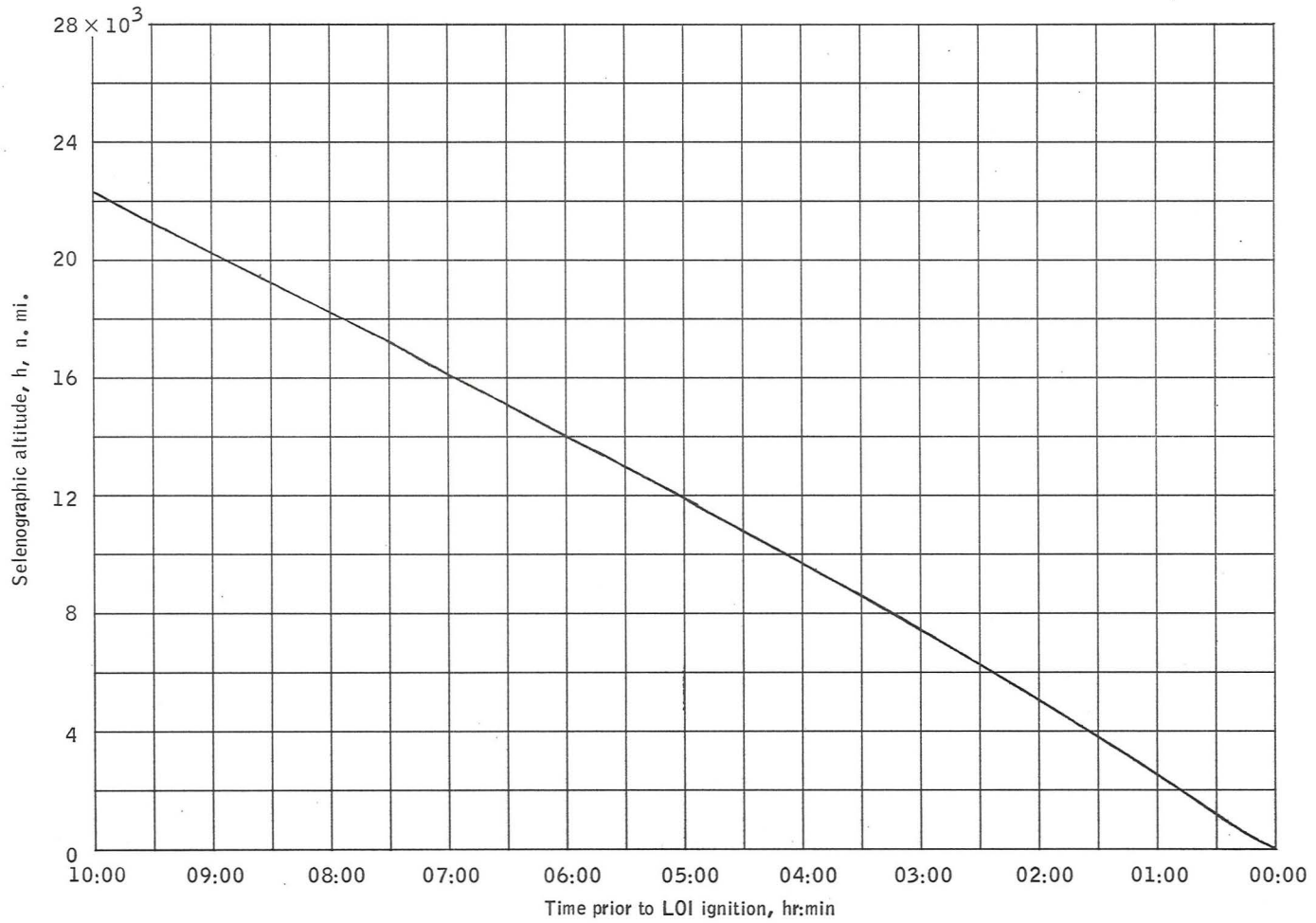

Figure 4.6-5.- Time history of altitude 10 hours prior to LOI ignition.

4.7 LUNAR ORBIT INSERTION

4.7 Lunar Orbit Insertion (LOI)

The LOI maneuver is designed to insert the CSM into approximately a 57- by 170-n. mi. lunar parking orbit (LPO). The lunar orbit insertion geometry is shown in figure 4.7-1, and the lunar orbit groundtrack from LOI to LM landing is shown in figure 4.7-2. A time history of trajectory parameters during the burn is presented in figure 4.7-3. The burn was simulated with external ΔV guidance. A description of the burn is as follows.

LOI burn initiation

| | |
|---------------------------------------------|------------|
| Time, hr:min:sec, g.e.t. | 82:38:13.6 |
| Mass, lb | 96 377.7 |
| Altitude above LLS, n. mi. | 76.4 |
| Selenographic latitude, deg | 2.2 |
| Selenographic longitude, deg | -178.2 |
| Inertial velocity, fps | 8094.4 |
| Perilune altitude above LLS, n. mi. | 57.1 |
| Selenographic inclination, deg | 3.2 |

LOI burnout - start LPO

| | |
|---------------------------------------------|------------|
| Time, hr:min:sec, g.e.t. | 82:44:20.2 |
| Altitude above LLS, n. mi. | 57.7 |
| Selenographic latitude, deg | -0.7 |
| Selenographic longitude, deg | 158.2 |
| Inertial velocity, fps | 5490.6 |
| Selenographic inclination, deg | 14.1 |
| Burn duration, sec | 366.6 |
| Inertial burn arc, deg | 23.7 |
| Plane change, deg | -11.2 |
| ΔV , fps | 2986.0 |
| SPS propellant used, lb | 24 695 |
| Orbit period, hr:min:sec | 02:08:27.4 |
| Perilune altitude above LLS, n. mi. | 57.1 |
| Apolune altitude above LLS, n. mi. | 170.0 |

The LOI burn parameters were computed without simulation of the SPS thrust buildup and tailoff. However, the effect of these is reflected in the burn parameters presented in the simulation data package (ref. 3).

The REFSMMAT used for the LOI burn as well as for the DOI burn is the lunar landing site alignment at the nominal lunar landing time.

The target load for the LOI burn is given in table 4.7-I. More detailed information about the burn, including reset points, navigation updates, and ignition gimbal angles, is given in reference 3.

TABLE 4.7-I.- TARGET LOAD FOR LOI MANEUVER

[Propulsion system: SPS; guidance: external ΔV]

(a) Target

| | |
|-----------------------------------------|------------|
| t_{IG} , hr:min:sec, g.e.t. | 82:38:13.6 |
| ΔV_X , fps | -2784.7 |
| ΔV_Y , fps | -1075.9 |
| ΔV_Z , fps | 66.0 |
| Mass, lb | 96 377.7 |

(b) REFSMMAT

Refer to table 5-III

(c) Gimbal angles at t_{IG}

| | |
|--------------------|-------|
| IGA, deg | -99.2 |
| MGA, deg | -33.2 |
| OGA, deg | -5.1 |

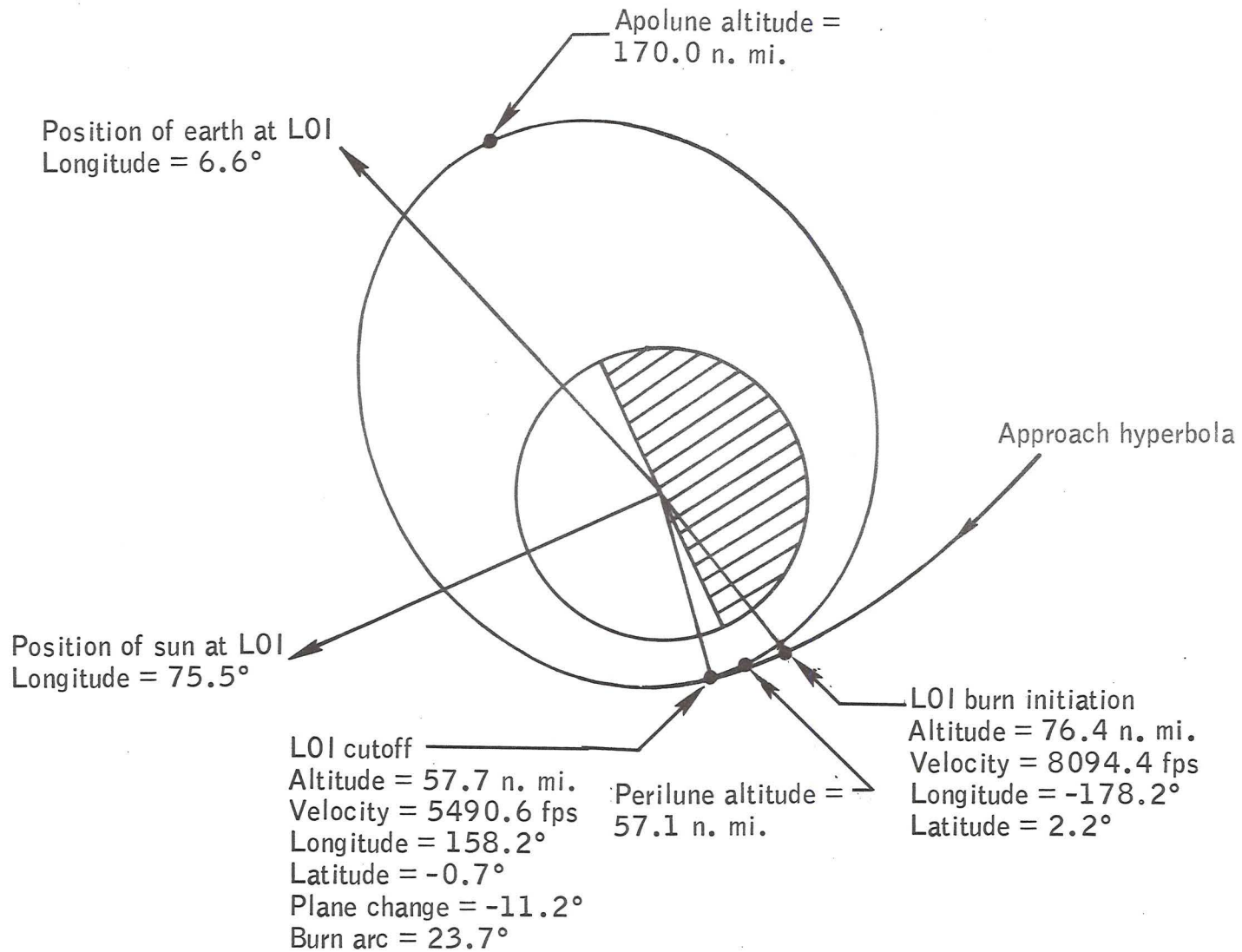

Figure 4.7-1.- LOI geometry.

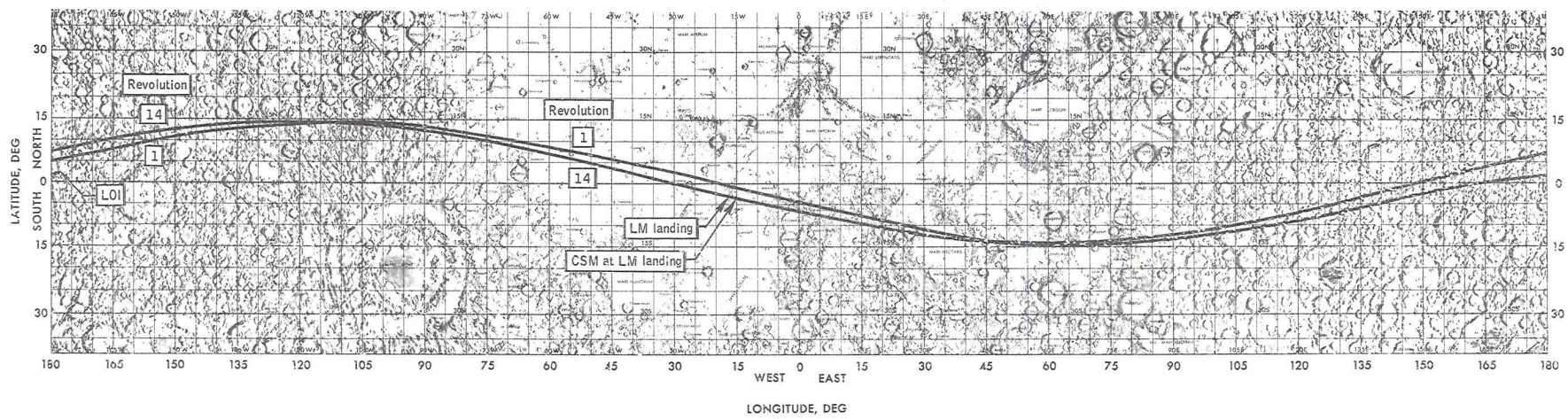
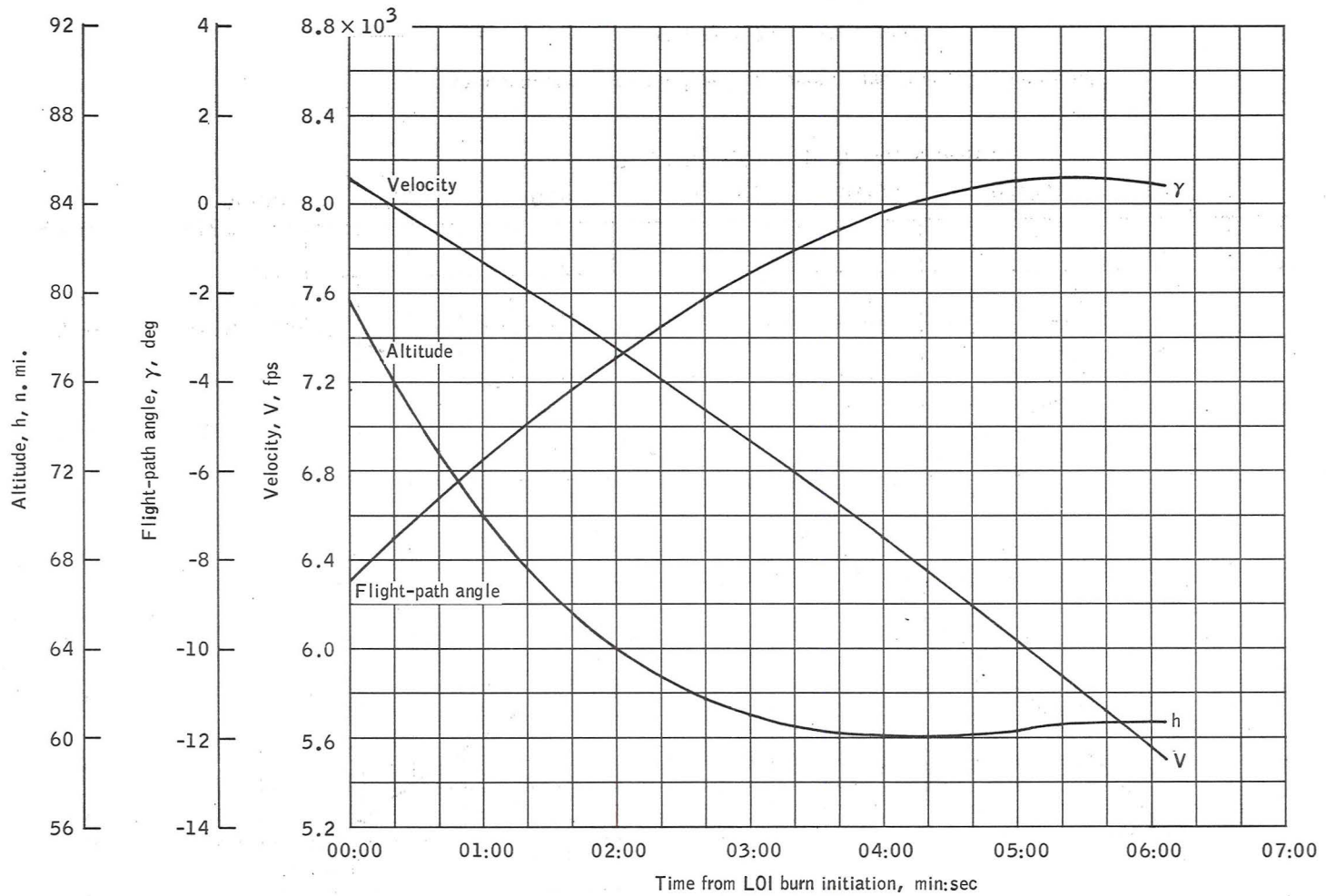

Figure 4.7-2.- Lunar orbit groundtrack from LOI to LM landing.

4-11



(a) Velocity, flight-path angle, and altitude versus time from LOI burn initiation.

Figure 4.7-3.- Time history of trajectory parameters for LOI.

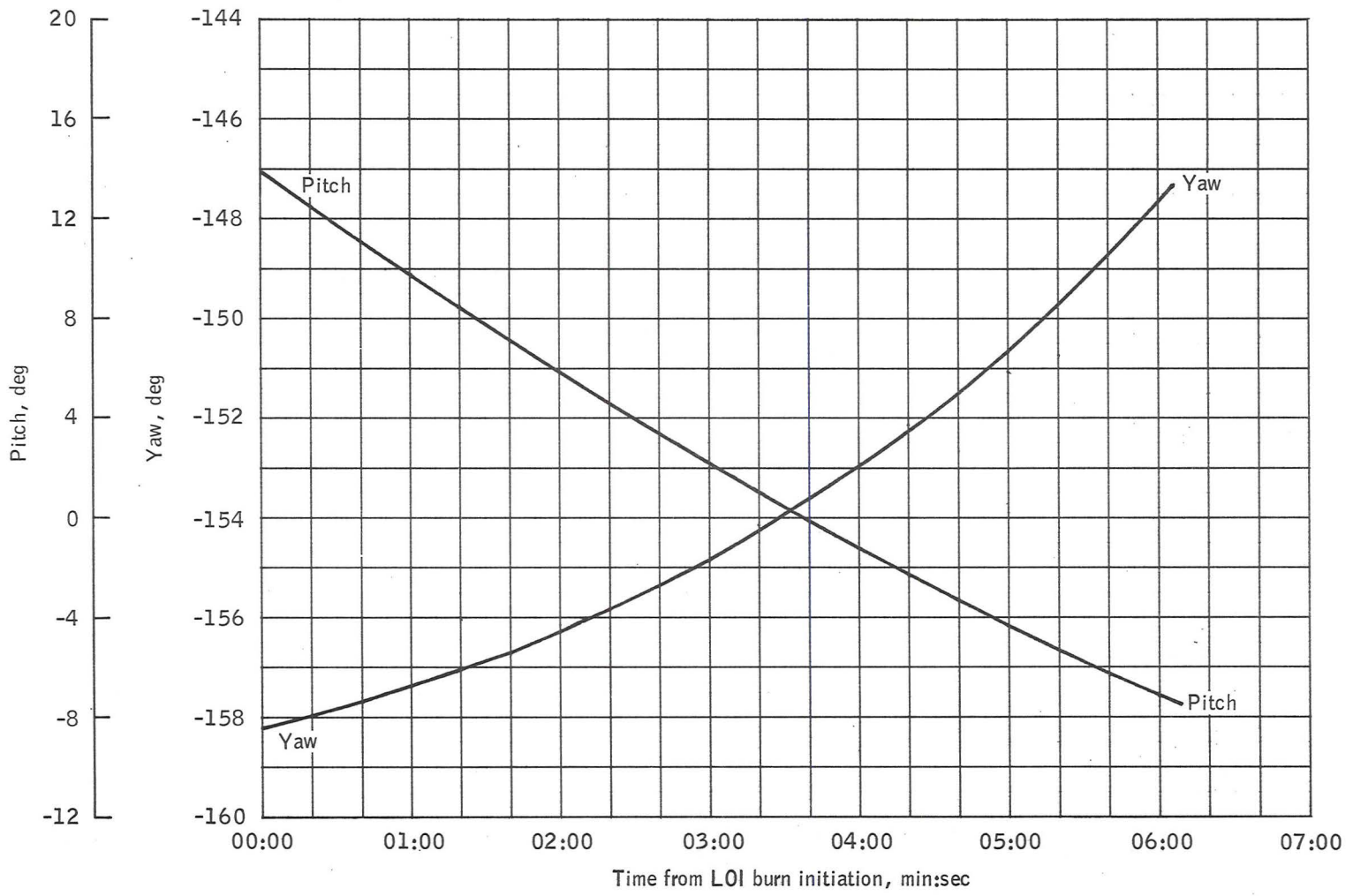

97-17

(b) Local horizontal pitch and yaw versus time from LOI burn initiation.

Figure 4.7-3.- Concluded.

4.8 DESCENT ORBIT INSERTION

4.8 Descent Orbit Insertion (DOI)

The DOI maneuver occurs after two revolutions in the 57- by 170-n. mi. orbit. The targeting is biased to place the spacecraft in an initial 9.8- by 58.4-n. mi. lunar orbit so that the predicted lunar potential perturbation will place the spacecraft in a 50 000-foot by 60-n. mi. orbit at PDI on rev 14. The orbit is designed so that the perilune is at 2.5°W selenographic longitude at PDI. The altitudes are relative to the landing site radius.

For the DOI burn, the landing REFSMMAT (table 5-III) is used, and the CSM is oriented heads down. The burn is initiated near perilune of the second revolution in the 59- by 170-n. mi. orbit. The target load for the DOI maneuver is presented in table 4.8-I. The characteristics of the burn are the following.

DOI burn initiation

| | |
|---------------------------------------------|------------|
| Time, hr:min:sec, g.e.t. | 86:56:57.6 |
| Mass, lb | 71 642.6 |
| Altitude above LLS, n. mi. | 57.3 |
| Selenographic latitude, deg | 2.4 |
| Selenographic longitude, deg | 168.6 |
| Inertial velocity, fps | 5492.7 |
| Perilune altitude above LLS, n. mi. | 57.1 |
| Apolune altitude above LLS, n. mi. | 170.0 |

DOI burnout

| | |
|---------------------------------------------|------------|
| Time, hr:min:sec, g.e.t. | 86:57:18.9 |
| Altitude above LLS, n. mi. | 57.2 |
| Selenographic latitude, deg | 2.2 |
| Selenographic longitude, deg | 167.5 |
| Inertial velocity, fps | 5287.7 |
| Selenographic inclination, deg | 14.2 |
| Burn duration, sec | 21.4 |
| Inertial burn arc, deg | 1.1 |
| Plane change, deg | 0.0 |
| ΔV, fps | 206.6 |
| SPS propellant used, lb | 1452.2 |
| Orbit period, hr:min:sec | 01:54:00 |
| Perilune altitude above LLS, n. mi. | 9.8 |
| Apolune altitude above LLS, n. mi. | 58.4 |

TABLE 4.8-I.- TARGET LOAD FOR DOI MANEUVER

[Propulsion system: SPS; guidance: external ΔV]

(a) Target

| | |
|---------------------------------------|------------|
| t_{IG} , hr:min:sec, g.e.t. | 86:56:57.6 |
| ΔV_X , fps | -205.7 |
| ΔV_Y , fps | 0.0 |
| ΔV_Z , fps | 19.3 |
| Mass, lb | 71 642.6 |

(b) REFSMMAT

Refer to table 5-III

(c) Gimbal angles at t_{IG}

| | |
|--------------------|-------|
| IGA, deg | -90.7 |
| MGA, deg | -.4 |
| OGA, deg | -.2 |

4.9 CSM/LM COAST FROM LOI TO UNDOCK

4.9 CSM/LM Coast from LOI to Undock

The main activities in lunar orbit prior to undock include the CSM DOI maneuver at the beginning of the third revolution, photography of Descartes, and a rest period. The following is a summary of major activities.

| Activity | Revolution number | Time, hr:min, g.e.t. |
|--------------------------|----------------------|-------------------------|
| LOI | Beginning of 1 | 82:38 |
| Landmark tracking | 2 | 85:50 |
| DOI | Beginning of 3 | 86:57 |
| Descartes photography | 4 | 89:35 |
| Begin rest period | 5 | 91:00 |
| End rest period | 9 | 99:30 |
| Begin IVT to LM | 10 | 101:50 |
| Undock | 12 | 104:28 |

4.10 CSM/LM UNDOCK TO LANDING

4.10 CSM/LM Undock to Landing

The interval of the mission from CSM/LM undocking to the LM landing on the lunar surface is described in this section. The maneuvers included are CSM/LM undock and separation, in preparation for the LM descent; CSM circularization, to place the CSM in a near circular orbit; and the LM powered descent to the landing site at Fra Mauro. In figure 4.10-1, the location of these maneuvers in lunar orbit is shown with respect to the landing site, MSFN tracking, and sunlight or darkness. Also indicated are the CSM and LM positions at each maneuver.

The LM MSFN tracking summary and LM shadow data from undocking to landing are presented in tables 1.1-V and 1.1-VI, respectively.

Time histories of the LM velocity, altitude above the landing site, and flight-path angle for the time period from undocking to landing are shown in figure 4.10-2(a); major events also are indicated. Time histories of the CSM/LM range, range rate, and phase angle are shown in figure 4.10-2(b). The CSM/LM relative motion (in curvilinear coordinates) is shown in figure 4.10-3.

More details of each maneuver in the time period from undocking to landing are given in the following subsections.

4.10.1 CSM/LM undock and separation.- The undocking and separation maneuver is performed as a single maneuver to separate the LM and CSM in preparation for the LM descent. The maneuver occurs at 12.5°S and 88.0°E during the twelfth orbit 4.2 hours before landing. The required data for this maneuver is given in table 4.10-I.

Undocking is accomplished by simultaneously releasing a set of clamps that allows springs to push the two spacecraft apart. Immediately after undocking, the CSM performs a manual maneuver directed radially downward toward the center of the moon to achieve a total ΔV of 1.0 fps. This maneuver provides an increase in LM-CSM separation distance.

4.10.2 CSM circularization.- This maneuver, which occurs at 9.7°N and 168.2°W and 79 minutes after undocking, transfers the CSM from the initial elliptical orbit to a near circular parking orbit which is necessary for two reasons: (1) landmark tracking is less difficult at higher altitudes and (2) after the powered ascent (or a descent abort), the rendezvous phasing is improved.

The maneuver is a 3.8-second external ΔV burn performed by the SPS. The target load for the maneuver is shown in table 4.10-II.

4.10.3 Powered descent.- The powered descent maneuver (PDI) which consists of an ullage phase, trim phase, braking phase, approach phase, and the landing phase is initiated at a central angle of 14.6° from the landing site at Fra Mauro (3.67°S , 17.46°W) and 50 000 feet above the landing site. The powered descent profile is shown in figure 4.10-4.

4.10.4 Ullage and trim phases.- A 7.5-second ullage maneuver is performed with the LM RCS to settle the DPS propellants. The DPS is then ignited and burned at the minimum throttle setting (approximately 10 percent) for 26 seconds to allow time for the DPS engine gimbal to trim through the cg. The ullage and trim are performed at the constant inertial attitude required by PGNCS guidance at DPS ignition.

4.10.5 Braking phase.- The braking phase is designed for efficient reduction of orbital velocity and, therefore, uses maximum thrust from the DPS for most of the phase; however, the DPS is throttled during the final 2 minutes of this phase for guidance control. The spacecraft is in a windows-up attitude so that the landing radar can be used; however, the crew has the option to be windows down for a maximum of 4.5 minutes after DPS ignition if they prefer to view the lunar surface. The targets for the braking phase are listed in table 4.10-III. However, these targets are not actually achieved because of increased guidance sensitivity as time to go (to achieve targets) becomes small. The guidance automatically switches from the braking phase targets to the approach phase targets when time to go becomes less than 62 seconds.

4.10.6 Approach phase.- The approach phase, which begins at an altitude of approximately 7500 feet (high gate), provides for pilot visual monitoring of the approach to the lunar surface. That is, the guidance is targeted to provide a 30° pitch transient at high gate to immediately bring the landing area into view in the forward window. Then the guidance provides an attitude which will maintain the landing area in the pilot's window until late in the approach phase. The quadratic acceleration guidance law is used in the approach phase as well as the braking phase. The targets for the approach phase are listed in table 4.10-III. Note that the altitude target is approximately 95 feet. However, the approach phase is operationally considered to be terminated at a time to landing of 80 seconds (low gate, altitude ≈ 650 ft) where the landing phase is initiated.

4.10.7 Landing phase.- The landing phase is designed to provide continued visual assessment of the landing site and to provide compatibility for pilot takeover from the automatic control. There is no change in the guidance law or targets at this point because the approach phase targets have been selected to satisfy these additional constraints. Under automatic guidance, a vertical descent is initiated when time-to-go becomes less than 12 seconds. The vertical descent portion of the landing

phase starts at an altitude of 100 feet and terminates at landing. The vertical descent guidance is a velocity nulling routine which nulls horizontal velocity while accepting the commanded vertical rate from the rate-of-descent (ROD) switch. Normally, a 3-fps rate of descent is used throughout the vertical descent.

4.10.8 Graphical description of the powered descent.- Shown in figure 4.10-5 is the LM lunar groundtrack from PDI to landing. Events indicated are PDI, high gate, and landing.

The time histories of the LM and LM-CSM trajectory parameters from PDI to landing are shown in figure 4.10-6. Major events indicated are DPS throttle recovery, high gate, low gate, and landing. In figure 4.10-6(a), time histories of the LM velocity, altitude above the landing site, and flight-path angle are shown. The time histories of the LM-CSM range, range rate, and phase angle are shown in figure 4.10-6(b). Time histories of the LM thrust angle and FDAI pitch angle are shown in figure 4.10-6(c). The thrust angle is the angle between the thrust vector and the local vertical, and the FDAI pitch angle is the angle between the X-body axis and the X-platform axis. The time histories of the commanded and actual thrust profiles are shown in figure 4.10-6(d). The two profiles are different because the DPS cannot be throttled above 63-percent thrust (100 percent is 10 500 lb of thrust). Therefore, the throttle is set at the maximum level (approximately 93 percent thrust) until the commanded value is below 57-percent thrust, then the DPS is throttled to the commanded values for the remainder of the descent. The 57-percent level allows margin for throttle operation without requiring a pulse back to FTP.

In figure 4.10-7, the LM altitude/altitude rate profile from PDI to landing is shown. Events indicated are PDI, DPS throttle recovery, high gate, low gate, and landing.

Shown in figure 4.10-8 is the S-band gimbal profile indicating the position in which the S-band antenna must be to maintain S-band communication. Also shown is the vehicle blockage pattern. Any antenna positions inside this pattern will result in loss of communication because parts of the LM hardware will reflect the signal. Events indicated are PDI, DPS throttle recovery, high gate, low gate, and landing.

To decrease the effects of the local terrain on the descent trajectory, a simple terrain model (called an a priori model) has been introduced into the guidance system. This model allows the guidance to compensate in advance for general terrain variations thus providing a smoother trajectory. Figure 4.10-9 shows the terrain for a -76° approach azimuth into the landing site at Fra Mauro. The a priori model (a series of slopes) has been superimposed over the actual terrain. An enlargement of the terrain from high gate to landing has been included for better illustration.

An approach phase summary (from high gate to low gate) is presented in figure 4.10-10. The LM landing point designator (LPD), LM altitude above the landing site, and the lunar terrain altitude above the landing site as functions of surface range to the landing site are presented as figures. A table presents the LM altitude rate, thrust angle, and horizontal velocity as functions of time from high gate.

A map showing the topography around the landing site at Fra Mauro is presented in figure 4.10-11. The LM approach path is shown from a surface range of approximately 6000 feet to the landing site. Several prominent topographical features are also indicated.

A landing phase summary (from low gate to landing) is presented in figure 4.10-12. The LM LPD, LM altitude, and terrain altitude as functions of surface range are presented in figures. The altitude versus altitude rate profile along with the APS abort boundary are also presented in a figure. A table presents the LM thrust angle and horizontal velocity as functions of time from low gate.

TABLE 4.10-I.- DATA FOR MANUAL CSM SEPARATION MANEUVER

[Propulsion system: SM RCS]

(a) Desired ΔV 's

| | |
|-----------------------------------------|-------------|
| t_{IG} , hr:min:sec, g.e.t. | 104:27:30.7 |
| ΔV_x , fps | 0.0 |
| ΔV_y , fps | 0.0 |
| ΔV_z , fps | 1.0 |
| CSM weight, lb | 35 942 |

(b) CSM REFSMMAT

Refer to table 5-III

(c) CSM gimbal angles at t_{IG}

| | |
|--------------------|-------|
| IGA, deg | 101.7 |
| MGA, deg | 0.0 |
| OGA, deg | 0.0 |

TABLE 4.10-II.- TARGET LOAD FOR CSM CIRCULARIZATION MANEUVER

[Propulsion system: SM SPS; guidance: external ΔV]

(a) Target

| | |
|---------------------------------------|-------------|
| t_{IG} , hr:min:sec, g.e.t. | 105:46:48.5 |
| ΔV_x , fps | 71.0999 |
| ΔV_y , fps | 0.0 |
| ΔV_z , fps | 13.9706 |
| CSM weight at t_{IG} , lb | 35 937.718 |

(b) REFSMMAT

Refer to table 5-III

(c) Gimbal angles at t_{IG}

| | |
|--------------------|-------|
| IGA, deg | 109.7 |
| MGA, deg | -1.3 |
| OGA, deg | 0.1 |

TABLE 4.10-III.- TARGET LOAD FOR LM POWERED DESCENT MANEUVER^a

[Propulsion system: LM DPS; guidance programs: P63, P64, P66]

(a) Ignition targets for PDI (P63)

| | |
|-----------------------------------------|----------------------|
| t_{IG} , hr:min:sec, g.e.t. | 108:42:01.1 |
| Ignition algorithm targets | |
| RIGXG, ft | -138 421.37 |
| RIGZG, ft | -1 458 219.8 |
| VIGG, fps | 5 546.1835 |
| Ignition algorithm correction factors | |
| k_x | 0.331 |
| k_y , ft ⁻¹ | 5.8694 ⁻⁷ |
| k_v , ft/fps | 438.0 |
| Gimbal angles at t_{IG} | |
| IGA, deg | 112.7 |
| MGA, deg | 0.0 |
| OGA, deg | 0.0 |

^aFor complete REFSMMAT, refer to table 5-III.

TABLE 4.10-III.- TARGET LOAD FOR LM POWERED

DESCENT MANEUVER - Continued

[Propulsion system: LM DPS; guidance programs: P63, P64, P66]

(b) Braking phase targets (P63)^a

| | |
|-----------------------------------|-----------------------|
| Position, ft | |
| R _x | -1773.725 |
| R _y | 0.0 |
| R _z | -14488.027 |
| Velocity, fps | |
| V _x | -168.1064 |
| V _y | 0.0 |
| V _z | -77.61437 |
| Acceleration, ft/sec ² | |
| A _x | -0.647236 |
| A _y | 0.0 |
| A _z | -8.414382 |
| Jerk, ft/sec ³ | |
| J _z | 8.25729 ⁻³ |

^aTENDBRAK = 62 sec (time-to-go at program switch).

TABLE 4.10-III.- TARGET LOAD FOR LM POWERED

DESCENT MANEUVER - Concluded

[Propulsion system: LM DPS; guidance programs: P63, P64, P66]

(c) Approach phase targets (P64)^a

| | |
|-----------------------------------|----------------------|
| Position, ft | |
| R _x | 94.9191 |
| R _y | 0.0 |
| R _z | -15.7208 |
| Velocity, fps | |
| V _x | 2.08358 |
| V _y | 0.0 |
| V _z | 0.830318 |
| Acceleration, ft/sec ² | |
| A _x | 0.540285 |
| A _y | 0.0 |
| A _z | -0.235423 |
| Jerk, ft/sec ³ | |
| J _z | 4.5092 ⁻² |

^aTENDAPP = 12 sec (time-to-go at program switch).

(d) Vertical descent targets (P66)

| | |
|--------------------------|------|
| Velocity, fps | |
| V _x | -3.0 |
| V _y | 0.0 |
| V _z | 0.0 |

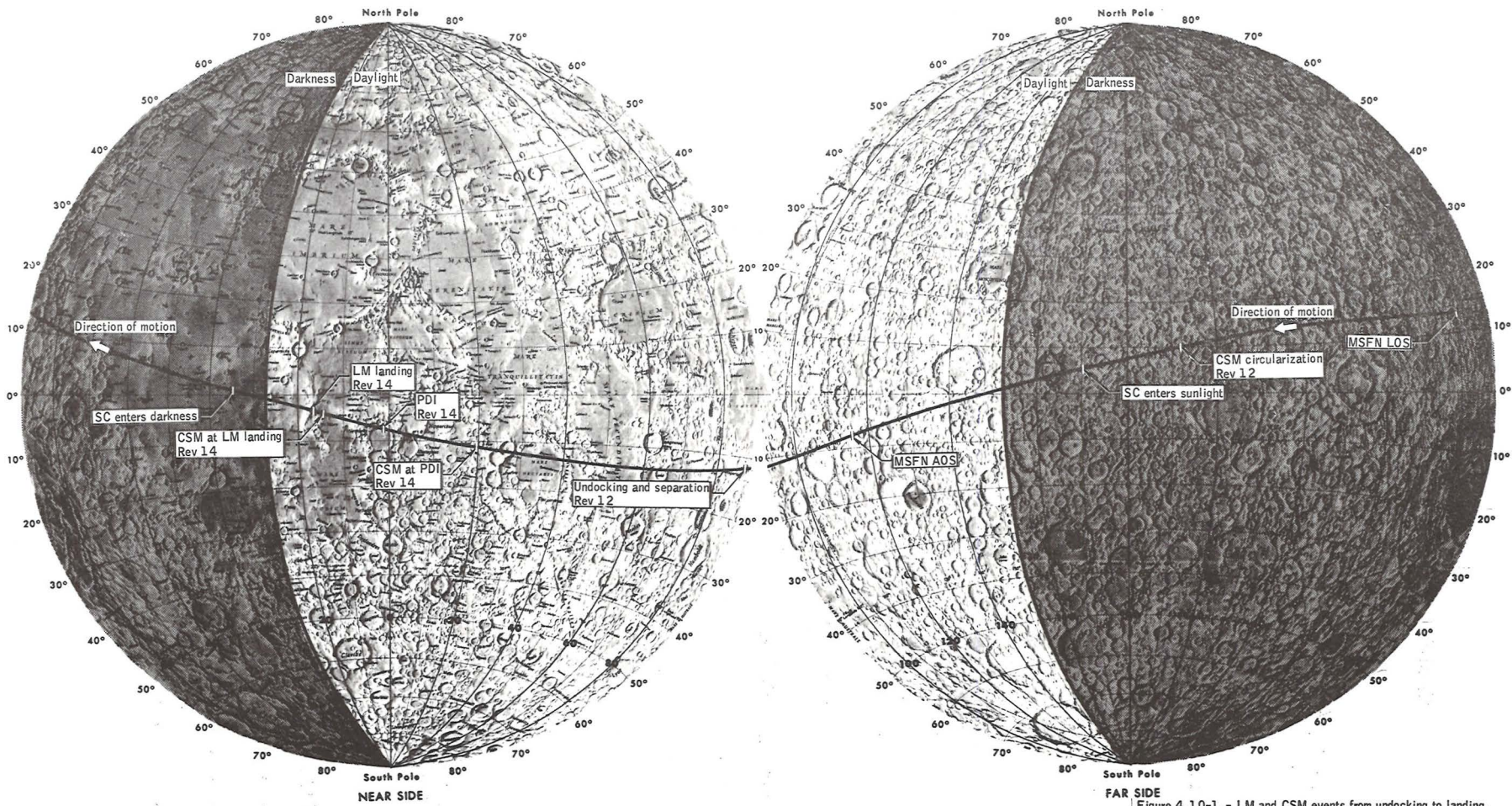

99-7

Figure 4.10-1.- LM and CSM events from undocking to landing.

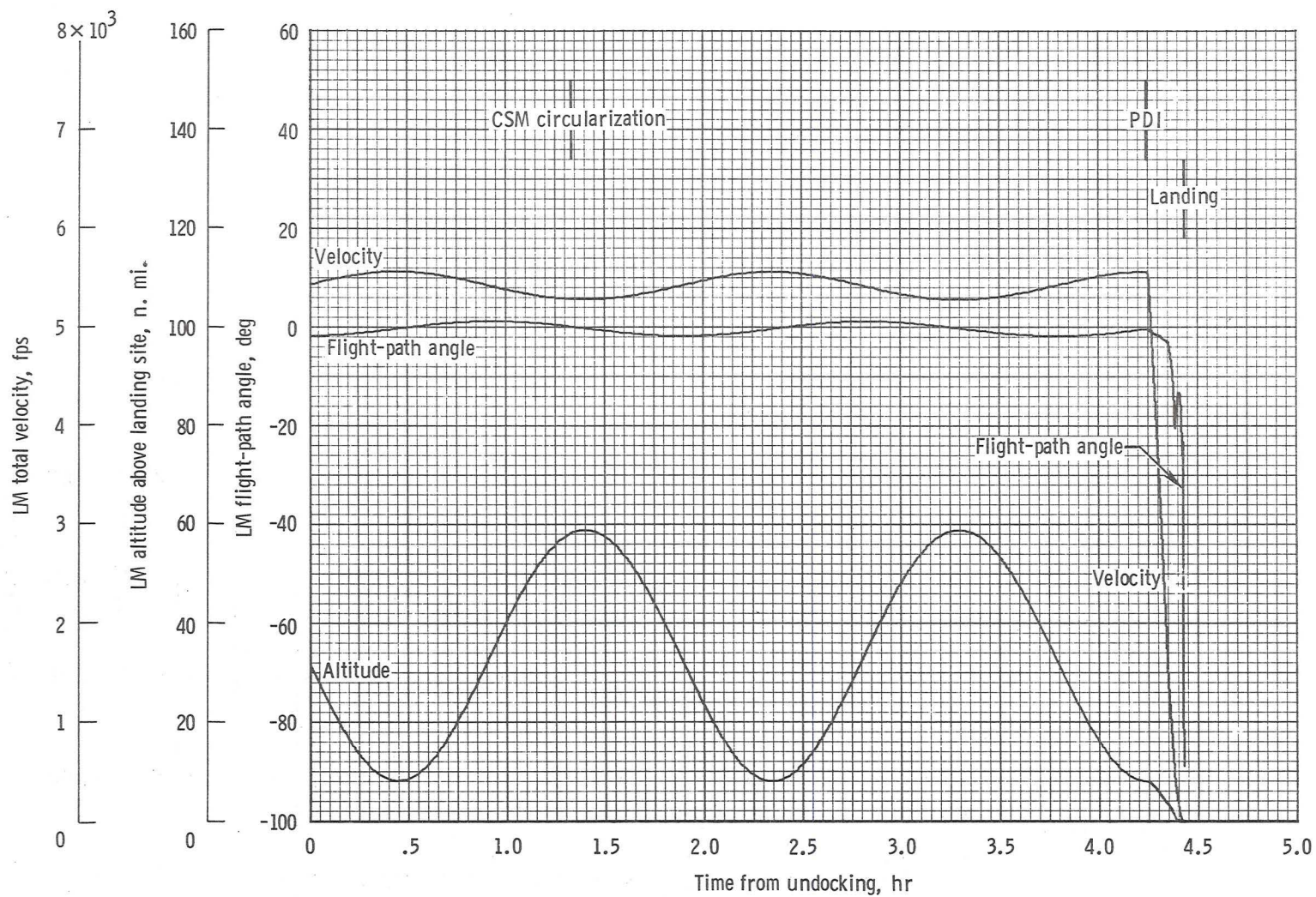

(a) LM total velocity, altitude above landing site, and flight-path angle.

Figure 4.10-2. - Time history of LM and LM-CSM trajectory parameters from undocking to landing.

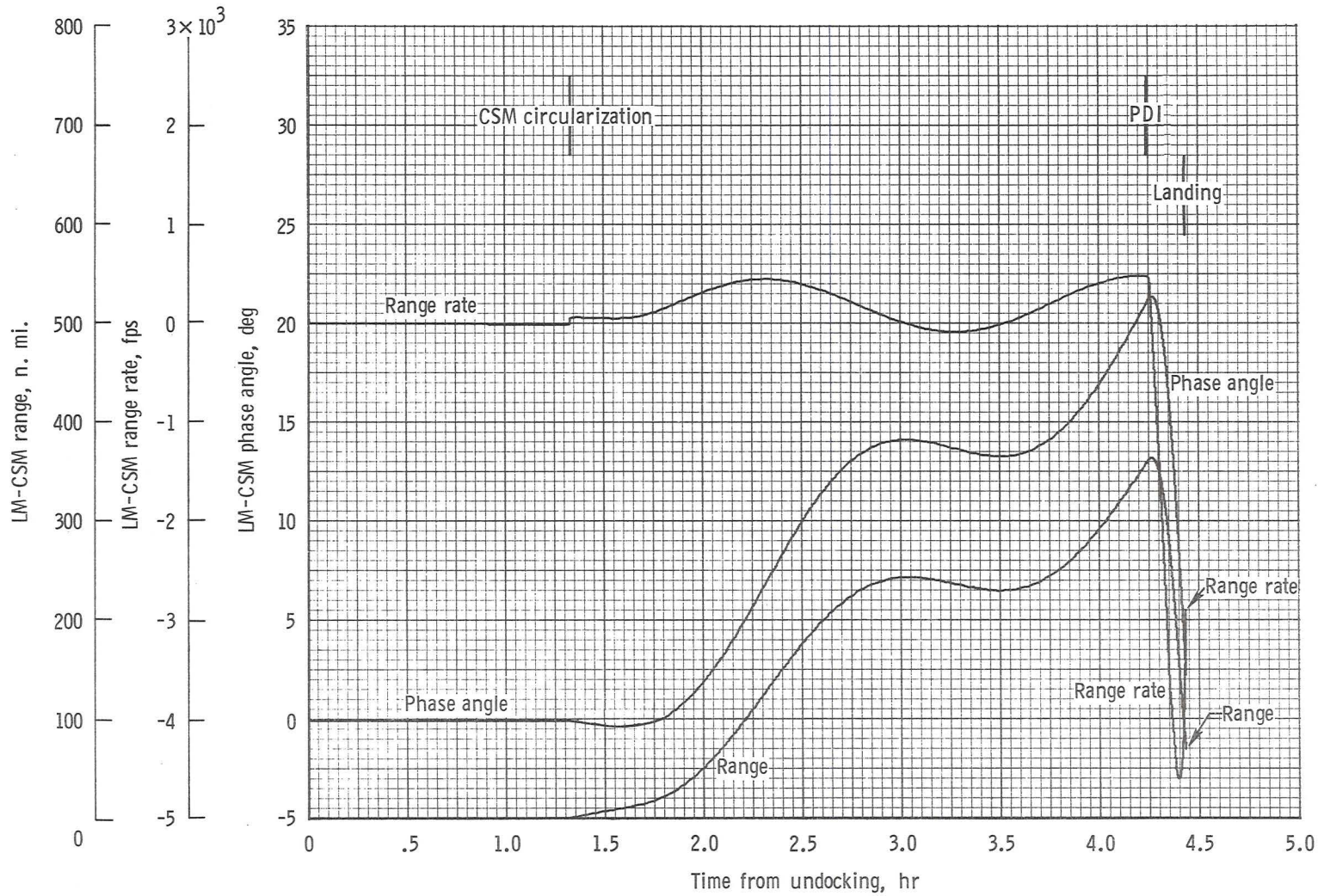

(b) LM-CSM range, range rate, and phase angle.

Figure 4.10-2. - Concluded.

89-7

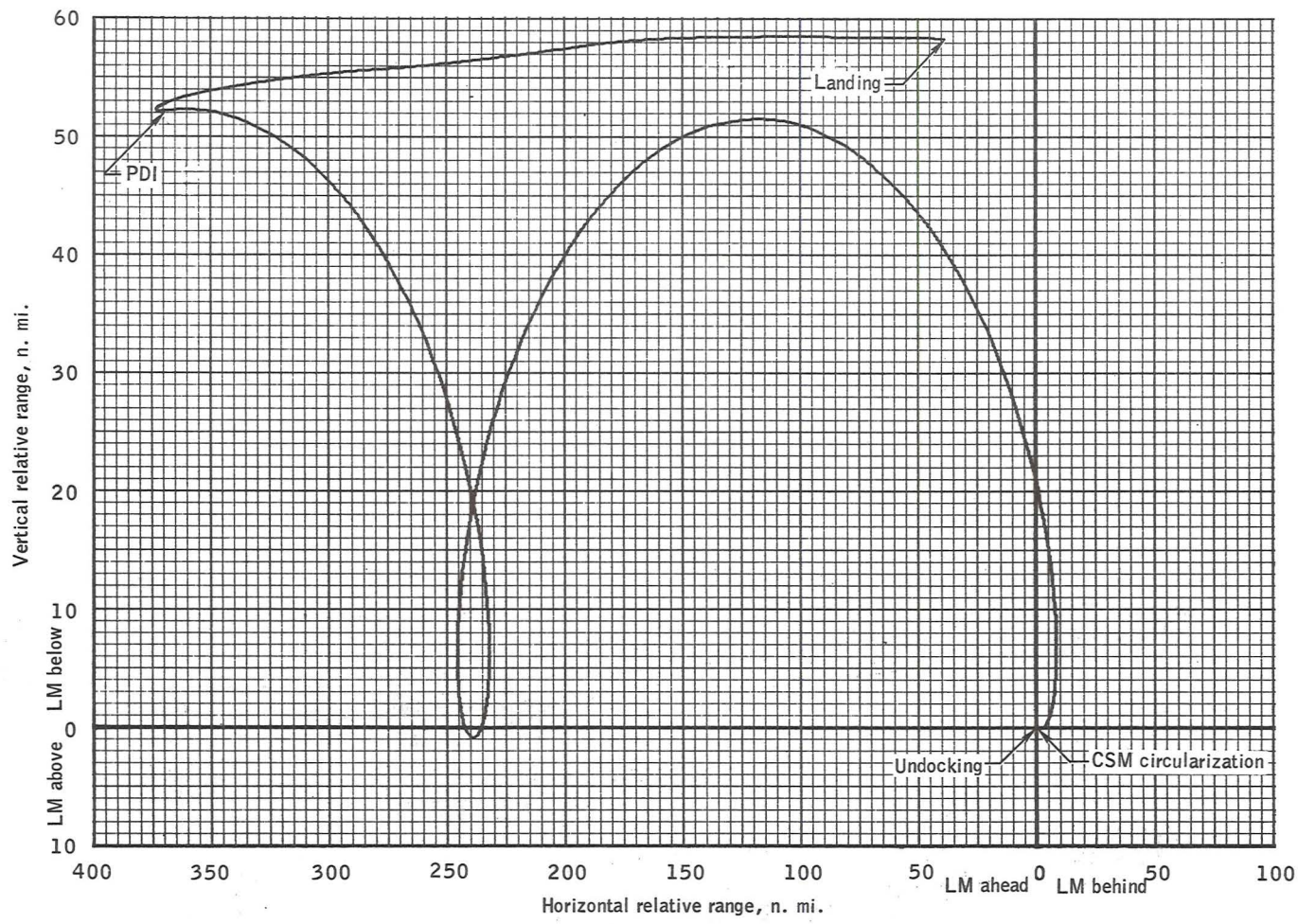
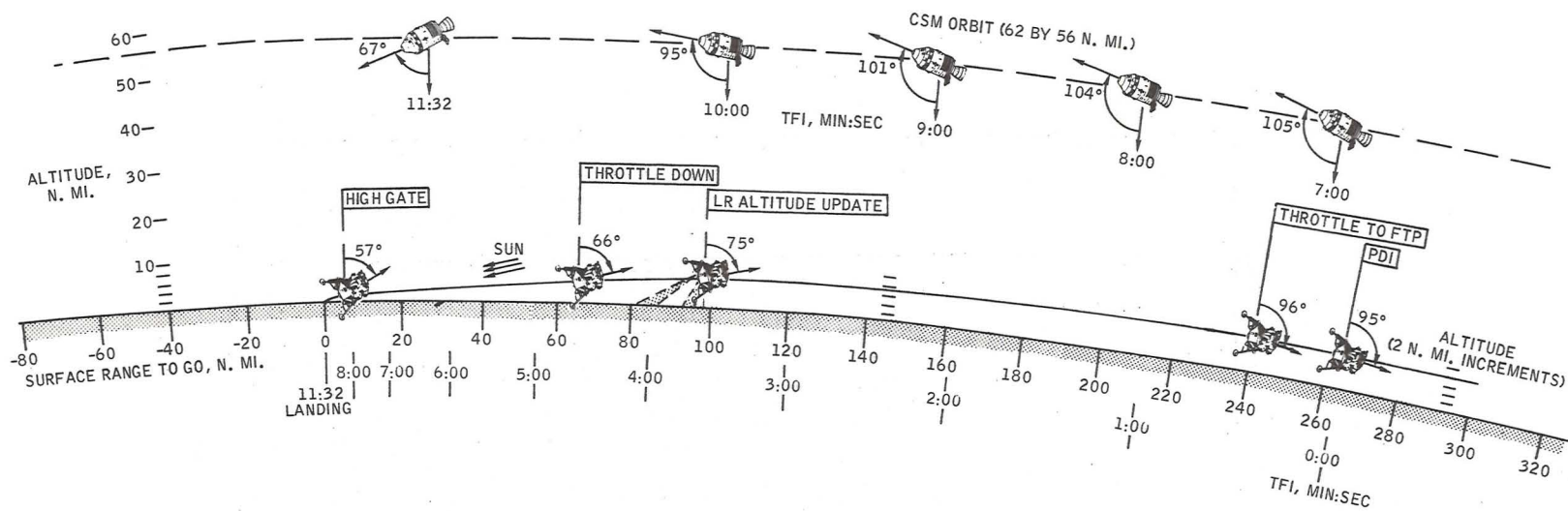

Figure 4.10-3.- LM-CSM relative motion from undocking to landing (curvilinear coordinate system).



4-70

| SUMMARY | | | | | |
|-------------------------------|--------------|-------------|-----------------|--------|------------------|
| EVENT | TFI, MIN:SEC | V_i , FPS | \dot{H} , FPS | H, FT | ΔV , FPS |
| POWERED DESCENT INITIATION | 0:00 | 5560 | -2 | 50 027 | 0 |
| THROTTLE TO MAXIMUM THRUST | 0:26 | 5526 | -3 | 49 964 | 34 |
| LANDING RADAR ALTITUDE UPDATE | 3:36 | 3601 | -89 | 37 779 | 1992 |
| LANDING RADAR VELOCITY UPDATE | 5:12 | 2500 | -94 | 28 783 | 3161 |
| THROTTLE RECOVERY | 6:34 | 1439 | -65 | 21 430 | 4289 |
| HIGH GATE | 8:34 | 450 | -153 | 7 602 | 5436 |
| LOW GATE | 10:12 | 70 (82)* | -20 | 659 | 6184 |
| LANDING | 11:32 | -15 (0)* | -3 | 5 | 6637 |

*(HORIZONTAL VELOCITY RELATIVE TO SURFACE)

Figure 4.10-4. - Powered descent profile.

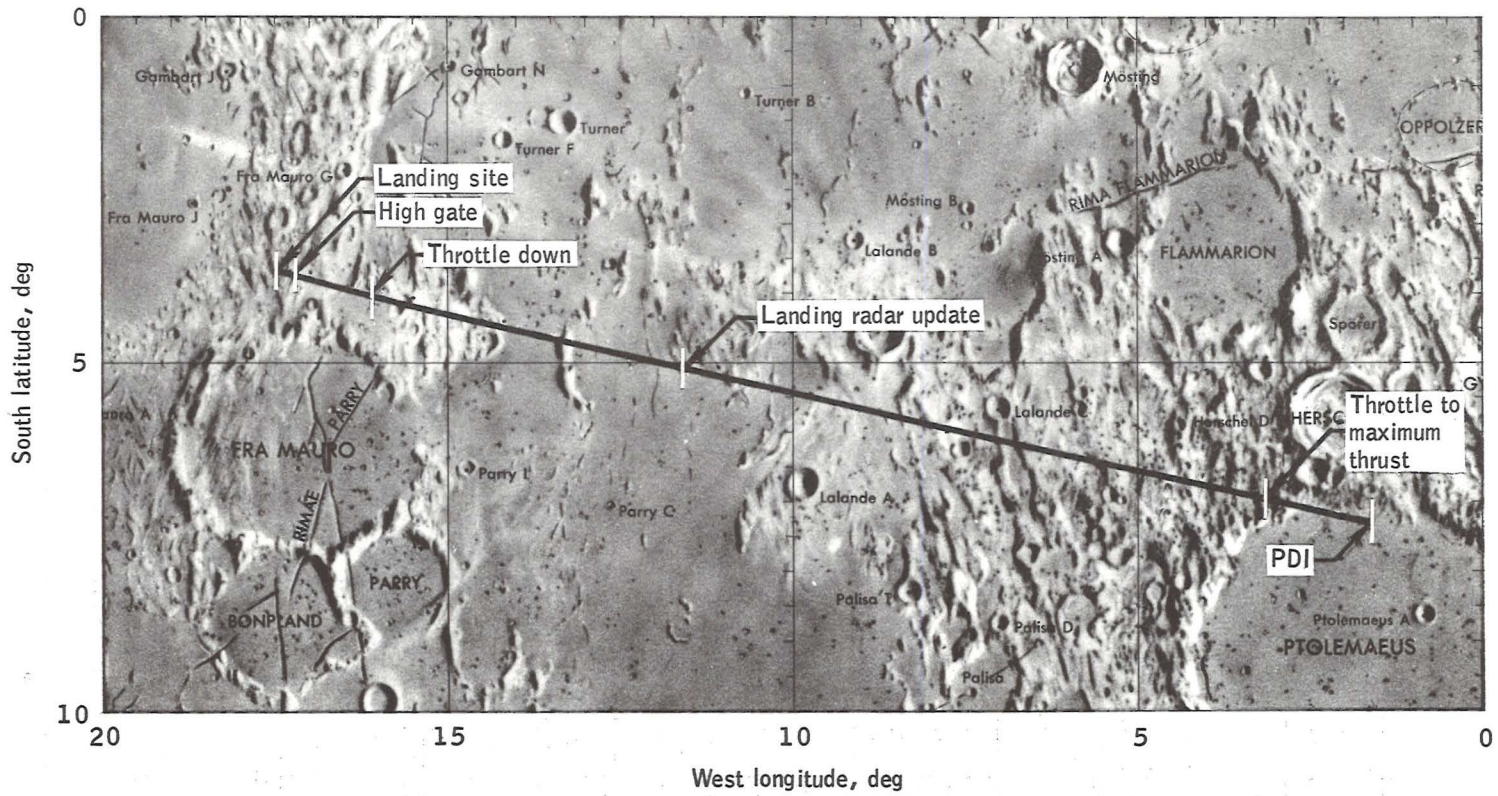
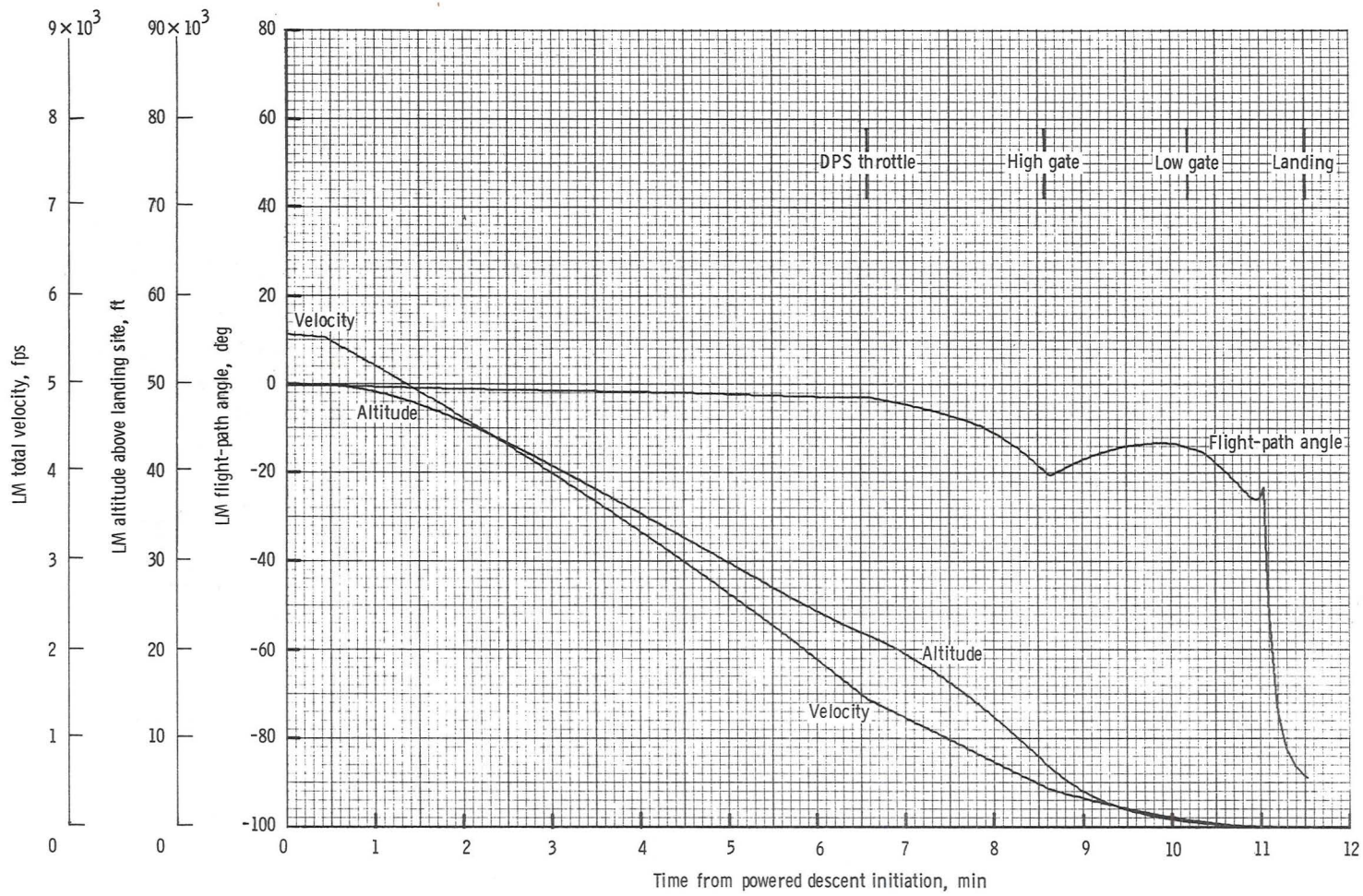
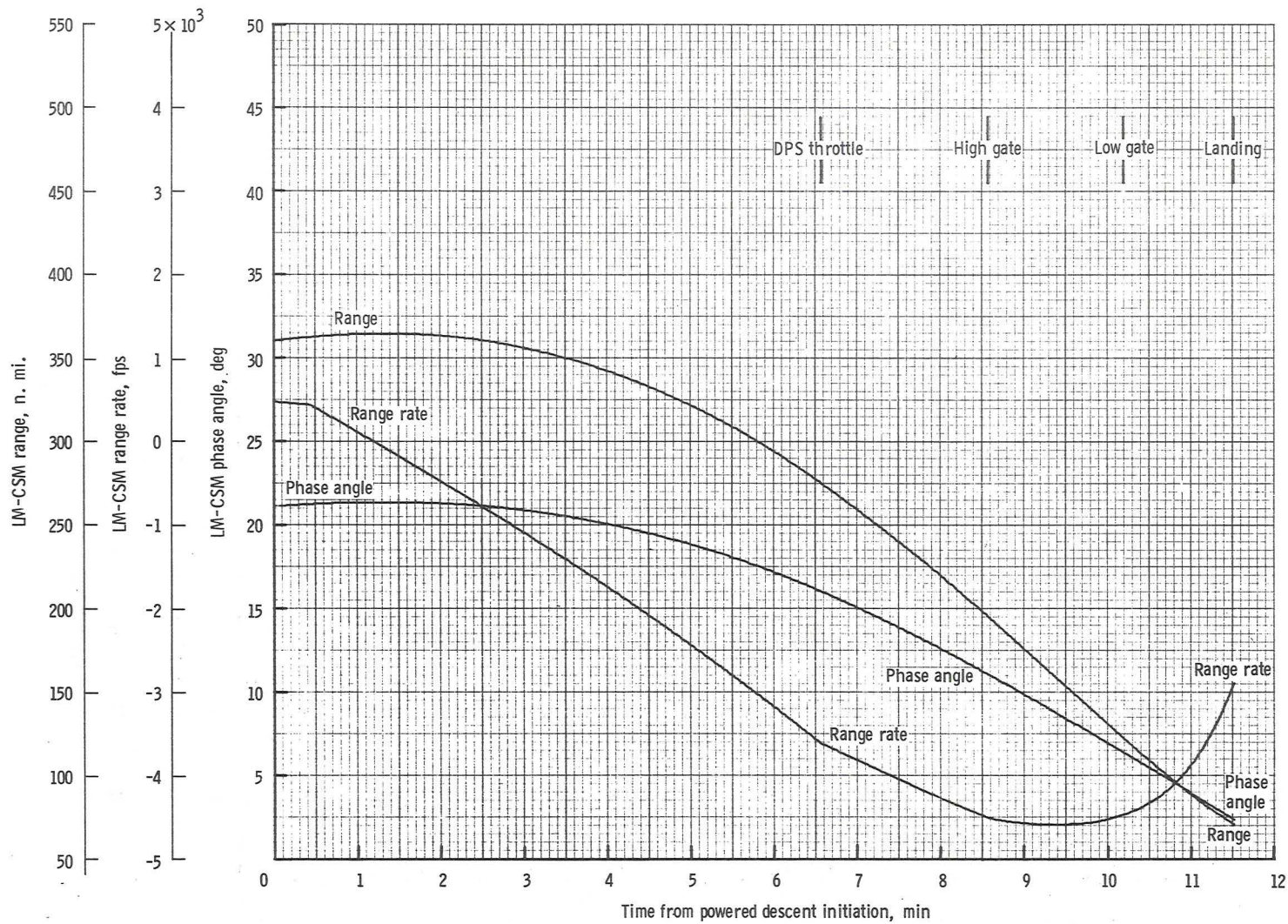

Figure 4.10-5.- LM powered descent groundtrack.



(a) LM velocity, altitude, and flight-path angle.

Figure 4.10-6. - Time histories of LM and LM-CSM trajectory parameters from PDI to landing.



(b) LM-CSM range, range rate, and phase angle.

Figure 4.10-6. - Continued.

4-73

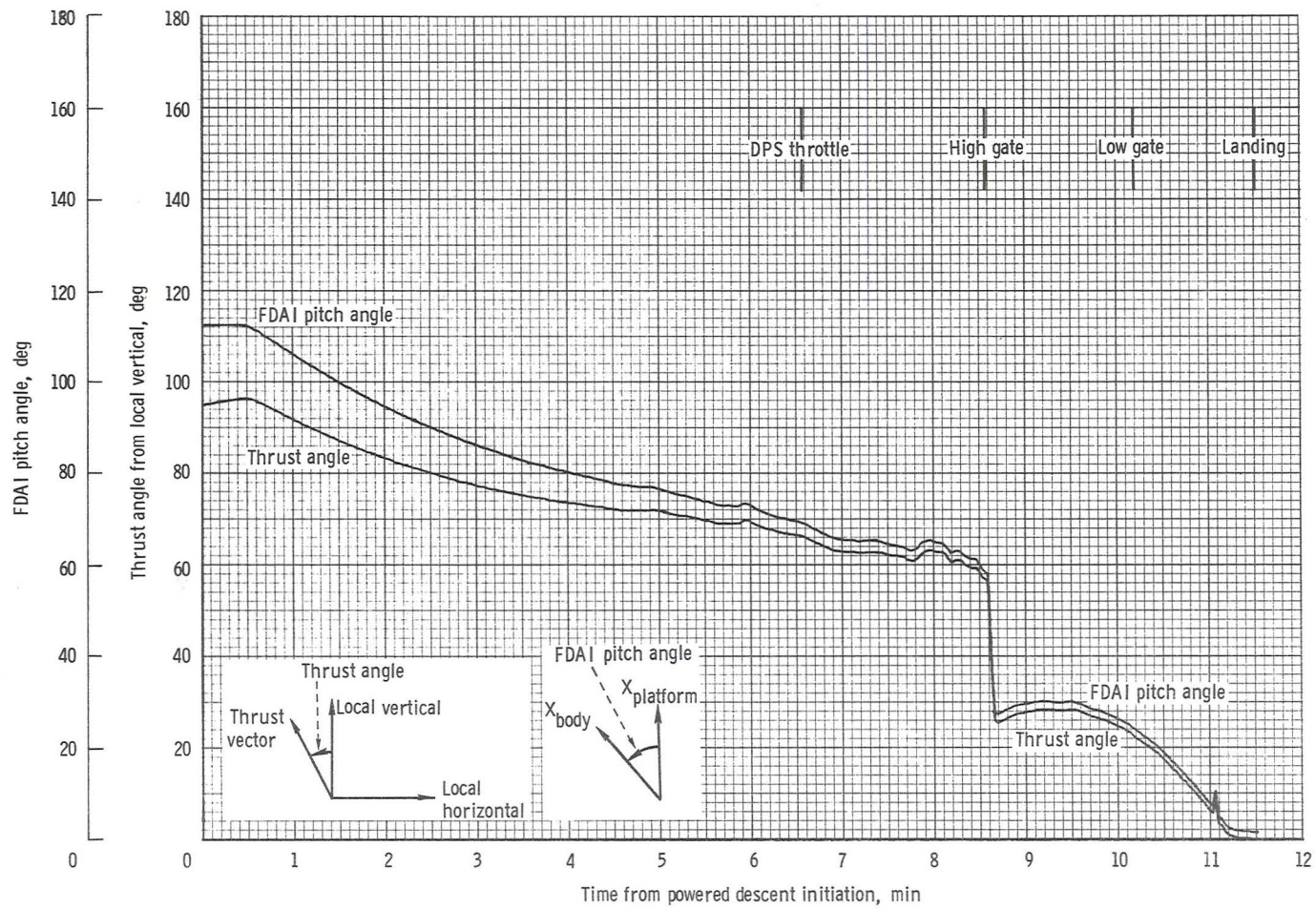

44-47

(c) FDAI pitch angle and thrust angle from local vertical.

Figure 4.10-6. - Continued.

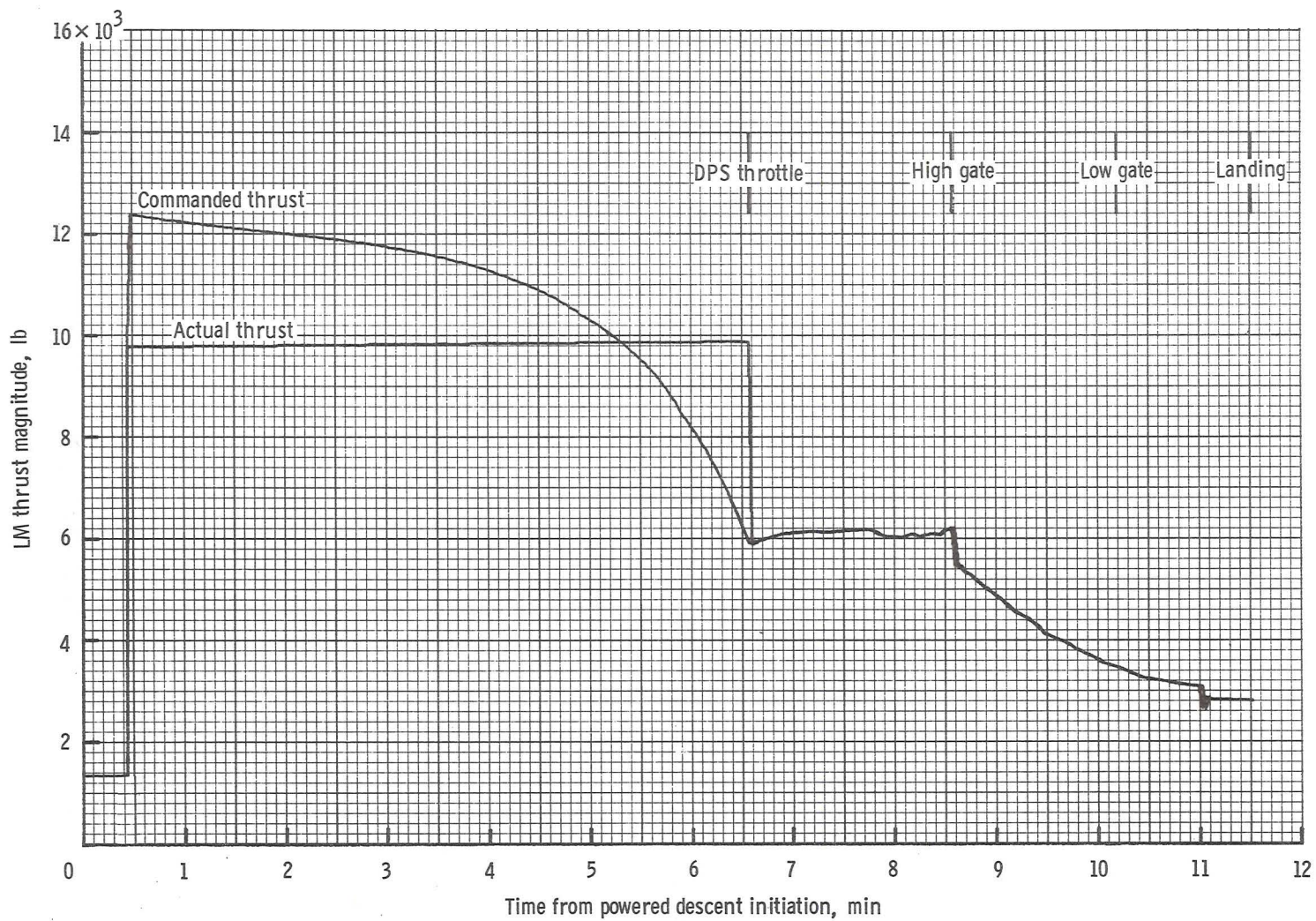

(d) LM thrust magnitude.

Figure 4.10-6.- Concluded.

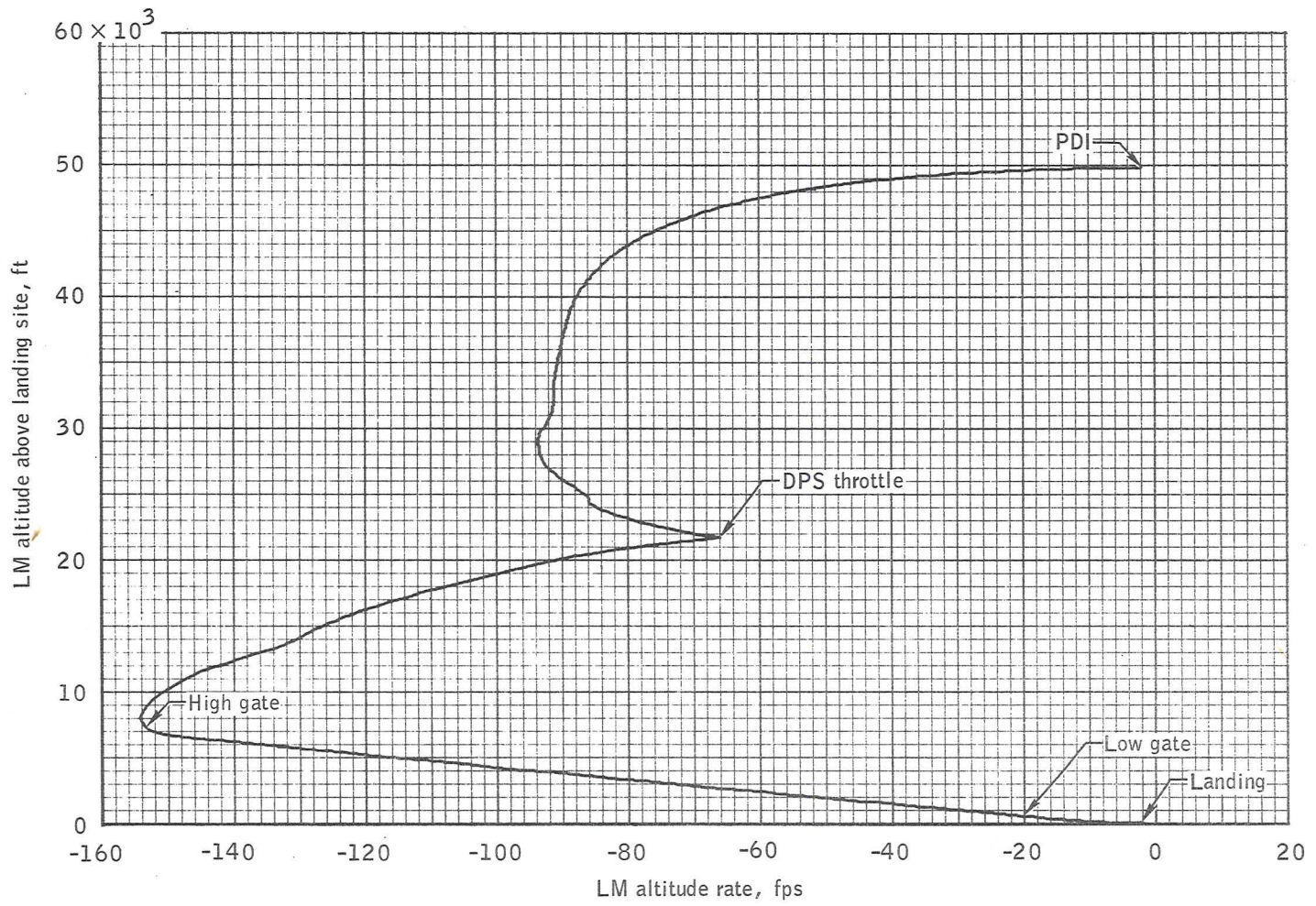
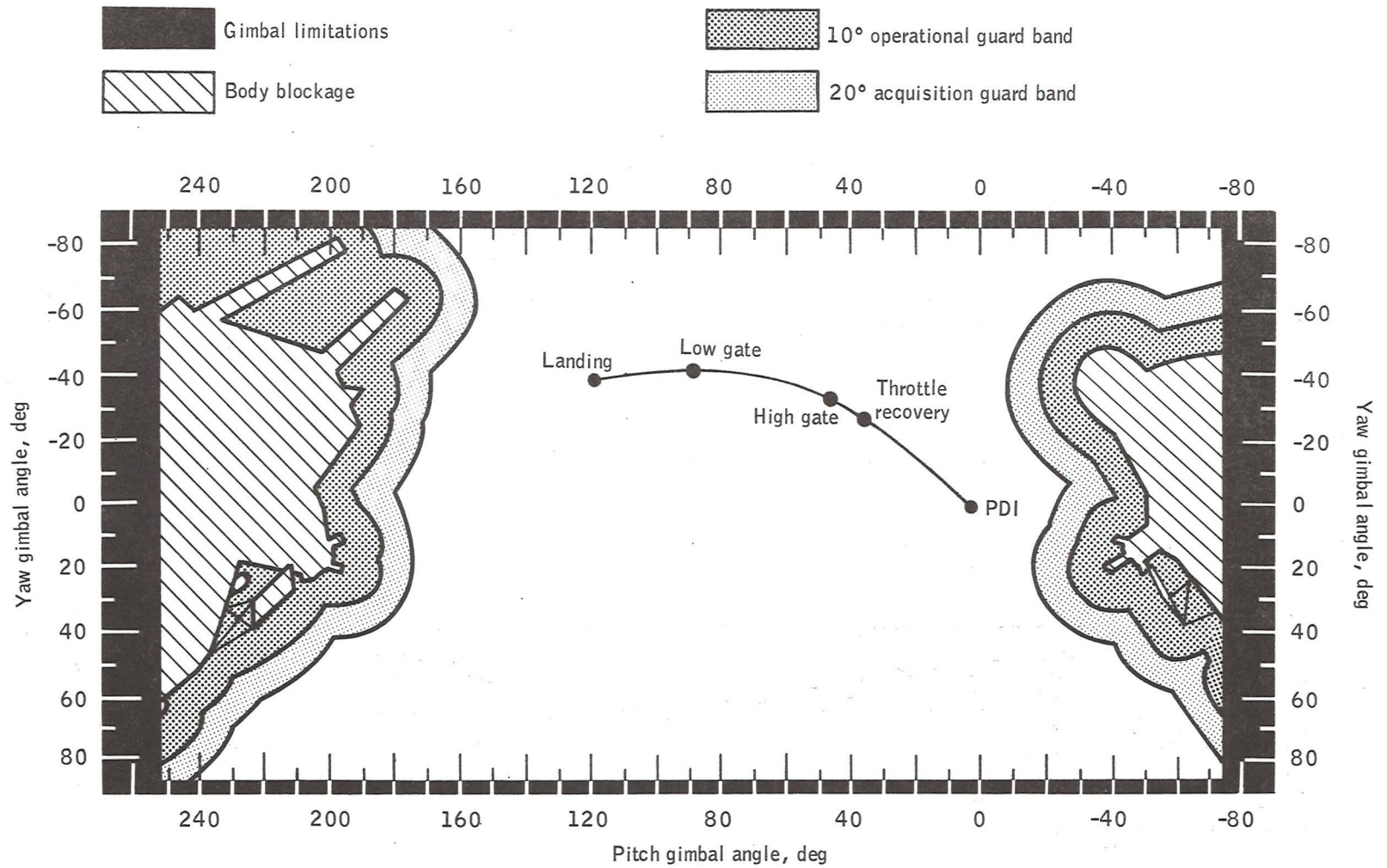

Figure 4.10-7.- Altitude above landing site versus altitude rate.



4-77

Figure 4.10-8.- S-band gimbal angle profile.

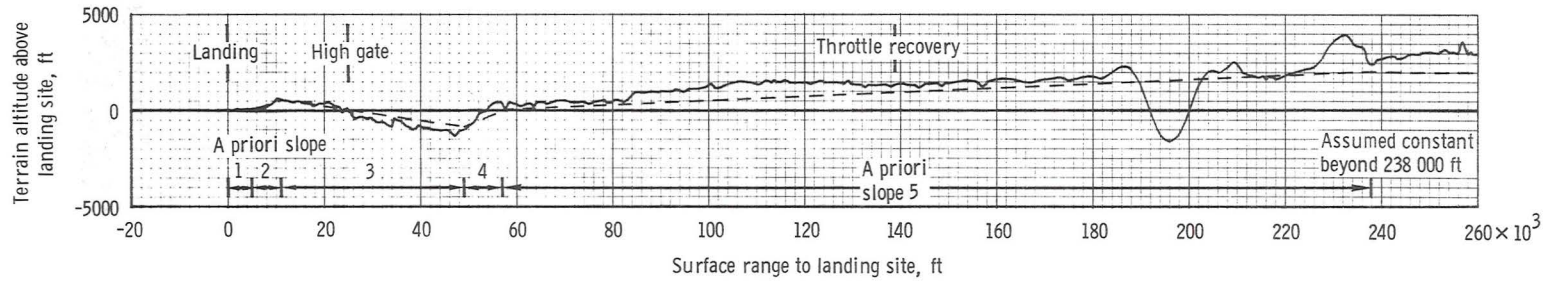
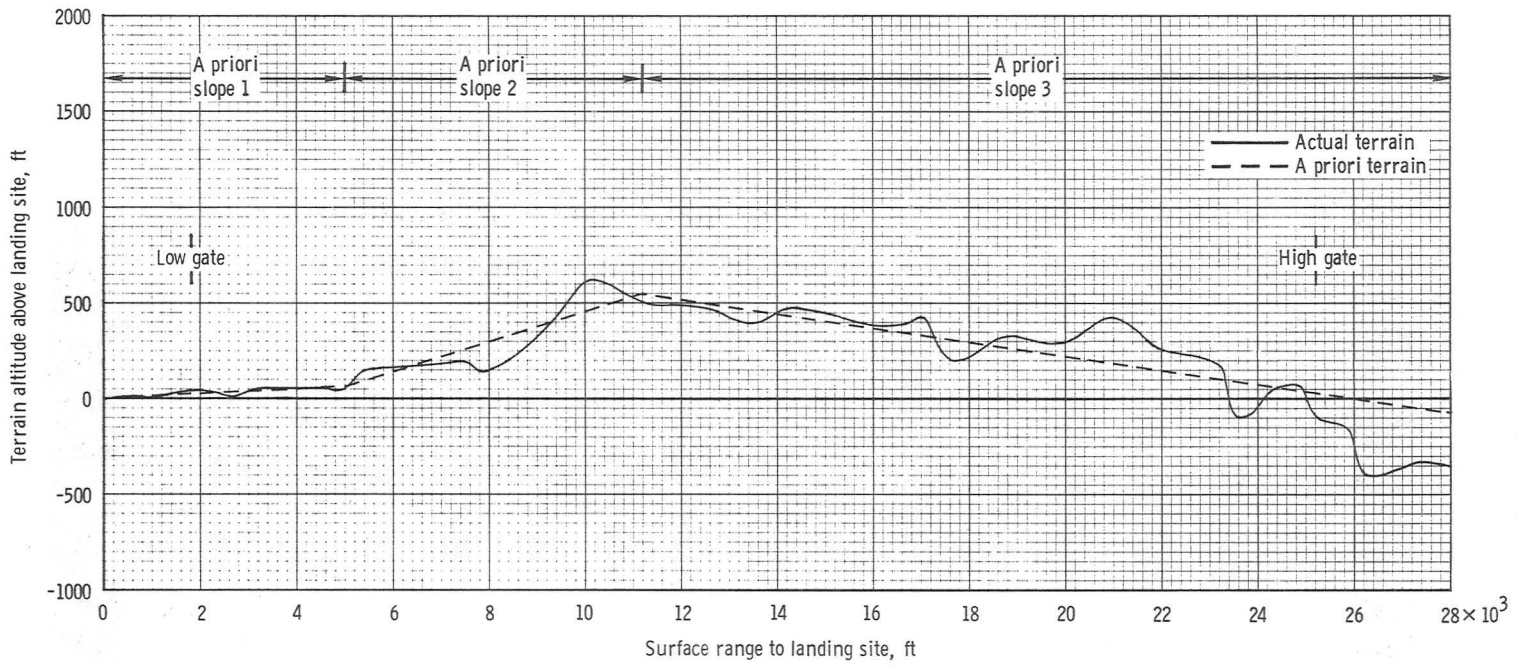

Figure 4.10-9. - Terrain altitude.

4-78

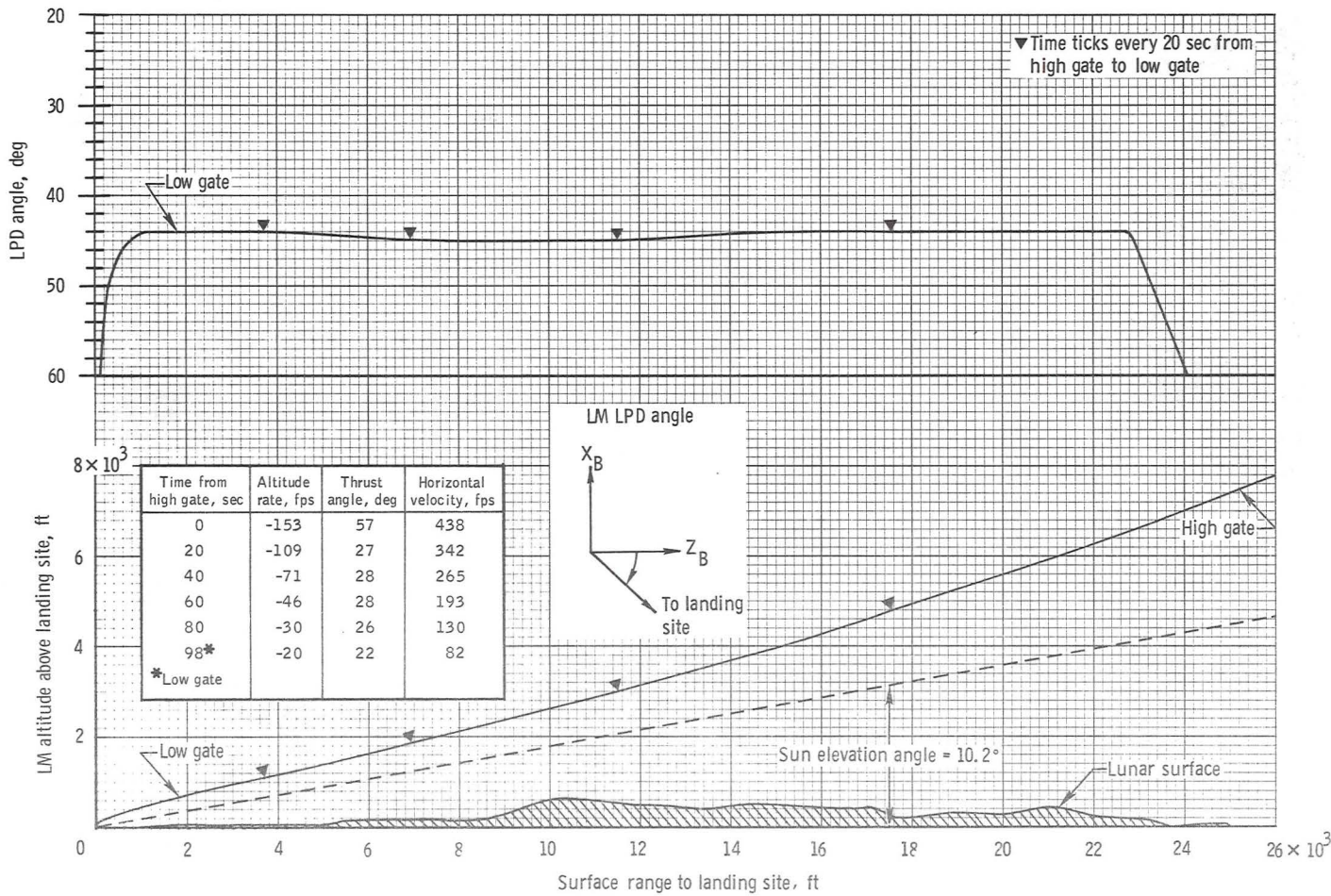

Figure 4.10-10. - Approach phase summary.

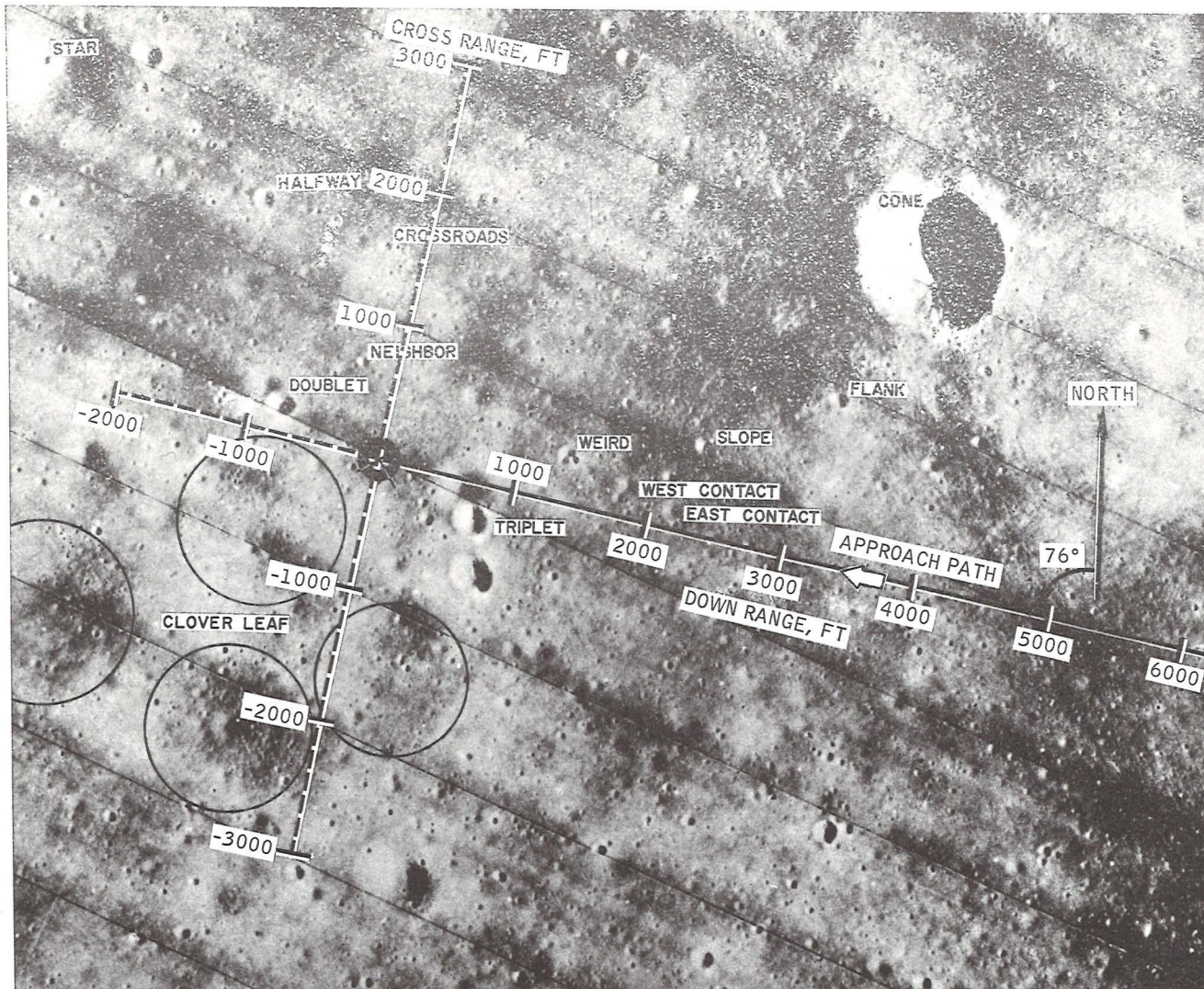

Figure 4.10-11.- Topography around the landing site at Fra Mauro.

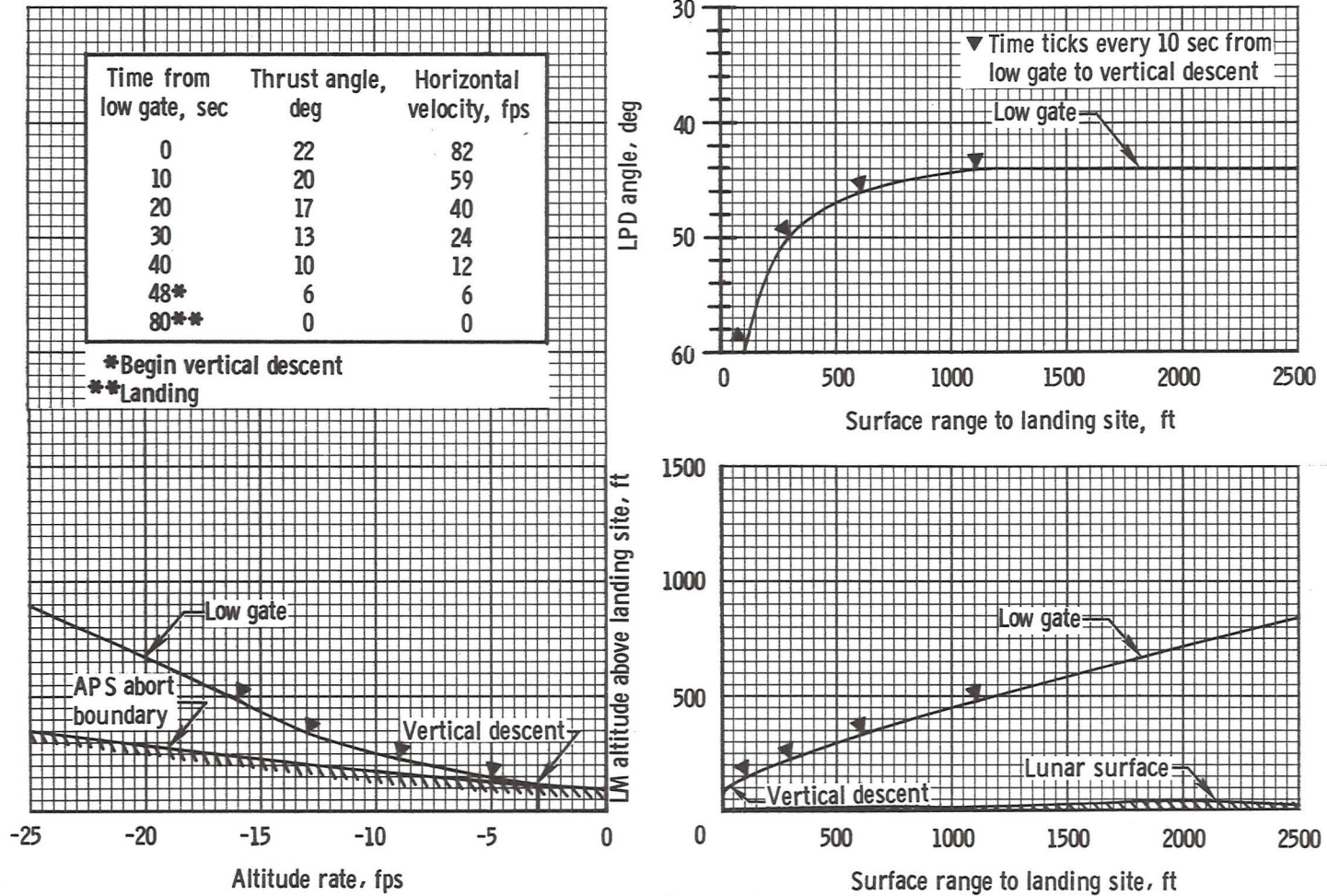

Figure 4.10-12. - Landing phase summary.

4.11 CSM PLANE CHANGE

4.11 CSM Lunar Orbit Plane Change

Approximately 35 hours 20 minutes after LOI, the CSM performs a plane change to place the LM in the CSM orbital plane at the time of LM lift-off. The maneuver is performed approximately 5.0 revolutions after LM landing. The target load for the maneuver is presented in table 4.11-I.

The burn characteristics are the following.

Burn initiation

| | |
|---------------------------------------------|-------------|
| Time, hr:min:sec, g.e.t. | 118:09:40.2 |
| Mass, lb | 35 585.0 |
| Altitude above LLS, n. mi. | 60.9 |
| Selenographic latitude, deg | -10.9 |
| Selenographic longitude, deg | 93.7 |
| Inertial velocity, fps | 5333.8 |
| Selenographic inclination, deg | 14.2 |
| Perilune altitude above LLS, n. mi. | 57.4 |
| Apolune altitude above LLS, n. mi. | 61.7 |

Burn cutoff

| | |
|---------------------------------------------|-------------|
| Time, hr:min:sec, g.e.t. | 118:09:58.5 |
| Altitude above LLS, n. mi. | 60.9 |
| Selenographic latitude, deg | -11.0 |
| Selenographic longitude, deg | 92.7 |
| Inertial velocity, fps | 5333.8 |
| Selenographic inclination, deg | 12.1 |
| Burn duration, sec | 18.4 |
| Inertial burn arc, deg | 0.9 |
| Plane change, deg | 3.9 |
| ΔV , fps | 360.7 |
| SPS propellant used, lb | 1249.8 |
| Perilune altitude above LLS, n. mi. | 57.4 |
| Apolune altitude above LLS, n. mi. | 61.7 |

TABLE 4.11-I.- TARGET LOAD FOR LUNAR ORBIT PLANE CHANGE MANEUVER

[Propulsion system: SPS; guidance: external ΔV]

(a) Target

| | |
|-----------------------------------------|-------------|
| t_{IG} , hr:min:sec, g.e.t. | 118:09:40.2 |
| ΔV_X , fps | -12.1 |
| ΔV_Y , fps | 360.5 |
| ΔV_Z , fps | 0.0 |
| Mass _{IG} , lb | 35 585.0 |

(b) REFSMMAT

Refer to table 5-IV

(c) Gimbal angles at t_{IG}

| | |
|--------------------|-----|
| IGA, deg | 0.0 |
| MGA, deg | 0.0 |
| OGA, deg | 0.0 |

4.12 LM ASCENT

4.12 LM Ascent

The LM powered ascent trajectory is an inplane launch into a 9.14-n. mi. (55 512-ft) by 50.96-n. mi. orbit about the moon. The LM lift-off time which is determined primarily by the LM-CSM phasing requirements for rendezvous occurs after approximately 33.5 hours of lunar stay time. A sketch of the powered ascent maneuver is shown in figure 4.12-1.

The LM ascent consists of two operational phases, a vertical rise phase and an orbital insertion phase. The first phase is necessary to achieve the desired altitude for terrain clearance. A description of trajectory parameters, vehicle attitudes, and the transition to the orbital insertion phase during vertical rise is shown in figure 4.12-2. For radial rates greater than 40 fps, the guidance switches to the orbital insertion phase; but, because of DAP steering lags, the pitchover does not occur until a radial rate of approximately 50 fps is achieved. Thus, the vertical rise phase is actually terminated 10 seconds after LM lift-off. During the vertical rise phase, the LM Z-body axis is rotated toward the desired azimuth which is normally in the CSM orbital plane.

The orbital insertion phase which is designed to insert the LM into the desired lunar orbit is described in figure 4.12-3. Included in this figure are orbital insertion parameters, total ascent phase performance, and onboard displays at insertion. Yaw steering is used during the orbital insertion phase if required to maneuver the LM into the CSM orbital plane or into a plane that is coplanar with the CSM orbit. Because the ascent is essentially inplane, no yaw steering is required. To avoid S-band communication blockage near the end of the orbit insertion phase, a 30° pilot yaw maneuver is initiated approximately 48 seconds into the ascent. Groundtrack information for the LM and CSM during powered ascent is shown in figure 4.12-4. The LM ascent radar coverage for a 0° minimum elevation is included in the mission radar timeline, table 1.1-V(c) (ref. 1). The radar coverage for a 3° minimum elevation is shown in volume II (ref. 1), table 1.1-V(g). The LM ascent weight summary is shown in table 4.12-I. The target load for LM ascent is presented in table 4.12-II, and the propulsion performance summary for LM ascent is shown in table 4.12-III. Because +X-axis RCS thrusting is used for attitude control, the data in table 4.12-III include the effect of both APS and RCS thrust. The APS interconnect is open during LM ascent, and all propellant is assumed to come from the APS tank.

Time histories of LM trajectory, attitude parameters, LM-CSM phasing, range, range rate and LM-CSM relative parameters are shown in figures 4.12-5, 4.12-6, and 4.12-7, respectively.

The LM-CSM range/range rate profile is shown in figure 4.12-8. The S-band gimble angle profile which shows the vehicle body blockage is shown in figure 4.12-9.

TABLE 4.12-I.- LM ASCENT WEIGHT SUMMARY

| | |
|--------------------------------------------------------------------------------------------|----------|
| Weight of LM crew, inert weights, consumables and unusable APS propellant, lb | 5 534.8 |
| LM APS fuel, lb | 2 002.2 |
| LM APS oxidizer, lb | 3 210.0 |
| Tanked APS propellant, lb | 5 212.2 |
| Total weight of ascent stage, lb | 10 810.9 |
| Net off-loaded weight on lunar surface, lb | -63.9 |
| Total ascent stage lift-off weight, lb | 10 747.0 |

TABLE 4.12-II.- TARGET LOAD FOR LM ASCENT

[Propulsion systems: APS, RCS; guidance:
orbit insertion (Pl2)]

(a) Target

| | |
|-------------------------------------------------------------|---------------|
| t_{IG} (lift-off), hr:min:sec, g.e.t. | 142:24:29.170 |
| R_D (desired injection radius), ft | 5 757 796.5 |
| Y_D (desired injection cross-range distance), ft | 0.0 |
| R_D (desired injection radial velocity), fps | 32.0 |
| Y_D (desired injection cross-range velocity), fps | 0.0 |
| Z_D (down-range velocity for desired injection), fps . . | 5 540.8 |
| Weight at t_{IG} , lb | 10 747.0 |

(b) REFSMMAT

Refer to table 5-V

(c) Gimbal angles at t_{IG}

| | |
|--------------------|-----|
| IGA, deg | 0.0 |
| MGA, deg | 0.0 |
| OGA, deg | 0.0 |

TABLE 4.12-III.- LM ASCENT PROPULSION PERFORMANCE SUMMARY

[Combined APS and RCS]

| Event | Time from lift-off, sec | APS thrust, lb | APS \dot{W} , lb/sec | RCS effective thrust, lb | RCS effective \dot{W} , lb/sec | Total thrust, lb | Total \dot{W} , lb/sec | I_{sp} , sec |
|--------------|-------------------------|----------------|------------------------|--------------------------|----------------------------------|------------------|--------------------------|----------------|
| LM lift-off | 0 | 3501.54 | 11.29 | 71.92 | 0.25 | 3573.46 | 11.54 | 309.58 |
| | 60 | 3492.37 | 11.25 | 62.24 | 0.22 | 3554.61 | 11.47 | 309.98 |
| | 120 | 3483.23 | 11.22 | 51.25 | 0.18 | 3534.48 | 11.40 | 310.17 |
| | 180 | 3475.45 | 11.19 | 39.39 | 0.14 | 3514.84 | 11.33 | 310.20 |
| | 240 | 3469.90 | 11.18 | 26.58 | 0.09 | 3496.48 | 11.27 | 310.17 |
| | 300 | 3466.96 | 11.18 | 12.30 | 0.04 | 3479.26 | 11.22 | 310.16 |
| | 360 | 3466.61 | 11.18 | 12.94 | 0.04 | 3479.55 | 11.22 | 310.11 |
| | 420 | 3468.29 | 11.17 | 25.25 | 0.09 | 3493.54 | 11.26 | 310.12 |
| LM insertion | 430.7 | 3468.74 | 11.18 | 29.53 | 0.10 | 3498.27 | 11.28 | 310.13 |

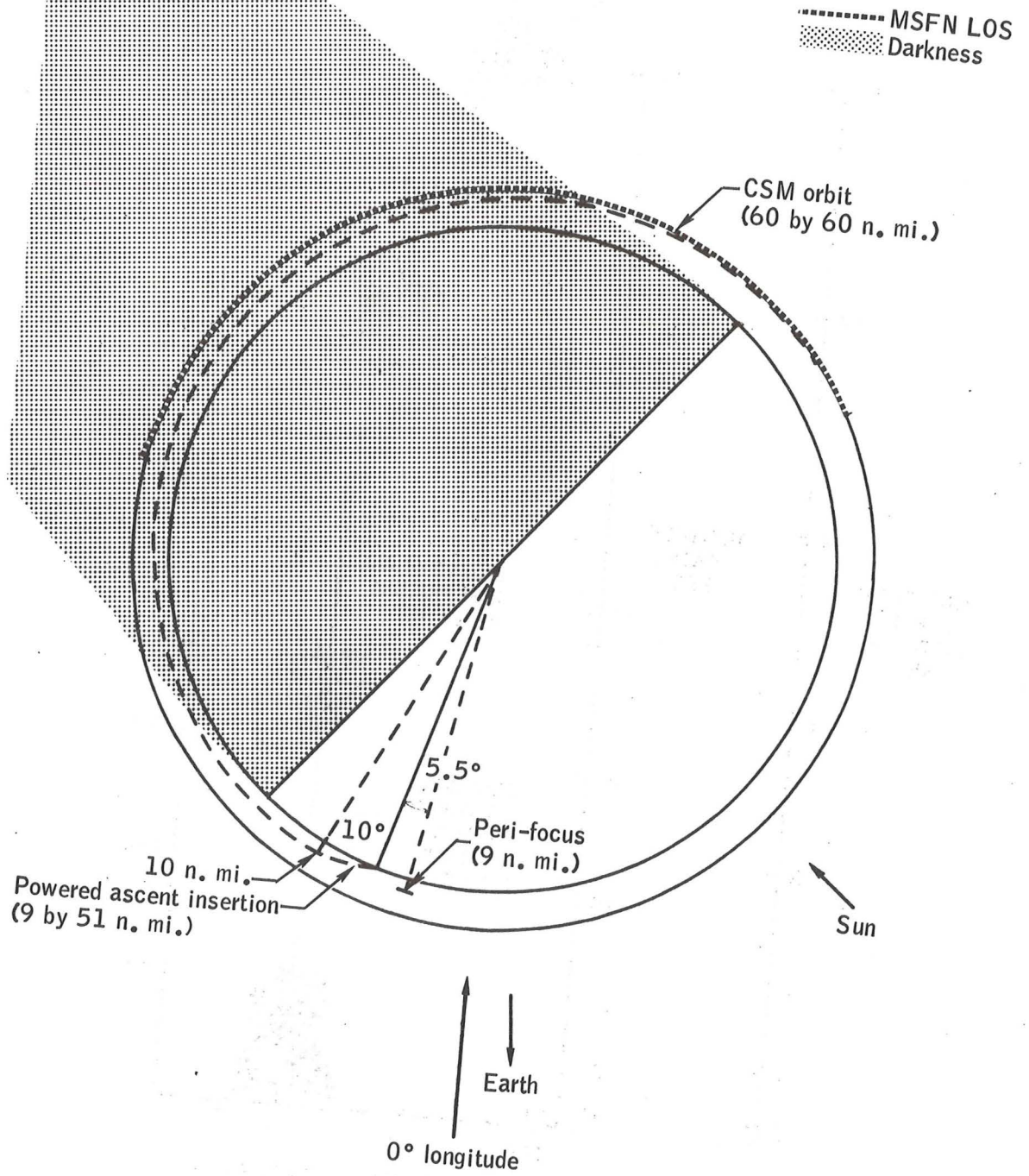

Figure 4.12-1.- LM ascent.

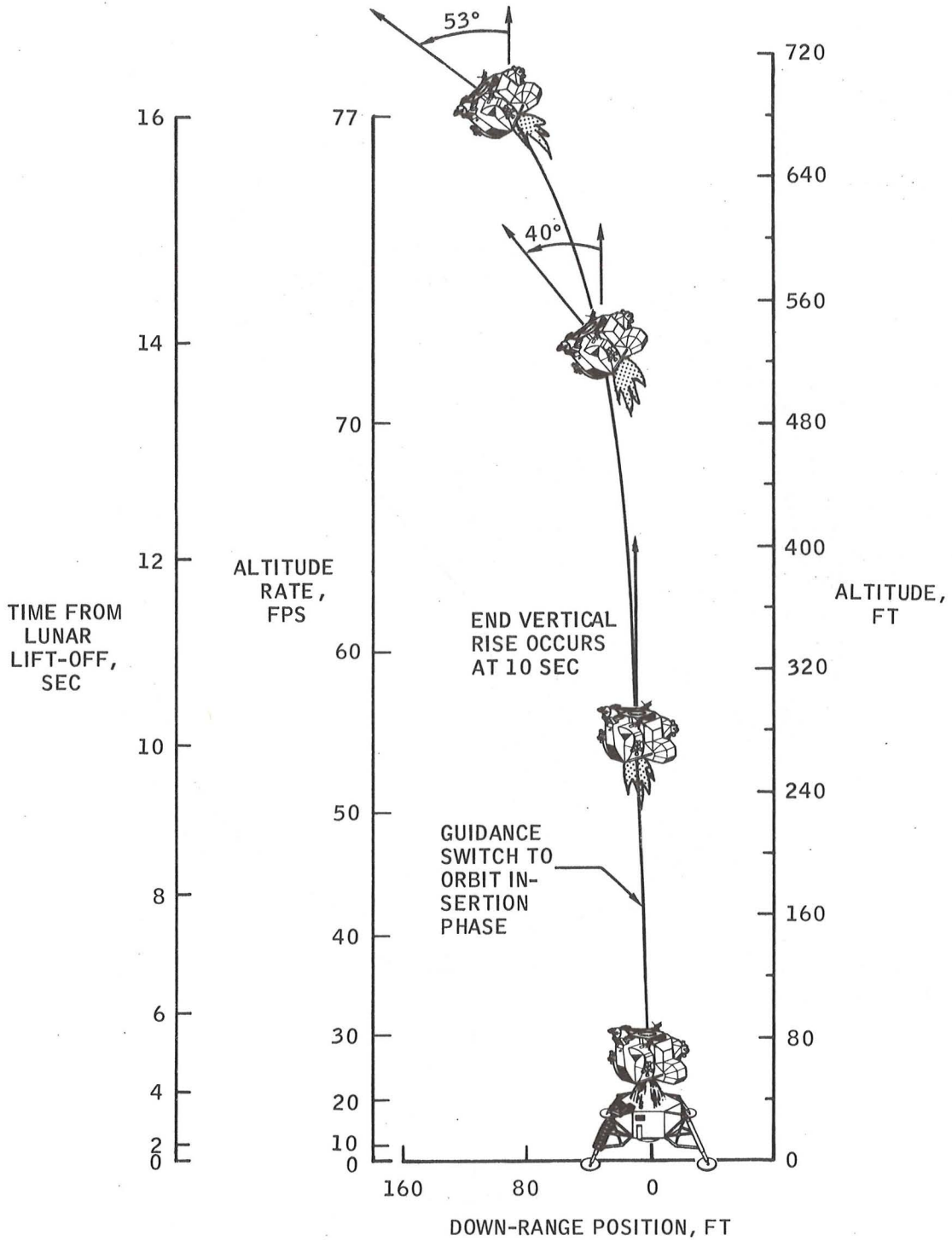
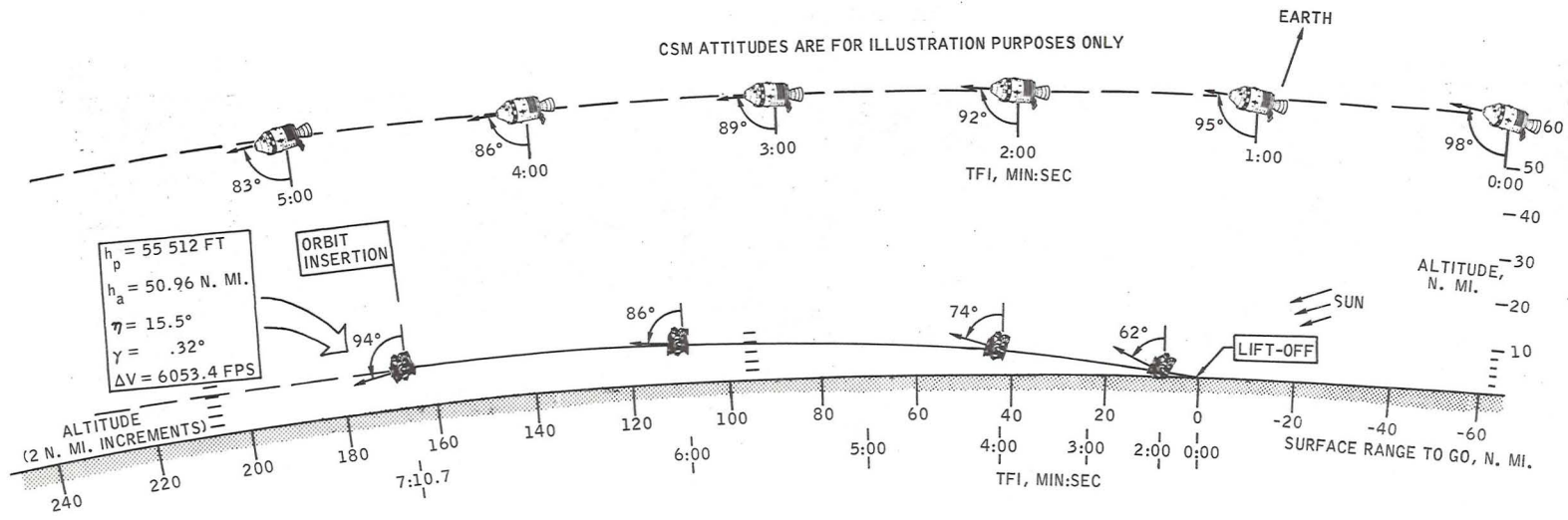

Figure 4.12-2.- Vertical rise phase.



| SUMMARY | | | | | | | |
|----------------------|--------------|------------------------|--------------------|--------------|------------------|------------|----------------|
| EVENT | TFI, MIN:SEC | INERTIAL VELOCITY, FPS | ALTITUDE RATE, FPS | ALTITUDE, FT | ΔV , FPS | WEIGHT, LB | PROPELLANT, LB |
| LIFT-OFF | 0:00 | 15.1 | 0 | 0 | 0 | 10 747.0 | 0 |
| END OF VERTICAL RISE | 0:10 | 55.7 | 54.2 | 269.4 | 107.5 | 10 630.8 | 115.4 |
| BEGIN LM PILOT YAW | 0:48 | 324.8 | 113.8 | 3 726.5 | 526.0 | 10 190.3 | 552.6 |
| END LM PILOT YAW | 1:00 | 435.0 | 126.5 | 5 169.0 | 661.6 | 10 051.5 | 690.3 |
| | 2:00 | 1036.0 | 172.5 | 14 279.2 | 1366.9 | 9 360.5 | 1376.2 |
| | 4:00 | 2474.5 | 184.8 | 36 727.0 | 2934.6 | 7 990.3 | 2736.0 |
| | 6:00 | 4272.9 | 105.9 | 54 969.6 | 4779.3 | 6 632.3 | 4083.8 |
| ORBIT INSERTION | 7:10.7 | 5540.6 | 31.3 | 59 932.7 | 6053.4 | 5 831.2 | 4878.5 |

Figure 4.12-3.- Orbit insertion phase.

4-95

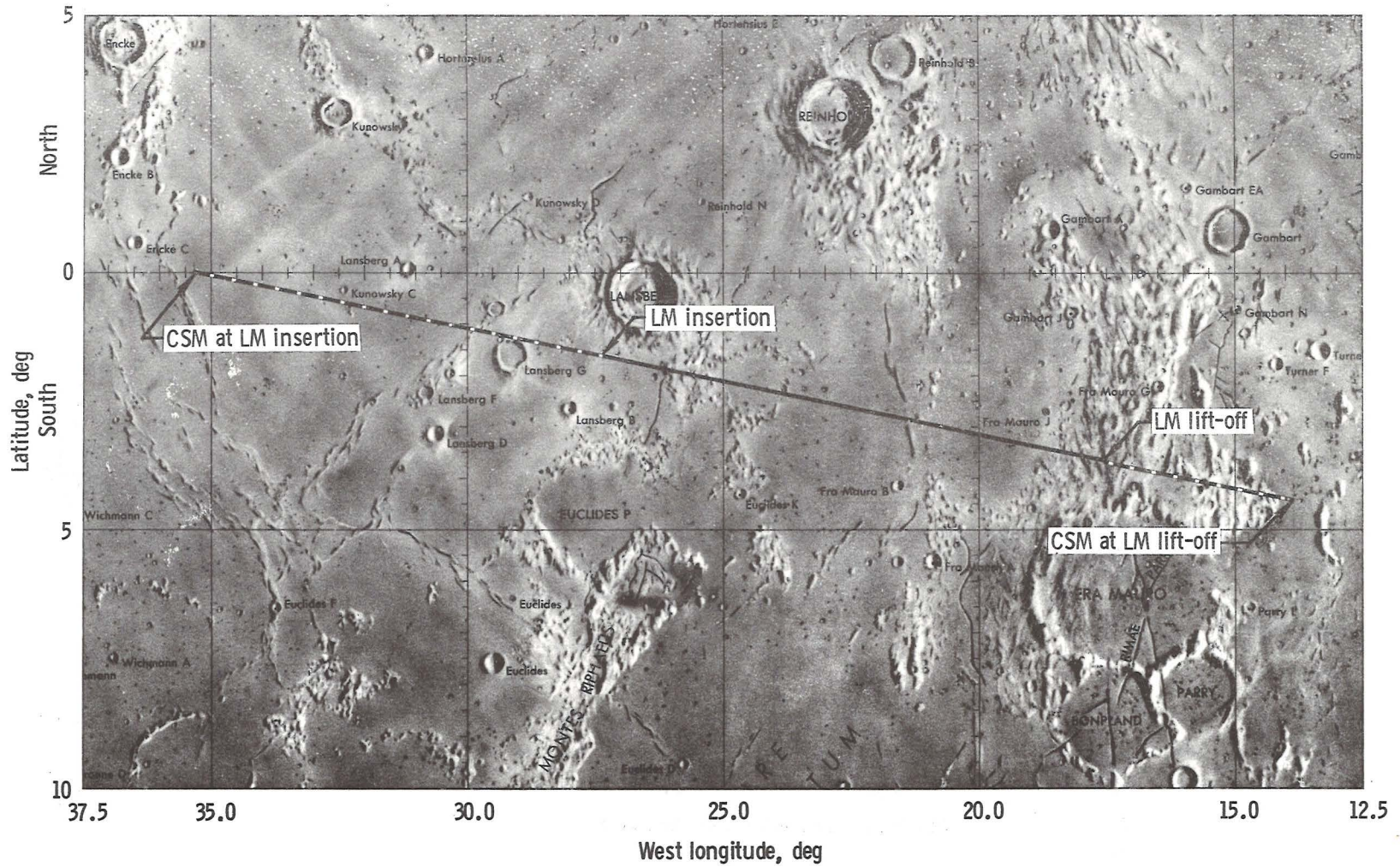

96-7

Figure 4.12-4.- LM and CSM groundtracks.

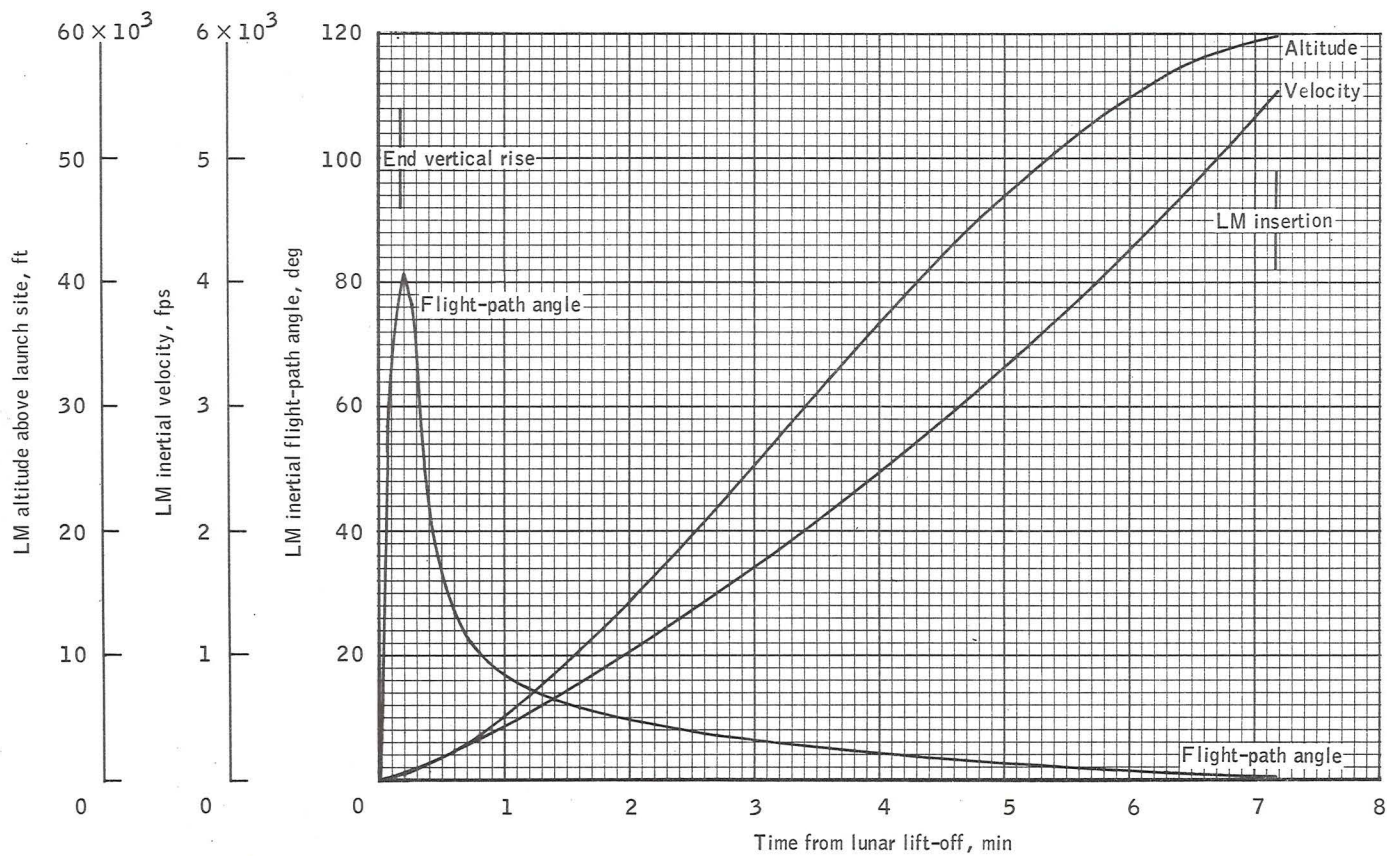

(a) LM altitude, inertial velocity, and inertial flight-path angle.

Figure 4.12-5. - Time histories of LM trajectory parameters from lunar lift-off to LM insertion.

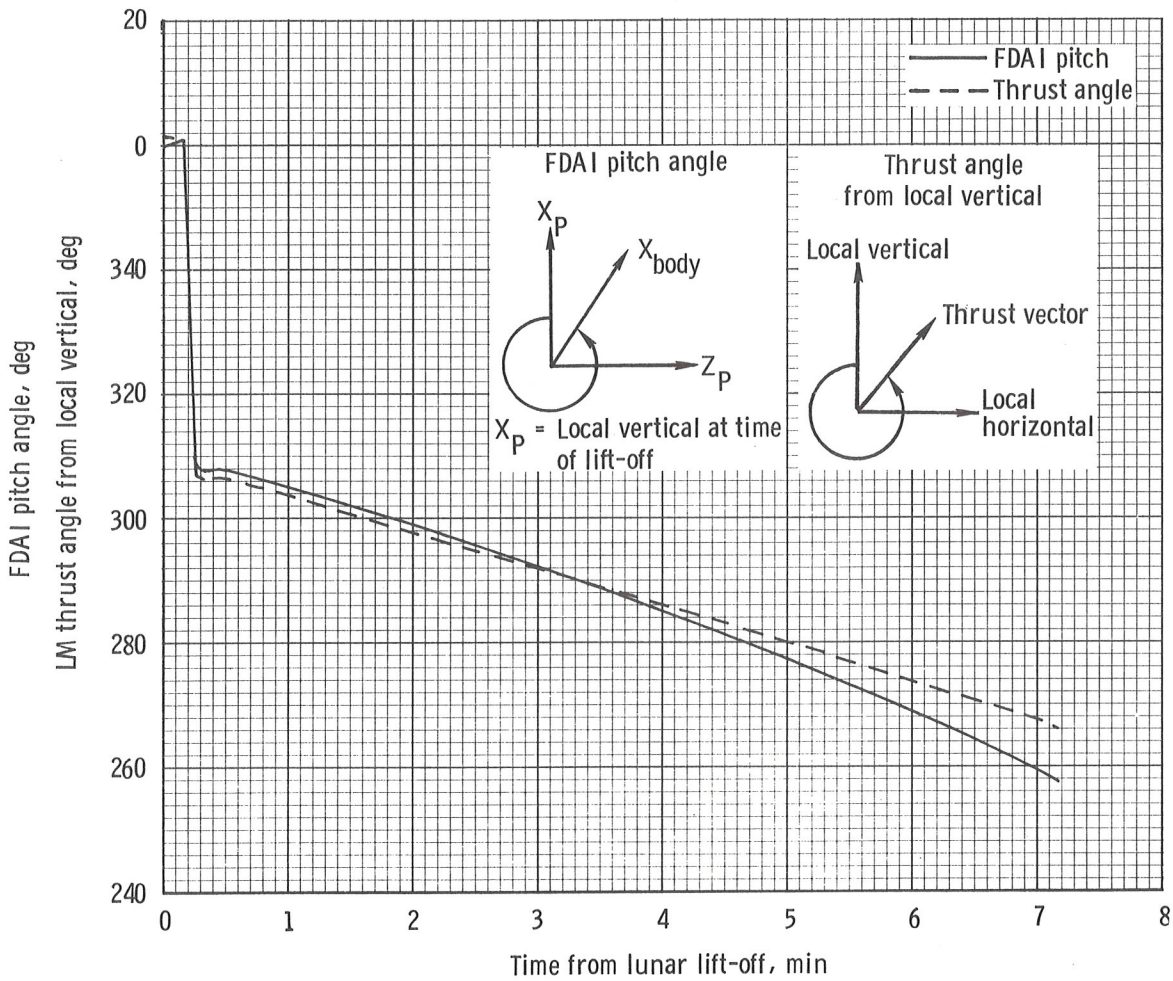
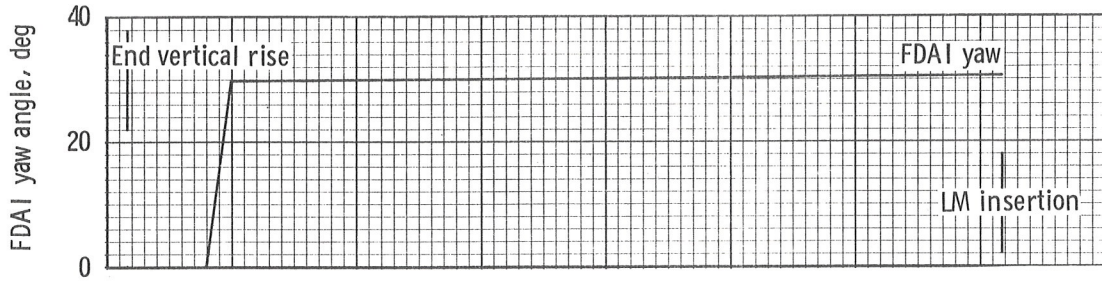

(b) LM thrust angle and FDAI angles.

Figure 4.12-5. - Concluded.

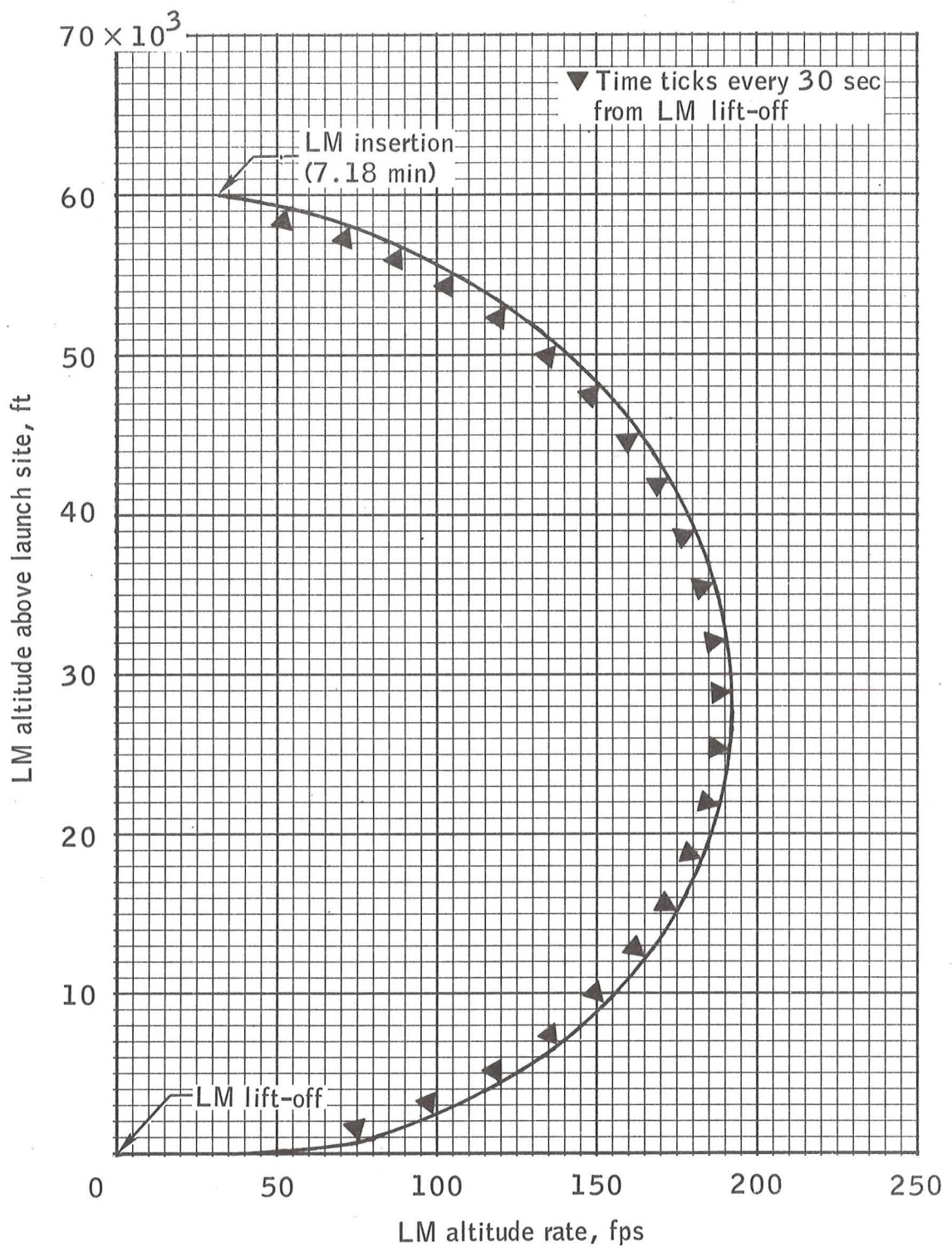

Figure 4.12-6.- LM altitude versus altitude rate during powered ascent.

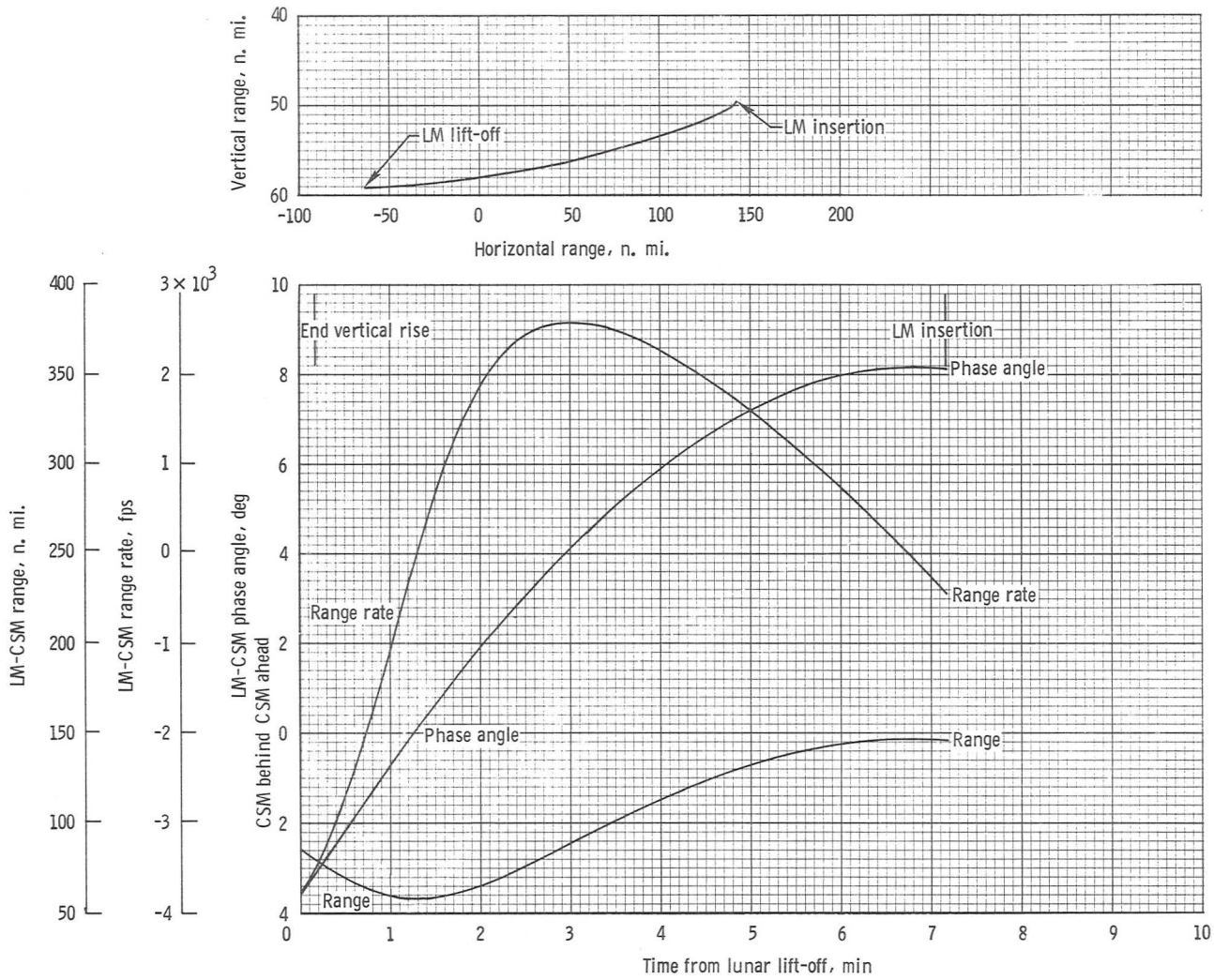

Figure 4.12-7. - LM-CSM phase angle, range, and range rate versus time from lift-off and vertical range versus horizontal range (CSM referenced).

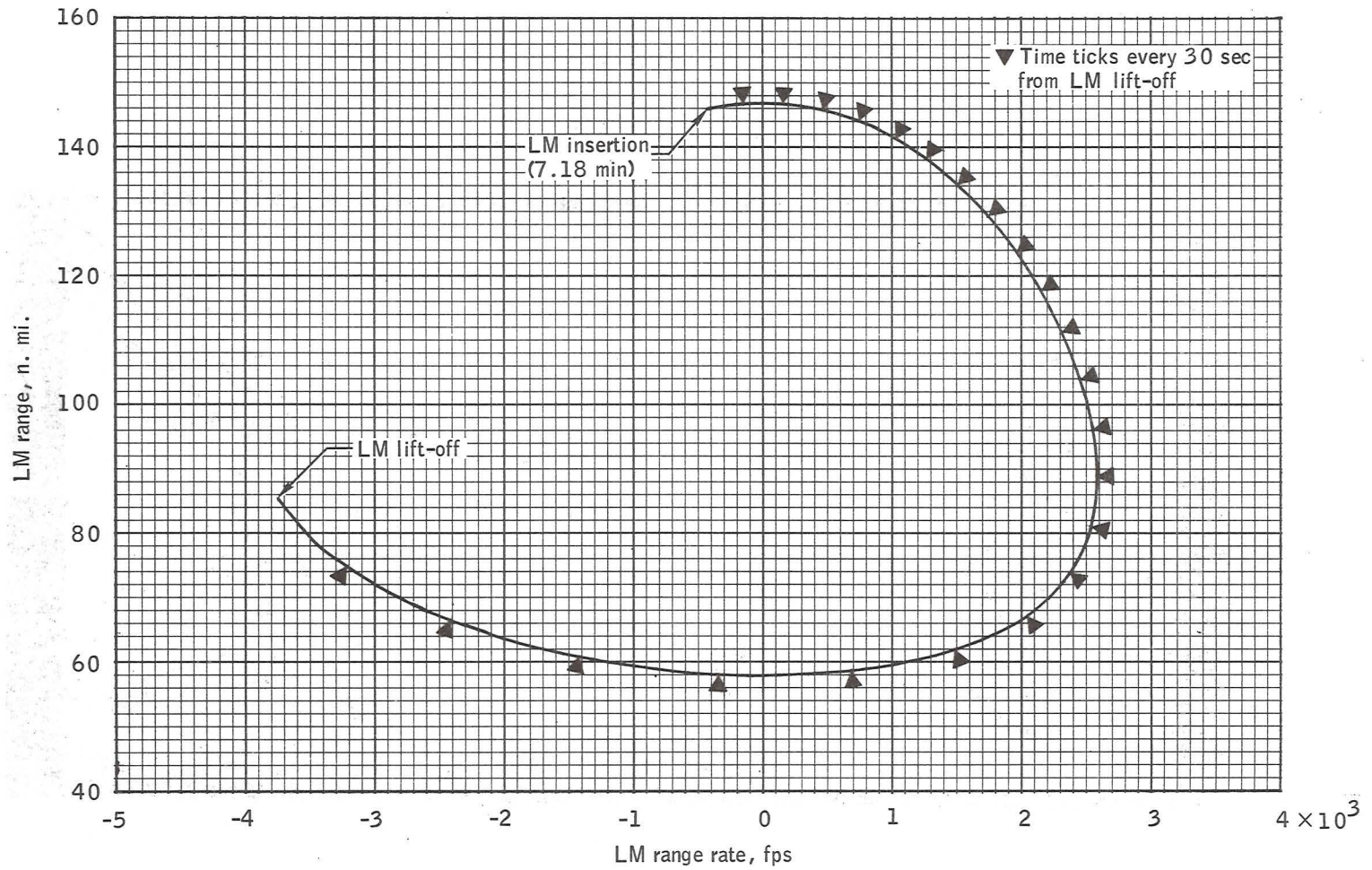

Figure 4.12-8.- LM-CSM range versus LM-CSM range rate during powered ascent.

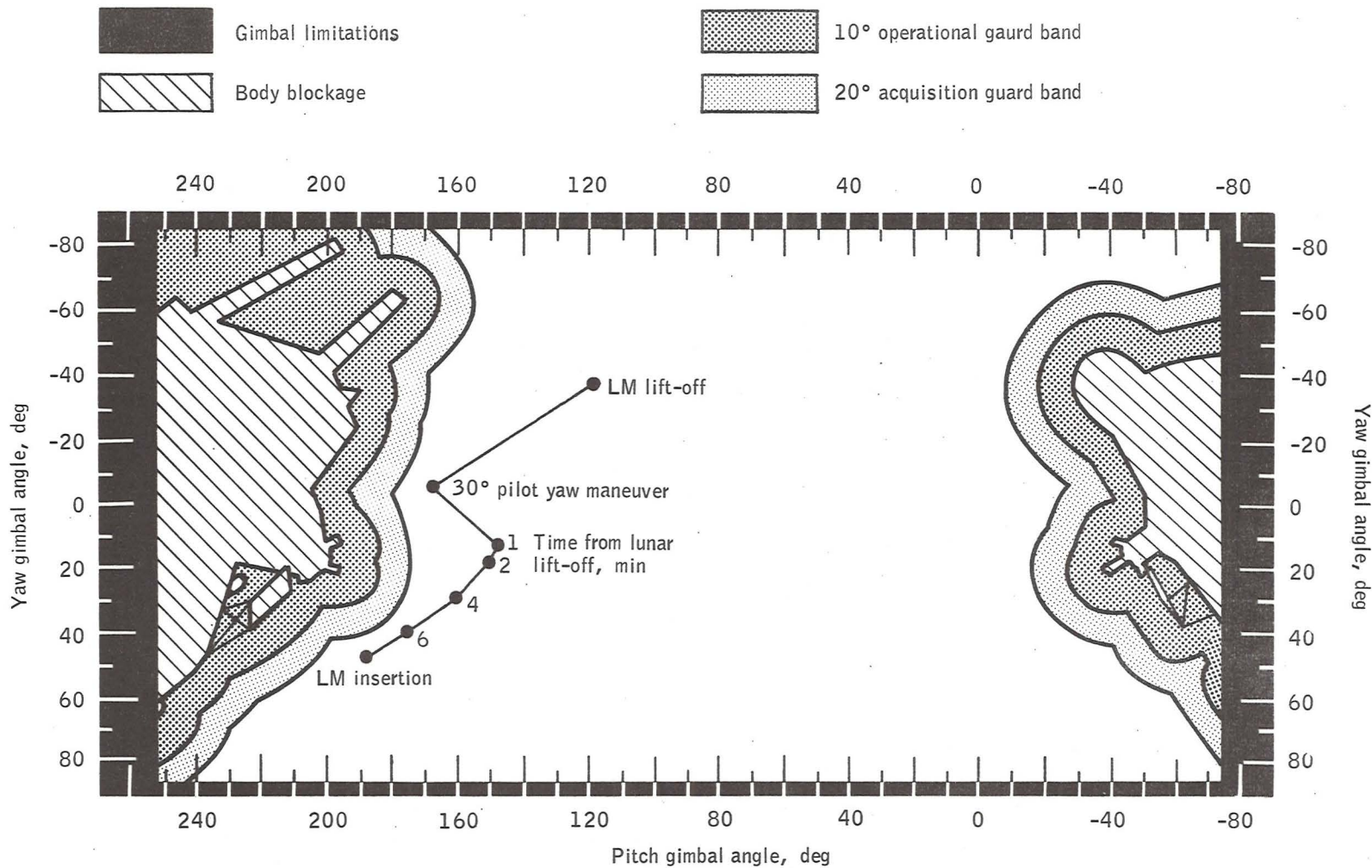

Figure 4.12-9.- S-band gimbal angle profile during powered ascent.

4.13 RENDEZVOUS SEQUENCE

4.13 Rendezvous Sequence

4.13.1 Sequence summary.— After insertion of the LM into orbit, the LM will compute and execute the early rendezvous sequence which nominally consists of two major maneuvers, TPI and TPF. A nominally-zero tweak maneuver will be scheduled 3 minutes after insertion, and two nominally-zero midcourse correction maneuvers will be scheduled between TPI and TPF; the TPF maneuver is actually divided into several braking maneuvers. The complete maneuver sequence is presented in table 4.13-I. All maneuvers except TPI will be performed with the LM RCS system with either two jets or four jets for a prescribed quad for thrust vector control. Latest planning required TPI to be performed with the APS preceded by a four-jet RCS ullage maneuver; however, this trajectory was computed with a two-jet RCS ullage maneuver. The entire maneuver sequence from lift-off through docking requires approximately 1.8 hours.

Before detailed information is presented about each maneuver, some general mission and trajectory design requirements for the rendezvous plan are noted.

- a. TPI will occur 38 minutes after insertion.
- b. The LM will be 15 n. mi. below the CSM orbit at TPI.
- c. Braking should occur in daylight; stationkeeping should begin approximately 25 minutes after the vehicles enter sunlight.

The orbital schematic for the rendezvous sequence is presented in figure 4.13-1. The time histories of range, range rate, phase angle, CSM-LM elevation angles, and the CSM-LM-sun angles are presented in figures 4.13-2(a) through 4.13-2(e). The relative motion of the LM with respect to the CSM is shown in figure 4.13-2(f). The onboard tracking, lighting, and mission events summary are presented in figure 4.13-3 and in table 4.13-II.

4.13.2 Tweak maneuver.— A nominally-zero tweak maneuver is scheduled 3 minutes after insertion. The purpose of this maneuver is to maintain the nominal TPI offsets (both inplane and out of plane) when insertion dispersions occur. Out-of-plane dispersions will be eliminated by a tweak/TPI combination. The tweak maneuver would force a common node at TPI, and the out-of-plane velocity component would be reduced to zero at TPI. Any out-of-plane situation not eliminated by the tweak/TPI combination must be eliminated during terminal phase.

4.13.3 TPI.— The TPI maneuver executed with the APS 18.5 minutes prior to daylight is initiated 38 minutes after insertion. The insertion orbit is such that at this time the LM will be 29 n. mi. behind and 15.0 n. mi. below the CSM. The thrust direction is posigrade 46.9° below the local horizontal. The APS burn is preceded by a +X (two-jet) RCS ullage maneuver which is 13.5 seconds long and overlaps the main engine burn by 0.5 second. The APS burn duration is 4.0 seconds.

The Lambert targeting for this maneuver is based on a 130° CSM central travel angle between TPI and TPF. The target load for this maneuver is presented in table 4.13-III. The LM-CSM orbital geometry is shown in figure 4.13-4. The characteristics of the TPI maneuver are as follows.

Ullage maneuver (two-jet RCS, +X)

| | |
|---------------------------------------------|-------------|
| Start time, hr:min:sec, g.e.t. | 143:09:26.9 |
| Latitude, deg N | 11.2 |
| Longitude, deg W | 149.0 |
| Altitude above landing site, n. mi. | 44.7 |
| Phase angle, deg | 1.7 |
| Duration, sec | 13.0 |
| ΔV , fps | 14.4 |
| Propellant used, lbs | 9.3 |

Main engine burn

| | |
|------------------------------------------|-------------|
| Start time, hr:min:sec, g.e.t. | 143:09:39.9 |
| ΔV , fps | 77.8 |
| Duration, sec | 4.0 |
| Propellant used, lb | 45.3 |

TPI termination

| | |
|---------------------------------------------|-------------|
| Time, hr:min:sec, g.e.t. | 143:09:43.9 |
| Latitude, deg N | 11.1 |
| Longitude, deg W | 149.9 |
| Altitude above landing site, n. mi. | 44.8 |
| Resultant h_a/h_p , n. mi. | 61.0/44.6 |
| Catchup rate, deg/min | 0.034 |

4.13.4 Midcourse corrections and TPF.- MC-1 and MC-2 occur 15 and 30 minutes after TPI, respectively, and are nominally-zero maneuvers. The terminal phase braking schedule performed with the two-jet -Z-thrusters is presented in table 5-XIV. Line-of-sight corrections will be made as required. Final approach and stationkeeping should occur at approximately $5^{\text{d}}23^{\text{h}}54^{\text{m}}47.8^{\text{s}}$ g.e.t., approximately 27 minutes after the vehicles enter sunlight on the back side of the moon. Docking should begin at approximately $6^{\text{d}}00^{\text{h}}10^{\text{m}}00^{\text{s}}$ g.e.t. to complete 1.8 hours of rendezvous activities.

TABLE 4.13-I.- RENDEZVOUS MANEUVER SUMMARY

| Event | Time, day:hr:min:sec, g.e.t. | Propulsion system | Burn time, sec | Total ΔV , fps | Weight at ignition, lb | Propellant used ^a , lb | Resultant orbit ^b h_a/h_p , n. mi. | Range at cutoff, n. mi. | Range rate at cutoff, fps |
|----------------------------|------------------------------------|----------------------|----------------------|------------------------------|------------------------------|-----------------------------------------|----------------------------------------------------------|-------------------------------|---------------------------------|
| Tweak ^c | 5:22:34:39.9 | RCS | 0.0 | 0.0 | 5831.5 | 0.0 | 50.3/9.1 | 133.0 | -439.5 |
| TPI APS burn ^d | 5:23:09:39.9 | APS | 4.0 | 77.8 | 5822.2 | 45.3 | 61.0/44.6 | 32.5 | -134.3 |
| MC-1 ^c | 5:23:24:39.9 | RCS +Z (two-jet) | 0.0 | 0.0 | 5776.9 | 0.0 | 61.0/44.6 | 14.9 | -97.3 |
| MC-2 ^c | 5:23:39:39.9 | RCS +Z (two-jet) | 0.0 | 0.0 | 5776.9 | 0.0 | 61.0/44.6 | 4.5 | -45.6 |
| First braking maneuver | 5:23:50:32.8 | RCS -Z (two-jet) | 12.0 | 13.4 | 5776.9 | 8.6 | 60.0/52.2 | 0.4 | -19.6 |
| Second braking maneuver | 5:23:51:45.7 | RCS -Z (two-jet) | 8.7 | 9.7 | 5768.3 | 6.2 | 59.3/55.9 | 0.2 | -9.8 |
| Third braking maneuver | 5:23:53:24.0 | RCS -Z (two-jet) | 4.3 | 4.8 | 5762.1 | 3.0 | 59.0/57.9 | 0.08 | -4.9 |
| Fourth braking maneuver | 5:23:54:43.6 | RCS -Z (two-jet) | 4.2 | 4.7 | 5759.1 | 3.0 | 60.2/58.7 | 0.01 | -0.2 |
| Docking | 6:00:10:00.0 | -- | -- | -- | 5756.1 | -- | 60.2/58.7 | 0.0 | 0.0 |

^aEstimates for completing consumables document will present official propellant usage. Slight changes caused by rigor of analysis are expected.

^bAltitudes measured above landing site.

^cNominally a zero ΔV maneuver.

^dPreceded by a 13.0 sec, two-jet, +X, RCS ullage.

TABLE 4.13-II. - MSFN TRACKING AND SHADOW TIMELINE

| Event | Time, day:hr:min:sec, g.e.t. |
|-------------------------|------------------------------|
| Insertion | 5:22:31:39.9 |
| Tweak | 5:22:34:39.9 |
| Sunset | 5:22:40:11.8 |
| MSFN LOS | 5:22:54:04.0 |
| TPI (ullage on) | 5:23:09:26.9 |
| MC-1 | 5:23:24:39.9 |
| Sunrise | 5:23:28:09.7 |
| MC-2 | 5:23:39:39.9 |
| MSFN AOS | 5:23:40:29.2 |
| First braking maneuver | 5:23:50:32.8 |
| Second braking maneuver | 5:23:51:45.7 |
| Third braking maneuver | 5:23:53:24.0 |
| Fourth braking maneuver | 5:23:54:43.6 |
| Docking | 6:00:10:00.0 |

TABLE 4.13-III.- TARGET LOADS FOR TPI MANEUVER^a[Propulsion system: APS; guidance: external ΔV]

(a) Target

| | |
|------------------------------------------------------|-------------|
| t_{IG} , ^b hr:min:sec, g.e.t. | 143:09:26.9 |
| ΔV_X , fps | 63.0 |
| ΔV_Y , fps | 0.1 |
| ΔV_Z , fps | 67.3 |
| Weight at t_{IG} , lb | 5831.5 |

(b) REFSMMAT

Refer to table 5-V

(c) Gimbal angles at t_{IG} ^b

| | |
|--------------------|------|
| IGA, deg | 92.1 |
| MGA, deg | 0.0 |
| OGA, deg | 0.0 |

^aAll targets include ΔV 's from ullage.^b t_{IG} is ullage on time.

4-111

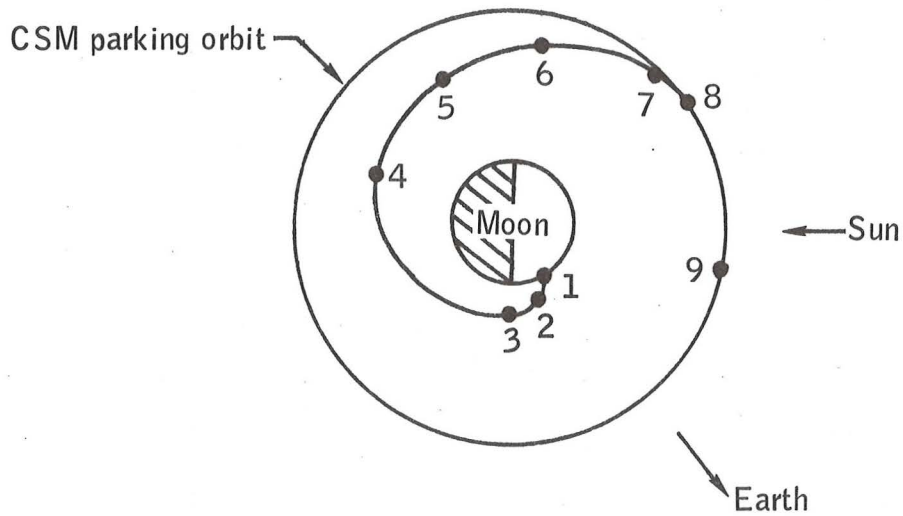

| Event | Ground elapsed time, hr:min:sec |
|-------------------------|------------------------------------|
| 1. Lift-off | 142:24:29.2 |
| 2. LM insertion | 142:31:39.9 |
| 3. Tweak | 142:34:39.9 |
| 4. TPI (ullage on) | 143:09:26.9 |
| 5. MC-1 | 143:24:39.9 |
| 6. MC-2 | 143:39:39.9 |
| 7. Begin braking | 143:50:32.8 |
| 8. Begin stationkeeping | 143:54:47.8 |
| 9. Docking | 144:10:00.0 |

Figure 4.13-1.- Orbital schematic of ascent through docking.

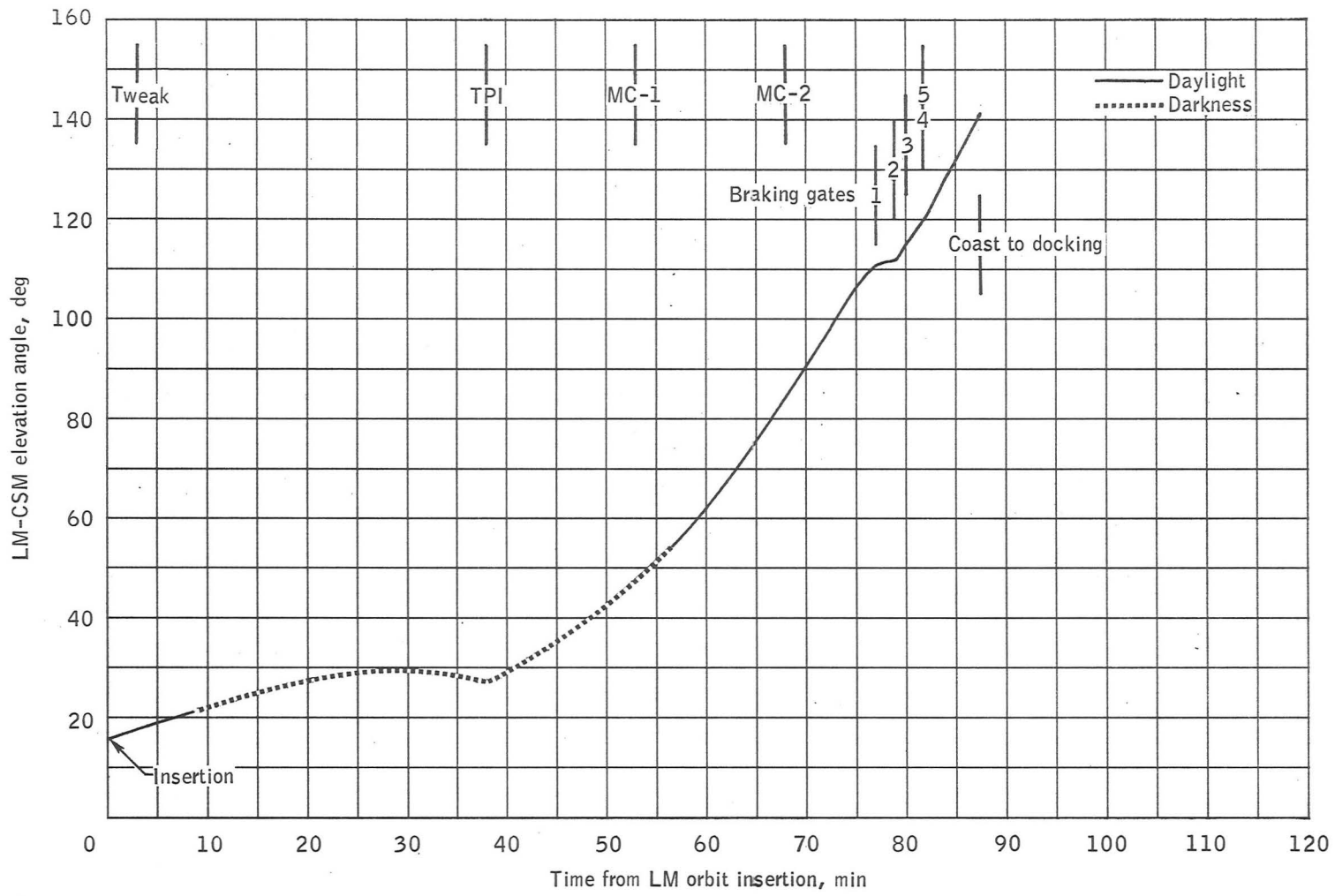

(a) LM-CSM elevation angle versus time from LM orbit insertion.

Figure 4.13-2.- Parameters from LM orbit insertion through terminal rendezvous.

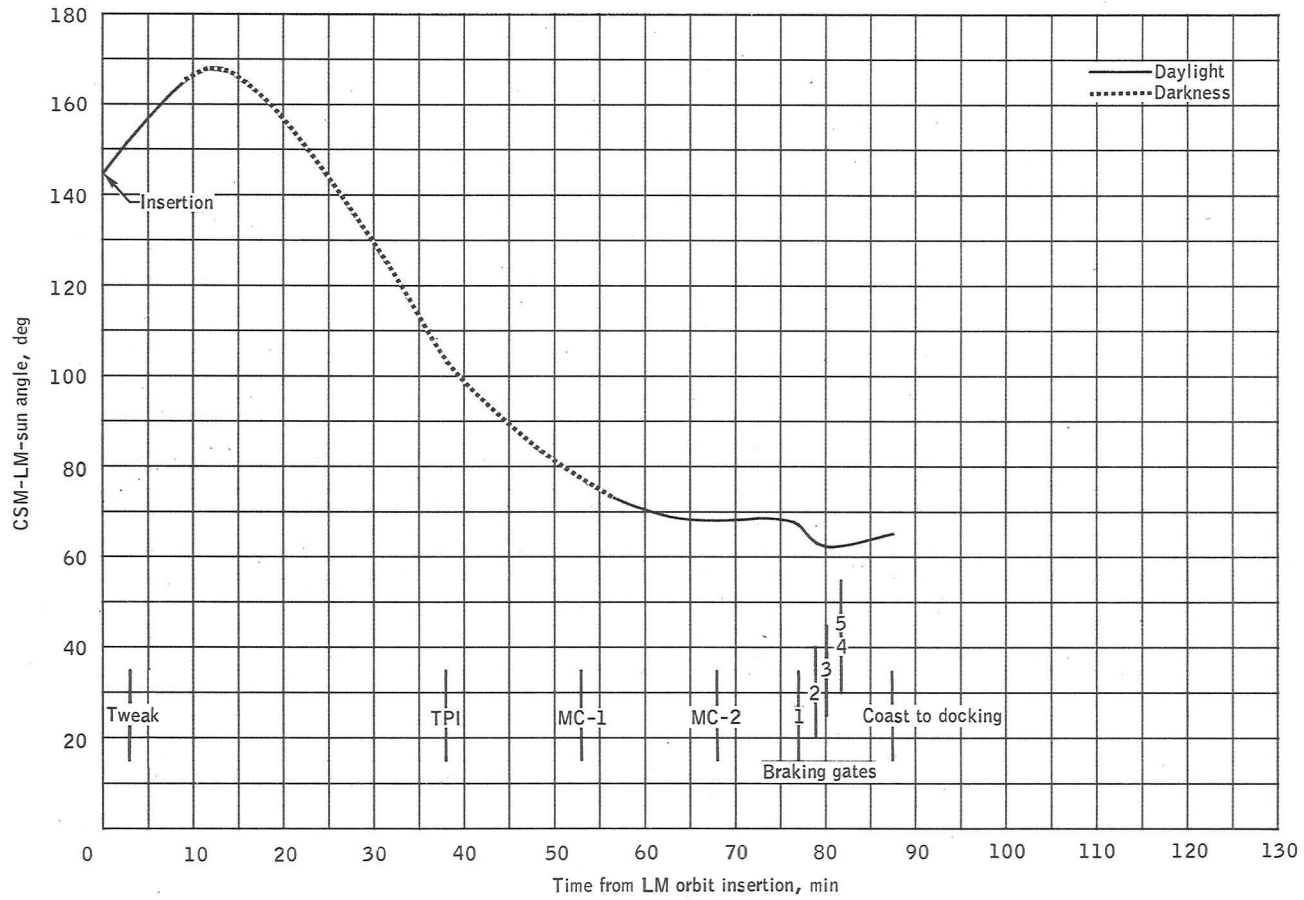

(b) CSM-LM-sun angle versus time from LM orbit insertion.

Figure 4.13-2.- Continued.

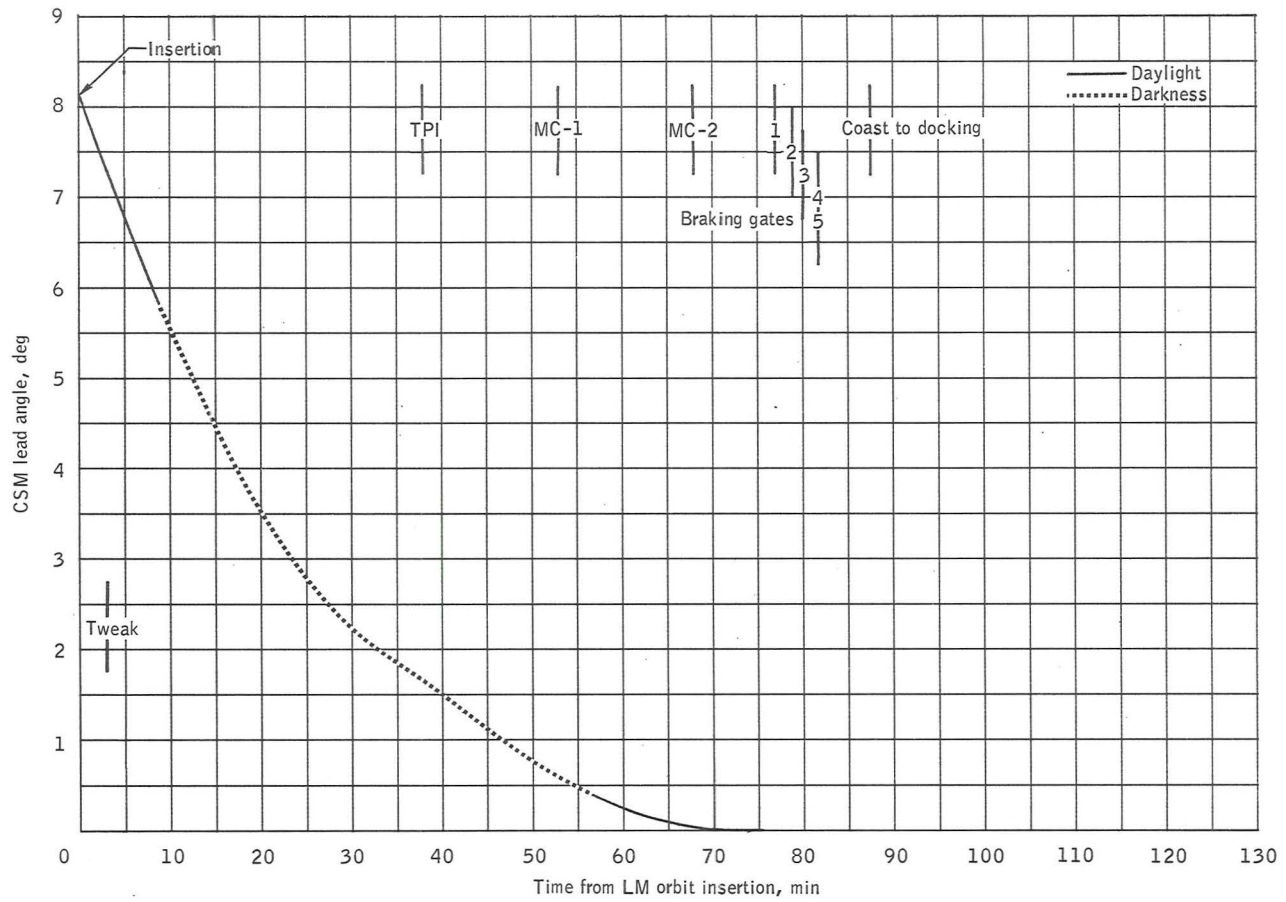

(c) CSM lead angle versus time from LM orbit insertion.

Figure 4.13-2.- Continued.

411-7

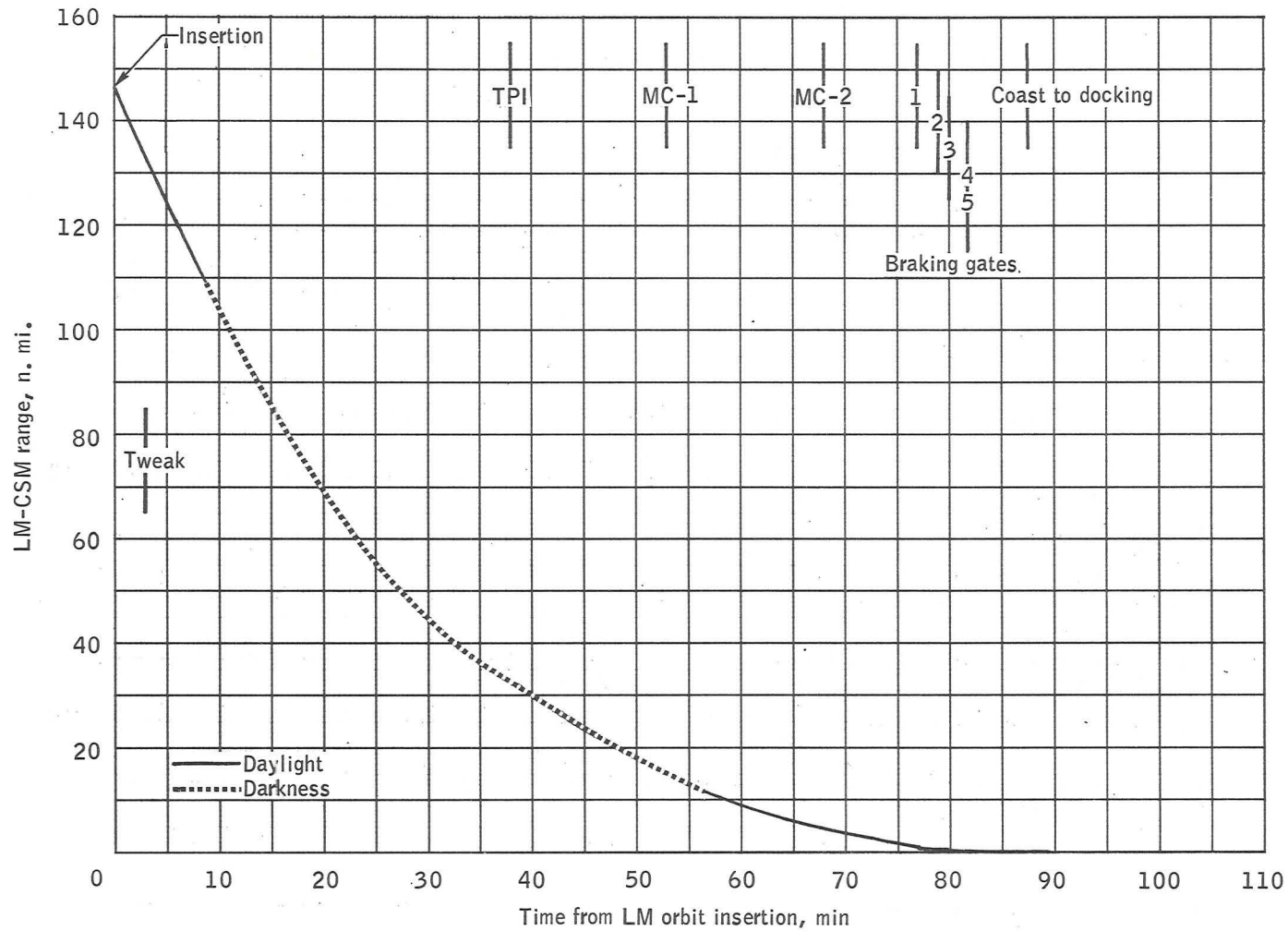

(d) LM-CSM range versus time from LM orbit insertion.

Figure 4.13-2.- Continued.

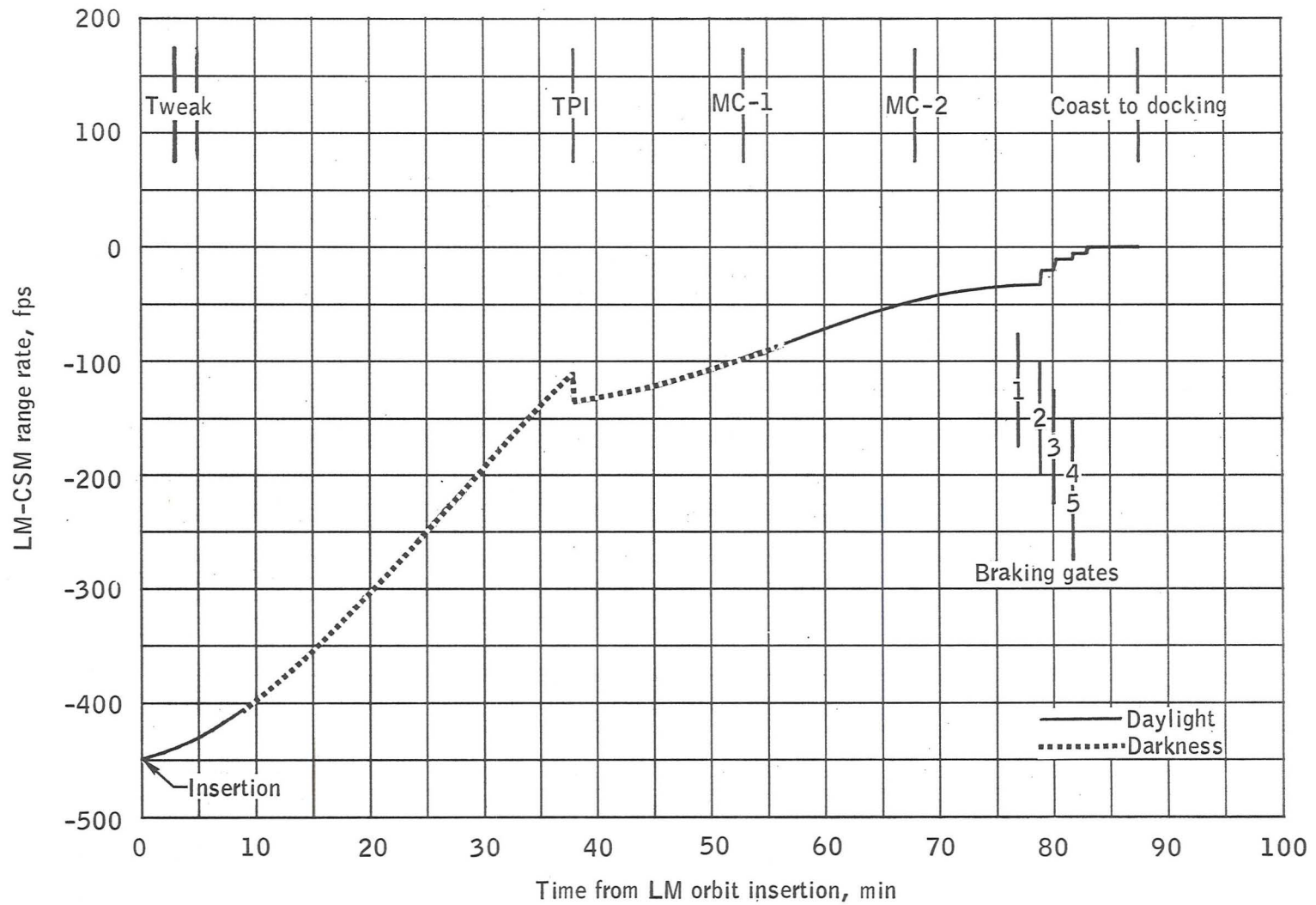

4-116

(e) LM-CSM range rate versus time from LM orbit insertion.

Figure 4.13-2.- Continued.

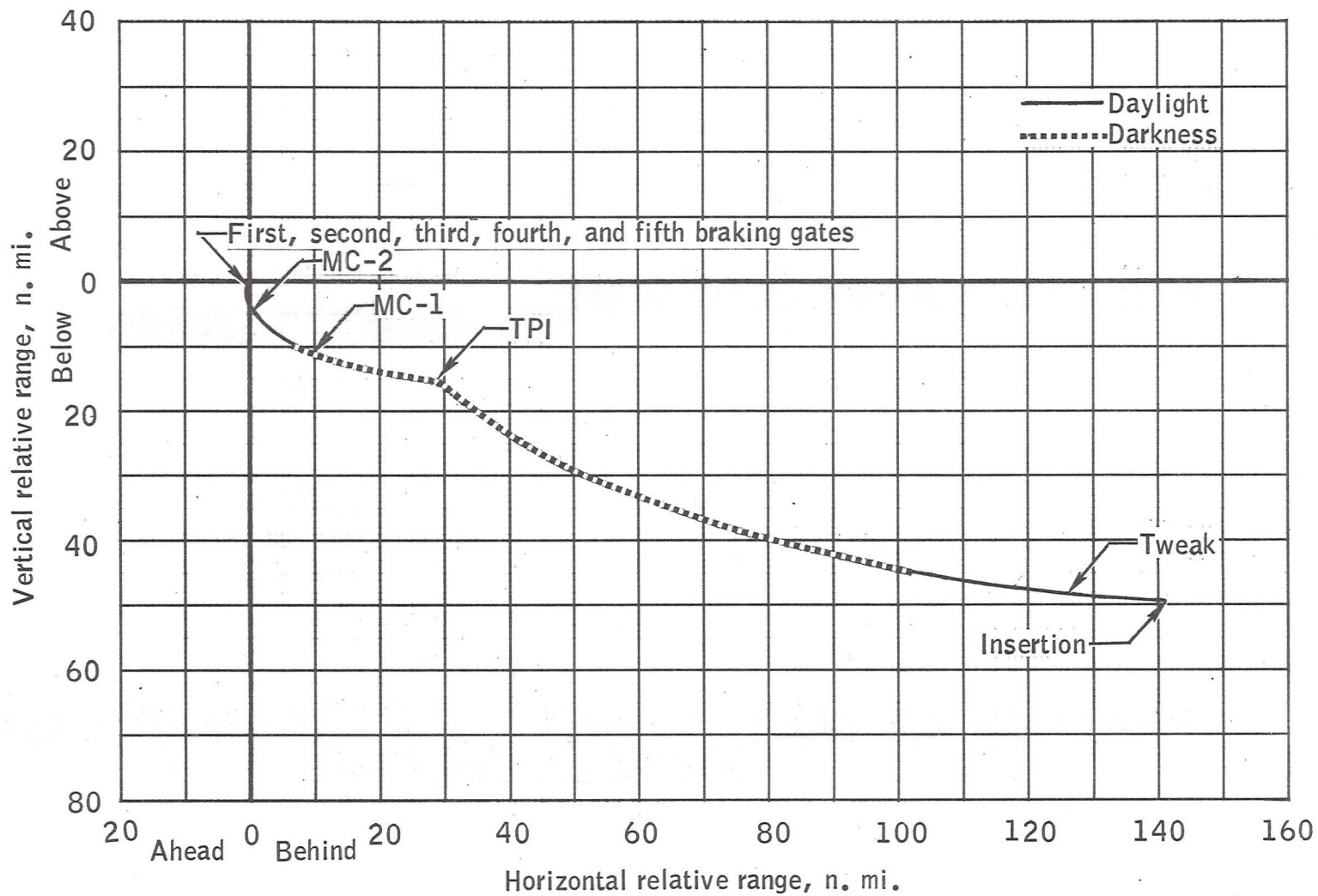

4-117

(f) Vertical relative range versus horizontal relative range.

Figure 4.13-2.- Concluded.

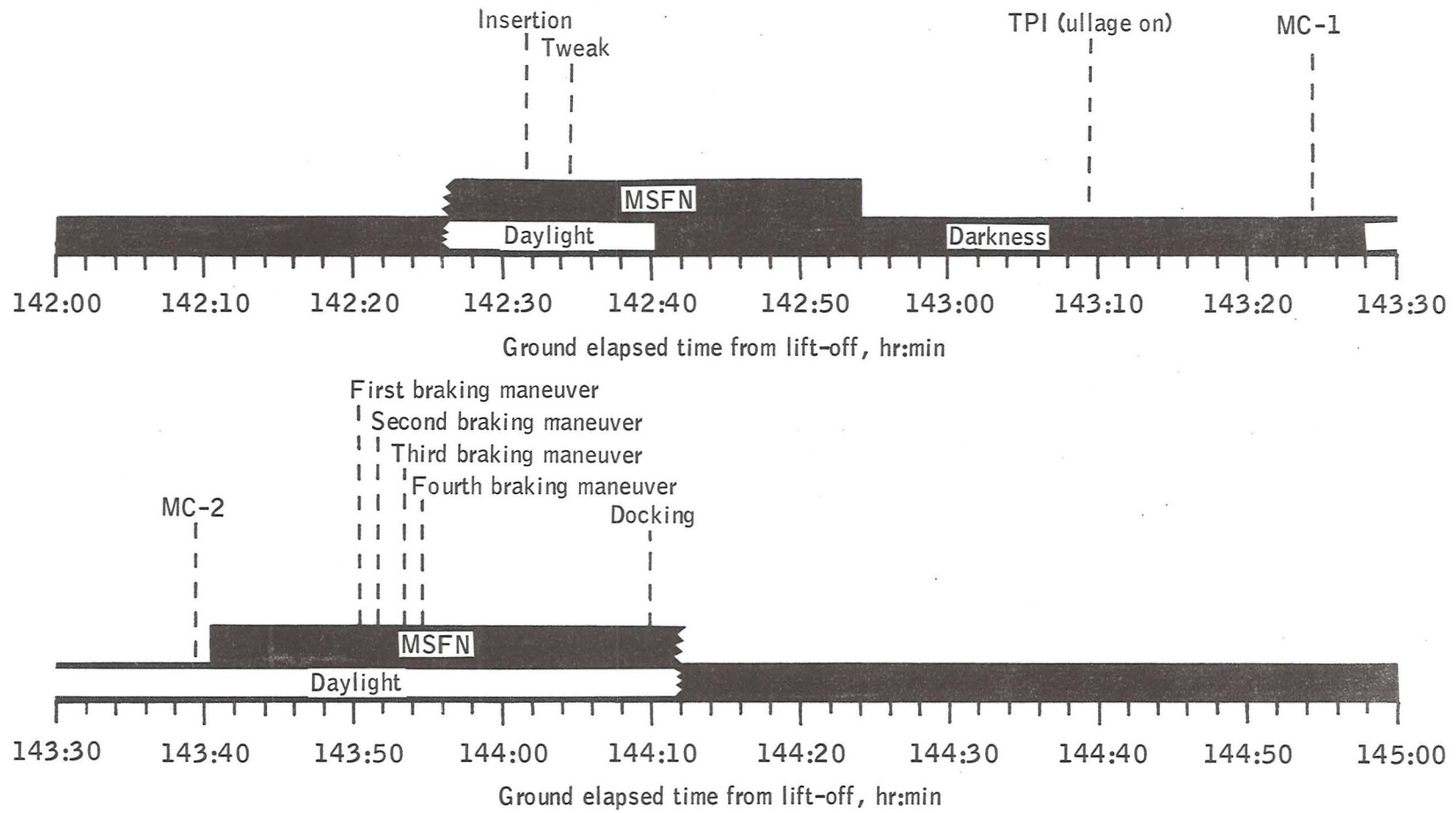

Figure 4.13-3.- Mission events and tracking summaries for LM-active rendezvous.

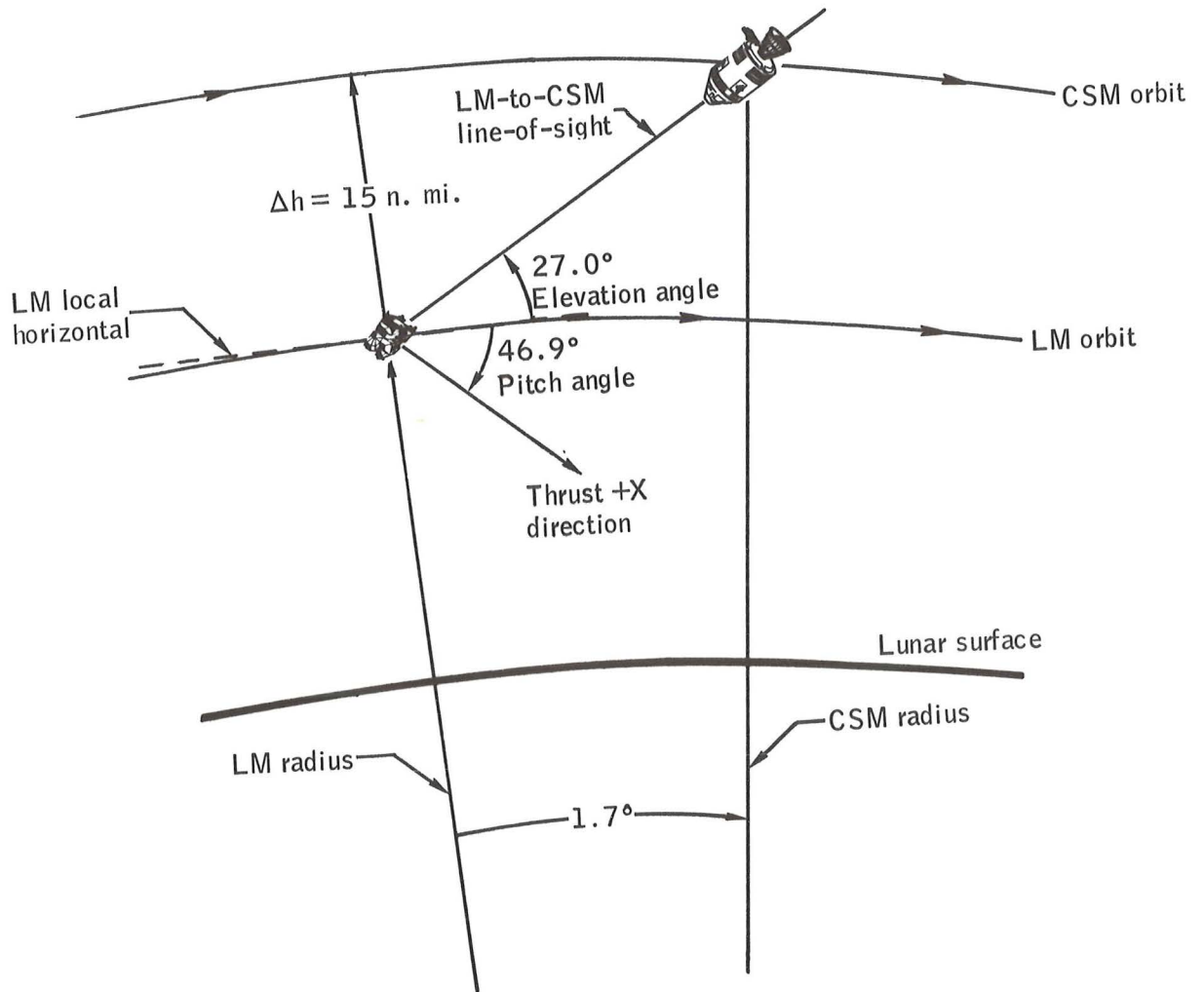

Figure 4.13-4.- LM-CSM relative geometry at TPI.

4.14 LM Ascent Stage Jettison and Separation to Transearth Injection

Docking occurs at approximately 144^h10^m g.e.t. After equipment transfer and decontamination procedures, the LM ascent stage is jettisoned at 146^h23^m30.6^s g.e.t. The CSM separates from the ascent stage by performing a +Z RCS translation of 1.0 fps in the inertial deorbit attitude. This separation maneuver occurs approximately 270° prior to the deorbit maneuver and is in a retrograde direction. The CSM target load for this separation maneuver is shown in table 4.14-I.

The discarded LM ascent stage will be targeted to impact the lunar surface at 3.30°S and 19.27°W approximately 29 n. mi. from the Apollo 14 landing site. The ascent stage deorbit burn duration will be 77.0 seconds beginning at 147^h52^m58.9^s g.e.t. This RCS burn (+X, four-jet) will be performed at a yaw attitude of approximately 168°. The burn targets are $\Delta V_x = -180.0$ fps and $\Delta V_y = 36.5$ fps, which will result in a total velocity change of 183.7 fps. After the burn, the ascent stage is in a 58.4- by -63.9-n. mi. orbit. The ascent stage will travel through a central angle of 85° before it impacts at approximately 26 minutes after the deorbit burn. At landing, the ascent stage will have a velocity of approximately 5506 fps (5500 fps horizontal and 365 fps radial). The flight-path angle of the ascent stage at impact will be approximately -4°. The ascent stage deorbit and landing are summarized in table 4.14-II with the ascent stage target load given in table 4.14-III. The groundtrack from LOPC to TEI is shown in figure 4.14-1.

TABLE 4.14-I.- TARGET LOAD FOR CSM SEPARATION

MANEUVER FOLLOWING LM JETTISON

[Propulsion system: CSM RCS]

(a) Target

| | |
|---------------------------------------|-------------|
| t_{IG} , hr:min:sec, g.e.t. | 146:28:30.6 |
| ΔV_X , fps | -1. |
| ΔV_Y , fps | 0.0 |
| ΔV_Z , fps | 0.0 |
| Weight, lb | 34 574.8 |

(b) REFSMMAT

Refer to table 5-V

(c) Gimbal angles at t_{IG}

| | |
|--------------------|-------|
| IGA, deg | -16.8 |
| MGA, deg | 0.0 |
| OGA, deg | 180.0 |

TABLE 4.14-II.- LM DEORBIT SUMMARY

| Event | Time, day:hr:min:sec g.e.t. | Latitude, deg | Longitude, deg | Burn duration, sec | ΔV , fps | Inertial velocity, fps | Mass, lb | Local horizontal attitudes, deg | |
|---------|-----------------------------------|------------------|-------------------|--------------------------|---------------------|------------------------------|-------------|------------------------------------|-------|
| | | | | | | | | Pitch | Yaw |
| Deorbit | 6:02:23:30.6 | -11.79 | 67.43 | 77.0 | 183.7 | 5351.6 | 5277.2 | 2.0 | 168.5 |
| Impact | 6:04:20:58.1 | -3.50 | -19.29 | -- | -- | 5505.9 | 5171.1 | -96.1 | 168.1 |

TABLE 4.14-III.- TARGET LOAD FOR LM DEORBIT

[Propulsion system LM RCS]

(a) Target

| | |
|---------------------------------------|-------------|
| t_{IG} , hr:min:sec, g.e.t. | 147:52:58.9 |
| ΔV_x , fps | -180.0 |
| ΔV_y , fps | 36.5 |
| ΔV_z , fps | 0.0 |
| Weight, lb | 5277.2 |

(b) REFSMMAT

Refer to table 5-V

(c) Gimbal angles at t_{IG}

| | |
|----------------------------------|-------|
| IGA, deg | 175.2 |
| MGA, deg | 11.4 |
| OGA ^a , deg | 180.4 |

^aWill be optimized for best communications attitude.

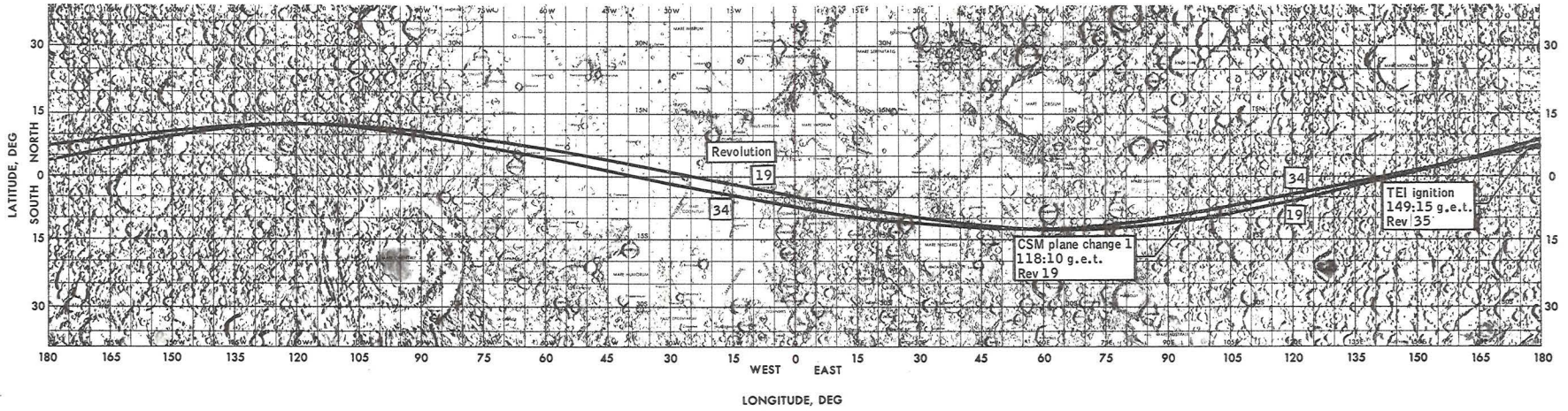

Figure 4.14-1.- Groundtrack from LOPC to TEI.

4.15 Transearth Injection

The TEI maneuver occurs 2^d18^h30^m after LOI. The burn was targeted for a 67.2-hour transearth flight time and a 40° ascending return inclination relative to the earth's equator. A time history of the trajectory parameters during the burn is presented in figure 4.15-1. The transearth injection geometry is shown in figure 4.15-2.

For the TEI burn, the IMU is aligned to the ascent REFSMMAT. The target load is presented in table 4.15-I.

The characteristics of the burn are the following.

TEI burn initiation

| | |
|---------------------------------------------|-------------|
| Time, hr:min:sec, g.e.t. | 149:14:50.1 |
| Mass, lb | 34 515.7 |
| Altitude above LLS, n. mi. | 59.3 |
| Selenographic latitude, deg | 7.1 |
| Selenographic longitude, deg | 177.3 |
| Inertial velocity, fps | 5346.4 |
| Selenographic inclination, deg | 12.2 |
| Perilune altitude above LLS, n. mi. | 58.1 |

TEI burnout

| | |
|---------------------------------------------|-------------|
| Time, hr:min:sec, g.e.t. | 149:17:17.3 |
| Altitude above LLS, n. mi. | 66.4 |
| Selenographic latitude, deg | 6.5 |
| Selenographic longitude, deg | 167.8 |
| Inertial velocity, fps | 8503.6 |
| Selenographic inclination, deg | 6.5 |
| Burn duration, min:sec | 147.1 |
| Inertial burn arc, deg | 9.4 |
| Plane change, deg | 11.0 |
| ΔV , fps | 3449.5 |
| SPS propellant used, lb | 9995.7 |
| Perilune altitude above LLS, n. mi. | 57.5 |

TABLE 4.15-I.- TARGET LOAD FOR TEI MANEUVER

[Propulsion system: SPS; guidance: external ΔV]

(a) Target

| | |
|---------------------------------------|-------------|
| t_{IG} , hr:min:sec, g.e.t. | 149:14:50.1 |
| ΔV_X , fps | 3014.7 |
| ΔV_Y , fps | 1622.2 |
| ΔV_Z , fps | -423.7 |
| Weight, lb | 34 515.7 |

(b) REFSMMAT

Refer to table 5-VII

(c) Gimbal angles at t_{IG}

| | |
|--------------------|-------|
| IGA, deg | 109.0 |
| MGA, deg | 29.2 |
| OGA, deg | 180.0 |

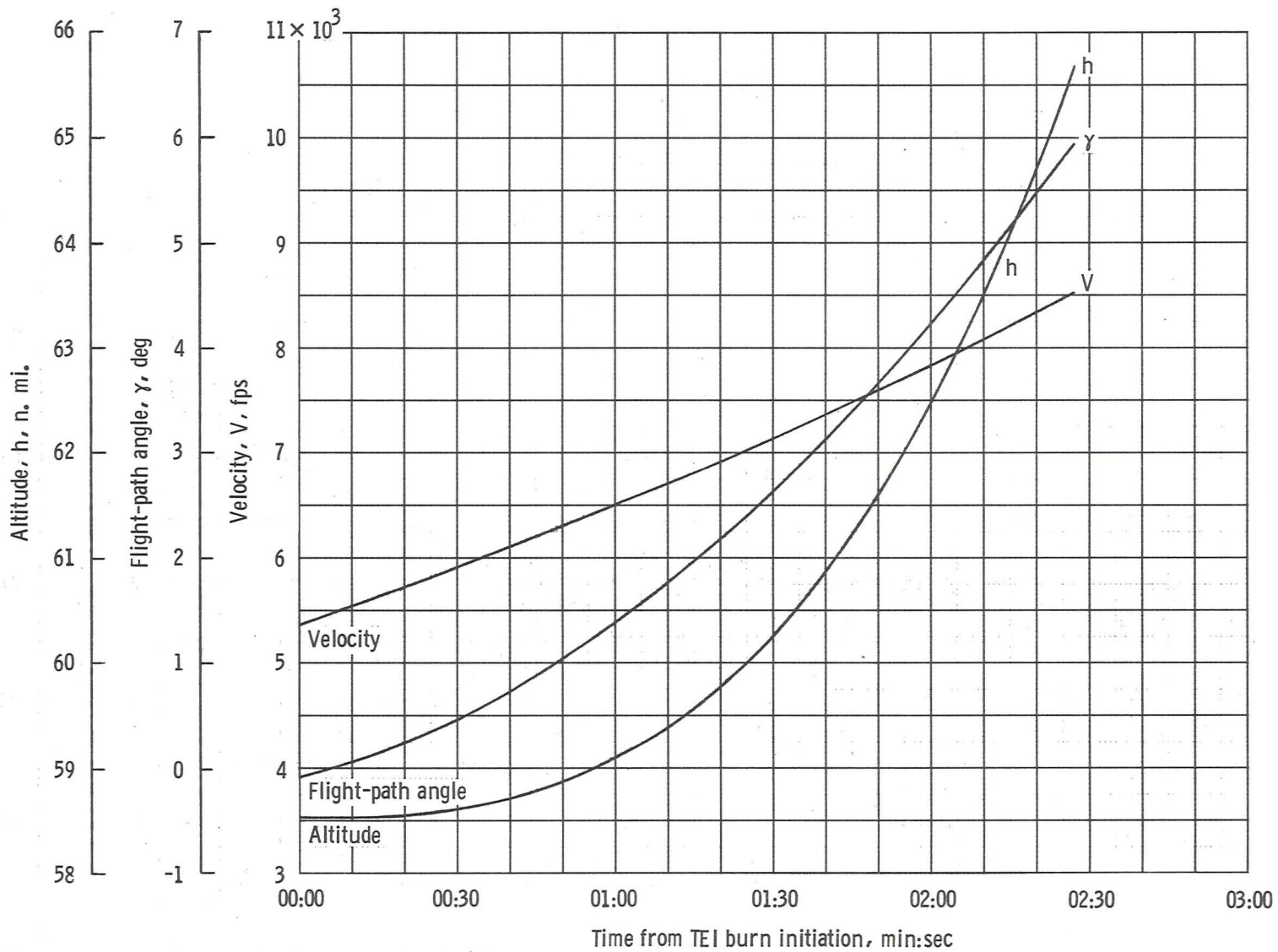

4-133

(a) Velocity, flight-path angle, and altitude versus time from TEI burn initiation.

Figure 4.15-1. - Time history of trajectory parameters for transearth injection.

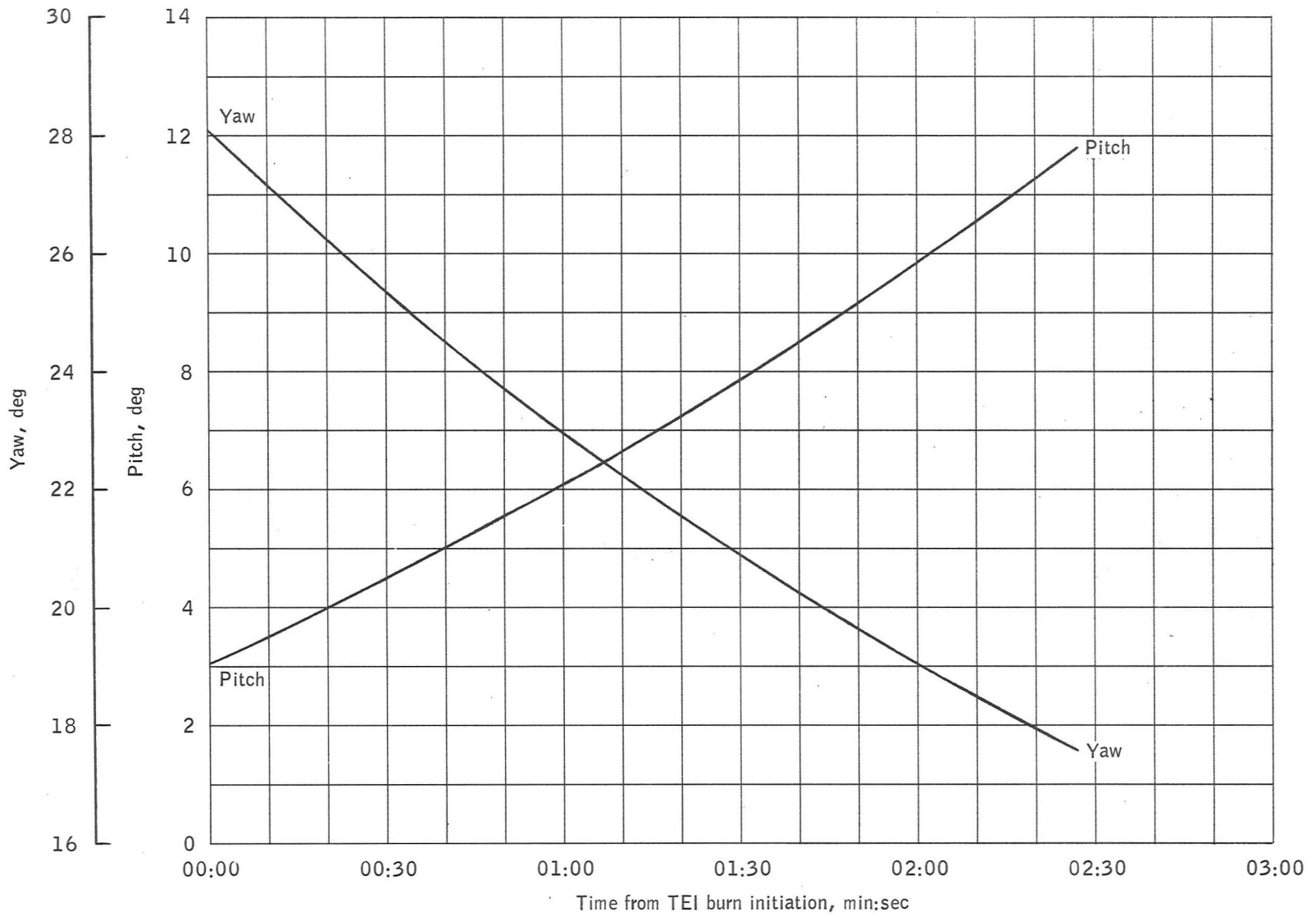

4-134

(b) Local horizontal pitch and yaw versus time from TEI burn initiation.

Figure 4.15-1.- Concluded.

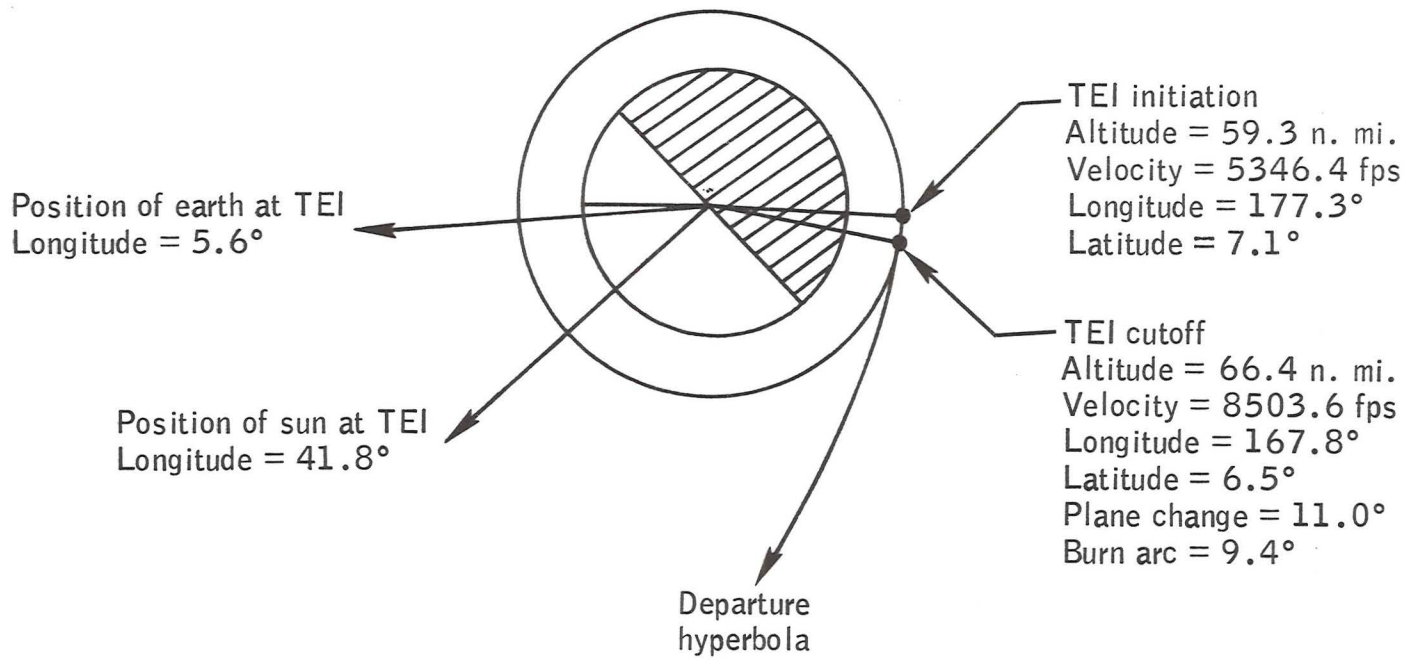

Figure 4.15-2.- TEI geometry.

4.16 Transearth Coast

A groundtrack of the transearth coast phase is provided in figure 4.16-1. Altitude above the moon is shown for the first 10 hours of coast in figure 4.16-2. The altitude time history for TEI to entry is shown in figure 4.16-3. Three midcourse decision points have been defined for the transearth phase.

- a. MCC-5, TEI plus 17 hours
- b. MCC-6, EI minus 22 hours
- c. MCC-7, EI minus 3 hours

The maneuvers will be targeted for corridor control only. The midcourse strategy, which includes the threshold values for each maneuver, is contained in reference 4. Altitude is plotted against time for the last 10 hours of transearth coast in figure 4.16-4.

The SC remains in the lunar umbra during the entire TEI burn, enters sunlight approximately 5 minutes after cutoff, and remains in sunlight until entry.

Passive thermal control will be maintained during most of the transearth coast phase. The PTC REFSMMAT (table 5-II) will be used for MCC-5 and MCC-6; the entry REFSMMAT (table 5-VI) will be used for MCC-7. The CM/SM separation occurs approximately 15 minutes prior to entry.

The SC is acquired by MSFN approximately 11 minutes after TEI cutoff, and the last station to lose signal is Honeysuckle (5° minimum elevation) which loses signal at 240^h46^m g.e.t. or approximately 4 minutes prior to entry.

The primary trajectory parameters at entry interface are the following.

| | |
|---------------------------------------------------|-------------|
| Time, hr:min:sec, g.e.t. | 216:26:58.7 |
| Transearth coast time, hr | 67.2 |
| Inertial velocity, fps | 36 170.1 |
| Altitude, n. mi. | 65.8 |
| Inertial flight-path angle, deg | -6.5 |
| Latitude, deg | -36.3 |
| Longitude, deg | 166.4 |
| Equatorial inclination (ascending), deg | 40 |

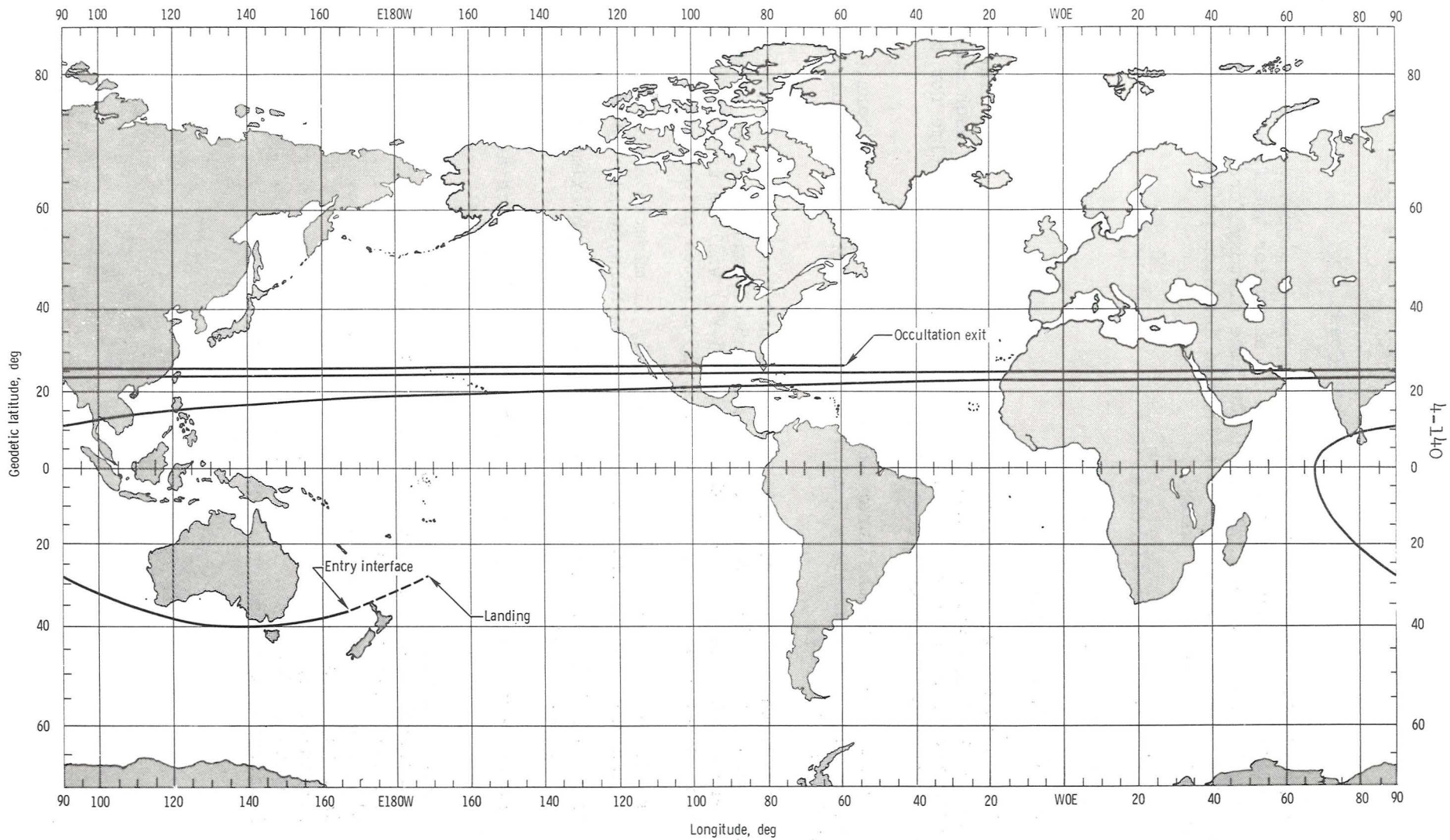
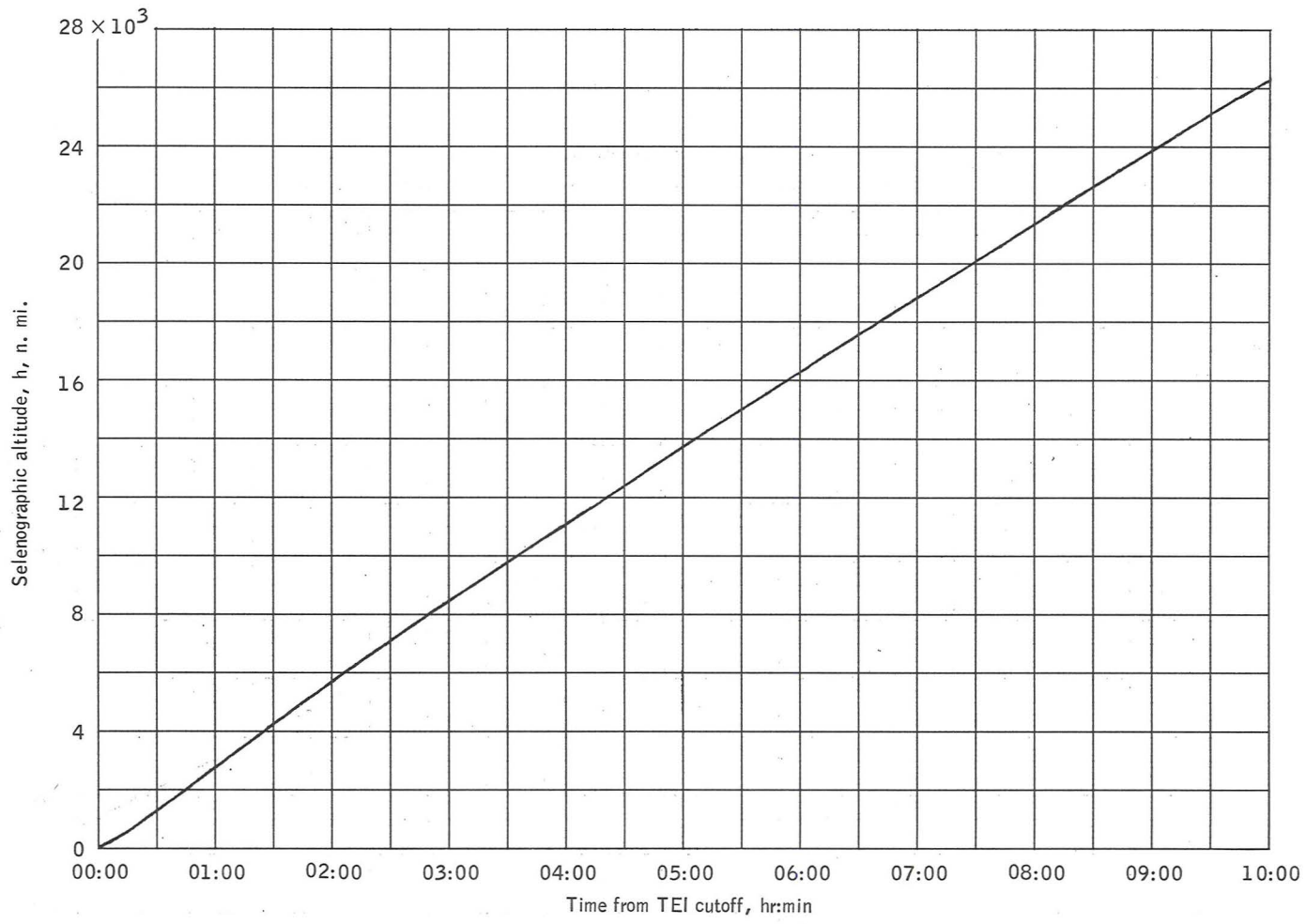

Figure 4.16-1. - Transearth coast groundtrack.



T471-7

Figure 4.16-2.- Altitude time history during the first 10 hours of transearth coast.

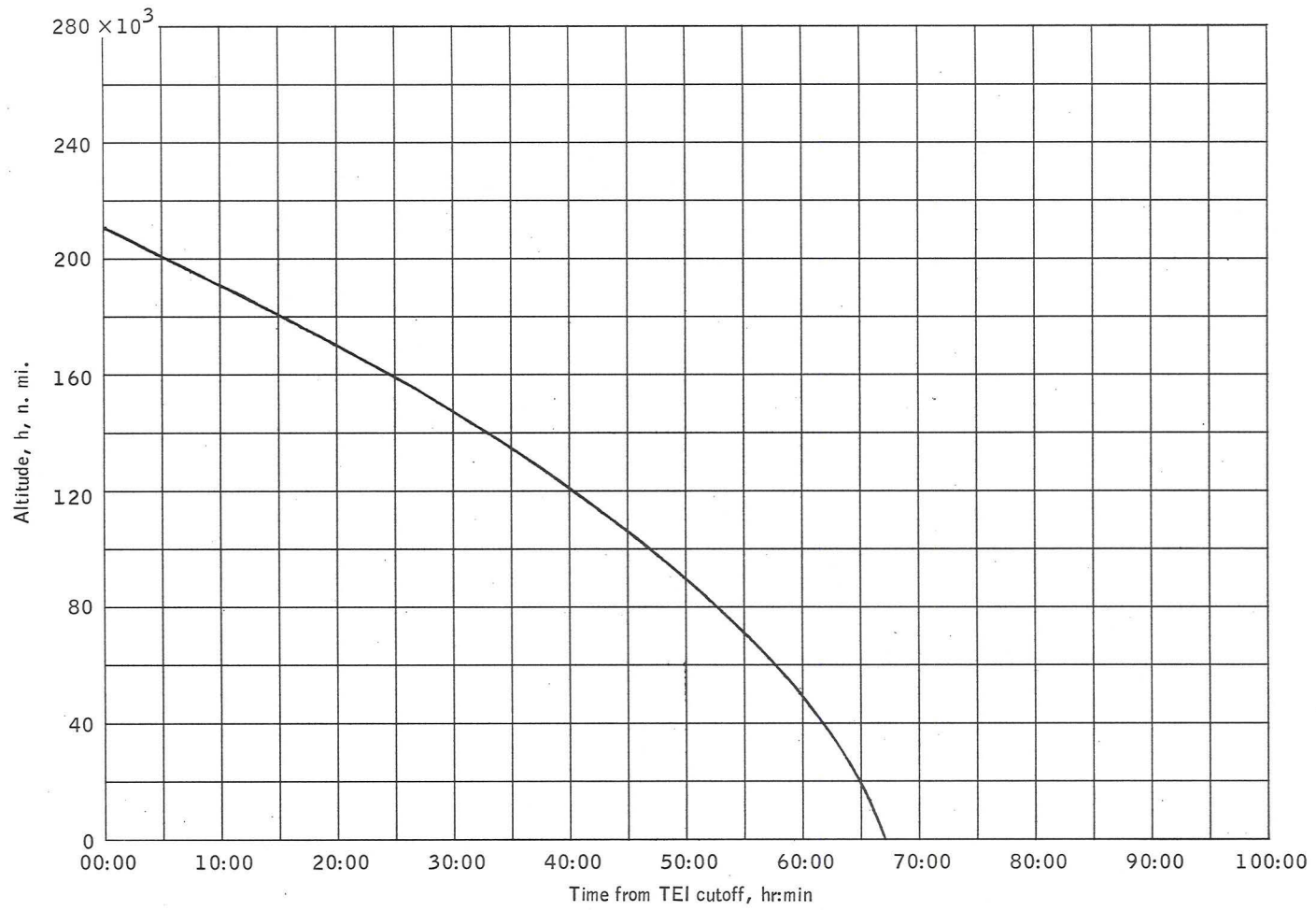

Figure 4.16-3.- Altitude time history from transearth injection to entry interface.

4-1142

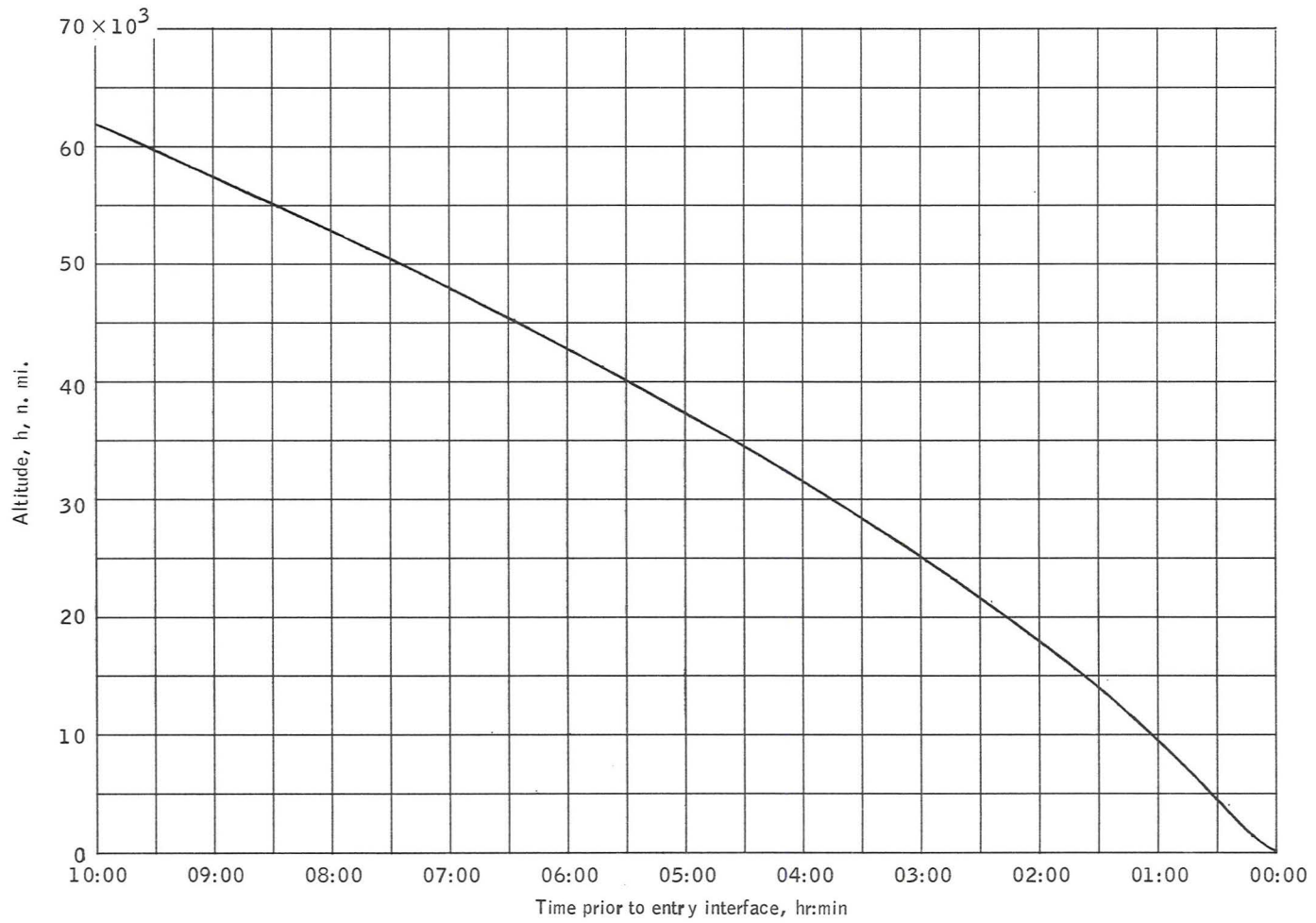

Figure 4.16-4.- Altitude time history 10 hours prior to entry interface.

4.17 Entry

The entry phase of the operational trajectory was simulated with the Apollo Reentry Simulation program with six degrees of freedom. Three-degree-of-freedom trajectories were used to determine the CM maneuver footprint. The entry corridor is presented in figure 4.17-1.

At the nominal EI time, $216^{\text{h}}26^{\text{m}}59^{\text{s}}$ after lift-off, the CM is at an altitude of 400 111 feet, and the coordinates are 36.282°S geodetic latitude and 166.356°E longitude. Inertial velocity, flight-path angle, and azimuth at this point are 36 170 fps, 6.50° below the local horizontal, and 71.461° , respectively. The gimbal angles are as follows: yaw = 0° , pitch = 152° , roll = 0° .

The CM maneuver footprint and the nominal ground trace on a map of the entry area are presented in figure 4.17-2 with the footprint extended to a 3500-n. mi. entry range. The nominal landing target location is 1250-n. mi. down range from the EI position, and the coordinates of the target are 171.5°W longitude and 27.247°S geodetic latitude. A sequence of pertinent events is given in table 4.17-I and includes the periods of communications blackout which occur along the trajectory. The guidance phases are described in figure 4.17-3 which shows altitude as a function of range to the target. Time histories of the bank angle commanded by the guidance system, of the altitude rate, and of the altitude are presented in figure 4.17-4. Time histories of the total heating rate and the total heat load are presented in figure 4.17-5. The maximum total heating rate is $304.3 \text{ Btu/ft}^2/\text{sec}$, and the total heat load is $26\ 542.0 \text{ Btu/ft}^2$. Time histories for inertial and relative velocity and flight-path angles are presented in figure 4.17-6.

The CM RCS uses 12 pounds of propellant for the separation and attitude hold maneuvers before the spacecraft reaches 400 000 feet, and the RCS uses 26.9 pounds of propellant to perform the guidance commands during the remainder of the entry. A time history of the total RCS propellant consumed from separation is presented in figure 4.17-7. The altitude is plotted in relation to relative velocity in figure 4.17-8, and the boundary for S-band communication blackout is shown (ref. 5). Time histories for the primary DSKY displays, commanded bank angle, inertial velocity, and load factor are shown in figure 4.17-9. The load factor at the c.g. reaches a first maximum of 6.60g and a second maximum of 3.12g. Time histories for the final phase DSKY displays, commanded bank angle, cross-range error, and down-range error are shown in figure 4.17-10.

The drogue parachute deployment sequence begins at an altitude of 23 300 feet, which is 8 minutes 15 seconds after EI, and the two drogue parachutes are deployed 2 seconds later. At an altitude of 10 500 feet,

the low altitude baroswitch closes, and the drogue parachutes are disconnected. The three main parachutes are deployed 1 second after the baroswitch closes. The CM, which is suspended on the main parachute, lands 13 minutes 54 seconds after EI. The relative velocity and relative flight-path angle are plotted against time from drogue chute deployment in figure 4.17-11, while load factor and altitude are plotted against the same parameter in figure 4.17-12.

An EMS scroll (non-exit pattern) is presented in figure 4.17-13(a) with the reference trajectory from 0.05g superimposed upon it. This pattern has limit lines which allow the crew to monitor the entry trajectory to prevent an exit by the spacecraft from the atmosphere ($g = 0.02$). The commanded bank angle and EMS range-to-go are plotted against the inertial velocity in figure 4.17-13(b).

The CM mass properties are shown in table 4.17-II. The conditions at EI are presented in table 4.17-III, and the entry REFSMMAT is presented in table 5-VIII.

TABLE 4.17-I.- ENTRY EVENTS SEQUENCE

| Event | Time from lift-off, hr:min:sec | Time from 400 000 ft, min:sec |
|-----------------------------------------------------------|-----------------------------------|----------------------------------|
| Entry | 216:26:59 | 00:00 |
| Enter S-band communication blackout | 216:27:17 | 00:18 |
| Guidance changes from P63 to P64 (load factor = 0.05g) | 216:27:29 | 00:30 |
| Initiate constant drag (KA) | 216:27:51 | 00:52 |
| Maximum heating rate | 216:28:09 | 01:10 |
| Guidance initiate at RDOT > -700 fps | 216:28:17 | 01:18 |
| Maximum load factor (FIRST) | 216:28:19 | 01:20 |
| Circular velocity (V_{CIRC}) | 216:29:05 | 02:06 |
| Change from P64 to P67 | 216:29:09 | 02:10 |
| Exit S-band communication blackout | 216:30:31 | 03:32 |
| Maximum load factor (SECOND) | 216:33:15 | 06:16 |
| Termination of CMC guidance | 216:34:15 | 07:16 |
| Drogues parachute deployment | 216:35:15 | 08:16 |
| Main parachute deployment | 216:36:05 | 09:05 |
| Landing | 216:40:53 | 13:54 |

TABLE 4.17-II.- COMMAND MODULE MASS PROPERTIES

CM weight, lb

| | |
|-----------------------------|----------|
| Entry | 12 580.8 |
| Main chute deploy | 12 007.3 |
| Landing | 11 357.7 |

Centers of gravity in Apollo
coordinate system, in.

| | |
|-----------------|--------|
| X_A | 1039.4 |
| Y_A | -0.3 |
| Z_A | 6.0 |

Moments of inertia, slug-ft²

| | |
|--------------------|--------|
| I_{XX} | 5890.0 |
| I_{YY} | 5338.0 |
| I_{ZZ} | 4798.0 |

Products of inertia, slug-ft²

| | |
|--------------------|--------|
| I_{XY} | 63.0 |
| I_{XZ} | -449.0 |
| I_{YZ} | -25.0 |

TABLE 4.17-III.- CONDITIONS AT ENTRY INTERFACE AND TARGET POINT

| | |
|----------------------------------------------|-----------|
| Elapsed time from launch, hr:min:sec | 216:26:59 |
| Inertial velocity, fps | 36 170 |
| Inertial flight-path angle, deg | -6.50 |
| Inertial azimuth, deg | 71.46 |
| Spacecraft geodetic latitude, deg S | 36.282 |
| Spacecraft longitude, deg E | 166.36 |
| Altitude, ft | 400 111 |
| Target geodetic latitude, deg S | 27.25 |
| Target longitude, deg W | 171.5 |
| LADPAD | 0.27 |
| LODPAD | 0.207 |

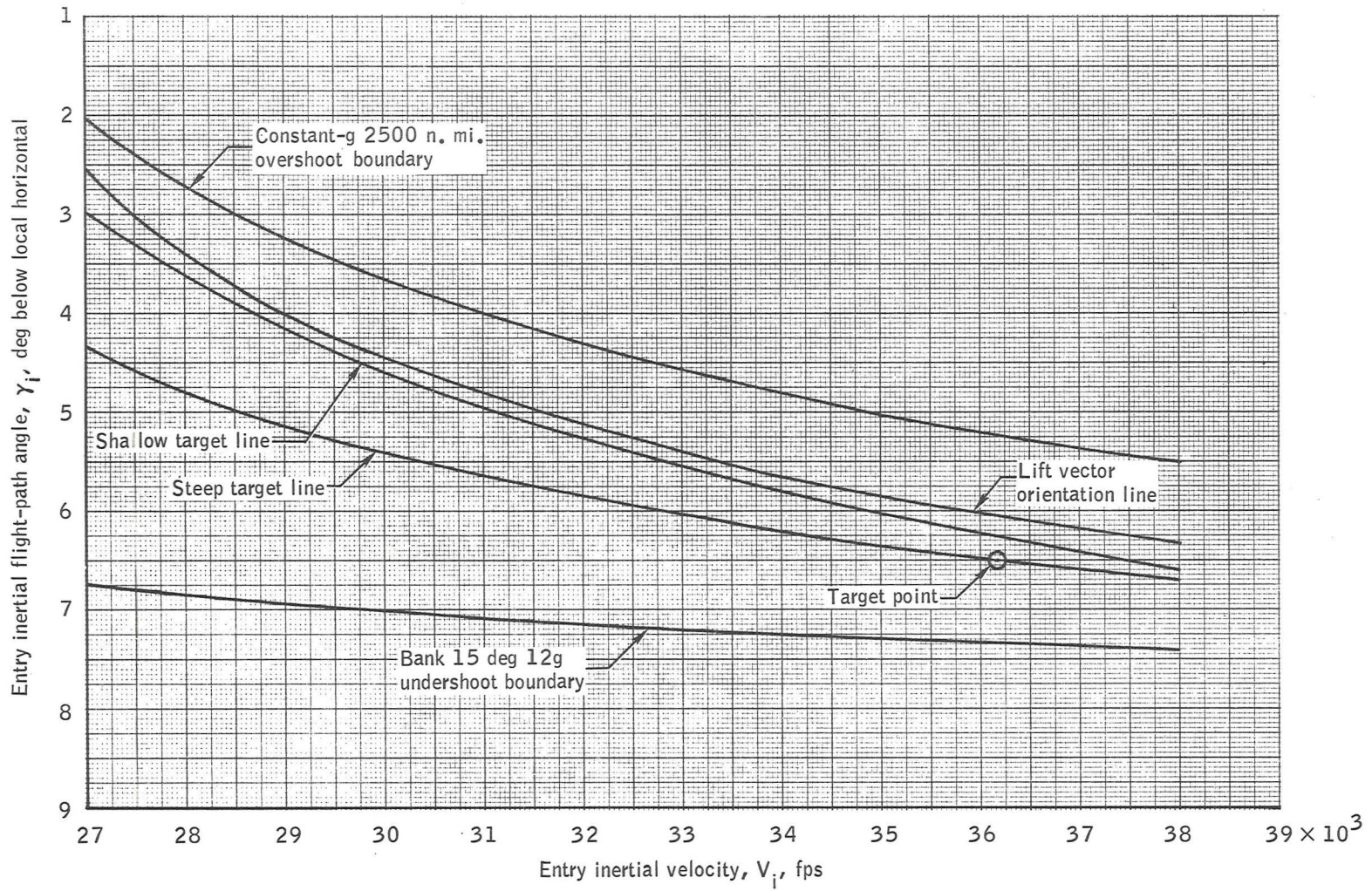

Figure 4.17-1.- Entry corridor.

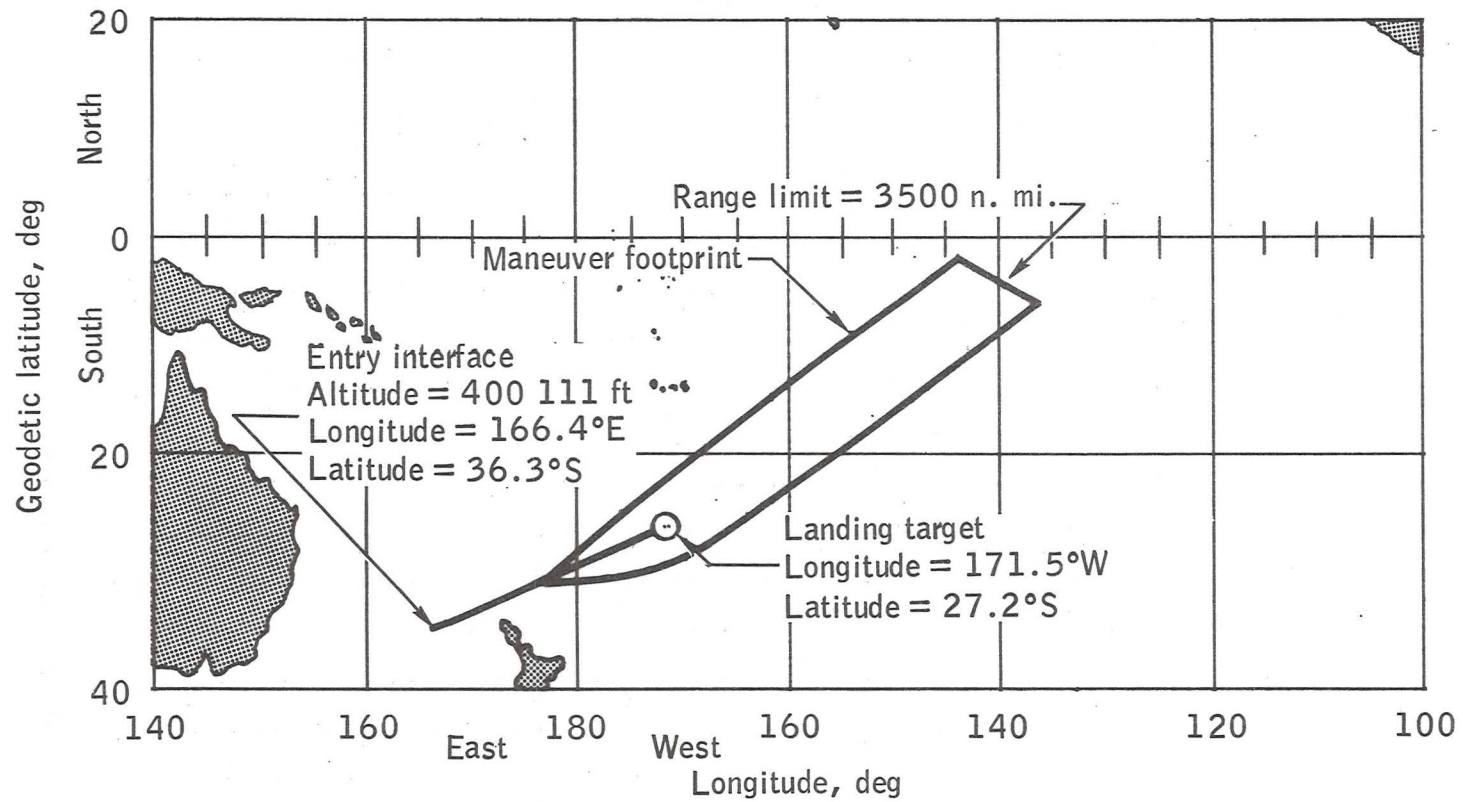
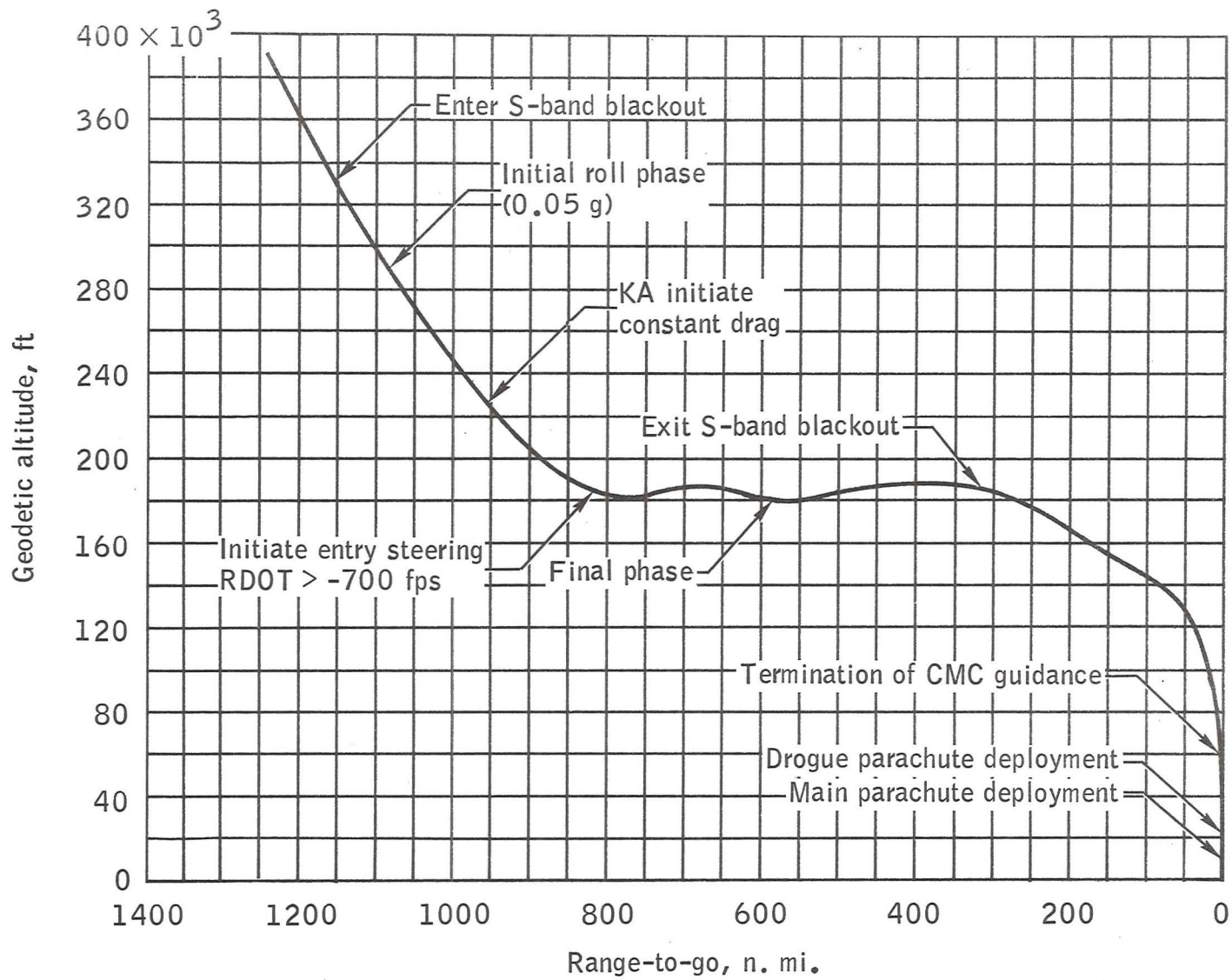

Figure 4.17-2.- Maneuver footprint and nominal groundtrack.



4-154

Figure 4.17-3.- Geodetic altitude versus range-to-go.

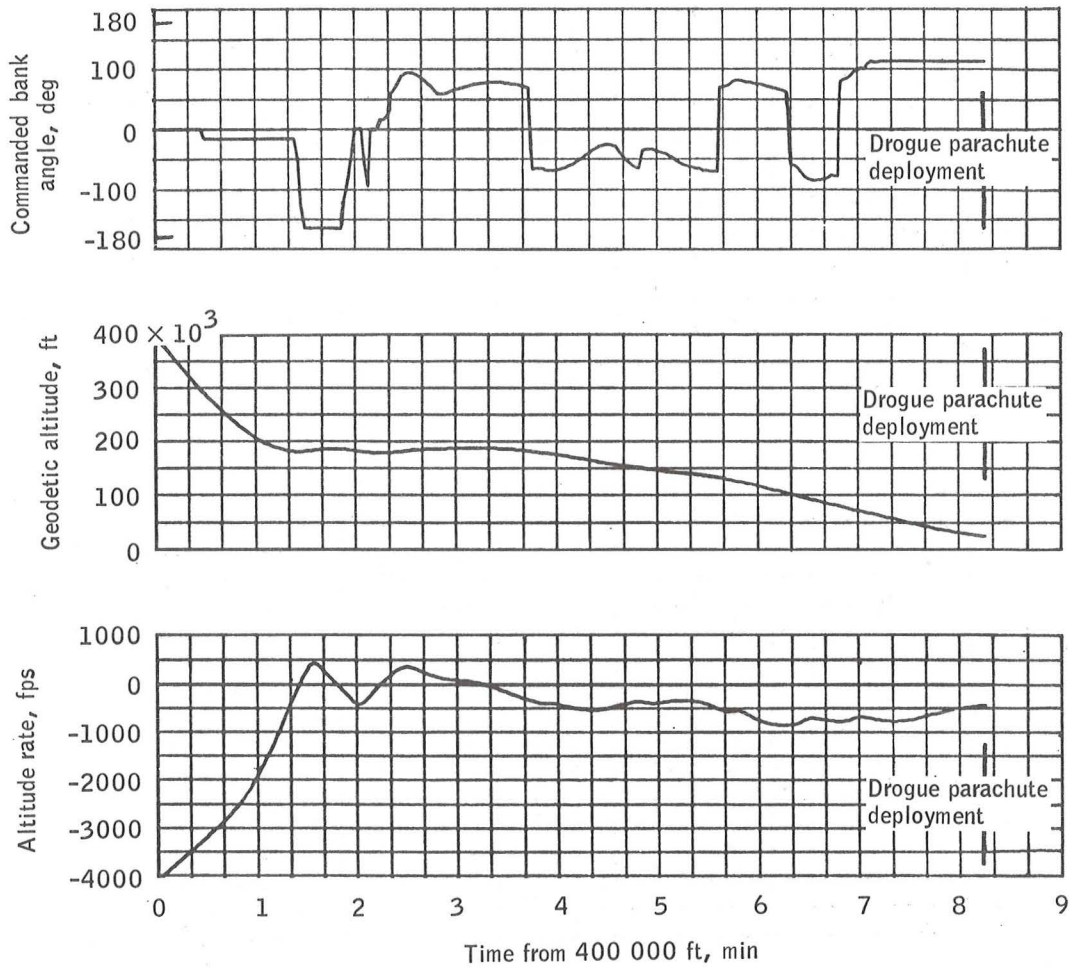

Figure 4.17-4.- CMC commanded bank angle, altitude, and altitude rate time histories.

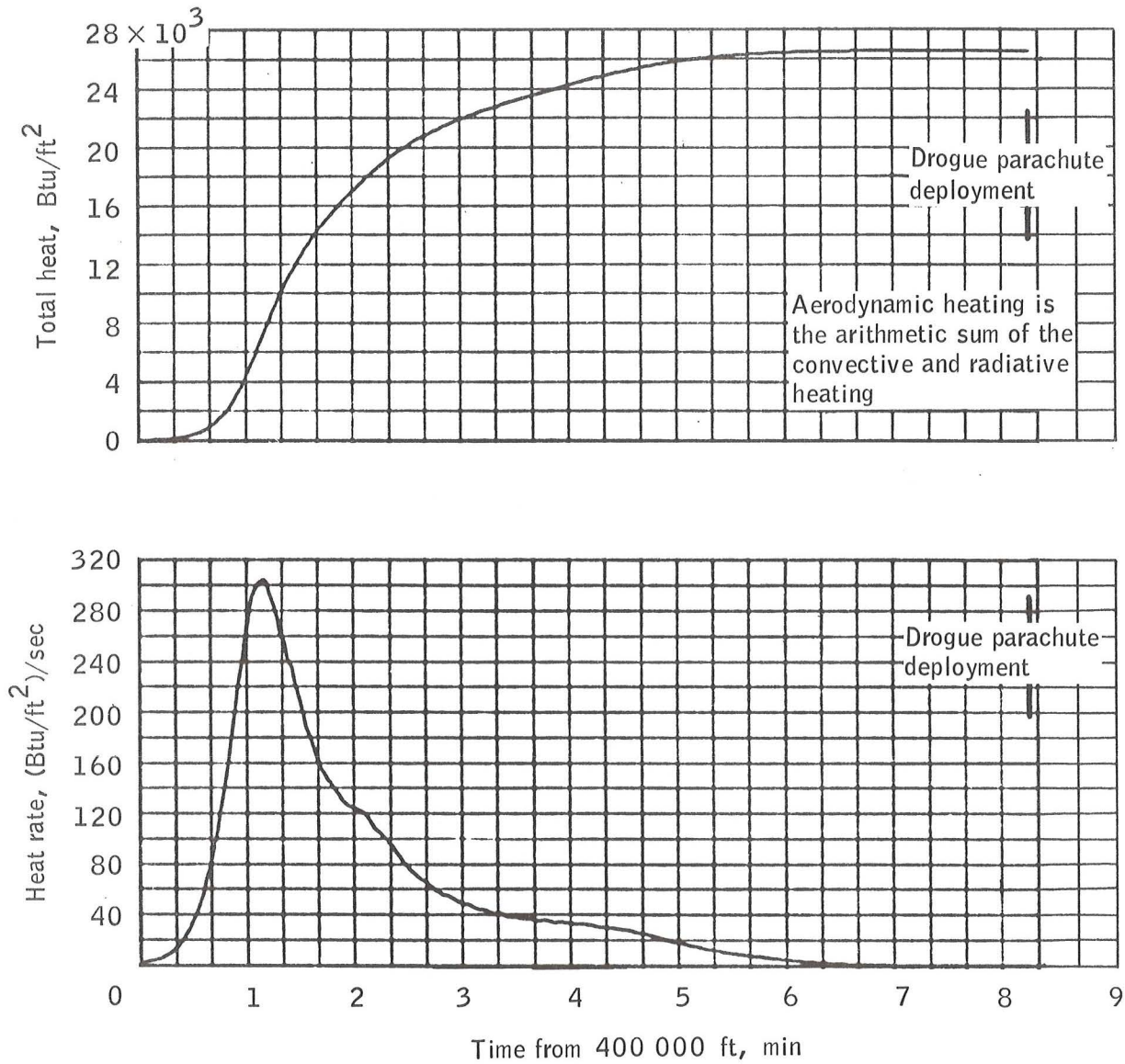
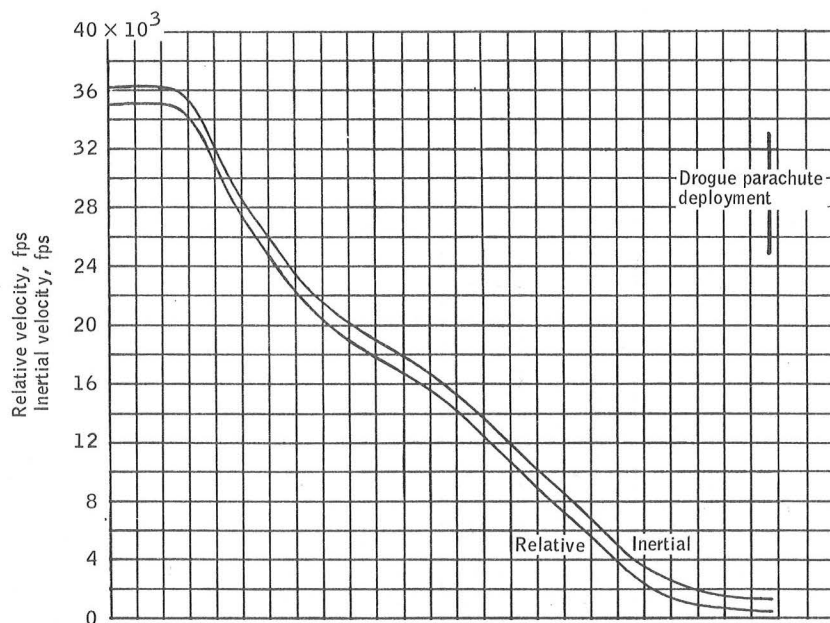
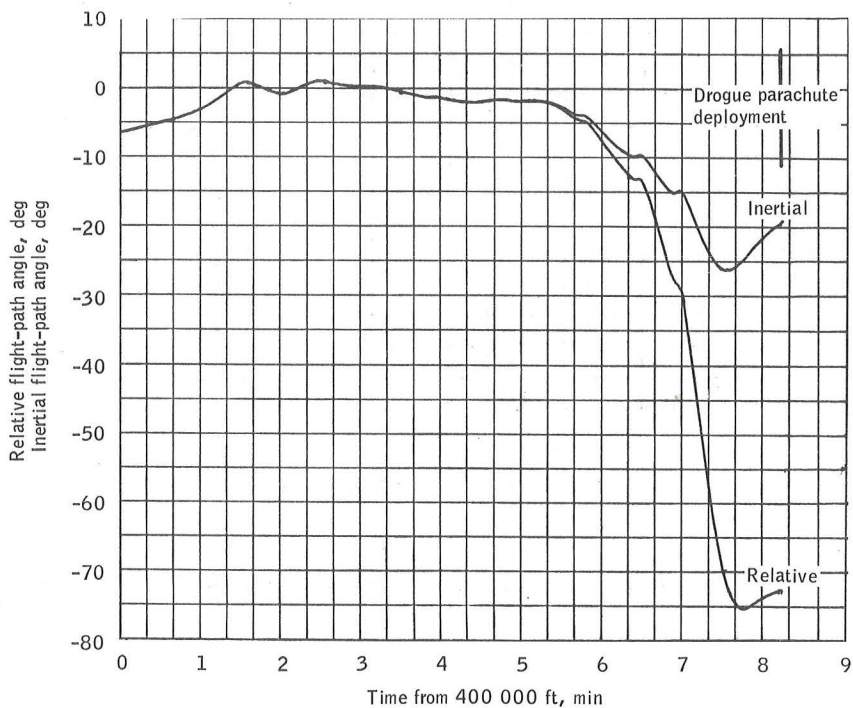

Figure 4.17-5.- Total aerodynamic heating rate and heat load time histories.



(a) Relative and inertial velocity.



(b) Relative and inertial flight-path angle.

Figure 4.17-6.- Time histories of velocity and flight-path angle for entry.

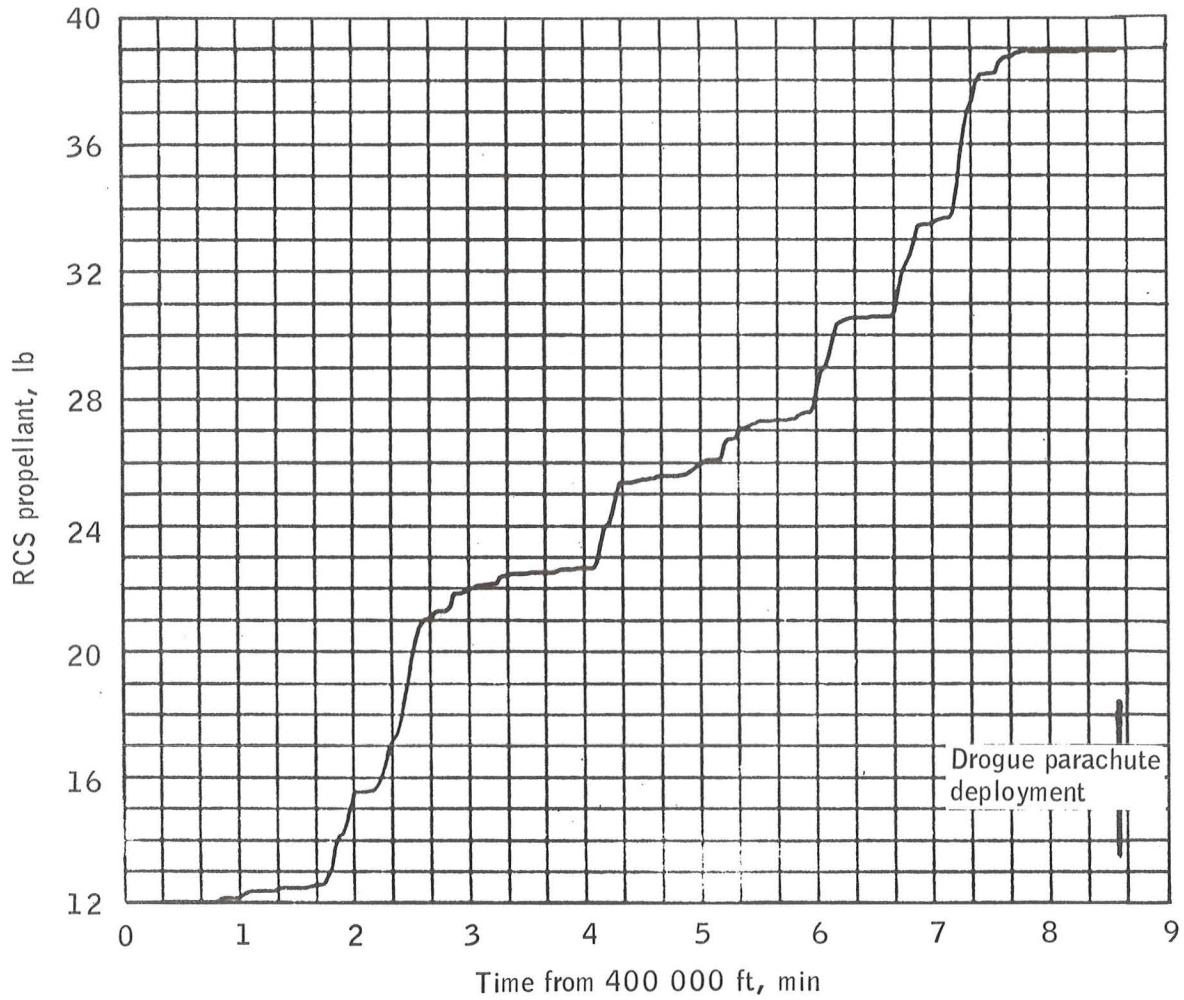

Figure 4.17-7.- Total propellant consumed from CSM separation.

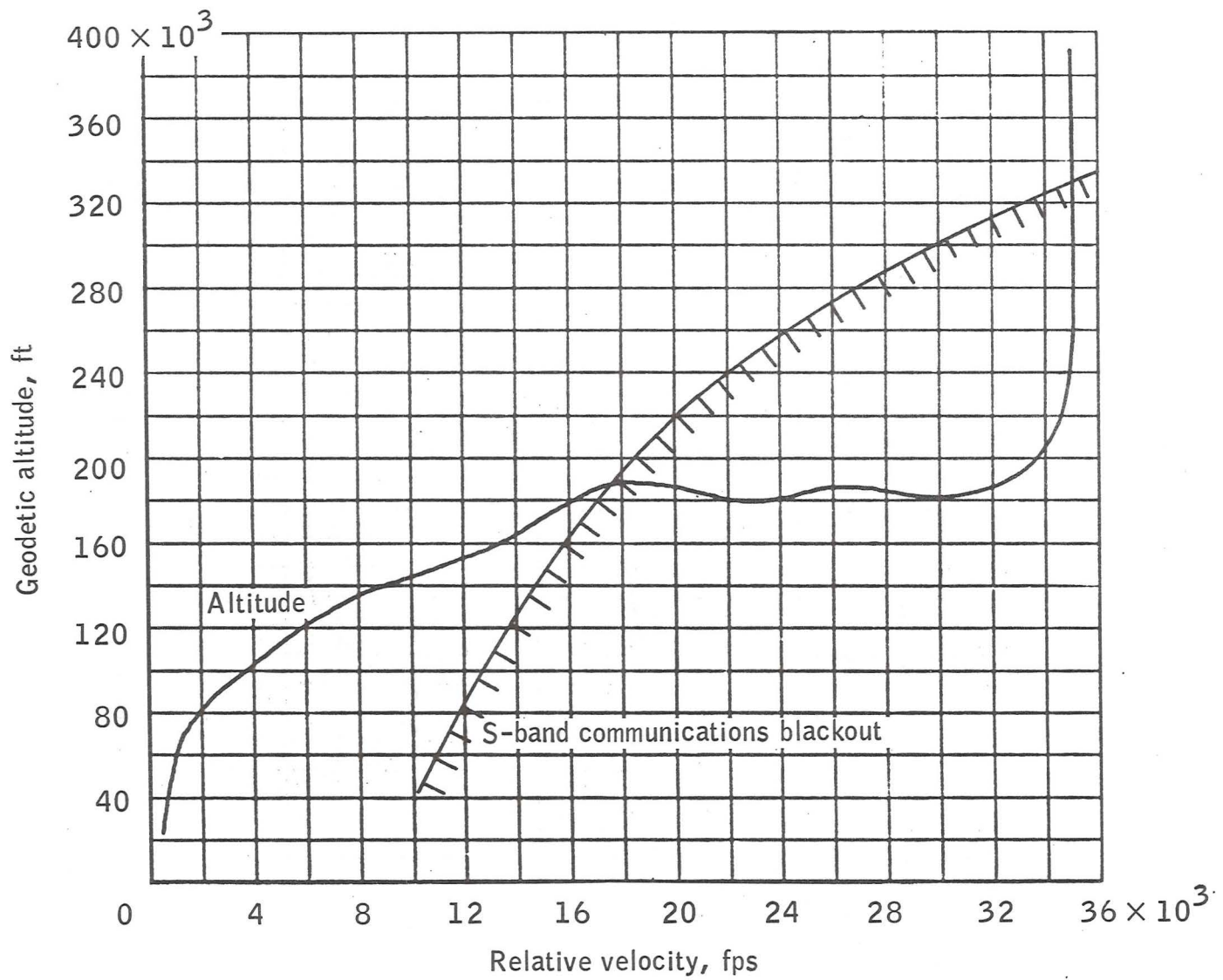

Figure 4.17-8.- Communications blackout.

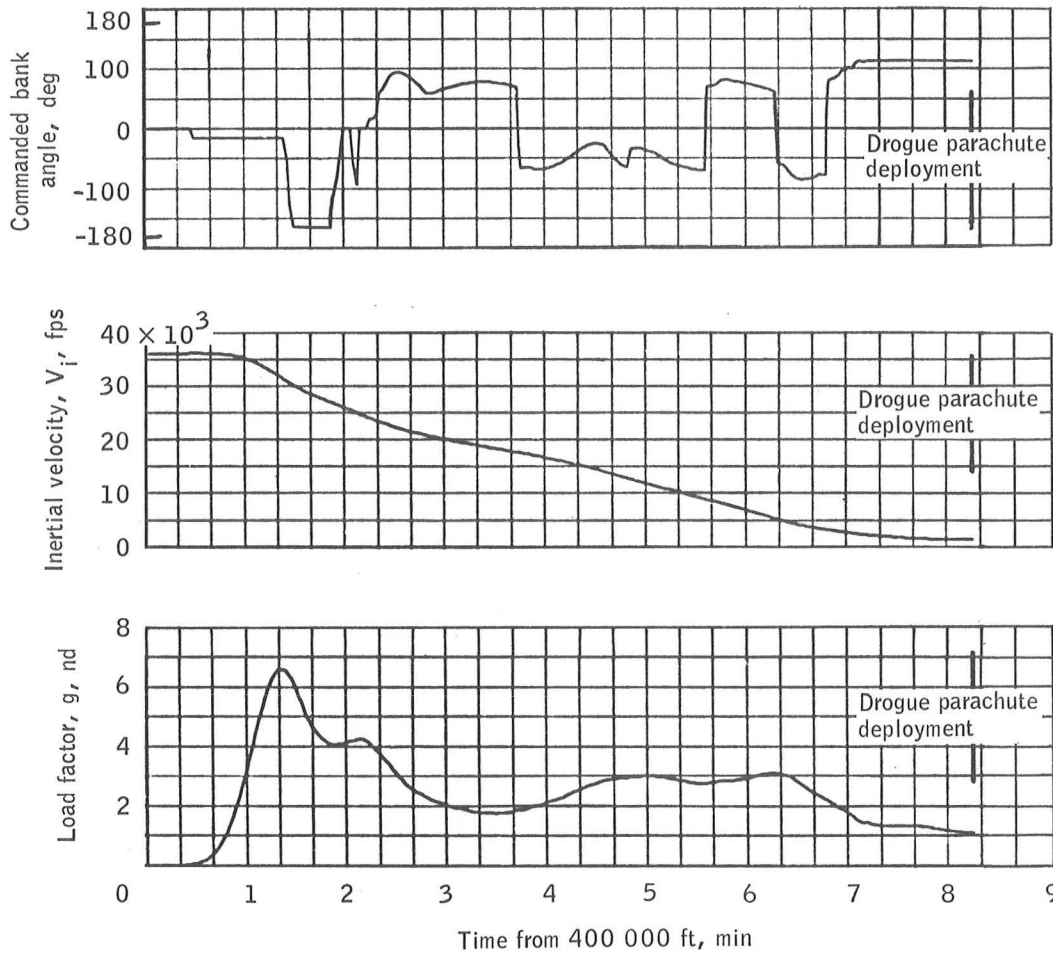

Figure 4.17-9.- Primary DSKY display VERB 06 NOUN 74.

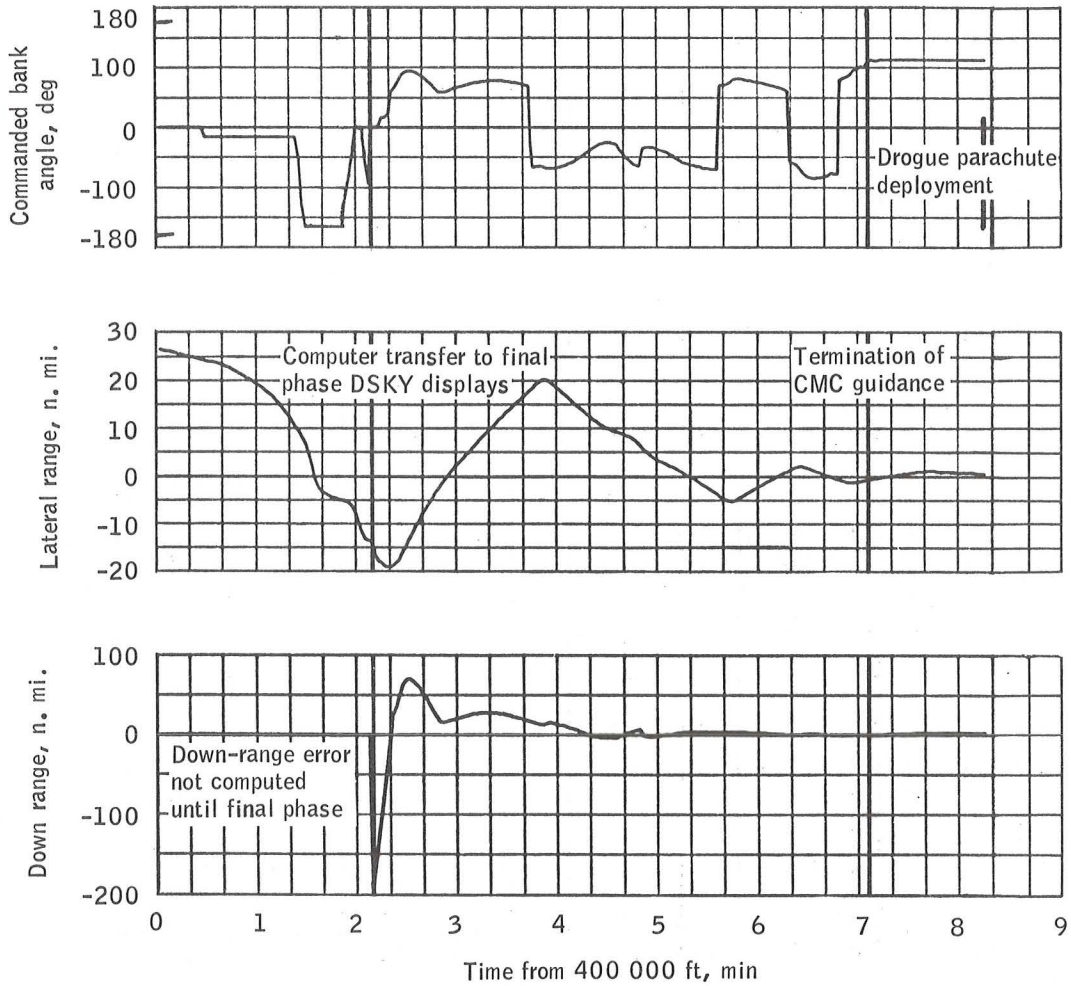

Figure 4.17-10.- DSKY displays (final phase) VERB 06 NOUN 66.

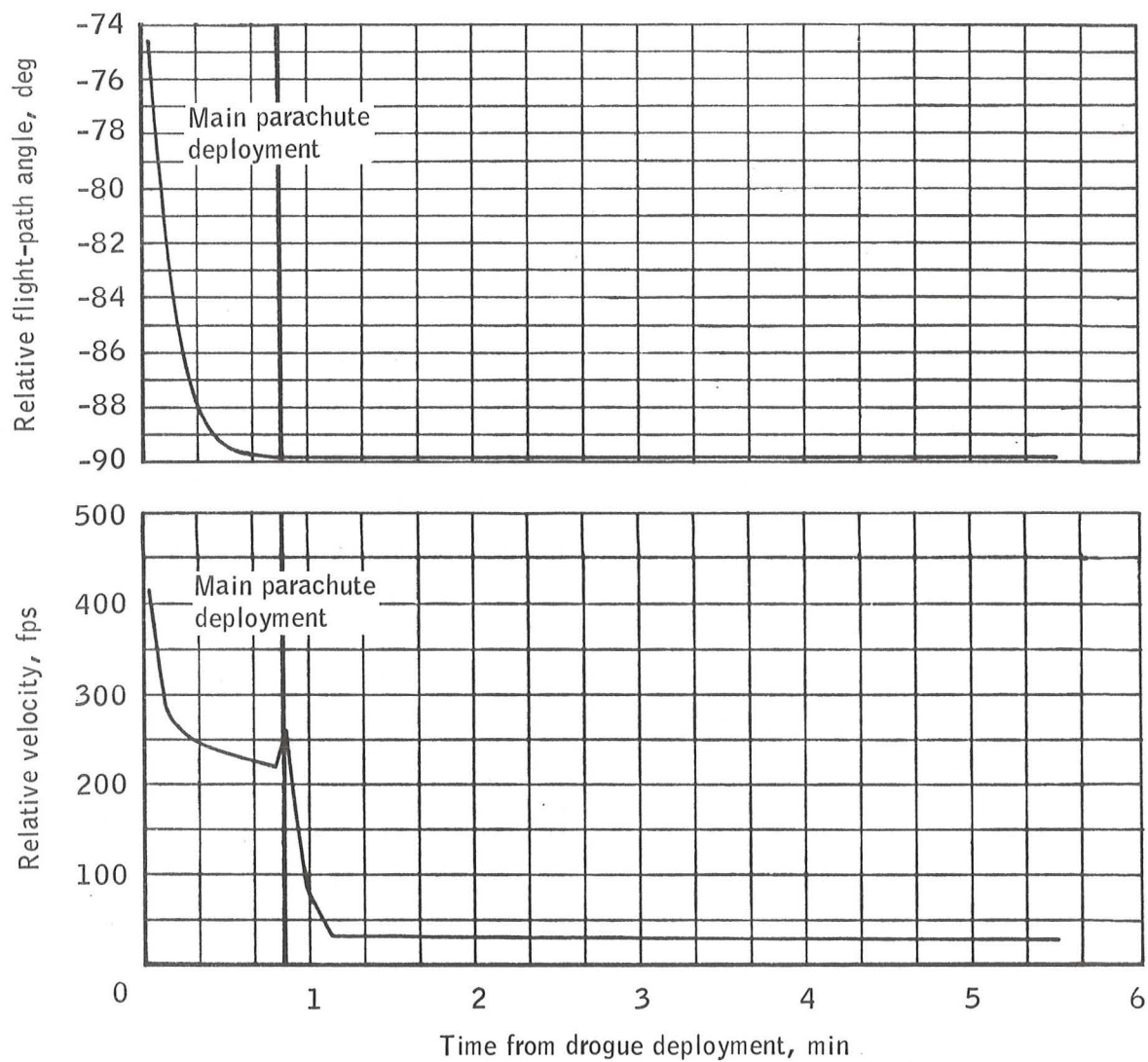

Figure 4.17-11.- Relative velocity and relative flight-path angle time histories from drogue parachute deployment.

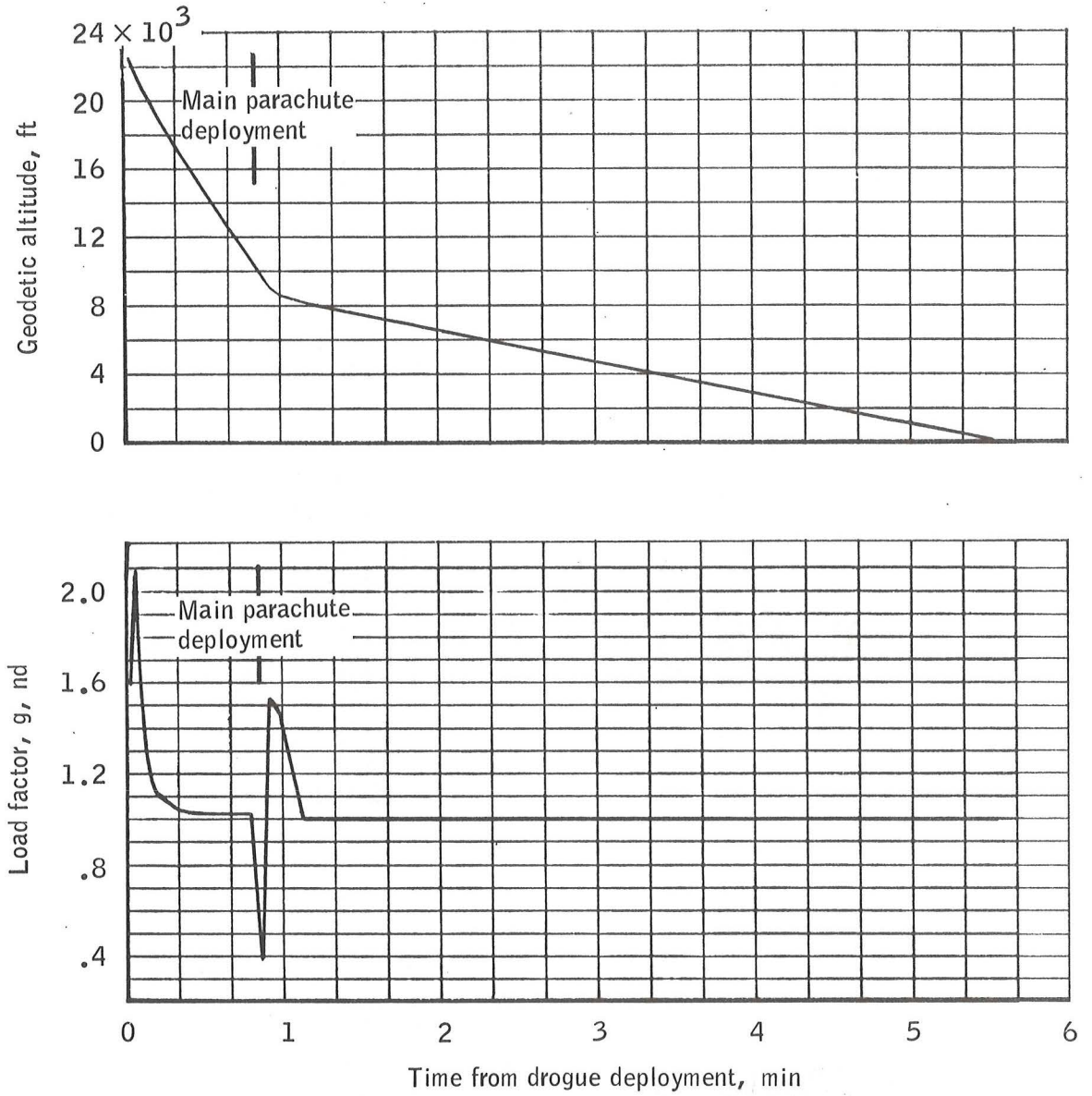
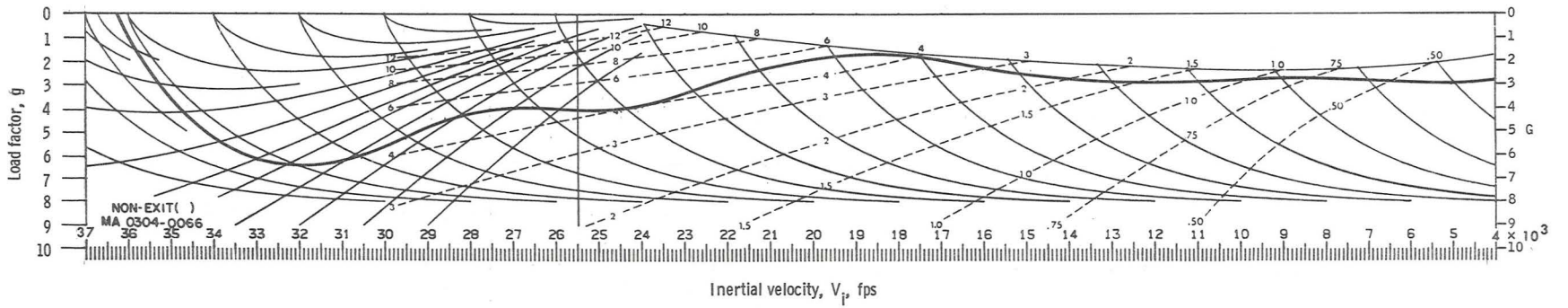
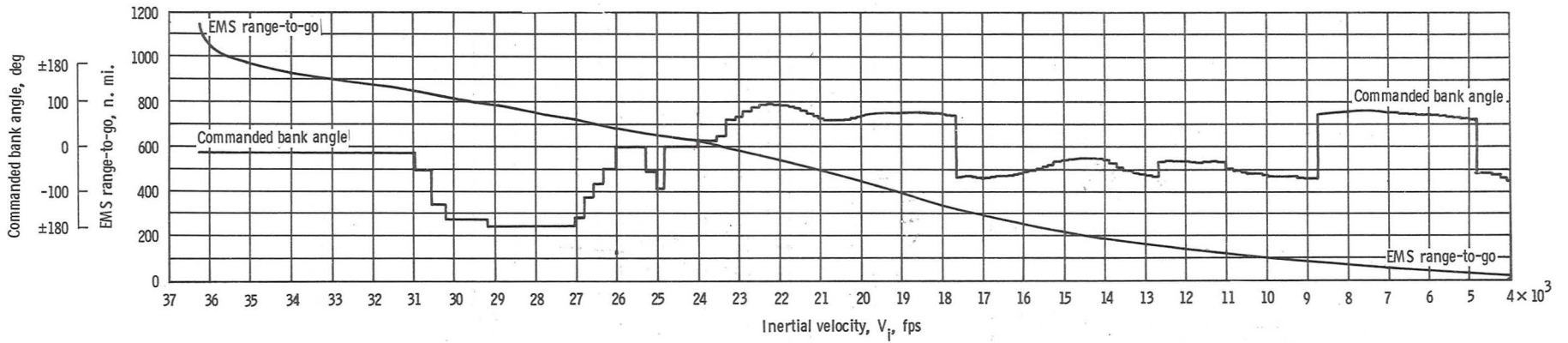

Figure 4.17-12.- Geodetic altitude and load factor time histories from drogue parachute deployment.



(a) Load factor versus inertial velocity.



(b) CMC commanded bank angle and EMS range-to-go versus inertial velocity.

Figure 4.17-13.- EMS parameters.

4-14

5.0 INPUT DATA

The following input data or reference sources were used to compute the Apollo 14 (H-3) mission operational trajectory.

| | |
|---------------------------------------------------|--------------------------|
| Launch pad REFSMMAT | Table 5-I |
| PTC REFSMMAT | Table 5-II |
| Landing site REFSMMAT | Table 5-III |
| Preferred (LOPC) REFSMMAT | Table 5-IV |
| LM ascent REFSMMAT | Table 5-V |
| Entry REFSMMAT | Table 5-VI |
| Spacecraft weight summary | Table 5-VII |
| Sequential mass properties | Reference 6 |
| Consumables weight change summary | Reference 6 |
| Assumed mission-independent expendables | Table 5-VIII |
| Service module propulsion performance | Table 5-IX |
| Command module RCS performance | Reference 7 |
| Lunar module propulsion performance | Table 5-X |
| Command module aerodynamic parameters | Table 5-XI |
| Lunar landing site positions | Table 5-XII |
| IMU alinement criteria | Table 5-XIII |
| Terminal rendezvous braking schedule | Table 5-XIV |
| MSFN station characteristics | Tables 5-XV and 5-XVI |
| Launch trajectory | Reference 2 |
| Mission requirements | Reference 8 |
| Aerodynamic heating data | References 9 and 10 |
| Atmosphere model | Reference 11 |
| Standards and constants | Reference 12 |
| Guidance equations and logic | References 13 and 14 |

TABLE 5-I.- LAUNCH PAD REFSMMAT

(a) Applicable maneuver

1. Launch

(b) Definition of REFSMMAT

$$\begin{bmatrix} X \\ Y \\ Z \end{bmatrix}_{\text{SPACECRAFT PLATFORM STABLE MEMBERS}} = \begin{bmatrix} \text{XIX} & \text{XIY} & \text{XIZ} \\ \text{YIX} & \text{YIY} & \text{YIZ} \\ \text{ZIX} & \text{ZIY} & \text{ZIZ} \end{bmatrix} \begin{bmatrix} X \\ Y \\ Z \end{bmatrix}_{\text{ECI (MNBY)}}$$

(c) REFSMMAT components

$$\begin{array}{lll}
 \text{XIX} = -0.061007433 & \text{XIY} = 0.96056227 & \text{XIZ} = 0.27128992 \\
 \text{YIX} = 0.48156036 & \text{YIY} = 0.26639687 & \text{YIZ} = -0.83494452 \\
 \text{ZIX} = -0.87428698 & \text{ZIY} = 0.079704651 & \text{ZIZ} = -0.47882091
 \end{array}$$

TABLE 5-II.- PTC REFSMMAT

(a) Applicable maneuvers

1. MCC-1
2. Non-free-return maneuver (MCC-2)
3. Passive thermal control
4. MCC-3
5. MCC-4

(b) Definition of REFSMMAT

$$\begin{bmatrix} X \\ Y \\ Z \end{bmatrix}_{\text{SPACECRAFT PLATFORM STABLE MEMBERS}} = \begin{bmatrix} XIX & XIY & XIZ \\ YIX & YIY & YIZ \\ ZIX & ZIY & ZIZ \end{bmatrix} \begin{bmatrix} X \\ Y \\ Z \end{bmatrix}_{\text{ECI (MNBV)}}$$

(c) REFSMMAT components

$$\begin{array}{lll}
 XIX = -0.93969262 & XIY = -0.31378923 & XIZ = -0.13606653 \\
 YIX = -0.34202014 & YIY = 0.86212879 & YIZ = 0.37383970 \\
 ZIX = 0.0 & ZIY = 0.39783191 & ZIZ = -0.91745832
 \end{array}$$

TABLE 5-III.- LANDING SITE REFSMMAT

(a) Applicable maneuvers

1. LOI
2. CSM separation
3. CSM circularization
4. LM powered descent

(b) Definition of REFSMMAT

$$\begin{bmatrix} X \\ Y \\ Z \end{bmatrix} \text{SPACECRAFT} \\ \text{PLATFORM} \\ \text{STABLE} \\ \text{MEMBERS} = \begin{bmatrix} XIX & XIY & XIZ \\ YIX & YIY & YIZ \\ ZIX & ZIY & ZIZ \end{bmatrix} \begin{bmatrix} X \\ Y \\ Z \end{bmatrix} \text{ECI (MNBY) or} \\ \text{MCI (MNBY)}$$

(c) REFSMMAT components

$$\begin{array}{lll}
 XIX = -0.55709886 & XIY = -0.74626008 & XIZ = -0.36433055 \\
 YIX = 0.17736372 & YIY = -0.53551514 & YIZ = 0.82569101 \\
 ZIX = -0.81128477 & ZIY = 0.39537251 & ZIZ = 0.43069435
 \end{array}$$

TABLE 5-IV.- PREFERRED (LOPC) REFSMMAT

(a) Applicable maneuver

1. LOPC

(b) Definition of REFSMMAT

$$\begin{bmatrix} X \\ Y \\ Z \end{bmatrix}_{\text{SPACECRAFT PLATFORM STABLE MEMBERS}} = \begin{bmatrix} XIX & XIY & XIZ \\ YIX & YIY & YIZ \\ ZIX & ZIY & ZIZ \end{bmatrix} \begin{bmatrix} X \\ Y \\ Z \end{bmatrix}_{\text{ECI (MNBY) or MCI (MNBY)}}$$

(c) REFSMMAT components

$$\begin{array}{lll} XIX = 0.13838206 & XIY = -0.48437922 & XIZ = 0.86384442 \\ YIX = -0.15380724 & YIY = -0.87216444 & YIZ = -0.46440558 \\ ZIX = 0.97836278 & ZIY = -0.068600122 & ZIZ = -0.19519294 \end{array}$$

TABLE 5-V.- LM ASCENT REFSMMAT

(a) Applicable maneuvers

1. LM ascent
2. CSI
3. CDH
4. TPI
5. CSM separation following LM jettison
6. LM deorbit
7. TEI

(b) Definition of REFSMMAT

$$\begin{bmatrix} X \\ Y \\ Z \end{bmatrix} \text{SPACECRAFT} \\ \text{PLATFORM} \\ \text{STABLE} \\ \text{MEMBERS} = \begin{bmatrix} XIX & XIY & XIZ \\ YIX & YIY & YIZ \\ ZIX & ZIY & ZIZ \end{bmatrix} \begin{bmatrix} X \\ Y \\ Z \end{bmatrix} \text{ECI (MNBY) or} \\ \text{MCI (MNBY)}$$

(c) REFSMMAT components

$$\begin{array}{lll}
 XIX = -0.26712678 & XIY = -0.86784820 & XIZ = -0.41890668 \\
 YIX = 0.19308503 & YIY = -0.47408943 & YIZ = 0.85904448 \\
 ZIX = -0.94411942 & ZIY = 0.14858917 & ZIZ = 0.29421047
 \end{array}$$

TABLE 5-VI.- ENTRY REFSMMAT

(a) Applicable maneuver

1. Entry

(b) Definition of REFSMMAT

$$\begin{bmatrix} X \\ Y \\ Z \end{bmatrix}_{\text{SPACECRAFT PLATFORM STABLE MEMBERS}} = \begin{bmatrix} XIX & XIY & XIZ \\ YIX & YIY & YIZ \\ ZIX & ZIY & ZIZ \end{bmatrix} \begin{bmatrix} X \\ Y \\ Z \end{bmatrix}_{\text{ECI (MNBY)}}$$

(c) REFSMMAT components

$$\begin{array}{lll} XIX = 0.88429904 & XIY = -0.38990236 & XIZ = 0.25688784 \\ YIX = 0.43228640 & YIY = 0.47571760 & YIZ = -0.76604258 \\ ZIX = 0.17647575 & ZIY = 0.78845983 & ZIZ = 0.58922610 \end{array}$$

TABLE 5-VII.- SPACECRAFT WEIGHT SUMMARY

| | |
|-------------------------------------------------------------|-----------|
| Total CSM inert, lb | 23 230.9 |
| CM inert, lb | 12 601.0 |
| SM inert, lb | 10 531.9 |
| SLA ring, lb | 98.0 |
| Total SPS propellant tanked, lb | 40 593.7 |
| SPS deliverable, lb | 40 354.6 |
| SPS trapped, lb | 239.1 |
| Total LM at earth launch, lb | 33 583.5 |
| LM descent stage, lb | 4 775.9 |
| LM DPS tanked, lb | 18 324.4 |
| LM ascent stage + RCS propellant, lb | 5 271.0 |
| LM APS tanked, lb | 5 212.2 |
| Spacecraft at earth launch (including LES), lb | 110 386.9 |
| Spacecraft before T&D | 101 380.3 |

TABLE 5-VIII.- ASSUMED MISSION-INDEPENDENT EXPENDABLES

| | |
|--------------------------------------|-----|
| Mission-independent SPS budget | |
| Translunar MCC (0 fps), lb | 0 |
| Transearth MCC (0 fps), lb | 0 |
| SPS propellant allowances | |
| Unbalance meter, lb | 100 |
| Mean outage, lb | 59 |
| Dispersions, lb | 426 |

TABLE 5-IX.- SERVICE MODULE PROPULSION PERFORMANCE SUMMARY

| Propulsion system | I_{sp} , sec | Thrust, lb | Flow rate, lb/sec |
|-------------------|-------------------|---------------|----------------------|
| RCS ^a | 263.58 | 181.87 | 0.69 |
| SPS ^b | 313.173 | 19 946 | 63.69 |
| SPS ^c | 313.48 | 21 032 | 67.09 |
| SPS ^d | 313.563 | 21 302 | 67.934 |

^aTwo-quad.

^bHybrid maneuver.

^cBefore crossover during LOI burn (258-sec burn time).

^dAfter crossover during LOI burn (258-sec burn time).

TABLE 5-X.- LUNAR MODULE PROPULSION PERFORMANCE SUMMARY

| Descent | | | | Ascent | | |
|---------------|--------------------------|--------------------------|--------------------------|----------------------|-------------------------|------------------------------------|
| DPS | | RCS | | APS + RCS | | |
| Thrust lb, | I _{sp} , sec | Thrust per engine, lb | I _{sp} , sec | Burn time, sec | Effective thrust, lb | Effective I _{sp} , sec |
| 1375 | 295.3 | 89.6 | 281.0 | 0 | 3573.5 | 309.6 |
| 2842 | 296.0 | | | 40 | 3561.2 | 309.9 |
| 3586 | 297.9 | | | 80 | 3547.9 | 310.1 |
| 5915 | 302.8 | | | 120 | 3534.5 | 310.2 |
| 6108 | 303.0 | | | 160 | 3521.3 | 310.2 |
| 9788 | 304.6 | | | 200 | 3508.6 | 310.2 |
| 9906 | 301.0 | | | 240 | 3496.5 | 310.2 |
| | | | | 280 | 3484.9 | 310.2 |
| | | | | 320 | 3478.5 | 310.1 |
| | | | | 360 | 3479.5 | 310.1 |
| | | | | 400 | 3485.3 | 310.1 |
| | | | | 430.7 | 3498.3 | 310.1 |

TABLE 5-XI.- COMMAND MODULE AERODYNAMIC COEFFICIENTS

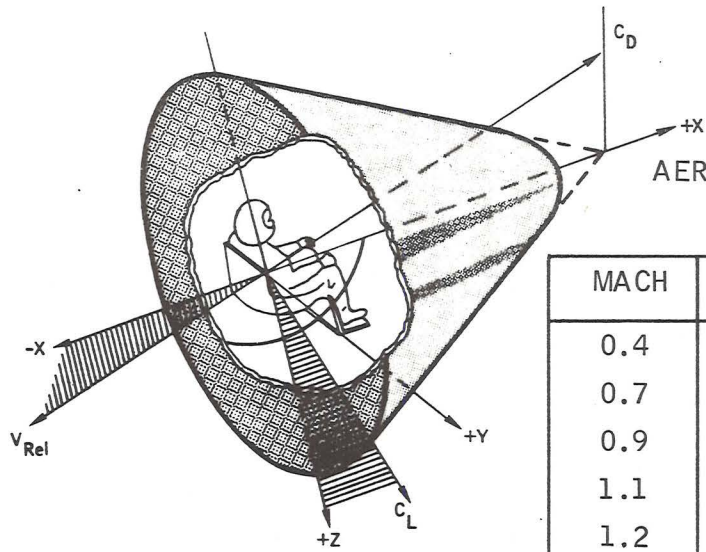

AERODYNAMIC COEFFICIENTS AT TRIM ANGLE OF ATTACK
AS A FUNCTION OF MACH NUMBER

| MACH | α , deg | C_L | C_D | L/D |
|------|----------------|----------|----------|----------|
| 0.4 | 167.021 | 0.247270 | 0.852535 | 0.290041 |
| 0.7 | 164.419 | 0.262858 | 0.985644 | 0.266687 |
| 0.9 | 161.786 | 0.319479 | 1.065963 | 0.299709 |
| 1.1 | 155.054 | 0.490841 | 1.171996 | 0.418808 |
| 1.2 | 155.296 | 0.475923 | 1.158027 | 0.410978 |
| 1.35 | 154.156 | 0.560154 | 1.280589 | 0.437419 |
| 1.65 | 153.441 | 0.547115 | 1.268507 | 0.431306 |
| 2.0 | 153.443 | 0.529746 | 1.278005 | 0.414510 |
| 2.4 | 153.953 | 0.504379 | 1.247470 | 0.404321 |
| 3.0 | 154.464 | 0.475752 | 1.223769 | 0.388760 |
| 4.0 | 156.378 | 0.438660 | 1.219548 | 0.359691 |
| 10.0 | 157.034 | 0.425825 | 1.229524 | 0.346333 |
| 29.5 | 160.258 | 0.385075 | 1.292907 | 0.297837 |

Center of gravity location in body coordinates

$X_{cg} = 1039.4$ in.

$Y_{cg} = -.30$ in.

$Z_{cg} = 6.0$ in.

TABLE 5-XII.- LUNAR LANDING AND PHOTOGRAPHY SITE POSITIONS

| Parameter | Landing site | Photography site |
|--------------------------|---------------|------------------|
| Launch date | Jan. 31, 1971 | Jan. 31, 1971 |
| Lunar site | Fra Mauro | Descartes |
| Latitude, deg | -3.6734 | -8.85 |
| Longitude, deg | -17.4646 | 15.567 |
| Altitude, n. mi. | -0.76 | -0.15 |

TABLE 5-XIII.-- IMU ALINEMENT CRITERIA AND REFSMMAT DEFINITIONS

| Applicable maneuvers | REFSMMAT | Alinement criteria (IMU) axis | Remarks |
|-------------------------------------------------------|---------------------------------------------|---------------------------------------------------------------------------------------------------------------------------------------------------------------------------------------------------------------------------------------------------------------------------------------------------------------------|-----------------------------------------------------------------------------------------------------------------------------------------------------------------------|
| Launch TLI T&D | Launch pad (CSM only) | X-axis along launch azimuth at pad Z-axis along negative radius vector Y-axis completes right-hand system | At earth launch, the FDAI will display roll = 180° pitch = 90° yaw = 0° |
| MCC-1 MCC-2 (hybrid transfer) MCC-3 MCC-4 | PTC (passive thermal control) (CSM only) | X-axis in the ecliptic plane and perpendicular to the earth-moon line projection in the ecliptic plane at the average time of trans-earth injection for the monthly launch window and azimuth range. Z-axis perpendicular to the ecliptic and directed south. Y-axis completes the right-hand system. | At the beginning of the Barbeque mode, the spacecraft will maneuver to an FDAI display of roll = 0° pitch = 90° yaw = 0° |
| LOI DOI PDI Landing | Landing site (CSM and LM) | X-axis along positive lunar radius vector at landing site at predicted landing time. Z-axis in direction of flight parallel to the CSM orbital plane and perpendicular to X. Y-axis completes the right-handed system. | At nominal touchdown, the LM FDAI will display roll = 0° pitch = 0° yaw = 0° |
| CSM plane changes | Preferred (CSM only) | X-axis alined with the spacecraft X-body axis at the vehicle attitude for ignition with the thrust directed through the center of gravity. Z-axis in the plane formed by the X-axis and position vector and directed down towards the moon. Y-axis completes the right-hand system. | At burn ignition, the FDAI will display roll = 0° pitch = 0° yaw = 0° |
| LM lift-off Rendezvous TEI | Ascent (CSM and LM) | X-axis along positive lunar radius vector at landing site at predicted lift-off time. Z-axis down range parallel to the CSM orbital plane and perpendicular to X. | At nominal lift-off time, the LM FDAI will display roll = 0° pitch = 0° yaw = 0° |
| MCC-5 MCC-6 MCC-7 | PTC (CSM only) | Same as above PTC alinement | Same as above PTC remarks. |
| Entry | Entry (CSM only) | X-axis is in local horizontal plane in the direction of flight at entry interface (400 000 ft). Z-axis is down along negative radius at entry interface. Y-axis completes right-hand system. | At entry interface with wings level local horizontal, heat shield forward, in place, lift up, heads down, the FDAI will display roll = 0° pitch = 180° yaw = 0° |

TABLE 5-XIV.- LM BRAKING SCHEDULE
DURING TERMINAL RENDEZVOUS PHASE

| Gate | Range, n. mi. | Range rate at cutoff, fps |
|--------|------------------|---------------------------------|
| First | 0.4 | -19.6 |
| Second | 0.2 | -9.8 |
| Third | 0.08 | -4.9 |
| Fourth | 0.01 | -0.2 |
| Fifth | 0.0 | 0.0 |

TABLE 5-XV. - MSFN STATION CHARACTERISTICS

Geodetic latitude, LATR, deg
 Longitude, LONR, deg
 Altitude, ALTR, ft
 Range capability, SRANGE, n. mi.
 Keyhole, FTINDC: 0 = none
 1 = north-south
 2 = east-west

| | | | |
|------------------|---------------------|--------------------|--------------------|
| RADAR =MAD-23 | X-Y USB-85, | LATR = 40.454991, | LONR = 355.831802 |
| ALTR = 2552.489, | SRANGE = 850000.0, | FTINDC = 2.0 | |
| RADAR =HSK-25 | X-Y USB-85, | LATR = -35.583494, | LONR = 148.978082 |
| ALTR = 3756.555, | SRANGE = 850000.0, | FTINDC = 2.0 | |
| RADAR =GDS-28 | X-Y USB-85, | LATR = 35.341594, | LONR = 243.126654 |
| ALTR = 2976.045, | SRANGE = 850000.0, | FTINDC = 2.0 | |
| RADAR =PKS-96 | H-D USB210, | LATR = -32.998938, | LONR = 148.263272 |
| ALTR = 1227.032, | SRANGE = 2100000.0, | FTINDC = 0.0 | |
| RADAR =STN-00 | A-E USB150, | LATR = 37.409722, | LONR = -122.177917 |
| ALTR = 525.000, | SRANGE = 1500000.0, | FTINDC = 0.0 | |
| RADAR =MIL-71 | X-Y USB-30, | LATR = 28.508272, | LONR = 279.306438 |
| ALTR = -59.055, | SRANGE = 300000.0, | FTINDC = 1.0 | |
| RADAR =GBM-41 | X-Y USB-30, | LATR = 26.632857, | LONR = 281.762191 |
| ALTR = 59.055, | SRANGE = 300000.0, | FTINDC = 1.0 | |
| RADAR =BDA-02 | X-Y USB-30, | LATR = 32.351250, | LONR = 295.341755 |
| ALTR = -6.562, | SRANGE = 300000.0, | FTINDC = 1.0 | |
| RADAR =ANG-91 | X-Y USB-30, | LATR = 17.016863, | LONR = 298.247038 |
| ALTR = 111.548, | SRANGE = 300000.0, | FTINDC = 1.0 | |
| RADAR =CYI-04 | X-Y USB-30, | LATR = 27.764536, | LONR = 344.366402 |
| ALTR = 567.584, | SRANGE = 300000.0, | FTINDC = 1.0 | |
| RADAR =ACN-75 | X-Y USB-30, | LATR = -7.954794, | LONR = 345.672938 |
| ALTR = 1712.595, | SRANGE = 300000.0, | FTINDC = 1.0 | |
| RADAR =CRO-08 | X-Y USB-30, | LATR = -24.906577, | LONR = 113.726049 |
| ALTR = 49.213, | SRANGE = 300000.0, | FTINDC = 1.0 | |
| RADAR =GWM-24 | X-Y USB-30, | LATR = 13.310575, | LONR = 144.736594 |
| ALTR = 469.159, | SRANGE = 300000.0, | FTINDC = 1.0 | |
| RADAR =HAW-12 | X-Y USB-30, | LATR = 22.126307, | LONR = 200.335058 |
| ALTR = 3723.747, | SRANGE = 300000.0, | FTINDC = 1.0 | |
| RADAR =GYM-14 | X-Y USB-30, | LATR = 27.963205, | LONR = 249.279004 |
| ALTR = -72.178, | SRANGE = 300000.0, | FTINDC = 1.0 | |
| RADAR =TEX-16 | X-Y USB-30, | LATR = 27.653750, | LONR = 262.621385 |
| ALTR = -65.617, | SRANGE = 300000.0, | FTINDC = 1.0 | |
| RADAR =GTI-51 | A-E TPQ-18, | LATR = 21.462888, | LONR = 288.867741 |
| ALTR = 91.863, | SRANGE = 23400.0, | FTINDC = 0.0 | |
| RADAR =PRE-76 | A-E MPS-25, | LATR = -25.943733, | LONR = 28.358286 |
| ALTR = 5334.636, | SRANGE = 23400.0, | FTINDC = 0.0 | |
| RADAR =TAN-22 | A-E FPS-16, | LATR = -19.003019, | LONR = 47.314444 |
| ALTR = 4329.389, | SRANGE = 23400.0, | FTINDC = 0.0 | |
| RADAR =SHIP 1 | INSEPTION, | LATR = 28.000000, | LONR = -49.000000 |
| ALTR = 0.000, | SRANGE = 23400.0, | FTINDC = 0.0 | |

TABLE 5-XVI.- MSFN STATION IDENTIFICATION

| | |
|---------------------|-----------------------|
| Ship 1 | Insertion ship C-band |
| MIL-71 | Merritt Island S-band |
| BDA-02 | Bermuda S-band |
| ANG-91 | Antigua S-band |
| CYI-04 | Grand Canary S-band |
| ACN-75 | Ascension S-band |
| CRO-08 | Carnarvon S-band |
| GWM-24 | Guam S-band |
| HAW-12 | Hawaii S-band |
| GYM-14 | Guaymas S-band |
| MAD-23 | Madrid deep space |
| HSK-25 | Canberra deep space |
| GDS-28 ^a | Goldstone deep space |
| Parks-96 | Parks deep space |
| Tex-16 | Texas S-band |
| STN-00 | Stanford S-band |
| GBM-41 | Grand Bahama S-band |
| GTI-51 | Grand Turk C-band |
| PRE-76 | Pretoria C-band |
| TAN-22 | Tananarive C-band |

^aData also applicable to MAR-95 210 ft.

6.0 REFERENCES

1. Lunar Mission Analysis Branch; Orbital Mission Analysis Branch; and Landing Analysis Branch: Spacecraft Operational Trajectory for Apollo 14 (Mission H-3) Launched January 31, 1971, Volume II - Trajectory Parameters. MSC IN 70-FM-128, Sept. 4, 1970.
2. Transmittal of AS-509 data tapes, MSFC memo S&E-AERO-MFT-109-70, Aug. 21, 1970.
3. The Apollo 14 (H-3) Mission Operational Trajectory Simulator Data Package. MSC memo to be published.
4. Apollo Mission Techniques, Mission F and G, Transearth Injection, Midcourse Corrections, and Entry. MSC IN SPS-040, Feb. 24, 1969, revised June 6, 1969.
5. RTCC Requirements: Revised S-band Communication Blackout Data for Apollo F and Subsequent Missions. MSC memo 69-FM23-43, Feb. 26, 1969.
6. CSM/LM Spacecraft Operational Data Book, Volume III - Mass Properties. SNS-8-D-027, Rev 2 through amendment 81, Aug. 20, 1969.
7. CSM/LM Spacecraft Operational Data Book, Volume I - CSM Data Book. SNA-8-D-027 (I) Rev 3, through amendment 43, Apr. 15, 1970.
8. Mission Requirements, SA-509/CSM-110/LM-8, H-3 Type Mission. SPD9-R-056, June, 9, 1970.
9. Ried, Robert C., Jr.: Apollo Command Module Entry Air Radiation Heating Rate. MSC memo ES5/1-2/67, Jan. 9, 1968.
10. Heating Rate Factors for Reentry Studies. MSC memo ES5/9-11/173M, Sept. 14, 1967.
11. United States Weather Bureau: U. S. Standard Atmosphere, 1962, Dec. 1962.
12. Apollo Navigation Working Group: Apollo Missions and Navigation Systems Characteristics. Technical report no. AN-1.3, Dec. 15, 1967.
13. MIT: Guidance Systems Operations Plan for Manned CM Earth Orbital and Lunar Missions Using Program COLOSSUS, Section 5, Guidance Equations, Revision 2. R577, Dec. 1968.
14. Tolin, J. W., Jr.: RTCC Requirements for Missions H and Subsequent Missions: Reentry Phase. MSC IN 69-FM-179, July 3, 1969.