

241

50

66



NATIONAL AERONAUTICS AND SPACE ADMINISTRATION

MSC INTERNAL NOTE NO. 69-FM-511

FEBRUARY 21, 1969

PRELIMINARY LUNAR ORBIT ATTITUDE SEQUENCE FOR MISSION F

FACILITY FORM 602

N70-34512 (ACCESSION NUMBER) (THRU)

58 (PAGES)

TMX-64388 (NASA CR OR TMX OR AD NUMBER)

1 (CODE)

31 (CATEGORY)

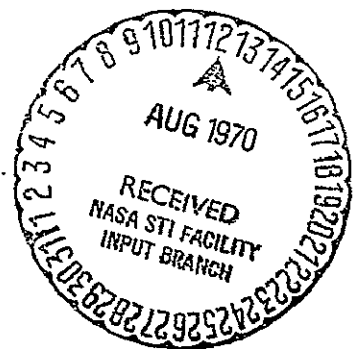

LUNAR MISSION ANALYSIS BRANCH  
MISSION PLANNING AND ANALYSIS DIVISION  
MANNED SPACECRAFT CENTER  
HOUSTON, TEXAS

Reproduced by  
NATIONAL TECHNICAL  
INFORMATION SERVICE  
Springfield, Va. 22151

PROJECT APOLLO  
PRELIMINARY LUNAR ORBIT ATTITUDE  
SEQUENCE FOR MISSION F

By E. C. Howell  
C. R. Hunt  
V. W. Simmons

Mission Design Section  
TRW Systems Group

---

February 21, 1969

MISSION PLANNING AND ANALYSIS DIVISION  
NATIONAL AERONAUTICS AND SPACE ADMINISTRATION  
MANNED SPACECRAFT CENTER  
HOUSTON, TEXAS

MSC Task Monitors  
H. D. Beck  
R. D. Duncan

Approved: Ronald L. Berry  
Ronald L. Berry, Chief  
Lunar Mission Analysis Branch

Approved: John P. Mayer  
John P. Mayer, Chief  
Mission Planning and Analysis Division

# CONTENTS

Section	Page
1. SUMMARY AND INTRODUCTION . . . . .	1
1.1 General . . . . .	1
1.2 Trajectory Profile . . . . .	1
1.3 Attitude Data Generation . . . . .	2
2. SYMBOLS . . . . .	3
3. LUNAR ORBIT ATTITUDE PROFILE . . . . .	5
3.1 First Revolution (Figure 1) . . . . .	5
3.2 Second Revolution (Figure 2) . . . . .	5
3.3 Third Revolution (Figure 3) . . . . .	6
3.4 Fourth Revolution (Figure 4) . . . . .	6
3.5 Fifth Revolution (Figure 5) . . . . .	6
3.6 Lunar Orbit Sleep (Figures 6, 7, 8, 9) . . . . .	7
3.7 Tenth Revolution (Figure 10) . . . . .	7
3.8 Eleventh Revolution (Figure 11) . . . . .	7
3.9 Undock to DOI (Figure 12) . . . . .	8
3.10 DOI Burn Cutoff to Phasing Burn Ignition (Figure 14) . . . . .	9
3.11 Phasing Burn Cutoff to Insertion Burn Ignition (Figure 16) . . . . .	10
3.12 Insertion Burn Cutoff to CDH Burn Ignition (Figure 17) . . . . .	11
3.13 CDH Burn Cutoff to TPF Burn Ignition (Figure 18) . . . . .	12
3.14 TPF Burn Cutoff To End of Sixteenth Revolution (Figure 19) . . . . .	12
3.15 Seventeenth Revolution (Figure 20) . . . . .	13
3.16 Second Lunar Orbit Sleep Period (Figures 21, 22, 23, 24) . . . . .	13

Section	Page
3.17 Twenty-second Revolution (Figure 25) . . . . .	13
3.18 Twenty-third Revolution (Figure 26) . . . . .	14
3.19 Twenty-fourth Revolution (Figure 27) . . . . .	14
3.20 Twenty-fifth Revolution (Figure 28) . . . . .	14
3.21 Twenty-sixth Revolution (Figure 29) . . . . .	15
3.22 Twenty-seventh Revolution (Figure 30) . . . . .	15
REFERENCES . . . . .	57

## FIGURES

Figure		Page
1	First Revolution Major Events and Attitudes . . . . .	27
2	Second Revolution Major Events and Attitudes . . . . .	28
3	Third Revolution Major Events and Attitudes . . . . .	29
4	Fourth Revolution Major Events and Attitudes . . . . .	30
5	Fifth Revolution Major Events and Attitudes . . . . .	31
6	Sixth Revolution Major Events and Attitudes . . . . .	32
7	Seventh Revolution Major Events and Attitudes . . . . .	33
8	Eighth Revolution Major Events and Attitudes . . . . .	34
9	Ninth Revolution Major Events and Attitudes . . . . .	35
10	Tenth Revolution Major Events and Attitudes . . . . .	36
11	Eleventh Revolution Major Events and Attitudes . . . . .	37
12	Start Twelfth Revolution to DOI Burn Ignition . . . . .	38
13	CSM/LM Relative Motion from Separation to DOI . . . . .	39
14	DOI Burn Cutoff to Phasing Burn Ignition . . . . .	40
15	CSM/LM Relative Motion from DOI to TPF (CSM Fixed) . . . . .	41
16	Phasing Burn Cutoff to Insertion Burn Ignition . . . . .	42
17	Insertion Burn Cutoff to CDH Burn Ignition . . . . .	43
18	CDH Burn Cutoff to TPF Burn Ignition . . . . .	44
19	TPF Burn Cutoff to End of Sixteenth Revolution . . . . .	45
20	Seventeenth Revolution Major Events and Attitudes . . . . .	46
21	Eighteenth Revolution Major Events and Attitudes . . . . .	47
22	Nineteenth Revolution Major Events and Attitudes . . . . .	48
23	Twentieth Revolution Major Events and Attitudes . . . . .	49

Figure		Page
24	Twenty-first Revolution Major Events and Attitudes . . . . .	50
25	Twenty-second Revolution Major Events and Attitudes. . . . .	51
26	Twenty-third Revolution Major Events and Attitudes . . . . .	52
27	Twenty-fourth Revolution Major Events and Attitudes . . . . .	53
28	Twenty-fifth Revolution Major Events and Attitudes . . . . .	54
29	Twenty-sixth Revolution Major Events and Attitudes . . . . .	55
30	Start of Twenty-seventh Revolution to TEI Burn Ignition . . . . .	56

# PRELIMINARY LUNAR ORBIT ATTITUDE SEQUENCE

## FOR MISSION F

By E. C. Howell  
C. R. Hunt  
V. W. Simmons

Mission Design Section

TRW Systems Group

## 1. SUMMARY AND INTRODUCTION

### 1.1 General

This document contains the preliminary spacecraft attitude sequence for the lunar orbit portion of mission F. Both command and service module (CSM) and lunar module (LM) activities are presented as based on current mission planning related to the respective vehicle attitude requirements. There is, however, lack of definition or agreement involving certain events during the lunar orbit operations. It should be emphasized, therefore, that the attitude data in this report are subject to revision as these problem areas are resolved. The cislunar phase will also be included in a later report.

The lunar orbit attitude sequence is presented as a sequence of events timeline and a schematic representation of the vehicle attitudes at major event times. The discussion consists primarily of the description, in chronological order, of the lunar orbit attitude profile. Those events noted previously as being under study are indicated as such. Event times for the mission were obtained from the mission F flight plan (Reference 1).

### 1.2 Trajectory Profile

The CSM state vector and ephemeris data for generating the CSM, LM, and docked CSM/LM attitude data were obtained from the Lunar Mission Analysis Branch of MPAD-MSC. Undocked CSM and LM trajectory parameters for the rendezvous events were furnished by the Orbital Mission Analysis Branch of MPAD-MSC. The complete lunar orbit phase of the mission was precision integrated on the Apollo Reference Mission Program Version ARM06. Launch date for the mission is May 17, 1968 with a launch azimuth of 72 degrees and a Pacific translunar injection on the first opportunity.

The lunar orbit phase involves first, LM operations in the lunar environment and second, landmark tracking and photography exercises similar to the Apollo 8 mission.

### 1.3 Attitude Data Generation

The ARM06 program was used in producing the required CSM and LM attitude data for this report. For the purpose of data generation, attitude maneuvers that reorient the spacecraft from an existing attitude are assumed to be instantaneous. An appropriate time interval is provided, however, for a finite reorientation. These maneuver times are representative only and not intended to reflect actual rates.

Spacecraft attitude requirements for the various lunar orbit events have been analyzed from the systems and operational constraints document (Reference 2). Violation of any constraint when necessitated by an operational requirement will be noted in the discussion.

In addition to the spacecraft attitude data supplied by this document, computer tapes of the lunar orbit attitude profile will be available shortly. Requests for these tapes should be made through the Mission Planning Support Office of MPAD-MSO.



## 2. SYMBOLS

AOT	alignment optical telescope
APS	ascent propulsion subsystem
ARM06	Apollo Reference Mission Program Version ARM06
CDH	constant delta altitude
CMP	command module pilot
COAS	crew optical alignment sight
CSI	coelliptic sequence initiation
CSM	command and service module
DOI	descent orbit insertion
DPS	descent propulsion subsystem
HGA	high-gain antenna
IMU	inertial measurement unit
LM	lunar module
LOI-1	first lunar orbit insertion burn
LOI-2	lunar orbit circularization burn
LR	landing radar
MI	mirror image
MPAD-MSC	Mission Planning and Analysis Division - Manned Spacecraft Center
MSFN	Manned Space Flight Network
PDI	powered descent initiation
RCS	reaction control subsystem
RR	rendezvous radar
SCT	scanning telescope

~~PRECEDING PAGE BEING REPRODUCED~~

SPS	service propulsion system
SXT	sextant
TEI	transearth injection
TPF	terminal phase final
TPI	terminal phase initiation
VHF	very high frequency

### 3. LUNAR ORBIT ATTITUDE PROFILE

This section contains a brief discussion of the lunar orbit attitude profile and those problem areas which are as yet unresolved. The events are discussed in chronological order with only those mission events that affect the attitude profile being mentioned.

The mission F lunar orbit profile may be divided into three major segments

1. LOI-1 burn cutoff to CSM/LM undocking
2. CSM/LM undocking to CSM/LM docking
3. CSM/LM docking to TEI burn ignition

The discussion will be divided into these segments with the first and third segments being discussed revolution by revolution while the second segment is discussed according to major events. For the purpose of this document, a vehicle revolution will be referenced to the lunar surface. The first vehicle revolution is assumed to start at LOI-1 burn cutoff and end at 180 degrees selenographic longitude. All other revolutions start and end at 180 degrees selenographic longitude.

#### 3.1 First Revolution (Figure 1)

The LOI-1 burn is designed to place the CSM/LM into a 60- by 170-nautical mile elliptical parking orbit around the moon. The burn is performed by the SPS engine with the CSM in a retrograde attitude, and the crew is heads down to afford visual reference with the lunar surface. The LOI-1 burn attitude is maintained until approximately 6 minutes prior to acquisition of MSFN line of sight. The spacecraft is then rolled 180 degrees to establish S-band high-gain communications. This attitude is held inertially fixed through the completion of the first revolution. S-band high-gain communications will be available from acquisition of MSFN line of sight to loss of MSFN line of sight.

#### 3.2 Second Revolution (Figure 2)

At the completion of the first revolution, the spacecraft is in an inertially fixed attitude which allows S-band high-gain communications when in line of sight of MSFN. This attitude is maintained inertially fixed through most of the second revolution. This inertially fixed attitude satisfies the attitude requirements for the IMU realignment which occurs approximately 4 minutes after the spacecraft enters darkness. Approximately 22 minutes prior to loss of MSFN line of sight, the inertial attitude hold is terminated, and the spacecraft is maneuvered to the LOI-2 burn attitude. This attitude is held inertially fixed through the remainder of the second revolution. S-band high-gain communications will be available from acquisition of MSFN line of sight until the maneuver to the LOI-2 burn attitude.

### 3.3 Third Revolution (Figure 3)

Immediately following the start of the third revolution, the LOI-2 burn is performed. The circularization burn transforms the initial elliptical parking orbit into a 60-nautical mile circular orbit. The SPS burn is performed with the CSM in a retrograde attitude, and the crew is heads down to afford visual reference with the lunar surface. Approximately 7 minutes prior to acquisition of MSFN line of sight, the spacecraft is rolled 180 degrees to establish S-band high-gain communications. This attitude is held inertially fixed through the completion of the third revolution. S-band high-gain communications will be available from acquisition of MSFN line of sight to loss of MSFN line of sight.

### 3.4 Fourth Revolution (Figure 4)

At the beginning of the fourth revolution, the spacecraft is in an inertially fixed S-band high-gain communication attitude. This attitude is held inertially fixed until approximately 5 minutes prior to acquisition of MSFN line of sight. The spacecraft is then maneuvered to an attitude which is rolled 180 degrees from the landmark sighting attitude to be used on the pseudo landing site landmark in the fifth revolution. The inertial attitude is such that the spacecraft will be pitched 2 degrees below the local horizontal at 35 degrees elevation east of the pseudo landing site landmark. During the fourth revolution the LM will be occupied as general housekeeping chores are performed. For the May 17 launch date, this inertially fixed attitude will allow both CSM and LM S-band high-gain communications, although no requirement for LM high-gain communications now exist for this portion of LM activity. This attitude is held inertially fixed through the completion of the fourth revolution. All attitude requirements are satisfied for the IMU realignment which occurs approximately 5 minutes after the spacecraft enters darkness. CSM and LM S-band high-gain communications will be available from acquisition of MSFN line of sight to loss of MSFN line of sight.

### 3.5 Fifth Revolution (Figure 5)

The inertially fixed attitude that exists at the end of the fourth revolution is maintained until approximately 12 minutes after the acquisition of MSFN line of sight. The spacecraft is then rolled 180 degrees into the initial landmark sighting attitude. Landmark sighting is one of the areas that is still under discussion. The docked landmark sighting procedure presented here is just one of the modes still under consideration. Using this mode, an inertial attitude hold is maintained until the spacecraft is 90 seconds from the closest point of approach to the landmark (approximately 35 degrees elevation east of the landmark). The spacecraft is then given a  $-0.3$  degree per second pitch rate. The pitch rate is maintained for 180 seconds, and the landmark remains in the optics field of coverage during the 3-minute interval. CSM high-gain communications are not available during the sighting sequence. The landmark used for this sighting is a pseudo landing site landmark which is picked to be at a 3-degree sun elevation angle at the tracking time. Following the landmark tracking,

the spacecraft is maneuvered to the lunar orbit sleep attitude. This attitude is held inertially fixed through the completion of the fifth revolution. CSM high-gain communications are available from acquisition of MSFN line of sight to the maneuver to the landmark sighting attitude and from the time of attaining the sleep attitude to loss of MSFN line of sight.

### 3.6 Lunar Orbit Sleep (Figures 6, 7, 8, 9)

The lunar orbit sleep attitude is still under discussion. The attitude presented here is an inertially fixed one with the CSM X-axis in the lunar orbit plane and perpendicular to the projection of the moon-to-earth line into the orbit plane. A large maneuver is made after the completion of the landmark tracking in the fifth revolution to point the CSM X-axis generally toward the sun. The spacecraft has been in a series of inertial holds with the CSM X-axis pointed generally away from the sun for four revolutions, and for the long inertial hold during sleep the pointings are reversed to help thermal conditions. Although an inertial attitude hold is shown, the spacecraft may be in a two-axis control mode with only spacecraft yaw and roll controlled, or in a roll mode with the spacecraft rolling at 0.1 to 0.2 degree per second. The lunar orbit sleep period lasts 8 hours, being terminated late in the ninth revolution. The inertial attitude existing at the completion of the sleep period is maintained through the completion of the ninth revolution. The inertial attitude hold during lunar orbit sleep will allow S-band high-gain communications from acquisition of MSFN line of sight to loss of MSFN line of sight in each revolution.

### 3.7 Tenth Revolution (Figure 10)

At the beginning of the tenth revolution, the spacecraft is in an inertially fixed S-band high-gain communication attitude. This attitude is maintained inertially fixed until approximately 20 minutes after acquisition of MSFN line of sight. The spacecraft is then maneuvered to an attitude that is rolled 180 degrees from the landmark sighting attitude to be used on the first landing site landmark in the eleventh revolution. The inertial attitude is such that the spacecraft will be pitched 2 degrees below the local horizontal at 35 degrees elevation east of the first landing site landmark. During the tenth and eleventh revolutions LM checkout is being performed with requirements for LM S-band high-gain communications. For the May 17 launch date, this inertial attitude hold will provide both CSM and LM S-band high-gain communications. The spacecraft is held inertially fixed through the completion of the tenth revolution. This attitude satisfies the attitude requirements for the IMU realignment which occurs approximately 13 minutes after the spacecraft enters darkness.

### 3.8 Eleventh Revolution (Figure 11)

At the beginning of the eleventh revolution, the spacecraft is in an inertially fixed attitude which allows both CSM and LM S-band high-gain communications. This attitude is held inertially fixed until approximately 7 minutes after acquisition of MSFN line of sight. The spacecraft is then

rolled 180 degrees into the initial landmark sighting attitude for the first landing site landmark. The mode of landmark sighting used is the same as that used for the pseudo landing site landmark in the fifth revolution. A -0.3 degree per second pitch rate is started 90 seconds before the spacecraft passes the closest point of approach to the landmark. The pitch rate is terminated after 180 seconds, and the spacecraft is maneuvered back to the same CSM and LM S-band high-gain communication attitude which existed prior to the landmark tracking. This attitude is held inertially fixed until about 10 minutes after the spacecraft loses MSFN line of sight. The spacecraft is then maneuvered to the undocking attitude. This attitude is held inertially fixed until undocking occurs early in the twelfth revolution. CSM and LM S-band high-gain communications are available from acquisition of MSFN line of sight to loss of MSFN line of sight except during landmark tracking.

### 3.9 Undock to DOI (Figure 12)

Undocking will occur at 98:30:44 g. e. t., which is approximately 25 minutes prior to the CSM/RCS separation burn. The orientation of the vehicles is such that the LM is ahead of the CSM. The CSM is inplane heads down and pitched 14 degrees above the local horizontal. This attitude is the CSM inertial separation burn attitude except for a 180-degree roll maneuver which is performed following AOS. After the CSM undocks from the LM, the LM will null the relative range rate after a separation distance of 40 to 50 feet is achieved. The CSM will then station keep at this distance while the LM performs a 120-degree negative roll (pilot yaw right) maneuver and a 90-degree pitch maneuver. This will place the LM heads down and at an attitude where the crews will be eye-to-eye. The CMP will then inspect and photograph the LM landing gear and descent engine bell while the LM does a rotation maneuver (pilot yaw) of 2 degrees per second for 360 degrees. After completion of the inspection, the LM will station keep while the CMP prepares for the RCS separation burn. Immediately after AOS, the CSM will manually roll 180 degrees to acquire the MSFN with the HGA.

Separation is accomplished by the CSM X-axis RCS thrusters applying a  $\Delta V$  of 2.5 feet per second radially downward. This maneuver is performed at approximately 180 degrees central angle prior to DOI. At separation burn ignition the CSM is inplane and pitched 90 degrees above the local horizontal (positive X-axis is coincident with the radius vector). An attitude maneuver should not be required at this time since the CSM undocking attitude was the inertial separation burn attitude. The LM will have performed small translation maneuvers during the station keeping phase so that it will be slightly ahead and above the CSM at separation. This will allow the LM to visually monitor the RCS separation burn while maintaining an attitude that is favorable for establishing the RR tracking attitude which follows separation. Each spacecraft will be in an attitude favorable for HGA communications during the separation burn.

After separation is accomplished, the CSM and LM will maneuver to the required attitudes for CSM SXT/VHF tracking and LM radar checks. The necessary tracking attitude results in the center of the

common coverage of the CSM SXT and RR transponder to be pointing at the LM (35 degrees from the positive X-axis toward the positive Z-axis measured in the X-Z plane). Likewise, the center of coverage of the LM tracking light should be pointing at the CSM (along the positive Z-axis). This attitude is also the preferred attitude for LM RR coverage. For this radar check, and for all subsequent RR tracking, the CSM is oriented in a heads-down attitude and the LM in a heads-up attitude. The initial attitudes of the vehicles will allow for CSM SXT and RR transponder and LM RR and tracking light line-of-sight maintenance if required.

A LM IMU realignment will be performed about 6 minutes after the spacecraft enters darkness using the IMU Realign Program, P52. Both vehicles will be in inertial attitude hold at this time. After the IMU realignment is performed, the LM will do a pitch maneuver in order to maintain the necessary attitude for CSM SXT/VHF tracking and LM RR tracking. The LM will then continue in inertial attitude hold. Both vehicles will have HGA communications with the MSFN.

Approximately 11 minutes prior to DOI, the CMP will perform a COAS calibration followed by a pitch maneuver to point the positive X-axis at the LM. This is the required COAS tracking attitude. While in this attitude the CSM will not have HGA communications with the MSFN. The initial attitudes of the two vehicles at this time will allow for line-of-sight maintenance if required.

Immediately following the COAS tracking phase, the LM maneuvers to the DOI burn attitude which is a retrograde, in-plane, heads-down orientation. The CSM maneuvers to the required attitude to monitor the LM burn and to provide radar transponder coverage as discussed previously. DOI burn ignition occurs at 99:54:12 g. e. t.

A relative motion plot of the two spacecraft from separation to DOI is illustrated in Figure 13. It was assumed that the LM was approximately 50 feet above the CSM at separation. The attitude sequences for this phase of the mission were developed by utilizing the crew procedures information presented in Reference 3.

### 3.10 DOI Burn Cutoff to Phasing Burn Ignition (Figure 14)

The CSM-LM relative motion for the lunar orbit phase from DOI to TPF is shown in Figure 15.

Following cutoff of the DPS DOI burn at 99:54:40 g. e. t., the LM orients to the RR tracking attitude described in the preceding section. This tracking interval lasts for approximately 5 minutes after which the LM orients to the inertial powered descent initiation (PDI) attitude. The PDI attitude is defined at pericyynthion of the descent orbit by a LM retrograde, local horizontal, and face down orientation. The CSM continues to track the LM for an onboard determination of the LM descent orbit state vector. Since the CSM is scheduled to begin SXT/VHF tracking

11 minutes after DOI cutoff, the DOI burn monitoring results in an essentially continuous tracking interval for the CSM. CSM and LM tracking periods were obtained from Reference 4 except that the LM tracking before phasing, which was shown in the reference, has been deleted. The CSM terminates SXT/VHF tracking 30 minutes after DOI cutoff and orients to an inertial mirror image (MI) phasing burn attitude. The MI burn attitude provides CSM backup capability for the LM rendezvous burns from phasing to TPF. The attitude consists of aligning the CSM propulsion system (SPS or RCS) in a thrusting direction opposite to the LM burn orientation. Ignition for the MI burn is scheduled to occur 1 minute after the nominal time of ignition for the LM burn. Thus, the CSM MI phasing burn attitude is essentially retrograde (plus X-axis 29 degrees below the local horizontal, opposite the direction of motion) and heads down at the scheduled ignition time. The CSM maintains this orientation, which provides S-band high-gain communications at MSFN acquisition, until a nominal LM phasing burn is verified.

The LM acquires earth line of sight in the PDI attitude. A negative roll (pilot yaw right) of 180 degrees and a negative pitch maneuver is executed in preparation for the landing radar (LR) test. The direction of the roll (pilot yaw) is necessary to maintain S-band high-gain communications, and the pitch maneuver orients the LM to the local vertical (LM plus X-axis up). A pitch rate of -0.05 degree per second is induced with the LM X-axis pitched back 10 degrees from the local vertical. The LR test is initiated 400 seconds prior to pericyynthion of the descent orbit trajectory and ends 800 seconds later. The landing site is visible through the LM window for approximately 2 minutes during the test.

Upon completion of the LR test, the LM prepares for the DPS phasing burn. The inertial burn attitude (plus X-axis 26 degrees above the local horizontal in the direction of motion and face down at ignition) is established 8 minutes prior to ignition which occurs at 101:06:35 g. e. t. The LM attitude profile from MSFN acquisition to ignition provides HGA-MSFN line of sight.

### 3.11 Phasing Burn Cutoff to Insertion Burn Ignition (Figure 16)

The DPS phasing burn is at 101:07:17 g. e. t. with the LM holding the attitude inertially until executing a pitch maneuver for RR tracking of the CSM starting 8 minutes after burn termination. The CSM, upon confirming the LM burn is nominal, orients from the MI phasing burn attitude to the heads down attitude for the tracking period beginning 10 minutes after the burn. The LM tracking attitude for this period is compatible with S-band high-gain communications. The LM attitude at the end of the period is then held inertially until the next tracking period. The CSM attitude may, however, be marginal from the communications standpoint as the earth line of sight is near the minus X-axis. For this reason, a reorientation has been included at the end of the CSM tracking to orient the high-gain antenna toward the earth. This attitude is held inertially until the next tracking period begins.



The CSM and LM initiate tracking again at 102:09:18 g. e. t. and 102:20:18 g. e. t., respectively. Both vehicles are out of MSFN line of sight during essentially all of this period with the LM having only about 1 minute of coverage at the end of the period.

The CSM maneuvers next to the MI insertion burn attitude (plus X-axis 24.5 degrees below the local horizontal in the direction of motion and heads down at ignition time +1 minute) and holds this attitude inertially until the LM insertion burn is performed and verified. The CSM MI burn attitude is compatible with S-band high-gain communications.

The LM, following tracking termination, prepares for the descent stage jettison that occurs 10 minutes before insertion burn ignition. The jettison attitude is retrograde local horizontal (minus X-axis forward and plus Z-axis down). Upon completion of the jettison the LM orients for the APS insertion burn (plus Z-axis forward along the local horizontal and heads up at ignition). The LM attitude from MSFN acquisition to burn ignition provides high-gain coverage with MSFN.

### 3.12 Insertion Burn Cutoff to CDH Burn Ignition (Figure 17)

Burn termination for the APS insertion burn occurs at 103:03:45 g. e. t. The LM holds the burnout attitude inertially until time to orient for a RR tracking period beginning 18 minutes after burn cutoff. This reorientation involves a negative roll (pilot yaw right) of 180 degrees and a pitch maneuver to point the Z-axis approximately along the local horizontal in the direction of motion.

The CSM, upon confirmation of a nominal APS insertion burn, orients from the MI insertion burn attitude to a retrograde, heads-down inertial attitude. The purpose of this orientation is to establish an attitude to perform an IMU realignment and provide S-band steerable antenna-MSFN line of sight. This attitude also prepares the CSM for the SXT/VHF tracking period starting 23 minutes after LM insertion burn cutoff.

The CSM and LM track until approximately 46 minutes and 11 minutes, respectively, prior to the CSI burn. At these times the vehicles maneuver to their inertial CSI burn attitudes (LM posigrade local horizontal and face down, CSM retrograde local horizontal and heads up at APS burn ignition). Both CSM and LM high-gain communications are satisfactory throughout the time from insertion burn cutoff to loss of MSFN.

The LM performs the CSI burn with the plus X-axis RCS thrusters beginning at 103:54:40 g. e. t. The burn attitude is maintained inertially and the LM prepares for another period of RR tracking starting 6 minutes after the CSI burn. This maneuver consists of pitching the Z-axis up to the local horizontal in the direction of motion.

The CSM, after verifying the LM CSI burn was nominal, also orients to the SXT/VHF tracking attitude. The maneuver is essentially a roll of

180 degrees to establish the heads-down tracking attitude. The roll maneuver is required because the MI CSI burn attitude is heads up to allow MSFN coverage until loss of signal.

After this period of tracking, another tracking interval is started 9 minutes later. The LM plane change maneuver occurs in this break but is not simulated in this document. After resuming tracking, both vehicles maintain the respective tracking attitude for the duration of the period. In this second period, MSFN line of sight is acquired. The LM tracking attitude provides S-band high-gain lock but the CSM attitude violates high-gain antenna pointing constraints. High-gain communications requirements are satisfied, however, when the CSM orients to the inertial MI CDH burn attitude (retrograde local horizontal and heads down at LM RCS ignition). The LM inertial CDH burn attitude (plus Z-axis forward along the local horizontal and heads up at ignition) also provides MSFN coverage with the LM steerable antenna.

### 3.13 CDH Burn Cutoff to TPF Burn Ignition (Figure 18)

After cutoff of the CDH burn at 104:52:48 g. e. t. (using the plus Z RCS jets), the LM and CSM begin another period of tracking 4 and 5 minutes later, respectively. The CSM and LM tracking attitudes provide high-gain coverage during this period. Both vehicles hold the tracking attitude inertially at the end of the period until executing their TPI burn attitude orientation. The LM performs TPI with the Z-axis jets in a heads-up posigrade attitude. The CSM MI burn attitude is heads down and retrograde at the nominal time of ignition. Following TPI cutoff, two short periods of tracking by the CSM and LM occur prior to the TPF burn at 106:11:41 g. e. t. The first of these two periods is within sight of MSFN stations. The CSM attitude is again, however, marginal for high-gain communications. The LM S-band high gain pointing is acceptable for MSFN acquisition.

The CSM prepares for the TPF burn and subsequent docking activities after terminating the second tracking period by orienting to an inertial attitude specified for docking. The LM orients to the TPF burn attitude which consists of aligning the Z-axis towards the CSM. This attitude provides for a series of braking maneuvers by the Z-axis RCS thrusters.

### 3.14 TPF Burn Cutoff To End of Sixteenth Revolution (Figure 19)

Following TPF, the LM flies formation with the CSM until 5-10 minutes before docking. The LM then maneuvers to the docking attitude and translates to capture the latch, with docking being completed about four minutes prior to the spacecraft entering darkness. Docking occurs with the LM ahead of the CSM and both vehicles approximately broadside to the sun. After docking and post docking checks, the spacecraft is maneuvered to the LM jettison attitude. The attitude is such that the LM is in the correct inertial burn attitude for the APS burn to depletion, which occurs approximately one revolution later. LM communications for the APS burn

will be checked at this time. This attitude is held inertially fixed through the completion of the sixteenth revolution. Both CSM and LM S-band high-gain communications should be available from acquisition of MSFN line of sight to loss of MSFN line of sight, although the earth line of sight is near the CSM X-axis when in the docking attitude.

### 3.15 Seventeenth Revolution (Figure 20)

At the beginning of the seventeenth revolution, the spacecraft is in the inertially fixed LM jettison attitude. Approximately 5 minutes after acquisition of MSFN line of sight LM jettison occurs with the LM in the correct burn attitude for the unmanned APS burn to depletion. Following LM jettison, the CSM performs RCS evasive maneuvers to translate above and behind the LM. The magnitude and directions of the maneuvers are still under discussion. Following the evasive maneuvers the CSM maneuvers to an attitude with which the LM may be seen through the CSM windows during the APS burn and which will provide S-band high-gain communications. The APS burn is made with the LM in line of sight with MSFN and in an attitude such that LM S-band high-gain communications are available. The burn is targeted to put the LM ascent stage in solar orbit. Following the LM burn and approximately 14 minutes after loss of MSFN line of sight, the CSM maneuvers to the lunar orbit sleep attitude. This attitude is held inertially fixed through the completion of the seventeenth revolution. Both CSM and LM S-band high-gain communications will be available from acquisition of MSFN line of sight to loss of MSFN line of sight.

### 3.16 Second Lunar Orbit Sleep Period (Figures 21, 22, 23, 24)

The CSM attitude for the second lunar orbit sleep period will be the same as the attitude for the first sleep period in lunar orbit. The sleep period will be 8 hours long, with sleep terminating early in the twenty-second revolution. The inertial attitude hold for the sleep period will provide CSM S-band high-gain communications from acquisition of MSFN line of sight to loss of MSFN line of sight during each revolution.

### 3.17 Twenty-second Revolution (Figure 25)

Early in the twenty-second revolution, the lunar orbit sleep period is terminated but the existing spacecraft attitude is maintained inertially fixed. Approximately 7 minutes before the CSM enters sunlight, the spacecraft is maneuvered to an attitude which will allow solar corona photography. After completion of this photography, the CSM is maneuvered to place the X-axis cameras down along the local vertical for strip photography and the Z-axis forward. This attitude is maintained locally fixed through the completion of the twenty-second revolution. S-band high-gain communications will be available from acquisition of MSFN line of sight to loss of MSFN line of sight.

### 3.18 Twenty-third Revolution (Figure 26)

At the beginning of the twenty-third revolution, the CSM is in the locally fixed strip photography attitude. This attitude is maintained locally fixed until approximately 9 minutes before the CSM enters darkness. The local attitude hold is then terminated and the existing vehicle attitude is held inertially fixed. This inertially fixed attitude satisfies the attitude requirements for the IMU realignment occurring approximately 5 minutes after the CSM enters darkness. About 4 minutes after the CSM enters sunlight, the spacecraft is maneuvered to the undocked landmark sighting attitude. The mode of landmark tracking for the undocked sightings is still under discussion. The undocked sightings will be made on a series of three control point landmarks plus the second landing site landmark. To avoid excessive maneuvering, and since LM blockage is no longer a problem, an orbital rate mode of landmark tracking is assumed for these undocked sightings. The vehicle attitude with respect to the local horizontal orientation is a pitch of -20 degrees. This attitude is held locally fixed through the completion of the twenty-third revolution. S-band high-gain communications will be available from acquisition of MSFN line of sight to loss of MSFN line of sight during this revolution.

### 3.19 Twenty-fourth Revolution (Figure 27)

At the beginning of the twenty-fourth revolution, the CSM is in the locally fixed landmark tracking attitude. This attitude is maintained locally fixed while the CSM tracks a series of three control point landmarks plus the second landing site landmark. CSM S-band high-gain communications will not be available during most of the landmark tracking. Approximately 4 minutes before the CSM enters darkness, the local attitude hold is terminated, and the CSM is rolled 180 degrees for S-band high-gain communications. The resulting attitude is maintained inertially fixed. This attitude satisfies the requirements for the IMU realignment which occurs approximately 6 minutes after the CSM enters darkness. Approximately 6 minutes after the loss of MSFN line of sight, the CSM is maneuvered to the locally fixed landmark tracking attitude for another series of landmark sightings in the twenty-fifth revolution. This attitude is held locally fixed through the completion of the twenty-fourth revolution. S-band high-gain communications are available from the maneuver following the end of landmark tracking until loss of MSFN line of sight.

### 3.20 Twenty-fifth Revolution (Figure 28)

At the beginning of the twenty-fifth revolution the CSM is in the locally fixed landmark tracking attitude. The CSM attitude is maintained locally fixed while landmark tracking is performed on the same series of landmarks which were tracked on the twenty-fourth revolution. Approximately 7 minutes before the CSM enters darkness, the local attitude hold is terminated, the CSM is rolled 180 degrees to establish S-band high-gain communications, and the resulting attitude is held inertially fixed. This inertially fixed attitude satisfies the attitude requirements for

the IMU realignment which occurs about 8 minutes after the CSM enters darkness. This attitude is maintained through the completion of the twenty-fifth revolution. S-band high-gain communications are available from the maneuver following the end of landmark tracking until loss of MSFN line of sight.

### 3.21 Twenty-sixth Revolution (Figure 29)

Following the start of the twenty-sixth revolution, the CSM is maneuvered to an attitude which is rolled 180 degrees from the TEI burn attitude. This attitude is held inertially fixed until approximately 16 minutes before loss of MSFN line of sight. The CSM is then rolled 180 degrees into the TEI burn attitude. This attitude is held inertially fixed through the completion of the twenty-sixth revolution. S-band high-gain communications will be available from acquisition of MSFN line of sight until the time to maneuver to the TEI burn attitude.

### 3.22 Twenty-seventh Revolution (Figure 30)

Shortly after the CSM begins the twenty-seventh revolution, the TEI burn occurs. The TEI burn boosts the CSM from the approximately 60-nautical mile circular lunar orbit into the transearth trajectory. The SPS burn is performed with the CSM in a posigrade attitude, and the crew is heads down to afford visual reference with the lunar surface.

Table I. Mission F Lunar Orbit Event Timeline

<u>Mission Time</u> (hr:min:sec)	<u>Event</u>
76:08:18	LOI-1 ignition
76:14:10	LOI-1 cutoff, inertial attitude hold
76:28:00	Roll 180 deg for S-band high-gain communications, inertial attitude hold
76:34:01	Acquire MSFN line of sight
77:12:47	Enter lunar umbra
77:59:15	Lose MSFN line of sight
77:59:27	Enter sunlight
78:42:25	Acquire MSFN line of sight
79:21:20	Enter lunar umbra
79:25:00	Begin IMU realignment
79:45:00	Maneuver to LOI -2 burn attitude, inertial attitude hold
80:07:25	Lose MSFN line of sight
80:08:02	Enter sunlight
80:32:12	LOI-2 ignition
80:32:27	LOI-2 cutoff, inertial attitude hold
80:45:00	Roll 180 deg for S-band high-gain communications, inertial attitude hold
80:51:50	Acquire MSFN line of sight
81:22:02	Enter lunar umbra
82:04:06	Lose MSFN line of sight
82:08:18	Enter sunlight
82:45:00	Maneuver to landmark sighting attitude except rolled 180 deg, inertial attitude hold
82:50:13	Acquire MSFN line of sight
83:20:36	Enter lunar umbra
83:25:00	Begin IMU realignment
84:02:24	Lose MSFN line of sight
84:06:53	Enter sunlight
84:48:33	Acquire MSFN line of sight

Table I. Mission F Lunar Orbit Event Timeline (Continued)

---

<u>Mission Time</u> (hr:min:sec)	<u>Event</u>
85:00:00	Roll 180 deg to landmark sighting attitude, inertial attitude hold
85:10:05	Begin -0.3 deg/sec pitch rate for landmark tracking
85:13:05	Terminate pitch rate, inertial attitude hold
85:19:11	Enter lunar umbra
85:25:00	Maneuver to sleep attitude, inertial attitude hold
86:00:41	Lose MSFN line of sight
86:05:28	Enter sunlight
86:46:58	Acquire MSFN line of sight
87:17:47	Enter lunar umbra
87:59:00	Lose MSFN line of sight
88:04:03	Enter sunlight
88:44:53	Acquire MSFN line of sight
89:16:21	Enter lunar umbra
89:57:22	Lose MSFN line of sight
90:02:38	Enter sunlight
90:43:07	Acquire MSFN line of sight
91:14:57	Enter lunar umbra
91:55:09	Lose MSFN line of sight
92:01:13	Enter sunlight
92:41:30	Acquire MSFN line of sight
93:13:31	Enter lunar umbra
93:45:00	Terminate sleep period
93:53:32	Lose MSFN line of sight
93:59:48	Enter sunlight
94:39:54	Acquire MSFN line of sight
95:00:00	Maneuver to landmark sighting attitude, except rolled 180 deg, inertial attitude hold
95:12:07	Enter lunar umbra
95:25:00	Begin IMU realignment
95:51:56	Lose MSFN line of sight

---

Table I. Mission F Lunar Orbit Event Timeline (Continued)

<u>Mission Time</u> <u>(hr:min:sec)</u>	<u>Event</u>
95:58:23	Enter sunlight
96:38:17	Acquire MSFN line of sight
96:45:00	Roll 180 deg to landmark sighting attitude, inertial attitude hold
97:00:24	Begin -0.3 deg/sec pitch rate for landmark tracking
97:03:24	Terminate pitch rate, maneuver to CSM/LM communication attitude, inertial attitude hold
97:10:41	Enter lunar umbra
97:50:19	Lose MSFN line of sight
97:56:58	Enter sunlight
98:00:00	Maneuver to undocking attitude, inertial attitude hold
98:15:00	Deploy LM landing gear
98:30:44	Undocking
98:33:16	LM maneuver to inspection attitude
98:36:16	Begin station keeping; LM acquire MSFN line of sight
98:36:17	CSM acquire MSFN line of sight
98:36:30	CSM roll 180 deg for communications, inertial attitude hold
98:55:44	Separation burn ignition
98:55:58	Separation burn cutoff
98:58:58	CSM maneuver to SXT/VHF tracking attitude; LM maneuver to RR tracking attitude, inertial attitude hold
99:09:15	CSM enter lunar umbra
99:09:16	LM enter lunar umbra
99:15:00	LM begin EMU realignment
99:28:58	LM maneuver to maintain RR tracking attitude
99:43:00	CSM perform COAS calibration and maneuver to COAS tracking attitude
99:48:35	CSM lose MSFN line of sight
99:48:38	LM lose MSFN line of sight



Table I. Mission F Lunar Orbit Event Timeline (Continued)

<u>Mission Time</u> (hr:min:sec)	<u>Event</u>
99:49:12	CSM maneuver to DOI monitoring attitude; LM maneuver to DOI burn attitude, inertial attitude hold
99:54:12	DOI burn ignition
99:54:40	DOI burn cutoff, inertial attitude hold
99:55:40	LM maneuver to RR tracking attitude
99:56:14	CSM enter sunlight
99:56:19	LM enter sunlight
99:59:40	LM terminate tracking, maneuver to PDI attitude, inertial attitude hold
100:05:40	CSM maneuver to SXT/VHF tracking attitude
100:26:40	CSM terminate tracking, maneuver to MI phasing burn attitude, inertial attitude hold
100:35:24	CSM acquire MSFN line of sight
100:38:25	LM acquire MSFN line of sight
100:48:11	LM maneuver to LR test attitude (begin pitch at -0.05 deg/sec)
100:51:31	Pericyynthion of LM descent orbit
100:54:21	LM at 0-deg landing site elevation angle
100:54:51	Terminate LR test, maneuver to phasing burn attitude, inertial attitude hold
100:56:40	LM at 90-deg landing site elevation angle
101:01:36	LM enter lunar umbra
101:06:35	Phasing burn ignition
101:07:17	Phasing burn cutoff, inertial attitude hold
101:08:39	CSM enter lunar umbra
101:15:17	LM maneuver to RR tracking attitude
101:17:17	CSM maneuver to SXT/VHF tracking attitude
101:35:18	CSM and LM terminate tracking, LM inertial attitude hold; CSM maneuver for S-band high-gain communications, inertial attitude hold
101:47:28	CSM lose MSFN line of sight
101:48:51	LM enter sunlight
101:50:12	LM lose MSFN line of sight

Table I. Mission F Lunar Orbit Event Timeline (Continued)

---

<u>Mission Time</u> <u>(hr:min:sec)</u>	<u>Event</u>
101:54:55	CSM enter sunlight
102:09:18	CSM maneuver to SXT/VHF tracking attitude
102:20:18	LM maneuver to RR tracking attitude
102:29:18	CSM terminate tracking, maneuver to MI insertion burn attitude, inertial attitude hold
102:33:47	CSM acquire MSFN line of sight
102:39:14	LM acquire MSFN line of sight
102:40:18	LM terminate tracking, maneuver to descent stage jettison attitude, inertial attitude hold
102:53:29	LM descent stage jettison, maneuver to insertion burn attitude, inertial attitude hold
103:03:29	Insertion burn ignition
103:03:45	Insertion burn cutoff, inertial attitude hold
103:07:16	CSM enter lunar umbra
103:08:21	LM enter lunar umbra
103:21:45	LM maneuver to RR tracking attitude
103:26:45	CSM maneuver to SXT/VHF tracking attitude
103:38:45	CSM terminate tracking, maneuver to MI CSI burn attitude, inertial attitude hold
103:44:45	LM terminate tracking, maneuver to CSI burn attitude, inertial attitude hold
103:45:41	CSM lose MSFN line of sight
103:47:36	LM lose MSFN line of sight
103:53:40	CSM enter sunlight
103:54:40	CSI burn ignition
103:55:12	CSI burn cutoff, inertial attitude hold
103:57:08	LM enter sunlight
104:01:12	CSM and LM maneuver to SXT/VHF and RR tracking attitude, respectively
104:18:12	LM terminate tracking, inertial attitude hold
104:22:12	CSM terminate tracking, inertial attitude hold
104:27:12	CSM and LM maneuver to SXT/VHF and RR tracking attitude, respectively

---

Table I. Mission F Lunar Orbit Event Timeline (Continued)

---

Mission Time (hr:min:sec)	Event
104:32:25	CSM acquire MSFN line of sight
104:34:54	LM acquire MSFN line of sight
104:41:12	CSM and LM terminate tracking, LM maneuver to CDH burn attitude, inertial attitude hold; CSM maneuver to MI CDH burn attitude, inertial attitude hold
104:52:41	CDH burn ignition
104:52:48	CDH burn cutoff, inertial attitude hold
104:56:48	LM maneuver to RR tracking attitude
104:57:48	CSM maneuver to SXT/VHF tracking attitude
105:05:58	CSM enter lunar umbra
105:06:12	LM enter lunar umbra
105:14:48	CSM terminate tracking, inertial attitude hold
105:15:48	LM terminate tracking, inertial attitude hold
105:19:48	LM maneuver to TPI burn attitude, inertial attitude hold
105:29:22	TPI burn ignition
105:29:46	TPI burn cutoff, inertial attitude hold
105:33:46	CSM and LM maneuver to SXT/VHF and RR tracking attitude, respectively
105:40:46	CSM and LM terminate tracking
105:43:54	LM lose MSFN line of sight
105:44:20	CSM lose MSFN line of sight
105:48:46	CSM and LM maneuver to SXT/VHF and RR tracking attitude, respectively
105:52:03	CSM enter sunlight
105:52:41	LM enter sunlight
105:56:46	CSM and LM terminate tracking, inertial attitude hold
106:01:41	LM maneuver to TPF burn attitude, inertial attitude hold
106:11:41	TPF burn ignition
106:12:21	TPF burn cutoff, inertial attitude hold

---

Table I. Mission F Lunar Orbit Event Timeline (Continued)

---

<u>Mission Time</u> (hr:min:sec)	<u>Event</u>
106:29:33	CSM and LM acquire MSFN line of sight
106:50:00	CSM and LM maneuver to docking attitude, LM translate to capture latch, inertial attitude hold
106:55:00	CSM/LM docking, inertial attitude hold
107:03:36	Enter lunar umbra
107:10:00	Maneuver to LM jettison attitude, inertial attitude hold
107:41:45	Lose MSFN line of sight
107:49:52	Enter sunlight
108:28:58	Acquire MSFN line of sight
108:34:02	LM jettison, LM inertial attitude hold
108:40:36	CSM evasive maneuver, CSM maneuver to keep LM in windows
109:03:16	Enter lunar umbra
109:03:41	LM APS burn to depletion
109:41:09	Lose MSFN line of sight
109:49:31	Enter sunlight
109:55:00	Maneuver to sleep attitude, inertial attitude hold
110:27:25	Acquire MSFN line of sight
111:01:55	Enter lunar umbra
111:39:30	Lose MSFN line of sight
111:48:09	Enter sunlight
112:25:48	Acquire MSFN line of sight
113:00:34	Enter lunar umbra
113:37:55	Lose MSFN line of sight
113:46:49	Enter sunlight
114:23:41	Acquire MSFN line of sight
114:59:13	Enter lunar umbra
115:35:45	Lose MSFN line of sight
115:45:28	Enter sunlight

---

Table I. Mission F Lunar Orbit Event Timeline (Continued)

---

<u>Mission Time</u> <u>(hr:min:sec)</u>	<u>Event</u>
116:22:06	Acquire MSFN line of sight
116:57:52	Enter lunar umbra
117:34:10	Lose MSFN line of sight
117:44:07	Enter sunlight
118:00:00	Terminate sleep period
118:20:31	Acquire MSFN line of sight
118:56:32	Enter lunar umbra
119:00:00	Begin IMU realignment
119:32:40	Lose MSFN line of sight
119:35:00	Maneuver to solar corona photography attitude, local attitude hold
119:42:46	Enter sunlight
119:45:00	Maneuver to strip photography attitude, local attitude hold
120:18:57	Acquire MSFN line of sight
120:46:00	Terminate local attitude hold, begin inertial attitude hold
120:55:11	Enter lunar umbra
121:00:00	Begin IMU realignment
121:31:05	Lose MSFN line of sight
121:41:25	Enter sunlight
121:45:00	Maneuver to landmark sighting attitude, local attitude hold
122:17:07	Acquire MSFN line of sight
122:50:00	Terminate local attitude hold, roll 180 deg, begin inertial attitude hold
122:53:50	Enter lunar umbra
123:00:00	Begin IMU realignment
123:29:30	Lose MSFN line of sight
123:35:00	Maneuver to landmark sighting attitude, local attitude hold
123:40:05	Enter sunlight

---

Table I. Mission F Lunar Orbit Event Timeline (Continued)

---

<u>Mission Time</u> <u>(hr:min:sec)</u>	<u>Event</u>
124:15:28	Acquire MSFN line of sight
124:45:00	Terminate local attitude hold, roll 180 deg, begin inertial attitude hold
124:52:30	Enter lunar umbra
125:00:00	Begin IMU realignment
125:27:57	Lose MSFN line of sight
125:38:44	Enter sunlight
125:56:15	Maneuver to TEI burn attitude except rolled 180 deg, inertial attitude hold
126:13:35	Acquire MSFN line of sight
126:51:08	Enter lunar umbra
127:10:00	Roll 180 deg to burn attitude, inertial attitude hold
127:26:17	Lose MSFN line of sight
127:37:23	Enter sunlight
127:51:35	TEI burn initiation
127:54:14	TEI burn cutoff

---

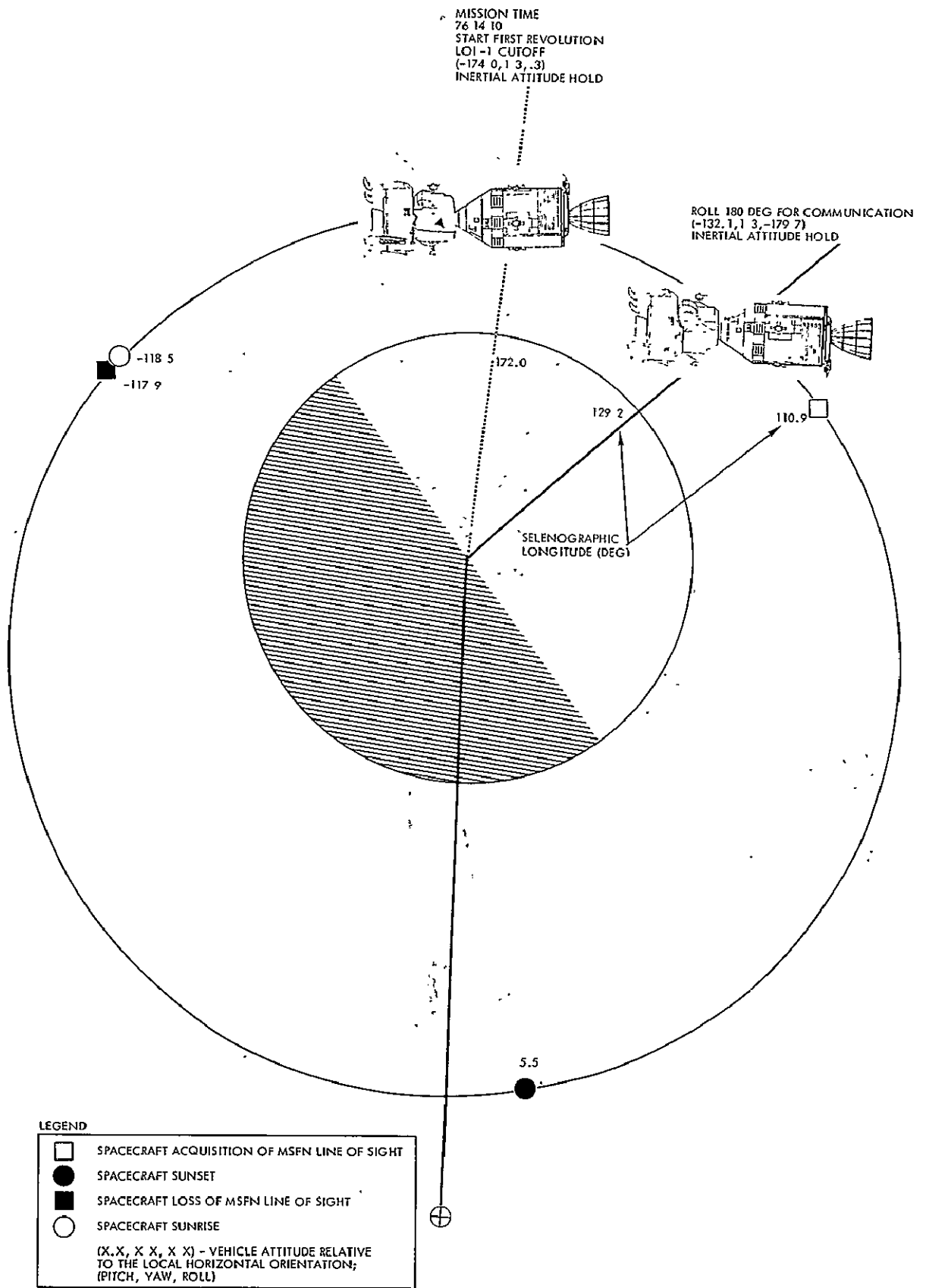

Figure 1. First Revolution Major Events and Attitudes

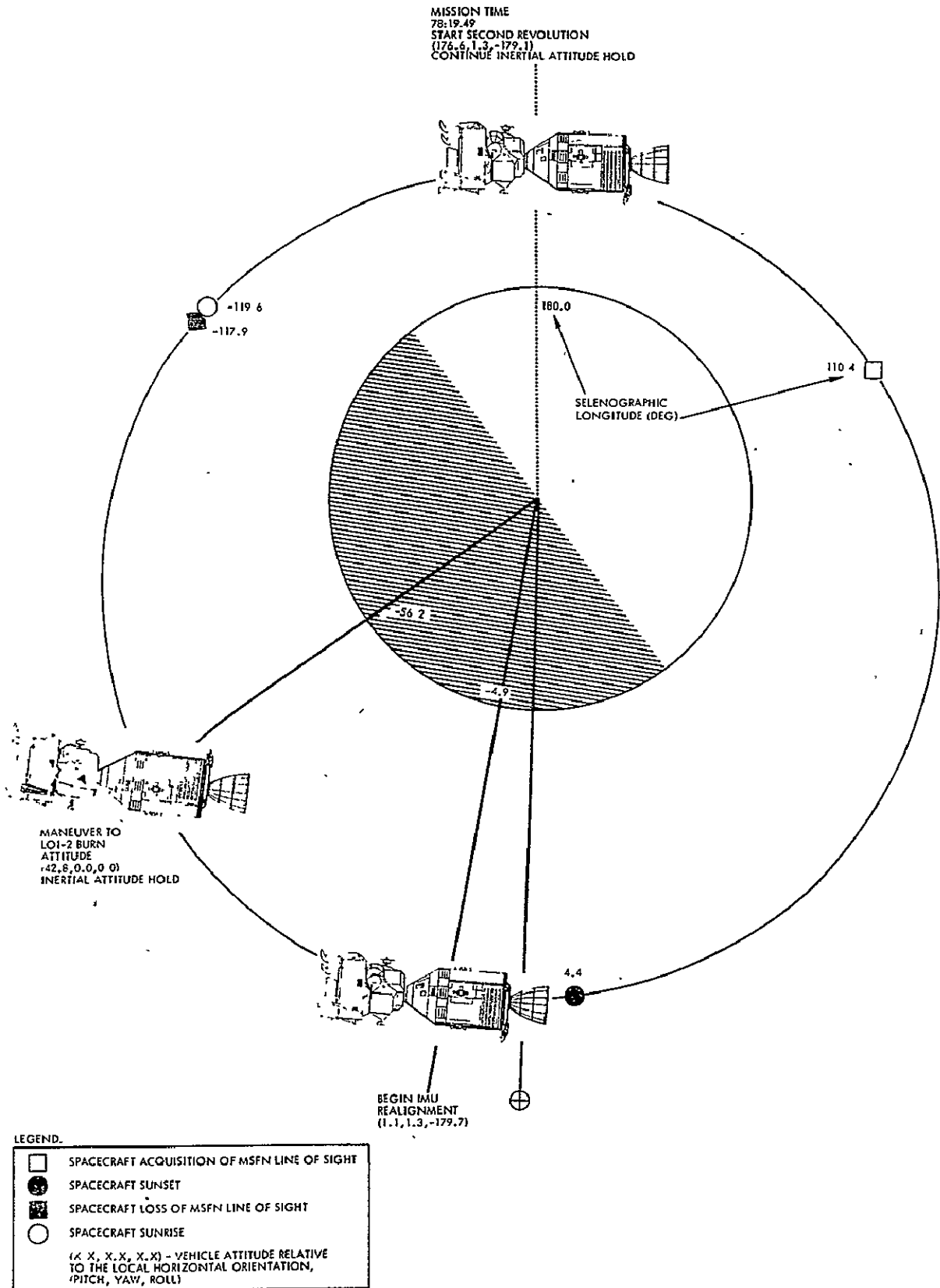

Figure 2. Second Revolution Major Events and Attitudes



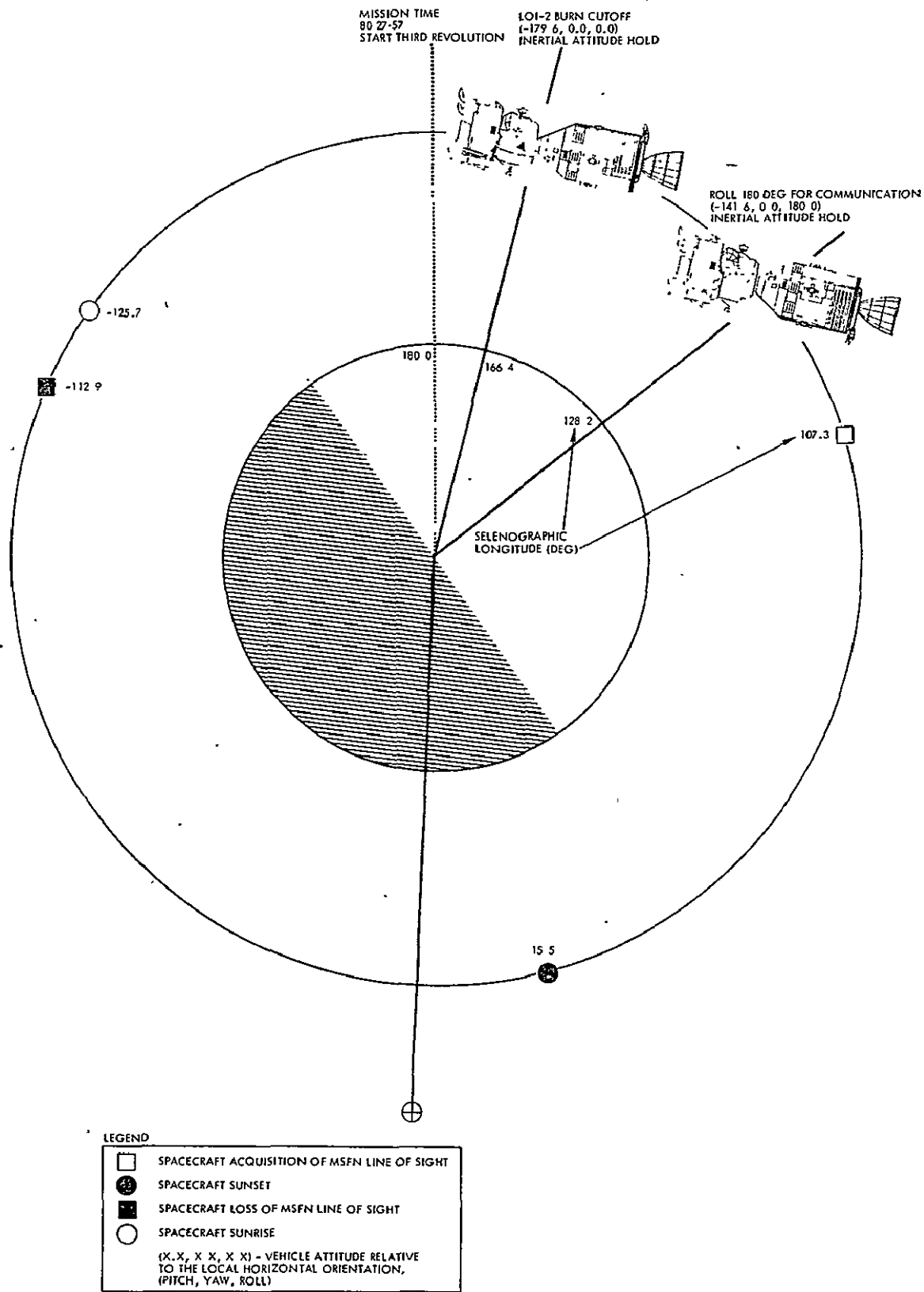

Figure 3. Third Revolution Major Events and Attitudes

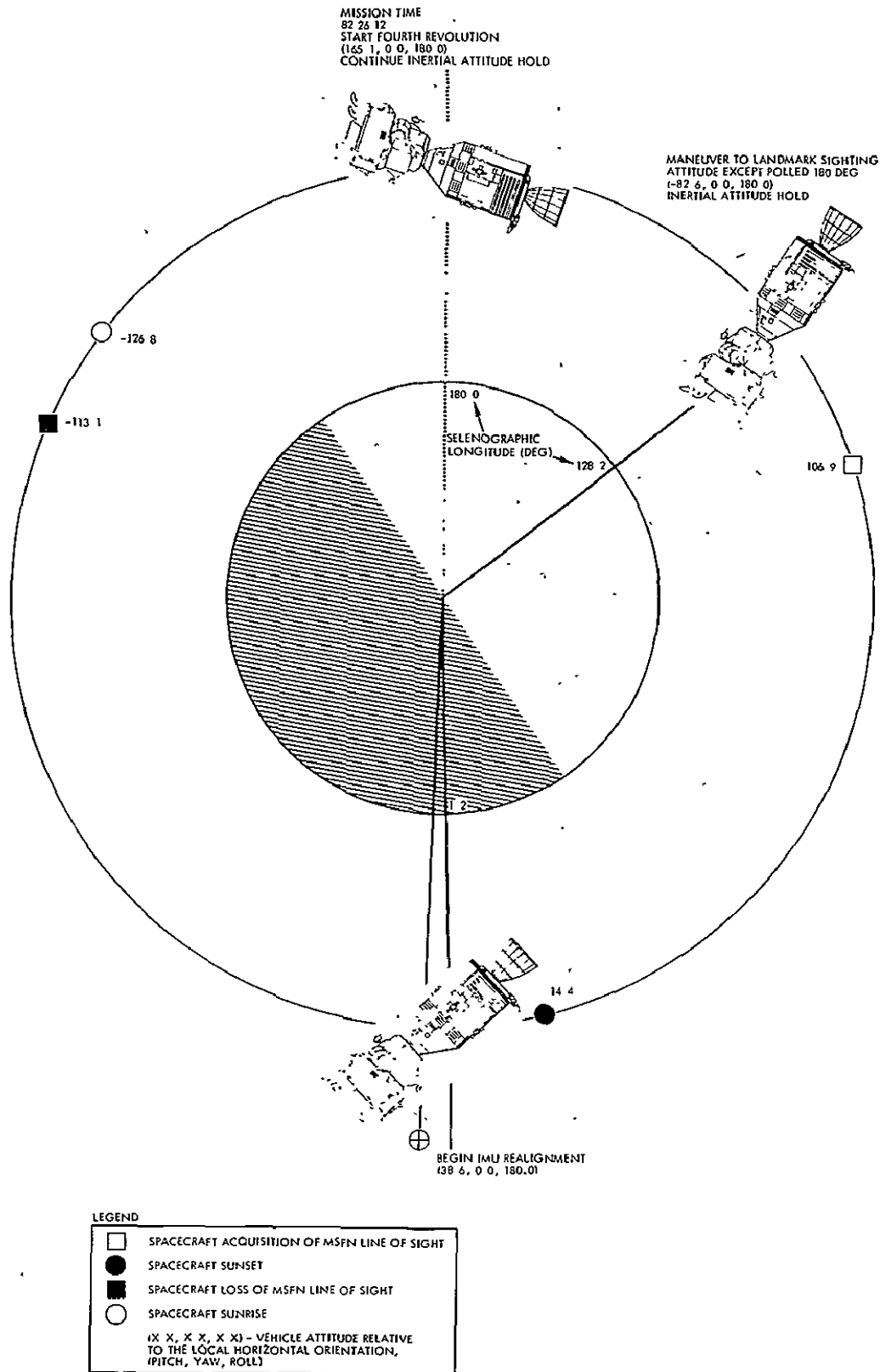

Figure 4. Fourth Revolution Major Events and Attitudes

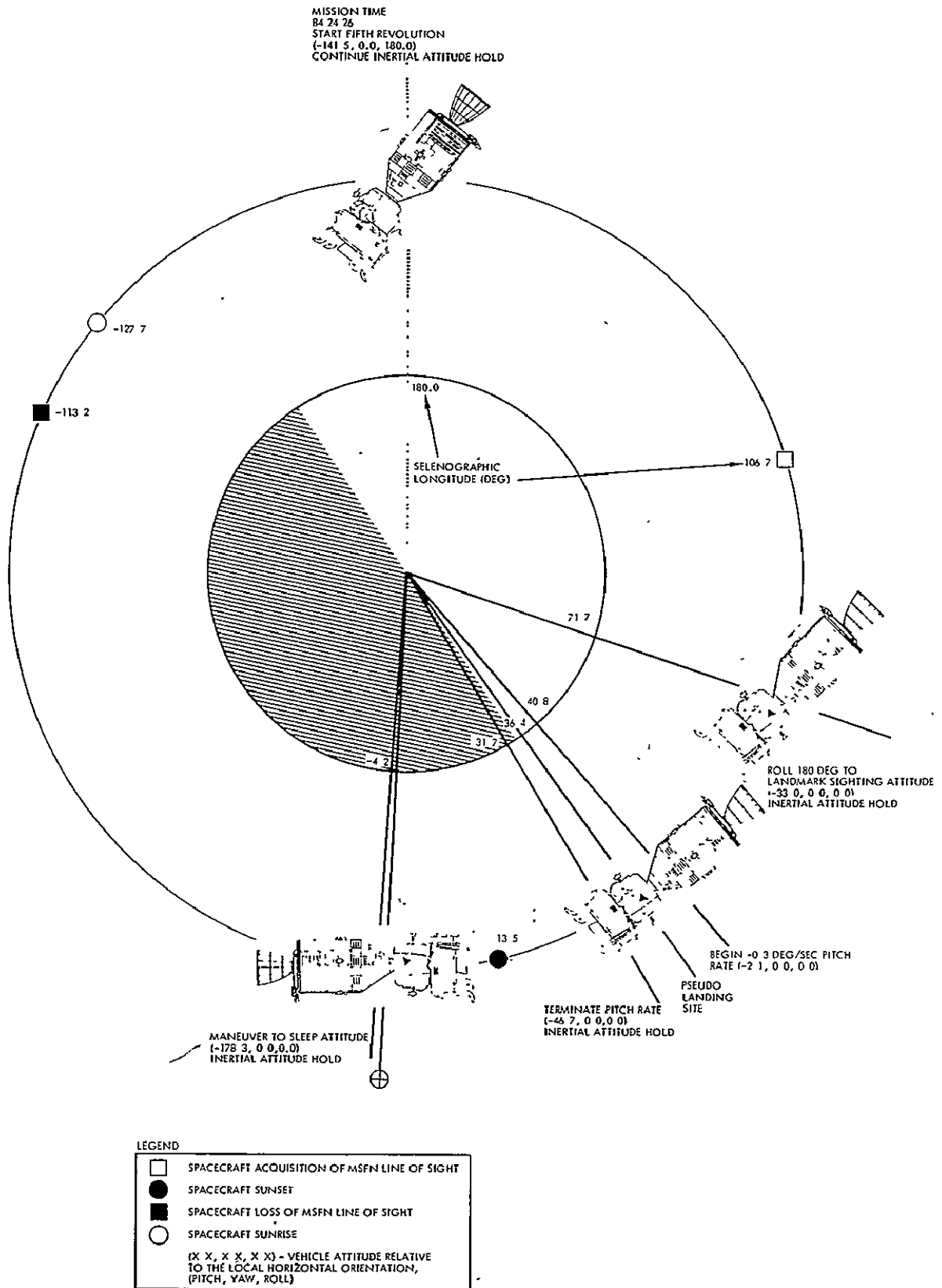

Figure 5. Fifth Revolution Major Events and Attitudes

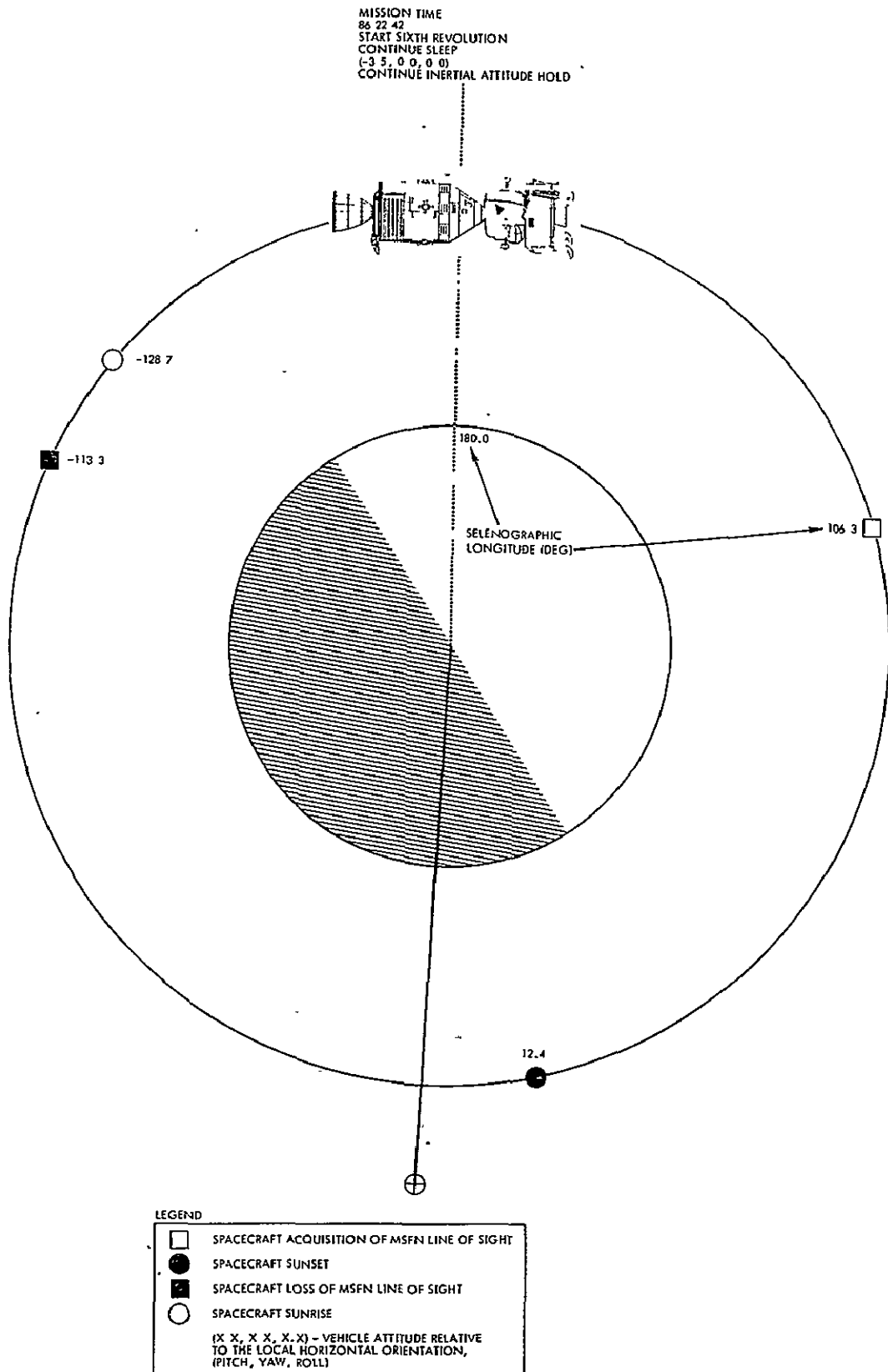

Figure 6. Sixth Revolution Major Events and Attitudes

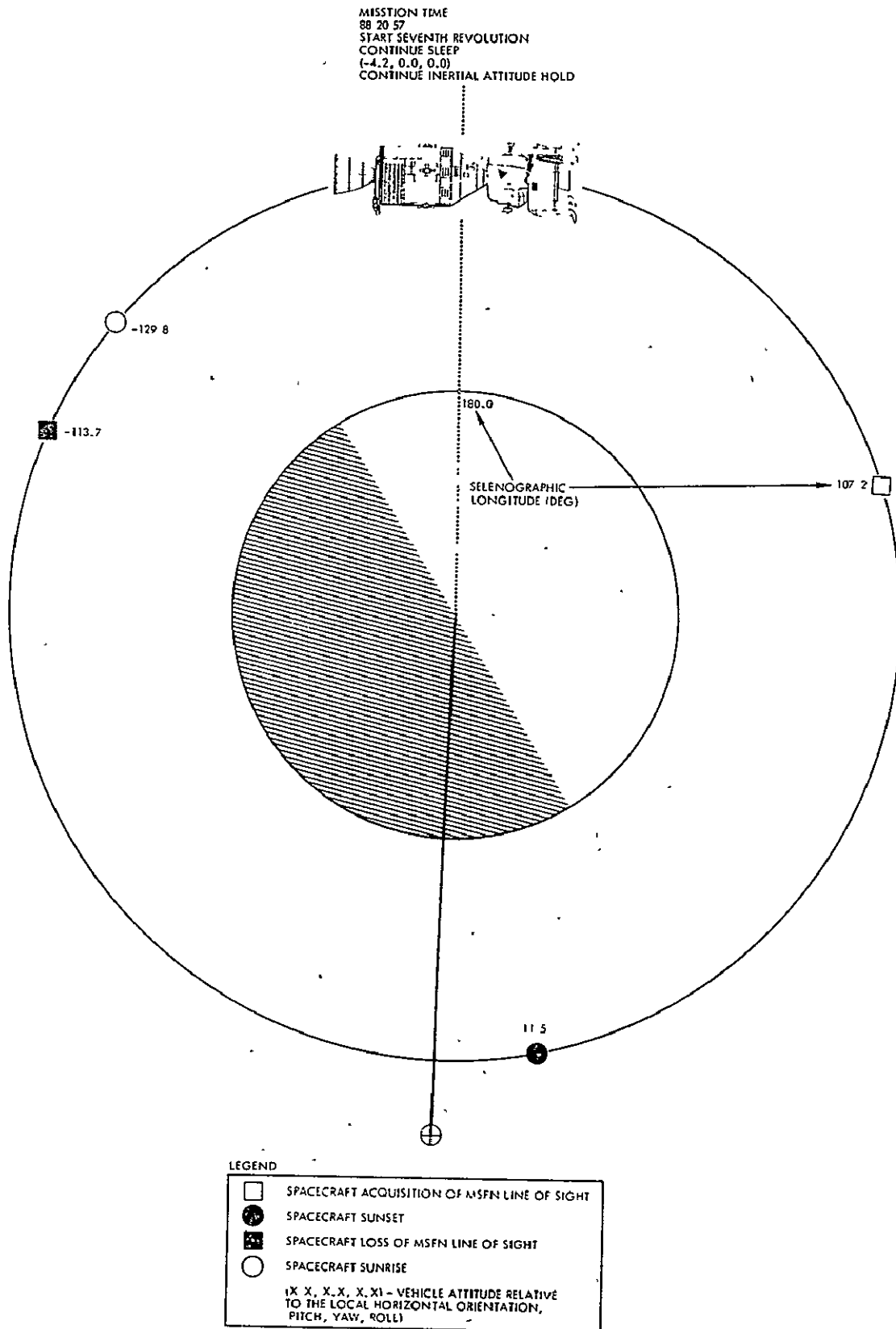

Figure 7. Seventh Revolution Major Events and Attitudes

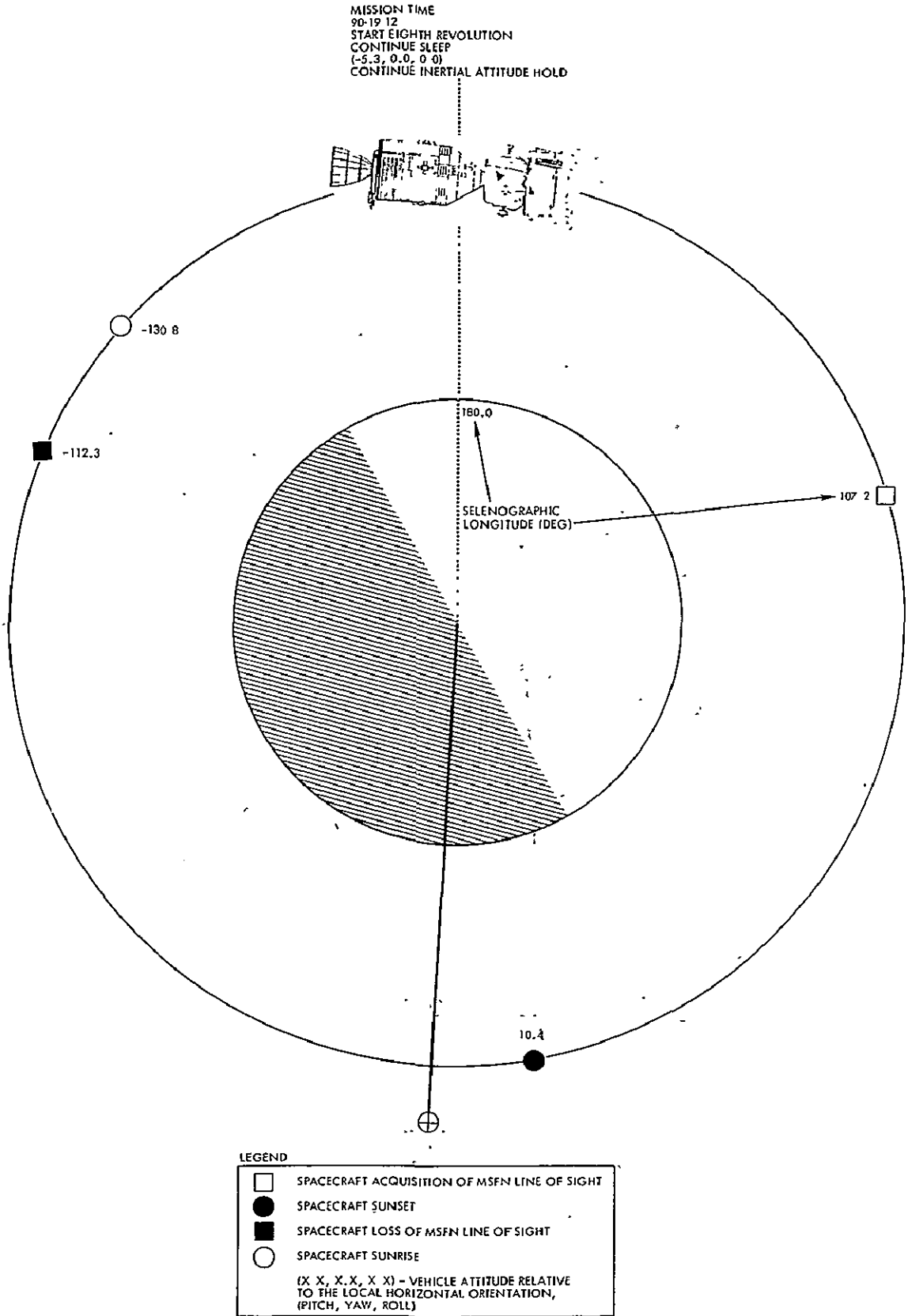

Figure 8. Eighth Revolution Major Events and Attitudes

MISSION TIME  
 92 17:27  
 START NINTH REVOLUTION  
 CONTINUE SLEEP  
 (-6.4, 0.0, 0.0)  
 CONTINUE INERTIAL ATTITUDE HOLD

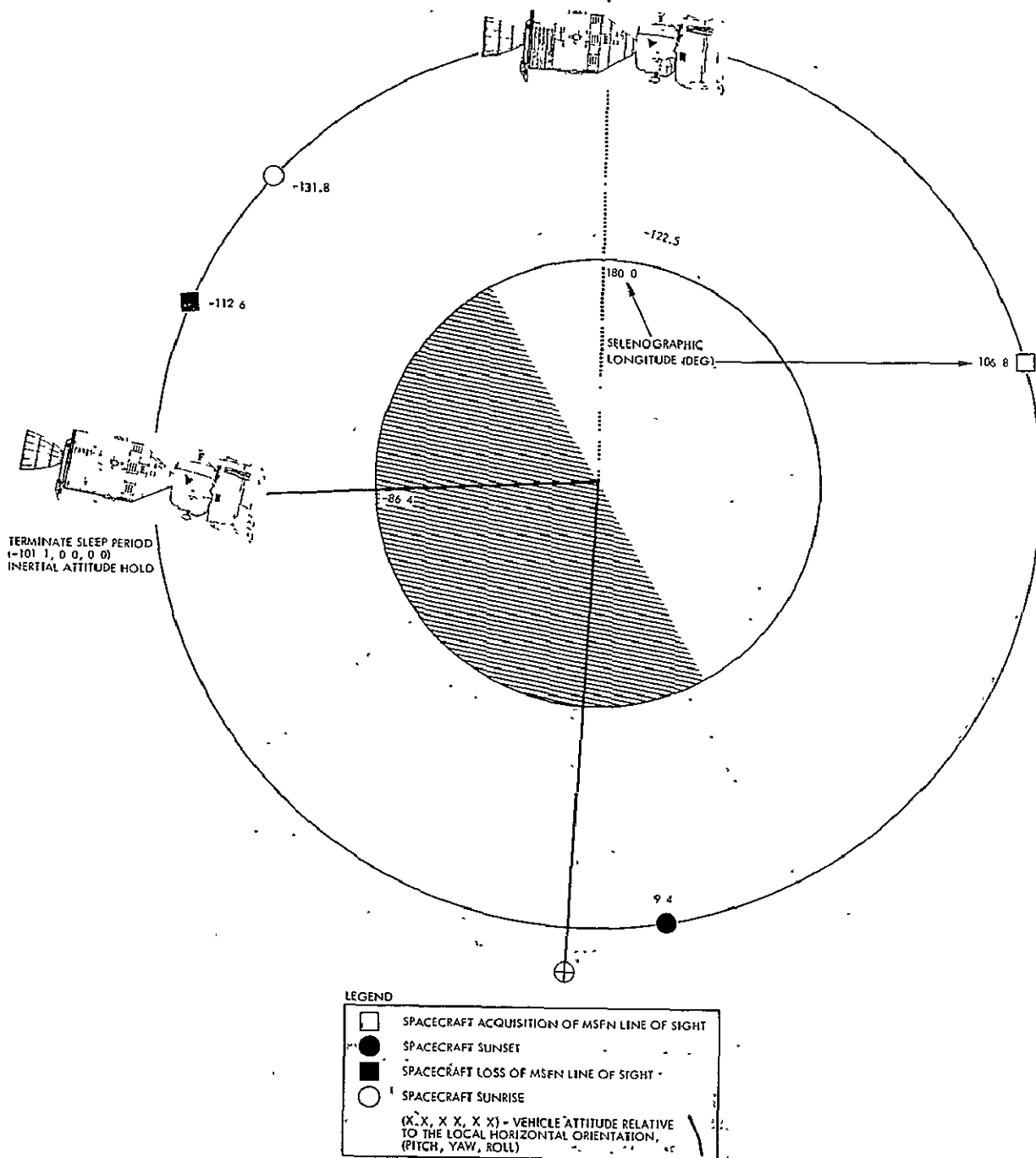

Figure 9. - Ninth Revolution Major Events and Attitudes

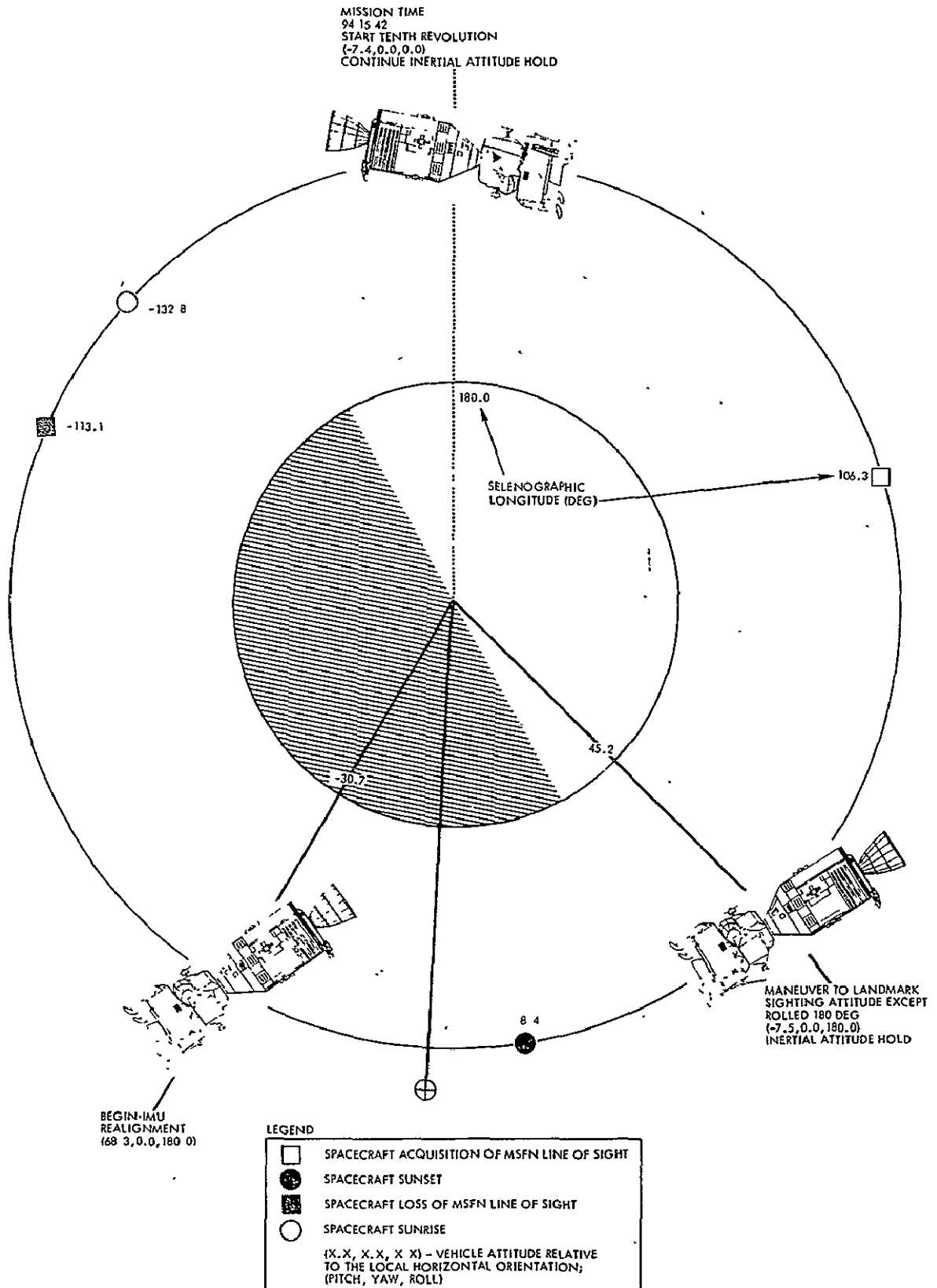

Figure 10. Tenth Revolution Major Events and Attitudes



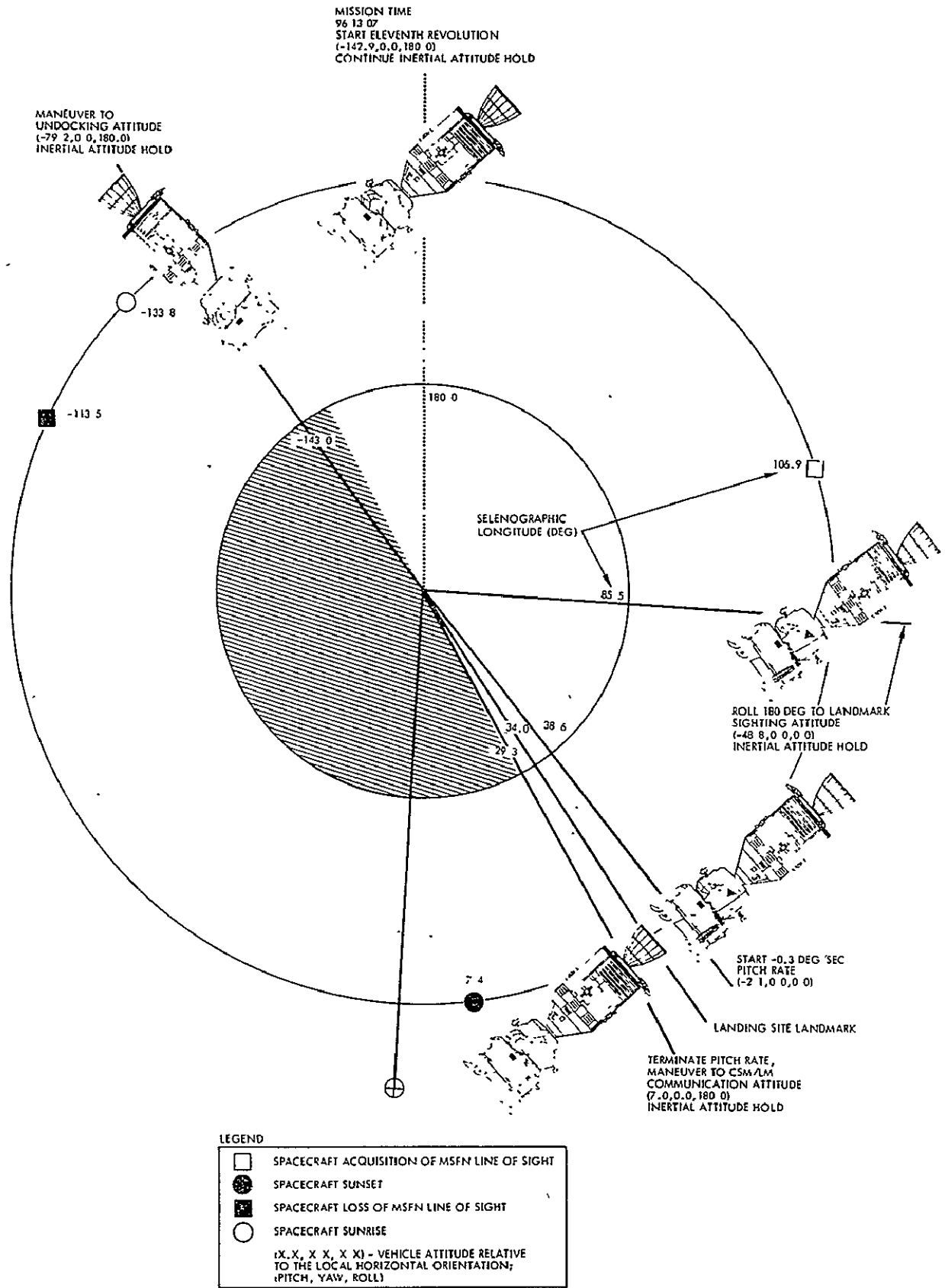

Figure 11. Eleventh Revolution Major Events and Attitudes

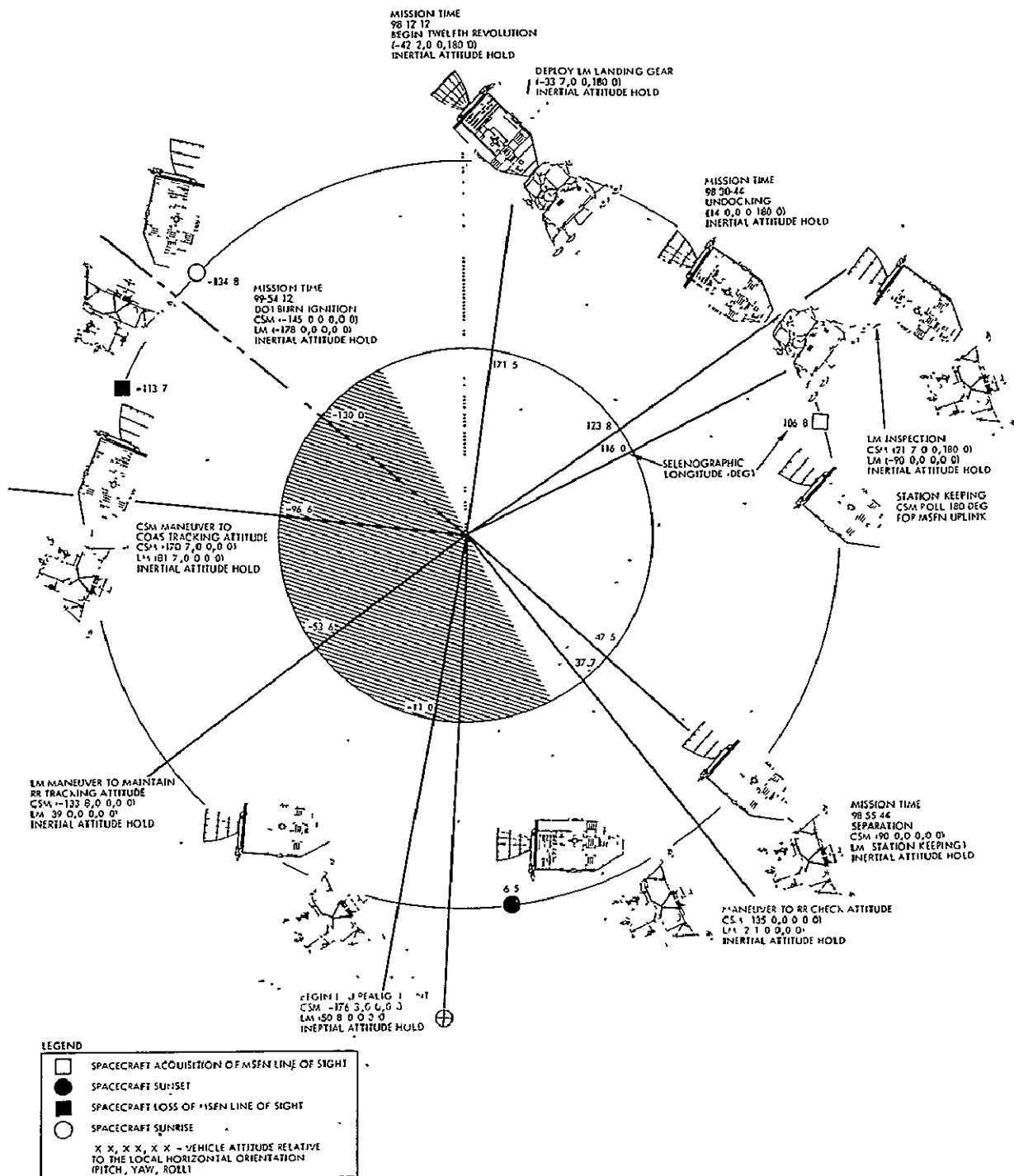

Figure 12. Start Twelfth Revolution to DOI Burn Ignition

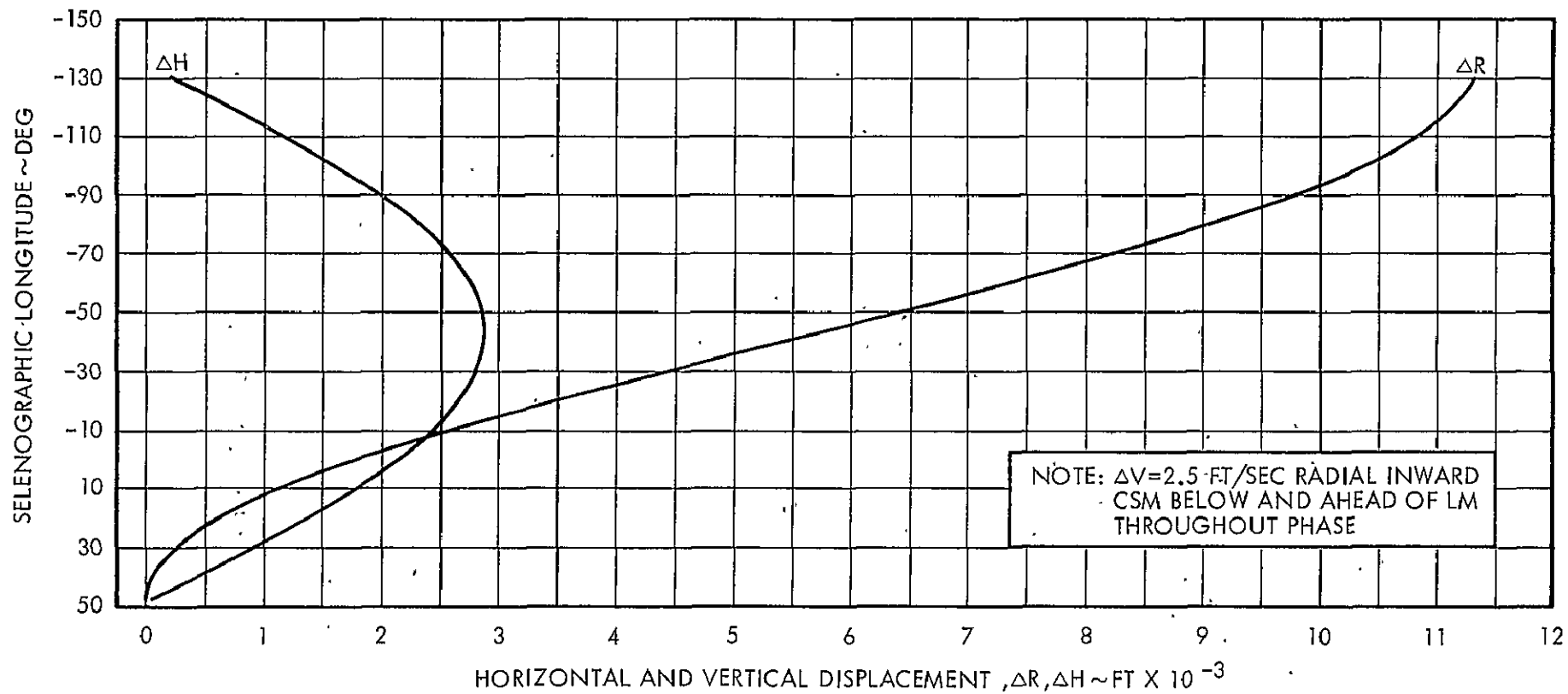

Figure 13. CSM/LM Relative Motion from Separation to DOI

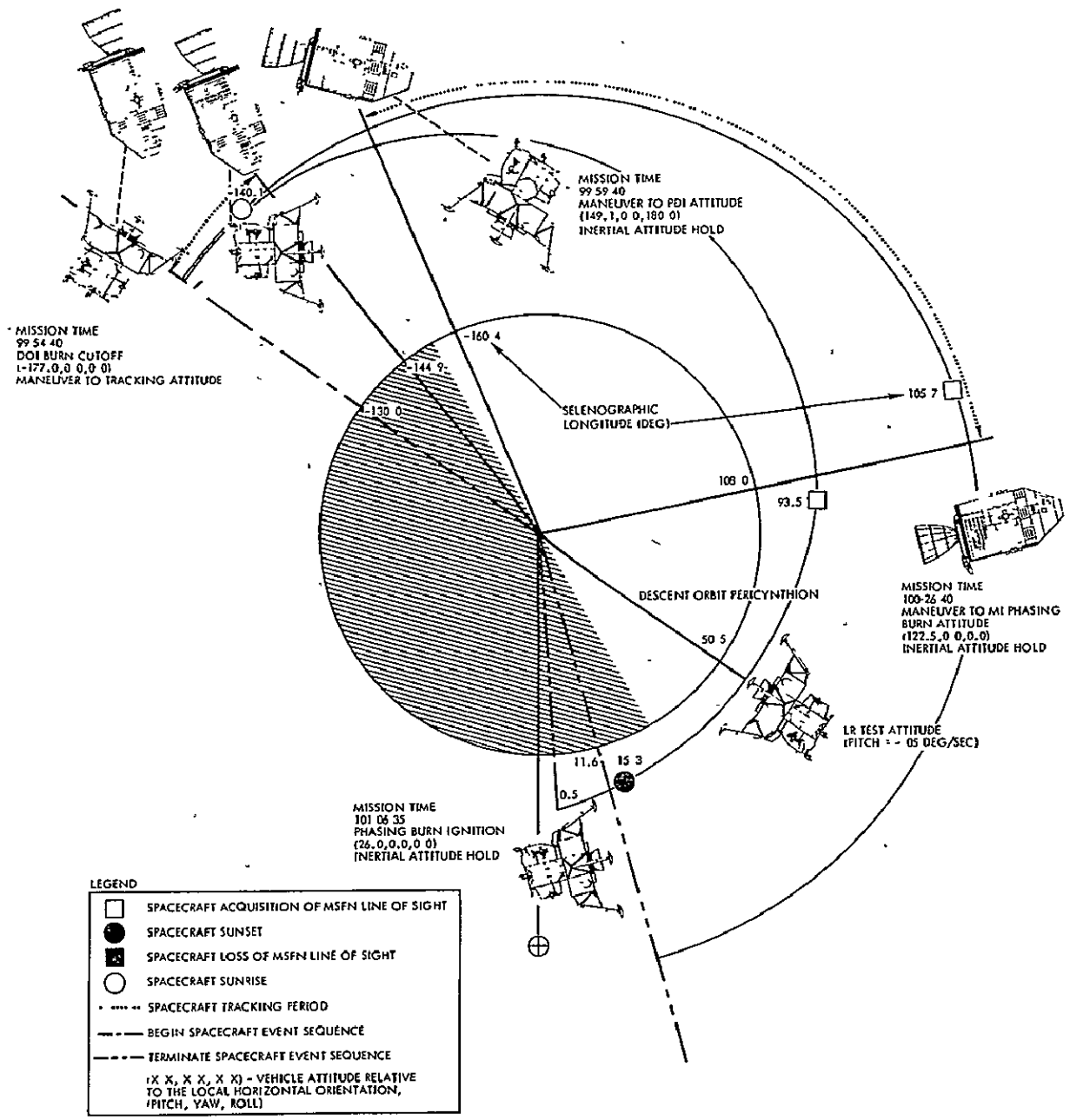

Figure 14. DOI Burn Cutoff to Phasing Burn Ignition

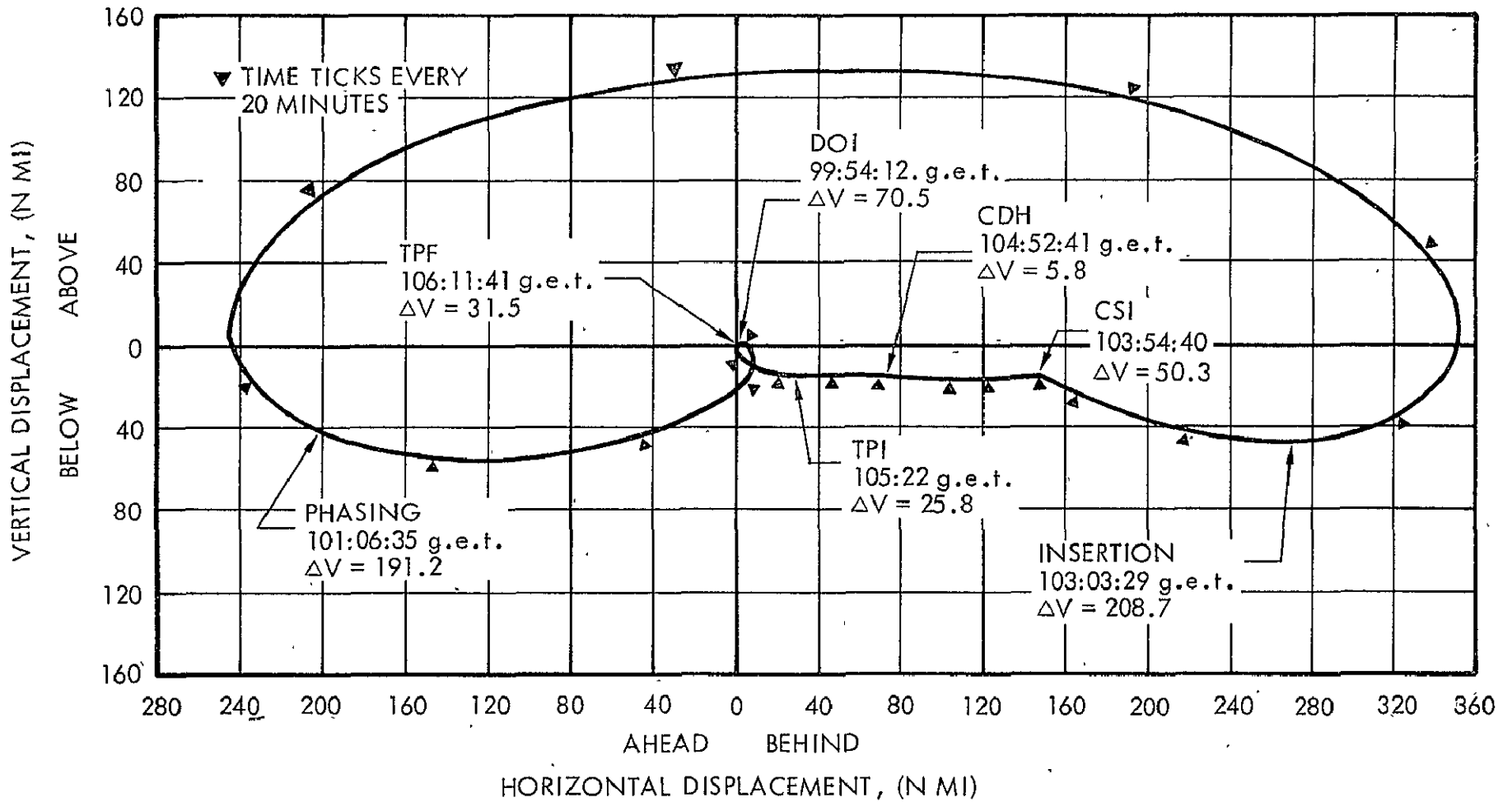

Figure 15. CSM/LM Relative Motion from DOI to TPF (CSM Fixed)

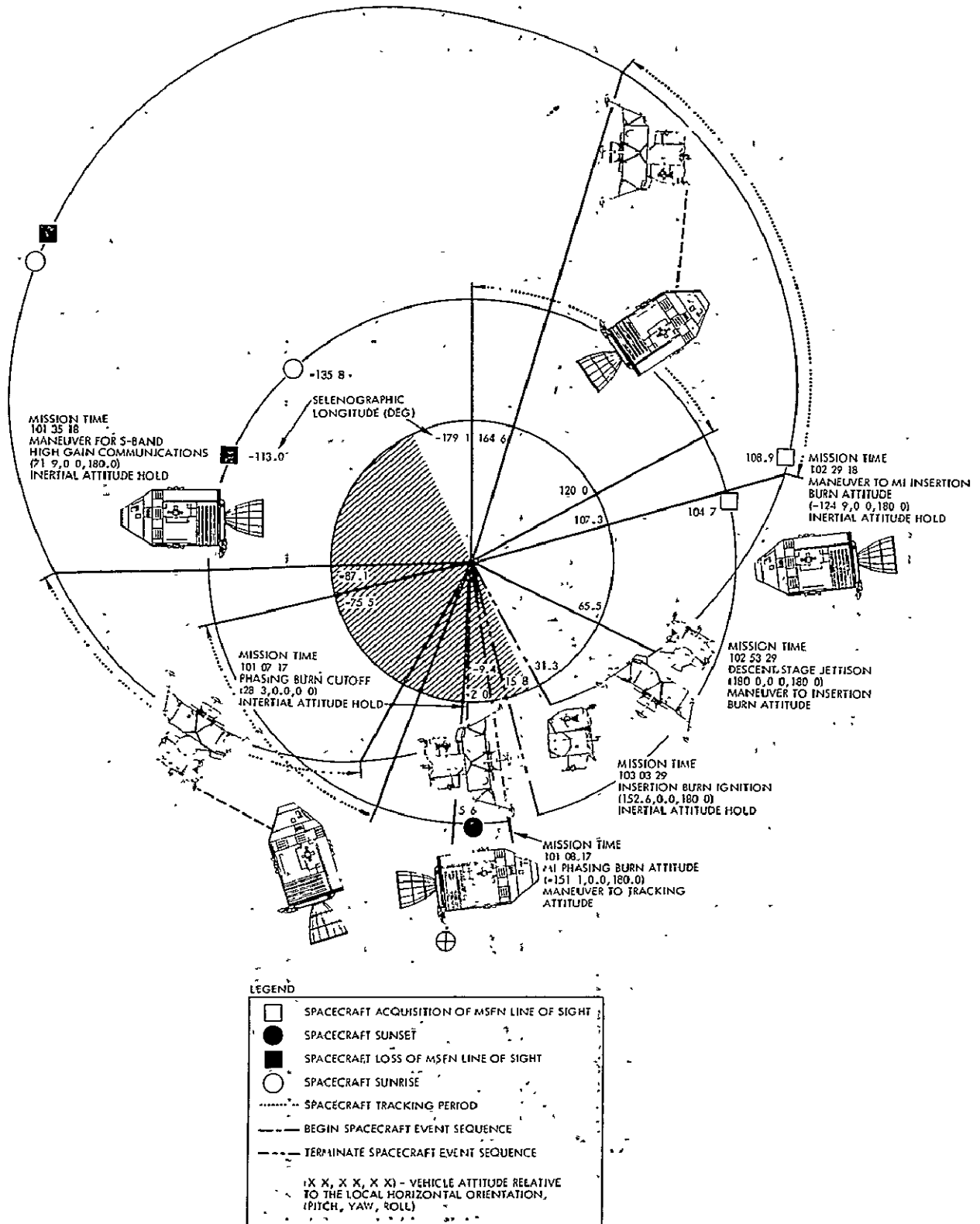

Figure 16. Phasing Burn Cutoff to Insertion Burn Ignition

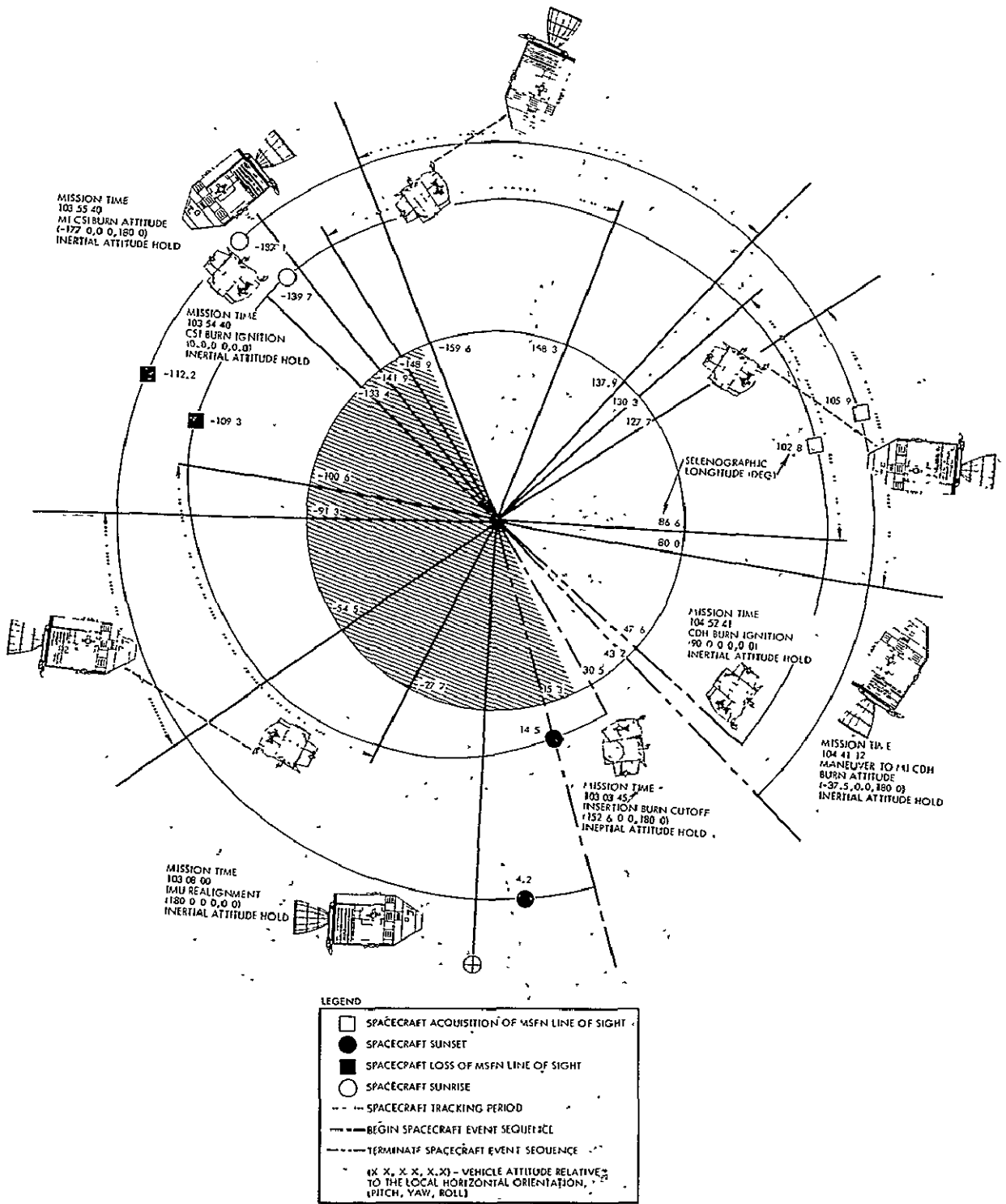

Figure 17. Insertion Burn Cutoff to CDH Burn Ignition

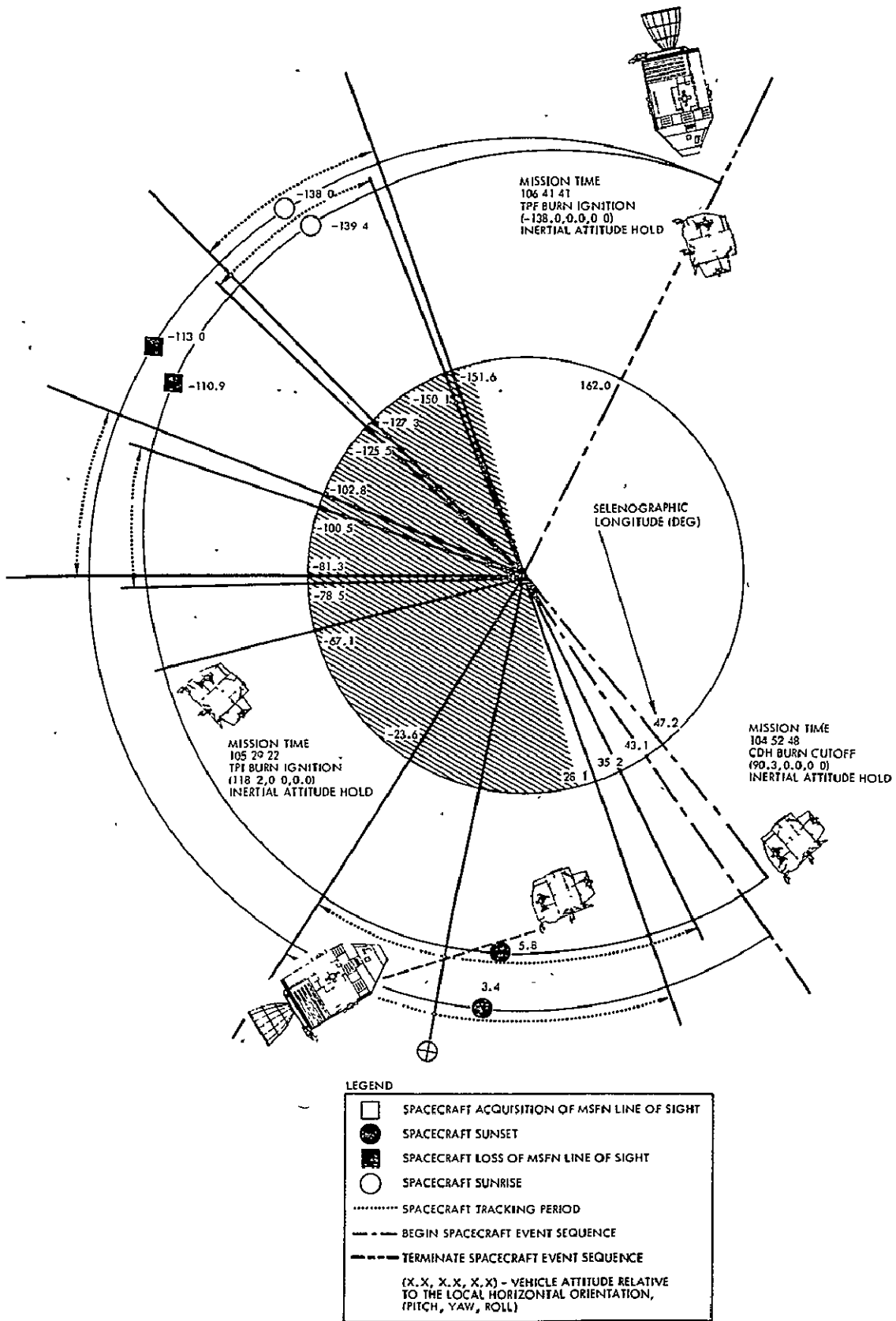

Figure 18. CDH Burn Cutoff to TPF Burn Ignition



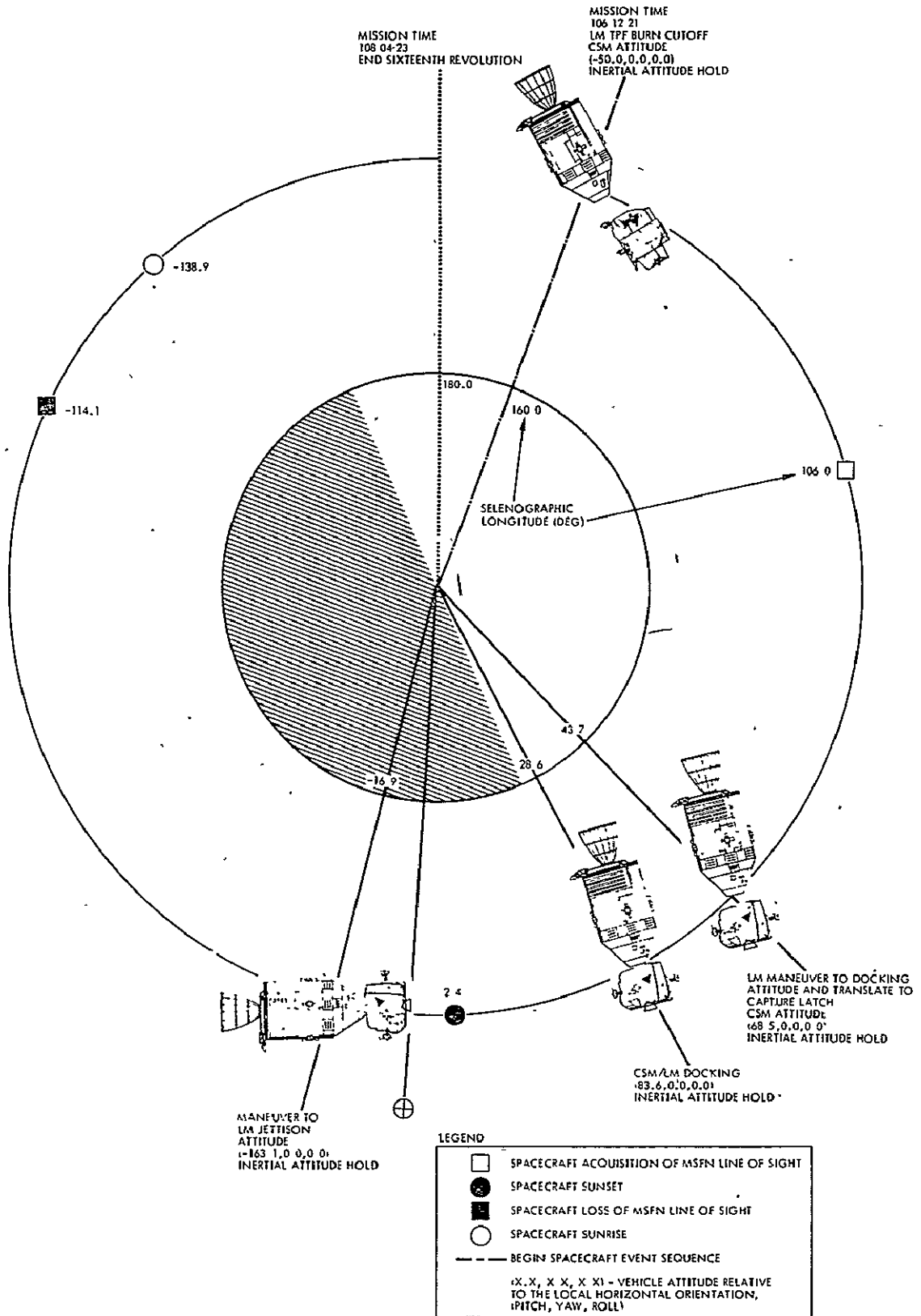

Figure 19. TPF Burn Cutoff to End of Sixteenth Revolution

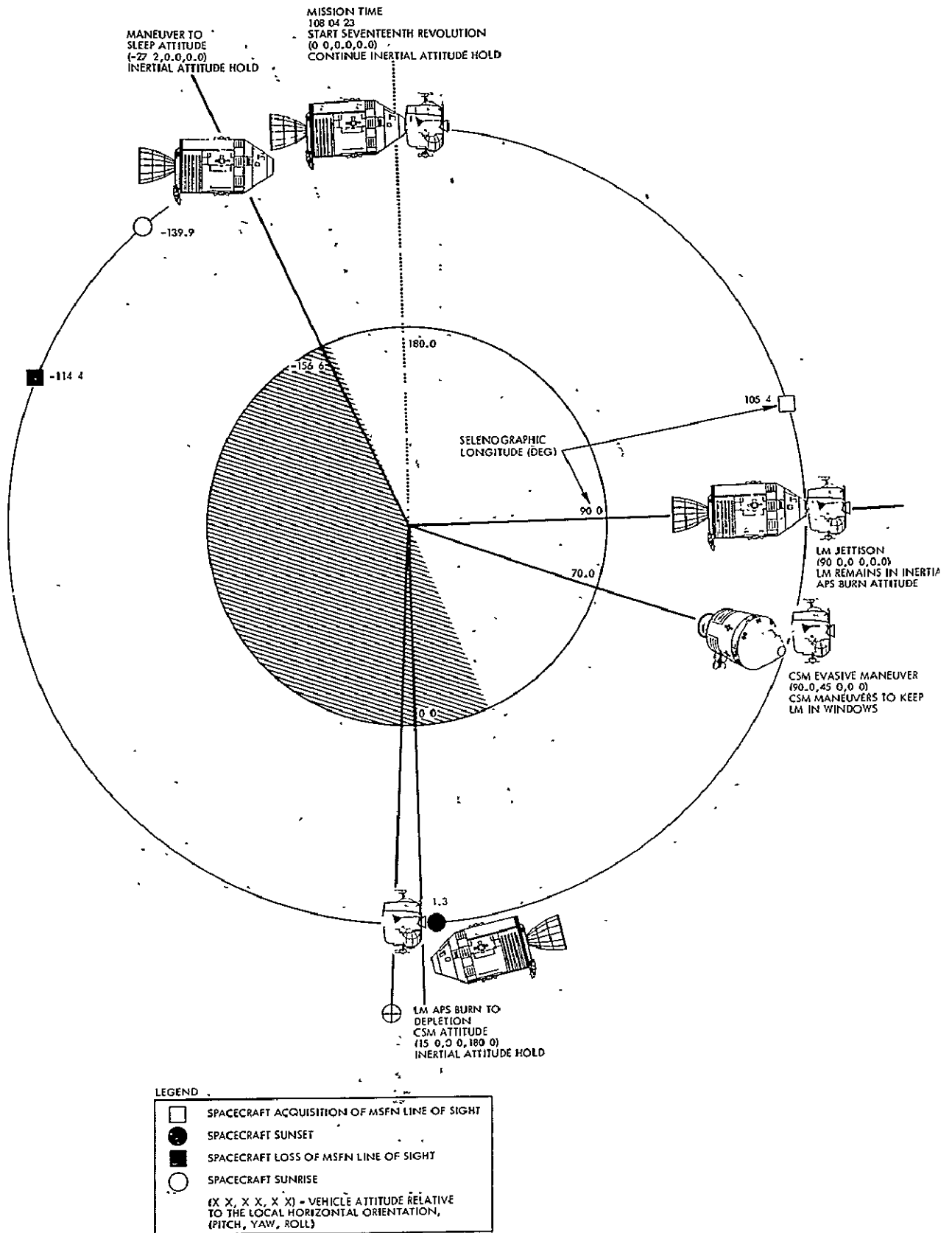

Figure 20. Seventeenth Revolution Major Events and Attitudes

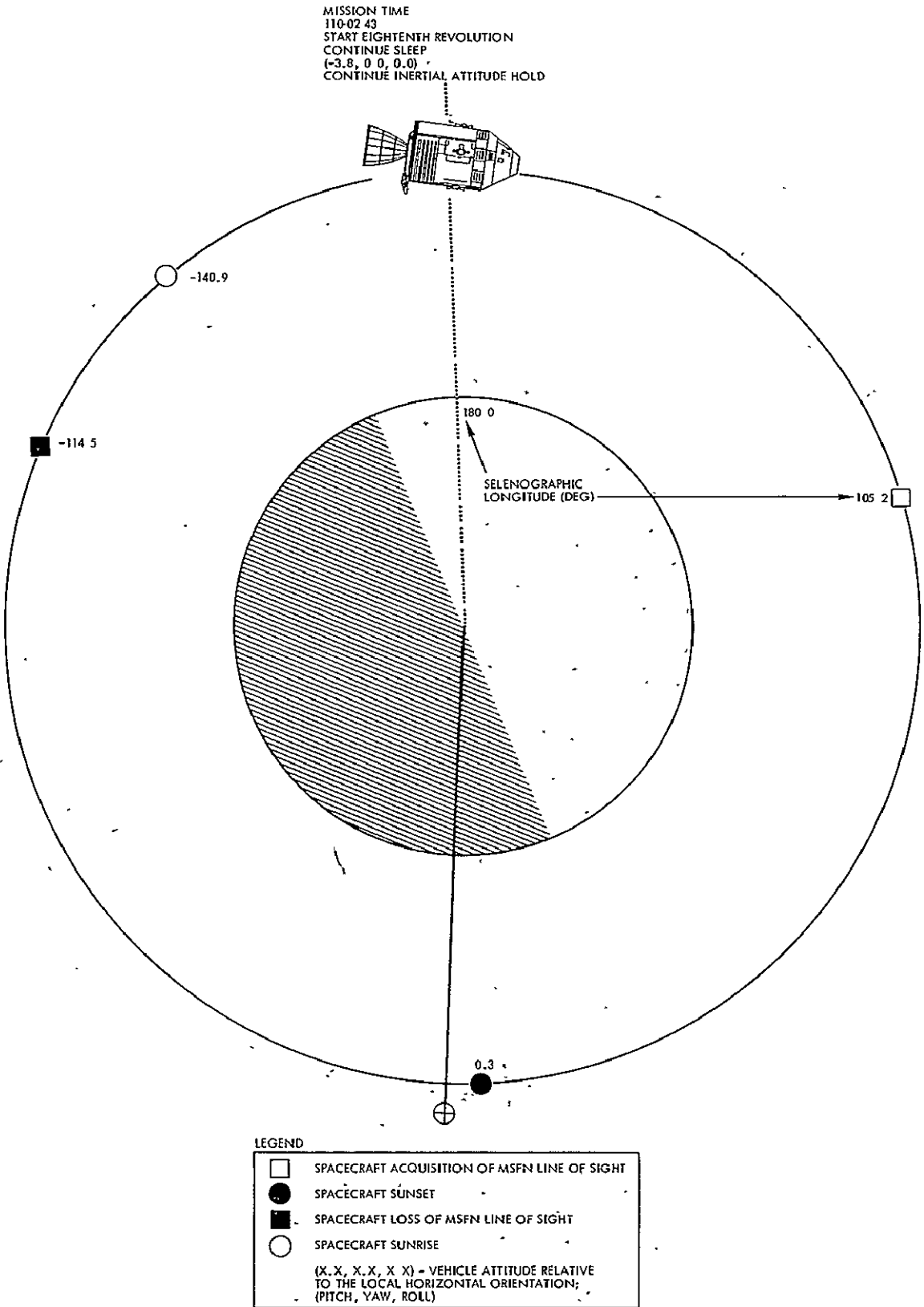

Figure 21. Eighteenth Revolution Major Events and Attitudes

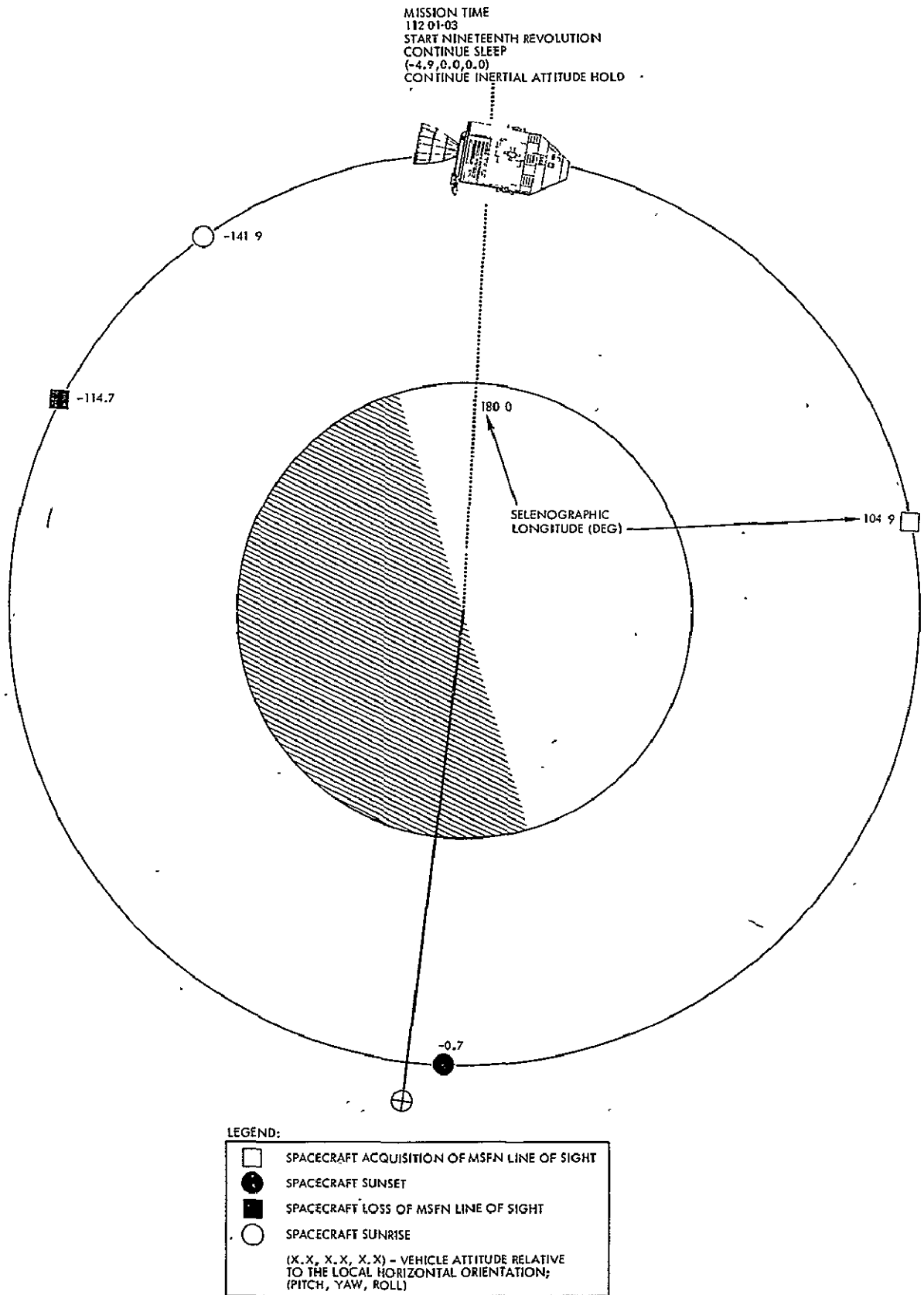

Figure 22. Nineteenth Revolution Major Events and Attitudes

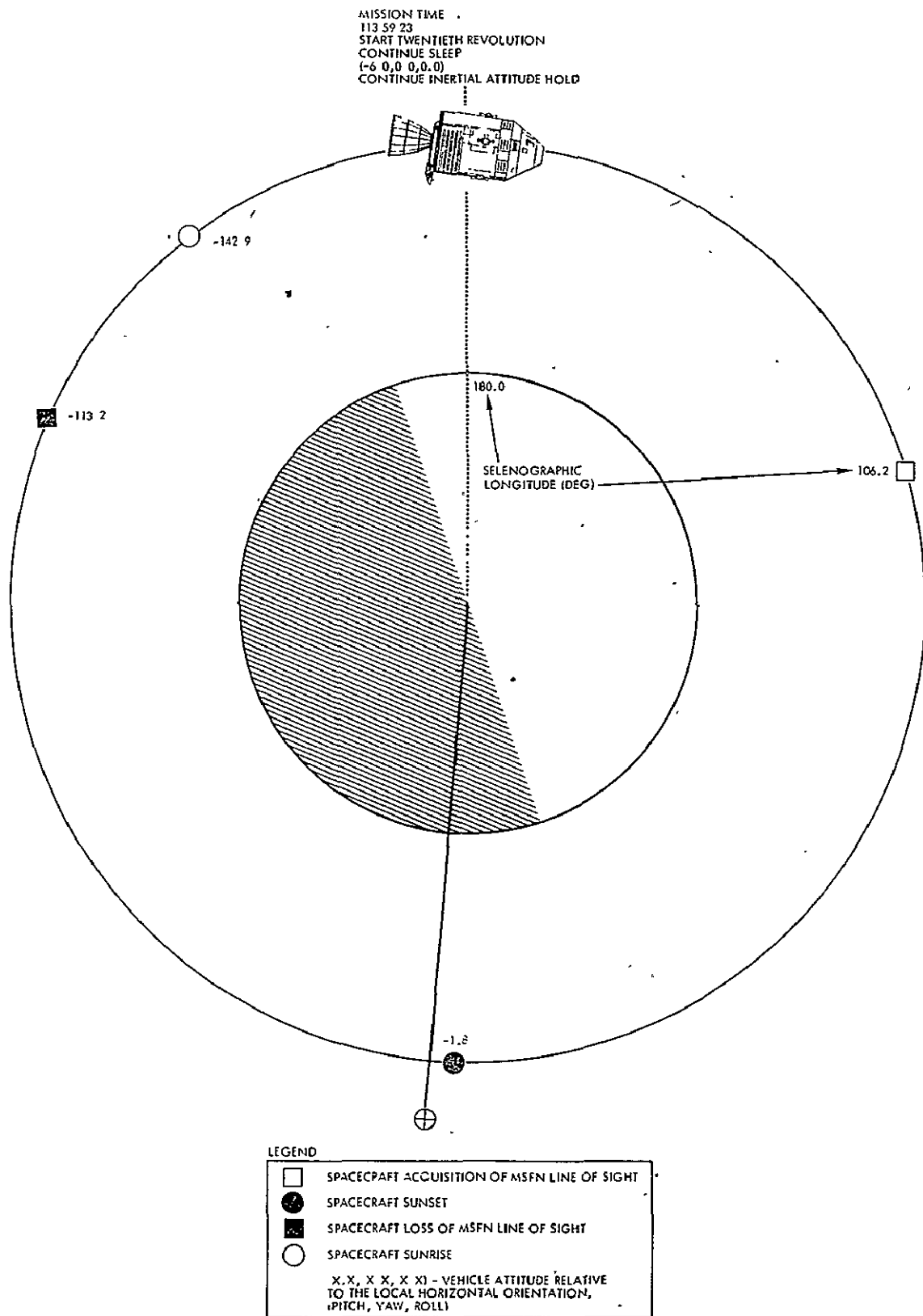

Figure 23. Twentieth Revolution Major Events and Attitudes

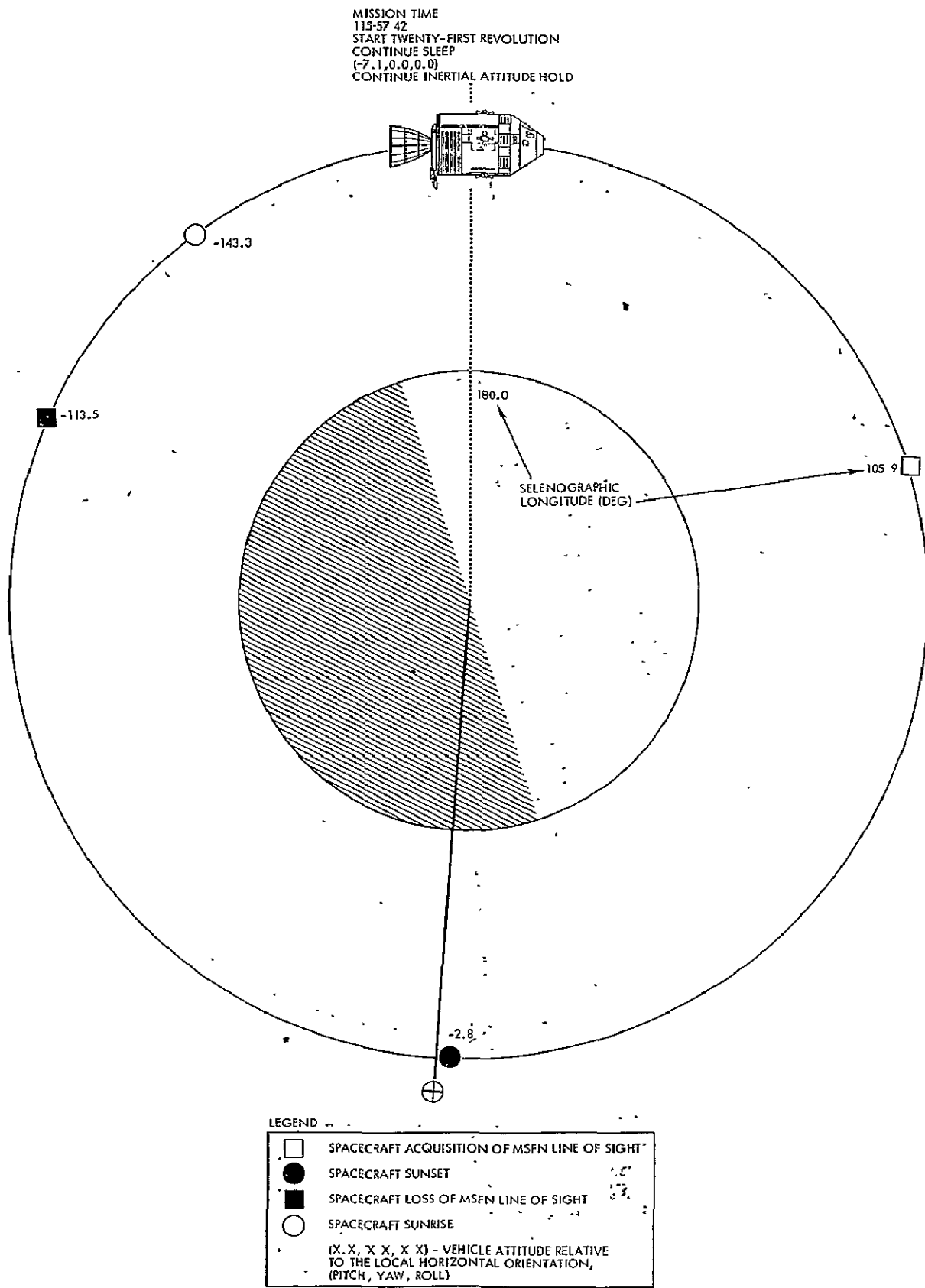

Figure 24. Twenty-first Revolution Major Events and Attitudes

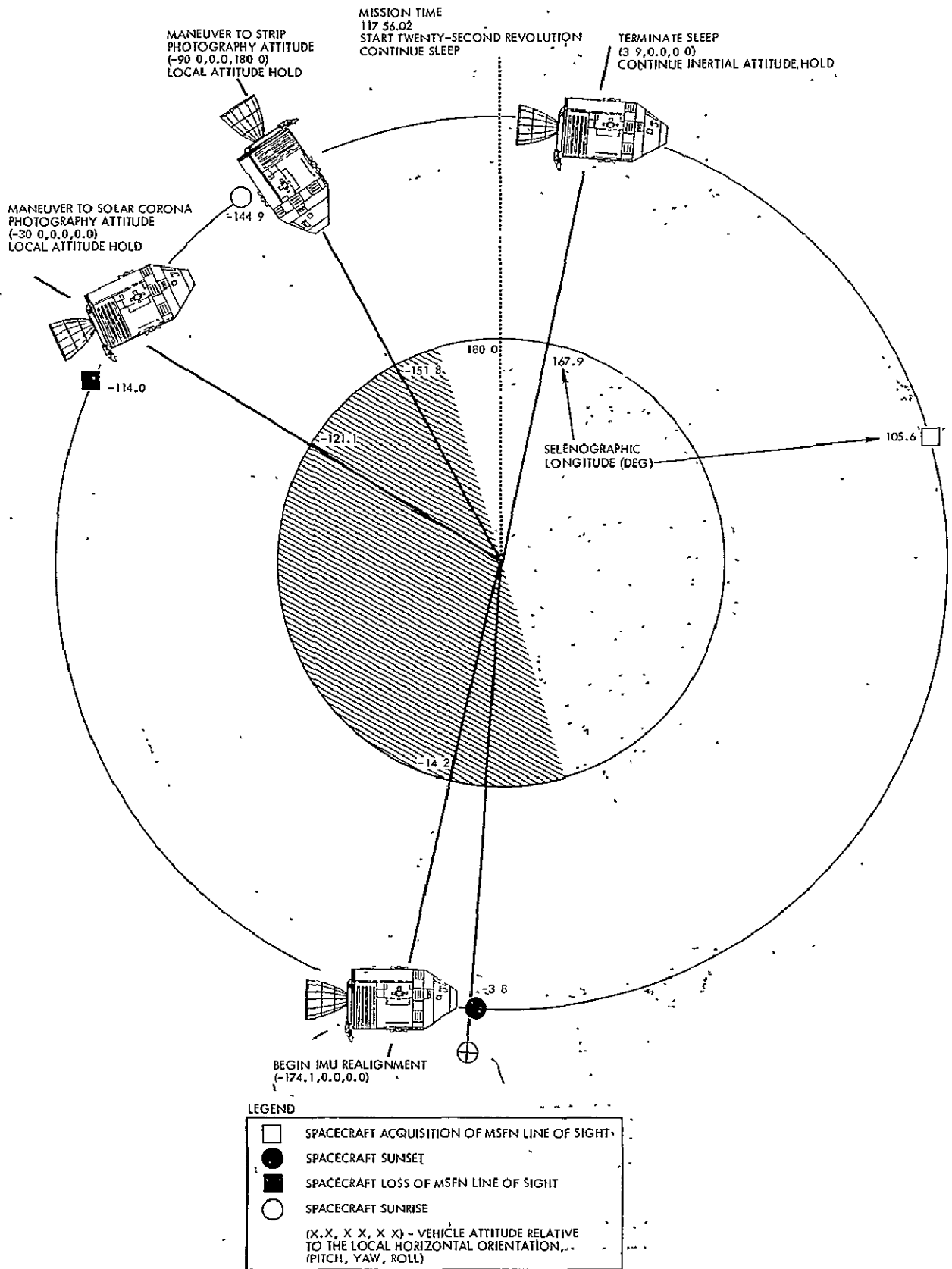

Figure 25. Twenty-second Revolution Major Events and Attitudes

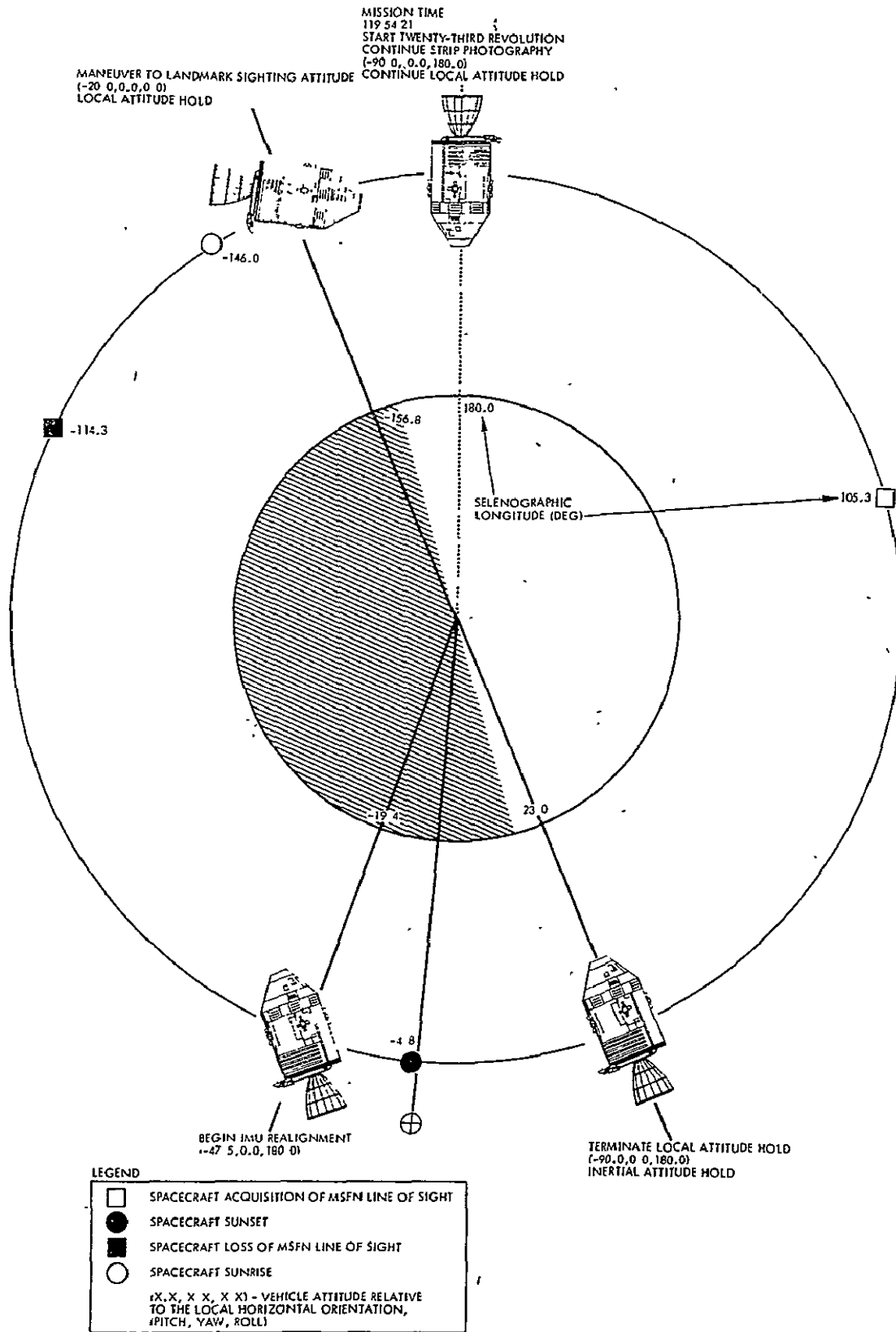

Figure 26. Twenty-third Revolution Major Events and Attitudes



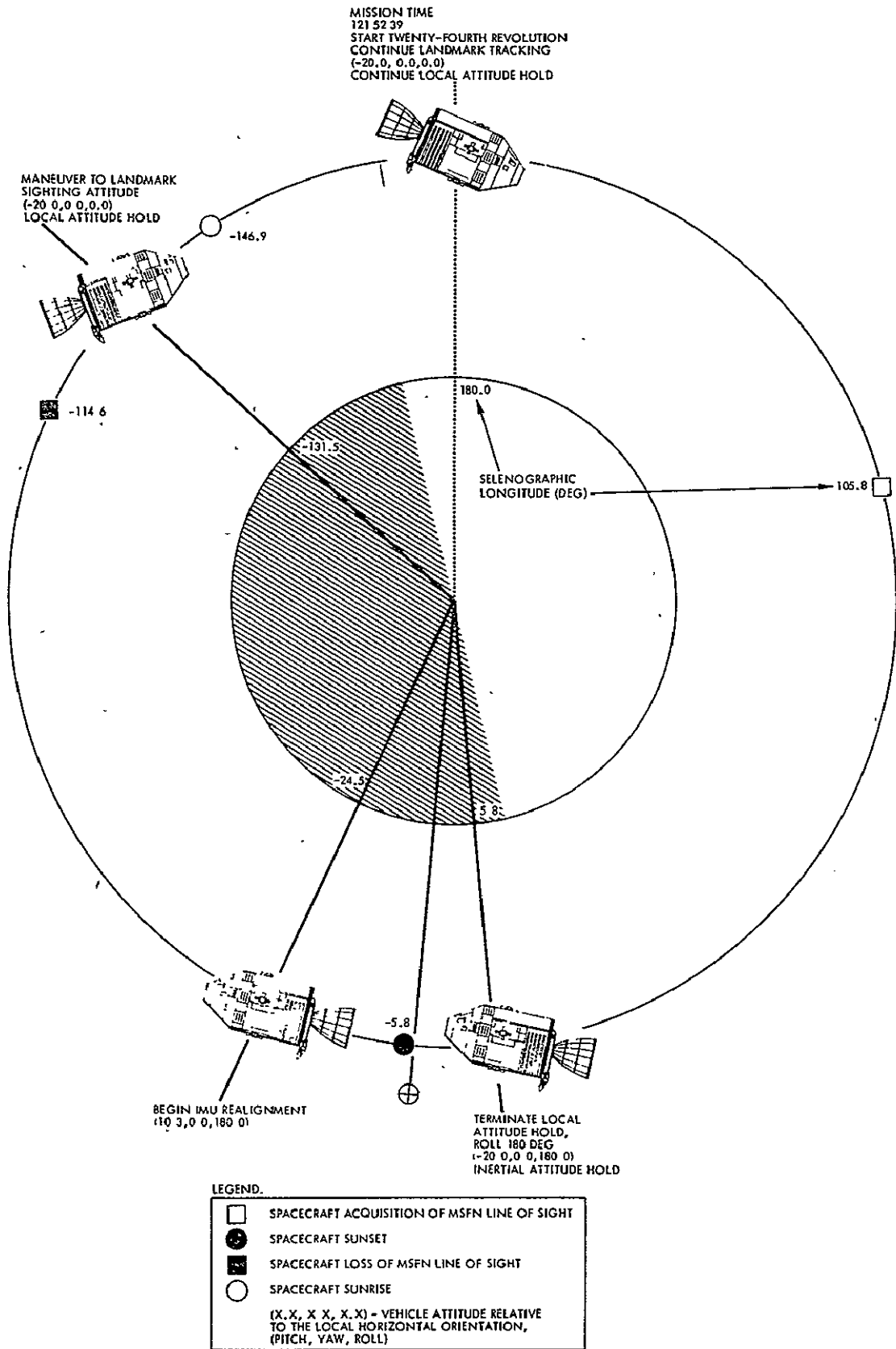

Figure 27. Twenty-fourth Revolution Major Events and Attitudes

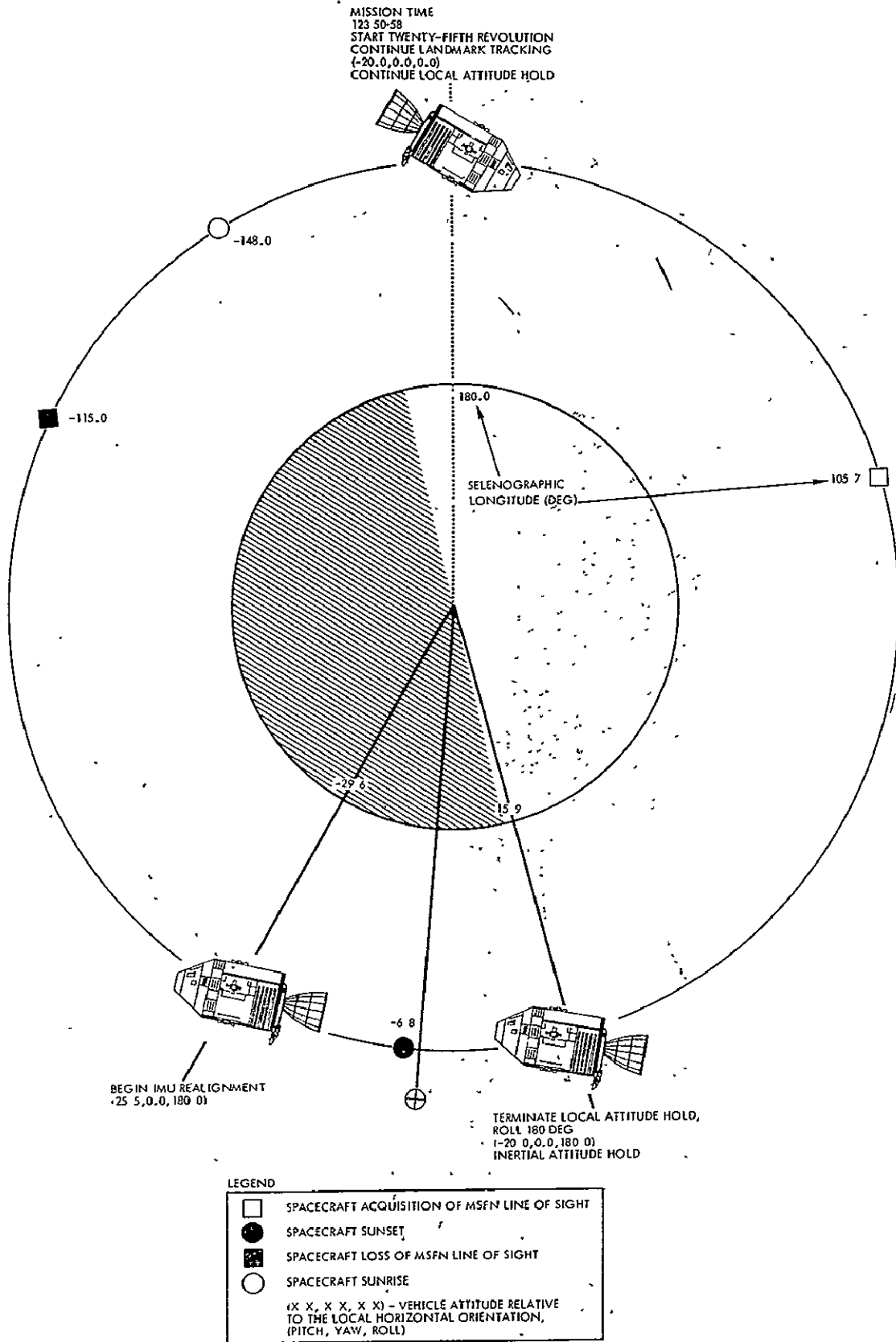

Figure 28. Twenty-fifth Revolution Major Events and Attitudes

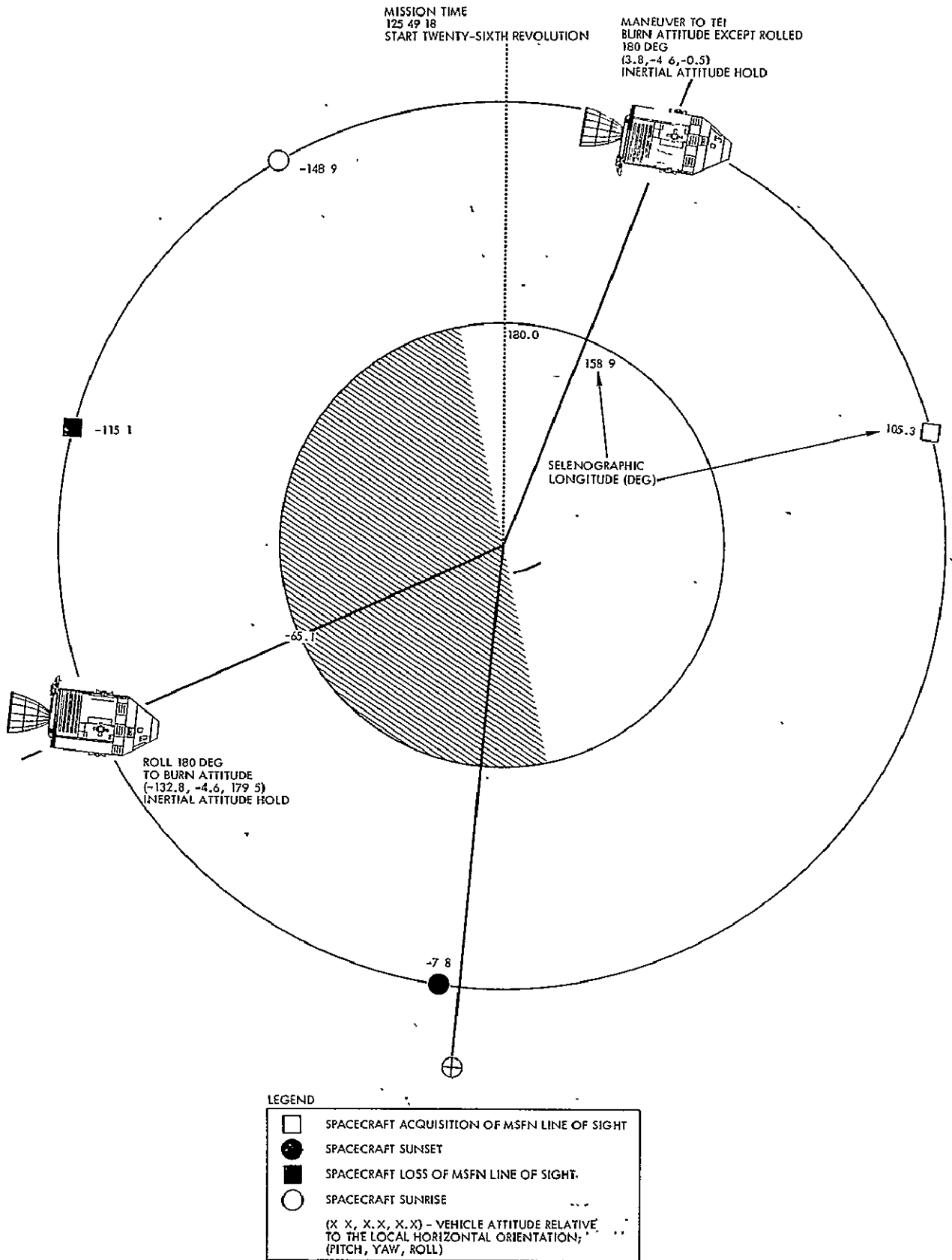
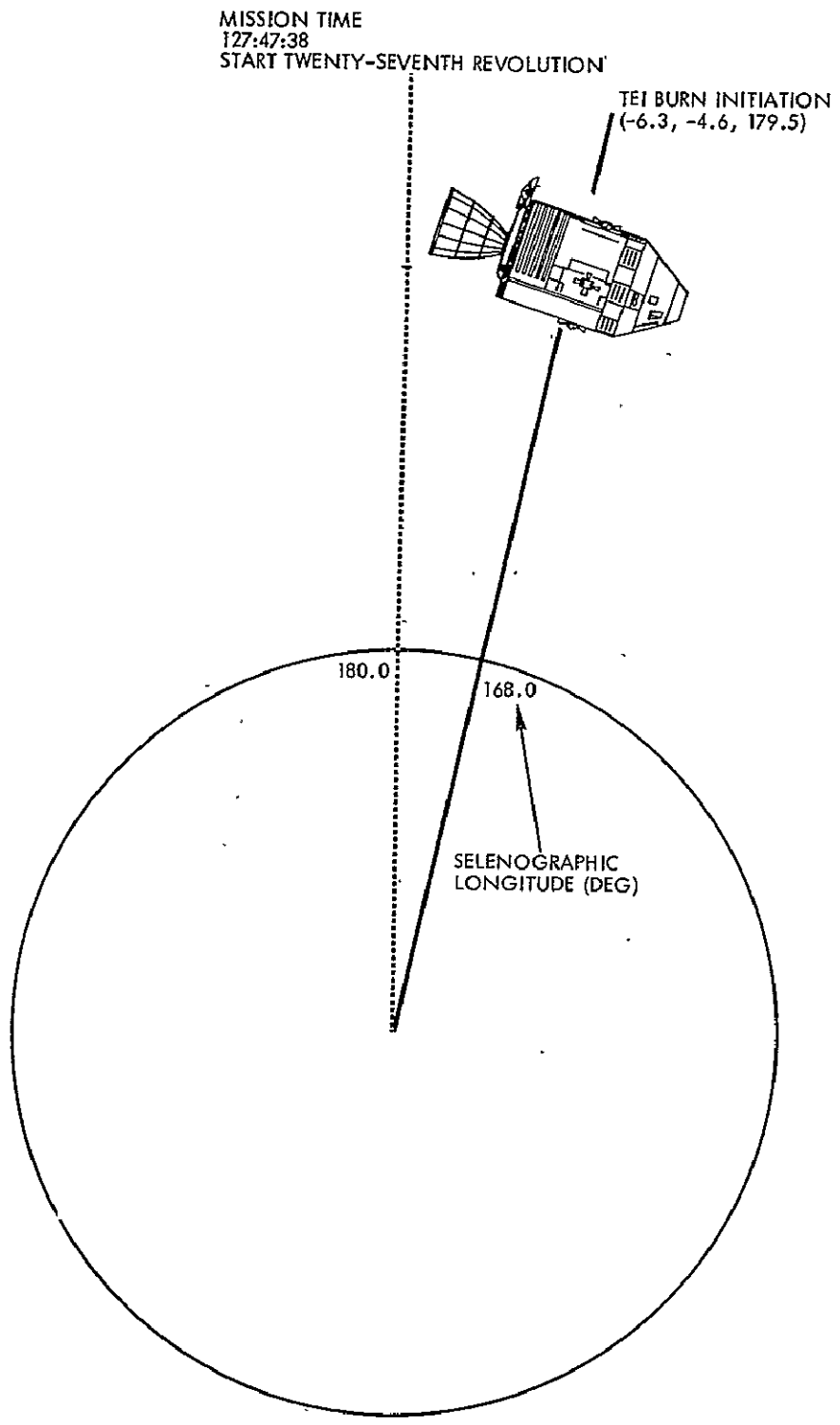

Figure 29. Twenty-sixth Revolution Major Events and Attitudes



(X.X, X.X, X.X) - VEHICLE ATTITUDE RELATIVE TO THE LOCAL HORIZONTAL ORIENTATION; (PITCH, YAW, ROLL)

Figure 30. Start of Twenty-seventh Revolution to TEI Burn Ignition

## REFERENCES

1. Preliminary Flight Plan - Apollo 10 (Draft). NASA-MSC Document, February 14, 1969.
2. Schuck, R. B.: Apollo Cislunar and Lunar Orbit Attitude Constraints, Revision 1. TRW Note 69-FMT-526A, February 15, 1969.
3. Mosel, D. K., Paddock, S. G.: CSM Rendezvous Procedures F Mission (Preliminary Copy). NASA MSC Document, January 23, 1969.
4. Shreffler, Jack H.: Onboard Tracking Schedules for Missions F and G. NASA MSC 68-FM46-471, December 3, 1968.