

GEORGE C. MARSHALL SPACE FLIGHT CENTER
HUNTSVILLE, ALABAMA

Memorandum

TO : Mr. W. K. Simmons, Jr., I-I/IB-U
Through: ~~Mr. Kammeier, R-ASTR-BU~~
FER 6-6-67

DATE : June 5, 1967

FROM : Chief, Guidance and Control Systems
Analysis Branch, R-ASTR-NG

In reply refer to:
R-ASTR-NG-40-67
RESmith/np/876-4595

SUBJECT: Control system information for AS-204L

The purpose of the enclosed memorandum is to present the latest control system information available for AS-204L.

S. M. Seltzer
S. M. Seltzer

1 Enc:
a/s

Approval:

F. B. Moore
F. B. Moore
Chief, Guidance and Control Division

cc:

I-IB-E, Mr. Huff
I-V-E, Mr. Bell
I-V-IU, Mr. Duerr
I-MO-F, Mr. Casey
R-QUAL-P, Mr. Ralston
R-P&VE-V, Mr. Glover
R-AERO-F, Mr. Hardage
Douglas (MSFC), Mr. Dixon
R-ASTR-BU, Mr. Cagle
R-ASTR-FT, Mr. Blackstone
R-ASTR-FO, Mr. Mink
R-ASTR-FT, Mr. Justice
R-ASTR-FO, Mr. Vallely
R-ASTR-FO, Mr. Darden
R-ASTR-E, Mr. R. Smith
R-ASTR-N, Mr. Moore
R-ASTR-NF, Mr. Tutt

R-ASTR-NF, Mr. Vick
R-ASTR-NG, Dr. Seltzer
R-ASTR-NGI, Mr. Scott
R-ASTR-NGI, Mr. Nicaise
R-ASTR-NGI, Mr. Balk (IBM) (2)
R-ASTR-NG, Branch file/record copy
R-ASTR-X, Reference file

SAT 13

716 ARCADIA CIRCLE
HUNTSVILLE, ALABAMA 35801

Sperry Rand Corporation

SPACE SUPPORT DIVISION

April 21, 1967

E.T. Hunt 539-3771 ext 266

J.H. Harper 539-3771 ext 266

Report No.: 211-67-013

TO: D.R. Scott
R-ASTR-NGI

FROM: Sperry Rand Corporation
Space Support Division

SUBJECT: Control System Information for AS-204L

1. The AS-204L configuration will include the AS-204 Launch Vehicle, the AS-208 Control Computer, and will be flying the AS-206 mission.
2. The purpose of this memorandum is to present the control system information for AS-204L. The combination of this memorandum and the "Control System Information for AS-206", by Sperry Rand Corporation, gives the control system information for AS-204L.
3. Reference is made to the following memoranda:
 - a. "Control System Information for AS-206", by Space Support Division, Sperry Rand Corporation, dated November 15, 1966.
 - b. Memorandum, R-ASTR-F- 66 -237, "Control Gains and Shaping Networks for AS-208, S-IB and S-IVB Stages", dated December 8, 1966.
4. This memorandum includes all those pages where information has been changed or deleted pertinent to the AS-204L configuration. The attached figures 19A, 26A, and 29A are Spacecraft control diagrams. The attached pages 48A through 48C are detailed drawings of the control system.

Enc 1

CONTROL SYSTEM INFORMATION FOR AS-204L

Prepared for
GEORGE C. MARSHALL SPACE FLIGHT CENTER
Contract No. NAS8-20055

by
SPACE SUPPORT DIVISION
Sperry Rand Corporation
Huntsville, Alabama

Submitted by:

Jerry Harper
Eddie T. Hunt

Approved by:

Paul Randall

REPORT NO: 211-67-013

DATE: April 21, 1967

GUIDANCE AND CONTROL SYSTEM GENERAL DIAGRAM

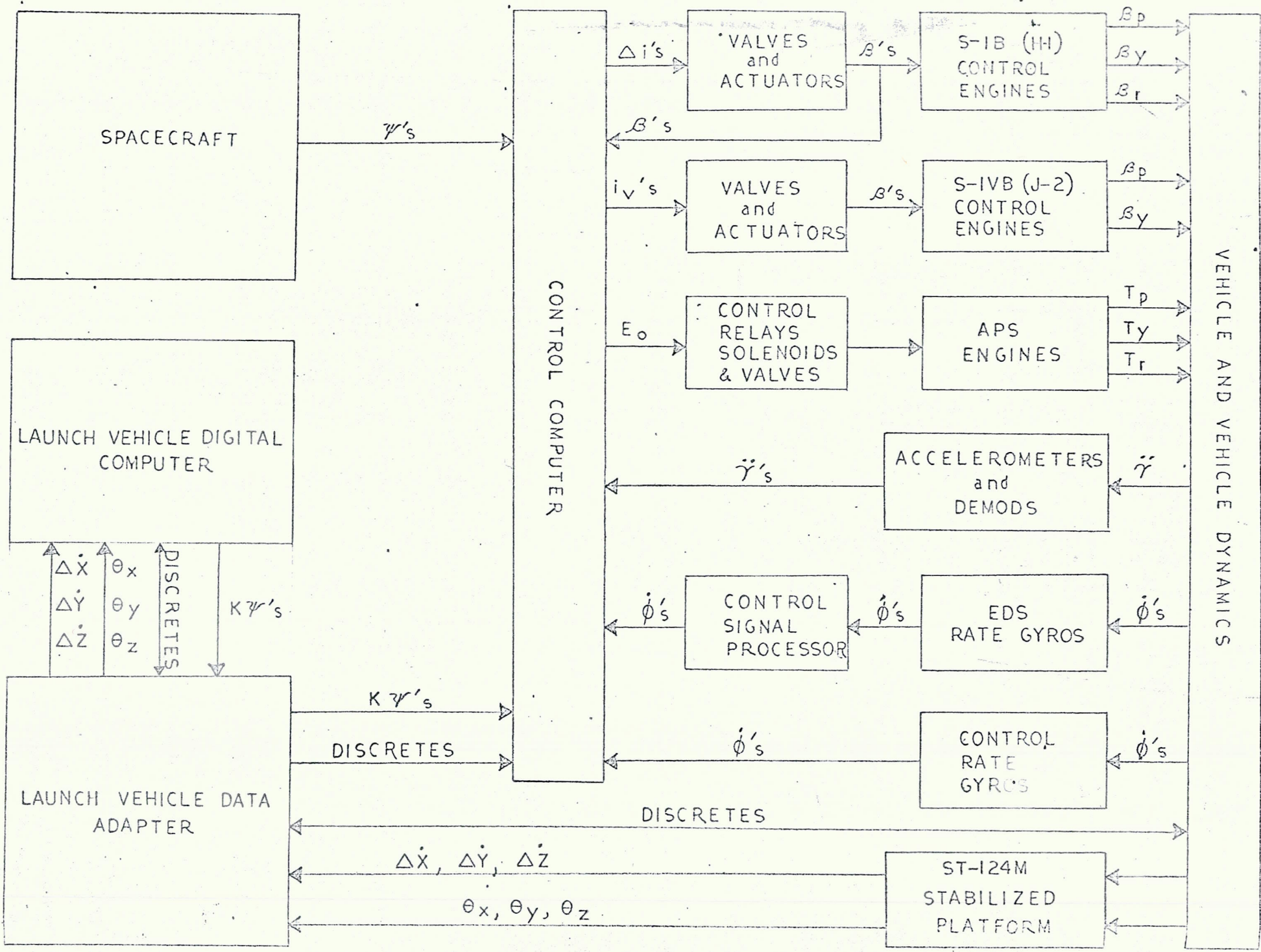

CONTROL SYSTEM SPECIFICATIONS
ATTITUDE ERROR CHANNEL
(PITCH AND YAW)

SUB-SYSTEM OR COMPONENT SPECIFICATION

SYSTEM SPECIFICATION

SCALE FACTOR & TOLERANCE	MAX. RANGE	NULL	S-IVB STAGE (POWERED)	TOLERANCE			NOTES
				θ	n_0		
.00279 deg./bit Fine	±5.62 deg. Fine (64:1)	±0.1 deg. Fine	θ ST-12J RESOLVERS	±5%	±7%	±10%	1,13
.08929 deg./bit Backup	±180 deg. Backup (2:1)	±1.0 deg. Backup		CROSS-OVER DETECTORS & REGISTER			
			MINOR LOOP				
$\psi = .8v/deg.$ ±2% from 0° to ±2.5° ±4% " ±2.5° ±15.3° Quantization level is .06deg./bit	±15.3 deg.		LADDERS				
1% 3.0v/deg	Gain = 3.75	±30 mv. (±.01°)	SCALING AMPLIFIER				2,13
1%			FILTER				
1%	±60 ma.	SERVO AMP COMPONENT NULL ±1.5 mV ±0.2248°	SERVO AMPLIFIER		SERVO AMP SYSTEM NULL ±2.0 ma ±.3°		14
$K_1 = 0.1496 \text{ deg./ma.}$ 1.5%	±46.7 ma.	±1 ma. (±.14°)	VALVE				
1.5%			ACTUATOR				
5%		(±.21 deg.)	ACTUATOR POT		NOT USED FOR CONTROL		

CONTROL SYSTEM SPECIFICATIONS
ATTITUDE RATE CHANNEL
(PITCH AND YAW)

SUB-SYSTEM COMPONENT SPECIFICATION

SYSTEM SPECIFICATION

SCALE FACTOR & TOLERANCE	MAX. RANGE	NULL	S-IVB STAGE (POWERED)	TOLERANCE	NOTES
$\dot{\phi} = 4.5 \text{ v/deg./sec.}$	$\pm 10 \text{ deg./sec.}$	$\pm 563 \text{ mv}$ ($\pm .125^\circ/\#$)	$\dot{\phi}$ 	ϕ_1 +8% 10.5% +10%	3, 4, 6, 13
6%					3, 4, 6, 13
1.5%			$\dot{\phi}$ 		
1%	$\pm 60 \text{ ma}$	SERVO AMP COMPONENT NULL $\pm 1.5 \text{ ma}$ ($\pm 0.2248^\circ$)	 i_v	SERVO AMP SYSTEM NULL $\pm 2 \text{ ma}$ $\pm 0.3^\circ$	12, 13, 14
$K_1 = 0.1496 / \text{ma}$ 1.5%	$\pm 46.7 \text{ ma}$	$\pm 1 \text{ ma}$ ($\pm .14^\circ$)			
1.5%					
5%		($\pm .21 \text{ deg.}$)		NOT USED FOR CONTROL	

CONTROL SYSTEM SPECIFICATIONS
ATTITUDE ERROR CHANNEL
(PITCH & YAW COAST)
(ROLL-POWERED OR COAST)

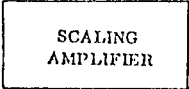
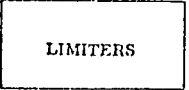
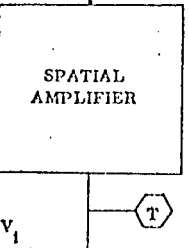
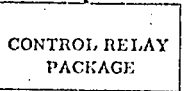
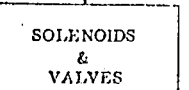
SUB-SYSTEM OR COMPONENT SPECIFICATION			SYSTEM SPECIFICATION		
SCALE FACTOR & TOLERANCE	MAX. RANGE	NULL	S-IVB STAGE	TOLERANCE	NOTES
$\psi = 0.3v/deg$			θ 	$\pm 5\%$ $\pm 10\%$ $\pm 10\%$	
	Gain = 10.0				2, 13
	$\psi_p = \pm 2.5^\circ$ $\psi_y = \pm 2.5^\circ$ $\psi_R = \pm 5.5^\circ$				
Triggering Threshold $\pm 0.8v \pm 6\%$ Full on Threshold $\pm 1.28v \pm 6\%$ Minimum Pulse Duration = 65ms $\pm 10\%$		$\pm 10\text{ mv.}$	V_1 	Triggering Threshold $\pm 0.8v \pm 10\%$ Full on Threshold $\pm 1.28v \pm 10\%$ Minimum Pulse Duration 65ms $\pm 10\%$	
0 or + 28 volts $\pm 2\text{ volts}$ 3 ms. delay				Same as the spatial amplifier	
					

CONTROL SYSTEM SPECIFICATIONS
ATTITUDE RATE CHANNEL
(PITCH & YAW - COAST)
(ROLL - POWERED OR COAST)

SUB-SYSTEM OR COMPONENT SPECIFICATION			SYSTEM SPECIFICATION		
SCALE FACTOR & TOLERANCE	MAX. RANGE	NULL	S-IVB STAGE	TOLERANCE	NOTES
$\dot{\phi} = 4.5 \text{ v/deg./sec.}$		$\pm 563 \text{ mv}$ ($\pm .125^\circ/\text{sec}$)	$\dot{\phi}$	$\pm 8\%$ $\pm 11\%$ $\pm 10\%$ ^{r1}	3, 4, 6, 13
8%			EDS RATE GYROS		
			CSP		3, 4, 6, 13
			$\dot{\phi}$		
1%	Gain = 5	$\pm 30 \text{ mv}$ ($\pm .0013^\circ/\text{sec}$)	SCALING AMPLIFIER		2, 13
Triggering Threshold = $\pm 0.9 \text{ v} \pm 6\%$ Full on Threshold = $\pm 1.44 \text{ v} \pm 6\%$ Minimum Pulse Duration = 65ms $\pm 10\%$		$\pm 10 \text{ mv}$	SPATIAL AMPLIFIER	triggering threshold $\pm 0.9 \text{ v} \pm 20\%$ full on threshold $\pm 1.44 \text{ v} \pm 10\%$ Minimum pulse duration 65ms $\pm 10\%$	
0 or +28 volts $\pm 2 \text{ v}$ 3 ms delay			V_1		
			CONTROL RELAY PACKAGE	Same as the spatial amplifier	
			SOLENOIDS & VALVES		

TELEMETRY FUNCTIONS
ATTITUDE ERROR CHANNEL
(PITCH, YAW, AND ROLL)

SUB-SYSTEM OR COMPONENT SPECIFICATION

SYSTEM SPECIFICATION

SCALE FACTOR & TOLERANCE	MAX. RANGE	NULL	S-B STAGE	TOLERANCE	NOTES
			θ ST-124 RESOLVERS	$\pm 5\%$ $\pm 11\%$ $\pm 10\%$	
			CROSS-OVER DETECTORS & REGISTER		
			MINOR LOOP		
			LADDERS		
			$K\psi$ SCALING AMPLIFIER		
$3.0v/deg.$ $\pm 2.22\%$	$\pm 15 deg$	$\pm 112.5 mv$ $\pm 0.0375 deg$	FILTER		1,4,7
			SERVO AMP INPUT FEED-BACK OUTPUT βD		4,5,7,14
$\Delta_f = 0.1v/mn$ $\pm 2\%$	$\pm 14 mn$	SERVO AMP COMPONENT NULL $\pm 0.6 mn$ ($\pm 0.075^\circ$)	VALVE		
			ACTUATOR		
$0.212 v/deg.$ $\pm 5\%$	$\pm 8 deg.$	$\pm 14.63 mv$ ($\pm 0.069^\circ$)	ACTUATOR POTS CONT. TELE.		4,5,7

TELEMETRY FUNCTIONS
ATTITUDE RATE CHANNEL
(PITCH, YAW, AND ROLL)

SUB-SYSTEM OR COMPONENT SPECIFICATION

SYSTEM SPECIFICATION

SCALE FACTOR & TOLERANCE	MAX. RANGE	NULL	S-SB STAGE	TOLERANCE	NOTES
				$\pm 12\%$ $\pm 18.6\%$ $\pm 10\%$	
$\dot{\theta} = 4.5 \text{ v/deg/sec}$ $\pm 8\%$	$\pm 10 \text{ deg/sec}$	$\pm 585 \text{ mv}$ $\pm 0.13\%/sec$			7
					8
$\pm 2\%$ $\Delta_I = 0.1 \text{ v/mg}$	$\pm 14 \text{ ma}$	SERVO AMP COMPONENT NULL $\pm 0.6 \text{ ma}$ ($\pm 0.075^\circ$)			4, 5, 7, 14
					4
0.212 v/deg. $\pm 5\%$	$\pm 8 \text{ deg.}$	$\pm 14.63 \text{ mv}$ ($\pm .069^\circ$)			4, 5, 7

TELEMETRY FUNCTIONS
ACCELEROMETER CHANNEL
(PITCH AND YAW)

SUB-SYSTEM OR COMPONENT SPECIFICATION

SYSTEM SPECIFICATION

SCALE FACTOR & TOLERANCE	MAX. RANGE	NULL	S-IB STAGE	TOLERANCE	NOTES
$\ddot{\gamma} = 1.0 \text{ v/m/s}^2$ $\pm 6\%$	$\pm 10 \text{ m/s}^2$	$\pm 80 \text{ mv}$ $(\pm .08 \text{ m/s}^2)$	$\ddot{\gamma}$ CONTROL ACCELEROMETER & DEMOD 	$\pm 0\%$ $\pm 18\%$ $\pm 10\%$ ϵ_2	3, 4, 7
			CONTROL ATTENUATION TIMER		
			SCALING AMPLIFIER & FILTER		8
$\pm 2\%$ $\Delta I = 0.1 \text{ v/ma}$	$\pm 14 \text{ ma}$	SERVO AMP COMPONENT NULL $\pm 0.6 \text{ ma}$ $(\pm 0.075^\circ)$	SERVO AMP INPUT FEED-BACK $\beta \Omega$ OUTPUT		4, 5, 7, 14
			VALVE		4
			ACTUATOR		
$.212 \text{ v/deg.}$ $\pm 5\%$	$\pm 8 \text{ deg.}$	$\pm 14.63 \text{ mv}$ $(\pm .069 \text{ deg.})$	ACTUATOR POTS CONT. TELE. 		4, 5, 7

TELEMETRY FUNCTIONS
ATTITUDE ERROR CHANNEL
(PITCH AND YAW)

SUB-SYSTEM OR COMPONENT SPECIFICATION

SYSTEM SPECIFICATION

SCALE FACTOR & TOLERANCE	MAX. RANGE	NULL	S-IVB STAGE (POWERED)	TOLERANCE			NOTES
				$\pm 6\%$	$\pm 0\%$	$\pm 10\%$	
			0				
			ST-124 RESOLVERS				
			↓ CROSS-OVER DETECTORS & REGISTER				
			↓ MINOR LOOP				
			↓ LADDERS				
			↓ K _φ SCALING AMPLIFIER				
$\pm 2.22\%$ 3.0v/deg.	± 15 deg	± 112.5 mv ± 0.375 deg	↓ (T)				7
			↓ FILTER				8
$i_v = .02$ v/ma 2%	± 50 ma	SERVO AMP COMPONENT NULL ± 1.5 ma ($\pm 0.2248^\circ$)	↓ SERVO AMPLIFIER				4,5,7,14
			↓ i_v (T)				
			↓ VALVE				
			↓ ACTUATOR				
$\beta = .339$ v/deg. $\pm 5\%$	± 7 deg.	± 52.25 mv ($\pm .154$ deg.)	↓ ACTUATOR POT (T)				4,5,7

TELEMETRY FUNCTIONS
ATTITUDE RATE CHANNEL
(PITCH AND YAW)

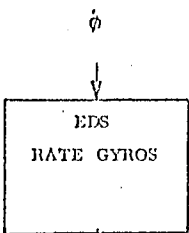
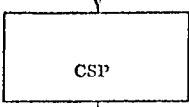
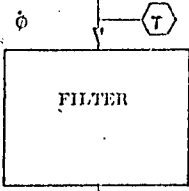
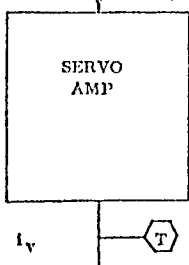
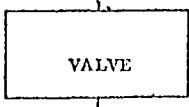
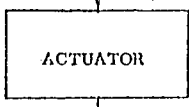
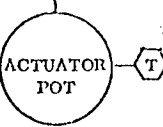
SUB-SYSTEM OR COMPONENT SPECIFICATION			SYSTEM SPECIFICATION		
SCALE FACTOR & TOLERANCE	MAX. RANGE	NULL	S-IVB STAGE (POWERED)	TOLERANCE	NOTES
			ϕ 	$\pm 12\%$ $\pm 16.5\%$ $\pm 10\%$	
					7
$\dot{\phi} = 4.5 \text{ v/deg./sec}$ $\pm 8\%$	$\pm 10 \text{ deg/sec}$	$\pm 585 \text{ mv}$ $\pm 0.13\%/sec$	ϕ 		8
$i_v = .02 \text{ v/ma}$ 2%	$\pm 50 \text{ ma}$	SERVO AMP COMPONENT NULL $\pm 1.5 \text{ ma}$ ($\pm 0.2248^\circ$)			14 7
					4, 5
					
0.339 v/deg. $\pm 5\%$	$\pm 7 \text{ deg.}$	$\pm 52.25 \text{ mv}$ ($\pm .164^\circ$)			4, 5, 7

TELEMETRY FUNCTIONS
 ATTITUDE ERROR CHANNEL
 (PITCH & YAW - COAST)
 (ROLL-POWERED OR COAST)

SUB-SYSTEM OR COMPONENT SPECIFICATION

SYSTEM SPECIFICATION

SCALE FACTOR & TOLERANCE	MAX. RANGE	NULL	S-IVB STAGE	TOLERANCE	NOTES
			θ 	$\pm 0\%$ $\pm 10\%$ $\pm 10\%$	
			CROSS-OVER DETECTORS & REGISTER		
			MINOR LOOP		
			LADDERS		
			$K\psi$ SCALING AMPLIFIER		7
$\pm 2.22\%$ 3.0 v/deg	± 15 deg	± 112.5 mv 0.0375 deg			4,5
			SPATIAL AMPLIFIER		7
$V_1 = 9.53$ mv/mg ± 2 volts 3 ms delay	± 210 mg	± 0.010 vdc	CONTROL RELAY PACKAGE		7
			SOLENOIDS & VALVES		9

TELEMETRY FUNCTIONS
 ATTITUDE ERROR CHANNEL
 (PITCH & YAW-COAST)
 (ROLL-POWERED OR COAST)

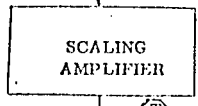
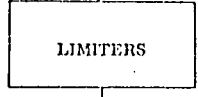
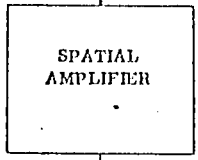
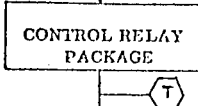
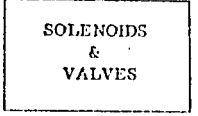
SUB-SYSTEM OR COMPONENT SPECIFICATION			SYSTEM SPECIFICATION		
SCALE FACTOR & TOLERANCE	MAX. RANGE	NULL	S-IVB STAGE	TOLERANCE	NOTES
			<p>9</p>  <p>SPACECRAFT</p>	<p>±6% ±10% ±10%</p>	
±2.22% 3.0 v/deg	±15 deg	±112.5 mv ±0.0375 deg	 <p>SCALING AMPLIFIER</p>		7,15
			 <p>LIMITERS</p>		
			 <p>SPATIAL AMPLIFIER</p>		4,5
$V_i = 9.53 \text{ mv/ma}$	±210 ma	±0.010 vdc	<p>V_i</p>  <p>CONTROL RELAY PACKAGE</p>		7
0 or + 28 volts ± 2 volta 3 ms delay			 <p>SOLENOIDS & VALVES</p>	Same as the spatial amplifier	7
					9

TELEMETRY FUNCTIONS
 ATTITUDE RATE CHANNEL
 (PITCH & YAW - COAST)
 (ROLL - POWERED OR COAST)

SUB-SYSTEM OR COMPONENT SPECIFICATION

SYSTEM SPECIFICATION

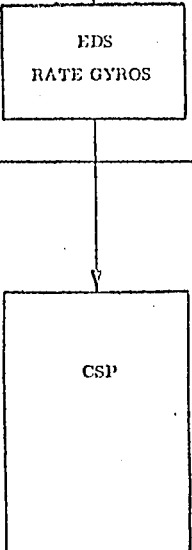
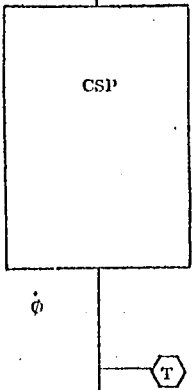
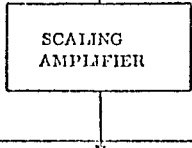
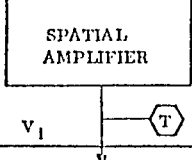
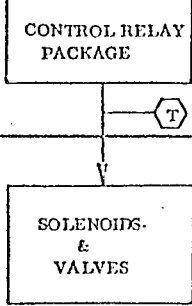
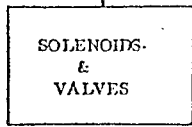
SCALE FACTOR & TOLERANCE	MAX. RANGE	NULL	S-IVB STAGE	TOLERANCE	NOTES
			ϕ 	$\pm 12\%$ $\pm 10\%$ $\pm 10\%$	
$\beta = 4.5 \text{ v/deg/sec}$ $\pm 8\%$	$\pm 10 \text{ deg/sec}$	$\pm 505 \text{ mv}$ $\pm 0.13 \text{ deg/c}$	ϕ 		7
					
$V_1 = 9.53 \text{ mv/md}$	$\pm 210 \text{ md}$	$\pm 0.010 \text{ vdc}$	V_1 		4,7
0 or +28 volts $\pm 2 \text{ volts}$ 3 ms delay					7
					9

11. The magnetic summing amplifier saturates at approximately ± 23 ma. The null shift is based on zero input to the control computer. This null shift may be represented by an equivalent β .

12. Same as note 11, except the S-IVB magamp saturates at ± 60 ma.

13. Control system unit output = nominal output value \pm the gain tolerance \pm the null shift.

14. The null tolerance of 0.6 and 1.5 ma on the 12 and 50 ma servo amps respectively are component tolerances and should not be adhered to for system testing. For system testing the null tolerance on the 12 and 50 ma servo amps shall be 1.2 and 2 ma respectively.

15. When telemetry measurements are measured in the blockhouse, refer to page 30.

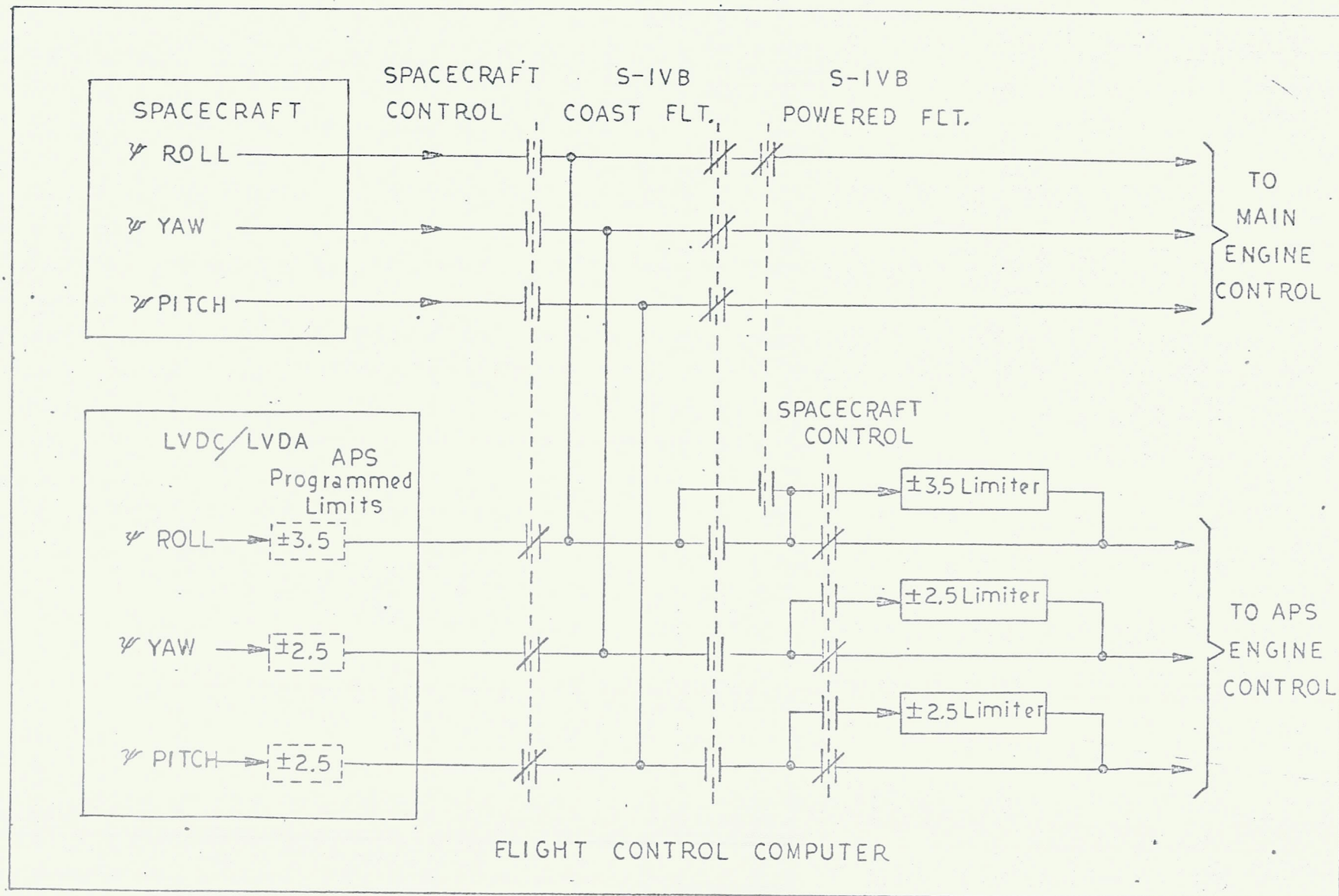

ATTITUDE ERROR SIGNAL SOURCES FUNCTIONAL BLOCK DIAGRAM

σ_0 TOLERANCE IS $\pm 10\%$ OR ± 1 SECOND AT THE SWITCH POINTS

First Stage Flight

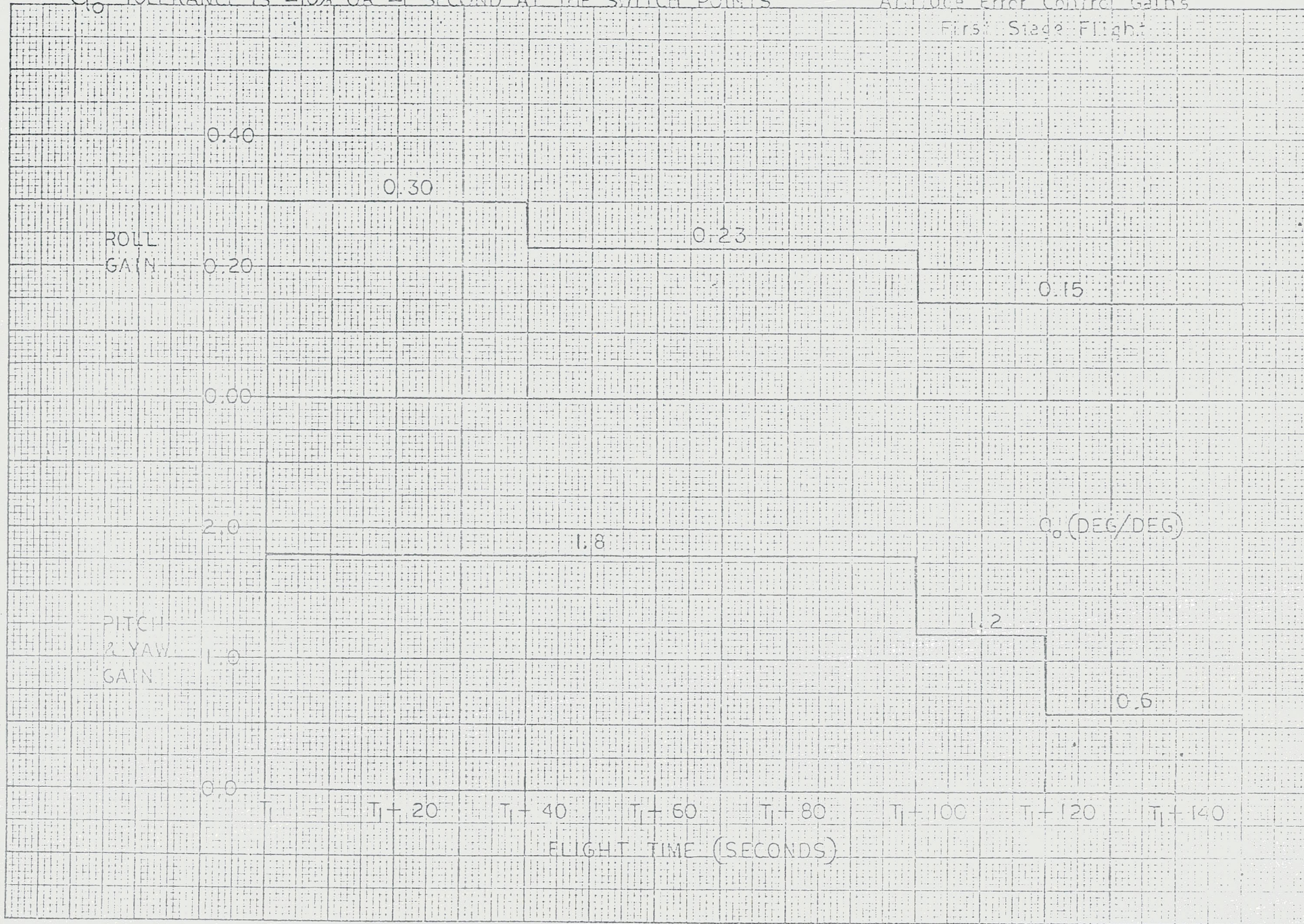

SATURN 1B/AS-204L
Attitude Rate Control Gains

Q_1 TOLERANCE IS $\pm 10\%$ OR ± 1 SECOND AT THE SWITCH POINTS

First Stage Flight

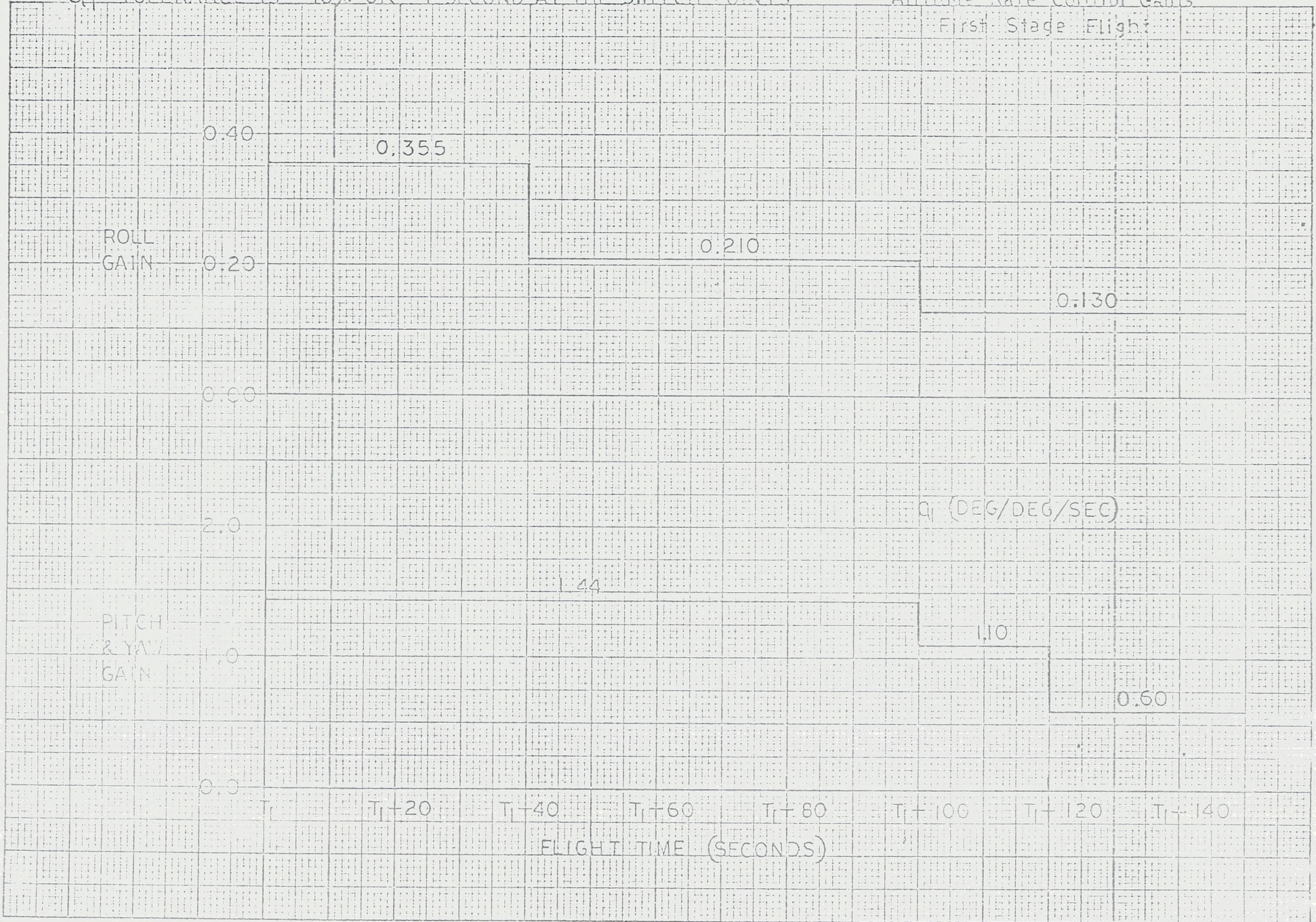

35

SATURN IB/AS-204 L

Attitude Error Control Gains

 TOLERANCE IS $\pm 10\%$ OR ± 1 SECOND AT THE SWITCH POINTS

Second Stage Flight

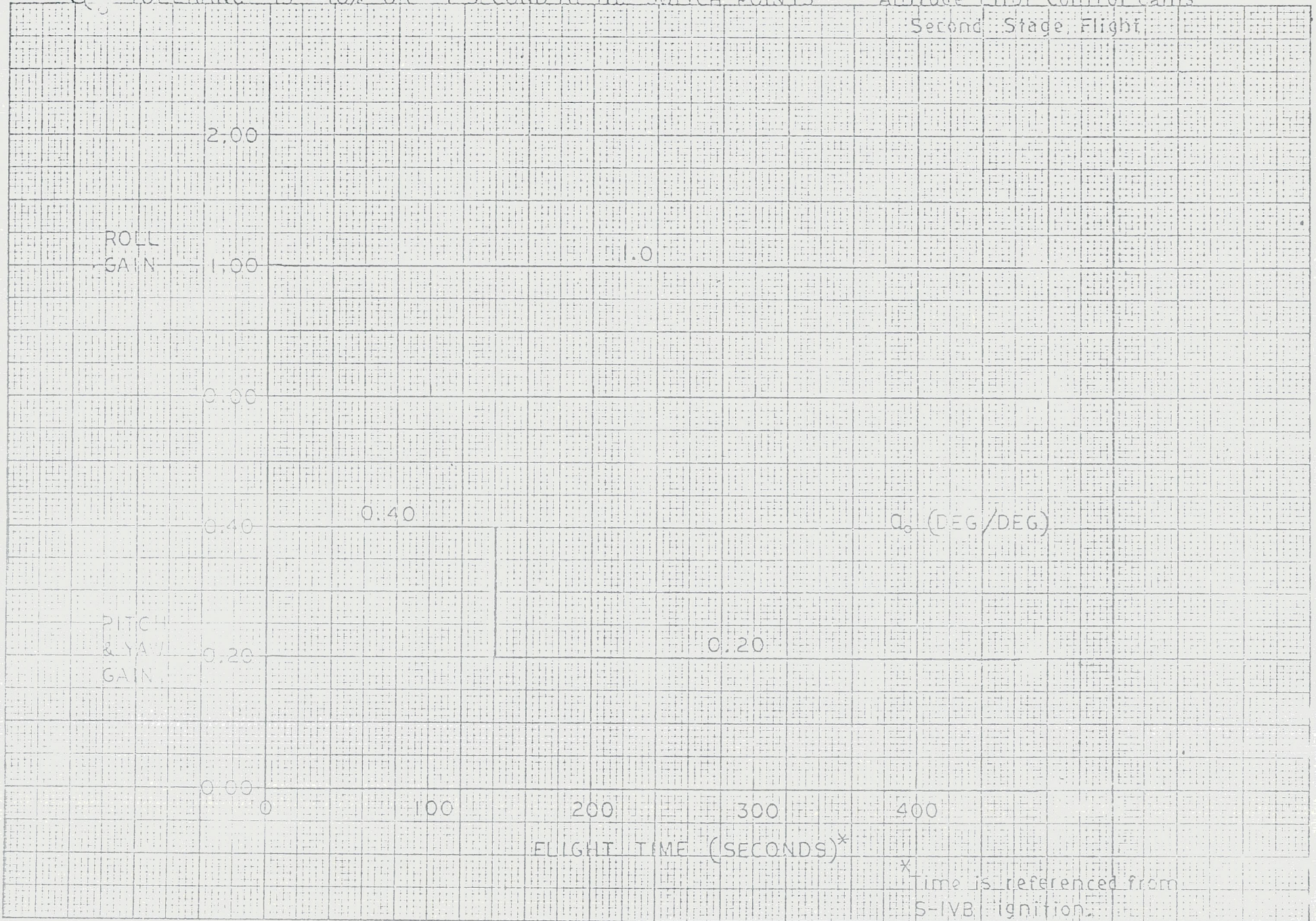

* Time is referenced from S-IVB ignition.

Q. TOLERANCE IS ±10% OR ±1 SECOND AT THE SWITCH POINTS

Second Stage Flight

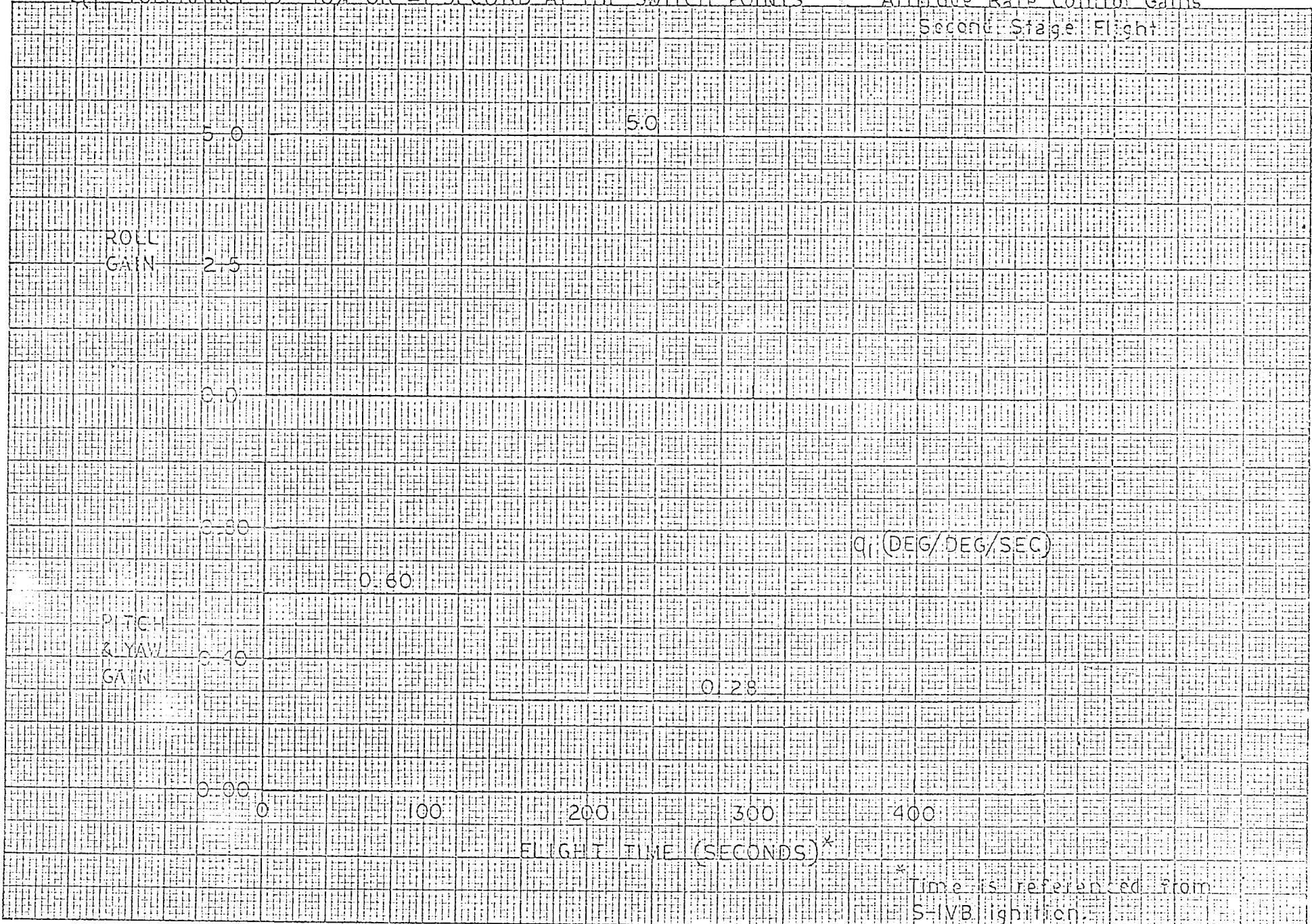

q_i (DEG/DEG/SEC)

FLIGHT TIME (SECONDS)*

* Time is referenced from S-IVB Ignition.

NOTICE - WHEN APPROVED DRAWING SPECIFICATIONS OR OTHER DATA ARE USED FOR ANY PURPOSE OTHER THAN IN CONNECTION WITH A SPECIFICALLY RELATED GOVERNMENT PURCHASE OPERATION, THE UNITED STATES GOVERNMENT BEYOND THE LIMITS OF THE SPECIFICATIONS AND OTHER DATA SO SPECIFICALLY AUTHORIZED, AND THE FACT THAT THE GOVERNMENT HAS MADE SUCH SPECIFICATIONS AND OTHER DATA AVAILABLE TO THE PUBLIC DOES NOT CONSTITUTE AN AUTHORITY TO REPRODUCE OR TO REPRODUCE BY TRANSMISSION OR OTHERWISE, IN ANY MANNER, OR TO USE THE INFORMATION OR ANY OTHER PORTION OR ESTIMATION OR CONVERSION THEREOF FOR ANY PURPOSE OTHER THAN THAT AUTHORIZED BY THE ORIGINAL AND PATENTED INVENTION THAT MAY BE RELATED THERETO.

CONTROL COMPUTER
MAGAMP INPUT AND OUTPUT

S-1B HYDRAULIC ACTUATOR SYSTEM

PART NO.		REVISIONS			
CONTR. SYM	DESCRIPTION	DATE	APPROVAL		

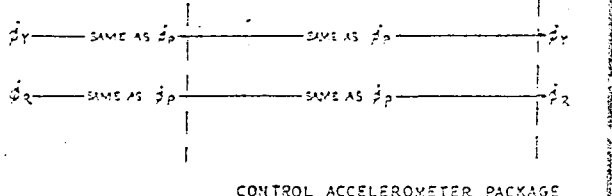
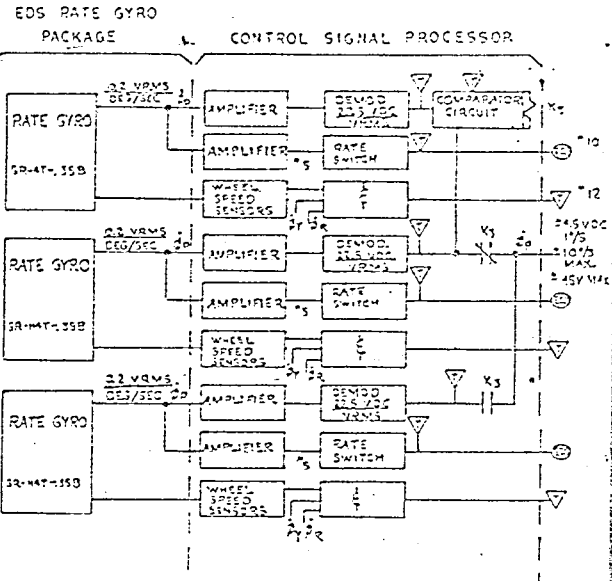
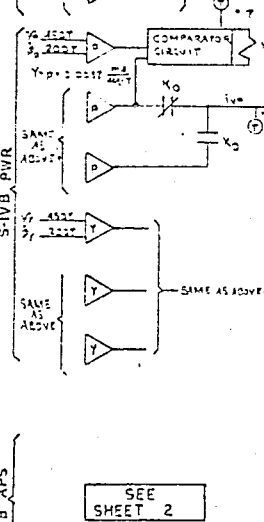
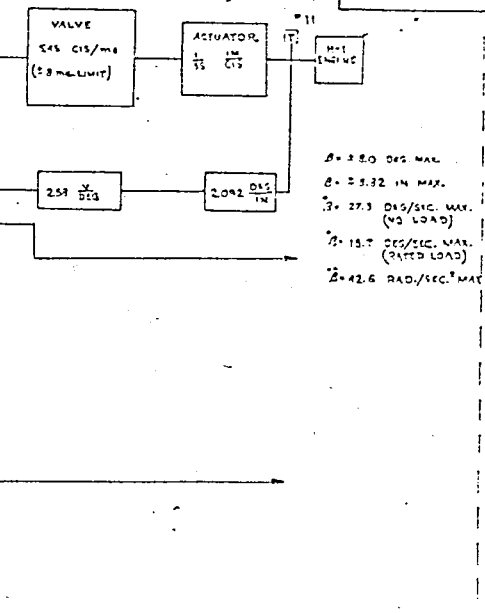
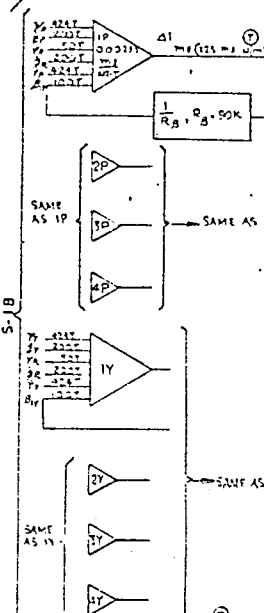
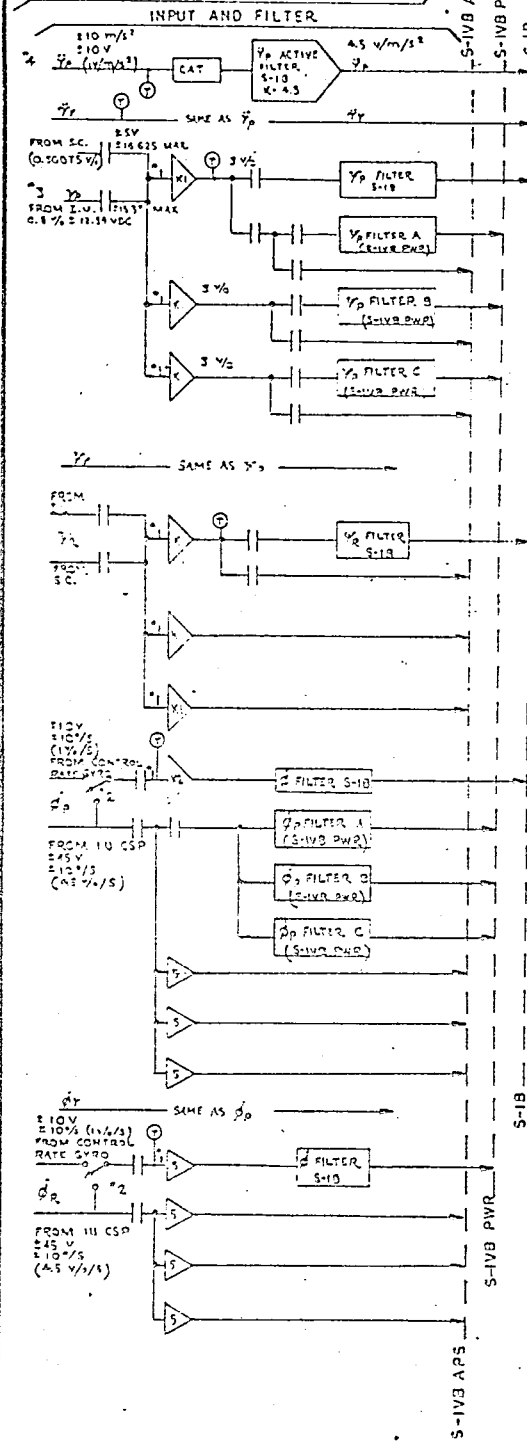

UNLESS OTHERWISE SPECIFIED			ORIGINAL DATE OF DRAWING	
DIMENSIONS ARE IN INCHES			DRAWN	CHECKED
TOLERANCES ON FRACTIONS DECIMALS ANGLES			ENGINEER	DESIGNED
MATERIAL			DESIGNED	ENGINEER
HEAT TREATMENT			APPROVED	
NEXT ASSY USED ON			APPROVED	
APPLICATION			APPROVED	

**SATURN-1B
CONTROL SYSTEM
DETAILED DIAGRAM**

GEORGE C. MARSHALL
SPACE FLIGHT CENTER
NATIONAL AERONAUTICS
AND SPACE ADMINISTRATION
MUNTSVILLE, ALABAMA

DWG NO.
 C

SCALE: _____ UNIT WEIGHT: _____ CODE: _____

THREE of 3

NOTICE - THESE DRAWINGS, SPECIFICATIONS, OR OTHER DATA ARE ISSUED FOR THE PURPOSE OF ORDERING PARTS IN CONNECTION WITH A SPECIFICALLY RELATED PROJECT. THE USER SHALL BE RESPONSIBLE FOR OBTAINING THE NECESSARY INFORMATION TO DETERMINE THE FACT THAT THE SPECIFICATIONS AND ANY OTHER DATA IN THIS DRAWING HAVE BEEN APPLIED TO THE PROJECT AND THAT THE USER HAS OBTAINED THE NECESSARY INFORMATION TO DETERMINE THE FACT THAT THE SPECIFICATIONS AND ANY OTHER DATA IN THIS DRAWING HAVE BEEN APPLIED TO THE PROJECT AND THAT THE USER HAS OBTAINED THE NECESSARY INFORMATION TO DETERMINE THE FACT THAT THE SPECIFICATIONS AND ANY OTHER DATA IN THIS DRAWING HAVE BEEN APPLIED TO THE PROJECT.

PART NO.	REVISIONS			
	NO.	DATE	BY	APPROVAL

S-IVB APS 13,14

CONTROL RELAY PACKAGES

S-IVB HYPERGOLIC ENGINE SYSTEM 8

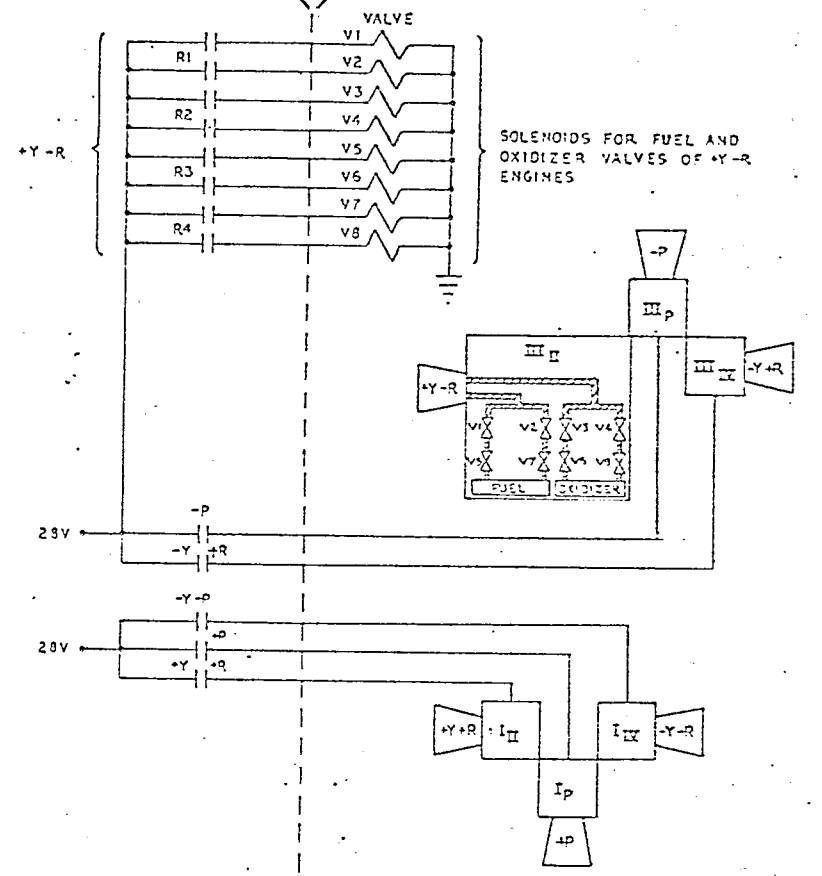
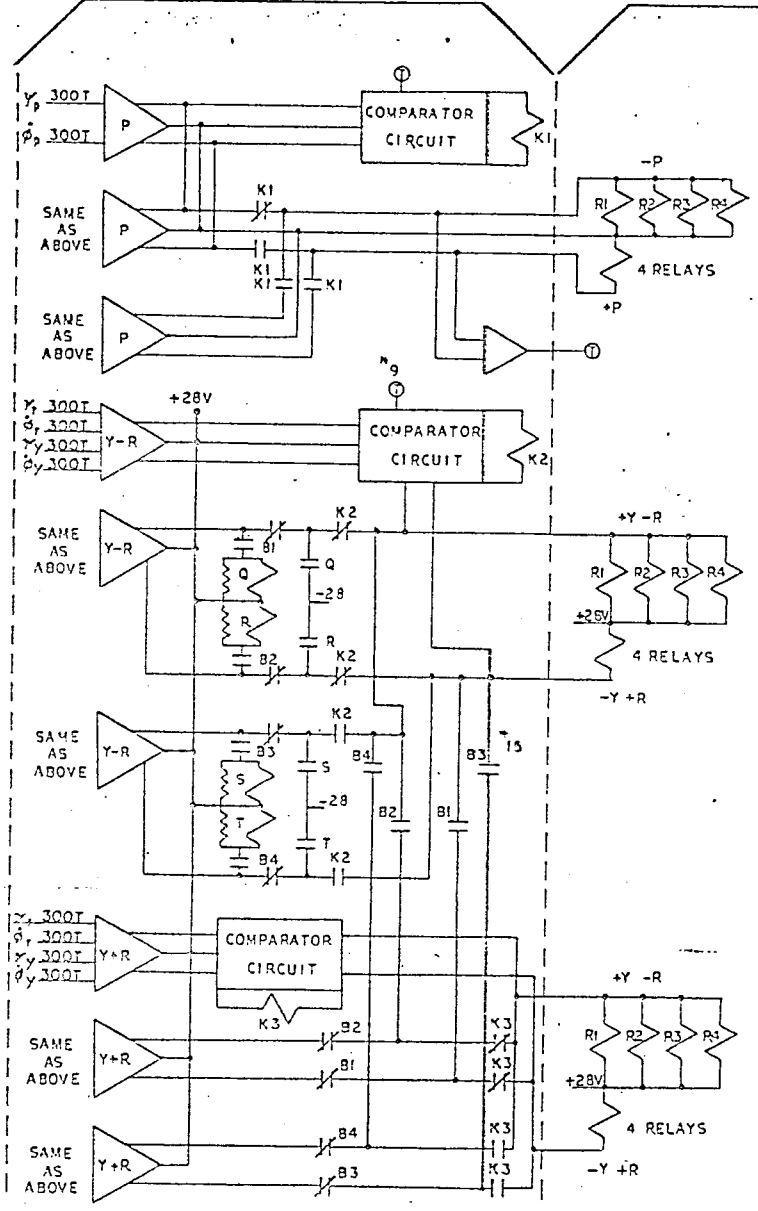

48B

UNLESS OTHERWISE SPECIFIED			ORIGINAL DATE OF DRAWING		SATURN-IB CONTROL SYSTEM DETAILED DIAGRAM			GEORGE C. MARSHALL SPACE FLIGHT CENTER	
SEE ENGINEERING RECORDS	DIMENSIONS ARE IN INCHES			DESIGNED BY	CHECKED BY	NATIONAL AERONAUTICS AND SPACE ADMINISTRATION			DRAWING TITLE
	TOLERANCES ON FRACTIONS DECIMALS ANGLES			ENGINEER	ENGINEER				
	MATERIAL			SUBMITTED		WEIGHT CHECKER DATE CODE			C
NEXT ASSY USED ON	HEAT TREATMENT			APPROVED					
APPLICATION	FINAL PROTECTIVE FINISH			DIRECTOR		SHEET 2 OF 3			

SATURN-IB CONTROL SYSTEM DETAILED DIAGRAM (SHEET 3)

*NOTES

1. K_1 and K_2 versus signal source

K_1	K_2	Signal Source
3.75	-	IU LVDA
10.00	-	APOLLO SC
-	1.00	IU CSP (For $K_2 = 1$ The amplifier will be removed)
-	4.50	CONTROL RG

2. The EDS Rate Gyros will be used during the entire flight.
3. Spacecraft control will not be utilized before Saturn IB Vehicle 207.
4. The control accelerometers are utilized only during S-IB flight. These filters will be active.
5. A telemetry signal available for ϕ_R only.
6. This diagram does not include dynamics. Values in each block are steady-state values.
7. The 50 ma magamps and the spatial amplifiers have pair-spare redundancy. A "no compare" signal will pick the relay and switch amplifiers.
8. The yaw and roll nozzles are canted 6° . The three nozzles of each module do not lie in the same plane.
9. The symbol \textcircled{T} indicates a telemetry signal available from the control computer at the indicated points.
10. The symbol \textcircled{EDS} indicates rate switch outputs to the emergency detection system. These signals are not voted by the control signal processor and are not limited to the demodulator limit of ± 10 degrees per second.
11. The symbol \boxed{T} indicates a telemetry signal available from the actuators.
12. The symbol ∇T indicates a telemetry signal available from the control signal processor.
13. In S-IVB burn mode both Y, R spatial amplifiers fire simultaneously.
14. In S-IVB burn mode the yaw signal is inhibited from reaching the spatial amplifier.
15. Relay-Contacts B_1 , B_2 , B_3 , and B_4 are activated by S-IVB burn DISCRETE FROM LVDA.

This memorandum prepared by Sperry Rand Corporation, Space Support Division under technical directive 7.

+ Information in this memorandum is the latest information available to this organization.