

GEORGE C. MARSHALL SPACE FLIGHT CENTER
HUNTSVILLE, ALABAMA

Memorandum

TO See Addressees

DATE November 21, 1967

FROM Chief, Guidance and Control Systems
Analysis Branch, R-ASTR-NG

In reply refer to:
R-ASTR-NG-93-67
CMcMahan/FHopkins/lw/876-8476

SUBJECT Predicted propellant consumption for the
AS-204/LM-1 S-IVB Auxiliary Propulsion System

1. The attached document presents the expected Auxiliary Propulsion System (APS) propellant consumption for the AS-204 L mission.
2. Propellant consumption figures are given for both maximum and minimum cases taking into account numerous uncertainties. A nominal mission will have propellant consumption close to the minimum case.

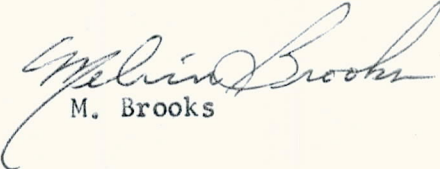
M. Brooks

1 Enc:
a/s

Approval:

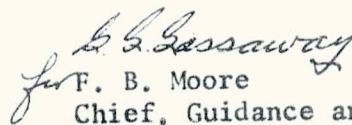
for F. B. Moore
Chief, Guidance and Control
Division

Addressees:

R-AERO-P, Mr. McNair
R-AERO-P, Mr. Ledford
R-AERO-P, Mr. Hoag
R-AERO-DAP, Mr. Cremin
R-AERO-FM, Mr. Hardage
R-TO, Mr. Richard
I-I/IB-E, Mr. Germany
R-P&VE-P, Mr. Paul
R-P&VE-PA, Mr. Garcia
R-ASTR-S, Mr. Mack
R-ASTR-S, Mr. Hammers
R-ASTR-F, Mr. Blackstone
R-ASTR-NG, Mr. Blanton

cc:

R-ASTR-N, Mr. Moore
R-ASTR-N, Mr. Gassaway
R-ASTR-NG, Mr. Brooks
R-ASTR-NG, Branch file/record file
R-ASTR-X, Reference file

Section 1B

AS-204/LM-1 S-IVB Auxiliary
PROPULSION SYSTEM PERFORMANCE

Prepared for
GEORGE C. MARSHALL SPACE FLIGHT CENTER
Contract No. NAS8-20055

by
SPACE SUPPORT DIVISION
Sperry Rand Corporation
Huntsville, Alabama

Submitted by: *E.H. Ball*

E. H. Ball

J.R. Chasteen

J. R. Chasteen

Approved by: *F.L. Randall*

F. L. Randall

REPORT NO: 211-67-029
DATE: November 3, 1967

AS-204/LM-1 S-IVB Auxiliary Propulsion
System Performance

This study was performed to reflect the APS propellant requirements for 7 1/2 hours of coast flight. The passivation experiment was assigned to this vehicle to verify the feasibility of passivation of the S-IVB stage for the orbital workshop. The increase in APS propellant requirements for S-IVB stage attitude control was a point of major concern.

Enclosure 2 presents the AS-204/LM-1/S-IVB attitude timeline with a detailed record of resulting APS propellant consumption. Presented in enclosures 3, 4, and 5, respectively are the system block diagram with applicable gains and limits, gimbal angle trace, and the rate history of APS propellant consumption.

Aerodynamic data were extracted from references 6 and 7 at 120 nautical miles. The following aerodynamic configurations were used: TB 4 + 0 to TB 4 + 600: S-IVB/IU/SLA closed/CSM; TB 4 + 600 to TB 4 + 2637: S-IVB/IU/SLA open 35°/LM; TB 4 + 2637 to TB 4 + 27,000: S-IVB/IU/SLA open 45°. Atmospheric density as a function of altitude was calculated at 8 second intervals (flight time) by a routine based on reference 5. A ± one degree uncertainty was employed in determining the local horizontal navigation reference.

Enclosure 6 gives the venting timeline with applicable thrust levels. The APS propellant requirements for the duration of the LOX and LH₂ dump through the J-2 engine are also shown. These figures are derived assuming that the thrust vector control system is not used to correct for disturbances due to misalignment of the thrust vector. The thrust vector misalignment can be located anywhere on a 360° cone centered about the longitudinal axis of the vehicle. This accounts for the large difference between the maximum and minimum APS requirements for a specific module. Any time duration which the thrust vector control system operates will decrease the APS propellant requirements proportionately. The cumulative probability distributions for APS propellant requirements during venting and J-2 engine dump are shown in enclosures 7-10. The geometric locations of the LOX and LH₂ vents are shown in enclosures 11 and 12.

REFERENCES:

1. R-P & VE - VAW - 67-108, AS-204 Final Predicted Mass Characteristics, Guidance Cutoff, August 1, 1967.
2. R-AERO-FM-184-67, AS-204/LM-1 Launch Vehicle Operational Flight Trajectory (Revision I), August 10, 1967.
3. MSFC No. III-4-425-2 (IBM), Guidance and Control Definition Document for AS-204/LM-1, May 4, 1967.
4. 80M92041, S-IVB/CSM Orbital Attitude Timeline and Vent Schedule for the Apollo-Saturn Mission AS-204 (SA-204/LM-1), Revision A, July 13, 1967.
5. NASA TM X-53139, A Reference Atmosphere for Patrick AFB, Florida, September 13, 1967.
6. R-AERO-AM-66-3, Orbital Aerodynamic Characteristics, May 25, 1966.
7. R-AERO-AM-66-5, Orbital Aerodynamic Characteristics, July 27, 1966.

AS-204 APS PROPELLANT CONSUMPTION (LBS)

TIME* (SECONDS)	EVENT (MANEUVER RATE LIMITS: $\dot{\Phi}_x = \dot{\Phi}_z = 0.3^\circ/s$, $\dot{\Phi}_y = 0.5^\circ/s$)	PERIOD** (SECONDS)	MINIMUM		MAXIMUM	
			MOD I	MOD III	MOD I	MOD III
(S-IB/S-IVB Separation)	S-IB/S-IVB Separation Transient	--	0.0	0.0	5.0	5.0
(S-IVB Ignition)	Roll Stabilization During S-IVB Burn	455	2.5	2.5	6.0	6.0
TB4 + 0 (S-IVB Cutoff)	Hold Last IGM X Commands	90	0.7	0.7	1.0	1.0
TB4 + 45	Jettison Nose Cap	-	-	-	-	-
TB4 + 90	Initial Convergence to local Horizontal (LM Forward/Position I Down)	87	1.9	1.7	1.9	1.7
	Maintain Local Horizontal Attitude	2225	0.9	0.9	0.9	0.9
TB4 + 600	SLA Panel Deployment	-	-	-	-	-
3005	Establish Separation inertial attitude specified by $\chi_x = -0.9^\circ$, $\chi_y = 0.0^\circ$, $\chi_z = 87.1^\circ$	30	0.6	0.9	0.6	0.9
	Hold Inertial Attitude	385	0.5	0.4	0.5	0.5
3240	S-IVB/LM Separation Transient	-	0.0	0.0	(?)	(?)
3420	Return to Local Horizontal Attitude (SLA Forward/Position I down)	120	0.9	0.6	0.9	0.6
	Maintain Local Horizontal Attitude	1950	1.1	1.0	1.1	1.0

AS-204 APS PROPELLANT CONSUMPTION (LBS)

TIME* (SECONDS)	EVENT (MANEUVER RATE LIMITS: $\dot{\Phi}_x = \dot{\Phi}_z = 0.3^\circ/s$, $\dot{\Phi}_y = 0.5^\circ/s$)	PERIOD** (SECONDS)	MINIMUM		MAXIMUM	
			MOD I	MOD III	MOD I	MOD III
(S-IB/S-IVB Separation)	S-IB/S-IVB Separation Transient	--	0.0	0.0	5.0	5.0
(S-IVB Ignition)	Roll Stabilization During S-IVB Burn	455	2.5	2.5	6.0	6.0
TB4 + 0 (S-IVB Cutoff)	Hold Last IGM X Commands	90	0.7	0.7	1.0	1.0
TB4 + 45	Jettison Nose Cap	-	-	-	-	-
TB4 + 90	Initial Convergence to local Horizontal (LM Forward/Position I Down)	87	1.9	1.7	1.9	1.7
	Maintain Local Horizontal Attitude	2225	0.9	0.9	0.9	0.9
TB4 + 600	SLA Panel Deployment	-	-	-	-	-
3005	Establish Separation inertial attitude specified by $\chi_x = -0.9^\circ$, $\chi_y = 0.0^\circ$, $\chi_z = 87.1^\circ$	30	0.6	0.9	0.6	0.9
	Hold Inertial Attitude	385	0.5	0.4	0.5	0.5
3240	S-IVB/LM Separation Transient	-	0.0	0.0	(?)	(?)
3420	Return to Local Horizontal Attitude (SLA Forward/Position I down)	120	0.9	0.6	0.9	0.6
	Maintain Local Horizontal Attitude	1950	1.1	1.0	1.1	1.0

<u>TIME</u>	<u>EVENT</u>	<u>PERIOD</u>	<u>MOD I</u>	<u>MOD III</u>	<u>MOD I</u>	<u>MOD III</u>
5490	Initiate Inertial Attitude Hold Using Present Gimbal Angles and Maintain Inertial Attitude	870	3.8	0.5	3.8	0.5
6360	Establish Local Horizontal Attitude in Retro-Position (Tail Leading/ Position I Up)	450	2.2	1.1	2.2	1.1
	Maintain Local Horizontal Attitude in Retro-Position	1633	1.1	0.7	1.1	0.7
TB4 + 7840	Initiate Maneuver to Pitch-90° (Nose Down) With Respect to Local Horizontal; Roll to Inertial Attitude Specified By $\chi_y = 85.0^\circ$; Maintain $\chi_x = 0.0^\circ$.	317	1.8	2.7	1.8	2.7
TB4 + 8157	Initiate Inertial Roll Ramp Command of -0.28°/s for <u>390</u> Sec; $\chi_y = 0.0^\circ$; Maintain Nose Down Along Local Vertical	25	0.1	0.1	0.1	0.1
TB4 + 8182	Initiate S-IVB Stage Passivation With Thrust Vector Attitude Control in Pitch and Yaw (Burn Mode). Test PSI Pitch and Yaw every <u>1</u> seconds Until TB4=8262. If Error > 12° Switch Back to Coast Phase Control and Maintain.	80	0.0	0.0	11.0	11.0
TB4 + 8262	Nominal Return to Coast Phase Control	285	0.1	0.5	1.8	1.8

<u>TIME</u>	<u>EVENT</u>	<u>PERIOD</u>	<u>MOD I</u>	<u>MOD III</u>	<u>MOD I</u>	<u>MOD III</u>
TB4 + 8547	Terminate Roll Ramp Command: Maintain Nose Down Along Local Vertical $\chi_x = 0.0^\circ$; $\chi_y = -24.2^\circ$	253	0.2	0.6	0.2	0.6
TB4 + 8800	Return to Local Horizontal Attitude in Retro-position (Tail Leaving/Position I Up)	327	1.1	2.0	1.1	2.0
	Maintain Local Horizontal Attitude in Retro-Position To TB4 + 27,000 (7 1/2 hrs.)	17,873	8.6	8.8	8.6	8.8
	S-IVB LOX and LH2 Venting		<u>3.6</u>	<u>5.4</u>	<u>4.4</u>	<u>6.2</u>
	TOTAL		31.7	31.1	54.0	53.1

* Times other than those noted as TB4 are ground elapse times from launch vehicle GRR (at TB4 + 0, Time from launch vehicle GRR=603.152 sec).

** Periods given for attitude maneuvers are taken from initiation of the maneuver to a nominal steady-state condition in the commanded attitude.

NOTICE - WHEN MODIFIERS, BRASSING, SPECIFICATIONS OR OTHER DATA ARE SHOWN FOR ANY PART OR OTHER ITEM IN CONNECTION WITH A DEFINITELY RELATED GOVERNMENT PURCHASE OR OPERATION, THE UNITED STATES GOVERNMENT WILL NOT BE RESPONSIBLE FOR THE DESIGN OR CONSTRUCTION OF THE ITEM OR FOR THE FAILURE OF THE ITEM OR FOR THE RESULTS THEREOF. THE UNITED STATES GOVERNMENT WILL NOT BE RESPONSIBLE FOR THE DESIGN OR CONSTRUCTION OF THE ITEM OR FOR THE FAILURE OF THE ITEM OR FOR THE RESULTS THEREOF. THE UNITED STATES GOVERNMENT WILL NOT BE RESPONSIBLE FOR THE DESIGN OR CONSTRUCTION OF THE ITEM OR FOR THE FAILURE OF THE ITEM OR FOR THE RESULTS THEREOF.

PART NO.	REVISIONS		
	ZONE	BYM	DESCRIPTION

ST-124-M
STABILIZED
PLATFORM

LAUNCH VEHICLE DIGITAL COMPUTER

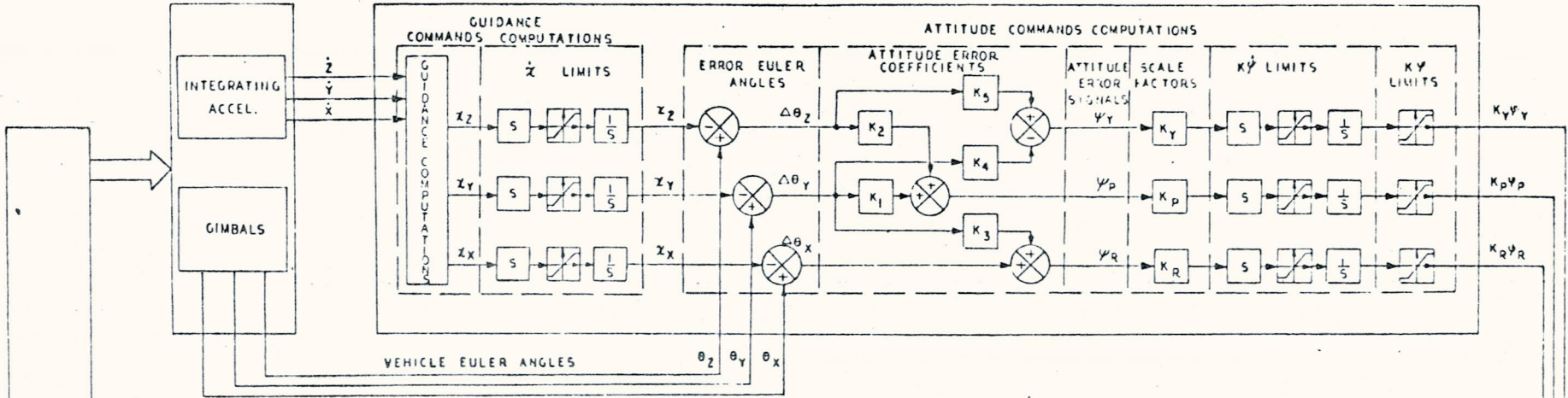

VEHICLE EULER ANGLES $\theta_z, \theta_y, \theta_x$

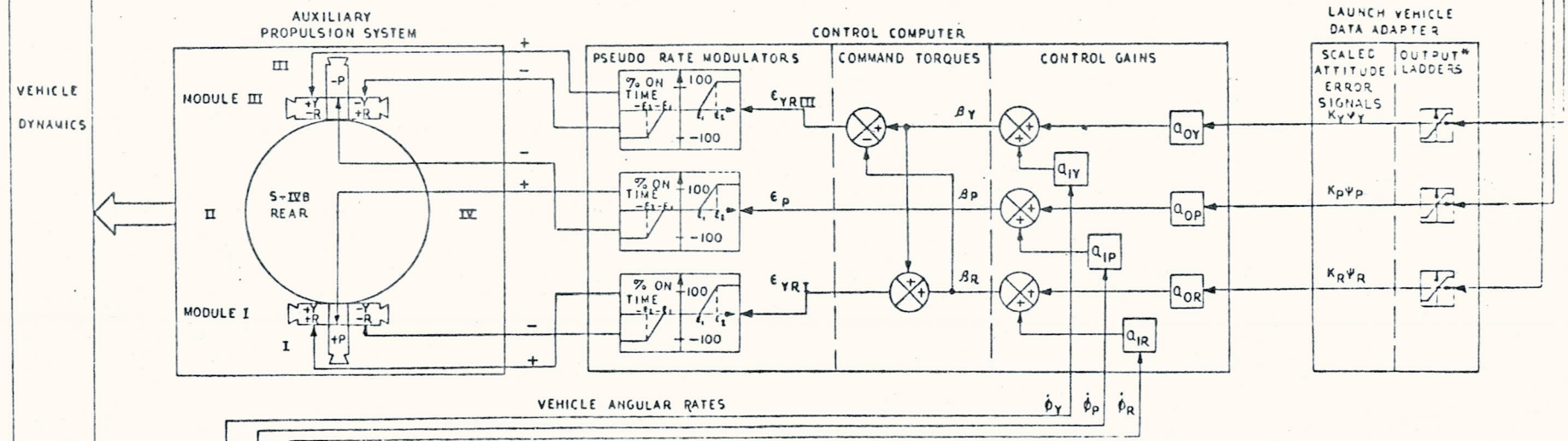

VEHICLE ANGULAR RATES $\dot{\psi}_y, \dot{\psi}_p, \dot{\psi}_r$

ATTITUDE CONTROL CONSTANTS

SYMBOL	GAINS						LIMITS										
	a_{OR}	a_{OP}	a_{OY}	a_{IR}	a_{IP}	a_{IY}	K_R	K_P	K_Y	$K_{R\Psi_R}$	$K_{P\Psi_P}$	$K_{Y\Psi_Y}$	$K_{R\Psi_R}$	$K_{P\Psi_P}$	$K_{Y\Psi_Y}$	ϵ_1	ϵ_2
S-IVB BURN	1	-	-	5	-	-	1	1	1	3.5°	15.3°	15.3°	12°/s	12°/s	12°/s	1°	1°
COAST PHASE	1	1	1	5	5	5	1	1	1	3.5°	2.5°	2.5°	2.4°/s	2.4°/s	2.4°/s	1.0°	1.6°

LADDER SATURATION = 15.3

- NOTE:
- $K_1 = \cos \frac{x_y + \theta_y}{2} \cos \frac{x_x + \theta_x}{2}$
 - $K_2 = \sin \frac{x_y + \theta_y}{2}$
 - $K_3 = \sin \frac{x_x + \theta_x}{2}$
 - $K_4 = \sin \frac{x_y + \theta_y}{2} \cos \frac{x_x + \theta_x}{2}$
 - $K_5 = \cos \frac{x_y + \theta_y}{2}$

SEE ENGINEERING RECORDS	UNLESS OTHERWISE SPECIFIED		ORIGINAL DATE OF DRAWING		AUX. CONTROL SYSTEM FLOW DIAGRAM SATURN S-IVB	GEORGE C. MARSHALL SPACE FLIGHT CENTER NATIONAL AERONAUTICS AND SPACE ADMINISTRATION HUNTSVILLE, ALABAMA
	DIMENSIONS ARE IN INCHES		DRAWN BY			
	TOLERANCES ON FRACTIONS DECIMALS ANGLES		CHECKED BY			
	MATERIAL		ENGINEER			
NEXT ASSY	USED ON	HEAT TREATMENT	APPROVED	WEIGHT CHECKER	DATE	LOG
APPLICATION		FINAL PROTECTIVE FINISH	DIRECTOR	SCALE	UNIT WEIGHT	SHEET

PLATFORM GIMBAL ANGLES



AS-204

MAXIMUM APS PROPELLANT CONSUMPTION

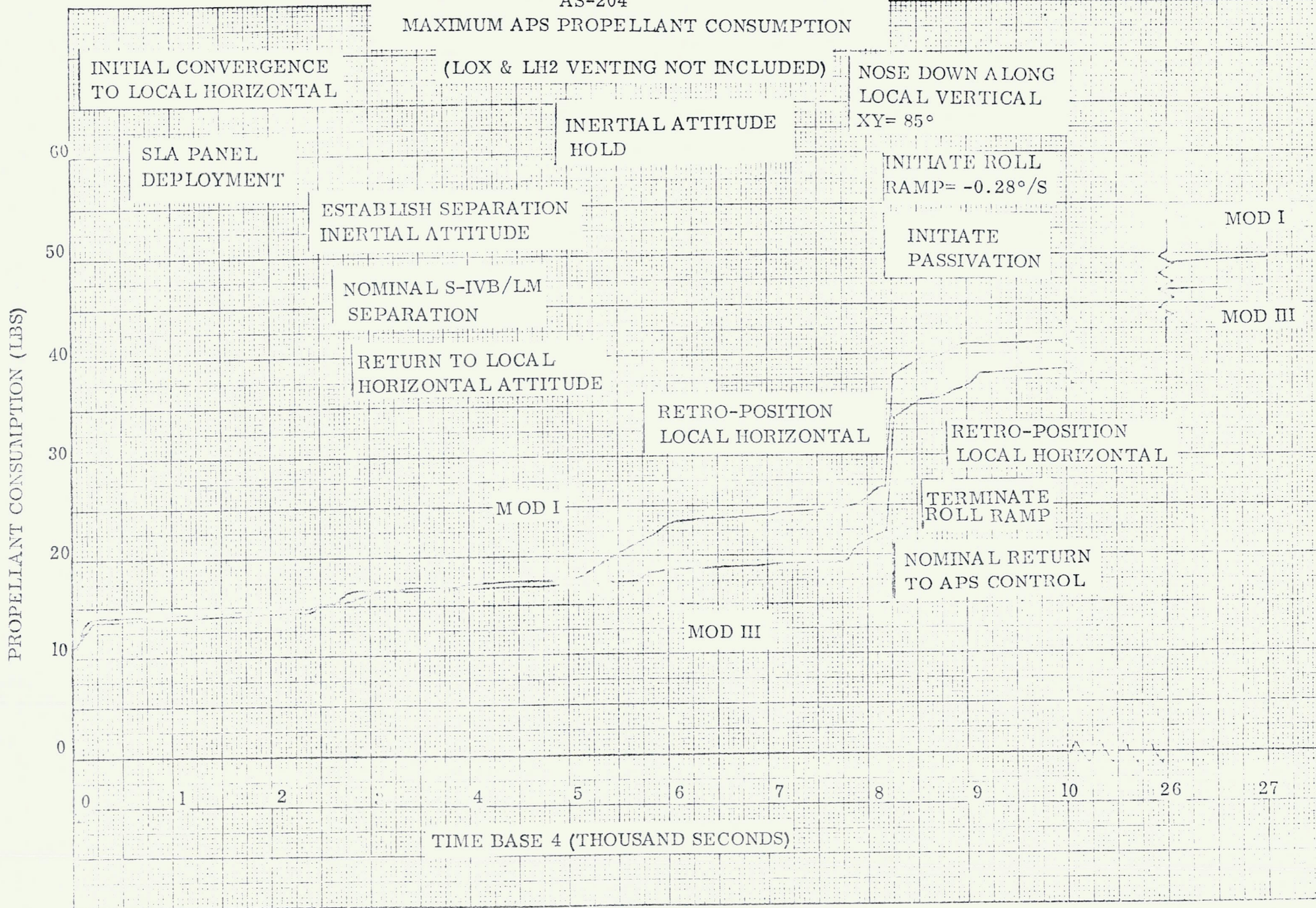

AS-204

MINIMUM APS PROPELLANT CONSUMPTION

INITIAL CONVERGENCE TO LOCAL HORIZONTAL (LOX & LH2 VENTING NOT INCLUDED)

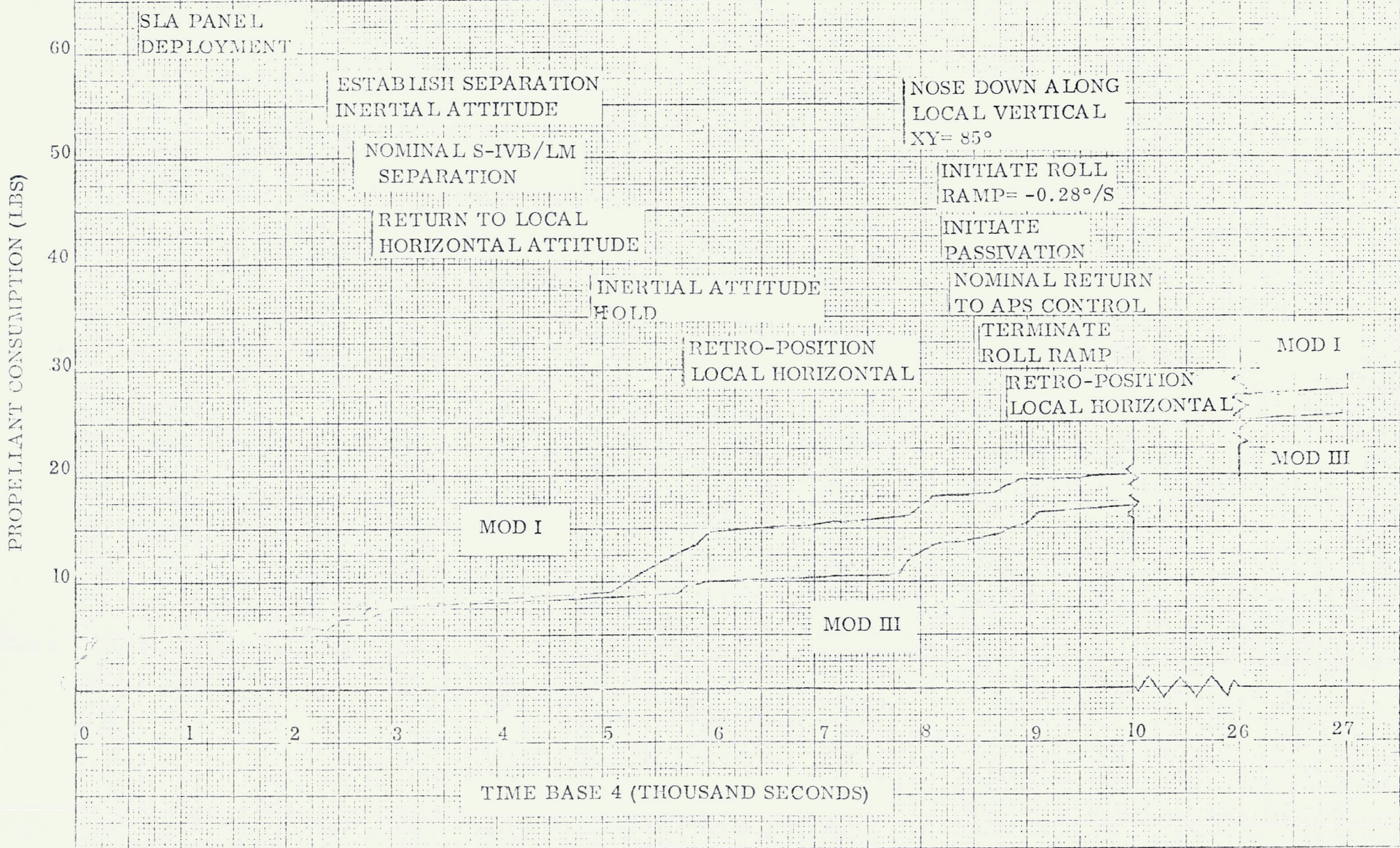

SLA PANEL DEPLOYMENT

ESTABLISH SEPARATION INERTIAL ATTITUDE

NOMINAL S-IVB/LM SEPARATION

RETURN TO LOCAL HORIZONTAL ATTITUDE

INERTIAL ATTITUDE HOLD

RETRO-POSITION LOCAL HORIZONTAL

NOSE DOWN ALONG LOCAL VERTICAL XY= 85°

INITIATE ROLL RAMP= -0.28°/S

INITIATE PASSIVATION

NOMINAL RETURN TO APS CONTROL

TERMINATE ROLL RAMP

RETRO-POSITION LOCAL HORIZONTAL

MOD I

MOD II

MOD I

MOD II

TIME BASE 4 (THOUSAND SECONDS)

AS-204/LM-1 VENTING TIMELINE

* Time is referenced to TB4

** Thrust level for two (2) nozzles

TYPE VENT	*FROM (SEC)	TO (SEC)	THRUST (LBS)
LOX VENT	.2	40.2	288.6
LH2 VENT	.4	1260.4	60.0 **
LOX DUMP	8,182.	8,254.	940.0
LOX DUMP	8,254.	8,301.	42.0
LH2 DUMP	8,311.	8,491.	56.0
LOX VENT, LH2 VENT	8,501.	9,797.	10.5, 5.8 **
LOX VENT, LH2 VENT	9,797.	11,058	3.5, 5.8 **
LOX VENT, LH2 VENT	13,623	15,063	1.6, 1.0 **
LH2 VENT	15,063	16,387	1.0 **

PREDICTED APS PROPELLANT REQUIREMENTS FOR CONTROL OF LOX AND LH2 DUMP DURING PASSIVATION OF AS-204/LM - 1

THRUST VECTOR MISALIGNMENT	MONTE CARLO PER MODULE	WORST CASE PER MODULE
1°	3.67 lbs	7.33 lbs
2°	7.33 lbs	14.66 lbs
3°	11.00 lbs	22.00 lbs

NOTE:

The above Monte Carlo values are the predicted APS propellant requirements for 960 out of 1000 flights.

The above Worst Case values are the predicted APS Propellant requirements calculated using worst case parameters. These values are slightly higher than any of the values generated by Monte Carlo for 1000 flights.

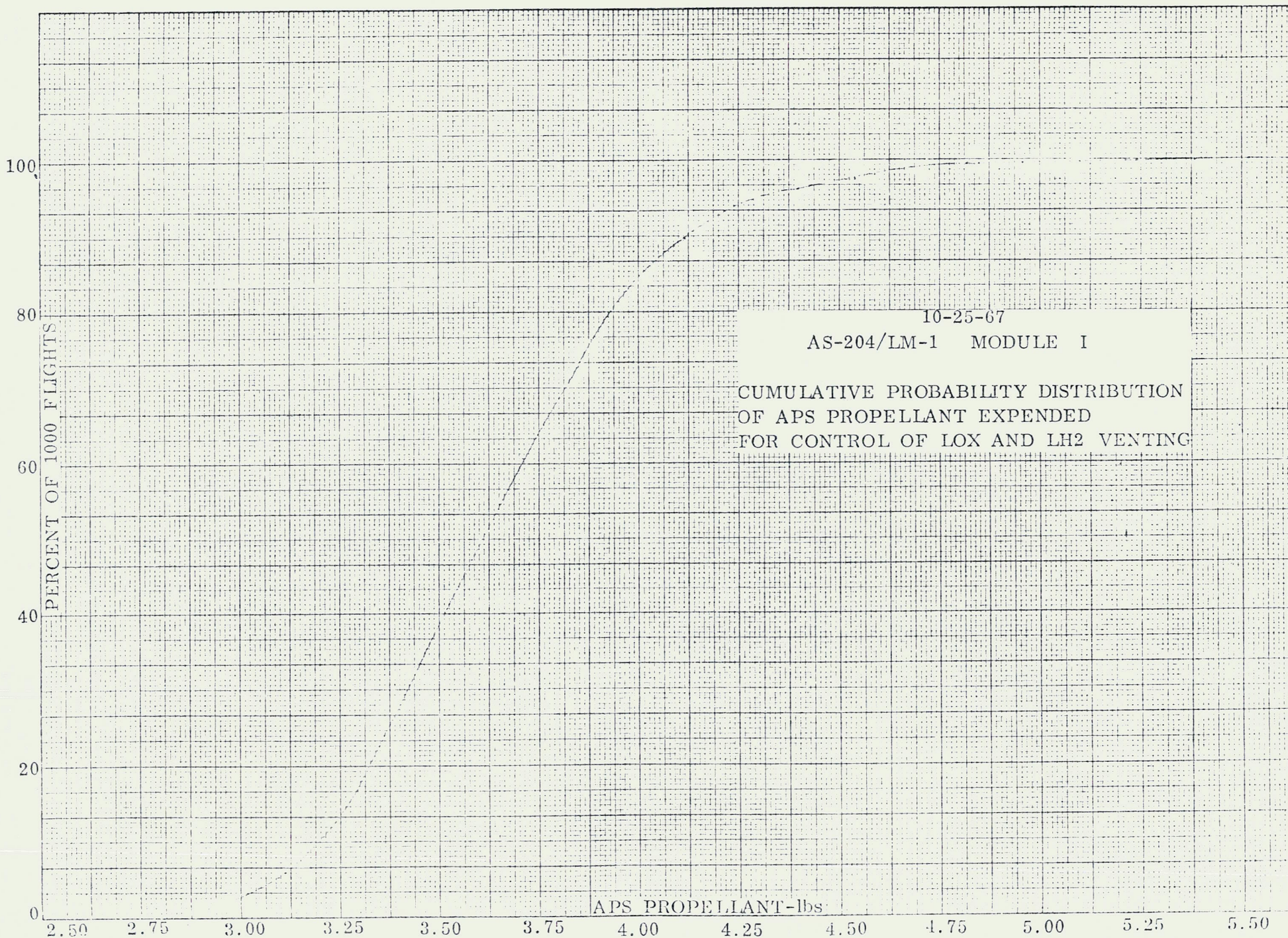

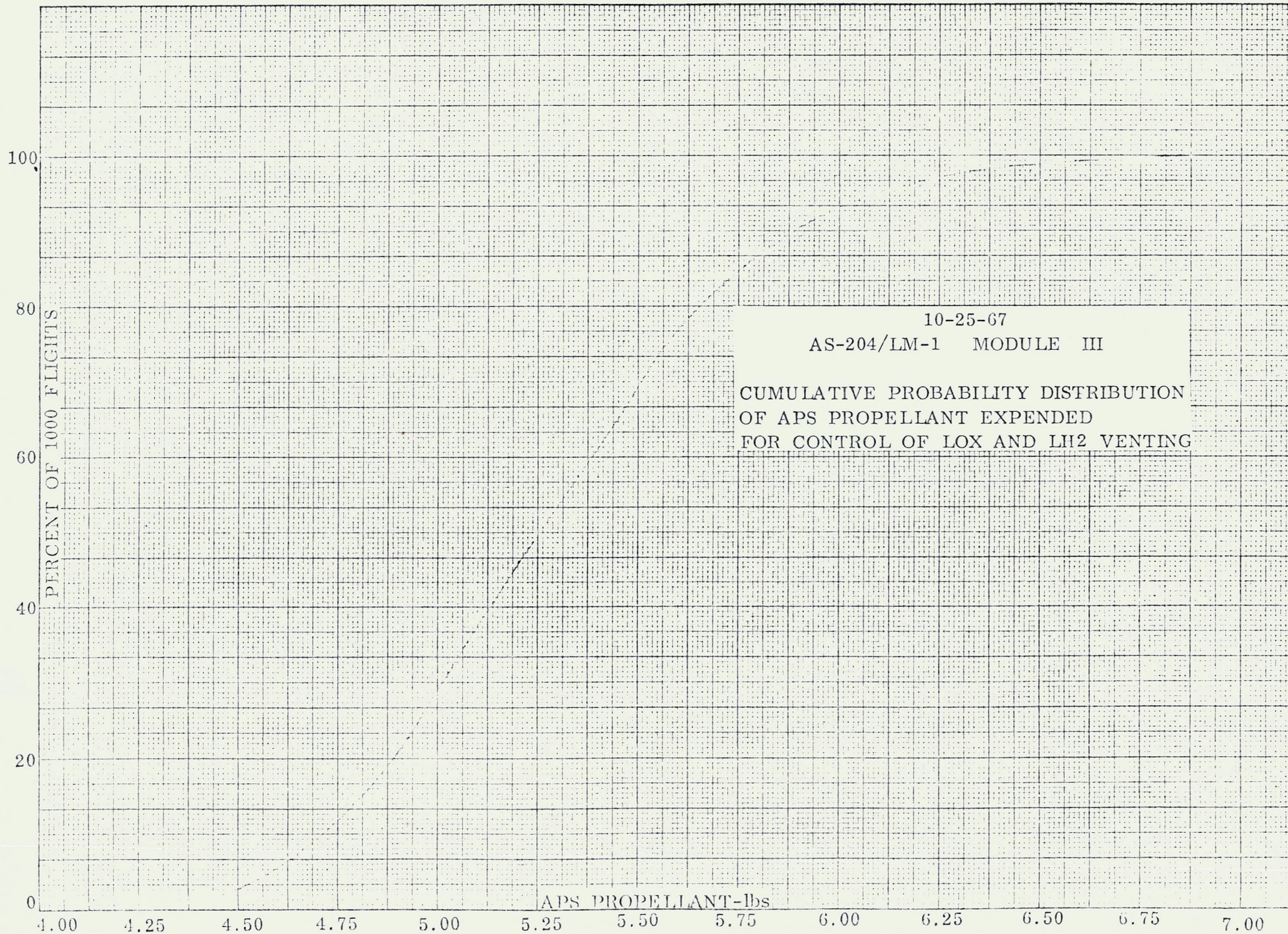

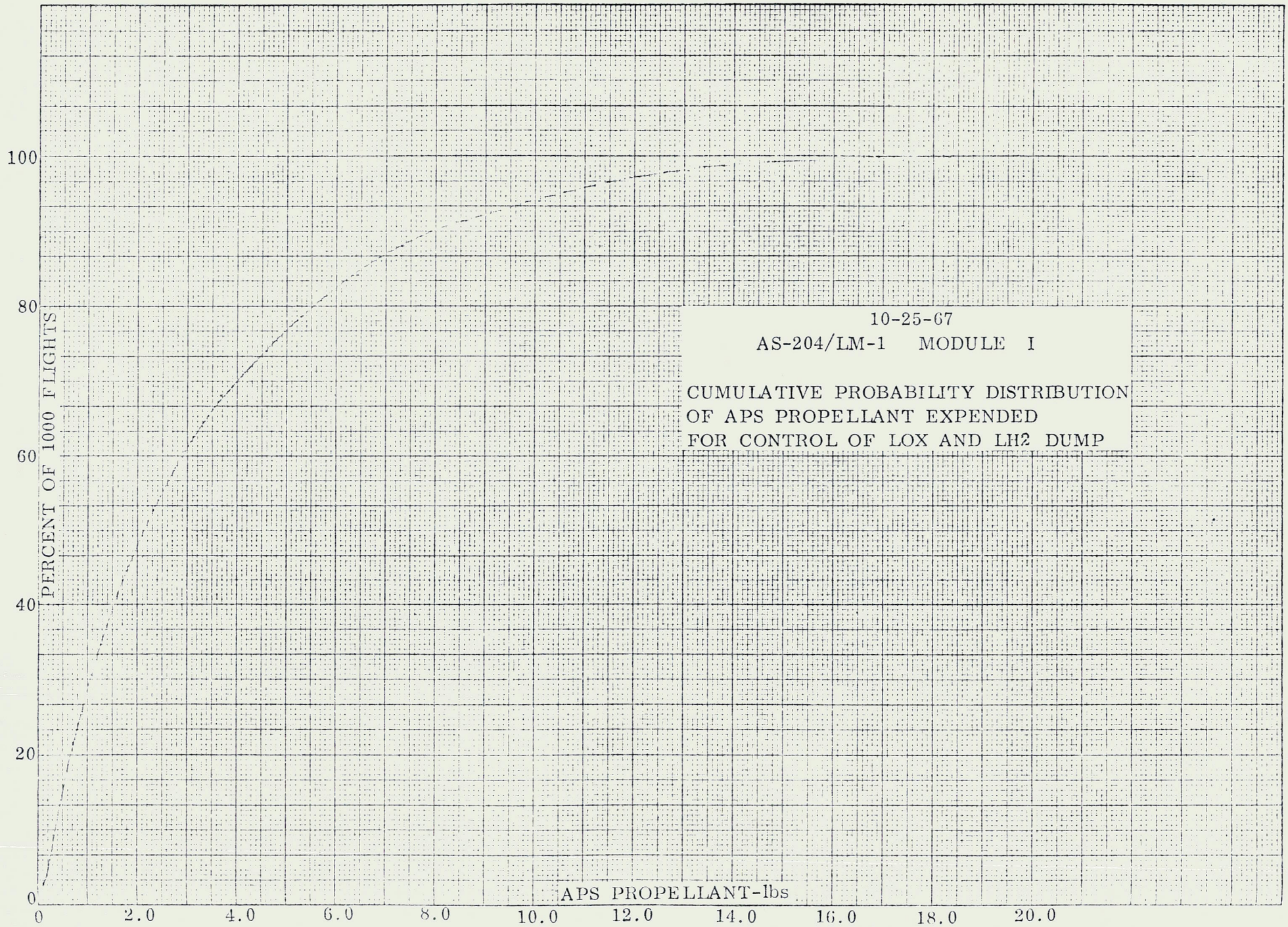

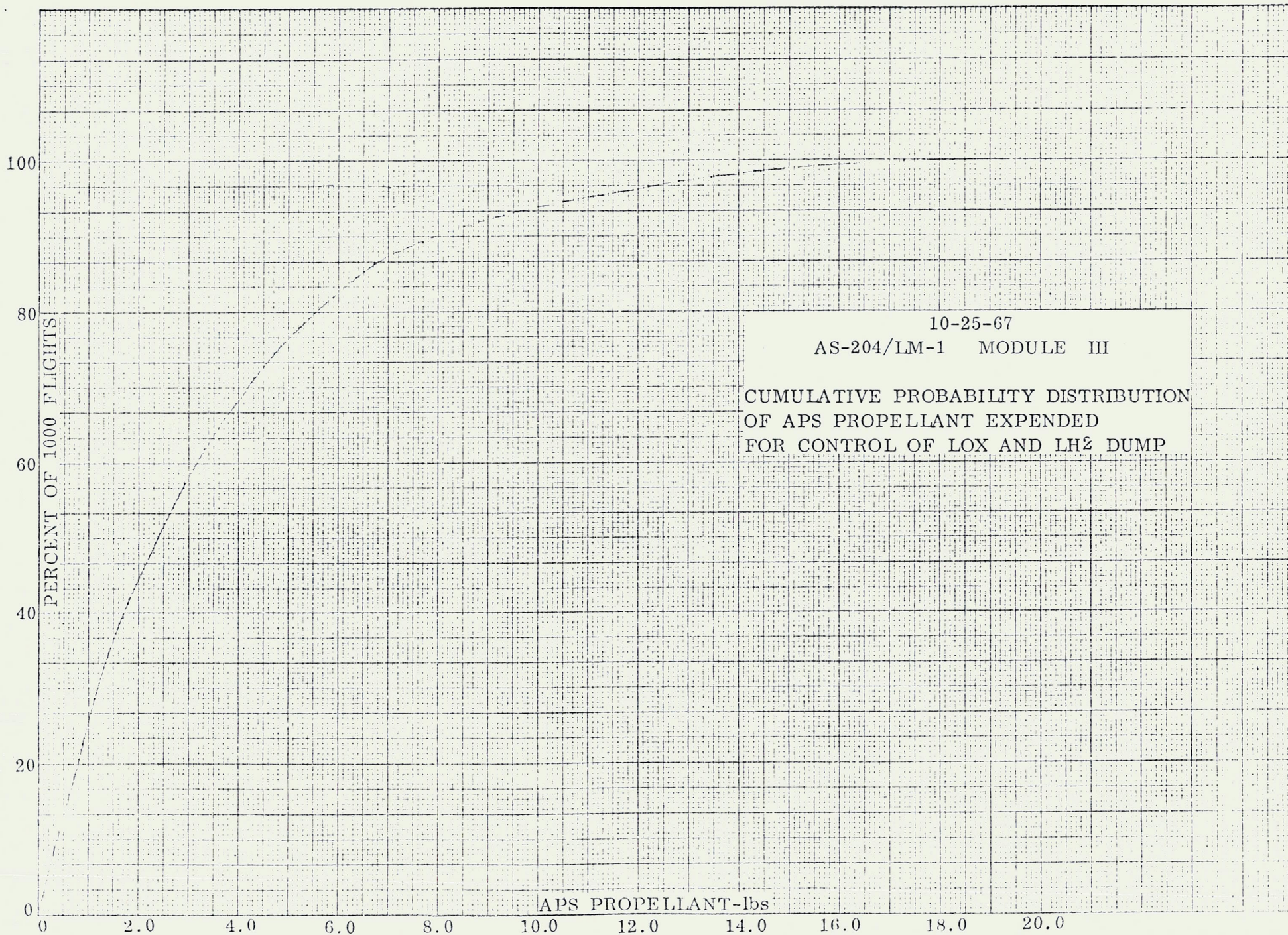

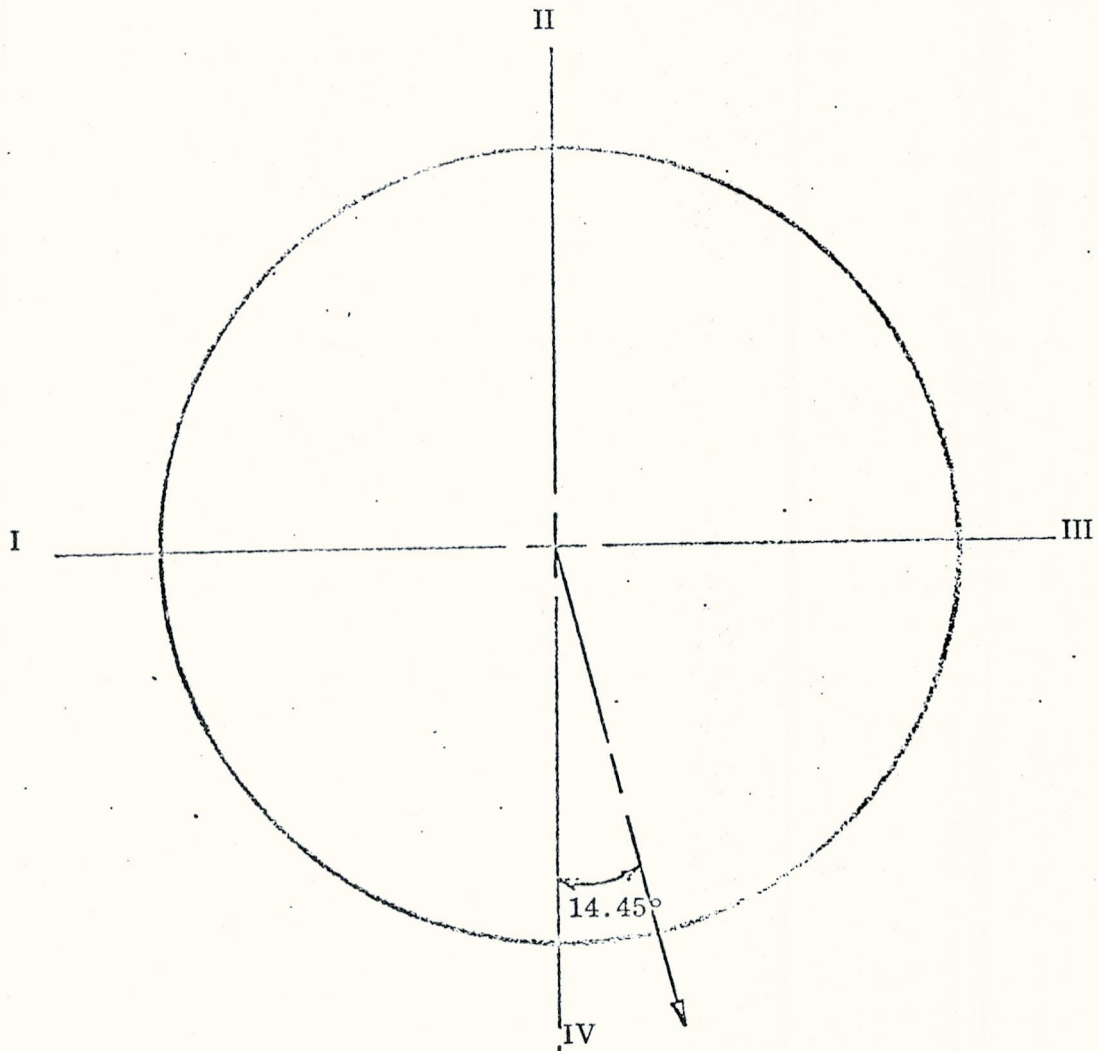

The cant angle α is varied to direct thrust through the C. G. at insertion.



Station 202.137

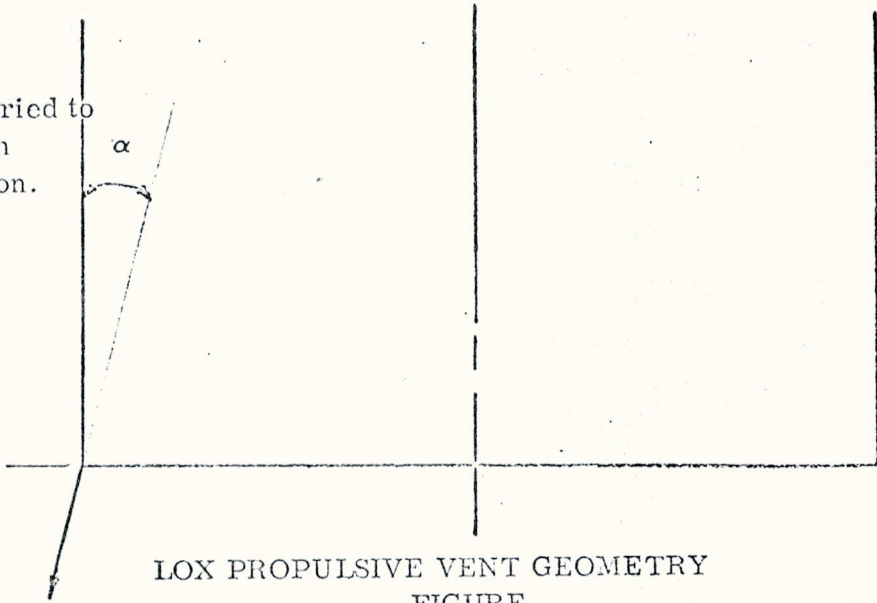

LOX PROPULSIVE VENT GEOMETRY
FIGURE

radial distance from
vehicle centerline = 132.0'

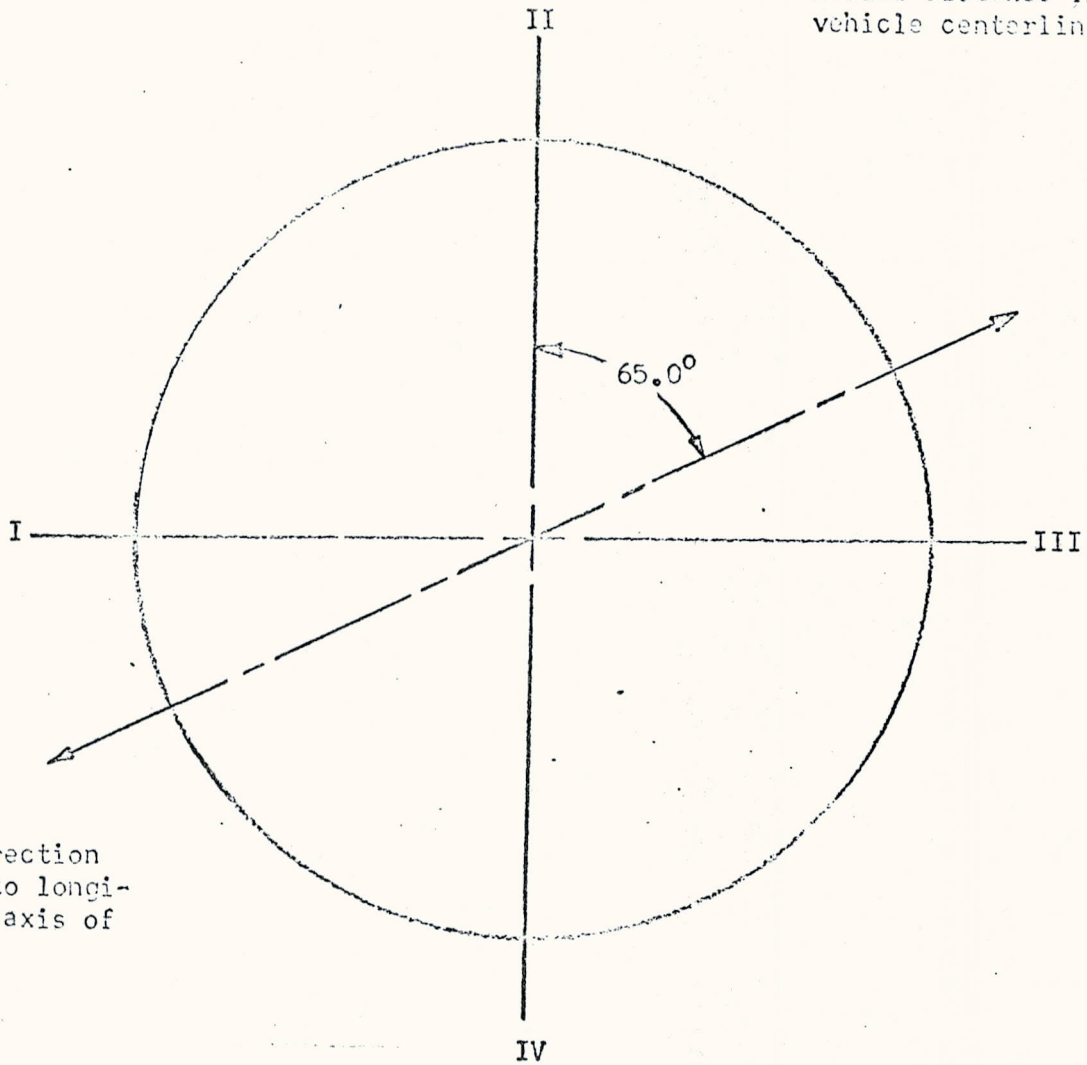

vent direction
normal to longi-
tudinal axis of
vehicle

STATION 615.7

LH2 NON PROPULSIVE VENT GEOMETRY

FIGURE