

imp

T 73-14253

C.1

CR-128961

SPACE SHUTTLE GN & C EQUATION DOCUMENT

No. 21

SHUTTLE UNIFIED NAVIGATION FILTER

by

Eugene S. Muller Jr.

(NASA-CR-128961) SPACE SHUTTLE GN AND C
EQUATION DOCUMENT NO. 21: SHUTTLE
UNIFIED NAVIGATION FILTER (Massachusetts
Inst. of Tech.) 95 p HC \$6.75 CSCL 17G

N73-25708

Unclas

G3/21 06416

LIBRARY COPY

JUN 18 1973

JOHNSON SPACE CENTER
HOUSTON, TEXAS

CHARLES STARK DRAPER
LABORATORY

MASSACHUSETTS INSTITUTE OF TECHNOLOGY

CAMBRIDGE, MASSACHUSETTS, 02139

SPACE SHUTTLE GN&C EQUATION DOCUMENT

No. 21

Shuttle Unified Navigation Filter

by

Eugene S. Muller Jr.

M.I. T. Charles Stark Draper Laboratory

November 1972

NAS9-10268

for

National Aeronautics and Space Administration
Systems Analysis Branch
Guidance and Control Division
Manned Spacecraft Center, Houston, Texas

ACKNOWLEDGEMENT

This report was prepared under DSR Project 55-40800, sponsored by the Manned Spacecraft Center of the National Aeronautics and Space Administration through Contract NAS9-10268.

The publication of this report does not constitute approval by the National Aeronautics and Space Administration of the findings or the conclusions contained therein. It is published only for the exchange and stimulation of ideas.

FOREWORD

This document is one of a series of candidates for inclusion in a future revision of MSC-04217, "Space Shuttle Guidance, Navigation, and Control Design Equations." The enclosed has been prepared under NAS9-10268, Task No. 15-A, "GN&C Flight Equation Specification Support", and applies to function 3 of the Orbital Coast Navigation Module (ON2), function 2 of the Co-orbiting Vehicle Navigation Module (ON3), function 2 of the Approach and Landing Navigation Module (ON4), and functions 2 and 3 of the Final Approach and Landing Navigation Module (ON5), as defined in MSC-03690, Rev. C, "Space Shuttle Guidance, Navigation, and Control Software Functional Requirements - Vertical Flight Operations", dated, 31 July 1972.

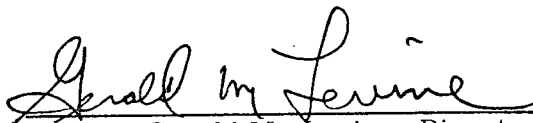

Gerald M. Levine, Director
APOLLO Space Guidance Analysis Division

TABLE OF CONTENTS

Section 1	Introduction
Section 2	Functional Flow Diagram
Section 3	Input and Output Variables
Section 4	Description of Equations
Section 5	Detailed Flow Diagrams
Section 6	Supplementary Information

NOMENCLATURE

Notational Conventions

Upper case letters represent matrices (dimension 3×3 unless otherwise noted)

Lower case and Greek letters reserved for scalars and vectors

Vector quantities are underlined (column vectors (3×1) in reference coordinates unless otherwise noted)

All switches not input are initially set to zero

Average value indicated by superbar e. g. $\overline{\beta_c}$

Symbol

a	Effective aerodynamic area of vehicle
a_F	Equatorial radius of Fischer Ellipsoid
a_H	Semi-major axis of horizon measurement plane ellipse
a_z	Angle between earth-fixed equatorial x-axis (through prime meridian) and reference equatorial x-axis
a_{z0}	Value of a_z at time = t_{EF}
b	Number of measurement biases included in navigated state
\underline{b}	$d \times 1$ measurement geometry vector used in filter weighting vector and matrix calculations
b_F	Polar radius of Fischer Ellipsoid
b_H	Semi-minor axis of horizon measurement plane ellipse
c	Intermediate scalar in measurement update equations

c_D Vehicle drag coefficient

c_{D0}, c_{D1} Coefficients in drag coefficient relation

c_i Measurement code identifying the i th measurement type at a given measurement time

c_i	Measurement	
0	Range	} Relative to fixed point or target
1	Range rate	
2	Angle (β)	
3	Angle (θ)	
4	Altitude	
5	Drag	

d State dimension in given mission phase

d_H Intermediate scalar used in Horizon Direction Routine

d_x Specifies weighting matrix dimension for extrapolation routine
($d_x = 0$ specifies no matrix extrapolation required)

dum, \underline{dum} Dummy scalar, vector

dt, dt_c Time increments used in Kepler Routine

e_H, f_H Intermediate scalars used in Horizon Direction Routine

g Index used to indicate number of ground beacons predicted in current beacon search interval

\underline{g} Gravitation force/unit mass

G Gravity gradient matrix

h Vehicle altitude

h_{INDR} Altitude at which drag measurements are first processed

h_{FINDP} Altitude at which drag measurements are no longer accepted

h_{INBAR}	Altitude at which baro-altimeter data are first processed
h_{FBAR}	Altitude below which no baro-altimeter data are processed
h_S	Atmospheric density model scale height
h_β	Angle between horizon position vector and sun vector
i	Index
I	Identity matrix
\underline{i}_2	Unit vector normal to horizon measurement plane
i_a, i_b, i_c	Intermediate scalars used in angle measurement calculations
$i_{\text{DB}, i}$	Code identifying ground beacon(s) found during search interval. Takes on values 1 through n_B depending on place beacon occupies in the stored list
$\underline{i}_{\text{dum}}$	Dummy vector used in orbital period calculation
$\underline{i}_{\text{pole}}$	Unit vector along earth's polar axis
\underline{i}_r	Unit vector along primary vehicle position vector
i_{res}	Dummy variable reserving index i in beacon search
\underline{i}_{rH}	Unit horizon position vector
\underline{i}_{RW}	Unit vector directed parallel to runway centerline (in earth fixed coordinates)
$\underline{i}_{v\rho}$	Unit vector along \underline{v}_ρ
$\underline{i}_x, \underline{i}_y, \underline{i}_z$	Unit vectors used to define local vertical coordinate system (also used as dummy unit vectors)

$\underline{i}_{xm'}$ $\underline{i}_{ym'}$ \underline{i}_{zm}	Unit vectors defining sensor coordinate system
\underline{i}_{XA}	Unit vector along vehicle longitudinal axis
\underline{i}_{ρ}	Unit vector along \underline{r}_{ρ}
$\underline{i}_{\rho a}$	Unit vector along $\underline{\rho} a$
$\underline{i}_{\rho H}$	Unit vector along $\underline{\rho} H$
j	Index
J_2, J_3, J_4	Gravitational harmonic coefficients
k	Index
k_0, k_1	Input constants used in W-matrix reinitialization (phase 4)
k_W	Takes on value k_0 at first VOR (or DME) data good and k_1 at first MLS data good
k_x	Constant used in predicting value for universal variable x
$k(\sigma^2)$	Factor used in correlated W-matrix initialization (phase 0)
l	Index
m	Mass of vehicle
M_{EF-R}	Transformation matrix from earth fixed to reference coordinates
M_{R-LV}	Transformation matrix from reference to local vertical coordinates

M_{LV-R} Transpose of M_{R-LV}
 M_{R-H} Transformation matrix from reference to horizon coordinate system
 M_{R-M} Transformation matrix from reference to navigation sensor coordinates
 n_B Total number of ground beacons (input)
 n_M Number of measurements to be sequentially incorporated at a given measurement time and mission phase
 n_{mft} Nautical miles to feet conversion factor
 n_W Desired number of accelerometer read cycles between W-matrix extrapolations (phase 4)
 $n_{\Delta t}$ Count of accelerometer read cycles (Δt_a) between W-matrix extrapolations (phase 4)
 $n_{\tau_{GB}}$ Number of orbital periods between W-matrix reinitializations in ground beacon, horizon sensing navigation modes
 $n_{\tau_{HS}}$
 n_T Dummy variable representing $n_{\tau_{GB}}$ or $n_{\tau_{HS}}$
 p Indicates current navigation mission phase

<u>p</u>	<u>Navigation Phase</u>
0	On-orbit
1	Rendezvous
2	Braking
3	Station-Keeping
4	Entry, approach, landing

q_i Value of i th measured parameter at a given measurement time
 q' On board estimate of measurement value
 q_{PN} Process noise acceleration
 \underline{r} Vehicle position vector (intermediate)

$\underline{r}^{(H)}$ Vehicle position vector in horizon coordinates

\underline{r}_B Ground-based sensor position vector used for current navigation update

\underline{r}_{Bn} Position vector (earth fixed coordinates) of current ground beacon to be interrogated

$\underline{r}_{B, j}$ Intermediate ground beacon position vector used in beacon search

\underline{r}_{con} Conic vehicle position vector used in Precision Extrapolation Routine and Kepler Routine

\underline{r}_0 Vehicle position vector used in Precision Extrapolation Routine

\underline{r}_{conP}
 \underline{r}_{conT}
 \underline{r}_{0P}
 \underline{r}_{0T} Dummy vehicle position vectors used to reserve values of \underline{r}_{con} and \underline{r}_0 for primary (P) and target (T) vehicle states

rd Radians to degrees conversion factor

r_E Average earth radius

r_{ET} Earth radius at nominal touchdown point

$r_{E\mu}$ Earth radius used in Precision Extrapolation Routine

$\underline{r}_H^{(H)}$ Horizon position vector in horizon coordinates

\underline{r}_L Position vector of target vehicle w. r. t. primary vehicle in local vertical coordinates (phase 3)

\underline{r}_P Primary vehicle position vector (permanent)

\underline{r}_ρ Relative position vector (fixed point or target w. r. t. primary vehicle)

r_{ρ}	Magnitude of \underline{r}_{ρ}
$r_{\dot{\rho}}$	Relative range rate
$\underline{r}_{s,j}$	Ground-based sensor position vector (earth-fixed coordinates) associated with given measurement (phase 4) $j = 0, 3 \dots 3n_M$
\underline{r}_{sun}	Sun position vector w. r. t. earth center
\underline{r}_T	Target vehicle position vector (permanent)
\underline{r}_{TD}	Position vector at location of nominal touchdown point (phase 4). Input in earth-fixed coordinates, converted to reference.
$\underline{r}_{tr,j}$	Ground beacon position vector (earth-fixed coordinates) stored in input list. ($j = 1, 4 \dots 3n_B - 2$)

The following parameters are switches set to "0" or "1". The "1" setting is defined below with the "0" setting the corresponding negation.

Switch

s_a	Accelerometer biases are estimated (phase 4)
s_{att}	No navigation update is performed after precision extrapolation of state. This mode used in pointing horizon sensor.
s_{az}	Angle measurement is from MLS azimuth radar
s_{beacon}	Ground-based sensor(s) are used in this phase
s_{cont}	No rectification is required in Precision Extrapolation Routine

s_{DG_i}	Switch indicating measurement data from i th source is to be incorporated																
$i =$	<table> <tr> <td>0</td> <td>Horizon angle or ground beacon measurements</td> </tr> <tr> <td>1</td> <td>for baro-altimeter measurement</td> </tr> <tr> <td>2</td> <td>for elevation-angle from MLS flare elevation radar</td> </tr> <tr> <td>3</td> <td>for elevation angle from MLS glide-slope elevation radar</td> </tr> <tr> <td>4</td> <td>for range from MLS ranging radar</td> </tr> <tr> <td>5</td> <td>for range from DME</td> </tr> <tr> <td>6</td> <td>for azimuth angle from MLS</td> </tr> <tr> <td>7</td> <td>for azimuth angle from VOR</td> </tr> </table>	0	Horizon angle or ground beacon measurements	1	for baro-altimeter measurement	2	for elevation-angle from MLS flare elevation radar	3	for elevation angle from MLS glide-slope elevation radar	4	for range from MLS ranging radar	5	for range from DME	6	for azimuth angle from MLS	7	for azimuth angle from VOR
0	Horizon angle or ground beacon measurements																
1	for baro-altimeter measurement																
2	for elevation-angle from MLS flare elevation radar																
3	for elevation angle from MLS glide-slope elevation radar																
4	for range from MLS ranging radar																
5	for range from DME																
6	for azimuth angle from MLS																
7	for azimuth angle from VOR																
s_{DV}	Velocity correction data is to be processed (phase 3)																
s_{ext}	After performing precision extrapolation, return to entry point																
s_{fp_0}	Signifies first reception of VOR or DME data																
s_{fp_1}	Signifies first reception of MLS data																
s_{fp}	Signifies either s_{fp_0} or s_{fp_1} has just been set to "1"																
s_{fp_2}	Signifies first reception of drag measurement																
s_{fpD}	Signifies s_{fp_2} has just been set to "1"																
s_{init}	Signifies first entry into UNF program in a new phase																
s_{LVW}	W-matrix initialization values have been input in local vertical coordinates																
s_{perm}	Permanent state vector is to be extrapolated after a search; thus perform rectification																

s_{rendW} Utilize automatic W-matrix reinitialization (phase = 1)
 s_{search} Perform search for (a) ground beacons, (b) UV horizon
or (c) target vehicle
 s_{strt} The sunlit horizon is being entered
 s_T Include target vehicle state in estimation state
 s_{TPI} Terminal phase initiation maneuver has been performed
(phase 1)
 s_{TPM} Perform W-matrix reinitialization(post TPI)
 s_τ After calculating orbital period, return to entry point
 s_{Wcorr} Insert correlation into initialized W-matrix (phase = 0)
 s_{xD} Perform no more drag measurement navigation updates
 s_{xt} Inhibit crosstrack navigation updates (ground beacon navigation)
 s_{xTAC} Perform no more VOR or DME navigation updates (first MLS
data good has been received)

The following switches take on multiple values as defined:

s_{count} Used to indicate when 3 rendezvous navigation marks have been
processed following a W-matrix initialization inhibit (phase 1)

s_{pert} Used in Precision Extrapolation Routine

'0' conic extrapolation
'1' include J_2
'2' include J_2, J_3, J_4

s_q	'0'	No process noise included in W-matrix extrapolation
	'1'	Place q_{PN} in 3 acceleration components of W
	'2'	Place q_{PN} in crosstrack acceleration component of W
s_ψ	'1'	Indicates horizon sensing navigation; s_ψ is then used to convert horizon threshold error variance to equivalent angle variance
$s_{\delta\beta}$		Sine of angle above horizontal at which ground beacon is "visible".
s_β		Angle between \underline{r}_{sun} and a terminator position vector
t		Time associated with state vector (\underline{r} , \underline{v})
t_0		Time associated with state vector (\underline{r}_0 , \underline{v}_0)
t_{0P}, t_{0T}		Dummy variables used to reserve value of t_0 associated with primary, target vehicle states
t_B		Time of predicted acquisition of most recent beacon found in search
$t_{B,j}$		Time of acquisition of j^{th} beacon in search
t_{bef}		Time increment before a rendezvous maneuver in which navigation is not performed
t_C		Current time
t_{con}		Time associated with conic state extrapolation in beacon search routine
t_{EF}		Time associated with a_{z0}
t_{ig}		Time of predicted rendezvous maneuver execution

t_{lim}	Limiting time in given beacon search interval
t_M	Time associated with navigation measurement (also used as final precision state extrapolation time during search mode and horizon sensing attitude mode)
t_{maxW}	Value of accumulated W-matrix extrapolation time beyond which W-matrix reinitialization is forced
t_{Mprev}	Time of previous navigation measurements
t_P	Time associated with permanent state vectors ($\underline{r}_P, \underline{v}_P$)
t_{res}	Dummy variable to reserve t
t_S	Time at which a given navigation phase is to be initiated
t_T	Time associated with permanent state vectors ($\underline{r}_T, \underline{v}_T$)
t_{UV}	Predicted time of next visible UV horizon
t_W	Value of accumulated W-matrix extrapolation time beyond which W-matrix reinitialization is requested
t_{Wcrit}	Time prior to rendezvous maneuver beyond which W-matrix reinitialization is inhibited
t_{xP}	Dummy variable used to reserve t_P
t_γ	Time associated with estimated biases (if $t_\gamma = 0$, biases are constant)
UNF	Abbreviation for Unified Navigation Filter
\underline{v}	Vehicle velocity vector (intermediate)
\underline{v}_0	Vehicle velocity vector used in Precision Extrapolation Routine

\underline{v}_{con}	Conic vehicle velocity vector used in Precision Extrapolation Routine and Kepler Routine
\underline{v}_{conP} \underline{v}_{conT} \underline{v}_{0P} \underline{v}_{0T}	Dummy vehicle velocity vectors used to reserve values of \underline{v}_{con} , \underline{v}_0 for primary (P) and target (T) vehicle states
\underline{v}_L	Velocity vector of target vehicle w. r. t. primary vehicle in local vertical coordinates (phase 3)
\underline{v}_P	Primary vehicle velocity vector (permanent)
v_{RHI} v_{RLO}	Velocity limits around Mach 1.0 between which no baro-altimeter data should be processed
\underline{v}_{RT}	Vehicle velocity vector w. r. t. touchdown point
\underline{v}_ρ	Relative velocity vector (fixed point or target w. r. t. primary vehicle)
v_ρ	Magnitude of \underline{v}_ρ
$v_{\rho prev}$	Value of v_ρ in previous time step (Δt_a)
\underline{v}_T	Target vehicle velocity vector (permanent)
W	Filter weighting matrix (dimension $d \times d$)
$w_{i,j}$	Elements of W (numbered as in Figure 2)
$\underline{w}_{i,j}$	Vector partition of W
W_{sub}	$b \times d$ partition of W which is extrapolated
\underline{x}	$d \times 1$ navigated state vector
x, x_c	Universal conic variables

\underline{x}_M	Horizon sensor boresight axis (unit vector)
x_{prev}	Previous value of x used in Precision Extrapolation Routine
x_{prevP} , x_{prevT}	Dummy variables used to reserve x_{prev} for primary (P) and target (T) vehicle states
\underline{z}	Intermediate $d \times 1$ vector used in measurement incorporation
α	Angle of attack
α_{prev}	Value of α in previous time step (Δt_a)
$\overline{\alpha^2}$	A priori filter measurement error variance used for incorporation of current measurement type
$\overline{\alpha_A^2}$	A priori random angular momentum error variance
$\overline{\alpha_D^2}$	A priori random drag measurement error variance
$\overline{\alpha_E^2}$	A priori random energy error variance
$\overline{\alpha_{H1}^2}$, $\overline{\alpha_{H2}^2}$ }	A priori random baro-altimeter measurement error variances
$\overline{\alpha_H^2}$	A priori random horizon threshold error variance
$\overline{\alpha_R^2}$	A priori random range measurement error variance
$\overline{\alpha_{\dot{R}}^2}$	A priori random range rate measurement error variance
$\overline{\alpha_{\beta}^2}, \overline{\alpha_{\theta}^2}$	A priori random measurement error variances for set of orthogonal gimbal angles
β	Angle measured in general coordinate system ($\underline{i}_{xm}, \underline{i}_{ym}, \underline{i}_{zm}$)
R_c	Vehicle ballistic coefficient

γ	Intermediate scalar used in filter weighting matrix update
$\underline{\gamma}$	Intermediate $b \times 1$ vector representing bias partition of measurement geometry vector (\underline{b})
$\underline{\gamma}_B$	$b \times 1$ vector representing measurement bias estimates (permanent)
γ_H	Horizon altitude
$\underline{\delta}$	Position deviation vector used in Precision Extrapolation Routine
$\underline{\delta}_P, \underline{\delta}_T$	Dummy vectors used to reserve $\underline{\delta}$ for primary (P) and target (T) vehicle states
δ_β	Angle above horizontal at which ground beacon is "visible"
Δq	Measurement residual
Δt	Time increment of W-matrix extrapolation (phase 4)
Δt_a	Minimum time interval between accelerometer reads (phase 4)
Δt_B	Time increment allotted for deorbit maneuver preparation
Δt_M	Minimum time interval between measurements
Δt_W	Total time filter weighting matrix has been integrated since last initialization
$\Delta \tau$	State extrapolation time interval (phase 3)
$\Delta \tau$	State extrapolation time interval (phase 4)
$\Delta \underline{x}$	Incremental update of state \underline{x} (dimension = $d \times 1$)
$\Delta \underline{v}_s$	Accelerometer-sensed velocity change
$\underline{\zeta}$	Unit vector normal to current orbital plane

η	Intermediate scalar set to "1" for W-matrix initialization and $k(\alpha^2)$ for reinitialization (phase 0)
θ	Angle measured in general coordinate system ($\underline{i}_{xm}, \underline{i}_{ym}, \underline{i}_{zm}$)
θ_T	Transfer angle of target vehicle in time interval $\Delta\tau$ (phase 3)
μ	Earth's gravitational constant
\underline{v}	Velocity deviation vector used in Precision Extrapolation Routine
$\underline{v}_P, \underline{v}_T$	Dummy vectors used to reserve \underline{v} for primary (P) and target (T) vehicle states
ξ	Elevation angle to horizon
ρ	Atmospheric density
ρ_0	Sea-level density of atmosphere
$\underline{\rho}_a$	Projection of \underline{r}_ρ on $\underline{i}_{xm} - \underline{i}_{zm}$ plane of sensor coordinate system
ρ_a	Magnitude of $\underline{\rho}_a$
$\underline{\rho}_H$	Position vector from vehicle to horizon
ρ_H	Magnitude of $\underline{\rho}_H$
$\underline{\rho}_H^{(H)}$	$\underline{\rho}_H$ in horizon coordinates
ρ_{prev}	Value of ρ from previous time step (Δt_a)
$\underline{\rho}_T$	Position vector from nominal touchdown point to vehicle

The following parameters (σ) represent a priori inputs for W-matrix diagonal components:

σ_{rF}	Reinitializing value for three position components (primary vehicle)
σ_{rFCT}	Reinitializing value for crosstrack position component (primary vehicle)
σ_{rFT}	Reinitializing value for three position components (target vehicle)
σ_{rI}	Initial value for three position components (primary vehicle)
σ_{rIT}	Initial value for three position components (target vehicle)
σ_{vF}	Reinitializing value for three velocity components (primary vehicle)
σ_{vFCT}	Reinitializing value for crosstrack velocity component (primary vehicle)
σ_{vFT}	Reinitializing value for three velocity components (target vehicle)
σ_{vI}	Initial value for three velocity components (primary vehicle)
σ_{vIT}	Initial value for three velocity components (target vehicle)
$\left. \begin{array}{l} \sigma_{\gamma I} \\ (b \times 1) \\ \sigma_{\gamma F} \\ (b \times 1) \end{array} \right\}$	Initial, reinitializing value(s) for b bias components
τ	Orbital period
τ_c	Time interval used in Precision Extrapolation Routine

τ_{cP}, τ_{cT}	Dummy variables used to reserve τ_c associated with primary (P), target (T) vehicle states
τ_{prev}	Value of τ_c from previous time step
τ_{prevP} τ_{prevT}	Dummy variables used to reserve τ_{prev} associated with primary (P), target (T) vehicle states
ϕ	Pre-loaded horizon direction azimuth angles in vehicle local horizontal frame, measured counterclockwise from forward direction
$\underline{\phi}$	Horizontal vector in horizon measurement plane indicating azimuth direction of sensed horizon
$\underline{\phi}^{(H)}$	$\underline{\phi}$ in horizon coordinates
$\underline{\Phi}_B$	$b \times b$ transition matrix for bias components of navigated state vector
$\phi_{B,j}$	Elements of $\underline{\Phi}_B$ ($j = 0, 1, \dots, b^2 - 1$) numbered along rows
$\underline{\Phi}_{RR}, \underline{\Phi}_{VV}$ $\underline{\Phi}_{RV}, \underline{\Phi}_{VR}$	3×3 submatrices of the relative state transition matrix (phase 3)
ψ	Angle measured by horizon sensor (between horizon and \underline{x}_m)
$\underline{\omega}$	Navigation filter weighting vector (dimension = $d \times 1$)
$\underline{\omega}_E$	Earth's angular velocity vector
ω_T	Angular velocity of target vehicle (phase 3)

Special Notation

$|\underline{a}|$ Magnitude of vector \underline{a}

$(\)^T$ Transpose of $(\)$

$\text{unit}(\underline{a})$ Unit vector of $\underline{a} = \underline{a} / |\underline{a}|$

$\text{sign}(\)$ Algebraic sign of $(\)$ with magnitude of 1

1. INTRODUCTION

Equations designed to meet the navigation requirements of the separate shuttle mission phases are presented in a series of reports entitled, "Space Shuttle GN & C Equation Document" (Ref. 1d to 1h). The development of these equations is based on performance studies carried out for each particular mission phase (Ref. 2 contains an extensive bibliography of these studies). Although navigation equations have been documented separately for each mission phase, a single unified navigation filter design is embodied in these "separate" designs. The purpose of this document is to present the shuttle navigation equations in a form in which they would most likely be coded-as the single unified navigation filter used in each mission phase. This document will then serve as a single general reference for the navigation equations replacing each of the individual mission phase navigation documents (which may still be used as a description of a particular navigation phase).

GENERAL DESCRIPTION

Fundamental characteristics of the navigation filter are as follows:

1. Recursive formulation of the Kalman filter providing minimum variance estimates
2. The square root formulation (W-matrix) of the state covariance matrix is used to provide greater computational accuracy and guarantees the covariance matrix to be at least positive semi-definite
3. The W-matrix is periodically reinitialized to compensate for unmodeled errors and provide independence of mission length
4. State process noise is utilized in selected short term applications (thereby allowing a very simply mechanized formulation)
5. Measurements are sequentially incorporated (avoids matrix inversion and provides flexibility with respect to number of measurements)

In the unified formulation, the filter has the following features:

1. Provides for estimation of the shuttle state (6 dimensions) plus (b) measurement biases (b = 0, 1, ---n where n will most likely be no greater than 4)

2. Provides for estimation of a target vehicle state (6 dimensions) if analyses establish the need for one in any phase.

The flow diagrams presented in this document show the target state included in the estimated state vector ($s_T = 1$) for the "rendezvous" phase only. To date, it has not been firmly established that estimation of the target state is required in this phase (depends on target state ephemeris uncertainties), but is shown here to illustrate how target state estimation would be accommodated in the unified filter. This feature would be mandatory if it is desired that the shuttle have the capability to perform orbit navigation via the "ejected satellite" scheme (Ref. 3). By providing for target state estimation in the unified filter, the option is left open for utilizing this unique orbit navigation scheme, which has distinct advantages over conventional on board orbit navigation systems.

3. Uses only the number of variables required for the state dimension of a given phase. Thus, the extra locations reserved for the maximum dimension phase are available for other purposes if required in a different phase. Figure 1-1 illustrates state vector definitions and dimensions for each navigation mission phase. Figure 1-2 presents the basic covariance matrix definition and illustrates the W-matrix component numbering scheme used in the variable dimension feature. The target submatrix (W_{sub}) is simply deleted for phases in which it is not required, and the bias submatrix column dimension has the dimension (b) associated with the mission phase. The row dimension is appropriate for target state phases and the value of b.

	Orbit Navigation		Rendezvous (or ejected satellite orbit navigation)	Braking	Station-Keeping	Entry, Approach & Landing
	Ground Beacon	Horizon Sensing				
State Vector (x) (d x 1)	$\begin{pmatrix} \underline{x}_0 \\ \underline{x}_3 \end{pmatrix} \begin{matrix} \underline{r}_p \\ \underline{v}_p \end{matrix}$	$\begin{pmatrix} \underline{x}_0 \\ \underline{x}_3 \\ \underline{x}_6 \end{pmatrix} \begin{matrix} \underline{r}_p \\ \underline{v}_p \\ \text{horizon bias} \end{matrix}$	$\begin{pmatrix} \underline{x}_0 \\ \underline{x}_3 \\ \underline{x}_6 \\ \underline{x}_9 \\ \underline{x}_{10} \\ \underline{x}_{13} \end{pmatrix} \begin{matrix} \underline{r}_p \\ \underline{v}_p \\ \text{biases} \\ \underline{r}_T \\ \underline{v}_T \end{matrix}$	$\begin{pmatrix} \underline{x}_0 \\ \underline{x}_3 \\ \underline{x}_6 \\ \underline{x}_9 \end{pmatrix} \begin{matrix} \underline{r}_p \\ \underline{v}_p \\ \text{biases} \end{matrix}$	$\begin{pmatrix} \underline{x}_0 \\ \underline{x}_3 \\ \underline{x}_6 \\ \underline{x}_9 \end{pmatrix} \begin{matrix} \underline{r}_\rho \\ \underline{v}_\rho \\ \text{biases} \end{matrix}$	$\begin{pmatrix} \underline{x}_0 \\ \underline{x}_3 \\ \underline{x}_6 \end{pmatrix} \begin{matrix} \underline{r}_p \\ \underline{v}_p \\ \text{biases} \end{matrix}$
Dimension (d)	6	7	16 ^{*†}	10 [†]	10 [†]	9 [†]

$\underline{r}_p, \underline{v}_p$ = primary vehicle state (shuttle)

$\underline{r}_T, \underline{v}_T$ = target vehicle state

$\underline{r}_\rho, \underline{v}_\rho$ = relative state

* This dimension would be 10 unless (1) analyses prove the need to estimate the target state, or (2) the ejected satellite navigation capability is desired.

† Provision is made for inclusion of biases in the navigated state, but the need for bias estimation (and the number of biases) can not be firmly established until the actual sensor error models are established.

Figure 1-1. State Vector Definitions

$$E \triangleq \begin{pmatrix} E_P & & \\ (6 \times 6) & 6 \times b & 6 \times 6 \\ & b \times 6 & b \times b & b \times 6 \\ & & & E_T \\ 6 \times 6 & 6 \times b & & (6 \times 6) \end{pmatrix}$$

(Filter covariance matrix)

$E_P \triangleq$ Shuttle covariance matrix

$E_T \triangleq$ Target covariance matrix

b = Number of measurement biases included in state

W (square root of covariance matrix)

$$= \begin{pmatrix} \underline{w}_{0,0} \underline{w}_{0,1} \dots \underline{w}_{0,5} & \underline{w}_{0,6} \dots \underline{w}_{0,(6+b-1)} & \underline{w}_{0,(6+b)} \underline{w}_{0,(6+b+1)} \dots \underline{w}_{0,(d-1)} \\ \underline{w}_{3,0} \underline{w}_{3,1} \dots \underline{w}_{3,5} & \underline{w}_{3,6} \dots \underline{w}_{3,(6+b-1)} & \underline{w}_{3,(6+b)} \underline{w}_{3,(6+b+1)} \dots \underline{w}_{3,(d-1)} \\ \underline{w}_{6,0} \underline{w}_{6,1} \dots \underline{w}_{6,5} & \underline{w}_{6,6} \dots \underline{w}_{6,(6+b-1)} & \underline{w}_{6,6+b} \dots \underline{w}_{6,(d-1)} \\ \underline{w}_{7,0} \underline{w}_{7,1} \dots \underline{w}_{7,5} & \underline{w}_{7,6} \dots \underline{w}_{7,(6+b-1)} & \underline{w}_{7,6+b} \dots \underline{w}_{7,(d-1)} \\ \vdots & \vdots & \vdots \\ \underline{w}_{(6+b-1),0} \dots \underline{w}_{(6+b-1),5} & \underline{w}_{(6+b-1),6} \dots \underline{w}_{(6+b-1),(6+b-1)} & \underline{w}_{(6+b-1),6+b} \dots \underline{w}_{(6+b-1),(d-1)} \\ \underline{w}_{(6+b),0} \underline{w}_{(6+b),1} \dots \underline{w}_{(6+b),5} & \underline{w}_{(6+b),6} \dots \underline{w}_{(6+b),(6+b-1)} & \underline{w}_{(6+b),(6+b)} \dots \underline{w}_{(6+b),(d-1)} \\ \underline{w}_{(9+b),0} \underline{w}_{(9+b),1} \dots \underline{w}_{(9+b),5} & \underline{w}_{(9+b),6} \dots \underline{w}_{(9+b),(6+b-1)} & \underline{w}_{(9+b),(6+b)} \dots \underline{w}_{(9+b),(d-1)} \end{pmatrix}$$

$\left. \begin{matrix} \text{W}_{sub} \\ (6 \times d) \\ \text{(shuttle)} \end{matrix} \right\}$
 $\left. \begin{matrix} \text{Bias} \\ \text{partition} \\ (b \times d) \end{matrix} \right\}$
 $\left. \begin{matrix} \text{W}_{sub} \\ (6 \times d) \\ \text{(target)} \end{matrix} \right\}$

Figure 1-2. W Matrix Definition

4. Considers six possible measurement types for all phases:

Range	}	Relative to fixed point or target vehicle
Range rate		
Sensor angle (β)		
Sensor angle (θ)		
Drag		
Altitude		

5. All angle measurements are unified, requiring only separate definitions of sensor "axes" (\underline{i}_{xm} , \underline{i}_{ym} , \underline{i}_{zm}). The basic sensor angles included in the unified filter are illustrated in Figure 1-3.
6. The unified filter provides the navigation capability for shuttle mission phases (p) defined as follows:

<u>Navigation Mission Phase*</u>	<u>p</u>
Orbit navigation	0
Rendezvous	1
Automatic braking	2
Station-keeping	3
Entry, approach and landing	4

a. Orbit Navigation (Phase 0)

The purpose of the Orbit Navigation phase is to provide a means of automatically reducing uncertainties in the on-board knowledge of the shuttle inertial state by accepting and processing data from the navigation sensor(s). This knowledge is required to (a) accurately compute orbital maneuvers, (b) provide accurate initial conditions for other mission phases such as rendezvous, deorbit and landing.

There are several candidate orbit navigation systems for the shuttle mission, e. g.:

1. horizon sensing
2. tracking ground based beacons
3. tracking navigation satellites
4. tracking satellites ejected from the primary vehicle.

* Two mission phases, ascent and docking, have not been included in this list since these phases do not currently utilize filtering of navigation data. Should ground beacon navigation be used during boost (a possibility under consideration), this navigation phase can be easily incorporated in the unified filter (basically similar to entry phase).

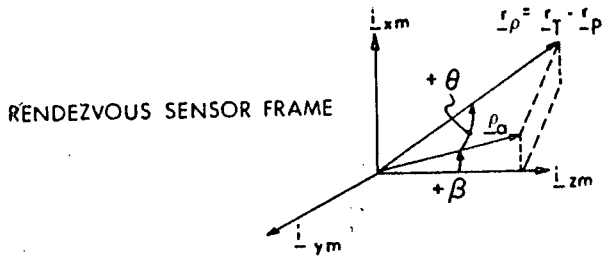

STANDARD DEFINITION OF SENSOR ANGLES (β, θ)

$-180^\circ < \beta < +180^\circ$

$-180^\circ < \theta < +180^\circ$

NAV SENSOR
VOR
(AZIMUTH ANGLE)

ACTUAL ANGLE DEFINITION

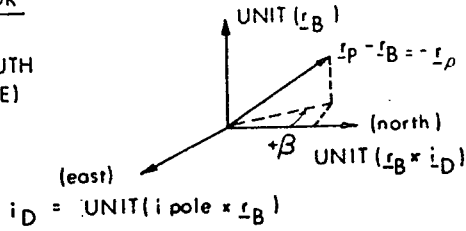

EQUIVALENT i_{xm}, i_{ym}, i_{zm} DEFINITION

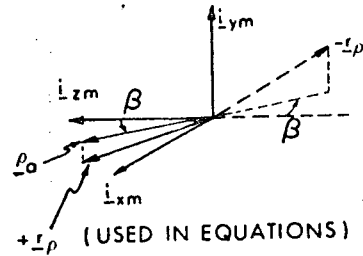

AILS (MLS)
AZIMUTH ANGLE
RADAR

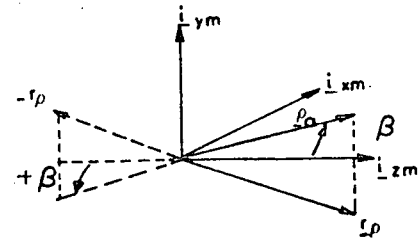
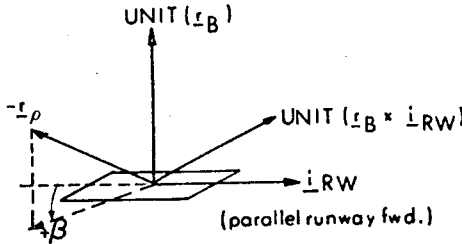

AILS (MLS)
ELEVATION ANGLE
RADAR

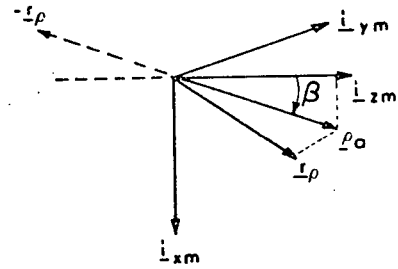
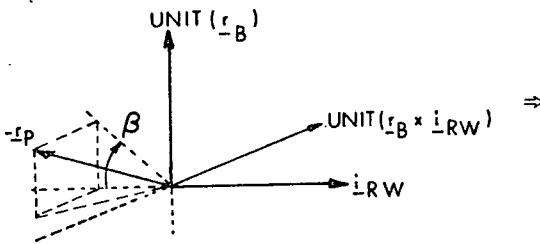

HORIZON SENSOR

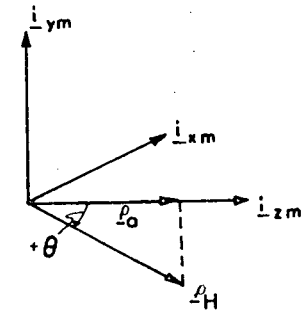
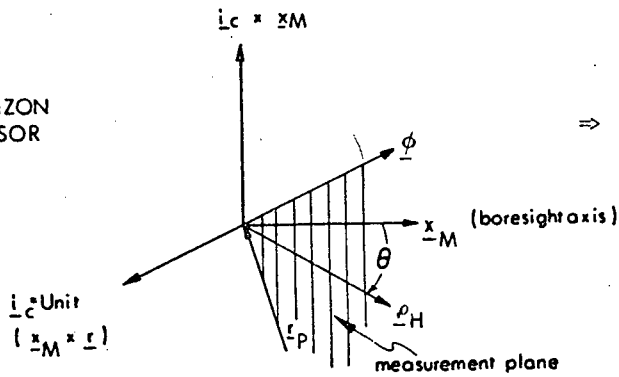

NOTE: Axes in a figure on the right are parallel to the axes in the corresponding figure on the left.

Figure 1-3. Navigation Sensor Coordinate Frame

The navigation equations required for systems (3) or (4) fall in the category of rendezvous navigation (phase 1). This document will present the equations required for horizon sensing systems and a ground beacon orbit navigation system. In the horizon sensing system, the direction of the line-of-sight to a horizon is measured with respect to inertially fixed coordinates provided by the inertial measurement unit (IMU). Equations are included which provide the attitude control system with inputs required to direct the sensor to the appropriate horizon according to a pre-determined schedule of azimuths (ϕ). In the ground beacon system, transponders located at known positions on the earth are interrogated by the shuttle navigation system. The return signals from the transponders provide range to the beacon and/or range rate relative to the beacon. Also included are equations required to predict which of the ground beacons stored in a catalog will be encountered next and at what times the encounters will occur. The logic equations around a "UV Horizon Prediction Routine"(TBD) are provided in order to yield a prediction of the time of the next visible UV horizon pass, for use in the horizon sensing navigation mode.

With minor modifications, the equations presented for these two systems (horizon sensing and ground beacon tracking) may be readily adapted to other orbit navigation systems, such as known or unknown landmark tracking, or to systems using different navigation sensors, e. g. radar altimeter.

b. Rendezvous Navigation (Phase 1)

Phase 1 of the UNF provides a means of automatically and autonomously improving on-board knowledge of the relative state between the shuttle (primary vehicle) and another orbiting vehicle (target vehicle). This knowledge would be required in (a) rendezvous missions as inputs to rendezvous targeting programs to compute maneuvers which effect rendezvous between the primary and target vehicles or (b) orbit navigation modes which utilize tracking of navigation satellites or satellites ejected from the primary vehicle. Rendezvous navigation sensor data consists of measurements of some portion of the relative state. Relative range, range rate, and line-of-sight angles (ρ, θ) (or any combination of these parameters) are the possible measurements accepted by the UNF in this phase.

c. Automatic Braking Navigation (Phase 2)

The purpose of the rendezvous terminal phase is to automatically bring the shuttle within the desired station-keeping boundaries relative to the target vehicle at a relative velocity commensurate with station-keeping guidance requirements. To accomplish this task, targeting and guidance functions must be supported by relative state navigation. The terminal phase is initiated

subsequent to the last midcourse maneuver (phase 1) at a relative range on the order of three to five miles.

Phase 2 of the UNF is essentially a continuation of phase 1 with respect to navigation equations and sensor measurements. Current analyses indicate that the target state need not be estimated, and a simple process noise model may be used in place of W-matrix reinitializations to account for modeling errors (e.g. maneuver uncertainties). Studies are underway to determine if computational inaccuracies will dictate carrying a relative state as opposed to subtracting two inertial states. If this proves more efficient, phase 2 navigation will simply merge into phase 3 navigation with no need for two separate phases.

d. Station-Keeping Navigation (Phase 3)

As in phase 1 or 2, the purpose of the station-keeping navigation phase is to determine the state of the active vehicle, i.e. the one performing the station-keeping maneuvers, with respect to the target vehicle. A low eccentricity orbit is assumed for the target vehicle. The fundamental difference between this phase and phase 2 is that the relative state is utilized as the navigated state. Typical values of relative range are 1000 ft or less, so that computational inaccuracies may preclude subtracting the primary vehicle state from the target state to obtain the desired relative state.

e. Entry, Approach and Landing Navigation (Phase 4)

The purpose of the entry navigation system is to provide up-to-date estimates of the shuttle state, i.e. the vehicle's position and velocity, during the entry, transition, cruise, approach, and landing phases of the mission. This information is required to guide the vehicle to the terminal area and on to a safe landing.

The entry phase is considered to start when the vehicle reaches an altitude of 400,000 ft. Significant aerodynamic forces on the vehicle first occur at an altitude of about 300,000 ft. During the period of flight from altitudes of about 300,000 to 150,000 ft there will be a radio-transmission blackout because of the plasma sheath around the entry vehicle (Ref. 4). When the vehicle's altitude is below 150,000 ft, it should be possible to obtain navigation updates from the PRS which is operated at S-band frequencies (2.2 GHz). At altitudes below 100,000 ft nav aids such as VOR/DME or TACAN can be used to provide state-vector updates. Finally at altitudes below 30,000 ft, terminal-phase navigation systems such as the AILS and MLS may also be used.

This phase is primarily concerned with navigation during the period of flight from an altitude of 400,000 ft (entry interface) to touchdown. The primary navigation sensor during the mission phases of interest is the inertial measurement unit (IMU), which measures changes in vehicle caused by non-gravitational forces. The navigation equations required for state-vector updating using IMU data alone are given in Ref. 1b.

This document presents a set of equations that can be used to update IMU-derived state estimates during the mission phases from entry through landing with drag, VOR/DME, baro-altimeter, and MLS measurement data. With minor modifications TACAN data could be used in place of that from VOR/DME, and AILS data could be used instead of that from the MLS. The navigation routine is structured so that PRS range measurements could be used in place of VOR/DME, AILS, and MLS with a small number of changes. Simulation results to demonstrate navigation performance are given in Refs. 5-9.

The unified navigation filter is structured as the basic navigation "subroutine" serving each mission phase within which appropriate switches and inputs are preset or generated. The main navigation program may be designed to cycle automatically from one navigation phase to the next. As an illustration of a possible sequencing scheme, Figure 1-4 is presented showing the cues which might be used to announce the entrance into a new navigation phase and the subsequent call to the unified navigation filter ("call UNF" box.)

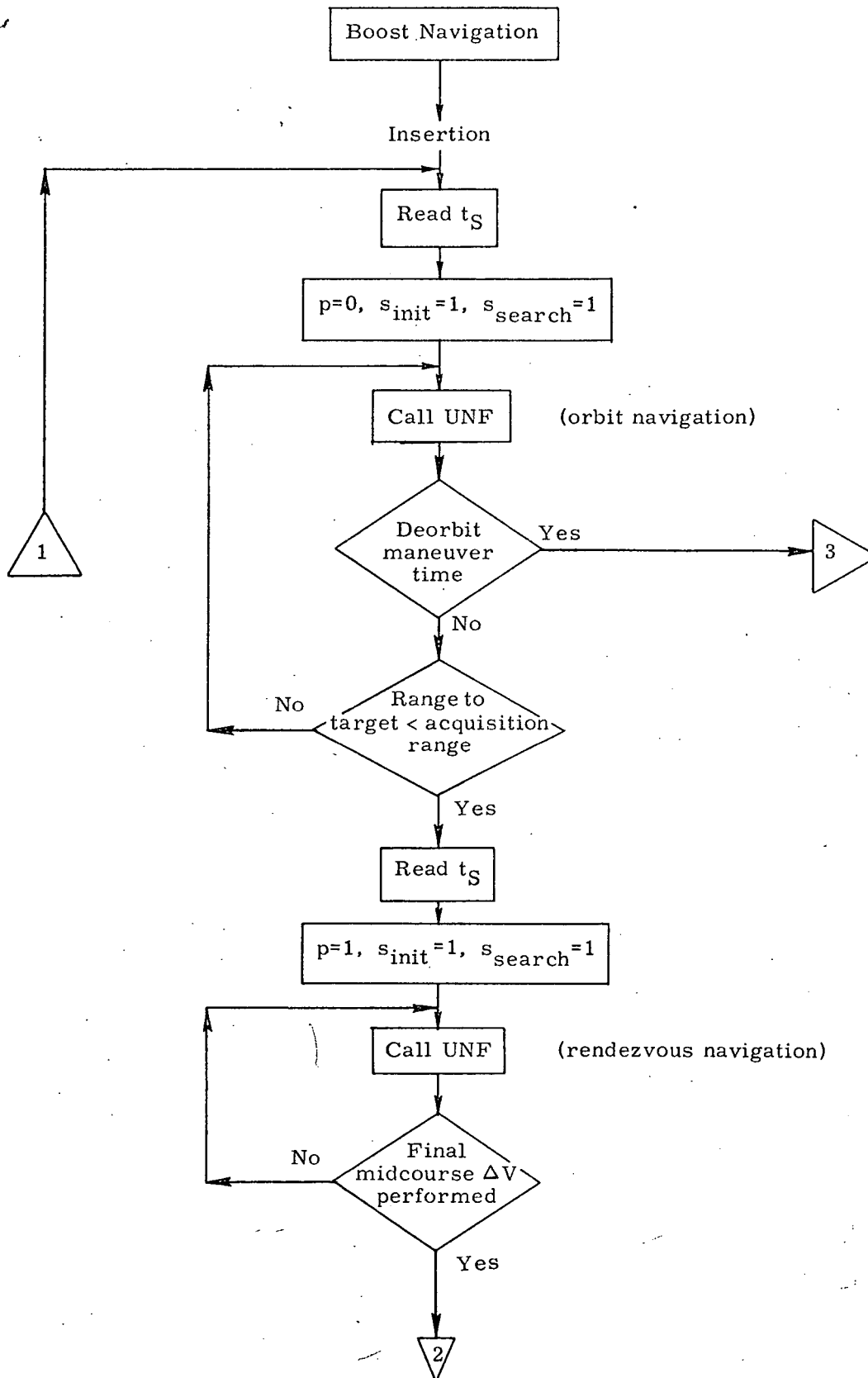

Figure 1-4a. Navigation Mission Phase Sequencing
(Typical rendezvous mission) (Sheet 1 of 2)

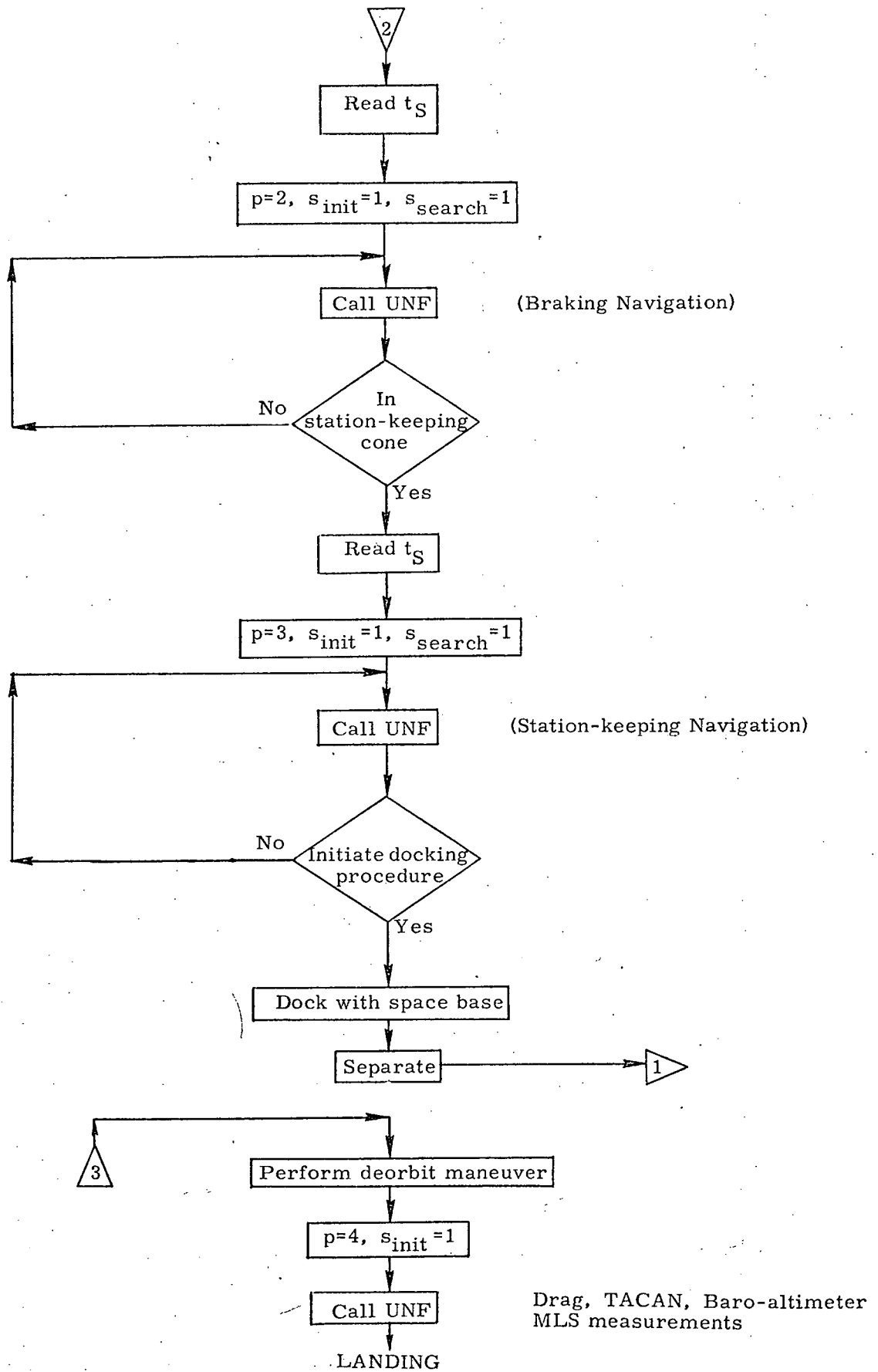



Figure 1-4b. Navigation Mission Phase Sequencing
(Typical rendezvous mission) (Sheet 2 of 2)

2. FUNCTIONAL FLOW DIAGRAM

A functional flow diagram of the UNF is presented in Figures 2-1a and 2-1b. The program is initiated (Figure 2-1a), at a specified start time t_S for all phases except entry where initiation occurs between accelerometer read times external to the UNF. Because of:

- a. synchronization with accelerometer reads,
- b. state extrapolation during specific force sensing, and
- c. possibility that W-matrix and state extrapolation not using same cycle time,

the entry phase follows a path separate from the other phases in the initial portion of the program (Figure 2-1a). Following the accelerometer read at time t_M in the entry phase, the vehicle state is extrapolated to time t_M . The estimated vehicle altitude is compared to altitude threshold values to determine if drag or baro-altimeter data is to be incorporated. Also data good signals are interrogated for VOR, DME and MLS systems. If none of these criterions is met, the accelerometer read cycle is continued. If good measurement(s) are available, the appropriate sensors are read (except for the drag measurement which is basically the accelerometer output) and the total number of separate parameters measured is computed (n_M). A check is made to see if the W-matrix is to be initialized, extrapolated or left alone and the flow joins the other phases for the functions shown in Figure 2-1b.

For phases other than entry, the vehicle state (or states in the case of rendezvous situations) are precision extrapolated to t_S after waiting until current time is a minute prior to t_S . At this point a search mode is entered on the initial call to the UNF program or any subsequent time the program is called from an external program. The purpose of this mode is to achieve lockon of a target vehicle in the rendezvous phases ($p = 1, 2, 3$), predict the time of the next visible UV horizon (at a prescribed horizon azimuth) in the horizon sensing orbit navigation mode, or predict the time(s) of first visibility of ground beacons in the ground beacon orbit navigation mode. (The reason for entering the search mode at subsequent program entries is that Δv maneuvers may be performed which will require a new search for the target or negate previous predicted horizon or ground beacon intercept times). When the search is completed in either rendezvous phases or ground beacon orbit navigation mode (i. e., the target is being tracked or the next ground beacon intercept time has been predicted), appropriate navigation sensors are read. ( in Figure 2-1a.)

The horizon sensing mode follows a slightly different path following the prediction of the next visible UV horizon because of the need to supply data to the attitude control system, so that the horizon sensor may be pointed at the predicted horizon at the predicted time t_{UV} . After waiting until the current time is 1 minute prior to t_{UV} , the vehicle state is precision extrapolated to time t_{UV} , the estimated direction to the prescribed horizon is computed, and fed to the attitude control system to point the horizon sensor. At this point the navigation sensor is read ($\nabla 1$ in Figure 2-1a) as in the other modes.

After reading the navigation sensor(s) and the time t_M associated with the readout, the total number of measured parameters is computed (n_M). The vehicle state(s) and the W-matrix (except on first entry into the program) are precision extrapolated to measurement time t_M . A check is made to see if the W-matrix is to be initialized and the flow for these phases joins the entry phase for the functions shown in Figure 2-1b.

Referring to Figure 2-1b, if any non-constant biases are estimated, they are extrapolated to time t_M . At this point, n_M measurements are incorporated sequentially in the following manner: for the i th measurement type, a "relative state" and unit vectors along "sensor axes" are computed (except drag and altitude); the measurement geometry vector (\underline{b}), measurement residual (Δq) and filter sensor variance (α^2) are computed. This measurement is then incorporated in the current estimated state vector and W-matrix.

Current time is then compared with mission event times and the UNF program is exited to the program sequencer if other functions are required (e.g. maneuver targeting or execution), or entry into a new navigation phase is called for. If program exit is not called for, navigation is continued after waiting a discrete time interval (preset for each individual navigation phase). The entry phase cycles back to accelerometer read ($\nabla 5$) and rendezvous phases cycle back to navigation sensor read ($\nabla 1$). The horizon sensing mode selects a new horizon azimuth (if scheduled) and calls the attitude control system to point the sensor in the estimated horizon direction (if the new direction is out of the sensor field of view) before cycling to the sensor read. The ground beacon navigation mode checks data good ($\nabla 4$). If acceptable data is available, it then cycles to navigation sensor read. If there is no data good signal, either of three options are selected based on programmed logic: (a) continue tracking same beacon (b) select the next predicted beacon (if one is available) or (c) reenter the ground beacon prediction routine.

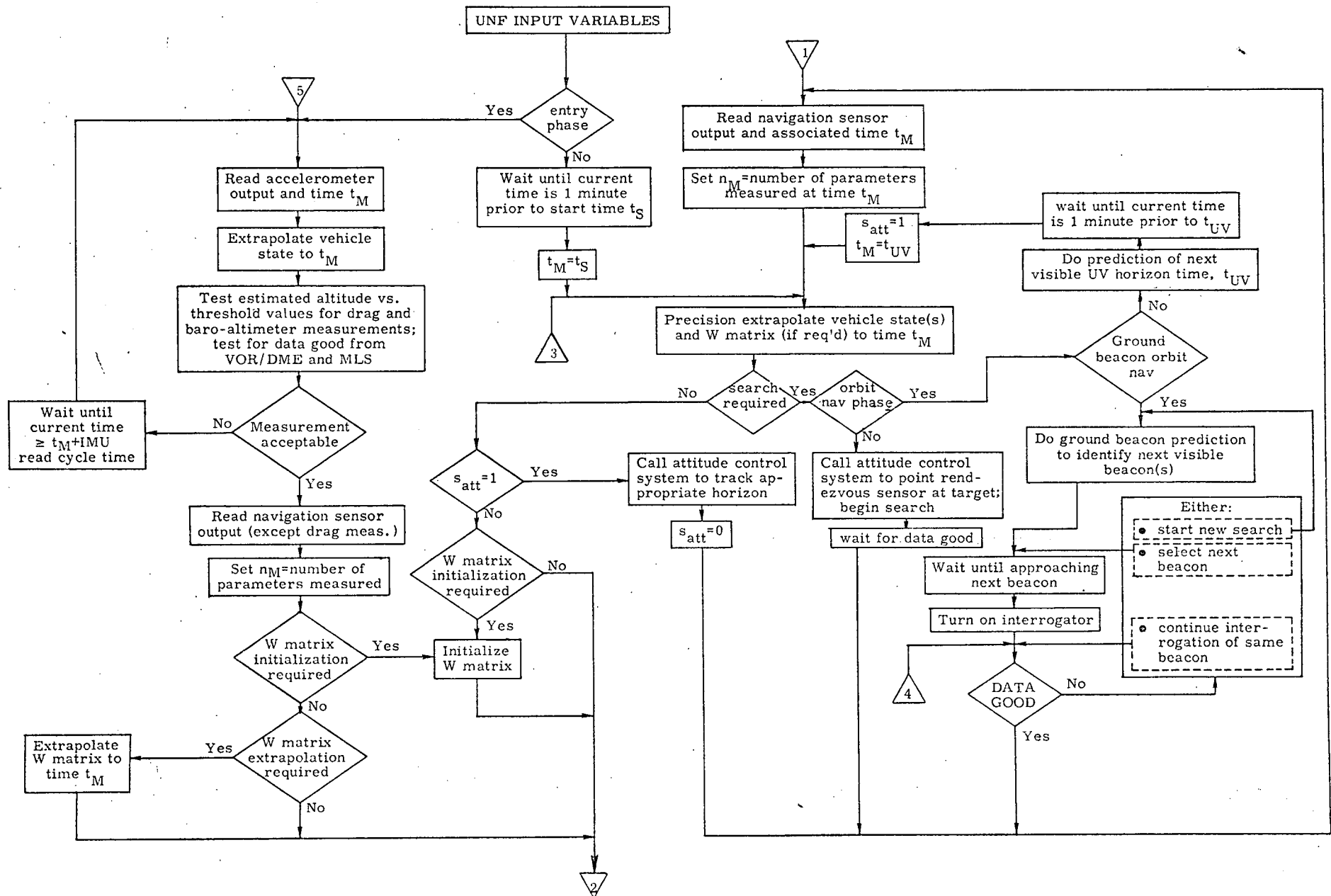

Figure 2-1a. Functional Flow Diagram

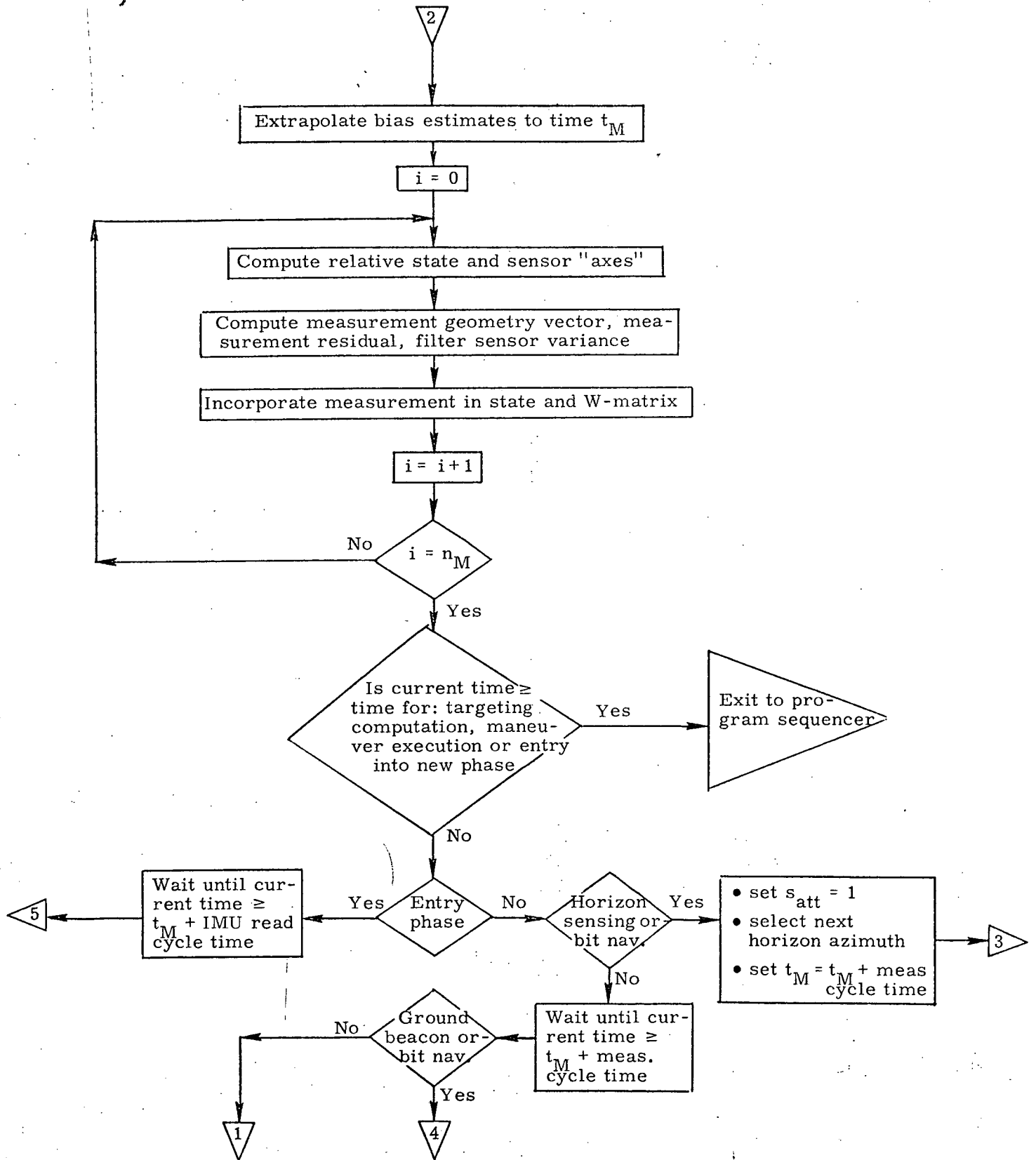

Figure 2-1b. Functional Flow Diagram

3. INPUT AND OUTPUT VARIABLES

Input Variables

p	Specifies the current navigation mission phase
t_S	Specifies when the given navigation phase (except entry) is to be initiated
s_{init}	Must be set to "1" on the first entry into the UNF program for each phase
s_{search}	Set to "1" any time it is desired to initiate a search (for the target in rendezvous phases, visible UV horizon or ground beacons in orbit navigation phase) in any phase except entry. Set to "1" on initial entry into UNF and thereafter if a maneuver may negate previous predictions, or break lockon to a target.
s_T	Set to "1" if target state is to be included in UNF navigated state
s_{beacon}	Set to "1" if ground-based sensors are used in a given phase
s_{pert}	Indicates type of gravity model to be used in Precision Extrapolation Routine
s_q	Non-zero if process noise is to be included in W-matrix extrapolation
q_{PN}	Process noise acceleration (if $s_q = 1$)
Δt_M	Basic measurement loop cycle time (except phase 4)
Δt_a	Accelerometer read cycle time (phase 4)
$\underline{r}_P, \underline{v}_P, t_P$	Primary vehicle state and time tag

$\underline{r}_T, \underline{v}_T, t_T$ Target vehicle state and time tag (phases 1, 2, 3)

b Number of biases included in navigated state

n_B Total number of ground beacons available (phase 0)

$\underline{r}_{tr, j}$ Position vector(s) of ground beacons in earth-fixed coordinates
 ($j = 1, 4, \dots, 3n_B - 2$) (phase 0)

\underline{r}_{sun} Sun position vector w. r. t. earth center (phase 0)

ϕ Azimuth direction of desired horizon measurement (phase 0)

$n_{\tau GB}$ Number of orbital periods between W-matrix reinitializations
 $n_{\tau HS}$ for ground beacon, horizon sensing orbit navigation

a_{z0}, t_{EF} Angle between earth-fixed equatorial x-axis (through prime
 meridian) and reference equatorial x-axis at time t_{EF}

γ_B, t_γ b bias estimates and time tag

s_{DV} Set to "1" if velocity correction data is to be processed
 (phase 3)

$\Delta \underline{v}_S$ Value of sensed $\Delta \underline{v}$ to be processed if $s_{DV} = 1$ (phase 3)

s_{rendW} Set to "1" if automatic W-matrix reinitialization scheme
 is to be used (phase 1)

If $s_{rendW} = 1$, the following additional inputs are required (de-
 fined in nomenclature)

$t_W, t_{maxW}, s_{TPI}, s_{TPM}, t_{bef}, t_{ig}, t_{Wcrit}$

r_{ET} Earth radius at nominal touchdown point (phase 4)

\underline{r}_{TD} Position vector at location of nominal touchdown point in
 earth-fixed coordinates (phase 4)

m Vehicle mass (phase 4)

Output Variables

$\underline{r}_P, \underline{v}_P, t_P$ Updated primary vehicle state and updated time tag
(NOTE: In phase 3 output $\underline{r}_P, \underline{v}_P$ are relative state vectors)

$\underline{r}_T, \underline{v}_T, t_T$ Updated target vehicle state and updated time tag (phases 1, 2, 3)

$\underline{r}_L, \underline{v}_L$ Relative state in local vertical coordinates (phase 3)

\underline{v}_{RT} Vehicle velocity w. r. t. touchdown point (phase 4)

\underline{v}_ρ Vehicle velocity w. r. t. air mass (phase 4)

$\underline{\rho}_T$ Position vector from touchdown point to vehicle (phase 4)

$\underline{\gamma}_B, t_\gamma$ Updated bias estimates and time tag

4. DESCRIPTION OF EQUATIONS

The detailed flow diagrams of the UNF program (Figures 5-1 to 5-20) contain the equations and logic required to perform the navigation functions of the shuttle on-orbit and entry, approach and landing phases. (Where subroutines are called, the appropriate reference is shown which contains the flow diagrams and equation description for that particular function). The purpose of this section is to explain those equations and the logic flow which are not essentially self-explanatory, or are not apparent from the discussion of the functional flow diagram. (Section 2).

Some general comments are in order before proceeding to the details of the flow diagrams. There are basically two sets of state vectors and time tags involved: permanent ones ($\underline{r}_P, \underline{v}_P, t_P, \underline{r}_T, \underline{v}_T, t_T, \underline{\gamma}_B, t_\gamma$) and their temporary counterparts used in the UNF filter ($\underline{x}, t_{xP}, t_{xT}$). In certain instances the temporary state may be advanced considerably beyond current time (e. g. in a ground beacon search) and it is obviously desirable to leave the permanent state prior to current time (e. g. maneuvers may be performed between the time of search initiation and beacon intercept). In addition, a permanent bias state ($\underline{\gamma}_B$) is required in order to allow different biases to be estimated when new navigation phases are initiated. The continuing advancement of the temporary state is accomplished by cycling to entry point ∇ . Advancement of the permanent state is accomplished by cycling to entry point ∇ . Because of the manner in which precision state extrapolation is performed (Ref. 1a), certain variables (e. g. $\underline{\delta}, \underline{\nu}$) must be maintained in the UNF for use in the Precision Extrapolation Routine to allow efficient continuous state advancement. Thus, when temporary state advancement has been taking place and a switch to permanent state advancement is desired (and these two states are not identical), it is necessary to initialize the state extrapolation variables (e. g. $\underline{r}_0, \underline{v}_0$) since they are no longer valid for the new state extrapolation. This initialization is accomplished by setting the switch s_{perm} to "1".

A special situation regarding the state extrapolation variables exists when two vehicle states are carried (rendezvous phases 1, 2, 3). In order to allow efficient continuous state extrapolation, separate state extrapolation variables must be maintained for the primary and target states. These intermediate variables are distinguished by adding the subscript P (primary) and T (target) (e. g. $\underline{\delta}_P, \underline{\nu}_T, \underline{r}_{0P}$, etc.)

4.1, State and W-matrix Extrapolation

All navigation phases except entry ($p = 4$) utilize the Precision State and Filter Weighting Matrix Extrapolation Routine. The entry navigation phase takes a separate path as indicated in Figure 5-1 to the accelerometer read block. After correcting the sensed velocity change (Δv_s), if accelerometer biases are estimated (i.e. $s_a = 1$), the entry phase flow cycles to entry point $\nabla 22$ where the Rapid Real-Time, State Advancement During Specific Force Sensing Routine is utilized to advance the primary state to the accelerometer read time t_M . (This routine requires the gravitational acceleration (g) from the previous time cycle. For the initial pass g is set to the null vector (Figure 5-1) which indicates to the routine that the previous g must be calculated before integration is started.)

For the non-entry navigation phases, vehicle state(s) and W-matrix (if required) are extrapolated to the time t_M which represents either: (a) the initial start time t_S , (b) measurement time, (c) time at which next horizon measurement is predicted (state at this time is used to point horizon sensor) or (d) time to which primary state is precision extrapolated to begin ground beacon search. Figure 5-2a and 5-2b present the equations and logic for accomplishing precision state (primary state in phases 0, 1, and 2, target state in phases 1, 2 and 3) and W-matrix extrapolation. (Primary state extrapolation is also performed at the first entry into the UNF for the station-keeping navigation phase ($p = 3$) in order to synch the target and primary states to form the initial relative state. s_{ext} is set to "1" (Figure 5-3) when $s_{init} = 1$ (1st entry into a given phase) and precision extrapolation performed via entry $\nabla 6$ and returned to phase 3 flow via entry $\nabla 9$.)

The logic and equations of Figures 5-2a and 5-2b determine the following:

- (a) When the W-matrix is extrapolated.

The variable d is set equal to the current dimension if W-matrix extrapolation is required, the dimension size indicating to the extrapolation routine the proper numbering of the W-matrix.

W-matrix extrapolation is not performed (indicated by $d_x = 0$) if either:

- first entry into a given phase ($s_{init} = 1$), since the W-matrix will subsequently be initialized
- a search is to be performed (no need for current W-matrix)
- a second vehicle is extrapolated in the current time step and this state is not included in the navigated state estimate ($s_T = 0$) (the W-matrix has already been extrapolated with the other vehicle state)

(b) Which vehicle state is being extrapolated.

This is indicated by the variable k . When $k = 0$, the first (and possibly only) state is being extrapolated. (This is always the primary state except in phase 3 where it is the target state). $k = 1$ indicates the second vehicle state is being extrapolated and $k = 6+b$ indicates in addition, this second state is included in the navigated state, thereby requiring its particular submatrix of W to be extrapolated. (The value of k (if $d_x \neq 0$) also is used to properly number the W -matrix in the extrapolation routine).

(c) Proper setting of the extrapolation variables ($\underline{\delta}$, \underline{v} , \underline{r}_0 , etc.)

If continuous extrapolation is desired, s_{cont} is set to '1' and the extrapolation variables are set to the values returned from the previous call to the precision extrapolation routine. (This requires identification of which vehicle is being extrapolated (from (b) above) so that the proper reserved values of the extrapolation variables are used). If rectification is desired (i. e. initialization of the extrapolation variables) because of:

- External entry into UNF,
- Switch from temporary state extrapolation to permanent state extrapolation, or
- Deviation vectors ($\underline{\delta}$, \underline{v}) exceed threshold values,

s_{cont} is set to "0" and extrapolation variables are initialized.

The extrapolation of the relative state in phase 3 is accomplished using the transition matrix defined as follows: $\begin{pmatrix} \Phi_{RR} & \Phi_{RV} \\ \Phi_{VR} & \Phi_{VV} \end{pmatrix}$. The equations required for this extrapolation are derived by linearizing differential gravity between the primary and target vehicles, and are presented in Figure 5-3. If a velocity correction ($\Delta \underline{v}_s$) has been made which is to be incorporated in the estimated state (in the UNF), the switch s_{DV} is set to "1" and $\Delta \underline{v}_s$ is incorporated as shown at the bottom of Figure 5-3.

The extrapolation of the W-matrix during the entry phase is accomplished using the Rapid Real-Time W-Matrix Advancement During Specific Force Sensing Routine (Ref. 1b). In order to save computer time, it may be possible to extrapolate the W-matrix at a slower rate than the state (studies are in progress to determine if any appreciable degradation will result). The logic for phase 4 W-matrix extrapolation is presented in Figure 5-14. If the W-matrix is to be extrapolated every n_W (pre-loaded constant) accelerometer read cycles (Δt_a), a running count ($n_{\Delta t}$) is maintained of the number of read cycles between W-matrix extrapolations and is compared to n_W . The gravity matrix (G) corresponding to the previous time to which the W-matrix has been extrapolated is required as an input to this extrapolation routine. G is calculated in the UNF only for the first entry into phase 4, thereafter it is obtained as an output from the routine to be used as an input in the next extrapolation cycle.

4.2 Search Modes and Navigation Sensor Reads

For the non-entry navigation phases, a search mode is included in the UNF. Its function is either:

- (a) Initiate a rendezvous sensor search to achieve target lockon. An initial pointing vector (along the estimated relative position vector) is made available from the UNF at time t_S for use in the rendezvous navigation phases ($p = 1, 2, 3$)
- (b) Predict the time of the next visible UV horizon. (Horizon sensing orbit navigation mode)
- (c) Predict time(s) of first visibility of ground beacons (ground beacon orbit navigation mode).

A search mode is initiated by setting the switch s_{search} to "1". This is done for all non-entry phases upon the first entry into the UNF, and is again set to "1" when a ground beacon search is to be reinitiated, or the time of the next visible UV horizon pass is to be predicted (e. g., at the end of the current UV horizon pass).

The logic at the top of Figure 5-4 determines which of the search functions (a, b or c above) is appropriate. Search function (a) is selected for rendezvous phases, and upon receipt of good sensor data, the rendezvous sensor(s) and measurement time t_M are read (at entry 36 page 5-21) n_M is set to the number of measurement parameters, measurement identification codes (c_1) are appropriately set, and the flow cycles back to 1 where states and W-matrix are extrapolated to time t_M in preparation for measurement incorporation.

Search function (c) is selected for the ground beacon orbit navigation phase ($p = 0$, $s_{\text{beacon}} = 1$). Ground beacon prediction is initiated at entry ∇_{12} (page 5-8), and will be discussed in Section 4.2.2.

4.2.1 Horizon Sensing Orbit Navigation

Figures 5-4 and 5-5 present flow diagrams for visible UV horizon prediction (search function (b)), horizon sensor pointing equations (to provide inputs to attitude control system), and horizon sensor read. If s_{search} has been set to "1" (as described above), the primary vehicle state and time tag, the sun position vector ($\underline{r}_{\text{sun}}$), and the desired horizon azimuth (preloaded value of ϕ) are used in a UV Horizon Prediction Routine (TBD) to predict the time t_{UV} when the next visible UV horizon will occur. A time interval is allowed to pass (if t_{UV} is greater than current time plus one minute) until current time is one minute prior to t_{UV} . (s_{search} is set to zero to bypass horizon prediction on the subsequent cycles, s_{att} is set to one to prepare for horizon sensor pointing, and s_{strt} is set to one to indicate the start of a visible UV horizon pass). The permanent vehicle state vector is then extrapolated to time t_{UV} (by setting $t_M = t_{\text{UV}}$ and $s_{\text{perm}} = 1$) by cycling back to entry ∇_{1} . This search mode is recycled prior to each visible UV horizon pass (i. e., once every rev).

After the horizon search mode is completed, the following sequence is repeated for each navigation measurement:

- (1) Precision extrapolate primary vehicle state to the predicted measurement time t_M
- (2) Compute estimated horizon direction vector and call attitude control system to point horizon sensor in that direction
- (3) If data good, read horizon sensor output and measurement time t_M
- (4) Precision extrapolate primary vehicle state and W-matrix to time t_M in preparation for measurement incorporation

(2) in this sequence is specified by setting the switch s_{att} to "1". (4) is specified by setting s_{att} to "0". With the search completed ($s_{\text{search}} = 0$) and $s_{\text{att}} = 1$, the flow in Figure 5-4 branches to the Horizon Direction Routine which is presented in Figure 5-20. The inputs required by this routine are: $\underline{\phi}$, the unit vector in the vehicle local horizontal plane directed toward the pre-scheduled horizon azimuth given by ϕ ; \underline{i}_2 , the unit vector normal to the horizon measurement plane (defined by $\underline{\phi}$ and vehicle position vector); \underline{x}_0 , primary vehicle position vector. The principal output is the vector from the primary vehicle to the horizon ($\underline{\rho}_H$). The angle ξ (elevation angle to horizon) is also supplied if needed by the attitude control system to point the sensor.

The equations shown in Figure 5-20 for computing the direction of the horizon are derived in Ref. 10 and will be described briefly here. Assuming that the horizon is at a constant altitude above the earth's surface, the intersection of the measurement plane with the horizon is approximately an ellipse. (The exception to this is when the measurement plane coincides with the earth's equatorial plane ($|\underline{\epsilon}|$ of Figure 5-20) and the intersection becomes approximately a circle. For this special case the flow branches as shown in the figure and the distance to the horizon (ρ_H) along with \underline{o}_H are computed quite simply as indicated.) The orientation of this horizon ellipse is defined in terms of three mutually orthogonal unit vectors: \underline{i}_2 , which is normal to the ellipse, \underline{i}_x and \underline{i}_y defined as shown in Figure 4-1. Referring to Figure 4-1, it is clear that \underline{i}_x and \underline{i}_y coincide with the semi-major and semi-minor axes of the horizon ellipse, respectively. The plane containing the horizon ellipse is inclined with respect to the earth's equatorial plane by an angle whose sine is $(\underline{i}_y \cdot \underline{i}_{\text{pole}})$.

The shape of the horizon ellipse is determined by the lengths of its major and minor axes. Assuming the contour of the earth to be well-approximated by the so-called Fischer ellipsoid, the semimajor axis of the horizon ellipse (a_H) is simply the sum of the semimajor axis of this ellipsoid and the constant horizon altitude (γ_H). Likewise, the semiminor axis (b_H) is found by adding the horizon altitude to that value of the radius of the Fischer ellipsoid which corresponds to a latitude equal to the inclination angle.

The problem of determining the horizon location is readily solved in the horizon coordinate system for which the x and y axes coincide with the directions \underline{i}_x and \underline{i}_y , respectively, as illustrated in Figure 4-2. The matrix M_{R-H} will serve to transform vectors from the reference coordinate system to the horizon system.

The two possible horizon locations are obtained by solving simultaneously the equation of the horizon ellipse

$$\frac{x^2}{a_H^2} + \frac{y^2}{b_H^2} = 1$$

and the equation of the line tangent to the ellipse and passing through the point (x_H, y_H)

$$\frac{xx_H}{a_H^2} + \frac{yy_H}{b_H^2} = 1$$

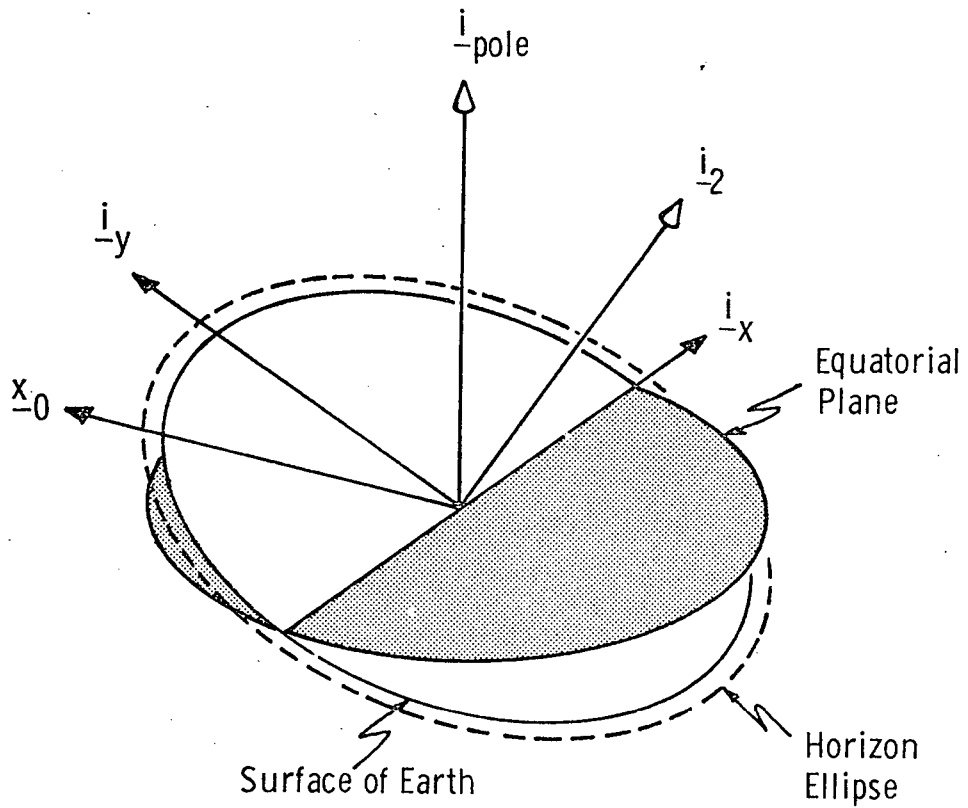

Figure 4-1. Horizon Coordinate System

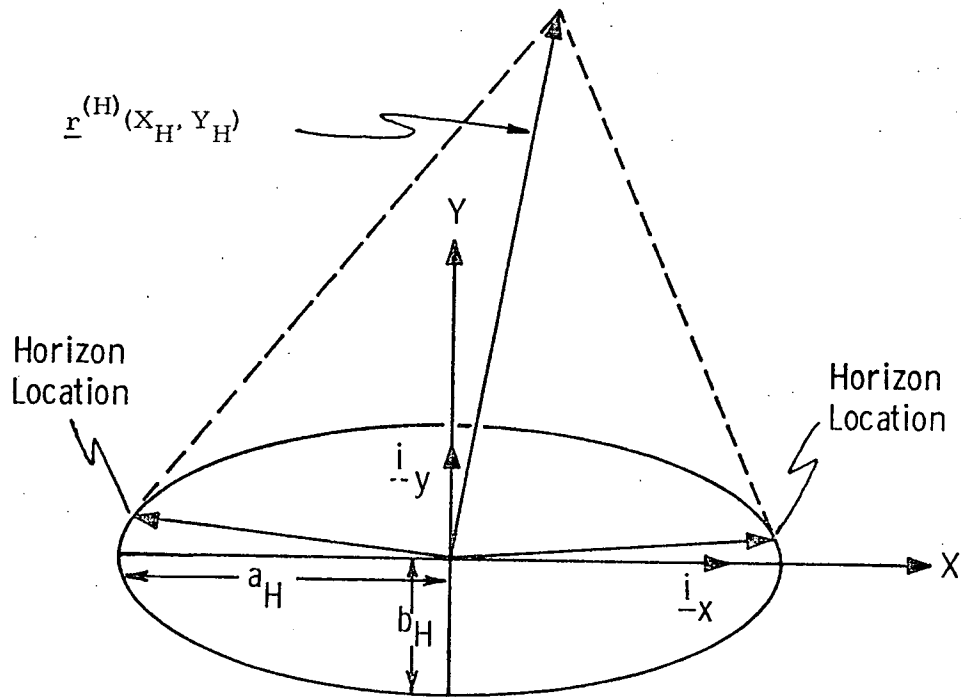
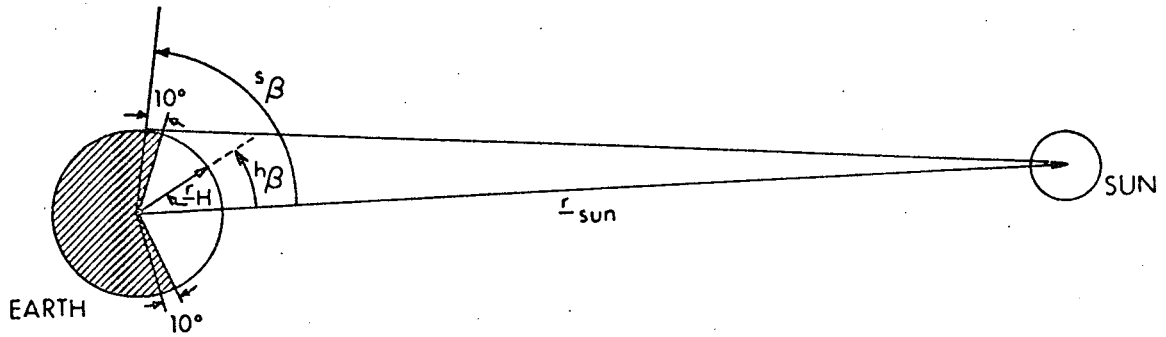

Figure 4-2. Geometry of Horizon Measurement

The horizon elevation angle (ξ) is used to select the desired solution for the horizon location position vector in horizon plane coordinates ($\underline{r}_H^{(H)}$). Of the two solutions, the one in the direction of ϕ (i. e., $\xi < \pi/2$) is the desired horizon location. The vector from the primary vehicle to the horizon is then obtained by subtracting the vehicle position vector (\underline{r}^H) from $\underline{r}_H^{(H)}$, and transforming the result from horizon coordinates to reference coordinates to achieve the desired output.

It should be noted that the equations used in the Horizon Direction Routine make the assumption that the horizon measurement plane passes through the earth's center, or equivalently, the horizon sensor "scan axis" is normal to the vehicle position vector (vertical scan). This assumption will not cause significant errors for scan axis deviations from vertical that are less than approximately one degree. However, if it becomes desirable (or necessary in order to save attitude maneuvers or utilize more than one sensor simultaneously) to utilize a non-vertical scan, equations only slightly more complicated than those described above will be required. (These equations have been developed for use in a CSDL environment model for shuttle orbit navigation simulations).

After computing the horizon direction vector, a check is made to see if this vector intersects an assumed visible UV horizon (continuing the flow in Figure 5-5). Referring to Figure 4-3, the visible UV horizon starts 10 degrees off the terminator. If the angle between the sun vector ($\underline{r}_{\text{sun}}$) and the estimated horizon location position vector (\underline{i}_{rH}), i. e., h_β , is within the visible UV horizon region ($h_\beta < s_\beta$), the attitude control system is called on to place the sensor boresight axis within the field of view of the horizon direction unit vector ($\underline{i}_{\rho H}$), and the scan axis normal to the estimated vehicle position vector (\underline{x}_0). (If $\underline{\rho}_H$ does not intersect the visible UV horizon, i. e., $h_\beta > s_\beta$, the signal flow joins the no data good path described below). When current time has reached computer time (t_{xP}), the horizon sensor data good signal is checked. If the data is good, the horizon sensor output is read (the angle between the sensor boresight and the sensed UV horizon) along with the measurement time t_M . n_M is set to 1, indicating a single measured parameter, C_0 is set to 3 indicating the angle measurement type (θ), s_{att} and s_{strt} are set to "0" and the flow cycles back to $\nabla 1$ for state and W-matrix extrapolation to time t_M . (Sequence (4) discussed above.) If no data good signal is received ($s_{\text{DG0}} = 0$), either of two options is exercised: (a) if a new visible UV horizon pass is forthcoming (indicated by $s_{\text{strt}} = 1$ which is set following the horizon search), the assumption is that the visible horizon has not been reached yet and the predicted measurement time t_M is incremented by 30 sec. The flow cycles back to entry $\nabla 3$ for a repeat of sequence (1) through (3); (b) if horizon sensing of a visible UV horizon has been in progress (indicated by $s_{\text{strt}} = 0$), the assumption is that the visible UV horizon has ended. Thus, the pre-stored horizon azimuth



Unshaded area of earth assumed to include visible
 UV horizons
 r_H = horizon location position vector

Figure 4-3. Visible UV Horizon Geometry

(ϕ) for the start of the next visible UV horizon pass is read, and a new horizon search will be initiated (by setting $s_{\text{search}} = 1$) after the state is extrapolated via entry $\nabla 3$. The extrapolation interval is set to 20 minutes which will allow sufficient time prior to the next visible UV horizon for the range of proposed shuttle orbital altitudes.

4.2.2 Ground Beacon Orbit Navigation

Figure 5-6 presents the flow diagram for ground beacon prediction. In a ground beacon orbit navigation system, a network of ground beacons (transponders) will be strategically located on the earth. The locations of these beacons, represented by position vectors in earth-fixed coordinates ($\underline{r}_{\text{tr},k}$), will be stored in a list ($k = 1, 4 \dots, 3n_B - 2$) in the on-board computer. The function of the ground beacon prediction routine is to (a) provide an estimate of the times ($t_{B,1}, t_{B,2} \dots, t_{B,g}$) that the shuttle will be in "viewing" range of the next ground beacon and all subsequent beacons within the current search interval ($1/2$ orbital period), and (b) specify, from the input list of beacon coordinates, the order in which these beacons come into view (using an identification code: $i_{DB,1}, i_{DB,2} \dots, i_{DB,g}$).

The basic approach embodied in the prediction scheme of Figure 5-6 is as follows:

Within a given search interval ($\tau/2$: $1/2$ of an orbital period), the shuttle state is extrapolated conically in 1 minute steps. At each step, all of the stored beacon locations are examined for visibility except: (a) those beacons already identified as visible in a previous 1 minute step within the search interval or (b) when a beacon passes the visibility criterion, none of the beacons following that one on the input list need be examined in a given 1 minute step. (A beacon is "visible" to the shuttle when the shuttle position vector lies within a cone about the beacon as illustrated in Figure 4-4). If no beacons are found visible in a $\tau/2$ search interval, the shuttle state (\underline{x}_0) is precision extrapolated over the time interval $\tau/4$, at which point the search is reinitiated for the next $\tau/2$ search interval. If a visible beacon (or beacons) has been found within a $\tau/2$ search interval, the search is terminated provided no beacon is visible within 15 minutes of the last predicted visible beacon (in order to assure a beacon overlapping (or closely spaced) to the last one is not overlooked when a new search is initiated.) Figure 4-5 illustrates the search sequence discussed above. Conic extrapolation of the shuttle state is utilized during a $\tau/2$ search interval in order to save computer time. This "conic search" interval is constrained to be half of an orbital period, with search reinitiation occurring a quarter of a period from the previous search initiation (after precision advancing the shuttle state) in order to minimize the error resulting from the conic extrapolation.

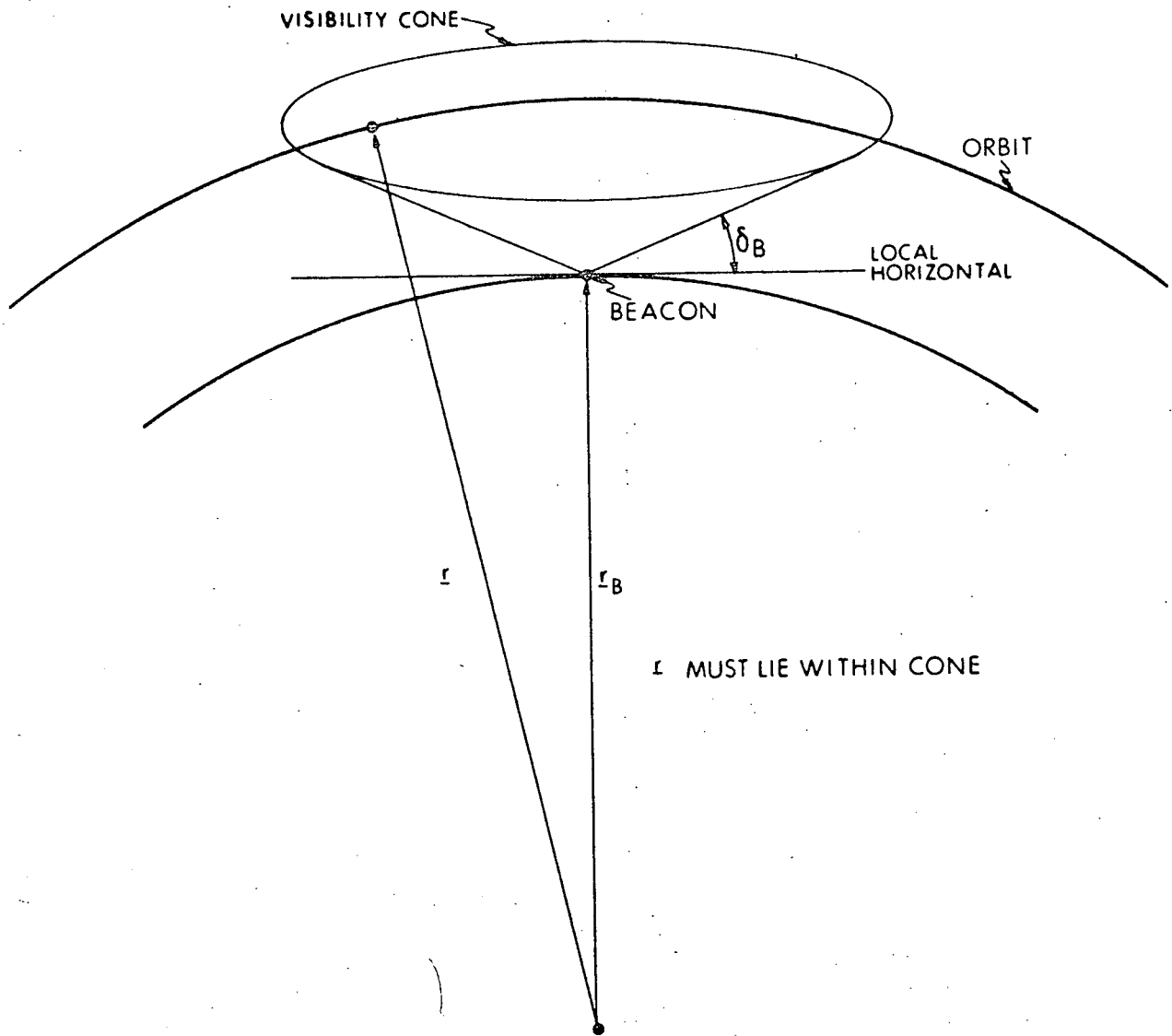
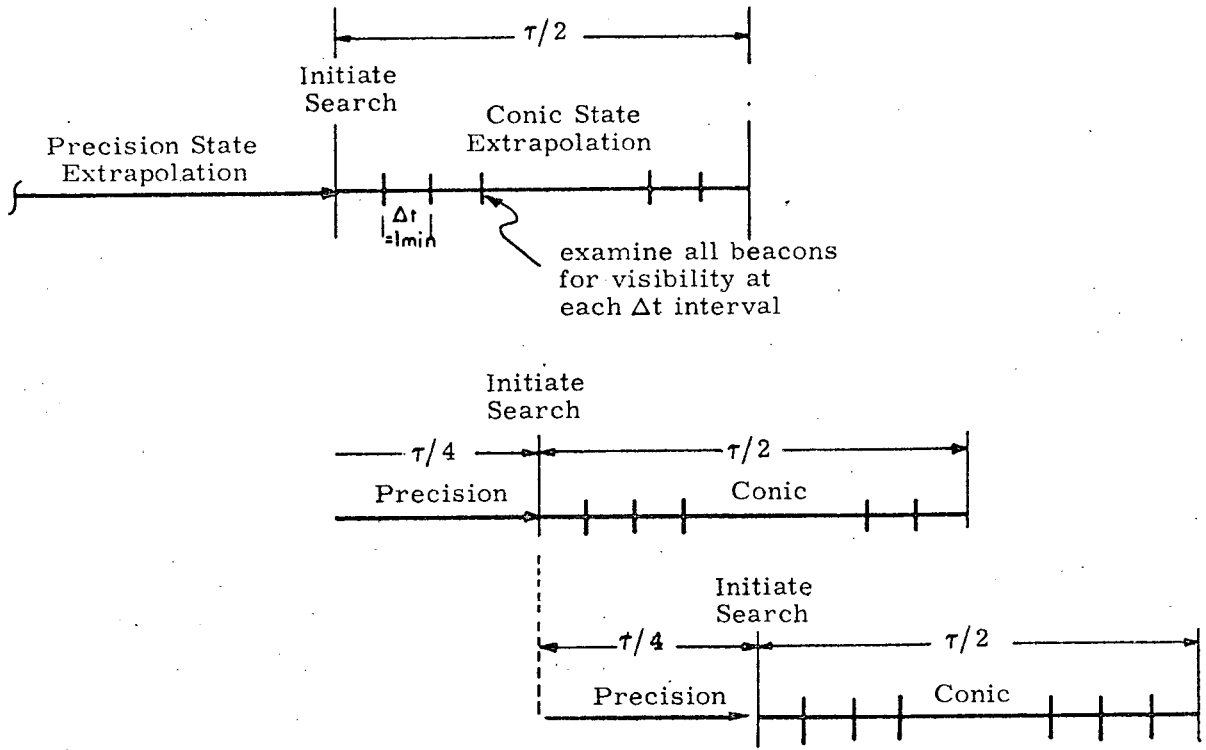
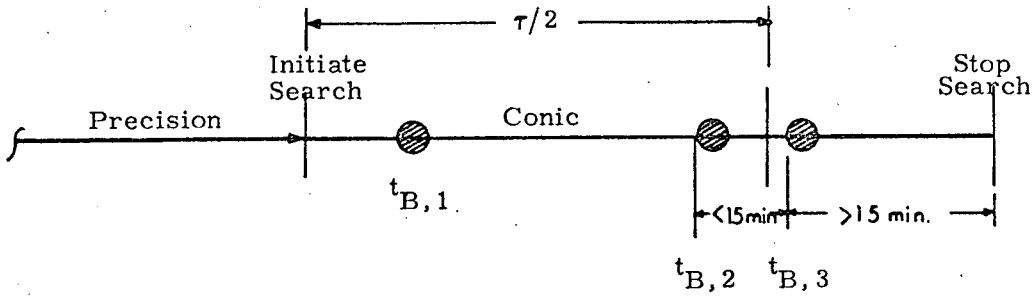

Figure 4-4. Beacon Visibility Constraint



(a) No visible beacons found in $\tau/2$ search interval



(b) Beacon(s) found in $\tau/2$ search interval

Figure 4-5. Ground Beacon Search Sequencing

Referring to Figure 5-6, there are three basic loops involved in this flow diagram:

(1) the outer loop which increments time (t_{con}) in 1 minute steps over the $\tau/2$ search interval (or further as discussed above and illustrated in Figure 4-5 (b)). The dummy state vectors (r_{con}, v_{con}) are returned in the Kepler Routine in order to preserve the precision state (x_0, x_3) at the start of the search. The transformation matrix (M_{EF-R}) from earth fixed to reference coordinates is required to transform the stored beacon coordinates (if analyses indicate the simple computation of M_{EF-R} shown is not accurate enough, a "Geodetic to Reference Coordinates Routine" (TBD) will replace this computation).

(2) The "j loop" which "picks" one beacon at a time from the pre-stored list of beacon coordinates ($r_{tr, 3j-2}$) to be checked for visibility at each value of t_{con} . If the jth beacon is visible, the time t_{con} is stored as $t_{B, g}$ (the predicted time of intercept of the gth beacon found visible in the given $\tau/2$ search interval), $i_{DB, g}$ is set equal to j and serves as the identifying code for the gth beacon, and t_B is set equal to t_{con} indicating the time of intercept of the most current beacon found in this search interval.

(3) The inner "k loop" which compares all possible beacon identification codes ($i_{DB, k}$) with the number j (indicating the jth beacon on the pre-stored list) and eliminates from the visibility check the jth beacon if it has already been identified.

As mentioned previously, the search is terminated when a $\tau/2$ search interval is completed with at least one beacon found visible and no visible beacon has been found within 15 minutes of the last predicted visible beacon. The program then cycles to entry  (Figure 5-7).

The first predicted visible beacon is then selected to be interrogated. The beacon coordinates are identified by $i_{DB, i}$ where i (set to "1" initially at the start of each search interval-Figure 5-6) indicates the number of beacons that have been selected from the total number (g-1) of predicted visible beacons (in the last search). The predicted time of intercept of the currently selected beacon (t_B) is set equal to $t_{B, i}$ and the current beacon coordinates (earth fixed) are designated r_{Bn} . (The current value of i is reserved using the dummy variable i_{res} since i is used elsewhere as an index.) When current time is at least 10 minutes prior to t_B , the currently selected ground beacon is interrogated and the return signal awaited. When the data good signal appears ($s_{DG0} = 1$), the navigation sensor output is read along with the associated time t_M , the measurement identification codes are set to indicate a range and range rate measurement and the number of mea-

asured parameters (n_M) is set to 2. The program then cycles back to entry ∇ for precision state and W-matrix extrapolation to time t_M . (Again, note that if a search has just been completed ($s_{\text{search}} = 1$), it is necessary to set s_{perm} to "1" so that the extrapolation variables will be initialized since a continuous extrapolation is not being performed—the temporary vehicle state ($\underline{x}_0, \underline{x}_3$) has been extrapolated during the search and the permanent state ($\underline{r}_P, \underline{v}_P$) must now be extrapolated).

Ground Beacon "No Data Good" Logic

The remainder of the flow diagram (Figure 5-7) contains the logic which determines which of the following options is selected following a "no data good" signal:

- Option (1): continue interrogating the same ground beacon every 30 sec.
- Option (2): select the next beacon from the list of visible beacons predicted in the previous search
- Option (3): start a new beacon search 1 minute from current time

In this logic, it is assumed that for the currently proposed shuttle missions and the maximum range constraint on the sensor (1500 n. mi.), the maximum time for the shuttle to traverse a beacon visibility cone is about 10 minutes.

Option (1) is selected under the following conditions:

- If current time t_C is less than the predicted time of intercepting the current beacon (t_B). The assumption is that the actual beacon visibility cone has not been reached yet or
- If there are no more visible beacons available from the previous search (or if another is available, it will not be encountered in less than another minute i. e. $t_C < t_{B, i+1} - 1$ minute), and $t_B < t_C < t_B + 10$ minutes. The assumption is the predicted t_B is inaccurate or the current beacon transponder is temporarily malfunctioning—thus keep interrogating it for the assumed maximum traverse time.

Option (2) is selected if there is another visible beacon available from the previous search ($i \neq g$) and:

- The previous beacon has been interrogated for the maximum traverse time, provided of course current time has not progressed to within 1 minute of the next predicted beacon intercept time ($t_{B, i+1}$), in which case option (2) will immediately be taken, only if
- Current time has not progressed past the predicted intercept time of the next beacon plus the maximum traverse time. This condition could be violated with overlapping beacon visibility cones, wherein the time consumed navigating over the previous beacon placed the shuttle out of the next beacon's visibility cone. In this case the index i (indicating the number of beacons selected in the current sequence) is incremented by two, and if there is yet another visible beacon available, option (2) is still selected.

Option (3) is selected when no more visible beacons are available from the previous search interval.

The ground beacon prediction scheme discussed in this section may not be the one ultimately coded when the final beacon network has been established. It does, however, represent a "brute force" approach which is not overly expensive in computer time. Typically, a half orbit search should take approximately 10-15 seconds assuming that a computer comparable to the Apollo Guidance computer is utilized.

4.2.3 Entry Phase Sensor Read Logic

As noted earlier in the discussion of Figure 5-1, after reading the accelerometer outputs, the entry phase navigation flow cycles to entry $\nabla 22$ (Figure 5-12) for extrapolation of the shuttle state to the accelerometer read time t_M . After computing orbital altitude (h), vehicle velocity with respect to air mass (\underline{v}_ρ), and the transformation matrix M_{EF-R} (as discussed earlier, if a more accurate computation of M_{EF-R} is required a "Geodetic to Reference Coordinates Routine will be written), the logic for determining which navigation measurements to process follows in Figures 5-12 through 5-16.

The navigation measurements considered here are drag, baro-altimeter altitude, range and azimuth from VOR/DME, and range, azimuth and two elevation angles from the MLS. Associated with each of these 8 measurement types, except the drag acceleration measurement which is derived from the accelerometer outputs (Δv_s), is a data good signal represented by the switches $s_{DG,i}$ ($i = 1, 2, \dots, 7$). The first possible measurement is drag acceleration which is not incorporated until the vehicle altitude (h) is less than a given threshold value (h_{INDR} , typically about 200,000 ft). Thus the accelerometers are read and the vehicle state extrapolated every Δt_a seconds without navigation updates until the altitude threshold is passed. (This threshold is then doubled to assure the h_{INDR} threshold is always passed thereafter despite a possible navigation update which might change the estimated altitude appreciably.)

Drag measurements (identified as such by setting $c_0 = 5$) are incorporated thereafter until the altitude threshold value (h_{FINDR} , typically about 100,000 ft) is reached. (The switch s_{xD} is then set to "1" and altitude thresholds are no longer checked.)

After the first altitude threshold (h_{INDR}) has been passed each of the other navigation measurement data good signals are checked. If any measurement passes data good ($s_{DG,i} = 1$), its corresponding sensor output is read, the measurement identifying code (c_i) is appropriately set, and the number of measurements to be incorporated (n_M) in a given time step is incremented by one. There are, however, additional constraints which must be met before incorporating baro-altimeter measurements: (a) vehicle altitude must be between h_{INBAR} and h_{FBAR} , and (b) vehicle velocity must not be in a specified region near Mach 1.0 as indicated by speed switch levels v_{RHI} and v_{RL0} . (Figure 5-13a).

Analyses have shown the desirability of reinitializing the filter weighting matrix (W-matrix) upon (1) first receipt of a VOR or DME measurement (whichever comes first), and (2) first receipt of an MLS measurement (whichever of the 4 possible types comes first). The "first pass" for a VOR or DME measurement is indicated by the switch s_{fpo} , and for MLS measurements, s_{fpl} . Provision is made for different W-matrix initializing values in these two cases by use of the factors k_0 and k_1 , respectively, which scale the W-matrix values used initially on entrance into the entry phase. After a "first pass" has been indicated the switch s_{fp} is set to "1" and specifies W-matrix initialization as shown in Figure 5-14.

Once an MLS measurement data good has been received, VOR/DME measurements are no longer accepted. Inhibiting VOR/DME under this condition is achieved by setting the switch s_{xTAC} to "1" as shown in Figures 5-13b and 5-13c.

Finally, if no "good" measurement data is available (indicated by $n_M = 0$), the accelerometer output is read after a time interval (Δt_a), and the cycle repeated. With one or more "good" measurements available, the flow cycles to Figure 5-14 where either W-matrix initialization is specified (by $s_{fp} = 1$ or $s_{init} = 1$) and performed at entry $\nabla 19$, or W-matrix extrapolation to time t_M is performed (discussed in Section 4.1) and the flow proceeds to entry $\nabla 27$.

4.3 W-matrix Initialization

Scheduling of W-matrix initializations for non-entry phases is contained in the flow diagram in Figures 5-8 and 5-9. (The relatively simple W-matrix initialization schedule for the entry phase was discussed in Section 4.2.3.) This section of the flow diagram ($\nabla 16$) is entered as shown at the top of Figure 5-8 after state and W-matrix extrapolation to the measurement time t_M associated with a navigation sensor read. If a particular navigation phase has been entered for the first time ($s_{init} = 1$), W-matrix initialization (entry $\nabla 19$) is specified immediately. Since no W-matrix reinitializations are required during automatic braking or station-keeping navigation phases ($p = 2$ and 3) after the initial entry into these phases, the remaining flow in Figures 5-8 to 5-9 is bypassed to entry $\nabla 27$. (This is also true of the rendezvous phase ($p = 1$), if analyses show W-matrix reinitializations are not required, indicated by $s_{rendW} = 0$.)

For the orbit navigation phase ($p = 0$), W-matrix reinitializations are specified to occur periodically after every n_τ orbital periods, (analyses to date indicate that recommended values for n_τ are: 1-1/2 periods for ground beacon orbit navigation (indicated by $n_{\tau GB}$) and 5 orbital periods (indicated by $n_{\tau HS}$) for horizon sensing orbit navigation). Thus, τ is first computed and Δt_W is compared with the product $n_\tau \tau$ to determine if W-matrix initialization (entry $\nabla 19$) is to be performed or bypassed (entry $\nabla 27$).

If W-matrix reinitializations are to be performed in the rendezvous navigation phase (indicated by $s_{rendW} = 1$), the flow branches to entry $\nabla 18$ where the logic for scheduling these reinitializations is contained (Figure 5-9). There are two basic branches in this logic indicated by the switch s_{TPI} : that for pre-TPI (Terminal Phase Initiation Maneuver) navigation, and post-TPI navigation. After the TPI maneuver is performed, s_{TPI} is set to one, and W-matrix initialization is performed prior to incorporation of the first navigation measurement following TPI and the first midcourse correction. Each of these W-matrix reinitializations is triggered by the switch s_{TPM} , which is set to "1" following execution of TPI and the first midcourse maneuver.

The approach underlying the pre-TPI W-matrix reinitialization logic shown in Figure 5-9 is as follows:

- A reinitialization is specified whenever the total time (Δt_W) that the current W-matrix has been extrapolated exceeds the stored threshold value t_W .
- The reinitialization will then be performed only if the following conditions are met:
 - (a) A sufficient time (t_{Wcrit}) exists prior to the final targeting computation time (estimated as a nominal pre-burn time interval (t_{bef}) prior to planned maneuver execution time (t_{ig})).
 - (b) A time interval (> 5 min) has not existed prior to the currently planned navigation update in which no navigation updates have been made. If this condition is not met, the specified W-matrix reinitialization is performed after 3 more navigation updates have been incorporated (controlled by the switch s_{count}).
- An upper limit (t_{maxW}) is placed on the total time the W-matrix may be extrapolated without a reinitialization. (The conditions (a) or (b) could preclude reinitializations for an excessive time). If this limit is exceeded, a reinitialization is immediately performed.

The threshold value t_W is selected so that reinitializations are specified more often than actually required (because of modeling errors), but the conditions (a) and (b) minimize any degrading effects from the slight transient in performance caused by a reinitialization. This is a conservative approach which guards against making navigation updates with a W-matrix which seriously misrepresents actual state errors, a condition which is difficult (if not impossible) to predict with any degree of accuracy, and which can produce highly deleterious effects on navigation performance.

W-matrix initialization is presented in the flow diagram in Figure 5-10 (and additionally in Figure 5-11 for the orbit navigation phase). For the phases other than orbit navigation, W-matrix initialization consists simply of zeroing the matrix components, and inserting a pre-stored position value in the three position components and a pre-stored velocity value in the three velocity components of the W-matrix diagonal, and bias values in the appropriate diagonal elements. This procedure is the same for the initial W-matrix ($s_{init} = 1$) as well as for subsequent reinitializations, with different pre-stored W-matrix values used in these two cases.

Two variations in this "standard" W-matrix initialization procedure are incorporated for the orbit navigation phase. The first involves pre-loading reduced values of crosstrack position and velocity components for incorporation into re-initialized W-matrices. (Once resolved, crosstrack errors experience only small secular growth and thus do not require W-matrix values as large as those used for in-plane errors). The reinitialization values are thus pre-loaded in local vertical coordinates (indicated by the switch s_{LVW} being set to "1" in Figure 5-8), and this "local vertical" diagonal matrix must be transformed to reference coordinates as shown in Figure 5-11.

The second variation involves inserting correlation into the initialized diagonal W-matrix. This variation was found to be particularly effective in reducing large state error growth rates experienced with diagonal W-matrix initializations in ground beacon navigation, where long periods exist (between beacon intercepts) with no navigation updates.

The technique used for producing a correlated W-matrix initialization (Ref. 11) is contained in the flow diagram in Figure 5-11. This technique takes advantage of the fact that orbital energy and angular momentum magnitude are known on board to a higher degree of accuracy than other orbital parameters (e. g. downrange position), and certainly more accurately than is implied by a diagonal W-matrix. This information is inserted into the W-matrix in a straight forward manner. Pseudo energy and momentum measurements (called pseudo since no actual measurement is made, indicated by setting the switch s_{Wcorr} to "1", and only the diagonal W-matrix is updated) are incorporated into the pre-loaded diagonal W-matrix using the standard measurement incorporation equations (via entry 31). Pre-loaded a-priori values of energy and momentum variances (α_E^2 , α_A^2) are utilized at the initiation of orbit navigation. At subsequent W-matrix reinitializations, smaller values for these variances are used since these uncertainties will be diminished after the initial navigation period. This is accomplished (Figure 5-11) by setting the variable η to "1" for the initial W-matrix initialization and to $k(\alpha^2)$ for subsequent initializations, to scale the initial measurement variance appropriately downward.

4.4 Bias Extrapolation

Figure 5-15 presents the flow diagram for advancement, to measurement time t_M , of the bias components of the navigated state and their associated partition of the W-matrix. If the sensor bias parameters to be estimated are modeled as invariant with time, this portion of the flow is bypassed by setting the input bias time tag t_γ to zero. If time variation is modeled, the $b \times b$ bias transition matrix Φ_B is computed to advance the bias state and bias partition (see Figure 1-2) of the W-matrix from the previous bias time t_γ to the current measurement time t_M . Since the ultimate sensor models have not been firmly established, the explicit computation of Φ_B is not shown; but the bias extrapolation equations utilizing Φ_B are given in Figure 5-15.

4.5 Measurement Incorporation

Figures 5-16 through 5-18b present the flow diagrams for incorporation of the current set of measurement data at time t_M into the navigated state and W-matrix. The first two figures (5-16 and 5-17) involve some preliminary computations, and Figures 5-18a and 5-18b present the equations for the actual navigation update.

4.5.1 Computation of Relative State and Sensor "Axes" (Figure 5-16)

As discussed in the introduction, navigation measurements for any of the mission phases fall into the category of "relative" measurements (range, range rate, angles (β, θ)) with two exceptions in the entry phase-altitude and drag measurements. (The equations of Figure 5-16 are bypassed for these two measurements, indicated by their measurement codes ($c_1 = 4$ and 5, respectively) being greater than 3.) For each relative measurement, a relative state is required for subsequent measurement incorporation equations. Thus, for each navigation phase, the appropriate relative state $(\underline{r}_\rho, \underline{v}_\rho)$ is computed, e.g. the rendezvous target or ground beacon state w. r. t. the primary vehicle state. In the horizon sensing mode, only the relative position of the horizon w. r. t. the primary vehicle is required (ρ_H) with no need for relative velocity. In the station-keeping phase ($p = 3$), the relative state is equivalent to the navigated vehicle state vector $(\underline{x}_0, \underline{x}_3)$, and thus requires only redefinition to $\underline{r}_\rho, \underline{v}_\rho$.

For any angle measurement ($1 < c_i < 4$), a basic set of sensor "axes" (unit vectors $\underline{i}_x, \underline{i}_y, \underline{i}_z$) is required for subsequent computations as discussed in the Introduction (see Figure 1-3). In a rendezvous phase ($p = 1, 2$ or 3), the sensor axes are the rows of the transformation matrix M_{R-M} from reference coordinates to sensor gimbal axes, which is computed using current IMU angles (yield orientation of inertial platform w. r. t. navigation base), and matrices describing orientation of inertial platform w. r. t. reference coordinates and orientation of navigation base w. r. t. sensor gimbal axes. Sensor axes for the other navigation phases are computed as defined in Figure 1-3.

Several additional details should be noted before leaving Figure 5-16. There are two different angle measurement types (azimuth and elevation) in MLS terminal navigation, which are modeled as a single measurement type (angle β in Figure 1-3 with measurement code $c_i = 2$). The sensor "axes" are defined appropriately to reflect the difference in these angles. To differentiate between the two angles, the azimuth angle code (c_i) is set at 20 after the navigation sensor read (Figure 5-13b), causing the switch s_{az} to be set to "1" (see $c_i > 10$ logic discussed in Figure 5-16). This switch setting then selects the proper equations for defining the sensor axes in the entry phase ($p = 4$) branch of the diagram. Also, the measurement code is divided by 10 to yield the proper code indicating a " β type" angle measurement.

Included in the ground beacon orbit navigation branch ($s_{beacon} = 1, p \neq 4$) is the logic for determining if crosstrack navigation updates should be inhibited. This criterion is based on studies which determined, as a function of altitude, the angle between the orbital plane ($\underline{\zeta}$ is a unit vector normal to the plane) and the beacon position vector (\underline{r}_B), below which degraded crosstrack navigation performance results if crosstrack updates are accepted. If crosstrack updates are to be inhibited, the switch s_{xt} is set to "1" and only the in-plane components of the vehicle state are updated for the current measurement (Figure 5-18a).

4.5.2 Computation of Measurement Geometry Vector $b(d \times 1)$, Measurement Residual (Δq), and Sensor Variance (α^2) (Figure 5-17)

Measurement incorporation into the navigated state (\underline{x}) and the W-matrix requires \underline{b} and α^2 for each measurement type. Also required for the state update is an estimate of the measurement (q') which, when subtracted from the actual i th measurement (q_i), yields the desired measurement residual (Δq). These parameters are computed as shown in Figure 5-17 for each of the six possible measurement types discussed in the Introduction.

The code c_i , which is set after each navigation sensor read to identify the i th measurement at the current measurement time t_M , determines the appropriate path for computing \underline{b} , q' and α^2 used to incorporate the i th measurement. Following these computations, the bias measurement geometry vector $(\frac{\underline{y}}{(b \times 1)})$ associated with the i th measurement is computed. For the horizon sensing mode, the horizon altitude uncertainty is assumed to be the bias estimated and its associated "b vector" is the scalar $(-1/r_\rho)$ as shown. The biases estimated in the other navigation phases have not been firmly established as yet and this computation is therefore represented by the defining relation for the bias "b vector". The intermediate variable \underline{y} is then converted to appropriate components of the general $d \times 1$ measurement geometry vector (\underline{b}) . The previously computed measurement estimate (q') is then corrected to include the effect of the extrapolated measurement bias estimate $(\frac{\underline{x}_6}{(b \times 1)})$, from which the desired measurement residual (Δq) is then computed.

Several items in Figure 5-17 should be noted. The expressions used for the angle measurement estimates (q' for $c_i = 2$ or 3) were formulated as shown to avoid computational inaccuracies associated with dot products of vectors separated by an angle close to zero degrees. Also included in the angle measurement branch is logic to avoid the sign ambiguity between the actual measured angle (q_i) and the estimated angle (q') near angles of 180 degrees.

In the drag measurement branch ($c_i = 5$), certain quantities have a bar over them ($\bar{\rho}$, $\bar{\beta}_c$, \bar{v}_ρ) which is used to indicate average values over the time interval $t_M - \Delta t_a$ to t_M . Also, the computation of the actual drag measurement (q_i) is included, which unlike the other measurement types, is not directly available from a navigation sensor read but must be computed from the accelerometer output ($\Delta \underline{v}_s$) as shown.

4.5.3 Incorporation of Measurement in the State and W-matrix (Figures 5-18a and 5-18b)

These equations are written to accommodate any state (and W-matrix) dimension (d), which is a function of the number of biases included in the navigated state of a given phase, and depends on whether the target state is included in the navigated state (indicated by s_T). After computing the weighting vector ($\underline{\omega}$), the primary vehicle crosstrack components of $\underline{\omega}$ are deleted, if required, as indicated by $s_{xT} = 1$ (discussed in Section 4.5.1), and the navigation update $(\frac{\Delta \underline{x}}{(d \times 1)})$ is computed. Provision is made for a "mark reject" procedure (TBD) which will check the "acceptability" of the i th measurement update ($\Delta \underline{x}$). If unacceptable, the flow cycles to entry  for incorporation of the next measurement (if available) at the current measurement time t_M .

If $\Delta \underline{x}$ is acceptable, the flow continues to entry $\nabla 32$ in Figure 5-18b. The sign of $\Delta \underline{x}$ is reversed in the station-keeping phase ($p = 3$) because of the standard definition used for the relative state (target vehicle—primary vehicle), coupled with the fact that this relative state is updated directly in this phase as opposed to updating the primary vehicle state in the other phases). Variables required for W-matrix reinitialization in the rendezvous phase (if $s_{\text{rendW}} = 1$) are then updated prior to applying the navigation update ($\Delta \underline{x}$) to the current state estimate (\underline{x}).

Permanent state variables ($\underline{r}_P, \underline{v}_P, t_P, \underline{y}_B$ and $\underline{r}_T, \underline{v}_T$ if included in \underline{x}) are updated by setting them equal to the temporary state (\underline{x}). The variables ($\delta_P, \nu_P, \delta_T, \nu_T$) are also updated (if their associated state has been updated) for those phases using the Precision Extrapolation Routine ($p = 0, 1$ or 2), and the relative state in local vertical coordinates ($\underline{r}_L, \underline{v}_L$) is updated for the station-keeping phase. Finally, the $d \times d$ W-matrix is updated as shown to reflect incorporation of the i th measurement.

4.6 Program Recycling or Termination (Figure 5-19)

The logic shown in Figure 5-19 determines which of the following options is to be selected following incorporation of the i th measurement at time t_M :

- (a) Incorporate the $i + 1$ th measurement at time t_M .
If the running count (indicated by $i+1$) of the number of measurements incorporated is not equal to the total number of measurements (n_M) available at time t_M , the next available measurement is incorporated via entry $\nabla 29$.
- (b) Exit the UNF to the program sequencer. If all measurements at time t_M have been incorporated and the current time t_C exceeds any stored event times, or one of the cues announcing entrance into a new phase is received (examples of cues given in Figures 1-4a and 1-4b), the UNF program is exited to a main "program sequencer" which then selects the appropriate function to be performed.
- (c) Cycle back to the start of the UNF (entry $\nabla 1$) program to prepare for incorporation of navigation measurements at the next time t_M .

(c) Cont'd.

The entry phase ($p = 4$) waits until current time t_C equals the previous measurement time t_M plus an increment Δt_a , increments the W-matrix extrapolation cycle counter $n_{\Delta t}$, and cycles to entry $\nabla 1$.

The horizon sensing mode reads the next scheduled horizon azimuth (ϕ), increments t_M by Δt_M , and proceeds to $\nabla 1$ for an attitude maneuver check (indicated by setting $s_{att} = 1$) prior to the next sensor read.

After waiting until current time equals the next planned measurement time ($t_M + \Delta t_M$), the ground beacon orbit navigation mode cycles back to entry $\nabla 15$ to check sensor data good, and the rendezvous phases ($p = 1, 2, 3$) read the navigation sensor before cycling to entry $\nabla 1$.

5. DETAILED FLOW DIAGRAMS

This section contains the UNF detailed flow diagrams which are discussed in detail in Section 4.

Each input and output variable in the subroutine call statements can be followed by a symbol in brackets. This symbol identifies the notation of the corresponding variable in the detailed description and flow diagrams of the called routine. When identical notation is used, the bracketed symbol is omitted.

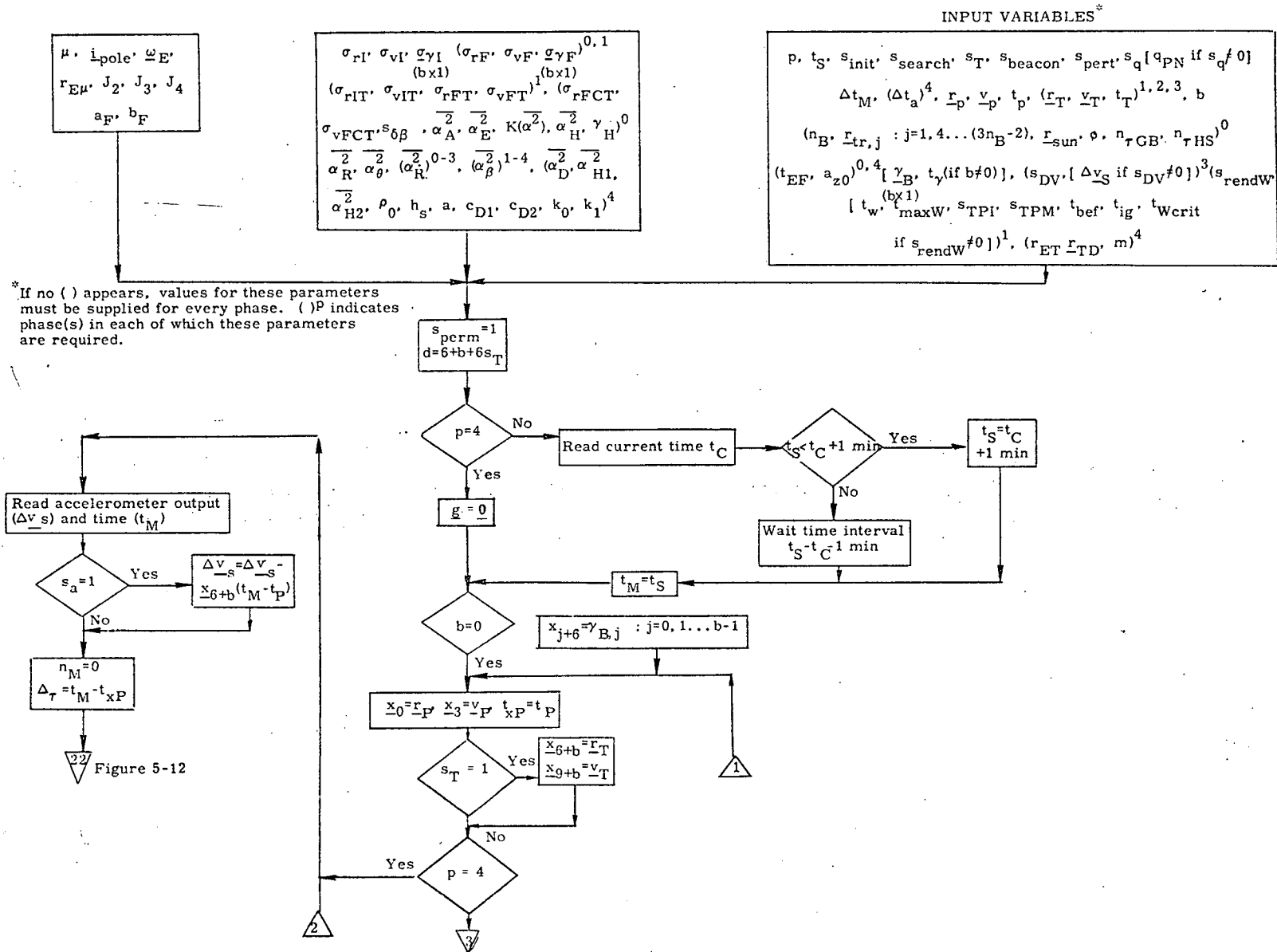

Figure 5-1. Detailed Flow Diagram, UNF Initialization

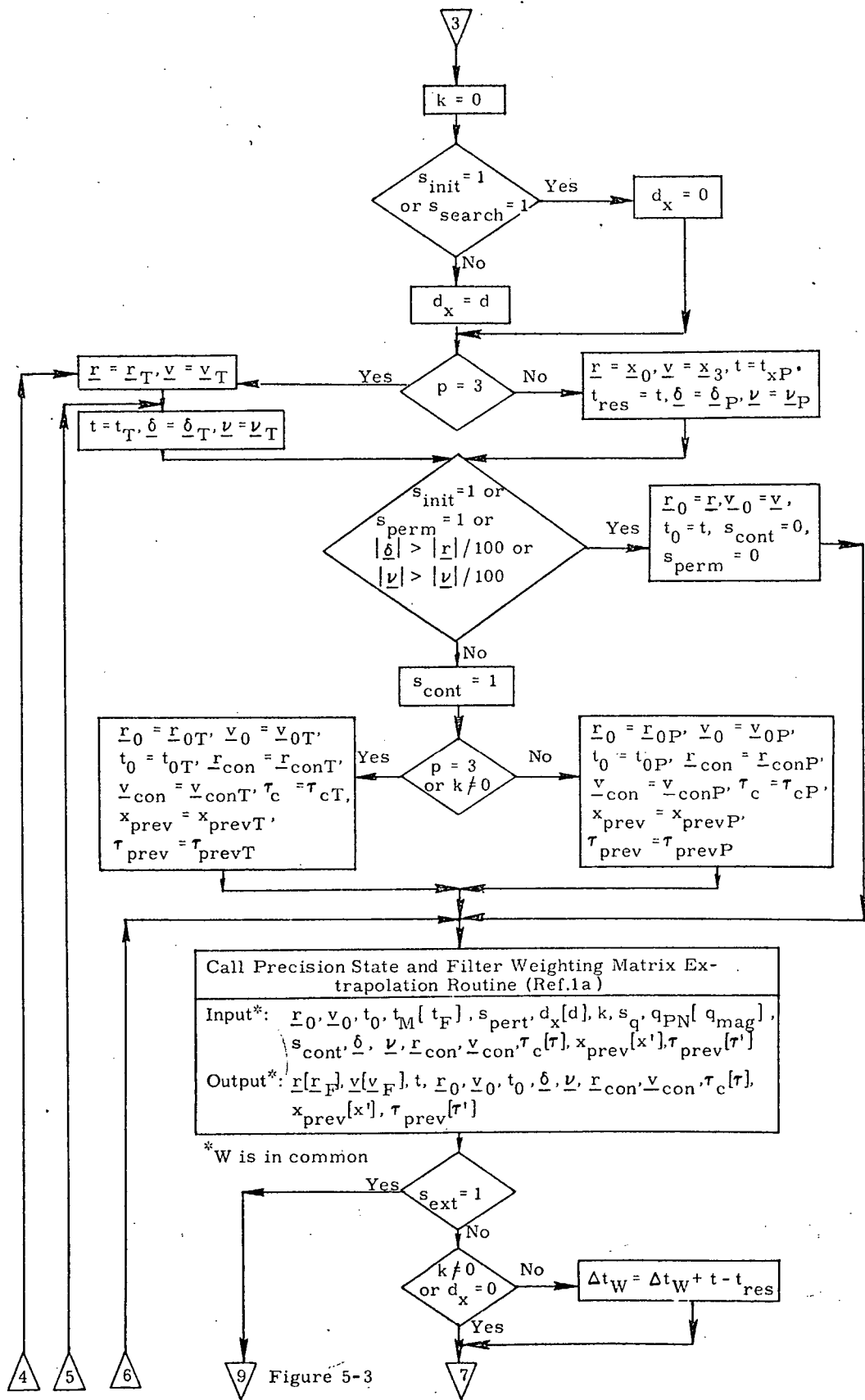

Figure 5-2a. Detailed Flow Diagram, Precision State and Filter Weighting Matrix Extrapolation

Figure 5-2a

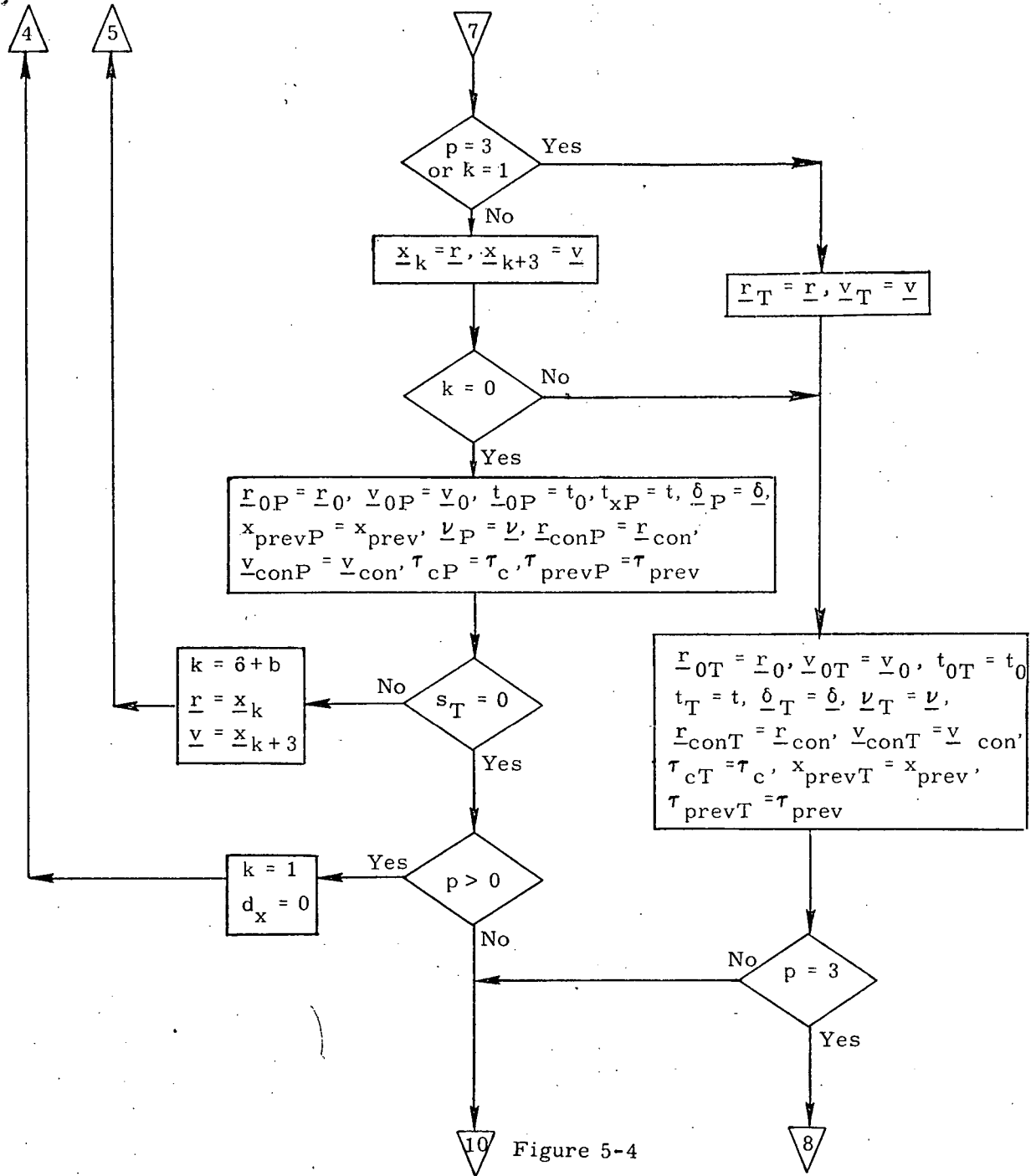

Figure 5-2b. Detailed Flow Diagram, Precision State and Filter Weighting Matrix Extrapolation

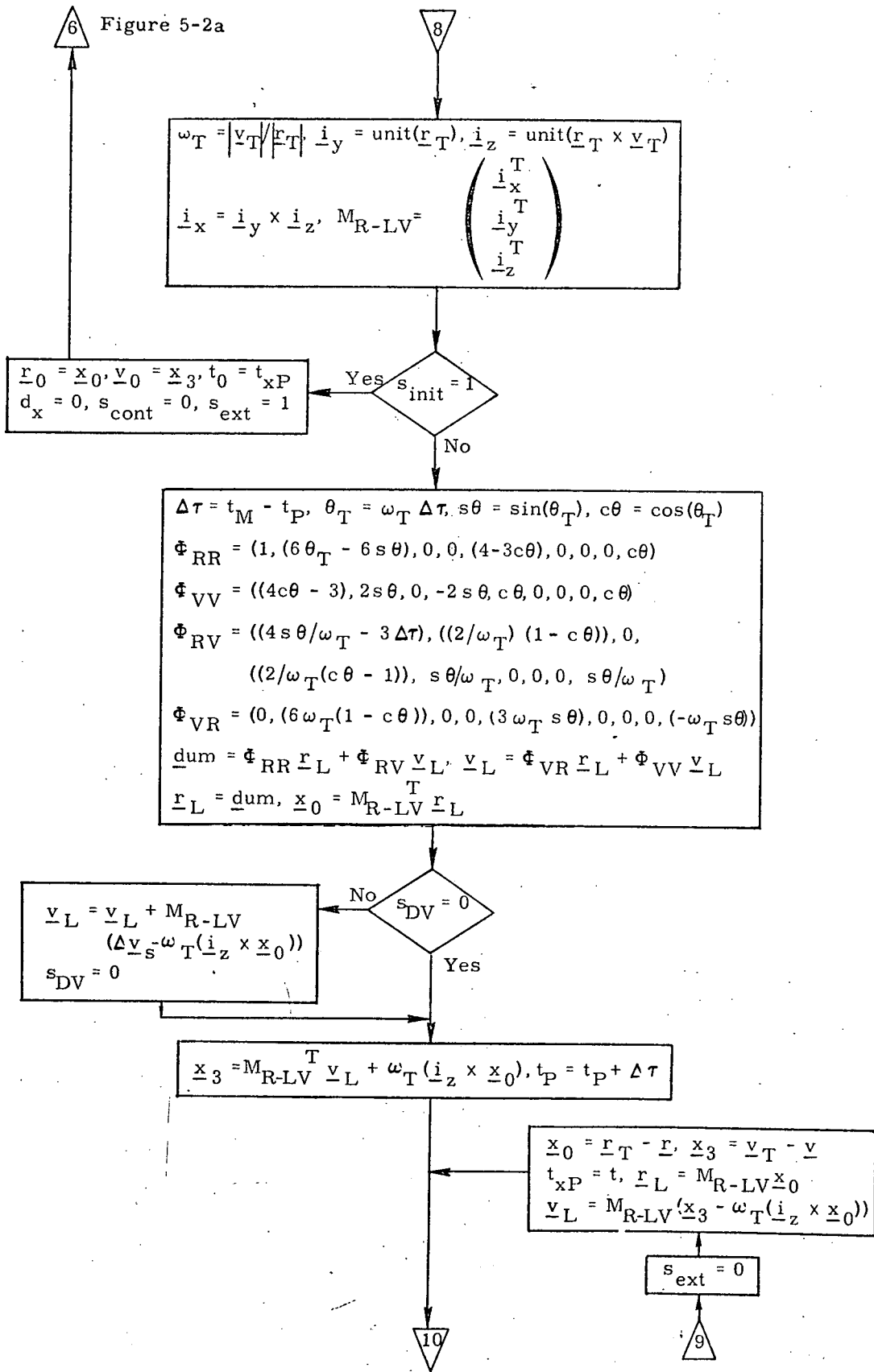

Figure 5-3. Detailed Flow Diagram, Relative State Extrapolation (Station-Keeping Phase).

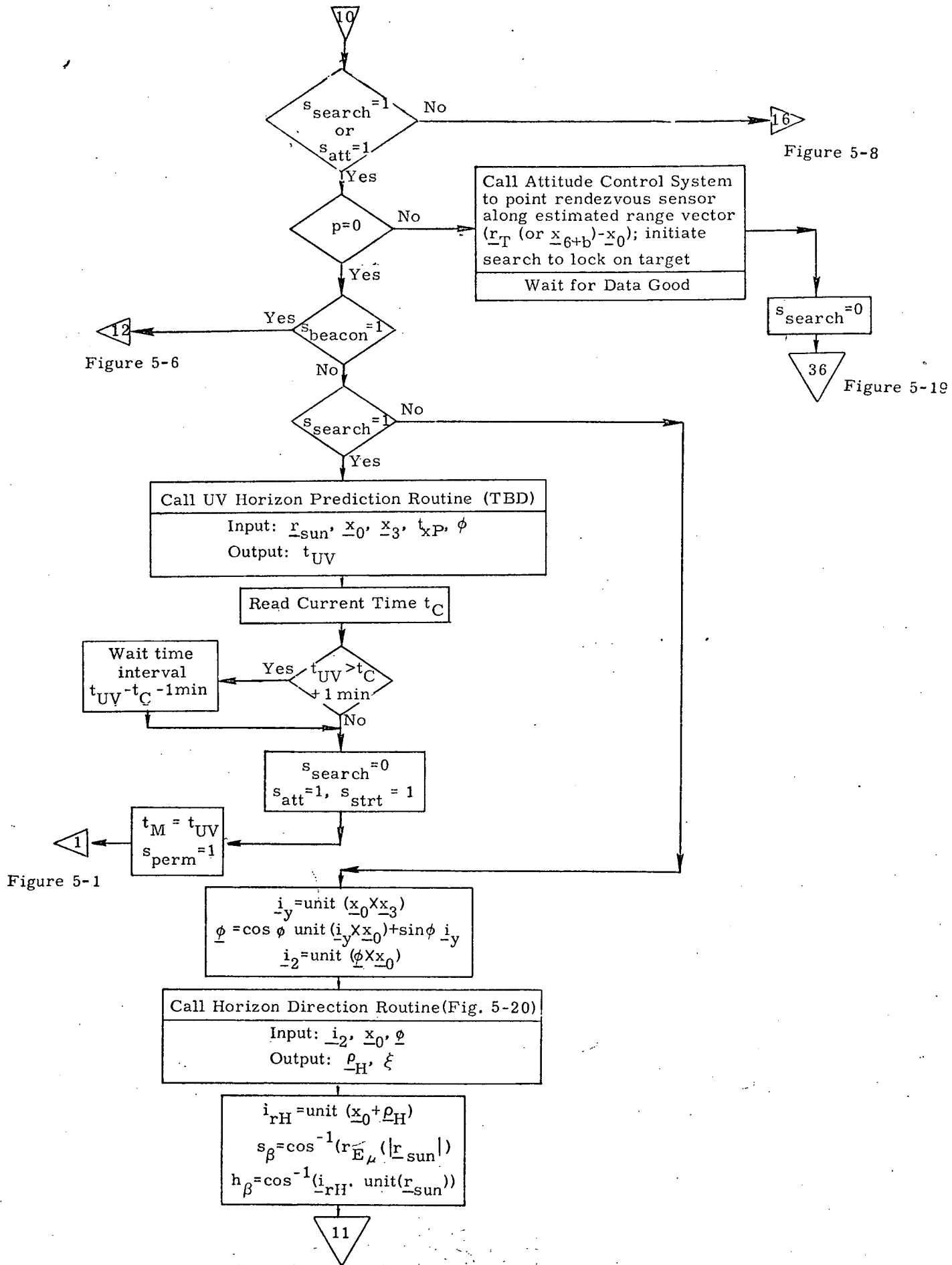

Figure 5-4. Detailed Flow Diagram, Search Mode Selection, UV Horizon Prediction

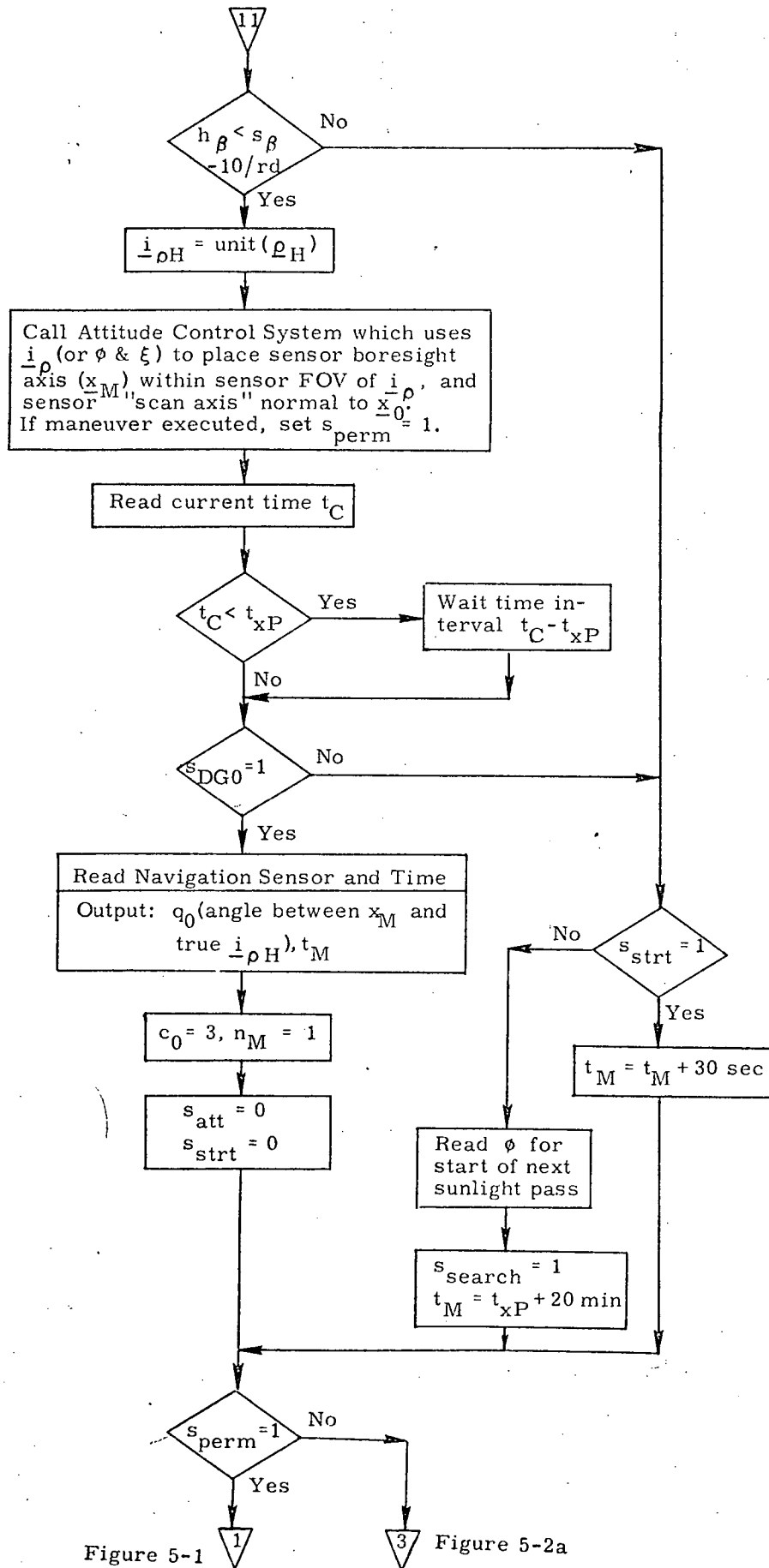

Figure 5-5. Detailed Flow Diagram, Horizon Sensor Pointing and Read

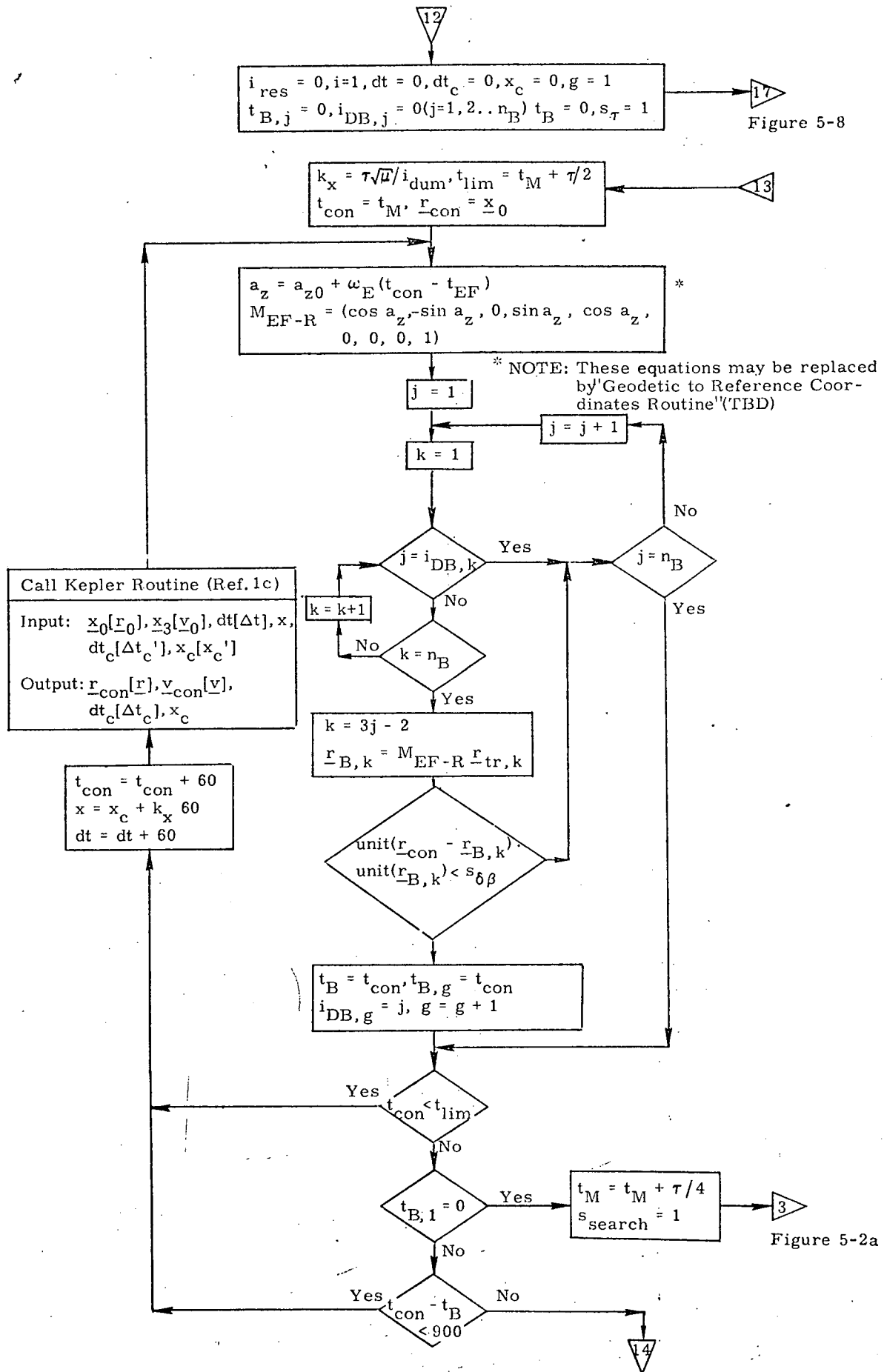

Figure 5-6. Detailed Flow Diagram, Ground Beacon Prediction (Orbit Navigation)

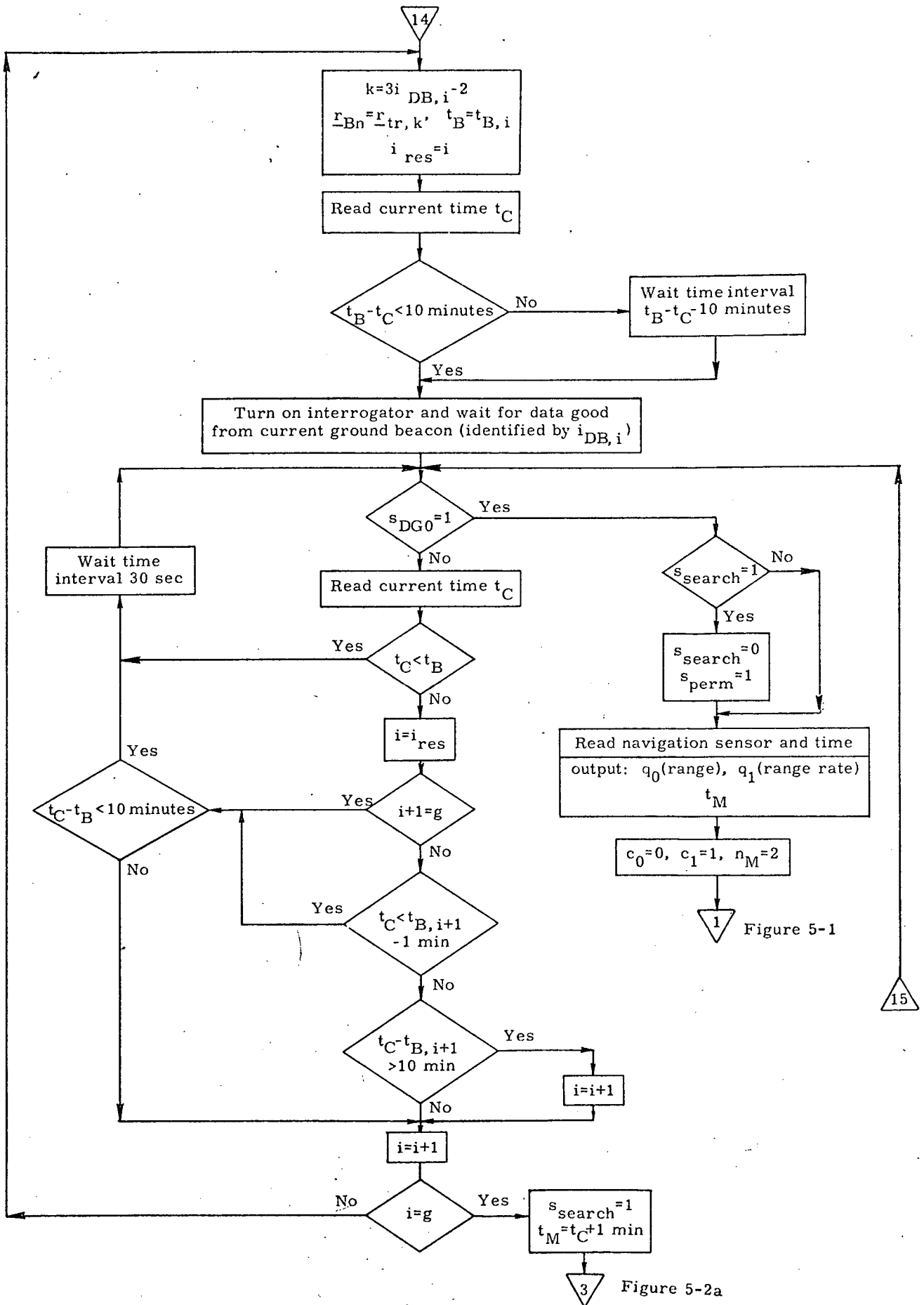

Figure 5-7. Detailed Flow Diagram, Ground Beacon Selection, Sensor Read, "No Data Good" Logic (Orbit Navigation)

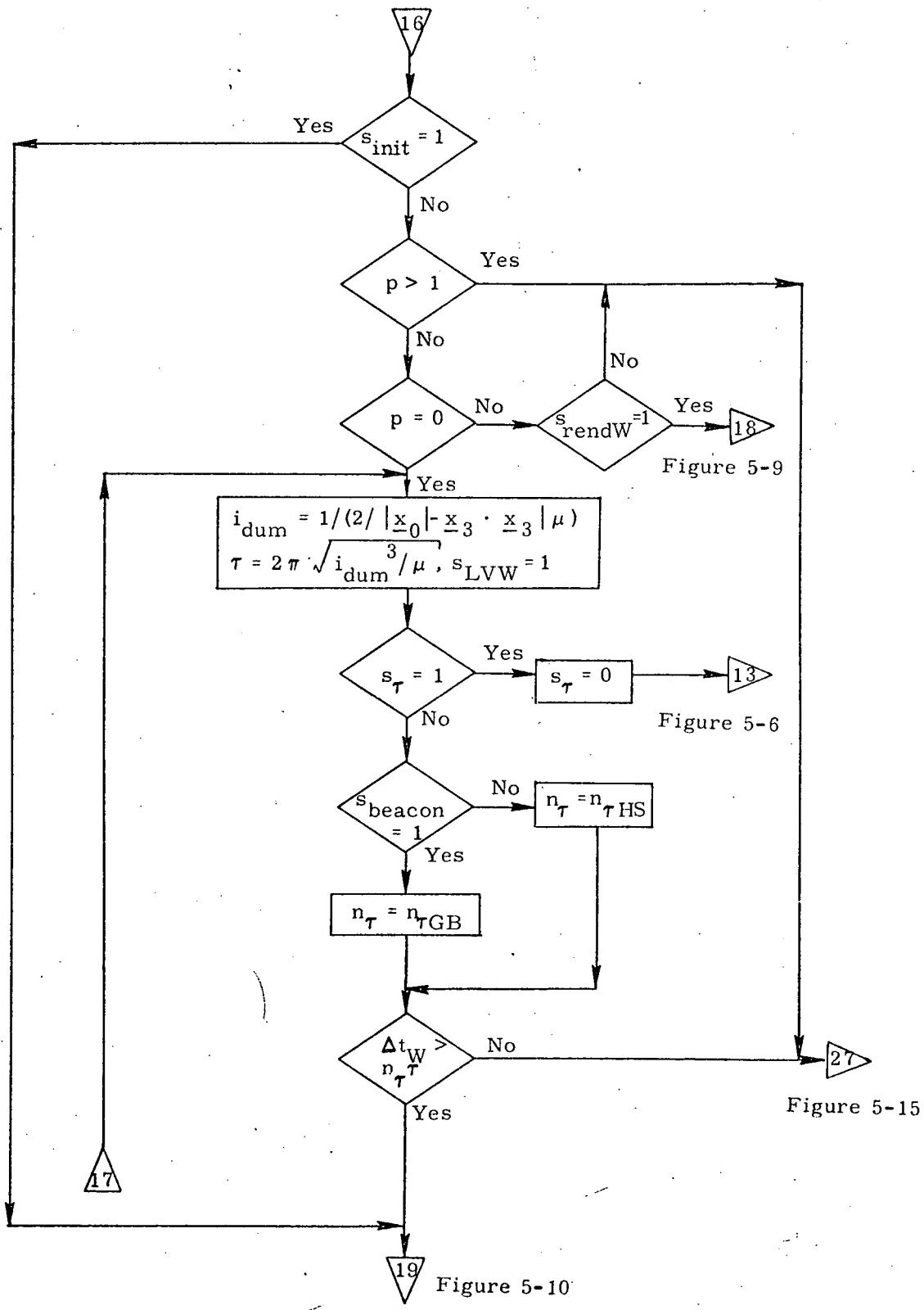

Figure 5-8. Detailed Flow Diagram, W-Matrix Initialization Scheduling (Orbit Navigation)

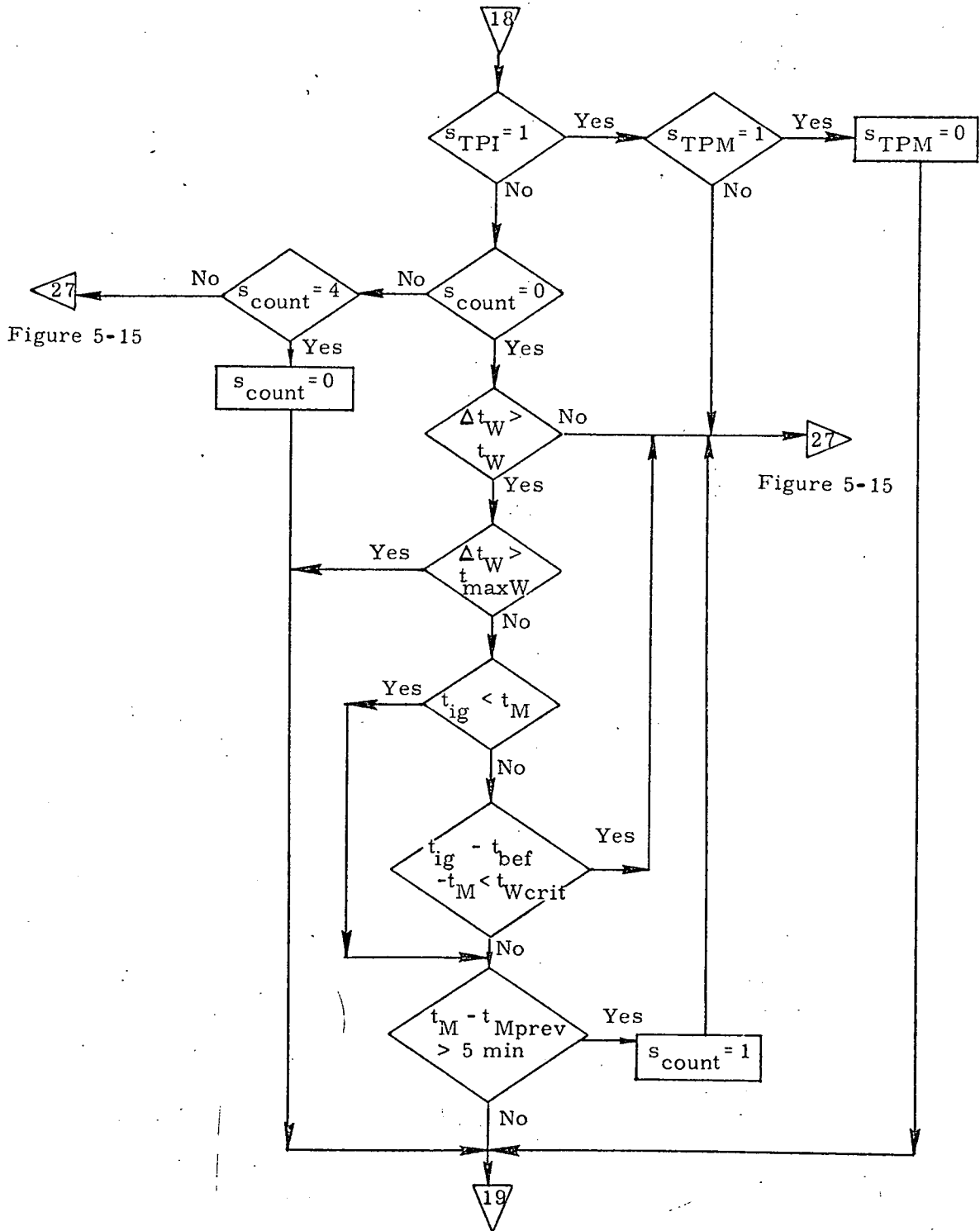

Figure 5-9. Detailed Flow Diagram, W-Matrix Initialization Scheduling (Rendezvous Navigation)

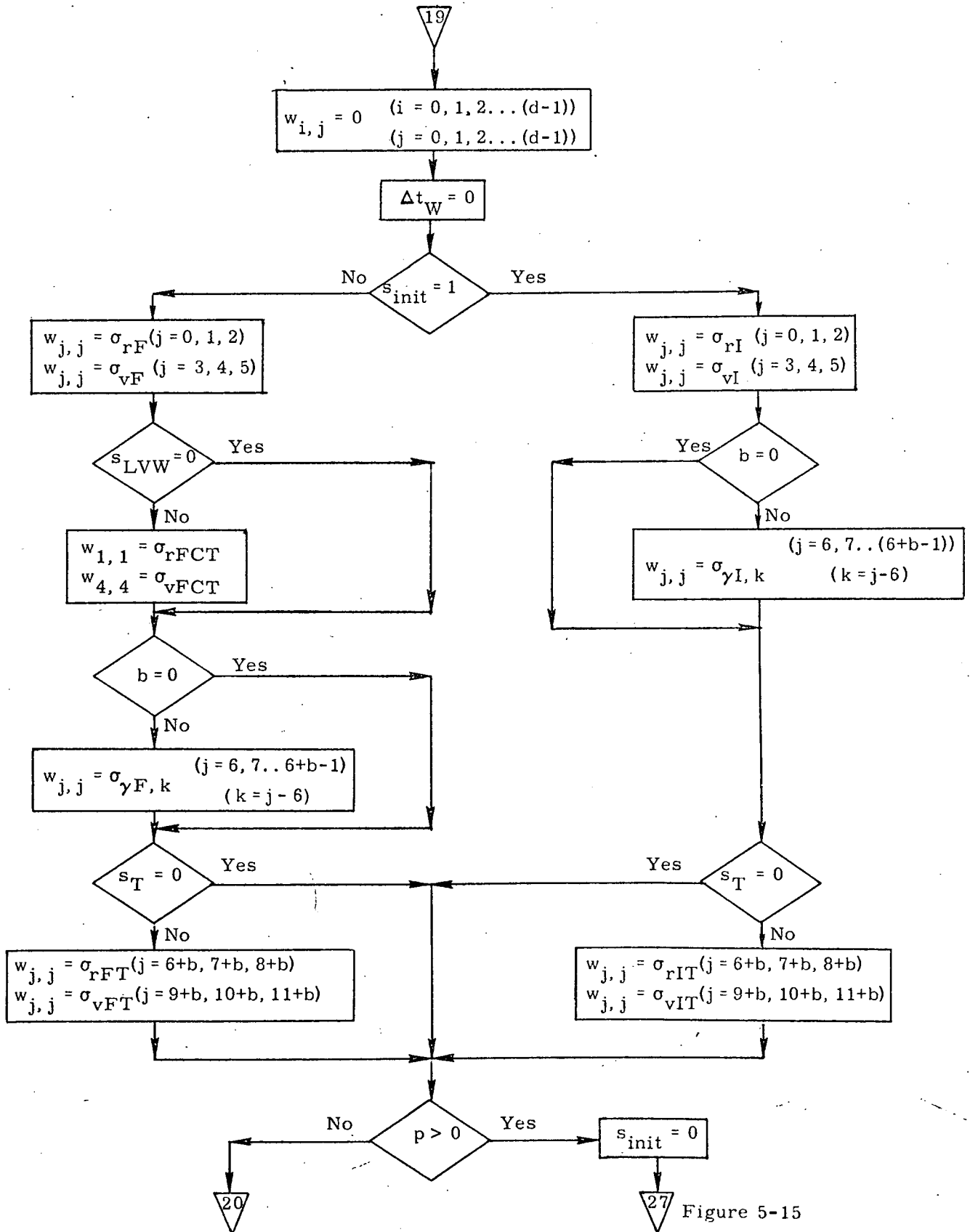

Figure 5-10. Detailed Flow Diagram, W-Matrix Initialization

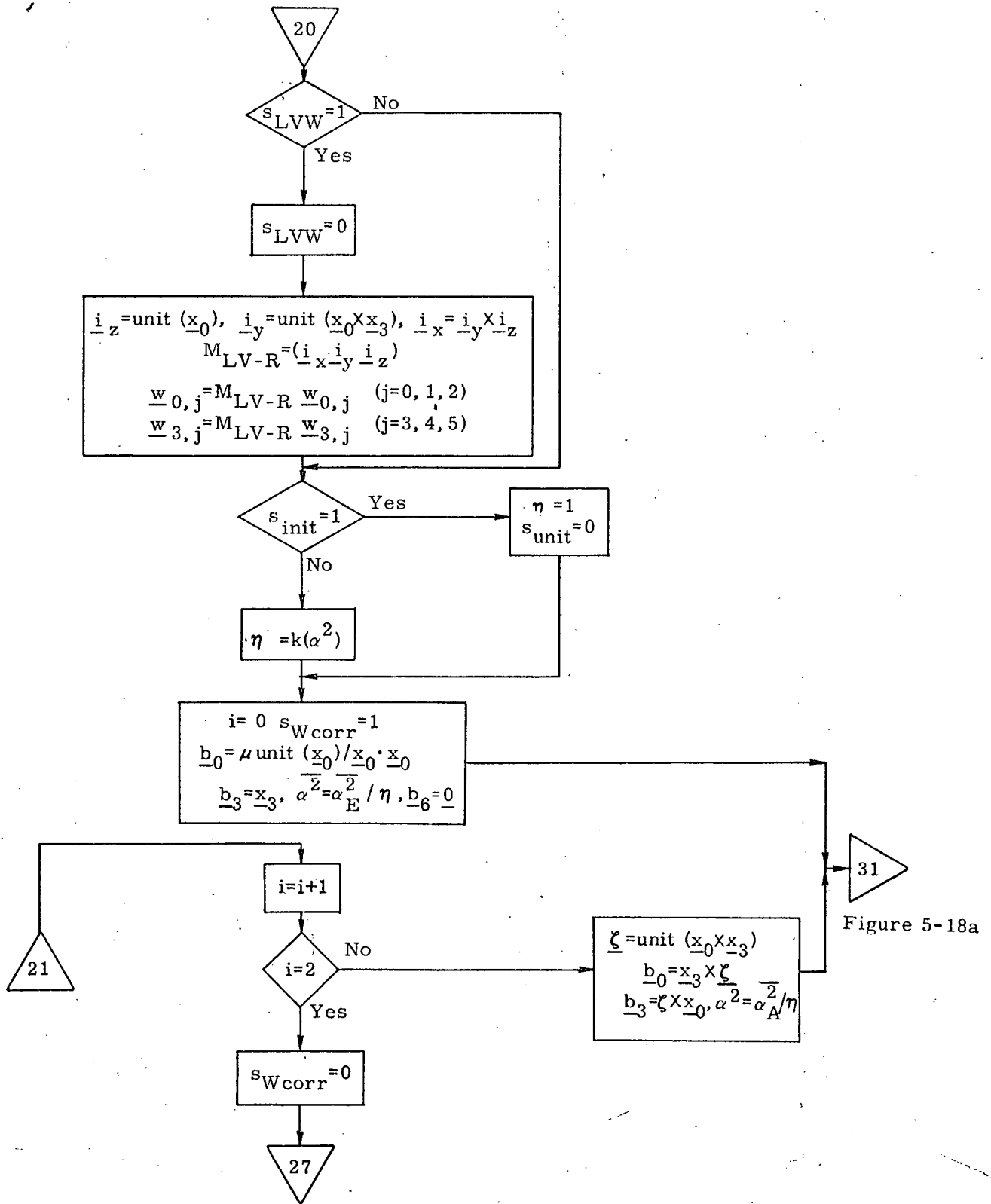

Figure 5-11. Detailed Flow Diagram, W-Matrix Initialization (Adding Correlation for Orbit Navigation)

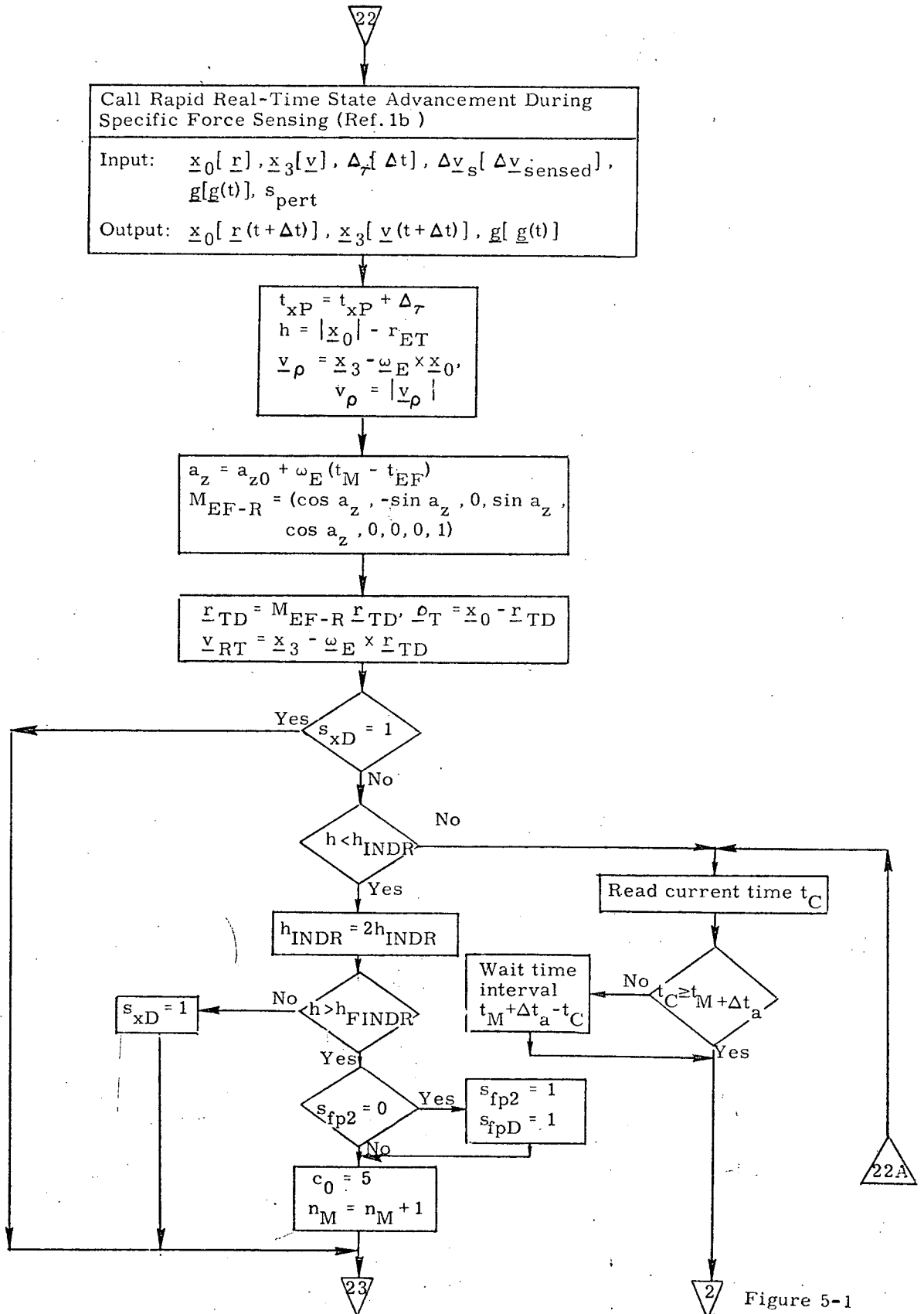

Figure 5-12. Detailed Flow Diagram, State Extrapolation and Drag Measurement Logic (Entry Phase)

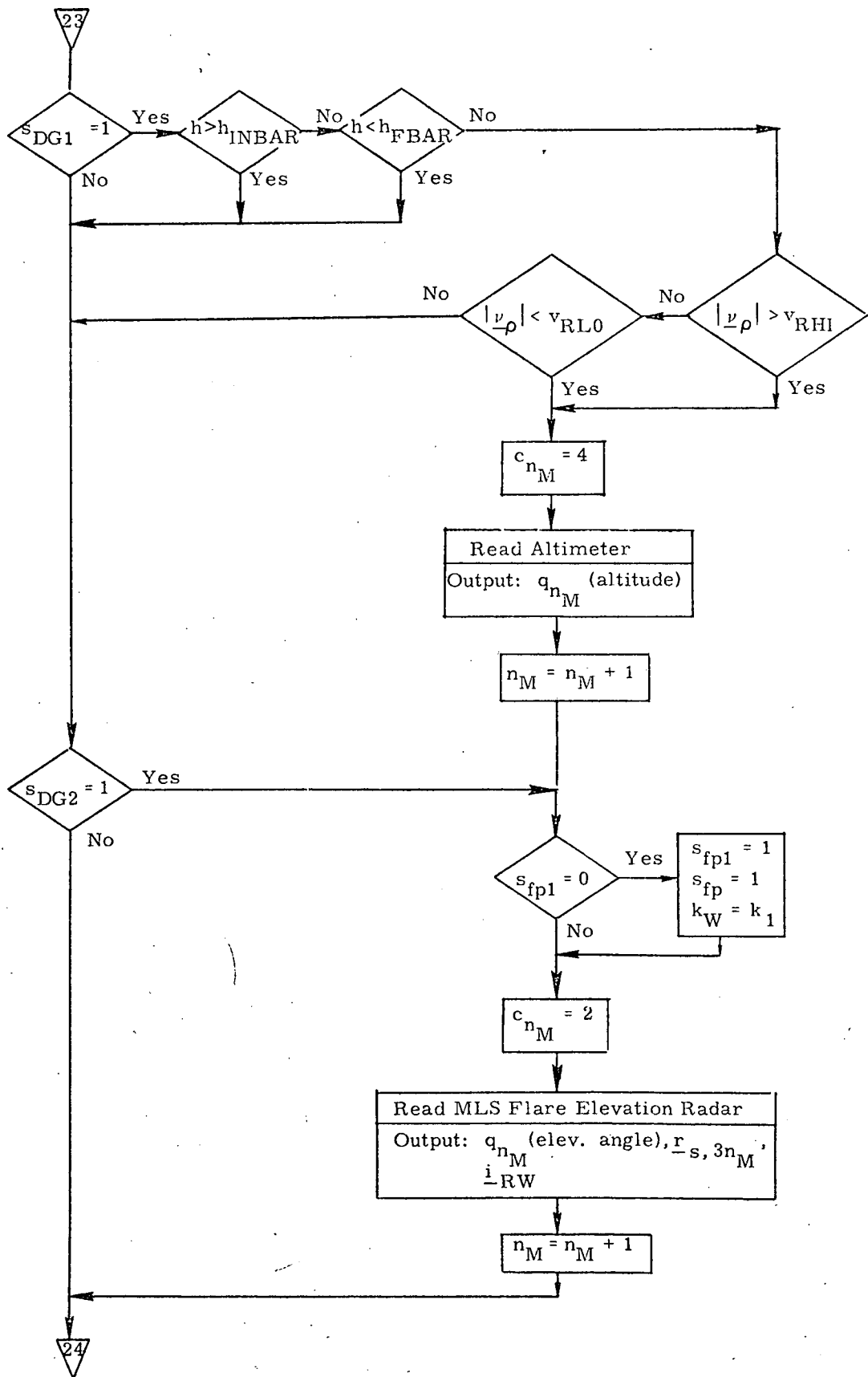

Figure 5-13a. Detailed Flow Diagram, Entry Phase Sensor Read Logic

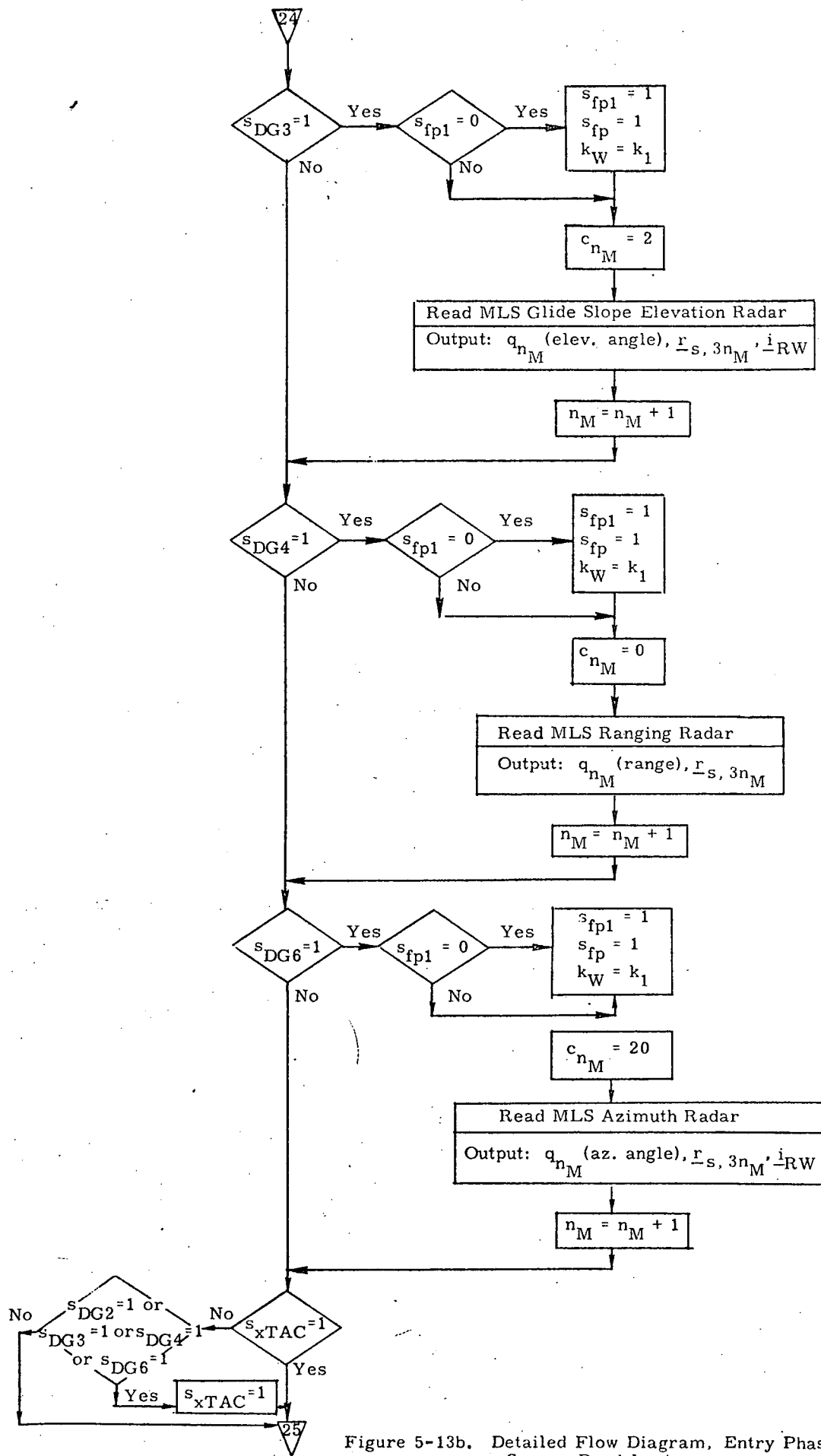

Figure 5-13b. Detailed Flow Diagram, Entry Phase Sensor Read Logic

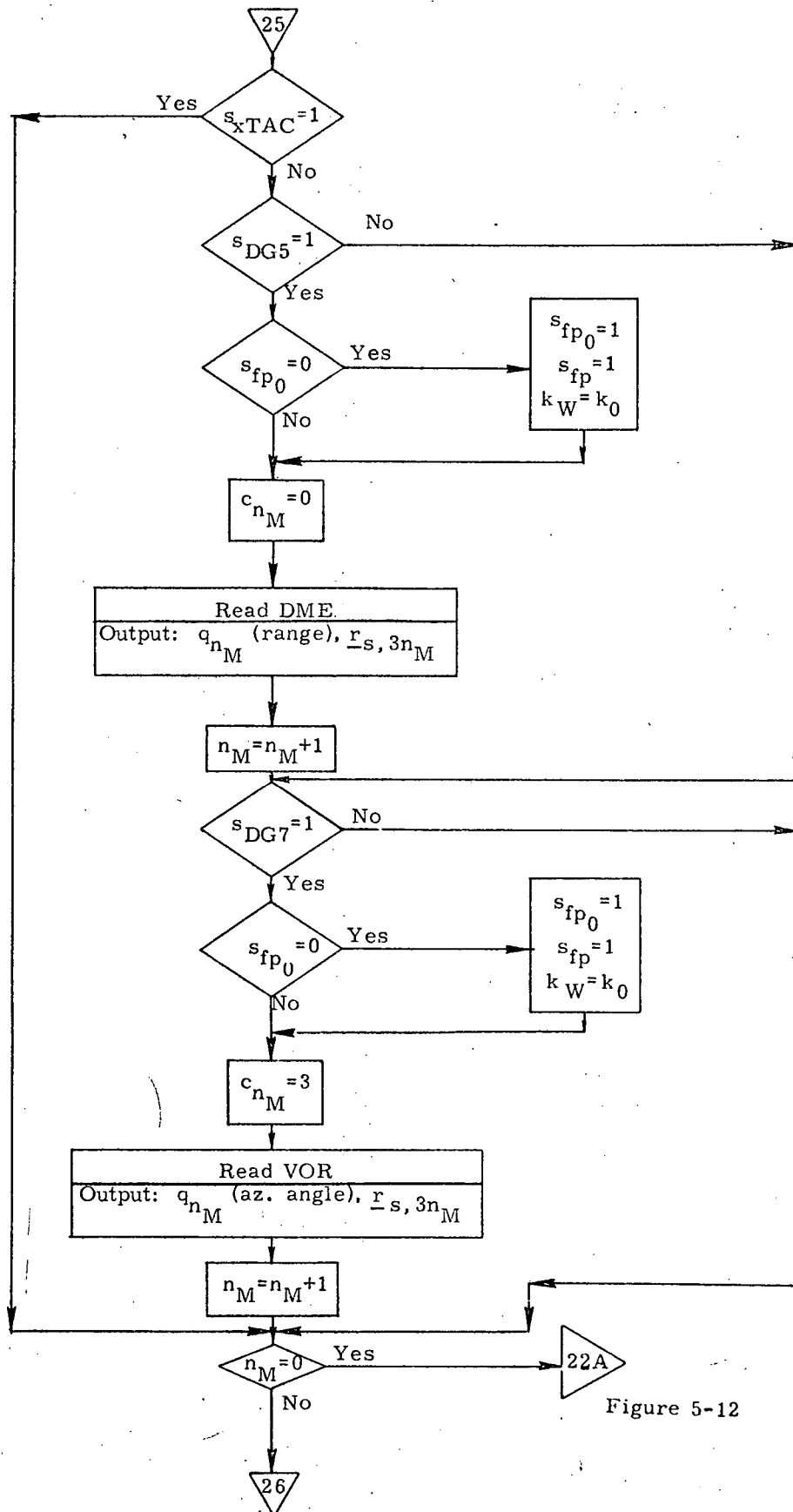

Figure 5-12

Figure 5-13c. Detailed Flow Diagram, Entry Phase Sensor Read Logic

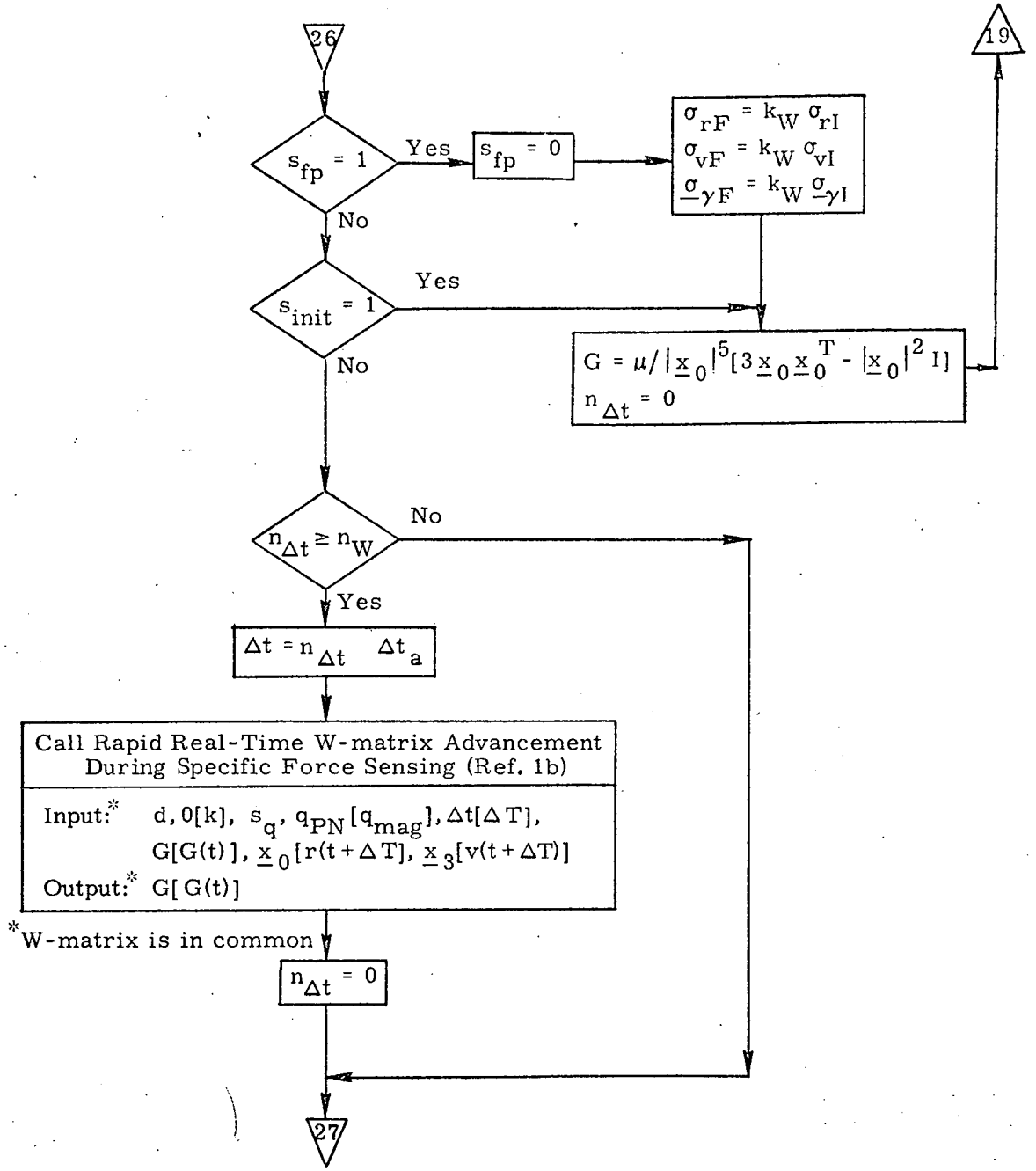

Figure 5-14. Detailed Flow Diagram, W-Matrix Extrapolation and Initialization Logic (Entry Phase)

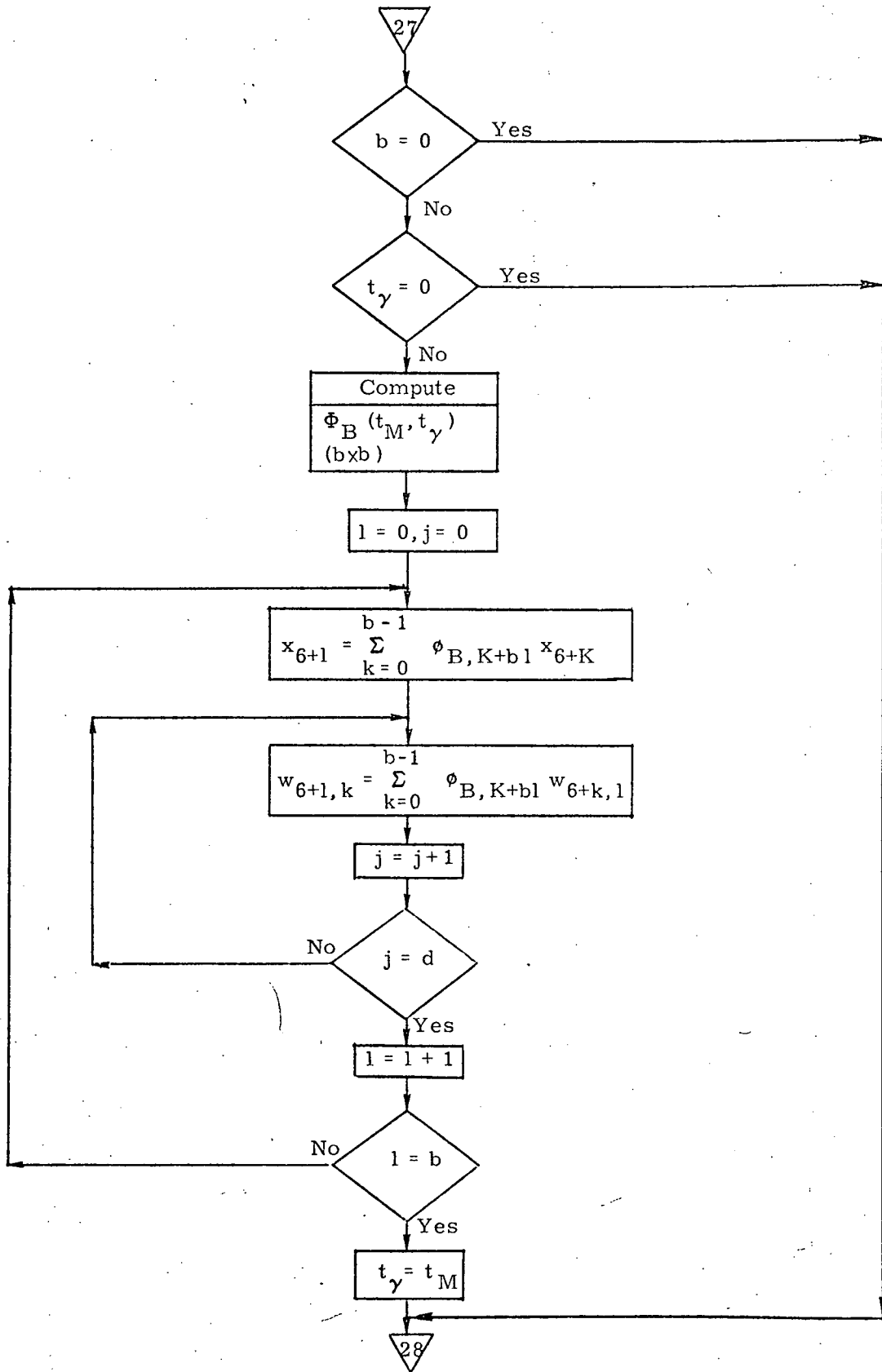
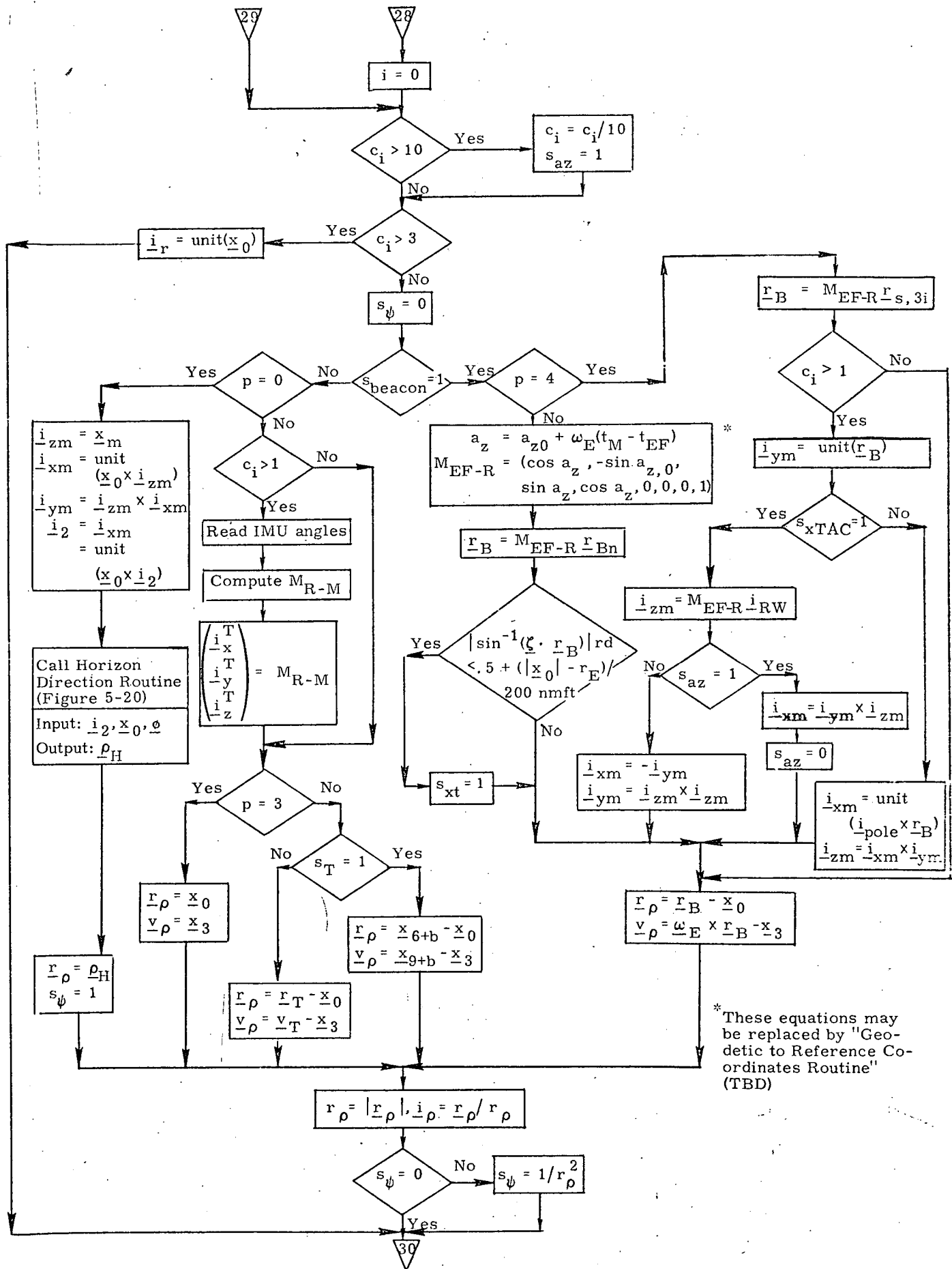

Figure 5-15. Detailed Flow Diagram, Bias and Bias W_{sub} Extrapolation



* These equations may be replaced by "Geodetic to Reference Coordinates Routine" (TBD)

Figure 5-16. Detailed Flow Diagram, Computation of Relative State and Sensor "Axes"

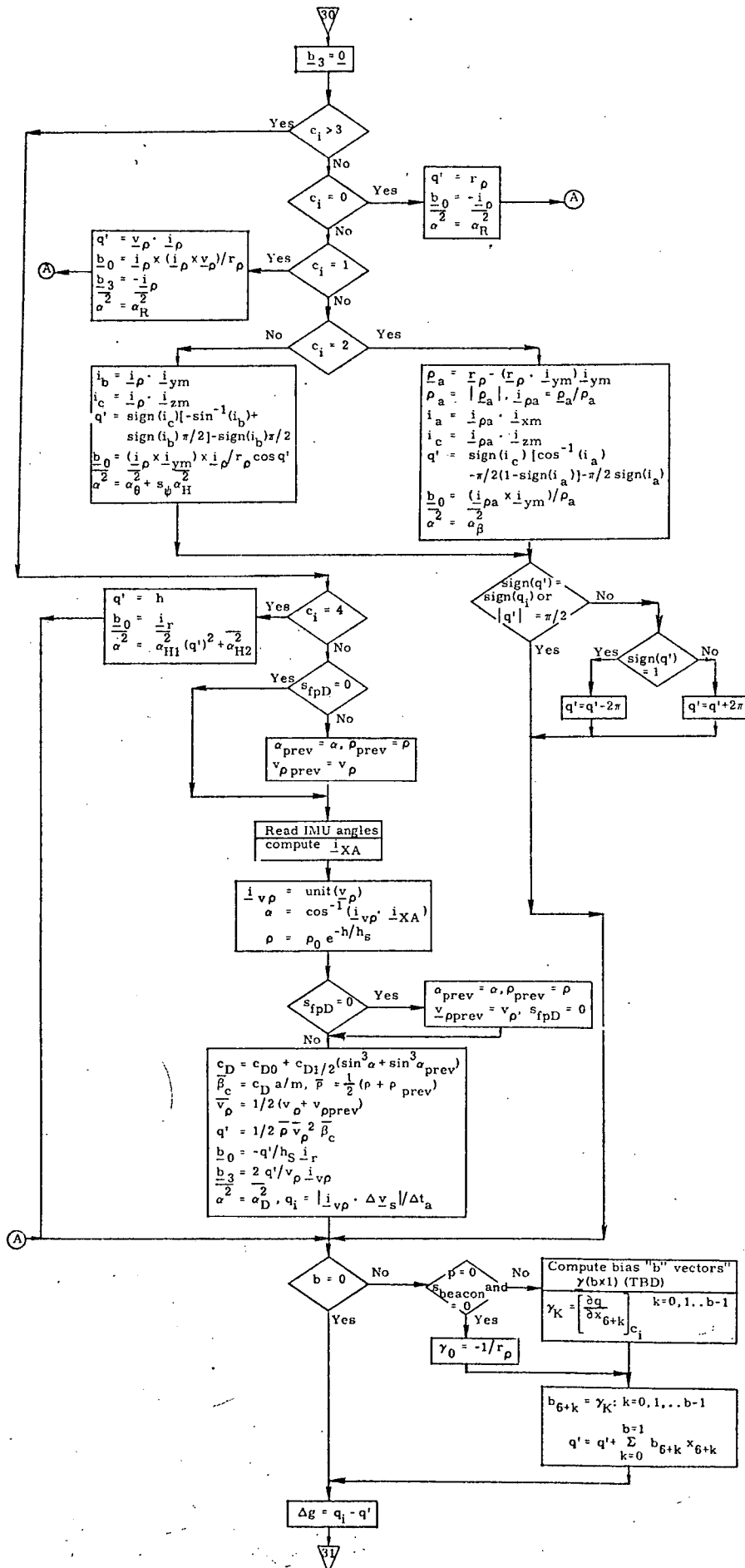

Figure 5-17. Detailed Flow Diagram, Computation b , Δq , and α^2

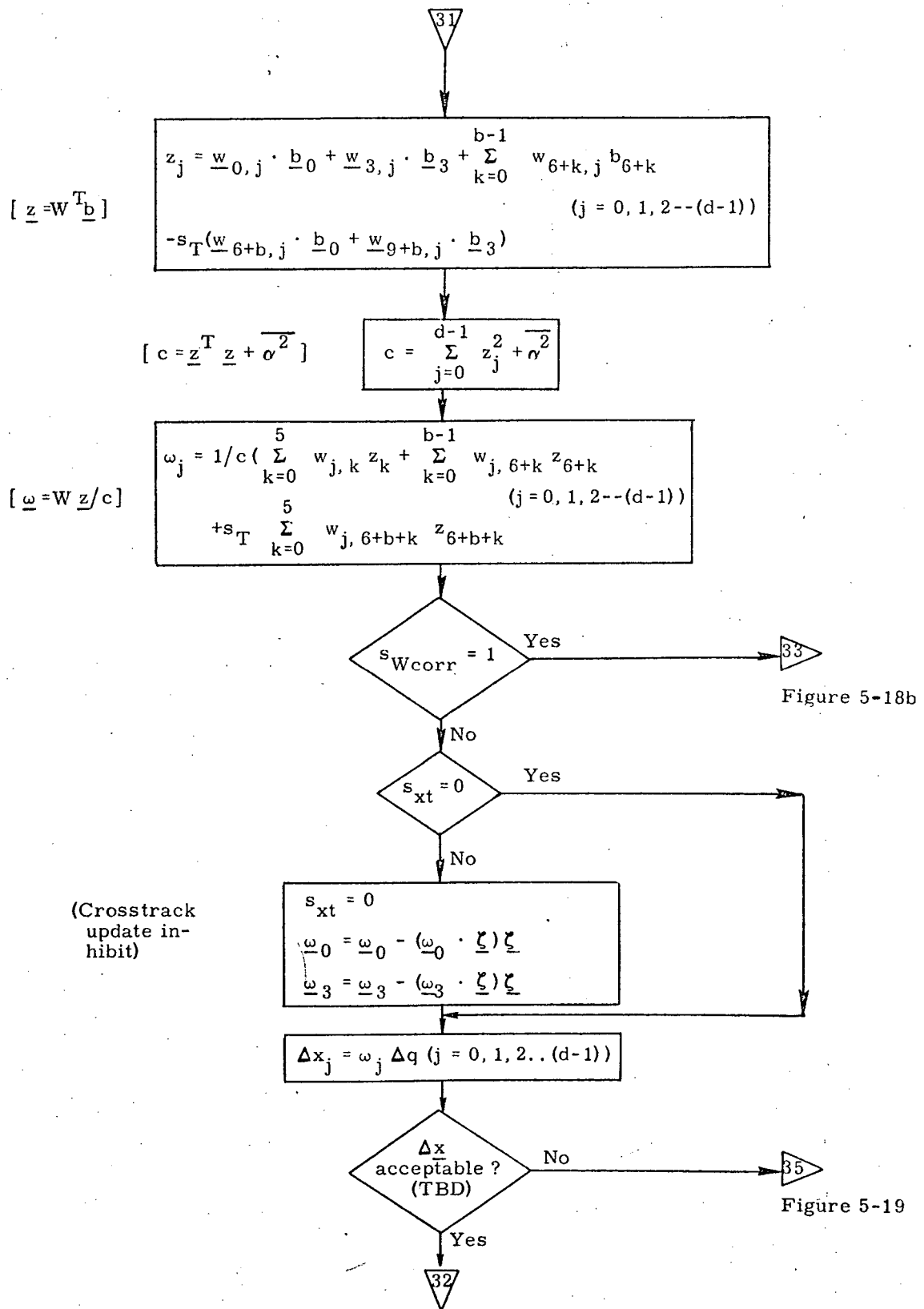

Figure 5-18a. Detailed Flow Diagram, Measurement Incorporation into State and W-Matrix

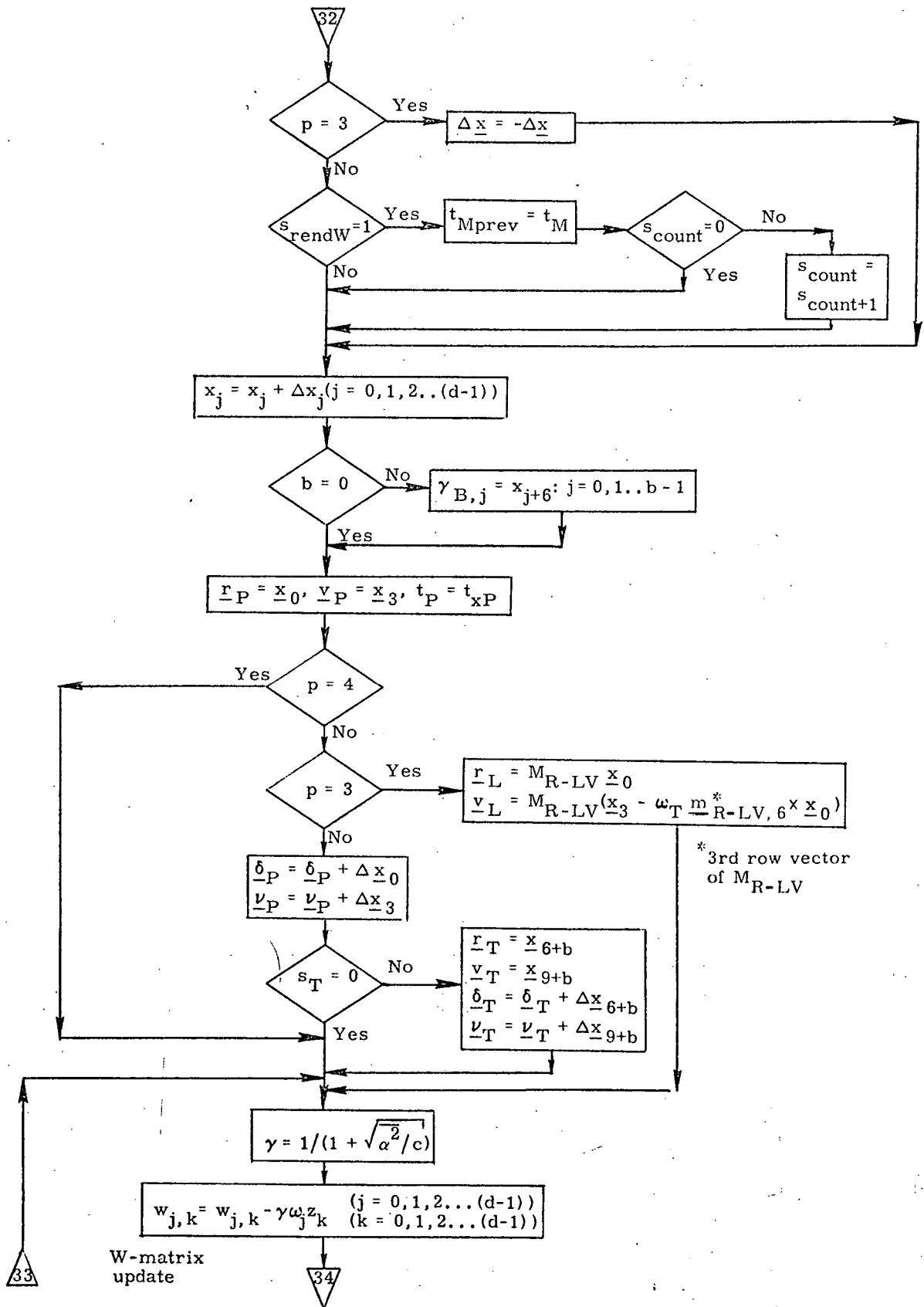

Figure 5-18b. Detailed Flow Diagram, Measurement Incorporation into State and W-Matrix

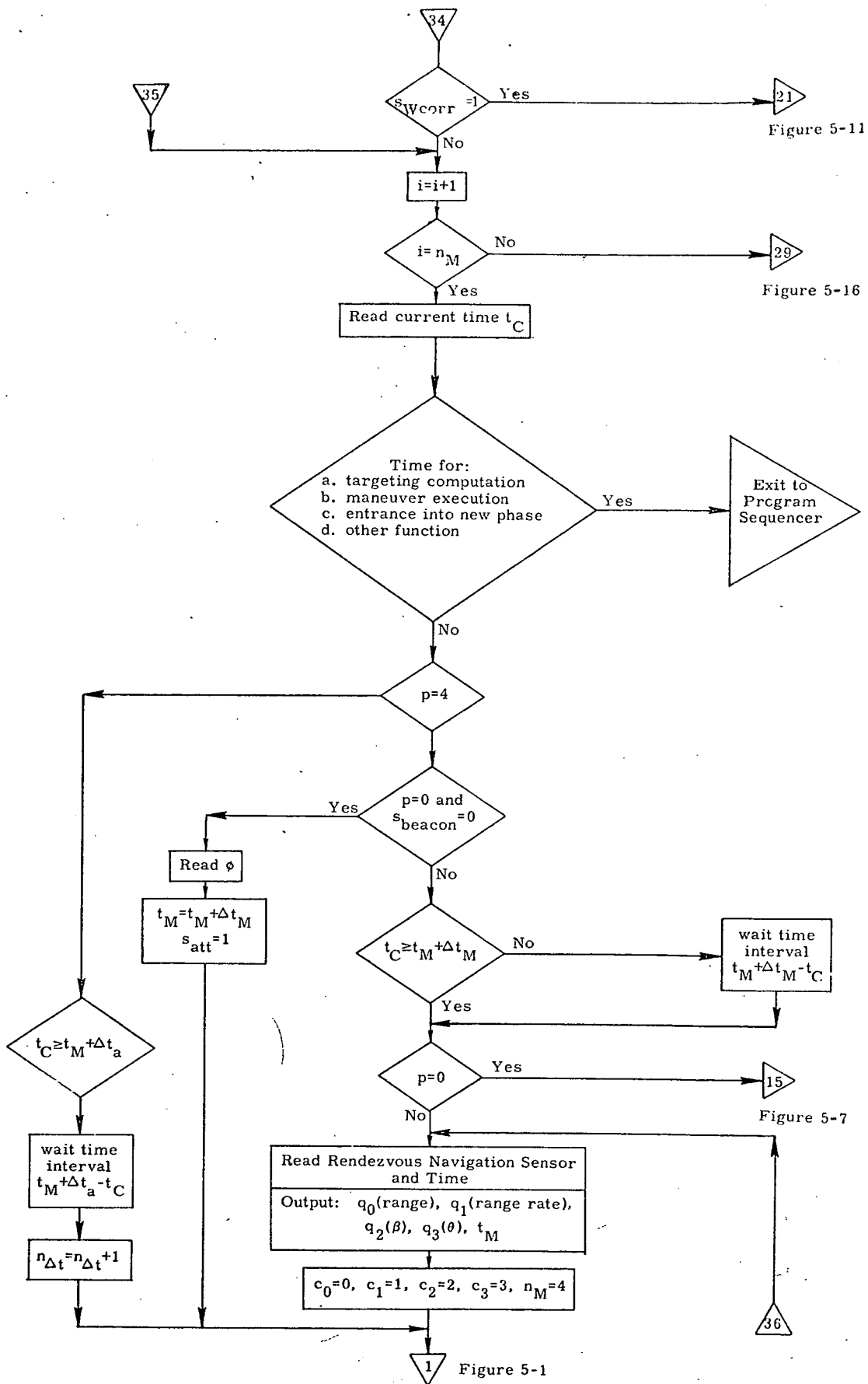

Figure 5-19. Detailed Flow Diagram, UNF Program Recycling or Termination

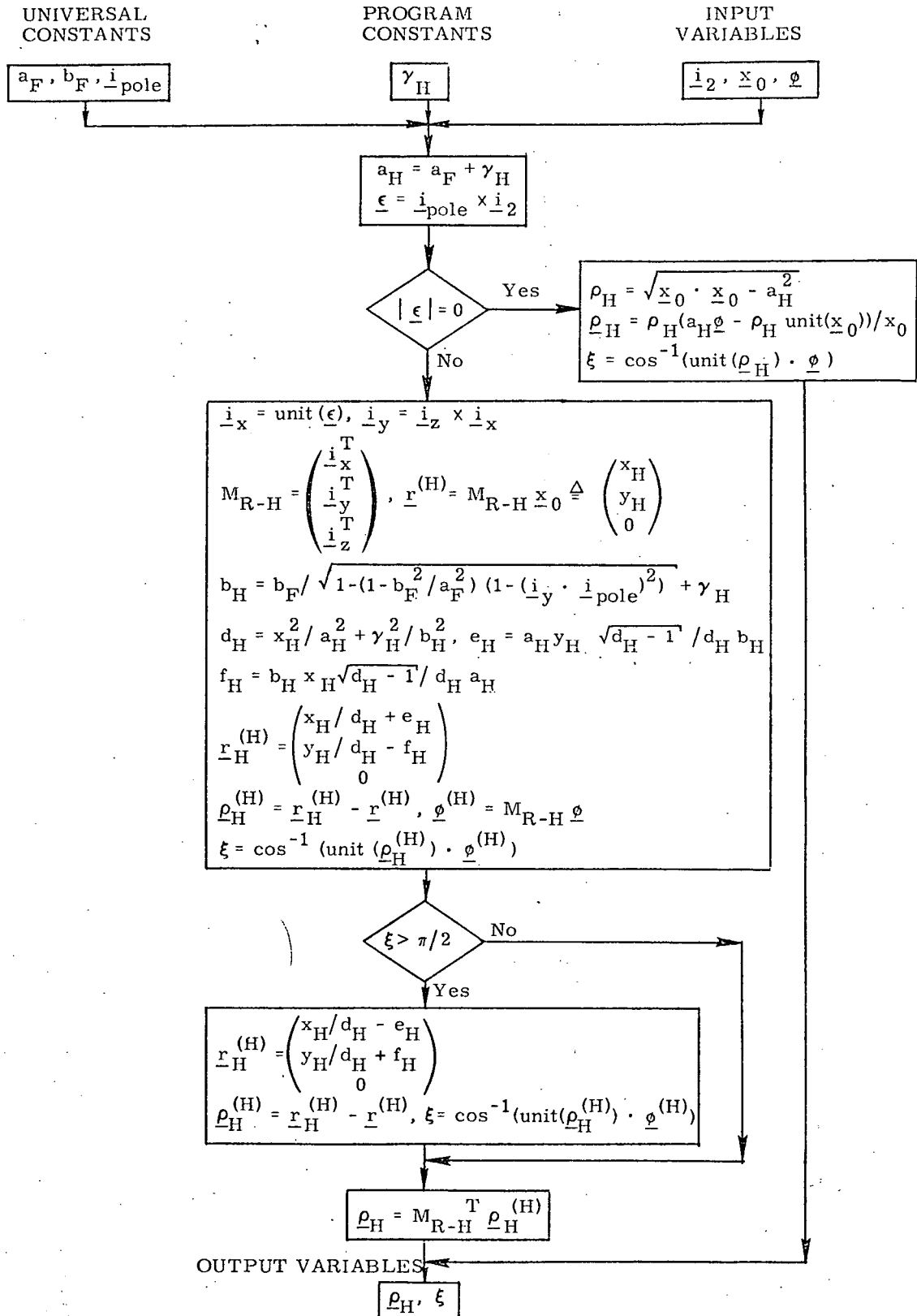

Figure 5-20. Detailed Flow Diagram, Horizon Direction Routine

6. SUPPLEMENTARY INFORMATION

The equations presented in this report are the results to date of studies performed under a G&C shuttle task to develop G&N equations for the on-orbit and entry-and-landing phases of the shuttle missions. The details of these studies may be found in a series of reports and memos listed in the periodically updated MIT/DL Space Shuttle Task Summary Document (Ref. 2), in NASA G&C Division Space Shuttle Task Review Memoranda, and Refs. 12 through 17 for station-keeping analyses.

The UNF formulation represents a design which is fundamentally sound, so that updates from the continuing navigation studies can be expected to require only minimal changes to the equations presented here. The design has been made flexible enough so that most modifications can be absorbed by appropriate changes to the input variables. Areas currently under investigation which fall in this category are:

- (a) Determination of appropriate measurement biases to be estimated (all phases).
- (b) Desirability of estimating target state, and if desirable, examine requirement for W-matrix reinitializations (rendezvous phase).
- (c) Advancing W-matrix at lower than measurement rate (entry phase).
- (d) Determine schedule of horizon azimuths, schedule of W-matrix reinitializations, and requirement for process noise (horizon sensing orbit navigation).
- (e) Desirability of using relative state formulation in automatic braking phase (if desirable, this phase simply becomes part of the station-keeping navigation phase).

Known areas in which equations need to be formulated are as follows:

- (a) UV horizon prediction routine
- (b) Automatic "mark reject" routine

Areas in which equations may need to be formulated are as follows:

- (a) Relative state formulation for the entry phase (if desirable)
- (b) Bias transition matrix (Φ_B) and bias measurement geometry vectors (γ) when final sensor models are established.

- (c) Geodetic to Reference Coordinates Routine (if simple formulation presented proves unsatisfactory).
- (d) Horizon direction equations for horizon sensors operated in "non vertical scan" mode.

REFERENCES

1. Space Shuttle GN&C Equation Documents, MIT/DL

- | | Doc.
No. | Rev. | | | |
|----|-------------|------|---|------------------------------|----------|
| a. | 4 | 3 | Precision State and Filter Weighting Matrix Extrapolation | W. Robertson | Oct 1972 |
| b. | 5 | 2 | Rapid Real-Time State Advancement During Specific Force Sensing | W. Robertson | Nov 1972 |
| c. | 3 | 2 | Conic State Extrapolation | W. Robertson | Oct 1972 |
| d. | 9 | 1 | Orbit Navigation | E. Muller | Feb 1972 |
| e. | 6 | 0 | Relative State Updating | E. Muller
R. Phillips | Feb 1971 |
| f. | 15 | 0 | Rendezvous Terminal Phase | P. Kachmar | Nov 1971 |
| g. | 16 | 0 | Station-Keeping Navigation | B. Kriegsman
D. Gustafson | Mar 1972 |
| h. | 12 | 2 | Entry, Approach, and Landing Navigation | B. Kriegsman | Apr 1972 |
2. MIT/DL Space Shuttle Task Summary (Edited by N. E. Sears).
 3. Muller, E., Kachmar, P., "A New Approach to On-board Orbit Navigation", Navigation Journal of the Institute of Navigation, Vol. 18, No. 4, Winter 1971-1972.
 4. Tanner, W., "Black-out of Radio Transmissions during Reentry of STS", MIT Draper Lab 23N STS Memo No. 11, September 10, 1970.
 5. Kriegsman, B., and Gustafson, D., "IMU Error Analysis for SSV Abort Trajectories from Launch through Entry", MIT Draper Lab 23A STS Memo No. 15-70, June 29, 1970.
 6. Gustafson, D., and Kriegsman, B., "SSV Reentry Navigation Studies using Barometric Altimeter and VOR/DME Measurements", MIT Draper Lab 23A STS Memo No. 22-70, July 14, 1970.
 7. Kriegsman, B., and Gustafson, D., "Drag Measurement as a Possible Means for Reducing Altitude Estimation Errors during SSV Entry", MIT Draper Lab 23A STS Memo No. 10-71, January 25, 1971.
 8. Kriegsman, B., "Entry and Terminal-Phase Navigation for SSV Orbiter using MLS or AILS, and VOR/DME, MIT Draper Lab 23A STS Memo No. 11-72, February 16, 1972.

9. Kriegsman, B. , and Gustafson, D. , "Entry-and-Landing Navigation Study for SSV Orbiter Using a PRS Navaid", MIT Draper Lab 23A STS Memo No. 49-71, (Ref. 1), October 4, 1971.
10. Battin, R.H. , Levine, G. M. , "Application of Kalman Filtering Techniques to the Apollo Program", Report E-2401, April 1969, MIT.
11. Haabe, J. M. , "Kalman Filter Initialization using Prior Information Applied to Midcourse Navigation", Report T-553, May 1971, MIT Draper Lab.
12. Gustafson, D. , "Automatic Station-Keeping for LM/ATM Above OWS", MIT Draper Lab AAP Memo No. 69-388M-8.
13. "Design and Development of GN&C Software for the AAP Wet-Workshop Missions", MIT Draper Lab Report E-2469, April 1970.
14. Gustafson, D. , and Kriegsman, B. , "Preliminary Design of Automatic Station-Keeping Guidance-And-Navigation System for AAP", MIT Draper Lab AAP Memo No. 69-388M-12, September 24, 1969.
15. Kriegsman, B. , and Gustafson, D. , "Station-Keeping Guidance and Navigation Systems for STS Mission", MIT Draper Lab, 23A STS Memo No. 2-69, November 17, 1969.
16. Gustafson, D. , and Kriegsman, B. , "A Guidance and Navigation System for Automatic Station-Keeping in a Near-Earth Orbit", MIT Draper Lab Report E-2534, August 1970.
17. Kriegsman, B. , and Gustafson, D. , "Station-Keeping Guidance and Navigation for LM/ATM", MIT Draper Lab AAP Memo No. 1-69, January 24, 1969.

Do not Reproduce

23A SHUTTLE DISTRIBUTION LIST

INTERNAL (82)		EXTERNAL (35)	
<u>23A</u>	(35)	<u>EA2</u>	(1)
<u>23B</u>	(2)	W. Bradford	
M. Hamilton		<u>EG</u>	(1)
J. Kernan		D. Cheatham	
<u>23C</u>	(22)	<u>EG2</u>	(12)
<u>23D</u>	(1)	K. Cox	
I. Johnson		D. Dyer	
<u>23I</u>	(2)	E. Kubiak	
R. McKern		F. Elam	
W. Tanner		B. Marcantel	
<u>23N</u>	(1)	W. Peters	
G. Ogletree		C. Price	
<u>23P</u>	(13)	R. Saldana	
R. Battin		E. Smith	
S. Copps		J. Suddath	
D. Dolan (4)		J. Sunkel	
T. Edelbaum		G. Zacharias	
D. Hoag		<u>EG3</u>	(1)
L. Larson		J. Lawrence	
R. Larson		<u>EG4</u>	(1)
R. Millard		P. Sollock	
R. Ragan		<u>EG5</u>	(1)
N. Sears		C. Manry	
<u>23S</u>	(3)	<u>EG6</u>	(1)
G. Edmonds		R. Reid	
P. Felleman		<u>EG7</u>	(2)
R. White		C. Hackler	
<u>33</u>	(2)	J. Hanaway	
L. Drane		<u>EG/MIT</u>	(3)
H. Laning		A. Cook	
<u>35</u>	(1)	E. Olsson	
M. Johnston		G. Silver	
		<u>FA</u>	(1)
		H. Tindall	
		<u>FD7</u>	(1)
		A. Hambleton	
		<u>FM4</u>	(3)
		B. Cockrell	
		P. Pixley	
		R. Savely	
		<u>FM6</u>	(2)
		R. Becker	
		P. Shannahan	
		<u>FM7</u>	(2)
		S. Mann	
		R. Nobles	
		<u>FS6</u>	(2)
		T. Price	
		J. Williams	
		<u>FS</u>	(1)
		T. Gibson	

Additional for GN&C Equation Documents (21)

G. Levine (10), E. Olsson (5), J. Rogers BC7, E. Smith (5)